

NASA Technical Paper 1238

TP
1238-
-v.2
C.1

LOAN COPY: RETURN
AFWL TECHNICAL LIBR
KIRTLAND AFB, N: A

0134524



Dielectric Constants of Soils at Microwave Frequencies - II

J. Wang, T. Schmugge, and D. Williams

MAY 1978

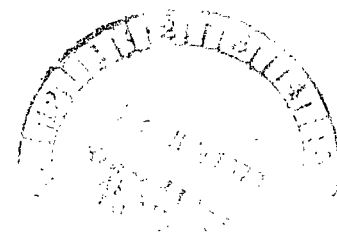



NASA Technical Paper 1238

Dielectric Constants of Soils at Microwave Frequencies - II

J. Wang, T. Schmugge, and D. Williams
*Goddard Space Flight Center
Greenbelt, Maryland*



National Aeronautics
and Space Administration

**Scientific and Technical
Information Office**

1978



CONTENTS

	<i>Page</i>
INTRODUCTION	1
METHOD OF MEASUREMENT	2
RESULTS	4
DISCUSSION	6
CONCLUSIONS	9
REFERENCES	31

DIELECTRIC CONSTANTS OF SOILS AT MICROWAVE FREQUENCIES-II

J. Wang, T. Schmugge, and D. Williams
*Goddard Space Flight Center
Greenbelt, Maryland*

INTRODUCTION

Although the water content in soils has long been known to be one of the most dominant factors in determining the dielectric properties of the soils in the microwave region, the systematic laboratory measurements of these properties as a function of soil water content began only in recent years (References 1 through 9). Early measurements of soil dielectric properties (References 10 through 12) were made at a few discrete values of water content only, and these measured data were probably useful for a few spot checks at best. Among other things, a systematic study of the soil dielectric properties requires the detail measurements of these properties over a wide range of moisture content. In particular, the recent, much-emphasized remote sensing of ground-water content (Reference 13) calls for a detailed knowledge on soil dielectric variability with water content. A full relationship between soil dielectric variables and moisture content must be established in order to correctly interpret, and to develop inversion algorithms for, data obtained from the microwave remote sensors.

Recent systematic measurements of soil dielectric properties with varying moisture content covered a wide range of frequencies. The measurements by Lundien, Davis, and Williamson (References 1 and 2) were made over the frequencies of 10 to 75 MHz, 297 MHz, and 1 to 1.5 GHz. Wiebe's (Reference 3) and Newton's (Reference 8) measurements were carried out at 10.6 GHz and 1.4 GHz, respectively. Leschanskiy et al. (Reference 4) made their measurements at many selected frequencies in the range of 0.1 to 16 GHz. Hipp's measurements (Reference 7) were made over the frequency range of 0.03 to 4 GHz, and Geiger and Williams' measurements (Reference 5) were made at 37 GHz. Finally, measurements for a single soil sample made over many frequencies in the 0.3- to 24-GHz range were reported by Njoku and Kong (Reference 9). Most of these results were summarized by Cihlar and Ulaby (Reference 14).

This document describes the measured dielectric properties of several soil samples as a function of moisture content. The measurements were performed at the frequencies of 5 and 19.35 GHz. The soil samples used in the measurements were the same as those used by Geiger and Williams (Reference 5) in their 37-GHz measurements. For the 19.35-GHz measurements, the moisture content was determined as a percentage of the soil dry-weight only. The 5-GHz

measurements were performed with moisture content determined in both percentage by dry-weight and on a volume basis. These measured dielectric properties of soils are presented and discussed with respect to their variations with moisture content, soil textures, and frequencies.

METHOD OF MEASUREMENT

The method used in the 5- and 19.35-GHz dielectric-constant measurements is the transmission method on an infinite line. Both the experimental setup and the measurement procedure were similar to that used in the 37-GHz measurements and were discussed in great detail by Geiger and Williams (Reference 5). Therefore, only a general description of the experiment will be given here. Figure 1 shows the setup of the 5-GHz experiment. The 19.35-GHz twin-arm bridge is similar to the one shown in figure 1, but the physical size of the apparatus is much smaller. Because the experimental setup and procedure are similar for the 5- and 19.35-GHz measurements, most of the description in the following is focused on the 5-GHz system only.

As shown in figure 1, the 5-GHz microwave signal is produced by an 8620B Hewlett-Packard sweep oscillator. The wavemeter is a resonant cavity that permits a precise measurement of the microwave output-signal frequency. During the entire course of the measurements, the signal frequency was maintained at 4.96 GHz. The first hybrid T acts as a power divider that splits the incoming signal into two equal components; one travels along the sample arm, and the other travels along the reference arm. In each arm of the bridge, an attenuator and two phase shifters were provided for signal adjustment and balance. Isolators were placed before and after each set of attenuators and phase shifters to reduce the reflected microwave signals caused by the inhomogeneities in the waveguide.

Another hybrid T at the other ends of the two arms serves as a signal comparator. The E-H tuner serves as a matched impedance so that the bridge effectively appears as an infinite microwave transmission line. A Hewlett-Packard standing-wave indicator displays the standing-wave ratio of the signals from the two arms. Either with or without soil sample in the system, the bridge could be balanced by varying the phase shifters and attenuators until the standing-wave indicator was nulled.

Two approaches were taken to measure the dielectric constants of the soil samples over the moisture range of interest. The first approach (low-loss) used a long-length soil sample and gave reasonably accurate measurements only for moisture content $\lesssim 3$ percent by dry weight. For higher moisture content (> 3 percent), because the signal attenuation caused by the presence of the soil sample was appreciable, the second approach (high-loss) using a short-length soil sample had to be used. A brief description of the two approaches follows.

The low-loss approach consisted of measuring the power losses and the phase shifts caused by the presence of the soil sample in the sample cell. The measurements of these parameters were made at the two sample lengths of L and $L + \Delta l$, with $L \gg \Delta l$ (typically $L = 52$ cm and $\Delta l = 1$ cm in the 5-GHz measurements). Because $L \simeq L + \Delta l$, the difference in measured power losses, A_1 and A_2 , for a given soil sample at these two lengths was negligible ($A_1 \simeq A_2 = A$). However, the phase-shift difference, $\Delta\phi$, attributable to the short sample length increment, Δl , was readily measurable. The measured A and $\Delta\phi$, together with the corresponding L and Δl , were treated as input parameters in the computer program for the derivation of ϵ' and ϵ'' , the real and imaginary parts of the dielectric constant.

In the high-loss approach, the measurement procedure was somewhat simpler. Both power loss, A , and phase shift, $\Delta\phi$, were determined with a single soil-sample length, L (typically, $L = 1 - 7$ cm in the 5-GHz measurements). Both with and without the soil sample in the sample cell, the bridge was balanced. The differences in the power losses and phase shifts when the soil sample was in and out of the sample cell, together with length L , provided the necessary input parameters to the computer program for determining ϵ' and ϵ'' in this approach.

There is a small difference in the formulas for computing ϵ' and ϵ'' between the low-loss and the high-loss approaches. The derivation of these formulas for both approaches and the iteration procedure for calculating ϵ' and ϵ'' were given in great detail by Geiger and Williams (Reference 5).

The laboratory in which the measurements were made was always maintained at a room temperature of ~ 293 K. All of the soil samples used in the measurements were first vacuum-dried for ~ 20 hours in an oven at 378 K. For a given set of measurements, a sufficient amount of the dry soil sample was placed in a sealed plastic bag and weighed. A desired amount of water (weight-percent) was added to the soil, and the soil-water mixture was well mixed in the sealed plastic bag before the sample was used for dielectric measurements. The empirical method was used for filling the waveguide sample cell. It consisted primarily of vigorous tapping and shaking of the cell as the sample was gradually added. Maintaining the moisture content while filling the sample cell is an obvious problem. Extreme care was taken to expose the moist soil to the air as little as possible. The weight of the sample in the sample cell in each measurement was measured so that the sample density and, therefore, the volumetric water content could be determined.

RESULTS

The soil samples used in the measurements were obtained from the Imperial Valley, Phoenix, Arizona, and Weslaco, Texas. There were a total of seven samples. Table 1 lists the soil types, texture, and field capacity (FC) of these samples. Field capacity is related to soil texture by:

$$FC = 25.1 - 0.21 \times \text{SAND} + 0.22 \times \text{CLAY} \quad (1)$$

Table 1
Soils Used in the 5- and 19-GHz Dielectric Measurements

No.	Soil Type	Texture (%)			Field Capacity*	Measurements	
		Sand	Silt	Clay		19.35 GHz	5 GHz
1	M5	88.0	7.3	4.7	7.9	Yes	Yes
2	E. Imperial Valley	76.3	11.7	12.0	12.0	Yes	No
3	F2	56.0	26.7	17.3	17.3	Yes	Yes
4	L3	48.0	34.0	18.0	19.1	Yes	No
5	E4	44.7	25.3	30.0	22.5	Yes	No
6	H7	19.3	46.0	34.7	28.8	Yes	Yes
7	Harlingen clay	2.0	37.0	61.0	38.0	Yes	Yes

*Calculated from $FC = 25.1 - 0.21 \times \text{SAND} + 0.22 \times \text{CLAY}$.

where SAND and CLAY represent their respective soil fractions in percent. This expression was derived from the multiple linear-regression analysis of 100 measured sets of soil textures and moisture characteristics (Reference 15). It is evident from the expression that the clayey soils have higher field capacity than the sandy soils.

The dielectric measurements were made at 19.35 GHz for all seven samples. But they were made at 5 GHz for only four samples; namely, Harlingen clay, H7, F2, and M5. The intrinsic accuracy of the measurements was about 5 to 7 percent as discussed by Geiger and Williams (Reference 5). The following subsections describe the results of the measurements.

Results at 19.35 GHz

Figures 2 through 8 show plots of the measured dielectric constants for the seven soil samples versus the moisture content in percent of soil dry weight. For each soil sample, four measurements were typically made at a given moisture content. In most cases, the scattered data points within each set indicated a precision of the measurements of about 10 percent. These figures clearly show that, at low moisture content, both ϵ' and ϵ'' increase slowly with moisture content. After reaching a breakpoint moisture value (transition moisture, Reference 8), ϵ' and ϵ'' increase steeply with moisture content. The breakpoint moisture is dependent on the soil types and usually occurs at larger moisture values for clayey soils. To show this dependence of transition moisture on soil types more clearly, smooth curves were drawn through the measured data points shown in figures 2 through 8 and were plotted on figure 9 for all seven soil samples. The solid and dashed curves in figure 9

represent the measured ϵ' and ϵ'' , respectively. A number was assigned to each pair of curves according to table 1 to distinguish one soil type from another. For example, curves 1 stand for the measured ϵ' and ϵ'' of M5, and curves 7, of Harlingen clay. It can be clearly seen that the transition moistures of curves 1 and 2 of low FC samples occurred at 5 percent. On the other hand, curves 6 and 7 of high FC samples show large transition moistures beyond 10 percent.

Figure 9 also shows that, after a steep rise, both ϵ' and ϵ'' begin to level off as moisture content increases further. This leveling off of the dielectric constants again depends on the field capacity of soils, which occurs at ~ 16 - to 20-percent moisture content for curves 1 and 2 and at ~ 24 - to 28-percent moisture content for curves 6 and 7. The reason for this leveling off was probably the water saturation in the sample and will be discussed further in the following section.

Results at 5 GHz

Figures 10 through 13 show the measured dielectric constants as a function of moisture content for the four soil samples of M5, F2, H7, and Harlingen clay. Again, a set of four measurements was made at each selected moisture content. The scatter of data points in each set was mostly within 5 to 10 percent of the average value, except for Harlingen clay. The measurements on this soil sample were made by two different persons, and, as a result, the measured dielectric constants at some moisture levels showed a scatter of as much as 30 percent. The following section shows that the scatter is reduced by expressing moisture content in volume basis.

Examination of figures 10 through 13 clearly shows a dependence of dielectric constants on soil moisture similar to those measured at 19.35 GHz. Both ϵ' and ϵ'' increase slowly as moisture content increases from 0 to the transition value. A steep rise in ϵ' and a moderate rise in ϵ'' follow for moisture content larger than transition moisture. The leveling off of the dielectric constants is also observed after the steep rises. The transition moisture is again dependent on soil texture as figure 14 clearly demonstrates. The curves in this figure were derived in the same way as those in figure 9—solid curves for ϵ' and dashed ones for ϵ'' . The numbers were assigned to the curves according to table 1. The transition moistures for low FC soil samples 1 and 2 were observed from the ϵ' curves to be ~ 5 and ~ 10 percent, respectively, whereas those for high FC samples 6 and 7 were about ~ 15 percent. At this frequency, the increase in ϵ'' with moisture content was small, and the determination of transition moisture became difficult.

A comparison of figures 9 and 14 showed that, for a given moisture content, ϵ' was higher at 5 GHz than at 19.35 GHz. On the other hand, ϵ'' was lower at 5 GHz than at 19.35 GHz for the same moisture content. For example, at 30-percent moisture content, ϵ' and ϵ'' at 5 GHz for sample 6 were 24 and 6, respectively. For the same sample and moisture content

at 19.35 GHz, ϵ' and ϵ'' were 17 and 9, respectively. This phenomenon is consistent with the frequency dependence of ϵ' and ϵ'' for water. The calculated values of ϵ' and ϵ'' for pure water are ~ 73 and ~ 22 , respectively, at 5 GHz and are ~ 35 and ~ 37 , respectively, at 19.35 GHz.

DISCUSSION

Cihlar and Ulaby's summary of the available dielectric constant measurements (Reference 14) shows that the difference in the measured ϵ' and ϵ'' due to soil types could be reduced if the moisture content was expressed on a volume basis. The measured data at 5 GHz will be examined here for this effect. Figure 15 shows the measured ϵ' and ϵ'' as a function of the volumetric water content for Harlingen clay. The measured data for the remaining three soil samples could be plotted in the same way. Figure 16 summarizes the results. The curves on this figure were numbered in accordance with the previous section. The data points displayed in figure 15 clearly show much less scatter compared to those in figure 13.

A comparison of figures 14 and 16 reveals that the difference in ϵ' due to soil types is indeed reduced when soil moisture is expressed on a volume basis. For example, at $\epsilon' = 10$, the maximum spread and the average volumetric water content for all four soil samples in figure 16 are $\sim 0.08 \text{ cm}^3/\text{cm}^3$ and $\sim 0.24 \text{ cm}^3/\text{cm}^3$, respectively. At the same ϵ' , figure 14 gives ~ 7 and ~ 15 percent for the maximum spread and the average moisture content, respectively. The maximum deviation from the mean is ~ 17 percent for volume-percent and ~ 23 percent for weight-percent. Although there is some improvement, the residual difference in ϵ' due to soil types is still appreciable even when the moisture content is determined on a volume basis. As will be discussed later, the difference in ϵ'' due to soil types is small because the frequency dependence of ϵ'' -moisture curves is small.

The residual difference in ϵ' was also observed in the L-band measurements (References 2 and 8) as demonstrated in figures 17 and 18. The smooth curves in figure 17, which show the data measured at 1.4 GHz, were derived from figures II-18 through II-23 of Newton (Reference 8). The curves in figure 18, which show the data measured at 1.412 GHz, were derived from table 5 of Lundien (Reference 2). Table 2 lists the soil types, textures, and field capacities of the samples used in these measurements. The curves in both figures 17 and 18 were numbered so that they could be identified with the soil types given in table 2. Although both ϵ' and ϵ'' were plotted as a function of volumetric water content in both figures, the differences in these parameters due to soil types were clearly observed. The transition moisture (from ϵ' curves) varied with FC of the soils in the same way as that of the 5-GHz data. This dependence of transition moisture on field capacity was also observed by Newton (Reference 8) and was interpreted as the capability of different soils in adsorbing water molecules. Figure 9 of Lundien (Reference 2) showed essentially the same effect from his data. To compare the present measurements with those of Newton and Lundien, the transition moisture at 5 GHz was derived from the intersection of two straight lines—one

Table 2
Soils Used in the 1.4-GHz Dielectric Measurements

No.	Soil Type	Texture (%)			Field Capacity	Remarks
		Sand	Silt	Clay		
1	Yuma sand	100	0	00	4.4	Lundien (Reference 2)
2	Eufaula fine sand	90	7	3	7.2	
3	Dougherty fine sand	82	14	4	9.0	
4	Minco very fine sand	70	22	8	12.4	
5	Chickasha loam	58	28	14	16.2	
6	Zaneis loam	48	36	16	18.6	
7	Collinville loam	45	39	16	19.3	
8	Openwood Street silt	22	70	8	22.3	
9	Kirkland silt loam	26	56	18	23.4	
10	Tabler silt loam	22	56	22	25.0	
11	Vernon clay loam	16	56	28	28.0	
12	Long Lake clay	6	54	40	32.7	
1	Sand	86	7	7	8.6	Newton (Reference 8)
2	Samples 14 and 15	52	9	39	23.0	
3	Samples 4 and 5	40	26	34	24.5	
4	Samples 7 and 18	36	29	35	25.2	
5	Sample 13	44	12	44	25.5	
6	Miller clay	3	35	62	38.1	

drawn through data points covering the 0 to transition moisture range, and the other through the steep-rise portion of the curve—for each curve in figure 16 and plotted against FC of the associated soil sample in figure 19. The transition moistures for soils measured at ~ 1.4 GHz (References 2 and 8) were determined in the same way as those at 5 GHz, and the results also appear in figure 19. Clearly, there is a strong dependence of transition moistures on FC for a given frequency. The small difference in the results between 1.4 and 1.412 GHz as shown in figure 19 is most likely attributable to the discrepancy in the two measurements. A linear regression between the transition moisture, W_t , and FC gives

$$W_t = 0.070 + 0.0047 \times FC \quad (2)$$

with a correlation coefficient $r = 0.85$.

The previous section briefly stated that the leveling off of ϵ' and ϵ'' at large volumetric water content for frequencies of both 5 and 19.35 GHz was possibly attributable to water saturation. To determine if this was indeed the case, the porosity, P_s , for each of the four soil samples measured at 5 GHz was computed according to the expression (Reference 16):

$$P_s = 1 - \rho_s/\rho_r \quad (3)$$

where ρ_s is the dry density of the soil sample in question, and ρ_r is the density of the corresponding solid rock. The value of ρ_r varies between 2.60 and 2.75 (Reference 16) and, for the present purpose, is simply taken to be 2.65; ρ_s was determined during the measurements. In figure 16, the computed P_s 's are indicated by arrows. The number designated for each soil sample is the same as before. It appears that a positive correlation exists between P_s and the moisture value where ϵ' begins to level off. For example, curve 2 of figure 16 shows a leveling-off moisture content of $0.4\text{-cm}^3/\text{cm}^3$; P_s for this soil is 0.42. The leveling-off moisture content of curve 7 is $0.5\text{ cm}^3/\text{cm}^3$, and the corresponding P_s is 0.51. Although the leveling-off moisture contents for curves 1 and 6 are difficult to determine, they are usually closely associated with their respective porosities.

This close association of leveling-off moisture values and the porosities for the four soil samples examined here strongly suggests that ϵ' and ϵ'' measurements made by the waveguide approach are probably not valid for volumetric water content $> P_s$. Some of the water added to the samples probably leaked out of the waveguide before the measurements were made. As shown in figures 17 and 18, no leveling off of ϵ' and ϵ'' with volumetric water content was observed in the measured results of Lundien (Reference 2) or Newton (Reference 8). However, when porosity was computed for each soil sample used in Lundien's measurements, it was found that all of the measurements were carried out for a volumetric water content of $< P_s$. In the 1.4-GHz measurements (R. W. Newton, personal communication), the soil-water mixture was put in a container so that the water would not leak out of the system even if the saturation points were reached. Thus, the leveling off of the dielectric constants at high moisture content observed in our measurements is a systematic error in our procedures. Unfortunately, we cannot verify this explanation at 19.35 GHz.

A comparison of figures 9, 16, 17, and 18 also reveals that the variations of ϵ'' with moisture content may be dependent on frequency. The data in figure 9 show that ϵ'' curves more or less followed the pattern of ϵ' curves. The steep rise and saturation in ϵ'' occur at smaller moisture content for sandy soils than for clayey soils. Crossover in ϵ'' occurred at a moisture content of ~ 15 to 25 percent. On the other hand, the ϵ'' curves in figures 17 and 18 did not show the same phenomenon. For sandy soils, ϵ'' remained smaller than that for clayey soils over the entire volumetric moisture range of 0 to $0.5\text{ cm}^3/\text{cm}^3$. The results at 5 GHz shown in figure 16 (or figure 14) fall between these two cases. Although the moisture content in figure 9 was expressed in percent of dry weight, a change in volumetric water content (if possible) is not likely to change the entire picture.

One possible explanation of this frequency-dependence of the ϵ'' moisture-content relation comes from the ionic conductivity of the soil/water mixture. The expression of ϵ'' for water with dissolved ions is given by (Reference 17):

$$\epsilon'' = \frac{\omega \tau (\epsilon_s - \epsilon_\infty)}{1 + \omega^2 \tau^2} + \frac{\sigma_i}{\omega \epsilon_0} \quad (4)$$

where ω is the angular frequency, τ is the relaxation time, ϵ_s is the static relative permittivity, ϵ_∞ is the relative permittivity at high frequencies, and σ_i is the ionic conductivity of the solution. ϵ_0 is the permittivity in vacuum and equals $10^{-9}/36 \pi$ farads per meter. Clearly, the value of ϵ'' is dominated by the first term at high frequencies and by the second term at low frequencies. For example, taking the approximate room-temperature values of $\epsilon_s \sim 75$, $\tau \sim 10^{-11}$ sec, $\epsilon_\infty \simeq 5$ (Reference 17), and assuming $\sigma_i \sim 1$ mho/m, the values for the first and second terms in equation 2 were estimated at 1.4 GHz to be ~ 6 and ~ 13 , respectively. The corresponding values at 19.35 GHz were ~ 33 and ~ 1 . Thus, if the water/clayey soil mixture contained more dissolved ions than the water/sandy soil mixture, the variations of ϵ'' with moisture content, soil texture, and frequencies should follow the patterns in figures 9, 16, 17, and 18. This inference is substantiated by the analysis of various U.S. surface soils in that clayey soils contain more phosphorus, potassium, and calcium than sandy soils (Reference 16). As observed by Rhoades et al. (Reference 18), the larger surface conductivity of clayey soils also implies more exchangeable ions for the clayey soils.

CONCLUSIONS

The dielectric properties of several soil samples were measured as a function of moisture content. The measurements were performed at the frequencies of 5 and 19.35 GHz and thereby extended the frequency range of the measured data reported in the literature (References 1 through 9). There are two advantages in determining soil water content on a volume basis. First, the compactness factor of the soil sample in the waveguide was removed to a large extent, and the precision of the measurements improved in comparison to the case when moisture content was expressed in terms of percentage by dry-weight. Secondly, as also reported by Cihlar and Ulaby (Reference 14), the difference in the measured dielectric constants due to soil types was reduced, although the residual difference was still appreciable as shown by the measured data at 5 and 1.40 GHz.

The dependence of the transition moisture on the soil field capacity is clearly present at 5 GHz, a phenomenon previously reported by Lundien (Reference 2) and Newton (Reference 8) at the frequency of 1.4 GHz. This observed dependence could serve as a basis for quantifying the measured dielectric constants for various soil types. The quantified dielectric constants as a function of volumetric water content could be useful in implementing the inversion algorithm for deriving soil-moisture data from the observed microwave parameters.



Examination of data at 1.4, 1.412, 5, and 19.35 GHz showed a possible frequency dependence in the variation of ϵ'' with moisture content for different soil types. At 19.35 GHz, both ϵ' and ϵ'' vary with moisture content in the same pattern according to the texture of the soil sample. The steep rise in both ϵ' and ϵ'' occurs at lower moisture content for sandy soils than for clayey soils at this frequency. At ~ 1.4 GHz, the measured ϵ'' for the sandy soils remain at lower values than those for the clayey soils over the entire volumetric moisture range of 0 to 0.4 cm^3/cm^3 . It is suggested that more ions were probably dissolved in the added water for the clayey soils than for the sandy soils. The contribution to ϵ'' from the ionic conductivity at low frequencies could be large enough to mask the similar pattern of ϵ'' curves observed at high frequencies.

Goddard Space Flight Center
National Aeronautics and Space Administration
Greenbelt, Maryland March 1978

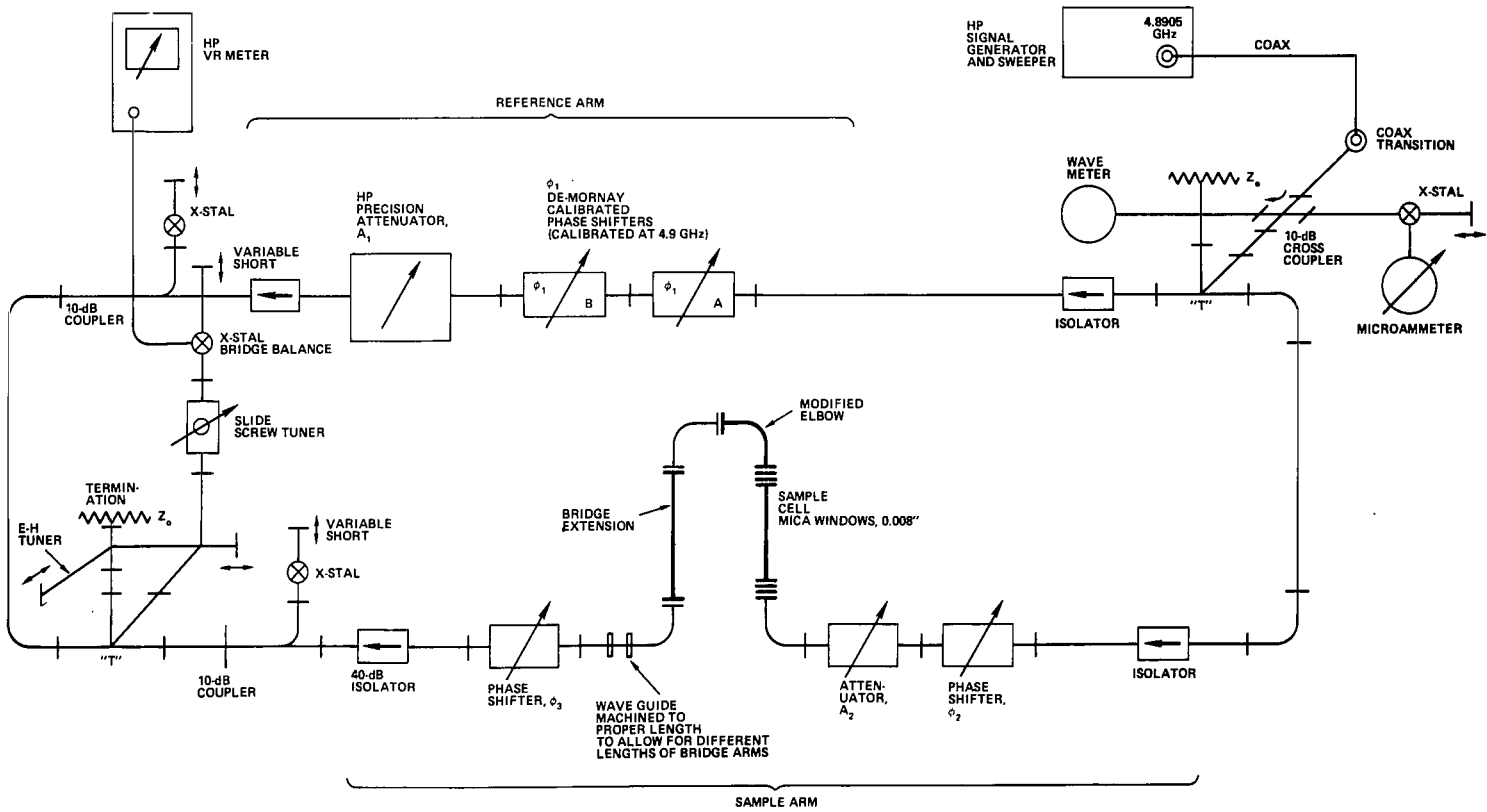

Figure 1. The schematic diagram of the 5-GHz twin-arm microwave bridge.

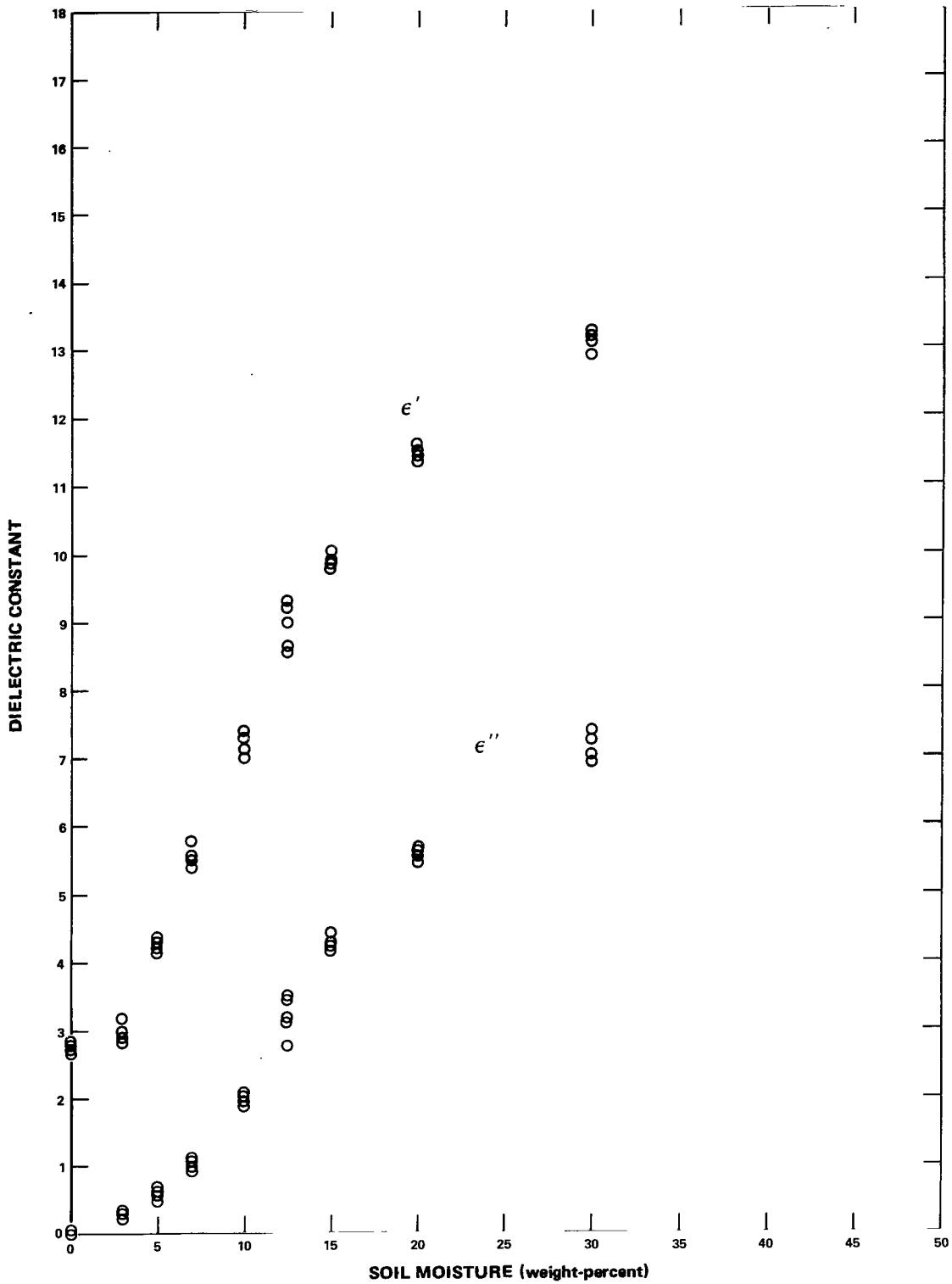

Figure 2. Values of ϵ' and ϵ'' versus water content at 19.35 GHz, loamy fine-sand sample M5.

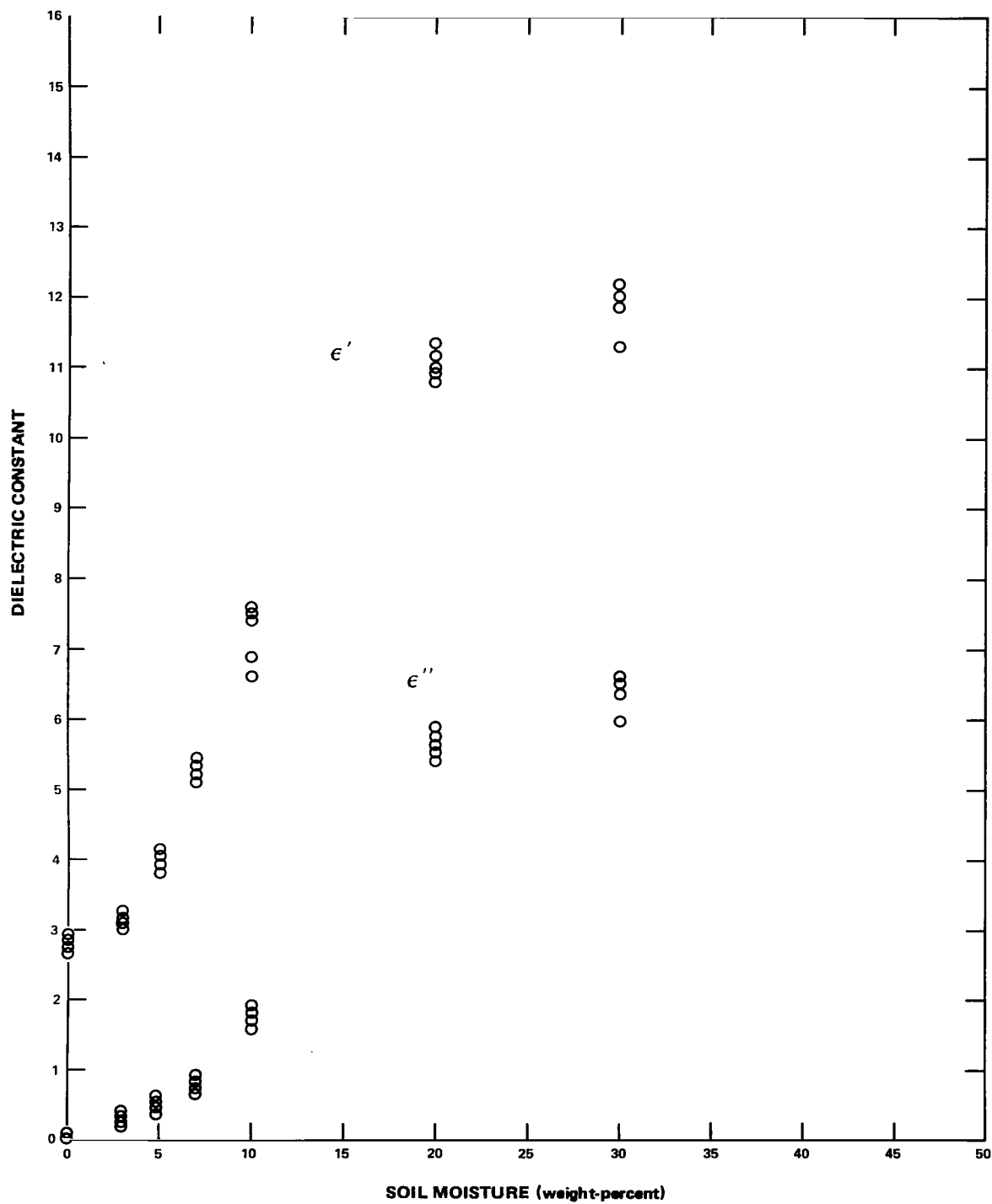

Figure 3. Values of ϵ' and ϵ'' versus water content at 19.35 GHz, sandy loam from East Imperial Valley.

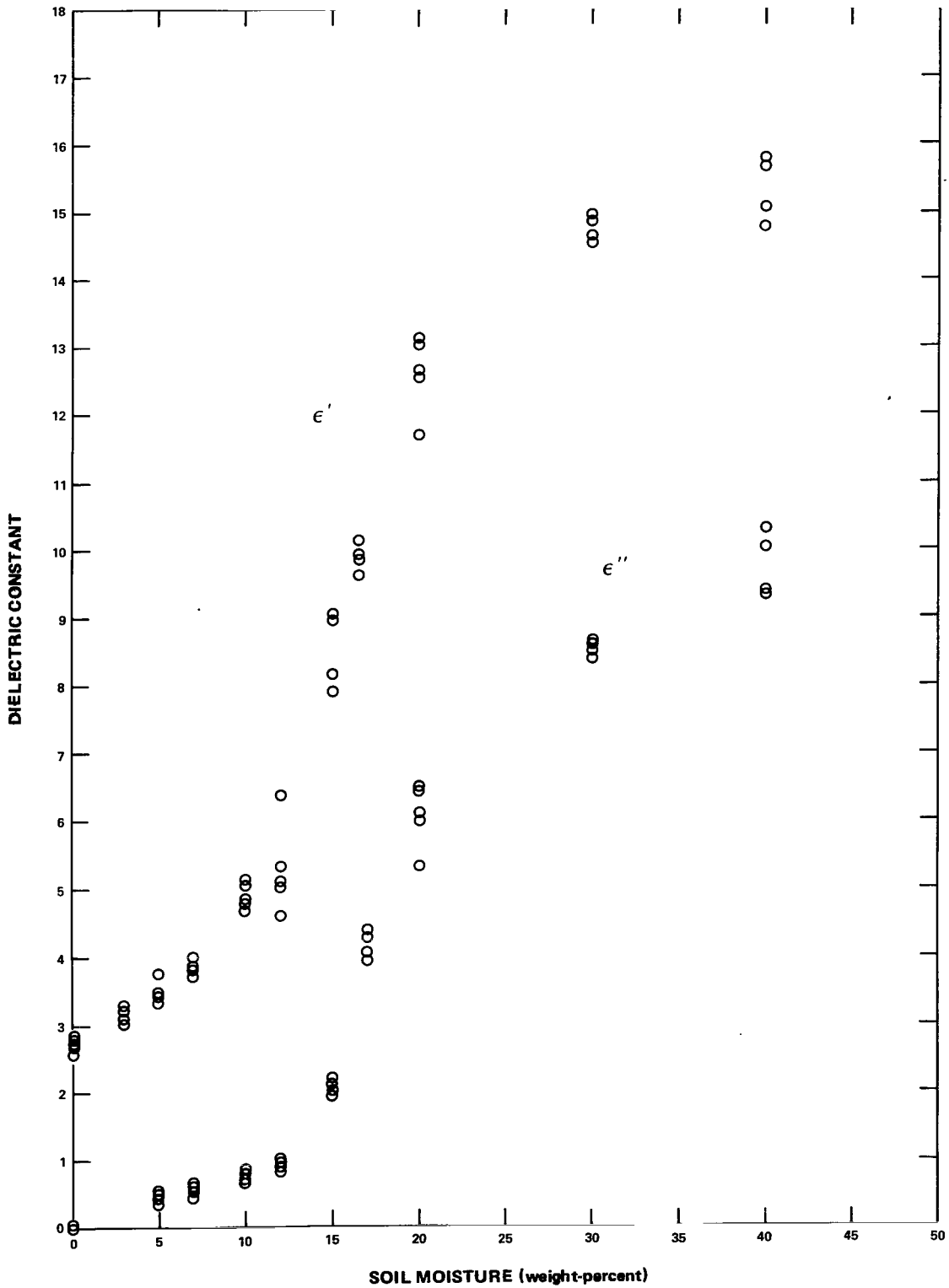

Figure 4. Values of ϵ' and ϵ'' versus water content at 19.35 GHz, sandy clay-loam sample F2.

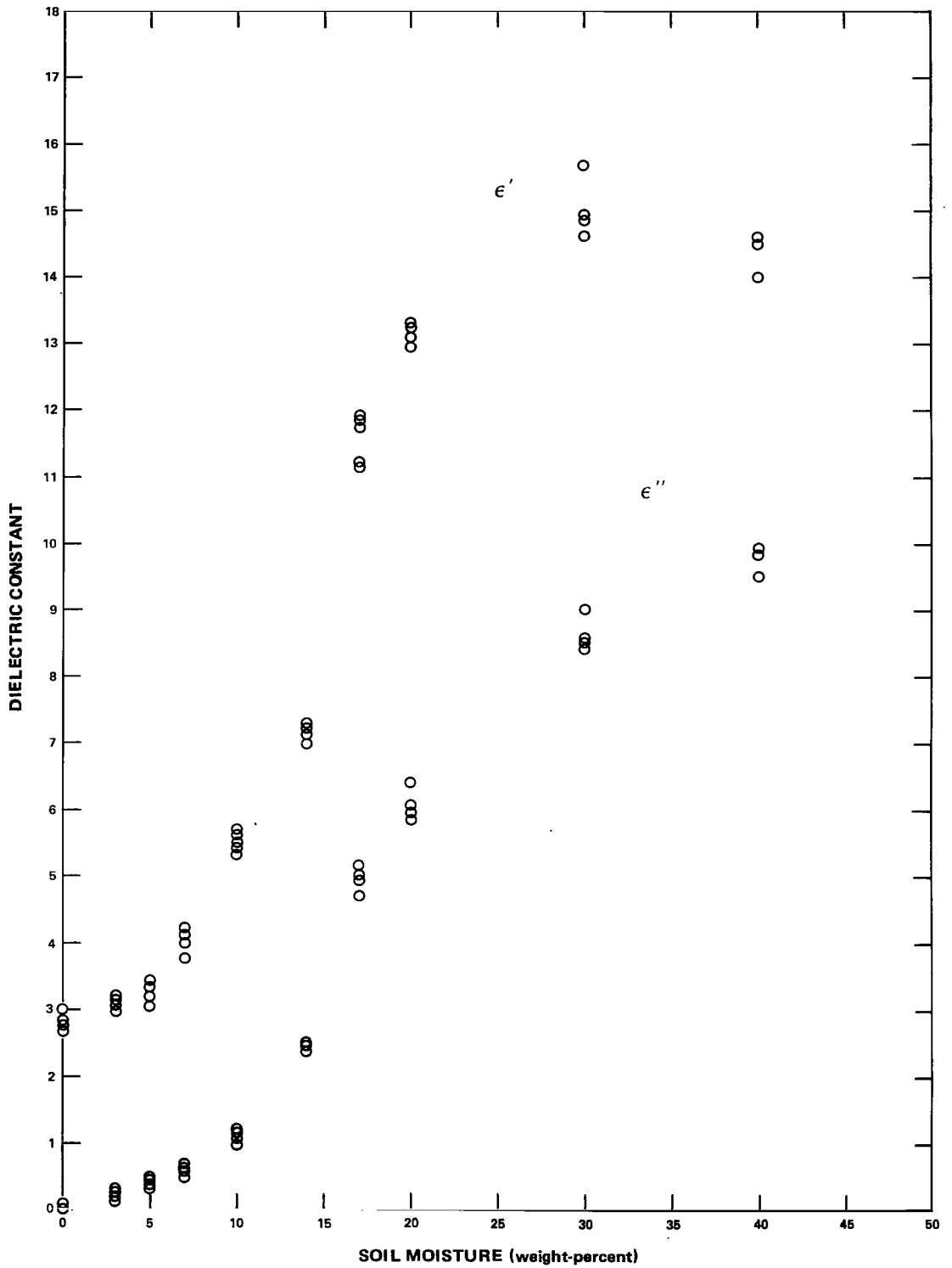

Figure 5. Values of ϵ' and ϵ'' versus water content at 19.35 GHz, fine sandy-loam sample L3.

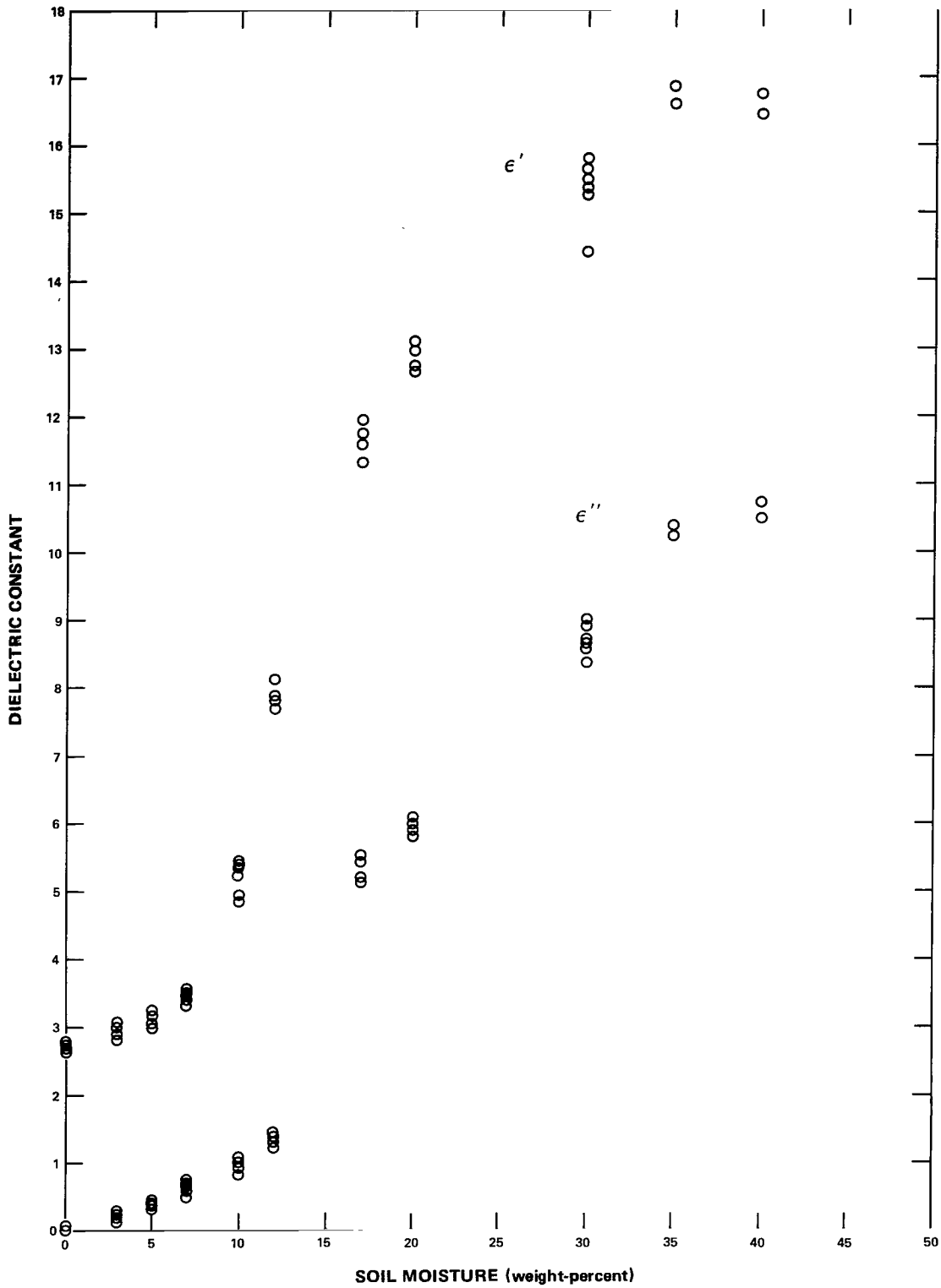

Figure 6. Values of ϵ' and ϵ'' versus water content at 19.35 GHz, clay-loam sample E4.

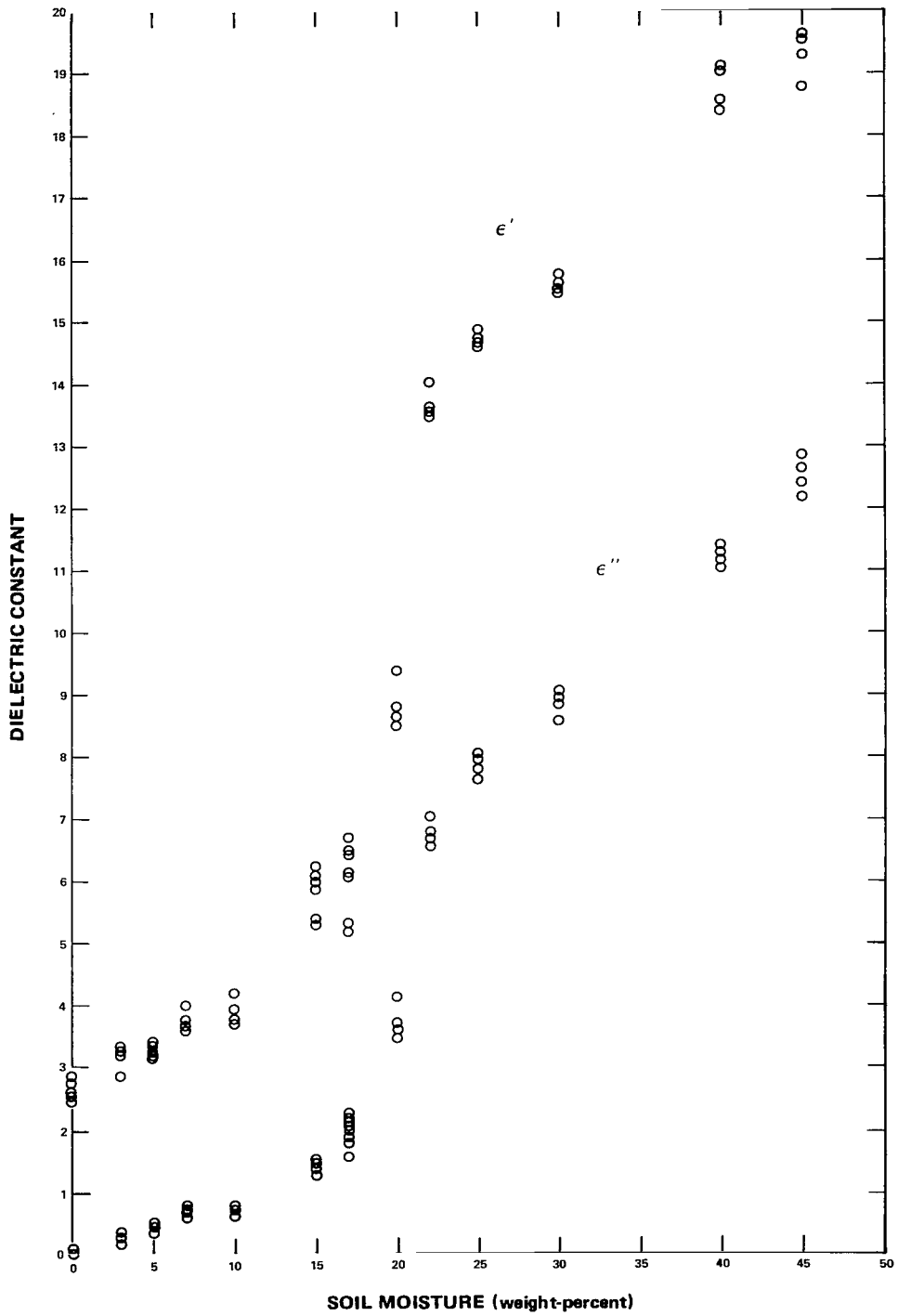

Figure 7. Values of ϵ' and ϵ'' versus water content at 19.35 GHz, silty clay-loam sample H7.

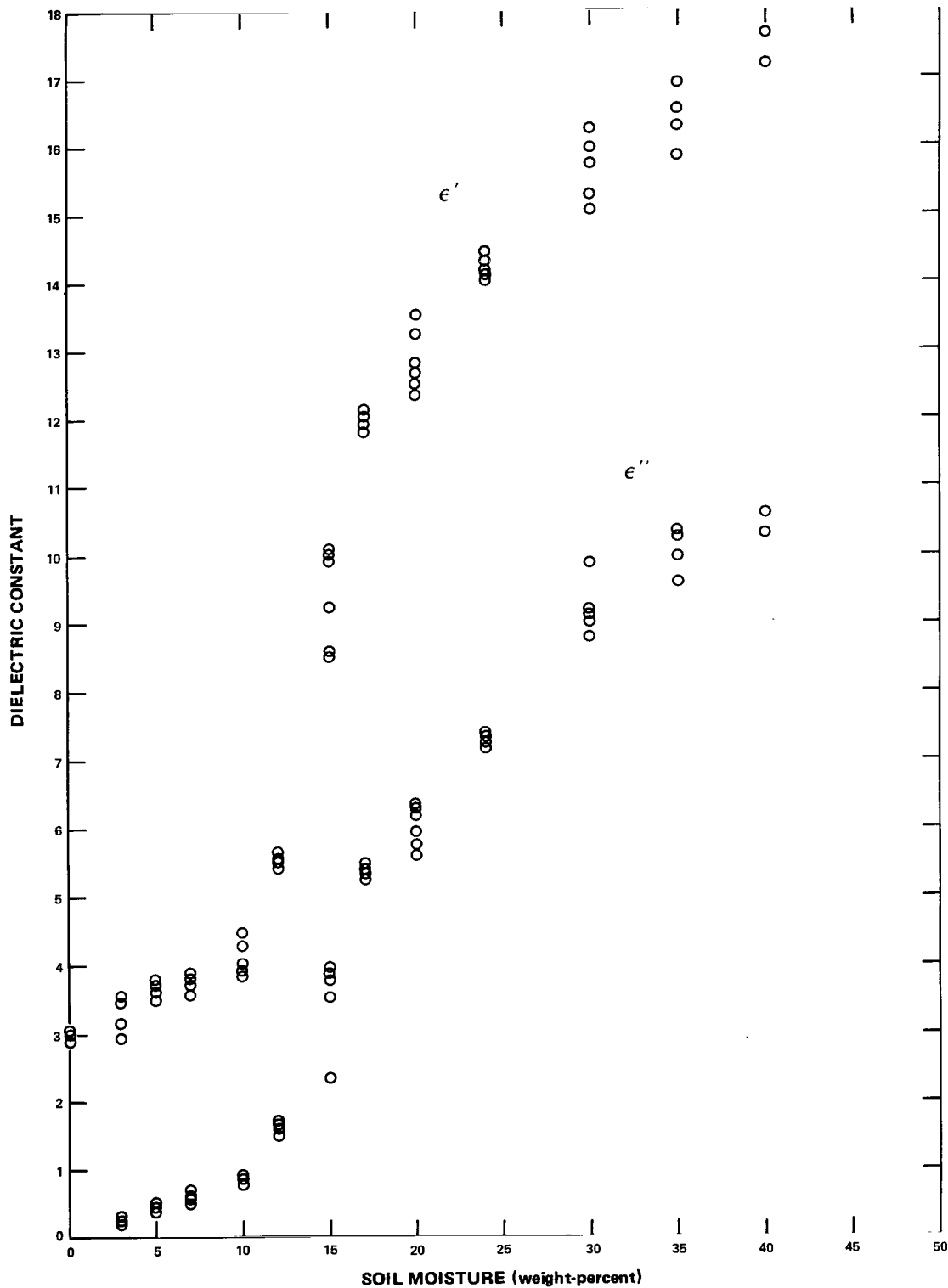

Figure 8. Values of ϵ' and ϵ'' versus water content measured at 19.35 GHz, Harlingen clay.

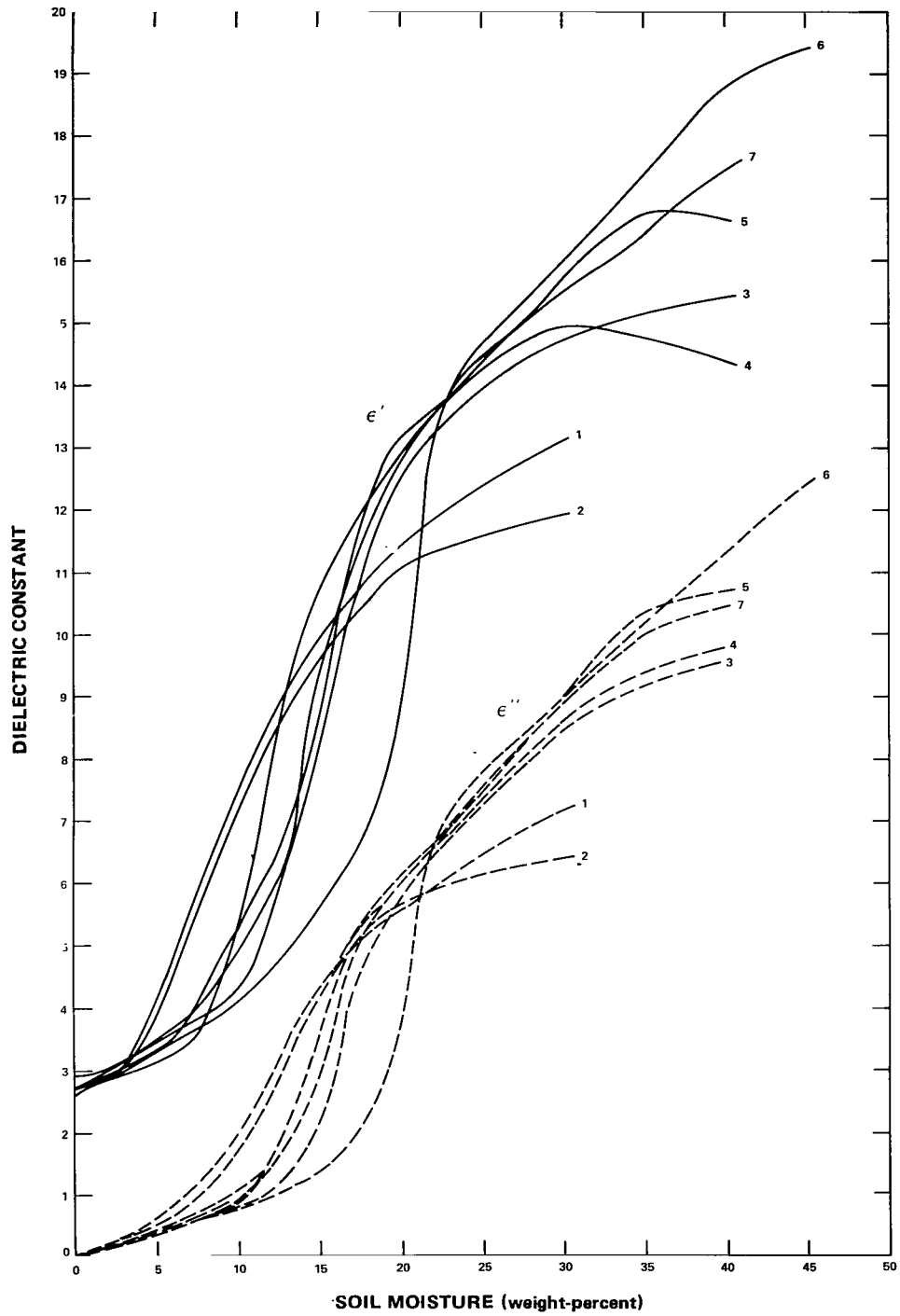

Figure 9. Comparison of ϵ' and ϵ'' values versus water content for all soils measured at 19.35 GHz.

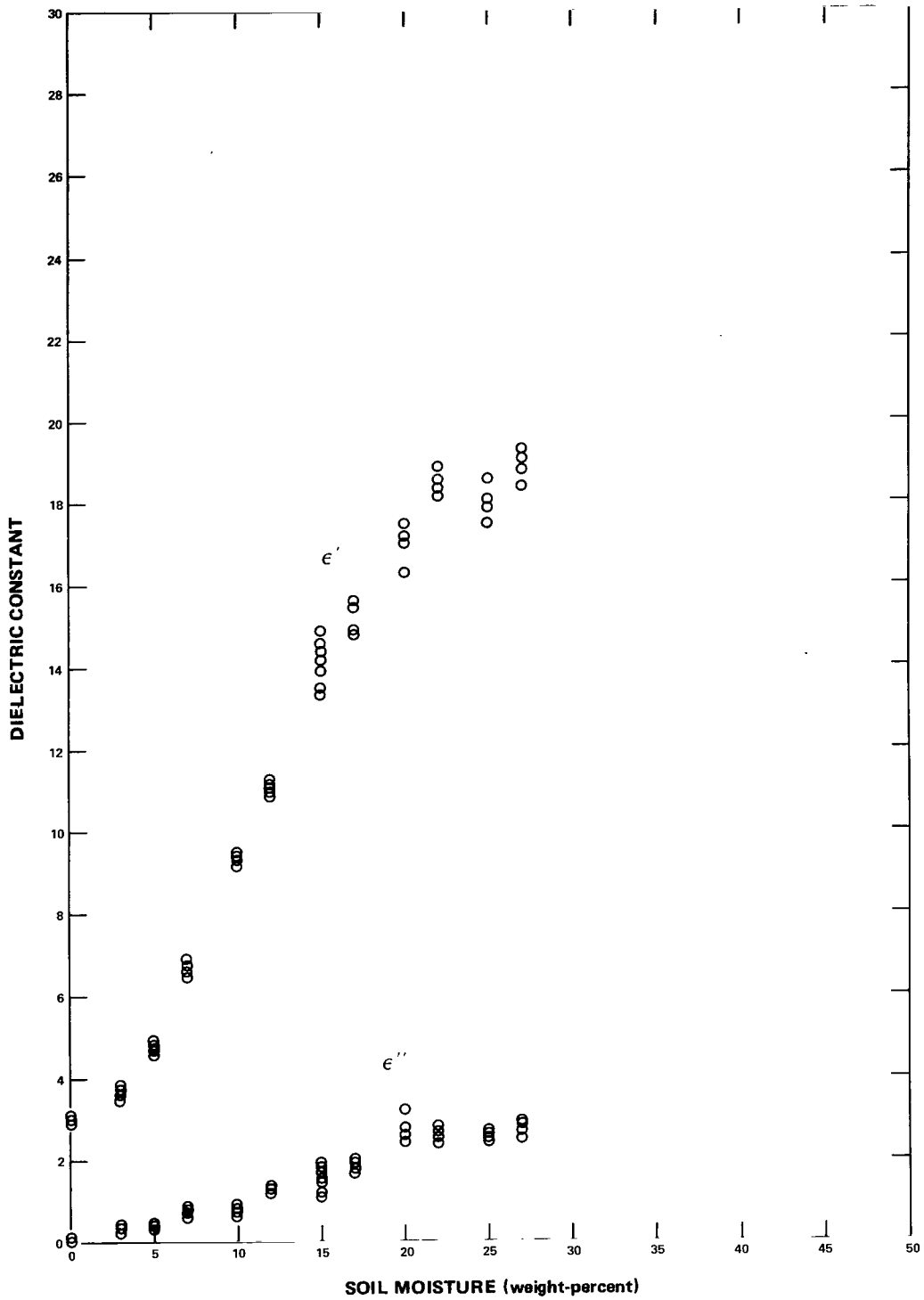

Figure 10. Values of ϵ' and ϵ'' versus water content measured at 5 GHz, loamy fine-sand sample M5.

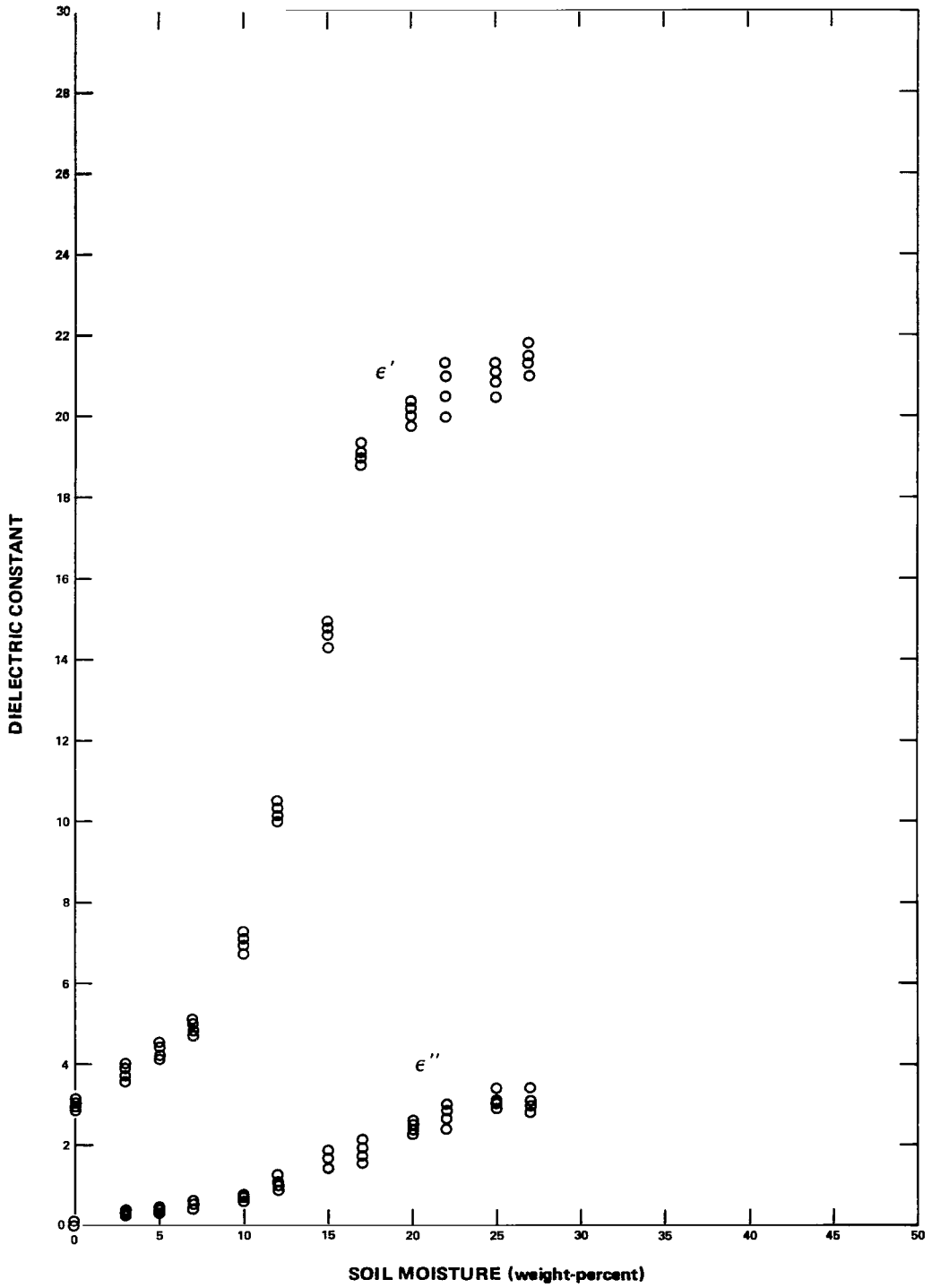

Figure 11. Values of ϵ' and ϵ'' versus water content measured at 5 GHz, sandy clay-loam sample F2.

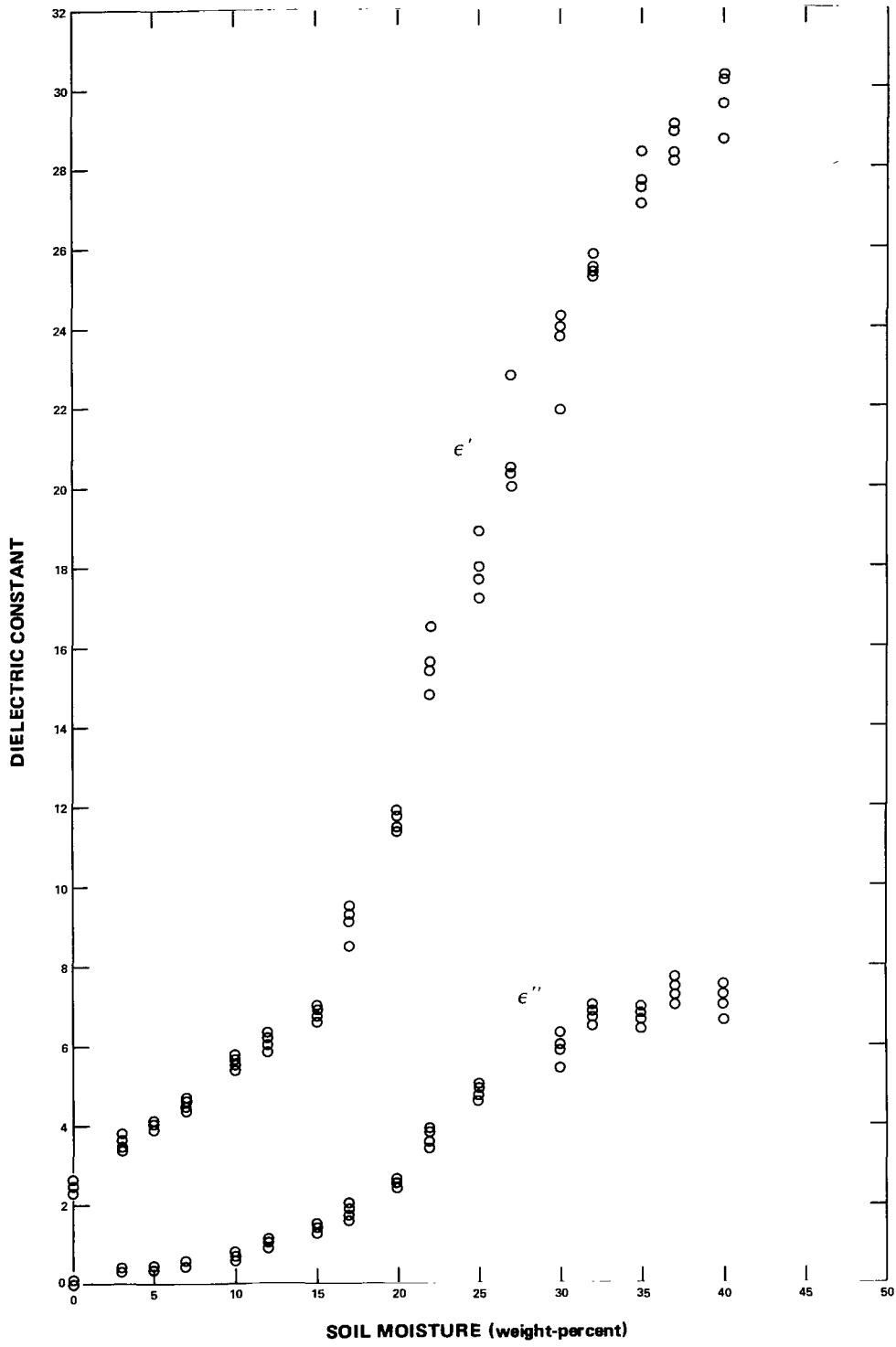

Figure 12. Values of ϵ' and ϵ'' versus water content measured at 5 GHz, silty clay-loam sample H7.

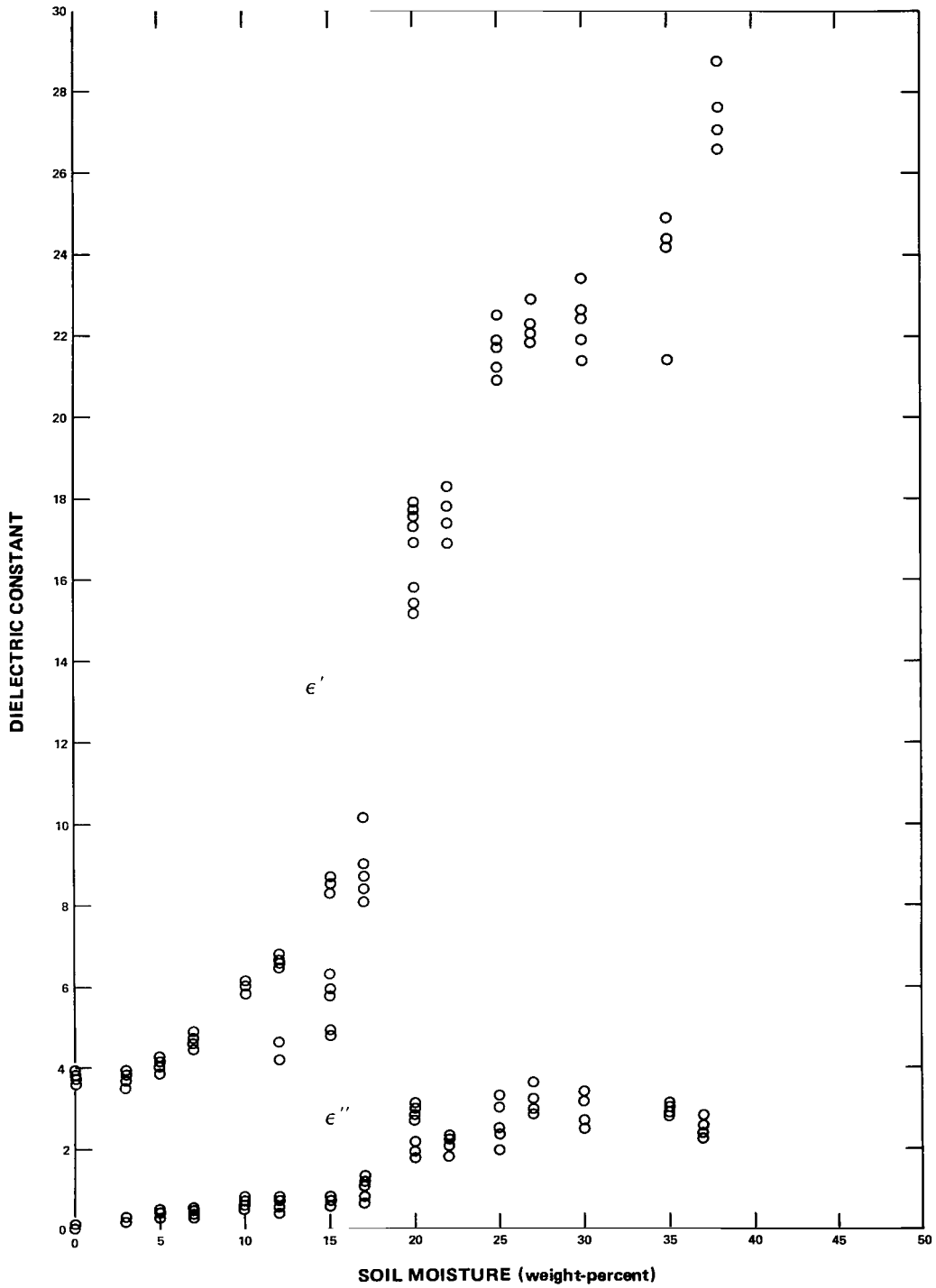

Figure 13. Values of ϵ' and ϵ'' versus water content measured at 5 GHz, Harlingen clay.

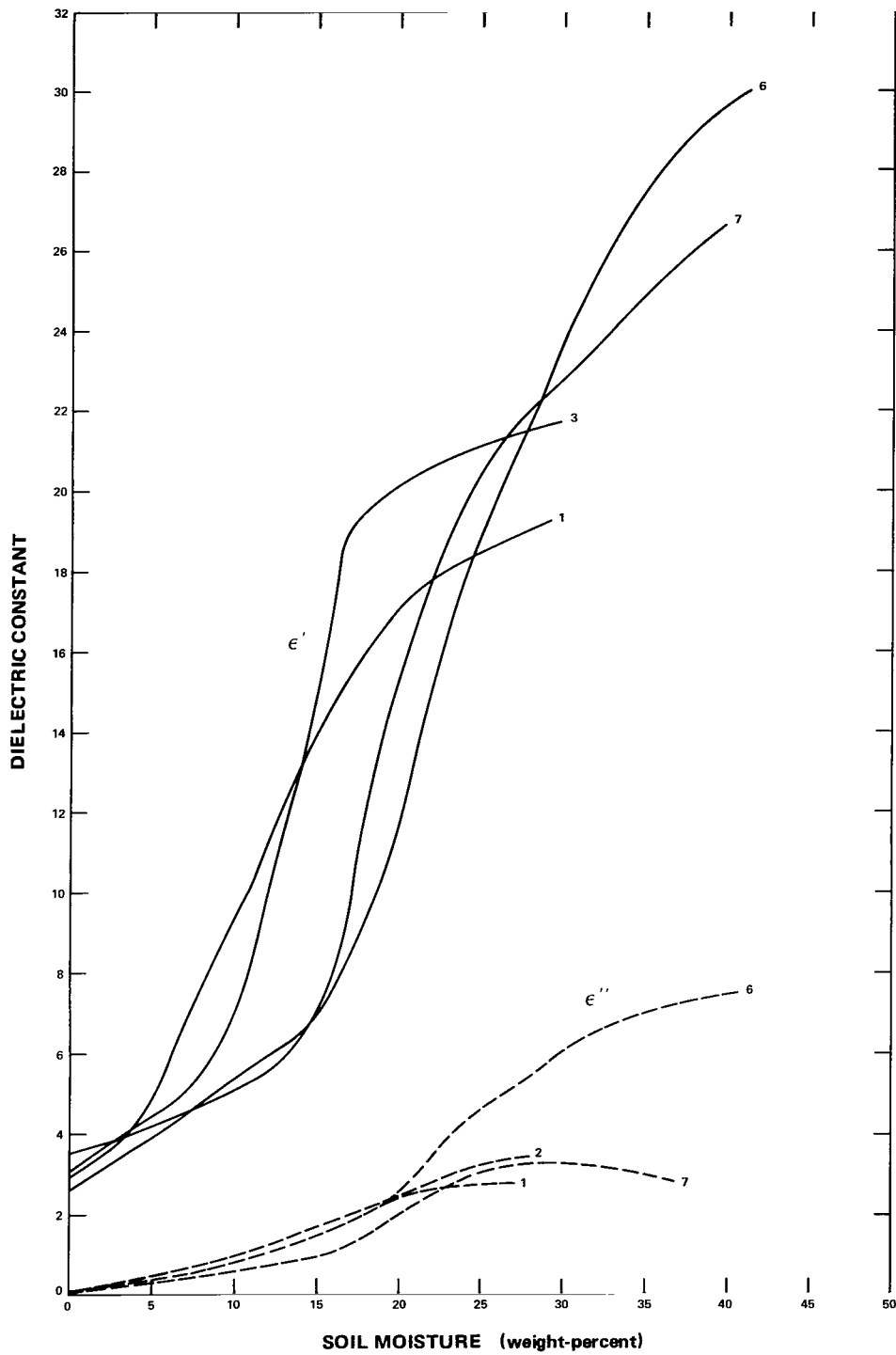

Figure 14. Comparison of ϵ' and ϵ'' values versus water content for four soils measured at 5 GHz.

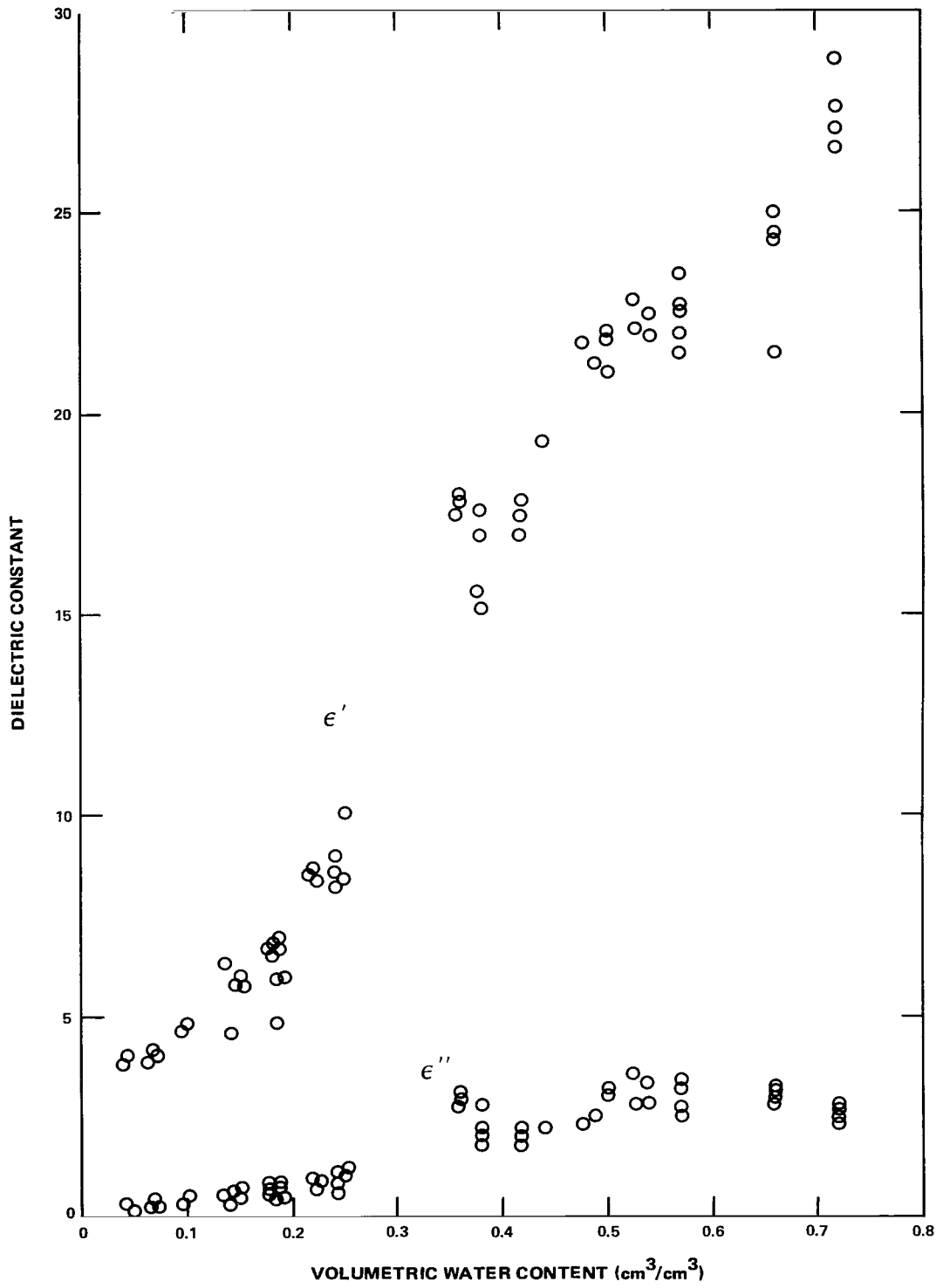

Figure 15. Values of ϵ' and ϵ'' versus volumetric water content measured at 5 GHz, Harlingen clay.

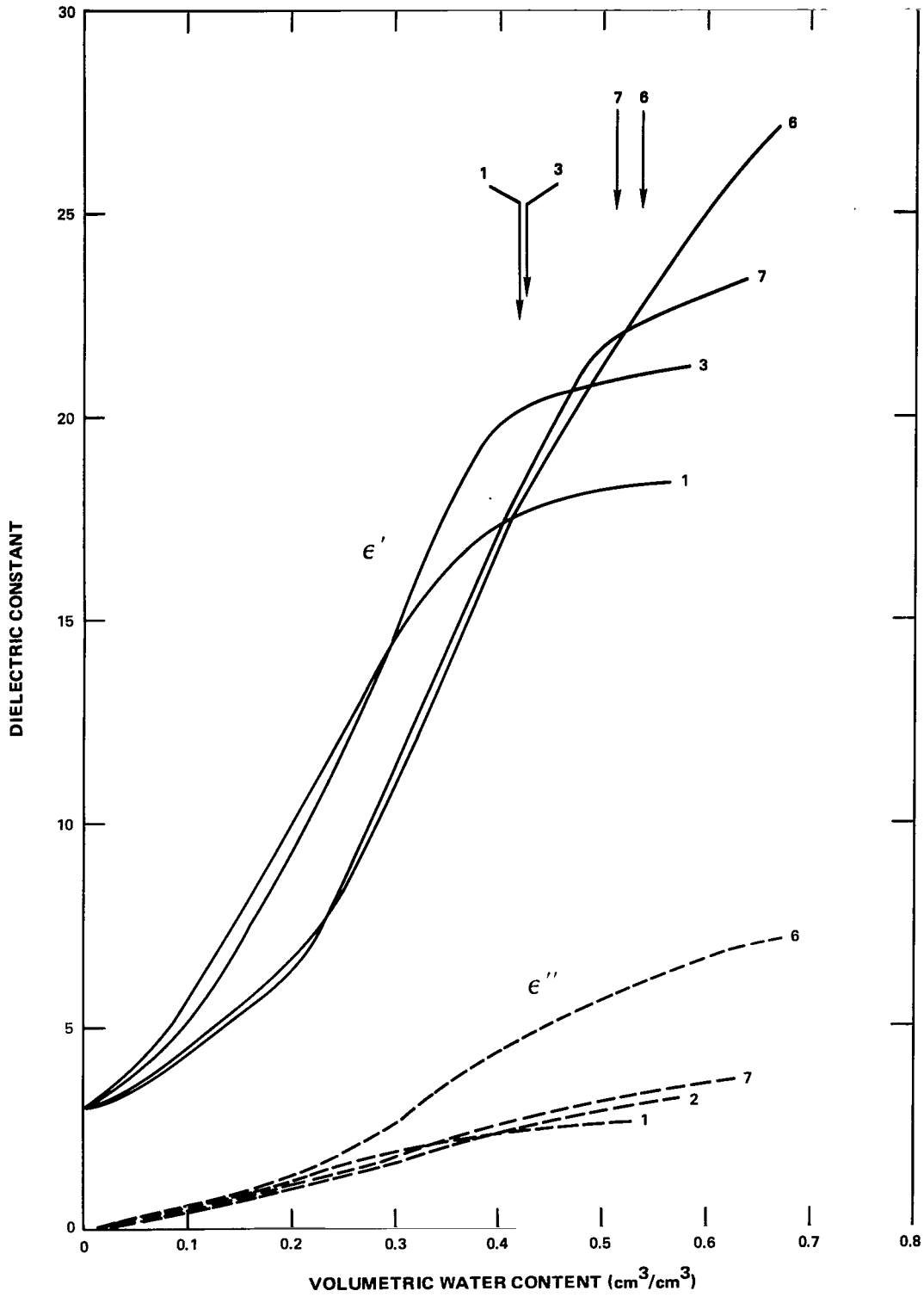

Figure 16. Comparison of ϵ' and ϵ'' versus volumetric water content for four soils measured at 5 GHz.

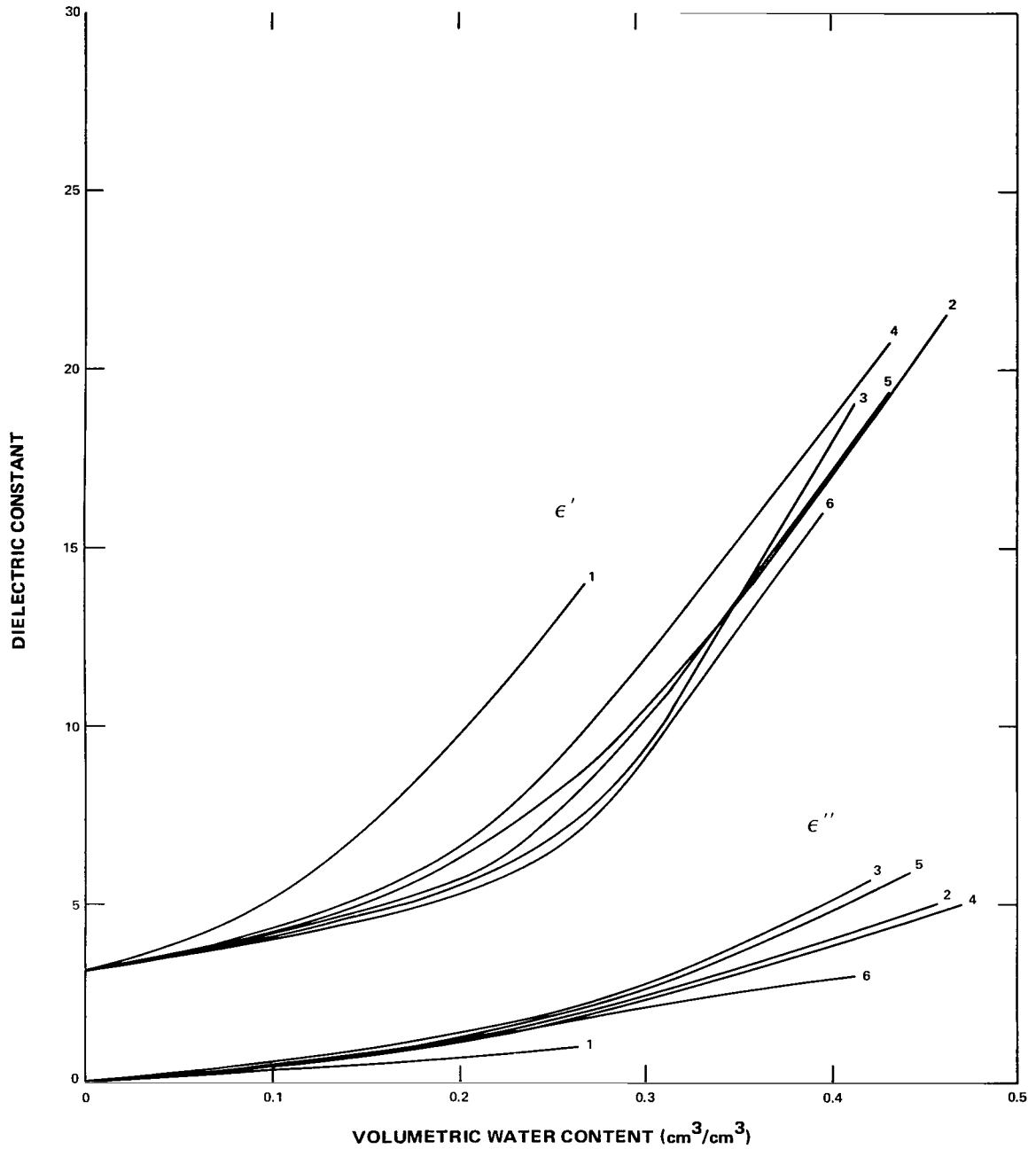

Figure 17. The smoothed values of ϵ' and ϵ'' versus volumetric water content measured at 1.412 GHz. Data were obtained from table 5 of Reference 2. Soil types are identified by the numbers assigned to the curves in table 2:

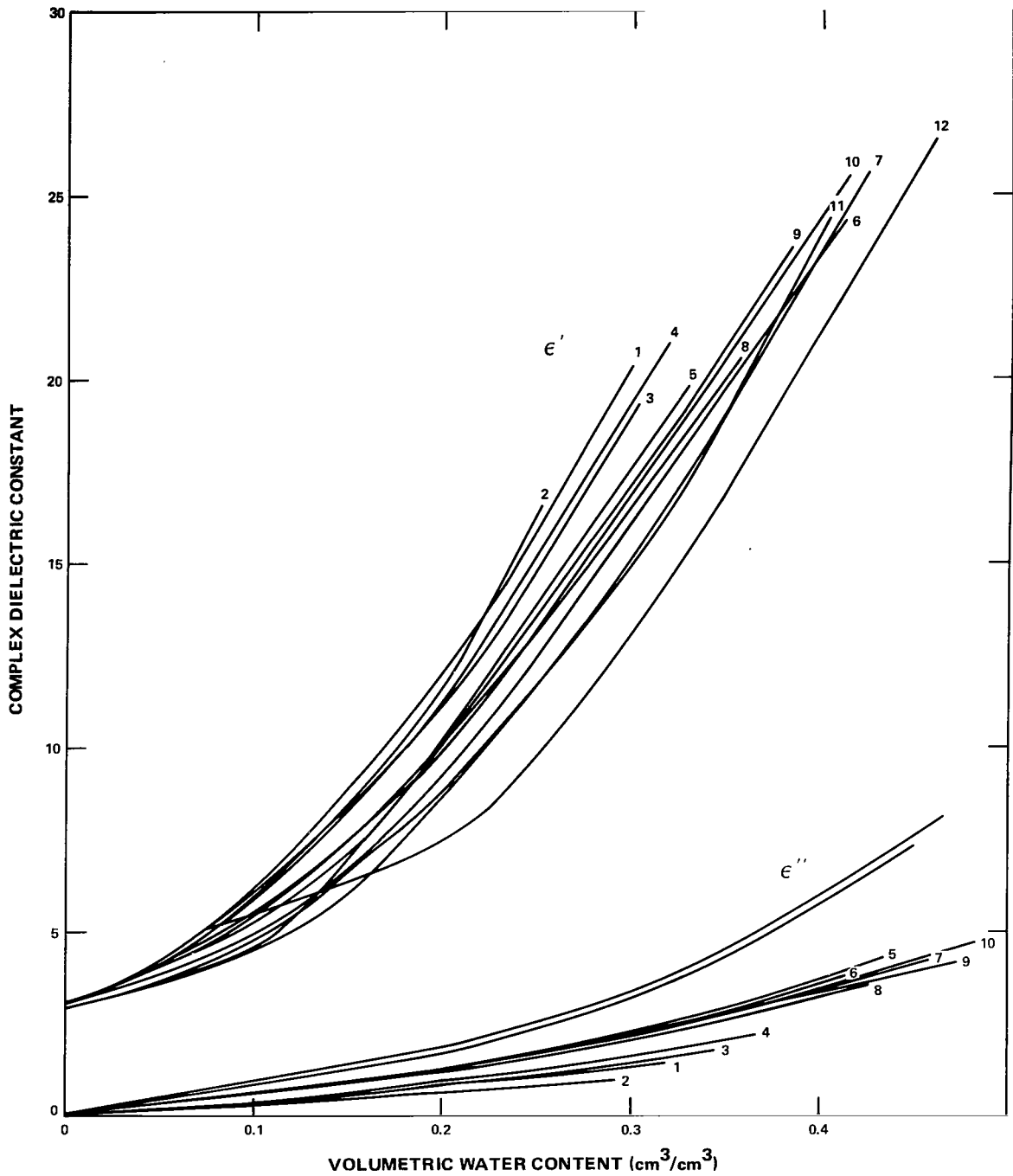

Figure 18. Smoothed values of ϵ' and ϵ'' versus volumetric water content measured at 1.4 GHz. Data were obtained from Reference 8. Soil types are identified by the numbers assigned to the curves in table 2.

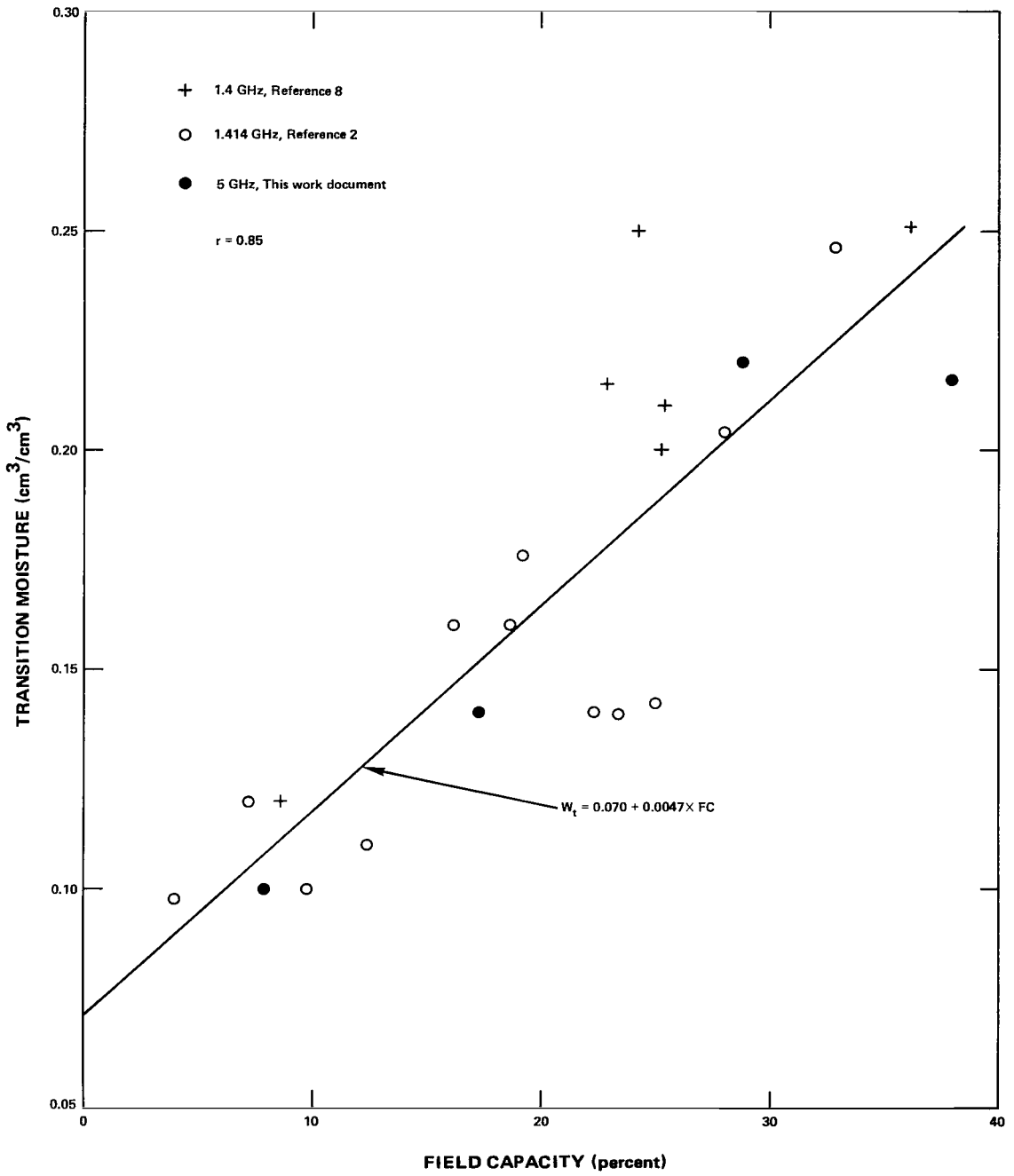

Figure 19. Transition moisture versus field capacity of soils.



REFERENCES

1. Davis, B. R., J. R. Lundien, and A. N. Williamson, "Feasibility Study of the Use of Radar to Detect Surface and Ground Water," Technical Report 3-727, U.S. Army Engineer Waterways Experiment Station, Vicksburg, Mississippi, April 1966.
2. Lundien, J. R., "Terrain Analysis by Electromagnetic Means," Technical Report 3-693m, U.S. Army Engineer Waterways Experiment Station, Vicksburg, Mississippi, February 1971.
3. Wiebe, M. L., "Laboratory Measurements of the Complex Dielectric Constant of Soils," Technical Report RSC-23, Texas A&M University, College Station, October 1971.
4. Leschanskiy, Yu. I., G. N. Lebedeva, and V. D. Schumilin, "Electrical Parameters of Sandy and Loamy Soils in the Range of Centimeter, Decimeter and Meter Wavelengths," *Izvestiya Vysshich Uchebnich Zavedenii, Radiofizika*, 14 (4), 1971, pp. 562-569.
5. Geiger, F. E., and D. Williams, "Dielectric Constants of Soils at Microwave Frequencies," NASA TM X-65987, April 1972.
6. Hockstra, P., and A. Delaney, "Dielectric Properties of Soils at UHF and Microwave Frequencies," *J. Geophys. Res.*, 79, 1974, pp. 1699-1708.
7. Hipp, J. E., "Soil Electromagnetic Parameters as a Function of Frequency, Soil Density and Soil Moisture," *Proceedings of the IEEE*, 62 (1), 1974, pp. 98-103.
8. Newton, R. W., "Microwave Remote Sensing and Its Application to Soil Moisture Detection," Technical Report RSC-81, Texas A&M University, College Station, January 1977.
9. Njoku, E. G., and J. A. Kong, "Theory for Passive Microwave Remote Sensing of Near-Surface Soil Moisture," *J. Geophys. Res.*, 82 (20), 1977, pp. 3108-3118.
10. Smith-Rose, R. L., "The Electrical Properties of Soil for Alternating Currents at Radio Frequencies," *Proc. Roy. Soc. Ser. A.*, 140, 1933, p. 359.

11. Hippel, A. Von, ed., *Dielectric Materials and Applications*, John Wiley & Sons, Inc., 1961, p. 314.
12. Ford, L. H., and R. Oliver, "An Experimental Investigation of the Reflection and Absorption of Radiation of 9-cm Wavelength." *Proc. Phys. Soc. London*, **58**, 1946, p. 265.
13. Schmugge, T. "Remote Sensing of Surface Soil Moisture," *2nd Conf. on Hydrometeorology*, Publ. American Meteorological Society, Boston, Massachusetts, October 1977, pp. 304-310.
14. Cihlar, J., and F. T. Ulaby, "Dielectric Properties of Soils as a Function of Moisture Content," RSL Technical Report 177-47, University of Kansas, Lawrence, November 1974.
15. Schmugge, T., T. Wilheit, W. Webster, Jr., and P. Gloerson, "Remote Sensing of Soil Moisture with Microwave Radiometer-II," NASA TN D-8321, September 1976.
16. Brady, N. C., *The Nature and Properties of Soils*, MacMillan Publishing Co., Inc., New York, 1974.
17. Paris, J. F., "Microwave Radiometry and Its Application to Marine Meteorology and Oceanography," Ref. No. 69-IT, Texas A&M University, January 1969.
18. Rhoades, J. D., P. A. C. Raats, and R. J. Prather, "Effects of Liquid-phase Electrical Conductivity, Water Content, and Surface Conductivity on Bulk Soil Electrical Conductivity," *Soil Sci. Soc. Am. J.*, **40**, 1976, pp. 651-655.

1. Report No. NASA TP-1238	2. Government Accession No.	3. Recipient's Catalog No.	
4. Title and Subtitle Dielectric Constants of Soils at Microwave Frequencies-II		5. Report Date May 1978	6. Performing Organization Code 910
7. Author(s) J. Wang, T. Schmutge, and D. Williams		8. Performing Organization Report No. G7802-13	
9. Performing Organization Name and Address Goddard Space Flight Center Greenbelt, Maryland 20771		10. Work Unit No. 177-51-41	11. Contract or Grant No.
12. Sponsoring Agency Name and Address National Aeronautics and Space Administration Washington, D.C. 20546		13. Type of Report and Period Covered Technical Paper	
15. Supplementary Notes		14. Sponsoring Agency Code	
16. Abstract The dielectric constants of several soil samples were measured at frequencies of 5 and 19 GHz using the infinite transmission line method. The results of these measurements are presented and discussed with respect to soil types and texture structures. A comparison is made with other measurements at 1.4 GHz. At all three frequencies, the dependence of dielectric constant on soil moisture can be approximated by two straight lines. At low moisture, the slope is less than at high moisture level. The intersection of the two lines is believed to be a function of soil texture.			
17. Key Words (Selected by Author(s)) Soil dielectric constants, Microwave, Soil moisture		18. Distribution Statement STAR Category 43 Unclassified-Unlimited	
19. Security Classif. (of this report) Unclassified	20. Security Classif. (of this page) Unclassified	21. No. of Pages 36	22. Price* \$4.50

*For sale by the National Technical Information Service, Springfield, Virginia 22161.

National Aeronautics and
Space Administration

Washington, D.C.
20546

Official Business

Penalty for Private Use, \$300

THIRD-CLASS BULK RATE

Postage and Fees Paid
National Aeronautics and
Space Administration
NASA-451



10 1 10, E, 050578 S00903DS
DEPT OF THE AIR FORCE
AF WEAPONS LABORATORY
ATTN: TECHNICAL LIBRARY (SUL)
KIRTLAND AFB NM 87117

NASA

S

POSTMASTER:

If Undeliverable (Section 158
Postal Manual) Do Not Return