

General Disclaimer

One or more of the Following Statements may affect this Document

- This document has been reproduced from the best copy furnished by the organizational source. It is being released in the interest of making available as much information as possible.
- This document may contain data, which exceeds the sheet parameters. It was furnished in this condition by the organizational source and is the best copy available.
- This document may contain tone-on-tone or color graphs, charts and/or pictures, which have been reproduced in black and white.
- This document is paginated as submitted by the original source.
- Portions of this document are not fully legible due to the historical nature of some of the material. However, it is the best reproduction available from the original submission.

NASA Contractor Report 145355

STRESS INTENSITY FACTORS OF COMPOSITE ORTHOTROPIC
PLATES CONTAINING PERIODIC BUFFER STRIPS

(NASA-CR-145355) STRESS INTENSITY FACTORS
OF COMPOSITE ORTHOTROPIC PLATES CONTAINING
PERIODIC BUFFER STRIPS (Lehigh Univ.) 123 p
HC A06/MF A01 CSCL 11D

N78-25134

Unclas
G3/24 21555

Feridun Delale and Fazil Erdogan

LEHIGH UNIVERSITY
Department of Mechanical Engineering
Bethlehem, PA 18015

NASA Grant NGR 39-007-011
January 1978

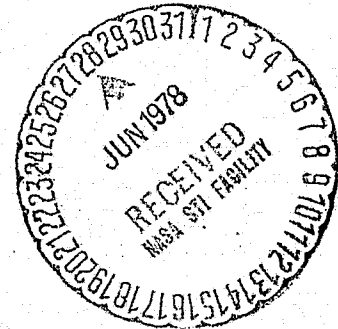

NASA
National Aeronautics and
Space Administration
Langley Research Center
Hampton, Virginia 23665

TABLE OF CONTENTS

| | |
|--|------|
| Acknowledgements..... | iii |
| Table of Contents..... | iv |
| List of Figures..... | vi |
| List of Tables | viii |
| Nomenclature..... | ix |
| Abstract..... | 1 |
| 1. INTRODUCTION..... | 3 |
| 2. ELASTICITY OF AN ANISOTROPIC BODY..... | 7 |
| 2.1 The Equilibrium Equations..... | 7 |
| 2.2 Strain-Displacement Relations..... | 7 |
| 2.3 Stress-Strain Relations..... | 7 |
| 2.4 The Field Equations for an Orthotropic Body..... | 8 |
| 2.4.1 Case of Plane Strain..... | 9 |
| 2.4.2 Case of Generalized Plane Stress..... | 10 |
| 3. DISPLACEMENT AND STRESS FIELDS FOR STRIPS..... | 12 |
| 3.1 Solutions $u^{(a)}(x,y), v^{(a)}(x,y)$ | 13 |
| 3.2 Solutions $u^{(b)}(x,y), v^{(b)}(x,y)$ | 14 |
| 3.3 The Displacements..... | 15 |
| 3.4 The Stresses..... | 16 |
| 4. FORMULATION OF THE PROBLEM..... | 18 |
| 5. CASE OF BROKEN LAMINATES..... | 25 |
| 6. CASE OF A CRACK CROSSING THE INTERFACE..... | 30 |
| 7. THE SOLUTION AND THE RESULTS..... | 46 |
| 7.1 Case of Internal Cracks..... | 46 |
| 7.2 Case of Broken Laminates..... | 52 |
| 7.3 Case of a Crack Crossing the Interface..... | 55 |
| 7.3.1 Singular Behavior at the Interface..... | 55 |
| 7.3.2 Non-Singular Behavior at the Interface..... | 60 |

| | |
|-------------------------|-----|
| 8. CONCLUSIONS..... | 64 |
| 9. RECOMMENDATIONS..... | 65 |
| Tables..... | 67 |
| Figures..... | 70 |
| References..... | 90 |
| Appendix A..... | 92 |
| Appendix B..... | 101 |
| Appendix C..... | 109 |
| Appendix D..... | 110 |
| Vita..... | 116 |

LIST OF FIGURES

| <u>Figure</u> | <u>Description</u> |
|---------------|---|
| 1 | - Geometry of the composite plate |
| 2 | - The superposition |
| 3 | - Initial geometry for the case of a crack crossing the interface |
| 4 | - The stress intensity factor k_a for the crack in the first strip (combination I) |
| 5 | - The stress intensity factor k_a for the crack in the first strip (combination II) |
| 6 | - The stress intensity factor k_b for the crack in buffer strip (combination I) |
| 7 | - The stress intensity factor k_b for the crack in buffer strip (combination II) |
| 8 | - The stress intensity factor k_a for the case in which both strips contain cracks (combination I) |
| 9 | - The stress intensity factor k_b for the case in which both strips contain cracks (combination I) |
| 10 | - The stress intensity factor k_a for the case in which both strips contain cracks (combination II) |
| 11 | - The stress intensity factor k_b for the case in which both strips contain cracks (combination II) |
| 12 | - Comparison of the stress intensity factor k_a for isotropic and orthotropic materials |
| 13 | - The stress intensity factor k_a when the first laminate is broken (combination I and II) |
| 14 | - The stress intensity factor k_b when the second laminate is broken (combination I and II) |

| <u>Figure</u> | <u>Description</u> |
|---------------|--|
| 15 | - The stress intensity factor k_a when the first laminate is broken and the second contains a crack (combination I and II) |
| 16 | - The stress intensity factor k_b when the first laminate is broken and the second contains a crack (combination I and II) |
| 17 | - The stress intensity factor k_b for a crack crossing the interface (singular behavior at the interface) |
| 18 | - The stress intensity factor k_{xx} for a crack crossing the interface |
| 19 | - The stress intensity factor k_{xy} for a crack crossing the interface |
| 20 | - The stress intensity factor k_b for a crack crossing the interface (non-singular behavior at the interface) |

LIST OF TABLES

| <u>Table</u> | <u>Description</u> |
|--------------|--|
| 1 | - The elastic constants and material combinations |
| 2 | - The dependence of k_a on the elastic constants |

NOMENCLATURE

| | |
|----------------------|---|
| A_{ij} | - material constants for orthotropic materials |
| E_x, E_x^* | - elasticity moduli in x direction |
| E_y, E_y^* | - elasticity moduli in y direction |
| E_z | - elasticity modulus in z direction |
| G_{xy}, G_{xy}^* | - shear moduli in x-y plane |
| G_{xz} | - shear modulus in x-z plane |
| G_{yz} | - shear modulus in y-z plane |
| a_{ij} | - material constants for orthotropic materials |
| a | - half crack length for the crack in the first strip |
| b | - half crack length for the crack in the second strip |
| c, d | - crack tip coordinates in second strip |
| h_1 | - half width of the first strip |
| h_2 | - half width of the second strip |
| l | - half crack length for the case when the crack crosses the interface |
| p_1, p_2 | - crack surface tractions |
| u_i | - displacements in x- direction |
| v_i | - displacements in y- direction |
| w | - displacements in z- direction |
| x, y, z | - cartesian coordinate system |
| x_1, y | - coordinates for the first strip |
| x_2, y | - coordinates for the second strip |
| β_i, β_i^* | - material constants defined by equations (2.15), (3.5) and (3.8) |

$\epsilon_x, \epsilon_y, \epsilon_z,$
 $\gamma_{xy}, \gamma_{yz}, \gamma_{xz}$

- components of strain tensor

γ_i, γ_i^*

- material constants defined in Appendix A

λ_i

- material constants defined in Appendix A

ν_{xy}, ν_{xy}^*

- material constants for orthotropic materials

ν_{yx}, ν_{yx}^*

ϕ, ϕ^*

- crack surface displacement derivatives

w_i

- material constants defined by equations (3.5)

$\sigma_{ix}, \sigma_{iy}, \sigma_z$

- components of stress tensor

$\tau_{ixy}, \tau_{xz}, \tau_{yz}$

ABSTRACT

The fracture problem of laminated plates which consist of bonded orthotropic layers is studied. It is assumed that the medium contains periodic cracks normal to the bi-material interfaces and the external loads are applied away from the crack region. The fields equations for an elastic orthotropic body are transformed to give the displacement and stress expressions for each layer or strip. The unknown functions in these expressions are found by satisfying the remaining boundary and continuity conditions. A system of singular integral equations is obtained from the mixed boundary conditions. Three cases are considered:

- a) The case of internal cracks
- b) The case of broken laminates
- c) The case of a crack crossing the interface.

The singular behavior around the crack tip and at the bi-material interface is studied. It is shown that the crack surface displacement derivative has a power singularity for practical orthotropic materials when the crack touches the interface, i.e., for case (b). In studying the singular behavior at the bimaterial interfaces in case (c), it is found that for some orthotropic material combinations there is no singularity in the crack surface displacement derivatives and the stresses. In each case the stress intensity

factors are computed for various material combinations and various crack geometries. The results for orthotropic materials are discussed and are compared with those for isotropic materials.

1. INTRODUCTION

In structural design one of the most important considerations is the fracture of individual components. Although, fracture may not always mean total failure, it is considered in modern engineering as an important problem for safe and economic design of structures. It would be very attractive to develop special types of designs for which the structural resistance to fatigue crack propagation is improved. In the aerospace industry, the use of composite sheet materials with buffer strips parallel to the main load-carrying laminates seems to be such a design practice. The process of manufacturing composites gives the opportunity to improve the structural resistance to fatigue crack propagation by strengthening the material in certain directions. The increasing use of composites in structures generates new problems for the structural designer. Among these problems, we are mainly interested in the fracture of layered composite materials.

There are two main problems in studying the fracture of composites: the development of an appropriate failure criterion and a mathematical model for the calculation of the related load factor. The failure criterion affects the course of the analytical work in the sense that it is the failure criterion which generally determines the physical quantities that one should compute (such as the stress

intensity factor, the strain energy release rate, COD, etc.). There are many failure criteria or theories which are used to predict failure of structures. In Elastic Fracture Mechanics where only small scale yielding is allowed, $K \leq K_{IC}$ is such a criterion. In this case failure occurs when the calculated value of the stress intensity factor reaches a critical value, K_{IC} , which can be determined experimentally as a material property. There are also other one-parameter failure criteria (such as critical plastic stress intensity factor K_{pC} and J integral) which have been recently proposed to predict failure from elastic to fully plastic range. K is a very highly effective correlation parameter in studying the fatigue crack propagation phenomena. In aerospace structures the basic problem is the nucleation and propagation of fatigue crack which may eventually reach a critical size causing catastrophic failure. That is why, in this study we focus our interest to the computation of the stress intensity factors and in the investigation of the singular behavior of the stress state around the crack tips.

In studying the fracture problem of composites, a mathematical model, which will reflect the geometrical and physical properties of the medium and the real mechanism of fracture, is needed. Because of mathematical difficulties and the lengthy computation that the analysis

requires, in the recent studies the geometry and the material properties have been considerably simplified. The problem of a multi-layered isotropic medium, which consists of many layers and where a crack normal to the interface can appear, has been treated by Hilton and Sih [1]. In this problem the geometry is simplified to a single layer between two dissimilar half-planes where the elastic properties are averaged. The same problem has been considered by Bogy [2]. The problem of a broken laminate between two half planes has been investigated by Ashbaugh [3] and Gupta [4]. The extension of the problem treated by Hilton and Sih to orthotropic media has been solved by Arin [5]. The fracture problem of a composite plate which consists of parallel load-carrying laminates and buffer strips has recently been solved by Erdogan and Bakioglu [6]. In this work the load carrying laminates and buffers are considered to be isotropic and linearly elastic. The orthotropic case of the problem treated in [3] and [4] has also been solved by Arin [7].

The objective of this work is to investigate the fracture problem of composite plates containing periodic buffer strips. The laminates and buffer strips are assumed to be linearly elastic and orthotropic. In general, this is the case in the actual plate and shell structures such as those, for example, which consist of boron-epoxy

composites. It is also assumed that the fatigue cracks may appear and propagate in main laminates, in buffer strips or in both normal to the interfaces. The external load is applied to the plate parallel to the strips and away from the crack region. Three different problems are studied: the internal crack problem, the case of broken laminates and the case of a crack crossing the interface. A general formulation of the problem is given for plane strain and generalized plane stress cases by the use of Fourier Integral Transform Technique. The singular behavior around ends and at the bimaterial interfaces is studied. The resulting singular integral equations are solved numerically and the stress intensity factors are calculated for various crack geometries and various material combinations.

2. ELASTICITY OF AN ANISOTROPIC ELASTIC BODY

For an anisotropic elastic body, in the absence of body forces, the equations which relate the field quantities can be written as follows:

2.1 The Equilibrium Equations

$$\begin{aligned} \frac{\partial \sigma_x}{\partial x} + \frac{\partial \tau_{xy}}{\partial y} + \frac{\partial \tau_{xz}}{\partial z} &= 0 \\ \frac{\partial \tau_{xy}}{\partial x} + \frac{\partial \sigma_y}{\partial y} + \frac{\partial \tau_{yz}}{\partial z} &= 0 \\ \frac{\partial \tau_{xz}}{\partial x} + \frac{\partial \tau_{yz}}{\partial y} + \frac{\partial \sigma_z}{\partial z} &= 0 \end{aligned} \quad (2.1)$$

2.2 Strain-Displacement Relations

$$\begin{aligned} \epsilon_x &= \frac{\partial u}{\partial x}, \quad \epsilon_y = \frac{\partial v}{\partial y}, \quad \epsilon_z = \frac{\partial w}{\partial z} \\ \gamma_{yz} &= \frac{\partial v}{\partial z} + \frac{\partial w}{\partial y}, \quad \gamma_{xz} = \frac{\partial w}{\partial x} + \frac{\partial u}{\partial z}, \quad \gamma_{xy} = \frac{\partial u}{\partial y} + \frac{\partial v}{\partial x} \end{aligned} \quad (2.2)$$

2.3 Stress-Strain Relations

$$\begin{bmatrix} \sigma_x \\ \sigma_y \\ \sigma_z \\ \tau_{yz} \\ \tau_{xz} \\ \tau_{xy} \end{bmatrix} = [A_{ij}] \begin{bmatrix} \epsilon_x \\ \epsilon_y \\ \epsilon_z \\ \gamma_{yz} \\ \gamma_{xz} \\ \gamma_{xy} \end{bmatrix}, \quad \begin{aligned} i, j &= 1, 6 \\ A_{ij} &= A_{ji} \end{aligned} \quad (2.3)$$

ORIGINAL PAGE IS
OF POOR QUALITY

2.4 The Field Equations for an Orthotropic Body

For an orthotropic solid the matrix $[A_{ij}]$ is:

$$[A_{ij}] = \begin{bmatrix} A_{11} & A_{12} & A_{13} & 0 & 0 & 0 \\ A_{12} & A_{22} & A_{23} & 0 & 0 & 0 \\ A_{13} & A_{23} & A_{33} & 0 & 0 & 0 \\ 0 & 0 & 0 & A_{44} & 0 & 0 \\ 0 & 0 & 0 & 0 & A_{55} & 0 \\ 0 & 0 & 0 & 0 & 0 & A_{66} \end{bmatrix} \quad (2.4)$$

Defining the inverse of $[A_{ij}]$ by

$$[a_{ij}] = [A_{ij}]^{-1}$$

for orthotropic materials we have:

$$[a_{ij}] = \begin{bmatrix} \frac{1}{E_x} & -\frac{\nu_{yx}}{E_y} & -\frac{\nu_{zx}}{E_z} & 0 & 0 & 0 \\ -\frac{\nu_{xy}}{E_x} & \frac{1}{E_y} & -\frac{\nu_{zy}}{E_z} & 0 & 0 & 0 \\ -\frac{\nu_{xz}}{E_x} & -\frac{\nu_{yz}}{E_y} & \frac{1}{E_z} & 0 & 0 & 0 \\ 0 & 0 & 0 & \frac{1}{G_{yz}} & 0 & 0 \\ 0 & 0 & 0 & 0 & \frac{1}{G_{xz}} & 0 \\ 0 & 0 & 0 & 0 & 0 & \frac{1}{G_{xy}} \end{bmatrix}$$

$$E_x \nu_{yx} = E_y \nu_{xy} \quad , \quad E_y \nu_{zy} = E_z \nu_{yz} \quad , \quad E_z \nu_{xz} = E_x \nu_{zx} \quad (2.5)$$

Substituting (2.2) into (2.3) and using (2.1) and (2.4), the stresses and the equilibrium equations can be expressed in terms of the displacements as follows:

$$\begin{aligned}
 \sigma_x &= A_{11} \frac{\partial u}{\partial x} + A_{12} \frac{\partial v}{\partial y} + A_{13} \frac{\partial w}{\partial z} \\
 \sigma_y &= A_{12} \frac{\partial u}{\partial x} + A_{22} \frac{\partial v}{\partial y} + A_{23} \frac{\partial w}{\partial z} \\
 \sigma_z &= A_{13} \frac{\partial u}{\partial x} + A_{23} \frac{\partial v}{\partial y} + A_{33} \frac{\partial w}{\partial z} \\
 \tau_{yz} &= A_{44} \left(\frac{\partial v}{\partial z} + \frac{\partial w}{\partial y} \right) \\
 \tau_{xz} &= A_{55} \left(\frac{\partial w}{\partial x} + \frac{\partial u}{\partial z} \right) \\
 \tau_{xy} &= A_{66} \left(\frac{\partial u}{\partial y} + \frac{\partial v}{\partial x} \right)
 \end{aligned} \tag{2.6}$$

$$\begin{aligned}
 A_{11} \frac{\partial^2 u}{\partial x^2} + A_{66} \frac{\partial^2 u}{\partial y^2} + A_{55} \frac{\partial^2 u}{\partial z^2} + (A_{12} + A_{66}) \frac{\partial^2 v}{\partial x \partial y} + (A_{13} + A_{55}) \frac{\partial^2 w}{\partial x \partial z} &= 0 \\
 A_{66} \frac{\partial^2 v}{\partial x^2} + A_{22} \frac{\partial^2 v}{\partial y^2} + A_{44} \frac{\partial^2 v}{\partial z^2} + (A_{12} + A_{66}) \frac{\partial^2 u}{\partial x \partial y} + (A_{23} + A_{44}) \frac{\partial^2 w}{\partial y \partial z} &= 0 \\
 A_{55} \frac{\partial^2 w}{\partial x^2} + A_{44} \frac{\partial^2 w}{\partial y^2} + A_{33} \frac{\partial^2 w}{\partial z^2} + (A_{13} + A_{55}) \frac{\partial^2 u}{\partial x \partial z} + (A_{23} + A_{44}) \frac{\partial^2 v}{\partial y \partial z} &= 0
 \end{aligned} \tag{2.7}$$

2.4.1 Case of Plane Strain

For the plane strain case we have:

$$u = u(x, y) \quad , \quad v = v(x, y) \quad , \quad w = 0 \tag{2.8}$$

and from (2.2),

$$\begin{aligned}\epsilon_x &= \frac{\partial u}{\partial x}, \quad \epsilon_y = \frac{\partial v}{\partial y}, \quad \gamma_{xy} = \frac{\partial u}{\partial y} + \frac{\partial v}{\partial x} \\ \epsilon_z &= 0, \quad \gamma_{yz} = 0, \quad \gamma_{xz} = 0\end{aligned}\quad (2.9)$$

Thus, the stress-displacement relations and the equilibrium equations become:

$$\begin{aligned}\sigma_x &= A_{11} \frac{\partial u}{\partial x} + A_{12} \frac{\partial v}{\partial y} \\ \sigma_y &= A_{12} \frac{\partial u}{\partial x} + A_{22} \frac{\partial v}{\partial y} \\ \sigma_z &= A_{13} \frac{\partial u}{\partial x} + A_{23} \frac{\partial v}{\partial y} \\ \tau_{xy} &= A_{66} \left(\frac{\partial u}{\partial y} + \frac{\partial v}{\partial x} \right) \\ \tau_{yz} &= \tau_{xz} = 0\end{aligned}\quad (2.10)$$

$$\begin{aligned}A_{11} \frac{\partial^2 u}{\partial x^2} + A_{66} \frac{\partial^2 u}{\partial y^2} + (A_{12} + A_{66}) \frac{\partial^2 v}{\partial x \partial y} &= 0 \\ A_{66} \frac{\partial^2 v}{\partial x^2} + A_{22} \frac{\partial^2 v}{\partial y^2} + (A_{12} + A_{66}) \frac{\partial^2 u}{\partial x \partial y} &= 0\end{aligned}\quad (2.11)$$

2.4.2 Case of Generalized Plane Stress

In this case since $\sigma_z = \tau_{xz} = \tau_{yz} = 0$ from (2.3), for the average stresses and strains we can write:

$$\begin{bmatrix} \epsilon_x \\ \epsilon_y \\ \gamma_{xy} \end{bmatrix} = [\bar{a}] \begin{bmatrix} \sigma_x \\ \sigma_y \\ \tau_{xy} \end{bmatrix}$$

where

$$[\bar{a}] = \begin{bmatrix} \frac{1}{E_x} & -\frac{\nu_{yx}}{E_y} & 0 \\ -\frac{\nu_{xy}}{E_x} & \frac{1}{E_y} & 0 \\ 0 & 0 & \frac{1}{G_{xy}} \end{bmatrix}, \quad [\bar{A}] = \begin{bmatrix} \frac{1}{E_y \cdot \Delta} & \frac{\nu_{yx}}{E_y \cdot \Delta} & 0 \\ \frac{\nu_{xy}}{E_x \cdot \Delta} & \frac{1}{E_x \cdot \Delta} & 0 \\ 0 & 0 & G_{xy} \end{bmatrix},$$

$$\text{and } \Delta = \frac{1}{E_x \cdot E_y} (1 - \nu_{xy} \nu_{yx}). \quad (2.12)$$

The equilibrium equations reduce to:

$$\begin{aligned} \bar{A}_{11} \frac{\partial^2 u}{\partial x^2} + \bar{A}_{33} \frac{\partial^2 u}{\partial y^2} + (\bar{A}_{12} + \bar{A}_{33}) \frac{\partial^2 v}{\partial x \partial y} &= 0 \\ \bar{A}_{33} \frac{\partial^2 v}{\partial x^2} + \bar{A}_{22} \frac{\partial^2 v}{\partial y^2} + (\bar{A}_{12} + \bar{A}_{33}) \frac{\partial^2 u}{\partial x \partial y} &= 0 \end{aligned} \quad (2.13)$$

Considering the structure of equations (2.11) and (2.13), the equilibrium equations can be written for plane strain and generalized plane stress cases in the following form:

ORIGINAL PAGE IS OF POOR QUALITY

$$\begin{aligned} \beta_1 \frac{\partial^2 u}{\partial x^2} + \frac{\partial^2 u}{\partial y^2} + \beta_3 \frac{\partial^2 v}{\partial y \partial x} &= 0 \\ \frac{\partial^2 v}{\partial x^2} + \beta_2 \frac{\partial^2 v}{\partial y^2} + \beta_3 \frac{\partial^2 u}{\partial x \partial y} &= 0 \end{aligned} \quad (2.14)$$

where

$$\beta_1 = \frac{A_{11}}{A_{66}}, \quad \beta_2 = \frac{A_{22}}{A_{66}}, \quad \beta_3 = 1 + \frac{A_{12}}{A_{66}} \quad \text{for plane strain}$$

and

$$\beta_1 = \frac{\bar{A}_{11}}{\bar{A}_{33}}, \quad \beta_2 = \frac{\bar{A}_{22}}{\bar{A}_{33}}, \quad \beta_3 = 1 + \frac{\bar{A}_{12}}{\bar{A}_{33}} \quad \text{for plane stress.} \quad (2.15)$$

3. DISPLACEMENT AND STRESS FIELDS FOR STRIPS

The two-dimensional composite medium is formed of two sets of periodically arranged strips having widths $2h_1$ and $2h_2$ as shown in Figure 1. They are perfectly bonded along their straight boundaries, and contain symmetrically located cracks normal to the interfaces, of length $2a$ and $2b$ respectively. The load is applied away from the crack region, such that the crack plane is a plane of symmetry.

Using the usual superposition technique, the solution of the actual traction-free crack problem may be obtained by superposing the homogeneous uncracked strip solution to the solution of a cracked strip loaded with self-equilibrating crack surface tractions (see Figure 2). Since we are interested only in the computation of stress intensity factors and the singular behavior of the stresses around crack ends, we will consider only the singular part of the solution, where the self-equilibrating crack tractions are the only external forces.

First we will find solutions to (2.14) satisfying certain boundary conditions of the strips. The combination of these solutions will be forced to satisfy the remaining boundary and continuity conditions.

3.1 Solutions $u^{(a)}(x,y), v^{(a)}(x,y)$

Assume:

$$\begin{aligned} u^{(a)}(x,y) &= \frac{2}{\pi} \int_0^{\infty} f(\alpha,x) \cos \alpha y \, d\alpha \\ v^{(a)}(x,y) &= \frac{2}{\pi} \int_0^{\infty} g(\alpha,x) \sin \alpha y \, d\alpha \end{aligned} \quad (3.1)$$

Substituting (3.1) into (2.14) we obtain:

$$\begin{aligned} \beta_1 \frac{d^2 f}{dx^2} - \alpha^2 f + \beta_3 \alpha \frac{dg}{dx} &= 0 \\ \frac{d^2 g}{dx^2} - \beta_2 \alpha^2 g - \beta_3 \alpha \frac{df}{dx} &= 0 \end{aligned} \quad (3.2)$$

The solution of (3.2) can be written as:

$$\begin{aligned} f(\alpha,x) &= A(\alpha)e^{s_1 \alpha x} + B(\alpha)e^{-s_1 \alpha x} + C(\alpha)e^{s_2 \alpha x} + D(\alpha)e^{-s_2 \alpha x} \\ g(\alpha,x) &= \beta_7 \left[A(\alpha)e^{s_1 \alpha x} - B(\alpha)e^{-s_1 \alpha x} \right] + \beta_8 \left[C(\alpha)e^{s_2 \alpha x} \right. \\ &\quad \left. - D(\alpha)e^{-s_2 \alpha x} \right] \end{aligned} \quad (3.3)$$

where s_1 and s_2 are the roots of

$$s^4 + \beta_4 s^2 + \beta_5 = 0 \quad (3.4)$$

and

$$\begin{aligned} \beta_4 &= \frac{\beta_3^2 - \beta_1 \beta_2 - 1}{\beta_1}, \quad \beta_5 = \frac{\beta_2}{\beta_1}, \quad \beta_6 = \sqrt{\beta_4^2 - 4\beta_5}, \\ \beta_7 &= \frac{1 - \beta_1 s_1^2}{\beta_3 s_1}, \quad \beta_8 = \frac{1 - \beta_1 s_2^2}{\beta_3 s_2} \end{aligned}$$

From (3.4) we can write :

$$\begin{aligned}
 s_1 &= w_1 + iw_2 = \sqrt{(-\beta_4 + \beta_6)/2} \\
 s_2 &= w_3 + iw_4 = \sqrt{(-\beta_4 - \beta_6)/2} \\
 s_3 &= -s_1 \quad , \quad s_4 = -s_2
 \end{aligned}
 \tag{3.5}$$

s_1 and s_2 are both real or complex conjugates.

3.2 Solutions $u^{(b)}(x,y)$, $v^{(b)}(x,y)$

Assume:

$$\begin{aligned}
 u^{(b)}(x,y) &= \frac{2}{\pi} \int_0^{\infty} h(\alpha,y) \sin \alpha x \, d\alpha \\
 v^{(b)}(x,y) &= \frac{2}{\pi} \int_0^{\infty} \ell(\alpha,y) \cos \alpha x \, d\alpha
 \end{aligned}
 \tag{3.6}$$

Substituting (3.6) into (2.14) we have:

$$\begin{aligned}
 \frac{d^2 h}{dy^2} - \beta_3 \alpha \frac{d\ell}{dy} - \beta_1 \alpha^2 h &= 0 \\
 \beta_2 \frac{d^2 \ell}{dy^2} + \beta_3 \alpha \frac{dh}{dy} - \alpha^2 \ell &= 0
 \end{aligned}
 \tag{3.7}$$

Solving (3.7) we obtain:

$$\begin{aligned}
 h(\alpha,y) &= E(\alpha)e^{s_1 \alpha y / \sqrt{\beta_5}} + F(\alpha)e^{-s_1 \alpha y / \sqrt{\beta_5}} \\
 &\quad + G(\alpha)e^{s_2 \alpha y / \sqrt{\beta_5}} + H(\alpha)e^{-s_2 \alpha y / \sqrt{\beta_5}} \quad ,
 \end{aligned}$$

and

$$\ell(\alpha,y) = \beta_9 \left(E(\alpha)e^{s_1 \alpha y / \sqrt{\beta_5}} - F(\alpha)e^{-s_1 \alpha y / \sqrt{\beta_5}} \right)$$

$$+ \beta_{10} \left(G(\alpha) e^{s_2 \alpha y / \sqrt{\beta_5}} - H(\alpha) e^{-s_2 \alpha y / \sqrt{\beta_5}} \right)$$

where

$$\begin{aligned} \beta_9 &= \frac{1}{\beta_3} \left[-\frac{\beta_1 \sqrt{\beta_5}}{s_1} + \frac{s_1}{\sqrt{\beta_5}} \right] , \\ \beta_{10} &= \frac{1}{\beta_3} \left[-\frac{\beta_1 \sqrt{\beta_5}}{s_2} + \frac{s_2}{\sqrt{\beta_5}} \right] \end{aligned} \quad (3.8)$$

A superscript * will be used for the material constants and unknown functions when the above expressions are used for the second strip.

If one examines the roots of equation (3.4), he will realize that there are two types of orthotropic materials. We will denote the material as type I when s_1 and s_2 are real, and as type II when they are complex conjugates. We will assume, in our analysis, that the materials of both strips are of type I. Similar analysis can be done for the remaining combinations.

3.3 The Displacements

For each strip, we can write:

$$\begin{aligned} u(x,y) &= u^{(a)}(x,y) + u^{(b)}(x,y) \\ v(x,y) &= v^{(a)}(x,y) + v^{(b)}(x,y) . \end{aligned}$$

Noting that;

$$u(x,y) = -u(-x,y) \text{ and } v(x,y) = -v(x,-y)$$

we will obtain:

$$B(\alpha) = -A(\alpha), D(\alpha) = -C(\alpha), F(\alpha) = -E(\alpha), H(\alpha) = -G(\alpha).$$

For material type I;

$$s_1 = w_1, \quad s_2 = w_3 \text{ and } \beta_6, \beta_7, \beta_8, \beta_9, \beta_{10} \text{ are real.}$$

Using the information given above, and keeping in mind that u and v vanish when y goes to infinity, for $y > 0$, the displacement expressions can be written as follows:

$$\begin{aligned} u(x,y) &= \frac{4}{\pi} \int_0^{\infty} [A(\alpha) \sinh(w_1 \alpha x) + C(\alpha) \sinh(w_3 \alpha x)] \cos \alpha y \, d\alpha \\ &\quad + \frac{2}{\pi} \int_0^{\infty} \left[E(\alpha) e^{-|w_1| \alpha y / \sqrt{\beta_5}} + G(\alpha) e^{-|w_3| \alpha y / \sqrt{\beta_5}} \right] \sin \alpha x \, d\alpha \\ v(x,y) &= \frac{4}{\pi} \int_0^{\infty} [\beta_7 A(\alpha) \cosh(w_1 \alpha x) + \beta_8 C(\alpha) \cosh(w_3 \alpha x)] \sin \alpha y \, d\alpha \\ &\quad - \frac{2}{\pi} \int_0^{\infty} \left[\text{sign}(w_1) \beta_9 E(\alpha) e^{-|w_1| \alpha y / \sqrt{\beta_5}} + \text{sign}(w_3) G(\alpha) \beta_{10} e^{-|w_3| \alpha y / \sqrt{\beta_5}} \right] \\ &\quad \cdot \cos \alpha x \, d\alpha \end{aligned} \quad (3.9)$$

3.4 The stresses

For generalized plane stress case:

$$\begin{aligned} \sigma_x &= \bar{A}_{11} \epsilon_x + \bar{A}_{12} \epsilon_y \\ \sigma_y &= \bar{A}_{12} \epsilon_x + \bar{A}_{22} \epsilon_y \\ \tau_{xy} &= \bar{A}_{33} \gamma_{xy} \end{aligned} \quad (3.10)$$

Differentiating (3.9) and using (2.12) and (3.10), the stress expressions can be written as:

$$\frac{\pi(1-\nu_{xy}\nu_{yx})}{2E_x} \sigma_x(x,y) = \int_0^\infty \left[\gamma_1 E(\alpha) e^{-|w_1|\alpha y/\sqrt{\beta_5}} + \gamma_2 G(\alpha) \right. \\ \left. e^{-|w_3|\alpha y/\sqrt{\beta_5}} \right] \alpha \cos \alpha x \, d\alpha + \int_0^\infty [2\gamma_3 A(\alpha) \cosh(w_1 \alpha x) + 2\gamma_4 C(\alpha) \cdot$$

$$\cdot \cosh(w_3 \alpha x)] \alpha \cos \alpha y \, d\alpha$$

$$\frac{\pi(1-\nu_{xy}\nu_{yx})}{2E_y} \sigma_y(x,y) = \int_0^\infty \left[\gamma_5 E(\alpha) e^{-|w_1|\alpha y/\sqrt{\beta_5}} + \gamma_6 G(\alpha) \right. \\ \left. e^{-|w_3|\alpha y/\sqrt{\beta_5}} \right] \alpha \cos \alpha x \, d\alpha + \int_0^\infty [2\gamma_7 A(\alpha) \cosh(w_1 \alpha x) + 2\gamma_8 C(\alpha) \cdot$$

$$\cdot \cosh(w_3 \alpha x)] \alpha \cos \alpha y \, d\alpha$$

$$\frac{\pi}{2G_{xy}} \tau_{xy}(x,y) = \int_0^\infty [2\gamma_9 A(\alpha) \sinh(w_1 \alpha x) + 2\gamma_{10} C(\alpha) \cdot \\ \cdot \sinh(w_3 \alpha x)] \alpha \sin \alpha y \, d\alpha + \int_0^\infty \left[\gamma_{11} E(\alpha) e^{-|w_1|\alpha y/\sqrt{\beta_5}} \right. \\ \left. + \gamma_{12} G(\alpha) e^{-|w_3|\alpha y/\sqrt{\beta_5}} \right] \alpha \sin \alpha x \, d\alpha \quad (3.11)$$

These expressions are valid also for the plane strain case with the following substitutions:

$$\nu_{yx} = A_{12}/A_{11} \quad , \quad \nu_{xy} = A_{12}/A_{22} \quad , \quad (E_y \cdot \Delta) = 1/A_{11} \quad , \\ (E_x \cdot \Delta) = 1/A_{22} \quad .$$

The elastic material constants γ_j are defined in Appendix A.

4. FORMULATION OF THE PROBLEM

The solution of the problem may be obtained by determining the unknown functions which appear in the displacement and stress expressions, under the following boundary and continuity conditions:

$$\begin{aligned}u_1(h_1, y) &= u_2(-h_2, y) \quad , \\v_1(h_1, y) &= v_2(-h_2, y) \quad (0 \leq y < \infty) \quad (4.1a, b)\end{aligned}$$

$$\begin{aligned}\sigma_{1x}(h_1, y) &= \sigma_{2x}(-h_2, y) \quad , \\ \tau_{1xy}(h_1, y) &= \tau_{2xy}(-h_2, y) \quad (0 \leq y < \infty) \quad (4.2a, b)\end{aligned}$$

$$u_1(0, y) = 0 \quad , \quad \tau_{1xy}(0, y) = 0 \quad (0 \leq y < \infty) \quad (4.3a, b)$$

$$u_2(0, y) = 0 \quad , \quad \tau_{2xy}(0, y) = 0 \quad (0 \leq y < \infty) \quad (4.4a, b)$$

$$\begin{aligned}\tau_{1xy}(x_1, 0) &= 0 \quad , \quad |x_1| < h_1 \quad , \\ \tau_{2xy}(x_2, 0) &= 0 \quad , \quad |x_2| < h_2 \quad (4.5a, b)\end{aligned}$$

$$\begin{aligned}\sigma_{1y}(x_1, 0) &= -p_1(x_1) \quad , \quad |x_1| < a \quad , \\ v_1(x_1, 0) &= 0 \quad , \quad a < |x_1| < h_1 \quad (4.6a, b)\end{aligned}$$

$$\begin{aligned}\sigma_{2y}(x_2, 0) &= -p_2(x_2) \quad , \quad |x_2| < b \quad , \\ v_2(x_2, 0) &= 0 \quad , \quad b < |x_2| < h_2 \quad (4.7a, b)\end{aligned}$$

The conditions (4.3a,b) and (4.4a,b) are satisfied identically.

Using (4.5a,b) we obtain:

$$G(\alpha) = -\frac{\gamma_{11}}{\gamma_{12}} E(\alpha) \quad , \quad G^*(\alpha) = -\frac{\gamma_{11}^*}{\gamma_{12}^*} E^*(\alpha)$$

The mixed condition (4.6) gives:

$$\begin{aligned} \lim_{y \rightarrow 0^+} \int_0^\infty E(\alpha) \left[\gamma_5 e^{-|w_1| \alpha y / \sqrt{\beta_5}} - \gamma_6 \frac{\gamma_{11}}{\gamma_{12}} e^{-|w_3| \alpha y / \sqrt{\beta_5}} \right] \alpha \cos \alpha x_1 da \\ + \int_0^\infty [2\gamma_7 A(\alpha) \cosh(w_1 \alpha x_1) + 2\gamma_8 C(\alpha) \cosh(w_3 \alpha x_1)] \alpha \cos \alpha y da \\ = -\frac{\pi(1-\nu_{xy}\nu_{yx})}{2E_y} p_1(x_1) \quad , \quad |x_1| < a \end{aligned} \quad (4.8a)$$

and

$$v_1(x_1, 0) = -\frac{2}{\pi} \gamma_{13} \int_0^\infty E(\alpha) \cos \alpha x_1 d\alpha = 0 \quad a < |x_1| < h_1 \quad (4.8b)$$

Define,

$$\frac{\partial v_1(x_1, 0)}{\partial x_1} = \phi(x_1) \quad \text{such that } \phi(x_1) = 0 \quad \text{for } |x_1| > a. \quad (4.9)$$

Differentiating (4.8b) with respect to x_1 and taking the inverse transform, we obtain:

$$\gamma_{13} \alpha E(\alpha) = \int_0^a \phi(x_1) \sin \alpha x_1 dx_1 \quad . \quad (4.10)$$

If we now substitute (4.10) into (4.8a) and evaluate some of the integrals in closed form (see Appendix C) we will end up with the following singular integral equation:

$$\begin{aligned} \gamma_{14} \int_{-a}^a \frac{\phi(t)}{t-x_1} dt + \int_0^{\infty} [2\gamma_7 A(\alpha) \cosh(w_1 \alpha x_1) + 2\gamma_8 C(\alpha) \cosh(w_3 \alpha x_1)] \alpha d\alpha \\ = - \frac{\pi(1-\nu_{xy} \nu_{yx})}{2E_y} p_1(x_1) \quad -a < x_1 < a \end{aligned} \quad (4.11)$$

where because of symmetry $\phi(t) = -\phi(-t)$.

Similarly defining,

$$\frac{\partial v_2(x_2, 0)}{\partial x_2} = \phi^*(x_2) \text{ such that } \phi^*(x_2) = 0 \text{ for } |x_2| > b \quad (4.12)$$

and using the mixed condition (4.7) by the same procedure we obtain:

$$\begin{aligned} \gamma_{14}^* \int_{-b}^b \frac{\phi^*(t)}{t-x_2} dt + \int_0^{\infty} [2\gamma_7^* A^*(\alpha) \cosh(w_1^* \alpha x_2) + 2\gamma_8^* C^*(\alpha) \cosh(w_3^* \alpha x_2)] \alpha d\alpha \\ = - \frac{\pi(1-\nu_{xy}^* \nu_{yx}^*)}{2E_y^*} p_2(x_2) \quad -b < x_2 < b \end{aligned} \quad (4.13)$$

The next step is to determine the unknown functions $A(\alpha)$, $C(\alpha)$, $A^*(\alpha)$, $C^*(\alpha)$. This can be done by using the continuity conditions (4.1a,b) and (4.2a,b) and taking the inverse transforms. Then we obtain the following system of linear equations:

$$\begin{aligned} 2A(\alpha) \sinh(w_1 \alpha h_1) + 2C(\alpha) \sinh(w_3 \alpha h_1) \\ + 2A^*(\alpha) \sinh(w_1^* \alpha h_2) + 2C^*(\alpha) \sinh(w_3^* \alpha h_2) = R_1(\alpha) \\ 2\beta_7 A(\alpha) \cosh(w_1 \alpha h_1) + 2\beta_8 C(\alpha) \cosh(w_3 \alpha h_1) \\ - 2\beta_7^* A^*(\alpha) \cosh(w_1^* \alpha h_2) - 2\beta_8^* C^*(\alpha) \cosh(w_3^* \alpha h_2) = R_2(\alpha) \end{aligned}$$

$$\begin{aligned}
& 2\gamma_3 A(\alpha) \cosh(w_1 \alpha h_1) + 2\gamma_4 C(\alpha) \cosh(w_3 \alpha h_1) \\
& - 2\lambda_1 \gamma_3^* A^*(\alpha) \cosh(w_1^* \alpha h_2) - 2\lambda_1 \gamma_4^* C^*(\alpha) \cosh(w_3^* \alpha h_2) = R_3(\alpha) \\
& 2\gamma_9 A(\alpha) \sinh(w_1 \alpha h_1) + 2\gamma_{10} C(\alpha) \sinh(w_3 \alpha h_1) \\
& + 2\gamma_9^* \lambda_2 A^*(\alpha) \sinh(w_1^* \alpha h_2) + 2\gamma_{10}^* \lambda_2 C^*(\alpha) \sinh(w_3^* \alpha h_2) = R_4(\alpha)
\end{aligned} \tag{4.14}$$

$R_i(\alpha)$ and λ_j are defined in Appendices B and A respectively.
Solving (4.14) we obtain:

$$\begin{aligned}
A(\alpha) &= \frac{1}{2 \cosh(w_1 \alpha h_1)} \left[\frac{R_1(\alpha)}{f(\alpha)} g_2(\alpha) + \frac{R_2(\alpha)}{f(\alpha)} h_2(\alpha) \right. \\
&\quad \left. + \frac{R_3(\alpha)}{f(\alpha)} m_2(\alpha) + \frac{R_4(\alpha)}{f(\alpha)} n_2(\alpha) \right] \\
C(\alpha) &= \frac{1}{2 \cosh(w_3 \alpha h_1)} \left[\frac{R_1(\alpha)}{f(\alpha)} g_1(\alpha) + \frac{R_2(\alpha)}{f(\alpha)} h_1(\alpha) \right. \\
&\quad \left. + \frac{R_3(\alpha)}{f(\alpha)} m_1(\alpha) + \frac{R_4(\alpha)}{f(\alpha)} n_1(\alpha) \right] \\
A^*(\alpha) &= \frac{1}{2 \cosh(w_1^* \alpha h_2)} \left[\frac{R_1(\alpha)}{f(\alpha)} g_0(\alpha) + \frac{R_2(\alpha)}{f(\alpha)} h_0(\alpha) \right. \\
&\quad \left. + \frac{R_3(\alpha)}{f(\alpha)} m_0(\alpha) + \frac{R_4(\alpha)}{f(\alpha)} n_0(\alpha) \right] \\
C^*(\alpha) &= \frac{1}{2 \cosh(w_3^* \alpha h_2)} \left[\frac{R_1(\alpha)}{f(\alpha)} g(\alpha) + \frac{R_2(\alpha)}{f(\alpha)} h(\alpha) \right. \\
&\quad \left. + \frac{R_3(\alpha)}{f(\alpha)} m(\alpha) + \frac{R_4(\alpha)}{f(\alpha)} n(\alpha) \right]
\end{aligned} \tag{4.15}$$

The functions $f(\alpha)$, $g(\alpha)$ etc., used above are given in Appendix B.

Substituting (4.15) into (4.11) and (4.13) we obtain the following system of singular integral equations:

$$\begin{aligned} \frac{1}{\pi} \int_{-a}^a \frac{\phi(t)}{t-x_1} dt + \int_{-a}^a k_{11}(x_1, t) \phi(t) dt \\ + \int_{-b}^b k_{12}(x_1, t) \phi^*(t) dt = - \frac{(1-\nu_{xy} \nu_{yx})}{2\gamma_{14} E_y} p_1(x_1) \\ - a < x_1 < a \end{aligned}$$

$$\begin{aligned} \frac{1}{\pi} \int_{-b}^b \frac{\phi^*(t)}{t-x_2} dt + \int_{-a}^a k_{21}(x_2, t) \phi(t) dt \\ + \int_{-b}^b k_{22}(x_2, t) \phi^*(t) dt = - \frac{(1-\nu_{xy}^* \nu_{yx}^*)}{2\gamma_{14}^* E_y^*} p_2(x_2) \\ - b < x_2 < b \end{aligned} \quad (4.16a, b)$$

where

$$\begin{aligned} k_{11}(x_1, t) &= \frac{1}{\pi\gamma_{14}} \int_0^\infty \left[k_1(x_1, \alpha) e^{-(h_1-t)\alpha\sqrt{\beta_5}/|w_1|} \right. \\ &\quad \left. + k_2(x_1, \alpha) e^{-(h_1-t)\alpha\sqrt{\beta_5}/|w_3|} \right] d\alpha \\ k_{12}(x_1, t) &= \frac{1}{\pi\gamma_{14}} \int_0^\infty \left[k_3(x_1, \alpha) e^{-(h_2-t)\alpha\sqrt{\beta_5^*}/|w_1^*|} \right. \\ &\quad \left. + k_4(x_1, \alpha) e^{-(h_2-t)\alpha\sqrt{\beta_5^*}/|w_3^*|} \right] d\alpha \end{aligned}$$

$$\begin{aligned}
k_{21}(x_2, t) &= \frac{1}{\pi\gamma_{14}^*} \int_0^\infty \left[k_5(x_2, \alpha) e^{-(h_1-t)\alpha\sqrt{\beta_5}/|w_1|} \right. \\
&\quad \left. + k_6(x_2, \alpha) e^{-(h_1-t)\alpha\sqrt{\beta_5}/|w_3|} \right] d\alpha \\
k_{22}(x_2, t) &= \frac{1}{\pi\gamma_{14}^*} \int_0^\infty \left[k_7(x_2, \alpha) e^{-(h_2-t)\alpha\sqrt{\beta_5^*}/|w_1^*|} \right. \\
&\quad \left. + k_8(x_2, \alpha) e^{-(h_2-t)\alpha\sqrt{\beta_5^*}/|w_3^*|} \right] d\alpha \tag{4.17}
\end{aligned}$$

The expressions k_j ($j = 1, 8$) are given in Appendix B.

By letting $h_2 \rightarrow \infty$ (or $h_1 \rightarrow \infty$) one can recover the special case studied in [5]. For $a < h_1$ and $b < h_2$, the integrands of kernels k_{ij} ($i, j = 1, 2$) vanish when $\alpha \rightarrow \infty$ and are bounded for all values of α , except when $\alpha = 0$.

Around $\alpha = 0$ the asymptotic behavior of the integrands I_{ij} of the kernels k_{ij} is of the following form:

$$I_{ij}(\alpha) = \frac{c_{ij}}{\alpha} + o(1) \quad (i, j = 1, 2) \tag{4.18}$$

where the c_{ij} 's are known constants. In order to obtain a solution, one should show that the singularity due to $1/\alpha$ is removable. Consider the following integral:

$$\int_{-a}^a \phi(t) dt \int_0^\infty I_{11}(x_1, t, \alpha) d\alpha = \int_{-a}^a \phi(t) dt \left[\int_0^\epsilon I_{11}(x_1, t, \alpha) d\alpha \right. \\
\left. + \int_\epsilon^\infty I_{11}(x_1, t, \alpha) d\alpha \right]$$

ORIGINAL PAGE IS
OF POOR QUALITY

where ϵ is a positive small number. Using (4.18) for the first part of the integral, we obtain:

$$\int_{-a}^a k_{11}(x_1, t) \phi(t) dt = \int_{-a}^a \phi(t) dt \left[\int_0^\epsilon \frac{c_{11}}{\alpha} d\alpha + \int_0^\epsilon 0(1) d\alpha + \int_\epsilon^\infty I_{11}(x_1, t, \alpha) d\alpha \right].$$

Making use of the single-valuedness condition

$\int_{-a}^a \phi(t) dt = 0$, the unbounded integral $\int_0^\epsilon \frac{c_{11}}{\alpha} d\alpha$ drops out, leaving only bounded integrals which can be evaluated numerically. Using $\int_{-b}^b \phi^*(t) dt = 0$ for the second crack, similarly one can show that the singularity due to $1/\alpha$ cancels in all the integrands I_{ij} .

5. CASE OF BROKEN LAMINATES

This is the case when one of the cracks touches the interfaces (i.e., $a = h_1$, or $b = h_2$). The integral equations (4.16a,b) are still valid but some of the kernels k_{ij} are no longer bounded. For example for $a = h_1$ k_{12} , k_{21} , k_{22} are bounded but k_{11} becomes unbounded as x_1 and t approach the ends $\pm h_1$ simultaneously. In this case the integrand I_{11} of k_{11} diverges as $\alpha \rightarrow \infty$.

In order to obtain the proper singularity at the crack tips and to compute k_{11} numerically, the singular part, k_{11s} , should be evaluated in closed form. In this case, the kernel k_{11} can be written as:

$$k_{11}(x_1, t) = k_{11s}(x_1, t) + k_{11f}(x_1, t)$$

where k_{11s} is the singular part and k_{11f} is the bounded part of k_{11} .

Following the procedure described in [4] $k_{11s}(x_1, t)$ is obtained as follows:

$$\begin{aligned} \pi k_{11s}(x_1, t) = & \lambda_{85} \left\{ \frac{(h_1 - t)\sqrt{\beta_5}/|w_1| + |w_1|h_1}{[(h_1 - t)\sqrt{\beta_5}/|w_1| + |w_1|h_1]^2 - (w_1 x_1)^2} \right\} \\ & + \lambda_{86} \left\{ \frac{(h_1 - t)\sqrt{\beta_5}/|w_1| + |w_3|h_1}{[(h_1 - t)\sqrt{\beta_5}/|w_1| + |w_3|h_1]^2 - (w_3 x_1)^2} \right\} \\ & + \lambda_{87} \left\{ \frac{(h_1 - t)\sqrt{\beta_5}/|w_3| + |w_1|h_1}{[(h_1 - t)\sqrt{\beta_5}/|w_3| + |w_1|h_1]^2 - (w_1 x_1)^2} \right\} \end{aligned}$$

$$+ \lambda_{88} \left\{ \frac{(h_1-t)\sqrt{\beta_5}/|w_3| + |w_3|h_1}{[(h_1-t)\sqrt{\beta_5}/|w_3| + |w_3|h_1]^2 - (w_3x_1)^2} \right\}$$

$$- h_1 \leq x_1, t \leq h_1 \quad (5.1)$$

The governing singular integral equations become:

$$\frac{1}{\pi} \int_{-h_1}^{h_1} \left[\frac{1}{t-x_1} + \pi k_{11s}(x_1, t) \right] \phi(t) dt + \int_{-h_1}^{h_1} \left[k_{11}(x_1, t) - k_{11s}(x_1, t) \right] \phi(t) dt$$

$$+ \int_{-b}^b k_{12}(x_1, t) \phi^*(t) dt = - \frac{(1-\nu_{xy}\nu_{yx})}{2\gamma_{14}E_y} p_1(x_1) \quad -h_1 < x_1 < h_1$$

$$\frac{1}{\pi} \int_{-b}^b \frac{\phi^*(t)}{t-x_2} dt + \int_{-h_1}^{h_1} k_{21}(x_2, t) \phi(t) dt + \int_{-b}^b k_{22}(x_2, t) \phi^*(t) dt =$$

$$- \frac{(1-\nu_{xy}^*\nu_{yx}^*)}{2\gamma_{14}^*E_y^*} p_2(x_2) \quad -b < x_2 < b \quad (5.2a, b)$$

Since in the integral equation (5.2b) the only singular term is $\frac{1}{t-x_2}$, the power of singularity at the end of the internal crack in the second layer is still 1/2. But in (5.2a) we have further singular contribution from the kernel k_{11s} resulting in a power different than 1/2. To find this singularity power γ , we will again use the procedure described in reference [14]. Throwing all the bounded terms to the right hand side, the singular integral equation (5.2a) can be written as follows:

$$\frac{1}{\pi} \int_{-h_1}^{h_1} \left[\frac{1}{t-x_1} + \pi k_{11s}(x_1, t) \right] \phi(t) dt = P(x_1) \quad -h_1 < x_1 < h_1 \quad (5.3)$$

where $P(x_1)$ is a bounded function for all values of x_1 .

The unknown function $\phi(t)$ can be written as (see [14]):

$$\phi(t) = \frac{F(t)}{(h_1^2 - t^2)^\gamma} \quad (5.4)$$

where $F(t)$ is bounded and Hölder-continuous in the interval $|t| < h_1$, and $0 < \text{Re}(\gamma) < 1$.

Define the sectionally holomorphic function:

$$\psi(z) = \frac{1}{\pi} \int_{-h_1}^{h_1} \frac{\phi(t)}{t-z} dt = \frac{1}{\pi} \int_{-h_1}^{h_1} \frac{F(t)e^{i\pi\gamma}}{(t-h_1)^\gamma(t+h_1)^\gamma(t-z)} dt$$

Then,

$$\psi(z) = \frac{F(-h_1)e^{i\pi\gamma}}{(2h_1)^\gamma \sin\pi\gamma} \frac{1}{(z+h_1)^\gamma} - \frac{F(h_1)}{(2h_1)^\gamma \sin\pi\gamma} \frac{1}{(z-h_1)^\gamma} + \psi_0(z) \quad (5.5)$$

where

$$|\psi_0(z)| < \frac{C}{|z \pm h_1|^{\gamma_0}}, \quad \gamma_0 < \text{Re}(\gamma)$$

C and γ_0 are real constants.

Using (5.5), equation (5.3) takes the form:

$$\frac{F(-h_1)\cot\pi\gamma}{(2h_1)^\gamma(h_1+x_1)^\gamma} - \frac{F(h_1)\cot\pi\gamma}{(2h_1)^\gamma(h_1-x_1)^\gamma} + \frac{\lambda_{85}}{2} \frac{|w_1|}{\sqrt{\beta_5}} \frac{F(h_1)}{(2h_1)^\gamma \sin\pi\gamma \left(\frac{w_1^2}{\sqrt{\beta_5}}\right)^\gamma}$$

$$\begin{aligned}
& \left[\frac{1}{(h_1+x_1)^\gamma} + \frac{1}{(h_1-x_1)^\gamma} \right] + \frac{\lambda_{86} |w_1|}{2 \sqrt{\beta_5}} \frac{F(h_1)}{(2h_1)^\gamma \sin \pi \gamma} \left[\frac{|w_1| |w_3|}{\sqrt{\beta_5}} \right]^\gamma \\
& \left[\frac{1}{(h_1+x_1)^\gamma} + \frac{1}{(h_1-x_1)^\gamma} \right] \\
& + \frac{\lambda_{87} |w_3|}{2 \sqrt{\beta_5}} \frac{F(h_1)}{(2h_1)^\gamma \sin \pi \gamma} \left[\frac{|w_1| |w_3|}{\sqrt{\beta_5}} \right]^\gamma \left[\frac{1}{(h_1+x_1)^\gamma} + \frac{1}{(h_1-x_1)^\gamma} \right] \\
& + \frac{\lambda_{88} |w_3|}{2 \sqrt{\beta_5}} \frac{F(h_1)}{(2h_1)^\gamma \sin \pi \gamma} \left[\frac{w_3^2}{\sqrt{\beta_5}} \right]^\gamma \left[\frac{1}{(h_1+x_1)^\gamma} + \frac{1}{(h_1-x_1)^\gamma} \right] = P_1(x_1)
\end{aligned} \tag{5.6}$$

where because of symmetry $F(h_1) = -F(-h_1)$.

Multiplying both sides of (5.6) by $(h_1+x_1)^\gamma$ and letting $x_1 = -h_1$ we obtain the following characteristic equation:

$$\begin{aligned}
& -2 \cos \pi \gamma + \lambda_{85} \frac{|w_1|}{\sqrt{\beta_5}} \frac{1}{\left[\frac{w_1^2}{\sqrt{\beta_5}} \right]^\gamma} + \lambda_{86} \frac{|w_1|}{\sqrt{\beta_5}} \frac{1}{\left[\frac{|w_1| |w_3|}{\sqrt{\beta_5}} \right]^\gamma} \\
& + \lambda_{87} \frac{|w_3|}{\sqrt{\beta_5}} \frac{1}{\left[\frac{|w_1| |w_3|}{\sqrt{\beta_5}} \right]^\gamma} + \lambda_{88} \frac{|w_3|}{\sqrt{\beta_5}} \frac{1}{\left[\frac{w_3^2}{\sqrt{\beta_5}} \right]^\gamma} = 0
\end{aligned} \tag{5.7}$$

where λ_j 's are elastic constants defined in Appendix A.

This is the same equation found in [7]. Choosing the orthotropic elastic constants close to isotropic constants numerically we find the same singularity power computed in [6] and [9]. The characteristic equation (5.7) can be solved numerically to find γ . For practical orthotropic materials equation (5.7) has only one root between 0 and 1. To establish the dependence of γ on the material constants more accurately, a separate study of equation (5.7) is needed.

6. CASE OF A CRACK CROSSING THE INTERFACE

To formulate this problem we will start by using the crack configuration shown in Figure 3. In this case we have again an internal crack in the first layer, but two symmetrically located cracks in the second layer. Using the symmetry property of $\phi^*(t)$, we can write:

$$\int_{-b}^b k_{i2}(x_i, t) \phi^*(t) dt = \int_0^b [k_{i2}(x_i, t) - k_{i2}(x_i, -t)] \phi^*(t) dt \quad (i = 1, 2)$$

and

$$\int_{-b}^b \frac{\phi^*(t)}{t-x_2} dt = \int_0^b \left[\frac{1}{t-x_2} + \frac{1}{t+x_2} \right] \phi^*(t) dt \quad (6.1)$$

Therefore we can write the governing singular integral equations, by simply changing the limits of the integrals from $(0, b)$ to (c, d) in equations (4.16a, b). Thus, we obtain:

$$\begin{aligned} & \frac{1}{\pi} \int_{-a}^a \frac{\phi(t)}{t-x_1} dt + \int_{-a}^a k_{11}(x_1, t) \phi(t) dt \\ & \quad + \int_c^d [k_{12}(x_1, t) - k_{12}(x_1, -t)] \phi^*(t) dt \\ & \quad = - \frac{(1-\nu_{xy} \nu_{yx})}{2\gamma_{14} E_y} p_1(x_1) \quad - a < x_1 < a \\ & \frac{1}{\pi} \int_c^d \left[\frac{1}{t-x_2} + \frac{1}{t+x_2} \right] \phi^*(t) dt + \int_{-a}^a k_{21}(x_2, t) \phi(t) dt \end{aligned}$$

$$+ \int_c^d [k_{22}(x_2, t) - k_{22}(x_2, -t)] \phi^*(t) dt = - \frac{(1 - \nu_{xy}^* \nu_{yx}^*)}{2\gamma_{14}^* E_y^*} p_2(x_2)$$

$$c < x_2 < d \quad (6.2a, b)$$

By letting $a = h_1$ and $d = h_2$ we obtain the case of a crack crossing the interface. As in the previous case for $a = h_1$ and $d = h_2$ all the kernels k_{ij} become unbounded when x_1, t approach the ends $\pm h_1$ and x_2, t approach the end h_2 simultaneously. Therefore to study the singular behavior at the interface and to make the kernels numerically integrable, the singular parts of the kernels k_{ij} must be separated. The kernels can be written as:

$$k_{ij}(x_i, t) = k_{ij_s}(x_i, t) + k_{ij_f}(x_i, t)$$

where $k_{ij_s}(x_i, t)$ is the singular and $k_{ij_f}(x_i, t)$ is the bounded part. Following the same procedure used in the previous section the expressions of k_{ij_s} are found as follows:

$$\begin{aligned} \pi k_{11_s}(x_1, t) = & \lambda_{85} \left\{ \frac{(h_1 - t)\sqrt{\beta_5}/|w_1| + |w_1|h_1}{[(h_1 - t)\sqrt{\beta_5}/|w_1| + |w_1|h_1]^2 - (w_1 x_1)^2} \right\} \\ & + \lambda_{86} \left\{ \frac{(h_1 - t)\sqrt{\beta_5}/|w_1| + |w_3|h_1}{[(h_1 - t)\sqrt{\beta_5}/|w_1| + |w_3|h_1]^2 - (w_3 x_1)^2} \right\} \\ & + \lambda_{87} \left\{ \frac{(h_1 - t)\sqrt{\beta_5}/|w_3| + |w_1|h_1}{[(h_1 - t)\sqrt{\beta_5}/|w_3| + |w_1|h_1]^2 - (w_1 x_1)^2} \right\} \\ & + \lambda_{88} \left\{ \frac{(h_1 - t)\sqrt{\beta_5}/|w_3| + |w_3|h_1}{[(h_1 - t)\sqrt{\beta_5}/|w_3| + |w_3|h_1]^2 - (w_3 x_1)^2} \right\} \end{aligned}$$

ORIGINAL PAGE IS
DE POOR QUALITY

$$\begin{aligned}
\pi k_{12s}(x_1, t) = & \lambda_{93} \left\{ \frac{(h_2-t)\sqrt{\beta_5^*}/|w_1^*| + |w_1|h_1}{[(h_2-t)\sqrt{\beta_5^*}/|w_1^*| + |w_1|h_1]^2 - (w_1x_1)^2} \right\} \\
& + \lambda_{94} \left\{ \frac{(h_2-t)\sqrt{\beta_5^*}/|w_1^*| + |w_3|h_1}{[(h_2-t)\sqrt{\beta_5^*}/|w_1^*| + |w_3|h_1]^2 - (w_3x_1)^2} \right\} \\
& + \lambda_{95} \left\{ \frac{(h_2-t)\sqrt{\beta_5^*}/|w_3^*| + |w_1|h_1}{[(h_2-t)\sqrt{\beta_5^*}/|w_3^*| + |w_1|h_1]^2 - (w_1x_1)^2} \right\} \\
& + \lambda_{96} \left\{ \frac{(h_2-t)\sqrt{\beta_5^*}/|w_3^*| + |w_3|h_1}{[(h_2-t)\sqrt{\beta_5^*}/|w_3^*| + |w_3|h_1]^2 - (w_3x_1)^2} \right\}
\end{aligned}$$

$$\begin{aligned}
\pi k_{21s}(x_2, t) = & \lambda_{101} \left\{ \frac{(h_1-t)\sqrt{\beta_5}/|w_1| + |w_1^*|h_2}{[(h_1-t)\sqrt{\beta_5}/|w_1| + |w_1^*|h_2]^2 - (w_1^*x_2)^2} \right\} \\
& + \lambda_{102} \left\{ \frac{(h_1-t)\sqrt{\beta_5}/|w_1| + |w_3^*|h_2}{[(h_1-t)\sqrt{\beta_5}/|w_1| + |w_3^*|h_2]^2 - (w_3^*x_2)^2} \right\} \\
& + \lambda_{103} \left\{ \frac{(h_1-t)\sqrt{\beta_5}/|w_3| + |w_1^*|h_2}{[(h_1-t)\sqrt{\beta_5}/|w_3| + |w_1^*|h_2]^2 - (w_1^*x_2)^2} \right\} \\
& + \lambda_{104} \left\{ \frac{(h_1-t)\sqrt{\beta_5}/|w_3| + |w_3^*|h_2}{[(h_1-t)\sqrt{\beta_5}/|w_3| + |w_3^*|h_2]^2 - (w_3^*x_2)^2} \right\}
\end{aligned}$$

$$\begin{aligned}
\pi k_{22s}(x_2, t) = & \lambda_{109} \left\{ \frac{(h_2-t)\sqrt{\beta_5^*}/|w_1^*| + |w_1^*|h_2}{[(h_2-t)\sqrt{\beta_5^*}/|w_1^*| + |w_1^*|h_2]^2 - (w_1^*x_2)^2} \right\} \\
& + \lambda_{110} \left\{ \frac{(h_2-t)\sqrt{\beta_5^*}/|w_1^*| + |w_3^*|h_2}{[(h_2-t)\sqrt{\beta_5^*}/|w_1^*| + |w_3^*|h_2]^2 - (w_3^*x_2)^2} \right\} \\
& + \lambda_{111} \left\{ \frac{(h_2-t)\sqrt{\beta_5^*}/|w_3^*| + |w_1^*|h_2}{[(h_2-t)\sqrt{\beta_5^*}/|w_3^*| + |w_1^*|h_2]^2 - (w_1^*x_2)^2} \right\} \\
& + \lambda_{112} \left\{ \frac{(h_2-t)\sqrt{\beta_5^*}/|w_3^*| + |w_3^*|h_2}{[(h_2-t)\sqrt{\beta_5^*}/|w_3^*| + |w_3^*|h_2]^2 - (w_3^*x_2)^2} \right\}
\end{aligned}$$

Separating the singular parts, equations (6.2a,b) take the form:

$$\begin{aligned}
 & \frac{1}{\pi} \int_{-h_1}^{h_1} \left[\frac{1}{t-x_1} + \pi k_{11s}(x_1, t) \right] \phi(t) dt \\
 & + \int_{-h_1}^{h_1} [k_{11}(x_1, t) - k_{11s}(x_1, t)] \phi(t) dt \\
 & + \int_c^{h_2} k_{12s}^*(x_1, t) \phi^*(t) dt \\
 & + \int_c^{h_2} [k_{12}^*(x_1, t) - k_{12s}^*(x_1, t)] \phi^*(t) dt \\
 & = - \frac{(1-\nu_{xy} \nu_{yx})}{2\gamma_{14} E_y} p_1(x_1) \quad -h_1 < x_1 < h_1
 \end{aligned}$$

and

$$\begin{aligned}
 & \frac{1}{\pi} \int_c^{h_2} \left[\frac{1}{t-x_2} + \frac{1}{t+x_2} + \pi k_{22s}^*(x_2, t) \right] \phi^*(t) dt \\
 & + \int_{-h_1}^{h_1} [k_{21}(x_2, t) - k_{21s}(x_2, t)] \phi(t) dt \\
 & + \int_{-h_1}^{h_1} k_{21s}(x_2, t) \phi(t) dt \\
 & + \int_c^{h_2} [k_{22}^*(x_2, t) - k_{22s}^*(x_2, t)] \phi^*(t) dt \\
 & = - \frac{(1-\nu_{xy}^* \nu_{yx}^*)}{2\gamma_{14}^* E_y^*} p_2(x_2) \quad c < x_2 < h_2
 \end{aligned}$$

(6.3a, b)

where

$$k_{i2}^*(x_i, t) = k_{i2}(x_i, t) - k_{i2}(x_i, -t) \quad (i = 1, 2) .$$

To find the proper singularity power β at the interface, we will first throw all the bounded terms to the right hand sides of the equations as it has been done in the previous case. Then, we obtain the following system of equations:

$$\begin{aligned} \frac{1}{\pi} \int_{-h_1}^{h_1} \left[\frac{1}{t-x_1} + \pi k_{11s}(x_1, t) \right] \phi(t) dt \\ + \int_c^{h_2} k_{12s}^*(x_1, t) \phi^*(t) dt = Q_1(x_1) \\ - h_1 < x_1 < h_1 \\ \frac{1}{\pi} \int_c^{h_2} \left[\frac{1}{t-x_2} + \frac{1}{t+x_2} + \pi k_{22s}^*(x_2, t) \right] \phi^*(t) dt \\ + \int_{-h_1}^{h_1} [k_{21s}(x_2, t) \phi(t) dt = Q_2(x_2) \\ c < x_2 < h_2 \end{aligned} \quad (6.4a, b)$$

where $Q_1(x_1)$ and $Q_2(x_2)$ are bounded functions of x_1 and x_2 . Considering the behavior of $\phi(t)$ and $\phi^*(t)$ at the end points, we can write:

$$\phi(t) = \frac{F(t)}{(h_1^2 - t^2)^\beta} \quad , \quad \phi^*(t) = \frac{F^*(t)}{(h_2 - t)^\beta (t - c)^\delta} \quad (6.5a, b)$$

Define the following sectionally holomorphic functions:

$$\psi(z) = \frac{1}{\pi} \int_{-h_1}^{h_1} \frac{\phi(t)}{t-z} dt, \quad \psi^*(z) = \frac{1}{\pi} \int_c^{h_2} \frac{\phi^*(t)}{t-z} dt \quad (6.6a, b)$$

From [14] and using (6.5a,b) and (6.6a,b) we have:

$$\psi(z) = \frac{F(-h_1)e^{i\pi\beta}}{(2h_1)^\beta \sin\pi\beta} \frac{1}{(z+h_1)^\beta} - \frac{F(h_1)}{(2h_1)^\beta \sin\pi\beta} \frac{1}{(z-h_1)^\beta} + \psi_0(z)$$

$$\psi^*(z) = \frac{F^*(c)e^{i\pi\delta}}{(h_2-c)^\delta \sin\pi\delta} \frac{1}{(z-c)^\delta} - \frac{F^*(h_2)}{(h_2-c)^\delta \sin\pi\delta} \frac{1}{(z-h_2)^\delta} + \psi_0^*(z)$$

(6.7a,b)

where $\psi_0(z)$ and $\psi_0^*(z)$ are bounded functions which around ends behave as follows:

$$|\psi_0(z)| \leq \frac{C_0}{|z+h_1|^{\beta_0}}, \quad \beta_0 < \text{Re}(\beta)$$

and

$$|\psi_0^*(z)| \begin{cases} \leq \frac{D_0}{|z-h_2|^{\beta_0^*}}, & \beta_0^* < \text{Re}(\beta) \\ \text{and} \\ \leq \frac{E_0}{|z-c|^{\delta_0}}, & \delta_0 < \text{Re}(\delta) \end{cases}$$

$C_0, D_0, E_0, \beta_0, \beta_0^*, \delta_0$ are real constants.

Using (6.7a,b) and following the procedure used in section 5, equations (6.4a,b) reduce to:

$$\cot\pi\delta = 0 \quad (6.8)$$

and

$$\begin{aligned}
 & \frac{F(h_1)}{2(2h_1)^\beta \sin\pi\beta} \left\{ -2\cos\pi\beta + \lambda_{85} \frac{|w_1|}{\sqrt{\beta_5}} \frac{1}{\left(\frac{w_1^2}{\sqrt{\beta_5}}\right)^\beta} + \lambda_{86} \frac{|w_1|}{\sqrt{\beta_5}} \frac{1}{\left(\frac{|w_1||w_3|}{\sqrt{\beta_5}}\right)^\beta} \right. \\
 & \quad \left. + \lambda_{87} \frac{|w_3|}{\sqrt{\beta_5}} \frac{1}{\left(\frac{|w_1||w_3|}{\sqrt{\beta_5}}\right)^\beta} + \lambda_{88} \frac{|w_3|}{\sqrt{\beta_5}} \frac{1}{\left(\frac{w_3^2}{\sqrt{\beta_5}}\right)^\beta} \right\} \\
 & + \frac{F^*(h_2)}{2(h_2-c)^\delta \sin\pi\beta} \left\{ \lambda_{93} \frac{|w_1^*|}{\sqrt{\beta_5^*}} \frac{1}{\left(\frac{|w_1||w_1^*|}{\sqrt{\beta_5^*}}\right)^\beta} + \lambda_{94} \frac{|w_1^*|}{\sqrt{\beta_5^*}} \frac{1}{\left(\frac{|w_3||w_1^*|}{\sqrt{\beta_5^*}}\right)^\beta} \right. \\
 & \quad \left. + \lambda_{95} \frac{|w_3^*|}{\sqrt{\beta_5^*}} \frac{1}{\left(\frac{|w_1||w_3^*|}{\sqrt{\beta_5^*}}\right)^\beta} + \lambda_{96} \frac{|w_3^*|}{\sqrt{\beta_5^*}} \frac{1}{\left(\frac{|w_3||w_3^*|}{\sqrt{\beta_5^*}}\right)^\beta} \right\} = 0
 \end{aligned}$$

$$\begin{aligned}
 & \frac{F(h_1)}{2(2h_1)^\beta \sin\pi\beta} \left\{ \lambda_{101} \frac{|w_1|}{\sqrt{\beta_5}} \frac{1}{\left(\frac{|w_1^*||w_1|}{\sqrt{\beta_5}}\right)^\beta} + \lambda_{102} \frac{|w_1|}{\sqrt{\beta_5}} \frac{1}{\left(\frac{|w_3^*||w_1|}{\sqrt{\beta_5}}\right)^\beta} \right. \\
 & \quad \left. + \lambda_{103} \frac{|w_3|}{\sqrt{\beta_5}} \frac{1}{\left(\frac{|w_1^*||w_3|}{\sqrt{\beta_5}}\right)^\beta} + \lambda_{104} \frac{|w_3|}{\sqrt{\beta_5}} \frac{1}{\left(\frac{|w_3^*||w_3|}{\sqrt{\beta_5}}\right)^\beta} \right\} \\
 & + \frac{F^*(h_2)}{2(h_2-c)^\delta \sin\pi\beta} \left\{ -2\cos\pi\beta + \lambda_{109} \frac{|w_1^*|}{\sqrt{\beta_5^*}} \frac{1}{\left(\frac{w_1^{*2}}{\sqrt{\beta_5^*}}\right)^\beta} + \lambda_{110} \frac{|w_1^*|}{\sqrt{\beta_5^*}} \frac{1}{\left(\frac{|w_3^*||w_1^*|}{\sqrt{\beta_5^*}}\right)^\beta} \right\}
 \end{aligned}$$

$$+ \lambda_{111} \frac{|w_3^*|}{\sqrt{\beta_5^*}} \frac{1}{\left[\frac{|w_1^*| |w_3^*|}{\sqrt{\beta_5^*}} \right]^\beta} + \lambda_{112} \frac{|w_3^*|}{\sqrt{\beta_5^*}} \frac{1}{\left[\frac{w_3^{*2}}{\sqrt{\beta_5^*}} \right]^\beta} \left. \right\} = 0$$

(6.9a,b)

Equation (6.8) gives the expected $\delta = 1/2$ singularity power at the crack tip.

(6.9a,b) is a system of homogeneous linear equations for $F(h_1)$ and $F^*(h_2)$. Since $F(h_1) \neq 0$, $F^*(h_2) \neq 0$, $\beta \neq 0, 1$ to solve the system one should equate the determinant of coefficients to zero. Thus,

$$\begin{aligned} \Delta(\beta) = & 4\cos^2\pi\beta - 2\cos\pi\beta \left\{ \lambda_{109} \frac{|w_1^*|}{\sqrt{\beta_5^*}} \frac{1}{(r_{11}^*)^\beta} + \left[\lambda_{110} \frac{|w_1^*|}{\sqrt{\beta_5^*}} \right. \right. \\ & \left. \left. + \lambda_{111} \frac{|w_3^*|}{\sqrt{\beta_5^*}} \right] \frac{1}{(r_{13}^*)^\beta} + \lambda_{112} \frac{|w_3^*|}{\sqrt{\beta_5^*}} \frac{1}{(r_{33}^*)^\beta} \right. \\ & + \lambda_{85} \frac{|w_1|}{\sqrt{\beta_5}} \frac{1}{(r_{11})^\beta} \\ & + \left[\lambda_{86} \frac{|w_1|}{\sqrt{\beta_5}} + \lambda_{87} \frac{|w_3|}{\sqrt{\beta_5}} \right] \frac{1}{(r_{13})^\beta} \\ & \left. \left. + \lambda_{88} \frac{|w_3|}{\sqrt{\beta_5}} \frac{1}{(r_{33})^\beta} \right\} \right. \end{aligned}$$

$$\begin{aligned}
& + \lambda_{113} \frac{1}{(r_{11}r_{11}^*)^\beta} + \lambda_{114} \frac{1}{(r_{11}r_{13}^*)^\beta} \\
& + \lambda_{115} \frac{1}{(r_{11}r_{33}^*)^\beta} + \lambda_{116} \frac{1}{(r_{13}r_{11}^*)^\beta} \\
& + \lambda_{117} \frac{1}{(r_{13}r_{13}^*)^\beta} + \lambda_{118} \frac{1}{(r_{13}r_{33}^*)^\beta} + \lambda_{119} \frac{1}{(r_{33}r_{11}^*)^\beta} \\
& + \lambda_{120} \frac{1}{(r_{33}r_{13}^*)^\beta} + \lambda_{121} \frac{1}{(r_{33}r_{33}^*)^\beta} = 0 \tag{6.10}
\end{aligned}$$

where

$$\begin{aligned}
r_{11} &= \frac{w_1^2}{\sqrt{\beta_5}} \quad , \quad r_{13} = \frac{|w_1| |w_3|}{\sqrt{\beta_5}} \quad , \quad r_{33} = \frac{w_3^2}{\sqrt{\beta_5}} \\
r_{11}^* &= \frac{w_1^{*2}}{\sqrt{\beta_5^*}} \quad , \quad r_{13}^* = \frac{|w_1^*| |w_3^*|}{\sqrt{\beta_5^*}} \quad , \quad r_{33}^* = \frac{w_3^{*2}}{\sqrt{\beta_5^*}}
\end{aligned}$$

From the characteristic equation (6.10) we can determine the singularity power β . Choosing the orthotropic elastic constants close to isotropic elastic constants, we recover the singularity power found in [8] and [9]. Equation (6.10) does not always have a root between 0 and 1. For some orthotropic material combinations, there is no power singularity at the interface. In this case one should investigate the possibility of pure imaginary or complex roots. Numerical computation shows that there are no pure imaginary roots or complex roots for which the real part

is between 0 and 1. On the other hand $F(h_1)$ and $F^*(h_2)$ are related through (6.9a) or (6.9b). This is a condition to be used while obtaining the solution. The absence of power singularity for some orthotropic material combinations may be very important from the view point of design applications. Therefore we will study in some detail the behavior of the crack surface displacement derivatives and the stresses at the interface.

Let's first investigate the possibility of a weaker i.e., logarithmic singularity in the crack surface displacement derivatives at the interface. Suppose that the power singularity β at the interface is zero. Define:

$$\psi(z) = \frac{1}{\pi} \int_{-h_1}^{h_1} \frac{\phi(t)}{t-z} dt, \quad \psi^*(z) = \frac{1}{\pi} \int_c^{h_2} \frac{\phi^*(t)}{t-z} dt$$

The behavior of $\psi(z)$ around $z = \pm h_1$, and of $\psi^*(z)$ around $z = h_2$ can be expressed as:

$$\psi^*(z) = \frac{\phi(h_1)}{\pi} \log(z-h_1) + \phi_{01}(z) \text{ near } z = h_1$$

$$\psi(z) = -\frac{\phi(-h_1)}{\pi} \log(z+h_1) + \phi_{02}(z) \text{ near } z = -h_1$$

$$\psi^*(z) = \frac{\phi^*(h_2)}{\pi} \log(z-h_2) + \phi_{03}(z) \text{ near } z = +h_2$$

(6.11a,b,c)

where $\phi_{01}(z)$, $\phi_{02}(z)$, $\phi_{03}(z)$ are bounded functions.

Using (6.11a,b,c), near $x_1 = h_1$ and $x_2 = h_2$ equations (6.4a,b) take the following form:

$$\begin{aligned} & \log(h_1 - x_1) \left\{ \frac{\phi(h_1)}{\pi} \left[1 - \lambda_{85} \frac{|w_1|}{2\sqrt{\beta_5}} - \lambda_{86} \frac{|w_1|}{2\sqrt{\beta_5}} - \lambda_{87} \frac{|w_3|}{2\sqrt{\beta_5}} - \lambda_{88} \frac{|w_3|}{2\sqrt{\beta_5}} \right] \right. \\ & \left. + \frac{\phi^*(h_2)}{\pi} \left[-\frac{|w_1^*|}{2\sqrt{\beta_5^*}} \lambda_{93} - \frac{|w_1^*|}{2\sqrt{\beta_5^*}} \lambda_{94} - \frac{|w_3^*|}{2\sqrt{\beta_5^*}} \lambda_{95} - \frac{|w_3^*|}{2\sqrt{\beta_5^*}} \lambda_{96} \right] \right\} = F_1(x_1) \\ & \log(h_2 - x_2) \left\{ \frac{\phi(h_1)}{\pi} \left[-\frac{|w_1|}{2\sqrt{\beta_5}} \lambda_{101} - \frac{|w_1|}{2\sqrt{\beta_5}} \lambda_{102} - \frac{|w_3|}{2\sqrt{\beta_5}} \lambda_{103} - \frac{|w_3|}{2\sqrt{\beta_5}} \lambda_{104} \right] \right. \\ & \left. + \frac{\phi^*(h_2)}{\pi} \left[1 - \frac{|w_1^*|}{2\sqrt{\beta_5^*}} \lambda_{109} - \frac{|w_1^*|}{2\sqrt{\beta_5^*}} \lambda_{110} - \frac{|w_3^*|}{2\sqrt{\beta_5^*}} \lambda_{111} - \frac{|w_3^*|}{2\sqrt{\beta_5^*}} \lambda_{112} \right] \right\} = F_2(x_2) \end{aligned} \quad (6.12a,b)$$

where $F_1(x_1)$ and $F_2(x_2)$ are bounded functions.

In order that equations (6.12a,b) be bounded for $x_1 = h_2$, the coefficients of the logarithmic terms must be zero. Thus:

$$\begin{aligned} & \frac{\phi(h_1)}{\pi} \left[1 - \lambda_{85} \frac{|w_1|}{2\sqrt{\beta_5}} - \lambda_{86} \frac{|w_1|}{2\sqrt{\beta_5}} - \lambda_{87} \frac{|w_3|}{2\sqrt{\beta_5}} - \lambda_{88} \frac{|w_3|}{2\sqrt{\beta_5}} \right] \\ & + \frac{\phi^*(h_2)}{\pi} \left[-\frac{|w_1^*|}{2\sqrt{\beta_5^*}} \lambda_{93} - \frac{|w_1^*|}{2\sqrt{\beta_5^*}} \lambda_{94} - \frac{|w_3^*|}{2\sqrt{\beta_5^*}} \lambda_{95} - \frac{|w_3^*|}{2\sqrt{\beta_5^*}} \lambda_{96} \right] = 0 \end{aligned}$$

and

$$\frac{\phi(h_1)}{\pi} \left[-\frac{|w_1|}{2\sqrt{\beta_5}} \lambda_{101} - \frac{|w_1|}{2\sqrt{\beta_5}} \lambda_{102} - \frac{|w_3|}{2\sqrt{\beta_5}} \lambda_{103} - \frac{|w_3|}{2\sqrt{\beta_5}} \lambda_{104} \right] \\ + \frac{\phi^*(h_2)}{\pi} \left[1 - \frac{|w_1^*|}{2\sqrt{\beta_5^*}} \lambda_{109} - \frac{|w_1^*|}{2\sqrt{\beta_5^*}} \lambda_{110} - \frac{|w_3^*|}{2\sqrt{\beta_5^*}} \lambda_{111} - \frac{|w_3^*|}{2\sqrt{\beta_5^*}} \lambda_{112} \right] = 0$$

(6.13a,b)

(6.13a,b) is a system of linear equations for $\phi(h_1)$ and $\phi^*(h_2)$. Since $\phi(h_1)$ and $\phi^*(h_2)$ are different than zero, in order to have a solution the determinant of coefficients, Δ , must be zero. Numerical computation shows that $\Delta = 0$ and either from equation (6.13a) or (6.13b) we have:

$$\frac{\phi(h_1)}{\phi^*(h_2)} = -1$$

and using the symmetry condition $\phi^*(h_2) = -\phi^*(-h_2)$, we obtain:

$$\frac{\phi(h_1)}{\phi^*(-h_2)} = 1 \quad (6.14)$$

Relation (6.14) shows that the surface displacement derivative is continuous at the interface. This is an important result which makes the solution of the singular integral equations easier.

To study the behavior of the stresses, let's first write their expressions at the interface. By making use of

(3.11) and (4.15) we obtain:

$$\sigma(y) = \frac{\pi(1-\nu_{xy}\nu_{yx})}{2E_x} \sigma_{1x}(h_1, y) = \int_{-h_1}^{h_1} K_1(n, y) \phi(n) dn + \int_c^{h_2} K_2(n, y) \phi^*(n) dn$$

$$\tau(y) = \frac{\pi}{2G_{xy}} \tau_{1xy}(h_1, y) = \int_{-h_1}^{h_1} K_3(n, y) \phi(n) dn + \int_c^{h_2} K_4(n, y) \phi^*(n) dn$$

(6.15a, b)

where $K_j(n, y)$ ($j = 1, 4$) are given in Appendix B.

The kernels K_j become unbounded as $y \rightarrow 0^+$ and $n \rightarrow \pm h_1$ or $n \rightarrow h_2$ respectively. When equation (6.10) has a root, i.e. when the functions $\phi(t)$ and $\phi^*(t)$ are singular, the stresses have the same singularity power as we will see in the derivation of the stress intensity factors. But it is necessary to know whether the stresses have a logarithmic singularity when the crack surface displacement derivatives are bounded. To do that let's first separate the singular parts of kernels K_j . Following the usual procedure, we obtain:

$$K_{1s}(n, y) = \frac{1}{4\gamma_{13}} \left[\frac{\gamma_1 (h_1 + n)}{\frac{w_1^2 y^2}{\beta_5} + (h_1 + n)^2} - \gamma_1 \frac{(h_1 - n)}{\frac{w_1^2 y^2}{\beta_5} + (h_1 - n)^2} \right. \\ \left. - \gamma_2 \frac{\gamma_{11}}{\gamma_{12}} \frac{h_1 + n}{\frac{w_3^2 y^2}{\beta_5} + (h_1 + n)^2} + \gamma_2 \frac{\gamma_{11}}{\gamma_{12}} \frac{h_1 - n}{\frac{w_3^2 y^2}{\beta_5} + (h_1 - n)^2} \right]$$

$$+ \frac{1}{2\gamma_{13}\lambda_{80}} (\gamma_3\lambda_{81} + \gamma_4\lambda_{82}) \frac{(h_1 - \eta)\sqrt{\beta_5}/|w_1|}{[(h_1 - \eta)\sqrt{\beta_5}/|w_1|]^2 + y^2}$$

$$+ \frac{1}{2\gamma_{13}\lambda_{80}} (\gamma_3\lambda_{83} + \gamma_4\lambda_{84}) \frac{(h_1 - \eta)\sqrt{\beta_5}/|w_3|}{[(h_1 - \eta)\sqrt{\beta_5}/|w_3|]^2 + y^2}$$

$$K_{2s}(n, y) = \frac{1}{2\gamma_{13}^*\lambda_{80}} (\gamma_3\lambda_{89} + \gamma_4\lambda_{90}) \frac{(h_2 - \eta)\sqrt{\beta_5^*}/|w_1^*|}{[(h_2 - \eta)\sqrt{\beta_5^*}/|w_1^*|]^2 + y^2}$$

$$+ \frac{1}{2\gamma_{13}^*\lambda_{80}} (\gamma_3\lambda_{91} + \gamma_4\lambda_{92}) \frac{(h_2 - \eta)\sqrt{\beta_5^*}/|w_3^*|}{[(h_2 - \eta)\sqrt{\beta_5^*}/|w_3^*|]^2 + y^2}$$

$$K_{3s}(n, y) = \frac{\gamma_{11}}{4\gamma_{13}} \left[- \frac{\frac{|w_1|y/\sqrt{\beta_5}}{w_1 y} + (h_1 + \eta)}{\frac{\beta_5}{\beta_5} + (h_1 + \eta)} + \frac{\frac{|w_1|y/\sqrt{\beta_5}}{w_1 y} + (h_1 - \eta)}{\frac{\beta_5}{\beta_5} + (h_1 - \eta)} \right. \\ \left. + \frac{\frac{|w_3|y/\sqrt{\beta_5}}{w_3 y^2} + (h_1 + \eta)}{\frac{\beta_5}{\beta_5} + (h_1 + \eta)} - \frac{\frac{|w_3|y/\sqrt{\beta_5}}{w_3 y^2} + (h_1 - \eta)}{\frac{\beta_5}{\beta_5} + (h_1 - \eta)} \right]$$

$$+ \frac{1}{2\gamma_{13}\lambda_{80}} (\gamma_9\lambda_{81} + \gamma_{10}\lambda_{82}) \frac{y}{[(h_1 - \eta)\sqrt{\beta_5}/|w_1|]^2 + y^2}$$

$$+ \frac{1}{2\gamma_{13}\lambda_{80}} (\gamma_9\lambda_{83} + \gamma_{10}\lambda_{84}) \frac{y}{[(h_1 - \eta)\sqrt{\beta_5}/|w_3|]^2 + y^2}$$

$$K_{4s}(n, y) = \frac{1}{2\gamma_{13}^*\lambda_{80}} (\gamma_9\lambda_{89} + \gamma_{10}\lambda_{90}) \frac{y}{[(h_2 - \eta)\sqrt{\beta_5^*}/|w_1^*|]^2 + y^2}$$

$$+ \frac{1}{2\gamma_{13}^*\lambda_{80}} (\gamma_9\lambda_{91} + \gamma_{10}\lambda_{92}) \frac{y}{[(h_2 - \eta)\sqrt{\beta_5^*}/|w_3^*|]^2 + y^2}$$

(6.16a, b, c, d)

Keeping only the singular terms, equations (6.15a,b) can be written as follows:

$$\begin{aligned}\sigma(y) &= \int_{-h_1}^{h_1} K_{1s}(n,y)\phi(n)dn + \int_C^{h_2} K_{2s}(n,y)\phi^*(n)dn + A(y) \\ \tau(y) &= \int_{-h_1}^{h_1} K_{3s}(n,y)\phi(n)dn + \int_C^{h_2} K_{2s}(n,y)\phi^*(n)dn + B(y) \quad (6.17a,b)\end{aligned}$$

where $A(y)$ and $B(y)$ are bounded functions.

Define:

$$\psi(z) = \int_{-h_1}^{h_1} \frac{\phi(t)}{t-z} dt \quad \text{and} \quad \psi^*(z) = \int_C^{h_2} \frac{\phi^*(t)}{t-z} dt$$

Considering their behavior around ends, we can write:

$$\psi(z) = \phi(h_1)\log(z-h_1) - \phi(-h_1)\log(z+h_1) + \psi_0(z)$$

and

$$\psi^*(z) = \phi^*(h_2)\log(z-h_2) + \psi_0^*(z) \quad (6.18a,b)$$

where $\psi_0(z)$ and $\psi_0^*(z)$ are bounded functions. Making use of (6.18a,b) and (6.14), equations (6.17a,b) become:

$$\begin{aligned}\sigma(y) &= \log y \phi(h_1) \left[\frac{1}{2\gamma_{13}} (\gamma_1 - \gamma_2 \frac{\gamma_{11}}{\gamma_{12}}) - \frac{1}{2\gamma_{13}\lambda_{80}} \frac{|w_1|}{\sqrt{\beta_5}} (\gamma_3\lambda_{81} + \gamma_4\lambda_{82}) \right. \\ &\quad - \frac{1}{2\gamma_{13}\lambda_{80}} \frac{|w_3|}{\sqrt{\beta_5}} (\gamma_3\lambda_{83} + \gamma_4\lambda_{84}) + \frac{1}{2\gamma_{13}^*\lambda_{80}} \frac{|w_1^*|}{\sqrt{\beta_5^*}} (\gamma_3\lambda_{89} + \gamma_4\lambda_{90}) \\ &\quad \left. + \frac{1}{2\gamma_{13}^*\lambda_{80}} \frac{|w_3^*|}{\sqrt{\beta_5^*}} (\gamma_3\lambda_{91} + \gamma_4\lambda_{92}) \right] + C(y)\end{aligned}$$

and

$$\tau(y) = D(y) \quad (6.19a,b)$$

where $C(y)$ and $D(y)$ are bounded functions. Equation (6.19b) indicates that the shear stress at the interface is bounded. Since $C(y)$ is bounded and $\phi(h_1) \neq 0$, if $\sigma(y)$ is bounded the coefficient of $\log y$ in equation (6.19a) should be zero. Numerical computation shows that the above mentioned coefficient is identically zero. Therefore the normal stress σ_x at the interface is also bounded. These are important results for orthotropic materials and may have practical implications in designing with composite materials.

7. THE SOLUTION AND THE RESULTS

Since we have mainly three different problems, the solution will be discussed in three sections.

7.1. Case of Internal Cracks

In this case we have to solve the system of singular equations (4.16a,b). Defining $x_1 = a\kappa_1$, $t = a\tau$ for $-a < x_1$, $t < a$ and $x_2 = a\kappa_2$, $t = b\tau$ for $-b < x_2$, $t < b$ after normalization, equations (4.16a,b) take the form:

$$\begin{aligned} \frac{1}{\pi} \int_{-1}^1 \frac{\phi_0(\tau)}{\tau - \kappa_1} d\tau + a \int_{-1}^1 k_{11}^0(\kappa_1, \tau) \phi_0(\tau) d\tau + b \int_{-1}^1 k_{12}^0(\kappa_1, \tau) \phi_0^*(\tau) d\tau \\ = - \frac{(1 - \nu_{xy} \nu_{yx})}{2\gamma_{14} E_y} p_1^0(\kappa_1) \quad -1 < \kappa_1 < 1 \\ \frac{1}{\pi} \int_{-1}^1 \frac{\phi_0^*(\tau)}{\tau - \kappa_2} d\tau + a \int_{-1}^1 k_{21}^0(\kappa_2, \tau) \phi_0(\tau) d\tau + b \int_{-1}^1 k_{22}^0(\kappa_2, \tau) \phi_0^*(\tau) d\tau \\ = - \frac{(1 - \nu_{xy}^* \nu_{yx}^*)}{2\gamma_{14}^* E_y^*} p_2^0(\kappa_2) \quad -1 < \kappa_2 < 1 \end{aligned} \quad (7.1a, b)$$

where the index "o" denotes the normalized quantities. To get the complete solution we need also the single-valuedness conditions:

$$\int_{-1}^1 \phi_0(\tau) d\tau = 0 \quad \text{and} \quad \int_{-1}^1 \phi_0^*(\tau) d\tau = 0 \quad (7.2a, b)$$

Since $\phi_0(\tau)$ and $\phi_0^*(\tau)$ have a power singularity $-1/2$ at

the ends, the solution will be sought in the form:

$$\phi_0(\tau) = \frac{F_0(\tau)}{\sqrt{1-\tau^2}} \quad \text{and} \quad \phi_0^*(\tau) = \frac{F_0^*(\tau)}{\sqrt{1-\tau^2}}$$

where $F_0(\tau)$ and $F_0^*(\tau)$ are Hölder continuous in the interval $-1 \leq \tau \leq 1$.

Using the method described in [11] we obtain:

$$\begin{aligned} \sum_{j=1}^N F_0(\tau_j) \left[\frac{1}{\tau_j - \kappa_i} + a\pi k_{11}^0(\kappa_i, \tau_j) \right] + \sum_{j=1}^N b\pi k_{12}^0(\kappa_i, \tau_j) F_0^*(\tau_j) \\ = -N \frac{(1-\nu_{xy}\nu_{yx})}{2\gamma_{14} E_y} p_1^0(\kappa_i) \quad i = 1, \dots, N-1 \end{aligned}$$

$$\begin{aligned} \sum_{j=1}^N a\pi k_{21}^0(\kappa_i, \tau_j) F_0(\tau_j) + \sum_{j=1}^N F_0^*(\tau_j) \left[\frac{1}{\tau_j - \kappa_i} + b\pi k_{22}^0(\kappa_i, \tau_j) \right] \\ = -N \frac{(1-\nu_{xy}^* \nu_{yx}^*)}{2\gamma_{14}^* E_y^*} p_2^0(\kappa_i) \quad i = 1, \dots, N-1 \end{aligned}$$

$$\sum_{j=1}^N \frac{\pi}{N} F_0(\tau_j) = 0 \quad \text{and} \quad \sum_{j=1}^N \frac{\pi}{N} F_0^*(\tau_j) = 0 \quad (7.3a, b, c, d)$$

where

ORIGINAL PAGE IS
DE POOR QUALITY

$$\tau_j = \cos \frac{\pi}{2N} (2j-1) \quad j = 1, \dots, N$$

$$\kappa_i = \cos \frac{\pi i}{N} \quad i = 1, \dots, N-1$$

The $2N$ unknowns $F_0(\tau_j)$ and $F_0^*(\tau_j)$ can be found by solving equations (7.3a, b, c, d). In this problem we are mostly interested in the computation of the stress intensity factors.

The stress intensity factors may be expressed in terms of the density functions $F_0(\tau)$ and $F_0^*(\tau)$ as follows:

$$\text{For } a < h_1: k_a = \lim_{x_1 \rightarrow a} \sqrt{2(x_1 - a)} \sigma_{1y}(x_1, 0)$$

$$\text{and for } b < h_2: k_b = \lim_{x_2 \rightarrow b} \sqrt{2(x_2 - b)} \sigma_{2y}(x_2, 0) \quad (7.4a, b)$$

Making use of equations (4.16a,b) and definitions (7.4a,b), after lengthy algebra (see Appendix D) we obtain:

$$k_a = - \frac{2\gamma_{14} E_y \sqrt{a}}{(1 - \nu_{xy} \nu_{yx})} F_0(1)$$

and

$$k_b = - \frac{2\gamma_{14}^* E_y^* \sqrt{b}}{(1 - \nu_{xy}^* \nu_{yx}^*)} F_0^*(1) \quad (7.5a, b)$$

The computation is done for generalized plane stress case only. Results can easily be obtained for plane strain case by redefining the elastic material constants. In the perturbation problem considered p_1 and p_2 are constant. Assuming that there is no constraint in x-direction, p_1 and p_2 satisfy the following condition:

$$\frac{p_1}{p_2} = \frac{E_y}{E_y^*}$$

where E_y and E_y^* are the Young's moduli in y direction.

Two material combinations are formed among the following three materials.

$$1. E_x = 5.62 \times 10^9 \text{ N/m}^2, E_y = 17.37 \times 10^9 \text{ N/m}^2,$$

$$G_{xy} = 0.492 \times 10^9 \text{ N/m}^2, \nu_{xy} = 0.036$$

$$(E_x = 8 \times 10^6 \text{ psi}), (E_y = 24.75 \times 10^6 \text{ psi}),$$

$$(G_{xy} = 0.7 \times 10^6 \text{ psi}), (\nu_{xy} = 0.036)$$

$$2. E_x = 13.71 \times 10^9 \text{ N/m}^2, E_y = 3.16 \times 10^9 \text{ N/m}^2,$$

$$G_{xy} = 2.46 \times 10^9 \text{ N/m}^2, \nu_{xy} = 0.650$$

$$(E_x = 19.5 \times 10^6 \text{ psi}), (E_y = 4.5 \times 10^6 \text{ psi}),$$

$$(G_{xy} = 3.5 \times 10^6 \text{ psi}), (\nu_{xy} = 0.650)$$

$$3. E_x = 15.76 \times 10^9 \text{ N/m}^2, E_y = 15.78 \times 10^9 \text{ N/m}^2,$$

$$G_{xy} = 6.09 \times 10^9 \text{ N/m}^2, \nu_{xy} = 0.300$$

$$(E_x = 22.447 \times 10^6 \text{ psi}), (E_y = 22.6 \times 10^6 \text{ psi}),$$

$$(G_{xy} = 8.655 \times 10^6 \text{ psi}), (\nu_{xy} = 0.300)$$

As it is seen from the values given above the first two materials are orthotropic, while the third is isotropic.

The following pairs of materials are used:

Combination I: The first layer is of material 1,
the second of material 2.

Combination II: The first layer is of material 3, the second of material 2.

Choosing the same materials and letting a , b , h_1 or h_2 go to proper limits we recover all the special cases done in [5], [6], and [10].

Figures 4-12 show some of the calculated results. In Figures 4 and 5 the stress intensity factors k_a are plotted versus h_2/h_1 for $b=0$ (there is no crack in the second material) and for the two material combinations. For $h_2=0$, we recover the solution of colinear cracks imbedded in a homogeneous material (see [10]). It is important to note that in the colinear crack problem the material doesn't have to be isotropic. As $h_2 \rightarrow \infty$, k_a reaches an asymptotic value which can be found in [5]. For a fixed h_2/h_1 ratio, k_a increases as a/h_1 becomes larger.

Figures 6 and 7 show the stress intensity factors k_b for the case $a=0$. In this case also, for $h_1=0$, we obtain the solution of colinear cracks. There is a critical value of (h_1/h_2) for which the stress intensity factor starts to decrease as the ratio b/h_2 increases. For the examples done this critical ratio is between 0 and 0.5. For $h_1 \rightarrow \infty$ the stress intensity factor k_b reaches an asymptotic value which also can be found in [5].

The stress intensity factors k_a and k_b when both layers contain cracks, are given in Figures 8-11. $k_b \rightarrow 0$ as $(b/h_2) \rightarrow 1$, since the power singularity γ is less than 0.5 when the crack in the second material touches the interface. Another interesting result is obtained from the comparison of isotropic and orthotropic materials. As it is seen in Figure 12, for the same E_y and E_y^* the stress intensity factor k_a for orthotropic materials can be larger or smaller than the stress intensity factor k_a for isotropic materials depending on the other elastic constants. One can significantly reduce k_a by a convenient choice of the elastic constants. The materials used in the comparison are given in Table 1. The dependence of k_a on the materials constants is given in Table 2. G_{xy} and G_{xy}^* are the most important constants, while keeping E_y and E_y^* constant. To reduce the stress intensity factor k_a , it is sufficient to increase E_x^* , G_{xy}^* , ν_{xy}^* or decrease E_x , G_{xy} , ν_{xy} .

ORIGINAL PAGE IS
OF POOR QUALITY

7.2 Case of Broken Laminates

The solution will be obtained by solving equations (5.2a,b), with the single-valuedness conditions,

$$\int_{-h_1}^{h_1} \phi(t) dt = 0 \quad \text{and} \quad \int_{-b}^b \phi^*(t) dt = 0 \quad (7.6a,b)$$

Defining again,

$$t = h_1 \tau_1, \quad x_1 = h_1 \kappa_1 \quad \text{for} \quad -h_1 < x_1, t < h_1$$

and

$$t = b \tau_2, \quad x_2 = b \kappa_2 \quad \text{for} \quad -b < x_2, t < b$$

the normalized form of equations (5.2a,b) and (7.6a,b) can be written as follows:

$$\begin{aligned} & \frac{1}{\pi} \int_{-1}^1 \left[\frac{1}{\tau_1 - \kappa_1} + \pi h_1 k_{11s}^0(\kappa_1, \tau_1) \right] \phi_0(\tau_1) d\tau_1 + h_1 \int_{-1}^1 k_{11f}^0(\kappa_1, \tau_1) \phi_0(\tau_1) d\tau_1 \\ & + b \int_{-1}^1 k_{12}^0(\kappa_1, \tau_2) \phi_0^*(\tau_2) d\tau_2 = - \frac{(1 - \nu_{xy} \nu_{yx})}{2\gamma_{14} E_y} p_1^0(\kappa_1) \quad -1 < \kappa_1 < 1 \\ & \frac{1}{\pi} \int_{-1}^1 \frac{\phi_0^*(\tau_2)}{\tau_2 - \kappa_2} d\tau_2 + h_1 \int_{-1}^1 k_{21}^0(\kappa_2, \tau_1) \phi_0(\tau_1) d\tau_1 + b \int_{-1}^1 k_{22}^0(\kappa_2, \tau_2) \phi_0^*(\tau_2) d\tau_2 = \\ & - \frac{(1 - \nu_{xy}^* \nu_{yx}^*)}{2\gamma_{14}^* E_y^*} p_2^0(\kappa_2) \quad , \quad -1 < \kappa_2 < 1 \\ & \int_{-1}^1 \phi_0(\tau_1) d\tau_1 = 0 \quad \text{and} \quad \int_{-1}^1 \phi_0^*(\tau_2) d\tau_2 = 0 \quad (7.7a,b,c,d) \end{aligned}$$

To obtain the solution, we will use the numerical method described in [11]. Hence, we obtain:

$$\begin{aligned} & \frac{1}{\pi} \sum_{j=1}^N w_j(\tau_{1j}) \left[\frac{1}{\tau_{1j} - \kappa_{1i}} + \pi h_1 k_{11s}^0(\kappa_{1i}, \tau_{1j}) \right] F_0(\tau_{1j}) \\ & + h_1 \sum_{j=1}^N w_j(\tau_{1j}) k_{11f}^0(\kappa_{1i}, \tau_{1j}) F_0(\tau_{1j}) \\ & + b \frac{\pi}{N} \sum_{j=1}^N k_{12}^0(\kappa_{1i}, \tau_{2j}) F_0^*(\tau_{2j}) \\ & = - \frac{(1 - \nu_{xy} \nu_{yx})}{2\gamma_{14} E_y} p_1^0(\kappa_{1i}) \quad , \quad i = 1, \dots, N-1 \end{aligned}$$

$$\begin{aligned} & \frac{1}{N} \sum_{j=1}^N \left[\frac{1}{\tau_{2j} - \kappa_{2i}} + \pi b k_{22}^0(\kappa_{2i}, \tau_{2j}) \right] F_0^*(\tau_{2j}) \\ & + \sum_{j=1}^N w_j(\tau_{1j}) k_{21}^0(\kappa_{2i}, \tau_{1j}) F_0(\tau_{1j}) \\ & = - \frac{(1 - \nu_{xy}^* \nu_{yx}^*)}{2\gamma_{14} E_y^*} p_2^0(\kappa_{2i}) \quad , \quad i = 1, \dots, N-1 \end{aligned}$$

$$\sum_{j=1}^N w_j(\tau_{1j}) F_0(\tau_{1j}) = 0 \quad \text{and} \quad \frac{\pi}{N} \sum_{j=1}^N F_0^*(\tau_{2j}) = 0$$

(7.8a, b, c, d)

where

$$\phi_0(\tau_1) = \frac{F_0(\tau_1)}{(1 - \tau_1^2)^\gamma} \quad , \quad \phi_0^*(\tau_2) = \frac{F_0^*(\tau_2)}{\sqrt{1 - \tau_2^2}}$$

$$P_N(-\gamma, -\gamma)(\tau_{1j}) = 0 \quad , \quad j = 1, \dots, N$$

$$P_{N-1}(1-\gamma, 1-\gamma)(\kappa_{1i}) = 0 \quad , \quad i = 1, \dots, N-1$$

$$\tau_{2j} = \cos \frac{\pi}{2N} (2j-1) \quad , \quad j = 1, \dots, N$$

$$\kappa_{2i} = \cos \frac{\pi i}{N} \quad , \quad i = 1, \dots, N-1$$

and $w_j(\tau_{1j})$ are the weights of $P_N(-\gamma, -\gamma)(\tau_{1j})$.

Solving the $2N \times 2N$ system of linear equations one can find the $2N$ unknowns $F_0(\tau_{1j})$ and $F_0^*(\tau_{2j})$. But again we are interested in the stress intensity factors, which can be calculated in terms of $F_0(\tau_{1j})$ and $F_0^*(\tau_{2j})$.

Define:

$$k_a = \lim_{x_2 \rightarrow -h_2} 2^\gamma (x_2 + h_2)^\gamma \sigma_{2y}(x_2, 0)$$

and

$$k_b = \lim_{x_2 \rightarrow b} \sqrt{2(x_2 - b)} \sigma_{2y}(x_2, 0)$$

After some calculation shown in Appendix D, we have:

$$k_a = \frac{(h_1)^\gamma \gamma_{14}^* E_y^* F_0(1)}{(1 - \nu_{xy}^* \nu_{yx}^*) \sin \pi \gamma} \left[\lambda_{101} \frac{|w_1| \sqrt{\beta_5}}{\frac{|w_1^*| |w_1|}{\sqrt{\beta_5}} \gamma} + \lambda_{102} \frac{|w_1| \sqrt{\beta_5}}{\frac{|w_3^*| |w_1|}{\sqrt{\beta_5}} \gamma} \right. \\ \left. + \lambda_{103} \frac{|w_3| \sqrt{\beta_5}}{\frac{|w_3| |w_1^*|}{\sqrt{\beta_5}} \gamma} + \lambda_{104} \frac{|w_3| \sqrt{\beta_5}}{\frac{|w_3^*| |w_3|}{\sqrt{\beta_5}} \gamma} \right]$$

and

$$k_b = - \frac{2\gamma_{14}^* E_y^* \sqrt{b}}{(1-\nu_{xy}^* \nu_{yx}^*)} F_0^*(1) \quad (7.9a,b)$$

The results for the case of broken laminates are shown in Figures 13-16. Again the same material combinations are used. In Figure 13 the stress intensity factor k_a is plotted versus the ratio h_2/h_1 for $b = 0$. When $h_2 \rightarrow \infty$ k_a has an asymptotic value which can be recovered in [7]. Figure 14 shows the variation of k_b with h_1/h_2 , for the case $a = 0$. For $b \neq 0$, the variation of k_a and k_b with b/h_2 are given in Figures 15 and 16.

7.3 Case of a Crack Crossing the Interface

In this case the governing singular integral equations are (6.3a,b). As it was pointed out in Section 6, the characteristic equation (6.10) does not always give a singularity power at the bimaterial interface. Therefore, the numerical solution needs care, and we should solve equations (6.3a,b) considering the singular and non-singular cases at the bimaterial interfaces.

7.3.1 Singular Behavior at the Interface

For the material combination II (isotropic-orthotropic) equation (6.10) has a root between 0 and 1. Using Newton-Raphson method to solve equation (6.10), we have:

$$\beta = 0.04248 .$$

We will make use of the following definitions to normalize equations (6.3a,b), the single-valuedness condition, and the relation (6.9a):

$$t = h_1 \tau_1, \quad x_1 = h_1 \kappa_1 \quad \text{for } -h_1 < t, \quad x_1 < h_1$$

$$t = \frac{h_2 - c}{2} \tau_2 + \frac{h_2 + c}{2}, \quad x_2 = \frac{h_2 - c}{2} \kappa_2 + \frac{h_2 + c}{2} \quad \text{for } c < t, \quad x_2 < h_2.$$

Then, we obtain:

$$\begin{aligned} & \frac{1}{\pi} \int_{-1}^1 \frac{\phi_0(\tau_1)}{\tau_1 - \kappa_1} d\tau_1 + h_1 \int_{-1}^1 k_{11s}^0(\kappa_1, \tau_1) \phi_0(\tau_1) d\tau_1 + h_1 \int_{-1}^1 k_{11f}^0(\kappa_1, \tau_1) \phi_0(\tau_1) d\tau_1 \\ & + \frac{h_2 - c}{2} \int_{-1}^1 k_{12s}^{*0}(\kappa_1, \tau_2) \phi_0^*(\tau_2) d\tau_2 + \frac{h_2 - c}{2} \int_{-1}^1 k_{12f}^{*0}(\kappa_1, \tau_2) \phi_0^*(\tau_2) d\tau_2 \\ & = - \frac{(1 - \nu_{xy} \nu_{yx})}{2\gamma_{14} E_y} p_1^0(\kappa_1) \quad -1 < \kappa_1 < 1 \end{aligned}$$

$$\begin{aligned} & \frac{1}{\pi} \int_{-1}^1 \left[\frac{1}{\tau_2 - \kappa_2} + \frac{1}{\tau_2 + \kappa_2 + \frac{2(h_2 + c)}{h_2 - c}} \right] \phi_0^*(\tau_2) d\tau_2 \\ & + h_1 \int_{-1}^1 k_{21s}^0(\kappa_2, \tau_1) \phi_0(\tau_1) d\tau_1 + h_1 \int_{-1}^1 k_{21f}^0(\kappa_2, \tau_1) \phi_0(\tau_1) d\tau_1 \\ & + \frac{h_2 - c}{2} \int_{-1}^1 k_{22s}^{*0}(\kappa_2, \tau_2) \phi_0^*(\tau_2) d\tau_2 + \frac{h_2 - c}{2} \int_{-1}^1 k_{22f}^{*0}(\kappa_2, \tau_2) \phi_0^*(\tau_2) d\tau_2 \\ & = - \frac{(1 - \nu_{xy}^* \nu_{yx}^*)}{2\gamma_{14}^* E_y^*} p_2^0(\kappa_2) \quad -1 < \kappa_2 < 1 \end{aligned}$$

$$h_1 \int_{-1}^1 \phi_0(\tau_1) d\tau_1 = 0 \quad \text{and} \quad F_0^*(1) = -\sqrt{2} \left(\frac{h_1}{h_2 - c} \right)^B \frac{a_1}{a_2} F_0(1)$$

(7.10a, b, c, d)

where

$$\begin{aligned}
 a_1 = & -2\cos\pi\beta + \lambda_{85} \frac{|w_1|}{\sqrt{\beta_5}} \left[\frac{1}{\frac{|w_1|^2}{\sqrt{\beta_5}}} \right]^\beta + \lambda_{86} \frac{|w_1|}{\sqrt{\beta_5}} \left[\frac{1}{\frac{|w_1||w_3|}{\sqrt{\beta_5}}} \right]^\beta \\
 & + \lambda_{87} \frac{|w_3|}{\sqrt{\beta_5}} \left[\frac{1}{\frac{|w_1||w_3|}{\sqrt{\beta_5}}} \right]^\beta + \lambda_{88} \frac{|w_3|}{\sqrt{\beta_5}} \left[\frac{1}{\frac{|w_3|^2}{\sqrt{\beta_5}}} \right]^\beta \\
 a_2 = & \lambda_{93} \frac{|w_1^*|}{\sqrt{\beta_5^*}} \left[\frac{1}{\frac{|w_1||w_1^*|}{\sqrt{\beta_5^*}}} \right]^\beta + \lambda_{94} \frac{|w_1^*|}{\sqrt{\beta_5^*}} \left[\frac{1}{\frac{|w_3||w_1^*|}{\sqrt{\beta_5^*}}} \right]^\beta \\
 & + \lambda_{95} \frac{|w_3^*|}{\sqrt{\beta_5^*}} \left[\frac{1}{\frac{|w_1||w_3^*|}{\sqrt{\beta_5^*}}} \right]^\beta + \lambda_{96} \frac{|w_3^*|}{\sqrt{\beta_5^*}} \left[\frac{1}{\frac{|w_3||w_3^*|}{\sqrt{\beta_5^*}}} \right]^\beta
 \end{aligned}$$

Using the numerical method given in [11] equations (7.10 a,b,c,d) further reduce to:

$$\begin{aligned}
 & \frac{1}{\pi} \sum_{j=1}^N w_j(\tau_{1j}) \left[\frac{1}{\tau_{1j} - \kappa_{1i}} + \pi h_1 k_{11s}^0(\kappa_{1i}, \tau_{1j}) + \pi h_1 k_{11f}^0(\kappa_{1i}, \tau_{1j}) \right] F_0(\tau_{1j}) \\
 & + \sum_{j=1}^N w_j^*(\tau_{2j}) \left[\frac{h_{2-c}}{2} k_{12s}^{*0}(\kappa_{1i}, \tau_{2j}) + \frac{h_{2-c}}{2} k_{12f}^{*0}(\kappa_{1i}, \tau_{2j}) \right] F_0^*(\tau_{2j}) \\
 & = - \frac{(1 - \nu_{xy} \nu_{yx})}{2\gamma_{14} E_y} p_1^0(\kappa_{1i}) \quad i = 1, \dots, N-1
 \end{aligned}$$

ORIGINAL PAGE IS
OF POOR QUALITY

$$\begin{aligned} & \frac{1}{\pi} \sum_{j=1}^N w_j^*(\tau_{2j}) \left[\frac{1}{\tau_{2j}^{-\kappa_{2i}}} + \frac{1}{\tau_{2j}^{\kappa_{2i}} + \frac{2(h_2^2 - c)}{h_2 - c}} + \pi \frac{h_2 - c}{2} k_{22s}^{*0}(\kappa_{2i}, \tau_{2j}) \right. \\ & \left. + \pi \frac{h_2 - c}{2} k_{22f}^{*0}(\kappa_{2i}, \tau_{2j}) \right] F_0^*(\tau_{2j}) + \sum_{j=1}^N w_j(\tau_{1j}) [h_1 k_{12s}^0(\kappa_{2i}, \tau_{1j}) \\ & + h_1 k_{21f}^0(\kappa_{2i}, \tau_{1j})] F_0(\tau_{1j}) = - \frac{(1 - v_{xy}^* v_{yx}^*)}{2\gamma_{14}^* E_y} p_2^0(\kappa_{2i}) \quad i = 1, \dots, N-1 \end{aligned}$$

$$h_1 \sum_{j=1}^N w_j(\tau_{1j}) F_0(\tau_{1j}) = 0$$

and

$$F_0^*(1) = -\sqrt{2} \left(\frac{h_1}{h_2 - c} \right)^\beta \frac{a_1}{a_2} F_0(1) \quad (7.11a, b, c, d)$$

where

$$\phi_0(\tau) = \frac{F_0(\tau)}{(1-\tau^2)^\beta}, \quad \phi_0^*(\tau) = \frac{F_0^*(\tau)}{(1-\tau)^\beta(1+\tau)^{\frac{1}{2}}}$$

$$P_N^{(-\beta, -\beta)}(\tau_{1j}) = 0 \quad j = 1, \dots, N$$

$$P_{N-1}^{(1-\beta, 1-\beta)}(\kappa_{1i}) = 0 \quad i = 1, \dots, N-1$$

$$P_N^{(-\beta, -\frac{1}{2})}(\tau_{2j}) = 0 \quad j = 1, \dots, N$$

$$P_{N-1}^{(1-\beta, \frac{1}{2})}(\kappa_{2i}) = 0 \quad i = 1, \dots, N-1$$

$w_j(\tau_{1j})$ and $w_j^*(\tau_{2j})$ are the corresponding weights of

$$P_N^{(-\beta, -\beta)}(\tau_{1j}) \text{ and } P_N^{(-\beta, -\frac{1}{2})}(\tau_{2j}).$$

Solving the $2N \times 2N$ system of linear equations, we obtain the $2N$ unknowns $F_0(\tau_{1j})$ and $F_0^*(\tau_{2j})$. The stress intensity factors can be defined as follows:

$$k_b = \lim_{x_2 \rightarrow c} \sqrt{2(c-x_2)} \sigma_{2y}(x_2, 0)$$

and at the bimaterial interfaces

$$k_{xx} = \lim_{y \rightarrow 0^+} y^\beta \sigma_{1x}(h_1, y)$$

$$k_{xy} = \lim_{y \rightarrow 0^+} y^\beta \tau_{1xy}(h_1, y) \quad (7.12a, b, c)$$

By making use of definitions (7.12a, b, c) and after lengthy calculation shown in Appendix D we obtain:

$$k_b = \frac{2^{1-\beta} \gamma_{14}^* E_y^*}{(1-\nu_{xy}^* \nu_{yx}^*)} \sqrt{h_2-c} F_0^*(-1)$$

$$k_{xx} = \frac{E_x}{(1-\nu_{xy}^* \nu_{yx}^*)} \frac{1}{2^{\beta+1} \sin \frac{\pi\beta}{2}} \left\{ \frac{h_1^\beta}{\gamma_{13}} \left[\frac{\gamma_1}{\left[\frac{|w_1|}{\sqrt{\beta_5}} \right]^\beta} - \gamma_2 \frac{\gamma_{11}}{\gamma_{12}} \frac{1}{\left[\frac{|w_3|}{\sqrt{\beta_5}} \right]^\beta} \right. \right. \\ \left. \left. - \frac{|w_1|}{\sqrt{\beta_5}} \frac{(\gamma_3 \lambda_{81} + \gamma_4 \lambda_{82})}{\left[\frac{|w_1|}{\sqrt{\beta_5}} \right]^\beta \lambda_{80}} - \frac{|w_3|}{\sqrt{\beta_5}} \frac{(\gamma_3 \lambda_{83} + \gamma_4 \lambda_{84})}{\left[\frac{|w_3|}{\sqrt{\beta_5}} \right]^\beta \lambda_{80}} \right] F_0(-1) \right. \\ \left. + \frac{(h_2-c)^\beta}{\sqrt{2} \gamma^* \lambda_{1380}} \left[\frac{|w_1^*|}{\sqrt{\beta_5^*}} \frac{(\gamma_3 \lambda_{89} + \gamma_4 \lambda_{90})}{\left[\frac{|w_1^*|}{\sqrt{\beta_5^*}} \right]^\beta} + \frac{|w_3^*|}{\sqrt{\beta_5^*}} \frac{(\gamma_3 \lambda_{91} + \gamma_4 \lambda_{92})}{\left[\frac{|w_3^*|}{\sqrt{\beta_5^*}} \right]^\beta} \right] F_0^*(1) \right\}$$

$$\begin{aligned}
k_{xy} = \frac{G_{xy}}{2^{\beta+1} \cos \frac{\pi\beta}{2}} \left\{ \frac{h_1^\beta}{\gamma_{13}} \left[- \frac{\gamma_{11}}{\left(\frac{|w_1|}{\sqrt{\beta_5}}\right)^\beta} + \frac{\gamma_{11}}{\left(\frac{|w_3|}{\sqrt{\beta_5}}\right)^\beta} \right. \right. \\
- \frac{(\gamma_9\lambda_{81} + \gamma_{10}\lambda_{82})}{\lambda_{80} \left(\frac{|w_1|}{\sqrt{\beta_5}}\right)^\beta} \frac{|w_1|}{\sqrt{\beta_5}} - \frac{(\gamma_9\lambda_{83} + \gamma_{10}\lambda_{84})}{\lambda_{80} \left(\frac{|w_3|}{\sqrt{\beta_5}}\right)^\beta} \frac{|w_3|}{\sqrt{\beta_5}} \left. \right] F_0(-1) \\
+ \frac{(h_2-c)^\beta}{\sqrt{2} \gamma_{13}^* \lambda_{80}} \left[\frac{(\gamma_9\lambda_{89} + \gamma_{10}\lambda_{90})}{\left(\frac{|w_1^*|}{\sqrt{\beta_5^*}}\right)^\beta} \frac{|w_1^*|}{\sqrt{\beta_5^*}} + \frac{(\gamma_9\lambda_{91} + \gamma_{10}\lambda_{92})}{\left(\frac{|w_3^*|}{\sqrt{\beta_5^*}}\right)^\beta} \frac{|w_3^*|}{\sqrt{\beta_5^*}} \right. \left. \right] F_0^*(1) \left. \right\}
\end{aligned}$$

(7.13a,b,c)

Extrapolating the results found from equations (7.11a,b,c, d) the stress intensity factors k_b , k_{xx} , k_{xy} can be computed in a straight-forward manner. The results are shown in Figures 17-19. Figure 17 shows the variation of k_b with c/h_2 , for different values of (h_1/h_2) ratio. k_b increases as (h_1/h_2) increases. Figures 18 and 19 show the variation of k_{xx} and k_{xy} with respect to c/h_2 .

7.3.2 Non-Singular Behavior at the Interface

In this case, the characteristic equation (6.10) has no root and therefore the surface displacement derivatives are bounded. Since, as it was shown in Section 6, the displacement derivatives are continuous at the bimaterial interfaces, using the single-valuedness condition to write

the integrals from 0 to ℓ , equations (6.2a,b) take the form (see [12]):

$$\frac{1}{\pi} \int_0^{\ell} \left[\frac{1}{r-s} + \frac{1}{r+s} \right] G(r) dr + \int_0^{\ell} k(r,s) G(r) dr = p(s) \quad 0 < s < \ell \quad (7.10)$$

where

$$G(r) = \begin{cases} \phi(t) & (0 < t < h_1, 0 < r < h_1) \\ \phi^*(t) & (-h_2 < t < -c, h_1 < r < \ell) \end{cases}$$

$$p(s) = \begin{cases} -\frac{(1-\nu_{xy}\nu_{yx})}{2\gamma_{14}E_y} p_1(x_1) & (0 < x_1 < h_1, 0 < s < h_1) \\ -\frac{(1-\nu_{xy}^*\nu_{yx}^*)}{2\gamma_{14}^*E_y^*} p_2(x_2) & (-h_2 < x_2 < -c, h_1 < s < \ell) \end{cases}$$

$$k(r,s) = \begin{cases} k_{11}^*(x_1, t) & (0 < x_1, t < h_1, 0 < r, s < h_1) \\ k_{12}^*(x_1, t) - \frac{1}{\pi} \left[\frac{1}{t-x_1} + \frac{1}{t+x_1} \right] & \begin{cases} 0 < x_1 < h_1, 0 < s < h_1 \\ -h_2 < t < -c, h_1 < r < \ell \end{cases} \\ k_{21}^*(x_2, t) - \frac{1}{\pi} \left[\frac{1}{t-x_2} + \frac{1}{t+x_2} \right] & \begin{cases} -h_2 < x_2 < -c, h_1 < s < \ell \\ 0 < t < h_1, 0 < r < h_1 \end{cases} \\ k_{22}^*(x_2, t) & (-h_2 < x_2, t < -c, h_1 < r, s < \ell) \end{cases}$$

with

$$k_{ij}^*(x_i, t) = k_{ij}(x_i, t) - k_{ij}(x_i, -t) \quad (i, j = 1, 2)$$

Now we have the governing equations for a crack imbedded in a non-homogeneous material, obviously with power singularity $-\frac{1}{2}$ at the crack tip. Normalizing equation (7.10) by means of:

$$r = \ell\tau \quad \text{and} \quad s = \ell\kappa$$

we obtain:

$$\frac{1}{\pi} \int_0^1 \left[\frac{1}{\tau-\kappa} + \frac{1}{\tau+\kappa} \right] G_0(\tau) d\tau + \ell \int_0^1 k_0(\tau, \kappa) G_0(\tau) d\tau = p_0(\kappa) \quad 0 < \kappa < 1 \quad (7.11)$$

Equation (7.11) reduces to a set of linear equations by using the method of collocations (see [11]):

$$\sum_{j=1}^N \left[\frac{1}{\tau_j - \kappa_i} + \frac{1}{\tau_j + \kappa_i} + \pi \ell k_0(\tau_j, \kappa_i) \right] H_0(\tau_j) = 2N p_0(\kappa_i) \quad i = 1, \dots, N \quad (7.12)$$

where

$$\begin{aligned} \tau_j &= \cos \left[\frac{2j-1}{4N} \pi \right], \quad j = 1, \dots, N \\ \kappa_i &= \cos \left[\frac{i}{2N} \pi \right], \quad i = 1, \dots, N \\ G_0(\tau) &= \frac{H_0(\tau)}{\sqrt{1-\tau^2}} \end{aligned}$$

The N unknowns $H_0(\tau_j)$ can be found from equation (7.12) in a straight-forward manner.

Defining the stress intensity factor at the crack tip as:

$$k_b = \lim_{x_2 \rightarrow \ell} \sqrt{2(x_2 - \ell)} \sigma_{2y}(x_2, 0)$$

we obtain:

$$k_b = - \frac{2\gamma_{14}^* E_y^* \sqrt{\ell}}{(1 - \nu_{xy}^* \nu_{yx}^*)} H_0(1) \quad (7.13)$$

Using the same material for both strips, we recover again the results of colinear cracks in homogeneous medium. Figure 20 shows the variation of k_b with c/h_2 . k_b increases as h_1/h_2 increases.

ORIGINAL PAGE IS
OF POOR QUALITY

8. CONCLUSIONS

The fracture problem of layered orthotropic composite plates has been studied. The following results have been obtained:

1) Depending on the elastic constants, orthotropic materials can be classified in two groups: materials of type I and materials of type II. (A different formulation is needed for each combination.)

2) The colinear crack solution is the same for homogeneous isotropic and orthotropic materials.

3) In the case of an internal crack in the first layer, the stress intensity factor k_a can be reduced significantly by a proper selection of the elastic constants.

4) For the case of broken laminates there is a singularity power which can be found from equation (5.7). The singularity power γ varies between 0 and 1 for different material combinations.

5) For a crack crossing the interface, the singular behavior at the interface disappears for some material combinations. In this case the crack surface displacement derivatives are bounded and continuous, and all stresses are bounded at the bimaterial interfaces.

9. RECOMMENDATIONS

In the present work, a general formulation of the fracture problem of layered orthotropic composites with periodic cracks is given. The formulation is done only for the case where both materials are of type I. Following the same procedure, the problem can also be studied for orthotropic materials of type II, or for the combination of type I and type II. The dependence of the singular behavior at the interface on the elastic constants can also be investigated.

In our formulation the thickness of the adhesive bonding the layers has been neglected. The study of the effect of the adhesive also can be recommended.

A more realistic approach also would be to study the problem of finite number of strips. But this problem requires lengthy algebra.

There are many other problems to be studied in the fracture of composites. We hope that our work will have a small contribution in the study of these problems.

**ORIGINAL PAGE IS
OF POOR QUALITY**

TABLES

1-2

ORIGINAL PAGE IS
OF POOR QUALITY

Table 1.
The elastic constants
and material
combinations

| Mat. No. | E_x | E_y | G_{xy} | ν_{xy} |
|-----------|---|--|--|------------------|
| 1 | $5.62 \times 10^9 \text{ N/m}^2$ ($8 \times 10^6 \text{ psi}$) | $17.37 \times 10^9 \text{ N/m}^2$ ($24.75 \times 10^6 \text{ psi}$) | $0.492 \times 10^9 \text{ N/m}^2$ ($0.7 \times 10^6 \text{ psi}$) | 0.036 (0.036) |
| 2 | $13.71 \times 10^9 \text{ N/m}^2$ ($19.5 \times 10^6 \text{ psi}$) | $3.16 \times 10^9 \text{ N/m}^2$ ($4.5 \times 10^6 \text{ psi}$) | $2.46 \times 10^9 \text{ N/m}^2$ ($3.5 \times 10^6 \text{ psi}$) | 0.650 (0.650) |
| 3 | $15.76 \times 10^9 \text{ N/m}^2$ ($22.447 \times 10^6 \text{ psi}$) | $15.78 \times 10^9 \text{ N/m}^2$ ($22.6 \times 10^6 \text{ psi}$) | $6.09 \times 10^9 \text{ N/m}^2$ ($8.655 \times 10^6 \text{ psi}$) | 0.300 (0.300) |
| 4 | $17.34 \times 10^9 \text{ N/m}^2$ ($24.3 \times 10^6 \text{ psi}$) | $17.37 \times 10^9 \text{ N/m}^2$ ($24.75 \times 10^6 \text{ psi}$) | $6.36 \times 10^9 \text{ N/m}^2$ ($9.05 \times 10^6 \text{ psi}$) | 0.300 (0.300) |
| 5 | $1.025 \times 10^9 \text{ N/m}^2$ ($1.46 \times 10^6 \text{ psi}$) | $3.16 \times 10^9 \text{ N/m}^2$ ($4.5 \times 10^6 \text{ psi}$) | $0.901 \times 10^8 \text{ N/m}^2$ ($0.128 \times 10^6 \text{ psi}$) | 0.036 (0.036) |
| 6 | $3.09 \times 10^9 \text{ N/m}^2$ ($4.4 \times 10^6 \text{ psi}$) | $3.16 \times 10^9 \text{ N/m}^2$ ($4.5 \times 10^6 \text{ psi}$) | $1.104 \times 10^9 \text{ N/m}^2$ ($1.57 \times 10^6 \text{ psi}$) | 0.400 (0.400) |
| Comb. No. | Material of the first strip | Material of the second strip | | |
| I | 1 | 2 | | |
| II | 3 | 2 | | |
| III | 4 | 2 | | |
| IV | 4 | 6 | | |
| V | 4 | 5 | | |

| Material constant | | k_a |
|-------------------------------------|-----------|-----------|
| E_x | increases | increases |
| E_x^* | increases | decreases |
| G_{xy} | increases | increases |
| G_{xy}^* | increases | decreases |
| ν_{xy} | increases | increases |
| ν_{xy}^* | increases | decreases |
| E_y and E_y^* are kept constant | | |

Table 2. Dependence of k_a on the elastic constants

FIGURES

1-20

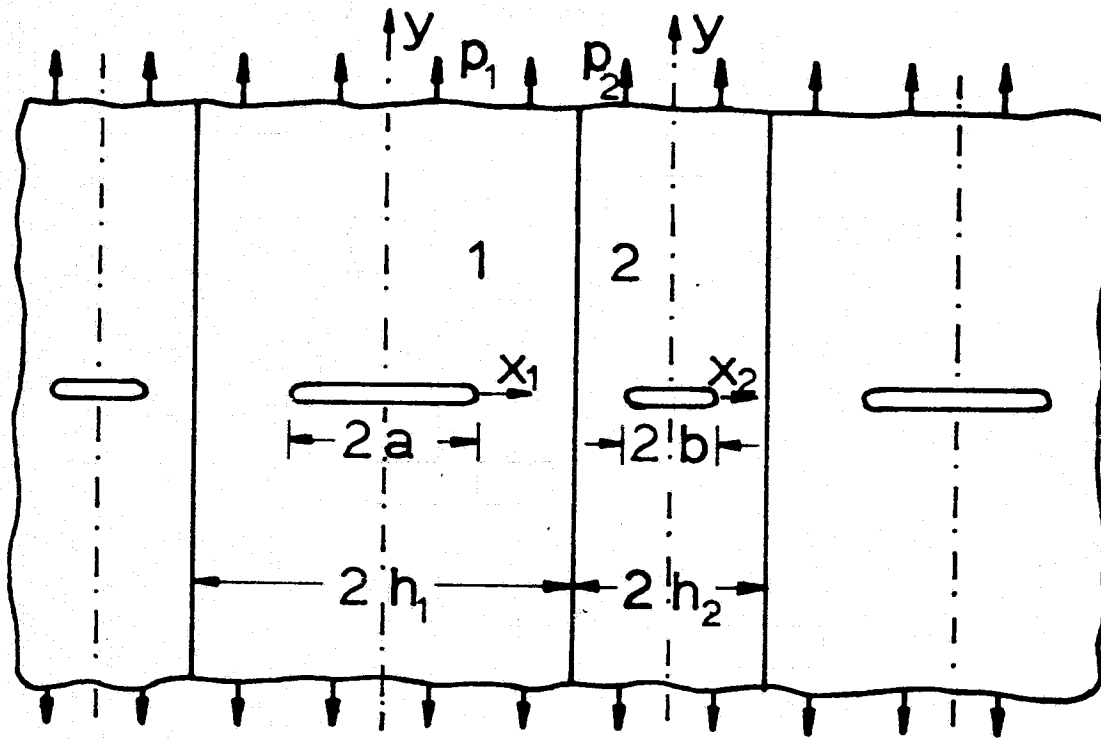

Figure 1. Geometry of the composite plate.

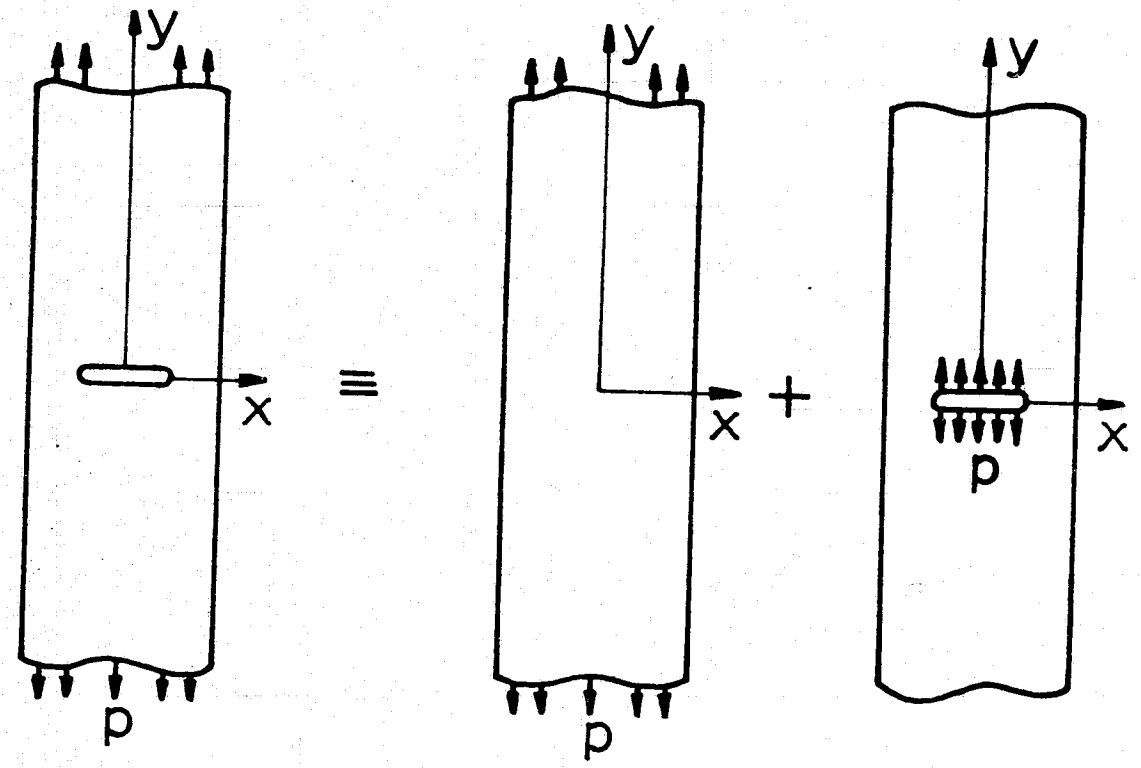

Figure 2. The superposition.

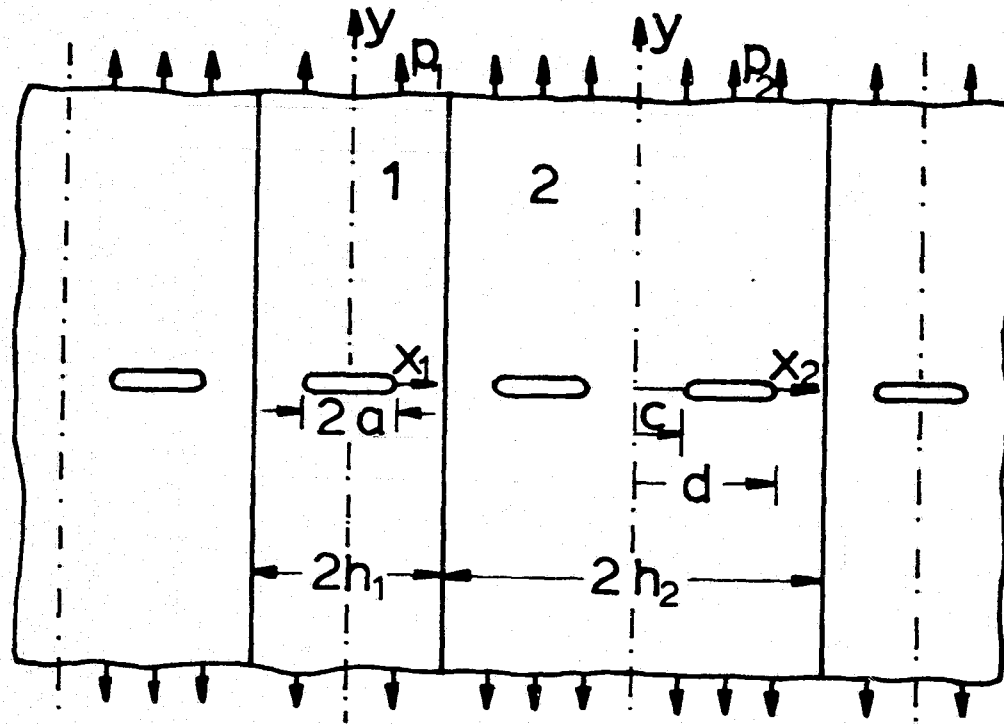

Figure 3. Initial geometry for the case of a crack crossing the interface.

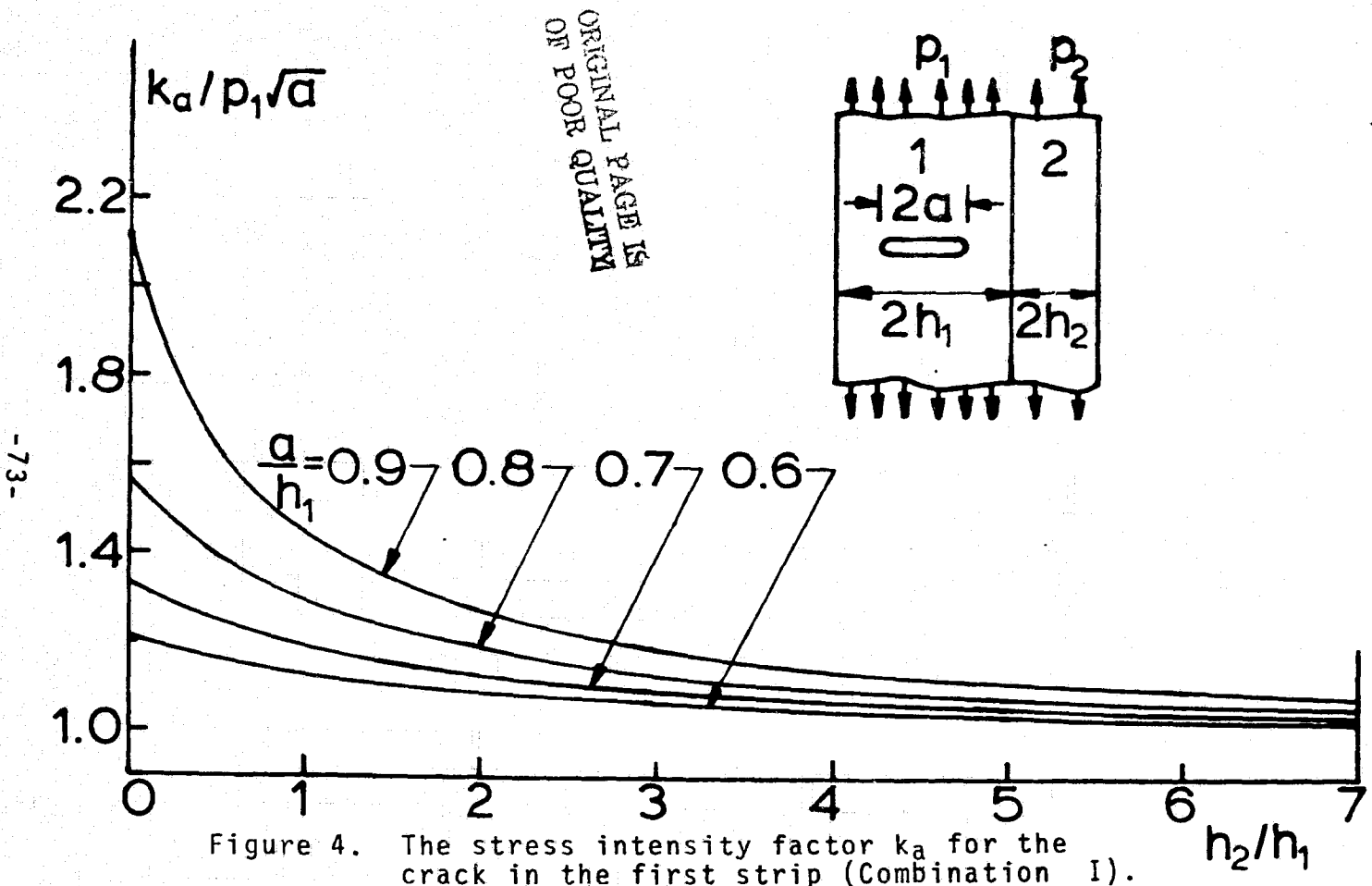

Figure 4. The stress intensity factor k_a for the crack in the first strip (Combination I).

-73-

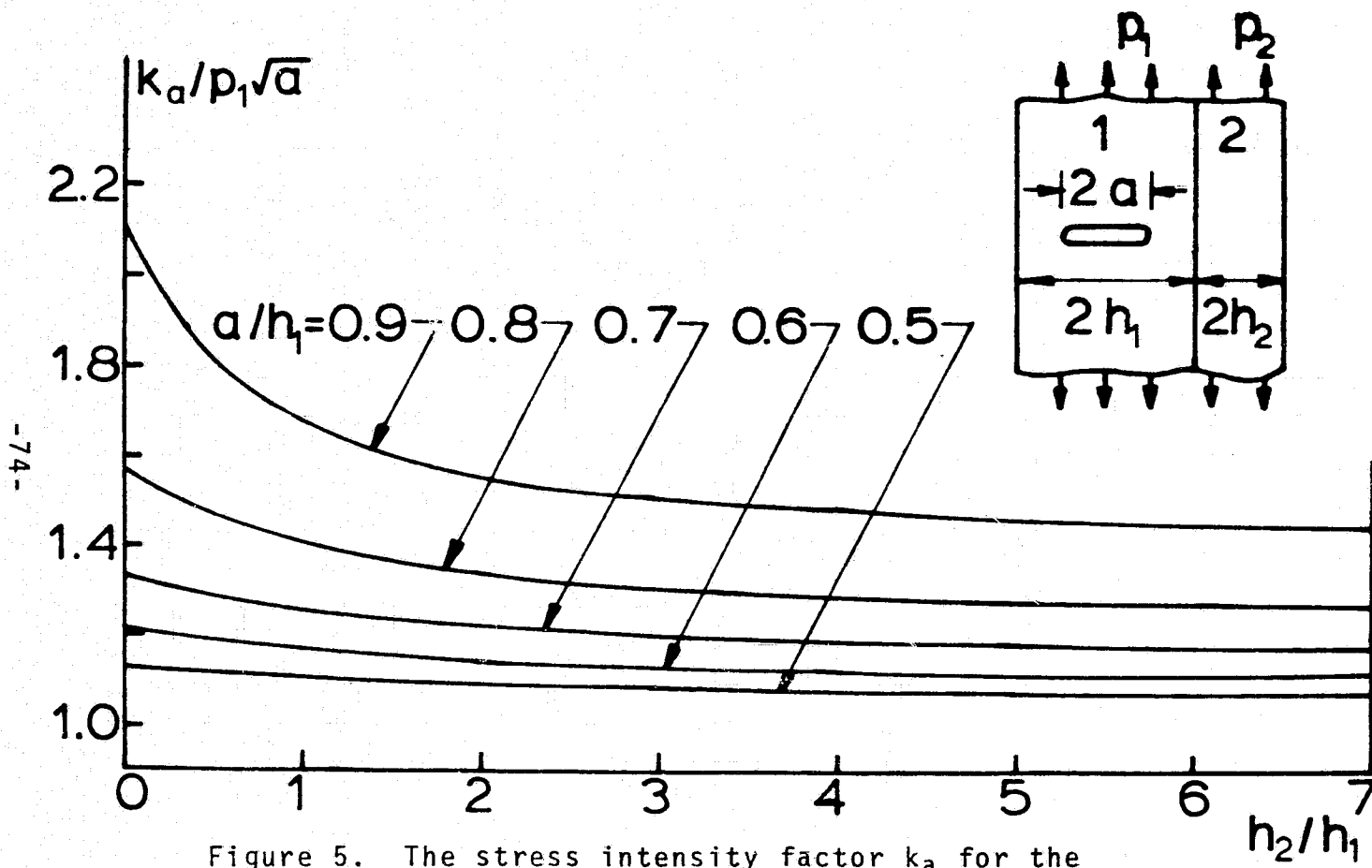

Figure 5. The stress intensity factor k_a for the crack in the first strip (Combination II).

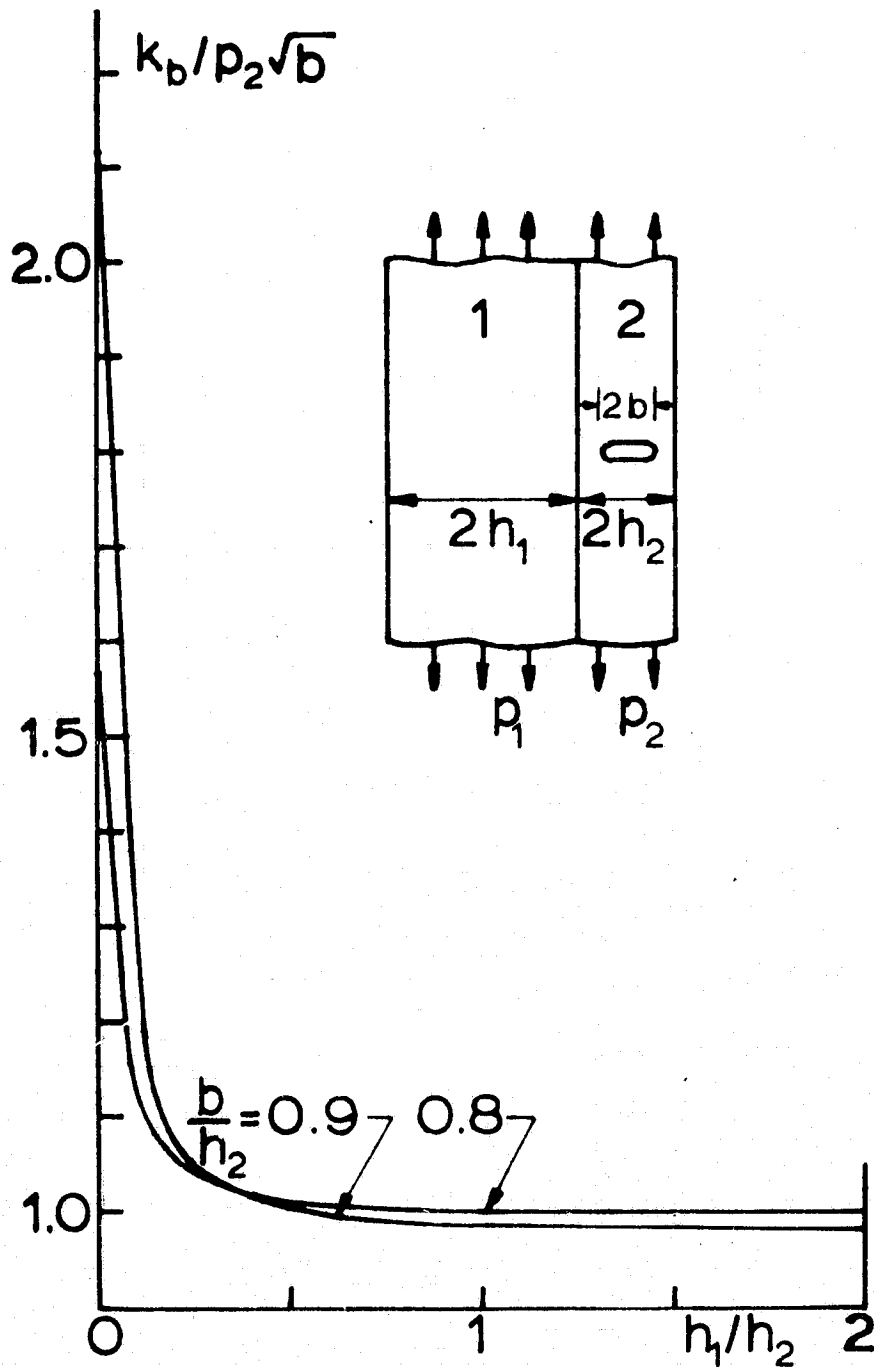

Figure 6. The stress intensity factor k_b for the crack in buffer strip (Combination I).

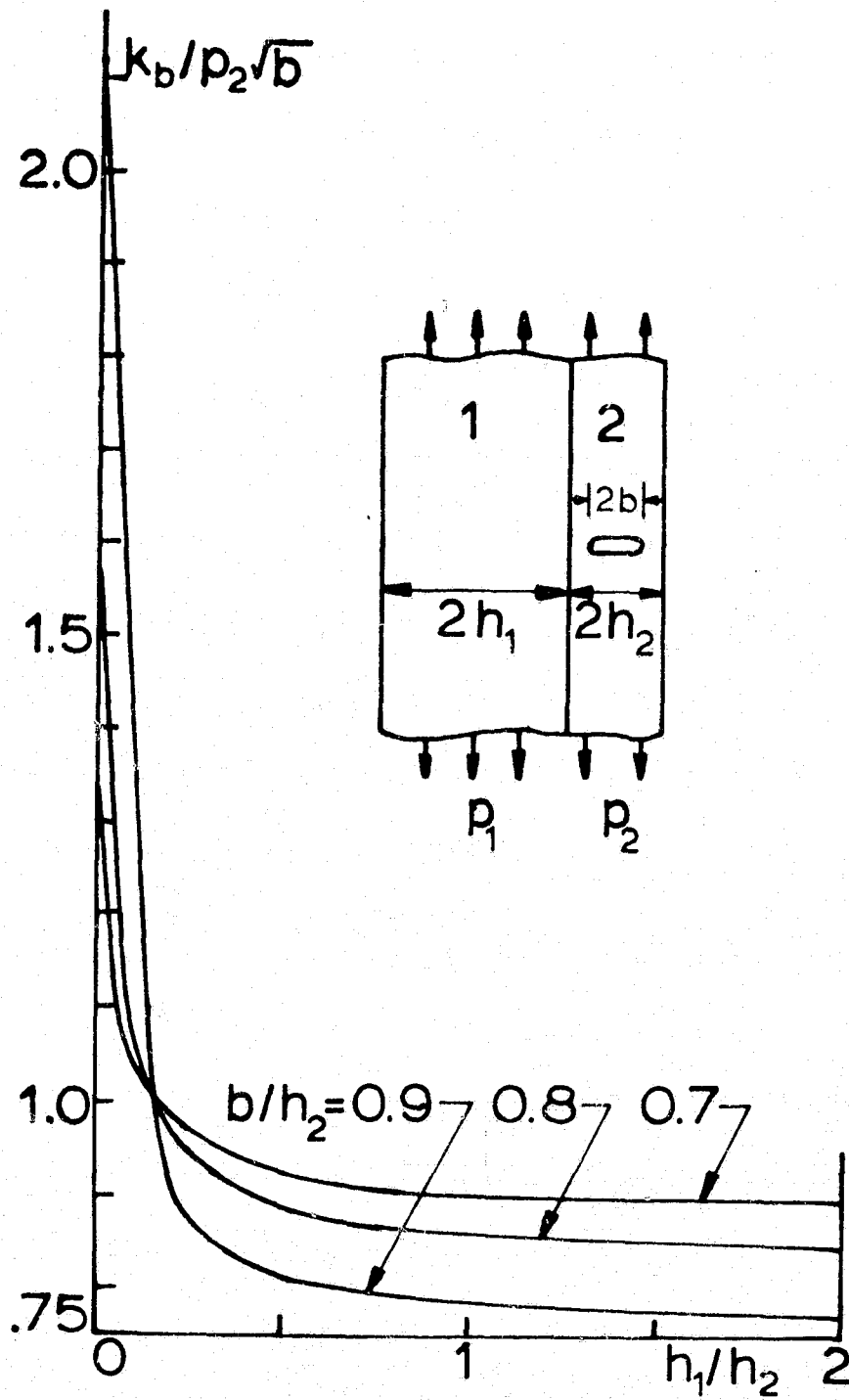
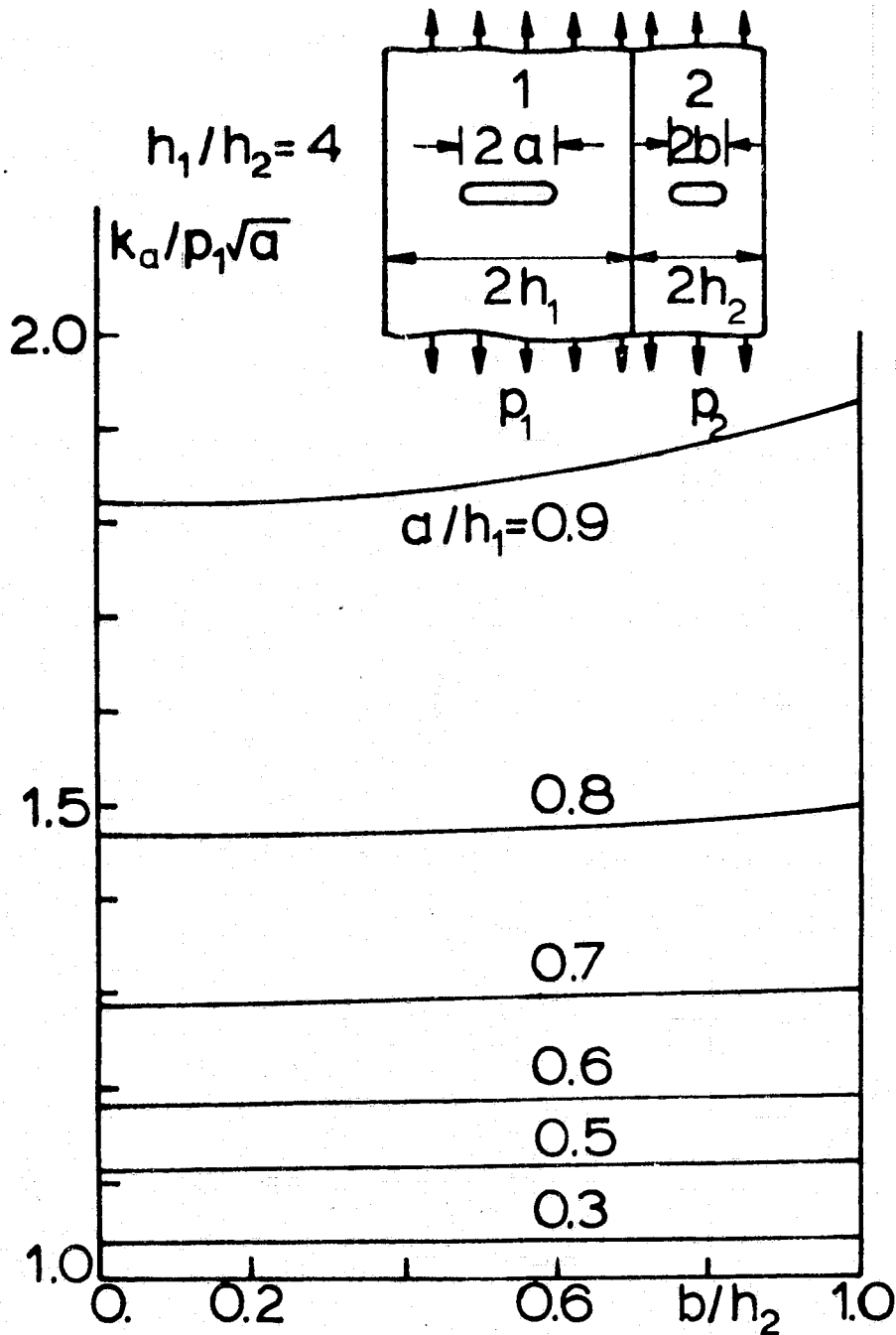

Figure 7. The stress intensity factor k_b for the crack in buffer strip (Combination II).



ORIGINAL PAGE IS
OF POOR QUALITY

Figure 8. The stress intensity factor k_a for the case in which both strips contain cracks (Combination I).

ORIGINAL PAGE IS
OF POOR QUALITY

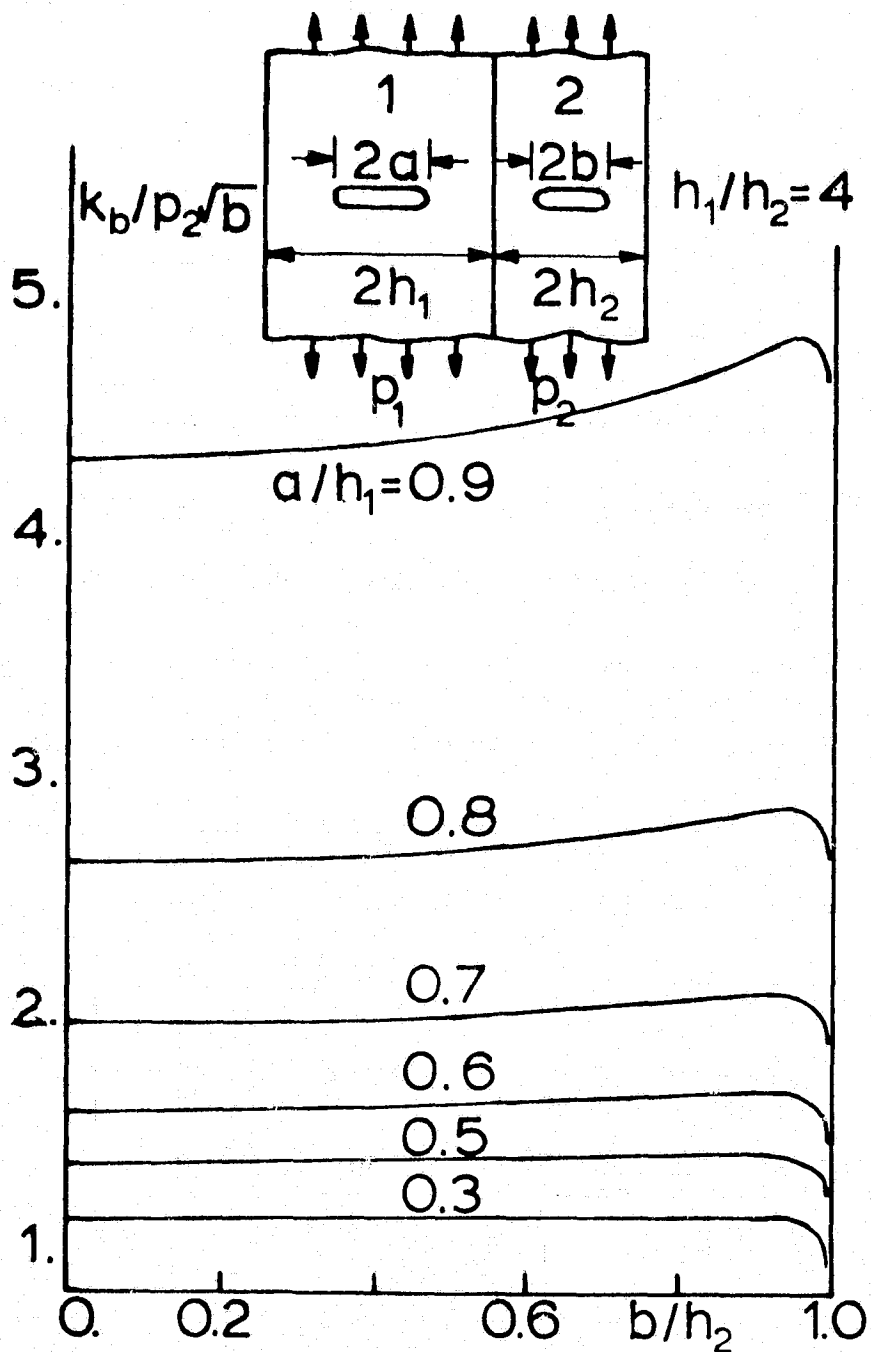
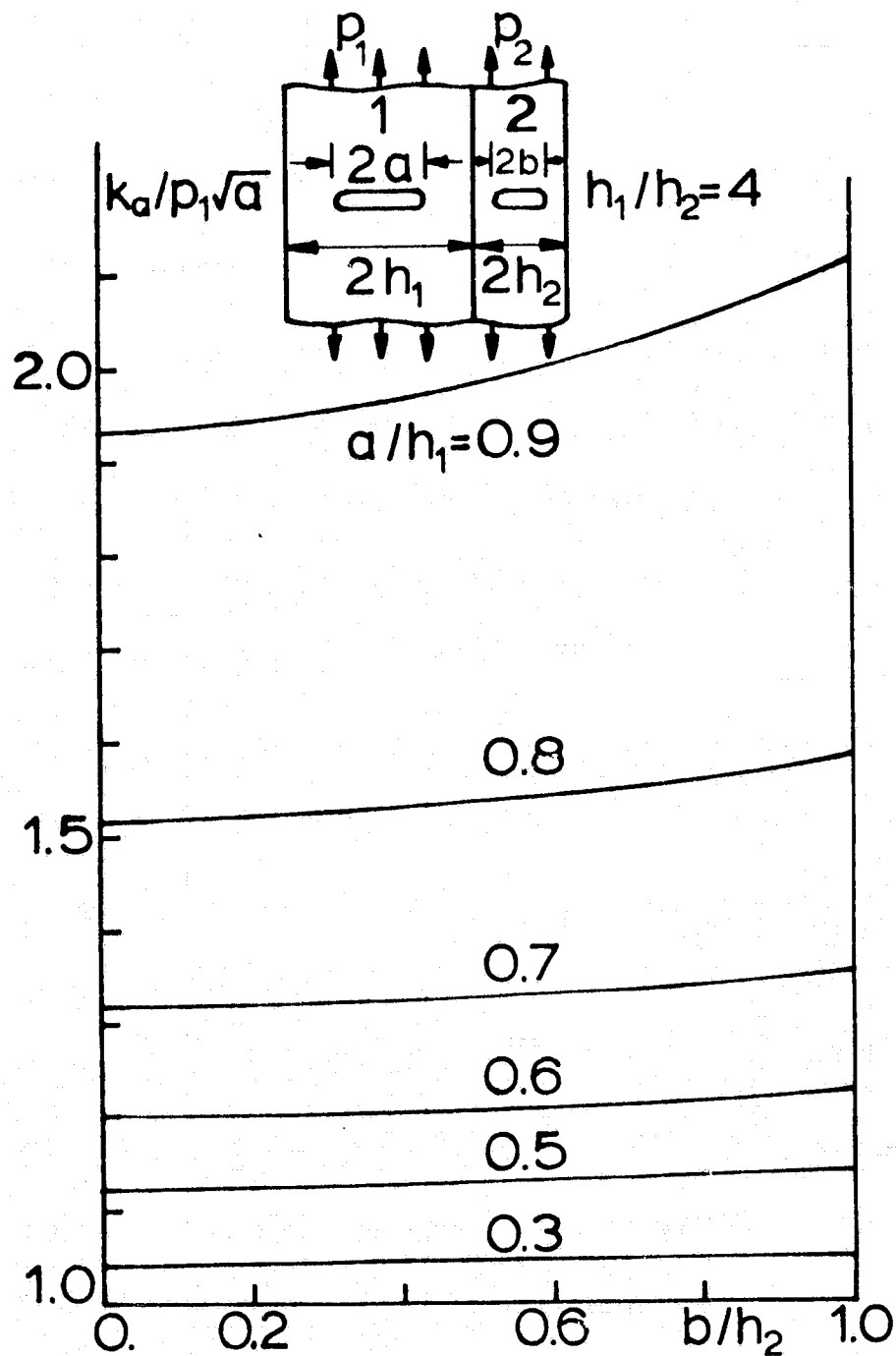

Figure 9. The stress intensity factor k_b for the case in which both strips contain cracks (Combination I).



ORIGINAL PAGE IS
OF POOR QUALITY

Figure 10. The stress intensity factor k_a for the case in which both strips contain cracks (Combination II).

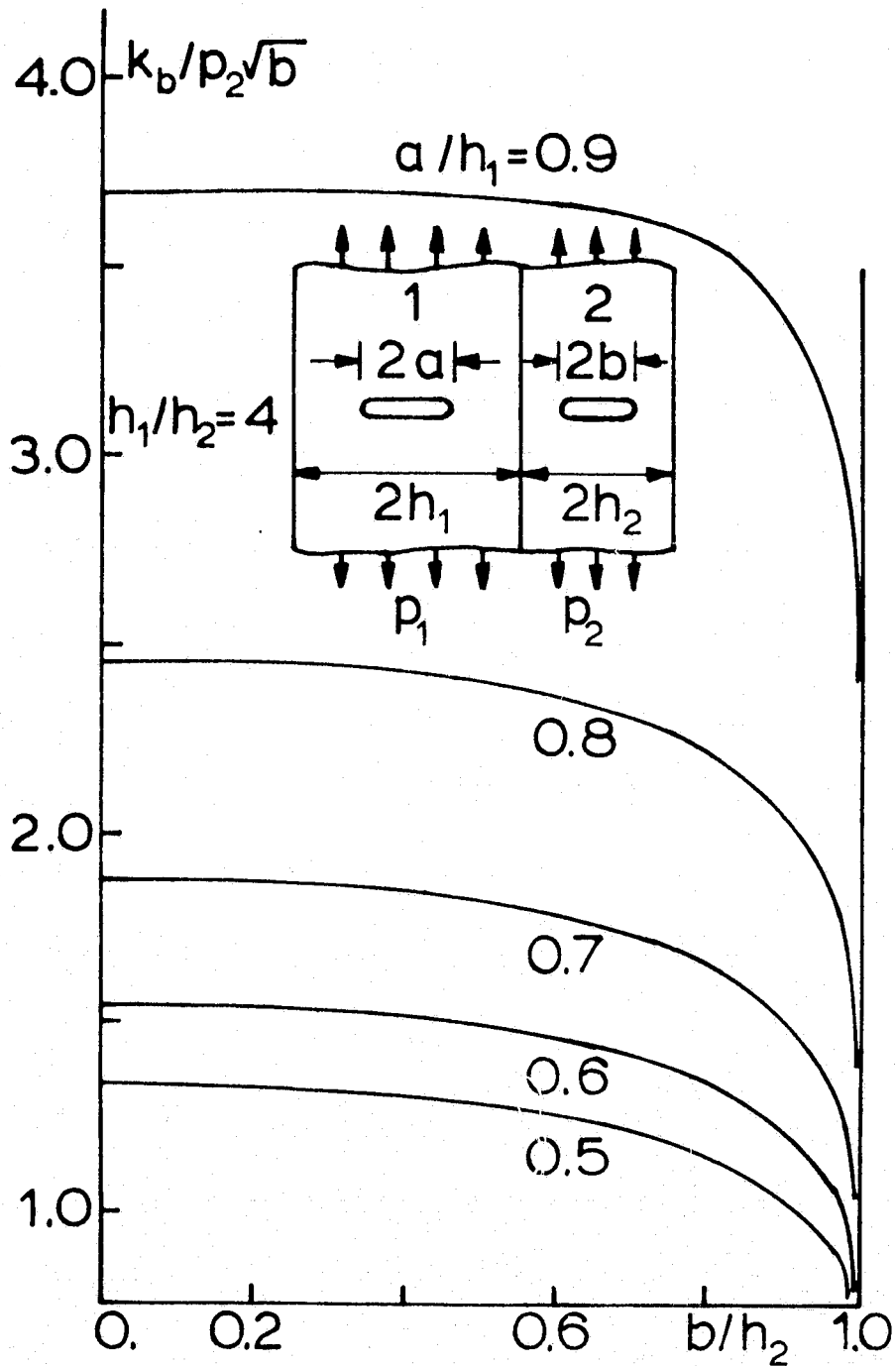

Figure 11. The stress intensity factor k_b for the case in which both strips contain cracks (Combination II).

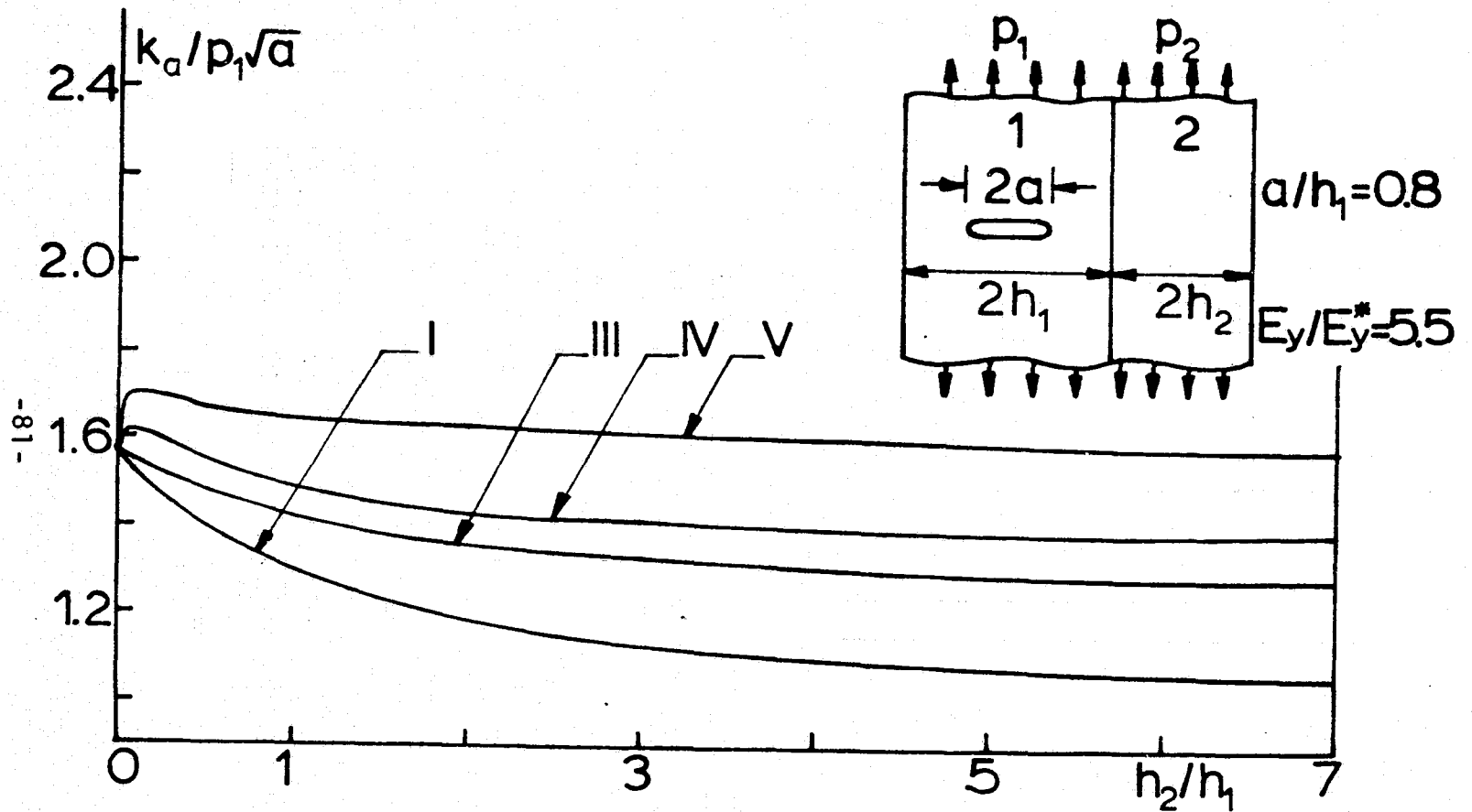

Figure 12. Comparison of the stress intensity factor k_a for isotropic and orthotropic materials.

ORIGINAL PAGE IS
OF POOR QUALITY

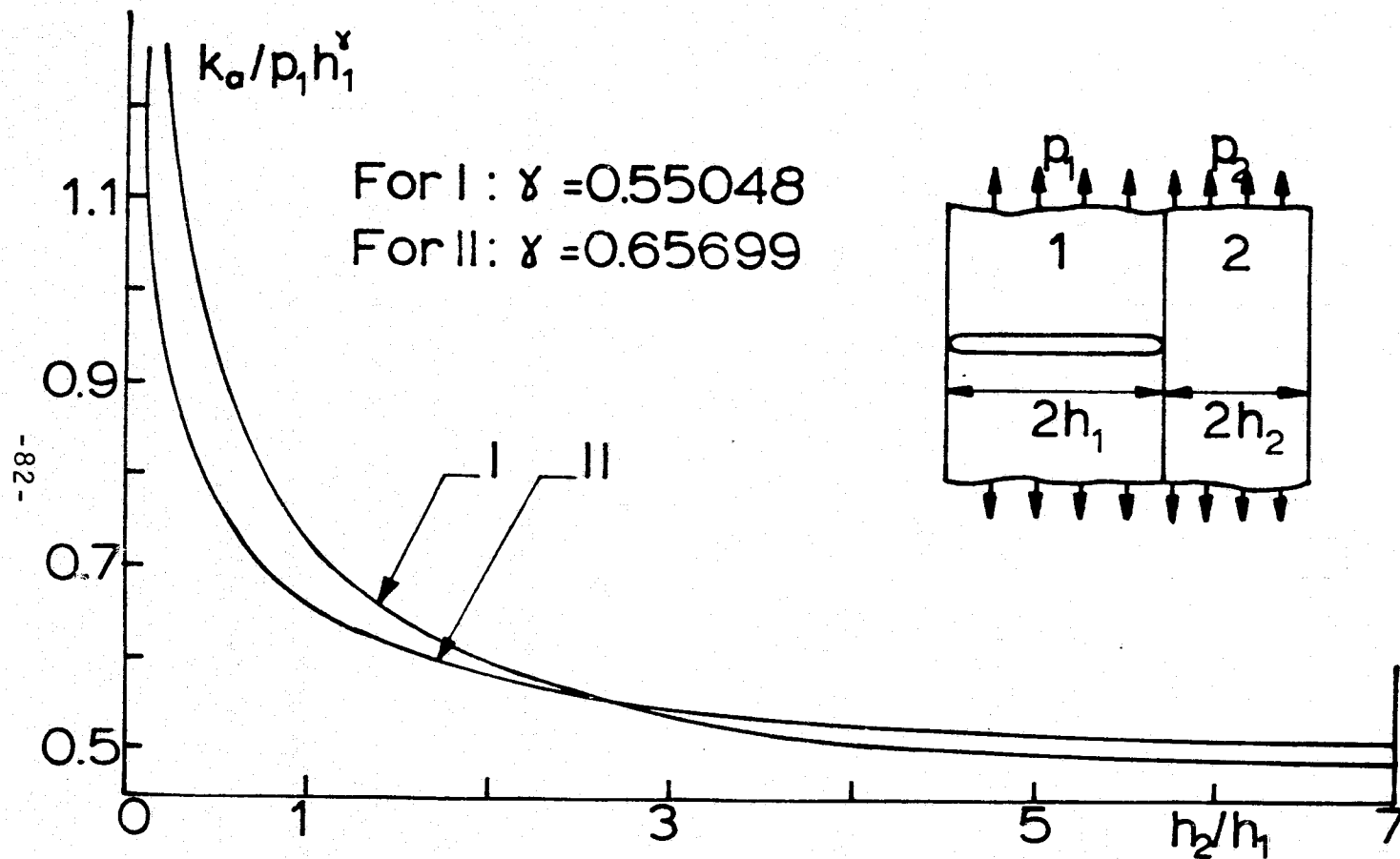

Figure 13. The stress intensity factor k_a when the first laminate is broken (Combination I and II).

ORIGINAL PAGE
OF POOR QUALITY

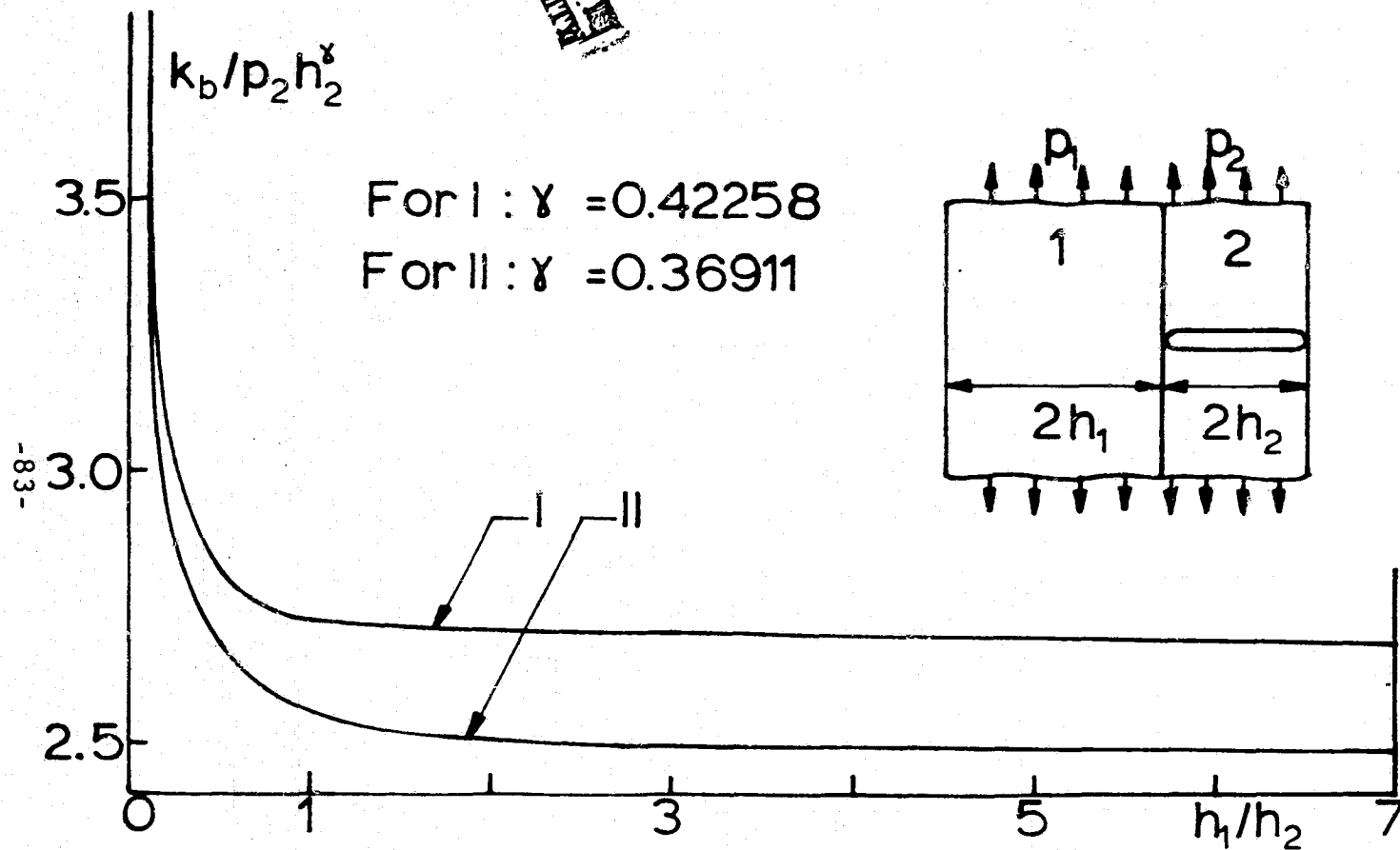

Figure 14. The stress intensity factor k_b when the second laminate is broken (Combination I and II).

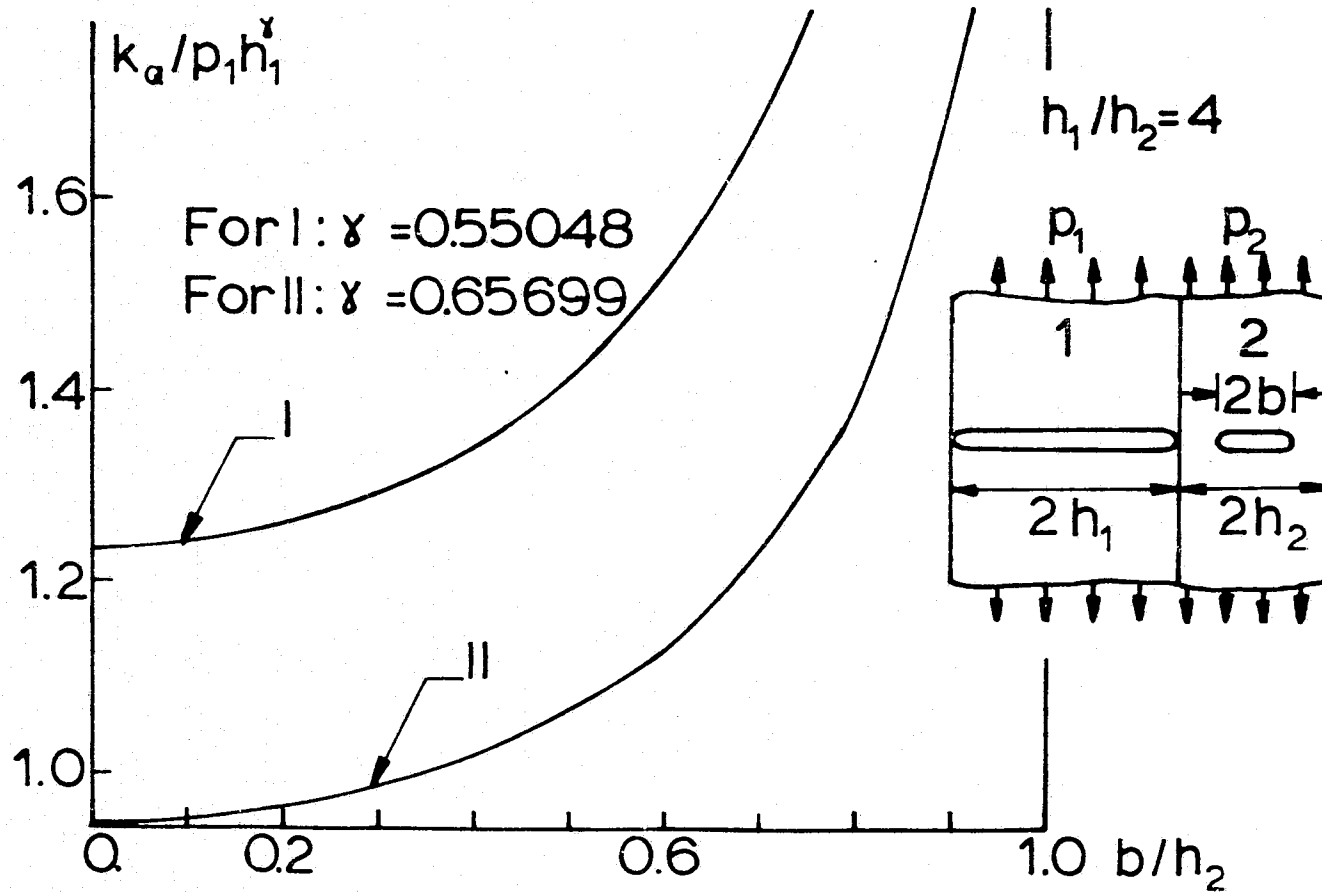

Figure 15. The stress intensity factor k_a when the first laminate is broken and the second contains a crack (Combination I and II).

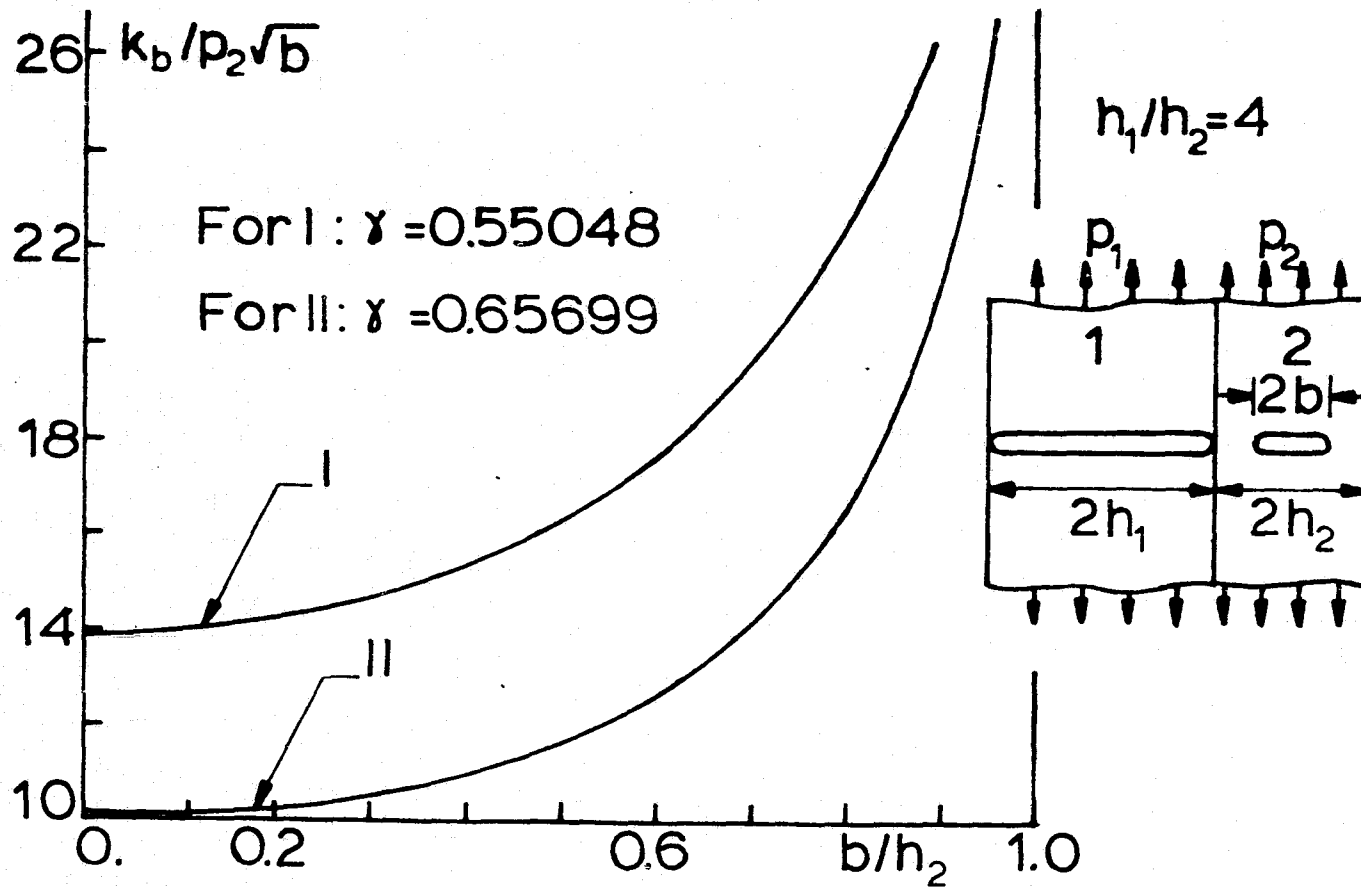

Figure 16. The stress intensity factor k_b when the first laminate is broken and the second contains a crack (Combination I and II).

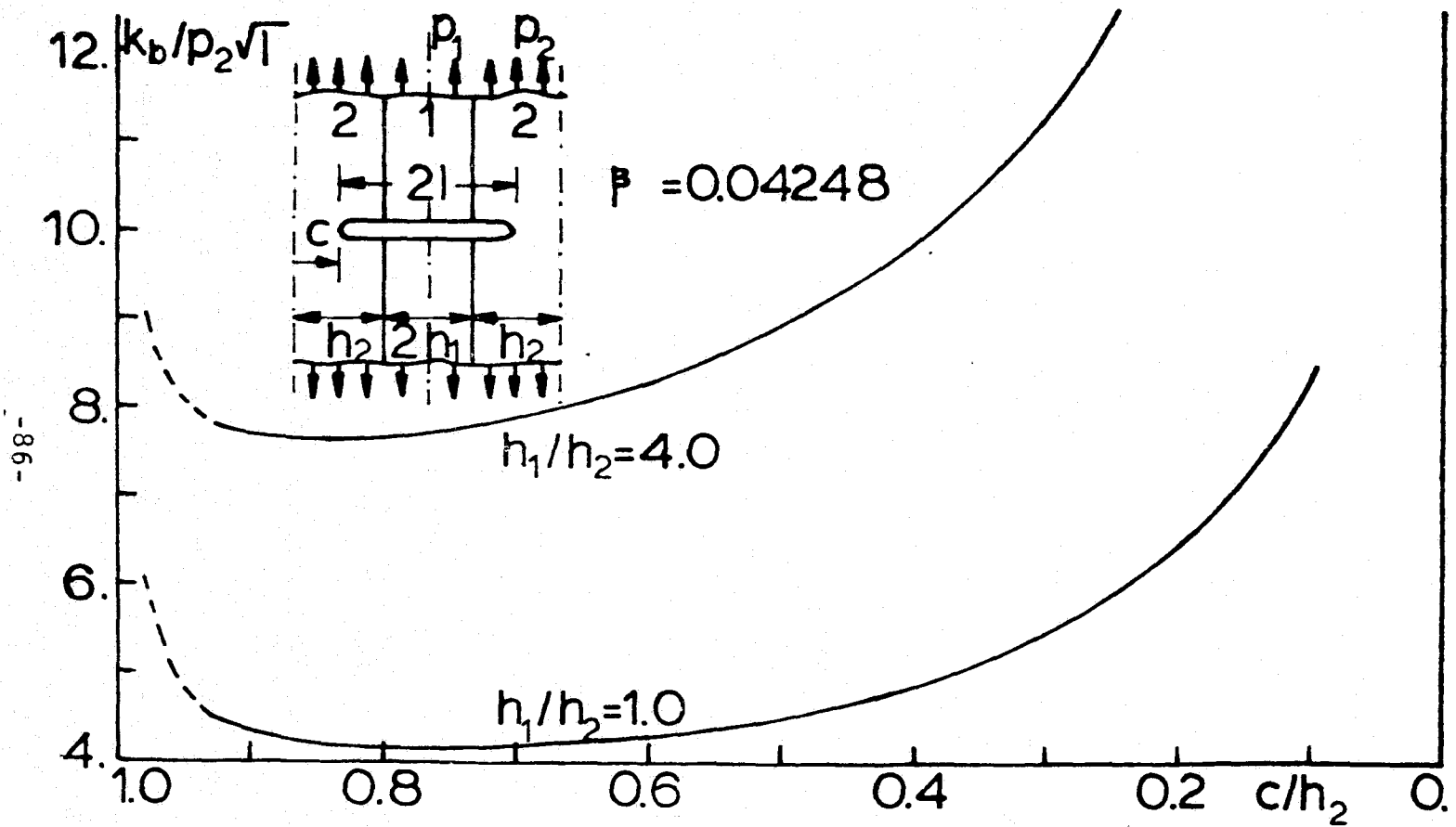

Figure 17. The stress intensity factor k_b for a crack crossing the interface (Singular behavior at the interface).

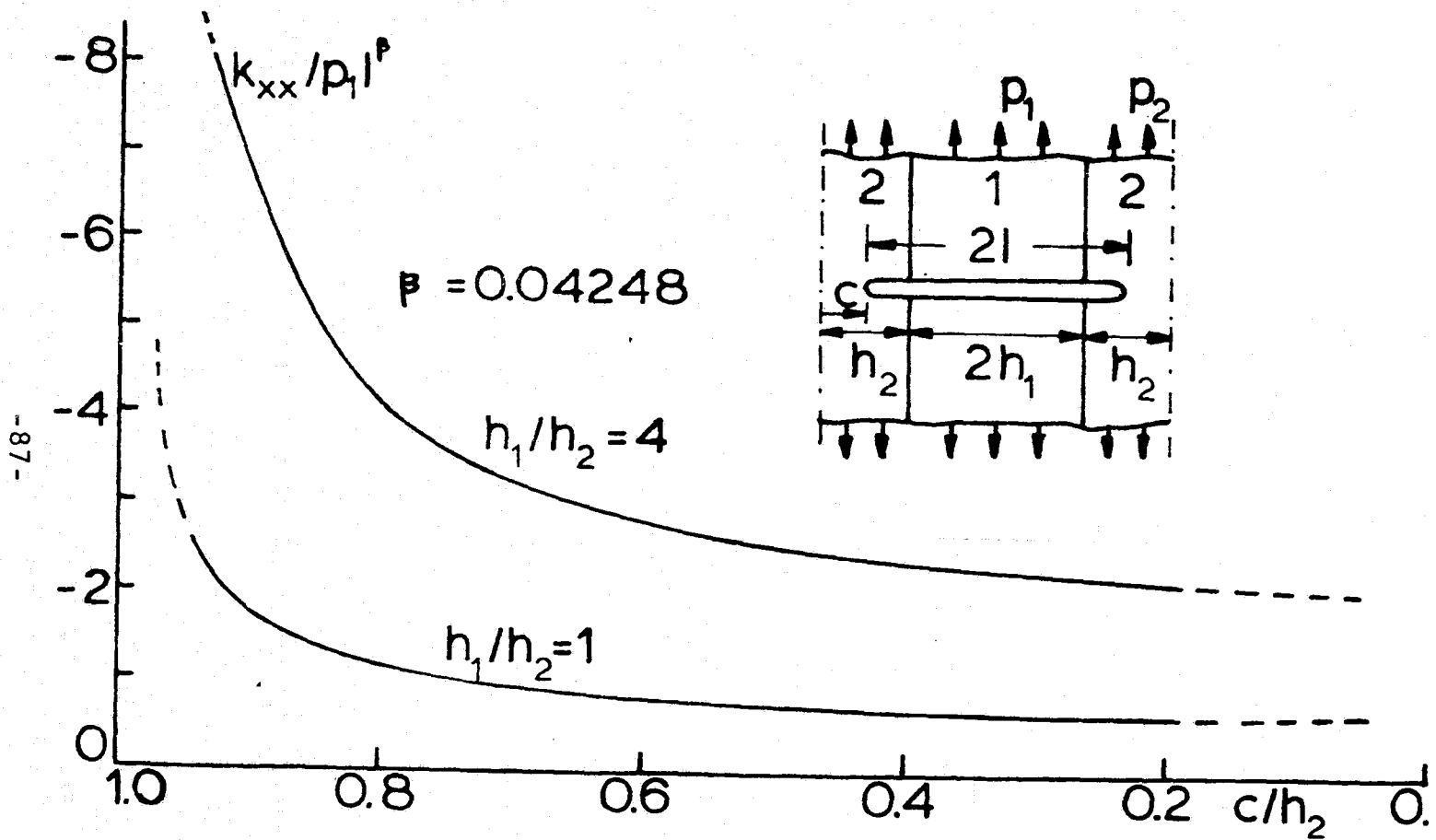

Figure 18. The stress intensity factor k_{xx} for a crack crossing the interface.

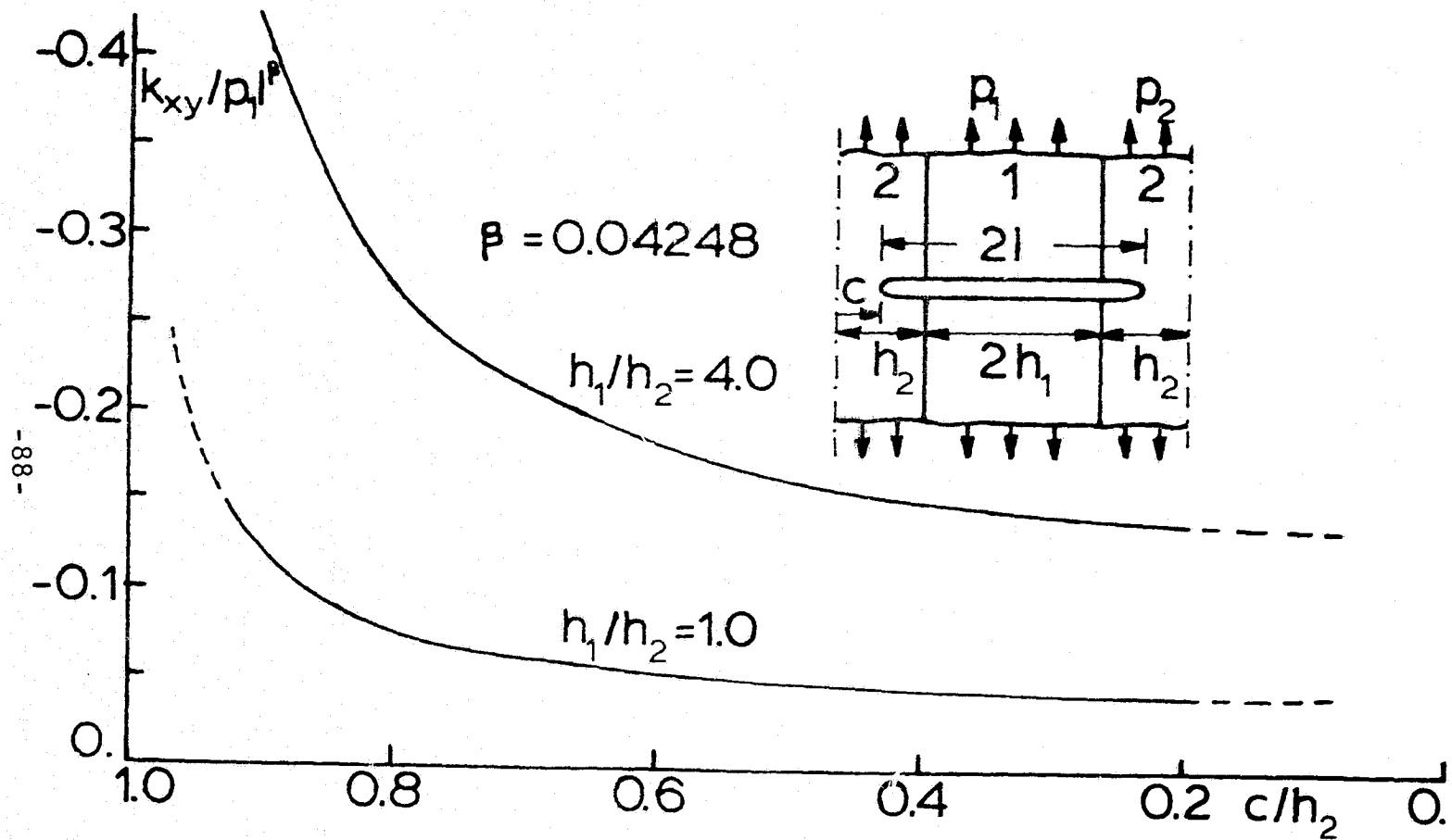

Figure 19. The stress intensity factor k_{xy} for a crack crossing the interface.

ORIGINAL PAGE IS
OF POOR QUALITY

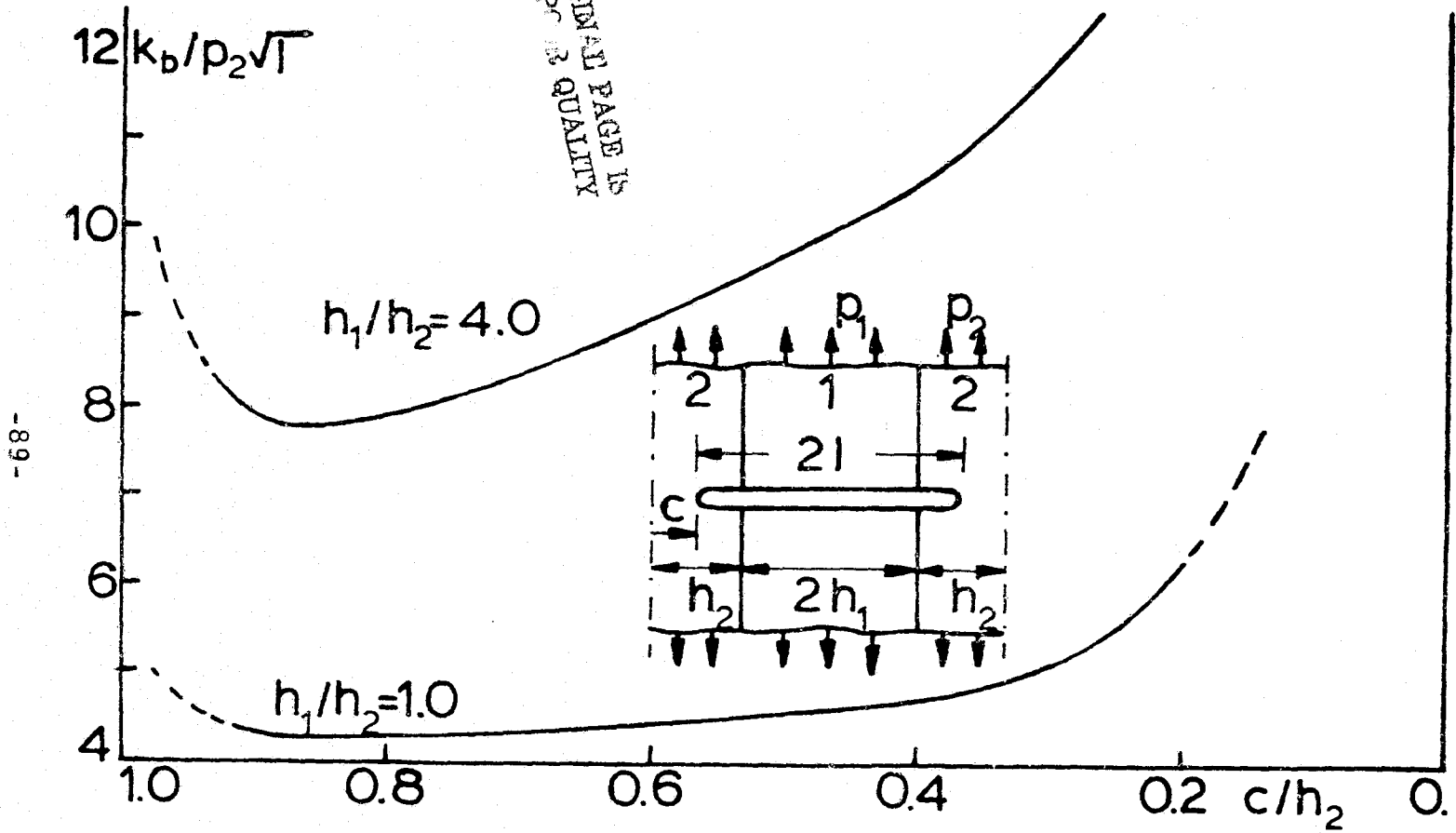

Figure 20. The stress intensity factor k_b for a crack crossing the interface (Non-singular behavior at the interface).

REFERENCES

1. Hilton, P. D. and Sih, G. C., "A Laminate Composite with a Crack Normal to the Interfaces", Int. J. Solids Structures, vol. 7 (1971) pp. 913-930.
2. Bogy, D. B., "The Plane Elastostatic Solution for a Symmetrically Loaded Crack in a Strip Composite", Int. J. Eng. Sci., vol. 11 (1973) pp. 985-996.
3. Ashbaugh, N. E., "Stresses in Laminated Composites Containing a Broken Layer", ASME Paper No. 72-WA/APM-14.
4. Gupta, G. D., "A Layered Composite with a Broken Laminate", Int. J. Solids Structures, vol. 9 (1973) pp. 1141-1154.
5. Arin, K., "An Orthotropic Laminate Composite Containing a Layer with a Crack", Int. J. Eng. Sci., vol. 15, Issue 9-10 (1977) pp. 545-559.
6. Erdogan, F. and Bakioglu, M., "Fracture of Composite Plates Containing Periodic Buffer Strips", NASA CR-132641, October 1974.
7. Arin, K., "A Note on a Broken Layer in an Orthotropic Laminate Composite", Letters in Applied and Engineering Science, vol. 5 (Oct. 1977) pp. 397-408.
8. Erdogan, F. and Biricikoglu, V., "Two Bonded Half Planes with a Crack Going Through the Interface", Int. J. Engng. Sci., vol. 11 (1973) pp. 745-766.
9. Isida, M., "Methods of Solution of Crack Problems", ed., G. C. Sih, Noordhoff International Publishing (1973) pp. 56-130.
10. Erdogan, F., Gupta, G. D. and Cook, T. S., "The Numerical Solutions of Singular Integral Equations", Methods of Analysis and Solutions to Crack Problems, ed., G. C. Sih, Wolters-Noordhoff Publishing, 1972.
11. Erdogan, F. and Cook, T. S., "Antiplane Shear Crack Terminating at and Going Through a Bimaterial Interface", International Journal of Fracture, vol. 10, no. 2, June 1974.

13. Lekhnitskii, S. G., "Theory of Elasticity of an Anisotropic Elastic Body", Holden-Day, Inc., 1963.
14. Muskhelishvili, N. I., "Singular Integral Equations", Wolters-Noordhoff Publishing, Groningen, 1958.
15. Krenk, S., "A Note on the Use of the Interpolation Polynomial for Solutions of Singular Integral Equations", Lehigh University, Report IFSM-73-48, August 1973.
16. Erdelyi, A., ed., "Tables of Integral Transforms", vol. 1, McGraw-Hill, New York (1953).
17. Abramowitz, M. and Stegun, I. A., "Handbook of Mathematical Functions", Dover Publications, Inc., New York, 1965.

APPENDIX A

Definitions of the material constants:

A superscript * will be used for the material in the second strip. The constants β_i , ($i = 1, \dots, 10$) and w_j ($j = 1, \dots, 4$) are given by equations (2.15), (3.5), and (3.8).

$$\gamma_1 = 1 + \frac{v_{yx} w_1 \beta_9}{\sqrt{\beta_5}}$$

$$\gamma_2 = 1 + \frac{v_{yx} w_3 \beta_{10}}{\sqrt{\beta_5}}$$

$$\gamma_3 = w_1 + v_{yx} \beta_7$$

$$\gamma_4 = w_3 + v_{yx} \beta_8$$

$$\gamma_5 = v_{xy} + \frac{\beta_9 w_1}{\sqrt{\beta_5}}$$

$$\gamma_6 = v_{xy} + \frac{\beta_{10} w_3}{\sqrt{\beta_5}}$$

$$\gamma_7 = v_{xy} w_1 + \beta_7$$

$$\gamma_8 = v_{xy} w_3 + \beta_8$$

$$\gamma_9 = -1 + \beta_7 w_1$$

$$\gamma_{10} = -1 + \beta_8 w_3$$

$$\gamma_{11} = -\frac{|w_1|}{\sqrt{\beta_5}} + \text{sign}(w_1) \beta_9$$

$$\gamma_{12} = -\frac{|w_3|}{\sqrt{\beta_5}} + \text{sign}(w_3) \beta_{10}$$

$$\gamma_{13} = \text{sign}(w_1) \beta_9 - \frac{\gamma_{11}}{\gamma_{12}} \text{sign}(w_3) \beta_{10}$$

$$\gamma_{14} = \frac{1}{2} \left[\frac{\gamma_5}{\gamma_{13}} - \frac{\gamma_6}{\gamma_{13}} \frac{\gamma_{11}}{\gamma_{12}} \right]$$

$$\lambda_1 = \frac{E_x^* \left[1 - v_{xy}^* v_{yx}^* \right]}{E_x \left[1 - v_{xy}^* v_{yx}^* \right]}$$

$$\lambda_2 = \frac{G_{xy}^*}{G_{xy}}$$

$$\lambda_3 = \beta_8 \gamma_3 - \beta_7 \gamma_4$$

$$\lambda_4 = \lambda_1 \gamma_3 \beta_7^* - \beta_7^* \gamma_3$$

$$\lambda_5 = \lambda_1 \gamma_4 \beta_8^* - \beta_8^* \gamma_4$$

$$\lambda_6 = \gamma_9 - \gamma_{10}$$

$$\lambda_7 = \gamma_9 - \gamma_9^* \lambda_2$$

$$\lambda_8 = \gamma_9 - \gamma_{10}^* \lambda_2$$

$$\begin{aligned} \lambda_9 &= \lambda_3 \lambda_7 & \lambda_{24} &= \lambda_{10} \lambda_{16} - \lambda_9 \lambda_{16} \\ \lambda_{10} &= \lambda_3 \lambda_8 & \lambda_{25} &= \lambda_{10} \lambda_{17} \\ \lambda_{11} &= \lambda_3 \gamma_9 & \lambda_{26} &= \lambda_{12} \lambda_{16} - \lambda_{10} \lambda_{18} \\ \lambda_{12} &= \lambda_6 \lambda_4 & \lambda_{27} &= \lambda_9 \lambda_{20} - \lambda_3 \lambda_{16} \\ \lambda_{13} &= \lambda_5 \lambda_6 & \lambda_{28} &= \lambda_9 \lambda_{19} \\ \lambda_{14} &= \lambda_6 \gamma_3 & \lambda_{29} &= \lambda_{12} \lambda_{19} - \lambda_{13} \lambda_{17} \\ \lambda_{15} &= \lambda_6 \beta_7 & \lambda_{30} &= \lambda_{13} \lambda_{18} - \lambda_{12} \lambda_{20} = 0 \\ \lambda_{16} &= \lambda_3 \beta_7 & \lambda_{31} &= \lambda_{11} \lambda_{16} - \lambda_9 \lambda_{16} \\ \lambda_{17} &= \lambda_3 \beta_7^* + \lambda_4 \beta_8 & \lambda_{32} &= \lambda_{11} \lambda_{17} \\ \lambda_{18} &= \lambda_4 \beta_7 & \lambda_{33} &= \lambda_{16} \lambda_{12} - \lambda_{11} \lambda_{18} \\ \lambda_{19} &= \lambda_3 \beta_8^* + \lambda_5 \beta_8 & \lambda_{34} &= \lambda_9 \lambda_{22} - \lambda_{14} \lambda_{16} \\ \lambda_{20} &= \lambda_5 \beta_7 & \lambda_{35} &= \lambda_9 \lambda_{21} \\ \lambda_{21} &= \lambda_3 - \gamma_3 \beta_8 & \lambda_{36} &= -\lambda_{14} \lambda_{17} - \lambda_{21} \lambda_{12} \\ \lambda_{22} &= \gamma_3 \beta_7 & \lambda_{37} &= \lambda_{14} \lambda_{18} - \lambda_{22} \lambda_{12} = 0 \\ \lambda_{23} &= \beta_7 \beta_8 & \lambda_{38} &= \lambda_{15} \lambda_{16} - \beta_7^2 \lambda_9 \end{aligned}$$

$$\lambda_{39} = \lambda_9 \lambda_{23}$$

$$\lambda_{40} = \lambda_{15} \lambda_{17} - \lambda_{12} \lambda_{23}$$

$$\lambda_{41} = \beta_7^2 \lambda_{12} - \lambda_{15} \lambda_{18} = 0$$

$$\lambda_{42} = \lambda_3 \lambda_{16}$$

$$\lambda_{43} = \lambda_3 \lambda_{17}$$

$$\lambda_{44} = \lambda_3 \lambda_{18}$$

$$\lambda_{45} = \lambda_{10} \lambda_{16} - \lambda_{11} \lambda_{16}$$

$$\lambda_{46} = \lambda_{11} \lambda_{20} - \lambda_{13} \lambda_{16}$$

$$\lambda_{47} = -\lambda_{11} \lambda_{19}$$

$$\lambda_{48} = \lambda_{14} \lambda_{16} - \lambda_{10} \lambda_{22}$$

$$\lambda_{49} = \lambda_{13} \lambda_{22} - \lambda_{14} \lambda_{20} = 0$$

$$\lambda_{50} = -\lambda_{10} \lambda_{21}$$

$$\lambda_{51} = \lambda_{14} \lambda_{19} + \lambda_{13} \lambda_{21}$$

$$\lambda_{52} = \lambda_{10} \beta_7^2 - \lambda_{15} \lambda_{16}$$

$$\lambda_{53} = \lambda_{15} \lambda_{20} - \lambda_{13} \beta_7^2 = 0$$

$$\lambda_{54} = -\lambda_{10} \lambda_{23}$$

$$\lambda_{55} = \lambda_{13} \lambda_{23} - \lambda_{15} \lambda_{19}$$

$$\lambda_{56} = -\lambda_3 \lambda_{20}$$

$$\lambda_{57} = \lambda_3 \lambda_{19}$$

$$\lambda_{58} = -\lambda_4 \lambda_{16} (\lambda_8 - \gamma_9)$$

$$\lambda_{59} = -\lambda_5 \lambda_{16} (\gamma_9 - \lambda_7)$$

$$\lambda_{60} = \gamma_9 (\lambda_4 \lambda_{19} - \lambda_5 \lambda_{17})$$

$$\lambda_{61} = \gamma_3 \beta_7 (\lambda_{10} - \lambda_9)$$

$$\lambda_{62} = \lambda_8 (\gamma_3 \lambda_{17} + \lambda_4 \lambda_{21})$$

$$\lambda_{63} = -\lambda_9 (\gamma_3 \beta_8^* + \lambda_5)$$

$$\lambda_{64} = -\beta_7^2 (\lambda_{10} - \lambda_9)$$

$$\lambda_{65} = \lambda_8 (\lambda_4 \lambda_{23} - \beta_7 \lambda_{17})$$

$$\lambda_{66} = \lambda_7 (\beta_7 \lambda_{19} - \lambda_5 \lambda_{23})$$

$$\lambda_{67} = -\lambda_4 \lambda_{16}$$

$$\lambda_{68} = \lambda_5 \lambda_{16}$$

$$\lambda_{69} = \lambda_5 \lambda_{17} - \lambda_4 \lambda_{19}$$

$$\lambda_{70} = \lambda_3 [\beta_7^* (\lambda_{10} - \lambda_{11}) + \beta_8 \lambda_4 (\lambda_8 - \gamma_9)]$$

$$\lambda_{71} = \lambda_3 [\beta_8^* (\lambda_{11} - \lambda_9) + \beta_8 \lambda_5 (\gamma_9 - \lambda_7)]$$

$$\lambda_{72} = \beta_7^* (\lambda_{11} \lambda_5 - \lambda_3 \lambda_{13}) + \beta_8^* (\lambda_3 \lambda_{12} - \lambda_{11} \lambda_4)$$

$$\lambda_{73} = \lambda_{21} (\lambda_{10} - \lambda_9)$$

$$\lambda_{74} = \lambda_{12} \lambda_3 - \lambda_{10} \lambda_4 + \beta_7^* (\lambda_{14} \lambda_3 - \lambda_{10} \gamma_3)$$

$$\lambda_{75} = \lambda_9 \lambda_5 - \lambda_{13} \lambda_3 + \beta_8^* (\lambda_9 \gamma_3 - \lambda_{14} \lambda_3)$$

$$\lambda_{76} = \lambda_{23} (\lambda_{10} - \lambda_9)$$

$$\lambda_{77} = \beta_7^* (\lambda_{10} \beta_7 - \lambda_{15} \lambda_3)$$

$$\lambda_{78} = \beta_8^* (\lambda_{15} \lambda_3 - \beta_7 \lambda_9)$$

$$\lambda_{79} = \lambda_3 (\lambda_4 \beta_8^* - \lambda_5 \beta_7^*)$$

$$\lambda_{80} = \lambda_{24} + \lambda_{25} + \lambda_{26} + \lambda_{27} - \lambda_{28} + \lambda_{29}$$

$$\lambda_{81} = -\lambda_{70} - \lambda_{71} - \lambda_{72} + \text{sign}(w_1) \beta_9 (\lambda_{73} + \lambda_{74} + \lambda_{75})$$

$$+ \frac{\sqrt{\beta_5} \gamma_1}{|w_1|} (\lambda_{76} + \lambda_{77} + \lambda_{78}) - \frac{\gamma_{11} \sqrt{\beta_5}}{|w_1|} (\lambda_{43} - \lambda_{57} + \lambda_{79})$$

$$\lambda_{82} = -\lambda_{58} - \lambda_{59} - \lambda_{60} + \text{sign}(w_1)\beta_9(\lambda_{61} + \lambda_{62} + \lambda_{63}) \\ + \frac{\sqrt{\beta_5}\gamma_1}{|w_1|} (\lambda_{64} + \lambda_{65} + \lambda_{66}) - \frac{\gamma_{11}\sqrt{\beta_5}}{|w_1|} (\lambda_{67} + \lambda_{68} + \lambda_{69})$$

$$\lambda_{83} = \frac{\gamma_{11}}{\gamma_{12}} (\lambda_{70} + \lambda_{71} + \lambda_{72}) - \frac{\gamma_{11}}{\gamma_{12}} \text{sign}(w_3)\beta_{10}(\lambda_{73} + \lambda_{74} + \lambda_{75}) \\ - \sqrt{\beta_5} \frac{\gamma_{11}}{\gamma_{12}} \frac{\gamma_2}{|w_3|} (\lambda_{76} + \lambda_{77} + \lambda_{78}) + \frac{\gamma_{11}\sqrt{\beta_5}}{|w_3|} (\lambda_{43} - \lambda_{57} + \lambda_{79})$$

$$\lambda_{84} = \frac{\gamma_{11}}{\gamma_{12}} (\lambda_{58} + \lambda_{59} + \lambda_{60}) - \frac{\gamma_{11}}{\gamma_{12}} \text{sign}(w_3)\beta_{10}(\lambda_{61} + \lambda_{62} + \lambda_{63}) \\ - \sqrt{\beta_5} \frac{\gamma_{11}}{\gamma_{12}} \frac{\gamma_2}{|w_3|} (\lambda_{64} + \lambda_{65} + \lambda_{66}) + \frac{\gamma_{11}\sqrt{\beta_5}}{|w_3|} (\lambda_{67} + \lambda_{68} + \lambda_{69})$$

$$\lambda_{85} = \frac{\gamma_7\lambda_{81}}{\gamma_{13}\gamma_{14}\lambda_{80}}$$

$$\lambda_{86} = \frac{\gamma_8\lambda_{82}}{\gamma_{13}\gamma_{14}\lambda_{80}}$$

$$\lambda_{87} = \frac{\gamma_7\lambda_{83}}{\gamma_{13}\gamma_{14}\lambda_{80}}$$

$$\lambda_{88} = \frac{\gamma_8\lambda_{84}}{\gamma_{13}\gamma_{14}\lambda_{80}}$$

$$\lambda_{89} = -\lambda_{70} - \lambda_{71} - \lambda_{72} - \text{sign}(w_1^*)\beta_9^*(\lambda_{73} + \lambda_{74} + \lambda_{75}) \\ - \lambda_1\sqrt{\beta_5^*} \frac{\gamma_1^*}{|w_1^*|} (\lambda_{76} + \lambda_{77} + \lambda_{78}) - \lambda_2 \frac{\gamma_{11}^*\sqrt{\beta_5^*}}{|w_1^*|} (\lambda_{43} - \lambda_{57} + \lambda_{79})$$

$$\lambda_{90} = -\lambda_{58} - \lambda_{59} - \lambda_{60} - \text{sign}(w_1^*)\beta_9^*(\lambda_{61} + \lambda_{62} + \lambda_{63}) \\ - \lambda_1\sqrt{\beta_5^*} \frac{\gamma_1^*}{|w_1^*|} (\lambda_{64} + \lambda_{65} + \lambda_{66}) - \lambda_2 \frac{\gamma_{11}^*\sqrt{\beta_5^*}}{|w_1^*|} (\lambda_{67} + \lambda_{68} + \lambda_{69})$$

$$\lambda_{91} = \frac{\gamma_{11}^*}{\gamma_{12}^*} (\lambda_{70} + \lambda_{71} + \lambda_{72}) + \frac{\gamma_{11}^*}{\gamma_{12}^*} \text{sign}(w_3^*) \beta_{10}^* (\lambda_{73} + \lambda_{74} + \lambda_{75})$$

$$+ \sqrt{\beta_5^*} \lambda_1 \frac{\gamma_{11}^*}{\gamma_{12}^*} \frac{\gamma_2^*}{|w_3^*|} (\lambda_{76} + \lambda_{77} + \lambda_{78}) + \frac{\gamma_{11}^* \lambda_2 \sqrt{\beta_5^*}}{|w_3^*|} (\lambda_{43} - \lambda_{57} + \lambda_{79})$$

$$\lambda_{92} = \frac{\gamma_{11}^*}{\gamma_{12}^*} (\lambda_{58} + \lambda_{59} + \lambda_{60}) + \frac{\gamma_{11}^*}{\gamma_{12}^*} \text{sign}(w_3^*) \beta_{10}^* (\lambda_{61} + \lambda_{62} + \lambda_{63})$$

$$+ \lambda_1 \sqrt{\beta_5^*} \frac{\gamma_{11}^*}{\gamma_{12}^*} \frac{\gamma_2^*}{|w_3^*|} (\lambda_{64} + \lambda_{65} + \lambda_{66}) + \frac{\gamma_{11}^* \lambda_2 \sqrt{\beta_5^*}}{|w_3^*|} (\lambda_{67} + \lambda_{68} + \lambda_{69})$$

$$\lambda_{93} = \frac{\gamma_7 \lambda_{89}}{\gamma_{13}^* \gamma_{14} \lambda_{80}}$$

$$\lambda_{94} = \frac{\gamma_8 \lambda_{90}}{\gamma_{13}^* \gamma_{14} \lambda_{80}}$$

$$\lambda_{95} = \frac{\gamma_7 \lambda_{91}}{\gamma_{13}^* \gamma_{14} \lambda_{80}}$$

$$\lambda_{96} = \frac{\gamma_8 \lambda_{92}}{\gamma_{13}^* \gamma_{14} \lambda_{80}}$$

$$\lambda_{97} = -\lambda_{45} - \lambda_{46} - \lambda_{47} + \text{sign}(w_1) \beta_9 (\lambda_{48} + \lambda_{50} + \lambda_{51})$$

$$+ \sqrt{\beta_5} \frac{\gamma_1}{|w_1|} (\lambda_{52} + \lambda_{54} + \lambda_{55}) - \frac{\gamma_{11} \sqrt{\beta_5}}{|w_1|} (\lambda_{42} + \lambda_{56} + \lambda_{57})$$

$$\lambda_{98} = -\lambda_{31} - \lambda_{32} - \lambda_{33} + \text{sign}(w_1) \beta_9 (\lambda_{34} + \lambda_{35} + \lambda_{36})$$

$$+ \sqrt{\beta_5} \frac{\gamma_1}{|w_1|} (\lambda_{38} + \lambda_{39} + \lambda_{40}) - \frac{\gamma_{11} \sqrt{\beta_5}}{|w_1|} (-\lambda_{42} - \lambda_{43} + \lambda_{44})$$

$$\lambda_{99} = \frac{\gamma_{11}}{\gamma_{12}} (\lambda_{45} + \lambda_{46} + \lambda_{47}) - \frac{\gamma_{11}}{\gamma_{12}} \text{sign}(w_3) \beta_{10} (\lambda_{48} + \lambda_{50} + \lambda_{51})$$

$$- \sqrt{\beta_5} \frac{\gamma_{11}}{\gamma_{12}} \frac{\gamma_2}{|w_3|} (\lambda_{52} + \lambda_{54} + \lambda_{55}) + \frac{\gamma_{11} \sqrt{\beta_5}}{|w_3|} (\lambda_{42} + \lambda_{56} + \lambda_{57})$$

$$\lambda_{100} = \frac{\gamma_{11}}{\gamma_{12}} (\lambda_{31} + \lambda_{32} + \lambda_{33}) - \frac{\gamma_{11}}{\gamma_{12}} \text{sign}(w_3) \beta_{10} (\lambda_{34} + \lambda_{35} + \lambda_{36})$$

$$- \sqrt{\beta_5} \frac{\gamma_{11}}{\gamma_{12}} \frac{\gamma_2}{|w_3|} (\lambda_{38} + \lambda_{39} + \lambda_{40}) + \frac{\gamma_{11} \sqrt{\beta_5}}{|w_3|} (-\lambda_{42} - \lambda_{43} + \lambda_{44})$$

$$\lambda_{101} = \frac{\lambda_{97} \gamma_7^*}{\gamma_{13} \gamma_{14}^* \lambda_{80}}$$

$$\lambda_{102} = \frac{\lambda_{98} \gamma_8^*}{\gamma_{13} \gamma_{14}^* \lambda_{80}}$$

$$\lambda_{103} = \frac{\lambda_{99} \gamma_7^*}{\gamma_{13} \gamma_{14}^* \lambda_{80}}$$

$$\lambda_{104} = \frac{\lambda_{100} \gamma_8^*}{\gamma_{13} \gamma_{14}^* \lambda_{80}}$$

$$\lambda_{105} = -\lambda_{45} - \lambda_{46} - \lambda_{47} - \text{sign}(w_1^*) \beta_9^* (\lambda_{48} + \lambda_{50} + \lambda_{51})$$

$$- \lambda_1 \sqrt{\beta_5^*} \frac{\gamma_1^*}{|w_1^*|} (\lambda_{52} + \lambda_{54} + \lambda_{55}) - \lambda_2 \frac{\gamma_{11}^* \sqrt{\beta_5^*}}{|w_1^*|} (\lambda_{42} + \lambda_{56} + \lambda_{57})$$

$$\lambda_{106} = -\lambda_{31} - \lambda_{32} - \lambda_{33} - \text{sign}(w_1^*) \beta_9^* (\lambda_{34} + \lambda_{35} + \lambda_{36})$$

$$- \lambda_1 \sqrt{\beta_5^*} \frac{\gamma_1^*}{|w_1^*|} (\lambda_{38} + \lambda_{39} + \lambda_{40}) - \lambda_2 \frac{\gamma_{11}^*}{|w_1^*|} \sqrt{\beta_5^*} (-\lambda_{42} - \lambda_{43} + \lambda_{44})$$

$$\lambda_{107} = \frac{\gamma_{11}^*}{\gamma_{12}^*} (\lambda_{45} + \lambda_{46} + \lambda_{47}) + \frac{\gamma_{11}^*}{\gamma_{12}^*} \text{sign}(w_3^*) \beta_{10}^* (\lambda_{48} + \lambda_{50} + \lambda_{51})$$

$$+ \sqrt{\beta_5^*} \lambda_1 \frac{\gamma_{11}^*}{\gamma_{12}^*} \frac{\gamma_2^*}{|w_3^*|} (\lambda_{52} + \lambda_{54} + \lambda_{55}) + \frac{\gamma_{11}^* \lambda_2 \sqrt{\beta_5^*}}{|w_3^*|} (\lambda_{42} + \lambda_{56} + \lambda_{57})$$

$$\lambda_{108} = \frac{\gamma_{11}^*}{\gamma_{12}^*} (\lambda_{31} + \lambda_{32} + \lambda_{33}) + \frac{\gamma_{11}^*}{\gamma_{12}^*} \text{sign}(w_3^*) \beta_{10}^* (\lambda_{34} + \lambda_{35} + \lambda_{36})$$

$$+ \lambda_1 \sqrt{\beta_5^*} \frac{\gamma_{11}^*}{\gamma_{12}^*} \frac{\gamma_2^*}{|w_3^*|} (\lambda_{38} + \lambda_{39} + \lambda_{40}) + \frac{\gamma_{11}^* \lambda_2 \sqrt{\beta_5^*}}{|w_3^*|} (-\lambda_{42} - \lambda_{43} + \lambda_{44})$$

$$\lambda_{109} = \frac{\lambda_{105} \gamma_7^*}{\gamma_{13}^* \gamma_{14}^* \lambda_{80}}$$

$$\lambda_{110} = \frac{\lambda_{106} \gamma_8^*}{\gamma_{13}^* \gamma_{14}^* \lambda_{80}}$$

$$\lambda_{111} = \frac{\lambda_{107} \gamma_7^*}{\gamma_{13}^* \gamma_{14}^* \lambda_{80}}$$

$$\lambda_{112} = \frac{\lambda_{108} \gamma_8^*}{\gamma_{13}^* \gamma_{14}^* \lambda_{80}}$$

$$\lambda_{113} = \frac{|w_1|}{\sqrt{\beta_5}} \frac{|w_1^*|}{\sqrt{\beta_5^*}} \lambda_{85} \lambda_{109} - \frac{|w_1|}{\sqrt{\beta_5}} \frac{|w_1^*|}{\sqrt{\beta_5^*}} \lambda_{93} \lambda_{101}$$

$$\lambda_{114} = \frac{|w_1|}{\sqrt{\beta_5}} \frac{|w_1^*|}{\sqrt{\beta_5^*}} \lambda_{85} \lambda_{110} + \frac{|w_1|}{\sqrt{\beta_5}} \frac{|w_3^*|}{\sqrt{\beta_5^*}} \lambda_{85} \lambda_{111} \\ - \frac{|w_1|}{\sqrt{\beta_5}} \frac{|w_1^*|}{\sqrt{\beta_5^*}} \lambda_{93} \lambda_{102} - \frac{|w_1|}{\sqrt{\beta_5}} \frac{|w_3^*|}{\sqrt{\beta_5^*}} \lambda_{95} \lambda_{101}$$

$$\lambda_{115} = \frac{|w_1|}{\sqrt{\beta_5}} \frac{|w_3^*|}{\sqrt{\beta_5^*}} \lambda_{85} \lambda_{112} - \frac{|w_1|}{\sqrt{\beta_5}} \frac{|w_3^*|}{\sqrt{\beta_5^*}} \lambda_{95} \lambda_{102}$$

$$\lambda_{116} = \frac{|w_1|}{\sqrt{\beta_5}} \frac{|w_1^*|}{\sqrt{\beta_5^*}} \lambda_{86} \lambda_{109} + \frac{|w_3|}{\sqrt{\beta_5}} \frac{|w_1^*|}{\sqrt{\beta_5^*}} \lambda_{87} \lambda_{109} \\ + \frac{|w_3|}{\sqrt{\beta_5}} \frac{|w_1^*|}{\sqrt{\beta_5^*}} \lambda_{93} \lambda_{103} - \frac{|w_1|}{\sqrt{\beta_5}} \frac{|w_1^*|}{\sqrt{\beta_5^*}} \lambda_{94} \lambda_{101}$$

$$\lambda_{117} = \frac{|w_1|}{\sqrt{\beta_5}} \frac{|w_1^*|}{\sqrt{\beta_5^*}} \lambda_{86} \lambda_{110} + \frac{|w_1|}{\sqrt{\beta_5}} \frac{|w_3^*|}{\sqrt{\beta_5^*}} \lambda_{86} \lambda_{111} \\ + \frac{|w_3|}{\sqrt{\beta_5}} \frac{|w_1^*|}{\sqrt{\beta_5^*}} \lambda_{87} \lambda_{110} + \frac{|w_3|}{\sqrt{\beta_5}} \frac{|w_3^*|}{\sqrt{\beta_5^*}} \lambda_{87} \lambda_{111} \\ - \frac{|w_3|}{\sqrt{\beta_5}} \frac{|w_1^*|}{\sqrt{\beta_5^*}} \lambda_{93} \lambda_{104} - \frac{|w_1|}{\sqrt{\beta_5}} \frac{|w_1^*|}{\sqrt{\beta_5^*}} \lambda_{94} \lambda_{102} \\ - \frac{|w_3|}{\sqrt{\beta_5}} \frac{|w_3^*|}{\sqrt{\beta_5^*}} \lambda_{95} \lambda_{103} - \frac{|w_1|}{\sqrt{\beta_5}} \frac{|w_3^*|}{\sqrt{\beta_5^*}} \lambda_{96} \lambda_{101}$$

ORIGINAL PAGE IS
OF POOR QUALITY

$$\lambda_{118} = \frac{|w_3|}{\sqrt{\beta_5}} \frac{|w_3^*|}{\sqrt{\beta_5^*}} \lambda_{87} \lambda_{112} + \frac{|w_1|}{\sqrt{\beta_5}} \frac{|w_3^*|}{\sqrt{\beta_5^*}} \lambda_{86} \lambda_{112}$$

$$- \frac{|w_3|}{\sqrt{\beta_5}} \frac{|w_3^*|}{\sqrt{\beta_5^*}} \lambda_{95} \lambda_{104} - \frac{|w_1|}{\sqrt{\beta_5}} \frac{|w_3^*|}{\sqrt{\beta_5^*}} \lambda_{96} \lambda_{102}$$

$$\lambda_{119} = \frac{|w_3|}{\sqrt{\beta_5}} \frac{|w_1^*|}{\sqrt{\beta_5^*}} \lambda_{88} \lambda_{109} - \frac{|w_3|}{\sqrt{\beta_5}} \frac{|w_1^*|}{\sqrt{\beta_5^*}} \lambda_{94} \lambda_{103}$$

$$\lambda_{120} = \frac{|w_3|}{\sqrt{\beta_5}} \frac{|w_1^*|}{\sqrt{\beta_5^*}} \lambda_{88} \lambda_{110} + \frac{|w_3|}{\sqrt{\beta_5}} \frac{|w_3^*|}{\sqrt{\beta_5^*}} \lambda_{88} \lambda_{111}$$

$$- \frac{|w_3|}{\sqrt{\beta_5}} \frac{|w_1^*|}{\sqrt{\beta_5^*}} \lambda_{94} \lambda_{104} - \frac{|w_3|}{\sqrt{\beta_5}} \frac{|w_3^*|}{\sqrt{\beta_5^*}} \lambda_{96} \lambda_{103}$$

$$\lambda_{121} = \frac{|w_3|}{\sqrt{\beta_5}} \frac{|w_3^*|}{\sqrt{\beta_5^*}} \lambda_{88} \lambda_{112} - \frac{|w_3|}{\sqrt{\beta_5}} \frac{|w_3^*|}{\sqrt{\beta_5^*}} \lambda_{96} \lambda_{104}$$

APPENDIX B

Expressions of the functions used in equations (4.14) and (4.15):

$$R_1(\alpha) = -\frac{1}{2\gamma_{13}\alpha} \int_{-a}^a \left[e^{-(h_1-\eta)\alpha\sqrt{\beta_5}/|w_1|} - \frac{\gamma_{11}}{\gamma_{12}} e^{-(h_1-\eta)\alpha\sqrt{\beta_5}/|w_3|} \right] \phi(\eta) d\eta$$

$$-\frac{1}{2\gamma_{13}^*\alpha} \int_{-b}^b \left[e^{-(h_2-\eta)\alpha\sqrt{\beta_5^*}/|w_1^*|} - \frac{\gamma_{11}^*}{\gamma_{12}^*} e^{-(h_2-\eta)\alpha\sqrt{\beta_5^*}/|w_3^*|} \right] \phi^*(\eta) d\eta$$

$$R_2(\alpha) = \frac{1}{2\gamma_{13}\alpha} \int_{-a}^a \left[\text{sign}(w_1)\beta_9 e^{-(h_1-\eta)\alpha\sqrt{\beta_5}/|w_1|} - \frac{\gamma_{11}}{\gamma_{12}} \text{sign}(w_3)\beta_{10} e^{-(h_1-\eta)\alpha\sqrt{\beta_5}/|w_3|} \right] \phi(\eta) d\eta$$

$$-\frac{1}{2\gamma_{13}^*\alpha} \int_{-b}^b \left[\text{sign}(w_1^*)\beta_9^* e^{-(h_2-\eta)\alpha\sqrt{\beta_5^*}/|w_1^*|} - \frac{\gamma_{11}^*}{\gamma_{12}^*} \text{sign}(w_3^*)\beta_{10}^* e^{-(h_2-\eta)\alpha\sqrt{\beta_5^*}/|w_3^*|} \right] \phi^*(\eta) d\eta$$

$$R_3(\alpha) = \frac{\sqrt{\beta_5}}{2\gamma_{13}\alpha} \int_{-a}^a \left[\frac{\gamma_{11}}{|w_1|} e^{-(h_1-\eta)\alpha\sqrt{\beta_5}/|w_1|} - \frac{\gamma_{11}}{\gamma_{12}} \frac{\gamma_2}{|w_3|} e^{-(h_1-\eta)\alpha\sqrt{\beta_5}/|w_3|} \right] \phi(\eta) d\eta$$

$$-\frac{\sqrt{\beta_5^*}}{2\gamma_{13}^*\alpha} \int_{-b}^b \left[\frac{\gamma_{11}^*\lambda}{|w_1^*|} e^{-(h_2-\eta)\alpha\sqrt{\beta_5^*}/|w_1^*|} - \frac{\gamma_{11}^*}{\gamma_{12}^*} \frac{\gamma_2^*\lambda}{|w_3^*|} e^{-(h_2-\eta)\alpha\sqrt{\beta_5^*}/|w_3^*|} \right] \phi^*(\eta) d\eta$$

$$\begin{aligned}
R_4(\alpha) = & -\frac{\gamma_{11}\sqrt{\beta_5}}{2\gamma_{13}\alpha} \int_{-a}^a \left[\frac{1}{|w_1|} e^{-(h_1-\eta)\alpha\sqrt{\beta_5}/|w_1|} \right. \\
& \left. - \frac{1}{|w_3|} e^{-(h_1-\eta)\alpha\sqrt{\beta_5}/|w_3|} \right] \phi(\eta) d\eta \\
& -\frac{\gamma_{11}^*\sqrt{\beta_5^*\lambda}}{2\gamma_{13}^*\alpha} \int_{-b}^b \left[\frac{1}{|w_1^*|} e^{-(h_2-\eta)\alpha\sqrt{\beta_5^*}/|w_1^*|} \right. \\
& \left. - \frac{1}{|w_3^*|} e^{-(h_2-\eta)\alpha\sqrt{\beta_5^*}/|w_3^*|} \right] \phi^*(\eta) d\eta
\end{aligned}$$

$$\begin{aligned}
f(\alpha) = & \lambda_{24}f_1(\alpha) + \lambda_{25}f_2(\alpha) + \lambda_{26}f_3(\alpha) + \lambda_{27}f_4(\alpha) \\
& - \lambda_{28}f_5(\alpha) + \lambda_{29}f_6(\alpha)
\end{aligned}$$

$$f_1(\alpha) = \tanh(w_1^*\alpha h_2) \tanh(w_3^*\alpha h_2)$$

$$f_2(\alpha) = \tanh(w_3^*\alpha h_2) \tanh(w_1\alpha h_1)$$

$$f_3(\alpha) = \tanh(w_3^*\alpha h_2) \tanh(w_3\alpha h_1)$$

$$f_4(\alpha) = \tanh(w_1^*\alpha h_2) \tanh(w_3\alpha h_1)$$

$$f_5(\alpha) = \tanh(w_1^*\alpha h_2) \tanh(w_1\alpha h_1)$$

$$f_6(\alpha) = \tanh(w_1\alpha h_1) \tanh(w_3\alpha h_1)$$

$$g(\alpha) = \lambda_{31} \tanh(w_1^*\alpha h_2) + \lambda_{32} \tanh(w_1\alpha h_1) + \lambda_{33} \tanh(w_3\alpha h_1)$$

$$h(\alpha) = \lambda_{34} f_4(\alpha) + \lambda_{35} f_5(\alpha) + \lambda_{36} f_6(\alpha)$$

$$m(\alpha) = \lambda_{38} f_4(\alpha) + \lambda_{39} f_5(\alpha) + \lambda_{40} f_6(\alpha)$$

$$n(\alpha) = -\lambda_{42} \tanh(w_1^*\alpha h_2) - \lambda_{43} \tanh(w_1\alpha h_1) + \lambda_{44} \tanh(w_3\alpha h_1)$$

$$g_0(\alpha) = \lambda_{45} \tanh(w_3^* \alpha h_2) + \lambda_{46} \tanh(w_3 \alpha h_1) + \lambda_{47} \tanh(w_1 \alpha h_1)$$

$$h_0(\alpha) = \lambda_{48} f_3(\alpha) + \lambda_{50} f_2(\alpha) + \lambda_{51} f_6(\alpha)$$

$$m_0(\alpha) = \lambda_{52} f_3(\alpha) + \lambda_{54} f_2(\alpha) + \lambda_{55} f_6(\alpha)$$

$$n_0(\alpha) = \lambda_{42} \tanh(w_3^* \alpha h_2) + \lambda_{56} \tanh(w_3 \alpha h_1) + \lambda_{57} \tanh(w_1 \alpha h_1)$$

$$g_1(\alpha) = \lambda_{58} \tanh(w_3^* \alpha h_2) + \lambda_{59} \tanh(w_1^* \alpha h_2) + \lambda_{60} \tanh(w_1 \alpha h_1)$$

$$h_1(\alpha) = \lambda_{61} f_1(\alpha) + \lambda_{62} f_2(\alpha) + \lambda_{63} f_5(\alpha)$$

$$m_1(\alpha) = \lambda_{64} f_1(\alpha) + \lambda_{65} f_2(\alpha) + \lambda_{66} f_5(\alpha)$$

$$n_1(\alpha) = \lambda_{67} \tanh(w_3^* \alpha h_2) + \lambda_{68} \tanh(w_1^* \alpha h_2) + \lambda_{69} \tanh(w_1 \alpha h_1)$$

$$g_2(\alpha) = \lambda_{70} \tanh(w_3^* \alpha h_2) + \lambda_{71} \tanh(w_1^* \alpha h_2) + \lambda_{72} \tanh(w_3 \alpha h_1)$$

$$h_2(\alpha) = \lambda_{73} f_1(\alpha) + \lambda_{74} f_3(\alpha) + \lambda_{75} f_4(\alpha)$$

$$m_2(\alpha) = \lambda_{76} f_1(\alpha) + \lambda_{77} f_3(\alpha) + \lambda_{78} f_4(\alpha)$$

$$n_2(\alpha) = \lambda_{43} \tanh(w_3^* \alpha h_2) - \lambda_{57} \tanh(w_1^* \alpha h_2) + \lambda_{79} \tanh(w_3 \alpha h_1)$$

Expressions of the functions k_j ($j = 1, 8$) used in Eqs. (4.17):

$$k_1(x_1, \alpha) = \frac{1}{2\gamma_{13} f(\alpha)} \left[\frac{\cosh(w_1 \alpha x_1)}{\cosh(w_1 \alpha h_1)} \gamma_7 \left(-g_2(\alpha) + \text{sign}(w_1) \beta_9 h_2(\alpha) \right) \right. \\ \left. + \sqrt{\beta_5} \frac{\gamma_1}{|w_1|} m_2(\alpha) - \frac{\gamma_{11} \sqrt{\beta_5}}{|w_1|} n_2(\alpha) \right] + \frac{\cosh(w_3 \alpha x_1)}{\cosh(w_3 \alpha h_1)} \gamma_8 \left(-g_1(\alpha) \right. \\ \left. + \text{sign}(w_1) \beta_9 h_1(\alpha) + \sqrt{\beta_5} \frac{\gamma_1}{|w_1|} m_1(\alpha) - \frac{\gamma_{11} \sqrt{\beta_5}}{|w_1|} n_1(\alpha) \right) \Bigg]$$

$$k_2(x_1, \alpha) = \frac{1}{2\gamma_{13}f(\alpha)} \left[\frac{\cosh(w_1 \alpha x_1)}{\cosh(w_1 \alpha h_1)} \gamma_7 \left(g_2(\alpha) \frac{\gamma_{11}}{\gamma_{12}} - \frac{\gamma_{11}}{\gamma_{12}} \text{sign}(w_3) \beta_{10} h_2(\alpha) \right. \right. \\ \left. \left. - \sqrt{\beta_5} \frac{\gamma_{11}}{\gamma_{12}} \frac{\gamma_2}{|w_3|} m_2(\alpha) + \frac{\gamma_{11} \sqrt{\beta_5}}{|w_3|} n_2(\alpha) \right) + \frac{\cosh(w_3 \alpha x_1)}{\cosh(w_3 \alpha h_1)} \gamma_8 \left(\frac{\gamma_{11}}{\gamma_{12}} g_1(\alpha) \right. \right. \\ \left. \left. - \frac{\gamma_{11}}{\gamma_{12}} \text{sign}(w_3) \beta_{10} h_1(\alpha) - \sqrt{\beta_5} \frac{\gamma_{11}}{\gamma_{12}} \frac{\gamma_2}{|w_3|} m_1(\alpha) + \frac{\gamma_{11} \sqrt{\beta_5}}{|w_3|} n_1(\alpha) \right) \right]$$

$$k_3(x_1, \alpha) = \frac{1}{2\gamma_{13}^* f(\alpha)} \left[\frac{\cosh(w_1 \alpha x_1)}{\cosh(w_1 \alpha h_1)} \gamma_7 \left(-g_2(\alpha) - \text{sign}(w_1^*) \beta_9^* h_2(\alpha) \right. \right. \\ \left. \left. - \lambda_1 \sqrt{\beta_5^*} \frac{\gamma_1^*}{|w_1^*|} m_2(\alpha) - \lambda_2 \frac{\gamma_{11}^* \sqrt{\beta_5^*}}{|w_1^*|} n_2(\alpha) \right) + \frac{\cosh(w_3 \alpha x_1)}{\cosh(w_3 \alpha h_1)} \gamma_8 \right. \\ \left. \left[-g_1(\alpha) - \text{sign}(w_1^*) \beta_9^* h_1(\alpha) - \lambda_1 \sqrt{\beta_5^*} \frac{\gamma_1^*}{|w_1^*|} m_1(\alpha) - \lambda_2 \frac{\gamma_{11}^* \sqrt{\beta_5^*}}{|w_1^*|} n_1(\alpha) \right] \right]$$

$$k_4(x_1, \alpha) = \frac{1}{2\gamma_{13}^* f(\alpha)} \left[\frac{\cosh(w_1 \alpha x_1)}{\cosh(w_1 \alpha h_1)} \gamma_7 \left(g_2(\alpha) \frac{\gamma_{11}^*}{\gamma_{12}^*} + \frac{\gamma_{11}^*}{\gamma_{12}^*} \text{sign}(w_3^*) \beta_{10}^* h_2(\alpha) \right. \right. \\ \left. \left. + \sqrt{\beta_5^*} \lambda_1 \frac{\gamma_{11}^*}{\gamma_{12}^*} \frac{\gamma_2^*}{|w_3^*|} m_2(\alpha) + \frac{\gamma_{11}^* \lambda_2 \sqrt{\beta_5^*}}{|w_3^*|} n_2(\alpha) \right) + \frac{\cosh(w_3 \alpha x_1)}{\cosh(w_3 \alpha h_1)} \gamma_8 \right. \\ \left. \left[\frac{\gamma_{11}^*}{\gamma_{12}^*} g_1(\alpha) + \frac{\gamma_{11}^*}{\gamma_{12}^*} \text{sign}(w_3^*) \beta_{10}^* h_1(\alpha) + \lambda_1 \sqrt{\beta_5^*} \frac{\gamma_{11}^*}{\gamma_{12}^*} \frac{\gamma_2^*}{|w_3^*|} m_1(\alpha) \right. \right. \\ \left. \left. + \frac{\gamma_{11}^* \lambda_2 \sqrt{\beta_5^*}}{|w_3^*|} n_1(\alpha) \right] \right]$$

$$k_5(x_2, \alpha) = \frac{1}{2\gamma_{13}f(\alpha)} \left[\frac{\cosh(w_1^* \alpha x_2)}{\cosh(w_1^* \alpha h_2)} \gamma_7^* \left(-g_0(\alpha) + \text{sign}(w_1) \beta_9 h_0(\alpha) \right. \right. \\ \left. \left. + \sqrt{\beta_5} \frac{\gamma_1}{|w_1|} m_0(\alpha) - \frac{\gamma_{11} \sqrt{\beta_5}}{|w_1|} n_0(\alpha) \right) + \frac{\cosh(w_3^* \alpha x_2)}{\cosh(w_3^* \alpha h_2)} \gamma_8^* \left(-g(\alpha) \right. \right.$$

$$\left. \left. + \text{sign}(w_1) \beta_9 h(\alpha) + \sqrt{\beta_5} \frac{\gamma_1}{|w_1|} m(\alpha) - \frac{\gamma_{11} \sqrt{\beta_5}}{|w_1|} n(\alpha) \right] \right]$$

$$k_6(x_2, \alpha) = \frac{1}{2\gamma_{13} f(\alpha)} \left[\frac{\cosh(w_1^* \alpha x_2)}{\cosh(w_1^* \alpha h_2)} \gamma_7^* \left(g_0(\alpha) \frac{\gamma_{11}}{\gamma_{12}} - \frac{\gamma_{11}}{\gamma_{12}} \text{sign}(w_3) \beta_{10} h_0(\alpha) \right. \right. \\ \left. \left. - \sqrt{\beta_5} \frac{\gamma_{11}}{\gamma_{12}} \frac{\gamma_2}{|w_3|} m_0(\alpha) + \frac{\gamma_{11} \sqrt{\beta_5}}{|w_3|} n_0(\alpha) \right) + \frac{\cosh(w_3^* \alpha x_2)}{\cosh(w_3^* \alpha h_2)} \gamma_8^* \left(\frac{\gamma_{11}}{\gamma_{12}} g(\alpha) \right. \right. \\ \left. \left. - \frac{\gamma_{11}}{\gamma_{12}} \text{sign}(w_3) \beta_{10} h(\alpha) - \sqrt{\beta_5} \frac{\gamma_{11}}{\gamma_{12}} \frac{\gamma_2}{|w_3|} m(\alpha) + \frac{\gamma_{11} \sqrt{\beta_5}}{|w_3|} n(\alpha) \right) \right]$$

$$k_7(x_2, \alpha) = \frac{1}{2\gamma_{13}^* f(\alpha)} \left[\frac{\cosh(w_1^* \alpha x_2)}{\cosh(w_1^* \alpha h_2)} \gamma_7^* \left(-g_0(\alpha) - \text{sign}(w_1^*) \beta_9^* h_0(\alpha) \right. \right. \\ \left. \left. - \lambda_1 \sqrt{\beta_5^*} \frac{\gamma_1^*}{|w_1^*|} m_0(\alpha) - \lambda_2 \frac{\gamma_{11}^* \sqrt{\beta_5^*}}{|w_1^*|} n_0(\alpha) \right) + \frac{\cosh(w_3^* \alpha x_2)}{\cosh(w_3^* \alpha h_2)} \gamma_8^* \left(-g(\alpha) \right. \right. \\ \left. \left. - \text{sign}(w_1^*) \beta_9^* h(\alpha) - \lambda_1 \sqrt{\beta_5^*} \frac{\gamma_1^*}{|w_1^*|} m(\alpha) - \lambda_2 \frac{\gamma_{11}^* \sqrt{\beta_5^*}}{|w_1^*|} n(\alpha) \right) \right]$$

$$k_8(x_2, \alpha) = \frac{1}{2\gamma_{13}^* f(\alpha)} \left[\frac{\cosh(w_1^* \alpha x_2)}{\cosh(w_1^* \alpha h_2)} \gamma_7^* \left(g_0(\alpha) \frac{\gamma_{11}^*}{\gamma_{12}^*} \right. \right. \\ \left. \left. + \frac{\gamma_{11}^*}{\gamma_{12}^*} \text{sign}(w_3^*) \beta_{10}^* h_0(\alpha) + \sqrt{\beta_5^*} \lambda_1 \frac{\gamma_{11}^*}{\gamma_{12}^*} \frac{\gamma_2^*}{|w_3^*|} m_0(\alpha) \right. \right. \\ \left. \left. + \frac{\gamma_{11}^* \lambda_2 \sqrt{\beta_5^*}}{|w_3^*|} n_0(\alpha) \right) + \frac{\cosh(w_3^* \alpha x_2)}{\cosh(w_3^* \alpha h_2)} \gamma_8^* \left(\frac{\gamma_{11}^*}{\gamma_{12}^*} g(\alpha) + \frac{\gamma_{11}^*}{\gamma_{12}^*} \text{sign}(w_3^*) \right. \right. \\ \left. \left. \beta_{10}^* h(\alpha) + \lambda_1 \sqrt{\beta_5^*} \frac{\gamma_{11}^*}{\gamma_{12}^*} \frac{\gamma_2^*}{|w_3^*|} m(\alpha) + \frac{\gamma_{11}^* \lambda_2 \sqrt{\beta_5^*}}{|w_3^*|} n(\alpha) \right) \right]$$

The kernels $K_j (j=1,4)$ used in Eqs. (6.15a,b):

ORIGINAL PAGE IS
OF POOR QUALITY

$$\begin{aligned}
K_1(n,y) = & \frac{1}{2\gamma_{13}} \int_0^\infty \left[\gamma_1 e^{-|w_1| \alpha y / \sqrt{\beta_5}} - \gamma_2 \frac{\gamma_{11}}{\gamma_{12}} e^{-|w_3| \alpha y / \sqrt{\beta_5}} \right] \operatorname{cosh}_1 \sin \alpha n d\alpha \\
& + \frac{1}{2\gamma_{13}} \int_0^\infty \left[e^{-(h_1-n)\alpha \sqrt{\beta_5} / |w_1|} \left[- \left[\gamma_3 g_2(\alpha) + \gamma_4 g_1(\alpha) \right] + \operatorname{sign}(w_1) \beta_9 \left[\gamma_3 h_2(\alpha) \right. \right. \right. \\
& \left. \left. \left. + \gamma_4 h_1(\alpha) \right] + \sqrt{\beta_5} \frac{\gamma_1}{|w_1|} \left[\gamma_3 m_2(\alpha) + \gamma_4 m_1(\alpha) \right] - \frac{\gamma_{11} \sqrt{\beta_5}}{|w_1|} \left[\gamma_3 n_2(\alpha) + \gamma_4 n_1(\alpha) \right] \right] \right. \\
& \left. + e^{-(h_1-n)\alpha \sqrt{\beta_5} / |w_3|} \left[\frac{\gamma_{11}}{\gamma_{12}} \left[\gamma_3 g_2(\alpha) + \gamma_4 g_1(\alpha) \right] - \frac{\gamma_{11}}{\gamma_{12}} \operatorname{sign}(w_3) \beta_{10} \left[\gamma_3 h_2(\alpha) \right. \right. \right. \\
& \left. \left. \left. + \gamma_4 h_1(\alpha) \right] - \sqrt{\beta_5} \frac{\gamma_{11}}{\gamma_{12}} \frac{\gamma_2}{|w_3|} \left[\gamma_3 m_2(\alpha) + \gamma_4 m_1(\alpha) \right] + \frac{\gamma_{11} \sqrt{\beta_5}}{|w_3|} \left[\gamma_3 n_2(\alpha) + \gamma_4 n_1(\alpha) \right] \right] \right] \frac{\cos \alpha y}{f(\alpha)} d\alpha
\end{aligned}$$

$$\begin{aligned}
K_2(n,y) = & \frac{1}{2\gamma_{13}^*} \int_0^\infty \left[\left\{ e^{-(h_2-n)\alpha \sqrt{\beta_5^*} / |w_1^*|} - e^{-(h_2+n)\alpha \sqrt{\beta_5^*} / |w_1^*|} \right\} \right. \\
& \left. \left\{ - \left[\gamma_3 g_2(\alpha) + \gamma_4 g_1(\alpha) \right] - \operatorname{sign}(w_1^*) \beta_9^* \left[\gamma_3 h_2(\alpha) + \gamma_4 h_1(\alpha) \right] \right. \right. \\
& \left. \left. - \sqrt{\beta_5^*} \frac{\gamma_1^* \lambda}{|w_1^*|} \left[\gamma_3 m_2(\alpha) \right. \right. \right. \\
& \left. \left. \left. + \gamma_4 m_1(\alpha) \right] - \frac{\gamma_{11}^* \sqrt{\beta_5^*} \lambda}{|w_1^*|} \left[\gamma_3 n_2(\alpha) + \gamma_4 n_1(\alpha) \right] \right\} + \left\{ e^{-(h_2-n)\alpha \sqrt{\beta_5^*} / |w_3^*|} \right. \right. \\
& \left. \left. - e^{-(h_2+n)\alpha \sqrt{\beta_5^*} / |w_3^*|} \right\} \left[\frac{\gamma_{11}^*}{\gamma_{12}^*} \left[\gamma_3 g_2(\alpha) + \gamma_4 g_1(\alpha) \right] \right. \right. \\
& \left. \left. + \frac{\gamma_{11}^*}{\gamma_{12}^*} \operatorname{sign}(w_3^*) \beta_{10}^* \left[\gamma_3 h_2(\alpha) \right. \right. \right.
\end{aligned}$$

$$+ \gamma_4 h_1(\alpha) \left. \right\} + \sqrt{\beta_5} \frac{\gamma_{11}^*}{\gamma_{12}^*} \frac{\gamma_{21}^* \lambda}{|w_3^*|} \left[\gamma_3 m_2(\alpha) + \gamma_4 m_1(\alpha) \right] + \frac{\gamma_{11}^* \sqrt{\beta_5} \lambda}{|w_3^*|} \left[\gamma_3 n_2(\alpha) \right. \\ \left. + \gamma_4 n_1(\alpha) \right] \left. \right\} \frac{\cos \alpha y}{f(\alpha)} d\alpha$$

$$K_3(n, y) = \frac{1}{2\gamma_{13}} \int_0^\infty \gamma_{11} \left[e^{-|w_1| \alpha y / \sqrt{\beta_5}} - e^{-|w_3| \alpha y / \sqrt{\beta_5}} \right] \sin \alpha h_1 \sin \alpha n d\alpha$$

$$+ \frac{1}{2\gamma_{13}} \int_0^\infty \left[e^{-(h_1 - n) \alpha \sqrt{\beta_5} / |w_1|} \left[- \left(\gamma_9 \tanh(w_1 \alpha h_1) g_2(\alpha) \right. \right. \right.$$

$$\left. \left. + \gamma_{10} \tanh(w_3 \alpha h_1) g_1(\alpha) \right) \right]$$

$$+ \text{sign}(w_1) \beta_9 \left[\gamma_9 \tanh(w_1 \alpha h_1) h_2(\alpha) + \gamma_{10} \tanh(w_3 \alpha h_1) h_1(\alpha) \right]$$

$$+ \sqrt{\beta_5} \frac{\gamma_1}{|w_1|} \left[\gamma_9 \tanh(w_1 \alpha h_1) m_2(\alpha) + \gamma_{10} \tanh(w_3 \alpha h_1) m_1(\alpha) \right]$$

$$- \frac{\gamma_{11} \sqrt{\beta_5}}{|w_1|} \left[\gamma_9 \tanh(w_1 \alpha h_1) n_2(\alpha) \right.$$

$$\left. + \gamma_{10} \tanh(w_3 \alpha h_1) n_1(\alpha) \right] + e^{-(h_1 - n) \alpha \sqrt{\beta_5} / |w_3|} \left[\frac{\gamma_{11}}{\gamma_{12}} \left[\gamma_9 \tanh(w_1 \alpha h_1) g_2(\alpha) \right. \right.$$

$$\left. + \gamma_{10} \tanh(w_3 \alpha h_1) g_1(\alpha) \right] - \frac{\gamma_{11}}{\gamma_{12}} \text{sign}(w_3) \beta_{10} \left[\gamma_9 \tanh(w_1 \alpha h_1) h_2(\alpha) \right.$$

$$\left. + \gamma_{10} \tanh(w_3 \alpha h_1) \right]$$

$$h_1(\alpha) \left. \right\} - \sqrt{\beta_5} \frac{\gamma_{11}}{\gamma_{12}} \frac{\gamma_2}{|w_3|} \left[\gamma_9 \tanh(w_1 \alpha h_1) m_2(\alpha) + \gamma_{10} \tanh(w_3 \alpha h_1) m_1(\alpha) \right]$$

$$\begin{aligned}
& + \frac{\gamma_{11} \sqrt{\beta_5^*}}{|w_3^*|} \left[\gamma_9 \tanh(w_1 \alpha h_1) n_2(\alpha) + \gamma_{10} \tanh(w_3 \alpha h_1) n_1(\alpha) \right] \left. \right] \frac{\sin \alpha y}{f(\alpha)} d\alpha \\
K_4(\eta, y) = & \frac{1}{2\gamma_{13}^*} \int_0^\infty \left\{ e^{-(h_2 - \eta) \alpha \sqrt{\beta_5^*} / |w_1^*|} - e^{-(h_2 + \eta) \alpha \sqrt{\beta_5^*} / |w_1^*|} \right\} \\
& \left\{ - \left[\gamma_9 \tanh(w_1 \alpha h_1) g_2(\alpha) + \gamma_{10} \tanh(w_3 \alpha h_1) g_1(\alpha) \right] - \text{sign}(w_1^*) \beta_9^* \right. \\
& \left. \left[\gamma_9 \tanh(w_1 \alpha h_1) h_2(\alpha) + \gamma_{10} \tanh(w_3 \alpha h_1) h_1(\alpha) \right] - \sqrt{\beta_5^*} \frac{\gamma_1^* \lambda_1}{|w_1^*|} \left[\gamma_9 \tanh(w_1 \alpha h_1) \right. \right. \\
& \left. \left. m_2(\alpha) + \gamma_{10} \tanh(w_3 \alpha h_1) m_1(\alpha) \right] - \frac{\gamma_{11}^* \sqrt{\beta_5^*} \lambda_2}{|w_1^*|} \left[\gamma_9 \tanh(w_1 \alpha h_1) n_2(\alpha) \right. \right. \\
& \left. \left. + \gamma_{10} \tanh(w_3 \alpha h_1) n_1(\alpha) \right] \right\} + \left\{ e^{-(h_2 - \eta) \alpha \sqrt{\beta_5^*} / |w_3^*|} \right. \\
& \left. - e^{-(h_2 + \eta) \alpha \sqrt{\beta_5^*} / |w_3^*|} \right\} \left\{ \frac{\gamma_{11}^*}{\gamma_{12}^*} \left[\gamma_9 \tanh(w_1 \alpha h_1) g_2(\alpha) \right. \right. \\
& \left. \left. + \gamma_{10} \tanh(w_3 \alpha h_1) g_1(\alpha) \right] \right. \\
& \left. + \frac{\gamma_{11}^*}{\gamma_{12}^*} \text{sign}(w_3^*) \beta_{10}^* \left[\gamma_9 \tanh(w_1 \alpha h_1) h_2(\alpha) + \gamma_{10} \tanh(w_3 \alpha h_1) h_1(\alpha) \right] \right. \\
& \left. + \sqrt{\beta_5^*} \frac{\gamma_{11}^*}{\gamma_{12}^*} \frac{\gamma_2^* \lambda_1}{|w_3^*|} \left[\gamma_9 \tanh(w_1 \alpha h_1) m_2(\alpha) + \gamma_{10} \tanh(w_3 \alpha h_1) m_1(\alpha) \right] \right. \\
& \left. + \frac{\gamma_{11}^* \sqrt{\beta_5^*} \lambda_2}{|w_3^*|} \left[\gamma_9 \tanh(w_1 \alpha h_1) n_2(\alpha) + \gamma_{10} \tanh(w_3 \alpha h_1) n_1(\alpha) \right] \right\} \frac{\sin \alpha y}{f(\alpha)} d\alpha
\end{aligned}$$

APPENDIX C

Evaluation of some Integrals

$$\int_0^{\infty} e^{-at} \sin bt \, dt = \frac{b}{a^2+b^2}, \quad a > 0$$

$$\int_0^{\infty} e^{-at} \cos bt \, dt = \frac{a}{a^2+b^2}, \quad a > 0$$

$$\int_0^{\infty} \frac{1}{\beta^2+x^2} \cos ax \, dx = \frac{\pi}{2\beta} e^{-a\beta}$$

$$\int_0^{\infty} \frac{x}{\beta^2+x^2} \sin ax \, dx = \frac{\pi}{2} e^{-a\beta}$$

$$\int_0^{\infty} \frac{1}{x(\beta^2+x^2)} \sin ax \, dx = \frac{\pi}{2\beta^2} (1 - e^{-a\beta})$$

$$\int_0^{\infty} e^{-a\alpha} \cosh \alpha y \, d\alpha = \frac{a}{a^2-y^2}, \quad a > 0$$

ORIGINAL PAGE IS
OF POOR QUALITY

APPENDIX D

Derivation of the Stress Intensity Factors

D.1 Case of Integral Cracks:

The stress intensity factors are defined as:

$$\begin{aligned}k_a &= \lim_{x_1 \rightarrow a} \sqrt{2(x_1-a)} \sigma_{1y}(x_1,0) \\k_b &= \lim_{x_2 \rightarrow b} \sqrt{2(x_2-b)} \sigma_{2y}(x_2,0)\end{aligned}\tag{D.1a,b}$$

From Eq. (4.16a) we can write:

$$\sigma_{1y}(x_1,0) = \frac{2\gamma_{14}}{\pi(1-\nu_{xy}\nu_{yx})} \int_a^a \frac{\phi(t)}{t-x_1} dt + \sigma_{1y}^0(x_1,0)\tag{D.2}$$

where $\sigma_{1y}^0(x_1,0)$ is a bounded function.

$$\phi(t) = \frac{F(t)}{\sqrt{a^2-t^2}} = \frac{F(t)e^{\pi i/2}}{(t-a)^{1/2}(t+a)^{1/2}}$$

Define the sectionally holomorphic function;

$$\psi(z) = \frac{1}{\pi} \int_a^a \frac{\phi(t)}{t-z} dt$$

From [14] we obtain:

$$\psi(z) = \frac{F(-a)e^{\pi i/2}}{(2a)^{1/2}(z+a)^{1/2}} - \frac{F(a)}{(2a)^{1/2}(z-a)^{1/2}} + \psi_0(z)\tag{D.3}$$

Using (D.3) to evaluate (D.2) and with the definitions given in (D.1a,b) we have:

$$k_a = - \frac{2\gamma_{14} E_y}{(1-\nu_{xy}\nu_{yx})} \frac{1}{\sqrt{a}} F(a) = - \frac{2\gamma_{14} E_y}{(1-\nu_{xy}\nu_{yx})} \sqrt{a} F_0(1)$$

and similarly

$$k_b = - \frac{2\gamma_{14}^* E_y^*}{(1-\nu_{xy}^*\nu_{yx}^*)} \frac{1}{\sqrt{b}} F^*(b) = - \frac{2\gamma_{14}^* E_y^*}{(1-\nu_{xy}^*\nu_{yx}^*)} \sqrt{b} F_0^*(1)$$

D.2 Case of Broken Laminates

$$k_a = \lim_{x_2 \rightarrow -h_2} 2\gamma(x_2 + h_2)^\gamma \sigma_{2y}(x_2, 0) \quad (D.4)$$

From Eq. (5.2b)

$$\sigma_{2y}(x_2, 0) = \frac{2\gamma_{14}^* E_y^*}{(1-\nu_{xy}^*\nu_{yx}^*)} \int_{-h_1}^{h_1} k_{21s}(x_2, t) \phi(t) dt + \sigma_{2y}^0(x_2, 0) \quad (D.5)$$

where $\sigma_{2y}^0(x_2, 0)$ is a bounded function.

$$\phi(t) = \frac{F(t)}{(h_1^2 - t^2)^\gamma} = \frac{F(t)e^{\pi i \gamma}}{(t-h_1)^\gamma (t+h_1)^\gamma}$$

Define:

$$\psi(z) = \frac{1}{\pi} \int_{-h_1}^{h_1} \frac{\phi(t)}{t-z} dt$$

then:

$$\psi(z) = \frac{F(-h_1)e^{i\pi\gamma}}{(2h_1)^\gamma \sin\pi\gamma} \frac{1}{(z+h_1)^\gamma} - \frac{F(h_1)}{(2h_1)^\gamma \sin\pi\gamma} \frac{1}{(z-h_1)^\gamma} + \psi_0(z) \quad (D.6)$$

Using (D.4), (D.5) and (D.6) we obtain:

$$k_a = \frac{(h_1)^\gamma \gamma_{14}^* E_y^* F_0(1)}{(1-\nu_{xy}^*\nu_{yx}^*) \sin\pi\gamma} \left[\lambda_{101} \frac{|w_1|/\sqrt{\beta_5}}{\left[\frac{|w_1^*||w_1|}{\sqrt{\beta_5}} \right]^\gamma} + \lambda_{102} \frac{|w_1|/\sqrt{\beta_5}}{\left[\frac{|w_3^*||w_1|}{\sqrt{\beta_5}} \right]^\gamma} \right]$$

$$+ \lambda_{103} \left[\frac{|w_3|/\sqrt{\beta_5}}{\left[\frac{|w_3| |w_1^*|}{\sqrt{\beta_5}} \right] \gamma} \right] + \lambda_{104} \left[\frac{|w_3|/\sqrt{\beta_5}}{\left[\frac{|w_3| |w_3^*|}{\sqrt{\beta_5}} \right] \gamma} \right]$$

k_b has the same expression as the one we derived in the previous case.

D.3 Case of a Crack Crossing the Interface

D.3.a Singular Behavior at the Interface:

In this case the definitions of the stress intensity factors are:

$$k_b = \lim_{x_2 \rightarrow c} \sqrt{2(c-x_2)} \sigma_{2y}(x_2, 0)$$

$$k_{xx} = \lim_{y \rightarrow 0^+} y^\beta \sigma_{1x}(h_1, y)$$

and

$$k_{xy} = \lim_{y \rightarrow 0^+} y^\beta \tau_{1xy}(h_1, y) \quad (D.7a, b, c)$$

From Eq. (6.2b) we can write:

$$\sigma_{2y}(x_2, 0) = \frac{2\gamma_{14}^* E_y^*}{(1-\nu_{xy}^* \nu_{yx}^*) \pi} \int_c^{h_2} \frac{\phi^*(t)}{t-x_2} dt + \sigma_{2y}^0(x_2, 0) \quad (D.8)$$

where $\sigma_{2y}^0(x_2, 0)$ is a bounded function.

$$\phi^*(t) = \frac{F^*(t)}{(t-c)^{\frac{1}{2}}(h_2-t)^\beta}$$

$$\psi^*(z) = \frac{1}{\pi} \int_c^{h_2} \frac{\phi^*(t)}{t-z} dt = \frac{F^*(c)e^{i\pi/2}}{(h_2-c)^\beta \sin\pi/2} \frac{1}{(z-c)^{1/2}} - \frac{F^*(h_2)}{(h_2-c)^{1/2} \sin\pi\beta} \frac{1}{(z-h_2)^\beta} + \psi_0^*(z) \quad (D.9)$$

Using (D.9) and (D.8), Eq. (D.7a) yields to:

$$k_b = \frac{2\gamma_{14}^* E_y^*}{(1-\nu_{xy}^* \nu_{yx}^*)} \frac{F^*(c)\sqrt{2}}{(h_2-c)^\beta}$$

or

$$k_b = \frac{2^{1-\beta} \gamma_{14}^* E_y^* (h_2-c)^{1/2}}{(1-\nu_{xy}^* \nu_{yx}^*)} F_0^*(-1)$$

Separating the singular parts of Eqs. (6.15a,b) we have:

$$\frac{\pi(1-\nu_{xy}^* \nu_{yx}^*)}{2E_x} \sigma_{1x}(h_1, y) = \int_{-h_1}^{h_1} K_{1s}(n, y) \phi(n) dn + \int_c^{h_2} K_{2s}(n, y) \phi^*(n) dn + \sigma_{1x}^0(y)$$

$$\frac{\pi}{2G_{xy}} \tau_{1xy}(h_1, y) = \int_{-h_1}^{h_1} K_{3s}(n, y) \phi(n) dn + \int_c^{h_2} K_{4s}(n, y) \phi^*(n) dn + \tau_{1xy}^0(y) \quad (D.10a, b)$$

where $\sigma_{1x}^0(y)$ and $\tau_{1xy}^0(y)$ are bounded.

Let:

$$\phi(t) = \frac{F(t)}{(h_1^2 - t^2)^\beta} = \frac{F(t)e^{i\pi\beta}}{(t+h_1)^\beta (t-h_1)^\beta}$$

then

$$\psi(z) = \frac{1}{\pi} \int_{-h_1}^{h_1} \frac{\phi(t)}{t-z} dt = \frac{F(-h_1)e^{i\pi\beta}}{(2h_1)^\beta \sin\pi\beta} \frac{1}{(z+h_1)^\beta} - \frac{F(h_1)}{(2h_1)^\beta \sin\pi\beta (z-h_1)^\beta} + \psi_0(z) \quad (D.11)$$

Using (D.11), (D.9), (D.10a,b) and the definitions (D.7b,c) after lengthy algebra we obtain:

$$k_{xx} = \frac{E_x}{(1-\nu_{xy}\nu_{yx})} \frac{1}{2^{\beta+1} \sin\pi\beta/2} \left\{ \frac{h_1^\beta}{\gamma_{13}} \left[\frac{\gamma_1}{\left(\frac{|w_1|}{\sqrt{\beta_5}}\right)^\beta} - \gamma_2 \frac{\gamma_{11}}{\gamma_{12}} \frac{1}{\left(\frac{|w_3|}{\sqrt{\beta_5}}\right)^\beta} \right. \right. \\ \left. \left. - \frac{|w_1|}{\sqrt{\beta_5}} \frac{(\gamma_3\lambda_{81} + \gamma_4\lambda_{82})}{\left(\frac{|w_1|}{\sqrt{\beta_5}}\right)^\beta \lambda_{80}} - \frac{|w_3|}{\sqrt{\beta_5}} \frac{(\gamma_3\lambda_{83} + \gamma_4\lambda_{84})}{\left(\frac{|w_3|}{\sqrt{\beta_5}}\right)^\beta \lambda_{80}} \right] F_0(-1) \right. \\ \left. + \frac{(h_2-c)^\beta}{\sqrt{2}\gamma_{13}^*\lambda_{80}} \left[\frac{|w_1^*|}{\sqrt{\beta_5^*}} \frac{(\gamma_3\lambda_{89} + \gamma_4\lambda_{90})}{\left(\frac{|w_1^*|}{\sqrt{\beta_5^*}}\right)^\beta} + \frac{|w_3^*|}{\sqrt{\beta_5^*}} \frac{(\gamma_3\lambda_{91} + \gamma_4\lambda_{92})}{\left(\frac{|w_3^*|}{\sqrt{\beta_5^*}}\right)^\beta} \right] F_0^*(1) \right\}$$

and

$$k_{xy} = \frac{G_{xy}}{2^{\beta+1} \cos \frac{\pi\beta}{2}} \left\{ \frac{h_1^\beta}{\gamma_{13}} \left[- \frac{\gamma_{11}}{\left(\frac{|w_1|}{\sqrt{\beta_5}}\right)^\beta} + \frac{\gamma_{11}}{\left(\frac{|w_3|}{\sqrt{\beta_5}}\right)^\beta} \right. \right. \\ \left. \left. - \frac{(\gamma_9\lambda_{81} + \gamma_{10}\lambda_{82})}{\lambda_{80}} \frac{|w_1|}{\left(\frac{|w_1|}{\sqrt{\beta_5}}\right)^\beta} - \frac{(\gamma_9\lambda_{83} + \gamma_{10}\lambda_{84})}{\lambda_{80}} \frac{|w_3|}{\left(\frac{|w_3|}{\sqrt{\beta_5}}\right)^\beta} \right] F_0(-1) \right\}$$

$$+ \frac{(h_2-c)^\beta}{\sqrt{2} \gamma_{13}^* \lambda_{80}} \left[\frac{(\gamma_9 \lambda_{89} + \gamma_{10} \lambda_{90}) \frac{|w_1^*|}{\sqrt{\beta_5^*}}}{\left(\frac{|w_1^*|}{\sqrt{\beta_5^*}} \right)^\beta} + \frac{(\gamma_9 \lambda_{91} + \gamma_{10} \lambda_{92}) \frac{|w_3^*|}{\sqrt{\beta_5^*}}}{\left(\frac{|w_3^*|}{\sqrt{\beta_5^*}} \right)^\beta} \right] F_0^*(1) \left. \right\}$$

D.3.b Non-Singular Behavior at the Interface

$$k_b = \lim_{x_2 \rightarrow \ell} \sqrt{2(x_2 - \ell)} \sigma_{2y}(x_2, 0)$$

The derivation is similar to the one done for the case of internal cracks. Thus, we have:

$$k_b = - \frac{2\gamma_{14}^* E_y^* \sqrt{\ell}}{(1 - \nu_{xy}^* \nu_{yx}^*)} H_0(1)$$

ORIGINAL PAGE IS
OF POOR QUALITY