

24

N78-32470

TYPICAL USES OF NASTRAN IN A PETROCHEMICAL INDUSTRY

J. Ronald Winter
Tennessee Eastman Company

OBJECTIVE

The two major objectives of this report are (1) to present a summary of the typical uses of NASTRAN in a petrochemical industry and (2) to describe the unique environment in which the program is used at the Tennessee Eastman Company (TEC).

BACKGROUND

NASTRAN is principally used at TEC to perform failure analysis and redesign process equipment. In addition, it is employed in the evaluation of vendor designs and proposed design modifications to existing process equipment. Its direct usage as a design tool is quite limited at this time, but I feel confident that this area of usage will grow in the future.

NASTRAN usage as a failure analysis tool is not unique, but its usage for this purpose in a production environment with primary emphasis on minimizing lost production due to mechanical/structural failures is probably unique. Its use in this way means that solutions to sometimes quite difficult problems must be obtained in relatively short periods of time. This often entails the use of models with much coarser mesh networks than would normally be desired if more time was available. However, we have found that even with the use of relatively coarse models one can obtain satisfactory results in a minimal length of time. In any event, the results obtained are generally superior to those obtained by hasty, error prone hand calculations that usually require numerous simplifying assumptions if a solution is to be obtained in the desired time frame.

We also use NASTRAN on some relatively small problems simply because the rigid formats available in NASTRAN allow one to perform several different types of analyses using essentially the same model. For instance, there are numerous cases where a stress analysis (Rigid Formats 1 or 2), a heat transfer analysis (Rigid Formats 1, 3 or 9) and a dynamic analysis (Rigid Formats 3, 8, 9, or 11) are required to insure the complete structural adequacy of a redesigned component. In these cases we find this procedure more efficient and more economical than performing the associated solutions via classical mechanics methods.

DISCUSSION

In this paper there will be no attempt to give "detailed" descriptions of any particular model or the results. In general, there will be a brief description of several problems and the associated models, the type analyses performed on the models, a summary of the results and conclusions, and typical undeformed and deformed plots. Photos of some failures will also be included. Some typical process equipment that has been analyzed via NASTRAN are listed below.

Table 1: Analyses Discussed in This Paper

<u>Description</u>	<u>Type Analyses</u>	<u>Rigid Formats</u>
(1) Large Forced Draft Fan	Static, Inertial Relief	1,2
(2) Distillation Trays (Orthogonally Stiffened Plates)	Static, Normal Mode	1
(3) Steel Stacks (Chimneys)	Static, Normal Mode, Frequency Response, Buckling	1,3,5,8
(4) Large Jacketed Pipe Systems	Static	1
(5) Heat Exchangers (Shell & Tube with Single and Double Tube Sheets)	Static, Heat Transfer	1
(6) Large Centrifugal Fans	Static, Normal Mode	1,3
(7) Agitator Support Structures	Static	1

Table 2: Analyses Not Discussed in This Paper

<u>Description</u>	<u>Type Analyses</u>	<u>Rigid Formats</u>
(1) Bimetallic Junctions	Static	1
(2) Fan-Motor Shaft Failures	Normal Mode	3
(3) Sigma Blade Mixers	Static	1

(4) Orthogonally Stiffened Flat Heads	Static	1
(5) Analysis of Pipe Systems	Static, Normal Mode, Forced Response, Frequency Response	1,3,8,9
(6) Frames and Trusses	Static, Buckling	1,5
(7) Storage Silos	Static, Buckling	1,5
(8) Large Dryers/Blenders	Static	1
(9) Pressure Vessels	Static	1
(10) Shells Associated With Combustion Chambers	Static	1
(11) Plastic Vessels	Static	1
(12) Cyclones	Static, Normal Mode	1,3
(13) Extruders	Static	1

Discussion of Analysis Listed in Table 1

(1) Forced Draft Fan Failure

During attempts to balance a large forced draft fan, the unit disintegrated at a rotational speed of ≈ 900 rpm (15 Hz). The normal operating speed for this unit is 1200 rpm (20 Hz). See Figures 1, 2, and 3 for photos of a typical forced draft fan and the debris from this failure.

Initially it was impossible to determine from the resulting debris what caused the failure. Several theories were postulated, but there was insufficient proof to substantiate any particular theory. This led to a NASTRAN analysis in an effort to prove or disprove several postulated sequences of events that could have resulted in the same failure. The NASTRAN model is shown in Figure 4. Rigid formats 1 (static analysis) and 2 (static analysis with inertial relief) were employed. The results indicated that the highest stress levels were at the ends of each blade and not in the outer rings. But the levels were not sufficiently high to cause failure in the absence of a defect (crack, poor weld, etc.). This led to a careful reexamination of the blades (see Figure 2). This inspection revealed that blades made by two different manufacturers were employed.* The inspection also revealed that only the blades of a welded construction had broken while the formed blades had not.

*Although the use of two different blade designs on the same fan is not desirable, this was found to be a common practice.

Detailed inspection of the ends of the broken blades revealed extremely poor welding (see Figure 3). The major weld defect was classified as lack of penetration. Of course, other weld defects such as porosity, undercutting, etc., were also present but were not of such a severe nature. When the resulting NASTRAN stress levels at the ends of the blades were multiplied by the applicable stress concentration factor, the stress levels were more than sufficient to cause failure. Subsequently, several runs were made to investigate the loads assuming one or more blades had broken. These results indicated that the failure pattern would be similar to that indicated by the debris.

(2) Distillation Trays (Orthogonally Stiffened Plates)

A distillation tray essentially consists of a thin plate supported by beams. A typical distillation tray is shown in Figure 5. Numerous failures have been encountered with such trays. The failures have been attributed to:

- (1) Fatigue associated with normal process pulsations (Figure 6).
- (2) Resonant or near resonant conditions.
- (3) Large pressure pulses due to process upsets, start-ups, etc. Flashing is a common problem (Figures 7 and 8).
- (4) Corrosion (general attack and specific types of attack, e.g., stress corrosion).

NASTRAN analyses have essentially eliminated the first two failure mechanisms and has aided us in designing/specifying trays that are more resistant to minor pressure pulses. NASTRAN is also used to evaluate vendor tray designs especially if an unusual design is submitted or if the particular design is used in a critical application.

Typical tray models are shown in Figures 9 and 10. Typical plots of the first and second modes are shown in Figures 11 and 12.

(3) Metal Stack Analysis

Due to potential pollution problems, it was desired to add a 15.24 meter (50 ft.) extension to an existing 30.48 meter (100 ft.) stack. The existing oil fired boiler stack is shown in Figures 13 and 14. Due to potential vortex shedding problems, an analysis was requested. The resulting NASTRAN model is shown in Figure 15. A NASTRAN modal analysis showed that a resonant condition would occur due to vortex shedding at moderate to high wind velocities which were typical in the particular region. See Figure 16 for the first bending mode. A static analysis also revealed that the foundation loads were far too large. Additional analyses revealed that the stack would encounter an ovaling resonant condition at high wind velocities. Thus, it was shown that the desired corrective action would require the installation of new stacks.

(4) Jacketed Pipe Analysis

In many situations in a petrochemical plant it is necessary to maintain the temperature of a product in a pipeline to prevent solidification. The use of jacketed pipe (steam in the external pipe, process material in the inner pipe) is often used to achieve this result. In these cases the internal pipe is typically a 300 series stainless steel while the outer pipe (steam jacket) is carbon steel. Due to the temperature difference between the inner and outer pipes and the fact that their thermal coefficients of expansions are quite different one can encounter large differential thermal expansions. As a result of these conditions, we have encountered numerous failures with this type of pipeline in the past. NASTRAN, with the MFC/rigid element capability, is ideally suited for "rapid" analysis of these type pipelines. A typical pipeline model is shown in Figure 17. The results of a NASTRAN analysis of a vendor's design before and after the implementation of modifications based on NASTRAN analyses is shown in Figures 18 and 19. The NASTRAN analyses of several lines led to the development of a set of general jacketed pipe design guidelines to be used by engineers and draftsmen. These layout guidelines have virtually eliminated failures in this type pipeline.

(5) Heat Exchangers

The failure of the tube sheet/flange assembly of several vendor designed heat exchangers led to a NASTRAN analysis. The typical failures encountered in this case are shown in Figures 20 and 21. The associated finite element models are shown in Figures 22 and 23. The NASTRAN analysis readily showed that differential radial thermal expansion was the major cause of failure (see Figure 24). However, differential thermal expansion between the tubes and shell wall also contributed to the problem. The units were redesigned based on the NASTRAN results.

(6) Large Centrifugal Fan

The development of cracks in the large centrifugal fan shown in Figure 25 led to the development of a NASTRAN model of a portion of the fan. The basic model is shown in Figure 26. As expected, the static analysis showed that the highest stress levels were in the region where the cracks had appeared. However, the stress levels were not sufficiently high to cause fatigue cracks to develop in the applicable time frame. This led to a modal (real eigenvalue) analysis. These results revealed the true culprit. A panel natural frequency existed relatively close to a normal operating frequency. The applicable mode shape is shown in Figure 27. Since the panel frequency was just below the normal operating frequency, it was established that the fan was being seriously damaged during each start-up and shutdown. Until a new fan could be built, it was recommended that the fan be allowed to run continuously if possible. It was later established that due to process problems and bearing problems the unit had been started and stopped numerous times during the period before the cracks were discovered.

The NASTRAN analysis established the cause of the failure and served as the basis for designing a new fan. The model was also used to modify the original fan which now serves as a back-up.

(7) Agitator Support Structures

Inadequate structural supports for large agitators have been diagnosed via NASTRAN analysis to be the cause of severe shaft wear, premature bearing failures and cracking of the agitator housings. This problem was resulting in unusually high maintenance costs. As a result of these analyses, a new design procedure which accounts for dynamic effects has been developed. A typical model of an agitator support system is shown in Figure 28.

CLOSING COMMENTS

From the previously discussed typical uses of NASTRAN, it should be evident that our use of the program is quite broad. We have found NASTRAN to be the only diversified tool presently available which allows the user to deal with a very wide variety of difficult problems in a relatively short period of time. Needless to say, we are very dependent on the capabilities available in this program.

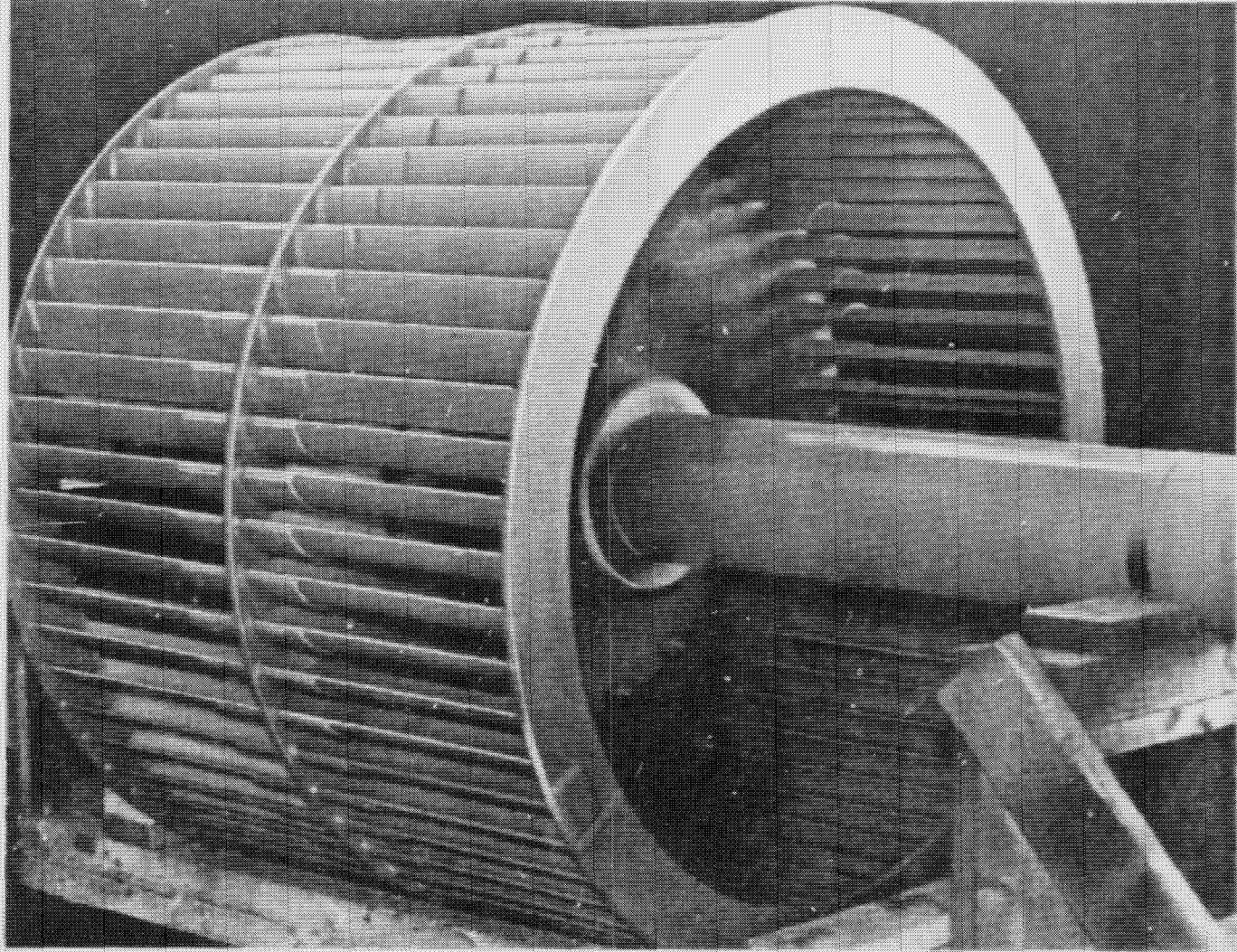

ORIGINAL PAGE IS
OF POOR QUALITY

FIGURE 1: TYPICAL FORCED DRAFT FAN

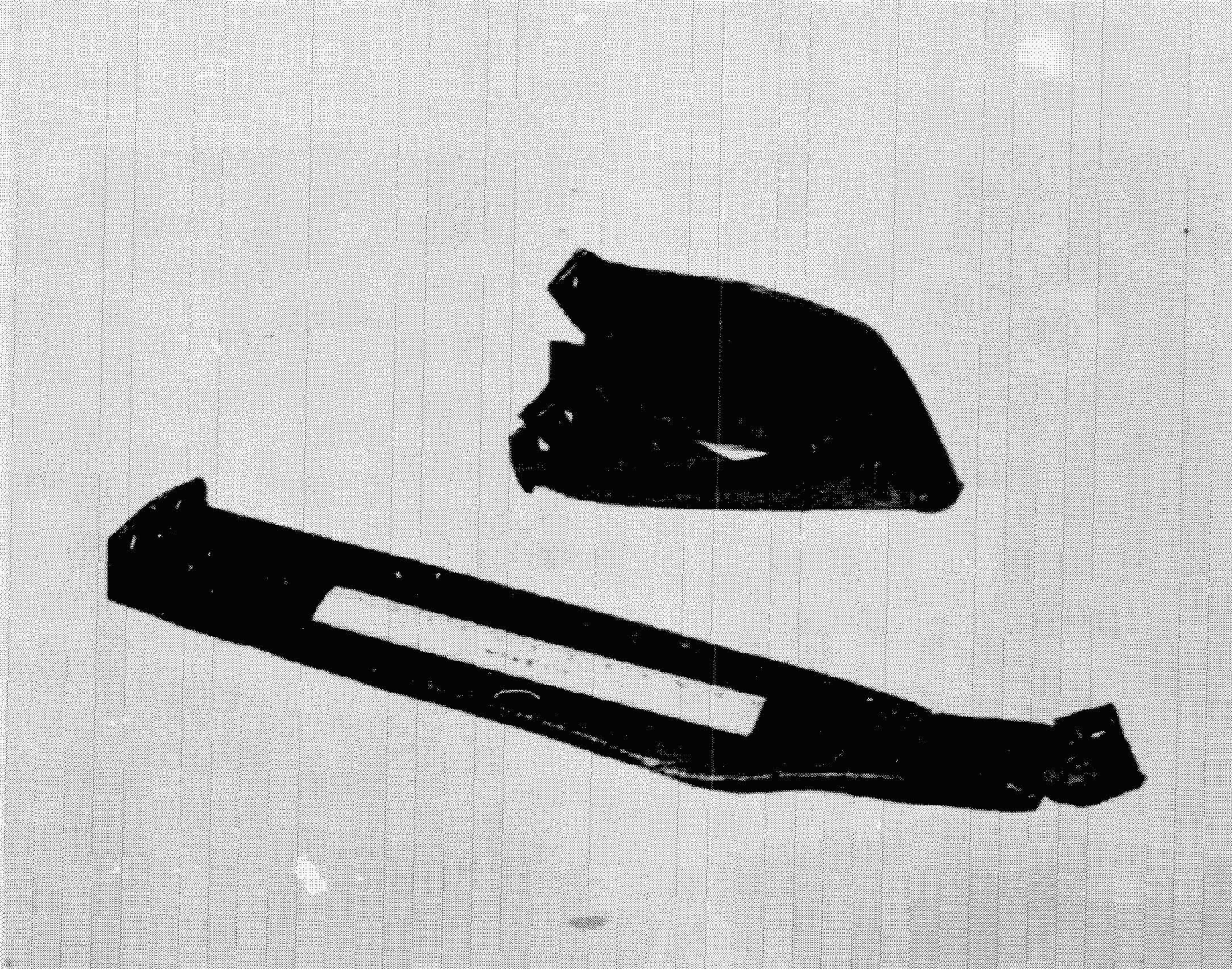
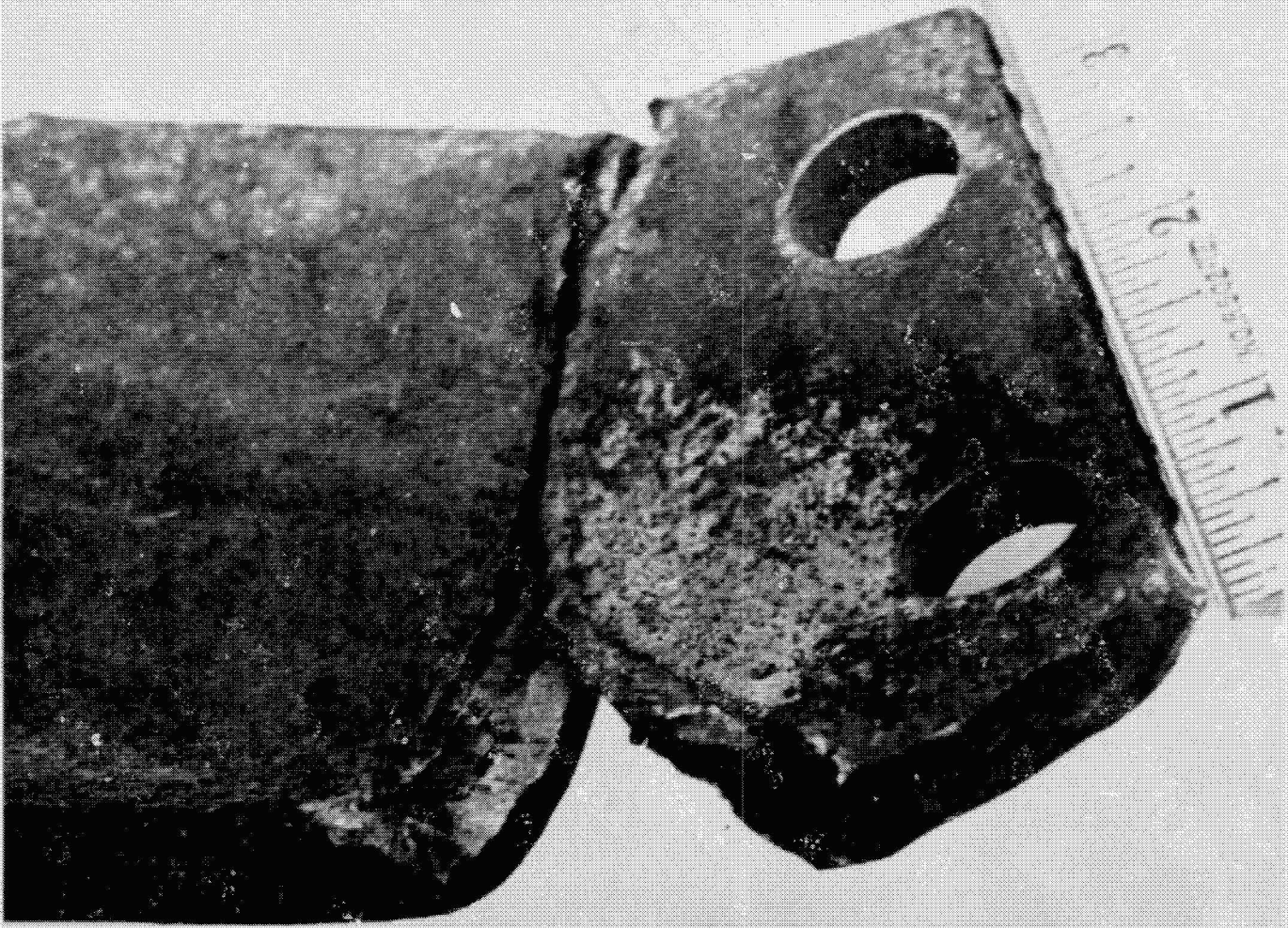

FIGURE 2: DAMAGED BLADES (FORMED BLADE AT TOP, WELDED BLADE AT BOTTOM)



ORIGINAL PAGE IS
OF POOR QUALITY

FIGURE 3: FAILURE OF A WELDED BLADE

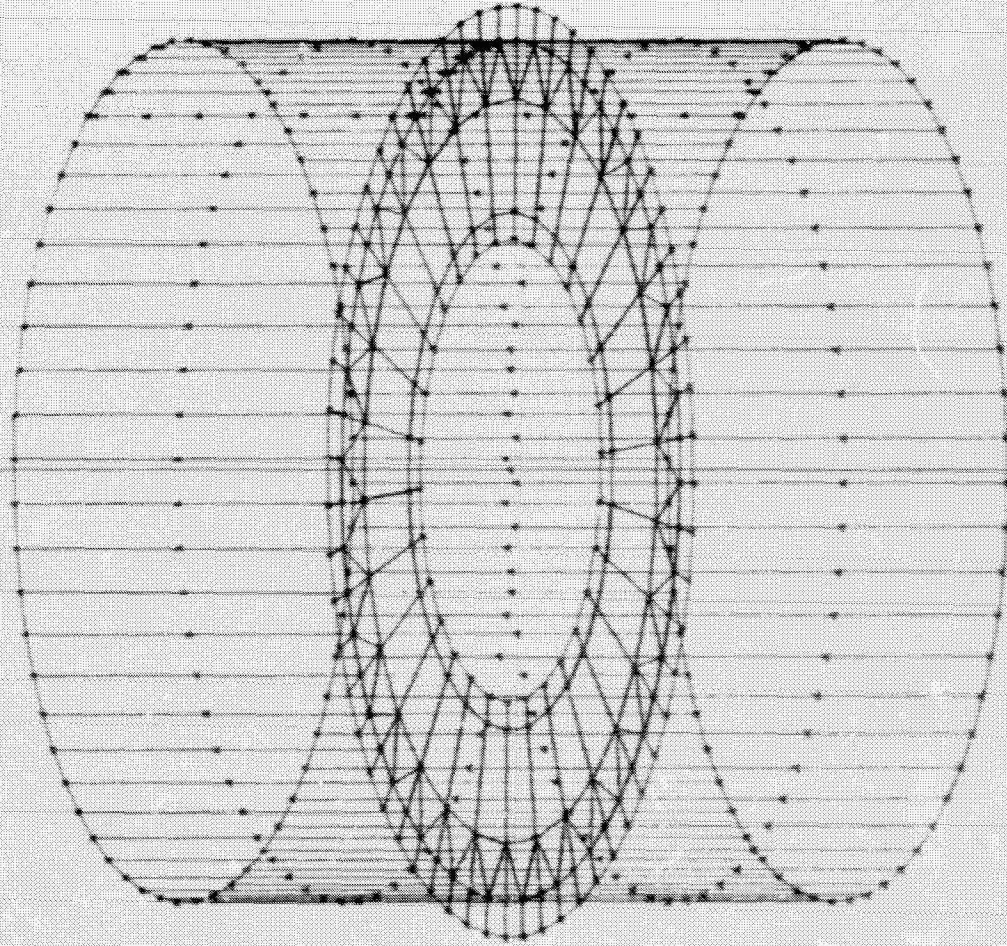
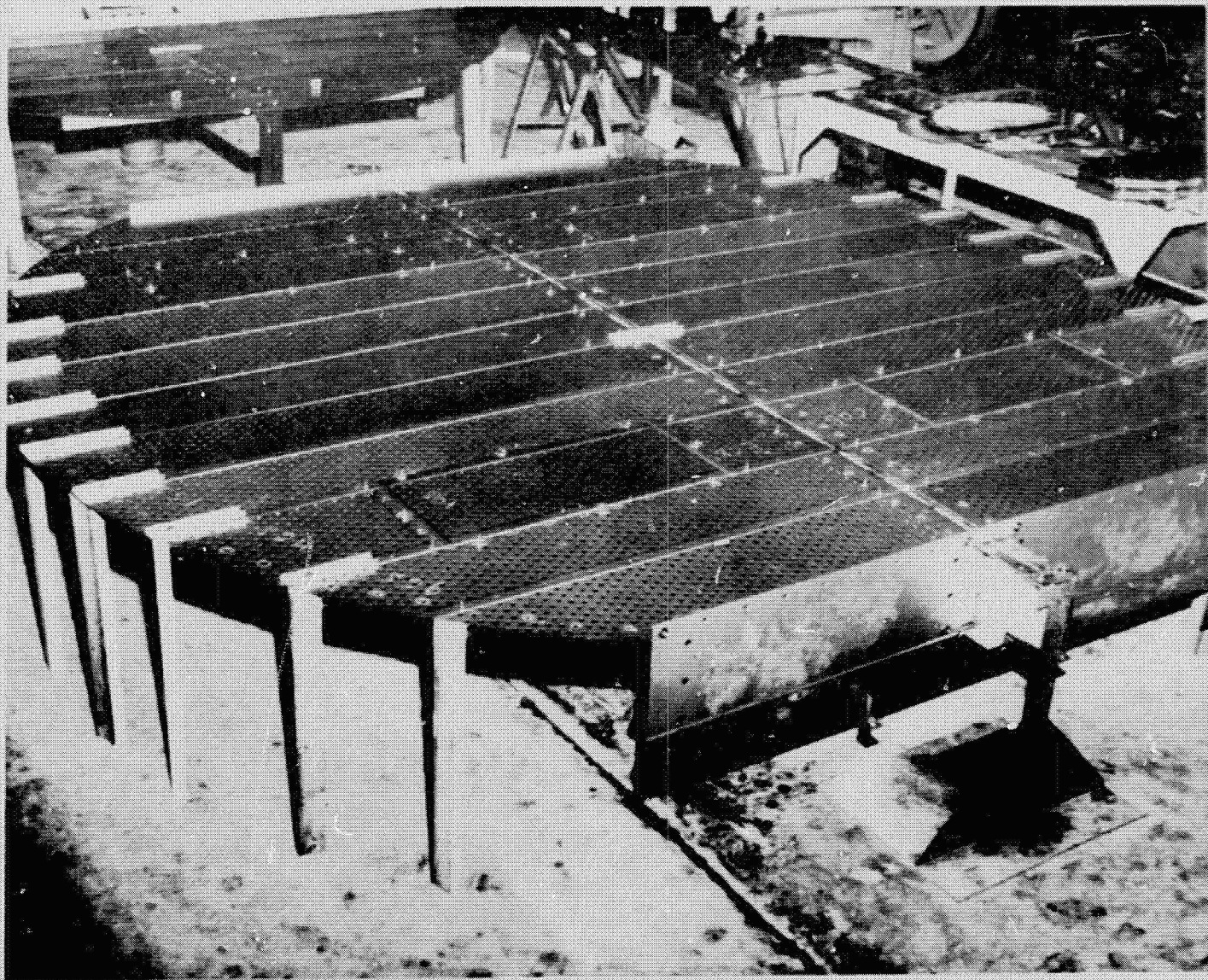

FIGURE 4: MODEL OF FORCED DRAFT FAN



ORIGINAL PAGE IS
OF POOR QUALITY

FIGURE 5: TYPICAL DISTILLATION TRAY

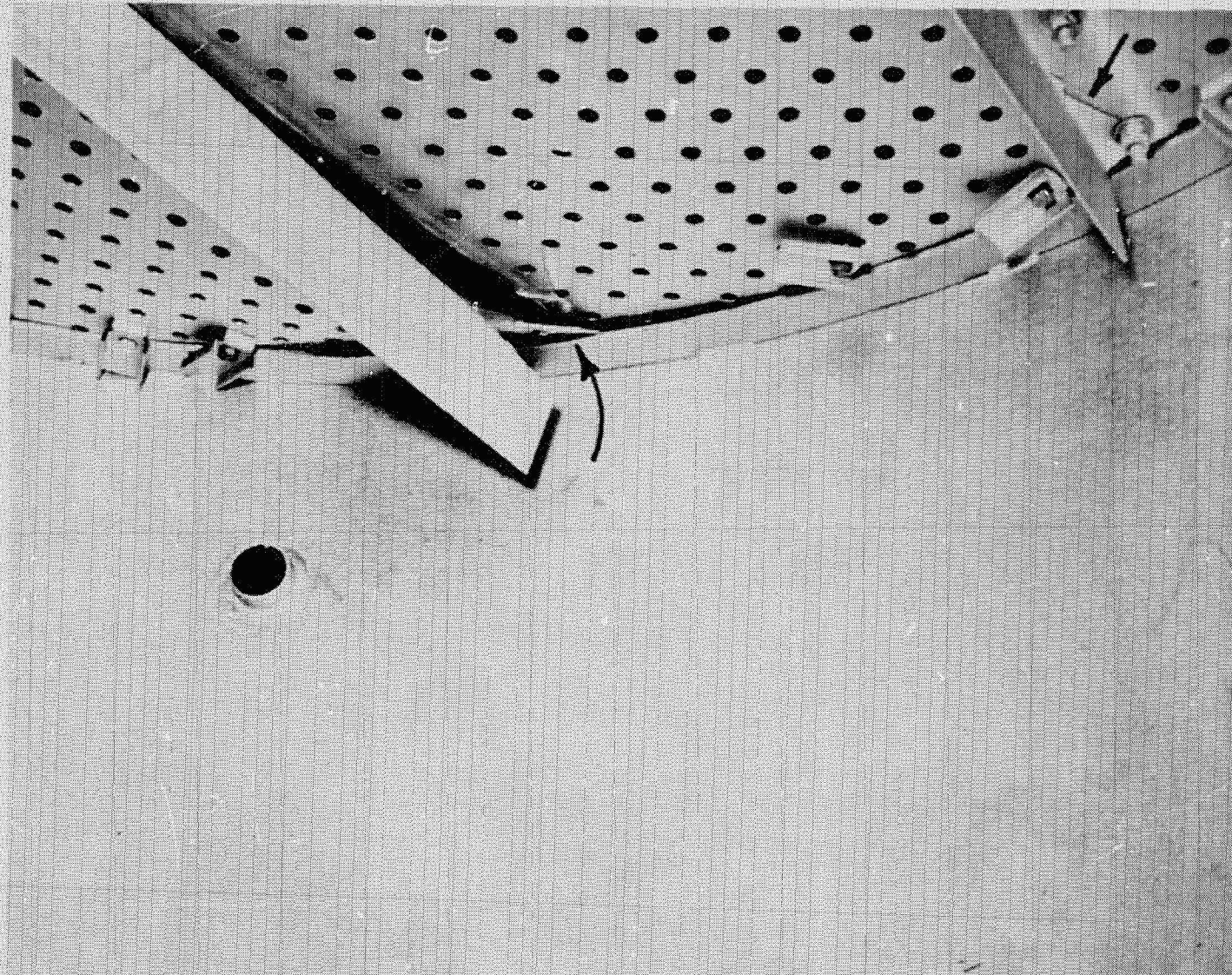
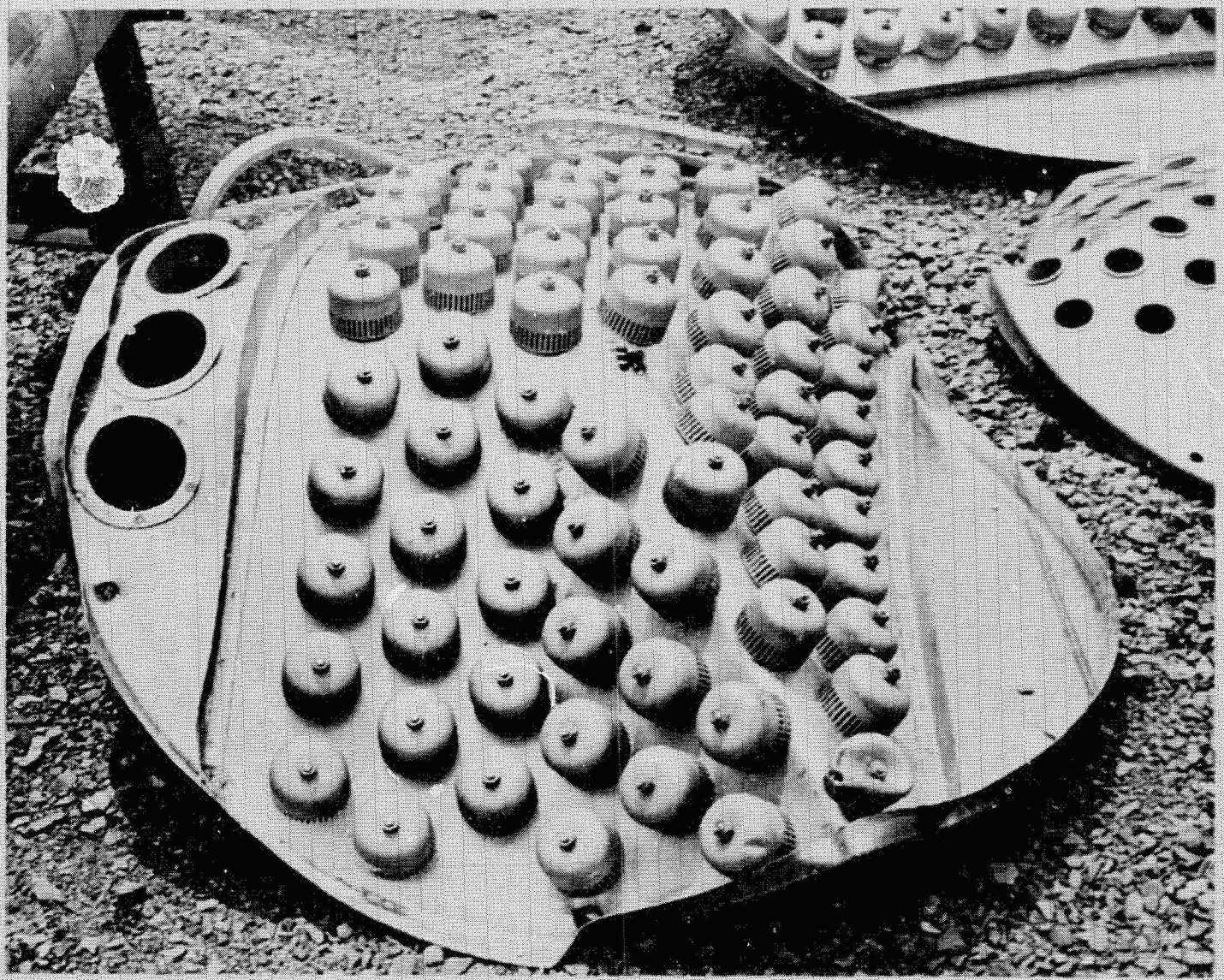

FIGURE 6: FATIGUE FAILURE OF A DISTILLATION TRAY DUE TO NORMAL PROCESS PULSATIONS



ORIGINAL PAGE IS
OF POOR QUALITY

FIGURE 7: FAILURE OF A SMALL DIAMETER DISTILLATION TRAY DUE TO A LARGE PRESSURE PULSE

ORIGINAL PAGE IS
OF POOR QUALITY

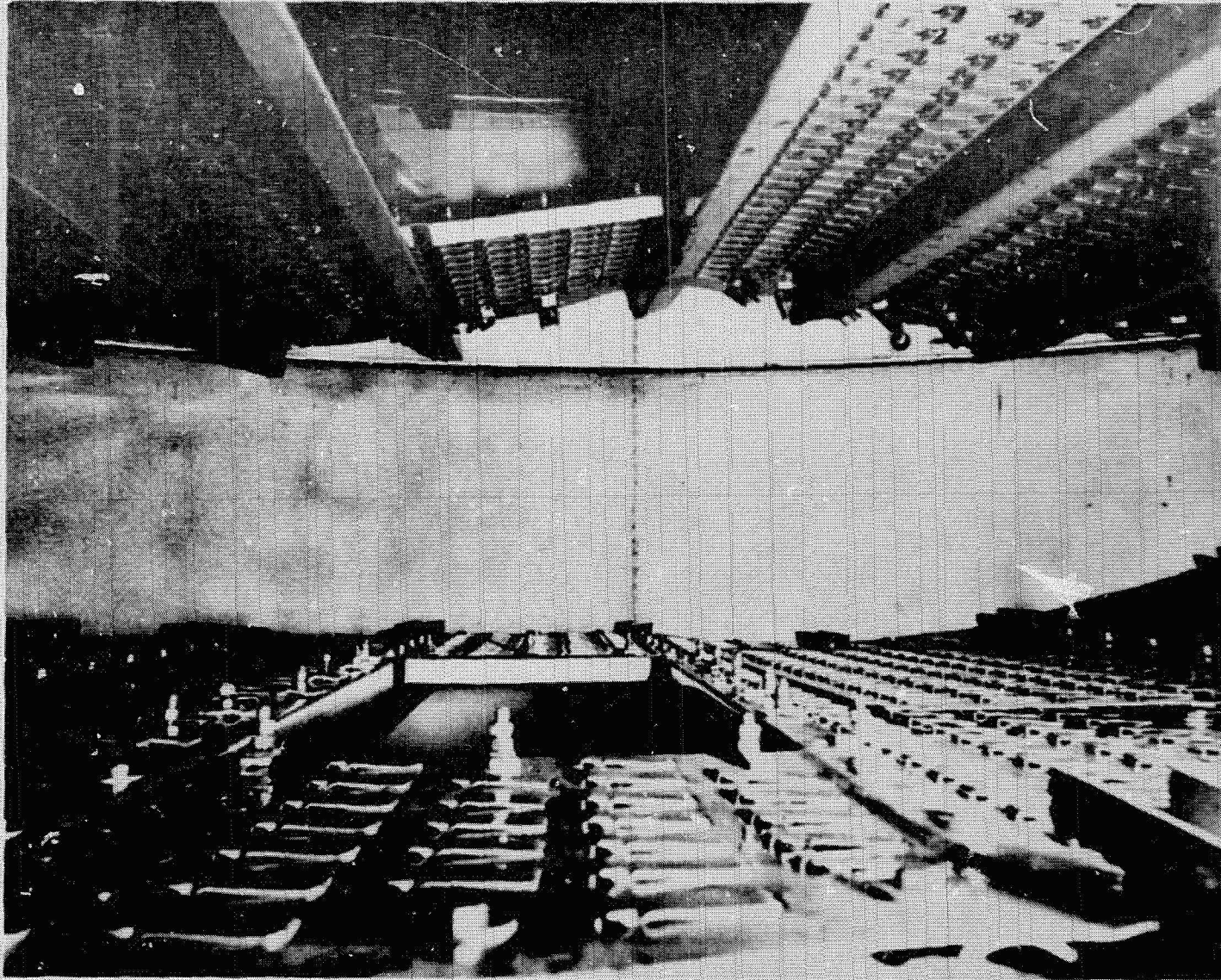

FIGURE 8: FAILURE OF A LARGE DIAMETER DISTILLATION TRAY DUE TO A LARGE PRESSURE DIFFERENTIAL

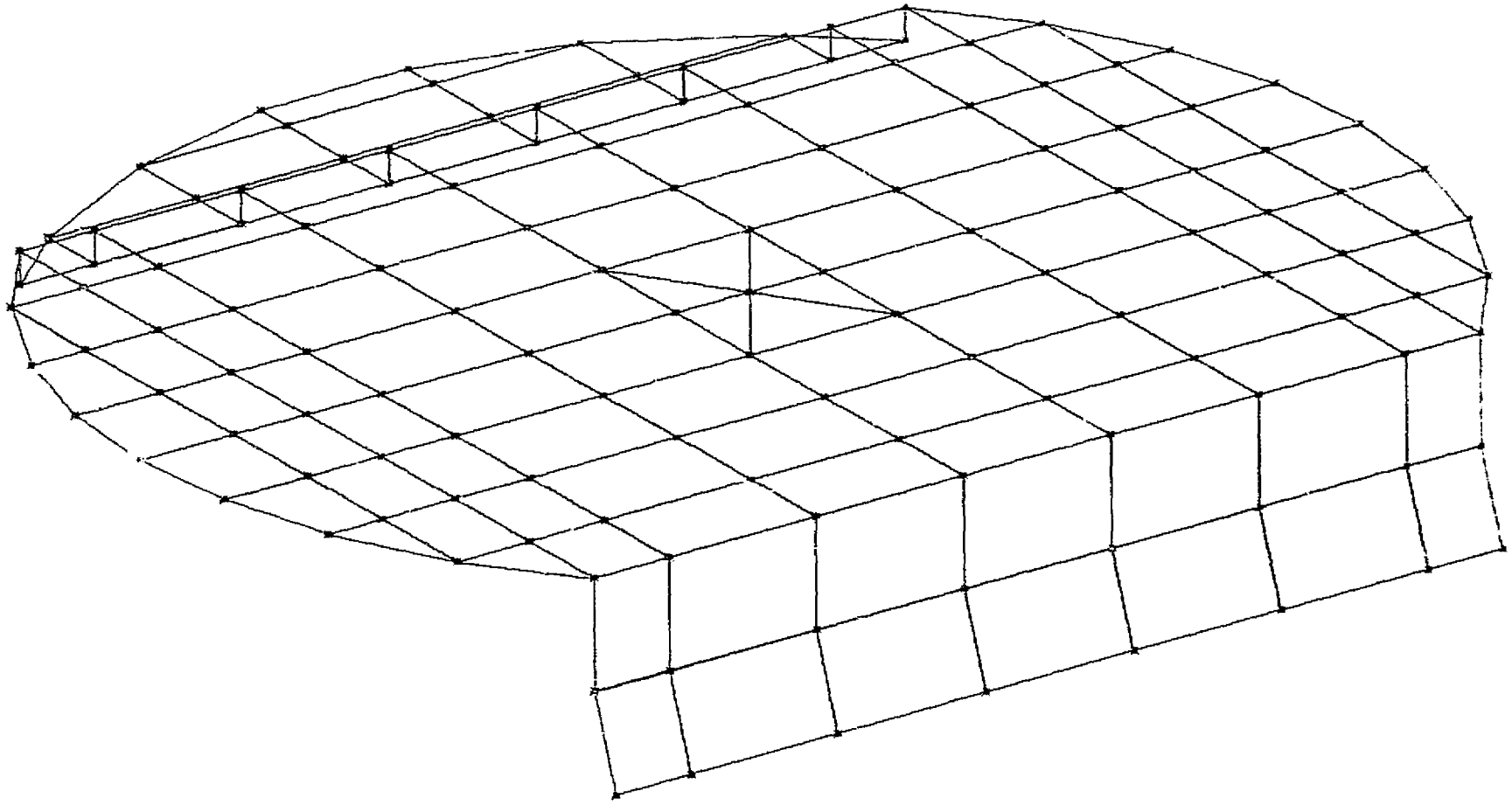

FIGURE 9: TYPICAL MODEL OF A LARGE DIAMETER DISTILLATION TRAY

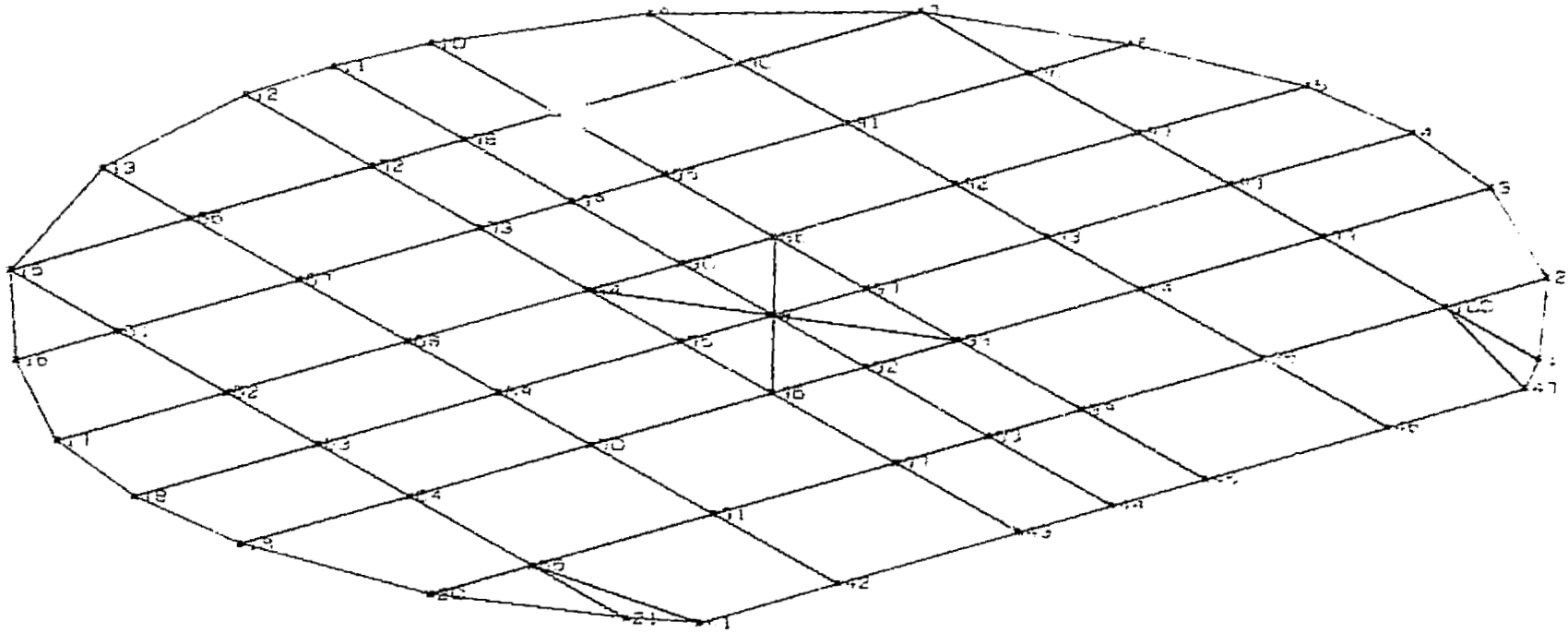

FIGURE 10: TYPICAL MODEL OF A SMALLER DISTILLATION TRAY

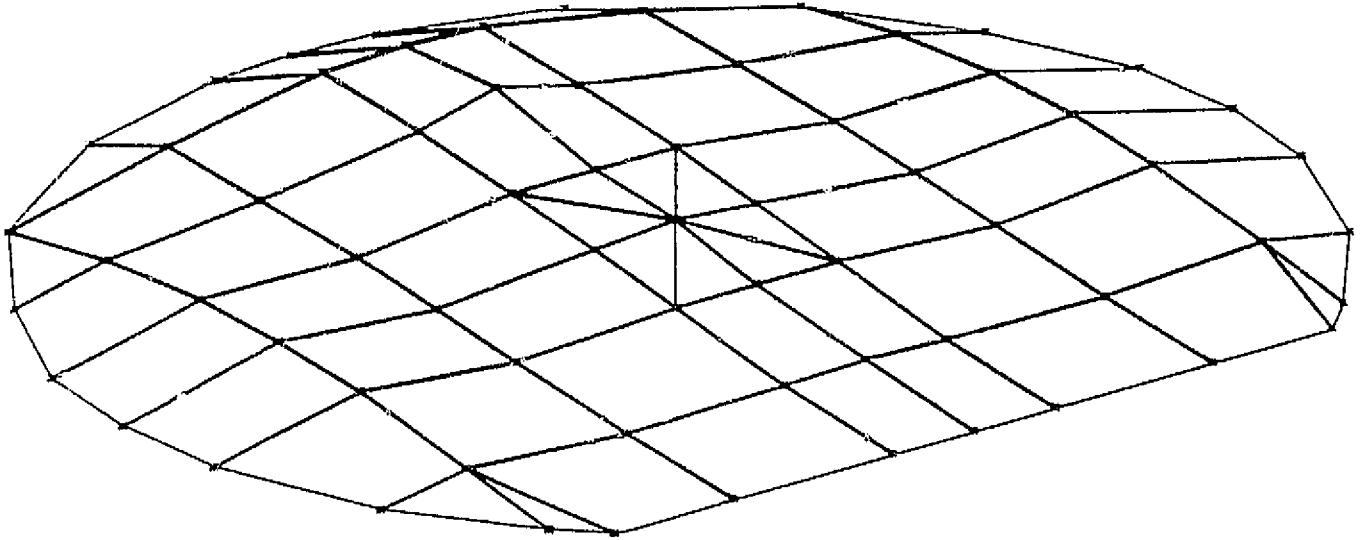

FIGURE 11: FIRST MODE OF A DISTILLATION TRAY

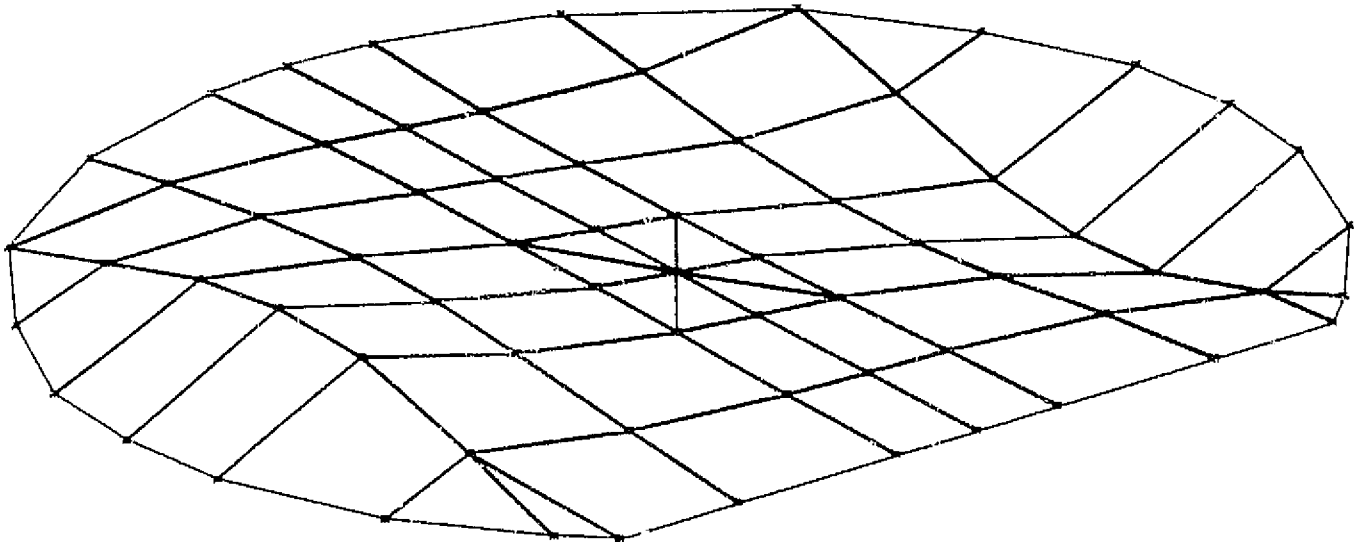

FIGURE 12: SECOND MODE OF A DISTILLATION TRAY

ORIGINAL PAGE IS
OF POOR QUALITY

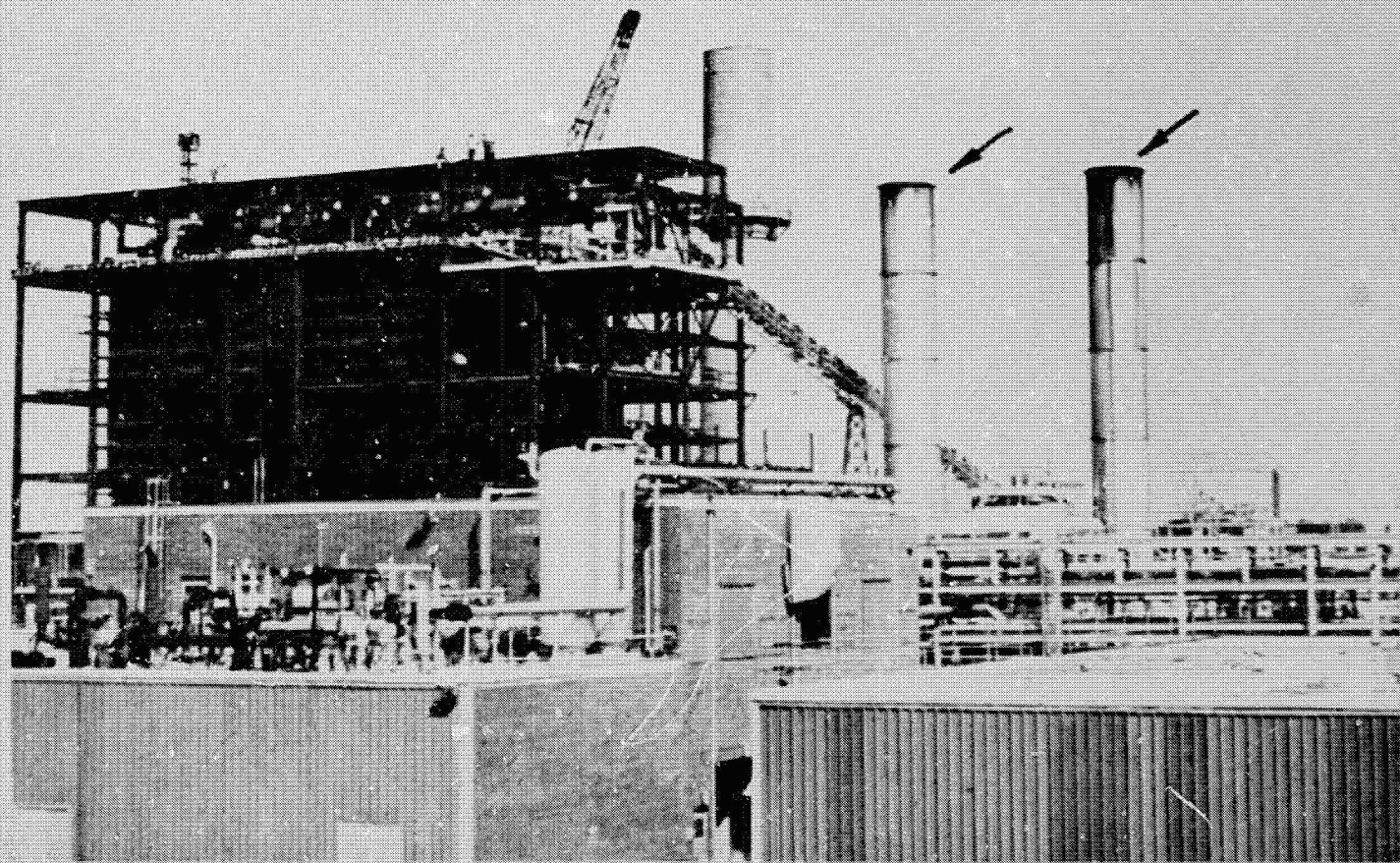

FIGURE 13: DISTANT VIEW OF ORIGINAL STACKS

ORIGINAL PAGE IS
OF POOR QUALITY

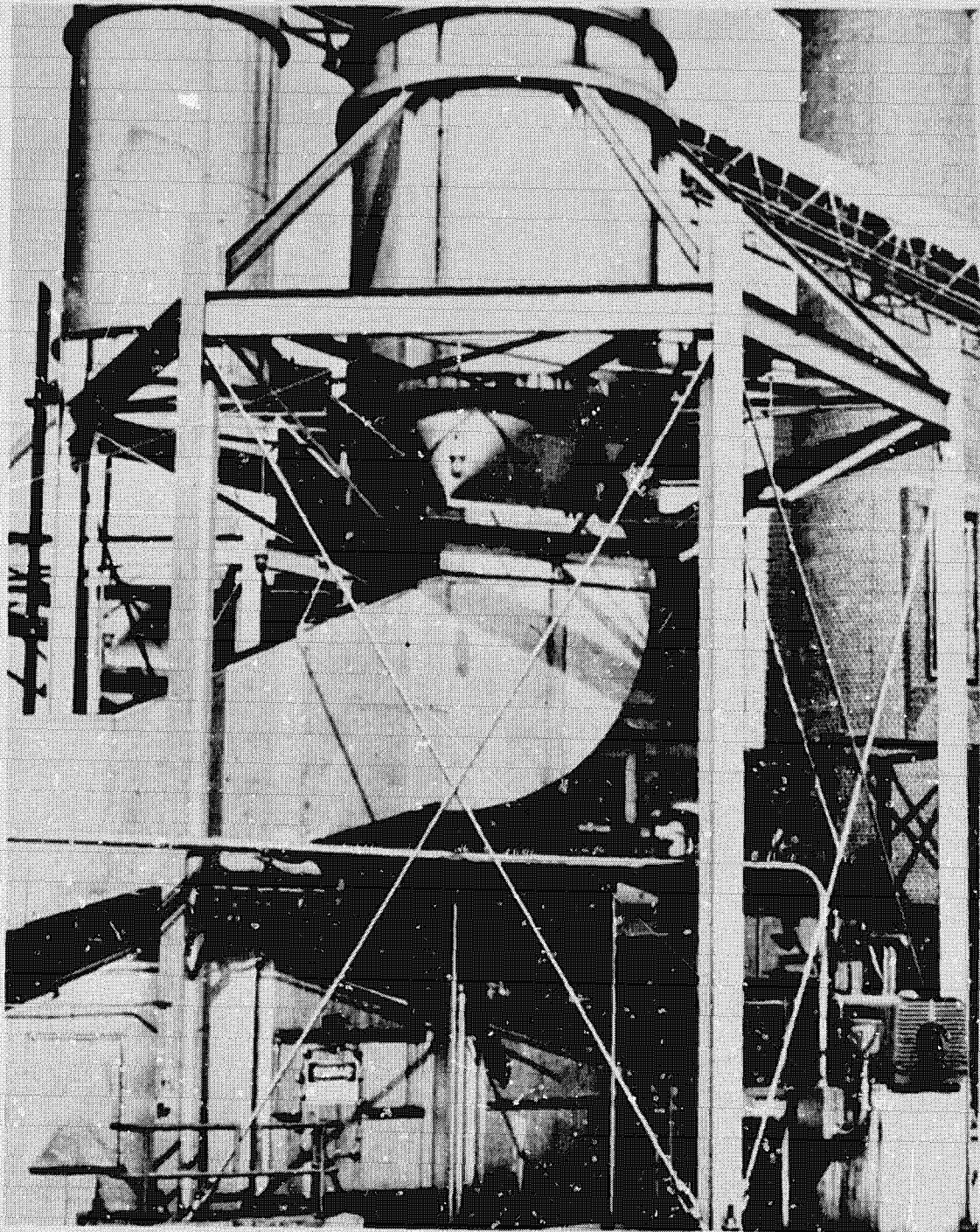

FIGURE 14: VIEW OF THE STACK SUPPORT STRUCTURE

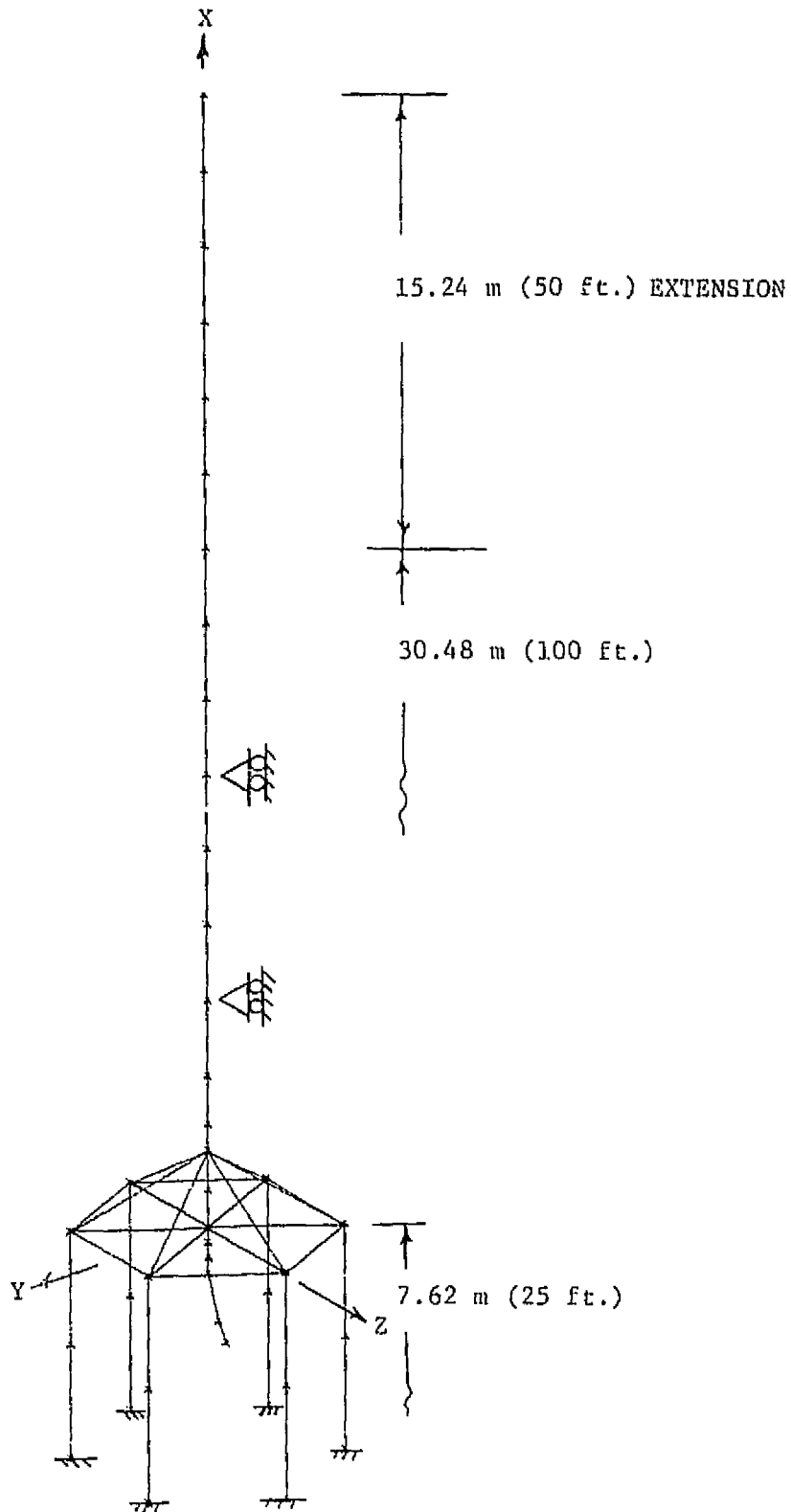

FIGURE 15: BASIC NASTRAN STACK MODEL

ORIGINAL PAGE IS
OF POOR QUALITY

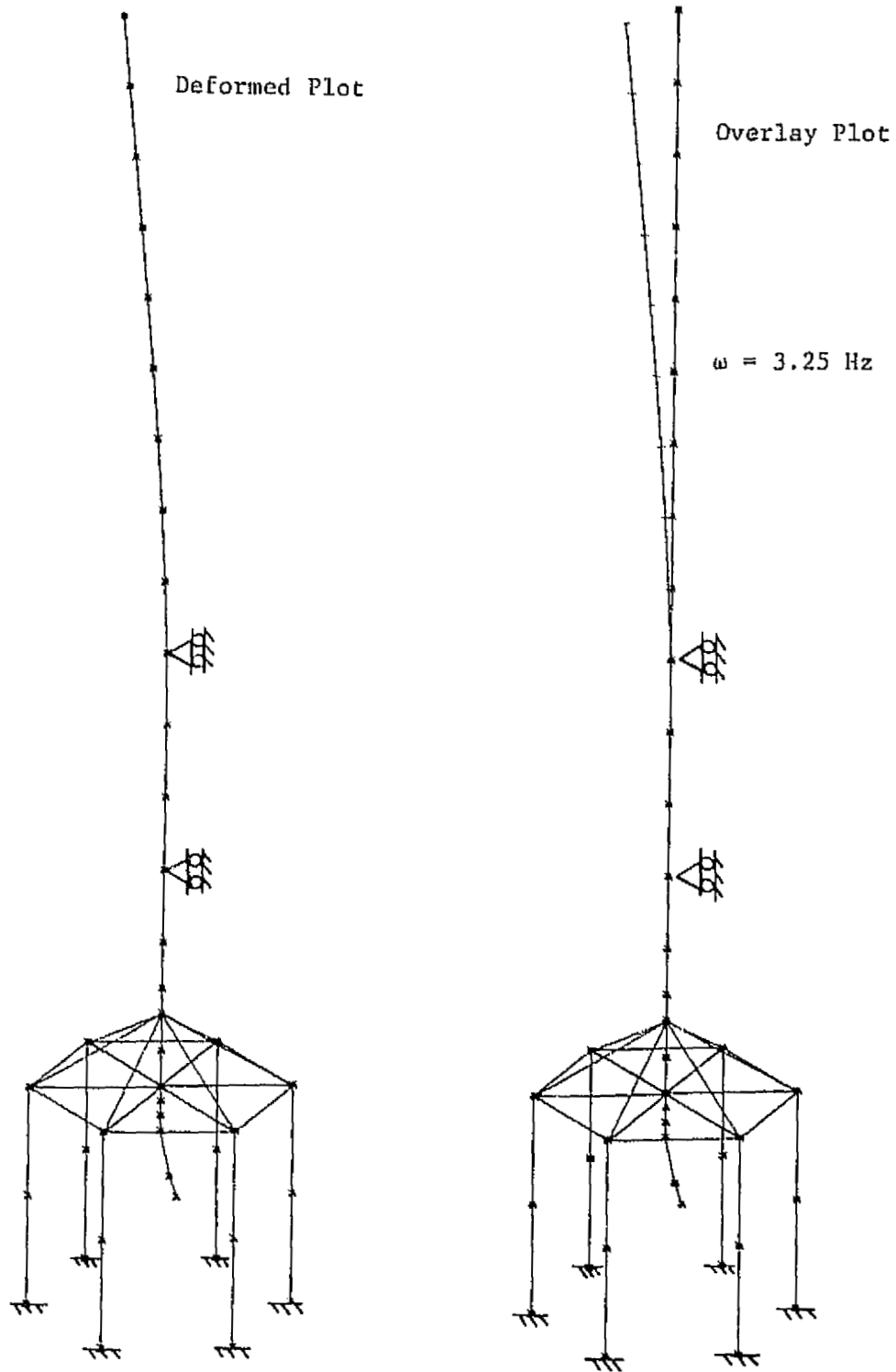

FIGURE 16: FIRST STACK BENDING MODE

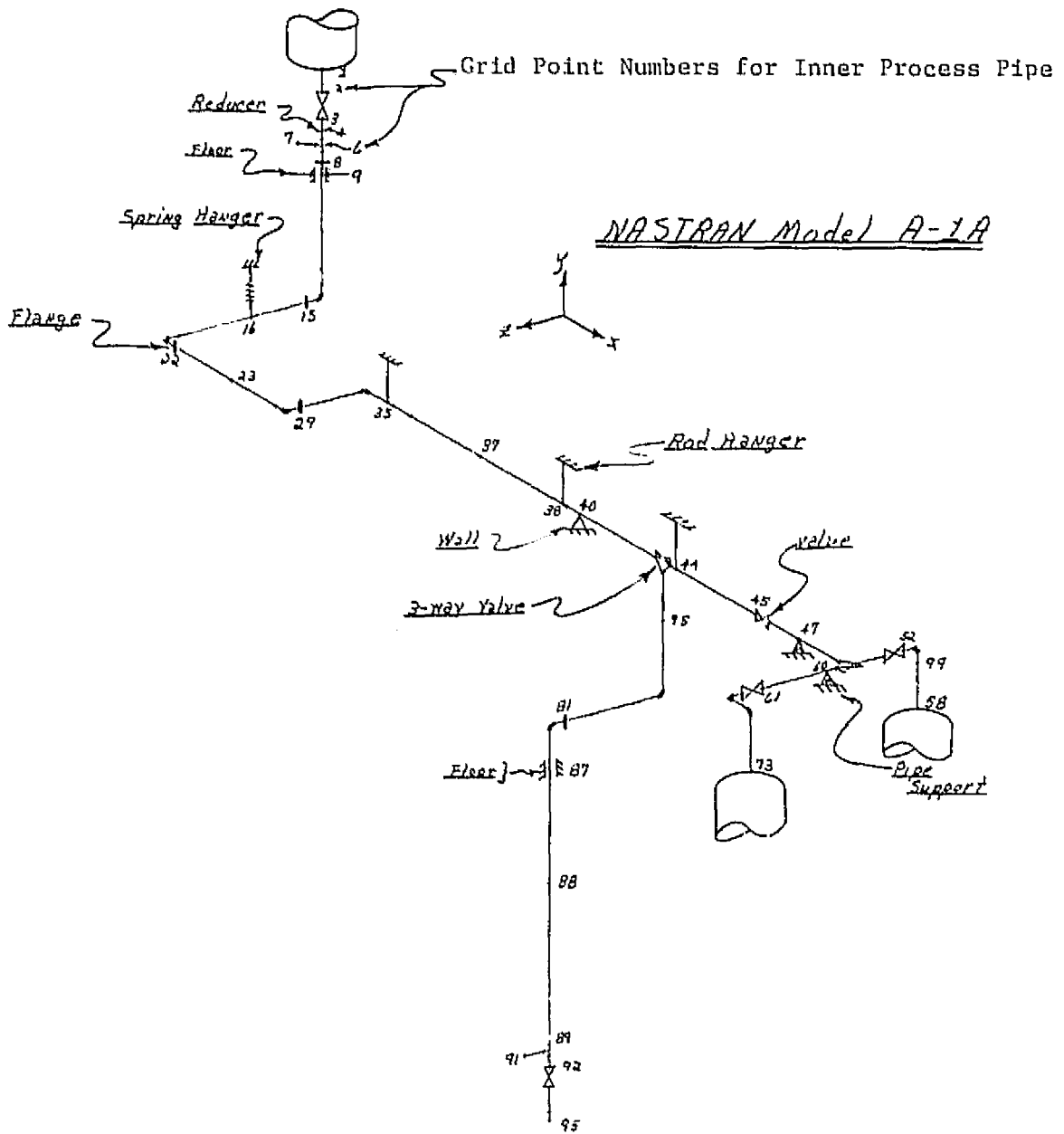
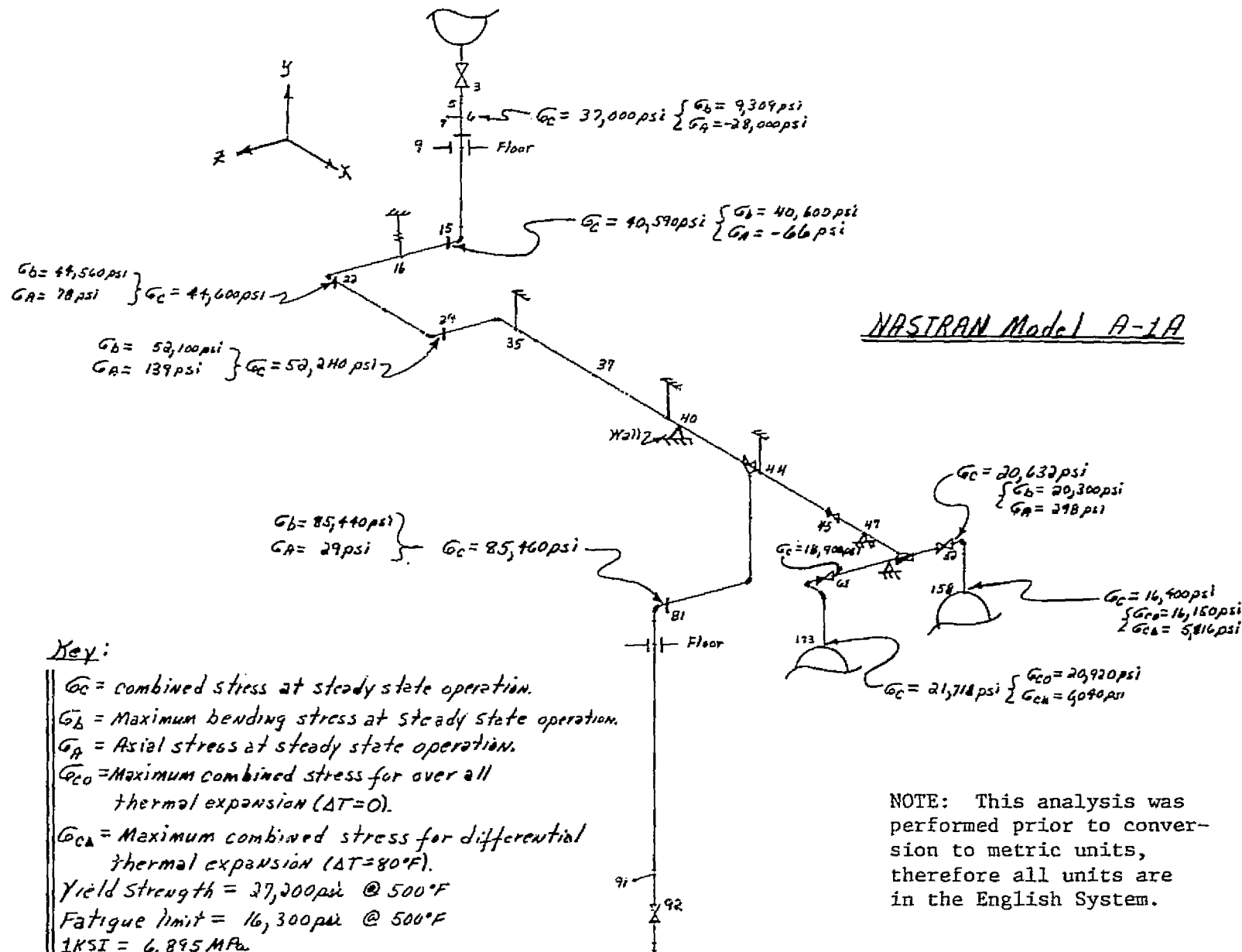
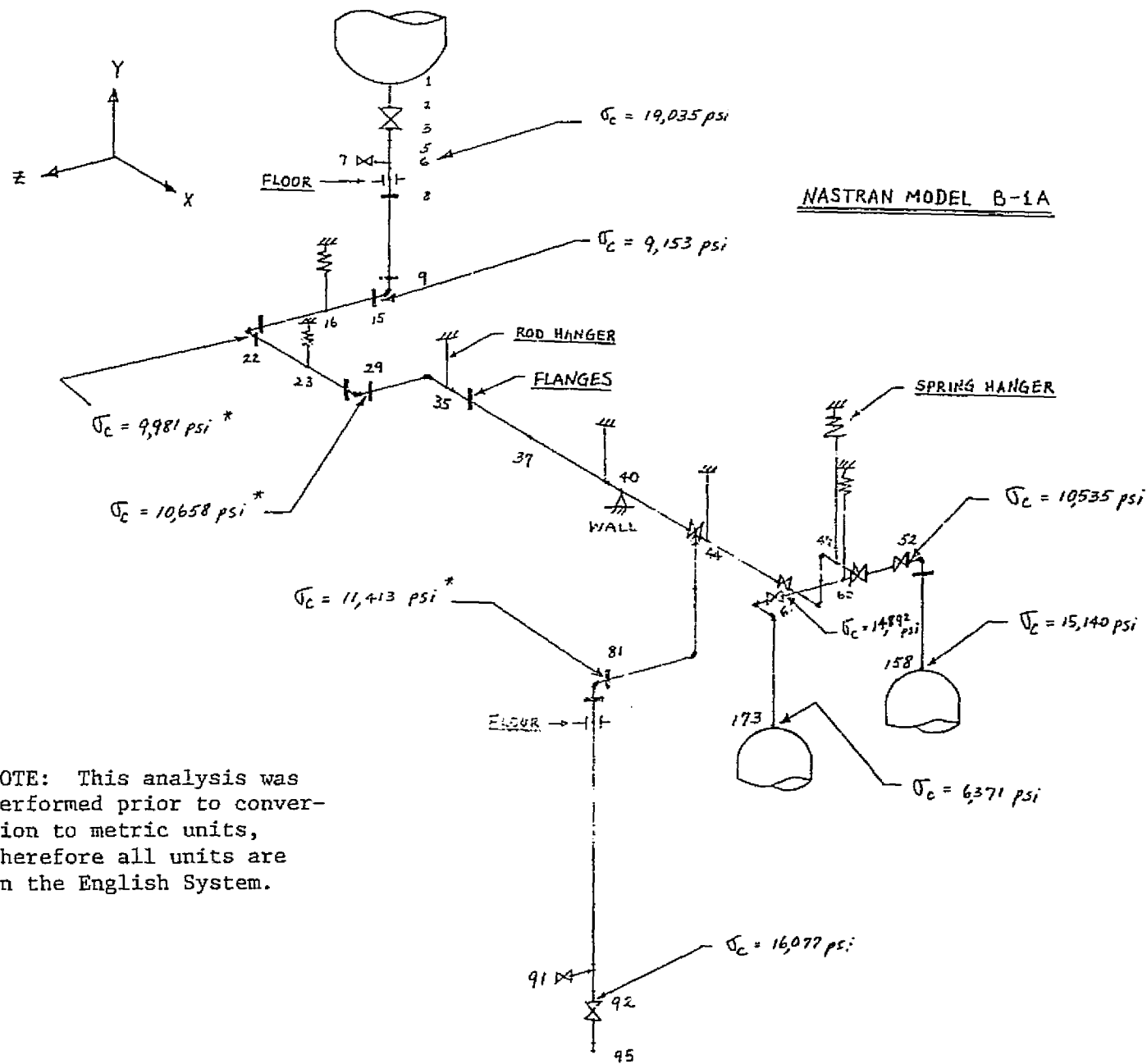

FIGURE 17: TYPICAL MODEL OF JACKETED PIPE SYSTEM



ORIGINAL PAGE IS OF POOR QUALITY

FIGURE 18: RESULTS FROM ANALYSIS OF DESIGN SUBMITTED BY VENDOR



NOTE: This analysis was performed prior to conversion to metric units, therefore all units are in the English System.

FIGURE 19: RESULTS AFTER MAKING REVISIONS BASED ON NASTRAN ANALYSIS

ORIGINAL PAGE IS
OF POOR QUALITY

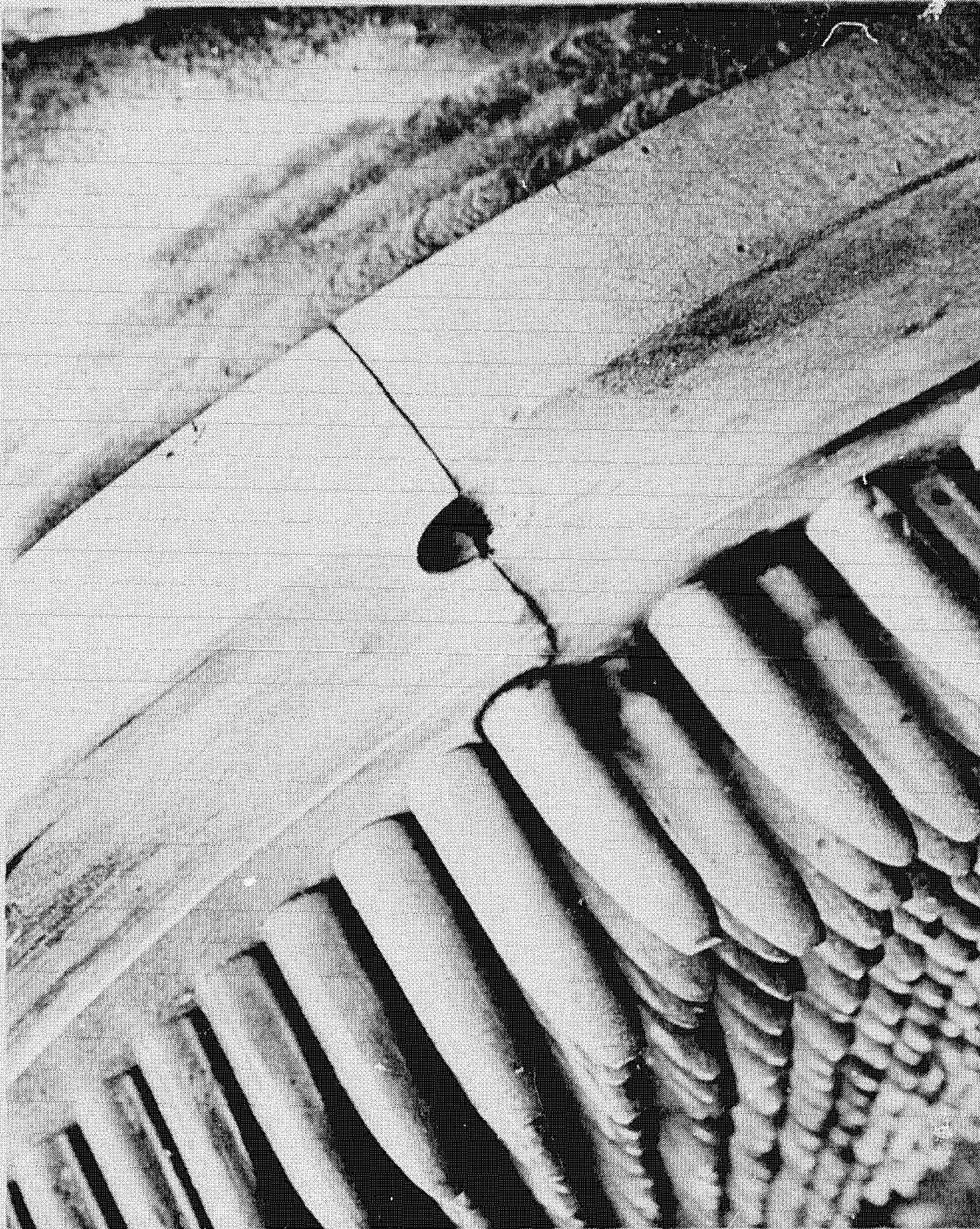

FIGURE 20: TYPICAL FAILURE IN A HEAT EXCHANGER TUBE SHEET/FLANGE ASSEMBLY
(NOTE: CRACK HAS PROGRESSED INTO THE TUBES)

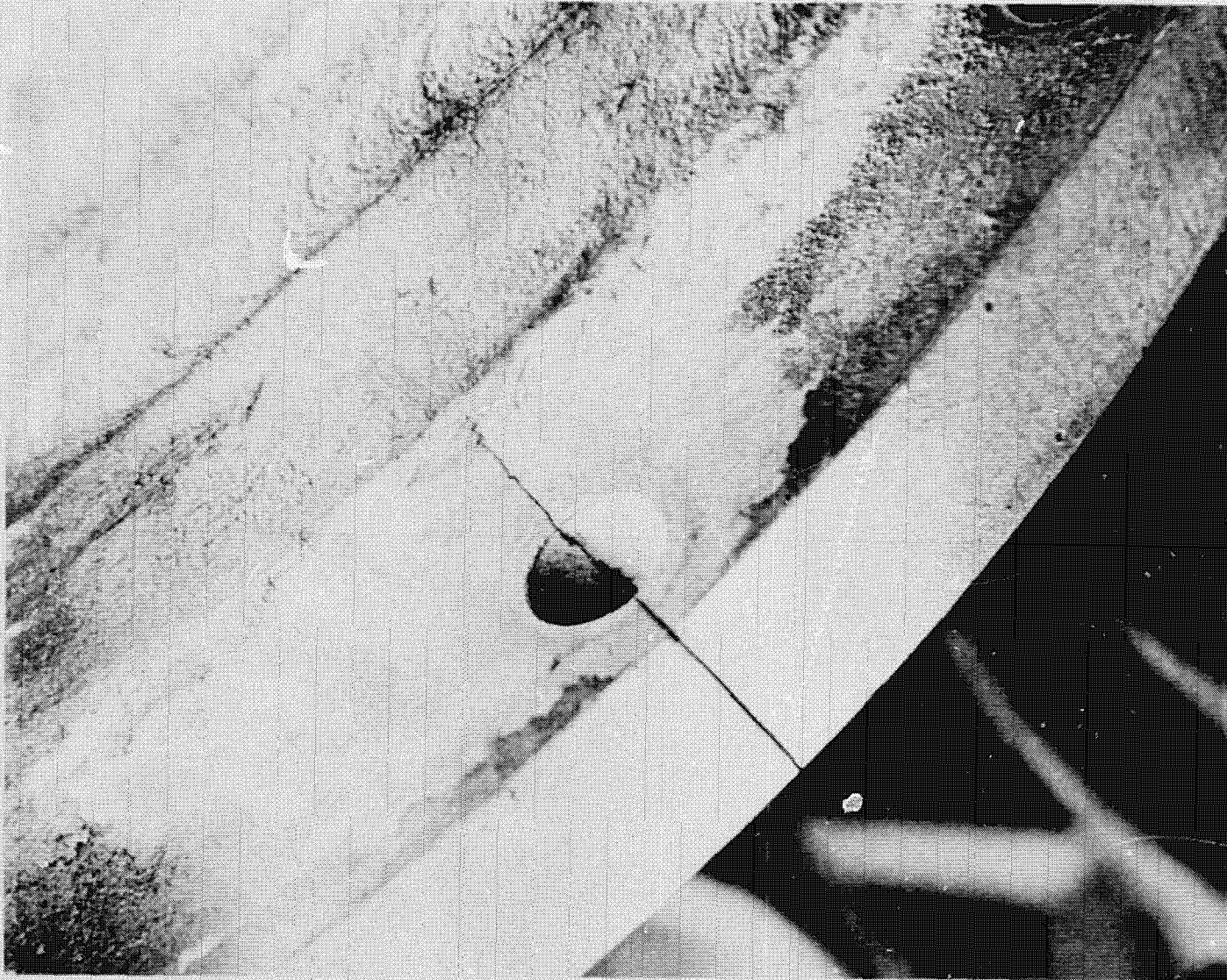
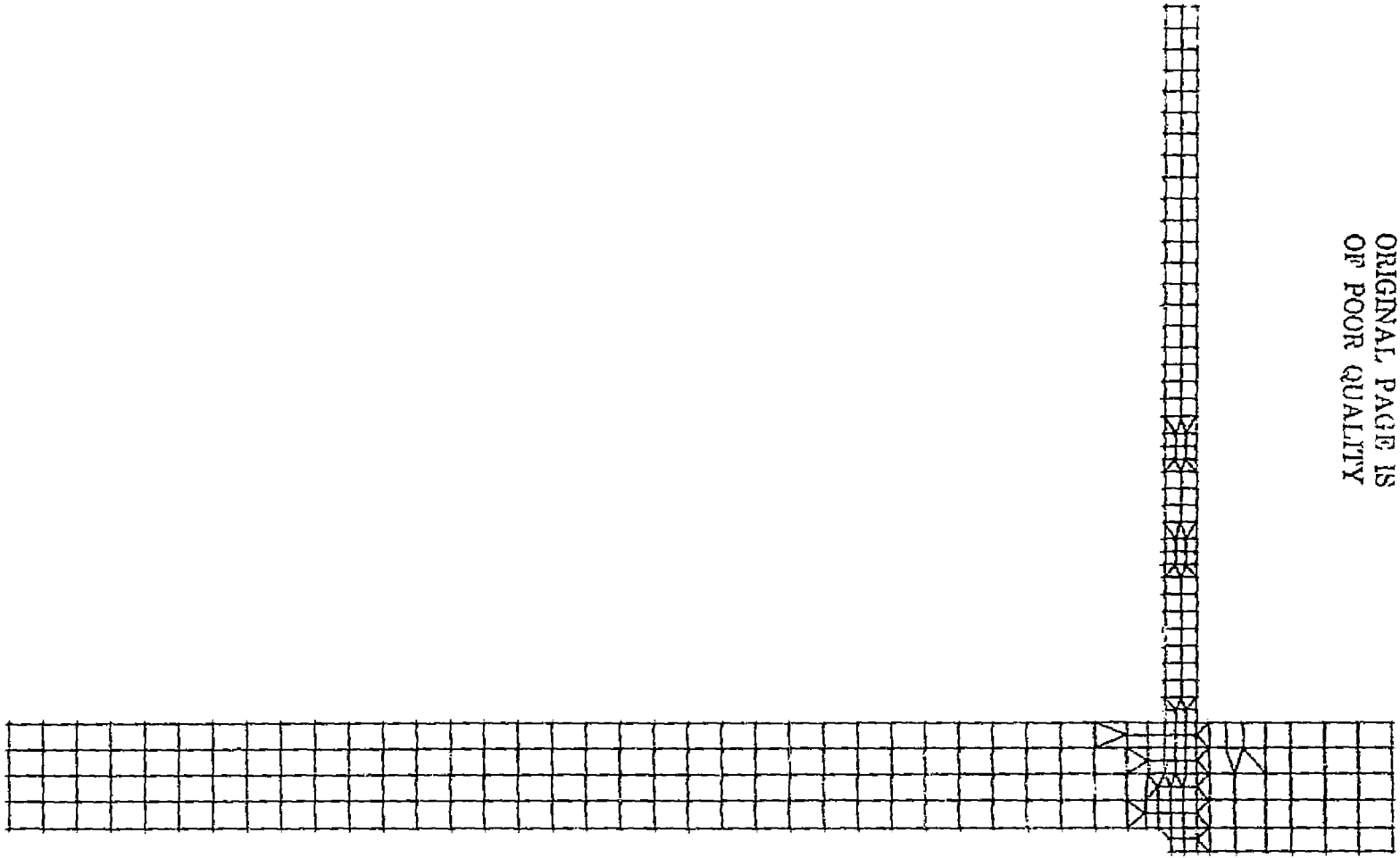

FIGURE 21: TYPICAL FAILURE OF A HEAT EXCHANGER TUBE SHEET/FLANGE ASSEMBLY
(NOTE: CRACK HAS PROGRESSED INTO VESSEL WALL)



ORIGINAL PAGE IS
OF POOR QUALITY

FIGURE 22: TYPICAL MODEL OF A SINGLE TUBE SHEET ASSEMBLY

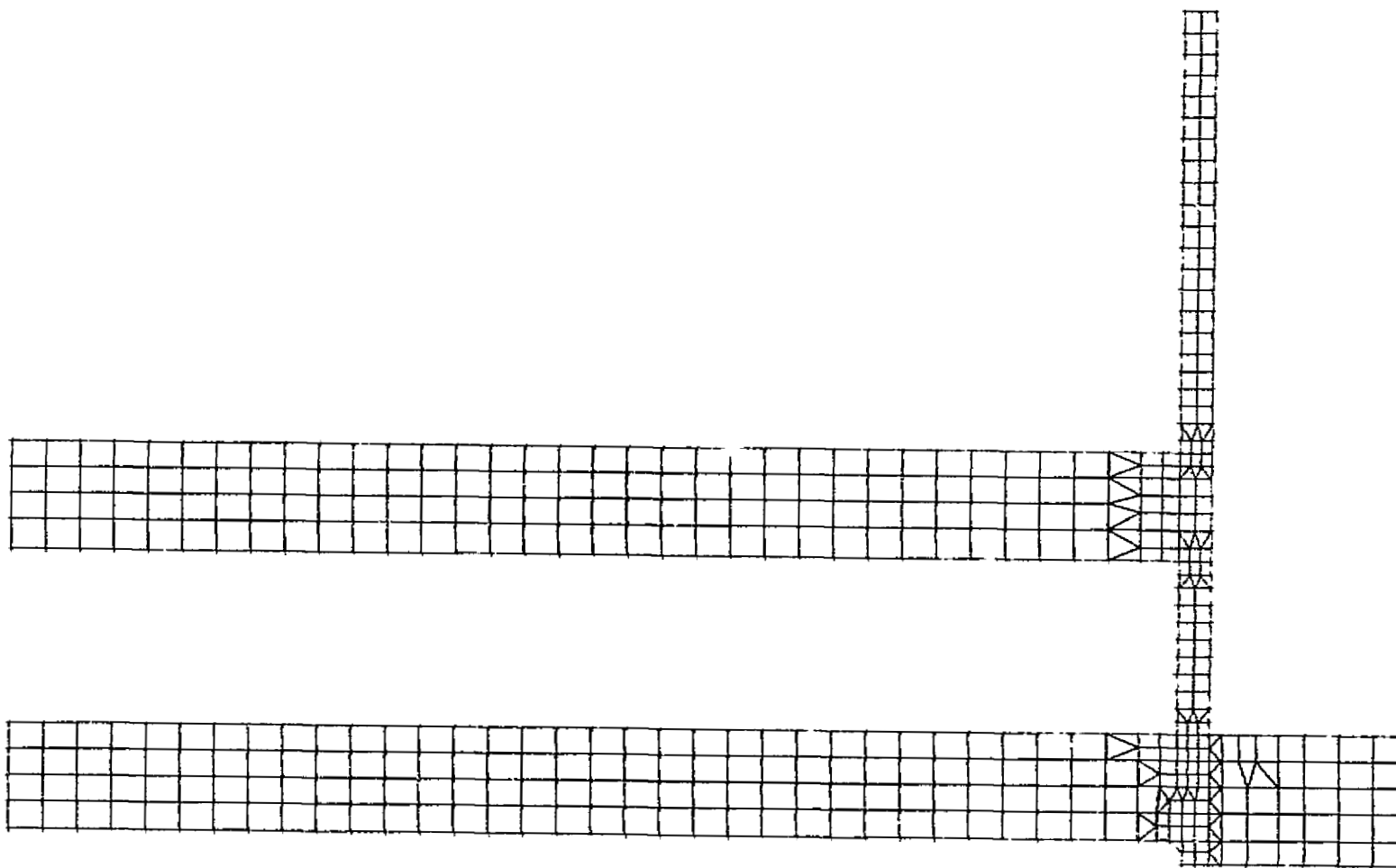
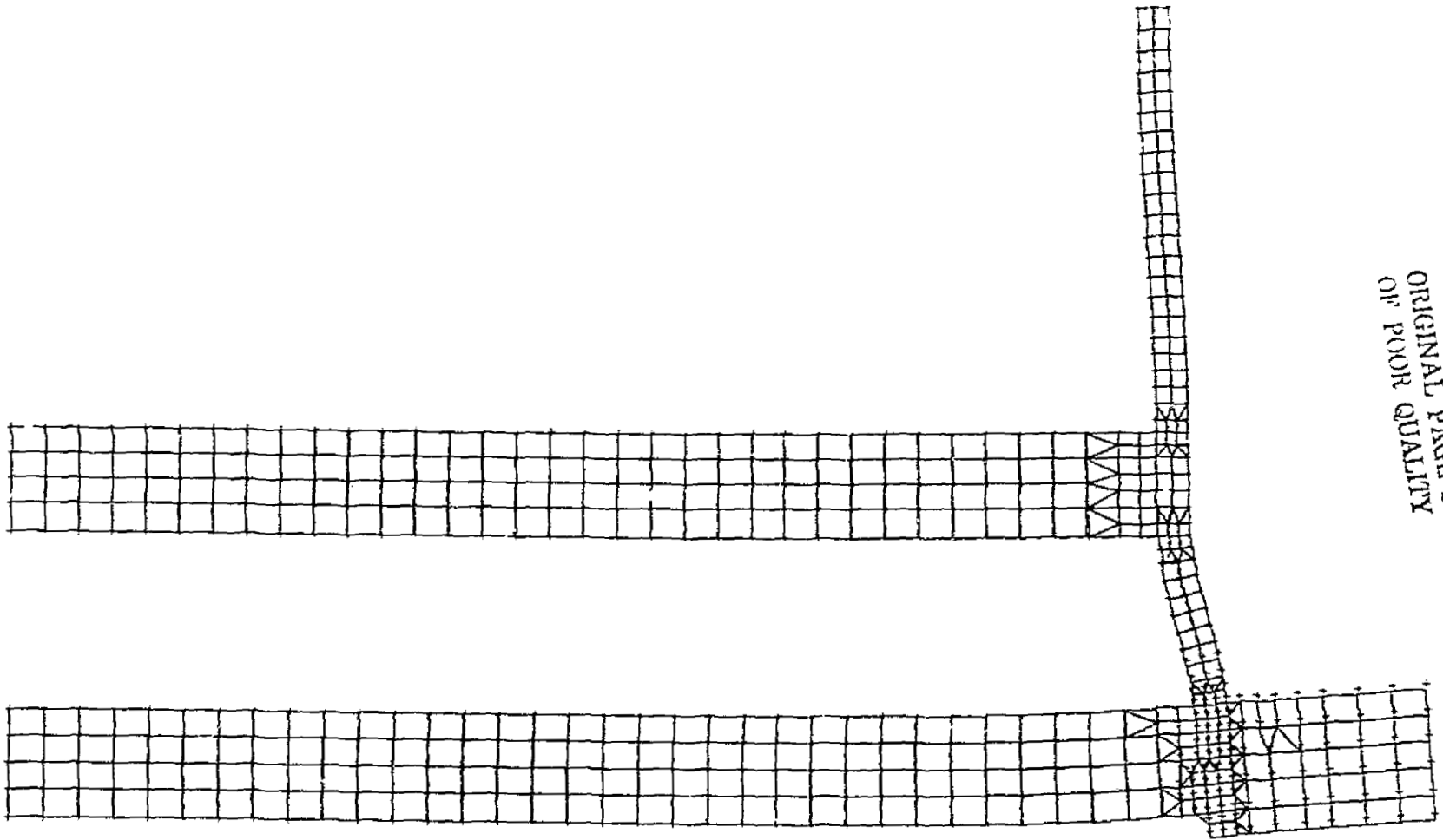

FIGURE 23: TYPICAL MODEL OF A DOUBLE TUBE SHEET ASSEMBLY



ORIGINAL PAGE IS
OF POOR QUALITY

FIGURE 24: THERMALLY INDUCED DEFORMATIONS OF A DOUBLE TUBE SHEET ASSEMBLY

ORIGINAL PAGE IS
OF POOR QUALITY

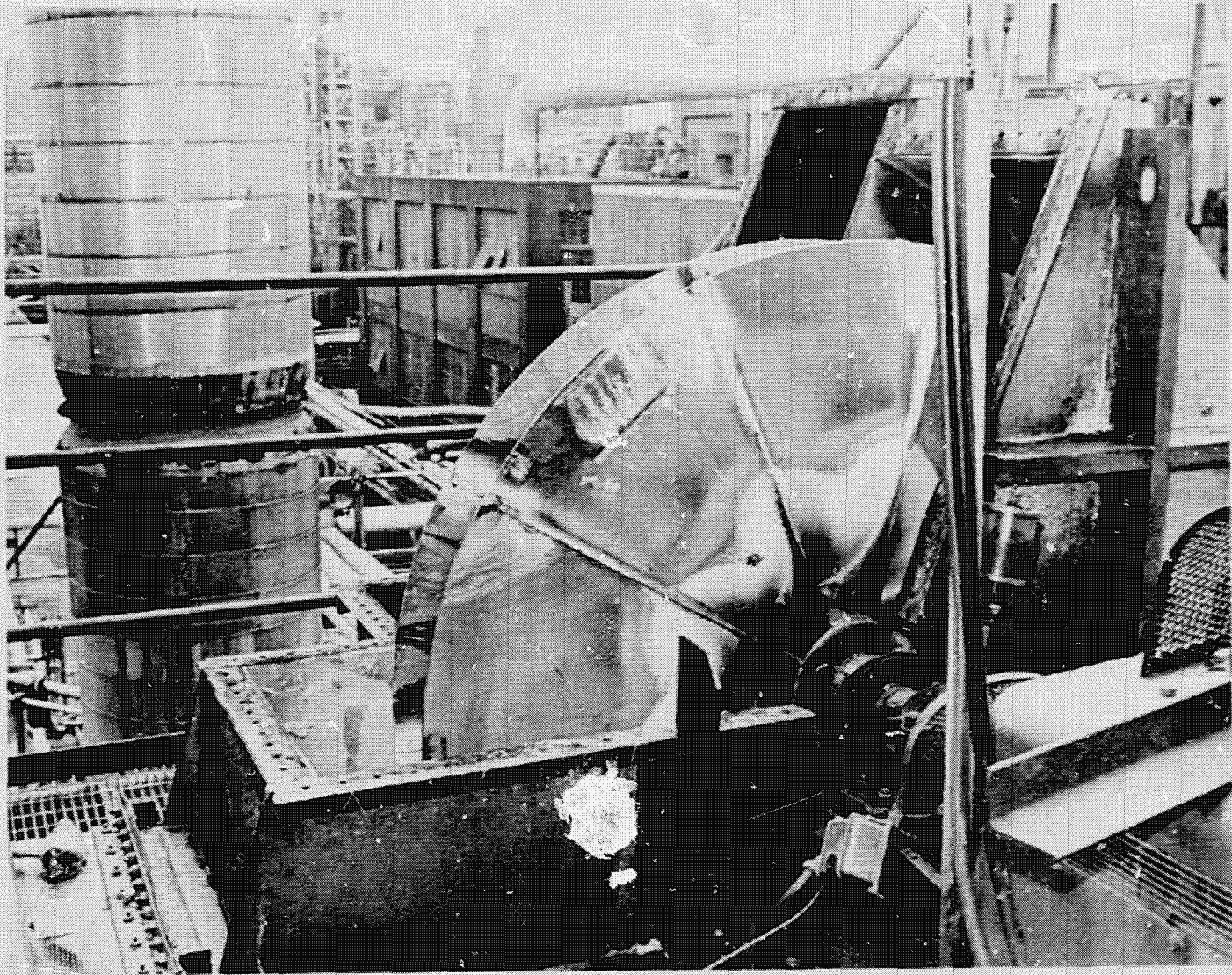

FIGURE 25: LARGE CENTRIFUGAL FAN

ORIGINAL PAGE IS
OF POOR QUALITY

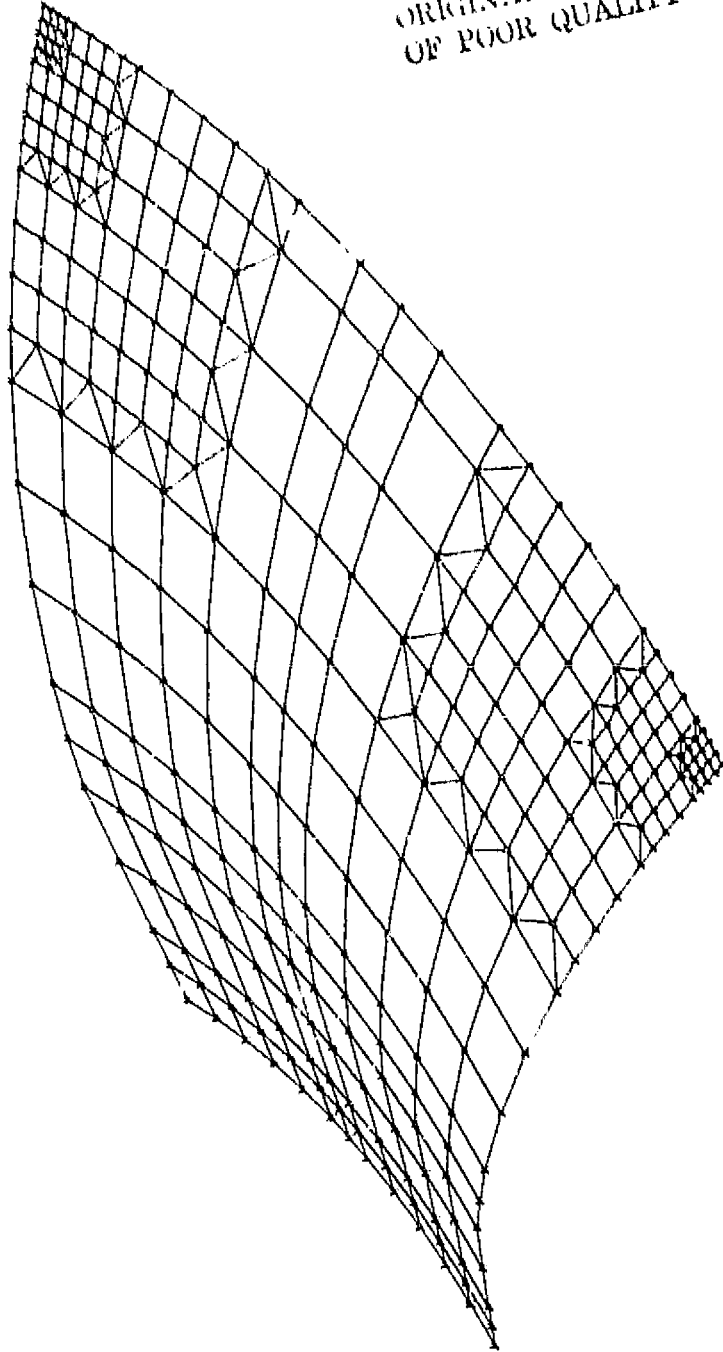

FIGURE 26: MODEL OF ONE PANEL OF THE CENTRIFUGAL FAN

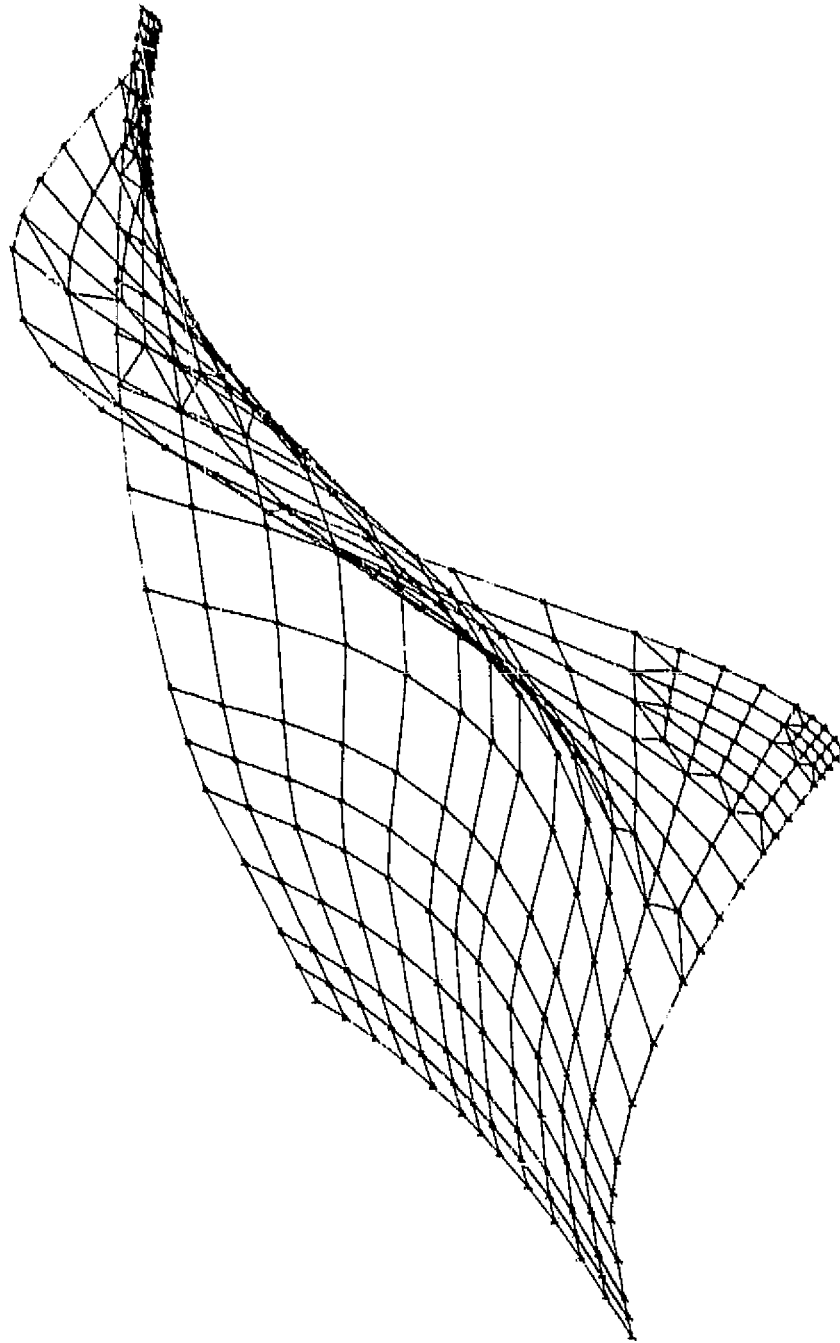
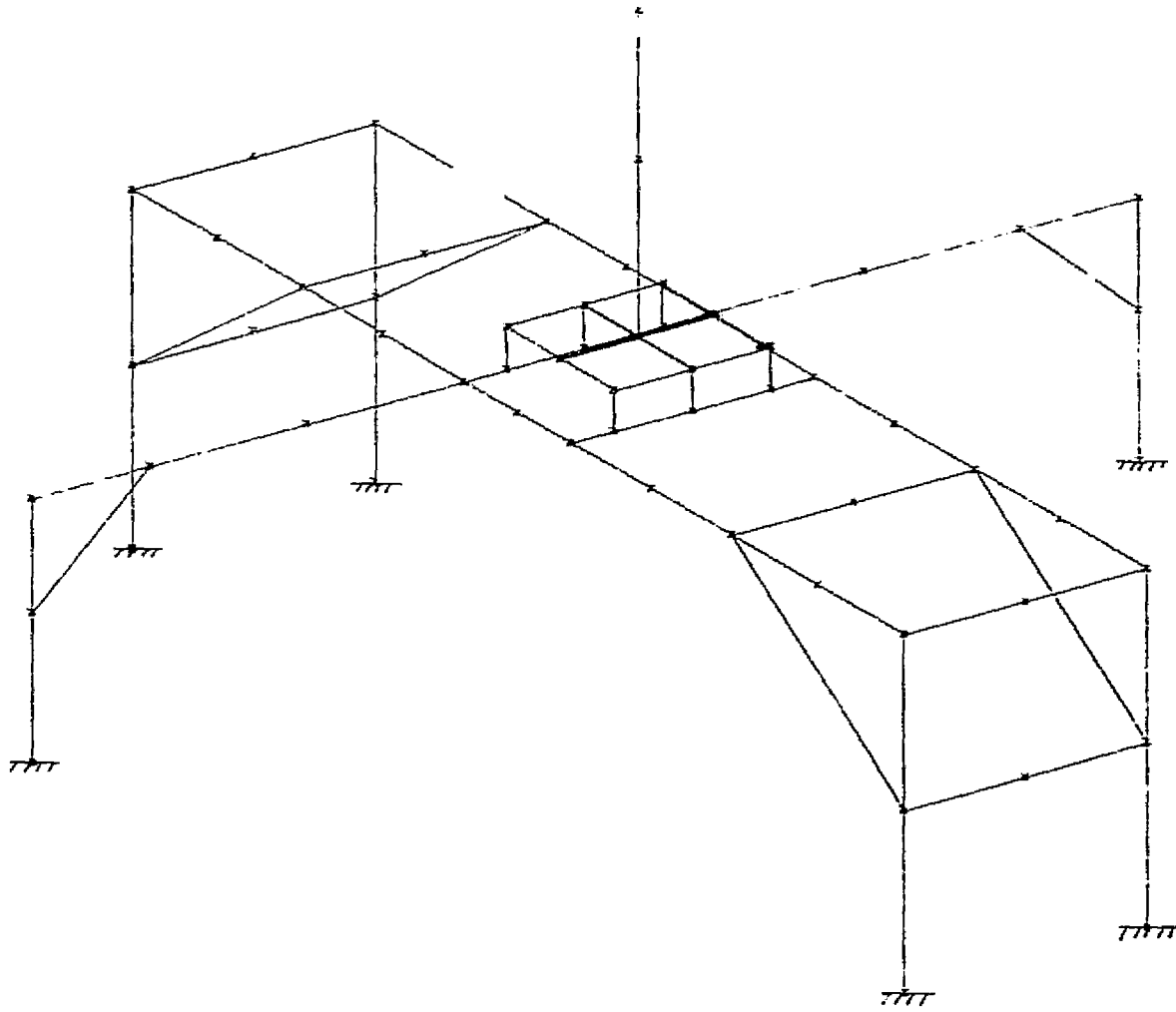

FIGURE 27: FIRST PANEL MODE



ORIGINAL PAGE IS
OF POOR QUALITY

FIGURE 28: MODEL OF A TYPICAL AGITATOR SUPPORT SYSTEM