

TP
1292
c.1

NASA Technical Paper 1292

LOAN COPY: RETURN
AFWL TECHNICAL LIBRARY
KIRTLAND AFB, NM



Laboratory and Field Measurements of Upwelled Radiance and Reflectance Spectra of Suspended James River Sediments Near Hopewell, Virginia

Charles H. Whitlock, William G. Witte,
E. A. Gurganus, and J. W. Usry

OCTOBER 1978

NASA



NASA Technical Paper 1292

Laboratory and Field Measurements
of Upwelled Radiance and Reflectance
Spectra of Suspended James River
Sediments Near Hopewell, Virginia

Charles H. Whitlock, William G. Witte,
E. A. Gurganus, and J. W. Usry
*Langley Research Center
Hampton, Virginia*



National Aeronautics
and Space Administration

**Scientific and Technical
Information Office**

1978

SUMMARY

Spectral reflectance characteristics of suspended Bermuda Hundred and Bailey Bay bottom sediments taken from the Hopewell, Va., area were measured in the laboratory for water mixture total suspended solids concentrations between 4 and 173 parts per million. Field spectral reflectance measurements were made of the James River waters near Bermuda Hundred on two occasions. The results of these tests indicate that both Bermuda Hundred and Bailey Bay suspended sediments produce their strongest reflectance in the green and red regions of the spectrum. The general spectral characteristic of Bermuda Hundred suspended sediments is similar to that observed for the James River. Differences do exist, however, because of variations in such factors as spectral resolution, algae content, and particle size distribution.

INTRODUCTION

Industrial waste outfalls on rivers and estuaries are a major contributor to water pollution. Costle (see ref. 1) notes that major polluters are the electric utilities as well as the iron and steel, pulp and paper, petroleum refining, non-ferrous metals, and chemical industries. Among the more dangerous industrial chemicals found in water are polychlorinated biphenyls (PCB's), polybrominated biphenyls (PBB's), and kepone.

One area with major industrial pollution problems is the James River near Hopewell, Va. Reference 2 discusses the nature of the problem and gives a historical summary. Since 1974, the National Aeronautics and Space Administration (NASA) has conducted remote sensing experiments in that area. (See refs. 3 and 4.) These experiments were conducted in cooperation with the Environmental Protection Agency (EPA), the U.S. Army Corps of Engineers (USACE), and the Virginia State Water Control Board (VSWCB) as part of an overall research program to evaluate the feasibility of remote sensing of various water parameters.

Another aspect of the overall research program is the laboratory measurement of upwelled spectral reflectances from deionized and filtered tap water with various types of suspended bottom sediments. It is desirable to compare laboratory measurements with actual field data, recognizing that the laboratory facility cannot duplicate field conditions. As part of this effort, the NASA Langley Research Center (LaRC) has made a number of laboratory tests using sediments taken from the bottom of the James River near Bermuda Hundred, which is about 3 miles north of Hopewell, Va. Spectral reflectance measurements of the river water at Bermuda Hundred were made from a NASA boat on April 14 and May 17, 1977.

During the same time period, the USACE conducted a feasibility study for EPA defining various alternatives for removal of bottom sediments from Bailey Bay to the east of Hopewell, Va. The Bailey Bay bottom sediments contain kepone as well as numerous other industrial wastes. Some dredging might be required

in the future, and there was a question as to whether the dredge waste plume could be monitored by using remote sensing techniques. In support of the USACE study, NASA-LaRC conducted several laboratory tests on bottom sediments taken from Bailey Bay. The objective of these tests was to determine whether the spectral reflectance of Bailey Bay sediment in suspension can be distinguished from that of Bermuda Hundred sediment, believed typical of suspended sediments in the James River.

This paper presents laboratory spectral reflectance data for bottom sediments in suspension from both the Bermuda Hundred and Bailey Bay locations. Furthermore, the reflectances from the Bermuda Hundred sediment tests are compared with field measurements of the James River. Finally, recommendations are made for improved laboratory procedures in future tests of bottom sediments in suspension.

SYMBOLS

A	area of spectrometer entrance slit, cm^2
D	vertical displacement of oscilloscope measurement, cm
$E(\lambda)$	spectral irradiance, $\text{W}/\text{m}^2\text{-nm}$
K	ratio of instrument throughput $A\Omega$ to vertical-scale sensitivity factor S, $\text{cm}^3\text{-sr-nm}/\text{mW}$
$L_u(\lambda)$	upwelled spectral radiance, $\text{mW}/\text{cm}^2\text{-sr-nm}$
$P(\lambda)$	spectral power, mW/nm
S	vertical-scale sensitivity factor, $\text{mW}/\text{cm-nm}$
λ	wavelength, nm
$\rho_u(\lambda)$	spectral reflectance (relative to 100-percent diffuse reflector), percent of input
σ	standard deviation of instrument error
Ω	acceptance solid angle of spectrometer, sr

EXPERIMENTAL METHOD

The arrangement shown in figure 1 was used to conduct laboratory tests. Main parts of the system include a water tank, circulation system, filtration and deionization system, solar simulator, first-surface mirror, and rapid-scan spectrometer. The light source is a 2.5-kW xenon short-arc lamp which produces a spectrum similar to that of the Sun at a solar elevation angle of 30° , as shown in figure 2. A more complete description of the laboratory and equipment is given in the appendix.

The Bermuda Hundred bottom sediment sample was taken from the location shown in figure 3 on February 15, 1977. Water depth at the sample location was approximately 3 m. The sample was in a mud state and was dark gray in color. The material was then converted to a dry state by slow baking in an oven at 115° C for 16 hours. Drying was required so that the sample could be held for a long period of time in a relatively inert state in sealed plastic bags. Low temperatures were used in the drying process to minimize the effect on organic content. Material color changed from dark to medium gray upon drying. Selected chemical properties of the dry Bermuda Hundred sediment were analyzed at LaRC and are given in table I. The laboratory experiment was conducted by first filling the tank with approximately 11 600 liters of conditioned (filtered and deionized) tap water. Measured weights of dry sediment were then mixed with the tank water in succession to achieve increasing levels of sediment concentration. Spectral measurements were made at mixture concentrations of 4, 17, 25, 52, 86, and 173 ppm of total solids by weight. (The conditioned tap water to which the sediments were added contained less than 0.5 ppm of suspended solids and 2 ppm of dissolved substances.)

The Bailey Bay bottom sediment was obtained by the USACE near the mouth of Bailey Creek as shown in figure 3. The sample was obtained from knee-deep waters near the time of low tide and was very dark gray, almost black, in color. This material was kept refrigerated in a wet, muddy state until the time of testing (approximately 3 weeks) because it was believed to contain organics which were volatile just above room temperature. Table II gives selected chemical properties of the wet Bailey Bay sediments which were furnished NASA by the USACE. Laboratory tests were conducted in a similar manner to those with the Bermuda Hundred material except that increments of wet material were added to achieve mixture concentrations of 4, 86, and 173 ppm of total solids by weight.

A third series of tests were conducted to simulate roughly conditions of Bailey Bay sediments thrown into suspension by a dredge at some future date. First, a weighted amount of Bermuda Hundred dry sediment was added to achieve 25 ppm of suspended solids. This addition was made to simulate the turbid James River background waters in an approximate manner. (No algae were added.) Next, increments of wet Bailey Bay sediments were added to the turbid water such that total suspended solids mixture concentrations of 25, 29, 42, 59, 111, 154, and 198 ppm were achieved for spectral reflectance measurements.

For each concentration level, the circulation system was activated (bypassing the filter-deionization system). Radiance measurements could not begin until a steady-state condition with near-uniform sediment concentration was achieved. Considering inaccuracies in filling the tank, errors in successive weight measurements, and inconsistency in tap water, the absolute accuracy of each concentration value is believed to be 0.5 ppm or 5 percent of the quoted value, whichever is higher.

Generally, after the water tank was filled, 3 to 4 hours were required to complete an experiment. Before, during, and after each experiment, diffuse reflectance measurements of the solar simulator spectral input at the water surface were made by using a 99-percent reflectance white card to monitor optical stability of the laboratory system and to derive spectral reflectance from upwelled spectral radiance values for each sediment. Spectral reflectance is

the upwelled spectral radiance of the water mixture divided by the diffuse reflectance of the input light.

RESULTS AND DISCUSSION

Measured spectral radiance and reflectance curves for the Bermuda Hundred bottom sediment in suspension are shown in figure 4. Estimated 3σ uncertainty values are based on manufacturer specifications. (See appendix.) Variations in the spectral radiance curves (fig. 4(a)) between 750 and 950 nm are caused by the spectral characteristics of the input xenon lamp source. (See fig. 2(b).) When spectral radiance values are divided by diffuse radiance measurements of the input light source to obtain spectral reflectance, the peaks in the region of the xenon spikes should disappear within the accuracy of the measurements. Scattered values are obtained because of the problem of making an accurate reading on steep slopes in the vicinity of sharp spikes. As a result of this problem, fairing of the data is required in the 750- to 950-nm region for all spectral reflectance values. Little fairing is required for wavelengths below 750 nm. Figure 4(b) shows the spectral reflectance values for Bermuda Hundred bottom sediment. Estimated 3σ uncertainty values are based on instrument manufacturer specifications combined with data readup inaccuracy in computing reflectance. For these curves the spectral reflectance at green and red wavelengths is much larger than the reflectance in the near-infrared region.

Spectral radiance and reflectance curves for the Bailey Bay bottom sediment are shown in figure 5. Again the strongest spectral reflectance (fig. 5(b)) is at the green and red wavelengths. Radiance and reflectance values for Bermuda Hundred and Bailey Bay bottom sediments are compared in figure 6. Both sediments have similar reflectances in the blue and near-infrared regions of the spectrum, but Bermuda Hundred material has the strongest reflectance at green and red wavelengths. At high mixture concentrations a ratio technique might be useful in identifying which sediment is present. For example, at a given concentration the ratio $L_u(565)/L_u(750)$ will be higher for Bermuda Hundred sediment than for Bailey Bay sediment. It is doubtful that such a technique would be useful for low concentrations, however.

Spectral radiance and reflectance curves for the dredge simulation tests are shown in figure 7. The composition of each mixture is also shown. The highest reflectance (fig. 7(b)) is at green wavelengths. Mixed sediment reflectance is interpolated from figure 7(b) for 173 ppm and is compared with Bermuda Hundred reflectance (fig. 4(b)) in figure 8. For high sediment concentrations the relative magnitudes of reflectance between the green wavelengths and the near-infrared wavelengths are different for the two types of sediment. Again a ratio such as $L_u(565)/L_u(750)$ might be useful in identifying sediment type in a dredge plume in turbid river water (25-ppm Bermuda Hundred sediment).

In an effort to determine how well laboratory tests with Bermuda Hundred bottom sediments simulate actual river water from a spectral reflectance viewpoint, field spectrometer measurements were made from a NASA boat at Bermuda Hundred on two occasions. A comparison of the laboratory and field reflectance data is shown in figures 9 and 10. The two laboratory tests (from figs. 4 and 6) have a concentration of 25 ppm and a spectral resolution of 32 nm.

Agreement of the laboratory data is within the limits of repetitive instrument error. Field spectral reflectance results taken on May 17, 1977, are also shown in figures 9 and 10. Total suspended solids concentration on that day was identical to the laboratory tests (25 ppm) but the river also had 44 ppb of chlorophyll a concentration. In addition, reflectance data were taken with a spectral resolution of 16 nm (instead of the laboratory resolution of 32 nm) to prevent instrument saturation because of the brilliance of the Sun. Also shown in figures 9 and 10 are field results (16-nm spectral resolution) obtained on April 14, 1977. Total suspended solids concentration was 35 ppm, which mismatched laboratory values. Unfortunately, the April 14, 1977, water sample was not analyzed for chlorophyll a concentration. Figure 9 indicates that laboratory reflectance values for suspended Bermuda Hundred bottom sediments are much lower than field data. Comparison of field data taken on the two occasions suggests that high reflectance values are typical of the James River at Bermuda Hundred in the April and May time period. Figure 10 shows a comparison of relative spectral characteristics of the laboratory and field data. Reflectance values are normalized to the value at 565 nm. From this figure, it is seen that the relative spectral characteristics of suspended Bermuda Hundred bottom sediments between 550 and 800 nm are similar to those of the field data.

Differences between laboratory and field results may be caused by a number of factors. Most obvious are the differences in chlorophyll a concentration, spectral resolution, diffuse skylight, and particle size distribution. Size range and average particle size are shown in table III. Average particle size of the bottom sediments has been defined here as that at which 50 percent of the particles are coarser by weight. Average particle size for the James River sample is defined as that at which 50 percent of the particles are coarser by volume. Unfortunately, the bottom sediments were analyzed by sieve and pipette techniques, whereas the water sample was analyzed by Coulter procedures because of limitations of each laboratory procedure. Table III clearly shows that the laboratory sediments had much larger particles than did the actual river waters. For a given mixture concentration (by weight), the laboratory waters had a fewer number of particles than did the river waters.

These results suggest that improved procedures are required when attempting to simulate the spectral reflectance of natural waters in the laboratory. The following procedures are recommended. First, a sample of the natural water should be obtained and analyzed for total suspended solids, volatile suspended solids, total organic carbon, algae species, chlorophyll a concentration, and particle size distribution as a minimum number of parameters. Next, bottom sediment samples should be obtained and analyzed for the same parameters. Comparisons of organic to inorganic sediment ratio, particle size distribution range, and chlorophyll magnitude should be made. If mismatches exist, the bottom sediments should be processed through settling tanks until a match is obtained. The processed sediments should then be the subject of the laboratory tests. In some cases, algae cells might be added to the mixture to further simulate natural conditions. Parallel with the preceding operations, a small sample of the natural water should be filtered and its absorption spectra measured on a spectrophotometer. Knowledge of the optical characteristics of dissolved substances in the natural water is necessary to understand the degree of laboratory simulation. When conducting the tests, it is particularly important that laboratory water samples be obtained and analyzed for particle size

distribution, chlorophyll a concentration, total organic carbon, and volatile suspended solids, as well as total suspended solids. Laboratory values of these parameters can then be compared with those of the natural water sample to assess differences in spectral reflectance characteristics.

CONCLUDING REMARKS

Spectral reflectance characteristics of suspended Bermuda Hundred and Bailey Bay bottom sediments taken from the Hopewell, Va., area were measured in the laboratory for water mixture total suspended solids concentrations between 4 and 173 parts per million. Field spectral reflectance measurements were made of the James River waters near Bermuda Hundred on two occasions. The results of these laboratory and field measurements indicate the following:

1. Both Bermuda Hundred and Bailey Bay bottom sediments produce their highest reflectances in the green and red regions of the spectrum. Reflectances at blue and near-infrared wavelengths are similar for the two materials.

2. For the same concentration, Bermuda Hundred bottom sediment has a higher reflectance at the green and red wavelengths than does the Bailey Bay bottom sediment.

3. In general, laboratory reflectance tests of suspended Bermuda Hundred bottom sediment have similar relative spectral characteristics, within the range 550 to 800 nm, as do reflectance data from the river taken on two occasions. The magnitude of reflectance values is quite different between laboratory and field results, however.

4. Ratio techniques should prove useful in applying remote sensing data to distinguish Bailey Bay sediments from James River sediments in high turbidity plumes, as may occur in dredging operations.

Improved laboratory procedures are required if the spectral reflectances of natural waters are to be simulated in the laboratory. Additional laboratory tests are recommended to develop and validate these procedures. The ability to better simulate natural waters will enhance the capability for understanding the effects of adding pollutants.

Langley Research Center
National Aeronautics and Space Administration
Hampton, VA 23665
August 31, 1978

APPENDIX

LABORATORY AND EQUIPMENT

The cylindrical, steel water tank has a 2.5-m diameter and a 3-m depth. The bottom is concave as illustrated in figure 1. The tank interior is coated with a black phenolic paint that absorbs 97 percent of incidence radiation over the spectral range of these measurements (400 to 980 nm). For these experiments, the tank was filled to within 0.3 m of the top with about 11 600 liters of water.

The circulation system was designed to maintain a vertical and horizontal homogeneous mixture in the tank and to maintain in suspension particles up to about 70 μm in diameter (specific gravity of 2.6). This particle size corresponds to fine sand. In order to accomplish these design goals, water is pumped from the drain at the bottom of the tank into a system of pipes which returns the water to the tank through two vertical pipes on opposite sides of the tank. The pipes empty just above the concave bottom. Water entering the tank through these pipes washes over the concave bottom, meets at a location away from the drain, and wells upward. Tests using tracer techniques and transmission measurements have confirmed that this circulation system provides a near-uniform homogeneous mixture throughout the tank. For pollutants such as sewage sludge with specific gravities less than 2.6, the present laboratory setup can suspend particles larger than 70 μm in diameter.

The filtration and deionization system includes a commercial fiber swimming-pool filter, an activated carbon filter, and a charged resin deionizer. These units were placed in waterlines parallel to the main circulation system waterlines and can be used separately or in any combination by using valves. The two filters remove particulates and dissolved organic materials from the water before it reaches the deionizer where dissolved ionic substances are removed. After tap water is conditioned through this system, it contains less than 0.5 ppm of suspended solids and less than 2 ppm of dissolved substances.

The light source is a solar-radiation simulator designed to approximate the spectral content of the Sun's rays. The radiation spectrum is produced by a 2.5-kW xenon short-arc lamp and transferred to the target plane through an optical arrangement inside the simulator and a collimating lens accessory. With the collimating lens accessory, the projected beam is collimated to a 0.15-m diameter 0.3 m from the simulator and has a $\pm 2.5^\circ$ collimation angle. For these experiments, the simulator was located approximately 15.2 m from the water tank as illustrated in figure 1. At this distance from the simulator, the beam is about 1.2 m in diameter. A mirror positioned 1.52 m above the water tank reflects the center of the beam to the water surface. The incidence angle with the water surface is 13° to avoid specular reflectance. The first-surface mirror is coated with aluminum and protected by an overcoat of silicon monoxide. It has a 0.3-m diameter and reflects an elliptical spot on the water surface, which has a maximum diameter of 0.35 m. The simulator spectral input to the water surface

APPENDIX

is similar to but not a precise duplicate of sea-level standard solar-radiation curves often used in engineering calculations (ref. 5). Figure 2(a) shows that the standard sea-level curves are quite variable, depending on the solar elevation angle. Figure 2(b) shows the simulator spectrum normalized at 600 nm to the solar spectrum at a solar elevation angle of 30°. These curves suggest that when laboratory measurements are made at a 32-nm spectral resolution, the input spectrum and possibly the output measurements are similar to those that would be expected in the field if the solar elevation angle is on the order of 30°. The total intensity of the light hitting the water surface is approximately 8 percent of that in actual field conditions.

The rapid-scanning spectrometer system consists of a spectrometer unit with a telephoto lens attachment and a plug-in unit with an oscilloscope and camera attachment. The spectrometer unit with telephoto lens attachment is mounted 2.43 m above the surface of the water as illustrated in figure 1. The spectrometer uses a Czerny-Turner monochromator without an exit slit. The spectral output of the monochromator is focused on the target of a vidicon tube where the spectrum is stored as an electrical charge image. An electron beam periodically scans the vidicon target to convert the charge image into an electronic signal. This signal is processed by the plug-in unit which functions as an electronic signal processor and controller between the spectrometer and the oscilloscope. The signal is displayed on the oscilloscope and is photographically recorded with the camera. The spectrometer is designed to measure power per spectral bandwidth (spectral power). The oscilloscope screen is used to show displacement of the instrument measurement. Oscilloscope displacement is proportional to spectral power, as shown in the equation

$$D = \frac{P(\lambda)}{S} \tag{1}$$

The signal is internally processed in such a manner that the vertical-scale sensitivity factor S has a constant value over the wavelength range from 400 to 980 nm. Values of S were obtained by the manufacturer using calibration procedures described in reference 6. (After receipt of the instrument, the manufacturer's calibration was checked in an approximate manner prior to the tests described herein.) The upwelled spectral radiance $L_u(\lambda)$ is defined as

$$L_u(\lambda) = \frac{P(\lambda)}{A\Omega} \tag{2}$$

where A is the area of the spectrometer entrance slit and Ω is the acceptance solid angle of the spectrometer. Radiance values given herein are based on power received at the detector and are not corrected for losses through the telephoto lens. Tests with and without the lens indicate that such losses are much less than 5 percent for wavelengths between 400 and 980 nm.

APPENDIX

Combining equations (1) and (2) results in

$$L_u(\lambda) = \frac{DS}{A\Omega} \quad (3)$$

or

$$L_u(\lambda) = \frac{D}{K} \quad (4)$$

where

$$K = \frac{A\Omega}{S}$$

Thus upwelled spectral radiance is determined from oscilloscope displacement and the proportionality constant K , which is a function of the calibration factor S (which includes optical transmissivity), as well as acceptance angle Ω and slit area A .

In order to obtain spectral reflectance $\rho_u(\lambda)$, $L_u(\lambda)$ measurements are made of a 99-percent horizontal diffuse reflector near the water surface. Values obtained are proportional to the spectrum being input to the water by the solar simulator. Reflectance is then computed by using the equation

$$\rho_u(\lambda) = \frac{|L_u(\lambda)|_{\text{Water mixture}}}{|L_u(\lambda)|_{\text{99-percent diffuse reflector}}} \quad (5)$$

By adjusting the slit area, spectral resolution of the spectrometer may be changed. For the tests described herein, all laboratory measurements were made with a spectral resolution of 32 nm. Field data were taken at a spectral resolution of 16 nm to prevent instrument saturation because of the brilliance of the Sun. Several aircraft multispectral scanners have bandwidths in the same general range.

The instrument has been observed to experience daily variations in the calibration factor K which affects absolute accuracy. According to instrument specifications, absolute accuracy of the measurements is believed to be ± 20 percent in the 400- to 600-nm range and ± 12 percent in the 600- to 900-nm range. (A comparison of results from a number of laboratory tests at NASA tends to verify the manufacturer's specifications.) Included in the absolute error is a repeatability uncertainty of ± 13 percent in the 400- to 600-nm range and ± 3.5 percent in the 600- to 900-nm range. Discussions with the manufacturer



APPENDIX

indicate that these values are believed to be representative of 3σ error bands. Because of these absolute errors, spectral radiances from tests conducted on different days usually differ somewhat in magnitude. The overall shape of the relative spectrum over the wavelength range is consistent between tests conducted on different days.

REFERENCES

1. New U.S. Pollution Challenge: A Deluge of Dangerous Chemicals - Interview With Douglas M. Costle, Administrator, Environmental Protection Agency. U.S. News & World Rep., vol. LXXXIII, no. 25, Dec. 19, 1977, pp. 31-32.
2. Environmental Quality - 1976. The Seventh Annual Report of the Council on Environmental Quality. Sept. 1976.
3. Whitlock, C. H.; and Talay, T. A.: Remote Sensing Observations of Industrial Plumes at Hopewell, Virginia. Proceedings of the EPA Kepone Seminar II, U.S. Environ. Prot. Agency (Region III), 1977.
4. Johnson, Robert W.; and Bahn, Gilbert S.: Quantitative Analysis of Aircraft Multispectral-Scanner Data and Mapping of Water-Quality Parameters in the James River in Virginia. NASA TP-1021, 1977.
5. Moon, Parry: Proposed Standard Solar-Radiation Curves for Engineering Use. J. Franklin Inst., vol. 230, no. 5, Nov. 1940, pp. 583-617.
6. Stair, Ralph; Johnston, Russell G.; and Halbach, E. W.: Standard of Spectral Radiance for the Region of 0.25 to 2.6 Microns. J. Res. Natl. Bur. Stand., vol. 64A, no. 4, July-Aug. 1960, pp. 291-296.



TABLE I.- DRY BERMUDA HUNDRED BOTTOM SEDIMENT CHEMICAL PROPERTIES

Moisture, percent	0.22
Volatile solids, percent of total solids	9.7
Carbon on demand, percent	7.6
Total Kjeldahl nitrogen, mg/liter	(a)
Oil and grease, percent	0.037
Sulfate, percent	<0.1
Mercury, ppm	0.14
Iron, ppm	1100
Cadmium, ppm	2.0
Lead, ppm	46.0
Zinc, ppm	280.0
Copper, ppm	28.0
Kepone, ppm	<0.05
PCB's (Arclor 1254), ppm	1.8

^aNot analyzed.

TABLE II.- WET BAILEY BAY BOTTOM SEDIMENT CHEMICAL PROPERTIES

Moisture, percent	65.94
Volatile solids, percent	6.0
Carbon on demand, percent	8.84
Total Kjeldahl nitrogen, mg/liter	4334.76
Oil and grease, percent	1.06
Sulfides, mg/liter	84.75
Mercury, ppm	0.66
Iron, ppm	25 220.0
Cadmium, ppm	<0.025
Lead, ppm	147.1
Zinc, ppm	1125.0
Copper, ppm	366.17
Kepone, ppm	0.89
PCB's (Arclor 1254), ppm	2.64

TABLE III.- PARTICLE SIZE CHARACTERISTICS

Water mixture	Size range, μ	Average size, μ
Bailey Bay bottom sediment ^a	<1 to 420	b28
Bermuda Hundred bottom sediment ^a	<1 to 300	b22
Bermuda Hundred water column ^c (May 17, 1977)	<1 to 30	d8

^aAnalyzed by sieve and pipette techniques.

^b50 percent coarser by weight.

^cAnalyzed by Coulter procedures.

^d50 percent coarser by volume.

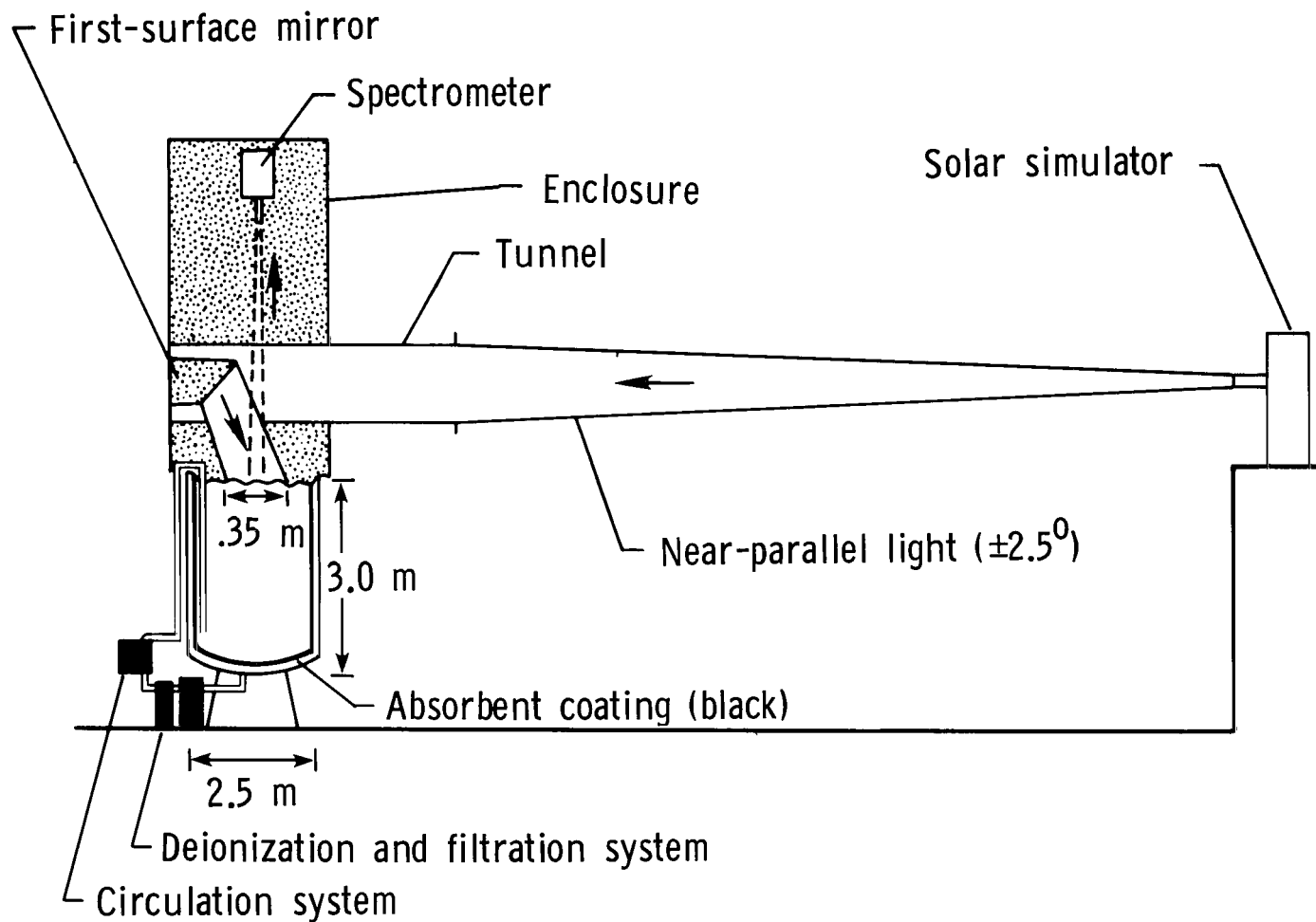
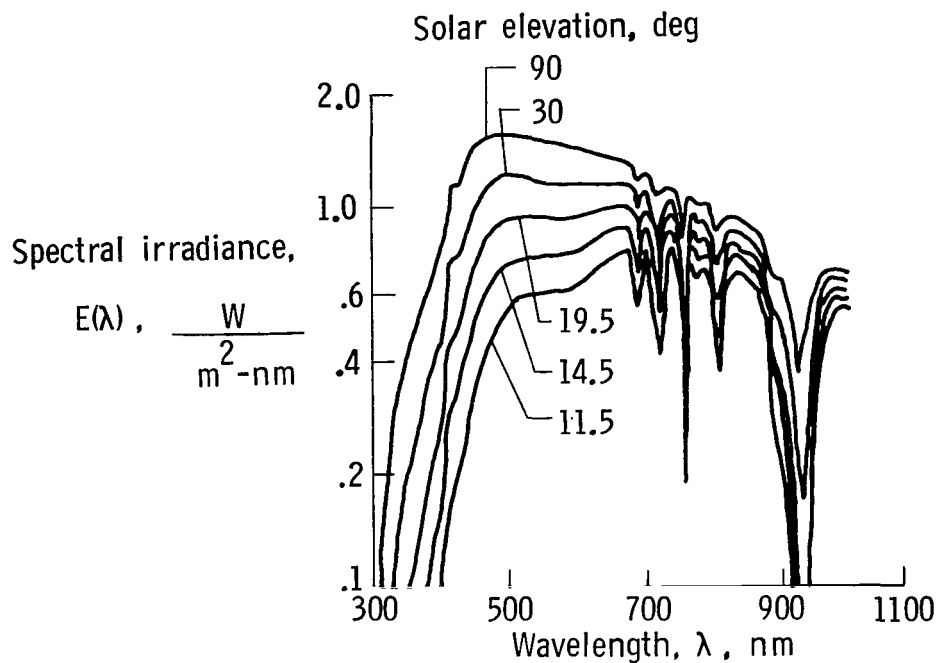
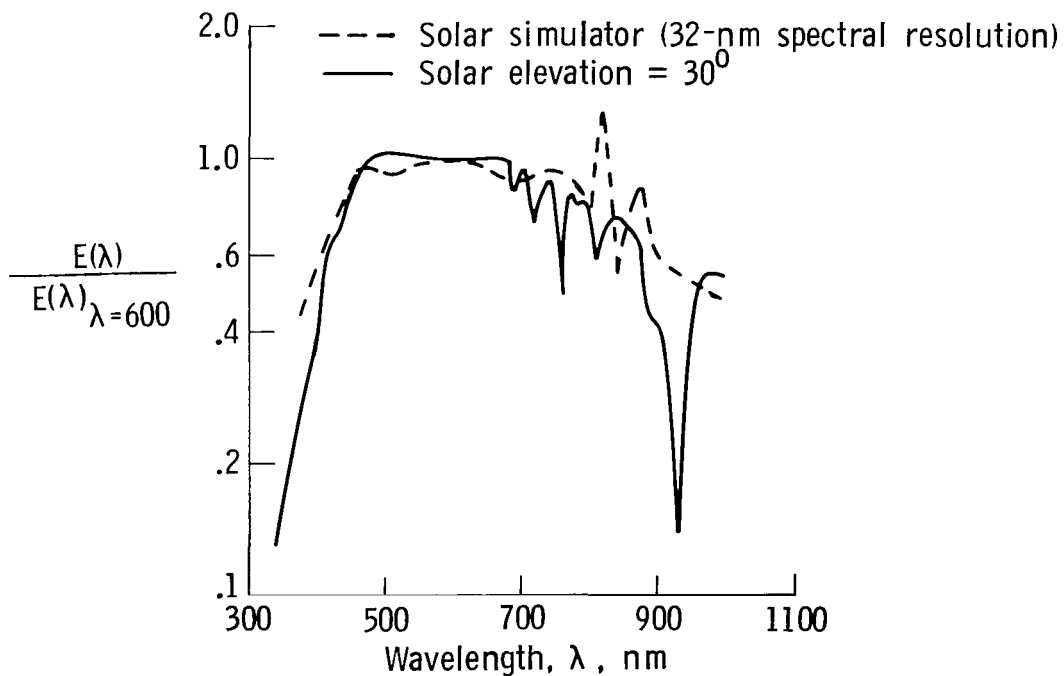

Figure 1.- Sketch of laboratory setup.



(a) Standard sea-level solar irradiance spectra (ref. 5).



(b) Laboratory and standard sea-level spectra.

Figure 2.- Comparison of laboratory and standard sea-level input spectra.

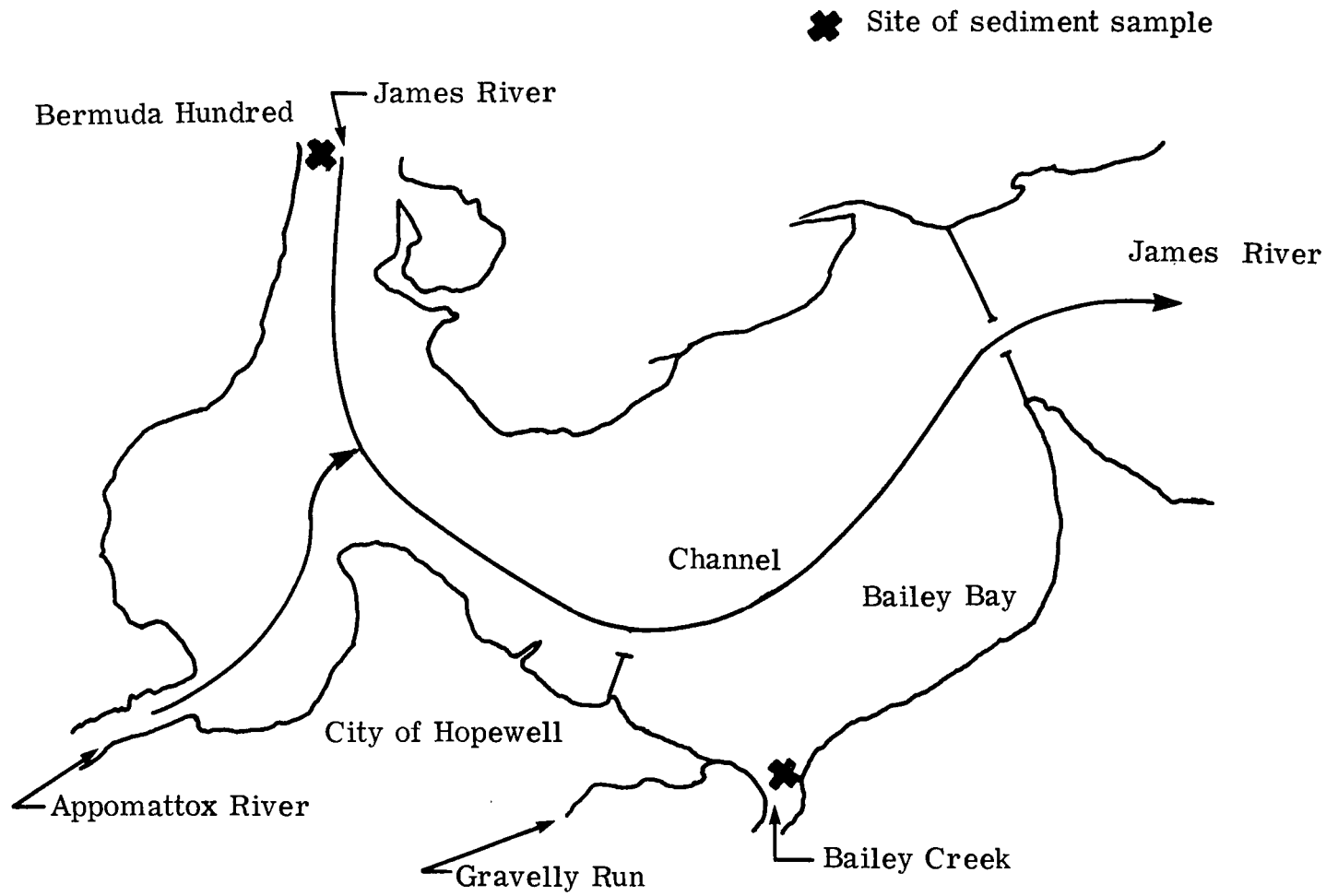
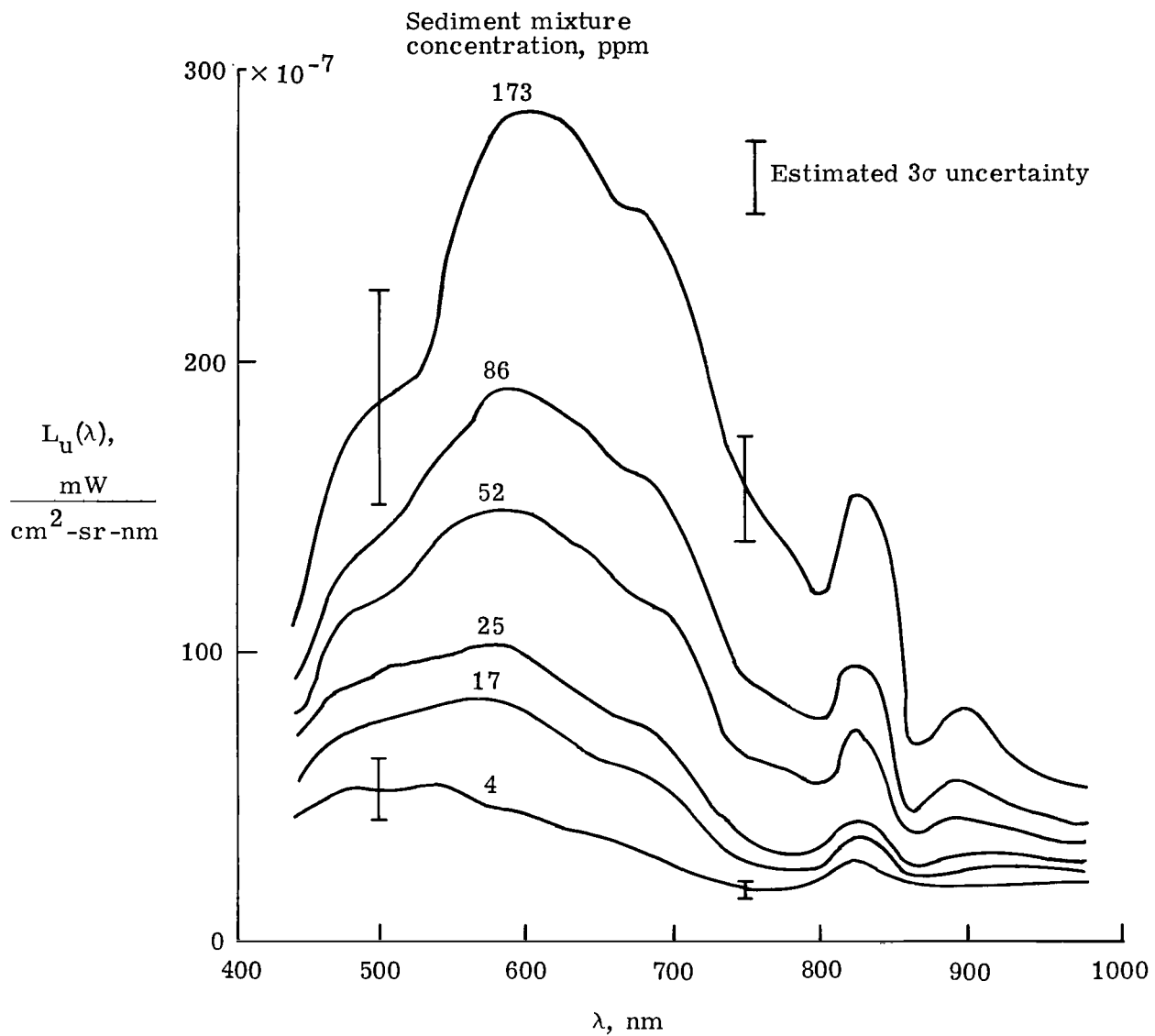
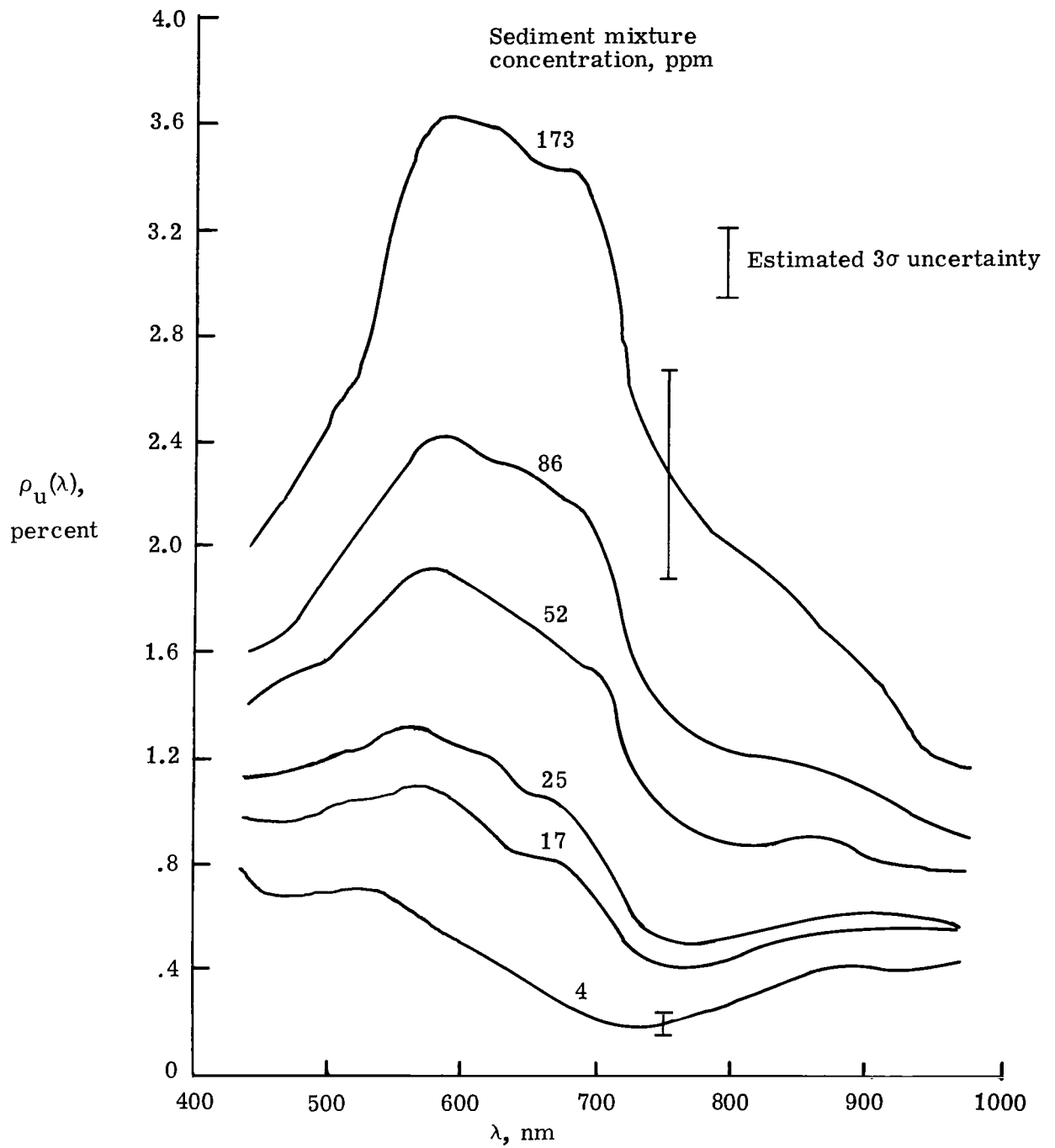

Figure 3.- Map of Hopewell, Va., area, showing locations of sediment sample sites.



(a) Spectral radiance.

Figure 4.- Laboratory spectral radiance and reflectance for suspended Bermuda Hundred bottom sediment in filtered, deionized water.



(b) Spectral reflectance.

Figure 4.- Concluded.

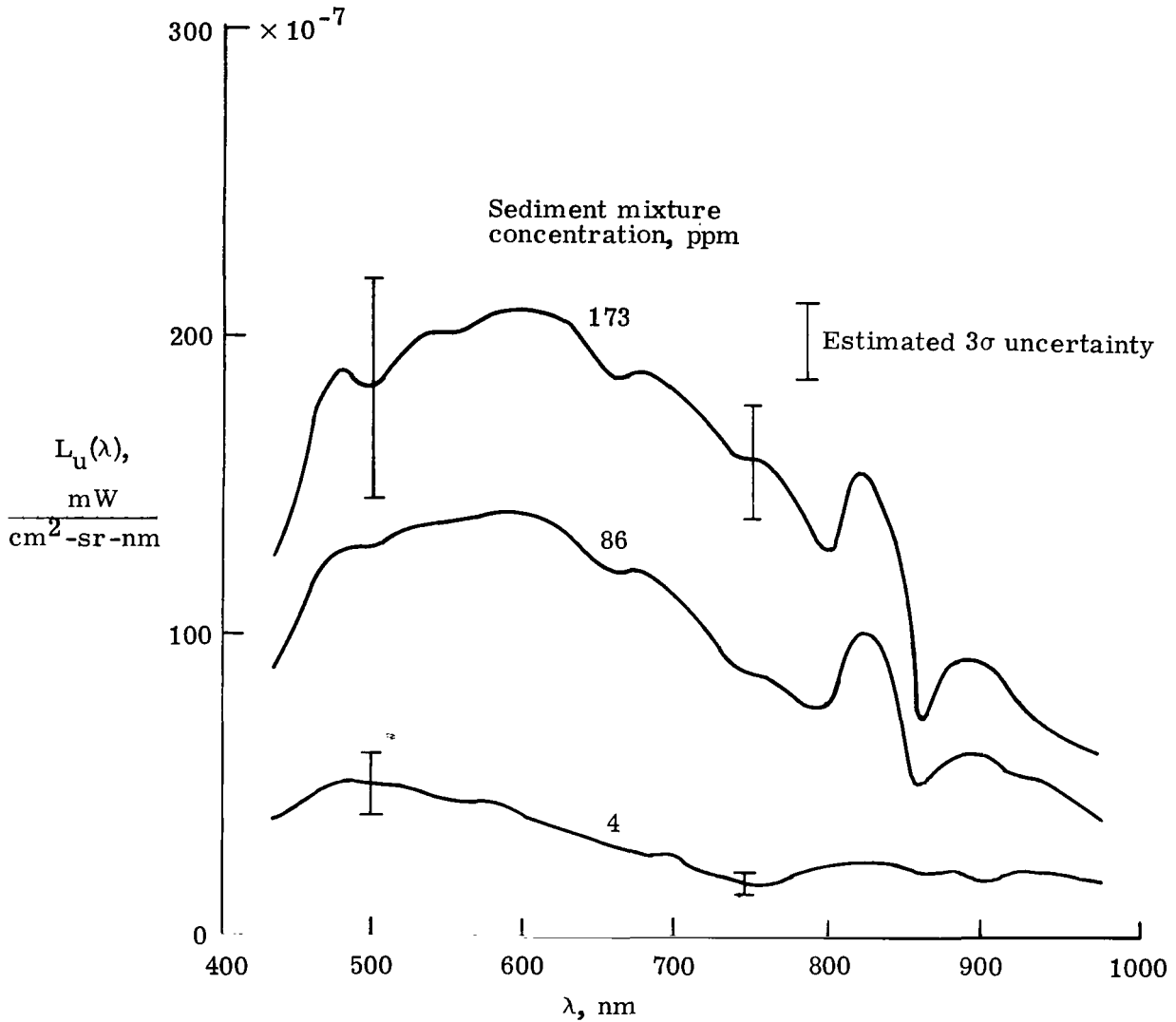

(a) Spectral radiance.

Figure 5.- Laboratory spectral radiance and reflectance for suspended Bailey Bay bottom sediment in filtered, deionized water.

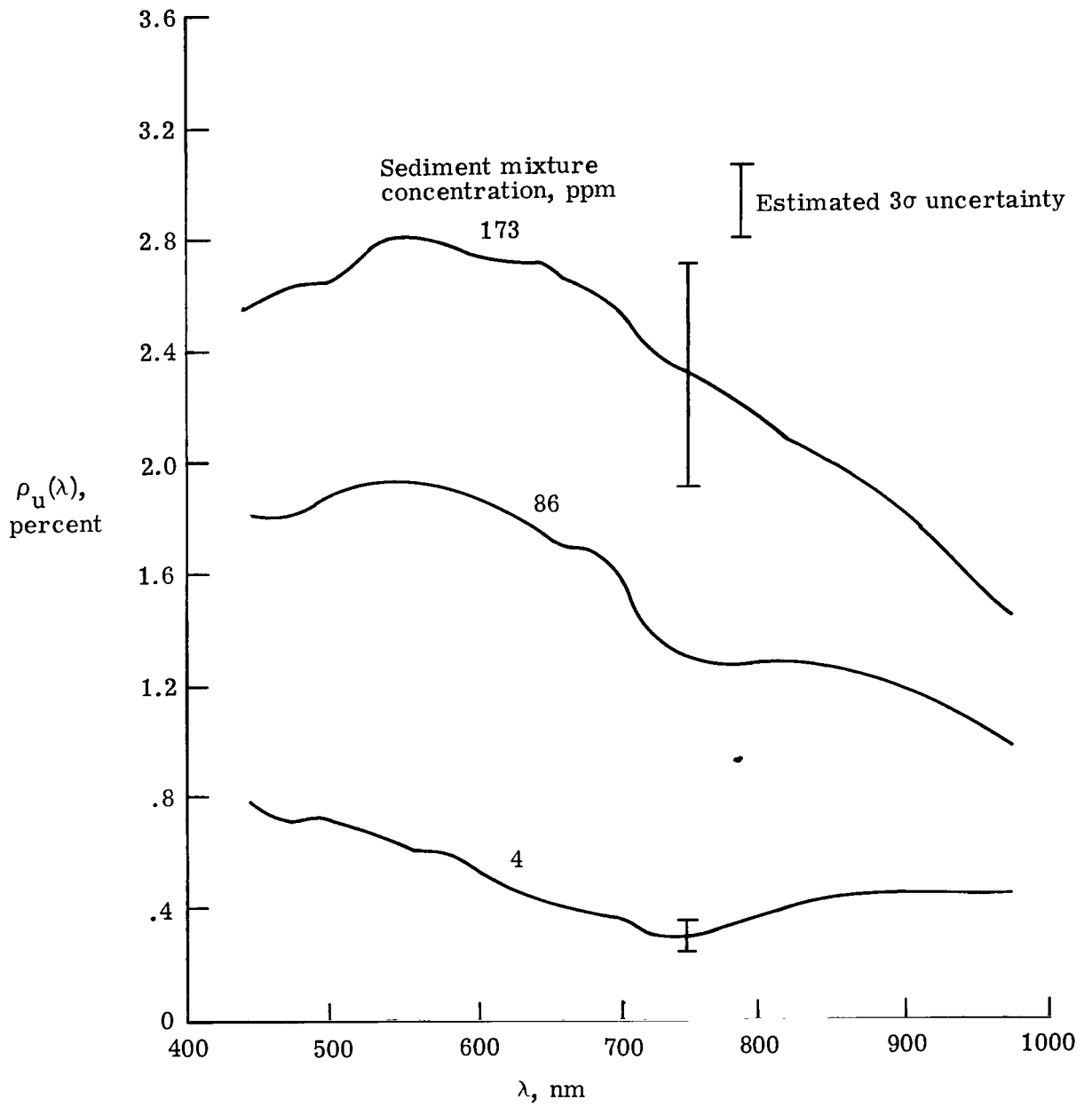

(b) Spectral reflectance.

Figure 5.- Concluded.

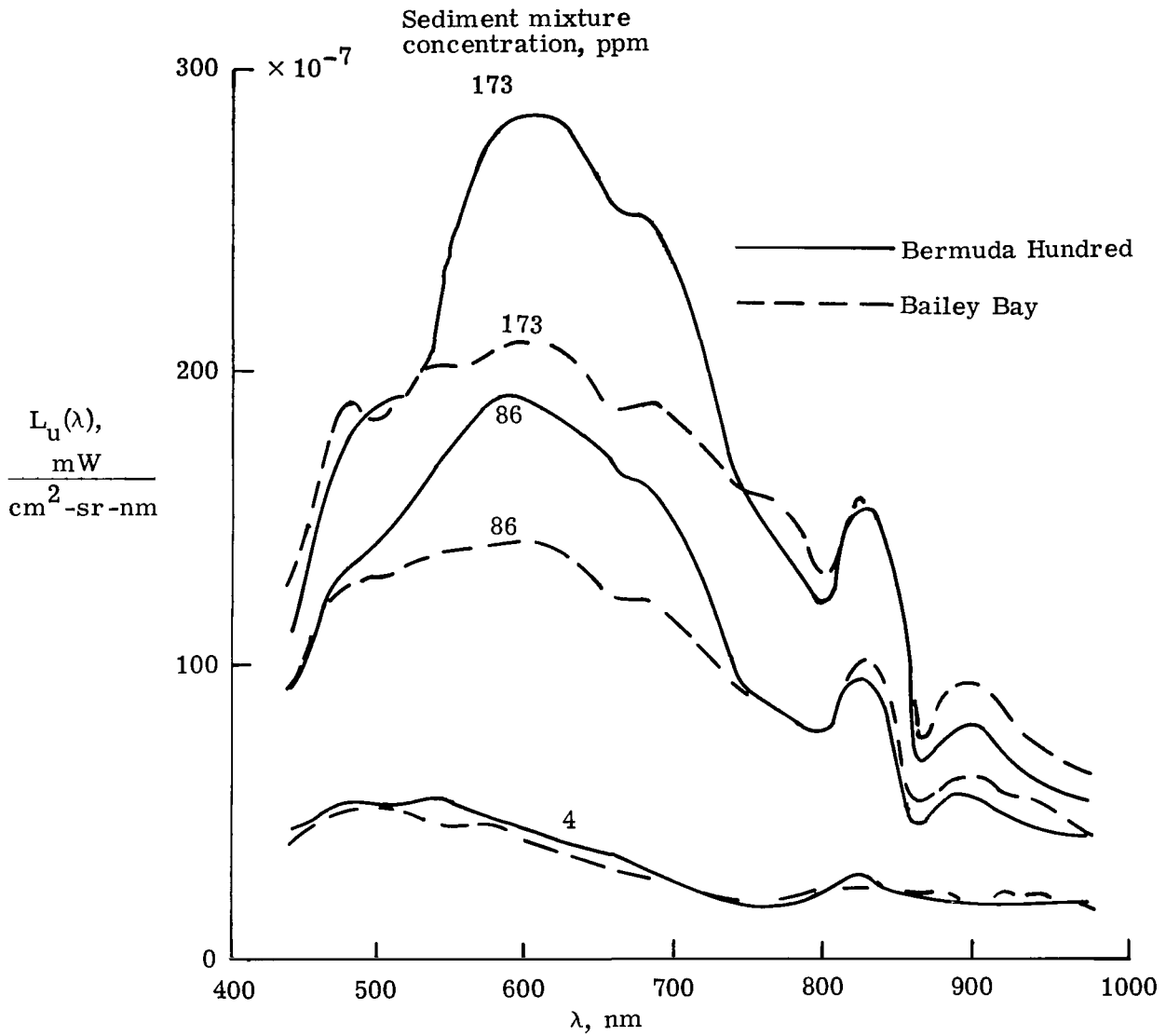

(a) Spectral radiance.

Figure 6.- Comparison of spectral radiance and reflectance of suspended Bermuda Hundred and Bailey Bay sediments.

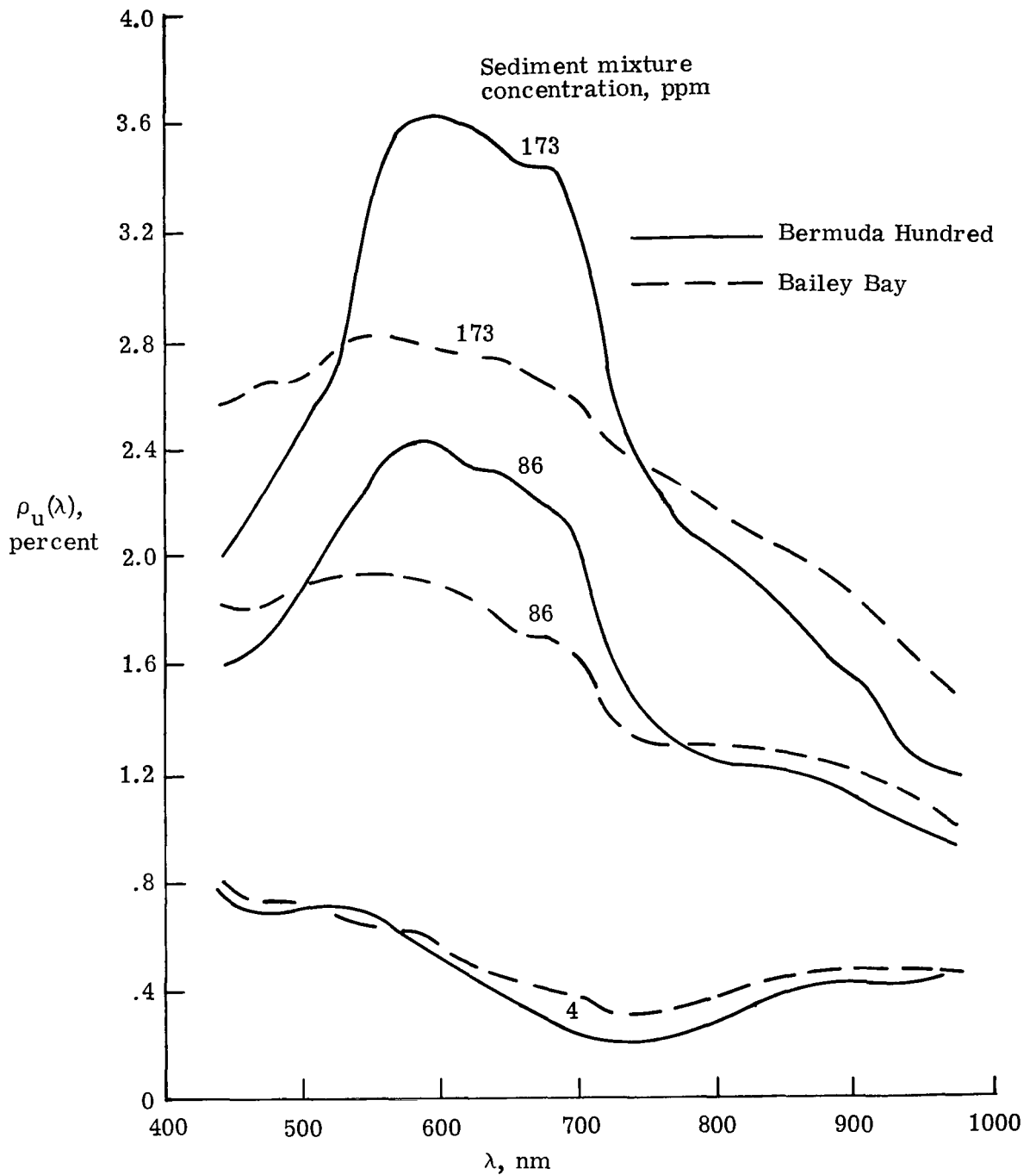

(b) Spectral reflectance.

Figure 6.- Concluded.

Mixture no.	Sediment mixture concentrations, ppm		
	Bermuda Hundred	Bailey Bay	Total
1	25	0	25
2	25	4	29
3	25	17	42
4	25	34	59
5	25	86	111
6	25	129	154
7	25	173	198

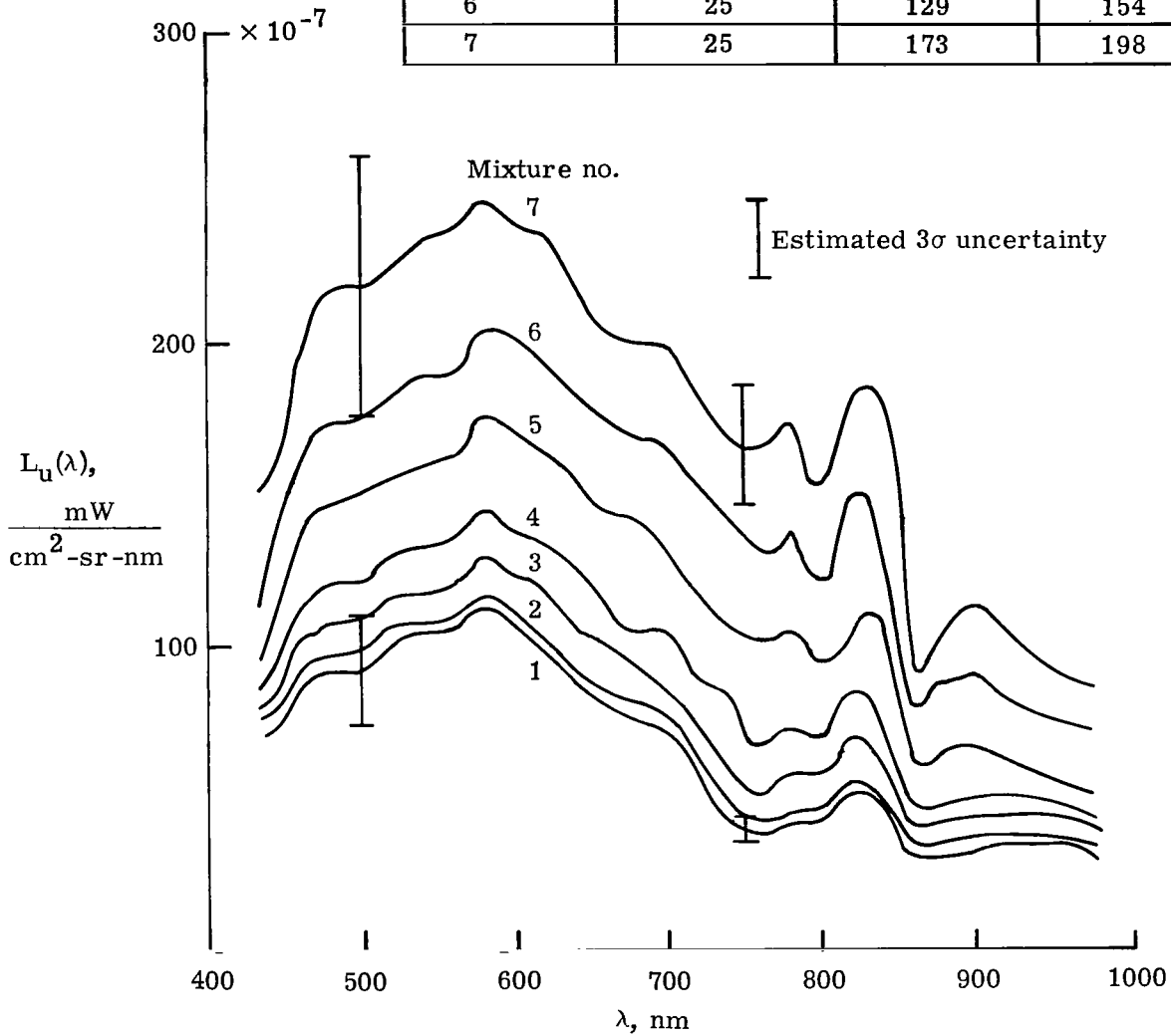

(a) Spectral radiance.

Figure 7.- Laboratory spectral radiance and reflectance for mixtures of suspended Bermuda Hundred and Bailey Bay bottom sediments in filtered, deionized water.

Mixture no.	Sediment mixture concentrations, ppm		
	Bermuda Hundred	Bailey Bay	Total
1	25	0	25
2	25	4	29
3	25	17	42
4	25	34	59
5	25	86	111
6	25	129	154
7	25	173	198

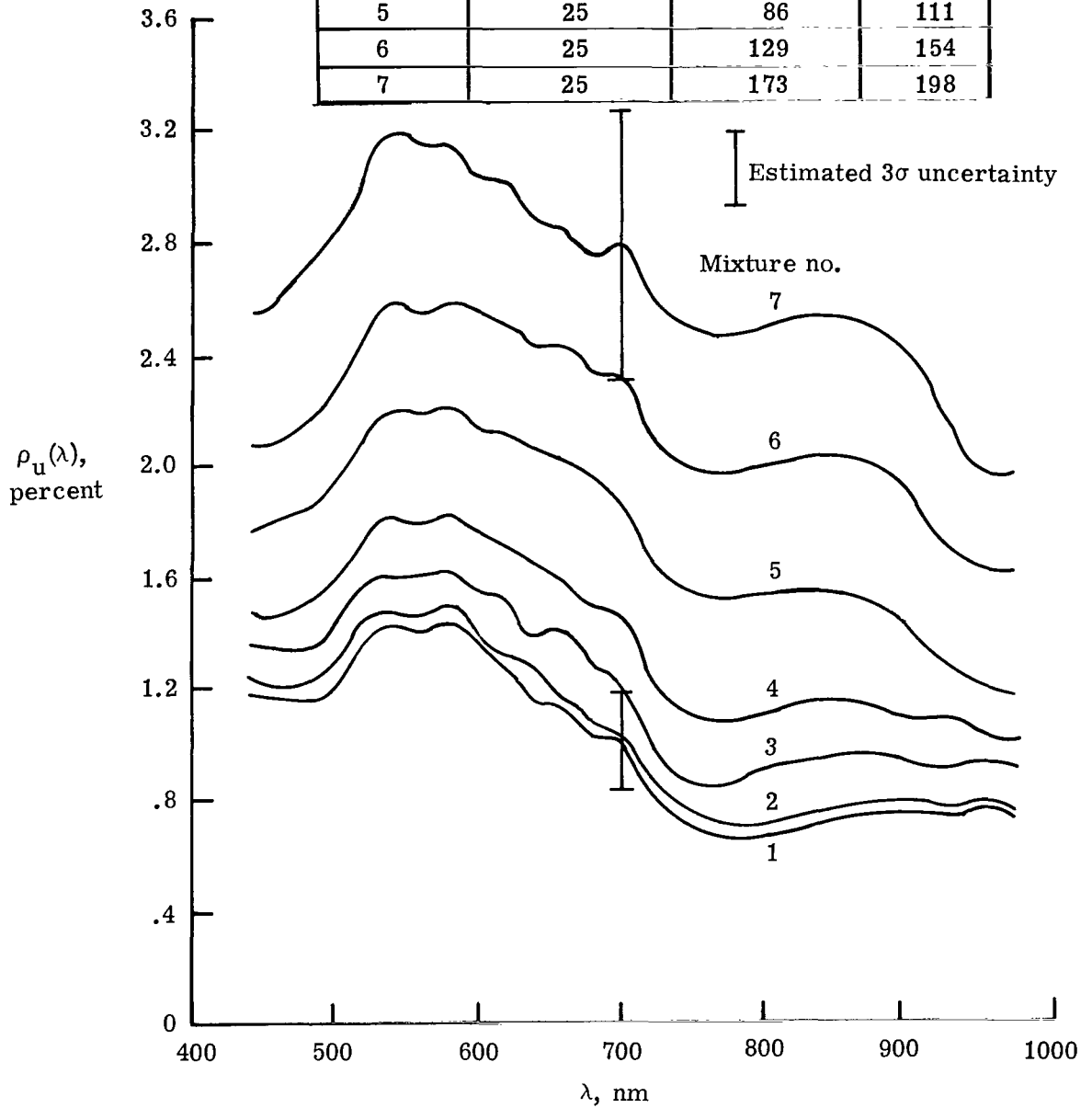

(b) Spectral reflectance.

Figure 7.- Concluded.

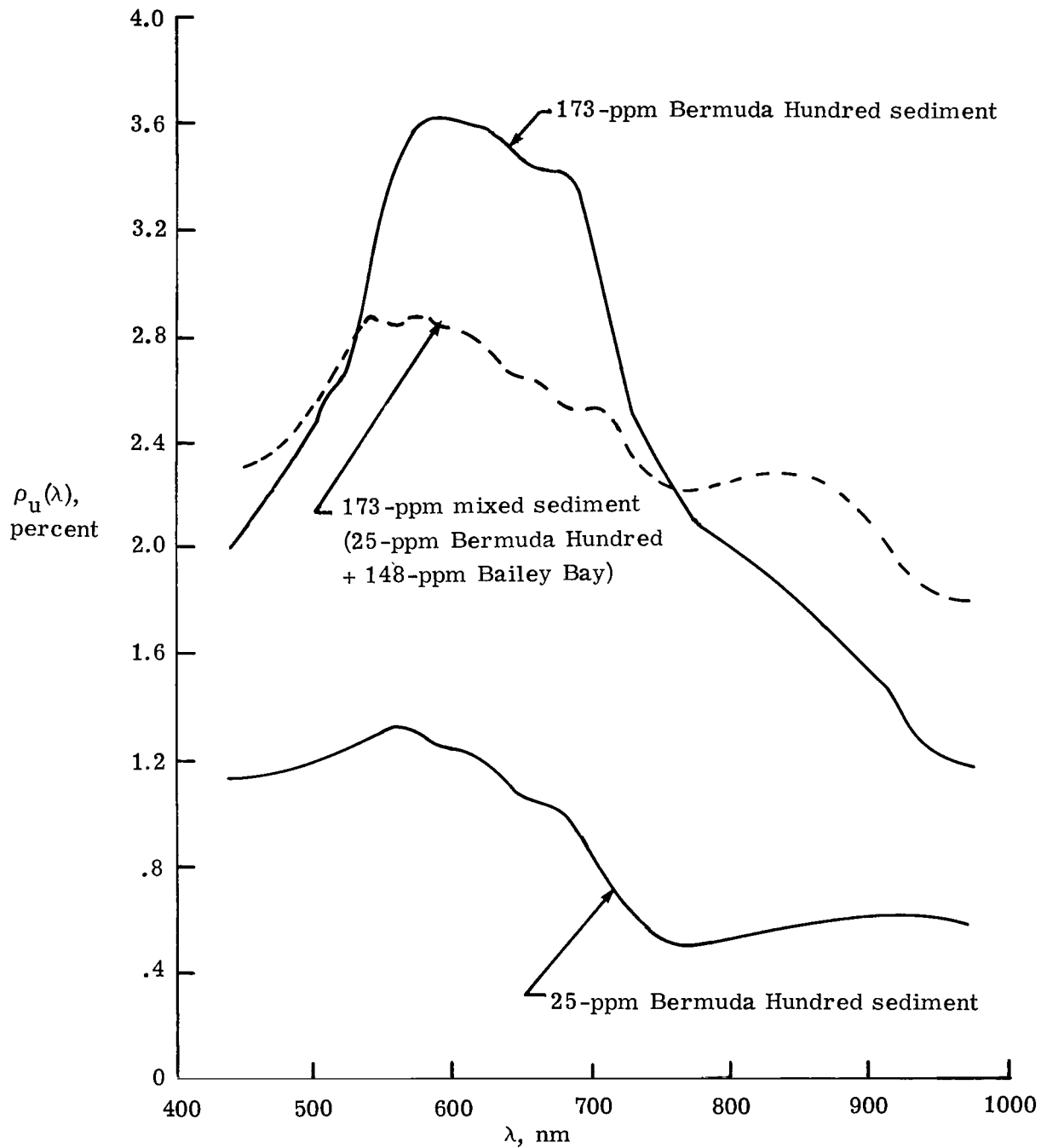

Figure 8.- Comparison of Bermuda Hundred and mixed sediment spectral reflectance.

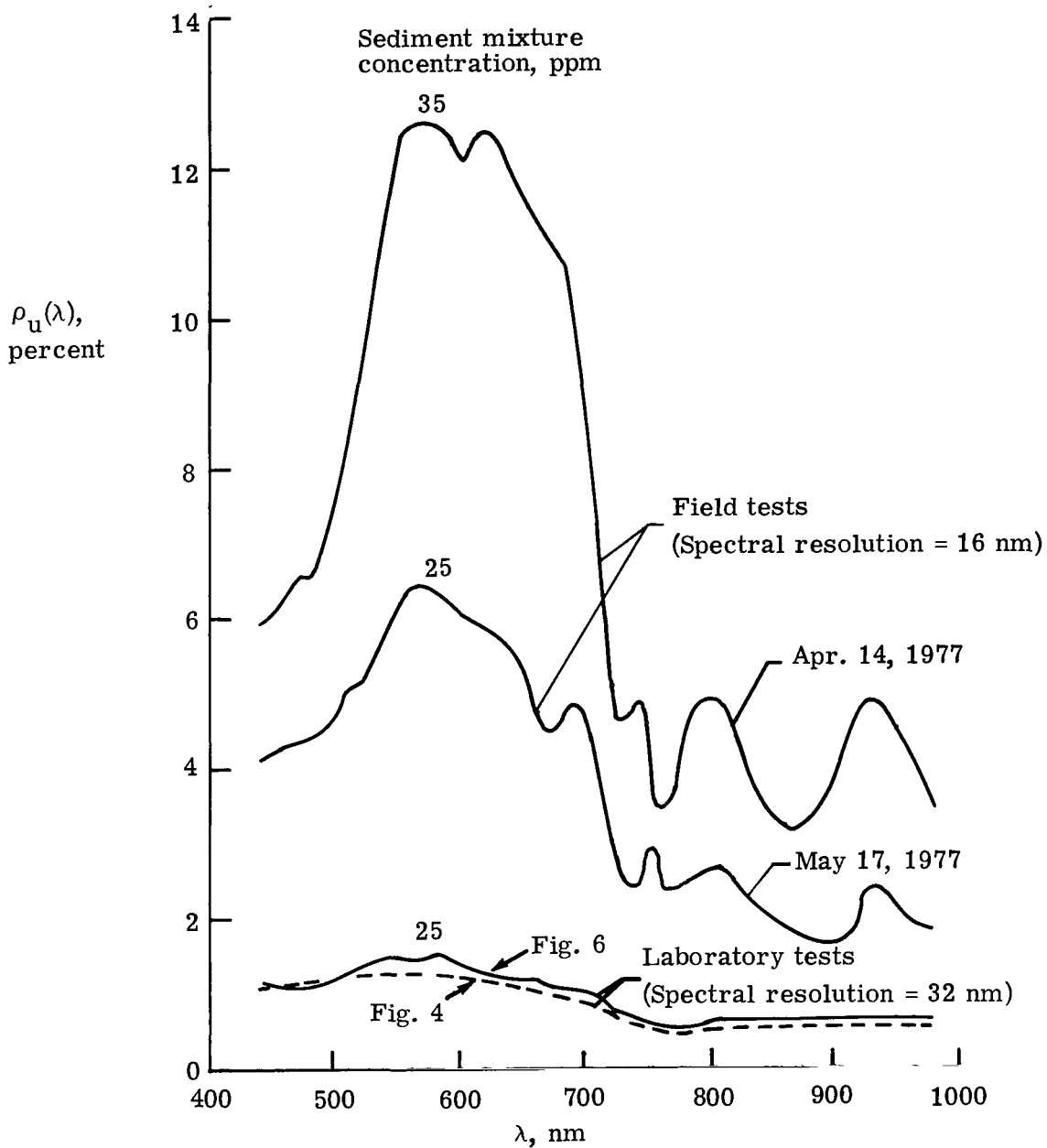

Figure 9.- Comparison of laboratory and field spectral reflectance data at Bermuda Hundred location.

—————	Fig. 6 (25 ppm)	} Laboratory tests
- - - - -	Fig. 4 (25 ppm)	
- - - - -	Apr. 14, 1977 (35 ppm)	} Field tests
- · - · -	May 17, 1977 (25 ppm)	
		Spectral resolution = 32 nm
		Spectral resolution = 16 nm

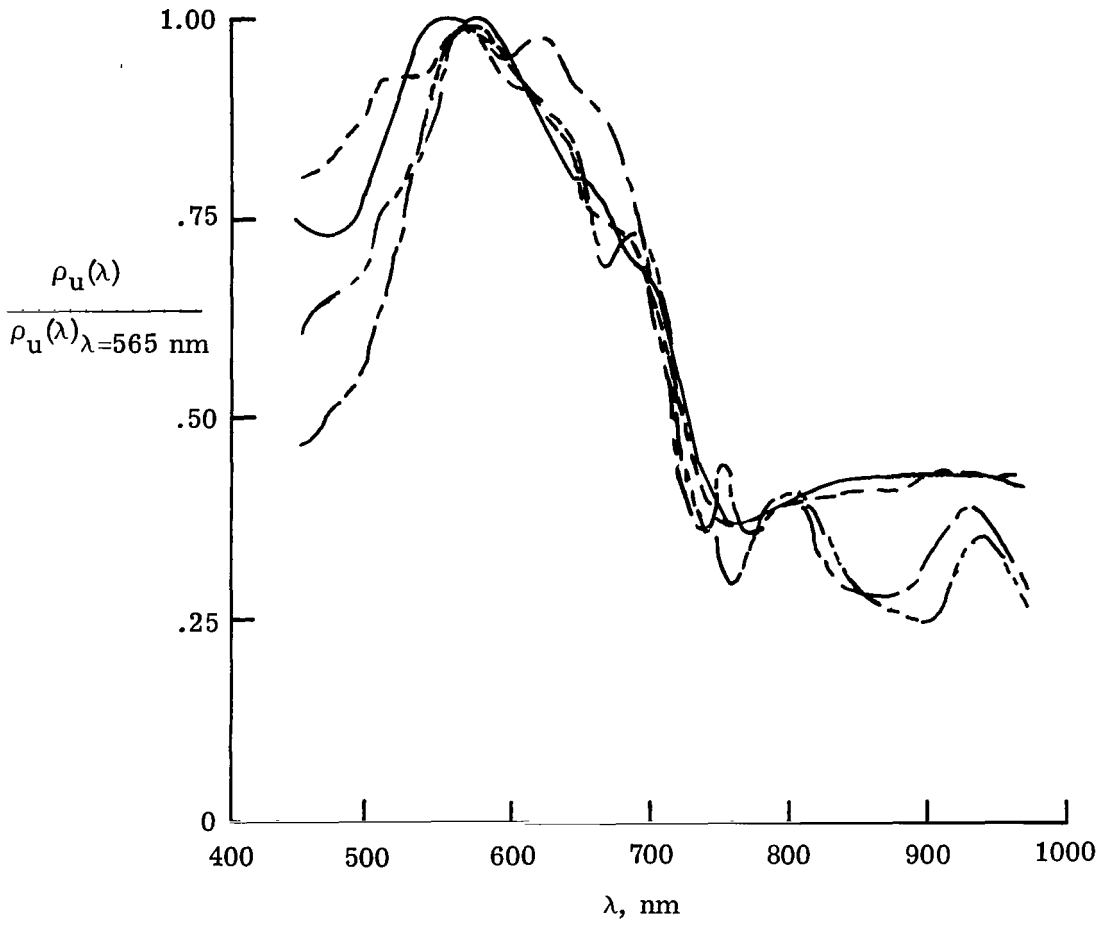

Figure 10.- Comparison of laboratory and field normalized spectral reflectance data at Bermuda Hundred location.

1. Report No. NASA TP-1292		2. Government Accession No.		3. Recipient's Catalog No.	
4. Title and Subtitle LABORATORY AND FIELD MEASUREMENTS OF UPWELLED RADIANCE AND REFLECTANCE SPECTRA OF SUSPENDED JAMES RIVER SEDIMENTS NEAR HOPEWELL, VIRGINIA				5. Report Date October 1978	
				6. Performing Organization Code	
7. Author(s) Charles H. Whitlock, William G. Witte, E. A. Gurganus, and J. W. Usry				8. Performing Organization Report No. L-12298	
				10. Work Unit No. 176-30-33-01	
9. Performing Organization Name and Address NASA Langley Research Center Hampton, VA 23665				11. Contract or Grant No.	
				13. Type of Report and Period Covered Technical Paper	
12. Sponsoring Agency Name and Address National Aeronautics and Space Administration Washington, DC 20546				14. Sponsoring Agency Code	
15. Supplementary Notes					
16. Abstract Spectral reflectance characteristics of suspended Bermuda Hundred and Bailey Bay bottom sediments taken from the Hopewell, Va., area were measured in the laboratory for water mixture total suspended solids concentrations between 4 and 173 parts per million. Field spectral reflectance measurements were made of the James River waters near Bermuda Hundred on two occasions. The results of these tests indicate that both Bermuda Hundred and Bailey Bay suspended sediments produce their strongest reflectance in the green and red regions of the spectrum.					
17. Key Words (Suggested by Author(s)) Remote sensing Spectral signature Laboratory measurements Environmental monitoring Marine sediments				18. Distribution Statement Unclassified - Unlimited Subject Category 45	
19. Security Classif. (of this report) Unclassified		20. Security Classif. (of this page) Unclassified		21. No. of Pages 27	22. Price* \$4.50

* For sale by the National Technical Information Service, Springfield, Virginia 22161

NASA-Langley, 1978

National Aeronautics and
Space Administration

Washington, D.C.
20546

Official Business

Penalty for Private Use, \$300

THIRD-CLASS BULK RATE

Postage and Fees Paid
National Aeronautics and
Space Administration
NASA-451



7 1 10, E, 091578 S00903DS
DEPT OF THE AIR FORCE
AF WEAPONS LABORATORY
ATTN: TECHNICAL LIBRARY (SUL)
KIRTLAND AFB NM 87117

NASA

POSTMASTER

erable (Section 158
Postal Manual) Do Not Return

S