

NASA Technical Paper 1338



LOAN COPY: RETURN TO
AFWL TECHNICAL LIBRARY
KIRTLAND AFB, N. M.

Performance of Single-Stage
Axial-Flow Transonic Compressor
With Rotor and Stator Aspect Ratios
of 1.19 and 1.26, Respectively, and
With Design Pressure Ratio of 1.82

Lonnie Reid and Royce D. Moore

NOVEMBER 1978





NASA Technical Paper 1338

Performance of Single-Stage
Axial-Flow Transonic Compressor
With Rotor and Stator Aspect Ratios
of 1.19 and 1.26, Respectively, and
With Design Pressure Ratio of 1.82

Lonnie Reid and Royce D. Moore
Lewis Research Center
Cleveland, Ohio

NASA

National Aeronautics
and Space Administration

**Scientific and Technical
Information Office**

1978



CONTENTS

	Page
SUMMARY	1
INTRODUCTION	1
AERODYNAMIC DESIGN	2
APPARATUS AND PROCEDURE	2
Compressor Test Facility	2
Instrumentation	2
Test Procedure	3
Calculation Procedure	4
RESULTS AND DISCUSSION	5
Overall Performance	5
Radial Distributions	5
Variations with Incidence Angle	6
SUMMARY OF RESULTS	8
APPENDIXES	
A - SYMBOLS	9
B - EQUATIONS	11
C - DEFINITIONS AND UNITS USED IN TABLES	17
REFERENCES	19
TABLES	20
FIGURES	66

SUMMARY

The overall and blade-element performance of an axial-flow, transonic-compressor-inlet stage is presented herein. The stage is one of a series of single stages that were designed and tested to investigate the performance characteristics of low-aspect-ratio blading for inlet stages of an advanced-core compressor. This stage was designed for a pressure ratio of 1.82 at a rotor tip speed of 455 meters per second. The rotor aspect ratio is 1.19, and the stator aspect ratio is 1.26. The stage was tested over the stable operating flow range at 70, 90, and 100 percent of design speeds. At the design speed the rotor and stage achieved peak efficiencies of 0.872 and 0.845 at pressure ratios of 1.875 and 1.842, respectively. The stage peak efficiency occurred at a mass flow that was about 3 percent higher than the design mass flow. The stage achieved a stall margin of 21.8 percent at design speed.

INTRODUCTION

The research program on axial-flow fans and compressors for advanced airbreathing engines at Lewis includes the study of advanced core compressor designs having high pressure ratio (about 20:1) good efficiency, and sufficient stall margin in as few stages as possible. A preliminary study of the aerodynamic and mechanical designs for an eight-stage core compressor having a pressure ratio of 20:1 (ref. 1) resulted in a compressor design of constant meanline diameter with an inlet hub-tip ratio of 0.7, and an inlet rotor-tip speed of 455 meters per second. Both the speed and the loading per stage is considerably higher than in current state-of-the-art core compressors. An experimental research program was therefore established to evaluate the performance characteristics and establish a data base for single stages that are representative of the inlet, middle, and rear stages of the eight-stage 20:1 pressure ratio compressor.

Four single stages that are representative of the inlet stage for the eight-stage compressor were designed and tested. The design and overall performance comparison for all four stages are presented in reference 2. These four stages represents two levels of pressure ratio (1.82 and 2.05) and two levels of rotor aspect ratio (1.19 and 1.63). The stages are designated as stages 35, 36, 37, and 38. Stages 35 and 37 have a rotor aspect ratio of 1.19 and design pressure ratios of 1.82 and 2.05, respectively; stages 36 and 38 have a rotor aspect ratio of 1.63 and design pressure ratios of 1.82 and 2.05, respectively.

This report presents the radial distribution of performance parameters and detailed blade-element data for the first stage in this series (stage 35). The overall performance of the stage is also included. Data are presented over the stable operating flow range for rotative speeds from 50 to 100 percent of design speed. Data are presented in

tabular form as well as in plots. The symbols and equations are defined in appendixes A and B.

AERODYNAMIC DESIGN

The detailed aerodynamic design is presented in reference 2, and therefore only a brief summary of the aerodynamic design parameters is presented herein.

The flow path geometry, including instrumentation stations, is shown in figure 1. The design overall performance parameters are shown in table I. The stage was designed for a total-pressure ratio of 1.82, a mass flow of 20.2 kg/sec, and a rotor tip speed of 455 meters per second. The design blade-element parameters are presented in table II. The rotor-inlet relative Mach number varies from 1.49 at the tip to 1.12 at the hub; the stator-inlet Mach number varies from 0.725 at the tip to 0.765 at the hub. The rotor diffusion factor at the hub and tip is roughly 0.46, with a maximum value of 0.48 near the midspan; the stator hub diffusion factor is 0.34.

The blade geometry is presented in table III for the rotor and stator.

Both rotor and stator have multiple circular arc (MCA) blade shapes. The rotor has 36 blades, the tip solidity is 1.3, and the aspect ratio is 1.19. The stator has 46 blades, the tip solidity is 1.3, and the aspect ratio is 1.26. A photograph of the rotor and stator is shown in figure 2. Manufacturing coordinates for both rotor and stator are presented in reference 2.

APPARATUS AND PROCEDURE

Compressor Test Facility

The compressor stage was tested in the Lewis single-stage compressor test facility (fig. 3), which is described in detail in reference 3. Atmospheric air enters the facility at an inlet located on the roof of the building and flows through the flow measuring orifice and into the plenum upstream of the test stage. The air passes through the experimental compressor stage into the collector and the vacuum exhaust system.

Instrumentation

The mass flow was determined from measurements on a calibrated thin-plate orifice. The orifice temperature was obtained from an average of two Chromel-constantan thermocouples. Orifice pressures were measured by calibrated transducers. An elec-

tronic speed counter, in conjunction with a magnetic pickup, was used to measure rotative speed.

Radial surveys of flow conditions at station 1 (upstream of rotor) were made using two combination probes (fig. 4(a)) and two 18° wedge probes (fig. 4(b)). The combination probe measures total temperature, total pressure, and flow angle. The wedge probe measures static pressure and flow angle. Each probe was equipped with a null-balancing control system which automatically alined the probe with the flow direction. Chromel-constantan thermocouples were used to measure temperature.

Because of the close spacing between the rotor and stator, no measurements were made between them. At station 3 (downstream of stator) two combination probes and two wedge probes were traversed both circumferentially and radially to obtain the distributions of pressure, temperature, and flow angle.

Static-pressure taps were installed on both inner and outer wall casings at stations 1 and 3. The circumferential location of the instrumentation at stations 1 and 3 are shown in figure 5. The estimated errors in the data, based on inherent accuracies of the instrumentation and the recording system, are as follows:

Mass flow, kg/sec	±0.3
Rotative speed, rpm	±30
Flow angle, deg	±1.0
Temperature, K	±0.6
Rotor-inlet (station 1) total pressure, N/cm ²	±0.01
Rotor-inlet (station 1) static pressure, N/cm ²	±0.03
Stator-outlet (station 3) total pressure, N/cm ²	±0.17
Stator-outlet (station 3) static pressure, N/cm ²	±0.10

Test Procedure

The stage survey data were taken over a range of flows and speeds. For the 70, 90, and 100 percent of design speeds, data were recorded at five or more flows from maximum to near-stall conditions. For the 50, 60, and 80 percent of design speeds, data were recorded at the near-stall flow only. Data were taken at nine radial positions for each flow point.

At each radial position the two combination probes behind the stator were traversed circumferentially to nine locations across the stator gap. The wedge static probes were set at midgap because preliminary studies showed that the static pressure across the gap was essentially constant. Values of total pressure, temperature, and flow angle were recorded at each circumferential position at station 3. At the last circumferential position, values of pressure, temperature, and flow angle were also recorded at sta-

tion 1. All probes were then traversed to the next radial position, and the circumferential traverse procedure was repeated.

Calculation Procedure

Measured total pressures, static pressures, and total temperatures were corrected for Mach number and streamline slope. These corrections were based on an average calibration for the type of instrument used. Orifice mass flow, rotative speed, total pressures, static pressures, and temperatures were all corrected to standard-day conditions based on the rotor-inlet condition.

The circumferential distribution of static pressure downstream of the stator was assumed to be constant for each radial position and equal to the midgap values. At each radial position averaged values of nine circumferential measurements of total pressure, total temperature, and flow angle downstream of the stator (station 3) were obtained in the following manner: The midgap static pressure was used with the local total pressure, total temperature, and flow angle to calculate the circumferential distributions of velocity, static density, and axial and tangential velocity components. These distributions are used in the circumferential mass averaging process. The nine values of total temperature were mass averaged to obtain the circumferentially averaged stator-outlet total temperature. The nine values of total pressure were divided by the rotor-inlet total pressure and converted to corresponding isentropic temperature ratios. These ratios were mass averaged, and the resulting value converted (through the isentropic-temperature-ratio - pressure-ratio relation) to an average total pressure ratio. The average absolute velocity was obtained from the midgap static pressure, average total pressure, and total temperature. The average tangential velocity component was calculated by mass averaging the local tangential velocity. The average absolute velocity and average tangential velocity component were used to calculate the average axial component. This calculation was performed for each of the two sets of probes at station 3, and the results from each set of probes were averaged to obtain single, averaged values of total pressure, total temperature, static pressure, and flow angle at each radial position. To obtain the overall performance, the radial distributions of the circumferentially averaged total temperature and total pressure were averaged using a procedure similar to that used for averaging the circumferential distributions of these parameters. The values of pressure, temperature, and flow angle at station 2 were obtained as follows: At each radial position total pressure and total temperature were translated along design streamlines from station 3. The mass-averaged total temperature was used as the total temperature for station 2. The arithmetic mean of the three highest total-pressure values from the circumferential distribution at station 3 was used as the total pressure at station 2. The radial distributions of static pressure and flow angle

were calculated based on continuity of mass flow and radial equilibrium. Measured mass flow, rotative speed, design values of streamline geometry, and annulus wall blockages were specified.

RESULTS AND DISCUSSION

The results of this investigation are presented in three parts: overall performance of both rotor and stage, radial distribution of several performance parameters, and blade-element data for both rotor and stator. The overall performance data are presented in table IV. For each overall-performance data point, blade-element data are presented for the rotor and stator in tables V and VI, respectively. The abbreviations and units used for the tabular data are defined in appendix C.

Overall Performance

The overall performances for the rotor and stage are presented in figures 6 and 7, respectively. At design speed the rotor and stage achieved peak efficiencies of 0.872 and 0.845, respectively, at a mass flow of 20.82 kilograms per second. The rotor and stage pressure ratios at peak efficiency conditions were 1.875 and 1.842, respectively. The design rotor and stage pressure ratios were 1.865 and 1.82, respectively. The mass flow at which peak efficiency occurred is about 3 percent higher than the design flow. At the design flow rate rotor and stage pressure ratios exceeded the design value, and the efficiencies were slightly lower than design; however, the peak efficiencies for both rotor and stage are higher than the design values. The maximum value of rotor efficiency of 0.905 occurred at 70 percent of design speed. At all three speed lines (70, 90, and 100 percent of design speeds), the peak efficiency occurred near the maximum mass flow. The stage stall margin, based on conditions at stall and peak efficiency, is very good. At design speed the stall margin is 21.8 percent.

Radial Distributions

Radial distributions of several parameters are presented in figures 8 and 9 for rotor and stator, respectively, for design speed at three flow conditions, maximum near design, and near stall. These distributions show how the blade rows operated at various spanwise locations for a given flow and the change in these parameters over the flow range. The design distributions are represented by the solid symbols.

Rotor. - For the near-design flow conditions (20.1 kg/sec), the total-pressure ratio is higher than the design values at all spanwise locations (fig. 8). The efficiency

distribution is very close to the design distribution. The energy addition is larger than design as shown by the temperature-ratio distribution. This increase in energy is mainly due to the lower-than-design deviation angles across the entire span. Both diffusion factor and total-loss coefficient have larger-than-design values over the entire span. The spanwise variations of total-pressure ratio, total-temperature ratio, and diffusion factor are similar to the design variations for these parameters. The suction-surface incidence angle is a little lower than design values in the hub region and about 3° higher than design at the 5 percent span location.

At the near-stall flow conditions the total-pressure ratio increased slightly but the distribution is relatively unchanged compared with the distribution for the near-design flow data. Both the total-temperature ratio and the diffusion factor show a larger difference in the tip than the hub region when compared with the near-design flow distributions. The efficiency in the hub region shows little variation from the near-design condition but drops quite rapidly in the tip region.

At the maximum flow condition both total-pressure ratio and total-temperature ratio are low compared with the near-design-flow distributions. However, there is very little change in the efficiency distribution.

Stator. - For the near-design-flow conditions (20.1 kg/sec) the suction-surface incidence angle and the diffusion factor are higher than the design values over the entire blade span (fig. 9). This is caused mainly by the greater-than-design energy addition through the rotor at this flow, thus the absolute tangential velocity and flow angle out of the rotor are larger than the design values. Even though the diffusion factor is larger than design, the losses are close to the design values over most of the span. The deviation angles are larger than the design values over the entire span. This can be attributed to the higher-than-design rotor-exit tangential velocity and flow angles.

At the near-stall flow condition diffusion factor and the losses were greater over the entire span than they were at the near-design flow condition. At the maximum flow condition both diffusion factor and losses are lower than the values at near-design over the entire span.

Variations with Incidence Angle

The variations of selected blade-element parameters with suction-surface incidence angle are presented in figures 10 and 11 for rotor and stator. The data are presented for the 70, 90, and 100 percent of design speeds for blade elements located at 5, 10, 15, 30, 50, 70, 85, 90, and 95 percent of span from blade tip. Design values are represented by solid symbols, and experimental values by open symbols. Some of the data points are missing from the 70-percent-of-design-speed plots primarily because they fall outside of the selected incidence-angle range. This incidence-angle range was

selected to provide good resolution of the blade-element parameter curves at 90 and 100 percent of design speed. These data points do appear, however, in the appropriate tables in this report.

Rotor. - Meridional velocity ratio, inlet relative Mach number, deviation angle, total-loss parameter, total-loss coefficient, diffusion factor, adiabatic efficiency, total-temperature ratio, and total-pressure ratio are plotted as functions of suction-surface incidence angle in figure 10. At design speed all the rotor-blade elements operated over a relatively wide range of incidence angles considering the fact that the inlet relative Mach numbers are supersonic over the entire blade span. Even at the 5-percent-of-span location, where the inlet relative Mach number varies from 1.41 to 1.49, this element operated over an incidence-angle range of nearly 5° . At high incidence angles (near stall) all of the blade elements operated at or above a total-pressure ratio of 2.0 and at approximately 0.6 diffusion factor. For low incidence angles (maximum flow), each blade element shows a sharp drop in total-pressure ratio and total-temperature ratio at a near constant incidence angle, indicating that all elements are operating at their maximum flow capacity. All of the elements are properly matched over the entire span. This could explain why the blade achieved the large stall margin of 21.8 percent.

At design incidence angle the total-loss coefficient is somewhat larger than the design values for all elements except for the 5-percent-of-span location. However, at the design incidence angle the diffusion factor is also larger than the design values at each element. The design and experimental losses for the same value of diffusion factor are quite comparable.

Stator. - Meridional velocity ratio, inlet Mach number, deviation angle, total-loss coefficient, total-loss parameter, and diffusion factor are plotted as functions of suction surface-incidence angle in figure 11. At design speed the stator operated over a range of incidence angle of about 24° at the 5-percent-of-span element, and this range decreases to about 10° at the 95-percent-of-span element. The stator-inlet Mach number varies from about 0.71 at the 5-percent-of-span element to 0.80 at the 95-percent-of-span element. For all three speeds (70, 90, and 100 percent of design) both the loss coefficient and the diffusion factor increase with increase incidence angle, and both parameters seem to be independent of inlet Mach number over the range of Mach numbers for which this stator operated. At design incidence angle the diffusion factor is slightly larger than the design values for all elements except at 95 percent of span. However, the experimental loss coefficient is lower than the design values at all elements except the 5 and 10 percent of span elements.

SUMMARY OF RESULTS

This report has presented the overall and blade-element performance of a single-stage axial-flow transonic compressor that is representative of an inlet stage for an advanced-core compressor. This is one of a series of stages designed to investigate the effects of aspect ratio and pressure ratio on the performance characteristics of an inlet stage of an advanced-core compressor. The stage consisted of a rotor and stator with aspect ratios of 1.19 and 1.26, respectively, and a design pressure ratio of 1.82. Detailed radial surveys of the flow conditions ahead of the rotor and behind the stator, were made over the stable operating range at 70, 90, and 100 percent of design speed. This investigation yielded the following results:

1. At design speed the peak rotor and stage efficiencies were 0.872 and 0.845 and occurred at rotor and stage pressure ratios of 1.875 and 1.842, respectively. Stage peak efficiency occurred at a mass flow of about 3 percent higher than the design value.
2. Stall margin at design speed for this stage was 21.8 percent, based on mass flows and total-pressure ratios at peak efficiency and stall.
3. At the design-speed peak-efficiency condition, the spanwise distribution of rotor total-pressure ratio is similar to the design distribution, but the level is somewhat higher. All rotor-blade elements operated near a 0.6 diffusion factor at near-stall conditions and maximum flow as choking conditions were approached, indicating that the elements are properly matched over the entire blade span.
4. At the design incidence angle, the stator diffusion factor is slightly larger than design over most of the span. The experimental loss coefficient is, however, lower than the design values for all elements except at the tip.

Lewis Research Center,
National Aeronautics and Space Administration,
Cleveland, Ohio, July 7, 1978,
505-04.

APPENDIX A

SYMBOLS

A_{an}	annulus area at rotor leading edge, 0.101 m^2
A_f	frontal area at rotor leading edge, 0.200 m^2
C_p	specific heat at constant pressure, 1004 (J/kg) K
c	aerodynamic chord, cm
D	diffusion factor
g	acceleration of gravity, 9.81 m/sec^2
i_{mc}	mean incidence angle, angle between inlet air direction and line tangent to blade mean camber line at leading edge, deg
i_{ss}	suction-surface incidence angle, angle between inlet air direction and line tangent to blade suction surface at leading edge, deg
N	rotative speed, rpm
P	total pressure, N/cm^2
p	static pressure, N/cm^2
r	radius, cm
SM	stall margin
T	total temperature, K
U	wheel speed, m/sec
V	air velocity, m/sec
W	weight flow, kg/sec
Z	axial distance referenced from rotor-blade-hub leading edge, cm
α_c	cone angle, deg
α_s	slope of streamline, deg
β	air angle, angle between air velocity and axial direction, deg
β'_c	relative meridional air angle based on cone angle, $\arctan(\tan \beta'_m \cos \alpha_c / \cos \alpha_s)$, deg
γ	ratio of specific heats (1.40)

δ	ratio of rotor-inlet total pressure to standard pressure of 10.13 N/cm ²
δ°	deviation angle, angle between exit air direction and tangent to blade mean camber line at trailing edge, deg
η	efficiency
θ	ratio of rotor-inlet total temperature to standard temperature of 288.2 K
κ_{mc}	angle between blade mean camber line and meridional plane, deg
κ_{SS}	angle between blade suction-surface camber line at leading edge and meridional plane, deg
σ	solidity, ratio of chord to spacing
$\bar{\omega}$	total-loss coefficient
$\bar{\omega}_p$	profile-loss coefficient
$\bar{\omega}_s$	shock-loss coefficient

Subscripts:

ad	adiabatic (temperature rise)
id	ideal
LE	blade leading edge
m	meridional direction
mom	momentum rise
p	polytropic
TE	blade trailing edge
t	tip
z	axial direction
θ	tangential direction
1	instrumentation plane upstream of rotor
2	instrumentation plane between rotor and stator
3	instrumentation plane downstream of stator

Superscript:

'	relative to blade
---	-------------------

APPENDIX B

EQUATIONS

Equations for Calculating Blade-Element Parameters

Suction-surface incidence angle:

$$i_{SS} = (\beta'_c)_{LE} - \kappa_{SS} \quad (B1)$$

Mean incidence angle:

$$i_{mc} = (\beta'_c)_{LE} - (\kappa_{mc})_{LE} \quad (B2)$$

Deviation angle:

$$\delta^0 = (\beta'_c)_{TE} - (\kappa_{mc})_{TE} \quad (B3)$$

Diffusion factor:

$$D = 1 - \frac{V'_{TE}}{V'_{LE}} + \left| \frac{(rV'_\theta)_{TE} - (rV'_\theta)_{LE}}{(r_{TE} + r_{LE})\sigma(V'_{LE})} \right| \quad (B4)$$

Total loss coefficient:

$$\bar{\omega} = \frac{(P'_{id})_{TE} - P'_{TE}}{P'_{LE} - p_{LE}} \quad (B5)$$

Profile loss coefficient:

$$\bar{\omega}_p = \bar{\omega} - \bar{\omega}_s \quad (B6)$$

Total loss parameter:

$$\frac{\bar{\omega} \cos (\beta'_m)_{TE}}{2\sigma} \quad (B7)$$

Profile loss parameter:

$$\frac{\bar{\omega}_p \cos(\beta'_m)_{TE}}{2\sigma} \quad (B8)$$

Adiabatic (temperature rise) efficiency:

$$\eta_{ad} = \frac{\left(\frac{P_{TE}}{P_{LE}}\right)^{(\gamma-1)/\gamma} - 1}{\frac{T_{TE}}{T_{LE}} - 1} \quad (B9)$$

Equations for Calculating Overall Performance Parameters

Rotor total pressure ratio:

$$\begin{aligned} \overline{(P_2/P_1)} &= \left[\frac{\int_{r_h}^{r_t} (P_2/P_1)^{(\gamma-1)/\gamma} \rho v_z r dr}{\int_{r_h}^{r_t} \rho v_z r dr} \right]^{\gamma/(\gamma-1)} \\ &= \left[\frac{\sum_{i=1}^{NR} (P_2/P_1)_i^{(\gamma-1)/\gamma} \rho_{2,i} V_{z2,i} \Delta A_{2,i}}{\sum_{i=1}^{NR} \rho_{2,i} V_{z2,i} \Delta A_{2,i}} \right]^{\gamma/(\gamma-1)} \end{aligned} \quad (B10)$$

Stage total pressure ratio:

$$\overline{(P_3/P_1)} = \left[\frac{\int_{r_h}^{r_t} (P_3/P_1)^{(\gamma-1)/\gamma} \rho v_z r dr}{\int_{r_h}^{r_t} \rho v_z r dr} \right]^{\gamma/(\gamma-1)}$$

$$= \left[\frac{\sum_{i=1}^{NR} (P_3/P_1)_i^{(\gamma-1)/\gamma} \rho_{3,i} V_{z3,i} \Delta A_{3,i}}{\sum_{i=1}^{NR} \rho_{3,i} V_{z3,i} \Delta A_{3,i}} \right]^{\gamma/(\gamma-1)} \quad (B11)$$

Total temperature ratio:

$$\overline{(T_2/T_1)} = \frac{\int_{r_h}^{r_t} (T_2/T_1) \rho v_z r dr}{\int_{r_h}^{r_t} \rho v_z r dr} = \frac{\sum_{i=1}^{NR} (T_2/T_1)_i \rho_{2,i} V_{z2,i} \Delta A_{2,i}}{\sum_{i=1}^{NR} \rho_{2,i} V_{z2,i} \Delta A_{2,i}} \quad (B12)$$

Rotor adiabatic efficiency:

$$\eta_{ad} = \frac{\overline{(P_2/P_1)}^{(\gamma-1)/\gamma} - 1}{\overline{(T_2/T_1)} - 1} \quad (B13)$$

Stage adiabatic efficiency:

$$\eta_{\text{ad}} = \frac{\overline{(P_3/P_1)}^{(\gamma-1)/\gamma} - 1}{\overline{(T_2/T_1)} - 1} \quad (\text{B14})$$

Rotor-inlet mass-average temperature:

$$\overline{T_1} = \frac{\int_{r_h}^{r_t} T_1 \rho v_z r \, dr}{\int_{r_h}^{r_t} \rho v_z r \, dr} = \frac{\sum_{i=1}^{\text{NR}} T_{1,i} \rho_{1,i} V_{z1,i} \Delta A_{1,i}}{\sum_{i=1}^{\text{NR}} \rho_{1,i} V_{z1,i} \Delta A_{1,i}} \quad (\text{B15})$$

Momentum-rise efficiency:

$$\eta_{\text{mom}} = \frac{\overline{(P_2/P_1)}^{(\gamma-1)/\gamma} - 1}{\overline{T_1} C_p} = \frac{\overline{(P_2/P_1)}^{(\gamma-1)/\gamma} - 1}{\overline{T_1} C_p} \frac{\int_{r_h}^{r_t} \left[(UV\theta)_2 - (UV\theta)_1 \right] \rho v_z r \, dr}{\sum_{i=1}^{\text{NR}} \left[(UV\theta)_2 - (UV\theta)_1 \right]_i \rho_{2,i} V_{z2,i} \Delta A_{2,i}} \quad (\text{B16})$$

Head rise coefficient:

$$\frac{C_p \overline{T_1}}{U_t^2} \left[\overline{(P_2/P_1)}^{(\gamma-1)/\gamma} - 1 \right] \quad (\text{B17})$$

Equivalent mass flow:

$$\frac{W \sqrt{\theta}}{\delta} \quad (\text{B18})$$

Equivalent rotative speed:

$$\frac{N}{\sqrt{\theta}} \quad (\text{B19})$$

Mass flow per unit annulus area:

$$\frac{w \sqrt{\theta}}{\delta A_{\text{an}}} \quad (\text{B20})$$

Mass flow per unit frontal area:

$$\frac{w \sqrt{\theta}}{\delta A_f} \quad (\text{B21})$$

Flow coefficient:

$$\left(\frac{V_z}{U_t} \right)_{\text{LE}} \quad (\text{B22})$$

Stall margin:

$$\text{SM} = \left[\frac{\left(\overline{P_3/P_1} \right)_{\text{stall}} \left(\frac{w \sqrt{\theta}}{\delta} \right)_{\text{ref}}}{\left(\overline{P_3/P_1} \right)_{\text{ref}} \left(\frac{w \sqrt{\theta}}{\delta} \right)_{\text{stall}}} - 1 \right] \times 100 \quad (\text{B23})$$

Rotor polytropic efficiency:

$$\eta_p = \frac{\ln(\overline{P_2/P_1})^{(\gamma-1)/\gamma}}{\ln(\overline{T_2/T_1})} \quad (\text{B24})$$



Stage polytropic efficiency:

$$\eta_p = \frac{\ln(P_3/P_1)^{(\gamma-1)/\gamma}}{\ln(T_2/T_1)} \quad (B25)$$

APPENDIX C

DEFINITIONS AND UNITS USED IN TABLES

ABS	absolute
AERO CHORD	aerodynamic chord, cm
AREA RATIO	minimum value of ratio of flow area to critical area minus unity
BETAM	meridional air angle, deg
CHOKE MARGIN	ratio of actual flow area minus critical area to critical area (where local Mach number is 1)
CONE ANGLE	angle between axial direction and conical surface representing blade element, deg
DELTA INC	difference between mean camber blade angle and suction surface blade angle at leading edge, deg
DEV	deviation angle (defined by eq. (B3)), deg
D-FACT	diffusion factor (defined by eq. (B4))
EFF	adiabatic efficiency (defined by eq. (B9))
IN	inlet (leading edge of blade)
INCIDENCE	incidence angle (suction surface defined by eq. (B1) and mean surface by eq. (B2))
KIC	angle between blade mean camber line at leading edge and meridional plane, deg
KOC	angle between blade mean camber line at trailing edge and meridional plane, deg
KTC	angle between blade mean camber line at transition point and meridional plane, deg
LOSS COEFF	loss coefficient (total defined by eq. (B5) and profile by eq. (B6))
LOSS PARAM	loss parameter (total defined by eq. (B7) and profile by eq. (B8))
MERID	meridional
MERID VEL R	meridional velocity ratio
OUT	outlet (trailing edge of blade)
PERCENT SPAN	percent of blade span from tip at rotor outlet

PHISS	suction-surface camber ahead of assumed shock location, deg
PRESS	pressure, N/cm^2
PROF	profile
RADII	radius, cm
REL	relative to blade
RI	inlet radius (leading edge of blade), cm
RO	outlet radius (trailing edge of blade), cm
RP	radial position
RPM	equivalent rotative speed, rpm
SETTING ANGLE	angle between aerodynamic chord and meridional plane, deg
SOLIDITY	ratio of aerodynamic chord to blade spacing
SPEED	speed, m/sec
SS	suction surface
STREAMLINE SLOPE	slope of streamline, deg
TANG	tangential
TEMP	temperature, K
TI	thickness of blade at leading edge, cm
TM	thickness of blade at maximum thickness, cm
TO	thickness of blade at trailing edge, cm
TOT	total
TOTAL CAMBER	difference between inlet and outlet blade mean camber lines, deg
TURN RATE	ratio of change in blade angle per unit path distance for front blade segment to the change in blade angle per unit path distance for aft blade segment
VEL	velocity, m/sec
WT FLOW	equivalent weight flow, kg/sec
ZI	axial distance from inlet hub to blade leading edge, cm
ZMC	axial distance from inlet hub to blade maximum thickness point, cm

REFERENCES

1. Hauser, Cavour H.; et al.: Compressor and Turbine Technology. Aeronautical Propulsion, NASA SP-381, 1975, pp. 229-288.
2. Reid, Lonnie; Moore, Royce C.: Design and Overall Performance of Four Highly Leaded, High Speed Inlet Stages for an Advanced High Pressure Ratio Core Compressor, NASA TP-1337, 1978.
3. Urasek, Donald C.; and Janetzke, David C.: Performance of Tandem-Bladed Transonic Compressor Rotor with Rotor Tip Speed of 1375 Feet Per Second. NASA TM X-2484, 1972.

TABLE I. - DESIGN OVERALL PARAMETERS
FOR STAGE 35-35

ROTOR TOTAL PRESSURE RATIO	1.865
STAGE TOTAL PRESSURE RATIO	1.820
ROTOR TOTAL TEMPERATURE RATIO	1.225
STAGE TOTAL TEMPERATURE RATIO	1.225
ROTOR ADIABATIC EFFICIENCY865
STAGE ADIABATIC EFFICIENCY828
ROTOR POLYTROPIC EFFICIENCY877
STAGE POLYTROPIC EFFICIENCY842
ROTOR HEAD RISE COEFFICIENT273
STAGE HEAD RISE COEFFICIENT262
FLOW COEFFICIENT451
AIRFLOW PER UNIT FRONTAL AREA	100.808
AIRFLOW PER UNIT ANNULUS AREA	199.989
AIRFLOW	20.188
RPM	17188.700
TIP SPEED	454.456
HUB-TIP RADIUS RATIO70
ROTOR ASPECT RATIO	1.19
STATOR ASPECT RATIO	1.26
NUMBER OF ROTOR BLADES	36.0
NUMBER OF STATOR BLADES	46.0

TABLE II. - DESIGN BLADE-ELEMENT PARAMETERS

(a) For rotor 35

RP	RADII		ABS BETAM		REL BETAM		TOTAL TEMP		TOTAL PRESS	
	IN	OUT	IN	OUT	IN	OUT	IN	RATIO	IN	RATIO
TIP	25.248	24.511	.0	42.7	67.4	57.6	288.2	1.248	10.14	1.865
1	24.916	24.221	.0	42.4	66.6	57.0	288.2	1.244	10.14	1.865
2	24.571	23.931	.0	42.2	65.9	56.4	288.2	1.241	10.14	1.865
3	24.224	23.642	.0	42.1	65.1	55.8	288.2	1.238	10.14	1.865
4	23.163	22.772	.0	42.1	63.2	54.0	288.2	1.230	10.14	1.865
5	21.726	21.613	.0	42.4	61.3	50.8	288.2	1.223	10.14	1.865
6	20.221	20.454	.0	42.3	60.0	46.7	288.2	1.216	10.14	1.865
7	19.019	19.584	.0	42.6	59.5	42.6	288.2	1.214	10.14	1.865
8	18.596	19.294	.0	42.5	59.5	41.0	288.2	1.214	10.14	1.865
9	18.158	19.005	.0	42.3	59.6	39.2	288.2	1.213	10.14	1.865
HUB	17.780	18.715	.0	42.1	59.8	37.3	288.2	1.212	10.14	1.865

RP	ABS VEL		REL VEL		MERID VEL		TANG VEL		WHEEL SPEED	
	IN	OUT	IN	OUT	IN	OUT	IN	OUT	IN	OUT
TIP	189.1	240.4	492.2	329.7	189.1	176.8	.0	162.9	454.5	441.2
1	193.7	240.7	488.5	326.3	193.7	177.7	.0	162.3	448.5	436.0
2	198.2	241.1	484.7	322.7	198.2	178.6	.0	162.0	442.3	430.8
3	202.0	241.5	480.6	318.6	202.0	179.1	.0	162.0	436.0	425.5
4	210.3	242.6	467.0	305.8	210.3	179.9	.0	162.7	416.9	409.9
5	214.4	246.3	446.0	287.9	214.4	182.0	.0	166.0	391.1	389.0
6	210.4	252.7	420.4	272.3	210.4	186.8	.0	170.1	364.0	368.2
7	201.8	260.4	397.4	260.5	201.8	191.7	.0	176.2	342.3	352.5
8	177.4	263.8	389.6	257.5	197.4	194.3	.0	178.4	334.7	347.3
9	191.6	268.0	378.9	255.7	191.6	198.2	.0	180.5	326.8	342.1
HUB	186.5	272.5	370.4	254.3	186.5	202.2	.0	182.6	320.0	336.9

RP	ABS MACH NO		REL MACH NO		MERID MACH NO		STREAMLINE SLOPE		MERID VEL	PEAK SS
	IN	OUT	IN	OUT	IN	OUT	IN	OUT		
TIP	.574	.659	1.494	.904	.574	.485	-14.35	-14.21	.935	1.632
1	.589	.661	1.485	.897	.589	.488	-12.96	-12.50	.918	1.640
2	.603	.664	1.475	.888	.603	.492	-11.58	-10.88	.901	1.644
3	.616	.666	1.465	.878	.616	.494	-10.28	-9.42	.887	1.638
4	.643	.671	1.428	.846	.643	.498	-6.68	-5.63	.856	1.592
5	.657	.685	1.366	.800	.657	.506	-1.98	-.92	.849	1.567
6	.643	.706	1.286	.761	.643	.522	2.91	3.55	.888	1.603
7	.615	.731	1.212	.731	.615	.538	7.05	6.68	.950	1.596
8	.601	.741	1.183	.724	.601	.546	8.61	7.57	.985	1.580
9	.582	.755	1.151	.720	.582	.558	10.32	8.29	1.034	1.564
HUB	.565	.769	1.123	.718	.565	.571	11.82	8.97	1.085	1.554

RP	PERCENT SPAN		INCIDENCE MEAN		DEV	D-FACT	EFF	LOSS COEFF		LOSS PARAM	
	SPAN	MEAN	SS	TOT				PROF	TOT	PROF	
TIP	.00	4.7	2.6	4.2	.456	.785	.185	.059	.038	.012	
1	5.00	5.0	2.6	4.3	.457	.797	.175	.048	.036	.010	
2	10.00	5.2	2.5	4.3	.459	.809	.165	.039	.034	.008	
3	15.00	5.3	2.3	4.4	.461	.819	.157	.035	.033	.007	
4	30.00	4.9	1.5	5.3	.469	.846	.135	.030	.029	.006	
5	50.00	5.1	.9	6.5	.480	.874	.116	.026	.025	.006	
6	70.00	6.3	.7	7.5	.482	.901	.097	.012	.021	.003	
7	85.00	7.1	.6	9.2	.480	.908	.097	.025	.021	.005	
8	90.00	7.4	.5	9.9	.475	.911	.097	.033	.022	.007	
9	95.00	7.7	.5	10.5	.466	.914	.098	.041	.022	.009	
HUB	100.00	8.0	.5	11.3	.457	.917	.097	.046	.022	.010	

TABLE II. - Concluded. DESIGN BLADE-ELEMENT PARAMETERS

(b) For stator 35

RP	RADII		ABS BETAM		REL BETAM		TOTAL TEMP		TOTAL	PRESS
	IN	OUT	IN	OUT	IN	OUT	IN	RATIO	IN	RATIO
TIP	24.262	24.011	38.9	9.3	38.9	9.3	359.7	1.000	18.91	.974
1	23.993	23.752	39.0	9.3	39.0	9.3	358.6	1.000	18.91	.975
2	23.737	23.524	39.0	9.3	39.0	9.3	357.6	1.000	18.91	.976
3	23.479	23.294	39.1	9.3	39.1	9.3	356.7	1.000	18.91	.977
4	22.685	22.593	39.4	9.5	39.4	9.5	354.5	1.000	18.91	.978
5	21.607	21.656	39.9	9.8	39.9	9.8	352.4	1.000	18.91	.977
6	20.506	20.708	40.3	10.3	40.3	10.3	350.5	1.000	18.91	.975
7	19.670	19.989	41.1	10.6	41.1	10.6	350.0	1.000	18.91	.973
8	19.387	19.747	41.4	10.7	41.4	10.7	349.8	1.000	18.91	.972
9	19.102	19.505	41.7	10.8	41.7	10.8	349.6	1.000	18.91	.971
HUB	18.821	19.238	42.1	10.9	42.1	10.9	349.4	1.000	18.91	.969

RP	ABS VEL		REL VEL		MERID VEL		TANG VEL		WHEEL	SPEED
	IN	OUT	IN	OUT	IN	OUT	IN	OUT	IN	OUT
TIP	262.2	212.2	262.2	212.2	204.0	209.4	164.7	34.3	.0	.0
1	260.6	214.4	260.6	214.4	202.6	211.6	163.9	34.7	.0	.0
2	259.3	216.2	259.3	216.2	201.5	213.3	163.3	35.0	.0	.0
3	258.5	217.6	258.5	217.6	200.5	214.7	163.2	35.3	.0	.0
4	257.3	220.3	257.3	220.3	198.8	217.3	163.3	36.4	.0	.0
5	258.6	222.2	258.6	222.2	198.3	219.0	166.0	38.0	.0	.0
6	262.2	223.4	262.2	223.4	199.9	219.8	169.7	39.8	.0	.0
7	266.7	224.3	266.7	224.3	200.9	220.4	175.4	41.2	.0	.0
8	268.3	224.6	268.3	224.6	201.1	220.7	177.5	41.7	.0	.0
9	269.7	225.0	269.7	225.0	201.2	221.0	179.6	42.2	.0	.0
HUB	271.1	225.4	271.1	225.4	201.3	221.3	181.6	42.8	.0	.0

RP	ABS MACH NO		REL MACH NO		MERID MACH NO		STREAMLINE SLOPE		MERID	PEAK SS
	IN	OUT	IN	OUT	IN	OUT	IN	OUT	VEL R	MACH NO
TIP	.725	.577	.725	.577	.564	.569	-8.56	-3.93	1.027	1.118
1	.722	.584	.722	.584	.561	.576	-7.53	-3.41	1.044	1.109
2	.719	.590	.719	.590	.558	.582	-6.58	-2.97	1.059	1.104
3	.717	.595	.717	.595	.556	.587	-5.70	-2.53	1.071	1.101
4	.716	.605	.716	.605	.553	.597	-3.25	-1.27	1.093	1.098
5	.722	.612	.722	.612	.554	.603	.09	.42	1.104	1.111
6	.736	.618	.736	.618	.561	.608	3.46	2.20	1.100	1.127
7	.750	.621	.750	.621	.565	.610	5.79	3.72	1.097	1.151
8	.755	.622	.755	.622	.566	.611	6.42	4.30	1.097	1.158
9	.760	.623	.760	.623	.567	.612	6.87	4.93	1.098	1.164
HUB	.765	.625	.765	.625	.568	.614	7.27	5.63	1.100	1.169

RP	PERCENT	INCIDENCE	DEV	D-FACT	EFF	LOSS	COEFF	LOSS	PARAM	
	SPAN	MEAN	SS			TOT	PROF	TOT	PROF	
TIP	.00	4.7	-3.2	6.8	.384	.000	.091	.091	.035	.035
1	5.00	4.6	-3.1	6.8	.369	.000	.085	.085	.032	.032
2	10.00	4.5	-2.9	6.8	.357	.000	.081	.081	.031	.031
3	15.00	4.4	-2.7	6.8	.347	.000	.079	.079	.030	.030
4	30.00	4.3	-2.1	6.7	.329	.000	.076	.076	.028	.028
5	50.00	4.2	-1.3	6.7	.321	.000	.079	.079	.028	.028
6	70.00	3.9	-.7	6.8	.323	.000	.083	.083	.029	.029
7	85.00	3.7	-.3	7.0	.332	.000	.088	.088	.030	.030
8	90.00	3.6	-.2	7.1	.335	.000	.090	.090	.030	.030
9	95.00	3.5	-.0	7.2	.337	.000	.093	.093	.031	.031
HUB	100.00	3.5	.1	7.3	.339	.000	.095	.095	.032	.032

TABLE III. - BLADE GEOMETRY

(a) For rotor 35

RP	PERCENT RADII		BLADE ANGLES			DELTA INC	CONE ANGLE
	SPAN	RI RG	KIC	KTC	KOC		
TIP	0.	25.248 24.511	62.55	62.99	53.21	2.09	-15.764
1	5.	24.916 24.221	61.52	61.84	52.53	2.41	-14.327
2	10.	24.571 23.931	60.55	60.74	51.87	2.72	-12.780
3	15.	24.224 23.642	59.80	59.85	51.23	2.96	-11.326
4	30.	23.163 22.772	58.34	57.74	48.54	3.41	-7.137
5	50.	21.726 21.613	56.16	54.31	44.26	4.21	-1.890
6	70.	20.221 20.454	53.70	49.53	39.16	5.51	3.545
7	85.	19.019 19.584	52.28	47.30	33.31	6.56	8.150
8	90.	18.596 19.294	52.00	46.85	30.96	6.86	9.887
9	95.	18.158 19.005	51.82	46.50	28.36	7.18	11.763
HUB	100.	17.780 18.715	51.69	46.24	25.70	7.46	12.787

RP	BLADE THICKNESSES			AXIAL DIMENSIONS			
	TI	TM	TO	ZI	ZMC	ZTC	ZO
TIP	.025	.175	.025	.698	2.410	2.379	3.308
1	.027	.187	.027	.635	2.531	2.345	3.354
2	.028	.199	.028	.576	2.313	2.301	3.398
3	.029	.212	.029	.529	2.269	2.242	3.438
4	.032	.252	.032	.417	2.188	2.051	3.542
5	.037	.305	.038	.280	2.133	1.896	3.701
6	.042	.361	.043	.129	2.045	1.749	3.884
7	.047	.408	.047	.058	1.992	1.715	4.007
8	.048	.425	.049	.037	1.967	1.646	4.046
9	.050	.443	.050	.017	1.940	1.579	4.082
HUB	.051	.458	.051	.000	1.915	1.520	4.118

RP	AERO CHORD	SETTING ANGLE	TOTAL CAMBER	SOLIDITY	TURN RATE	PHISS	CHOKE MARGIN
TIP	5.609	61.25	9.34	1.292	-.022	1.45	.028
1	5.608	60.14	8.98	1.308	-.018	1.99	.030
2	5.604	59.08	8.68	1.324	-.012	2.47	.032
3	5.599	58.17	8.56	1.340	-.003	2.80	.033
4	5.583	55.84	9.80	1.393	.052	3.36	.035
5	5.572	52.30	11.91	1.473	.180	4.97	.037
6	5.574	47.75	14.54	1.570	.461	8.41	.059
7	5.594	44.71	18.96	1.661	.421	10.33	.043
8	5.605	43.65	21.05	1.695	.408	10.60	.041
9	5.621	42.56	23.46	1.733	.391	10.92	.043
HUB	5.622	41.50	25.99	1.765	.376	11.19	.046

TABLE III. - Concluded. BLADE GEOMETRY

(b) For stator 35

RP	PERCENT		RADII		BLADE ANGLES			DELTA	CONC
	SPAN	RI	RO	KTC	KTC	KOC	INC	ANGLE	
TIP	0.	24.262	24.011	34.52	23.62	2.52	7.88	-3.556	
1	5.	23.993	23.752	34.59	23.74	2.54	7.62	-3.430	
2	10.	23.737	23.524	34.67	23.86	2.57	7.38	-3.053	
3	15.	23.479	23.294	34.81	23.99	2.59	7.14	-2.660	
4	20.	22.685	22.593	35.09	24.31	2.80	6.41	-1.340	
5	50.	21.607	21.656	35.72	24.93	3.11	5.49	.732	
6	70.	20.506	20.708	36.43	25.74	3.44	4.63	3.104	
7	85.	19.670	19.989	37.48	26.73	3.54	3.99	5.031	
8	90.	19.387	19.747	37.85	27.15	3.57	3.78	5.719	
9	95.	19.102	19.505	38.23	27.60	3.59	3.57	6.447	
HUB	100.	18.821	19.238	38.62	28.05	3.62	3.36	6.725	

RP	BLADE THICKNESSES			AXIAL DIMENSIONS			
	TI	TM	TO	ZI	ZMC	ZTC	ZO
TIP	.026	.324	.026	4.598	6.524	5.884	8.644
1	.025	.315	.025	4.608	6.527	5.888	8.630
2	.025	.306	.025	4.617	6.530	5.892	8.618
3	.025	.297	.025	4.628	6.533	5.898	8.607
4	.025	.270	.025	4.662	6.544	5.913	8.571
5	.024	.234	.024	4.711	6.555	5.936	8.523
6	.024	.200	.024	4.768	6.565	5.961	8.479
7	.023	.174	.023	4.818	6.572	5.992	8.443
8	.023	.166	.023	4.837	6.575	6.002	8.432
9	.023	.158	.023	4.856	6.577	6.013	8.420
HUB	.023	.150	.023	4.875	6.580	6.025	8.407

RP	AERO	SETTING	TOTAL	SOLIDITY	TURN	PHISS	CHOKE
	CHORD	ANGLE	CAMBER		RATE		MARGIN
TIP	4.273	18.48	32.00	1.296	1.005	16.34	.105
1	4.250	18.56	32.04	1.303	.993	16.06	.110
2	4.227	18.66	32.10	1.310	.982	15.83	.113
3	4.205	18.77	32.22	1.316	.975	15.64	.116
4	4.136	19.08	32.29	1.337	.960	14.97	.120
5	4.046	19.66	32.61	1.369	.938	14.29	.125
6	3.961	20.34	32.99	1.407	.904	13.59	.122
7	3.899	21.13	33.94	1.440	.860	13.24	.118
8	3.880	21.45	34.28	1.452	.836	13.05	.116
9	3.861	21.78	34.64	1.464	.811	12.84	.114
HUB	3.838	22.11	35.00	1.477	.786	12.64	.112

TABLE IV. - OVERALL PERFORMANCE FOR STAGE 35

(a) 100 Percent of design speed

Parameters	Reading					
	4004	3978	3977	3974	3976	3975
ROTOR TOTAL PRESSURE RATIO	1.738	1.875	1.955	1.985	2.036	2.014
STATOR TOTAL PRESSURE RATIO	0.986	0.982	0.974	0.968	0.945	0.959
ROTOR TOTAL TEMPERATURE RATIO	1.198	1.226	1.245	1.254	1.277	1.263
STATOR TOTAL TEMPERATURE RATIO	1.000	1.000	1.000	1.000	1.001	1.000
ROTOR ADIABATIC EFFICIENCY	0.865	0.872	0.863	0.853	0.812	0.841
ROTOR MOMENTUM-RISE EFFICIENCY	0.861	0.869	0.859	0.853	0.808	0.836
ROTOR HEAD-RISE COEFFICIENT	0.286	0.341	0.371	0.380	0.402	0.391
FLOW COEFFICIENT	0.412	0.412	0.402	0.390	0.340	0.373
AIRFLOW PER UNIT FRONTAL AREA	101.42	100.77	99.15	97.42	88.08	94.57
AIRFLOW PER UNIT ANNULUS AREA	190.55	189.33	186.28	183.03	165.49	177.67
AIRFLOW AT ORIFICE	20.95	20.82	20.48	20.13	18.20	19.54
AIRFLOW AT ROTOR INLET	21.10	21.00	20.64	20.27	18.26	19.64
AIRFLOW AT ROTOR OUTLET	20.97	20.83	20.50	20.14	18.21	19.55
AIRFLOW AT STATOR OUTLET	20.08	19.92	19.49	19.11	16.98	18.41
ROTATIVE SPEED	17220.2	17119.1	17125.1	17196.8	17218.5	17224.5
PERCENT OF DESIGN SPEED	100.2	99.6	99.6	100.0	100.2	100.2
Compressor performance						
STAGE TOTAL PRESSURE RATIO	1.714	1.842	1.905	1.922	1.923	1.932
STAGE TOTAL TEMPERATURE RATIO	1.198	1.225	1.244	1.253	1.279	1.263
STAGE ADIABATIC EFFICIENCY	0.841	0.845	0.827	0.810	0.737	0.786

(b) 90 Percent of design speed

Parameters	Reading				
	3979	3982	3983	3984	3985
ROTOR TOTAL PRESSURE RATIO	1.591	1.680	1.729	1.748	1.781
STATOR TOTAL PRESSURE RATIO	0.989	0.988	0.982	0.979	0.965
ROTOR TOTAL TEMPERATURE RATIO	1.160	1.182	1.196	1.202	1.218
STATOR TOTAL TEMPERATURE RATIO	1.000	1.000	1.000	1.000	1.000
ROTOR ADIABATIC EFFICIENCY	0.888	0.879	0.864	0.854	0.823
ROTOR MOMENTUM-RISE EFFICIENCY	0.886	0.877	0.863	0.852	0.821
ROTOR HEAD-RISE COEFFICIENT	0.286	0.327	0.351	0.360	0.378
FLOW COEFFICIENT	0.416	0.399	0.379	0.369	0.338
AIRFLOW PER UNIT FRONTAL AREA	94.39	91.83	88.31	86.24	80.39
AIRFLOW PER UNIT ANNULUS AREA	177.34	172.53	165.92	162.02	151.04
AIRFLOW AT ORIFICE	19.50	18.97	18.24	17.82	16.61
AIRFLOW AT ROTOR INLET	19.66	19.09	18.33	17.93	16.68
AIRFLOW AT ROTOR OUTLET	19.51	18.98	18.25	17.83	16.62
AIRFLOW AT STATOR OUTLET	18.60	18.08	17.24	16.81	15.45
ROTATIVE SPEED	15451.3	15477.7	15467.9	15473.4	15474.3
PERCENT OF DESIGN SPEED	89.9	90.0	90.0	90.0	90.0
Compressor performance					
STAGE TOTAL PRESSURE RATIO	1.574	1.660	1.698	1.711	1.719
STAGE TOTAL TEMPERATURE RATIO	1.160	1.182	1.196	1.202	1.218
STAGE ADIABATIC EFFICIENCY	0.865	0.858	0.835	0.820	0.768

TABLE IV. - Continued. OVERALL PERFORMANCE FOR STAGE 35

(c) 80 Percent of design speed

Parameters	Reading
	3987
ROTOR TOTAL PRESSURE RATIO	1.571
STATOR TOTAL PRESSURE RATIO	0.977
ROTOR TOTAL TEMPERATURE RATIO	1.168
STATOR TOTAL TEMPERATURE RATIO	1.000
ROTOR ADIABATIC EFFICIENCY	0.818
ROTOR MOMENTUM-RISE EFFICIENCY	0.817
ROTOR HEAD-RISE COEFFICIENT	0.351
FLOW COEFFICIENT	0.322
AIRFLOW PER UNIT FRONTAL AREA	69.30
AIRFLOW PER UNIT ANNULUS AREA	130.19
AIRFLOW AT ORIFICE	14.32
AIRFLOW AT ROTOR INLET	14.48
AIRFLOW AT ROTOR OUTLET	14.32
AIRFLOW AT STATOR OUTLET	13.55
ROTATIVE SPEED	13774.4
PERCENT OF DESIGN SPEED	80.1
Compressor performance	
STAGE TOTAL PRESSURE RATIO	1.535
STAGE TOTAL TEMPERATURE RATIO	1.168
STAGE ADIABATIC EFFICIENCY	0.774

(d) 70 Percent of design speed

Parameters	Reading				
	3995	3994	3993	3990	3989
ROTOR TOTAL PRESSURE RATIO	1.264	1.300	1.343	1.356	1.375
STATOR TOTAL PRESSURE RATIO	0.989	0.993	0.993	0.992	0.982
ROTOR TOTAL TEMPERATURE RATIO	1.076	1.087	1.101	1.108	1.120
STATOR TOTAL TEMPERATURE RATIO	1.000	1.000	1.000	1.000	1.000
ROTOR ADIABATIC EFFICIENCY	0.905	0.893	0.873	0.840	0.793
ROTOR MOMENTUM-RISE EFFICIENCY	0.899	0.895	0.871	0.842	0.794
ROTOR HEAD-RISE COEFFICIENT	0.212	0.240	0.275	0.288	0.306
FLOW COEFFICIENT	0.407	0.393	0.366	0.340	0.296
AIRFLOW PER UNIT FRONTAL AREA	76.53	74.11	69.63	64.93	57.06
AIRFLOW PER UNIT ANNULUS AREA	143.78	139.23	130.82	121.99	107.19
AIRFLOW AT ORIFICE	15.81	15.31	14.38	13.41	11.79
AIRFLOW AT ROTOR INLET	15.87	15.37	14.46	13.50	11.86
AIRFLOW AT ROTOR OUTLET	15.81	15.31	14.39	13.42	11.79
AIRFLOW AT STATOR OUTLET	15.12	14.60	13.74	12.78	11.15
ROTATIVE SPEED	12074.9	12074.5	12073.2	12040.8	12022.9
PERCENT OF DESIGN SPEED	70.2	70.2	70.2	70.1	69.9
Compressor performance					
STAGE TOTAL PRESSURE RATIO	1.250	1.291	1.334	1.345	1.350
STAGE TOTAL TEMPERATURE RATIO	1.077	1.087	1.101	1.108	1.120
STAGE ADIABATIC EFFICIENCY	0.860	0.868	0.852	0.816	0.744

TABLE IV. - Concluded. OVERALL PERFORMANCE

FOR STAGE 35

(e) 60 Percent of design speed

Parameters	Reading
	3997
ROTOR TOTAL PRESSURE RATIO	1.275
STATOR TOTAL PRESSURE RATIO	0.989
ROTOR TOTAL TEMPERATURE RATIO	1.089
STATOR TOTAL TEMPERATURE RATIO	1.000
ROTOR ADIABATIC EFFICIENCY	0.810
ROTOR MOMENTUM-RISE EFFICIENCY	0.810
ROTOR HEAD-RISE COEFFICIENT	0.297
FLOW COEFFICIENT	0.300
AIRFLOW PER UNIT FRONTAL AREA	50.81
AIRFLOW PER UNIT ANNULUS AREA	95.46
AIRFLOW AT ORIFICE	10.50
AIRFLOW AT ROTOR INLET	10.54
AIRFLOW AT ROTOR OUTLET	10.50
AIRFLOW AT STATOR OUTLET	9.99
ROTATIVE SPEED	10453.2
PERCENT OF DESIGN SPEED	60.8
Compressor performance	
STAGE TOTAL PRESSURE RATIO	1.262
STAGE TOTAL TEMPERATURE RATIO	1.089
STAGE ADIABATIC EFFICIENCY	0.771

(f) 50 Percent of design speed

Parameters	Reading
	4000
ROTOR TOTAL PRESSURE RATIO	1.174
STATOR TOTAL PRESSURE RATIO	0.995
ROTOR TOTAL TEMPERATURE RATIO	1.057
STATOR TOTAL TEMPERATURE RATIO	1.000
ROTOR ADIABATIC EFFICIENCY	0.820
ROTOR MOMENTUM-RISE EFFICIENCY	0.820
ROTOR HEAD-RISE COEFFICIENT	0.279
FLOW COEFFICIENT	0.307
AIRFLOW PER UNIT FRONTAL AREA	43.51
AIRFLOW PER UNIT ANNULUS AREA	81.75
AIRFLOW AT ORIFICE	8.99
AIRFLOW AT ROTOR INLET	8.96
AIRFLOW AT ROTOR OUTLET	8.99
AIRFLOW AT STATOR OUTLET	8.47
ROTATIVE SPEED	8582.4
PERCENT OF DESIGN SPEED	49.9
Compressor performance	
STAGE TOTAL PRESSURE RATIO	1.168
STAGE TOTAL TEMPERATURE RATIO	1.057
STAGE ADIABATIC EFFICIENCY	0.792

TABLE V. - BLADE-ELEMENT DATA AT BLADE EDGES FOR ROTOR 35

(a) 100 Percent of design speed; reading 4004

RP	RADII		ABS BETAM		REL. BETAM		TOTAL TEMP		TOTAL PRESS	
	IN	OUT	IN	OUT	IN	OUT	IN	RATIO	IN	RATIO
1	24.915	24.221	-0.1	35.4	67.0	59.4	288.9	1.194	9.92	1.657
2	24.572	23.932	-0.0	34.8	64.4	57.3	288.1	1.198	10.13	1.669
3	24.224	23.642	-0.0	34.3	63.5	56.2	288.1	1.195	10.14	1.692
4	23.162	22.771	-0.0	34.5	61.3	54.1	288.5	1.193	10.13	1.710
5	21.725	21.613	-0.1	36.3	59.2	49.5	287.9	1.203	10.15	1.767
6	20.221	20.455	-0.0	37.0	57.6	45.0	288.1	1.203	10.15	1.798
7	19.029	19.583	-0.0	37.3	56.5	42.5	288.2	1.193	10.15	1.751
8	18.575	19.294	-0.0	37.8	56.4	41.7	287.9	1.195	10.15	1.737
9	18.158	19.004	-0.1	38.9	56.3	39.2	288.0	1.201	10.12	1.743

RP	ABS VEL		REL VEL		MERID VEL		TANG VEL		WHEEL SPEED	
	IN	OUT	IN	OUT	IN	OUT	IN	OUT	IN	OUT
1	190.9	223.9	489.5	358.1	190.9	182.5	-0.3	129.7	450.4	437.9
2	211.0	232.2	489.0	353.2	211.0	190.8	-0.1	132.4	441.1	429.6
3	216.7	236.4	486.1	350.7	216.7	195.2	-0.0	133.4	435.2	424.7
4	229.1	241.7	477.5	339.7	229.1	199.3	-0.0	136.7	418.9	411.8
5	234.5	254.6	458.2	316.0	234.5	205.1	-0.4	150.8	393.2	391.1
6	231.8	264.3	433.1	298.5	231.8	211.1	-0.0	159.0	365.8	370.0
7	226.2	263.7	409.8	284.6	226.2	209.9	-0.1	159.6	341.7	351.8
8	223.6	265.1	404.1	280.8	223.6	209.6	-0.1	162.3	336.6	349.2
9	218.2	270.6	392.8	271.5	218.2	210.5	-0.4	170.0	326.2	341.4

RP	ABS MACH NO		REL MACH NO		MERID MACH NO		MERID PEAK SS	
	IN	OUT	IN	OUT	IN	OUT	VEL R	MACH NO
1	0.579	0.624	1.484	0.998	0.579	0.509	0.956	1.653
2	0.645	0.649	1.496	0.987	0.645	0.533	0.904	1.616
3	0.664	0.663	1.490	0.983	0.664	0.547	0.901	1.609
4	0.706	0.679	1.470	0.955	0.706	0.560	0.870	1.569
5	0.725	0.717	1.416	0.889	0.725	0.577	0.875	1.546
6	0.715	0.747	1.336	0.843	0.715	0.596	0.911	1.571
7	0.696	0.748	1.261	0.807	0.696	0.596	0.928	1.539
8	0.688	0.752	1.243	0.797	0.688	0.595	0.937	1.527
9	0.670	0.767	1.205	0.770	0.670	0.597	0.965	1.494

RP	PERCENT SPAN		INCIDENCE MEAN SS		DEV	D FACT	EFF	LOSS COEFF		LOSS PARAM	
	TOT	PROF	TOT	PROF				TOT	PROF		
1	5.00	5.4	3.0	6.6	0.369	0.799	0.145	0.016	0.028	0.003	
2	10.00	3.8	1.1	5.3	0.379	0.794	0.151	0.028	0.031	0.006	
3	15.00	3.7	0.7	4.8	0.380	0.831	0.123	0.004	0.026	0.001	
4	30.00	3.0	-0.4	5.5	0.391	0.859	0.105	-0.002	0.022	-0.000	
5	50.00	3.1	-1.2	5.2	0.422	0.872	0.105	0.013	0.023	0.003	
6	70.00	3.9	-1.6	5.8	0.428	0.900	0.090	0.004	0.020	0.001	
7	85.00	4.2	-2.4	9.1	0.425	0.899	0.093	0.026	0.021	0.006	
8	90.00	4.3	-2.5	10.6	0.426	0.878	0.116	0.053	0.025	0.012	
9	95.00	4.3	-2.9	10.5	0.437	0.855	0.147	0.095	0.033	0.021	

TABLE V. - Continued. BLADE-ELEMENT DATA AT BLADE EDGES

FOR ROTOR 35

(b) 100 Percent of design speed; reading 3978

RP	RADII		ABS BETAM		REL BETAM		TOTAL TEMP		TOTAL PRESS	
	IN	OUT	IN	OUT	IN	OUT	IN	RATIO	IN	RATIO
1	24.915	24.221	-0.1	42.4	67.2	58.4	288.8	1.233	9.91	1.819
2	24.572	23.932	-0.1	41.6	64.6	56.6	288.1	1.234	10.14	1.817
3	24.224	23.642	-0.1	40.2	63.7	55.6	288.2	1.227	10.14	1.836
4	23.162	22.771	0.0	39.7	61.3	53.0	288.4	1.220	10.13	1.849
5	21.725	21.613	-0.0	42.0	59.2	48.0	287.9	1.231	10.15	1.896
6	20.221	20.455	-0.0	42.1	57.7	43.1	287.9	1.228	10.15	1.923
7	19.020	19.583	-0.1	41.4	56.7	40.8	288.3	1.214	10.15	1.882
8	18.595	19.294	-0.1	41.9	56.4	39.1	288.0	1.216	10.15	1.877
9	18.158	19.004	0.0	43.2	56.3	36.1	288.1	1.225	10.12	1.899

RP	ABS VEL		REL VEL		MERID VEL		TANG VEL		WHEEL SPEED	
	IN	OUT	IN	OUT	IN	OUT	IN	OUT	IN	OUT
1	188.4	231.7	465.3	326.5	188.4	171.1	-0.4	156.3	446.8	434.4
2	209.5	238.4	498.1	324.3	209.5	178.4	-0.4	158.2	440.4	429.0
3	214.7	240.6	485.0	325.7	214.7	183.9	-0.5	155.2	434.4	424.0
4	227.4	245.8	473.3	314.5	227.4	189.3	0.0	156.9	415.1	408.1
5	232.4	258.9	453.5	288.1	232.4	192.6	-0.1	173.1	389.3	387.3
6	229.4	268.8	429.0	273.0	229.4	199.5	-0.1	180.1	362.4	366.6
7	224.3	268.3	408.6	265.9	224.3	201.3	-0.5	177.5	341.1	351.2
8	221.8	271.5	400.6	260.4	221.8	202.0	-0.5	181.4	333.2	345.7
9	217.0	280.0	391.3	252.7	217.0	204.1	0.0	191.8	325.7	340.8

RP	ABS MACH NO		REL MACH NO		MERID MACH NO		MERID PEAK SS	
	IN	OUT	IN	OUT	IN	OUT	VEL R	MACH NO
1	0.571	0.637	1.470	0.897	0.571	0.470	0.908	1.643
2	0.640	0.658	1.492	0.894	0.640	0.492	0.852	1.617
3	0.657	0.666	1.485	0.901	0.657	0.509	0.856	1.610
4	0.700	0.683	1.457	0.874	0.700	0.526	0.832	1.554
5	0.717	0.721	1.400	0.802	0.717	0.536	0.829	1.529
6	0.707	0.752	1.323	0.764	0.707	0.558	0.870	1.560
7	0.690	0.755	1.256	0.748	0.690	0.567	0.897	1.541
8	0.681	0.765	1.231	0.733	0.681	0.569	0.911	1.516
9	0.665	0.788	1.200	0.711	0.665	0.575	0.941	1.492

RP	PERCENT SPAN	INCIDENCE		DEV	D FACT	EFF	LOSS COEFF		LOSS PARAM	
		MEAN	SS				TOT	PROF	TOT	PROF
1	5.00	5.5	3.1	5.7	0.449	0.799	0.168	0.044	0.034	0.009
2	10.00	3.9	1.2	4.6	0.457	0.797	0.169	0.048	0.035	0.010
3	15.00	3.8	0.9	4.2	0.447	0.835	0.137	0.018	0.029	0.004
4	30.00	2.9	-0.5	4.4	0.453	0.870	0.109	0.008	0.024	0.002
5	50.00	3.0	-1.2	3.8	0.494	0.867	0.123	0.036	0.028	0.008
6	70.00	4.0	-1.5	3.9	0.498	0.901	0.098	0.017	0.023	0.004
7	85.00	4.4	-2.2	7.4	0.482	0.927	0.074	0.007	0.017	0.001
8	90.00	4.3	-2.6	8.0	0.486	0.912	0.093	0.034	0.021	0.008
9	95.00	4.4	-2.8	7.5	0.499	0.893	0.120	0.070	0.028	0.016

TABLE V. - Continued. BLADE-ELEMENT DATA AT BLADE EDGES

FOR ROTOR 35

(c) 100 Percent of design speed; reading 3977

RP	RADII		ABS BETAM		REL BETAM		TOTAL TEMP		TOTAL PRESS	
	IN	OUT	IN	OUT	IN	OUT	IN	RATIO	IN	RATIO
1	24.915	24.221	-0.0	46.4	67.7	57.8	288.0	1.259	9.92	1.929
2	24.572	23.932	-0.0	45.5	65.0	55.8	288.2	1.258	10.14	1.921
3	24.224	23.642	-0.1	44.4	64.3	54.6	288.1	1.254	10.14	1.939
4	23.162	22.771	-0.0	43.7	62.1	51.9	288.2	1.246	10.13	1.953
5	21.725	21.613	-0.1	45.1	60.1	47.5	288.1	1.248	10.15	1.967
6	20.221	20.455	-0.1	45.1	58.6	42.7	288.0	1.242	10.15	1.981
7	19.020	19.583	-0.0	44.2	57.5	40.2	288.2	1.227	10.15	1.938
8	18.595	19.294	-0.0	44.6	57.2	38.3	288.2	1.229	10.15	1.940
9	18.158	19.004	-0.1	45.6	57.1	35.2	288.2	1.236	10.12	1.965

RP	ABS VEL		REL VEL		MERID VEL		TANG VEL		WHEEL SPEED	
	IN	OUT	IN	OUT	IN	OUT	IN	OUT	IN	OUT
1	184.4	240.3	485.9	310.7	184.4	165.7	-0.1	174.1	449.4	436.9
2	205.1	245.9	485.9	306.7	205.1	172.4	-0.1	175.3	440.4	429.0
3	208.9	248.5	481.7	306.1	208.9	177.5	-0.4	173.9	433.6	423.2
4	219.9	252.9	469.7	296.3	219.9	182.9	-0.2	174.7	414.9	407.9
5	224.0	261.9	449.3	273.7	224.0	185.0	-0.5	185.3	389.0	387.0
6	221.2	269.6	425.0	258.8	221.2	190.1	-0.3	191.1	362.5	366.7
7	217.3	269.4	404.5	252.9	217.3	193.1	-0.1	187.9	341.1	351.2
8	215.3	273.6	397.0	248.1	215.3	194.7	-0.1	192.2	333.5	346.0
9	210.6	282.0	388.1	241.5	210.6	197.4	-0.5	201.4	325.5	340.6

RP	ABS MACH NO		REL MACH NO		MERID MACH NO		MERID PEAK SS	
	IN	OUT	IN	OUT	IN	OUT	VEL R	MACH NO
1	0.558	0.655	1.470	0.847	0.558	0.452	0.898	1.661
2	0.626	0.673	1.483	0.839	0.626	0.472	0.841	1.623
3	0.638	0.682	1.472	0.840	0.638	0.487	0.850	1.617
4	0.675	0.697	1.442	0.817	0.675	0.504	0.832	1.566
5	0.689	0.724	1.382	0.757	0.689	0.512	0.826	1.542
6	0.680	0.750	1.306	0.720	0.680	0.529	0.859	1.575
7	0.666	0.754	1.240	0.708	0.666	0.541	0.889	1.554
8	0.659	0.766	1.216	0.695	0.659	0.546	0.904	1.529
9	0.644	0.790	1.187	0.677	0.644	0.553	0.937	1.508

RP	PERCENT SPAN		INCIDENCE		DEV	D FACT	EFF	LOSS COEFF		LOSS PARAM	
	SPAN	MEAN	SS	SS				TOT	PROF	TOT	PROF
1	5.00	6.1	3.6	5.1	0.496	0.797	0.185	0.056	0.038	0.011	
2	10.00	4.4	1.7	3.7	0.503	0.795	0.185	0.063	0.039	0.013	
3	15.00	4.4	1.5	3.2	0.498	0.821	0.163	0.044	0.035	0.010	
4	30.00	3.7	0.3	3.3	0.502	0.858	0.131	0.029	0.029	0.006	
5	50.00	3.9	-0.3	3.2	0.531	0.862	0.136	0.050	0.031	0.011	
6	70.00	4.9	-0.6	3.6	0.535	0.891	0.115	0.033	0.027	0.008	
7	85.00	5.2	-1.4	6.8	0.517	0.918	0.089	0.021	0.020	0.005	
8	90.00	5.1	-1.8	7.2	0.521	0.911	0.100	0.040	0.023	0.009	
9	95.00	5.2	-2.0	6.5	0.531	0.901	0.117	0.066	0.028	0.016	

TABLE V. - Continued. BLADE-ELEMENT DATA AT BLADE EDGES

FOR ROTOR 35

(d) 100 Percent of design speed; reading 3974

RP	RADII		ABS BETAM		REL BETAM		TOTAL TEMP		TOTAL PRESS	
	IN	OUT	IN	OUT	IN	OUT	IN	RATIO	IN	RATIO
1	24.915	24.221	-0.1	48.7	68.6	57.4	288.8	1.275	9.93	1.980
2	24.572	23.932	0.0	47.7	65.9	55.5	287.9	1.274	10.13	1.967
3	24.224	23.642	-0.1	46.7	65.3	54.8	288.2	1.268	10.14	1.980
4	23.162	22.771	-0.0	45.5	63.2	52.2	288.4	1.257	10.12	1.987
5	21.725	21.613	0.0	46.2	60.9	48.0	288.1	1.255	10.15	1.996
6	20.221	20.455	-0.0	46.4	59.4	43.3	288.1	1.246	10.15	2.002
7	19.020	19.583	-0.0	45.8	58.3	40.8	287.9	1.234	10.16	1.956
8	18.595	19.294	-0.1	46.1	58.0	38.7	287.8	1.235	10.15	1.959
9	18.158	19.004	-0.0	46.0	57.9	35.7	288.1	1.241	10.12	1.987

RP	ABS VEL		REL VEL		MERID VEL		TANG VEL		WHEEL SPEED	
	IN	OUT	IN	OUT	IN	OUT	IN	OUT	IN	OUT
1	175.9	244.8	482.4	299.7	175.9	161.5	-0.3	184.0	448.9	436.4
2	196.3	249.0	481.4	296.0	196.3	167.6	0.0	184.2	439.6	428.2
3	201.2	251.1	481.3	298.5	201.2	172.3	-0.3	182.6	436.9	426.4
4	211.3	253.8	468.3	290.7	211.3	178.0	-0.1	180.9	417.8	410.7
5	218.3	261.4	448.4	270.3	218.3	180.8	0.0	188.7	391.7	389.7
6	215.9	268.3	423.8	254.1	215.9	184.9	-0.1	194.5	364.5	368.8
7	212.3	267.8	403.5	246.5	212.3	186.5	-0.1	192.1	343.0	353.2
8	209.7	272.3	395.4	241.8	209.7	188.7	-0.5	196.2	334.8	347.4
9	205.1	280.8	385.7	240.1	205.1	195.1	-0.0	202.0	326.7	341.9

RP	ABS MACH NO		REL MACH NO		MERID MACH NO		MERID VEL R	PEAK SS MACH NO
	IN	OUT	IN	OUT	IN	OUT		
1	0.530	0.664	1.455	0.812	0.530	0.438	0.918	1.678
2	0.597	0.678	1.465	0.806	0.597	0.456	0.854	1.636
3	0.613	0.685	1.466	0.815	0.613	0.470	0.856	1.644
4	0.646	0.696	1.432	0.798	0.646	0.488	0.842	1.594
5	0.670	0.720	1.375	0.745	0.670	0.498	0.828	1.562
6	0.662	0.744	1.299	0.705	0.662	0.513	0.856	1.594
7	0.650	0.747	1.235	0.688	0.650	0.521	0.879	1.575
8	0.641	0.761	1.209	0.676	0.641	0.527	0.900	1.551
9	0.626	0.785	1.177	0.671	0.626	0.546	0.951	1.527

RP	PERCENT SPAN	INCIDENCE MEAN	INCIDENCE SS	DEV	D FACT	EFF	LOSS TOT	COEFF PROF	LOSS TOT	PARAM PROF
	1	5.00	7.0	4.6	4.7	0.523	0.783	0.208	0.077	0.043
2	10.00	5.3	2.6	3.5	0.528	0.779	0.209	0.088	0.045	0.019
3	15.00	5.4	2.5	3.4	0.520	0.804	0.185	0.061	0.040	0.013
4	30.00	4.8	1.4	3.6	0.517	0.843	0.150	0.044	0.033	0.010
5	50.00	4.7	0.5	3.7	0.540	0.856	0.146	0.056	0.033	0.013
6	70.00	5.7	0.1	4.2	0.548	0.890	0.118	0.033	0.027	0.008
7	85.00	5.9	-0.6	7.4	0.535	0.904	0.107	0.035	0.024	0.008
8	90.00	5.9	-1.0	7.6	0.538	0.901	0.114	0.051	0.026	0.012
9	95.00	5.9	-1.2	7.0	0.532	0.901	0.120	0.067	0.028	0.016

TABLE V. - Continued. BLADE-ELEMENT DATA AT BLADE EDGES

FOR ROTOR 35

(e) 100 Percent of design speed; reading 3976

RP	RADII		ABS BETAM		REL BETAM		TOTAL TEMP		TOTAL PRESS	
	IN	OUT	IN	OUT	IN	OUT	IN	RATIO	IN	RATIO
1	24.915	24.221	-0.1	58.5	71.7	58.9	288.9	1.324	9.97	2.062
2	24.572	23.932	-0.0	57.2	69.7	57.7	288.6	1.316	10.13	2.031
3	24.224	23.642	-0.1	55.8	69.0	56.3	288.7	1.310	10.12	2.039
4	23.162	22.771	-0.1	53.0	67.3	52.7	288.5	1.291	10.11	2.048
5	21.725	21.613	-0.0	51.3	64.8	48.2	288.1	1.276	10.14	2.043
6	20.221	20.455	-0.1	49.9	62.7	43.9	287.9	1.259	10.16	2.031
7	19.020	19.583	-0.1	48.8	61.3	40.1	287.7	1.247	10.16	1.998
8	18.595	19.294	-0.1	48.4	61.0	37.5	287.5	1.248	10.16	2.017
9	18.158	19.004	-0.1	48.1	60.9	34.2	287.6	1.251	10.14	2.051

RP	ABS VEL		REL VEL		MERID VEL		TANG VEL		WHEEL SPEED	
	IN	OUT	IN	OUT	IN	OUT	IN	OUT	IN	OUT
1	148.8	254.0	473.2	256.7	148.8	132.6	-0.3	216.6	448.9	436.4
2	163.7	254.0	472.3	257.5	163.7	137.4	-0.1	213.6	442.9	431.4
3	167.5	255.2	468.2	258.6	167.5	143.4	-0.4	211.2	436.9	426.4
4	174.6	258.3	453.0	256.6	174.6	155.4	-0.4	206.3	417.6	410.5
5	184.3	263.5	433.2	247.3	184.3	164.9	-0.1	205.5	391.8	389.8
6	188.4	266.2	410.7	238.2	188.4	171.5	-0.3	203.6	364.7	368.9
7	187.9	270.2	391.4	232.8	187.9	178.0	-0.3	203.3	343.1	353.3
8	185.8	276.5	383.6	231.3	185.8	183.5	-0.4	206.9	335.2	347.8
9	182.6	285.9	375.3	231.0	182.6	191.0	-0.4	212.8	327.5	342.8

RP	ABS MACH NO		REL MACH NO		MERID MACH NO		MERID PEAK SS	
	IN	OUT	IN	OUT	IN	OUT	VEL R	MACH NO
1	0.445	0.677	1.416	0.684	0.445	0.353	0.891	1.744
2	0.492	0.680	1.420	0.689	0.492	0.368	0.840	1.720
3	0.504	0.685	1.409	0.694	0.504	0.385	0.856	1.715
4	0.527	0.699	1.367	0.695	0.527	0.421	0.890	1.671
5	0.558	0.720	1.312	0.676	0.558	0.451	0.895	1.636
6	0.572	0.734	1.246	0.657	0.572	0.473	0.911	1.659
7	0.570	0.751	1.188	0.647	0.570	0.495	0.948	1.639
8	0.564	0.770	1.164	0.644	0.564	0.511	0.987	1.618
9	0.553	0.798	1.137	0.645	0.553	0.533	1.046	1.598

RP	PERCENT SPAN	INCIDENCE		DEV	D FACT	EFF	LOSS COEFF		LOSS PARAM	
		MEAN	SS				TOT	PROF	TOT	PROF
1	5.00	10.1	7.6	6.2	0.630	0.708	0.314	0.173	0.062	0.034
2	10.00	9.1	6.4	5.7	0.623	0.710	0.308	0.172	0.062	0.035
3	15.00	9.2	6.2	4.9	0.614	0.729	0.287	0.155	0.059	0.032
4	30.00	9.0	5.6	4.1	0.596	0.781	0.236	0.122	0.051	0.027
5	50.00	8.7	4.4	3.9	0.590	0.822	0.198	0.102	0.045	0.023
6	70.00	9.0	3.5	4.8	0.579	0.867	0.153	0.062	0.035	0.014
7	85.00	9.0	2.4	6.7	0.564	0.885	0.139	0.061	0.032	0.014
8	90.00	8.9	2.1	6.4	0.559	0.894	0.132	0.063	0.031	0.015
9	95.00	8.9	1.8	5.6	0.552	0.907	0.122	0.060	0.029	0.014

TABLE V. - Continued. BLADE-ELEMENT DATA AT BLADE EDGES

FOR ROTOR 35

(f) 100 Percent of design speed; reading 3975

RP	RADII		ABS BETAM		REL BETAM		TOTAL TEMP		TOTAL PRESS	
	IN	OUT	IN	OUT	IN	OUT	IN	RATIO	IN	RATIO
1	24.915	24.221	-0.0	52.2	69.6	57.8	288.5	1.295	9.95	2.013
2	24.572	23.932	-0.0	51.1	67.4	56.2	288.0	1.290	10.13	2.002
3	24.224	23.642	-0.1	49.9	66.7	54.9	288.3	1.284	10.13	2.014
4	23.162	22.771	-0.0	48.2	64.7	52.0	288.5	1.270	10.12	2.026
5	21.725	21.613	-0.1	48.3	62.2	47.8	288.1	1.264	10.15	2.022
6	20.221	20.455	0.0	47.8	60.4	43.6	288.1	1.251	10.15	2.019
7	19.020	19.583	-0.1	47.1	59.2	40.6	287.8	1.240	10.15	1.977
8	18.595	19.294	-0.1	47.3	58.9	38.2	287.8	1.241	10.16	1.989
9	18.158	19.004	-0.1	47.3	58.8	34.9	288.0	1.246	10.13	2.024

RP	ABS VEL		REL VEL		MERID VEL		TANG VEL		WHEEL SPEED	
	IN	OUT	IN	OUT	IN	OUT	IN	OUT	IN	OUT
1	166.9	247.5	479.0	284.6	166.9	151.7	-0.1	195.6	448.8	436.3
2	184.6	251.7	480.1	283.6	184.6	157.9	-0.0	196.0	443.2	431.6
3	188.5	253.6	476.2	284.0	188.5	163.3	-0.4	194.0	436.9	426.4
4	197.6	256.7	461.9	278.1	197.6	171.2	-0.0	191.3	417.5	410.5
5	207.1	263.2	443.6	260.8	207.1	175.2	-0.4	196.5	391.8	389.8
6	207.6	267.5	420.0	248.0	207.6	179.6	0.0	198.2	365.1	369.3
7	204.6	268.7	399.8	240.9	204.6	183.0	-0.3	196.7	343.2	353.4
8	202.6	274.4	392.3	237.0	202.6	186.2	-0.4	201.6	335.5	348.2
9	198.6	284.1	383.4	234.9	198.6	192.7	-0.3	208.7	327.7	343.0

RP	ABS MACH NO		REL MACH NO		MERID MACH NO		MERID VEL	PEAK SS
	IN	OUT	IN	OUT	IN	OUT		
1	0.502	0.667	1.442	0.766	0.502	0.409	0.909	1.698
2	0.559	0.681	1.454	0.767	0.559	0.427	0.855	1.675
3	0.572	0.688	1.444	0.771	0.572	0.443	0.866	1.669
4	0.601	0.701	1.405	0.759	0.601	0.467	0.866	1.618
5	0.633	0.723	1.355	0.717	0.633	0.481	0.846	1.586
6	0.634	0.740	1.283	0.686	0.634	0.497	0.865	1.614
7	0.625	0.748	1.221	0.671	0.625	0.510	0.894	1.555
8	0.618	0.765	1.197	0.661	0.618	0.519	0.919	1.572
9	0.605	0.794	1.168	0.656	0.605	0.539	0.971	1.550

RP	PERCENT SPAN		INCIDENCE MEAN		DEV	D FACT	EFF	LOSS COEFF		LOSS PARAM	
	SPAN	MEAN	SS	SS				TOT	PROF	TOT	PROF
1	5.00	8.0	5.6	5.1	0.560	0.751	0.250	0.116	0.051	0.024	
2	10.00	6.7	4.0	4.1	0.561	0.756	0.242	0.112	0.051	0.024	
3	15.00	6.8	3.8	3.5	0.554	0.781	0.217	0.090	0.047	0.019	
4	30.00	6.3	2.9	3.4	0.545	0.827	0.174	0.067	0.038	0.015	
5	50.00	6.0	1.8	3.5	0.562	0.845	0.162	0.070	0.037	0.016	
6	70.00	6.7	1.1	4.4	0.561	0.886	0.126	0.039	0.029	0.009	
7	85.00	6.9	0.3	7.2	0.548	0.898	0.117	0.044	0.027	0.010	
8	90.00	6.8	-0.0	7.1	0.551	0.901	0.116	0.052	0.027	0.012	
9	95.00	6.9	-0.3	6.2	0.548	0.906	0.117	0.061	0.028	0.014	

TABLE V. - Continued. BLADE-ELEMENT DATA AT BLADE EDGES

FOR ROTOR 35

(g) 90 Percent of design speed; reading 3979

RP	RADII		ABS BETAM		REL BETAM		TOTAL TEMP		TOTAL PRESS	
	IN	OUT	IN	OUT	IN	OUT	IN	RATIO	IN	RATIO
1	24.915	24.221	0.0	33.0	67.2	57.7	288.4	1.154	9.94	1.515
2	24.572	23.932	-0.0	32.6	64.8	55.8	288.2	1.157	10.12	1.529
3	24.224	23.642	-0.0	32.0	64.1	54.7	288.6	1.155	10.12	1.550
4	23.162	22.771	0.0	32.9	61.8	51.7	288.7	1.157	10.13	1.574
5	21.725	21.613	-0.0	34.7	59.5	47.5	288.1	1.164	10.15	1.604
6	20.221	20.455	-0.1	34.9	57.9	43.0	287.8	1.162	10.15	1.632
7	19.020	19.583	-0.0	35.2	56.9	40.2	287.8	1.158	10.15	1.617
8	18.595	19.294	-0.0	36.0	56.6	38.8	287.7	1.160	10.15	1.610
9	18.158	19.004	-0.0	37.4	56.5	35.8	287.8	1.169	10.12	1.626

RP	ABS VEL		REL VEL		MERID VEL		TANG VEL		WHEEL SPEED	
	IN	OUT	IN	OUT	IN	OUT	IN	OUT	IN	OUT
1	169.4	209.3	436.5	328.1	169.4	175.6	0.0	113.9	402.3	321.1
2	186.9	217.7	439.4	326.3	186.9	183.4	-0.1	117.3	397.5	387.2
3	190.8	221.8	436.3	325.3	190.8	188.1	-0.1	117.4	392.2	382.8
4	201.0	229.2	425.2	310.7	201.0	192.5	0.0	124.4	374.7	368.4
5	207.6	238.4	408.5	290.2	207.6	195.9	-0.1	135.8	351.7	349.9
6	205.9	247.4	387.1	277.7	205.9	203.0	-0.4	141.5	327.3	331.1
7	200.7	250.1	367.2	267.4	200.7	204.3	-0.0	144.1	307.5	316.6
8	198.8	252.7	361.0	262.2	198.8	204.5	-0.1	148.5	301.3	312.6
9	194.6	260.5	352.6	255.3	194.6	206.9	-0.1	158.2	293.9	307.6

RP	ABS MACH NO		REL MACH NO		MERID MACH NO		MERID VEL	PEAK SS	MACH NO
	IN	OUT	IN	OUT	IN	OUT			
1	0.510	0.592	1.315	0.928	0.510	0.497	1.036	1.493	
2	0.567	0.617	1.332	0.925	0.567	0.520	0.981	1.468	
3	0.579	0.629	1.323	0.923	0.579	0.534	0.986	1.463	
4	0.612	0.652	1.294	0.883	0.612	0.547	0.958	1.414	
5	0.634	0.679	1.248	0.826	0.634	0.558	0.944	1.395	
6	0.629	0.708	1.182	0.794	0.629	0.581	0.986	1.441	
7	0.612	0.717	1.119	0.767	0.612	0.586	1.018	1.435	
8	0.606	0.725	1.100	0.753	0.606	0.587	1.029	1.420	
9	0.592	0.747	1.073	0.732	0.592	0.593	1.063	1.405	

RP	PERCENT SPAN		INCIDENCE MEAN SS		DEV	D FACT	EFF	LOSS COEFF		LOSS PARAM	
								TOT	PROF	TOT	PROF
1	5.00	5.5	3.1	4.9	0.347	0.817	0.123	0.057	0.025	0.012	
2	10.00	4.2	1.5	3.7	0.357	0.824	0.119	0.055	0.025	0.012	
3	15.00	4.2	1.2	3.3	0.354	0.860	0.095	0.033	0.021	0.007	
4	30.00	3.4	0.0	3.1	0.373	0.881	0.085	0.037	0.019	0.008	
5	50.00	3.3	-0.9	3.3	0.402	0.882	0.093	0.053	0.021	0.012	
6	70.00	4.1	-1.4	3.9	0.400	0.926	0.062	0.023	0.014	0.005	
7	85.00	4.5	-2.0	6.8	0.392	0.930	0.063	0.032	0.014	0.007	
8	90.00	4.5	-2.4	7.6	0.397	0.911	0.082	0.055	0.019	0.013	
9	95.00	4.6	-2.6	7.2	0.409	0.883	0.117	0.094	0.027	0.022	

TABLE V. - Continued. BLADE-ELEMENT DATA AT BLADE EDGES

FOR ROTOR 35

(h) 90 Percent of design speed; reading 3982

RP	RADII		ABS BETAM		REL BETAM		TOTAL TEMP		TOTAL PRESS	
	IN	OUT	IN	OUT	IN	OUT	IN	RATIO	IN	RATIO
1	24.915	24.221	-0.1	39.3	68.0	56.5	288.7	1.187	9.95	1.645
2	24.572	23.932	-0.0	38.9	65.8	54.9	288.3	1.188	10.12	1.648
3	24.224	23.642	0.0	38.2	65.1	54.0	288.8	1.183	10.12	1.659
4	23.162	22.771	-0.0	38.3	63.0	51.5	288.5	1.181	10.13	1.674
5	21.725	21.613	-0.1	40.1	60.8	47.0	288.0	1.187	10.15	1.692
6	20.221	20.455	-0.1	39.8	59.0	43.0	287.7	1.179	10.16	1.703
7	19.020	19.583	0.0	39.7	57.9	40.4	287.9	1.172	10.15	1.677
8	18.595	19.294	-0.0	40.7	57.7	38.4	287.8	1.176	10.15	1.679
9	18.158	19.004	0.0	41.7	57.7	35.1	287.9	1.184	10.12	1.706

RP	ABS VEL		REL VEL		MERID VEL		TANG VEL		WHEEL SPEED	
	IN	OUT	IN	OUT	IN	OUT	IN	OUT	IN	OUT
1	162.9	217.7	435.5	304.9	162.9	168.4	-0.4	138.0	403.5	392.3
2	179.0	223.5	436.6	302.6	179.0	174.0	-0.1	140.2	398.1	387.7
3	182.7	225.8	433.3	301.4	182.7	177.3	0.0	139.7	392.9	383.5
4	191.7	229.8	421.7	289.8	191.7	180.4	-0.1	142.4	375.5	369.1
5	197.3	239.2	403.8	268.0	197.3	182.9	-0.4	154.2	351.9	350.1
6	196.9	244.6	382.7	257.0	196.9	188.0	-0.4	156.4	327.8	331.6
7	193.0	245.3	363.4	247.8	193.0	188.8	0.0	156.5	307.9	317.0
8	190.4	249.7	356.8	241.6	190.4	189.3	-0.1	162.8	301.6	313.0
9	186.5	259.2	348.7	236.4	186.5	193.4	0.0	172.5	294.7	308.4

RP	ABS MACH NO		REL MACH NO		MERID MACH NO		MERID PEAK SS	
	IN	OUT	IN	OUT	IN	OUT	VEL R	MACH NO
1	0.489	0.608	1.309	0.851	0.489	0.470	1.034	1.516
2	0.541	0.626	1.319	0.847	0.541	0.487	0.972	1.490
3	0.552	0.633	1.310	0.845	0.552	0.497	0.971	1.485
4	0.582	0.646	1.279	0.815	0.582	0.507	0.941	1.441
5	0.600	0.674	1.229	0.755	0.600	0.515	0.927	1.423
6	0.600	0.694	1.165	0.729	0.600	0.533	0.955	1.467
7	0.587	0.698	1.104	0.705	0.587	0.537	0.978	1.461
8	0.578	0.710	1.084	0.687	0.578	0.539	0.994	1.449
9	0.565	0.737	1.057	0.673	0.565	0.550	1.037	1.437

RP	PERCENT SPAN	INCIDENCE		DEV	D FACT	EFF	LOSS COEFF		LOSS PARAM	
		MEAN	SS				TOT	PROF	TOT	PROF
1	5.00	6.4	4.0	3.8	0.420	0.817	0.145	0.075	0.031	0.016
2	10.00	5.2	2.4	2.8	0.427	0.818	0.144	0.078	0.031	0.017
3	15.00	5.2	2.2	2.6	0.423	0.849	0.119	0.055	0.026	0.012
4	30.00	4.6	1.2	2.9	0.433	0.876	0.101	0.049	0.023	0.011
5	50.00	4.6	0.4	2.7	0.466	0.869	0.116	0.074	0.027	0.017
6	70.00	5.3	-0.2	3.8	0.460	0.917	0.077	0.036	0.018	0.008
7	85.00	5.6	-1.0	7.0	0.450	0.924	0.075	0.041	0.017	0.009
8	90.00	5.6	-1.2	7.3	0.460	0.906	0.096	0.066	0.022	0.015
9	95.00	5.7	-1.5	6.4	0.468	0.898	0.112	0.087	0.026	0.021

TABLE V. - Continued. BLADE-ELEMENT DATA AT BLADE EDGES

FOR ROTOR 35

(i) 90 Percent of design speed; reading 3983

RP	RADII		ABS BETAM		REL BETAM		TOTAL TEMP		TOTAL PRESS	
	IN	OUT	IN	OUT	IN	OUT	IN	RATIO	IN	RATIO
1	24.915	24.221	-0.0	44.8	69.1	56.5	288.6	1.210	9.97	1.709
2	24.572	23.932	-0.1	43.5	67.2	54.8	288.8	1.208	10.11	1.714
3	24.224	23.642	-0.0	43.0	66.5	53.7	288.6	1.205	10.11	1.721
4	23.162	22.771	0.0	42.4	64.5	51.5	288.0	1.197	10.13	1.730
5	21.725	21.613	-0.0	43.7	62.1	47.1	288.0	1.199	10.15	1.737
6	20.221	20.455	-0.1	43.0	60.4	43.2	287.8	1.189	10.16	1.740
7	19.020	19.583	-0.0	42.8	59.3	40.4	287.7	1.181	10.15	1.715
8	18.595	19.294	-0.0	43.8	59.0	38.1	287.5	1.186	10.15	1.720
9	18.158	19.004	-0.0	44.2	58.9	34.7	287.6	1.192	10.13	1.748

RP	ABS VEL		REL VEL		MERID VEL		TANG VEL		WHEEL SPEED	
	IN	OUT	IN	OUT	IN	OUT	IN	OUT	IN	OUT
1	153.9	220.8	431.9	283.7	153.9	156.6	-0.1	155.6	403.4	392.2
2	167.6	226.1	432.5	284.4	167.6	164.0	-0.3	155.7	398.4	388.0
3	170.8	228.2	427.9	282.0	170.8	167.0	-0.1	155.5	392.2	382.8
4	179.4	230.0	416.0	273.0	179.4	169.8	0.0	155.2	375.3	369.0
5	186.2	238.6	398.3	253.3	186.2	172.6	-0.1	164.7	352.0	350.2
6	186.3	242.1	377.3	243.2	186.3	177.1	-0.3	165.0	327.8	331.6
7	183.0	243.2	358.3	234.1	183.0	178.3	-0.1	165.4	307.9	317.1
8	180.8	248.4	351.4	228.0	180.8	179.4	-0.1	171.9	301.3	312.6
9	177.1	257.6	343.2	224.6	177.1	184.7	-0.1	179.6	293.8	307.5

RP	ABS MACH NO		REL MACH NO		MERID MACH NO		MERID VEL	PEAK SS	MACH NO
	IN	OUT	IN	OUT	IN	OUT			
1	0.462	0.611	1.295	0.785	0.462	0.433	1.017	1.540	
2	0.504	0.627	1.301	0.789	0.504	0.455	0.978	1.520	
3	0.515	0.635	1.289	0.784	0.515	0.464	0.978	1.514	
4	0.542	0.642	1.256	0.762	0.542	0.474	0.946	1.470	
5	0.565	0.668	1.207	0.710	0.565	0.484	0.927	1.451	
6	0.565	0.682	1.144	0.686	0.565	0.499	0.951	1.498	
7	0.554	0.689	1.086	0.663	0.554	0.505	0.975	1.496	
8	0.548	0.704	1.064	0.646	0.548	0.508	0.992	1.483	
9	0.536	0.730	1.038	0.637	0.536	0.523	1.043	1.471	

RP	PERCENT SPAN	INCIDENCE		DEV	D FACT	EFF	LOSS TOT	COEFF PROF	LOSS TOT	PARAM PROF
		MEAN	SS							
1	5.00	7.5	5.1	3.8	0.479	0.788	0.185	0.112	0.039	0.024
2	10.00	6.6	3.8	2.7	0.477	0.801	0.172	0.103	0.038	0.022
3	15.00	6.6	3.6	2.3	0.475	0.818	0.159	0.093	0.035	0.021
4	30.00	6.1	2.7	2.9	0.477	0.861	0.123	0.070	0.028	0.016
5	50.00	6.0	1.8	2.8	0.504	0.858	0.135	0.091	0.031	0.021
6	70.00	6.7	1.2	4.1	0.496	0.906	0.093	0.049	0.022	0.011
7	85.00	6.9	0.4	7.0	0.482	0.919	0.085	0.048	0.019	0.011
8	90.00	6.9	0.1	7.0	0.498	0.903	0.106	0.074	0.025	0.017
9	95.00	7.0	-0.2	6.1	0.500	0.900	0.117	0.089	0.028	0.021

TABLE V. - Continued. BLADE-ELEMENT DATA AT BLADE EDGES

FOR ROTOR 35

(j) 90 Percent of design speed; reading 3984

RP	RADII		ABS BETAM		REL BETAM		TOTAL TEMP		TOTAL PRESS	
	IN	OUT	IN	OUT	IN	OUT	IN	RATIO	IN	RATIO
1	24.915	24.221	-0.1	47.5	69.9	56.5	288.9	1.221	9.98	1.737
2	24.572	23.932	-0.1	46.0	67.9	54.7	288.8	1.219	10.10	1.741
3	24.224	23.642	0.0	45.3	67.2	53.6	289.0	1.215	10.11	1.748
4	23.162	22.771	-0.0	44.2	65.3	51.5	288.8	1.205	10.13	1.755
5	21.725	21.613	-0.0	45.1	62.8	47.1	288.0	1.204	10.15	1.753
6	20.221	20.455	-0.1	44.7	61.1	43.6	287.6	1.194	10.15	1.751
7	19.020	19.583	-0.0	44.5	59.9	40.5	287.4	1.186	10.15	1.722
8	18.595	19.294	-0.0	45.3	59.6	37.7	287.5	1.190	10.16	1.738
9	18.158	19.004	-0.0	45.5	59.6	34.3	287.5	1.196	10.13	1.767

RP	ABS VEL		REL VEL		MERID VEL		TANG VEL		WHEEL SPEED	
	IN	OUT	IN	OUT	IN	OUT	IN	OUT	IN	OUT
1	148.0	223.1	430.0	273.0	148.0	150.6	-0.3	164.5	403.4	392.1
2	161.5	227.8	429.8	274.1	161.5	158.2	-0.3	163.8	398.0	387.6
3	164.7	229.8	425.6	272.8	164.7	161.7	0.0	163.3	392.4	383.0
4	173.0	231.0	413.5	265.8	173.0	165.5	-0.1	161.2	375.5	369.1
5	180.9	238.4	395.8	247.2	180.9	168.1	-0.1	169.0	352.0	350.2
6	181.4	240.4	375.0	235.7	181.4	170.7	-0.4	169.2	327.8	331.6
7	178.6	242.2	356.1	227.1	178.6	172.8	-0.1	169.6	307.9	317.0
8	177.1	249.3	349.7	221.5	177.1	175.3	-0.1	177.3	301.5	312.8
9	173.1	258.6	341.7	219.7	173.1	181.4	-0.1	184.4	294.6	308.3

RP	ABS MACH NO		REL MACH NO		MERID MACH NO		MERID PEAK SS	
	IN	OUT	IN	OUT	IN	OUT	VEL R	MACH NO
1	0.443	0.614	1.286	0.752	0.443	0.415	1.018	1.558
2	0.485	0.629	1.291	0.757	0.485	0.437	0.980	1.536
3	0.495	0.636	1.279	0.755	0.495	0.448	0.982	1.530
4	0.521	0.643	1.246	0.740	0.521	0.460	0.956	1.489
5	0.547	0.666	1.198	0.691	0.547	0.470	0.930	1.466
6	0.550	0.676	1.136	0.663	0.550	0.480	0.941	1.514
7	0.541	0.684	1.078	0.642	0.541	0.488	0.968	1.512
8	0.536	0.705	1.058	0.626	0.536	0.496	0.990	1.497
9	0.523	0.732	1.032	0.622	0.523	0.513	1.048	1.490

RP	PERCENT		INCIDENCE		DEV	D FACT	EFF	LOSS COEFF		LOSS PARAM	
	SPAN	MEAN	MEAN	SS				TOT	PROF	TOT	PROF
1	5.00	8.2	5.8	3.8	0.510	0.772	0.208	0.133	0.044	0.028	
2	10.00	7.3	4.6	2.7	0.505	0.785	0.195	0.124	0.042	0.027	
3	15.00	7.4	4.4	2.2	0.500	0.806	0.177	0.109	0.039	0.024	
4	30.00	6.9	3.5	2.9	0.496	0.852	0.137	0.081	0.031	0.018	
5	50.00	6.7	2.4	2.9	0.520	0.853	0.143	0.098	0.033	0.023	
6	70.00	7.4	1.8	4.4	0.517	0.896	0.106	0.061	0.025	0.014	
7	95.00	7.5	1.0	7.1	0.508	0.902	0.104	0.066	0.024	0.015	
8	90.00	7.5	0.6	6.6	0.519	0.898	0.114	0.081	0.027	0.019	
9	95.00	7.6	0.4	5.7	0.517	0.901	0.118	0.088	0.028	0.021	

TABLE V. - Continued. BLADE-ELEMENT DATA AT BLADE EDGES

FOR ROTOR 35

(k) 90 Percent of design speed; reading 3985

RP	RADII		ABS BETAM		REL BETAM		TOTAL TEMP		TOTAL PRESS	
	IN	OUT	IN	OUT	IN	OUT	IN	RATIO	IN	RATIO
1	24.715	24.221	-0.0	55.2	71.8	57.5	289.0	1.252	9.99	1.796
2	24.572	23.932	-0.0	53.9	70.2	56.4	289.4	1.246	10.10	1.779
3	24.224	23.642	-0.0	52.1	69.5	54.8	289.6	1.239	10.11	1.788
4	23.162	22.771	-0.0	49.2	67.5	51.4	288.8	1.225	10.13	1.793
5	21.725	21.613	-0.1	48.8	65.0	47.4	288.0	1.216	10.15	1.782
6	20.221	20.455	-0.1	48.1	63.0	43.5	287.4	1.205	10.15	1.774
7	19.020	19.583	-0.0	47.0	61.8	39.8	287.1	1.196	10.15	1.753
8	18.595	19.294	-0.0	46.7	61.5	37.3	287.4	1.197	10.15	1.767
9	18.158	19.004	-0.1	46.4	61.5	33.7	287.4	1.201	10.13	1.799

RP	ABS VEL		REL VEL		MERID VEL		TANG VEL		WHEEL SPEED	
	IN	OUT	IN	OUT	IN	OUT	IN	OUT	IN	OUT
1	132.4	228.4	424.9	242.8	132.4	130.4	-0.1	187.6	403.6	392.4
2	143.3	229.2	423.6	243.6	143.3	134.9	-0.1	185.3	398.5	388.1
3	146.7	230.8	418.9	245.6	146.7	141.7	-0.1	182.2	392.3	382.9
4	155.5	234.3	406.4	245.1	155.5	153.0	-0.1	177.5	375.3	369.0
5	163.9	238.1	388.4	232.1	163.9	157.0	-0.4	179.0	351.8	350.0
6	167.2	240.4	368.2	221.6	167.2	160.7	-0.4	178.8	327.7	331.5
7	165.3	244.3	349.8	216.6	165.3	166.5	-0.1	178.8	308.2	317.4
8	163.5	250.2	343.1	215.7	163.5	171.6	-0.1	182.1	301.5	312.8
9	160.2	260.1	335.4	215.8	160.2	179.5	-0.3	188.2	294.3	308.0

RP	ABS MACH NO		REL MACH NO		MERID MACH NO		MERID PEAK SS	
	IN	OUT	IN	OUT	IN	OUT	VEL R	MACH NO
1	0.394	0.622	1.266	0.661	0.394	0.355	0.985	1.606
2	0.428	0.625	1.264	0.664	0.428	0.368	0.941	1.590
3	0.438	0.632	1.251	0.672	0.438	0.388	0.966	1.582
4	0.466	0.647	1.218	0.677	0.466	0.422	0.984	1.541
5	0.493	0.662	1.169	0.645	0.493	0.436	0.958	1.519
6	0.504	0.673	1.111	0.620	0.504	0.450	0.961	1.561
7	0.499	0.688	1.055	0.610	0.499	0.469	1.007	1.564
8	0.493	0.705	1.034	0.608	0.493	0.484	1.049	1.553
9	0.482	0.735	1.010	0.610	0.482	0.507	1.120	1.548

RP	PERCENT SPAN		INCIDENCE		DEV	D FACT	EFF	LOSS COEFF		LOSS PARAM	
	SPAN	MEAN	SS	SS				TOT	PROF	TOT	PROF
1	5.00	10.2	7.8	4.8	0.595	0.721	0.282	0.200	0.058	0.041	
2	10.00	9.6	6.9	4.3	0.588	0.728	0.271	0.193	0.057	0.040	
3	15.00	9.6	6.7	3.4	0.574	0.754	0.246	0.171	0.053	0.037	
4	30.00	9.1	5.7	2.8	0.552	0.806	0.196	0.134	0.044	0.030	
5	50.00	8.9	4.7	3.2	0.559	0.830	0.177	0.126	0.041	0.029	
6	70.00	9.3	3.8	4.4	0.554	0.869	0.143	0.092	0.033	0.021	
7	85.00	9.5	2.9	6.4	0.537	0.885	0.131	0.087	0.030	0.020	
8	90.00	9.4	2.6	6.2	0.531	0.896	0.124	0.084	0.029	0.020	
9	95.00	9.5	2.3	5.1	0.522	0.908	0.116	0.080	0.028	0.019	

TABLE V. - Continued. BLADE-ELEMENT DATA AT BLADE EDGES

FOR ROTOR 35

(ℓ) 80 Percent of design speed; reading 3987

RP	RADII		ABS BETAM		REL BETAM		TOTAL TEMP		TOTAL PRESS	
	IN	OUT	IN	OUT	IN	OUT	IN	RATIO	IN	RATIO
1	24.915	24.221	-0.0	52.5	73.4	57.8	289.9	1.189	10.00	1.574
2	24.572	23.932	-0.0	52.3	71.3	57.3	290.2	1.186	10.10	1.554
3	24.224	23.642	-0.0	51.5	70.5	56.0	289.9	1.184	10.12	1.559
4	23.162	22.771	-0.0	49.2	68.4	52.4	288.6	1.176	10.14	1.567
5	21.725	21.613	-0.0	47.6	66.1	48.3	287.6	1.166	10.14	1.572
6	20.221	20.455	-0.0	46.4	64.3	43.0	287.4	1.158	10.14	1.575
7	19.020	19.583	-0.0	45.8	63.3	39.0	287.2	1.155	10.14	1.569
8	18.595	19.294	-0.1	46.3	63.1	36.6	287.3	1.156	10.14	1.577
9	18.158	19.004	-0.0	47.1	63.2	33.7	287.3	1.161	10.13	1.597

RP	ABS VEL		REL VEL		MERID VEL		TANG VEL		WHEEL SPEED	
	IN	OUT	IN	OUT	IN	OUT	IN	OUT	IN	OUT
1	107.3	198.9	376.0	227.4	107.3	121.2	-0.1	157.8	360.3	350.2
2	120.4	198.5	375.2	224.7	120.4	121.5	-0.1	157.0	355.3	346.0
3	124.1	200.6	371.9	223.4	124.1	125.0	-0.1	156.9	350.5	342.1
4	132.4	205.1	360.2	219.7	132.4	134.1	-0.1	155.2	334.9	329.3
5	139.1	209.3	343.8	212.1	139.1	141.2	-0.1	154.4	314.4	312.7
6	139.6	214.6	322.0	202.5	139.6	148.0	-0.1	155.3	290.1	293.4
7	137.2	219.0	305.4	196.4	137.2	152.6	-0.1	157.2	272.7	280.8
8	135.7	223.9	299.5	192.7	135.7	154.8	-0.3	161.9	266.7	276.7
9	133.0	232.1	294.7	189.9	133.0	158.1	-0.1	169.9	262.9	275.1

RP	ABS MACH NO		REL MACH NO		MERID MACH NO		MERID PEAK SS	
	IN	OUT	IN	OUT	IN	OUT	VEL R	MACH NO
1	0.317	0.550	1.112	0.629	0.317	0.335	1.130	1.536
2	0.357	0.550	1.112	0.622	0.357	0.336	1.009	1.503
3	0.369	0.557	1.104	0.620	0.369	0.347	1.007	1.500
4	0.395	0.573	1.074	0.614	0.395	0.375	1.013	1.465
5	0.416	0.589	1.029	0.597	0.416	0.398	1.015	1.468
6	0.418	0.608	0.964	0.574	0.418	0.419	1.061	1.497
7	0.411	0.623	0.914	0.558	0.411	0.434	1.112	1.458
8	0.406	0.637	0.896	0.548	0.406	0.440	1.140	1.429
9	0.397	0.661	0.881	0.541	0.397	0.450	1.189	1.413

RP	PERCENT SPAN		INCIDENCE MEAN SS		DEV	D FACT	EFF	LOSS COEFF		LOSS PARAM	
	SPAN	MEAN	SS	SS				TOT	PROF	TOT	PROF
1	5.00	11.8	9.4	5.1	0.553	0.732	0.254	0.207	0.052	0.042	
2	10.00	10.7	7.9	5.2	0.557	0.723	0.258	0.217	0.053	0.044	
3	15.00	10.6	7.7	4.6	0.555	0.737	0.247	0.208	0.052	0.043	
4	30.00	10.1	6.7	3.8	0.544	0.780	0.210	0.180	0.046	0.039	
5	50.00	10.0	5.8	4.0	0.535	0.830	0.167	0.141	0.038	0.032	
6	70.00	10.6	5.1	3.9	0.526	0.877	0.129	0.106	0.030	0.025	
7	85.00	11.0	4.4	5.6	0.514	0.889	0.125	0.111	0.029	0.026	
8	90.00	11.0	4.1	5.5	0.519	0.889	0.131	0.121	0.031	0.029	
9	95.00	11.2	4.1	5.0	0.526	0.890	0.137	0.129	0.033	0.031	

TABLE V. - Continued. BLADE-ELEMENT DATA AT BLADE EDGES

FOR ROTOR 35

(m) 70 Percent of design speed; reading 3995

RP	RADII		ABS BETAM		REL BETAM		TOTAL TEMP		TOTAL PRESS	
	IN	OUT	IN	OUT	IN	OUT	IN	RATIO	IN	RATIO
1	24.915	24.221	-0.0	23.2	68.5	58.0	289.0	1.068	10.01	1.195
2	24.572	23.932	-0.1	22.9	65.8	55.8	288.4	1.071	10.14	1.208
3	24.224	23.642	-0.0	22.0	64.9	54.6	288.5	1.069	10.14	1.227
4	23.162	22.771	-0.1	23.0	62.8	51.5	288.3	1.072	10.14	1.248
5	21.725	21.613	-0.1	25.1	60.8	47.9	288.0	1.076	10.14	1.268
6	20.221	20.455	-0.1	26.8	59.2	43.2	287.9	1.080	10.14	1.289
7	19.020	19.583	-0.0	27.8	58.3	39.0	288.0	1.083	10.14	1.299
8	18.595	19.294	-0.0	28.4	57.9	37.0	287.9	1.085	10.14	1.308
9	18.158	19.004	-0.0	29.3	57.9	34.7	288.0	1.089	10.12	1.316

RP	ABS VEL		REL VEL		MERID VEL		TANG VEL		WHEEL SPEED	
	IN	OUT	IN	OUT	IN	OUT	IN	OUT	IN	OUT
1	124.0	164.5	338.9	285.2	124.0	151.2	-0.0	64.7	315.3	306.5
2	140.0	173.3	340.9	284.3	140.0	159.6	-0.3	67.3	310.6	302.5
3	143.6	178.2	338.3	284.9	143.6	165.2	-0.0	66.8	306.3	298.9
4	150.8	185.8	329.7	274.9	150.8	171.0	-0.3	72.7	292.9	287.9
5	153.9	191.7	315.1	258.8	153.9	173.6	-0.3	81.3	274.6	273.2
6	152.7	200.3	297.9	245.3	152.7	178.7	-0.3	90.4	255.5	258.5
7	148.9	209.2	283.0	238.2	148.9	185.0	-0.0	97.7	240.6	247.7
8	147.6	214.3	277.8	236.2	147.6	188.5	-0.0	101.9	235.3	244.1
9	144.1	219.9	271.0	233.1	144.1	191.8	-0.0	107.6	229.5	240.2

RP	ABS MACH NO		REL MACH NO		MERID MACH NO		MERID VEL R	PEAK MACH NO	SS
	IN	OUT	IN	OUT	IN	OUT			
1	0.369	0.477	1.008	0.828	0.369	0.439	1.219	1.312	
2	0.418	0.504	1.019	0.827	0.418	0.465	1.141	1.256	
3	0.429	0.520	1.012	0.831	0.429	0.482	1.151	1.253	
4	0.452	0.542	0.988	0.803	0.452	0.499	1.134	1.217	
5	0.462	0.560	0.946	0.756	0.462	0.507	1.128	1.201	
6	0.458	0.586	0.894	0.717	0.458	0.523	1.170	1.232	
7	0.446	0.613	0.848	0.698	0.446	0.542	1.243	1.208	
8	0.442	0.628	0.832	0.692	0.442	0.553	1.277	1.181	
9	0.431	0.644	0.811	0.683	0.431	0.562	1.331	1.155	

RP	PERCENT SPAN	INCIDENCE		DEV	D FACT	EFF	LOSS COEFF		LOSS TOT	PARAM PROF
		MEAN	SS				TOT	PROF		
1	5.00	6.9	4.5	5.3	0.230	0.768	0.103	0.095	0.021	0.019
2	10.00	5.1	2.4	3.8	0.240	0.784	0.099	0.094	0.021	0.020
3	15.00	5.0	2.1	3.2	0.231	0.865	0.062	0.057	0.013	0.012
4	30.00	4.4	1.0	2.9	0.245	0.903	0.048	0.046	0.011	0.010
5	50.00	4.6	0.4	3.6	0.266	0.922	0.044	0.043	0.010	0.010
6	70.00	5.4	-0.1	4.1	0.274	0.937	0.040	0.040	0.009	0.009
7	85.00	5.9	-0.6	5.6	0.264	0.941	0.043	0.043	0.010	0.010
8	90.00	5.8	-1.1	5.9	0.260	0.935	0.049	0.049	0.012	0.012
9	95.00	5.9	-1.2	6.0	0.257	0.913	0.073	0.073	0.017	0.017

TABLE V. - Continued. BLADE-ELEMENT DATA AT BLADE EDGES

FOR ROTOR 35

(n) 70 Percent of design speed; reading 3994

RP	RADII		ABS BETAM		REL BETAM		TOTAL TEMP		TOTAL PRESS	
	IN	OUT	IN	OUT	IN	OUT	IN	RATIO	IN	RATIO
1	24.915	24.221	-0.0	28.6	69.3	57.7	289.1	1.083	10.02	1.245
2	24.572	23.932	-0.1	28.6	66.5	55.6	288.4	1.086	10.13	1.255
3	24.224	23.642	-0.0	27.0	65.7	54.6	288.8	1.082	10.14	1.269
4	23.162	22.771	-0.1	27.7	63.7	51.4	288.3	1.085	10.14	1.288
5	21.725	21.613	-0.1	28.9	61.7	48.2	288.1	1.086	10.14	1.304
6	20.221	20.455	-0.0	30.6	60.1	43.5	288.0	1.089	10.14	1.319
7	19.020	19.583	-0.0	31.3	59.2	39.2	287.7	1.092	10.14	1.329
8	18.595	19.294	-0.1	31.8	58.9	37.3	287.8	1.093	10.14	1.335
9	18.158	19.004	-0.0	33.2	58.9	34.7	287.8	1.097	10.12	1.342

RP	ABS VEL		REL VEL		MERID VEL		TANG VEL		WHEEL SPEED	
	IN	OUT	IN	OUT	IN	OUT	IN	OUT	IN	OUT
1	119.4	164.1	337.1	269.4	119.4	144.0	-0.0	78.7	315.2	306.4
2	134.9	171.9	338.9	266.9	134.9	150.8	-0.2	82.4	310.7	302.6
3	138.2	175.3	336.1	269.3	138.2	156.2	-0.0	79.6	306.3	299.0
4	144.7	182.9	327.1	259.8	144.7	161.9	-0.3	84.9	293.1	288.1
5	148.2	187.1	312.5	245.5	148.2	163.7	-0.3	90.5	274.9	273.5
6	147.1	195.5	295.4	231.9	147.1	168.3	-0.0	99.5	256.1	259.0
7	142.9	203.4	279.5	224.1	142.9	173.7	-0.0	105.7	240.1	247.3
8	141.8	207.5	274.8	221.8	141.8	176.3	-0.3	109.5	235.1	243.9
9	138.5	212.9	267.8	216.6	138.5	178.1	-0.0	116.6	229.2	239.9

RP	ABS MACH NO		REL MACH NO		MERID MACH NO		MERID PEAK SS	
	IN	OUT	IN	OUT	IN	OUT	VEL R	MACH NO
1	0.355	0.473	1.001	0.776	0.355	0.415	1.206	1.337
2	0.403	0.496	1.012	0.771	0.403	0.436	1.118	1.283
3	0.413	0.507	1.003	0.779	0.413	0.452	1.130	1.282
4	0.433	0.530	0.979	0.753	0.433	0.469	1.119	1.242
5	0.444	0.543	0.936	0.713	0.444	0.475	1.105	1.222
6	0.441	0.568	0.885	0.674	0.441	0.489	1.144	1.249
7	0.428	0.592	0.837	0.652	0.428	0.506	1.215	1.220
8	0.424	0.605	0.822	0.646	0.424	0.514	1.243	1.196
9	0.414	0.620	0.801	0.631	0.414	0.519	1.287	1.167

RP	PERCENT SPAN		INCIDENCE MEAN SS		DEV	D FACT	EFF	LOSS COEFF		LOSS PARAM	
	TOT	PROF	TOT	PROF				TOT	PROF		
1	5.00	7.6	5.2	5.0	0.289	0.778	0.120	0.111	0.025	0.023	
2	10.00	5.9	3.2	3.5	0.303	0.780	0.121	0.115	0.026	0.024	
3	15.00	5.8	2.9	3.2	0.286	0.861	0.075	0.069	0.016	0.015	
4	30.00	5.4	2.0	2.8	0.298	0.886	0.066	0.063	0.015	0.014	
5	50.00	5.5	1.3	3.9	0.313	0.917	0.052	0.051	0.012	0.012	
6	70.00	6.4	0.9	4.3	0.323	0.923	0.055	0.055	0.013	0.013	
7	85.00	6.9	0.3	5.8	0.314	0.923	0.062	0.062	0.014	0.014	
8	90.00	6.8	-0.0	6.2	0.313	0.929	0.060	0.060	0.014	0.014	
9	95.00	6.9	-0.3	6.0	0.320	0.905	0.087	0.087	0.021	0.021	

TABLE V. - Continued. BLADE-ELEMENT DATA AT BLADE EDGES

FOR ROTOR 35

(o) 70 Percent of design speed; reading 3993

RP	RADII		ABS BETAM		REL BETAM		TOTAL TEMP		TOTAL PRESS	
	IN	OUT	IN	OUT	IN	OUT	IN	RATIO	IN	RATIO
1	24.915	24.221	-0.1	36.1	70.6	57.3	289.4	1.103	10.03	1.309
2	24.572	23.932	-0.1	36.5	68.2	55.7	288.1	1.106	10.14	1.310
3	24.224	23.642	-0.0	35.1	67.3	54.7	288.5	1.102	10.14	1.318
4	23.162	22.771	-0.0	34.4	65.3	51.8	288.3	1.100	10.14	1.333
5	21.725	21.613	-0.1	34.9	63.4	48.6	288.1	1.098	10.14	1.341
6	20.221	20.455	-0.1	35.8	61.9	43.5	287.9	1.101	10.14	1.359
7	19.020	19.583	-0.1	36.2	61.0	39.1	287.8	1.101	10.14	1.368
8	18.595	19.294	-0.0	36.5	60.6	37.6	287.8	1.102	10.14	1.369
9	18.158	19.004	-0.1	38.6	60.7	34.6	287.9	1.106	10.12	1.379

RP	ABS VEL		REL VEL		MERID VEL		TANG VEL		WHEEL SPEED	
	IN	OUT	IN	OUT	IN	OUT	IN	OUT	IN	OUT
1	111.2	165.7	334.6	248.3	111.2	134.0	-0.2	97.6	315.4	306.6
2	124.6	170.6	335.0	243.4	124.6	137.1	-0.2	101.5	310.8	302.7
3	128.1	172.5	331.6	244.1	128.1	141.1	-0.0	99.3	305.8	298.5
4	134.4	178.0	321.9	237.8	134.4	146.9	-0.0	100.6	292.5	287.5
5	137.4	181.8	307.3	225.6	137.4	149.1	-0.3	103.9	274.6	273.2
6	136.7	190.8	290.2	213.4	136.7	154.7	-0.3	111.7	255.8	258.7
7	133.4	198.4	275.1	206.3	133.4	160.0	-0.2	117.3	240.3	247.5
8	132.2	201.0	269.7	204.0	132.2	161.7	-0.0	119.5	235.0	243.8
9	129.4	206.9	264.1	196.6	129.4	161.8	-0.2	129.0	230.0	240.7

RP	ABS MACH NO		REL MACH NO		MERID MACH NO		MERID PEAK SS	
	IN	OUT	IN	OUT	IN	OUT	VEL R	MACH NO
1	0.330	0.473	0.992	0.708	0.330	0.382	1.205	1.373
2	0.371	0.488	0.998	0.696	0.371	0.392	1.100	1.337
3	0.382	0.494	0.988	0.699	0.382	0.404	1.102	1.323
4	0.401	0.512	0.961	0.683	0.401	0.422	1.093	1.275
5	0.410	0.524	0.918	0.650	0.410	0.430	1.086	1.255
6	0.409	0.551	0.867	0.616	0.409	0.446	1.131	1.277
7	0.399	0.574	0.822	0.597	0.399	0.463	1.199	1.247
8	0.395	0.582	0.805	0.590	0.395	0.468	1.222	1.218
9	0.386	0.599	0.788	0.569	0.386	0.468	1.250	1.197

RP	PERCENT SPAN		INCIDENCE MEAN SS		DEV	D FACT	EFF	LOSS COEFF		LOSS PARAM	
	SPAN	MEAN	SS	SS				TOT	PROF	TOT	PROF
1	5.00	9.0	6.6	4.6	0.368	0.777	0.148	0.136	0.030	0.028	
2	10.00	7.5	4.8	3.7	0.387	0.756	0.164	0.155	0.035	0.033	
3	15.00	7.4	4.4	3.3	0.374	0.802	0.133	0.125	0.029	0.027	
4	30.00	7.0	3.5	3.2	0.373	0.861	0.096	0.092	0.021	0.020	
5	50.00	7.3	3.1	4.3	0.381	0.896	0.076	0.074	0.017	0.017	
6	70.00	8.2	2.7	4.4	0.388	0.909	0.075	0.074	0.017	0.017	
7	85.00	8.6	2.1	5.7	0.381	0.931	0.062	0.062	0.015	0.015	
8	90.00	8.5	1.7	6.4	0.377	0.922	0.074	0.074	0.017	0.017	
9	95.00	8.7	1.5	6.0	0.400	0.905	0.097	0.097	0.023	0.023	

TABLE V. - Continued. BLADE-ELEMENT DATA AT BLADE EDGES

FOR ROTOR 35

(p) 70 Percent of design speed; reading 3990

RP	RADII		ABS BETAM		REL BETAM		TOTAL TEMP		TOTAL PRESS	
	IN	OUT	IN	OUT	IN	OUT	IN	RATIO	IN	RATIO
1	24.915	24.221	0.0	42.9	72.0	59.1	289.2	1.114	10.03	1.320
2	24.572	23.952	-0.1	43.4	69.6	57.9	288.0	1.117	10.14	1.314
3	24.224	23.642	-0.0	42.0	68.8	56.9	288.4	1.114	10.14	1.320
4	23.162	22.771	-0.0	39.2	67.0	53.4	288.3	1.108	10.14	1.337
5	21.725	21.613	-0.0	38.3	65.3	49.2	288.0	1.105	10.14	1.354
6	20.221	20.455	-0.0	39.3	63.7	42.5	288.0	1.108	10.14	1.384
7	19.020	19.583	-0.0	38.9	62.7	39.2	288.0	1.105	10.14	1.385
8	18.595	19.294	-0.0	39.1	62.4	37.4	287.7	1.107	10.14	1.384
9	18.158	19.004	-0.1	40.5	62.3	34.6	288.1	1.110	10.12	1.395

RP	ABS VEL		REL VEL		MERID VEL		TANG VEL		WHEEL SPEED	
	IN	OUT	IN	OUT	IN	OUT	IN	OUT	IN	OUT
1	102.1	160.4	330.3	228.8	102.1	117.6	0.0	109.1	314.1	305.4
2	115.4	163.4	330.5	223.3	115.4	118.7	-0.3	112.2	309.5	301.4
3	118.8	165.1	328.2	224.6	118.8	122.7	-0.1	110.4	305.9	298.5
4	124.0	171.0	316.8	222.2	124.0	132.4	-0.1	108.1	291.5	286.6
5	126.1	178.2	301.7	214.3	126.1	139.9	-0.1	110.3	274.1	272.6
6	125.8	191.7	284.0	201.4	125.8	148.4	-0.1	121.3	254.6	257.5
7	124.1	196.1	270.5	197.0	124.1	152.7	-0.1	123.0	240.3	247.4
8	122.4	198.3	264.3	193.7	122.4	153.8	-0.1	125.2	234.2	243.0
9	120.4	204.4	259.3	188.8	120.4	155.4	-0.3	132.8	229.4	240.1

RP	ABS MACH NO		REL MACH NO		MERID MACH NO		MERID PEAK SS	
	IN	OUT	IN	OUT	IN	OUT	VEL R	MACH NO
1	0.302	0.455	0.978	0.649	0.302	0.333	1.152	1.401
2	0.343	0.464	0.983	0.634	0.343	0.337	1.029	1.366
3	0.353	0.470	0.976	0.639	0.353	0.349	1.034	1.359
4	0.369	0.488	0.943	0.635	0.369	0.378	1.068	1.307
5	0.376	0.511	0.899	0.615	0.376	0.401	1.110	1.287
6	0.375	0.551	0.846	0.579	0.375	0.427	1.180	1.298
7	0.370	0.566	0.806	0.568	0.370	0.440	1.231	1.269
8	0.365	0.572	0.788	0.559	0.365	0.444	1.257	1.239
9	0.358	0.590	0.772	0.545	0.358	0.448	1.290	1.216

RP	PERCENT SPAN	INCIDENCE		DEV	D FACT	EFF	LOSS TOT	COEFF PROF	LOSS TOT	PARAM PROF
		MEAN	SS							
1	5.00	10.4	8.0	6.4	0.432	0.722	0.205	0.191	0.040	0.038
2	10.00	8.9	6.2	5.8	0.451	0.693	0.229	0.218	0.046	0.044
3	15.00	8.9	6.0	5.5	0.440	0.727	0.201	0.192	0.041	0.039
4	30.00	8.6	5.2	4.8	0.420	0.803	0.148	0.143	0.032	0.031
5	50.00	9.1	4.9	5.0	0.414	0.859	0.113	0.111	0.025	0.025
6	70.00	10.0	4.5	3.4	0.428	0.904	0.087	0.086	0.020	0.020
7	85.00	10.4	3.8	5.8	0.411	0.929	0.068	0.068	0.016	0.016
8	90.00	10.3	3.5	6.3	0.409	0.914	0.087	0.087	0.020	0.020
9	95.00	10.4	3.2	6.0	0.423	0.910	0.097	0.097	0.023	0.023

TABLE V. - Continued. BLADE-ELEMENT DATA AT BLADE EDGES

FOR ROTOR 35

(q) 70 Percent of design speed; reading 3989

RP	RADII		ABS BETAM		REL BETAM		TOTAL TEMP		TOTAL PRESS	
	IN	OUT	IN	OUT	IN	OUT	IN	RATIO	IN	RATIO
1	24.915	24.221	-0.0	56.6	75.6	62.4	289.3	1.142	10.04	1.350
2	24.572	23.932	-0.1	57.9	73.0	62.6	288.1	1.142	10.13	1.333
3	24.224	23.642	-0.0	55.2	72.2	61.0	288.5	1.136	10.13	1.335
4	23.162	22.771	-0.0	50.0	70.3	55.5	288.0	1.129	10.13	1.345
5	21.725	21.613	-0.0	45.1	68.1	49.6	288.1	1.117	10.14	1.371
6	20.221	20.455	-0.0	41.6	66.3	43.0	288.1	1.112	10.14	1.402
7	19.020	19.583	-0.0	41.0	64.9	39.2	287.8	1.110	10.14	1.402
8	18.595	19.294	-0.0	41.8	64.6	37.2	288.0	1.110	10.14	1.404
9	18.158	19.004	-0.0	42.7	64.6	34.4	288.2	1.114	10.13	1.414

RP	ABS VEL		REL VEL		MERID VEL		TANG VEL		WHEEL SPEED	
	IN	OUT	IN	OUT	IN	OUT	IN	OUT	IN	OUT
1	80.7	161.6	324.1	191.9	80.7	88.9	-0.0	135.0	313.9	305.1
2	94.9	161.1	323.7	185.7	94.9	85.6	-0.2	136.4	309.3	301.2
3	97.7	160.8	320.0	189.0	97.7	91.7	-0.1	132.1	304.6	297.3
4	104.2	168.3	309.6	191.2	104.2	108.2	-0.1	128.9	291.5	286.6
5	110.0	176.8	294.7	192.7	110.0	124.8	-0.1	125.2	273.4	272.0
6	112.1	189.3	278.3	193.5	112.1	141.5	-0.1	125.7	254.7	257.7
7	111.9	193.7	264.1	188.5	111.9	146.1	-0.1	127.2	239.2	246.3
8	111.1	197.1	259.3	184.4	111.1	146.8	-0.1	131.4	234.2	243.0
9	108.8	203.1	253.7	180.8	108.8	149.3	-0.1	137.7	229.1	239.7

RP	ABS MACH NO		REL MACH NO		MERID MACH NO		MERID PEAK SS	
	IN	OUT	IN	OUT	IN	OUT	VEL R	MACH NO
1	0.238	0.453	0.956	0.538	0.238	0.249	1.102	1.488
2	0.281	0.452	0.959	0.521	0.281	0.240	0.902	1.444
3	0.289	0.452	0.947	0.531	0.289	0.258	0.939	1.431
4	0.309	0.476	0.919	0.541	0.309	0.306	1.038	1.379
5	0.327	0.504	0.875	0.549	0.327	0.356	1.134	1.336
6	0.333	0.543	0.827	0.555	0.333	0.406	1.263	1.340
7	0.333	0.557	0.785	0.542	0.333	0.420	1.305	1.296
8	0.330	0.567	0.770	0.531	0.330	0.423	1.321	1.270
9	0.323	0.584	0.753	0.520	0.323	0.430	1.372	1.246

RP	PERCENT SPAN		INCIDENCE MEAN SS		DEV	D FACT	EFF	LOSS COEFF		LOSS PARAM	
								TOT	PROF	TOT	PROF
1	5.00	14.0	11.6	9.7	0.565	0.633	0.330	0.308	0.058	0.055	
2	10.00	12.3	9.6	10.5	0.584	0.604	0.353	0.337	0.062	0.059	
3	15.00	12.4	9.4	9.6	0.562	0.632	0.326	0.312	0.059	0.056	
4	30.00	12.0	8.6	6.9	0.531	0.685	0.281	0.273	0.057	0.056	
5	50.00	11.9	7.7	5.3	0.490	0.805	0.177	0.173	0.039	0.038	
6	70.00	12.5	7.0	3.8	0.450	0.906	0.091	0.090	0.021	0.021	
7	85.00	12.6	6.0	5.8	0.434	0.924	0.079	0.079	0.018	0.018	
8	90.00	12.5	5.7	6.1	0.441	0.928	0.077	0.077	0.018	0.018	
9	95.00	12.7	5.5	5.7	0.447	0.913	0.101	0.101	0.024	0.024	

TABLE V. - Continued. BLADE-ELEMENT DATA AT BLADE EDGES

FOR ROTOR 35

(r) 60 Percent of design speed; reading 3997

RP	RADII		ABS BETAM		REL BETAM		TOTAL TEMP		TOTAL PRESS	
	IN	OUT	IN	OUT	IN	OUT	IN	RATIO	IN	RATIO
1	24.915	24.221	-0.0	52.7	74.9	61.0	289.2	1.102	10.07	1.257
2	24.572	23.932	-0.1	55.1	72.6	61.6	288.2	1.104	10.13	1.244
3	24.224	23.642	-0.0	52.6	71.9	59.8	288.2	1.101	10.13	1.249
4	23.162	22.771	-0.0	47.1	70.1	54.3	288.2	1.094	10.13	1.257
5	21.725	21.613	-0.0	42.7	68.0	49.4	288.1	1.085	10.13	1.272
6	20.221	20.455	-0.0	41.3	66.1	42.8	288.1	1.084	10.14	1.295
7	19.020	19.583	-0.0	40.8	65.0	38.2	288.0	1.082	10.14	1.293
8	18.595	19.294	-0.0	40.2	64.7	36.8	288.1	1.082	10.13	1.296
9	18.158	19.004	-0.0	42.0	64.5	33.7	287.8	1.086	10.13	1.303

RP	ABS VEL		REL VEL		MERID VEL		TAN VEL		WHEEL SPEED	
	IN	OUT	IN	OUT	IN	OUT	IN	OUT	IN	OUT
1	73.7	140.7	282.8	175.6	73.7	85.2	-0.0	111.9	273.0	265.4
2	84.6	139.8	282.6	168.1	84.6	80.0	-0.2	114.7	269.5	262.5
3	87.0	141.0	279.4	170.2	87.0	85.7	-0.0	112.0	265.5	259.1
4	91.9	148.3	269.5	172.9	91.9	100.9	-0.0	108.6	253.3	249.0
5	96.3	154.3	256.9	174.3	96.3	113.5	-0.0	104.5	238.1	236.9
6	97.8	164.6	241.4	168.7	97.8	123.7	-0.0	108.6	220.7	223.3
7	97.0	171.2	229.3	165.0	97.0	129.6	-0.0	111.9	207.8	214.0
8	96.1	173.6	225.2	165.5	96.1	132.6	-0.0	112.1	203.6	211.2
9	95.0	178.7	220.3	159.6	95.0	132.9	-0.0	119.6	198.8	208.0

RP	ABS MACH NO		REL MACH NO		MERID MACH NO		MERID PEAK SS	
	IN	OUT	IN	OUT	IN	OUT	VEL R	MACH NO
1	0.217	0.399	0.833	0.498	0.217	0.242	1.157	1.278
2	0.250	0.397	0.836	0.477	0.250	0.227	0.945	1.248
3	0.257	0.401	0.826	0.484	0.257	0.244	0.984	1.238
4	0.272	0.424	0.798	0.494	0.272	0.289	1.098	1.190
5	0.285	0.444	0.761	0.501	0.285	0.326	1.178	1.159
6	0.290	0.475	0.715	0.487	0.290	0.357	1.265	1.155
7	0.287	0.496	0.680	0.478	0.287	0.375	1.337	1.123
8	0.285	0.503	0.667	0.479	0.285	0.384	1.379	1.102
9	0.282	0.518	0.653	0.462	0.282	0.385	1.398	1.076

RP	PERCENT		INCIDENCE		DEV	D FACT	EFF	LOSS COEFF		LOSS PARAM	
	SPAN	MEAN	SS	SS				TOT	PROF	TOT	PROF
1	5.00	13.3	10.9	8.2	0.528	0.660	0.283	0.293	0.053	0.052	
2	10.00	12.0	9.2	9.6	0.557	0.620	0.319	0.319	0.057	0.057	
3	15.00	12.0	9.0	8.4	0.539	0.646	0.298	0.298	0.056	0.056	
4	30.00	11.7	8.3	5.7	0.502	0.720	0.235	0.235	0.049	0.049	
5	50.00	11.8	7.6	5.1	0.459	0.835	0.140	0.140	0.031	0.031	
6	70.00	12.4	6.9	3.7	0.445	0.911	0.084	0.084	0.020	0.020	
7	85.00	12.7	6.1	4.8	0.430	0.936	0.064	0.064	0.015	0.015	
8	90.00	12.6	5.8	5.7	0.414	0.940	0.062	0.062	0.015	0.015	
9	95.00	12.5	5.3	5.0	0.436	0.911	0.101	0.101	0.024	0.024	

TABLE V. - Concluded. BLADE-ELEMENT DATA AT BLADE EDGES

FOR ROTOR 35

(s) 50 Percent of design speed; reading 4000

RP	RADII		ABS BETAM		REL BETAM		TOTAL TEMP		TOTAL PRESS	
	IN	OUT	IN	OUT	IN	OUT	IN	RATIO	IN	RATIO
1	24.915	24.221	-0.1	47.3	73.8	59.8	289.1	1.063	10.10	1.155
2	24.572	23.932	-0.0	48.6	72.0	58.9	288.3	1.064	10.13	1.153
3	24.224	23.642	-0.0	46.8	71.3	57.7	288.6	1.063	10.13	1.154
4	23.162	22.771	-0.1	42.0	69.5	53.9	288.3	1.058	10.13	1.162
5	21.725	21.613	-0.0	39.7	67.6	48.8	288.0	1.055	10.13	1.174
6	20.221	20.455	-0.1	39.7	66.0	41.7	287.8	1.057	10.13	1.187
7	19.020	19.583	-0.0	38.6	64.8	39.0	288.0	1.054	10.13	1.188
8	18.595	19.294	-0.0	39.7	64.5	37.0	288.0	1.054	10.13	1.188
9	18.158	19.004	-0.1	41.3	64.3	34.0	287.8	1.057	10.13	1.192

RP	ABS VEL		REL VEL		MERID VEL		TANG VEL		WHEEL SPEED	
	IN	OUT	IN	OUT	IN	OUT	IN	OUT	IN	OUT
1	65.0	114.5	233.3	154.4	65.0	77.6	-0.1	84.2	223.9	217.7
2	71.9	116.5	232.0	148.9	71.9	77.0	-0.0	87.4	220.6	214.9
3	73.7	116.9	229.4	149.9	73.7	80.0	-0.0	85.3	217.3	212.0
4	78.0	121.1	222.2	152.8	78.0	90.1	-0.1	81.0	208.0	204.4
5	80.7	128.2	211.6	149.8	80.7	98.6	-0.0	81.8	195.6	194.6
6	81.1	138.8	199.2	143.0	81.1	106.7	-0.1	88.7	181.8	183.9
7	80.7	140.3	189.3	141.1	80.7	109.7	-0.0	87.6	171.2	176.3
8	79.9	142.2	185.2	137.1	79.9	109.5	-0.0	90.8	167.1	173.4
9	78.7	146.6	181.4	132.8	78.7	110.2	-0.1	96.7	163.3	170.9

RP	ABS MACH NO		REL MACH NO		MERID MACH NO		MERID PEAK SS	
	IN	OUT	IN	OUT	IN	OUT	VEL R	MACH NO
1	0.191	0.329	0.687	0.444	0.191	0.223	1.194	1.027
2	0.212	0.335	0.685	0.429	0.212	0.222	1.072	1.008
3	0.217	0.337	0.677	0.432	0.217	0.230	1.086	1.000
4	0.230	0.350	0.656	0.442	0.230	0.260	1.155	0.965
5	0.238	0.372	0.625	0.434	0.238	0.286	1.222	0.944
6	0.240	0.403	0.589	0.416	0.240	0.310	1.316	0.949
7	0.239	0.408	0.560	0.411	0.239	0.319	1.358	0.921
8	0.236	0.414	0.547	0.399	0.236	0.319	1.370	0.899
9	0.233	0.427	0.536	0.387	0.233	0.321	1.400	0.880

RP	PERCENT		INCIDENCE		DEV	D FACT	EFF	LOSS COEFF		LOSS PARAM	
	SPAN	MEAN	SS	SS				TOT	PROF	TOT	PROF
1	5.00	12.2	9.8	7.1	0.474	0.667	0.246	0.246	0.047	0.047	
2	10.00	11.3	8.6	6.8	0.499	0.645	0.268	0.268	0.052	0.052	
3	15.00	11.4	8.4	6.4	0.484	0.667	0.251	0.251	0.050	0.050	
4	30.00	11.1	7.7	5.3	0.442	0.758	0.180	0.180	0.038	0.038	
5	50.00	11.4	7.2	4.5	0.423	0.854	0.114	0.114	0.025	0.025	
6	70.00	12.3	6.8	2.6	0.425	0.888	0.100	0.100	0.024	0.024	
7	85.00	12.4	5.9	5.6	0.396	0.936	0.060	0.060	0.014	0.014	
8	90.00	12.4	5.5	5.9	0.407	0.935	0.064	0.064	0.015	0.015	
9	95.00	12.4	5.2	5.3	0.425	0.905	0.102	0.102	0.024	0.024	

TABLE VI. - BLADE-ELEMENT DATA AT BLADE EDGES FOR STATOR 35

(a) 100 Percent of design speed; reading 4004

RP	RADII		ABS BETAM		REL BETAM		TOTAL TEMP IN RATIO	TOTAL PRESS	
	IN	OUT	IN	OUT	IN	OUT		IN	RATIO
1	23.993	23.752	32.1	11.1	32.1	11.1	345.1	1.000	16.44 0.969
2	23.736	23.523	31.6	10.4	31.6	10.4	345.3	1.000	16.91 0.984
3	23.480	23.294	31.3	10.2	31.3	10.2	344.3	1.000	17.16 0.988
4	22.685	22.593	31.6	9.7	31.6	9.7	344.1	1.000	17.33 0.991
5	21.608	21.656	33.7	10.9	33.7	10.9	346.3	1.000	17.94 0.987
6	20.505	20.709	34.8	11.6	34.8	11.6	346.5	1.000	18.25 0.987
7	19.670	19.990	35.7	10.7	35.7	10.7	343.8	1.000	17.78 0.985
8	19.388	19.746	36.6	9.5	36.6	9.5	343.9	1.000	17.64 0.981
9	19.103	19.505	38.3	9.3	38.3	9.3	345.9	1.000	17.63 0.970

RP	ABS VEL		REL VEL		MERID VEL		TANG VEL		WHEEL SPEED	
	IN	OUT	IN	OUT	IN	OUT	IN	OUT	IN	OUT
1	246.6	200.2	246.6	200.2	209.0	196.4	131.0	38.4	0.0	0.0
2	254.9	215.6	254.9	215.6	217.2	212.0	133.5	38.8	0.0	0.0
3	258.5	223.2	258.5	223.2	220.9	219.6	134.3	39.5	0.0	0.0
4	261.6	232.6	261.6	232.6	222.7	229.3	137.3	39.1	0.0	0.0
5	271.9	245.1	271.9	245.1	226.2	240.7	150.8	46.5	0.0	0.0
6	278.0	253.7	278.0	253.7	228.3	248.5	158.6	51.0	0.0	0.0
7	272.5	249.1	272.5	249.1	221.3	244.7	158.9	46.2	0.0	0.0
8	271.1	246.8	271.1	246.8	217.7	243.4	161.6	40.7	0.0	0.0
9	272.8	244.0	272.8	244.0	214.1	240.8	169.1	39.5	0.0	0.0

RP	ABS MACH NO		REL MACH NO		MERID MACH NO		MERID PEAK SS	
	IN	OUT	IN	OUT	IN	OUT	VEL R	MACH NO
1	0.693	0.554	0.693	0.554	0.587	0.543	0.940	0.900
2	0.719	0.599	0.719	0.599	0.612	0.589	0.976	0.917
3	0.731	0.623	0.731	0.623	0.625	0.613	0.994	0.921
4	0.741	0.651	0.741	0.651	0.631	0.642	1.029	0.935
5	0.771	0.687	0.771	0.687	0.641	0.675	1.064	1.019
6	0.790	0.713	0.790	0.713	0.649	0.699	1.088	1.060
7	0.776	0.702	0.776	0.702	0.630	0.690	1.106	1.045
8	0.771	0.695	0.771	0.695	0.619	0.686	1.118	1.054
9	0.774	0.684	0.774	0.684	0.608	0.675	1.125	1.094

RP	PERCENT SPAN	INCIDENCE		DEV	D FACT	EFF	LOSS COEFF		LOSS PARAM	
		MEAN	SS				TOT	PRCF	TOT	PROF
1	5.00	-2.3	-10.0	8.5	0.334	0.000	0.113	0.113	0.042	0.042
2	10.00	-3.0	-10.3	7.8	0.297	0.000	0.054	0.054	0.020	0.020
3	15.00	-3.4	-10.6	7.6	0.277	0.000	0.042	0.042	0.016	0.016
4	30.00	-3.4	-9.8	6.9	0.252	0.000	0.029	0.029	0.011	0.011
5	50.00	-2.0	-7.5	7.8	0.238	0.000	0.040	0.040	0.014	0.014
6	70.00	-1.6	-6.3	8.1	0.224	0.000	0.037	0.037	0.013	0.013
7	85.00	-1.8	-5.8	7.1	0.227	0.000	0.047	0.047	0.016	0.016
8	90.00	-1.2	-5.0	5.9	0.241	0.000	0.059	0.059	0.020	0.020
9	95.00	0.1	-3.5	5.7	0.265	0.000	0.091	0.091	0.031	0.031

TABLE VI. - Continued. BLADE-ELEMENT DATA AT BLADE EDGES

FOR STATOR 35

(b) 100 Percent of design speed; reading 3978

RP	RADII		ABS BETAM		REL BETAM		TOTAL TEMP		TOTAL PRESS	
	IN	OUT	IN	OUT	IN	OUT	IN	RATIO	IN	RATIO
1	23.993	23.752	39.1	11.8	39.1	11.8	356.1	1.000	18.03	0.968
2	23.736	23.523	38.4	11.1	38.4	11.1	355.5	1.000	18.42	0.979
3	23.480	23.294	37.1	11.0	37.1	11.0	353.7	1.000	18.61	0.984
4	22.685	22.593	36.9	10.8	36.9	10.8	352.0	1.000	18.73	0.990
5	21.608	21.656	39.4	12.1	39.4	12.1	354.5	1.000	19.24	0.986
6	20.505	20.709	40.0	12.5	40.0	12.5	353.6	1.000	19.52	0.981
7	19.670	19.990	39.9	11.1	39.9	11.1	349.8	1.000	19.11	0.980
8	19.388	19.746	40.8	11.4	40.8	11.4	350.3	1.000	19.05	0.975
9	19.103	19.505	42.6	12.7	42.6	12.7	352.9	1.000	19.22	0.964

RP	ABS VEL		REL VEL		MERID VEL		TANG VEL		WHEEL SPEED	
	IN	OUT	IN	OUT	IN	OUT	IN	OUT	IN	OUT
1	250.3	183.1	250.3	183.1	194.3	179.2	157.8	37.4	0.0	0.0
2	256.8	196.8	256.8	196.8	201.3	193.0	159.5	38.0	0.0	0.0
3	258.9	203.8	258.9	203.8	206.4	200.0	156.3	39.1	0.0	0.0
4	262.6	211.9	262.6	211.9	210.1	208.2	157.5	39.6	0.0	0.0
5	272.7	222.8	272.7	222.8	210.7	217.9	173.2	46.7	0.0	0.0
6	279.7	229.8	279.7	229.8	214.4	224.4	179.7	49.7	0.0	0.0
7	275.6	228.0	275.6	228.0	211.5	223.7	176.7	44.1	0.0	0.0
8	276.4	227.9	276.4	227.9	209.4	223.4	180.5	44.9	0.0	0.0
9	281.7	230.1	281.7	230.1	207.3	224.4	190.8	50.6	0.0	0.0

RP	ABS MACH NO		REL MACH NO		MERID MACH NO		MERID PEAK SS	
	IN	OUT	IN	OUT	IN	OUT	VEL R	MACH NO
1	0.693	0.496	0.693	0.496	0.538	0.485	0.922	1.067
2	0.713	0.535	0.713	0.535	0.559	0.525	0.959	1.080
3	0.721	0.557	0.721	0.557	0.575	0.547	0.969	1.058
4	0.735	0.582	0.735	0.582	0.588	0.572	0.991	1.063
5	0.763	0.612	0.763	0.612	0.590	0.598	1.034	1.160
6	0.787	0.634	0.787	0.634	0.603	0.619	1.047	1.196
7	0.778	0.632	0.778	0.632	0.597	0.620	1.057	1.161
8	0.780	0.631	0.780	0.631	0.591	0.619	1.067	1.179
9	0.794	0.635	0.794	0.635	0.584	0.619	1.083	1.238

RP	PERCENT SPAN		INCIDENCE MEAN SS		DEV	D FACT	EFF	LOSS COEFF		LOSS PARAM	
	TOT	PROF	TOT	PROF				TOT	PROF		
1	5.00		4.7	-2.9	9.2	0.455	0.000	0.118	0.118	0.044	0.044
2	10.00		3.9	-3.5	8.6	0.416	0.000	0.073	0.073	0.027	0.027
3	15.00		2.4	-4.7	8.5	0.386	0.000	0.053	0.053	0.020	0.020
4	30.00		1.8	-4.6	8.0	0.361	0.000	0.034	0.034	0.013	0.013
5	50.00		3.7	-1.8	9.0	0.352	0.000	0.045	0.045	0.016	0.016
6	70.00		3.6	-1.1	9.0	0.342	0.000	0.057	0.057	0.020	0.020
7	85.00		2.4	-1.6	7.6	0.338	0.000	0.062	0.062	0.021	0.021
8	90.00		2.9	-0.8	7.8	0.342	0.000	0.076	0.076	0.026	0.026
9	95.00		4.4	0.8	9.1	0.350	0.000	0.105	0.105	0.035	0.035

TABLE VI. - Continued. BLADE-ELEMENT DATA AT BLADE EDGES

FOR STATOR 35

(c) 100 Percent of design speed; reading 3977

RP	RADII		ABS BETAM		REL BETAM		TOTAL TEMP		TOTAL PRESS	
	IN	OUT	IN	OUT	IN	OUT	IN	RATIO	IN	RATIO
1	23.993	23.752	43.1	12.3	43.1	12.3	363.7	1.000	19.13	0.966
2	23.736	23.523	42.4	11.7	42.4	11.7	362.5	1.000	19.47	0.972
3	23.480	23.294	41.4	12.0	41.4	12.0	361.2	1.000	19.66	0.978
4	22.685	22.593	40.9	12.1	40.9	12.1	359.0	1.000	19.78	0.983
5	21.608	21.656	42.6	13.0	42.6	13.0	359.4	1.000	19.97	0.979
6	20.505	20.709	43.1	13.1	43.1	13.1	357.7	1.000	20.12	0.968
7	19.670	19.990	42.7	11.7	42.7	11.7	353.6	1.000	19.68	0.971
8	19.388	19.746	43.5	12.1	43.5	12.1	354.1	1.000	19.70	0.966
9	19.103	19.505	45.0	13.4	45.0	13.4	356.3	1.000	19.88	0.957

RP	ABS VEL		REL VEL		MERID VEL		TANG VEL		WHEEL SPEED	
	IN	OUT	IN	OUT	IN	OUT	IN	OUT	IN	OUT
1	257.1	178.1	257.1	178.1	187.7	174.0	175.7	38.1	0.0	0.0
2	262.4	189.2	262.4	189.2	193.9	185.3	176.8	38.4	0.0	0.0
3	264.7	196.2	264.7	196.2	198.5	191.9	175.1	40.9	0.0	0.0
4	267.7	204.5	267.7	204.5	202.3	199.9	175.4	42.9	0.0	0.0
5	273.9	212.2	273.9	212.2	201.6	206.8	185.4	47.7	0.0	0.0
6	278.9	215.3	278.9	215.3	203.6	209.7	190.6	48.6	0.0	0.0
7	275.6	213.1	275.6	213.1	202.4	208.7	187.1	43.1	0.0	0.0
8	277.8	214.3	277.8	214.3	201.5	209.6	191.2	45.0	0.0	0.0
9	283.4	217.6	283.4	217.6	200.4	211.7	200.4	50.3	0.0	0.0

RP	ABS MACH NO		REL MACH NO		MERID MACH NO		MERID VEL	PEAK MACH NO	SS
	IN	OUT	IN	OUT	IN	OUT			
1	0.705	0.476	0.705	0.476	0.515	0.465	0.927	1.183	
2	0.722	0.508	0.722	0.508	0.534	0.498	0.956	1.191	
3	0.731	0.529	0.731	0.529	0.548	0.518	0.967	1.178	
4	0.743	0.555	0.743	0.555	0.561	0.542	0.988	1.177	
5	0.761	0.577	0.761	0.577	0.560	0.562	1.026	1.239	
6	0.779	0.587	0.779	0.587	0.569	0.572	1.030	1.267	
7	0.774	0.584	0.774	0.584	0.568	0.572	1.031	1.230	
8	0.780	0.587	0.780	0.587	0.566	0.574	1.040	1.250	
9	0.795	0.595	0.795	0.595	0.552	0.579	1.056	1.304	

RP	PERCENT SPAN	INCIDENCE		DEV	D FACT	EFF	LOSS COEFF		LOSS PARAM	
		MEAN	SS				TOT	PROF	TOT	PROF
1	5.00	8.7	1.1	9.8	0.514	0.000	0.122	0.122	0.046	0.046
2	10.00	7.8	0.5	9.2	0.481	0.000	0.095	0.095	0.035	0.035
3	15.00	6.7	-0.4	9.4	0.452	0.000	0.074	0.074	0.027	0.027
4	30.00	5.9	-0.5	9.3	0.422	0.000	0.055	0.055	0.020	0.020
5	50.00	6.9	1.4	9.9	0.408	0.000	0.065	0.065	0.023	0.023
6	70.00	6.7	2.1	9.6	0.408	0.000	0.096	0.096	0.033	0.033
7	85.00	5.3	1.3	8.1	0.406	0.000	0.090	0.090	0.031	0.031
8	90.00	5.7	1.9	8.5	0.407	0.000	0.104	0.104	0.035	0.035
9	95.00	6.8	3.2	9.7	0.410	0.000	0.126	0.126	0.042	0.042

TABLE VI. - Continued. BLADE-ELEMENT DATA AT BLADE EDGES

FOR STATOR 35

(d) 100 Percent of design speed; reading 3974

RP	RADII		ABS BETAM		REL BETAM		TOTAL TEMP		TOTAL PRESS	
	IN	OUT	IN	OUT	IN	OUT	IN	RATIO	IN	RATIO
1	23.993	23.752	45.5	12.8	45.5	12.8	368.4	1.000	19.66	0.963
2	23.736	23.523	44.6	12.4	44.6	12.4	366.6	1.000	19.93	0.965
3	23.480	23.294	43.7	12.7	43.7	12.7	365.4	1.000	20.07	0.972
4	22.685	22.593	42.8	12.9	42.8	12.9	362.4	1.000	20.11	0.978
5	21.608	21.656	43.8	13.2	43.8	13.2	361.6	1.000	20.26	0.971
6	20.505	20.709	44.5	13.2	44.5	13.2	359.1	1.000	20.32	0.962
7	19.670	19.990	44.4	12.1	44.4	12.1	355.2	1.000	19.86	0.966
8	19.388	19.746	45.0	12.9	45.0	12.9	355.5	1.000	19.89	0.962
9	19.103	19.505	45.4	14.1	45.4	14.1	357.4	1.000	20.12	0.951

RP	ABS VEL		REL VEL		MERID VEL		TANG VEL		WHEEL SPEED	
	IN	OUT	IN	OUT	IN	OUT	IN	OUT	IN	OUT
1	260.4	176.7	260.4	176.7	182.6	172.3	185.8	39.2	0.0	0.0
2	264.3	185.9	264.3	185.9	188.0	181.6	185.7	39.9	0.0	0.0
3	266.0	193.0	266.0	193.0	192.2	188.3	183.9	42.3	0.0	0.0
4	267.5	201.0	267.5	201.0	196.4	195.9	181.6	45.0	0.0	0.0
5	272.7	207.5	272.7	207.5	196.7	202.1	188.8	47.3	0.0	0.0
6	276.9	210.0	276.9	210.0	197.6	204.4	194.0	48.1	0.0	0.0
7	273.3	207.7	273.3	207.7	195.3	203.1	191.3	43.4	0.0	0.0
8	276.0	209.5	276.0	209.5	195.1	204.2	195.3	46.8	0.0	0.0
9	282.1	212.8	282.1	212.8	198.0	206.5	201.0	51.7	0.0	0.0

RP	ABS MACH NO		REL MACH NO		MERID MACH NO		MERID PEAK SS	
	IN	OUT	IN	OUT	IN	OUT	VEL R	MACH NO
1	0.710	0.469	0.710	0.469	0.498	0.458	0.944	1.249
2	0.724	0.496	0.724	0.496	0.515	0.485	0.966	1.249
3	0.730	0.517	0.730	0.517	0.527	0.504	0.980	1.235
4	0.738	0.542	0.738	0.542	0.542	0.528	0.997	1.216
5	0.755	0.561	0.755	0.561	0.545	0.546	1.027	1.260
6	0.771	0.570	0.771	0.570	0.550	0.555	1.035	1.290
7	0.764	0.567	0.764	0.567	0.546	0.555	1.040	1.258
8	0.773	0.572	0.773	0.572	0.546	0.558	1.047	1.279
9	0.789	0.580	0.789	0.580	0.554	0.563	1.043	1.306

RP	PERCENT SPAN		INCIDENCE MEAN		DEV	D FACT	EFF	LOSS COEFF		LOSS PARAM	
	SPAN	MEAN	SS	SS				TOT	PROF	TOT	PROF
1	5.00	11.1	3.5	10.3	0.539	0.000	0.131	0.131	0.049	0.049	
2	10.00	10.1	2.7	9.8	0.508	0.000	0.118	0.118	0.044	0.044	
3	15.00	9.0	1.9	10.1	0.478	0.000	0.093	0.093	0.034	0.034	
4	30.00	7.7	1.3	10.1	0.440	0.000	0.071	0.071	0.026	0.026	
5	50.00	8.1	2.6	10.1	0.428	0.000	0.091	0.091	0.032	0.032	
6	70.00	8.1	3.4	9.8	0.427	0.000	0.116	0.116	0.040	0.040	
7	85.00	7.0	3.0	8.5	0.425	0.000	0.106	0.106	0.036	0.036	
8	90.00	7.2	3.4	9.3	0.423	0.000	0.116	0.116	0.039	0.039	
9	95.00	7.2	3.7	10.4	0.423	0.000	0.144	0.144	0.048	0.048	

TABLE VI. - Continued. BLADE-ELEMENT DATA AT BLADE EDGES

FOR STATOR 35

(e) 100 Percent of design speed; reading 3976

RP	RADII		ABS BETAM		REL BETAM		TOTAL TEMP		TOTAL PRESS	
	IN	OUT	IN	OUT	IN	OUT	IN	RATIO	IN	RATIO
1	23.993	23.752	55.8	16.0	55.8	16.0	382.6	1.000	20.56	0.948
2	23.736	23.523	54.7	14.5	54.7	14.5	379.8	1.000	20.57	0.944
3	23.480	23.294	53.3	13.5	53.3	13.5	378.0	1.000	20.64	0.943
4	22.685	22.593	50.6	12.4	50.6	12.4	372.5	1.000	20.71	0.945
5	21.608	21.656	49.0	12.9	49.0	12.9	367.5	1.000	20.72	0.946
6	20.505	20.709	48.0	13.7	48.0	13.7	362.4	1.000	20.64	0.944
7	19.670	19.990	47.4	13.8	47.4	13.8	358.8	1.000	20.30	0.949
8	19.388	19.746	47.4	14.9	47.4	14.9	358.9	1.000	20.49	0.941
9	19.103	19.505	47.5	15.9	47.5	15.9	359.8	1.000	20.80	0.929

RP	ABS VEL		REL VEL		MERID VEL		TANG VEL		WHEEL SPEED	
	IN	OUT	IN	OUT	IN	OUT	IN	OUT	IN	OUT
1	264.3	181.0	264.3	181.0	148.4	174.0	218.7	49.8	0.0	0.0
2	263.9	182.4	263.9	182.4	152.5	176.6	215.4	45.7	0.0	0.0
3	265.1	184.5	265.1	184.5	158.3	179.4	212.6	43.2	0.0	0.0
4	267.9	189.4	267.9	189.4	170.0	185.0	207.1	40.6	0.0	0.0
5	272.2	192.9	272.2	192.9	178.5	188.0	205.6	43.2	0.0	0.0
6	273.1	193.5	273.1	193.5	182.6	188.0	203.1	45.7	0.0	0.0
7	274.9	191.4	274.9	191.4	186.0	185.9	202.4	45.5	0.0	0.0
8	279.8	193.3	279.8	193.3	189.5	186.8	205.9	49.7	0.0	0.0
9	286.9	195.8	286.9	195.8	193.7	188.3	211.7	53.6	0.0	0.0

RP	ABS MACH NO		REL MACH NO		MERID MACH NO		MERID VEL R	PEAK SS MACH NO
	IN	OUT	IN	OUT	IN	OUT		
1	0.707	0.472	0.707	0.472	0.397	0.454	1.172	1.505
2	0.709	0.477	0.709	0.477	0.410	0.462	1.158	1.475
3	0.714	0.484	0.714	0.484	0.426	0.471	1.134	1.447
4	0.728	0.502	0.728	0.502	0.462	0.490	1.088	1.398
5	0.747	0.515	0.747	0.515	0.489	0.502	1.053	1.380
6	0.755	0.521	0.755	0.521	0.505	0.506	1.030	1.356
7	0.765	0.517	0.765	0.517	0.518	0.502	0.999	1.337
8	0.780	0.523	0.780	0.523	0.528	0.505	0.986	1.354
9	0.801	0.529	0.801	0.529	0.541	0.509	0.972	1.384

RP	PERCENT SPAN	INCIDENCE		DEV	D FACT	EFF	LOSS COEFF		LOSS TOT	PARAM PROF
		MEAN	SS				TOT	PROF		
1	5.00	21.4	13.8	13.4	0.562	0.000	0.183	0.179	0.068	0.066
2	10.00	20.2	12.8	11.9	0.556	0.000	0.195	0.192	0.072	0.071
3	15.00	18.6	11.5	10.9	0.548	0.000	0.199	0.197	0.073	0.073
4	30.00	15.6	9.2	9.6	0.526	0.000	0.186	0.185	0.068	0.068
5	50.00	13.3	7.8	9.8	0.509	0.000	0.175	0.174	0.062	0.062
6	70.00	11.6	7.0	10.2	0.495	0.000	0.176	0.176	0.061	0.061
7	85.00	10.0	6.0	10.2	0.499	0.000	0.159	0.159	0.054	0.054
8	90.00	9.6	5.8	11.3	0.499	0.000	0.179	0.178	0.060	0.059
9	95.00	9.3	5.8	12.3	0.503	0.000	0.205	0.202	0.067	0.066

TABLE VI. - Continued. BLADE-ELEMENT DATA AT BLADE EDGES

FOR STATOR 35

(f) 100 Percent of design speed; reading 3975

RP	RADII		ABS BETAM		REL BETAM		TOTAL TEMP		TOTAL PRESS	
	IN	OUT	IN	OUT	IN	OUT	IN	RATIO	IN	RATIO
1	23.993	23.752	49.1	14.0	49.1	14.0	373.5	1.000	20.03	0.960
2	23.736	23.523	48.2	13.4	48.2	13.4	371.6	1.000	20.28	0.957
3	23.480	23.294	47.1	13.9	47.1	13.9	370.0	1.000	20.41	0.961
4	22.685	22.593	45.6	13.2	45.6	13.2	366.5	1.000	20.50	0.967
5	21.608	21.656	45.9	13.4	45.9	13.4	364.1	1.000	20.53	0.960
6	20.505	20.709	45.9	13.2	45.9	13.2	360.4	1.000	20.50	0.955
7	19.670	19.990	45.7	12.6	45.7	12.6	356.8	1.000	20.08	0.960
8	19.388	19.746	46.2	13.6	46.2	13.6	357.1	1.000	20.20	0.954
9	19.103	19.505	46.7	14.6	46.7	14.6	358.8	1.000	20.50	0.943

RP	ABS VEL		REL VEL		MERID VEL		TANG VEL		WHEEL SPEED	
	IN	OUT	IN	OUT	IN	OUT	IN	OUT	IN	OUT
1	261.0	177.0	261.0	177.0	170.8	171.8	197.4	42.8	0.0	0.0
2	264.9	183.2	264.9	183.2	176.4	178.3	197.6	42.4	0.0	0.0
3	266.6	188.8	266.6	188.8	181.5	183.3	195.4	45.5	0.0	0.0
4	269.0	196.3	269.0	196.3	189.3	191.1	192.0	44.8	0.0	0.0
5	273.5	200.6	273.5	200.6	190.2	195.2	196.6	46.3	0.0	0.0
6	275.4	201.9	275.4	201.9	191.6	196.6	197.8	45.9	0.0	0.0
7	273.8	200.2	273.8	200.2	191.4	195.4	195.9	43.6	0.0	0.0
8	277.9	202.5	277.9	202.5	192.4	196.8	200.6	47.7	0.0	0.0
9	285.2	205.6	285.2	205.6	195.5	199.0	207.6	51.7	0.0	0.0

RP	ABS MACH NO		REL MACH NO		MERID MACH NO		MERID VEL R	PEAK MACH NO	SS
	IN	OUT	IN	OUT	IN	OUT			
1	0.707	0.467	0.707	0.467	0.462	0.453	1.006	1.332	
2	0.720	0.485	0.720	0.485	0.490	0.472	1.010	1.332	
3	0.727	0.502	0.727	0.502	0.495	0.487	1.010	1.314	
4	0.738	0.525	0.738	0.525	0.517	0.512	1.015	1.286	
5	0.755	0.539	0.755	0.539	0.525	0.525	1.026	1.314	
6	0.765	0.546	0.765	0.546	0.532	0.532	1.026	1.316	
7	0.764	0.544	0.764	0.544	0.534	0.531	1.021	1.290	
8	0.777	0.550	0.777	0.550	0.537	0.535	1.023	1.316	
9	0.797	0.558	0.797	0.558	0.547	0.540	1.018	1.355	

RP	PERCENT SPAN	INCIDENCE		DEV	D FACT	EFF	LOSS COEFF		LOSS PARAM	
		MEAN	SS				TOT	PROF	TOT	PROF
1	5.00	14.7	7.1	11.4	0.551	0.000	0.140	0.140	0.052	0.052
2	10.00	13.7	6.3	10.8	0.533	0.000	0.146	0.146	0.054	0.054
3	15.00	12.4	5.3	11.3	0.507	0.000	0.132	0.132	0.049	0.049
4	30.00	10.5	4.1	10.4	0.476	0.000	0.110	0.110	0.040	0.040
5	50.00	10.2	4.7	10.2	0.467	0.000	0.126	0.125	0.045	0.045
6	70.00	9.5	4.9	9.7	0.461	0.000	0.140	0.140	0.049	0.048
7	85.00	8.2	4.2	9.0	0.460	0.000	0.123	0.123	0.042	0.042
8	90.00	8.4	4.6	10.0	0.458	0.000	0.140	0.139	0.047	0.047
9	95.00	8.5	4.9	10.9	0.463	0.000	0.168	0.166	0.055	0.055

TABLE VI. - Continued. BLADE-ELEMENT DATA AT BLADE EDGES

FOR STATOR 35

(g) 90 Percent of design speed; reading 3979

RP	RADII		ABS BETAM		REL BETAM		TOTAL TEMP		TOTAL PRESS	
	IN	OUT	IN	OUT	IN	OUT	IN	RATIO	IN	RATIO
1	23.993	23.752	29.9	11.3	29.9	11.3	332.9	1.000	15.07	0.969
2	23.736	23.523	29.6	10.5	29.6	10.5	333.4	1.000	15.48	0.983
3	23.480	23.294	29.1	10.4	29.1	10.4	333.3	1.000	15.69	0.989
4	22.685	22.593	30.2	9.8	30.2	9.8	334.0	1.000	15.95	0.991
5	21.608	21.656	32.3	10.6	32.3	10.6	335.3	1.000	16.28	0.992
6	20.505	20.709	32.8	10.6	32.8	10.6	334.5	1.000	16.57	0.991
7	19.670	19.990	33.7	10.5	33.7	10.5	333.4	1.000	16.42	0.987
8	19.388	19.746	34.8	10.6	34.8	10.6	333.7	1.000	16.35	0.986
9	19.103	19.505	36.8	12.1	36.8	12.1	336.3	1.000	16.46	0.976

RP	ABS VEL		REL VEL		MERID VEL		TANG VEL		WHEEL SPEED	
	IN	OUT	IN	OUT	IN	OUT	IN	OUT	IN	OUT
1	231.0	192.7	231.0	192.7	200.3	189.0	115.0	37.8	0.0	0.0
2	239.2	207.5	239.2	207.5	208.0	204.0	118.2	37.7	0.0	0.0
3	242.9	215.7	242.9	215.7	212.1	212.2	118.2	39.1	0.0	0.0
4	248.3	226.4	248.3	226.4	214.5	223.2	124.9	38.4	0.0	0.0
5	254.5	237.1	254.5	237.1	215.2	233.1	135.9	43.5	0.0	0.0
6	260.5	245.0	260.5	245.0	219.0	240.8	141.2	45.2	0.0	0.0
7	258.7	244.6	258.7	244.6	215.3	240.5	143.5	44.4	0.0	0.0
8	258.7	244.3	258.7	244.3	212.3	240.2	147.7	45.0	0.0	0.0
9	262.8	243.6	262.8	243.6	210.5	238.2	157.4	51.1	0.0	0.0

RP	ABS MACH NO		REL MACH NO		MERID MACH NO		MERID VEL R	PEAK MACH NO	SS
	IN	OUT	IN	OUT	IN	OUT			
1	0.658	0.542	0.658	0.542	0.571	0.532	0.943	0.798	
2	0.683	0.586	0.683	0.586	0.594	0.576	0.981	0.819	
3	0.695	0.611	0.695	0.611	0.607	0.601	1.000	0.815	
4	0.711	0.643	0.711	0.643	0.614	0.634	1.040	0.858	
5	0.729	0.675	0.729	0.675	0.616	0.663	1.083	0.926	
6	0.749	0.700	0.749	0.700	0.630	0.688	1.100	0.952	
7	0.745	0.700	0.745	0.700	0.620	0.688	1.117	0.950	
8	0.744	0.699	0.744	0.699	0.611	0.687	1.131	0.971	
9	0.754	0.694	0.754	0.694	0.604	0.678	1.132	1.026	

RP	PERCENT SPAN	INCIDENCE		DEV	D FACT	EFF	LOSS COEFF		LOSS PARAM	
		MEAN	SS				TOT	PROF	TOT	PROF
1	5.00	-4.6	-12.2	8.8	0.295	0.000	0.122	0.122	0.046	0.046
2	10.00	-4.9	-12.3	7.9	0.262	0.000	0.065	0.065	0.024	0.024
3	15.00	-5.6	-12.7	7.8	0.237	0.000	0.038	0.038	0.014	0.014
4	30.00	-4.8	-11.3	7.0	0.219	0.000	0.031	0.031	0.011	0.011
5	50.00	-3.5	-8.9	7.5	0.200	0.000	0.026	0.026	0.009	0.009
6	70.00	-3.6	-8.2	7.2	0.189	0.000	0.028	0.028	0.010	0.010
7	85.00	-3.8	-7.7	6.9	0.186	0.000	0.042	0.042	0.014	0.014
8	90.00	-3.0	-6.8	7.0	0.190	0.000	0.044	0.044	0.015	0.015
9	95.00	-1.4	-5.0	8.5	0.208	0.000	0.077	0.077	0.026	0.026

TABLE VI. - Continued. BLADE-ELEMENT DATA AT BLADE EDGES

FOR STATOR 35

(h) 90 Percent of design speed; reading 3982

RP	RADII		ABS BETAM		REL BETAM		TOTAL IN	TEMP RATIO	TOTAL IN	PRESS RATIO
	IN	OUT	IN	OUT	IN	OUT				
1	23.993	23.752	36.1	11.8	36.1	11.8	342.7	1.000	16.38	0.971
2	23.736	23.523	35.8	11.2	35.8	11.2	342.4	1.000	16.67	0.980
3	23.480	23.294	35.3	11.0	35.3	11.0	341.7	1.000	16.78	0.989
4	22.685	22.593	35.6	11.0	35.6	11.0	340.8	1.000	16.96	0.991
5	21.608	21.656	37.7	11.9	37.7	11.9	341.7	1.009	17.17	0.991
6	20.505	20.709	37.8	11.5	37.8	11.5	339.2	1.000	17.30	0.990
7	19.670	19.990	38.2	10.5	38.2	10.5	337.5	1.000	17.03	0.988
8	19.388	19.746	39.6	11.3	39.6	11.3	338.5	1.000	17.04	0.986
9	19.103	19.505	41.1	13.0	41.1	13.0	340.8	1.000	17.28	0.973

RP	ABS VEL		REL VEL		MERID VEL		TANG VEL		WHEEL SPEED	
	IN	OUT	IN	OUT	IN	OUT	IN	OUT	IN	OUT
1	236.6	177.2	236.6	177.2	191.2	173.4	139.3	36.2	0.0	0.0
2	241.7	189.1	241.7	189.1	196.1	185.5	141.4	36.8	0.0	0.0
3	243.3	196.4	243.3	196.4	198.5	192.7	140.7	37.5	0.0	0.0
4	245.5	204.7	245.5	204.7	199.6	201.0	142.9	39.1	0.0	0.0
5	252.1	213.0	252.1	213.0	199.5	208.5	154.2	43.8	0.0	0.0
6	254.8	218.9	254.8	218.9	201.5	214.5	156.0	43.6	0.0	0.0
7	252.0	218.8	252.0	218.8	198.0	215.1	155.9	40.1	0.0	0.0
8	254.2	221.1	254.2	221.1	195.9	216.8	162.0	43.4	0.0	0.0
9	260.9	223.1	260.9	223.1	196.4	217.4	171.6	50.1	0.0	0.0

RP	ABS MACH NO		REL MACH NO		MERID MACH NO		MERID VEL R	PEAK MACH NO	SS
	IN	OUT	IN	OUT	IN	OUT			
1	0.665	0.489	0.665	0.489	0.537	0.478	0.907	0.957	
2	0.681	0.524	0.681	0.524	0.553	0.514	0.946	0.971	
3	0.687	0.545	0.687	0.545	0.560	0.535	0.971	0.965	
4	0.695	0.571	0.695	0.571	0.565	0.560	1.007	0.975	
5	0.714	0.595	0.714	0.595	0.565	0.582	1.045	1.044	
6	0.726	0.615	0.726	0.615	0.574	0.603	1.065	1.049	
7	0.719	0.616	0.719	0.616	0.565	0.606	1.087	1.032	
8	0.725	0.622	0.725	0.622	0.558	0.610	1.106	1.066	
9	0.743	0.626	0.743	0.626	0.559	0.610	1.107	1.122	

RP	PERCENT SPAN	INCIDENCE		DEV	D FACT	EFF	LOSS TOT	COEFF PROF	LOSS TOT	PARAM PROF
		MEAN	SS							
1	5.00	1.7	-5.9	9.3	0.420	0.000	0.113	0.113	0.043	0.043
2	10.00	1.3	-6.1	8.6	0.384	0.000	0.074	0.074	0.028	0.028
3	15.00	0.6	-6.5	8.4	0.355	0.000	0.041	0.041	0.015	0.015
4	30.00	0.6	-5.9	8.2	0.325	0.000	0.031	0.031	0.012	0.012
5	50.00	2.0	-3.5	8.8	0.314	0.000	0.033	0.033	0.012	0.012
6	70.00	1.3	-3.3	8.0	0.296	0.000	0.035	0.035	0.012	0.012
7	85.00	0.8	-3.2	7.0	0.289	0.000	0.043	0.043	0.015	0.015
8	90.00	1.8	-2.0	7.7	0.289	0.000	0.046	0.046	0.015	0.015
9	95.00	2.9	-0.6	9.4	0.301	0.000	0.087	0.087	0.029	0.029

TABLE VI. - Continued. BLADE-ELEMENT DATA AT BLADE EDGES

FOR STATOR 35

(i) 90 Percent of design speed; reading 3983

RP	RADII		ABS BETAM		REL BETAM		TOTAL TEMP		TOTAL PRESS	
	IN	OUT	IN	OUT	IN	OUT	IN	RATIO	IN	RATIO
1	23.993	23.752	41.6	12.3	41.6	12.3	349.2	1.000	17.04	0.971
2	23.736	23.523	40.5	12.0	40.5	12.0	348.7	1.000	17.32	0.974
3	23.480	23.294	40.1	12.1	40.1	12.1	347.8	1.000	17.40	0.983
4	22.685	22.593	39.8	12.1	39.8	12.1	345.7	1.000	17.52	0.987
5	21.608	21.656	41.3	12.7	41.3	12.7	345.4	1.000	17.63	0.985
6	20.505	20.709	41.0	12.2	41.0	12.2	342.2	1.000	17.67	0.982
7	19.670	19.990	41.4	11.2	41.4	11.2	339.9	1.000	17.41	0.985
8	19.388	19.746	42.7	12.4	42.7	12.4	340.9	1.000	17.47	0.980
9	19.103	19.505	43.6	13.7	43.6	13.7	342.9	1.000	17.70	0.967

RP	ABS VEL		REL VEL		MERID VEL		TANG VEL		WHEEL SPEED	
	IN	OUT	IN	OUT	IN	OUT	IN	OUT	IN	OUT
1	236.5	166.8	236.5	166.8	176.8	162.9	157.1	35.6	0.0	0.0
2	241.7	176.4	241.7	176.4	183.8	172.5	157.0	36.8	0.0	0.0
3	243.2	183.3	243.2	183.3	186.0	179.2	156.6	38.3	0.0	0.0
4	243.3	191.0	243.3	191.0	186.9	186.7	155.8	40.1	0.0	0.0
5	249.6	197.6	249.6	197.6	187.5	192.8	164.8	43.4	0.0	0.0
6	250.7	200.8	250.7	200.8	189.1	196.3	164.6	42.3	0.0	0.0
7	248.8	201.1	248.8	201.1	186.5	197.3	164.6	38.9	0.0	0.0
8	252.2	203.6	252.2	203.6	185.4	198.9	171.0	43.6	0.0	0.0
9	258.9	206.3	258.9	206.3	187.4	200.4	178.7	48.9	0.0	0.0

RP	ABS MACH NO		REL MACH NO		MERID MACH NO		MERID VEL R	PEAK MACH NO	SS
	IN	OUT	IN	OUT	IN	OUT			
1	0.658	0.454	0.658	0.454	0.492	0.444	0.922	1.071	
2	0.674	0.482	0.674	0.482	0.513	0.471	0.939	1.069	
3	0.680	0.502	0.680	0.502	0.520	0.491	0.963	1.065	
4	0.683	0.526	0.683	0.526	0.524	0.515	0.999	1.057	
5	0.702	0.546	0.702	0.546	0.527	0.533	1.029	1.112	
6	0.709	0.558	0.709	0.558	0.535	0.546	1.038	1.104	
7	0.706	0.561	0.706	0.561	0.529	0.550	1.058	1.091	
8	0.715	0.567	0.715	0.567	0.526	0.554	1.073	1.128	
9	0.734	0.574	0.734	0.574	0.531	0.557	1.069	1.171	

RP	PERCENT SPAN	INCIDENCE		DEV	D FACT	EFF	LOSS COEFF		LOSS PARAM	
		MEAN	SS				TOT	PROF	TOT	PROF
1	5.00	7.2	-0.4	9.8	0.494	0.000	0.114	0.114	0.043	0.043
2	10.00	6.0	-1.4	9.5	0.461	0.000	0.098	0.098	0.037	0.037
3	15.00	5.4	-1.8	9.5	0.432	0.000	0.063	0.063	0.023	0.023
4	30.00	4.8	-1.6	9.3	0.394	0.000	0.049	0.049	0.018	0.018
5	50.00	5.6	0.1	9.6	0.385	0.000	0.054	0.054	0.019	0.019
6	70.00	4.6	-0.0	8.7	0.371	0.000	0.062	0.062	0.022	0.022
7	85.00	4.0	-0.0	7.6	0.365	0.000	0.055	0.055	0.019	0.019
8	90.00	4.9	1.1	8.8	0.364	0.000	0.070	0.070	0.023	0.023
9	95.00	5.4	1.9	10.1	0.371	0.000	0.110	0.110	0.037	0.037

TABLE VI. - Continued. BLADE-ELEMENT DATA AT BLADE EDGES

FOR STATOR 35

(j) 90 Percent of design speed; reading 3984

RP	RADII		ABS BETAM		REL BETAM		TOTAL TEMP		TOTAL PRESS	
	IN	OUT	IN	OUT	IN	OUT	IN	RATIO	IN	RATIO
1	23.993	23.752	44.4	12.8	44.4	12.8	352.9	1.000	17.33	0.969
2	23.736	23.523	43.0	12.8	43.0	12.8	352.0	1.000	17.59	0.972
3	23.480	23.294	42.5	12.8	42.5	12.8	351.1	1.000	17.67	0.980
4	22.685	22.593	41.7	12.6	41.7	12.6	348.0	1.000	17.78	0.983
5	21.608	21.656	42.8	13.0	42.8	13.0	346.7	1.000	17.80	0.981
6	20.505	20.709	42.8	12.4	42.8	12.4	343.3	1.000	17.78	0.979
7	19.670	19.990	43.1	11.3	43.1	11.3	341.0	1.000	17.49	0.983
8	19.388	19.746	44.3	12.8	44.3	12.8	342.2	1.000	17.65	0.975
9	19.103	19.505	44.9	14.0	44.9	14.0	343.8	1.000	17.90	0.963

RP	ABS VEL		REL VEL		MERID VEL		TANG VEL		WHEEL SPEED	
	IN	OUT	IN	OUT	IN	OUT	IN	OUT	IN	OUT
1	237.4	162.6	237.4	162.6	169.6	158.6	166.1	36.0	0.0	0.0
2	242.0	172.3	242.0	172.3	176.9	168.1	165.2	38.1	0.0	0.0
3	243.6	178.8	243.6	178.8	179.7	174.3	164.5	39.6	0.0	0.0
4	243.4	186.1	243.4	186.1	181.9	181.6	161.8	40.7	0.0	0.0
5	248.6	191.2	248.6	191.2	182.3	186.3	169.0	43.0	0.0	0.0
6	248.2	193.9	248.2	193.9	181.9	189.4	168.8	41.7	0.0	0.0
7	247.3	193.4	247.3	193.4	180.6	189.6	168.9	38.0	0.0	0.0
8	252.7	196.5	252.7	196.5	181.0	191.6	176.4	43.5	0.0	0.0
9	259.8	199.9	259.8	199.9	184.0	193.9	183.4	48.3	0.0	0.0

RP	ABS MACH NO		REL MACH NO		MERID MACH NO		MERID VEL	PEAK R	SS MACH NO
	IN	OUT	IN	OUT	IN	OUT			
1	0.657	0.440	0.657	0.440	0.469	0.429	0.935	1.131	
2	0.672	0.468	0.672	0.468	0.491	0.457	0.950	1.123	
3	0.678	0.487	0.678	0.487	0.500	0.475	0.970	1.116	
4	0.680	0.510	0.680	0.510	0.508	0.498	0.998	1.095	
5	0.698	0.526	0.698	0.526	0.512	0.513	1.022	1.141	
6	0.700	0.537	0.700	0.537	0.513	0.524	1.041	1.133	
7	0.700	0.537	0.700	0.537	0.511	0.527	1.050	1.121	
8	0.716	0.545	0.716	0.545	0.512	0.532	1.059	1.166	
9	0.736	0.554	0.736	0.554	0.521	0.537	1.054	1.205	

RP	PERCENT SPAN	INCIDENCE		DEV	D FACT	EFF	LOSS COEFF		LOSS PARAM	
		MEAN	SS				TOT	PROF	TOT	PROF
1	5.00	10.0	2.4	10.3	0.527	0.000	0.123	0.123	0.046	0.046
2	10.00	8.5	1.1	10.2	0.490	0.000	0.107	0.107	0.040	0.040
3	15.00	7.8	0.6	10.2	0.462	0.000	0.074	0.074	0.028	0.028
4	30.00	6.6	0.2	9.8	0.422	0.000	0.064	0.064	0.023	0.023
5	50.00	7.1	1.6	9.9	0.416	0.000	0.070	0.070	0.025	0.025
6	70.00	6.4	1.8	9.0	0.399	0.000	0.074	0.074	0.026	0.026
7	85.00	5.6	1.7	7.8	0.399	0.000	0.061	0.061	0.021	0.021
8	90.00	6.5	2.7	9.2	0.401	0.000	0.086	0.086	0.029	0.029
9	95.00	6.7	3.1	10.4	0.405	0.000	0.123	0.123	0.041	0.041

TABLE VI. - Continued. BLADE-ELEMENT DATA AT BLADE EDGES

FOR STATOR 35

(k) 90 Percent of design speed; reading 3985

RP	RADII		ABS BETAM		REL BETAM		TOTAL TEMP		TOTAL PRESS	
	IN	OUT	IN	OUT	IN	OUT	IN	RATIO	IN	RATIO
1	23.993	23.752	52.4	15.5	52.4	15.5	362.0	1.000	17.93	0.959
2	23.736	23.523	51.3	14.5	51.3	14.5	360.5	1.000	17.96	0.959
3	23.480	23.294	49.6	13.8	49.6	13.8	358.9	1.000	18.07	0.960
4	22.685	22.593	46.8	12.6	46.8	12.6	353.8	1.000	18.16	0.968
5	21.608	21.656	46.6	12.9	46.6	12.9	350.3	1.000	18.10	0.967
6	20.505	20.709	46.2	13.0	46.2	13.0	346.3	1.000	18.02	0.967
7	19.670	19.990	45.7	12.6	45.7	12.6	343.5	1.000	17.80	0.971
8	19.388	19.746	45.7	14.0	45.7	14.0	344.0	1.000	17.94	0.964
9	19.103	19.505	45.8	15.3	45.8	15.3	345.2	1.000	18.23	0.950

RP	ABS VEL		REL VEL		MERID VEL		TANG VEL		WHEEL SPEED	
	IN	OUT	IN	OUT	IN	OUT	IN	OUT	IN	OUT
1	239.0	160.5	239.0	160.5	145.8	154.7	189.4	43.0	0.0	0.0
2	239.3	163.0	239.3	163.0	149.6	157.8	186.8	40.9	0.0	0.0
3	241.1	167.9	241.1	167.9	156.3	163.0	183.5	40.2	0.0	0.0
4	244.4	175.6	244.4	175.6	167.4	171.4	178.2	38.3	0.0	0.0
5	246.6	177.8	246.6	177.8	169.6	173.5	179.1	39.8	0.0	0.0
6	247.0	179.6	247.0	179.6	170.8	175.0	178.4	40.4	0.0	0.0
7	248.7	179.2	248.7	179.2	173.7	174.9	178.0	39.0	0.0	0.0
8	253.3	181.8	253.3	181.8	177.0	176.3	181.2	44.1	0.0	0.0
9	261.2	184.4	261.2	184.4	182.1	177.9	187.2	48.6	0.0	0.0

RP	ABS MACH NO		REL MACH NO		MERID MACH NO		MERID VEL	PEAK MACH NO	SS
	IN	OUT	IN	OUT	IN	OUT			
1	0.653	0.429	0.653	0.429	0.398	0.413	1.061	1.307	
2	0.655	0.436	0.655	0.436	0.409	0.422	1.055	1.283	
3	0.662	0.451	0.662	0.451	0.429	0.438	1.042	1.253	
4	0.677	0.476	0.677	0.476	0.464	0.465	1.024	1.209	
5	0.688	0.485	0.688	0.485	0.473	0.472	1.021	1.212	
6	0.693	0.493	0.693	0.493	0.479	0.480	1.024	1.201	
7	0.702	0.494	0.702	0.494	0.490	0.482	1.007	1.186	
8	0.715	0.501	0.715	0.501	0.500	0.486	0.996	1.199	
9	0.738	0.508	0.738	0.508	0.515	0.490	0.977	1.231	

RP	PERCENT SPAN	INCIDENCE		DEV	D FACT	EFF	LOSS COEFF		LOSS PARAM	
		MEAN	SS				TOT	PROF	TOT	PROF
1	5.00	18.0	10.4	13.0	0.565	0.000	0.164	0.164	0.061	0.061
2	10.00	16.8	9.4	12.0	0.553	0.000	0.164	0.164	0.061	0.061
3	15.00	14.9	7.7	11.3	0.531	0.000	0.156	0.156	0.057	0.057
4	30.00	11.7	5.3	9.8	0.496	0.000	0.122	0.122	0.045	0.045
5	50.00	10.8	5.3	9.8	0.485	0.000	0.122	0.122	0.043	0.043
6	70.00	9.8	5.2	9.6	0.470	0.000	0.119	0.119	0.041	0.041
7	85.00	8.3	4.3	9.0	0.471	0.000	0.103	0.103	0.035	0.035
8	90.00	7.9	4.1	10.4	0.466	0.000	0.124	0.124	0.041	0.041
9	95.00	7.6	4.0	11.7	0.472	0.000	0.165	0.165	0.054	0.054

TABLE VI. - Continued. BLADE-ELEMENT DATA AT BLADE EDGES

FOR STATOR 35

(ℓ) 80 Percent of design speed; reading 3987

RP	RADII		ABS BETAM		REL BETAM		TOTAL TEMP		TOTAL PRESS	
	IN	OUT	IN	OUT	IN	OUT	IN	RATIO	IN	RATIO
1	23.993	23.752	49.7	15.3	49.7	15.3	344.8	1.000	15.74	0.968
2	23.736	23.523	49.7	14.2	49.7	14.2	344.0	1.000	15.70	0.973
3	23.480	23.294	49.0	13.3	49.0	13.3	343.1	1.000	15.77	0.975
4	22.685	22.593	46.9	12.4	46.9	12.4	339.3	1.000	15.89	0.979
5	21.608	21.656	45.4	12.8	45.4	12.8	335.4	1.000	15.95	0.979
6	20.505	20.709	44.6	12.5	44.6	12.5	332.8	1.000	15.98	0.979
7	19.670	19.990	44.5	12.2	44.5	12.2	331.6	1.000	15.92	0.982
8	19.388	19.746	45.3	13.3	45.3	13.3	332.2	1.000	16.00	0.977
9	19.103	19.505	46.5	14.7	46.5	14.7	333.5	1.000	16.18	0.967

RP	ABS VEL		REL VEL		MERID VEL		TANG VEL		WHEEL SPEED	
	IN	OUT	IN	OUT	IN	OUT	IN	OUT	IN	OUT
1	208.9	141.1	208.9	141.1	135.1	136.1	159.3	37.3	0.0	0.0
2	207.6	144.1	207.6	144.1	134.3	139.7	158.3	35.3	0.0	0.0
3	209.3	149.4	209.3	149.4	137.3	145.4	157.9	34.4	0.0	0.0
4	213.5	157.2	213.5	157.2	146.0	153.5	155.8	33.6	0.0	0.0
5	216.8	162.2	216.8	162.2	152.1	158.2	154.5	35.8	0.0	0.0
6	220.6	166.7	220.6	166.7	157.0	162.7	154.9	36.1	0.0	0.0
7	223.1	169.8	223.1	169.8	159.0	165.9	156.5	36.0	0.0	0.0
8	226.7	171.2	226.7	171.2	159.5	166.6	161.1	39.5	0.0	0.0
9	232.9	173.6	232.9	173.6	160.2	167.9	169.0	43.9	0.0	0.0

RP	ABS MACH NO		REL MACH NO		MERID MACH NO		MERID VEL	PEAK MACH NO	SS
	IN	OUT	IN	OUT	IN	OUT			
1	0.580	0.385	0.580	0.385	0.375	0.371	1.007	1.104	
2	0.576	0.393	0.576	0.393	0.373	0.381	1.040	1.096	
3	0.582	0.409	0.582	0.409	0.382	0.398	1.059	1.090	
4	0.599	0.434	0.599	0.434	0.409	0.423	1.052	1.070	
5	0.612	0.451	0.612	0.451	0.429	0.439	1.040	1.056	
6	0.626	0.465	0.626	0.465	0.446	0.454	1.036	1.051	
7	0.635	0.476	0.635	0.476	0.453	0.465	1.044	1.048	
8	0.646	0.479	0.646	0.479	0.454	0.466	1.045	1.074	
9	0.664	0.485	0.664	0.485	0.456	0.469	1.048	1.123	

RP	PERCENT SPAN		INCIDENCE MEAN		DEV	D FACT	EFF	LOSS COEFF		LOSS PARAM	
	SPAN	MEAN	SS	TOT				PROF	TOT	PROF	
1	5.00	15.3	7.7	12.8	0.550	0.000	0.158	0.158	0.058	0.058	
2	10.00	15.2	7.8	11.6	0.534	0.000	0.136	0.136	0.050	0.050	
3	15.00	14.3	7.2	10.7	0.512	0.000	0.120	0.120	0.045	0.045	
4	30.00	11.8	5.4	9.6	0.479	0.000	0.098	0.098	0.036	0.036	
5	50.00	9.7	4.2	9.6	0.452	0.000	0.092	0.092	0.033	0.033	
6	70.00	8.2	3.6	9.1	0.434	0.000	0.089	0.089	0.031	0.031	
7	85.00	7.1	3.1	8.7	0.424	0.000	0.074	0.074	0.025	0.025	
8	90.00	7.5	3.7	9.7	0.426	0.000	0.093	0.093	0.031	0.031	
9	95.00	8.3	4.8	11.0	0.435	0.000	0.129	0.129	0.043	0.043	

TABLE VI. - Continued. BLADE-ELEMENT DATA AT BLADE EDGES

FOR STATOR 35

(m) 70 Percent of design speed; reading 3995

RP	RADII		ABS BETAM		REL BETAM		TOTAL IN	TEMP RATIO	TOTAL IN	PRESS RATIO
	IN	OUT	IN	OUT	IN	OUT				
1	23.993	23.752	21.0	11.4	21.0	11.4	308.6	1.000	11.95	0.980
2	23.736	23.523	20.8	9.6	20.8	9.6	308.8	1.000	12.25	0.990
3	23.480	23.294	20.1	8.9	20.1	8.9	308.5	1.000	12.44	0.988
4	22.685	22.593	21.1	8.0	21.1	8.0	309.1	1.000	12.65	0.987
5	21.608	21.656	23.3	9.1	23.3	9.1	310.0	1.000	12.86	0.990
6	20.505	20.709	25.2	10.0	25.2	10.0	311.0	1.000	13.07	0.989
7	19.670	19.990	26.6	10.5	26.6	10.5	311.8	1.000	13.17	0.991
8	19.388	19.746	27.4	10.9	27.4	10.9	312.5	1.000	13.26	0.990
9	19.103	19.505	28.8	11.3	28.8	11.3	313.8	1.000	13.31	0.984

RP	ABS VEL		REL VEL		MERID VEL		TANG VEL		WHEEL IN	SPEED OUT
	IN	OUT	IN	OUT	IN	OUT	IN	OUT		
1	182.6	177.1	182.6	177.1	170.5	173.6	65.3	35.0	0.0	0.0
2	191.4	191.9	191.4	191.9	178.9	189.3	67.9	31.9	0.0	0.0
3	196.2	199.3	196.2	199.3	164.3	196.9	67.3	30.9	0.0	0.0
4	202.4	209.1	202.4	209.1	188.8	207.1	72.9	29.0	0.0	0.0
5	205.8	221.3	205.8	221.3	189.1	218.5	81.3	35.2	0.0	0.0
6	211.6	229.9	211.6	229.9	191.4	226.5	90.2	39.7	0.0	0.0
7	217.2	233.9	217.2	233.9	194.3	230.0	97.3	42.6	0.0	0.0
8	220.2	236.0	220.2	236.0	195.5	231.8	101.4	44.4	0.0	0.0
9	222.5	235.6	222.5	235.6	195.0	231.0	107.1	46.0	0.0	0.0

RP	ABS MACH NO		REL MACH NO		MERID MACH NO		MERID VEL IN	PEAK MACH NO	SS
	IN	OUT	IN	OUT	IN	OUT			
1	0.533	0.516	0.533	0.516	0.498	0.506	1.018	0.533	
2	0.560	0.562	0.560	0.562	0.524	0.554	1.058	0.560	
3	0.575	0.585	0.575	0.585	0.540	0.578	1.069	0.575	
4	0.594	0.615	0.594	0.615	0.554	0.609	1.097	0.594	
5	0.604	0.653	0.604	0.653	0.555	0.645	1.155	0.604	
6	0.621	0.680	0.621	0.680	0.562	0.669	1.183	0.621	
7	0.638	0.692	0.638	0.692	0.571	0.680	1.184	0.638	
8	0.647	0.698	0.647	0.698	0.574	0.685	1.186	0.647	
9	0.653	0.695	0.653	0.695	0.572	0.681	1.185	0.653	

RP	PERCENT SPAN	INCIDENCE		DEV	D FACT	EFF	LOSS TOT	COEFF PROF	LOSS TOT	PARAM PROF
		MEAN	SS							
1	5.00	-13.5	-21.1	8.8	0.095	0.000	0.114	0.114	0.043	0.043
2	10.00	-13.8	-21.2	7.0	0.070	0.000	0.050	0.050	0.019	0.019
3	15.00	-14.7	-21.8	6.3	0.055	0.000	0.057	0.057	0.022	0.022
4	30.00	-13.9	-20.3	5.2	0.048	0.000	0.059	0.059	0.022	0.022
5	50.00	-12.5	-18.0	6.0	0.006	0.000	0.045	0.045	0.016	0.016
6	70.00	-11.2	-15.8	6.5	-0.003	0.000	0.048	0.048	0.017	0.017
7	85.00	-10.9	-14.8	6.9	0.009	0.000	0.038	0.038	0.013	0.013
8	90.00	-10.4	-14.2	7.3	0.015	0.000	0.043	0.043	0.014	0.014
9	95.00	-9.4	-13.0	7.7	0.032	0.000	0.065	0.065	0.022	0.022

TABLE VI. - Continued. BLADE-ELEMENT DATA AT BLADE EDGES

FOR STATOR 35

(n) 70 Percent of design speed; reading 3994

RP	RADII		ABS BETAM		REL BETAM		TOTAL TEMP		TOTAL PRESS	
	IN	OUT	IN	OUT	IN	OUT	IN	RATIO	IN	RATIO
1	23.993	23.752	26.1	10.1	26.1	10.1	313.1	1.000	12.47	0.984
2	23.736	23.523	26.3	10.0	26.3	10.0	313.1	1.000	12.72	0.992
3	23.480	23.294	24.8	9.6	24.8	9.6	312.4	1.000	12.87	0.991
4	22.685	22.593	25.6	9.2	25.6	9.2	312.6	1.000	13.06	0.993
5	21.608	21.656	27.0	9.3	27.0	9.3	312.8	1.000	13.22	0.994
6	20.505	20.709	28.9	10.0	28.9	10.0	313.6	1.000	13.37	0.993
7	19.670	19.990	30.1	10.5	30.1	10.5	314.0	1.000	13.47	0.993
8	19.388	19.746	30.8	10.9	30.8	10.9	314.5	1.000	13.53	0.992
9	19.103	19.505	32.7	12.1	32.7	12.1	315.7	1.000	13.58	0.984

RP	ABS VEL		REL VEL		MERID VEL		TANG VEL		WHEEL SPEED	
	IN	OUT	IN	OUT	IN	OUT	IN	OUT	IN	OUT
1	180.3	162.2	180.3	162.2	161.9	159.7	79.4	28.6	0.0	0.0
2	187.7	175.2	187.7	175.2	168.3	172.5	83.0	30.4	0.0	0.0
3	191.0	181.4	191.0	181.4	173.4	178.8	80.1	30.2	0.0	0.0
4	197.4	191.4	197.4	191.4	178.0	188.9	85.2	30.5	0.0	0.0
5	199.4	200.8	199.4	200.8	177.6	198.2	90.5	32.4	0.0	0.0
6	205.2	209.2	205.2	209.2	179.6	206.0	99.3	36.4	0.0	0.0
7	210.1	213.7	210.1	213.7	181.8	210.1	105.3	39.0	0.0	0.0
8	212.5	216.2	212.5	216.2	182.4	212.2	108.7	41.0	0.0	0.0
9	214.9	216.4	214.9	216.4	180.9	211.6	116.0	45.2	0.0	0.0

RP	ABS MACH NO		REL MACH NO		MERID MACH NO		MERID VEL R	PEAK MACH NO	SS
	IN	OUT	IN	OUT	IN	OUT			
1	0.522	0.467	0.522	0.467	0.469	0.460	0.986	0.534	
2	0.545	0.506	0.545	0.506	0.488	0.499	1.025	0.557	
3	0.555	0.526	0.555	0.526	0.504	0.518	1.031	0.555	
4	0.575	0.556	0.575	0.556	0.519	0.549	1.061	0.575	
5	0.581	0.586	0.581	0.586	0.518	0.578	1.116	0.590	
6	0.598	0.611	0.598	0.611	0.524	0.602	1.147	0.662	
7	0.613	0.625	0.613	0.625	0.531	0.614	1.155	0.691	
8	0.620	0.632	0.620	0.632	0.532	0.620	1.164	0.711	
9	0.627	0.631	0.627	0.631	0.528	0.617	1.169	0.756	

RP	PERCENT SPAN	INCIDENCE		DEV	D FACT	EFF	LOSS COEFF		LOSS PARAM	
		MEAN	SS				TOT	PROF	TOT	PROF
1	5.00	-8.3	-15.9	7.6	0.210	0.000	0.092	0.092	0.035	0.035
2	10.00	-8.3	-15.7	7.4	0.175	0.000	0.044	0.044	0.016	0.016
3	15.00	-9.9	-17.1	7.0	0.151	0.000	0.046	0.046	0.017	0.017
4	30.00	-9.5	-15.9	6.4	0.135	0.000	0.033	0.033	0.012	0.012
5	50.00	-8.7	-14.2	6.2	0.099	0.000	0.029	0.029	0.011	0.011
6	70.00	-7.5	-12.1	6.6	0.088	0.000	0.031	0.031	0.011	0.011
7	85.00	-7.4	-11.4	7.0	0.091	0.000	0.032	0.032	0.011	0.011
8	90.00	-7.0	-10.8	7.3	0.090	0.000	0.035	0.035	0.012	0.012
9	95.00	-5.5	-9.1	8.4	0.103	0.000	0.068	0.068	0.023	0.023

TABLE VI. - Continued, BLADE-ELEMENT DATA AT BLADE EDGES

FOR STATOR 35

(o) 70 Percent of design speed; reading 3993

RP	RADII		ABS BETAM		REL BETAM		TOTAL TEMP		TOTAL PRESS	
	IN	OUT	IN	OUT	IN	OUT	IN	RATIO	IN	RATIO
1	23.993	23.752	33.3	12.0	33.3	12.0	319.2	1.000	13.13	0.985
2	23.736	23.523	33.9	7.9	33.9	7.9	318.7	1.000	13.27	0.992
3	23.480	23.294	32.7	7.6	32.7	7.6	318.0	1.000	13.36	0.995
4	22.685	22.593	32.1	7.5	32.1	7.5	317.0	1.000	13.51	0.994
5	21.608	21.656	32.8	7.4	32.8	7.4	316.2	1.000	13.59	0.993
6	20.505	20.709	34.1	7.9	34.1	7.9	316.9	1.000	13.78	0.993
7	19.670	19.990	35.0	8.1	35.0	8.1	316.8	1.000	13.87	0.993
8	19.388	19.746	35.5	8.3	35.5	8.3	317.1	1.000	13.88	0.993
9	19.103	19.505	38.0	9.1	38.0	9.1	318.5	1.000	13.95	0.987

RP	ABS VEL		REL VEL		MERID VEL		TANG VEL		WHEEL SPEED	
	IN	OUT	IN	OUT	IN	OUT	IN	OUT	IN	OUT
1	179.4	146.6	179.4	146.6	150.0	143.3	98.5	30.6	0.0	0.0
2	183.4	155.9	183.4	155.9	152.2	154.4	102.4	21.5	0.0	0.0
3	185.1	161.7	185.1	161.7	155.7	160.3	106.0	21.5	0.0	0.0
4	199.7	168.9	189.7	168.9	160.6	167.4	100.9	22.0	0.0	0.0
5	191.7	174.9	191.7	174.9	161.1	173.5	103.9	22.4	0.0	0.0
6	198.7	184.7	198.7	184.7	164.5	182.9	111.5	25.4	0.0	0.0
7	203.8	190.2	203.8	190.2	167.0	188.3	116.8	26.7	0.0	0.0
8	204.9	191.8	204.9	191.8	166.9	189.8	118.9	27.6	0.0	0.0
9	208.3	193.7	208.3	193.7	164.1	191.2	128.3	30.5	0.0	0.0

RP	ABS MACH NO		REL MACH NO		MERID MACH NO		MERID VEL R	PEAK SS MACH NO
	IN	OUT	IN	OUT	IN	OUT		
1	0.514	0.416	0.514	0.416	0.430	0.407	0.956	0.690
2	0.527	0.444	0.527	0.444	0.437	0.440	1.014	0.716
3	0.532	0.462	0.532	0.462	0.448	0.458	1.029	0.698
4	0.547	0.484	0.547	0.484	0.463	0.480	1.043	0.701
5	0.554	0.503	0.554	0.503	0.465	0.499	1.077	0.715
6	0.575	0.532	0.575	0.532	0.476	0.527	1.112	0.758
7	0.591	0.549	0.591	0.549	0.484	0.543	1.127	0.781
8	0.594	0.553	0.594	0.553	0.484	0.548	1.138	0.788
9	0.603	0.558	0.603	0.558	0.475	0.551	1.165	0.846

RP	PERCENT SPAN	INCIDENCE		DEV	D FACT	EFF	LOSS COEFF		LOSS PARAM	
		MEAN	SS				TOT	PROF	TOT	PROF
1	5.00	-1.1	-8.7	9.5	0.350	0.000	0.093	0.093	0.035	0.035
2	10.00	-0.6	-8.0	5.4	0.319	0.000	0.046	0.046	0.018	0.018
3	15.00	-2.0	-9.1	5.0	0.288	0.000	0.028	0.028	0.011	0.011
4	30.00	-2.9	-9.3	4.7	0.266	0.000	0.034	0.034	0.013	0.013
5	50.00	-2.9	-8.4	4.2	0.242	0.000	0.035	0.035	0.013	0.013
6	70.00	-2.3	-6.9	4.5	0.223	0.000	0.035	0.035	0.012	0.012
7	85.00	-2.5	-6.5	4.5	0.218	0.000	0.032	0.032	0.011	0.011
8	90.00	-2.3	-6.1	4.7	0.215	0.000	0.033	0.033	0.011	0.011
9	95.00	-0.2	-3.7	5.4	0.228	0.000	0.060	0.060	0.020	0.020

TABLE VI. - Continued. BLADE-ELEMENT DATA AT BLADE EDGES

FOR STATOR 35

(p) 70 Percent of design speed; reading 3990

RP	RADII		ABS BETAM		REL BETAM		TOTAL TEMP		TOTAL PRESS	
	IN	OUT	IN	OUT	IN	OUT	IN	RATIO	IN	RATIO
1	23.993	23.752	40.1	13.1	40.1	13.1	322.3	1.000	13.25	0.986
2	23.736	23.523	40.8	11.6	40.8	11.6	321.7	1.000	13.31	0.992
3	23.480	23.294	39.5	11.0	39.5	11.0	321.1	1.000	13.38	0.995
4	22.685	22.593	37.0	10.3	37.0	10.3	319.3	1.000	13.55	0.992
5	21.608	21.656	36.2	10.8	36.2	10.8	318.3	1.000	13.72	0.992
6	20.505	20.709	37.5	11.9	37.5	11.9	319.1	1.000	14.03	0.990
7	19.670	19.990	37.6	11.3	37.6	11.3	318.2	1.000	14.04	0.991
8	19.388	19.746	38.2	11.7	38.2	11.7	318.3	1.000	14.03	0.992
9	19.103	19.505	40.0	13.4	40.0	13.4	319.7	1.000	14.12	0.986

RP	ABS VEL		REL VEL		MERID VEL		TANG VEL		WHEEL SPEED	
	IN	OUT	IN	OUT	IN	OUT	IN	OUT	IN	OUT
1	171.1	133.1	171.1	133.1	131.0	129.6	110.1	30.1	0.0	0.0
2	173.2	140.5	173.2	140.5	131.1	137.7	113.1	28.2	0.0	0.0
3	174.7	145.6	174.7	145.6	134.8	142.9	111.2	27.9	0.0	0.0
4	180.5	152.6	180.5	152.6	144.2	150.1	108.6	27.4	0.0	0.0
5	186.8	161.1	186.8	161.1	150.7	158.2	110.4	30.3	0.0	0.0
6	198.6	172.8	198.6	172.8	157.5	169.1	121.0	35.6	0.0	0.0
7	200.9	177.4	200.9	177.4	159.3	174.0	122.5	34.8	0.0	0.0
8	201.7	179.0	201.7	179.0	158.6	175.3	124.6	36.2	0.0	0.0
9	205.6	181.8	205.6	181.8	157.6	176.9	132.1	42.0	0.0	0.0

RP	ABS MACH NO		REL MACH NO		MERID MACH NO		MERID PEAK SS	
	IN	OUT	IN	OUT	IN	OUT	VEL R	MACH NO
1	0.487	0.375	0.487	0.375	0.372	0.365	0.990	0.766
2	0.493	0.397	0.493	0.397	0.373	0.389	1.050	0.787
3	0.498	0.412	0.498	0.412	0.384	0.404	1.060	0.771
4	0.517	0.434	0.517	0.434	0.413	0.427	1.041	0.751
5	0.537	0.460	0.537	0.460	0.433	0.452	1.050	0.758
6	0.573	0.494	0.573	0.494	0.454	0.484	1.074	0.823
7	0.589	0.509	0.580	0.509	0.460	0.499	1.093	0.820
8	0.583	0.513	0.583	0.513	0.458	0.503	1.105	0.828
9	0.594	0.521	0.594	0.521	0.455	0.507	1.123	0.873

RP	PERCENT	INCIDENCE		DEV	D FACT	EFF	LOSS COEFF		LOSS PARAM	
	SPAN	MEAN	SS				TOT	PROF	TOT	PROF
1	5.00	5.7	-2.0	10.5	0.403	0.000	0.095	0.095	0.035	0.035
2	10.00	6.3	-1.1	9.0	0.377	0.000	0.054	0.054	0.020	0.020
3	15.00	4.8	-2.3	8.5	0.349	0.000	0.031	0.031	0.011	0.011
4	30.00	1.9	-4.5	7.5	0.323	0.000	0.047	0.047	0.017	0.017
5	50.00	0.5	-5.0	7.7	0.294	0.000	0.043	0.043	0.015	0.015
6	70.00	1.1	-3.5	8.4	0.281	0.000	0.053	0.053	0.018	0.018
7	85.00	0.1	-3.9	7.7	0.266	0.000	0.042	0.042	0.014	0.014
8	90.00	0.3	-3.4	8.1	0.261	0.000	0.039	0.039	0.013	0.013
9	95.00	1.8	-1.8	9.7	0.262	0.000	0.054	0.064	0.021	0.021

TABLE VI. - Continued. BLADE-ELEMENT DATA AT BLADE EDGES

FOR STATOR 35

(q) 70 Percent of design speed; reading 3989

RP	RADII		ABS BETAM		REL BETAM		TOTAL TEMP		TOTAL PRESS	
	IN	OUT	IN	OUT	IN	OUT	IN	RATIO	IN	RATIO
1	23.993	23.752	54.2	15.0	54.2	15.0	330.2	1.000	13.56	0.972
2	23.736	23.523	55.7	13.5	55.7	13.5	329.0	1.000	13.51	0.973
3	23.480	23.294	53.0	13.1	53.0	13.1	327.9	1.000	13.53	0.973
4	22.685	22.593	47.8	13.0	47.8	13.0	325.1	1.000	13.63	0.976
5	21.608	21.656	43.1	13.8	43.1	13.8	321.9	1.000	13.89	0.982
6	20.505	20.709	39.9	13.7	39.9	13.7	320.3	1.000	14.21	0.986
7	19.670	19.990	39.8	12.5	39.8	12.5	319.3	1.000	14.21	0.990
8	19.388	19.746	40.8	13.0	40.8	13.0	319.6	1.000	14.23	0.990
9	19.103	19.505	42.1	14.4	42.1	14.4	321.0	1.000	14.32	0.984

RP	ABS VEL		REL VEL		MERID VEL		TANG VEL		WHEEL SPEED	
	IN	OUT	IN	OUT	IN	OUT	IN	OUT	IN	OUT
1	168.1	117.8	168.1	117.8	98.4	113.8	136.3	30.5	0.0	0.0
2	166.6	117.7	166.6	117.7	93.9	114.4	137.6	27.4	0.0	0.0
3	166.4	121.2	166.4	121.2	100.1	118.1	133.0	27.4	0.0	0.0
4	174.6	128.6	174.6	128.6	117.2	125.4	129.4	28.8	0.0	0.0
5	183.4	144.5	183.4	144.5	134.0	140.3	125.2	34.4	0.0	0.0
6	195.5	160.3	195.5	160.3	150.0	155.7	125.4	38.1	0.0	0.0
7	198.0	164.7	198.0	164.7	152.2	160.9	126.6	35.6	0.0	0.0
8	200.0	166.9	200.0	166.9	151.3	162.6	130.8	37.4	0.0	0.0
9	204.1	169.1	204.1	169.1	151.3	163.8	137.0	42.1	0.0	0.0

RP	ABS MACH NO		REL MACH NO		MERID MACH NO		MERID PEAK SS	
	IN	OUT	IN	OUT	IN	OUT	VEL R	MACH NO
1	0.472	0.327	0.472	0.327	0.276	0.316	1.156	0.975
2	0.468	0.327	0.468	0.327	0.264	0.318	1.219	0.992
3	0.468	0.338	0.468	0.338	0.282	0.329	1.180	0.944
4	0.495	0.360	0.495	0.360	0.332	0.351	1.070	0.901
5	0.524	0.408	0.524	0.408	0.383	0.397	1.047	0.861
6	0.562	0.456	0.562	0.456	0.431	0.443	1.038	0.853
7	0.570	0.470	0.570	0.470	0.438	0.459	1.057	0.849
8	0.576	0.476	0.576	0.476	0.436	0.464	1.075	0.872
9	0.588	0.482	0.588	0.482	0.436	0.466	1.082	0.907

RP	PERCENT	INCIDENCE		DEV	D FACT	EFF	LOSS COEFF		LOSS PARAM	
	SPAN	MEAN	SS				TOT	PROF	TOT	PROF
1	5.00	19.8	12.1	12.5	0.543	0.000	0.196	0.196	0.073	0.073
2	10.00	21.2	13.8	10.9	0.548	0.000	0.194	0.194	0.072	0.072
3	15.00	18.3	11.2	10.5	0.514	0.000	0.191	0.191	0.071	0.071
4	30.00	12.8	6.4	10.2	0.479	0.000	0.153	0.153	0.056	0.056
5	50.00	7.3	1.8	10.6	0.393	0.000	0.107	0.107	0.038	0.038
6	70.00	3.5	-1.2	10.3	0.337	0.000	0.072	0.072	0.025	0.025
7	85.00	2.3	-1.7	8.9	0.325	0.000	0.049	0.049	0.017	0.017
8	90.00	3.0	-0.8	9.4	0.324	0.000	0.049	0.049	0.017	0.017
9	95.00	3.9	0.4	10.8	0.327	0.000	0.078	0.078	0.026	0.026

TABLE VI. - Continued. BLADE-ELEMENT DATA AT BLADE EDGES

FOR STATOR 35

(r) 60 Percent of design speed; reading 3997

RP	RADII		ABS BETAM		REL BETAM		TOTAL TEMP		TOTAL PRESS	
	IN	OUT	IN	OUT	IN	OUT	IN	RATIO	IN	RATIO
1	23.993	23.752	50.1	15.9	50.1	15.9	318.7	1.000	12.65	0.980
2	23.736	23.523	52.8	9.9	52.8	9.9	318.1	1.000	12.61	0.986
3	23.480	23.294	50.4	10.2	50.4	10.2	317.4	1.000	12.66	0.987
4	22.685	22.593	45.0	11.4	45.0	11.4	315.2	1.000	12.74	0.990
5	21.608	21.656	40.7	11.3	40.7	11.3	312.7	1.000	12.89	0.991
6	20.505	20.709	39.6	9.8	39.6	9.8	312.3	1.000	13.13	0.990
7	19.670	19.990	39.6	9.2	39.6	9.2	311.5	1.000	13.11	0.993
8	19.388	19.746	39.3	9.5	39.3	9.5	311.7	1.000	13.14	0.992
9	19.103	19.505	41.5	10.4	41.5	10.4	312.6	1.000	13.20	0.986

RP	ABS VEL		REL VEL		MERID VEL		TANG VEL		WHEEL SPEED	
	IN	OUT	IN	OUT	IN	OUT	IN	OUT	IN	OUT
1	147.1	104.5	147.1	104.5	94.3	100.5	113.0	28.6	0.0	0.0
2	145.1	107.1	145.1	107.1	87.7	105.5	115.6	18.4	0.0	0.0
3	146.4	110.8	146.4	110.8	93.4	109.0	112.8	19.6	0.0	0.0
4	154.4	119.0	154.4	119.0	109.2	116.7	109.1	23.5	0.0	0.0
5	160.4	128.6	160.4	128.6	121.6	126.1	104.6	25.2	0.0	0.0
6	169.8	141.3	169.8	141.3	130.8	139.2	108.3	24.0	0.0	0.0
7	174.9	144.2	174.9	144.2	134.8	142.3	111.4	23.1	0.0	0.0
8	176.2	145.6	176.2	145.6	136.5	143.6	111.5	24.0	0.0	0.0
9	179.6	147.2	179.6	147.2	134.6	144.8	118.9	26.6	0.0	0.0

RP	ABS MACH NO		REL MACH NO		MERID MACH NO		MERID PEAK SS	
	IN	OUT	IN	OUT	IN	OUT	VEL R	MACH NO
1	0.418	0.294	0.418	0.294	0.268	0.283	1.066	0.804
2	0.413	0.302	0.413	0.302	0.249	0.298	1.204	0.831
3	0.417	0.313	0.417	0.313	0.266	0.308	1.167	0.801
4	0.442	0.338	0.442	0.338	0.313	0.332	1.068	0.761
5	0.462	0.368	0.462	0.368	0.350	0.361	1.037	0.722
6	0.491	0.405	0.491	0.405	0.378	0.399	1.064	0.740
7	0.507	0.414	0.507	0.414	0.391	0.409	1.056	0.751
8	0.511	0.419	0.511	0.419	0.395	0.413	1.053	0.746
9	0.520	0.423	0.520	0.423	0.390	0.416	1.075	0.791

RP	PERCENT SPAN		INCIDENCE MEAN SS		DEV	D FACT	EFF	LOSS COEFF		LOSS PARAM	
	IN	OUT	IN	OUT				TOT	PROF	TOT	PROF
1	5.00	15.8	8.1	13.4	0.512	0.000	0.173	0.173	0.064	0.064	
2	10.00	18.3	10.9	7.3	0.519	0.000	0.129	0.129	0.049	0.049	
3	15.00	15.7	8.5	7.6	0.487	0.000	0.115	0.115	0.043	0.043	
4	30.00	9.9	3.5	8.5	0.437	0.000	0.082	0.082	0.030	0.030	
5	50.00	5.0	-0.5	8.2	0.378	0.000	0.067	0.067	0.024	0.024	
6	70.00	3.2	-1.4	6.3	0.343	0.000	0.065	0.065	0.023	0.023	
7	85.00	2.1	-1.9	5.7	0.349	0.000	0.043	0.043	0.015	0.015	
8	90.00	1.4	-2.3	5.9	0.342	0.000	0.051	0.051	0.017	0.017	
9	95.00	3.3	-0.3	6.8	0.353	0.000	0.081	0.081	0.027	0.027	

TABLE VI. - Concluded. BLADE-ELEMENT DATA AT BLADE EDGES

FOR STATOR 35

(s) 50 Percent of design speed; reading 4000

RP	RADI I		ABS BETAM		REL BETAM		TOTAL TEMP		TOTAL PRESS	
	IN	OUT	IN	OUT	IN	OUT	IN	RATIO	IN	RATIO
1	23.993	23.752	44.8	11.4	44.8	11.4	307.3	1.000	11.66	0.993
2	23.736	23.523	46.2	10.5	46.2	10.5	306.9	1.000	11.68	0.995
3	23.480	23.294	44.6	9.8	44.6	9.8	306.7	1.000	11.70	0.996
4	22.685	22.593	39.9	8.4	39.9	8.4	365.0	1.000	11.77	0.996
5	21.608	21.656	37.8	10.4	37.8	10.4	303.9	1.000	11.90	0.995
6	20.505	20.709	38.2	12.2	38.2	12.2	304.1	1.000	12.03	0.995
7	19.670	19.990	37.4	11.5	37.4	11.5	303.5	1.000	12.04	0.995
8	19.388	19.746	38.8	9.4	38.8	9.4	303.5	1.000	12.03	0.995
9	19.103	19.505	40.8	10.2	40.8	10.2	304.2	1.000	12.08	0.991

RP	ABS VEL		REL VEL		MERID VEL		TANG VEL		WHEEL SPEED	
	IN	OUT	IN	OUT	IN	OUT	IN	OUT	IN	OUT
1	120.7	90.4	120.7	90.4	85.7	88.6	85.0	17.8	0.0	0.0
2	122.0	95.6	122.0	95.6	84.4	94.0	88.1	17.4	0.0	0.0
3	122.4	98.6	122.4	98.6	87.1	97.2	85.9	16.8	0.0	0.0
4	126.8	103.7	126.8	103.7	97.3	102.6	81.3	15.1	0.0	0.0
5	133.5	111.9	133.5	111.9	105.5	110.0	81.9	20.2	0.0	0.0
6	143.2	121.1	143.2	121.1	112.6	118.3	88.5	25.6	0.0	0.0
7	143.4	123.4	143.4	123.4	113.9	121.0	87.2	24.7	0.0	0.0
8	144.3	124.8	144.3	124.8	112.5	123.1	90.4	20.3	0.0	0.0
9	147.3	125.8	147.3	125.8	111.6	123.8	96.2	22.3	0.0	0.0

RP	ABS MACH NO		REL MACH NO		MERID MACH NO		MERID VEL R	PEAK MACH NO	SS
	IN	OUT	IN	OUT	IN	OUT			
1	0.348	0.259	0.348	0.259	0.247	0.254	1.034	0.603	
2	0.352	0.274	0.352	0.274	0.243	0.270	1.114	0.626	
3	0.353	0.283	0.353	0.283	0.251	0.279	1.115	0.607	
4	0.367	0.299	0.367	0.299	0.282	0.296	1.054	0.569	
5	0.388	0.323	0.388	0.323	0.306	0.318	1.043	0.568	
6	0.417	0.351	0.417	0.351	0.328	0.343	1.051	0.608	
7	0.418	0.358	0.418	0.358	0.332	0.351	1.062	0.589	
8	0.426	0.362	0.420	0.362	0.328	0.357	1.094	0.607	
9	0.429	0.364	0.429	0.364	0.325	0.359	1.109	0.642	

RP	PERCENT SPAN		INCIDENCE MEAN SS		DEV	D FACT	EFF	LOSS COEFF		LOSS PARAM	
	SPAN	MEAN	SS	SS				TOT	PROF	TOT	PROF
1	5.00	10.4	2.7	8.8	0.467	0.000	0.093	0.093	0.035	0.035	
2	10.00	11.7	4.3	7.9	0.439	0.000	0.060	0.060	0.022	0.022	
3	15.00	9.9	2.7	7.2	0.410	0.000	0.044	0.044	0.017	0.017	
4	30.00	4.8	-1.6	5.5	0.378	0.000	0.047	0.047	0.017	0.017	
5	50.00	2.1	-3.4	7.3	0.331	0.000	0.051	0.051	0.018	0.018	
6	70.00	1.7	-2.9	8.7	0.309	0.000	0.046	0.046	0.016	0.016	
7	85.00	-0.0	-4.0	8.0	0.288	0.000	0.043	0.043	0.015	0.015	
8	90.00	1.0	-2.8	5.8	0.300	0.000	0.041	0.041	0.014	0.014	
9	95.00	2.6	-1.0	6.6	0.315	0.000	0.072	0.072	0.024	0.024	

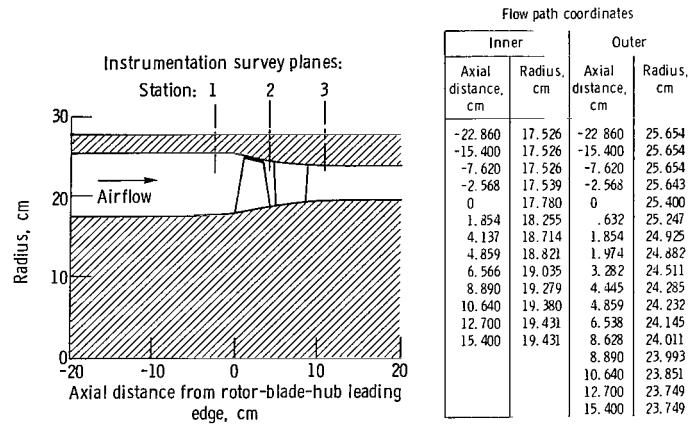
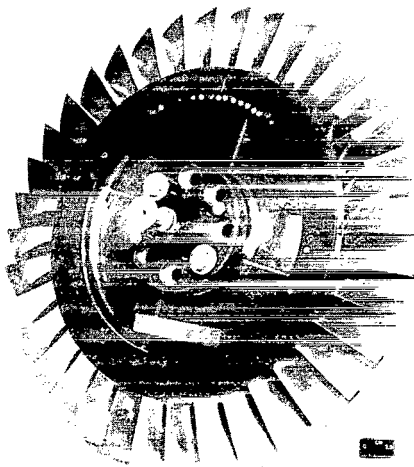
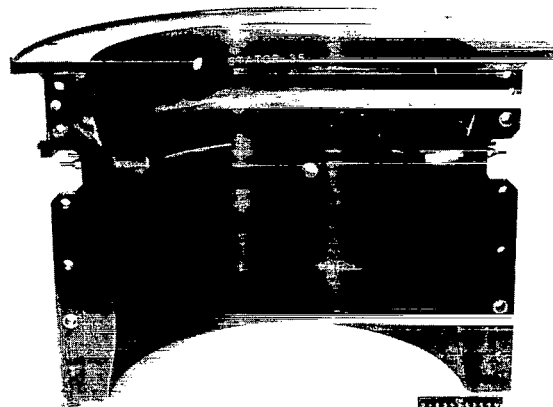

Figure 1. - Flow path and instrumentation stations.



C-77-677

(a) Rotor 35.



C-78-803

(b) Stator 35.

Figure 2. - Stage blade rows.

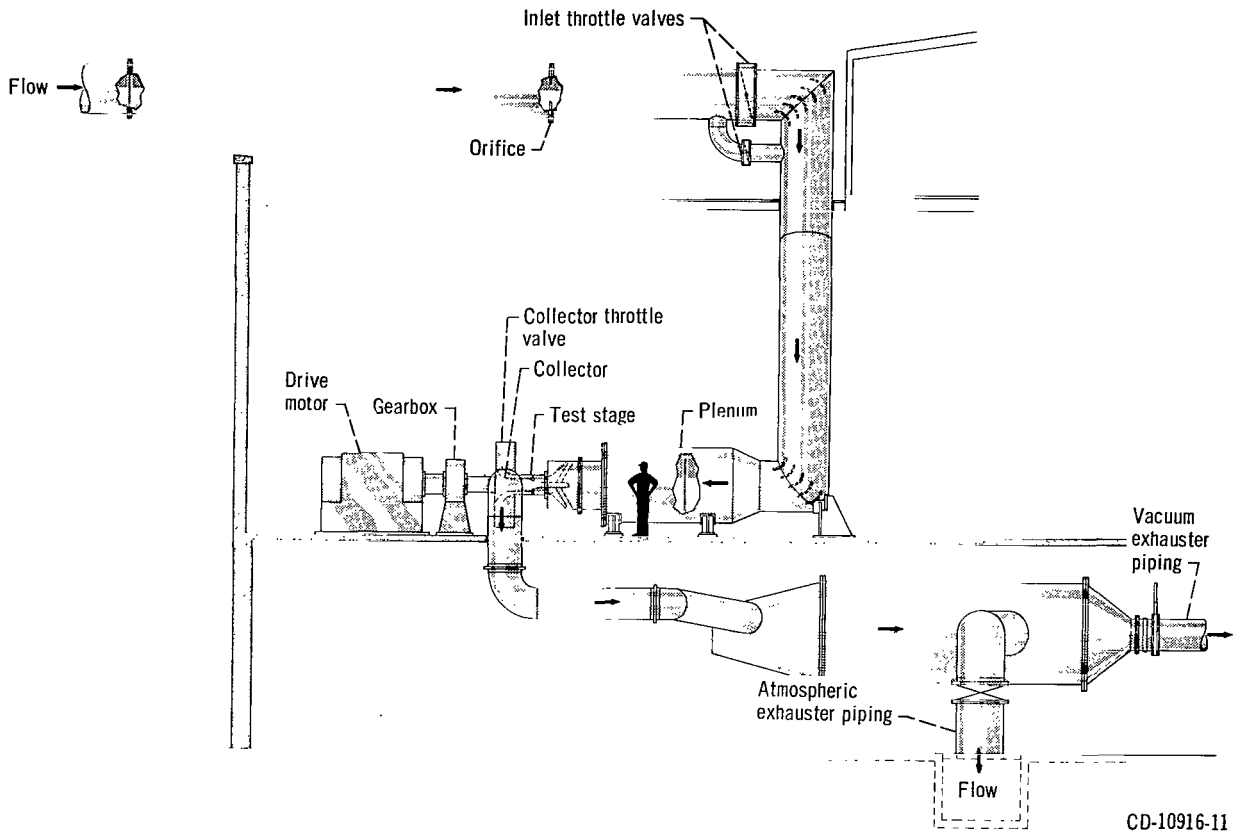
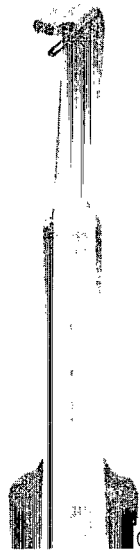

Figure 3. - Compressor test facility.



C-75-2727

(a) Combination probe (total pressure, temperature, and flow angle).



C-75-2726

(b) Wedge probe (static pressure and flow angle).

Figure 4. - Traverse probes.

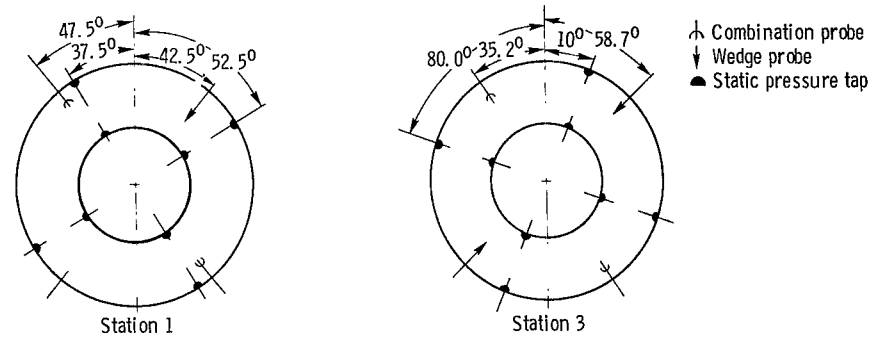

(a) Stages 35 and 37.

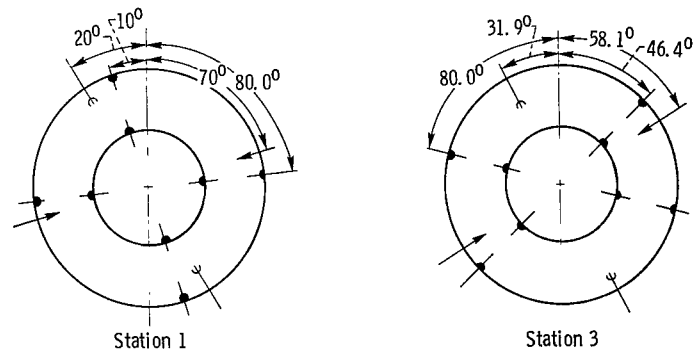

(b) Stages 36 and 38.

Figure 5. - Circumferential location of instrumentation at measuring station (facing upstream).

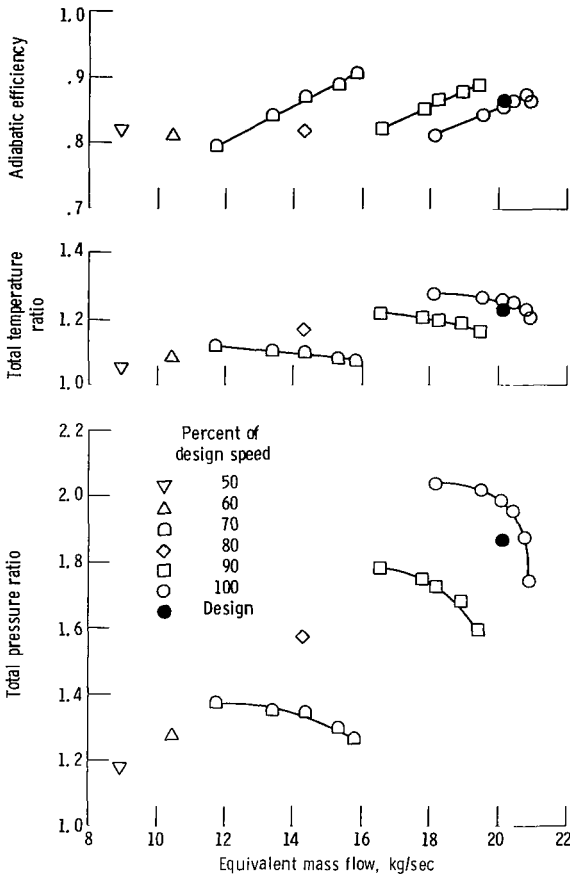

Figure 6. - Overall performance for rotor 35.

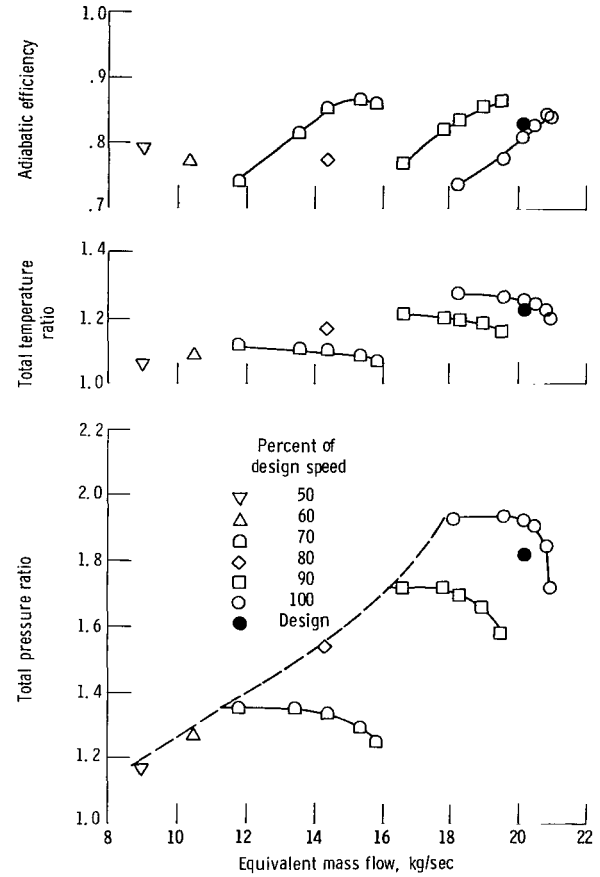

Figure 7. - Overall performance for stage 35.

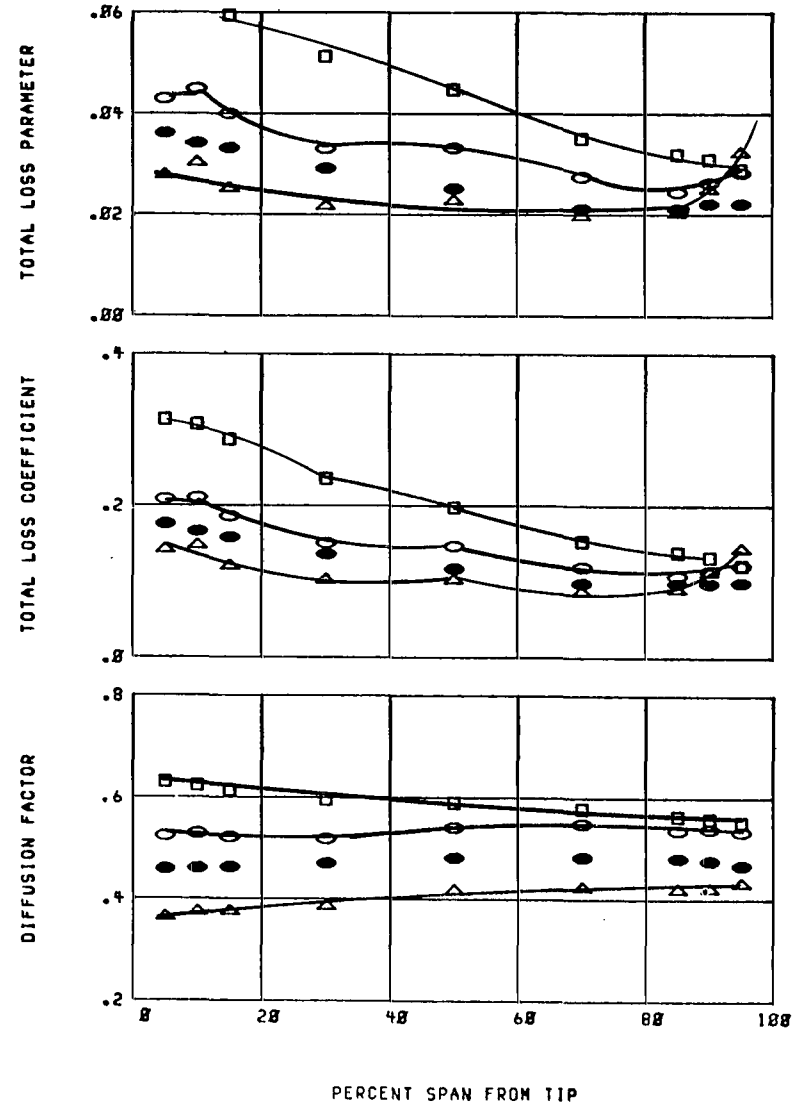
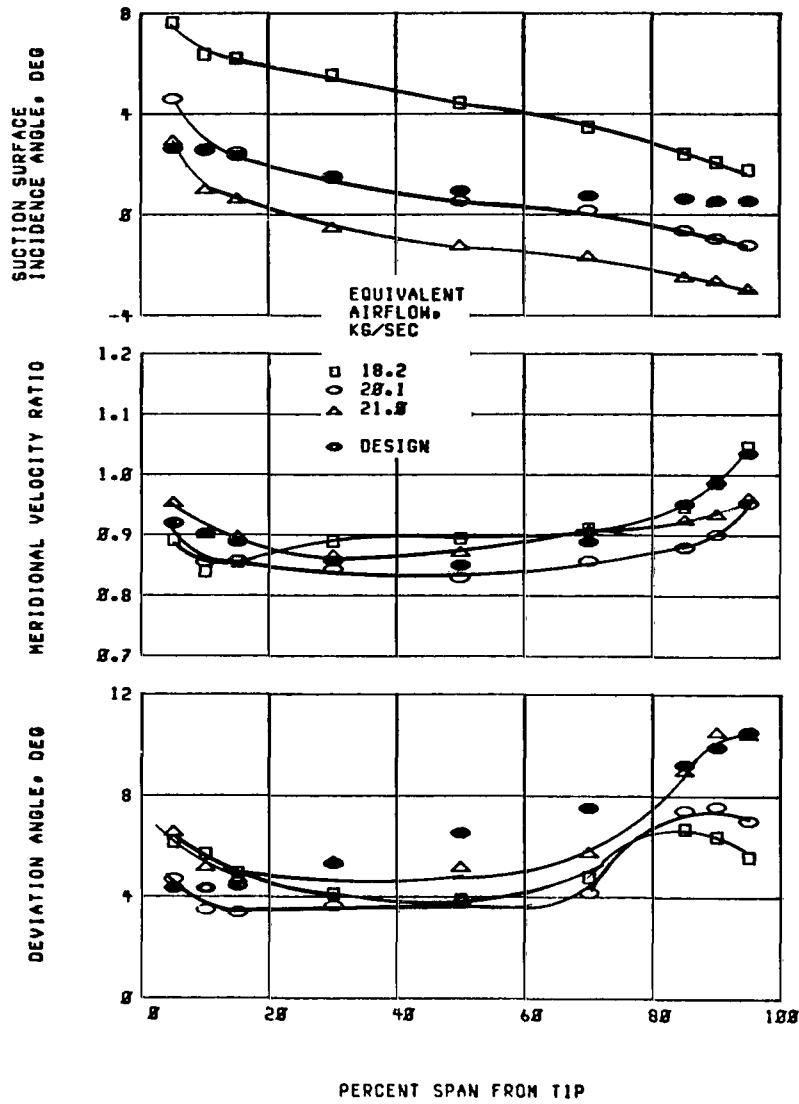

Figure 8. - Radial distribution of performance for rotor 35. 100 Percent of design speed.

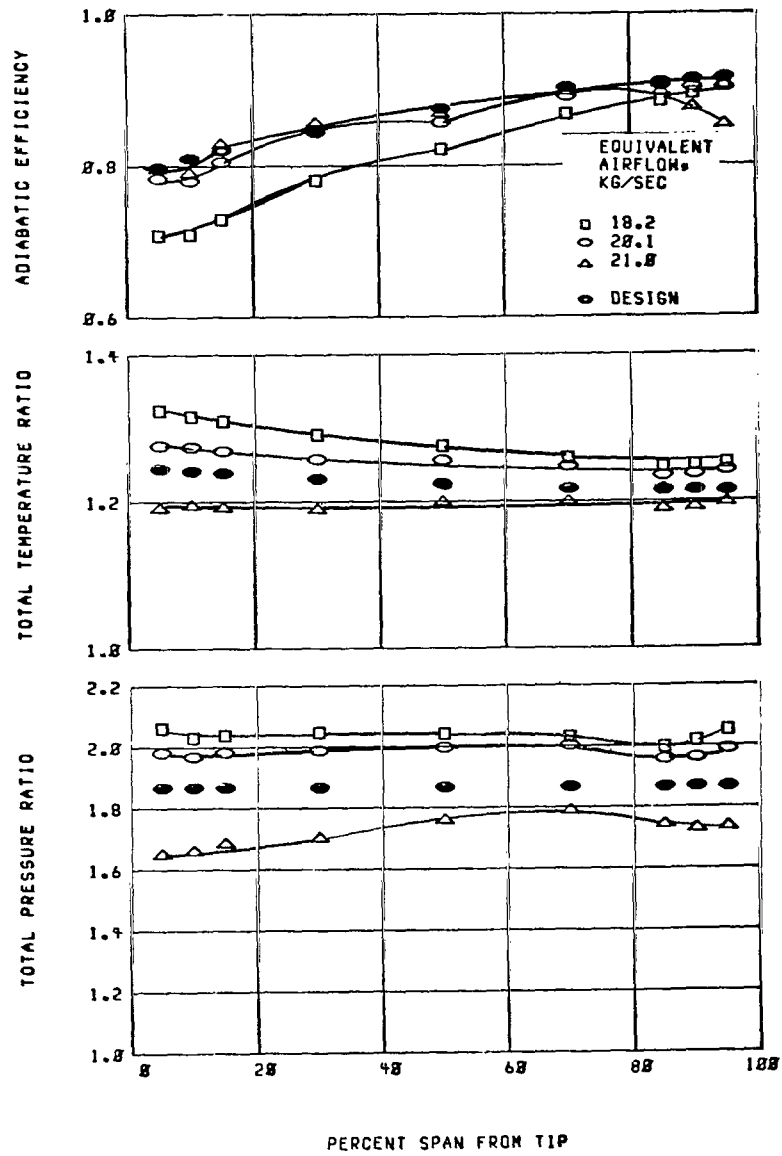

Figure 8. - Concluded.

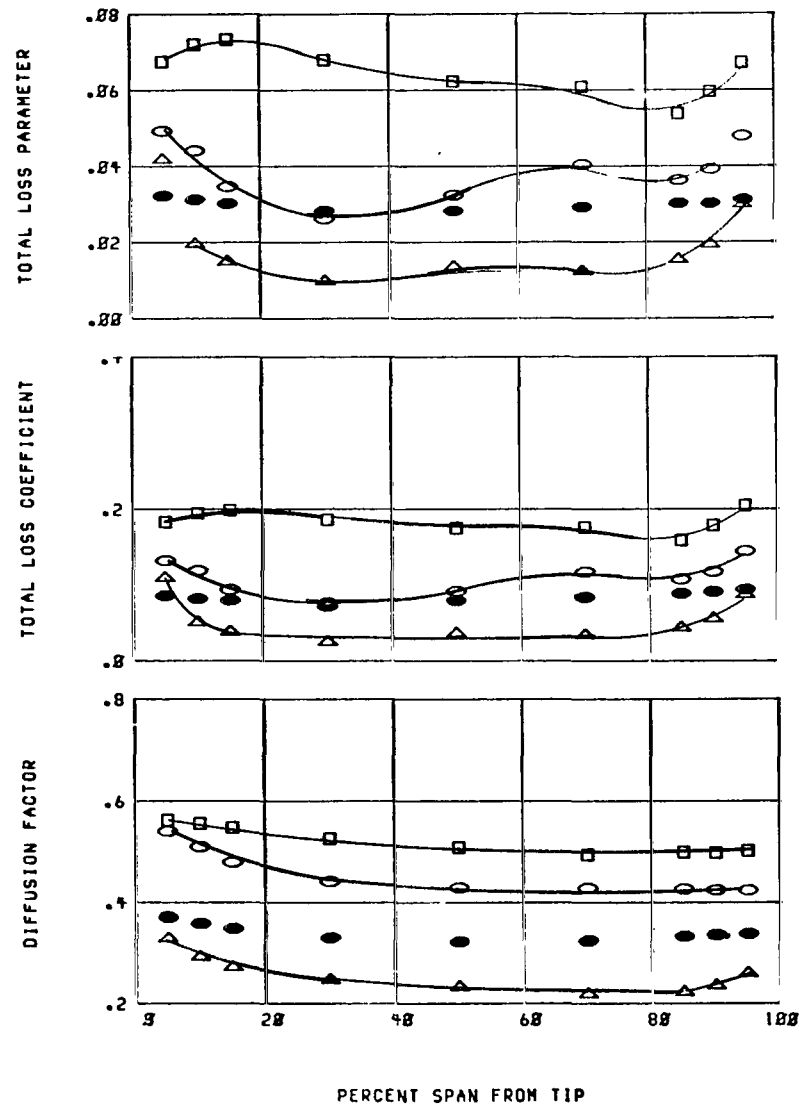
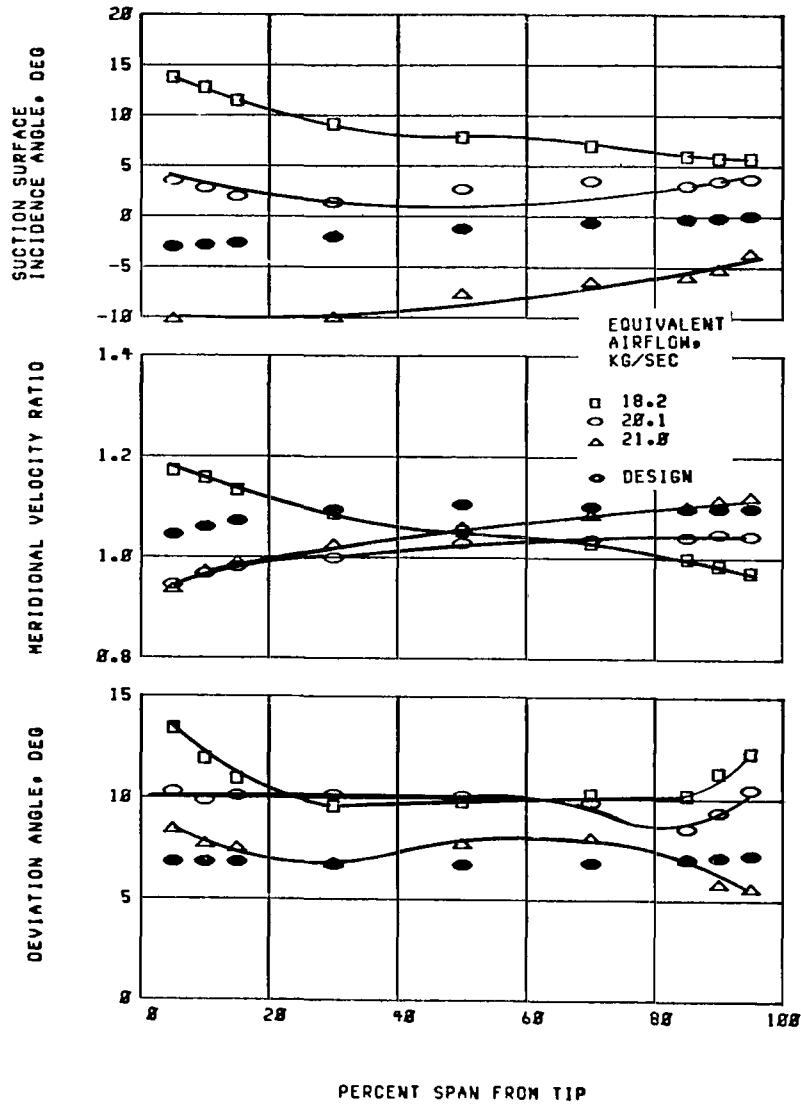
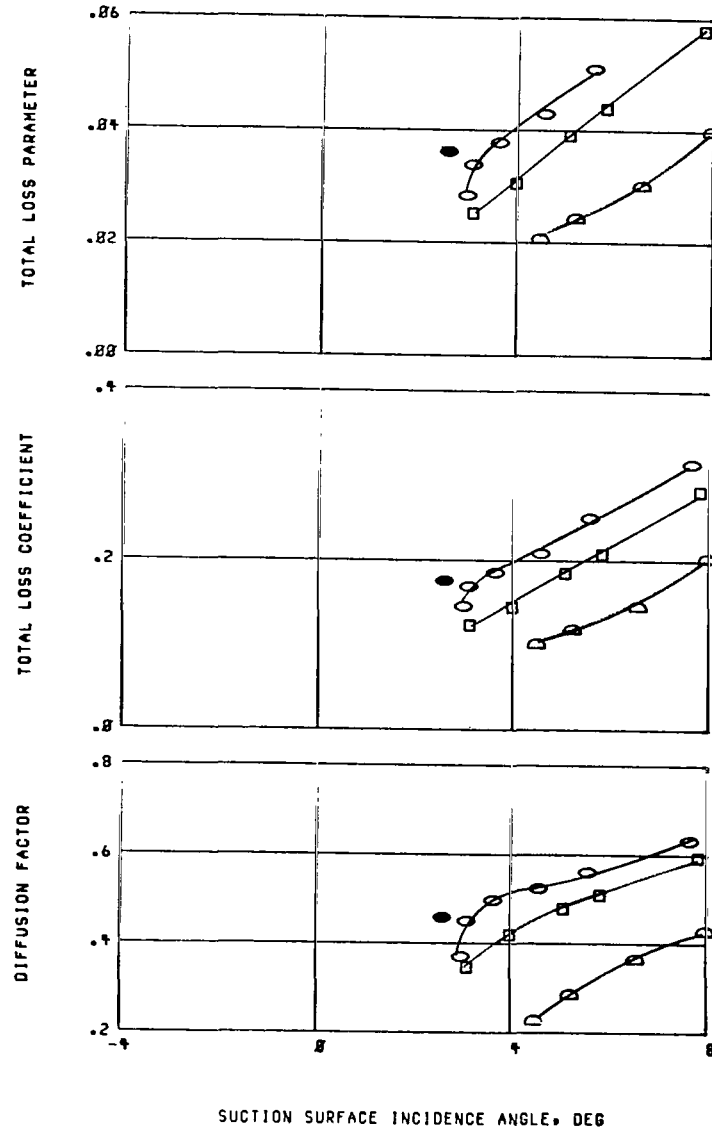
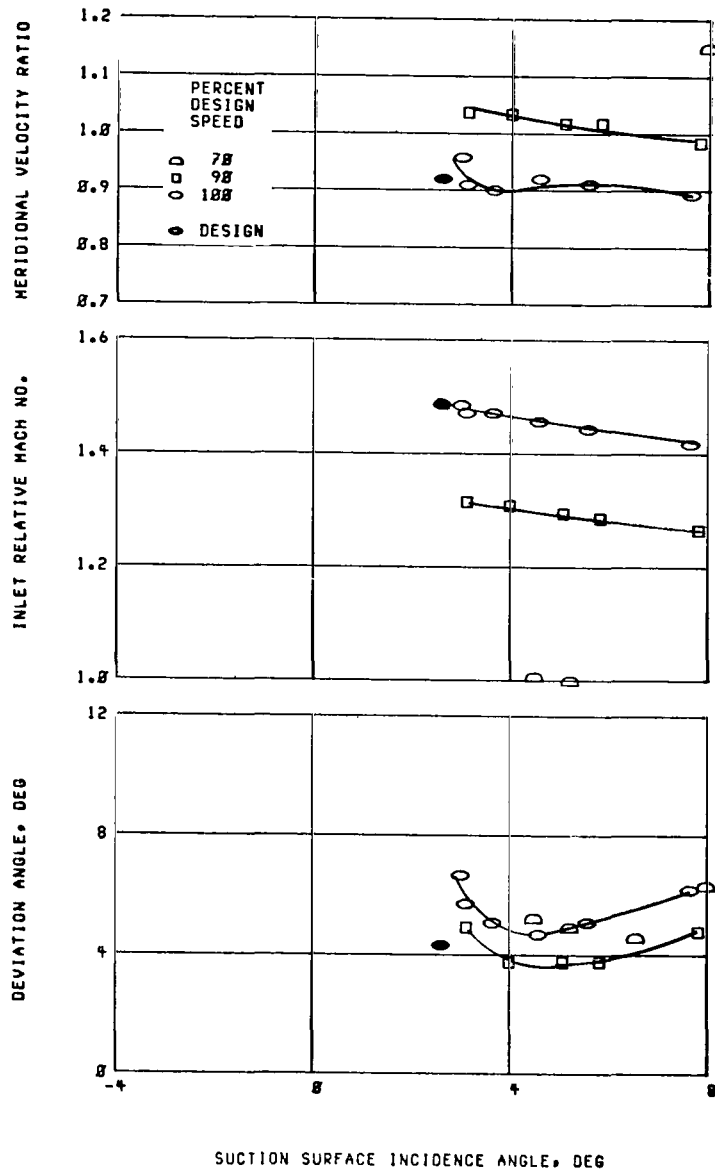
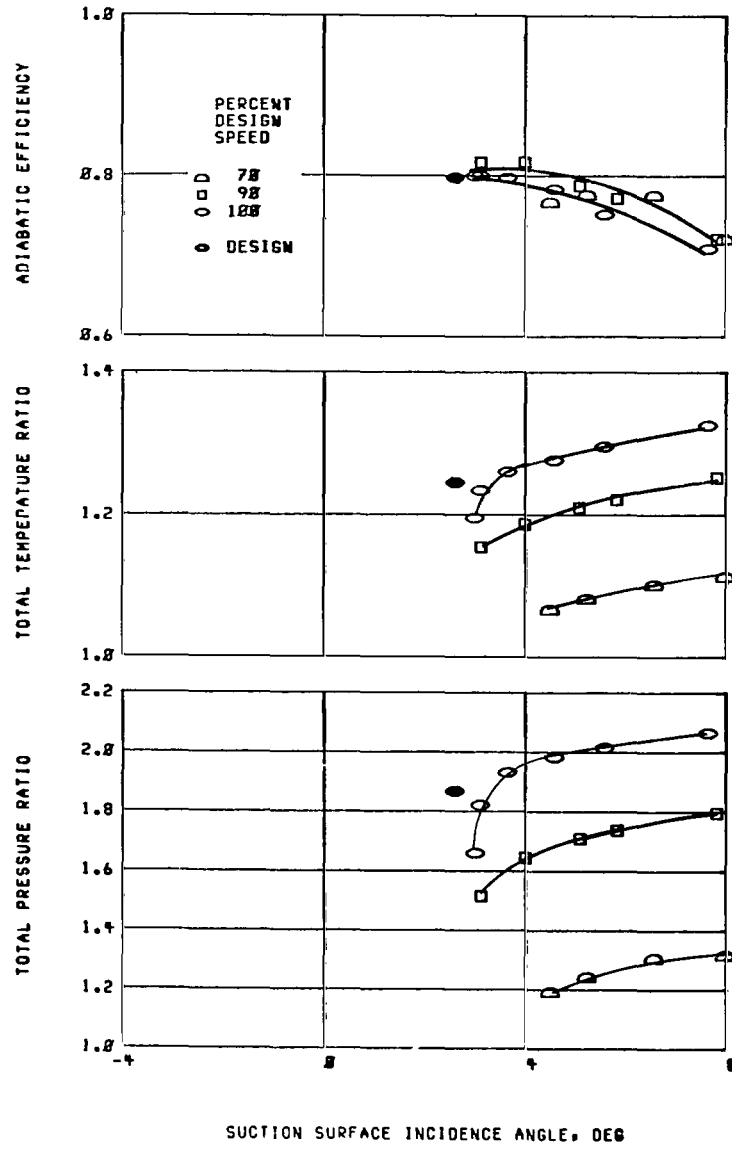

Figure 9. - Radial distribution of performance for stator 35. 100 Percent of design speed.



(a) 5 Percent span.

Figure 10. - Blade-element performance for rotor 35.



(a) Concluded.

Figure 10. - Continued.

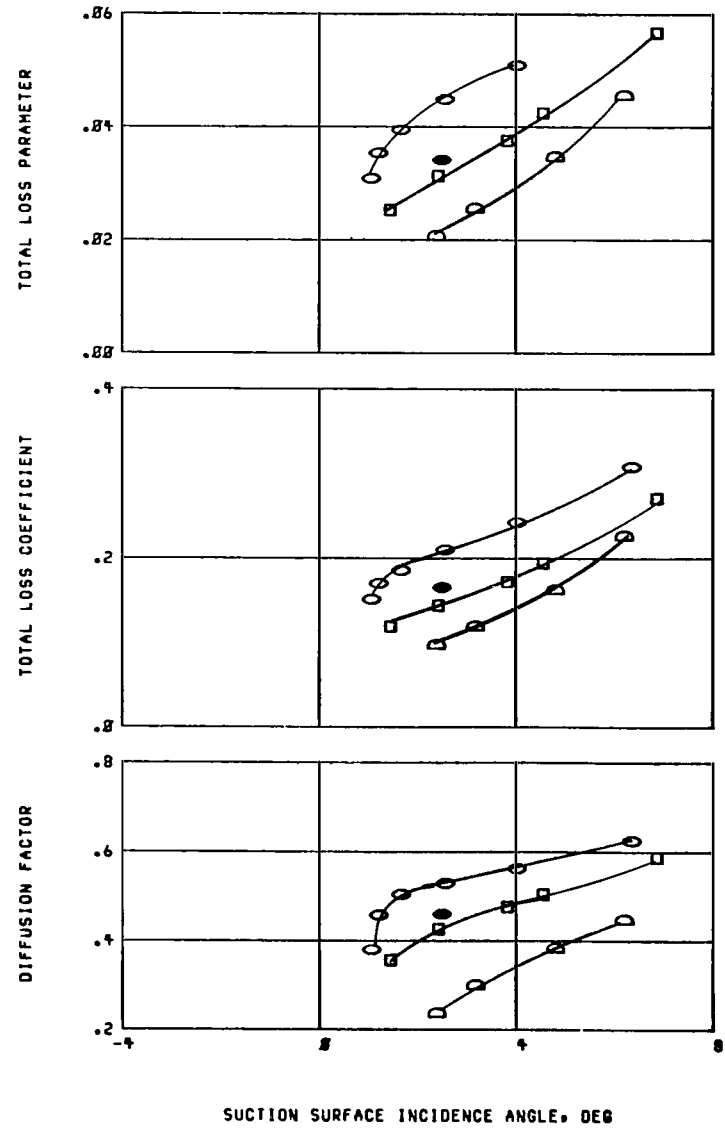
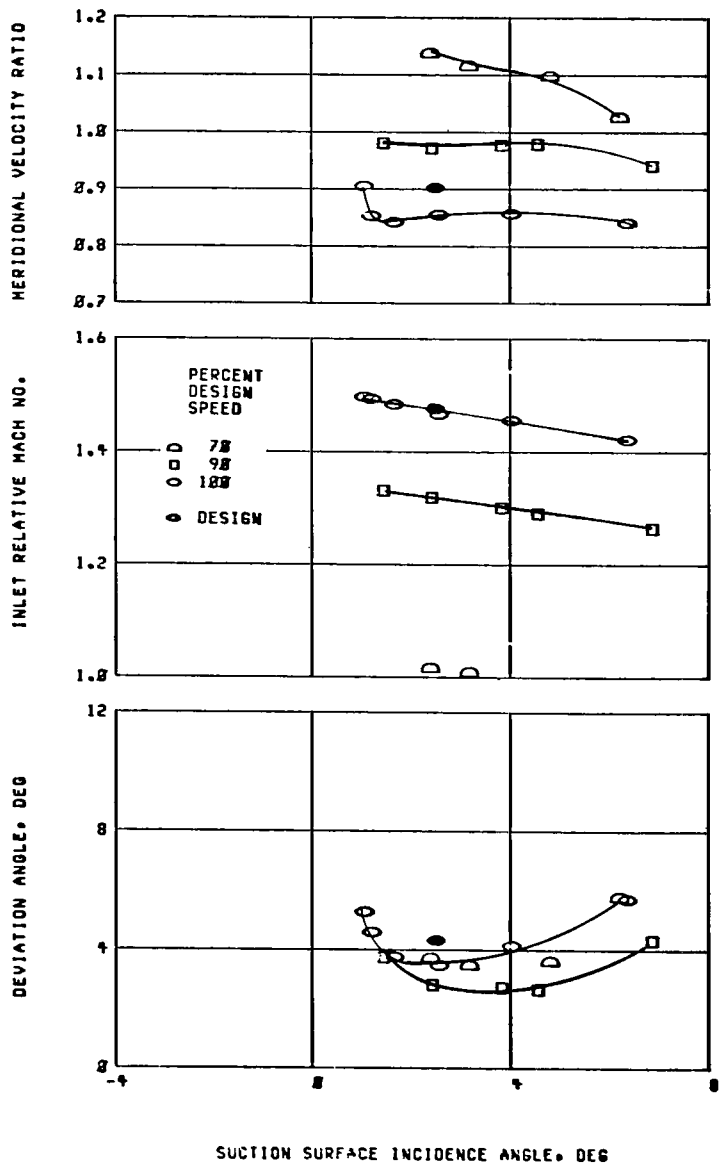

(b) 10 Percent span.

Figure 10. - Continued.

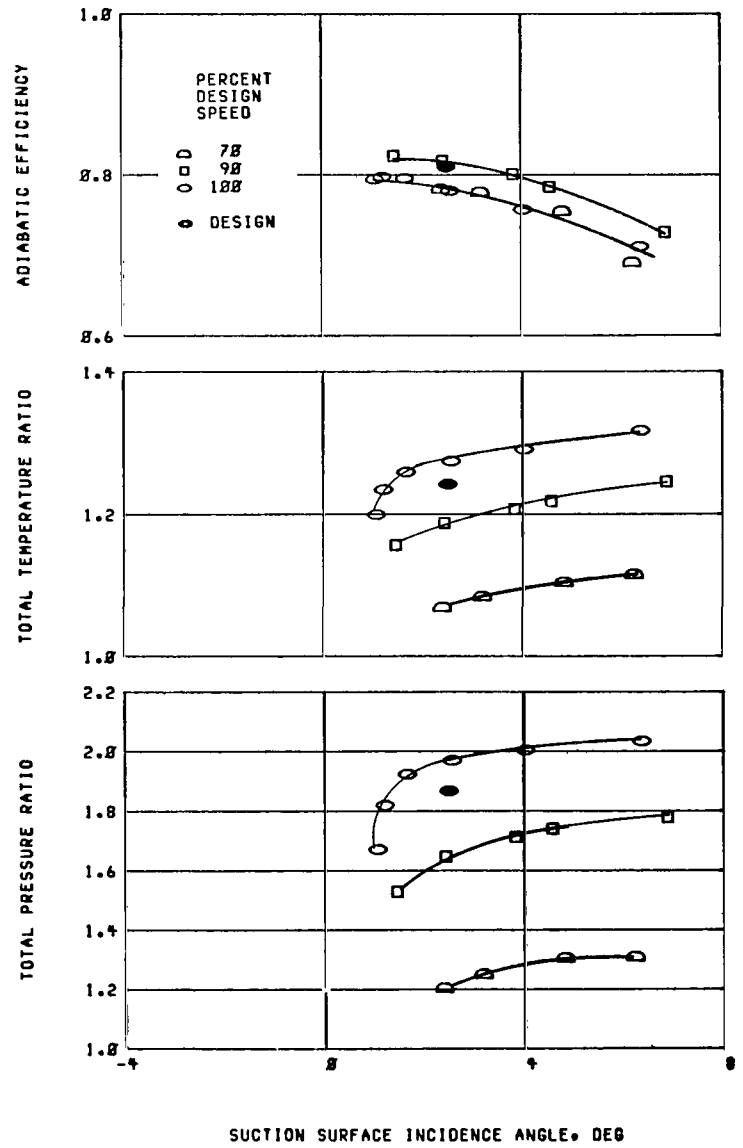

(b) Concluded.

Figure 10. - Continued.

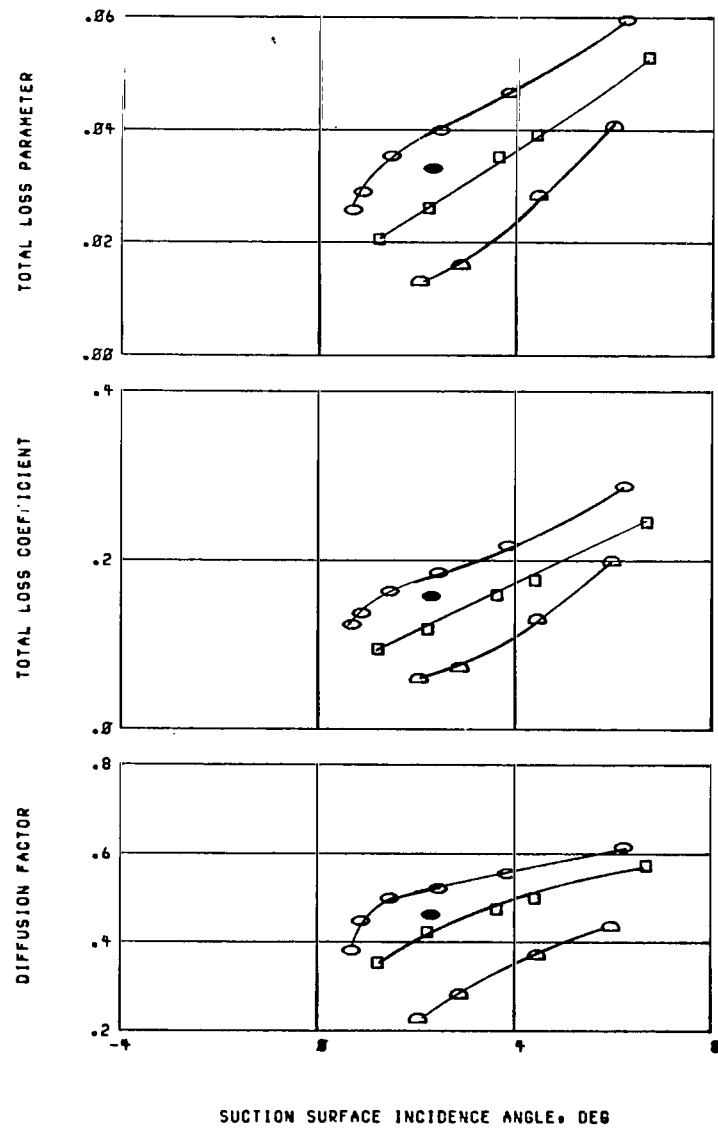
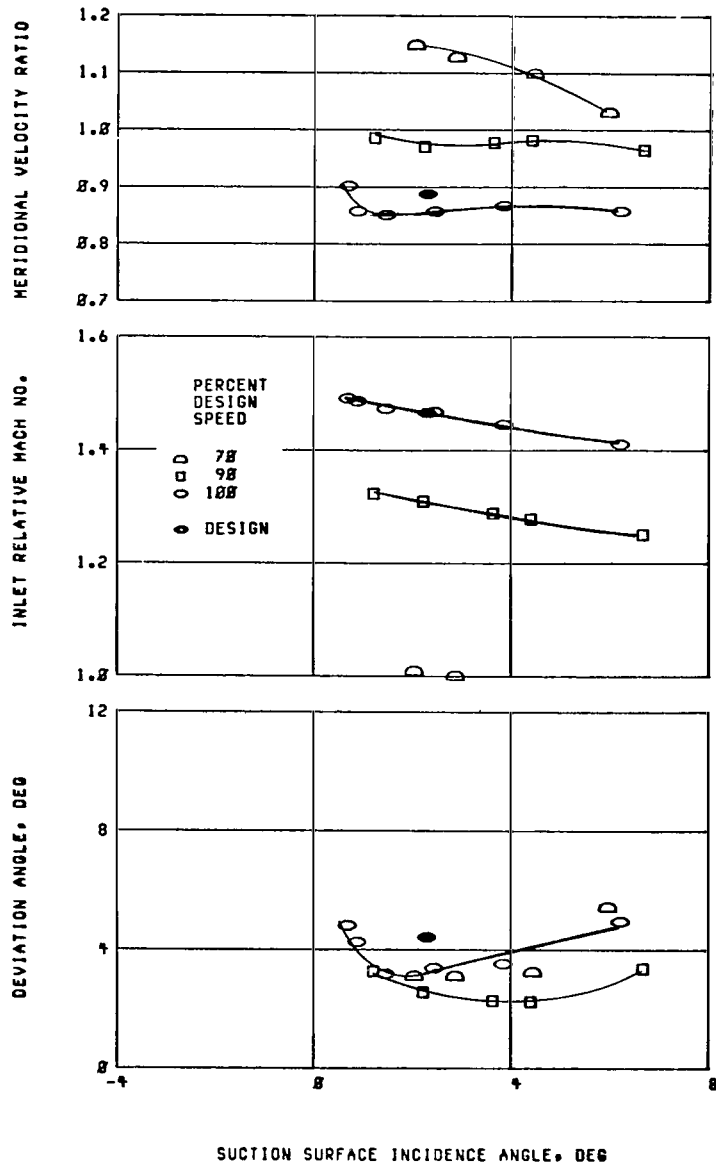

(c) 15 Percent span.

Figure 10. - Continued.

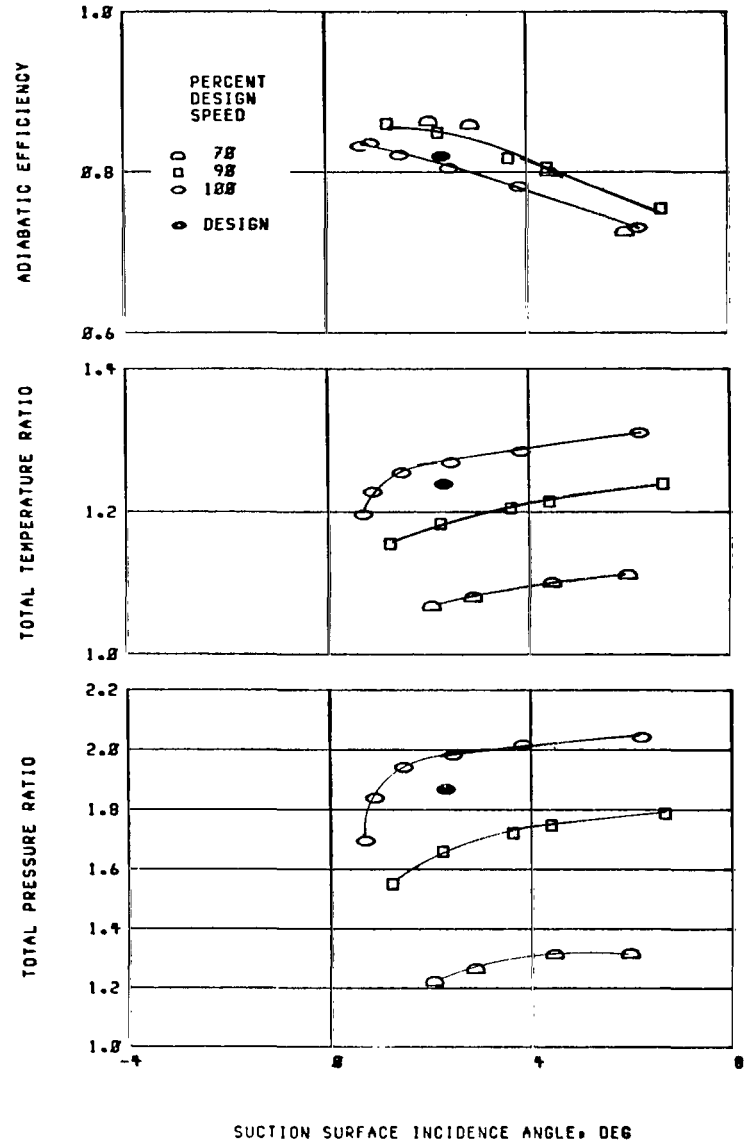

(c) Concluded.

Figure 10. - Continued.

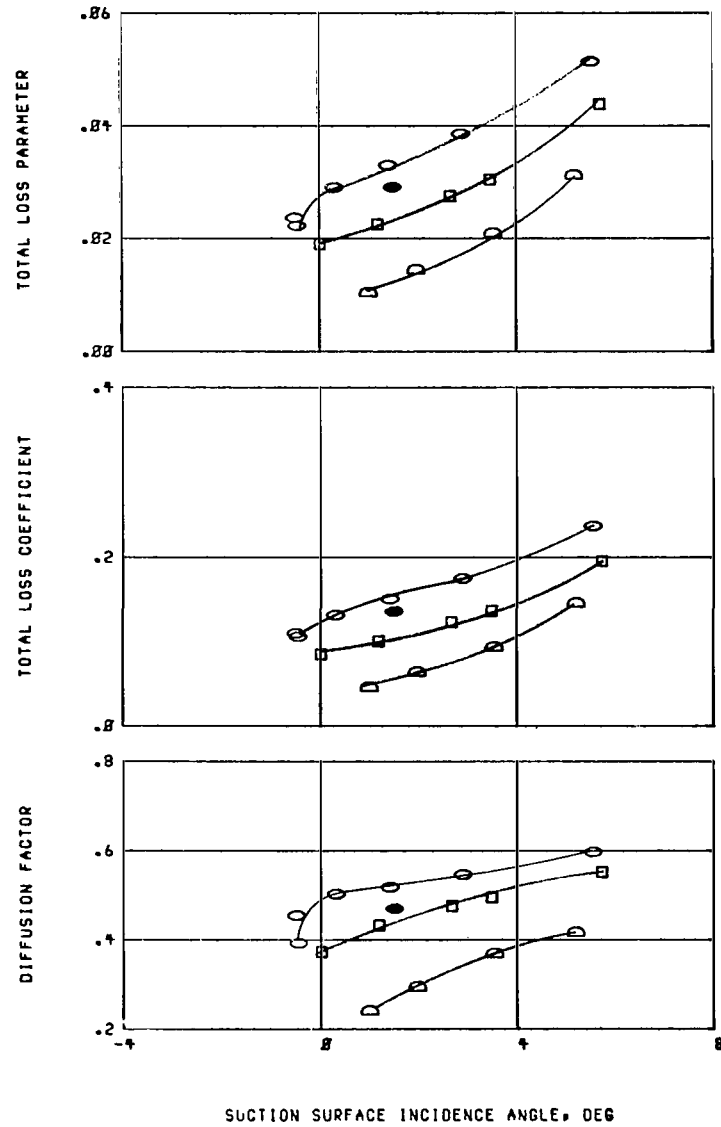
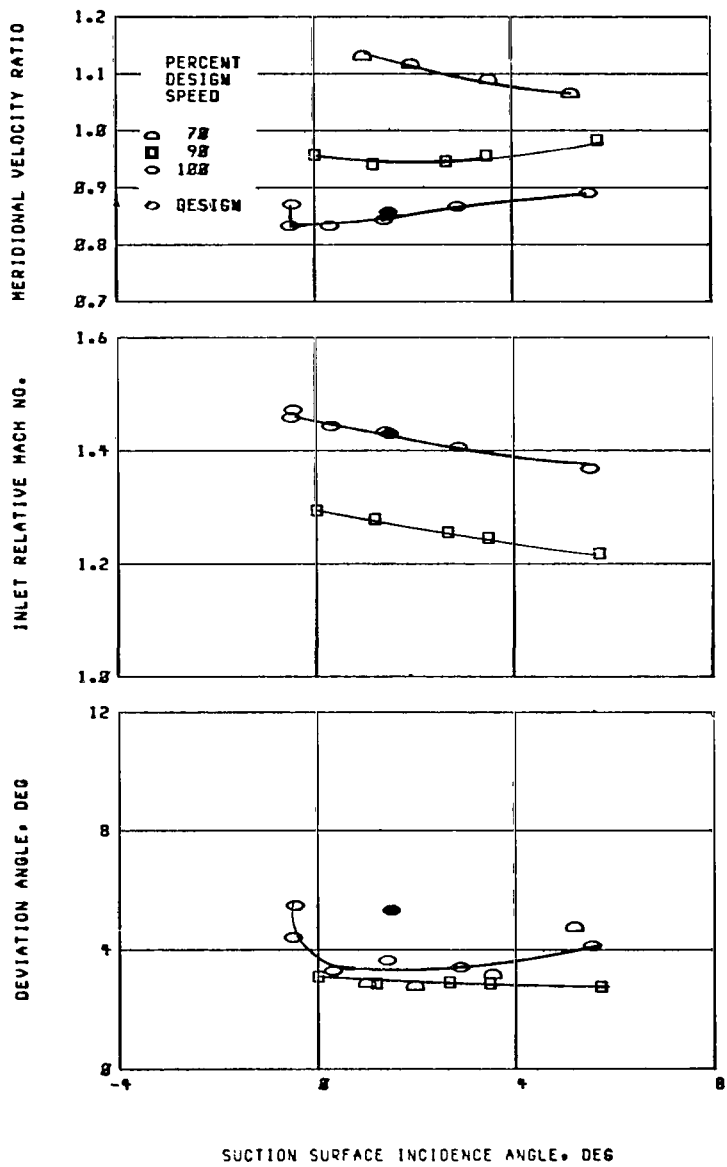

(d) 30 Percent span.

Figure 10. - Continued.

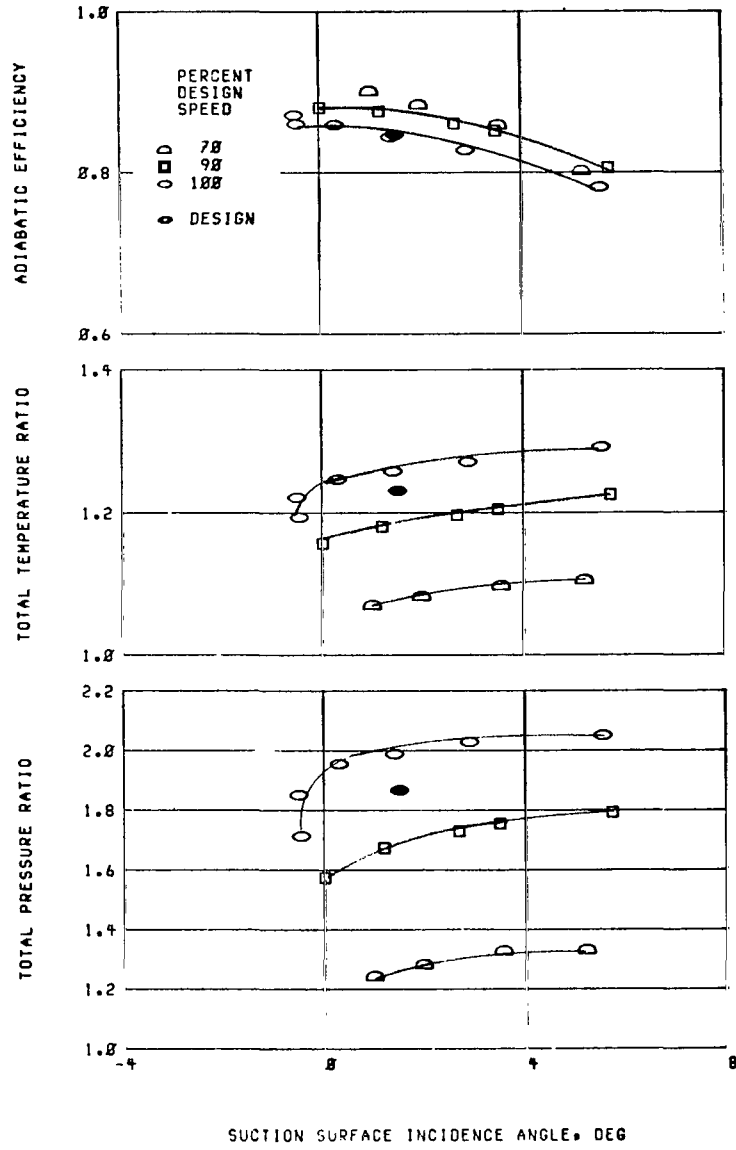

(d) Concluded.

Figure 10. - Continued.

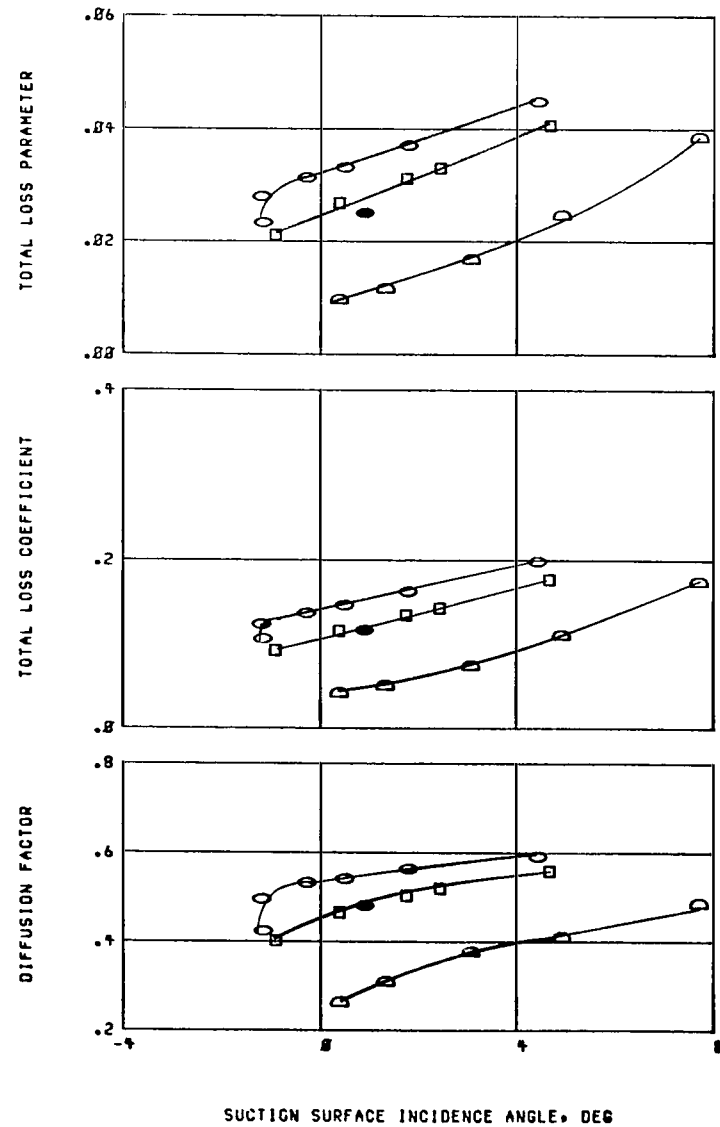
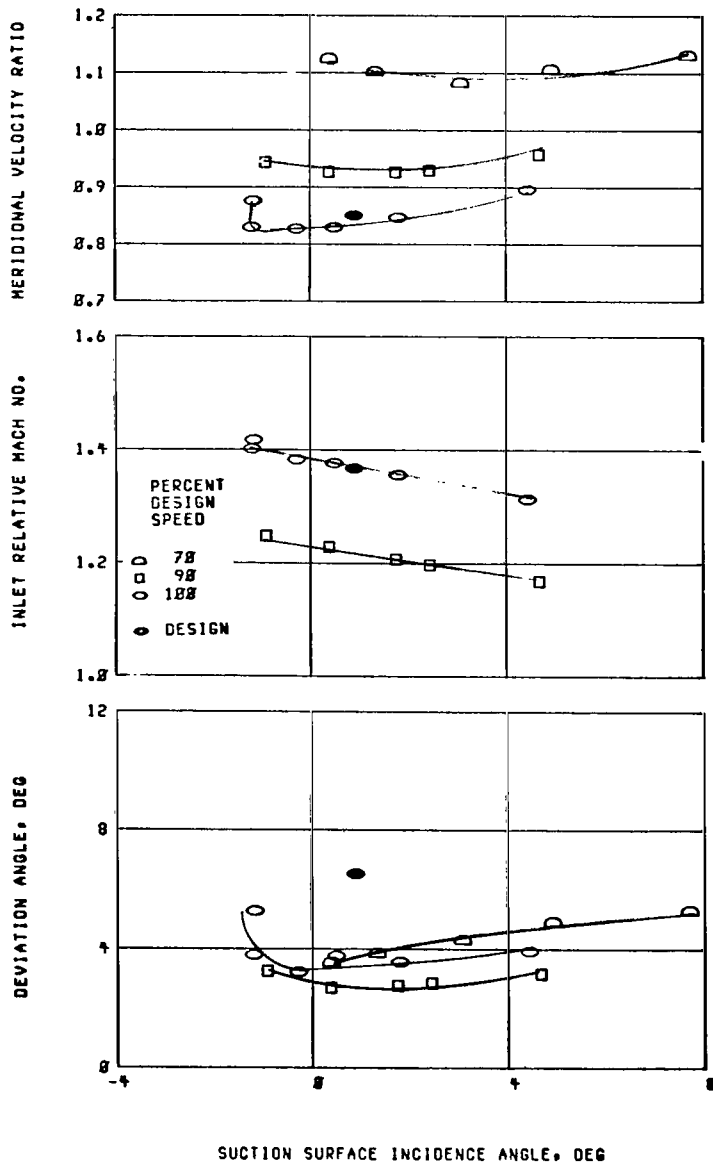

(e) 50 Percent span.

Figure 10. - Continued.

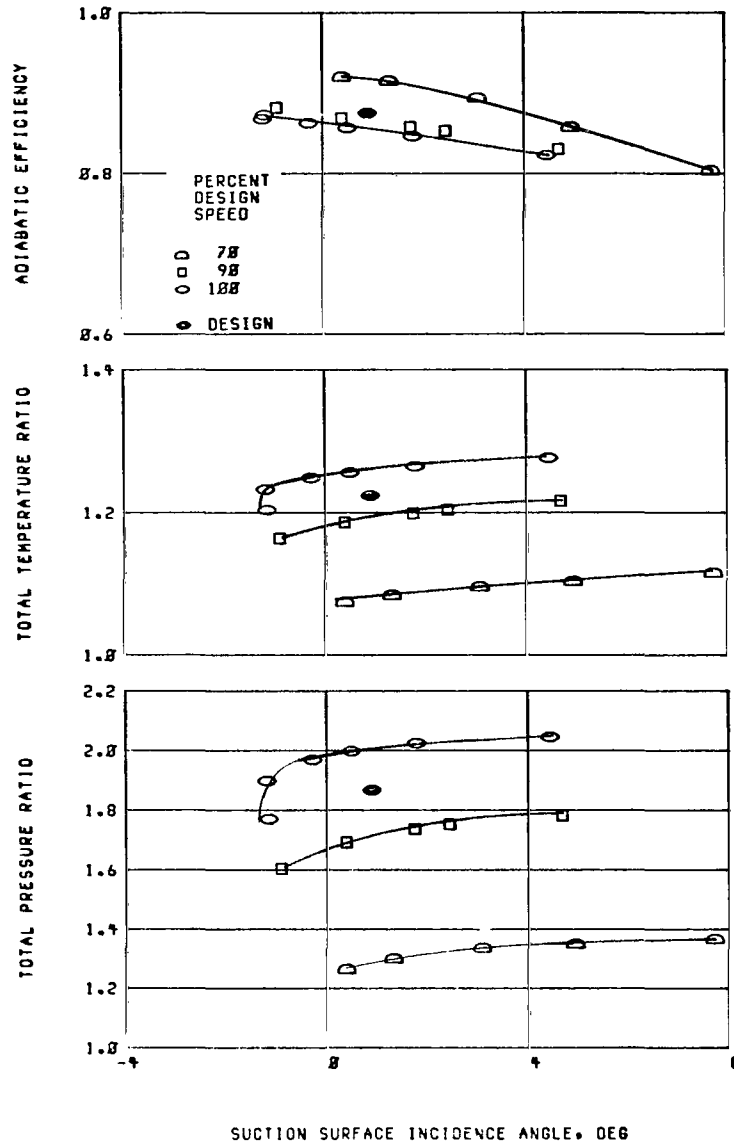

(e) Concluded.

Figure 10. - Continued.

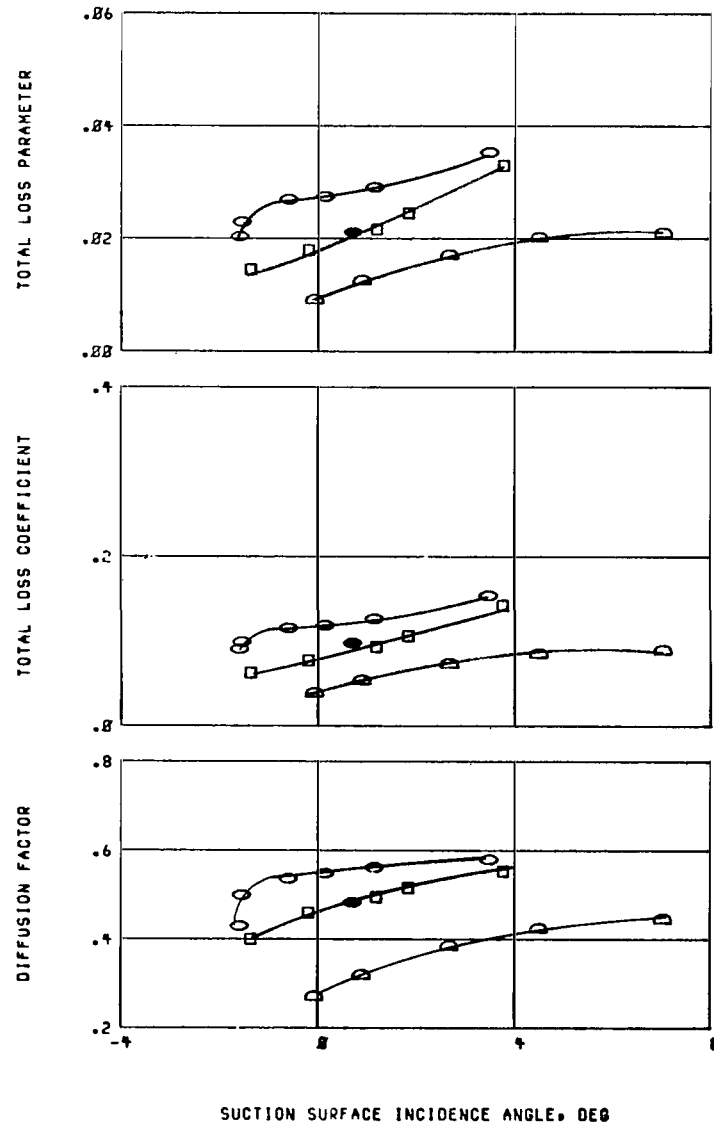
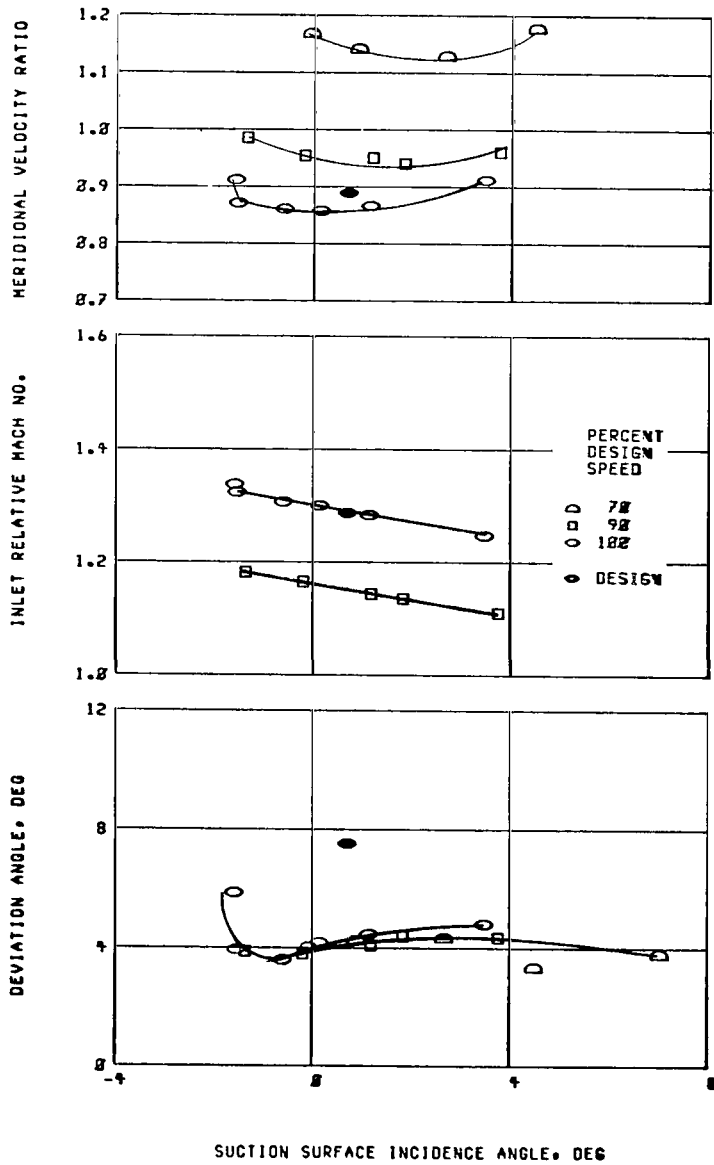

(f) 70 Percent span.

Figure 10. - Continued.

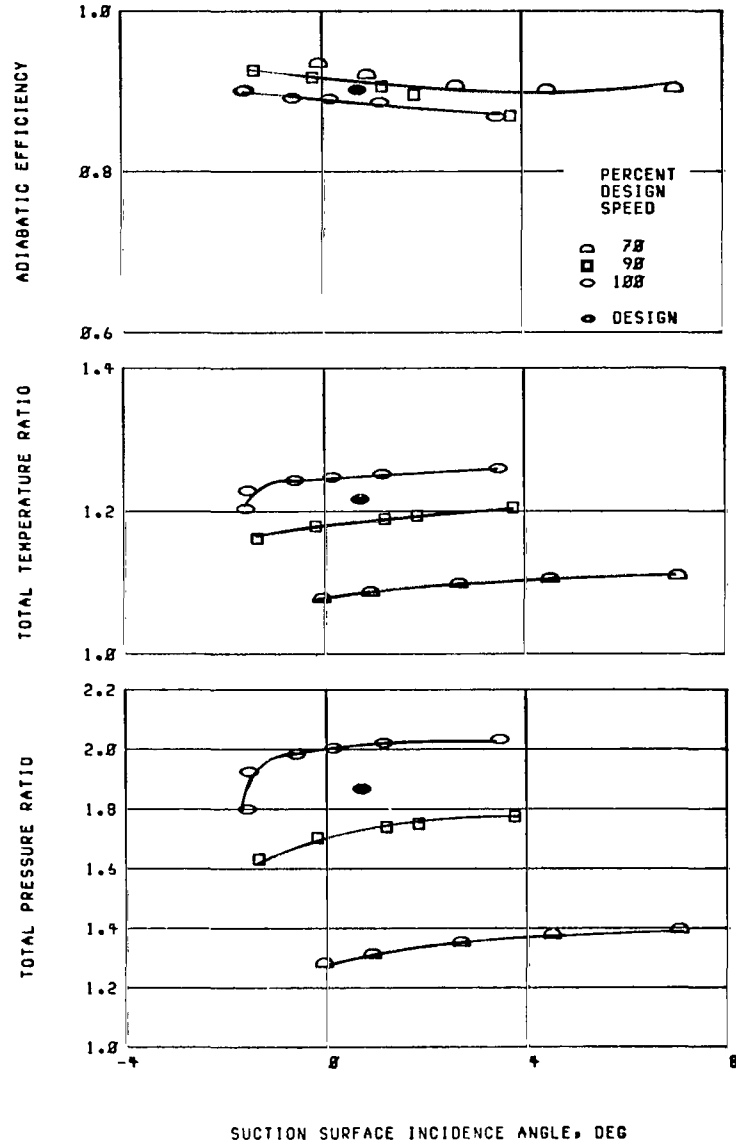

(f) Concluded.

Figure 10. - Continued.

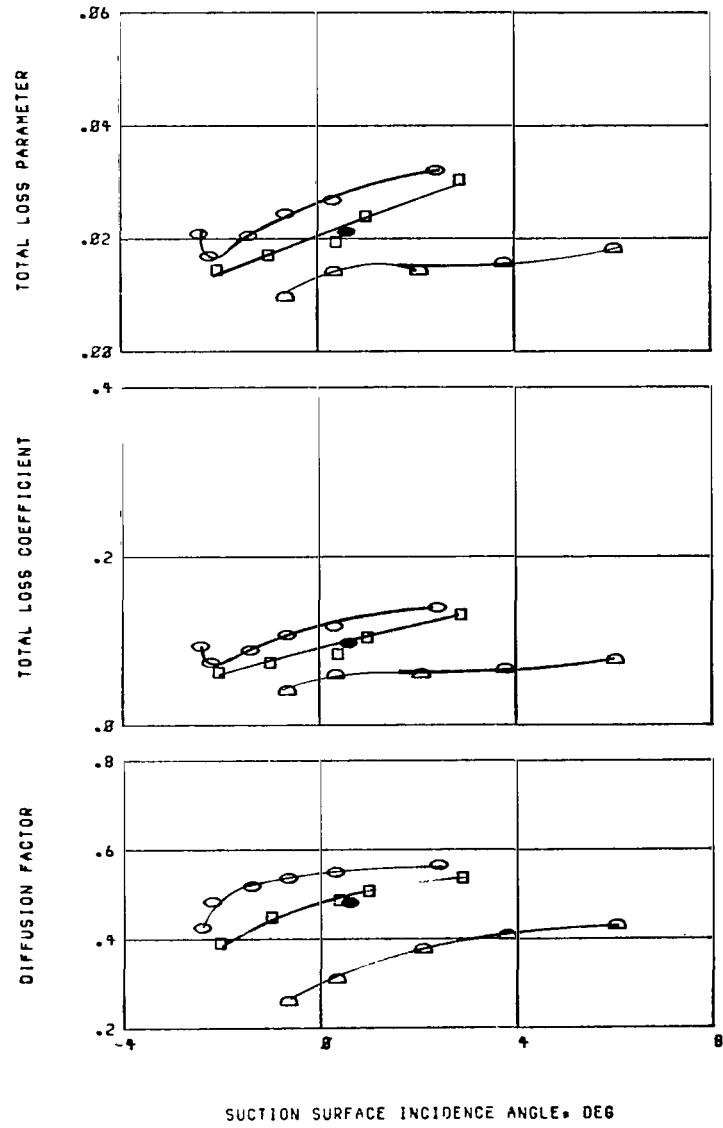
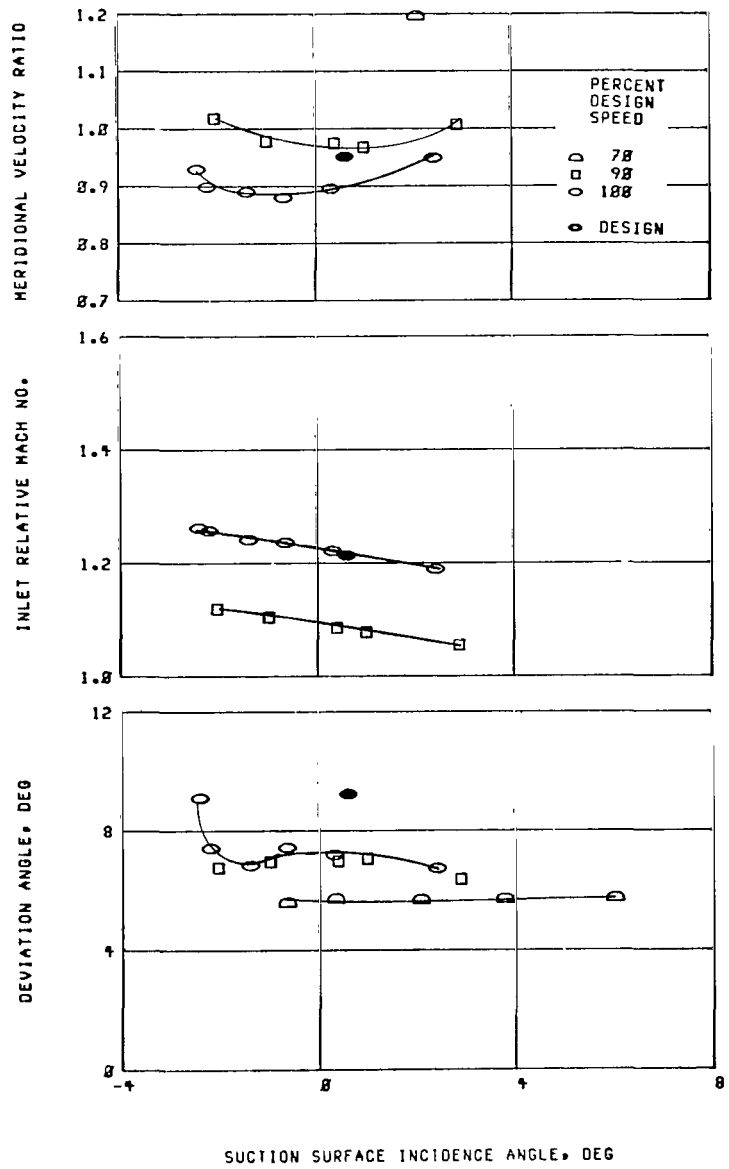

(g) 85 Percent span.

Figure 10. - Continued.

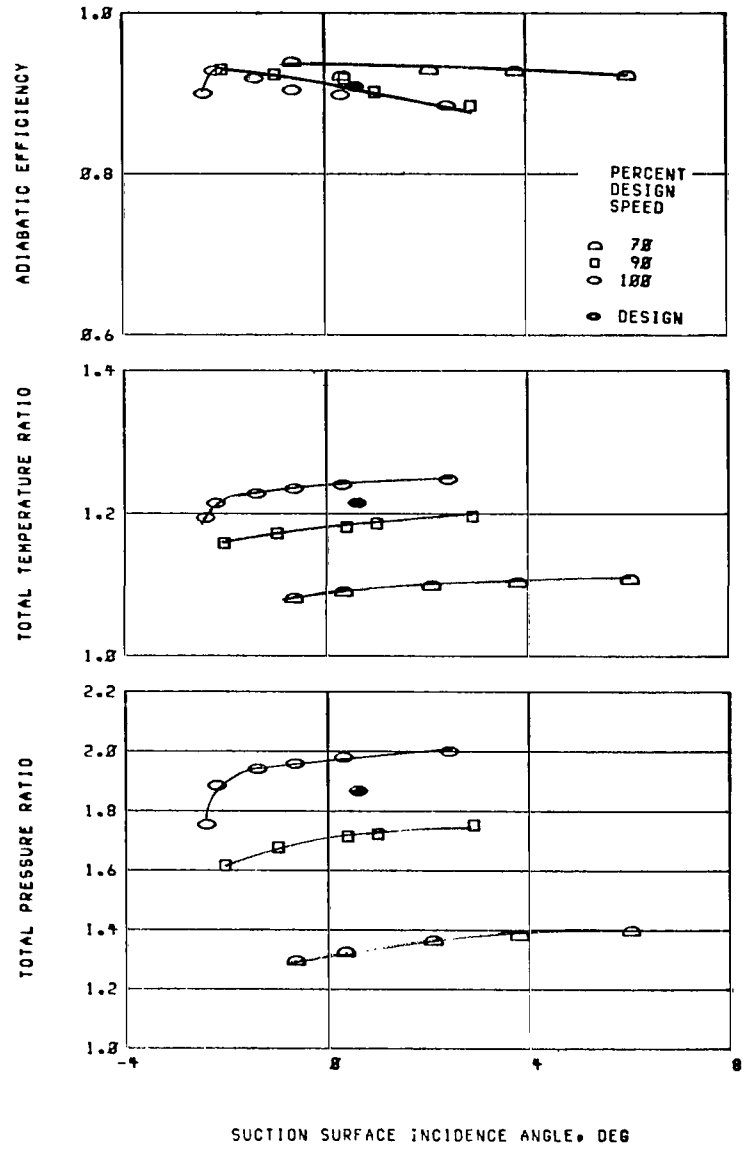

(g) Concluded.

Figure 10. - Continued.

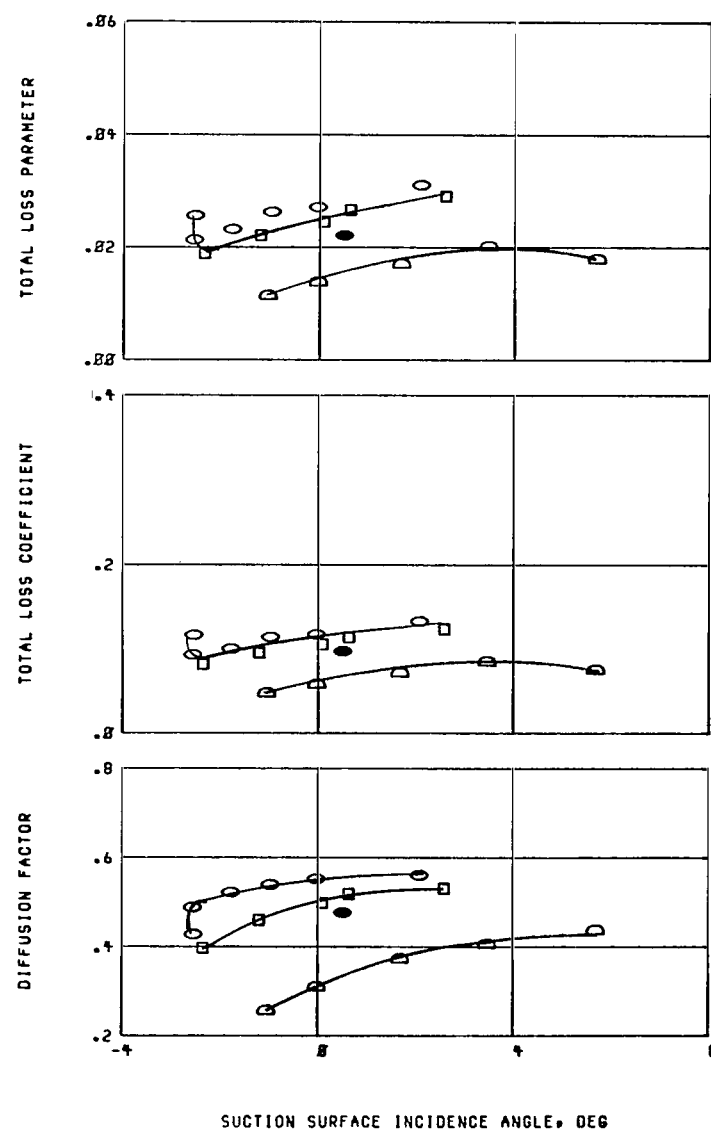
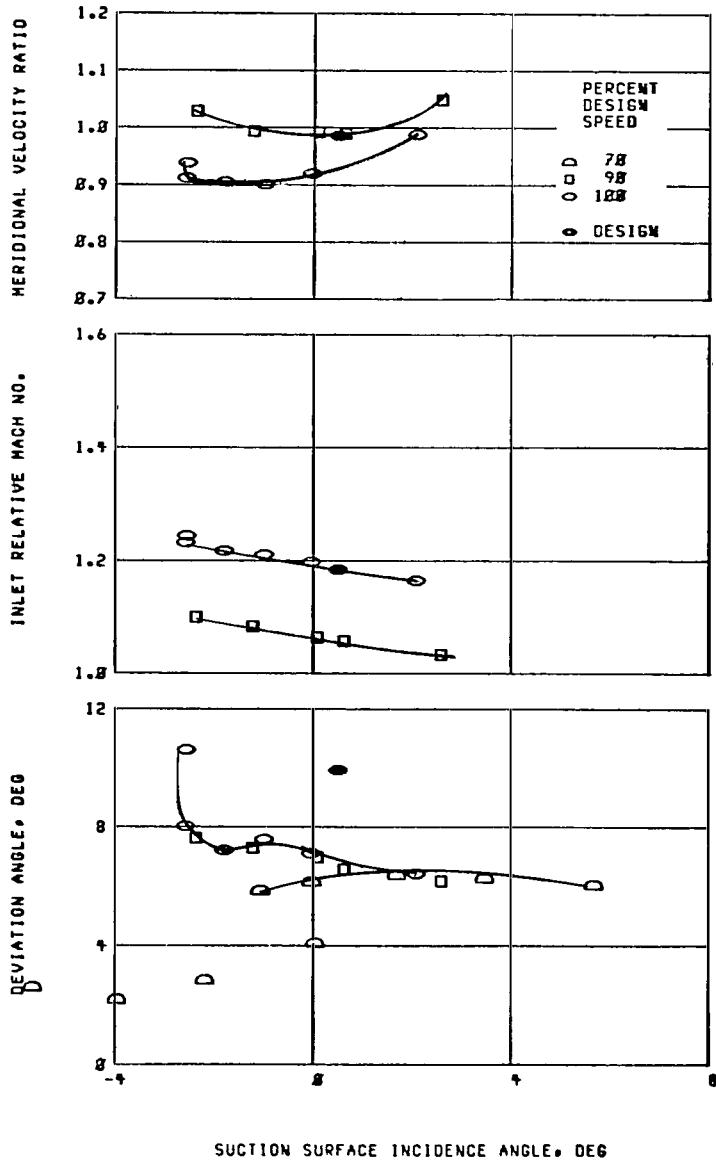

(h) 90 Percent span,
Figure 10. - Continued.

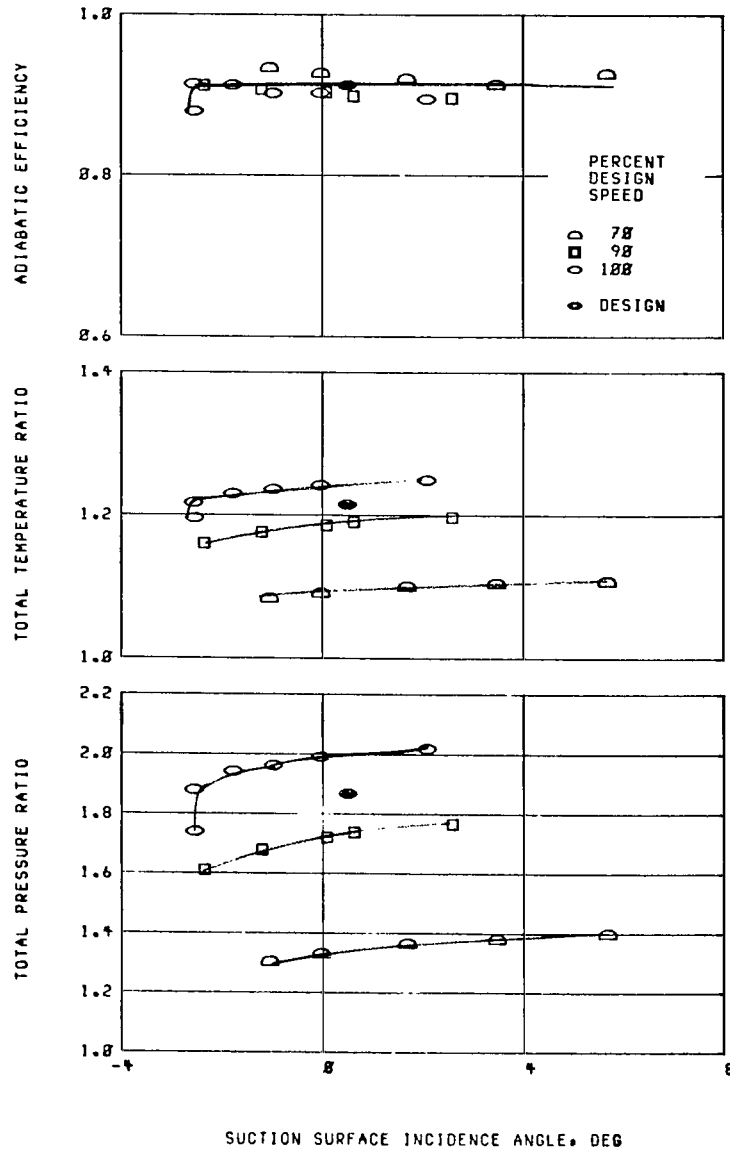

(h) Concluded.

Figure 10. - Continued.

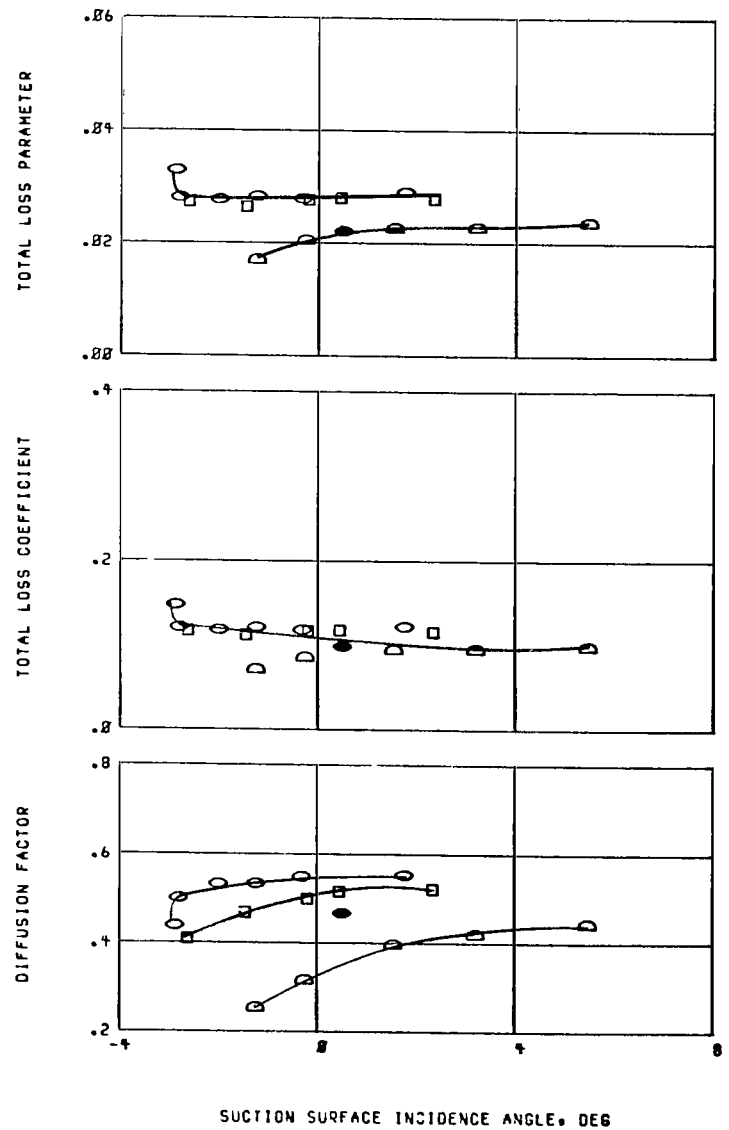
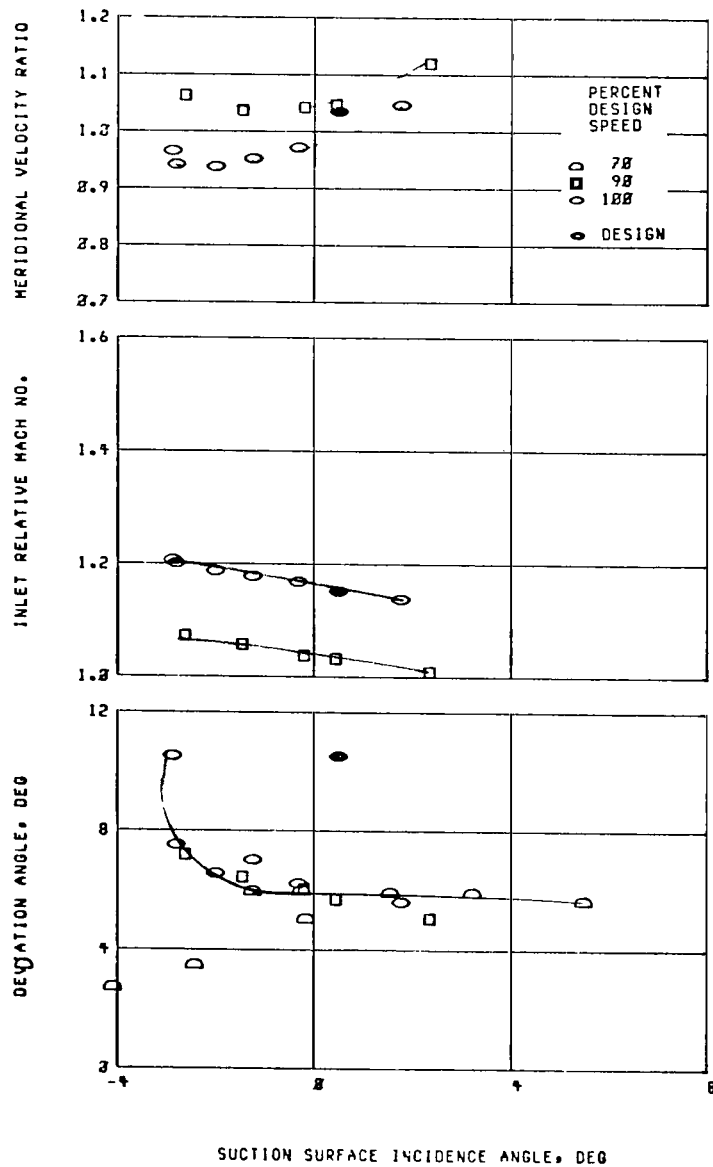

(i) 95 Percent span.

Figure 10. - Continued.

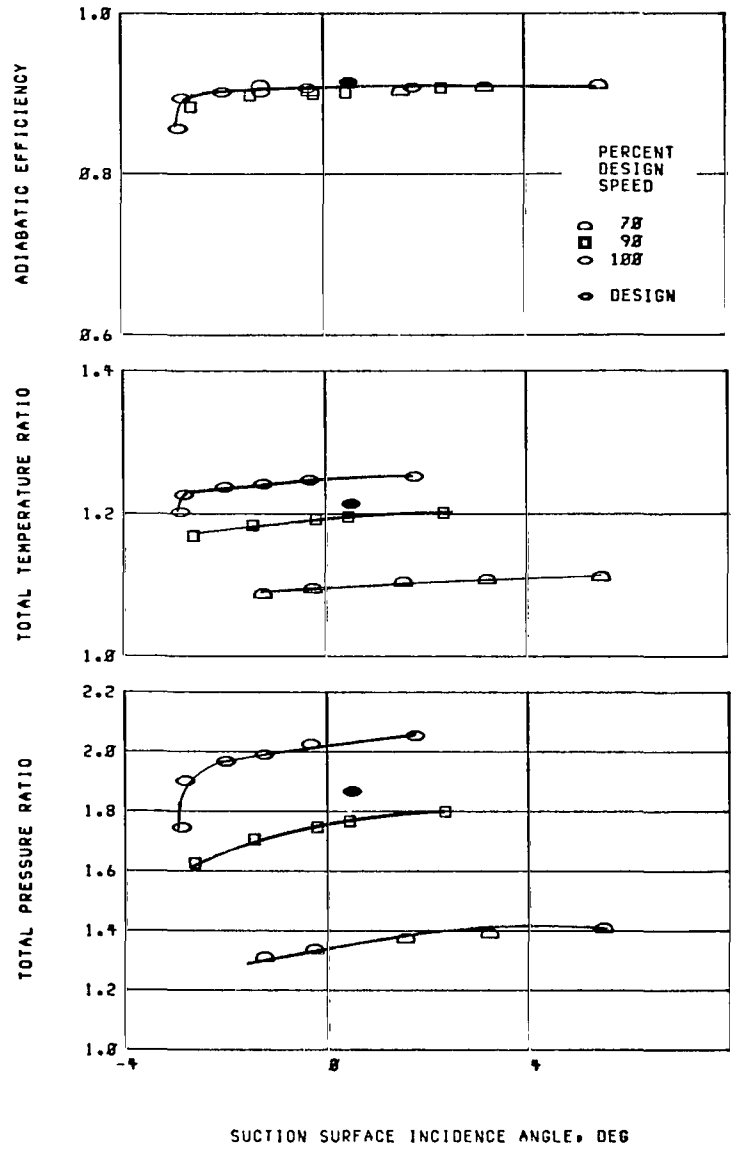

(i) Concluded.

Figure 10. - Concluded.

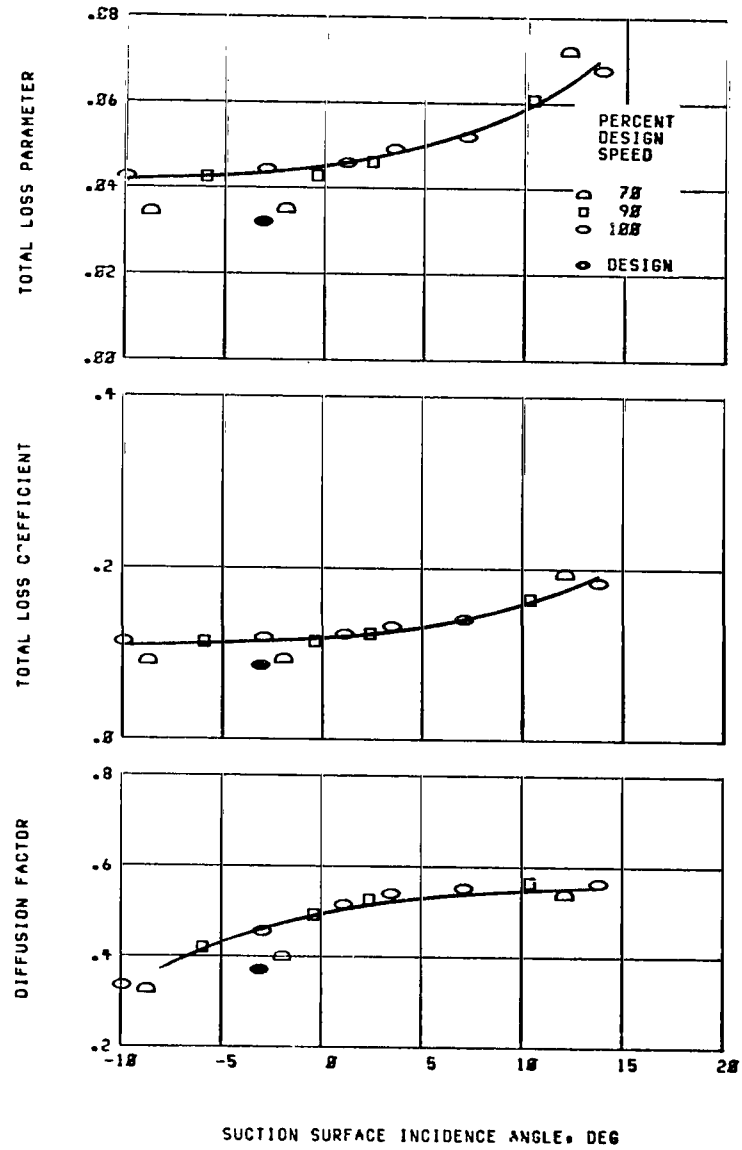
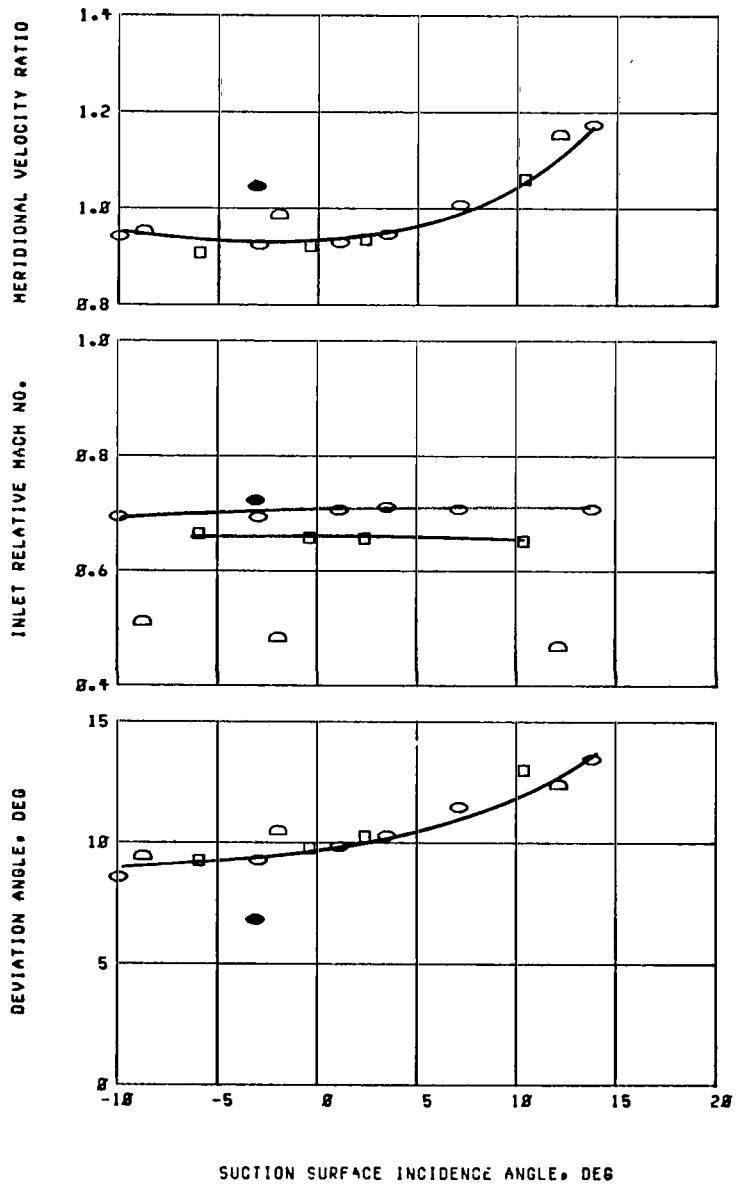

(a) 5 Percent span.

Figure 11. - Blade-element performance for stator 35.

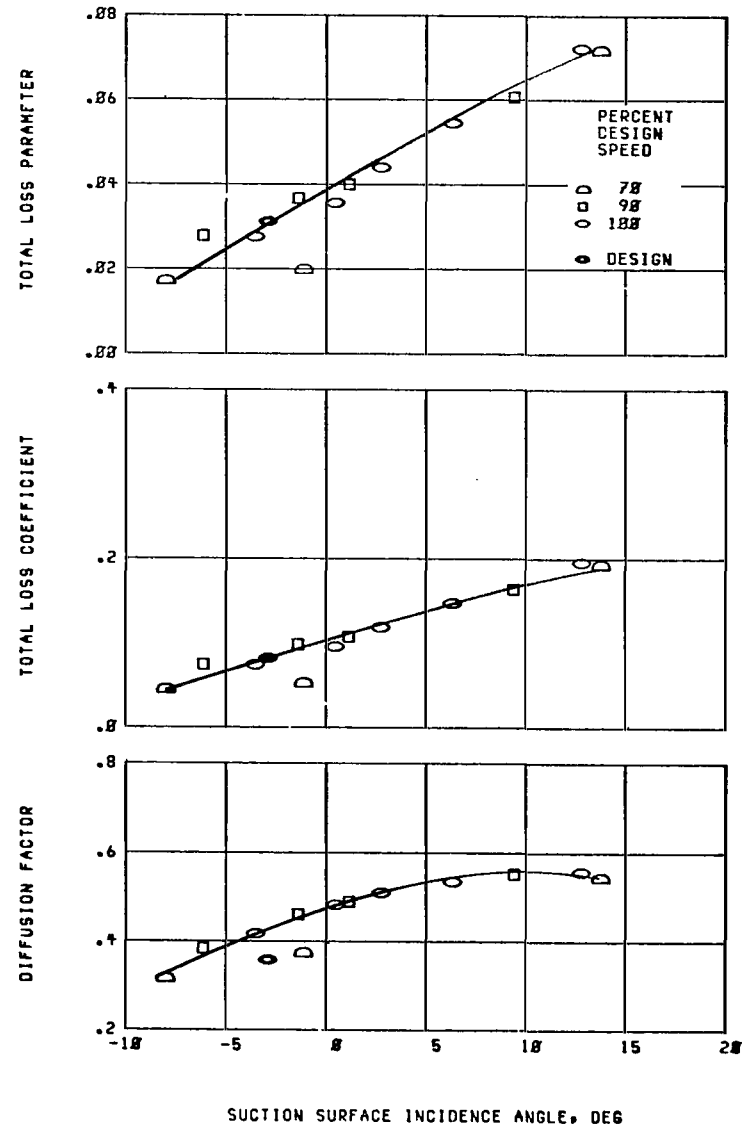
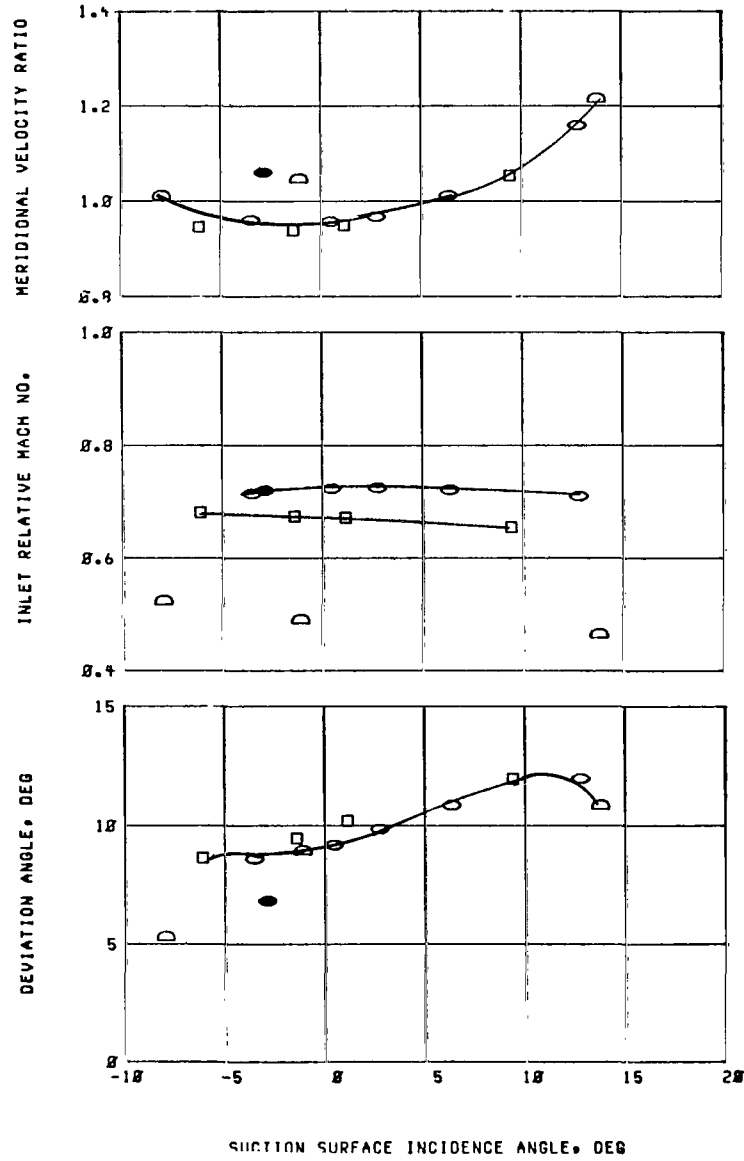

(b) 10 Percent span.

Figure 11. - Continued.

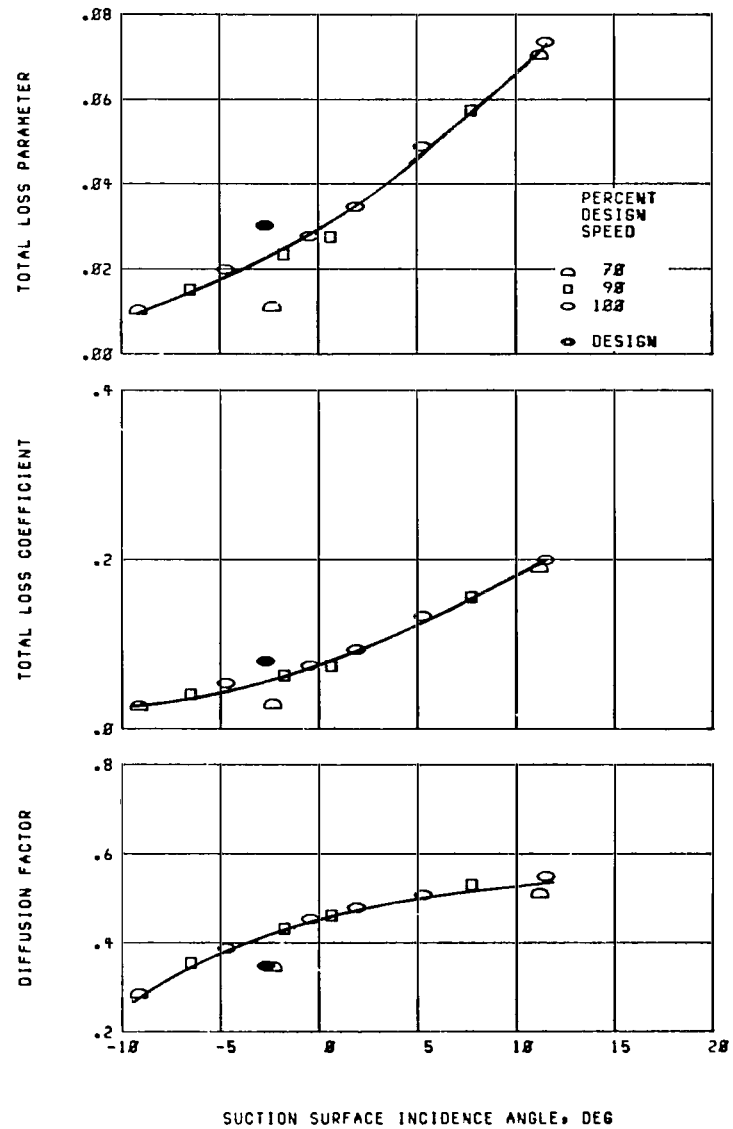
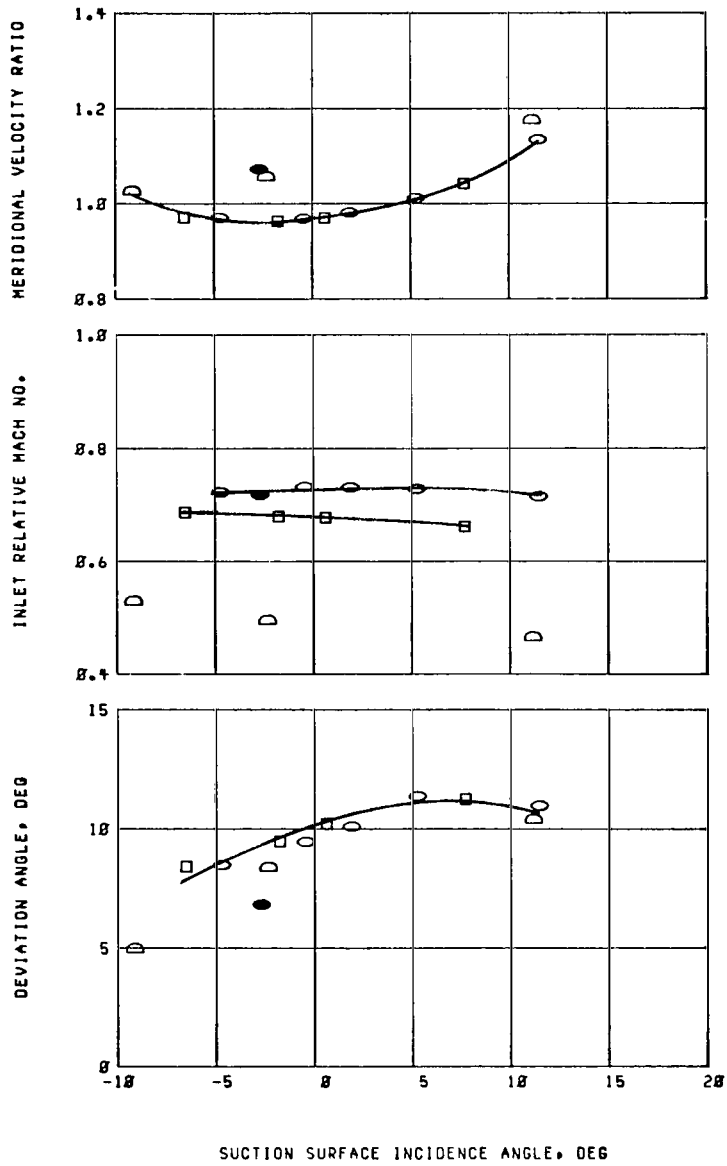

(c) 15 Percent span.

Figure 11. - Continued.

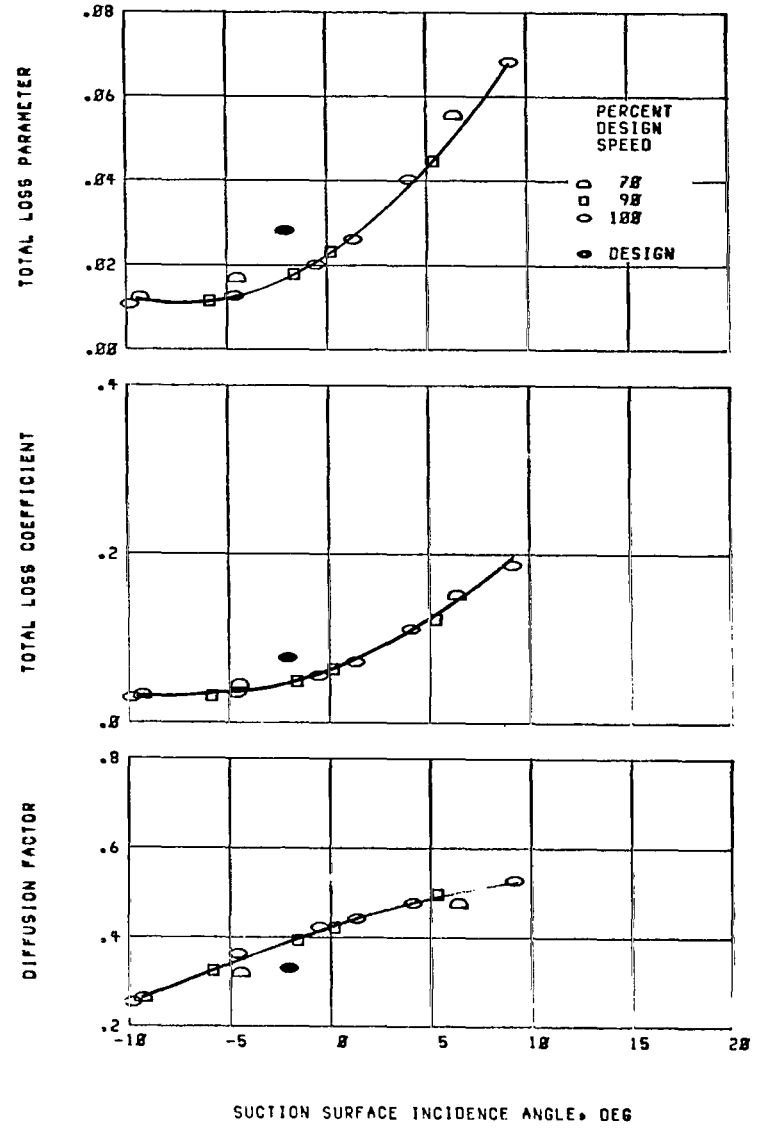
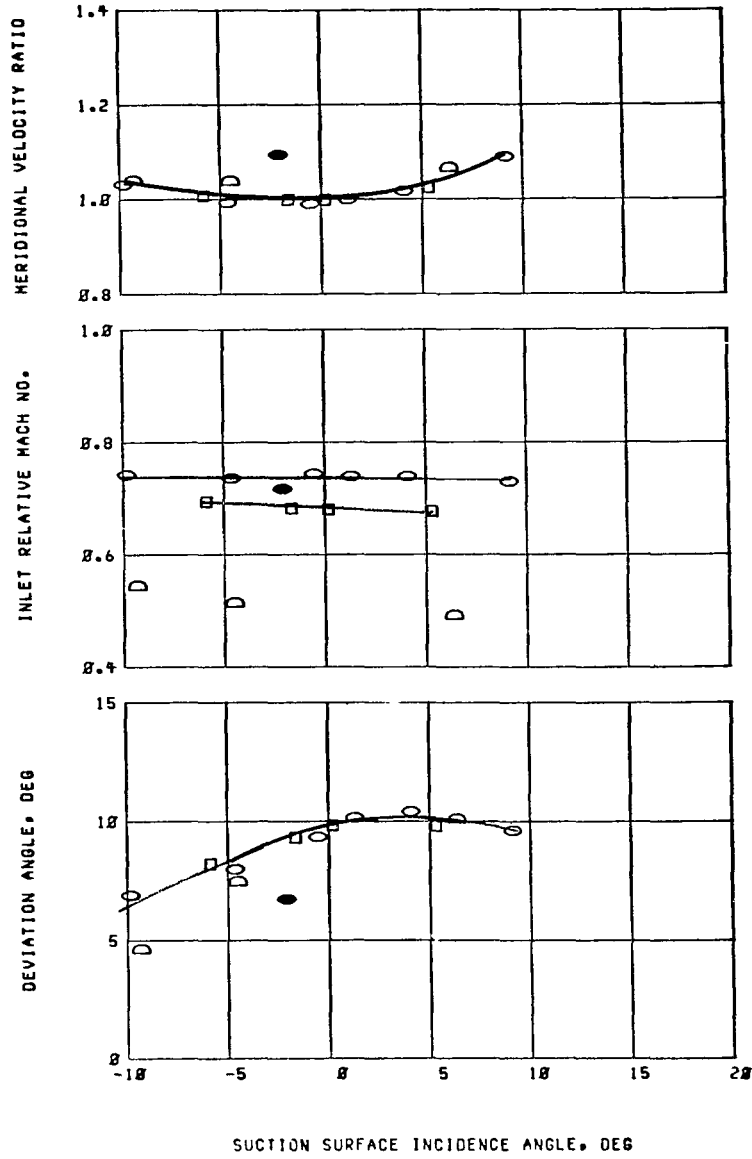

(d) 30 Percent span.

Figure 11. - Continued.

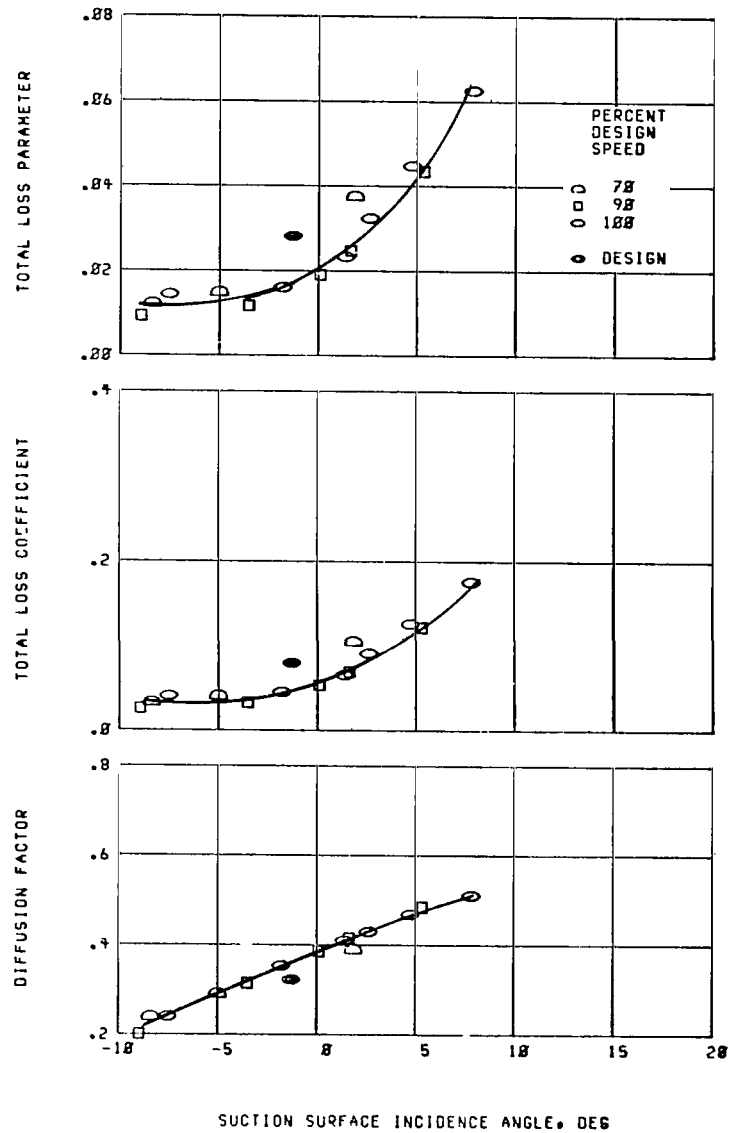
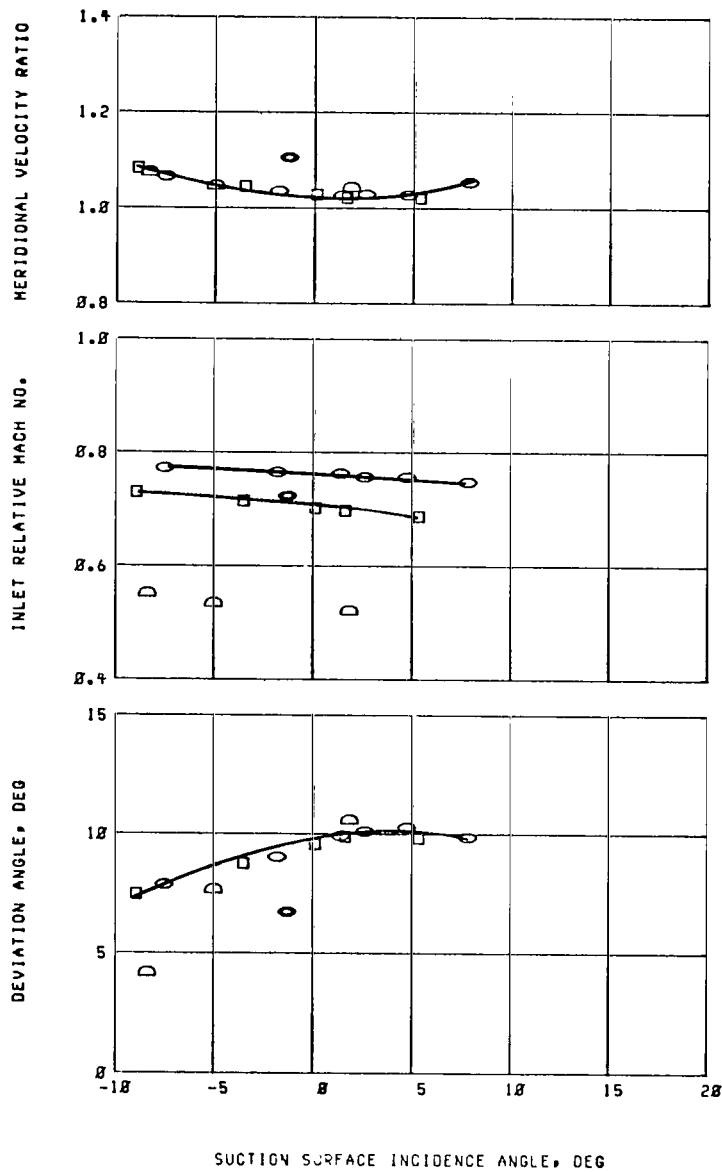

(e) 50 Percent span.

Figure 11. - Continued.

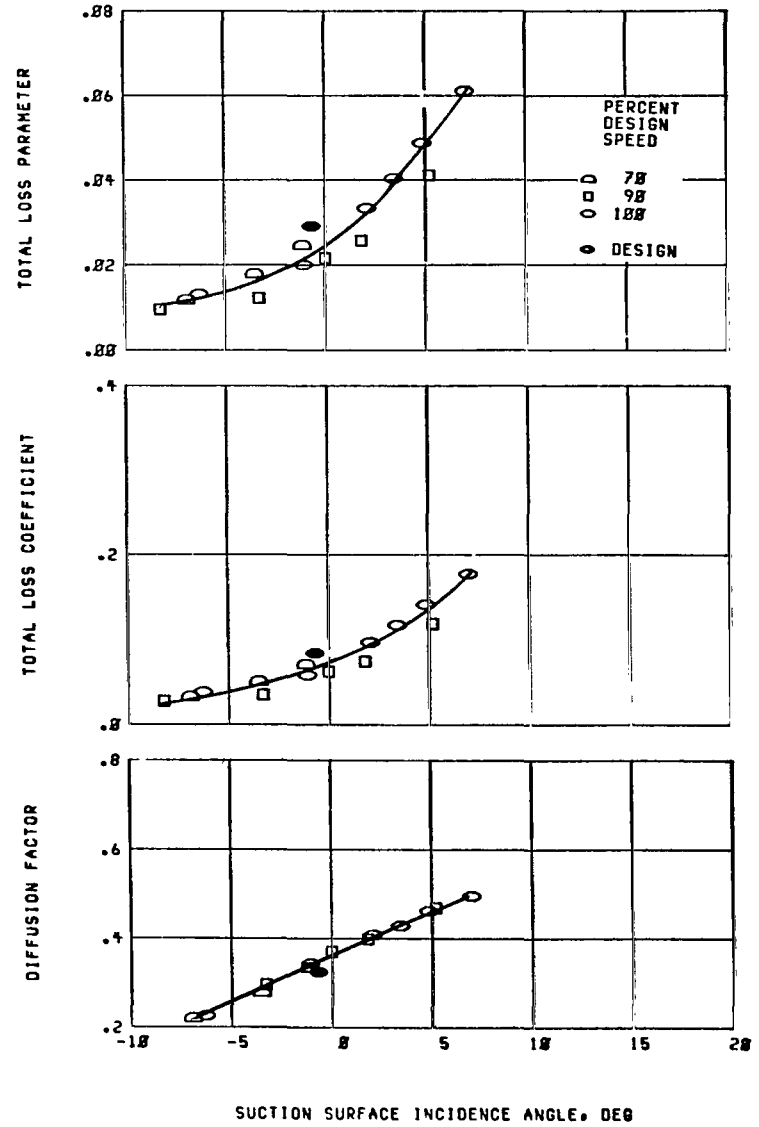
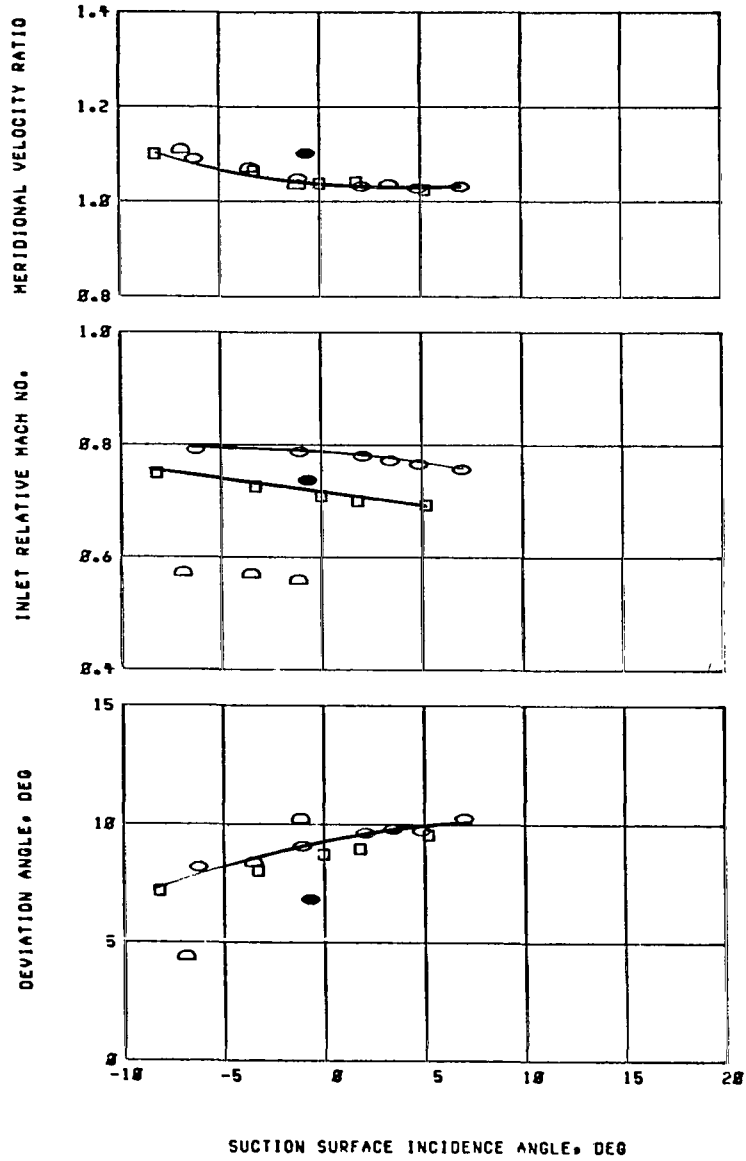

(f) 70 Percent span.

Figure 11. - Continued.

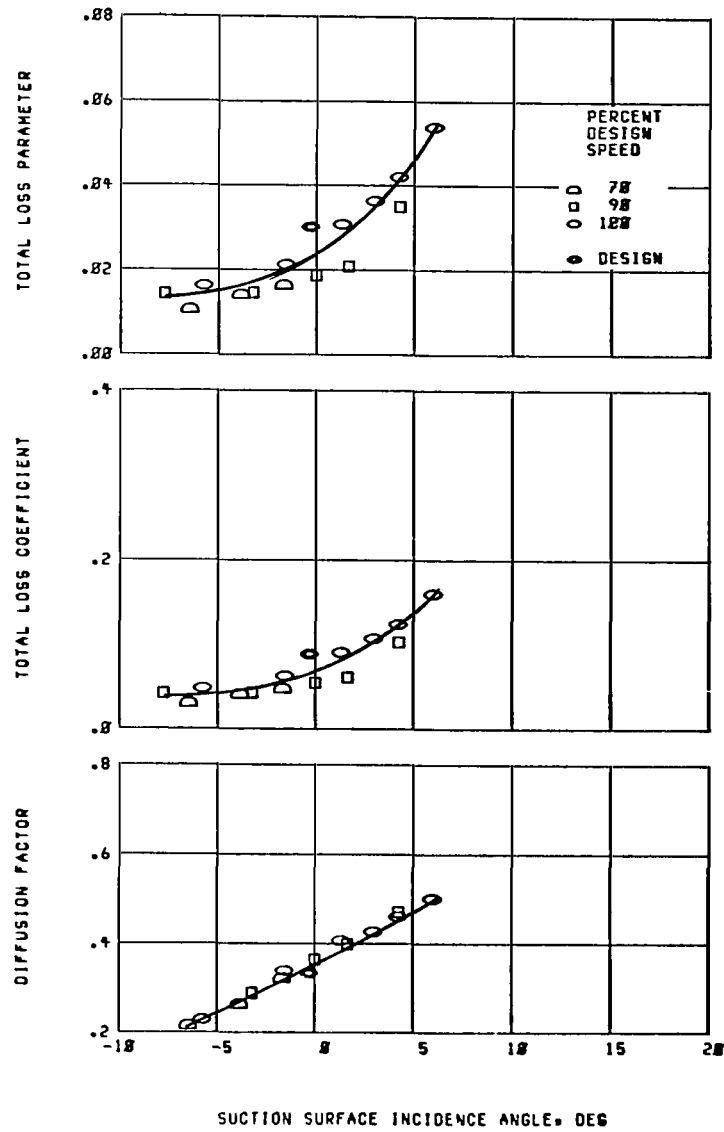
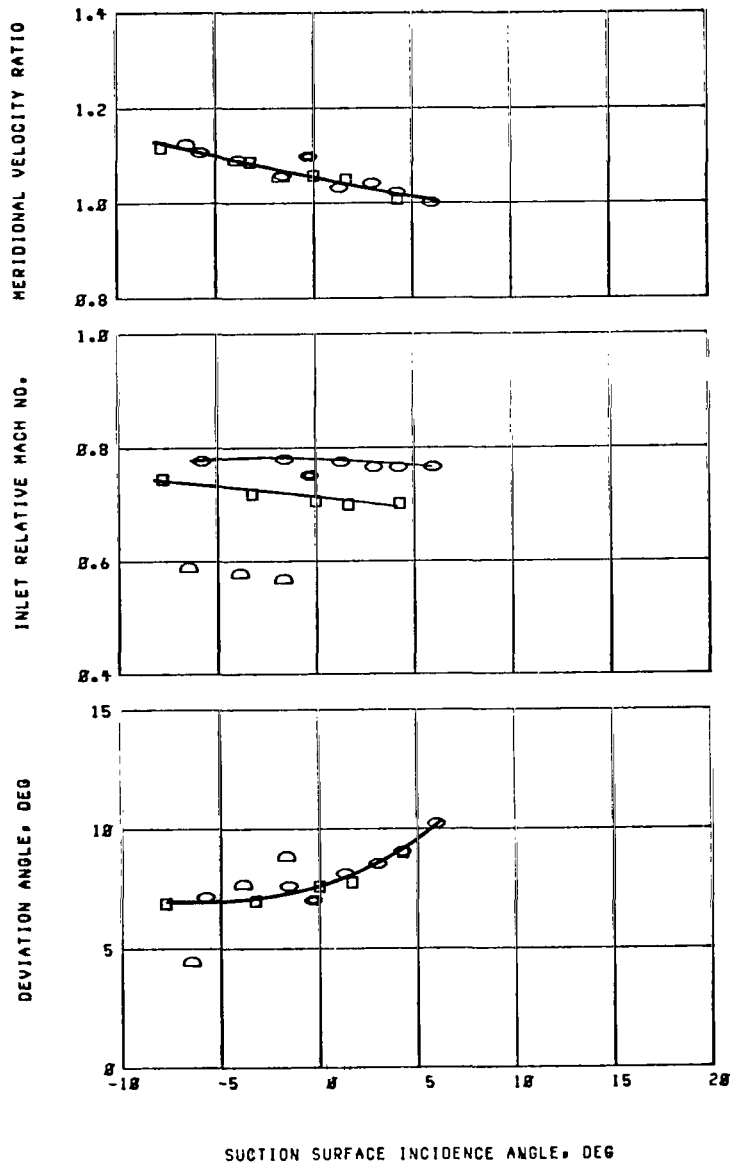

(g) 85 Percent span.

Figure 11. - Continued.

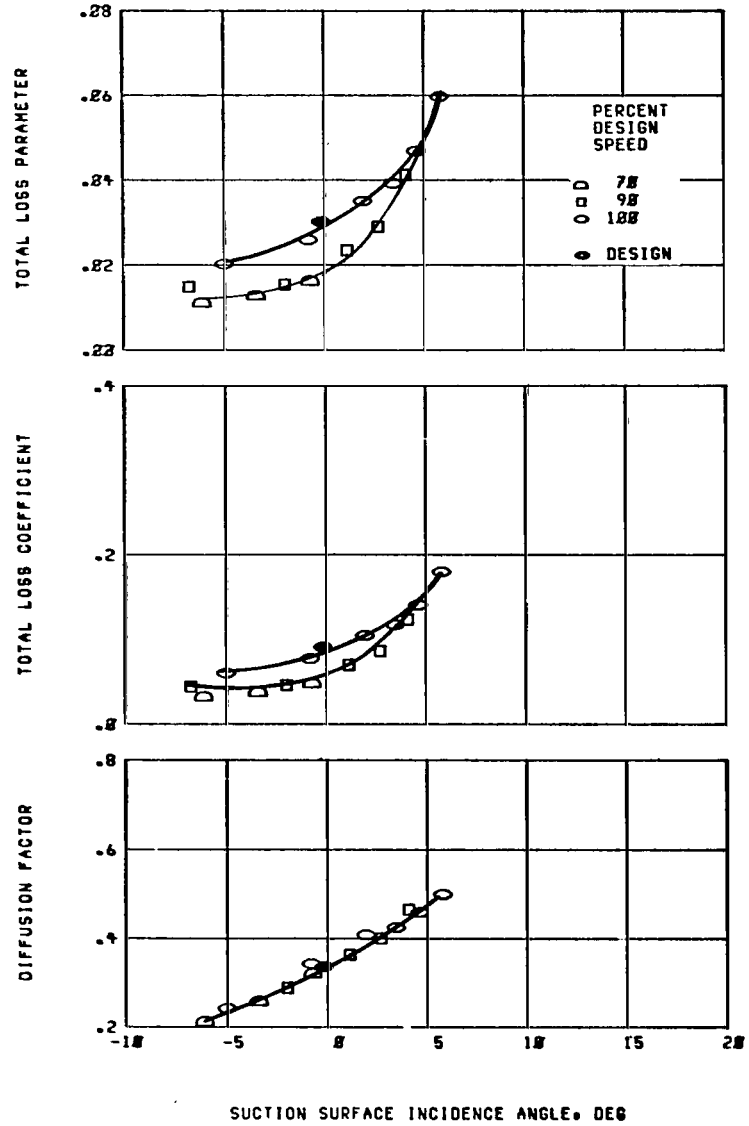
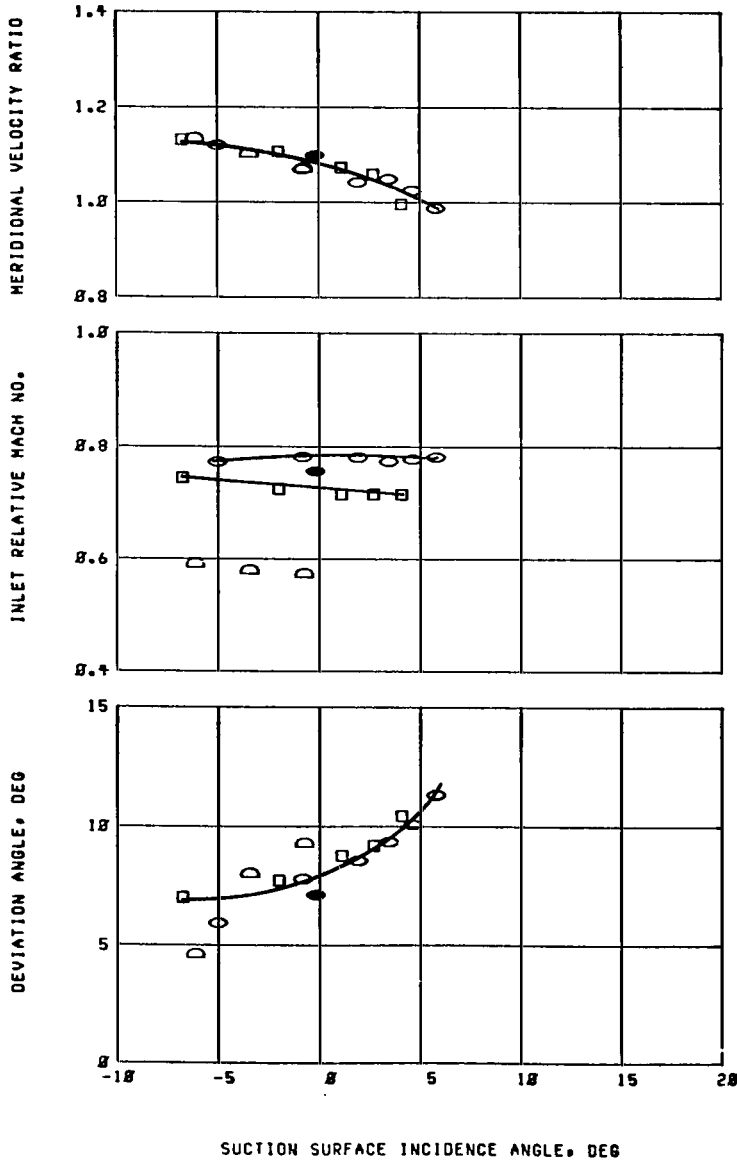

(h) 90 Percent span.

Figure 11. - Continued.

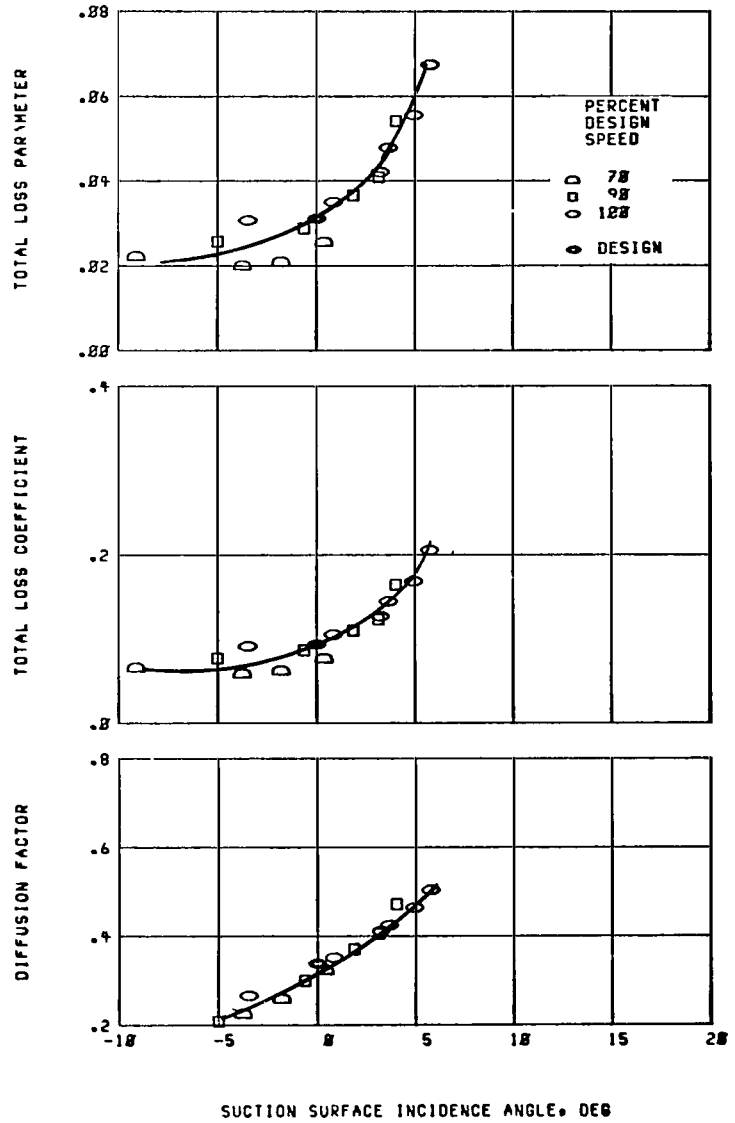
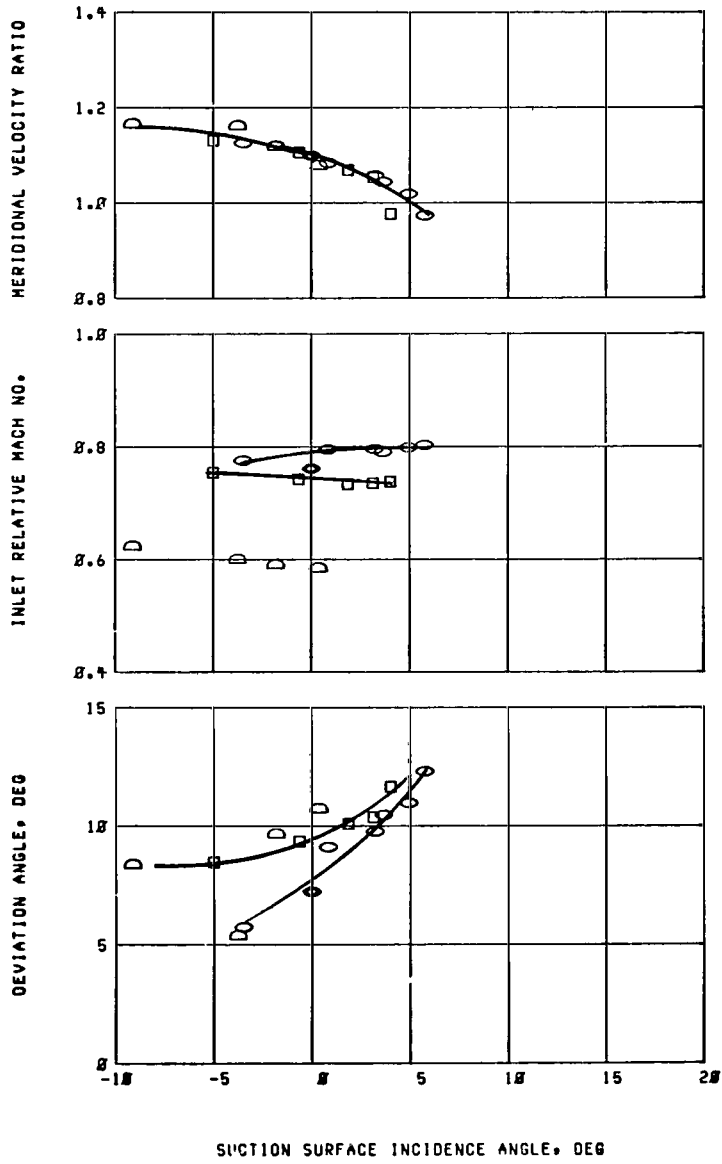

(i) 95 Percent span.

Figure 11. - Concluded.

1. Report No. NASA TP-1338	2. Government Accession No.	3. Recipient's Catalog No.
4. Title and Subtitle PERFORMANCE OF SINGLE-STAGE AXIAL-FLOW TRANSONIC COMPRESSOR WITH ROTOR AND STATOR ASPECT RATIOS OF 1.19 AND 1.26, RESPECTIVELY, AND WITH DESIGN PRESSURE RATIO OF 1.82	5. Report Date November 1978	6. Performing Organization Code
7. Author(s) Lonnie Reid and Royce D. Moore	8. Performing Organization Report No. E-9461	10. Work Unit No. 505-04
9. Performing Organization Name and Address National Aeronautics and Space Administration Lewis Research Center Cleveland, Ohio 44135	11. Contract or Grant No.	13. Type of Report and Period Covered Technical Paper
12. Sponsoring Agency Name and Address National Aeronautics and Space Administration Washington, D.C. 20546	14. Sponsoring Agency Code	
15. Supplementary Notes		
16. Abstract <p>The overall and blade-element performance of a low-aspect-ratio transonic compressor stage is presented over the stable operating flow range at 70, 90, and 100 percent design speeds. At design speed the rotor and stage achieved peak efficiencies of 0.872 and 0.845 at pressure ratios of 1.875 and 1.842, respectively. The stage stall margin at design speed was 21.8 percent.</p>		
17. Key Words (Suggested by Author(s)) Compressors Turbomachinery	18. Distribution Statement Unclassified - unlimited STAR Category 07	
19. Security Classif. (of this report) Unclassified	20. Security Classif. (of this page) Unclassified	21. No. of Pages 102
		22. Price* A06

* For sale by the National Technical Information Service, Springfield, Virginia 22161

NASA-Langley, 1978

National Aeronautics and
Space Administration

Washington, D.C.
20546

Official Business
Penalty for Private Use, \$300

THIRD-CLASS BULK RATE

Postage and Fees Paid
National Aeronautics and
Space Administration
NASA-451



3 1 10, A, 101678 S00903DS
DEPT OF THE AIR FORCE
AF WEAPONS LABORATORY
ATTN: TECHNICAL LIBRARY (SUL)
KIRTLAND AFB NM 87117

NASA

S

POSTMASTER: If Undeliverable (Section 158
Postal Manual) Do Not Return