



79-10028  
 Tm-79906

"Made available under NASA sponsorship  
 in the interest of early and wide dis-  
 semination of Earth Resources Survey  
 Program information and without liability  
 for any use made thereof."

# PROCEEDINGS OF PLENARY SESSION

## THE LACIE SYMPOSIUM

OCTOBER 1978

(E79-10028)	PROCEEDINGS OF PLENARY SESSION:	N79-14449
THE LACIE SYMPOSIUM (NASA)	130 p	THRU
HC A07/MF A01	CSCCL 02C	N79-14457
		Unclas
		00028



National Aeronautics and  
 Space Administration

Lyndon B. Johnson Space Center  
 Houston, Texas 77058

## PREFACE

This Plenary document contains key papers presented at the LACIE Symposium held at the NASA Lyndon B Johnson Space Center, Houston, Texas, from October 23 to 26, 1978. An overview of the Large Area Crop Inventory Experiment (LACIE) is provided in this compilation. The LACIE was sponsored by the following three agencies: the National Aeronautics and Space Administration (NASA) Lyndon B Johnson Space Center, the United States Department of Agriculture (USDA), and the National Oceanic and Atmospheric Administration (NOAA). The papers included in this document are as follows:

- 1 "The Status of Existing Global Crop Forecasting"
- 2 "LACIE: An Experiment in Global Crop Forecasting"
- 3 "The LACIE Applications Evaluation System: A Design Overview"
- 4 "The LACIE Supporting Research Program: A Focused Approach to Research and Development"
- 5 "Data Processing Systems in Support of LACIE and Future Agricultural Research Programs"
- 6 "Technology Transfer: Concepts, User Requirements, and a Practical Application"
- 7 "The Impact of LACIE on a National Meteorological Capability"
- 8 "The Outlook for Satellite Remote Sensing for Crop Inventory"

Those readers desiring more detailed information on the various aspects of LACIE should consult the Proceedings of the LACIE Symposium, which will be available sometime following the symposium.

Original photography may be purchased from:  
EROS Data Center

Sioux Falls, SD 57198

~~PRECEDING PAGE BLANK NOT FILMED~~

# CONTENTS

	<i>Page</i>
THE STATUS OF EXISTING GLOBAL CROP FORECASTING . <i>Bruce A Scherr, William E Kibler, and Forrest G Hall</i>	1
LACIE. AN EXPERIMENT IN GLOBAL CROP FORECASTING .. . . . . <i>R B MacDonald and F G Hall</i>	17
THE LACIE APPLICATIONS EVALUATION SYSTEM: A DESIGN OVERVIEW .. . . . . <i>J L Dragg, W E. Hensley, R. O Hill, R. G Musgrove, and T T White</i>	49
THE LACIE SUPPORTING RESEARCH PROGRAM A FOCUSED APPROACH TO RESEARCH AND DEVELOPMENT <i>Jon D Erickson, Richard P. Heydorn, Milton C Trichel, and Allen L Grandfield</i>	65
DATA PROCESSING SYSTEMS IN SUPPORT OF LACIE AND FUTURE AGRICULTURAL RESEARCH PROGRAMS . . . . . <i>Donald H Hay</i>	91
TECHNOLOGY TRANSFER CONCEPTS, USER REQUIREMENTS, AND A PRACTICAL APPLICATION .. . . . . <i>J D. Murphy, F. C David, R E Hatch, R L. Packard, and D Durica</i>	105
THE IMPACT OF LACIE ON A NATIONAL METEOROLOGICAL CAPABILITY . . . . . <i>N. Strommen, M Reid, and J Hill</i>	119
THE OUTLOOK FOR SATELLITE REMOTE SENSING FOR CROP INVENTORY . . . . . <i>R. Bryan Erb, Robert E Tokerud, and Robert B MacDonald</i>	125

PRECEDING PAGE BLANK NOT FILMED.

# The Status of Existing Global Crop Forecasting

*Bruce A. Scherr,<sup>a</sup> William E. Kibler,<sup>b</sup> and Forrest G. Hall<sup>c</sup>*

## INTRODUCTION

The agricultural analyst of today has at his disposal an extremely broad range of agricultural data. Unfortunately, this same analyst does not have a storehouse of agricultural information. Data or observations of economic activity must be transformed into meaningful decision-related inputs before they can accurately be classified as information. This paper will discuss the need for and the approach to improving one set of specific agricultural data—crop production estimates. The agricultural community is flooded with a great number of crop estimates from all over the world, some of which are well founded and others very questionable. The nature of today's highly interrelated agricultural world has promoted an overemphasis on highly suspect data (i.e., U.S.S.R. crop estimates) as major market determinants. The agricultural community must move toward the evolution of a fully integrated agricultural information system that includes crop production estimates with continuous adjustments in these estimates as a key component. Existing crop inventory systems do not meet this goal, consequently, the redevelopment and the use of these systems have been haphazard, and, more importantly, they have served as major sources of misinformation for agricultural analysts.

A review of current crop inventory systems requires a statement of their purpose and a description of the analytic environment in which they exist. The authors will assume that most agricultural decision needs can be cataloged under four main headings: (1) market analysis and business decisions, (2) policymaking, (3) use and development of resources, and (4) technology assessment and development. A number of country-specific crop inventory systems that are currently in operation

around the world are described. It is clear from the discussion of these systems that agriculture has evolved into an interrelated world process and that the distinct and separate nature of the information systems is inadequate for decisionmaking purposes. Furthermore, world agriculture has become much more dependent on nonagricultural forces (i.e., economic, social, political) which influence the process of producing and distributing food and fiber.

The most pressing problem limiting the effectiveness of existing crop inventory systems is that these systems were evolved largely apart from an overall information system for world agriculture. Little attention is paid to the crop production estimate as an integral component of the total agricultural economic situation or to the risks or opportunities that surround the estimate. Today's crop reporting systems are rightfully concerned with the accuracy of their estimates but these systems should also be designed to describe the status of the crops. The user of crop estimates, in most cases, is not so naive as to expect perfection in crop estimates but does require estimates based on sound assumptions accompanied by a description of the factors that generated the estimate. Moreover, the user desires a tracking of the estimate to allow for continual reevaluation of related decisions.

## A NORMATIVE VIEW OF AGRICULTURAL INFORMATION SYSTEMS

Information about the area, yield, and production of a particular agricultural commodity is used in a wide variety of ways in the context of business and market analysis, domestic and international agricultural policymaking, resource use and development, and agricultural technology. Therefore, the crop inventory systems described in this paper represent an integral component of the much larger information system required for agricultural decisionmaking.

A brief account of the structure and dynamic

<sup>a</sup>Data Resources, Inc., Lexington, Maine

<sup>b</sup>USDA Economics, Statistics, and Cooperatives Service, Washington, D.C.

<sup>c</sup>NASA Johnson Space Center, Houston, Texas



nature of an effective information system is appropriate, since this discussion is in essence the conceptual foundation on which an operational system can be based (refs 1 to 7). Clearly, the entire system is developed for the purpose of meeting well-defined decision needs. The decision needs are initially handled by developing a conceptual or working model. Conceptual work is followed by a process of data management, analysis, and exposition that provides the decisionmaker a series of alternative solutions to the stated problem. The decision made becomes a critical element in the development of new or restated decision needs, and these needs serve as a catalyst for the data-reconfiguration, analytic, and report-writing activities. The process is shown schematically in figure 1.

## CROP INVENTORY INFORMATION: HOW IS IT USEFUL?

### Decision Needs

The purpose of the entire information system is derived from the decision needs generated by the full range of agricultural decisionmakers. In this section, a selected set of agricultural commodity information—area, yield, and production—as it relates to a broad range of agricultural decision areas is examined.

*Market analysis and business decisions*—The informational needs of the business and farm communities cover a multitude of production, consump-

tion, distribution, and pricing problems. Regardless of the position of the decisionmaker in the vertical chain from the farm to the consumer, the information imparted to him by crop estimates is a starting point and not an end in itself. The impact of new-crop expectations is seen in inventory movements, demands, and, ultimately, prices. In short, the market is probably the most important information system serving the business and farm communities today. It would be a more efficient market if better, more timely, and more accurate information were available to all participants.

Improved information about the magnitude and timing of production of major crops, on a worldwide basis, is an essential input to the agribusiness decisionmaker. Agribusiness decisions include those related to the supply of machinery, chemicals, fertilizer, and other products to the farmer. In addition, there are many decisions related to the distribution and assembly of food products once the commodity leaves the farm (i.e., transportation issues, purchasing issues, processing and packaging issues). Given the state of existing agrometeorological arts, an improved status and tracking system that brings timely and accurate crop production information to the decisionmaker is of great benefit.

Some of the problems of timeliness of information and updating of obsolete information can be met by the use of satellite-based remote-sensing and supporting crop information data bases. The continuous nature of the Landsat technology is clearly a means of providing routine monitoring of worldwide crop production. Furthermore, Landsat can provide information about major crop production in particular areas of the world where the current infrastructure for crop inventory assessment does not exist. This paper deals specifically with the use of crop area estimates as an input which can assist in formulating improved new-crop expectations and ultimately improved estimates of market price movements for agribusiness decisions. Once again, it must be emphasized that the crop production detail is useful *only* if the data are developed as part of a larger analytic network, i.e., a fully integrated agricultural information system. The agribusiness decision must, of necessity, focus on factors that relate to the firm's profitability, therefore, commodity production details must be translated clearly into business terms, such as sales or costs of production.

*Policymaking*—The policymaker is faced with the task of analyzing legislative alternatives which have both short- and long-term impacts. The use of an

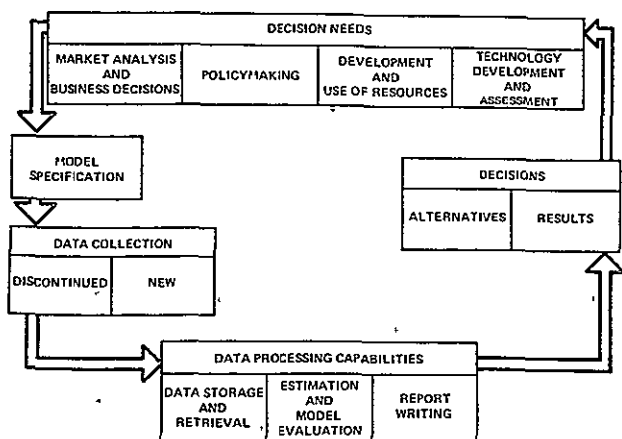

FIGURE 1.—An agriculture information system.

agricultural information system is for "baseline" analysis of alternative initiatives. Further analysis follows the development of the baseline in analyzing the risks and opportunities that could surround the baseline. The dynamic nature of the system is essential for the reconfiguration of farm and agricultural trade policy as the world agricultural and general economies change.

The capability to monitor domestic crop production has become increasingly important to the U.S. farm policymaker since the establishment of the Government grain reserve. Under current law, wheat that was placed in the long-term reserve cannot be withdrawn until the market price at the farm reaches 140 percent of the established loan rate. When the market price is below 140 percent of the loan rate, the wheat must stay in the reserve, while the Federal Government pays both the costs of storage and interest charges for the farmer in addition to providing the loan for cash-flow needs. With market prices at 140 percent of the loan rate, the Government will not pay the costs of storage or the interest charges associated with the loan. Therefore, a considerable amount of the wheat will be withdrawn from the reserve and placed on the effective market. When market prices at the farm are 175 percent of the loan rate, the Government will recall the loan and the entire reserve will be placed on the effective market. There are two major concerns associated with these Government inventory movements: (1) the placement of the added supply will depress market prices, and (2) the buffer against future shortages is removed. The Secretary of Agriculture must determine by August 15 of each crop year whether land should be placed into an acreage set-aside program. This decision obviously establishes limits on the capacity available for wheat production and on future wheat prices and must be based on the most up-to-date and accurate estimate of the supply and use of wheat for the following four calendar quarters.

Clearly, more and better decisions related to trade policy can be made as improved assessments of worldwide crop production become available. In essence, the implementation of domestic production policies (i.e., price supports, acreage programs, farm credit) can be fine-tuned on the basis of improved monitoring of crop production in countries such as the U.S.S.R., the People's Republic of China, and Brazil. The U.S.S.R. November 1977 announcement of a total grain output of 194 million metric tons for 1977 was a shocking 21 million metric tons below current U.S. estimates of their crop. This announce-

ment was made just before the November 15 deadline for a feed-grain set-aside program for 1978. The announcement served as an additional source of uncertainty in the already uncertain policy situation which then prevailed through May of 1978. With better preharvest information on foreign crop outputs, the domestic farm policymaker can judge the export drawdown of U.S. supplies and the overall supply and use outlook for major crops.

*Development and use of resources*—The range of problems relating commercial agricultural activity with land use, water resource development, environmental issues, and community development is wide. A dynamic agricultural information system enables the planner to evaluate more accurately the current economic impact of alternative initiatives, but, more importantly, a viable information system allows a continuous monitoring of the results.

The informational requirements associated with this area are extremely broad. Land use classification and the changes in land use over a period of years, the monitoring of water quality and availability, and a catalog of alternative farming practices during particular time periods are good examples of such requirements.

*Technology development and assessment*.—The analysis of technological issues for agricultural production and marketing requires a dynamic information system. The continued reconfiguration and technological changes associated with agricultural data and information must be evaluated as part of the overall complex.

Some of the informational needs associated with agricultural technology relate to the mechanization of planting, crop cultivation, and harvest. The concern over poor weather conditions during the 1978 planting period led to much speculation about reduced crop production, due to delays in planting progress. There is contradictory information about just how quickly the U.S. corn crop can be planted. Therefore, a means of continually monitoring planting progress at as high a frequency as possible would greatly improve market knowledge. In fact, the current survey method used to determine plantings could not fully account for plantings in 1978 as of the June 30 deadline, since planting progress during the survey period was lagging and many producers still had to respond with intentions.

Another technological consideration relates to the ability of the general agricultural sector to incorporate the most effective information technology. The remote sensing of agricultural land is a good

example, since this information must be properly collected and disseminated to users in order to achieve the benefits of the high-frequency data

### **Model Specification and Data Collection and Processing**

The data processing capabilities of the system represent the "cement" that holds the various components together. A fully integrated complex of data collection, storage, and retrieval and analytic and report-writing tools is a necessary input to the effective maintenance and evolution of an information system. The timeliness and accessibility of the information are extremely important. Even if the analyst clearly defined his needs, the mechanics of providing the decision inputs could block the success of the overall system. In this section, some of the general issues associated with the processing of data and information are described.

Once an understanding of the decision need is achieved, the process of specifying an analytic framework is undertaken. Either the specification of a mental model or the processing of a mathematical scheme is a means of organizing the cause and effect of the problem area. The model specification activity is followed by data considerations. The primary criterion for data collection is that the data be obtained with specific purposes in mind. The discovery of decision needs and the development of analytic filters for use with the data are additional considerations. Vested interests in certain historical data are difficult to break down, but the viability of the overall information system requires that data collection and storage be constantly reevaluated in terms of the benefits derived from their use.

The storing of data is a costly and time-consuming effort. Therefore, the continued storage of useless or obsolete data must be avoided. The capability to add new sources of data and to mesh old and new sources of data is essential to the storage process. In short, the vested interests in a particular set of data must be challenged in terms of the benefits and costs of the continued maintenance of those data.

Another important aspect of data collection is the mechanical process of bringing the data into the system. Clearly, a timely and accurate information system must use state-of-the-art data collection and storage processes. The collection of the data cannot be accomplished properly unless the means of storing and updating the data meet the time require-

ments of the analyst and, more importantly, of the decisionmaker.

Storage is the first element of an effective data reservoir. The capability to access the data easily allows the system to be exploited more fully. Therefore, well-documented and easy data retrieval is of the utmost importance. The retrieval mechanisms must be developed concurrently with the analytic tools to avoid wasteful data storage.

In today's world of advancing analytical techniques, discussions concerning data manipulation often begin with models. The place to start is with data organization and the capability to expose the information available to the analyst and the decisionmaker. The user must also have the capability to develop and reconfigure data displays, either graphically or in tabular form. Given a well-defined and well-documented data set, model building and statistical analysis can help the user derive further benefits from the system. The statistical and mathematical developments and outputs from the modeling effort are a major input to the decision process, but these results are also useful as redevelopment feedback, both in terms of the overall data processing capabilities and in the discovery of new decision needs.

### **The Decision**

The decision alternatives and the results of the ultimate decision are important not only intrinsically but also as a catalyst for the dynamic adjustment of the entire system. The feedback based on the evaluation of the decision helps to determine new data needs, data collection that should be discontinued, and the need for new models or means of exposing the information. It may well be that the decision results will focus on a different set of decision needs and the attendant changes in the data processing component of the system.

### **A REVIEW OF EXISTING CROP INVENTORY SYSTEMS**

Information about agricultural production is of the utmost importance to all countries in conducting their domestic and international affairs. It is also important in managing natural resources and providing for human nutritional needs by improving allocation of the means of food production, processing, marketing, and distribution.

Some factors that must be considered in evaluating the strengths and weaknesses of agricultural information are objectivity, reliability, timeliness, adequacy in terms of coverage, efficiency, and effectiveness (ref. 5). Agricultural production statistics in many very important agricultural countries will not meet any of these quality standards. In fact, several very important agricultural countries have no formal system for acquiring agricultural statistics. Fewer than 10 countries have what can be classified as a relatively sophisticated system that provides crop production estimates considered satisfactory for most of the characteristics listed. A much larger number of countries have what might be described as a system of medium complexity that provides reliable annual production data for major crops. Close to half the countries of the world have either very simple or no agricultural production estimates except those provided by a census of agriculture conducted every 10 years (ref. 8). The United States, which recently started issuing measures of precision for its domestic crop production forecasts, is the only country that publishes information on survey methodology and reliability of estimates. The chief reasons for the absence of quality agricultural production statistics are (1) lack of funds for collecting and tabulating data, (2) inadequate technical capability to formulate sound sampling and data collection procedures, (3) absence of a suitable sampling frame, and (4) difficulty in quantifying the benefits of improved information. The accuracy of the current U.S. Department of Agriculture (USDA) forecasts of foreign commodity production and the USDA accuracy goals for 1985 are given in table I. For example, in the U.S.S.R., at-harvest estimates are of 65/90 accuracy. This means that in only 65 percent of the years will the USDA at-harvest estimate be within  $\pm 10$  percent of the final U.S.S.R. estimate. Note that the most accurate system is in the United States.

The following are brief descriptions of several national agricultural statistical systems that vary in quality.

### U.S.S.R.

The Central Statistical Administration (CSA) is responsible for all statistical work in the U.S.S.R. The CSA has the status of a ministry in the U.S.S.R. government. It includes central statistical administrations in each of the union republics and oblasts as

well as statistical inspectorates in each raion. The U.S.S.R. statistical organization is responsible for collecting, processing, and publishing data. Many data collected are not published but are made available to the various administrative, planning, and economic organizations of the government.

Statistical work is centrally planned. The characteristics of the U.S.S.R. statistical system parallel those of an accounting or inventory recordkeeping operation and include little or no statistical sampling and estimation. Recordkeeping at the farm level is designed to provide the data required by CSA, with each collective or state farm having a bookkeeping unit to provide basic data. With roughly 50,000 collective and state farms reporting through the raion-oblast-republic chain, each administrative unit contains 15 to 20 subordinate units. The system includes built-in checks by inspectors on the validity of data and severe penalties for falsification of records. It also provides a timely way of aggregating data through the various administrative levels. Sampling is used only to provide data on food consumption and private-plot crop and livestock production.

The system provides a large volume of data at

TABLE I—USDA Current Forecast Accuracies and 1985 Goals for Wheat Production Estimates in Six Countries

Country	Forecast			
	Early season <sup>a</sup>	Midseason <sup>b</sup>	Preharvest <sup>c</sup>	At harvest
	Current accuracy			
Argentina	46/90	—	61/90	64/90
Brazil	8/90	—	31/90	31/90
Canada	26/90	—	45/90	94/90
India	57/90	64/90	88/90	—
U.S.S.R.	23/90	31/90	34/90	65/90
U.S.	<sup>d</sup> 90/90	100/90	100/90	100/90
	1985 goal			
Argentina	60/90	—	75/90	80/90
Brazil	30/90	—	50/90	60/90
Canada	50/90	—	60/90	95/90
India	70/90	75/90	90/90	90/90
U.S.S.R.	50/90	60/90	65/90	85/90
U.S.	90/92	95/95	99/95	99/95

<sup>a</sup>90 to 120 days before harvest

<sup>b</sup>45 to 60 days before harvest

<sup>c</sup>15 to 30 days before harvest

<sup>d</sup>Winter wheat only, June 1

various intervals throughout the year. Data on spring and fall seeding, plowing, and harvest progress are submitted weekly. Spring seeding progress reports are made from April 1 to June 15 and reports on harvesting progress are made from July 1 to October 1. A special report on area sown to crops, which is prepared following spring seeding, contains more detailed data than do the weekly progress reports. Compilation of the crop area and production data is completed during the second half of October and publicly announced shortly thereafter. Special surveys on grain production at other times during the growing season can be developed if authorized by the CSA.

The estimates of U.S.S.R. crop production have been extremely important in international grain markets since the large and unexpected U.S.S.R. purchases of U.S. grain in 1972. Market analysts have speculated about both the objectivity and the reliability of the U.S.S.R. crop projections and it seems proper in this paper to devote added attention to the U.S.S.R. system. An analysis of the U.S.S.R. purchases of U.S. wheat and corn since 1972 would indicate that their ultimate decision to buy is delayed until there is reasonably clear evidence that their domestic supply will not be adequate to meet their demand in the coming year. It would appear that U.S.S.R. trading activity may not be as well informed as purported by most U.S. analysts who in some cases place an inordinate degree of importance on data about which very little is known. The smoother adjustments of the U.S.-U.S.S.R. grain trade agreement of 1976 offer further evidence of this exaggerated U.S. response to earlier U.S.S.R. crop estimates. Given this, one might conclude that the degree to which the U.S.S.R. "politicizes" its estimates for specific market purposes is overstated.

No quantitative data are available regarding the reliability and accuracy of the U.S.S.R. crop estimates. However, as was stated earlier, this is largely the case for most countries except the United States. Therefore, the following comments are based on analyses of the U.S.S.R. agricultural reporting system (ref. 9).

Twice each year, the U.S.S.R. makes a complete inventory of the use of all cultivated land on each collective and state farm. The first inventory is, in essence, a statement of intentions since each farm manager answers the question, "As of June 30, what use do you plan to make of the cultivated land on your farm?" The next survey is not taken until late

October, when each manager states the use made of the cultivated land on his farm. The major problem apparent from the description of this system is that there is little or no survey of yield, which is derived after the fact from area and production data. Furthermore, there is a complete lack of harvested area data. As a result, hectareage data appear to be rather constant from year to year, whereas production varies widely.

An additional consideration concerning U.S.S.R. crop data is that the U.S.S.R. reports yield and production in terms of bunker weight, which can be as much as 15 percent greater than barn weight (grain weight after cleaning and drying to a standard moisture content). Thus, in comparing U.S.S.R. and U.S. crop production figures, there is an important difference in grain quality resulting from differences in trash and moisture content (ref. 10).

Currently, the U.S.S.R. crop inventory system does not make use of advanced data processing technology. Some research is being conducted to develop techniques for making quantitative crop forecasts during the growing season, but, to date, the system relies on manual compilation of data. This might imply a rather limited objective in terms of the detail to be publicly provided about U.S.S.R. crop production. Clearly, the publication of a final yearend report of area sown and crop production can be handled in this fashion, but, if more timely and detailed data were to be provided, there would be a need for improved data processing capabilities. Furthermore, it is not known to what extent the U.S.S.R. crop inventory data are analyzed in more depth without public release of the results.

In providing crop inventory data, the U.S.S.R. system has a series of objectives to meet which are distinctly different from those in the United States. Their projections are not intended to support a broad range of private and public interests. For example, they do not publish a report of the total country-level production of a crop until after harvest (about November 1). It is very likely that they compile these data as part of the preharvest progress reports but simply find it in their national interest not to release the data publicly until later. In essence, the most important distinction to be made between U.S.S.R. and U.S. crop reporting systems is a clearly disparate set of objectives. One can criticize the U.S.S.R. system for not meeting U.S. data needs, but it is difficult to claim that their own internal information is inadequate.

## United States

The U.S. Department of Agriculture collects information on the production and supply of crops on a worldwide basis and publishes regular crop reports on domestic and foreign crop production. USDA activities include data collection, tabulation, and summarization, data analysis and publication of production forecasts during the growing season, and estimates after harvest.

Foreign crop production estimates are prepared and published quarterly by the Foreign Agricultural Service. The Foreign Commodity Analysis Office has primary responsibility for preparing production estimates of wheat and other grain crops for all major crop-producing countries. Commodity analysts receive information on crops from several sources: agricultural attaches, foreign statistical publications, commodity periodicals, Reuters commodity reports, the commodity trade, foreign newspapers, and the wire services. Commodity analysts base their crop production estimates on information provided by these sources. They depend primarily on the attaches' scheduled reports, prepared quarterly and developed from information obtained from foreign governments and trade contacts. Analysis is also based on an attache's own observations; information from grain importers, grain processors, and farm organizations, and various published reports available in the country. The World Food and Agricultural Outlook and Situation Board reviews and approves all estimates of production, disposition, and trade.

The major constraints within the foreign crop estimating process are (1) the quality of the data received for analysis, (2) the time required to collect, receive, review, and report, and (3) the limited application of data processing to the crop estimating process.

The existing system for collecting, maintaining, and analyzing data to estimate foreign crop production could be improved significantly by exploiting advanced data gathering techniques and by applying more advanced data processing techniques. Improvement of data processing techniques will require the development of an integrated crop production information system.

The USDA Economics, Statistics, and Cooperatives Service (ESCS) is responsible for collecting, maintaining, and analyzing data and reporting crop production estimates within the United States. By

regulation, ESCS is required to prepare and issue official state and national estimates and USDA reports relating to crop production, livestock and livestock products, stocks of agricultural commodities, local market prices, value of farm products, and other subjects. Crop reports prepared by ESCS include estimates of the acreage farmers intend to plant, acres planted and harvested, production, disposition of crops, and crop stock levels, both on and off the farm.

The preparation of crop production estimates by ESCS requires that various types of information be collected and analyzed. This information is usually collected at the state level through the ESCS state statistical offices by a variety of methods, including both nonprobability and probability surveys, field observations, and personal interviews. The data then are processed, reviewed, and summarized by the state office and forwarded to Washington, D.C. The summarized data are received by the Survey Division of ESCS for further processing and distribution to the appropriate offices within the Estimates Division.

Nonprobability surveys are currently limited to mail surveys, in which questionnaires are sent to farmers asking for specific information about their agricultural activities. Today, mail surveys also supplement probability surveys. Probability surveys, first initiated by ESCS in 1954, include both enumerative and objective yield surveys. Probability sampling techniques used include the area frame, list frame, and multiple frame samples, depending on the type of crop or other agricultural product being surveyed.

If the incoming state information concerns a commodity defined by law as speculative, the information is handled according to special security procedures and is delivered to the Crop Reporting Board, consisting of a chairman, other appointed members selected for their specialized knowledge of a particular crop, and individuals from the field and Washington, D.C., staffs who analyze the data and prepare the official production estimate. This crop reporting process takes place in what is termed a "lock-up," wherein the Crop Reporting Board and other support personnel are restricted from outside contact until the crop report has been released.

The ESCS crop reporting estimates are accurate, reliable, and impartial when compared to those in most foreign countries. Based on these ESCS estimates, farmers, businessmen, and the U.S. Govern-

ment make decisions each year that can involve billions of dollars. Constraints within the ESCS crop reporting process present less of a problem than those within the USDA foreign crop estimating process.

The ESCS Survey Division currently maintains production estimates for most commodities from the 1800's to 1959 and area, yield, and production estimates from 1964 to the present time. The more recent data on area, yield, and production include all reported commodities, however, only the official final estimate for the year is available. In addition to this limited data base, data input from some state offices is constrained by mail delivery. However, 48 states can now enter data using the Infont system or transmit the data using teletype or facsimile.

At this time, a development effort is underway within ESCS to create a data system that will eliminate these data handling constraints. The new ESCS data system will be composed of various subsystems related to ESCS functional areas. The crop subsystem will include an official-estimate data base that will contain estimates made by the Crop Reporting Board at each scheduled report date. It is also anticipated that state estimates will be entered directly as recommendations, by way of telecommunications, and the data base will aid the Crop Reporting Board in its review process. Special computer security procedures and techniques also will be used extensively in this system. This development effort appears to be well planned and logically organized for supporting ESCS information and reporting needs.

The limited use of meteorological data by ESCS in making current forecasts and estimates is a result of the ESCS reporting methods, which are designed to reflect the effects of weather on crop production to the date of the survey. Short-term and long-term weather forecasts have not been used because they lack the precision needed to evaluate prospects at the state level. Objective yield models used by ESCS rely on actual measurements rather than on subjective appraisals of crop development.

## **Canada**

Canada's statistical service is organized on a highly centralized basis under Statistics Canada, formerly known as the Dominion Bureau of Statistics. The agency is responsible for developing an integrated system of social and economic statistics pertaining to the whole of Canada and its provinces. This proce-

dures involves the collection, analysis, and publication of regular statistical information on social, economic, and general activities.

The Agriculture Division is responsible for the collection of farm-based agricultural data on a regular basis each year. Two methods of data collection are used: the mail questionnaire, because of its low cost, and the personal interview, because of improved responses. About 55 separate surveys are performed during the year. Most of these surveys are conducted by mail, with response being on a strictly voluntary basis for most crops.

The major surveys are the semiannual June and December surveys designed to collect information on crop acreages and livestock numbers. Questionnaires are mailed to all 350 000 farmers. About 15 to 20 percent of the farmers respond. The information from these surveys is used in conjunction with 5-year census benchmark data to provide annual estimates.

With rapid structural changes taking place in agriculture and the trend toward fewer and larger farm units, this method no longer meets the requirements for reliable data collection. A nationwide annual survey covering a probability sample of about 6500 farms has been tested experimentally for several years. It will ultimately become an integral part of the survey system, and, when the sample is expanded, it will provide data at the national level similar in quality to that provided by the 5-year census of agriculture.

A sample of farmers is surveyed in March each year to estimate the acreage farmers intend to plant. The June survey collects actual plantings. Three times each year, a sample of 13 000 farms is contacted by mail and asked to report yield per acre for major crops. These surveys are conducted in mid-August, in mid-September, and after harvest. Some experimental work has been done with objective yield counts for potatoes and several fruit crops in an effort to overcome the subjective nature of forecasts made from the mail survey. Work is continuing in training enumerators, improving field instruction, and refining procedures for this work in an effort to resolve the differences that exist between objective yield data and census information.

The census of agriculture is taken every 5 years for crop years ending in 1 and 6. It consists of a personal enumeration of every farm holding that is at least an acre in size or has sales of \$50 or more. It provides basic data on land use, crop acreage, livestock number, and sales of farm products. A quality check survey of about 15 000 farms is done

several weeks after completion of the census interviews. This survey provides information on the quality of the census data and its data collection procedures. The presence of this accurate 5-year benchmark strengthens the capability of the mail survey to provide satisfactory current statistics. The Special Surveys Division, through its regional offices, is responsible for collecting the data for many of the surveys.

### **Australia**

The Australian Bureau of Census and Statistics is responsible for the collection, compilation, and publication of all official statistics, including those relating to agricultural industries. The basic framework of the system is a nearly complete annual self-enumeration agricultural census conducted in March of each year covering the 250 000 rural holdings. It covers about 500 individual items including land use, crop acreage and production, crop varieties, and irrigation.

Annual probability sample surveys are conducted at designated times throughout the growing season to obtain early estimates of acreage and production for major crops. Acreage data are collected at the end of the sowing period, and production data are obtained during the harvest period. The annual census uses state registers and rural holdings for the distribution of forms and the collection of completed forms. Comprehensive coverage is checked through governmental authorities and departments and through marketing boards to ensure that the registries are complete. The returns are edited, tabulated, and published about 12 months after collection. Post-enumeration surveys are used to check the accuracy of reporting and to improve the design of the forms.

The complete census is possible because the number of rural holdings is small and their average size large. This characteristic limits the time and expense required for collection and processing. The register is kept current and provides a very suitable sampling frame for the annual sample surveys of crop production and other rural development statistics.

The system has some nice advantages as the census provides an annual benchmark for both efficient sampling and current estimation of the production of major crops. Quality checks of survey procedures are performed routinely to ensure reliability and objectivity. Statistics are collected under the Commonwealth Census and Statistics Act, which requires that

questionnaires be returned within a specified period and provides for the confidentiality of individual reports.

### **Brazil**

The Brazilian Institute of Geography and Statistics in the Ministry of Planning is responsible for statistical programs. Statistics on crop acreages and yields have been collected through municipio agents in each of the 4000 municipios for about 30 years. At about 3-month intervals (April 1, July 1, September 1, and January 1), each municipio agent completes questionnaires on temporary and permanent crops.

The first part of each questionnaire deals with crops harvested during the previous 3 months and the second part with crops still in cultivation. The agent reports area harvested, yield, production, price, area planted during the quarter, expected yield, stage of growth, and month of sowing. Agents are instructed to consult with knowledgeable people in the municipio before completing the questionnaire. Two copies of the questionnaire are completed, one being sent to the state government and the other to the federal government.

A number of problems arise with this statistical system. No rigorous control is maintained over respondents, and the survey process is time consuming and incomplete. Often, statistics developed at the federal level are different from those published by the state governments and the two are never reconciled. Little or no systematic work has been done to evaluate the ability of agents to report accurately.

Some preliminary work has been done in trying to forecast yields. Statistically, Brazil is divided into three major regions, and two forecasts—at the time of sowing and at harvest—are issued for each. A probability sample of 1000 municipios is selected with probability proportional to size for all crops. Forecasts are collected on the basis of group interviews with knowledgeable people at the municipio headquarters. Again, wide differences between data obtained in this survey and from the municipio agent exist, but no attempts have been made to reconcile these.

Some attempts have been made to collect agricultural statistics from a probability sample of producers. The State Department of Agriculture in São Paulo has developed its own modern and effective system of collecting current agricultural statis-



tics Sampling frames similar to those in the United States have been used, with the data being collected by interviewing producers. These data are used to prepare state estimates but are not used to establish national totals. The last benchmark census data available were obtained in 1960.

## Sweden

The National Central Bureau of Statistics (SCB) is the central administrative agency for official statistics in Sweden. In agricultural statistics work, the SCB collaborates closely with the National Board of Agriculture and the National Agricultural Marketing Board. The agricultural data system is built around the farm register system and has three principal components: current agricultural statistical activities, agricultural censuses, and special statistics surveys.

The current agricultural statistics are composed of (1) data on units with agricultural operations, their size, commodities produced, and specialized agricultural items, provided through an annual survey by the farm register system of all holdings of 2 hectares or more, (2) data on the agricultural structure of units and their resources of land, machines, animals, labor force, etc., obtained from the farm register, (3) data on crop area for 25 crops, available land, natural pastures, grass-sown land, and forest land, obtained from the register, (4) qualitative information on crop outlook and development of crops during the growing season, developed on the basis of three surveys made by the county agricultural boards, (5) quantitative data on probable crop yields, developed from objective surveys that cover the 9 principal crops; (6) livestock statistics on numbers of livestock by category, animal production, and milk production, obtained from a sample of 12 000 register units, (7) data on agricultural requisites, such as the consumption of fertilizer, pesticides, and feedstuffs, and (8) data on economic factors, such as labor, farm wages, real estate and buildings, cash income and expenditures, and price statistics.

The agricultural census is conducted annually using a sampling method that ensures that each unit will be included at intervals of about 5 years. Using the farm register, it provides general agricultural statistics similar to the current agricultural statistics for individual parishes and communities.

The farm register system provides a very precise sampling frame for all statistical surveys using holdings (individual farms) as the reporting unit. Crop

acres are established on the basis of complete information collected in the farm register. A complete and objective yield sample survey system establishes biological yields, harvesting losses, and data on harvest quality and is similar to the U.S. system (ref 11). Subjective reports of crop outlook during the growing season are submitted in May, July, and October for each of the 2500 parishes. Data on crop yield prospects are expressed numerically on a scale of 0 to 5.

## Kenya

The Statistics Division in the Ministry of Planning and Development of Kenya is responsible for collection, tabulation, and publication of all agricultural statistics through its Agricultural Branch. The Branch has two principal units: (1) General Statistics, which deals with commodity prices and quantities and the value of marketed agricultural products, and (2) Field Data Collection, which is responsible for all data collection.

Basic agricultural statistics are available for large-scale farms (20 or more acres) through an annual census that is more than 85-percent complete. For small-scale farms, a probability sample of geographic subdivisions is selected annually for enumeration. Field enumerators collect the basic acreage data, using the farm holding as a reporting unit. Crop and farm acreages are measured using compasses and measuring wheels.

Thus, historical crop acreages are available on an annual basis but are derived using less than satisfactory statistical procedures. No statistics on crop yields are available for Kenya. Significant portions of the most important crops, such as corn, pass through a marketing board, where quantities and prices are recorded and provide estimates for the monetary sector. Estimates for the nonmonetary sector are now based on projections that are factored up by population growth from a 1957 survey.

A census of agriculture was attempted in 1960-61, but deficiencies in sampling frames, measurement techniques, and staff quality and training; non-cooperation of respondents; and unfavorable weather made the results inaccurate. A relatively complete current agricultural census would be very helpful for establishing benchmark production and acreage data. Forecasts of crop conditions during the growing season are not attempted. Limited resources are spread thin in an attempt to also collect some in-

formation on livestock and livestock products, enterprise costs, and rural households. No measures of precision or reliability can be computed for any of the statistics.

## **United Nations**

The United Nations Food and Agriculture Organization (FAO) published the "Food Quarterly" for the first time in 1975. Issued under the Global Information and Early Warning System on Food and Agriculture, it provides information on current world food production based on data from official and nonofficial sources and gives the latest developments and short-term prospects for food crops, livestock, and fertilizers, trade availabilities and requirements, and stocks and prices. This quarterly report was supplemented on a monthly basis through the Early Warning System in 1976 as a trial undertaking and in an effort to fill many critical data needs.

In addition, FAO annually publishes two volumes of the "Production Yearbook," giving agricultural statistics for major geographic areas of the world and for more than 200 countries. Volume I provides data related to land, population, and crops, livestock numbers and livestock products, the means of production, and index numbers of food and agricultural production. Volume II contains data on prices of agricultural products, prices of certain production means, freight rates, farm wages, and index numbers of prices. These volumes are made possible by the cooperation of those governments that supply most of the information to FAO.

## **NEED FOR IMPROVED ACREAGE INFORMATION: THE POTENTIAL OF LANDSAT**

### **Economic Realities**

The hard evidence facing either private or public agricultural analysts is that new-crop expectations affect the agricultural economic activity during the marketing year for crops already in the bin. Once a crop is harvested, there is a limited crop-year supply available for use. The inability to produce most major crops on a year-round timetable produces this problem.

Given the available crop-year supply, this inventory is drawn down on the basis of price expectations of both the storer of the commodity and the user. Simply stated, if the expectations are of low prices for the commodity in future months, it may well be in the interest of the inventory holder to liquidate his holdings and, conversely, good for the buyer to wait. The expectations about future crop prices are determined largely by the anticipated size of the new crop. The future size of the new crop can be analyzed in terms of the land devoted to production (i.e., acres planted) and the potential yield. The uncertain and unpredictable nature of weather and the impact of this weather on crop yield suggest that the acreage component of production variation is extremely important as an early-season indicator of crop output.

The most extreme example of acreage planted as the "key" indicator of new crop production is winter wheat. The crop is planted in the fall and remains dormant until revitalized by warmer spring weather. There are certain weather conditions, such as damaging wind or lack of winter moisture, which determine future output expectations, but past experience has shown that such information can be greatly misleading. Therefore, truly good estimates of the size of the new winter wheat crop cannot be made until March-April weather impacts are known. The acreage-planted figure serves as the only "hard" piece of evidence about new-crop production until late spring. Of course, yield models do provide considerable information as to the crop output, but these models are limited by the capability for forecasting weather. The case is similar for spring-sown crops but over a shorter period of time.

### **Empirical Evidence**

An examination of the historical data concerning wheat production and stocks indicates the drawdown situation described previously. Given that wheat is harvested during the third calendar quarter of each year; the USDA supply and use data account for new crop production in the third quarter and consider it to be zero in all other calendar quarters. Therefore, the available quarterly supply of wheat during any quarter of the year is the beginning inventory of that quarter plus the new production if that quarter is the third. These data manipulations are described in table II. The drawdown levels for wheat stocks are then described as the available quarterly supply minus the ending stocks for that quarter. Finally,

TABLE II—Wheat Stocks and Production (by Calendar Quarter)

[In bushels]

Year quarter	Wheat production	Available quarterly supply	End-of-quarter stocks	Quarterly use of stocks	Percent quarterly drawdown
1967 1	0	1 047 400	699 200	348 200	33 2
1967 2	0	699 200	512 800	186 400	26 7
1967 3	1 507 598	2 020 398	1 556 100	464 298	23 0
1967 4	0	1 556 100	1 209 700	346 400	22 3
1968 1	0	1 209 700	838 100	371 600	30 7
1968 2	0	838 100	630 200	207 900	24 8
1968 3	1 556 635	2 186 835	1 679 300	507 535	23 2
1968 4	0	1 679 300	1 341 400	337 900	20 1
1969 1	0	1 341 400	1 109 500	231 900	17 3
1969 2	0	1 109 500	904 000	205 500	18 5
1969 3	1 442 679	2 346 679	1 872 400	474 279	20 2
1969 4	0	1 872 400	1 532 800	339 600	18 1
1970 1	0	1 532 800	1 197 200	335 600	21 9
1970 2	0	1 197 200	982 600	214 600	17 9
1970 3	1 351 558	2 334 158	1 788 500	545 658	23 4
1970 4	0	1 788 500	1 410 000	378 500	21 2
1971 1	0	1 410 000	1 060 400	349 600	24 8
1971 2	0	1 060 400	822 800	237 600	22 4
1971 3	1 618 636	2 441 436	1 873 800	567 636	23 3
1971 4	0	1 873 800	1 547 600	326 200	17 4
1972 1	0	1 547 600	1 210 700	336 900	21 8
1972 2	0	1 210 700	983 400	227 300	18 8
1972 3	1 546 209	2 529 609	1 870 200	659 409	26 1
1972 4	0	1 870 200	1 398 600	471 600	—25 2
1973 1	0	1 398 600	927 200	471 400	33 7
1973 2	0	927 200	597 000	330 200	35 6
1973 3	1 710 787	2 307 787	1 451 600	856 187	37 1
1973 4	0	1 451 600	928 300	523 300	36 0
1974 1	0	928 300	548 100	380 200	41 0
1974 2	0	548 100	340 100	208 000	37 9
1974 3	1 781 918	2 122 018	1 562 100	559 918	26 4
1974 4	0	1 562 100	1 107 500	454 600	29 1
1975 1	0	1 107 500	662 100	445 400	40 2
1975 2	0	662 100	435 000	227 100	34 3
1975 3	2 122 500	2 557 500	1 884 544	672 956	26 3
1975 4	0	1 884 544	1 385 650	498 894	26 5
1976 1	0	1 385 650	936 800	448 850	32 4
1976 2	0	936 800	665 300	271 500	29 0
1976 3	2 142 362	2 807 662	2 188 200	619 462	22 1
1976 4	0	2 188 200	1 781 800	406 400	18 6
1977 1	0	1 781 800	1 389 500	392 300	22 0
1977 2	0	1 389 500	1 112 200	277 300	20 0
1977 3	2 025 793	3 137 993	2 397 600	740 393	23 6
1977 4	0	2 397 600	1 990 800	406 800	17 0

table II shows the percentage of wheat inventories drawn down each quarter

The drawdown process is shown in figure 2. The movement from point A to point B represents a quarterly reduction of available wheat supply described by the following data (in bushels), which were extracted from table II.

Year quarter	Wheat production	Available quarterly supply	End-of-quarter stocks	Quarterly use of stocks
1968 3	1 556 635	2 186 835	1 679 300	507 535
1968 4	0	1 679 300	1 341 400	337 900

Note that the movement from point A to point B represents the 507 535-bushel usage of the available quarterly supply, which was 2 186 835 bushels. Furthermore, the 1968 4 available quarterly supply is the 2 186 835 bushels minus the 507 535 bushels, or 1 679 300 bushels

Points C and D represent the change from year to year in available quarterly supply of wheat. In other words, this change is described by the following data

Year quarter	Available quarterly supply, bushels
1974 3	2 122 018
1973 3	2 307 787
Change	-185 769

In this case, the new crop production in 1974 was 71 131 bushels larger than that of the previous year,

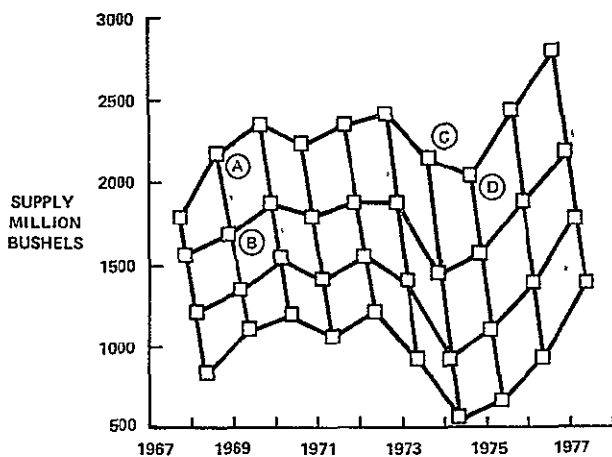

FIGURE 2.—Drawdown of U.S. quarterly supply of wheat.

but total domestic-use was very high at 1 967 687 bushels and the 1973-74 carryover of wheat was a mere 340 100 bushels. Thus, the total available quarterly supply for 1974 3 (the first quarter of the new crop year) indicates a decline of 185 769 bushels

In work done at Data Resources, Inc., quarterly wheat inventory drawdown was modeled econometrically.<sup>1</sup> The time series of the quarterly use of stocks in table II was modeled in terms of new-crop expectations, which were expressed as acreage-planted variables for winter wheat and all wheat as well as prices and seasonal factors. The model was developed by using ordinary least squares. The model is described in the following equation, where the values in parentheses are t-statistics

$$\frac{(K_{t-1} + PRD_t) - K_t}{(K_{t-1} + PRD_t)} = \frac{\text{quarterly utilization of stocks}}{\text{available quarterly supply}} \equiv Y \quad (1)$$

$$K_{t-1} + PRD_t = \text{available quarterly supply} \equiv AQS \quad (2)$$

$$Y = -0.1471 - 0.9373 \left( \frac{X_t}{AQS} \right) - 0.0007 \left( \frac{ACPW_t}{AQS} \right) - 0.0018 \left( \frac{ACPWW_t}{AQS} \right) - 0.0069 PW_t + 1.15 \times 10^{-5} \left[ \frac{PRD_t}{K_{t-1}} \right] + 0.0295 Q1 + 0.0456 Q2 - 0.0508 Q3 + 0.0005 QT \quad (3)$$

<sup>1</sup>A discussion of the development of inventory equations in the Data Resources, Inc., Agriculture Model was done by Roger E. Brinner and Leonard E. Burman in "The Crop Sector," DRI Agriculture Service Working Paper 2, May 1976. The work was refined further by Burman in "The 1977 DRI Agriculture Model: New Developments in the Domestic Crop Sector," DRI Agriculture Service Working Paper 6, October 1977.

ORIGINAL PAGE IS  
OF POOR QUALITY

Interval of the regression—Quarterly 1966:1 to 1976:4

Correlation coefficient  $R = 0.95$

Durbin-Watson statistic = 1.83

Sum of squared residuals = 0.0069

Standard error (SE) of the regression = 0.014, normalized SE = 5.40 percent

where  $K$  = quarterly stocks of wheat  
 $PRD$  = production of wheat  
 $Y$  = the drawdown of crop-year supply  
 $X$  = quarterly exports of wheat  
 $ACPWW$  = number of acres planted in winter wheat  
 $ACPW$  = number of acres planted in all wheat  
 $PW$  = cash price for wheat  
 $Q1, Q2, Q3$  = seasonal factors  
 $QT$  = trend factor  
 $t$  = calendar quarter

(Note:  $K_{t-1}$  = beginning stocks for a quarter and  $K_t$  = ending stocks for the same quarter.)

The information germane to this discussion, which is aptly shown in the regression, is the inverse relationship of the amount drawn down (i.e., decumulation of stocks) to the acreage-planting intentions for winter wheat and all wheat. In short, the model indicates that if new-crop expectations are for a large harvest, currently held inventories will be depleted faster since future prices of wheat are expected to be lower. Therefore, information about new-crop production which becomes available well before harvest is extremely important. A good device for monitoring acreage planted would enable analysts to fine-tune their expectations of future supply and other economic factors associated with the crop.

## REMOTE SENSING AND CROP PRODUCTION ASSESSMENT

In view of the previously discussed need for improved early-season assessments of commodity production, how can the agricultural remote-sensing technology augment the current crop estimation systems to provide improved information? The capabilities demonstrated to date indicate that im-

provements can be achieved in the following areas. (1) early-season forecasts of total harvested area for a crop; (2) early-season estimates of the changes in a crop area (planted or standing) relative to previous years; (3) early-season estimates of changes in the quantities of major classes within a crop (i.e., classes with significantly different production potential, such as winter wheat and spring wheat); (4) monitoring of an area affected by a critical meteorological event, such as drought; and (5) additional data to help make midseason and late-season forecasts of crop yield. The major constraint associated with yield forecasts is that early-season yield-forecast accuracy is limited by the ability to adequately forecast the major variables which determine yield, mainly weather. Therefore, area estimates serve as the single "hard" piece of early evidence available for production assessments.

Since 1974, satellite remote sensing technology, developed in the previous decade and assembled into an experimental crop inventory system (the Large Area Crop Inventory Experiment (LACIE)), has been tested for wheat in several countries. The capability of this first-generation technology to provide improved commodity forecasts at a country level outside the United States was evaluated by LACIE. The experiment has clearly shown that satellite data can be used to improve foreign wheat production estimates (in particular, those for the U.S.S.R.) In a separate experiment, the USDA Statistical Reporting Service (SRS) (now part of the ESCS) evaluated remote sensing as an additional tool for their ground enumerative survey. This experiment was aimed at testing the technical capability to produce estimates with significantly improved accuracies at the state and lower levels. These experiments have demonstrated that Landsat data could be used to augment the existing ground data to obtain accurate area estimates for several commodities at the state level and below.

What is the status of remote-sensing technology in terms of obtaining better early-season estimates of yield and production? LACIE has conducted quantitative tests over large areas and evaluated the use of simple, first-generation, pure-regression-type yield models based on an approach which utilizes monthly averages of temperature and precipitation to assess the impact of weather on yields. Results of these tests proved that reasonably accurate forecasts of crop yields can be made before harvest, provided there are no extreme deviations in the weather conditions. This qualifier is important because it is the

historical data series which permits estimates through regression analysis of the crop yield. Thus, in years greatly different from the average, these simple yield models cannot respond fully. Many improvements can and should be made in these crop yield models. However, the magnitude of the pursuit of these improvements must be tempered by the fact that a large source of the yield prediction error is the unpredictability of the weather. Thus, there is a limit to the reduction in the preharvest forecast uncertainty that can be accomplished through yield model improvements. For example, in Oklahoma, the 1976 wheat crop survived the early concerns about "dust bowl" conditions as a result of late April rains. The timely rains came only 1 month before harvest and the crop recovered to a near-record level. In short, even with a perfectly specified yield model, yield estimates are really no better than the weather forecasts which drive them.

Given that extremely accurate early-season yield forecasts are not expected to be technically possible in the near future, how does the remote-sensing capability augment existing crop forecasting capability? First, Landsat data can be used to quantify the total wheat area within a country or region. It also can be used to quantify the proportion of wheat classes within the region—that is, the amount of winter wheat compared to the amount of spring wheat—which is a critical input to forecasting total wheat production since winter wheat hectareage has twice the average productivity (yield) of spring wheat. In addition to the information associated with the type of wheat, geographic delineation of the area is important. For example, the eastern half of the Ukraine can be experiencing extreme drought, but if there has been a recent shift in planting toward more westerly regions, then production may not be as radically affected as one might forecast using historical data to ascertain the amount of hectareage affected by the drought. Finally, Landsat data can be used to monitor the condition of the crop in an ongoing program. The monitoring of a crop can be achieved since Landsat data can be used to quantify the amount of hectareage affected by currently poor growing conditions, and, therefore, the potential impact on harvest production can be estimated.

## SUMMARY

The current systems providing crop inventory information are deficient mainly in two ways. (1) there is a need for more frequent information and (2) the

crop production data are not well incorporated into the total agricultural information system for each country, with the exception of the United States. Moreover, the capabilities associated with international crop production assessment are greatly lacking in content, accuracy, and timeliness. Remote-sensing technology clearly constitutes a new tool for the crop assessment analyst, but the system that has been developed is devoted largely to wheat and has not been integrated into the overall agricultural information system of any country. Empirical analysis has clearly shown the potential of integrating the area, yield, and production capabilities of remote sensing into the total agricultural information program of the United States. The ultimate objective to be served by the crop production data is to better anticipate the supply and usage of a commodity during future periods. Crop production estimates represent a key component of a general agricultural information system. Crop estimates cannot be evaluated as a distinct part of the system but rather as a force which critically influences the supply/usage and prices of agricultural commodities. The discussion concerning the impact of acreage data focuses on a very particular use of agricultural data in a forecasting mode. Currently, agricultural analysts study the alternative drawdown patterns for a crop in terms of the USDA prospective plantings and acreage reports. The use of continuously monitored crop area data, which could be provided by remote sensing, would improve information about new crop production and, ultimately, be a force which would promote more efficient market activity.

## REFERENCES

- 1 Bonen, J. T. Improving Information on Agricultural and Rural Life. *American J Agric Econ*, vol 57, 1975
- 2 Churchman, C. W. *The Systems Approach*. Dell (New York), 1968
- 3 Dunn, E. S. *Social Information Processing and Statistical Systems: Change and Reform*. John Wiley and Sons (New York), 1974
- 4 Eisgruber, L. M. Managerial Information on Decision Systems. *American J Agric Econ*, vol 55, 1973
- 5 Hjort, H. W. World Agricultural Information Systems: A Critical Evaluation. Paper presented to the U.S. Congress, Office of Technology Assessment, 1975

- 6 Park, A B A Global Agricultural Information System Paper presented to the U S Congress, Office of Technology Assessment, 1976
- 7 The National Research Council Supporting Papers World Food and Nutrition Study, Vol III National Academy of Sciences, 1977
- 8 Food and Agricultural Organization National Methods of Collecting Agricultural Statistics, Vols I and II. FAO (Rome), 1974
9. Pope, F, Jr Collecting Agricultural Statistics in the Soviet Union. USDA Economic Research Service, Foreign Agricultural Economic Report 112, Nov 1975
- 10 Walters, H E, and Judy, R W Soviet Agricultural Output by 1970 Soviet and East European Agriculture, J F Karaz, ed, 1967, pp 306-344
- 11 Statistical Reporting Service Scope and Methods of the Statistical Reporting Service USDA Misc Pub 1308, Sept 1977

## LACIE: An Experiment in Global Crop Forecasting

*R. B. MacDonald<sup>a</sup> and F. G. Hall<sup>a</sup>*

From Biblical times when Joseph, son of Israel, convinced the Pharaoh of Egypt to hold grain during the 7 years of plenty for the 7 years of famine, history has recorded large and irregular fluctuations in agricultural production throughout the world. Consider the fluctuations that have been evidenced during the last two decades. Crop production in most of the major grain-producing regions benefited in the 1960's from rather ideal weather, improved technology, and adequate supplies of fertilizers. In the early 1970's, weather in major regions returned to a more normal state of greater variability (ref 1). Additionally, energy shortages affected fertilization practices. Analyses of these growing conditions within the hard-red-wheat areas of the United States reveal that in recent years only the timely occurrence of favorable weather prevented major crop failures.

These fluctuations in the food supply, coupled with an ever-increasing demand resulting from an expanding world population and an improving standard of living in the less developed countries, have increased the need for more effective approaches to the management of global food production, storage, distribution, and marketing. Considerable attention is being given to possible short- and long-term improvements to these approaches with much deliberation currently being given to the creation and management of an improved world grain reserve and production monitoring system. Global agricultural planning is of particular importance to the United States (the world's largest food exporter), where food is a principal product of industry and is currently a major positive factor in the nation's balance of trade.

Timely and accurate global crop production estimates and forecasts are important inputs to more effective food production, reserve, distribution, and marketing decisions. These estimates and forecasts must identify existing conditions and predict future fluctuations with an accuracy, timeliness, and known reliability sufficient to permit necessary adjustments with as much advance warning as possible.

### THE NEED FOR GLOBAL AGRICULTURAL MONITORING INFORMATION SYSTEMS

In general, importing and exporting countries manage a delicate balance between supply and demand, anticipating determining factors as far in advance of transactions as possible. Periodically, reserves decline to a fraction of the historic demand. In 1974, world wheat reserves dwindled to 108 million metric tons, an amount equivalent to about 30 days of consumption at the 960-million-metric-ton yearly rate observed in the 1973 to 1974 period (ref 2). In such situations, timely information relevant to anticipated resupply from new harvests is crucial. Without timely and reliable crop demand and supply information, an exporting nation may impose a costly, but unnecessary, moratorium on its grain sales. Importing countries with limited storage must have early forecasts of their own supply positions to make effective purchasing decisions. Distribution and transportation arrangements within and between export and import nations benefit greatly when accurate crop forecast and food supply information is available. It is the context of balancing worldwide supply and demand that has historically defined and, more recently, brought attention to the need for improved global food and fiber monitoring capabilities.

Accurate and timely crop production forecasts with known reliability must incorporate two types of assessment: first, a periodic within-season assessment of the crop hectareage and condition based on estimates of the areal extent of the existing crop and the growth conditions through the reporting period; second, an accurate forecast of the most likely range of future growth conditions and the range of probable effects on production at harvest. Within a season, both hectares of existing wheat and wheat yield per hectare are subject to a forecast. For example, in winter wheat regions during the late fall period, the existing hectares of wheat plants can be measured, whereas the potential loss to winterkill must be forecasted. It is also vitally important to predict the

<sup>a</sup>NASA Johnson Space Center, Houston, Texas



confidence or "odds" that the forecast will agree, to a specified tolerance, with the hectarage and production actually harvested

## CURRENT OPERATIONAL FORECAST SYSTEMS

Global supply estimates are a compilation of national supply estimates generated mostly by the various national agricultural information systems. The quality of global estimates, therefore, is a direct function of the quality of the systems in the various countries. The estimates from this conglomerate range from timely and reliable to nonexistent. Frequently, estimates based on past trends, sometimes adjusted by judgment, are used in lieu of objective sources. The primary properties of an effective world agricultural information system are objectivity, reliability, timeliness, adequacy in terms of coverage, and efficiency and effectiveness.

The U.S. Department of Agriculture (USDA) and the Food and Agriculture Organization (FAO) of the United Nations currently compile supply estimates produced by nations and report world supply estimates. A qualitative analysis of the primary characteristics of currently available world agricultural supply estimates leads to the following summarization.

1. The objectivity of estimates is largely a function of the objectivity of the estimates released by the host government.

2. The reliability of the estimates is largely a function of the methods used by the nation to collect agricultural statistics and to assess them. This procedure varies significantly from country to country.

3. Most national systems rank poorly in terms of timeliness of estimates of supply.

4. Adequacy is impaired by lack of uniformity of reporting both in terms of content and in terms of geographic coverage from nation to nation.

5. The efficiency and effectiveness of most national systems require significant improvements.

These factors are the main determinants of the forecast accuracies of the various USDA surveys outside the United States.

Accuracies of USDA wheat production estimates for the period 1966 to 1975 are shown in table I. The most accurate and timely estimates are made for U.S. agriculture. The Statistical Reporting Service (SRS) of the USDA uses probability surveys of area

planted, area harvested, and the average productivity (yield) from area harvested. For example, winter wheat production estimates are made in December and May and every month thereafter through harvest until the following December. A final estimate for that crop is then made the following December—1 year later (ref. 3). With its objective and systematic approach, the SRS clearly makes very accurate estimates of U.S. wheat production at the national level. However, the statistical design does not provide such high accuracies at state levels and below. The SRS is currently investigating the use of Landsat data as a cost-effective aid to improve the precision of estimates below state levels (ref. 4).

The frequency and magnitude of the early-season-to-harvest differences for the USDA foreign estimates can be explained in part by the fact that the early-season estimates assume that historic trends in weather and planting patterns will prevail. Generally, these estimates are based on reports of planted hectarage by national governments and the historic value for average yields. Because weather patterns differ widely from year to year, the probability in any one year that weather conditions will be very near the average (or normal weather) is not very high.

TABLE I—Accuracy of USDA Worldwide Wheat Production Estimates<sup>a</sup>

Country	Years of record	Early season	Mid-season	At harvest
United States	1966-75	—	10 of 10	10 of 10
Australia	1966-75	5 of 10	8 of 10	10 of 10
Canada	1966-75	—	9 of 10	<sup>b</sup> 9 of 10
USSR	1973-75	0 of 3	0 of 3	1 of 3
India	1970-75	<sup>c</sup> 3 of 5	3 of 6	<sup>c</sup> 4 of 5
Brazil	1971-75	3 of 5	3 of 5	4 of 5
Argentina	1969-75	2 of 7	4 of 7	4 of 7

<sup>a</sup>Historical USDA forecasts compiled by USDA/LACIE Project Office, Washington, D.C. based on number of years of record in which USDA wheat production forecasts were within  $\pm 10$  percent of final foreign estimates.

<sup>b</sup>At-harvest estimates on file for only 1972-75. In these years, USDA estimates were within  $\pm 10$  percent in only 3 of 4 years. "9 of 10" assumes at-harvest estimates to be at least as accurate as midseason estimates in other years.

<sup>c</sup>No data for 1971.

Because hectares planted, the fraction of hectares actually harvested, and the resulting yields from the hectares harvested are critically dependent on weather patterns, there is a correspondingly small chance that actual hectareage, actual yield, or actual production will be very close to average or normal values

## **ELEMENTS OF CROP PRODUCTION FORECASTS**

Wheat production estimates serve as an example of the fundamentals involved in the assessments necessary for accurate crop forecasts. The quantity of wheat to be produced by a current crop will depend on the quantity of producing units (wheat plants) that are finally harvested (product of wheat hectareage and the average number of plants per hectare) and the average productivity per harvested plant (number of heads, grains per head, weight per grain). At each reporting period in the season before harvest, the production forecast must consider the total hectareage of wheat currently existing and its current condition as determined by factors such as soil type, slope, precipitation, temperature history, and other growth conditions to date. These conditions in turn are manifested through crop condition parameters such as stand density (plant population density) and root development which, together with future weather, will determine the final production. As an example, the seasonal yield of a wheat crop in regions of soils with high water-holding capacities and adequate soil moisture can often be predicted with high reliability well before harvest, given an accurate assessment of the stand density and height. Thus, at each particular point in the season, observations of the plant, together with measurements of the past and present weather parameters, can be used to assess the present quantity and condition of the crop. A prediction of future events is therefore required to forecast the production at harvest.

This example leads to discussion of the manner in which various factors affect the hectareage harvested and the "average productivity" of harvested hectareage, i.e., "yield" for harvested hectareages. Terminology can be confusing; often, "yield" is used interchangeably with "production." Also, hectareage must be defined as either planted or harvested hectareage. When the quantity of interest is the tonnage

of wheat to the marketplace, then harvested hectareage (as opposed to abandoned or grazed hectareage) must be estimated, as well as the average productivity (yield per harvested hectare). Yield for harvested hectares is defined as the production from harvested hectares averaged over all hectares harvested. The better reporting systems make separate estimates of hectareage planted and harvested, as well as of yield, and combine these to estimate production. Forecast production then is inferred from individual estimates of hectareage and yield.

Yield for a region is derived from the observations of the quantity and distribution of wheat hectareage and its condition. Therefore, in a foreign country, where the government may release an estimate of its total wheat hectareage, neither production nor yield for the country can be accurately estimated without knowledge of how this hectareage and the associated meteorology is distributed geographically. For example, western Oklahoma may be undergoing drought while the eastern portion has favorable growing conditions. To get acceptably accurate forecasts of production, it is critical to associate the weather with the quantity of hectareage being affected. Planted hectareage actually removed from production because of severe drought or winterkill should be accounted for.

Another significant factor affecting the approach to crop production estimation is the presence within a single crop, such as wheat, of several hectareage subclasses. These subclasses have significantly different yields and require different yield estimation models, therefore, the hectareage and yield of each of these major subclasses must be separately estimated. For example, in the U.S.S.R., two major classes of wheat comprise the total crop: hard red winter wheat and hard red spring wheat. The U.S.S.R. winter wheat has almost twice the yield of its spring wheat. Therefore, even if the yield for each crop could be accurately estimated by observing weather parameters related to crop condition, the harvested wheat production could not be precisely estimated without a precise knowledge of the harvested hectareage individually for both classes of wheat. (The U.S.S.R. Government releases a planning figure for total wheat hectareage at the beginning of each crop year. One might naively suppose that accurate production estimates could be achieved by using the U.S.S.R. figure for total hectareage and monitoring only the weather over the country to determine average yield per hectare and, thereby, production.) Other hec-

tarage subclasses within wheat (or other crops) having significantly different yields are wheat fields remaining idle in alternate years (fallow rotation) versus those continuously cropped, and irrigated versus dryland hectarage. Because production at a national level is directly dependent on the geographic distribution of hectarage actually harvested and its associated weather, in addition to the hectarage distribution within the various subclasses, a survey system must monitor both hectarage and yield.

## **THE LARGE AREA CROP INVENTORY EXPERIMENT**

The Large Area Crop Inventory Experiment (LACIE) (refs 5, 6, and 7) was initiated in 1974 as a proof-of-concept experiment (1) to assimilate remote-sensing technology developed during the previous decade, (2) to apply a resultant experimental system to the task of monitoring a singularly important agricultural commodity over the world, (3) to isolate and establish priorities for key technical problems, (4) to modify the approach as necessary and conceivable, and (5) to demonstrate the technical and cost feasibility of global agricultural monitoring systems.

The LACIE was designed to accomplish these objectives in major producing regions of the world. An important departure in LACIE for the application of existing remote-sensing technology was a self-imposed constraint against the use of ground observations to identify wheat. This restriction was imposed to ensure the development of a technology applicable to regions inaccessible to ground observations. Timeliness and accuracy goals were established in recognition of the essential requirements for global agricultural information. The experiment was designed to establish the feasibility of acquiring and analyzing Landsat data within a 15-day interval. The at-harvest estimates were to be within 10 percent of the true estimate at the national level 90 percent of the time (the 90/90 criterion). A significant additional objective was to determine how early in the crop year estimates could be produced and with what accuracy and repeatability. Also, the estimates were to be made with repeatable and objective procedures. Qualitative judgments were to be minimized. Finally, extensive accuracy assessment program objectives were defined that required quantitative evaluation of the quality of LACIE estimates, definition of the specific nature of key technical problems encoun-

tered, and development, test, and evaluation of modified approaches where necessary to meet performance goals.

The experiment was scheduled in three phases.

1. In Phase I, first-generation technology to estimate the proportion of regions in wheat would be implemented and tested, and similarly, the technique to estimate the yield from specific areas would be developed and tested.

2. In Phase II, the first-generation technology as modified during Phase I would be further tested over expanded geographic regions and modified as required.

3. In Phase III, the modified first-generation technology and some second-generation technology would be tested and evaluated over a still wider range of geographic conditions.

The experiment was composed of three major elements.

1. A quasi-operational element to acquire and analyze Landsat and meteorological data to make experimental estimates of production.

2. An off-line element to test and evaluate alternative approaches as required to meet the performance goals of the experiment.

3. An element to research and develop alternative approaches.

The experiment has been jointly conducted by personnel from NASA, USDA, and the National Oceanic and Atmospheric Administration (NOAA) of the Department of Commerce. They represent the many disciplines important to meeting the objectives of the experiment.

The major components of the experiment include Landsat and its acquisition and preprocessing subsystems; the World Meteorological Organization (WMO) weather reporting system; the NOAA development and operational facilities in Washington, D.C., and Columbia, Missouri, and the analysis, compilation, and evaluation activities by personnel from USDA, NASA, and NOAA at the NASA Johnson Space Center (JSC) in Houston, Texas. The experiment also draws significantly on the expertise of university and industrial research personnel.

### **The LACIE Technical Approach**

The LACIE approach uses primarily Landsat data to forecast the amount and geographic distribution of the harvested wheat hectarage and meteorological data to forecast the average productivity (yield) of

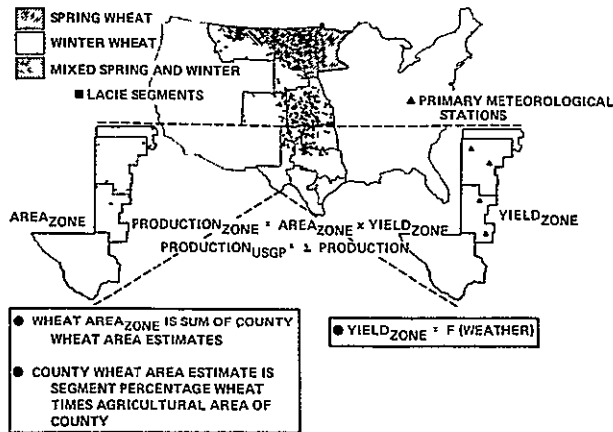

FIGURE 1.— Technical elements of area, yield, and production estimation using the sampling approach—U.S. Great Plains (USGP).

this hectareage This approach requires that each geographic subregion (the zones of figure 1, selected to be relatively homogeneous with regard to wheat hectareage and yield) in a country be monitored (1) to forecast the quantity of wheat hectares available for harvest (both winter and spring individually in each subregion) and (2) to forecast the expected productivity for each subregion (yield) of the hectares available for harvest The total wheat production for each subregion is then obtained as the product of available hectares for harvest and yield for harvested hectares. The production forecasts for all subregions are then summed to obtain the national-level forecast In addition, the subregional forecasts of hectares for harvest are summed to obtain a forecast of national hectares for harvest An average yield for all hectares harvested nationally is then obtained, which is by definition the hectareage-weighted average of subregion yields. This hectareage-weighted average yield is a desirable estimate to have since, when multiplied by national hectareage, it will reproduce the national production estimate

Within each zone shown in figure 1, Landsat multispectral data are collected each 18 days from 5-by 6-nautical-mile segments randomly drawn from each stratum (In the US first-generation sample design, an area stratum is a county ) Within each segment, manually assisted machine-processing techniques are used to distinguish wheat from nonwheat by monitoring the temporal development of wheat from planting through harvest (See reference 8 and the symposium paper by Heydorn for detailed descriptions of LACIE machine-processing tech-

niques ) The areal percentage of wheat in each segment in the stratum is then estimated, and thereby an average percent for the stratum can be determined The average areal percent wheat can then be multiplied by the total agricultural hectareage in the stratum to estimate total wheat for the stratum.<sup>1</sup>

The following characteristics of the Landsat estimates of harvested wheat hectareage can be noted

1 The spectral differences both over time and at any one time between wheat and other crops permit wheat to be distinguished from other crops and its hectareage estimated

2. Wheat areas subjected to weather conditions so harsh as to result in disappearing hectareage (e.g , bare soil or extremely sparse vegetation) will not be visible as standing vegetation in the Landsat data and thus will not contribute to the LACIE estimate of wheat hectareage or wheat production. In this way, Landsat data partly account for severe conditions in the production estimates.

3. Landsat data can be used to monitor abandonment For example, if a field identified in the early winter (November-December) time frame does not reemerge following dormancy in January-February, hectareage loss to this factor can be identified

4 In early season, LACIE estimates only the detectable wheat hectareage as opposed to planted wheat hectareage Generally, a minimum of 20 percent ground cover is required before wheat is detectable. As the season progresses, the wheat hectareage detectable by Landsat will increase and converge in midseason to the total standing hectareage potential for harvest (By way of contrast, most existing systems measure total field hectareage-including bare spots )

The errors associated with this technique derive from the fact that certain other crop types have characteristics similar to wheat, both in its growth cycle and its appearance at each time in the growth cycle Such crops are referred to as confusion crops In addition, the Landsat spatial resolution of approximately 0.44 hectare introduces error in measurement on field boundaries, particularly in agricultural regions with small fields (field dimensions on the order of Landsat resolution) Results of LACIE to date have indicated that the major confusion crops

<sup>1</sup>Stratum agriculture is delineated on full-frame Landsat imagery and planimetered to determine total agriculture hectareage within a stratum Agriculture is defined as any area of the image on which field patterns are evident

with respect to wheat are certain small grains, particularly spring barley and winter rye. In subregions where these confusion crops are in appreciable abundance, LACIE has identified total small grains and reduced these estimates to wheat estimates using historic relative abundance figures for these crops.

As a remote-sensing system such as LACIE begins to develop a year-to-year image history for a segment, the use of these data to monitor crop rotation patterns will permit an increasingly accurate estimate of both wheat area and potential yield. There is, in addition, within any one year, potential information in the spectral data related to crop condition and thus yield. To date, the Landsat multispectral data have not been used to completely quantify the reduction on yield of soil moisture deficiencies and other such episodic events which affect the spectral reflectance. Of course, if such events are severe enough to cause abandonment of hectarage, this would be detected in the Landsat data, and the resulting decrease in the hectarage estimate would decrease the estimate of total production. The spectral data are currently used only to monitor the geographic extent of the episodic events, and the regular LACIE analyses are used to quantify the impact of these events on yield and production (refs 9 and 10). Research efforts are underway to use the spectral data directly to estimate yield.

The yield for harvested hectares is forecast in LACIE through the use of regression models which incorporate weather-related variables obtained from the ground-based stations of the WMO network (fig 1). These models (refs. 11, 12, and 13) are referred to as agrometeorological models. The first-generation models currently used in LACIE are based on regressions of historic yields and monthly averages of temperature and precipitation. In the U.S. Great Plains (USGP) yardstick area, there are both winter and spring wheat models covering the 12 zones designated in figure 2. The yield and historic meteorological data series used to develop the U.S. models is approximately 45 years in length. In the U.S.S.R. (fig 3), the data series used to develop the models is only 10 years in length, there are 15 winter wheat and 16 spring wheat models covering 33 zones. In both the U.S. and the U.S.S.R., the yield data for each zone are derived by dividing the reported harvested production for the zone by the reported harvested hectarage. These data are computed individually for winter and spring wheat. The historic meteorological data for each zone consist of a hectarage-weighted sum of data for the smallest reporting subareas with-

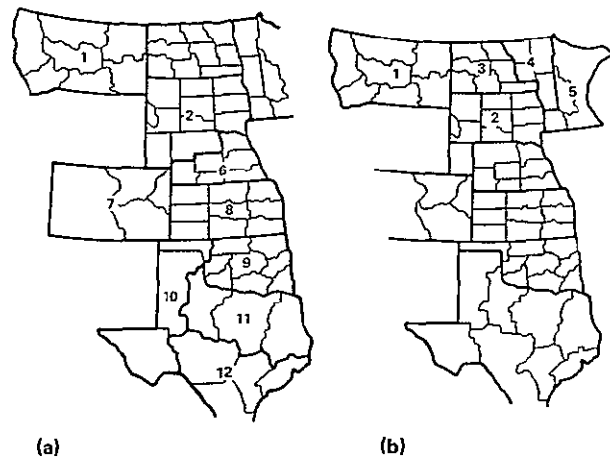

FIGURE 2.—Wheat yield regression model coverage for the U.S. Great Plains. (a) Winter wheat model boundaries. (b) Spring wheat model boundaries.

in the zone. For example, the U.S. zones are collections of counties. Average monthly temperature for a U.S. zone is a hectarage-weighted sum of average monthly temperatures for the counties.

Yield models must cover a wide range of climates found in the U.S.S.R., the wheat-growing region of which spans more than a thousand miles from north to south. Winter wheat is grown primarily in European U.S.S.R. Since 1949, both spring and winter wheat have shown an upward yield trend. Factors contributing to improved yields include improved varieties, increased mechanization, greater fertilizer use, increased irrigation, and application of pesticides. Winterkill and moisture stress are two major weather hazards that reduce both harvested hectarage and harvest yields.

### Summary of Results

Late in 1974, LACIE began using data acquired by Landsat-1 to measure wheat hectarage in Kansas. By 1977, the experiment had evolved into a global experiment monitoring wheat hectarage and yield. At global scale, LACIE incorporated about 15 000 data sets acquired by Landsat-2 from more than 2600 sample segments in 5 major global crop regions and meteorological data from more than 1500 reporting stations.

Both the accuracy and the efficiency with which LACIE crop survey estimates are made have shown significant improvement in these 3 years. In the U.S.

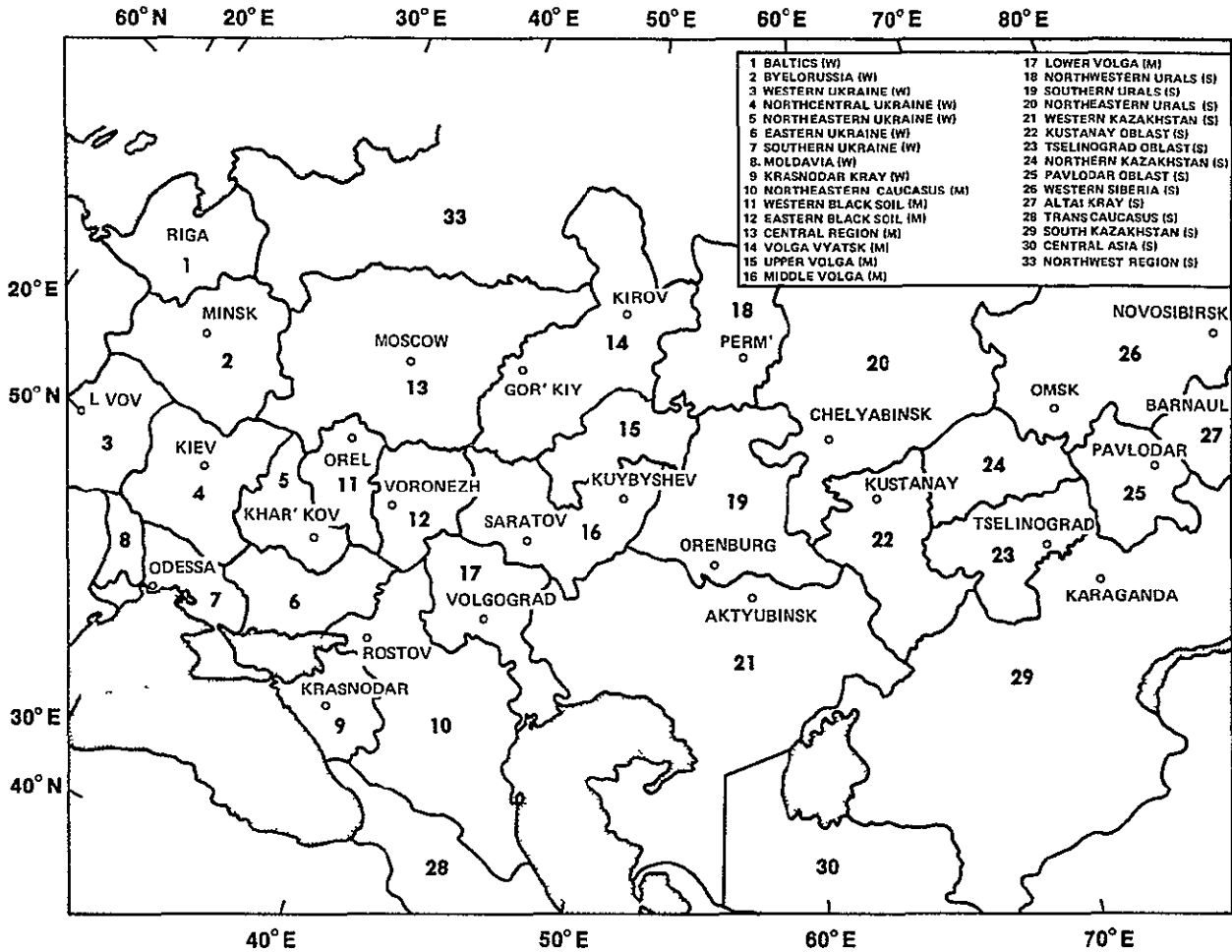

FIGURE 3.—Crop regions in the U.S.S.R. covered by wheat yield regression models; W is winter, S is spring, and M is mixed.

and USSR winter wheat regions, the original accuracy goals have been met or exceeded, with 90/90 estimates achieved in the United States 15 to 2 months before harvest. Additionally, all available accuracy parameters indicate 90/90 estimates for the USSR total crop. Key technology problems were identified during Phase II with spring wheat in the United States and Canada which prevented the attainment of 90/90 accuracies in these regions. Technology solutions developed and tested in Phase III partly resolved these issues with a significant improvement realized in the accuracy of the spring wheat area estimates. In Phase III, the LACIE estimates of total USGP hard red spring and winter wheat hectareage supported the 90/90 criterion for production 15 months before harvest. Hectareage estimates, based on Landsat data acquired through June 1, were within 1 percent of the SRS estimates of harvested area. The spring wheat hectareage estimates

were about 9 percent under those of the SRS, compared to nearly 15 percent in Phase II. Further improvements are being tested in the LACIE Transition Year Results of the 3 years of LACIE experimental surveys and simulation tests of the LACIE yield models using 10 years of historic data have indicated that these simple, first-generation regression models worked reasonably well in view of their many limitations. In fact, the model estimate accuracy parameters are sufficiently high to marginally support the 90/90 criterion. However, several factors indicate that these models can and should be improved. The efficiency of the analysis systems has improved by a factor of 4 in these same years. Additionally, the knowledge to meet or exceed the original turnaround goal of 14 days from Landsat acquisition to analysis and the throughput performance required for data volumes encountered in a global survey have been developed.

## Summary of Achievements

Much of the improvement in performance, in both accuracy and efficiency, from Phase II to Phase III was the direct result of the introduction in Phase III of a second-generation machine-processing technology called Procedure 1 (P-1) (refs 7 and 8). Procedure 1 was developed within LACIE to address the key issues defined as a result of LACIE experience through Phase II. It provided the first capability to process multirate Landsat data in a high-throughput mode. Also, P-1 represented a significant step in the evolution from manual modes toward computer-assisted modes of processing. With the multirate capability, P-1 enabled development of initial analyst procedures for distinguishing between spring wheat and other small grains such as spring barley. In addition, the single-pixel training approach used in P-1 has produced more accurate estimates in regions with small fields.

A major component of the remote-sensing-survey technology that was largely undeveloped before LACIE but has been successfully developed and demonstrated during LACIE is the sampling and aggregation technology. A first-generation technology, which relied on full-frame Landsat imagery and historic ancillary data at the political reporting levels of various countries to develop strata, has been used through Phase III with excellent results. In Phase III, the error component contribution from sample error was small compared to the nonsample components and was well within the design specifications. An improved second-generation strategy, with strata not constrained to conform to political units and with more uniform strata, was developed and tested in Phase III and shown to be more efficient than the first-generation strategy. This strategy is being implemented with a more comprehensive evaluation over the entire U.S. test region and has resulted in a 20-percent reduction in the number of samples required to maintain the small sample error achieved in Phase III.

## Priorities for Key Technical and Applications Research Issues

In addition to the achievements of developing and demonstrating a remote-sensing technology that can produce improved wheat production information on a global scale, LACIE has identified the key technical and applications research issues relevant to

remote-sensing crop surveys. Many issues anticipated to be major obstacles to successful global surveys, such as the efficient handling of large volumes of data and the inability to acquire data as a result of cloud cover, have proved to have rather straightforward solutions or simply never materialized as real problems. Certain other issues not seen at the outset of LACIE as particular problem areas (e.g., clustering technology to automatically delineate the statistical structure of the Landsat multispectral scanner data) became major problem areas in the intense and extensive evaluation environment of LACIE. Thus, an important product of LACIE is a collection of well-defined research problem priorities. The solutions of these problems would result in significant improvements in the timeliness and accuracies achievable using remote-sensing-survey techniques.

## PHASE I SUMMARY

The wheat area estimation portion of the LACIE Applications Evaluation System (AES) was preliminarily evaluated in November 1974, using 28 Kansas 5- by 6-nautical-mile segments acquired during 1973 by Landsat-1. These segments were chosen to coincide with 1- by 1-nautical-mile samples regularly visited by personnel from the SRS. The ground observations made by SRS for its crop enumerative survey were used to check the performance of the LACIE AES. The results of this initial evaluation were very encouraging. The relative difference of -3 percent observed in the Kansas test between the LACIE and the SRS estimates of wheat hectareage was not statistically significant. Although Kansas was one of the less difficult U.S. areas, it was concluded from the success there that the 90/90 criterion was a reasonable goal which would productively stimulate the development of the LACIE technology (ref. 14).

As the 1975 wheat season proceeded, there was a period of bringing Phase I system components into operation and testing their capability to meet experiment goals. An overall experiment design was completed (hardware, software, sample design, etc.) to support all three planned LACIE phases. U.S. Great Plains wheat area estimates were made regularly throughout Phase I. A single summary report for yield and production was developed at the end of the phase. After correction of significant implementation problems, the initial Phase I wheat area estimation system was deemed marginally adequate to sup-

port the 90/90 accuracy criterion for at-harvest production estimates. The wheat area estimation system produced estimates generally lower than SRS estimates. The LACIE wheat area estimate for the USGP was approximately 46 000 000 acres, compared to the SRS estimate of approximately 51 000 000 acres, or about 10 percent below the SRS figure. (See reference 6 for a detailed discussion of Phase I.) Testing of the yield models on 10 years of historic data indicated that the model performance was adequate to support the 90/90 criterion (ref. 14). The Phase I estimates of the USGP yield differed from the SRS estimate by about 4 percent. The corresponding production estimates were about 9 percent below the SRS estimates and the LACIE production estimator accuracies (coefficient of variation (CV) = 5.9 percent, no statistically significant bias) were adequate to support the 90/90 criterion (table II). Of most concern at the conclusion of Phase I was the observed underestimate of spring wheat hectareage in the four northern USGP states of about -10.7 percent. The winter wheat area estimates were within 1 percent of SRS estimates. A study of performance over about 20 LACIE sample segments in North Dakota for which (unknown to LACIE analysts) all fields had been identified by USDA field personnel ("blind" sites) indicated that the underestimates resulted from both sampling error and classification error. At the end of Phase I, additional samples were selected to reduce sample error in North Dakota to further evaluate classification error in Phase II. In addition, efforts were intensified to improve the Phase I classification procedures. From Phase I processing experience, it was concluded that the initial signature extension approach taken in LACIE (ref. 15) was not adequate to meet perform-

ance objectives. Furthermore, procedures for processing of the multitemporal Landsat acquisitions were unsatisfactory; without this capability, it was not possible to spectrally separate spring wheat from an almost identical crop, spring barley. Without the ability to differentiate between these two crops, only total small grains hectareage could be estimated. These estimates were reduced to a wheat hectareage estimate through the use of historic harvested hectareage ratios of wheat to total small grains.

## PHASE II SUMMARY

### Results

In Phase II, quasi-operational wheat area estimation was extended to yield and production for the U.S. Great Plains yardstick region and, in addition, for Canada and indicator regions of the U.S.S.R. The overall accuracy of LACIE wheat production estimates for Phase II strongly supported the contention that the technology was capable of providing improved early-season and at-harvest production estimates in major wheat-producing regions of the world outside the United States. Results of LACIE were particularly encouraging in the winter wheat regions of the world. The LACIE midseason to late-season estimates of winter wheat were adequate to support the LACIE 90/90 at-harvest goal for production (tables III(a) and III(b)). There was again a tendency to underestimate spring wheat in the United States and Canada primarily as a result of underestimating spring wheat acreage (tables III(c) and III(d)). However, this underestimation tendency was not observed in either the U.S.S.R. spring (table III(e)) or winter wheat region. Although the accuracy of the LACIE yield estimates supported the 90/90 criterion in Phase II, testing also revealed that yield models were not adequately responsive to episodic events and therefore required improvement to achieve accurate estimates in years with extended episodic conditions.

As a result of more confusion crops, smaller fields, and a shorter growing season, the area estimates in the U.S. and Canadian spring wheat regions did not support 90/90 estimates. However, in the U.S.S.R. spring wheat regions, small fields are not as prevalent as in the United States and Canada (fig. 4). All indicators of accuracy supported the contention

TABLE II—Results Achieved at End of Phase I  
(for a Relatively "Normal" Agricultural Year)

[Values are the relative difference plus or minus coefficient of variation between LACIE and SRS estimates.]

Region	Area, percent	Yield, percent	Production, percent
Total yardstick	-10.7 ± 5.7	4.3 ± 4	-5.6 ± 5.9
Southern portion of yardstick	-0.13 ± 7.0	4.2 ± 2.6	4.95 ± 7.04



TABLE III.—Comparison of Key SRS and LACIE Estimates for Phase II

(a) U S Southern Great Plains,<sup>a</sup> 1976

(b) U S S R winter wheat indicator region, 1976

<i>Estimate</i>	<i>Area, million acres</i>	<i>Yield, bushels/ acre</i>	<i>Production, million bushels</i>	<i>Estimate</i>	<i>Area, million hectares</i>	<i>Yield, quintals/ hectare</i>	<i>Production, million metric tons (MMT)</i>
<i>Early season (January)<sup>b</sup></i>				<i>Early season (January)<sup>b</sup></i>			
SRS	33 1	19 9	659 6	Foreign Agriculture Service (FAS)	11 3	24 0	27 1
LACIE	22 7	27 6	626 0	LACIE	10 8	25 7	27 8
Relative difference, <sup>c</sup> percent	(-45 8)	(27 9)	(-5 4)	Relative difference, <sup>d</sup> percent	(-4 6)	(6 6)	(2 5)
Coefficient of variation, percent	(9 0)	(7 0)	(11)	Coefficient of variation, percent	(7)	(4)	(7)
<i>Midseason (May)<sup>b</sup></i>				<i>Midseason (July)<sup>b</sup></i>			
SRS	27 3	24 4	616	FAS	11 3	24 7	27 9
LACIE	26 7	26 5	706	LACIE	11 9	25 3	30 0
Relative difference, <sup>c</sup> percent	(-2 2)	(7 9)	(12 7)	Relative difference, <sup>d</sup> percent	(5 0)	(2 4)	(7 0)
Coefficient of variation, percent	(5 0)	(5 0)	(7 0)	Coefficient of variation, percent	(6)	(6)	(8)
<i>Harvest (July)<sup>b</sup></i>				<i>Harvest (October)<sup>b</sup></i>			
SRS	27 4	26 2	726	FAS	11 3	27 6	31 2
LACIE	25 7	26 5	682	LACIE	14 2	24 6	34 9
Relative difference, <sup>c</sup> percent	(-6 6)	(1 1)	(-6 4)	Relative difference, <sup>d</sup> percent	(20 4)	(-12 2)	(10 6)
Coefficient of variation, percent	(5 0)	(5 0)	(7 0)	Coefficient of variation, percent	(6)	(5)	(7)

<sup>a</sup>Southern Great Plains (winter wheat states) Colorado, Kansas, Nebraska, Oklahoma, and Texas

<sup>b</sup>Effective operational release date 14 days following latest Landsat acquisition date

<sup>c</sup> $((LACIE - SRS) + LACIE) \times 100$

<sup>b</sup>Effective operational release date 14 days following latest Landsat acquisition date

<sup>d</sup> $((LACIE - FAS) - LACIE) \times 100$

TABLE III.—Continued

(c) US Northern Great Plains,<sup>4</sup> May 27, 1977

(d) Canadian spring wheat, May 27, 1977

Estimate	Area, million acres	Yield, bushels/ acre	Production, million bushels
<i>Early season (July)<sup>b</sup></i>			
SRS	23 8	25	595
LACIE	16 6	27	448
Relative difference, <sup>c</sup> percent	(-43 4)	(7 4)	(-32 8)
Coefficient of variation, percent	(9 4)	(29 6)	(11 6)
<i>Midseason (August)<sup>b</sup></i>			
SRS	23 8	26 7	636
LACIE	19 1	27.1	518
Relative difference, <sup>c</sup> percent	(-24 6)	(1 5)	(-22 8)
Coefficient of variation, percent	(6 2)	(27 6)	(8 9)
<i>Harvest (September)<sup>b</sup></i>			
SRS	23 8	25 9	617
LACIE	19 1	27 0	515 8
Relative difference, <sup>c</sup> percent	(-24 6)	(4 1)	(-19 6)
Coefficient of variation, percent	(6 7)	(27 7)	(8 7)

Estimate	Area, million acres	Yield, bushels/ acre	Production, million bushels
<i>Early season (July)<sup>b</sup></i>			
FAS	27	29 6	800
LACIE	13 5	27 7	375
Relative difference, <sup>d</sup> percent	(-100)	(-6 9)	(-113 3)
Coefficient of variation, percent	(4)	(4)	(5)
<i>Midseason (August)<sup>b</sup></i>			
FAS	26 8	29 6	800
LACIE	17 3	27 8	481
Relative difference, <sup>d</sup> percent	(-55)	(-6 5)	(-66 3)
Coefficient of variation, percent	(3)	(4)	(5)
<i>Harvest (September)<sup>b</sup></i>			
FAS	26 8	31 1	834
LACIE	20 8	27 7	576
Relative difference, <sup>d</sup> percent	(-29)	(-12 3)	(-44 8)
Coefficient of variation, percent	(3)	(3)	(5)

<sup>b</sup>Effective operational release date 14 days following latest Landsat acquisition date

<sup>c</sup> $((LACIE - SRS) \div LACIE) \times 100$

<sup>4</sup>Northern Great Plains—Montana (mixed), North Dakota (spring), South Dakota (mixed), and Minnesota (spring)

<sup>b</sup>Effective operational release date 14 days following latest Landsat acquisition date.

<sup>d</sup> $((LACIE - FAS) \div LACIE) \times 100$

TABLE III—Concluded

(e) U.S.S.R. spring wheat indicator region, 1976

Estimate	Area, million hectares	Yield quintals/ hectare	Production MMT
<i>Early season (August)<sup>b</sup></i>			
FAS	171	10	171
LACIE	134	107	143
Relative difference, <sup>d</sup> percent	(-27.6)	(6.5)	(-19.6)
Coefficient of variation, percent	(7)	(9)	(11)
<i>Midseason (September)<sup>b</sup></i>			
FAS	171	109	186
LACIE	165	106	175
Relative difference, <sup>d</sup> percent	(-3.6)	(-2.8)	(-6.3)
Coefficient of variation, percent	(5)	(8)	(9)
<i>Harvest (October)<sup>b</sup></i>			
FAS	171	113	193
LACIE	191	105	201
Relative difference, <sup>d</sup> percent	(10.5)	(-7.6)	(4)
Coefficient of variation, percent	(4)	(8)	(9)

<sup>b</sup>Effective operational release date 14 days following latest Landsat acquisition date  
<sup>d</sup> $(LACIE - FAS) \div LACIE \times 100$

that the U.S.S.R. estimates were satisfying the 90/90 criterion, although base comparisons between LACIE and other U.S.S.R. wheat estimates are not as reliable as the U.S. comparisons. These disparate

results between the U.S. and U.S.S.R. estimates indicate the need for technology verifications in a variety of situations.

### Technical Issues

Although the classification and area estimation technology had met or exceeded goals for winter wheat, there was a need to further refine the technology in regions where episodic or unusual agrometeorological conditions were encountered. For example, during Phase II, Oklahoma and other states of the Southern Great Plains had generally dry conditions through April 1976. These conditions created poor wheat stands and subsequent acreage underestimates. In some cases, sparsely vegetated fields were not detected as "emerged" wheat in the Landsat data, or even on the aircraft ground-truth color-infrared imagery. The April rains greatly improved the wheat stands. However, the drought-altered growth cycle led the analysts to believe that the late-recovering wheat was a spring-planted crop. Episodic events such as this are a part of the learning process. As more of these situations are encountered, the technology will adapt to accurately estimate their impact on hectareage, yield, and production.

In the U.S. and Canadian spring wheat regions, the underestimates of spring wheat acreage observed were primarily the result of the inability to differentiate spring wheat from other small grains, primarily spring barley. Spectrally, these crops are similar, as are their growth cycles. Therefore, it was necessary during Phase II to develop and test procedures to improve discriminability of these crops for Phase III. For Phase II, it was necessary to use historic wheat/small-grain ratios to reduce LACIE small-grains area estimates to wheat area estimates, as was done in Phase I. Use of the ratios introduced additional error into the spring wheat area estimates, particularly in the Phase II crop year for which the planting of wheat in preference to nonwheat small grains had greatly increased from previous years. In many instances, the actual wheat/small-grains ratios were as much as 60 percent greater than the historic ratios. This was responsible for a significant amount of the wheat area underestimates for Canada. There was, however, also a residual tendency to underestimate undifferentiated spring small-grains area for the United States and Canada. This was verified by the comparisons of the Landsat estimates to ground-observed small-grains hectareage in the LACIE blind



sites. The cause was found to be partly a result of the greatly increased tendency toward strip-fallow practice in the spring wheat regions. Strip-fallow fields, narrow compared to the 80-meter Landsat spatial resolution, are difficult to detect and measure in the imagery (fig. 5). The absence of the U.S.S.R. spring wheat hectareage underestimation problem may indicate more stable (government controlled, and a decrease in strip-fallow practice) year-to-year ratios of spring wheat to other small grains.

Because of the underestimates of spring wheat for North America and the Oklahoma episodic problem mentioned earlier, it was concluded late in Phase II that the first-generation machine-processing procedures needed significant improvement. These procedures provided no capability to process spatially registered multirate Landsat acquisitions. In addition, they require the analyst to delineate the multivariate structure of the 16-dimensional multirate Landsat data. This procedure was too complex and time consuming for the analyst and, in most cases, resulted in inadequate training of the machine classifier. The failure of the machine-clustering algorithm was a key to these problems. Clustering had not been considered a problem before LACIE. However, the algorithm failed to perform consistently when used in the semiautomated mode required for LACIE because the input parameter could not be individually tuned to each of the many Landsat data sets processed.

In addition to the problems requiring improvements for the machine-processing algorithms, blind-site results were indicating an undesirably high error rate in analyst identification of wheat and nonwheat. There was a misidentification problem resulting from abnormal signatures due to episodic weather conditions. There was also a second class of labeling errors for wheat signatures which (for a particular combination of Landsat acquisitions) were also characteristic of nonwheat. Because the analysts could not reliably distinguish every signature and because they tended to employ a "wheat conservative" labeling procedure, the analyst labeling errors led to a negative bias in the area estimates. The "wheat conservative" approach calls for analysts to label a signature as wheat only if there is a high degree of confidence that it is wheat; otherwise, they are required to label it nonwheat. Given a nonzero error rate, this procedure obviously leads to a negative bias. The "wheat liberal" alternative (i.e., label the signature wheat if there is a reasonable chance it is wheat) would lead to a positive bias. Therefore, the

issue to be investigated in the case of analyst labeling is twofold: (1) how to reduce the analyst error rate and (2) how to label the signature such that a minimally biased proportion estimate can be achieved given a nonzero error rate in the labeling; i.e., a procedure which balances errors of omission against errors of commission. Such statistically unbiased procedures are being investigated as a part of the LACIE research effort.

Another key technical issue at the end of Phase II was the adequacy of the LACIE crop development models used to estimate the development stage of wheat within a sample segment at a particular Landsat acquisition date. This information is used by the analyst to ascertain the expected signature for wheat at a particular date. Generally, these model predictions agreed well with ground observations when a ground-observed planting date and an emergence-from-dormancy date were used to start the models. However, no model was available to accurately predict planting and emergence dates for winter wheat, and no estimates of winter wheat stages (other than historical averages) were available. This was also a factor in the analyst labeling problem in Oklahoma. The spring wheat planting dates could be accurately predicted; thus, the spring wheat models were satisfactory. Still, there was no equivalent model for spring barley, which was a major contributor to the difficulties in distinguishing spring wheat from spring barley.

The yield estimation system was also found to have problems calling for improvements. The models were not responsive to weather extremes. Also, there were problems with implementing the models for countries with little historic data to develop the regression models and only sparse meteorological data with which to operate them. In a simulation test using 10 years of historic data, where the model coefficients were developed using data records prior to the test year, the yield model forecast error for the United States was large in 1974 and slightly over the tolerable error in 1971 (fig. 6); 1974 was a year of extremely dry weather over a large part of the USGP and the impact on yield was much larger than could be responded to by the models. A state-by-state test of these models indicated that the LACIE yield estimates were highly correlated with the SRS yield figures but did not respond completely to year-to-year deviations from normal yields. This can be seen in figure 7, which compares the SRS Texas yield figures to the estimates from the LACIE yield model.





(a)

FIGURE 4.—Comparison of small spring wheat strip fields in North America with the large spring wheat fields of the U.S.S.R. (a) North American spring wheat fields. (b) U.S.S.R. spring wheat fields.

Two basic categories of improvements are possible to the LACIE yield estimation approach: improvements to the models themselves and improvements in the collection of parametric inputs to these models. Several avenues are open for model improvements: development of models based on daily (as opposed to monthly) averages of meteorological observations; inclusion of yield-influencing factors not directly accounted for in the current models (e.g., fertilizer and variety factors as well as regional cultural practice such as percent irrigated area and percent fallow area); inclusion of a continually updated crop calendar to render the model response to weather a function of the actual crop development stage at which the weather occurred; and inclusion of parameters obtainable from remote sensors such as the Landsat multispectral scanner or, in the future, microwave measurements of soil moisture conditions.

With regard to improvements in the collection of the parametric inputs used in the models, the most pressing need is for the incorporation of meteorologi-

cal satellite data. This would increase the spatial density and representativeness of the meteorological data used, even in the current models. Weather data for the current models are obtained from only 171 USGP stations, located in most instances near airports. In contrast, wheat area is monitored using nearly 600 USGP Landsat samples. Given that weather has considerable spatial variability, particularly precipitation, substantial sample error can be introduced by the sparsity and nonrepresentativeness of the existing ground stations.

### PHASE III SUMMARY

#### Technology Modifications

For Phase III, the highest priority was improvement of technology for identifying spring wheat directly from the Landsat data. As a result of this emphasis, a greatly improved automatic processing



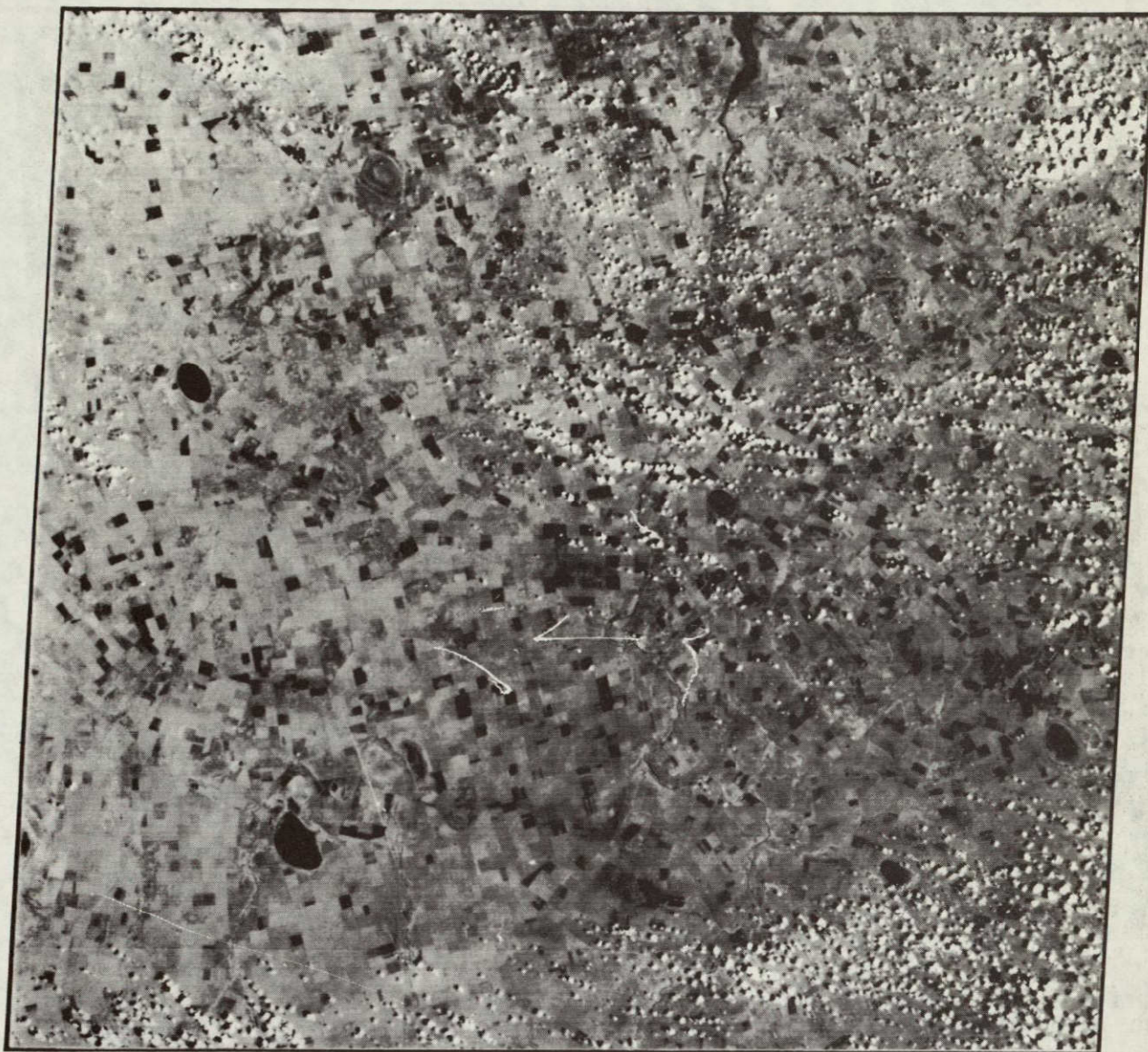

(b)

FIGURE 4.— Concluded.

procedure was developed and implemented by mid-Phase III of LACIE. The procedure had three important properties.

1. The need for manual intervention was almost eliminated from the machine-processing sequence.
2. Every measurement in the scene, as well as the full dimensionality of the spectral data, was used in statistics computation before maximum likelihood classification.
3. With correct analyst determinations of crop identity for a very small sample of the segment, the

machine-processing procedure would provide an unbiased estimate of the segment crop proportion.

From an operational viewpoint, Phase III procedures were designed to be much less labor intensive than the first-generation ones. Phase III practice also provided analysts with improved and more repeatable decisionmaking procedures utilizing improved analyst aids such as image interpretation keys and displays of quantitative spectral data.

Econometric models for the prediction of wheat/small-grains ratios were also developed and



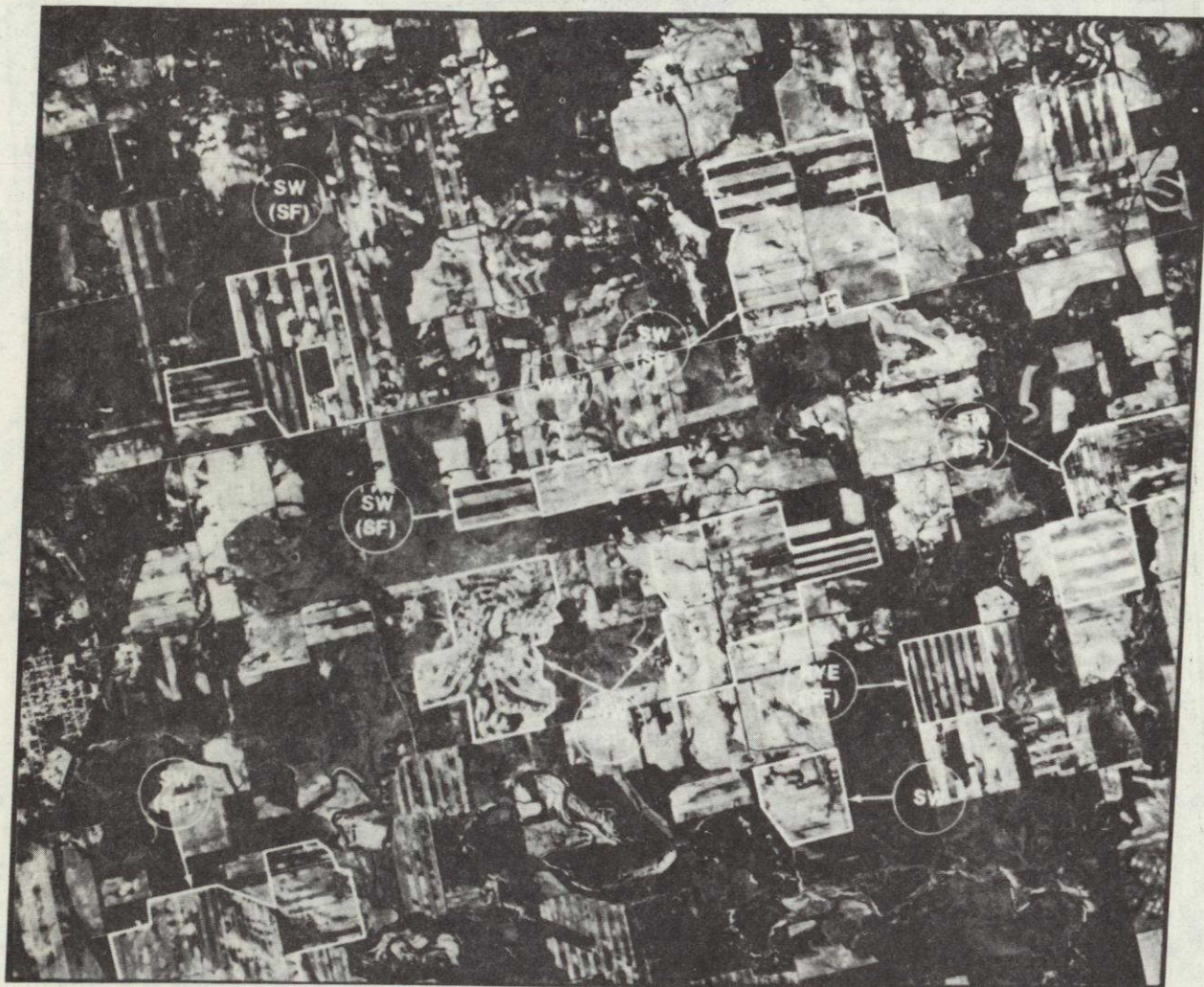

(a)

FIGURE 5.—Comparison of low-altitude aerial photograph of strip fields with Landsat image of same area; SW = spring wheat, WW = winter wheat, and (SF) = strip fields. (a) Low-altitude aerial photograph. (b) Landsat image.

tested in Phase III. These models predicted the current ratios of wheat to small grains resulting from influential factors such as historical crop and livestock patterns, current-year growing conditions (available soil moisture, etc.), economic conditions, and prevailing government farm programs.

In Phase III, an improved partitioning of the survey region into subregions which are climatologically and agriculturally homogeneous was implemented for testing. Such partitioning could render sampling strategies more efficient and thus more cost effective. Agrometeorological data compiled to effect partitioning would also improve understanding of the agrometeorological properties of

the survey regions and thus improve the ability to correctly classify crop hectareage and estimate yield.

The first-generation yield models were slightly modified for Phase III, primarily to remove geographic overlays in some of the U.S. models and to develop models for the additional U.S. and U.S.S.R. regions to be covered for Phase III. Second-generation models initiated in Phase II were implemented in a test mode for Kansas and North Dakota, as well as for a spring wheat and a winter wheat oblast in the U.S.S.R.

Finally, a new activity, crop condition assessment, was initiated in Phase III. An interdisciplinary team of LACIE personnel was assigned to monitor the



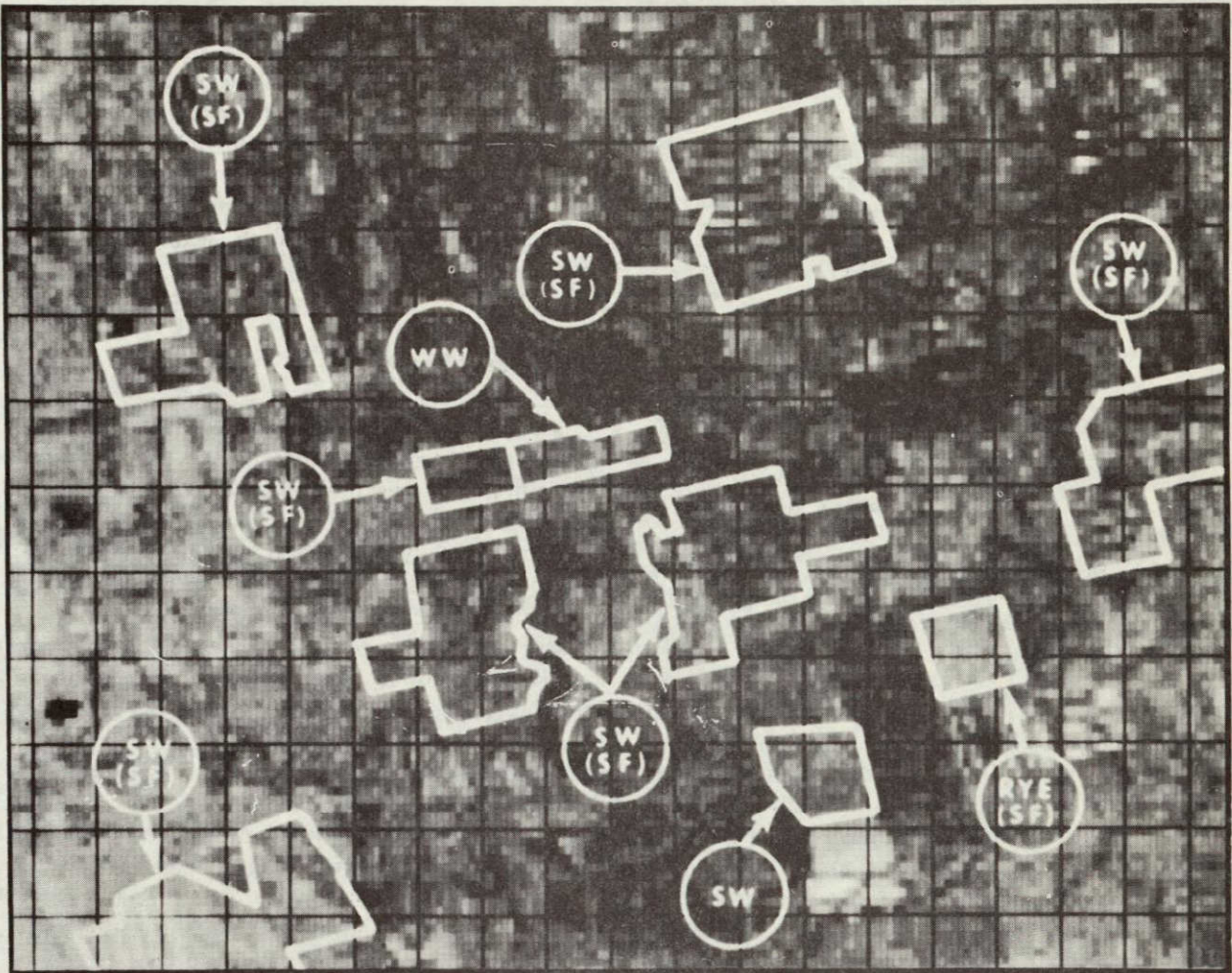

(b)

FIGURE 5.— Concluded.

U.S. and U.S.S.R. general moisture and temperature conditions throughout Phase III using Landsat full-frame imagery, Landsat measurements on segment data, and meteorological data.

### Results and Achievements

Phase III consisted of real-time data analysis of nearly 15 000 Landsat-2 acquisitions from some 2600 sample segments located in the USGP, the U.S.S.R., and Canada as well as daily and monthly meteorological observations from about 1000 ground stations in these countries. Estimates were made for the

USGP wheat crop where the SRS estimates of the crop over this region were available as a reference standard, and detailed ground truth from about 200 test sites was available for accuracy assessment and technology development. In Phase II, LACIE estimates were made only for two subregions within the U.S.S.R.; the Phase III scope was expanded to obtain estimates for the entire U.S.S.R. Estimates for the entire U.S.S.R. were necessary to obtain more reliable and timely independent estimates for use as LACIE reference estimates. Regional U.S.S.R. estimates are not available until about 2 years after harvest and are of questionable reliability. Although the reliability of the U.S.S.R. final estimates of total



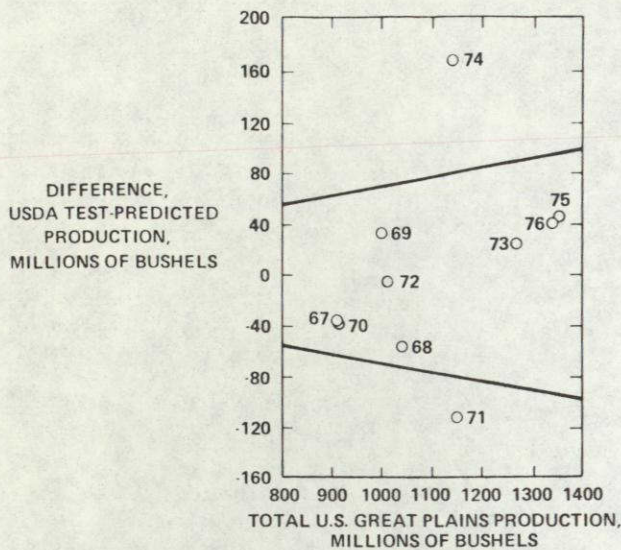

FIGURE 6.—Distribution of U.S. Great Plains yield-related production errors with respect to LACIE tolerance bounds. The data points are labeled by year; e.g., "67" is 1967.

wheat production is unknown (ref. 16), they are the best data available for comparison. In Canada, Phase II experience had indicated the need to focus on improving the machine-processing technology for analysis of the difficult spring wheat strip-fallow areas. Thus, Canadian participation and cooperation was sought and obtained to acquire ground truth over 30 LACIE sample segments in Canada with the idea of evaluating the second-generation machine-processing procedures in Phase III. The Canadian test site evaluations are in progress, and no results are available. As with the first two phases of LACIE, analyses of 34 intensive test sites were also conducted. The intensive test sites are sites having more detailed ground observations than do blind sites; these observations are relevant to crop parameters at

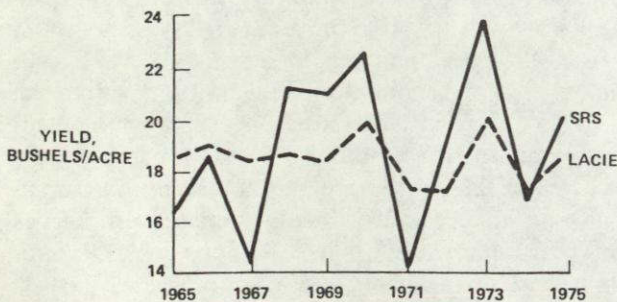

FIGURE 7.—Year-to-year comparison of LACIE versus SRS yield estimates for Texas.

the field level for intensive assessment of LACIE technology problems.

In addition to the evaluations just described, a second-generation sample strategy and yield estimation technology was evaluated in Kansas, in North Dakota, and in two U.S.S.R. oblasts. The use of P-1 to separate spring wheat from spring barley was also evaluated for the North Dakota segments and for Canadian blind sites.

### Operational Performance

The LACIE systems performance goals were to achieve a turnaround time of 14 days from Landsat acquisition to aggregation for production estimation. When the observed time lines actually achieved with the geographically distributed system operating one shift per day/5 days per week are projected for an operational system operating three shifts per day/7 days per week, the 14-day goal was achieved. The LACIE throughput time for all phases averaged about 30 days. About 6 days were weekend time, about 10 days were the result of overnight holds on data, and about 13 days were spent actually moving the data through the system.

From Phase I, when the analyst contact time for analyzing and processing a Landsat segment was 12 hours, the implementation of Procedure 1 reduced the contact time by almost a factor of 4 to slightly more than 3 hours. This reduction was largely a result of the more automated analyst functions discussed previously. Although more than three-fourths of the analyst's 12-hour contact time in Phase I was spent in functions other than labeling (such as batch deck preparation and visual clustering), the use of P-1 in Phase III has permitted the analyst-interpreter to spend only about one-half the 3-hour contact time in nonlabeling activities and has automated many of the time-consuming functions such as clustering, a function that the analyst did not do well. Based on the systems performance achieved to date and the trend toward rapidly improving efficiency, there are good reasons to project a cost-effective operational system design.

### ACCURACY OF LACIE ESTIMATES

The accuracy of each LACIE estimate is specified by the probability that it will be to within  $\pm X$  percent of the true estimate. The at-harvest accuracy

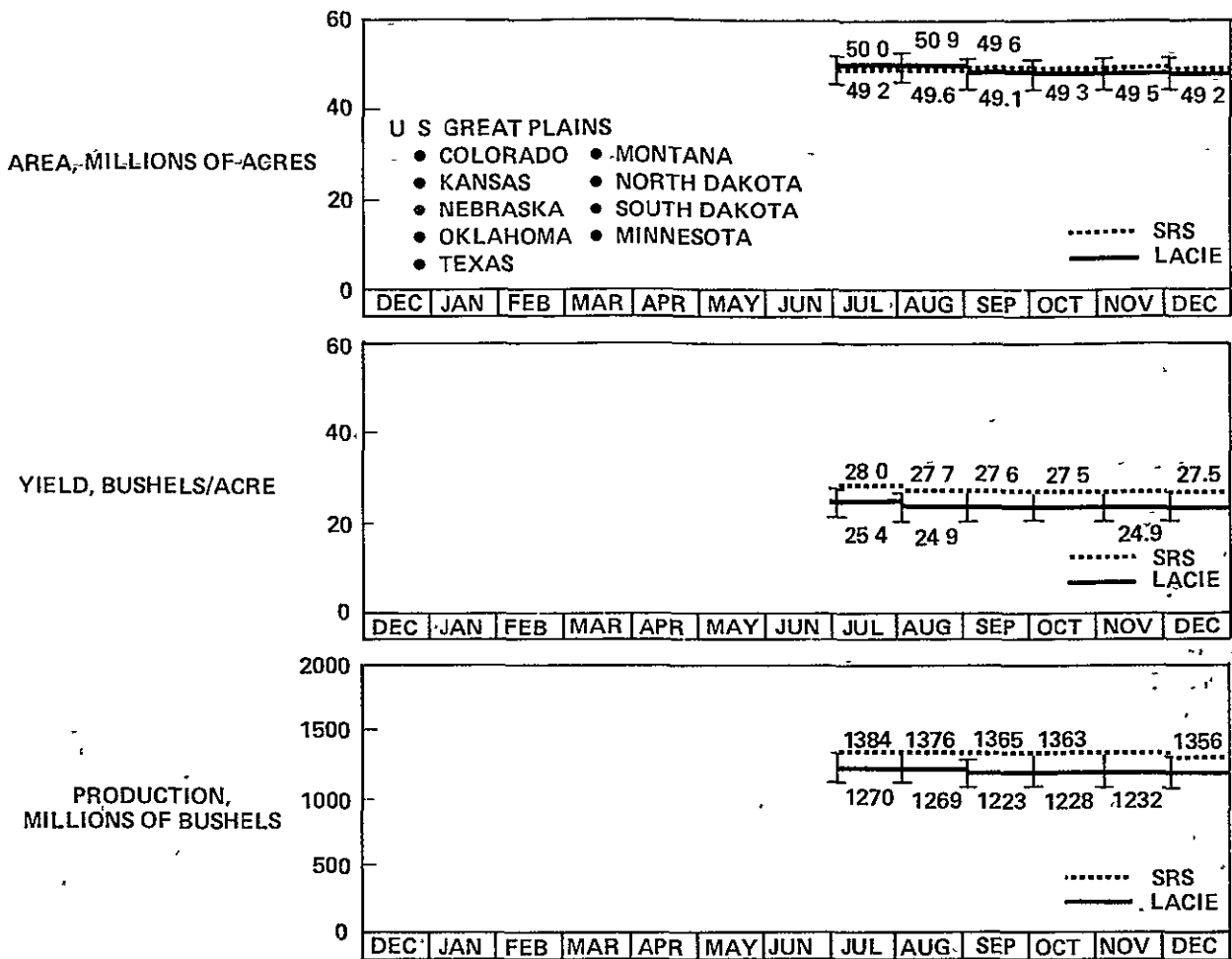

(a)

FIGURE 9.—Monthly comparison of LACIE and SRS Phase III estimates. Error bars represent  $\pm 1$  standard deviation (a) USGP, nine states. (b) Southern Great Plains. (c) Northern Great Plains.

however, reflect a tendency of LACIE to underestimate the yields. This tendency, in turn, is responsible for an underestimate of USGP total wheat production. The final SRS estimate of 1.36 billion bushels was some 10 percent above the at-harvest LACIE estimate of  $1.20 \pm 0.06$  billion bushels for this same region. This relative difference of -10 percent is not necessarily indicative of a persistent bias of similar magnitude. (In some test years, the LACIE yield estimates have exceeded those of SRS.) But it is likely that there is some negative bias. The LACIE USGP production estimate had a CV of 5.2 percent. On the basis of the earlier discussion and figure 8, a bias of -3.6 percent can be tolerated and still satisfy 90/90. A statistical test indicates that under the hypothesis that the LACIE estimator is no more

negatively biased than -3.6 percent, the probability is 0.13 of encountering a relative difference more negative than 10 percent in any one trial year. Thus, it cannot be concluded that there is a bias in the LACIE estimator large enough to cause more than 1 of 10 estimates to fall outside the  $\pm 10$ -percent accuracy bounds required by the 90/90 criterion. Similar analyses indicate that even with a bias as large as -10 percent, the variability of 5.2 percent is small enough to produce estimates to within  $\pm 15$  percent in 9 of 10 years. Thus, it would appear from these analyses that the LACIE estimate of USGP total wheat marginally satisfies 90/90.

As shown in figure 9(b), the LACIE estimates for the five-state U.S. Southern Great Plains (USSGP) winter wheat production agreed very well with the



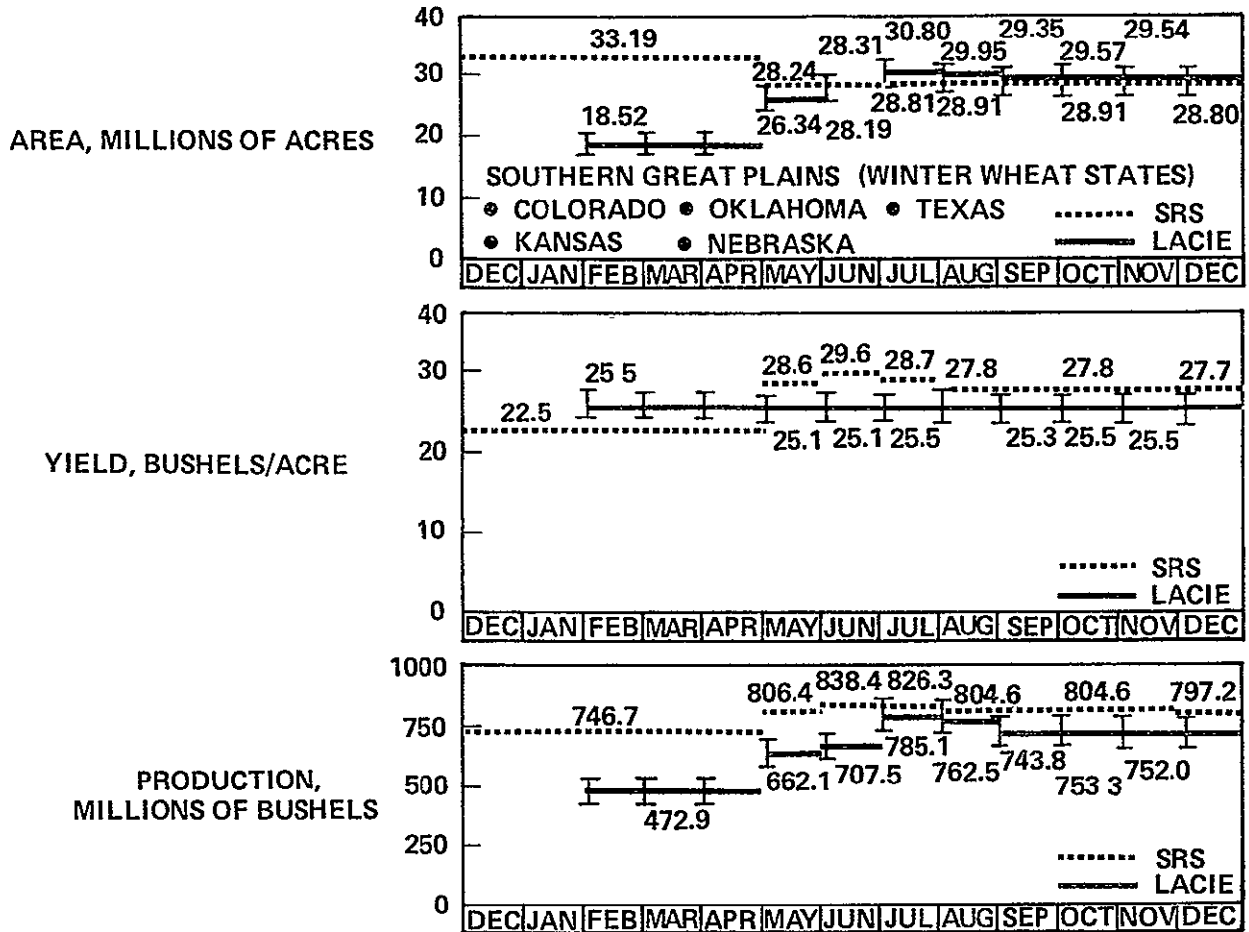

(b)

FIGURE 9.— Continued

SRS final estimate from the June report through harvest, achieving the 90/90 performance levels 1.5 to 2 months before harvest. June is the release date of the report. The wheat area estimates on which the report is based used Landsat data acquired through April, 1.5 to 2 months before harvest.

The LACIE production estimate for the four-state U.S. Northern Great Plains (USNGP) region (fig 9(c)) was significantly lower than the SRS figure, a result of a moderate underestimate of both spring wheat area and yield. Although the LACIE area estimates in these four states were within 10 percent of the SRS estimates from the August report forward (based on Landsat data acquired 1 to 1.5 months before harvest), they did not converge to the SRS as in the winter wheat states. However, it can be stated

that the Phase III at-harvest difference is significantly smaller than that observed in Phase II for these same states and marginally supports the 90/90 criterion.

This improved performance in the Phase III area estimation technology is also borne out by the results of the blind-site comparisons. Figure 10 shows charts plotting the differences between the areal percent of wheat estimated by LACIE and those determined from ground observations. These charts indicate that the Phase III winter wheat area estimates are relatively unbiased. (A slight negative bias is indicated statistically.) Significant improvement for spring wheat estimation is also shown, although segments with wheat areal percentages greater than about 25 percent are underestimated. Preliminary

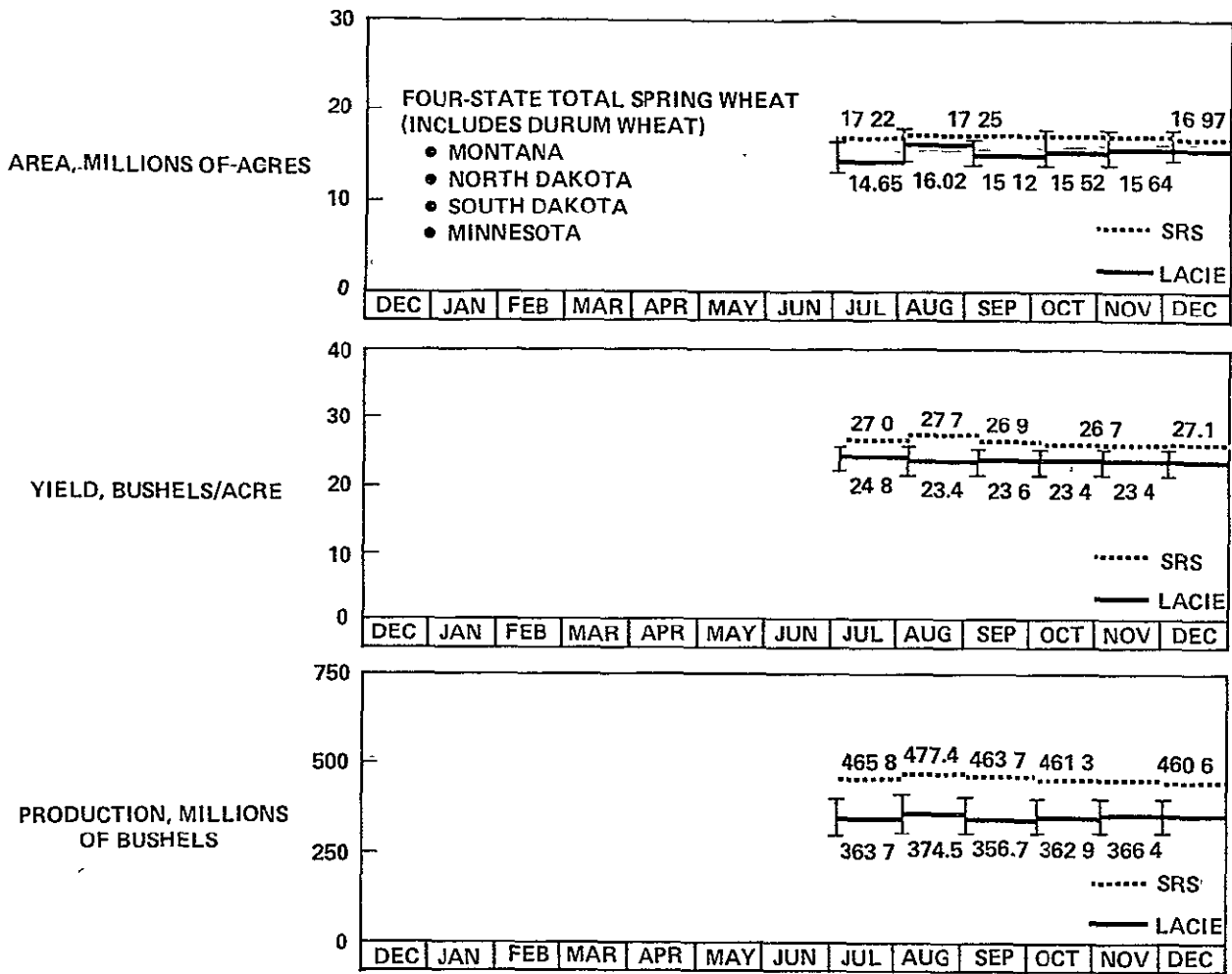

(c)

FIGURE 9.— Concluded.

investigations of these spring wheat blind sites indicate that these underestimates are a residual tendency of the analyst-interpreter to miss small-grains signatures. Once again, these investigations indicate that the strip-fallow fields, narrow in comparison to the Landsat resolution, are a major source of the problem.

With regard to the Phase III underestimate of the yield, state-by-state comparisons indicate that the major regions being underestimated are the Texas and Oklahoma panhandle regions, Minnesota, and Montana. Earlier discussions in this paper have indicated the general nature of the problems with these models, and the Phase III underestimates are manifestations of the errors inherent to these simple first-generation models. It is worth mentioning,

however, that perhaps the performance of these models would be greatly improved by altering their trend terms.

Most of the USGP yield models account for no trend toward increasing yields in the last few years. For example, the LACIE Texas model shows no average increase in yield since 1960. In fact, the amount of irrigated hectareage in that state has increased from almost none in 1960 to nearly 25 percent of the total hectareage in 1977. Such disparities have resulted in a steadily increasing divergence between the LACIE and SRS yield estimates. In LACIE Phase I, the LACIE yield estimates were some 4 percent larger than those of the SRS. In Phase II, this difference decreased to 1 percent, and in Phase III, LACIE and SRS differ by some 10 percent.

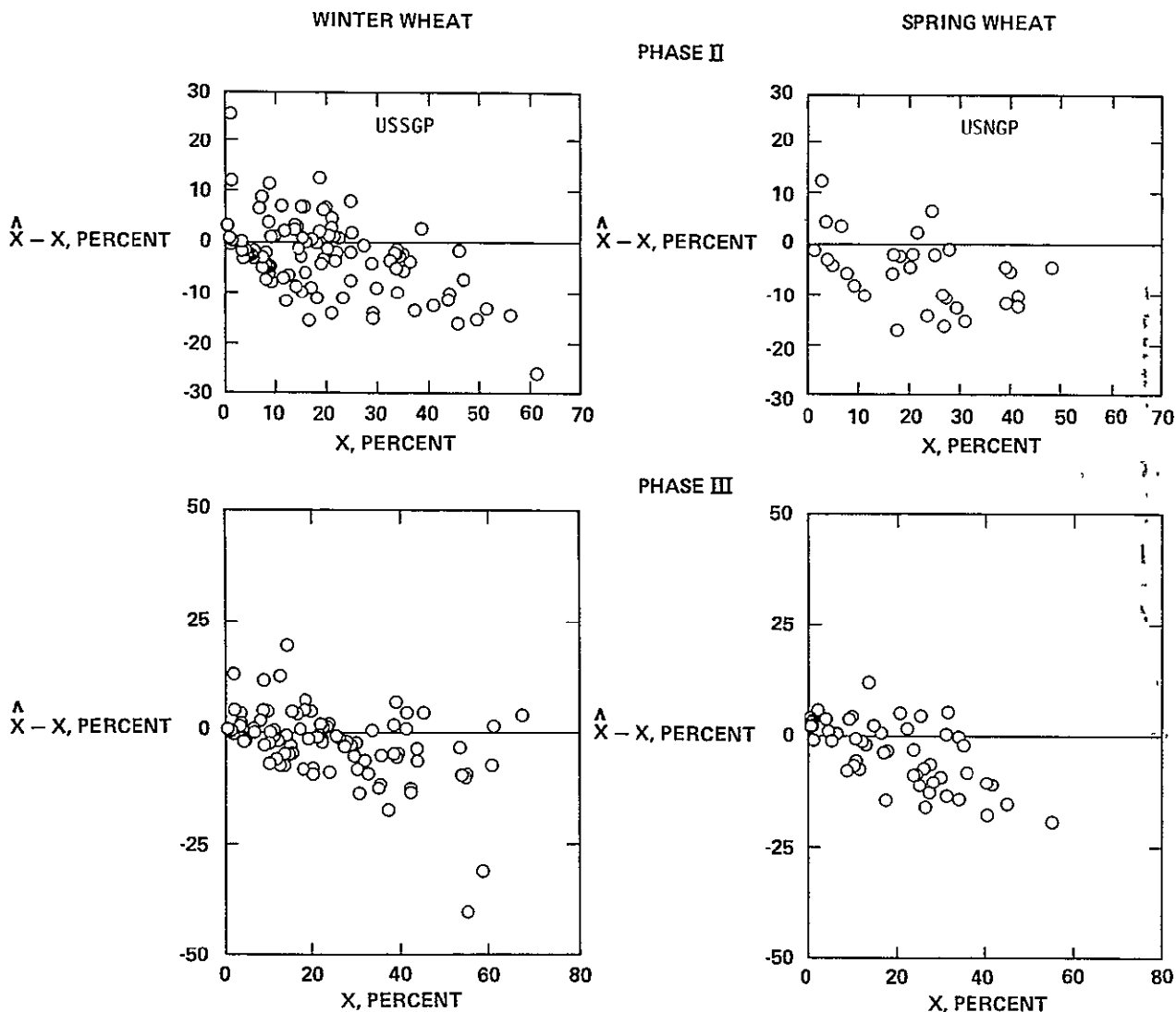

FIGURE 10 —LACIE wheat proportion estimates versus blind-site ground truth for Phases II and III.

With simple corrections for this factor, the LACIE yield estimator may be capable of marginally supporting the 90/90 criterion with the remaining problem of overestimating or underestimating in years with extremely poor or extremely good growing conditions over a significant portion of the survey region

#### Accuracy of U.S.S.R. Wheat Estimates for Phase III

Of all the LACIE results and accomplishments, perhaps the most important was the demonstration that LACIE technology can provide dramatically im-

proved wheat production information in important global regions and can respond in a timely manner to large weather-induced changes in production. The most graphic example of this capability occurred in the 1977 LACIE inventory of the wheat crop in the U.S.S.R.

In 1977, the LACIE experimental commodity production forecast system was utilized to monitor the U.S.S.R. total country wheat production from the early season through harvest. Commodity production forecasts for winter wheat were generated and released to the LACIE Project Office of the USDA in Washington, D.C., the day prior to the corresponding public release by the USDA Foreign Agricultural Service (FAS). LACIE initiated forecasts for U.S.S.R.

winter wheat production on April 1, 1977, the initial LACIE forecast for spring and total wheat was released on August 8, 1977. Shown in figure 11 are the LACIE in-season forecasts for U.S.S.R. total wheat, the FAS forecasts, and the LACIE recomputed estimates generated after harvest but before the USSR wheat release. The recomputed estimates are the seasonal forecasts obtained from the LACIE system after correction of two Landsat data problems encountered during the Phase III operation: a 45- to 60-day processing backlog and missing data resulting from an inadvertent omission in a Landsat data order.

The initial 1977 LACIE in-season forecast of total USSR wheat production, released on August 8, 1977, was 97.6 million metric tons (MMT), more than 11 percent below the most recent FAS July projection but only 6 percent above the final USSR wheat figure of 92.0 MMT. The final LACIE estimate of 91.4 MMT differed from the USSR final figure by about 1 percent. The wheat production forecasts released by the FAS are shown in figure 11. In comparison to the accuracy and timeliness of USSR information currently available without LACIE technology, LACIE Soviet forecast accuracies demonstrate an important advance in the problem of global commodity production forecasting.

Without the reliable data sources and repeatable analysis techniques tested in LACIE, commodity production forecast techniques must rely heavily on statistics and reports released by the countries themselves. Disregarding questions as to the reliability of

TABLE IV—U.S.S.R. Wheat and Total Grains Production for the Years 1971 to 1976<sup>a</sup>

Year	Wheat production, MMT			Grain production, <sup>b</sup> MMT	Ratio wheat to grain production percent
	Winter	Spring	Total		
1971	47 787	50 973	98 790	181 175	54.5
1972	29 380	56 613	85 993	168 238	51.1
1973	49 435	60 349	109 784	222 530	49.3
1974	44 698	39 215	83 913	195 708	42.9
1975	36 651	29 573	66 224	140 118	47.2
1976	44 594	52 288	96 864	223 755	43.3
Av	42 091	48 166	90 264	188 587	47.9

<sup>a</sup>U.S.S.R. Agricultural Situation Review of 1977 and Outlook for 1978. USDA I SCS April 1978.

<sup>b</sup>Grains include wheat, rye, barley, oats, corn, and other grains.

such information, perhaps the major problem is its timeliness. The USSR releases only a planning figure for total grains production early in the year and a postharvest estimate of total grains production in early November; wheat statistics are not released until January or February after harvest.

In January 1977, the USSR released a 213.3-MMT planning figure for total grains, about 13 percent above the 1971-76 average shown in table IV. Since wheat had historically comprised 48 percent of the total grains, the original USSR goal would have contained about 102 MMT of wheat. FAS estimates of total wheat began at about 97 MMT in February 1977 (ref. 17). The FAS carried a total grains forecast of 224 MMT, which was significantly above the USSR figure of 213.3 MMT. The FAS steadily increased its wheat forecasts to a high of 110 MMT in the July 8 report (ref. 18), primarily in response to its assessment of a much better than average USSR winter wheat crop and a forecast of an average to above-average spring wheat crop. As can be seen in figure 11, the FAS decreased the USSR forecast from the July figure of 110 MMT by about 5 MMT per month thereafter; the reduction on August 10 (ref. 19) was primarily in response to June and July drought conditions in the spring wheat regions. The 5-MMT reduction in September was primarily in response to a mid- to late-August official USSR release of winter wheat acreage information (ref. 20). The data compiled about June 1 by the USSR indicated a loss of winter wheat acreage due to winterkill during the harsh USSR winter. The final FAS release on October 20, 1977 (ref. 21) carried a wheat

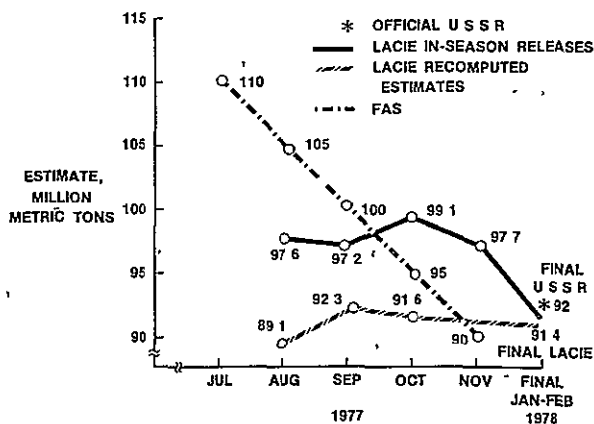

FIGURE 11—LACIE Phase III U.S.S.R. total wheat production results for 1977 compared to FAS and official U.S.S.R. estimates.

estimate of 95 MMT and an estimate of total grains at 215 MMT

On November 2, 1977, Chairman Brezhnev announced that U.S.S.R. total grains production was expected to be only 194 MMT. The U.S.S.R. had missed its target figure by 19 MMT, the FAS estimate of 2 weeks prior exceeded the figure by 21 MMT. In late January 1978, the U.S.S.R. announced its 1977 wheat production at 92 MMT, winter wheat at 51.9 MMT (9.8 MMT above average, as shown in table IV), and spring wheat at 40.1 MMT (8.1 MMT below average).

The July USDA Task Force wheat forecast had exceeded the U.S.S.R. wheat figures by 18 MMT. Both the FAS winter wheat and spring wheat seasonal forecasts had been considerably above the U.S.S.R. figures. A review of the FAS reports indicates that unanticipated loss of winter wheat acreage to winterkill and a misreading of poor harvesting conditions were the primary causes of the FAS winter wheat overestimate and that the spring wheat overestimate was a result of misreading the impact and the extent of the drought which affected a majority of the spring wheat region in the U.S.S.R.

The early-season May and June LACIE forecasts for U.S.S.R. winter wheat ranging from 51 to 55 MMT were indicating a near-record winter wheat crop (table V(a)). The LACIE winter wheat estimate of 21 million hectares indicated a 15-percent increase in U.S.S.R. plantings above average<sup>2</sup> and a 22-percent increase over the 1976 figure. In addition, LACIE yield forecasts stood at 25.5 quintals per hectare, 11 percent above the U.S.S.R. average.<sup>2</sup> Given that the U.S.S.R. could produce a spring wheat crop near its 48-MMT average,<sup>2</sup> its 1977 total wheat production would achieve near-record proportions of 100 to 105 MMT. The LACIE system was then focused on the U.S.S.R. spring wheat crop. The early-season August estimate of 39 million hectares indicated an almost 9-percent decrease from average in the U.S.S.R. spring wheat planting. This, combined with the LACIE yield model forecasts of a surprising 12.5-percent decline in yield from average,<sup>2</sup> indicated that the U.S.S.R. spring wheat crop would fall a disastrous 30 percent below average.<sup>2</sup> If these trends held, the U.S.S.R. would achieve only an average total wheat crop.

<sup>2</sup>For the years 1971 to 1976, averages are given in Foreign Agricultural Economic Report 132, Economic Research Service, April 1977.

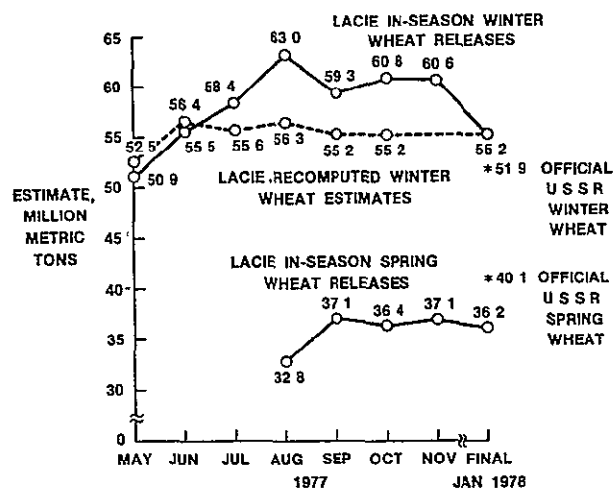

FIGURE 12—The contributions of LACIE U.S.S.R. winter and spring wheat production estimates for 1977 to the total production results (fig 11)

As figure 12 shows, the LACIE winter wheat forecasts had increased from the May to June report. On the basis of LACIE forecast experience in the United States, the increase was a result of steadily increasing visibility to Landsat of the wheat crop as it completed its early spring development. However, the continued increase in winter wheat hectareage forecasts through July and August was known to be the result of a system problem since such increases had no known physical basis. Thus, LACIE analysts, alerted to technical problems, initiated efforts to isolate the source of this apparent increase. The spring wheat estimates seemed to be unaffected by the problem; they stabilized after the August forecast as expected. LACIE in-season forecasts were continued as usual even though the winter wheat forecasts were believed to be inflated by a few percent.

The winter wheat problem was quickly isolated as being the result of an inadvertent omission in the Landsat data acquisition order from JSC to the NASA Goddard Space Flight Center for the U.S.S.R. wheat region above the 48th parallel. The failure to order these acquisitions affected accuracies in about 20 percent of the U.S.S.R. winter wheat sample segments. In these segments, Landsat data was not acquired during March and April, the winter wheat greening and recovery period following dormancy. As a result, the Landsat analysts could not differentiate between winter wheat and spring grains, such as barley, which by May had already emerged sufficiently to be confused with winter grains. Fortunately, the effect was only a few percent and the

real-time LACIE forecasts for winter wheat remained reasonably accurate. To evaluate the effect of the data order error, "recomputed estimates" were generated in December 1977 to obtain the seasonal estimates which would have resulted from the LACIE system if planned Landsat data orders for winter wheat had been correctly placed. To generate the recomputed estimates, winter wheat areas for those segments affected by the faulty data orders were computed utilizing the original segment area estimates as estimates of the total small grains. The total grains estimates were then reduced to winter wheat figures, using historical ratios of winter wheat to total small grains area. Additionally, a problem arising from the 45- to 60-day Landsat data processing backlog observed in Phase III was removed by utilizing for each report Landsat data acquired up to 30 days before the reporting date. No Landsat data order problems existed for the spring wheat forecasts. Recomputed estimates for spring wheat are not significantly different from the in-season forecasts. The recomputed LACIE winter wheat area, yield, and production estimates are in very good agreement with the U.S.S.R. figures, as shown in table V(a). Early, midseason, and at-harvest forecasts of area, yield, and production differ from the U.S.S.R. forecasts by only a few percent. Table V(b) shows similar good agreement with the LACIE spring wheat forecasts released during the season. The August through final LACIE forecasts of U.S.S.R. total wheat were also in good agreement (table V(c)) and support the 90/90 accuracy criterion. It should be emphasized that the total wheat forecasts given in table V(c) use recomputed winter wheat estimates and real-time in-season releases for spring wheat. Total wheat estimates were also generated using recomputed estimates for both spring and winter wheat. These will not be treated here because the spring wheat recomputed estimates do not differ significantly from the real-time in-season releases. These estimates are treated in full in various LACIE accuracy assessment documents.

A more detailed examination of the response of the LACIE wheat yield models to the 1977 meteorological conditions in the U.S.S.R. indicates that these models responded to both significantly above- and below-average growing conditions in U.S.S.R. wheat regions, accurately predicting a final yield about 13 percent above average. These models responded realistically to below-average growing conditions in the spring wheat regions, accurately predicting a final yield 22 percent below average.

Clues to the potential shortfall in the U.S.S.R. spring wheat region came early in the season when unfavorable weather conditions began. The average air temperature for the 2-month period of May and June was considerably above normal throughout the spring wheat area as shown in figure 13. During the same period of May and June, rainfall was below average in many of the crop regions noted in figure 14. The above-average demand for moisture, combined with the below-average supply, indicated a potential shortfall early in the season. Figure 15 highlights the instances in which the supply-demand difference deviated the most from average. The differences between precipitation and potential evapotranspiration are used in the LACIE yield models to represent relative soil moisture available to the crop. As figure 15 indicates, significant drought effects were forecast in the eastern and southern crop regions. An investigation of the Landsat data at subregional levels indicated that the drought conditions were clearly observable in the Landsat data. An examination of the yield model responses indicates that the LACIE yield models responded by reducing yield estimates in the affected regions. Figure 16 displays the model yield reductions by crop region in response to the pre-season through harvest weather conditions. Note the severe reductions in yield in the affected regions, in many cases 50 percent below normal. In figure 17, it can be seen that these drought conditions were also quite evident in the Landsat data. In this figure, Landsat

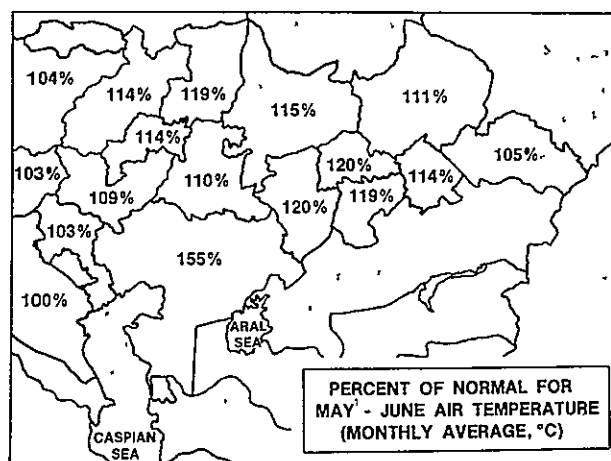

FIGURE 13.—Percent of average for May-June 1977 air temperatures in U.S.S.R. spring wheat regions. The percentage values were obtained by dividing the 1977 May-June average by the long-term May-June average.



TABLE V.—Comparison of LACIE Seasonal and U.S.S.R. Final Estimates For Phase III

(a) U.S.S.R. winter wheat—1977 recomputed estimates

(b) U.S.S.R. spring wheat—1977 in-season LACIE forecasts

Estimate	Area, million hectares	Yield, quintals/ hectare	Production, MMT
<i>Final (February 1978)</i>			
U.S.S.R.	20.7	<sup>a</sup> 25.1	51.9
<i>Early season (April)<sup>b</sup></i>			
LACIE	21.3	24.3	51.7
Relative difference, <sup>c</sup> percent	(2.8)	(-3.3)	(-0.4)
Coefficient of variation, percent	(6.3)	(4.4)	(7.0)
<i>Midseason (June)<sup>b</sup></i>			
LACIE	22.1	25.6	56.4
Relative difference, <sup>c</sup> percent	(6.3)	(2.0)	(8.0)
Coefficient of variation, percent	(4.5)	(4.2)	(5.7)
<i>At-harvest (October)<sup>b</sup></i>			
LACIE	21.6	25.6	55.2
Relative difference, <sup>c</sup> percent	(4.2)	(2.0)	(6.0)
Coefficient of variation, percent	(2.5)	(3.6)	(4.2)
<i>Final (January 23, 1978)</i>			
LACIE	21.5	25.6	55.2
Relative difference, <sup>c</sup> percent	(3.7)	(2.0)	(6.0)
Coefficient of variation, percent	(2.5)	(3.6)	(4.2)

Estimate	Area, million hectares	Yield, quintals/ hectare	Production MMT
<i>Final (February 1978)</i>			
U.S.S.R.	41.3	<sup>a</sup> 9.7	40.1
<i>Early season (August)</i>			
LACIE	38.9	8.9	34.6
Relative difference, <sup>c</sup> percent	(-6.2)	(-9.0)	(-15.9)
Coefficient of variation, percent	(3.5)	(8.7)	(9.2)
<i>Midseason (September)</i>			
LACIE	41.0	9.3	37.9
Relative difference, <sup>c</sup> percent	(-0.7)	(-4.3)	(-5.8)
Coefficient of variation, percent	(2.9)	(7.1)	(7.2)
<i>At-harvest (October)</i>			
LACIE	42.6	9.0	38.3
Relative difference, <sup>c</sup> percent	(3.1)	(-7.8)	(-4.7)
Coefficient of variation, percent	(2.6)	(6.9)	(7.0)
<i>Final (January 23, 1978)</i>			
LACIE	41.4	8.8	36.3
Relative difference, <sup>c</sup> percent	(0.0)	(-10.2)	(-10.5)
Coefficient of variation, percent	(2.3)	(7.0)	(7.2)

<sup>a</sup>Derived from ratio of production to area—no U.S.S.R. figures available

<sup>b</sup>Based on Landsat data acquired through the first day of the previous month

<sup>c</sup> $((LACIE - U.S.S.R.) \div LACIE) \times 100$

<sup>a</sup>Derived from ratio of production to area—no U.S.S.R. figures available

<sup>c</sup> $((LACIE - U.S.S.R.) \div LACIE) \times 100$

TABLE V—Concluded

(c) U.S.S.R. total wheat—1977

Estimate	Area, million hectares	Yield, quintals/hectare	Production, MMT
<i>Final (February 1978)</i>			
U.S.S.R.	620	<sup>a</sup> 14.8	920
<i>August</i>			
LACIE	610	14.9	90.9
Relative difference, <sup>c</sup> percent	(-1.6)	(0.7)	(-1.2)
Coefficient of variation, percent	(-2.6)	(-)	(-4.3)
<i>September</i>			
LACIE	62.6	14.9	93.1
Relative difference, <sup>c</sup> percent	(1.0)	(0.7)	(1.2)
Coefficient of variation, percent	(1.9)	(-)	(3.9)
<i>October</i>			
LACIE	64.2	14.6	93.5
Relative difference, <sup>c</sup> percent	(3.4)	(-1.4)	(1.6)
Coefficient of variation, percent	(1.8)	(-)	(3.8)
<i>Final (January 23, 1978)</i>			
LACIE	62.9	14.5	91.4
Relative difference, <sup>c</sup> percent	(1.4)	(-2.1)	(-7)
Coefficient of variation, percent	(1.8)	(-)	(3.8)

<sup>a</sup>Derived from ratio of production to area—no U.S.S.R. figures available  
<sup>c</sup> $((LACIE - U.S.S.R.) \div LACIE) \times 100$

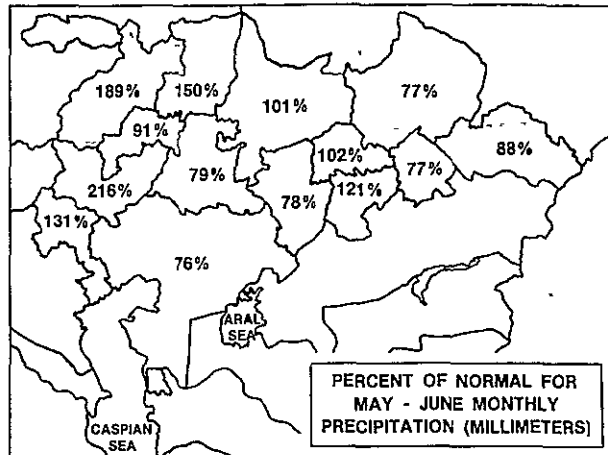

FIGURE 14.—Percent of normal for May-June 1977 monthly precipitation in U.S.S.R. spring wheat regions.

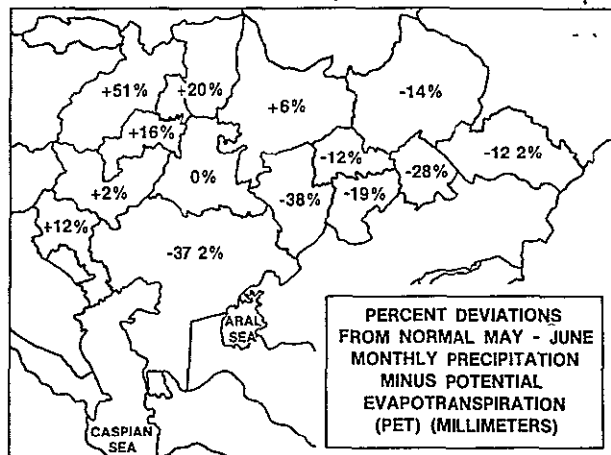

FIGURE 15.—Percent deviation from normal May-June monthly precipitation minus potential evapotranspiration (computed using the Thornthwaite method) for U.S.S.R. spring wheat regions during 1977

radiometric measurements known to be related to the crop canopy condition indicated that the shaded areas, which contained a significant share of the wheat acreage in regions 21, 22, 23, 24, 25, 27, and 29, were under severe drought conditions. For these regions, LACIE yield models were forecasting below-average yields. For the northern regions, however, LACIE was forecasting above-average yields.

Figure 18 illustrates the drought effects visible on Landsat imagery of the affected area. The two segment images on the right, collected on July 4, 1977,

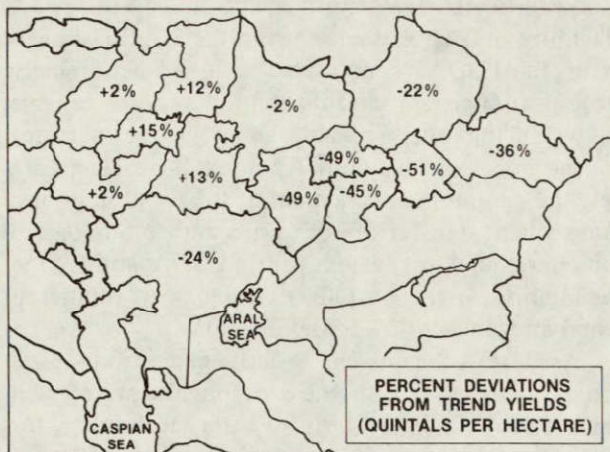

FIGURE 16.—Percent deviation from trend yields in 1977, assuming normal May-June weather and adjusted for trend as forecast by the LACIE U.S.S.R. spring wheat models.

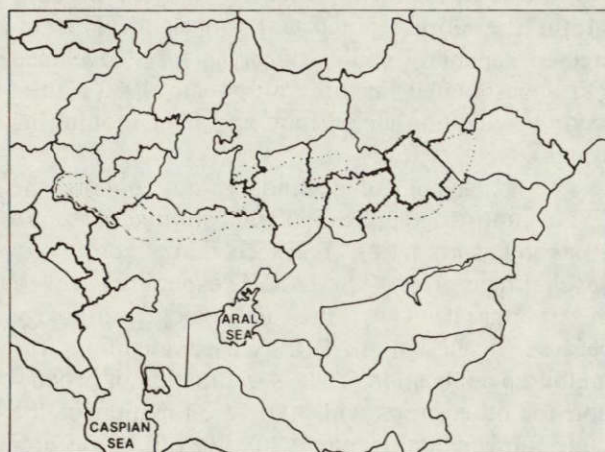

FIGURE 17.—Stressed vegetation areas (shaded) mapped from Landsat radiometric measurements of U.S.S.R. spring wheat areas in July 1977.

were from a normal moisture area (Omsk Oblast at the top) and from moisture-stressed areas (Kokchetav Oblast at the bottom). The effects of moisture stress are detectable by the lack of darkness (redness) in the image, an indicator of crop canopy condition. The image on the left collected in the previous year for the Kokchetav segment, when compared to the 1977 image, shows a dramatic decrease in crop vigor in 1977.

To quantitatively assess the impact of reduced spring wheat yield, the total wheat area growing in each of these crop regions had to be estimated. The

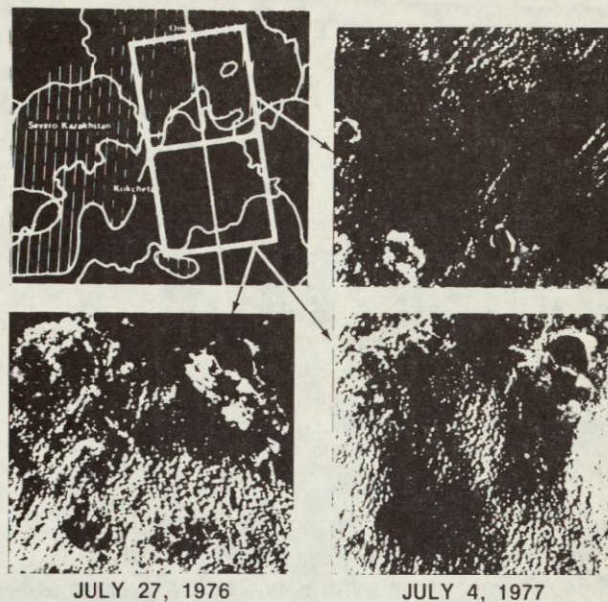

FIGURE 18.—Drought conditions as shown in Landsat imagery of two U.S.S.R. oblasts.

LACIE wheat area estimates for each region were multiplied by the forecast yield per hectare to obtain production estimates for each region. When these individual production figures were summed, the overall estimate of spring wheat production was 36.3 MMT, a deviation of about 21 percent below normal.

Although the LACIE models responded realistically to the 1977 departure in the U.S.S.R. spring wheat yields, there is some evidence to suggest that these models tend to underestimate the yield. For the period from 1955 to 1976, U.S.S.R. country-level spring wheat yield data seem to have a moderately strong trend component, as shown by the linear best-fit trend line of figure 19. The LACIE models, which used data no more recent than 1973,<sup>3</sup> show the trend to level off after 1973 and thus project a trend value of 1.2 quintals per hectare below the linear trend projection. Thus, it would appear that if a larger trend value had been used, the LACIE final spring wheat yield estimate would have been in closer agreement with the U.S.S.R. estimate. Note, however, from figure 19 that the LACIE yield models did respond to the adverse weather with

<sup>3</sup>LACIE U.S.S.R. yield models were developed at the crop region level. At the time of their development, the most recent data available were for 1973.



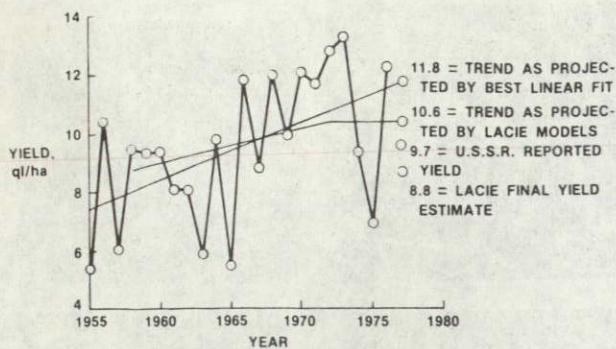

FIGURE 19.—Trend series of historical U.S.S.R. spring wheat yields and alternative trend lines.

forecasts 1.8 quintals per hectare below the LACIE trend projections. This response is due primarily to above-average temperatures and below-average precipitation in April and below-average available soil moisture in June. The above-average April temperature could not have directly affected the mid-May planted spring wheat crop. The yield forecast reduction due to April temperature may be unwarranted unless it is a statistical result of induced model correlations between April temperature and future seasonal conditions which reduce wheat yields; for example, a warmer-than-average April may imply a warmer-than-average May and June with a correspondingly shorter wheat development cycle. Such correlations would be manifest as terms in the LACIE yield models.

## FUTURE PLANS

As currently envisioned, LACIE is a major step toward developing a remote-sensing-survey technology capable of global food and fiber monitoring. The contribution of LACIE is a demonstration of "proof of concept" of this new technology for significantly improving currently available information on one major global crop—wheat. As of the end of LACIE Phase III, the experiment has demonstrated the utility of remote-sensing-survey technology over several countries, has identified key areas of the technology that need improvement, and has brought the USDA advanced system to a point of initial testing. The effort to transfer LACIE technology to the USDA was begun early in Phase II. Designated "LACIE transition," this effort continues after Phase III in order to complete, document, and make

an orderly transfer of proven technology to USDA facilities and personnel. During the LACIE transition, the USDA "constructed" and is operationally testing first-generation information systems capable of producing timely, reliable, and objective estimates of the global wheat supply. The next logical steps are (1) the continuing refinement of the technology and subsequent transfer of both skills and technology to an operational test system within USDA, and (2) the adaptation of the LACIE technology to multicrop food and fiber inventory applications.

As USDA begins an orderly expansion of its operational test system, the experimental system will be used to refine the wheat-inventory technology for important wheat-producing regions. This will validate the technology before transfer to the USDA and adapt it to inventory production of other food and fiber crops. These include corn, rice, soybeans, and inventories of nonfood crops such as forest products. It will also be adapted to monitor forage conditions within the world's important rangeland. This increased capability could conceivably be developed and incorporated in the mid-to-late 1980's in a second-generation global food and fiber monitoring system.

The expansion of technology to support the USDA multicrop application will continue to require a strong supporting research and technology development effort. The LACIE experience will be the fountainhead for the developing technology because, by design, LACIE is a paradigm for the multicrop application. That is, estimation of production for other crops will involve estimation of the same fundamental elements involved in wheat production estimation—crop area, average plant or producing unit population per unit area, and average productivity per producing unit. It should be emphasized that the estimation approach used to date in LACIE is not the only approach which can be taken to estimating these quantities. And, quite possibly, modifications of the LACIE approach will produce a more optimum survey approach for applications different than global wheat estimation. However, all such approaches will involve to a large extent the same data input and analysis systems required for LACIE, as well as many of the same solutions to technology problems.

To be more specific, the LACIE approach to date has used primarily Landsat data to estimate wheat area for harvest and primarily meteorological data to estimate the average productivity, or yield, for each hectare harvested. In a sense, this separation is ar-

- 3 Scope and Methods of the SRS US Department of Agriculture, SRS no 108, Washington, D C , 1975
- 4 Ray, R M , III, and Huddleston, H F Illinois Crop-Acreage Estimation Experiment Proceedings of Symposium on Machine Processing of Remotely Sensed Data, IEEE, New York, 1976, pp PB-14 to PB-21
- 5 MacDonald, R B , Hall, F G , and Erb, R B The Use of Landsat Data in a Large Area Crop Inventory Experiment (LACIE) Proceedings of Second Symposium on Machine Processing of Remotely Sensed Data, C D McGillem, ed , IEEE, New York, 1975, pp 1B-1 to 1B-23
- 6 MacDonald, R B , Hall, F G , and Erb, R B The Large Area Crop Inventory Experiment (LACIE), An Assessment After One Year of Operation Proceedings of 10th International Symposium on Remote Sensing of Environment, Vol 1, ERIM, Ann Arbor, Mich , Oct 1976, pp 17-37
- 7 MacDonald, R B , and Hall, F G LACIE A Proof of Concept Experiment in Global Crop Monitoring Paper presented at Midcon/77 Electronic Show and Convention, Chicago, 1977
- 8 Austin, W W Detailed Description of the Wheat Acreage Estimation Procedure Used in the Large Area Crop Inventory Experiment Lockheed Electronics Co rept LEC-11497, Houston, Tex , 1978
- 9 Thompson, D R Large Area Crop Inventory Experiment (LACIE) Results of LACIE Integrated Drought Analysis (Southern US Great Plains Drought 1975-76) NASA TM X-74640, 1976
- 10 Thompson, D R Results of Large Area Crop Inventory Experiment (LACIE) Drought Analysis (South Dakota Drought 1976). NASA TM-74760, 1976
- 11 LACIE Wheat Yield Models for the United States NASA JSC rept LACIE-00431-Rev A, 1977
- 12 Sakamoto, C M , and LeDuc, S K LACIE Wheat Yield Models for the USSR NASA TM-74834, 1977
- 13 LeDuc, S K LACIE Yield-Weather Regression Models for the Canadian Prairies NASA TM-74833, 1976
- 14 Barnett, T L YES Phase I Feasibility Report NASA JSC rept LACIE-00439, 1977
- 15 Large Area Crop Inventory Experiment (LACIE) Phase I Evaluation Report NASA TM X-74226, 1976
- 16 Walters, H E , and Judy, R W Soviet Agricultural Output by 1970 Soviet and East European Agriculture, J F Karaz, ed , 1967, pp 306-344
- 17 Wheat Situation WS-239, USDA Economic Research Service, Feb 1977
- 18 Second Forecast of 1977 Soviet Grain Crop FG 10-77, USDA Foreign Agricultural Service, July 8, 1977
- 19 Third Forecast of the 1977 Soviet Grain Crop FG 12-77, USDA Foreign Agricultural Service, Aug 10, 1977
- 20 USDA Forecast of 1977 Soviet Grain Crop Unchanged FG 20-77, USDA Foreign Agricultural Service, Sept 29, 1977
- 21 World Grain Situation 1977/78 Crop and Trade Development FG 21-77, USDA Foreign Agricultural Service, Oct 20, 1977
- 22 Ulanova, S Y Utilization of Air Inspection Data on the State of Winter Wheat Over Large Areas for Harvest Forecasting Meteorologiya i Gidrologiya , no 8, Aug 1970, pp 64-72
- 23 Haun, J R Prediction of Spring Wheat Yields From Temperature and Precipitation Data Agronomy J , vol 66, May-June 1974, pp. 405-409
- 24 Feyerherm, Arlin M , Kanemasu, Edward T , and Paulsen, Gary M Response of Winter and Spring Wheat Grain Yields to Meteorological Variation—Final Report NASA CR-151429, Feb 1977
- 25 Sherwood, B I , Jackson, R D , and Reginato, R J Remote Sensing of Crop Yields Science, vol 196, Apr 1, 1977, pp 19-25



# LACIE Applications Evaluation System: A Design Overview

*J L Dragg,<sup>a</sup> W.E. Hensley,<sup>a</sup> R O. Hill,<sup>a</sup> R G. Musgrove,<sup>a</sup> and T. T White<sup>a</sup>*

## INTRODUCTION

The LACIE was a major effort toward the development and demonstration of the technology for an operational global crop inventory system. Specific planning for what eventually became the LACIE was initiated within NASA as early as 1973 and provided for the Applications Evaluation System (AES) — the quasi-operational<sup>1</sup> element of LACIE responsible for the acquisition and analysis of Landsat, meteorological, and ancillary data to make experimental estimates of wheat area, yield, and production and the assessment of the performance

A significant portion of the basic design and implementation of the AES was accomplished before the initiation of LACIE and was based on existing research and development components and experience. However, because no similar system had been previously designed, much of the knowledge had to be obtained within the LACIE experience, resulting in significant evolution from the initial system. That such a system was designed, implemented, and operated with the performance achieved within the time frame of LACIE is considered a major and significant accomplishment by LACIE participants. Numerous technological issues for an operational crop inventory system have been identified and resolved through the AES experience.

This paper describes the design of the AES and its evolution from an operational or data flow implementation perspective. Because the AES was

designed in an applications research and development context, no attempt should be made to equate the AES to a potential user operational system except for the fundamental technology involved

## OBJECTIVES

The objectives of the AES were primarily technical in nature. These objectives were to design, develop, and manage a demonstration data system to provide a timely continuum of production information for technology evaluation. Specific objectives were the following:

1 To provide, from an analysis of Landsat data acquired over a sample of the potential crop-producing area in major wheat-growing regions, estimates of the area planted to wheat; similarly, from an analysis of historical and real-time meteorological data over the same regions, to provide estimates of wheat yield and combine these area and yield factors to estimate production

2 To provide data processing and delivery techniques so that the selected samples can be made available to the analyst teams for initiation of analysis no later than 14 days after acquisition of the data. During the experiment, the goal was adjusted to learn how to acquire data and complete analysis all within a 14-day period to facilitate more timely reporting

3 To provide an AES design that will permit a minimum of redesign and conversion to implement an operational system within the U.S. Department of Agriculture (USDA)

4 To monitor and assess wheat progress (calendar) based on agricultural/meteorological (agromet) models using surface-based meteorological observations and evaluate the model potential for yield from surface data

5 To promote the advancement of the state of the art by identifying the key technical issues in remote-sensing crop inventory to be solved by supporting research and development.

<sup>a</sup>NASA Johnson Space Center, Houston, Texas

<sup>1</sup>"Quasi-operational" describes an experimental system which is technologically and functionally equivalent to an operational system. The quasi-operational AES extensively utilized existing hardware, software, and procedures to meet resource and schedule constraints while it also allowed for development and test of the technology.

## PERFORMANCE CRITERIA

Although the reliabilities of wheat production estimates in foreign countries had not been established, they were known to vary widely. The general goal was to demonstrate a significant improvement to current capabilities in major foreign countries. Discussions with commodity analysts of the USDA led to the establishment of the criterion that production estimates at harvest be within  $\pm 10$  percent of the true country production 90 percent of the time (referred to as the 90/90 criterion). Because key agricultural decisions are made throughout the crop year, an additional goal was to establish the accuracy of estimates from early season in the first quarter of the crop cycle through the harvest period. Other criteria applied to the estimates were that they would be objective and repeatable, minimizing subjective influences, and that the precision of the estimates would also be provided.

## TECHNICAL APPROACH

The basic technical approach of the AES (fig. 1) was to develop production, area, and yield estimates based on area analyses from Landsat data and yield estimation from worldwide weather data and to evaluate the accuracy of these estimates to verify where the technology was performing adequately and to isolate and identify the key technical issues where it was not. The integrating factor for the area, yield, and production approach was a sampling and aggregation strategy which allocated the sample segments (5 by 6 nautical miles) to be acquired by Landsat and analyzed for wheat area, defined the strata boundaries for yield models, and formulated the expansion (aggregation) of these estimates to regional and country levels. These aggregations were performed on a monthly basis throughout the crop season, resulting in commodity reports of area, yield, and production with estimated confidence limits. These reports were transmitted for user evaluation and accuracy assessment. Accuracy assessment was performed at two basic levels — large area (such as state, region, or country) where overall performance could be evaluated, and small area (such as segment or yield strata) where more detailed problem areas could be isolated. Although comparison to the USDA Foreign Agricultural Service (FAS) and foreign country estimates were made in foreign regions, the primary large-area assessments were

made over the US Great Plains (USGP) hard red wheat or "yardstick" region where highly reliable USDA Statistical Reporting Service (SRS) estimates are available. Collection programs through the USDA Agricultural Stabilization and Conservation Service (ASCS) provided data at the field level for the more detailed evaluations.

## IMPLEMENTATION AND DATA FLOW

In this section, the description of the basic technical approach is expanded from an implementation and data flow aspect. As illustrated in figure 2, the AES was a widely dispersed system designed to take advantage of existing facilities to keep initial investments down and adhere to schedule. Primary interagency management and integration of the AES was performed at the facilities of the NASA Johnson Space Center (JSC).

### Landsat Data Acquisition

The initiation of Landsat data acquisition (fig. 3) began at JSC. The sampling strategy defined the locations of the segments to be acquired, and the growing season defined the time frame of acquisition. The data acquisition information was transmitted via existing Apollo hard lines to the NASA Goddard Space Flight Center (GSFC), which commanded the satellite for multispectral scanner data acquisition each 18 days during the crop season. Data were, for the majority of LACIE, transmitted to ground receiving stations at the GSFC in Maryland, at Fairbanks, Alaska, and at Goldstone, California, either in real time or by use of the onboard tape recorders. During the latter parts of LACIE, ground stations in Rome, Italy, and in Rawalpindi, Pakistan, were utilized to conserve the onboard tape recorders. Data from the ground stations were shipped by air to the GSFC, where the Landsat preprocessing was performed. Segment-sized data were screened for cloud cover, registered to previous acquisitions, and extracted and transmitted in computer-compatible digital format to JSC for entry into an electronic data base. In addition, regenerated 70-millimeter black-and-white film for each multispectral scanner band was shipped to the USDA in Salt Lake City to be converted to 9-inch color-infrared film composites and shipped to JSC. The 9-inch composites were prepared approximately four times per crop season.

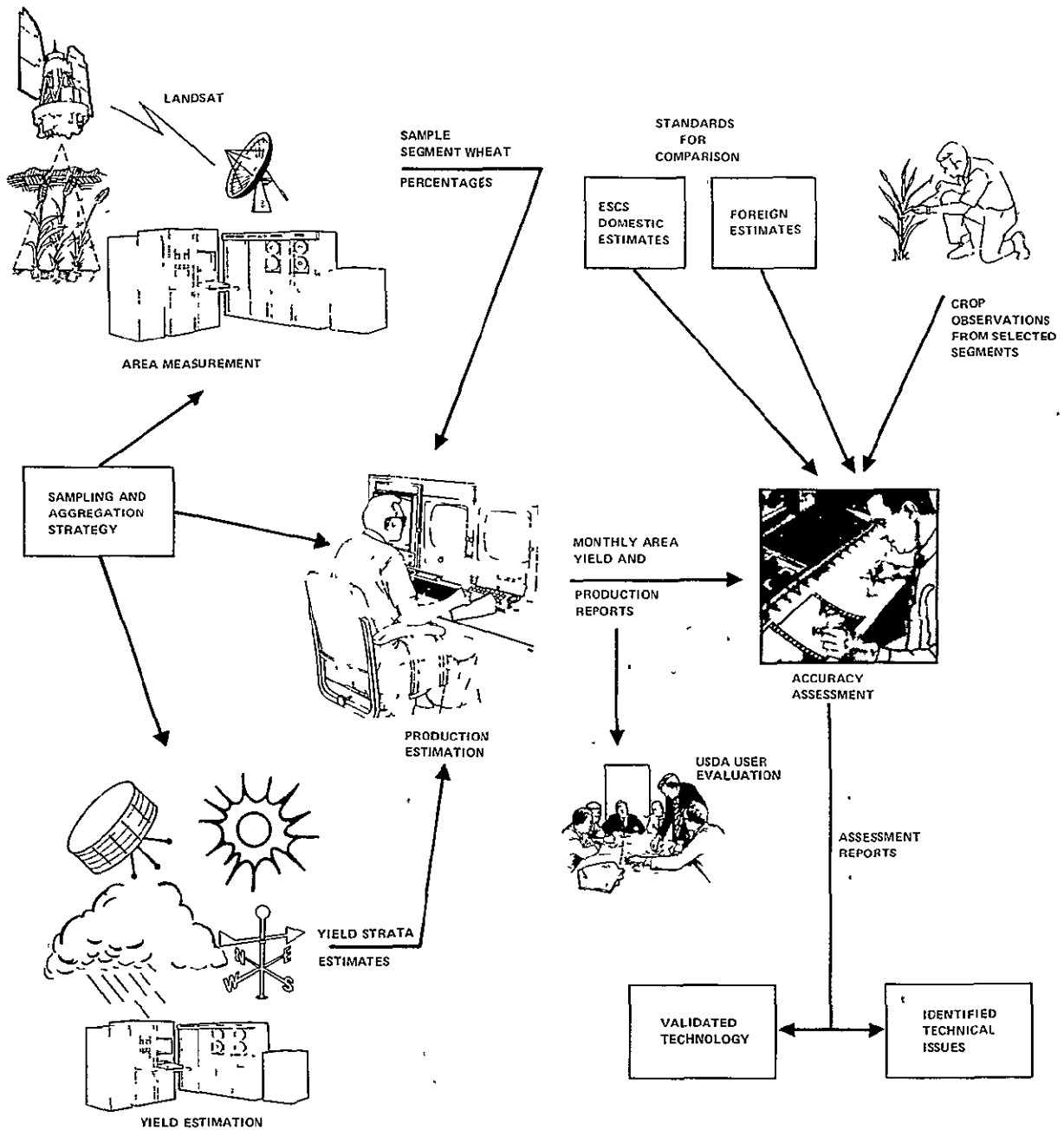

FIGURE 1.—Basic technical approach of the AES.

### Landsat Analysis for Area Estimation

The analysis of the Landsat data was performed at the JSC (fig 4), where procedures had been designed and personnel had been trained in the analysis of Landsat data for crop identification and mensura-

tion. The analysis was basically a four-step process. First, the Landsat hard-copy and ancillary data were prepared and assembled into packets to be used by a trained analyst to identify crops without in situ ground-truth information. The assembled Landsat data included the available full-frame (100- by 100-



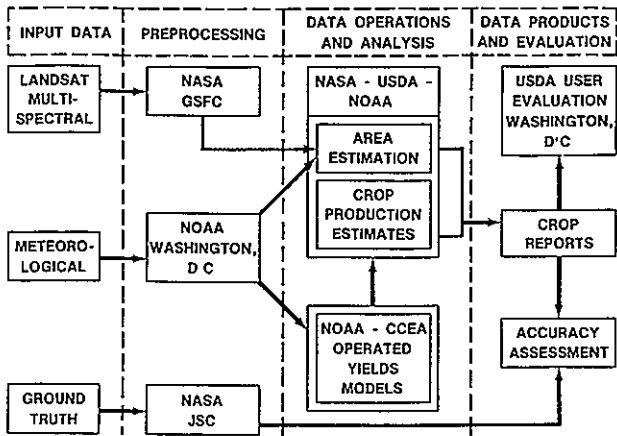

FIGURE 2—General implementation and data flow of the AES

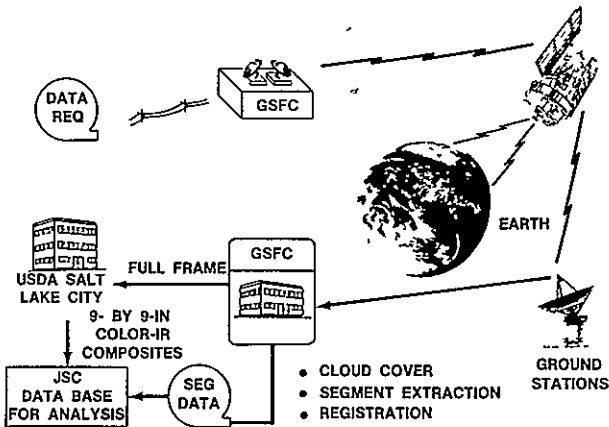

FIGURE 3.—Landsat data acquisition for area

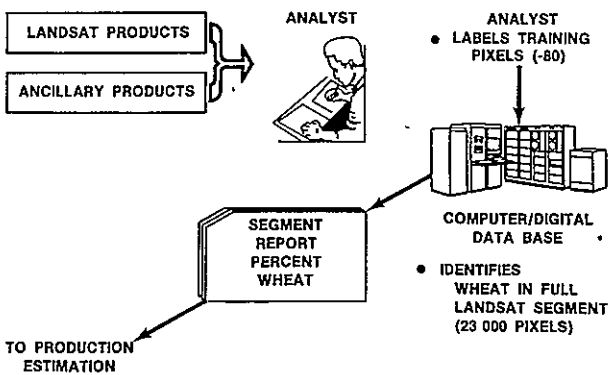

FIGURE 4—Landsat analysis for area estimation.

nautical-mile) color-infrared film, segment-level color-infrared film products generated from digital data at JSC after receipt of acquisitions from GSFC,

and graphic and numerical plot data of multispectral scanner response generated at JSC for the segment acquisitions. Ancillary data included available historical agronomic information on crop calendars, cropping practices, field size, etc., adjustments to the normal wheat crop calendar based on current-year weather, and summaries of the meteorological conditions for the current crop year. The second step in the analytical process was the labeling, based on experience, established procedures, and the data available, of approximately 0.5 percent of the segment data elements (approximately 80 pixels). These were identified as being wheat or nonwheat, or small grains or non-small-grains.<sup>2</sup> Third, the analyst labels were input to a computer to train a pattern recognition algorithm to identify as wheat or nonwheat all the data elements (approximately 23 000-pixels) of the Landsat segment. The results were tabulated as a percentage of wheat for the entire segment. The final step was the evaluation by the analyst of the result as acceptable, before submitting the data for production aggregation.

### Meteorological Data Acquisition

The overall implementation and operation of the application of meteorological data was directed by the National Oceanic and Atmospheric Administration (NOAA) Center for Climatic and Environmental Assessment (CCEA). This included global meteorological data acquisition and yield and crop calendar models. The international meteorological data were routinely acquired from the Global Telecommunications System of the World Meteorological Organization (WMO), the US Air Force Environmental Technical Applications Center, and the NOAA National Environmental Satellite Service. The NOAA Center for Experimental Design and Data Analysis preprocessed the data for the project and the meteorological data were stored on computers of the National Meteorological Center (NMC) in Suitland, Maryland (fig 5).

<sup>2</sup>Early attempts to discriminate between wheat and other small grains (e.g., between spring wheat and spring barley) could not be reliably done, and labeling was primarily either small grains or non-small-grains. Historically derived ratios were then applied to the resultant segment-level estimates of small grains to estimate wheat percentages. Limited success in direct labeling of wheat was attained in the latter part of LACIE.

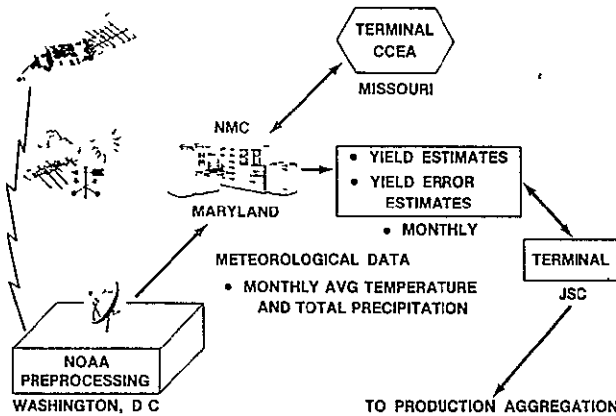

FIGURE 5.—Meteorological data acquisition and data flow for wheat yield estimation

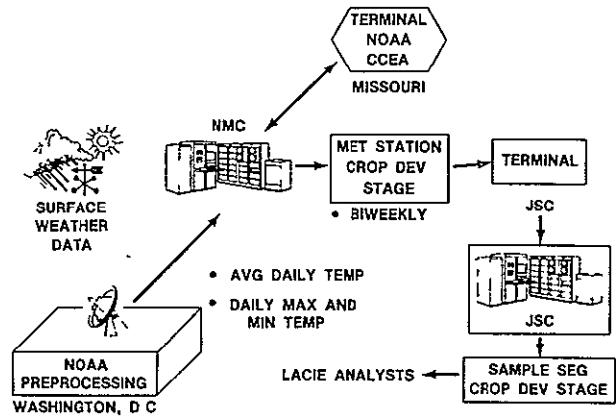

FIGURE 6.—Analysis steps and flow of data for crop calendar models.

### Yield Estimation

The wheat yield models utilized in LACIE were statistical regression models developed from historical wheat yields and weather. These regression models forecast wheat yield for fairly broad geographic regions (yield strata) using calendar monthly values of temperature and cumulative precipitation over the strata. They provided monthly updated yield estimates during the growing season. The required meteorological data and the yield models for each of the model strata were stored on the NMC computers (fig 5). Operation of the yield models was controlled by the NOAA CCEA Modeling Division at Columbia, Missouri, through remote-terminal access. After the yield estimates were generated, they were transmitted to the NASA JSC terminal for input to the wheat production estimation, along with the segment area estimates.

### Crop Calendar Models

Models which estimated the current year's growth stage for wheat utilizing meteorological data as input were also implemented on the NMC computers under the operational control of the NOAA personnel at Columbia, Missouri. These models utilized daily values of meteorological data (fig 6) and were run biweekly for selected meteorological stations in the regions of interest. At JSC, the results of the crop calendar models were input to a program for inter-

polation to a wheat growth stage at the location of the sample segments at the times of Landsat acquisition for utilization by the analysts performing the crop identification and labeling.

### Meteorological Summaries

To support the analysis of Landsat data and to assess crop conditions for identifying regions of anomalous events, weekly meteorological summaries were prepared by the NOAA Assessment Division and by meteorologists at JSC. Analysts working with the Landsat imagery were routinely briefed on the weather and interpreted crop conditions by agronomists and climatologists.

### Production Estimation

The wheat production estimation process (fig 7) involves the expansion (aggregation) of segment-level wheat percentages and yield model estimates to regional and country-level estimates of area, yield, and production with confidence statistics. These aggregations were performed by a computer operating under the interactive control of commodity analysts. The commodity analysts ensured that data bases involving the segment wheat percentages, the yield model estimates, the hierarchical definitions for aggregation, and historical and other derived agricultural data required for the aggregation and computation of confidence statistics were current. The major

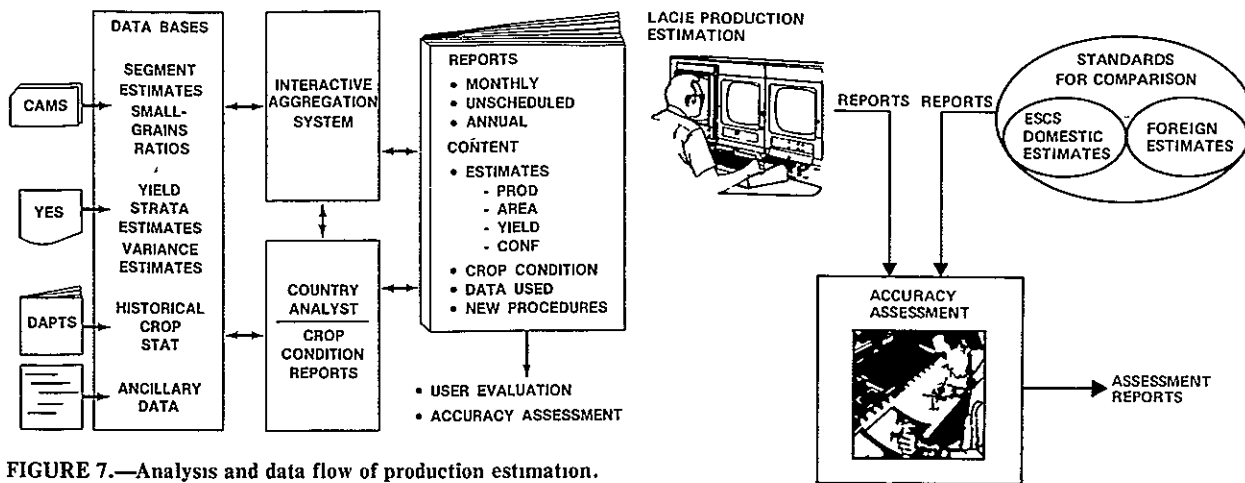

FIGURE 7.—Analysis and data flow of production estimation.

parts of the commodity report were the narrative description of the data and procedures used, results and interpretations, and assessments of crop conditions from weather and Landsat data. These reports were generally prepared monthly during the crop season and were scheduled for completion just prior to official USDA releases. Unscheduled reports were prepared occasionally, and annual reports were prepared after the crop season. The reports served as the bases for accuracy assessment and evaluation and, because of the experimental nature of the project, required careful and complete documentation.

### Accuracy Assessment

The accuracy assessment effort (fig 8) was designed to determine the accuracy of the LACIE area, yield, and production results in order to evaluate the adequacy of LACIE technology. This assessment was performed both at the large-area level (i.e., state, region, and country) and at the detailed level (i.e., segment, yield model, and lower) in order to isolate problem areas and identify causal factors to be addressed for potential resolution. Although comparisons to FAS and foreign country estimates were made, these estimates were not as reliable as the SRS estimates in the United States where the primary assessments were made over the USGP hard red wheat "yardstick" region. In addition, collection programs through the USDA ASCS provided information at the field level over the yardstick region for detailed evaluations. The field-level data were acquired during Phase I for 29 of the sample segments in North Dakota and Montana. In Phases II and III,

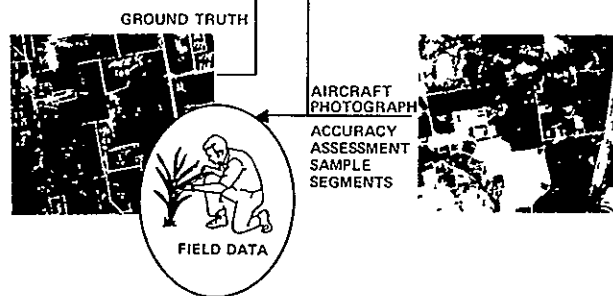

FIGURE 8.—Accuracy assessment flow.

this program was expanded to cover approximately one-third (approximately 175) of the total USGP sample segments. The field data and the identity of the specific sites were not accessible to the segment analysts, thereby ensuring that results obtained over the test segments would be representative of those obtained over all segments. Accuracy assessment reports consisted of three primary types—quick-look reports released about 5 working days after the commodity reports in order to provide rapid feedback to management, interim reports released approximately every 3 months, and final reports for each LACIE phase on the detailed results, analyses, and assessments. From accuracy assessment results, the AES was able to identify the sources of error and "prioritize" issues for further research, as well as verify which procedures and approaches were adequate.

### Field Data Acquisition

To support both the accuracy assessment and the supporting research and development efforts, in situ field observations were collected over selected sites

in the United States and Canada. These sites were of two types "blind" sites (so labeled because their identities were unknown to the area analysts) selected at random from the regular sample sites and intensive test sites selected to represent the variability in wheat-growing conditions, including sites outside the USGP. The field observations included both complete inventories and 18-day observations coincident with Landsat overpasses. Observations in the United States were collected through the USDA and annotated on high-altitude aircraft photographs acquired through NASA. The types of data collected are shown in figure 9.

### ORGANIZATION, INTEGRATION, AND CONTROL

The basic functional organization (fig 10) of the AES was focused around five subsystems, an accuracy assessment component, and the interface with the user evaluation effort. Each of the subsystems, representing components of the activities described in the technical approach section, involved the multidisciplinary expertise of at least two of the participating agencies with agency lead responsibilities for each. The functional elements and their responsibilities are described in the following sections.

#### Data Acquisition, Preprocessing, and Transmission Subsystem (DAPTS)

The DAPTS was responsible for the coordination,

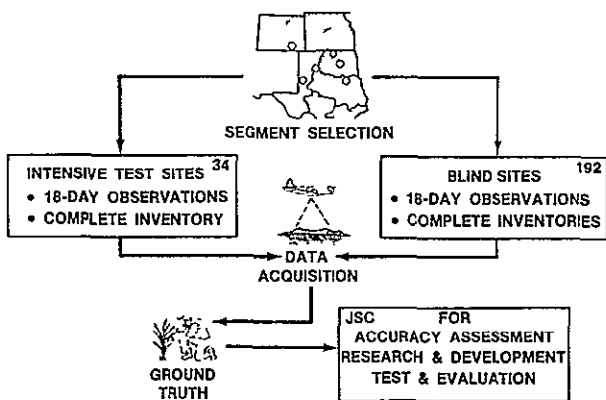

FIGURE 9.—Field data acquisition.

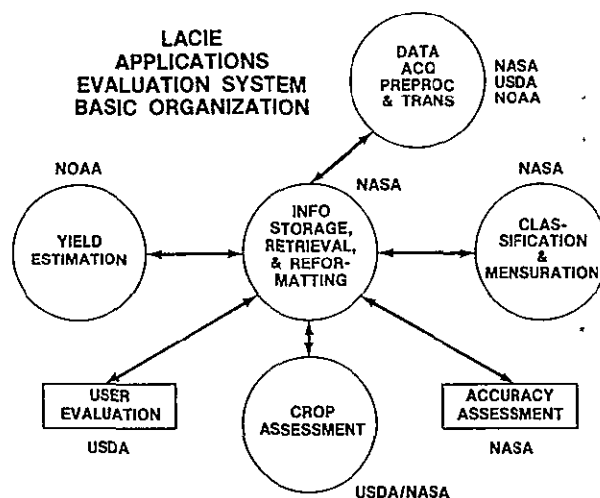

FIGURE 10.—Basic functional organization of the AES.

collection, and acquisition of data for the AES and supporting research. Preprocessing operations (e.g., multitemporal registration of Landsat segment data) which were standard for all elements were also a function of DAPTS. Specific functions included the following:

- 1 Acquisition of Landsat segment and full-frame data
- 2 Acquisition of historic agricultural data
- 3 Acquisition of field observations and ground-truth data
- 4 Acquisition of aircraft imagery for ground-truth annotation
- 5 Standard preprocessing functions, such as Landsat segment registration and initial cloud cover screening
- 6 Preparation of regional agricultural summaries and normal crop calendars

#### Classification and Mensuration Subsystem (CAMS)

The CAMS was responsible for analysis of Landsat data for the AES and was a NASA lead responsibility. Specific functions included the following:

- 1 Design and implementation of procedures, methods, and techniques for the interpretation, classification, and mensuration of Landsat multispectral scanner data
- 2 Estimation of the proportions of wheat and/or small grains for Landsat segments throughout the crop year

3 Landsat analysis for crop condition assessment and notation of deviation of crop growth stage from agromet model estimates

4 Design and conduct of analyst training

### **Yield Estimation Subsystem (YES)**

The YES was responsible for the acquisition and analytical processing of meteorological data for the AES and was a NOAA lead responsibility. Specific functions included the following:

- 1 Meteorological data acquisition
- 2 Design, implementation, and operation of agromet models to estimate yield over defined strata
- 3 Design, implementation, and operation of models for seasonal adjustment of crop calendars
- 4 Preparation of meteorological data summaries to aid in the analysis of Landsat data
- 5 Analysis of meteorological data for the assessment of crop conditions

### **Crop Assessment Subsystem (CAS)**

The CAS was responsible for the integration of the CAMS segment areal estimates and the YES strata yield estimates into aggregated area, yield, and production estimates and reports. The USDA had lead responsibility with NASA serving a major support role. Specific functions were as follows:

- 1 Design of the sampling strategy and allocation of segments for Landsat analyses
- 2 Definition of strata requirements for YES yield estimates
- 3 Design, implementation, and operation of models for the aggregation of the CAMS segment areal estimates and YES strata yield estimates into stratum, zone, region, and country area, yield, and production estimates
- 4 Design, implementation, and operation of methods that provide the confidence statistics on the area, yield, and production estimates at the various levels
- 5 Analyses of the aggregated estimates and preparation of reports, including estimates and crop condition assessments on a regularly scheduled basis
- 6 Ensuring that the CAS reports and schedules are compatible with USDA crop reporting system standards

### **Information, Storage, Retrieval, and Reformatting Subsystem (ISRRS)**

As large quantities of both physical and electronic data (table I) were accumulated for the use in analysis, it was necessary to ensure that they were stored in an orderly fashion for retrieval as needed.

*TABLE I—Typical LACIE Landsat Data Load at Mid-Phase III*

Number of segments for digital data acquisition	3 000
Number per day to GSFC	300
Number preprocessed per day	110
Number processed photographically per day	330
Number of digital acquisitions in data base at JSC	18 000
Number of segments in data packages	3 000
Average number of segments in work	700
New data products generated per day	1 000

This function was performed by the ISRRS, which was the focal point for storage, custom preprocessing, and transfer of data between the subsystems. By being such a focal point, the ISRRS could accommodate status and tracking of data and analysis products. Specific functions of the ISRRS, a NASA lead responsibility, included the following:

- 1 Implementation and management of automatic data processing data bases
- 2 Storage and retrieval of digital data
- 3 Design, implementation, and operation of physical data storage facilities
- 4 Design, implementation, and operation of data status and tracking and query capabilities
- 5 Custom preprocessing, such as conversion of Landsat segment data tapes to film

### **Accuracy Assessment**

The accuracy assessment element was originally a part of the CAS. However, near the end of Phase I, the recognized need for expanding the accuracy assessment effort led to its becoming a separate element of the AES. Specific functions of the accuracy assessment included the following:

- 1 Design, implementation, and execution of procedures for the assessment of the accuracy of the area, yield, and production estimates
- 2 Definition and conduct of test designs for assessing the accuracy of the AES components in

sampling and aggregation, segment proportion estimation, yield estimation, crop calendar models, etc

3 Definition of ground-truth requirements for accuracy assessment

4 Development of recommendations for areas needing improvement in accuracy and reliability

### Integration and Control

The environment in which the AES was operating during the LACIE was one of periodic change. These changes resulted from design modifications received as input from user requirements, from the ongoing supporting research program, and from recommendations of the peer reviews held throughout the experiment. At the same time, the experiment's scope (in terms of regions to be investigated, etc) and content were undergoing modifications based on previous results and current-year agroclimatological conditions. Within a crop year, the data load was highly variable (fig 11) for these reasons and because of the variability in cloud cover. For the experimental evaluations to be valid, careful integration and control of procedures and operations planning were required and were a continuing process.

The primary mechanism for integration of new procedures into the AES was a systems engineering effort that involved the subsystems and the implementing organizations. Concurrence on proposed changes was required by the AES functional organizations to ensure that integration was complete. A LACIE configuration control board comprised of senior triagency project management personnel was established to review and approve

changes. Before new procedures were incorporated into operations, tests were designed and conducted to ensure that they were properly functioning. An independent quality assurance effort monitored the tests.

Operations required an equivalent amount of planning, integration, and control. As noted earlier, the scope of LACIE was periodically changing as a function of events occurring in real time within a phase as well as the major scope definition activities generally occurring before a phase. The ability to cope with these changes resided in a small group of operations-oriented personnel who were well versed in the capabilities and limitations of each part of the AES. By continual reassessment of current data loads and system capabilities, this group focused the analysis effort where needed to meet scheduled report dates, and problems were solved as they occurred. In addition to the daily operations of planning and analysis, four other management tools (operational readiness reviews (ORR's), paper simulations, quality assurance, and an operations control center) were employed to ensure integration and orderly data flow. The ORR's were conducted before each LACIE phase to provide an overall appraisal of the system's capability to respond to the operating scope, new technology, and processing approaches to be implemented in the upcoming phase. While the ORR's provided a useful focus for operating elements to establish their ability to support each upcoming phase, the primary purpose of the paper simulations was to baseline the flow of products. These paper simulations were held annually, generally just after the ORR's. They provided a valuable mechanism for maintaining the currency, accuracy, and compatibility of the flow of products. To ensure that the agreed-to procedures were being followed in daily operations, an independent quality assurance effort was established to monitor and audit operational functions. The role of the operations control center was to ensure the orderly flow of data on a daily basis by ensuring that problem areas were being worked, priorities were being established, etc.

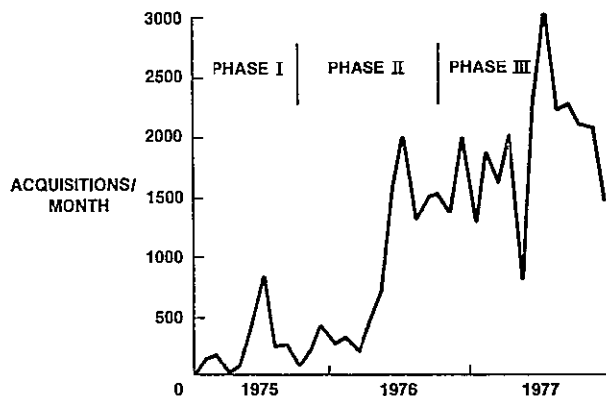

FIGURE 11.—Landsat acquisitions received at JSC.

### RELATIONSHIP OF AES TO OTHER PROJECT ELEMENTS

#### Supporting Research

The initial technology designed into the AES was extracted, almost exclusively, directly from the

research community. Key technology issues, such as spectral discrimination of wheat from barley, had been identified at the initiation of LACIE as needing additional research. As additional or more focused technology issues were identified through the AES, they were incorporated, as resources permitted, into the supporting research program. The supporting research element provided both direct and indirect inputs into the AES design.

Besides performing research studies and technique development, members of the supporting research community participated, when needed, jointly with AES personnel in identifying problems and developing solutions. Their participation in peer reviews was instrumental in providing directions for the AES.

### Test and Evaluation

The test and evaluation element served as the mechanism for evaluation of techniques and procedures before their use in the AES. Although of limited scope, these tests served to identify problems and assist in their resolution before full-scale AES application. The functional relationship among the AES, supporting research, and test and evaluation is illustrated in figure 12.

### Peer Reviews

In the course of LACIE, five peer reviews were held (in December 1974, August 1975, September

1975, March 1976, and January 1977), from which the AES was the primary beneficiary. The participants in these reviews included experts from universities, government agencies, and industry in the disciplines relevant to the LACIE. At these peer reviews, the design, methodology, implementation and operations, and results of the AES were carefully examined and recommendations were made. Most of the peer recommendations were valid and were incorporated, by intent if not literally, into the AES design. Those which were not incorporated were generally omitted because they required further research, in which case they were incorporated into the supporting research program.

## CHRONOLOGICAL DESIGN OF THE AES

### Phase I

The initial technology of the AES was based on the best available technology at the time which had the best chance of being implemented on a large scale according to the initial ambitious schedule. This was considered necessary in order to begin the evaluation of technology from a total system aspect and over the wide range of agronomic and climatological conditions, thereby identifying the most critical technical issues and providing the required focus for supporting research and development. After the initial design, the changes originated from deficiencies recognized in the AES within the analysis activity, from performance evaluations, through peer reviews, and as a result of supporting research activities.

The overall approach to the design emphasized machine-oriented technology and procedures that minimized human interaction and made it as objective, efficient, and repeatable as practical. This approach was necessary to reduce the variability to levels supportive of the 90/90 criterion and to attain a cost-effective technology with timely results.

Two major, related constraints were placed by the experiment design on the methodology to be employed in the AES. The first constraint was that no current-year ground truth (field observations, USDA county, state, etc., estimates, etc.) or aircraft-acquired data could be utilized in the quasi-operational AES except in performance evaluation. The second constraint was that only globally and operationally available meteorological data could be

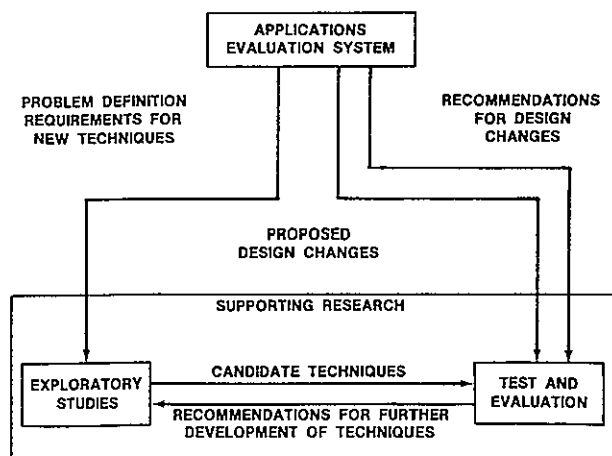

FIGURE 12.—Functional interface of the AES and supporting research.

utilized except in performance evaluation. The constraints recognized the information which would be generally available in foreign countries.

In Phase I, the major emphasis was on bringing AES components on line, identifying significant problems, and initiating necessary changes. The quasi-operational scope of the AES (fig 13) was for area estimates over the USGP with exploratory segment analyses in the other seven countries (Canada, the U.S.S.R., India, Australia, Argentina, Brazil, and the People's Republic of China) of LACIE interest. Although limited evaluations began on retrospective data in November 1974 and current-year Landsat-1 data in January 1975, the initial implementation of Landsat preprocessing, classification, and mensuration components to LACIE requirements occurred in April 1975. Even then, many technical requirements had been deleted to meet this delivery date. This early design was based on the goal of being capable of supporting an eight-country evaluation with monthly reports during the growing seasons through multitemporal analysis of 4800 5- by 6-nautical-mile sample segments acquired four times each crop season. For efficiency, a signature extension approach had been selected that established a ratio of five segments being machine processed for only one segment on which an analyst actually labeled fields for training statistics. The 28 analysts available had been recently employed, and experts from the scientific community conducted training programs. Analysts had been prepared for either training field selection and labeling or machine processing based on the ratio of expected throughput in each category.

Labeling was based almost exclusively on infrared imagery from the Landsat multispectral scanner system, historical information on cropping practices, and normal and adjusted crop calendars.

The crop calendar models, also implemented in April 1975 at Columbia, Missouri, were based on models developed for spring wheat utilizing temperature as the primary variable. However, there were no starter models for the establishment of the

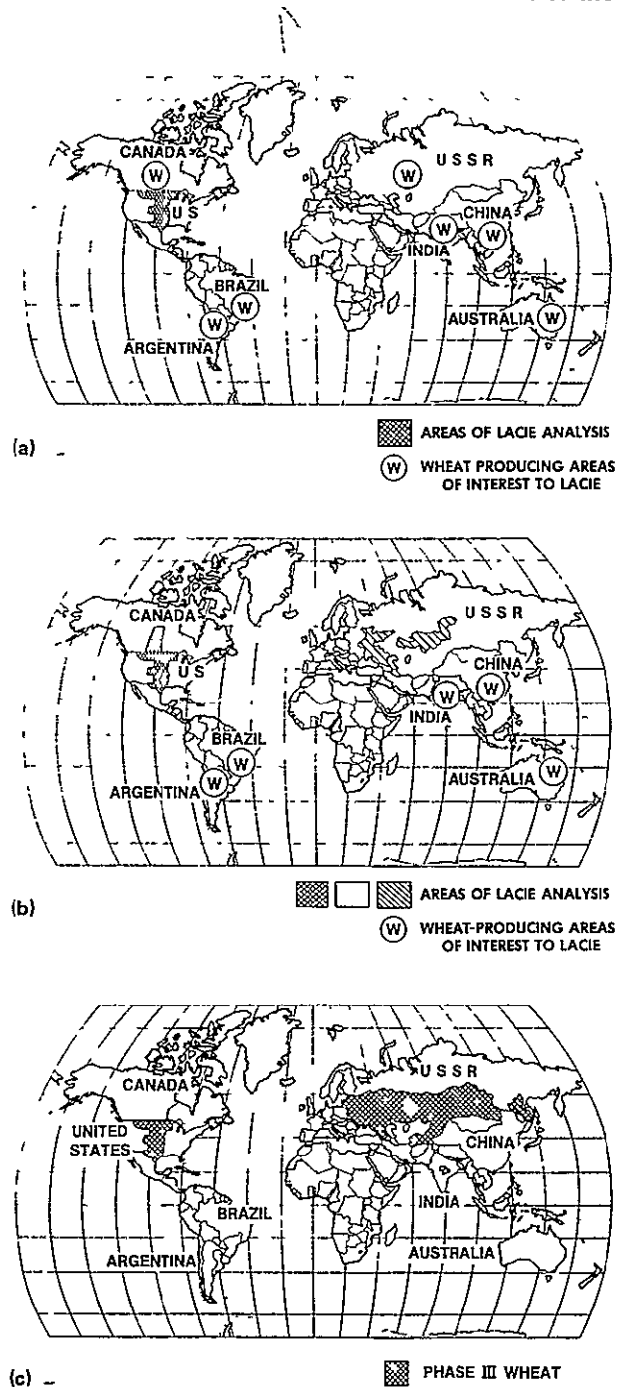

FIGURE 13.—Major wheat-producing regions in the three phases of LACIE. (a) In Phase I, global crop year 1974-75, integration and implementation of technology components into a system to estimate the proportion of the major producing region planted to wheat and the development and feasibility testing of yield and production estimation systems were accomplished. An end-of-season report for area estimates of wheat in the USGP was generated. Exploratory experiments were begun in wheat areas of interest. (b) In Phase II, global crop year 1975-76, Phase I technology was evaluated for monitoring wheat production for the USGP, Canada, and two large indicator regions in the U.S.S.R. Monthly reports of area, yield, and production of wheat for these regions were generated. Exploratory experiments were conducted in the other five countries. (c) In Phase III, global crop year 1976-77, new technology was implemented and evaluated for monitoring wheat production for the USGP and the U.S.S.R. Monthly reports of area, yield, and production estimation of wheat were generated. Additional tests of area technology over Canadian ground-truth sites were conducted.

ORIGINAL PAGE IS  
OF POOR QUALITY



required planting date or for emergence of winter wheat from dormancy, and they were started with USDA reported planting dates

The sampling strategy was designed to utilize statistics on wheat area from the available political subdivision level (county-level substrata in the United States) for allocation to support a 90/90 criterion at the country level. In areas of both winter and spring wheat, the segments were designated as one or the other based on historical statistics.

Segment estimates were expanded to substrata (county) estimates based on the number of 5- by 6-nautical-mile equivalent areas in the substrata. Estimates of the substrata that lost their segments because of cloud cover were based on the ratios of current to historical estimates for the substrata in the strata (crop reporting district in the United States). The substrata estimates were summed to strata (crop reporting district), zone (state), region (e.g., spring wheat), and country levels by summing up the appropriate substrata.

Although yield and production were not implemented in a quasi-operational mode for Phase I, they were implemented for test and evaluation. Originally, the design required generation of yield estimates at meteorological stations and a mathematical surface modeled to estimate yield at the segment or substratum level. However, development and implementation of this design was not considered practical within the required time frame, and the design was modified to provide yield estimates at regional levels based on regression models utilizing historical yields and weather. The regression models consisted of trend terms and coefficients for monthly values of precipitation and temperature. Production was estimated by summing the product of area and yield from the strata level.

Much effort during Phase I was oriented just to implement and manage components necessary to handle the data flow. The specifications for production estimation had not been implemented, and operations were conducted with a developmental version. Reports had to be generated manually and typed. Estimates of variance on the area estimates were performed manually.

Minimal resources were initially allocated to accuracy assessment, and accuracy assessment was limited essentially to a comparison of estimates at state and higher levels to SRS estimates until near the end of the phase when aircraft and field data were acquired over 29 blind sites in North Dakota and Montana to augment the 26 intensive test sites

distributed over the United States and Canada. Several years would be required to determine whether a consistent bias existed in the estimator. Therefore, to assess the technology under a variety of agricultural/climatological conditions, results were evaluated at state levels even though samples were not allocated on a state basis. The blind sites provided the best basis for evaluation of classification results. The yield models were assessed more directly through the repetition of tests based on 10 years or more of available historical yield and weather data.

During Phase I, major modifications were made to the area methodology. First, the Landsat preprocessing system allowed a large amount of data with excessive haze and cloud cover to pass through. Improvement in the screening criteria and an on-line monitoring station improved the data to acceptable levels. Second, the signature extension was judged to be working satisfactorily in only about 20 percent of its use. Signature extension was therefore deleted from the operations.

Initially, the winter wheat area estimates were large overestimates when compared to the SRS estimates. The strategy of acquiring segments once per biowindow, coupled with a late crop year, resulted in extensive fall acquisitions prior to winter wheat detection. For these early acquisitions, ground plowed in the fall was estimated to become wheat and resulted in large overestimates. Single winter wheat acquisitions in the spring without the proper fall acquisitions resulted in the confusion of wheat with other crops and thus in overestimates. After an area estimation technology peer review in August 1975 and a reexamination of both the CAMS and CAS technology, the winter wheat segments were reworked with modified procedures. The plowed-ground estimates were deleted, and segments with good acquisition histories were selectively analyzed. The rework results supported the accuracy goals.

For spring wheat, the rework procedures were applied, but another significant problem was encountered. The analysts could not reliably differentiate between spring wheat and other spring small grains, primarily barley and oats. The method employed to compensate for this was to apply historical ratios of wheat to small grains to the segment estimates.

## Phase II

Phase II represented an additional set of challenges. The scope was more than doubled (fig

13) to include Canada and large winter wheat and spring wheat indicator regions in the USSR., in addition to the USGP. Quasi-operational evaluations of yield and production, in addition to area, were also incorporated

Examination of the Phase I blind sites indicated a sample error in North Dakota, and 21 additional segments were allocated to that state

The Landsat preprocessing experience in Phase I provided insight into which type of acquisition periods provided good and bad reference scenes for correlation for multitemporal registration, and many of the segment reference scenes were changed

In CAMS, several changes were implemented on the basis of the Phase I experience. First, the analyst-interpreters (labeling) and the data-processing analysts were organized to work as teams following an analysis of a segment to completion and were assigned to specific geographic regions for analysis. Segments were acquired at every opportunity rather than once per biowindow, and full-frame imagery was available four times per crop season for use in the analysis. A clustering product was provided to aid in identifying the spectral data structure in the imagery but had to be withdrawn because it did not perform consistently. In Phase I, problems were encountered in estimates for segments with low wheat proportions, and a hand-count procedure was implemented for segments with less than 2 percent wheat. To handle the additional segment load caused by the increased scope and the need for every acquisition, a no-change procedure was implemented whereby analysts did not modify previous estimates if they were judged to change by 2 percent or less. Changes in the hardware also occurred. The cathode-ray tube on the film converter used to generate analyst film products had to be replaced and produced a different-appearing image with which analysts had to become familiar. A special-purpose parallel processor was installed, it provided the significantly higher machine-processing throughput rate required for the additional data load.

The agrometeorological crop calendar models were implemented with a starter model for spring wheat. Use of normal dates for planting and emergence from dormancy was the best method available for starting winter wheat model operations.

The yield models were implemented with a few residual problems. In the USGP, three of the model boundaries overlapped, the overlap resulted in undefined biases and affected the validity of the error statistics. Some areas with smaller but significant

amounts of wheat, primarily in Texas and Minnesota, were unmodeled. The data bases and software were not available to provide error statistics for the USSR and Canada until late in the phase.

For CAS, the initial system deliveries provided flexible capabilities for treating CAMS segment inputs and for generating reports and provided for the required production aggregation. Confidence statistics for the USGP and Canada were not formulated on this system, they continued to be generated on the developmental version. Although much attention had been given to development of test cases for system verification, the potential conditions were so extensive and varied that only in operations were some deficiencies uncovered. This necessitated formulation and software modifications.

In accuracy assessment, additional resources were applied, and an extensive blind site program was implemented to allow evaluation of sampling and classification errors over the entire USGP.

The extensive drought in the USGP placed new emphasis on the crop condition assessment activities. An attempt was made to use imagery acquired by Landsat-1 and Landsat-2 in conjunction with meteorological station data to interpret extent of precipitation levels and input this into the yield models. Although this attempt was not completely successful, methods were developed and implemented for the use of vegetative indexes from Landsat to delineate regions of drought stress.

By the end of Phase II, most of the initial system implementation and operational deficiencies had been resolved and improved technologies were being implemented based on the supporting research of Phases I and II.

### **Phase III**

The experiment scope in Phase III was expanded (fig 13) to the total USSR in addition to the USGP and 30 sites in Canada where ground truth was acquired by Canada. Emphasis was placed on improvement in areas of key problems, particularly in spring wheat in the United States and Canada, and on implementation and testing of second-generation technology developed through the supporting research program. These second-generation technologies were based on deficiencies identified during Phases I and II.

Based on previous experience and utilization of the Landsat data that had been acquired, realloca-

tions of sample segments were made in the United States and U S S R for Phase III. The reallocations were not completed by the beginning of the crop year, necessitating sizeable retrospective data orders for Landsat data in late 1976. These segments were worked in the January to March 1977 time frame, and the commodity reports scheduled for January and February were completed on a delayed basis. In addition, a desire to extend the lifetime of the Landsat-2 tape recorder resulted in activation of ground stations in Pakistan and Italy to collect the U S S R. data. Subsequent problems with the ground station tapes resulted in some loss of data, and the recorder was again put to use. A faulty data order between JSC and GSFC resulted in loss of critical data over the U S S R winter wheat region, which significantly affected the results. This could have been discovered in real time and largely corrected if the reallocation could have been completed before the crop year.

The most extensive implementation of new technology in Phase III was in the area of segment analysis. A new software-analyst procedure, referred to within the experiment as Procedure 1, was implemented in early June 1977 and provided the improved analyst-machine technology required for increased accuracy and to process approximately 3000 active segments. The procedure was also implemented, for additional throughput and technology transfer, in a new hybrid computer system similar to that planned by the USDA. USDA analysts used this system for processing the Canadian data and one oblast in the U S S R. To support analyst labeling further, a set of labeling keys was implemented that covered variations in the signature of wheat under varying agronomic and climatological conditions.

The yield models in the USGP and the U S S R. were revised. The boundaries of selected models were adjusted to remove biases caused by overlap, and models were extended into the marginal producing regions.

Commodity reports were generated regularly. The full-up interactive production estimation software was completed; it provided the production estimate and the full complement of area, yield, and production statistics. In the USGP and Canadian spring wheat regions, econometric models were developed and implemented to improve the ratioing of wheat from small grains estimates. Technical innovations, such as thresholding out early-season results obtained before full crop emergence and detection, were also implemented and evaluated. The commodity reports also included a comprehensive crop

condition assessment analysis prepared by agronomists, climatologists, and remote-sensing analysts to augment the production estimates.

In addition, operational testing was performed on a limited basis for newly emerging second-generation technology. A procedure for direct estimation of wheat without the use of historically derived ratios was tested over North Dakota and Canada. A second-generation more efficient sampling strategy based on natural stratification and a new yield model designed to be more responsive to crop phenology was implemented and tested in Kansas, North Dakota, and three oblasts in the U S S R.

Coping with these technological and real-time changes was a real challenge in Phase III. However, by continual reassessment of data loads and system capabilities, analysis efforts were focused where needed to meet scheduled report dates and to solve problems.

## DATA LOAD AND EFFICIENCY

Major studies were made of the efficiency and throughput of the AES over the three phases of LACIE. During this time frame (fig. 14), the scope increased fourfold in the number of active segments and ninefold in the number of Landsat acquisitions. At the same time, the number of Landsat area analysts remained at the same level. Machine processing increased fivefold, whereas analyst contact time decreased to one-fourth of the Phase I level. Yield estimates, weather summaries, and crop calendar models increased by a factor of four and were generally provided on schedule. Equivalently, the

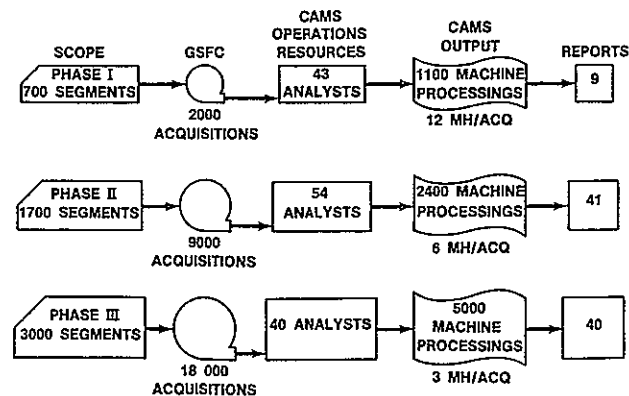

FIGURE 14.—LACIE systems operations.

number of commodity and accuracy assessment reports increased by a factor of four

## MAJOR AES ACCOMPLISHMENTS

The AES offered a unique opportunity to test state-of-the-art technology in an important applications problem. The many accomplishments were attributable to a large number of organizations and to many dedicated personnel. The following list represents the more significant AES accomplishments.

1. First integration of remote-sensing and data processing technology into a crop inventory system
2. First-time test of technology over a sufficiently representative range of agronomic and climatological conditions to evaluate the technology
3. First-time evaluation of technology under realistic foreign situations — without in situ ground truth and with limited historical information
4. Demonstration that the technology will support timely, accurate production estimates for a major wheat-growing region at or before harvest
5. Focus of key technical issues for remote-sensing crop inventory in wheat (also applicable to other crops)
6. Acquisition of data processing and handling experience that would allow design of a system to support future operational systems
7. Transfer of validated technology to a first-generation USDA hardware/software system
8. Establishment of a base of interagency, multidisciplinary, experienced personnel for additional research and development in remote-sensing agricultural applications

## BIBLIOGRAPHY

- Memorandum of Understanding Among the US Department of Agriculture, the National Aeronautics and Space Administration, and the National Oceanic and Atmospheric Administration for the Experimental Large Scale Crop Inventory Demonstration USDA LACIE, Washington, D C , Oct 10, 1974
- LACIE Project Plan LACIE-C00605, NASA Johnson Space Center, Houston, Texas, Aug 1975
- LACIE Management Plan LACIE-C00617, NASA Johnson Space Center, Houston, Texas, Sept 1976
- LACIE Phase I Evaluation Report LACIE-00418, NASA Johnson Space Center, Houston, Texas, May 1976
- LACIE Phase II Evaluation Report LACIE-00453, NASA Johnson Space Center, Houston, Texas, July 1977
- LACIE First Interim Phase III Evaluation Report LACIE-00464, NASA Johnson Space Center, Houston, Texas, Jan 1978
- Erickson, Jon D , Heydorn, Richard P , Trichel, Milton C , and Grandfield, Allen L. The LACIE Supporting Research Program A Focused Approach to Research and Development The LACIE Symposium Proceedings of Plenary Session, NASA Johnson Space Center, Houston, Texas, Oct 1978
- MacDonald, R B , and Hall, F G. LACIE An Experiment in Global Crop Forecasting The LACIE Symposium Proceedings of Plenary Session, NASA Johnson Space Center, Houston, Texas, Oct 1978

# The LACIE Supporting Research Program: A Focused Approach to Research and Development

Jon D. Erickson,<sup>a</sup> Richard P. Heydorn,<sup>a</sup> Milton C. Trichel,<sup>a</sup> and Allen L. Grandfield<sup>a</sup>

## INTRODUCTION

Although LACIE was not the first project to successfully demonstrate an application of technology that had previously existed only in the research community to a problem of major national significance, it was the first major application of satellite remote sensing to worldwide crop production monitoring. This application is characterized by a unique diversity of problems, approaches, technologies, and data because of the extremely diverse nature of worldwide agriculture and the cultural, meteorological, and economic factors which drive it. It is important, therefore, to review the success of, and the methods used in, the efforts to identify and correct the key problems in the remote-sensing and crop-forecasting technologies.

The changes required in the approach to research and development and in management to accommodate the LACIE goals were fully as extensive as the changes required in the existing technology to achieve the desired performance.

Before LACIE, research related to remote sensing and crop forecasting was accomplished in a number of disciplines and by a number of investigators. In general, each investigation had its own goal, and there was little concern about how the pieces might be fit together to satisfy some major goal. There was little agreement about what the major goal(s) should be. Consequently, the technology had developed on a broad front as dictated by the interest of investigators, the availability of data, and the vagaries of funding (fig. 1). The resulting technology base was advertised as being sturdy but was not, in fact, adequate to support any substantial application.

The LACIE provided a unifying goal. To achieve this goal, it was necessary to identify approaches and their components and to obtain these components

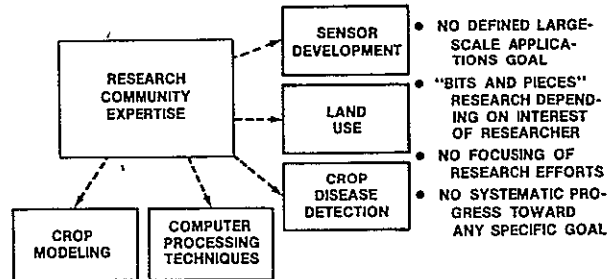

FIGURE 1.—Pre-LACIE agricultural remote-sensing research.

Commonly, the components were found to be unobtainable or obtainable only in unexpected locations; when obtained, some components were found to be inadequate. A new system of research management was developed to identify key problems and focus resources on those problems.

Because of the diversity of worldwide agriculture and weather, the conditions under which an analysis technique must perform are also very diverse. This situation has not been widely recognized by researchers (although there are ample examples of similar situations in the past; e.g., the introduction of electronics into the military), and many of the available components could have been expected to be somewhat "fragile." LACIE provided a "proving ground" on which these components could be tested on a large scale over global variability—it provided a path to a validated, reliable technology.

## APPROACH

The research issues were identified but were not fully understood or quantified at the beginning of LACIE. Consequently, the LACIE project structure was developed to provide suitable interfaces for a supporting research effort, as shown in figure 2. This structure is considered to be one of the more important project accomplishments because it permitted

<sup>a</sup>NASA Johnson Space Center, Houston, Texas



the focusing of resources on those problem areas which were "key" to the ultimate operation of the Applications Evaluation System (AES), as illustrated in figure 3. In this scheme, the AES had the function of acquiring, adapting, and applying state-of-the-art technology to the satellite-aided worldwide crop inventory and forecasting problem for verifying the adequacy of this technology and identifying its weaknesses (The AES is discussed in the plenary paper by Dragg et al.) The function of accuracy assessment was to compare intermediate and final outputs of the AES with information from other sources in order to quantitatively estimate the performance of the technology (Accuracy assessment is discussed in detail in the symposium paper by Houston et al.) Problems identified within the AES by the AES production system and accuracy assessment were distilled into lists of critical issues (table I) that could be used to focus supporting research efforts. This distillation process was a key role of LACIE technical management, especially of supporting research management. This role was so important that the project frequently used a peer review process to assist in the distillation and to recommend research approaches that might be used to solve the problems represented by the critical issues. Peer review panel members were selected from a broad range of technical backgrounds appropriate to these problems; they came from various organizations (including NASA, the U.S. Department of Agriculture (USDA), and the National Oceanic and Atmospheric Administration (NOAA)), industrial firms, and universities and involved individuals from both within and outside

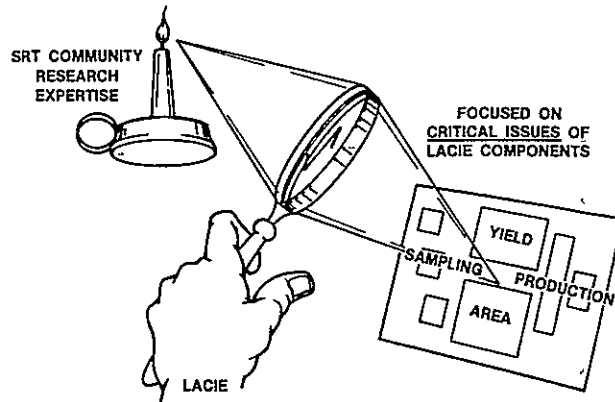

FIGURE 3.—LACIE supporting research, test, and evaluation program.

LACIE Peer review recommendations to LACIE were handled using procedures similar to those used in other NASA system reviews.

The critical issues were then used to design the supporting research program, another key role for supporting research and other project technical management. In this program, the exploratory studies element had the function of developing new analysis techniques or repairing deficiencies in existing techniques, whereas the test and evaluation component had the function of testing and evaluating research products and alternate approaches over large and diverse data sets. These tests had to be sufficient to determine whether significant improvement in AES performance was likely to result from implementation of the new products. In summary, the entire LACIE project functioned as a proving ground for an eventual user such as the USDA; within the project, test and evaluation served as a proving ground for the AES.

During the LACIE, the research performed was highly applied rather than basic because of the need to correct a number of specific deficiencies in the state-of-the-art technology, as will be discussed later. The emphasis on applied rather than basic research is not, however, fundamental; the substantial success of LACIE has already allowed a significant shift toward basic research and has opened new avenues for such research. Note, however, that even basic research can be focused on resolving issues of long-range practical significance.

The functional elements just described (AES, accuracy assessment, and supporting research) cannot be viewed as corresponding to specific organizational entities. Each of the functional elements was dis-

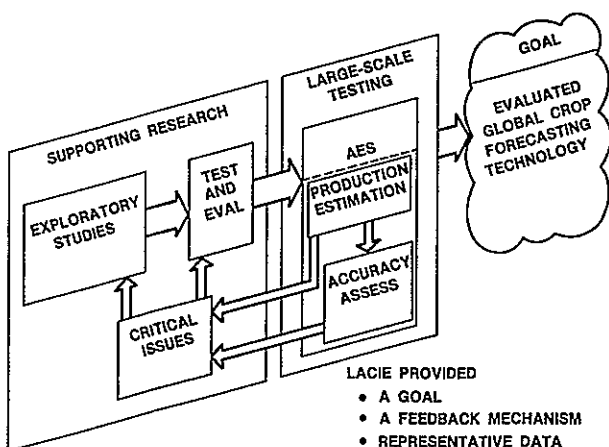

FIGURE 2.—LACIE project elements.

TABLE I — Summary of Critical Issues

<i>End of Phase I</i>	
Sampling problems	Analysis-interpretation keys
Upgrade of yield models	Analyst training
Upgrade of crop calendar models	Signature extension
Accuracy assessment	Partitioning
Throughput and efficiency	Clustering
USDA advanced system design	Thresholding
Cloud cover impact	Wheat proportion estimates from small fields
Unrepresentative training	Precision (error) estimates
<i>End of Phase II</i>	
Sampling problems	Definition of small-fields problem
Stratification	Signature extension
Inefficient usage of ancillary data	Clustering
Yield model insensitivity to extreme weather conditions	Classification bias
Crop calendar models	Need for improved classification procedures
LACIE error model	Ratios of wheat to small grains
Early-season classification performance	Episodic events
<i>End of Phase III</i>	
Tracking major departures from yield trend	Landsat analysis in regions with small or narrow fields
Yield models in areas of deficient historical data	Wheat from Landsat in regions with other small grains
Use of Landsat crop appearance variables in yield models	Correction of early-season bias
Improvement of crop calendar models	Correction of labeling problems
Correction of physical factors	Optimum times and bands
Availability of R&D data sets	Multitemporal classification
Landsat-3 use	Improved selection of labeled samples

persed through several organizations, particularly the supporting research efforts carried out by a combined team of NASA, USDA, NOAA, industry, and university personnel. The organizations involved and their responsibilities are shown in table II.

The LACIE used a lead institution effort, a support contractor effort, and other contractor effort in the supporting research program. The lead institutions were the Laboratory for Application of Remote Sensing (LARS) at Purdue University, the Environmental Research Institute of Michigan (ERIM), and the Space Sciences Laboratory at the University of California at Berkeley (UCB). These institutions lent strong capabilities to the effort.

1. Substantial previous accomplishment and experience in their respective discipline areas
2. Multidisciplinary expertise
3. Substantial data processing and data management capabilities

4. Specialized data and technical libraries
5. Sufficient commitment to maintain staff and facilities for the long-term development of the technology

The civil service staff of the Earth Observations Division at the NASA Johnson Space Center (JSC) was supported on a short-term task basis by several support contractors also located at JSC. Two of these, Lockheed Electronics Company (LEC) and International Business Machines (IBM), played substantial key roles in supporting research. Support contractors at the NASA Goddard Space Flight Center (GSFC), notably Computer Sciences Corporation and General Electric Company, played key roles in adapting the results of previous research work to LACIE-GSFC requirements. For tasks requiring specialized expertise not available from the lead institutions or from the support contractors, contracts or other agreements were made with industrial contractors, univer-

TABLE II — LACIE Supporting Research Participating Organizations and Roles

<i>Organization</i>	<i>Role</i>
<i>Overall</i>	
NASA USDA NOAA	
<i>Production sampling/aggregation</i>	
Lockheed Electronics Company	Support contractor (sampling, aggregation stratification)
South Dakota State University	Stratification
Texas A & M University	Sampling, statistics, mathematics, agriculture
Texas Technological University	Statistics
TRW, Inc	Error modeling
University of Texas at Dallas	Statistics
<i>Area estimation</i>	
Lockheed Electronics Company	Support contractor (broad technical and management support in analysis, design, and testing and evaluation)
Colorado State University	Canopy modeling
ERIM	Physics, sensors, modeling, pattern recognition
IBM, Inc	Statistical design, problem solving
Oregon State University	Agricultural economics
Pan American University	Canopy modeling
Purdue University, LARS	Agriculture, pattern recognition
Rice University	Computation and mathematics
University of California at Berkeley	Image and data interpretation sampling
University of Houston	Mathematics
University of Missouri	Agricultural economics
<i>Yield/crop calendar modeling and estimation</i>	
Lockheed Electronics Company	Support contractor (test and evaluation and yield and crop modeling)
Clemson University	Crop physiology
Development Planning and Research Associates	Crop modeling
EarthSat Corporation	Yield modeling
Fort Lewis College	Crop modeling
Kansas State University	Crop physiology and yield modeling
NOAA CCEA	Yield modeling and meteorological data
Prairie View A & M University	Agriculture
University of Wisconsin	Yield modeling
USDA SEA	Yield and winterkill modeling

sities, or other government organizations. Where appropriate, this effort was competitively procured. Thus, the lead institution approach, which recognized the efficiencies of building on established institutional capabilities and profiting from earlier in-

vestment, was tempered with mechanisms for entry of new ideas, competition, and performance incentives. This required a major contract management effort to utilize 17 universities and 6 industrial organizations.

## DISCUSSION

The primary LACIE objectives were to research, develop, apply, and test a technology to improve crop production forecasts in foreign countries. To ensure that these were accomplished, an accuracy goal of  $\pm 10$  percent of the national production at harvest 90 percent of the time was established. This goal, referred to as the 90/90 criterion, was believed to be well above the accuracies achieved in most existing foreign forecasts and not dramatically worse than those routinely obtained in the United States. This belief has since been substantiated by the figures given in table III, which show accuracies currently obtained by the Foreign Agricultural Service and their goals for 1985. It is evident that the 90/90 goal represented a substantial improvement over existing information on foreign wheat production.

The original LACIE system was assembled from 1974 state-of-the-art technology. The pre-LACIE remote-sensing state of the art is given in reference 1. Little development was conducted in this implementation because of the rather short lead time available to implement a system that would have to be an adequate "breadboard" of an optimum state-of-the-art or future operational system. Most of the development accompanying the initial implementation was in the nature of streamlining the existing elements for more nearly automated operation.

From the beginning, it was recognized that the 1974 technology was not likely to achieve 90/90 performance. Consequently, supporting research components of the LACIE project were identified. The original goal of the test and evaluation effort was to identify those portions of the original technology that required upgrading. Subsequently, test and evaluation was used to verify that research products that were intended to upgrade quasi-operational components were, in fact, improvements. The original exploratory studies effort was aimed at several technical areas which were believed to offer the most risk.

### Original LACIE Technology

The following discussion outlines the original LACIE system and some of the design considerations and constraints that shaped it. Subsequent discussions trace the role of supporting research in identifying and correcting deficiencies in that system.

TABLE III — USDA Performance Figures and Goals

Country	Forecast			
	Early season <sup>a</sup>	Midseason <sup>b</sup>	Preharvest <sup>c</sup>	At harvest
<i>Current accuracy</i>				
Argentina	46/90	—	61/90	64/90
Brazil	8/90	—	31/90	31/90
Canada	26/90	—	45/90	94/90
India	57/90	64/90	88/90	—
U S S R	23/90	31/90	34/90	65/90
U S	<sup>d</sup> 90/90	-100/90	100/90	100/90
<i>1985 goal</i>				
Argentina	60/90	—	75/90	80/90
Brazil	30/90	—	50/90	60/90
Canada	50/90	—	60/90	95/90
India	70/90	75/90	90/90	90/90
U S S R	50/90	60/90	65/90	85/90
U S	90/92	95/95	99/95	99/95

<sup>a</sup>90 to 120 days before harvest

<sup>b</sup>45 to 60 days before harvest

<sup>c</sup>15 to 30 days before harvest

<sup>d</sup>Winter wheat only June 1

1 A most basic decision in LACIE was to monitor crop area while simultaneously predicting crop yield. This decision was based on the (then) unsubstantiated belief that 90/90 performance could not be achieved without monitoring both area and yield.

2 Crop area would be monitored using electronic imagery data obtained by the NASA Landsat-1 and Landsat-2. Several aspects of the Landsat system would provide fundamental limitations to system performance.

a The system ground resolution is 80 meters. Objects smaller than this would be difficult to resolve.

b The four spectral bands ("colors") available in the electronic images do not uniquely identify most crops but rather certain properties of the crop, such as the amounts of green and yellow vegetation present.

c Each satellite passes over the same point on the ground once every 18 days at a local time of approximately 1030 in the Northern Hemisphere wheat-growing regions. A fraction of the Earth,

especially at high latitudes, lies in the overlap between two Landsat groundtracks and can be observed on two successive days out of each 18

d The probability of cloud cover over the wheat-growing regions of the world at 1030 local time is about one-third. When this is combined with the 18-day satellite repeat cycle, each wheatfield can be seen about once every 50 to 60 days.

e Data acquired by the Landsats can be downlinked directly when the Landsats are within view of a ground station. Otherwise, the data must be recorded on an onboard tape recorder and downlinked over a ground station. The tape recorder has a limited life. At the beginning of LACIE, the available ground stations provided coverage of North America. Coverage of other areas could be obtained only with Landsat-2 because the Landsat-1 tape recorders were mostly inoperable.

f The existing historical Landsat data acquired over North America were quite good but the data for regions elsewhere were rather spotty.

3. Wheat was to be recognized by observing the vegetation development pattern over a sequence of Landsat acquisitions at the same point on the Earth (multitemporal analysis)

a The basic analysis would be done by an analyst interpreting multiple dates of Landsat data, together with ancillary data providing such information as crops nominally present, average planting dates, weather, etc. Such analyses had been conducted on a very small scale prior to LACIE.

b Because the analyst could economically identify only a limited number of points on the ground, an automatic classifier was trained by the analyst to recognize certain combinations of Landsat measurements as wheat or nonwheat. The classifier also had to use multitemporal data.

4 LACIE was the first major attempt to replace current-year ground observation data with imagery and data interpretation for training the machine classifier. Ground data in the countries of interest were unavailable during LACIE, and training with ground data is more cost effective for global use.

5 The requirement that the classifier use multitemporal data necessitated the registration of successive electronic images so that the same electronic picture element (pixel) in all images would correspond to the same point on the ground. Although Landsat data are processed in frames (full frames) that are 100 nautical miles on each side, the 1974 technology did not permit routine production registration of such data (NASA is currently bringing

a system to accomplish this on line) nor could full-frame data be delivered on the required schedule. Studies by GSFC indicated that a production system could be built to automatically extract and register Landsat data segments approximately 5 by 6 nautical miles in size with an average positional error of about 70 meters and that available hardware could support the production load associated with about 5000 such segments distributed worldwide (after reduction due to cloud cover). Although registration of multiple Landsat dates to each other or to the ground had been accomplished by several organizations, the available systems required extensive manual intervention and large amounts of computer time and rarely achieved an accuracy of 70 meters.

6. Studies by JSC had already indicated that it was both impractical and unnecessary to classify all the Landsat pixels in the wheat-growing regions of the LACIE countries. Sampling techniques could be used to select a subset of the available image pixels for machine processing to obtain an estimate of the amount of wheat present in the total set of available pixels. While it was recognized that dispersing the sample pixels more widely would reduce the sample error (or the number of pixels required), it was also recognized that image analysis of segments smaller than the 5 by 6 nautical miles proposed by GSFC might be difficult because of the lack of contextual information. Preliminary studies also suggested that about 5000 sample segments could give an acceptable sampling error for all eight LACIE countries and that JSC probably could not process more than 5000 segments. It was decided to accept the GSFC proposal and develop a sampling strategy that would achieve the required sample error with the constraint of 5000 segments for all wheat-growing countries to be studied.

7 The original LACIE sampling strategy was quite conventional in that it used historical agricultural data for political subdivisions to allocate a number of sample segments to each political subdivision. Landsat data and the best available maps were used to exclude noncropland from the survey. Formulas to aggregate individual segment estimates of wheat acreage into regional estimates were developed. Whereas the sampling strategy itself was straightforward, the methods used to compensate for segments not acquired because of cloud cover represented a new development. The collection and reduction of supporting data also represented a major effort.

8. Interpretation of the segments would require



the conversion of electronic imagery to high-contrast stable color film. This was a time-consuming manual process in 1974, so an automatic process was developed and tested.

9. The computer classification system to be used was the conventional Gaussian maximum likelihood system. This system had been developed for analysis of aircraft electronic imagery and had been tested, to some degree, in the analysis of Landsat data, primarily unitemporal. Most previous research had been concerned with the classifier's ability to make an accurate map of a region rather than with its ability to make an accurate estimate of the amount of some ground cover class present. Although theoretical studies by LARS had suggested that it was not an optimum choice for a multitemporal classifier, the limited experience in multi-temporal processing had been fairly successful. The classifier was to be trained by an analyst who selected, outlined, and labeled "training" fields in the electronic imagery; in all previous applications, the labels had been supplied on the basis of ground-acquired data or aircraft photographs that provided much greater detail than the Landsat data. Most of the effort on the classifier centered on developing an operationally efficient implementation. Such classifiers had primarily been operated in an iterative step-by-step mode. For LACIE, this had to be replaced by an all-at-once mode for efficiency and timeliness.

10. The required throughput could not be achieved with available analyst-interpreter resources. Training of the classifier appeared to require considerably more analyst resources than other parts of the classification procedure. It was planned, therefore, to conserve analyst-interpreter resources by training the classifier on approximately one of every five segments. The other segments would be classified by signature extension, a method in which signatures compiled from a "training" segment would be used to classify several nearby "recognition" segments. Signature extension was an active research topic in 1974 and was believed to be feasible, but little data supported or denied the belief.

11. The initial LACIE yield models were simple weather-driven regression estimators of the Thompson type. They were to be developed using historical yield and meteorological data for each region of interest. The models would not explicitly account for the effects of soils or agricultural technology; these effects would be modeled in a trend term that would have the effect of predicting the nominal yield for each region. Real-time weather

data would be obtained from the National Weather Service in the United States and from the World Meteorological Organization (WMO) in foreign areas. Like the Landsat system, the WMO imposes noteworthy restrictions on its users.

a. Data (which are intended to serve international aviation) are collected at major airports. The station density is very low in some important agricultural regions, such as the U S S R "new lands" spring wheat region.

b. Data are collected at 0000, 0600, 1200, and 1800 hours universal time. Therefore, no true daily maximum or minimum temperature is acquired.

c. Precipitation data were of low quality.

d. Data transmission errors are frequent.

Historical data for the construction of the yield models were recognized as being difficult to obtain, but no clear estimate of that difficulty could be made. These yield models predict the crop yield and implicitly account for the future weather, based on the weather to date. The initial design of the yield models did not consider the problem of estimating the likely errors in the yield forecast based on the input data as this appeared to be a difficult problem.

### **Supporting Research Improvements in LACIE Technology**

*Contributions in sampling, aggregation, and error estimation*—The original LACIE sampling strategy depended on the availability of regional historical data on wheat acreage (or production) to allocate samples. In some countries, such as the United States and Canada, high-quality data are available for small regions (such as counties). In other countries, such data may be totally unavailable, as in the People's Republic of China (P R C), or partially unavailable, or the available data may apply to such large regions (as in the U S S R.) that the data cannot support an efficient sampling scheme.

Additionally, it was found that the historical data base available to support exclusion of noncropland areas was inadequate for many countries. The best available maps rarely distinguish cropland from rangeland, furthermore, map data are frequently out of date. Landsat imagery provides a highly accurate basis for the exclusion of noncropland. The principal difficulty experienced with this approach was the incomplete coverage of agricultural regions in the LACIE countries by Landsat data when LACIE

began. This problem was overcome by the acquisition of full-frame Landsat imagery during LACIE, and a high-quality exclusion of noncropland was made. The magnitude of the problem is illustrated by the original allocation of 1949 segments in the USSR using maps and the available Landsat data. When Landsat imagery became available, some 700 of the segments were found to be located in areas that were primarily noncropland.

Some relatively minor modifications to the original sampling strategy were made, including the following:

1. Revision of the allocation so that errors in the wheat production estimate rather than in the wheat area estimate were minimized.

2. Improvements in sampling regions of mixed wheat (both winter and spring wheat).

3. Improvements in handling regions where the wheat area was small.

The marginal applicability of the original strategy to regions without good historical data, discovery of regions with unexpectedly high sampling error (e.g., North Dakota), and the understanding that an improved sampling strategy would lower analysis costs, lower errors, or allow more regions to be worked triggered the development of a second-generation sampling strategy. This new sampling strategy used Landsat full-frame data to identify natural bounded regions of relatively homogeneous crop density. Sample allocations in the regions were based on the estimated wheat area as obtained from Landsat data. Fewer samples were needed because the natural bounded regions were more homogeneous than the political bounded regions. The major technical problem here was the design of a procedure whose objective estimates could not be contaminated by the subjective nature of some of the input data. This strategy was tested in several regions during Phase III and implemented for the total US Great Plains for the 1977-78 crop year. Its use reduced the number of sample segments required to achieve the same precision by 20 percent; this was accomplished in a region with high-quality historical data. Larger savings would be expected in the USSR and elsewhere. Key contributions to development of the new sampling strategy (described in the symposium paper by Hallum) were made by LEC, Texas A & M University (TAMU), UCB, USDA, and NASA.

During LACIE, an advanced sampling strategy that used prior-year Landsat data in an even more extensive way was developed by UCB, but it was never implemented in the AES. In this strategy, prior-year

Landsat imagery for all possible sample segments was quickly and coarsely classified. The selection of the segments to be worked on in the current year was based on a stratification of all possible segments (similar to the LACIE second-generation strategy). Estimates for the current-year segments were regressed against previous-year estimates for the same segments to obtain a regression estimator that could be used to correct the prior-year coarse estimates for all possible segments to result in a current-year estimate. In a test in one crop reporting district in Kansas, this strategy was 10 times as efficient as the original LACIE strategy (see fig. 4 and ref. 2). This result could not, however, be safely extrapolated to the general case because of the limited scale of the test.

The LACIE goal of demonstrating the 90/90 criterion required that estimates be made of the random error components in the system, i.e., those errors that would prevent obtaining exactly the same result if the experiment could somehow be repeated with exactly the same methodology but, for example, with a different allocation of segments to analysts. This was (and is) an extremely difficult theoretical and practical problem that required considerable effort from sampling and aggregation supporting research and from accuracy assessment. The discussion here does not separate the efforts by these two elements of LACIE.

Methods were developed to quantitatively estimate the random errors of LACIE area, yield, and production estimates from data available within the

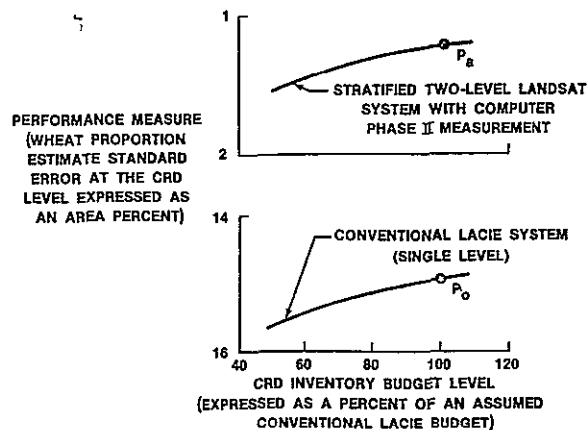

FIGURE 4.—Cost and capability comparison of two-level versus single-level Landsat sample allocation and estimation systems (from ref. 2).

quasi-operational system and to propagate these error estimates to all levels of aggregation. It was evident that more than internal system data and historical data were required for an adequate understanding of the errors in the system. The acquisition of ground-observed data from a certain randomly selected fraction of the LACIE segments in the U.S. Great Plains was proven essential for two reasons:

1. Certain assumptions about the nature of the problem had to be made so that the problem could be theoretically tractable. These assumptions were questionable and could not be checked with available data.

2. Certain inadequacies of the historical data had not been understood earlier. Consequently, the role of accuracy assessment was greatly expanded by the establishment of an effort to acquire and analyze ground observations of crop identification on regular LACIE segments. The identity of these segments was concealed from the LACIE analysts until final acreage estimates for the phase in question had been made. The blind-site program required development of substantial new technology to handle the data efficiently. Major development in variance propagation theory was also required.

During the LACIE project, there was a substantial controversy about whether the loss of Landsat data caused by cloud cover could bias LACIE results. Experiments conducted by LEC (ref. 3) using segments with ground-observed data indicated that no bias was demonstrable and that any bias which might be present should be insignificant with respect to achieving the 90/90 goal. (This might have to be verified each year in an operational system.)

Partially in support of earlier attempts to resolve the cloud cover issue, several computer simulations of the interaction between Landsat orbit, sampling strategy, and cloud cover were made. These culminated in a model of the complete LACIE system. While all these models have contributed to an understanding of the LACIE problem, the complete system model was proven, at least on current-generation computers, to be too cumbersome to provide the systemwide benefits that had been hoped for. These simulations by LEC, NASA, and TRW have proven to be extremely useful in understanding a number of issues in data acquisition rates, the effects of using two satellites, and the effects of new acquisitions on an existing estimate.

Major progress has been made in several practical areas related to aggregation. Probably the most important area relates to choosing the size of the region

that was considered to have constant yield when area and yield estimates were combined.

Other accomplishments include determination of more nearly optimum strategies to account for missing data, development of procedures for data editing, and development of systems that provide an aggregation analyst rapid visibility into a trial aggregation. The latter allows the accomplishment of a large number of aggregations and edits in a short time.

*Contributions in labeling and classification for area estimation.*—Unlike sampling, in which technical problems were corrected before major problems were actually experienced in LACIE analysis, major difficulties were experienced in area estimation.

A number of startup problems experienced in Phase I had to do primarily with analyst inexperience and data inadequacy. These problems were essentially resolved by the end of Phase I and do not warrant further discussion. However, six other problems of lasting importance also surfaced during Phase I.

1. Analysts proved unable to distinguish wheat from other small grains.

2. Signature extension proved to have an unacceptably poor accuracy.

3. Multitemporal classification proved to have an unacceptably low throughput. In the analyst's judgment, given adequate analyst time, he could obtain acceptable results, but the effort required was prohibitive for routine use.

4. Multitemporal classification accuracy was adequate for winter small grains but no more than marginal for spring small grains. Unitemporal classification accuracy was marginal to adequate for winter small grains but inadequate for spring small grains.

5. Unitemporal classification throughput was poor because of the excessive effort required of the analyst.

6. Classification accuracy was poor in segments with little wheat.

The real-time estimates of wheat area made during Phase I were very poor. At the end of the season, the Phase I activities were examined and evaluated. After recognizing the analyst's inability to separate wheat from other small grains and after correcting some of the identified problems (including use of wheat to small grains ratios), LACIE reworked Phase I data and demonstrated that the modified Phase I system could make fairly reasonable estimates of winter, spring, and total wheat. The winter wheat estimate was within 1 percent of the USDA

estimate, but the spring wheat estimate was 30-percent low. The total wheat area estimate was inferred to support the 90/90 criterion.

During this period, the in-house supporting research indicated that the most critical task performed by the analyst was training field selection rather than training field labeling. Figure 5 shows the effect of the analyst's selecting different training fields when the selected fields were labeled with ground-observed data. Operational results showed that analysts were spending more time in selecting training fields than in labeling them. Consequently, a procedure in which automated clustering of the data (which has the function of identifying the discernible classes present in the data) was used to select the training fields was tested. These tests were successful when performed in a research mode but unsuccessful in an operational mode. There appeared to be two problems with the approach: the clustering algorithm did not give good results without multiple iterations, and the clustering output products available to the analyst were difficult to interpret because the colors

assigned to the clusters were not correlated with the spectral properties of the cluster.

Simultaneously, work was being performed on the signature extension problem. Two probable causes of the signature extension failure are that (1) the recognition segments were poorly matched to the training segments in terms of soil color, crops present, crop condition, etc., because the training segments were not representative of the variability present, and (2) haze depth variations were present. Research on the signature extension problem centered around these two issues. Two efforts to stratify the Landsat data into regions that might be expected to have homogeneous crop signatures were undertaken by LARS and UCB. One of these efforts was based on automatic clustering of the data; the results did not appear to be useful. The other method was based on interpretation of full-frame Landsat imagery and supporting data, such as small-scale soils maps. The results of this task suggested that the techniques might be useful in signature extension but the value could not be demonstrated at that time. However, the results of this task strongly contributed to the second-generation sampling strategy and are now contributing to signature extension research.

Analysis by ERIM of Landsat data acquired on successive days for several sample segments substantiated the effects of different haze depths in the Landsat data and demonstrated that this problem was too severe to permit regularly successful signature extension without correction. Several approaches to correcting this problem were attempted, while some of these worked fairly well at correcting haze effects for successive-day acquisitions of the same segment, none of them worked well for the useful case of different segments on the same or different days.

Even at the start of LACIE, certain theoretical disadvantages were recognized in the conventional classifier being used. Basically, it can be shown that the classifier can be expected to overestimate for segments with low wheat proportions and to underestimate for segments with high wheat proportions. Results from Phase I (fig. 6) appeared to prove this, although it was unclear whether this effect was the result of the classifier or analyst errors. There are other machine methods, generically called "proportion estimators," which are not expected to have this problem. A limited evaluation of nine such methods was carried out during Phase I (ref. 4). The results of this evaluation were disappointing. None of the proportion estimators worked significantly better than

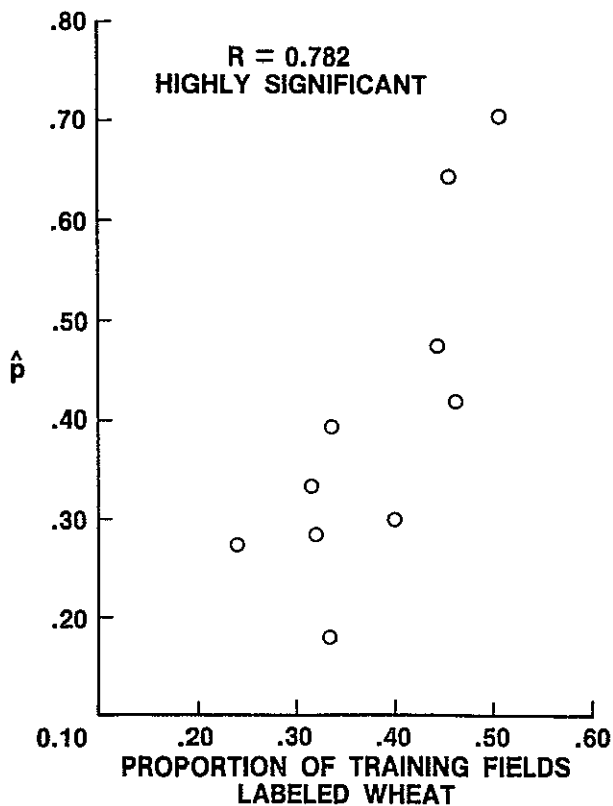

FIGURE 5—Dependence of the wheat proportion estimate on the fraction of training fields labeled as wheat (LACIE Phase I).

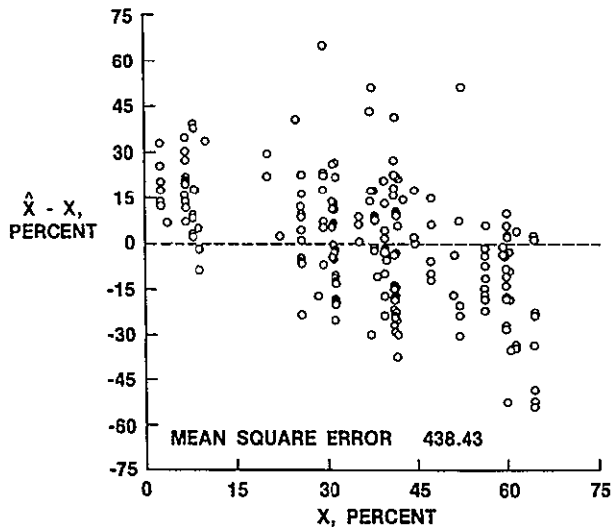

FIGURE 6.—Proportion error versus ground-truth small grains proportions (LACIE Phase I).

the classifier, most were substantially worse. Furthermore, it appeared that these methods would suffer from the same sensitivity to selection of training fields as the current classifier. Consequently, work on most of these methods was suspended.

One general result of Phase I supporting research was of special importance. The results of all these tests made two facts very clear. First, the performance of methods tested during Phase I was highly variable. To discern the true average performance of a method, many tests were necessary. Second, the available data sets and facilities for test and evaluation were inadequate to support the testing now obviously required. To solve the latter problem, the following steps were taken.

1. Test and evaluation resources were expanded
2. Some test and evaluation was done jointly with quasi-operational analysis using the high throughput of the quasi-operational system
3. Arrangements were made to incorporate the ground-observed data being acquired by accuracy assessment into the data base available for supporting research tasks

At the beginning of Phase II, it was evident that the LACIE analysts were fairly adept at identifying small grains on Landsat imagery but could not separate the wheat; that they could usually recognize a good classification by comparing the classification map to their mental image of what was small grains in the Landsat imagery; and that they were reasonably adept at selecting and labeling training fields

which would produce a good classification map, though multiple iterations were frequently required. During Phase II, the impact of the previously discussed Phase I technical problems was partially alleviated by initiation of the following two steps

1. Wheat pixels in segments with small amounts of wheat were hand-counted rather than classified.
2. Once an apparently satisfactory classification of a segment was obtained, no effort to obtain a better classification was made unless interpretation of the data revealed an apparent change in the amount of wheat present

These changes substantially reduced the amount of classification required and thus increased the analyst's throughput. However, the lack of a quantitative procedure for determining when to reclassify and the failure to use late-season data where separability of wheat should be improved for those segments classified only during the early season opened the possibility of errors that could be significant. Additionally, historical ratios of wheat to total small grains were used to derive wheat area estimates from total small grains area estimates.

These strategies were largely successful, except on application to North American spring wheat. The necessary throughputs were achieved in the U.S. Great Plains, Canada, and the U.S.S.R. Adequate accuracies were achieved in the U.S. Great Plains winter wheat region. Inadequate data were available to determine accuracies in the U.S.S.R. winter wheat indicator region and the U.S.S.R. spring wheat indicator region, but the precision of the estimates that could be checked was good. North American spring wheat remained a problem. The area of U.S. Great Plains spring wheat was underestimated by 26 percent, a greater underestimate occurred in Canada. Furthermore, the historical ratios used to convert the spring small grains area estimate to a spring wheat area estimate failed in the U.S. Great Plains spring wheat region and in Canada because substantial changes (up to 300 percent) in these ratios had occurred between the current year and the historical base. These changes alone were sufficient to prevent satisfaction of the 90/90 criterion.

During the course of Phase II, a number of supporting research activities began to yield concrete results. Perhaps the first of these was ERIM's development of the "tasselled cap" (TACAP) transform, which is able to project most of the information present in the original four-dimensional Landsat data onto a two-dimensional representation, such as a graph. In the TACAP representation, one



of the two derived dimensions conveys information primarily about the green development of vegetation, whereas the other conveys information primarily about the brightness of the underlying soil. Figure 7 illustrates the TACAP transform. This development was put in work almost immediately in a successful combined effort by NASA, USDA, and LEC to quantitatively monitor the development, severity, and extent of droughts that occurred in Kansas, Oklahoma, northern Texas, southeastern Colorado, and South Dakota during Phase II. Figure 8 shows a delineation of drought-stricken areas in the Southern Great Plains based on TACAP representation.

During this period, it also became apparent that the LACIE high-contrast color transparencies did not reliably indicate the presence or health of vegetation. In particular, the least healthy vegetation (which might still be very healthy) in a sample segment that contained large amounts of healthy vegetation might appear to be sickly or even nonexistent and vice versa. To solve this problem, a number of candidate approaches to create imagery that would be more consistent indicators of vigorous growth while losing as little contrast as possible were developed and tested, primarily by NASA, LEC, and IBM. Eventually one of these methods, the Kraus method (ref 5), was selected. Figure 9 shows an example of the original product and the corresponding Kraus product.

Also during Phase II, a Goodyear STARAN array processor was installed in the LACIE quasi-operational analysis system. This installation, which was a breakthrough in itself, vastly increased the speed of classification and clustering and thereby greatly increased the potential payoffs of improvements in clustering. With this in mind, a team from NASA, LEC, and the University of Houston (UH) undertook a major effort to correct the deficiencies observed in clustering. The major improvements can be summarized as being a correction for variation in

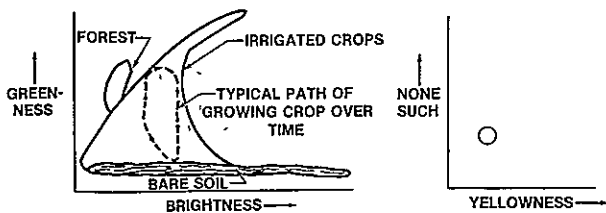

FIGURE 7.—Tassel cap transformed Landsat data showing regions occupied by typical agricultural data

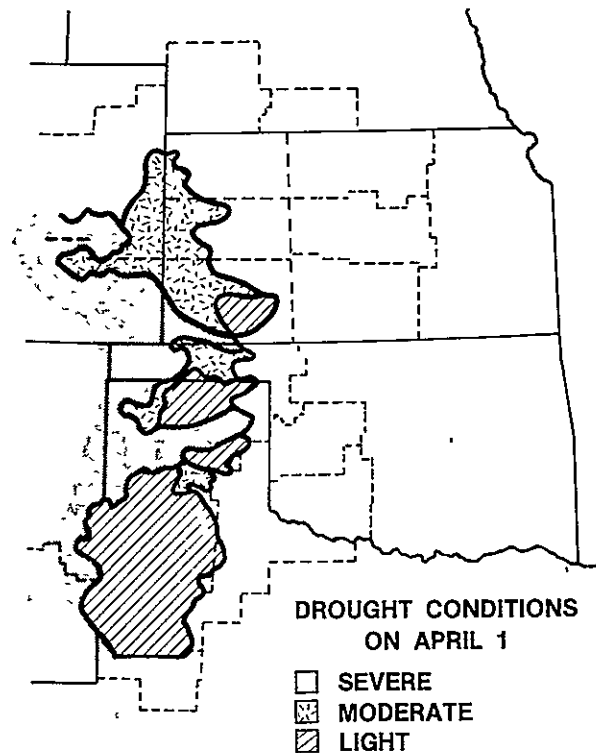

FIGURE 8 —Areal extent and effect of drought on April 1, 1976.

Sun angle, an increase in the number of clusters available (from 20 to 60), an improved start procedure for the cluster algorithm using cluster seeds, and a substantial cleanup of the general logical design. These improvements were immediately implemented in the quasi-operational analysis system software, though not all of the improvements were used until after further testing was completed.

As noted previously, the cluster map format that had been used was not easily interpreted. Supporting research developed several improved map displays, one of which was used in LACIE during Phase III. A different display developed by LEC and NASA, the cluster image display, is probably more appropriate for most non-LACIE applications. The cluster image display has the advantages that clusters which are similar in the Landsat data space appear similar in the display and that the display colors can be made reasonable to an analyst.

Approximately simultaneously, ERIM developed BLOB, the first spatial clustering algorithm really suitable for use with Landsat data, previous spatial clustering algorithms had been aimed at the processing of aircraft electronic imagery data and were only marginally appropriate to Landsat data. This

algorithm was not implemented in the LACIE quasi-operational system but was later to play an important role in advanced signature extension research.

During this period, it was suspected that analyst labeling of training fields represented a problem. This problem was difficult to quantify, because the analyst selected the fields to be labeled and there were indications that his selection was biased towards those fields he could identify with confidence. When the labeling accuracies were checked in blind sites, they appeared to be quite good (92 percent); but there were indications that certain difficult-to-label classes were not present in the training fields. To help address this problem, analysis-interpretation keys were developed to provide instruction and exemplary documentation, complete with imagery, ancillary data, etc., on labeling. The use of the keys was also expected to increase the consistency of analyst labeling.

During late Phase II and early Phase III, much of the Phase I and Phase II supporting research effort on local classification came to fruition in the development of a new approach to area estimation (Procedure 1), which was tested and implemented for use by late spring of 1977, in time for final winter wheat segment area estimates and all spring wheat segment area estimates to be made using the new procedure. Key roles in this development were played by NASA, LEC, and IBM; contributions were made by LARS and ERIM.

As mentioned previously, training field selection had been identified as a major source of variation and a major consumer of analyst time in the original procedures. It was believed, therefore, that the use of analyst-selected training fields should be discarded. It was further known that in small-field areas, such as the Northern Great Plains, India, and the P.R.C., the selection of training fields was extremely

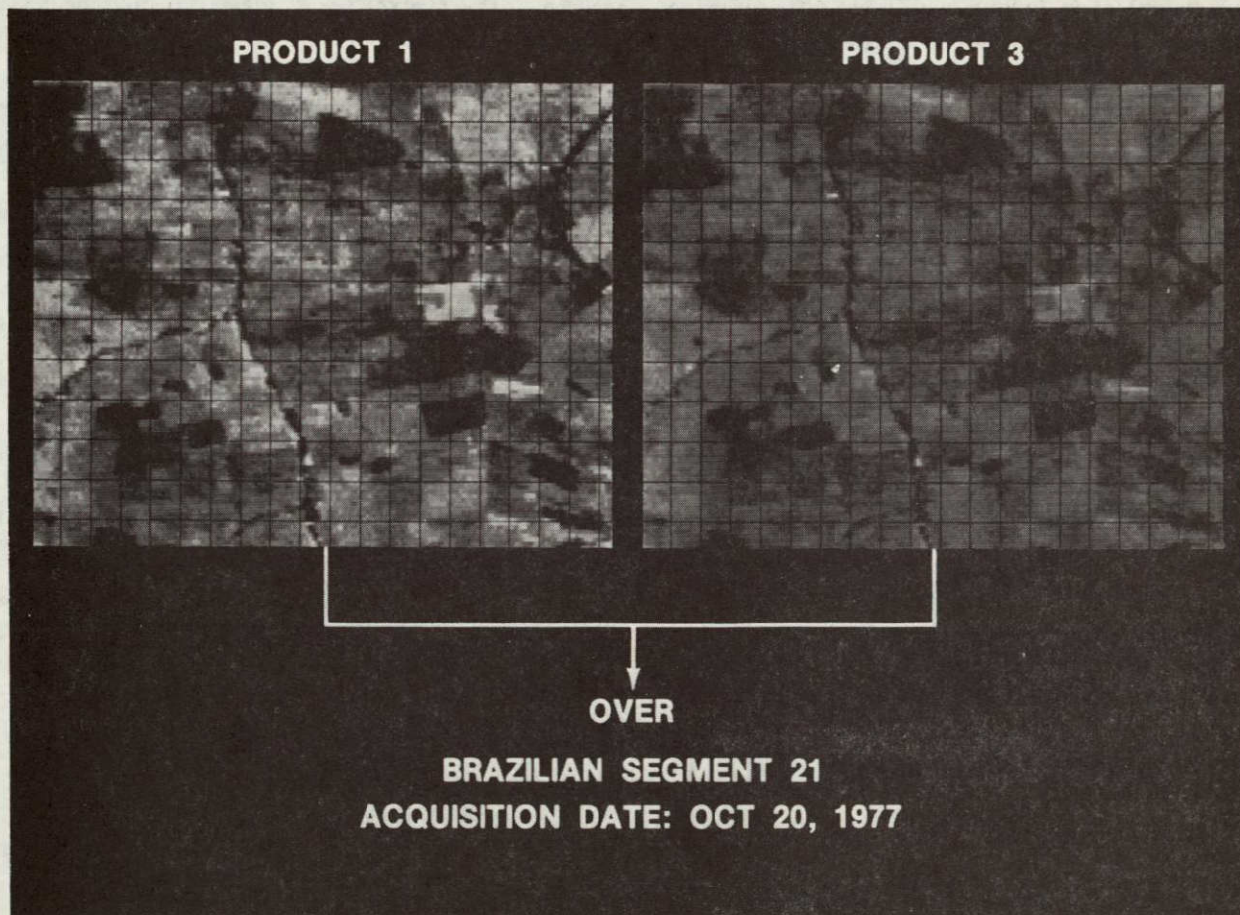

FIGURE 9.—Examples of LACIE imagery product types.



difficult. These facts indicated that the most desirable form of training field would be a single pixel. Previous attempts to use single-pixel training fields had broken down over the need to calculate training statistics for the classifier from a reasonable number of such pixels ("dots"). However, with the recent progress in clustering accuracy and speed, which appeared to support the calculation of the desired statistics, it seemed that a reasonable solution might be at hand. This solution was to use the clustering to find the classes present and calculate their statistics. The analyst-labeled dots are then used to label the clusters as wheat or nonwheat and thereby produce a classification. A final step uses more analyst-labeled dots to correct for the effect of classifier bias (but does not correct for analyst bias).

This procedure was a major success during Phase III, bringing with it the following advantages.

1. Accuracy was improved, especially in U.S. Great Plains spring wheat (fig. 10).
2. Analyst throughput, especially for multitemporal classification (which is no more difficult using Procedure 1 than unitemporal classification), was greatly increased (fig. 11).
3. The interface between analyst and classifier was greatly simplified. This not only allowed the analyst to concentrate on labeling, which is his fundamentally critical role, but it also greatly simplified

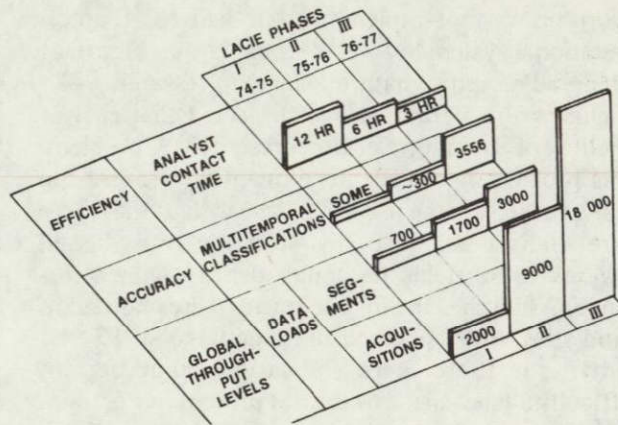

FIGURE 11.—LACIE system utilization and performance summary.

the test and evaluation of Procedure 1 and, later, the accuracy assessment of Phase III results.

It had always been suspected that the registration accuracy of  $\pm 1$  pixel ( $\pm 70$  meters) would be an obstacle to multitemporal processing in LACIE; in fact, imperfect registration had been frequently indicated as a major factor in the difficulties of multitemporal classification. The suspicion that this is so remains; certainly, misregistration is a substantial nuisance for the LACIE analyst. However, very limited testing by IBM of classification accuracy using LACIE registration versus improved registration has not demonstrated significant differences. Perhaps this indicates that even Procedure 1 does not fully avail itself of the multitemporal information present on Landsat data (ref. 6).

During this period, a major difficulty in signature extension also gradually became evident. The variation of crops, soils, planting dates, etc., occurring within a small group of segments was so large that it was unusual for a single segment to be able to adequately represent all members of the group. However, it appeared that the variability of these factors across large regions might result in the classification of large regions or large groups of segments using training not from one but rather from several segments, especially if these segments could be appropriately selected. Almost simultaneously, it became evident that in the TACAP coordinate system, certain features of the Landsat data appeared to provide diagnostic information on the haze depth. These discoveries, based on work by ERIM, UCB, LEC, IBM, UH, and NASA, led to the essential dissolution of earlier signature extension efforts and the

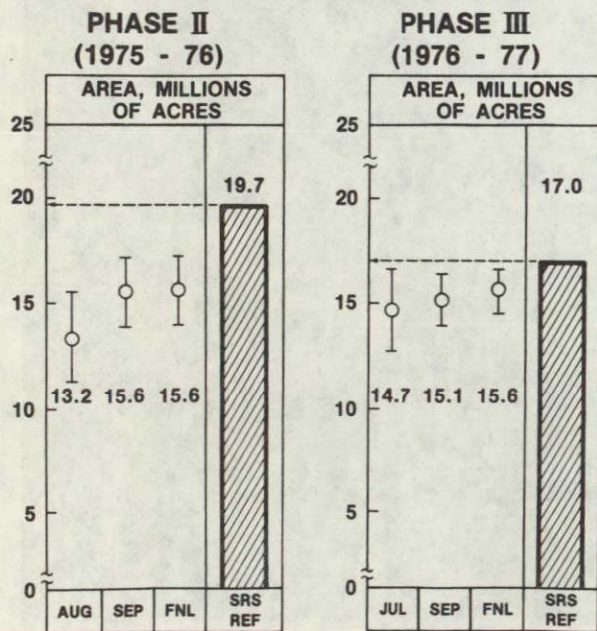

FIGURE 10.—Four-state spring wheat estimates.

together with some mutually supporting efforts carried on within the AES, have shown that

1. Barley is moderately, probably adequately, separable from wheat in Landsat-1 and Landsat-2 data if Landsat data are acquired at the correct time.

2. The key acquisitions occur around the time of wheat heading, when the faster maturing barley begins to yellow as it ripens while the wheat is still green. Crop development stage information is very important to the technique.

3. The distinction obtained is consistent over the entire state of North Dakota.

4. Acquisition success rate is too low for practical application of the method with only one satellite. However, with two satellites (as Landsat-2 and Landsat-3, now in operation), the method should be practical.

During LACIE, the improvement of analyst labeling of training data appeared to be an intractable problem. Although substantial improvements in labeling accuracy were achieved, these were primarily achieved through analyst experience—by an increase in the quantity and quality of ancillary data provided to the analyst, by the acquisition of multiyear Landsat data sets over many sites, and by exposure of the analysts to ground-acquired data from previous years, especially in the form of analysis-interpretation keys. One of the major problems with this approach was the difficulty of ascertaining how much each of the above contributed to improved labeling accuracy and how important each item of data was to accurate labeling. Late in LACIE, a procedure called Label Identification by Statistical Tabulation (LIST) was developed by NASA, LEC, UCB, and ERIM to obviate these problems. LIST used the analyst to extract certain attributes about a Landsat pixel that was to be labeled (e.g., whether or not it is in a field or whether it is vegetated). The extracted attributes were then entered into a special classifier to obtain the label. Testing of LIST to date indicates performance on a par with the analyst's. LIST is regarded as a major breakthrough because it is objective, it largely eliminates analyst variability and requires less analyst expertise, it allows determination of the contribution of each piece of data to the decision process, it allows the fundamental variables in the decision process elements to be understood, and it can be largely automated.

Also during Phase III, two substantial breakthroughs were made in clustering. One was TAMU's development of AMOEBA, a new and completely unique spatial clustering algorithm for

Landsat data. AMOEBA (discussed in the symposium paper by Bryant) uses spatial information in a much more sophisticated way than previous spatial clustering algorithms and offers breakthroughs on some other issues as well. A completely different clustering algorithm called CLASSY, described in the paper by Lenington, was developed simultaneously but independently by LEC and a postdoctoral fellow from the National Research Council. CLASSY is a maximum likelihood clustering algorithm. While it is not the first such algorithm tested, it is the first that has appeared to be practical. All previous clustering algorithms have been rather heuristic, the maximum likelihood approach is a way to obtain an unbiased proportion estimate directly from clustering. The computational problems associated with maximum likelihood clustering have been very difficult. CLASSY does not use spatial information, therefore, future efforts will not only test CLASSY in its current form but also address the possibility of using spatial information in a maximum likelihood approach.

Also during Phase III, after the development of the Kraus film product, it became evident that further improvements in film products were needed and that significant improvements in the color film process were only likely to be obtained as a result of really understanding the processes of Landsat data acquisition and calibration, film generation, and eye-brain response. This has been addressed in an effort to apply existing uniform chromaticity scale technology (obtained from such organizations as the National Bureau of Standards and Eastman Kodak) to these processes. Although this work (discussed further in the symposium paper by Juday) is only now coming to fruition, it has greatly enhanced an understanding of the display problem.

Before LACIE, it was believed that the basics of classification technology were well in hand and that the needed research was primarily in augmentations of the basic technology. LACIE first demonstrated the naivete of this belief, then obtained reasonable (but probably not comprehensive) solutions to most of the basic technological problems and has now begun to address the augmentations that were the targets of research in 1974.

Many of these developments can have broad application in the processing of Landsat or other data, for example, the Census Bureau has made inquiries on the use of CLASSY to process demographic data.

*Contributions in yield and crop calendar modeling.*—Wheat yield is known to be driven by the combined



effects of a large number of variables whose individual and combined contributions are functions of the growth stage of the plant (For example, grazing or mowing before jointing normally does not decrease yield where practiced in the U.S. Great Plains, after jointing, these practices can reduce yield to zero ) Important factors are temperature, available soil moisture, plant variety, and soil fertility (as augmented by fertilization). Large variations in yield occur from year to year and region to region because of these factors, similar variations occur within a given region and year for several reasons

1. Soil fertility and water-holding capacity vary widely, even on a local scale

2. Precipitation varies considerably on a local scale.

3. Differing planting dates expose the crop to different histories of the various driving factors

4. Farmer's skill and luck vary widely.

The LACIE problem, of course, was to obtain measurements or estimates of those driving factors accessible for measurement or estimation and to use those values, obtained throughout the growing season, to predict the final yield. Yield values would not be required on a point-by-point basis. The size of the regions was not predetermined. It should be noted that, with the current state of the art in long-range weather forecasting, it is fundamentally impossible to make an accurate early prediction of the final yield because of inaccuracies in predicting the late-season weather

At the beginning of LACIE, work had been completed on a broad spectrum of approaches to yield modeling, with an equally broad spectrum of objectives. Estimation and prediction of regional or large-area yields was only one such objective, and no clearly superior approach was apparent at the time. The existing approaches are discussed here in the following four groups (other hierarchies can be and have been used)

1. First-generation models. These are models in which the modeling is entirely empirical. Little knowledge of the plant is used in constructing the model. Effects due to plant response and later weather response to early-season weather are not distinguishable. Such factors as soil fertility, plant variety, fertilizer application, and other technology are implicitly modeled together in a trend term

2. Second-generation models. These models might be described as physiologically motivated in that they recognize certain key features of the plant's response to its environment without really attempt-

ing to model the plant. Typical differences from first-generation models include

- a. Defining plant response to environmental variables as a function of biological time rather than of calendar time. This requires that the model "know" the development stage of the crop at a given time

- b. Using soil moisture rather than precipitation as the moisture supply variable

- c. Using varieties, fertilizer application, irrigation, etc., to explain yield trends explicitly

- d. Using natural differences in soil fertility, water-holding capacity, etc

These models typically use submodels, such as a crop development model, to calculate inputs needed by the basic model.

3. Third-generation models. These models attempt to model the plant's physiological response to environmental input variables and, on this basis, to predict yield. Submodels are also used in these models.

Note that although the structure of second- and third-generation models is established by nonstatistical considerations, statistical analysis of historical data is required to determine the models' (and some submodels') coefficients

4. Landsat yield models. These models attempt to use Landsat data, frequently with other environmental data such as the data used in the foregoing models, to estimate yield. The general idea is that Landsat data can provide a rather good estimate of a canopy-related parameter, such as green leaf area, which is in turn correlated with yield

To meet the LACIE Phase I schedules, there was little alternative to the use of first-generation models, especially since these were already under development by NOAA's Center for Climatic and Environmental Assessment (CCEA). However, it was uncertain at that time whether such models would satisfy the LACIE global 90/90 criterion because

1. Adequate region-specific historical and meteorological data to derive model coefficients would probably not be available for some countries (e.g., the P.R.C.)

2. The models were insensitive to extremes, which are excluded from the historical data by averaging over large regions and long time periods (months)

3. There was considerable doubt that the first-generation models could achieve 90/90 performance even with historical data of the kind available in the United States.



It was recognized that the third-generation models could not be brought to fruition during LACIE, but it appeared that second-generation models could be and that they might contribute in two ways. Estimation accuracy was expected to be always better than first-generation models because of the model's increased sensitivity to environmental factors. Second-generation models offered substantial hope of "universality", i.e., one model might be applicable over a very wide region so that yield estimates could be provided for areas for which insufficient historical data prevented development of first-generation models.

There appeared to be one other hope for the development of models to apply to regions without detailed historical data. This was the construction of models in analog regions to the target regions (regions that were sufficiently like the target region so that a yield model developed for the analog region would apply to the target region with only minor adjustments). Because the analog region approach was recognized as risky and because the performance of LACIE first-generation models was expected to be lower than 90/90, work was undertaken on several second-generation models and on Landsat models simultaneously with the work at CCEA.

The second-generation models initially investigated were those of Baier (ref. 9), Haun (ref. 10), and EarthSat (ref. 11). The EarthSat model used meteorological satellite data to assist in the estimation of precipitation. None of these models appeared promising by the end of Phase I, additionally, tests showed that the use of the meteorological satellite data in the EarthSat model, using techniques then available, did not improve the estimates of precipitation.

Simultaneously, work on the models using Landsat (or field measurement) data showed the following:

1. Landsat data were highly correlated with leaf area index, biomass, number of heads, and yield in individual experiments.

2. Agronomic data acquired elsewhere made it clear that the correlations between leaf area index or biomass and yield were untrustworthy. Good correlations were frequently obtained, but severe breakdowns in the correlation could occur when the late-season weather was not average.

3. Reliable acquisition of Landsat data appeared to be a problem because of the 18-day repeat cycle and cloud cover.

4. Inadequate data existed to develop a large-area calibration of a Landsat yield model.

At the same time, testing of the first-generation models was revealing the following:

1. Performance during the 1974-75 growing season was adequate to support the 90/90 criterion.

2. Results of a 10-year bootstrap test (the same methodology was used to derive model coefficients for the 10 years from 1965 to 1974; each model was then tested over the year for which it applied) showed that the models did not meet the 90/90 criterion over the previous 10 years but that, with minor improvement, they probably would.

3. The LACIE baseline models tended to underestimate deviations in yield from the trend, but the predicted deviations were rather reliable in the correct direction.

Therefore, it was decided to proceed with minor improvements to the LACIE baseline Phase I models for use in Phase II and to abandon the current second-generation yield models.

After careful consideration, work was initiated at Kansas State University (KSU) on two more yield models. One of these was to be a second-generation, physiologically motivated model using Landsat and meteorological inputs (the Kanemasu model, ref. 12). The approach chosen was intended to avoid the difficulties inherent in obtaining a general calibration data base and to solve the problems inherent in models that used only Landsat data. The other new model, the Feyerherm model (refs. 13 to 15), was a derivation of the Baier model; it was to be a physiologically motivated model that would use inputs obtained from weather, a crop calendar model, soils, a soil moisture model, and technology and would hopefully represent the wheat plant well enough that very limited historical data would be required to adapt it to a new region. It was also expected that the Feyerherm model would have a wider dynamic range than the LACIE baseline models.

The Kanemasu model was not brought to fruition during LACIE but is now undergoing testing. The results of that testing are not available at this time.

The LACIE baseline models were upgraded throughout LACIE, but the models did not support the 90/90 criterion in the United States in Phase III. Table IV lists the results of a test of the Phase III yield models with historical data for the years 1967 to 1976. The models were developed with data for the 45 years before each of the test years. A non-

TABLE IV—Results of an Evaluation of the LACIE Phase III U S Yield Models on 10 Years of Independent Test Data

Year	LSCS estimate bu/acre	LACIE estimate, bu/acre	Error <sup>a</sup>	Within tolerance <sup>c</sup>
1967	21.6	22.5	+0.9	Yes
1968	26.0	24.6	-1.4	Yes
1969	28.4	29.4	+1.0	Yes
1970	28.2	26.6	-1.6	Yes
1971	30.8	27.9	-2.9	No
1972	29.3	29.1	-0.2	Yes
1973	30.8	30.6	-0.2	Yes
1974	23.8	28.4	+4.6	No
1975	26.8	27.3	+0.5	Yes
1976	26.4	27.1	+0.7	Yes
1977 <sup>b</sup>	27.5	24.9	-2.6	

<sup>a</sup>Mean error = -0.1 bu/acre RMSE = 1.90 bu/acre  
<sup>b</sup>Phase III results

parametric statistical test employed to analyze the data did not reject the 90/90 hypothesis, however, had the models exceeded the tolerance bounds in at least one more year (as it appears to have done in 1977), the 90/90 hypothesis could have been rejected. Additionally, the root mean square error (RMSE) of 1.9 bushels per acre is larger than is desirable for a 90/90 estimator. It should be noted, however, that 1974 was a very dry year in the U S Great Plains, and wheat yields were very poor. The LACIE yield models failed to respond to this deviation and overestimated the yield by 4.6 bushels per acre. Without 1974, the RSME would drop from 1.9 to 1.3 bushels per acre, which is not significantly different from that required for a 90/90 estimator. Thus, it appears that the yield models may satisfy the 90/90 criterion in years without extreme departures in yield. Figure 13 shows the results for each regional yield model in the U S Great Plains in the 10-year test of the Phase III models; and figure 14 shows a summary of the five LACIE baseline spring wheat model results for the 10-year test period from 1967 to 1976. As can be noted from this contingency table, there is a significant tendency of the spring wheat models to underestimate above-normal yields and to overestimate below-normal yields.

During Phase III, the Feyerherm model was tested in Kansas, North Dakota, Tselinograd and Kurgan (spring wheat), and Khmel'nitskiy (winter

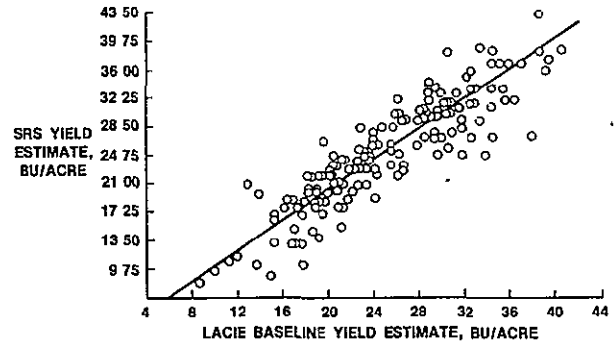

FIGURE 13.—Ten-year bootstrap test of LACIE baseline Phase III yield models

wheat) A 10-year bootstrap test has been conducted for spring (fig 15) and winter (fig. 16) wheat models of the U S Great Plains; the winter wheat model has been tested in other regions.

These tests do not support a claim for improved (better than LACIE-baseline model) performance in regions where the historical data are good. However, they do support, to some degree, the claim of universality. Also, the 10-year bootstrap tests of the LACIE baseline models used a much finer network of meteorological stations than the tests of the Feyerherm model.

During Phase III, a simpler physiologically motivated model, the Cate-Liebig model (discussed in the symposium paper by Cate et al.), was developed. This model concept could develop into a primitive

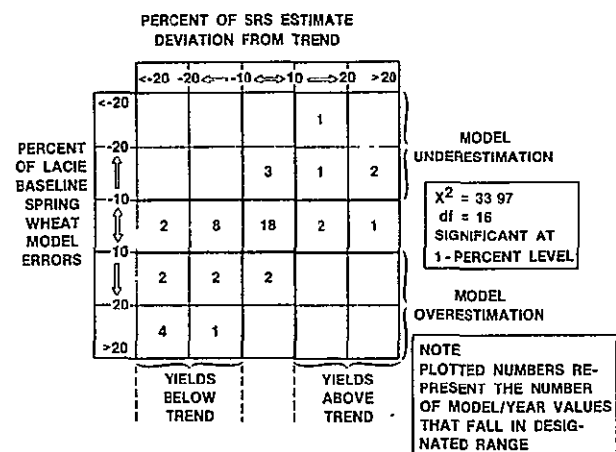

FIGURE 14.—Contingency table for 10-year test of five LACIE baseline spring wheat models versus deviation of actual yield from normal.

ORIGINAL PAGE IS OF POOR QUALITY

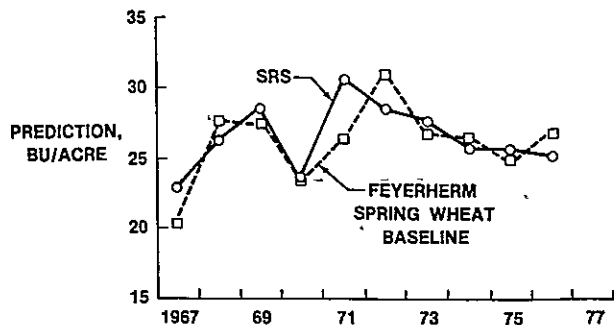

FIGURE 15.—Ten-year time series plot of the Feyerherm baseline spring wheat model predictions and SRS predictions.

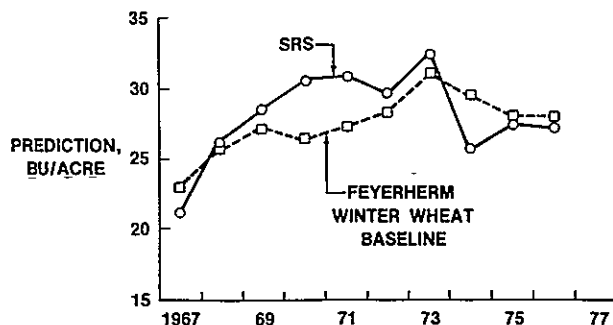

FIGURE 16.—Ten-year time series plot of the Feyerherm baseline winter wheat model predictions versus SRS predictions.

third-generation model because it actually assumes some experimentally derived photosynthesis and respiration plant responses. The model form has the highly desirable property of making very efficient use of the available historical data. In preliminary tests (table V), performance of the Cate-Liebig model appears equivalent to that of the LACIE baseline and Feyerherm models.

The analog area approach to obtaining yield models for areas without adequate historical data has proven to be a blind alley because of the inability to find adequate analog areas.

The original LACIE yield models did not provide estimates of the likely errors in the estimates. These models were required to make estimates of the error in estimated production. The derivation of these estimates has been accomplished for the LACIE baseline and Feyerherm models.

In summary, throughout LACIE, improvements have been made to the LACIE baseline models, to the capabilities for testing them, and to an understanding of the propagation of errors through them. The performance of these models is still somewhat questionable, and their lack of worldwide applicability is a major flaw. Based on the performance of these models and comparative testing, it seems that the problem of finding a superior model that is more accurate given good historical data or that can satisfy the 90/90 criterion without good historical data will be extremely difficult.

Crop calendars were required in the LACIE system to aid the Landsat data analyst in distinguishing crops by their growth stage and to assist in the construction and application of yield models (such as the Feyerherm model), which accumulate meteorological inputs by growth stage rather than by

TABLE V.—Results of 10-Year (1967-76) Bootstrap Test on the Cate-Liebig Yield Model for Spring Wheat Compared to LACIE Baseline and Feyerherm Phase III Yield Models

Zone	LACIE Baseline Phase III		Feyerherm		Cate-Liebig	
	Bias	RMSE	Bias	RMSE	Bias	RMSE
Montana	-0.6	2.18	-0.1	2.57	1.1	3.49
North Dakota	-1.2	2.94	-1	2.53	2	1.38
Red River	-1.4	3.95	.9	2.69	-1	2.92
Minnesota	-6	3.81	2.6	5.62	7	6.38
South Dakota	-8	3.00	.9	4.96	9	4.11
Total spring wheat	-1.0	2.56	-0.4	2.06	0.4	1.31

calendar interval. The following discussion applies only to the first of these purposes; the crop calendars used in these models were developed by personnel familiar with the LACIE crop calendars, but there are differences.

Purely historical crop calendars have been widely used in LACIE. However, because the rate of wheat development is strongly affected by weather and by day length, it was (and is) believed that an adjusted crop calendar driven by meteorological inputs would be required. This belief has been reinforced by the quality and availability of historical crop calendars for many regions.

A meteorologically driven crop calendar (the Robertson model) was available for spring wheat, but it required knowledge of the planting date. No comparable model existed for winter wheat. To provide adjusted crop calendars for LACIE required the development of models for the complete winter wheat crop calendar and for the spring wheat planting date driven by meteorology and by other factors.

The lack of historical data is a major problem in the development and application of crop calendar models. Contrary to the yield situation, in which good historical data are common, the historical data base for crop calendar modeling is extremely poor. The number of observations is small, the consistency (in location and in terminology) of observation is poor, and little or no information exists for documenting field-to-field variability in crop growth stage for a given region. This has greatly complicated the process of establishing performance requirements for crop calendars, building crop calendar models, and testing their performance.

In support of the AES, five models were constructed.

1. The Robertson model for spring wheat was recalibrated using a more extensive (and more appropriate for LACIE) data set.

2. A meteorologically driven spring wheat starter model was developed.

3. The Robertson model was modified to account for dormancy in order to obtain a winter wheat model. Several generations of this model were built.

4. Winter wheat planting models were developed.

5. Models for winter wheat emergence from dormancy were constructed.

The lack of data discussed previously has made it impossible to present definitive conclusions about crop calendar model performance. However, the situation can be summarized as follows:

1. The spring wheat crop calendar model and

starter model worked well in the United States and appeared to work satisfactorily in the U.S.S.R.

2. The winter wheat model worked well in the United States from the spring emergence to harvest, provided that it was properly started when wheat emerged from dormancy in the spring. It appeared to work satisfactorily in the U.S.S.R.

3. The winter wheat model worked poorly when it was allowed to run through the winter because it did not model dormancy accurately.

4. No adequate starter model was obtained for the winter wheat model primarily because of the great flexibility of planting date available to winter wheat farmers in the U.S. Southern Great Plains. The winter wheat starter problem might be simpler, if adequate data could be obtained, for South Dakota, Montana, and the U.S.S.R., where the weather is much more constraining.

5. No adequate model for reemergence from dormancy has been obtained. However, this information is usually available from newspaper reports, at least in the United States and the U.S.S.R. Furthermore, it could usually be observed by the Landsat analysts to assist in adjusting the model.

6. Little data have been found for the construction of a crop calendar for the dwarf wheat commonly grown in warm winter climates, such as in India, Argentina, Brazil, and Australia.

7. The existing crop calendar performed poorly in the countries with warm winter climates. It is not known whether this failure was due to the presence of dwarf wheat or to the different climatic regime.

8. No weather-related models have been constructed for other crops.

It now appears that the most practical solution to this problem will be the development of relationships between Landsat data and the crop calendar to allow Landsat observations to replace the unavailable field observations of growth stage.

### Major Findings of LACIE Supporting Research

*Research critical to the success of LACIE technology.*—It is abundantly clear that the 1974 technology was quite inadequate to meet the original LACIE goals. Deficiencies exist in the current LACIE technology, but, with the exceptions of area estimation in areas of small fields and yield model construction in areas with very poor historical data, they do not appear to be severe. Even these problems do not appear to be insoluble, but solutions may be

slow in coming. A corollary to this is that further research will be required to achieve success for other crops and other regions.

*Test and evaluation critical to the research contribution to LACIE*—A key finding of LACIE was the documentation of the wide variability that can be expected when a given method is applied to different agricultural regions. This is illustrated in figure 17. The extent of this variability is such that successful research results must be at least partially confirmed by more extensive test and evaluation. By the same token, there is no guarantee that results which appear to work well in test and evaluation will, in fact, survive quasi-operational evaluation. Only by pursuing an extensive test and evaluation program can one ensure that "improvements" entered in the AES would have a reasonable probability of success. No direct path to a validated, reliable technology exists from "point" scale research results.

*Testing critical to LACIE supporting research*—LACIE has provided two critical contributions to research. First, it has provided a goal. The presence of this goal defines requirements that must be met if the technology is to be completely adequate for meeting that goal. Without LACIE, many of these requirements (e.g., the requirement for real-time crop calendars for foreign countries) would be unrecognized and unmet. Second, it has identified major deficiencies in technology that were viewed, before LACIE, as being rather adequate. Because of the identification by LACIE, research has been focused on correcting the deficiencies rather than on continuing research tasks based on inaccurate assumptions.

*Representative data sets essential to supporting research success in LACIE*—Acquisition and testing of data for exploration studies and testing have been the largest obstacles to the progress of LACIE supporting research and a major consumer of supporting research resources. Additionally, the use of inadequate

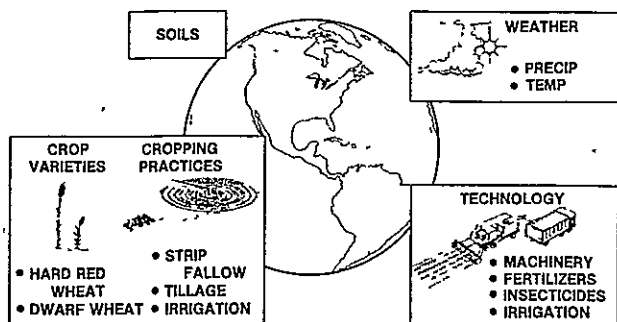

FIGURE 17.—Variable conditions in global forecasting.

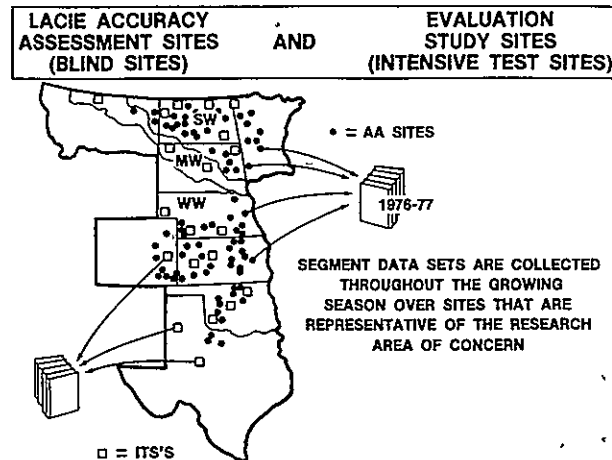

FIGURE 18.—LACIE accuracy assessment sites (blind sites) and evaluation study sites (intensive test sites).

data sets in the early stages of LACIE supporting research was the single largest source of incorrect or confusing results.

During LACIE, extensive data sets were acquired for the primary purpose of supporting AES and accuracy assessment. These data sets, summarized in figures 18 to 21, were major contributions to the success of supporting research.

The research analysis associated with LACIE field measurements, a supporting research program element to study the spectral radiation patterns of crops in their regional environment, was generally more of a basic nature analyzing the spectral and temporal radiation differences characteristic of various crops and soils under varying conditions (fig 22). Field data consisted of fully annotated and calibrated multitemporal sets of spectral reflectance and thermal measurements and extensive detailed agronomic and meteorological data for LACIE test

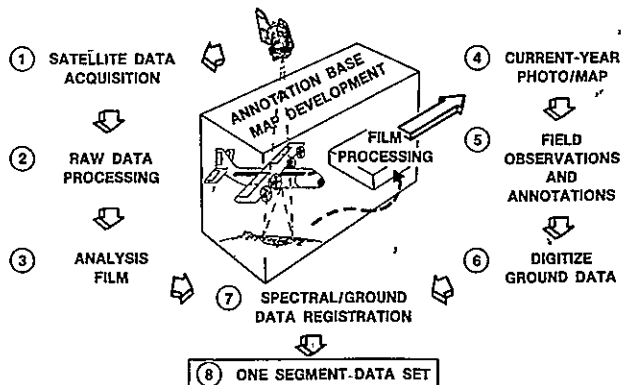

FIGURE 19.—Remote-sensing research and test data collection.



	ACQ SITES	OPER SEGS	BLIND SITES	INTENSIVE TEST SITES	SUPER-SITES	EXP FARMS
IMAGERY						
• SPACECRAFT						
• AIRCRAFT						
• HELICOPTER						
• TRUCK						
• HANDHELD						
CROP ID'S						
YIELD						
FIELD OBS		S	E	C	C	
LOCAL MET DATA						
OPTICAL DEPTH						
LOCAL HIST AGR DATA						

FIGURE 20.—LACIE spectral and agronomic data.

sites in Kansas and North Dakota (3 years each) and in South Dakota (2 years). The calibration to reflectance, a target attribute, allows valid time, location, and sensor comparisons in studying sources of variability quantitatively. Research on crop canopy modeling, studies on specifications of an improved Landsat multispectral scanner called the thematic mapper, investigation of the early-season detection threshold, and studies of agronomic sources of variability (leaf area index, biomass, percentage of cover, surface soil moisture, variety, maturity stage, irrigated versus dry land) all made use of the field data to obtain basic understanding and insight that could be used in developing improved techniques for analyzing spectral data or improved sensors.

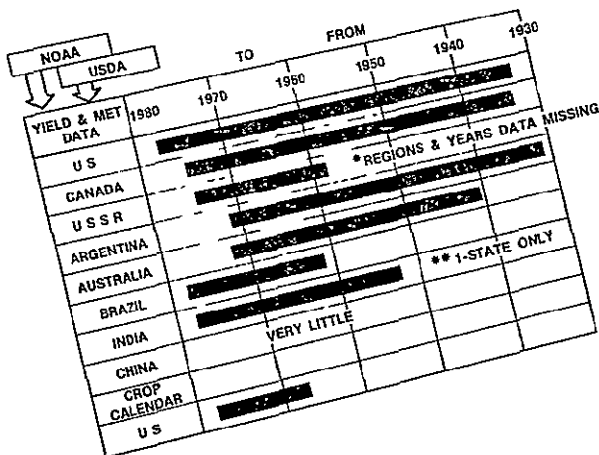

FIGURE 21.—LACIE historical meteorological/agricultural modeling data.

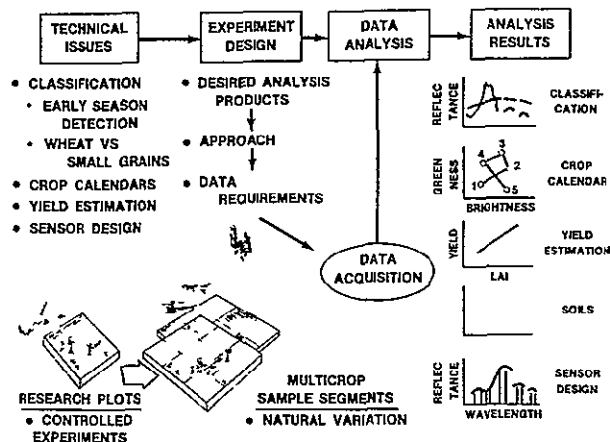

FIGURE 22 —LACIE field measurements

One further example is related to the study of discriminating wheat from small grains (such as barley). Analysis of field data was instrumental in understanding how maturity stage and spectral differences are related near heading and how wheat and barley are spectrally and temporally distinct enough for discrimination with Landsat data to be possible, given sufficient acquisitions. Development of techniques for direct identification of wheat (without rationing) used this insight.

*Research that can only contribute effectively to tractable problems*—During LACIE, extensive research was performed on some basically intractable problems. The two best examples are the attempts to improve the accuracy of the pre-Procedure 1 classifier and the analyst's labeling accuracy. While improvements did result from early research, these improvements were basically minor and could not be quantified. In both cases, the actual improvements (Procedure 1 and LIST) came through redefinition of the problem into a tractable context in which subcomponent performance could be related to component performance. This redefinition was, of course, an indirect product of the research.

## STATUS OF THE TECHNOLOGY

### In Relation to Wheat

On the basis of results in the United States, the USSR, and Canada and the knowledge of each region obtained in the exploratory analysis, it seems possible to define some regions in which current

LACIE technology can be used successfully to predict wheat production and to define other regions in which improvements are needed. A summary follows

1. United States Technology can best be developed and tested in the U.S. yardstick regions where 90/90 estimates for winter wheat have been shown. Some improvements in area estimation have been shown to be needed for spring wheat to meet the 90/90 criterion.

2. U.S.S.R. Current technology is adequate for a 90/90 estimate.

3. Canada Improvements in both acreage and yield technology are required.

4. Argentina. Current area technology should support the 90/90 criterion. The LACIE quasi-operational yield models may not support the 90/90 estimate, but second-generation models developed in LACIE probably would.

5. Brazil The status for Brazil is the same as for Argentina, but a high degree of cloud cover increases Landsat data collection risk for area estimation; cloud cover may require the use of two satellites.

6. Australia Current technology should support the 90/90 estimate

7. India Current area technology will not support the 90/90 estimate. Further work is required on yield models, but a historical data base may be adequate to support development of 90/90 models

8. P.R.C. Current area technology should support 90/90 for the "new lands" wheat region but not for the traditional wheat region because of the small field size there. Substantial development work will be required to obtain any yield model with a chance of meeting 90/90. However, information on the P.R.C. is so limited that significant improvement is indicated at much less than 90/90

In general, it appears that the most important problem for area estimation is small fields, the second most important is wheat/small grains separation. For yield estimation, the quality of historical data and tracking extreme weather excursions are the major issues

### **In Relation to Other Crops**

The LACIE experience cannot be used to predict performance for crops other than small grains, although it certainly provides a framework for predicting the important problems. For example, the presence of small fields will be a serious problem for

any crop until Landsat-D reduces the problem. Crop spectral-temporal separation as a function of development stage remains a critical and extremely important problem. LACIE quasi-operational and research results can be used to predict that relatively minor revisions of the technology will suffice to inventory barley and possibly oats, rye, and flax.

### **CONCLUSIONS**

The LACIE has been viewed by some in the remote-sensing community primarily as a quasi-operational project. This may have been a rather narrow view in that the original (and final) goals and the overall accomplishments of LACIE had as much to do with research as with evaluations.

The LACIE was reasonably successful in meeting its quasi-operational evaluation goals, it was outstandingly successful in research accomplishments. This success was accomplished through an approach which used the AES, accuracy assessment, and test and evaluation to identify critical issues and the supporting research to resolve these issues. An important corollary to this approach was the availability of a substantial body of data for the supporting research.

The challenge today is to continue the accomplishments of the LACIE years in other crops and other regions and in a new environment in which the responsibility for large-scale technology evaluation has shifted from primarily NASA to primarily USDA. The LACIE philosophy of using critical issues derived from that large-scale evaluation to focus supporting research on problems that most need solution could, and should, be used to meet this challenge.

### **ACKNOWLEDGMENTS**

Special recognition is due Dr. Andrew E. Potter, Chief of the Research, Test, and Evaluation Branch at JSC until early 1976, for his contributions to, and leadership of, the work reported here. Thanks also go to Dr. Jack Waggoner for his illustrations, diagrammatic systems analysis, and functional flow communications. The extra efforts of the many researchers in government, university, and industrial organizations who gave their best creative ideas and dedicated contributions made it a rewarding and pleasant association.

## REFERENCES

- 1 Erickson, J D Advances in Automatic Extraction of Earth Resources Information From Multispectral Scanner Data Vol I-B, Proceedings of the NASA Earth Resources Survey Symposium (Houston, Tex ), NASA TM X-58168, June 1975, pp 1245-1274
- 2 Hay, C M , and Thomas, R W Application of Photointerpretive Techniques to Wheat Identification, Signature Extension, and Sampling Strategy Univ of California at Berkeley, May 14, 1976
- 3 Houston, A G Effects of Non-Response Including Cloud Cover on Aggregation of Wheat Area in the U S Great Plains LACIE-00441, NASA Johnson Space Center, Houston, Texas, Dec 1976
- 4 Ziegler, L R An Evaluation of Algorithms for Estimating Wheat Proportions From Landsat Data LEC 9180, Lockheed Electronics Co , Houston, Texas, May 1977
- 5 Kraus, G R Description of the Kraus Product-Imaging Technique NASA Johnson Space Center, Houston, Texas, July 1977
- 6 Davenport, W D Registration Methods LACIE vs MPP IBM Rep 23-58, Houston, Texas, July 1978
- 7 Brachler, Curtis Final Report Forecasting Change in Ratios of Wheat to Confusion Crop Ratios in the Northern Great Plains Univ of Missouri (final report prepared for Lockheed Electronics Company under action document 63-1347-3763-35), July 1977
- 8 Clark, J E , and Eisgruber, L M Projection of Confusion Crop Ratios With Econometric Models Oregon State Univ (final report prepared for Lockheed Electronics Company under action document 63-1347-3763-36), June 1977
- 9 Baier, W R Weather Analysis Model Review and Model Development J Applied Meteorol , vol 12, Sept 1973, pp 937-947
- 10 Haun, J R Crop Status Evaluation and Yield Prediction Final report prepared under NASA contract NAS9-14006 for period from April 1, 1974, to October 1, 1976, Sept 1976
- 11 EarthSat Spring Wheat Yield System Test Final report prepared under NASA contract NAS 9-14655, Earth Satellite Corp , Washington, D C , April 1976
- 12 Kanemasu, E T Estimated Winter Wheat Yield From Crop Growth Predicted by Landsat Final report prepared under NASA contract NAS 9-14899 for period from March 1976 to March 1977 and from April 1977 to December 1978, Kansas State Univ , Manhattan, Kansas, Dec 1978
- 13 Feyerherm, A M Response of Winter and Spring Wheat Grain Yields to Meteorological Variation Final report prepared under NASA contract NAS 9-14282, Kansas State Univ , Manhattan, Kansas, Feb 1977
- 14 Feyerherm, A M Planting Date and Wheat Yield Models Final report prepared under NASA contract NAS9-14533 for period from February 1975 to March 1977, Kansas State Univ , Manhattan, Kansas, Sept 1977.
- 15 Feyerherm, A M Application of Wheat Yield Model to United States and India Final report prepared under NASA contract NAS 9-14533 for period from March 1977 to November 1977, Kansas State Univ , Manhattan, Kansas, Dec 1977

# Data Processing Systems in Support of LACIE and Future Agricultural Research Programs

Donald H Hay<sup>a</sup>

## INTRODUCTION

The LACIE data processing system made significant contributions to the overall success of the project. Primarily, this was the first data processing system developed to satisfy the needs of a large-scale agricultural inventory project. However, many of the system components also represented major advances. First, a data acquisition system was developed that channeled large quantities of satellite imagery, meteorological summaries, crop yield data, agronomic parameters, and cartographic products from multiagency, multiorganizational sources into the project data base. Compilation of the data base involved several levels of complexity ranging from high-volume, low-logic manipulation of digital imagery through the complex Boolean query requirements of an administrative and management information system.

In addition, noncomputerized cartographic, textual, and analysis support package data bases were maintained. These required the development of pertinent information management and process control methodology which, together with the data base content, will have long-range applicability to remote-sensing projects.

In accordance with the overall project approach, existing equipment and processes were assembled and modified to produce a system that supported a high-volume area estimation procedure. Similarly, yield and growth stage models were implemented and modified as needed to meet accuracy and throughput requirements.

Design and implementation of an interactive area, yield, and crop production estimation subsystem proved the feasibility of a high-throughput production estimation process that could simultaneously

operate in several regions of interest. The effectiveness of man-machine interactive processes was verified for area and production estimation functions.

The applications of special computer hardware, such as the STARAN array processor and interactive terminals, were tested and incorporated as effective means of accelerating the analysis process. Indeed, without the implementation of these hardware components, it is doubtful that a key development — Procedure 1, a volume multitemporal area estimation procedure — could have been realized during the life of the project.

In summary, the system was a satisfactory development and test apparatus, and it also proved to be an effective design tool. Its development and operation illuminated improvements that will be incorporated into future planning. This paper, therefore, reviews the chronology of, and rationale for, the development as a reference to those interested in an applied example of remote-sensing data system design.

## DATA SYSTEM ELEMENTS

### Data System Tasks

As figure 1 indicates, the LACIE data system supported two principal functions: research, test, and evaluation (RT&E) and the Applications Evaluation System (AES). The RT&E function managed and participated in ongoing research, concept development, and prototype test activities. In addition, this function managed the operation of a field research program and the project accuracy assessment that are described in the detailed technical papers on those subjects. The AES function incorporated promising RT&E components into an overall area, yield, and production estimation system for large-area high-volume evaluation.

<sup>a</sup>NASA Johnson Space Center, Houston, Texas

PAGE 90. INTENTIONALLY BLANK

C-2

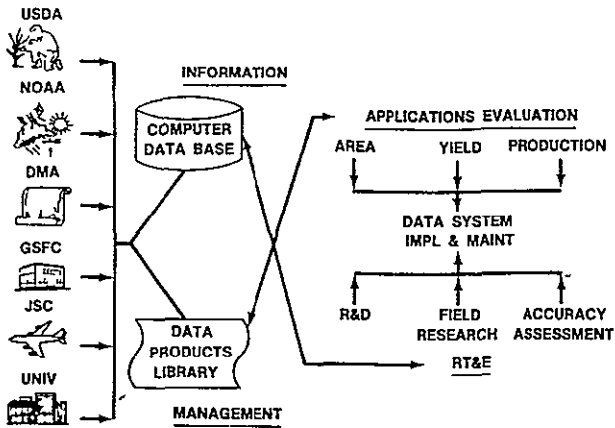

FIGURE 1 —Data system tasks.

Each of these functions was serviced by a combination of off-line and computerized data base and information management systems. Landsat digital imagery comprised the largest volume component of the computerized data base, a capacity of 4.2 billion bytes. Other on-line components were the historical and spatial parameters, examples of which were average precipitation, historical crop yield, soil types, and political boundaries pertinent to the estimation of crop production. The field measurement results were also stored in a computer data base at the Purdue University Laboratory for Applications of Remote Sensing (LARS) facility.

The most active part of the off-line data base was the analyst's data packets that contained Landsat film products, crop calendar model results, precipitation averages, cartographic products, and other ancillary items identified with each LACIE acquisition site and used heavily in the area estimation process. A map library of relevant areas of coverage was maintained, including required annotation overlays to support the RT&E and AES operation. Area and yield estimation results and accuracy assessment input and results were also placed in off-line storage.

The data acquisition and preprocessing activity supplied data to the information management system in the required formats. Landsat digital imagery and film, meteorological data, aircraft and ground measurements, agronomic data, and cartographic products were obtained from the relevant agencies and organizations and transformed as necessary to the required formats.

## Data Processing System Functions

Briefly, the data processing organization developed, acquired, or otherwise obtained the use of hardware and software systems to service the activities described previously and also maintained the system to project standards. The major facilities were the Earth Resources Interactive Processing System (ERIPS) installed in the Real-Time Computer Complex at the NASA Johnson Space Center (JSC); the Crop Assessment Subsystem (CAS), an interactive program installed in the Earth Observations Division (EOD) Data Techniques Laboratory, the yield estimation and crop calendar models installed at the National Oceanic and Atmospheric Administration (NOAA) facility in Suitland, Maryland, and the Landsat imagery preprocessing system at the NASA Data Processing Facility (NDPF) at the NASA Goddard Space Flight Center (GSFC). A complete inventory of applicable equipment and facilities is given in the appendix.

## The Initial Situation

Before LACIE, remote-sensing activities at JSC consisted of a number of small-scale investigative efforts. The data systems that were developed to support these tasks were either small, fragmented systems or were developed as appendages to larger general-use configurations. Figure 2 summarizes the initial situation.

*Data acquisition and preprocessing.*—Initially, there were no established procedures for acquiring and compiling the necessary types and quantities of data required by the areal and temporal extent of a project such as LACIE. The GSFC facility was equipped to provide one-quarter- and full-frame unregistered computer-compatible tapes and full-frame film in small quantities. Infrequent, manually compiled agronomic and meteorological summaries and domestic cartographic products were available, however, there was little access to high-resolution foreign maps. Although some preliminary field studies had been conducted, there were no detailed, intensive study area data collection procedures.

*Information management.*—In general, pre-LACIE software and hardware facilities and procedures were not suited to the project's intended scope or func-



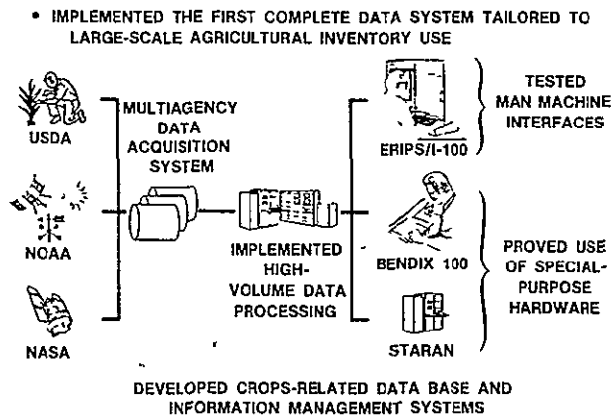

FIGURE 2 —Data processing highlights.

tions The information bank consisted of a general-content data library with a rudimentary capability for coordinating and retrieving aircraft photography coverage. There were no computerized data bases. Facility operations were adapted to small-scale investigations with few component validation procedures or integrated processes and minimal configuration control.

*Research, test, and evaluation* —The research and development (R&D) activity was constrained by poor user accessibility—a condition that persisted to some degree for the duration of the project—and by a limited software and hardware capability. Investigative data bases were largely maintained off-line with attendant accessibility and validity limitations by individual analysts. Area estimation tools, such as classification, clustering, and feature selection programs, were limited to prototype local implementations, although there was some limited access to the newly implemented ERIPS interactive classification system. There were no available yield or production estimation investigative tools at JSC.

*Applications evaluation.*—The applications evaluation function required the most data processing implementation support. There was no yield or production estimation capability, and there were few components to build on. The area estimation function was in slightly better condition with the newly implemented ERIPS interactive classifier. This system, however, was designed to support operations of high flexibility and low throughput, not at all the intended LACIE use. ERIPS was also limited to single-

channel displays and did not have access to a large-volume on-line data base. In addition, the system could produce low-volume custom film products but was in no way prepared to support the LACIE film requirements.

Other persistent conditions were long implementation schedules and the inflexibility of developed software. These conditions complicated the timely implementation of RT&E results into the AES for the entire duration of the project.

## ORIGINAL SYSTEMS SCOPE

### Applications Design Parameters

The project was initially scoped for a 2-year life (table I). Monthly wheat area, yield, and production reports (estimates) to be released on the day preceding each report of the US Department of Agriculture (USDA) Statistical Reporting Service (SRS) were planned for as many as eight countries using satellite data as the primary method for area determination. The accuracy goal for production estimates was to be within  $\pm 10$  percent of the USDA SRS value at harvest for 9 years out of 10. A statistical sampling approach was devised wherein approximately 2 percent of the total applicable land area was analyzed. The study areas were identified by a random positional assignment of 5- by 6-nautical-mile rectangular segments over the areas of interest. Landsat area proportion estimates were to be ready for aggregation in no more than 14 days after acquisition by the satellite; monthly yield estimates were to be available for the same month's input into the aggregation process. Similarly, meteorological data inputs were to be timely enough to support the same month's update of crop growth stage estimation models.

The system was scoped for the ultimate processing of 20 000 Landsat acquisitions per year or approximately 4 successful acquisitions per growing season for each of 4800 LACIE sample segments. The system was to reach approximately two-thirds of this capacity during the first year of operation. Full capacity was to be reached during the second year, when total country coverage of eight countries was to be realized.

TABLE I—Data Processing System Scope

<i>Original scope</i>	<i>Issues</i>	<i>Revised scope</i>
2-yr project	Insufficient local capability	3-yr project
Integrated system	Limited funds	Dispersed system
8 countries	Limited skills	8 countries
4800 Landsat segment capacity in second year	Long implementation schedules	4800 Landsat segment capacity in third year
14-day segment throughput		Demonstration of 14-day throughput
Monthly production reporting		Monthly production reporting

### Applications Rescope

Shortly before the start of the initial operation, it was recognized that the planned scope was not feasible under the existing data system operation and development constraints. As previously discussed, the data processing system was limited in both throughput and capability and had essentially no capability in the yield or production components. Also, as the first operational year approached, it became evident that final specifications for the total system could not be completed until some operational experience was gained and until computer systems design personnel developed sufficient remote-sensing expertise to correct the existing limitations. The deficiencies resulted in projected implementation costs that far exceeded available funding and implementation schedules that extended past the planned life of the project.

Thus, a project rescope was indicated and was shortly accomplished. The rescope was based on a phased 3-year program with gradually increased capability and throughput. Research and applications evaluation goals were modified to agree with schedules for data system development. These development milestones were, in turn, constrained by available funding, reasonable expectation for improvement in analysis and data system design skills, and equipment procurement schedules.

The eventual system processing capacity requirement of 4800 segments was maintained; however, full capability was to be reached during the third year. The segment throughput requirement was relaxed. The new goal was to demonstrate the feasibility of 14-day segment throughput from acquisition rather than to actually produce this result.

The project was divided into three phases corresponding to three wheat-growth years. Phase I covered the 1974-75 year; the U.S. Great Plains was the main area of interest and 693 segments were to be processed. During Phase II, 1975-76, coverage of 1800 segments was planned with significant Northern Hemisphere coverage. Phase III, 1976-77, brought the system to a full processing capacity of 4800 segments, including full coverage of eight countries in the Northern and Southern Hemispheres.

The idea of an integrated system was abandoned in favor of a dispersed data processing approach that took advantage of in-place equipment and skills, thereby lowering implementation costs and at the same time alleviating the lack of local expertise. Thus, the project entered into operation greatly constrained by the data processing system capability and faced with an evolutionary development of facilities in parallel with project operations.

### DATA SYSTEM EVOLUTION

The development of the LACIE data system was an evolutionary process that progressed in parallel with operations. This was directed in part by the factors discussed thus far. In addition, the project's applications research approach required a level of ongoing systems modifications to incorporate promising R&D and test results into the AES.

#### Phase I (1974-75)

The majority of the data system modifications during the initial project year were associated with

the adaptation of existing capabilities to the LACIE situation. Figure 3 summarizes this activity

Initial capabilities installed at the GSFC facility were the extraction of 5- by 6-nautical-mile data segments required by LACIE and adaptation to the Landsat-2 data system. Procedures for identification and mail transmission of the segments to JSC were also implemented at both installations. With these modifications, the GSFC arrived at the required throughput capacity of 4800 segments per year.

Collection of ground and aircraft data was initiated at 56 U.S. and 16 Canadian accuracy assessment sites. This data collection comprised the initial accuracy assessment data base.

Phase I area estimation throughput requirements were met through the implementation of computerized disk data bases to automate the handling of digital imagery. The concept of analyst-interpreter data packets supplied with standard film products was implemented together with a manual status and tracking system that supported an operation of 20 acquisitions per day.

Low-interaction area estimation software including automated run preparation was installed on the ERIPS, and standard Landsat film products were also implemented. This brought the throughput capacity of this system to 35 acquisitions per day and eliminated the requirements for as many as 30 key-punch clerks. Manually compiled meteorological summaries permitted limited testing of yield and crop growth stage estimation models. Interim production estimation software was installed to produce crop production estimates for political subdivisions of the U.S. Great Plains. A versatile computer-based image analysis terminal, the Image-100, was installed to improve computer accessibility for the RT&E analyst.

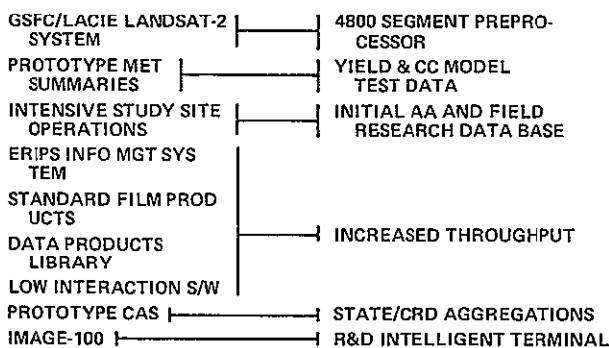

FIGURE 3 —Data systems evolution during Phase I (1974-75).

Field research data collection operations were initiated at one winter wheat and one spring wheat test site. Calibration and data base installation software were implemented at JSC and the Purdue LARS facility, thus establishing a 1-year data base of ground and aircraft observations that were coincident with Landsat overpasses.

In summary, at the end of the first year of operation, significant throughput increases had been incorporated into the system, prototype yield estimation models were undergoing tests, interim production estimation software was in operation, several important data bases were automated, and an up-to-date analysis tool for the RT&E analyst was in use.

### Phase II (1975-76)

During Phase II, efforts to increase system throughput continued, however, some modifications were directed toward increasing the scope and improving the accuracy of the process (fig. 4). The data system was also exercised over the U.S.S.R., where the absence of ground-observed data produced a greater dependence on satellite data.

Early in the year, hard-line transmission of imagery data from GSFC to JSC was initiated. This improvement in the efficiency of the data transmission process was more than offset by a Landsat-2 tape recorder failure that made it necessary to collect U.S.S.R. overpass data in real time at the Italian and Pakistani ground stations. This caused a 2-week mail transmission delay in the receipt of these data at GSFC.

The Phase II segment load required a throughput of approximately 60 segments per day. The capacity to handle this threefold increase in data was met and exceeded through implementation of the STARAN array processor on the JSC ERIPS. This installation produced a sixfold to tenfold increase in ERIPS throughput capacity, which made computerized 16-channel multitemporal analysis practical. Implementation of an automated status and tracking system that facilitated the accessibility and updating of the analyst-interpreter's packets was also a key to the increase in Phase II processing capacity.

A capability to handle multiyear imagery data bases was installed on ERIPS in anticipation of overlapping growing seasons in the Northern and Southern Hemispheres.

Automated access to the World Meteorological Organization (WMO) data base and the inclusion of

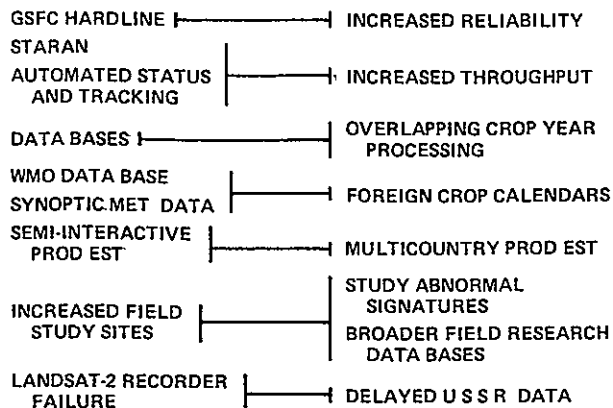

FIGURE 4.—Data systems evolution during Phase II (1975-76).

synoptic meteorological data into the crop calendar starter models provided a capability to start foreign crop growth stage estimation models

A multicountry production estimation capability was realized with the implementation of combination interactive and batch crop aggregation software in the EOD facility at JSC

A measure of configuration control was established on the yield and crop calendar software through the allocation of contract resources to test and document these systems.

The extension of accuracy assessment data base coverage to 161 sites and the addition of a mixed wheat test site to the field measurements program added broader coverage to each of these efforts. In accuracy assessment, the increased number of sites also provided more chances for evaluation of abnormal signatures such as drought or other stress conditions.

Overall, the most significant Phase II throughput increase was accomplished by the installation of the STARAN processor. Also, significant scope and accuracy improvements were realized by the installation of improved yield, crop calendar, and aggregation software

### Phase III (1976-77)

Before the start of Phase III, a decision was made to conserve the use of the Landsat-2 tape recorder. This step deleted the Southern Hemisphere from the operational project scope. Because of the new multitemporal analysis capability, the project also

decided to process all acquisitions during the growing season rather than the average of four that were specified during the original rescope. This effort to increase classification accuracy overloaded the GSFC system so much that a 21-day average segment backlog was experienced there during the peak acquisition period.

Procedure 1, the project's most significant advance in area estimation analysis techniques, was implemented and exercised during Phase III. The initial effort was an ERIPS/Image-100 tandem system that installed the high-throughput operations on the ERIPS/STARAN and reserved the analyst's spectral aid displays for the versatile Image-100 terminal. This arrangement provided for earliest implementation of spectral aids to improve analyst performance as well as an excellent training station at the Image-100 for in-house EOD and USDA analysts. At the same time, the high-throughput capability of the ERIPS was fully utilized. Implementation of the entire system increased the automation and objectivity of the area estimation procedure and thereby increased the accuracy and reduced the overall time needed to complete the segment analysis process.

Improvement in yield model inputs was introduced with the addition of increased reporting stations for maximum and minimum temperatures and the availability of daily precipitation measurements. Investigation of the Feyerherm yield models that took advantage of the more frequent meteorological measurements had the potential for introducing increased accuracy into this component.

Fully interactive production estimation software that met the project's specification for a timely eight-country capability was also completed during Phase III.

Accuracy assessment sites were increased to 212 U.S. and 30 Canadian sites, this number was dictated by the variety of situations that were encountered during the Phase II evaluation. The increased volume of accuracy assessment data led to the implementation of an automated comparison of Landsat classification results to ground and aircraft observation data. Besides increased throughput, this implementation produced more accurate pixel-by-pixel analysis of classification results.

Thus, Phase III accomplishments included the implementation of Procedure 1, the final delivery of the interactive production estimation system, significant improvements in meteorological inputs, and yield model refinements (fig 5)

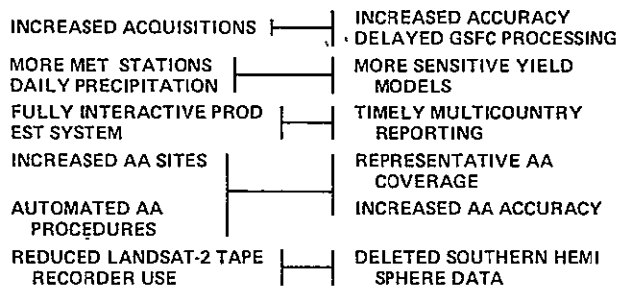

FIGURE 5.—Data systems evolution during Phase III (1976-77).

### Data Systems Evolution Summary

Figure 5 summarizes the major accomplishments resulting from implementation of the data system. The GSFC developed a capability to provide digital imagery for use in large-scale agricultural inventories. Besides its close participation in JSC operations, the USDA provided extensive sets of ground observation parameters.

The USDA Aerial Photography Laboratory in Salt Lake City, Utah, provided full-frame color imagery, and the Defense Mapping Agency (DMA) and other sources provided adequate domestic and foreign map inventories.

Frequent and timely meteorological summaries were made available. Computerized access to NOAA data bases and extensive data collection operations was established.

The information management system was largely automated and set up for agricultural inventory operations. Computer data bases were established for digital imagery, field research, accuracy assessment, status information, and yield and production results. Automated status and tracking and low-interaction analyst interface systems were developed. The non-automated data bases, such as the analyst-interpreter's data packet library, were highly organized and operated under adequate configuration control.

The AES function proceeded from a set of disjointed programs that were quite limited in throughput to Procedure 1 and was implemented on an equipment configuration that was mainly limited by analyst availability.

Terminal access to frequently updated meteorological data bases was established. Growth stage and yield estimation models were available for both domestic and foreign coverage. An interactive

crop aggregation system readily acceptable to expanded agricultural inventory use was in operation.

The RT&E function had access to an extensive Landsat imagery data base correlated to field research and accuracy assessment and ground and aircraft measurements. Yield and crop calendar data bases were available, and automation of the accuracy assessment system was underway.

### FUTURE SYSTEM DESIGN

The LACIE data processing system was more than a test bed for remote-sensing technology developments, it was also a model for the design of future remote-sensing data systems. When one balances the lessons learned from the development and 3-year operation of the data system against projected program scope, general computer and remote-sensing technology updates, and supporting data acquisition facility roles, an estimate of the future system begins to emerge. Figure 6 summarizes the factors discussed in this section.

#### Program Scope

It is anticipated that the agricultural inventory program will be expanded in the near future to include additional food and fiber crops. Preparations are already underway to enter into a preliminary domestic corn and soybeans program in 1980, with phased expansion to foreign areas and to additional crops that will extend the program well into the

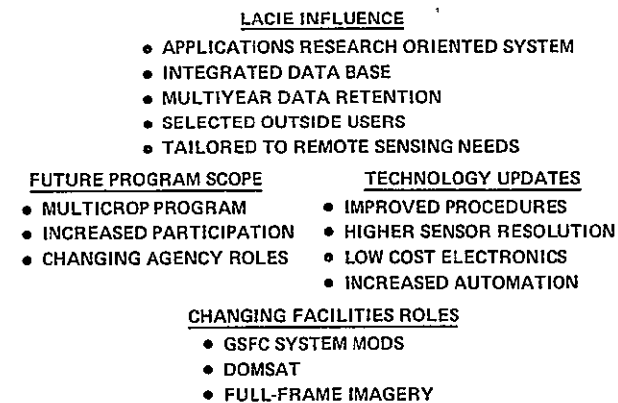

FIGURE 6.—Future system scope



volume increases. The domestic communications satellite (Domsat) will be used for site-to-site data transmission

### The LACIE Influence

The LACIE data processing system serviced a variety of user communities with varying degrees of success. The 3-year operational experience in a semi-productional environment provided a stringent test of the interface with these communities and pointed out several areas that needed improvements.

*System flexibility*—One of the most persistent LACIE data system deficiencies was the length of time needed to adapt promising R&D results into the integrated test system. Dispersed hardware was the main contributor to this problem in that prototype hardware and software developed and tested on one set of equipment was not easily transferred to an integrated test system residing on an entirely different configuration.

*Data base integration and scope*.—Even though the field research data sets were correlated to Landsat overpasses, obstacles in bringing these data sets together still existed. The main difficulty was that the imagery and field research data bases resided on different computers and were maintained in formats that were difficult to relate. This was not a unique condition among the various RT&E data bases that serviced LACIE. At the end of the project, it was evident that these data bases should be integrated to maintain validity and adequate accessibility. It was also evident that multiyear on-line imagery data bases should be maintained to have an accessible spectral history of selected ground areas for comparison and to service overlapping Northern and Southern Hemisphere growing seasons.

*User interface*—During LACIE, the R&D analyst's accessibility to the imagery data base was limited by a lack of terminals and by lack of direct access to the data base from the R&D software. To include a broad range of industry and university participants in the program, it will be necessary to provide them with cost-effective access to the software, procedures, and data that presently reside at JSC. This can be done with medium- to low-data-rate terminals at the user facility connected to the JSC integrated data base.

*Remote-sensing systems*—Several main components of the LACIE system, notably ERIPS, were implemented in general-purpose installations that were not designed for remote-sensing use. This situation worked to the disadvantage of all participants. Remote-sensing data bases, software components, and special peripherals consumed the available resource so that none of the coresident applications could operate when a remote-sensing task was in work. Large portions of the specified remote-sensing system were forced onto other computers because of their incompatibility with the coapplication environment.

*Future systems scope summary*.—A functional diagram of an R&D-oriented system that incorporates the successes and needed improvements of the LACIE system applied to the multicrop situation is given in figure 7. To put this diagram in proper context, it should be noted that this is the R&D component of the total multicrop system. The main features of this component are an integrated main frame large enough to support simultaneous local and remote R&D user, limited testing, evaluation, and information management. Both local and distant remote terminals are provided.

Besides the standard peripherals, a parallel processor, a film recorder, a cartographic processor, an imagery preprocessor, and a large on- and off-line mass storage complex are included.

The NASA investigations indicate that a facility of this type with a large central processor will provide the flexibility, facility of use, and breadth of interface that are vital to continued success of the remote-sensing program.

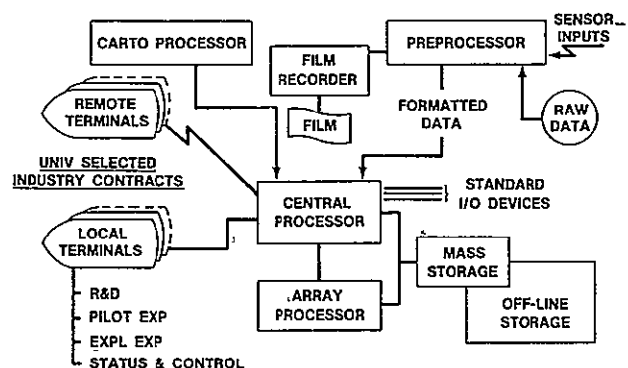

FIGURE 7—Future remote-sensing data processing functions.

**APPENDIX  
EQUIPMENT AND FACILITIES OF THE LACIE  
DATA PROCESSING SYSTEM**

With the exception of the GSFC imagery preprocessing system, described elsewhere, LACIE's major computer associated components, their locations, and assigned tasks are listed in table II

**EOD Facility**

At the start of the project, the EOD facility provided incidental R&D and technique development support. However, as the project progressed, several on-line production tasks were assumed, including data flow control, status and tracking, crop production estimation, and the display of spectral aids in support of an improved area estimation process (Procedure 1) developed during the latter stages of LACIE. There was no electronic interface between the EOD facility equipment and the ERIPS described in the next section. Therefore, data ex-

changes were made through the medium of cards or tapes.

*Image-100 system*—The Image-100 is an image analysis terminal in which the image display is driven by a programmed data processor (PDP 11/45) computer configured with 256 megabytes of main storage and 264 megabytes of dedicated disk storage. An additional 88 megabytes of disk is shared with a companion PDP 11/45, located in the same facility, so that both computers have direct access to the same data.

The image analysis terminal was initially used for area estimation techniques development, for example, the initial investigation into the Procedure-1 process occurred on this complex. Later, the interactive portion of Procedure 1 was installed productionally on the system. The processing and reporting associated with LACIE blind sites have also been implemented on the system. This system was operated for 15 shifts per week during LACIE.

*Support processor*—The companion PDP 11/45 to the Image-100 is referred to as the support processor. The general configuration of this computer is similar

TABLE II — Current System Equipment, Use, Location, and Assigned Tasks

Equipment	Equipment use, percent of total	Location	Tasks
Image-100 (PDP 11/45)	27	JSC Building 17	LACIE image analysis LACIE accuracy assessment Forestry/soil moisture image analysis
IBM 360/75	20	JSC Building 30	LACIE area estimation Landsat image and area estimation results data management
IBM 370/148	14	Purdue University LARS	R&D data base maintenance LACIE area estimation data preparation and process control
PDP 11/45	11	JSC Building 17	LACIE status and tracking LACIE crop aggregation LACIE techniques implementation
PDP 11/45	11	Houston Ford Aerospace facility	Aggregation software development
UNIVAC 1108/1110	6	JSC Building 12	LACIE area estimation techniques development LACIE accuracy assessment error model Cartographic and bilateral data formatting and calibration
PDP 11/45	5	JSC Building 30	LACIE quality analysis
IBM 360/195	4	NOAA Suitland, Maryland, facility	Yield model development and testing LACIE crop yield estimation
IBM 370/135	2	Houston IBM Federal Systems/ERL	Area estimation procedures development

to the Image-100 without the image terminal. The system has 88 megabytes of dedicated disk storage and an additional 88 megabytes of shared disk through which it can communicate with the Image-100

The support processor configuration includes five alphanumeric terminals, four of which were dedicated to the interactive CAS. This program operated on area estimation and crop yield results to produce crop production estimates at region and country levels. The system was designed to allow four separate aggregations to occur simultaneously at each of the four terminals. The fifth alphanumeric terminal was dedicated to the automated status and tracking system, which was designed to provide unit and aggregate status of LACIE data in a timely, accurate manner. In addition, the support processor was used as a technique and program development tool for yield and aggregation techniques. This facility was staffed to operate 10 shifts per week.

*EOD support computers.*—EOD support computers include the Bendix-100, the Gerber plotter, two NOVA-1200 computers (one mounted on a truck and another installed in the laboratory), and the Passive Microwave Imaging System (PMIS)

The Bendix-100 interactive graphics terminal is a computer-driven device used to produce graphics and store a digital representation of the graphic products. Driven by a NOVA minicomputer, the main system outputs completed graphics and digital representations stored on computer-compatible tapes. The Bendix-100 system was used in LACIE as an aid to accurate locations of geographic sample segments. In the latter stages of the project, it was also used by the accuracy assessment team to digitize blind site ground-truth maps for computerized comparison with Landsat classification results. This system was staffed to operate 10 shifts per week.

The Gerber plotter is a computer-driven large-area high-resolution ink or photographic plotter. Inputs to the Gerber system are prepared on the Institutional Data Systems Division (IDSD) computer and placed on magnetic tape in a standard format. These tapes are input to the Gerber system through a NOVA-1200 minicomputer. The Gerber system was used as a general-purpose graphics device during LACIE. Tasks ranged from the production of bar charts and schedules to the preparation of detailed map and photographic overlays. The equipment was staffed to operate five shifts per week.

Three other EOD support computers were used by the project. Data calibration for the field research

program was accomplished in one truck-mounted and one laboratory-installed NOVA-1200 computer. The third system was the PMIS, an image display terminal driven by an SEL-810B computer. A film recorder is also attached to the system. The PMIS was used in LACIE as an R&D image analysis device. Special film products were also produced on this system. Each of these computers was operated on an as-needed basis not to exceed one shift per day.

### **Ground Data Systems Division (GDSD) Facility**

The GDSD facility provided support to LACIE on specially modified computers within the Real-Time Computer Complex and on several colocated support facilities.

*ERIPS*—The design baseline for ERIPS was the LARSYS program developed at Purdue University's LARS. The initial LARSYS was reprogrammed, installed on an IBM-360/75 computer with 1 megabyte of main core memory and 4 megabytes of extended core memory and interfaced to two interactive display consoles. This system is located in the GDSD facility at JSC.

Originally, the configuration was intended for low-volume investigative use with system access constrained to the interactive terminals. The principal adaptations for the initial phase of LACIE were directed toward improving the user's access to the system and increasing the throughput. Forty-two 100-megabyte disks were installed, and the Information Management System was adopted as an automated imagery data manager. A batch interface was developed, interactive access ports were installed in the user facility, and considerable recoding was accomplished to minimize program run times. This configuration was capable of producing sets of analysis results on typical LACIE data sets at the rate of two per hour.

Because of the heavy data loads planned for the LACIE third year, the IBM-360/75 configuration was further enhanced by the addition of the STARAN array processor. By performing repetitive operations on multiple sets of data in parallel, this Goodyear-developed device is able to execute image analysis operations such as classification and clustering in one-tenth the time required by the IBM 360/75. The augmented configuration wherein the IBM 360/75 acts as process controller and data manager and the STARAN as a "number cruncher" has reduced the execution time for a typical LACIE analysis pro-

cedure by a factor of 6. Later improvements to the IBM-360/75 system in the areas of data transmission and modifications to the feature selection algorithm promise to improve this performance even further. At peak load, the ERIPS system was scheduled for 12 hours per day.

*GDS D supporting computers*—GDS D supporting computers were the PDP 11/45 and the production film converter (PFC). Final quality checks on Landsat imagery before its insertion on the imagery data base were accomplished on a general-purpose PDP-11/45 computer. This complex required approximately 2 hours per day in testing for sensors, software, and data preprocessing algorithm accuracy.

The PFC is a computer-driven high-resolution cathode-ray-tube color graphics production device used to produce standard film products for Landsat digital imagery. The PFC is a stand-alone system that uses magnetic tapes as an interface medium. At peak load, LACIE required more than one shift per day for PFC tasks.

### Supporting Computer Facilities

In addition to the EOD and GDS D complexes, LACIE also used five other facilities, some at JSC and others offsite. Individual use of these facilities was low; however, when considered together, they provided some 35 percent of the total LACIE computer support.

*IDSD*.—The IDSD provides general computational support to various engineering, scientific, and management organizations at JSC. The LACIE project is one of many subscribers to the service.

The IDSD configuration is based on one UNIVAC-1110 and four UNIVAC-1108 computers. LACIE users were provided access to the system through a set of remote alphanumeric terminals located in the EOD facility and through batch program submissions in JSC Building 12.

The IDSD facility was used extensively by the LACIE test and evaluation technique development group. The Purdue LARSYS was converted to this configuration, and early implementations of Procedure-1 software were conducted here. An early version of the crop aggregation system and several accuracy assessment prototype programs were also developed in the IDSD facility.

The LACIE AES utilized the facility for independent software verification. Software that was to

be installed on ERIPS was duplicated on the IDSD configuration and tested in parallel with ERIPS programs.

The facility also performed data preparation and calibration tasks in support of the field research program, the EOD cartographic facility, and the Gerber plotter.

*IBM Earth Resources Laboratory (ERL)*.—The IBM Corporation maintains an IBM-370/135-based facility adjacent to JSC that is equipped with an ERIPS-like image analysis system. Under contract with EOD, the system was used by LACIE for development of improved clustering and feature selection algorithms. Due to the ERL's similarity to ERIPS, these algorithms could be developed and implemented in much the same environment as existed in the GDS D facility, thus sharply reducing the total integration time required for these improvements.

*Ford Aerospace facility*.—The Ford Aerospace & Communications Corporation maintains a facility similar to that which exists in EOD. Similarly to the ERL, CAS elements were implemented by Ford on its PDP-11/45 computer and transferred without modification to the production system in EOD.

*NOAA facility*.—NOAA maintains a large weather information system at its IBM-360/95-based computer facility in Surtland, Maryland. This facility provided support to LACIE in the testing and production of models to predict crop yield. The system interface to LACIE was through hard-copy and low-volume alphanumeric terminal reports on yield model results, crop calendars, and general weather information.

*LARS facility*.—LARS, located in West Lafayette, Indiana, has been involved with remote-sensing and Earth resources studies since the mid-1960's. In 1977, LARS operated an IBM-360/67 computer that was later replaced by an IBM-370/148 to support its own research and that of several state and federal agencies, including JSC. The EOD facility has a remote job entry station (printer, tape drive card reader and punch, and alphanumeric terminals) connected to the LARS facility. The LARS facility is used to support some routine LACIE processing such as execution of the FLOCON program, which controls and keeps track of the data flow through the LACIE analysis procedures. The facility was also employed as the data base manager for data sets collected during the LACIE field research program, this role has lately been expanded to include other portions of the R&D data set.

## Supporting Noncomputer Facilities

Several noncomputer facilities were important to the successful operation of LACIE. A high-capability cartographic laboratory was maintained within the EOD facility to provide special cartographic products to LACIE.

The JSC LACIE Physical Data Library (LPDL) procured and maintained nonelectronic products such as maps, reports, and periodicals. The LPDL also tracked and maintained LACIE data packets, which were the basic information unit for the system.

The EOD facility, in cooperation with other organizations, also performed field operations in support of the field research program to collect detailed ground and aircraft spectral, meteorological, spatial, and other agronomic data sets required by LACIE. These data sets were subsequently sent to the LARS facility for inclusion in the field research data base.

The JSC Center Operations Directorate (COD) contributed to the LACIE effort by maintaining a capability to process standard film products required by the AES team. The COD also established and staffed a photogrammetric unit within the EOD facility. This laboratory maintained a capability for producing high-quality photographic products and performed special-purpose photogrammetric functions as required by LACIE.

Full-frame color photographic imagery was supplied to the project by the USDA Aerial Photography Field Office in Salt Lake City, Utah. Under contract with NASA, the Aerial Photography Field Office provided LACIE with 9- by 9-inch imagery of those Landsat scenes that contained LACIE segments.

## BIBLIOGRAPHY

ADP Acquisition Plan for an Earth Resources Data System for the Johnson Space Center, Nov 1977

Dragg, J. L. FY78-79 Transition Plan. NASA Johnson Space Center, Houston, Texas, May 24, 1978

Gregor, Paul L. Image Stations for an Earth Resources Data System Requirements as Preliminary Specifications. NASA Johnson Space Center, Houston, Texas, Mar 1978

Gregor, Paul L., Moldoff, Barry, and Spitzer, James. Requirements and Costs for Earth Resources Data System. Vol 1, Executive Summary, Vol 2, Detailed Requirements. The Mitre Corp., Nov 1977

LACIE First Interim Phase III Evaluation Report LACIE-00464, NASA Johnson Space Center, Houston, Texas, Jan 1978

LACIE Phase I Evaluation Report LACIE-00418, NASA Johnson Space Center, Houston, Texas, May 1976

LACIE Phase II Second Interim Evaluation Report LACIE-00443, NASA Johnson Space Center, Houston, Texas, Jan 1977

LACIE Project Management Response. Monthly publication, NASA Johnson Space Center, Houston, Texas, 1975-77

LACIE Project Documentation Plan LACIE C00603, NASA Johnson Space Center, Houston, Texas, Aug 1975

LACIE Rescoping Study Report Vol 1, Baseline Capabilities Team Results LACIE-00401, NASA Johnson Space Center, Houston, Texas, Apr 1978

LACIE Rescoping Study Report Vol 3, Summary and Conclusions LACIE-00403, NASA Johnson Space Center, Houston, Texas, May 1975

Preliminary Program Plan for a Joint Remote Sensing Program in Agriculture, USDA, NASA, USDI, and NOAA, May 1978



# Technology Transfer: Concepts, User Requirements, and a Practical Application

*J. D. Murphy,<sup>a</sup> F. C. David,<sup>a</sup> R. E. Hatch,<sup>b</sup> R. L. Packard,<sup>c</sup> and D. Durica<sup>d</sup>*

## INTRODUCTION

In the scientific community, the term "technology transfer" is used to denote the movement of technical capabilities from a research and development (R&D) environment to a user-oriented group for application in an operational program. This definition implies a simple, straightforward process and gives no indication of the complexities that are likely to be encountered.

The ultimate implementation of new or existing technology by a user organization will be determined by (1) the degree to which user needs are satisfied, (2) cost/benefit trade-offs, (3) user-imposed constraints, such as budget and personnel ceilings, and (4) the rapidity of technological development in the R&D community. The selection and evaluation process will identify user requirements that cannot be satisfied by existing technology and components of technology that require further attention from the R&D community before implementation in the user environment. Two basic conditions must prevail before technological development and application can occur logically and smoothly. First, the needs of the end user must play a paramount role in R&D planning if user requirements are to be addressed in an optimal manner. Second, the user must assume major responsibility for testing and evaluating technology in an operational environment so that R&D resources can concentrate on developmental tasks,

including a timely response to changes in user requirements.

The R&D community, as well as some elements of the user community, recognized a potential for applying satellite-based remote-sensing techniques to agriculture. However, research efforts in the early 1970's were fragmented among the academic community, government agencies, and industry. Planning for a large geographical area test with specific objectives was not evident. The recognition of potential applications created the impetus to conduct an experiment that would enhance the possibility of transferring applicable elements of existing technology to a specific user, the U.S. Department of Agriculture (USDA). Primary objectives underlying USDA participation in the LACIE were to assess the feasibility of transferring state-of-the-art remote-sensing technology into a user-designed system and to emerge from LACIE with a group of USDA personnel trained to utilize available analytical techniques and procedures.

The purpose of this paper is to present a management overview of the approach formulated by USDA to apply LACIE-like technology—an approach which culminated in the establishment of the USDA Application Test System (ATS) as a technology transfer vehicle. The paper is divided into three major sections. First, a conceptually oriented discussion of the technology transfer process is used to establish the roles played by the R&D and user communities, to describe the relationship between user requirements and technological development, and to identify some major factors that can influence the technology transfer process. The second section defines two approaches that have been used to identify specific USDA information requirements to which remote-sensing technology has potential applicability. The third section of the paper is an overview of the USDA Application Test System and a

<sup>a</sup>USDA Agricultural Stabilization and Conservation Service, Houston, Texas  
<sup>b</sup>USDA Economics, Statistics, and Cooperatives Service, Houston, Texas  
<sup>c</sup>USDA Foreign Agricultural Service, Houston, Texas  
<sup>d</sup>USDA Foreign Agricultural Service, Washington, D C

discussion of relevant management-oriented issues that influenced the ultimate design and implementation.

### CONCEPTUAL FRAMEWORK

From a purely conceptual viewpoint, certain conditions must exist for technology transfer to occur. First, someone must perceive a need to apply existing technology, a potential application of existing technology, or a need to develop new technology. Second, user requirements must be clearly and concisely specified in order to provide guidelines for identifying, adapting, and implementing applicable elements of existing technology. Third, transferred

technology must be fully tested and evaluated in the user environment. Results of user tests and evaluation suggest either readiness for operational implementation or the need for further development or modification. These general steps are the basic elements of the closed-loop information system portrayed in figure 1.

It is recognized that LACIE development and subsequent establishment of the ATS did not follow the conceptualized flow of technology transfer. Deviations occurred for a number of reasons. For example, major project planning was completed and LACIE was initiated before a complete, formalized statement of USDA requirements was available. Continued refinement and clarification of requirements occurred concurrently with the development and

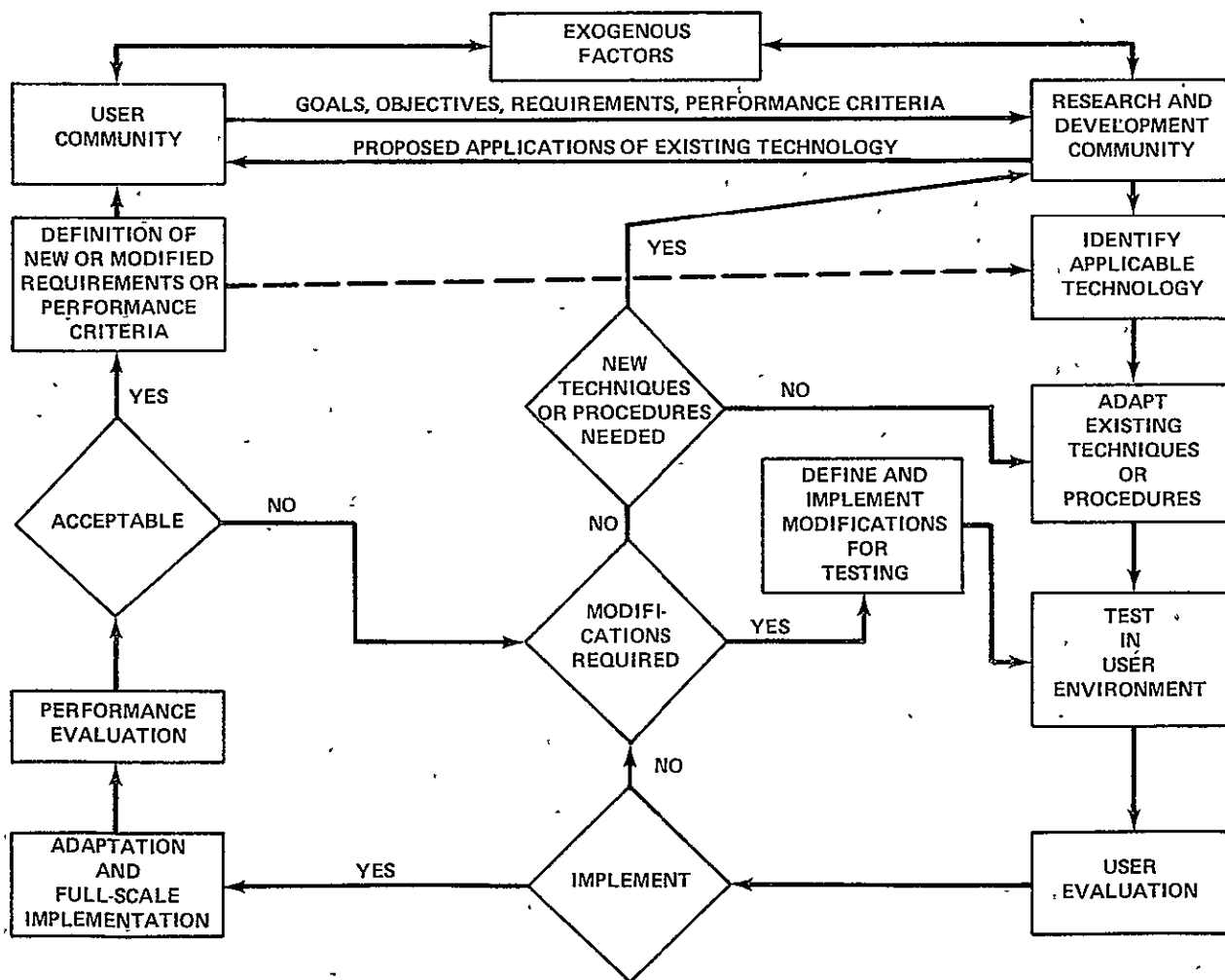

FIGURE 1.—Conceptual illustration of the technology transfer process.

modification of analytical techniques and procedures by the LACIE staff. In addition, USDA management elected to emphasize the transfer of techniques that supported crop condition assessment and early warning factors rather than the crop inventory techniques being pursued by LACIE. This series of events simply indicates that LACIE activities and ATS development were occurring in a dynamic environment. These observed deviations should not be interpreted as a failure to achieve stated objectives by either the user or the R&D community. Although a significant transfer of technology from LACIE to the ATS did occur, the technology transfer would have approached the optimum more closely if circumstances had allowed the conceptual flow to be followed. The following discussions emphasize the conceptual aspects of the technology transfer process which, hopefully, will be useful in planning and conducting future activities.

### **Impetus To Apply Technology**

The impetus for large-scale application of existing or evolving technology may originate from either of two sources: (1) a user organization or (2) the R&D community. If the point of origin is to be a user organization, someone within the organization must perceive a need for procedures or techniques not currently employed in normal operations. At this point, organizational goals, objectives, and associated performance criteria must be translated into a clear, concise statement of user requirements. If requirements indicate a need for new technology, purposeful direction is then available to appropriate elements of the R&D community. An accurate, thorough statement of user requirements will also provide the guidelines needed to modify existing technology in a timely manner.

The research and development community may perceive a practical application for new technology. If the interest of a user is aroused, the following steps are necessary: (1) obtain a clear, thorough statement of user requirements and performance criteria; (2) determine whether or not the research product has the potential to satisfy the stated user requirements; (3) identify and make needed modifications in preparation for testing; (4) evaluate performance of the research product (original or modified) in the research and development environment; and (5) assist the user in implementing, testing, and evaluating the selected technology in the user environment.

This situation is the most representative of LACIE experience. Although not all the specified steps occurred in the stated sequence, the basic elements of the process were present. Concurrent activities in the areas outlined above increase the criticality of clear communication between user and R&D personnel. The assignment of USDA personnel to the operational elements of LACIE helped bridge this potential communication gap.

Regardless of the source of impetus for applying existing or evolving technology, it is absolutely necessary to establish user requirements and associated performance criteria and to explicitly document the agreed-on roles of user and R&D personnel in the technology transfer process.

### **Evolution of User Requirements**

All potential user organizations, public and private, have an established set of goals and objectives which serve as guidelines for day-to-day decision-making. In addition, these goals and objectives provide guidance for intermediate and long-term decisions. The exact definition and relative importance of decision criteria vary from firm to firm in the private sector of the economy and are likely to differ significantly between organizations in the private sector and organizations in the public sector. A familiar product, crop production estimates, can be used to illustrate the point. A private firm may logically choose to enhance its capabilities for monitoring or estimating expected crop production on the basis of the profit motive, i.e., slight changes in expected market conditions may affect the profit position sufficiently to justify expenditures for improving the accuracy and timeliness of information used in the decisionmaking process. In the public sector, an organization may make a similar decision to improve its crop estimation capabilities for a different reason; the relative importance of the information to public policymakers and the anticipated benefits to US producers and consumers are likely to be the prime decision criteria. In either case, there is a motivation to improve a product. This motivation may be perceived internally or externally.

The goals and objectives of a user organization provide the basic framework around which a thorough specification of user requirements can be built. Associated with the user requirements is a set of performance criteria that must be met by new or existing technology before implementation in the

user environment can be justified. Performance criteria and user requirements are integral components in evaluating whether or not the technology satisfies the perceived need of the user organization.

### **User Test and Evaluation**

Evaluation activities conducted in the user environment must reflect the initially stated requirements and associated performance criteria. A prime result of the user evaluation process is to determine the degree to which stated requirements are satisfied. It is absolutely mandatory that all parties, technology developers and users, recognize the following: *Failure to satisfy all stated requirements does not mean that requirements should be changed or modified. Such failure does mean that modification of techniques and procedures and/or further research are needed to totally satisfy the full set of documented user requirements.*

When evaluation results are good enough to support a decision for either full-scale or partial implementation of tested technology in normal organizational activities, additional adaptation and integration functions will be necessary.

### **Other Factors To Consider**

Additional endogenous factors in the user environment and in the research community will influence (1) the degree of success experienced in the transfer and (2) the level of application of existing technology. Two categories that are immediately obvious are personnel and costs. It should be recognized that these categories are not totally independent of each other.

Much consideration should be given to the advantages that stem from staff exchanges (temporary detailing of key individuals) between the user community and the research community. Such an exchange can be used to provide additional technical strength to support research and development activities (i.e., to infuse a better understanding of the user viewpoint) and to support implementation and evaluation activities in the user environment. Staff exchanges should also enhance the probability of successfully making modifications to techniques and procedures in a timely manner whenever the need for modifications is pinpointed by ongoing evaluations. In short, staff exchanges between the user and research communities can be a prime method for es-

tablishing and maintaining an effective communication interface. LACIE experience supports this position. Within LACIE, USDA personnel were assigned to support project elements responsible for sampling strategy, data acquisition, analysis of Landsat data, analysis of yield and crop calendar model outputs, aggregation and report preparation, and accuracy assessment. This involvement exposed USDA personnel to the various elements of existing technology that would be evaluated for transfer to the ATS. When the ATS was established, NASA personnel were assigned to assist USDA in the implementation process and to provide needed interfaces with R&D personnel.

Cost considerations affect the amount of technology transferred and the method of implementation. Budget limitations normally act as an effective constraint in terms of both investment expenditures (hardware and software acquisitions) and operational costs. Since expenditure levels are constrained in the user environment, the cost effectiveness of technology transfer and methods of increasing the relative efficiency of the transfer process become major issues. Research and development activities conducted on state-of-the-art hardware (representative of that available in the user community) and utilizing software packages written in computer languages common to the user environment increase the chances of making a one-to-one transfer of technology. From the user viewpoint, a one-to-one transfer is most cost effective since adaptation and integration tasks are minimized if sufficient consideration is given to known user constraints (budget limitations, user personnel available for operations, facilities, and other similar factors) in the development phase. In addition, the use of similar hardware, software, and procedures to support research and development would improve capabilities for projecting performance levels in the user environment. If the user system is built in a modular fashion, modifications to procedures and techniques provided by the research community can be implemented in a more timely, cost-effective manner. The criticality of a user's need for new technology will likely be a major determinant of the speed of adoption and implementation of new technology.

It must also be recognized that the R&D community is guided by a set of generally established scientific procedures and is faced with many of the same types of constraints that affect users, specifically budget and personnel limitations. These factors have a significant impact on the time required

for technology development and on the degree to which technology can be transferred directly to the user organization. For example, the LACIE project was conducted using existing hardware components that had supported previous space missions. Consequently, techniques and procedures were developed on a system composed of large-scale computers and associated peripheral equipment, a configuration that was not designed specifically to acquire and process Landsat imagery in support of a commodity production estimation function. This process of technology development, dictated by resource availability and evaluation of cost trade-off alternatives in the R&D community, deviates from the ideal. However, this deviation does not imply that the technology developers failed to satisfy their initial objectives or that the available technology will be any less useful. It does imply that a one-to-one transfer of available technology to a user organization is not likely to be economically feasible and that users must be willing to absorb additional adaptation and integration costs in order to implement components of the newly developed technology.

In essence, user requirements in conjunction with established resource constraints will ultimately determine what technology components will be transferred, when the transfer will occur, and how the transferred technology will be implemented in the user environment. Since user needs are such a critical element of the technology transfer process, the next section of the paper will address the procedures used by USDA to develop statements of user requirements related to the potential applicability of satellite-based remote-sensing techniques.

## **USDA USER REQUIREMENTS**

Early in the 1970's, USDA recognized that remote-sensing techniques were potentially useful in agricultural studies. It was also recognized that a systematic expression of agricultural user requirements did not exist to guide the research-generated impetus for application of the existing or emerging technology. The first effort to specify requirements was a workflow approach. This approach involved a study that identified the information needs of individual work elements within the organization. The second approach taken by USDA is described as the information scenario approach which focuses on identifying and establishing a priority of information needed by top-level decisionmakers to improve

policy and program administration decisions. These approaches to requirement specification will be discussed in the following sections.

## **Workflow Approach**

The USDA Remote Sensing User Requirements Task Force was established by the Secretary of Agriculture on August 17, 1973 (ref 1). Its purpose was (1) to identify those areas where departmental needs for Earth resources data could be satisfied by remote-sensing technology and (2) to develop a plan for remote-sensing and automatic data processing (ADP) applications that could collect, sort, process, and deliver acquired data to users in a more timely and cost-effective manner than the current methods permitted. This effort was initiated before the start of LACIE and is representative of USDA's comprehensive interest in remote sensing.

The Task Force was composed of representatives from eight agencies within USDA. A survey of each agency work element (program area) was conducted using a structured questionnaire. The initial set of requirements was screened for duplication and technical practicality, and those requirements that could potentially be addressed by an application of remote-sensing technology were identified. The Task Force report is in final review draft and is due to be released soon.

Global wheat production estimation was included in the initial set of requirements. Concurrent with Task Force activities, a set of LACIE-related requirements was defined. Specific emphasis was placed on developing a comprehensive statement of USDA requirements for information regarding foreign wheat production. In addition, performance criteria to be used in evaluating LACIE results were specified. The documented requirements also provided a method of formalizing the user needs of all participating agencies.

At the time of the Task Force study (1975), the US Department of Agriculture was organized as shown in figure 2. The Foreign Agricultural Service (FAS) and the Statistical Reporting Service (SRS) are of particular interest. FAS is responsible for foreign crop information, and SRS is responsible for domestic crop forecasting. Personal interviews and procedural studies at the work-station level provided information regarding currently implemented crop forecasting and reporting procedures (figs 3 and 4 and ref 2). These interviews and materials were used



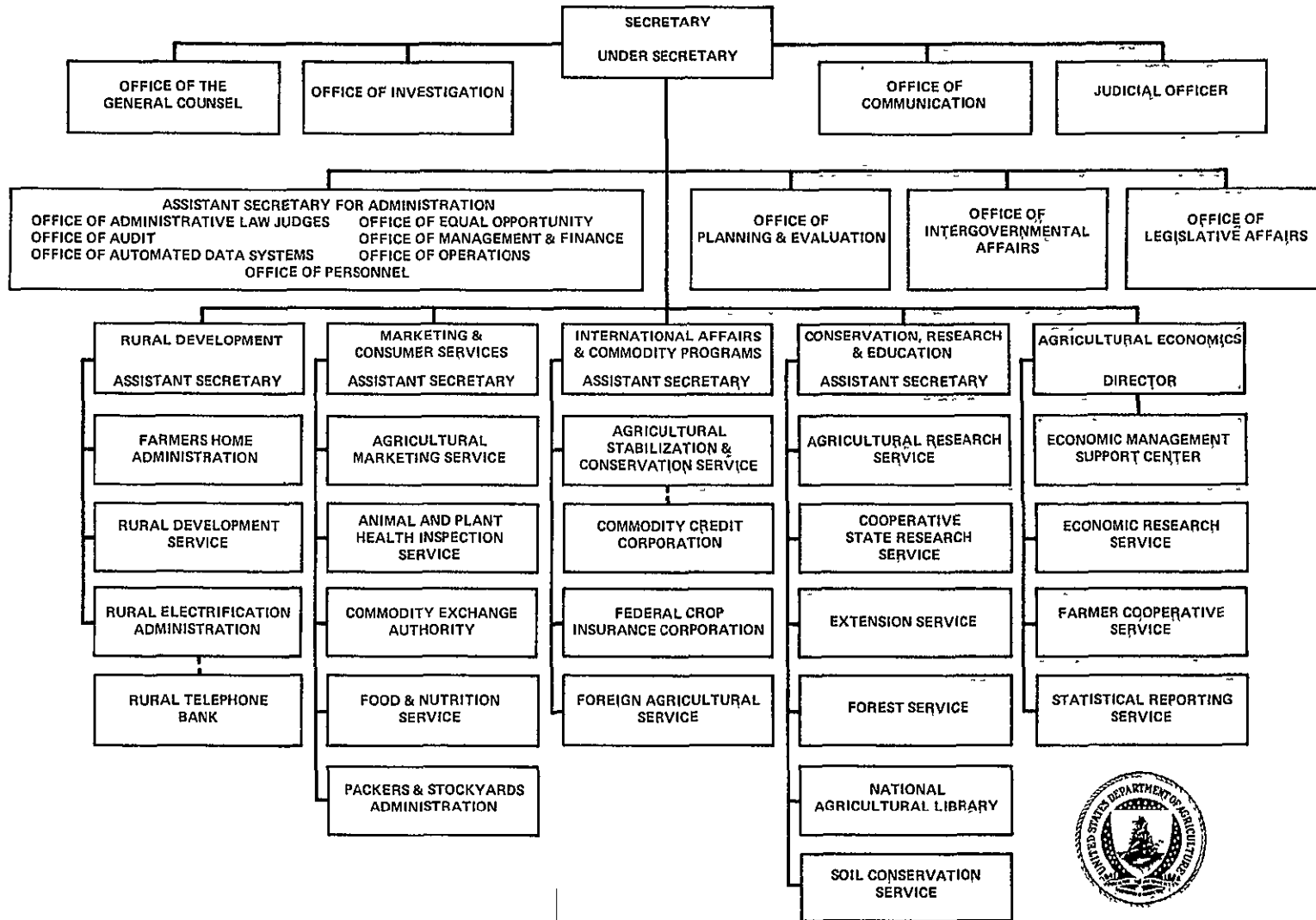
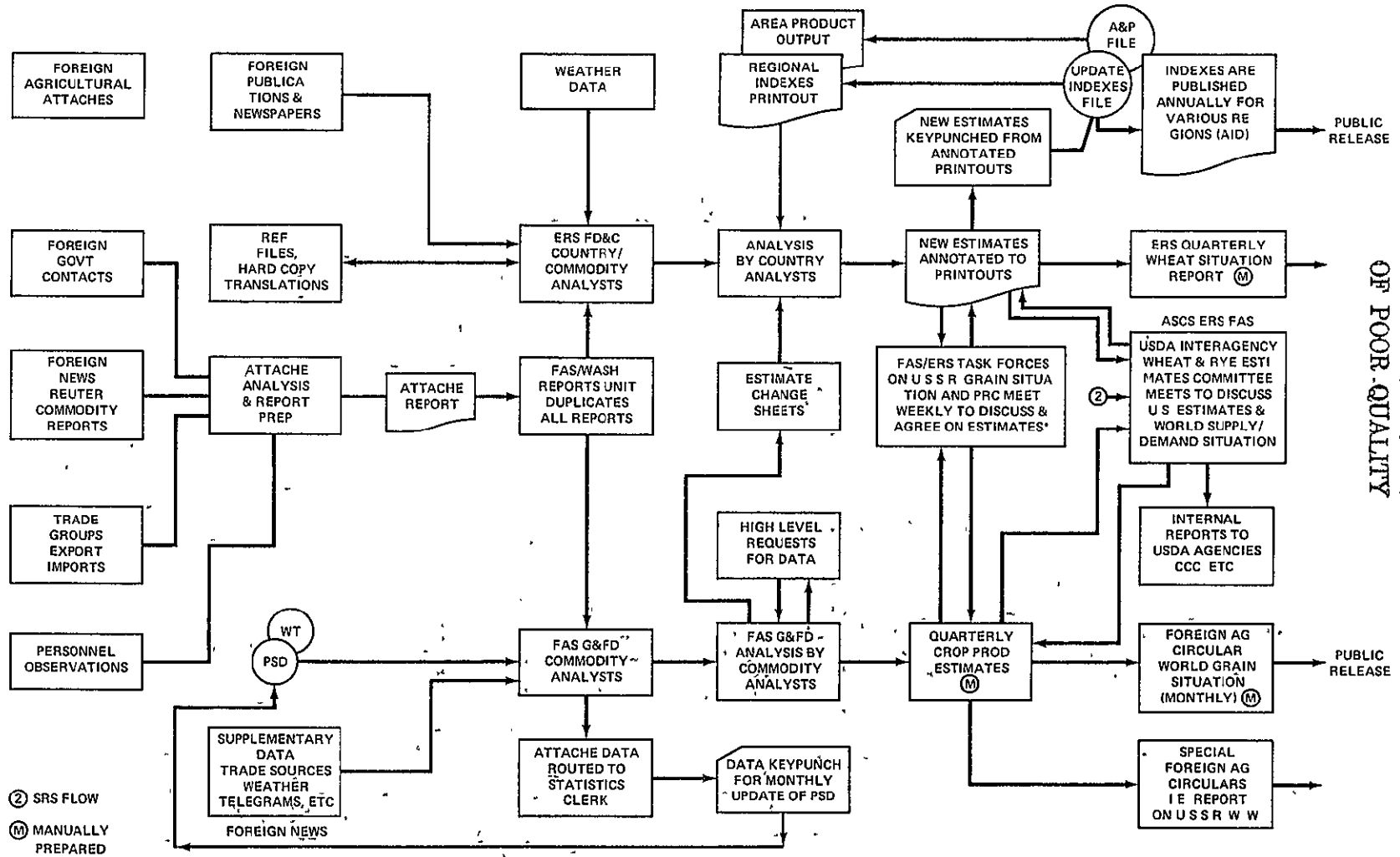

FIGURE 2.—USDA organizational structure in 1975.



ORIGINAL PAGE IS  
OF POOR QUALITY



ORIGINAL PAGE IS  
OF POOR QUALITY

\*OCCASIONALLY, ANALYSTS IN OTHER AREAS MAY MEET TO DISCUSS CHANGES

FIGURE 3.—Foreign crop estimating process.

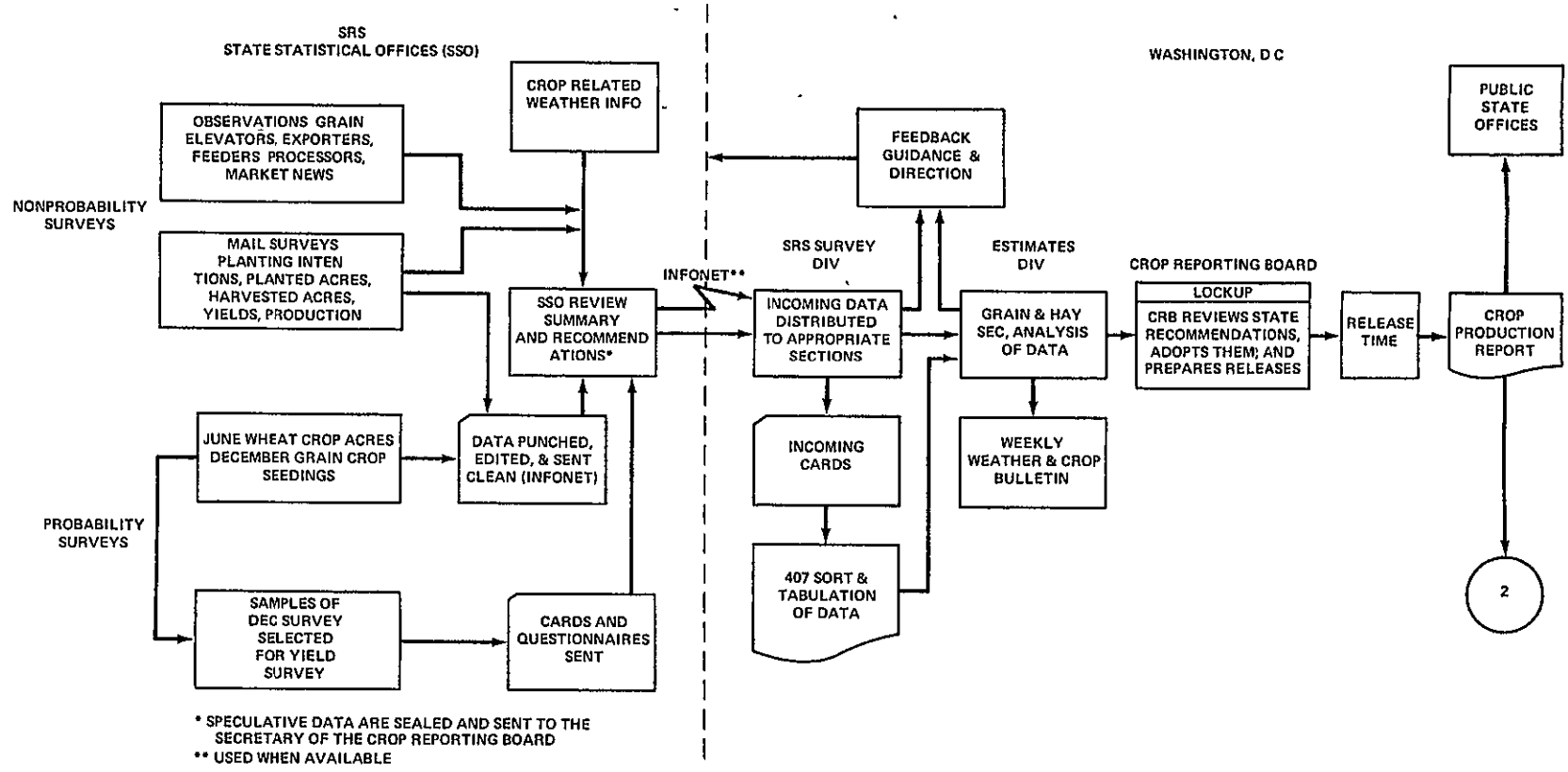

FIGURE 4.—U.S. crop reporting process.

to develop a definitive statement of the detailed crop forecasting information requirements. Specifically, these requirements addressed the type, amount, timeliness, and accuracy of the information required to support an effective crop forecasting system. These requirements were then phased to coincide with the LACIE phasing. The LACIE Executive Steering Group (representatives of NASA, the National Oceanic and Atmospheric Administration (NOAA), and USDA) approved the requirements document in November 1975.

The LACIE tasks were already underway before the approved USDA requirements were available, and many of the approved requirements were not scheduled to be addressed by LACIE. Over time, however, some of the requirements were incorporated into project activities. Other high-priority requirements played an important role in the design of the USDA Application Test System.

### **Information Scenario**

Recently, USDA top-level managers specified informational elements needed to improve their decisionmaking capabilities. This expression of requirements resulted from a recognition that the LACIE approach could provide a basis for an improved and expanded statement of requirements to guide future remote-sensing research, development, and application.

At a joint meeting of the Secretaries of the USDA and the US Department of the Interior and the administrator of NASA, a report entitled "USDA Initiative for Joint Program in Aerospace Remote Sensing" was released. USDA information requirements potentially supportable by aerospace technology and arranged by priority are as follows:

- 1 Early warning of changes affecting production and quality of renewable resources
- 2 Commodity production forecasts
- 3 Land use classification and measurement
- 4 Renewable resources inventory and assessment
- 5 Land productivity estimates
- 6 Conservation practices assessment
7. Pollution detection and impact evaluation

Narrative sections of the report provided additional details concerning information needs in each of the areas on the priority list. Most of the requirements identified by the Task Force are represented by one of the seven initiatives.

User requirements, regardless of how they are developed, must play a paramount role in research and development planning if technological advances are to evolve in an organized manner. Currently, the requirements outlined above are among the major factors that are affecting planning activities related to future remote-sensing endeavors. Users must recognize, however, that sufficient time and resources must be allocated to research and development tasks before successful implementation in an operational environment can be expected.

### **OVERVIEW OF THE USDA ATS**

The purpose of this section is to provide a general overview of the USDA Application Test System in conjunction with a discussion of the relevant management-oriented issues that influenced the ultimate design and implementation. The basic premises are that user requirements exist to guide ATS development, USDA personnel are trained to utilize LACIE-like technology, a technology transfer can occur, and a practical application can be implemented within given cost and management constraints.

The USDA management decision to proceed with an application of remote-sensing technology was made about the end of LACIE Phase I (mid-1975). At this time, much of the LACIE technology was yet to be fully developed. Another concern was that the technology was being developed in an environment that was not specifically designed to process Landsat imagery. This test environment was throughput limited and labor intensive. Except for a few items, such as the maximum likelihood classifier, a one-to-one transfer of an expensive, less-than-optimal configuration could not be justified in terms of budget expenditures. Finally, the LACIE experience itself over time would encourage the development of improved technology, again suggesting that a straightforward mirror-image transfer from LACIE was not an optimal approach. A fundamental approach had to be found which would facilitate incorporation of evolving technology and accommodate probable drastic changes in design and concepts over time. Accepted engineering and automated data processing practices for system design and implementation would have to be followed. As a result of these considerations, a USDA system design and technology transfer model (fig 5) was developed.

This classical approach provided a baseline and the necessary framework for initial system design development and subsequent changes.

The following is a summation of actions completed according to the design model and is presented to establish direct relationships and to illustrate the validity of this approach

Event	Date
Management Plan	February 1976
Design Study Initiated	April 1976
Critical Design Review	August 1976
Competitive Procurement of First System Module	June 1977
Implementation of First System Module	October 1977
Processing Initiated and Capabilities Expanded	December 1977

The activities listed above were conducted within a set of guidelines provided by USDA management. Some of the guidelines had a direct impact on the technical approach finally taken, while others served primarily to identify attributes that the ATS should have to optimize its usefulness over time.

### Planning Guidelines and Constraints

A major problem frequently encountered in implementing new technology is the potentially long lead time required to complete the implementation, even when the technology is functionally understood by technical personnel. In order to obtain timely management decisions, managers must be made

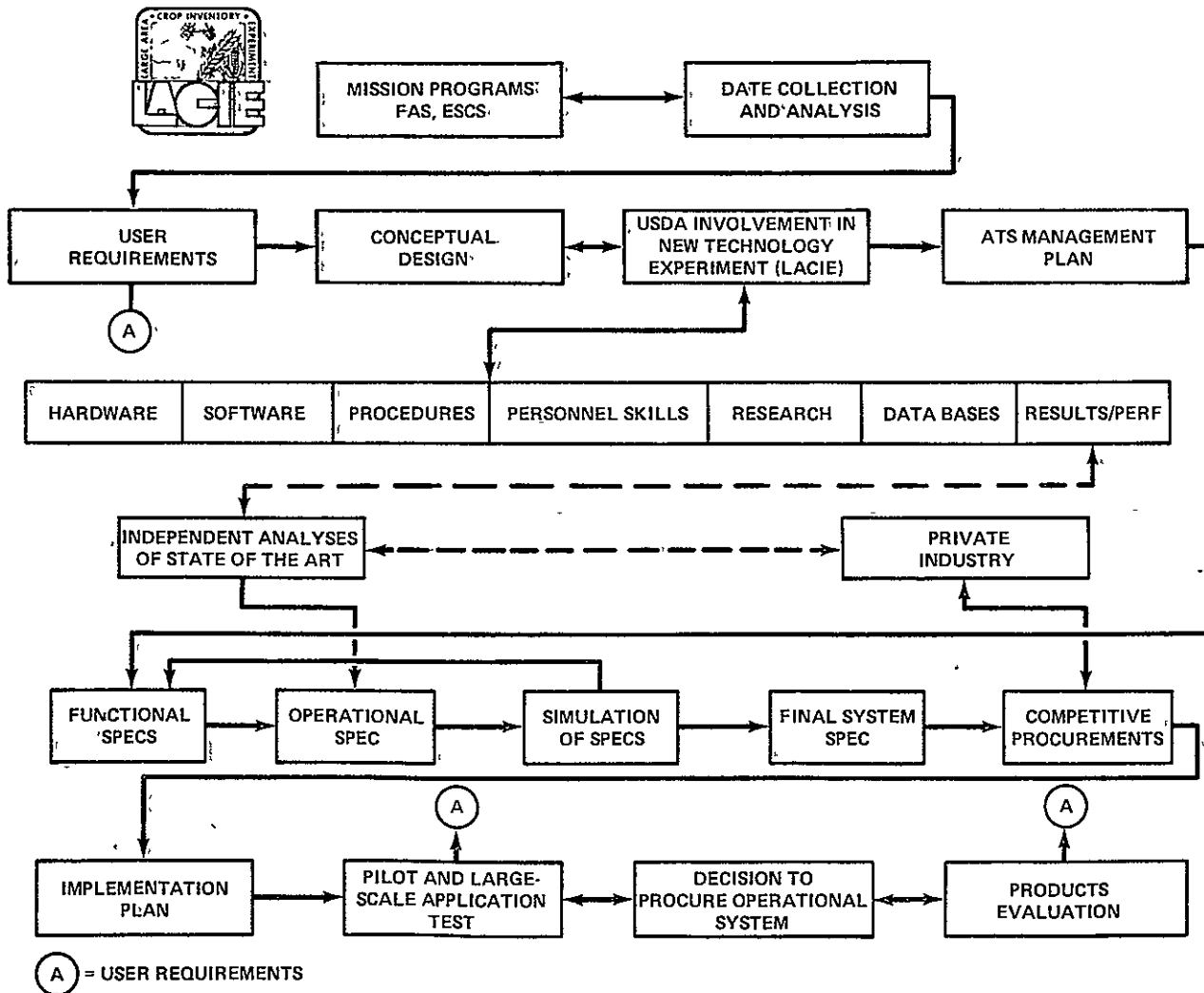

FIGURE 5.—USDA system design and technology transfer model.



aware of technological capabilities in terms of potential contributions to ongoing programs and trade-offs associated with alternative decision paths. Initial USDA planning efforts required constant communication with management so that decisions could be based on cost versus risk and would be timely enough to minimize the time required to complete the implementation process.

Two factors were considered major determinants of system characteristics. First, it was recognized that USDA user requirements would change because user missions and programs change over time in response to shifts in legislative, domestic, and foreign policy. Another facet of changing user requirements is that the very existence of new system products can generate a further demand for additional products. Second, it was recognized that the transfer of technology would never be amenable to a "turnkey" approach (a one-to-one transfer of R&D components to the user) because technology is continually changing. USDA was not interested in conducting computer design R&D or developing new ADP technology. It was apparent that (1) some technology would never be transferred because of changing user needs and (2) periodic USDA technical decisions would be necessary to identify candidate technology for transfer and to select the "best" of LACIE from the USDA viewpoint.

An additional constraint was that a measurable index of cost versus performance for any new system design had to be shown. The recommended approach had to show that, over an 8-year system life, required performance goals were met at the least amortized cost. The system simulation studies initiated in April 1976 and a cost model (see the symposium paper by Fouts and Hurst) were used to generate the required cost-versus-performance index.

Technology transfer can involve massive investments to fully utilize new technology, or implementation can be approached in a more conservative modular manner. The USDA management selected the latter option. Resources were to be invested over a period of time on the basis of potential utility demonstrated by research and development activities and application testing in a user environment. Each investment decision must be relatively small, in contrast to an initial large investment and its inherent risk. For this project, USDA management considers an expenditure of \$750,000 as approaching the upper investment limit for a computer system representing a modular incremental increase in processing capabilities. The USDA strategy of a phased component-

by-component implementation, with appropriate tests and evaluations conducted to assess the merits of each component, limits investment risk and allows the user to adapt evolving technology.

Given the above guidelines and existing expressions of user requirements, system design efforts were initiated.

## System Design

The basic design philosophy adopted by USDA management was to develop an ATS composed of modular computer hardware that was flexible and easy to adapt to specific application tests. Primary reasons for selecting this approach were anticipation of relatively rapid advances by the R&D community, anticipation of changes in USDA needs or program emphasis, and the apparent cost effectiveness of incremental increases in capabilities. The total system design has as its most notable characteristic a closed-loop information handling system (fig. 6). The nucleus of the system is a data base component that supports recurring processing components. (For further details, see the symposium paper by Evans et al.)

In order to provide optimal support for anticipated analyses, areas of similar contiguous conditions (soils, climate, and the like) had to be addressed as entities within the data base. Data had to be systematically subdivided into geographical areas so that specific local areas could be identified. The potentially massive amount of data required an automated approach with consistent rules of data subdivision and structuring such that a generalized data base management system could be used, rather than a mass of applications programs for adding, changing, deleting, and retrieving records. (For additional details, see the symposium paper by Driggers et al.) The resultant data base structure could be used to support a wide variety of application tests, including crop condition assessment, early warning factors, and crop inventory procedures. The characteristics inherent in the data base provide a potentially useful means of supporting USDA requirements other than those associated exclusively with remote sensing. Data base interaction with the other five components is shown in figure 6.

The requirements/systems management component responds to public policy and evaluation of system production. New or changing user needs are identified, and those data that must be collected by

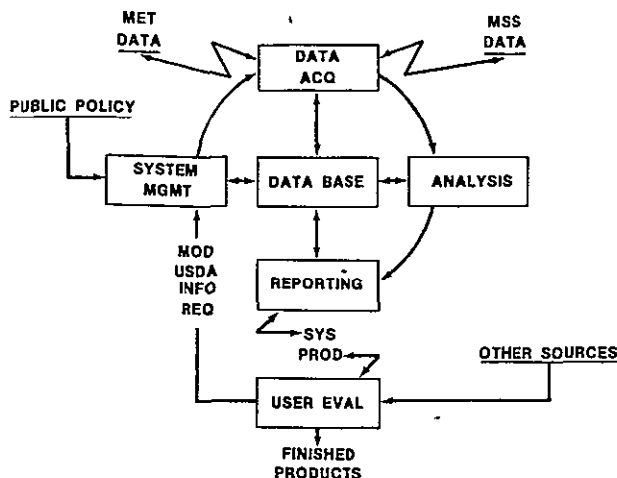

FIGURE 6.—Product and information flow.

the data acquisition component are determined. Requirements and systems management are the means for formalizing, validating, and specifying data collection activities. The process is to be automated to the extent it is cost effective, with provision for manual intervention and review.

The data acquisition component responds to data collection requirements defined by the requirements/systems management component. Data acquisition is devoted to collecting all data necessary to operate the total system. There is an obvious need to collect current multispectral scanner (MSS) and meteorological data. However, there is also a need to collect historical data, including previous MSS and meteorological data, agricultural statistics, and other ancillary data (such as "ground truth").

The analysis component uses acquired data to conduct those application tests of remote sensing that have been selected by USDA management. This component represents the focal point of this technology transfer. It is here that most remote-sensing concepts from LACIE or other sources are tested in an automated fashion. Typical MSS processing includes the clustering and classification techniques tested by LACIE, as well as other crop analyst aids (such as the green index number for vegetation) that are in various stages of testing and evaluation.

The reporting component represents the actual generation of final crop reports to be used by USDA and its agencies. Typically, such reports are forwarded to Washington, D C., for evaluation and use.

The evaluation component represents the evaluation of products developed by the analysis and re-

porting components. The evaluation is of two types. One is the use of these products in conjunction with other data sources to develop crop production and related forecasts. The other type of evaluation is essentially a technical internal evaluation as a part of the accuracy assessment/performance evaluation of remote-sensing techniques used to produce the reports. Based on both types of evaluation, new or revised information requirements are passed on to the requirements/systems management component.

In addition to accommodating a series of investment decisions, the USDA approach also has the following characteristics:

1. Cost-effective telecommunications will be incorporated to acquire data for processing and to transmit results to the user at his or her work station.

2. Administrative, physical, and automated procedures will be incorporated to safeguard sensitive materials and processing results.

3. The crop analyst will have the means, usually through terminals and cathode-ray tubes (CRT's), to interactively communicate with the computer system(s).

4. Standard off-the-shelf hardware will be employed. Special one-of-a-kind equipment is to be avoided. Design and programming modular techniques are to be employed. FORTRAN or COBOL are to be used unless a lower-level language is clearly justified. The standardization/design modularity techniques not only provide the basis for efficient system maintenance but also place the USDA in the strongest possible position to competitively procure additional capabilities in the form of enhancements, augmentation, or additional components.

The prime attribute of this approach is to put the human in direct interaction with every module of the system in order to meet all processing needs.

### The Human Interface Approach

The USDA approaches to data base design, system processing, and technology transfer were not developed as independent entities. The total effort was planned to provide a relatively efficient and direct human interface with the system. It was recognized that crop analysts would not be expected to have a sophisticated knowledge of ADP, nor were they expected to develop this knowledge. Their training to interface with the system was expected to be limited to understanding the basic system capabilities. Accordingly, the human interface ele-

ment of the design has the following attributes.

1 In the use of CRT's and terminals, an executive language is provided the analyst to call up techniques and procedures for MSS data manipulation. Clustering and classification of sample segments is a totally interactive process, augmented with aids that enhance analyst accuracy and that can be used to assess segment-level results. Results can be accepted and saved or, if the analyst desires, modified or discarded. In the latter case, the analyst can immediately reinstate the wheat definition/clustering/classification procedure.

2 Alternate means of processing sample segments are provided the analyst. The most promising techniques from each LACIE phase are available. This multiple approach was implemented because user experience supports the position that no single method (technique) is adequate for all circumstances.

3. Enhancements in processing are implemented under control of the executive system used by the crop analyst, thus continually increasing options and/or processing aids.

4 The planning of enhancements of any aspect of the system is always a joint undertaking of crop and ADP analysts, thus providing the optimal implementation considering cost and capability.

### **Practical Attributes of the Approach**

The evolution of a USDA concept and its implementation into an approach have provided USDA with a practical means to participate in Landsat remote-sensing R&D and application tests. Some specific practical advantages of the USDA concept are discussed below.

A modular approach to both component procurement and system/design programming provides USDA with extreme flexibility. New technology can be implemented in minimal time, usually by either (1) adding hardware to existing equipment or (2) implementing software into existing software inventory. At the other extreme, a contraction of the remote-sensing participation of USDA would not entail an unacceptable financial loss in terms of hardware and general-purpose executive software investment. The basic systems, because they are standard configurations with standard executive software, are very well suited for other data processing uses.

Besides the obvious benefits of standard off-the-shelf equipment and general-purpose executive soft-

ware, other long-term benefits accrue. They include the following:

1 Planning is simplified. Projections of resources (equipment and personnel) are greatly simplified.

2 Software design and programming are relatively easy to specify. Maintenance and modification of software is simplified, and the eventuality of software conversion to other computers is attainable.

The highest common denominator among various seemingly unrelated requirements can be determined by two basic means. One is the data base with its fundamentally stable means of organizing data based primarily on geographic location, exclusive of political boundaries or other indexes that can be volatile over time. The other means is the integration of MSS data processing and manipulation techniques under an executive software system available to the crop analyst. Limited experience indicates that this approach gives all crop analysts a common ground for assessing existing or proposed technology.

The analyst has at his disposal a wide range of procedures and aids to manipulate and quantify MSS imagery. Earliest USDA efforts aimed at a system with a high degree of interaction. Present efforts are giving attention to limited interactive and front-end processing to prepare and preprocess the data where experience shows the crop analyst can relinquish direct control of the process. New interactive enhancements for the analyst are also under consideration.

The USDA approach provides a positive means of cost control from the standpoint of hardware/software investment. These cost projections are continually updated using the cost model. In fact, experience with major redirections of system utilization has shown that alternative cost scenarios can be constructed in a timely and detailed manner, well within budgetary submission cycles.

### **Present Status**

Originally, near-term plans for USDA application testing emphasized wheat production estimates. In February 1978, the Secretary of Agriculture issued a statement of priorities relative to remote sensing. Based on these initiatives, the following are some of the areas that will be investigated with USDA resources:

- 1 Early warning and crop condition assessment
2. Support for meteorological/climatic alarm analyses

- 3 Yield model testing
- 4 Data base implementation/evaluation
5. Vegetative indexes evaluation

Crop production forecasting is and will continue to be the subject of joint research efforts among USDA, NASA, NOAA, and other interested agencies

With respect to system expansion, the USDA plans in FY78 to award a contract based on competitive procurement to acquire an MSS data acquisition system that will process the Landsat high-density digital tapes (HDDT's). This will allow direct extraction of MSS data of interest from the full frames on the tapes, providing more timely processing of data. This is a very critical need. Presently, a minimum of 14 days is required to ready acquired data for use by crop analysts. During the periods of peak processing, significantly longer delays are encountered. The planned data acquisition method will reduce this period to less than a week.

Plans also include future procurement of a system devoted to data base processing so that multicrop data for all important agricultural areas of the world can be accommodated. This procurement would provide a total "end-to-end" research and development system that provides for data acquisition, image analysis, and yield estimation, with a supporting data base.

## SUMMARY AND CONCLUSIONS

User requirements and a concept of practical application of new technology are more often than not extremely difficult to synchronize in an economical manner. The USDA LACIE experience has been a valuable learning tool for all parties involved in the research and development efforts. USDA development of user requirements has followed traditional lines of logical data flow through organizations and the decision unit definition of information needs. The R&D community must be made aware of future

changes in user requirements so that modifications to existing technology and the development of new technology can address user needs in a timely manner.

Technology transfer as a concept is not a "turn-key" approach as one could visualize in a product development world. For a new technology which produces information as its sole product, a more pragmatic approach must be taken. The evolution of a USDA Application Test System from LACIE experience addressed the practicalities of research and development. This approach, through the consideration of known constraints such as cost/performance and changing technology, led to a USDA design influenced by experiences in other U.S. Government agencies.

The design approach builds on a data base shared by other components of a "closed loop" information processing system. The basic components of the system relative to a supporting common data base are a data acquisition function, an analysis function, a reporting function, and an evaluation and requirements function. This design can accommodate changing technology and user requirements in a cost-effective manner.

In summary, this paper presents a management overview of the approach the USDA has formulated to apply LACIE-like technology. It is predicated on an understanding of the user environment of an operational agency and draws its strength from proven experience in operations and systems analysis theory.

## REFERENCES

- 1 Secretary Memorandum 1822, USDA, Washington, D.C., Aug 17, 1973 (as revised)
- 2 LACIE U.S. Department of Agriculture User Requirements. USDA LACIE Project Office, Foreign Agricultural Service, Washington, D.C., Oct 1975

# The Impact of LACIE on a National Meteorological Capability

*N Strommen,<sup>a</sup> M Reid,<sup>a</sup> and J. Hill<sup>b</sup>*

## INTRODUCTION

The LACIE was an attempt to exploit the agriculture-related information available from the Landsat Earth-observing satellite and the global meteorological observational network, as supplemented by meteorological satellites. The three agencies which agreed to participate in LACIE were responsible for developing these diverse information sources to support the requirements determined by the U.S. Department of Agriculture (USDA). The Landsat data capability was developed by NASA and included the use of satellite remote-sensing technology for crop identification and area estimation. The ability to acquire and use the meteorological data for real-time assessment and crop yield prediction was developed by the National Oceanic and Atmospheric Administration (NOAA), the government agency responsible for providing basic weather services in the United States.

The LACIE methodology consisted of producing estimates of total wheat production in a country based on independently derived estimates of wheat area and yield for each growing region of the country. A sampling strategy was devised which used 5- by 6-nautical-mile segments acquired by Landsat over the wheat areas to estimate the proportion of cropland planted to small grains. Analysts who reviewed the Landsat imagery classified each field in the segment on the basis of their interpretation of the crop's appearance and characteristic differences between crop species. Weather data were used to estimate crop growth stage and vigor, both of which could cause anomalous appearances in the crop. Crop assess-

ments based on the weather data were routinely provided to the analysts as ancillary information necessary for correct interpretation of the imagery.

The yield estimates required for each crop region were obtained using multiple linear-regression equations developed from historical weather-yield relationships in those regions. The accuracy of the yield estimates was dependent on timely collection of adequate weather data to define the weather patterns in the crop region and characterize their departure from normal. Final production estimates were simply calculated as the product of wheat area and wheat yield within a crop region.

The LACIE methodology was dependent on high-quality meteorological data to maximize the accuracy of both components of the crop production equation. The ability to use meteorological data to describe likely crop appearance was an important capability needed to correctly estimate crop area. For the same region where area estimates were made, weather data were used to predict the most probable yield. Thus, the success of LACIE, as measured by its accuracy, was influenced in two ways, by the available meteorological data and the techniques developed to apply that data.

As a result of its support of the LACIE applications of meteorological data, NOAA extended its capability to serve government policymakers and the general public. The capability which evolved is characterized by the near-real-time ability to monitor global climatic fluctuations and assess their impact on critical resources, both foreign and domestic.

## METEOROLOGICAL DATA REQUIREMENTS FOR LACIE

The LACIE objectives determined the project requirements for meteorological data. Since the system was intended to produce estimates of foreign wheat

<sup>a</sup>NOAA Environmental Data and Information Service, Washington, D C

<sup>b</sup>NOAA Environmental Data and Information Service, Houston, Texas

production, the data must necessarily be global in scope. The data must be comprehensive and sufficiently timely to use while the crop is growing and being observed by satellite. Finally, an analytical capability was needed to interpret the weather data and transform it into information regarding crop development, appearance, vigor, and potential yield.

A review of crop environmental physiology would produce a rather lengthy list of weather variables necessary to adequately define the growing conditions in a crop region. These would include daily temperature extremes, precipitation totals, evaporative demand, snow depth, solar radiation, soil temperature, windspeed, dewpoint or other measurement of atmospheric moisture content, and weather episodes.

At the start of LACIE, a global weather data system existed but it was not designed to support a LACIE-type crop assessment. Weather observations have been exchanged internationally for many years to support forecasting for aviation, the maritime industry, or public service. These observations are used to prepare surface weather charts depicting major features such as fronts or pressure centers. There was an internationally agreed on list of stations and observational elements to be reported. The list was established by mutual consent of the member nations of the World Meteorological Organization (WMO), an agency of the United Nations. Approximately 2500 observation stations were selected to comprise the global network for weather analysis, and the WMO sponsored a telecommunication system for international relay of their reports. Those 2500 stations were intended to be a representative subset of about 8000 total stations worldwide where routine weather observations are made.

Each station prepares a complete synoptic observation every 6 hours—4 times per day—which reports a number of weather elements. These coded reports indicate the current cloud cover, wind direction and force, cloud types and height, air temperature, highest or lowest observed temperatures, total precipitation, and visibility, as well as several other elements. Additional reports containing only current weather data are transmitted 4 times per day, mid-way between the complete synoptic reports. Since data of a climatic nature such as temperature extremes and accumulated precipitation are not necessary for the preparation of surface weather charts, they are usually omitted from the international relay of reports through the Global Telecommunications System.

In addition to the 6-hourly synoptic weather observations, there is an internationally agreed on report prepared by selected worldwide stations each month to summarize monthly climatic data. This *CLIMAT* message includes average monthly sea level pressure data, average monthly temperature, and total monthly precipitation.

Much additional daily weather data that could be useful for monitoring crop growing conditions is collected from climatic weather-observing networks which exist in most countries. In contrast to the synoptic reports, these climatic observers record temperature extremes, precipitation totals, snow depth, and other elements once each day. The observers usually mail their reports to a central location at the end of each month. Most countries summarize these reports and publish them anywhere from 1 to 12 months after they were observed.

A dilemma appeared to exist in the availability of meteorological data needed to support LACIE. Important reports of temperature extremes and precipitation amounts were usually not included in the international relay of synoptic weather observations which were the source of timely data needed for day-to-day crop monitoring. In addition, the number of stations from which reports were relayed was significantly less than the total number of observing sites. Thus, the comprehensiveness of the data was at issue. The comprehensive network of stations which observed the weather elements of interest reported only by mail and thus lacked the timeliness needed.

The data problem was attacked on two separate fronts with efforts both to improve the content of the synoptic observations relayed internationally and to capitalize on the available data. In 1976, it was proposed to the WMO committee on agrometeorology that the precipitation and temperature extreme reports become recommended elements in the international relay of synoptic weather observations. The proposal was forwarded to the WMO committee on meteorological data and was accepted in part when the committee voted to include temperature extremes in the synoptic reports effective July 1, 1977. This response by an international organization came as a direct reaction to the NOAA effort to provide meteorological data support to LACIE.

It was decided that crop yield modeling efforts should be directed toward use of the *CLIMAT* reports, which contained monthly precipitation and temperature data—the two principal factors in assessing crop yield potential. These data were available from a reasonably large sample of weather sta-



tions in important crop regions, and they were compatible with pre-LACIE efforts by various investigators to model crop yield as a function of departures from normal monthly temperature and precipitation. Since the impact of surplus or deficient moisture manifests itself over extended periods, the use of monthly rather than daily precipitation appeared to be consistent with known plant response.

## METEOROLOGICAL DATA COLLECTION

A central facility has been developed by NOAA to collect meteorological data in support of its national weather functions. This facility is the National Meteorological Center (NMC) at Suitland, Maryland, near Washington, D.C., where data are received and processed from several sources as shown in figure 1. Three sources of data are identified as being available at the Center. These include the 2500 stations from the WMO Global Telecommunications System whose reports are relayed from the various regional centers. Domestic data for the United States and nearby oceanic areas are received primarily from stations operated by the National Weather Service and the Federal Aviation Agency. Their reports are received in their entirety and none of the observational groups are deleted from the coded observation. The third source is a link to the U.S. Air Force weather service, which gathers military reports and also domestic data from countries where the United States has a military mission or a national security interest.

At the beginning of LACIE, the NMC was acquiring data from approximately 5000 stations globally for use in its various analysis and forecasting pro-

grams. Once the data were used, they were archived for use in forecast technique development or verification. In response to LACIE needs, the NMC agreed to expand its data base from 5000 reporting stations to more than 8000, which is the total of all designated reporting stations in all countries. This made the data base comprehensive for not only the countries LACIE concerned itself with but also the remaining food-producing regions of the world.

An evaluation of the data base at NMC revealed that it was surprisingly adequate for LACIE needs despite the apparent constraints imposed by the WMO on its system. A wide variety of reports was being forwarded by the various regional relay centers in the WMO system and many of these included the temperature and precipitation groups. Also, the U.S. Air Force reports, which were not subject to the WMO conventions, added important additional information to the data base.

## ORGANIZATIONAL RESPONSE

The requirement to support LACIE with timely meteorological data, weather assessments, and crop yield predictions necessitated that NOAA bring together a mixture of skills within an organization. To meet this requirement, a Center for Climatic and Environmental Assessment (CCEA)<sup>1</sup> was established in 1974 as a line organization within the NOAA Environmental Data and Information Service. Within CCEA, an assessment division was created at Washington, D.C., to develop and utilize the NMC data base for defining and assessing the meteorological conditions within the countries of interest. A modeling division was created at Columbia, Missouri, to develop the analytical methods needed to predict crop yield using the input data provided by the assessment division. The model unit capitalized on the close proximity of the University of Missouri as a resource where experts in agronomy, meteorology, and related sciences could be found to expand the skills available within NOAA.

## CAPABILITY DEVELOPED

The contributions of the CCEA yield models to LACIE will be evaluated in a separate paper in this collection, but it would be well to comment here at

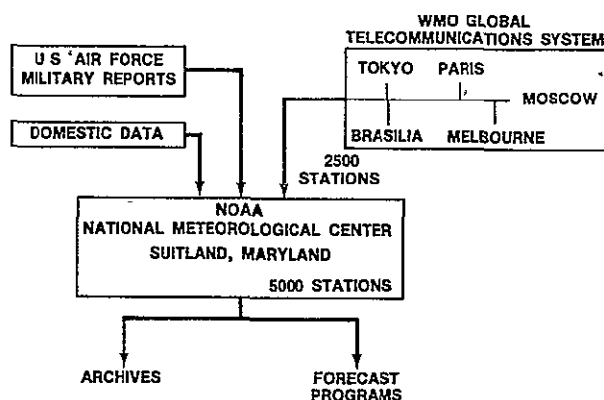

FIGURE 1 —U.S. system to gather global meteorological data.

<sup>1</sup>In a NOAA reorganization during 1978, CCEA became an integral part of a new Center for Environmental Assessment Services (CEAS).

some length on the assessment capability, since it has potential value far beyond this project. The ability to prepare timely global weather assessments is built on cooperation between NMC, CCEA, and other elements of the Environmental Data and Information Service. It is focused on the NMC data base, which now supports global weather assessment as an expanded U.S. capability. In figure 2, the scope of the expanded capability is shown as a third activity based on the NMC collection of global meteorological data. Validated files of daily weather data are used to prepare the summaries, listings, and analyses necessary for the assessment function. These surface weather reports are used together with meteorological satellite imagery of cloud patterns to put as much detail as possible into the analyses. Typical examples of data analyses are shown in figures 3 and 4.

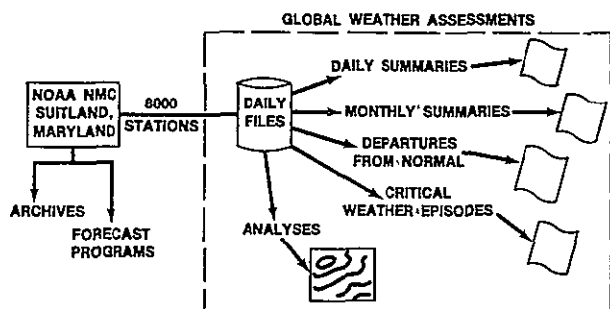

FIGURE 2.—Expanded use of meteorological data to produce global weather assessments.

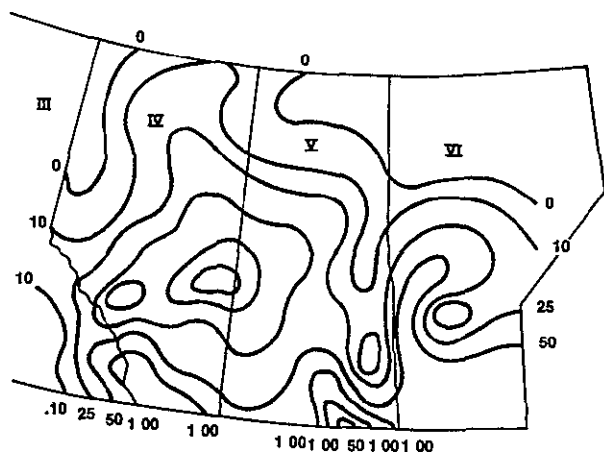

FIGURE 3.—Observed precipitation totals in the Canadian prairie provinces, May 29 to June 4, 1978.

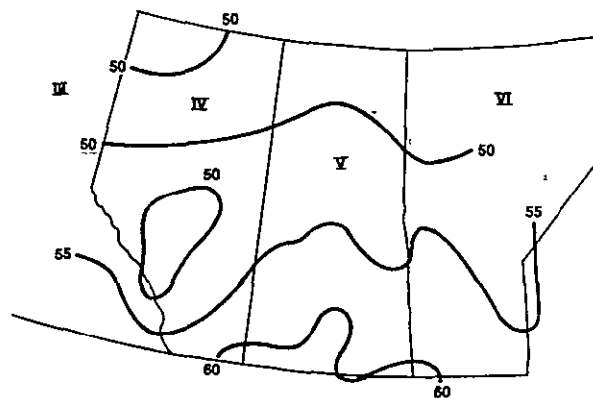

FIGURE 4.—Observed weekly average temperature in the Canadian prairie provinces, August 23 to 29, 1977.

To illustrate the usefulness of the information to be extracted from these data, we can look at the impact of the weather on the U.S.S.R. spring wheat crop of 1977. Spring wheat is grown from the lower Volga region eastward to Siberia, and the area east of the Ural Mountains is particularly critical to supplying the Soviet grain needs. In figure 5(a), the May precipitation, important for establishment of the crop, is shown to be below normal over much of the area from Volgograd to western Siberia. Figures 5(b) and 5(c) reveal that the succeeding months were also drier than normal. The wheat yield models developed for that area were used to prepare predictions based on data through July, and the results shown in figure 6 project yields to be about 50 percent below normal in the driest areas. At the end of the year, the U.S.S.R. reported a total grain harvest of 190 million metric tons, far below their national goal of 225 million tons in 1977, thus confirming the shortfall suggested by the weather 5 months earlier.

The ability to collect timely global meteorological data, quantify its impact, and assess the implications is a powerful national capability which has evolved from LACIE-related efforts. Its importance cannot be overestimated in this time of erratic climatic fluctuations and wildly oscillating food supplies. A NOAA publication which originally was designed to provide crop assessments in the countries of LACIE interest is now available publicly and has a growing list of subscribers.

During the winter of 1976-77, which brought unusual cold and energy shortages to the eastern half of the United States, the CCEA modeling division was asked to apply the capability developed for

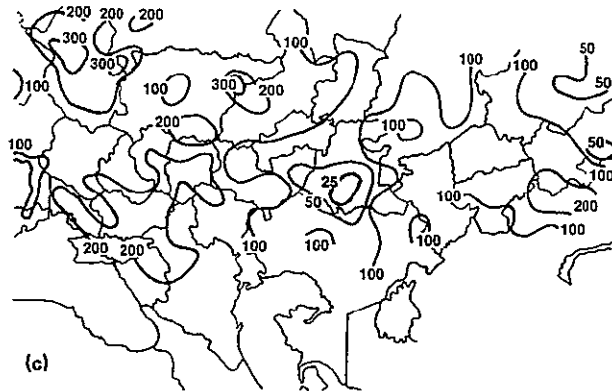
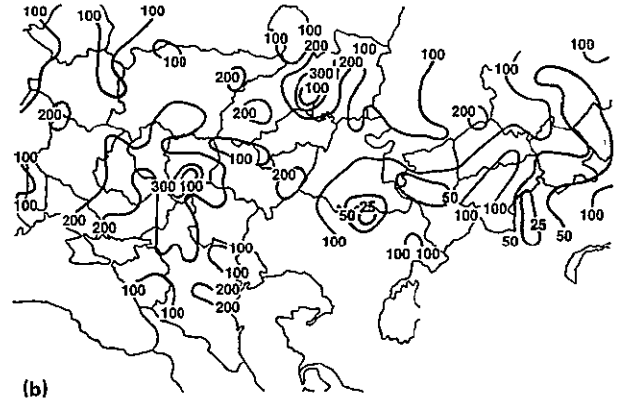
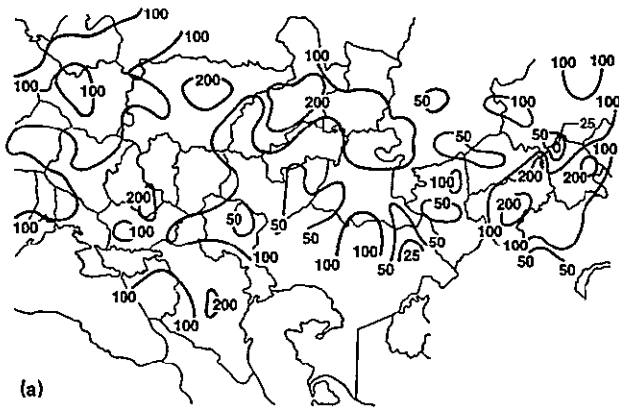

FIGURE 5.—Percent of normal monthly precipitation in the wheat-growing regions of the U.S.S.R. (a) May 1977 (b) June 1977. (c) July 1977.

As a result of its involvement with LACIE, NOAA, the agency responsible for providing weather services to the nation, has expanded the scope of those services. A capability now exists for timely monitoring of global climatic variation and assessments of weather impacts on a major food crop. This capability establishes a precedent for the application of weather data to other critical national problems. The successful use of meteorological data to support LACIE needs has demonstrated the feasibility of the approach and prompted similar endeavors in private industry. Commercial services are now available to anyone who wishes to utilize timely weather data for crop monitoring or similar applications.

LACIE to the nation's energy problems. Models of natural gas consumption based on temperature departures from normal were prepared and used with extended weather forecasts to project where shortages might occur so that critical supplies could be allocated in anticipation of the regional shortages. The record cold of the 1977-78 winter provided a second opportunity to utilize the natural gas models to provide valuable advice to the Department of Energy.

The Agency for International Development (AID) has taken notice of the capability developed to support LACIE and has requested that weather assessments be prepared for nations where AID has development programs. These assessments will be based on the global weather data acquired at the NMC.

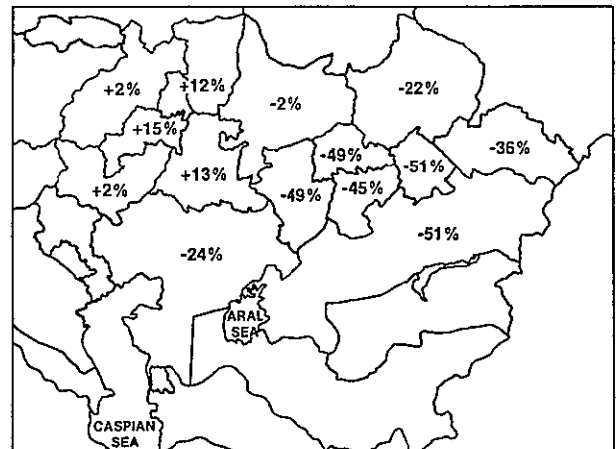

FIGURE 6.—Forecast departures from normal yield in the Soviet spring wheat area, August 1977.

## **NEEDED IMPROVEMENTS IN THE GLOBAL METEOROLOGICAL CAPABILITY**

A quantum leap has been made in the development and use of meteorological data for crop monitoring, however, further improvements are needed to refine the capability. Many of these improvements involve international cooperation to arrive at an optimum system which could be of immeasurable value to every country affected by the vagaries of climatic variability. Basic to the refinement is a need for all countries to agree that crop-related weather elements contained in the synoptic observations must be mandatory in the international exchange of reports. The case for such international cooperation will become clear as a global food management policy evolves among major food producing and consuming nations.

Even with more comprehensive data, the system that produces the reports in each country must make a commitment to improve its adherence to the synoptic weather code. Observer errors in encoding the data occasionally occur, as do garbled electronic transmissions of the reports. No country's national weather service is free of such problems, even in the United States, encoding errors are occasionally noted among both civilian and military organizations. Closer quality control within the system and a greater awareness among observers worldwide of the increased uses to which their reports are being put can be of immeasurable value to the specialists using them for real-time climate assessment.

Even though the surface-weather-observing network will never be perfect for supporting real-time crop assessment and yield estimation requirements, these data will still provide a source rich in information. This information can be further enhanced with the detail that satellites provide by directly observing the crops. A capability to use meteorological satellites to make quantitative estimates of many plant-related variables is considered by knowledgeable scientists to be achievable. This capability would overcome several of the key deficiencies in the existing system. Satellite-derived measurements can not only provide estimates of parameters not currently available but can also increase the coverage in areas where data are sparse. While the development of techniques to acquire needed data from the satellites will require a commitment of resources, these resources are small compared to the initial cost incurred in establishing an operational environmental satellite system for our country.

## **THE FUTURE OF GLOBAL FOOD MONITORING FROM METEOROLOGICAL DATA**

The success achieved by LACIE in its effort to monitor wheat production from selected areas of the world is unprecedented. Never before has there been such a potential to provide decisionmakers with timely, comprehensive information regarding the condition of crops and potential grain production. This capability, supported to a large extent by the meteorological data, is now a candidate for further evolution and application to a broader range of agricultural and other uses.

To date, the major impacts of weather on crops have been assessed as moisture influences or temperature stress. The ability to use weather data for wider application has been demonstrated in selected research work and is now awaiting pilot testing in a crop monitoring system. Dynamic models of plant disease, insect outbreaks, or other adverse crop growing conditions have been developed and simulate these events as functions of weather elements. These models form the next generation of analytical methods available for implementation in a crop assessment system.

In addition to increasing the breadth of the manner in which weather impacts on crops are assessed, the depth of the capability will be enhanced. As noted earlier, meteorological satellite data are available to complement the surface-weather-observing network and increase the temporal as well as the spatial definition of the climatic patterns. A wider variety of meteorological measurements will become available to describe more adequately the complete growing environment. With this increased detail, the models of crop yield can operate at a more basic level of plant response.

The importance of a capability to monitor global food production in a timely manner cannot be overestimated. Large variations in supplies and prices globally during recent years have been a result, in large part, of inadequate knowledge about the true "global supply-and-demand situation." In the United States, the establishment of grain prices at a realistic level is important to maximize the contribution of grain exports to the balance of trade. The development within LACIE of the necessary technology to use weather information for crop monitoring and the further exploitation of this capability will be of vital importance to the future well-being of our country.

# The Outlook for Satellite Remote Sensing for Crop Inventory

R. Bryan Erb,<sup>a</sup> Robert E. Tokerud,<sup>b</sup> and Robert B. MacDonald<sup>a</sup>

## INTRODUCTION

The LACIE has advanced, in a major way, the application of aerospace remote sensing and weather effects modeling for crop inventory. Further, it has established the applicability of this technology to global wheat-production estimation. It is fitting, at this symposium reporting on the total LACIE experience, to reflect on the future directions and uses of this technology.

The purpose of this paper is to project, on the basis of the LACIE experience, the technological prospects for crop inventory over the next few years. To arrive at this projection, an attempt is made to state the essence of the conclusions from LACIE—conclusions necessarily from the project's point of view. The outlook itself addresses the following issues: improvements needed in the technology, availability of the technology, and the project's recommendations for future activity.

## MAJOR LACIE FINDINGS

The detailed performance and accuracy results of LACIE are given in other papers of this symposium. In this section, an effort is made to extract the major conclusions as they pertain to this technology's future directions. The most important LACIE finding is that the technology worked very well in estimating wheat production in important geographic regions. Notably, LACIE produced what proved to be an accurate estimate of the USSR's spring wheat shortfall in August 1977, well before more definitive information was released by the

USSR. These results are shown in figure 1. Additionally, 2 years of study in both spring and winter wheat regions of the USSR, resulted in estimates that supported the experiment performance goals. The confidence in this success was reinforced by the accuracy of the production estimates in the U.S. hard red winter wheat region during 3 years of study. Exploratory investigations made in other countries show that the current technology may be applicable to some countries (Australia, Argentina, and possibly Brazil) but may require improvement in others (China and India).

The LACIE estimates were made using Landsat and meteorological data routinely available and were not dependent on ground observations or on other data from existing crop inventory systems. Figure 2 depicts the general flow of LACIE information.

A major goal of LACIE was to identify the technological issues related to wheat-production estimation and to provide a better understanding of the significance of these issues. LACIE did provide, as called for in the experiment design, an identification

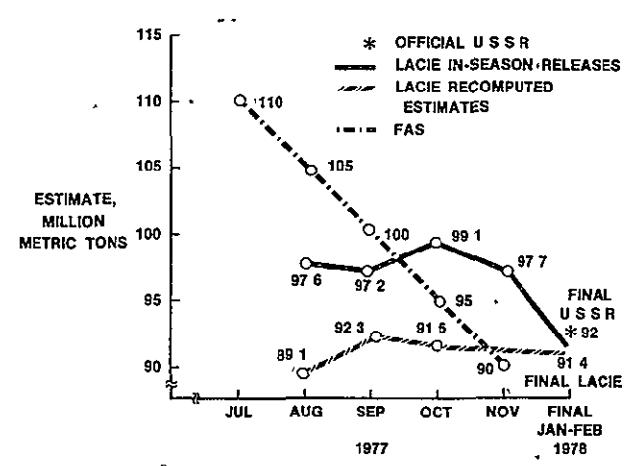

FIGURE 1.—U.S.S.R. estimates for the 1977 crop year.

<sup>a</sup>NASA Johnson Space Center, Houston, Texas  
<sup>b</sup>Lockheed Electronics Company, Houston, Texas

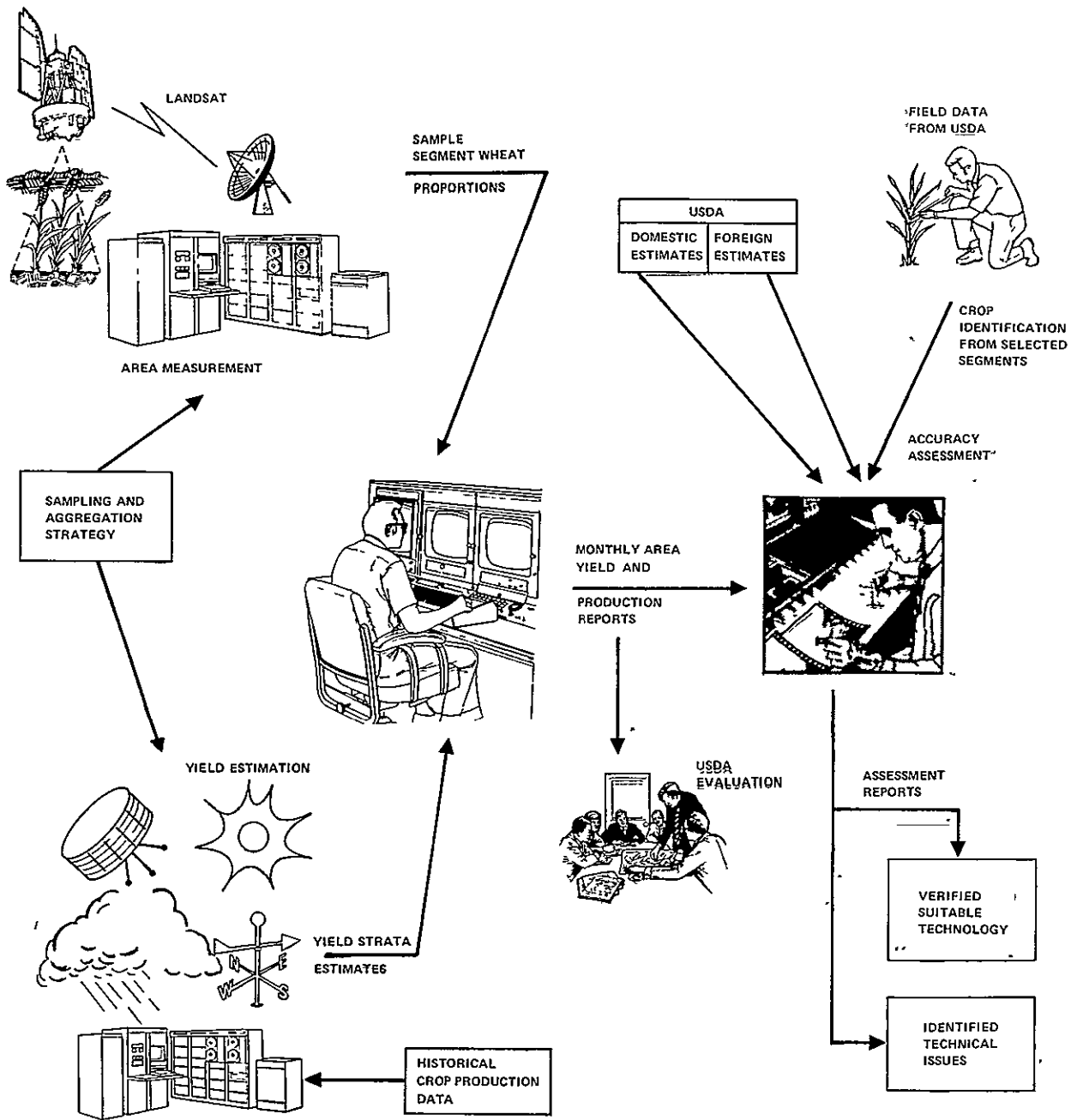

FIGURE 2.—Flow of LACIE information.

of technology issues that, when resolved, could significantly improve the technology for wheat inventory. In addition, specific approaches for the resolution of many of these issues have been identified.

A significant result of the experiment was the development of an improved scientific base on which production estimation studies for other crops

could be pursued. An accomplishment of LACIE was the development of methodologies for sampling, for computer-aided spectral discrimination, for yield modeling, and for accuracy assessment. These methodologies provide a basis for studying other crops. The parameters involved in estimating production for other crops are far more complex. The



task will not be easy. The technology base produced in LACIE will provide a sound starting point.

The LACIE was the first demonstration of the operational potential of using satellite spectral and weather data for global crop production estimation, and the experiment demonstrated that a system could be engineered to provide timely production estimates. The self-imposed LACIE practice of deferring the release of production estimates until 120 days after report generation was simply to ensure that experimental results from LACIE would not be confused with official estimates.

The LACIE effort resulted in many technological improvements in the application of satellite and weather data: global sampling using the Landsat data, a production estimation technology using area and yield components, an area estimation technology of acceptable accuracy accomplished *without* the use of ground data, and crop yield estimation technology of acceptable accuracy. Further, the execution of LACIE resulted in several significant lessons about the planning, management, and implementation of crop-monitoring technology development programs. The major lessons were that

1. Research, development, and evaluation require several years of testing with large data sets over extensive geographic regions to verify technological issues resulting from the wide range of variability of the contributory factors.

2. A comprehensive accuracy assessment effort is vital, and considerable ground data for the regions under investigation are essential to the understanding of the experimental results and to the identification and correction of deficiencies in the technology.

3. A research and development program involving diverse scientific disciplines focused on technical issues arising from a project similar to LACIE stimulates a more applied research activity and provides an improved and common understanding in the supporting research and industrial community.

4. The periodic use of a peer review, in which critical issues on methodology and results are subjected to the scrutiny of independent reviewers, provides essential feedback.

### **IMPROVEMENTS NEEDED IN THE TECHNOLOGY**

There were, of course, shortcomings in the technology tested in LACIE. There were issues which were not resolved during the experiment. They must

be resolved to expand the usability of LACIE technology for wheat inventory in other important geographic regions. The application of the technology during LACIE was less successful in Canada than in the United States or the U.S.S.R. The causes are reasonably well understood. Because of crop planting practices (i.e., strip farming) the effective field size is typically close to the present satellite resolution limits. Also, Canadian spring wheat is grown in proximity to other crops which are spectrally similar. More recent work on spring wheat in the U.S. Great Plains indicates that these problems can be overcome. Other difficulties arose in crop years that showed extreme departures from normal; the result was estimation errors in both yield and area estimation. In some cases, historical data with which to build the data bases for the yield models were poor to nonexistent. To overcome these problems, improvements in sensor resolution, area estimation technology, and yield models will be required. Although these issues are far better understood because of LACIE, the usefulness of the current LACIE total system inventory technology will be limited to areas with moderately large fields and adequate historical data until these issues are resolved.

### **AVAILABILITY OF THE TECHNOLOGY**

At this stage of technology development, there is a logical question about whether the present capability is generally available. Until Landsat-D is launched, it could be available to the U.S. Government or to other governments with access to Landsat ground stations covering their own country. Because of the tape-recorder limitations of the current Landsat spacecraft system, reliable and timely availability of the data for all potential users cannot be guaranteed. Although the weather data are routinely available through the World Meteorological Organization for input to yield models, the nonavailability of Landsat data on either a temporal or geographical basis would have significant impact on local or regional production estimates. LACIE has clearly demonstrated the important interrelationship of yield and acreage (in local agrophysical regions) in estimating production before aggregation to obtain regional or national crop production estimates. The nonavailability of adequate historical data on some crops in certain areas of the world would also limit the use of current yield models.

Although the total technology may not be available, parts of it are currently being used by the U.S. Federal Government. Examples are the efforts to use early warning indicators of wheat production changes and test use for augmenting U.S. domestic local statistics by the U.S. Department of Agriculture (USDA). In addition, several private and commercial firms are using portions of the technology for the United States and other nations, notably weather-driven yield models and assessments of weather episodic effects. Because of limitations on the availability of timely Landsat data as mentioned previously, acreage estimation technology is only being used in a research and development (R&D) environment and as a tool to train future commercial and government users. As to the more general availability of the LACIE technology, one must look from a practical viewpoint to the Landsat-D time frame. The current plans for that spacecraft include a multispectral scanner and rely on the incorporation of the Tracking and Data Relay Satellite System (TDRSS) into the data transmission loop to overcome the current tape-recorder limitations. Also, by the time of the Landsat-D launch, improved distribution systems will be available for more timely dissemination of the Landsat data.

The evolution of the Landsat-LACIE program has an analog in the environmental satellite program. A comparison between the time phasing of these two programs is shown in figure 3. As can be noted, the environmental satellite program really started with the launch of TIROS-1 in 1960. In its early stages, this program had problems very similar to those of Landsat. A new source of raw data, completely different from any source previously available, was provided to users. New models and analysis procedures had to be developed and tested, first on a limited basis and then on an operational scale, before the users could incorporate the new data into their decision models. In the early stages, analysis techniques and distribution systems were rudimentary and the applications were simple. As the program developed, various stages of operational systems and subsystems were developed, evaluated, and implemented. Now, some 18 years later, the National Oceanic and Atmospheric Administration (NOAA) is looking toward the establishment of a world weather-reporting system. Assuming a similar time scale for Earth resources agricultural applications and working from the launch of Landsat-1 in 1972, one can look forward to a global agricultural informa-

tion system in the late 1980's or early 1990's, if national priorities allow the needed support. Figure 3 also shows a lack of planned Landsat-type components beyond the early 1980's. However, one can easily correlate the feasibility of developing the necessary Landsat data acquisition, transmission, and distribution technology with that accomplished by the environmental satellite program within a similar time frame.

In connection with the availability of the technology, and specifically the availability and reliability of satellite spectral data, it should be pointed out that this issue is not solely technical but also includes policy and institutional considerations. Current legislative and executive matters must be resolved to enable the application of the technology to meet its potential. LACIE has identified several technical issues and shortcomings that need to be addressed. Problems in need of special attention in the future include the following:

1. Yield models that are based on daily or weekly rather than monthly averages of temperature and precipitation and that closely simulate critical biological functions of the plant and its interactions with the external environment must be formulated to provide a yield response of greater fidelity to a wider range of conditions than present models.

2. Analysis techniques are needed to deal more effectively with the spatial information in Landsat data and to improve area estimation accuracies in regions having a high percentage of fields with sizes near the resolution limit of Landsat. Additionally, the anticipated improvements in area estimation resulting from the increased resolution of Landsat-D and spatial resolution requirements for future Landsats must be investigated.

3. Landsat coverage at more frequent intervals than every 18 days may be needed, as well as the addition of spectral channels to identify vegetation stress more reliably and to differentiate crops of interest from confusion vegetation more reliably. Also, the additional spectral channels of Landsat-D must be evaluated together with definition of recommended spectral channels for future Landsats.

4. A special challenge is assessment of crop production in tropical regions. Crop varieties tend to be significantly different and crop growing conditions tend to depart radically from those experienced in the temperate zones.

5. The effects of cloud cover as it prevents the acquisition of usable Landsat data at critical periods in

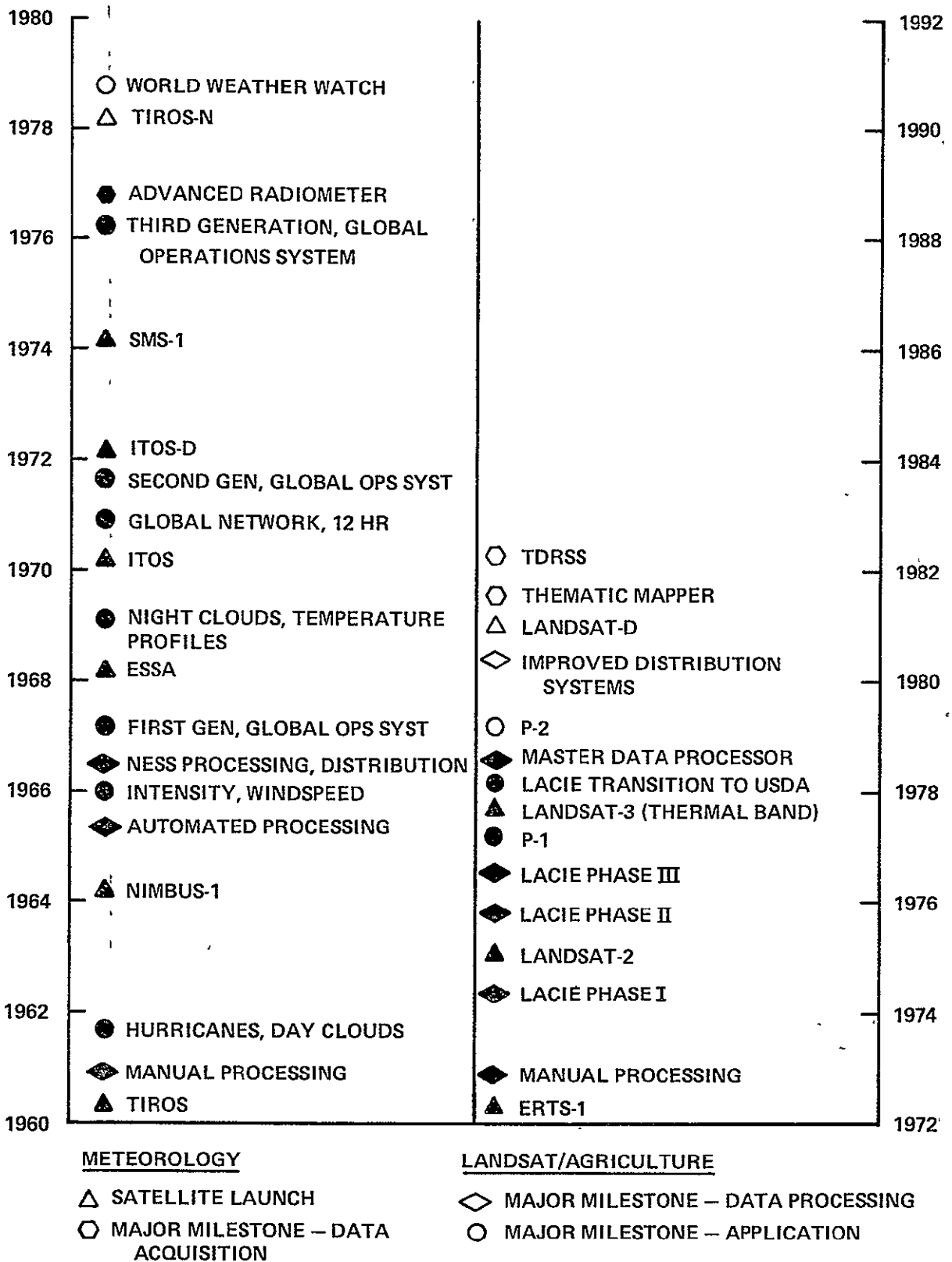

FIGURE 3.—Remote-sensing applications in major space programs

the crop season need to be better quantified, particularly in more humid environments, such as the US Corn Belt

6. The trade-offs between the need to shorten the time between data acquisition, analysis, and reporting and the costs of obtaining such shortened response need to be evaluated. While considerable improvements can be made, considerable costs may be required to obtain them.

With development of solutions to these specific technical issues, testing over other significant geographic regions will be required. As stated earlier, a lesson of LACIE was that extensive temporal and geographical testing is required because of the complex factors affecting crop production. It can be safely assumed that this technology will not evolve automatically but that it needs to be purposely pursued. It will require a substantial commitment to a research, development, and evaluation program conducted on a basis similar to LACIE's. In addition, it will have to cover the full range of variability present in the important growing regions of the globe. The LACIE experience has shown that it requires a positive dedication on the part of the involved parties to this type of experimentation to gain the desired results.

## PROJECT RECOMMENDATIONS

A major result of the LACIE investment was the development and organization of a multidiscipline team with participation from three government agencies, several universities, and industry. This team has the experience necessary to continue the development of agricultural applications and should pursue further development of crop production estimation technology. Delay in initiation of this program will only increase the startup costs at a later date. Since the technology will work now in important areas, the basic policy issues discussed should be resolved to establish program direction more firmly. In addition, the project recommends development of a dialog between other potential users of this type of information and the technology's developers. To date, the only significant involvement has been with the USDA. However, it is clear that if the information is available, reliable, and economical, a wide array of "secondary users" (e.g., agribusiness concerns such as seed, fertilizer, and implement manufacturers and transportation concerns) will use this information in their own decision models. Interaction

between all types of users and the technology's developers is essential to ensure that the information will be useful and timely. In addition, a dedicated technology transfer mechanism between government agencies and to the private sector will be critical to the adaptation of the technology.

## NEAR-TERM PLANS

The encouraging results of LACIE had led to major planning efforts among the participating agencies to assess the information requirements of the USDA and to define a follow-on activity for the early 1980's which will advance the LACIE capability to allow its use on other important global crops and agricultural problems. In the USDA Secretary's Initiative proposed to NASA on uses of aerospace technology for agriculture, Secretary Bergland prepared a list of seven information requirements that could benefit from application of aerospace technology. These broad information requirements, in priority order, are as follows:

1. Early warning of changes affecting production and quality of commodities and renewable resources
2. Commodity production forecasts
3. Land use classification and measurement
4. Inventory and assessment of renewable resources
5. Land productivity estimates
6. Conservation practices assessment
7. Pollution detection and impact evaluation

Although all seven requirements are of major importance to the USDA, the first two comprise 60 to 75 percent of the USDA's effort in these areas. Early warning of unusual events that affect crop quality or yield, such as floods, drought, or frost, provides the input for decisionmakers, particularly on the World Food and Agricultural Outlook Situation Board (WFAOSB). Commodity production forecasts are essential to USDA agencies with mission responsibility for commodities marketing, natural resources management, and international trade and supply management, as well as to the WFAOSB. Future experiments and applications of the LACIE technology will address these requirements.

## CONCLUSIONS

In summary, the authors have attempted to distill their assessment of the significance of LACIE over

its lifetime from 1974 to 1978. These conclusions are based on working through the many successes and the shortcomings of LACIE. Thus, it can be stated with confidence that

1 The current technology can successfully monitor wheat production in regions having similar characteristics to those of the U.S.S.R. wheat areas and the U.S. hard red winter wheat area

2. With additional applied research, significant improvements in capabilities to monitor wheat in

these and other important production regions can be expected in the near future

3 The remote-sensing and weather effects modeling technology approach followed by LACIE is generally applicable to other major crops and crop-producing regions of the world.

4 With suitable effort, this technology can now advance rapidly and could be in widespread use in the late 1980's

