

Local Precision Nets for Monitoring Movements of Faults and Large Engineering Structures

Heinz G. Henneberg
Escuela de Geodesia, Universidad del Zulia
Maracaibo, Venezuela

Foreword. Although the title of the paper indicates a general presentation, I am exposing only some special cases from our country, Venezuela. Naturally, these special cases may contribute to general conclusions later on. It was a splendid idea from Dr. Charles Whitten to include in this presentation man-made big structures. As I see it now, in discussing crustal deformations, big structures cannot be excluded because they are affected too, as well as the geodetic nets which should control the structure. There exists a certain public interest in the stability and security of structures and we may further this interest for more support for our programs. We should see "local deformation and movement measurements" as a program which includes deformations and movements of structures like bridges, dams, tunnels etc., earth surface deformations as subsidences and horizontal components caused by water- and oil withdrawals and the natural neo tectonic movements and deformations; that is because sometimes there could be a superposition of components coming from different sources.

Abstract. Along Bocono Fault were installed local high precision geodetic nets to observe the possible horizontal crustal deformations and movements. In the fault area there are few big structures which are also included in the mentioned investigation. In the near future, measurements shall be extended to other sites of Bocono Fault and also to the El Pilar Fault. In the same way and by similar methods high precision geodetic nets are applied in Venezuela to observe the behavior of big structures, as bridges and large dams and of earth surface deformations due to industrial activities. This presentation gives some general and detailed information about the measurements and net installations at the following sites and the mentioned structures: (a) Bocono Fault and dam at Mitisus, (b) Bocono Fault at Mucubaji, (c) Bocono Fault and tunnel at Yacambu, (d) faults and dams at Uribante Caparo, (e) Guri Dam, (f) Maracaibo-Lake-Bridge (g) Orinoco River Bridge, (h) oilfield of Tia Juana, (i) Socuy-Tule dams.

Introduction. As a result of geological investigations the Bocono- and the El Pilar Fault separate the Caribbean Plate from the South American as is shown in figure 1. Between the ecological department of IVIC (Instituto Venezolano de Investigaciones Cientificas) and the geodetic department of Zulia University was established a geodetic investigation program to control the behavior of fault sites and of some big structures located

in the fault area (fig.4). This program is supported principally by CADAFE (Empresa de Energia Electrica del Estado Venezolano), by Conicit (Consejo Nacional de Investigaciones Cientificas y Tecnologicas - Venezuelan research counsel), and by the engineering faculty of Zulia University. The observations of bridge behavior are made through a cooperation program with the MTC (Ministerio de Transporte y Comunicaciones), the Socuy-Tule dams with MARN (Ministerio del Ambiente y Recursos Naturales), the Guri Dam with EDELCA (Electrificacion del Caroni) as part of CVG (Corporacion Venezolano de Guayana), the oilfield measurements with Maraven (Venezuelan oil company) and the Yacambu tunnel measurements with TRANARG (Venezuelan geodetic company). In figures 2 and 3 we see the sites of faults and structures, subjects of geodetic investigations. In figure 5 are shown in a schematic representation the geodetic net installations at Tia Juana oilfield, Socuy-Tule dams, Maracaibo-Lake-Bridge, Guri Dam, Uribante-Caparo project and Orinoco Bridge.

Mucubaji

In the Mucubaji fault area were installed two local precision nets: The principal net with 10.5 km maximum extension and the secondary net as a small extension net with maximum side lengths of 1.8 km (fig.6). The principal net covers laterally the total fault area and the observation stations are anchored in solid rock, as is shown in fig.6 (bottom). The small net extends around the visible fault trace and is located on moraines in consolidated soil or on individual rock sites. The foundation of the observation stations as shown in fig. 6 varies according to the soil conditions. All observation stations have the forced centering device for all types of instruments and targets. The two nets were measured as combined trilateration-triangulation. In the principal net only five distances could be measured in the first net determination due to topographic and weather conditions at that time. Two distances were measured several times with the Geodimeter Model 8 Laser and three distances several times with Tellurometer 1000. (It should be mentioned that the laser instrument can only be operated in two distances of the principal net due to its own weight and the very difficult accessibility of the stations). Angular measurements were made with T3 and DKM 3 theodolites and as targets were used specially constructed metal plates. The distances in the small net were measured with Mekometers, ELDI 2 and ELDI 3 instruments and angles were measured with T3 and DKM 3 instruments. The Mekometers were run by personnel from Prof. Linkwitz's institute at Stuttgart University in a cooperation program.

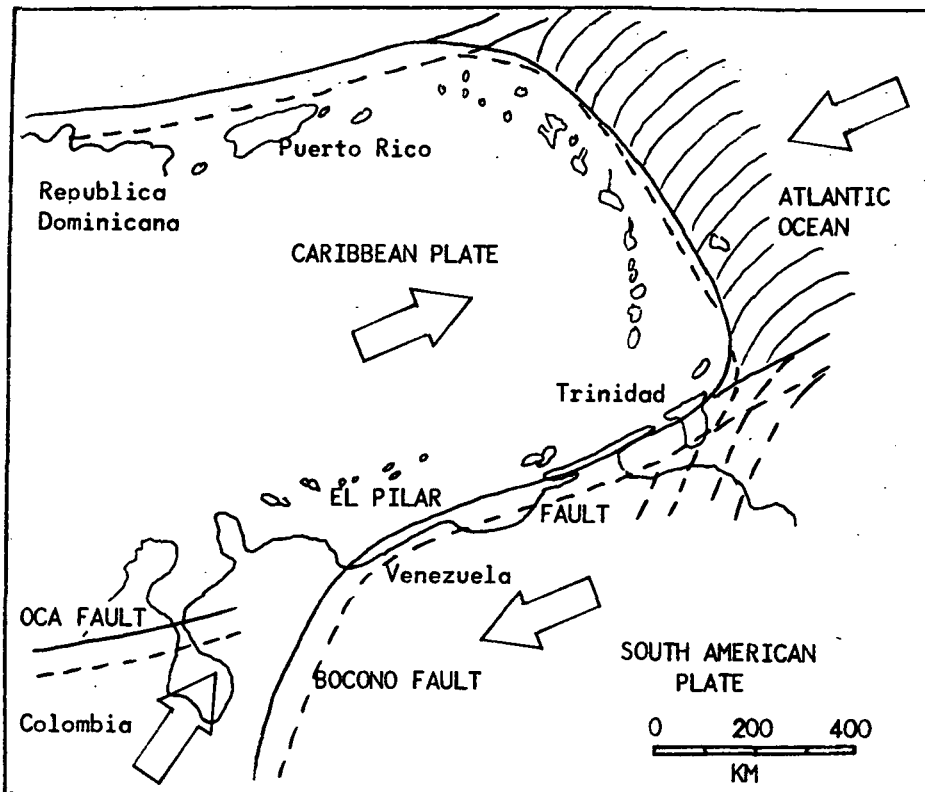

Fig. 1 Schematic representation of tectonic relations in the Caribbean area. The arrows show relative movements. The Caribbean Plate is separated from the South American Plate by the Bocono and the Pilar fault. (Molnar and Sykes 1969; Schubert 1970a).

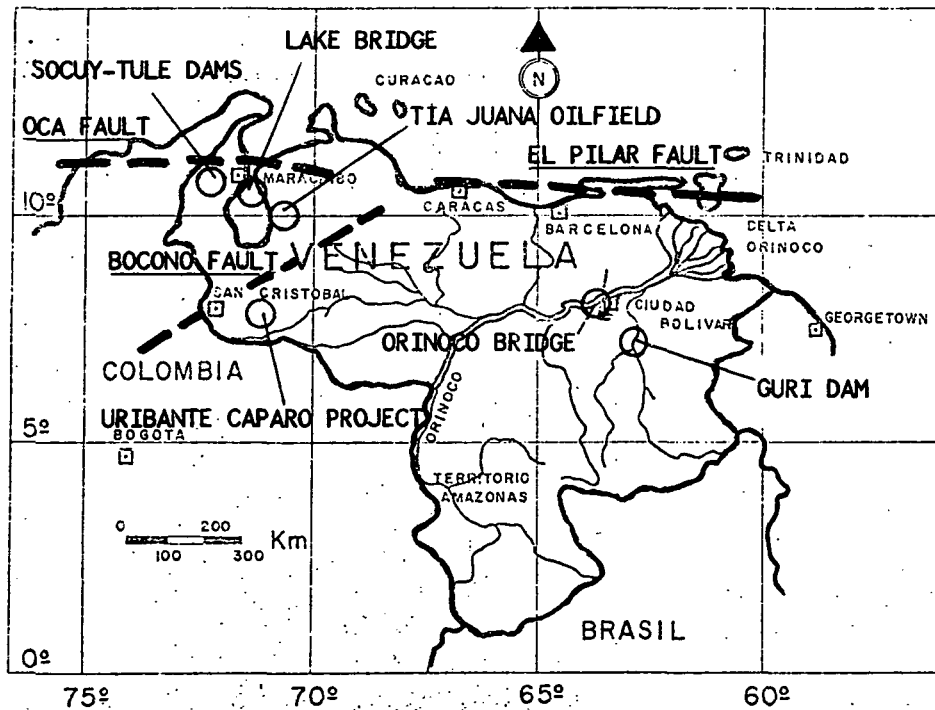

Fig. 2 Map of Venezuela, showing the principal faults and the sites of Socuy-Tule Dams, Lake Bridge, Tia Juana oilfield, Orinoco Bridge, Guri Dam and Uribante-Caparo project.

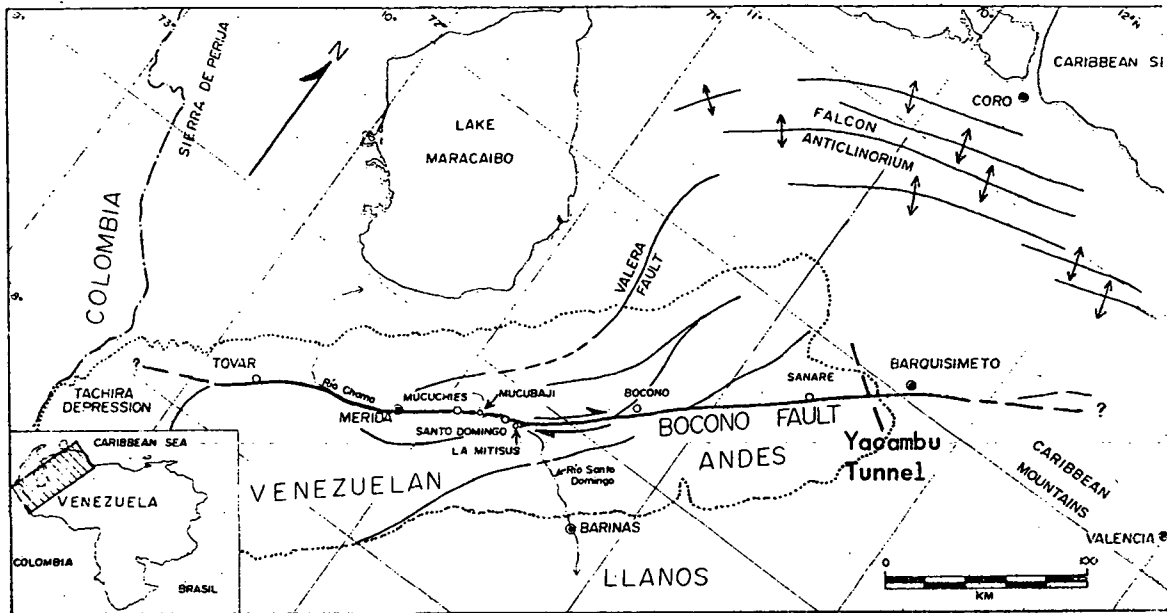

Fig. 3 Bocono Fault system in the Venezuelan Andes mountains showing the study sites Mucubaji, Mitisus and Yacambu.

Measurements started in spring 1975 and lasted about one year in the principal net. The small net was measured three times: 1975, 1976 and 1977. The 1975 and 1976 measurements are combined trilateration-triangulation with Mekometers and T3/DKM 3, and in 1977 only distances were measured with ELDI 2 and ELDI 3. In the principal net the free net work adjustments gave an accuracy range from ± 0.8 to ± 2.1 cm in coordinates (see table 1). In the secondary net the free net work adjustments gave accuracy ranges in coordinates: 1975 from ± 0.8 to ± 1.6 mm -Mekometer with angles-, 1976 from ± 0.7 to ± 1.4 mm -Mekometer with angles-, 1977 from ± 1.5 to ± 2.8 mm -only ELDI length measurements-, (see table 2).

TABLE 1. Computacion Results In The Principal Net At Mucubaji

P.No.	x(m)	$\pm M_x$ (cm)	y(m)	$\pm M_y$ (cm)
1	13579,780	0,8	7632,521	1,5
2	15378,922	1,2	13350,643	0,9
3	15343,666	0,9	17040,829	0,9
4	14664,429	0,9	17826,734	0,9
5	10000,001	1,1	17446,142	1,2
6	10583,620	1,0	14584,284	1,1
7	10259,229	1,1	10787,580	1,8
8	10000,006	0,9	10000,011	2,1

TABLE 2 Computation Results Of The Small Mucubaji Network

P.No.	Year	x (m)	$\pm M_x$ (mm)	y (m)	$\pm M_y$ (mm)
9	1975	9593,748	1,5	9843,714	0,8
	1976	,744	1,3	,714	0,9
	1977	,747	2,6	,717	2,0
10	1975	10000,002	1,0	10000,000	0,8
	1976	,005	1,0	,001	0,9
	1977	,005	1,5	,006	2,5
11	1975	10444,733	1,0	10099,985	0,9
	1976	,736	1,1	,986	0,8
	1977	,735	1,6	,983	1,9
12	1975	10671,059	1,5	10169,278	0,9
	1976	,056	1,4	,280	0,9
	1977	,056	2,3	,278	1,9
13	1975	10519,561	1,2	11445,089	0,8
	1976	,559	0,8	,089	0,7
	1977	,555	2,8	,086	2,1
14	1975	10400,740	1,6	11315,878	1,0
	1976	,741	0,9	,878	0,7
	1977	,742	2,5	,875	2,2
15	1975	10000,000	1,1	10985,165	0,8
	1976	,003	1,2	,163	0,9
	1977	,001	2,0	,166	1,7
16	1975	9465,427	1,0	10560,885	1,0
	1976	,426	1,0	,885	1,0
	1977	,429	2,5	,884	1,9

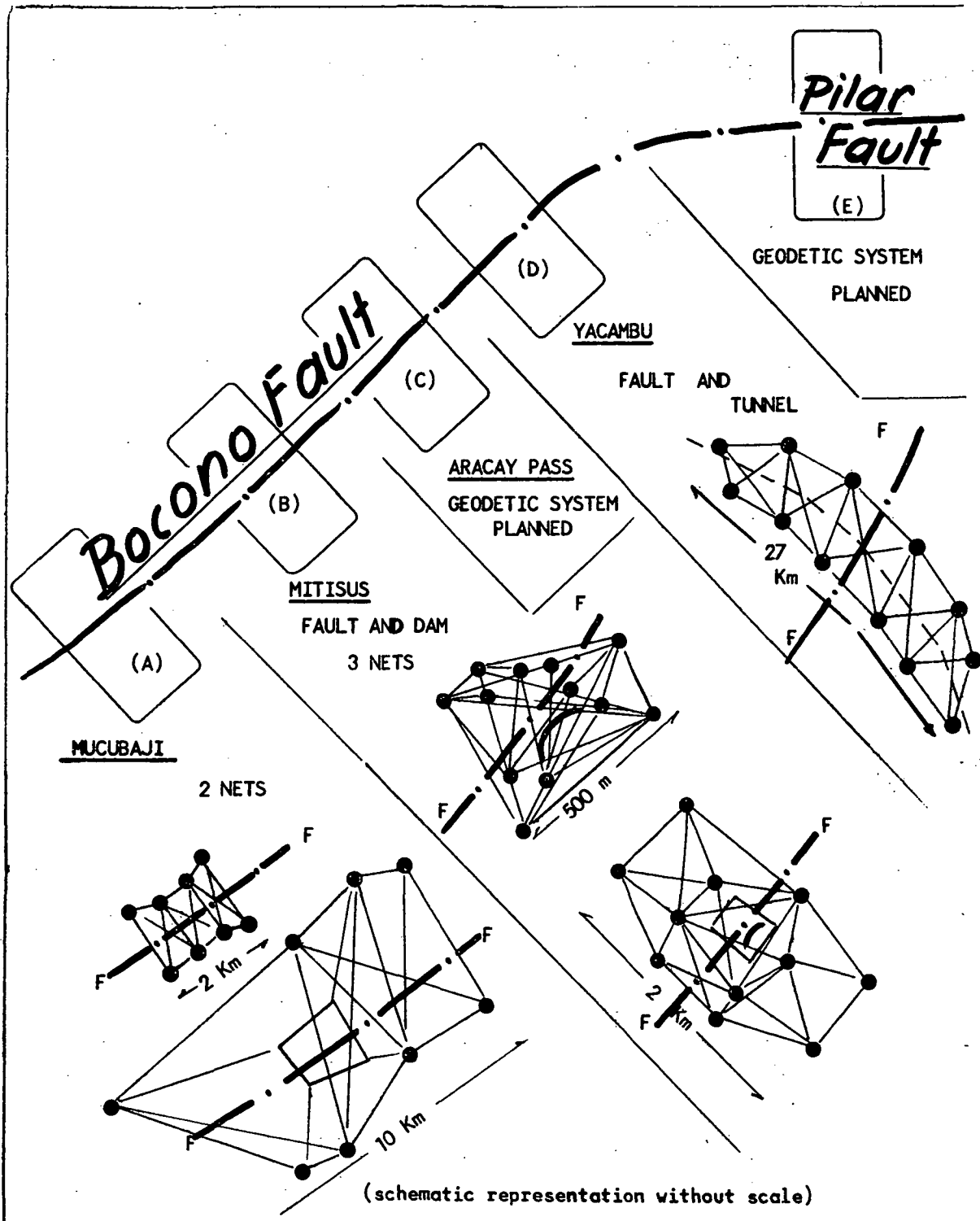

Fig. 4 Schematic representation of geodetic systems installed and planned along Bocono and Pilar Fault.

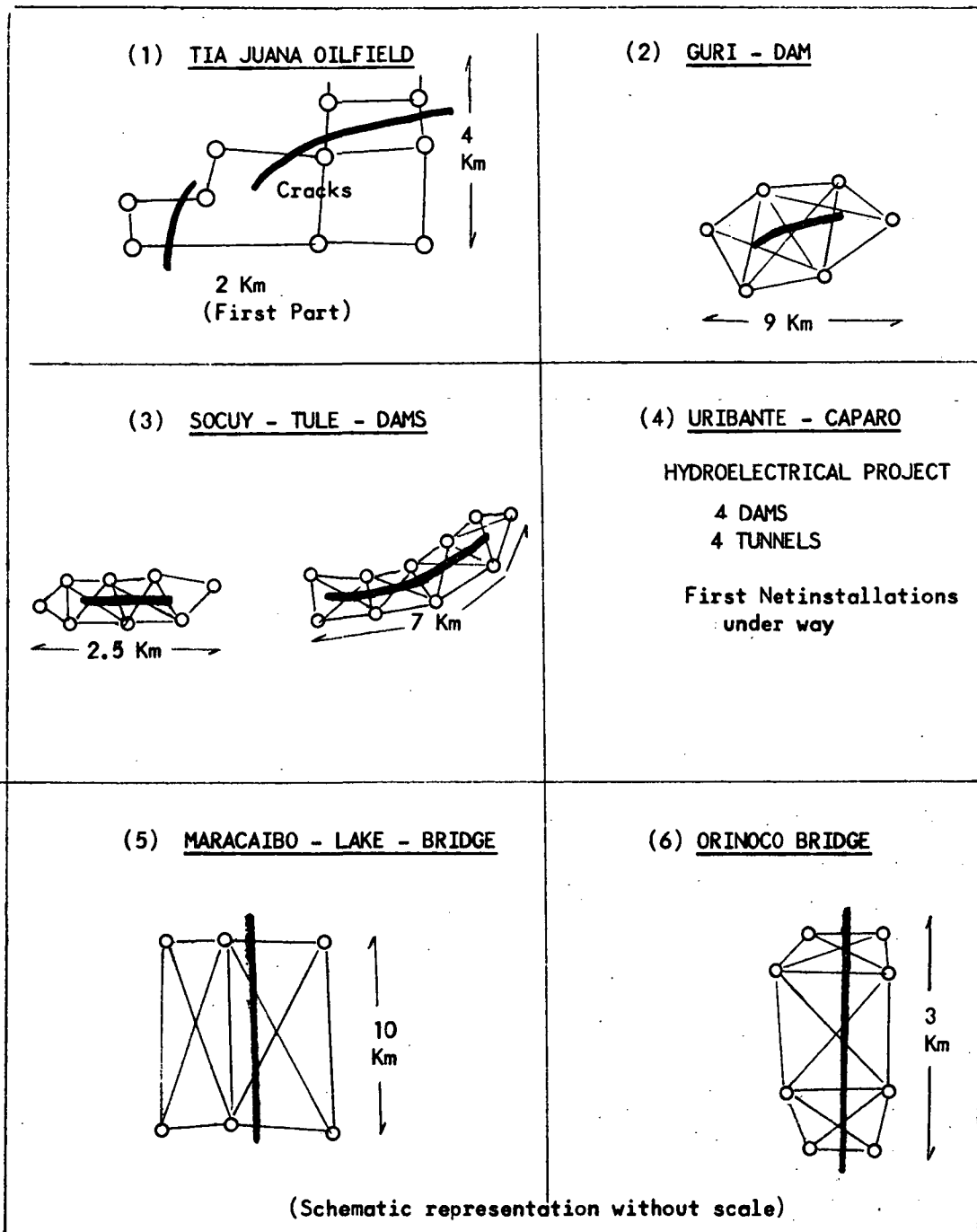

Fig. 5 Schematic representation of geodetic systems to investigate movements of structures and earth surface.

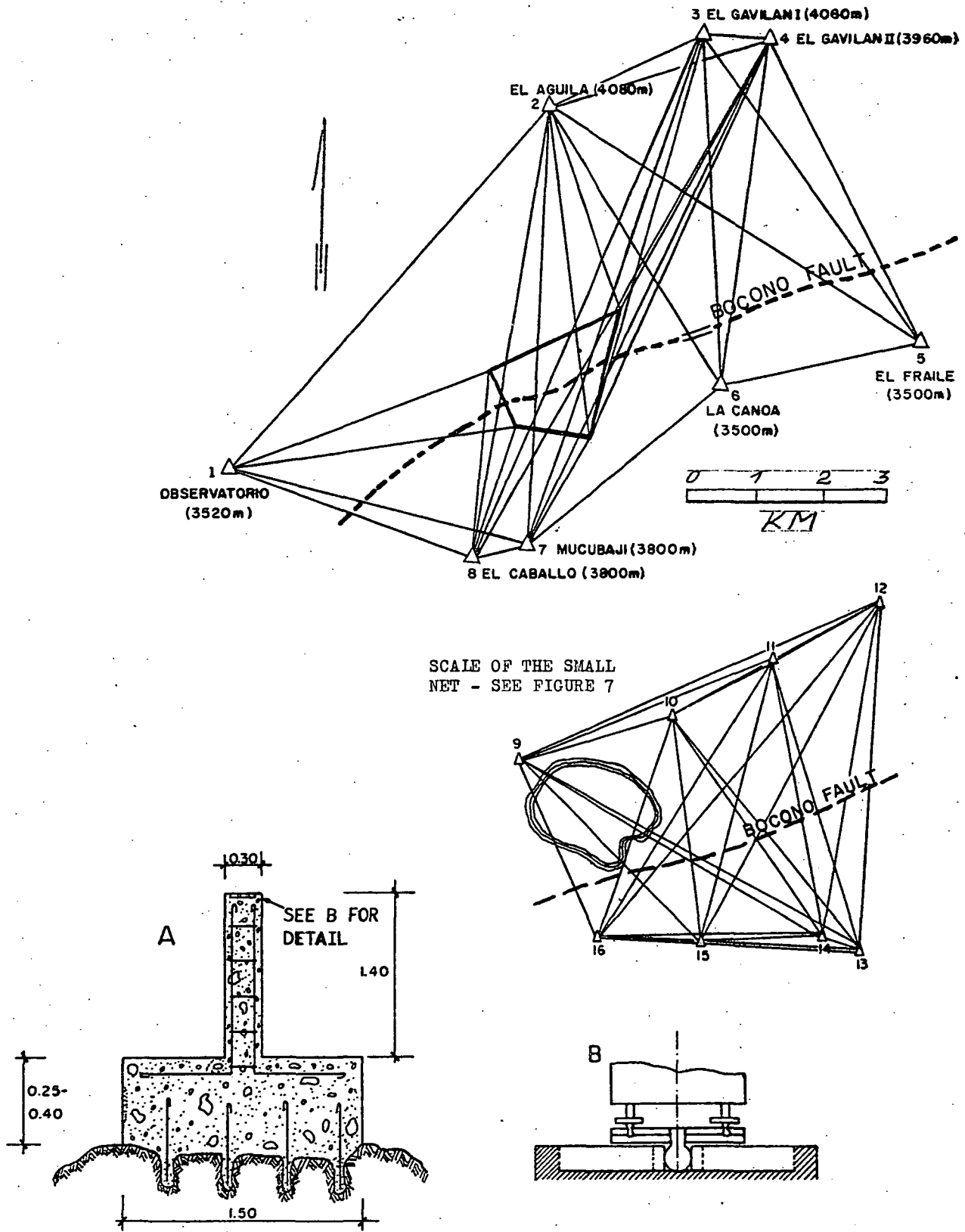

Fig. 6 Principal (large) and secondary (small) net at Mucubaji site including type of structure of observation stations.

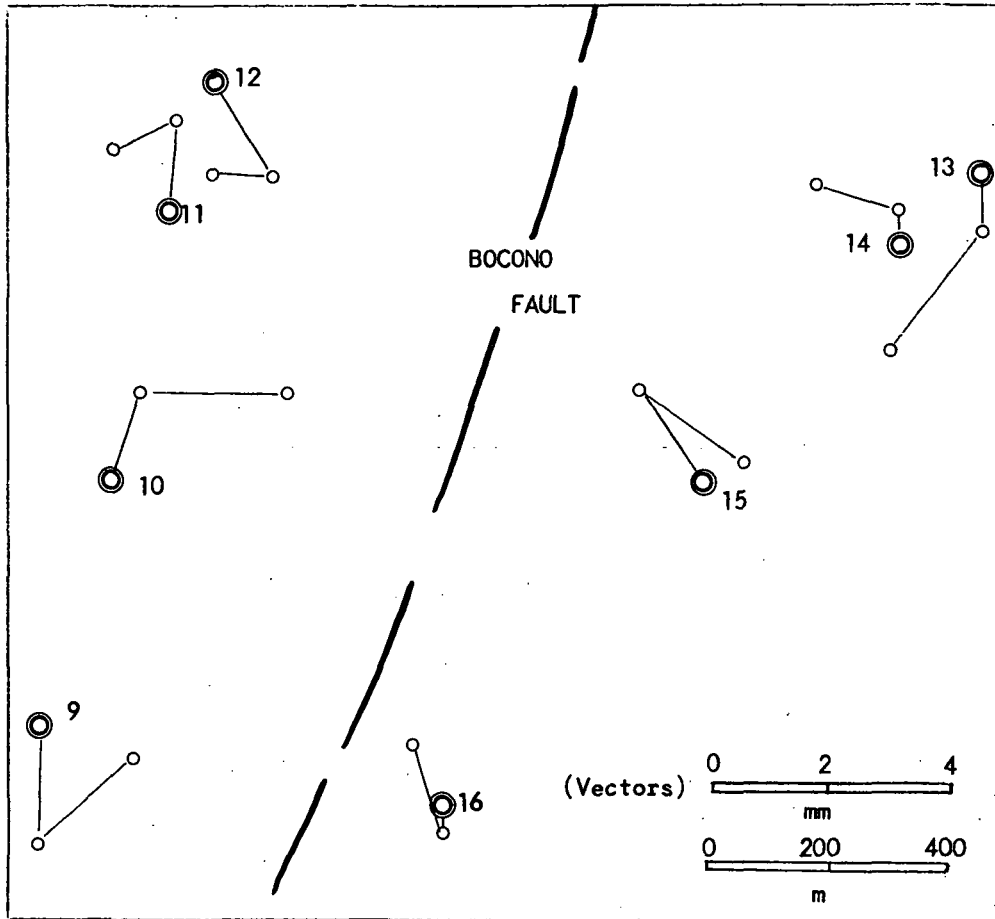

Fig. 7 Difference vectors as result of coordentate determination in the small Mucubaji net 1975 (initial), 1976, 1977.

La Mitisus

At "La Mitisus" (figure 3) we have three precision nets: 1. the principal dam system, 2. the "Pentagon" as security system of the dam system (the two systems are shown in figure 9) 3. the fault system as shown in figure 8, where the "Pentagon" mentioned before, constitutes the center part. The observation stations, constructed at each point, are similar to those installed at Mucubaji and as demonstrated in figure 6. Due to the different precisions, the measurements and computations are independent in the dam system and in the fault system (see tables 4 and 5). There are used two local coordinate systems: The fault system has F_b as origin and $F_b - F_d$ as main direction; the dam system is computed in UTM with local coordinates. The two systems are connected in between through the "Pentagon" which belongs to the two coordinate systems. Measurements started in September 1973 at the dam site to observe the deformation of the structure and its surroundings which are situated in the Bocono Fault zone. The measurements for the dam are made through triangulations, using T 2 and sometimes T 3 instruments. The accuracies after adjustments after each triangulation vary between 0.3 to 1.4 mm in

the coordinates. In this way the movement vectors of the damcrest are shown with high significance, as we can see in figure 10, where the movement vectors indicate the horizontal crest components of the dam deformation between low- and high water in the reservoir. In the figure the dashed line represents the dam axis. The dam is a doble curved concrete structure, 70m high and 210m long. The powerhouse lies about 16 km from the dam at a height difference of approx. 900m below. The energy capacity is of 240 MW. The fault system was measured first in 1974/5 and shall be observed again in 1979. The coordinates and accuracies are shown in table 4. The scale of the fault system was obtained through a trilateration in the Pentagon, applying a HP 3800 (see table 3). Later, T3 measurements completed the fault system observations.

Yacambu

The "Yacambu project" consists of two big structures: a doble-arc concrete dam of 150m height and a 24 km tunnel, which transports the water of the Yacambu river through the mountain chain of the Andes from south to north. The tunnel crosses Bocono Fault at Km 15 from the south entrance. Along the curved tunnel pro-

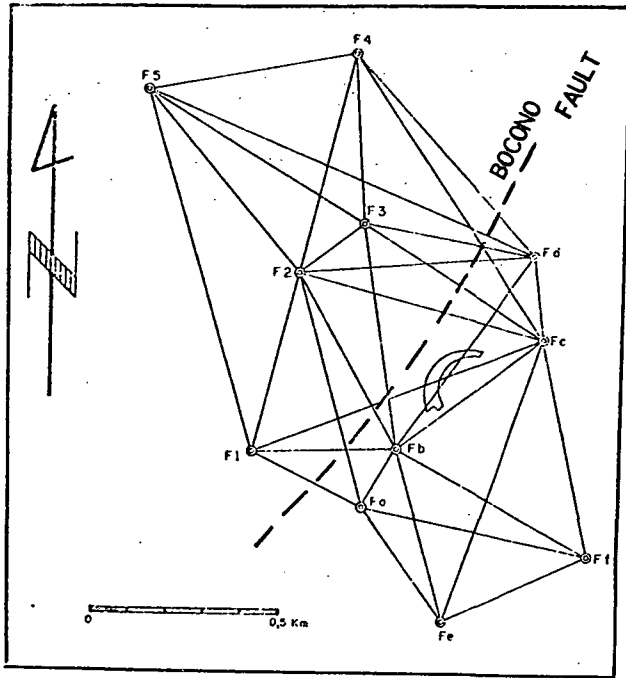

Fig. 8 Fault net at Mitisus

TABLE 3 Double Distance Measurements With HP 3800 In The rentagon

	D	1	2	M	D - Hor.
Fb -Fd	656,624	,627	,625	,625	656,606
Fb -Fc	490,599	,604	,601	,601	487,530
Fb -F2	509,092	,100	,096	,096	508,827
Fb -F3	580,804	,806	,805	,805	580,749
F2 -Fc	667,522	,527	,524	,524	666,427
F2 -Fd	627,080	,087	,083	,083	626,978
F2 -F3	202,222	,220	,221	,221	202,044
F3 -Fc	527,926	,927	,926	,926	571,018
F3 -Fd	465,020	,023	,021	,021	465,012
Fd -Fc	266,246	,245	,245	,245	261,551

TABLE 4 Coordinates And Accuracies In The Fault Network.

	x	± Mx(mm)	y	± My(mm)
Fa	9818,471	1,9	10023,178	1,3
Fb	10000,000	0	10000,000	0
Fc	10457,216	2,8	10169,259	2,6
Fd	10656,609	1,7	10000,000	0
Fe	9800,972	2,7	10449,179	3,2
Ff	10097,675	2,9	10625,525	2,9
F1	9741,673	2,3	9654,599	2,2
F2	10226,119	2,1	9544,175	1,4
F3	10420,469	2,0	9599,408	1,4
F4	10904,227	2,9	9101,358	2,8
F5	10383,998	1,7	8909,294	3,3

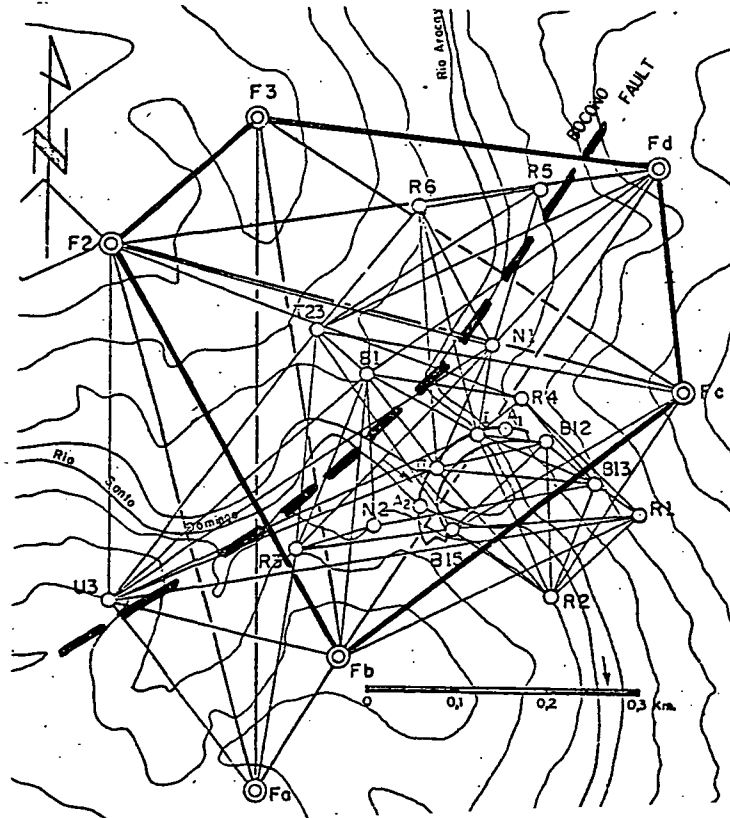

Fig. 9 Santo Domingo Dam triangulation with security system (pentagon F2, F3, Fb, Fc, Fd as part of the fault net).

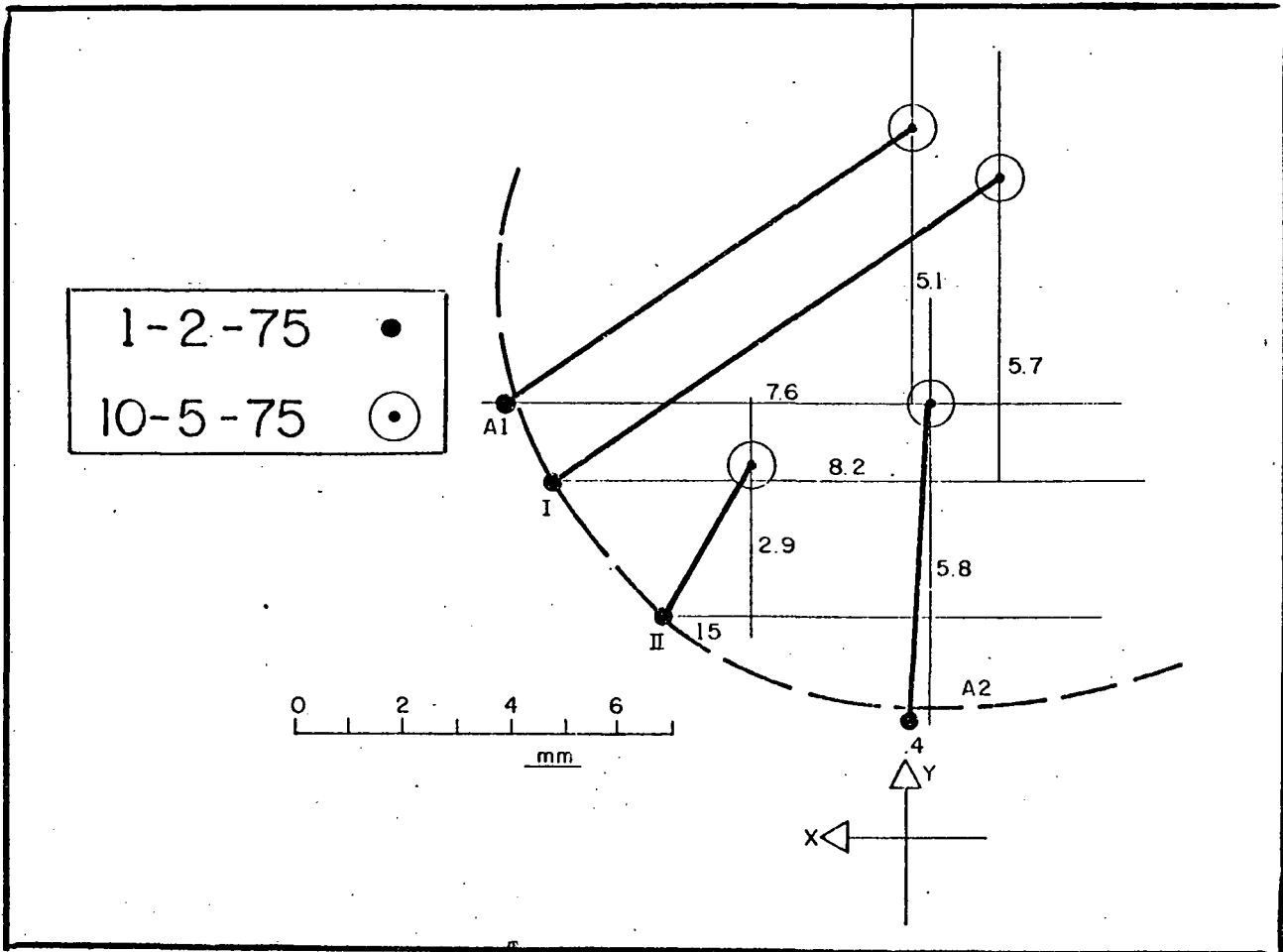

Fig. 10 Movement vectors of the dam crest between February and May 1975 (low- and high water in the reservoir).

jection a typical combined trilateration-triangulation was installed. The narrow band of the net work has the advantage of a high precision traverse: strong lateral rigidity by angular measurements and strong longitudinal rigidity through the distances (figure 11). For the distance measurements was used an "Electrotape". There were measured 45 distances and 76 angles, having thus 121 observation equations for 34 unknowns. For the final computations, shown in this paper, the "free network adjustment method" was used. Measurements were made at two epochs: 1973 and 1975. Between the two measurements strong coordinate differences showed a change of sign, where the network passes Bocono Fault (table 6). The question arose, if these coordinate differences were significant enough in comparison with the coordinate accuracies to de-

TABLE 5 Coordinate Accuracies Of Three Independent Determinations Of 2 Fault - points (N1,N2) And 2 Dampoints (I,II) In The Dam Network (in mm)

Station	1		2		3	
	± Mx	± My	± mx	± My	± Mx	± My
N1	0,9	0,9	1,3	1,4	0,6	0,7
N2	0,4	0,6	0,8	1,2	0,4	0,6
I	0,4	0,6	0,1	0,8	0,3	0,5
II	0,4	0,4	0,6	0,6	0,4	0,4

termine a possible crustal deformation, due to Bocono Fault. As shown in table 6, the maximum value in coordinate changes is 52mm in x-direction at point 6, 47mm in y-direction at point 10. The maximum difference

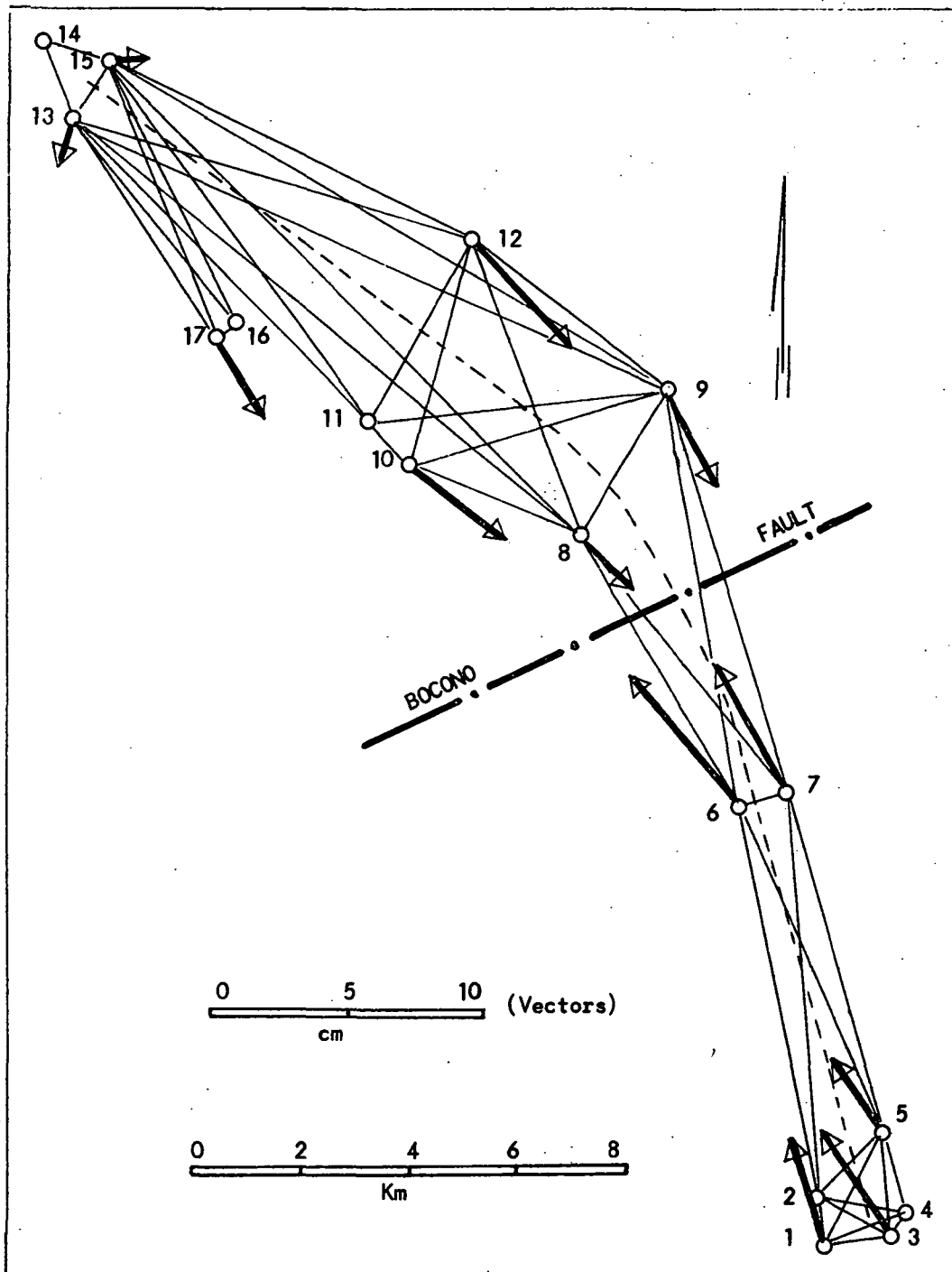

Fig. 11 Combined triangulation-trilateration for Yacambu tunnel and difference vectors 1973 - 1975

vector exists at point 6 with 63 mm. In the mentioned point the accuracies in the coordinates by single determination are 20 to 25 mm. We see that the coordinate accuracies show errors still too high for real significant movement. Nevertheless, at points 6 and 7, where we have strong difference vectors south of Bocono fault, we may come to a certain expression about the existence of movement. At these points the cofactors of the variance - covariance matrix are (values from 1973): point 6 - $Q_{xx} = 0.14$, $Q_{yy} = 0.11$, $Q_{xy} = -0.0037$, point 7 - $Q_{xx} = 0.13$, $Q_{yy} = 0.13$, $Q_{xy} = -0.0026$. The low covariance values in comparison with the variance values show very little correlation. At these points the computation of the accuracy values for the difference vectors gave: point 6 - Difference vector $\mu = 63\text{mm}$, $M_D = +32\text{mm}$, point 7 - difference vector $D = 56\text{mm}$, $M_D = 31\text{mm}$. Thus, we can say, that the accuracy values expressed in "mean square errors" have the half size in comparison with the vectors. This is true only for points 6 and 7. As we may deduct from table 6, in the other points the relation is not so good. Therefore, I incline to say that it is still too early to speak of significant movements in the fault area. But it is still interesting to outline: 1. the change of sign of the coordinate differences at Bocono Fault trace, 2. the directions of vectors, showing all toward Bocono Fault trace, 3. increasing values of vectors approaching Bocono Fault, specially in points 6, 7, 10, 12. Therefore, we may interpret these results as an obvious trend situation, showing possible compression in the fault surroundings. A trend analysis, as used sometimes in gravity measurement computations, may be very useful for the interpretation of the existing results. Further measurements shall bring more information.

Uribante - Caparo - Project

The Uribante - Caparo project is one of the largest hydroelectrical enterprises on the continent. Several net work installations are under way at this moment to investigate the behavior of dam- and tunnel structures, their surroundings and the existence of fault traces in the area. The net installations are very similar to those discussed before. Definite information about measurements, instrumentation and results shall be given at later events. The project consists in the interconnection of four large dams from Uribante River at 1104 m above sea level down to Caparo River at 277 a.s.l. The interconnections are realised through tunnel constructions. The dimensions of the structures are: La Honda Dam - $L = 450\text{m}$, $H = 118\text{m}$; Las Cuevas Dam - $L = 740\text{m}$, $H = 106\text{m}$; Borde Seco Dam - $L = 340\text{m}$, $H = 108\text{m}$; La Vueltoza Dam - $L = 430\text{m}$, $H = 118\text{m}$; Uribante Doradas Tunnel - $L = 7884\text{m}$; Doradas Camburito Tunnel - $L = 4484\text{m}$; Agua Linda Doradas Tunnel - $L = 5500\text{m}$; Camburito Caparo Tunnel - $L = 640\text{m}$. The total hydroelectrical capacity of the final project is 2.260 MW. The

project is situated in the Tachira, Merida y Barinas states of Venezuela in the west, south of Maracaibo Lake, near San Cristobal, capital of Tachira. The total length of influenced area of dams, tunnels and reservoirs comprises about 80 km.

Guri

Guri Dam is the biggest hydroelectrical installation in Venezuela and shall be at completion one of the biggest on the continent. At this moment the energy capacity is of 2.100 MW, at the final stage of construction will be about 9.000 MW. The dam is situated on Caroni River in the south eastern part of Venezuela (see figure 2). The Caroni River contributes to the Orinoco River from the south and is the second river of the country. The hydroelectrical generation is principally used for the development of the industrial area, situated near Ciudad Guayana at the entrance of Caroni in the Orinoco River. The actual length and maximum height of Guri Dam are: $L = 690\text{m}$, $H = 106\text{m}$ (main dam), the final length and maximum height are: $L = 6-7\text{ km}$, $H = 160\text{m}$ (see figure 12). The first geodetic measurements in situ started in 1956. 1950 Cartografia Nacional (national survey) completed the Caroni triangulation. From that time on several local net works were used for construction surveys and behavior measurements. Actually, precision measurements through triangulations and levellings are applied to determine the behavior of the dam structure. In figure 13, we see the results in a three dimensional representation of the movement of point 19, situated on the right side rock fill dam. This movement is the consequence of the consolidation deformation of the dam, as we can note from the down-slowing motion of the different components. The movements as functions of time have already an asymptotic approach. For the final project development of Guri all existing geodetic network shall vanish because of the extension of the new reservoir at 54 m uplift of lake level. Therefore, a new observation system was planned and is actually in execution as shown in figure 12. This network is a combined triangulation - trilateration system and in the observation points will be concrete pillars as shown in Mucubaji and Mitisus. This geodetic program is going to work in combination with geophysical measurements, specially with the microseismological net already prepared in the dam and reservoir area. The extension of the observation net is planned, as shown in figure 12, to the surroundings of the future lake.

Maracaibo Lake Bridge

Maracaibo Lake Bridge has a length of 9 km and is situated in the southern part of Maracaibo city. The bridge spans Maracaibo Lake at one of the narrowest parts. The maximum height of the bridge table is 50m above lake level at the bridge site. The bridge is a pre-

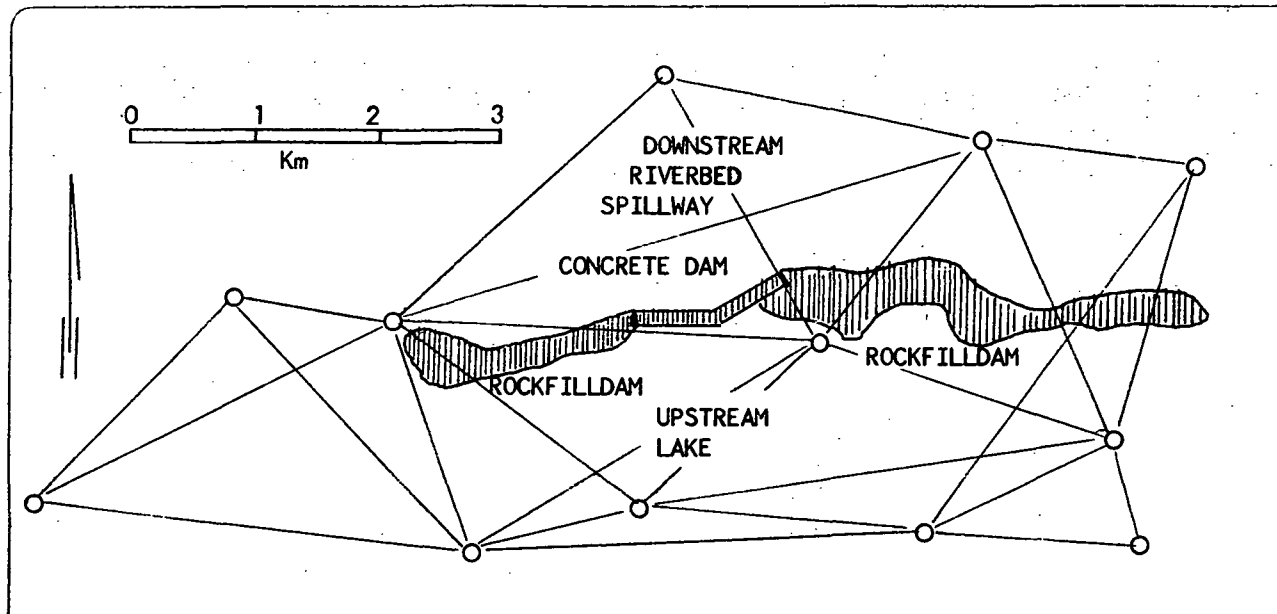

Fig. 12 Geodetic observation system for the final construction stage of Guri Dam

TABLE 6 Results Of The 1973 And 1975 Net - work Computations At Yacambu

P.	1975 - 1973			1973		1975	
	x (mm)	y (mm)	D (mm)	$\pm M_x$ (mm)	$\pm M_y$ (mm)	$\pm M_x$ (mm)	$\pm M_y$ (mm)
1	44	-14	46	27	24	29	26
2	35	-15	38	27	22	29	23
3	45	-28	53	26	22	28	23
4	41	-31	51	26	21	28	23
5	26	-27	37	27	17	29	19
6	52	-36	63	22	20	24	23
7	49	-27	56	21	21	23	22
8	-21	20	29	19	20	22	20
9	-37	11	38	22	18	24	21
10	-31	47	56	22	24	24	25
11	-24	40	47	20	22	21	25
12	-43	33	54	21	19	24	20
13	-19	9	21	28	16	31	18
14	7	4	8	31	25	34	27
15	-1	12	12	25	19	28	21
16	-	-	-	-	-	-	-
17	-30	19	35	36	32	36	33

TABLE 7 Height Of Maracaibo Observation Towers And Visuals Over Lakelevel

Station	Construction Height	Visual over Lake Level
Camacho	11,50 m	12,00 m
San Francisco	11,50 m	12,50 m
Pálmarejo	11,50 m	17,00 m
Iguana Sur	9,50 m	14,00 m
Iguana Norte	9,60 m	11,50 m
Redonda	9,50 m	18,00 m
Isla de Aves	7,50 m	12,00 m
Punta Piedras N	7,50 m	20,00 m
Manzanillo	7,50 m	27,50 m

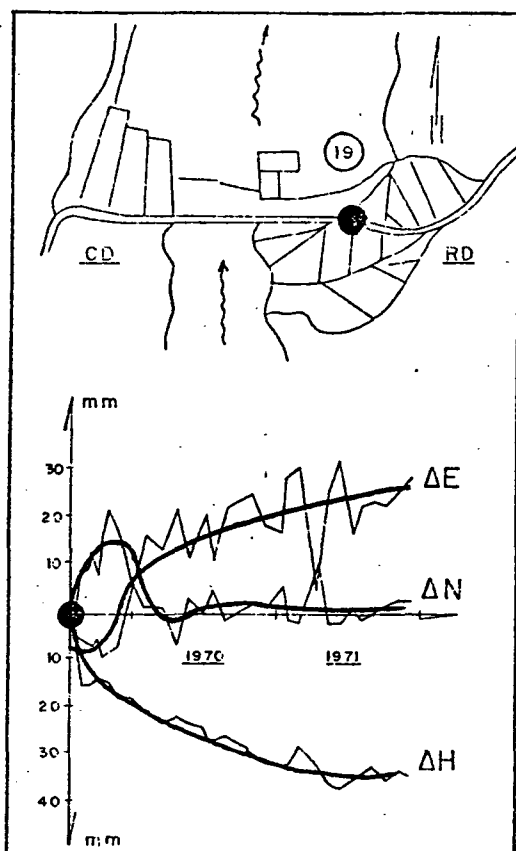

Fig. 13 Accumulated 3 dimensional movements of point 19 located in the actual right side rockfill dam of Guri.

stressed concrete structure, where beams of 46.6 m length were prefabricated on shore and used later on in the construction process. For the horizontal control of the bridge was installed a triangulation, as we see in fig. 14, with error ellipses in the outer stations. The ellipse values are in mm. At each net point was erected an observation tower of 7.50 m to 11.50 m height (see figure 16). The forced centering device is the same as used in the other networks described before and shown in figure 6. The different construction heights of observation towers and the height of visuals above lake level is to be seen in table 7. The network is a local system, with coordinate origin at bridge pillar 1: $x_0 = 10\ 000\ 000$, $y_0 = 10\ 000\ 000$. The following instruments were used for the net installation: Tellurometers, T3 and DKM3. It was necessary to undergo an extensive research program to investigate the strong atmospheric perturbances in the bridge site and lake area. Horizontal- and vertical refraction investigations showed periodical influences as functions of time in optical measurements. For electromagnetic measurements with Tellurometer it was necessary to determine the refraction index distribution over the lake area to obtain minimum perturbed values in the side measurements.

Orinoco River Bridge

Orinoco River Bridge is a suspension bridge of $L = 1272\text{m}$ with a main span of 712m . The total bridge length with connected concrete spans is $L = 1679\text{m}$. The height of bridge towers is 140m above zero river level, and of the bridge table 68m . The maximum water depth at bridge site from zero water level is 45m and the high water range from zero water level is about 20m . Due to this big range of water level we distinguish two characteristic streambeds: the low water bed and the high water bed (see figure 15). The level change is periodical: low water in March, high water at the end of August. The medium level change per day is 10 cm . These special conditions were essential for the network planning. The network, as seen in figure 15, has two parts: the main system, surrounding the suspension bridge and located around the low water bed (figure 16), and the security system on higher parts which are islands in the high water zone, and in the north two stations outside the high water bed. The security system has the principal purpose to serve as a possibility to reproduce local net deformations of the main net. In the net points were used concrete towers from 3 to 12 m height, as shown in figure 16, with forced centering device as mentioned before. The coordinate system is a local one as applied at Maracaibo Bridge. The point accuracies are shown in figure 16 by error ellipses (max. and min. values 2.6mm , 0.9mm).

Tia Juana Oilfield

As a consequence of the withdrawal of oil from the approx. 500m deep soil strata, a considerable subsidence of the ground surface of the oilfields has occurred. These subsidence values are now about 4 meters at the center of the three main oilfields (figures 17, 18): a. Pueblo Viejo - Bachaquero, b. Lagunillas, c. Tia Juana. The 1974 - 1976 rate of movement has been at: a. Pueblo Viejo - Bachaquero - 17 cm (max), b. Lagunillas - 39 cm (max), Tia Juana - 33 cm (max). The subsided parts on land are protected by dyke constructions permanently under supervision. The height of the dykes increases according to the subsidence of the area involved. Figure 18 shows the subsidence cone at Tia Juana Oilfield. Caused by this subsidence, horizontal cracks of width up to 1m have appeared at the edges of the cone as shown in figure 19 where the dashed lines show the location of these cracks. The subsidence measurements started at Lagunilla site in June 1926, at Tia Juana site in November 1937 and at Pueblo Viejo-Bachaquero site in April 1938. At this moment, measurements of the total area are carried out every two years by the "Departamento de Topografía de Maraven". Before the nationalization of the Venezuelan oil industry the measurements were made principally by "Shell Oil Company of Venezuela". Between Maraven and the geodetic department of the University of Zulia a new, more complete measurement program was established, which included a "geodetic-geophysical study of the subsidence area". The additional investigations to be carried out are: 1. Horizontal control by high precision geodetic network, 2. gravity measurements, 3. seismic measurements and registration, 4. study of the Z-component of the geomagnetic field. The horizontal control is carried out to observe horizontal components of the subsidence movement. The observations are made through a high precision traverse of various interconnected quadrilateral figures of the Hollister type, in which are measured the outer sides with the electro-optical method (Zeiss ELDI 2) and the inner and outer angles at the traverse points with Wild T3 and Kern DKM3 theodolites. The diagonal lines of the Hollister figures are not measured, but computed afterwards (figure 19). All measurements are made from reinforced concrete columns with forced centering device. The accuracy of adjusted measurements gives a mean square error in coordinates of about $\pm 3\text{ mm}$ (table 8).

Socuy - Tule Dam System

The two dams, Socuy and Tule, are located in the north-west of Maracaibo (figure 2). They are constructed as rockfill and earth dams and are interconnected through a tunnel and an open canal. The rivers controlled by these dams are the Socuy and the Cachiri River which are coming from the mountain range between Venezuela and Colombia. The dimensions of

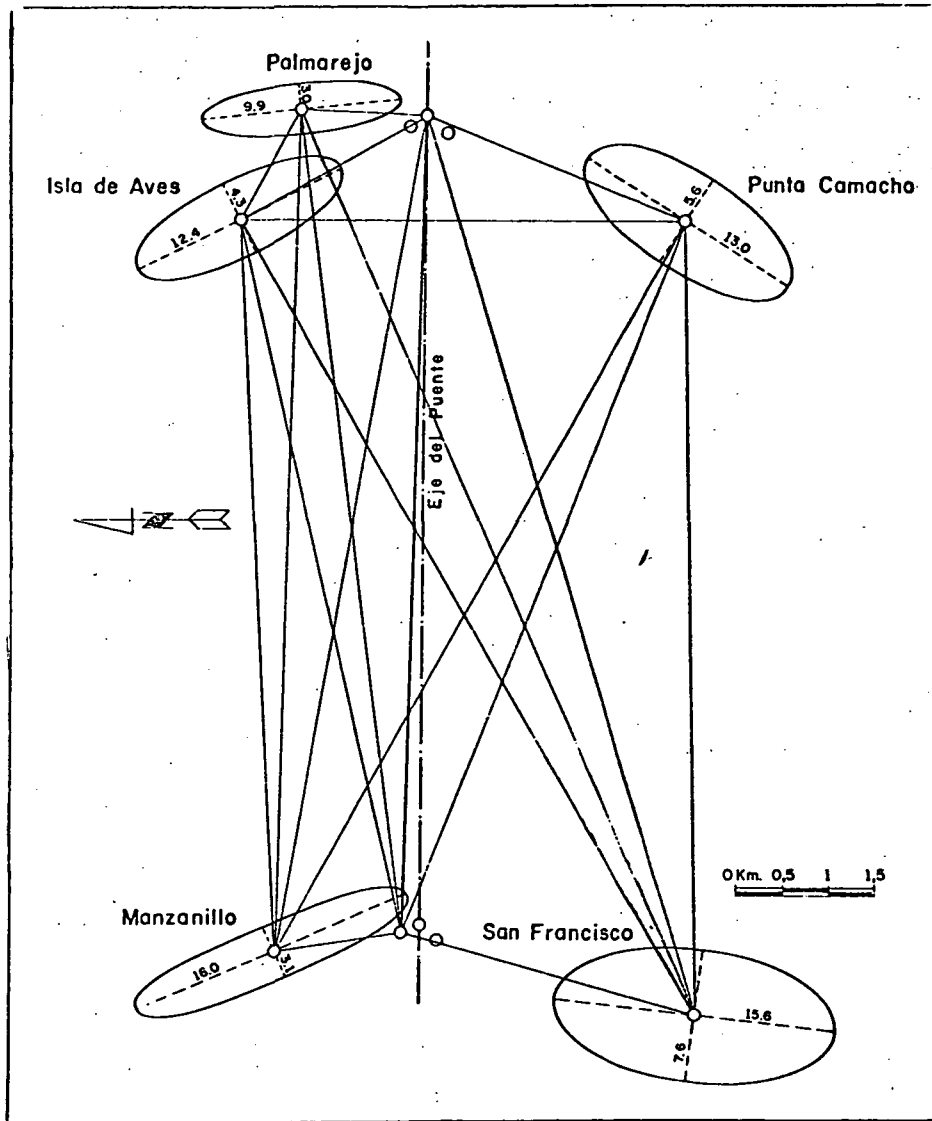

Fig. 14 Maracaibo Lake Bridge triangulation with error ellipses.

TABLE 8. Coordinate Accuracies In The High Precision Traverse

Station	$\pm M_x$ (mm)	$\pm M_y$ (mm)
U 1	3,0	2,6
U 2	2,7	2,6
U 3	2,3	2,9
U 4	2,1	2,8
U 8	1,9	2,5
U 9	2,7	2,4
U 10	3,2	2,6
U 11	3,3	3,1
U 12	2,8	3,3

TABLE 9 Coordinate Accuracies Socuy Net

Station	$\pm M_x$ (mm)	$\pm M_y$ (mm)
1	1,7	0,7
2	1,1	0,5
3	1,1	0,5
4	2,4	1,1
5	1,7	0,4
6	1,6	0,5
7	1,7	0,7
8	2,8	1,4
9	2,7	1,0
10	2,7	1,0
11	0,9	0,5
12	1,0	0,6
13	1,7	0,7
14	0,9	0,5

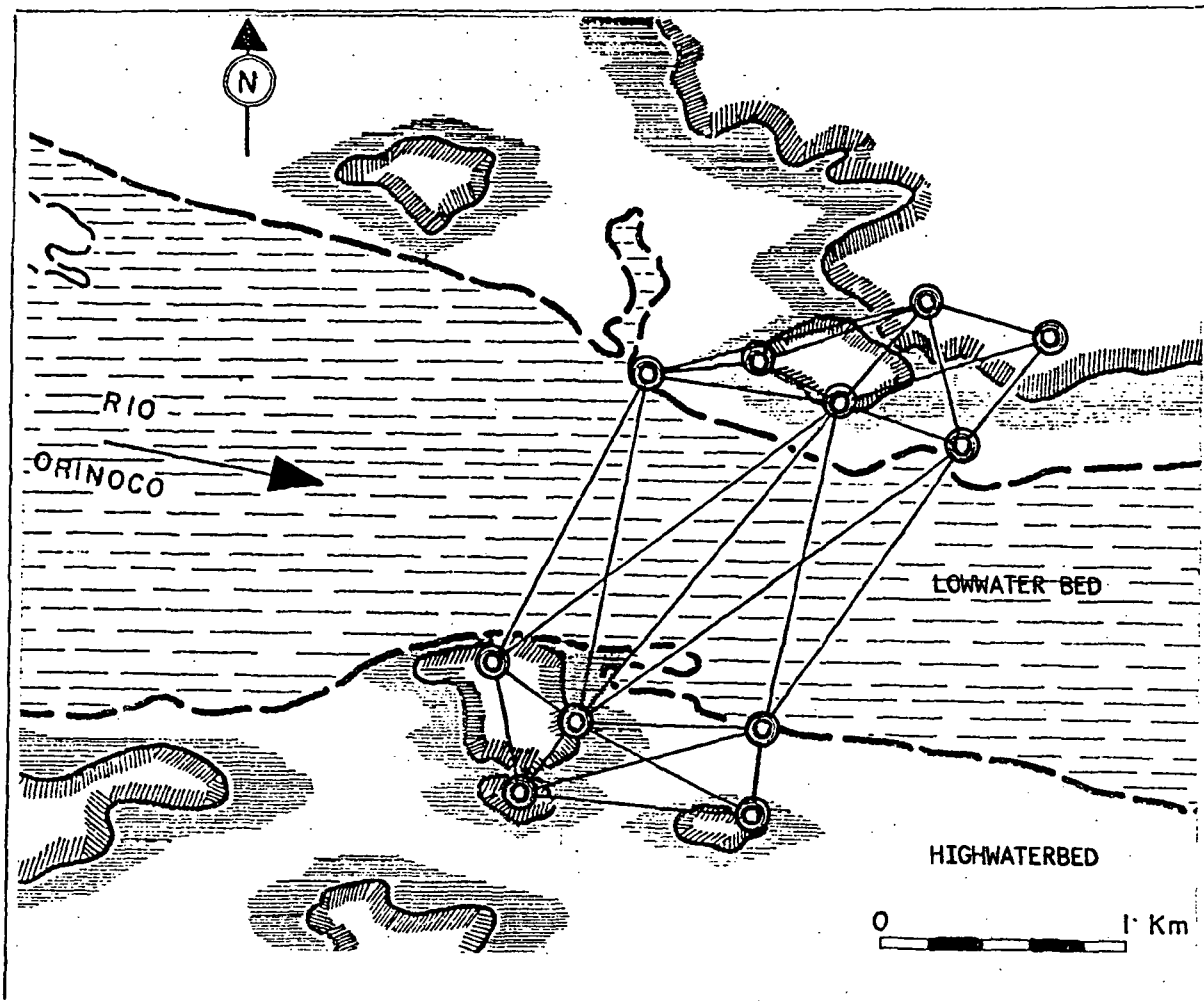

Fig. 15 Location of Orinoco Bridge triangulation.

Socuy dam are: main dam - $L=1300m$, $H=40m$; side dam - $L=1600m$, $H=14m$, and the dimensions of Tule dam: $L=5200m$, $H=20m$. The tunnel length is $1035m$ and the length of the canal is $5240m$. For this large extension complex there were located several local geodetic systems. We distinguish four different control systems: Network 1 with ground fixed stations, as combined triangulation-trilateration, serves as controlnet for the surroundings of Socuy dam and lake. Network 2, as shown in figure 20 (1), with pillar observation stations similar to those at Mucubaji, only with different foundations, serves as observation net to investigate the deformation of Socuy main dam. Network 3, as shown in figure 20 (2), with pillar observation stations is the observation net to investigate deformations of Tule dam. Network 4, with ground fixed stations, is a high precision traverse to control the tunnel and canal and to connect the different dam networks -see figure 20 (3)-. Networks 2 and 3, too, are combined trilateration - triangulations. Distances were measured in net 1 with DI 10 and ELDI 3, in the other nets only with ELDI 3. All nets were computed as free networks and combined together

through coordinate transformations and later on transformed also to the national system - figure 20 (4)-. Table 9 shows the results of the Socuy adjustment: instruments - ELDI 3, DKM 3; observation equations: 296, unknowns:28

Acknowledgments. Part of the research work described in this paper was supported by CADAPE (Venezuelan electrical power institution), CONICIT (Venezuelan research counsel), Maraven (Venezuelan oil company), MARN and MTC (Ministry of Natural Resources and Ministry of Transportation - former Ministry of Public Works), CVG (Venezuelan Guayana Corporation). The author thanks the following persons and institutions for their cooperation: K. Baer, C. Schubert, K. Linkwitz, H. Boettinger, H. Arp, J. Fischer, H. Drewes, A. Sandoval, Cartografia Nacional, Tranarg company, Carl Zeiss-Oberkochen, students and personnel of the geodetic department and all other who helped directly and indirectly.

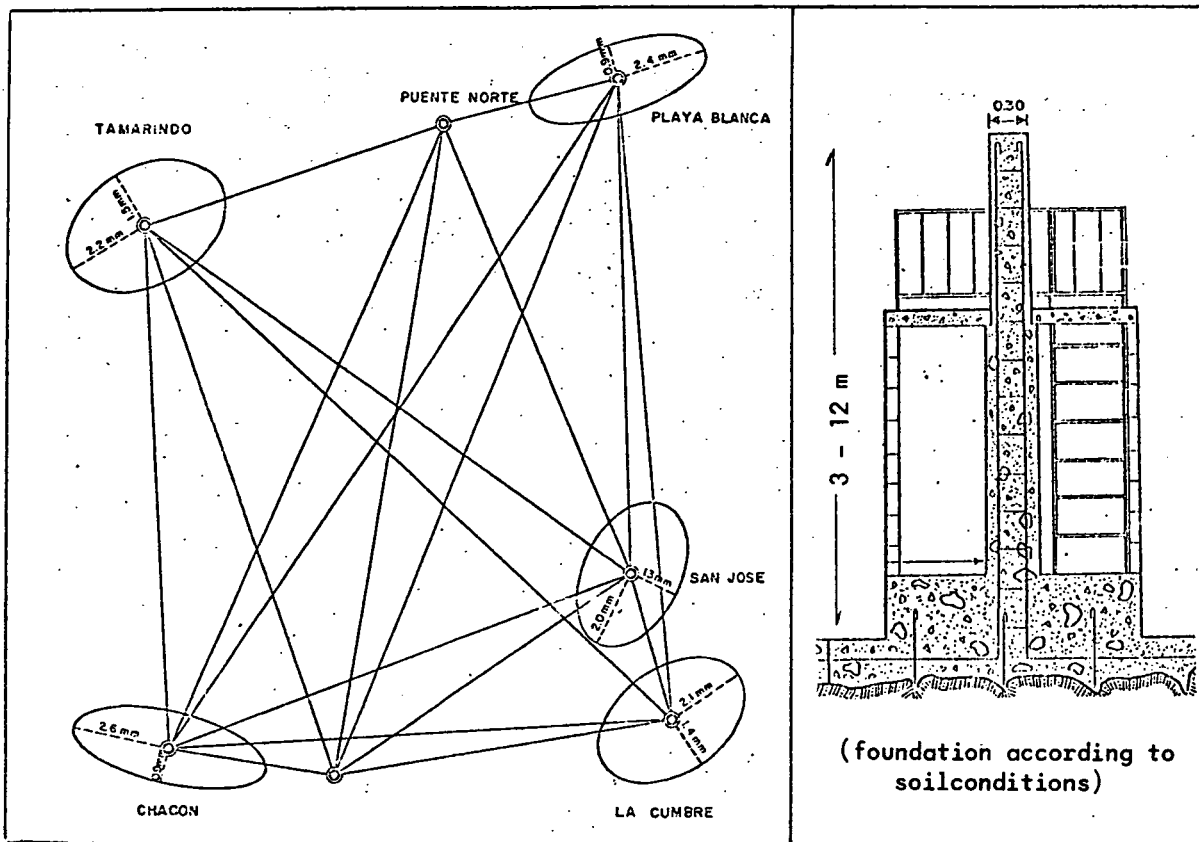

Fig. 16 left: Main net of Orinoco Bridge triangulation with error ellipses. right: Construction type of observation towers for Maracaibo and Orinoco Bridge triangulation.

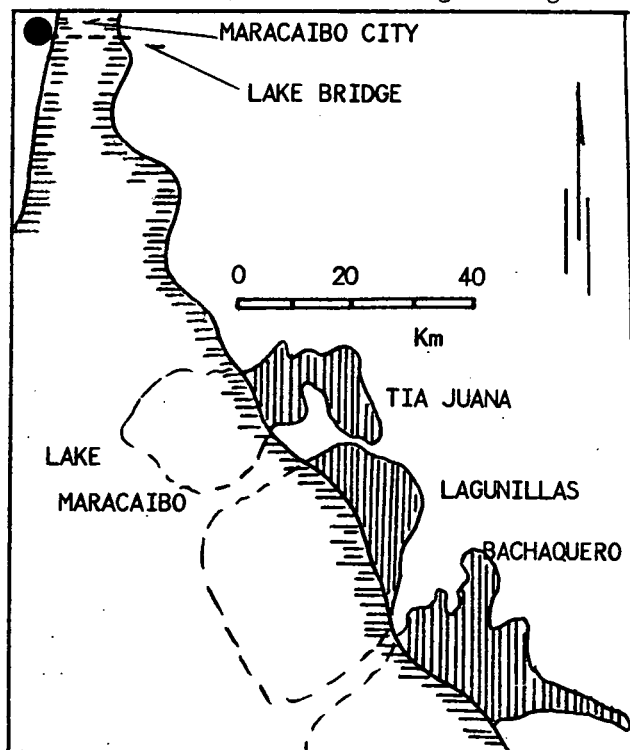

Fig. 17 Location of the main oilfields on the east shore of Maracaibo Lake.

References

- Molnar, P., and Sykes, L. R., Tectonics of the Caribbean and Middle America regions from local mechanisms and seismicity, *Geol. Soc. America Bull.*, v. 80, p. 1639 - 1684, 1969.
- Schubert, C., Venezuela y la "Nueva Tectonica Global", *Acta cient.venezolana*, v. 21, p. 13-16, 1970a.
- Schubert, C., Glaciation of the Sierra de Santo Domingo, Venezuelan Andes, *Quaternaria*, v. 13, p. 225-246, 1970b.
- Schubert, C., and Henneberg, H. G., Geological and geodetic investigations on the movement along the Bocono Fault, Venezuelan Andes, *Tectonophysics*, v. 29, p. 199-207, 1975.
- Henneberg, H. G., Results of geodetic deformation measurements on large scale structures including some application in geology, *Int. Symp. on Deformation Measurements by Geod. Methods*, Krakow - Poland, 1975.
- Muñoz, O., and Escogido, D., Subsidence in the Bolivar Coast, *Second Int. Symp. on Land Subsidence in Anaheim*, 1976.
- Henneberg, H. G., Geodaetische Arbeiten an Tal-sperrerbauten in Venezuela, *Veroeff. d. Geod. Inst. T. H. Aachen*, No. 23, 1977.

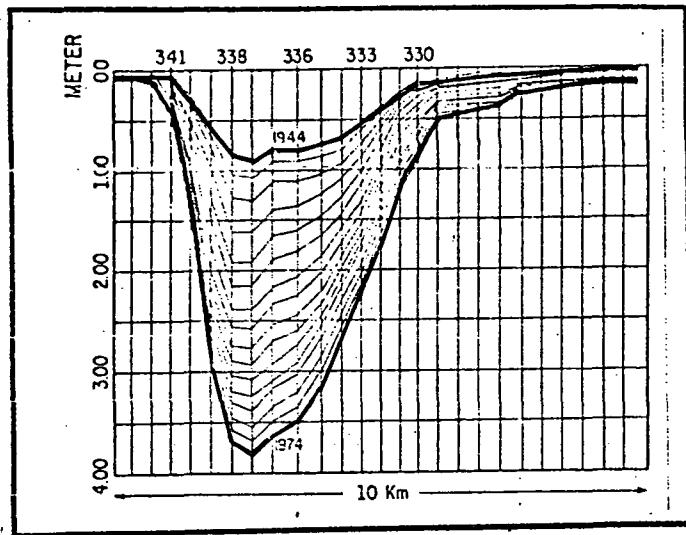

Fig. 18 Subsidence cone of Tia Juana oilfield.

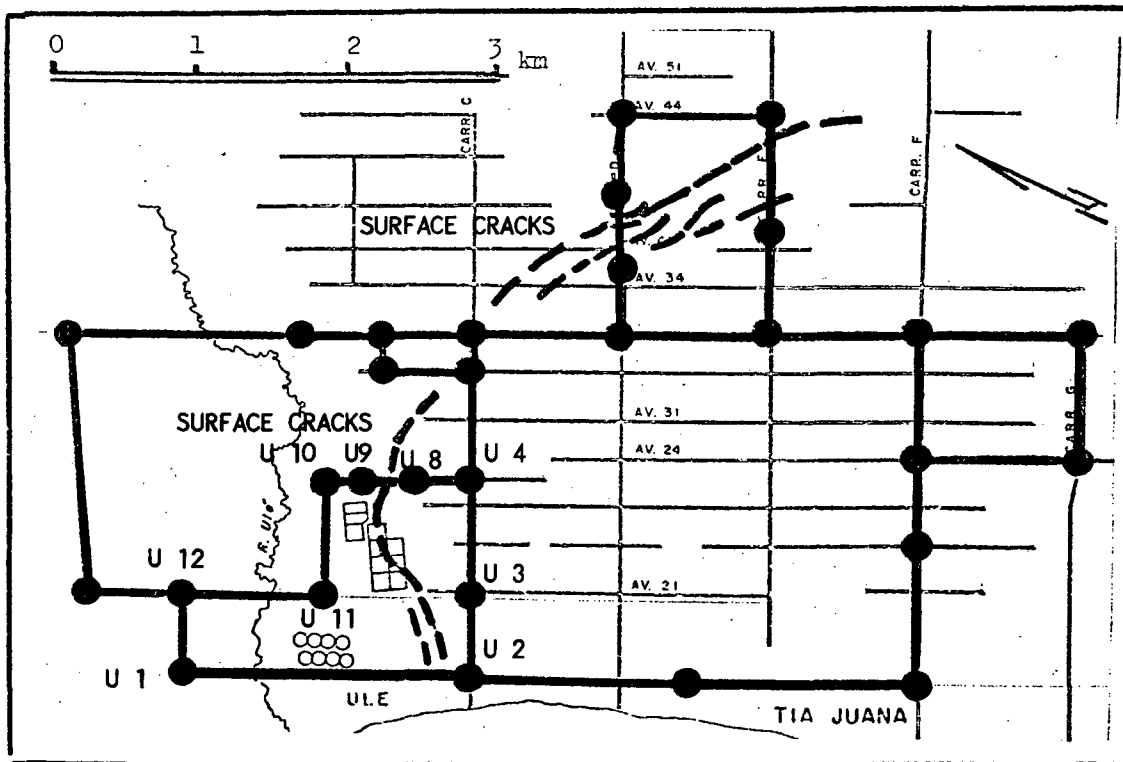

Fig. 19 High precision traverse to investigate the horizontal movements of surface cracks at Tia Juana oilfield.

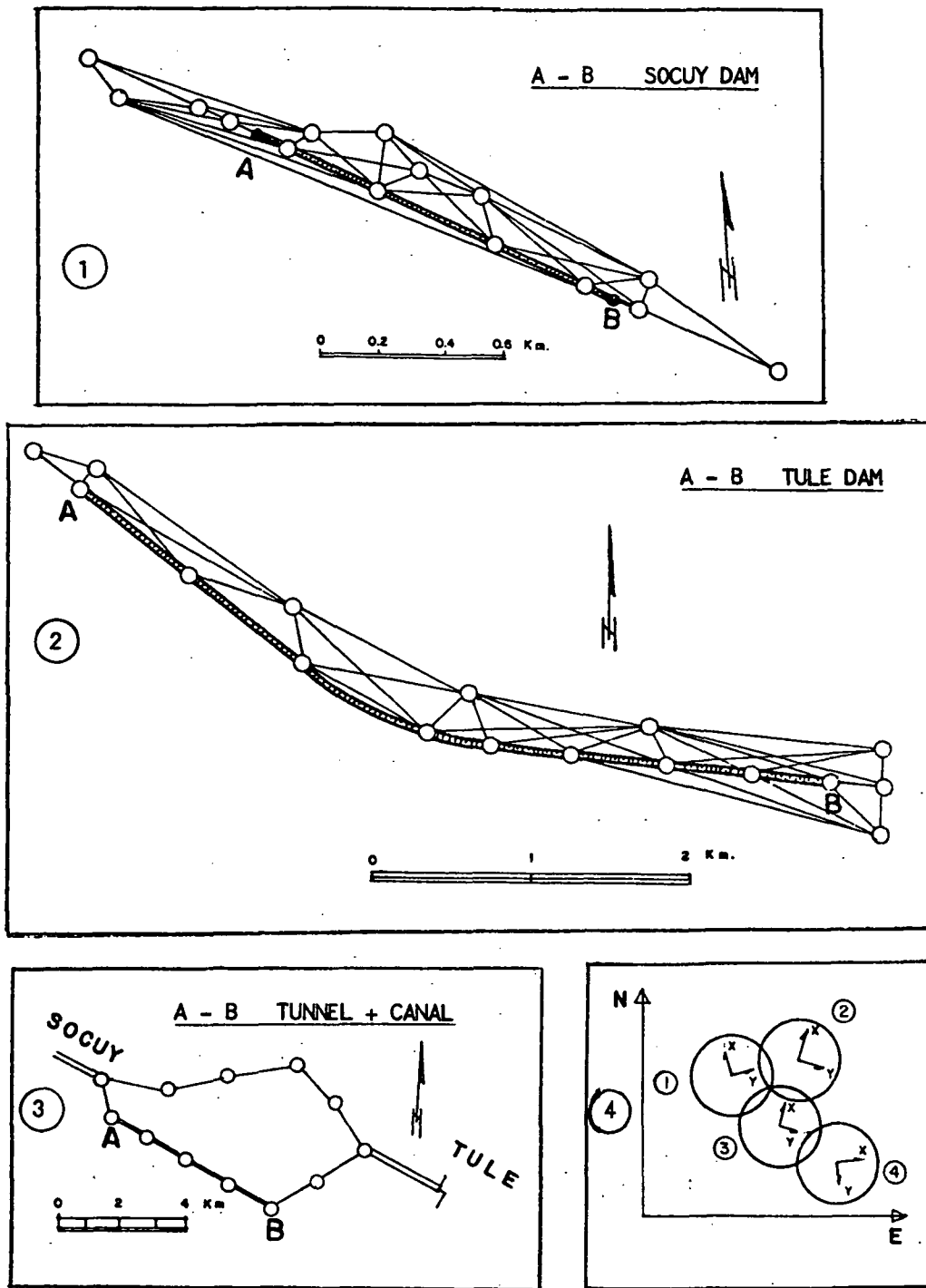

Fig. 20 (1) Socuy Dam - triangulation-trilateration, (2) Tule Dam - triangulation-trilateration, (3) Precision traverse for Socuy tunnel and canal and to combine the Socuy and Tule nets, (4) Schematic representation for the combination and transformation of the different coordinate systems at Socuy-Tule.