

The Measurement of Surface Gravity

N79 21494

J. C. Harrison
Cooperative Institute for Research in Environmental Sciences
University of Colorado/NOAA, Boulder, Colorado 80309
and

L.J.B. LaCoste
LaCoste and Romberg, Inc.
6606 North Lamar Blvd., Austin, Texas 78752

LaCoste and Romberg G and D gravity meters are normally employed when attempting high precision measurement of gravity differences on land, and we therefore discuss the capabilities and limitations of these instruments. Their design differs only trivially (mainly in the reset mechanism) from that described in the 1945 patent (LaCoste, 1945) and shown in figure 1. A negative length spring 4 with wire added to bring it to the zero length condition supports the beam 3. The beam pivots about the line joining the points of attachment of the springs 5 to the support rods 6 and theory (LaCoste, 1935) shows that for equilibrium of the beam in a horizontal position the distance, l , of the upper support 35 of the zero length spring above this pivot line is

proportional to g . The meter is read by moving the support 35 vertically to bring the beam into this position. The change δl in l required to do this as the meter is read first in one place and then in another is proportional to the gravity difference δg by the relation $\delta l/l = \delta g/g$. The meters are built with $l = 2.5$ cm so that the (worldwide) 7 gal range of the G meter requires moving the support 1.75×10^{-2} cm, and 1 microgal accuracy means positioning the support to within 0.25 A.

These movements are generated with a measuring screw and double reduction lever system. In an ideal system the vertical motion of the support is proportional to the rotation of the measuring screw (which is driven through a gearbox) but in practice there are departures from this ideal due to periodic errors in the screw, eccentricity in the screw resulting in wobble, and non-linearity of the lever system. The screw problems result in errors with periodicities of once and twice per turn of the screw, or about 70 and 35 mgal with the G meter. There is some variation between meters, but 35 μ gal (about 5×10^{-6} of full scale) is a typical amplitude for this error in the G meter, and it is the most important source of error. The reduction factor of the lever system varies smoothly over its range, leading to departures of perhaps a part in 1000 of full scale from perfect linearity. These departures are determined by weighing a 200 mgal rider at various parts of the meter's range, and a calibration curve based on these weighings is supplied with the meter. The main improvement in accuracy of the D meter over the G is that the periodic screw errors have been reduced by increasing the reduction ratio of the lever system to reduce the range of the meter to 200 mgal. Thus the screw errors (still about 5 ppm of full scale) have been reduced to about 1 μ gal. They can be determined in the G meter by weighing a small rider at many points on the meter's range but this is laborious. It is advisable to run the measuring screw back and forth some before starting a day's readings in order to spread out the lubricant. The reduction factor of the lever system should be stable and there is no reason to suppose that the calibration factor will change in a larger ratio than the meter drift is of total gravity.

When the state of strain in a metal is changed it does not attain its final strain immediately following the change in stress, but the last .02% or so of response takes place slowly over a matter of hours. The high magnification of astatic gravity meters means that the mass moves a long way for a small change in gravity, with a consequently large change of tension in the spring. The change in moving a gravity meter beam from reading line to stop corresponds to many hundreds of milligals equivalent spring

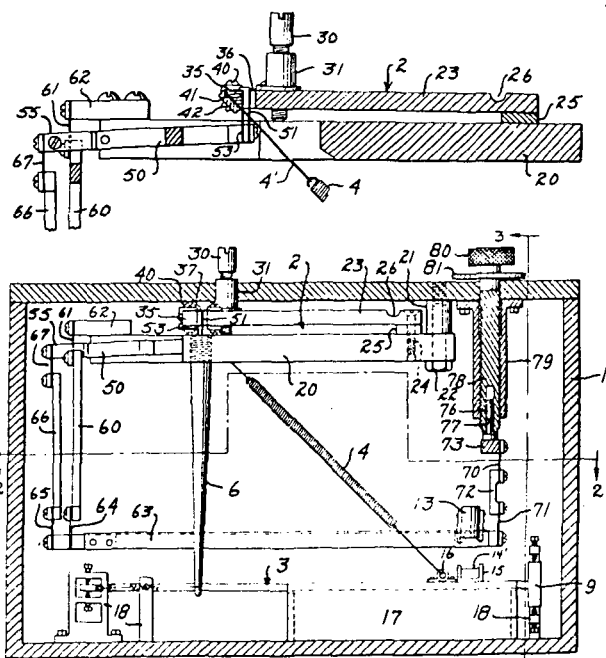

Fig. 1.

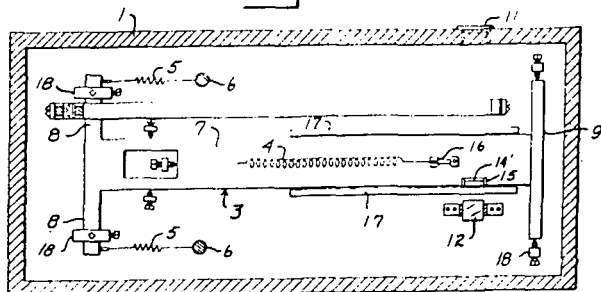

Fig. 1. Construction of LaCoste-Romberg land gravity meter.

Proc. of the 9th GEOP Conference, An International Symposium on the Applications of Geodesy to Geodynamics, October 2-5, 1978, Dept. of Geodetic Science Rept. No. 280, The Ohio State Univ., Columbus, Ohio 43210.

tension, even though this motion may be produced by only a few mgal change in gravity. Hysteresis on the hundreds of mgals tension will be seen in the meter reading. Great care is taken during manufacture to ensure that the spring length is exactly the same when the beam is clamped, as when it is at the reading line. The meter is clamped for an hour, then read; then left at the reading line for an hour and read again, and so on. Adjustments continue until a single smooth tidal curve can be put through the two sets of data. However if the arrestment gets out of adjustment the meter will drift rapidly after unclamping. Astatic gravity meters should not be used in the deflection mode for measuring earth tides as the changes in spring length result in appreciable hysteresis.

The spring material has the property that there is an inflection in the variation of its rigidity with temperature. This allows the meter to be thermostated at the temperature of zero temperature coefficient and renders the meter rather insensitive to changes in external temperature, although large fluctuations will induce transients. An outer crudely thermostated box could be added by the user, if the meter is to be used in applications where large fluctuations in external temperature are inevitable.

A large hollow container is added to the rear of the beam to bring its center of volume above the pivot axis and thus compensate for changes in atmospheric pressure. The coefficient is reduced to below $10 \mu\text{gal/cm}$ of mercury and the meter sealed. While the seal is not perfect, changes in internal pressure are slowed down to the point where their effects will be removed as "drift".

The spring material is magnetic and the spring is carefully demagnetized when a meter is assembled. Sensitivity to horizontal magnetic field is detected by reading the meter in various orientations. Demagnetization continues until the variation in reading with azimuth is reduced below about $10 \mu\text{gal}$. Sensitivity to vertical field is tested by bringing a large permanent magnet up to the meter - typically changes of the order of 100% of the earth's field produce effects of the order of $100 \mu\text{gal}$. The meter is then doubly shielded and this reduces the effects below the detectable level. However, magnetic effects are always a danger; meters should never be exposed to large magnetic fields and gravity stations should not be located in places with abnormal magnetic fields. Periodic checks should be made by reading the meter in various azimuths, to ensure that the meter is still compensated magnetically.

Current accuracy of the G meter is about $30 \mu\text{gal}$ rms unless precautions are taken to avoid periodic screw errors when considerable improvement can be expected. Accuracies of $3-6 \mu\text{gal}$ are reported for a single measurement with the D meter, with $1 \mu\text{gal}$ possible by repetition or network adjustment.

The introduction of portable free-fall absolute gravity apparatus has been an important innovation. J.A. Hammond and R.L. Iliff discuss the absolute gravity program of the Air Force Geophysical Laboratory in a companion paper.

There has been little change over the last 10 years either in the names of the commonly used

sea gravimeters or in their principles of operation. The changes have been mainly refinement and improvement of design, and have resulted in substantial upgrading of performance, so that the state of the art accuracy is now about $1 \mu\text{gal}$ as against 5 mgal ten years ago. The meters are mounted on gyrostabilized platforms to keep the sensitive axes vertical. The platform is slaved to stay aligned with the gyros (either a single two-axis gyro or two single-axis gyros). The orientation of the gyros can be slowly changed by the outputs of horizontal accelerometers mounted on the platform, and this feedback is arranged so that the means of these outputs are nulled. The detailed behaviour of the platform depends on exactly how the accelerometer outputs are processed to provide the feedback to the gyros (LaCoste, 1967; Talwani, 1970) and it can be made to behave like a simple pendulum with a chosen damping and period. The period must be long enough that the platform is unaffected by the horizontal wave accelerations and a 4-6 minute period, 0.707 critical damping, combination functions excellently for this purpose, although we shall later discuss applications where these periods are made much larger.

The Askania sea gravity meter is now manufactured by the Bodenseewerk. Two models are available: the Kss 5 is a refurbished Gss 2 sensor (Graf, 1958; Graf and Schulze, 1961; Schulze, 1962) in which the main improvement is more accurate location of, and increased tension in, the constraining filaments, mounted on an Anschütz platform. The meter is designed to operate with horizontal accelerations up to 50 gal and vertical up to 100 gal ; accuracies of 1 mgal in "rough" sea and 2.5 mgal in "very rough" sea are claimed. A new sensor, the Gss 3 (Figure 2), consists of a tubular mass constrained by 5 filaments and 2 springs to move in a straight line. Most of the weight is supported by a spring. A feedback loop using a capacitive displacement sensor and an electromagnetic thruster keeps the mass stationary relative to its supporting structure, and the current in this thruster provides the measure of gravity. The straight line motion eliminates cross-coupling effects and an accuracy of better

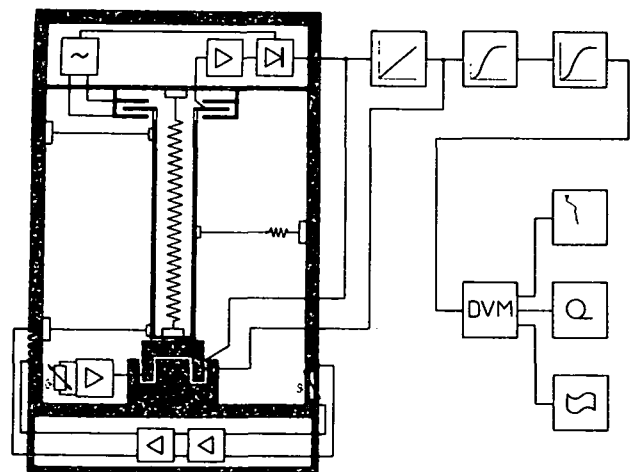

Fig. 2. The Gss-3 sea gravity meter sensor

than 1 mgal up to 200 gal wave acceleration is specified. This sensor is operated with a newly developed KT 30 stable platform.

The LaCoste and Romberg meter is still substantially as described by LaCoste (1967) and the main improvement in performance results from the use of cross-correlation techniques in correcting for cross-coupling errors (LaCoste, 1973a). The correction for inherent cross-coupling itself is, in fact, trivial as beam position and horizontal acceleration are both sensed anyway, and a correction proportional to their product is easily computed. More serious errors of cross-coupling type arise in these (and presumably other) sensors because of unwanted motions in degrees of freedom which have been supposedly suppressed, but which in fact occur because materials are not infinitely rigid. This problem is especially severe with the LaCoste-Romberg instrument owing to the small clearances on the air dampers. As long as these errors are small they will be linearly proportional to certain products of accelerations and velocities in the x, y and z directions, the exact combinations which are important depending on the construction of the sensor and the source of the errors. A number of such corrections are computed and applied along with the correction for inherent cross-coupling. The constants of proportionality may change with age or shipment of the meter but can be determined empirically by cross-correlation of the short period gravity variations with the acceleration and velocity products known to be important, using the reasonable assumption that gravity and wave accelerations are uncorrelated. This technique allows one both to correct data already obtained and to correct the compensation of the meter, provided the necessary information was recorded during the survey. As an example we show (Figure 3) data obtained with 3 LaCoste-Romberg meters in the North Sea by the (British) Institute of Geological Sciences (M. Tully, personal communication) in up to Force 7 sea conditions. Meters S-40 and S-75 had been in use for some time and had been correctly compensated on the basis of earlier cross-correlation analyses. Meter S-84 was a new system being used at sea for the first time, and the raw data differs from that obtained with S-40 by up to 7 mgal. Correction on the basis of cross-correlation analysis brings the two into perfect agreement. S-75 read systematically about 2 mgal higher, probably as a result of vibration. The mean of 143 cross ties with S-75 was 0.84 mgal, and with S-40 was 1.04 mgal.

However, the real solution is to build a more rigid meter and LaCoste and Romberg have been experimenting for some time with a straight line meter similar in some respects to the Gss 3 but employing an infinite period-zero length spring suspension (LaCoste, 1973b).

Bell Aerospace have brought out the BGM-3 system to replace their BGM-2. The gravity sensor, a pendulous mass with capacitive position sensing and electromagnetic feedback, has been significantly improved by a simplified design and use of improved materials and manufacturing techniques. Accuracies of 1 mgal are claimed in up to 100 gals wave acceleration. The meter can

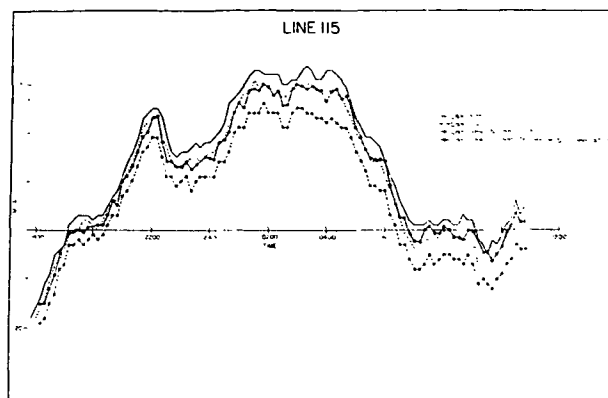

Fig. 3. North Sea profile obtained by the Institute of Geological Sciences (M. Tully, personal communication) showing effectiveness of cross-correlation correction.

accept inputs from a shipboard inertial navigator and will then produce free air anomalies in real time.

Woods Hole Oceanographic Institution (C. Bowin, personal communication) have continued to use a vibrating string accelerometer (Bowin et al., 1969, 1972) on a Sperry Mark 19 Mod 3c gyrocompass mount and use a Hewlett-Packard 2114 computer for instrument control and data recording. A more portable system has also been developed using a Aeroflex ART-57 table. RMS differences of crossings in the open ocean have varied between 1 and 3 mgal.

With sea gravity meter accuracy at the 1 mgal level the Eötvös correction becomes a major source of error in the gravity anomalies. Satellite navigation systems have improved navigation at sea very considerably and one can probably count on getting good fixes every two hours or so. However, if sea or current conditions are variable, or the ship does any manoeuvring between fixes, the velocity uncertainties may introduce considerable noise into the anomaly profiles. Determination of velocity to 1/10 knot over a 6 minute interval requires fixes accurate to about .01 mile or 20 m. Electronic navigational aids may provide this accuracy in the survey area but more probably they will not. In this latter case it is worth considering the use of inertial navigation in conjunction with the other methods. The ship may carry an inertial navigator. There are many implementations of inertial navigation and the performance depends on this implementation and the quality of components used. All ideal (meaning that no errors in indicated position are produced by the navigator's history of acceleration over the earth's surface) systems however, behave as undamped pendulums with 84 minute period. Initial errors, component imperfections or deflections of the vertical excite free oscillations of the navigator. An example of such oscillations is shown in Figure 4, which is a plot of longitude indicated by a Honeywell SPN system using electrostatic gyros minus LORAN longitude on a U.S. Navy Oceanographic Office aircraft gravity test in 1976 (J. Ford, personal communication). The 84 minute Schuler oscillation

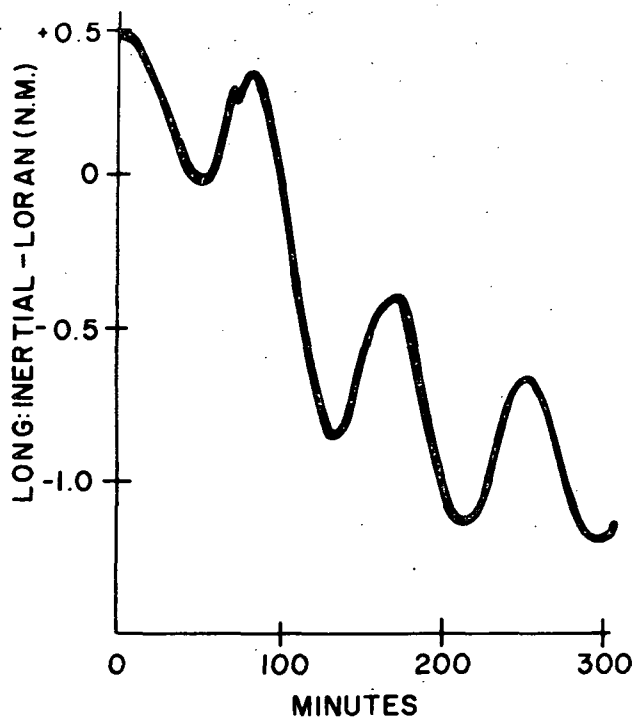

Fig. 4. Difference between inertially determined and LORAN longitudes during Naval Oceanographic Office airborne tests (J. Ford, personal communication) showing Schuler oscillations of the inertial navigator.

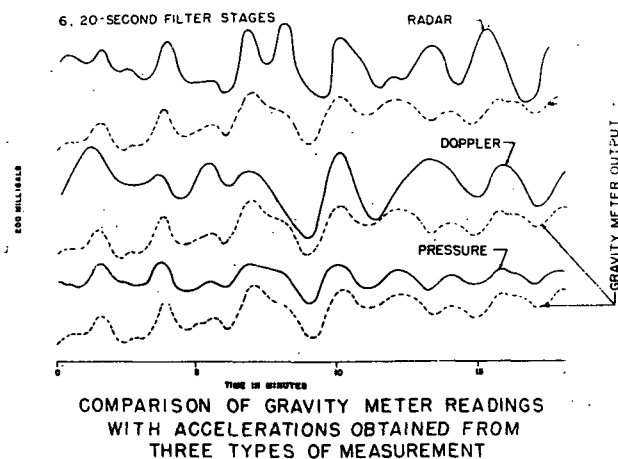

Fig. 5. Vertical acceleration of plane from radar, Doppler radar and barometric altimeters compared with observed gravity.

tions are apparent and velocity errors of up to about 2 knots occur. Such oscillations can of course be removed by real time Kalman or post facto filtering using the electronic positioning information.

The gyro-stabilized platform used in sea gravity meters is almost an inertial navigator in itself and LaCoste has done some interesting experiments to ascertain whether it could be used in this capacity. He added a third gyro to provide azimuth stabilization and has shown how the accelerometer and gyro outputs may be combined to pro-

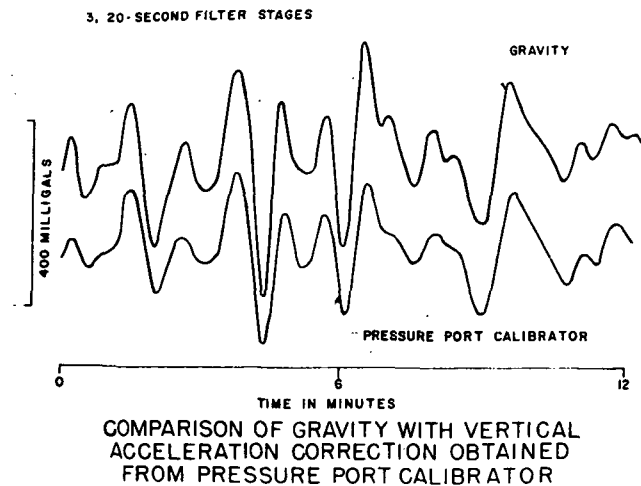

Fig. 6. Gravity compared with acceleration from barometric altimeter.

vide a Schuler-type equation for the Eötvös correction even if the platform itself is not Schuler tuned. (Valliant & LaCoste, 1976) The danger with using a Schuler tuned platform is that any malfunction may initiate oscillations which, being undamped, can spoil results for an indefinite time. However, LaCoste-Romberg platforms have been used satisfactorily with periods up to and including 84 minutes; the 84 minute period is not necessary for the theory to be valid but the gyros behave better in long period servo loops as less external precession is required. Gravity profiles with Eötvös effects corrected with the platform navigator are significantly smoother than when Lorac fixes were used (LaCoste, 1977). Adding the third gyro is very much cheaper than an entire inertial navigator, and while the performance of the platform is not comparable with that of a good commercial inertial navigator over long periods of time, it is able to improve the determination of Eötvös corrections in ships and aircraft when used to interpolate within a framework of satellite or electronic fixes.

Probably the most interesting developments in recent years have come in gravity measurements from aircraft. An aircraft normally gives a much smoother ride than a ship, so the gravity meter errors are correspondingly less. The problems are in correcting for the Eötvös effect and vertical accelerations of the aircraft over short time intervals that the gravity information is not smeared out by the high speed of the vehicle to the point of losing important detail. A low-speed aircraft is therefore advantageous and the most impressive results to date have been obtained by Bill Gumert of the Geoscience Division of Carson Helicopters using a Sikorsky S-61 helicopter at speeds of 70 knots. He used a Del Norte trisponder positioning system which (with modification) gives positions within a 3-m circle of error out to 160 km range. This is adequate for 1 mgal accuracy in Eötvös correction over 1 minute intervals. The comments made above concerning the value of inertial navigators for interpolating between electronic fixes are equally

applicable to aircraft work. Gumert finds that the LaCoste-Romberg inertial system gives results agreeing to 2 mgal with those derived from the trisponder positions.

A simple harmonic height variation of ± 5 cm with a period of 1 minute produces accelerations of 50 mgal amplitude, 35 mgal rms value. These accelerations decrease for longer period motions as the inverse square of the period; for example to 2 mgal maximum, 1.6 mgal rms at 5 minutes. The correction for these height variations is thus critical and the quality of the altimetry controls the detail which can be obtained. Many types of altimeters are available. Figure 5 compares vertical accelerations derived from data taken with a radar, a Doppler radar and a barometric altimeter, with the gravity meter record during 15 minutes of the previously mentioned Oceanographic Office airplane tests in 1976 (data filtered with 6 stages of 20 sec R-C smoothing). The correspondence between observed gravity and the pressure altimetry is impressive but the scale bar is 200 mgal and there are differences of the order of 5 mgal between the curves. Figure 6 shows less filtered data from the same test shorter periods are present and the acceleration amplitudes are bigger. Bill Gumert (personal communication) in his helicopter work has used a precise pressure sensor (Rosemont 1201 F), a laser altimeter (Geodolite 3A) and a radar altimeter (Honeywell AN/APN-194). The pressure altimeter has a repeatability of ± 7.5 cm over a 50 m altitude range but is not an absolute instrument. The laser altimeter range but has some sensitivity to the color of the target, while the radar altimeter gives absolute altitudes to about 1m. In use, the pressure and radar altimeters are intercompared frequently over flat areas of known elevation to provide an absolute calibration for the former. The rms difference at 244 line crossings during a survey in New York State was 2.3 mgal and eleven of these were misties of over 5 mgal at the beginning of lines where the instruments probably had not had time to stabilize. Comparison with ground data is about as good as the internal consistency of the airborne data (2-3 mgal). Current accuracies are about 2 mgal after smoothing to remove features of wavelength shorter than 3-4 miles. This is a most important achievement holding much promise for medium scale structural investigations which, by keeping the topography at arms length, eases the computation of terrain corrections very considerably and, in poorly surveyed areas, eliminates the necessity of leveling to determine station heights. Comparable accuracies can probably be obtained with fixed wing aircraft with the horizontal distance scale expanded in the ratio of the speeds - for example 10 miles wavelength with a 350 knot aircraft - although there may be more high frequency altitude variation in the faster moving airplane which could increase the required averaging time slightly.

References

- Bowin, C., C.G. Wing and T.C. Aldrich, Tests of the M.I.T. vibrating string gravimeter, 1967. Jour. Geophys. Res., 74, 3278-3280, 1969.
- Bowin, C., T.C. Aldrich and R.A. Folinsbee, VSA gravity meter system: tests and recent developments, Jour. Geophys. Res., 77, 2018-2033, 1973.
- Graf, A., Das Seegravimeter, Z. für Instrumkde, 60, 151-162, 1958.
- Graf, A. and R. Schulze, Improvements on the sea gravimeter Gss 2, Jour. Geophys. Res., 66, 1813-1821, 1961.
- LaCoste, L.J.B., A Simplification in the Conditions for the Zero-length-Spring Seismograph, Bull. Seis. Soc. Amer., 25, 176-179, 1935.
- LaCoste, L.J.B. and A. Romberg, U.S. Patent 2,377,889, 1945.
- LaCoste, L.J.B., Measurement of gravity at sea and in the air, Rev. Geophys. 5, 477-526, 1967.
- LaCoste, L.J.B., Cross-correlation method for evaluating and correcting shipboard gravity data, Geophysics, 38, 701-738, 1973a.
- LaCoste, L.J.B., U.S. Patent 3,717,036, 1973b.
- LaCoste, L.J.B., 1974 test of LaCoste and Romberg inertial navigation system, Geophysics, 42, 594-601, 1977.
- Schulze, R., Automation of the sea gravimeter Gss 2, Jour. Geophys. Res., 67, 3397-3401, 1962.
- Talwani, M., Chap. 8 Gravity (espec. § 3) in The Sea, Vol. IVa, Interscience- John Wiley, New York, 1970.
- Valliant, H.D. and L.J.B. LaCoste, Theory and evaluation of the LaCoste and Romberg three-axis inertial platform for marine gravimetry, Geophysics, 41, 459-467, 1976.
- Wing, C.G., M.I.T. vibrating string surface-ship gravimeter, Jour. Geophys. Res., 74, 5882-5894, 1969.