

NASA Technical Memorandum 80097

NASA-TM-80097-VOL-3
19790019969

Pressure Distributions on Three Different Cruciform Aft-Tail Control Surfaces of a Wingless Missile at Mach 1.60, 2.36, and 3.70 Volume III - Cranked Tail

Milton Lamb, Wallace C. Sawyer,
Donald L. Wassum, and C. Donald Babb

AUGUST 1979

FOR REFERENCE
NOT TO BE TAKEN FROM THIS ROOM

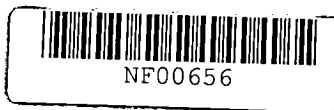

NASA Technical Memorandum 80097

Pressure Distributions on Three
Different Cruciform Aft-Tail Control
Surfaces of a Wingless Missile at
Mach 1.60, 2.36, and 3.70

Volume III - Cranked Tail

Milton Lamb, Wallace C. Sawyer,
Donald L. Wassum, and C. Donald Babb
*Langley Research Center
Hampton, Virginia*

NASA

National Aeronautics
and Space Administration

**Scientific and Technical
Information Branch**

1979

SUMMARY

The results of pressure distribution tests conducted in the Langley Unitary Plan wind tunnel are presented without analysis. The data were obtained for three sets of cruciform aft-tail control surfaces on a wingless missile model at Mach numbers of 1.60, 2.36, and 3.70 for angles of attack from -4° to 20° , model roll angles from 0° to 90° , and tail deflections of 0° and -15° . The test Reynolds number used was 6.6×10^6 per meter.

Volume I presents the pressure distributions for a trapezoidal tail; volume II, for a clipped delta tail; and volume III, for a cranked tail.

INTRODUCTION

Theoretical aerodynamicists are continually seeking consistent and accurate experimental data as an aid in the development and evaluation of computational methods. This study was made to provide a complete set of pressure distribution data on three sets of cruciform aft-tail control surfaces for a wingless missile model.

The investigation was conducted in the Langley Unitary Plan wind tunnel at Mach numbers of 1.60, 2.36, and 3.70 at a Reynolds number per meter of 6.6×10^6 . The angle of attack was varied from -4° to 20° , model roll angle was varied from 0° to 90° in 22.5° increments, and tail deflections were 0° and -15° . The model consisted of a body of revolution with interchangeable aft-tail control surfaces. Three sets of model tails with identical root chords and span lengths were used. The pressures were measured on two adjacent tail surfaces (tails 1 and 2) using 91 pressure orifices per tail surface. The results are presented in plotted and tabular form.

SYMBOLS

b	exposed tail span, cm
C_p	pressure coefficient, $\frac{p_l - p_\infty}{q_\infty}$ (Cp on tables and plots)
c	tail local chord, cm
M	free-stream Mach number
p_l	local pressure, Pa
p_∞	free-stream static pressure, Pa

q_{∞}	free-stream dynamic pressure, Pa
x	longitudinal distance measured from local chord leading edge, cm
x/c	fraction of local tail chord (see fig. 1)
y	lateral distance measured from root chord, cm
y/b	fraction of exposed tail span (see fig. 1)
α	angle of attack, deg
δ	pitch control deflection (negative with leading edge down; without subscripts, refers to all tails; with subscripts, only to those tails indicated), deg
ϕ	model roll angle, positive clockwise when viewed from rear ($\phi = 0^{\circ}$ when tail no. 1 is in lower vertical position, see fig. 1), deg

Abbreviations:

L.S.	lower surface (see fig. 1)
U.S.	upper surface (see fig. 1)

APPARATUS AND TESTS

Tunnel

The tests were conducted in both the low and high Mach number test sections of the Langley Unitary Plan wind tunnel which is a variable-pressure, continuous-flow facility. The asymmetric sliding-block nozzles lead to the test sections and permit a continuous variation in Mach number from about 1.5 to 2.9 in the low Mach number test section and from about 2.3 to 4.7 in the high Mach number test section.

Model

The configuration consisted of a simple wingless aft-tail cruciform control missile model with three sets of interchangeable tail surfaces. The pressure tubes were integrally cast into the tail surfaces to permit a greater number of more closely spaced pressure orifices (91 per tail surface). Details of the model and pressure orifice locations are given in figures 1 and 2. The upper- and lower-surface orifices were serviced by the same pressure tube, and thus required the taping of one surface while the other surface was being

tested. The missile model was sting mounted from the rear on the main support system of the tunnel.

Test Conditions

Tests were conducted at the following test conditions:

Mach number	Stagnation temperature, K	Stagnation pressure, kPa	Reynolds number, m^{-1}
1.60	339	54.6	6.6×10^6
2.36	339	75.7	6.6
3.70	339	152.7	6.6

The dew-point temperature measured at stagnation pressures was maintained below 239 K to assure negligible condensation effects. In order to assure a turbulent boundary layer, all tests were conducted with a boundary-layer transition strip on the body 3.05 cm aft of the nose. At a Mach number of 1.60, the transition strip consisted of a 0.16-cm-wide strip of sprinkled No. 60 sand. For the other two Mach numbers, the strip was composed of single-spaced No. 40 sand.

Measurements

The angles of attack have been corrected for tunnel-flow misalignment. Pressures were measured by six scanning valves. All pressure coefficients were referenced to free-stream conditions. The accuracy of the scanning-valve system is within 1 percent of the gage range. When expressed as pressure coefficients C_p , 1 percent of the gage range is 0.030 at Mach 1.60, 0.016 at Mach 2.36, and 0.024 at Mach 3.70.

PRESENTATION OF RESULTS

Due to the large volume of data and for the convenience of the reader, the data are presented as three volumes as follows:

- Volume I Trapezoidal tail (planform A)
- Volume II Clipped delta tail (planform B)
- Volume III Cranked tail (planform C)

The pressure coefficients are given in tables I to XXIV, and, to aid the reader, an index of tables follows:

Table	M	ϕ , deg	$\delta_{1,3}$, deg	$\delta_{2,4}$, deg			
I	1.60	0	0	0			
II	↓	22.5	↓	↓			
III		45					
IV		67.5					
V		90					
VI		0					
VII	2.36	22.5					
VIII	↓	45					
IX		67.5					
X		90					
XI		0					
XII		22.5					
XIII	↓	45					
XIV		67.5					
XV		90					
XVI		1.60			0		
XVII		2.36	↓	-15			
XVIII	3.70						
XIX	1.60	45					
XX	2.36	↓		↓			
XXI	3.70						
XXII	1.60				90		
XXIII	2.36				↓	0	
XXIV	3.70					↓	↓

Only a limited amount of machine-plotted data are presented to show trends, but all data are presented in tabular form. The plotted data are presented in the following figures:

	Figure
Pressure coefficients, $\phi = 0^\circ$, $\delta = 0^\circ$ -	
M = 1.60	3
M = 2.36	4
M = 3.70	5
Pressure coefficients, $\phi = 22.5^\circ$, $\delta = 0^\circ$ -	
M = 1.60	6
M = 2.36	7
M = 3.70	8

	Figure
Pressure coefficients, $\phi = 45^\circ$, $\delta = 0^\circ$ -	
M = 1.60	9
M = 2.36	10
M = 3.70	11
Pressure coefficients, $\phi = 67.5^\circ$, $\delta = 0^\circ$ -	
M = 1.60	12
M = 2.36	13
M = 3.70	14
Pressure coefficients, $\phi = 90^\circ$, $\delta = 0^\circ$ -	
M = 1.60	15
M = 2.36	16
M = 3.70	17
Pressure coefficients, $\phi = 0^\circ$, $\delta_{2,4} = -15^\circ$ -	
M = 1.60	18
M = 2.36	19
M = 3.70	20
Pressure coefficients, $\phi = 45^\circ$, $\delta = -15^\circ$ -	
M = 1.60	21
M = 2.36	22
M = 3.70	23
Pressure coefficients, $\phi = 90^\circ$, $\delta_{1,3} = -15^\circ$ -	
M = 1.60	24
M = 2.36	25
M = 3.70	26

Langley Research Center
National Aeronautics and Space Administration
Hampton, VA 23665
May 25, 1979

TABLE I. - PRESSURE COEFFICIENTS, $\phi = 0^\circ$, $\delta = 0^\circ$, $M = 1.60$.
(a) $\alpha = -3.55^\circ$

Cp at y/b of														
x/c	0.02		0.22		0.44		0.56		0.67		0.83		0.98	
	U.S.	L.S.	U.S.	L.S.	U.S.	L.S.	U.S.	L.S.	U.S.	L.S.	U.S.	L.S.	U.S.	L.S.
.05	.1243	.1362	.2850	.2676							.7388	.5421	.6285	.6989
.10	.1253	.1276	.2445	.2313					.7070	.7518	.6808	.7926	.5348	.6294
.15	.1164	.1176	.2144	.2143	.2723	.2717	.4310	.4922			.6345	.6966	.4539	.5363
.20	.1119	.1154							.5467	.5644	.5962	.6475		
.25	.0923	.0964	.2215	.2059	.2381	.2361			.5052	.5261			.3923	.4126
.30	-.0553	-.0382	.1661	.1551			.4023	.4453	.4913	.5217	.5321	.5795	.3544	.3752
.40	.0168	.0251					.3506	.3942	.4167	.4516	.4577	.4929	.2964	.3070
.50				-.1005			-.0751	-.0581	.1248	.0037	.2971	.1161	.1975	.0329
.60	.0025	.0110	-.0991	-.0577	-.1788	-.1334	-.3131	-.2884	-.2911	-.2720	-.2865	-.2749	-.2717	-.2619
.70			-.0120	.0004	-.3647	-.3352	-.3496	-.3229			-.3142	-.2926	-.2753	-.2648
.80	-.2414	-.1368	-.2906	-.2539	-.3327	-.3274	-.2374	-.2471					-.2442	-.2240
.90	-.2523	-.2362	-.2922	-.2530	-.3326	-.3045	-.2683	-.2578	-.2767	-.2992	-.2629	-.2750	-.1733	-.1437
.95			-.2758	-.2404	-.3204	-.2995	-.2499	-.2598	-.2866	-.2971	-.2615	-.2609		

TAIL 1

Cp at y/b of														
x/c	0.02		0.22		0.44		0.56		0.67		0.83		0.98	
	U.S.	L.S.	U.S.	L.S.	U.S.	L.S.	U.S.	L.S.	U.S.	L.S.	U.S.	L.S.	U.S.	L.S.
.05	.2843		.4602		.5332	-.1367	.9408	-.0071			1.1006	.2336		
.10	.2669		.4146		.4855	-.0473	.8185	.0179			.9367	.3326	.7407	.2507
.15	.2627		.3856		.4473	.0387	.7292	.0645			.8580	.3822	.6109	.2692
.20					.4193	.0690	.6806	.1355	.7612	.1798	.7913	.3750	.5383	.2788
.25	.2388	.0307	.3474		.4062	.0847			.7165	.1646	.7364	.3529	.4797	.2847
.30	.0314	-.0653	.3005		.4133	.0952			.6662	.1664	.6843	.3214	.4392	.2707
.40	.1318	-.0091			.4157	.1347	.5227	.2237	.5797	.1864	.5907	.2657	.3603	.2285
.50			.0142	-.1660			.0254	-.1370					.2465	-.0245
.60			.1575	-.0972	-.1110	-.1992			-.2501	-.3181	-.2511	-.3267	-.2590	-.2835
.70			.1441	-.0611			-.3023	-.3526	-.2827	-.3388	-.2808	-.3455	-.2750	-.1788
.80			-.1844	-.2722	-.2654	-.3345	-.3177	-.3274	-.2924	-.3183	-.2875	-.3120	-.2781	-.2164
.90				-.2799	-.1858	-.3279	-.3022	-.3118	-.3018	-.2953	-.2905	-.3046	-.1958	-.2577
.95			-.1783	-.2330	-.1883	-.3201			-.3059	-.2912	-.2852	-.2955		

TAIL 2

TABLE I. - CONTINUED
(b) $\alpha = -1.55^\circ$

Cp at γ/b of														
x/c	0.02		0.22		0.44		0.56		0.67		0.83		0.98	
	U.S.	L.S.	U.S.	L.S.	U.S.	L.S.	U.S.	L.S.	U.S.	L.S.	U.S.	L.S.	U.S.	L.S.
.05	.1223	.1192	.2868	.2642							.7673	.5248	.6146	.6597
.10	.1266	.1202	.2491	.2300					.7320	.7756	.7039	.8097	.5133	.5946
.15	.1238	.1174	.2230	.2141	.2824	.2965	.4598	.5183			.6541	.6978	.4364	.5072
.20	.1224	.1167							.5745	.5848	.6094	.6439		
.25	.1078	.1037	.2297	.2121	.2551	.2593			.5307	.5472			.3749	.3912
.30	-.0205	-.0039	.1735	.1629			.4329	.4615	.5173	.5419	.5384	.5752	.3364	.3576
.40	.0434	.0482					.3815	.4073	.4402	.4732	.4585	.4852	.2825	.2946
.50				-.0832			-.0629	-.0471	.1294	.0207	.2915	.1092	.1841	.0287
.60	.0211	.0475	-.0517	.0063	-.1717	-.1263	-.3072	-.2824	-.2906	-.2673	-.2925	-.2785	-.2790	-.2657
.70			-.0003	.0300	-.3598	-.3322	-.3450	-.3161			-.3194	-.3002	-.2825	-.2683
.80	-.2298	-.1351	-.2799	-.2367	-.3254	-.3223	-.2329	-.2446					-.2483	-.2243
.90	-.2295	-.2051	-.2820	-.2350	-.3298	-.3001	-.2620	-.2556	-.2768	-.2986	-.2674	-.2765	-.1893	-.1535
.95			-.2566	-.2182	-.3164	-.2952	-.2452	-.2456	-.2846	-.2974	-.2651	-.2641		

TAIL 1

Cp at γ/b of														
x/c	0.02		0.22		0.44		0.56		0.67		0.83		0.98	
	U.S.	L.S.	U.S.	L.S.	U.S.	L.S.	U.S.	L.S.	U.S.	L.S.	U.S.	L.S.	U.S.	L.S.
.05	.1425		.3816		.4615	.0879	.8306	.2292			.9940	.4889		
.10	.1581		.3369		.4189	.2063	.7166	.3010			.8485	.5391	.6019	.4354
.15	.1942		.3141		.3834	.1809	.6270	.3564			.7781	.5075	.5320	.3820
.20					.3569	.1781	.5886	.3603	.6792	.3970	.7183	.4785	.4713	.3502
.25	.1734	.0737	.2803		.3434	.1730			.6436	.3994	.6681	.4625	.4153	.3352
.30	.0001	-.0285	.2488		.3508	.1760			.5974	.3867	.6204	.4453	.3796	.3097
.40	.0831	.0307			.3383	.1990	.4630	.3241	.5234	.3708	.5315	.4100	.3171	.2638
.50			-.0593	-.1339			-.0009	-.0901					.2207	.0009
.60			.0896	-.0486	-.1373	-.1685			-.2646	-.2869	-.2644	-.2803	-.2613	-.2655
.70			.0887	-.0114			-.3172	-.3346	-.2984	-.3150	-.2966	-.3110	-.2600	-.2175
.80			-.2273	-.2475	-.3083	-.3163	-.3251	-.3175	-.3083	-.3208	-.3013	-.2963	-.2327	-.1887
.90				-.2557	-.2939	-.3067	-.2962	-.2965	-.3026	-.2887	-.2632	-.2680	-.1719	-.2195
.95			-.2037	-.2324	-.2843	-.3022			-.2809	-.2782	-.2544	-.2640		

TAIL 2

TABLE I. - CONTINUED
(c) $\alpha = 0.45^\circ$

Cp at y/b of															
x/c	0.02		0.22		0.44 *		0.56		0.67		0.83		0.98		
	U.S.	L.S.	U.S.	L.S.	U.S.	L.S.	U.S.	L.S.	U.S.	L.S.	U.S.	L.S.	U.S.	L.S.	
.05	.1295	.1378	.2979	.2821							.7505	.5162	.5987	.6541	
.10	.1335	.1340	.2589	.2454						.7513	.7927	.7066	.8278	.5046	.5811
.15	.1308	.1284	.2313	.2286	.2977	.3098	.4789	.5554			.6605	.7144	.4373	.5144	
.20	.1326	.1328							.5977	.6070	.6185	.6557			
.25	.1196	.1223	.2420	.2268	.2678	.2726			.5549	.5680			.3844	.4020	
.30	-.0305	-.0091	.1885	.1842			.4497	.4839	.5390	.5575	.5440	.5864	.3489	.3691	
.40	.0455	.0584					.3988	.4269	.4631	.4869	.4617	.4956	.2989	.3115	
.50				-.0722			-.0509	-.0333	.1491	.0229	.2936	.1146	.2024	.0474	
.60	.0373	.0634	-.0533	-.0185	-.1660	-.1253	-.2995	-.2760	-.2847	-.2645	-.2901	-.2757	-.2713	-.2557	
.70			.0252	.0453	-.3558	-.3301	-.3376	-.3077			-.3177	-.2972	-.2860	-.2661	
.80	-.2190	-.1042	-.2631	-.2214	-.3208	-.3212	-.2332	-.2422					-.1915	-.1721	
.90	-.2240	-.1937	-.2578	-.2039	-.3305	-.2976	-.2602	-.2558	-.2729	-.2951	-.2659	-.2765	-.2089	-.1593	
.95			-.2402	-.1877	-.3257	-.2934	-.2437	-.2444	-.2818	-.2944	-.2638	-.2634			

TAIL 1

Cp at y/b of														
x/c	0.02		0.22		0.44		0.56		0.67		0.83		0.98	
	U.S.	L.S.	U.S.	L.S.	U.S.	L.S.	U.S.	L.S.	U.S.	L.S.	U.S.	L.S.	U.S.	L.S.
.05	.1236		.2836		.3638	.3350	.6188	.4689			.5739	.7473		
.10	.1360		.2571		.3376	.2977	.5978	.5017			.7321	.6962	.4713	.5239
.15	.1427		.2487		.3052	.2738	.5027	.5098			.6865	.6544	.4455	.4578
.20					.2829	.2650	.4818	.4864	.5695	.5559	.6334	.6174	.4092	.4172
.25	.1242	.1101	.2199		.2702	.2558			.5370	.5359	.5895	.5908	.3671	.3993
.30	-.0258	-.0038	.1973		.2711	.2580			.5004	.5064	.5442	.5643	.3409	.3691
.40	.0433	.0480			.2794	.2668	.3949	.4039	.4452	.4737	.4674	.4960	.2867	.3145
.50			-.1032	-.0875			-.0317	-.0535					-.2025	-.0210
.60			.0018	.0042	-.1674	-.1184			-.2819	-.2589	-.2789	-.2563	-.2619	-.2515
.70			.0326	.0454			-.3322	-.3146	-.3146	-.2919	-.3118	-.2902	-.2953	-.2679
.80			-.2589	-.2114	-.3170	-.3170	-.3325	-.3134	-.3042	-.3023	-.2867	-.2995	-.1783	-.1806
.90				-.2217	-.3190	-.2919	-.2993	-.2925	-.2718	-.3051	-.2628	-.2676	-.1774	-.1650
.95			-.2235	-.2090	-.3197	-.2886			-.2683	-.2889	-.2610	-.2558		

TAIL 2

TABLE I. - CONTINUED
(d) $\alpha = 2.45^\circ$

Cp at y/b of														
x/c	0.02		0.22		0.44		0.56		0.67		0.83		0.98	
	U.S.	L.S.	U.S.	L.S.	U.S.	L.S.	U.S.	L.S.	U.S.	L.S.	U.S.	L.S.	U.S.	L.S.
.05	.1457	.1539	.3185	.2946							.7493	.4993	.5851	.5612
.10	.1456	.1477	.2723	.2554					.7736	.7983	.7125	.8252	.4939	.5781
.15	.1397	.1354	.2413	.2329	.3153	.3282	.5073	.5743			.6717	.7225	.4424	.5113
.20	.1415	.1435							.6163	.6223	.6294	.6598		
.25	.1255	.1316	.2477	.2281	.2831	.2890			.5734	.5822			.3955	.4035
.30	-.0398	-.0098	.1948	.1851			.4644	.4935	.5549	.5720	.5535	.5851	.3622	.3799
.40	.0413	.0642					.4153	.4373	.4768	.4992	.4692	.4972	.3164	.3236
.50				-.0503			-.0420	-.0093	.1583	.0442	.3020	.1277	.2222	.0726
.60	.0606	.0814	-.0380	-.0248	-.1597	-.0978	-.2946	-.2341	-.2799	-.2203	-.2888	-.2364	-.2629	-.2109
.70			.0492	.0871	-.3520	-.2832	-.3320	-.2636			-.3172	-.2551	-.2653	-.2099
.80	-.2074	-.0507	-.2424	-.1701	-.3161	-.2774	-.2301	-.2040					-.1854	-.1306
.90	-.2150	-.1535	-.2286	-.1382	-.3281	-.2537	-.2573	-.2177	-.2682	-.2518	-.2665	-.2399	-.2278	-.1436
.95			-.2196	-.1288	-.3284	-.2508	-.2425	-.2061	-.2778	-.2536	-.2646	-.2261		

TAIL 1

Cp at y/b of														
x/c	0.02		0.22		0.44		0.56		0.67		0.83		0.98	
	U.S.	L.S.	U.S.	L.S.	U.S.	L.S.	U.S.	L.S.	U.S.	L.S.	U.S.	L.S.	U.S.	L.S.
.05	.0957		.2048		.2133	.4227	.2877	.6869			.2116	.9371		
.10	.0958		.1760		.2454	.3785	.4598	.6837			.5240	.8421	.2721	.6401
.15	.1005		.1717		.2240	.3450	.3929	.6511			.5562	.7810	.3321	.5532
.20					.2090	.3323	.3653	.6088	.4415	.6851	.5197	.7314	.3349	.4980
.25	.0945	.1643	.1686		.1992	.3192			.4185	.6532	.4862	.6921	.3232	.4710
.30	-.0376	.0242	.1520		.2002	.3300			.3912	.6088	.4467	.6536	.3016	.4317
.40	.0261	.0636			.2127	.3356	.3116	.4783	.3466	.5567	.3863	.5650	.2578	.3559
.50			-.1188	-.0408			-.0517	-.0206					.1831	.0391
.60			-.0410	.0718	-.1636	-.0897			-.2634	-.2398	-.2557	-.2392	-.2312	-.2478
.70			-.0063	.1056			-.3043	-.2994	-.2897	-.2748	-.2862	-.2723	-.2361	-.2539
.80			-.2439	-.1789	-.2883	-.2855	-.2792	-.3214	-.2762	-.2871	-.2563	-.2815	-.1444	-.2236
.90			-.1822		-.2951	-.2490	-.2627	-.3101	-.2514	-.2966	-.2421	-.2858	-.1855	-.1781
.95			-.1874	-.1676	-.2845	-.2171			-.2465	-.3037	-.2389	-.2814		

TAIL 2

TABLE I. - CONTINUED
(e) $\alpha = 4.44^\circ$

Cp at y/b of														
x/c	0.02		0.22		0.44		0.56		0.67		0.83		0.98	
	U.S.	L.S.	U.S.	L.S.	U.S.	L.S.	U.S.	L.S.	U.S.	L.S.	U.S.	L.S.	U.S.	L.S.
.05	.1602	.1615	.3421	.3084							.7445	.4965	.5685	.4373
.10	.1562	.1556	.2884	.2694							.7175	.8218	.4811	.5445
.15	.1521	.1384	.2549	.2452	.3391	.3492	.5344	.5944	.7905	.8106	.6808	.7332	.4447	.5080
.20	.1496	.1473							.6320	.6392	.6388	.6679		
.25	.1316	.1286	.2569	.2346	.3088	.3032			.5877	.5955			.4036	.4149
.30	-.0451	-.0386	.2027	.1917			.4762	.5040	.5672	.5864	.5586	.5949	.3737	.3908
.40	.0236	.0426					.4223	.4515	.4839	.5100	.4733	.5018	.3302	.3407
.50				-.0798			-.0378	-.0245	.1588	.0265	.3076	.1253	.2398	.0782
.60	.0778	.0850	-.0602	-.0592	-.1582	-.1198	-.2935	-.2714	-.2747	-.2534	-.2870	-.2734	-.2518	-.2394
.70			.0509	.1269	-.3497	-.3256	-.3310	-.3025			-.3173	-.2943	-.2482	-.1786
.80	-.1905	-.0469	-.2204	-.1721	-.3159	-.3162	-.2291	-.2381					-.1825	-.1617
.90	-.1961	-.1683	-.1966	-.1343	-.3324	-.2927	-.2584	-.2494	-.2625	-.2889	-.2667	-.2764	-.2537	-.1953
.95			-.1923	-.1354	-.3317	-.2904	-.2452	-.2387	-.2711	-.2876	-.2666	-.2632		

TAIL 1

Cp at y/b of														
x/c	0.02		0.22		0.44		0.56		0.67		0.83		0.98	
	U.S.	L.S.	U.S.	L.S.	U.S.	L.S.	U.S.	L.S.	U.S.	L.S.	U.S.	L.S.	U.S.	L.S.
.05	.0277		.0055		-.0812	.5191	.0046	.8629			.0461	1.0504		
.10	.0314		.0654		.0603	.4690	-.1114	.8171			.2352	.9425	.1677	.7279
.15	.0424		.0887		.1214	.4270	-.1672	.7644			.3384	.8715	.2199	.6351
.20					.1275	.4054	.2414	.7091	.2134	.7819	.3765	.8131	.2366	.5653
.25	.0557	.2242	.1117		.1223	.3885			.2064	.7423	.3622	.7646	.2386	.5317
.30	-.0904	.0566	.0990		.1285	.4078			.2139	.6866	.3223	.7212	.2421	.4845
.40	-.0161	.1058			.1329	.4008	.2210	.5358	.2325	.6206	.2454	.6199	.2252	.3947
.50			-.1754	.0355			-.1175	.0066					.1532	.0549
.60			-.1110	.1657	-.2200	-.0293			-.3350	-.2240	-.3403	-.2247	-.2824	-.2505
.70			-.0687	.1699			-.3644	-.2829	-.3582	-.2583	-.3493	-.2541	-.2260	-.2487
.80			-.3045	-.1464	-.3508	-.2017	-.3315	-.2912	-.3250	-.2700	-.3171	-.2610	-.2132	-.2135
.90				-.1358	-.3487	-.1393	-.3211	-.2777	-.3123	-.2794	-.3098	-.2687	-.2255	-.2002
.95			-.1839	-.1309	-.3323	-.1344			-.3080	-.2889	-.3033	-.2767		

TAIL 2

TABLE I. - CONTINUED

(f) $\alpha = 6.46^\circ$

Cp at y/b of														
x/c	0.02		0.22		0.44		0.56		0.67		0.83		0.98	
	U.S.	L.S.	U.S.	L.S.	U.S.	L.S.	U.S.	L.S.	U.S.	L.S.	U.S.	L.S.	U.S.	L.S.
.05	.1740	.1757	.3626	.3281							.7403	.4934	.5460	.3708
.10	.1702	.1668	.3029	.2857					.8104	.8266	.7162	.8049	.4641	.5222
.15	.1667	.1515	.2678	.2633	.3685	.3644	.5572	.6138			.6793	.7453	.4391	.5045
.20	.1596	.1577							.6464	.6566	.6404	.6758		
.25	.1430	.1366	.2687	.2486	.3312	.3164			.5986	.6148			.4068	.4287
.30	-.0385	-.0371	.2146	.2036			.4879	.5242	.5775	.6083	.5603	.6022	.3823	.4113
.40	.0174	.0353					.4306	.4669	.4912	.5227	.4767	.5090	.3447	.3625
.50				-.0847			-.0328	-.0240	.1669	.0252	.3128	.1209	.2575	.0919
.60	.0913	.1023	-.0909	-.0527	-.1538	-.1169	-.2901	-.2693	-.2734	-.2534	-.2843	-.2694	-.2428	-.2270
.70			.0446	.1251	-.3452	-.3261	-.3275	-.3013			-.3150	-.2910	-.1804	-.1310
.80	-.1683	-.0222	-.1901	-.1279	-.3146	-.3176	-.2204	-.2345					-.1777	-.1562
.90	-.1755	-.1483	-.1579	-.1035	-.3277	-.2939	-.2523	-.2464	-.2577	-.2821	-.2625	-.2684	-.2636	-.2092
.95			-.1618	-.1096	-.3248	-.2925	-.2419	-.2350	-.2657	-.2767	-.2611	-.2563		

TAIL 1

Cp at y/b of														
x/c	0.02		0.22		0.44		0.56		0.67		0.83		0.98	
	U.S.	L.S.	U.S.	L.S.	U.S.	L.S.	U.S.	L.S.	U.S.	L.S.	U.S.	L.S.	U.S.	L.S.
.05	-.0438		-.1570		-.2147	.5929	-.1363	.9880			-.0572	1.1308		
.10	-.0363		-.0777		-.1392	.5400	-.0645	.9225			-.0836	1.0209	.0800	.8022
.15	-.0203		-.0336		-.0711	.4917	-.0324	.8563			.1690	.9436	.1296	.7066
.20					-.0430	.4668	-.0267	.7905	.0932	.8634	.2280	.8807	.1896	.6348
.25	.0152	.2847	.0342		-.0194	.4571			.0754	.8177	.2450	.8270	.1928	.5950
.30	-.1098	.0976	.0358		.0016	.4745			.0553	.7546	.2413	.7789	.1836	.5424
.40	-.0340	.1593			.0353	.4936	.0796	.5887	.0298	.6761	.1731	.6679	.1834	.4433
.50			-.1966	.1565			-.1944	.0277					.1290	.0730
.60			-.1359	.2280	-.2478	.0626			-.3650	-.2081	-.3685	-.2087	-.2881	-.2528
.70			-.0985	.2252			-.3572	-.2547	-.3538	-.2393	-.3743	-.2331	-.2461	-.2537
.80			-.3157	-.1003	-.3651	-.1089	-.3467	-.2303	-.3525	-.2493	-.3552	-.2391	-.2461	-.2291
.90			-.0930		-.3642	-.0995	-.3387	-.2231	-.3460	-.2576	-.3484	-.2467	-.2605	-.2114
.95			-.1498	-.1012	-.3423	-.1051			-.3384	-.2671	-.3440	-.2583		

TAIL 2

TABLE I. - CONTINUED
(g) $\alpha = 8.46^\circ$

Cp at y/b of														
x/c	0.02		0.22		0.44		0.56		0.67		0.83		0.98	
	U.S.	L.S.	U.S.	L.S.	U.S.	L.S.	U.S.	L.S.	U.S.	L.S.	U.S.	L.S.	U.S.	L.S.
.05	.1933	.1867	.3847	.3520							.7107	.4901	.5076	.2804
.10	.1861	.1804	.3234	.3093					.8205	.8428	.7001	.7683	.4384	.5154
.15	.1836	.1673	.2860	.2836	.3857	.3848	.5673	.6446			.6776	.7463	.4265	.5015
.20	.1736	.1725							.6515	.6794	.6397	.6791		
.25	.1544	.1509	.2909	.2575	.3508	.3464			.6059	.6323			.4078	.4382
.30	-.0303	-.0313	.2337	.2117			.4980	.5387	.5892	.6213	.5636	.6029	.3890	.4254
.40	.0243	.0306					.4445	.4747	.5055	.5336	.4871	.5139	.3623	.3775
.50				-.0867			-.0220	-.0208	.1791	.0316	.3269	.1237	.2810	.1073
.60	.1076	.1231	-.1125	-.0554	-.1414	-.1203	-.2848	-.2690	-.2697	-.2549	-.2761	-.2659	-.2268	-.2095
.70			.0371	.0178	-.3455	-.3272	-.3193	-.2998			-.3076	-.2884	-.1171	-.1084
.80	-.1404	-.0008	-.1513	-.0800	-.3086	-.3112	-.2216	-.2342					-.1706	-.1336
.90	-.1445	-.1271	-.1334	-.0825	-.3203	-.2928	-.2470	-.2466	-.2516	-.2803	-.2572	-.2619	-.2208	-.1960
.95			-.1412	-.0892	-.3213	-.2904	-.2352	-.2326	-.2596	-.2757	-.2526	-.2498		

TAIL 1

Cp at y/b of														
x/c	0.02		0.22		0.44		0.56		0.67		0.83		0.98	
	U.S.	L.S.	U.S.	L.S.	U.S.	L.S.	U.S.	L.S.	U.S.	L.S.	U.S.	L.S.	U.S.	L.S.
.05	-.1327		-.2714		-.2999	.6505	-.2376	1.0783			-.1409	1.1915		
.10	-.0919		-.1840		-.2598	.5924	-.1935	1.0044			-.0529	1.0819	-.0049	.8655
.15	-.0668		-.1438		-.1988	.5419	-.1522	.9307			.0584	1.0046	.0378	.7699
.20					-.1614	.5170	-.1366	.8573	-.0073	.9306	.0936	.9391	.1123	.6954
.25	-.0216	.3469	-.0510		-.1432	.5211			-.0246	.8812	.1285	.8834	.1464	.6520
.30	-.1384	.1553	-.0302		-.1241	.5349			-.0434	.8110	.1314	.8312	.1338	.5961
.40	-.0553	.2273			-.0942	.5652	-.0952	.6381	-.0650	.7234	.1022	.7130	.1227	.4835
.50			-.2181	.2677			-.2741	.0463					.0870	.0876
.60			-.1614	.2820	-.2917	.2643			-.3452	-.1905	-.3911	-.1870	-.3058	-.2543
.70			-.1358	.2882			-.3675	-.1760	-.3544	-.2169	-.3679	-.2101	-.2755	-.2505
.80			-.3282	-.0390	-.3833	-.0707	-.3716	-.1657	-.3552	-.2159	-.3628	-.2152	-.2783	-.2383
.90				-.0557	-.3550	-.0709	-.3659	-.1108	-.3492	-.2061	-.3544	-.2205	-.3041	-.2219
.95			-.1657	-.0716	-.3354	-.0809			-.3453	-.2166	-.3485	-.2324		

TAIL 2

TABLE I. - CONTINUED
(h) $\alpha = 10.45^\circ$

Cp at γ/b of														
x/c	0.02		0.22		0.44		0.56		0.67		0.83		0.98	
	U.S.	L.S.	U.S.	L.S.	U.S.	L.S.	U.S.	L.S.	U.S.	L.S.	U.S.	L.S.	U.S.	L.S.
.05	-.2129	.2111	.3602	.3741							.6954	.4790	.4837	.2137
.10	.2041	.2044	.3681	.3258					.8271	.8535	.7071	.7326	.4288	.5032
.15	.2043	.1880	.4287	.2958	.4175	.4131	.5845	.6652			.6912	.7391	.4307	.4979
.20	.1937	.1870							.6723	.6898	.6556	.6765		
.25	.1735	.1579	.3005	.2716	.3915	.3847			.6275	.6453			.4334	.4402
.30	-.0233	-.0266	.2385	.2256			.5276	.5521	.6108	.6316	.5804	.6035	.4213	.4357
.40	.0257	.0368					.4687	.4891	.5218	.5411	.5047	.5195	.3981	.4032
.50				-.0885			-.0137	-.0101	.1868	.0404	.3398	.1390	.3109	.1248
.60	.1322	.1356	-.0938	-.0546	-.1312	-.1072	-.2823	-.2601	-.2667	-.2489	-.2716	-.2613	-.2088	-.1995
.70			.0466	-.0101	-.3263	-.3189	-.3152	-.2914			-.3028	-.2839	-.0991	-.1006
.80	-.1118	.0236	-.1378	-.0866	-.2980	-.2994	-.2100	-.2270					-.0888	-.1055
.90	-.1086	-.0960	-.1245	-.0709	-.3097	-.2838	-.2386	-.2407	-.2525	-.2755	-.2542	-.2541	-.1797	-.1746
.95			-.1318	-.0731	-.3017	-.2822	-.2261	-.2264	-.2607	-.2720	-.2494	-.2437		

TAIL 1

Cp at γ/b of														
x/c	0.02		0.22		0.44		0.56		0.67		0.83		0.98	
	U.S.	L.S.	U.S.	L.S.	U.S.	L.S.	U.S.	L.S.	U.S.	L.S.	U.S.	L.S.	U.S.	L.S.
.05	-.2080		-.3447		-.3533	.6942	-.3173	1.1568			-.2153	1.2424		
.10	-.1213		-.2774		-.3425	.6427	-.3014	1.0819			-.1562	1.1383	-.0843	.9167
.15	-.0960		-.2317		-.3174	.5946	-.2613	1.0043			-.0590	1.0610	-.0498	.8223
.20					-.2865	.5853	-.2366	.9224	-.0933	.9959	-.0104	.9942	.0263	.7459
.25	-.0602	.4238	-.1585		-.2570	.6107			-.1088	.9425	.0102	.9355	.0836	.6980
.30	-.1587	.2203	-.1047		-.2316	.6334			-.1266	.8702	.0258	.8810	.0856	.6393
.40	-.0751	.2939			-.1849	.6321	-.2036	.6970	-.1452	.7712	.0168	.7556	.0644	.5187
.50			-.2344	.3434			-.3568	.0736					.0301	.1010
.60			-.1867	.3434	-.3548	.4148			-.3331	-.1692	-.3773	-.1704	-.3286	-.2631
.70			-.1690	.3747			-.3843	-.0957	-.3452	-.1858	-.3733	-.1908	-.3052	-.2636
.80			-.3416	.0035	-.4037	-.0538	-.3927	-.0702	-.3523	-.1584	-.3665	-.1910	-.3196	-.2450
.90				-.0341	-.3738	-.0551	-.3890	-.0713	-.3542	-.1444	-.3406	-.1921	-.3467	-.2293
.95			-.1948	-.0562	-.3542	-.0666			-.3525	-.1543	-.3240	-.2024		

TAIL 2

TABLE I. - CONTINUED
(1) $\alpha = 12.46^\circ$

Cp at y/b of														
x/c	0.02		0.22		0.44		0.56		0.67		0.83		0.98	
	U.S.	L.S.	U.S.	L.S.	U.S.	L.S.	U.S.	L.S.	U.S.	L.S.	U.S.	L.S.	U.S.	L.S.
.05	.2418	.2309	.3715	.3976							.7144	.4700	.4995	.1939
.10	.2279	.2172	.3638	.3452					.8570	.8681	.7267	.7321	.4437	.4823
.15	.2259	.2031	.3612	.3146	.4576	.4379	.6279	.6908			.6999	.7428	.4413	.5003
.20	.2045	.2046							.6982	.7058	.6608	.6788		
.25	.1778	.1767	.3133	.2844	.4651	.4295			.6524	.6612			.4414	.4534
.30	-.0240	-.0138	.2616	.2363			.5490	.5749	.6296	.6481	.5895	.6131	.4310	.4463
.40	-.0316	-.0425					.4880	.5031	.5355	.5541	.5155	.5313	.4106	.4225
.50				-.0788			-.0075	.0014	.1947	.0440	.3510	.1431	.3273	.1449
.60	.1564	.1586	-.0895	-.0431	-.1242	-.1023	-.2753	-.2555	-.2623	-.2473	-.2683	-.2565	-.1994	-.1878
.70			.0634	.0341	-.3172	-.3182	-.3067	-.2867			-.2983	-.2786	-.1438	-.0979
.80	-.0855	-.0519	-.1192	-.0787	-.2954	-.2896	-.2108	-.2229					-.1374	-.1129
.90	-.0555	-.0495	-.1064	-.0824	-.3070	-.2800	-.2294	-.2307	-.2469	-.2730	-.2494	-.2462	-.2055	-.1915
.95			-.0941	-.0822	-.2987	-.2777	-.2176	-.2180	-.2549	-.2666	-.2441	-.2373		

TAIL 1

Cp at y/b of														
x/c	0.02		0.22		0.44		0.56		0.67		0.83		0.98	
	U.S.	L.S.	U.S.	L.S.	U.S.	L.S.	U.S.	L.S.	U.S.	L.S.	U.S.	L.S.	U.S.	L.S.
.05	-.2791		-.4009		-.3928	.7381	-.3774	1.2191			-.2830	1.2829		
.10	-.1583		-.3474		-.3916	.6924	-.3757	1.1466			-.2408	1.1849	-.1737	.9565
.15	-.1232		-.3028		-.3831	.6577	-.3552	1.0716			-.1623	1.1077	-.1240	.8634
.20					-.3649	.6763	-.3160	.9854	-.1733	1.0528	-.1060	1.0400	-.0496	.7856
.25	-.0904	.4885	-.2385		-.3452	.6990			-.1827	.9987	-.0827	.9797	.0108	.7360
.30	-.1687	.2822	-.1886		-.3195	.7099			-.1991	.9195	-.0709	.9226	.0220	.6760
.40	-.1089	.3595			-.2717	.7222	-.2852	.7529	-.2179	.8098	-.0698	.7908	.0148	.5486
.50			-.2432	.4116			-.4013	.0988					-.0210	.1127
.60			-.2110	.4013	-.3934	.4317			-.3282	-.1468	-.3631	-.1580	-.3606	-.2535
.70			-.2047	.4650			-.3902	-.0394	-.3410	-.1490	-.3487	-.1710	-.3426	-.2495
.80			-.3636	.0249	-.4111	-.0309	-.3970	-.0359	-.3507	-.1083	-.3552	-.1634	-.3575	-.2315
.90				-.0227	-.3745	-.0348	-.3924	-.0413	-.3552	-.0906	-.3573	-.1587	-.3831	-.2183
.95			-.2001	-.0402	-.3555	-.0441			-.3522	-.0927	-.3532	-.1675		

TAIL 2

TABLE I. - CONTINUED
(j) $\alpha = 16.46^\circ$

Cp at y/b of														
x/c	0.02		0.22		0.44		0.56		0.67		0.83		0.98	
	U.S.	L.S.	U.S.	L.S.	U.S.	L.S.	U.S.	L.S.	U.S.	L.S.	U.S.	L.S.	U.S.	L.S.
.05	.2876	.2754	.4333	.4435							.7109	.4543	.4751	.1676
.10	.2733	.2565	.4195	.3921					.8897	.8977	.7216	.7027	.4251	.4381
.15	.2758	.2397	.3913	.3608	.5456	.5057	.6757	.7246			.6931	.7362	.4187	.4592
.20	.2534	.2370							.7280	.7291	.6564	.6765		
.25	.2229	.2041	.3502	.3260	.5673	.5122			.6802	.6788			.4311	.4424
.30	.0118	.0091	.3045	.2746			.5822	.6056	.6531	.6629	.5889	.6161	.4296	.4504
.40	.0756	.0769					.5079	.5205	.5538	.5700	.5214	.5413	.4206	.4420
.50				-.0398			.0002	.0141	.2040	.0518	.3596	.1498	.3433	.1674
.60	.2107	.2375	-.0566	-.0069	-.1150	-.0931	-.2605	-.2479	-.2582	-.2427	-.2638	-.2533	-.1931	-.1575
.70			.0985	.1450	-.2436	-.3151	-.2234	-.2775			-.2928	-.2703	-.1193	-.0990
.80	.0056	.1220	-.0890	-.0350	-.2564	-.2708	-.1546	-.2056					-.1560	-.1446
.90	.0353	.0892	-.0651	-.0726	-.2649	-.2667	-.2025	-.2035	-.2235	-.2558	-.2396	-.2319	-.2750	-.2776
.95			-.0062	-.0742	-.2539	-.2548	-.1916	-.1968	-.2424	-.2493	-.2315	-.2235		

TAIL 1

Cp at y/b of														
x/c	0.02		0.22		0.44		0.56		0.67		0.83		0.98	
	U.S.	L.S.	U.S.	L.S.	U.S.	L.S.	U.S.	L.S.	U.S.	L.S.	U.S.	L.S.	U.S.	L.S.
.05	-.3682		-.4554		-.4452	.8192	-.4492	1.2931			-.3830	1.3242		
.10	-.1817		-.4441		-.4501	.8258	-.4525	1.2311			-.3638	1.2444	-.3185	1.0156
.15	-.1613		-.4116		-.4487	.8424	-.4513	1.1601			-.3222	1.1737	-.2724	.9291
.20					-.3962	.8685	-.4161	1.0575	-.3099	1.1332	-.2733	1.1079	-.2016	.8530
.25	-.1520	.5859	-.3255		-.4380	.8824			-.3093	1.0765	-.2443	1.0478	-.1670	.8022
.30	-.1967	.3855	-.2854		-.4246	.8870			-.3192	.9911	-.2260	.9898	-.1470	.7403
.40	-.1608	.4729			-.3820	.8184	-.4132	.8164	-.3347	.8671	-.2222	.8528	-.1149	.6013
.50			-.2783	.5293			-.4156	.1470					-.1286	.1291
.60			-.2649	.5965	-.4213	.5120			-.3405	-.0939	-.3360	-.1242	-.4142	-.2228
.70			-.2628	.5411			-.4214	.0357	-.3538	-.0416	-.3362	-.1218	-.4020	-.2095
.80			-.3737	.0575	-.4132	.0290	-.4257	.0339	-.3634	.0072	-.3390	-.0899	-.3966	-.1820
.90				-.0315	-.3972	.0520	-.4150	.0412	-.3600	.0376	-.3409	-.0684	-.3925	-.1690
.95			-.2412	.0474	-.3985	.0515			-.3578	.0278	-.3411	-.0754		

TAIL 2

TABLE I. - CONCLUDED
(k) $\alpha = 20.45^\circ$

Cp at y/b of															
x/c	0.02		0.22		0.44		0.56		0.67		0.83		0.98		
	U.S.	L.S.	U.S.	L.S.	U.S.	L.S.	U.S.	L.S.	U.S.	L.S.	U.S.	L.S.	U.S.	L.S.	
.05	.3609	.3401	.5134	.5124							.7329	.5189	.4958	.1935	
.10	.3440	.3201	.4908	.4665						.9236	.9408	.7404	.7571	.4623	.4663
.15	.3459	.3026	.4606	.4272	.6591	.6110	.7181	.7757			.7133	.7687	.4598	.5053	
.20	.3203	.3020								.7608	.7675	.6766	.7091		
.25	.2851	.2663	.5303	.3853	.6314	.6084			.7109	.7197			.4752	.4884	
.30	.0586	.0625	.5641	.3311			.6142	.6410	.6828	.6996	.6174	.6480	.4769	.4979	
.40	.1364	.1376					.5381	.5514	.5829	.5984	.5535	.5721	.4680	.4942	
.50				.0187			.0142	.0187	.2256	.0618	.3870	.1760	.3897	.2093	
.60	.2586	.3252	-.0446	.0714	-.1018	-.0827	-.1213	-.2395	-.1759	-.2343	-.2517	-.2457	-.1700	-.1321	
.70			.0622	.2592	-.1289	-.2485	-.1395	-.2041			-.2177	-.2586	-.1174	-.0908	
.80	.0911	.2090	-.0190	.0129	-.1420	-.2381	-.0993	-.1403					-.1912	-.1978	
.90	.1007	.1179	.0296	-.0321	-.1581	-.2146	-.1270	-.1632	-.1867	-.1874	-.2001	-.2057	-.3301	-.3297	
.95			.0667	-.0225	-.1488	-.1784	-.1089	-.1529	-.1761	-.1948	-.1860	-.1971			

TAIL 1

Cp at y/b of														
x/c	0.02		0.22		0.44		0.56		0.67		0.83		0.98	
	U.S.	L.S.	U.S.	L.S.	U.S.	L.S.	U.S.	L.S.	U.S.	L.S.	U.S.	L.S.	U.S.	L.S.
.05	-.4297		-.4532		-.4625	.9047	-.4591	1.2998			-.4504	1.3458		
.10	-.2577		-.4660		-.4674	.9372	-.4537	1.2618			-.4456	1.2859	-.4129	1.0528
.15	-.2379		-.4662		-.4663	.9514	-.4522	1.2033			-.4277	1.2238	-.3969	.9763
.20					-.4017	.9682	-.4491	1.0818	-.4178	1.1843	-.4026	1.1620	-.3600	.9040
.25	-.2112	.5680	-.4362		-.4596	.9728			-.4109	1.1293	-.3801	1.1023	-.3264	.8559
.30	-.2403	.4183	-.4203		-.4582	.9742			-.4103	1.0440	-.3626	1.0437	-.2914	.7962
.40	-.1946	.5723			-.4468	.8986	-.4458	.8623	-.4049	.9119	-.3439	.9006	-.2614	.6521
.50			-.3863	.6763			-.4399	.3423					-.2614	.1480
.60			-.3923	.7130	-.4422	.6169			-.3771	.0448	-.3250	-.0621	-.4219	-.1792
.70			-.3640	.6664			-.4191	.1063	-.3850	.0958	-.3297	-.0164	-.4365	-.1394
.80			-.4231	.1135	-.4197	.1143	-.4149	.1194	-.3851	.1116	-.3372	.0293	-.4271	-.0966
.90				-.0408	-.4200	.1387	-.4017	.1425	-.3716	.1231	-.3390	.0562	-.4095	-.0712
.95			-.3187	-.1003	-.4260	.1363			-.3594	.1138	-.3380	.0746		

TAIL 2

TABLE II. - PRESSURE COEFFICIENTS, $\phi = 22.5^\circ$, $\delta = 0^\circ$, $M = 1.60$.
(a) $\alpha = -3.17^\circ$

Cp at y/b of														
x/c	0.02		0.22		0.44		0.56		0.67		0.83		0.98	
	U.S.	L.S.	U.S.	L.S.	U.S.	L.S.	U.S.	L.S.	U.S.	L.S.	U.S.	L.S.	U.S.	L.S.
.05	.0952	.1229	.2775	.1618							.8406	.3719	.6987	.4969
.10	.1060	.1187	.2365	.1598					.7890	.5965	.7688	.6564	.5838	.4562
.15	.1074	.1111	.2078	.1521	.3092	.2083	.5138	.3940			.7102	.6109	.4938	.4603
.20	.1073	.1042							.6234	.4836				
.25	.0952	.0855	.2051	.1513	.2669	.1882			.5783	.4599			.4117	.3648
.30	-.0024	-.0141	.1558	.0960			.4624	.3730	.5603	.4608	.5842	.5045	.3690	.3338
.40	.0558	.0135					.4070	.3425	.4804	.3963	.5005	.4320	.3125	.2822
.50				-.0942			-.0443	-.0776	.1640	-.0164	.3262	.0855	.2077	.0337
.60	.0249	-.0040	.0064	-.0240	-.1509	-.1630	-.2996	-.3005	-.2763	-.2852	-.2770	-.2867	-.2650	-.2619
.70			.0118	-.0226	-.3462	-.3501	-.3336	-.3339			-.3065	-.3053	-.2731	-.2628
.80	-.2305	-.1686	-.2603	-.2694	-.3211	-.3214	-.2323	-.2500					-.2502	-.1819
.90	-.2184	-.2293	-.2714	-.2703	-.3079	-.3150	-.2620	-.2645	-.2864	-.2841	-.2592	-.2688	-.1736	-.1492
.95			-.2508	-.2417	-.2984	-.3129	-.2482	-.2540	-.2814	-.2855	-.2567	-.2614		

TAIL 1

Cp at y/b of														
x/c	0.02		0.22		0.44		0.56		0.67		0.83		0.98	
	U.S.	L.S.	U.S.	L.S.	U.S.	L.S.	U.S.	L.S.	U.S.	L.S.	U.S.	L.S.	U.S.	L.S.
.05	.1464		.4690		.5485	-.1150	.9464	.0099			1.1071	.2492		
.10	.2699		.4185		.4993	-.0293	.8302	.0405			.9441	.3461	.7084	.2725
.15	.2699		.3867		.4624	.0603	.7390	.0898			.8629	.3957	.6123	.2842
.20					.4328	.0914	.6911	.1690	.7717	.2080	.7976	.3885	.5395	.2950
.25	.2461	.0215	.3500		.4267	.0995			.7287	.1951	.7434	.3684	.4851	.2984
.30	.0346	-.0818	.3087		.4396	.1034			.6752	.1944	.6887	.3379	.4438	.2919
.40	.1212	-.0139			.4438	.1736	.5317	.2362	.5898	.2142	.5962	.2823	.3681	.2534
.50			-.0052	-.1806			.0243	-.1254					.2566	.0023
.60			.1723	-.1074	-.1109	-.1946			-.2480	-.3137	-.2487	-.3201	-.2571	-.2683
.70			.1630	-.0641			-.2993	-.3473	-.2815	-.3345	-.2794	-.3385	-.2703	-.1746
.80			-.1712	-.2682	-.2790	-.3295	-.3165	-.3198	-.2910	-.3128	-.2874	-.3065	-.2526	-.1964
.90				.0667	-.2074	-.3216	-.3026	-.3048	-.2983	-.2905	-.2853	-.2976	-.1986	-.2286
.95			-.1662	-.2216	-.1808	-.3120			-.3002	-.2860	-.2752	-.2892		

TAIL 2

TABLE II. - CONTINUED
(b) $\alpha = -1.15^\circ$

Cp at y/b of														
x/c	0.02		0.22		0.44		0.56		0.67		0.83		0.98	
	U.S.	L.S.	U.S.	L.S.	U.S.	L.S.	U.S.	L.S.	U.S.	L.S.	U.S.	L.S.	U.S.	L.S.
.05	.1272	.1089	.2643	.2310							.7983	.4506	.6400	.5723
.10	.1341	.1088	.2488	.2038					.7693	.7185	.7325	.7723	.5370	.5193
.15	.1324	.1054	.2279	.1908	.3036	.2535	.4876	.4753			.6819	.6691	.4563	.4848
.20	.1316	.1051							.6095	.5496	.6373	.6135		
.25	.1175	.0924	.2313	.1890	.2633	.2275			.5668	.5163			.3916	.3737
.30	-.0105	-.0103	.1880	.1401			.4566	.4339	.5515	.5112	.5616	.5463	.3550	.3401
.40	.0586	.0355					.4043	.3883	.4753	.4482	.4809	.4633	.3007	.2824
.50				-.0970			-.0475	-.0545	.1578	.0098	.3096	.0990	.1990	.0261
.60	.0269	.0365	-.0253	-.0152	-.1589	-.1352	-.2979	-.2869	-.2788	-.2722	-.2831	-.2814	-.2721	-.2653
.70			.0086	.0145	-.3486	-.3366	-.3336	-.3186			-.3136	-.3029	-.2824	-.2720
.80	-.2227	-.1454	-.2616	-.2466	-.3160	-.3165	-.2318	-.2422					-.2455	-.1913
.90	-.2225	-.2063	-.2651	-.2415	-.3199	-.3005	-.2565	-.2525	-.2726	-.2878	-.2624	-.2650	-.1774	-.1578
.95			-.2454	-.2202	-.3105	-.2980	-.2423	-.2455	-.2801	-.2854	-.2594	-.2583		

TAIL 1

Cp at y/b of														
x/c	0.02		0.22		0.44		0.56		0.67		0.83		0.98	
	U.S.	L.S.	U.S.	L.S.	U.S.	L.S.	U.S.	L.S.	U.S.	L.S.	U.S.	L.S.	U.S.	L.S.
.05	.1090		.3842		.4682	.1044	.8318	.2390			.9830	.4777		
.10	.1976		.3385		.4260	.2144	.7222	.3031			.8543	.5443	.6149	.4292
.15	.1998		.3167		.3908	.1843	.6333	.3533			.7831	.5143	.5396	.3858
.20					.3636	.1807	.5955	.3622	.6858	.4055	.7239	.4845	.4766	.3567
.25	.1805	.0704	.2822		.3499	.1733			.6499	.4096	.6743	.4675	.4228	.3431
.30	.0008	-.0384	.2539		.3567	.1779			.6024	.3987	.6264	.4497	.3901	.3201
.40	.0812	.0178			.3642	.2094	.4717	.3269	.5302	.3839	.5397	.4091	.3275	.2789
.50			-.0601	-.1342			-.0003	-.0854					.2300	.0118
.60			.0924	-.0548	-.1363	-.1633			-.2628	-.2808	-.2616	-.2768	-.2593	-.2576
.70			.0954	-.0131			-.3146	-.3295	-.2965	-.3106	-.2942	-.3090	-.2666	-.1904
.80			-.2240	-.2416	-.3056	-.3145	-.3233	-.3193	-.3060	-.3162	-.3000	-.2949	-.2222	-.1893
.90				.0685	-.2950	-.3038	-.2952	-.2959	-.2978	-.2850	-.2617	-.2675	-.1714	-.2340
.95			-.1981	-.2183	-.2940	-.2992			-.2769	-.2746	-.2521	-.2622		

TAIL 2

TABLE II. - CONTINUED
(c) $\alpha = 0.84^\circ$

Cp at y/b of															
x/c	0.02		0.22		0.44		0.56		0.67		0.83		0.98		
	U.S.	L.S.	U.S.	L.S.	U.S.	L.S.	U.S.	L.S.	U.S.	L.S.	U.S.	L.S.	U.S.	L.S.	
.05	.1273	.1425	.2762	.2845							.7205	.5230	.5676	.6415	
.10	.1321	.1378	.2570	.2452						.7315	.7924	.6796	.8424	.4857	.5671
.15	.1286	.1313	.2395	.2258	.2931	.2992	.4547	.5590			.6422	.7233	.4255	.5110	
.20	.1325	.1348							.5818	.6103	.6044	.6618			
.25	.1193	.1235	.2443	.2209	.2538	.2659			.5421	.5717			.3794	.3980	
.30	-.0282	-.0100	.2055	.1762			.4387	.4879	.5291	.5670	.5384	.5913	.3466	.3652	
.40	.0484	.0583					.3953	.4334	.4573	.4953	.4600	.4995	.3004	.3077	
.50				-.0753			-.0498	-.0322	.1492	.0248	.2944	.1160	.2072	.0438	
.60	.0263	.0640	-.0547	-.0199	-.1609	-.1188	-.2990	-.2750	-.2822	-.2643	-.2881	-.2741	-.2676	-.2561	
.70			.0033	.0455	-.3506	-.3257	-.3345	-.3072			-.3162	-.2953	-.2818	-.2667	
.80	-.2186	-.1039	-.0269	-.2227	-.3177	-.3181	-.2323	-.2426					-.1889	-.1698	
.90	-.2224	-.1927	-.2546	-.2016	-.3314	-.2939	-.2561	-.2563	-.2691	-.2956	-.2644	-.2792	-.2051	-.1566	
.95			-.2323	-.1823	-.3187	-.2894	-.2418	-.2439	-.2776	-.2938	-.2615	-.2644			

TAIL 1

Cp at y/b of														
x/c	0.02		0.22		0.44		0.56		0.67		0.83		0.98	
	U.S.	L.S.	U.S.	L.S.	U.S.	L.S.	U.S.	L.S.	U.S.	L.S.	U.S.	L.S.	U.S.	L.S.
.05	.1368		.2861		.3611	.3221	.6260	.4625			.6062	.7466		
.10	.1450		.2551		.3368	.2913	.6053	.4895			.7552	.6944	.4835	.5273
.15	.1481		.2451		.3048	.2669	.5108	.4988			.7006	.6538	.4539	.4607
.20					.2832	.2562	.4900	.4795	.5662	.5514	.6443	.6175	.4136	.4199
.25	.1311	.1099	.2181		.2710	.2457			.5365	.5339	.5994	.5893	.3721	.4024
.30	-.0174	-.0051	.1959		.2726	.2513			.5018	.5092	.5546	.5627	.3451	.3733
.40	.0489	.0415			.2809	.2633	.3965	.4031	.4471	.4756	.4762	.4948	.2876	.3190
.50			-.1047	-.0857			-.0334	-.0527					.1994	.0245
.60			.0034	-.0023	-.1664	-.1186			-.2810	-.2582	-.2751	-.2557	-.2656	-.2497
.70			.0269	.0365			-.3312	-.3137	-.3138	-.2917	-.3084	-.2891	-.2895	-.2644
.80			-.2606	-.2115	-.3137	-.3186	-.3305	-.3142	-.3037	-.3023	-.2876	-.2977	-.1933	-.1765
.90				.0651	-.3161	-.2918	-.2972	-.2919	-.2710	-.3046	-.2617	-.2655	-.1758	-.1699
.95			-.2245	-.2038	-.3161	-.2882			-.2670	-.2884	-.2593	-.2537		

TAIL 2

TABLE II. - CONTINUED
(d) $\alpha = 2.87^\circ$

Cp at y/b of														
x/c	0.02		0.22		0.44		0.56		0.67		0.83		0.98	
	U.S.	L.S.	U.S.	L.S.	U.S.	L.S.	U.S.	L.S.	U.S.	L.S.	U.S.	L.S.	U.S.	L.S.
.05	.1097	.1815	.2864	.3379							.5804	.6132	.4739	.7183
.10	.1148	.1711	.2545	.2915					.6887	.8530	.6014	.8844	.4233	.6270
.15	.1136	.1567	.2494	.2674	.2742	.3542	.4208	.6346			.5929	.7663	.3933	.5415
.20	.1157	.1628							.5491	.6807		.5638	.7036	
.25	.1016	.1473	.2496	.2520	.2354	.3105			.5133	.6365			.3644	.4279
.30	-.0532	-.0145	.2178	.2061			.4027	.5419	.5009	.6252	.5080	.6277	.3385	.3986
.40	.0221	.0693					.3710	.4802	.4284	.5430	.4350	.5301	.3000	.3383
.50				-.0554			-.0624	-.0093	.1348	.0481	.2781	.1364	.2145	.0684
.60	.0255	.0911	-.0816	-.0066	-.1688	-.1070	-.3038	-.2630	-.2854	-.2495	-.2955	-.2667	-.2606	-.2446
.70			-.0018	.0973	-.3507	-.3153	-.3385	-.2951			-.3239	-.2870	-.2549	-.2517
.80	-.2191	-.0590	-.2634	-.1865	-.3232	-.3141	-.2307	-.2357					-.1850	-.1577
.90	-.2227	-.1767	-.2416	-.1496	-.3335	-.2927	-.2589	-.2627	-.2701	-.2873	-.2754	-.2807	-.2606	-.1517
.95			-.2200	-.1372	-.3145	-.2857	-.2445	-.2424	-.2788	-.3006	-.2707	-.2639		

TAIL 1

Cp at y/b of														
x/c	0.02		0.22		0.44		0.56		0.67		0.83		0.98	
	U.S.	L.S.	U.S.	L.S.	U.S.	L.S.	U.S.	L.S.	U.S.	L.S.	U.S.	L.S.	U.S.	L.S.
.05	.0945		.2118		.2321	.4207	.3214	.6533			.2606	.9175		
.10	.0947		.1770		.2465	.3739	.4713	.6540			.6096	.8277	.3067	.6350
.15	.0985		.1719		.2247	.3405	.3922	.6269			.5745	.7681	.3666	.5499
.20					.2080	.3244	.3668	.5889	.4534	.6683	.5340	.7218	.3599	.4918
.25	.0826	.1456	.1625		.1977	.3066			.4279	.6388	.5011	.6826	.3343	.4632
.30	-.0375	.0241	.1422		.1963	.3135			.3964	.5952	.4613	.6458	.3045	.4255
.40	.0198	.0601			.2057	.3166	.3126	.4662	.3521	.5476	.4005	.5589	.2533	.3487
.50			-.1393	-.0441			-.0732	-.0246					.1732	.0340
.60			-.0488	.0674	-.1970	-.0883			-.3029	-.2410	-.2923	-.2400	-.2731	-.2504
.70			-.0273	.0913			-.3494	-.3011	-.3325	-.2753	-.3265	-.2727	-.3085	-.2562
.80			-.2854	-.1892	-.3306	-.2845	-.3202	-.3223	-.3163	-.2875	-.2966	-.2824	-.1789	-.2344
.90				.0588	-.3391	-.2456	-.3030	-.3091	-.2900	-.2969	-.2790	-.2862	-.2087	-.1916
.95			-.2183	-.1806	-.3294	-.2156			-.2853	-.3029	-.2763	-.2779		

TAIL 2

TABLE II. - CONTINUED
(e) $\alpha = 4.85^\circ$

Cp at y/b of														
x/c	0.02		0.22		0.44		0.56		0.67		0.83		0.98	
	U.S.	L.S.	U.S.	L.S.	U.S.	L.S.	U.S.	L.S.	U.S.	L.S.	U.S.	L.S.	U.S.	L.S.
.05	.0852	.2272	.2814	.3913							.4410	.7077	.3892	.7762
.10	.0961	.2129	.2558	.3381					.6348	.9183	.4887	.9359	.3489	.6701
.15	.0991	.1918	.2578	.3095	.2551	.4082	.3862	.7034			.5488	.8146	.3428	.5713
.20	.0964	.1995							.5119	.7409	.5219	.7488		
.25	.0813	.1782	.2506	.2847	.2215	.3627			.4761	.6922			.3442	.4579
.30	-.0767	-.0069	.2252	.2352			.3743	.5995	.4679	.6752	.4760	.6645	.3304	.4295
.40	-.0110	-.0782					.3444	.5239	.3960	.5830	.4110	.5610	.3014	.3705
.50				-.0398			-.0723	.0071	.1099	.0563	.2641	.1531	.2234	.0896
.60	.0175	.1254	-.1335	.0273	-.1782	-.0987	-.3087	-.2562	-.2894	-.2376	-.3004	-.2595	-.2538	-.2349
.70			-.0191	.1556	-.3412	-.3061	-.3430	-.2886			-.3292	-.2788	-.1652	-.2417
.80	-.2118	-.0176	-.2568	-.1253	-.3272	-.3031	-.2314	-.2323					-.1857	-.1491
.90	-.2172	-.1542	-.2270	-.1010	-.3331	-.2869	-.2628	-.2675	-.2719	-.2806	-.2823	-.2668	-.2810	-.1470
.95			-.2016	-.1033	-.3156	-.2814	-.2504	-.2475	-.2832	-.2968	-.2782	-.2509		

TAIL 1

Cp at y/b of														
x/c	0.02		0.22		0.44		0.56		0.67		0.83		0.98	
	U.S.	L.S.	U.S.	L.S.	U.S.	L.S.	U.S.	L.S.	U.S.	L.S.	U.S.	L.S.	U.S.	L.S.
.05	.0530		.0391		-.0698	.4842	.0211	.8120			.0811	1.0266		
.10	.0526		.0909		.1079	.4378	.1360	.7801			.2680	.9235	.1820	.7149
.15	.0555		.0965		.1530	.3963	.2453	.7332			.3847	.8507	.2363	.6207
.20					.1395	.3774	.2686	.6702	.2287	.7553	.3893	.7944	.2443	.5490
.25	.0473	.1861	.1066		.1256	.3586			.2475	.7165	.3721	.7488	.2501	.5135
.30	-.0521	.0472	.0876		.1258	.3705			.2676	.6661	.3315	.7064	.2480	.4700
.40	.0065	-.0886			.1185	.3591	.2223	.5148	.2567	.6039	.2650	.6078	.2081	.3764
.50			-.1545	-.0078			-.1126	-.0049					.1307	.0402
.60			-.0800	.1350	-.2246	-.0342			-.3321	-.2271	-.3233	-.2274	-.2914	-.2583
.70			-.0647	.1376			-.3659	-.2877	-.3567	-.2610	-.3489	-.2559	-.2681	-.2546
.80			-.3020	-.1727	-.3496	-.2109	-.3315	-.2945	-.3225	-.2728	-.3130	-.2654	-.2036	-.2233
.90				.0533	-.3520	-.1509	-.3214	-.2806	-.3111	-.2831	-.3027	-.2748	-.2321	-.2146
.95			-.1709	-.1600	-.3373	-.1487			-.3067	-.2930	-.2994	-.2838		

TAIL 2

TABLE II. - CONTINUED
(f) $\alpha = 6.86^\circ$

Cp at y/b of														
x/c	0.02		0.22		0.44		0.56		0.67		0.83		0.98	
	U.S.	L.S.	U.S.	L.S.	U.S.	L.S.	U.S.	L.S.	U.S.	L.S.	U.S.	L.S.	U.S.	L.S.
.05	.0624	.2766	.2841	.4476							.3476	.7836	.3428	.8707
.10	.0765	.2569	.2575	.3854					.5655	.9803	.3750	.9776	.3084	.7104
.15	.0821	.2300	.2581	.3536	.2385	.4665	.3624	.7719			.4797	.8577	.3071	.6070
.20	.0767	.2385							.4656	.7971	.4731	.7869		
.25	.0655	.2110	.2536	.3205	.2087	.4339			.4414	.7446			.3077	.4920
.30	-.0879	.0138	.2246	.2692			.3445	.6560	.4362	.7213	.4363	.6984	.3042	.4666
.40	-.0356	.0923					.3126	.5606	.3650	.6145	.3793	.5897	.2950	.4005
.50				-.0178			-.0845	.0170	.0940	.0625	.2449	.1667	.2222	.1099
.60	.0031	.1674	-.1765	-.0404	-.1873	-.0892	-.3158	-.2496	-.2990	-.2311	-.3053	-.2517	-.2448	-.2241
.70			-.0710	.2359	-.3311	-.2997	-.3406	-.2834			-.3340	-.2703	-.1872	-.2223
.80	-.2042	.0218	-.2504	-.0716	-.3277	-.2901	-.2152	-.2271					-.1844	-.1377
.90	-.2038	-.1234	-.2202	-.0712	-.3249	-.2773	-.2524	-.2621	-.2766	-.2717	-.2848	-.2656	-.2457	-.1382
.95			-.1603	-.0760	-.3097	-.2728	-.2420	-.2470	-.2882	-.2900	-.2786	-.2505		

TAIL 1

Cp at y/b of														
x/c	0.02		0.22		0.44		0.56		0.67		0.83		0.98	
	U.S.	L.S.	U.S.	L.S.	U.S.	L.S.	U.S.	L.S.	U.S.	L.S.	U.S.	L.S.	U.S.	L.S.
.05	.0094		-.1237		-.2175	.5396	-.1359	.9174			-.0324	1.0924		
.10	.0136		-.0297		-.1423	.4922	-.0687	.8631			-.1215	.9854	.0858	.7710
.15	.0193		.0237		-.0557	.4485	-.0501	.8059			.2050	.9108	.1345	.6783
.20					.0033	.4258	-.0206	.7242	.0907	.8209	.2585	.8494	.1872	.6058
.25	.0234	.2227	.0493		.0411	.4032			.0703	.7783	.2506	.7987	.1883	.5654
.30	-.0445	.0712	.0334		.0548	.4111			.0532	.7187	.2346	.7528	.1870	.5183
.40	.0024	.1297			.0420	.4094	.1398	.5542	.0395	.6453	.1707	.6470	.1771	.4177
.50			-.1488	-.1091			-.1640	.0121					.1122	.0564
.60			-.0870	.1847	-.2459	.0562			-.3704	-.2158	-.3680	-.2089	-.3036	-.2607
.70			-.0832	.1776			-.3729	-.2667	-.3620	-.2470	-.3674	-.2389	-.2600	-.2592
.80			-.3116	-.1535	-.3638	-.1307	-.3473	-.2440	-.3411	-.2564	-.3516	-.2491	-.2426	-.2386
.90				.0537	-.3668	-.1231	-.3367	-.2367	-.3354	-.2649	-.3463	-.2570	-.2475	-.2202
.95			-.1747	-.1373	-.3500	-.1357			-.3272	-.2748	-.3413	-.2684		

TAIL 2

TABLE II. - CONTINUED
(g) $\alpha = 8.85^\circ$

Cp at γ/b of														
x/c	0.02		0.22		0.44		0.56		0.67		0.83		0.98	
	U.S.	L.S.	U.S.	L.S.	U.S.	L.S.	U.S.	L.S.	U.S.	L.S.	U.S.	L.S.	U.S.	L.S.
.05	.0433	.3249	.2711	.5046							.2773	.8573	.3091	.9668
.10	.0588	.3016	.2458	.4364							.3065	1.0184	.2855	.7519
.15	.0667	.2722	.2515	.3998	.2357	.5342	.3339	.8280			.3914	.8980	.2904	.6474
.20	.0612	.2802							.3819	.8435	.4194	.8255		
.25	.0546	.2487	.2538	.3623	.2020	.5374			.3832	.7854			.2893	.5304
.30	-.0973	.0393	.2188	.3102			.3098	.6906	.3994	.7568	.3926	.7279	.2840	.5047
.40	-.0614	.1138					.2797	.5843	.3360	.6440	.3376	.6178	.2793	.4351
.50				.0089			-.1004	.0243	.0723	.0726	.2161	.1761	.2137	.1307
.60	-.0068	.2173	-.2072	.0770	-.1963	-.0823	-.3226	-.2466	-.3080	-.2263	-.3131	-.2438	-.2508	-.2120
.70			-.1374	.3460	-.3216	-.2937	-.3087	-.2794			-.3378	-.2615	-.1947	-.1953
.80	-.1887	.0605	-.2691	-.0296	-.3233	-.2727	-.2078	-.2221					-.2350	-.1252
.90	-.1888	-.0740	-.2258	-.0406	-.3145	-.2687	-.2476	-.2545	-.2824	-.2624	-.2876	-.2645	-.3196	-.1258
.95			-.0929	-.0469	-.2981	-.2493	-.2379	-.2464	-.2930	-.2811	-.2828	-.2558		

TAIL 1

Cp at γ/b of														
x/c	0.02		0.22		0.44		0.56		0.67		0.83		0.98	
	U.S.	L.S.	U.S.	L.S.	U.S.	L.S.	U.S.	L.S.	U.S.	L.S.	U.S.	L.S.	U.S.	L.S.
.05	-.0200		-.2411		-.3028	.5788	-.2350	.9920			-.1208	1.1393		
.10	-.0094		-.1359		-.2673	.5308	-.2025	.9267			-.0137	1.0355	-.0129	.8295
.15	-.0040		-.0558		-.2139	.4820	-.1801	.8598			.0896	.9623	.0424	.7366
.20					-.1733	.4589	-.1518	.7596	-.0091	.8724	.1244	.9008	.0971	.6606
.25	-.0019	.2558	-.0010		-.1259	.4374			-.0285	.8260	.1330	.8479	.1249	.6189
.30	-.0462	.1004	-.0210		-.0684	.4471			-.0503	.7623	.1289	.7994	.1249	.5645
.40	-.0088	.1686			-.0254	.4479	-.0739	.5865	-.0748	.6816	.1025	.6895	.1239	.4532
.50			-.1149	.1866			-.2329	.0255					.0729	.0681
.60			-.0912	.2183	-.2732	.1697			-.3759	-.2027	-.3894	-.2015	-.3181	-.2624
.70			-.0992	.2040			-.3846	-.2094	-.3791	-.2306	-.3666	-.2289	-.2912	-.2595
.80			-.3246	-.1367	-.3861	-.1017	-.3704	-.1921	-.3794	-.2349	-.3699	-.2346	-.2716	-.2472
.90				.0432	-.3678	-.1084	-.3274	-.1628	-.3774	-.2302	-.3627	-.2398	-.2787	-.2317
.95			-.1852	-.1177	-.3198	-.1116			-.3702	-.2375	-.3509	-.2506		

TAIL 2

TABLE II. - CONTINUED
(h) $\alpha = 10.86^\circ$

Cp at y/b of														
x/c	0.02		0.22		0.44		0.56		0.67		0.83		0.98	
	U.S.	L.S.	U.S.	L.S.	U.S.	L.S.	U.S.	L.S.	U.S.	L.S.	U.S.	L.S.	U.S.	L.S.
.05	.0280	.3839	.1898	.5625							.2298	.9335	.2769	1.0040
.10	.0492	.3563	.2430	.4889					.4629	1.0733	.2625	1.0600	.2735	.7828
.15	.0555	.3197	.2386	.4537	.2089	.5874	.2414	.8705			.3260	.9388	.2785	.6832
.20	.0405	.3268							.3296	.8805	.3576	.8613		
.25	.0262	.2908	.2574	.4047	.1992	.6221			.3069	.8184			.2790	.5654
.30	-.1191	.0685	.2209	.3439			.2807	.7218	.3271	.7854	.3621	.7597	.2709	.5402
.40	-.0806	.1372					.2549	.6105	.2943	.6667	.3111	.6459	.2564	.4640
.50				.0374			-.1178	.0351	.0548	.0803	.1850	.1855	.1928	.1475
.60	-.0182	.2761	.2265	.1253	-.2070	-.0655	-.3227	-.2384	-.3166	-.2187	-.3267	-.2361	-.2537	-.2025
.70			-.1747	.4466	-.3046	-.2789	-.2958	-.2670			-.3367	-.2531	.2215	-.1751
.80	-.1860	.1087	-.2947	.0100	-.3139	-.2535	-.2042	-.2095					-.2856	-.1115
.90	-.1694	.0302	-.2232	-.0047	-.2978	-.2470	-.2404	-.2374	-.2822	-.2503	-.2989	-.2580	-.3706	-.1112
.95			-.0764	-.0165	-.2796	-.1898	-.2276	-.2287	-.2896	-.2679	-.2922	-.2562		

TAIL 1

Cp at y/b of														
x/c	0.02		0.22		0.44		0.56		0.67		0.83		0.98	
	U.S.	L.S.	U.S.	L.S.	U.S.	L.S.	U.S.	L.S.	U.S.	L.S.	U.S.	L.S.	U.S.	L.S.
.05	-.0296		-.3322		-.3468	.6043	-.3090	1.0370			-.1949	1.1846		
.10	-.0242		-.2003		-.3426	.5562	-.3035	.9817			-.1275	1.0869	-.0971	.8730
.15	-.0236		-.1191		-.3287	.5060	-.2839	.9096			-.0181	1.0143	-.0535	.7807
.20					-.3034	.4811	-.2437	.7764	-.0993	.9252	.0163	.9502	-.0004	.7034
.25	-.0288	.2764	-.0562		-.2679	.4602			-.1184	.8778	.0253	.8971	.0523	.6580
.30	-.0678	.1298	-.0765		-.2199	.4700			-.1368	.8100	.0225	.8464	.0618	.6027
.40	-.0256	.2097			-.1099	.4678	-.2039	.6293	-.1567	.7219	.0063	.7292	.0506	.4818
.50			-.1233	.2334			-.3264	.0469					.0201	.0763
.60			-.1169	.2430	-.2960	.3339			-.3780	-.1861	-.3598	-.1881	-.3393	-.2751
.70			-.1246	.2416			-.3890	-.1445	-.3864	-.2066	-.3661	-.2150	-.3169	-.2825
.80			-.3261	-.1201	-.3933	-.0818	-.3906	-.1083	-.3882	-.1885	-.3652	-.2176	-.3070	-.2695
.90				.0365	-.3055	-.0820	-.3760	-.0965	-.3788	-.1743	-.3602	-.2183	-.3056	-.2594
.95			-.2091	-.0984	-.2319	-.0855			-.3673	-.1844	-.3546	-.2284		

TAIL 2

TABLE II. - CONTINUED
(1) $\alpha = 12.86^\circ$

Cp at γ/b of														
x/c	0.02		0.22		0.44		0.56		0.67		0.83		0.98	
	U.S.	L.S.	U.S.	L.S.	U.S.	L.S.	U.S.	L.S.	U.S.	L.S.	U.S.	L.S.	U.S.	L.S.
.05	.0043	.4328	.1183	.6234							.1883	.9868	.2414	1.0473
.10	.0230	.4074	.2385	.5467					.4131	1.1195	.2205	1.0932	.2542	.8226
.15	.0301	.3633	.2258	.5066	.1736	.6819	.1528	.9147			.2682	.9721	.2589	.7210
.20	.0212	.3675							.3033	.9225	.2994	.8947		
.25	.0128	.3275	.2617	.4499	.2041	.7142			.2742	.8578			.2623	.6025
.30	-.1272	.0394	.2167	.3827			.2358	.7539	.2792	.8210	.3129	.7896	.2577	.5803
.40	-.0796	.1756					.2194	.6360	.2303	.6948	.2858	.6736	.2418	.5018
.50				.0885			-.1287	.0451	.0128	.0904	.1705	.1967	.1830	.1736
.60	-.0582	.3577	-.2369	.2898	-.2193	-.0538	-.2664	-.2297	-.3107	-.2133	-.3322	-.2286	-.2609	-.1887
.70			-.1958	.5270	-.2713	-.2507	-.2816	-.2532			-.3209	-.2440	-.2480	-.1256
.80	-.1875	.2197	-.3012	.0914	-.2863	-.2339	-.1973	-.1941					-.3443	-.0842
.90	-.1430	.1166	-.2649	.0627	-.2710	-.1413	-.2287	-.2140	-.2691	-.2357	-.2983	-.2424	-.3833	-.0899
.95			-.1583	.0498	-.2584	-.0867	-.2164	-.2087	-.2718	-.2541	-.2935	-.2407		

TAIL 1

Cp at γ/b of														
x/c	0.02		0.22		0.44		0.56		0.67		0.83		0.98	
	U.S.	L.S.	U.S.	L.S.	U.S.	L.S.	U.S.	L.S.	U.S.	L.S.	U.S.	L.S.	U.S.	L.S.
.05	-.0462		-.3523		-.3804	.6164	-.3556	1.0892			-.2665	1.2181		
.10	-.0438		-.2319		-.3810	.5740	-.3556	1.0371			-.2058	1.1262	-.1844	.9024
.15	-.0443		-.1660		-.3733	.5248	-.3480	.9579			-.1171	1.0531	-.1345	.8133
.20					-.3634	.5011	-.3216	.7678	-.1799	.9779	-.0878	.9896	-.0837	.7370
.25	-.0501	.2779	-.1159		-.3480	.4866			-.1939	.9278	-.0763	.9340	-.0415	.6911
.30	-.0986	.1448	-.1312		-.3219	.5010			-.2118	.8564	-.0749	.8810	-.0088	.6350
.40	-.0503	.2436			-.2472	.5057	-.2783	.6859	-.2272	.7584	-.0843	.7588	-.0090	.5083
.50			-.1583	.2749			-.3832	.0698					-.0340	.0833
.60			-.1356	.2731	-.3002	.3973			-.3781	-.1672	-.3352	-.1748	-.3627	-.2662
.70			-.1463	.2776			-.3945	-.0691	-.3875	-.1730	-.3432	-.1960	-.3482	-.2724
.80			-.3240	-.0914	-.3880	-.0623	-.3972	-.0723	-.3911	-.1341	-.3449	-.1942	-.3291	-.2619
.90				.0170	-.3130	-.0552	-.3932	-.0778	-.3845	-.1170	-.3452	-.1920	-.3174	-.2595
.95			-.2417	-.0806	-.2472	-.0650			-.3739	-.1194	-.3406	-.2013		

TAIL 2

TABLE II. - CONTINUED
(j) $\alpha = 16.84^\circ$

Cp at y/b of														
x/c	0.02		0.22		0.44		0.56		0.67		0.83		0.98	
	U.S.	L.S.	U.S.	L.S.	U.S.	L.S.	U.S.	L.S.	U.S.	L.S.	U.S.	L.S.	U.S.	L.S.
.05	-.0143	.5452	.0356	.7322							.0945	1.1157	.1922	1.1142
.10	.0135	.5154	.1957	.6544					.2936	1.2105	.1334	1.1662	.2509	.9129
.15	.0249	.4600	.2001	.6051	.1415	.9120	-.0170	1.0221			.1771	1.0533	.2561	.8164
.20	.0115	.4653							.2233	1.0160	.2112	.9734		
.25	.0009	.4127	.2629	.5343	.1966	.8852			.2124	.9490			.2561	.6976
.30	-.1422	.1714	.2432	.4657			.1056	.8599	.2204	.9070	.2329	.8629	.2478	.6702
.40	-.0773	.3705					.1254	.7217	.1389	.7692	.2310	.7420	.2329	.5896
.50				.5919			-.1695	.1012	-.0744	.1222	.1414	.2426	.1774	.2270
.60	-.0988	.7279	-.2358	.6744	-.2489	.1628	-.2586	-.1812	-.2713	-.1856	-.3360	-.2057	-.2820	-.1581
.70			-.2315	.5860	-.2466	-.0297	-.2721	-.1751			-.3109	-.2143	-.3554	-.0668
.80	-.1764	.2564	-.2860	.0882	-.2595	-.0510	-.1890	-.0936					-.4204	-.0252
.90	-.1353	.0909	-.2892	.0362	-.2575	-.0552	-.2210	-.1050	-.2716	-.1807	-.2915	-.1946	-.3989	-.0291
.95			-.2529	.0229	-.2516	-.0576	-.2130	-.1037	-.2717	-.1930	-.2761	-.1949		

TAIL 1

Cp at y/b of														
x/c	0.02		0.22		0.44		0.56		0.67		0.83		0.98	
	U.S.	L.S.	U.S.	L.S.	U.S.	L.S.	U.S.	L.S.	U.S.	L.S.	U.S.	L.S.	U.S.	L.S.
.05	-.0393		-.3753		-.4004	.6110	-.3702	1.1816			-.3898	1.2594		
.10	-.0580		-.3624		-.4087	.5876	-.3537	1.1086			-.3470	1.1735	-.3357	.9315
.15	-.0651		-.3429		-.4087	.5494	-.3561	1.0366			-.2957	1.1013	-.3054	.8502
.20					-.3956	.5416	-.3543	.8191	-.3141	1.0376	-.2653	1.0384	-.2599	.7769
.25	-.0677	.1907	-.2850		-.4023	.5578			-.3147	.9871	-.2496	.9813	-.2235	.7302
.30	-.1554	.1226	-.2152		-.3938	.5665			-.3173	.9108	-.2423	.9262	-.1995	.6752
.40	-.1086	.2716			-.3774	.6426	-.3744	.7453	-.3179	.7977	-.2441	.7968	-.1555	.5448
.50			-.1885	.3300			-.4301	.1119					-.1689	.0963
.60			-.1871	.3265	-.3349	.4394			-.4153	-.1272	-.3588	-.1478	-.3975	-.2454
.70			-.1879	.3228			-.4334	-.0242	-.4222	-.0921	-.3649	-.1558	-.3958	-.2410
.80			-.3482	-.0422	-.4334	-.0250	-.4182	-.0266	-.4255	-.0468	-.3746	-.1384	-.3778	-.2242
.90				-.0014	-.3902	-.0296	-.3963	-.0240	-.4210	-.0259	-.3745	-.1230	-.3574	-.2185
.95			-.2676	-.0600	-.3398	-.0408			-.4059	-.0356	-.3703	-.1299		

TAIL 2

TABLE II. - CONCLUDED
(k) $\alpha = 20.87^\circ$

Cp at y/b of														
x/c	0.02		0.22		0.44		0.56		0.67		0.83		0.98	
	U.S.	L.S.	U.S.	L.S.	U.S.	L.S.	U.S.	L.S.	U.S.	L.S.	U.S.	L.S.	U.S.	L.S.
.05	-.0161	.6720	.0477	.8959							.0251	1.2453	.1557	1.2159
.10	.0238	.6351	.0911	.8444					.2099	1.2984	.0624	1.2562	.2700	1.0320
.15	.0411	.5836	.1837	.8149	-.0148	.2950	-.1577	1.1080			.1183	1.1423	.2988	.9315
.20	.0230	.6093							.1456	1.1004	.1536	1.0634		
.25	.0172	.6236	.4228	.7844	.1050	.4870			.1527	1.0296			.2944	.8089
.30	-.1265	.4373	.3934	.7404			-.0472	.9291	.1794	.9820	.1996	.9476	.2872	.7741
.40	-.0629	.7436					-.0113	.7735	.1054	.8303	.2397	.8157	.2787	.6885
.50				.7599			-.2462	.1335	-.1030	.1478	.1647	.2794	.2033	.2809
.60	-.0971	.7887	-.2388	.7262	-.2678	.2149	-.2350	-.1539	-.2479	-.1632	-.3314	-.1810	-.2821	-.1176
.70			-.2555	.6358	-.2313	-.0002	-.2455	-.1347			-.3015	-.1817	-.4000	.0382
.80	-.1405	.2775	-.2516	.0583	-.2310	-.0142	-.1669	-.0574					-.4067	.0509
.90	-.1315	.1052	-.2544	.0374	-.2276	-.0138	-.2000	-.0679	-.2652	-.1407	-.2706	-.1352	-.3950	.0503
.95			-.2393	.0320	-.2229	-.0155	-.1888	-.0519	-.2649	-.1532	-.2547	-.1439		

TAIL 1

Cp at y/b of														
x/c	0.02		0.22		0.44		0.56		0.67		0.83		0.98	
	U.S.	L.S.	U.S.	L.S.	U.S.	L.S.	U.S.	L.S.	U.S.	L.S.	U.S.	L.S.	U.S.	L.S.
.05	-.0604		-.3939		-.4223	.5833	-.4216	1.0860			-.4573	1.2480		
.10	-.0950		-.4133		-.4322	.5866	-.4117	1.0743			-.4441	1.1843	-.4254	.9469
.15	-.1129		-.4190		-.4389	.5703	-.4093	1.0327			-.4213	1.1216	-.4137	.8820
.20					-.4054	.5656	-.3996	.8495	-.4043	1.0528	-.3966	1.0622	-.3937	.8195
.25	-.1112	.1322	-.3499		-.4510	.5521			-.3836	1.0060	-.3793	1.0072	-.3730	.7784
.30	-.1931	.0962	-.2963		-.4537	.6064			-.3707	.9317	-.3691	.9535	-.3515	.7283
.40	-.1371	.2704			-.4413	.7005	-.4314	.7646	-.3508	.8145	-.3657	.8224	-.3153	.5928
.50			-.2360	.4001			-.4663	.2254					-.3092	.1144
.60			-.2279	.3867	-.4381	.5227			-.4503	-.0125	-.4303	-.1054	-.4053	-.2066
.70			-.2220	.3786			-.4572	.0484	-.4238	.0523	-.4305	-.0666	-.4067	-.1793
.80			-.3668	.0027	-.4496	.0458	-.4558	.0564	-.3960	.0620	-.4342	-.0202	-.3865	-.1474
.90				.0261	-.3819	.0459	-.4494	.0681	-.3879	.0677	-.4262	.0276	-.3778	-.1278
.95			-.2555	.0302	-.3500	.0372			-.3767	.0595	-.4186	.0385		

TAIL 2

TABLE III. - PRESSURE COEFFICIENTS, $\phi = 45^\circ$, $\delta = 0^\circ$, $M = 1.60$.
(a) $\alpha = -2.94^\circ$

Cp at y/b of														
x/c	0.02		0.22		0.44		0.56		0.67		0.83		0.98	
	U.S.	L.S.	U.S.	L.S.	U.S.	L.S.	U.S.	L.S.	U.S.	L.S.	U.S.	L.S.	U.S.	L.S.
.05	.1360	.0687	.4041	.0720							.9348	.2285	.7663	.3158
.10	.1494	.0684	.2028	.1118							.8498	.4088	.6378	.3050
.15	.1532	.0648	.1902	-.1080	-.3697	-.2007	.5979	.3160			.7797	.5178	.5403	.3883
.20	.1525	.0613							.6973	.3449	.7229	.4729		
.25	.1389	.0481	.1955	.1096	.3237	.2419			.6466	.3676			.4449	.3135
.30	.0211	-.0155	.1460	.0645			.5236	.3100	.6217	.3856	.6330	.4034	.3969	.2723
.40	.0918	.0046					.4583	.2806	.5341	.3370	.5417	.3568	.3257	.2163
.50			-.0435	-.1020			-.0193	-.1093	.1936	-.0499	.3539	.0384	.2136	-.0164
.60	.0640	-.0062	.0536	-.0426	-.1332	-.1860	-.2901	-.3126	-.2666	-.3032	-.2685	-.3096	-.2743	-.2877
.70			.0546	-.0287	-.3298	-.3634	-.3247	-.3438			-.2972	-.3287	-.2889	-.3160
.80	-.2091	-.2000	-.2412	-.2715	-.3104	-.3352	-.2291	-.2559					-.2805	-.1893
.90	-.2029	-.2070	-.2468	-.2757	-.2877	-.3269	-.2510	-.2648	-.3050	-.2875	-.2810	-.2836	-.2242	-.2094
.95			-.2263	-.2306	-.2571	-.3179	-.2389	-.2553	-.3056	-.2956	-.2683	-.2788		

TAIL 1

Cp at y/b of														
x/c	0.02		0.22		0.44		0.56		0.67		0.83		0.98	
	U.S.	L.S.	U.S.	L.S.	U.S.	L.S.	U.S.	L.S.	U.S.	L.S.	U.S.	L.S.	U.S.	L.S.
.05	.0557	.1236	.4567	.1675	.5398	-.0240	.9166	.1189			1.0699	.3317		
.10	.2520	.1642	.4043	.2888	.4895	.0931	.8043	.1597			.9159	.4448	.6757	.3334
.15	.2511	.1581	.3691	.1746	.4499	.1703	.7128	.2413			.8352	.4693	.5856	.3261
.20					.4224	.1596	.6670	.3172	.7534	.2936	.7704	.4434	.5171	.3298
.25	.2265	.0284	.3210	.1740	.4142	.1437			.7124	.2988	.7182	.4175	.4671	.3298
.30	.0135	-.0882	.2902	.1304	.4282	.1466			.6577	.3201	.6656	.3883	.4338	.3187
.40	.0951	-.0045			.4502	.2024	.5202	.2826	.5747	.3303	.5763	.3383	.3673	.2784
.50			-.0357	-.1755			.0182	-.1079					.2682	.0213
.60			.1592	-.0925	-.1195	-.1852			-.2530	-.2967	-.2530	-.2956	-.2454	-.2577
.70			.1611	-.0328			-.3027	-.3380	-.2851	-.3234	-.2851	-.3220	-.2461	-.1559
.80			-.1702	-.2498	-.2980	-.3199	-.3191	-.3121	-.2930	-.3203	-.2921	-.2963	-.1852	-.1807
.90					-.2771	-.3130	-.2948	-.2946	-.2990	-.2871	-.2572	-.2771	-.1635	-.2151
.95			-.1615	-.2067	-.2563	-.3015			-.2906	-.2798	-.2456	-.2712		

TAIL 2

TABLE III. - CONTINUED
(b) $\alpha = -0.95^\circ$

Cp at y/b of														
x/c	0.02		0.22		0.44		0.56		0.67		0.83		0.98	
	U.S.	L.S.	U.S.	L.S.	U.S.	L.S.	U.S.	L.S.	U.S.	L.S.	U.S.	L.S.	U.S.	L.S.
.05	.1461	.0990	.2976	.1963							.8462	.3693	.6794	.5178
.10	.1523	.1002	.2453	.1807							.7739	.6991	.5638	.4496
.15	.1515	.0983	.2221	.1679	.3397	.2369	.5401	.4388			.7156	.6447	.4801	.4562
.20	.1513	.0992							.6431	.5141	.6687	.5926		
.25	.1380	.0878	.2203	.1696	.2985	.2716			.5971	.4841			.4092	.3579
.30	-.0020	-.0140	.1766	.1238			.4826	.4047	.5792	.4762	.5897	.5262	.3699	.3238
.40	.0705	.0296					.4253	.3661	.4986	.4095	.5031	.4444	.3129	.2687
.50			-.0729	-.1114			-.0389	-.0696	.1736	-.0093	.3256	.0875	.2094	.0173
.60	.0436	.0314	.0032	-.0489	-.1526	-.1509	-.2933	-.2931	-.2734	-.2831	-.2782	-.2872	-.2709	-.2700
.70			.0351	.0019	-.3456	-.3429	-.3308	-.3267			-.3094	-.3094	-.2781	-.2885
.80	-.2105	-.1523	-.2445	-.2533	-.3123	-.3299	-.2326	-.2574					-.2547	-.1766
.90	-.2119	-.2052	-.2498	-.2448	-.3136	-.3121	-.2552	-.2640	-.2790	-.2742	-.2619	-.2663	-.1789	-.1787
.95			-.2327	-.2208	-.3054	-.3079	-.2428	-.2550	-.2807	-.2784	-.2586	-.2623		

TAIL 1

Cp at y/b of														
x/c	0.02		0.22		0.44		0.56		0.67		0.83		0.98	
	U.S.	L.S.	U.S.	L.S.	U.S.	L.S.	U.S.	L.S.	U.S.	L.S.	U.S.	L.S.	U.S.	L.S.
.05	.0961	.1412	.3785	.2646	.4532	.1743	.8161	.3215			.9175	.5644		
.10	.1961	.1553	.3341	.3188	.4118	.2334	.7135	.3688			.8507	.5836	.5902	.4650
.15	.1964	.1618	.3092	.2085	.3762	.2078	.6218	.4022			.7768	.5544	.5237	.4037
.20			.3498	.2044	.3498	.2044	.5872	.3987	.6619	.4608	.7179	.5296	.4627	.3731
.25	.1809	.0756	.2671	.1760	.3370	.1958			.6286	.4471	.6694	.5110	.4119	.3620
.30	-.0017	-.0403	.2407	.1512	.3432	.2017			.5831	.4296	.6192	.4901	.3821	.3412
.40	.0778	.0266			.3573	.2382	.4679	.3525	.5139	.4089	.5348	.4395	.3261	.3021
.50			-.0708	-.1213			-.0032	-.0744					.2359	.0260
.60			.0671	-.0444	-.1457	-.1547			-.2676	-.2752	-.2627	-.2706	-.2538	-.2478
.70			.0905	.0080			-.3162	-.3245	-.3004	-.3044	-.2952	-.3040	-.2647	-.1723
.80			-.2259	-.2279	-.3043	-.3122	-.3268	-.3210	-.3090	-.3116	-.2935	-.2928	-.1774	-.1800
.90					-.2982	-.3006	-.2983	-.2970	-.2891	-.2838	-.2550	-.2631	-.1741	-.2235
.95			-.1984	-.2057	-.3011	-.2973			-.2720	-.2720	-.2498	-.2575		

TAIL 2

TABLE III. - CONTINUED
(c) $\alpha = 1.06^\circ$

Cp at γ/b of														
x/c	0.02		0.22		0.44		0.56		0.67		0.83		0.98	
	U.S.	L.S.	U.S.	L.S.	U.S.	L.S.	U.S.	L.S.	U.S.	L.S.	U.S.	L.S.	U.S.	L.S.
.05	.1249	.1116	.2757	.2412							.7018	.6313	.5537	.4622
.10	.1301	.1208	.2602	.2268							.6658	.4994	.4764	.5988
.15	.1278	.1218	.2382	.2356	.2938	.3063	.4598	.5091			.6322	.6551	.4203	.4718
.20	.1331	.1236							.5756	.6371	.5971	.6512		
.25	.1220	.1235	.2326	.1883	.2616	.2793			.5347	.5707			.3756	.4058
.30	-.0248	-.0138	.1930	.1887			.4314	.4907	.5235	.5516	.5328	.5968	.3430	.3832
.40	.0438	.0562					.3865	.4396	.4523	.4913	.4554	.5119	.2983	.3249
.50			-.0905	-.0774			-.0555	-.0399	.1461	.0260	.2925	.1148	.2056	.0484
.60	.0204	.0637	-.0370	.0367	-.1652	-.1268	-.3011	-.2855	-.2853	-.2662	-.2897	-.2745	-.2676	-.2542
.70			.0092	.0461	-.3553	-.3245	-.3382	-.3138			-.3179	-.2955	-.2859	-.2728
.80	-.2165	-.1152	-.2604	-.2150	-.3206	-.3116	-.2339	-.2599					-.1908	-.1697
.90	-.2208	-.1964	-.2530	-.1954	-.3319	-.2930	-.2579	-.2606	-.2704	-.2987	-.2661	-.2623	-.2062	-.1660
.95			-.2336	-.1828	-.3175	-.2915	-.2443	-.1729	-.2791	-.2929	-.2629	-.2526		

TAIL 1

Cp at γ/b of														
x/c	0.02		0.22		0.44		0.56		0.67		0.83		0.98	
	U.S.	L.S.	U.S.	L.S.	U.S.	L.S.	U.S.	L.S.	U.S.	L.S.	U.S.	L.S.	U.S.	L.S.
.05	.1318	.1405	.3027	.2944	.3539	.3236	.6010	.4729			.5562	.7562		
.10	.1389	.1457	.2601	.3180	.3306	.2943	.6016	.5037			.7514	.7002	.4857	.5313
.15	.1414	.1585	.2487	.2116	.3019	.2693	.5050	.5053			.6921	.6592	.4567	.4633
.20					.2807	.2610	.4832	.4866	.5644	.5574	.6350	.6229	.4154	.4240
.25	.1331	.1091	.2167	.1551	.2691	.2528			.5333	.5371	.5916	.5967	.3764	.4073
.30	-.0184	.0002	.1970	.1472	.2747	.2574			.4976	.5108	.5470	.5671	.3504	.3774
.40	.0504	.0467			.2821	.2732	.3945	.4044	.4461	.4759	.4714	.4976	.2944	.3251
.50			-.1079	-.0843			-.0360	-.0535					.2074	.0298
.60			.0007	.0005	-.1668	-.1184			-.2809	-.2589	-.2781	-.2562	-.2608	-.2470
.70			.0233	.0400			-.3317	-.3149	-.3137	-.2921	-.3084	-.2898	-.2941	-.2589
.80			-.2578	-.2110	-.3145	-.3195	-.3242	-.3162	-.3054	-.3029	-.2860	-.2966	-.1786	-.1694
.90					-.3206	-.2928	-.2937	-.2953	-.2715	-.3019	-.2610	-.2617	-.1799	-.1650
.95			-.2202	-.2057	-.3195	-.2891			-.2668	-.2825	-.2592	-.2517		

TAIL 2

TABLE III. - CONTINUED
(d) $\alpha = 3.04^\circ$

Cp at y/b of														
x/c	0.02		0.22		0.44		0.56		0.67		0.83		0.98	
	U.S.	L.S.	U.S.	L.S.	U.S.	L.S.	U.S.	L.S.	U.S.	L.S.	U.S.	L.S.	U.S.	L.S.
.05	.0784	.1743	.2693	.3223							.4558	.8012	.3845	.6451
.10	.0900	.1735	.2566	.2878							.5003	.5330	.3668	.6419
.15	.0914	.1664	.2374	.2975	.2413	.3760	.3722	.6213			.5357	.7428	.3538	.5174
.20	.0984	.1691							.4880	.7230	.5057	.7289		
.25	.0898	.1688	.2334	.2372	.2143	.3433			.4553	.6564			.3406	.4488
.30	-.0551	-.0061	.1989	.2359			.3517	.5722	.4468	.6346	.4641	.6548	.3187	.4235
.40	.0098	.0853					.3273	.4967	.3788	.5647	.4018	.5576	.2820	.3581
.50			-.0962	-.0398			-.0862	-.0102	.1010	.0485	.2558	.1435	.2011	.0678
.60	-.0022	.1018	-.0837	.0989	-.1818	-.1052	-.3124	-.2675	-.2978	-.2529	-.3039	-.2625	-.2653	-.2450
.70			-.0242	.1053	-.3487	-.3081	-.3465	-.2966			-.3328	-.2826	-.2480	-.2513
.80	-.2278	-.0686	-.2740	-.1627	-.3292	-.2942	-.2280	-.2534					-.1954	-.1726
.90	-.2318	-.1758	-.2569	-.1422	-.3375	-.2833	-.2592	-.2778	-.2795	-.2901	-.2842	-.2673	-.2915	-.1532
.95			-.2263	-.1372	-.3225	-.2726	-.2449	-.1781	-.2874	-.3010	-.2786	-.2519		

TAIL 1

Cp at y/b of														
x/c	0.02		0.22		0.44		0.56		0.67		0.83		0.98	
	U.S.	L.S.	U.S.	L.S.	U.S.	L.S.	U.S.	L.S.	U.S.	L.S.	U.S.	L.S.	U.S.	L.S.
.05	.1062	.1198	.2320	.2495	.2482	.3925	.3808	.6008			.3135	.8848		
.10	.1045	.1323	.1921	.3234	.2524	.3512	.4959	.6073			.6304	.8004	.3624	.6161
.15	.1062	.1440	.1841	.2482	.2324	.3176	.4024	.5903			.5868	.7424	.3931	.5335
.20					.2154	.3027	.3814	.5560	.4722	.6329	.5548	.6974	.3792	.4776
.25	.0922	.1228	.1635	.1223	.2040	.2865			.4441	.6068	.5228	.6598	.3446	.4493
.30	-.0175	.0257	.1421	.1219	.2038	.2913			.4125	.5712	.4765	.6262	.3144	.4150
.40	.0289	.0567			.2131	.2991	.3247	.4412	.3630	.5236	.4151	.5433	.2584	.3416
.50			-.1281	-.0350			-.0648	-.0369					.1776	.0314
.60			-.0402	.0518	-.1926	-.0926			-.3006	-.2469	-.2924	-.2444	-.2711	-.2503
.70			-.0257	.0717			-.3484	-.3078	-.3298	-.2806	-.3235	-.2772	-.3076	-.2602
.80			-.2827	-.2039	-.3279	-.2975	-.3191	-.3273	-.3151	-.2931	-.2989	-.2872	-.1867	-.2321
.90					-.3341	-.2636	-.3010	-.3035	-.2861	-.3026	-.2767	-.2913	-.2000	-.1808
.95			-.2190	-.2058	-.3242	-.2412			-.2816	-.3035	-.2750	-.2809		

TAIL 2

TABLE III. - CONTINUED
(e) $\alpha = 5.05^\circ$

Cp at γ/b of														
x/c	0.02		0.22		0.44		0.56		0.67		0.83		0.98	
	U.S.	L.S.	U.S.	L.S.	U.S.	L.S.	U.S.	L.S.	U.S.	L.S.	U.S.	L.S.	U.S.	L.S.
.05	.0217	.2469	.2106	.3986							.2889	.9506	.2785	.7604
.10	.0432	.2348	.2273	.3520							.3121	.5752	.2734	.6972
.15	.0510	.2221	.2022	.3596	.1918	.4450	.3092	.7327			.4156	.8171	.2777	.5687
.20	.0563	.2231							.3642	.7970	.4101	.7940		
.25	.0499	.2216	.2215	.2892	.1629	.4100			.3624	.7299			.2785	.4977
.30	-.0923	.0130	.1922	.2831			.2798	.6398	.3747	.7029	.3691	.7073	.2753	.4670
.40	-.0342	.1203					.2546	.5475	.3152	.6162	.3253	.5999	.2583	.3931
.50			-.0954	.0113			-.1218	.0145	.0519	.0696	.2038	.1618	.1834	.0049
.60	-.0277	.1468	-.1476	.1711	-.2023	-.0823	-.3283	-.2549	-.3131	-.2394	-.3209	-.2513	-.2670	-.2388
.70			-.0671	.1807	-.3476	-.2867	-.3373	-.2853			-.3465	-.2697	-.1948	-.2298
.80	-.2362	-.0254	-.2878	-.0951	-.3344	-.2608	-.2190	-.2435					-.1882	-.1897
.90	-.2408	-.1489	-.2631	-.1001	-.3274	-.2239	-.2613	-.2653	-.2887	-.2755	-.2983	-.2729	-.2338	-.1440
.95			-.1978	-.0996	-.3075	-.1754	-.2534	-.1760	-.3010	-.2914	-.2946	-.2556		

TAIL 1

Cp at γ/b of														
x/c	0.02		0.22		0.44		0.56		0.67		0.83		0.98	
	U.S.	L.S.	U.S.	L.S.	U.S.	L.S.	U.S.	L.S.	U.S.	L.S.	U.S.	L.S.	U.S.	L.S.
.05	.0823	.0931	.0869	.1912	.0501	.4322	.1141	.7065			.1384	.9691		
.10	.0782	.1066	.1238	.2616	.1570	.3886	.2932	.6961			.3888	.8709	.2312	.6840
.15	.0754	.1183	.1153	.2224	.1660	.3524	.3335	.6553			.4726	.8077	.2911	.5912
.20					.1532	.3345	.2934	.5906	.3414	.6949	.4421	.7542	.3035	.5220
.25	.0572	.1194	.0987	.0850	.1429	.3167			.3440	.6618	.4192	.7130	.2959	.4896
.30	-.0079	.0443	.0765	.1072	.1405	.3225			.3271	.6160	.3888	.6742	.2702	.4492
.40	.0122	.0709			.1279	.3171	.2414	.4746	.2863	.5647	.3387	.5827	.2167	.3610
.50			-.1220	.0182			-.1045	-.0232					.1410	.0349
.60			-.0650	.0852	-.2206	-.0591			-.3258	-.2367	-.3115	-.2318	-.2869	-.2573
.70			-.0594	.0860			-.3635	-.2992	-.3516	-.2696	-.3410	-.2612	-.3176	-.2460
.80			-.3046	-.2005	-.3458	-.2432	-.3290	-.3113	-.3200	-.2811	-.3128	-.2732	-.1917	-.2290
.90					-.3458	-.1845	-.3196	-.2961	-.3036	-.2911	-.2958	-.2827	-.2248	-.2221
.95			-.1753	-.2022	-.3331	-.1767			-.3008	-.3006	-.2930	-.2920		

TAIL 2

TABLE III. - CONTINUED
(1) $\alpha = 7.06^\circ$

Cp at γ/b of														
x/c	0.02		0.22		0.44		0.56		0.67		0.83		0.98	
	U.S.	L.S.	U.S.	L.S.	U.S.	L.S.	U.S.	L.S.	U.S.	L.S.	U.S.	L.S.	U.S.	L.S.
.05	-.0319	.3228	.1077	.4680							.1848	1.0628	.1979	.8579
.10	-.0009	.2988	.1647	.4269							.2031	.6168	.2289	.7548
.15	.0118	.2797	.1542	.4226	.1035	.5108	.1142	.8137			.2810	.8850	.2435	.6234
.20	.0177	.2812							.2518	.8618	.3256	.8497		
.25	.0114	.2746	.2203	.3418	.1080	.5175			.2199	.7900			.2460	.5463
.30	-.1303	.0437	.1886	.3289			.2071	.6990	.2315	.7615	.3125	.7537	.2385	.5126
.40	-.0807	.1630					.1887	.5960	.2025	.6607	.2576	.6404	.2308	.4301
.50			-.0701	.1017			-.1610	.0372	.0019	.0871	.1395	.1802	.1693	.1048
.60	-.0441	.2039	-.2040	.2507	-.2248	-.0560	-.3445	-.2409	-.3337	-.2265	-.3444	-.2409	-.2707	-.2318
.70			-.1251	.2983	-.3359	-.2346	-.3256	-.2691			-.3634	-.2571	-.2206	-.2245
.80	-.2428	.0220	-.3032	-.0400	-.3405	-.1992	-.2237	-.2236					-.2499	-.1952
.90	-.2465	-.1098	-.2623	-.0657	-.3319	-.1255	-.2685	-.2341	-.3040	-.2567	-.3233	-.2656	-.3165	-.1360
.95			-.1392	-.0647	-.3144	-.1400	-.2605	-.1594	-.3141	-.2741	-.3166	-.2663		

TAIL 1

Cp at γ/b of														
x/c	0.02		0.22		0.44		0.56		0.67		0.83		0.98	
	U.S.	L.S.	U.S.	L.S.	U.S.	L.S.	U.S.	L.S.	U.S.	L.S.	U.S.	L.S.	U.S.	L.S.
.05	.0832	.0929	-.0483	.1319	-.1600	.4649	-.0665	.7817			.0346	1.0292		
.10	.0783	.1045	-.0680	.2098	.0164	.4212	-.0245	.7603			.2143	.9276	.1370	.7362
.15	.0705	.1149	-.0663	.1877	-.0864	.3800	.1334	.7131			.3379	.8585	.1863	.6429
.20					.0896	.3615	.1967	.6308	.1481	.7465	.3331	.8036	.2091	.5662
.25	.0484	.1081	.0477	.0889	.0827	.3389			.1560	.7112	.3079	.7584	.2261	.5255
.30	-.0243	.0501	-.0146	.1024	-.0780	.3405			.1802	.6618	.2809	.7163	.2199	.4796
.40	-.0041	.0834			.0544	.3198	-.1686	.5048	.1972	.5937	.2143	.6185	.1684	.3800
.50			-.0770	.0737			-.1451	-.0087					.0932	.0340
.60			-.0684	.1022	-.2459	.0117			-.3489	-.2271	-.3453	-.2206	-.3147	-.2652
.70			-.0850	.0995			-.3787	-.2867	-.3690	-.2584	-.3613	-.2537	-.3281	-.2704
.80			-.3115	-.1930	-.3572	-.1793	-.3487	-.2751	-.3344	-.2691	-.3329	-.2658	-.2265	-.2467
.90					-.3615	-.1574	-.3336	-.2644	-.3248	-.2787	-.3185	-.2752	-.2536	-.2287
.95			-.2258	-.1968	-.3505	-.1665			-.3199	-.2890	-.3128	-.2866		

TAIL 2

TABLE III. - CONTINUED
(g) $\alpha = 9.08^\circ$

Cp at y/b of														
x/c	0.02		0.22		0.44		0.56		0.67		0.83		0.98	
	U.S.	L.S.	U.S.	L.S.	U.S.	L.S.	U.S.	L.S.	U.S.	L.S.	U.S.	L.S.	U.S.	L.S.
.05	-.0863	.4182	-.0567	.5447							.0929	1.1435	.1196	.9282
.10	-.0418	.3619	.0755	.5065							.1226	.6954	.1852	.8103
.15	-.0258	.3389	.1057	.4792	-.0147	.5879	-.0214	.8896			.1809	.9444	.2089	.6814
.20	-.0300	.3397							.1982	.9217	.2150	.9033		
.25	-.0416	.3304	.2082	.3971	.0370	.6569			.1644	.8502			.2190	.5932
.30	-.1672	.0850	.1820	.3772			.0765	.7599	.1697	.8155	.2402	.7994	.2138	.5552
.40	-.1186	.2197					.0924	.6443	.0988	.7049	.2136	.6803	.1978	.4656
.50			-.0160	.2458			-.1884	.0596	-.0879	.1025	.1102	.2009	.1381	.1253
.60	-.0708	.2756	-.2460	.3442	-.2560	.0076	-.3390	-.2266	-.3354	-.2109	-.3533	-.2288	-.2830	-.2235
.70			-.1883	.4224	-.3377	-.1486	-.3279	-.2530			-.3749	-.2430	-.2484	-.2222
.80	-.2496	.0754	-.3172	-.0102	-.3472	-.0969	-.2315	-.1892					-.2999	-.1875
.90	-.2547	-.0227	-.2607	-.0316	-.3359	-.1161	-.2740	-.1987	-.3221	-.2380	-.3328	-.2492	-.3630	-.1294
.95			-.1351	-.0353	-.3180	-.1289	-.2636	-.1364	-.3314	-.2551	-.3301	-.2523		

TAIL 1

Cp at y/b of														
x/c	0.02		0.22		0.44		0.56		0.67		0.83		0.98	
	U.S.	L.S.	U.S.	L.S.	U.S.	L.S.	U.S.	L.S.	U.S.	L.S.	U.S.	L.S.	U.S.	L.S.
.05	.0880	.0951	-.1313	.0786	-.2622	.4823	-.1650	.8464			-.0573	1.0612		
.10	.0802	.1052	.0139	.1648	-.1872	.4380	-.1087	.8212			.0800	.9588	.0648	.7621
.15	.0742	.1197	.0315	.1489	-.0136	.3992	-.0574	.7666			.1936	.8889	.1036	.6696
.20					.0173	.3803	.0241	.6603	.0408	.7907	.2209	.8323	.1306	.5920
.25	.0480	.1075	.0056	.0899	.0142	.3597			.0251	.7484	.2042	.7849	.1395	.5482
.30	-.0605	.0509	-.0348	.0872	.0116	.3590			.0191	.6895	.1844	.7404	.1480	.5028
.40	-.0155	.0765			-.0124	.3320	.0860	.5274	.0464	.6217	.1393	.6373	.1217	.4017
.50			-.0825	.1039			-.1776	.0015					.0597	.0417
.60			-.0861	.1223	-.2663	.0708			-.3715	-.2211	-.3792	-.2188	-.3278	-.2704
.70			-.0996	.1143			-.3903	-.2602	-.3881	-.2510	-.3701	-.2510	-.3413	-.2684
.80			-.3146	-.1887	-.3667	-.1465	-.3758	-.2378	-.3572	-.2605	-.3580	-.2601	-.2591	-.2482
.90					-.3435	-.1517	-.3559	-.2239	-.3491	-.2676	-.3537	-.2665	-.2647	-.2314
.95			-.2633	-.1945	-.3143	-.1578			-.3399	-.2761	-.3426	-.2773		

TAIL 2

TABLE III. - CONTINUED
(h) $\alpha = 11.09^\circ$.

Cp at y/b of														
x/c	0.02		0.22		0.44		0.56		0.67		0.83		0.98	
	U.S.	L.S.	U.S.	L.S.	U.S.	L.S.	U.S.	L.S.	U.S.	L.S.	U.S.	L.S.	U.S.	L.S.
.05	-.1347	.5267	-.0661	.6173							.0160	1.2023	-.0495	.9831
.10	-.0947	.4177	.0284	.5870							.0468	1.2199	-.1425	.8642
.15	-.0807	.3949	.0493	.5428	-.0986	.7124	-.1178	.9571			.1015	.9972	-.1765	.7363
.20	-.0825	.4015							.1426	.9771	.1316	.9514		
.25	-.0849	.3922	.1838	.4605	-.0144	.7696			.1173	.9020			.1923	.6421
.30	-.1886	.1352	.1598	.4238			-.0251	.8071	.1226	.8633	.1554	.8418	-.1891	.6013
.40	-.1377	.3011					-.0041	.6817	.0423	.7409	.1481	.7143	-.1771	.5074
.50			.0507	.3684			-.2370	.0765	-.1382	.1125	.0697	.2185	-.1199	.1483
.60	-.1026	.3431	-.2738	.4623	-.2912	.1255	-.3057	-.2132	-.3146	-.1968	-.3610	-.2170	-.3045	-.2113
.70			-.2267	.4994	-.3241	-.0526	-.3222	-.2086			-.3579	-.2284	-.2910	-.2128
.80	-.2625	.1778	-.3363	.0222	-.3381	-.0846	-.2320	-.1409					-.3726	-.1682
.90	-.2528	.0641	-.2681	.0190	-.3273	-.0904	-.2762	-.1526	-.3226	-.2086	-.3341	-.2293	-.3873	-.1221
.95			-.1633	.0095	-.3132	-.0996	-.2673	-.0913	-.3327	-.2229	-.3290	-.2316		

TAIL 1.

Cp at y/b of														
x/c	0.02		0.22		0.44		0.56		0.67		0.83		0.98	
	U.S.	L.S.	U.S.	L.S.	U.S.	L.S.	U.S.	L.S.	U.S.	L.S.	U.S.	L.S.	U.S.	L.S.
.05	.0920	.0895	-.1543	.0288	-.3027	.4898	-.2316	.8728			-.1355	1.0853		
.10	.0887	.1013	-.0043	.1535	-.2592	.4531	-.1986	.8570			-.0143	.9887	-.0306	.7980
.15	.0812	.1195	.0039	.1260	-.1075	.4126	-.1564	.7955			.0711	.9205	.0191	.7092
.20					-.1007	.3914	-.0972	.6592	-.0607	.8110	.1158	.8632	.0553	.6343
.25	.0561	.1025	-.0228	.0573	-.0957	.3671			-.0728	.7679	.1059	.8160	.0819	.5892
.30	-.0665	.0364	-.0638	.0620	-.0848	.3624			-.0773	.7071	.0902	.7724	.0904	.5408
.40	-.0298	.0647			-.0789	.3356	-.0230	.5408	-.0621	.6356	.0607	.6691	.0769	.4315
.50			-.0916	.0732			-.2369	.0056					.0258	.0496
.60			-.1021	.1293	-.2507	.1715			-.4002	-.2136	-.4023	-.2066	-.3454	-.2684
.70			-.1163	.1242			-.4125	-.2207	-.3890	-.2399	-.3806	-.2363	-.3581	-.2689
.80			-.3281	-.1791	-.3684	-.1431	-.3964	-.2047	-.3818	-.2451	-.3806	-.2435	-.2970	-.2593
.90					-.3594	-.1457	-.3762	-.1693	-.3790	-.2397	-.3733	-.2491	-.2923	-.2470
.95			-.2905	-.1916	-.3256	-.1558			-.3707	-.2462	-.3626	-.2600		

TAIL 2

TABLE III. - CONTINUED
(i) $\alpha = 13.06^\circ$

Cp at γ/b of														
x/c	0.02		0.22		0.44		0.56		0.67		0.83		0.98	
	U.S.	L.S.	U.S.	L.S.	U.S.	L.S.	U.S.	L.S.	U.S.	L.S.	U.S.	L.S.	U.S.	L.S.
.05	-.1894	.6316	-.0502	.6977							-.0638	1.2698	-.0128	1.0341
.10	-.1436	.4825	-.0330	.6628							-.0299	1.2825	.0870	.9255
.15	-.1177	.4637	-.0138	.6126	-.1502	.8528	-.1947	1.0336			.0268	1.0601	.1319	.8011
.20	-.1075	.4737							.0783	1.0366	-.0569	1.0086		
.25	-.1070	.4638	.1721	.5164	-.0519	.8612			.0634	.9612			.1666	.6972
.30	-.2137	.1979	.1390	.4717			-.1110	.8857	.0767	.9200	.0769	.8948	.1610	.6547
.40	-.1612	.4040					-.0862	.7540	-.0043	.7882	.0738	.7631	.1528	.5494
.50			.1634	.5768			-.2936	.1204	-.1823	.1296	.0138	.2426	.1014	.1721
.60	-.1400	.5657	-.2952	.6841	-.3248	.3774	-.3107	-.1682	-.3148	-.1721	-.3713	-.1988	-.3191	-.1985
.70			-.2517	.6024	-.3191	-.0093	-.3259	-.1304			-.3541	-.2037	-.3400	-.1927
.80	-.2688	.2320	-.3473	.0750	-.3327	-.0280	-.2329	-.0649					-.4167	-.1330
.90	-.2568	.0964	-.3265	.0470	-.3290	-.0339	-.2773	-.0402	-.3377	-.1444	-.3364	-.1941	-.3921	-.0914
.95			-.2418	.0392	-.3221	-.0420	-.2703	.0073	-.3477	-.1574	-.3239	-.1947		

TAIL 1

Cp at γ/b of														
x/c	0.02		0.22		0.44		0.56		0.67		0.83		0.98	
	U.S.	L.S.	U.S.	L.S.	U.S.	L.S.	U.S.	L.S.	U.S.	L.S.	U.S.	L.S.	U.S.	L.S.
.05	.0893	.0834	-.1593	.0468	-.2951	.4765	-.2468	.8534			-.2168	1.1235		
.10	.0909	.0956	-.0122	.1368	-.2810	.4468	-.2256	.8657			-.1183	1.0279	-.1038	.8236
.15	.0814	.1143	-.0174	.1003	-.2426	.4066	-.2213	.8005			-.0557	.9565	-.0623	.7374
.20					-.2339	.3884	-.2111	.6340	-.1392	.8438	.0079	.8978	-.0285	.6619
.25	.0531	.0956	-.0436	.0354	-.2214	.3652			-.1399	.8022	.0091	.8477	-.0005	.6169
.30	-.0813	.0184	-.0805	.0521	-.1945	.3561			-.1347	.7442	-.0006	.8001	.0120	.5657
.40	-.0307	.0534			-.1403	.3266	-.1365	.5536	-.1263	.6676	-.0272	.6902	.0037	.4504
.50			-.1417	.0090			-.2918	.0136					-.0257	.0543
.60			-.1058	.0957	-.2294	.2406			-.4044	-.2018	-.3939	-.1977	-.3680	-.2735
.70			-.1217	.1260			-.4296	-.1767	-.4012	-.2243	-.3888	-.2237	-.3869	-.2815
.80			-.3359	-.1766	-.3695	-.1284	-.4149	-.1457	-.4023	-.2156	-.3910	-.2280	-.3324	-.2784
.90					-.3573	-.1323	-.3872	-.1380	-.4008	-.2000	-.3766	-.2314	-.3188	-.2731
.95			-.3037	-.1976	-.3207	-.1364			-.3887	-.2064	-.3693	-.2420		

TAIL 2

TABLE III. - CONTINUED
(j) $\alpha = 17.06^\circ$

Cp at y/b of														
x/c	0.02		0.22		0.44		0.56		0.67		0.83		0.98	
	U.S.	L.S.	U.S.	L.S.	U.S.	L.S.	U.S.	L.S.	U.S.	L.S.	U.S.	L.S.	U.S.	L.S.
.05	-.2524	.7562	-.0002	.9004							-.2039	1.3762	-.1460	1.1351
.10	-.2031	.6245	-.0593	.8574							-.1716	1.3875	-.0452	1.0410
.15	-.1780	.6286	-.0743	.8353	-.3003	1.0871	-.3497	1.1549			-.1107	1.1706	.1050	.9218
.20	-.1701	.6428							-.0723	1.1443	-.0733	1.1139		
.25	-.1662	.6770	.3886	.7733	-.2014	1.0336			-.0692	1.0673			.1298	.8047
.30	-.2541	.4333	.3609	.7687			-.2773	.9828	-.0319	1.0162	-.0465	.9915	.1261	.7567
.40	-.2099	.7208					-.2536	.8201	-.1037	.8657	-.0333	.8463	.1192	.6364
.50			.2063	.7413			-.3400	.1712	-.2468	.1642	-.0767	.2841	.0597	.2219
.60	-.1964	.7802	-.3503	.7428	-.3546	.4641	-.3114	-.0901	-.3241	-.1323	-.3790	-.1639	-.3499	-.1837
.70			-.3175	.6467	-.3302	.0297	-.3274	-.0278			-.3670	-.1539	-.4081	-.1479
.80	-.2833	.2581	-.3444	.0775	-.3240	.0218	-.2345	.0395					-.4272	-.1133
.90	-.2652	.1030	-.3494	.0629	-.3283	.0218	-.2800	.0292	-.3445	-.0498	-.3300	-.1238	-.4093	-.0696
.95			-.3287	.0566	-.3267	.0159	-.2710	.0593	-.3544	-.0582	-.3002	-.1213		

TAIL 1

Cp at y/b of														
x/c	0.02		0.22		0.44		0.56		0.67		0.83		0.98	
	U.S.	L.S.	U.S.	L.S.	U.S.	L.S.	U.S.	L.S.	U.S.	L.S.	U.S.	L.S.	U.S.	L.S.
.05	.0732	.0860	-.0388	.1258	-.3133	.3855	-.2963	.7086			-.3618	1.1457		
.10	.0786	.0696	-.0283	.1759	-.3291	.3774	-.2853	.8814			-.2918	1.0573	-.2825	.8465
.15	.0787	.0826	-.0240	.1189	-.3468	.3555	-.2899	.8097			-.2484	.9882	-.2539	.7687
.20					-.3340	.3495	-.2949	.6482	-.2385	.8644	-.2181	.9302	-.2208	.6992
.25	.0543	.0539	-.0213	.0595	-.2845	.3303			-.2134	.8278	-.2037	.8817	-.1929	.6557
.30	-.0935	-.0451	-.0473	.0753	-.2263	.3153			-.2037	.7692	-.1966	.8317	-.1682	.6062
.40	-.0354	.0115			-.2006	.2940	-.3438	.5875	-.2091	.6881	-.2090	.7165	-.1421	.4899
.50			-.1742	-.0006			-.3961	.0450					-.1617	.0683
.60			-.1269	.0537	-.2573	.2694			-.4516	-.1785	-.4054	-.1789	-.4171	-.2675
.70			-.1303	.1295			-.4573	-.1040	-.4473	-.1789	-.4110	-.1954	-.4074	-.2731
.80			-.3416	-.1683	-.3752	-.1067	-.4426	-.1059	-.4353	-.1397	-.4160	-.1902	-.4020	-.2637
.90					-.3536	-.0988	-.3935	-.1067	-.4080	-.1148	-.4044	-.1844	-.3908	-.2624
.95			-.3147	-.1974	-.3224	-.1077			-.3929	-.1175	-.3961	-.1924		

TAIL 2

TABLE III. - CONCLUDED
(k) $\alpha = 21.06^\circ$

Cp at y/b of														
x/c	0.02		0.22		0.44		0.56		0.67		0.83		0.98	
	U.S.	L.S.	U.S.	L.S.	U.S.	L.S.	U.S.	L.S.	U.S.	L.S.	U.S.	L.S.	U.S.	L.S.
.05	-.3040	.8907	.0619	1.1052							-.2873	1.4565	-.2447	1.2061
.10	-.2447	.8410	.1999	1.0643							-.2622	1.4676	-.1572	1.1312
.15	-.2182	.8986	-.0076	1.0363	-.3925	1.1911	-.4178	1.2345			-.2060	1.2603	.0709	1.0166
.20	-.2073	.9153							-.1548	1.2261	-.1671	1.2001		
.25	-.1991	.9136	.5279	.9496	-.3199	1.1237			-.1474	1.1470			.0879	.8894
.30	-.2752	.7215	.4800	.9258			-.3582	1.0540	-.0977	1.0921	-.1401	1.0729	.0913	.8374
.40	-.2453	.8877					-.3348	.8752	-.1706	.9304	-.1228	.9177	.0549	.7086
.50			.2478	.8263			-.3244	.2214	-.2924	.1937	-.1483	.3244	-.0825	.2620
.60	-.2591	.8634	.5157	.8075	-.3871	.5541	-.3137	.0034	-.3349	-.0970	-.3910	-.1301	-.3867	-.1780
.70			-.3577	.6881	-.3416	.0665	-.3331	.0589			-.3875	-.1049	-.4280	-.1205
.80	-.2962	.2802	-.3399	.0983	-.3379	.0676	-.2404	.0921					-.4345	-.0564
.90	-.2747	.1198	-.3393	.0973	-.3334	.0767	-.2894	.0804	-.3622	.0330	-.3295	-.0564	-.4283	-.0050
.95			-.3296	.0938	-.3268	.0720	-.2801	.1058	-.3683	.0365	-.2862	-.0525		

TAIL 1

Cp at y/b of														
x/c	0.02		0.22		0.44		0.56		0.67		0.83		0.98	
	U.S.	L.S.	U.S.	L.S.	U.S.	L.S.	U.S.	L.S.	U.S.	L.S.	U.S.	L.S.	U.S.	L.S.
.05	.0363	.0541	-.0436	.0979	-.3707	.3150	-.3635	.6055			-.4520	1.0776		
.10	.0463	.0432	-.0409	.1616	-.3858	.3205	-.3702	.6752			-.4270	1.0254	-.4159	.8632
.15	.0480	.0521	-.0452	.1190	-.3864	.3044	-.3782	.6878			-.3996	.9705	-.3995	.7964
.20					-.3442	.2998	-.3754	.5691	-.3428	.8280	-.3776	.9193	-.3801	.7354
.25	.0251	.0225	-.0571	.0205	-.2907	.2853			-.3319	.8025	-.3633	.8743	-.3625	.6937
.30	-.1013	-.0676	-.0852	.0312	-.2654	.2785			-.3269	.7504	-.3517	.8303	-.3508	.6462
.40	-.0610	-.0130			-.2737	.2528	-.3342	.5746	-.3475	.6663	-.3442	.7154	-.3381	.5278
.50			-.1881	-.0143			-.3904	.0786					-.3435	.0776
.60			-.1499	.0332	-.3149	.2747			-.4811	-.1383	-.4534	-.1539	-.4273	-.2343
.70			-.1539	.1525			-.4673	-.0685	-.4727	-.0896	-.4489	-.1487	-.4311	-.2176
.80			-.3481	-.1561	-.4157	-.0794	-.4510	-.0646	-.4562	-.0572	-.4505	-.1132	-.4225	-.1959
.90					-.3833	-.0776	-.4036	-.0588	-.4561	-.0519	-.4264	-.0837	-.4139	-.1880
.95			-.3181	-.1907	-.3550	-.0818			-.4531	-.0582	-.4133	-.0782		

TAIL 2

TABLE IV. - PRESSURE COEFFICIENTS, $\phi = 67.5^\circ$, $\delta = 0^\circ$, $M = 1.60$.
(a) $\alpha = -2.80^\circ$

Cp at y/b of														
x/c	0.02		0.22		0.44		0.56		0.67		0.83		0.98	
	U.S.	L.S.	U.S.	L.S.	U.S.	L.S.	U.S.	L.S.	U.S.	L.S.	U.S.	L.S.	U.S.	L.S.
.05	.2111	-.0174	.4314	-.0344							1.0388	.1658	.7758	.0938
.10	.2177	-.0352	.3751	-.0637							.9118	.4851	.6918	-.3608
.15	.2212	-.0413	.3442	-.1077	.4218	-.0873	.6786	-.1624			.8334	.3537	.5838	-.2803
.20	.2152	-.0446							.7553	.2633	.7737	.4129		
.25	.1874	-.0439	.3359	-.0869	.3699	-.1399			.7014	.2481			.4765	.2952
.30	.0179	-.0509	.2804	-.0816			.5847	.2876	.6720	.2939	.6762	.3594	.4278	-.2817
.40	.1122	-.0044					.5078	.2671	.5780	.3108	.5734	.2947	.3526	-.2271
.50			-.0239	-.1405			-.0034	-.1167	.2143	-.0671	.3741	.0009	.2329	-.0176
.60	-.1054	.0012	.1003	-.0605	-.1345	-.1876	-.2765	-.3213	-.2605	-.3128	-.2636	-.3232	-.2726	-.2929
.70			.0933	-.0361	-.3178	-.3652	-.3145	-.3488			-.2902	-.3373	-.2812	-.2464
.80	-.1885	-.1998	-.2167	-.2745	-.2928	-.3345	-.2399	-.2660					-.2719	-.2376
.90	-.1959	-.2086	-.2084	-.2739	-.2436	-.3278	-.2591	-.2723	-.2997	-.2911	-.2907	-.2916	-.2232	-.2767
.95			-.1977	-.2276	-.2194	-.3186	-.2457	-.1837	-.3071	-.2950	-.2758	-.2850		

TAIL 1

Cp at y/b of														
x/c	0.02		0.22		0.44		0.56		0.67		0.83		0.98	
	U.S.	L.S.	U.S.	L.S.	U.S.	L.S.	U.S.	L.S.	U.S.	L.S.	U.S.	L.S.	U.S.	L.S.
.05	.1702	.0959	.3974	.1773	.4867	.1489	.8528	.2566			.8955	.4187		
.10	.2129	.0938	.3580	.1858	.4426	.2632	.7365	.4017			.8604	.5315	.6016	.3308
.15	.2116	-.0867	.3298	.1706	.4024	.2371	.6460	.4268			.7823	.5614	.5282	.3771
.20					.3735	.2182	.6082	.4147	.6974	.4810	.7221	.5420	.4688	.3797
.25	.1958	-.0632	.2917	.1519	.3642	.2029			.6583	.4706	.6717	.5217	.4279	.3746
.30	-.0098	-.0711	.2660	.1444	.3854	.2033			.6126	.4451	.6218	.5018	.4014	.3595
.40	.0521	-.0180			.3970	.2678	.4865	.3629	.5367	.4191	.5377	.4426	.3469	.3223
.50			-.0819	-.1563			.0028	-.0711					.2587	.0501
.60			.0749	-.0741	-.1361	-.1542			-.2601	-.2699	-.2610	-.2709	-.2429	-.2373
.70			.1269	.0083			-.3102	-.3207	-.2925	-.2993	-.2940	-.3027	-.2580	-.1295
.80			-.1840	-.2171	-.2970	-.3057	-.3195	-.3195	-.3014	-.3086	-.2897	-.2865	-.1564	-.1728
.90					-.2957	-.3034	-.2881	-.2913	-.2896	-.2772	-.2511	-.2605	-.1702	-.2126
.95			-.1693	-.1695	-.2986	-.2962			-.2685	-.2651	-.2474	-.2555		

TAIL 2

TABLE IV. - CONTINUED
(b) $\alpha = -0.80^\circ$

Cp at γ/b of														
x/c	0.02		0.22		0.44		0.56		0.67		0.83		0.98	
	U.S.	L.S.	U.S.	L.S.	U.S.	L.S.	U.S.	L.S.	U.S.	L.S.	U.S.	L.S.	U.S.	L.S.
.05	.1686	.0666	.3615	.1306							.9315	.3583	.6474	.2343
.10	.1747	.0784	.3107	.1687							.8240	.5180	.6113	.4740
.15	.1743	.0866	.2797	.1725	.3664	.2381	.5839	.3917			.7523	.5205	.5120	.3940
.20	.1716	.0873							.6735	.5113	.7000	.5467		
.25	.1475	.0845	.2827	.1425	.3180	.2139			.6236	.4820			.4309	.3616
.30	-.0018	-.0298	.2236	.1422			.5119	.3903	.6017	.4724	.6152	.5008	.3868	.3388
.40	.0722	.0220					.4557	.3580	.5213	.4035	.5219	.4419	.3266	.2848
.50			-.0852	-.1125			-.0270	-.0689	.1893	-.0181	.3394	.0857	.2178	.0255
.60	.0696	.0333	.0447	-.0180	-.1592	-.1582	-.2902	-.3021	-.2730	-.2842	-.2762	-.2890	-.2679	-.2652
.70			.0540	.0041	-.3431	-.3468	-.3264	-.3323			-.3048	-.3101	-.2708	-.2685
.80	-.2022	-.1581	-.2390	-.2489	-.3119	-.3140	-.2396	-.2625					-.2562	-.1807
.90	-.2054	-.2079	-.2297	-.2454	-.3074	-.3111	-.2571	-.2641	-.2837	-.2811	-.2663	-.2696	-.1902	-.1988
.95			-.2145	-.2224	-.3091	-.3082	-.2488	-.1750	-.2816	-.2787	-.2594	-.2635		

TAIL 1

Cp at γ/b of														
x/c	0.02		0.22		0.44		0.56		0.67		0.83		0.98	
	U.S.	L.S.	U.S.	L.S.	U.S.	L.S.	U.S.	L.S.	U.S.	L.S.	U.S.	L.S.	U.S.	L.S.
.05	.1590	.1185	.3567	.2334	.4313	.2615	.7753	.3678			.7415	.5673		
.10	.1804	.1161	.3178	.2112	.3939	.2763	.6787	.4539			.8216	.6542	.5539	.4298
.15	.1814	.1094	.2982	.1917	.3612	.2550	.5885	.4728			.7519	.6248	.5045	.4450
.20					.3354	.2370	.5570	.4626	.6444	.5335	.6909	.5921	.4490	.4192
.25	.1723	.0902	.2639	.1756	.3237	.2233			.6138	.5105	.6423	.5640	.4063	.3901
.30	-.0129	-.0364	.2419	.1670	.3383	.2237			.5694	.4843	.5960	.5403	.3802	.3704
.40	.0610	.0406			.3452	.2794	.4528	.3904	.5061	.4533	.5149	.4718	.3287	.3228
.50			-.0907	-.1197			-.0117	-.0589					.2425	.0356
.60			.0449	-.0225	-.1446	-.1396			-.2683	-.2654	-.2673	-.2636	-.2480	-.2431
.70			.0825	.0196			-.3174	-.3173	-.3000	-.2950	-.2986	-.2968	-.2745	-.1913
.80			-.2242	-.2216	-.2991	-.3052	-.3199	-.3134	-.3044	-.3049	-.2844	-.2832	-.1596	-.1610
.90					-.3047	-.2950	-.2860	-.2913	-.2686	-.2867	-.2532	-.2545	-.1716	-.1881
.95			-.1961	-.1825	-.3046	-.2936			-.2587	-.2703	-.2490	-.2498		

TAIL 2

TABLE IV. - CONTINUED
(c) $\alpha = 1.20^\circ$

Cp at γ/b of														
x/c	0.02		0.22		0.44		0.56		0.67		0.83		0.98	
	U.S.	L.S.	U.S.	L.S.	U.S.	L.S.	U.S.	L.S.	U.S.	L.S.	U.S.	L.S.	U.S.	L.S.
.05	.1260	.1112	.2864	.2369							.5987	.6402	.4379	.4788
.10	.1338	.1215	.2437	.2287							.7101	.5425	.5169	.5974
.15	.1295	.1247	.2178	.2383	.2989	.3066	.4781	.5075			.6539	.6590	.4476	.4721
.20	.1327	.1265							.5747	.6327	.6054	.6480		
.25	.1120	.1225	.2310	.1906	.2633	.2813			.5345	.5689			.3868	.4046
.30	-.0276	-.0140	.1752	.1907			.4343	.4881	.5192	.5510	.5395	.5964	.3527	.3810
.40	.0318	.0532					.3922	.4377	.4481	.4905	.4624	.5131	.3028	.3215
.50			-.1344	-.0755			-.0607	-.0385	.1488	.0258	.2976	.1166	.2063	.0457
.60	.0342	.0656	-.0282	-.0383	-.1823	-.1301	-.3050	-.2856	-.2869	-.2656	-.2892	-.2742	-.2689	-.2564
.70			.0112	.0479	-.3572	-.3250	-.3378	-.3138			-.3182	-.2950	-.2796	-.2748
.80	-.2200	-.1163	-.2611	-.2147	-.3218	-.3123	-.2403	-.2589					-.2062	-.1733
.90	-.2205	-.1964	-.2539	-.1985	-.3228	-.2937	-.2637	-.2613	-.2731	-.2989	-.2656	-.2623	-.2033	-.1623
.95			-.2289	-.1862	-.3191	-.2923	-.2567	-.1733	-.2819	-.2941	-.2622	-.2529		

TAIL 1

Cp at γ/b of														
x/c	0.02		0.22		0.44		0.56		0.67		0.83		0.98	
	U.S.	L.S.	U.S.	L.S.	U.S.	L.S.	U.S.	L.S.	U.S.	L.S.	U.S.	L.S.	U.S.	L.S.
.05	.1313	.1298	.3083	.2733	.3581	.3261	.6193	.4613			.5692	.6965		
.10	.1411	.1292	.2686	.2346	.3343	.2993	.6079	.5155			.7541	.7274	.4887	.5183
.15	.1448	.1259	.2578	.2142	.3045	.2681	.5136	.5303			.6919	.6709	.4588	.4937
.20					.2835	.2526	.4883	.5061	.5728	.5742	.6408	.6329	.4166	.4375
.25	.1352	.1082	.2260	.1986	.2724	.2414			.5415	.5434	.5971	.6003	.3766	.4050
.30	-.0167	-.0010	.2035	.1825	.2795	.2478			.5037	.5150	.5517	.5735	.3512	.3830
.40	.0537	.0521			.2860	.2835	.4008	.4122	.4510	.4813	.4748	.5001	.2970	.3279
.50			-.1063	-.0935			-.0339	-.0512					.2118	.0273
.60			.0085	-.0032	-.1638	-.1257			-.2795	-.2599	-.2775	-.2576	-.2595	-.2464
.70			.0297	.0299			-.3294	-.3154	-.3113	-.2926	-.3080	-.2898	-.2937	-.2684
.80			-.2567	-.2220	-.3122	-.3137	-.3253	-.3122	-.3044	-.3027	-.2867	-.2914	-.1753	-.1643
.90					-.3182	-.2899	-.2938	-.2908	-.2694	-.2987	-.2603	-.2546	-.1773	-.1569
.95			-.2193	-.1985	-.3163	-.2874			-.2643	-.2792	-.2581	-.2470		

TAIL 2

TABLE IV. - CONTINUED
(d) $\alpha = 3.20^\circ$

Cp at y/b of														
x/c	0.02		0.22		0.44		0.56		0.67		0.83		0.98	
	U.S.	L.S.	U.S.	L.S.	U.S.	L.S.	U.S.	L.S.	U.S.	L.S.	U.S.	L.S.	U.S.	L.S.
.05	.0630	.1964	.1759	.3369							.2812	.8710	.2367	.7140
.10	.0837	.1822	.1707	.2971							.4135	.5802	.3357	.6602
.15	.0850	.1825	.1500	.3159	.2272	.3898	.3762	.6439			.4921	.7654	.3270	.5359
.20	.0935	.1829							.4675	.7390	.4988	.7468		
.25	.0772	.1788	.1776	.2494	.2025	.3551			.4340	.6716			.3282	.4560
.30	-.0554	.0034	.1305	.2466			.3364	.5807	.4213	.6475	.4478	.6691	.3135	.4276
.40	-.0043	.0946					.3205	.5024	.3551	.5735	.3855	.5696	.2734	.3596
.50			-.1652	-.0171			-.0907	-.0080	.0923	.0584	.2438	.1494	.1866	.0608
.60	.0031	.1075	-.0930	.1135	-.1962	-.1011	-.3109	-.2660	-.2977	-.2518	-.2973	-.2597	-.2647	-.2489
.70			-.0309	.1084	-.3522	-.2996	-.3432	-.2940			-.3258	-.2794	-.2492	-.2505
.80	-.2329	-.0714	-.2754	-.1631	-.3246	-.2791	-.2372	-.2495					-.1938	-.1996
.90	-.2306	-.1765	-.2648	-.1474	-.3267	-.2619	-.2648	-.2766	-.2808	-.2872	-.2767	-.2781	-.2765	-.1533
.95			-.2233	-.1412	-.3148	-.2264	-.2526	-.1803	-.2929	-.3003	-.2722	-.2581		

TAIL 1

Cp at y/b of														
x/c	0.02		0.22		0.44		0.56		0.67		0.83		0.98	
	U.S.	L.S.	U.S.	L.S.	U.S.	L.S.	U.S.	L.S.	U.S.	L.S.	U.S.	L.S.	U.S.	L.S.
.05	.1200	.1159	.2628	.2920	.2919	.3539	.4843	.5330			.4270	.7669		
.10	.1247	.1212	.2226	.2487	.2827	.3141	.5408	.5581			.6776	.7725	.4365	.5844
.15	.1253	.1200	.2138	.2293	.2588	.2806	.4374	.5550			.6298	.7081	.4245	.5260
.20					.2394	.2674	.4205	.5236	.5079	.6005	.5919	.6672	.3940	.4605
.25	.1066	.1035	.1852	.2023	.2269	.2604			.4794	.5685	.5534	.6292	.3546	.4255
.30	-.0132	.0176	.1582	.1752	.2298	.2659			.4447	.5383	.5060	.6004	.3282	.3967
.40	.0350	.0536			.2392	.2727	.3535	.4187	.3997	.4968	.4424	.5227	.2691	.3315
.50			-.1182	-.0760			-.0514	-.0424					.1874	.0255
.60			-.0214	.0201	-.1720	-.1112			-.2907	-.2488	-.2843	-.2442	-.2708	-.2458
.70			-.0127	.0465			-.3412	-.3061	-.3206	-.2784	-.3145	-.2746	-.2675	-.2604
.80			-.2780	-.2156	-.3210	-.3034	-.3251	-.3181	-.3108	-.2904	-.2946	-.2834	-.2208	-.2194
.90					-.3284	-.2725	-.2999	-.2866	-.2779	-.2960	-.2680	-.2667	-.1803	-.1638
.95			-.2323	-.2093	-.3239	-.2446			-.2734	-.2852	-.2654	-.2498		

TAIL 2

TABLE IV. - CONTINUED
(e) $\alpha = 5.21^\circ$

Cp at y/b of														
x/c	0.02		0.22		0.44		0.56		0.67		0.83		0.98	
	U.S.	L.S.	U.S.	L.S.	U.S.	L.S.	U.S.	L.S.	U.S.	L.S.	U.S.	L.S.	U.S.	L.S.
.05	-.0079	.2947	.0097	.4220							.1362	1.0294	.1330	.8416
.10	.0292	.2516	.0647	.3763							.2341	.6269	.2267	.7312
.15	.0379	.2466	.0831	.3888	.1288	.4604	.1563	.7546			.3229	.8506	.2527	.6023
.20	.0330	.2457							.2541	.8226	.3442	.8209		
.25	.0140	.2392	.1221	.3172	.1292	.4257			.2338	.7526			.2442	.5110
.30	-.1091	.0279	.0746	.3008			.2365	.6604	.2538	.7255	.3311	.7307	.2381	.4774
.40	-.0494	.1445					.2296	.5622	.2363	.6361	.2629	.6195	.2212	.3985
.50			-.2057	.0744			-.1362	.0207	.0137	.0811	.1348	.1724	.1493	.0752
.60	-.0319	.1561	-.1552	.1932	-.2300	-.0728	-.3366	-.2493	-.3278	-.2376	-.3470	-.2470	-.2815	-.2431
.70			-.0871	.1787	-.3640	-.2544	-.3625	-.2781			-.3580	-.2644	-.2289	-.2449
.80	-.2593	-.0267	-.3047	-.0988	-.3475	-.2182	-.2403	-.2316					-.2281	-.2254
.90	-.2584	-.1526	-.2863	-.1082	-.3419	-.1532	-.2757	-.2456	-.3085	-.2701	-.3183	-.2731	-.2604	-.1644
.95			-.2081	-.1040	-.3210	-.1656	-.2651	-.1675	-.3168	-.2868	-.3108	-.2695		

TAIL 1.

Cp at y/b of														
x/c	0.02		0.22		0.44		0.56		0.67		0.83		0.98	
	U.S.	L.S.	U.S.	L.S.	U.S.	L.S.	U.S.	L.S.	U.S.	L.S.	U.S.	L.S.	U.S.	L.S.
.05	.1330	.0809	.2054	.2928	.2228	.3799	.3497	.5869			.2888	.8293		
.10	.1556	.0921	.1795	.2393	.2345	.3315	.4527	.5745			.5964	.8073	.3799	.6325
.15	.1494	.0948	.1751	.2144	.2164	.2954	.3913	.5710			.5674	.7408	.4039	.5505
.20					.2030	.2784	.3628	.5381	.4491	.6167	.5422	.6933	.3709	.4778
.25	.1226	.0779	.1434	.1781	.1930	.2645			.4275	.5867	.5078	.6581	.3289	.4418
.30	-.0135	.0040	.1073	.1590	.1917	.2651			.4030	.5496	.4657	.6255	.3010	.4034
.40	.0073	.0439			.1865	.2765	.3093	.4243	.3563	.5068	.4116	.5432	.2438	.3297
.50			-.1028	-.0164			-.0776	-.0377					.1606	.0148
.60			-.0479	.0376	-.2030	-.0867			-.3080	-.2534	-.2932	-.2454	-.2844	-.2633
.70			-.0484	.0376			-.3546	-.3128	-.3370	-.2829	-.3246	-.2750	-.2952	-.2555
.80			-.2951	-.2266	-.3326	-.2787	-.3254	-.3287	-.3220	-.2947	-.3078	-.2885	-.2449	-.2433
.90					-.3379	-.2242	-.3088	-.3073	-.2927	-.3027	-.2806	-.2937	-.1830	-.2227
.95			-.2331	-.2294	-.3290	-.2196			-.2894	-.3053	-.2785	-.2808		

TAIL 2

TABLE IV. - CONTINUED
(f) $\alpha = 7.20^\circ$

Cp at γ/b of														
x/c	0.02		0.22		0.44		0.56		0.67		0.83		0.98	
	U.S.	L.S.	U.S.	L.S.	U.S.	L.S.	U.S.	L.S.	U.S.	L.S.	U.S.	L.S.	U.S.	L.S.
.05	-.0935	.4024	-.1141	.5078							.0142	1.1236	.0549	.9044
.10	-.0385	.3185	-.0559	.4695							.1187	1.1381	.1304	.7988
.15	-.0274	.3075	-.0325	.4568	-.0894	.5269	-.0164	.8494			.1769	.9268	.1841	.6685
.20	-.0349	.3105							.1669	.8970	.2173	.8864		
.25	-.0492	.3054	.0530	.3751	.0164	.5172			.1385	.8237			.2116	.5670
.30	-.1557	.0677	.0113	.3516			.0638	.7288	.1457	.7910	.2269	.7861	.2040	.5276
.40	-.0903	.2105					.0852	.6203	.0802	.6899	.1911	.6669	.1885	.4363
.50			-.2454	.2071			-.2063	.0478	-.1040	.0960	.0776	.1921	.1326	.0947
.60	-.0688	.2095	-.2078	.2642	-.2596	-.0037	-.3644	-.2328	-.3464	-.2229	-.3671	-.2338	-.2876	-.2379
.70			-.1512	.2908	-.3633	-.1458	-.3491	-.2584			-.3846	-.2474	-.2422	-.2406
.80	-.2704	.0194	-.3260	-.0421	-.3646	-.1135	-.2510	-.1886					-.2661	-.2255
.90	-.2667	-.1217	-.2856	-.0710	-.3554	-.1330	-.2897	-.2015	-.3414	-.2502	-.3480	-.2528	-.3223	-.1867
.95			-.1647	-.0671	-.3332	-.1490	-.2797	-.1396	-.3474	-.2665	-.3438	-.2554		

TAIL 1

Cp at γ/b of														
x/c	0.02		0.22		0.44		0.56		0.67		0.83		0.98	
	U.S.	L.S.	U.S.	L.S.	U.S.	L.S.	U.S.	L.S.	U.S.	L.S.	U.S.	L.S.	U.S.	L.S.
.05	.1327	.0325	.1562	.2575	.1246	.4050	.1933	.6350			.1832	.8694		
.10	.2272	.0458	.1474	.2379	.1825	.3506	.3608	.6045			.5012	.8355	.2795	.6643
.15	.1982	.0643	.1440	.2198	.1829	.3102	.3513	.5905			.4933	.7623	.3635	.5781
.20					.1662	.2890	.3069	.5542	.3797	.6370	.4757	.7158	.3458	.5006
.25	.1630	.0745	.1018	.1671	.1506	.2674			.3623	.6025	.4516	.6748	.3004	.4591
.30	-.0293	-.0407	.0548	.1296	.1471	.2607			.3349	.5635	.4140	.6420	.2679	.4171
.40	-.0175	.0263			.1186	.2709	.2463	.4329	.2972	.5174	.3583	.5580	.2091	.3365
.50			-.0669	.0350			-.1140	-.0301					.1242	.0121
.60			-.0620	.0374	-.2220	-.0886			-.3249	-.2506	-.3056	-.2405	-.3002	-.2664
.70			-.0729	.0325			-.3649	-.3110	-.3516	-.2797	-.3355	-.2738	-.3167	-.2592
.80			-.2958	-.2252	-.3442	-.2280	-.3356	-.3158	-.3252	-.2903	-.3150	-.2862	-.2792	-.2420
.90					-.3408	-.2127	-.3215	-.2992	-.3045	-.2991	-.2914	-.2948	-.1964	-.2387
.95			-.2551	-.2286	-.3300	-.2173			-.3030	-.3067	-.2896	-.2961		

TAIL 2

TABLE IV. - CONTINUED
(g) $\alpha = 9.20^\circ$

Cp at y/b of															
x/c	0.02		0.22		0.44		0.56		0.67		0.83		0.98		
	U.S.	L.S.	U.S.	L.S.	U.S.	L.S.	U.S.	L.S.	U.S.	L.S.	U.S.	L.S.	U.S.	L.S.	
.05	-.1847	.4975	-.2182									-.0925	1.1934	-.0176	.9549
.10	-.1118	.3752	-.1485	.5603								.0030	1.2061	.0402	.8562
.15	-.0883	.3653	-.1284	.5191	-.1877	.6009	-.1444	.9308				.0626	.9892	.1087	.7286
.20	-.0857	.3777							.0788	.9638		.0967	.9419		
.25	-.0893	.3767	-.0429	.4338	-.1273	.6676			.0576	.8853				.1827	.6172
.30	-.1885	.1203	-.0689	.3987			-.0752	.7884	.0691	.8467	.1224	.8335	.1811	.5754	
.40	-.1352	.2912					-.0593	.6674	-.0062	.7334	.1166	.7071	.1529	.4737	
.50			-.2860	.3046			-.2673	.0699	-.1750	.1130	.0273	.2101	.1021	.1135	
.60	-.1219	.2760	-.2565	.3382	-.3084	.1659	-.3431	-.2150	-.3381	-.2100	-.3795	-.2211	-.3102	-.2386	
.70			-.2127	.4258	-.3671	-.0581	-.3541	-.1913			-.3865	-.2305	-.2709	-.2303	
.80	-.2897	.0690	-.3523	-.0134	-.3768	-.0984	-.2602	-.1317					-.3166	-.2180	
.90	-.2806	-.0516	-.2670	-.0331	-.3671	-.1115	-.2989	-.1357	-.3484	-.2151	-.3542	-.2303	-.3783	-.1945	
.95			-.1671	-.0339	-.3482	-.1149	-.2926	-.0708	-.3574	-.2275	-.3500	-.2336			

TAIL 1

Cp at y/b of														
x/c	0.02		0.22		0.44		0.56		0.67		0.83		0.98	
	U.S.	L.S.	U.S.	L.S.	U.S.	L.S.	U.S.	L.S.	U.S.	L.S.	U.S.	L.S.	U.S.	L.S.
.05	.1150	-.0219	.1570	.1807	-.0737	.4266	.0337	.6750			.0873	.8978		
.10	.3111	.0005	.1417	.1924	.1211	.3682	.1977	.6330			.3395	.8550	.1963	.6917
.15	.2696	.0032	.1282	.1917	.1208	.3219	.2588	.6154			.3859	.7827	.2627	.6032
.20					.1056	.2975	.2354	.5721	.2590	.6594	.3779	.7348	.2848	.5241
.25	.1922	.0426	.0898	.1570	.0958	.2722			.2734	.6257	.3401	.6927	.2507	.4801
.30	-.0210	-.0480	.0414	.1199	.0902	.2628			.2677	.5806	.3225	.6612	.2212	.4373
.40	-.0183	-.0084			.0490	.2600	.1799	.4402	.2398	.5286	.2970	.5775	.1663	.3502
.50			-.0809	.0407			-.1438	-.0305					.0858	.0153
.60			-.0809	.0384	-.2357	-.0730			-.3444	-.2472	-.3218	-.2377	-.3150	-.2704
.70			-.0995	.0252			-.3760	-.3062	-.3662	-.2754	-.3515	-.2694	-.3322	-.2729
.80			-.3200	-.2241	-.3499	-.2073	-.3492	-.2914	-.3322	-.2843	-.3260	-.2815	-.3054	-.2504
.90					-.3360	-.2126	-.3352	-.2807	-.3204	-.2932	-.3080	-.2909	-.2209	-.2333
.95			-.2804	-.2263	-.3202	-.2191			-.3171	-.3016	-.3060	-.3004		

TAIL 2

TABLE IV. - CONTINUED
(h) $\alpha = 11.20^\circ$

Cp at y/b of															
x/c	0.02		0.22		0.44		0.56		0.67		0.83		0.98		
	U.S.	L.S.	U.S.	L.S.	U.S.	L.S.	U.S.	L.S.	U.S.	L.S.	U.S.	L.S.	U.S.	L.S.	
.05	-.2537	.5689	-.3057									-.1805	1.2551	-.1026	1.0092
.10	-.1669	.4367	-.2363	.6316								-.1022	1.2670	-.0469	.9125
.15	-.1300	.4429	-.2091	.5824	-.2606	.7177	-.2658	1.0079				-.0375	1.0493	.0330	.7865
.20	-.1160	.4601									-.0105	1.0262	.0073	.9977	
.25	-.1284	.4558	-.1276	.4882	-.2042	.7793				-.0220	.9515			.1369	.6709
.30	-.2200	.1835	-.1683	.4438			-.1771	.8626	-.0008	.9077	.0299	.8843	.1336	.6262	
.40	-.1728	.3843					-.1617	.7328	-.0757	.7826	.0387	.7500	.1164	.5161	
.50			-.3161	.3977			-.3387	.1080	-.2285	.1314	-.0327	.2307	-.0643	.1350	
.60	-.1681	.3410	-.2919	.4639	-.3583	.3293	-.3339	-.1776	-.3399	-.1885	-.3962	-.2046	-.3315	-.2429	
.70			-.2547	.4983	-.3725	-.0561	-.3489	-.1499			-.3780	-.2073	-.3157	-.2201	
.80	-.3135	.1647	-.3657	.0079	-.3838	-.0745	-.2604	-.0859					-.3870	-.2046	
.90	-.2940	.0370	-.2558	.0056	-.3684	-.0767	-.3024	-.0912	-.3574	-.1740	-.3562	-.1980	-.4127	-.1901	
.95			-.1943	-.0025	-.3531	-.0874	-.2962	-.0444	-.3709	-.1864	-.3479	-.1998			

TAIL 1

Cp at y/b of														
x/c	0.02		0.22		0.44		0.56		0.67		0.83		0.98	
	U.S.	L.S.	U.S.	L.S.	U.S.	L.S.	U.S.	L.S.	U.S.	L.S.	U.S.	L.S.	U.S.	L.S.
.05	.0932	.0028	.1285	.0032	-.0901	.4096	-.0430	.7171			-.0021	.9304		
.10	.2952	.0094	.1178	.0861	.0602	.3617	.0662	.6771			.1988	.8755	.1274	.7006
.15	.3133	.0012	.1100	.1228	.0608	.3235	.1097	.6487			.2882	.8008	.1735	.6142
.20					.0583	.3031	.1472	.6037	.1359	.6855	.2918	.7508	.2047	.5351
.25	.2530	-.0187	.0810	.1355	.0459	.2767			.1644	.6452	.2571	.7040	.1978	.4896
.30	.0099	-.1200	.0381	.1050	.0273	.2664			.1730	.5981	.2270	.6681	.1776	.4410
.40	-.0133	-.0481			-.0160	.2728	.1106	.4471	.1630	.5393	.2016	.5788	.1247	.3514
.50			-.0833	.0035			-.1761	-.0343					.0402	.0077
.60			-.0848	.0186	-.1603	-.0338			-.3653	-.2464	-.3415	-.2378	-.3405	-.2780
.70			-.1029	.0062			-.3733	-.2972	-.3603	-.2748	-.3664	-.2692	-.3552	-.2785
.80			-.3267	-.2214	-.3395	-.1981	-.3638	-.2757	-.3415	-.2855	-.3389	-.2798	-.3365	-.2609
.90					-.3267	-.2041	-.3482	-.2679	-.3420	-.2944	-.3236	-.2879	-.2594	-.2516
.95			-.2985	-.2355	-.2992	-.2106			-.3359	-.3019	-.3213	-.2978		

TAIL 2

TABLE IV. - CONTINUED
(1) $\alpha = 13.20^\circ$

Cp at y/b of														
x/c	0.02		0.22		0.44		0.56		0.67		0.83		0.98	
	U.S.	L.S.	U.S.	L.S.	U.S.	L.S.	U.S.	L.S.	U.S.	L.S.	U.S.	L.S.	U.S.	L.S.
.05	-.3012	.6317	-.3773	.7219							-.2471	1.3037	-.1805	1.0459
.10	-.2202	.5094	-.3193	.7010							-.1932	1.3150	-.1374	.9671
.15	-.1793	.5214	-.2748	.6592	-.3213	.8663	-.3630	1.0778			-.1321	1.1034	-.0240	.8435
.20	-.1626	.5387							-.0822	1.0827	-.0853	1.0487		
.25	-.1721	.5369	-.1876	.5541	-.2495	.8870			-.0864	1.0055			.0882	.7214
.30	-.2506	.2624	-.2436	.5001			-.2670	.9134	-.0556	.9557	-.0536	.9300	.0842	.6721
.40	-.2014	.4839					-.2462	.7684	-.1329	.8191	-.0499	.7890	.0701	.5543
.50			-.3566	.5134			-.3797	.1321	-.2709	.1477	-.0954	.2498	.0195	.1564
.60	-.1900	.4143	-.3258	.5488	-.3958	.3928	-.3334	-.1458	-.3378	-.1702	-.3895	-.1864	-.3518	-.2503
.70			-.2841	.5738	-.3720	-.0082	-.3492	-.0960			-.3778	-.1817	-.3622	-.2207
.80	-.3358	.2180	-.3801	.0666	-.3804	-.0184	-.2612	-.0203					-.4304	-.1970
.90	-.3180	.0852	-.3018	.0622	-.3719	-.0138	-.3046	-.0209	-.3526	-.1182	-.3487	-.1624	-.4233	-.1789
.95			-.2411	.0524	-.3599	-.0177	-.2979	.0191	-.3673	-.1281	-.3361	-.1628		

TAIL 1

Cp at y/b of														
x/c	0.02		0.22		0.44		0.56		0.67		0.83		0.98	
	U.S.	L.S.	U.S.	L.S.	U.S.	L.S.	U.S.	L.S.	U.S.	L.S.	U.S.	L.S.	U.S.	L.S.
.05	.0902	.0079	.1227	-.2101	-.0041	.3270	-.0840	.7070			-.0838	.9592		
.10	.2622	.0099	.1198	-.0047	.0426	.3010	-.0348	.6772			.0606	.9037	.0511	.7329
.15	.2724	-.0002	.1151	.0232	.0416	.2763	.0183	.6382			.1763	.8297	.0967	.6464
.20					.0244	.2682	.0602	.5873	.0601	.6907	.1802	.7797	.1227	.5700
.25	.2639	-.0271	.1114	.0847	-.0030	.2495			.0807	.6486	.1640	.7368	.1152	.5236
.30	.0278	-.1419	.0703	.0847	-.0289	.2438			.0921	.5996	.1412	.6978	.1126	.4756
.40	.0098	-.0935			-.0731	.2520	.0426	.4204	.0844	.5450	.1184	.6067	.0756	.3821
.50			-.0813	-.0797			-.2286	-.0488					.0036	.0201
.60			-.0474	-.0185	-.1322	-.0296			-.3835	-.2403	-.3657	-.2275	-.3575	-.2843
.70			-.0696	-.0071			-.3868	-.2851	-.3762	-.2668	-.3826	-.2556	-.3666	-.2799
.80			-.3241	-.2403	-.3483	-.2113	-.3732	-.2596	-.3651	-.2756	-.3516	-.2644	-.3504	-.2664
.90					-.3377	-.2101	-.3358	-.2432	-.3665	-.2801	-.3423	-.2715	-.2835	-.2560
.95			-.3085	-.2556	-.3172	-.2115			-.3541	-.2853	-.3393	-.2821		

TAIL 2

TABLE IV. - CONTINUED
(j) $\alpha = 17.20^\circ$

Cp at γ/b of														
x/c	0.02		0.22		0.44		0.56		0.67		0.83		0.98	
	U.S.	L.S.	U.S.	L.S.	U.S.	L.S.	U.S.	L.S.	U.S.	L.S.	U.S.	L.S.	U.S.	L.S.
.05	-.3841	.7241	-.4617	.8942							-.3694	1.3951	-.3167	1.1185
.10	-.3319	.6259	-.4307	.8624							-.3341	1.4055	-.2907	1.0676
.15	-.2772	.6775	-.3972	.8355	-.4415	1.0783	-.4517	1.1909			-.2866	1.2089	-.1571	.9457
.20	-.2349	.7040							-.2183	1.1810	-.2468	1.1516		
.25	-.2323	.7283	-.2684	.7753	-.3942	1.0475			-.2109	1.1046			-.0249	.8140
.30	-.2859	.4670	-.3465	.7727			-.4072	1.0209	-.1595	1.0496	-.2125	1.0268	-.0215	.7615
.40	-.2222	.7226					-.3829	.8487	-.2403	.8948	-.2039	.8749	-.0355	.6312
.50			-.3969	.7563			-.3698	.2250	-.3464	.1789	-.2346	.2987	-.0648	.1958
.60	-.2188	.7854	-.3569	.7592	-.4270	.5509	-.3526	.0295	-.3468	-.1022	-.3859	-.1422	-.3888	-.2175
.70			-.3284	.6586	-.4030	.0587	-.3677	.0425			-.3865	-.1177	-.4003	-.2005
.80	-.3445	.2708	-.4145	.0922	-.3937	.0481	-.2729	.0723					-.4469	-.1708
.90	-.2371	.1162	-.3814	.0911	-.3918	.0565	-.3197	.0630	-.3579	.0447	-.3887	-.0618	-.4680	-.1396
.95			-.3442	.0816	-.3883	.0507	-.3118	.0904	-.3701	.0389	-.3713	-.0586		

TAIL 1

Cp at γ/b of														
x/c	0.02		0.22		0.44		0.56		0.67		0.83		0.98	
	U.S.	L.S.	U.S.	L.S.	U.S.	L.S.	U.S.	L.S.	U.S.	L.S.	U.S.	L.S.	U.S.	L.S.
.05	.0599	.0064	.3128	-.1120	-.0563	-.0842	.0025	.3971			-.2909	1.0220		
.10	.1617	.0073	.2857	-.0021	-.0700	-.0061	.0436	.4133			-.2024	.9454	-.1553	.7922
.15	.1682	-.0009	.2679	-.0099	-.0815	.0194	.0297	.4153			-.1425	.8755	-.1136	.7084
.20					-.0901	.0432	.0079	.4092	-.0237	.6667	-.0847	.8248	-.0811	.6328
.25	.1606	-.0275	.2541	-.0445	-.0981	.0574			-.0147	.6327	-.0685	.7763	-.0641	.5835
.30	-.0400	-.1520	.2201	-.0521	-.1091	.0817			-.0275	.5904	-.0430	.7329	-.0640	.5311
.40	-.0161	-.1111			-.1428	.1222	-.0814	.3198	-.0506	.5264	.0078	.6354	-.0716	.4252
.50			-.1187	-.2356			-.2994	-.0777					-.0938	.0314
.60			-.0758	-.2024	-.1709	-.1428			-.4178	-.2257	-.3908	-.2108	-.3885	-.2931
.70			-.0445	-.1598			-.4048	-.2769	-.4088	-.2410	-.3955	-.2311	-.3734	-.3012
.80			-.3020	-.3102	-.3146	-.2700	-.3955	-.2715	-.3922	-.2430	-.3755	-.2348	-.3629	-.2942
.90					-.3144	-.2331	-.3743	-.2531	-.3637	-.2452	-.3596	-.2376	-.3451	-.2874
.95			-.3092	-.3026	-.3157	-.2268			-.3345	-.2517	-.3393	-.2475		

TAIL 2

TABLE IV. - CONCLUDED
(k) $\alpha = 21.20^\circ$

Cp at γ/b of														
x/c	0.02		0.22		0.44		0.56		0.67		0.83		0.98	
	U.S.	L.S.	U.S.	L.S.	U.S.	L.S.	U.S.	L.S.	U.S.	L.S.	U.S.	L.S.	U.S.	L.S.
.05	-.4579	.7338	-.4880	1.0494							-.4366	1.4457	-.4055	1.1790
.10	-.4433	.7236	-.4869	1.0391							-.4159	1.4555	-.3926	1.1297
.15	-.4322	.8328	-.4835	1.0220	-.4785	1.1678	-.4751	1.2570			-.3905	1.2790	-.3192	1.0126
.20	-.4104	.8838							-.2933	1.2551	-.3618	1.2220		
.25	-.3627	.9047	-.3354	.9642	-.4758	1.1286			-.2832	1.1785			-.1637	.8794
.30	-.3505	.7303	-.4448	.9400			-.4725	1.0863	-.2165	1.1176	-.3270	1.0956	-.1570	.8252
.40	-.2718	.9276					-.4497	.9004	-.3089	.9545	-.3132	.9377	-.1365	.6868
.50			-.4383	.8615			-.4003	.3857	-.3682	.2132	-.3364	.3297	-.1790	.2260
.60	-.2692	.8874	-.4240	.8378	-.4227	.6448	-.3786	.0974	-.3589	-.0025	-.3880	-.0992	-.4524	-.1804
.70			-.4209	.7173	-.4206	.0961	-.3929	.0921			-.3896	-.0370	-.4539	-.1428
.80	-.3660	.2952	-.4510	.1049	-.4199	.1060	-.2862	.1344					-.4412	-.1021
.90	-.2990	.1665	-.4314	.1231	-.4183	.1323	-.3312	.1368	-.3769	.1137	-.3954	.0396	-.4343	-.0664
.95			-.4015	.1223	-.4125	.1292	-.3238	.1682	-.3890	.1035	-.3932	.0571		

TAIL 1

Cp at γ/b of														
x/c	0.02		0.22		0.44		0.56		0.67		0.83		0.98	
	U.S.	L.S.	U.S.	L.S.	U.S.	L.S.	U.S.	L.S.	U.S.	L.S.	U.S.	L.S.	U.S.	L.S.
.05	.0373	-.0291	.2636	-.2476	-.0935	-.1912	-.0202	.0295			-.3920	.7292		
.10	.1539	-.0340	.2476	-.1337	-.1031	-.1542	-.0251	.0519			-.3148	.6952	-.3329	.7850
.15	.1616	-.0446	.2379	-.0917	-.0943	-.1258	-.0473	.0784			-.2406	.6618	-.3025	.7036
.20					-.1126	-.0983	-.0661	.0854	-.1036	.2331	-.1744	.6325	-.2719	.6319
.25	.1489	-.0685	.2166	-.0626	-.1250	-.0854			-.1095	.2258	-.1424	.5982	-.2428	.5848
.30	-.0469	-.1690	.1703	-.0669	-.1409	-.0723			-.1270	.2161	-.1251	.5740	-.2100	.5324
.40	-.0222	-.1363			-.1538	-.0865	-.1331	.0720	-.1514	.1964	-.1195	.4783	-.1546	.4168
.50			-.1167	-.2256			-.3053	-.1732					-.1596	.0226
.60			-.0730	-.2106	-.1729	-.1761			-.4239	-.2647	-.4255	-.2315	-.4117	-.2830
.70			-.0477	-.2064			-.4029	-.3059	-.4205	-.2674	-.4120	-.2436	-.4010	-.2851
.80			-.2952	-.3539	-.3451	-.3139	-.4002	-.2922	-.4041	-.2653	-.4021	-.2364	-.3640	-.2718
.90					-.3475	-.3068	-.3806	-.2708	-.3732	-.2563	-.3711	-.2212	-.3192	-.2672
.95			-.3184	-.3486	-.3429	-.3068			-.3412	-.2533	-.3518	-.2238		

TAIL 2

TABLE V. - PRESSURE COEFFICIENTS, $\phi = 90^\circ$, $\delta = 0^\circ$, $M = 1.60$.
(a) $\alpha = -2.84^\circ$

Cp at y/b of														
x/c	0.02		0.22		0.44		0.56		0.67		0.83		0.98	
	U.S.	L.S.	U.S.	L.S.	U.S.	L.S.	U.S.	L.S.	U.S.	L.S.	U.S.	L.S.	U.S.	L.S.
.05	.2671	-.0585	.4576	-.0555							1.0623	.1340	.7868	.0920
.10	.2638	.0359	.4058	.0350							.9365	.4806	.6994	.3317
.15	.2551	.0162	.3752	.0944	.4488	.0495	.7211	.1267			.8553	.3251	.5931	.2667
.20	.2451	.0393							.7886	.2567	.7915	.4089		
.25	.2049	.0476	.3563	.0836	.4005	.1345			.7311	.2307			.4934	.2846
.30	.0246	-.0793	.3029	.0880			.6146	.2773	.7001	.2560	.6923	.3558	.4426	.2822
.40	.1292	-.0189					.5307	.2643	.6003	.2642	.5872	.2839	.3712	.2390
.50			-.0138	-.1558			.0075	-.1178	.2264	-.0810	.3838	-.0125	.2534	-.0014
.60	.1331	-.0034	.1293	-.0838	-.1272	-.1821	-.2695	-.3208	-.2546	-.3168	-.2607	-.3343	-.2653	-.2835
.70			.1234	-.0390	-.3119	-.3632	-.3068	-.3483			-.2878	-.3474	-.2680	-.1812
.80	-.1744	-.1793	-.1918	-.2744	-.2854	-.3326	-.2377	-.2639					-.2574	-.2198
.90	-.1875	-.2256	-.1785	-.2679	-.2311	-.3270	-.2592	-.2712	-.2949	-.2923	-.2777	-.3013	-.1842	-.2729
.95			-.1770	-.2301	-.2028	-.3140	-.2444	-.1814	-.3057	-.2967	-.2644	-.2950		

TAIL 1

Cp at y/b of														
x/c	0.02		0.22		0.44		0.56		0.67		0.83		0.98	
	U.S.	L.S.	U.S.	L.S.	U.S.	L.S.	U.S.	L.S.	U.S.	L.S.	U.S.	L.S.	U.S.	L.S.
.05	.1524	.1570	.3416	.2957	.4095	.3634	.7534	.5170			.5641	.6891		
.10	.1637	.1517	.2969	.2576	.3821	.3413	.6596	.5762			.7844	.7396	.4830	.4906
.15	.1663	.1425	.2758	.2329	.3514	.3037	.5666	.5802			.7221	.6814	.4729	.4813
.20					.3280	.2922	.5331	.5365	.6172	.6039	.6601	.6405	.4263	.4441
.25	.1545	.1127	.2402	.2036	.3171	.2827			.5823	.5733	.6146	.6030	.3974	.4149
.30	-.0382	-.0372	.2231	.1866	.3321	.2980			.5416	.5403	.5667	.5777	.3767	.3946
.40	.0183	.0419			.3394	.3488	.4296	.4314	.4836	.4974	.4921	.5034	.3350	.3513
.50			-.1174	-.1103			-.0195	-.0410					.2493	.0555
.60			-.0160	.0030	-.1576	-.1277			-.2692	-.2516	-.2701	-.2539	-.2404	-.2320
.70			.0683	.0632			-.3199	-.3070	-.3025	-.2831	-.3035	-.2877	-.2507	-.1650
.80			-.2078	-.1851	-.3076	-.3041	-.3194	-.3101	-.3032	-.2936	-.2887	-.2921	-.1607	-.1515
.90					-.3152	-.2881	-.2852	-.2820	-.2623	-.2874	-.2600	-.2576	-.2010	-.1885
.95			-.1881	-.1330	-.3140	-.2873			-.2562	-.2668	-.2582	-.2482		

TAIL 2

TABLE V. - CONTINUED
(b) $\alpha = -0.85^\circ$

Cp at y/b of														
x/c	0.02		0.22		0.44		0.56		0.67		0.83		0.98	
	U.S.	L.S.	U.S.	L.S.	U.S.	L.S.	U.S.	L.S.	U.S.	L.S.	U.S.	L.S.	U.S.	L.S.
.05	.1926	.0444	.3771								.9546	.3290	.6599	.2053
.10	.1968	.0770	.3314	.1677							.8380	.5054	.6142	.4352
.15	.1894	.0769	.3020	.1676	.3802	.2323	.6102	.3930			.7668	.4969	.5151	.3618
.20	.1820	.0824							.6919	.4927	.7115	.5312		
.25	.1520	.0825	.2986	.1391	.3311	.2107			.6438	.4704			.4342	.3478
.30	-.0043	-.0434	.2396	.1384			.5332	.3857	.6202	.4632	.6246	.4841	.3907	.3267
.40	.0796	.0147					.4725	.3544	.5368	.3940	.5303	.4278	.3323	.2788
.50			-.0785	-.1208			-.0198	-.0726	.1975	-.0213	.3437	.0760	.2270	.0272
.60	.0849	.0268	.0575	-.0269	-.1542	-.1560	-.2869	-.2988	-.2709	-.2848	-.2752	-.2927	-.2626	-.2617
.70			.0684	.0004	-.3416	-.3427	-.3226	-.3301			-.3039	-.3142	-.2643	-.2333
.80	-.1955	-.1507	-.2295	-.2483	-.3116	-.3121	-.2411	-.2603					-.2365	-.1885
.90	-.2031	-.2121	-.2153	-.2386	-.3049	-.3086	-.2562	-.2633	-.2891	-.2787	-.2638	-.2728	-.1786	-.2229
.95			-.2042	-.2177	-.3075	-.3057	-.2479	-.1743	-.2849	-.2802	-.2577	-.2664		

TAIL 1

Cp at y/b of														
x/c	0.02		0.22		0.44		0.56		0.67		0.83		0.98	
	U.S.	L.S.	U.S.	L.S.	U.S.	L.S.	U.S.	L.S.	U.S.	L.S.	U.S.	L.S.	U.S.	L.S.
.05	.1400	.1448	.3262	.2807	.3871	.3430	.6993	.4913			.5788	.6846		
.10	.1545	.1419	.2846	.2445	.3629	.3189	.6460	.5525			.7747	.7308	.4891	.4993
.15	.1562	.1350	.2670	.2211	.3367	.2873	.5488	.5563			.7096	.6726	.4678	.4872
.20					.3141	.2784	.5152	.5222	.5967	.5842	.6549	.6325	.4217	.4371
.25	.1521	.1121	.2347	.1973	.3021	.2699			.5641	.5541	.6086	.5980	.3898	.4042
.30	-.0271	-.0205	.2171	.1817	.3120	.2780			.5253	.5219	.5652	.5701	.3662	.3838
.40	.0441	.0511			.3151	.3171	.4190	.4162	.4732	.4832	.4873	.4986	.3178	.3345
.50			-.1056	-.0937			-.0265	-.0484					.2329	.0418
.60			.0004	.0086	-.1570	-.1306			-.2750	-.2582	-.2730	-.2556	-.2501	-.2384
.70			.0510	.0431			-.3229	-.3112	-.3068	-.2877	-.3053	-.2893	-.2769	-.2193
.80			-.2348	-.2098	-.3079	-.3061	-.3202	-.3122	-.2999	-.2973	-.2832	-.2898	-.1650	-.1512
.90					-.3154	-.2894	-.2870	-.2901	-.2656	-.2945	-.2585	-.2538	-.1874	-.1673
.95			-.2041	-.1647	-.3149	-.2878			-.2604	-.2762	-.2547	-.2454		

TAIL 2

TABLE V. - CONTINUED
 (c) $\alpha = 1.15^\circ$

Cp at y/b of														
x/c	0.02		0.22		0.44		0.56		0.67		0.83		0.98	
	U.S.	L.S.	U.S.	L.S.	U.S.	L.S.	U.S.	L.S.	U.S.	L.S.	U.S.	L.S.	U.S.	L.S.
.05	.1312	.1174	.2872	.2393							.6297	.6475	.4491	.4724
.10	.1407	.1248	.2507	.2334							.7195	.5477	.5213	.5902
.15	.1327	.1270	.2285	.2423	.2998	.3082	.4797	.5121			.6557	.6605	.4458	.4691
.20	.1301	.1266							.5786	.6347	.6084	.6476		
.25	.1061	.1213	.2396	.1921	.2609	.2844			.5387	.5710			.3800	.4002
.30	-.0300	-.0139	.1806	.1906			.4355	.4919	.5227	.5516	.5401	.5937	.3446	.3769
.40	.0337	.0531					.3955	.4390	.4501	.4906	.4625	.5100	.2978	.3195
.50			-.1317	-.0732			-.0588	-.0384	.1527	.0252	.2968	.1157	.2053	.0470
.60	.0394	.0687	-.0244	.0418	-.1815	-.1285	-.3036	-.2874	-.2856	-.2654	-.2899	-.2756	-.2666	-.2541
.70			.0118	.0500	-.3575	-.3235	-.3373	-.3148			-.3186	-.2969	-.2780	-.2737
.80	-.2214	-.1146	-.2614	-.2130	-.3227	-.3117	-.2412	-.2595					-.1958	-.1636
.90	-.2218	-.1942	-.2544	-.1945	-.3237	-.2930	-.2629	-.2623	-.2721	-.2986	-.2663	-.2602	-.1964	-.1594
.95			-.2290	-.1835	-.3201	-.2917	-.2558	-.1736	-.2811	-.2932	-.2629	-.2529		

TAIL 1

Cp at y/b of														
x/c	0.02		0.22		0.44		0.56		0.67		0.83		0.98	
	U.S.	L.S.	U.S.	L.S.	U.S.	L.S.	U.S.	L.S.	U.S.	L.S.	U.S.	L.S.	U.S.	L.S.
.05	.1289	.1290	.3091	.2708	.3701	.3266	.6315	.4781			.6038	.6806		
.10	.1445	.1305	.2706	.2340	.3481	.3060	.5189	.5262			.7605	.7233	.4960	.5099
.15	.1475	.1273	.2571	.2145	.3191	.2792	.5199	.5299			.6981	.6628	.4634	.4899
.20					.2968	.2691	.4922	.5007	.5747	.5629	.6440	.6253	.4220	.4326
.25	.1362	.1105	.2272	.1935	.2848	.2583			.5468	.5353	.6048	.5923	.3806	.3984
.30	-.0146	.0009	.2087	.1770	.2879	.2605			.5098	.5058	.5590	.5672	.3553	.3755
.40	.0562	.0518			.2921	.2859	.4039	.3995	.4585	.4717	.4797	.4973	.3000	.3268
.50			-.1037	-.0852			-.0313	-.0561					.2132	.0282
.60			.0029	.0031	-.1636	-.1348			-.2791	-.2593	-.2775	-.2559	-.2613	-.2454
.70			.0287	.0256			-.3302	-.3160	-.3123	-.2911	-.3082	-.2886	-.2919	-.2696
.80			-.2551	-.2252	-.3123	-.3124	-.3247	-.3134	-.3048	-.3013	-.2872	-.2924	-.1816	-.1655
.90					-.3187	-.2912	-.2945	-.2915	-.2706	-.2995	-.2612	-.2564	-.1769	-.1564
.95			-.2189	-.1988	-.3185	-.2887			-.2662	-.2800	-.2590	-.2473		

TAIL 2

TABLE V. - CONTINUED
(d) $\alpha = 3.15^\circ$

Cp at y/b of														
x/c	0.02		0.22		0.44		0.56		0.67		0.83		0.98	
	U.S.	L.S.	U.S.	L.S.	U.S.	L.S.	U.S.	L.S.	U.S.	L.S.	U.S.	L.S.	U.S.	L.S.
.05	.0707	.1986	.1686	.3419							.2700	.8875	.2273	.7247
.10	.0882	.1808	.1720	.3011							.4061	.5898	.3274	.6636
.15	.0826	.1802	.1536	.3202	.2180	.3960	.3627	.6473			.4989	.7693	.3212	.5365
.20	.0871	.1792							.4507	.7378	.4920	.7453		
.25	.0666	.1718	.1783	.2518	.1925	.3560			.4253	.6689			.3204	.4503
.30	-.0583	.0102	.1254	.2455			.3270	.5842	.4149	.6460	.4336	.6711	.3014	.4233
.40	-.0047	.0981					.3101	.5025	.3484	.5737	.3745	.5685	.2635	.3570
.50			-.1695	-.0019			-.0984	-.0085	.0867	.0566	.2355	.1456	.1806	.0550
.60	-.0015	.1092	-.0920	.1157	-.2064	-.1033	-.3224	-.2693	-.3077	-.2517	-.3106	-.2616	-.2727	-.2481
.70			-.0398	.1059	-.3642	-.3000	-.3559	-.2975			-.3380	-.2803	-.2669	-.2437
.80	-.2489	-.0770	-.2890	-.1679	-.3376	-.2784	-.2485	-.2524					-.1964	-.2014
.90	-.2375	-.1776	-.2810	-.1529	-.3383	-.2469	-.2751	-.2763	-.2915	-.2879	-.2885	-.2740	-.2841	-.1505
.95			-.2324	-.1476	-.3247	-.2131	-.2631	-.1801	-.3033	-.3030	-.2841	-.2562		

TAIL 1

Cp at y/b of														
x/c	0.02		0.22		0.44		0.56		0.67		0.83		0.98	
	U.S.	L.S.	U.S.	L.S.	U.S.	L.S.	U.S.	L.S.	U.S.	L.S.	U.S.	L.S.	U.S.	L.S.
.05	.1236	.1186	.2910	.2563	.3525	.3151	.5924	.4452			.6146	.6700		
.10	.1365	.1194	.2566	.2220	.3289	.2952	.5884	.4932			.7451	.7018	.4988	.5134
.15	.1379	.1147	.2453	.2029	.2990	.2653	.4861	.4890			.6860	.6537	.4626	.4875
.20					.2752	.2521	.4645	.4670	.5568	.5321	.6389	.6189	.4170	.4323
.25	.1199	.0955	.2192	.1834	.2615	.2386			.5261	.5152	.5940	.5891	.3696	.3991
.30	-.0176	-.0025	.1920	.1647	.2613	.2345			.4911	.4931	.5450	.5656	.3398	.3722
.40	.0440	.0371			.2637	.2484	.3865	.3817	.4364	.4615	.4700	.4973	.2811	.3155
.50			-.1122	-.0970			-.0381	-.0591					.1916	.0148
.60			-.0054	-.0134	-.1645	-.1391			-.2859	-.2631	-.2791	-.2582	-.2709	-.2577
.70			.0098	.0113			-.3380	-.3219	-.3175	-.2939	-.3118	-.2889	-.2729	-.2773
.80			-.2698	-.2342	-.3173	-.3181	-.3277	-.3168	-.3107	-.3057	-.2958	-.2954	-.2389	-.2190
.90					-.3233	-.2936	-.3008	-.2953	-.2760	-.3047	-.2657	-.2614	-.1779	-.1596
.95			-.2385	-.2284	-.3209	-.2878			-.2719	-.2845	-.2618	-.2506		

TAIL 2

TABLE V. - CONTINUED
(e) $\alpha = 5.15^\circ$

Cp at γ/b of														
x/c	0.02		0.22		0.44		0.56		0.67		0.83		0.98	
	U.S.	L.S.	U.S.	L.S.	U.S.	L.S.	U.S.	L.S.	U.S.	L.S.	U.S.	L.S.	U.S.	L.S.
.05	.0003	.2905	-.0214	.4306							.1191	1.0346	.1216	.8452
.10	.0276	.2392	-.0525	.3803							.2083	1.0480	.2045	.7365
.15	.0344	.2390	.0825	.3903	.0945	.4565	.0881	.7565			.2904	.8556	.2412	.6113
.20	.0397	.2377							.2234	.8193	.3144	.8208		
.25	.0276	.2327	.1149	.3140	.1149	.4165			.1986	.7495			.2486	.5113
.30	-.0853	.0335	.0720	.2982			.2251	.6566	.2179	.7187	.3059	.7315	.2458	.4775
.40	-.0323	.1542					.2109	.5570	.2108	.6317	.2381	.6204	.2253	.3982
.50			-.1964	.1014			-.1422	.0177	.0056	.0763	.1146	.1689	.1485	.0711
.60	-.0344	.1463	-.1346	.1856	-.2342	-.0708	-.3409	-.2521	-.3342	-.2382	-.3531	-.2483	-.2861	-.2453
.70			-.0836	.1608	-.3679	-.2360	-.3660	-.2809			-.3554	-.2640	-.2359	-.2459
.80	-.2628	-.0398	-.3102	-.1165	-.3528	-.1775	-.2455	-.2292					-.2285	-.2287
.90	-.2435	-.1643	-.2807	-.1226	-.3453	-.1644	-.2786	-.2388	-.3095	-.2732	-.3247	-.2710	-.2510	-.1805
.95			-.1808	-.1195	-.3246	-.1791	-.2682	-.1632	-.3198	-.2906	-.3184	-.2713		

TAIL 1

Cp at γ/b of														
x/c	0.02		0.22		0.44		0.56		0.67		0.83		0.98	
	U.S.	L.S.	U.S.	L.S.	U.S.	L.S.	U.S.	L.S.	U.S.	L.S.	U.S.	L.S.	U.S.	L.S.
.05	.1435	.1404	.3064	.2765	.3371	.3004	.5670	.4068			.6623	.6724		
.10	.1605	.1359	.2704	.2328	.3111	.2769	.5715	.4518			.7237	.7046	.4973	.5223
.15	.1542	.1202	.2540	.2099	.2817	.2449	.4713	.4607			.6741	.6486	.4518	.4894
.20					.2584	.2296	.4514	.4451	.5395	.5215	.6200	.6080	.4080	.4304
.25	.1232	.0863	.2124	.1783	.2476	.2199			.5058	.5082	.5772	.5775	.3574	.3964
.30	-.0595	-.0481	.1848	.1589	.2506	.2206			.4677	.4832	.5307	.5564	.3257	.3645
.40	-.0192	-.0021			.2573	.2314	.3652	.3772	.4142	.4478	.4609	.4884	.2683	.2999
.50			-.1508	-.1429			-.0512	-.0580					.1767	.0017
.60			-.0698	-.0428	-.1781	-.1359			-.2911	-.2687	-.2797	-.2584	-.2799	-.2691
.70			.0018	.0116			-.3447	-.3281	-.3212	-.2972	-.3109	-.2885	-.2888	-.2694
.80			-.2758	-.2321	-.3239	-.3348	-.3393	-.3298	-.3175	-.3084	-.3030	-.2997	-.2798	-.2563
.90					-.3324	-.3023	-.3133	-.3045	-.2820	-.3097	-.2693	-.2663	-.1825	-.1916
.95			-.2688	-.2411	-.3305	-.2938			-.2793	-.2920	-.2645	-.2547		

TAIL 2

TABLE V. - CONTINUED
(1) $\alpha = 7.15^\circ$

Cp at y/b of														
x/c	0.02		0.22		0.44		0.56		0.67		0.83		0.98	
	U.S.	L.S.	U.S.	L.S.	U.S.	L.S.	U.S.	L.S.	U.S.	L.S.	U.S.	L.S.	U.S.	L.S.
.05	-.0858	.3762	-.1618	.5075							-.0123	1.1213	.0200	.9012
.10	-.0358	.2937	-.0892	.4665							.0824	1.1348	.0922	.8087
.15	-.0210	.2943	-.0532	.4532	-.1469	.5236	-.0836	.8411			.1385	.9324	.1545	.6811
.20	-.0126	.2985							.1134	.8947	.1790	.8885		
.25	-.0098	.2993	.0481	.3772	-.0408	.4817			-.0855	.8188			.2035	.5695
.30	-.1013	.0703	.0127	.3472			.0023	.7216	.0957	.7856	.1935	.7883	.1965	.5290
.40	-.0519	.2200					.0402	.6124	.0359	.6849	.1660	.6693	.1783	.4347
.50			-.2145	.2074			-.2220	.0430	-.1395	.0946	.0549	.1937	.1114	.0859
.60	-.0585	.1921	-.1568	.2480	-.2607	.0281	-.3714	-.2357	-.3453	-.2228	-.3746	-.2326	-.2983	-.2445
.70			-.1178	.2281	-.3813	-.1056	-.3576	-.2533			-.3825	-.2427	-.2578	-.2433
.80	-.2743	-.0021	-.3235	-.0696	-.3707	-.1231	-.2581	-.1774					-.2530	-.2335
.90	-.2305	-.1439	-.2572	-.0931	-.3600	-.1433	-.2907	-.1922	-.3446	-.2530	-.3569	-.2494	-.2973	-.2092
.95			-.1461	-.0897	-.3291	-.1581	-.2753	-.1263	-.3507	-.2695	-.3511	-.2540		

TAIL 1

Cp at y/b of														
x/c	0.02		0.22		0.44		0.56		0.67		0.83		0.98	
	U.S.	L.S.	U.S.	L.S.	U.S.	L.S.	U.S.	L.S.	U.S.	L.S.	U.S.	L.S.	U.S.	L.S.
.05	.1649	.1420	.3390	.2960	.3340	.2931	.5691	.4045			.6506	.6627		
.10	.1750	.1359	.2871	.2416	.3103	.2735	.5524	.4707			.6976	.6879	.4898	.5189
.15	.1710	.1277	.2587	.2051	.2800	.2470	.4550	.4602			.6592	.6306	.4436	.4798
.20					.2555	.2346	.4299	.4432	.5148	.4978	.6024	.5944	.4030	.4227
.25	.1424	.0773	.2091	.1611	.2394	.2246			.4836	.4876	.5612	.5655	.3486	.3891
.30	-.0733	-.0842	.1847	.1480	.2349	.2227			.4494	.4672	.5218	.5449	.3122	.3561
.40	-.0739	-.0483			.2341	.2243	.3508	.3656	.3964	.4337	.4561	.4831	.2535	.2908
.50			-.1809	-.1738			-.0593	-.0606					.1580	-.0075
.60			-.1558	-.1065	-.1829	-.1384			-.2950	-.2726	-.2795	-.2576	-.2884	-.2774
.70			-.0342	-.0016			-.3481	-.3322	-.3234	-.3003	-.3135	-.2909	-.3065	-.2688
.80			-.2756	-.2405	-.3305	-.3411	-.3467	-.3468	-.3221	-.3105	-.3022	-.3031	-.3104	-.2656
.90					-.3334	-.3221	-.3241	-.3192	-.2861	-.3134	-.2713	-.2750	-.2156	-.2467
.95			-.2838	-.2475	-.3350	-.3081			-.2816	-.2973	-.2680	-.2622		

TAIL 2

TABLE V. - CONTINUED
 (g) $\alpha = 9.15^\circ$

Cp at y/b of														
x/c	0.02		0.22		0.44		0.56		0.67		0.83		0.98	
	U.S.	L.S.	U.S.	L.S.	U.S.	L.S.	U.S.	L.S.	U.S.	L.S.	U.S.	L.S.	U.S.	L.S.
.05	-.1693	.4392	-.2675	.5782										
.10	-.0907	.3391	-.1929	.5455							-.1215	1.1928	-.0619	.9550
.15	-.0636	.3476	-.1607	.5172	-.2480	.5781	-.2026	.9157			-.0396	1.2050	-.0112	.8678
.20	-.0443	.3631									.0244	.9917	-.0538	.7388
.25	-.0426	.3671	-.0426	.4295	-.1954	.5622				.0171	.9587	.0662	.9459	
.30	-.1226	.1152	-.0509	.3875			-.1337	.7769	-.0025	.8795			.1270	.6204
.40	-.0751	.2966					-.1164	.6585	-.0113	.8424	.0901	.8400	.1403	.5750
.50			-.2398	.2789			-.3000	.0674	-.0591	.7299	.0796	.7120	.1268	.4701
.60	-.0836	.2395	-.1799	.2892	-.3062	.2745	-.3543	-.2092	-.2112	.1146	-.0075	.2142	.0790	.1019
.70			-.1523	.3282	-.3845	-.0684	-.3671	-.1759	-.3370	-.2051	-.3937	-.2161	-.3199	-.2541
.80	-.2804	.0332	-.3374	-.0302	-.3893	-.1022	-.2745	-.1123			-.3724	-.2198	-.2843	-.2398
.90	-.2441	-.1195	-.2440	-.0597	-.3759	-.1184	-.3150	-.1070	-.3450	-.2022	-.3537	-.2248	-.2941	-.2330
.95			-.1615	-.0564	-.3506	-.1249	-.3047	-.0571	-.3564	-.2173	-.3388	-.2282	-.3449	-.2231

TAIL 1

Cp at y/b of														
x/c	0.02		0.22		0.44		0.56		0.67		0.83		0.98	
	U.S.	L.S.	U.S.	L.S.	U.S.	L.S.	U.S.	L.S.	U.S.	L.S.	U.S.	L.S.	U.S.	L.S.
.05	.1660	.1362	.3861	.3142	.3422	.3213	.5614	.4143			.6427	.6607		
.10	.1611	.1151	.3212	.2577	.3129	.2932	.5451	.4734			.6810	.6814	.4729	.5175
.15	.1477	.0904	.2696	.2139	.2811	.2578	.4483	.4588			.6388	.6271	.4311	.4762
.20					.2572	.2412	.4226	.4431	.5076	.4902	.5842	.5889	.3940	.4175
.25	.1296	.0523	.1953	.1525	.2425	.2276			.4774	.4768	.5464	.5647	.3411	.3833
.30	-.0719	-.0935	.1690	.1356	.2402	.2288			.4420	.4635	.5079	.5438	.3014	.3496
.40	-.0892	-.0608			.2469	.2396	.3525	.3705	.3913	.4297	.4460	.4838	.2452	.2795
.50			-.1928	-.1965			-.0572	-.0589					.1478	-.0180
.60			-.2172	-.1987	-.1720	-.1224			-.2971	-.2723	-.2843	-.2597	-.2949	-.2852
.70			-.1606	-.1137			-.3471	-.3302	-.3251	-.2992	-.3162	-.2928	-.3075	-.2828
.80			-.2935	-.2477	-.3462	-.3416	-.3503	-.3468	-.3245	-.3084	-.3005	-.3037	-.3046	-.2676
.90					-.3237	-.3427	-.3260	-.3350	-.2897	-.3130	-.2716	-.2780	-.2750	-.2699
.95			-.2758	-.2336	-.3257	-.3319			-.2844	-.2982	-.2683	-.2646		

TAIL 2

TABLE V. - CONTINUED
(h) $\alpha = 11.16^\circ$

Cp at y/b of														
x/c	0.02		0.22		0.44		0.56		0.67		0.83		0.98	
	U.S.	L.S.	U.S.	L.S.	U.S.	L.S.	U.S.	L.S.	U.S.	L.S.	U.S.	L.S.	U.S.	L.S.
.05	-.2205	.4956	-.3538	.6200							-.2028	1.2477	-.1587	.9823
.10	-.1255	.3931	-.2831	.6138							-.1547	1.2604	-.1172	.9194
.15	-.1031	.4126	-.2423	.5721	-.3269	.6327	-.3221	.9948			-.0956	1.0484	-.0509	.7912
.20	-.0805	.4386							-.0655	1.0275	-.0486	.9991		
.25	-.0786	.4434	-.1287	.4756	-.2764	.6750			-.0781	.9509			.0828	.6661
.30	-.1377	.1715	-.1413	.4247			-.2321	.8580	-.0543	.9046	-.0117	.8888	.0880	.6170
.40	-.0973	.3722					-.2192	.7293	-.1309	.7820	-.0119	.7526	.0709	.5038
.50			-.2581	.3470			-.3682	.1107	-.2644	.1316	-.0791	.2280	.0206	.1162
.60	-.1069	.2901	-.2024	.3487	-.3709	.3506	-.3621	-.1658	-.3247	-.1832	-.3694	-.1956	-.3506	-.2714
.70			-.1818	.4467	-.4025	-.0598	-.3801	-.1282			-.3747	-.1970	-.3193	-.2481
.80	-.2897	.0810	-.3493	-.0065	-.4093	-.0852	-.2846	-.0686					-.3306	-.2381
.90	-.2649	-.0618	-.2317	-.0309	-.3883	-.0835	-.3256	-.0868	-.3480	-.1559	-.3489	-.1952	-.3838	-.2297
.95			-.1743	-.0286	-.3629	-.0903	-.3095	-.0577	-.3601	-.1700	-.3259	-.1974		

TAIL 1

Cp at y/b of														
x/c	0.02		0.22		0.44		0.56		0.67		0.83		0.98	
	U.S.	L.S.	U.S.	L.S.	U.S.	L.S.	U.S.	L.S.	U.S.	L.S.	U.S.	L.S.	U.S.	L.S.
.05	.1419	.1024	.4109	.2920	.3818	.3810	.5769	.4570			.6337	.6525		
.10	.1498	.0944	.3593	.2767	.3472	.3325	.5621	.4970			.6694	.6711	.4606	.5129
.15	.1453	.0870	.2863	.2184	.3081	.2872	.4583	.4809			.6252	.6160	.4279	.4753
.20					.2742	.2629	.4313	.4616	.5047	.5018	.5739	.5826	.3935	.4174
.25	.1115	.0575	.1575	.1119	.2514	.2413			.4741	.4896	.5423	.5554	.3402	.3837
.30	-.0900	-.0938	.1206	.0818	.2464	.2372			.4379	.4681	.5026	.5354	.2986	.3486
.40	-.0992	-.0824			.2558	.2604	.3537	.3838	.3884	.4326	.4452	.4801	.2385	.2795
.50			-.2279	-.2350			-.0528	-.0499					.1430	-.0206
.60			-.2500	-.2383	-.1537	-.1156			-.2966	-.2709	-.2824	-.2582	-.2994	-.2880
.70			-.2332	-.2231			-.3404	-.3195	-.3232	-.2971	-.3150	-.2908	-.3093	-.2881
.80			-.3521	-.3234	-.3705	-.3493	-.3567	-.3383	-.3216	-.3044	-.2982	-.3013	-.2910	-.2640
.90					-.3303	-.3518	-.3240	-.3376	-.2868	-.3066	-.2695	-.2766	-.2959	-.2675
.95			-.2925	-.2342	-.3259	-.3441			-.2797	-.2906	-.2663	-.2621		

TAIL 2

TABLE V. - CONTINUED
(ii) $\alpha = 13.16^\circ$

Cp at y/b of														
x/c	0.02		0.22		0.44		0.56		0.67		0.83		0.98	
	U.S.	L.S.	U.S.	L.S.	U.S.	L.S.	U.S.	L.S.	U.S.	L.S.	U.S.	L.S.	U.S.	L.S.
.05	-.2735	.5410	-.4182	.6807							-.2710	1.2890	-.2379	1.0060
.10	-.1672	.4364	-.3695	.6671							-.2432	1.3002	-.2083	.9598
.15	-.1343	.4671	-.3238	.6241	-.3933	.7041	-.3930	1.0652			-.1971	1.0936	-.1476	.8320
.20	-.1068	.4985							-.1360	1.0798	-.1486	1.0435		
.25	-.1020	.5080	-.1920	.5219	-.3444	.7981			-.1437	1.0002			.0200	.7037
.30	-.1507	.2269	-.2133	.4660			-.3134	.9100	-.1092	.9507	-.1045	.9271	.0323	.6539
.40	-.1245	.4437					-.2988	.7627	-.1922	.8161	-.0994	.7869	.0106	.5322
.50			-.2718	.4096			-.3948	.1384	-.3129	.1439	-.1514	.2412	-.0350	.1304
.60	-.1294	.3453	-.2320	.4272	-.4063	.3856	-.3596	-.1276	-.3151	-.1630	-.3547	-.1813	-.3710	-.2611
.70			-.2170	.4915	-.4107	-.0311	-.3825	-.0824			-.3529	-.1775	-.3521	-.2593
.80	-.3033	.1390	-.3537	.0124	-.4080	-.0425	-.2855	-.0342					-.3642	-.2408
.90	-.2836	-.0048	-.2315	.0023	-.3764	-.0487	-.3251	-.0449	-.3446	-.1139	-.3582	-.1649	-.3923	-.2233
.95			-.1943	-.0044	-.3607	-.0592	-.3108	-.0175	-.3559	-.1207	-.3562	-.1659		

TAIL 1

Cp at y/b of														
x/c	0.02		0.22		0.44		0.56		0.67		0.83		0.98	
	U.S.	L.S.	U.S.	L.S.	U.S.	L.S.	U.S.	L.S.	U.S.	L.S.	U.S.	L.S.	U.S.	L.S.
.05	.1388	.1160	.4036	.2462	.4602	.4654	.6372	.5468			.6427	.6708		
.10	.1397	.1041	.3217	.2292	.4140	.4065	.5924	.5572			.6742	.6904	.4598	.5204
.15	.1292	.0834	.2724	.1942	.3577	.3332	.4854	.5390			.6290	.6384	.4295	.4827
.20					.3085	.2898	.4574	.4930	.5284	.5461	.5841	.6028	.3985	.4273
.25	.1045	.0400	.1521	.0724	.2702	.2506			.4970	.5246	.5534	.5781	.3469	.3929
.30	-.0906	-.1090	.0864	.0223	.2538	.2395			.4586	.4957	.5155	.5590	.3080	.3567
.40	-.0975	-.0908			.2515	.2622	.3601	.3833	.4071	.4612	.4595	.4961	.2451	.2850
.50			-.2678	-.2718			-.0488	-.0571					.1482	-.0175
.60			-.2665	-.2666	-.1804	-.1592			-.2897	-.2625	-.2783	-.2571	-.3012	-.2898
.70			-.2606	-.2585			-.3345	-.3149	-.3169	-.2897	-.3087	-.2857	-.3059	-.2854
.80			-.3681	-.3457	-.3871	-.3653	-.3499	-.3352	-.3187	-.3001	-.2986	-.2947	-.2859	-.2617
.90					-.3562	-.3681	-.3277	-.3445	-.2804	-.3041	-.2636	-.2700	-.2923	-.2671
.95			-.3444	-.3141	-.3461	-.3616			-.2736	-.2873	-.2589	-.2550		

TAIL 2

TABLE V. - CONTINUED
(j) $\alpha = 17.15^\circ$

Cp at y/b of														
x/c	0.02		0.22		0.44		0.56		0.67		0.83		0.98	
	U.S.	L.S.	U.S.	L.S.	U.S.	L.S.	U.S.	L.S.	U.S.	L.S.	U.S.	L.S.	U.S.	L.S.
.05	-.3320	.5838	-.4742	.7821							-.3793	1.3414	-.3645	1.0557
.10	-.2090	.4859	-.4661	.7619							-.3676	1.3524	-.3531	1.0207
.15	-.1704	.5499	-.4421	.7194	-.4630	.9064	-.4637	1.1478			-.3459	1.1653	-.3156	.8967
.20	-.1525	.5948							-.2488	1.1549	-.3099	1.1118		
.25	-.1540	.6204	-.2976	.6073	-.4452	.9263			-.2464	1.0768			-.1415	.7661
.30	-.1860	.3441	-.3431	.5893			-.4372	.9855	-.1940	1.0199	-.2634	.9951	-.1228	.7153
.40	-.1676	.5829					-.4186	.8200	-.2889	.8713	-.2493	.8485	-.1208	.5823
.50			-.3046	.5178			-.3965	.2117	-.3416	.1689	-.2832	.2727	-.1453	.1544
.60	-.1716	.4662	-.2676	.6284	-.4321	.5076	-.3805	.0080	-.3316	-.1143	-.3400	-.1541	-.4417	-.2336
.70			-.2691	.5877	-.4198	.0341	-.4050	.0173			-.3433	-.1314	-.4367	-.2179
.80	-.3289	.2255	-.3637	.0667	-.4200	.0275	-.2982	.0499					-.4207	-.1963
.90	-.3116	.0415	-.2861	.0626	-.3981	.0433	-.3382	.0416	-.3489	.0176	-.3483	-.0757	-.4051	-.1795
.95			-.2509	.0634	-.3918	.0412	-.3240	.0645	-.3612	.0101	-.3487	-.0731		

TAIL 1

Cp at y/b of														
x/c	0.02		0.22		0.44		0.56		0.67		0.83		0.98	
	U.S.	L.S.	U.S.	L.S.	U.S.	L.S.	U.S.	L.S.	U.S.	L.S.	U.S.	L.S.	U.S.	L.S.
.05	.0949	.0756	.3096	.1852	.4251	.2231	.7644	.6610			.6466	.7942		
.10	.0936	.0650	.2563	.1705	.4753	.3341	.6696	.5932			.7488	.8050	.4968	.6001
.15	-.1009	.0525	.2055	-.1423	.4722	.3749	.5646	.5191			.7110	.7436	.4632	.5442
.20					.4370	.3418	.4825	.4299	.6262	.6214	.6711	.6978	.4280	.4801
.25	.0825	.0225	.1506	.0773	.3622	.2498			.5766	.5629	.6263	.6570	.3788	.4469
.30	-.0936	-.1199	.1272	.0514	.2807	.1752			.5105	.4992	.5792	.6213	.3458	.4119
.40	-.1066	-.0996			.1275	.0511	.2427	.2079	.4153	.4366	.4991	.5364	.2879	.3395
.50			-.2347	-.2496			-.1414	-.1660					.1847	.0174
.60			-.2596	-.2509	-.2984	-.3220			-.2996	-.2834	-.2701	-.2478	-.2827	-.2623
.70			-.2541	-.2355			-.3856	-.3760	-.3361	-.3160	-.3053	-.2831	-.2932	-.2546
.80			-.3782	-.3460	-.4349	-.4418	-.3997	-.3905	-.3497	-.3309	-.3118	-.2956	-.2836	-.2346
.90					-.4248	-.4339	-.3880	-.3939	-.3304	-.3382	-.2727	-.2807	-.2617	-.2254
.95			-.3687	-.3309	-.4203	-.4288			-.3143	-.3327	-.2637	-.2636		

TAIL 2

TABLE V. - CONCLUDED
(k) $\alpha = 21.15^\circ$

Cp at γ/b of														
x/c	0.02		0.22		0.44		0.56		0.67		0.83		0.98	
	U.S.	L.S.	U.S.	L.S.	U.S.	L.S.	U.S.	L.S.	U.S.	L.S.	U.S.	L.S.	U.S.	L.S.
.05	-.4168	.5319	-.4913	.8487							-.4541	1.3680	-.4396	1.0937
.10	-.2608	.4456	-.4974	.8484							-.4470	1.3780	-.4402	1.0622
.15	-.2307	.5557	-.4681	.8228	-.4811	1.0055	-.4729	1.2002			-.4391	1.2180	-.4301	.9471
.20	-.2199	.6262							-.3213	1.2048	-.4195	1.1649		
.25	-.2103	.6600	-.2983	.7591	-.4746	1.0105			-.3103	1.1313			-.3240	.8211
.30	-.2314	.4226	-.3800	.7399			-.4654	1.0440	-.2365	1.0729	-.3846	1.0487	-.2694	.7668
.40	-.2043	.7097					-.4600	.8684	-.3225	.9168	-.3592	.8971	-.2597	.6301
.50			-.3518	.7195			-.4579	.4054	-.3510	.2015	-.3429	.2950	-.2737	.1758
.60	-.2022	.6876	-.3430	.7485	-.4375	.6212	-.4093	.0773	-.3442	.0169	-.3392	-.1055	-.4387	-.1939
.70			-.3477	.6756	-.4400	.0873	-.4254	.0746			-.3417	-.0355	-.4398	-.1543
.80	-.3587	.2529	-.4153	.0877	-.4139	.0928	-.3002	.1186					-.4379	-.1192
.90	-.2885	.1086	-.3700	.0805	-.4074	.1133	-.3361	.1250	-.3556	.0952	-.3455	.0494	-.4196	-.0898
.95			-.3387	.0818	-.4024	.1094	-.3230	.1514	-.3645	.0834	-.3451	.0686		

TAIL 1

Cp at γ/b of														
x/c	0.02		0.22		0.44		0.56		0.67		0.83		0.98	
	U.S.	L.S.	U.S.	L.S.	U.S.	L.S.	U.S.	L.S.	U.S.	L.S.	U.S.	L.S.	U.S.	L.S.
.05	.0603	.0287	.2834	.0933	.2462	.1013	.5604	.4310			.3725	.6630		
.10	.0978	.0222	.2012	.0759	.3410	.1788	.5143	.4487			.5449	.6968	.4682	.6058
.15	.0829	.0126	.1485	.0412	.3708	.2296	.4756	.4205			.6212	.6548	.4566	.5527
.20					.3549	.2762	.4158	.3713	.5470	.4790	.6339	.6258	.4442	.5232
.25	.0571	-.0206	.0923	-.0105	.3059	.2617			.5204	.4499	.6116	.6181	.4481	.5134
.30	-.1200	-.1580	.0638	-.0318	.2485	.2255			.4691	.3920	.5870	.5830	.4459	.4956
.40	-.1270	-.1362			.1286	.0891	.1920	.1639	.3555	.3145	.5186	.5007	.4128	.4413
.50			-.2564	-.2796			-.1798	-.2008					.3184	.1041
.60			-.2661	-.2757	-.3026	-.3192			-.3260	-.3295	-.2671	-.2669	-.2130	-.2008
.70			-.2570	-.2634			-.4041	-.4021	-.3665	-.3651	-.3070	-.3036	-.1903	-.1633
.80			-.3811	-.3701	-.4545	-.4530	-.4224	-.4201	-.3825	-.3835	-.3238	-.3238	-.1441	-.1494
.90					-.4536	-.4524	-.4258	-.4239	-.3876	-.3876	-.3123	-.3188	-.1619	-.1680
.95			-.3917	-.3726	-.4473	-.4471			-.3747	-.3797	-.2949	-.3042		

TAIL 2

TABLE VI. - PRESSURE COEFFICIENTS, $\phi = 0^\circ$, $\delta = 0^\circ$, $M = 2.36$.
(a) $\alpha = -4.06^\circ$

Cp at y/b of														
x/c	0.02		0.22		0.44		0.56		0.67		0.83		0.98	
	U.S.	L.S.	U.S.	L.S.	U.S.	L.S.	U.S.	L.S.	U.S.	L.S.	U.S.	L.S.	U.S.	L.S.
.05	.0745	.0721	.2146	.2410		.2616			.2440		.2784	.3480	.2672	.3423
.10	.0815	.0676	.1846	.2033	.2204	.2454			.2705	.3314	.2599	.3295	.2433	.3013
.15	.0733	.0689	.1683	.1795	.2035	.2336			.2932	.3632	.2575	.3198	.2187	.2764
.20	.0654	.0627							.2987	.3808	.2564	.3183		
.25	.0599	.0586	.1445	.1546	.1840	.2130	.2990	.3668	.3011	.3891			.1782	.2298
.30	-.0186	-.0172	.1334	.1423		.2038	.3028	.3672	.2981	.3902	.2566	.3202	.1647	.2175
.40	-.0211	-.0097	-.0471	-.0235	.1580	.2059	.2810	.3499	.2951	.3776	.2515	.3186	.1460	.1959
.50	.0060	.0192	-.0656	-.0338			.0297	.0553	.1421	.1087	.1889	.1384	.1024	.0543
.60	-.0008	.0497	-.0671	-.0326	-.0208	.0129	-.1305	-.1100	-.1169	-.0995	-.1245	-.1017	-.1056	-.1281
.70			-.0643	-.0282	-.1513	-.1251	-.1506	-.1280	-.1155	-.0986	-.1245	-.1120	-.1054	-.1165
.80	-.1128	-.0748	-.1529	-.1324	-.1502	-.1422	-.1485	-.1339			-.1068	-.1134	-.1041	-.1098
.90	-.1309	-.1097	-.1398	-.1327	-.1344	-.1464	-.1340	-.1400	-.1172	-.1224	-.1024	-.1133	-.1046	-.1049
.95			-.1384	-.1301	-.1338	-.1433	-.1281	-.1354	-.1127	-.1191	-.1017	-.1099	-.1057	-.1054

TAIL 1

Cp at y/b of														
x/c	0.02		0.22		0.44		0.56		0.67		0.83		0.98	
	U.S.	L.S.	U.S.	L.S.	U.S.	L.S.	U.S.	L.S.	U.S.	L.S.	U.S.	L.S.	U.S.	L.S.
.05	.1880	-.0008	.3906	.0537	.4469	-.0267	.6916	.1325	.5151		.4480	.1721		
.10	.1722	.0007	.3422	.0437	.4133	.0128		.1548			.4330	.1804	.3729	.0687
.15	.1764	.0012	.3157	.0338	.3849	.0699	.5908	.1378	.6046	.1684	.4312	.1597	.3549	.1120
.20					.3583	.0686	.5458	.1369	.5920	.1882	.4335	.1520	.3239	.1158
.25	.1690	-.0038	.2791	.0275	.3399	.0642	.5197	.1399	.5736	.1864	.4411	.1588	.3048	.1068
.30	.0490	-.0476	.2618	.0271	.3266	.0668	.5024	.1405	.5478	.1791	.4552	.1671	.2873	.1013
.40	.0465	-.0438			.3108	.0686	.4678	.1420	.5098	.1680	.4668	.1744	.2579	.0907
.50	.0373	-.0198	.0177	-.0903			.1300	-.0523					.2102	-.0117
.60	.0788	-.0221	.0179	-.0812	.0331	-.0818	-.0661	-.1584	-.0485	-.1467	-.0446	-.1455	-.1161	-.1441
.70			.0240	-.0837			-.1065	-.1669	-.0726	-.1634	-.0705	-.1488	-.1132	-.1412
.80			-.1105	-.1559	-.1226	-.1419	-.1187	-.1505	-.0817	-.1426	-.0787	-.1338	-.1091	-.1051
.90			-.1156	-.1555	-.1324	-.1438	-.1291	-.1461	-.0929	-.1390	-.0898	-.1305	-.1023	-.1197
.95			-.1159	-.1448		-.1432			-.0989	-.1401	-.0955	-.1300	-.1013	-.1381

TAIL 2

TABLE VI. - CONTINUED
(b) $\alpha = -2.04^\circ$

Cp at γ/b of														
x/c	0.02		0.22		0.44		0.56		0.67		0.83		0.98	
	U.S.	L.S.	U.S.	L.S.	U.S.	L.S.	U.S.	L.S.	U.S.	L.S.	U.S.	L.S.	U.S.	L.S.
.05	.0675	-.0669	.2176	.2427		.2785			.2540		.2790	.3503	.2692	.3402
.10	.0714	-.0674	.1849	.2043	.2304	.2584			.2677	.3222	.2606	.3326	.2441	.2965
.15	.0683	-.0706	.1681	.1792	.2127	.2432			.2873	.3478	.2588	.3214	.2175	.2700
.20	.0646	-.0701							.2996	.3677	.2574	.3181		
.25	.0619	-.0665	.1406	.1534	.1915	.2183	.3027	.3689	.3009	.3797			.1788	.2253
.30	-.0086	-.0025	.1298	.1402		.2064	.3060	.3698	.2984	.3846	.2558	.3207	.1673	.2152
.40	.0020	-.0141	-.0478	-.0237	.1630	.2159	.2848	.3516	.2975	.3801	.2501	.3171	.1482	.1940
.50	.0213	.0364	-.0682	-.0356			.0348	.0569	.1398	.1128	.1883	.1350	.1046	.0538
.60	.0055	-.0497	-.0663	-.0286	-.0230	.0048	-.1310	-.1092	-.1155	-.0976	-.1268	-.1064	-.1045	-.1249
.70			-.0561	-.0208	-.1521	-.1292	-.1505	-.1255	-.1140	-.0967	-.1213	-.1165	-.1051	-.1178
.80	-.1090	-.0621	-.1489	-.1240	-.1451	-.1429	-.1480	-.1316			-.1066	-.1166	-.1040	-.1097
.90	-.1182	-.0934	-.1381	-.1291	-.1327	-.1456	-.1335	-.1378	-.1155	-.1208	-.1034	-.1138	-.1057	-.1065
.95			-.1352	-.1273	-.1316	-.1420	-.1277	-.1347	-.1113	-.1169	-.1026	-.1101	-.1091	-.1048

TAIL 1

Cp at γ/b of														
x/c	0.02		0.22		0.44		0.56		0.67		0.83		0.98	
	U.S.	L.S.	U.S.	L.S.	U.S.	L.S.	U.S.	L.S.	U.S.	L.S.	U.S.	L.S.	U.S.	L.S.
.05	.1290	.0419	.3197	.1240	.3624	.0215	.5662	.2481	.3813		.3725	.2331		
.10	.1257	-.0374	.2794	.1054	.3403	.1100		.2148			.3590	.2366	.3066	.1227
.15	.1311	-.0366	.2556	.0933	.3185	.1318	.4856	.2067	.4483	.2194	.3548	.2146	.2907	.1575
.20					.2971	.1319	.4493	.2140	.4621	.2379	.3517	.2085	.2650	.1555
.25	.1254	.0271	.2218	.0857	.2794	.1296	.4333	.2242	.4645	.2433	.3486	.2163	.2473	.1553
.30	.0209	-.0243	.2085	.0824	.2688	.1312	.4177	.2278	.4555	.2379	.3483	.2252	.2309	.1459
.40	.0218	-.0229			.2517	.1251	.3917	.2293	.4294	.2284	.3525	.2293	.2035	.1260
.50	.0407	-.0060	-.0143	-.0745			.0884	-.0110					.1600	.0050
.60	.0467	-.0050	-.0152	-.0679	.0038	-.0468	-.0639	-.1406	-.0847	-.1224	-.0854	-.1299	-.1245	-.1335
.70			-.0128	-.0650			-.1257	-.1554	-.1062	-.1407	-.1044	-.1379	-.1216	-.1362
.80			-.1300	-.1442	-.1402	-.1479	-.1349	-.1502	-.1115	-.1349	-.1074	-.1182	-.1130	-.1187
.90			-.1307	-.1393	-.1483	-.1352	-.1421	-.1364	-.1176	-.1226	-.1118	-.1127	-.1059	-.1043
.95			-.1248	-.1335		-.1320			-.1183	-.1172	-.1112	-.1118	-.1073	-.1145

TAIL 2

TABLE VI. - CONTINUED
(c) $\alpha = -0.05^\circ$

Cp at y/b of														
x/c	0.02		0.22		0.44		0.56		0.67		0.83		0.98	
	U.S.	L.S.	U.S.	L.S.	U.S.	L.S.	U.S.	L.S.	U.S.	L.S.	U.S.	L.S.	U.S.	L.S.
.05	.0666	.0814	.2255	.2536		.2713			.2610		.2814	.3533	.2709	.3376
.10	.0790	.0811	.1944	.2177	.2346	.2609			.2624	.3203	.2616	.3325	.2397	.2900
.15	.0752	.0851	.1736	.1918	.2213	.2497			.2798	.3363	.2601	.3211	.2100	.2640
.20	.0707	.0811							.2944	.3564	.2583	.3188		
.25	.0672	.0780	.1511	.1647	.2025	.2284	.3106	.3726	.2984	.3679			.1755	.2196
.30	-.0114	-.0077	.1387	.1507		.2145	.3116	.3747	.2949	.3731	.2555	.3173	.1660	.2120
.40	-.0077	.0103	-.0450	-.0206	.1747	.2250	.2906	.3597	.2944	.3761	.2495	.3128	.1494	.1926
.50	.0168	.0291	-.0643	-.0299			.0340	.0626	.1397	.1171	.1872	.1321	.1073	.0549
.60	.0069	.0553	-.0662	-.0256	-.0198	.0192	-.1279	-.1064	-.1146	-.0946	-.1277	-.1109	-.1031	-.1220
.70			-.0607	-.0233	-.1500	-.1202	-.1468	-.1229	-.1124	-.0937	-.1167	-.1226	-.1028	-.1163
.80	-.1057	-.0561	-.1486	-.1290	-.1429	-.1406	-.1460	-.1290			-.1050	-.1213	-.1016	-.1076
.90	-.1204	-.0957	-.1366	-.1290	-.1317	-.1454	-.1300	-.1356	-.1131	-.1185	-.1027	-.1135	-.1025	-.1053
.95			-.1344	-.1265	-.1300	-.1418	-.1238	-.1347	-.1100	-.1142	-.1022	-.1095	-.1052	-.1030

TAIL 1

Cp at y/b of														
x/c	0.02		0.22		0.44		0.56		0.67		0.83		0.98	
	U.S.	L.S.	U.S.	L.S.	U.S.	L.S.	U.S.	L.S.	U.S.	L.S.	U.S.	L.S.	U.S.	L.S.
.05	.0865	.0774	.2410	.2058	.2706	.0822	.4255	.3325	.3070		.3052	.3035		
.10	.0858	.0722	.2112	.1758	.2625	.2010		.2876			.2916	.2958	.2481	.1730
.15	.0909	.0725	.1915	.1595	.2478	.2059	.3790	.2954	.3241	.2787	.2863	.2712	.2344	.2094
.20					.2321	.1983	.3572	.3179	.3387	.3061	.2830	.2696	.2127	.2111
.25	.0858	.0593	.1638	.1408	.2188	.1954	.3450	.3377	.3458	.3094	.2799	.2792	.1964	.2012
.30	-.0040	-.0005	.1531	.1348	.2101	.1940	.3340	.3343	.3482	.3078	.2757	.2887	.1806	.1886
.40	-.0005	-.0008			.1971	.1840	.3133	.3140	.3382	.3064	.2718	.2893	.1559	.1639
.50	.0359	.0129	-.0423	-.0481			.0466	.0313					.1172	.0356
.60	.0207	.0259	-.0447	-.0477	-.0278	-.0218	-.0659	-.1190	-.1076	-.0916	-.1171	-.1121	-.1029	-.1219
.70			-.0432	-.0415			-.1435	-.1349	-.1307	-.1125	-.1273	-.1305	-.1028	-.1310
.80			-.1323	-.1338	-.1350	-.1418	-.1444	-.1437	-.1267	-.1203	-.1097	-.1221	-.1009	-.1186
.90			-.1257	-.1366	-.1258	-.1417	-.1275	-.1366	-.1058	-.1233	-.1045	-.1047	-.1006	-.1116
.95			-.1255	-.1310		-.1291			-.1012	-.1103	-.1021	-.1005	-.1047	-.1032

TAIL 2

TABLE VI. - CONTINUED
(d) $\alpha = 1.96^\circ$

Cp at y/b of														
x/c	0.02		0.22		0.44		0.56		0.67		0.83		0.98	
	U.S.	L.S.	U.S.	L.S.	U.S.	L.S.	U.S.	L.S.	U.S.	L.S.	U.S.	L.S.	U.S.	L.S.
.05	.0702	.1002	.2324	.2638		.2824			.2665		.2792	.3546	.2715	.3337
.10	.0891	.0950	.2070	.2320	.2387	.2710			.2614	.3210	.2646	.3341	.2389	.2858
.15	.0827	.0989	.1831	.2053	.2290	.2621			.2753	.3292	.2642	.3221	.2074	.2578
.20	.0778	.0903							.2880	.3425	.2619	.3180		
.25	.0739	.0881	.1593	.1749	.2142	.2429	.3093	.3777	.2931	.3548			.1776	.2189
.30	-.0116	-.0128	.1493	.1599		.2265	.3144	.3813	.2919	.3647	.2580	.3166	.1682	.2110
.40	-.0215	.0005	-.0434	-.0176	.1862	.2385	.2995	.3697	.2926	.3670	.2503	.3125	.1523	.1935
.50	.0028	.0164	-.0615	-.0278			.0393	.0675	.1426	.1174	.1876	.1299	.1102	.0564
.60	-.0035	.0457	-.0647	-.0259	-.0077	.0179	-.1250	-.1027	-.1150	-.0923	-.1279	-.1132	-.1033	-.1194
.70			-.0640	-.0262	-.1488	-.1238	-.1443	-.1194	-.1133	-.0916	-.1158	-.1270	-.1037	-.1152
.80	-.1062	-.0588	-.1479	-.1358	-.1423	-.1389	-.1448	-.1250			-.1063	-.1244	-.1024	-.1078
.90	-.1265	-.1030	-.1360	-.1306	-.1314	-.1433	-.1286	-.1312	-.1092	-.1163	-.1049	-.1134	-.1046	-.1039
.95			-.1344	-.1259	-.1300	-.1394	-.1209	-.1308	-.1076	-.1128	-.1046	-.1093	-.1061	-.1020

TAIL 1

Cp at y/b of														
x/c	0.02		0.22		0.44		0.56		0.67		0.83		0.98	
	U.S.	L.S.	U.S.	L.S.	U.S.	L.S.	U.S.	L.S.	U.S.	L.S.	U.S.	L.S.	U.S.	L.S.
.05	.0487	.1145	.1575	.2883	.1793	.2061	.3014	.4194	.2408		.2422	.3732		
.10	.0478	.1135	.1419	.2446	.1797	.3029		.4129			.2289	.3609	.1968	.2146
.15	.0499	.1109	.1297	.2215	.1737	.2777	.2688	.4268	.2437	.3682	.2240	.3365	.1849	.2568
.20					.1641	.2689	.2574	.4392	.2526	.3979	.2212	.3392	.1650	.2628
.25	.0478	.0960	.1076	.1967	.1551	.2603	.2523	.4385	.2555	.4068	.2180	.3497	.1490	.2534
.30	-.0279	.0249	.0989	.1899	.1498	.2572	.2479	.4242	.2533	.4114	.2145	.3574	.1345	.2377
.40	-.0199	.0225			.1435	.2389	.2355	.3937	.2460	.4183	.2101	.3567	.1143	.2126
.50	.0292	.0393	-.0691	-.0180			.0037	.0756					.0809	.0713
.60	-.0021	.0580	-.0660	-.0186	-.0569	.0073	-.0719	-.0914	-.1304	-.0628	-.1344	-.0879	-.1114	-.1114
.70			-.0663	-.0134			-.1398	-.1124	-.1436	-.0844	-.1161	-.1052	-.1125	-.1172
.80			-.1307	-.1160	-.1230	-.1254	-.1301	-.1258	-.1207	-.0965	-.1113	-.1079	-.1122	-.1150
.90			-.1299	-.1189	-.1252	-.1378	-.1278	-.1329	-.1168	-.1079	-.1104	-.1106	-.1140	-.1118
.95			-.1297	-.1188		-.1402			-.1162	-.1114	-.1101	-.1125	-.1178	-.1103

TAIL 2

TABLE VI. - CONTINUED
(e) $\alpha = 3.95^\circ$

Cp at γ/b of														
x/c	0.02		0.22		0.44		0.56		0.67		0.83		0.98	
	U.S.	L.S.	U.S.	L.S.	U.S.	L.S.	U.S.	L.S.	U.S.	L.S.	U.S.	L.S.	U.S.	L.S.
.05	.0731	.1187	.2412	.2751		.2824			.2730		.2742	.3558	.2694	.3294
.10	.0572	.1056	.2198	.2458	.2412	.2755			.2616	.3210	.2637	.3346	.2340	.2819
.15	.0897	.1116	.1950	.2186	.2376	.2697			.2737	.3244	.2644	.3225	.2025	.2542
.20	.0839	.1009							.2858	.3351	.2612	.3192		
.25	.0792	.0982	.1676	.1847	.2251	.2559	.3084	.3821	.2893	.3455			.1779	.2180
.30	-.0103	-.0113	.1571	.1686		.2412	.3151	.3871	.2898	.3554	.2581	.3206	.1690	.2115
.40	-.0259	-.0037	-.0418	-.0129	.1970	.2529	.3065	.3811	.2892	.3611	.2496	.3144	.1544	.1944
.50	-.0040	.0111	-.0589	-.0251			.0449	.0748	.1333	.1142	.1856	.1310	.1138	.0587
.60	-.0143	.0363	-.0624	-.0253	-.0051	.0275	-.1207	-.0976	-.1160	-.0919	-.1284	-.1144	-.1102	-.1189
.70			-.0656	-.0255	-.1465	-.1192	-.1403	-.1148	-.1142	-.0912	-.1191	-.1295	-.1076	-.1265
.80	-.1086	-.0642	-.1442	-.1381	-.1435	-.1366	-.1427	-.1206			-.1088	-.1297	-.1067	-.1047
.90	-.1291	-.1061	-.1355	-.1312	-.1306	-.1414	-.1256	-.1263	-.1076	-.1140	-.1067	-.1173	-.1418	-.1029
.95			-.1344	-.1246	-.1291	-.1379	-.1176	-.1256	-.1069	-.1110	-.1061	-.1123	-.1425	-.1169

TAIL 1

Cp at γ/b of														
x/c	0.02		0.22		0.44		0.56		0.67		0.83		0.98	
	U.S.	L.S.	U.S.	L.S.	U.S.	L.S.	U.S.	L.S.	U.S.	L.S.	U.S.	L.S.	U.S.	L.S.
.05	.0136	.1692	.0836	.3631	.0991	.3460	.2108	.5482	.1823		.1866	.4417		
.10	.0113	.1626	.0729	.3077	.1075	.3870		.5489			.1732	.4316	.1476	.2517
.15	.0138	.1548	.0671	.2814	.1040	.3477	.1783	.5434	.1857	.5106	.1676	.4092	.1374	.3186
.20					.0976	.3300	.1695	.5327	.1915	.5320	.1638	.4164	.1190	.3228
.25	.0167	.1355	.0526	.2501	.0915	.3171	.1666	.5282	.1915	.5365	.1606	.4292	.1048	.3083
.30	-.0488	.0512	.0458	.2407	.0881	.3113	.1631	.5060	.1844	.5294	.1577	.4369	.0922	.2911
.40	-.0368	.0453			.0840	.2887	.1560	.4714	.1700	.5145	.1536	.4457	.0764	.2704
.50	.0231	.0779	-.0899	.0155			-.0403	.1184					.0489	.1143
.60	-.0178	.0936	-.0824	.0160	-.0819	.0477	-.0866	-.0652	-.1498	-.0338	-.1367	-.0484	-.1280	-.1016
.70			-.0852	.0239			-.1298	-.0933	-.1331	-.0590	-.1240	-.0648	-.1284	-.1021
.80			-.1435	-.0942	-.1261	-.1074	-.1291	-.1100	-.1280	-.0735	-.1225	-.0722	-.1218	-.1045
.90			-.1434	-.0954	-.1290	-.1188	-.1285	-.1164	-.1272	-.0857	-.1229	-.0808	-.1220	-.1029
.95			-.1398	-.0970		-.1223			-.1277	-.0903	-.1222	-.0897	-.1384	-.1026

TAIL 2

TABLE VI. - CONTINUED
(f) $\alpha = 5.95^\circ$

Cp at γ/b of														
x/c	0.02		0.22		0.44		0.56		0.67		0.83		0.98	
	U.S.	L.S.	U.S.	L.S.	U.S.	L.S.	U.S.	L.S.	U.S.	L.S.	U.S.	L.S.	U.S.	L.S.
.05	.0737	.1346	.2485	.2868		.2857			.2785		.2681	.3586	.2644	.3248
.10	.1056	.1159	.2317	.2598	.2420	.2811			.2604	.3256	.2616	.3372	.2268	.2788
.15	.0966	.1225	.2075	.2335	.2426	.2766			.2688	.3258	.2624	.3264	.1975	.2528
.20	.0897	.1107							.2811	.3346	.2592	.3237		
.25	.0838	.1067	.1755	.1967	.2316	.2688	.3043	.3868	.2858	.3417			.1780	.2208
.30	-.0062	-.0060	.1640	.1794		.2583	.3126	.3945	.2871	.3517	.2550	.3243	.1703	.2141
.40	-.0239	-.0023	-.0386	-.0080	.2090	.2725	.3087	.3910	.2854	.3576	.2466	.3171	.1580	.1995
.50	-.0057	.0103	-.0551	-.0213			.0494	.0824	.1433	.1061	.1829	.1324	.1197	.0658
.60	-.0184	.0380	-.0609	-.0201	-.0032	.0428	-.1174	-.0917	-.1182	-.0926	-.1288	-.1144	-.1134	-.1168
.70			-.0656	-.0219	-.1438	-.1149	-.1364	-.1096	-.1164	-.0917	-.1183	-.1310	-.1163	-.1293
.80	-.1102	-.0700	-.1367	-.1370	-.1422	-.1336	-.1396	-.1160						
.90	-.1297	-.1073	-.1329	-.1298	-.1295	-.1386	-.1216	-.1216	-.1061	-.1117	-.1064	-.1129	-.0805	-.1454
.95			-.1328	-.1223	-.1284	-.1340	-.1120	-.1210	-.1057	-.1088	-.1054	-.1077	-.0971	-.1490

TAIL 1

Cp at γ/b of														
x/c	0.02		0.22		0.44		0.56		0.67		0.83		0.98	
	U.S.	L.S.	U.S.	L.S.	U.S.	L.S.	U.S.	L.S.	U.S.	L.S.	U.S.	L.S.	U.S.	L.S.
.05	-.0210	.2218	.0183	.4255	.0270	.4662	.1237	.6567	.1337		.1356	.5229		
.10	-.0228	.2071	.0118	.3646	.0420	.4459		.6683			.1220	.5148	.1024	.2977
.15	-.0188	.1949	.0087	.3366	.0429	.4069	.1017	.6398	.1453	.6588	.1165	.4999	.0943	.4329
.20					.0390	.3874	.0967	.6301	.1467	.6609	.1123	.5157	.0779	.3851
.25	-.0126	.1752	.0010	.3017	.0346	.3713	.0941	.6216	.1422	.6471	.1090	.5380	.0667	.3670
.30	-.0679	.0789	-.0031	.2916	.0324	.3648	.0916	.5890	.1285	.6264	.1055	.5625	.0570	.3532
.40	-.0541	.0717			.0290	.3434	.0850	.5451	.1097	.6027	.1020	.5824	.0466	.3408
.50	.0201	.1209	-.1039	.0489			-.0768	.1765					.0223	.1795
.60	-.0333	.1360	-.1007	.0543	-.1146	.0689	-.0930	-.0446	-.1296	-.0033	-.1286	-.0042	-.1313	-.0894
.70			-.1047	.0659			-.1290	-.0769	-.1295	-.0340	-.1287	-.0332	-.1339	-.0915
.80			-.1576	-.0689	-.1316	-.0857	-.1297	-.0954	-.1284	-.0484	-.1290	-.0473	-.1232	-.0758
.90			-.1531	-.0702	-.1347	-.0360	-.1293	-.0996	-.1295	-.0610	-.1294	-.0557	-.1369	-.0713
.95			-.1368	-.0739		-.0988			-.1291	-.0665	-.1290	-.0647	-.1454	-.0724

TAIL 2

TABLE VI. - CONTINUED
(g) $\alpha = 7.95^\circ$

Cp at y/b of														
x/c	0.02		0.22		0.44		0.56		0.67		0.83		0.98	
	U.S.	L.S.	U.S.	L.S.	U.S.	L.S.	U.S.	L.S.	U.S.	L.S.	U.S.	L.S.	U.S.	L.S.
.05	.0803	.1519	.2633	.3040		.2919			.2819		.2569	.3610	.2627	.3251
.10	.1173	.1290	.2492	.2778	.2490	.2898			.2617	.3293	.2578	.3380	.2237	.2794
.15	.1072	.1363	.2232	.2510	.2543	.2876			.2693	.3324	.2583	.3281	.1964	.2514
.20	.0986	.1230							.2790	.3377	.2568	.3255		
.25	.0922	.1173	.1875	.2119	.2452	.2866	.3088	.3891	.2859	.3437			.1800	.2234
.30	.0002	.0016	.1756	.1947		.2752	.3176	.4015	.2879	.3507	.2527	.3218	.1740	.2182
.40	-.0195	.0033	-.0334	.0011	.2281	.2931	.3138	.4003	.2865	.3537	.2429	.3126	.1629	.2025
.50	-.0006	.0155	-.0498	-.0145			.0555	.0905	.1417	.1077	.1783	.1281	.1257	.0695
.60	-.0154	.0467	-.0574	-.0142	.0030	.0550	-.1123	-.0877	-.1186	-.0942	-.1282	-.1170	-.1070	-.1142
.70			-.0631	-.0188	-.1401	-.1104	-.1314	-.1054	-.1165	-.0932	-.1114	-.1346	-.1139	-.1095
.80	-.1098	-.0730	-.1330	-.1357	-.1445	-.1301	-.1353	-.1109			-.1056	-.1291	-.0970	-.0883
.90	-.1297	-.1075	-.1295	-.1267	-.1278	-.1349	-.1159	-.1156	-.1056	-.1109	-.1036	-.1130	-.1008	-.1009
.95			-.1301	-.1195	-.1266	-.1315	-.1065	-.1136	-.1041	-.1081	-.1029	-.1094	-.1209	-.1295

TAIL 1

Cp at y/b of														
x/c	0.02		0.22		0.44		0.56		0.67		0.83		0.98	
	U.S.	L.S.	U.S.	L.S.	U.S.	L.S.	U.S.	L.S.	U.S.	L.S.	U.S.	L.S.	U.S.	L.S.
.05	-.0539	.2656	-.0401	.4775	-.0363	.5692	.0376	.7559	.0978		.0901	.6212		
.10	-.0521	.2464	-.0415	.4196	-.0176	.5047		.7688			.0762	.6349	.0587	.3675
.15	-.0454	.2295	-.0441	.3839	-.0138	.4643	.0361	.7454	.1163	.7988	.0700	.6471	.0537	.5066
.20					-.0150	.4422	.0317	.7290	.1102	.7709	.0655	.6808	.0442	.4591
.25	-.0364	.2119	-.0483	.3517	-.0183	.4232	.0294	.7101	.0975	.7492	.0620	.7080	.0369	.4563
.30	-.0808	.1051	-.0500	.3371	-.0200	.4162	.0271	.6692	.0769	.7186	.0591	.7257	.0298	.4539
.40	-.0645	.1001			-.0226	.3918	.0217	.6242	.0545	.6885	.0568	.7242	.0254	.4608
.50	.0188	.1669	-.1210	.0853			-.1081	.2037					.0007	.2525
.60	-.0579	.1821	-.1228	.0939	-.1400	.1135	-.0999	-.0255	-.1293	.0147	-.1286	.0200	-.1331	-.0571
.70			-.1273	.1147			-.1351	-.0612	-.1328	-.0140	-.1325	-.0128	-.1356	-.0785
.80			-.1627	-.0379	-.1424	-.0665	-.1369	-.0786	-.1327	-.0265	-.1337	-.0219	-.1387	-.0743
.90			-.1544	-.0456	-.1470	-.0729	-.1369	-.0802	-.1342	-.0416	-.1342	-.0287	-.1459	-.0697
.95			-.1431	-.0517	-.0743				-.1344	-.0475	-.1334	-.0390	-.1475	-.0749

TAIL 2

TABLE VI. - CONTINUED
(h) $\alpha = 9.95^\circ$

Cp at y/b of														
x/c	0.02		0.22		0.44		0.56		0.67		0.83		0.98	
	U.S.	L.S.	U.S.	L.S.	U.S.	L.S.	U.S.	L.S.	U.S.	L.S.	U.S.	L.S.	U.S.	L.S.
.05	.0884	.1693	.2718	.3186		.2943			.2939		.2667	.3787	.2741	.3355
.10	.1297	.1434	.2618	.2971	.2528	.2941			.2704	.3397	.2695	.3513	.2343	.2913
.15	.1200	.1500	.2370	.2727	.2596	.2944			.2730	.3382	.2702	.3383	.2098	.2640
.20	.1111	.1348							.2813	.3416	.2675	.3339		
.25	.1029	.1274	.2026	.2361	.2515	.2965	.3055	.3867	.2869	.3439			.1951	.2386
.30	.0077	.0092	.1901	.2172		.2878	.3148	.3983	.2894	.3478	.2628	.3299	.1896	.2336
.40	-.0131	.0106	-.0256	-.0111	-.2445	-.3063	-.3114	-.3983	-.2871	-.3490	.2531	.3213	-.1791	.2205
.50	.0078	.0239	-.0425	-.0045			.0579	.0948	.1383	.1010	.1868	.1349	.1413	.0824
.60	-.0076	.0577	-.0506	-.0079	.0091	.0642	-.1099	-.0849	-.1197	-.0969	-.1272	-.1157	-.1095	-.1082
.70			-.0581	-.0125	-.1363	-.1035	-.1283	-.1012	-.1178	-.0961	-.1096	-.1342	-.1091	-.1218
.80	-.1073	-.0734	-.1278	-.1339	-.1443	-.1252	-.1279	-.1060			-.1038	-.1286	-.0973	-.0891
.90	-.1279	-.1085	-.1247	-.1237	-.1251	-.1306	-.1104	-.1107	-.1038	-.1118	-.1028	-.1114	-.1229	-.1181
.95			-.1249	-.1161	-.1231	-.1274	-.1028	-.1088	-.1036	-.1083	-.1021	-.1074	-.1438	-.1457

TAIL 1

Cp at y/b of														
x/c	0.02		0.22		0.44		0.56		0.67		0.83		0.98	
	U.S.	L.S.	U.S.	L.S.	U.S.	L.S.	U.S.	L.S.	U.S.	L.S.	U.S.	L.S.	U.S.	L.S.
.05	-.0859	.3016	-.0921	.5194	-.0958	.6124	-.0292	.8302	.0687		.0468	.8562		
.10	-.0726	.2753	-.0891	.4648	-.0716	.5558		.8507			.0332	.8737	.0222	.5398
.15	-.0643	.2563	-.0896	.4306	-.0646	.5153	-.0259	.8374	.0911	.9176	.0260	.8632	.0195	.6357
.20					-.0646	.4947	-.0296	.8206	.0742	.8784	.0206	.8571	.0154	.6357
.25	-.0574	.2410	-.0912	.3926	-.0661	.4708	-.0322	.7958	.0542	.8457	.0174	.8546	.0124	.6481
.30	-.0886	.1273	-.0919	.3781	-.0671	.4638	-.0341	.7539	.0292	.8048	.0153	.8464	.0085	.6309
.40	-.0800	.1265			-.0689	.4215	-.0361	.6948	.0047	.7645	.0144	.7957	.0100	.5803
.50	.0174	.2140	-.1412	.1298			-.1364	.2444					-.0103	.2871
.60	-.0787	.2279	-.1459	.1337	-.1624	.1561	-.1034	-.0078	-.1406	.0234	-.1395	.0401	-.1481	-.0338
.70			-.1500	.1649			-.1464	-.0407	-.1440	-.0000	-.1429	.0135	-.1530	-.0644
.80			-.1723	-.0066	-.1551	-.0349	-.1491	-.0576	-.1444	-.0084	-.1443	.0085	-.1664	-.0758
.90			-.1620	-.0220	-.1597	-.0370	-.1486	-.0573	-.1449	-.0250	-.1448	.0026	-.1657	-.0823
.95			-.1539	-.0300		-.0381			-.1456	-.0335	-.1438	-.0075	-.1628	-.0877

TAIL 2

TABLE VI. - CONTINUED
(1) $\alpha = 11.95^\circ$

Cp at γ/b of														
x/c	0.02		0.22		0.44		0.56		0.67		0.83		0.98	
	U.S.	L.S.	U.S.	L.S.	U.S.	L.S.	U.S.	L.S.	U.S.	L.S.	U.S.	L.S.	U.S.	L.S.
.05	.1054	.1918	.3030	.3552		.3309			.3184		.2902	.4062	.2917	.3511
.10	.1468	.1620	.2930	.3301	.2836	.3294			.2948	.3666	.2981	.3801	.2512	.3076
.15	.1334	.1681	.2658	.3018	.2917	.3279			.2971	.3663	.2979	.3675	.2288	.2822
.20	.1228	.1527							.3033	.3686	.2944	.3633		
.25	.1135	.1457	.2248	.2585	.2810	.3290	.3316	.4205	.3101	.3696			.2169	.2616
.30	.0131	.0225	.2086	.2375		.3162	.3435	.4321	.3133	.3760	.2890	.3587	.2140	.2577
.40	-.0057	.0233	-.0180	.0190	.2758	.3377	.3402	.4312	.3124	.3766	.2775	.3482	.2029	.2464
.50	.0165	.0389	-.0368	.0036			.0747	.1113	.1602	.1191	.2076	.1513	.1621	.0998
.60	.0002	.0727	-.0461	-.0011	.0207	.0779	-.1015	-.0755	-.1127	-.0877	-.1238	-.1089	-.1067	-.1020
.70			-.0555	-.0068	-.1309	-.0973	-.1203	-.0922	-.1110	-.0868	-.1034	-.1279	-.1026	-.1023
.80	-.1051	-.0693	-.1252	-.1320	-.1449	-.1188	-.1202	-.0971			-.0983	-.1215	-.1005	-.0890
.90	-.1260	-.1081	-.1229	-.1207	-.1228	-.1247	-.1031	-.1019	-.0956	-.1030	-.0976	-.1040	-.1373	-.1325
.95			-.1231	-.1131	-.1199	-.1238	-.0956	-.1015	-.0951	-.0999	-.0973	-.1000	-.1560	-.1551

TAIL 1

Cp at γ/b of														
x/c	0.02		0.22		0.44		0.56		0.67		0.83		0.98	
	U.S.	L.S.	U.S.	L.S.	U.S.	L.S.	U.S.	L.S.	U.S.	L.S.	U.S.	L.S.	U.S.	L.S.
.05	-.1053	.3170	-.1323	.5539	-.1452	.6450	-.0895	.9085	.0414		.0044	1.0927		
.10	-.0820	.2839	-.1268	.5003	-.1203	.5997		.9215			.0019	1.0437	-.0103	.8539
.15	-.0776	.2669	-.1249	.4695	-.1084	.5595	-.0823	.9281	.0665	1.0176	-.0048	1.0014	-.0070	.8432
.20					-.1050	.5408	-.0795	.9030	.0423	.9616	-.0113	.9664	-.0009	.7820
.25	-.0770	.2527	-.1221	.4332	-.1059	.5159	-.0794	.8748	.0183	.9239	-.0156	.9402	-.0018	.7442
.30	-.0991	.1429	-.1237	.4161	-.1064	.5060	-.0818	.8313	-.0087	.8804	-.0184	.9132	-.0067	.6943
.40	-.0917	.1475			-.1075	.4483	-.0832	.7614	-.0356	.8364	-.0183	.8358	-.0045	.6021
.50	.0050	.2601	-.1570	.1738			-.1611	.2852					-.0183	.2973
.60	-.0919	.2721	-.1603	.1769	-.1775	.1908	-.1045	.0079	-.1513	.0440	-.1509	.0546	-.1672	-.0270
.70			-.1510	.2220			-.1576	-.0230	-.1544	.0137	-.1538	.0334	-.1710	-.0560
.80			-.1845	.0229	-.1665	.0075	-.1604	-.0351	-.1546	.0023	-.1554	.0350	-.1865	-.0595
.90			-.1724	.0009	-.1716	.0044	-.1601	-.0286	-.1548	-.0144	-.1560	.0294	-.1942	-.0626
.95			-.1676	-.0108		.0016			-.1561	-.0219	-.1551	.0174	-.1916	-.0689

TAIL 2

TABLE VI. - CONTINUED
(j) $\alpha = 15.96^\circ$

Cp at y/b of														
x/c	0.02		0.22		0.44		0.56		0.67		0.83		0.98	
	U.S.	L.S.	U.S.	L.S.	U.S.	L.S.	U.S.	L.S.	U.S.	L.S.	U.S.	L.S.	U.S.	L.S.
.05	.1658	.2745	.4039	.4655		.4258			.3880		.3468	.4871	.3518	.4186
.10	.2138	.2420	.3815	.4264	.3635	.4274			.3649	.4445	.3612	.4572	.3064	.3721
.15	.1982	.2493	.3446	.3904	.3777	.4264			.3646	.4450	.3614	.4466	.2861	.3443
.20	.1867	.2272							.3726	.4473	.3584	.4417		
.25	.1746	.2166	.2980	.3373	.3703	.4270	.4166	.5262	.3809	.4513			.2736	.3263
.30	.0571	.0733	.2806	.3142		.4010	.4304	.5395	.3835	.4585	.3511	.4357	.2719	.3220
.40	.0419	.0756	.0186	.0604	.3724	.4387	.4280	.5373	.3865	.4643	.3367	.4211	.2622	.3132
.50	.0687	.1014	-.0035	.0423			.1208	.1681	.2098	.1753	.2581	.1966	.2168	.1530
.60	.0442	.1329	-.0140	.0383	.0577	.1257	-.0759	-.0447	-.0917	-.0579	-.1024	-.0901	-.0835	-.0796
.70			-.0234	.0338	-.1130	-.0739	-.0967	-.0625	-.0902	-.0575	-.0781	-.1101	-.0777	-.0594
.80	-.0797	-.0357	-.1184	-.1077	-.1280	-.0959	-.0977	-.0680			-.0745	-.1049	-.0925	-.0778
.90	-.1051	-.0837	-.1089	-.0982	-.1038	-.1023	-.0778	-.0736	-.0712	-.0754	-.0747	-.0850	-.1486	-.1475
.95			-.1047	-.0902	-.0989	-.1046	-.0695	-.0758	-.0701	-.0744	-.0748	-.0804	-.1589	-.1611

TAIL 1

Cp at y/b of														
x/c	0.02		0.22		0.44		0.56		0.67		0.83		0.98	
	U.S.	L.S.	U.S.	L.S.	U.S.	L.S.	U.S.	L.S.	U.S.	L.S.	U.S.	L.S.	U.S.	L.S.
.05	-.1166	.2418	-.1726	.5965	-.2037	.6997	-.1747	1.0086	-.0516		-.1194	1.2944		
.10	-.1105	.2080	-.1663	.5470	-.1909	.6662		1.0432			-.0877	1.2047	-.0878	1.0414
.15	-.1093	.1987	-.1640	.5252	-.1808	.6287	-.1624	1.0580	.0000	1.1281	-.0775	1.1390	-.0710	.9487
.20					-.1742	.6075	-.1607	1.0274	-.0255	1.0746	-.0739	1.0857	-.0571	.8668
.25	-.0990	.1659	-.1629	.4935	-.1709	.5767	-.1576	.9940	-.0466	1.0388	-.0725	1.0420	-.0568	.8199
.30	-.1214	.1151	-.1637	.4641	-.1688	.5563	-.1542	.9383	-.0731	.9864	-.0705	.9990	-.0591	.7649
.40	-.1110	.1618			-.1668	.4816	-.1548	.8524	-.0995	.9260	-.0691	.8974	-.0518	.6592
.50	-.0253	.3194	-.1704	.2560			-.1921	.3031					-.0525	.3174
.60	-.1184	.3560	-.1742	.2882	-.1830	.3151	-.1233	.0341	-.1745	.0737	-.1665	.0933	-.1866	-.0089
.70			-.1753	.3536			-.1799	.0145	-.1770	.0444	-.1682	.0877	-.1826	-.0213
.80			-.1898	.0783	-.1782	.0966	-.1826	.0405	-.1757	.0279	-.1690	.0850	-.1864	-.0171
.90			-.1896	.0464	-.1838	.0987	-.1836	.0554	-.1717	.0092	-.1691	.0747	-.1895	-.0156
.95			-.1893	.0387		.1045			-.1748	.0023	-.1685	.0605	-.1883	-.0204

TAIL 2

TABLE VI. - CONCLUDED
(k) $\alpha = 19.95^\circ$

Cp at y/b of														
x/c	0.02		0.22		0.44		0.56		0.67		0.83		0.98	
	U.S.	L.S.	U.S.	L.S.	U.S.	L.S.	U.S.	L.S.	U.S.	L.S.	U.S.	L.S.	U.S.	L.S.
.05	.2464	.3683	.5334	.5906		.5622			.4736		.4286	.5792	.4316	.4961
.10	.3001	.3382	.4856	.5350	.4801	.5572			.4574	.5348	.4506	.5457	.3822	.4463
.15	.2814	.3376	.4387	.4890	.5042	.5527			.4542	.5338	.4522	.5294	.3647	.4173
.20	.2673	.3122							.4635	.5361	.4470	.5221		
.25	.2549	.2999	.3928	.4302	.4888	.5364	.5354	.6509	.4751	.5416			.3540	.3997
.30	.1131	.1332	.3717	.4040		.5062	.5538	.6623	.4811	.5499	.4382	.5122	.3522	.3938
.40	.1037	.1387	.0648	.1062	.4951	.5375	.5489	.6476	.4846	.5567	.4172	.4856	.3403	.3832
.50	.1330	.1807	.0388	.0842			.1806	.2213	.2815	.2309	.3241	.2356	.2913	.2028
.60	.1001	.2025	.0279	.0796	.1038	.1679	-.0437	-.0167	-.0628	-.0250	-.0774	-.0742	-.0606	-.0562
.70			.0168	.0731	-.0906	-.0525	-.0663	-.0353	-.0619	-.0248		-.0521	-.0939	-.0503
.80	-.0451	.0031	-.0868	-.0837	-.1065	-.0743	-.0731	-.0403			-.0495	-.0791	-.0912	-.0874
.90	-.0712	-.0496	-.0816	-.0697	-.0803	-.0803	-.0507	-.0461	-.0467	-.0473	-.0502	-.0605	-.1595	-.1570
.95			-.0786	-.0619	-.0753	-.0806	-.0382	-.0481	-.0442	-.0473	-.0503	-.0577	-.1566	-.1519

TAIL 1

Cp at y/b of														
x/c	0.02		0.22		0.44		0.56		0.67		0.83		0.98	
	U.S.	L.S.	U.S.	L.S.	U.S.	L.S.	U.S.	L.S.	U.S.	L.S.	U.S.	L.S.	U.S.	L.S.
.05	-.1604	.3931	-.1965	.6769	-.2112	.7792	-.2044	1.1137	-.0937		-.1635	1.4298		
.10	-.1565	.3064	-.1991	.6458	-.2089	.7552		1.1629			-.1288	1.3423	-.1221	1.1593
.15	-.1454	.2651	-.1990	.6268	-.2077	.7174	-.1940	1.1687	-.0679	1.2767	-.1125	1.2759	-.1026	1.0718
.20					-.2058	.6949	-.1939	1.1419	-.0819	1.2194	-.1048	1.2187	-.0864	.9896
.25	-.1285	.2154	-.1988	.5958	-.2052	.6571	-.1957	1.1124	-.0969	1.1787	-.1007	1.1681	-.0795	.9390
.30	-.1455	.1600	-.1991	.5452	-.2043	.6358	-.1949	1.0538	-.1183	1.1163	-.0972	1.1209	-.0766	.8759
.40	-.1316	.2385			-.1993	.5604	-.1928	.9540	-.1391	1.0476	-.0956	1.0072	-.0627	.7514
.50	-.0509	.4083	-.1980	.3832			-.1996	.3674					-.0740	.3650
.60	-.1424	.4301	-.2040	.4425	-.1927	.5023	-.1908	.0797	-.1871	.1138	-.1802	.1233	-.1882	.0200
.70			-.2045	.4574			-.1925	.1246	-.1890	.0904	-.1813	.1264	-.1862	.0191
.80			-.1989	.1325	-.1879	.2015	-.1949	.1520	-.1876	.0799	-.1804	.1294	-.1840	.0324
.90			-.2026	.1037	-.1890	.1943	-.1961	.1665	-.1840	.0795	-.1791	.1249	-.1830	.0381
.95			-.2054	.0989		.1879			-.1875	.0806	-.1793	.1121	-.1802	.0324

TAIL 2

TABLE VII. - PRESSURE COEFFICIENTS, $\phi = 22.5^\circ$, $\delta = 0^\circ$, $M = 2.36$.(a) $\alpha = -4.20^\circ$

Cp at y/b of														
x/c	0.02		0.22		0.44		0.56		0.67		0.83		0.98	
	U.S.	L.S.	U.S.	L.S.	U.S.	L.S.	U.S.	L.S.	U.S.	L.S.	U.S.	L.S.	U.S.	L.S.
.05	.0362	.0895	.2679	.1564	.2613	.1981			.3133		.3359	.3010	.3206	.2938
.10	.0515	.0841	.2266	.1379	.2889	.1858			.3378	.2710	.3105	.2814	.2921	.2536
.15	.0532	.0826	.1988	.1256	.2590	.1769			.3807	.2893	.3094	.2694	.2660	.2292
.20	.0555	.0771							.4018	.3023	.3100	.2656		
.25	.0556	.0701	.1695	.1126	.2290	.1627	.3703	.2895	.3969	.3072			.2223	.1861
.30	-.0068	-.0024	.1582	.1025		.1545	.3647	.2924	.3888	.3078	.3139	.2647	.2060	.1754
.40	.0110	.0039	-.0343	-.0534	.1950	.1602	.3356	.2787	.3709	.2995	.3132	.2599	.1838	.1559
.50	.0422	.0080	-.0546	-.0555			.0507	.0172	.1844	.0678	.2469	.0953	.1351	.0273
.60	.0200	.0184	-.0544	-.0440	-.0037	-.0229	-.1157	-.1297	-.0963	-.1196	-.1033	-.1245	-.1236	-.1068
.70			-.0328	-.0346	-.1425	-.1447	-.1378	-.1439	-.0947	-.1181	-.1204	-.1299	-.1109	-.1043
.80	-.1063	-.0822	-.1388	-.1346	-.1555	-.1447	-.1456	-.1459			-.1215	-.1108	-.1075	-.1020
.90	-.1115	-.1115	-.1420	-.1350	-.1328	-.1303	-.1353	-.1310	-.1267	-.1090	-.1070	-.1017	-.1078	-.1028
.95			-.1363	-.1286	-.1276	-.1289	-.1251	-.1237	-.1131	-.1061	-.0985	-.0993	-.1082	-.1066

TAIL 1

Cp at y/b of														
x/c	0.02		0.22		0.44		0.56		0.67		0.83		0.98	
	U.S.	L.S.	U.S.	L.S.	U.S.	L.S.	U.S.	L.S.	U.S.	L.S.	U.S.	L.S.	U.S.	L.S.
.05	.2112	-.0024	.3943	.0687	.4486	-.0331	.6892	.1823	.4612		.4352	.1826		
.10	.1847	-.0011	.3466	.0570	.4165	-.0019		.1715			.4217	.1836	.3577	.0935
.15	.1890	-.0013	.3185	.0472	.3886	.1056	.5749	.1486	.5603	.1737	.4173	.1691	.3382	.1139
.20					.3631	.0898	.5385	.1424	.5719	.1938	.4143	.1592	.3098	.1292
.25	.1794	-.0099	.2821	.0378	.3428	.0815	.5176	.1429	.5674	.1989	.4137	.1655	.2909	.1217
.30	.0550	-.0588	.2642	.0363	.3308	.0811	.4983	.1451	.5446	.1933	.4205	.1734	.2727	.1123
.40	.0426	-.0585			.3139	.0822	.4680	.1580	.5098	.1796	.4326	.1808	.2437	.0944
.50	.0518	-.0382	-.0143	-.0997			.1326	-.0425					.1983	-.0123
.60	.0740	-.0408	.0160	-.0925	.0344	-.0755	-.0609	-.1548	-.0605	-.1435	-.0572	-.1447	-.1170	-.1441
.70			.0183	-.0912			-.1072	-.1680	-.0797	-.1620	-.0786	-.1457	-.1192	-.1277
.80			-.1177	-.1578	-.1243	-.1438	-.1179	-.1517	-.0855	-.1409	-.0844	-.1310	-.1209	-.1147
.90			-.1194	-.1493	-.1349	-.1443	-.1277	-.1442	-.0947	-.1376	-.0939	-.1286	-.1147	-.1318
.95			-.1196	-.1421		-.1437			-.1006	-.1374	-.0991	-.1279	-.1122	-.1449

TAIL 2

TABLE VII. - CONTINUED
(b) $\alpha = -2.20^\circ$

Cp at y/b of														
x/c	0.02		0.22		0.44		0.56		0.67		0.83		0.98	
	U.S.	L.S.	U.S.	L.S.	U.S.	L.S.	U.S.	L.S.	U.S.	L.S.	U.S.	L.S.	U.S.	L.S.
.05	.0702	.0639	.2453	.2116	.2002	.2463			.2843		.3054	.3334	.2960	.3215
.10	.0737	.0646	.2073	.1791	.2634	.2313			.2953	.3015	.2825	.3135	.2654	.2767
.15	.0725	.0661	.1870	.1586	.2398	.2194			.3199	.3185	.2821	.3008	.2379	.2510
.20	.0700	.0646							.3366	.3350	.2814	.2972		
.25	.0682	.0602	.1584	.1372	.2171	.1984	.3449	.3395	.3432	.3435			.1980	.2058
.30	-.0042	-.0055	.1477	.1251		.1797	.3423	.3393	.3403	.3479	.2819	.2949	.1862	.1960
.40	.0090	.0081	-.0366	-.0338	.1868	.1952	.3168	.3212	.3379	.3419	.2769	.2895	.1653	.1743
.50	.0345	.0234	-.0564	-.0460			.0503	.0394	.1696	.0933	.2133	.1147	.1193	.0399
.60	.0172	.0355	-.0581	-.0385	-.0083	-.0077	-.1219	-.1188	-.1056	-.1073	-.1192	-.1175	-.1064	-.1186
.70			-.0469	-.0347	-.1453	-.1369	-.1421	-.1342	-.1040	-.1063	-.1321	-.1286	-.1039	-.1105
.80	-.1043	-.0683	-.1452	-.1309	-.1480	-.1496	-.1462	-.1397			-.1110	-.1219	-.1025	-.1054
.90	-.1138	-.0980	-.1360	-.1320	-.1288	-.1377	-.1307	-.1393	-.1149	-.1153	-.1018	-.1075	-.1034	-.1046
.95			-.1318	-.1290	-.1282	-.1292	-.1234	-.1282	-.1075	-.1059	-.0998	-.1015	-.1065	-.1023

TAIL 1

Cp at y/b of														
x/c	0.02		0.22		0.44		0.56		0.67		0.83		0.98	
	U.S.	L.S.	U.S.	L.S.	U.S.	L.S.	U.S.	L.S.	U.S.	L.S.	U.S.	L.S.	U.S.	L.S.
.05	.1399	.0447	.3197	.1322	.3596	.0074	.5560	.2711	.3728		.3656	.2511		
.10	.1317	.0388	.2811	.1130	.3395	.0892		.2194			.3521	.2399	.2987	.1226
.15	.1367	.0370	.2567	.1007	.3178	.1440	.4756	.2073	.4284	.2233	.3482	.2172	.2825	.1610
.20					.2975	.1373	.4485	.2074	.4440	.2483	.3450	.2114	.2575	.1677
.25	.1303	.0263	.2230	.0906	.2792	.1375	.4315	.2205	.4500	.2509	.3396	.2188	.2401	.1602
.30	.0228	-.0282	.2086	.0866	.2680	.1381	.4171	.2357	.4480	.2437	.3376	.2279	.2238	.1453
.40	.0174	-.0296			.2526	.1306	.3912	.2379	.4272	.2303	.3387	.2333	.1973	.1287
.50	.0548	-.0111	-.0145	-.0744			.0889	-.0099					.1545	.0128
.60	.0440	-.0088	-.0170	-.0706	.0051	-.0426	-.0596	-.1391	-.0859	-.1231	-.0924	-.1305	-.1235	-.1338
.70			-.0149	-.0676			-.1250	-.1532	-.1086	-.1408	-.1106	-.1384	-.1190	-.1337
.80			-.1334	-.1465	-.1398	-.1503	-.1338	-.1503	-.1128	-.1321	-.1122	-.1183	-.1081	-.1153
.90			-.1308	-.1373	-.1475	-.1366	-.1410	-.1358	-.1176	-.1213	-.1130	-.1130	-.1059	-.0992
.95			-.1247	-.1323		-.1328			-.1176	-.1176	-.1103	-.1117	-.1070	-.1151

TAIL 2

TABLE VII. - CONTINUED
(c) $\alpha = -0.20^\circ$

Cp at γ/b of														
x/c	0.02		0.22		0.44		0.56		0.67		0.83		0.98	
	U.S.	L.S.	U.S.	L.S.	U.S.	L.S.	U.S.	L.S.	U.S.	L.S.	U.S.	L.S.	U.S.	L.S.
.05	.0695	.0810	.2236	.2556	.1723	.2881			.2651		.2831	.3654	.2767	.3471
.10	.0791	.0806	.1909	.2194	.2342	.2726			.2655	.3313	.2634	.3442	.2448	.2980
.15	.0750	.0854	.1717	.1947	.2218	.2593			.2840	.3475	.2640	.3306	.2150	.2704
.20	.0700	.0822							.2993	.3669	.2631	.3264		
.25	.0668	.0793	.1490	.1678	.2043	.2360	.3141	.3830	.3032	.3777			.1809	.2243
.30	-.0109	-.0060	.1385	.1540		.2184	.3163	.3828	.2999	.3841	.2609	.3240	.1713	.2153
.40	-.0067	.0113	-.0439	-.0182	.1817	.2321	.2966	.3638	.2997	.3821	.2543	.3181	.1533	.1938
.50	.0185	.0306	-.0624	-.0286			.0361	.0631	.1427	.1178	.1918	.1343	.1098	.0542
.60	.0104	.0548	-.0638	-.0264	-.0180	.0117	-.1268	-.1065	-.1130	-.0947	-.1278	-.1105	-.1044	-.1223
.70			-.0582	-.0255	-.1491	-.1271	-.1460	-.1229	-.1113	-.0938	-.1179	-.1224	-.1042	-.1153
.80	-.1051	-.0582	-.1484	-.1314	-.1433	-.1417	-.1456	-.1290			-.1058	-.1210	-.1030	-.1069
.90	-.1190	-.0969	-.1356	-.1300	-.1311	-.1449	-.1293	-.1356	-.1120	-.1189	-.1034	-.1134	-.1037	-.1056
.95			-.1334	-.1265	-.1294	-.1395	-.1231	-.1339	-.1090	-.1142	-.1031	-.1092	-.1066	-.1033

TAIL 1

Cp at γ/b of														
x/c	0.02		0.22		0.44		0.56		0.67		0.83		0.98	
	U.S.	L.S.	U.S.	L.S.	U.S.	L.S.	U.S.	L.S.	U.S.	L.S.	U.S.	L.S.	U.S.	L.S.
.05	.0859	.0782	.2419	.2053	.2702	.0508	.4230	.3325	.3048		.3016	.3109		
.10	.0857	.0728	.2120	.1768	.2621	.2160		.2859			.2874	.2971	.2454	.1764
.15	.0902	.0716	.1924	.1605	.2469	.2089	.3732	.2875	.3205	.2857	.2826	.2732	.2312	.2100
.20					.2314	.1982	.3561	.3194	.3358	.3134	.2797	.2705	.2095	.2146
.25	.0852	.0594	.1639	.1412	.2177	.1961	.3450	.3400	.3443	.3129	.2759	.2793	.1939	.2033
.30	-.0042	-.0006	.1521	.1350	.2086	.1941	.3345	.3336	.3464	.3075	.2719	.2883	.1783	.1912
.40	-.0018	-.0015			.1956	.1839	.3132	.3141	.3370	.3044	.2677	.2894	.1538	.1665
.50	.0448	.0126	-.0426	-.0482			.0465	.0309					.1151	.0370
.60	.0196	.0256	-.0457	-.0482	-.0286	-.0226	-.0638	-.1160	-.1083	-.0929	-.1185	-.1121	-.1034	-.1213
.70			-.0443	-.0430			-.1437	-.1338	-.1313	-.1134	-.1274	-.1301	-.1033	-.1306
.80			-.1327	-.1341	-.1355	-.1422	-.1454	-.1429	-.1282	-.1213	-.1103	-.1218	-.1015	-.1173
.90			-.1260	-.1355	-.1266	-.1412	-.1283	-.1359	-.1068	-.1230	-.1060	-.1045	-.1018	-.1104
.95			-.1258	-.1309		-.1282			-.1018	-.1091	-.1039	-.1002	-.1060	-.1030

TAIL 2

TABLE VII. - CONTINUED
(d) $\alpha = 1.80^\circ$

Cp at y/b of														
x/c	0.02		0.22		0.44		0.56		0.67		0.83		0.98	
	U.S.	L.S.	U.S.	L.S.	U.S.	L.S.	U.S.	L.S.	U.S.	L.S.	U.S.	L.S.	U.S.	L.S.
.05	.0474	.1207	.1922	.2949	.1402	.3277			.2421		.2540	.3960	.2519	.3711
.10	.0690	.1115	.1754	.2568	.2020	.3116			.2363	.3587	.2383	.3748	.2189	.3199
.15	.0637	.1167	.1543	.2290	.1966	.2985			.2486	.3768	.2402	.3604	.1886	.2883
.20	.0596	.1079							.2625	.3992	.2386	.3558		
.25	.0552	.1061	.1325	.1978	.1865	.2735	.2736	.4262	.2669	.4124			.1615	.2432
.30	-.0247	-.0021	.1243	.1817		.2501	.2787	.4270	.2645	.4177	.2360	.3533	.1533	.2330
.40	-.0334	.0145	-.0563	-.0031	.1665	.2684	.2684	.4059	.2616	.4186	.2283	.3458	.1388	.2125
.50	-.0115	.0409	-.0723	-.0135			.0224	.0863	.1192	.1428	.1678	.1526	.0984	.0685
.60	-.0097	.0613	-.0743	-.0118	-.0206	.0305	-.1318	-.0938	-.1248	-.0821	-.1343	-.1035	-.1102	-.1194
.70			-.0737	-.0140	-.1547	-.1169	-.1511	-.1113	-.1229	-.0814	-.1174	-.1161	-.1099	-.1307
.80	-.1116	-.0553	-.1489	-.1319	-.1447	-.1317	-.1478	-.1178			-.1105	-.1172	-.1091	-.1198
.90	-.1300	-.0986	-.1406	-.1306	-.1356	-.1370	-.1326	-.1253	-.1146	-.1093	-.1090	-.1160	-.1162	-.1078
.95			-.1393	-.1284	-.1338	-.1382	-.1265	-.1284	-.1149	-.1107	-.1087	-.1140	-.1172	-.0964

TAIL 1

Cp at y/b of														
x/c	0.02		0.22		0.44		0.56		0.67		0.83		0.98	
	U.S.	L.S.	U.S.	L.S.	U.S.	L.S.	U.S.	L.S.	U.S.	L.S.	U.S.	L.S.	U.S.	L.S.
.05	.0520	.0930	.1611	.2771	.1815	.1896	.3043	.4003	.2424		.2438	.3609		
.10	.0540	.0941	.1431	.2342	.1816	.2963		.4011			.2296	.3539	.1959	.2089
.15	.0553	.0947	.1302	.2113	.1749	.2689	.2724	.4295	.2471	.3707	.2244	.3332	.1844	.2476
.20					.1648	.2573	.2631	.4257	.2557	.3938	.2207	.3303	.1650	.2646
.25	.0507	.0844	.1088	.1861	.1554	.2492	.2574	.4225	.2591	.3968	.2177	.3421	.1498	.2511
.30	-.0221	.0191	.0998	.1800	.1494	.2454	.2516	.4093	.2575	.4042	.2144	.3494	.1351	.2339
.40	-.0097	.0212			.1425	.2276	.2382	.3825	.2504	.4079	.2102	.3485	.1137	.2107
.50	.0349	.0375	-.0683	-.0220			.0066	.0727					.0793	.0676
.60	.0004	.0533	-.0629	-.0246	-.0584	.0036	-.0716	-.0914	-.1299	-.0681	-.1336	-.0894	-.1095	-.1128
.70			-.0630	-.0170			-.1428	-.1151	-.1450	-.0895	-.1152	-.1060	-.1111	-.1171
.80			-.1356	-.1170	-.1242	-.1286	-.1312	-.1292	-.1214	-.1016	-.1101	-.1087	-.1099	-.1188
.90			-.1336	-.1216	-.1260	-.1403	-.1287	-.1360	-.1161	-.1128	-.1090	-.1114	-.1102	-.1126
.95			-.1328	-.1221		-.1420			-.1158	-.1150	-.1087	-.1134	-.1107	-.1165

TAIL 2

TABLE VII. - CONTINUED
(a) $\alpha = 3.83^\circ$

Cp at γ/b of														
x/c	0.02		0.22		0.44		0.56		0.67		0.83		0.98	
	U.S.	L.S.	U.S.	L.S.	U.S.	L.S.	U.S.	L.S.	U.S.	L.S.	U.S.	L.S.	U.S.	L.S.
.05	.0235	.1664	.1652	.3401	.1147	.3755			.2260		.2279	.4260	.2306	.3931
.10	.0553	.1469	.1581	.2978	.1765	.3573			.2141	.3905	.2161	.4031	.1968	.3402
.15	.0512	.1527	.1418	.2667	.1767	.3424			.2225	.4097	.2189	.3882	.1687	.3072
.20	.0479	.1380							.2356	.4357	.2166	.3832		
.25	.0434	.1353	.1157	.2330	.1677	.3138	.2393	.4694	.2403	.4481			.1476	.2634
.30	-.0359	.0095	.1074	.2147		.2911	.2468	.4697	.2396	.4554	.2132	.3792	.1409	.2539
.40	-.0512	.0233	-.0656	.0128	.1574	.3075	.2392	.4486	.2331	.4567	.2051	.3708	.1288	.2337
.50	-.0357	.0576	-.0798	.0031			.0108	.1098	.0933	.1679	.1481	.1674	.0921	.0836
.60	-.0319	.0663	-.0847	.0038	-.0316	.0536	-.1370	-.0808	-.1350	-.0690	-.1395	-.0965	-.1248	-.1105
.70			-.0860	.0010	-.1586	-.1049	-.1542	-.0388	-.1326	-.0686	-.1218	-.1097	-.1266	-.1267
.80	-.1196	-.0533	-.1429	-.1249	-.1461	-.1218	-.1454	-.1059			-.1160	-.1118	-.0917	-.1231
.90	-.1379	-.0959	-.1439	-.1252	-.1389	-.1280	-.1328	-.1140	-.1187	-.0964	-.1153	-.1138	-.1324	-.0933
.95			-.1438	-.1240	-.1380	-.1314	-.1277	-.1188	-.1195	-.0996	-.1146	-.1151	-.1354	-.0880

TAIL 1

Cp at γ/b of														
x/c	0.02		0.22		0.44		0.56		0.67		0.83		0.98	
	U.S.	L.S.	U.S.	L.S.	U.S.	L.S.	U.S.	L.S.	U.S.	L.S.	U.S.	L.S.	U.S.	L.S.
.05	.0249	.1103	.0855	.3389	.0989	.3312	.2085	.5202	.1866		.1904	.4221		
.10	.0283	.1141	.0728	.2842	.1080	.3640		.5427			.1760	.4215	.1498	.2257
.15	.0264	.1162	.0665	.2575	.1052	.3263	.1788	.5192	.1946	.5108	.1704	.4010	.1384	.3264
.20					.0993	.3076	.1747	.5050	.1996	.5203	.1663	.4054	.1209	.3229
.25	.0216	.1072	.0539	.2293	.0925	.2932	.1710	.4992	.1971	.5199	.1630	.4160	.1076	.3009
.30	-.0363	.0354	.0483	.2222	.0886	.2886	.1676	.4804	.1869	.5095	.1592	.4240	.0946	.2820
.40	-.0181	.0404			.0837	.2653	.1595	.4468	.1738	.4905	.1554	.4380	.0769	.2640
.50	.0302	.0704	-.0829	.0063			-.0357	.1249					.0471	.1179
.60	-.0101	.0816	-.0759	.0028	-.0859	.0342	-.0852	-.0724	-.1488	-.0421	-.1388	-.0487	-.1251	-.1096
.70			-.0788	.0182			-.1289	-.1007	-.1325	-.0691	-.1240	-.0668	-.1254	-.1079
.80			-.1550	-.0951	-.1271	-.1123	-.1284	-.1182	-.1271	-.0835	-.1220	-.0757	-.1265	-.1051
.90			-.1474	-.1005	-.1304	-.1236	-.1275	-.1235	-.1268	-.0936	-.1220	-.0847	-.1278	-.1058
.95			-.1349	-.1047		-.1264			-.1266	-.0977	-.1217	-.0928	-.1311	-.1085

TAIL 2

TABLE VII. - CONTINUED
(f) $\alpha = 5.80^\circ$

Cp at γ/b of														
x/c	0.02		0.22		0.44		0.56		0.67		0.83		0.98	
	U.S.	L.S.	U.S.	L.S.	U.S.	L.S.	U.S.	L.S.	U.S.	L.S.	U.S.	L.S.	U.S.	L.S.
.05	.0032	.2116	.1443	.3897	.0971	.4272			.2117		.2021	.4560	.2067	.4143
.10	.0394	.1835	.1389	.3417	.1585	.4050			.1955	.4228	.1936	.4314	.1735	.3595
.15	.0370	.1891	.1283	.3079	.1594	.3873			.1997	.4443	.1965	.4174	.1485	.3251
.20	.0336	.1693							.2100	.4708	.1942	.4131		
.25	.0289	.1652	.1043	.2699	.1516	.3564	.2092	.5200	.2149	.4880			.1337	.2827
.30	-.0446	.0278	.0930	.2502		.3284	.2176	.5174	.2161	.4957	.1903	.4098	.1291	.2747
.40	-.0615	.0399	-.0741	.0308	.1423	.3484	.2129	.4943	.2108	.4967	.1820	.4017	.1194	.2527
.50	-.0522	.0762	-.0902	.0205			-.0047	.1341	.0816	.2011	.1275	.1920	.0855	.0989
.60	-.0500	.0832	-.0939	.0211	-.0398	.0760	-.1425	-.0663	-.1428	-.0552	-.1412	-.0887	-.1246	-.1027
.70			-.0962	.0181	-.1605	-.0940	-.1560	-.0849	-.1403	-.0550	-.1224	-.1038	-.1346	-.1215
.80	-.1280	-.0464	-.1386	-.1158	-.1431	-.1127	-.1371	-.0925			-.1184	-.1068	-.1008	-.1073
.90	-.1441	-.0873	-.1416	-.1169	-.1389	-.1186	-.1323	-.1011	-.1216	-.0837	-.1185	-.1094	-.1183	-.0804
.95			-.1434	-.1161	-.1390	-.1232	-.1272	-.1064	-.1221	-.0868	-.1178	-.1123	-.1385	-.0949

TAIL 1

Cp at γ/b of														
x/c	0.02		0.22		0.44		0.56		0.67		0.83		0.98	
	U.S.	L.S.	U.S.	L.S.	U.S.	L.S.	U.S.	L.S.	U.S.	L.S.	U.S.	L.S.	U.S.	L.S.
.05	.0062	.1140	.0190	.3818	.0219	.4414	.1135	.6138	.1397		.1391	.4963		
.10	.0108	.1203	.0122	.3253	.0383	.4069		.6219			.1244	.5008	.1056	.2871
.15	.0092	.1255	.0079	.2979	.0390	.3725	.1006	.5969	.1585	.6322	.1187	.4916	.0953	.4098
.20					.0361	.3528	.0994	.5828	.1541	.6244	.1151	.5053	.0798	.3712
.25	.0039	.1188	.0073	.2683	.0323	.3360	.0964	.5729	.1437	.6103	.1123	.5271	.0685	.3600
.30	-.0414	.0431	.0054	.2632	.0300	.3304	.0931	.5504	.1260	.5896	.1098	.5494	.0576	.3467
.40	-.0305	.0561			.0254	.3092	.0864	.5116	.1074	.5654	.1077	.5685	.0439	.3380
.50	.0210	.1032	-.0947	.0367			-.0713	.1584					.0181	.1663
.60	-.0249	.1145	-.0926	.0340	-.1132	.0576	-.0911	-.0569	-.1288	-.0215	-.1302	-.0145	-.1300	-.0959
.70			-.0937	.0604			-.1297	-.0891	-.1286	-.0518	-.1280	-.0433	-.1317	-.0972
.80			-.1657	-.0734	-.1345	-.0966	-.1309	-.1064	-.1275	-.0630	-.1278	-.0535	-.1313	-.0778
.90			-.1455	-.0839	-.1388	-.1050	-.1308	-.1093	-.1282	-.0764	-.1283	-.0591	-.1314	-.0719
.95			-.1330	-.0900	-.1071				-.1277	-.0808	-.1281	-.0682	-.1392	-.0759

TAIL 2

TABLE VII. - CONTINUED
(g) $\alpha = 7.80^\circ$

Cp at y/b of														
x/c	0.02		0.22		0.44		0.56		0.67		0.83		0.98	
	U.S.	L.S.	U.S.	L.S.	U.S.	L.S.	U.S.	L.S.	U.S.	L.S.	U.S.	L.S.	U.S.	L.S.
.05	-.0100	.2623	.1288	.4397	.0829	.4813			.1970		.1737	.4853	.1823	.4322
.10	.0251	.2283	.1230	.3877	.1428	.4576			.1773	.4563	.1708	.4592	.1510	.3776
.15	.0238	.2316	.1150	.3519	.1431	.4364			.1789	.4825	.1734	.4457	.1299	.3423
.20	.0206	.2063							.1858	.5120	.1716	.4415		
.25	.0164	.2004	.0950	.3089	.1371	.4019	.1830	.5702	.1906	.5251			.1193	.3028
.30	-.0520	.0523	.0826	.2882		.3756	.1909	.5653	.1919	.5341	.1682	.4386	.1165	.2943
.40	-.0701	.0624	-.0831	.0510	.1297	.3933	.1877	.5403	.1889	.5461	.1603	.4291	.1079	.2738
.50	-.0626	.0388	-.0386	.0388			-.0157	.1600	.0658	.2307	.1077	.2074	.0749	.1169
.60	-.0603	.1060	-.1026	.0402	-.0496	.1069	-.1479	-.0506	-.1480	-.0414	-.1402	-.0825	-.1291	-.0985
.70			-.1072	.0380	-.1624	-.0823	-.1536	-.0702	-.1454	-.0414	-.1256	-.0986	-.1316	-.1111
.80	-.1370	-.0352	-.1384	-.1047	-.1423	-.1021	-.1347	-.0779			-.1234	-.1015	-.1284	-.0719
.90	-.1488	-.0754	-.1419	-.1048	-.1397	-.1083	-.1328	-.0864	-.1251	-.0704	-.1233	-.1038	-.1567	-.0900
.95			-.1432	-.1053	-.1391	-.1126	-.1289	-.0927	-.1259	-.0732	-.1228	-.1078	-.1677	-.0913

TAIL 1

Cp at y/b of														
x/c	0.02		0.22		0.44		0.56		0.67		0.83		0.98	
	U.S.	L.S.	U.S.	L.S.	U.S.	L.S.	U.S.	L.S.	U.S.	L.S.	U.S.	L.S.	U.S.	L.S.
.05	.0005	.1001	-.0411	.4082	-.0473	.5106	.0258	.6677	.1042		.0911	.5918		
.10	.0014	.1103	-.0406	.3562	-.0265	.4461		.6876			.0773	.6307	.0634	.3991
.15	-.0026	.1195	-.0382	.3273	-.0223	.4075	.0246	.6645	.1277	.7334	.0712	.6415	.0545	.4755
.20					-.0234	.3892	.0243	.6479	.1077	.7115	.0676	.6654	.0424	.4512
.25	-.0080	.1154	-.0300	.3027	-.0257	.3720	.0237	.6457	.0891	.6924	.0652	.6831	.0335	.4623
.30	-.0474	.0416	-.0312	.2959	-.0272	.3652	.0227	.6185	.0652	.6617	.0639	.6889	.0248	.4610
.40	-.0463	.0664			-.0299	.3309	.0184	.5706	.0433	.6295	.0638	.6739	.0161	.4647
.50	.0163	.1304	-.1078	.0652			-.1118	.1803					-.0065	.2380
.60	-.0432	.1468	-.1068	.0666	-.1411	.0939	-.0982	-.0440	-.1308	-.0148	-.1312	.0042	-.1346	-.0620
.70			-.1056	.0992			-.1408	-.0770	-.1342	-.0383	-.1329	-.0215	-.1380	-.0819
.80			-.1676	-.0522	-.1451	-.0737	-.1429	-.0916	-.1339	-.0465	-.1336	-.0253	-.1328	-.0877
.90			-.1495	-.0710	-.1502	-.0810	-.1433	-.0926	-.1353	-.0624	-.1343	-.0323	-.1421	-.0906
.95			-.1399	-.0793		-.0838			-.1350	-.0684	-.1339	-.0417	-.1453	-.0948

TAIL 2

TABLE VII. - CONTINUED
(h) $\alpha = 9.81^\circ$

Cp at γ/b of														
x/c	0.02		0.22		0.44		0.56		0.67		0.83		0.98	
	U.S.	L.S.	U.S.	L.S.	U.S.	L.S.	U.S.	L.S.	U.S.	L.S.	U.S.	L.S.	U.S.	L.S.
.05	-.0185	.3063	.1209	.4934	.0627	.5360			.1804		.1612	.5275	.1751	.4683
.10	.0136	.2671	.1125	.4331	.1209	.5076			.1590	.4884	.1597	.4963	.1454	.4114
.15	.0144	.2687	.1041	.3941	.1268	.4828			.1556	.5196	.1614	.4823	.1275	.3733
.20	.0118	.2397							.1580	.5486	.1582	.4776		
.25	.0087	.2322	.0869	.3470	.1274	.4444	.1542	.6159	.1614	.5632			.1201	.3348
.30	-.0581	.0758	.0759	.3232		.4112	.1600	.6107	.1641	.5677	.1535	.4740	.1173	.3263
.40	-.0774	.0847	-.0886	.0700	.1235	.4352	.1598	.5864	.1623	.5953	.1449	.4608	.1085	.3036
.50	-.0718	.1231	-.1060	.0572			-.0243	.1865	.0457	.2316	.0939	.2276	.0742	.1389
.60	-.0685	.1319	-.1109	.0596	-.0578	.1356	-.1517	-.0341	-.1506	-.0279	-.1470	-.0760	-.1392	-.0871
.70			-.1156	.0587	-.1564	-.0704	-.1408	-.0541	-.1481	-.0279	-.1327	-.0934	-.1394	-.1030
.80	-.1464	-.0198	-.1386	-.0905	-.1391	-.0901	-.1323	-.0625			-.1307	-.0967	-.1501	-.0618
.90	-.1506	-.0609	-.1414	-.0905	-.1369	-.0962	-.1326	-.0716	-.1296	-.0581	-.1307	-.0991	-.1700	-.0778
.95			-.1427	-.0893	-.1379	-.1012	-.1309	-.0785	-.1306	-.0613	-.1302	-.1035	-.1727	-.0720

TAIL 1

Cp at γ/b of														
x/c	0.02		0.22		0.44		0.56		0.67		0.83		0.98	
	U.S.	L.S.	U.S.	L.S.	U.S.	L.S.	U.S.	L.S.	U.S.	L.S.	U.S.	L.S.	U.S.	L.S.
.05	-.0025	.0799	-.0915	.4232	-.1115	.5125	-.0551	.7204	.0805		.0446	.8218		
.10	-.0049	.0902	-.0800	.3783	-.0887	.4674		.7268			.0312	.8300	.0246	.5775
.15	-.0116	.1010	-.0684	.3534	-.0803	.4335	-.0445	.7152	.0893	.8266	.0246	.8099	.0169	.6508
.20					-.0779	.4163	-.0458	.7168	.0579	.7916	.0209	.7955	.0092	.6409
.25	-.0171	.1004	-.0620	.3286	-.0787	.3995	-.0445	.7089	.0334	.7621	.0195	.7855	.0059	.6301
.30	-.0607	.0342	-.0622	.3216	-.0783	.3941	-.0443	.6773	.0078	.7295	.0201	.7739	.0011	.6113
.40	-.0572	.0678			-.0797	.3517	-.0463	.6244	-.0151	.6982	.0239	.7345	-.0000	.5537
.50	.0079	.1466	-.1237	.0936			-.1434	.2030					-.0235	.2648
.60	-.0571	.1676	-.1130	.1031	-.1619	.1103	-.1112	-.0371	-.1450	.0014	-.1396	.0280	-.1407	-.0353
.70			-.0998	.1326			-.1541	-.0639	-.1486	-.0241	-.1410	.0086	-.1426	-.0750
.80			-.1656	-.0365	-.1534	-.0497	-.1562	-.0750	-.1488	-.0359	-.1415	.0057	-.1416	-.0846
.90			-.1538	-.0616	-.1582	-.0559	-.1565	-.0711	-.1474	-.0533	-.1418	-.0019	-.1468	-.0880
.95			-.1453	-.0709		-.0578			-.1481	-.0591	-.1418	-.0144	-.1621	-.0939

TAIL 2

TABLE VII. - CONTINUED
(i) $\alpha = 11.80^\circ$

Cp at y/b of														
x/c	0.02		0.22		0.44		0.56		0.67		0.83		0.98	
	U.S.	L.S.	U.S.	L.S.	U.S.	L.S.	U.S.	L.S.	U.S.	L.S.	U.S.	L.S.	U.S.	L.S.
.05	-.0303	.3617	.1090	.5534	.0672	.6027			.1885		.1619	.5833	-.1766	.5127
.10	-.0011	.3188	.0991	.4877	.1235	.5680			.1656	.5447	.1647	.5491	-.1481	.4504
.15	.0011	.3164	.0892	.4462	.1249	.5386			.1623	.5880	.1654	.5327	-.1334	.4117
.20	-.0002	.2812							.1643	.6151	.1627	.5267		
.25	-.0035	.2719	.0741	.3951	.1188	.4970	.1570	.6823	.1676	.6269			.1288	.3723
.30	-.0668	.1027	.0639	.3692		.4647	.1613	.6763	.1696	.6364	.1565	.5216	.1275	.3641
.40	-.0865	.1125	-.0965	.0943	.1153	.4935	.1558	.6485	.1681	.6674	.1474	.5060	.1189	.3403
.50	-.0857	.1599	-.1141	.0853			-.0334	.2245	.0522	.2703	.0955	.2575	-.0834	-.1661
.60	-.0782	.1660	-.1214	.0869	-.0677	.1654	-.1561	-.0112	-.1494	-.0071	-.1449	-.0630	-.1395	-.0738
.70			-.1256	.0865	-.1447	-.0538	-.1399	-.0320	-.1467	-.0077	-.1316	-.0796	-.1409	-.0885
.80	-.1510	-.0035	-.1382	-.0754	-.1376	-.0741	-.1332	-.0421			-.1298	-.0809	-.1659	-.0609
.90	-.1518	-.0463	-.1397	-.0728	-.1381	-.0807	-.1346	-.0528	-.1292	-.0369	-.1302	-.0828	-.1752	-.0431
.95			-.1404	-.0710	-.1389	-.0863	-.1344	-.0608	-.1302	-.0401	-.1295	-.0875	-.1749	-.0460

TAIL 1

Cp at y/b of														
x/c	0.02		0.22		0.44		0.56		0.67		0.83		0.98	
	U.S.	L.S.	U.S.	L.S.	U.S.	L.S.	U.S.	L.S.	U.S.	L.S.	U.S.	L.S.	U.S.	L.S.
.05	.0017	.0590	-.1222	.4321	-.1588	.5221	-.1147	.7694	.0621		-.0018	.9967		
.10	-.0051	.0726	-.1063	.3918	-.1380	.4877		.7635			-.0053	.9475	-.0087	.8843
.15	-.0163	.0791	-.1010	.3723	-.1268	.4552	-.0979	.7640	.0496	.8988	-.0114	.9121	-.0102	.8062
.20					-.1213	.4409	-.1022	.7541	.0121	.8612	-.0156	.8789	-.0094	.7437
.25	-.0263	.0764	-.1003	.3524	-.1192	.4230	-.0999	.7568	-.0131	.8295	-.0165	.8586	-.0101	.7103
.30	-.0742	.0196	-.0809	.3449	-.1175	.4170	-.0990	.7259	-.0374	.7930	-.0138	.8378	-.0142	.6672
.40	-.0701	.0589			-.1182	.3583	-.0990	.6588	-.0607	.7521	-.0086	.7775	-.0166	.5730
.50	.0027	.1368	-.1310	.1201			-.1688	.2120					-.0384	.2806
.60	-.0713	.1567	-.1260	.1456	-.1766	.1359	-.1199	-.0239	-.1589	.0183	-.1553	.0446	-.1592	-.0402
.70			-.1203	.1672			-.1661	-.0535	-.1614	-.0087	-.1554	.0366	-.1585	-.0613
.80			-.1762	-.0239	-.1649	-.0261	-.1687	-.0542	-.1608	-.0246	-.1563	.0301	-.1627	-.0630
.90			-.1616	-.0530	-.1701	-.0297	-.1696	-.0452	-.1594	-.0420	-.1569	.0188	-.1659	-.0658
.95			-.1555	-.0623		-.0301			-.1607	-.0485	-.1570	.0057	-.1713	-.0714

TAIL 2

TABLE VII. - CONTINUED
(j) $\alpha = 15.80^\circ$

Cp at γ/b of														
x/c	0.02		0.22		0.44		0.56		0.67		0.83		0.98	
	U.S.	L.S.	U.S.	L.S.	U.S.	L.S.	U.S.	L.S.	U.S.	L.S.	U.S.	L.S.	U.S.	L.S.
.05	-.0055	.4824	.1425	.7006	.0855	.7777			.2205		.1776	.7296	.1912	.6190
.10	.0281	.4348	.1313	.6221	.1565	.7297			.1930	.7714	.1871	.6882	.1664	.5509
.15	.0314	.4311	.1202	.5745	.1604	.6894			.1901	.8216	.1881	.6711	.1573	.5091
.20	.0304	.3874							.1912	.8648	.1861	.6666		
.25	.0262	.3777	.1020	.5161	.1528	.6371	.1840	.8543	.1969	.8880			.1573	.4735
.30	-.0445	.1769	.0895	.4845		.5872	.1872	.8437	.2002	.8923	.1789	.6683	.1569	.4677
.40	-.0614	.1924	-.0841	.1545	.1486	.6456	.1814	.8050	.1994	.8528	.1679	.6531	.1485	.4447
.50	-.0658	.2672	-.1022	.1467			-.0220	.3015	.0737	.3589	.1135	.3577	.1146	.2465
.60	-.0679	.2608	-.1109	.1521	-.0580	.2314	-.1495	.0356	-.1380	.0390	-.1315	-.0120	-.1355	-.0353
.70			-.1151	.1556	-.1363	-.0176	-.1313	.0145	-.1355	.0380	-.1223	-.0227	-.1389	-.0421
.80	-.1432	.0501	-.1275	-.0303	-.1305	-.0386	-.1255	.0019			-.1223	-.0238	-.1840	-.0045
.90	-.1456	-.0006	-.1304	-.0181	-.1305	-.0456	-.1268	-.0121	-.1200	.0034	-.1230	-.0277	-.1819	.0114
.95			-.1309	-.0130	-.1320	-.0527	-.1264	-.0206	-.1206	-.0010	-.1223	-.0334	-.1738	-.0001

TAIL 1

Cp at γ/b of														
x/c	0.02		0.22		0.44		0.56		0.67		0.83		0.98	
	U.S.	L.S.	U.S.	L.S.	U.S.	L.S.	U.S.	L.S.	U.S.	L.S.	U.S.	L.S.	U.S.	L.S.
.05	.0158	-.0149	-.1597	.4253	-.1887	.5300	-.1792	.8068	-.0037		-.1080	1.1486		
.10	-.0012	.0206	-.1600	.4024	-.1920	.5100		.8212			-.0846	1.0739	-.0857	.9637
.15	-.0156	.0502	-.1514	.3939	-.1955	.4835	-.1651	.8099	-.0399	.9882	-.0794	1.0188	-.0751	.8925
.20					-.1780	.4732	-.1726	.7949	-.0734	.9395	-.0765	.9774	-.0670	.8237
.25	-.0411	.0427	-.1280	.3878	-.1593	.4554	-.1738	.7844	-.0965	.9095	-.0732	.9505	-.0657	.7810
.30	-.0963	-.0073	-.1142	.3819	-.1581	.4439	-.1719	.7502	-.1208	.8631	-.0697	.9215	-.0691	.7305
.40	-.0958	.0188			-.1598	.3646	-.1686	.6872	-.1411	.8134	-.0686	.8468	-.0740	.6273
.50	-.0361	.0660	-.1498	.1928			-.1972	.2366					-.0874	.2924
.60	-.0925	.0989	-.1516	.2165	-.1846	.2293	-.1395	-.0102	-.1872	.0382	-.1784	.0803	-.1818	-.0175
.70			-.1446	.2281			-.1898	-.0173	-.1898	.0093	-.1780	.0655	-.1812	-.0256
.80			-.1911	-.0007	-.1824	.0285	-.1929	.0074	-.1879	-.0033	-.1785	.0544	-.1812	-.0166
.90			-.1790	-.0293	-.1790	.0240	-.1940	.0212	-.1806	-.0192	-.1784	.0437	-.1818	-.0141
.95			-.1717	-.0376		.0228			-.1858	-.0227	-.1785	.0309	-.1793	-.0201

TAIL 2

TABLE VII. - CONCLUDED
(k) $\alpha = 19.80^\circ$

Cp at γ/b of														
x/c	0.02		0.22		0.44		0.56		0.67		0.83		0.98	
	U.S.	L.S.	U.S.	L.S.	U.S.	L.S.	U.S.	L.S.	U.S.	L.S.	U.S.	L.S.	U.S.	L.S.
.05	.0302	.6234	.1826	.8642	.1076	.9695			.2692		.2090	.9143	.2245	.7597
.10	.0685	.5733	.1717	.7748	.1974	.9067			.2388	1.1512	.2275	.8630	.2032	.6820
.15	.0725	.5630	.1595	.7195	.2082	.8541			.2380	1.1577	.2272	.8559	.1995	.6341
.20	.0717	.5088							.2458	1.1333	.2244	.8641		
.25	.0665	.4997	.1378	.6511	.1980	.7939	.2218	1.0524	.2551	1.1014			.2012	.5961
.30	-.0150	.2715	.1257	.6136		.7633	.2284	1.0360	.2585	1.0773	.2164	.8892	.2009	.5902
.40	-.0262	.2944	-.0655	.2215	.2031	.8694	.2228	.9708	.2561	1.0198	.2047	.8653	.1936	.5694
.50	-.0385	.4005	-.0863	.2231			.0013	.3762	.1123	.4499	.1446	.5056	.1585	.3401
.60	-.0378	.3761	-.0936	.2351	-.0418	.2985	-.1375	.0806	-.1273	.0770	-.1190	.0589	-.1230	.0140
.70			-.0977	.2491	-.1255	.0225	-.1182	.0619	-.1251	.0753	-.1103	.0409	-.1447	.0230
.80	-.1249	.1233	-.1171	.0379	-.1192	-.0000	-.1123	.0487			-.1094	.0316	-.1849	.0687
.90	-.1362	.0700	-.1224	.0638	-.1194	-.0075	-.1184	.0309	-.1061	.0474	-.1098	.0214	-.1765	.0850
.95			-.1230	.0666	-.1207	-.0139	-.1150	.0191	-.1068	.0413	-.1089	.0131	-.1665	.0775

TAIL 1

Cp at γ/b of														
x/c	0.02		0.22		0.44		0.56		0.67		0.83		0.98	
	U.S.	L.S.	U.S.	L.S.	U.S.	L.S.	U.S.	L.S.	U.S.	L.S.	U.S.	L.S.	U.S.	L.S.
.05	-.0126	-.0297	-.1860	.4532	-.2032	.5299	-.1901	.7902	-.1111		-.1766	1.1722		
.10	-.0352	-.0199	-.1902	.4460	-.2040	.5241		.8123			-.1497	1.1033	-.1601	.9828
.15	-.0515	.0356	-.1893	.4447	-.2036	.5023	-.1820	.8025	-.1235	1.0389	-.1345	1.0492	-.1481	.9172
.20					-.2037	.4904	-.1879	.7871	-.1440	.9830	-.1264	1.0037	-.1392	.8519
.25	-.0755	.0083	-.1833	.4444	-.2052	.4672	-.1904	.7765	-.1593	.9437	-.1219	.9826	-.1335	.8108
.30	-.1217	-.0307	-.1792	.4296	-.2067	.4497	-.1915	.7433	-.1738	.8933	-.1198	.9418	-.1316	.7586
.40	-.1207	.0074			-.2040	.3617	-.1971	.6814	-.1798	.8388	-.1110	.8613	-.1307	.6485
.50	-.0497	.0511	-.1795	.2814			-.2092	.2428					-.1422	.2941
.60	-.1162	.0986	-.1763	.2951	-.1986	.3250	-.1542	.0225	-.1981	.0570	-.1907	.0702	-.1931	.0004
.70			-.1685	.2920			-.2037	.0657	-.1991	.0356	-.1912	.0492	-.1934	.0132
.80			-.2019	.0322	-.1983	.0728	-.2050	.0769	-.1967	.0383	-.1924	.0466	-.1929	.0246
.90			-.1896	.0040	-.2062	.0658	-.2028	.0825	-.1914	.0532	-.1926	.0465	-.1920	.0213
.95			-.1848	-.0036		.0616			-.1955	.0592	-.1925	.0381	-.1868	.0130

TAIL 2

TABLE VIII. - PRESSURE COEFFICIENTS, $\phi = 45^\circ$, $\delta = 0^\circ$, $M = 2.36$.
(a) $\alpha = -4.17^\circ$

Cp at y/b of														
x/c	0.02		0.22		0.44		0.56		0.67		0.83		0.98	
	U.S.	L.S.	U.S.	L.S.	U.S.	L.S.	U.S.	L.S.	U.S.	L.S.	U.S.	L.S.	U.S.	L.S.
.05	.0644	.0439	.3194	.1118	.3845	.1409			.4294		.3617	.2605	.3701	.2536
.10	.0748	.0428	.2694	.0926	.3447	.1389			.4762	.2325	.3624	.2404	.3081	.2146
.15	.0808	.0410	.2415	.0810	.3150	.1339			.4958	.2470	.3639	.2295	.3122	.1926
.20	.0842	.0394							.5033	.2558	.3667	.2261		
.25	.0816	.0325	.2118	.0705	.2760	.1242	.4289	.2330	.4892	.2536			.2682	.1547
.30	.0133	-.0088	.2005	.0626	.2484	.1611	.4294	.2374	.4706	.2522	.3814	.2240	.2525	.1465
.40	.0364	-.0027	.0004	-.0710	.2374	.1246	.3999	.2278	.4381	.2436	.3896	.2189	.2295	.1282
.50	.0764	.0042	-.0219	-.0617			.0882	-.0089	.2306	.0360	.3232	.0670	.1772	.0084
.60	.0475	.0051	-.0218	-.0525	.0196	-.0435	-.1006	-.1419	-.0739	-.1332	-.0700	-.1339	-.1270	-.1135
.70			.0030	-.0515	-.1256	-.1518	-.1226	-.1492	-.0733	-.1315	-.0937	-.1108	-.1217	-.1113
.80	-.0781	-.0889	-.1120	-.1432	-.1403	-.1290	-.1313	-.1291			-.0994	-.1051	-.1212	-.1094
.90	-.0849	-.0986	-.1281	-.1415	-.1422	-.1255	-.1386	-.1241	-.1121	-.1117	-.1064	-.1038	-.1112	-.1083
.95			-.1239	-.1260	-.1342	-.1233	-.1310	-.1220	-.1189	-.1120	-.1105	-.1032	-.1099	-.1068

TAIL 1

Cp at y/b of														
x/c	0.02		0.22		0.44		0.56		0.67		0.83		0.98	
	U.S.	L.S.	U.S.	L.S.	U.S.	L.S.	U.S.	L.S.	U.S.	L.S.	U.S.	L.S.	U.S.	L.S.
.05	.1990	.0976	.3695	.1108	.4180	.1600	.6299	.2383	.4090	.2262	.4014	.2322		
.10	.1726	.0365	.3263	.1145	.3936	.1438					.3883	.2137	.3274	.2127
.15	.1771	.0312	.2994	.1075	.3697	.1370		.2383	.4768	.2296	.3846	.2219	.3083	.1920
.20					.3465	.1351	.5015	.2432	.4927	.2344	.3806	.2147	.2820	.1684
.25	.1679	.0155	.2607	.0897	.3276	.1349	.4849	.2416	.5023	.2400	.3760	.2173	.2638	.1609
.30	.0462	-.0543	.2445	.0865	.3150	.1374	.4688	.2358	.5026	.2427	.3746	.2193	.2479	.1516
.40	.0276	-.0421			.2989	.1473	.4405	.2309	.4822	.2448	.3753	.2172	.2219	.1348
.50	.0582	-.0361	.0026	-.0772			.1176	.0022					.1794	.0180
.60	.0537	-.0308	-.0000	-.0813	.0328	-.0519	-.0634	-.1113	-.0719	-.1242	-.0824	-.1240	-.1168	-.1271
.70			.0008	-.0806			-.1134	-.1473	-.0960	-.1402	-.1015	-.1401	-.1270	-.1274
.80			-.1299	-.1430	-.1311	-.1365	-.1212	-.1388	-.1000	-.1181	-.1037	-.1208	-.1312	-.0955
.90			-.1306	-.1317	-.1420	-.1269	-.1301	-.1233	-.1053	-.1052	-.1083	-.1129	-.1189	-.1119
.95			-.1292	-.1304		-.1251			-.1094	-.1076	-.1105	-.1109	-.0958	-.1374

TAIL 2

TABLE VIII. - CONTINUED
(b) $\alpha = -2.15^\circ$

Cp at γ/b of														
x/c	0.02		0.22		0.44		0.56		0.67		0.83		0.98	
	U.S.	L.S.	U.S.	L.S.	U.S.	L.S.	U.S.	L.S.	U.S.	L.S.	U.S.	L.S.	U.S.	L.S.
.05	.0807	.0514	.2824	.1812	.3242	.2092			.3544		.3170	.3111	.3215	.2976
.10	.0870	.0538	.2393	.1545	.3007	.1988			.3637	.2776	.3103	.2911	.2618	.2548
.15	.0879	.0546	.2123	.1359	.2765	.1906			.3814	.2888	.3127	.2787	.2643	.2304
.20	.0882	.0535							.3988	.3012	.3132	.2743		
.25	.0842	.0493	.1828	.1163	.2465	.1766	.3766	.3063	.4034	.3082			.2248	.1876
.30	.0056	-.0124	.1711	.1057	.2376	.1613	.3792	.3093	.4008	.3123	.3137	.2724	.2118	.1795
.40	.0190	-.0000	-.0147	-.0452	.2139	.1727	.3546	.2950	.3853	.3088	.3108	.2661	.1903	.1597
.50	.0570	.0141	-.0356	-.0536			.0640	.0273	.1937	.0759	.2452	.0983	.1427	.0303
.60	.0447	.0249	-.0393	-.0445	-.0062	-.0155	-.1131	-.1251	-.0907	-.1147	-.0992	-.1255	-.1285	-.1091
.70			-.0307	-.0431	-.1374	-.1414	-.1311	-.1401	-.0900	-.1133	-.1175	-.1281	-.1208	-.1057
.80	-.0823	-.0727	-.1236	-.1337	-.1483	-.1451	-.1374	-.1424			-.1199	-.1081	-.1133	-.1027
.90	-.0938	-.1005	-.1318	-.1305	-.1289	-.1274	-.1307	-.1278	-.1152	-.1048	-.1116	-.1012	-.1054	-.1008
.95			-.1233	-.1279	-.1221	-.1253	-.1197	-.1203	-.1055	-.1012	-.1024	-.0996	-.1097	-.1020

TAIL 1

Cp at γ/b of														
x/c	0.02		0.22		0.44		0.56		0.67		0.83		0.98	
	U.S.	L.S.	U.S.	L.S.	U.S.	L.S.	U.S.	L.S.	U.S.	L.S.	U.S.	L.S.	U.S.	L.S.
.05	.1370	.0974	.3047	.1671	.3438	.1981	.5265	.2942	.3546	.2699	.3509	.2771		
.10	.1261	.0663	.2689	.1621	.3274	.1872					.3379	.2563	.2851	.2475
.15	.1312	.0578	.2456	.1471	.3081	.1794		.2990	.3898	.2766	.3338	.2667	.2692	.2291
.20					.2883	.1770	.4291	.3019	.4081	.2839	.3302	.2576	.2458	.2061
.25	.1245	.0464	.2118	.1276	.2723	.1756	.4147	.3046	.4185	.2910	.3263	.2589	.2293	.1959
.30	.0181	-.0282	.1975	.1229	.2613	.1783	.4015	.2963	.4196	.2967	.3226	.2599	.2133	.1820
.40	.0081	-.0151			.2446	.1867	.3760	.2884	.4084	.2997	.3198	.2574	.1887	.1613
.50	.0587	-.0064	-.0206	-.0584			.0805	.0291					.1480	.0355
.60	.0340	.0046	-.0242	-.0601	.0022	-.0331	-.0613	-.0973	-.0907	-.1059	-.1024	-.1100	-.1180	-.1214
.70			-.0245	-.0558			-.1287	-.1344	-.1144	-.1246	-.1208	-.1293	-.1101	-.1313
.80			-.1402	-.1433	-.1436	-.1427	-.1369	-.1420	-.1190	-.1222	-.1171	-.1247	-.1037	-.1158
.90			-.1297	-.1341	-.1415	-.1301	-.1416	-.1275	-.1211	-.0972	-.1093	-.1083	-.1031	-.1105
.95			-.1242	-.1279		-.1206			-.1134	-.0953	-.1055	-.1047	-.1045	-.1005

TAIL 2

TABLE VIII. - CONTINUED
(c) $\alpha = -0.15^\circ$

Cp at y/b of														
x/c	0.02		0.22		0.44		0.56		0.67		0.83		0.98	
	U.S.	L.S.	U.S.	L.S.	U.S.	L.S.	U.S.	L.S.	U.S.	L.S.	U.S.	L.S.	U.S.	L.S.
.05	.0748	.0750	.2333	.2490	.2555	.2815			.3039		.2723	.3640	.2801	.3433
.10	.0798	.0784	.1998	.2135	.2463	.2675			.3059	.3289	.2673	.3438	.2201	.2952
.15	.0770	.0820	.1781	.1886	.2299	.2554			.3031	.3452	.2701	.3296	.2221	.2676
.20	.0756	.0791							.3123	.3634	.2701	.3254		
.25	.0713	.0767	.1531	.1634	.2117	.2330	.3191	.3790	.3197	.3753			.1903	.2223
.30	-.0072	-.0077	.1424	.1498	.2070	.2068	.3253	.3794	.3227	.3817	.2662	.3224	.1773	.2142
.40	-.0028	.0099	-.0307	-.0205	.1847	.2294	.3087	.3599	.3190	.3800	.2595	.3168	.1600	.1930
.50	.0278	.0291	-.0521	-.0303			.0411	.0609	.1566	.1172	.1967	.1333	.1173	.0542
.60	.0288	.0530	-.0537	-.0274	-.0172	.0105	-.1252	-.1076	-.1109	-.0952	-.1218	-.1116	-.1204	-.1215
.70			-.0525	-.0261	-.1470	-.1279	-.1424	-.1235	-.1036	-.0941	-.1365	-.1238	-.1141	-.1142
.80	-.0895	-.0588	-.1333	-.1308	-.1397	-.1419	-.1406	-.1292			-.1156	-.1217	-.1100	-.1058
.90	-.1030	-.0976	-.1299	-.1295	-.1253	-.1445	-.1258	-.1354	-.1032	-.1176	-.1062	-.1121	-.1088	-.1047
.95			-.1245	-.1258	-.1233	-.1373	-.1193	-.1334	-.1026	-.1123	-.1043	-.1074	-.1093	-.1032

TAIL 1

Cp at y/b of														
x/c	0.02		0.22		0.44		0.56		0.67		0.83		0.98	
	U.S.	L.S.	U.S.	L.S.	U.S.	L.S.	U.S.	L.S.	U.S.	L.S.	U.S.	L.S.	U.S.	L.S.
.05	.0856	.0876	.2404	.2331	.2702	.2600	.4225	.3664	.3050	.3229	.3021	.3243		
.10	.0854	.0861	.2113	.2070	.2626	.2464					.2885	.3005	.2467	.2964
.15	.0898	.0813	.1918	.1884	.2484	.2343		.3755	.3197	.3353	.2839	.3120	.2324	.2762
.20					.2331	.2267	.3555	.3772	.3352	.3483	.2808	.3018	.2112	.2500
.25	.0846	.0720	.1633	.1608	.2187	.2214	.3443	.3764	.3441	.3596	.2770	.3055	.1959	.2360
.30	-.0054	-.0026	.1516	.1544	.2101	.2200	.3342	.3652	.3465	.3680	.2734	.3059	.1804	.2183
.40	-.0032	.0106			.1957	.2258	.3124	.3497	.3384	.3706	.2697	.3028	.1561	.1934
.50	.0443	.0219	-.0434	-.0361			.0454	.0571					.1173	.0559
.60	.0177	.0358	-.0473	-.0413	-.0285	-.0148	-.0650	-.0854	-.1084	-.0850	-.1181	-.0936	-.1034	-.1188
.70			-.0464	-.0323			-.1440	-.1218	-.1312	-.1060	-.1277	-.1130	-.1031	-.1282
.80			-.1321	-.1253	-.1354	-.1335	-.1449	-.1324	-.1274	-.1114	-.1102	-.1163	-.1014	-.1234
.90			-.1261	-.1282	-.1269	-.1420	-.1282	-.1370	-.1066	-.1100	-.1055	-.1152	-.1016	-.1130
.95			-.1260	-.1265		-.1383			-.1015	-.1106	-.1035	-.1099	-.1058	-.1056

TAIL 2

TABLE VIII. - CONTINUED
 (d) $\alpha = 1.86^\circ$

Cp at y/b of														
x/c	0.02		0.22		0.44		0.56		0.67		0.83		0.98	
	U.S.	L.S.	U.S.	L.S.	U.S.	L.S.	U.S.	L.S.	U.S.	L.S.	U.S.	L.S.	U.S.	L.S.
.05	.0454	.1319	.1746	.3187	.1939	.3628			.2574		.2218	.4211	.2405	.3909
.10	.0556	.1232	.1601	.2763	.1912	.3394			.2574	.3884	.2282	.3986	.1807	.3386
.15	.0526	.1283	.1418	.2481	.1800	.3214			.2527	.4189	.2301	.3843	.1839	.3069
.20	.0530	.1190							.2548	.4420	.2294	.3799		
.25	.0489	.1170	.1194	.2161	.1711	.2921	.2546	.4556	.2580	.4529			.1576	.2597
.30	-.0264	.0052	.1100	.1991	.1704	.2601	.2639	.4529	.2589	.4592	.2240	.3777	.1478	.2505
.40	-.0330	.0257	-.0504	.0071	.1526	.2837	.2534	.4295	.2553	.4586	.2159	.3717	.1327	.2283
.50	-.0082	.0599	-.0691	-.0018			.0131	.0994	.1122	.1563	.1574	.1723	.0953	.0793
.60	.0050	.0758	-.0689	-.0000	-.0307	.0400	-.1363	-.0874	-.1278	-.0754	-.1339	-.0935	-.1223	-.1166
.70			-.0716	-.0006	-.1543	-.1114	-.1506	-.1048	-.1262	-.0747	-.1240	-.1045	-.1190	-.1281
.80	-.0995	-.0494	-.1246	-.1228	-.1336	-.1262	-.1340	-.1117			-.1137	-.1046	-.1163	-.1216
.90	-.1139	-.0925	-.1296	-.1207	-.1288	-.1311	-.1267	-.1201	-.1103	-.1018	-.1117	-.1066	-.1198	-.1141
.95			-.1269	-.1193	-.1284	-.1339	-.1234	-.1248	-.1128	-.1039	-.1111	-.1093	-.1299	-.0973

TAIL 1

Cp at y/b of														
x/c	0.02		0.22		0.44		0.56		0.67		0.83		0.98	
	U.S.	L.S.	U.S.	L.S.	U.S.	L.S.	U.S.	L.S.	U.S.	L.S.	U.S.	L.S.	U.S.	L.S.
.05	.0607	.0789	.1729	.2952	.1993	.3358	.3255	.4687	.2549	.3789	.2564	.3761		
.10	.0635	.0863	.1518	.2467	.1976	.3055					.2418	.3454	.2090	.3470
.15	.0636	.0879	.1376	.2222	.1873	.2813		.4560	.2643	.4236	.2370	.3578	.1962	.3236
.20					.1756	.2687	.2818	.4514	.2738	.4434	.2341	.3487	.1767	.2948
.25	.0572	.0850	.1167	.1906	.1646	.2584	.2734	.4436	.2779	.4543	.2312	.3517	.1617	.2779
.30	-.0144	.0156	.1076	.1845	.1574	.2548	.2653	.4270	.2768	.4539	.2280	.3573	.1470	.2532
.40	-.0020	.0323			.1498	.2596	.2497	.4004	.2679	.4424	.2242	.3652	.1240	.2305
.50	.0375	.0460	-.0654	-.0172			.0138	.0854					.0875	.0805
.60	.0021	.0546	-.0600	-.0242	-.0557	.0000	-.0721	-.0752	-.1257	-.0664	-.1302	-.0654	-.1060	-.1164
.70			-.0606	-.0041			-.1477	-.1103	-.1448	-.0879	-.1140	-.0844	-.1075	-.1158
.80			-.1371	-.1042	-.1246	-.1215	-.1324	-.1228	-.1214	-.0948	-.1076	-.0878	-.1069	-.1169
.90			-.1320	-.1141	-.1259	-.1309	-.1289	-.1288	-.1138	-.0970	-.1062	-.0926	-.1065	-.1108
.95			-.1312	-.1164		-.1331			-.1130	-.1048	-.1058	-.0993	-.1078	-.1082

TAIL 2

TABLE VIII. - CONTINUED
(e) $\alpha = 3.85^\circ$

Cp at y/b of														
x/c	0.02		0.22		0.44		0.56		0.67		0.83		0.98	
	U.S.	L.S.	U.S.	L.S.	U.S.	L.S.	U.S.	L.S.	U.S.	L.S.	U.S.	L.S.	U.S.	L.S.
.05	.0093	.1971	.1185	.3867	.1473	.4425			.2156		.1844	.4775	.2008	.4423
.10	.0230	.1768	.1151	.3370	.1466	.4085			.2146	.4622	.1881	.4540	.1485	.3855
.15	.0230	.1814	.1050	.3058	.1360	.3857			.2117	.5090	.1913	.4395	.1499	.3490
.20	.0254	.1646							.2106	.5273	.1906	.4354		
.25	.0220	.1617	.0848	.2675	.1308	.3505	.1981	.5300	.2120	.5356			.1304	.2995
.30	-.0470	.0256	.0744	.2481	.1335	.3209	.2074	.5245	.2114	.5435	.1849	.4357	.1235	.2890
.40	-.0608	.0476	-.0710	.0340	.1186	.3360	-.2007	.4984	.2062	.5358	.1753	.4315	.1115	.2659
.50	-.0473	.0959	-.0885	.0241			-.0155	.1359	.0744	.1987	.1223	.2158	.0767	.1048
.60	-.0247	.0989	-.0892	.0272	-.0510	.0722	-.1465	-.0675	-.1428	-.0543	-.1446	-.0718	-.1326	-.1053
.70			-.0921	.0276	-.1557	-.0940	-.1487	-.0855	-.1406	-.0541	-.1295	-.0811	-.1395	-.1164
.80	-.1121	-.0364	-.1284	-.1085	-.1352	-.1102	-.1329	-.0939			-.1234	-.0824	-.1162	-.1135
.90	-.1262	-.0826	-.1354	-.1056	-.1335	-.1155	-.1309	-.1038	-.1204	-.0796	-.1223	-.0863	-.1318	-.1062
.95			-.1325	-.1048	-.1341	-.1201	-.1304	-.1100	-.1238	-.0834	-.1217	-.0908	-.1448	-.0906

TAIL 1

Cp at y/b of														
x/c	0.02		0.22		0.44		0.56		0.67		0.83		0.98	
	U.S.	L.S.	U.S.	L.S.	U.S.	L.S.	U.S.	L.S.	U.S.	L.S.	U.S.	L.S.	U.S.	L.S.
.05	.0506	.0680	.0948	.3302	.1249	.3921	.2329	.5450	.2088	.4636	.2113	.4302		
.10	.0526	.0706	.0851	.2747	.1326	.3508					.1970	.4000	.1718	.3992
.15	.0504	.0781	.0808	.2494	.1269	.3184		.5255	.2220	.5528	.1921	.4073	.1592	.3742
.20					.1182	.3033	.2090	.5197	.2242	.5526	.1891	.4075	.1412	.3401
.25	.0405	.0774	.0691	.2211	.1089	.2912	.2022	.5024	.2205	.5397	.1871	.4176	.1276	.3230
.30	-.0092	.0280	.0616	.2150	.1038	.2859	.1965	.4806	.2116	.5225	.1844	.4360	.1140	.3025
.40	-.0019	.0457			.0979	.2739	.1833	.4490	.2013	.4934	.1811	.4604	.0928	.2732
.50	.0319	.0643	-.0742	-.0046			-.0183	.1128					.0594	.1131
.60	-.0108	.0602	-.0716	-.0006	-.0797	.0278	-.0872	-.0675	-.1430	-.0426	-.1401	-.0318	-.1195	-.1081
.70			-.0712	.0373			-.1416	-.1018	-.1461	-.0674	-.1217	-.0549	-.1206	-.1001
.80			-.1567	-.0904	-.1319	-.1116	-.1374	-.1158	-.1298	-.0782	-.1177	-.0644	-.1195	-.0923
.90			-.1399	-.1039	-.1347	-.1221	-.1357	-.1204	-.1271	-.0832	-.1173	-.0731	-.1200	-.0905
.95			-.1275	-.1075	-.1246				-.1268	-.0918	-.1170	-.0822	-.1202	-.0934

TAIL 2

TABLE VIII. - CONTINUED
 (f) $\alpha = 5.85^\circ$

Cp at y/b of														
x/c	0.02		0.22		0.44		0.56		0.67		0.83		0.98	
	U.S.	L.S.	U.S.	L.S.	U.S.	L.S.	U.S.	L.S.	U.S.	L.S.	U.S.	L.S.	U.S.	L.S.
.05	-.0306	.2628	.0734	.4522	-.1076	.5209			.1779		.1534	.5387	.1587	.4909
.10	-.0125	.2358	.0707	.3962	-.1052	.4777			.1751	.5656	.1521	.5116	.1176	.4289
.15	-.0092	.2389	.0645	.3626	-.0968	.4498			.1739	.6105	.1539	.4955	.1179	.3902
.20	-.0043	.2133							.1733	.6234	.1527	.4919		
.25	-.0062	.2099	.0539	.3199	-.0929	.4097	.1499	.6064	.1715	.6289			.1043	.3399
.30	-.0663	.0532	.0427	.2986	-.0978	.3747	.1580	.5979	.1698	.6359	.1473	.4986	.1004	.3290
.40	-.0807	.0759	-.0899	.0588	-.0861	.4001	.1519	.5645	.1645	.6132	.1392	.5021	.0931	.3052
.50	-.0800	.1328	-.1088	.0529			-.0389	.1731	.0449	.2390	.0906	.2658	.0613	.1326
.60	-.0532	.1276	-.1078	.0575	-.0724	.1042	-.1564	-.0469	-.1533	-.0333	-.1540	-.0449	-.1383	-.0925
.70			-.1116	.0594	-.1427	-.0755	-.1409	-.0665	-.1512	-.0333	-.1377	-.0551	-.1397	-.1011
.80	-.1239	-.0177	-.1309	-.0911	-.1353	-.0932	-.1347	-.0755			-.1328	-.0586	-.1204	-.1003
.90	-.1355	-.0667	-.1390	-.0889	-.1346	-.0987	-.1367	-.0864	-.1293	-.0571	-.1322	-.0652	-.1455	-.0913
.95			-.1362	-.0870	-.1350	-.1038	-.1364	-.0937	-.1330	-.0615	-.1312	-.0716	-.1638	-.0786

TAIL 1

Cp at y/b of														
x/c	0.02		0.22		0.44		0.56		0.67		0.83		0.98	
	U.S.	L.S.	U.S.	L.S.	U.S.	L.S.	U.S.	L.S.	U.S.	L.S.	U.S.	L.S.	U.S.	L.S.
.05	.0620	.0735	.0157	.3418	.0445	.4299	.1380	.6055	.1654	.6473	.1688	.4875		
.10	.0677	.0570	.0331	.2910	.0600	.3830					.1538	.4602	.1358	.4516
.15	.0666	.0680	.0381	.2666	.0592	.3482		.5874	.1877	.6484	.1486	.4834	.1220	.4270
.20					.0544	.3322	.1322	.5746	.1785	.6203	.1457	.5020	.1053	.3924
.25	.0566	.0714	.0346	.2413	.0490	.3167	.1299	.5624	.1666	.5980	.1436	.5364	.0933	.3756
.30	-.0186	.0319	.0250	.2342	.0474	.3096	.1264	.5314	.1493	.5723	.1411	.5606	.0811	.3567
.40	-.0184	.0461			.0476	.2883	.1168	.4926	.1340	.5451	.1393	.5672	.0622	.3383
.50	.0188	.0617	-.0847	.0098			-.0562	.1316					.0324	.1689
.60	-.0317	.0546	-.0623	.0435	-.1004	.0545	-.0959	-.0631	-.1544	-.0332	-.1481	-.0147	-.1329	-.0856
.70			-.0571	.0758			-.1343	-.0934	-.1375	-.0566	-.1315	-.0393	-.1329	-.0908
.80			-.1454	-.0782	-.1342	-.0969	-.1341	-.1072	-.1339	-.0677	-.1284	-.0511	-.1324	-.0726
.90			-.1401	-.0962	-.1385	-.1078	-.1334	-.1104	-.1336	-.0740	-.1293	-.0606	-.1334	-.0703
.95			-.1259	-.1006		-.1110			-.1339	-.0838	-.1295	-.0693	-.1331	-.0765

TAIL 2

TABLE VIII. - CONTINUED
(g) $\alpha = 7.85^\circ$

Cp at y/b of														
x/c	0.02		0.22		0.44		0.56		0.67		0.83		0.98	
	U.S.	L.S.	U.S.	L.S.	U.S.	L.S.	U.S.	L.S.	U.S.	L.S.	U.S.	L.S.	U.S.	L.S.
.05	-.0634	.3277	.0423	.5187	.0742	.5985			.1455		.1240	.6108	.1252	.5458
.10	-.0462	.2988	.0333	.4567	.0719	.5473			.1410	.6969	.1185	.5747	.0866	.4791
.15	-.0398	.2970	.0269	.4184	.0666	.5161			.1408	.7269	.1216	.5606	.0909	.4364
.20	-.0323	.2648							.1408	.7276	.1191	.5599		
.25	-.0332	.2596	.0216	.3742	.0637	.4711	.1089	.6850	.1385	.7455			.0837	.3835
.30	-.0836	.0846	.0149	.3502	.0709	.4375	.1155	.6748	.1357	.7258	.1140	.5808	.0825	.3720
.40	-.0972	.1085	-.1036	.0846	.0572	.4663	.1098	.6352	.1304	.6796	.1060	.5865	.0755	.3479
.50	-.1049	.1720	-.1241	.0828			-.0627	.2102	.0198	.2751	.0607	.3283	.0491	.1633
.60	-.0742	.1606	-.1249	.0912	-.0927	.1386	-.1560	-.0263	-.1562	-.0129	-.1573	-.0145	-.1450	-.0798
.70			-.1291	.0944	-.1371	-.0573	-.1393	-.0476	-.1537	-.0133	-.1427	-.0277	-.1482	-.0825
.80	-.1327	.0063	-.1315	-.0708	-.1359	-.0756	-.1357	-.0572			-.1397	-.0360	-.1513	-.0827
.90	-.1423	-.0454	-.1403	-.0668	-.1351	-.0811	-.1373	-.0686	-.1354	-.0311	-.1394	-.0468	-.1780	-.0691
.95			-.1372	-.0653	-.1359	-.0859	-.1364	-.0768	-.1391	-.0354	-.1382	-.0549	-.1773	-.0530

TAIL 1

Cp at y/b of														
x/c	0.02		0.22		0.44		0.56		0.67		0.83		0.98	
	U.S.	L.S.	U.S.	L.S.	U.S.	L.S.	U.S.	L.S.	U.S.	L.S.	U.S.	L.S.	U.S.	L.S.
.05	.0401	.0684	-.0168	.3029	-.0387	.4463	.0442	.6460	.1292	.8243	.1227	.5699		
.10	.0562	.0557	.0046	.2709	-.0188	.4005					.1077	.5938	.0967	.5128
.15	.0618	.0543	.0058	.2557	-.0144	.3662		.6296	.1492	.7088	.1018	.6538	.0835	.4975
.20					-.0131	.3509	.0445	.6200	.1239	.6729	.0986	.6603	.0685	.4733
.25	.0559	.0664	-.0033	.2397	-.0119	.3359	.0451	.6090	.1044	.6441	.0975	.6628	.0581	.4740
.30	-.0161	.0223	-.0126	.2314	-.0083	.3309	.0434	.5701	.0822	.6140	.0968	.6577	.0479	.4722
.40	-.0107	.0418			-.0015	.2984	.0411	.5361	.0621	.5839	.0982	.6308	.0318	.4594
.50	.0070	.0588	-.0884	.0321			-.0903	.1584					.0055	.2273
.60	-.0417	.0462	-.0784	.0774	-.1214	.0713	-.1004	-.0596	-.1427	-.0259	-.1569	-.0026	-.1423	-.0635
.70			-.0754	.0953			-.1420	-.0853	-.1428	-.0503	-.1427	-.0273	-.1426	-.0850
.80			-.1600	-.0683	-.1442	-.0853	-.1438	-.0980	-.1420	-.0600	-.1396	-.0326	-.1437	-.0865
.90			-.1495	-.0870	-.1501	-.0917	-.1440	-.0980	-.1409	-.0681	-.1416	-.0351	-.1410	-.0798
.95			-.1417	-.0936		-.0923			-.1408	-.0789	-.1423	-.0429	-.1383	-.0823

TAIL 2

TABLE VIII. - CONTINUED
(h) $\alpha = 9.85^\circ$

Cp at γ/b of														
x/c	0.02		0.22		0.44		0.56		0.67		0.83		0.98	
	U.S.	L.S.	U.S.	L.S.	U.S.	L.S.	U.S.	L.S.	U.S.	L.S.	U.S.	L.S.	U.S.	L.S.
.05	-.0888	.3923	.0161	.5854	.0466	.6799			.1199		.0832	.6781	.0950	.6014
.10	-.0763	.3631	.0043	.5182	.0448	.6210			.1146	.8664	.0765	.6386	.0578	.5276
.15	-.0689	.3544	-.0036	.4771	.0403	.5845			.1154	.8654	.0786	.6321	.0620	.4824
.20	-.0600	.3162							.1171	.8472	.0756	.6516		
.25	-.0601	.3109	-.0093	.4264	.0379	.5339	.0776	.7699	.1152	.8222			.0596	.4275
.30	-.1019	.1188	-.0161	.4008	.0455	.4947	.0821	.7557	.1121	.7991	.0721	.6896	.0596	.4169
.40	-.1135	.1460	-.1191	.1118	.0329	.5303	.0753	.7091	.1058	.7517	.0689	.6916	.0539	.3940
.50	-.1266	.2171	-.1376	.1156			-.0818	.2507	.0015	.3107	.0309	.3991	.0268	.1992
.60	-.0936	.1988	-.1392	.1254	-.1088	.1959	-.1518	-.0066	-.1550	.0135	-.1523	.0182	-.1523	-.0669
.70			-.1433	.1298	-.1399	-.0365	-.1420	-.0296	-.1526	.0128	-.1455	-.0052	-.1553	-.0562
.80	-.1449	.0376	-.1351	-.0487	-.1400	-.0570	-.1394	-.0402			-.1447	-.0192	-.1754	-.0513
.90	-.1451	-.0182	-.1443	-.0420	-.1393	-.0623	-.1407	-.0518	-.1408	-.0048	-.1454	-.0330	-.1800	-.0384
.95			-.1410	-.0372	-.1395	-.0675	-.1387	-.0602	-.1450	-.0113	-.1442	-.0424	-.1626	-.0385

TAIL 1

Cp at γ/b of														
x/c	0.02		0.22		0.44		0.56		0.67		0.83		0.98	
	U.S.	L.S.	U.S.	L.S.	U.S.	L.S.	U.S.	L.S.	U.S.	L.S.	U.S.	L.S.	U.S.	L.S.
.05	.0273	.0520	-.0029	.2250	-.1109	.4291	-.0520	.6593	.1018	.9208	.0715	.7550		
.10	.0459	.0530	-.0027	.2194	-.0886	.3920					.0584	.7894	.0544	.6603
.15	.0562	.0439	-.0090	.2147	-.0767	.3635		.6419	.0931	.7623	.0526	.7698	.0433	.6657
.20					-.0696	.3505	-.0413	.6385	.0579	.7198	.0494	.7403	.0302	.6309
.25	.0558	.0474	-.0227	.2121	-.0649	.3372	-.0387	.6271	.0346	.6925	.0483	.7235	.0215	.6113
.30	-.0202	.0029	-.0312	.2043	-.0524	.3334	-.0355	.6033	.0113	.6602	.0493	.7082	.0128	.5779
.40	-.0135	.0234			-.0491	.2944	-.0275	.5607	-.0110	.6304	.0544	.6713	.0015	.5090
.50	.0010	.0434	-.1160	.0513			-.1203	.1574					-.0207	.2420
.60	-.0274	.0414	-.1142	.0861	-.1381	.0763	-.1086	-.0509	-.1569	-.0135	-.1699	.0167	-.1589	-.0498
.70			-.1074	.0951			-.1604	-.0773	-.1596	-.0402	-.1625	-.0016	-.1654	-.0784
.80			-.1801	-.0643	-.1606	-.0705	-.1629	-.0852	-.1589	-.0537	-.1580	-.0027	-.1488	-.0822
.90			-.1690	-.0837	-.1678	-.0689	-.1627	-.0831	-.1559	-.0612	-.1597	-.0107	-.1295	-.0853
.95			-.1627	-.0909		-.0673			-.1572	-.0715	-.1608	-.0218	-.1366	-.0903

TAIL 2

TABLE VIII. - CONTINUED
(1) $\alpha = 11.85^\circ$

Cp at y/b of														
x/c	0.02		0.22		0.44		0.56		0.67		0.83		0.98	
	U.S.	L.S.	U.S.	L.S.	U.S.	L.S.	U.S.	L.S.	U.S.	L.S.	U.S.	L.S.	U.S.	L.S.
.05	-.1189	.4634	-.0145	.6550	.0112	.7558			.0903		.0746	.7772	.0870	.6778
.10	-.1097	.4326	-.0250	.5810	.0106	.6939			.0850	.9907	.0676	.7338	.0511	.5941
.15	-.0987	.4197	-.0335	.5396	.0109	.6540			.0852	.9584	.0695	.7606	.0574	.5453
.20	-.0887	.3767							.0869	.9270	.0658	.7989		
.25	-.0869	.3691	-.0400	.4850	.0092	.5977	.0376	.8581	.0852	.8949			.0592	.4894
.30	-.1175	.1529	-.0470	.4559	.0189	.5615	.0406	.8373	.0824	.8700	.0591	.8254	.0599	.4816
.40	-.1286	.1927	-.1357	.1411	.0092	.5988	.0346	.7792	.0753	.8200	.0517	.8114	.0527	.4687
.50	-.1441	.2747	-.1528	.1535			-.1016	.2852	-.0205	.3359	.0120	.4604	.0258	.2604
.60	-.1109	.2463	-.1529	.1674	-.1265	.2392	-.1500	.0126	-.1510	.0513	-.1547	.0311	-.1586	-.0381
.70			-.1510	.1732	-.1440	-.0151	-.1450	-.0135	-.1486	.0505	-.1513	.0054	-.1670	-.0214
.80	-.1541	.0764	-.1384	-.0187	-.1442	-.0348	-.1431	-.0241			-.1510	-.0089	-.1951	-.0139
.90	-.1442	.0142	-.1474	-.0067	-.1440	-.0412	-.1444	-.0344	-.1454	.0199	-.1512	-.0224	-.1912	-.0084
.95			-.1441	.0005	-.1443	-.0469	-.1420	-.0430	-.1498	.0119	-.1503	-.0312	-.1857	-.0126

TAIL 1

Cp at y/b of														
x/c	0.02		0.22		0.44		0.56		0.67		0.83		0.98	
	U.S.	L.S.	U.S.	L.S.	U.S.	L.S.	U.S.	L.S.	U.S.	L.S.	U.S.	L.S.	U.S.	L.S.
.05	.0054	.0264	.0146	.2058	-.1440	.3802	-.1230	.6105	.0670	.9518	.0166	.9548		
.10	.0226	.0436	.0144	.1979	-.1306	.3554					.0076	.8708	.0133	.7787
.15	.0364	.0327	.0111	.1957	-.1164	.3328		.6236	.0232	.7809	.0012	.8308	-.0047	.7377
.20					-.1131	.3250	-.1013	.6294	-.0111	.7450	-.0014	.7891	-.0041	.6854
.25	.0396	.0220	.0011	.1976	-.1016	.3163	-.0967	.6220	-.0333	.7199	-.0007	.7703	-.0101	.6535
.30	-.0320	-.0170	-.0033	.1974	-.0856	.3158	-.0890	.5966	-.0582	.6878	.0030	.7500	-.0183	.6135
.40	-.0241	.0013			-.0824	.2762	-.0666	.5564	-.0774	.6565	.0093	.7040	-.0263	.5342
.50	-.0011	.0256	-.1139	.0340			-.1350	.1722					-.0471	.2642
.60	-.0336	.0351	-.1151	.0814	-.1554	.0892	-.1117	-.0461	-.1739	-.0040	-.1837	.0373	-.1759	-.0423
.70			-.1065	.0881			-.1793	-.0749	-.1765	-.0334	-.1791	.0257	-.1816	-.0625
.80			-.1797	-.0672	-.1759	-.0617	-.1807	-.0733	-.1761	-.0444	-.1765	.0149	-.1641	-.0656
.90			-.1832	-.0907	-.1812	-.0593	-.1806	-.0683	-.1731	-.0539	-.1772	.0023	-.1600	-.0681
.95			-.1693	-.0972		-.0579			-.1770	-.0642	-.1780	-.0104	-.1543	-.0725

TAIL 2

TABLE VIII. - CONTINUED
 (j) $\alpha = 15.85^\circ$

Cp at y/b of														
x/c	0.02		0.22		0.44		0.56		0.67		0.83		0.98	
	U.S.	L.S.	U.S.	L.S.	U.S.	L.S.	U.S.	L.S.	U.S.	L.S.	U.S.	L.S.	U.S.	L.S.
.05	-.1167	.5926	-.0263	.8000	-.0109	.9172			.1076		.0743	1.2185	.0879	.8818
.10	-.1121	.5579	-.0321	.7198	-.0017	.8502			.1097	1.2591	-.0712	1.1526	.0545	.7988
.15	-.1037	.5480	-.0412	.6764	.0039	.8040			.1072	1.1929	-.0745	1.1123	-.0665	.7627
.20	-.0953	.5015							.1042	1.1437	-.0702	1.0762		
.25	-.0964	.4920	-.0506	.6143	.0020	.7451	.0337	1.0708	.0994	1.0982			.0703	.7181
.30	-.1236	.2396	-.0594	.5797	.0048	.7127	.0373	1.0437	-.0947	1.0595	.0635	1.0149	-.0710	.7099
.40	-.1384	.2362	-.1436	.2083	-.0012	.7659	.0266	.9533	.0818	.9760	-.0554	.9231	-.0652	.6686
.50	-.1584	.4034	-.1610	.2443			-.1089	.3633	-.0201	.3901	.0148	.4979	.0414	.3873
.60	-.1292	.3714	-.1566	.2659	-.1389	.2997	-.1534	.0560	-.1647	.0956	-.1550	.0590	-.1632	-.0053
.70			-.1486	.2869	-.1503	.0335	-.1496	.0219	-.1622	.0944	-.1508	.0392	-.1826	.0035
.80	-.1697	.1699	-.1389	.0592	-.1505	.0175	-.1478	.0086			-.1509	.0301	-.1944	.0200
.90	-.1432	.0949	-.1492	.0967	-.1509	.0105	-.1492	.0004	-.1512	.0609	-.1512	.0214	-.1888	.0253
.95			-.1457	.1227	-.1511	.0027	-.1471	-.0075	-.1561	.0522	-.1503	.0133	-.1808	.0232

TAIL 1

Cp at y/b of														
x/c	0.02		0.22		0.44		0.56		0.67		0.83		0.98	
	U.S.	L.S.	U.S.	L.S.	U.S.	L.S.	U.S.	L.S.	U.S.	L.S.	U.S.	L.S.	U.S.	L.S.
.05	-.0035	.0119	.0157	.0863	-.1840	.3072	-.1663	.5063	-.0645	.8592	-.1206	.9577		
.10	.0132	-.0087	.0021	.0890	-.1815	.3040					-.1108	.8627	-.0921	.8426
.15	.0234	-.0143	-.0055	.0999	-.1844	.2919		.5468	-.1138	.7292	-.1102	.8166	-.0905	.7770
.20					-.1820	.2900	-.1648	.5487	-.1411	.6993	-.1095	.7762	-.0907	.7205
.25	.0272	-.0236	-.0249	.1254	-.1700	.2846	-.1727	.5485	-.1506	.6762	-.1073	.7556	-.0949	.6875
.30	-.0396	-.0608	-.0332	.1347	-.1575	.2873	-.1766	.5306	.3379	.6514	-.1045	.7382	-.1024	.6459
.40	-.0319	-.0516			-.1531	.2477	-.1813	.5021	.4863	.6247	-.1041	.6935	-.1117	.5580
.50	-.0150	-.0354	-.1341	-.0004			-.2014	.1473					-.1255	.2436
.60	-.0423	-.0160	-.1357	.0445	-.1832	.1122	-.1436	-.0626	-.1777	-.0067	-.1970	.0317	-.2032	-.0282
.70			-.1285	.0421			-.2001	-.0611	-.1987	-.0317	-.1967	.0135	-.2003	-.0312
.80			-.1911	-.0876	-.1961	-.0469	-.2019	-.0546	-.1962	-.0433	-.1977	.0068	-.1987	-.0237
.90			-.1937	-.1059	-.2028	-.0520	-.2030	-.0518	-.1905	-.0486	-.1972	.0015	-.1938	-.0256
.95			-.1828	-.1124		-.0545			-.1959	-.0548	-.1969	-.0080	-.1832	-.0324

TAIL 2

TABLE VIII. - CONCLUDED
(k) $\alpha = 19.85^\circ$

Cp at y/b of														
x/c	0.02		0.22		0.44		0.56		0.67		0.83		0.98	
	U.S.	L.S.	U.S.	L.S.	U.S.	L.S.	U.S.	L.S.	U.S.	L.S.	U.S.	L.S.	U.S.	L.S.
.05	-.1072	.7519	-.0328	.9680	-.0355	1.0984			.1087		.0760	1.6024	.0946	1.2260
.10	-.1023	.7017	-.0278	.8823	-.0095	1.0316			.1451	1.5276	.0834	1.4484	.0718	1.0819
.15	-.0914	.6956	-.0340	.8292	-.0063	.9799			.1451	1.4355	.0920	1.3584	.0903	1.0005
.20	-.0817	.6423							.1372	1.3664	.0879	1.2884		
.25	-.0837	.6369	-.0425	.7633	.0118	.9380	.0340	1.2888	.1272	1.3028			.1002	.9082
.30	-.1151	.3528	-.0520	.7191	.0112	.9194	.0484	1.2411	.1185	1.2486	.0782	1.1850	.1018	.8808
.40	-.1286	.4191	-.1403	.2843	.0185	1.0750	.0365	1.1103	.0986	1.1319	.0680	1.0653	.0962	.8058
.50	-.1506	.5595	-.1585	.3555			-.1046	.4331	-.0139	.4565	.0261	.5683	.0695	.4626
.60	-.1282	.5401	-.1526	.3865	-.1370	.3664	-.1497	.0932	-.1620	.1349	-.1480	.0979	-.1676	.0312
.70			-.1438	.4762	-.1461	.0826	-.1464	.0568	-.1595	.1337	-.1444	.0869	-.1815	.0288
.80	-.1708	.2923	-.1343	.1927	-.1469	.0714	-.1450	.0442			-.1437	.0818	-.1832	.0608
.90	-.1403	.1926	-.1447	.2682	-.1473	.0658	-.1467	.0393	-.1497	.1073	-.1437	.0750	-.1697	.0781
.95			-.1416	.2463	-.1482	.0583	-.1444	.0330	-.1549	.0980	-.1425	.0672	-.1623	.0769

TAIL 1

Cp at y/b of														
x/c	0.02		0.22		0.44		0.56		0.67		0.83		0.98	
	U.S.	L.S.	U.S.	L.S.	U.S.	L.S.	U.S.	L.S.	U.S.	L.S.	U.S.	L.S.	U.S.	L.S.
.05	-.0240	-.0203	-.0556	.0718	-.2002	.2978	-.1881	.4813	-.1277	.8713	-.1738	.8629		
.10	-.0119	-.0490	-.0621	.0896	-.2019	.3051					-.1570	.7950	-.1597	.8230
.15	-.0027	-.0520	-.0659	.1063	-.2047	.2984		.5329	-.1631	.7171	-.1493	.7608	-.1554	.7703
.20					-.2055	.2989	-.1884	.5345	-.1778	.6862	-.1452	.7276	-.1554	.7224
.25	.0017	-.0574	-.0805	.1308	-.2037	.2941	-.1949	.5339	-.1489	.6641	-.1426	.7092	-.1578	.6932
.30	-.0620	-.0825	-.0887	.1335	-.1968	.2943	-.1963	.5125	.2799	.6352	-.1425	.6942	-.1616	.6555
.40	-.0584	-.0744			-.1857	.2484	-.2007	.4769	.1995	.6020	-.1493	.6543	-.1658	.5743
.50	-.0375	-.0555	-.1595	.0253			-.2148	.1369					-.1752	.2531
.60	-.0693	-.0362	-.1627	.0477	-.1959	.1593	-.1611	-.0627	-.1997	-.0083	-.2062	.0220	-.2090	-.0050
.70			-.1587	.0474			-.2117	-.0356	-.2109	-.0331	-.2056	.0012	-.2081	.0054
.80			-.2035	-.0825	-.2043	-.0253	-.2133	-.0315	-.2068	-.0397	-.2069	-.0052	-.2075	.0081
.90			-.2023	-.1024	-.2117	-.0376	-.2148	-.0294	-.2006	-.0290	-.2067	-.0090	-.2062	.0023
.95			-.1957	-.1085		-.0423			-.2072	-.0307	-.2061	-.0174	-.1967	-.0055

TAIL 2

TABLE IX. - PRESSURE COEFFICIENTS, $\phi = 67.5^\circ$, $\delta = 0^\circ$, $M = 2.36$.
(a) $\alpha = -4.20^\circ$

Cp at y/b of														
x/c	0.02		0.22		0.44		0.56		0.67		0.83		0.98	
	U.S.	L.S.	U.S.	L.S.	U.S.	L.S.	U.S.	L.S.	U.S.	L.S.	U.S.	L.S.	U.S.	L.S.
.05	.1200	.0137	.3656	.0902	.4243	.1059			.4731		.3995	.2371	.4094	.2305
.10	.1275	.0193	.3148	.0785	.3821	.1085			.5289	.2059	.3943	.2171	.3416	.1913
.15	.1296	.0205	.2835	.0648	.3532	.1046			.5472	.2195	.4045	.2060	.3451	.1703
.20	.1287	.0205							.5508	.2280	.4080	.2021		
.25	.1268	.0177	.2497	.0543	.3140	.0993	.4781	.1930	.5331	.2262			.2979	.1361
.30	.0295	-.0318	.2374	.0481	.2831	.1833	.4757	.1986	.5133	.2213	.4267	.1993	.2821	.1288
.40	.0407	-.0196	.0177	-.0770	.2726	.1061	.4439	.1934	.4804	.2093	.4397	.1945	.2565	.1130
.50	.0992	-.0038	.0045	-.0711			.1112	-.0256	.2558	.0150	.3703	.0501	.2027	-.0003
.60	.0611	.0043	.0010	-.0604	.0392	-.0541	-.0898	-.1493	-.0584	-.1430	-.0537	-.1366	-.1211	-.1171
.70			.0129	-.0637	-.1165	-.1462	-.1122	-.1387	-.0581	-.1413	-.0800	-.1154	-.1150	-.1156
.80	-.0640	-.0873	-.1038	-.1442	-.1318	-.1271	-.1223	-.1273			-.0870	-.1114	-.1142	-.1146
.90	-.0812	-.0971	-.1169	-.1410	-.1356	-.1246	-.1315	-.1252	-.0996	-.1164	-.0954	-.1110	-.1076	-.1143
.95			-.1149	-.1346	-.1368	-.1205	-.1335	-.1240	-.1075	-.1183	-.1026	-.1105	-.1049	-.1145

TAIL 1

Cp at y/b of														
x/c	0.02		0.22		0.44		0.56		0.67		0.83		0.98	
	U.S.	L.S.	U.S.	L.S.	U.S.	L.S.	U.S.	L.S.	U.S.	L.S.	U.S.	L.S.	U.S.	L.S.
.05	.1628	.1028	.3247	.1657	.3579	.2046	.5206	.2955	.3590	.2701	.3546	.2771		
.10	.1420	.0721	.2876	.1690	.3435	.1900					.3425	.2569	.2869	.2458
.15	.1483	.0657	.2641	.1571	.3267	.1842		.2954	.3741	.2732	.3387	.2644	.2696	.2261
.20					.3069	.1809	.4370	.3002	.3952	.2771	.3342	.2553	.2473	.2029
.25	.1407	.0506	.2262	.1356	.2911	.1805	.4296	.3024	.4052	.2825	.3290	.2589	.2302	.1960
.30	.0266	-.0346	.2113	.1285	.2803	.1850	.4173	.2969	.2972	.2878	.3256	.2614	.2145	.1861
.40	.0045	-.0271			.2628	.1968	.3922	.2910	.2897	.2904	.3216	.2598	.1912	.1664
.50	.0543	-.0163	-.0174	-.0563			.0883	.0365					.1528	.0390
.60	.0278	-.0121	-.0229	-.0616	.0137	-.0262	-.0659	-.0918	-.0497	-.1076	-.1055	-.1118	-.1177	-.1219
.70			-.0244	-.0626			-.1239	-.1313	-.1102	-.1259	-.1278	-.1319	-.1235	-.1321
.80			-.1433	-.1510	-.1428	-.1415	-.1317	-.1386	-.1155	-.1174	-.1196	-.1249	-.1068	-.0947
.90			-.1304	-.1332	-.1444	-.1281	-.1379	-.1205	-.1200	-.0942	-.1073	-.1097	-.1000	-.1025
.95			-.1262	-.1294		-.1198			-.1156	-.0939	-.1046	-.1063	-.1041	-.1288

TAIL 2

TABLE IX. - CONTINUED
(b) $\alpha = -2.20^\circ$

Cp at γ/b of														
x/c	0.02		0.22		0.44		0.56		0.67		0.83		0.98	
	U.S.	L.S.	U.S.	L.S.	U.S.	L.S.	U.S.	L.S.	U.S.	L.S.	U.S.	L.S.	U.S.	L.S.
.05	.1018	.0391	.3057	.1650	.3506	.1887			.3745		.3415	.2973	.3440	.2860
.10	.1067	.0453	.2621	.1435	.3248	.1801			.3869	.2605	.3272	.2764	.2825	.2418
.15	.1068	.0474	.2337	.1249	.2990	.1742			.4069	.2688	.3347	.2648	.2814	.2174
.20	.1055	.0462							.4242	.2736	.3352	.2609		
.25	.1013	.0431	.2034	.1074	.2682	.1649	.4027	.2824	.4304	.2862			.2439	.1780
.30	.0141	-.0214	.1915	.0969	.2605	.1427	.4036	.2873	.4266	.2890	.3362	.2585	.2284	.1698
.40	.0229	-.0081	-.0043	-.0507	.2360	.1618	.3763	.2771	.4103	.2855	.3342	.2528	.2072	.1514
.50	.0663	-.0072	-.0231	-.0577			.0712	.0175	.2115	.0628	.2681	.0897	.1578	.0260
.60	.0535	.0216	-.0276	-.0488	.0016	-.0222	-.1090	-.1295	-.0842	-.1207	-.0917	-.1299	-.1263	-.1046
.70			-.0231	-.0485	-.1319	-.1445	-.1265	-.1438	-.0835	-.1192	-.1103	-.1139	-.1283	-.1030
.80	-.0758	-.0734	-.1206	-.1345	-.1452	-.1357	-.1339	-.1384			-.1135	-.1027	-.1234	-.1012
.90	-.0908	-.1033	-.1285	-.1290	-.1349	-.1256	-.1350	-.1230	-.1156	-.1054	-.1145	-.0999	-.1073	-.0994
.95			-.1211	-.1270	-.1247	-.1251	-.1233	-.1184	-.1117	-.1034	-.1086	-.0991	-.1082	-.0998

TAIL 1

Cp at γ/b of														
x/c	0.02		0.22		0.44		0.56		0.67		0.83		0.98	
	U.S.	L.S.	U.S.	L.S.	U.S.	L.S.	U.S.	L.S.	U.S.	L.S.	U.S.	L.S.	U.S.	L.S.
.05	.1228	.0961	.2807	.1962	.3091	.2256	.4659	.3245	.3276	.2941	.3290	.3013		
.10	.1117	.0832	.2484	.1887	.2997	.2161					.3160	.2809	.2660	.2686
.15	.1170	.0774	.2271	.1721	.2845	.2072		.3332	.3414	.3005	.3117	.2882	.2508	.2510
.20					.2666	.2034	.3916	.3377	.3613	.3075	.3072	.2792	.2282	.2263
.25	.1111	.0630	.1929	.1492	.2511	.2019	.3851	.3373	.3709	.3164	.3026	.2821	.2114	.2151
.30	.0075	-.0195	.1792	.1431	.2412	.2042	.3735	.3285	.3069	.3237	.2991	.2829	.1959	.2007
.40	-.0052	-.0090			.2264	.2119	.3505	.3209	.3093	.3276	.2949	.2813	.1722	.1798
.50	.0578	.0008	-.0315	-.0478			.0651	.0445					.1335	.0477
.60	.0191	.0138	-.0373	-.0510	-.0082	-.0214	-.0623	-.0844	-.0945	-.0961	-.1127	-.1033	-.1077	-.1184
.70			-.0386	-.0471			-.1348	-.1268	-.1215	-.1154	-.1299	-.1236	-.1031	-.1342
.80			-.1415	-.1405	-.1485	-.1369	-.1424	-.1364	-.1261	-.1194	-.1123	-.1266	-.1008	-.1203
.90			-.1285	-.1354	-.1315	-.1393	-.1378	-.1349	-.1209	-.1035	-.1063	-.1100	-.1004	-.1055
.95			-.1272	-.1274		-.1238			-.1093	-.0965	-.1049	-.1034	-.1038	-.0937

TAIL 2

TABLE IX. - CONTINUED
(c) $\alpha = -0.20^\circ$

Cp at y/b of														
x/c	0.02		0.22		0.44		0.56		0.67		0.83		0.98	
	U.S.	L.S.	U.S.	L.S.	U.S.	L.S.	U.S.	L.S.	U.S.	L.S.	U.S.	L.S.	U.S.	L.S.
.05	.0787	.0723	.2365	.2469	.2596	.2764			.3063		.2829	.3611	.2863	.3442
.10	.0828	.0779	.2031	.2117	.2510	.2627			.3075	.3252	.2692	.3401	.2255	.2965
.15	.0802	.0811	.1812	.1868	.2347	.2509			.3049	.3391	.2737	.3271	.2278	.2692
.20	.0784	.0784							.3158	.3557	.2736	.3231		
.25	.0740	.0759	.1576	.1626	.2151	.2294	.3232	.3756	.3227	.3680			.1956	.2236
.30	-.0050	-.0082	.1469	.1494	.2131	.2076	.3272	.3761	.3249	.3747	.2712	.3201	.1829	.2145
.40	-.0010	.0096	-.0288	-.0212	.1881	.2280	.3098	.3575	.3220	.3737	.2642	.3146	.1655	.1930
.50	.0301	.0288	-.0501	-.0307			.0424	.0592	.1593	.1145	.2022	.1329	.1226	.0543
.60	.0316	.0536	-.0523	-.0278	-.0158	.0090	-.1249	-.1088	-.1102	-.0963	-.1195	-.1118	-.1164	-.1205
.70			-.0514	-.0263	-.1467	-.1286	-.1422	-.1245	-.1091	-.0953	-.1350	-.1242	-.1112	-.1124
.80	-.0883	-.0592	-.1326	-.1315	-.1393	-.1426	-.1404	-.1302			-.1137	-.1213	-.1075	-.1044
.90	-.1022	-.0982	-.1286	-.1298	-.1248	-.1451	-.1259	-.1361	-.1018	-.1176	-.1042	-.1103	-.1058	-.1035
.95			-.1235	-.1261	-.1231	-.1369	-.1193	-.1334	-.1011	-.1106	-.1020	-.1054	-.1072	-.1021

TAIL 1

Cp at y/b of														
x/c	0.02		0.22		0.44		0.56		0.67		0.83		0.98	
	U.S.	L.S.	U.S.	L.S.	U.S.	L.S.	U.S.	L.S.	U.S.	L.S.	U.S.	L.S.	U.S.	L.S.
.05	.0841	.0845	.2394	.2307	.2673	.2585	.4188	.3676	.3041	.3227	.3028	.3281		
.10	.0839	.0873	.2101	.2091	.2596	.2451					.2889	.3021	.2466	.2988
.15	.0882	.0827	.1895	.1874	.2451	.2337		.3762	.3178	.3347	.2840	.3126	.2324	.2783
.20					.2291	.2267	.3507	.3775	.3335	.3482	.2810	.3029	.2108	.2520
.25	.0826	.0729	.1609	.1618	.2155	.2204	.3429	.3767	.3414	.3597	.2771	.3048	.1956	.2383
.30	-.0069	-.0019	.1489	.1541	.2065	.2207	.3327	.3651	.3201	.3669	.2731	.3070	.1803	.2205
.40	-.0056	.0108			.1925	.2257	.3108	.3483	.3357	.3703	.2686	.3077	.1556	.1954
.50	.0485	.0223	-.0453	-.0371			.0444	.0570					.1165	.0574
.60	.0161	.0360	-.0494	-.0419	-.0302	-.0144	-.0626	-.0800	-.0926	-.0849	-.1189	-.0930	-.1028	-.1180
.70			-.0491	-.0316			-.1443	-.1213	-.1313	-.1054	-.1264	-.1124	-.1026	-.1281
.80			-.1337	-.1251	-.1367	-.1325	-.1460	-.1319	-.1326	-.1110	-.1094	-.1158	-.1010	-.1235
.90			-.1277	-.1294	-.1277	-.1418	-.1318	-.1366	-.1124	-.1096	-.1053	-.1150	-.1013	-.1141
.95			-.1277	-.1267		-.1381			-.1066	-.1101	-.1034	-.1096	-.1053	-.1041

TAIL 2

TABLE IX. - CONTINUED
(d) $\alpha = 1.79^\circ$

Cp at y/b of														
x/c	0.02		0.22		0.44		0.56		0.67		0.83		0.98	
	U.S.	L.S.	U.S.	L.S.	U.S.	L.S.	U.S.	L.S.	U.S.	L.S.	U.S.	L.S.	U.S.	L.S.
.05	.0388	.1279	.1591	.3257	.1781	.3765			.2453		.2300	.4347	.2344	.4100
.10	.0468	.1228	.1457	.2816	.1772	.3479			.2473	.4100	.2174	.4126	.1764	.3570
.15	.0468	.1275	.1288	.2542	.1650	.3282			.2424	.4498	.2192	.3979	.1796	.3253
.20	.0474	.1204							.2440	.4701	.2187	.3940		
.25	.0435	.1187	.1096	.2212	.1577	.2977	.2371	.4697	.2467	.4792			.1529	.2748
.30	-.0273	.0087	.1012	.2047	.1589	.2674	.2443	.4636	.2460	.4851	.2147	.3934	.1439	.2662
.40	-.0293	.0327	-.0548	.0107	.1401	.2888	.2363	.4406	.2410	.4767	.2072	.3907	.1294	.2425
.50	-.0057	.0711	-.0725	.0023			.0050	.1037	.1000	.1601	.1520	.1874	.0921	.0877
.60	.0074	.0853	-.0689	.0041	-.0378	.0420	-.1412	-.0846	-.1325	-.0725	-.1371	-.0846	-.1254	-.1161
.70			-.0713	.0049	-.1572	-.1095	-.1524	-.1021	-.1307	-.0719	-.1252	-.0939	-.1217	-.1250
.80	-.0999	-.0461	-.1263	-.1182	-.1341	-.1238	-.1334	-.1098			-.1158	-.0949	-.1193	-.1191
.90	-.1117	-.0878	-.1306	-.1168	-.1306	-.1288	-.1290	-.1183	-.1137	-.0974	-.1140	-.0975	-.1214	-.1163
.95			-.1281	-.1157	-.1303	-.1320	-.1261	-.1235	-.1166	-.1002	-.1135	-.1015	-.1300	-.1023

TAIL 1

Cp at y/b of														
x/c	0.02		0.22		0.44		0.56		0.67		0.83		0.98	
	U.S.	L.S.	U.S.	L.S.	U.S.	L.S.	U.S.	L.S.	U.S.	L.S.	U.S.	L.S.	U.S.	L.S.
.05	.0708	.0793	.1978	.2687	.2246	.2979	.3660	.4245	.2758	.3538	.2765	.3554		
.10	.0723	.0789	.1726	.2262	.2196	.2768					.2618	.3217	.2260	.3277
.15	.0734	.0774	.1562	.2016	.2071	.2569		.4174	.2925	.3862	.2572	.3352	.2122	.3051
.20					.1932	.2461	.3083	.4163	.3044	.4027	.2543	.3286	.1922	.2777
.25	.0664	.0732	.1325	.1722	.1806	.2378	.3005	.4110	.3098	.4128	.2515	.3296	.1770	.2623
.30	-.0115	.0073	.1226	.1659	.1728	.2352	.2903	.3960	.3335	.4149	.2485	.3356	.1620	.2437
.40	-.0029	.0219			.1635	.2401	.2722	.3725	.3326	.4098	.2446	.3395	.1382	.2153
.50	.0352	.0358	-.0602	-.0291			.0258	.0696					.0998	.0698
.60	.0057	.0449	-.0586	-.0363	-.0488	-.0099	-.0679	-.0786	-.0971	-.0758	-.1251	-.0772	-.1029	-.1186
.70			-.0572	-.0172			-.1524	-.1176	-.1410	-.0969	-.1179	-.0953	-.1040	-.1199
.80			-.1368	-.1110	-.1289	-.1279	-.1402	-.1294	-.1291	-.1033	-.1064	-.0980	-.1037	-.1211
.90			-.1316	-.1210	-.1287	-.1377	-.1314	-.1351	-.1150	-.1046	-.1035	-.1015	-.1038	-.1132
.95			-.1311	-.1224		-.1393			-.1123	-.1116	-.1028	-.1062	-.1062	-.1093

TAIL 2

TABLE IX. - CONTINUED
(e) $\alpha = 3.80^\circ$

Cp at y/b of														
x/c	0.02		0.22		0.44		0.56		0.67		0.83		0.98	
	U.S.	L.S.	U.S.	L.S.	U.S.	L.S.	U.S.	L.S.	U.S.	L.S.	U.S.	L.S.	U.S.	L.S.
.05	-.0079	.1977	.0854	.4033	.1138	.4707			.1906		.1789	.5110	.1850	.4779
.10	.0079	.1809	.0841	.3521	.1167	.4280			.1930	.5447	.1681	.4866	.1341	.4189
.15	.0090	.1854	.0772	.3201	.1074	.4031			.1906	.5813	.1694	.4717	.1364	.3815
.20	-.0129	.1708							.1900	.5934	.1692	.4687		
.25	.0101	.1690	.0615	.2847	.1021	.3648	.1657	.5598	.1908	.6039			.1169	.3266
.30	-.0523	.0307	.0524	.2640	.1071	.3336	.1732	.5513	.1882	.5992	.1645	.4785	.1106	.3175
.40	-.0584	.0615	-.0816	.0418	.0898	.3550	.1654	.5213	.1792	.5664	.1567	.4851	.0989	.2918
.50	-.0470	.1182	-.0968	.0369			-.0356	.1479	.0547	.2072	.1064	.2586	.0656	.1213
.60	-.0204	.1205	-.0928	.0415	-.0660	.0733	-.1564	-.0610	-.1505	-.0472	-.1507	-.0462	-.1381	-.1049
.70			-.0951	.0426	-.1487	-.0891	-.1439	-.0803	-.1482	-.0470	-.1354	-.0564	-.1430	-.1074
.80	-.1113	-.0286	-.1322	-.0967	-.1371	-.1033	-.1358	-.0898			-.1293	-.0612	-.1109	-.1018
.90	-.1217	-.0751	-.1388	-.0942	-.1363	-.1084	-.1358	-.0998	-.1275	-.0698	-.1282	-.0691	-.1382	-.0961
.95			-.1362	-.0925	-.1367	-.1130	-.1350	-.1066	-.1311	-.0743	-.1279	-.0760	-.1549	-.0968

TAIL 1

Cp at y/b of														
x/c	0.02		0.22		0.44		0.56		0.67		0.83		0.98	
	U.S.	L.S.	U.S.	L.S.	U.S.	L.S.	U.S.	L.S.	U.S.	L.S.	U.S.	L.S.	U.S.	L.S.
.05	.1111	.0773	.1431	.2991	.1712	.3387	.2978	.4739	.2478	.3925	.2495	.3827		
.10	.1012	.0508	.1328	.2392	.1710	.3047					.2348	.3546	.2049	.3582
.15	.0995	.0535	.1262	.2112	.1633	.2770		.4584	.2646	.4596	.2297	.3625	.1912	.3339
.20					.1538	.2627	.2587	.4543	.2694	.4742	.2277	.3611	.1721	.3040
.25	.0848	.0603	.1124	.1825	.1451	.2517	.2512	.4445	.2702	.4745	.2255	.3646	.1578	.2879
.30	-.0018	.0000	.1049	.1773	.1398	.2467	.2417	.4210	.3271	.4607	.2223	.3747	.1437	.2682
.40	-.0063	.0196			.1348	.2403	.2309	.3958	.3015	.4416	.2189	.3886	.1201	.2397
.50	.0302	.0406	-.0717	-.0324			.0065	.0863					.0829	.0893
.60	-.0097	.0475	-.0653	-.0319	-.0598	.0082	-.0810	-.0785	-.1014	-.0639	-.1311	-.0558	-.1124	-.1166
.70			-.0578	.0026			-.1502	-.1137	-.1465	-.0859	-.1167	-.0749	-.1127	-.1108
.80			-.1469	-.1020	-.1274	-.1234	-.1350	-.1261	-.1262	-.0942	-.1091	-.0812	-.1115	-.1080
.90			-.1354	-.1127	-.1292	-.1347	-.1320	-.1308	-.1200	-.0977	-.1078	-.0883	-.1119	-.1050
.95			-.1291	-.1175		-.1367			-.1192	-.1061	-.1074	-.0959	-.1130	-.1060

TAIL 2

TABLE IX. - CONTINUED
(f) $\alpha = 5.79^\circ$

Cp at γ/b of														
x/c	0.02		0.22		0.44		0.56		0.67		0.83		0.98	
	U.S.	L.S.	U.S.	L.S.	U.S.	L.S.	U.S.	L.S.	U.S.	L.S.	U.S.	L.S.	U.S.	L.S.
.05	-.0561	.2679	.0292	.4756	.0608	.5573			.1450		.1335	.5987	.1398	.5535
.10	-.0363	.2454	.0270	.4180	.0642	.5029			.1476	.7255	.1229	.5694	-.0977	.4863
.15	-.0303	.2483	.0226	.3829	.0577	.4740			.1474	.7407	.1229	.5571	-.0998	.4433
.20	-.0230	.2258							.1472	.7321	.1222	.5670		
.25	-.0242	.2225	.0174	.3431	.0536	.4308	.1019	.6538	.1467	.7082			.0858	.3845
.30	-.0763	.0594	.0091	.3206	.0535	.3980	.1087	.6428	.1435	.6890	.1185	.6030	.0819	.3750
.40	-.0831	.0959	-.1063	.0738	.0447	.4204	.1034	.6011	.1310	.6462	.1108	.6090	.0742	.3489
.50	-.0878	.1681	-.1206	.0731			-.0668	.1910	.0175	.2535	.0654	.3473	.0436	.1622
.60	-.0587	.1624	-.1125	.0802	-.0944	.1079	-.1496	-.0392	-.1535	-.0111	-.1561	-.0022	-.1433	-.0907
.70			-.1171	.0828	-.1365	-.0664	-.1382	-.0602	-.1513	-.0111	-.1408	-.0232	-.1445	-.0824
.80	-.1233	-.0035	-.1341	-.0712	-.1361	-.0810	-.1352	-.0724			-.1379	-.0353	-.1331	-.0711
.90	-.1295	-.0556	-.1421	-.0689	-.1356	-.0860	-.1360	-.0832	-.1353	-.0396	-.1383	-.0484	-.1533	-.0607
.95			-.1396	-.0675	-.1368	-.0903	-.1342	-.0905	-.1387	-.0458	-.1375	-.0574	-.1653	-.0610

TAIL 1

Cp at γ/b of														
x/c	0.02		0.22		0.44		0.56		0.67		0.83		0.98	
	U.S.	L.S.	U.S.	L.S.	U.S.	L.S.	U.S.	L.S.	U.S.	L.S.	U.S.	L.S.	U.S.	L.S.
.05	.1974	.0588	.0979	.2501	.1083	.3701	.2207	.5108	.2168	.4677	.2209	.4117		
.10	.1585	.0038	.1048	.2045	.1160	.3289					.2049	.3875	.1830	.3891
.15	.1542	.0085	.1056	.1821	.1140	.2949		.4966	.2364	.5438	.2002	.3943	.1688	.3663
.20					.1113	.2783	.2034	.4885	.2314	.5311	.1974	.3997	.1500	.3357
.25	.1226	.0249	.0949	.1604	.1092	.2657	.1986	.4734	.2263	.5129	.1952	.4154	.1367	.3196
.30	.0132	-.0245	.0828	.1564	.1078	.2585	.1940	.4483	.2950	.4907	.1924	.4395	.1237	.3011
.40	-.0107	-.0121			.1046	.2458	.1886	.4188	.2816	.4659	.1900	.4568	.1007	.2729
.50	.0235	.0367	-.0523	-.0427			-.0184	.0913					.0652	.1100
.60	-.0155	.0490	-.0512	-.0139	-.0704	.0248	-.0926	-.0783	-.1081	-.0553	-.1381	-.0397	-.1248	-.1097
.70			-.0476	.0348			-.1531	-.1094	-.1500	-.0798	-.1253	-.0625	-.1232	-.1011
.80			-.1430	-.0927	-.1353	-.1170	-.1420	-.1215	-.1343	-.0893	-.1175	-.0724	-.1223	-.0897
.90			-.1438	-.1067	-.1379	-.1314	-.1391	-.1251	-.1328	-.0929	-.1170	-.0811	-.1236	-.0851
.95			-.1291	-.1113	-.1354				-.1327	-.1018	-.1169	-.0896	-.1227	-.0863

TAIL 2

TABLE IX. - CONTINUED
(g) $\alpha = 7.81^\circ$

Cp at y/b of														
x/c	0.02		0.22		0.44		0.56		0.67		0.83		0.98	
	U.S.	L.S.	U.S.	L.S.	U.S.	L.S.	U.S.	L.S.	U.S.	L.S.	U.S.	L.S.	U.S.	L.S.
.05	-.0977	.3355	-.0140	.5440	.0092	.6366			.1075		.0942	.7014	.0963	.6379
.10	-.0788	.3110	-.0214	.4813	.0179	.5754			.1114	.8923	.0819	.6718	.0624	.5588
.15	-.0697	.3103	-.0260	.4448	.0119	.5434			.1125	.8593	.0819	.6940	.0646	.5117
.20	-.0588	.2799							.1138	.8285	.0805	.7304		
.25	-.0577	.2773	-.0283	.3995	.0101	.4953	.0502	.7557	.1129	.7978			.0582	.4540
.30	-.0982	.0904	-.0337	.3747	.0184	.4591	.0550	.7357	.1077	.7734	.0766	.7556	.0577	.4471
.40	-.1020	.1354	-.1267	.1021	.0026	.4883	.0493	.6852	.0904	.7261	.0697	.7497	.0531	.4355
.50	-.1156	.2241	-.1404	.1138			-.0933	.2331	-.0142	.3006	.0290	.4240	.0271	.2328
.60	-.0862	.2094	-.1332	.1239	-.1193	.1508	-.1472	-.0140	-.1505	.0304	-.1540	.0188	-.1495	-.0635
.70			-.1389	.1281	-.1421	-.0424	-.1431	-.0396	-.1483	.0297	-.1464	-.0067	-.1515	-.0561
.80	-.1466	.0287	-.1411	-.0409	-.1423	-.0577	-.1414	-.0547			-.1455	-.0219	-.1583	-.0421
.90	-.1489	-.0304	-.1505	-.0361	-.1423	-.0613	-.1429	-.0654	-.1426	-.0126	-.1461	-.0352	-.1765	-.0412
.95			-.1479	-.0339	-.1436	-.0646	-.1414	-.0727	-.1467	-.0186	-.1450	-.0431	-.1760	-.0479

TAIL 1

Cp at y/b of														
x/c	0.02		0.22		0.44		0.56		0.67		0.83		0.98	
	U.S.	L.S.	U.S.	L.S.	U.S.	L.S.	U.S.	L.S.	U.S.	L.S.	U.S.	L.S.	U.S.	L.S.
.05	.2335	-.1176	.0963	.0953	.0190	.4056	.1292	.5584	.1804	.6222	.1867	.4534		
.10	.2025	-.0243	.0932	.0904	.0394	.3565					.1701	.4304	.1572	.4223
.15	.1977	-.0285	.0895	.0878	.0532	.3180		.5349	.2021	.6020	.1639	.4487	.1417	.4011
.20					.0617	.2998	.1230	.5233	.1840	.5711	.1611	.4804	.1243	.3727
.25	.1680	-.0246	.0777	.0933	.0676	.2835	.1272	.5109	.1712	.5472	.1599	.5105	.1125	.3587
.30	.0382	-.0649	.0682	.0978	.0724	.2770	.1308	.4781	.2554	.5185	.1578	.5259	.1002	.3423
.40	-.0001	-.0340			.0736	.2596	.1391	.4450	.2271	.4903	.1575	.5212	.0787	.3347
.50	.0196	.0035	-.0463	-.0502			-.0416	.1111					.0451	.1736
.60	-.0084	.0176	-.0509	-.0114	-.0933	.0334	-.0989	-.0747	-.1188	-.0539	-.1458	-.0328	-.1385	-.0907
.70			-.0528	.0261			-.1677	-.1022	-.1557	-.0748	-.1383	-.0563	-.1350	-.0994
.80			-.1522	-.0878	-.1492	-.1196	-.1551	-.1143	-.1452	-.0841	-.1291	-.0676	-.1331	-.0814
.90			-.1511	-.1118	-.1552	-.1298	-.1501	-.1195	-.1468	-.0886	-.1291	-.0746	-.1340	-.0763
.95			-.1364	-.1173		-.1317			-.1458	-.0984	-.1293	-.0821	-.1325	-.0812

TAIL 2

TABLE IX. - CONTINUED
(h) $\alpha = 9.79^\circ$

Cp at γ/b of														
x/c	0.02		0.22		0.44		0.56		0.67		0.83		0.98	
	U.S.	L.S.	U.S.	L.S.	U.S.	L.S.	U.S.	L.S.	U.S.	L.S.	U.S.	L.S.	U.S.	L.S.
.05	-.1333	.3985	-.0581	.6064	-.0413	.7078			.0805		.0640	.9017	.0619	.7382
.10	-.1188	.3689	-.0635	.5403	-.0275	.6414			.0858	1.0226	.0500	.9145	.0338	.6535
.15	-.1072	.3682	-.0690	.5024	-.0307	.6067			.0840	.9708	.0484	.9196	.0378	.6144
.20	-.0956	.3254							.0843	.9281	.0460	.9122		
.25	-.0921	.3277	-.0709	.4536	-.0298	.5558	.0048	.8556	.0823	.8912			.0383	.5944
.30	-.1174	.1224	-.0764	.4262	-.0172	.5226	.0081	.8362	.0744	.8641	.0415	.8860	.0394	.5948
.40	-.1176	.1748	-.1473	.1304	-.0372	.5441	.0006	.7715	.0522	.8088	.0350	.8255	.0361	.5637
.50	-.1294	.2834	-.1546	.1551			-.1226	.2744	-.0442	.3299	-.0023	.4468	.0099	.3036
.60	-.0994	.2655	-.1473	.1668	-.1415	.1818	-.1517	.0096	-.1542	.0477	-.1566	.0272	-.1581	-.0412
.70			-.1514	.1834	-.1491	-.0174	-.1499	-.0186	-.1518	.0469	-.1540	.0050	-.1633	-.0614
.80	-.1572	.0659	-.1481	-.0057	-.1493	-.0299	-.1484	-.0368			-.1539	-.0040	-.1860	-.0528
.90	-.1593	-.0012	-.1571	-.0033	-.1489	-.0315	-.1498	-.0480	-.1509	.0080	-.1543	-.0111	-.1837	-.0461
.95			-.1496	-.0016	-.1492	-.0341	-.1477	-.0551	-.1554	.0016	-.1534	-.0179	-.1715	-.0535

TAIL 1

Cp at γ/b of														
x/c	0.02		0.22		0.44		0.56		0.67		0.83		0.98	
	U.S.	L.S.	U.S.	L.S.	U.S.	L.S.	U.S.	L.S.	U.S.	L.S.	U.S.	L.S.	U.S.	L.S.
.05	.1843	.1056	.1145	-.1030	-.0616	.3551	.0173	.6041	.1287	.7677	.1429	.5129		
.10	.1621	-.0058	.1037	-.0776	-.0081	.3199					.1274	.5330	.1231	.4627
.15	.1656	-.0115	.1024	-.0528	.0241	.2929		.5692	.1457	.6505	.1215	.5870	.1089	.4494
.20					.0392	.2820	.0642	.5528	.1206	.6150	.1184	.5947	.0918	.4338
.25	.1579	-.0227	.0968	-.0120	.0492	.2708	.0854	.5361	.1044	.5840	.1170	.5939	.0811	.4351
.30	.0411	-.0807	.0922	-.0039	.0503	.2670	.0956	.5064	.2487	.5510	.1157	.5866	.0701	.4332
.40	.0093	-.0708			.0229	.2463	.0992	.4694	.1836	.5206	.1187	.5581	.0518	.4164
.50	.0167	-.0660	-.0414	-.0590			-.0579	.1205					.0215	.1960
.60	.0100	-.0646	-.0474	-.0383	-.0730	.0372	-.1055	-.0715	-.1238	-.0463	-.1548	-.0254	-.1480	-.0717
.70			-.0492	-.0266			-.1686	-.0972	-.1592	-.0696	-.1498	-.0491	-.1444	-.0956
.80			-.1563	-.1150	-.1573	-.1039	-.1626	-.1106	-.1558	-.0798	-.1405	-.0548	-.1424	-.0897
.90			-.1492	-.1240	-.1500	-.1082	-.1598	-.1152	-.1564	-.0861	-.1416	-.0578	-.1430	-.0823
.95			-.1368	-.1274		-.1079			-.1542	-.0965	-.1420	-.0654	-.1418	-.0854

TAIL 2

TABLE IX. - CONTINUED
(1) $\alpha = 11.79^\circ$

Cp at γ/b of														
x/c	0.02		0.22		0.44		0.56		0.67		0.83		0.98	
	U.S.	L.S.	U.S.	L.S.	U.S.	L.S.	U.S.	L.S.	U.S.	L.S.	U.S.	L.S.	U.S.	L.S.
.05	-.1583	.4619	-.0982	.6612	-.0907	.7728			.0512		.0372	1.2059	.0157	.9405
.10	-.1497	.4220	-.0986	.5962	-.0707	.7060			.0609	1.1471	.0229	1.1074	-.0077	.8336
.15	-.1371	.4260	-.1033	.5583	-.0697	.6716			.0576	1.0851	.0211	1.0535	.0001	.7685
.20	-.1246	.3676							.0565	1.0346	.0179	1.0095		
.25	-.1216	.3718	-.1038	.5083	-.0658	.6180	-.0405	.9575	.0519	.9955			.0125	.6832
.30	-.1334	.1579	-.1098	.4783	-.0463	.5842	-.0366	.9293	.0414	.9624	.0111	.9413	.0167	.6622
.40	-.1267	.2185	-.1623	.1610	-.0681	.6070	-.0439	.8526	.0161	.8837	.0029	.8519	.0136	.6017
.50	-.1365	.3510	-.1621	.2051			-.1465	.3164	-.0718	.3744	-.0316	.4434	.0028	.3180
.60	-.1072	.3423	-.1565	.2176	-.1607	.2442	-.1533	.0333	-.1532	.0582	-.1559	.0386	-.1739	-.0286
.70			-.1593	.2535	-.1525	.0132	-.1524	.0026	-.1507	.0570	-.1567	.0217	-.1729	-.0484
.80	-.1594	.1105	-.1555	.0372	-.1528	.0043	-.1512	-.0186			-.1572	.0152	-.1821	-.0511
.90	-.1559	.0359	-.1584	.0361	-.1528	.0052	-.1527	-.0290	-.1527	.0229	-.1578	.0117	-.1764	-.0467
.95			-.1437	.0376	-.1528	.0035	-.1502	-.0352	-.1572	.0155	-.1571	.0055	-.1637	-.0477

TAIL 1

Cp at γ/b of														
x/c	0.02		0.22		0.44		0.56		0.67		0.83		0.98	
	U.S.	L.S.	U.S.	L.S.	U.S.	L.S.	U.S.	L.S.	U.S.	L.S.	U.S.	L.S.	U.S.	L.S.
.05	.1226	.0903	.1951	-.1479	-.0216	.1188	-.0317	.5252	.0466	.8535	.0889	.6926		
.10	.1122	.0051	.1717	-.1210	-.0085	.1187					.0745	.7171	.0876	.5814
.15	.1229	-.0012	.1587	-.0962	-.0107	.1103		.4972	.0583	.6906	.0684	.6902	.0752	.5913
.20					-.0148	.1127	.0342	.4830	.0343	.6447	.0648	.6584	.0600	.5684
.25	.1230	-.0112	.1314	-.0730	-.0196	.1131	.0408	.4720	.0324	.6153	.0625	.6394	.0503	.5567
.30	.0165	-.0741	.1241	-.0637	-.0248	.1124	.0426	.4498	.2193	.5815	.0609	.6201	.0395	.5258
.40	-.0038	-.0646			-.0455	.1124	.0293	.4164	.1823	.5518	.0631	.5811	.0226	.4607
.50	.0182	-.0674	-.0425	-.1002			-.1018	.0991					-.0043	.2140
.60	.0169	-.0806	-.0459	-.0819	-.0922	-.0275	-.1138	-.0746	-.1268	-.0430	-.1653	-.0109	-.1559	-.0624
.70			-.0462	-.0572			-.1784	-.0943	-.1701	-.0717	-.1527	-.0338	-.1537	-.0903
.80			-.1594	-.1326	-.1670	-.0971	-.1707	-.1049	-.1637	-.0820	-.1496	-.0365	-.1520	-.0926
.90			-.1567	-.1350	-.1623	-.1063	-.1609	-.1056	-.1610	-.0852	-.1499	-.0410	-.1520	-.0926
.95			-.1437	-.1351		-.1100			-.1581	-.0944	-.1498	-.0505	-.1472	-.0967

TAIL 2

TABLE IX. - CONTINUED
(j) $\alpha = 15.80^\circ$

Cp at y/b of														
x/c	0.02		0.22		0.44		0.56		0.67		0.83		0.98	
	U.S.	L.S.	U.S.	L.S.	U.S.	L.S.	U.S.	L.S.	U.S.	L.S.	U.S.	L.S.	U.S.	L.S.
.05	-.1835	.5579	-.1504	.7677	-.1515	.8934			-.0082		-.0248	1.4634	-.0030	1.2200
.10	-.1840	.4922	-.1429	.7077	-.1239	.8294			.0271	1.3481	-.0147	1.3213	-.0084	1.0574
.15	-.1753	.4966	-.1455	.6713	-.1217	.7946			.0364	1.2743	-.0133	1.2346	.0085	.9567
.20	-.1662	.4554							.0356	1.2089	-.0154	1.1687		
.25	-.1673	.4529	-.1452	.6211	-.1087	.7395	-.0956	1.1364	.0250	1.1514			.0149	.8329
.30	-.1647	.2206	-.1539	.5794	-.0902	.6855	-.0923	1.0964	.0091	1.1034	-.0242	1.0719	.0186	.7968
.40	-.1536	.3103	-.1784	.2418	-.1120	.7325	-.0968	.9872	-.0209	1.0095	-.0344	.9566	.0170	.7079
.50	-.1688	.5063	-.1744	.3073			-.1710	.3730	-.1004	.4076	-.0661	.4894	-.0079	.3723
.60	-.1370	.5475	-.1705	.3437	-.1777	.3437	-.1630	.0711	-.1622	.0739	-.1662	.0710	-.1858	.0007
.70			-.1709	.4524	-.1645	.0874	-.1620	.0366	-.1594	.0726	-.1674	.0651	-.1883	-.0130
.80	-.1745	.1807	-.1652	.1209	-.1649	.0823	-.1607	.0179			-.1681	.0689	-.1907	-.0157
.90	-.1624	.1128	-.1708	.1166	-.1649	.0842	-.1618	.0190	-.1615	.0598	-.1687	.0703	-.1938	-.0129
.95			-.1588	.1173	-.1643	.0874	-.1589	.0139	-.1669	.0533	-.1676	.0640	-.1933	-.0150

TAIL 1

Cp at y/b of														
x/c	0.02		0.22		0.44		0.56		0.67		0.83		0.98	
	U.S.	L.S.	U.S.	L.S.	U.S.	L.S.	U.S.	L.S.	U.S.	L.S.	U.S.	L.S.	U.S.	L.S.
.05	.1500	.0584	.0959	-.1516	-.0880	-.0548	-.0643	.1013	-.0755	.5535	-.0536	.8449		
.10	.1337	-.0591	.0816	-.1378	-.0840	-.0452					-.0598	.7546	-.0039	.7476
.15	.1374	-.0612	.0792	-.1228	-.0837	-.0413		.1241	-.0723	.4602	-.0654	.7088	-.0130	.6877
.20					-.0843	-.0353	-.0440	.1358	-.0674	.4402	-.0684	.6654	-.0249	.6337
.25	.1316	-.0704	.0649	-.1019	-.0854	-.0310	-.0516	.1482	-.0605	.4272	-.0668	.6425	-.0334	.6050
.30	.0215	-.1162	.0605	-.0936	-.0872	-.0248	-.0572	.1522	.1285	.4187	-.0625	.6230	-.0423	.5682
.40	-.0091	-.1117			-.0934	-.0237	-.0720	.1634	.0804	.4132	-.0543	.5851	-.0558	.4914
.50	.0235	-.1098	-.0680	-.1339			-.1482	-.0121					-.0756	.2358
.60	-.0099	-.1191	-.0701	-.1240	-.1213	-.0910	-.1303	-.1141	-.1488	-.0583	-.1765	.0047	-.1701	-.0557
.70			-.0701	-.1183			-.1956	-.1320	-.1950	-.0781	-.1725	-.0130	-.1719	-.0721
.80			-.1668	-.1740	-.1795	-.1520	-.1933	-.1325	-.1880	-.0861	-.1746	-.0282	-.1720	-.0726
.90			-.1753	-.1808	-.1853	-.1587	-.1870	-.1292	-.1766	-.0879	-.1743	-.0416	-.1724	-.0754
.95			-.1768	-.1740		-.1594			-.1780	-.0953	-.1728	-.0526	-.1699	-.0803

TAIL 2

TABLE IX. - CONCLUDED
(k) $\alpha = 19.82^\circ$

Cp at γ/b of														
x/c	0.02		0.22		0.44		0.56		0.67		0.83		0.98	
	U.S.	L.S.	U.S.	L.S.	U.S.	L.S.	U.S.	L.S.	U.S.	L.S.	U.S.	L.S.	U.S.	L.S.
.05	-.1880	.6984	-.1684	.9082	-.1753	1.0408			-.0383		-.0696	1.6589	-.0320	1.4365
.10	-.1876	.5994	-.1552	.8490	-.1447	.9771			.0150	1.5357	-.0321	1.5225	-.0027	1.2599
.15	-.1806	.6179	-.1545	.8121	-.1394	.9416			.0361	1.4521	-.0234	1.4250	-.0243	1.1400
.20	-.1717	.5737							.0394	1.3805	-.0183	1.3468		
.25	-.1747	.5737	-.1508	.7572	-.1211	.8839	-.1174	1.3179	.0272	1.3201			.0460	.9860
.30	-.1733	.3194	-.1584	.6972	-.1108	.8615	-.1135	1.2562	.0094	1.2665	-.0210	1.2267	.0532	.9402
.40	-.1751	.4308	-.1750	.3528	-.1188	.8897	-.1128	1.1257	-.0241	1.1534	-.0292	1.0874	.0401	.8243
.50	-.1930	.7131	-.1733	.4430			-.1734	.4401	-.1041	.4713	-.0617	.5602	.0060	.4356
.60	-.1554	.7338	-.1717	.5640	-.1832	.4528	-.1715	.1125	-.1735	.1103	-.1747	.1104	-.1796	.0332
.70			-.1752	.6162	-.1705	.1817	-.1704	.0790	-.1708	.1084	-.1732	.1185	-.1989	.0281
.80	-.1856	.2591	-.1679	.2181	-.1704	.2122	-.1693	.0861			-.1728	.1323	-.2144	.0311
.90	-.1671	.2016	-.1775	.2222	-.1706	.2407	-.1709	.0983	-.1714	.1026	-.1732	.1355	-.2097	.0373
.95			-.1728	.2300	-.1700	.2358	-.1768	.0938	-.1775	.0965	-.1708	.1282	-.2061	.0353

TAIL 1

Cp at γ/b of														
x/c	0.02		0.22		0.44		0.56		0.67		0.83		0.98	
	U.S.	L.S.	U.S.	L.S.	U.S.	L.S.	U.S.	L.S.	U.S.	L.S.	U.S.	L.S.	U.S.	L.S.
.05	.1417	.0387	.0189	-.1350	-.0927	-.0530	-.0998	.0290	-.1534	.3089	-.1662	.4120		
.10	.1245	-.1054	.0083	-.1273	-.0831	-.0531					-.1610	.3757	-.0820	.6550
.15	.1252	-.1075	.0061	-.1211	-.0822	-.0569					-.1570	.3542	-.0887	.5823
.20					-.0826	-.0563	-.0711	.0672	-.1309	.2358	-.1525	.3360	-.0980	.5304
.25	.1106	-.1086	-.0030	-.1075	-.0843	-.0543	-.0752	.0790	-.1253	.2280	-.1472	.3284	-.1054	.4969
.30	.0027	-.1382	-.0075	-.1017	-.0873	-.0499	-.0776	.0826	.0247	.2216	-.1428	.3225	-.1117	.4626
.40	-.0357	-.1339			-.0957	-.0479	-.0871	.0950	-.0069	.2184	-.1372	.3071	-.1198	.3923
.50	.0110	-.1324	-.1024	-.1440			-.1567	-.0508					-.1329	.1574
.60	-.0513	-.1372	-.1044	-.1373	-.1368	-.1096	-.1430	-.1345	-.1663	-.1045	-.2036	-.0743	-.1980	-.0633
.70			-.1055	-.1331			-.2040	-.1556	-.2101	-.1217	-.1991	-.0929	-.1964	-.0645
.80			-.1795	-.1832	-.1872	-.1646	-.2050	-.1576	-.2029	-.1302	-.1990	-.0993	-.1938	-.0636
.90			-.1890	-.1915	-.1944	-.1728	-.1983	-.1567	-.1941	-.1304	-.1971	-.1028	-.1896	-.0683
.95			-.1903	-.1856		-.1737			-.1979	-.1390	-.1952	-.1083	-.1832	-.0739

TAIL 2

TABLE X. - PRESSURE COEFFICIENTS, $\phi = 90^\circ$, $\delta = 0^\circ$, $M = 2.36$.
(a) $\alpha = -4.05^\circ$

Cp at y/b of														
x/c	0.02		0.22		0.44		0.56		0.67		0.83		0.98	
	U.S.	L.S.	U.S.	L.S.	U.S.	L.S.	U.S.	L.S.	U.S.	L.S.	U.S.	L.S.	U.S.	L.S.
.05	.1753	-.0172	.3968	.0769	.4530	.0999			.4843		.4151	.2269	.4208	.2235
.10	.1682	.0058	.3430	.0722	.4102	.1007			.5389	.1917	.4073	.2061	.3466	.1811
.15	.1624	.0062	.3108	.0643	.3794	.0968			.5599	.2027	.4200	.1948	.3488	.1591
.20	.1580	.0115							.5716	.2113	.4210	.1914		
.25	.1593	.0112	.2714	.0470	.3405	.0915	.5050	.1782	.5583	.2134			.3050	.1292
.30	.0461	.1015	.2572	.0379	.2661	.0984	.5045	.1838	.5409	.2109	.4339	.1896	.2886	.1240
.40	.0446	.1259	.0260	-.0828	.2947	.1006	.4684	.1795	.5075	.1990	.4472	.1841	.2632	.1103
.50	.1051	-.0033	.0128	-.0839			.1220	-.0317	.2714	.0082	.3747	.0425	.2070	-.0008
.60	.0566	-.0093	.0116	-.0720	.0493	-.0575	-.0848	-.1519	-.0514	-.1469	-.0482	-.1414	-.1181	-.1246
.70			.0160	-.0753	-.1121	-.1426	-.1063	-.1358	-.0511	-.1449	-.0759	-.1209	-.1151	-.1200
.80	-.0591	-.0896	-.1040	-.1361	-.1278	-.1269	-.1166	-.1271			-.0832		-.1172	-.1216
.90	-.0806	-.1118	-.1127	-.1349	-.1317	-.1251	-.1259	-.1255	-.0928	-.1225	-.0921	-.1106	-.1119	-.1353
.95			-.1112	-.1331	-.1358	-.1247	-.1306	-.1237	-.1008	-.1225	-.1001	-.1152	-.1079	-.1500

TAIL 1

Cp at y/b of														
x/c	0.02		0.22		0.44		0.56		0.67		0.83		0.98	
	U.S.	L.S.	U.S.	L.S.	U.S.	L.S.	U.S.	L.S.	U.S.	L.S.	U.S.	L.S.	U.S.	L.S.
.05	.1222	.1431	.2578	.2458	.2735	.2659	.4573	.3603	.3166	.3252	.3121	.3256		
.10	.1003	.1146	.2322	.2329	.2703	.2550					.3102	.3029	.2359	.2932
.15	.1072	.1102	.2127	.2128	.2618	.2469		.3708	.3038	.3257	.3015	.3104	.2197	.2675
.20						.2434	.3456	.3773	.3132	.3314	.2811	.3020	.2003	.2414
.25	.1017	.0877	.1778	.1853	.2366	.2412	.3438	.3788	.3242	.3403	.2692	.3060	.1878	.2323
.30	-.0010	-.0097	.1641	.1778	.2297	.2431	.3379	.3719	.3292	.3509	.2641	.3087	.1741	.2204
.40	-.0215	-.0012			.2236	.2531	.3284	.3639	.3153	.3574	.2602	.3088	.1568	.2004
.50	.0496	.0122	-.0432	-.0326			.0637	.0733					.1245	.0625
.60	-.0031	.0194	-.0511	-.0370	-.0168	-.0002	-.0696	-.0803	-.1027	-.0848	-.1229	-.0972	-.1189	-.1130
.70			-.0521	-.0365			-.1342	-.1148	-.1259	-.1039	-.1332	-.1184		-.1297
.80			-.1195	-.1372	-.1327	-.1276	-.1405	-.1242	-.1251	-.1082	-.1146	-.1250	-.0910	-.1143
.90			-.1223	-.1356	-.1238	-.1389	-.1214	-.1287	-.1061	-.1053	-.1113	-.1200	-.0929	-.0860
.95			-.1223	-.1283					-.1011	-.1032	-.1100	-.1111	-.1162	-.1022

TAIL 2

TABLE X. - CONTINUED
(b) $\alpha = -2.05^\circ$

Cp at y/b of														
x/c	0.02		0.22		0.44		0.56		0.67		0.83		0.98	
	U.S.	L.S.	U.S.	L.S.	U.S.	L.S.	U.S.	L.S.	U.S.	L.S.	U.S.	L.S.	U.S.	L.S.
.05	.1229	.0273	.3221	.1579	.3663	.1798			.3826		.3506	.2892	.3493	.2789
.10	.1235	.0464	.2776	.1410	.3392	.1713			.3932	.2509	.3357	.2688	.2849	.2359
.15	.1210	.0431	.2491	.1228	.3136	.1656			.4141	.2586	.3446	.2570	.2839	.2112
.20	.1178	.0470							.4345	.2673	.3438	.2533		
.25	.1149	.0439	.2158	.1028	.2812	.1589	.4180	.2682	.4413	.2731			.2488	.1731
.30	.0194	.0563	.2022	.0935	.2724	.1413	.4193	.2740	.4401	.2762	.3435	.2510	.2323	.1655
.40	.0219	.0802	-.0006	-.0523	.2505	.1582	.3907	.2673	.4240	.2727	.3416	.2444	.2120	.1489
.50	.0685	.0080	-.0189	-.0604			.0799	.0131	.2229	.0550	.2741	.0839	.1617	.0237
.60	.0551	.0088	-.0221	-.0529	.0087	-.0251	-.1060	-.1315	-.0821	-.1244	-.0908	-.1331	-.1241	-.1058
.70			-.0204	-.0533	-.1303	-.1454	-.1237	-.1449	-.0815	-.1227	-.1084	-.1128	-.1297	-.1040
.80	-.0743	-.0771	-.1236	-.1332	-.1432	-.1354	-.1310	-.1346			-.1118		-.1261	-.1023
.90	-.0924	-.1100	-.1301	-.1268	-.1385	-.1247	-.1360	-.1215	-.1139	-.1064	-.1149	-.0968	-.1105	-.1022
.95			-.1225	-.1257	-.1269	-.1241	-.1255	-.1185	-.1142	-.1052	-.1125	-.1011	-.1088	-.1032

TAIL 1

Cp at y/b of														
x/c	0.02		0.22		0.44		0.56		0.67		0.83		0.98	
	U.S.	L.S.	U.S.	L.S.	U.S.	L.S.	U.S.	L.S.	U.S.	L.S.	U.S.	L.S.	U.S.	L.S.
.05	.1046	.1269	.2476	.2380	.2674	.2618	.4646	.3620	.3119	.3232	.3129	.3275		
.10	.0917	.1037	.2201	.2215	.2627	.2508					.3131	.3031	.2383	.2963
.15	.0974	.0989	.2012	.2018	.2507	.2402		.3741	.3055	.3273	.2957	.3118	.2222	.2729
.20						.2359	.3440	.3771	.3190	.3373	.2749	.3040	.2012	.2458
.25	.0921	.0828	.1675	.1750	.2227	.2309	.3396	.3774	.3298	.3477	.2676	.3064	.1882	.2338
.30	-.0055	-.0062	.1545	.1668	.2159	.2320	.3299	.3691	.3371	.3584	.2639	.3073	.1754	.2193
.40	-.0184	.0023			.2076	.2398	.3199	.3576	.3255	.3649	.2626	.3061	.1568	.1980
.50	.0495	.0147	-.0449	-.0353			.0574	.0627					.1224	.0594
.60	.0046	.0293	-.0512	-.0391	-.0227	-.0100	-.0602	-.0765	-.1041	-.0832	-.1202	-.0950	-.1130	-.1150
.70			-.0506	-.0352			-.1387	-.1171	-.1276	-.1035	-.1301	-.1158		-.1316
.80			-.1232	-.1337	-.1320	-.1294	-.1430	-.1272	-.1283	-.1086	-.1128	-.1212	-.1004	-.1238
.90			.1243	-.1334	-.1239	-.1397	-.1247	-.1325	-.1077	-.1066	-.1099	-.1189	-.1060	-.1076
.95			-.1247	-.1279					-.1028	-.1053	-.1092	-.1114	-.1082	-.0887

TAIL 2

TABLE X. - CONTINUED
(c) $\alpha = -0.05^\circ$

Cp at y/b of														
x/c	0.02		0.22		0.44		0.56		0.67		0.83		0.98	
	U.S.	L.S.	U.S.	L.S.	U.S.	L.S.	U.S.	L.S.	U.S.	L.S.	U.S.	L.S.	U.S.	L.S.
.05	.0817	.0669	.2431	.2418	.2639	.2705			.3083		.2877	.3575	.2874	.3394
.10	.0854	.0830	.2079	.2077	.2549	.2573			.3096	.3184	.2706	.3357	.2260	.2957
.15	.0829	.0792	.1848	.1837	.2382	.2465			.3068	.3317	.2762	.3224	.2280	.2671
.20	.0809	.0839							.3178	.3487	.2757	.3186		
.25	.0763	.0789	.1599	.1599	.2175	.2256	.3267	.3675	.3255	.3609			.1961	.2212
.30	-.0038	.0339	.1491	.1472	.2140	.2036	.3307	.3685	.3284	.3661	.2732	.3161	.1826	.2123
.40	-.0000	.0562	-.0277	-.0218	.1890	.2222	.3126	.3507	.3253	.3563	.2673	.3102	.1649	.1914
.50	.0318	.0335	-.0489	-.0313			.0436	.0563	.1614	.1114	.2042	.1294	.1215	.0525
.60	.0317	.0332	-.0512	-.0283	-.0154	.0086	-.1239	-.1108	-.1092	-.0977	-.1194	-.1136	-.1161	-.1210
.70			-.0501	-.0277	-.1463	-.1298	-.1416	-.1254	-.1081	-.0967	-.1358	-.1261	-.1108	-.1127
.80	-.0879	-.0599	-.1331	-.1342	-.1391	-.1435	-.1403	-.1310			-.1147		-.1075	-.1051
.90	-.1026	-.0992	-.1284	-.1309	-.1242	-.1459	-.1257	-.1368	-.1017	-.1177	-.1045	-.1041	-.1058	-.1037
.95			-.1236	-.1258	-.1228	-.1360	-.1190	-.1330	-.1010	-.1090	-.1023	-.1039	-.1073	-.1028

TAIL 1

Cp at y/b of														
x/c	0.02		0.22		0.44		0.56		0.67		0.83		0.98	
	U.S.	L.S.	U.S.	L.S.	U.S.	L.S.	U.S.	L.S.	U.S.	L.S.	U.S.	L.S.	U.S.	L.S.
.05	.0825	.1059	.2370	.2327	.2610	.2583	.4600	.3699	.3080	.3243	.3164	.3282		
.10	.0812	.0900	.2078	.2119	.2533	.2457					.3129	.2986	.2409	.2988
.15	.0858	.0856	.1876	.1901	.2393	.2331		.3766	.3118	.3342	.2868	.3105	.2258	.2778
.20						.2267	.3426	.3784	.3270	.3468	.2683	.3021	.2030	.2511
.25	.0804	.0750	.1580	.1639	.2100	.2213	.3373	.3775	.3369	.3574	.2644	.3033	.1896	.2375
.30	-.0095	-.0009	.1454	.1557	.2022	.2201	.3225	.3670	.3434	.3667	.2616	.3068	.1763	.2204
.40	-.0087	.0113			.1926	.2259	.3114	.3512	.3359	.3710	.2607	.3075	.1573	.1955
.50	.0443	.0227	-.0468	-.0370			.0479	.0577					.1211	.0572
.60	.0157	.0369	-.0498	-.0414	-.0306	-.0146	-.0567	-.0783	-.1038	-.0856	-.1167	-.0924	-.1128	-.1181
.70			-.0480	-.0315			-.1417	-.1215	-.1291	-.1058	-.1309	-.1123		-.1275
.80			-.1266	-.1248	-.1326	-.1330	-.1446	-.1322	-.1315	-.1113	-.1139	-.1156	-.1009	-.1229
.90			-.1266	-.1286	-.1251	-.1421	-.1278	-.1370	-.1100	-.1086	-.1090	-.1151	-.1065	-.1130
.95			-.1263	-.1253	.0433	.0642			-.1049	-.1097	-.1073	-.1108	-.1083	-.1044

TAIL 2

TABLE X. - CONTINUED
(d) $\alpha = 1.95^\circ$

Cp at y/b of														
x/c	0.02		0.22		0.44		0.56		0.67		0.83		0.98	
	U.S.	L.S.	U.S.	L.S.	U.S.	L.S.	U.S.	L.S.	U.S.	L.S.	U.S.	L.S.	U.S.	L.S.
.05	.0424	.1088	.1551	.3201	.1716	.3721			.2420		.2292	.4317	.2298	.4065
.10	.0503	.1220	.1400	.2758	.1714	.3413			.2452	.4100	.2127	.4096	.1737	.3613
.15	.0471	.1184	.1229	.2487	.1595	.3214			.2399	.4533	.2144	.3955	.1765	.3280
.20	.0467	.1248							.2418	.4699	.2142	.3911		
.25	.0422	.1183	.1052	.2170	.1511	.2897	.2298	.4623	.2441	.4794			.1489	.2752
.30	-.0245	.0281	.0967	.2017	.1558	.2692	.2378	.4575	.2428	.4831	.2104	.3919	.1395	.2676
.40	-.0217	.0498	-.0583	.0099	.1322	.2828	.2295	.4317	.2361	.4707	.2035	.3908	.1247	.2430
.50	-.0001	.0679	-.0742	.0013			.0018	.1000	.0958	.1514	.1483	.1870	.0867	.0864
.60	.0114	.0621	-.0661	.0035	-.0420	.0373	-.1423	-.0873	-.1331	-.0746	-.1376	-.0824	-.1251	-.1166
.70			-.0696	.0055	-.1569	-.1112	-.1511	-.1041	-.1314	-.0740	-.1253	-.0916	-.1211	-.1233
.80	-.1003	-.0394	-.1293	-.1160	-.1332	-.1244	-.1324	-.1118			-.1163		-.1201	-.1200
.90	-.1086	-.0837	-.1321	-.1179	-.1301	-.1289	-.1297	-.1203	-.1148	-.0989	-.1147	-.0919	-.1214	-.1176
.95			-.1293	-.1175	-.1296	-.1316	-.1266	-.1251	-.1178	-.1026	-.1145	-.0999	-.1248	-.1133

TAIL 1

Cp at y/b of														
x/c	0.02		0.22		0.44		0.56		0.67		0.83		0.98	
	U.S.	L.S.	U.S.	L.S.	U.S.	L.S.	U.S.	L.S.	U.S.	L.S.	U.S.	L.S.	U.S.	L.S.
.05	.0690	.0928	.2293	.2312	.2559	.2564	.4649	.3781	.3059	.3247	.3198	.3285		
.10	.0712	.0825	.1969	.2021	.2453	.2415					.3116	.2950	.2448	.3029
.15	.0746	.0780	.1764	.1794	.2297	.2265		.3732	.3265	.3439	.2814	.3083	.2299	.2809
.20						.2185	.3412	.3745	.3422	.3572	.2677	.3029	.2077	.2554
.25	.0703	.0687	.1493	.1546	.1982	.2123	.3324	.3740	.3491	.3680	.2656	.3025	.1938	.2413
.30	-.0109	.0030	.1380	.1479	.1917	.2099	.3192	.3625	.3499	.3737	.2644	.3080	.1814	.2235
.40	-.0035	.0144			.1811	.2153	.3010	.3418	.3395	.3724	.2666	.3099	.1612	.1964
.50	.0319	.0256	-.0489	-.0408			.0463	.0544					.1224	.0571
.60	.0159	.0328	-.0503	-.0442	-.0343	-.0200	-.0601	-.0822	-.1056	-.0863	-.1105	-.0888	-.1116	-.1211
.70			-.0471	-.0273			-.1445	-.1243	-.1312	-.1066	-.1290	-.1072		-.1243
.80			-.1279	-.1190	-.1333	-.1346	-.1463	-.1350	-.1346	-.1123	-.1178	-.1096	-.1012	-.1219
.90			-.1275	-.1279	-.1271	-.1437	-.1301	-.1392	-.1126	-.1113	-.1081	-.1108	-.1063	-.1101
.95			-.1270	-.1282					-.1068	-.1137	-.1039	-.1086	-.1102	-.1066

TAIL 2

TABLE X. - CONTINUED
(e) $\alpha = 3.95^\circ$

Cp at y/b of														
x/c	0.02		0.22		0.44		0.56		0.67		0.83		0.98	
	U.S.	L.S.	U.S.	L.S.	U.S.	L.S.	U.S.	L.S.	U.S.	L.S.	U.S.	L.S.	U.S.	L.S.
.05	.0000	.1617	.0762	.3913	.0979	.4611			.1837		.1742	.5142	.1774	.4814
.10	.0137	.1714	.0740	.3411	.1023	.4162			.1891	.5744	.1594	.4903	.1273	.4311
.15	.0129	.1645	.0651	.3103	.0926	.3910			.1854	.6012	.1583	.4749	.1306	.3932
.20	.0152	.1690							.1854	.6138	.1582	.4741		
.25	.0123	.1615	.0502	.2752	.0872	.3530	.1495	.5537	.1856	.6117			.1081	.3348
.30	-.0437	.0337	.0438	.2581	.0963	.3272	.1571	.5447	.1809	.5939	.1541	.4941	.1003	.3239
.40	-.0402	.0565	-.0843	.0429	.0782	.3420	.1503	.5138	.1675	.5591	.1471	.5019	.0882	.2981
.50	-.0281	.1008	-.0960	.0388			-.0403	.1441	.0450	.2039	.0986	.2720	.0562	.1235
.60	-.0034	.0950	-.0862	.0414	-.0746	.0675	-.1587	-.0648	-.1531	-.0458	-.1532	-.0368	-.1410	-.1088
.70			-.0884	.0436	-.1395	-.0919	-.1391	-.0839	-.1510	-.0456	-.1385	-.0503	-.1450	-.1063
.80	-.1064	-.0163	-.1372	-.0930	-.1345	-.1031	-.1343	-.0942			-.1320		-.1103	-.0962
.90	-.1075	-.0684	-.1398	-.0958	-.1336	-.1074	-.1340	-.1040	-.1290	-.0709	-.1309	-.0647	-.1386	-.0880
.95			-.1350	-.0962	-.1339	-.1112	-.1324	-.1101	-.1324	-.0764	-.1305	-.0748	-.1543	-.0886

TAIL 1

Cp at y/b of														
x/c	0.02		0.22		0.44		0.56		0.67		0.83		0.98	
	U.S.	L.S.	U.S.	L.S.	U.S.	L.S.	U.S.	L.S.	U.S.	L.S.	U.S.	L.S.	U.S.	L.S.
.05	.0838	.1051	.2297	.2275	.2469	.2490	.4569	.3714	.3058	.3264	.3241	.3286		
.10	.0711	.1005	.2016	.2063	.2381	.2347					.3085	.3002	.2463	.3076
.15	.0762	.0932	.1825	.1890	.2259	.2198		.3674	.3371	.3534	.2747	.3068	.2319	.2852
.20						.2135	.3373	.3696	.3502	.3666	.2667	.3060	.2108	.2600
.25	.0682	.0705	.1558	.1646	.1986	.2080	.3290	.3692	.3517	.3738	.2673	.3059	.1981	.2452
.30	-.0198	-.0102	.1463	.1584	.1925	.2077	.3170	.3573	.3465	.3742	.2662	.3105	.1860	.2275
.40	-.0304	-.0122			.1813	.2164	.3005	.3413	.3337	.3689	.2718	.3134	.1655	.2006
.50	.0322	.0066	-.0469	-.0354			.0430	.0528					.1238	.0608
.60	.0123	.0243	-.0542	-.0427	-.0351	-.0160	-.0741	-.0889	-.1050	-.0858	-.1066	-.0863	-.1122	-.1232
.70			-.0542	-.0400			-.1451	-.1247	-.1310	-.1061	-.1242	-.1034		-.1220
.80			-.1271	-.1323	-.1387	-.1338	-.1476	-.1358	-.1364	-.1123	-.1225	-.1066	-.1010	-.1184
.90			-.1280	-.1328	-.1285	-.1435	-.1311	-.1390	-.1152	-.1118	-.1078	-.1078	-.1071	-.1082
.95			-.1281	-.1305					-.1082	-.1142	-.1008	-.1047	-.1111	-.1070

TAIL 2

TABLE X. - CONTINUED
(f) $\alpha = 5.95^\circ$

Cp at γ/b of														
x/c	0.02		0.22		0.44		0.56		0.67		0.83		0.98	
	U.S.	L.S.	U.S.	L.S.	U.S.	L.S.	U.S.	L.S.	U.S.	L.S.	U.S.	L.S.	U.S.	L.S.
.05	-.0394	.2143	.0104	.4587	.0308	.5383			.1353		.1257	.6095	.1288	.5678
.10	-.0213	.2205	.0106	.4032	.0408	.4853			.1442	.7763	.1118	.5832	.0847	.5105
.15	-.0183	.2119	.0080	.3695	.0346	.4560			.1439	.7576	.1082	.5832	.0883	.4663
.20	-.0126	.2137							.1443	.7304	.1078	.6087		
.25	-.0142	.2060	.0018	.3308	.0318	.4138	.0796	.6523	.1412	.7014			.0714	.4044
.30	-.0597	.0465	-.0047	.3110	.0447	.3852	.0877	.6377	.1316	.6802	.1033	.6451	.0671	.3934
.40	-.0555	.0731	-.1101	.0707	.0229	.4085	.0818	.5955	.1114	.6383	.0966	.6490	.0588	.3731
.50	-.0480	.1452	-.1049	.0783			-.0792	.1852	.0014	.2546	.0527	.3675	.0300	.1786
.60	-.0198	.1360	-.0979	.0837	-.1041	.1017	-.1364	-.0411	-.1403	-.0029	-.1508	-.0001	-.1434	-.0861
.70			-.1041	.0909	-.1411	-.0695	-.1335	-.0636	-.1380	-.0031	-.1400	-.0222	-.1480	-.0783
.80	-.1126	.0122	-.1546	-.0694	-.1425	-.0810	-.1324	-.0767			-.1380		-.1308	-.0621
.90	-.1078	-.0501	-.1489	-.0717	-.1428	-.0833	-.1341	-.0877	-.1343	-.0453	-.1380	-.0461	-.1390	-.0578
.95			-.1276	-.0723	-.1422	-.0865	-.1332	-.0941	-.1374	-.0499	-.1375	-.0564	-.1572	-.0621

TAIL 1

Cp at γ/b of														
x/c	0.02		0.22		0.44		0.56		0.67		0.83		0.98	
	U.S.	L.S.	U.S.	L.S.	U.S.	L.S.	U.S.	L.S.	U.S.	L.S.	U.S.	L.S.	U.S.	L.S.
.05	.1068	.1232	.2324	.2282	.2450	.2409	.4544	.3576	.3054	.3288	.3291	.3261		
.10	.0767	.1134	.2158	.2164	.2375	.2274					.3046	.3008	.2501	.3133
.15	.0810	.1060	.2026	.2015	.2270	.2156		.3616	.3454	.3591	.2719	.3054	.2375	.2907
.20						.2115	.3342	.3664	.3541	.3684	.2684	.3064	.2165	.2642
.25	.0681	.0720	.1737	.1796	.2053	.2093	.3294	.3690	.3531	.3717	.2711	.3085	.2045	.2501
.30	-.0276	-.0217	.1559	.1733	.2012	.2123	.3210	.3596	.3413	.3692	.2726	.3135	.1935	.2336
.40	-.0475	-.0334			.1921	.2267	.3077	.3430	.3308	.3637	.2793	.3174	.1711	.2064
.50	.0306	-.0248	-.0504	-.0344			.0494	.0592					.1264	.0563
.60	-.0152	-.0122	-.0610	-.0499	-.0320	-.0057	-.0839	-.0914	-.1022	-.0857	-.1036	-.0845	-.1101	-.1246
.70			-.0667	-.0533			-.1450	-.1237	-.1288	-.1057	-.1218	-.1019		-.1204
.80			-.1287	-.1491	-.1510	-.1308	-.1497	-.1351	-.1343	-.1110	-.1242	-.1057	-.1011	-.1146
.90			-.1323	-.1487	-.1315	-.1427	-.1321	-.1377	-.1141	-.1103	-.1094	-.1065	-.1063	-.1075
.95			-.1329	-.1391					-.1069	-.1131	-.1010	-.1021	-.1052	-.1029

TAIL 2

TABLE X. - CONTINUED
(g) $\alpha = 7.95^\circ$

Cp at γ/b of														
x/c	0.02		0.22		0.44		0.56		0.67		0.83		0.98	
	U.S.	L.S.	U.S.	L.S.	U.S.	L.S.	U.S.	L.S.	U.S.	L.S.	U.S.	L.S.	U.S.	L.S.
.05	-.0738	.2527	-.0418	.5143	-.0325	.6010			.0994		.0810	.7443	-.0849	.6686
.10	-.0519	.2579	-.0424	.4559	-.0154	.5451			.1109	.9077	.0684	.7727	-.0463	.6012
.15	-.0442	.2497	-.0441	.4208	-.0202	.5135			.1103	.8604	.0623	.8003	-.0502	.5563
.20	-.0354	.2522							.1099	.8230	.0617	.8095		
.25	-.0359	.2449	-.0433	.3819	-.0183	.4687	.0168	.7509	.1021	.7895			-.0398	.5209
.30	-.0696	.0628	-.0487	.3590	-.0052	.4376	.0243	.7347	.0864	.7642	.0581	.8001	-.0389	.5238
.40	-.0664	.0950	-.1321	.0965	-.0263	.4580	.0207	.6805	.0587	.7088	.0527	.7601	-.0345	.5100
.50	-.0724	.1905	-.1207	.1165			-.1079	.2289	-.0382	.3101	.0134	.4163	-.0099	.2674
.60	-.0470	.1818	-.1182	.1261	-.1313	.1230	-.1386	-.0173	-.1394	.0119	-.1439	.0160	-.1459	-.0536
.70			-.1276	.1402	-.1460	-.0430	-.1384	-.0434	-.1370	.0111	-.1426	-.0076	-.1462	-.0741
.80	-.1221	.0408	-.1548	-.0407	-.1494	-.0545	-.1374	-.0596			-.1424		-.1511	-.0744
.90	-.1198	-.0286	-.1540	-.0461	-.1498	-.0553	-.1382	-.0704	-.1389	-.0271	-.1429	-.0210	-.1640	-.0726
.95			-.1408	-.0464	-.1501	-.0571	-.1366	-.0767	-.1425	-.0332	-.1423	-.0282	-.1576	-.0786

TAIL 1

Cp at γ/b of														
x/c	0.02		0.22		0.44		0.56		0.67		0.83		0.98	
	U.S.	L.S.	U.S.	L.S.	U.S.	L.S.	U.S.	L.S.	U.S.	L.S.	U.S.	L.S.	U.S.	L.S.
.05	.1052	.1199	.2282	.2178	.2430	.2418	-.4476	.3536	.3099	.3328	.3379	.3263		
.10	.0725	.1046	.2145	.2136	.2353	.2266					.3046	.3063	.2544	.3180
.15	.0752	.0963	.2048	.2026	.2254	.2152		.3575	.3456	.3594	.2726	.3079	.2425	.2956
.20						.2121	.3303	.3622	.3503	.3671	.2717	.3086	.2230	.2687
.25	.0629	.0638	.1807	.1840	.2071	.2118	.3271	.3633	.3480	.3703	.2736	.3126	.2116	.2552
.30	-.0322	-.0307	.1665	.1787	.2090	.2178	.3184	.3551	.3350	.3652	.2752	.3175	.1995	.2392
.40	-.0578	-.0456			.2155	.2368	.3108	.3427	.3229	.3585	.2820	.3221	.1749	.2122
.50	.0269	-.0446	-.0601	-.0335			.0585	.0593					.1285	.0694
.60	-.0506	-.0387	-.0799	-.0551	-.0128	.0181	-.0888	-.0924	-.1030	-.0867	-.1019	-.0851	-.1114	-.1275
.70			-.0888	-.0707			-.1384	-.1172	-.1283	-.1070	-.1217	-.1029		-.1205
.80			-.1458	-.1653	-.1485	-.1210	-.1456	-.1267	-.1303	-.1120	-.1257	-.1070	-.1018	-.1128
.90			-.1511	-.1615	-.1323	-.1353	-.1266	-.1289	-.1095	-.1087	-.1083	-.1081	-.1055	-.1045
.95			-.1517	-.1538					-.1035	-.1055	-.1002	-.1037	-.1037	-.0999

TAIL 2

TABLE X. - CONTINUED
(h) $\alpha = 9.95^\circ$

Cp at γ/b of														
x/c	0.02		0.22		0.44		0.56		0.67		0.83		0.98	
	U.S.	L.S.	U.S.	L.S.	U.S.	L.S.	U.S.	L.S.	U.S.	L.S.	U.S.	L.S.	U.S.	L.S.
.05	-.0977	.2797	-.0880	.5599	-.0905	.6527			.0699		.0400	1.0741	.0444	.8779
.10	-.0730	.2828	-.0866	.5015	-.0662	.5972			.0839	1.0302	.0301	.9975	.0107	.8007
.15	-.0618	.2793	-.0874	.4681	-.0680	.5652			.0836	.9723	.0209	.9590	.0163	.7410
.20	-.0526	.2754							.0773	.9282	.0201	.9287		
.25	-.0528	.2719	-.0826	.4289	-.0633	.5200	-.0398	.8466	.0626	.8767			.0160	.6492
.30	-.0767	.0809	-.0868	.4037	-.0496	.4855	-.0329	.8249	.0436	.8531	.0160	.8847	.0193	.6268
.40	-.0787	.1204	-.1456	.1233	-.0700	.5011	-.0340	.7607	.0119	.7987	.0123	.8142	.0186	.5662
.50	-.0931	.2352	-.1381	.1567			-.1332	.2665	-.0735	.3356	-.0219	.4268	-.0020	.2897
.60	-.0712	.2296	-.1367	.1691	-.1552	.1501	-.1456	.0039	-.1449	.0266	-.1488	.0323	-.1566	-.0428
.70			-.1467	.1894	-.1560	-.0159	-.1460	-.0244	-.1425	.0258	-.1498	.0151	-.1556	-.0640
.80	-.1336	.0656	-.1609	-.0098	-.1594	-.0188	-.1460	-.0408			-.1498		-.1750	-.0707
.90	-.1333	-.0046	-.1579	-.0200	-.1601	-.0175	-.1463	-.0478	-.1459	-.0087	-.1505	.0096	-.1775	-.0740
.95			-.1448	-.0210	-.1580	-.0203	-.1437	-.0530	-.1498	-.0165	-.1494	.0030	-.1794	-.0780

TAIL 1

Cp at γ/b of															
x/c	0.02		0.22		0.44		0.56		0.67		0.83		0.98		
	U.S.	L.S.	U.S.	L.S.	U.S.	L.S.	U.S.	L.S.	U.S.	L.S.	U.S.	L.S.	U.S.	L.S.	
.05	.0918	.1057	.2013	.1847	.2389	.2300	.4392	.3519	.3157	.3408	.3417	.3284			
.10	.0584	.0887	.1885	.1877	.2372	.2221					.3047	.3102	.2582	.3211	
.15	.0609	.0795	.1792	.1770	.2305	.2152		.3469		.3366	.3498	.2735	.3118	.2470	.3003
.20						.2148	.3289	.3539	.3395	.3546	.2740	.3101	.2278	.2729	
.25	.0535	.0486	.1506	.1553	.2122	.2150	.3242	.3566	.3403	.3583	.2762	.3163	.2158	.2602	
.30	-.0339	-.0389	.1320	.1457	.2119	.2220	.3160	.3494	.3316	.3555	.2773	.3190	.2039	.2433	
.40	-.0580	-.0510			.2206	.2400	.3097	.3409	.3202	.3515	.2802	.3207	.1783	.2156	
.50	.0296	-.0424	-.0771	-.0616			.0625	.0586					.1321	.0727	
.60	-.0531	-.0373	-.0928	-.0722	.0195	.0305	-.0868	-.0909	-.1051	-.0891	-.1036	-.0882	-.1157	-.1282	
.70			-.1118	-.0859			-.1242	-.1100	-.1289	-.1081	-.1244	-.1063		-.1191	
.80			-.1614	-.1739	-.1428	-.1128	-.1321	-.1125	-.1157	-.1118	-.1251	-.1105	-.1017	-.1104	
.90			-.1684	-.1769	-.1450	-.1283	-.1218	-.1140	-.1026	-.1047	-.1041	-.1100	-.1056	-.1017	
.95			-.1691	-.1707					-.0986	-.1003	-.0988	-.1046	-.1035	-.0969	

TAIL 2

TABLE X. - CONTINUED
(i) $\alpha = 11.95^\circ$

Cp at γ/b of														
x/c	0.02		0.22		0.44		0.56		0.67		0.83		0.98	
	U.S.	L.S.	U.S.	L.S.	U.S.	L.S.	U.S.	L.S.	U.S.	L.S.	U.S.	L.S.	U.S.	L.S.
.05	-.1112	.2789	-.1273	.5932	-.1385	.6889			.0372		-.0024	1.2529	.0052	1.0583
.10	-.0850	.2783	-.1220	.5399	-.1109	.6401			.0638	1.1387	-.0007	1.1341	-.0199	.9258
.15	-.0741	.2829	-.1216	.5089	-.1100	.6092			.0642	1.0670	-.0107	1.0676	-.0072	.8323
.20	-.0671	.2738							.0498	1.0125	-.0129	1.0183		
.25	-.0700	.2772	-.1133	.4724	-.1004	.5647	-.0859	.9337	.0296	.9675			.0018	.7139
.30	-.0869	.0976	-.1179	.4419	-.0850	.5299	-.0809	.9066	.0088	.9337	-.0187	.9450	.0059	-.6813
.40	-.0939	.1485	-.1554	.1579	-.1056	.5400	-.0809	.8278	-.0251	.8699	-.0209	.8542	.0040	.6057
.50	-.1084	.2806	-.1536	.2012			-.1577	.2990	-.1019	.3659	-.0519	.4346	-.0110	.3037
.60	-.0865	.2768	-.1522	.2184	-.1712	.1868	-.1517	.0245	-.1471	.0406	-.1518	.0437	-.1623	-.0294
.70			-.1466	.2563	-.1620	.0225	-.1527	-.0053	-.1446	.0395	-.1531	.0348	-.1582	-.0462
.80	-.1403	.0936	-.1674	.0142	-.1642	.0198	-.1529	-.0200			-.1534		-.1810	-.0530
.90	-.1413	.0211	-.1653	.0067	-.1647	.0221	-.1534	-.0199	-.1493	.0015	-.1538	.0363	-.2023	-.0557
.95			-.1536	.0056	-.1621	.0206	-.1497	-.0236	-.1535	-.0066	-.1531	.0290	-.2017	-.0602

TAIL 1

Cp at γ/b of														
x/c	0.02		0.22		0.44		0.56		0.67		0.83		0.98	
	U.S.	L.S.	U.S.	L.S.	U.S.	L.S.	U.S.	L.S.	U.S.	L.S.	U.S.	L.S.	U.S.	L.S.
.05	.0807	.0966	.1535	.1473	.2086	.2029	.4292	.3218	.3258	.3391	.3493	.3332		
.10	.0502	.0758	.1430	.1488	.2037	.1833					.3125	.3137	.2654	.3236
.15	.0532	.0680	.1337	.1390	.1956	.1728		.3250	.3335	.3394	.2824	.3143	.2551	.3038
.20						.1698	.3096	.3304	.3377	.3422	.2834	.3160	.2370	.2766
.25	.0440	.0356	.1033	.1144	.1787	.1731	.3078	.3335	.3382	.3454	.2850	.3202	.2259	.2643
.30	-.0420	-.0457	.0838	.1018	.1773	.1794	.3050	.3257	.3347	.3484	.2855	.3220	.2140	.2478
.40	-.0650	-.0573			.1835	.2015	.3006	.3208	.3252	.3484	.2858	.3230	.1872	.2211
.50	.0293	-.0506	-.1041	-.0896			.0498	.0524					.1396	.0731
.60	-.0610	-.0468	-.1187	-.1031	.0069	-.0125	-.0889	-.0936	-.1071	-.0925	-.1049	-.0907	-.1209	-.1272
.70			-.1227	-.1097			-.1283	-.1215	-.1316	-.1114	-.1259	-.1083		-.1184
.80			-.1682	-.1742	-.1422	-.1100	-.1185	-.1190	-.1097	-.1161	-.1237	-.1116	-.1013	-.1105
.90			-.1753	-.1769	-.1590	-.1271	-.1128	-.1045	-.1009	-.1056	-.1038	-.1095	-.1060	-.1011
.95			-.1755	-.1757					-.0984	-.0982	-.0987	-.1026	-.1043	-.0964

TAIL 2

TABLE X. - CONTINUED
(j) $\alpha = 15.95^\circ$

Cp at γ/b of														
x/c	0.02		0.22		0.44		0.56		0.67		0.83		0.98	
	U.S.	L.S.	U.S.	L.S.	U.S.	L.S.	U.S.	L.S.	U.S.	L.S.	U.S.	L.S.	U.S.	L.S.
.05	-.1110	.1659	-.1820	.6426	-.1980	.7382			-.0437		-.1168	1.3683	-.0926	1.2138
.10	-.1061	.1698	-.1701	.5933	-.1723	.7015			.0065	1.2387	-.0887	1.2557	-.0780	1.0660
.15	-.1018	.1714	-.1640	.5664	-.1750	.6736			.0028	1.1736	-.0846	1.1787	-.0529	.9616
.20	-.0965	.1756							-.0200	1.1195	-.0807	1.1172		
.25	-.0953	.1811	-.1511	.5352	-.1566	.6260	-.1534	1.0616	-.0381	1.0733			-.0474	.8169
.30	-.1108	.1041	-.1553	.4987	-.1280	.5848	-.1510	1.0179	-.0537	1.0325	-.0737	1.0264	-.0469	.7737
.40	-.1136	.1783	-.1700	.2450	-.1602	.5890	-.1506	.9144	-.0831	.9527	-.0715	.9140	-.0398	.6721
.50	-.1355	.3268	-.1718	.3044			-.1860	.3444	-.1448	.3962	-.0976	.4501	-.0533	.3294
.60	-.1084	.3184	-.1539	.3477	-.1809	.3409	-.1745	.0519	-.1674	.0664	-.1691	.0814	-.1920	-.0073
.70			-.1542	.3676	-.1800	.1199	-.1747	.0306	-.1647	.0652	-.1704	.0887	-.1849	-.0135
.80	-.1569	.1243	-.1777	.0777	-.1816	.1239	-.1738	.0529			-.1712		-.1839	-.0127
.90	-.1565	.0627	-.1788	.0674	-.1813	.1243	-.1751	.0669	-.1667	.0229	-.1713	.0838	-.1841	-.0103
.95			-.1710	.0618	-.1774	.1186	-.1713	.0682	-.1729	.0168	-.1703	.0757	-.1852	-.0130

TAIL 1

Cp at γ/b of														
x/c	0.02		0.22		0.44		0.56		0.67		0.83		0.98	
	U.S.	L.S.	U.S.	L.S.	U.S.	L.S.	U.S.	L.S.	U.S.	L.S.	U.S.	L.S.	U.S.	L.S.
.05	.0547	.0672	.0897	.0852	.0409	.0361	.2425	.1542	.2709	.2610	.3588	.3548		
.10	.0196	.0512	.0814	.0798	.0379	.0253					.3485	.3203	.2825	.3421
.15	.0177	.0408	.0773	.0765	.0305	.0182		.1539	.2503	.2527	.3170	.3355	.2705	.3223
.20						.0149	.1399	.1502	.2439	.2501	.3050	.3322	.2498	.2942
.25	.0036	.0069	.0593	.0702	.0174	.0141	.1349	.1471	.2445	.2472	.3043	.3376	.2388	.2819
.30	-.0754	-.0701	.0446	.0634	.0138	.0147	.1232	.1416	.2366	.2480	.3021	.3402	.2262	.2664
.40	-.0961	-.0840			.0112	.0241	.1125	.1278	.2178	.2459	.3019	.3388	.2028	.2410
.50	.0115	-.0850	-.1248	-.1091			-.0606	-.0567					.1579	.0900
.60	-.0939	-.0763	-.1435	-.1241	-.1354	-.1278	-.1136	-.1291	-.1394	-.1276	-.1080	-.0850	-.1332	-.1206
.70			-.1517	-.1329			-.1838	-.1729	-.1626	-.1469	-.1320	-.1073		-.1141
.80			-.1832	-.1868	-.1808	-.1771	-.1886	-.1781	-.1681	-.1530	-.1345	-.1147	-.1100	-.1120
.90			-.1916	-.1878	-.1838	-.1798	-.1792	-.1774	-.1567	-.1482	-.1139	-.1186	-.1090	-.1105
.95			-.1908	-.1852					-.1512	-.1504	-.1084	-.1175	-.1090	-.1082

TAIL 2

TABLE X. - CONCLUDED
(k) $\alpha = 19.95^\circ$

Cp at γ/b of														
x/c	0.02		0.22		0.44		0.56		0.67		0.83		0.98	
	U.S.	L.S.	U.S.	L.S.	U.S.	L.S.	U.S.	L.S.	U.S.	L.S.	U.S.	L.S.	U.S.	L.S.
.05	-.1666	.2749	-.1944	.7087	-.2023	.8072			-.0751		-.1556	1.4825	-.1382	1.3397
.10	-.1485	.2286	-.1927	.6836	-.1856	.7850			-.0377	1.3838	-.1265	1.3828	-.1086	1.1989
.15	-.1400	.2113	-.1925	.6708	-.1974	.7600			-.0466	1.3181	-.1130	1.3067	-.0807	1.0904
.20	-.1295	.2118							-.0633	1.2608	-.1058	1.2443		
.25	-.1241	.2263	-.1838	.6394	-.1806	.7102	-.1865	1.2017	-.0810	1.2089			-.0665	.9333
.30	-.1355	.1131	-.1933	.5790	-.1588	.6701	-.1861	1.1449	-.0955	1.1638	-.0980	1.1457	-.0640	.8827
.40	-.1394	.2209	-.1837	.3788	-.1886	.6818	-.1835	1.0315	-.1191	1.0719	-.0967	1.0236	-.0556	.7622
.50	-.1620	.4108	-.1916	.4598			-.1873	.4073	-.1682	.4398	-.1208	.5065	-.0704	.3771
.60	-.1305	.4092	-.1913	.4965	-.1862	.5825	-.1837	.1093	-.1763	.1051	-.1725	.1036	-.1838	.0220
.70			-.1956	.4948	-.1829	.2254	-.1852	.1477	-.1734	.1038	-.1738	.1252	-.1818	.0271
.80	-.1727	.1854	-.1835	.1415	-.1842	.2086	-.1850	.1750			-.1740		-.1807	.0367
.90	-.1644	.1212	-.1961	.1270	-.1797	.2010	-.1864	.1759	-.1750	.1064	-.1735	.1355	-.1797	.0431
.95			-.1924	.1194	-.1765	.1953	-.1812	.1680	-.1809	.1057	-.1724	.1303	-.1782	.0403

TAIL 1

Cp at γ/b of														
x/c	0.02		0.22		0.44		0.56		0.67		0.83		0.98	
	U.S.	L.S.	U.S.	L.S.	U.S.	L.S.	U.S.	L.S.	U.S.	L.S.	U.S.	L.S.	U.S.	L.S.
.05	.0211	.0280	-.0003	.0210	-.0165	-.0066	.0777	.0325	.0434	.0447	.1281	.1131		
.10	-.0150	.0279	-.0009	.0243	-.0178	-.0131					.1109	.1024	.2311	.2500
.15	-.0192	.0162	-.0026	.0238	-.0235	-.0172		.0350	.0394	.0395	.1094	.0963	.2166	.2225
.20						-.0181	.0169	.0345	.0354	.0380	.1027	.0930	.1936	.1957
.25	-.0396	-.0215	-.0168	.0201	-.0324	-.0175	.0123	.0355	.0257	.0379	.0965	.0965	.1826	.1877
.30	-.1059	-.0929	-.0238	.0154	-.0355	-.0138	.0093	.0310	.0138	.0375	.0873	.0946	.1644	.1780
.40	-.1254	-.1088			-.0345	-.0075	-.0007	.0259	.0055	.0358	.0723	.0834	.1417	.1630
.50	.0059	-.1126	-.1496	-.1311			-.1169	-.1067					.1082	.0357
.60	-.1247	-.1068	-.1678	-.1459	-.1504	-.1363	-.1272	-.1438	-.1836	-.1793	-.1761	-.1629	-.1422	-.1327
.70			-.1748	-.1546			-.1989	-.1908	-.1973	-.1915	-.1911	-.1799		-.1392
.80			-.1869	-.1984	-.1917	-.1830	-.1957	-.1937	-.1936	-.1915	-.1958	-.1868	-.1386	-.1315
.90			-.2009	-.1985	-.1943	-.1892	-.1905	-.1889	-.1814	-.1758	-.1906	-.1854	-.1577	-.1446
.95			-.2011	-.1973					-.1839	-.1818	-.1876	-.1829	-.1739	-.1601

TAIL 2

TABLE XI. - PRESSURE COEFFICIENTS, $\phi = 90^\circ$, $\delta = 0^\circ$, $M = 3.70$.
(a) $\alpha = -4.15^\circ$

Cp at γ/b of														
x/c	0.02		0.22		0.44		0.56		0.67		0.83		0.98	
	U.S.	L.S.	U.S.	L.S.	U.S.	L.S.	U.S.	L.S.	U.S.	L.S.	U.S.	L.S.	U.S.	L.S.
.05	.0391	.0463	.1271	.1391	.1351	.1483			.2007		.1944	.2438	.2011	.2388
.10	.0401	.0452	.1241	.1371	.1360	.1432			.1969	.2177	.1922	.2313	.1684	.2201
.15	.0392	.0434	.1205	.1342	.1257	.1400			.1928	.2197	.1829	.2231	.1667	.2077
.20	.0381	.0439							.1904	.2210	.1759	.2197		
.25	.0334	.0407	.1147	.1256	.1241	.1399	.1863	.2244	.1857	.2208			.1456	.1851
.30	.0038	.1508	.1051	.1169	.1459		.1914	.2325	.1825	.2218	.1711	.2162	.1376	.1798
.40	-.0083	.1458	.0201	.0326	.1198	.1528	.1874	.2320	.1774	.2193	.1648	.2110	.1259	.1633
.50	-.0072	.0899	-.0020	.0132			.0398	.0579	.0957	.0873	.1256	.1066	.0967	.0761
.60	.0062	-.0057	-.0062	.0114	.0116	.0435	-.0423	-.0241	-.0372	-.0206	-.0431	-.0287	-.0507	-.0377
.70			-.0151	.0029	-.0457	-.0241	-.0511	-.0339	-.0324	-.0166	-.0568	-.0412	-.0541	-.0416
.80	-.0369	-.0180	-.0329	-.0333	-.0444	-.0346	-.0412	-.0359			-.0491		-.0497	-.0433
.90	-.0366	-.0234	-.0430	-.0380	-.0410	-.0351	-.0414	-.0359	-.0365	-.0194	-.0451	-.0354	-.0476	-.0417
.95			-.0366	-.0353	-.0333	-.0132	-.0339	-.0295	-.0445	-.0331	-.0435	-.0365	-.0463	-.0404

TAIL 1

Cp at γ/b of														
x/c	0.02		0.22		0.44		0.56		0.67		0.83		0.98	
	U.S.	L.S.	U.S.	L.S.	U.S.	L.S.	U.S.	L.S.	U.S.	L.S.	U.S.	L.S.	U.S.	L.S.
.05	.1080	.0018	.2753	.0306	.2544	.0600	.4087	.1010		.1179	.3267	.1311		
.10	.1052	-.0053	.2620	.0329	.2581	.0527					.3179	.1161	.2731	.1319
.15	.1087	-.0037	.2501	.0323	.2568	.0494		.1025	.3007	.1090	.3117	.1118	.2608	.1070
.20						.0464	.3380	.1039	.3052	.1072	.3015	.1080	.2442	.0924
.25	.1084	-.0050	.2251	.0298	.2484	.0472	.3429	.1039	.3088	.1075	.2929	.1081	.2326	.0875
.30	.0473	-.0238	.2134	.0293	.2491	.0490	.3408	.1025	.3094	.1071	.2853	.1085	.2205	.0816
.40	.0414	-.0271			.2487	.0539	.3367	.1009	.3064	.1064	.2788	.1054	.2015	.0722
.50	.0300	-.0274	.0449	-.0387			.1313	.0005					.1698	.0182
.60	.0478	-.0243	.0398	-.0418	.0611	-.0177	-.0277	-.0501	-.0000	-.0537	-.0144	-.0452	-.0322	-.0492
.70			.0340	-.0439			-.0343	-.0511	-.0260	-.0515	-.0362	-.0466		-.0509
.80			-.0388	-.0488	-.0286	-.0267	-.0390	-.0481	-.0329	-.0451	-.0406	-.0451	-.0422	-.0479
.90			-.0517	-.0487	-.0495	-.0456	-.0422	-.0485	-.0368	-.0347	-.0438	-.0444	-.0453	-.0474
.95			-.0515	-.0492					-.0427	-.0435	-.0454	-.0448	-.0395	-.0416

TAIL 2

TABLE XI. - CONTINUED
(b) $\alpha = -2.14^\circ$

Cp at y/b of														
x/c	0.02		0.22		0.44		0.56		0.67		0.83		0.98	
	U.S.	L.S.	U.S.	L.S.	U.S.	L.S.	U.S.	L.S.	U.S.	L.S.	U.S.	L.S.	U.S.	L.S.
.05	.0337	.0359	.1342	.1472	.1380	.1507			.2017		.1964	.2455	.2029	.2417
.10	.0350	.0404	.1290	.1435	.1386	.1453			.1972	.2192	.1929	.2328	.1683	.2214
.15	.0354	.0410	.1217	.1352	.1281	.1422			.1934	.2207	.1826	.2248	.1666	.2073
.20	.0363	.0428							.1912	.2219	.1761	.2216		
.25	.0330	.0415	.1118	.1215	.1263	.1419	.1848	.2248	.1869	.2213			.1450	.1818
.30	.0084	.1077	.1018	.1126	.1264		.1894	.2327	.1837	.2222	.1724	.2185	.1359	.1777
.40	.0006	.1080	.0162	.0244	.1213	.1517	.1866	.2313	.1784	.2197	.1664	.2135	.1245	.1622
.50	.0051	.0354	-.0060	.0075			.0444	.0563	.0953	.0860	.1268	.1075	.0953	.0753
.60	.0120	.0184	-.0088	.0066	.0108	.0380	-.0431	-.0278	-.0377	-.0237	-.0425	-.0312	-.0496	-.0378
.70			-.0166	-.0006	-.0473	-.0304	-.0514	-.0382	-.0330	-.0197	-.0575	-.0443	-.0538	-.0422
.80	-.0298	-.0145	-.0304	-.0369	-.0438	-.0415	-.0395	-.0394			-.0494		-.0498	-.0445
.90	-.0342	-.0254	-.0412	-.0379	-.0406	-.0385	-.0404	-.0387	-.0393	-.0291	-.0450	-.0374	-.0475	-.0417
.95			-.0352	-.0358	-.0370	-.0229	-.0332	-.0314	-.0458	-.0393	-.0439	-.0385	-.0463	-.0402

TAIL 1

Cp at y/b of														
x/c	0.02		0.22		0.44		0.56		0.67		0.83		0.98	
	U.S.	L.S.	U.S.	L.S.	U.S.	L.S.	U.S.	L.S.	U.S.	L.S.	U.S.	L.S.	U.S.	L.S.
.05	.0743	.0231	.2149	.0693	.1988	.0972	.3383	.1450			.2737	.1690		
.10	.0738	.0163	.2060	.0769	.2002	.0902					.2640	.1561	.2273	.1704
.15	.0789	.0167	.1988	.0732	.1980	.0865		.1479	.2426	.1536	.2594	.1532	.2146	.1454
.20						.0837	.2667	.1518	.2441	.1521	.2510	.1499	.1987	.1295
.25	.0804	.0147	.1806	.0693	.1913	.0848	.2708	.1537	.2476	.1526	.2432	.1506	.1885	.1248
.30	.0320	-.0109	.1709	.0688	.1920	.0873	.2664	.1527	.2493	.1523	.2354	.1517	.1781	.1184
.40	.0494	-.0152			.1941	.0936	.2639	.1507	.2471	.1516	.2291	.1482	.1611	.1074
.50	.0345	-.0162	.0210	-.0228			.0983	.0240					.1325	.0414
.60	.0254	-.0145	.0150	-.0293	.0404	-.0147	-.0292	-.0451	-.0163	-.0481	-.0230	-.0425	-.0364	-.0479
.70			.0098	-.0333			-.0432	-.0605	-.0390	-.0586	-.0415	-.0552		-.0542
.80			-.0458	-.0502	-.0338	-.0304	-.0475	-.0524	-.0414	-.0482	-.0469	-.0499	-.0466	-.0501
.90			-.0480	-.0477	-.0516	-.0479	-.0499	-.0494	-.0396	-.0420	-.0486	-.0460	-.0471	-.0474
.95			-.0459	-.0484					-.0464	-.0460	-.0470	-.0454	-.0379	-.0435

TAIL 2

TABLE XI. - CONTINUED
(c) $\alpha = -0.16^\circ$

Cp at y/b of														
x/c	0.02		0.22		0.44		0.56		0.67		0.83		0.98	
	U.S.	L.S.	U.S.	L.S.	U.S.	L.S.	U.S.	L.S.	U.S.	L.S.	U.S.	L.S.	U.S.	L.S.
.05	.0373	.0417	.1342	.1446	.1413	.1541			.2031		.1973	.2462	.2027	.2387
.10	.0401	.0480	.1284	.1408	.1411	.1480			.1976	.2199	.1937	.2332	.1849	.2176
.15	.0409	.0479	.1245	.1385	.1306	.1446			.1933	.2208	.1818	.2245	.1632	.2014
.20	.0419	.0508							.1917	.2214	.1764	.2214		
.25	.0390	.0500	.1203	.1318	.1287	.1439	.1848	.2239	.1874	.2202			.1410	.1753
.30	.0096	.0826	.1102	.1228	.1278		.1898	.2314	.1847	.2208	.1730	.2178	.1331	.1697
.40	-.0014	.0856	.0209	.0290	.1245	.1528	.1855	.2297	.1787	.2182	.1668	.2129	.1209	.1572
.50	.0014	.0306	-.0034	.0114			.0408	.0545	.0967	.0845	.1274	.1071	.0925	.0721
.60	.0124	.0162	-.0064	.0103	.0105	.0368	-.0426	-.0284	-.0379	-.0248	-.0425	-.0331	-.0485	-.0374
.70			-.0144	.0024	-.0473	-.0307	-.0505	-.0388	-.0336	-.0207	-.0583	-.0459	-.0544	-.0431
.80	-.0316	-.0153	-.0292	-.0370	-.0435	-.0422	-.0395	-.0401			-.0515		-.0515	-.0469
.90	-.0359	-.0276	-.0394	-.0363	-.0402	-.0391	-.0399	-.0390	-.0399	-.0309	-.0469	-.0395	-.0484	-.0440
.95			-.0341	-.0345	-.0370	-.0233	-.0334	-.0316	-.0463	-.0409	-.0451	-.0403	-.0479	-.0422

TAIL 1

Cp at y/b of														
x/c	0.02		0.22		0.44		0.56		0.67		0.83		0.98	
	U.S.	L.S.	U.S.	L.S.	U.S.	L.S.	U.S.	L.S.	U.S.	L.S.	U.S.	L.S.	U.S.	L.S.
.05	.0533	.0441	.1581	.1256	.1505	.1404	.2757	.1935		.2076	.2251	.2126		
.10	.0516	.0385	.1505	.1247	.1496	.1349					.2138	.2006	.1846	.2116
.15	.0551	.0398	.1454	.1214	.1472	.1284		.2000	.1859	.2026	.2094	.1995	.1710	.1883
.20						.1273	.2064	.2072	.1903	.2009	.2028	.1959	.1566	.1727
.25	.0550	.0377	.1329	.1129	.1408	.1277	.2090	.2103	.1971	.2018	.1960	.1976	.1473	.1673
.30	.0154	.0052	.1258	.1103	.1413	.1315	.2065	.2083	.1964	.2024	.1884	.1990	.1380	.1598
.40	.0512	.0021			.1413	.1388	.2010	.2055	.1927	.2019	.1818	.1956	.1235	.1467
.50	.0347	.0012	-.0010	.0004			.0543	.0487					.0987	.0673
.60	.0066	.0043	-.0083	-.0090	.0143	.0083	-.0339	-.0393	-.0291	-.0379	-.0328	-.0325	-.0401	-.0439
.70			-.0125	-.0134			-.0521	-.0548	-.0495	-.0544	-.0482	-.0505		-.0512
.80			-.0450	-.0562	-.0350	-.0360	-.0528	-.0587	-.0480	-.0537	-.0498	-.0543	-.0475	-.0530
.90			-.0447	-.0496	-.0453	-.0520	-.0473	-.0551	-.0390	-.0436	-.0444	-.0492	-.0445	-.0496
.95			-.0442	-.0484					-.0437	-.0459	-.0426	-.0463	-.0359	-.0443

TAIL 2

TABLE XI. - CONTINUED
(d) $\alpha = 1.85^\circ$

Cp at y/b of														
x/c	0.02		0.22		0.44		0.56		0.67		0.83		0.98	
	U.S.	L.S.	U.S.	L.S.	U.S.	L.S.	U.S.	L.S.	U.S.	L.S.	U.S.	L.S.	U.S.	L.S.
.05	.0447	.0558	.1377	.1485	.1464	.1588			.2032		.1972	.2468	.2039	.2394
.10	.0488	.0600	.1308	.1439	.1447	.1518			.1970	.2207	.1921	.2326	.1646	.2173
.15	.0483	.0587	.1267	.1409	.1336	.1479			.1929	.2215	.1793	.2234	.1615	.1998
.20	.0484	.0604							.1914	.2223	.1749	.2139		
.25	.0444	.0589	.1238	.1369	.1315	.1471	.1843	.2228	.1878	.2208			.1409	.1732
.30	.0092	.0682	.1153	.1298	.1309		.1895	.2309	.1855	.2209	.1722	.2170	.1336	.1679
.40	-.0070	.0707	.0238	.0334	.1282	.1554			.1852	.2290	.1792	.2179	.1662	.2124
.50	-.0061	.0261	-.0016	.0136			.0421	.0547	.0965	.0814	.1261	.1053	.0935	.0708
.60	.0040	.0087	-.0051	.0120	.0107	.0365	-.0421	-.0283	-.0386	-.0260	-.0417	-.0337	-.0458	-.0359
.70			-.0138	.0035	-.0476	-.0315	-.0513	-.0395	-.0343	-.0219	-.0580	-.0464	-.0535	-.0424
.80	-.0385	-.0223	-.0294	-.0380	-.0462	-.0433	-.0414	-.0407			-.0525		-.0524	-.0459
.90	-.0366	-.0326	-.0397	-.0375	-.0417	-.0411	-.0418	-.0406	-.0397	-.0311	-.0473	-.0403	-.0467	-.0418
.95			-.0345	-.0351	-.0380	-.0247	-.0349	-.0332	-.0466	-.0412	-.0456	-.0410	-.0475	-.0425

TAIL 1

Cp at y/b of														
x/c	0.02		0.22		0.44		0.56		0.67		0.83		0.98	
	U.S.	L.S.	U.S.	L.S.	U.S.	L.S.	U.S.	L.S.	U.S.	L.S.	U.S.	L.S.	U.S.	L.S.
.05	.0289	.0670	.1061	.1735	.1079	.1907	.2192	.2454		.2588	.1801	.2601		
.10	.0259	.0614	.0995	.1747	.1048	.1832					.1671	.2491	.1461	.2567
.15	.0295	.0640	.0942	.1767	.1023	.1762		.2602	.1371	.2549	.1630	.2493	.1318	.2361
.20						.1757	.1526	.2681	.1429	.2537	.1576	.2463	.1184	.2191
.25	.0288	.0604	.0849	.1624	.0961	.1765	.1535	.2726	.1490	.2556	.1521	.2490	.1097	.2135
.30	-.0011	.0182	.0799	.1595	.0963	.1816	.1518	.2721	.1477	.2571	.1452	.2508	.1014	.2050
.40	.0491	.0181			.0956	.1896	.1470	.2720	.1445	.2570	.1387	.2468	.0888	.1893
.50	.0312	.0133	-.0216	.0241			.0221	.0795					.0676	.0955
.60	-.0066	.0261	-.0278	.0129	-.0048	.0350	-.0379	-.0326	-.0394	-.0253	-.0409	-.0212	-.0441	-.0404
.70			-.0308	.0081			-.0535	-.0444	-.0554	-.0430	-.0511	-.0423		-.0457
.80			-.0434	-.0488	-.0318	-.0292	-.0480	-.0500	-.0453	-.0460	-.0460	-.0484	-.0474	-.0485
.90			-.0460	-.0557	-.0455	-.0530	-.0459	-.0524	-.0384	-.0436	-.0437	-.0506	-.0456	-.0504
.95			-.0462	-.0546					-.0448	-.0484	-.0431	-.0509	-.0369	-.0464

TAIL 2

TABLE XI. - CONTINUED
(e) $\alpha = 3.85^\circ$

Cp at y/b of														
x/c	0.02		0.22		0.44		0.56		0.67		0.83		0.98	
	U.S.	L.S.	U.S.	L.S.	U.S.	L.S.	U.S.	L.S.	U.S.	L.S.	U.S.	L.S.	U.S.	L.S.
.05	.0556	.0715	.1453	.1535	.1526	.1629			.2083		.2042	.2510	.2109	.2438
.10	.0587	.0714	.1378	.1490	.1507	.1555			.2015	.2216	.1979	.2374	.1708	.2200
.15	.0566	.0690	.1332	.1459	.1394	.1517			.1966	.2226	.1857	.2281	.1660	.2022
.20	.0556	.0695							.1948	.2230	.1825	.2249		
.25	.0511	.0677	.1302	.1422	.1374	.1508	.1880	.2222	.1916	.2208			.1457	.1753
.30	.0119	.0598	.1219	.1358	.1355		.1934	.2294	.1894	.2206	.1792	.2213	.1396	.1705
.40	-.0073	.0615	.0259	.0374	.1345	.1585	.1881	.2279	.1828	.2172	.1725	.2161	.1274	.1572
.50	-.0065	.0247	.0007	.0170			.0422	.0576	.0992	.0773	.1318	.1081	.0985	.0740
.60	.0006	.0077	-.0034	.0151	.0130	.0375	-.0395	-.0268	-.0381	-.0256	-.0413	-.0326	-.0442	-.0331
.70			-.0126	.0065	-.0467	-.0304	-.0499	-.0381	-.0339	-.0217	-.0594	-.0455	-.0531	-.0419
.80	-.0421	-.0253	-.0297	-.0364	-.0471	-.0420	-.0422	-.0395			-.0540		-.0506	-.0391
.90	-.0343	-.0328	-.0402	-.0356	-.0421	-.0410	-.0420	-.0400	-.0404	-.0303	-.0484	-.0404	-.0611	-.0496
.95			-.0350	-.0335	-.0377	-.0241	-.0345	-.0325	-.0472	-.0400	-.0462	-.0403	-.0602	-.0488

TAIL 1

Cp at y/b of														
x/c	0.02		0.22		0.44		0.56		0.67		0.83		0.98	
	U.S.	L.S.	U.S.	L.S.	U.S.	L.S.	U.S.	L.S.	U.S.	L.S.	U.S.	L.S.	U.S.	L.S.
.05	.0085	.0992	.0620	.2077	.0695	.2471	.1648	.3035		.3148	.1375	.3136		
.10	.0043	.0910	.0546	.2344	.0645	.2370					.1226	.3026	.1093	.3051
.15	.0076	.0932	.0499	.2297	.0616	.2305		.3295	.0936	.3115	.1178	.3030	.0947	.2881
.20						.2309	.1037	.3407	.0972	.3119	.1130	.3008	.0828	.2703
.25	.0075	.0855	.0418	.2108	.0560	.2317	.1034	.3469	.1034	.3151	.1084	.3043	.0751	.2639
.30	-.0145	.0296	.0381	.2057	.0557	.2371	.1019	.3470	.1018	.3185	.1032	.3053	.0677	.2541
.40	.0431	.0375			.0548	.2450	.0979	.3469	.0994	.3193	.0972	.3017	.0572	.2343
.50	.0258	.0407	-.0356	.0506			.0034	.1137					.0400	.1248
.60	-.0153	.0538	-.0386	.0388	-.0204	.0658	-.0441	-.0250	-.0486	-.0072	-.0459	-.0080	-.0464	-.0354
.70			-.0409	.0334			-.0500	-.0299	-.0529	-.0271	-.0456	-.0315		-.0411
.80			-.0440	-.0359	-.0314	-.0196	-.0481	-.0363	-.0451	-.0312	-.0439	-.0377	-.0449	-.0416
.90			-.0473	-.0472	-.0459	-.0442	-.0482	-.0397	-.0378	-.0340	-.0441	-.0419	-.0447	-.0442
.95			-.0476	-.0502					-.0447	-.0383	-.0439	-.0445	-.0381	-.0438

TAIL 2

TABLE XI. - CONTINUED
(f) $\alpha = 5.86^\circ$

Cp at y/b of														
x/c	0.02		0.22		0.44		0.56		0.67		0.83		0.98	
	U.S.	L.S.	U.S.	L.S.	U.S.	L.S.	U.S.	L.S.	U.S.	L.S.	U.S.	L.S.	U.S.	L.S.
.05	.0701	.0904	.1617	.1694	.1679	.1783			.2194		.2203	.2716	.2260	.2640
.10	.0723	.0867	.1529	.1640	.1652	.1702			.2140	.2352	.2120	.2567	.1870	.2378
.15	.0693	.0830	.1481	.1609	.1534	.1660			.2089	.2373	.2010	.2468	.1800	.2190
.20	.0663	.0817							.2078	.2379	.1982	.2432		
.25	.0615	.0789	.1449	.1571	.1514	.1651	.2012	.2384	.2051	.2358			.1596	.1916
.30	.0184	.0542	.1363	.1504	.1459		.2068	.2461	.2025	.2356	.1948	.2397	.1531	.1864
.40	-.0038	.0545	.0308	.0429	.1473	.1730	.2012	.2432	.1962	.2315	.1875	.2341	.1424	.1737
.50	-.0026	.0254	.0060	.0219			.0458	.0651	.1058	.0939	.1456	.1196	.1118	.0870
.60	.0019	.0104	.0009	.0199	.0192	.0431	-.0365	-.0261	-.0362	-.0247	-.0372	-.0299	-.0400	-.0296
.70			-.0083	.0105	-.0446	-.0297	-.0481	-.0379	-.0321	-.0206	-.0559	-.0439	-.0497	-.0394
.80	-.0420	-.0266	-.0299	-.0369	-.0478	-.0421	-.0423	-.0392			-.0510		-.0549	-.0436
.90	-.0321	-.0335	-.0390	-.0362	-.0412	-.0416	-.0407	-.0400	-.0376	-.0294	-.0452	-.0395	-.0581	-.0485
.95			-.0336	-.0340	-.0371	-.0247	-.0329	-.0317	-.0438	-.0384	-.0432	-.0389	-.0584	-.0487

TAIL 1

Cp at y/b of														
x/c	0.02		0.22		0.44		0.56		0.67		0.83		0.98	
	U.S.	L.S.	U.S.	L.S.	U.S.	L.S.	U.S.	L.S.	U.S.	L.S.	U.S.	L.S.	U.S.	L.S.
.05	-.0114	.1246	.0246	.2901	.0368	.3064	.1180	.3752		.3767	.0993	.3712		
.10	-.0150	.1123	.0164	.2986	.0300	.2993					.0830	.3578	.0752	.3579
.15	-.0118	.1131	.0116	.2782	.0265	.2934		.4118	.0604	.3743	.0779	.3600	.0603	.3410
.20						.2923	.0639	.4259	.0602	.3768	.0734	.3585	.0497	.3216
.25	-.0114	.1008	.0045	.2523	.0218	.2927	.0616	.4346	.0653	.3827	.0697	.3610	.0429	.3147
.30	-.0264	.0355	.0016	.2461	.0208	.2965	.0587	.4328	.0646	.3888	.0655	.3637	.0363	.3033
.40	.0376	.0525			.0199	.3038	.0555	.4331	.0636	.3919	.0604	.3599	.0283	.2792
.50	.0245	.0635	-.0469	.0773			-.0167	.1626					.0144	.1542
.60	-.0251	.0830	-.0465	.0648	-.0342	.0931	-.0480	-.0152	-.0539	.0171	-.0493	.0084	-.0496	-.0281
.70			-.0484	.0607			-.0489	-.0123	-.0496	-.0050	-.0463	-.0174		-.0382
.80			-.0481	-.0222	-.0344	-.0095	-.0487	-.0200	-.0445	-.0096	-.0464	-.0246	-.0461	-.0370
.90			-.0521	-.0361	-.0493	-.0328	-.0491	-.0242	-.0400	-.0147	-.0468	-.0282	-.0479	-.0378
.95			-.0520	-.0386					-.0472	-.0182	-.0466	-.0320	-.0394	-.0387

TAIL 2

TABLE XI. - CONTINUED
(g) $\alpha = 7.85^\circ$

Cp at y/b of														
x/c	0.02		0.22		0.44		0.56		0.67		0.83		0.98	
	U.S.	L.S.	U.S.	L.S.	U.S.	L.S.	U.S.	L.S.	U.S.	L.S.	U.S.	L.S.	U.S.	L.S.
.05	.0913	.1146	.1877	.1956	.1922	.2023			.2452		.2431	.2977	.2466	.2877
.10	.0930	.1091	.1787	.1899	.1886	.1936			.2372	.2595	.2333	.2815	.2059	.2585
.15	.0892	.1041	.1733	.1865	.1765	.1892			.2305	.2606	.2234	.2706	.1979	.2383
.20	.0845	.1018							.2289	.2608	.2209	.2669		
.25	.0792	.0987	.1692	.1827	.1745	.1878	.2249	.2634	.2267	.2582			.1789	.2110
.30	.0301	.0542	.1605	.1754	.1730		.2310	.2717	.2239	.2579	.2170	.2633	.1723	.2061
.40	.0058	.0535	.0406	.0547	.1706	.1960	.2242	.2679	.2176	.2537	.2093	.2572	.1609	.1934
.50	.0062	.0321	.0152	.0332			.0595	.0782	.1216	.1037	.1651	.1342	.1291	.1006
.60	.0112	.0213	.0091	.0305	.0323	.0546	-.0315	-.0215	-.0339	-.0215	-.0332	-.0264	-.0365	-.0258
.70			-.0003	.0201	-.0402	-.0251	-.0449	-.0344	-.0292	-.0175	-.0536	-.0416	-.0465	-.0347
.80	-.0382	-.0216	-.0269	-.0343	-.0444	-.0390	-.0393	-.0359			-.0465		-.0458	-.0399
.90	-.0284	-.0313	-.0353	-.0327	-.0371	-.0392	-.0360	-.0361	-.0333	-.0276	-.0406	-.0373	-.0484	-.0438
.95			-.0296	-.0303	-.0337	-.0226	-.0284	-.0266	-.0391	-.0354	-.0382	-.0362	-.0510	-.0466

TAIL 1

Cp at y/b of														
x/c	0.02		0.22		0.44		0.56		0.67		0.83		0.98	
	U.S.	L.S.	U.S.	L.S.	U.S.	L.S.	U.S.	L.S.	U.S.	L.S.	U.S.	L.S.	U.S.	L.S.
.05	-.0273	.1247	-.0053	.3648	-.0090	.3804	.0769	.4626		.4341	.0668	.4369		
.10	-.0305	.1180	-.0140	.3348	-.0012	.3713					.0476	.4175	.0541	.4203
.15	-.0254	.1163	-.0183	.3115	-.0031	.3583		.5098	.0260	.4372	.0412	.4216	.0392	.4040
.20						.3515	.0286	.5252	.0256	.4477	.0361	.4179	.0296	.3837
.25	-.0262	.1029	-.0245	.2850	-.0070	.3465	.0242	.5329	.0286	.4599	.0327	.4223	-.0234	.3759
.30	-.0354	.0337	-.0267	.2809	-.0092	.3458	.0219	.5239	.0279	.4713	.0286	.4246	.0175	.3611
.40	.0315	.0607			-.0093	.3487	.0179	.5117	.0276	.4812	.0235	.4209	.0121	.3307
.50	.0239	.0790	-.0539	.1016			-.0347	.1996					-.0001	.1891
.60	-.0371	.1038	-.0546	.0925	-.0429	.1208	-.0484	-.0035	-.0547	.0489	-.0503	.0280	-.0497	-.0166
.70			-.0551	.0860			-.0517	.0052	-.0531	.0234	-.0488	.0004		-.0336
.80			-.0519	-.0090	-.0375	.0042	-.0522	-.0039	-.0472	.0179	-.0496	-.0062	-.0493	-.0354
.90			-.0560	-.0231	-.0534	-.0169	-.0528	-.0089	-.0419	.0138	-.0498	-.0087	-.0508	-.0371
.95			-.0560	-.0256					-.0499	.0084	-.0498	-.0128	-.0419	-.0378

TAIL 2

TABLE XI. - CONTINUED
(h) $\alpha = 9.86^\circ$

Cp at y/b of														
x/c	0.02		0.22		0.44		0.56		0.67		0.83		0.98	
	U.S.	L.S.	U.S.	L.S.	U.S.	L.S.	U.S.	L.S.	U.S.	L.S.	U.S.	L.S.	U.S.	L.S.
.05	.1160	.1438	.2206	.2295	.2232	.2338			.2764		.2698	.3289	.2745	.3159
.10	.1183	.1363	.2112	.2239	.2189	.2243			.2682	.2915	.2600	.3120	.2293	.2837
.15	.1139	.1311	.2057	.2205	.2060	.2203			.2606	.2934	.2518	.3005	.2219	.2623
.20	.1074	.1274							.2584	.2927	.2500	.2967		
.25	.1022	.1237	.2005	.2163	.2034	.2184	.2556	.2972	.2557	.2895			.2033	.2350
.30	.0457	.0580	.1917	.2090	.1946		.2623	.3060	.2525	.2887	.2455	.2928	.1971	.2303
.40	.0188	.0553	.0542	.0716	.1976	.2262	.2542	.3017	.2454	.2838	.2374	.2862	.1851	.2181
.50	.0187	.0426	.0271	.0489			.0800	.0930	.1432	.1170	.1902	.1551	.1525	.1183
.60	.0198	.0355	.0202	.0448	.0465	.0707	-.0249	-.0158	-.0289	-.0171	-.0271	-.0213	-.0300	-.0209
.70			.0104	.0336	-.0353	-.0194	-.0396	-.0298	-.0247	-.0132	-.0484	-.0381	-.0408	-.0319
.80	-.0327	-.0139	-.0215	-.0300	-.0404	-.0350	-.0345	-.0315			-.0393		-.0349	-.0277
.90	-.0247	-.0278	-.0286	-.0273	-.0312	-.0355	-.0293	-.0305	-.0276	-.0239	-.0335	-.0337	-.0421	-.0379
.95			-.0236	-.0244	-.0283	-.0195	-.0218	-.0200	-.0324	-.0299	-.0314	-.0317	-.0489	-.0453

TAIL 1

Cp at y/b of														
x/c	0.02		0.22		0.44		0.56		0.67		0.83		0.98	
	U.S.	L.S.	U.S.	L.S.	U.S.	L.S.	U.S.	L.S.	U.S.	L.S.	U.S.	L.S.	U.S.	L.S.
.05	-.0343	.1309	-.0243	.3879	-.0148	.4540	.0461	.5705		.5069	.0545	.5164		
.10	-.0375	.1284	-.0330	.3626	-.0226	.4298					.0343	.4885	.0437	.4932
.15	-.0326	.1278	-.0365	.3352	-.0274	.4063		.6077	.0111	.5321	.0272	.4936	.0289	.4770
.20						.3924	.0034	.6169	.0066	.5531	.0218	.4911	.0201	.4551
.25	-.0341	.1057	-.0403	.3146	-.0301	.3813	-.0034	.6151	.0064	.5688	.0181	.4974	-.0147	.4458
.30	-.0411	.0350	-.0420	.3102	-.0328	.3813	-.0061	.5994	.0048	.5831	.0141	.4984	.0098	.4273
.40	.0247	.0684			-.0307	.3687	-.0107	.5763	.0036	.5802	.0092	.4972	-.0070	.3909
.50	.0193	.0929	-.0583	.1274			-.0465	.2512					-.0053	.2307
.60	-.0444	.1218	-.0593	.1209	-.0468	.1568	-.0485	.0092	-.0570	.0739	-.0531	.0536	-.0540	-.0008
.70			-.0583	.1117			-.0548	.0214	-.0562	.0491	-.0517	.0240		-.0231
.80			-.0536	.0055	-.0391	.0206	-.0555	.0097	-.0501	.0436	-.0526	.0218	-.0557	-.0273
.90			-.0583	-.0084	-.0553	.0009	-.0562	.0052	-.0445	.0372	-.0529	.0209	-.0570	-.0291
.95			-.0587	-.0108					-.0532	.0321	-.0526	.0160	-.0460	-.0312

TAIL 2

TABLE XI. - CONCLUDED
(i) $\alpha = 11.86^\circ$

Cp at y/b of														
x/c	0.02		0.22		0.44		0.56		0.67		0.83		0.98	
	U.S.	L.S.	U.S.	L.S.	U.S.	L.S.	U.S.	L.S.	U.S.	L.S.	U.S.	L.S.	U.S.	L.S.
.05	.1472	.1784	.2615	.2705	.2593	.2718			.3129		.3009	.3693	.3085	.3521
.10	.1496	.1693	.2513	.2646	.2546	.2615			.3033	.3291	.2900	.3498	.2566	.3156
.15	.1449	.1632	.2457	.2614	.2409	.2570			.2955	.3318	.2841	.3369	.2499	.2925
.20	.1362	.1590							.2929	.3302	.2818	.3333		
.25	.1303	.1551	.2388	.2570	.2387	.2555	.2926	.3380	.2901	.3270			.2308	.2650
.30	.0659	.0650	.2297	.2499	.2248		.2995	.3470	.2867	.3263	.2770	.3292	.2247	.2604
.40	.0353	.0605	.0722	.0924	.2305	.2627	.2912	.3432	.2785	.3206	.2685	.3221	.2126	.2477
.50	.0351	.0573	.0426	.0681			.1044	.1112	.1665	.1350	.2172	.1803	.1790	.1387
.60	.0329	.0537	.0351	.0626	.0657	.0909	-.0159	-.0086	-.0231	-.0113	-.0214	-.0139	-.0224	-.0146
.70			.0239	.0503	-.0286	-.0113	-.0332	-.0237	-.0190	-.0075			-.0361	-.0287
.80	-.0246	-.0027	-.0149	-.0241	-.0349	-.0294	-.0281	-.0256			-.0310		-.0271	-.0188
.90	-.0191	-.0226	-.0211	-.0200	-.0237	-.0307	-.0209	-.0219	-.0217	-.0183	-.0253	-.0272	-.0413	-.0368
.95			-.0165	-.0166	-.0218	-.0150	-.0142	-.0105	-.0253	-.0223	-.0237	-.0239	-.0507	-.0465

TAIL 1

Cp at y/b of														
x/c	0.02		0.22		0.44		0.56		0.67		0.83		0.98	
	U.S.	L.S.	U.S.	L.S.	U.S.	L.S.	U.S.	L.S.	U.S.	L.S.	U.S.	L.S.	U.S.	L.S.
.05	-.0414	.1855	-.0356	.4365	-.0218	.5172	-.0403	.6865		.5921	.0494	.6010		
.10	-.0471	.1738	-.0459	.4001	-.0282	.4855					.0289	.5691	.0400	.5760
.15	-.0407	.1567	-.0493	.3742	-.0328	.4585		.6953	.0066	.6531	.0207	.5734	.0248	.5583
.20						.4430	-.0053	.6989	-.0002	.6727	.0149	.5757	.0163	.5349
.25	-.0438	.1165	-.0532	.3555	-.0365	.4320	-.0114	.6985	.0004	.6889	.0113	.5802	.0115	.5223
.30	-.0487	.0437	-.0548	.3507	-.0398	.4302	-.0147	.6800	-.0014	.6844	.0071	.5847	.0077	.5010
.40	.0178	.0832			-.0381	.4085	-.0195	.6546	-.0025	.6915	.0020	.5913	.0064	.4601
.50	.0108	.1135	-.0607	.1571			-.0516	.2806					-.0055	.2746
.60	-.0512	.1475	-.0619	.1504	-.0503	.1863	-.0517	.0256	-.0613	.1095	-.0558	.0882	-.0563	.0189
.70			-.0612	.1420			-.0594	.0369	-.0599	.0807	-.0542	.0623		-.0060
.80			-.0562	.0238	-.0421	.0368	-.0597	.0257	-.0526	.0698	-.0551	.0604	-.0590	-.0099
.90			-.0615	.0101	-.0594	.0182	-.0605	.0220	-.0466	.0575	-.0554	.0578	-.0625	-.0128
.95			-.0621	.0060					-.0561	.0512	-.0549	.0507	-.0492	-.0159

TAIL 2

TABLE XII. - PRESSURE COEFFICIENTS, $\phi = 22.5^\circ$, $\delta = 0^\circ$, $M = 3.70$.
(a) $\alpha = -4.00^\circ$

Cp at γ/b of														
x/c	0.02		0.22		0.44		0.56		0.67		0.83		0.98	
	U.S.	L.S.	U.S.	L.S.	U.S.	L.S.	U.S.	L.S.	U.S.	L.S.	U.S.	L.S.	U.S.	L.S.
.05	.0110	.0489	.2003	.0837	.1807	.1085			.2437		.2353	.2061	.2394	.2059
.10	.0163	.0506	.1743	.0834	.1814	.1029			.2418	.1786	.2338	.1925	.2059	.1854
.15	.0187	.0486	.1520	.0814	.1735	.0985			.2371	.1786	.2240	.1844	.2053	.1733
.20	.0226	.0493							.2347	.1795	.2172	.1809		
.25	.0210	.0469	.1347	.0776	.1723	.0977	.2440	.1726	.2306	.1783			.1830	.1511
.30	.0040	.1617	.1235	.0718	.1524		.2483	.1791	.2280	.1788	.2131	.1774	.1739	.1466
.40	.0014	.1811	.0275	.0095	.1657	.1081	.2464	.1779	.2237	.1757	.2060	.1725	.1607	.1319
.50	.0080	.0781	.0064	-.0052			.0692	.0320	.1297	.0621	.1619	.0809	.1270	.0554
.60	.0120	.0096	.0014	-.0022	.0289	.0176	-.0321	-.0325	-.0273	-.0261	-.0350	-.0346	-.0461	-.0395
.70			-.0071	-.0068	-.0413	-.0338	-.0436	-.0400	-.0232	-.0222	-.0522	-.0437	-.0529	-.0410
.80	-.0259	-.0205	-.0354	-.0321	-.0479	-.0342	-.0433	-.0344			-.0537		-.0521	-.0390
.90	-.0291	-.0258	-.0421	-.0361	-.0413	-.0315	-.0444	-.0321	-.0415	-.0185	-.0465	-.0303	-.0478	-.0364
.95			-.0360	-.0350	-.0359	-.0147	-.0341	-.0281	-.0474	-.0321	-.0429	-.0333	-.0462	-.0356

TAIL 1

Cp at γ/b of														
x/c	0.02		0.22		0.44		0.56		0.67		0.83		0.98	
	U.S.	L.S.	U.S.	L.S.	U.S.	L.S.	U.S.	L.S.	U.S.	L.S.	U.S.	L.S.	U.S.	L.S.
.05	.1363	.0021	.2731	.0610	.2501	.0672	.4024	.1075		.1252	.3207	.1377		
.10	.1267	-.0072	.2620	.0387	.2530	.0603					.3106	.1235	.2689	.1393
.15	.1276	-.0070	.2535	.0365	.2512	.0554		.1111	.3045	.1170	.3064	.1191	.2557	.1121
.20						.0531	.3210	.1119	.3006	.1153	.2982	.1158	.2391	.0988
.25	.1242	-.0087	.2310	.0356	.2438	.0538	.3286	.1124	.3019	.1148	.2907	.1154	.2270	.0937
.30	.0574	-.0292	.2198	.0339	.2452	.0553	.3267	.1108	.3022	.1144	.2825	.1155	.2151	.0872
.40	.0560	-.0339			.2475	.0601	.3233	.1077	.2983	.1133	.2749	.1128	.1960	.0771
.50	.0395	-.0364	.0445	-.0376			.1267	.0049					.1639	.0214
.60	.0432	-.0375	.0390	-.0434	.0645	-.0189	-.0285	-.0496	-.0077	-.0532	-.0160	-.0452	-.0325	-.0477
.70			.0335	-.0457			-.0361	-.0562	-.0319	-.0532	-.0386	-.0512		-.0532
.80			-.0389	-.0495	-.0294	-.0303	-.0413	-.0516	-.0372	-.0465	-.0434	-.0481	-.0417	-.0478
.90			-.0522	-.0496	-.0505	-.0490	-.0445	-.0507	-.0383	-.0389	-.0464	-.0463	-.0478	-.0470
.95			-.0515	-.0492					-.0447	-.0461	-.0476	-.0458	-.0409	-.0453

TAIL 2

TABLE XII. - CONTINUED
(b) $\alpha = -2.00^\circ$

Cp at y/b of														
x/c	0.02		0.22		0.44		0.56		0.67		0.83		0.98	
	U.S.	L.S.	U.S.	L.S.	U.S.	L.S.	U.S.	L.S.	U.S.	L.S.	U.S.	L.S.	U.S.	L.S.
.05	.0343	.0346	.1625	.1201	.1600	.1323			.2244		.2189	.2265	.2240	.2235
.10	.0380	.0377	.1572	.1179	.1608	.1265			.2211	.1936	.2160	.2131	.1886	.2022
.15	.0389	.0369	.1481	.1147	.1512	.1229			.2168	.2000	.2051	.2046	.1872	.1879
.20	.0409	.0383							.2148	.2009	.1991	.2011		
.25	.0380	.0363	.1348	.1052	.1488	.1220	.2120	.1996	.2107	.1999			.1651	.1633
.30	.0117	.1181	.1233	.0967	.1544		.2179	.2067	.2075	.2006	.1953	.1975	.1550	.1588
.40	.0051	.1339	.0262	.0162	.1439	.1302	.2151	.2054	.2024	.1977	.1888	.1927	.1431	.1446
.50	.0106	.0339	.0027	-.0018			.0558	.0434	.1121	.0733	.1464	.0928	.1111	.0633
.60	.0209	.0118	-.0013	-.0019	.0230	.0246	-.0380	-.0319	-.0328	-.0264	-.0382	-.0357	-.0479	-.0405
.70			-.0092	-.0082	-.0433	-.0346	-.0484	-.0411	-.0283	-.0225	-.0554	-.0473	-.0535	-.0448
.80	-.0259	-.0180	-.0325	-.0340	-.0479	-.0406	-.0435	-.0396			-.0530		-.0514	-.0455
.90	-.0316	-.0267	-.0409	-.0362	-.0418	-.0352	-.0415	-.0354	-.0411	-.0265	-.0460	-.0347	-.0478	-.0417
.95			-.0345	-.0354	-.0364	-.0206	-.0333	-.0299	-.0462	-.0378	-.0435	-.0372	-.0463	-.0404

TAIL 1

Cp at y/b of														
x/c	0.02		0.22		0.44		0.56		0.67		0.83		0.98	
	U.S.	L.S.	U.S.	L.S.	U.S.	L.S.	U.S.	L.S.	U.S.	L.S.	U.S.	L.S.	U.S.	L.S.
.05	.0851	.0266	.2127	.0931	.1973	.1015	.3373	.1507		.1658	.2728	.1748		
.10	.0823	.0187	.2040	.0771	.1981	.0950					.2619	.1622	.2262	.1750
.15	.0863	.0184	.1978	.0759	.1956	.0908		.1541	.2523	.1590	.2577	.1592	.2130	.1492
.20						.0880	.2610	.1577	.2482	.1574	.2504	.1557	.1971	.1343
.25	.0859	.0164	.1812	.0738	.1885	.0889	.2658	.1593	.2493	.1574	.2431	.1565	.1867	.1290
.30	.0339	-.0132	.1719	.0725	.1898	.0914	.2630	.1579	.2479	.1575	.2352	.1571	.1759	.1217
.40	.0589	-.0171			.1917	.0974	.2583	.1557	.2440	.1567	.2282	.1539	.1589	.1105
.50	.0394	-.0204	.0198	-.0232			.0889	.0277					.1303	.0437
.60	.0216	-.0198	.0134	-.0303	.0384	-.0130	-.0302	-.0451	-.0198	-.0469	-.0245	-.0415	-.0368	-.0461
.70			.0084	-.0318			-.0437	-.0608	-.0412	-.0588	-.0433	-.0554		-.0542
.80			-.0455	-.0502	-.0340	-.0317	-.0477	-.0541	-.0426	-.0485	-.0485	-.0505	-.0460	-.0503
.90			-.0483	-.0478	-.0522	-.0488	-.0502	-.0497	-.0408	-.0422	-.0493	-.0460	-.0482	-.0470
.95			-.0462	-.0474					-.0466	-.0459	-.0472	-.0453	-.0391	-.0432

TAIL 2

TABLE XII. - CONTINUED
(c) $\alpha = 0.00^\circ$

Cp at y/b of														
x/c	0.02		0.22		0.44		0.56		0.67		0.83		0.98	
	U.S.	L.S.	U.S.	L.S.	U.S.	L.S.	U.S.	L.S.	U.S.	L.S.	U.S.	L.S.	U.S.	L.S.
.05	.0389	.0408	.1394	.1430	.1452	.1521			.2076		.2018	.2466	.2080	.2398
.10	.0426	.0467	.1332	.1391	.1447	.1459			.2026	.2178	.1986	.2333	.1696	.2184
.15	.0425	.0467	.1292	.1367	.1343	.1425			.1984	.2189	.1864	.2247	.1678	.2023
.20	.0440	.0488							.1964	.2193	.1815	.2214		
.25	.0412	.0478	.1242	.1299	.1322	.1420	.1893	.2210	.1925	.2180			.1456	.1761
.30	.0106	.0899	.1139	.1210	.1376		.1945	.2285	.1895	.2185	.1778	.2177	.1376	.1705
.40	.0001	.1011	.0221	.0273	.1281	.1506	.1901	.2266	.1834	.2154	.1716	.2126	.1249	.1578
.50	.0032	.0286	-.0023	.0096			.0432	.0531	.0999	.0832	.1311	.1080	.0960	.0738
.60	.0148	.0141	-.0058	.0084	.0129	.0353	-.0419	-.0287	-.0371	-.0249	-.0420	-.0297	-.0483	-.0335
.70			-.0136	.0004	-.0463	-.0313	-.0504	-.0390	-.0327	-.0208	-.0580	-.0420	-.0546	-.0390
.80	-.0308	-.0166	-.0296	-.0367	-.0446	-.0419	-.0403	-.0397			-.0526		-.0520	-.0424
.90	-.0356	-.0285	-.0399	-.0365	-.0409	-.0378	-.0404	-.0382	-.0405	-.0260	-.0474	-.0344	-.0487	-.0392
.95			-.0340	-.0347	-.0366	-.0223	-.0334	-.0312	-.0468	-.0364	-.0453	-.0356	-.0480	-.0373

TAIL 1

Cp at y/b of														
x/c	0.02		0.22		0.44		0.56		0.67		0.83		0.98	
	U.S.	L.S.	U.S.	L.S.	U.S.	L.S.	U.S.	L.S.	U.S.	L.S.	U.S.	L.S.	U.S.	L.S.
.05	.0532	.0443	.1570	.1301	.1506	.1412	.2748	.1956		.2100	.2265	.2159		
.10	.0513	.0393	.1496	.1208	.1492	.1346					.2148	.2039	.1858	.2145
.15	.0553	.0401	.1442	.1208	.1467	.1297		.2017	.2027	.2048	.2104	.2029	.1723	.1910
.20						.1277	.2050	.2089	.1991	.2033	.2040	.1988	.1576	.1753
.25	.0551	.0379	.1319	.1155	.1400	.1278	.2075	.2115	.2000	.2040	.1970	.2007	.1480	.1699
.30	.0160	.0041	.1249	.1130	.1411	.1319	.2051	.2097	.1979	.2044	.1894	.2018	.1387	.1619
.40	.0576	.0018			.1409	.1388	.1997	.2065	.1937	.2041	.1827	.1981	.1237	.1485
.50	.0373	-.0001	-.0014	-.0026			.0529	.0494					.0989	.0684
.60	.0066	.0028	-.0081	-.0119	.0144	.0072	-.0337	-.0395	-.0311	-.0378	-.0327	-.0327	-.0401	-.0440
.70			-.0124	-.0162			-.0527	-.0553	-.0497	-.0542	-.0484	-.0513		-.0513
.80			-.0435	-.0565	-.0347	-.0360	-.0526	-.0590	-.0489	-.0536	-.0496	-.0545	-.0452	-.0533
.90			-.0438	-.0496	-.0452	-.0517	-.0470	-.0551	-.0392	-.0434	-.0441	-.0494	-.0442	-.0499
.95			-.0438	-.0479					-.0436	-.0453	-.0424	-.0465	-.0360	-.0444

TAIL 2

TABLE XII. - CONTINUED
(d) $\alpha = 2.00^\circ$

Cp at y/b of														
x/c	0.02		0.22		0.44		0.56		0.67		0.83		0.98	
	U.S.	L.S.	U.S.	L.S.	U.S.	L.S.	U.S.	L.S.	U.S.	L.S.	U.S.	L.S.	U.S.	L.S.
.05	.0336	.0633	.1236	.1666	.1329	.1738			.1902		.1837	.2633	.1923	.2548
.10	.0388	.0697	.1165	.1622	.1314	.1666			.1837	.2368	.1792	.2491	.1535	.2330
.15	.0390	.0680	.1120	.1593	.1197	.1634			.1791	.2383	.1660	.2402	.1495	.2151
.20	.0394	.0703							.1779	.2388	.1619	.2369		
.25	.0361	.0693	.1101	.1544	.1183	.1626	.1690	.2427	.1742	.2375			.1297	.1876
.30	.0040	.0744	.1014	.1460	.1228		.1738	.2507	.1715	.2378	.1591	.2339	.1224	.1817
.40	-.0109	.0828	.0173	.0404	.1141	.1716	.1692	.2490	.1656	.2348	.1530	.2291	.1112	.1686
.50	-.0112	.0301	-.0069	.0215			.0358	.0644	.0867	.0921	.1148	.1174	.0839	.0800
.60	.0012	.0170	-.0101	.0195	.0047	.0456	-.0442	-.0248	-.0403	-.0226	-.0450	-.0300	-.0480	-.0336
.70			-.0183	.0107	-.0490	-.0279	-.0511	-.0361	-.0359	-.0185	-.0598	-.0429	-.0554	-.0396
.80	-.0389	-.0182	-.0288	-.0357	-.0447	-.0402	-.0405	-.0375			-.0522		-.0536	-.0442
.90	-.0357	-.0307	-.0400	-.0385	-.0418	-.0412	-.0417	-.0399	-.0410	-.0298	-.0485	-.0404	-.0479	-.0411
.95			-.0347	-.0351	-.0376	-.0246	-.0351	-.0335	-.0480	-.0410	-.0469	-.0409	-.0505	-.0401

TAIL 1

Cp at y/b of														
x/c	0.02		0.22		0.44		0.56		0.67		0.83		0.98	
	U.S.	L.S.	U.S.	L.S.	U.S.	L.S.	U.S.	L.S.	U.S.	L.S.	U.S.	L.S.	U.S.	L.S.
.05	.0321	.0519	.1059	.1760	.1084	.1879	.2179	.2415		.2581	.1844	.2618		
.10	.0299	.0494	.0990	.1728	.1053	.1806					.1712	.2495	.1500	.2573
.15	.0326	.0524	.0943	.1702	.1030	.1736		.2573	.1578	.2535	.1666	.2491	.1357	.2369
.20						.1723	.1550	.2654	.1546	.2527	.1607	.2457	.1219	.2204
.25	.0307	.0514	.0849	.1559	.0965	.1737	.1562	.2711	.1549	.2545	.1546	.2488	.1136	.2152
.30	.0020	.0163	.0795	.1503	.0967	.1776	.1534	.2688	.1531	.2559	.1476	.2505	.1054	.2066
.40	.0528	.0165			.0959	.1856	.1489	.2714	.1483	.2556	.1410	.2465	.0928	.1903
.50	.0321	.0189	-.0203	.0194			.0238	.0789					.0713	.0955
.60	-.0012	.0258	-.0258	.0088	-.0035	.0335	-.0389	-.0327	-.0388	-.0243	-.0399	-.0211	-.0433	-.0409
.70			-.0290	.0039			-.0543	-.0444	-.0550	-.0427	-.0503	-.0423		-.0462
.80			-.0422	-.0496	-.0316	-.0299	-.0479	-.0502	-.0448	-.0455	-.0453	-.0484	-.0442	-.0484
.90			-.0457	-.0547	-.0451	-.0533	-.0460	-.0523	-.0380	-.0437	-.0425	-.0502	-.0446	-.0497
.95			-.0457	-.0506					-.0440	-.0479	-.0419	-.0498	-.0364	-.0462

TAIL 2

TABLE XII. - CONTINUED
(e) $\alpha = 4.00^\circ$

Cp at γ/b of														
x/c	0.02		0.22		0.44		0.56		0.67		0.83		0.98	
	U.S.	L.S.	U.S.	L.S.	U.S.	L.S.	U.S.	L.S.	U.S.	L.S.	U.S.	L.S.	U.S.	L.S.
.05	.0256	.0980	.1097	.1947	.1223	.1974			.1768		.1743	.2890	.1835	.2789
.10	.0300	.1004	.1012	.1904	.1191	.1906			.1686	.2591	.1684	.2755	.1452	.2561
.15	.0295	.0947	.0967	.1875	.1068	.1876			.1636	.2610	.1554	.2662	.1394	.2367
.20	.0300	.0959							.1623	.2615	.1514	.2627		
.25	.0267	.0943	.0950	.1822	.1059	.1868	.1505	.2669	.1587	.2596			.1200	.2074
.30	-.0039	.0671	.0870	.1732	.1111		.1552	.2755	.1564	.2598	.1478	.2588	.1145	.2014
.40	-.0191	.0732	-.0093	.0548	.1013	.1968	.1494	.2741	.1500	.2569	.1414	.2531	.1040	.1864
.50	-.0206	.0352	-.0129	.0348			.0226	.0784	.0757	.0971	.1048	.1313	.0779	.0922
.60	-.0090	.0254	-.0160	.0320	-.0016	.0585	-.0452	-.0196	-.0431	-.0199	-.0470	-.0263	-.0465	-.0299
.70			-.0248	.0224	-.0505	-.0233	-.0502	-.0323	-.0389	-.0160	-.0607	-.0396	-.0552	-.0373
.80	-.0460	-.0163	-.0284	-.0329	-.0443	-.0367	-.0398	-.0339			-.0524		-.0565	-.0410
.90	-.0348	-.0315	-.0407	-.0425	-.0424	-.0396	-.0421	-.0375	-.0414	-.0292	-.0491	-.0405	-.0617	-.0374
.95			-.0358	-.0376	-.0380	-.0252	-.0357	-.0336	-.0489	-.0407	-.0475	-.0417	-.0606	-.0451

TAIL 1

Cp at γ/b of														
x/c	0.02		0.22		0.44		0.56		0.67		0.83		0.98	
	U.S.	L.S.	U.S.	L.S.	U.S.	L.S.	U.S.	L.S.	U.S.	L.S.	U.S.	L.S.	U.S.	L.S.
.05	.0166	.0507	.0613	.2277	.0692	.2383	.1643	.2935		.3096	.1447	.3100		
.10	.0148	.0530	.0541	.2291	.0652	.2285					.1304	.2978	.1167	.3030
.15	.0163	.0591	.0495	.2137	.0624	.2218		.3218	.1158	.3063	.1255	.2975	.1023	.2873
.20						.2220	.1085	.3345	.1116	.3068	.1199	.2961	.0892	.2702
.25	.0134	.0599	.0413	.1900	.0566	.2222	.1075	.3431	.1124	.3103	.1144	.3000	.0814	.2645
.30	-.0079	.0221	.0375	.1863	.0565	.2262	.1055	.3413	.1106	.3135	.1082	.3009	.0741	.2551
.40	.0467	.0280			.0556	.2320	.1015	.3403	.1060	.3146	.1021	.2971	.0631	.2337
.50	.0243	.0351	-.0341	.0396			.0048	.1121					.0447	.1241
.60	-.0062	.0452	-.0341	.0307	-.0182	.0583	-.0437	-.0251	-.0464	-.0071	-.0457	-.0082	-.0471	-.0359
.70			-.0371	.0247			-.0473	-.0317	-.0509	-.0270	-.0462	-.0329		-.0430
.80			-.0439	-.0413	-.0307	-.0225	-.0454	-.0380	-.0428	-.0316	-.0437	-.0389	-.0442	-.0422
.90			-.0477	-.0502	-.0447	-.0469	-.0460	-.0413	-.0376	-.0346	-.0434	-.0423	-.0456	-.0438
.95			-.0477	-.0522					-.0441	-.0388	-.0437	-.0447	-.0380	-.0433

TAIL 2

TABLE XII. - CONTINUED
(f) $\alpha = 6.00^\circ$

Cp at y/b of														
x/c	0.02		0.22		0.44		0.56		0.67		0.83		0.98	
	U.S.	L.S.	U.S.	L.S.	U.S.	L.S.	U.S.	L.S.	U.S.	L.S.	U.S.	L.S.	U.S.	L.S.
.05	.0208	-.1369	.1052	.2303	.1214	-.2296			.1740		.1749	.3252	.1827	.3129
.10	.0221	-.1341	-.0959	.2260	.1169	-.2222			.1659	.2911	.1670	.3112	.1459	.2877
.15	.0223	-.1261	-.0904	.2229	.1040	-.2197			.1600	.2943	.1547	.3012	.1381	.2665
.20	.0227	-.1264							.1586	.2949	.1507	.2974		
.25	-.0188	-.1241	-.0882	.2173	.1029	-.2191	.1452	.3024	.1552	.2928			.1199	.2354
.30	-.0091	.0659	.0792	.2071	.1051		.1496	.3113	.1529	.2930	.1468	.2940	.1143	.2292
.40	-.0240	.0703	-.0046	.0727	-.0973	.2304	.1436	.3100	.1466	.2890	.1397	.2876	.1060	.2135
.50	-.0264	.0470	-.0168	.0514			.0198	.0968	.0717	.1227	.1037	.1570	.0799	.1122
.60	-.0154	.0402	-.0196	.0476	-.0039	.0763	-.0458	-.0136	-.0443	-.0155	-.0478	-.0209	-.0449	-.0269
.70			-.0281	.0373	-.0506	-.0171	-.0491	-.0275	-.0400	-.0116	-.0597	-.0366	-.0526	-.0359
.80	-.0492	-.0093	-.0280	-.0284	-.0436	-.0322	-.0394	-.0294			-.0509		-.0586	-.0351
.90	-.0333	-.0288	-.0405	-.0419	-.0420	-.0358	-.0414	-.0338	-.0410	-.0282	-.0479	-.0398	-.0625	-.0417
.95			-.0354	-.0394	-.0383	-.0248	-.0353	-.0309	-.0483	-.0400	-.0465	-.0422	-.0601	-.0460

TAIL 1

Cp at y/b of															
x/c	0.02		0.22		0.44		0.56		0.67		0.83		0.98		
	U.S.	L.S.	U.S.	L.S.	U.S.	L.S.	U.S.	L.S.	U.S.	L.S.	U.S.	L.S.	U.S.	L.S.	
.05	.0072	-.3366	-.0243	.2842	-.0351	.2911	.1165	.3590		.3646	.1104	.3625			
.10	.0055	.0422	-.0164	.2668	.0295	.2849					.0943	.3488	.0888	.3544	
.15	.0063	.0515	-.0120	.2436	-.0265	.2766			.4007	.0787	.3626	.0890	.3512	.0742	.3406
.20						.2745	.0660	.4175	.0739	.3670	.0837	.3509	.0618	.3235	
.25	-.0039	.0540	-.0058	.2182	-.0214	.2725	.0642	.4262	.0742	.3738	.0787	.3531	.0546	.3172	
.30	-.0126	.0216	-.0026	.2113	.0207	.2735	.0616	.4214	.0722	.3817	.0729	.3550	.0478	.3055	
.40	.0420	.0311			.0197	.2769	.0592	.4187	.0680	.3865	.0672	.3498	.0385	.2799	
.50	-.0175	.0467	-.0413	.0629			-.0149	.1500					.0229	.1548	
.60	-.0177	.0569	-.0412	.0521	-.0319	.0792	-.0473	-.0170	-.0526	.0178	-.0485	.0059	-.0485	-.0274	
.70			-.0440	.0450			-.0475	-.0179	-.0492	-.0055	-.0452	-.0202		-.0410	
.80			-.0474	-.0292	-.0332	-.0141	-.0467	-.0258	-.0442	-.0118	-.0451	-.0263	-.0441	-.0400	
.90			-.0509	-.0398	-.0476	-.0378	-.0475	-.0299	-.0386	-.0178	-.0455	-.0295	-.0470	-.0399	
.95			-.0512	-.0422					-.0456	-.0218	-.0456	-.0327	-.0388	-.0397	

TAIL 2

TABLE XII. - CONTINUED
(g) $\alpha = 8.01^\circ$

Cp at γ/b of														
x/c	0.02		0.22		0.44		0.56		0.67		0.83		0.98	
	U.S.	L.S.	U.S.	L.S.	U.S.	L.S.	U.S.	L.S.	U.S.	L.S.	U.S.	L.S.	U.S.	L.S.
.05	.0256	.1767	.1142	.2750	.1309	.2704			.1806		.1828	.3694	.1896	.3533
.10	.0265	.1707	.1040	.2713	.1246	.2632			.1712	.3296	.1733	.3542	.1517	.3259
.15	.0268	.1607	.0982	.2678	.1121	.2608			.1654	.3338	.1615	.3431	.1435	.3026
.20	.0271	.1603							.1643	.3345	.1576	.3391		
.25	.0229	.1571	.0952	.2602	.1106	.2606	.1515	.3479	.1611	.3328			.1267	.2699
.30	-.0071	.0687	.0862	.2484	.1078		.1558	.3580	.1589	.3335	.1531	.3355	.1218	.2634
.40	-.0223	.0710	.0070	.0954	.1041	.2719	.1498	.3563	.1520	.3295	.1457	.3289	.1132	.2473
.50	-.0260	.0616	-.0154	.0735			.0272	.1205	.0766	.1493	.1093	.1819	.0879	.1371
.60	-.0170	.0604	-.0182	.0682	-.0016	.0981	-.0441	-.0041	-.0438	-.0083	-.0466	-.0125	-.0429	-.0194
.70			-.0269	.0568	-.0487	-.0083	-.0461	-.0196	-.0394	-.0045	-.0561	-.0296	-.0505	-.0298
.80	-.0479	.0024	-.0257	-.0210	-.0410	-.0252	-.0362	-.0213			-.0477		-.0529	-.0253
.90	-.0305	-.0226	-.0379	-.0352	-.0397	-.0294	-.0383	-.0261	-.0393	-.0241	-.0450	-.0343	-.0615	-.0331
.95			-.0329	-.0346	-.0371	-.0210	-.0328	-.0238	-.0459	-.0349	-.0435	-.0378	-.0576	-.0361

TAIL 1

Cp at γ/b of														
x/c	0.02		0.22		0.44		0.56		0.67		0.83		0.98	
	U.S.	L.S.	U.S.	L.S.	U.S.	L.S.	U.S.	L.S.	U.S.	L.S.	U.S.	L.S.	U.S.	L.S.
.05	.0045	.0159	-.0049	.3329	.0036	.3534	.0746	.4386		.4224	.0769	.4164		
.10	.0015	.0229	-.0126	.2758	-.0021	.3402					.0593	.4008	.0597	.4091
.15	.0019	.0335	-.0160	.2532	-.0049	.3224		.4896	.0365	.4294	.0532	.4078	.0457	.3961
.20						.3129	.0283	.5010	.0332	.4442	.0477	.4055	.0345	.3790
.25	-.0013	.0371	-.0178	.2304	-.0088	.3023	.0242	.5027	.0339	.4587	.0430	.4084	.0279	.3718
.30	-.0201	.0133	-.0195	.2327	-.0106	.3001	.0227	.4925	.0333	.4682	.0378	.4109	.0218	.3583
.40	.0365	.0255			-.0103	.2893	.0196	.4739	.0312	.4697	.0331	.4038	.0145	.3280
.50	.0175	.0448	-.0473	.0834			-.0332	.1866					.0022	.1844
.60	-.0252	.0527	-.0478	.0719	-.0404	.1088	-.0501	-.0084	-.0547	.0408	-.0513	.0231	-.0510	-.0150
.70			-.0494	.0667			-.0512	-.0047	-.0521	.0152	-.0489	-.0016		-.0344
.80			-.0499	-.0149	-.0361	-.0038	-.0508	-.0148	-.0472	.0080	-.0492	-.0060	-.0476	-.0373
.90			-.0538	-.0282	-.0511	-.0256	-.0512	-.0194	-.0405	.0021	-.0496	-.0079	-.0506	-.0397
.95			-.0541	-.0322					-.0483	-.0025	-.0497	-.0123	-.0416	-.0399

TAIL 2

TABLE XII. - CONTINUED
(h) $\alpha = 10.01^\circ$

Cp at γ/b of														
x/c	0.02		0.22		0.44		0.56		0.67		0.83		0.98	
	U.S.	L.S.	U.S.	L.S.	U.S.	L.S.	U.S.	L.S.	U.S.	L.S.	U.S.	L.S.	U.S.	L.S.
.05	.0357	.2219	.1297	.3261	.1467	.3182			.1962		.1955	.4198	.2035	.3999
.10	.0365	.2124	.1193	.3225	.1385	.3103			.1853	.3803	.1845	.4039	.1616	.3699
.15	.0368	.2002	.1128	.3196	.1257	.3086			.1781	.3841	.1738	.3920	.1537	.3440
.20	.0366	.1998							.1760	.3839	.1702	.3876		
.25	.0323	.1963	.1089	.3090	.1241	.3083	.1645	.4034	.1732	.3820			.1384	.3097
.30	-.0010	.0781	.1003	.2949	.1185		.1694	.4138	.1704	.3824	.1654	.3844	.1345	.3033
.40	-.0165	.0775	.0132	.1210	.1165	.3224	.1627	.4114	.1637	.3784	.1577	.3767	.1259	.2861
.50	-.0226	.0840	-.0105	.0972			.0371	.1497	.0854	.1750	.1201	.2143	.1010	.1638
.60	-.0140	.0842	-.0141	.0908	.0045	.1280	-.0411	.0080	-.0420	.0009	-.0437	-.0026	-.0360	-.0107
.70			-.0226	.0788	-.0453	.0045	-.0416	-.0083	-.0373	.0043	-.0500	-.0213	-.0465	-.0226
.80	-.0454	.0174	-.0219	.0133	-.0371	-.0144	-.0314	-.0107			-.0420		-.0482	-.0230
.90	-.0270	-.0151	-.0340	-.0280	-.0359	-.0191	-.0343	-.0154	-.0351	-.0184	-.0400	-.0285	-.0615	-.0219
.95			-.0287	-.0283	-.0339	-.0145	-.0288	-.0139	-.0415	-.0275	-.0384	-.0320	-.0527	-.0216

TAIL 1

Cp at γ/b of														
x/c	0.02		0.22		0.44		0.56		0.67		0.83		0.98	
	U.S.	L.S.	U.S.	L.S.	U.S.	L.S.	U.S.	L.S.	U.S.	L.S.	U.S.	L.S.	U.S.	L.S.
.05	.0076	-.0023	-.0275	.3442	-.0239	.3957	.0280	.5377		.4793	.0428	.4653		
.10	.0019	.0051	-.0336	.2785	-.0272	.3679					.0250	.4519	.0328	.4619
.15	.0007	.0165	-.0325	.2484	-.0299	.3414		.5471	.0045	.5268	.0183	.4588	.0199	.4485
.20						.3300	-.0024	.5535	.0016	.5439	.0131	.4577	.0106	.4297
.25	-.0048	.0211	-.0314	.2461	-.0312	.3218	-.0067	.5509	.0027	.5486	.0094	.4641	.0053	.4210
.30	-.0252	.0054	-.0329	.2453	-.0319	.3170	-.0073	.5328	.0023	.5477	.0052	.4679	.0009	.4058
.40	.0313	.0184			-.0287	.3038	-.0078	.5156	.0029	.5465	.0012	.4673	-.0013	.3748
.50	.0129	.0353	-.0510	.1000			-.0470	.2057					-.0113	.2165
.60	-.0325	.0430	-.0522	.0911	-.0462	.1249	-.0529	.0036	-.0554	.0644	-.0529	.0486	-.0539	.0014
.70			-.0543	.0901			-.0550	.0068	-.0539	.0352	-.0515	.0296		-.0213
.80			-.0528	-.0047	-.0394	.0063	-.0549	-.0037	-.0484	.0225	-.0516	.0265	-.0502	-.0253
.90			-.0578	-.0207	-.0556	-.0132	-.0549	-.0086	-.0442	.0126	-.0519	.0228	-.0539	-.0293
.95			-.0581	-.0245					-.0538	.0065	-.0517	.0172	-.0437	-.0311

TAIL 2

TABLE XII. - CONTINUED
(i) $\alpha = 12.00^\circ$

Cp at y/b of														
x/c	0.02		0.22		0.44		0.56		0.67		0.83		0.98	
	U.S.	L.S.	U.S.	L.S.	U.S.	L.S.	U.S.	L.S.	U.S.	L.S.	U.S.	L.S.	U.S.	L.S.
.05	.0493	.2717	.1502	.3868	.1678	.3728			.2157		.2111	.4792	.2196	.4533
.10	.0508	.2594	.1387	.3834	.1573	.3652			.2039	.4377	.1989	.4615	.1728	.4198
.15	.0508	.2437	.1323	.3799	.1436	.3642			.1955	.4416	.1888	.4487	.1654	.3910
.20	.0496	.2441							.1931	.4410	.1854	.4441		
.25	.0455	.2407	.1271	.3650	.1419	.3648	.1826	.4678	.1905	.4387			.1514	.3548
.30	.0076	.0896	.1181	.3479	.1343		.1873	.4797	.1872	.4392	.1800	.4405	.1480	.3480
.40	-.0080	.0871	.0210	.1507	.1339	.3795	.1807	.4776	.1805	.4352	.1721	.4319	.1404	.3299
.50	-.0169	.1077	-.0048	.1250			.0482	.1847	.0966	.2043	.1324	.2528	.1137	.1945
.60	-.0089	.1122	-.0086	.1174	.0132	.1628	-.0371	.0235	-.0390	.0128	-.0429	.0087	-.0363	-.0010
.70			-.0172	.1042	-.0401	.0202	-.0344	.0062	-.0343	.0161	-.0436	-.0119	-.0420	-.0140
.80	-.0423	.0352	-.0169	-.0031	-.0312	-.0011	-.0253	.0031			-.0373		-.0495	-.0149
.90	-.0224	-.0049	-.0284	-.0180	-.0304	-.0069	-.0281	-.0016	-.0310	-.0098	-.0360	-.0218	-.0620	-.0040
.95			-.0235	-.0190	-.0294	-.0055	-.0233	-.0009	-.0367	-.0171	-.0347	-.0248	-.0569	-.0057

TAIL 1

Cp at y/b of														
x/c	0.02		0.22		0.44		0.56		0.67		0.83		0.98	
	U.S.	L.S.	U.S.	L.S.	U.S.	L.S.	U.S.	L.S.	U.S.	L.S.	U.S.	L.S.	U.S.	L.S.
.05	.0003	-.0097	-.0388	.3147	-.0403	.4128	-.0005	.5885		.5435	.0170	.5131		
.10	-.0065	-.0006	-.0447	.2905	-.0415	.3838					-.0002	.5004	-.0100	.5143
.15	-.0071	.0086	-.0432	.2780	-.0438	.3584		.5748	-.0136	.6147	-.0071	.5056	-.0013	.4990
.20						.3444	-.0218	.5814	-.0150	.6095	-.0133	.5122	-.0085	.4795
.25	-.0136	.0128	-.0431	.2651	-.0456	.3342	-.0271	.5782	-.0154	.6082	-.0156	.5234	-.0116	.4694
.30	-.0323	-.0011	-.0447	.2655	-.0477	.3331	-.0287	.5643	-.0168	.5911	-.0185	.5325	-.0136	.4547
.40	.0255	.0155			-.0442	.3165	-.0318	.5440	-.0170	.5674	-.0204	.5452	-.0145	.4275
.50	-.0024	.0311	-.0569	.1158			-.0562	.2269					-.0235	.2567
.60	-.0406	.0403	-.0591	.1109	-.0485	.1311	-.0543	.0176	-.0568	.0694	-.0553	.0835	-.0587	.0194
.70			-.0601	.1174			-.0574	.0149	-.0566	.0416	-.0538	.0614		-.0027
.80			-.0561	.0057	-.0414	.0135	-.0574	.0026	-.0507	.0290	-.0551	.0515	-.0595	-.0046
.90			-.0615	-.0125	-.0582	-.0044	-.0581	-.0011	-.0459	.0206	-.0551	.0456	-.0616	-.0042
.95			-.0618	-.0165					-.0552	.0136	-.0546	.0383	-.0479	-.0057

TAIL 2

TABLE XII. - CONTINUED
(j) $\alpha = 16.01^\circ$

Cp at y/b of														
x/c	0.02		0.22		0.44		0.56		0.67		0.83		0.98	
	U.S.	L.S.	U.S.	L.S.	U.S.	L.S.	U.S.	L.S.	U.S.	L.S.	U.S.	L.S.	U.S.	L.S.
.05	.0850	.4004	.2073	.5530	.2192	.5201			.2644		.2515	.6293	.2455	.5746
.10	.0875	.3813	.1922	.5493	.2047	.5130			.2501	.5868	.2372	.6069	.1903	.5220
.15	.0882	.3537	.1844	.5401	.1914	.5133			.2405	.5905	.2296	.5908	.1878	.4861
.20	.0864	.3581							.2373	.5900	.2255	.5857		
.25	.0825	.3561	.1754	.5090	.1884	.5159	.2297	.6407	.2345	.5878			.1816	.4423
.30	.0340	.1159	.1661	.4850	.1739		.2353	.6555	.2304	.5891	.2191	.5822	.1808	.4379
.40	.0152	.1097	.0410	.2256	.1801	.5372	.2273	.6551	.2229	.5850	.2101	.5714	.1748	.4178
.50	-.0003	.1703	.0126	.1938			.0709	.2748	.1251	.2823	.1650	.3504	.1450	.2520
.60	.0050	.1916	.0077	.1859	.0348	.2587	-.0278	.0655	-.0289	.0458	-.0340	.0412	-.0240	.0236
.70			-.0017	.1710	-.0247	.0629	-.0188	.0456	-.0244	.0486	-.0261	.0154	-.0287	.0048
.80	-.0355	.0849	-.0034	.0249	-.0170	.0344	-.0111	.0418			-.0214		-.0461	.0081
.90	-.0111	.0254	-.0143	.0091	-.0164	.0268	-.0142	.0367	-.0180	.0174	-.0205	.0003	-.0482	.0284
.95			-.0097	.0070	-.0179	.0204	-.0096	.0360	-.0217	.0133	-.0198	-.0025	-.0426	.0211

TAIL 1

Cp at y/b of														
x/c	0.02		0.22		0.44		0.56		0.67		0.83		0.98	
	U.S.	L.S.	U.S.	L.S.	U.S.	L.S.	U.S.	L.S.	U.S.	L.S.	U.S.	L.S.	U.S.	L.S.
.05	-.0248	-.0149	-.0515	.3322	-.0579	.4547	-.0327	.6570		.7909	.0115	.6409		
.10	-.0328	-.0144	-.0577	.3194	-.0582	.4274					-.0063	.6513	.0008	.6481
.15	-.0294	-.0078	-.0572	.3123	-.0605	.4034		.6483	-.0236	.7384	-.0152	.6776	-.0089	.6318
.20						.3959	-.0419	.6530	-.0243	.6999	-.0231	.6943	-.0140	.6110
.25	-.0372	.0023	-.0572	.3077	-.0601	.3861	-.0483	.6427	-.0276	.6834	-.0271	.7111	-.0150	.6050
.30	-.0470	-.0017	-.0586	.3080	-.0627	.3831	-.0493	.6336	-.0314	.6619	-.0309	.7261	-.0163	.6005
.40	.0183	.0228			-.0566	.3600	-.0527	.6193	-.0319	.6430	-.0335	.7153	-.0171	.5827
.50	-.0083	.0379	-.0643	.1603			-.0651	.2726					-.0253	.3778
.60	-.0518	.0569	-.0664	.1665	-.0512	.1785	-.0573	.0391	-.0625	.0899	-.0603	.1217	-.0636	.0903
.70			-.0669	.1735			-.0630	.0408	-.0625	.0607	-.0591	.1003		.0571
.80			-.0610	.0353	-.0449	.0407	-.0629	.0325	-.0552	.0501	-.0602	.1052	-.0617	.0510
.90			-.0665	.0116	-.0634	.0250	-.0637	.0300	-.0497	.0400	-.0605	.1023	-.0623	.0460
.95			-.0675	.0055					-.0601	.0316	-.0599	.0933	-.0493	.0399

TAIL 2

TABLE XII. - CONCLUDED
(k) $\alpha = 20.00^\circ$

Cp at y/b of														
x/c	0.02		0.22		0.44		0.56		0.67		0.83		0.98	
	U.S.	L.S.	U.S.	L.S.	U.S.	L.S.	U.S.	L.S.	U.S.	L.S.	U.S.	L.S.	U.S.	L.S.
.05	.1335	.5605	.2771	.7837	.2798	.7180			.3185		.0960	.4775	.1014	.4236
.10	.1360	.5356	.2580	.7689	.2633	.7127			.3021	.7764	.0827	.4524	.0691	.3961
.15	.1362	.4915	.2483	.7414	.2530	.7162			.2913	.7781	.0792	.4419	.0668	.3811
.20	.1362	.4980							.2875	.7775	.0749	.4406		
.25	.1311	.5002	.2359	.6853	.2458	.7251	.2875	.8680	.2824	.7734			.0624	.3724
.30	.0690	.1595	.2250	.6544	.2283		.2936	.8871	.2753	.7742	.0769	.4481	.0624	.3710
.40	.0438	.1494	.0682	.3153	.2423	.7525	.2847	.8921	.2639	.7655	.0782	.4472	.0568	.3654
.50	.0260	.2725	.0366	.2799			.1026	.4015	.1543	.3774	.0478	.2624	.0379	.2215
.60	.0315	.2976	.0304	.2735	.0618	.3838	-.0168	.1293	-.0274	.0833	-.0479	.0211	-.0536	.0016
.70			.0195	.2552	-.0189	.1188	-.0174	.1072	-.0228	.0856	-.0454	.0029	-.0600	-.0021
.80	-.0210	.1475	.0103	.0626	-.0075	.0835	-.0061	.1014			-.0442		-.0575	-.0169
.90	-.0001	.0705	-.0009	.0484	-.0052	.0739	-.0073	.0954	-.0172	.0606	-.0421	-.0098	-.0569	-.0382
.95			.0024	.0463	-.0061	.0654	-.0031	.0918	-.0226	.0576	-.0335	-.0133	-.0554	-.0404

TAIL 1

Cp at y/b of														
x/c	0.02		0.22		0.44		0.56		0.67		0.83		0.98	
	U.S.	L.S.	U.S.	L.S.	U.S.	L.S.	U.S.	L.S.	U.S.	L.S.	U.S.	L.S.	U.S.	L.S.
.05	-.0452	.0027	-.0581	.4105	-.0650	.5307	-.0456	.7604		.9952	.0112	.8767		
.10	-.0522	.0056	-.0654	.3999	-.0641	.5102					-.0052	.9003	.0012	.8506
.15	-.0441	.0159	-.0653	.3939	-.0651	.4877		.7753	-.0025	.8689	-.0147	.9000	-.0070	.8499
.20						.4784	-.0482	.7745	-.0131	.8367	-.0232	.8848	-.0114	.8395
.25	-.0522	.0265	-.0655	.3893	-.0634	.4677	-.0537	.7760	-.0213	.8214	-.0278	.8777	-.0142	.8307
.30	-.0570	.0157	-.0661	.3862	-.0663	.4652	-.0548	.7539	-.0294	.8010	-.0320	.8689	-.0181	.8160
.40	.0113	.0493			-.0600	.4272	-.0573	.7189	-.0361	.7826	-.0351	.8336	-.0228	.7677
.50	-.0042	.0652	-.0675	.2283			-.0674	.3405					-.0327	.4826
.60	-.0592	.0895	-.0693	.2341	-.0533	.2409	-.0565	.0633	-.0660	.1303	-.0624	.1964	-.0653	.1213
.70			-.0688	.2439			-.0650	.0704	-.0660	.0953	-.0610	.1758		.0995
.80			-.0619	.0655	-.0462	.0789	-.0650	.0687	-.0580	.0794	-.0622	.1610	-.0628	.0954
.90			-.0689	.0463	-.0664	.0652	-.0656	.0689	-.0524	.0652	-.0629	.1482	-.0641	.0952
.95			-.0695	.0408					-.0632	.0573	-.0627	.1367	-.0504	.0903

TAIL 2

TABLE XIII. - PRESSURE COEFFICIENTS, $\phi = 45^\circ$, $\delta = 0^\circ$, $M = 3.70$.
(a) $\alpha = -4.00^\circ$

Cp at y/b of														
x/c	0.02		0.22		0.44		0.56		0.67		0.83		0.98	
	U.S.	L.S.	U.S.	L.S.	U.S.	L.S.	U.S.	L.S.	U.S.	L.S.	U.S.	L.S.	U.S.	L.S.
.05	.0236	.0306	.2397	.0637	.2233	.0841			.2848		.2743	.1767	.2773	.1786
.10	.0292	.0260	.2131	.0616	.2237	.0783			.2832	.1494	.2738	.1624	.2427	.1562
.15	.0338	.0252	.1939	.0578	.2163	.0729			.2795	.1482	.2630	.1543	.2423	.1440
.20	.0391	.0256							.2777	.1489	.2571	.1508		
.25	.0389	.0228	.1744	.0518	.2131	.0731	.2960	.1383	.2743	.1473			.2179	.1219
.30	.0163	.1365	.1634	.0449	.2103	.2424	.3027	.1435	.2729	.1473	.2537	.1478	.2083	.1180
.40	.0162	.1719	.0495	-.0014	.2032	.0848	.3031	.1422	.2699	.1441	.2467	.1429	.1925	.1054
.50	.0296	.1135	.0259	-.0150			.1008	.0174	.1639	.0443	.1974	.0612	.1555	.0384
.60	.0366	.0048	.0207	-.0101	.0486	.0106	-.0199	-.0349	-.0159	-.0282	-.0256	-.0370	-.0405	-.0410
.70			.0101	-.0164	-.0352	-.0310	-.0361	-.0327	-.0119	-.0243	-.0462	-.0388	-.0502	-.0408
.80	-.0188	-.0197	-.0340	-.0274	-.0477	-.0275	-.0370	-.0287			-.0510		-.0508	-.0391
.90	-.0254	-.0200	-.0472	-.0348	-.0449	-.0273	-.0442	-.0295	-.0396	-.0109	-.0512	-.0301	-.0497	-.0375
.95			-.0378	-.0337	-.0366	-.0068	-.0354	-.0265	-.0491	-.0297	-.0472	-.0330	-.0481	-.0374

TAIL 1

Cp at y/b of														
x/c	0.02		0.22		0.44		0.56		0.67		0.83		0.98	
	U.S.	L.S.	U.S.	L.S.	U.S.	L.S.	U.S.	L.S.	U.S.	L.S.	U.S.	L.S.	U.S.	L.S.
.05	.1365	.0211	.2504	.0893	.2307	.0975	.3772	.1396	.3556	.1570	.2991	.1706		
.10	.1238	.0157	.2409	.0709	.2316	.0897					.2869	.1579	.2504	.1706
.15	.1241	.0124	.2340	.0674	.2294	.0848		.1458	.2816	.1507	.2835	.1538	.2368	.1440
.20						.0832	.2931	.1486	.2779	.1486	.2770	.1499	.2201	.1307
.25	.1206	.0072	.2170	.0657	.2216	.0830	.2953	.1494	.2780	.1485	.2704	.1495	.2087	.1250
.30	.0540	-.0228	.2062	.0644	.2234	.0858	.2931	.1483	.2763	.1481	.2626	.1496	.1970	.1174
.40	.0572	-.0272			.2255	.0914	.2920	.1438	.2722	.1474	.2543	.1465	.1795	.1059
.50	.0406	-.0318	.0351	-.0266			.1000	.0239					.1494	.0408
.60	.0301	-.0337	.0287	-.0332	.0515	-.0149	-.0320	-.0468	-.0177	-.0491	-.0229	-.0425	-.0336	-.0439
.70			.0228	-.0375			-.0417	-.0623	-.0401	-.0582	-.0435	-.0563		-.0542
.80			-.0406	-.0496	-.0329	-.0338	-.0469	-.0546	-.0428	-.0473	-.0475	-.0515	-.0441	-.0479
.90			-.0527	-.0478	-.0538	-.0506	-.0499	-.0508	-.0418	-.0416	-.0496	-.0474	-.0492	-.0470
.95			-.0481	-.0487					-.0488	-.0466	-.0493	-.0468	-.0387	-.0521

TAIL 2

TABLE XIII. - CONTINUED
(b) $\alpha = -2.00^\circ$

Cp at γ/b of														
x/c	0.02		0.22		0.44		0.56		0.67		0.83		0.98	
	U.S.	L.S.	U.S.	L.S.	U.S.	L.S.	U.S.	L.S.	U.S.	L.S.	U.S.	L.S.	U.S.	L.S.
.05	.0418	.0282	.1880	.1034	.1838	.1180			.2479		.2397	.2116	.2421	.2060
.10	.0448	.0314	.1828	.0999	.1839	.1122			.2447	.1845	.2378	.1982	.2065	.1845
.15	.0462	.0307	.1731	.0975	.1746	.1081			.2411	.1842	.2264	.1899	.2054	.1709
.20	.0487	.0321							.2392	.1846	.2208	.1865		
.25	.0468	.0302	.1573	.0919	.1721	.1072	.2396	.1800	.2354	.1835			.1830	.1481
.30	.0172	.1023	.1453	.0841	.1797	.1158	.2472	.1863	.2325	.1836	.2178	.1830	.1726	.1438
.40	.0109	.1274	.0357	.0094	.1675	.1143	.2446	.1848	.2276	.1806	.2111	.1783	.1605	.1312
.50	.0207	.0343	.0119	-.0077			.0699	.0335	.1295	.0637	.1657	.0841	.1263	.0562
.60	.0308	.0079	.0080	-.0070	.0351	.0147	-.0321	-.0349	-.0270	-.0284	-.0334	-.0361	-.0450	-.0386
.70			-.0022	-.0129	-.0391	-.0370	-.0441	-.0419	-.0224	-.0243	-.0523	-.0457	-.0518	-.0427
.80	-.0235	-.0198	-.0354	-.0305	-.0495	-.0369	-.0424	-.0357			-.0554		-.0531	-.0414
.90	-.0302	-.0263	-.0425	-.0353	-.0430	-.0335	-.0431	-.0337	-.0418	-.0232	-.0485	-.0325	-.0488	-.0385
.95			-.0357	-.0346	-.0360	-.0195	-.0330	-.0290	-.0478	-.0355	-.0449	-.0352	-.0469	-.0377

TAIL 1

Cp at γ/b of														
x/c	0.02		0.22		0.44		0.56		0.67		0.83		0.98	
	U.S.	L.S.	U.S.	L.S.	U.S.	L.S.	U.S.	L.S.	U.S.	L.S.	U.S.	L.S.	U.S.	L.S.
.05	.0861	.0405	.2012	.1147	.1889	.1239	.3256	.1750	.3324	.1879	.2595	.1951		
.10	.0807	.0355	.1925	.1008	.1885	.1181					.2483	.1845	.2161	.1959
.15	.0844	.0331	.1865	.0986	.1864	.1124					.2447	.1823	.2026	.1714
.20						.1103	.2482	.1852	.2371	.1816	.2386	.1789	.1871	.1566
.25	.0829	.0290	.1727	.0966	.1785	.1112	.2511	.1875	.2378	.1820	.2321	.1798	.1769	.1508
.30	.0318	-.0075	.1639	.0947	.1799	.1137	.2492	.1859	.2364	.1825	.2246	.1808	.1665	.1426
.40	.0585	-.0121			.1810	.1211	.2442	.1837	.2326	.1822	.2176	.1782	.1501	.1304
.50	.0428	-.0165	.0153	-.0131			.0727	.0426					.1230	.0571
.60	.0156	-.0169	.0087	-.0198	.0328	-.0011	-.0325	-.0416	-.0241	-.0418	-.0268	-.0360	-.0365	-.0427
.70			.0037	-.0231			-.0474	-.0583	-.0449	-.0578	-.0451	-.0532		-.0530
.80			-.0448	-.0543	-.0359	-.0364	-.0516	-.0596	-.0461	-.0504	-.0498	-.0543	-.0457	-.0531
.90			-.0456	-.0474	-.0522	-.0501	-.0524	-.0518	-.0405	-.0413	-.0480	-.0476	-.0471	-.0481
.95			-.0439	-.0474					-.0451	-.0444	-.0453	-.0452	-.0372	-.0424

TAIL 2

TABLE XIII. - CONTINUED
(c) $\alpha = 0.00^\circ$

Cp at γ/b of														
x/c	0.02		0.22		0.44		0.56		0.67		0.83		0.98	
	U.S.	L.S.	U.S.	L.S.	U.S.	L.S.	U.S.	L.S.	U.S.	L.S.	U.S.	L.S.	U.S.	L.S.
.05	.0425	.0401	.1451	.1436	.1511	.1531			.2150		.2073	.2470	.2139	.2386
.10	.0456	.0461	.1397	.1394	.1514	.1466			.2097	.2200	.2057	.2338	.1752	.2170
.15	.0458	.0460	.1353	.1368	.1406	.1433			.2057	.2210	.1933	.2251	.1733	.2006
.20	.0470	.0486							.2037	.2216	.1879	.2217		
.25	.0442	.0476	.1304	.1302	.1388	.1423	.1973	.2224	.1996	.2203			.1506	.1744
.30	.0127	.0754	.1200	.1215	.1533	.1352	.2027	.2297	.1962	.2205	.1845	.2179	.1429	.1687
.40	.0013	.0919	.0258	.0269	.1351	.1504	.1981	.2277	.1904	.2175	.1780	.2128	.1304	.1561
.50	.0059	.0266	-.0000	.0093			.0485	.0530	.1044	.0839	.1368	.1068	.1007	.0713
.60	.0196	.0133	-.0028	.0081	.0180	.0332	-.0396	-.0297	-.0346	-.0254	-.0396	-.0334	-.0473	-.0373
.70			-.0122	-.0000	-.0440	-.0326	-.0489	-.0397	-.0300	-.0214	-.0567	-.0456	-.0535	-.0429
.80	-.0300	-.0175	-.0306	-.0364	-.0455	-.0420	-.0397	-.0400			-.0525		-.0519	-.0463
.90	-.0346	-.0290	-.0411	-.0363	-.0406	-.0380	-.0402	-.0381	-.0401	-.0282	-.0470	-.0375	-.0484	-.0429
.95			-.0351	-.0348	-.0355	-.0224	-.0324	-.0313	-.0463	-.0395	-.0451	-.0389	-.0472	-.0412

TAIL 1

Cp at γ/b of														
x/c	0.02		0.22		0.44		0.56		0.67		0.83		0.98	
	U.S.	L.S.	U.S.	L.S.	U.S.	L.S.	U.S.	L.S.	U.S.	L.S.	U.S.	L.S.	U.S.	L.S.
.05	.0521	.0502	.1568	.1430	.1512	.1550	.2763	.2109	.3006	.2239	.2273	.2295		
.10	.0507	.0465	.1494	.1349	.1499	.1489					.2156	.2195	.1873	.2289
.15	.0549	.0456	.1440	.1331	.1472	.1423		.2187	.2044	.2206	.2113	.2189	.1735	.2062
.20						.1405	.2066	.2264	.2011	.2191	.2048	.2147	.1588	.1902
.25	.0548	.0435	.1316	.1293	.1401	.1415	.2090	.2291	.2015	.2200	.1980	.2165	.1491	.1849
.30	.0155	.0072	.1246	.1269	.1413	.1449	.2069	.2264	.2002	.2211	.1902	.2180	.1399	.1769
.40	.0593	.0038			.1410	.1530	.2017	.2238	.1954	.2203	.1836	.2142	.1249	.1625
.50	.0414	.0030	-.0017	.0028			.0540	.0564					.1000	.0776
.60	.0063	.0066	-.0087	-.0061	.0148	.0135	-.0330	-.0370	-.0305	-.0339	-.0329	-.0291	-.0396	-.0420
.70			-.0131	-.0113			-.0529	-.0523	-.0496	-.0513	-.0487	-.0482		-.0489
.80			-.0429	-.0558	-.0358	-.0360	-.0528	-.0571	-.0484	-.0518	-.0495	-.0533	-.0441	-.0522
.90			-.0442	-.0500	-.0462	-.0538	-.0470	-.0565	-.0391	-.0428	-.0439	-.0509	-.0437	-.0500
.95			-.0443	-.0485					-.0435	-.0442	-.0420	-.0470	-.0351	-.0441

TAIL 2

TABLE XIII. - CONTINUED
(d) $\alpha = 2.20^\circ$

Cp at y/b of														
x/c	0.02		0.22		0.44		0.56		0.67		0.83		0.98	
	U.S.	L.S.	U.S.	L.S.	U.S.	L.S.	U.S.	L.S.	U.S.	L.S.	U.S.	L.S.	U.S.	L.S.
.05	.0254	.0689	.1109	.1845	.1226	.1902			.1805		.1709	.2794	.1825	.2699
.10	.0305	.0773	.1041	.1798	.1213	.1833			.1734	.2554	.1687	.2666	.1442	.2485
.15	.0310	.0750	.0996	.1767	.1090	.1803			.1693	.2578	.1567	.2585	.1404	.2301
.20	.0318	.0774							.1680	.2586	.1525	.2558		
.25	.0283	.0768	.0986	.1692	.1079	.1791	.1578	.2652	.1638	.2576			.1206	.2015
.30	-.0003	.0667	.0903	.1598	.1124	.1680	.1619	.2735	.1613	.2581	.1497	.2527	.1140	.1954
.40	-.0143	.0785	.0122	.0469	.1039	.1881	.1574	.2714	.1552	.2551	.1438	.2476	.1029	.1825
.50	-.0152	.0336	-.0115	.0292			.0296	.0747	.0796	.1046	.1074	.1300	.0770	.0883
.60	-.0010	.0250	-.0146	.0264	-.0000	.0540	-.0457	-.0221	-.0417	-.0199	-.0462	-.0282	-.0483	-.0339
.70			-.0229	.0176	-.0499	-.0256	-.0497	-.0338	-.0373	-.0158	-.0596	-.0419	-.0552	-.0396
.80	-.0385	-.0142	-.0286	-.0332	-.0441	-.0379	-.0387	-.0349			-.0511		-.0523	-.0447
.90	-.0364	-.0291	-.0413	-.0402	-.0418	-.0400	-.0416	-.0383	-.0410	-.0297	-.0482	-.0415	-.0477	-.0444
.95			-.0356	-.0355	-.0394	-.0243	-.0342	-.0335	-.0479	-.0422	-.0469	-.0429	-.0504	-.0428

TAIL 1

Cp at y/b of														
x/c	0.02		0.22		0.44		0.56		0.67		0.83		0.98	
	U.S.	L.S.	U.S.	L.S.	U.S.	L.S.	U.S.	L.S.	U.S.	L.S.	U.S.	L.S.	U.S.	L.S.
.05	.0374	.0433	.1148	.1679	.1157	.1780	.2283	.2292	.2712	.2475	.1944	.2501		
.10	.0358	.0405	.1079	.1659	.1135	.1702					.1819	.2388	.1596	.2486
.15	.0385	.0429	.1030	.1626	.1110	.1636		.2442	.1680	.2431	.1774	.2386	.1461	.2291
.20						.1627	.1665	.2525	.1655	.2423	.1708	.2349	.1320	.2130
.25	.0369	.0422	.0928	.1467	.1044	.1634	.1669	.2586	.1654	.2445	.1644	.2380	.1236	.2083
.30	.0068	.0126	.0869	.1402	.1049	.1671	.1641	.2554	.1634	.2455	.1568	.2400	.1151	.2002
.40	.0554	.0118			.1041	.1751	.1603	.2593	.1586	.2458	.1507	.2366	.1019	.1836
.50	.0319	.0144	-.0173	.0118			.0348	.0729					.0795	.0915
.60	.0033	.0219	-.0222	.0025	.0002	.0296	-.0378	-.0326	-.0373	-.0256	-.0384	-.0225	-.0429	-.0417
.70			-.0255	-.0029			-.0553	-.0456	-.0538	-.0437	-.0507	-.0439		-.0468
.80			-.0411	-.0523	-.0316	-.0302	-.0483	-.0514	-.0457	-.0465	-.0456	-.0502	-.0435	-.0485
.90			-.0450	-.0536	-.0447	-.0538	-.0457	-.0535	-.0376	-.0450	-.0421	-.0512	-.0439	-.0493
.95			-.0453	-.0502					-.0436	-.0482	-.0415	-.0492	-.0359	-.0452

TAIL 2

TABLE XIII. - CONTINUED
(e) $\alpha = 4.00^\circ$

Cp at y/b of														
x/c	0.02		0.22		0.44		0.56		0.67		0.83		0.98	
	U.S.	L.S.	U.S.	L.S.	U.S.	L.S.	U.S.	L.S.	U.S.	L.S.	U.S.	L.S.	U.S.	L.S.
.05	.0042	.1159	.0802	.2310	.0954	.2306			.1493		.1469	.3230	.1571	.3083
.10	.0078	.1203	.0716	.2266	.0942	.2244			.1410	.2943	.1415	.3096	.1208	.2861
.15	.0089	.1098	.0671	.2229	.0811	.2220			.1356	.2974	.1283	.3003	.1144	.2654
.20	.0110	.1130							.1345	.2982	.1239	.2963		
.25	.0079	.1125	.0673	.2131	.0806	.2213	.1213	.3116	.1311	.2967			.0965	.2338
.30	-.0154	.0634	.0586	.2022	.0904	.2059	.1249	.3209	.1285	.2979	.1197	.2922	.0913	.2272
.40	-.0279	.0719	-.0027	.0699	.0758	.2323	.1195	.3198	.1224	.2958	.1138	.2861	.0819	.2125
.50	-.0309	.0468	-.0233	.0510			.0086	.0986	.0567	.1238	.0811	.1527	.0590	.1077
.60	-.0157	.0445	-.0258	.0471	-.0130	.0788	-.0493	-.0127	-.0466	-.0138	-.0521	-.0225	-.0494	-.0306
.70			-.0337	.0371	-.0506	-.0167	-.0477	-.0266	-.0420	-.0100	-.0597	-.0372	-.0563	-.0362
.80	-.0475	-.0061	-.0294	-.0277	-.0446	-.0317	-.0399	-.0279			-.0528		-.0556	-.0416
.90	-.0371	-.0270	-.0433	-.0413	-.0435	-.0353	-.0432	-.0322	-.0421	-.0276	-.0509	-.0393	-.0608	-.0397
.95			-.0377	-.0398	-.0393	-.0238	-.0364	-.0299	-.0508	-.0399	-.0495	-.0428	-.0590	-.0385

TAIL 1

Cp at y/b of														
x/c	0.02		0.22		0.44		0.56		0.67		0.83		0.98	
	U.S.	L.S.	U.S.	L.S.	U.S.	L.S.	U.S.	L.S.	U.S.	L.S.	U.S.	L.S.	U.S.	L.S.
.05	.0298	.0213	.0707	.2185	.0800	.2171	.1806	.2678	.2381	.2864	.1616	.2860		
.10	.0291	.0251	.0619	.2053	.0770	.2082					.1487	.2750	.1339	.2850
.15	.0309	.0307	.0569	.1852	.0741	.2030		.2947	.1317	.2828	.1437	.2745	.1196	.2698
.20						.2016	.1255	.3089	.1285	.2835	.1371	.2731	.1058	.2540
.25	.0276	.0335	.0485	.1614	.0677	.2024	.1256	.3189	.1291	.2857	.1305	.2773	.0981	.2491
.30	.0054	.0147	.0451	.1586	.0677	.2067	.1228	.3162	.1268	.2896	.1234	.2786	.0906	.2396
.40	.0518	.0164			.0665	.2096	.1212	.3164	.1220	.2911	.1178	.2748	.0787	.2198
.50	.0268	.0240	-.0282	.0244			.0145	.1004					.0586	.1151
.60	-.0020	.0300	-.0270	.0133	-.0139	.0461	-.0431	-.0274	-.0441	-.0132	-.0438	-.0132	-.0465	-.0380
.70			-.0305	.0080			-.0489	-.0370	-.0536	-.0324	-.0479	-.0367		-.0449
.80			-.0445	-.0473	-.0314	-.0273	-.0459	-.0439	-.0438	-.0376	-.0439	-.0430	-.0431	-.0441
.90			-.0475	-.0543	-.0455	-.0516	-.0458	-.0473	-.0373	-.0379	-.0431	-.0454	-.0446	-.0453
.95			-.0473	-.0533					-.0442	-.0424	-.0433	-.0471	-.0366	-.0435

TAIL 2

TABLE XIII. - CONTINUED

(f) $\alpha = 6.00^\circ$

Cp at y/b of														
x/c	0.02		0.22		0.44		0.56		0.67		0.83		0.98	
	U.S.	L.S.	U.S.	L.S.	U.S.	L.S.	U.S.	L.S.	U.S.	L.S.	U.S.	L.S.	U.S.	L.S.
.05	-.0171	.1638	.0550	.2836	.0775	.2754			.1327		.1329	.3722	.1439	.3566
.10	-.0173	.1669	.0455	.2794	.0749	.2692			.1229	.3412	.1257	.3583	.1096	.3328
.15	-.0155	.1467	.0403	.2739	.0603	.2676			.1165	.3447	.1129	.3486	.1020	.3093
.20	-.0122	.1531							.1152	.3455	.1083	.3449		
.25	-.0157	.1519	.0404	.2587	.0609	.2682	.0972	.3650	.1115	.3441			.0846	.2745
.30	-.0301	.0663	.0312	.2455	.0689	.2546	.1007	.3755	.1089	.3460	.1039	.3408	.0804	.2667
.40	-.0396	.0729	-.0155	.0941	.0544	.2830	.0947	.3745	.1024	.3441	.0975	.3341	.0731	.2498
.50	-.0436	.0679	-.0347	.0747			-.0026	.1271	.0421	.1455	.0665	.1839	.0514	.1328
.60	-.0288	.0689	-.0355	.0691	-.0231	.1091	-.0519	-.0002	-.0494	-.0053	-.0556	-.0141	-.0504	-.0261
.70			-.0422	.0589	-.0482	-.0046	-.0472	-.0156	-.0447	-.0017	-.0596	-.0304	-.0552	-.0320
.80	-.0507	.0053	-.0307	-.0205	-.0457	-.0221	-.0402	-.0175			-.0543		-.0586	-.0376
.90	-.0373	-.0223	-.0451	-.0351	-.0450	-.0270	-.0441	-.0222	-.0442	-.0230	-.0528	-.0347	-.0580	-.0342
.95			-.0392	-.0358	-.0407	-.0196	-.0374	-.0207	-.0528	-.0338	-.0518	-.0387	-.0566	-.0316

TAIL 1

Cp at y/b of														
x/c	0.02		0.22		0.44		0.56		0.67		0.83		0.98	
	U.S.	L.S.	U.S.	L.S.	U.S.	L.S.	U.S.	L.S.	U.S.	L.S.	U.S.	L.S.	U.S.	L.S.
.05	.0300	.0100	.0199	.2420	.0426	.2657	.1332	.3207	.1999	.3308	.1288	.3241		
.10	.0345	.0100	-.0170	.2056	.0388	.2602					.1148	.3128	.1071	.3225
.15	.0385	.0162	.0177	.1868	.0355	.2506		.3670	.0943	.3288	.1095	.3153	.0929	.3109
.20						.2435	.0816	.3848	.0920	.3332	.1027	.3139	.0798	.2962
.25	.0386	.0219	.0164	.1740	.0298	.2380	.0818	.3919	.0919	.3403	.0965	.3184	.0723	.2909
.30	.0061	.0113	.0138	.1742	.0289	.2361	.0796	.3874	.0902	.3479	.0901	.3202	.0654	.2803
.40	.0508	.0141			.0291	.2345	.0756	.3784	.0858	.3518	.0853	.3162	.0549	.2576
.50	.0196	.0202	-.0313	.0324			-.0115	.1295					.0370	.1396
.60	-.0126	.0243	-.0294	.0223	-.0274	.0576	-.0497	-.0209	-.0521	.0095	-.0488	-.0033	-.0500	-.0308
.70			-.0299	.0227			-.0511	-.0277	-.0533	-.0140	-.0467	-.0270		-.0447
.80			-.0491	-.0375	-.0347	-.0213	-.0496	-.0351	-.0453	-.0213	-.0451	-.0325	-.0446	-.0449
.90			-.0498	-.0464	-.0495	-.0449	-.0501	-.0393	-.0391	-.0245	-.0457	-.0353	-.0465	-.0435
.95			-.0482	-.0483					-.0464	-.0298	-.0458	-.0385	-.0382	-.0418

TAIL 2

TABLE XIII. - CONTINUED
(g) $\alpha = 8.00^\circ$

Cp at y/b of														
x/c	0.02		0.22		0.44		0.56		0.67		0.83		0.98	
	U.S.	L.S.	U.S.	L.S.	U.S.	L.S.	U.S.	L.S.	U.S.	L.S.	U.S.	L.S.	U.S.	L.S.
.05	-.0243	.2215	.0493	.3454	.0757	.3326			.1280		.1290	.4350	.1395	.4168
.10	-.0264	.2139	.0392	.3394	.0700	.3267			.1170	.3999	.1202	.4198	.1050	.3902
.15	-.0255	.1857	.0329	.3300	.0544	.3264			.1104	.4045	.1073	.4087	.0970	.3639
.20	-.0221	.1950							.1089	.4054	.1024	.4049		
.25	-.0266	.1944	.0326	.3089	.0554	.3273	.0896	.4349	.1049	.4046			.0812	.3253
.30	-.0375	.0753	.0226	.2931	.0596	.3222	.0925	.4469	.1027	.4066	.0977	.4014	.0781	.3171
.40	-.0457	.0817	-.0201	.1211	.0485	.3463	.0867	.4466	.0959	.4054	.0908	.3943	.0718	.2976
.50	-.0499	.0982	-.0392	.1017			-.0040	.1655	.0372	.1785	.0610	.2280	.0509	.1663
.60	-.0357	.0970	-.0401	.0954	-.0272	.1456	-.0531	.0173	-.0501	.0077	-.0569	.0014	-.0493	-.0158
.70			-.0458	.0853	-.0473	.0109	-.0473	.0000	-.0458	.0112	-.0555	-.0159	-.0542	-.0216
.80	-.0483	.0213	-.0324	-.0101	-.0459	-.0089	-.0404	-.0022			-.0519		-.0622	-.0269
.90	-.0380	-.0139	-.0467	-.0250	-.0458	-.0147	-.0445	-.0070	-.0443	-.0095	-.0518	-.0225	-.0682	-.0243
.95			-.0406	-.0265	-.0416	-.0115	-.0378	-.0070	-.0527	-.0180	-.0505	-.0268	-.0646	-.0210

TAIL 1

Cp at y/b of														
x/c	0.02		0.22		0.44		0.56		0.67		0.83		0.98	
	U.S.	L.S.	U.S.	L.S.	U.S.	L.S.	U.S.	L.S.	U.S.	L.S.	U.S.	L.S.	U.S.	L.S.
.05	.0086	.0209	.0052	.1729	.0007	.3070	.0814	.4010	.1556	.3782	.0952	.3644		
.10	.0151	.0113	.0022	.1623	-.0025	.2845					.0797	.3539	.0803	.3665
.15	.0245	.0080	-.0005	.1560	-.0058	.2625		.4318	.0566	.3898	.0741	.3603	.0666	.3563
.20						.2509	.0375	.4356	.0532	.4047	.0673	.3587	.0546	.3417
.25	.0307	.0039	-.0076	.1522	-.0083	.2426	.0346	.4387	.0531	.4155	.0617	.3628	.0473	.3351
.30	.0025	-.0069	-.0118	.1530	-.0094	.2388	.0323	.4259	.0508	.4194	.0560	.3649	.0412	.3241
.40	.0514	-.0032			-.0072	.2299	.0288	.4084	.0464	.4207	.0515	.3622	.0322	.2989
.50	.0196	.0054	-.0445	.0329			-.0339	.1459					.0168	.1647
.60	-.0083	.0154	-.0459	.0257	-.0390	.0768	-.0504	-.0192	-.0571	.0231	-.0537	.0085	-.0529	-.0185
.70			-.0472	.0283			-.0537	-.0209	-.0559	-.0023	-.0506	-.0118		-.0376
.80			-.0521	-.0324	-.0385	-.0140	-.0533	-.0295	-.0491	-.0098	-.0501	-.0149	-.0481	-.0409
.90			-.0559	-.0420	-.0543	-.0379	-.0542	-.0337	-.0433	-.0142	-.0504	-.0170	-.0510	-.0432
.95			-.0562	-.0452					-.0517	-.0199	-.0511	-.0209	-.0411	-.0422

TAIL 2

TABLE XIII. - CONTINUED
(h) $\alpha = 10.00^\circ$

Cp at γ/b of														
x/c	0.02		0.22		0.44		0.56		0.67		0.83		0.98	
	U.S.	L.S.	U.S.	L.S.	U.S.	L.S.	U.S.	L.S.	U.S.	L.S.	U.S.	L.S.	U.S.	L.S.
.05	-.0251	.2753	.0531	.4169	.0802	.4003			.1304		.1308	.5075	.1417	.4856
.10	-.0272	.2645	.0413	.4061	.0721	.3953			.1187	.4681	.1212	.4911	.1060	.4554
.15	-.0266	.2280	.0350	.3907	.0558	.3959			.1113	.4735	.1078	.4788	.0974	.4251
.20	-.0228	.2401							.1099	.4742	.1032	.4741		
.25	-.0274	.2414	.0336	.3638	.0568	.3978	.0897	.5187	.1056	.4749			.0834	.3822
.30	-.0379	.0908	.0233	.3456	.0578	.3911	.0928	.5317	.1032	.4781	.0978	.4709	.0810	.3730
.40	-.0466	.0970	-.0205	.1517	.0494	.4195	.0870	.5318	.0966	.4789	.0909	.4629	.0755	.3505
.50	-.0498	.1297	-.0398	.1322			-.0028	.2127	.0376	.2196	.0607	.2760	.0549	.2027
.60	-.0373	.1292	-.0403	.1254	-.0276	.1841	-.0525	.0390	-.0496	.0256	-.0572	.0162	-.0481	-.0073
.70			-.0447	.1149	-.0454	.0274	-.0457	.0202	-.0452	.0288	-.0537	-.0032	-.0533	-.0125
.80	-.0437	.0403	-.0319	.0018	-.0444	.0058	-.0390	.0168			-.0508		-.0637	-.0177
.90	-.0368	-.0021	-.0454	-.0128	-.0449	-.0004	-.0428	.0115	-.0436	.0053	-.0505	-.0113	-.0695	-.0159
.95			-.0398	-.0143	-.0415	-.0004	-.0367	.0103	-.0519	-.0012	-.0493	-.0157	-.0669	-.0118

TAIL 1

Cp at γ/b of														
x/c	0.02		0.22		0.44		0.56		0.67		0.83		0.98	
	U.S.	L.S.	U.S.	L.S.	U.S.	L.S.	U.S.	L.S.	U.S.	L.S.	U.S.	L.S.	U.S.	L.S.
.05	-.0014	.0044	-.0009	.1127	-.0333	.2923	.0189	.4413	.1179	.4190	.0597	.4030		
.10	.0037	-.0017	-.0044	.1138	-.0345	.2632					.0424	.3982	.0517	.4099
.15	.0129	-.0044	-.0064	.1154	-.0359	.2469		.4360	.0173	.4611	.0366	.4014	.0390	.3999
.20						.2358	-.0051	.4474	.0140	.4696	.0302	.3995	.0283	.3845
.25	.0209	-.0117	-.0135	.1186	-.0331	.2296	-.0108	.4332	.0135	.4686	.0251	.4046	.0217	.3770
.30	-.0051	-.0261	-.0170	.1217	-.0347	.2273	-.0134	.4316	.0106	.4679	.0205	.4091	.0161	.3645
.40	.0483	-.0212			-.0314	.2199	-.0168	.4139	.0067	.4505	.0166	.4112	.0083	.3448
.50	.0238	-.0131	-.0508	.0239			-.0503	.1496					-.0036	.2008
.60	-.0116	.0007	-.0548	.0204	-.0456	.0811	-.0516	-.0127	-.0631	.0332	-.0590	.0295	-.0572	-.0037
.70			-.0558	.0251			-.0599	-.0149	-.0614	.0052	-.0562	.0128		-.0261
.80			-.0566	-.0334	-.0428	-.0110	-.0597	-.0253	-.0541	-.0055	-.0561	.0081	-.0508	-.0309
.90			-.0623	-.0426	-.0602	-.0342	-.0608	-.0292	-.0478	-.0117	-.0564	.0038	-.0523	-.0329
.95			-.0626	-.0458					-.0575	-.0185	-.0564	-.0014	-.0455	-.0340

TAIL 2

TABLE XIII. - CONTINUED
(1) $\alpha = 12.00^\circ$

Cp at y/b of														
x/c	0.02		0.22		0.44		0.56		0.67		0.83		0.98	
	U.S.	L.S.	U.S.	L.S.	U.S.	L.S.	U.S.	L.S.	U.S.	L.S.	U.S.	L.S.	U.S.	L.S.
.05	-.0213	.3374	.0618	.5026	.0896	.4828			.1377		.1373	.5933	.1478	.5660
.10	-.0243	.3233	.0487	.4825	.0788	.4777			.1248	.5491	.1263	.5750	.1097	.5296
.15	-.0230	.2770	.0417	.4612	.0628	.4795			.1172	.5554	.1131	.5611	.1017	.4953
.20	-.0191	.2922							.1154	.5570	.1082	.5561		
.25	-.0236	.2973	.0392	.4278	.0632	.4811	.0951	.6225	.1112	.5594			.0898	.4470
.30	-.0339	.1089	.0288	.4075	.0631	.4698	.0982	.6366	.1088	.5651	.1026	.5528	.0887	.4368
.40	-.0445	.1162	-.0182	.1879	.0541	.5023	.0918	.6376	.1017	.5679	.0951	.5431	.0838	.4114
.50	-.0463	.1665	-.0381	.1672			.0009	.2701	.0413	.2695	.0644	.3304	.0618	.2448
.60	-.0333	.1671	-.0388	.1606	-.0253	.2264	-.0512	.0656	-.0478	.0488	-.0553	.0354	-.0456	.0046
.70			-.0428	.1487	-.0427	.0463	-.0431	.0441	-.0435	.0517	-.0499	.0142	-.0525	.0002
.80	-.0420	.0634	-.0296	.0164	-.0423	.0230	-.0367	.0393			-.0472		-.0657	-.0047
.90	-.0345	.0125	-.0428	.0021	-.0426	.0163	-.0407	.0331	-.0415	.0268	-.0473	.0037	-.0675	-.0040
.95			-.0373	.0000	-.0406	.0135	-.0347	.0305	-.0490	.0220	-.0464	-.0005	-.0632	-.0001

TAIL 1

Cp at y/b of														
x/c	0.02		0.22		0.44		0.56		0.67		0.83		0.98	
	U.S.	L.S.	U.S.	L.S.	U.S.	L.S.	U.S.	L.S.	U.S.	L.S.	U.S.	L.S.	U.S.	L.S.
.05	-.0096	-.0008	-.0153	.0952	-.0463	.2756	-.0124	.4374	.0904	.4491	.0249	.4277		
.10	-.0058	-.0082	-.0185	.1020	-.0469	.2544					.0079	.4260	.0222	.4477
.15	-.0035	-.0106	-.0186	.1056	-.0483	.2361		.4317	-.0071	.4934	.0019	.4299	.0109	.4361
.20						.2278	-.0301	.4261	-.0115	.4888	-.0047	.4295	.0020	.4196
.25	.0109	-.0193	-.0232	.1128	-.0448	.2206	-.0359	.4207	-.0143	.4824	-.0085	.4376	-.0035	.4114
.30	-.0120	-.0324	-.0257	.1163	-.0469	.2203	-.0371	.4187	-.0186	.4580	-.0122	.4485	-.0080	.4023
.40	.0443	-.0281			-.0427	.2125	-.0399	.4026	-.0217	.4382	-.0150	.4612	-.0127	.3798
.50	.0236	-.0210	-.0553	.0279			-.0612	.1627					-.0214	.2258
.60	-.0190	-.0070	-.0595	.0253	-.0504	.0829	-.0552	-.0083	-.0658	.0275	-.0625	.0476	-.0600	.0114
.70			-.0607	.0316			-.0647	-.0141	-.0659	.0028	-.0596	.0266		-.0093
.80			-.0605	-.0301	-.0464	-.0089	-.0653	-.0233	-.0585	-.0057	-.0599	.0201	-.0581	-.0112
.90			-.0666	-.0412	-.0653	-.0310	-.0658	-.0274	-.0505	-.0106	-.0603	.0159	-.0621	-.0114
.95			-.0673	-.0452					-.0606	-.0185	-.0600	.0103	-.0483	-.0132

TAIL 2

TABLE XIII. - CONTINUED
(j) $\alpha = 16.00^\circ$

Cp at γ/b of														
x/c	0.02		0.22		0.44		0.56		0.67		0.83		0.98	
	U.S.	L.S.	U.S.	L.S.	U.S.	L.S.	U.S.	L.S.	U.S.	L.S.	U.S.	L.S.	U.S.	L.S.
.05	-.0107	.4851	.0881	.7118	.1154	.7123			.1621		.1577	.8076	.1667	.7618
.10	-.0133	.4683	.0698	.6666	.1016	.7042			.1473	.7541	.1444	.7831	.1233	.7121
.15	-.0114	.3965	.0611	.6302	.0851	.7032			.1386	.7618	.1301	.7651	.1167	.6671
.20	-.0062	.4179							.1361	.7680	.1252	.7599		
.25	-.0102	.4338	.0564	.5828	.0833	.6894	.1160	.9006	.1320	.7804			.1106	.6060
.30	-.0233	.1407	.0457	.5567	.0757	.6567	.1189	.9144	.1292	.7956	.1185	.7564	.1109	.5934
.40	-.0375	.1511	-.0119	.2742	.0733	.6909	.1117	.9066	.1215	.8052	.1105	.7450	.1056	.5615
.50	-.0427	.2524	-.0332	.2537			.0103	.4060	.0546	.4104	.0779	.4614	.0810	.3494
.60	-.0300	.2616	-.0345	.2487	-.0163	.3270	-.0470	.1314	-.0411	.1213	-.0484	.0864	-.0418	.0382
.70			-.0376	.2355	-.0376	.0965	-.0370	.1046	-.0367	.1228	-.0421	.0624	-.0525	.0369
.80	-.0356	.1217	-.0244	.0580	-.0369	.0719	-.0312	.0966			-.0405		-.0650	.0327
.90	-.0285	.0524	-.0368	.0428	-.0376	.0642	-.0348	.0876	-.0372	.0941	-.0407	.0455	-.0586	.0322
.95			-.0316	.0405	-.0356	.0571	-.0291	.0820	-.0438	.0910	-.0396	.0418	-.0504	.0306

TAIL 1

Cp at γ/b of														
x/c	0.02		0.22		0.44		0.56		0.67		0.83		0.98	
	U.S.	L.S.	U.S.	L.S.	U.S.	L.S.	U.S.	L.S.	U.S.	L.S.	U.S.	L.S.	U.S.	L.S.
.05	-.0198	-.0235	-.0412	.1697	-.0616	.2608	-.0431	.4074	.0727	.5479	-.0096	.4426		
.10	-.0201	-.0288	-.0472	.1664	-.0608	.2466					-.0230	.4663	-.0184	.4782
.15	-.0124	-.0292	-.0465	.1638	-.0616	.2293		.4004	-.0178	.4951	-.0287	.4836	-.0251	.4676
.20						.2235	-.0469	.4077	-.0254	.4682	-.0345	.4938	-.0305	.4566
.25	-.0106	-.0237	-.0465	.1679	-.0572	.2180	-.0527	.4038	-.0311	.4551	-.0358	.5040	-.0336	.4582
.30	-.0276	-.0330	-.0474	.1722	-.0599	.2187	-.0527	.3992	-.0381	.4392	-.0375	.5053	-.0368	.4506
.40	.0373	-.0273			-.0539	.2088	-.0546	.3900	-.0397	.4288	-.0380	.4878	-.0403	.4530
.50	.0114	-.0184	-.0620	.0678			-.0671	.1555					-.0457	.2877
.60	-.0349	-.0141	-.0655	.0729	-.0532	.0909	-.0575	-.0089	-.0671	.0262	-.0649	.0601	-.0660	.0468
.70			-.0662	.0744			-.0671	-.0108	-.0675	.0040	-.0627	.0491		.0252
.80			-.0625	-.0136	-.0482	.0005	-.0672	-.0163	-.0596	-.0043	-.0637	.0455	-.0620	.0183
.90			-.0699	-.0279	-.0679	-.0184	-.0683	-.0181	-.0532	-.0103	-.0642	.0367	-.0650	.0161
.95			-.0706	-.0329					-.0638	-.0173	-.0638	.0278	-.0511	.0128

TAIL 2

TABLE XIII. - CONCLUDED
(k) $\alpha = 20.00^\circ$

Cp at y/b of														
x/c	0.02		0.22		0.44		0.56		0.67		0.83		0.98	
	U.S.	L.S.	U.S.	L.S.	U.S.	L.S.	U.S.	L.S.	U.S.	L.S.	U.S.	L.S.	U.S.	L.S.
.05	.0080	.6813	.1238	.9641	.1515	1.0341			.1937		.1854	1.0821	.0453	.6559
.10	.0030	.6655	.1000	.8909	.1332	.9935			.1770	1.0174	.1697	1.0470	.0144	.6150
.15	.0058	.5555	.0885	.8428	.1180	.9719			.1675	1.0411	.1555	1.0237	.0141	.5852
.20	.0126	.5836							.1641	1.0837	.1493	1.0168		
.25	.0094	.6153	.0804	.7820	.1108	.9272	.1453	1.2398	.1604	1.1163			.0130	.5764
.30	-.0076	.1878	.0693	.7492	.1004	.8666	.1479	1.2370	.1571	1.1320	.1378	1.0103	.0172	.5850
.40	-.0253	.2025	-.0039	.3807	.1041	.9065	.1383	1.2008	.1486	1.1547	.1254	.9737	.0151	.5774
.50	-.0367	.3685	-.0250	.3633			.0215	.5628	.0733	.6836	.0897	.5943	-.0177	.3703
.60	-.0246	.3855	-.0277	.3603	-.0058	.4563	-.0374	.2109	-.0367	.2253	-.0396	.1228	-.0510	.0746
.70			-.0299	.3488	-.0284	.1680	-.0270	.1828	-.0321	.2250	-.0351	.0911	-.0450	.0734
.80	-.0287	.1962	-.0155	.1109	-.0281	.1399	-.0230	.1690			-.0333		-.0397	.0785
.90	-.0207	.1106	-.0276	.0970	-.0287	.1268	-.0272	.1551	-.0311	.1846	-.0335	.0829	-.0389	.0865
.95			-.0227	.0967	-.0281	.1173	-.0211	.1462	-.0369	.1821	-.0330	.0796	-.0392	.0898

TAIL 1

Cp at y/b of														
x/c	0.02		0.22		0.44		0.56		0.67		0.83		0.98	
	U.S.	L.S.	U.S.	L.S.	U.S.	L.S.	U.S.	L.S.	U.S.	L.S.	U.S.	L.S.	U.S.	L.S.
.05	-.0307	-.0334	-.0510	.2301	-.0708	.2673	-.0597	.3856	.0445	.5812	-.0316	.5392		
.10	-.0341	-.0390	-.0589	.2278	-.0699	.2590					-.0394	.5546	-.0319	.5747
.15	-.0269	-.0318	-.0601	.2337	-.0699	.2447		.4144	-.0310	.5000	-.0429	.5489	-.0372	.5682
.20						.2385	-.0587	.4223	-.0416	.4868	-.0483	.5359	-.0422	.5517
.25	-.0314	-.0268	-.0608	.2456	-.0652	.2333	-.0643	.4245	-.0481	.4785	-.0490	.5306	-.0451	.5490
.30	-.0427	-.0319	-.0614	.2486	-.0678	.2343	-.0637	.4167	-.0549	.4705	-.0504	.5237	-.0484	.5391
.40	.0271	-.0280			-.0604	.2155	-.0655	.4018	-.0521	.4648	-.0504	.5062	-.0521	.5045
.50	.0062	-.0284	-.0667	.1406			-.0702	.1693					-.0557	.2890
.60	-.0487	-.0327	-.0696	.1389	-.0554	.1174	-.0589	-.0020	-.0708	.0449	-.0667	.0884	-.0669	.0704
.70			-.0705	.1357			-.0702	.0033	-.0712	.0193	-.0648	.0684		.0524
.80			-.0637	.0145	-.0495	.0185	-.0701	.0027	-.0620	.0087	-.0658	.0575	-.0635	.0542
.90			-.0724	-.0077	-.0705	.0007	-.0713	.0028	-.0549	.0011	-.0664	.0462	-.0662	.0525
.95			-.0732	-.0155					-.0658	-.0042	-.0662	.0371	-.0518	.0472

TAIL 2

TABLE XIV. - PRESSURE COEFFICIENTS, $\phi = 67.5^\circ$, $\delta = 0^\circ$, $M = 3.70$.
(a) $\alpha = -4.16^\circ$

Cp at y/b of														
x/c	0.02		0.22		0.44		0.56		0.67		0.83		0.98	
	U.S.	L.S.	U.S.	L.S.	U.S.	L.S.	U.S.	L.S.	U.S.	L.S.	U.S.	L.S.	U.S.	L.S.
.05	.0661	.0081	.2640	.0504	.2541	.0715			.3130		.3021	.1574	.2987	.1591
.10	.0696	.0102	.2501	.0464	.2552	.0646			.3121	.1318	.2985	.1430	.2632	.1351
.15	.0741	.0089	.2333	.0437	.2465	.0590			.3088	.1299	.2884	.1347	.2632	.1222
.20	.0794	.0101							.3073	.1307	.2835	.1314		
.25	.0785	.0083	.2119	.0420	.2433	.0589	.3263	.1187	.3044	.1286			.2388	.1017
.30	.0390	.0243	.1984	.0364	.1888	.0655	.3349	.1238	.3030	.1285	.2807	.1282	.2276	.0978
.40	.0350	.0288	.0711	-.0142	.2313	.0641	.3343	.1221	.3001	.1252	.2730	.1240	.2117	.0876
.50	.0544	.0064	.0487	-.0276			.1194	.0055	.1874	.0334	.2213	.0486	.1729	.0271
.60	.0495	-.0041	.0445	-.0231	.0671	-.0092	-.0085	-.0445	-.0037	-.0375	-.0164	-.0475	-.0321	-.0451
.70			.0342	-.0284	-.0248	-.0401	-.0244	-.0376	.0003	-.0333	-.0378	-.0448	-.0422	-.0451
.80	-.0030	-.0284	-.0179	-.0350	-.0370	-.0357	-.0256	-.0330			-.0421		-.0433	-.0429
.90	-.0110	-.0303	-.0382	-.0405	-.0382	-.0350	-.0324	-.0347	-.0270	-.0290	-.0442	-.0367	-.0443	-.0417
.95			-.0251	-.0395	-.0320	-.0234	-.0268	-.0306	-.0402	-.0409	-.0425	-.0394	-.0434	-.0420

TAIL 1

Cp at y/b of														
x/c	0.02		0.22		0.44		0.56		0.67		0.83		0.98	
	U.S.	L.S.	U.S.	L.S.	U.S.	L.S.	U.S.	L.S.	U.S.	L.S.	U.S.	L.S.	U.S.	L.S.
.05	.1164	.1115	.2132	.1302	.1985	.1348	.3340	.1818	.2954	.1998	.2692	.2103		
.10	.1027	.0499	.2051	.1123	.1984	.1269					.2565	.1990	.2254	.2072
.15	.1036	.0461	.1995	.1101	.1959	.1223		.1887	.2498	.1930	.2529	.1967	.2112	.1847
.20						.1206	.2529	.1933	.2456	.1910	.2479	.1933	.1954	.1702
.25	.1011	.0395	.1868	.1074	.1874	.1208	.2544	.1949	.2445	.1910	.2420	.1931	.1851	.1642
.30	.0414	-.0006	.1785	.1051	.1892	.1237	.2518	.1933	.2423	.1911	.2351	.1939	.1738	.1565
.40	.0274	-.0068			.1901	.1308	.2470	.1887	.2381	.1903	.2264	.1909	.1574	.1431
.50	.0331	-.0102	.0206	-.0027			.0751	.0507					.1299	.0699
.60	.0123	-.0111	.0130	-.0105	.0366	.0126	-.0346	-.0332	-.0246	-.0344	-.0254	-.0235	-.0320	-.0286
.70			.0076	-.0159			-.0460	-.0495	-.0456	-.0502	-.0448	-.0395		-.0403
.80			-.0447	-.0474	-.0361	-.0301	-.0507	-.0524	-.0454	-.0430	-.0499	-.0432	-.0442	-.0381
.90			-.0448	-.0406	-.0537	-.0446	-.0520	-.0450	-.0381	-.0238	-.0466	-.0369	-.0418	-.0346
.95			-.0437	-.0403					-.0420	-.0331	-.0433	-.0340	-.0339	-.0398

TAIL 2

TABLE XIV. - CONTINUED
(b) $\alpha = -2.15^\circ$

Cp at y/b of														
x/c	0.02		0.22		0.44		0.56		0.67		0.83		0.98	
	U.S.	L.S.	U.S.	L.S.	U.S.	L.S.	U.S.	L.S.	U.S.	L.S.	U.S.	L.S.	U.S.	L.S.
.05	-.0660	-.0199	.2076	-.0950	.2040	.1115			.2643		.2574	.1997	-.2576	.1978
.10	-.0672	-.0247	.2035	-.0908	.2051	.1048			.2620	-.1739	.2530	-.1860	-.2205	.1745
.15	-.0691	-.0244	.1944	-.0884	.1951	.1003			.2584	-.1734	.2417	-.1773	-.2189	.1596
.20	-.0723	-.0262							.2562	-.1737	.2368	-.1740		
.25	-.0700	-.0249	.1804	-.0854	.1932	-.0992	.2581	.1680	.2526	-.1721			.1962	-.1358
.30	-.0344	-.0271	.1676	-.0784	.2126	-.0875	.2662	-.1745	.2499	-.1724	.2339	-.1704	-.1863	-.1309
.40	-.0265	-.0306	.0555	-.0050	.1853	-.1049	.2632	-.1726	.2449	-.1691	.2269	-.1659	-.1733	-.1196
.50	-.0366	-.0111	-.0316	-.0117			.0853	-.0281	.1447	-.0575	-.1803	-.0757	-.1388	-.0477
.60	-.0509	-.0011	-.0273	-.0112	.0487	-.0081	-.0216	-.0386	-.0166	-.0326	-.0228	-.0425	-.0358	-.0421
.70			-.0165	-.0173	-.0288	-.0405	-.0336	-.0439	-.0121	-.0287	-.0421	-.0501	-.0428	-.0470
.80	-.0098	-.0235	-.0209	-.0322	-.0404	-.0374	-.0336	-.0352			-.0468		-.0452	-.0444
.90	-.0142	-.0308	-.0311	-.0363	-.0374	-.0349	-.0365	-.0346	-.0278	-.0286	-.0429	-.0360	-.0420	-.0414
.95			-.0208	-.0355	-.0293	-.0222	-.0266	-.0300	-.0401	-.0400	-.0385	-.0393	-.0397	-.0411

TAIL 1

Cp at y/b of														
x/c	0.02		0.22		0.44		0.56		0.67		0.83		0.98	
	U.S.	L.S.	U.S.	L.S.	U.S.	L.S.	U.S.	L.S.	U.S.	L.S.	U.S.	L.S.	U.S.	L.S.
.05	.0793	.0932	.1829	.1388	.1731	.1454	.3046	-.1998	.2880	-.2146	.2460	.2208		
.10	.0723	.0546	.1755	.1254	.1724	.1391					.2332	.2099	.2043	.2202
.15	.0759	.0521	.1695	.1242	.1696	.1342		.2059	.2272	.2083	.2292	.2084	.1905	.1966
.20						.1317	.2293	-.2112	.2224	-.2067	.2237	-.2055	-.1755	-.1817
.25	.0748	.0474	.1574	.1212	.1616	.1328	.2309	-.2137	.2227	-.2075	.2176	-.2062	-.1655	-.1759
.30	.0258	-.0060	.1500	-.1189	.1635	-.1359	.2274	-.2122	.2203	-.2083	.2106	-.2076	-.1554	-.1674
.40	.0231	-.0005			.1636	-.1437	.2244	-.2096	.2156	-.2079	.2031	-.2052	-.1396	-.1550
.50	.0405	-.0025	.0087	.0030			.0629	-.0602					.1140	.0779
.60	.0067	-.0024	.0019	-.0055	.0264	-.0178	-.0330	-.0311	-.0264	-.0306	-.0284	-.0206	-.0351	-.0285
.70			-.0030	-.0092			-.0489	-.0475	-.0464	-.0478	-.0460	-.0377		-.0388
.80			-.0442	-.0494	-.0376	-.0304	-.0526	-.0525	-.0459	-.0462	-.0494	-.0426	-.0442	-.0417
.90			-.0429	-.0413	-.0485	-.0454	-.0492	-.0477	-.0370	-.0223	-.0436	-.0372	-.0434	-.0372
.95			-.0431	-.0399					-.0416	-.0321	-.0411	-.0338	-.0332	-.0312

TAIL 2

TABLE XIV. - CONTINUED
(c) $\alpha = -0.16^\circ$

Cp at γ/b of														
x/c	0.02		0.22		0.44		0.56		0.67		0.83		0.98	
	U.S.	L.S.	U.S.	L.S.	U.S.	L.S.	U.S.	L.S.	U.S.	L.S.	U.S.	L.S.	U.S.	L.S.
.05	.0550	.0398	.1558	.1445	.1597	.1535			.2216		.2168	.2446	.2200	.2375
.10	.0553	.0456	.1502	.1403	.1612	.1474			.2168	.2182	.2119	.2313	.1825	.2157
.15	.0554	.0456	.1460	.1378	.1495	.1437			.2126	.2192	.1999	.2228	.1801	.1994
.20	.0577	.0484							.2106	.2198	.1947	.2193		
.25	.0541	.0475	.1408	.1313	.1490	.1426	.2040	.2211	.2067	.2187			.1580	.1732
.30	.0232	.0322	.1298	.1226	.1729	.1379	.2099	.2286	.2035	.2190	.1914	.2154	.1502	.1676
.40	.0123	.0343	.0388	.0272	.1421	.1503	.2052	.2268	.1976	.2162	.1849	.2103	.1377	.1549
.50	.0164	.0216	.0124	.0096			.0561	.0525	.1122	.0832	.1441	.1052	.1087	.0704
.60	.0359	.0127	.0094	.0079	.0252	.0339	-.0312	-.0310	-.0263	-.0272	-.0296	-.0357	-.0375	-.0383
.70			-.0004	-.0003	-.0359	-.0336	-.0409	-.0409	-.0219	-.0231	-.0462	-.0478	-.0436	-.0442
.80	-.0174	-.0185	-.0167	-.0375	-.0375	-.0436	-.0320	-.0410			-.0424		-.0420	-.0475
.90	-.0198	-.0311	-.0305	-.0366	-.0328	-.0391	-.0320	-.0393	-.0249	-.0316	-.0370	-.0390	-.0384	-.0437
.95			-.0215	-.0348	-.0276	-.0247	-.0246	-.0319	-.0365	-.0415	-.0352	-.0404	-.0375	-.0419

TAIL 1

Cp at γ/b of														
x/c	0.02		0.22		0.44		0.56		0.67		0.83		0.98	
	U.S.	L.S.	U.S.	L.S.	U.S.	L.S.	U.S.	L.S.	U.S.	L.S.	U.S.	L.S.	U.S.	L.S.
.05	.0513	.0737	.1569	.1484	.1503	.1597	.2761	.2173	.2834	.2339	.2290	.2399		
.10	.0497	.0532	.1494	.1428	.1493	.1532					.2175	.2299	.1891	.2395
.15	.0541	.0538	.1441	.1404	.1469	.1475		.2255	.2071	.2283	.2131	.2289	.1752	.2167
.20						.1454	.2060	.2332	.2024	.2270	.2067	.2252	.1605	.2006
.25	.0544	.0501	.1318	.1348	.1396	.1469	.2089	.2362	.2022	.2280	.1997	.2271	.1507	.1953
.30	.0155	.0143	.1248	.1324	.1408	.1503	.2063	.2343	.2000	.2289	.1919	.2288	.1414	.1870
.40	.0185	.0107			.1407	.1588	.2011	.2320	.1950	.2284	.1850	.2247	.1262	.1732
.50	.0404	.0099	-.0015	.0089			.0537	.0646					.1013	.0888
.60	.0061	.0134	-.0083	-.0001	.0140	.0265	-.0333	-.0290	-.0305	-.0259	-.0320	-.0173	-.0388	-.0307
.70			-.0126	-.0057			-.0526	-.0443	-.0497	-.0435	-.0484	-.0362		-.0375
.80			-.0420	-.0499	-.0357	-.0282	-.0523	-.0496	-.0471	-.0449	-.0487	-.0417	-.0432	-.0413
.90			-.0432	-.0449	-.0455	-.0477	-.0460	-.0498	-.0368	-.0247	-.0424	-.0401	-.0425	-.0393
.95			-.0434	-.0425					-.0417	-.0328	-.0407	-.0363	-.0338	-.0337

TAIL 2

TABLE XIV. - CONTINUED
(d) $\alpha = 1.84^\circ$

Cp at y/b of														
x/c	0.02		0.22		0.44		0.56		0.67		0.83		0.98	
	U.S.	L.S.	U.S.	L.S.	U.S.	L.S.	U.S.	L.S.	U.S.	L.S.	U.S.	L.S.	U.S.	L.S.
.05	.0345	.0667	.1131	.1967	.1233	.2006			.1797		.1741	.2904	.1800	.2794
.10	.0350	.0765	.1070	.1928	.1242	.1944			.1736	.2657	.1693	.2778	.1432	.2583
.15	.0354	.0751*	.1019	.1894	.1108	.1915			.1694	.2683	.1570	.2695	.1398	.2399
.20	.0377	.0782							.1681	.2695	.1520	.2662		
.25	.0336	.0779	.1014	.1793	.1116	.1901	.1567	.2790	.1639	.2686			.1198	.2110
.30	.0086	.0368	.0919	.1685	.1353	.1724	.1605	.2874	.1612	.2695	.1485	.2625	.1130	.2048
.40	-.0031	.0382	.0227	.0512	.1042	.1990	.1556	.2859	.1550	.2673	.1426	.2573	.1027	.1916
.50	-.0037	.0340	-.0016	.0344			.0320	.0808	.0822	.1121	.1072	.1356	.0779	.0936
.60	.0214	.0315	-.0035	.0312	.0054	.0599	-.0385	-.0209	-.0340	-.0191	-.0401	-.0286	-.0424	-.0354
.70			-.0129	.0226	-.0410	-.0245	-.0400	-.0330	-.0296	-.0152	-.0510	-.0424	-.0481	-.0409
.80	-.0226	-.0107	-.0146	-.0328	-.0353	-.0378	-.0306	-.0341			-.0435		-.0449	-.0456
.90	-.0207	-.0284	-.0308	-.0419	-.0333	-.0402	-.0334	-.0376	-.0269	-.0318	-.0408	-.0424	-.0418	-.0468
.95			-.0224	-.0371	-.0282	-.0262	-.0267	-.0335	-.0401	-.0436	-.0396	-.0447	-.0434	-.0460

TAIL 1

Cp at y/b of														
x/c	0.02		0.22		0.44		0.56		0.67		0.83		0.98	
	U.S.	L.S.	U.S.	L.S.	U.S.	L.S.	U.S.	L.S.	U.S.	L.S.	U.S.	L.S.	U.S.	L.S.
.05	.0425	.0640	.1299	.1675	.1273	.1786	.2462	.2334	.2636	.2548	.2099	.2581		
.10	.0416	.0477	.1233	.1670	.1267	.1718					.1986	.2475	.1750	.2595
.15	.0448	.0485	.1188	.1618	.1240	.1654		.2491	.1854	.2498	.1936	.2465	.1614	.2398
.20						.1643	.1844	.2572	.1822	.2489	.1865	.2439	.1467	.2233
.25	.0435	.0455	.1066	.1486	.1172	.1654	.1854	.2632	.1819	.2508	.1792	.2470	.1381	.2190
.30	.0108	.0158	.1004	.1427	.1178	.1696	.1819	.2606	.1796	.2524	.1711	.2490	.1294	.2109
.40	.0185	.0137			.1176	.1776	.1792	.2637	.1744	.2524	.1654	.2458	.1156	.1944
.50	.0352	.0158	-.0109	.0148			.0496	.0782					.0916	.1020
.60	.0057	.0227	-.0173	.0055	.0061	.0381	-.0357	-.0260	-.0341	-.0191	-.0348	-.0119	-.0408	-.0311
.70			-.0202	.0003			-.0555	-.0395	-.0524	-.0371	-.0495	-.0329		-.0361
.80			-.0413	-.0477	-.0329	-.0251	-.0493	-.0451	-.0472	-.0399	-.0458	-.0388	-.0421	-.0381
.90			-.0443	-.0473	-.0448	-.0482	-.0455	-.0473	-.0362	-.0257	-.0408	-.0401	-.0421	-.0384
.95			-.0446	-.0436					-.0421	-.0368	-.0399	-.0381	-.0339	-.0339

TAIL 2

TABLE XIV. - CONTINUED
(e) $\alpha = 3.85^\circ$

Cp at y/b of														
x/c	0.02		0.22		0.44		0.56		0.67		0.83		0.98	
	U.S.	L.S.	U.S.	L.S.	U.S.	L.S.	U.S.	L.S.	U.S.	L.S.	U.S.	L.S.	U.S.	L.S.
.05	.0078	.1151	.0750	.2564	.0902	.2527			.1416		.1364	.3411	.1453	.3263
.10	.0076	.1222	.0675	.2514	.0919	.2470			.1337	.3165	.1303	.3277	.1109	.3051
.15	.0090	.1107	.0623	.2450	.0762	.2450			.1290	.3204	.1179	.3190	.1057	.2844
.20	.0132	.1147							.1280	.3222	.1131	.3156		
.25	.0100	.1156	.0638	.2284	.0791	.2445	.1143	.3448	.1244	.3218			.0877	.2515
.30	-.0075	.0450	.0537	.2143	.1012	.2342	.1174	.3543	.1219	.3236	.1096	.3124	.0825	.2447
.40	-.0185	.0471	.0054	.0776	.0702	.2568	.1120	.3535	.1161	.3224	.1041	.3068	.0745	.2308
.50	-.0221	.0577	-.0152	.0608			.0118	.1153	.0548	.1446	.0737	.1693	.0532	.1189
.60	.0043	.0585	-.0161	.0585	-.0103	.0948	-.0430	-.0067	-.0393	-.0080	-.0468	-.0183	-.0450	-.0311
.70			-.0251	.0495	-.0402	-.0113	-.0387	-.0212	-.0346	-.0045	-.0489	-.0337	-.0493	-.0353
.80	-.0311	.0026	-.0168	-.0239	-.0364	-.0278	-.0319	-.0224			-.0442		-.0455	-.0392
.90	-.0230	-.0235	-.0344	-.0384	-.0360	-.0322	-.0356	-.0271	-.0289	-.0248	-.0431	-.0365	-.0544	-.0426
.95			-.0254	-.0385	-.0301	-.0232	-.0288	-.0255	-.0435	-.0355	-.0420	-.0406	-.0567	-.0441

TAIL 1

Cp at y/b of															
x/c	0.02		0.22		0.44		0.56		0.67		0.83		0.98		
	U.S.	L.S.	U.S.	L.S.	U.S.	L.S.	U.S.	L.S.	U.S.	L.S.	U.S.	L.S.	U.S.	L.S.	
.05	.0623	.0657	.0887	.2056	.1027	.2040	.2137	.2545	.2359	.2784	.1895	.2780			
.10	.0587	.0264	.0871	.1905	.1016	.1956					.1783	.2666	.1531	.2784	
.15	.0598	.0268	.0864	.1701	.0989	.1907			.2799	.1622	.2731	.1730	.2661	.1459	.2632
.20						.1899	.1571	.2929	.1594	.2732	.1648	.2649	.1316	.2482	
.25	.0556	.0273	.0815	.1465	.0920	.1917	.1583	.3019	.1593	.2761	.1572	.2686	.1232	.2439	
.30	.0177	.0073	.0783	.1412	.0923	.1955	.1562	.3009	.1569	.2782	.1496	.2703	.1154	.2349	
.40	.0238	.0084			.0921	.2023	.1530	.2998	.1516	.2792	.1450	.2669	.1025	.2165	
.50	.0284	.0129	-.0167	.0147			.0340	.0960					.0800	.1168	
.60	.0025	.0215	-.0195	.0068	-.0045	.0500	-.0397	-.0220	-.0383	-.0096	-.0384	-.0072	-.0436	-.0286	
.70			-.0222	.0021			-.0547	-.0325	-.0553	-.0284	-.0504	-.0290		-.0352	
.80			-.0434	-.0469	-.0313	-.0221	-.0479	-.0386	-.0459	-.0326	-.0448	-.0349	-.0422	-.0345	
.90			-.0457	-.0485	-.0449	-.0462	-.0462	-.0418	-.0367	-.0215	-.0417	-.0374	-.0430	-.0353	
.95			-.0459	-.0443					-.0434	-.0341	-.0412	-.0372	-.0347	-.0323	

TAIL 2

TABLE XIV. - CONTINUED
(f) $\alpha = 5.85^\circ$

Cp at y/b of														
x/c	0.02		0.22		0.44		0.56		0.67		0.83		0.98	
	U.S.	L.S.	U.S.	L.S.	U.S.	L.S.	U.S.	L.S.	U.S.	L.S.	U.S.	L.S.	U.S.	L.S.
.05	-.0167	.1649	.0420	.3227	.0585	.3115			.1076		.1098	.4002	.1218	.3841
.10	-.0197	.1656	.0340	.3114	.0594	.3066			.0977	.3705	.1024	.3866	.0897	.3609
.15	-.0174	.1411	.0289	.2977	.0425	.3056			.0914	.3757	.0900	.3767	.0836	.3372
.20	-.0112	.1508							.0906	.3776	.0843	.3728		
.25	-.0146	.1516	.0319	.2730	.0493	.3058	-.0725	.4170	.0865	.3789			.0665	.2938
.30	-.0221	.0534	.0209	.2587	.0711	.2799	.0750	.4292	.0845	.3828	.0799	.3695	.0629	.2930
.40	-.0309	.0549	-.0092	.1028	.0396	.3202	.0705	.4289	.0782	.3833	.0740	.3630	.0560	.2769
.50	-.0352	.0795	-.0269	.0869			-.0089	.1549	.0282	.1809	.0475	.2073	.0377	.1496
.60	-.0111	.0894	-.0262	.0858	-.0242	.1265	-.0454	.0107	-.0423	.0062	-.0516	-.0061	-.0461	-.0247
.70			-.0337	.0763	-.0403	.0011	-.0399	-.0049	-.0377	.0095	-.0494	-.0227	-.0492	-.0230
.80	-.0388	.0179	-.0204	-.0145	-.0394	-.0169	-.0342	-.0072			-.0466		-.0528	-.0315
.90	-.0247	-.0166	-.0392	-.0285	-.0394	-.0222	-.0385	-.0127	-.0313	-.0145	-.0464	-.0267	-.0576	-.0351
.95			-.0300	-.0299	-.0335	-.0171	-.0318	-.0126	-.0463	-.0224	-.0452	-.0313	-.0569	-.0377

TAIL 1

Cp at y/b of														
x/c	0.02		0.22		0.44		0.56		0.67		0.83		0.98	
	U.S.	L.S.	U.S.	L.S.	U.S.	L.S.	U.S.	L.S.	U.S.	L.S.	U.S.	L.S.	U.S.	L.S.
.05	.1250	.0708	.0503	.1713	.0735	.2381	.1782	.2852	.2089	.3049	.1679	.2998		
.10	.1092	-.0045	.0577	.1401	.0710	.2338					.1564	.2878	.1418	.2979
.15	.1031	-.0048	.0625	.1217	.0679	.2282		.3233	.1365	.3000	.1506	.2887	.1289	.2874
.20						.2241	.1258	.3415	.1335	.3014	.1415	.2872	.1151	.2741
.25	.0944	-.0017	.0651	.1032	.0619	.2194	.1274	.3503	.1334	.3070	.1340	.2912	.1074	.2636
.30	.0353	-.0126	.0619	.1006	.0624	.2177	.1243	.3479	.1306	.3122	.1272	.2935	.1002	.2600
.40	.0326	-.0077			.0635	.2155	.1208	.3446	.1254	.3140	.1228	.2901	.0883	.2395
.50	.0296	.0009	-.0077	-.0008			.0147	.1161					.0672	.1315
.60	.0027	.0105	-.0113	-.0048	-.0116	.0547	-.0436	-.0200	-.0430	.0043	-.0415	-.0017	-.0461	-.0239
.70			-.0161	-.0030			-.0518	-.0283	-.0565	-.0170	-.0492	-.0232		-.0355
.80			-.0464	-.0463	-.0324	-.0197	-.0482	-.0349	-.0454	-.0232	-.0441	-.0288	-.0418	-.0341
.90			-.0477	-.0495	-.0461	-.0441	-.0479	-.0389	-.0371	-.0139	-.0422	-.0311	-.0434	-.0334
.95			-.0465	-.0482					-.0441	-.0271	-.0420	-.0331	-.0351	-.0307

TAIL 2

TABLE XIV. - CONTINUED
(g) $\alpha = 7.86^\circ$

Cp at γ/b of														
x/c	0.02		0.22		0.44		0.56		0.67		0.83		0.98	
	U.S.	L.S.	U.S.	L.S.	U.S.	L.S.	U.S.	L.S.	U.S.	L.S.	U.S.	L.S.	U.S.	L.S.
.05	-.0349	.2147	.0163	.3847	.0422	.3823			.0929		.0963	.4713	.1092	.4529
.10	-.0419	.2051	.0076	.3630	.0417	.3778			.0822	.4385	.0883	.4569	.0784	.4268
.15	-.0402	.1727	.0009	.3433	.0221	.3767			.0751	.4450	.0753	.4462	.0721	.4002
.20	-.0326	.1852							.0744	.4487	.0697	.4419		
.25	-.0361	.1816	.0048	.3161	.0295	.3725	.0525	.5103	.0700	.4529			.0564	.3582
.30	-.0355	.0619	-.0080	.3007	.0483	.3484	.0541	.5238	.0679	.4596	.0650	.4391	.0539	.3509
.40	-.0411	.0668	-.0210	.1312	.0166	.3784	.0483	.5224	.0613	.4630	.0588	.4321	.0486	.3317
.50	-.0448	.1105	-.0355	.1145			-.0182	.2064	.0163	.2301	.0343	.2535	.0314	.1871
.60	-.0212	.1211	-.0311	.1117	-.0344	.1580	-.0470	.0327	-.0448	.0299	-.0534	.0110	-.0466	-.0153
.70			-.0359	.1023	-.0419	.0161	-.0426	.0147	-.0402	.0331	-.0500	-.0068	-.0513	-.0215
.80	-.0427	.0362	-.0237	-.0022	-.0418	-.0029	-.0370	.0104			-.0481		-.0563	-.0213
.90	-.0276	-.0061	-.0432	-.0160	-.0426	-.0086	-.0412	.0039	-.0339	.0049	-.0481	-.0120	-.0596	-.0239
.95			-.0337	-.0176	-.0358	-.0073	-.0343	.0022	-.0496	-.0003	-.0471	-.0166	-.0583	-.0279

TAIL 1

Cp at γ/b of														
x/c	0.02		0.22		0.44		0.56		0.67		0.83		0.98	
	U.S.	L.S.	U.S.	L.S.	U.S.	L.S.	U.S.	L.S.	U.S.	L.S.	U.S.	L.S.	U.S.	L.S.
.05	.1335	.0798	.0380	.0096	.0237	.3053	.1285	.3593	.1754	.3374	.1403	.3232		
.10	.1150	-.0106	.0353	.0068	.0205	.2751					.1285	.3127	.1206	.3230
.15	.1093	-.0159	.0331	.0053	.0227	.2491					.1227	.3160	.1088	.3147
.20						.2338	.0794	.3985	.0996	.3519	.1135	.3139	.0963	.3023
.25	.1040	-.0195	.0327	.0110	.0307	.2228	.0791	.3922	.0990	.3624	.1064	.3184	.0891	.2969
.30	.0418	-.0349	.0326	.0127	.0333	.2174	.0768	.3830	.0964	.3674	.1001	.3204	.0824	.2873
.40	.0410	-.0327			.0386	.2093	.0739	.3604	.0913	.3682	.0961	.3182	.0712	.2653
.50	.0339	-.0258	-.0129	-.0270			-.0091	.1260					.0517	.1495
.60	.0004	-.0173	-.0144	-.0188	-.0181	.0585	-.0480	-.0192	-.0495	.0141	-.0467	.0050	-.0496	-.0164
.70			-.0184	-.0098			-.0522	-.0231	-.0563	-.0100	-.0482	-.0148		-.0329
.80			-.0492	-.0443	-.0367	-.0189	-.0508	-.0301	-.0466	-.0172	-.0451	-.0184	-.0434	-.0349
.90			-.0498	-.0495	-.0511	-.0426	-.0516	-.0353	-.0392	-.0081	-.0458	-.0205	-.0458	-.0336
.95			-.0485	-.0504					-.0471	-.0212	-.0463	-.0238	-.0368	-.0306

TAIL 2

TABLE XIV. - CONTINUED
(h) $\alpha = 9.84^\circ$

Cp at γ/b of														
x/c	0.02		0.22		0.44		0.56		0.67		0.83		0.98	
	U.S.	L.S.	U.S.	L.S.	U.S.	L.S.	U.S.	L.S.	U.S.	L.S.	U.S.	L.S.	U.S.	L.S.
.05	-.0394	.2595	.0135	.4491	.0401	.4720			.0881		.0914	.5567	.1041	.5333
.10	-.0477	.2461	.0038	.4180	.0390	.4610			.0768	.5186	.0827	.5400	.0742	.5036
.15	-.0462	.2077	-.0035	.3934	.0185	.4546			.0692	.5279	.0696	.5277	.0677	.4733
.20	-.0381	.2200							.0687	.5359	.0635	.5230		
.25	-.0422	.2134	.0003	.3645	.0264	.4396	.0464	.6236	.0638	.5474			.0538	.4255
.30	-.0391	.0752	-.0136	.3498	.0390	.4239	.0471	.6331	.0619	.5588	.0588	.5203	.0524	.4182
.40	-.0434	.0853	-.0225	.1630	.0108	.4406	.0411	.6152	.0551	.5639	.0524	.5127	.0485	.3945
.50	-.0475	.1491	-.0351	.1468			-.0209	.2526	.0123	.2973	.0290	.3069	.0315	.2305
.60	-.0239	.1549	-.0295	.1448	-.0367	.1913	-.0479	.0572	-.0446	.0626	-.0516	.0311	-.0458	-.0040
.70			-.0358	.1364	-.0427	.0336	-.0435	.0360	-.0400	.0652	-.0480	.0124	-.0515	-.0154
.80	-.0417	.0576	-.0241	.0123	-.0427	.0139	-.0380	.0304			-.0469		-.0577	-.0126
.90	-.0276	.0073	-.0438	-.0024	-.0432	.0077	-.0420	.0228	-.0340	.0329	-.0481	.0062	-.0589	-.0133
.95			-.0339	-.0042	-.0361	.0064	-.0351	.0193	-.0499	.0279	-.0465	.0016	-.0535	-.0185

TAIL 1

Cp at γ/b of														
x/c	0.02		0.22		0.44		0.56		0.67		0.83		0.98	
	U.S.	L.S.	U.S.	L.S.	U.S.	L.S.	U.S.	L.S.	U.S.	L.S.	U.S.	L.S.	U.S.	L.S.
.05	.1205	.0679	.0081	-.0387	-.0245	.2040	-.0516	.4147	.1302	.3788	.1099	.3465		
.10	.1035	-.0171	.0053	-.0387	-.0173	.1845					.0967	.3397	.0987	.3478
.15	.0983	-.0210	.0072	-.0359	-.0137	.1679		.4010	.0600	.4046	.0910	.3444	.0871	.3402
.20						.1621	.0222	.3960	.0563	.4142	.0823	.3431	.0756	.3278
.25	.0980	-.0242	.0105	-.0274	-.0047	.1579	.0207	.3913	.0557	.4160	.0761	.3473	.0692	.3217
.30	.0378	-.0404	.0121	-.0244	-.0020	.1570	.0223	.3782	.0528	.4103	.0705	.3515	.0632	.3117
.40	.0469	-.0450			.0001	.1543	.0292	.3599	.0480	.3997	.0668	.3518	.0528	.2935
.50	.0399	-.0414	-.0249	-.0351			-.0274	.1315					.0357	.1704
.60	-.0040	-.0366	-.0249	-.0330	-.0254	.0460	-.0501	-.0193	-.0584	.0202	-.0507	.0167	-.0514	-.0066
.70			-.0271	-.0312			-.0560	-.0223	-.0579	-.0031	-.0506	-.0005		-.0256
.80			-.0524	-.0519	-.0418	-.0174	-.0539	-.0305	-.0505	-.0117	-.0487	-.0036	-.0454	-.0296
.90			-.0577	-.0546	-.0556	-.0394	-.0549	-.0349	-.0425	-.0044	-.0495	-.0068	-.0486	-.0313
.95			-.0562	-.0555					-.0514	-.0177	-.0503	-.0111	-.0388	-.0295

TAIL 2

TABLE XIV. - CONTINUED
(1) $\alpha = 11.86^\circ$

Cp at γ/b of														
x/c	0.02		0.22		0.44		0.56		0.67		0.83		0.98	
	U.S.	L.S.	U.S.	L.S.	U.S.	L.S.	U.S.	L.S.	U.S.	L.S.	U.S.	L.S.	U.S.	L.S.
.05	-.0427	.3093	.0125	.5192	.0391	.5743			.0868		.0893	.6539	.1017	.6297
.10	-.0519	.2936	.0015	.4809	.0378	.5496			.0752	.6124	.0797	.6365	.0715	.5931
.15	-.0514	.2494	-.0066	.4530	.0164	.5354			.0672	.6305	.0660	.6233	.0652	.5570
.20	-.0429	.2607							.0664	.6527	.0601	.6183		
.25	-.0474	.2522	-.0034	.4242	.0237	.5105	.0435	.7410	.0617	.6713			.0538	.5029
.30	-.0431	.0886	-.0176	.4082	.0318	.4786	.0440	.7411	.0594	.6817	.0552	.6151	.0534	.4939
.40	-.0459	.1029	-.0255	.1988	.0077	.5089	.0371	.7180	.0527	.6877	.0487	.6063	.0502	.4654
.50	-.0485	.1810	-.0360	.1828			-.0234	.3086	.0100	.3774	.0253	.3704	.0324	.2798
.60	-.0271	.1950	-.0310	.1832	-.0395	.2301	-.0493	.0846	-.0456	.0941	-.0516	.0570	-.0476	.0124
.70			-.0374	.1733	-.0441	.0536	-.0448	.0607	-.0409	.0959	-.0487	.0381	-.0544	-.0046
.80	-.0407	.0834	-.0257	.0299	-.0444	.0327	-.0392	.0524			-.0479		-.0608	-.0028
.90	-.0280	.0235	-.0451	.0150	-.0448	.0263	-.0435	.0430	-.0361	.0603	-.0492	.0325	-.0576	-.0027
.95			-.0348	.0129	-.0383	.0218	-.0361	.0380	-.0523	.0578	-.0471	.0283	-.0538	-.0082

TAIL 1

Cp at γ/b of														
x/c	0.02		0.22		0.44		0.56		0.67		0.83		0.98	
	U.S.	L.S.	U.S.	L.S.	U.S.	L.S.	U.S.	L.S.	U.S.	L.S.	U.S.	L.S.	U.S.	L.S.
.05	.1081	.0588	.0032	-.0481	-.0440	.0470	-.0046	.2863	.0793	.4210	.0764	.3742		
.10	.0932	-.0251	-.0007	-.0465	-.0403	.0462					.0619	.3768	.0739	.3755
.15	.0878	-.0285	-.0010	-.0436	-.0378	.0445		.2618	.0190	.4466	.0565	.3797	.0627	.3679
.20						.0455	-.0043	.2588	.0170	.4359	.0482	.3791	.0525	.3549
.25	.0858	-.0323	-.0012	-.0360	-.0294	.0487	-.0065	.2571	.0154	.4210	.0430	.3830	.0467	.3479
.30	.0284	-.0477	-.0018	-.0339	-.0321	.0529	-.0040	.2553	.0114	.3961	.0383	.3886	.0411	.3394
.40	.0493	-.0529			-.0284	.0607	-.0045	.2519	-.0077	.3681	.0351	.3954	.0320	.3240
.50	.0434	-.0513	-.0336	-.0463			-.0387	.0962					.0174	.1956
.60	-.0111	-.0466	-.0338	-.0455	-.0334	.0140	-.0524	-.0217	-.0614	.0095	-.0552	.0317	-.0545	.0035
.70			-.0352	-.0451			-.0605	-.0191	-.0594	-.0119	-.0536	.0121		-.0149
.80			-.0538	-.0606	-.0443	-.0230	-.0589	-.0272	-.0519	-.0159	-.0525	.0047	-.0499	-.0193
.90			-.0639	-.0636	-.0598	-.0448	-.0596	-.0319	-.0447	-.0051	-.0529	-.0009	-.0529	-.0201
.95			-.0621	-.0627					-.0541	-.0187	-.0532	-.0061	-.0407	-.0208

TAIL 2

TABLE XIV. - CONTINUED
(j) $\alpha = 15.86^\circ$

Cp at y/b of														
x/c	0.02		0.22		0.44		0.56		0.67		0.83		0.98	
	U.S.	L.S.	U.S.	L.S.	U.S.	L.S.	U.S.	L.S.	U.S.	L.S.	U.S.	L.S.	U.S.	L.S.
.05	-.0423	.4386	.0201	.6951	.0486	.8100			.0976		.1016	.8955	.1103	.8630
.10	-.0511	.4206	.0064	.6392	.0469	.7585			.0841	.8783	.0910	.8717	.0801	.8107
.15	-.0507	.3620	-.0036	.6057	.0248	.7290			.0758	.9444	.0748	.8529	.0744	.7630
.20	-.0424	.3655							.0749	.9678	.0678	.8467		
.25	-.0477	.3568	-.0024	.5691	-.0297	.6885	.0491	1.0029	.0703	.9822			.0681	.6913
.30	-.0443	.1104	-.0165	.5458	.0334	.6334	.0493	.9894	.0681	1.0004	.0616	.8476	.0686	.6766
.40	-.0486	.1314	-.0252	.2828	.0125	.6795	.0408	.9570	.0608	1.0011	.0545	.8433	.0641	.6339
.50	-.0463	.2654	-.0364	.2716			-.0221	.4298	.0155	.4985	.0304	.5406	.0471	.3962
.60	-.0271	.2950	-.0311	.2755	-.0390	.3306	-.0509	.1451	-.0453	.1586	-.0460	.1316	-.0448	.0548
.70			-.0375	.2604	-.0457	.1048	-.0463	.1148	-.0407	.1597	-.0436	.1214	-.0509	.0295
.80	-.0394	.1529	-.0259	.0707	-.0459	.0821	-.0404	.1020			-.0430		-.0523	.0249
.90	-.0281	.0713	-.0450	.0592	-.0460	.0760	-.0450	.0894	-.0336	.1398	-.0442	.1186	-.0511	.0252
.95			-.0348	.0575	-.0392	.0685	-.0377	.0818	-.0493	.1359	-.0415	.1160	-.0495	.0223

TAIL 1

Cp at y/b of														
x/c	0.02		0.22		0.44		0.56		0.67		0.83		0.98	
	U.S.	L.S.	U.S.	L.S.	U.S.	L.S.	U.S.	L.S.	U.S.	L.S.	U.S.	L.S.	U.S.	L.S.
.05	.0645	.0251	-.0124	-.0422	-.0568	.0179	-.0450	.1449	-.0206	.2771	-.0262	.2584		
.10	.0550	-.0382	-.0181	-.0404	-.0554	.0211					-.0324	.2735	.0340	.3955
.15	.0550	-.0395	-.0193	-.0382	-.0544	.0224		.1579	-.0438	.2356	-.0351	.2817	.0218	.3688
.20						.0255	-.0406	.1649	-.0470	.2241	-.0410	.2812	.0122	.3539
.25	.0516	-.0422	-.0216	-.0321	-.0464	.0295	-.0472	.1699	-.0497	.2191	-.0382	.2807	.0061	.3443
.30	.0065	-.0533	-.0222	-.0306	-.0491	.0351	-.0446	.1711	-.0502	.2168	-.0381	.2776	.0011	.3348
.40	.0454	-.0562			-.0433	.0417	-.0427	.1751	-.0398	.2170	-.0355	.2666	-.0056	.3076
.50	.0366	-.0547	-.0452	-.0512			-.0570	.0591					-.0156	.1837
.60	-.0255	-.0526	-.0457	-.0510	-.0422	.0058	-.0553	-.0312	-.0681	-.0121	-.0633	.0179	-.0624	.0171
.70			-.0465	-.0499			-.0679	-.0338	-.0675	-.0285	-.0614	.0021	-.0002	
.80			-.0550	-.0641	-.0487	-.0265	-.0669	-.0391	-.0586	-.0327	-.0613	-.0060	-.0571	-.0033
.90			-.0676	-.0671	-.0665	-.0498	-.0675	-.0428	-.0500	-.0194	-.0613	-.0120	-.0590	-.0065
.95			-.0670	-.0679					-.0609	-.0345	-.0614	-.0169	-.0454	-.0086

TAIL 2

TABLE XIV. - CONCLUDED
(k) $\alpha = 19.84^\circ$

Cp at y/b of														
x/c	0.02		0.22		0.44		0.56		0.67		0.83		0.98	
	U.S.	L.S.	U.S.	L.S.	U.S.	L.S.	U.S.	L.S.	U.S.	L.S.	U.S.	L.S.	U.S.	L.S.
.05	-.0379	.6095	.0332	.9156	.0580	1.0718			.1156		.1172	1.2130	.1225	1.1612
.10	-.0470	.5824	.0175	.8426	.0606	.9973			.1014	1.3578	.1046	1.1747	.0922	1.0847
.15	-.0454	.5090	.0059	.8019	.0398	.9553			.0940	1.3908	.0862	1.1523	.0878	1.0222
.20	-.0367	.4943							.0944	1.3992	.0781	1.1594		
.25	-.0422	.4979	.0046	.7546	.0415	.9015	.0606	1.3225	.0905	1.3655			.0849	.9263
.30	-.0404	.1446	-.0101	.7241	.0415	.8255	.0607	1.2882	.0881	1.3358	.0704	1.2051	.0850	.9061
.40	-.0472	.1766	-.0222	.3820	.0229	.8821	.0509	1.2317	.0803	1.2859	.0624	1.2147	.0795	.8556
.50	-.0455	.3890	-.0342	.3870			-.0175	.5820	.0292	.6737	.0364	.8173	.0638	.5496
.60	-.0250	.4246	-.0289	.3914	-.0356	.4443	-.0490	.2186	-.0405	.2858	-.0422	.2798	-.0485	.1182
.70			-.0347	.3796	-.0449	.1765	-.0436	.1804	-.0357	.2853	-.0411	.2513	-.0496	.0920
.80	-.0369	.2447	-.0231	.1278	-.0449	.1528	-.0386	.1586			-.0410		-.0493	.0881
.90	-.0255	.1383	-.0418	.1178	-.0452	.1456	-.0430	.1464	-.0324	.2291	-.0416	.2076	-.0439	.0913
.95			-.0318	.1163	-.0400	.1375	-.0342	.1380	-.0461	.2226	-.0391	.1989	-.0440	.0911

TAIL 1

Cp at y/b of														
x/c	0.02		0.22		0.44		0.56		0.67		0.83		0.98	
	U.S.	L.S.	U.S.	L.S.	U.S.	L.S.	U.S.	L.S.	U.S.	L.S.	U.S.	L.S.	U.S.	L.S.
.05	.0187	-.0029	-.0238	-.0295	-.0654	.0584	-.0550	.1578	-.0145	.2831	-.0432	.2674		
.10	.0099	-.0466	-.0300	-.0302	-.0645	.0649					-.0480	.2751	-.0387	.2952
.15	.0130	-.0458	-.0316	-.0308	-.0644	.0645		.1800	-.0496	.2390	-.0504	.2759	-.0418	.2914
.20					.0651		-.0514	.1886	-.0557	.2303	-.0543	.2704	-.0458	.2856
.25	.0063	-.0478	-.0336	-.0313	-.0557	.0669	-.0584	.1944	-.0596	.2282	-.0527	.2669	-.0472	.2835
.30	-.0200	-.0551	-.0343	-.0303	-.0591	.0696	-.0571	.1947	-.0603	.2257	-.0530	.2636	-.0494	.2798
.40	.0364	-.0573			-.0517	.0664	-.0569	.1991	-.0503	.2249	-.0516	.2545	-.0509	.2667
.50	.0439	-.0566	-.0519	-.0454			-.0644	.0694					-.0529	.1527
.60	-.0375	-.0551	-.0537	-.0435	-.0475	.0250	-.0546	-.0275	-.0725	-.0079	-.0673	.0135	-.0668	.0118
.70			-.0546	-.0390			-.0722	-.0303	-.0727	-.0250	-.0657	-.0044		-.0020
.80			-.0551	-.0585	-.0509	-.0196	-.0713	-.0344	-.0629	-.0311	-.0659	-.0136	-.0609	-.0049
.90			-.0700	-.0634	-.0701	-.0428	-.0721	-.0374	-.0538	-.0209	-.0660	-.0193	-.0651	-.0080
.95			-.0693	-.0653					-.0655	-.0351	-.0659	-.0241	-.0503	-.0104

TAIL 2

TABLE XV. - PRESSURE COEFFICIENTS, $\phi = 90^\circ$, $\delta = 0^\circ$, $M = 3.70$.
(a) $\alpha = -4.15^\circ$

Cp at y/b of														
x/c	0.02		0.22		0.44		0.56		0.67		0.83		0.98	
	U.S.	L.S.	U.S.	L.S.	U.S.	L.S.	U.S.	L.S.	U.S.	L.S.	U.S.	L.S.	U.S.	L.S.
.05	.1100	.0026	.2722	.0507	.2629	.0728			.3209		.3106	.1529	.3080	.1551
.10	.1078	.0007	.2640	.0458	.2643	.0653			.3204	.1273	.3042	.1379	.2692	.1306
.15	.1082	.0019	.2523	.0430	.2554	.0591			.3169	.1256	.2936	.1296	.2691	.1129
.20	.1088	.0038							.3151	.1262	.2905	.1263		
.25	.1053	.0033	.2317	.0418	.2535	.0586	.3301	.1148	.3124	.1241			.2434	.0960
.30	.0533	.0560	.2167	.0363	.2313	.1009	.3408	.1201	.3105	.1241	.2881	.1232	.2317	.0924
.40	.0424	.0763	.0792	-.0087	.2445	.0657	.3402	.1184	.3071	.1205	.2807	.1192	.2160	.0825
.50	.0625	.0075	.0567	-.0257			.1220	-.0082	.1895	.0308	.2273	.0460	.1769	.0244
.60	.0624	-.0152	.0522	-.0238	.0763	-.0022	-.0068	-.0406	-.0027	-.0335	-.0132	-.0450	-.0306	-.0434
.70			.0421	-.0291	-.0199	-.0381	-.0214	-.0377	.0019	-.0294	-.0351	-.0445	-.0389	-.0452
.80	-.0013	-.0296	-.0141	-.0328	-.0319	-.0361	-.0220	-.0333			-.0398		-.0417	-.0412
.90	-.0099	-.0327	-.0370	-.0384	-.0347	-.0354	-.0289	-.0347	-.0228	-.0275	-.0424	-.0366	-.0442	-.0419
.95			-.0253	-.0374	-.0294	-.0206	-.0244	-.0299	-.0375	-.0403	-.0420	-.0388	-.0441	-.0441

TAIL 1

Cp at y/b of														
x/c	0.02		0.22		0.44		0.56		0.67		0.83		0.98	
	U.S.	L.S.	U.S.	L.S.	U.S.	L.S.	U.S.	L.S.	U.S.	L.S.	U.S.	L.S.	U.S.	L.S.
.05	.0859	.1122	.1688	.1687	.1623	.1724	.2896	.2253	.2192	.2373	.2312	.2445		
.10	.0695	.0841	.1619	.1555	.1600	.1652					.2189	.2338	.1935	.2416
.15	.0716	.0789	.1563	.1536	.1566	.1604		.2323	.2114	.2322	.2162	.2331	.1790	.2192
.20						.1579	.2086	.2381	.2080	.2302	.2122	.2297	.1643	.2036
.25	.0713	.0704	.1451	.1515	.1485	.1595	.2089	.2401	.2073	.2306	.2072	.2299	.1549	.1958
.30	.0211	.0163	.1385	.1482	.1501	.1628	.2151	.2384	.2036	.2308	.2009	.2312	.1449	.1865
.40	.0047	.0111			.1502	.1715	.2002	.2338	.1976	.2302	.1918	.2278	.1302	.1733
.50	.0302	.0070	.0020	.0179			.0532	.0731					.1056	.0902
.60	-.0050	.0086	-.0050	.0096	.0143	.0310	-.0382	-.0277	-.0331	-.0247	-.0308	-.0163	-.0334	-.0251
.70			-.0097	.0046			-.0519	-.0409	-.0509	-.0425	-.0468	-.0342		-.0366
.80			-.0406	-.0449	-.0370	-.0264	-.0527	-.0461	-.0433	-.0421	-.0443	-.0407	-.0349	-.0391
.90			-.0418	-.0430	-.0453	-.0477	-.0465	-.0477	-.0317	-.0233	-.0391	-.0411	-.0409	-.0326
.95			-.0421	-.0403					-.0385	-.0334	-.0374	-.0375	-.0350	-.0363

TAIL 2

TABLE XV. - CONTINUED
(b) $\alpha = -2.15^\circ$

Cp at y/b of														
x/c	0.02		0.22		0.44		0.56		0.67		0.83		0.98	
	U.S.	L.S.	U.S.	L.S.	U.S.	L.S.	U.S.	L.S.	U.S.	L.S.	U.S.	L.S.	U.S.	L.S.
.05	.0781	.0160	.2109	-.0941	.2077	.1103			.2632		.2607	.1977	.2612	.1956
.10	.0782	.0213	.2069	-.0889	.2091	-.1033			.2662	.1722	.2555	.1841	.2231	-.1721
.15	.0796	.0219	.1999	-.0862	.1989	-.0986			.2624	.1716	.2437	.1756	.2219	-.1568
.20	.0819	.0239							.2603	.1719	.2396	.1722		
.25	.0789	.0232	.1881	-.0837	.1977	-.0975	.2616	.1657	.2567	.1702			.1978	.1334
.30	.0380	.0445	.1755	-.0778	.1889	-.0939	.2703	.1722	.2538	.1700	.2369	.1687	.1884	-.1286
.40	.0269	.0594	.0584	-.0063	.1901	-.1047	.2676	.1704	.2488	.1667	.2297	.1641	.1741	-.1172
.50	.0366	-.0086	.0337	-.0119			.0883	.0275	.1482	.0555	.1828	.0748	.1396	.0465
.60	.0453	-.0052	.0294	-.0119	.0502	-.0092	-.0219	-.0366	-.0172	-.0304	-.0247	-.0410	-.0370	-.0403
.70			.0182	-.0184	-.0288	-.0388	-.0336	-.0427	-.0126	-.0261	-.0444	-.0489	-.0438	-.0454
.80	-.0126	-.0263	-.0211	-.0316	-.0396	-.0365	-.0328	-.0341			-.0484		-.0470	-.0431
.90	-.0163	-.0329	-.0320	-.0361	-.0379	-.0341	-.0363	-.0337	-.0298	-.0269	-.0454	-.0356	-.0434	-.0398
.95			-.0215	-.0351	-.0298	-.0196	-.0267	-.0288	-.0421	-.0389	-.0409	-.0382	-.0413	-.0400

TAIL 1

Cp at y/b of														
x/c	0.02		0.22		0.44		0.56		0.67		0.83		0.98	
	U.S.	L.S.	U.S.	L.S.	U.S.	L.S.	U.S.	L.S.	U.S.	L.S.	U.S.	L.S.	U.S.	L.S.
.05	.0657	.0908	.1607	.1578	.1545	.1652	.2794	.2218	.2148	.2337	.2259	.2388		
.10	.0577	.0684	.1535	.1471	.1524	.1585					.2145	.2285	.1882	.2389
.15	.0613	.0661	.1477	.1456	.1499	.1534					.2121	.2276	.1739	.2152
.20						.1511	.2049	.2348	.2018	.2267	.2066	.2243	.1595	.1994
.25	.0612	.0598	.1364	.1427	.1417	.1520	.2057	.2379	.2023	.2275	.2012	.2252	.1498	.1929
.30	.0167	.0133	.1300	.1398	.1431	.1557	.2019	.2355	.1999	.2281	.1938	.2265	.1401	.1841
.40	.0040	.0091			.1429	.1639	.1980	.2325	.1945	.2278	.1853	.2240	.1262	.1714
.50	.0360	.0054	-.0002	-.0134			.0521	.0719					.1019	.0888
.60	-.0025	.0080	-.0069	.0041	-.0152	.0292	-.0348	-.0273	-.0322	-.0248	-.0316	-.0162	-.0343	-.0262
.70			-.0117	.0004			-.0522	-.0421	-.0504	-.0424	-.0472	-.0341		-.0355
.80			-.0396	-.0473	-.0356	-.0267	-.0518	-.0476	-.0428	-.0431	-.0425	-.0404	-.0394	-.0411
.90			-.0411	-.0433	-.0442	-.0475	-.0459	-.0484	-.0319	-.0249	-.0374	-.0403	-.0389	-.0394
.95			-.0418	-.0411					-.0385	-.0346	-.0364	-.0366	-.0290	-.0311

TAIL 2

TABLE XV. - CONTINUED
(c) $\alpha = -0.15^\circ$

Cp at y/b of														
x/c	0.02		0.22		0.44		0.56		0.67		0.83		0.98	
	U.S.	L.S.	U.S.	L.S.	U.S.	L.S.	U.S.	L.S.	U.S.	L.S.	U.S.	L.S.	U.S.	L.S.
.05	.0557	.0361	.1566	.1436	.1596	.1528			.2212		.2148	.2460	.2176	.2385
.10	.0558	.0443	.1511	.1395	.1615	.1464			.2162	.2205	.2099	.2328	.1801	.2169
.15	.0560	.0443	.1466	.1367	.1497	.1430			.2123	.2211	.1976	.2241	.1781	.2005
.20	.0584	.0471							.2101	.2217	.1927	.2208		
.25	.0547	.0463	.1417	.1306	.1498	.1418	.2039	.2230	.2063	.2205			.1556	.1744
.30	.0234	.0416	.1305	.1222	.1669	.1225	.2095	.2302	.2032	.2207	.1895	.2167	.1480	.1684
.40	.0127	.0523	.0399	.0255	.1428	.1507	.2052	.2279	.1975	.2178	.1828	.2116	.1353	.1561
.50	.0163	.0164	.0131	.0085			.0560	.0537	.1122	.0840	.1422	.1058	.1061	.0712
.60	.0358	.0100	.0104	.0067	.0253	.0312	-.0307	-.0292	-.0254	-.0245	-.0328	-.0350	-.0401	-.0375
.70			.0004	-.0011	-.0353	-.0325	-.0403	-.0390	-.0210	-.0205	-.0494	-.0471	-.0460	-.0432
.80	-.0174	-.0203	-.0150	-.0379	-.0362	-.0410	-.0314	-.0390			-.0455		-.0446	-.0463
.90	-.0186	-.0322	-.0292	-.0378	-.0322	-.0371	-.0313	-.0374	-.0262	-.0286	-.0402	-.0386	-.0409	-.0428
.95			-.0203	-.0360	-.0264	-.0199	-.0242	-.0300	-.0387	-.0402	-.0379	-.0397	-.0401	-.0411

TAIL 1.

Cp at y/b of														
x/c	0.02		0.22		0.44		0.56		0.67		0.83		0.98	
	U.S.	L.S.	U.S.	L.S.	U.S.	L.S.	U.S.	L.S.	U.S.	L.S.	U.S.	L.S.	U.S.	L.S.
.05	.0505	.0743	.1554	.1502	.1484	.1620	.2737	.2186	.2158	.2338	.2282	.2412		
.10	.0485	.0557	.1476	.1439	.1473	.1552					.2199	.2310	.1889	.2411
.15	.0531	.0561	.1420	.1426	.1447	.1497		.2266	.2048	.2289	.2168	.2302	.1748	.2182
.20						.1475	.2034	.2340	.2018	.2273	.2100	.2264	.1601	.2024
.25	.0528	.0524	.1299	.1371	.1372	.1488	.2062	.2369	.2011	.2283	.2024	.2287	.1504	.1968
.30	.0144	.0161	.1224	.1352	.1382	.1521	.2038	.2343	.1988	.2290	.1933	.2300	.1409	.1888
.40	.0059	.0130			.1379	.1605	.1976	.2319	.1937	.2287	.1855	.2264	.1259	.1746
.50	.0377	.0119	-.0027	.0114			.0517	.0649					.1009	.0901
.60	.0046	.0162	-.0096	.0021	.0137	.0284	-.0348	-.0280	-.0322	-.0246	-.0318	-.0155	-.0375	-.0293
.70			-.0138	-.0029			-.0532	-.0427	-.0504	-.0419	-.0468	-.0342		-.0363
.80			-.0409	-.0477	-.0349	-.0270	-.0517	-.0480	-.0432	-.0430	-.0419	-.0404	-.0390	-.0402
.90			-.0429	-.0435	-.0443	-.0470	-.0459	-.0485	-.0319	-.0236	-.0373	-.0395	-.0391	-.0388
.95			-.0428	-.0417					-.0384	-.0325	-.0361	-.0360	-.0301	-.0324

TAIL 2

TABLE XV. - CONTINUED
(d) $\alpha = 1.84^\circ$

Cp at γ/b of														
x/c	0.02		0.22		0.44		0.56		0.67		0.83		0.98	
	U.S.	L.S.	U.S.	L.S.	U.S.	L.S.	U.S.	L.S.	U.S.	L.S.	U.S.	L.S.	U.S.	L.S.
.05	.0331	.0599	.1077	.2012	.1177	.2033			.1771		.1719	.2985	.1773	.2863
.10	.0388	.0694	.1023	.1976	.1197	.1974			.1704	.2724	.1670	.2855	.1411	.2658
.15	.0329	.0700	.0974	.1931	.1057	.1950			.1659	.2747	.1548	.2770	.1377	.2478
.20	.0357	.0739							.1644	.2756	.1494	.2731		
.25	.0317	.0739	.0970	.1793	.1075	.1943	.1529	.2870	.1601	.2751			.1173	.2182
.30	.0088	.0445	.0869	.1679	.1299	.1760	.1566	.2955	.1569	.2761	.1452	.2691	.1105	.2123
.40	-.0012	.0522	.0203	.0511	.1009	.2042	.1521	.2942	.1510	.2741	.1394	.2635	.0998	.1980
.50	-.0008	.0352	-.0034	.0349			.0294	.0857	.0736	.1158	.1045	.1396	.0753	.0984
.60	.0250	.0343	-.0046	.0324	.0046	.0642	-.0379	-.0185	-.0328	-.0164	-.0405	-.0267	-.0433	-.0349
.70			-.0135	.0237	-.0381	-.0223	-.0371	-.0312	-.0283	-.0123	-.0497	-.0407	-.0474	-.0399
.80	-.0201	-.0085	-.0142	-.0323	-.0328	-.0360	-.0286	-.0319			-.0427		-.0444	-.0437
.90	-.0189	-.0270	-.0308	-.0429	-.0320	-.0384	-.0316	-.0357	-.0259	-.0289	-.0407	-.0409	-.0424	-.0451
.95			-.0221	-.0383	-.0265	-.0231	-.0250	-.0317	-.0398	-.0415	-.0394	-.0437	-.0430	-.0448

TAIL 1

Cp at γ/b of														
x/c	0.02		0.22		0.44		0.56		0.67		0.83		0.98	
	U.S.	L.S.	U.S.	L.S.	U.S.	L.S.	U.S.	L.S.	U.S.	L.S.	U.S.	L.S.	U.S.	L.S.
.05	.0424	.0654	.1529	.1452	.1436	.1536	.2665	.2136	.2154	.2343	.2282	.2405		
.10	.0409	.0524	.1457	.1427	.1432	.1533					.2213	.2295	.1903	.2444
.15	.0454	.0515	.1398	.1402	.1412	.1475		.2253	.2031	.2289	.2169	.2284	.1770	.2233
.20						.1452	.2038	.2324	.2001	.2279	.2079	.2249	.1618	.2071
.25	.0460	.0473	.1237	.1331	.1337	.1464	.2053	.2367	.2002	.2293	.1986	.2280	.1527	.2026
.30	.0127	.0153	.1156	.1291	.1351	.1499	.2019	.2364	.1982	.2301	.1896	.2296	.1438	.1953
.40	.0076	.0126			.1355	.1574	.1994	.2366	.1930	.2297	.1830	.2267	.1287	.1799
.50	.0347	.0124	-.0057	.0092			.0613	.0654					.1035	.0928
.60	.0090	.0172	-.0117	.0003	.0134	.0290	-.0343	-.0278	-.0304	-.0230	-.0317	-.0150	-.0394	-.0311
.70			-.0154	-.0044			-.0537	-.0420	-.0495	-.0404	-.0467	-.0345		-.0362
.80			-.0413	-.0476	-.0338	-.0265	-.0511	-.0471	-.0438	-.0420	-.0419	-.0403	-.0386	-.0384
.90			-.0434	-.0440	-.0439	-.0463	-.0451	-.0481	-.0320	-.0237	-.0367	-.0387	-.0390	-.0372
.95			-.0439	-.0416					-.0383	-.0329	-.0365	-.0350	-.0301	-.0313

TAIL 2

TABLE XV. - CONTINUED
(a) $\alpha = 3.86^\circ$

Cp at y/b of														
x/c	0.02		0.22		0.44		0.56		0.67		0.83		0.98	
	U.S.	L.S.	U.S.	L.S.	U.S.	L.S.	U.S.	L.S.	U.S.	L.S.	U.S.	L.S.	U.S.	L.S.
.05	.0123	.0895	.0667	.2640	.0816	.2602			.1366		.1322	.3552	.1393	.3389
.10	.0117	.1009	.0601	.2568	.0840	.2548			.1288	.3287	.1265	.3421	.1061	.3183
.15	.0119	.0970	.0549	.2457	.0677	.2532			.1240	.3326	.1151	.3335	.1018	.2986
.20	.0161	.1006							.1234	.3349	.1095	.3298		
.25	.0124	.1023	.0572	.2240	.0724	.2522	.1083	.3613	.1192	.3355			.0833	.2659
.30	-.0034	.0482	.0470	.2110	.0969	.2351	.1103	.3715	.1163	.3383	.1055	.3257	.0777	.2604
.40	-.0123	.0552	.0050	.0754	.0643	.2646	.1057	.3710	.1101	.3374	.0999	.3196	.0694	.2435
.50	-.0136	.0566	-.0158	.0603			.0109	.1244	.0514	.1535	.0704	.1775	.0490	.1288
.60	.0169	.0608	-.0140	.0592	-.0111	.0977	-.0395	-.0034	-.0365	-.0031	-.0461	-.0146	-.0447	-.0299
.70			-.0222	.0499	-.0336	-.0104	-.0326	-.0180	-.0318	.0005	-.0448	-.0305	-.0459	-.0350
.80	-.0219	.0047	-.0157	-.0246	-.0318	-.0265	-.0271	-.0197			-.0410		-.0418	-.0368
.90	-.0174	-.0219	-.0331	-.0382	-.0318	-.0310	-.0312	-.0248	-.0262	-.0209	-.0405	-.0330	-.0447	-.0393
.95			-.0241	-.0384	-.0262	-.0205	-.0251	-.0229	-.0407	-.0311	-.0390	-.0373	-.0473	-.0416

TAIL 1

Cp at y/b of														
x/c	0.02		0.22		0.44		0.56		0.67		0.83		0.98	
	U.S.	L.S.	U.S.	L.S.	U.S.	L.S.	U.S.	L.S.	U.S.	L.S.	U.S.	L.S.	U.S.	L.S.
.05	.0535	.0754	.1505	.1443	.1400	.1585	.2620	.2084	.2161	.2339	.2278	.2400		
.10	.0478	.0577	.1438	.1425	.1410	.1522					.2223	.2278	.1900	.2440
.15	.0507	.0548	.1395	.1410	.1387	.1457		.2241	.2020	.2282	.2164	.2267	.1775	.2257
.20						.1435	.2027	.2327	.1992	.2274	.2044	.2243	.1626	.2103
.25	.0478	.0472	.1283	.1357	.1313	.1447	.2055	.2391	.1990	.2288	.1943	.2272	.1540	.2067
.30	.0085	.0102	.1216	.1324	.1327	.1477	.2042	.2363	.1970	.2301	.1860	.2286	.1458	.1994
.40	.0004	.0043			.1332	.1548	.2006	.2381	.1919	.2296	.1800	.2261	.1316	.1834
.50	.0336	.0013	-.0028	.0109			.0548	.0631					.1059	.0951
.60	-.0075	.0023	-.0096	.0013	.0130	.0278	-.0374	-.0315	-.0286	-.0238	-.0312	-.0148	-.0397	-.0316
.70			-.0142	-.0040			-.0543	-.0442	-.0487	-.0412	-.0459	-.0344		-.0366
.80			-.0442	-.0485	-.0375	-.0282	-.0540	-.0495	-.0452	-.0434	-.0419	-.0400	-.0373	-.0373
.90			-.0452	-.0454	-.0470	-.0497	-.0476	-.0460	-.0329	-.0245	-.0367	-.0377	-.0380	-.0355
.95			-.0452	-.0425					-.0382	-.0345	-.0364	-.0338	-.0294	-.0299

TAIL 2

TABLE XV. - CONTINUED

(f) $\alpha = 5.84^\circ$

Cp at y/b of														
x/c	0.02		0.22		0.44		0.56		0.67		0.83		0.98	
	U.S.	L.S.	U.S.	L.S.	U.S.	L.S.	U.S.	L.S.	U.S.	L.S.	U.S.	L.S.	U.S.	L.S.
.05	-.0062	.1103	.0331	.3285	.0518	.3280			.1011		.0941	.4130	.1018	.3937
.10	-.0076	.1218	.0259	.3085	.0536	.3227			.0918	.3889	.0874	.3996	.0718	.3716
.15	-.0063	.1117	.0209	.2894	.0354	.3205			.0858	.3948	.0767	.3908	.0669	.3496
.20	-.0003	.1156							.0856	.3987	.0714	.3867		
.25	-.0035	.1197	.0256	.2648	.0433	.3158	.0677	.4511	.0812	.4032			.0503	.3136
.30	-.0128	.0534	.0140	.2512	.0627	.2955	.0688	.4632	.0787	.4089	.0679	.3832	.0463	.3077
.40	-.0201	.0612	-.0085	.1032	.0301	.3204	.0639	.4587	.0727	.4114	.0631	.3766	.0407	.2868
.50	-.0189	.0813	-.0229	.0880			-.0095	.1689	.0251	.2012	.0387	.2174	.0239	.1579
.60	.0075	.0898	-.0182	.0854	-.0267	.1256	-.0373	.0165	-.0363	.0169	-.0468	-.0013	-.0457	-.0242
.70			-.0266	.0769	-.0356	.0014	-.0338	-.0009	-.0314	.0204	-.0438	-.0183	-.0447	-.0327
.80	-.0254	.0196	-.0180	-.0138	-.0355	-.0161	-.0292	-.0046			-.0425		-.0431	-.0318
.90	-.0180	-.0150	-.0362	-.0284	-.0357	-.0212	-.0330	-.0106	-.0280	-.0064	-.0424	-.0219	-.0470	-.0333
.95			-.0263	-.0295	-.0296	-.0150	-.0269	-.0106	-.0425	-.0138	-.0410	-.0262	-.0456	-.0365

TAIL 1

Cp at y/b of															
x/c	0.02		0.22		0.44		0.56		0.67		0.83		0.98		
	U.S.	L.S.	U.S.	L.S.	U.S.	L.S.	U.S.	L.S.	U.S.	L.S.	U.S.	L.S.	U.S.	L.S.	
.05	.0753	.0935	.1507	.1456	.1410	.1590	.2613	.2068	.2158	.2346	.2256	.2384			
.10	.0539	.0726	.1429	.1375	.1414	.1524					.2216	.2259	.1881	.2411	
.15	.0533	.0638	.1378	.1367	.1395	.1456			.2245	.2014	.2291	.2136	.2254	.1769	.2260
.20						.1434	.2035	.2353	.1991	.2282	.2001	.2229	.1628	.2128	
.25	.0480	.0496	.1305	.1363	.1313	.1441	.2077	.2407	.1991	.2296	.1903	.2260	.1550	.2093	
.30	.0051	.0061	.1250	.1355	.1323	.1472	.2061	.2397	.1965	.2307	.1833	.2289	.1473	.2018	
.40	-.0072	-.0041			.1325	.1541	.2021	.2398	.1921	.2303	.1783	.2266	.1340	.1857	
.50	.0308	-.0093	-.0016	.0118			.0520	.0630					.1083	.0972	
.60	-.0206	-.0117	-.0089	.0024	.0126	.0282	-.0397	-.0315	-.0279	-.0220	-.0309	-.0149	-.0398	-.0319	
.70			-.0157	-.0026			-.0546	-.0437	-.0482	-.0396	-.0453	-.0341		-.0378	
.80			-.0483	-.0510	-.0394	-.0273	-.0552	-.0486	-.0457	-.0420	-.0424	-.0396	-.0372	-.0374	
.90			-.0496	-.0519	-.0489	-.0497	-.0484	-.0497	-.0341	-.0258	-.0370	-.0365	-.0375	-.0349	
.95			-.0496	-.0491	.0307	.0372			-.0403	-.0363	-.0368	-.0325	-.0291	-.0292	

TAIL 2

TABLE XV. - CONTINUED
(g) $\alpha = 7.85^\circ$

Cp at y/b of														
x/c	0.02		0.22		0.44		0.56		0.67		0.83		0.98	
	U.S.	L.S.	U.S.	L.S.	U.S.	L.S.	U.S.	L.S.	U.S.	L.S.	U.S.	L.S.	U.S.	L.S.
.05	-.0184	.1110	.0059	.3742	.0245	.4107			.0604		.0643	.4790	.0791	.4605
.10	-.0223	.1224	-.0007	.3434	.0284	.3951			.0517	.4475	.0553	.4647	.0511	.4360
.15	-.0204	.1145	-.0064	.3211	.0077	.3845			.0455	.4604	.0447	.4547	.0463	.4123
.20	-.0133	.1189							.0475	.4747	.0387	.4498		
.25	-.0170	.1198	-.0000	.2985	.0189	.3655	.0339	.5454	.0435	.4880			.0311	.3726
.30	-.0210	.0579	-.0134	.2840	.0386	.3475	.0337	.5500	.0429	.4973	.0345	.4465	.0284	.3654
.40	-.0268	.0693	-.0201	.1269	.0034	.3624	.0282	.5304	.0382	.5013	.0283	.4394	.0242	.3372
.50	-.0291	.1031	-.0289	.1125			-.0251	.2079	.0022	.2666	.0088	.2614	.0095	.1920
.60	-.0036	.1090	-.0254	.1122	-.0371	.1501	-.0382	.0362	-.0367	.0456	-.0456	.0162	-.0467	-.0140
.70			-.0325	.0997	-.0379	.0143	-.0360	.0164	-.0321	.0485	-.0452	-.0008	-.0460	-.0287
.80	-.0335	.0320	-.0218	-.0029	-.0386	-.0040	-.0319	.0105			-.0445		-.0467	-.0299
.90	-.0228	-.0076	-.0401	-.0160	-.0389	-.0093	-.0358	.0025	-.0300	.0164	-.0446	-.0029	-.0467	-.0316
.95			-.0300	-.0179	-.0323	-.0071	-.0291	.0005	-.0453	.0119	-.0431	-.0072	-.0470	-.0349

TAIL 1.

Cp at y/b of														
x/c	0.02		0.22		0.44		0.56		0.67		0.83		0.98	
	U.S.	L.S.	U.S.	L.S.	U.S.	L.S.	U.S.	L.S.	U.S.	L.S.	U.S.	L.S.	U.S.	L.S.
.05	.0630	.0820	.1320	.1362	.1420	.1577	.2644	.2089	.2178	.2365	.2275	.2377		
.10	.0429	.0590	.1259	.1190	.1415	.1513					.2240	.2259	.1871	.2395
.15	.0422	.0517	.1220	.1164	.1384	.1438		.2258	.2028	.2308	.2141	.2256	.1766	.2274
.20						.1408	.2048	.2353	.2003	.2306	.1989	.2230	.1633	.2162
.25	.0385	.0400	.1141	.1173	.1294	.1408	.2079	.2406	.2003	.2323	.1892	.2258	.1560	.2125
.30	-.0002	-.0003	.1097	.1163	.1302	.1436	.2058	.2382	.1981	.2335	.1827	.2284	.1488	.2051
.40	-.0125	-.0107			.1301	.1520	.2014	.2387	.1927	.2327	.1781	.2268	.1359	.1884
.50	.0360	-.0161	-.0107	.0012			.0522	.0615					.1103	.0968
.60	-.0278	-.0191	-.0204	-.0107	.0121	.0270	-.0394	-.0324	-.0290	-.0233	-.0305	-.0167	-.0399	-.0322
.70			-.0270	-.0180			-.0552	-.0447	-.0493	-.0410	-.0450	-.0352		-.0399
.80			-.0532	-.0566	-.0405	-.0282	-.0560	-.0498	-.0470	-.0433	-.0430	-.0406	-.0372	-.0385
.90			-.0574	-.0608	-.0515	-.0515	-.0489	-.0511	-.0350	-.0271	-.0370	-.0373	-.0377	-.0358
.95			-.0579	-.0585					-.0409	-.0372	-.0369	-.0333	-.0293	-.0301

TAIL 2.

TABLE XV. - CONTINUED
(h) $\alpha = 9.85^\circ$

Cp at y/b of														
x/c	0.02		0.22		0.44		0.56		0.67		0.83		0.98	
	U.S.	L.S.	U.S.	L.S.	U.S.	L.S.	U.S.	L.S.	U.S.	L.S.	U.S.	L.S.	U.S.	L.S.
.05	-.0265	.1175	-.0119	.4035	.0021	.4785			.0456		.0519	.5559	.0667	.5379
.10	-.0306	.1295	-.0175	.3684	.0098	.4490			.0363	.5272	.0419	.5416	.0401	.5105
.15	-.0293	.1263	-.0228	.3479	-.0136	.4305			.0281	.5643	.0313	.5306	.0356	.4849
.20	-.0226	.1256							.0291	.5870	.0252	.5260		
.25	-.0265	.1178	-.0142	.3255	.0009	.4047	.0073	.6219	.0232	.5986			.0223	.4404
.30	-.0274	.0607	-.0283	.3136	.0197	.3889	.0061	.6237	.0220	.6050	.0207	.5234	.0210	.4296
.40	-.0325	.0782	-.0251	.1491	-.0178	.4020	.0000	.5946	.0154	.6165	.0142	.5176	.0183	.3959
.50	-.0351	.1204	-.0318	.1417			-.0366	.2565	-.0139	.3095	-.0035	.3158	.0043	.2341
.60	-.0122	.1244	-.0283	.1411	-.0431	.1824	-.0419	.0582	-.0399	.0651	-.0503	.0421	-.0519	.0007
.70			-.0347	.1274	-.0410	.0313	-.0405	.0345	-.0352	.0677	-.0502	.0274	-.0516	-.0177
.80	-.0383	.0449	-.0233	.0116	-.0419	.0128	-.0366	.0262			-.0492		-.0522	-.0229
.90	-.0255	.0009	-.0426	-.0014	-.0422	.0067	-.0408	.0174	-.0327	.0447	-.0495	.0283	-.0522	-.0260
.95			-.0326	-.0038	-.0341	.0050	-.0338	.0147	-.0492	.0409	-.0481	.0248	-.0522	-.0284

TAIL 1

Cp at y/b of														
x/c	0.02		0.22		0.44		0.56		0.67		0.83		0.98	
	U.S.	L.S.	U.S.	L.S.	U.S.	L.S.	U.S.	L.S.	U.S.	L.S.	U.S.	L.S.	U.S.	L.S.
.05	.0598	.0757	.0749	.0834	.1379	.1494	.2655	.2134	.2218	.2410	.2299	.2408		
.10	.0336	.0520	.0687	.0714	.1339	.1417					.2263	.2285	.1871	.2392
.15	.0291	.0417	.0660	.0661	.1301	.1360		.2230	.2051	.2335	.2155	.2284	.1776	.2293
.20						.1337	.2008	.2292	.2020	.2319	.1995	.2252	.1650	.2196
.25	.0231	.0263	.0576	.0607	.1227	.1348	.2017	.2348	.2011	.2321	.1896	.2278	.1585	.2162
.30	-.0124	-.0124	.0515	.0568	.1235	.1375	.1988	.2330	.1970	.2310	.1835	.2299	.1517	.2087
.40	-.0232	-.0247			.1226	.1464	.1962	.2349	.1908	.2321	.1788	.2281	.1392	.1925
.50	.0365	-.0304	-.0366	-.0294			.0588	.0626					.1137	.0996
.60	-.0383	-.0331	-.0438	-.0373	.0056	.0217	-.0403	-.0315	-.0292	-.0230	-.0304	-.0175	-.0397	-.0311
.70			-.0477	-.0413			-.0559	-.0434	-.0497	-.0402	-.0455	-.0359		-.0407
.80			-.0555	-.0632	-.0432	-.0302	-.0579	-.0484	-.0467	-.0424	-.0428	-.0404	-.0378	-.0389
.90			-.0620	-.0639	-.0599	-.0551	-.0517	-.0508	-.0351	-.0267	-.0368	-.0370	-.0382	-.0363
.95			-.0628	-.0625					-.0412	-.0365	-.0370	-.0329	-.0297	-.0305

TAIL 2

TABLE XV. - CONTINUED
(i) $\alpha = 11.85^\circ$

Cp at γ/b of														
x/c	0.02		0.22		0.44		0.56		0.67		0.83		0.98	
	U.S.	L.S.	U.S.	L.S.	U.S.	L.S.	U.S.	L.S.	U.S.	L.S.	U.S.	L.S.	U.S.	L.S.
.05	-.0347	.1650	-.0221	.4441	-.0048	.5420			.0395		.0458	.6470	.0594	.6273
.10	-.0410	.1590	-.0283	.4083	.0048	.5047			.0300	.6455	.0347	.6313	.0335	.5957
.15	-.0396	.1481	-.0341	.3873		.4818			.0221	.6939	.0241	.6183	.0294	.5668
.20	-.0320	.1385							.0233	.7104	.0173	.6136		
.25	-.0360	.1264	-.0251	.3666	-.0038	.4526	.0002	.7038	.0174	.7222			.0178	.5163
.30	-.0346	.0643	-.0404	.3538	.0088	.4293	-.0014	.7061	.0165	.7314	.0126	.6153	.0180	.5001
.40	-.0395	.0869	-.0283	.1744	-.0262	.4523	-.0077	.6708	.0092	.7066	.0060	.6144	.0156	.4672
.50	-.0417	.1375	-.0339	.1730			-.0408	.2929	-.0179	.3673	-.0107	.3866	.0012	.2830
.60	-.0196	.1493	-.0307	.1722	-.0463	.2025	-.0457	.0774	-.0437	.1004	-.0558	.0802	-.0558	.0190
.70			-.0379	.1596	-.0442	.0463	-.0446	.0528	-.0389	.1024	-.0549	.0698	-.0577	-.0020
.80	-.0421	.0599	-.0269	.0293	-.0453	.0278	-.0403	.0411			-.0543		-.0591	-.0092
.90	-.0284	.0109	-.0466	.0153	-.0453	.0219	-.0444	.0316	-.0366	.0658	-.0545	.0635	-.0586	-.0119
.95			-.0358	.0124	-.0362	.0182	-.0376	.0281	-.0540	.0613	-.0531	.0589	-.0573	-.0142

TAIL 1

Cp at γ/b of															
x/c	0.02		0.22		0.44		0.56		0.67		0.83		0.98		
	U.S.	L.S.	U.S.	L.S.	U.S.	L.S.	U.S.	L.S.	U.S.	L.S.	U.S.	L.S.	U.S.	L.S.	
.05	.0527	.0680	.0155	.0183	.0942	.1017	.2459	.1990	.2202	.2369	.2358	.2435			
.10	.0285	.0447	.0170	.0182	.0895	.0929					.2303	.2302	.1923	.2431	
.15	.0227	.0346	.0193	.0195	.0838	.0866			.2031	.1982	.2309	.2182	.2285	.1825	.2334
.20						.0835	.1757	.2075	.1964	.2297	.1999	.2228	.1696	.2237	
.25	.0147	.0183	.0164	.0183	.0746	.0819	.1755	.2091	.1967	.2318	.1874	.2249	.1624	.2190	
.30	-.0188	-.0172	.0128	.0149	.0723	.0822	.1730	.2087	.1948	.2337	.1803	.2298	.1552	.2108	
.40	-.0278	-.0319			.0678	.0859	.1686	.2040	.1913	.2351	.1785	.2283	.1413	.1899	
.50	.0414	-.0377	-.0435	-.0399			.0368	.0549					.1144	.0983	
.60	-.0435	-.0418	-.0501	-.0467	-.0165	-.0058	-.0434	-.0349	-.0332	-.0243	-.0301	-.0170	-.0395	-.0309	
.70			-.0538	-.0503			-.0589	-.0485	-.0523	-.0416	-.0451	-.0345		-.0412	
.80			-.0569	-.0663	-.0480	-.0374	-.0624	-.0540	-.0494	-.0439	-.0411	-.0395	-.0361	-.0392	
.90			-.0662	-.0679	-.0671	-.0633	-.0613	-.0569	-.0359	-.0282	-.0358	-.0378	-.0367	-.0365	
.95			-.0673	-.0681					-.0420	-.0396	-.0363	-.0340	-.0289	-.0306	

TAIL 2

TABLE XV. - CONTINUED
(j) $\alpha = 15.86^\circ$

Cp at γ/b of														
x/c	0.02		0.22		0.44		0.56		0.67		0.83		0.98	
	U.S.	L.S.	U.S.	L.S.	U.S.	L.S.	U.S.	L.S.	U.S.	L.S.	U.S.	L.S.	U.S.	L.S.
.05	-.0466	.2544	-.0246	.5542	-.0119	.6892			.0402		-.0456	.8677	-.0586	.8422
.10	-.0559	.2131	-.0302	.5135	-.0028	.6403			.0312	.9900	-.0333	.8455	-.0328	.8055
.15	-.0547	.1930	-.0367	.4922	-.0206	.6116			.0247	1.0016	-.0215	.8366	-.0294	.7669
.20	-.0470	.1757							.0269	.9774	-.0141	.8496		
.25	-.0507	.1635	-.0289	.4711	-.0055	.5764	-.0039	.9293	.0211	.9510			.0217	.6950
.30	-.0454	.0719	-.0457	.4558	-.0013	.5307	-.0059	.9200	.0199	.9308	.0080	.8855	-.0226	.6785
.40	-.0478	.1013	-.0311	.2411	-.0306	.5727	-.0130	.8751	.0114	.8794	.0012	.8935	-.0196	.6437
.50	-.0511	.1782	-.0365	.2523			-.0431	.3932	-.0179	.4832	-.0153	.6023	-.0065	.4008
.60	-.0276	.2173	-.0338	.2499	-.0500	.2823	-.0501	.1280	-.0479	.1569	-.0578	.1735	-.0566	.0737
.70			-.0412	.2428	-.0483	.0863	-.0490	.0952	-.0434	.1581	-.0570	.1437	-.0560	.0544
.80	-.0434	.1010	-.0297	.0723	-.0490	.0685	-.0442	.0796			-.0568		-.0550	.0507
.90	-.0303	.0414	-.0501	.0587	-.0492	.0644	-.0484	.0697	-.0408	.1016	-.0571	.1222	-.0549	.0504
.95			-.0396	.0556	-.0397	.0560	-.0412	.0657	-.0589	.0943	-.0559	.1183	-.0547	.0475

TAIL 1

Cp at γ/b of														
x/c	0.02		0.22		0.44		0.56		0.67		0.83		0.98	
	U.S.	L.S.	U.S.	L.S.	U.S.	L.S.	U.S.	L.S.	U.S.	L.S.	U.S.	L.S.	U.S.	L.S.
.05	.0260	.0378	.0114	.0147	.0158	.0214	.0753	.0490	.0693	.0750	.1916	.2024		
.10	.0039	.0187	.0065	.0089	.0143	.0162					.1772	.1931	.1848	.2387
.15	.0016	.0100	.0045	.0053	.0110	.0114		.0486	.0614	.0678	.1732	.1909	.1748	.2273
.20						.0082	.0410	.0475	.0569	.0638	.1687	.1858	.1625	.2158
.25	-.0082	-.0045	-.0024	.0004	.0065	.0068	.0342	.0456	.0540	.0606	.1642	.1874	.1555	.2118
.30	-.0328	-.0319	-.0063	-.0020	.0025	.0061	.0315	.0424	.0486	.0568	.1564	.1845	.1480	.2049
.40	-.0365	-.0434			.0015	.0065	.0242	.0349	.0413	.0516	.1465	.1777	.1354	.1902
.50	.0508	-.0476	-.0515	-.0496			-.0263	-.0261					.1116	.1019
.60	-.0499	-.0507	-.0579	-.0550	-.0329	-.0339	-.0494	-.0493	-.0576	-.0570	-.0396	-.0296	-.0395	-.0298
.70			-.0600	-.0571			-.0670	-.0647	-.0660	-.0646	-.0529	-.0443		-.0379
.80			-.0568	-.0688	-.0505	-.0431	-.0691	-.0676	-.0585	-.0604	-.0557	-.0502	-.0423	-.0366
.90			-.0696	-.0710	-.0702	-.0697	-.0690	-.0689	-.0462	-.0414	-.0552	-.0524	-.0457	-.0371
.95			-.0704	-.0710					-.0569	-.0559	-.0541	-.0520	-.0349	-.0333

TAIL 2

TABLE XV. - CONCLUDED
(k) $\alpha = 19.84^\circ$

Cp at γ/b of														
x/c	0.02		0.22		0.44		0.56		0.67		0.83		0.98	
	U.S.	L.S.	U.S.	L.S.	U.S.	L.S.	U.S.	L.S.	U.S.	L.S.	U.S.	L.S.	U.S.	L.S.
.05	-.0533	.3424	-.0276	.7004	-.0204	.8586			.0550		.0546	1.1750	.0683	1.1198
.10	-.0638	.2790	-.0318	.6555	-.0002	.8067			.0465	1.3023	.0408	1.2007	.0408	1.0733
.15	-.0628	.2499	-.0384	.6321	-.0220	.7743			.0426	1.2638	.0280	1.2257	.0381	1.0297
.20	-.0539	.2249							.0446	1.2248	.0195	1.2334		
.25	-.0589	.2132	-.0305	.6097	-.0063	.7329	-.0047	1.1652	.0386	1.1601			.0327	.9734
.30	-.0521	.0873	-.0476	.5886	-.0034	.6899	-.0059	1.1572	.0352	1.1424	.0120	1.2207	.0337	.9697
.40	-.0543	.1300	-.0320	.3328	-.0308	.7243	-.0131	1.1218	.0211	1.0921	.0044	1.1761	.0310	.9388
.50	-.0548	.2500	-.0374	.3497			-.0438	.5144	-.0154	.5854	-.0132	.7452	.0202	.6058
.60	-.0325	.3051	-.0349	.3482	-.0515	.3626	-.0518	.1908	-.0501	.2051	-.0547	.2365	-.0549	.1673
.70			-.0425	.3529	-.0490	.1374	-.0505	.1481	-.0455	.2053	-.0546	.2195	-.0610	.1328
.80	-.0452	.1583	-.0312	.1368	-.0501	.1236	-.0452	.1272			-.0537		-.0641	.1182
.90	-.0323	.0891	-.0522	.1180	-.0501	.1212	-.0498	.1200	-.0429	.1523	-.0541	.2229	-.0631	.1096
.95			-.0416	.1126	-.0417	.1176	-.0417	.1161	-.0613	.1430	-.0519	.2193	-.0619	.1039

TAIL 1

Cp at γ/b of														
x/c	0.02		0.22		0.44		0.56		0.67		0.83		0.98	
	U.S.	L.S.	U.S.	L.S.	U.S.	L.S.	U.S.	L.S.	U.S.	L.S.	U.S.	L.S.	U.S.	L.S.
.05	-.0065	.0014	-.0070	-.0085	-.0085	-.0058	.0376	.0227	.0250	.0302	.0478	.0585		
.10	-.0221	-.0160	-.0125	-.0124	-.0091	-.0086					.0442	.0528	.0458	.0729
.15	-.0202	-.0200	-.0149	-.0158	-.0112	-.0118		.0196	.0233	.0277	.0426	.0503	.0376	.0607
.20						-.0146	.0143	.0151	.0209	.0245	.0394	.0463	.0295	.0511
.25	-.0298	-.0298	-.0203	-.0193	-.0115	-.0153	.0079	.0146	.0198	.0231	.0367	.0463	.0250	.0457
.30	-.0450	-.0465	-.0233	-.0219	-.0161	-.0153	.0066	.0123	.0173	.0211	.0335	.0445	.0193	.0405
.40	-.0436	-.0536			-.0149	-.0142	.0015	.0090	.0132	.0202	.0291	.0396	.0113	.0306
.50	.0782	-.0561	-.0562	-.0577			-.0371	-.0358					.0006	-.0073
.60	-.0520	-.0574	-.0620	-.0610	-.0394	-.0403	-.0494	-.0490	-.0619	-.0601	-.0543	-.0494	-.0562	-.0520
.70			-.0644	-.0632			-.0690	-.0664	-.0680	-.0657	-.0604	-.0560		-.0550
.80			-.0540	-.0711	-.0509	-.0420	-.0705	-.0683	-.0603	-.0619	-.0626	-.0592	-.0531	-.0562
.90			-.0711	-.0734	-.0717	-.0698	-.0707	-.0693	-.0512	-.0459	-.0622	-.0599	-.0603	-.0575
.95			-.0724	-.0738					-.0624	-.0601	-.0612	-.0594	-.0463	-.0497

TAIL 2

TABLE XVI. - PRESSURE COEFFICIENTS, $\phi = 0^\circ$, $\delta_{2,4} = -15^\circ$, $M = 1.60$.
 (a) $\alpha = -3.55^\circ$

Cp at y/b of														
x/c	0.02		0.22		0.44		0.56		0.67		0.88		0.98	
	U.S.	L.S.	U.S.	L.S.	U.S.	L.S.	U.S.	L.S.	U.S.	L.S.	U.S.	L.S.	U.S.	L.S.
.05	.1538	.1645	.3304	.2857							.7204	.8114	.6052	.6837
.10	.1210	.1411	.2463	.2406					.6655	.6889	.6621	.7397	.5453	.5791
.15	.1312	.1252	.2208	.2189	.2735	.2589	.4334	.4732			.6177	.6808	.4577	.4928
.20	.1022	.1065							.5257	.5854	.5896	.6400		
.25	.0846	.0949	.1912	.1913	.2271	.2411			.4926	.5349			.3969	.4248
.30	-.0705	-.0830	.1622	.1544			.3826	.4424	.4743	.5259	.5295	.5818	.3633	.4094
.40	-.0321	-.0085					.3438	.4092	.4101	.4598	.4625	.5030	.3126	.3228
.50			-.1952	-.1392			-.0578	-.0571	.1112	.0071	.2995	.1170	.2035	.0403
.60	-.0727	-.0598	-.1514	-.0590			-.3124	-.2954	-.2967	-.2733	-.2861	-.2720	-.2679	-.2560
.70			-.1013	-.0553	-.3768	-.3420	-.3495	-.3226			-.3121	-.2893	-.2757	-.2602
.80	-.3014	-.2170	-.3254	-.3073	-.3505	-.3456	-.2902	-.2765					-.2333	-.1967
.90	-.3016	-.2860	-.3326	-.3087	-.3388	-.3239	-.2986	-.2972	-.2843	-.3034	-.2634	-.2790	-.1757	-.1501
.95			-.3211	-.2950	-.3374	-.3121	-.2293	-.2253	-.2862	-.2976	-.2603	-.2630		

TAIL 1

Cp at y/b of														
x/c	0.02		0.22		0.44		0.56		0.67		0.88		0.98	
	U.S.	L.S.	U.S.	L.S.	U.S.	L.S.	U.S.	L.S.	U.S.	L.S.	U.S.	L.S.	U.S.	L.S.
.05			.8928	-.4445	.9125	-.4415	1.3242	-.4576			1.3531	-.3879		
.10	.4802	-.0917	.8462	-.4377	.9156	-.4465					1.2498	-.3716	1.0142	-.3568
.15	.5117	-.1192	.7926	-.4047	.9220	-.4455	1.1472	-.4480			1.1744	-.3339	.9340	-.3203
.20					.9305	-.4413			1.1369	-.3103	1.1174	-.2920	.8495	-.2487
.25	.5882	-.1107	.7106	-.2991	.9320	-.4314			1.0758	-.3064	1.0531	-.2606	.7784	-.1520
.30	.3687	-.2300	.6353	-.2647	.9234	-.4147					.9878	-.2410	.7162	-.1015
.40	.5060	-.1883					.8357	-.4080	.8549	-.3085	.8561	-.2254	.5332	-.0881
.50			.6092	-.2951			.1643	-.4246					.4066	-.2217
.60			.6700	-.2713	.4587	-.4528			-.1386	-.3848	-.1520	-.3972	-.2314	-.4249
.70			.6078	-.2651			-.0197	-.4213	-.1222	-.3895	-.1492	-.3934	-.2264	-.4275
.80			.0311	-.3655	-.0135	-.4318	-.0088	-.4255	-.0719	-.3949	-.1239	-.3990	-.2061	-.4397
.90					-.0067	-.4315	-.0136	-.4258	-.0472	-.3988	-.1123	-.3974	-.1874	-.4291
.95			-.0347	-.2713	-.0016	-.4100			-.0477	-.3962	-.1125	-.3894		

TAIL 2

TABLE XVI. - CONTINUED
(b) $\alpha = -1.52^\circ$

Cp at y/b of															
x/c	0.02		0.22		0.44		0.56		0.67		0.83		0.98		
	U.S.	L.S.	U.S.	L.S.	U.S.	L.S.	U.S.	L.S.	U.S.	L.S.	U.S.	L.S.	U.S.	L.S.	
.05	.1354	.1450	.3286	.2827							.7292	.8073	.5648	.6416	
.10	.1241	.1351	.2484	.2403						.6948	.7134	.6695	.7368	.5232	.5420
.15	.1349	.1271	.2265	.2209	.3002	.2865	.4691	.5036			.6266	.6798	.4334	.4611	
.20	.1162	.1155							.5551	.6075	.5954	.6399			
.25	.1010	.1041	.1993	.2009	.2531	.2686			.5166	.5534			.3667	.4000	
.30	-.0377	-.0532	.1729	.1658			.4132	.4571	.4953	.5488	.5251	.5806	.3299	.3888	
.40	-.0044	.0296					.3649	.4293	.4249	.4778	.4502	.4948	.2825	.3071	
.50			-.1698	-.1079			-.0528	-.0492	-.1107	-.0143	.2884	.1140	.1844	.0337	
.60	-.0607	-.0386	-.1152	-.0335			-.3101	-.2897	-.2954	-.2703	-.2911	-.2774	-.2732	-.2625	
.70			-.0859	-.0468	-.3745	-.3400	-.3466	-.3188			-.3181	-.2975	-.2883	-.2683	
.80	-.2918	-.2017	-.3225	-.2924	-.3426	-.3404	-.2878	-.2724					-.2238	-.2005	
.90	-.2951	-.2793	-.3233	-.2868	-.3363	-.3153	-.2950	-.2911	-.2819	-.3033	-.2670	-.2817	-.1873	-.1588	
.95			-.3062	-.2793	-.3347	-.3076	-.2276	-.2204	-.2856	-.2971	-.2641	-.2672			

TAIL 1

Cp at y/b of														
x/c	0.02		0.22		0.44		0.56		0.67		0.83		0.98	
	U.S.	L.S.	U.S.	L.S.	U.S.	L.S.	U.S.	L.S.	U.S.	L.S.	U.S.	L.S.	U.S.	L.S.
.05			.8225	-.4327	.8464	-.4240	1.2848	-.4359			1.3300	-.3421		
.10	.4285	-.0571	.7729	-.4049	.8266	-.4261					1.2201	-.3145	.9865	-.3053
.15	.4513	-.0917	.7155	-.3552	.8328	-.4232	1.0885	-.4215			1.1392	-.2692	.9050	-.2598
.20					.8433	-.4155			1.0946	-.2517	1.0820	-.2289	.8167	-.1785
.25	.4891	-.0941	.6470	-.2003	.8440	-.3994			1.0350	-.2511	1.0178	-.1986	.7471	-.0755
.30	.2739	-.2223	.5823	-.1755	.8360	-.3756					.9535	-.1773	.6842	-.0346
.40	.3981	-.1703					.7922	-.3559	.8226	-.2632	.8263	-.1531	.5655	-.0382
.50			.4283	-.2681			.1442	-.4346					.3903	-.1864
.60			.5132	-.2406	.4135	-.4391			-.1604	-.3876	-.1665	-.4092	-.2453	-.3775
.70			.5696	-.2342			-.0861	-.4171	-.1634	-.3940	-.1731	-.4051	-.2489	-.3899
.80			.0235	-.3488	-.0460	-.4285	-.0514	-.4221	-.1333	-.3982	-.1563	-.4054	-.2348	-.4097
.90					-.0425	-.4182	-.0524	-.4228	-.1107	-.4016	-.1520	-.3891	-.2186	-.4198
.95			-.0484	-.2498	-.0370	-.3927			-.1155	-.4001	-.1555	-.3730		

TAIL 2

TABLE XVI. - CONTINUED
(c) $\alpha = 0.47^\circ$

Cp at y/b of														
x/c	0.02		0.22		0.44		0.56		0.67		0.83		0.98	
	U.S.	L.S.	U.S.	L.S.	U.S.	L.S.	U.S.	L.S.	U.S.	L.S.	U.S.	L.S.	U.S.	L.S.
.05	.1489	.1526	.3364	.2965							.7348	.8145	.5547	.6263
.10	.1241	.1398	.2621	.2512					.7218	.7358	.6790	.7425	.5189	.5303
.15	.1460	.1349	.2410	.2326	.3209	.3074	.4963	.5291			.6397	.6863	.4359	.4573
.20	.1298	.1295							.5807	.6238	.6100	.6467		
.25	.1238	.1257	.2179	.2184	.2806	.2968			.5402	.5740			.3755	.4037
.30	-.0335	-.0530	.1940	.1909			.4405	.4820	.5166	.5630	.5363	.5831	.3431	.3989
.40	.0091	.0445					.3897	.4450	.4456	.4967	.4572	.4991	.2958	.3204
.50			-.1559	-.1037			-.0449	-.0384	.1254	.0170	.2918	.1222	.1972	.0491
.60	-.0414	-.0204	-.0993	-.0247			-.3070	-.2841	-.2936	-.2681	-.2905	-.2757	-.2664	-.2555
.70			-.0675	-.0206	-.3718	-.3379	-.3425	-.3132			-.3173	-.2961	-.2670	-.2606
.80	-.2845	-.1818	-.3101	-.2750	-.3363	-.3379	-.2845	-.2688					-.2021	-.1796
.90	-.2920	-.2708	-.3050	-.2610	-.3312	-.3086	-.2923	-.2867	-.2780	-.3001	-.2648	-.2724	-.2019	-.1666
.95			-.2946	-.2568	-.3306	-.3020	-.2267	-.2164	-.2821	-.2971	-.2621	-.2602		

TAIL 1

Cp at y/b of														
x/c	0.02		0.22		0.44		0.56		0.67		0.83		0.98	
	U.S.	L.S.	U.S.	L.S.	U.S.	L.S.	U.S.	L.S.	U.S.	L.S.	U.S.	L.S.	U.S.	L.S.
.05			.7458	-.3940	.7905	-.4000	1.2441	-.4093			1.3020	-.2967		
.10	.4036	-.0217	.6939	-.3444	.7496	-.3978					1.1838	-.2499	.9545	-.2484
.15	.4198	-.0530	.6406	-.2885	.7475	-.3896	1.0330	-.3811			1.1011	-.1970	.8694	-.1876
.20					.7616	-.3772			1.0462	-.1916	1.0428	-.1573	.7812	-.1027
.25	.4334	-.0579	.5743	-.1063	.7720	-.3549			.9868	-.1949	.9789	-.1242	.7117	-.0123
.30	.1872	-.2031	.5148	-.0991	.7718	-.3274					.9149	-.0945	.6496	.0125
.40	.2998	-.1474					.7297	-.2996	.7799	-.2144	.7915	-.0882	.5361	.0034
.50			.2685	-.2492			.1128	-.4158					.3711	-.1555
.60			.3677	-.1999	.2382	-.3971			-.1818	-.3836	-.1805	-.4252	-.2576	-.3597
.70			.4611	-.1922			-.1737	-.4141	-.1982	-.3934	-.1947	-.4067	-.2667	-.3493
.80			-.0121	-.3306	-.0730	-.4143	-.1321	-.4200	-.1920	-.3977	-.1861	-.4034	-.2558	-.3669
.90					-.0783	-.3921	-.0798	-.4188	-.1807	-.3967	-.1868	-.3823	-.2402	-.3803
.95			-.0637	-.2388	-.0715	-.3693			-.1881	-.3931	-.1922	-.3615		

TAIL 2

TABLE XVI. - CONTINUED
(d) $\alpha = 2.45^\circ$

Cp at y/b of														
x/c	0.02		0.22		0.44		0.56		0.67		0.83		0.98	
	U.S.	L.S.	U.S.	L.S.	U.S.	L.S.	U.S.	L.S.	U.S.	L.S.	U.S.	L.S.	U.S.	L.S.
.05	.1651	.1666	.3437	.3051							.7339	.8086	.5309	.6114
.10	.1149	.1499	.2665	.2582					.7404	.7529	.6873	.7451	.5094	.5182
.15	.1502	.1363	.2463	.2347	.3305	.3194	.5148	.5412			.6466	.6897	.4375	.4568
.20	.1288	.1317							.5968	.6349	.6152	.6516		
.25	.1322	.1270	.2225	.2175	.2937	.3061			.5546	.5884			.3824	.4111
.30	-.0333	-.0596	.2023	.1975			.4601	.4936	.5331	.5731	.5427	.5877	.3546	.4011
.40	.0140	.0505					.4112	.4609	.4602	.5074	.4604	.5029	.3098	.3329
.50			-.1465	-.1006			-.0354	-.0269	.1333	.0235	.2960	.1197	.2134	.0648
.60	-.0185	-.0041	-.0884	-.0209			-.3013	-.2784	-.2891	-.2613	-.2894	-.2736	-.2610	-.2479
.70			-.0476	.0020	-.3664	-.3350	-.3349	-.3084			-.3177	-.2942	-.2635	-.2368
.80	-.2756	-.1631	-.2953	-.2546	-.3306	-.3360	-.2811	-.2658					-.1837	-.1718
.90	-.2844	-.2589	-.2817	-.2350	-.3240	-.3053	-.2853	-.2861	-.2703	-.2970	-.2653	-.2696	-.2268	-.1802
.95			-.2797	-.2345	-.3206	-.2980	-.2190	-.2156	-.2761	-.2921	-.2639	-.2572		

TAIL 1

Cp at y/b of														
x/c	0.02		0.22		0.44		0.56		0.67		0.83		0.98	
	U.S.	L.S.	U.S.	L.S.	U.S.	L.S.	U.S.	L.S.	U.S.	L.S.	U.S.	L.S.	U.S.	L.S.
.05			.6800	-.3296	.7421	-.3744	1.1968	-.3727			1.2676	-.2451		
.10	.3936	.0111	.6303	-.2475	.6863	-.3644					1.1457	-.1741	.9177	-.1799
.15	.4079	-.0083	.5779	-.1342	.6650	-.3467	.9826	-.3314			1.0604	-.1131	.8319	-.1016
.20					.6755	-.3234			1.0005	-.1260	1.0005	-.0669	.7446	-.0193
.25	.4001	-.0312	.5136	-.0562	.6940	-.2956			.9417	-.1344	.9371	-.0310	.6759	.0465
.30	.1451	-.1682	.4530	-.0554	.7086	-.2610					.8762	-.0160	.6140	.0585
.40	.2077	-.1278					.6924	-.2293	.7449	-.1603	.7580	-.0239	.5071	.0499
.50			.1542	-.2291			.0973	-.3698					.3515	-.1239
.60			.2777	-.1711	.0447	-.3142			-.1957	-.3839	-.1922	-.4162	-.2666	-.3385
.70			.3517	-.1541			-.2380	-.4011	-.2183	-.3935	-.2117	-.4019	-.2700	-.3069
.80			-.0557	-.3204	-.1019	-.3983	-.2186	-.4038	-.2206	-.3957	-.2077	-.3971	-.2616	-.3304
.90					-.1148	-.3740	-.1953	-.4044	-.2260	-.3908	-.2119	-.3923	-.2451	-.3537
.95			-.1044	-.2507	-.1117	-.3327			-.2368	-.3853	-.2184	-.3846		

TAIL 2

TABLE XVI. - CONTINUED
(e) $\alpha = 4.45^\circ$

Cp at y/b of														
x/c	0.02		0.22		0.44		0.56		0.67		0.83		0.98	
	U.S.	L.S.	U.S.	L.S.	U.S.	L.S.	U.S.	L.S.	U.S.	L.S.	U.S.	L.S.	U.S.	L.S.
.05	.1754	.1809	.3602	.3184							.7235	.8049	.5053	.5848
.10	.1136	.1672	.2782	.2711					.7545	.7689	.6844	.7522	.4897	.5081
.15	.1582	.1424	.2569	.2442	.3479	.3384	.5342	.5521			.6525	.6932	.4387	.4525
.20	.1306	.1374							.6097	.6488				
.25	.1331	.1258	.2273	.2244	.3025	.3147			.5652	.5966			.3897	.4172
.30	-.0384	-.0687	.2059	.1981			.4651	.5002	.5417	.5829	.5474	.5890	.3661	.4083
.40	.0098	.0482					.4117	.4630	.4653	.5151	.4650	.5051	.3231	.3479
.50			-.1485	-.1063			-.0310	-.0240	.1372	.0218	.3016	.1254	.2298	.0767
.60	-.0017	.0142	-.0908	-.0294			-.3020	-.2762	-.2837	-.2575	-.2877	-.2720	-.2532	-.2376
.70			-.0330	.0224	-.3654	-.3310	-.3330	-.3058			-.3174	-.2933	-.2347	-.1888
.80	-.2631	-.1417	-.2787	-.2298	-.3259	-.3344	-.2783	-.2633					-.1753	-.1721
.90	-.2716	-.2429	-.2603	-.2116	-.3206	-.3006	-.2814	-.2837	-.2668	-.2913	-.2682	-.2657	-.2499	-.2080
.95			-.2667	-.2159	-.3158	-.2949	-.2155	-.2130	-.2730	-.2871	-.2644	-.2548		

TAIL 1

Cp at y/b of														
x/c	0.02		0.22		0.44		0.56		0.67		0.83		0.98	
	U.S.	L.S.	U.S.	L.S.	U.S.	L.S.	U.S.	L.S.	U.S.	L.S.	U.S.	L.S.	U.S.	L.S.
.05			.6081	-.2304	.6953	-.3430	1.1405	-.3200			1.2235	-.1737		
.10	.3546	.0247	.5657	-.1296	.6357	-.3102					1.0991	-.0869	.8760	-.0943
.15	.3721	.0272	.5220	-.0397	.6010	-.2664	.9233	-.2491			1.0130	-.0193	.7887	.0030
.20					.5862	-.2258			.9457	-.0528	.9544	.0313	.7008	.0745
.25	.3401	-.0001	.4667	-.0047	.6090	-.1924			.8921	-.0661	.8931	.0617	.6354	.1019
.30	.1363	-.1369	.4068	-.0045	.6323	-.1307					.8339	.0653	.5765	.1038
.40	.1291	-.1034					.6500	-.1335	.7040	-.0997	.7208	.0481	.4758	.1014
.50			.0714	-.1931			.0799	-.3007					.3312	-.0893
.60			.1723	-.1232	-.0219	-.2732			-.2103	-.3801	-.2072	-.3976	-.2673	-.3135
.70			.2299	-.1208			-.2593	-.3885	-.2364	-.3855	-.2276	-.4035	-.2647	-.2748
.80			-.1055	-.3073	-.1838	-.3807	-.2699	-.3802	-.2424	-.3867	-.2273	-.3892	-.2614	-.2861
.90					-.1560	-.3664	-.2572	-.3683	-.2497	-.3828	-.2333	-.3786	-.2500	-.3155
.95			-.1293	-.2680	-.1502	-.3406			-.2614	-.3744	-.2399	-.3732		

TAIL 2

TABLE XVI. - CONTINUED
(f) $\alpha = 6.45^\circ$

Cp at y/b of														
x/c	0.02		0.22		0.44		0.56		0.67		0.83		0.98	
	U.S.	L.S.	U.S.	L.S.	U.S.	L.S.	U.S.	L.S.	U.S.	L.S.	U.S.	L.S.	U.S.	L.S.
.05	.1872	.1924	.3821	.3338							.7080	.7992	.4730	.5598
.10	.1201	.1783	.2930	.2869					.7673	.7797	.6802	.7523	.4539	.4963
.15	.1685	.1493	.2711	.2620	.3623	.3543	.5493	.5695			.6544	.6974	.4279	.4510
.20	.1387	.1461							.6254	.6661	.6269	.6574		
.25	.1390	.1317	.2420	.2389	.3179	.3260			.5832	.6148			.3954	.4214
.30	-.0380	-.0693	.2208	.2085			.4751	.5196	.5577	.6018	.5536	.5954	.3760	.4186
.40	.0059	.0454					.4244	.4744	.4819	.5268	.4750	.5094	.3396	.3631
.50			-.1612	-.1222			-.0243	-.0187	.1461	.0319	.3129	.1271	.2518	.0889
.60	.0135	.0342	-.1131	-.0537			-.2985	-.2744	-.2807	-.2570	-.2823	-.2698	-.2422	-.2301
.70			-.0217	.0438	-.3658	-.3323	-.3284	-.3045			-.3127	-.2912	-.1762	-.1299
.80	-.2482	-.1242	-.2501	-.2044	-.3247	-.3339	-.2754	-.2615					-.1658	-.1756
.90	-.2541	-.2275	-.2369	-.1933	-.3199	-.2994	-.2794	-.2841	-.2613	-.2845	-.2666	-.2629	-.2391	-.2257
.95			-.2512	-.1994	-.3157	-.2950	-.2140	-.2132	-.2661	-.2787	-.2619	-.2523		

TAIL 1

Cp at y/b of														
x/c	0.02		0.22		0.44		0.56		0.67		0.83		0.98	
	U.S.	L.S.	U.S.	L.S.	U.S.	L.S.	U.S.	L.S.	U.S.	L.S.	U.S.	L.S.	U.S.	L.S.
.05			.5111	-.1028	.6360	-.2681	1.0649	-.2139			1.1679	-.0740	.8279	-.0049
.10	.2825	.0462	.4740	-.0148	.5754	-.2071					1.0434	.0275	.8279	-.0049
.15	.2970	.0481	.4400	.0372	.5414	-.1492	.8472	-.1397			.9588	.0905	.7395	.0897
.20					.5124	-.0925			.8852	.0345	.9009	.1331	.6532	.1575
.25	.2762	.0408	.4050	.0484	.5130	.0111			.8330	.0148	.8406	.1580	.5891	.1607
.30	.1025	-.1074	.3598	.0428	.5401	.0414					.7838	.1517	.5326	.1552
.40	.0655	-.0661					.6052	.1024	.6570	-.0203	.6779	.1235	.4393	.1534
.50			.0063	-.1341			.0586	-.1821					.3050	-.0561
.60			.0952	-.0631	-.0602	-.2391			-.2238	-.3728	-.2225	-.3737	-.2614	-.2910
.70			.1475	-.0885			-.2765	-.3806	-.2537	-.3678	-.2467	-.3885	-.2600	-.2399
.80			-.1523	-.2980	-.2539	-.3630	-.2931	-.3552	-.2620	-.3648	-.2473	-.3695	-.2531	-.2508
.90					-.2254	-.3519	-.2967	-.3410	-.2704	-.3549	-.2539	-.3550	-.2380	-.2779
.95			-.1515	-.2702	-.2134	-.3374			-.2815	-.3461	-.2602	-.3519		

TAIL 2

TABLE XVI. - CONTINUED
(g) $\alpha = 8.45^\circ$

Cp at γ/b of														
x/c	0.02		0.22		0.44		0.56		0.67		0.83		0.98	
	U.S.	L.S.	U.S.	L.S.	U.S.	L.S.	U.S.	L.S.	U.S.	L.S.	U.S.	L.S.	U.S.	L.S.
.05	.2036	.2048	.4086	.3592							.6845	.7911	.4383	.5389
.10	.1332	.1891	.3180	.3087					.7804	.8055	.6751	.7552	.4201	.4844
.15	.1832	.1620	.2940	.2816	.3777	.3707	.5667	.5946			.6595	.7033	.4140	.4494
.20	.1517	.1604							.6460	.6827	.6374	.6624		
.25	.1508	.1465	.2590	.2487	.3386	.3504			.6077	.6312			.4023	.4277
.30	-.0299	-.0626	.2278	.2174			.5002	.5354	.5861	.6114	.5698	.5945	.3956	.4228
.40	-.0019	.0455					.4530	.4828	.5068	.5309	.4918	.5125	.3729	.3753
.50			-.1674	-.1288			-.0094	-.0161	.1632	.0328	.3256	.1286	.2808	.1057
.60	.0278	.0494	-.1206	-.0852			-.2950	-.2722	-.2781	-.2581	-.2779	-.2684	-.2261	-.2222
.70			-.0358	.0608	-.3612	-.3322	-.3234	-.2999			-.3084	-.2890	-.1378	-.1061
.80	-.2288	-.1072	-.2197	-.1837	-.3222	-.3352	-.2721	-.2566					-.1418	-.1582
.90	-.2346	-.2107	-.2170	-.1773	-.3154	-.2999	-.2794	-.2828	-.2578	-.2815	-.2632	-.2599	-.1946	-.2230
.95			-.2353	-.1842	-.3121	-.2947	-.2152	-.2107	-.2652	-.2741	-.2567	-.2499		

TAIL 1

Cp at γ/b of														
x/c	0.02		0.22		0.44		0.56		0.67		0.83		0.98	
	U.S.	L.S.	U.S.	L.S.	U.S.	L.S.	U.S.	L.S.	U.S.	L.S.	U.S.	L.S.	U.S.	L.S.
.05			.4142	.0463	.5552	-.1397	.9577	-.0479			1.0954	.0526		
.10	.2025	.0642	.3757	.0815	.4978	-.0478					.9754	.1636	.7664	.1011
.15	.2230	.0641	.3418	.0876	.4636	.0924	.7486	.0396			.8943	.2383	.6797	.1825
.20					.4354	.0949			.8072	.1310	.8385	.2651	.5931	.2053
.25	.1988	.0883	.3263	.0925	.4230	.1002			.7638	.1163	.7813	.2659	.5307	.2044
.30	.0395	-.0420	.2913	.0860	.4403	.1065					.7267	.2503	.4799	.2059
.40	-.0036	-.0308					.5529	.2045	.6047	.1625	.6288	.2042	.3935	.1987
.50			-.0593	-.0589			.0330	-.1385					.2757	-.0316
.60			.0051	-.0139	-.0985	-.2104			-.2382	-.3277	-.2373	-.3476	-.2578	-.2764
.70			.0827	-.0684			-.2939	-.3630	-.2707	-.3484	-.2669	-.3408	-.2661	-.2182
.80			-.1915	-.2808	-.3017	-.3413	-.3117	-.3375	-.2805	-.3305	-.2703	-.3206	-.2622	-.2142
.90					-.2807	-.3335	-.3200	-.3257	-.2890	-.3078	-.2750	-.3119	-.2465	-.2345
.95			-.1643	-.2615	-.2651	-.3123			-.2977	-.3029	-.2753	-.2967		

TAIL 2

TABLE XVI. - CONTINUED
(h) $\alpha = 10.45^\circ$

Cp at y/b of														
x/c	0.02		0.22		0.44		0.56		0.67		0.83		0.98	
	U.S.	L.S.	U.S.	L.S.	U.S.	L.S.	U.S.	L.S.	U.S.	L.S.	U.S.	L.S.	U.S.	L.S.
.05	.2220	.2234	.4418	.3777							.6999	.7881	.4395	.5193
.10	.1528	.2090	.3427	.3226					.8093	.8106	.7038	.7490	.4308	.4723
.15	.2062	.1803	.3054	.2919	.3978	.3947	.6081	.6152			.6791	.6987	.4309	.4417
.20	.1720	.1749							.6680	.6925				
.25	.1605	.1572	.2614	.2589	.3836	.3781			.6267	.6414			.4246	.4327
.30	-.0280	-.0559	.2322	.2294			.5256	.5473	.6002	.6213	.5810	.5967	.4131	.4337
.40	-.0032	.0533					.4672	.4957	.5130	.5384	.5017	.5176	.3877	.3954
.50			-.1590	-.1324			-.0037	-.0113	.1685	.0352	.3354	.1384	.2970	.1232
.60	.0571	.0495	-.1229	-.1022			-.2929	-.2698	-.2758	-.2552	-.2744	-.2658	-.2148	-.2124
.70			-.0333	.0621	-.3592	-.3273	-.3195	-.2953			-.3045	-.2853	-.1310	-.1062
.80	-.2117	-.0882	-.1985	-.1653	-.3183	-.3315	-.2681	-.2516					-.1319	-.1231
.90	-.2157	-.1894	-.2022	-.1608	-.3113	-.2941	-.2711	-.2791	-.2521	-.2763	-.2576	-.2549	-.1846	-.1911
.95			-.2228	-.1709	-.3087	-.2900	-.2134	-.2070	-.2563	-.2694	-.2520	-.2451		

TAIL 1

Cp at y/b of														
x/c	0.02		0.22		0.44		0.56		0.67		0.83		0.98	
	U.S.	L.S.	U.S.	L.S.	U.S.	L.S.	U.S.	L.S.	U.S.	L.S.	U.S.	L.S.	U.S.	L.S.
.05			.3228	.1609	.4615	.1073	.8103	.1994			1.0050	.2241		
.10	.1387	.0950	.2945	.1423	.4109	.1700					.8891	.3442	.6908	.2288
.15	.1656	.0981	.2549	.1376	.3806	.1605	.6219	.3009			.8142	.4106	.5999	.2637
.20					.3557	.1592			.7143	.3300	.7609	.3954	.5186	.2720
.25	.1184	.1439	.2516	.1415	.3391	.1603			.6750	.3364	.7087	.3833	.4631	.2794
.30	-.0570	.0281	.2200	.1287	.3431	.1723					.6588	.3669	.4183	.2720
.40	-.0760	.0074					.4866	.2949	.5433	.3278	.5692	.3411	.3475	.2376
.50			-.1211	-.0471			.0034	-.0942					.2423	-.0044
.60			-.0706	.0373	-.1327	-.1709			-.2546	-.2963	-.2524	-.2937	-.2580	-.2723
.70			.0286	-.0371			-.3093	-.3388	-.2882	-.3209	-.2845	-.3194	-.2710	-.1613
.80			-.2224	-.2654	-.3271	-.3021	-.3255	-.3156	-.2977	-.3177	-.2871	-.2941	-.2660	-.1966
.90					-.2998	-.2584	-.2976	-.3019	-.3042	-.2859	-.2533	-.2729	-.1890	-.2183
.95			-.1884	-.2568	-.2926	-.2514			-.2962	-.2791	-.2446	-.2677		

TAIL 2

TABLE XVI. - CONTINUED
(1) $\alpha = 12.45^\circ$

Cp at γ/b of														
x/c	0.02		0.22		0.44		0.56		0.67		0.83		0.98	
	U.S.	L.S.	U.S.	L.S.	U.S.	L.S.	U.S.	L.S.	U.S.	L.S.	U.S.	L.S.	U.S.	L.S.
.05	.2437	.2436	.4498	.3966							.7131	.7798	.4508	.4961
.10	.1646	.2219	.3565	.3393					.8347	.8295	.7106	.7484	.4232	.4599
.15	.2111	.1926	.3227	.3073	.4344	.4222	.6290	.6350			.6899	.6990	.4255	.4381
.20	.1764	.1892							.6882	.7063		.6603	.6606	
.25	.1648	.1736	.2858	.2686	.4464	.4353			.6466	.6570			.4334	.4433
.30	-.0236	-.0481	.2575	.2413			.5462	.5668	.6201	.6360	.5880	.6028	.4274	.4470
.40	.0111	.0573					.4843	.5082	.5319	.5503	.5107	.5256	.4021	.4162
.50			-.1523	-.1272			.0020	-.0077	.1756	.0406	.3435	.1500	.3149	.1427
.60	.0686	.0506	-.1217	-.1016			-.2873	-.2666	-.2724	-.2529	-.2723	-.2625	-.2078	-.1989
.70			-.0527	.0532	-.3565	-.3272	-.3133	-.2924			-.3020	-.2814	-.1295	-.1086
.80	-.1956	-.0608	-.1988	-.1628	-.3135	-.3313	-.2625	-.2494					-.1430	-.1275
.90	-.1931	-.1569	-.1905	-.1474	-.3080	-.2939	-.2617	-.2766	-.2472	-.2731	-.2529	-.2505	-.2051	-.2012
.95			-.2112	-.1590	-.3047	-.2897	-.1998	-.2038	-.2543	-.2668	-.2480	-.2413		

TAIL 1

Cp at γ/b of														
x/c	0.02		0.22		0.44		0.56		0.67		0.83		0.98	
	U.S.	L.S.	U.S.	L.S.	U.S.	L.S.	U.S.	L.S.	U.S.	L.S.	U.S.	L.S.	U.S.	L.S.
.05			.2286	.2300	.3651	.2738	.6287	.4154			.8557	.5557		
.10	.0856	.1224	.2111	.1932	.3176	.2587					.7704	.5735	.5926	.4620
.15	.1047	.1245	.1849	.1869	.2854	.2464	.4940	.4494			.7089	.5680	.5125	.3978
.20					.2670	.2454			.5948	.5108	.6644	.5430	.4408	.3520
.25	.0202	.2025	.1706	.2011	.2511	.2425			.5665	.4901	.6222	.5246	.3981	.3438
.30	-.1809	.0799	.1464	.1832	.2532	.2473					.5808	.5042	.3616	.3250
.40	-.1334	.0453					.4070	.3821	.4638	.4372	.5045	.4536	.3018	.2863
.50			-.1648	.0546			-.0317	-.0647					.2143	.0148
.60			-.1276	-.0627	-.1645	-.0906			-.2746	-.2707	-.2695	-.2672	-.2605	-.2557
.70			-.0332	-.0207			-.3265	-.3161	-.3061	-.3006	-.3016	-.2978	-.2808	-.2526
.80			-.2486	-.2497	-.3263	-.2263	-.3335	-.2889	-.3094	-.3090	-.2728	-.2953	-.1969	-.1675
.90					-.3156	-.2158	-.2950	-.2886	-.2745	-.2811	-.2527	-.2608	-.1772	-.1733
.95			-.2325	-.2370	-.3118	-.2292			-.2660	-.2689	-.2507	-.2546		

TAIL 2

TABLE XVI. - CONTINUED
(j) $\alpha = 16.45^\circ$

Cp at y/b of														
x/c	0.02		0.22		0.44		0.56		0.67		0.83		0.98	
	U.S.	L.S.	U.S.	L.S.	U.S.	L.S.	U.S.	L.S.	U.S.	L.S.	U.S.	L.S.	U.S.	L.S.
.05	.2863	.2841	.5083	.4387							.6869	.7636	.4311	.4691
.10	.2095	.2555	.4159	.3817					.8654	.8589	.7020	.7418	.3965	.4375
.15	.2620	.2244	.3734	.3534	.5030	.4813	.6810	.6747			.6846	.6955	.3876	.4235
.20	.2251	.2149							.7163	.7281	.6539	.6625		
.25	.2075	.2008	.3301	.3102	.5503	.5367			.6700	.6816			.4115	.4338
.30	.0088	-.0313	.2988	.2803			.5784	.5953	.6386	.6555	.5857	.6082	.4157	.4467
.40	.0427	.0845					.5035	.5298	.5444	.5692	.5147	.5400	.4102	.4348
.50			-.1332	-.1122			.0091	.0062	.1847	.0495	.3535	.1536	.3326	.1702
.60	.0746	.0626	-.0935	-.0758			-.2810	-.2556	-.2696	-.2501	-.2669	-.2557	-.1965	-.1616
.70			-.0452	.0538	-.3551	-.3243	-.3058	-.2806			-.2953	-.2740	-.1217	-.1051
.80	-.1541	-.0106	-.2310	-.1874	-.3054	-.3222	-.2543	-.2395					-.1519	-.1493
.90	-.1148	-.0709	-.1977	-.1348	-.3042	-.2870	-.2438	-.2677	-.2402	-.2620	-.2431	-.2339	-.2604	-.2734
.95			-.2038	-.1375	-.3021	-.2858	-.1781	-.1975	-.2485	-.2536	-.2364	-.2261		

TAIL 1

Cp at y/b of														
x/c	0.02		0.22		0.44		0.56		0.67		0.83		0.98	
	U.S.	L.S.	U.S.	L.S.	U.S.	L.S.	U.S.	L.S.	U.S.	L.S.	U.S.	L.S.	U.S.	L.S.
.05			.0201	.3464	.0087	.4677	.1119	.7737			.3534	.9735		
.10	-.0406	.1706	.0531	.3071	.1270	.4261					.4378	.8696	.3582	.6749
.15	-.0355	.1977	.0541	.3100	.1264	.3900	.2561	.6932			.4292	.8133	.3509	.5740
.20					.1156	.3681			.2779	.7267	.4045	.7602	.3115	.5003
.25	-.1647	.3222	.0392	.2950	.1013	.3435			.2930	.6888	.3714	.7174	.2811	.4657
.30	-.3033	.1651	.0265	.2482	.0923	.3456					.3407	.6775	.2474	.4255
.40	-.2387	.1265					.2050	.4904	.2498	.5702	.2972	.5831	.1997	.3531
.50			-.2393	.1678			-.1201	-.0107					.1353	.0353
.60			-.1827	.1053	-.2393	.0794			-.3343	-.2373	-.3202	-.2372	-.2895	-.2596
.70			-.0967	.0250			-.3669	-.2646	-.3580	-.2668	-.3458	-.2648	-.2918	-.2388
.80			-.2882	-.2158	-.3582	-.1722	-.3314	-.2477	-.3204	-.2772	-.3134	-.2719	-.2048	-.2288
.90					-.3574	-.1899	-.3251	-.2386	-.3080	-.2838	-.3028	-.2814	-.2467	-.2146
.95			-.2693	-.2003	-.3387	-.2023			-.3037	-.2911	-.3004	-.2897		

TAIL 2

TABLE XVI. - CONCLUDED
(k) $\alpha = 20.45^\circ$

Cp at y/b of														
x/c	0.02		0.22		0.44		0.56		0.67		0.83		0.98	
	U.S.	L.S.	U.S.	L.S.	U.S.	L.S.	U.S.	L.S.	U.S.	L.S.	U.S.	L.S.	U.S.	L.S.
.05	.3582	.3565	.5738	.5116							.7106	.8194	.4611	.4948
.10	.2665	.3152	.4947	.4442					.8907	.9071	.7426	.7808	.4330	.4769
.15	.3216	.2915	.4400	.4138	.6160	.6062	.7127	.7269			.6997	.7252	.4311	.4676
.20	.2812	.2803							.7459	.7698	.6789	.6893		
.25	.2624	.2627	.3846	.3737	.6088	.6150			.6999	.7180			.4561	.4788
.30	.0497	.0129	.3514	.3361			.6058	.6321	.6673	.6901	.6075	.6359	.4584	.4857
.40	.0968	.1335					.5290	.5578	.5726	.5977	.5439	.5694	.4509	.4822
.50			-.1058	-.0722			.0205	.0155	.2055	.0609	.3780	.1757	.3673	.2087
.60	.1022	.1014	-.0664	-.0330			-.2719	-.2490	-.2625	-.2407	-.2566	-.2456	-.1784	-.1344
.70			-.0336	.0683	-.3487	-.3189	-.2943	-.2722			-.2835	-.2612	-.1189	-.0945
.80	-.0940	.0830	-.2329	-.1789	-.2994	-.3050	-.2443	-.2311					-.1898	-.1946
.90	-.0667	-.0217	-.2041	-.1354	-.2972	-.2765	-.2305	-.2490	-.2263	-.2399	-.2266	-.2176	-.3365	-.3297
.95			-.1883	-.1293	-.2966	-.2756	-.1710	-.1798	-.2321	-.2352	-.2136	-.2101		

TAIL 1

Cp at y/b of														
x/c	0.02		0.22		0.44		0.56		0.67		0.83		0.98	
	U.S.	L.S.	U.S.	L.S.	U.S.	L.S.	U.S.	L.S.	U.S.	L.S.	U.S.	L.S.	U.S.	L.S.
.05			-.2488	.4514	-.3236	.5506	-.2062	.9698			-.0265	1.1189		
.10	-.1664	.2217	-.1868	.4363	-.2656	.5054					.0671	1.0053	.0350	.8068
.15	-.2066	.2812	-.1231	.4373	-.1968	.4583	-.1740	.8417			.1133	.9379	.1110	.7034
.20					-.1619	.4345			-.0067	.8564	.1454	.8778	.1531	.6233
.25	-.3510	.4016	-.0547	.3718	-.1390	.4194			-.0300	.8090	.1431	.8267	.1531	.5785
.30	-.3968	.2311	-.0769	.3135	-.1033	.4340					.1292	.7794	.1370	.5283
.40	-.3170	.2005					-.0526	.5893	-.0733	.6650	.0895	.6718	.1272	.4249
.50			-.2668	.2329			-.2384	.0329					.0713	.0605
.60			-.2197	.1335	-.2911	.2858			-.3661	-.2065	-.3855	-.2040	-.3139	-.2706
.70			-.1685	.0909			-.3735	-.1703	-.3760	-.2281	-.3623	-.2289	-.2838	-.2618
.80			-.3236	-.1741	-.3855	-.1381	-.3567	-.1501	-.3783	-.2223	-.3642	-.2358	-.2719	-.2440
.90					-.3747	-.1551	-.3104	-.1529	-.3696	-.2102	-.3573	-.2420	-.2828	-.2246
.95			-.2821	-.1320	-.3450	-.1610			-.3588	-.2178	-.3503	-.2532		

TAIL 2

TABLE XVII. - PRESSURE COEFFICIENTS, $\phi = 0^\circ$, $\delta_{2,4} = -15^\circ$, $M = 2.36$.
(a) $\alpha = -4.06^\circ$

Cp at y/b of														
x/c	0.02		0.22		0.44		0.56		0.67		0.83		0.98	
	U.S.	L.S.	U.S.	L.S.	U.S.	L.S.	U.S.	L.S.	U.S.	L.S.	U.S.	L.S.	U.S.	L.S.
.05	.0759	.0628	.2240	.2344	.2536	.2656					.2783	.3436	.2741	.3290
.10	.0755	.0755	.1914	.2008	.2325	.2463			.2951	.3242	.2611	.3280	.2483	.2981
.15	.0754	.0697	.1719	.1785	.2117	.2325			.3080	.3566	.2618	.3183	.2249	.2729
.20	.0709	.0716							.3164	.3736	.2601	.3145		
.25	.0683	.0686	.1491	.1560	.1866	.2110	.2998	.3630	.3158	.3819			.1831	.2270
.30	-.0141	.0836	.1477	.1462	.1729	.2029	.3012	.3635	.3130	.3849	.2551	.3158	.1699	.2155
.40	-.0283	.1109	-.0411	-.0213	.1673	.2130	.2839	.3466	.3015	.3735	.2486	.3152	.1495	.1933
.50	-.0008	.0276	-.0605	-.0340			.0254	.0526	.1374	.1082	.1897	.1356	.1062	.0513
.60	-.0203	.0111	-.0664	-.0376	-.0338	.0034	-.1349	-.1120	-.1208	-.1014	-.1229	-.1045	-.1107	-.1289
.70			-.0717	-.0409	-.1522	-.1296	-.1503	-.1273	-.1195	-.1002	-.1336	-.1150	-.1097	-.1173
.80	-.1294	-.0950	-.1414	-.1441	-.1556	-.1426	-.1440	-.1336					-.1084	-.1107
.90	-.1498	-.1274	-.1382	-.1475	-.1325	-.1463	-.1307	-.1392	-.1108	-.1230	-.1007	-.1101	-.1093	-.1060
.95			-.1380	-.1435	-.1309	-.1453	-.1256	-.1330	-.1101	-.1179	-.1038	-.1095		-.1063

TAIL 1

Cp at y/b of														
x/c	0.02		0.22		0.44		0.56		0.67		0.83		0.98	
	U.S.	L.S.	U.S.	L.S.	U.S.	L.S.	U.S.	L.S.	U.S.	L.S.	U.S.	L.S.	U.S.	L.S.
.05			.8338	-.1707	.8601	-.2005	1.4034	-.1697		-.0670	1.4405	-.1157		
.10	-.3925	-.0357	.7770	-.1627	.8279	-.1865					1.3281	-.0754	1.1052	-.0610
.15	.3732	-.0617	.7449	-.1576	.7947	-.1744				.0238	1.2504	-.0623	1.0204	-.0424
.20							1.1563	-.1374	1.2082	-.0042	1.1855	-.0593	.9338	-.0261
.25	.4721	-.0814	.6921	-.1495	.7319	-.1553	1.1130	-.1386	1.1453	-.0229	1.1276	-.0574	.8690	-.0211
.30	.2916	-.1222	.6498	-.1501	.7233	-.1572	1.0621	-.1395	1.0877	-.0480	1.0727	-.0551	.8080	-.0097
.40	.3018	-.1160			.6823	-.1473	.9666	-.1400	.9968	-.0708	.9652	-.0540	.7087	-.0092
.50			.2919	-.1726			.3821	-.1900					.5617	-.0873
.60	.3899	-.0984	.3068	-.1795	.3109	-.1858	-.0191	-.0976	.0756	-.1711	.0767	-.1699	-.0008	-.1889
.70			.3439	-.1753			.0161	-.1743	.0450	-.1745	.0751	-.1697		
.80			.0523	-.1906	.0755	-.1787	.0148	-.1780	.0324	-.1741	.0841	-.1723	-.0148	-.1756
.90					.0640	-.1833	.0260	-.1781	.0163	-.1729	.0743	-.1735	-.0126	-.1820
.95			.0416	-.1713					.0081	-.1746	.0679	-.1730	-.0213	-.1807

TAIL 2

TABLE XVII. - CONTINUED
(b) $\alpha = -2.05^\circ$

Cp at y/b of														
x/c	0.02		0.22		0.44		0.56		0.67		0.83		0.98	
	U.S.	L.S.	U.S.	L.S.	U.S.	L.S.	U.S.	L.S.	U.S.	L.S.	U.S.	L.S.	U.S.	L.S.
.05	.0665	.0646	.2251	.2359	.2624	.2741					.2785	.3462	.2761	.3275
.10	.0683	.0734	.1876	.2015	.2418	.2549			.2906	.3185	.2594	.3271	.2465	.2929
.15	.0704	.0726	.1664	.1781	.2217	.2398			.3006	.3426	.2606	.3160	.2216	.2674
.20	.0696	.0778							.3100	.3620	.2595	.3132		
.25	.0686	.0740	.1419	.1524	.1941	.2151	.3036	.3653	.3113	.3724			.1801	.2224
.30	-.0076	.0546	.1393	.1414	.1766	.2021	.3045	.3655	.3108	.3784	.2547	.3151	.1696	.2123
.40	-.0017	.0791	-.0445	-.0247	.1680	.2134	.2860	.3475	.3040	.3751	.2465	.3109	.1500	.1915
.50	.0165	.0310	-.0630	-.0360			.0241	.0541	.1434	.1108	.1859	.1320	.1074	.0512
.60	-.0169	.0145	-.0637	-.0336	-.0346	.0026	-.1340	-.1114	-.1204	-.0992	-.1246	-.1092	-.1098	-.1257
.70			-.0640	-.0260	-.1531	-.1297	-.1506	-.1267	-.1189	-.0979	-.1300	-.1198	-.1087	-.1192
.80	-.1265	-.0922	-.1355	-.1344	-.1467	-.1431	-.1450	-.1325					-.1070	-.1110
.90	-.1433	-.1201	-.1322	-.1424	-.1308	-.1461	-.1314	-.1363	-.1099	-.1219	-.1008	-.1104	-.1084	-.1083
.95			-.1329	-.1404	-.1295	-.1440	-.1259	-.1337	-.1088	-.1164	-.1041	-.1101		-.1072

TAIL 1

Cp at y/b of														
x/c	0.02		0.22		0.44		0.56		0.67		0.83		0.98	
	U.S.	L.S.	U.S.	L.S.	U.S.	L.S.	U.S.	L.S.	U.S.	L.S.	U.S.	L.S.	U.S.	L.S.
.05			.7605	-.1422	.8077	-.1796	1.3537	-.1413		-.0156	1.3712	-.0644		
.10	.3489	-.0172	.7004	-.1333	.7708	-.1577					1.2561	-.0343	1.0304	-.0229
.15	.3379	-.0391	.6656	-.1307	.7363	-.1429				.0400	1.1830	-.0307	.9524	-.0188
.20							1.0724	-.1161	1.1336	.0280	1.1199	-.0338	.8691	-.0086
.25	.4084	-.0677	.6179	-.1244	.6735	-.1246	1.0341	-.1099	1.0821	.0121	1.0689	-.0357	.8108	-.0043
.30	.2290	-.1093	.5850	-.1253	.6639	-.1256	.9920	-.1094	1.0265	-.0242	1.0182	-.0353	.7564	-.0018
.40	.2461	-.1084			.6538	-.1257	.9146	-.1102	.9482	-.0495	.9196	-.0360	.6661	-.0040
.50			.2225	-.1610			.3620	-.1783					.5344	-.0750
.60	.3031	-.0964	.2241	-.1695	.2683	-.1848	-.0245	-.0943	.0592	-.1651	.0615	-.1642	-.0111	-.1774
.70			.2702	-.1642			-.0016	-.1669	.0279	-.1684	.0493	-.1650		
.80			.0166	-.1883	.0295	-.1749	-.0155	-.1702	.0160	-.1687	.0577	-.1669	-.0340	-.1811
.90					.0230	-.1793	-.0129	-.1704	.0024	-.1692	.0493	-.1678	-.0356	-.1801
.95			.0070	-.1666					-.0059	-.1706	.0426	-.1677	-.0444	-.1737

TAIL 2

TABLE XVII. - CONTINUED
(c) $\alpha = -0.04^\circ$

Cp at y/b of															
x/c	0.02		0.22		0.44		0.56		0.67		0.83		0.98		
	U.S.	L.S.	U.S.	L.S.	U.S.	L.S.	U.S.	L.S.	U.S.	L.S.	U.S.	L.S.	U.S.	L.S.	
.05	.0729	.0758	.2313	.2474	.2626	.2773					.2816	.3506	.2761	.3229	
.10	.0757	.0905	.1980	.2151	.2452	.2625				.2886	.3153	.2631	.3295	.2436	.2857
.15	.0778	.0858	.1765	.1904	.2285	.2491				.2938	.3307	.2644	.3178	.2173	.2589
.20	.0740	.0882								.2992	.3473	.2622	.3149		
.25	.0734	.0844	.1504	.1627	.2044	.2271	.3087	.3696	.2999	.3586			.1792	.2162	
.30	-.0081	.0372	.1462	.1486	.1894	.2137	.3110	.3717	.3011	.3680	.2566	.3136	.1697	.2095	
.40	-.0093	.0609	-.0434	-.0237	.1806	.2243	.2935	.3555	.2994	.3696	.2465	.3086	.1514	.1897	
.50	.0196	.0368	-.0598	-.0324			.0296	.0609	.1429	.1148	.1844	.1298	.1093	.0524	
.60	-.0122	.0211	-.0579	-.0298	-.0263	.0095	-.1308	-.1087	-.1196	-.0965	-.1274	-.1129	-.1092	-.1223	
.70			-.0604	-.0274	-.1511	-.1281	-.1484	-.1236	-.1183	-.0955	-.1257	-.1251	-.1089	-.1175	
.80	-.1222	-.0851	-.1332	-.1357	-.1431	-.1421	-.1434	-.1300					-.1070	-.1089	
.90	-.1439	-.1204	-.1301	-.1398	-.1300	-.1457	-.1288	-.1360	-.1083	-.1194	-.1046	-.1094	-.1074	-.1067	
.95			-.1301	-.1366	-.1274	-.1423	-.1235	-.1350	-.1070	-.1138	-.1078	-.1096		-.1051	

TAIL 1

Cp at y/b of														
x/c	0.02		0.22		0.44		0.56		0.67		0.83		0.98	
	U.S.	L.S.	U.S.	L.S.	U.S.	L.S.	U.S.	L.S.	U.S.	L.S.	U.S.	L.S.	U.S.	L.S.
.05			.6806	-.1048	.7453	-.1473	1.2451	-.1062		.0206	1.2582	-.0076		
.10	.3091	-.0080	.6212	-.1002	.7052	-.1197					1.1576	.0000	.9314	.0020
.15	.3049	-.0185	.5868	-.0999	.6713	-.1065					1.0930	-.0054	.8636	-.0028
.20							.9723	-.0799	1.0458	.0516	1.0405	-.0119	.7900	.0034
.25	.3549	-.0486	.5379	-.0945	.6122	-.0963	.9406	-.0748	.9968	.0320	.9976	-.0145	.7401	.0060
.30	.1881	-.1023	.5120	-.0954	.6024	-.0967	.9093	-.0752	.9472	.0014	.9546	-.0142	.6931	.0067
.40	.1712	-.0998			.5869	-.0948	.8475	-.0753	.8852	-.0238	.8700	-.0147	.6163	.0037
.50			.1608	-.1463			.3384	-.1605					.5013	-.0696
.60	.2335	-.0945	.1550	-.1507	.2204	-.1750	-.0309	-.0959	.0432	-.1619	.0485	-.1572	-.0227	-.1716
.70			.1789	-.1496			-.0185	-.1621	.0110	-.1655	.0249	-.1589		
.80			-.0189	-.1791	-.0100	-.1666	-.0360	-.1651	.0041	-.1660	.0295	-.1604	-.0518	-.1817
.90					-.0175	-.1702	-.0429	-.1654	-.0093	-.1651	.0234	-.1608	-.0561	-.2005
.95			-.0260	-.1582					-.0182	-.1660	.0173	-.1597	-.0646	-.2000

TAIL 2

TABLE XVII. - CONTINUED
(d) $\alpha = 1.94^\circ$

Cp at y/b of														
x/c	0.02		0.22		0.44		0.56		0.67		0.83		0.98	
	U.S.	L.S.	U.S.	L.S.	U.S.	L.S.	U.S.	L.S.	U.S.	L.S.	U.S.	L.S.	U.S.	L.S.
.05	.0823	.0917	.2399	.2573	.2650	.2776					.2818	.3529	.2778	.3219
.10	.0869	.1094	.2109	.2282	.2494	.2670			.2879	.3154	.2659	.3320	.2421	.2830
.15	.0873	.1008	.1874	.2017	.2369	.2577			.2912	.3233	.2679	.3195	.2135	.2547
.20	.0822	.0985							.2931	.3363	.2655	.3165		
.25	.0805	.0963	.1606	.1737	.2174	.2394	.3140	.3757	.2941	.3501			.1804	.2147
.30	-.0083	.0262	.1549	.1585	.2015	.2257	.3171	.3799	.2952	.3578	.2613	.3144	.1707	.2065
.40	-.0252	.0481	-.0402	-.0203	.1955	.2377	.3033	.3659	.2946	.3617	.2498	.3092	.1540	.1901
.50	.0118	.0329	-.0574	-.0295			.0383	.0664	.1428	.1150	.1870	.1284	.1133	.0544
.60	-.0076	.0224	-.0581	-.0286	-.0130	.0174	-.1274	-.1049	-.1182	-.0943	-.1272	-.1146	-.1095	-.1196
.70			-.0606	-.0300	-.1480	-.1243	-.1449	-.1201	-.1172	-.0933	-.1247	-.1282	-.1085	-.1156
.80	-.1169	-.0757	-.1296	-.1395	-.1403	-.1394	-.1411	-.1261					-.1070	-.1085
.90	-.1441	-.1203	-.1277	-.1390	-.1286	-.1438	-.1255	-.1320	-.1057	-.1173	-.1052	-.1085	-.1091	-.1039
.95			-.1275	-.1334	-.1267	-.1399	-.1215	-.1314	-.1042	-.1123	-.1104	-.1092		-.1028

TAIL 1

Cp at y/b of														
x/c	0.02		0.22		0.44		0.56		0.67		0.83		0.98	
	U.S.	L.S.	U.S.	L.S.	U.S.	L.S.	U.S.	L.S.	U.S.	L.S.	U.S.	L.S.	U.S.	L.S.
.05			.5966	-.0646	.6761	-.1010	1.1458	-.0620		.0521	1.0877	.0363		
.10	.2805	-.0089	.5400	-.0650	.6344	-.0720					1.0261	.0265	.8125	.0209
.15	.2763	-.0014	.5098	-.0653	.6004	-.0680				.0812	.9821	.0185	.7652	.0108
.20							.8715	-.0431	.9498	.0732	.9441	.0128	.7069	.0130
.25	.3063	-.0225	.4665	-.0609	.5441	-.0650	.8481	-.0337	.9108	.0585	.9147	.0114	.6657	.0174
.30	.1639	-.0892	.4410	-.0612	.5355	-.0642	.8135	-.0326	.8594	.0305	.8779	.0124	.6270	.0186
.40	.1081	-.0913			.5315	-.0613	.7632	-.0334	.8041	.0080	.8139	.0123	.5634	.0161
.50			.1170	-.1278			.2977	-.1389					.4646	-.0628
.60	.1713	-.0953	.1082	-.1292	.1749	-.1567	-.0436	-.1005	.0238	-.1553	.0347	-.1505	-.0354	-.1622
.70			.1097	-.1318			-.0373	-.1558	-.0025	-.1596	.0040	-.1528		
.80			-.0611	-.1704	-.0430	-.1557	-.0551	-.1580	-.0082	-.1590	.0006	-.1539	-.0697	-.1730
.90					-.0509	-.1590	-.0656	-.1584	-.0215	-.1590	-.0046	-.1538	-.0761	-.1893
.95			-.0597	-.1507					-.0298	-.1594	-.0097	-.1525	-.0842	-.1939

TAIL 2

TABLE XVII. - CONTINUED
(e) $\alpha = 3.94^\circ$

Cp at y/b of														
x/c	0.02		0.22		0.44		0.56		0.67		0.83		0.98	
	U.S.	L.S.	U.S.	L.S.	U.S.	L.S.	U.S.	L.S.	U.S.	L.S.	U.S.	L.S.	U.S.	L.S.
.05	.0870	.1091	.2481	.2698	.2685	.2797					.2760	.3539	.2759	.3188
.10	.0931	.1214	.2229	.2432	.2537	.2722			.2871	.3186	.2645	.3324	.2333	.2807
.15	.0928	.1122	.1992	.2163	.2444	.2658			.2892	.3219	.2663	.3202	.2100	.2515
.20	.0880	.1081							.2890	.3238	.2642	.3166		
.25	.0855	.1067	.1688	.1839	.2298	.2525	.3134	.3779	.2898	.3407			.1824	.2159
.30	-.0065	.0169	.1634	.1692	.2118	.2392	.3205	.3849	.2918	.3495	.2611	.3174	.1736	.2096
.40	-.0315	.0355	-.0383	-.0155	.2068	.2530	.3093	.3756	.2910	.3553	.2505	.3099	.1576	.1928
.50	-.0053	.0243	-.0560	-.0273			.0418	.0739	.1406	.1101	.1869	.1296	.1184	.0568
.60	-.0104	.0179	-.0586	-.0280	-.0066	.0247	-.1230	-.1004	-.1176	-.0942	-.1281	-.1154	-.1133	-.1193
.70			-.0616	-.0296	-.1451	-.1203	-.1403	-.1159	-.1164	-.0932	-.1266	-.1308	-.1112	-.1259
.80	-.1131	-.0715	-.1270	-.1415	-.1394	-.1371	-.1388	-.1221					-.1074	-.1038
.90	-.1423	-.1181	-.1261	-.1373	-.1275	-.1423	-.1210	-.1275	-.1054	-.1149	-.1062	-.1117	-.1364	-.1038
.95			-.1258	-.1295	-.1257	-.1386	-.1152	-.1269	-.1041	-.1102	-.1099	-.1122		-.1204

TAIL 1

Cp at y/b of														
x/c	0.02		0.22		0.44		0.56		0.67		0.83		0.98	
	U.S.	L.S.	U.S.	L.S.	U.S.	L.S.	U.S.	L.S.	U.S.	L.S.	U.S.	L.S.	U.S.	L.S.
.05			.4946	-.0237	.5963	-.0443	1.0056	-.0158		.0736	.7664	.0688		
.10	.2487	-.0018	.4477	-.0260	.5560	-.0295					.8316	.0557	.6200	.0504
.15	.2383	.0056	.4209	-.0276	.5213	-.0306				.0951	.8389	.0484	.6004	.0357
.20							.7522	.0025	.8415	.0965	.8302	.0436	.5711	.0292
.25	.2652	.0021	.3861	-.0257	.4693	-.0279	.7375	.0140	.7987	.0911	.8126	.0431	.5602	.0302
.30	.1298	-.0703	.3694	-.0253	.4621	-.0246	.7127	.0151	.7561	.0693	.7918	.0444	.5456	.0295
.40	.0664	-.0842			.4562	-.0224	.6656	.0133	.7074	.0491	.7522	.0441	.5101	.0255
.50			.0800	-.1098			.2432	-.1135					.4274	-.0604
.60	.1044	-.0989	.0751	-.1086	.1188	-.1343	-.0601	-.1082	.0061	-.1565	.0217	-.1478	-.0505	-.1569
.70			.0697	-.1127			-.0583	-.1520	-.0174	-.1567	-.0207	-.1483		
.80			-.0941	-.1674	-.0703	-.1497	-.0745	-.1530	-.0260	-.1553	-.0284	-.1488	-.0861	-.1516
.90					-.0791	-.1522	-.0869	-.1531	-.0384	-.1546	-.0363	-.1489	-.0880	-.1685
.95			-.0924	-.1480					-.0452	-.1556	-.0408	-.1481	-.0914	-.1649

TAIL 2

TABLE XVII. - CONTINUED
(f) $\alpha = 5.94^\circ$

Cp at y/b of														
x/c	0.02		0.22		0.44		0.56		0.67		0.83		0.98	
	U.S.	L.S.	U.S.	L.S.	U.S.	L.S.	U.S.	L.S.	U.S.	L.S.	U.S.	L.S.	U.S.	L.S.
.05	.0965	.1228	.2603	.2816	.2732	.2800					.2740	.3545	.2710	.3136
.10	.1049	.1317	.2372	.2573	.2585	.2756			.2874	.3209	.2677	.3316	.2337	.2757
.15	.1029	.1222	.2136	.2302	.2512	.2720			.2880	.3217	.2680	.3203	.2050	.2491
.20	.0967	.1170							.2853	.3272	.2654	.3178		
.25	.0937	.1143	.1738	.1937	.2393	.2649	.3147	.3801	.2863	.3367			.1823	.2175
.30	-.0023	.0118	.1739	.1784	.2245	.2539	.3227	.3889	.2887	.3453	.2616	.3172	.1749	.2115
.40	-.0288	.0252	-.0341	-.0108	.2246	.2730	.3165	.3838	.2886	.3517	.2523	.3109	.1605	.1964
.50	-.0126	.0193	-.0537	-.0248			.0438	.0819	.1387	.1029	.1879	.1291	.1230	.0637
.60	-.0081	.0187	-.0569	-.0242	-.0012	.0383	-.1178	-.0950	-.1173	-.0957	-.1269	-.1159	-.1140	-.1162
.70			-.0607	-.0269	-.1415	-.1165	-.1359	-.1113	-.1164	-.0947	-.1236	-.1322	-.1199	-.1275
.80	-.1128	-.0736	-.1240	-.1418	-.1418	-.1347	-.1363	-.1175					-.0908	-.1022
.90	-.1400	-.1158	-.1236	-.1356	-.1262	-.1395	-.1178	-.1232	-.1028	-.1128	-.1046	-.1089	-.0760	-.1464
.95			-.1234	-.1274	-.1240	-.1355	-.1150	-.1224	-.1015	-.1083	-.1081	-.1095		-.1506

TAIL 1

Cp at y/b of														
x/c	0.02		0.22		0.44		0.56		0.67		0.83		0.98	
	U.S.	L.S.	U.S.	L.S.	U.S.	L.S.	U.S.	L.S.	U.S.	L.S.	U.S.	L.S.	U.S.	L.S.
.05			.4065	.0216	.5113	.0151	.8818	.0321		.1023	.6095	.1099		
.10	.1738	.0110	.3549	.0180	.4734	.0143					.5939	.0953	.5159	.0850
.15	.1836	.0197	.3364	.0120	.4426	.0118				.1175	.6041	.0881	.4898	.0703
.20							.6391	.0520	.7243	.1237	.6368	.0834	.4528	.0580
.25	.2150	.0233	.3072	.0120	.3935	.0149	.6230	.0711	.6964	.1251	.6564	.0836	.4277	.0556
.30	.0717	-.0432	.2923	.0106	.3847	.0198	.6030	.0698	.6656	.1115	.6746	.0853	.4059	.0518
.40	.0213	-.0720			.3744	.0204	.5666	.0677	.6138	.0950	.6607	.0847	.3841	.0440
.50			.0409	-.0921			.1859	-.0909					.3341	-.0456
.60	.0372	-.0960	.0288	-.0887	.0629	-.1088	-.0776	-.1159	-.0111	-.1603	-.0003	-.1462	-.0744	-.1508
.70			.0289	-.0914			-.0802	-.1469	-.0388	-.1505	-.0381	-.1416		
.80			-.1230	-.1616	-.0978	-.1439	-.0940	-.1462	-.0499	-.1479	-.0517	-.1411	-.0765	-.1226
.90					-.1067	-.1470	-.1069	-.1459	-.0622	-.1483	-.0651	-.1411	-.0730	-.1402
.95			-.1189	-.1409					-.0673	-.1490	-.0708	-.1404	-.0768	-.1565

TAIL 2

TABLE XVII. - CONTINUED
(g) $\alpha = 7.95^\circ$

Cp at y/b of															
x/c	0.02		0.22		0.44		0.56		0.67		0.83		0.98		
	U.S.	L.S.	U.S.	L.S.	U.S.	L.S.	U.S.	L.S.	U.S.	L.S.	U.S.	L.S.	U.S.	L.S.	
.05	.1062	.1394	.2757	.2976	.2776	.2843					.2637	.3549	.2676	.3147	
.10	.1160	.1441	.2540	.2741	.2629	.2831				.2856	.3238	.2624	.3335	.2294	.2768
.15	.1137	.1344	.2293	.2477	.2587	.2826				.2859	.3267	.2632	.3232	.2029	.2490
.20	.1066	.1284								.2837	.3306	.2610	.3195		
.25	.1021	.1244	.1922	.2090	.2505	.2809	.3160	.3841	.2847	.3354			.1840	.2207	
.30	.0032	.0108	.1872	.1936	.2356	.2706	.3262	.3945	.2865	.3420	.2573	.3169	.1779	.2159	
.40	-.0250	.0201	-.0292	-.0018	.2426	.2943	.3226	.3933	.2867	.3472	.2481	.3077	.1649	.2002	
.50	-.0120	.0209	-.0494	-.0178			.0552	.0886	.1377	.1042	.1836	.1262	.1274	.0679	
.60	-.0024	.0275	-.0537	-.0180	.0053	.0489	-.1131	-.0909	-.1171	-.0970	-.1301	-.1184	-.1130	-.1146	
.70			-.0580	-.0234	-.1377	-.1125	-.1317	-.1069	-.1161	-.0960	-.1187	-.1356	-.1191	-.1102	
.80	-.1156	-.0753	-.1203	-.1404	-.1426	-.1310	-.1316	-.1119					-.1012	-.0872	
.90	-.1384	-.1135	-.1206	-.1306	-.1244	-.1359	-.1091	-.1166	-.1040	-.1117	-.1049	-.1103	-.1119	-.1043	
.95			-.1206	-.1230	-.1212	-.1318	-.1039	-.1115	-.1027	-.1075	-.1080	-.1113		-.1338	

TAIL 1

Cp at y/b of														
x/c	0.02		0.22		0.44		0.56		0.67		0.83		0.98	
	U.S.	L.S.	U.S.	L.S.	U.S.	L.S.	U.S.	L.S.	U.S.	L.S.	U.S.	L.S.	U.S.	L.S.
.05			.3168	.0712	.4192	.0679	.7457	.0984		.1412	.5069	.1567		
.10	.1031	.0225	.2745	.0601	.3881	.0647					.4873	.1410	.4281	.1287
.15	.1187	.0325	.2514	.0519	.3605	.0635				.1500	.4738	.1343	.4062	.1106
.20							.5259	.1162	.6062	.1575	.4762	.1304	.3730	.0929
.25	.1552	.0408	.2324	.0460	.3126	.0644	.5073	.1390	.5852	.1626	.4828	.1313	.3526	.0892
.30	.0148	-.0158	.2186	.0430	.3068	.0686	.4910	.1369	.5583	.1555	.5004	.1337	.3322	.0823
.40	-.0265	-.0546			.2931	.0646	.4642	.1340	.5210	.1455	.5235	.1328	.2997	.0703
.50			-.0002	-.0733			.1307	-.0540					.2460	-.0265
.60	-.0118	-.0934	-.0147	-.0669	.0352	-.0820	-.0931	-.1180	-.0420	-.1538	-.0343	-.1466	-.1091	-.1463
.70			-.0179	-.0672			-.1056	-.1525	-.0696	-.1440	-.0635	-.1334		
.80			-.1453	-.1510	-.1237	-.1398	-.1159	-.1419	-.0790	-.1359	-.0743	-.1303	-.0935	-.1010
.90					-.1332	-.1408	-.1260	-.1400	-.0893	-.1374	-.0864	-.1297	-.0904	-.1294
.95			-.1271	-.1354					-.0955	-.1369	-.0922	-.1266	-.0911	-.1505

TAIL 2

TABLE XVII. - CONTINUED
(h) $\alpha = 9.96^\circ$

Cp at y/b of														
x/c	0.02		0.22		0.44		0.56		0.67		0.83		0.98	
	U.S.	L.S.	U.S.	L.S.	U.S.	L.S.	U.S.	L.S.	U.S.	L.S.	U.S.	L.S.	U.S.	L.S.
.05	.1194	.1549	.2847	.3101	.2751	.2904					.2758	.3744	.2790	.3255
.10	.1303	.1578	.2679	.2907	.2600	.2884			.2904	.3349	.2774	.3496	.2409	.2878
.15	.1273	.1482	.2449	.2681	.2591	.2892			.2874	.3341	.2771	.3375	.2166	.2607
.20	.1192	.1409							.2852	.3362	.2734	.3318		
.25	.1138	.1364	.2082	.2313	.2559	.2905	.3125	.3805	.2859	.3381			.1994	.2355
.30	.0128	.0133	.2052	.2149	.2463	.2821	.3231	.3915	.2866	.3422	.2694	.3276	.1943	.2305
.40	-.0195	.0190	-.0198	-.0086	.2626	.3070	.3187	.3904	.2833	.3435	.2590	.3176	.1810	.2171
.50	-.0062	.0307	-.0422	-.0080			.0615	.0888	.1360	.0979	.1925	.1325	.1424	.0796
.60	.0067	.0415	-.0477	-.0115	.0121	.0612	-.1096	-.0883	-.1188	-.0994	-.1288	-.1170	-.1155	-.1091
.70			-.0533	-.0173	-.1347	-.1077	-.1288	-.1034	-.1177	-.0984	-.1166	-.1352	-.1157	-.1236
.80	-.1120	-.0706	-.1178	-.1375	-.1427	-.1267	-.1210	-.1081					-.1034	-.0915
.90	-.1356	-.1099	-.1180	-.1241	-.1227	-.1315	-.1037	-.1122	-.1037	-.1134	-.1029	-.1091	-.1304	-.1211
.95			-.1183	-.1173	-.1193	-.1277	-.1003	-.1082	-.1028	-.1084	-.1064	-.1098		-.1478

TAIL 1

Cp at y/b of														
x/c	0.02		0.22		0.44		0.56		0.67		0.83		0.98	
	U.S.	L.S.	U.S.	L.S.	U.S.	L.S.	U.S.	L.S.	U.S.	L.S.	U.S.	L.S.	U.S.	L.S.
.05			.2300	.1207	.3214	.1280	.6071	.1733		.1930	.4144	.2098		
.10	.0432	.0350	.1921	.1017	.2995	.1255				.1975	.3972	.1939	.3471	.1733
.15	.0578	.0420	.1734	.0880	.2761	.1206				.1975	.3801	.1879	.3279	.1555
.20							.4197	.1986	.4433	.2055	.3748	.1850	.2990	.1357
.25	.0943	.0559	.1558	.0746	.2363	.1135	.4049	.2225	.4631	.2128	.3736	.1865	.2815	.1285
.30	-.0512	.0120	.1506	.0712	.2295	.1173	.3906	.2176	.4546	.2099	.3749	.1894	.2642	.1178
.40	-.0714	-.0316			.2162	.1098	.3678	.2120	.4271	.2095	.3848	.1884	.2357	.1034
.50			-.0371	-.0542			.0783	-.0138					.1873	-.0045
.60	-.0400	-.0914	-.0452	-.0421	-.0120	-.0604	-.1000	-.1112	-.0775	-.1313	-.0689	-.1364	-.1248	-.1369
.70			-.0562	-.0357			-.1306	-.1564	-.1052	-.1461	-.0941	-.1224		
.80			-.1469	-.1328	-.1465	-.1533	-.1386	-.1534	-.1135	-.1274	-.1028	-.1160	-.1250	-.1092
.90					-.1535	-.1397	-.1454	-.1401	-.1202	-.1227	-.1122	-.1143	-.1262	-.1163
.95			-.1317	-.1443					-.1238	-.1197	-.1164	-.1140	-.1242	-.1197

TAIL 2

TABLE XVII. - CONTINUED
(i) $\alpha = 11.94^\circ$

Cp at y/b of															
x/c	0.02		0.22		0.44		0.56		0.67		0.83		0.98		
	U.S.	L.S.	U.S.	L.S.	U.S.	L.S.	U.S.	L.S.	U.S.	L.S.	U.S.	L.S.	U.S.	L.S.	
.05	.1387	.1759	.3172	.3466	.3091	.3254					.2953	.3998	.2960	.3407	
.10	.1474	.1758	.2970	.3240	.2928	.3233				.3148	.3615	.3007	.3746	.2561	.3041
.15	.1410	.1642	.2714	.2973	.2915	.3230				.3104	.3606	.3006	.3628	.2337	.2784
.20	.1307	.1574								.3084	.3617	.2971	.3568		
.25	.1235	.1531	.2316	.2542	.2858	.3234	.3440	.4147	.3099	.3642			.2193	.2577	
.30	.0220	.0182	.2261	.2352	.2752	.3110	.3536	.4257	.3117	.3698	.2916	.3533	.2156	.2531	
.40	-.0137	-.0212	-.0109	.0170	.2950	.3375	.3484	.4229	.3099	.3714	.2810	.3432	.2028	.2416	
.50	-.0006	.0428	-.0362	.0007			.0768	.1047	.1546	.1160	.2127	.1485	.1625	.0974	
.60	.0178	.0541	-.0430	-.0045	.0229	.0768	-.1011	-.0796	-.1114	-.0909	-.1232	-.1107	-.1089	-.1034	
.70			-.0504	-.0114	-.1302	-.1013	-.1211	-.0948	-.1104	-.0899	-.1073	-.1299	-.1054	-.1041	
.80	-.1077	-.0630	-.1152	-.1351	-.1422	-.1209	-.1139	-.0995					-.1000	-.0920	
.90	-.1311	-.1061	-.1158	-.1212	-.1205	-.1264	-.0953	-.1037	-.0962	-.1055	-.0962	-.1018	-.1382	-.1364	
.95			-.1159	-.1142	-.1164	-.1241	-.0916	-.1006	-.0949	-.1004	-.0992	-.1019		-.1574	

TAIL 1

Cp at y/b of														
x/c	0.02		0.22		0.44		0.56		0.67		0.83		0.98	
	U.S.	L.S.	U.S.	L.S.	U.S.	L.S.	U.S.	L.S.	U.S.	L.S.	U.S.	L.S.	U.S.	L.S.
.05			.1506	.1659	.2320	.2041	.4650	.2775		.2554	.3332	.2678		
.10	-.0082	.0493	.1257	.1381	.2202	.1895					.3184	.2520	.2643	.2250
.15	.0061	.0564	.1077	.1205	.2014	.1761				.2660	.3009	.2472	.2495	.2058
.20							.3220	.2990	.3111	.2796	.2920	.2444	.2271	.1821
.25	.0313	.0717	.0913	.1050	.1658	.1601	.3088	.3118	.3491	.2907	.2888	.2467	.2138	.1731
.30	-.1025	.0340	.0892	.1012	.1602	.1608	.2947	.2995	.3476	.2962	.2872	.2501	.1994	.1588
.40	-.1074	-.0063			.1472	.1459	.2764	.2812	.3324	.3014	.2890	.2482	.1775	.1408
.50			-.0691	-.0239			.0284	.0264					.1346	.0144
.60	-.0457	-.0917	-.0771	-.0189	-.0520	-.0311	-.1051	-.1022	-.1047	-.1060	-.1050	-.1202	-.1332	-.1337
.70			-.0865	-.0106			-.1530	-.1421	-.1323	-.1268	-.1258	-.1379		
.80			-.1368	-.1178	-.1417	-.1515	-.1541	-.1525	-.1403	-.1322	-.1316	-.1262	-.1294	-.1098
.90					-.1358	-.1526	-.1404	-.1502	-.1351	-.1267	-.1313	-.1131	-.1214	-.1072
.95			-.1339	-.1370					-.1231	-.1157	-.1228	-.1094	-.1223	-.1126

TAIL 2

TABLE XVII. - CONTINUED
(j) $\alpha = 15.95^\circ$

Cp at y/b of														
x/c	0.02		0.22		0.44		0.56		0.67		0.83		0.98	
	U.S.	L.S.	U.S.	L.S.	U.S.	L.S.	U.S.	L.S.	U.S.	L.S.	U.S.	L.S.	U.S.	L.S.
.05	.2058	.2545	.4192	.4536	.3995	.4151					.3577	.4789	.3598	.4058
.10	.2158	.2574	.3867	.4191	.3815	.4150			.3850	.4377	.3692	.4491	.3137	.3670
.15	.2074	.2427	.3523	.3833	.3827	.4163			.3799	.4398	.3676	.4367	.2938	.3389
.20	.1953	.2322							.3804	.4407	.3640	.4331		
.25	.1866	.2239	.3068	.3316	.3773	.4166	.4332	.5148	.3837	.4422			.2784	.3217
.30	.0630	.0329	.2968	.3108	.3584	.3945	.4437	.5285	.3856	.4479	.3578	.4276	.2761	.3182
.40	.0287	.0329	.0225	.0572	.3857	.4268	.4385	.5289	.3843	.4532	.3445	.4133	.2631	.3086
.50	.0568	.0927	-.0023	.0383			.1261	.1630	.2093	.1693	.2641	.1921	.2172	.1490
.60	.0667	.1082	-.0108	.0339	.0605	.1220	-.0761	-.0484	-.0893	-.0623	-.1060	-.0928	-.0879	-.0815
.70			-.0191	-.0275	-.1127	-.0766	-.0978	-.0647	-.0888	-.0617	-.0822	-.1121	-.0804	-.0636
.80	-.0815	-.0303	-.0901	-.1134	-.1216	-.0980	-.0968	-.0700					-.0941	-.0830
.90	-.1054	-.0770	-.0913	-.0997	-.0994	-.1043	-.0719	-.0755	-.0747	-.0789	-.0762	-.0844	-.1485	-.1506
.95			-.0918	-.0912	-.0965	-.1063	-.0662	-.0756	-.0719	-.0761	-.0775	-.0821		-.1603

TAIL 1

Cp at y/b of														
x/c	0.02		0.22		0.44		0.56		0.67		0.83		0.98	
	U.S.	L.S.	U.S.	L.S.	U.S.	L.S.	U.S.	L.S.	U.S.	L.S.	U.S.	L.S.	U.S.	L.S.
.05			-.0148	.2283	.0464	.3248	.2140	.4890		.4088	.1665	.3884		
.10	-.0771	.0862	-.0344	.1918	.0598	.2912					.1469	.3742	.1215	.3375
.15	-.0844	.0912	-.0452	.1710	.0565	.2632				.4949	.1338	.3711	.1070	.3195
.20							.1339	.4433	.1535	.5007	.1274	.3713	.0886	.2893
.25	-.1045	.1116	-.0153	.1532	.0409	.2342	.1282	.4527	.1600	.4946	.1309	.3821	.0767	.2757
.30	-.1767	.0863	-.0107	.1475	.0371	.2330	.1218	.4286	.1499	.4740	.1350	.3966	.0645	.2584
.40	-.1525	.0351			.0258	.2168	.1094	.3998	.1411	.4525	.1396	.4073	.0509	.2319
.50			-.1140	.0195			-.0639	.0830					.0264	.0817
.60	-.0367	-.0691	-.1100	.0384	-.1163	.0106	-.1228	-.1021	-.1544	-.0559	-.1486	-.0543	-.1404	-.1232
.70			-.1088	.0627			-.1553	-.1154	-.1734	-.0813	-.1466	-.0756		
.80			-.1637	-.0965	-.1530	-.1199	-.1540	-.1274	-.1556	-.0907	-.1373	-.0839	-.1340	-.1101
.90					-.1567	-.1184	-.1534	-.1321	-.1498	-.1026	-.1380	-.0911	-.1330	-.1076
.95			-.1561	-.1172					-.1510	-.1066	-.1389	-.0992	-.1345	-.1096

TAIL 2

TABLE XVII. - CONCLUDED
(k) $\alpha = 19.94^\circ$

Cp at y/b of														
x/c	0.02		0.22		0.44		0.56		0.67		0.83		0.98	
	U.S.	L.S.	U.S.	L.S.	U.S.	L.S.	U.S.	L.S.	U.S.	L.S.	U.S.	L.S.	U.S.	L.S.
.05	.2916	.3440	.5377	.5729	.5189	.5461					.4347	.5700	.4306	.4833
.10	.3018	.3489	.4892	.5237	.5004	.5422			.4688	.5263	.4495	.5368	.3806	.4396
.15	.2910	.3317	.4463	.4792	.4999	.5384			.4659	.5263	.4495	.5218	.3647	.4116
.20	.2775	.3189							.4705	.5262	.4459	.5143		
.25	.2670	.3105	.3937	.4218	.4868	.5234	.5557	.6365	.4746	.5293			.3497	.3943
.30	.1173	.0627	.3799	.3975	.4556	.4955	.5663	.6468	.4786	.5365	.4380	.5050	.3479	.3888
.40	.0830	.0602	.0631	.1027	.4991	.5295	.5537	.6346	.4785	.5433	.4175	.4784	.3351	.3766
.50	.1353	.1695	.0376	.0807			.1846	.2145	.2780	.2208	.3253	.2310	.2865	.1973
.60	.1263	.1715	.0293	.0753	.1071	.1654	-.0461	-.0218	-.0611	-.0322	-.0861	-.0765	-.0682	-.0589
.70			.0203	.0666	-.0921	-.0555	-.0697	-.0389	-.0610	-.0317	-.0582	-.0961	-.0516	-.0366
.80	-.0474	.0072	-.0697	-.0900	-.1032	-.0764	-.0745	-.0438					-.0952	-.0938
.90	-.0734	-.0471	-.0691	-.0748	-.0775	-.0826	-.0452	-.0498	-.0502	-.0521	-.0547	-.0614	-.1541	-.1595
.95			-.0688	-.0657	-.0731	-.0834	-.0363	-.0494	-.0440	-.0500	-.0549	-.0595		-.1532

TAIL 1

Cp at y/b of														
x/c	0.02		0.22		0.44		0.56		0.67		0.83		0.98	
	U.S.	L.S.	U.S.	L.S.	U.S.	L.S.	U.S.	L.S.	U.S.	L.S.	U.S.	L.S.	U.S.	L.S.
.05			-.0362	.3104	-.0200	.4235	.0844	.6321		.7441	.1491	.5429		
.10	-.0727	.1528	-.0507	.2681	-.0097	.3835					.1196	.5373	.1043	.4773
.15	-.0815	.1589	-.0615	.2478	-.0153	.3493				.6820	.0988	.5605	.0907	.4562
.20							.0325	.5778	.1526	.6534	.0815	.5901	.0733	.4202
.25	-.1460	.1878	-.0851	.2294	-.0352	.3157	.0283	.5892	.0770	.6354	.0744	.6113	.0631	.4048
.30	-.1972	.1599	-.0962	.2234	-.0422	.3163	.0203	.5584	.0599	.6061	.0692	.6266	.0520	.3856
.40	-.1881	.0948			-.0568	.2878	.0072	.5226	.0448	.5739	.0664	.6194	.0391	.3817
.50			-.1613	.0835			-.1158	.1479					.0115	.1867
.60	-.0815	-.0157	-.1609	.1306	-.1624	.0646	-.1385	-.1041	-.1769	-.0260	-.1666	-.0077	-.1558	-.0738
.70			-.1619	.1243			-.1666	-.0908	-.1654	-.0493	-.1556	-.0358		
.80			-.1874	-.0658	-.1701	-.0681	-.1676	-.1036	-.1628	-.0610	-.1531	-.0461	-.1358	-.0739
.90					-.1744	-.0540	-.1676	-.1036	-.1606	-.0764	-.1544	-.0520	-.1425	-.0701
.95			-.1700	-.0876					-.1618	-.0832	-.1546	-.0604	-.1539	-.0776

TAIL 2

TABLE XVIII. - PRESSURE COEFFICIENTS, $\phi = 0^\circ$, $\delta_{2,4} = -15^\circ$, $M = 3.70$.
(a) $\alpha = -4.14^\circ$

Cp at y/b of															
x/c	0.02		0.22		0.44		0.56		0.67		0.83		0.98		
	U.S.	L.S.	U.S.	L.S.	U.S.	L.S.	U.S.	L.S.	U.S.	L.S.	U.S.	L.S.	U.S.	L.S.	
.05	.0389	.0406	.1337	.1393	.1421	.1468					.2124	.2457	.2086	.2414	
.10	.0393	.0432	.1307	.1372	.1385	.1423				.1953	.2194	.1950	.2331	.1911	.2241
.15	.0396	.0411	.1271	.1342	.1321	.1393				.1980	.2219	.1890	.2250	.1779	.2109
.20	.0376	.0412								.1983	.2232	.1856	.2217		
.25	.0350	.0386	.1178	.1248	.1270	.1386	.1956	.2266	.1947	.2229			.1577	.1879	
.30	.0047	.0396	.1150	.1163	.1439	.1451	.2004	.2358	.1919	.2238	.1818	.2184	.1493	.1825	
.40	-.0043	.0457	.0197	.0265	.1279	.1507	.1951	.2349	.1857	.2216	.1749	.2131	.1346	.1653	
.50	-.0018	.0154	-.0022	.0088			.0455	.0566	.1011	.0881	.1353	.1075	.1045	.0769	
.60	-.0101	.0012	-.0050	.0069	.0190	.0373	-.0314	-.0301	-.0217	-.0261	-.0288	-.0332	-.0361	-.0412	
.70			-.0118	-.0008	-.0349	-.0328	-.0396	-.0408	-.0179	-.0221	-.0421	-.0470	-.0388	-.0459	
.80	-.0355	-.0309	-.0340	-.0437	-.0376	-.0447	-.0355	-.0415					-.0368	-.0473	
.90	-.0302	-.0394	-.0379	-.0474	-.0329	-.0456	-.0325	-.0429	-.0169	-.0344	-.0300	-.0412	-.0345	-.0443	
.95			-.0376	-.0435	-.0139	-.0300	-.0280	-.0347	-.0323	-.0430	-.0316	-.0406		.0071	

TAIL 1

Cp at y/b of														
x/c	0.02		0.22		0.44		0.56		0.67		0.83		0.98	
	U.S.	L.S.	U.S.	L.S.	U.S.	L.S.	U.S.	L.S.	U.S.	L.S.	U.S.	L.S.	U.S.	L.S.
.05			.7230	-.0337	.7826	-.0413	1.1381	-.0227		-.0023	.8824	.0058		
.10	.2518	-.0239	.6702	-.0435	.7435	-.0399					.9060	-.0082	.7748	.0029
.15	.2325	-.0185	.6431	-.0469	.7103	-.0429					.9369	-.0155	.7554	-.0123
.20							1.0327	-.0019	1.0037	-.0211	.9696	-.0220	.7202	-.0175
.25	.2691	-.0340	.6086	-.0496	.6553	-.0426	.9679	-.0303	.9883	-.0219	.9715	-.0236	.7032	-.0182
.30	.2331	-.0464	.5919	-.0514	.6517	-.0463	.9225	-.0323	.9388	-.0236	.9705	-.0252	.6909	-.0187
.40	.1727	-.0412			.6445	-.0155	.8988	-.0371	.8872	-.0208	.9362	-.0266	.6745	-.0195
.50			.2869	-.0549			.4421	-.0560					.6025	-.0347
.60	.2761	-.0416	.2785	-.0561	.2833	-.0380	.0294	-.0445	.1598	-.0521	.1839	-.0478	.1112	-.0549
.70			.2623	-.0524			.0913	-.0508	.1335	-.0517	.1393	-.0452		
.80			.0684	-.0539	.0876	-.0395	.0747	-.0506	.1248	-.0421	.1358	-.0477	.0625	-.0512
.90					.0770	-.0529	.0672	-.0520	.1117	-.0331	.1346	-.0485	.0571	-.0537
.95			.0486	-.0511					.1013	-.0468	.1301	-.0470	.0484	-.0385

TAIL 2

TABLE XVIII. - CONTINUED
(b) $\alpha = -2.16^\circ$

Cp at y/b of														
x/c	0.02		0.22		0.44		0.56		0.67		0.83		0.98	
	U.S.	L.S.	U.S.	L.S.	U.S.	L.S.	U.S.	L.S.	U.S.	L.S.	U.S.	L.S.	U.S.	L.S.
.05	.0335	.0356	.1385	.1465	.1435	.1492					.2128	.2457	.2092	.2425
.10	.0359	.0404	.1340	.1428	.1394	.1441			.1951	.2200	.1949	.2331	.1908	.2231
.15	.0371	.0401	.1265	.1346	.1327	.1407			.1978	.2219	.1882	.2249	.1767	.2088
.20	.0371	.0419							.1978	.2232	.1856	.2219		
.25	.0359	.0408	.1140	.1203	.1277	.1402	.1926	.2256	.1945	.2222			.1544	.1830
.30	.0076	.0359	.1109	.1116	.1227	.1458	.1963	.2342	.1918	.2232	.1823	.2184	.1464	.1783
.40	.0019	.0417	.0115	.0208	.1287	.1526	.1927	.2325	.1855	.2208	.1755	.2133	.1327	.1625
.50	.0079	.0210	-.0095	.0037			.0444	.0559	.1007	.0866	.1364	.1069	.1034	.0746
.60	.0027	.0152	-.0115	.0027	.0154	.0372	-.0367	-.0301	-.0278	-.0261	-.0321	-.0343	-.0389	-.0409
.70			-.0176	-.0040	-.0407	-.0328	-.0457	-.0411	-.0240	-.0222	-.0476	-.0481	-.0433	-.0459
.80	-.0366	-.0251	-.0369	-.0439	-.0421	-.0450	-.0393	-.0417					-.0410	-.0483
.90	-.0387	-.0368	-.0413	-.0445	-.0379	-.0447	-.0374	-.0428	-.0255	-.0352	-.0349	-.0419	-.0383	-.0449
.95			-.0411	-.0421	-.0231	-.0286	-.0321	-.0347	-.0378	-.0438	-.0364	-.0420		.0232

TAIL 1

Cp at y/b of														
x/c	0.02		0.22		0.44		0.56		0.67		0.83		0.98	
	U.S.	L.S.	U.S.	L.S.	U.S.	L.S.	U.S.	L.S.	U.S.	L.S.	U.S.	L.S.	U.S.	L.S.
.05			.6513	-.0336	.7128	-.0334	1.0301	-.0146		-.0005	.7753	.0160		
.10	.2236	-.0242	.6013	-.0429	.6767	-.0354					.7635	-.0007	.6896	.0124
.15	.2141	-.0177	.5718	-.0471	.6443	-.0395				-.0171	.7592	-.0098	.6713	-.0051
.20							.9268	-.0171	.9025	-.0189	.7673	-.0162	.6360	-.0115
.25	.2519	-.0306	.5383	-.0508	.5919	-.0414	.8673	-.0252	.9020	-.0190	.7797	-.0192	.6121	-.0122
.30	.1999	-.0495	.5238	-.0525	.5872	-.0451	.8189	-.0283	.8759	-.0202	.7963	-.0209	.5909	-.0125
.40	.1534	-.0498			.5790	-.0286	.7996	-.0333	.8372	-.0198	.8093	-.0239	.5567	-.0139
.50			.2362	-.0591			.3933	-.0600					.4859	-.0368
.60	.1982	-.0468	.2274	-.0603	.2460	-.0475	.0202	-.0468	.1503	-.0559	.1455	-.0534	.0632	-.0603
.70			.2102	-.0586			.0710	-.0555	.1147	-.0562	.1150	-.0527		
.80			.0371	-.0575	.0624	-.0431	.0558	-.0556	.1032	-.0498	.1063	-.0549	.0326	-.0552
.90					.0488	-.0566	.0465	-.0571	.0922	-.0433	.0959	-.0557	.0327	-.0576
.95			.0209	-.0562					.0840	-.0541	.0912	-.0540	.0289	-.0451

TAIL 2

TABLE XVIII. - CONTINUED
(c) $\alpha = -0.15^\circ$

Cp at y/b of														
x/c	0.02		0.22		0.44		0.56		0.67		0.83		0.98	
	U.S.	L.S.	U.S.	L.S.	U.S.	L.S.	U.S.	L.S.	U.S.	L.S.	U.S.	L.S.	U.S.	L.S.
.05	.0392	.0415	.1382	.1435	.1475	.1523					.2134	.2478	.2081	.2416
.10	.0440	.0478	.1323	.1397	.1422	.1464			.1963	.2207	.1948	.2352	.1887	.2211
.15	.0440	.0470	.1292	.1373	.1354	.1430			.1981	.2221	.1880	.2266	.1732	.2045
.20	.0438	.0490							.1977	.2229	.1846	.2234		
.25	.0431	.0490	.1224	.1303	.1304	.1421	.1921	.2253	.1939	.2215			.1489	.1783
.30	.0102	.0353	.1191	.1216	.1338	.1481	.1952	.2332	.1915	.2220	.1815	.2197	.1409	.1722
.40	-.0001	.0405	.0157	.0253	.1305	.1539	.1907	.2311	.1847	.2192	.1748	.2146	.1283	.1587
.50	.0050	.0238	-.0060	.0073			.0468	.0552	.1004	.0850	.1353	.1083	.0995	.0728
.60	.0008	.0143	-.0083	.0061	.0166	.0365	-.0358	-.0301	-.0279	-.0265	-.0332	-.0337	-.0401	-.0384
.70			-.0149	-.0017	-.0405	-.0328	-.0453	-.0413	-.0242	-.0227	-.0490	-.0470	-.0457	-.0445
.80	-.0369	-.0245	-.0351	-.0438	-.0415	-.0449	-.0390	-.0420					-.0443	-.0484
.90	-.0383	-.0380	-.0394	-.0422	-.0372	-.0443	-.0372	-.0428	-.0271	-.0337	-.0370	-.0411	-.0413	-.0452
.95			-.0394	-.0404	-.0226	-.0278	-.0322	-.0346	-.0391	-.0425	-.0389	-.0413		-.0213

TAIL 1

Cp at y/b of														
x/c	0.02		0.22		0.44		0.56		0.67		0.83		0.98	
	U.S.	L.S.	U.S.	L.S.	U.S.	L.S.	U.S.	L.S.	U.S.	L.S.	U.S.	L.S.	U.S.	L.S.
.05			.5631	-.0239	.6239	-.0216	.8971	.0058		.0136	.6799	.0308		
.10	.2148	-.0167	.5198	-.0330	.5958	-.0257					.6653	.0124	.6038	.0256
.15	.1902	-.0122	.4991	-.0371	.5681	-.0312				-.0046	.6583	.0025	.5873	.0060
.20							.8165	-.0095	.7725	-.0077	.6527	-.0036	.5565	-.0015
.25	.2161	-.0201	.4650	-.0407	.5222	-.0335	.7740	-.0140	.7890	-.0079	.6512	-.0072	.5340	-.0026
.30	.1611	-.0418	.4491	-.0418	.5181	-.0360	.7333	-.0166	.7679	-.0095	.6540	-.0082	.5133	-.0025
.40	.1221	-.0455			.5093	-.0239	.7019	-.0209	.7431	-.0093	.6602	-.0112	.4811	-.0041
.50			.1834	-.0585			.3355	-.0552					.4193	-.0298
.60	.1416	-.0463	.1732	-.0590	.2194	-.0478	.0084	-.0467	.1256	-.0549	.1060	-.0525	.0364	-.0585
.70			.1575	-.0565			.0487	-.0547	.0928	-.0554	.0765	-.0518		
.80			.0087	-.0551	.0403	-.0416	.0365	-.0551	.0808	-.0497	.0727	-.0539	.0000	-.0545
.90					.0253	-.0549	.0274	-.0559	.0713	-.0432	.0654	-.0541	-.0030	-.0577
.95			-.0066	-.0536					.0639	-.0536	.0601	-.0523	-.0030	-.0457

TAIL 2

TABLE XVIII. - CONTINUED
(d) $\alpha = 1.86^\circ$

C _p at y/b of														
x/c	0.02		0.22		0.44		0.56		0.67		0.83		0.98	
	U.S.	L.S.	U.S.	L.S.	U.S.	L.S.	U.S.	L.S.	U.S.	L.S.	U.S.	L.S.	U.S.	L.S.
.05	.0472	.0550	.1421	.1476	.1517	.1570					.2129	.2468	.2074	.2412
.10	.0514	.0598	.1355	.1429	.1459	.1502			.1963	.2201	.1927	.2331	.1867	.2188
.15	.0524	.0580	.1316	.1398	.1380	.1462			.1976	.2217	.1857	.2238	.1699	.2011
.20	.0510	.0591							.1965	.2221	.1825	.2206		
.25	.0493	.0590	.1267	.1355	.1333	.1452	.1897	.2240	.1930	.2206			.1468	.1746
.30	.0107	.0348	.1244	.1286	.1281	.1502	.1936	.2320	.1903	.2207	.1795	.2175	.1399	.1695
.40	-.0055	.0384	.0195	.0298	.1334	.1561	.1894	.2295	.1837	.2179	.1730	.2125	.1273	.1559
.50	-.0039	.0200	-.0041	.0103			.0457	.0558	.1001	.0814	.1342	.1065	.0995	.0714
.60	-.0102	.0062	-.0078	.0084	.0152	.0362	-.0353	-.0298	-.0289	-.0278	-.0350	-.0342	-.0404	-.0361
.70			-.0149	-.0000	-.0411	-.0330	-.0454	-.0414	-.0249	-.0237	-.0509	-.0473	-.0469	-.0431
.80	-.0420	-.0277	-.0353	-.0436	-.0423	-.0451	-.0392	-.0420					-.0469	-.0464
.90	-.0379	-.0399	-.0400	-.0418	-.0377	-.0443	-.0378	-.0431	-.0291	-.0334	-.0395	-.0418	-.0419	-.0424
.95			-.0396	-.0399	-.0237	-.0281	-.0325	-.0349	-.0406	-.0423	-.0414	-.0418		.0180

TAIL 1

C _p at y/b of														
x/c	0.02		0.22		0.44		0.56		0.67		0.83		0.98	
	U.S.	L.S.	U.S.	L.S.	U.S.	L.S.	U.S.	L.S.	U.S.	L.S.	U.S.	L.S.	U.S.	L.S.
.05			.4765	-.0114	.5270	-.0088	.7507	.0209		.0320	.5923	.0491		
.10	.1923	-.0102	.4381	-.0194	.5103	-.0135					.5755	.0305	.5229	.0413
.15	.1613	-.0081	.4136	-.0234	.4898	-.0186					.5692	.0205	.5080	.0201
.20							.6962	.0003	.6259	.0106	.5625	.0143	.4804	.0109
.25	.1828	-.0099	.3872	-.0257	.4480	-.0216	.6725	.0049	.6350	.0104	.5576	.0110	.4606	.0094
.30	.1295	-.0334	.3736	-.0273	.4453	-.0228	.6423	.0029	.6396	.0083	.5532	.0102	.4408	.0088
.40	.0839	-.0420			.4360	-.0160	.6089	-.0011	.6367	.0077	.5499	.0082	.4129	.0068
.50			.1378	-.0558			.2886	-.0476					.3595	-.0244
.60	.0814	-.0477	.1307	-.0576	.1686	-.0491	-.0033	-.0460	.0879	-.0537	.0674	-.0508	.0164	-.0554
.70			.1183	-.0559			.0265	-.0530	.0548	-.0538	.0339	-.0505		
.80			-.0097	-.0533	.0160	-.0105	.0174	-.0533	.0463	-.0490	.0318	-.0516	-.0165	-.0520
.90					-.0003	-.0541	.0091	-.0547	.0426	-.0433	.0291	-.0522	-.0205	-.0551
.95			-.0277	-.0523					.0343	-.0526	.0250	-.0510	-.0184	-.0443

TAIL 2

TABLE XVIII. - CONTINUED
(e) $\alpha = 3.85^\circ$

Cp at y/b of														
x/c	0.02		0.22		0.44		0.56		0.67		0.83		0.98	
	U.S.	L.S.	U.S.	L.S.	U.S.	L.S.	U.S.	L.S.	U.S.	L.S.	U.S.	L.S.	U.S.	L.S.
.05	.0574	.0715	.1497	.1543	.1578	.1624					.2193	.2545	.2165	.2490
.10	.0616	.0721	.1419	.1495	.1520	.1554			.2009	.2238	.1990	.2411	.1939	.2247
.15	.0615	.0693	.1381	.1461	.1437	.1515			.2012	.2253	.1929	.2320	.1762	.2063
.20	.0587	.0685							.1992	.2255	.1900	.2285		
.25	.0561	.0679	.1332	.1422	.1389	.1504	.1908	.2261	.1956	.2234			.1531	.1795
.30	.0137	.0341	.1311	.1357	.1391	.1538	.1958	.2336	.1926	.2231	.1866	.2249	.1470	.1743
.40	-.0065	.0366	.0222	.0336	.1398	.1606	.1913	.2312	.1860	.2198	.1801	.2193	.1345	.1608
.50	-.0044	.0173	-.0024	.0130			.0464	.0591	.1017	.0784	.1407	.1112	.1065	.0760
.60	-.0141	.0037	-.0063	.0105	.0178	.0369	-.0337	-.0292	-.0285	-.0281	-.0316	-.0332	-.0366	-.0338
.70			-.0132	.0019	-.0401	-.0327	-.0450	-.0409	-.0245	-.0241	-.0479	-.0467	-.0448	-.0425
.80	-.0447	-.0317	-.0353	-.0435	-.0416	-.0450	-.0389	-.0417					-.0421	-.0397
.90	-.0371	-.0406	-.0395	-.0421	-.0369	-.0444	-.0371	-.0431	-.0279	-.0329	-.0371	-.0429	-.0462	-.0505
.95			-.0393	-.0402	-.0233	-.0281	-.0319	-.0348	-.0393	-.0415	-.0379	-.0422		.0133

TAIL 1

Cp at y/b of														
x/c	0.02		0.22		0.44		0.56		0.67		0.83		0.98	
	U.S.	L.S.	U.S.	L.S.	U.S.	L.S.	U.S.	L.S.	U.S.	L.S.	U.S.	L.S.	U.S.	L.S.
.05			.3869	.0034	.4215	.0071	.5947	.0363		.0516	.5055	.0686		
.10	.1551	-.0044	.3564	-.0028	.4190	.0020					.4865	.0496	.4414	.0593
.15	.1473	-.0022	.3357	-.0059	.4070	-.0033				.0338	.4801	.0398	.4287	.0375
.20							.5712	.0159	.4978	.0310	.4754	.0339	.4051	.0267
.25	.1474	-.0005	.3067	-.0079	.3757	-.0061	.5675	.0278	.5104	.0313	.4701	.0311	.3884	.0241
.30	.0988	-.0238	.2945	-.0097	.3750	-.0058	.5460	.0260	.5141	.0289	.4647	.0311	.3707	.0216
.40	.0536	-.0381			.3621	-.0050	.5216	.0214	.5100	.0279	.4581	.0297	.3458	.0174
.50			.0918	-.0497			.2334	-.0387					.3004	-.0174
.60	.0411	-.0481	.0869	-.0512	.1252	-.0463	-.0166	-.0511	.0566	-.0547	.0404	-.0488	.0009	-.0526
.70			.0801	-.0524			.0029	-.0539	.0234	-.0540	.0083	-.0481		
.80			-.0232	-.0511	-.0032	-.0397	-.0043	-.0537	.0155	-.0489	.0020	-.0490	-.0254	-.0494
.90					-.0189	-.0526	-.0109	-.0542	.0169	-.0416	-.0016	-.0493	-.0294	-.0514
.95			-.0392	-.0509					.0070	-.0508	-.0041	-.0481	-.0250	-.0428

TAIL 2

TABLE XVIII. - CONTINUED
(1) $\alpha = 5.84^\circ$

Cp at y/b of															
x/c	0.02		0.22		0.44		0.56		0.67		0.83		0.98		
	U.S.	L.S.	U.S.	L.S.	U.S.	L.S.	U.S.	L.S.	U.S.	L.S.	U.S.	L.S.	U.S.	L.S.	
.05	.0728	.0915	.1656	.1693	.1728	.1769					.2355	.2713	.2327	.2669	
.10	.0752	.0880	.1567	.1640	.1665	.1689				.2134	.2350	.2148	.2575	.2083	.2403
.15	.0744	.0839	.1526	.1606	.1576	.1645				.2142	.2379	.2090	.2477	.1893	.2209
.20	.0704	.0813								.2123	.2385	.2060	.2445		
.25	.0670	.0800	.1473	.1564	.1525	.1632	.2042	.2396		.2083	.2363			.1662	.1940
.30	.0198	.0346	.1451	.1498	.1509	.1655	.2101	.2474		.2054	.2359	.2025	.2410	.1602	.1886
.40	-.0035	.0359	.0266	.0399	.1515	.1735	.2049	.2440		.1987	.2318	.1953	.2351	.1478	.1756
.50	-.0007	.0190	.0019	.0190			.0549	.0661		.1098	.0941	.1534	.1209	.1195	.0885
.60	-.0118	.0079	-.0019	.0168	.0240	.0425	-.0312	-.0278		-.0264	-.0265	-.0296	-.0287	-.0340	-.0292
.70			-.0094	.0072	-.0384	-.0310	-.0435	-.0394		-.0227	-.0226	-.0468	-.0430	-.0421	-.0390
.80	-.0452	-.0312	-.0346	-.0424	-.0414	-.0437	-.0382	-.0400						-.0471	-.0435
.90	-.0358	-.0394	-.0383	-.0410	-.0355	-.0436	-.0353	-.0414		-.0266	-.0302	-.0363	-.0398	-.0477	-.0480
.95			-.0382	-.0390	-.0229	-.0277	-.0299	-.0322		-.0370	-.0380	-.0375	-.0383		.0091

TAIL 1

Cp at y/b of														
x/c	0.02		0.22		0.44		0.56		0.67		0.83		0.98	
	U.S.	L.S.	U.S.	L.S.	U.S.	L.S.	U.S.	L.S.	U.S.	L.S.	U.S.	L.S.	U.S.	L.S.
.05			.2902	.0237	.3219	.0270	.4719	.0589		.0768	.4130	.0891		
.10	.1070	.0014	.2714	.0180	.3232	.0217					.3964	.0714	.3545	.0774
.15	.1047	.0040	.2572	.0156	.3173	.0157				.0607	.3919	.0624	.3433	.0556
.20							.4480	.0442	.3973	.0581	.3882	.0571	.3229	.0437
.25	.1083	.0072	.2304	.0128	.2960	.0132	.4537	.0573	.4037	.0587	.3851	.0548	.3086	.0400
.30	.0600	-.0132	.2185	.0111	.2971	.0151	.4365	.0558	.4057	.0564	.3802	.0555	.2938	.0353
.40	.0210	-.0346			.2901	.0121	.4231	.0514	.4024	.0551	.3748	.0537	.2720	.0293
.50			.0504	-.0420			.1727	-.0225					.2347	-.0099
.60	.0067	-.0499	.0459	-.0429	.0872	-.0405	-.0271	-.0520	.0296	-.0568	.0169	-.0514	-.0151	-.0521
.70			.0402	-.0455			-.0157	-.0538	-.0001	-.0541	-.0114	-.0493		
.80			-.0363	-.0505	-.0193	-.0397	-.0206	-.0527	-.0067	-.0487	-.0186	-.0493	-.0300	-.0501
.90					-.0359	-.0514	-.0259	-.0529	-.0071	-.0414	-.0226	-.0493	-.0335	-.0510
.95			-.0496	-.0499					-.0170	-.0505	-.0251	-.0482	-.0280	-.0434

TAIL 2

TABLE XVIII. - CONTINUED
(g) $\alpha = 7.86^\circ$

Cp at y/b of														
x/c	0.02		0.22		0.44		0.56		0.67		0.83		0.98	
	U.S.	L.S.	U.S.	L.S.	U.S.	L.S.	U.S.	L.S.	U.S.	L.S.	U.S.	L.S.	U.S.	L.S.
.05	.0931	.1157	.1927	.1951	.1981	.2007					.2580	.2971	.2538	.2896
.10	.0960	.1103	.1828	.1894	.1910	.1924			.2370	.2595	.2362	.2819	.2269	.2599
.15	.0949	.1054	.1787	.1857	.1813	.1879			.2364	.2613	.2307	.2713	.2074	.2391
.20	.0894	.1013							.2333	.2614	.2278	.2674		
.25	.0857	.0997	.1729	.1815	.1763	.1866	.2278	.2650	.2290	.2584			.1843	.2125
.30	.0324	.0372	.1709	.1746	.1690	.1824	.2348	.2731	.2260	.2579	.2236	.2635	.1787	.2074
.40	.0054	.0367	.0376	.0512	.1737	.1962	.2288	.2690	.2194	.2539	.2161	.2570	.1665	.1945
.50	.0087	.0247	.0123	.0302			.0706	.0773	.1241	.1036	.1716	.1349	.1366	.1014
.60	-.0039	.0177	.0074	.0270	.0345	.0533	-.0271	-.0239	-.0237	-.0233	-.0270	-.0274	-.0321	-.0274
.70			-.0007	.0166	-.0355	-.0269	-.0411	-.0362	-.0201	-.0195	-.0454	-.0425	-.0410	-.0361
.80	-.0419	-.0269	-.0308	-.0403	-.0387	-.0411	-.0349	-.0372					-.0415	-.0415
.90	-.0330	-.0375	-.0334	-.0373	-.0323	-.0408	-.0312	-.0374	-.0247	-.0295	-.0332	-.0392	-.0423	-.0450
.95			-.0333	-.0352	-.0210	-.0253	-.0258	-.0276	-.0340	-.0361	-.0341	-.0369		.0041

TAIL 1

Cp at y/b of														
x/c	0.02		0.22		0.44		0.56		0.67		0.83		0.98	
	U.S.	L.S.	U.S.	L.S.	U.S.	L.S.	U.S.	L.S.	U.S.	L.S.	U.S.	L.S.	U.S.	L.S.
.05			.1909	.0433	.2294	.0488	.3547	.0831		.1015	.3348	.1147		
.10	.0474	.0079	.1810	.0395	.2328	.0430					.3144	.0980	.2973	.1034
.15	.0407	.0091	.1742	.0367	.2299	.0375				.0879	.3076	.0899	.2843	.0817
.20							.3354	.0748	.2990	.0857	.3005	.0848	.2662	.0683
.25	.0534	.0134	.1581	.0323	.2151	.0356	.3407	.0891	.3049	.0870	.2956	.0830	.2527	.0648
.30	.0147	-.0051	.1482	.0304	.2168	.0392	.3325	.0880	.3065	.0852	.2899	.0844	.2384	.0596
.40	-.0103	-.0302			.2117	.0360	.3209	.0844	.3041	.0849	.2822	.0826	.2166	.0502
.50			.0128	-.0342			.1130	-.0070					.1816	.0033
.60	-.0182	-.0515	.0064	-.0337	.0511	-.0322	-.0365	-.0511	.0021	-.0538	-.0058	-.0493	-.0263	-.0501
.70			.0014	-.0373			-.0341	-.0578	-.0229	-.0556	-.0265	-.0489		
.80			-.0486	-.0536	-.0301	-.0408	-.0379	-.0543	-.0251	-.0473	-.0333	-.0473	-.0370	-.0466
.90					-.0482	-.0527	-.0417	-.0534	-.0208	-.0407	-.0368	-.0469	-.0413	-.0481
.95			-.0507	-.0499					-.0328	-.0495	-.0385	-.0460	-.0339	-.0429

TAIL 2

TABLE XVIII. - CONTINUED
(h) $\alpha = 9.85^\circ$

Cp at y/b of														
x/c	0.02		0.22		0.44		0.56		0.67		0.83		0.98	
	U.S.	L.S.	U.S.	L.S.	U.S.	L.S.	U.S.	L.S.	U.S.	L.S.	U.S.	L.S.	U.S.	L.S.
.05	.1189	.1459	.2263	.2294	.2297	.2324					.2846	.3289	.2815	.3200
.10	.1217	.1382	.2162	.2235	.2213	.2233			.2682	.2913	.2623	.3129	.2517	.2868
.15	.1204	.1325	.2119	.2199	.2111	.2187			.2668	.2938	.2575	.3016	.2312	.2648
.20	.1139	.1270							.2622	.2930	.2554	.2981		
.25	.1093	.1253	.2054	.2155	.2058	.2172	.2590	.2985	.2570	.2897			.2084	.2378
.30	.0489	.0429	.2036	.2079	.1968	.2133	.2664	.3070	.2538	.2889	.2509	.2943	.2023	.2327
.40	.0181	.0407	.0522	.0685	.2019	.2268	.2597	.3025	.2470	.2837	.2430	.2872	.1897	.2201
.50	.0218	.0371	.0254	.0463			.0885	.0910	.1445	.1172	.1949	.1572	.1581	.1201
.60	.0074	.0329	.0191	.0418	.0500	.0706	-.0210	-.0177	-.0197	-.0189	-.0240	-.0202	-.0282	-.0201
.70			.0104	.0306	-.0308	-.0200	-.0371	-.0313	-.0158	-.0150	-.0433	-.0370	-.0386	-.0315
.80	-.0367	-.0185	-.0255	-.0356	-.0343	-.0363	-.0295	-.0326					-.0337	-.0269
.90	-.0290	-.0337	-.0275	-.0306	-.0267	-.0363	-.0253	-.0318	-.0220	-.0238	-.0288	-.0331	-.0392	-.0371
.95			-.0271	-.0284	-.0174	-.0216	-.0202	-.0214	-.0304	-.0285	-.0292	-.0300		.0012

TAIL 1

Cp at y/b of														
x/c	0.02		0.22		0.44		0.56		0.67		0.83		0.98	
	U.S.	L.S.	U.S.	L.S.	U.S.	L.S.	U.S.	L.S.	U.S.	L.S.	U.S.	L.S.	U.S.	L.S.
.05			.1505	.0647	.1715	.0727	.2813	.1116		.1315	.3015	.1469		
.10	.0315	.0208	.1326	.0612	.1688	.0665					.2800	.1311	.2647	.1330
.15	.0192	.0213	.1185	.0575	.1621	.0617				.1200	.2723	.1230	.2508	.1135
.20							.2502	.1100	.2441	.1181	.2652	.1181	.2338	.0988
.25	.0255	.0256	.0934	.0515	.1437	.0598	.2490	.1236	.2444	.1202	.2592	.1168	.2209	.0954
.30	-.0087	.0069	.0828	.0489	.1438	.0645	.2428	.1223	.2398	.1182	.2529	.1184	.2072	.0888
.40	-.0292	-.0233			.1374	.0649	.2271	.1192	.2301	.1176	.2442	.1168	.1863	.0770
.50			-.0139	-.0244			.0625	.0028					.1537	.0235
.60	-.0313	-.0503	-.0165	-.0226	.0189	-.0213	-.0441	-.0504	-.0192	-.0493	-.0174	-.0449	-.0331	-.0473
.70			-.0201	-.0265			-.0484	-.0619	-.0392	-.0601	-.0364	-.0527		
.80			-.0548	-.0529	-.0389	-.0451	-.0512	-.0581	-.0380	-.0488	-.0434	-.0487	-.0427	-.0500
.90					-.0556	-.0554	-.0535	-.0548	-.0340	-.0397	-.0471	-.0467	-.0467	-.0487
.95			-.0501	-.0516					-.0447	-.0480	-.0461	-.0454	-.0376	-.0402

TAIL 2

TABLE XVIII.- CONTINUED
(i) $\alpha = 11.84^\circ$

Cp at y/b of														
x/c	0.02		0.22		0.44		0.56		0.67		0.83		0.98	
	U.S.	L.S.	U.S.	L.S.	U.S.	L.S.	U.S.	L.S.	U.S.	L.S.	U.S.	L.S.	U.S.	L.S.
.05	.1499	.1803	.2674	.2698	.2676	.2691					.3186	.3668	.3131	.3548
.10	.1532	.1710	.2565	.2638	.2576	.2596					.2953	.3485	.2804	.3168
.15	.1517	.1645	.2518	.2598	.2468	.2551					.3024	.3310	.2914	.3361
.20	.1436	.1580									.2967	.3297	.2882	.3324
.25	.1379	.1559	.2448	.2552	.2414	.2532	.2963	.3383	.2912	.3265			.2359	.2668
.30	.0688	.0524	.2430	.2469	.2293	.2464	.3041	.3476	.2878	.3255	.2835	.3282	.2299	.2618
.40	.0340	.0478	.0700	.0886	.2363	.2628	.2973	.3426	.2805	.3197	.2742	.3207	.2167	.2488
.50	.0380	.0530	.0412	.0652			.1067	.1080	.1688	.1349	.2219	.1807	.1827	.1403
.60	.0223	.0507	.0338	.0595	.0679	.0909	-.0135	-.0102	-.0140	-.0131	-.0188	-.0130	-.0235	-.0135
.70			.0242	.0469	-.0250	-.0118	-.0317	-.0251	-.0103	-.0096	-.0393	-.0314	-.0351	-.0272
.80	-.0296	-.0077	-.0189	-.0299	-.0283	-.0303	-.0231	-.0265					-.0266	-.0171
.90	-.0242	-.0284	-.0200	-.0231	-.0196	-.0306	-.0181	-.0244	-.0162	-.0180	-.0233	-.0260	-.0375	-.0353
.95			-.0196	-.0202	-.0127	-.0171	-.0127	-.0135	-.0226	-.0210	-.0232	-.0219		-.0026

TAIL 1

Cp at y/b of														
x/c	0.02		0.22		0.44		0.56		0.67		0.83		0.98	
	U.S.	L.S.	U.S.	L.S.	U.S.	L.S.	U.S.	L.S.	U.S.	L.S.	U.S.	L.S.	U.S.	L.S.
.05			.1420	.0902	.1591	.0999	.2618	.1457		.1684	.2861	.1837		
.10	.0284	.0376	.1227	.0867	.1552	.0931					.2637	.1686	.2485	.1690
.15	.0147	.0376	.1081	.0811	.1482	.0891				.1579	.2550	.1609	.2342	.1510
.20							.2288	.1455	.2269	.1561	.2478	.1562	.2169	.1357
.25	.0147	.0425	.0784	.0735	.1289	.0869	.2283	.1629	.2262	.1589	.2407	.1554	.2048	.1311
.30	-.0189	.0233	.0630	.0703	.1273	.0933	.2221	.1601	.2215	.1577	.2341	.1576	.1919	.1229
.40	-.0394	-.0146			.1174	.0939	.2057	.1610	.2111	.1580	.2250	.1562	.1716	.1096
.50			-.0334	-.0133			.0505	.0239					.1403	.0435
.60	-.0422	-.0475	-.0401	-.0101	.0020	-.0051	-.0467	-.0497	-.0243	-.0411	-.0214	-.0385	-.0347	-.0441
.70			-.0408	-.0144			-.0524	-.0583	-.0435	-.0557	-.0399	-.0514		
.80			-.0539	-.0480	-.0436	-.0446	-.0554	-.0603	-.0420	-.0493	-.0463	-.0493	-.0440	-.0490
.90					-.0562	-.0603	-.0550	-.0571	-.0371	-.0388	-.0465	-.0448	-.0458	-.0469
.95			-.0530	-.0564					-.0440	-.0456	-.0432	-.0430	-.0367	-.0379

TAIL 2

TABLE XVIII. - CONTINUED
(j) $\alpha = 15.85^\circ$

Cp at y/b of														
x/c	0.02		0.22		0.44		0.56		0.67		0.83		0.98	
	U.S.	L.S.	U.S.	L.S.	U.S.	L.S.	U.S.	L.S.	U.S.	L.S.	U.S.	L.S.	U.S.	L.S.
.05	.2277	.2675	.3698	.3737	.3633	.3616					.3965	.4553	.2162	.2538
.10	.2317	.2542	.3586	.3676	.3494	.3509			.3908	.4189	.3734	.4338	.1927	.2205
.15	.2291	.2454	.3534	.3634	.3380	.3471			.3887	.4228	.3708	.4194	.1974	.2229
.20	.2181	.2367							.3805	.4213	.3668	.4153		
.25	.2098	.2335	.3448	.3575	.3328	.3460	.3916	.4397	.3749	.4176			.2136	.2400
.30	.1183	.0711	.3436	.3464	.3000	.3232	.4003	.4505	.3719	.4162	.3599	.4097	.2177	.2451
.40	.0750	.0635	.1165	.1404	.3273	.3558			.3922	.4446	.3644	.4091	.2147	.2423
.50	.0794	.0876	.0820	.1121			.1573	.1547	.2282	.1882	.2858	.2329	.1813	.1465
.60	.0644	.0979	.0725	.1043	.1116	.1438	.0062	.0089	.0017	.0025	-.0061	-.0001	-.0121	-.0033
.70			.0610	.0901	-.0091	.0095	-.0170	-.0079	.0050	.0062	-.0315	-.0228	-.0212	-.0145
.80	-.0080	.0240	-.0085	-.0155	-.0190	-.0141	-.0103	-.0097					-.0270	-.0311
.90	-.0152	-.0127	-.0046	-.0044	-.0049	-.0166	-.0008	-.0074	-.0048	-.0107	-.0151	-.0191	-.0268	-.0321
.95			-.0040	-.0005	-.0010	-.0070	.0053	.0059	-.0081	-.0096	-.0138	-.0146		-.0130

TAIL 1

Cp at y/b of														
x/c	0.02		0.22		0.44		0.56		0.67		0.83		0.98	
	U.S.	L.S.	U.S.	L.S.	U.S.	L.S.	U.S.	L.S.	U.S.	L.S.	U.S.	L.S.	U.S.	L.S.
.05			.1461	.1592	.1569	.1701	.2562	.2345		.2603	.2811	.2770		
.10	.0358	.0830	.1229	.1509	.1524	.1649					.2558	.2631	.2400	.2594
.15	.0225	.0830	.1081	.1413	.1442	.1602					.2456	.2556	.2250	.2459
.20							.2195	.2313	.2217	.2512	.2374	.2509	.2070	.2281
.25	.0151	.0888	.0730	.1283	.1226	.1575	.2199	.2665	.2191	.2559	.2304	.2515	.1952	.2203
.30	-.0240	.0650	.0575	.1240	.1202	.1656	.2118	.2692	.2123	.2555	.2227	.2542	.1829	.2101
.40	-.0452	.0094			.1068	.1619	.1969	.2684	.2008	.2567	.2129	.2526	.1631	.1876
.50			-.0384	.0161			.0463	.0814					.1322	.0863
.60	-.0539	-.0389	-.0471	.0239	-.0058	.0270	-.0505	-.0435	-.0290	-.0194	-.0250	-.0213	-.0352	-.0339
.70			-.0508	.0194			-.0568	-.0435	-.0477	-.0393	-.0432	-.0411		
.80			-.0545	-.0341	-.0465	-.0368	-.0575	-.0486	-.0425	-.0408	-.0409	-.0450	-.0396	-.0408
.90					-.0588	-.0541	-.0526	-.0510	-.0333	-.0370	-.0355	-.0429	-.0373	-.0402
.95			-.0558	-.0503					-.0385	-.0440	-.0337	-.0388	-.0314	-.0337

TAIL 2

TABLE XVIII. - CONCLUDED
(k) $\alpha = 19.85^\circ$

Cp at y/b of														
x/c	0.02		0.22		0.44		0.56		0.67		0.83		0.98	
	U.S.	L.S.	U.S.	L.S.	U.S.	L.S.	U.S.	L.S.	U.S.	L.S.	U.S.	L.S.	U.S.	L.S.
.05	.3249	.3770	.4950	.5058	.4827	.4774					.2306	.2717	.2111	.2513
.10	.3309	.3592	.4826	.4979	.4588	.4662			.4792	.5175	.2154	.2488	.1865	.2151
.15	.3260	.3474	.4775	.4934	.4502	.4623			.4679	.5136	.2108	.2382	.1808	.2073
.20	.3120	.3365							.4533	.5118	.2059	.2347		
.25	.3016	.3325	.4654	.4852	.4434	.4618	.5047	.5636	.4470	.5086			.1756	.2041
.30	.1736	.0970	.4754	.4686	.4137	.4342	.5133	.5740	.4435	.5071	-.2001	-.2312	-.1769	.2042
.40	-.1292	-.0856	-.1747	-.2046	-.4417	-.4720	-.5024	-.5660	-.4357	-.4973	-.1921	-.2241	-.1723	-.2031
.50	-.1339	-.1402	-.1319	-.1676			.2154	.2143	.2736	.2155	-.1491	-.1145	-.1520	-.1089
.60	-.1284	-.1632	-.1191	-.1598	-.1686	-.2124	-.0292	-.0349	-.0085	-.0109	-.0298	-.0287	-.0347	-.0321
.70			-.1084	-.1439	-.0137	-.0402	-.0014	-.0151	-.0118	-.0140	-.0377	-.0418	-.0439	-.0454
.80	.0245	-.0677	-.0073	-.0049	-.0017	.0119	.0025	-.0114					-.0563	-.0568
.90	-.0020	-.0146	-.0166	-.0143	-.0187	-.0062	-.0157	-.0076	.0085	-.0022	-.0290	-.0314	-.0547	-.0582
.95			-.0181	-.0217	-.0196	-.0120	-.0219	-.0168	-.0046	-.0011	-.0300	-.0307		-.0169

TAIL 1

Cp at y/b of														
x/c	0.02		0.22		0.44		0.56		0.67		0.83		0.98	
	U.S.	L.S.	U.S.	L.S.	U.S.	L.S.	U.S.	L.S.	U.S.	L.S.	U.S.	L.S.	U.S.	L.S.
.05			.1635	.2511	.1690	.2680	.2704	.3510		.3793	.2964	.3999		
.10	-.0531	.1447	.1374	.2333	.1641	.2639					.2664	.3855	.2510	.3796
.15	-.0382	.1462	.1202	.2183	.1546	.2574					.2546	.3776	-.2342	.3675
.20							.2293	.3705	.2360	.3741	.2447	.3723	.2149	.3453
.25	-.0260	.1524	.0795	.2005	.1307	.2515	.2293	.4073	.2306	.3808	.2367	.3742	.2023	.3365
.30	-.0270	.1280	.0639	.1951	.1274	.2589	.2203	.3999	.2226	.3836	.2290	.3774	.1900	.3213
.40	-.0459	.0525			.1119	.2500	.2032	.4008	-.2091	.3871	.2187	.3756	.1697	.2983
.50			-.0377	.0585			.0469	.1467					.1375	.1741
.60	-.0575	-.0220	-.0467	.0705	-.0062	.0833	-.0510	-.0341	-.0284	.0137	-.0234	.0059	-.0298	-.0136
.70			-.0522	.0688			-.0566	-.0192	-.0474	-.0104	-.0381	-.0207		
.80			-.0531	-.0089	-.0457	-.0221	-.0523	-.0286	-.0368	-.0171	-.0293	-.0258	-.0268	-.0240
.90					-.0568	-.0400	-.0481	-.0336	-.0276	-.0216	-.0264	-.0279	-.0256	-.0268
.95			-.0557	-.0361					-.0335	-.0267	-.0267	-.0294	-.0221	-.0245

TAIL 2

TABLE XIX. - PRESSURE COEFFICIENTS, $\phi = 45^\circ$, $\delta = -15^\circ$, $M = 1.60$.
(a) $\alpha = -2.95^\circ$

Cp at y/b of														
x/c	0.02		0.22		0.44		0.56		0.67		0.83		0.98	
	U.S.	L.S.	U.S.	L.S.	U.S.	L.S.	U.S.	L.S.	U.S.	L.S.	U.S.	L.S.	U.S.	L.S.
.05	.2796	.0204	.7789	-.3899							1.3281	-.3581	1.1177	-.3291
.10	.2543	-.0038	.7143	-.3672							1.2318	-.3456	.9829	-.3113
.15	.2620	-.0380	.6758	-.3031	.8130	-.4278	1.0980	-.4398			1.1482	-.3017	.8902	-.2549
.20	.2688	-.0792							1.1077	-.2198	1.0803	-.2433		
.25	.2989	-.0977	.6389	-.2182	.8325	-.3884			1.0406	-.2291			.7521	-.0964
.30	.2172	-.1794	.5976	-.2450			.9330	-.4110	.9846	-.1952	.9583	-.1950	.6802	-.0559
.40	.3197	-.2024					.7874	-.3831	.8382	-.2685	.8214	-.1806	.5683	-.0716
.50			.3720	-.3095			.1597	-.4406	.3091	-.3953	.5420	-.2950	.3678	-.2017
.60	.2670	-.2683	.3764	-.2966			-.1111	-.4134	-.1084	-.4017	-.1274	-.4196	-.1852	-.4103
.70			.4043	-.2964	-.0239	-.4456	-.0707	-.4257			-.1280	-.4217	-.1880	-.4078
.80	-.0650	-.3743	-.0140	-.4136	-.0295	-.4328	-.0162	-.3457					-.1759	-.4224
.90	-.1085	-.3402	-.0523	-.3689	-.0375	-.3975	-.0191	-.3786	-.0741	-.4083	-.1062	-.4157	-.1663	-.4213
.95			-.0756	-.3323	-.0482	-.3704	-.0002	-.2988	-.0814	-.4180	-.1126	-.4013		

TAIL 1

Cp at y/b of														
x/c	0.02		0.22		0.44		0.56		0.67		0.83		0.98	
	U.S.	L.S.	U.S.	L.S.	U.S.	L.S.	U.S.	L.S.	U.S.	L.S.	U.S.	L.S.	U.S.	L.S.
.05			.9670	-.3429	1.0529	-.3183	1.2117	-.3197			1.3935	-.3033		
.10	.6661	-.0353	.9235	-.3460	1.0602	-.3250					1.3014	-.2833	1.0798	-.2572
.15	.6782	-.0476	.8865	-.3214	1.0561	-.3243	1.1973	-.3171			1.2246	-.2465	.9735	-.2223
.20					1.0478	-.3231			1.1705	-.2335	1.1556	-.2113	.8838	-.1210
.25	.7788	.0174	.8215	-.2475	1.0340	-.3207			1.1094	-.2268	1.0889	-.1848	.8154	-.0504
.30	.4765	-.0772	.7703	-.2081	1.0116	-.3164					1.0236	-.1684	.7485	-.0280
.40	.6726	-.0692					.8771	-.3165	.8817	-.2195	.8872	-.1577	.6224	-.0188
.50			.7643	-.1092			.1856	-.2985					.4347	-.1460
.60			.7523	-.0647	.5427	-.2515			-.1178	-.1988	-.1402	-.1568	-.2207	-.2499
.70			.6826	-.0254			.0355	-.2440	-.0557	-.2020	-.1300	-.1581		.2445
.80			.0603	-.1799	.0362	-.2419	.0410	-.2424	-.0082	-.2036	-.0936	-.1624	-.1790	-.2588
.90					.0587	-.2011	.0453	-.2394	.0315	-.1982	-.0680	-.1645	-.1643	-.2607
.95			.0435	-.0592	.0625	-.1979			.0271	-.1949	-.0689	-.1635		

TAIL 2

TABLE XIX. - CONTINUED
(b) $\alpha = -0.95^\circ$

Cp at y/b of														
x/c	0.02		0.22		0.44		0.56		0.67		0.83		0.98	
	U.S.	L.S.	U.S.	L.S.	U.S.	L.S.	U.S.	L.S.	U.S.	L.S.	U.S.	L.S.	U.S.	L.S.
.05	.3863	-.0121	.7920	-.4132							1.3242	-.3243	1.1184	-.2827
.10	.3574	-.0144	.7232	-.3702					1.2611	-.0570	1.2212	-.3067	.9756	-.2591
.15	.3574	-.0496	.6724	-.3165	.7841	-.4164	1.0621	-.4218			1.1342	-.2514	.8797	-.1960
.20	.3441	-.0831							1.0835	-.1827	1.0652	-.1911		
.25	.3789	-.0955	.6136	-.1238	.8029	-.3830			1.0168	-.1946			.7421	-.0034
.30	.2065	-.1739	.5670	-.1469			.8991	-.3811	.9613	-.1659	.9426	-.1456	.6712	-.0022
.40	.3135	-.1782					.7548	-.3498	.8161	-.2328	.8050	-.1277	.5619	-.0227
.50			.2710	-.2806			.1332	-.4399	.3011	-.3739	.5300	-.2621	.3660	-.1683
.60	.2417	-.2480	.3562	-.2539			-.1917	-.4110	-.1798	-.3938	-.1894	-.4448	-.2575	-.3800
.70			.3642	-.2525	-.0656	-.4435	-.1613	-.4226			-.1937	-.4296	-.2659	-.3723
.80	-.1453	-.3610	-.0753	-.3899	-.0825	-.4313	-.1031	-.3412					-.2537	-.3978
.90	-.2011	-.3341	-.1111	-.3539	-.0938	-.4019	-.0910	-.3742	-.1724	-.4062	-.1815	-.4077	-.2417	-.4122
.95			-.1420	-.3095	-.1088	-.3737	-.0437	-.2944	-.1852	-.4148	-.1903	-.3936		

TAIL 1

Cp at y/b of														
x/c	0.02		0.22		0.44		0.56		0.67		0.83		0.98	
	U.S.	L.S.	U.S.	L.S.	U.S.	L.S.	U.S.	L.S.	U.S.	L.S.	U.S.	L.S.	U.S.	L.S.
.05			.8834	-.4321	.9578	-.4204	1.1643	-.4418			1.3586	-.3569		
.10	.5298	-.0471	.8366	-.4130	.9721	-.4292					1.2608	-.3302	1.0455	-.3046
.15	.5465	-.0652	.7958	-.3658	.9779	-.4295	1.1568	-.4367			1.1836	-.2805	.9380	-.2575
.20					.9844	-.4233			1.1389	-.2678	1.1147	-.2339	.8482	-.1514
.25	.6278	.0074	.7183	-.1647	.9819	-.4038			1.0787	-.2649	1.0494	-.2081	.7800	-.0521
.30	.3523	-.0916	.6470	-.1360	.9688	-.3786					.9855	-.1892	.7146	-.0217
.40	.5435	-.0553					.8495	-.3457	.8583	-.2682	.8540	-.1695	.5901	-.0268
.50			.7197	-.1256			.1688	-.3236					.4109	-.1848
.60			.6972	-.1142	.4946	-.3548			-.1375	-.2707	-.1550	-.2296	-.2348	-.3134
.70			.6398	-.0847			.0049	-.3088	-.1027	-.2753	-.1528	-.2318		-.2911
.80			.0452	-.2583	.0087	-.3140	.0113	-.3104	-.0541	-.2787	-.1279	-.2349	-.2072	-.2969
.90					.0240	-.2810	.0119	-.3141	-.0225	-.2755	-.1100	-.2364	-.1963	-.3158
.95			.0049	-.0611	.0251	-.2802			-.0188	-.2739	-.1117	-.2351		

TAIL 2

TABLE XIX. - CONTINUED
(c) $\alpha = 1.05^\circ$

Cp at y/b of														
x/c	0.02		0.22		0.44		0.56		0.67		0.83		0.98	
	U.S.	L.S.	U.S.	L.S.	U.S.	L.S.	U.S.	L.S.	U.S.	L.S.	U.S.	L.S.	U.S.	L.S.
.05	.4760	-.0390	.7668	-.3828							1.3172	-.2968	1.1109	-.2320
.10	.4222	-.0019	.6995	-.3286							1.2087	-.2575	.9614	-.2031
.15	.4171	-.0282	.6464	-.2802	.7664	-.3898	1.0412	-.4006	1.2406	-.0200	1.1203	-.1896	.8632	-.1366
.20	.3880	-.0611							1.0623	-.1450	1.0487	-.1332		
.25	.4289	-.0767	.5808	-.0730	.7817	-.3234			.9958	-.1594			.7273	.0484
.30	.1939	-.1811	.5257	-.0931					.8753	-.3253	.9427	-.1305	.9253	-.0901
.40	.2792	-.1504							.7354	-.3003	.8009	-.1921	.7888	-.0756
.50			.1884	-.2714					.1258	-.4179	.2993	-.3510	.5186	-.2313
.60	.2268	-.2136	.3519	-.2404					-.2033	-.4069	-.1920	-.3973	-.1945	-.4351
.70			.3559	-.2167	-.0722	-.4328			-.2117	-.4185			-.2023	-.4290
.80	-.1687	-.3467	-.0896	-.3691	-.0900	-.4223	-.1380	-.3376					-.2666	-.3411
.90	-.2376	-.3278	-.1238	-.3472	-.1047	-.4062	-.1438	-.3699	-.2001	-.4147	-.1966	-.4003	-.2542	-.3957
.95			-.1533	-.3169	-.1235	-.3895	-.1033	-.2889	-.2203	-.4231	-.2062	-.3886		

TAIL 1

Cp at y/b of														
x/c	0.02		0.22		0.44		0.56		0.67		0.83		0.98	
	U.S.	L.S.	U.S.	L.S.	U.S.	L.S.	U.S.	L.S.	U.S.	L.S.	U.S.	L.S.	U.S.	L.S.
.05			.8013	-.4093	.8166	-.4017	1.1092	-.4214			1.3202	-.3072		
.10	.4274	-.0222	.7494	-.3723	.8162	-.4070					1.2186	-.2770	1.0029	-.2633
.15	.4413	-.0446	.7110	-.2941	.8314	-.4032	1.0898	-.4109			1.1397	-.2285	.8960	-.2076
.20					.8447	-.3936			1.0916	-.2154	1.0712	-.1838	.8042	-.1144
.25	.4915	-.0112	.6452	-.0825	.8554	-.3727			1.0320	-.2178	1.0097	-.1520	.7380	-.0094
.30	.2695	-.0832	.5831	-.0911	.8586	-.3435					.9453	-.1213	.6722	.0128
.40	.4218	-.0225					.8109	-.3179	.8231	-.2325	.8200	-.1071	.5516	-.0014
.50			.4735	-.1125			.1502	-.3187					.3821	-.1617
.60			.6768	-.1023	.4559	-.3584			-.1581	-.2804	-.1721	-.2371	-.2511	-.3096
.70			.5877	-.0780			-.0386	-.3183	-.1466	-.2867	-.1796	-.2404		-.2543
.80			.0167	-.2686	-.0202	-.2996	-.0210	-.3203	-.0983	-.2900	-.1638	-.2422	-.2335	-.2399
.90					-.0125	-.2605	-.0210	-.3215	-.0774	-.2878	-.1520	-.2418	-.2255	-.2600
.95			-.0430	-.0634	-.0146	-.2111			-.0753	-.2871	-.1548	-.2398		

TAIL 2

TABLE XIX. - CONTINUED
(d) $\alpha = 3.06^\circ$

Cp at y/b of														
x/c	0.02		0.22		0.44		0.56		0.67		0.83		0.98	
	U.S.	L.S.	U.S.	L.S.	U.S.	L.S.	U.S.	L.S.	U.S.	L.S.	U.S.	L.S.	U.S.	L.S.
.05	.5327	-.0473	.7459	-.3351							1.3052	-.2619	1.0977	-.1759
.10	.4614	-.0069	.6750	-.2746					1.2185	-.0195	1.1916	-.1943	.9442	-.1401
.15	.4668	-.0077	.6260	-.2258	.7539	-.3197	1.0173	-.3699			1.1006	-.1212	.8461	-.0795
.20	.4284	-.0328							1.0397	-.0951	1.0277	-.0741		
.25	.4735	-.0489	.5530	-.0424	.7736	-.2709			.9749	-.1119			.7116	.0880
.30	.2039	-.1800	.4940	-.0521			.8514	-.2725	.9229	-.0879	.9037	-.0283	.6441	.0742
.40	.2253	-.1338					.7166	-.2439	.7817	-.1485	.7691	-.0275	.5426	.0532
.50			.1383	-.2580			.1121	-.3877	.2928	-.3267	.5064	-.1971	.3588	-.1062
.60	.2015	-.1682	.3172	-.2292			-.2135	-.3987	-.2033	-.3902	-.2054	-.4197	-.2637	-.3410
.70			.3414	-.1818	-.1566	-.4253	-.2421	-.4085			-.2162	-.4238	-.2710	-.3353
.80	-.1795	-.3323	-.0967	-.3470	-.1082	-.4108	-.1788	-.3302					-.2529	-.4109
.90	-.2605	-.3196	-.1359	-.3461	-.1153	-.3978	-.1858	-.3617	-.2180	-.4084	-.2113	-.3892	-.2334	-.4135
.95			-.1588	-.3171	-.1333	-.3818	-.1487	-.2821	-.2380	-.4170	-.2213	-.3737		

TAIL 1

Cp at y/b of														
x/c	0.02		0.22		0.44		0.56		0.67		0.83		0.98	
	U.S.	L.S.	U.S.	L.S.	U.S.	L.S.	U.S.	L.S.	U.S.	L.S.	U.S.	L.S.	U.S.	L.S.
.05			.6992	-.3666	.7343	-.3826	1.0470	-.3923			1.2749	-.2620		
.10	.3449	-.0051	.6440	-.2878	.7066	-.3843					1.1692	-.2158	.9582	-.2139
.15	.3520	-.0287	.6069	-.1695	.6957	-.3767	1.0152	-.3661			1.0908	-.1638	.8516	-.1522
.20					.7136	-.3646			1.0297	-.1634	1.0238	-.1071	.7594	-.0760
.25	.3787	.0150	.5496	-.0562	.7325	-.3424			.9711	-.1706	.9620	-.0647	.6929	.0055
.30	.1859	-.0780	.5006	-.0591	.7419	-.3122					.9010	-.0490	.6282	.0408
.40	.3210	-.0067					.7386	-.2645	.7723	-.1965	.7802	-.0574	.5124	.0308
.50			.3490	-.0985			.1181	-.3357					.3530	-.1394
.60			.3856	-.0770	.4188	-.2973			-.1832	-.2909	-.1906	-.2457	-.2651	-.3125
.70			.4957	-.0547			-.1268	-.3321	-.1946	-.3018	-.2094	-.2495		-.2632
.80			.0162	-.2667	-.0598	-.2945	-.0839	-.3368	-.1655	-.3062	-.2025	-.2512	-.2556	-.2473
.90					-.0536	-.2147	-.0651	-.3339	-.1480	-.3008	-.1975	-.2546	-.2521	-.2251
.95			-.0867	-.0779	-.0530	-.1578			-.1578	-.2955	-.2026	-.2557		

TAIL 2

TABLE XIX. - CONTINUED
(e) $\alpha = 5.05^\circ$

Cp at y/b of															
x/c	0.02		0.22		0.44		0.56		0.67		0.83		0.98		
	U.S.	L.S.	U.S.	L.S.	U.S.	L.S.	U.S.	L.S.	U.S.	L.S.	U.S.	L.S.	U.S.	L.S.	
.05	.5174	-.0358	.7180	-.2755							1.2903	-.2267	1.0808	-.1170	
.10	.4653	.0162	.6434	-.2131						1.1902	.0805	1.1715	-.1105	.9218	-.0752
.15	.4649	.0063	.5966	-.1607	.7329	-.2647	.9931	-.2988			1.0782	-.0483	.8227	-.0147	
.20	.4197	-.0118							1.0157	-.0420	1.0063	-.0014			
.25	.4702	-.0167	.5281	-.0184	.7604	-.2043			.9507	-.0585			.6945	.1276	
.30	.1984	-.1555	.4699	-.0206			.8288	-.2205	.8992	-.0364	.8827	.0306	.6294	.1155	
.40	.1648	-.1194					.6990	-.1623	.7619	-.0965	.7511	.0243	.5311	.0962	
.50			.0985	-.2390			.1033	-.3482	.2840	-.2997	.4961	-.1608	.3544	-.0810	
.60	.1690	-.1350	.2709	-.2061			-.2233	-.3896	-.2142	-.3793	-.2123	-.4031	-.2614	-.3254	
.70			.3199	-.1504	-.2235	-.4222	-.2538	-.3954			-.2284	-.4101	-.2422	-.3268	
.80	-.1870	-.3155	-.1077	-.3244	-.1711	-.3918	-.2133	-.3198					-.2326	-.4081	
.90	-.2692	-.3084	-.1430	-.3384	-.1374	-.3828	-.2252	-.3494	-.2286	-.3952	-.2256	-.3691	-.2297	-.3847	
.95			-.1676	-.3139	-.1517	-.3682	-.1812	-.2727	-.2469	-.4010	-.2357	-.3570			

TAIL 1

Cp at y/b of														
x/c	0.02		0.22		0.44		0.56		0.67		0.83		0.98	
	U.S.	L.S.	U.S.	L.S.	U.S.	L.S.	U.S.	L.S.	U.S.	L.S.	U.S.	L.S.	U.S.	L.S.
.05			.5871	-.3103	.6481	-.3661	.9733	-.3472			1.2301	-.2089		
.10	.2643	.0015	.5300	-.2119	.6164	-.3605					1.1236	-.1557	.9148	-.1601
.15	.2605	-.0198	.4879	-.0955	.5877	-.3422	.9474	-.3171			1.0456	-.0782	.8107	-.0890
.20					.5762	-.3197			.9745	-.1111	.9788	-.0113	.7178	-.0049
.25	.2757	.0159	.4326	-.0381	.5983	-.2818			.9189	-.1222	.9199	.0055	.6523	.0568
.30	.0818	-.0643	.3903	-.0336	.6104	-.2158					.8623	.0090	.5908	.0577
.40	.2348	.0021					.6854	-.2002	.7321	-.1555	.7478	-.0091	.4776	.0616
.50			.1910	-.0749			.0911	-.3478					.3265	-.1103
.60			.3064	-.0524	.1375	-.2610			-.1992	-.3531	-.2010	-.3028	-.2740	-.3269
.70			.3266	-.0406			-.1945	-.3623	-.2206	-.3607	-.2265	-.2980		-.2866
.80			-.0468	-.2645	-.0907	-.3295	-.1746	-.3632	-.2185	-.3613	-.2268	-.2957	-.2621	-.2859
.90					-.0928	-.2421	-.1528	-.3471	-.2096	-.3479	-.2263	-.3116	-.2560	-.2717
.95			-.1240	-.0806	-.0953	-.1336			-.2169	-.3345	-.2327	-.3123		

TAIL 2

TABLE XIX. - CONTINUED
(f) $\alpha = 7.06^\circ$

Cp at y/b of														
x/c	0.02		0.22		0.44		0.56		0.67		0.83		0.98	
	U.S.	L.S.	U.S.	L.S.	U.S.	L.S.	U.S.	L.S.	U.S.	L.S.	U.S.	L.S.	U.S.	L.S.
.05	.4869	-.0211	.6777	-.2072							1.2623	-.1635	1.0490	-.0511
.10	.4476	.0333	.5961	-.1462					1.1605	.1508	1.1423	-.0239	.8880	-.0004
.15	.4432	.0274	.5490	-.0942	.7018	-.1955	.9621	-.2302			1.0477	.0233	.7928	.0633
.20	.3848	.0103							.9859	.0238	.9756	.0762		
.25	.4238	.0113	.4903	.0180	.7430	-.1202			.9199	.0032			.6700	.1701
.30	.1567	-.1324	.4366	.0098			.8066	-.1271	.8715	.0220	.8542	.0959	.6066	.1559
.40	.0925	-.1176					.6810	-.0752	.7385	-.0352	.7274	.0921	.5158	.1339
.50			.0464	-.2116			.0951	-.3027	.2735	-.2666	.4816	-.1196	.3478	-.0554
.60	.1325	-.1052	.1610	-.1716			-.2315	-.3876	-.2243	-.3782	-.2205	-.3839	-.2590	-.3085
.70			.3011	-.1125	-.2647	-.4091	-.2637	-.3813			-.2408	-.3955	-.2422	-.3092
.80	-.2006	-.2928	-.1169	-.2993	-.2416	-.3709	-.2285	-.3082					-.2314	-.3962
.90	-.2742	-.2968	-.1548	-.3233	-.2144	-.3653	-.2570	-.3338	-.2388	-.3744	-.2435	-.3528	-.2199	-.3719
.95			-.1829	-.3092	-.2039	-.3523	-.2075	-.2612	-.2587	-.3787	-.2534	-.3419		

TAIL 1

Cp at y/b of														
x/c	0.02		0.22		0.44		0.56		0.67		0.83		0.98	
	U.S.	L.S.	U.S.	L.S.	U.S.	L.S.	U.S.	L.S.	U.S.	L.S.	U.S.	L.S.	U.S.	L.S.
.05			.4885	-.2424	.5697	-.3378	.8792	-.2869			1.1771	-.1518		
.10	.2125	.0116	.4341	-.1206	.5390	-.3165					1.0712	-.0789	.8692	-.1090
.15	.2041	-.0042	.3965	-.0109	.5085	-.2765	.8601	-.2429			.9935	.0400	.7652	-.0181
.20					.4885	-.2267			.9103	-.0574	.9295	.0593	.6730	.0528
.25	.2212	.0279	.3542	-.0007	.4869	-.1075			.8577	-.0745	.8723	.0718	.6096	.0801
.30	.0480	-.0443	.3192	-.0036	.5071	-.0094					.8170	.0721	.5511	.0835
.40	.2127	.0088					.6361	-.0222	.6876	-.1078	.7094	.0424	.4444	.0841
.50			.2059	-.0461			.0740	-.2182					.3018	-.1059
.60			.2822	-.0323	.1446	-.2017			-.2122	-.3727	-.2119	-.3495	-.2809	-.3305
.70			.2716	-.0329			-.2114	-.3918	-.2352	-.3773	-.2402	-.3534	-.2917	
.80			-.1077	-.2628	-.1087	-.3083	-.1902	-.3766	-.2336	-.3755	-.2437	-.3590	-.2735	-.2868
.90					-.1034	-.2663	-.1747	-.3254	-.2268	-.3721	-.2451	-.3571	-.2654	-.2833
.95			-.0741	-.0778	-.1060	-.1686			-.2342	-.3621	-.2517	-.3488		

TAIL 2

TABLE XIX. - CONTINUED
(g) $\alpha = 9.05^\circ$

Cp at y/b of														
x/c	0.02		0.22		0.44		0.56		0.67		0.83		0.98	
	U.S.	L.S.	U.S.	L.S.	U.S.	L.S.	U.S.	L.S.	U.S.	L.S.	U.S.	L.S.	U.S.	L.S.
.05	.4707	-.0040	.6425	-.1361							1.2313	-.0876	1.0096	.0169
.10	.4338	.0610	.5628	-.0743					1.1289	-.2184	1.1084	-.0597	-.8474	-.0928
.15	.4169	.0561	.5132	-.0243	-.6600	-.1141	-.9271	-.1542			1.0157	-.1095	-.7558	-.1462
.20	.3419	.0397							.9523	.0891	.9431	-.1549		
.25	.3675	.0418	.4547	.0519	.7099	-.0335			.8902	.0707			.6416	.2022
.30	.1180	-.0973	.4054	.0486			.7759	-.0130	.8418	.0849	.8230	-.1656	.5820	.1852
.40	.0438	-.0873					.6573	.0214	.7125	.0303	.6989	-.1537	-.4973	-.1544
.50			-.0034	-.1840			.0818	-.2491	.2636	-.2266	-.4642	-.0824	-.3381	-.0327
.60	.0862	-.0688	.0555	-.1318			-.2413	-.3820	-.2269	-.3902	-.2289	-.3669	-.2524	-.2880
.70			.2700	-.0699	-.2931	-.3975	-.2755	-.3702			-.2530	-.3817	-.2417	-.2799
.80	-.2191	-.2658	-.1242	-.2787	-.2795	-.3566	-.2394	-.2916					-.2263	-.3832
.90	-.2792	-.2862	-.1670	-.3080	-.2693	-.3519	-.2723	-.3148	-.2522	-.3540	-.2607	-.3403	-.2002	-.3743
.95			-.1979	-.3025	-.2729	-.3403	-.2202	-.2435	-.2705	-.3569	-.2700	-.3312		

TAIL 1

Cp at y/b of														
x/c	0.02		0.22		0.44		0.56		0.67		0.83		0.98	
	U.S.	L.S.	U.S.	L.S.	U.S.	L.S.	U.S.	L.S.	U.S.	L.S.	U.S.	L.S.	U.S.	L.S.
.05			.3981	-.1755	.4810	-.2937	.7657	-.2181			1.1062	-.0707		
.10	.1748	.0258	.3523	.0253	.4458	-.2574					1.0018	.0391	.8112	-.0609
.15	.1735	.0166	.3233	.0164	.4164	-.1009	.7481	-.1520			.9280	-.1212	.7153	-.0351
.20					.3978	.0175			.8253	-.0059	.8681	.1244	.6230	.0939
.25	.1992	.0414	.2859	.0232	.3879	.0217			.7795	-.0232	.8130	-.1302	.5585	.1136
.30	.0769	-.0380	.2529	.0156	.3936	.0307					.7599	-.1220	.5049	.1184
.40	.2013	.0145					.5740	.0831	.6286	-.0097	.6614	.0800	.4025	.1122
.50			.2182	-.0192			.0520	-.1782					.2701	-.0806
.60			.2419	-.0278	.1471	-.1477			-.2282	-.3637	-.2252	-.3719	-.2819	-.3264
.70			.2243	-.0345			-.2357	-.3692	-.2537	-.3734	-.2556	-.3550		-.2732
.80			-.1670	-.2653	-.1386	-.2884	-.2145	-.3503	-.2554	-.3629	-.2632	-.3668	-.2641	-.2646
.90					-.1340	-.2651	-.1966	-.3167	-.2388	-.3352	-.2674	-.3638	-.2495	-.2656
.95			-.0127	-.0777	-.1369	-.1870			-.2246	-.2943	-.2748	-.3473		

TAIL 2

TABLE XIX. - CONTINUED
(h) $\alpha = 11.05^\circ$

Cp at y/b of														
x/c	0.02		0.22		0.44		0.56		0.67		0.83		0.98	
	U.S.	L.S.	U.S.	L.S.	U.S.	L.S.	U.S.	L.S.	U.S.	L.S.	U.S.	L.S.	U.S.	L.S.
.05	.4485	.0167	.6140	-.0596							1.1835	-.0011	.9515	-.0994
.10	.3999	.0886	.5278	.0040					1.0885	.2913	1.0596	.1493	.7935	.1801
.15	.3739	.0833	.4766	.0527	.6196	-.0213	.8850	-.0675			.9664	.2056	.7092	.2207
.20	.2960	.0707							.9137	.1591	.8977	.2301		
.25	.3178	.0755	.4155	.0971	.6768	.0635			.8534	.1449			.6024	.2135
.30	.0871	-.0606	.3726	.0907			.7413	.1284	.8070	.1568	.7823	.2374	.5485	.2085
.40	.0191	-.0471					.6288	.1463	.6799	.1047	.6632	.2137	.4725	.2023
.50			-.0547	-.1521			.0674	-.1728	.2432	-.1758	.4396	-.0443	.3297	-.0049
.60	.0316	-.0242	.0009	-.0869			-.2515	-.3451	-.2342	-.3663	-.2394	-.3513	-.2347	-.2602
.70			.1512	-.0264	-.3143	-.3837	-.2866	-.3622			-.2646	-.3675	-.2378	-.2478
.80	-.2428	-.2378	-.1409	-.2610	-.3082	-.3420	-.2470	-.2787					-.2116	-.3545
.90	-.2859	-.2708	-.1819	-.2924	-.3066	-.3389	-.2815	-.2891	-.2631	-.3263	-.2687	-.3242	-.1417	-.3651
.95			-.2150	-.2928	-.3110	-.3301	-.2272	-.2259	-.2845	-.3283	-.2677	-.3161		

TAIL 1

Cp at y/b of														
x/c	0.02		0.22		0.44		0.56		0.67		0.83		0.98	
	U.S.	L.S.	U.S.	L.S.	U.S.	L.S.	U.S.	L.S.	U.S.	L.S.	U.S.	L.S.	U.S.	L.S.
.05			.3293	-.0415	.3860	-.2253	.6110	-.1335			1.0214	.0340		
.10	.1551	.0338	.2902	.0383	.3552	-.0716					.9207	.1932	.7515	.0419
.15	.1689	.0251	.2645	.0354	.3263	.0550	.6128	.0649			.8522	.2102	.6625	.1469
.20					.3046	.0555			.7055	.0462	.7941	.2079	.5699	.1753
.25	.1919	.0466	.2290	.0453	.2872	.0517			.6691	.0675	.7441	.2079	.5069	.1919
.30	.1062	-.0353	.1978	.0320	.2854	.0592					.6955	.1872	.4564	.1870
.40	.1850	.0125					.4813	.1772	.5503	.1521	.6078	.1386	.3606	.1320
.50			.1967	-.0059			.0192	-.1454					.2394	-.0982
.60			.2128	-.0321	.1425	-.1016			-.2455	-.3361	-.2387	-.3566	-.2780	-.3270
.70			.1950	-.0444			-.2453	-.3567	-.2698	-.3489	-.2695	-.3437		-.3179
.80			-.1903	-.2716	-.1441	-.2833	-.2258	-.3349	-.2690	-.3236	-.2785	-.3202	-.2620	-.2332
.90					-.1555	-.2783	-.2028	-.3101	-.2417	-.3010	-.2832	-.3156	-.2542	-.2506
.95			-.1109	-.0907	-.1675	-.2278			-.2278	-.2766	-.2851	-.3003		

TAIL 2

TABLE XIX. - CONTINUED
(i) $\alpha = 13.05^\circ$

Cp at y/b of														
x/c	0.02		0.22		0.44		0.56		0.67		0.83		0.98	
	U.S.	L.S.	U.S.	L.S.	U.S.	L.S.	U.S.	L.S.	U.S.	L.S.	U.S.	L.S.	U.S.	L.S.
.05	.4090	.0523	.5829	.0424							1.1240	.1070	.8757	.1833
.10	.3734	.1170	.4911	.0935					1.0393	-.3720	1.0067	.2579	.7293	.2461
.15	.3529	.1169	.4322	.1214	.5715	.1146	.8357	.0542			.9171	.2960	.6625	.2552
.20	.2820	.1101							.8675	.2375	.8519	.3165		
.25	.2842	.1153	.3738	.1419	.6342	.1680			.8083	.2183			.5774	.2509
.30	.0555	-.0034	.3390	.1281			.6979	.2652	.7646	.2308	.7437	.3204	.5368	.2461
.40	.0046	.0163					.5951	.2469	.6456	.2035	.6372	.2765	.4740	.2462
.50			-.1009	-.0939			.0516	-.0950	.2272	-.0803	.4259	.0068	.3418	.0453
.60	-.0270	.0106	-.0475	-.0164			-.2622	-.2858	-.2440	-.2854	-.2434	-.2935	-.2275	-.1980
.70			.0220	.0282	-.3300	-.3277	-.2965	-.3058			-.2695	-.3074	-.2128	-.1838
.80	-.2665	-.1849	-.1921	-.2114	-.3277	-.2912	-.2533	-.2394					-.1262	-.2836
.90	-.2938	-.2133	-.2034	-.2361	-.3257	-.2889	-.2875	-.2443	-.2720	-.2567	-.2633	-.2659	-.1355	-.3202
.95			-.2321	-.2375	-.3144	-.2858	-.2288	-.1871	-.2901	-.2621	-.2506	-.2578		

TAIL 1

Cp at y/b of														
x/c	0.02		0.22		0.44		0.56		0.67		0.83		0.98	
	U.S.	L.S.	U.S.	L.S.	U.S.	L.S.	U.S.	L.S.	U.S.	L.S.	U.S.	L.S.	U.S.	L.S.
.05			.2697	.0530	.2959	-.1112	.4370	-.0127			.9193	.2128		
.10	.1500	.0400	.2380	.0547	.2642	.0871					.8195	.3341	.6786	.2228
.15	.1759	.0329	.2147	.0479	.2374	.0734	.4657	.1952			.7543	.3118	.6057	.2864
.20					.2161	.0748			.5710	.2092	.7031	.2936	.5115	.2574
.25	.1948	.0496	.1778	.0574	.1977	.0762			.5442	.2371	.6587	.2789	.4453	.2377
.30	.1260	-.0402	.1520	.0407	.1893	.0923					.6138	.2665	.3984	.2068
.40	.1648	.0031					.3659	.2204	.4517	.2919	.5371	.2665	.3082	.1394
.50			.1378	-.0065			-.0239	-.1352					.1995	-.0901
.60			.1808	-.0387	.0835	-.0603			-.2378	-.3117	-.2226	-.2978	-.2449	-.3182
.70			.1467	-.0502			-.2355	-.3241	-.2619	-.3329	-.2522	-.3192		-.3069
.80			-.1220	-.2759	-.1440	-.2722	-.2184	-.3063	-.2534	-.2998	-.2627	-.2994	-.2365	-.2825
.90					-.1590	-.2679	-.1790	-.2934	-.2273	-.2829	-.2484	-.2761	-.2324	-.2059
.95			-.1095	-.1728	-.1568	-.2231			-.2205	-.2718	-.2323	-.2721		

TAIL 2

TABLE XIX. - CONTINUED
(j) $\alpha = 17.05^\circ$

Cp at y/b of														
x/c	0.02		0.22		0.44		0.56		0.67		0.83		0.98	
	U.S.	L.S.	U.S.	L.S.	U.S.	L.S.	U.S.	L.S.	U.S.	L.S.	U.S.	L.S.	U.S.	L.S.
.05	.3817	.1074	.5281	.2180							.9701	.3719	.7031	.3527
.10	.3501	.1715	.4311	.2161					.9471	.5666	.8825	.4950	.6013	.3514
.15	.3086	.1773	.3697	.2201	.4746	.3032	.7250	.3952			.8115	.5165	.5620	.3276
.20	.2485	.1809							.7855	.5229	.7577	.5104		
.25	.2231	.1907	.3000	.2344	.4815	.2943			.7303	.5170			.5063	.3248
.30	.0073	.0659	.2655	.2089			.6181	.4566	.6932	.5149	.6612	.4733	.4847	.3298
.40	-.0767	.1077					.5363	.4184	.5859	.4565	.5697	.4294	.4393	.3347
.50			-.1618	-.0235			.0256	-.0311	.2014	.0041	.3818	.0932	.3311	.0940
.60	-.1048	.0469	-.1561	-.1003			-.2780	-.2789	-.2604	-.2737	-.2589	-.2837	-.2098	-.2020
.70			-.1217	-.1063	-.3478	-.3397	-.3050	-.3047			-.2876	-.3015	-.1419	-.1473
.80	-.3140	-.1553	-.2828	-.2020	-.3230	-.3164	-.2589	-.2563					-.1260	-.2155
.90	-.3046	-.1938	-.2830	-.2072	-.3044	-.2976	-.2788	-.2552	-.2571	-.2508	-.2412	-.2578	-.1811	-.3266
.95			-.2644	-.2213	-.3023	-.2952	-.2022	-.1913	-.2549	-.2560	-.2353	-.2516		

TAIL 1

Cp at y/b of														
x/c	0.02		0.22		0.44		0.56		0.67		0.83		0.98	
	U.S.	L.S.	U.S.	L.S.	U.S.	L.S.	U.S.	L.S.	U.S.	L.S.	U.S.	L.S.	U.S.	L.S.
.05			.1824	.0653	.1369	.0828	.2088	.2489			.5576	.6117		
.10	.1669	.0298	.1610	.0611	.1145	.1111					.4932	.5408	.4541	.5240
.15	.2186	.0258	.1454	.0528	.0948	.1191	.2588	.3224			.4528	.5161	.4180	.4466
.20					.0771	.1234			.2864	.3929	.4152	.4949	.3472	.3800
.25	.2610	.0286	.1159	.0571	.0644	.1112			.2687	.3833	.3878	.4786	.2893	.3527
.30	.1041	-.0621	.0957	.0340	.0572	.1034					.3608	.4611	.2458	.3121
.40	.1376	-.0383					.1809	.2542	.2080	.3268	.3175	.4185	.1680	.2334
.50			.0960	-.0369			-.1392	-.1240					.0837	-.0473
.60			.1498	-.0721	-.0079	-.0160			-.3416	-.2987	-.3119	-.2711	-.2993	-.3056
.70			.1917	-.0853			-.3113	-.3095	-.3220	-.3237	-.3053	-.2988		-.3042
.80			-.1488	-.2950	-.2051	-.2703	-.2893	-.2921	-.3067	-.3050	-.2812	-.3118	-.2783	-.2891
.90					-.1975	-.2737	-.2595	-.2589	-.3051	-.2813	-.2781	-.3062	-.2847	-.2930
.95			-.1590	-.2580	-.2016	-.2490			-.2975	-.2791	-.2766	-.2904		

TAIL 2

TABLE XIX. - CONCLUDED
(k) $\alpha = 21.05^\circ$

Cp at y/b of														
x/c	0.02		0.22		0.44		0.56		0.67		0.83		0.98	
	U.S.	L.S.	U.S.	L.S.	U.S.	L.S.	U.S.	L.S.	U.S.	L.S.	U.S.	L.S.	U.S.	L.S.
.05	.3774	.1855	.4913	.3674							.7313	.8559	.4697	.5522
.10	.3435	.2465	.3755	.3336					.8243	.8786	.7246	.7984	.4446	.5205
.15	.2988	.2577	.3207	.3342	.4228	.4653	.6107	.7197			.6955	.7410	.4471	.4910
.20	.2422	.2700							.6798	.7499	.6601	.6994		
.25	.2024	.3079	.2485	.3434	.4309	.5217			.6339	.7088			.4464	.4803
.30	-.0166	.1840	.2088	.3186			.5183	.6379	.6038	.6813	.5827	.6354	.4397	.4731
.40	-.1303	.2497					.4506	.5566	.5125	.5953	.5051	.5576	.4148	.4498
.50			-.1946	.0537			-.0157	.0250	.1620	.0617	.3395	.1693	.3266	.1631
.60	-.1595	.1334	-.2010	.2808			-.2935	-.2499	-.2797	-.2415	-.2729	-.2521	-.1992	-.1718
.70			-.1877	.2672	-.3666	-.3078	-.3197	-.2764			-.3020	-.2704	-.1242	-.0811
.80	-.3568	-.0719	-.3470	-.1335	-.3352	-.2833	-.2686	-.2350					-.1505	-.1104
.90	-.2859	-.0900	-.3279	-.1559	-.3229	-.2859	-.2658	-.2667	-.2527	-.2679	-.2515	-.2333	-.2303	-.1890
.95			-.3105	-.1732	-.3233	-.2871	-.2026	-.2030	-.2592	-.2700	-.2461	-.2247		

TAIL 1

Cp at y/b of														
x/c	0.02		0.22		0.44		0.56		0.67		0.83		0.98	
	U.S.	L.S.	U.S.	L.S.	U.S.	L.S.	U.S.	L.S.	U.S.	L.S.	U.S.	L.S.	U.S.	L.S.
.05			.1118	.0755	.0187	.1009	.0503	.2554			.0891	.6791		
.10	.1431	.0145	.1032	.0749	.0056	.1031					.1312	.5731	.1072	.5699
.15	.2147	.0125	.0913	.0759	-.0094	.0853	.0748	.3082			.1153	.5234	.1417	.5014
.20					-.0229	.0759			.0453	.3730	.0989	.4885	.1206	.4411
.25	.2169	.0178	.0497	.0650	-.0292	.0622			.0390	.3541	.0871	.4667	.0914	.4145
.30	.0346	-.0866	.0284	.0308	-.0304	.0520					.0762	.4470	.0598	.3748
.40	.0905	-.0782					.0321	.2193	.0074	.2883	.0547	.3956	.0049	.2876
.50			.0816	-.0499			-.2314	-.1541					-.0553	-.0253
.60			.1396	-.0988	-.0797	-.0706			-.3964	-.3101	-.3759	-.2737	-.3739	-.3011
.70			.1560	-.1210			-.3469	-.3000	-.3786	-.3339	-.3505	-.2960		-.2908
.80			-.1710	-.3129	-.2772	-.2906	-.3193	-.2916	-.3701	-.3125	-.3487	-.3039	-.3441	-.2790
.90					-.2799	-.2965	-.3054	-.2922	-.3643	-.2919	-.3454	-.3087	-.3395	-.2773
.95			-.1690	-.2959	-.2764	-.2742			-.3488	-.2865	-.3434	-.3171		

TAIL 2

TABLE XX. - PRESSURE COEFFICIENTS, $\phi = 45^\circ$, $\delta = -15^\circ$, $M = 2.36$.
 (a) $\alpha = -4.17^\circ$

Cp at γ/b of														
x/c	0.02		0.22		0.44		0.56		0.67		0.83		0.98	
	U.S.	L.S.	U.S.	L.S.	U.S.	L.S.	U.S.	L.S.	U.S.	L.S.	U.S.	L.S.	U.S.	L.S.
.05	.2468	-.0190	.7877	-.1693	.7197	.0086					1.3883	-.0943	1.2276	-.0638
.10	.1961	-.0036	.7082	-.1572	.7571	-.1666			1.2590	.0130	1.2776	-.0544	1.0803	-.0376
.15	.1945	-.0156	.6653	-.1474	.7261	-.1607			1.1883	.0434	1.1998	-.0446	.9709	-.0227
.20	.2060	-.0257							1.1403	.0226	1.1396	-.0419		
.25	.2199	-.0393	.6143	-.1294	.6760	-.1458	1.0624	-.1286	1.0839	-.0040			.8419	-.0186
.30	.1237	-.0974	.5962	-.1293	.6415	-.1210	1.0300	-.1233	1.0400	-.0247	1.0418	-.0402	.7816	-.0194
.40	.2059		.2045	-.1643	.6514	-.1318	.9334	-.1227	.9638	-.0598	.9347	-.0394	.6896	-.0081
.50	.2152	-.1067	.2024	-.1629			.3494	-.1815	.5533	-.1505	.7037	-.1079	.5385	-.0784
.60	.2207	-.1356	.2282	-.1595	.3232	-.1834	.0351	-.1738	.0524	-.1712	.0641	-.1714	-.0098	-.1886
.70			.3335	-.1578	.0626	-.1763	.0024	-.1734	.0497	-.1687	.0638	-.1711	-.0255	-.1804
.80	-.0298	-.1746	.0276	-.1804	.0441	-.1767	.0076	-.1725					-.0283	-.1808
.90	-.1094	-.1678	-.0014	-.1790	.0373	-.1775	.0146	-.1737	.0043	-.1711	.0589	-.1657	-.0308	-.1784
.95			-.0123	-.1781	.0303	-.1737	.0071	-.1710	-.0053	-.1744	.0473	-.1727		

TAIL 1

Cp at γ/b of														
x/c	0.02		0.22		0.44		0.56		0.67		0.83		0.98	
	U.S.	L.S.	U.S.	L.S.	U.S.	L.S.	U.S.	L.S.	U.S.	L.S.	U.S.	L.S.	U.S.	L.S.
.05			.8425	-.1485	.8911	-.1789	1.4817	-.1400	1.4448	-.0621	1.4293	-.0790		
.10	.5948	-.0706	.7833	-.1437	.8507	-.1572					1.3090	-.0458	1.0636	-.0283
.15	.5404	-.0436	.7462	-.1412	.8125	-.1453			1.2429	.0224	1.2279	-.0395	.9797	-.0228
.20							1.1343	-.1040	1.1810	.0262	1.1612	-.0411	.8980	-.0104
.25	.6075	-.0809	.6859	-.1394	.7429	-.1293	1.1103	-.1160	1.1359	.0111	1.1044	-.0425	.8384	-.0092
.30	.4125	-.1316	.6418	-.1400	.7495	-.1313	1.0611	-.1161	1.0738	-.0225	1.0492	-.0434	.7849	-.0045
.40	.3287	-.0892			.7247	-.1182	.9587	-.1171	.9781	-.0483	.9439	-.0470	.6921	-.0076
.50			.2659	-.1551			.3790	-.1797					.5570	-.0857
.60	.3508	.0009	.2853	-.1639	.2887	-.1713	-.0157	-.1084	.0664	-.1606	.0655	-.1410	-.0026	-.1613
.70			.3092	-.1614			.0108	-.1643	.0351	-.1641	.0520	-.1438		
.80			.0491	-.1948	.0454	-.1625	-.0054	-.1671	.0302	-.1576	.0611	-.1458	-.0224	-.1778
.90					.0411	-.1582	-.0040	-.1670	.0236	-.1542	.0611	-.1453	-.0223	-.1930
.95			.0875	-.1307					.0151	-.1518	.0537	-.1432	-.0277	-.1894

TAIL 2

TABLE XX. - CONTINUED
(b) $\alpha = -2.15^\circ$

Cp at y/b of														
x/c	0.02		0.22		0.44		0.56		0.67		0.83		0.98	
	U.S.	L.S.	U.S.	L.S.	U.S.	L.S.	U.S.	L.S.	U.S.	L.S.	U.S.	L.S.	U.S.	L.S.
.05	.2903	-.0321	.7309	-.1326	.7165	.0114					1.3417	-.0501	1.1712	-.0226
.10	.2584	-.0100	.6612	-.1216	.7479	-.1449			1.2296	.0365	1.2307	-.0219	1.0247	-.0108
.15	.2548	-.0224	.6225	-.1186	.7114	-.1366			1.1547	.0595	1.1576	-.0208	.9197	.0010
.20	.2676	-.0347							1.1042	.0502	1.0994	-.0226		
.25	.2852	-.0452	.5757	-.1098	.6573	-.1229	1.0204	-.1015	1.0461	.0218			.8005	.0001
.30	.1513	-.1018	.5572	-.1114	.6191	-.1212	.9910	-.0972	1.0056	-.0021	1.0059	-.0252	.7464	-.0019
.40	.2089		.1892	-.1594	.6285	-.1112	.9030	-.0971	.9339	-.0382	.9030	-.0262	.6633	.0077
.50	.2160	-.1022	.1941	-.1600			.3388	-.1709	.5405	-.1391	.6847	-.1004	.5242	-.0660
.60	.2260	-.1248	.1877	-.1580	.2447	-.1758	.0282	-.1679	.0428	-.1684	.0510	-.1669	-.0163	-.1771
.70			.2385	-.1523	.0314	-.1693	-.0056	-.1672	.0404	-.1658			-.0356	-.1775
.80	-.0285	-.1693	-.0014	-.1784	.0197	-.1692	-.0196	-.1663					-.0412	-.1934
.90	-.1186	-.1702	-.0156	-.1752	.0159	-.1695	-.0181	-.1677	.0007	-.1697	.0434	-.1612	-.0458	-.1977
.95			-.0234	-.1722	.0081	-.1688	-.0238	-.1649	-.0086	-.1719	.0326	-.1682		

TAIL 1

Cp at y/b of														
x/c	0.02		0.22		0.44		0.56		0.67		0.83		0.98	
	U.S.	L.S.	U.S.	L.S.	U.S.	L.S.	U.S.	L.S.	U.S.	L.S.	U.S.	L.S.	U.S.	L.S.
.05			.7627	-.1276	.8213	-.1632	1.3150	-.1255	1.3703	-.0257	1.3527	-.0424		
.10	.4329	-.0318	.7037	-.1235	.7814	-.1388					1.2357	-.0201	1.0057	-.0101
.15	.4122	-.0323	.6678	-.1221	.7458	-.1291			1.1766	.0540	1.1639	-.0208	.9264	-.0114
.20							1.0585	-.0995	1.1172	.0423	1.1069	-.0263	.8477	-.0051
.25	.4544	-.0694	.6143	-.1192	.6786	-.1146	1.0392	-.0978	1.0787	.0218	1.0555	-.0289	.7915	-.0036
.30	.2943	-.1102	.5818	-.1201	.6761	-.1158	.9983	-.0978	1.0213	-.0114	1.0058	-.0300	.7427	-.0039
.40	.2446	-.0785			.6639	-.1144	.9086	-.0984	.9415	-.0376	.9088	-.0326	.6572	.0002
.50			.2127	-.1479			.3558	-.1703					.5306	-.0706
.60	.2954	-.0048	.2199	-.1566	.2491	-.1778	-.0251	-.1106	.0575	-.1615	.0566	-.1428	-.0119	-.1585
.70			.2517	-.1473			-.0031	-.1676	.0262	-.1654	.0387	-.1460		
.80			.0224	-.1864	.0148	-.1674	-.0212	-.1715	.0185	-.1607	.0450	-.1487	-.0366	-.1742
.90					.0093	-.1710	-.0228	-.1717	.0061	-.1568	.0438	-.1485	-.0389	-.1860
.95			.0394	-.1135					-.0024	-.1564	.0364	-.1460	-.0451	-.1820

TAIL 2

TABLE XX. - CONTINUED
(c) $\alpha = -0.15^\circ$

Cp at γ/b of														
x/c	0.02		0.22		0.44		0.56		0.67		0.83		0.98	
	U.S.	L.S.	U.S.	L.S.	U.S.	L.S.	U.S.	L.S.	U.S.	L.S.	U.S.	L.S.	U.S.	L.S.
.05	.3541	-.0390	.6950	-.1033	.7025	.0132					1.2781	-.0028	1.0866	.0098
.10	.3091	-.0118	.6251	-.0966	.7262	-.1161			1.1812	-.0527	1.1709	.0049	.9540	.0052
.15	.3011	-.0188	.5857	-.0957	.6874	-.1072			1.1156	-.0678	1.1064	-.0018	.8556	.0127
.20	.3049	-.0293							1.0591	-.0656	1.0544	-.0062		
.25	.3153	-.0401	.5357	-.0911	.6325	-.0963	.9718	-.0716	1.0072	-.0440			.7526	.0129
.30	.1682	-.1025	.5155	-.0934	.5961	-.0985	.9477	-.0662	.9694	-.0217	.9693	-.0102	.7048	.0105
.40	.1765		.1542	-.1534	.6107	-.0841	.8674	-.0664	.8980	-.0138	.8730	-.0126	.6324	.0122
.50	.1880	-.0983	.1670	-.1506			.3306	-.1572	.5213	-.1244	.6656	-.0916	.5065	-.0629
.60	.2078	-.1144	.1573	-.1482	.2162	-.1621	.0225	-.1613	.0346	-.1626	.0409	-.1622	-.0221	-.1751
.70			.1710	-.1491	-.0006	-.1605	-.0126	-.1606	.0325	-.1602	.0239	-.1622	-.0456	-.1784
.80	-.0415	-.1634	-.0283	-.1670	-.0067	-.1608	-.0317	-.1597					-.0528	-.1956
.90	-.1254	-.1681	-.0325	-.1687	-.0081	-.1611	-.0399	-.1609	-.0004	-.1634	.0225	-.1558	-.0580	-.2046
.95			-.0352	-.1680	-.0136	-.1608	-.0461	-.1587	-.0097	-.1652	.0128	-.1616		

TAIL 1

Cp at γ/b of														
x/c	0.02		0.22		0.44		0.56		0.67		0.83		0.98	
	U.S.	L.S.	U.S.	L.S.	U.S.	L.S.	U.S.	L.S.	U.S.	L.S.	U.S.	L.S.	U.S.	L.S.
.05			.6845	-.1036	.7455	-.1449	1.1721	-.1059	1.2814	.0154	1.2683	-.0060		
.10	.3157	-.0089	.6259	-.1010	.7067	-.1183					1.1627	.0010	.9402	.0048
.15	.3114	-.0196	.5914	-.1012	.6706	-.1094			1.0952	.0752	1.0986	-.0051	.8663	-.0009
.20							.9713	-.0806	1.0341	.0555	1.0479	-.0123	.7923	.0013
.25	.3404	-.0493	.5400	-.0955	.6088	-.0990	.9597	-.0763	1.0030	.0333	1.0038	-.0150	.7416	.0031
.30	.1990	-.0916	.5135	-.0969	.6051	-.0988	.9251	-.0752	.9527	.0007	.9598	-.0155	.6965	.0045
.40	.1758	-.0649			.5914	-.0996	.8519	-.0756	.8856	-.0247	.8721	-.0162	.6170	.0004
.50			.1657	-.1365			.3327	-.1621					.5005	-.0751
.60	.2512	-.0146	.1635	-.1365	.2086	-.1730	-.0357	-.1137	.0442	-.1548	.0482	-.1427	-.0222	-.1556
.70			.2077	-.1235			-.0176	-.1670	.0124	-.1598	.0265	-.1464		
.80			.0103	-.1721	-.0073	-.1677	-.0357	-.1703	.0027	-.1583	.0298	-.1493	-.0511	-.1732
.90					-.0134	-.1726	-.0404	-.1710	-.0074	-.1553	.0275	-.1500	-.0556	-.1906
.95			.0186	-.1188					-.0158	-.1550	.0200	-.1478	-.0619	-.1907

TAIL 2

TABLE XX. - CONTINUED
(d) $\alpha = 1.86^\circ$

Cp at γ/b of														
x/c	0.02		0.22		0.44		0.56		0.67		0.83		0.98	
	U.S.	L.S.	U.S.	L.S.	U.S.	L.S.	U.S.	L.S.	U.S.	L.S.	U.S.	L.S.	U.S.	L.S.
.05	.3798	-.0523	.6596	-.0722	.6832	.0202					1.1656	.0334	.9615	.0324
.10	.3516	-.0176	.5911	-.0707	.7004	-.0820			1.1187	.0615	1.0874	-.0226	.8625	.0190
.15	.3387	-.0106	.5536	-.0715	.6608	-.0747			1.0548	.0725	1.0383	-.0121	.7788	.0216
.20	.3403	-.0176							1.0081	.0756	.9960	-.0077		
.25	.3418	-.0291	.4999	-.0701	.6035	-.0667	.9178	-.0372	.9624	.0639			.6995	.0222
.30	.1814	-.1023	.4805	-.0721	.5707	-.0736	.8941	-.0322	.9188	.0463	.9265	.0061	.6602	.0215
.40	.1432		.1344	-.1442	.5854	-.0582	.8256	-.0343	.8499	.0132	.8410	-.0041	.5998	.0185
.50	.1508	-.0957	.1382	-.1402			.3065	-.1445	.4976	-.1085	.6492	-.0809	.4881	-.0590
.60	.1755	-.1027	.1361	-.1365	.2049	-.1481	.0115	-.1575	.0311	-.1587	.0337	-.1573	-.0317	-.1721
.70			.1339	-.1395	-.0181	-.1553	-.0220	-.1563	.0290	-.1565	.0094	-.1574	-.0587	-.1732
.80	-.0587	-.1583	-.0512	-.1617	-.0323	-.1555	-.0411	-.1551					-.0669	-.1790
.90	-.1334	-.1655	-.0541	-.1630	-.0332	-.1557	-.0538	-.1560	-.0003	-.1597	-.0018	-.1514	-.0711	-.1814
.95			-.0536	-.1637	-.0379	-.1558	-.0621	-.1541	-.0092	-.1613	-.0112	-.1569		

TAIL 1

Cp at γ/b of														
x/c	0.02		0.22		0.44		0.56		0.67		0.83		0.98	
	U.S.	L.S.	U.S.	L.S.	U.S.	L.S.	U.S.	L.S.	U.S.	L.S.	U.S.	L.S.	U.S.	L.S.
.05			.5979	-.0763	.6817	-.1211	1.0373	-.0853	1.1924	.0512	1.1398	.0244		
.10	.2371	-.0029	.5430	-.0766	.6422	-.0920					1.0574	.0192	.8695	.0179
.15	.2319	-.0080	.5088	-.0755	.6061	-.0834			1.0131	.0919	1.0027	.0104	.8094	.0086
.20							.8708	-.0574	.9547	.0689	.9620	.0032	.7440	.0082
.25	.2474	-.0343	.4601	-.0659	.5436	-.0769	.8626	-.0514	.9287	.0465	.9283	.0016	.6969	.0101
.30	.1266	-.0817	.4388	-.0677	.5374	-.0757	.8362	-.0504	.8820	.0151	.8963	.0023	.6565	.0109
.40	.1260	-.0614			.5243	-.0769	.7796	-.0498	.8212	-.0093	.8241	.0041	.5835	.0098
.50			.1159	-.1203			.2989	-.1497					.4764	-.0655
.60	.2189	-.0259	.1208	-.1165	.1553	-.1604	-.0459	-.1156	.0280	-.1488	.0379	-.1466	-.0305	-.1578
.70			.1980	-.1092			-.0347	-.1598	-.0012	-.1538	.0124	-.1488		
.80			.0082	-.1642	-.0332	-.1670	-.0519	-.1628	-.0100	-.1542	.0127	-.1502	-.0623	-.1658
.90					-.0392	-.1714	-.0575	-.1640	-.0245	-.1546	.0101	-.1508	-.0688	-.1888
.95			-.0022	-.1259					-.0329	-.1556	.0026	-.1496	-.0755	-.1983

TAIL 2

TABLE XX. - CONTINUED
(e) $\alpha = 3.85^\circ$

Cp at y/b of														
x/c	0.02		0.22		0.44		0.56		0.67		0.83		0.98	
	U.S.	L.S.	U.S.	L.S.	U.S.	L.S.	U.S.	L.S.	U.S.	L.S.	U.S.	L.S.	U.S.	L.S.
.05	.3729	-.0459	.6124	-.0423	.6552	.0128					.9491	.0604	.7721	.0529
.10	.3672	-.0119	.5486	-.0427	.6678	-.0461			1.0363	.0679	.9563	.0426	.7153	.0350
.15	.3490	.0025	.5142	-.0453	.6270	-.0394			.9840	.0745	.9431	.0328	.6740	.0330
.20	.3490	-.0011							.9427	.0811	.9243	.0290		
.25	.3514	-.0104	.4671	-.0455	.5731	-.0355	.8574	-.0005	.9016	.0786			.6382	.0297
.30	.1757	-.0912	.4411	-.0484	.5415	-.0438	.8347	.0030	.8701	.0694	.8826	.0281	.6155	.0310
.40	.1177		.1086	-.1321	.5569	-.0279	.7693	-.0011	.8094	.0435	.8169	.0258	.5717	.0288
.50	.1075	-.0817	.1098	-.1275			.2851	-.1299	.4640	-.0897	.6392	-.0658	.4731	-.0506
.60	.1202	-.0895	.1080	-.1231	.1969	-.1315	-.0018	-.1510	.0334	-.1532	.0249	-.1498	-.0426	-.1593
.70			.1014	-.1283	-.0396	-.1480	-.0327	-.1494	.0319	-.1509	-.0049	-.1501	-.0699	-.1738
.80	-.0777	-.1512	-.0771	-.1524	-.0520	-.1483	-.0510	-.1481					-.0710	-.1797
.90	-.1391	-.1587	-.0765	-.1527	-.0557	-.1484	-.0642	-.1491	-.0049	-.1526	-.0230	-.1446	-.0697	-.1665
.95			-.0758	-.1530	-.0613	-.1489	-.0733	-.1469	-.0133	-.1533	-.0337	-.1498		

TAIL 1

Cp at y/b of														
x/c	0.02		0.22		0.44		0.56		0.67		0.83		0.98	
	U.S.	L.S.	U.S.	L.S.	U.S.	L.S.	U.S.	L.S.	U.S.	L.S.	U.S.	L.S.	U.S.	L.S.
.05			.5159	-.0549	.5975	-.0934	.9290	-.0599	1.0694	.0843	1.0045	.0498		
.10	.1806	.0078	.4565	-.0541	.5600	-.0634					.9531	.0386	.7764	.0337
.15	.1654	-.0037	.4176	-.0505	.5241	-.0589			.9156	.1131	.9128	.0297	.7348	.0207
.20							.7738	-.0303	.8524	.0868	.8802	.0234	.6774	.0147
.25	.1676	-.0262	.3602	-.0376	.4645	-.0537	.7625	-.0206	.8284	.0637	.8519	.0231	.6362	.0164
.30	.0673	-.0766	.3346	-.0376	.4583	-.0510	.7370	-.0181	.7892	.0339	.8261	.0252	.6021	.0164
.40	.0916	-.0626			.4455	-.0510	.6902	-.0171	.7347	.0123	.7708	.0294	.5378	.0137
.50			.0459	-.1080			.2562	-.1272					.4408	-.0657
.60	.1783	-.0375	.0831	-.1048	.1075	-.1460	-.0599	-.1172	.0037	-.1447	.0256	-.1445	-.0436	-.1527
.70			.1817	-.1053			-.0558	-.1554	-.0228	-.1494	-.0028	-.1451		
.80			-.0236	-.1615	-.0628	-.1630	-.0721	-.1575	-.0228	-.1503	-.0054	-.1457	-.0767	-.1323
.90					-.0706	-.1675	-.0801	-.1573	-.0428	-.1521	-.0084	-.1469	-.0840	-.1549
.95			-.0391	-.1231					-.0518	-.1527	-.0158	-.1467	-.0904	-.1806

TAIL 2

TABLE XX. - CONTINUED
(1) $\alpha = 5.85^\circ$

Cp at γ/b of														
x/c	0.02		0.22		0.44		0.56		0.67		0.83		0.98	
	U.S.	L.S.	U.S.	L.S.	U.S.	L.S.	U.S.	L.S.	U.S.	L.S.	U.S.	L.S.	U.S.	L.S.
.05	.3567	-.0326	.5722	-.0096	.6221	.0054					.7046	.0873	.6715	-.0791
.10	.3492	-.0017	.5044	-.0111	.6332	-.0083			.9335	.0834	.7250	-.0697	.6020	-.0587
.15	.3373	.0156	.4706	-.0160	.5895	-.0035			.8978	.0850	.7702	-.0598	.5455	.0540
.20	.3319	.0148							.8688	.0931	.7986	.0557		
.25	.3275	.0074	.4252	-.0177	.5344	-.0039	.7878	.0361	.8349	.0950			.5054	-.0440
.30	.1640	-.0759	.4083	-.0211	.5049	-.0121	.7674	.0401	.8076	.0924	.8120	-.0539	.4913	-.0439
.40	.0873		.0868	-.1177	.5231	.0057	.7103	.0359	.7566	.0759	.7763	-.0502	.4857	.0412
.50	.0734	-.0647	.0775	-.1142			.2582	-.1085	.4404	-.0696	.6229	-.0495	.4221	-.0367
.60	.0766	-.0800	.0765	-.1088	.1704	-.1129	-.0178	-.1476	.0247	-.1506	.0168	-.1462	-.0526	-.1520
.70			.0727	-.1143	-.0580	-.1433	-.0447	-.1443	.0232	-.1485	-.0187	-.1458	-.0585	-.1650
.80	-.0977	-.1419	-.0995	-.1480	-.0724	-.1427	-.0598	-.1427					-.0484	-.1826
.90	-.1438	-.1496	-.1000	-.1480	-.0767	-.1427	-.0711	-.1436	-.0126	-.1469	-.0425	-.1404	-.0503	-.1763
.95			-.0993	-.1480	-.0821	-.1433	-.0812	-.1417	-.0216	-.1475	-.0534	-.1459		

TAIL 1

Cp at γ/b of														
x/c	0.02		0.22		0.44		0.56		0.67		0.83		0.98	
	U.S.	L.S.	U.S.	L.S.	U.S.	L.S.	U.S.	L.S.	U.S.	L.S.	U.S.	L.S.	U.S.	L.S.
.05			.4204	-.0356	.5085	-.0549	.8148	-.0290	.9436	.1100	.8233	.0763		
.10	.1329	.0075	.3614	-.0318	.4716	-.0326					.8273	.0632	.6509	.0564
.15	.1266	-.0026	.3205	-.0260	.4392	-.0292			.8089	.1371	.8084	.0538	.6442	.0414
.20							.6695	.0057	.7492	.1084	.7840	.0477	.6087	.0281
.25	.1376	-.0213	.2605	-.0132	.3813	-.0265	.6547	.0192	.7279	.0858	.7617	.0487	.5813	.0259
.30	.0439	-.0728	.2362	-.0123	.3740	-.0233	.6352	.0216	.6936	.0571	.7415	.0526	.5520	.0227
.40	.0933	-.0604			.3630	-.0221	.5924	.0206	.6457	.0374	.6965	.0583	.4962	.0163
.50			.0200	-.1028			.2013	-.1125					.4091	-.0614
.60	.1174	-.0459	.0536	-.0973	.0564	-.1310	-.0781	-.1252	-.0217	-.1425	.0067	-.1444	-.0568	-.1492
.70			.1203	-.0940			-.0797	-.1516	-.0484	-.1457	-.0222	-.1410		
.80			-.0509	-.1538	-.0984	-.1592	-.0938	-.1535	-.0553	-.1466	-.0269	-.1408	-.0907	-.1206
.90					-.1064	-.1647	-.1043	-.1500	-.0669	-.1476	-.0299	-.1425	-.0984	-.1214
.95			-.0544	-.1174					-.0749	-.1468	-.0362	-.1426	-.1043	-.1570

TAIL 2

TABLE XX. - CONTINUED
(g) $\alpha = 7.85^\circ$

Cp at γ/b of															
x/c	0.02		0.22		0.44		0.56		0.67		0.83		0.98		
	U.S.	L.S.	U.S.	L.S.	U.S.	L.S.	U.S.	L.S.	U.S.	L.S.	U.S.	L.S.	U.S.	L.S.	
.05	.3371	-.0164	.5412	.0260	.5860	-.0017					.6163	.1191	.5924	.1094	
.10	.3210	.0124	.4664	.0225	.5942	.0283				.8300	.1073	.6156	.1014	.5323	.0868
.15	.3138	.0315	.4322	.0162	.5524	.0335				.8191	.1081	.6195	.0915	.4799	.0785
.20	.3061	.0331								.7991	.1122	.6325	.0875		
.25	.2950	.0275	.3853	.0131	.4971	.0321	.7159	.0743	.7736	.1144			.4443	.0643	
.30	.1459	-.0589	.3652	.0089	.4675	.0230	.7020	.0732	.7473	.1151	.6685	.0856	.4245	.0634	
.40	.0558		.0707	-.1015	.4765	.0403	.6526	.0733	.7033	.1062	.6715	.0802	.3976	.0589	
.50	.0412	-.0429	.0504	-.1010			.2265	-.0627	.4119	-.0482	.5620	-.0290	.3342	-.0242	
.60	.0400	-.0655	.0468	-.0943	.1425	-.0922	-.0317	-.1501	-.0073	-.1482	.0050	-.1422	-.0788	-.1455	
.70			.0414	-.0983	-.0707	-.1399	-.0566	-.1400	-.0087	-.1467	-.0297	-.1397	-.0741	-.1522	
.80	-.1181	-.1291	-.1147	-.1432	-.0875	-.1375	-.0650	-.1376					-.0659	-.1865	
.90	-.1507	-.1439	-.1184	-.1426	-.0940	-.1373	-.0761	-.1379	-.0323	-.1396	-.0530	-.1348	-.0619	-.1803	
.95			-.1193	-.1434	-.0995	-.1381	-.0863	-.1366	-.0397	-.1400	-.0643	-.1391			

TAIL 1

Cp at γ/b of															
x/c	0.02		0.22		0.44		0.56		0.67		0.83		0.98		
	U.S.	L.S.	U.S.	L.S.	U.S.	L.S.	U.S.	L.S.	U.S.	L.S.	U.S.	L.S.	U.S.	L.S.	
.05			.3301	-.0176	.4110	-.0160	.6915	.0067	.8038	.1374	.6158	.1079			
.10	.1184	.0072	.2861	-.0125	.3787	-.0008					.6584	.0934	.5296	.0852	
.15	.1386	-.0002	.2594	-.0062	.3480	-.0009				.6928	.1654	.6796	.0840	.5139	.0710
.20							.5638	.0511	.6529	.1355	.6796	.0789	.4884	.0549	
.25	.1624	-.0206	.2030	.0019	.2929	-.0010	.5424	.0698	.6210	.1135	.6661	.0816	.4794	.0500	
.30	.0832	-.0727	.1713	.0012	.2815	.0038	.5230	.0716	.5949	.0871	.6509	.0867	.4703	.0421	
.40	.0993	-.0606			.2673	.0058	.4832	.0675	.5515	.0731	.6156	.0931	.4412	.0301	
.50			.0058	-.1003			.1390	-.0822					.3668	-.0581	
.60	.0981	-.0518	.0617	-.0933	.0033	-.1088	-.0964	-.1327	-.0495	-.1523	-.0204	-.1515	-.0692	-.1477	
.70			.0801	-.0775			-.1066	-.1490	-.0750	-.1450	-.0484	-.1415			
.80			-.0824	-.1492	-.1316	-.1509	-.1174	-.1480	-.0825	-.1435	-.0537	-.1374	-.0998	-.1328	
.90					-.1277	-.1543	-.1281	-.1472	-.0936	-.1443	-.0559	-.1392	-.1000	-.1385	
.95			-.0766	-.1152					-.1012	-.1438	-.0608	-.1390	-.1002	-.1427	

TAIL 2

TABLE XX. - CONTINUED
(h) $\alpha = 9.84^\circ$

Cp at y/b of														
x/c	0.02		0.22		0.44		0.56		0.67		0.83		0.98	
	U.S.	L.S.	U.S.	L.S.	U.S.	L.S.	U.S.	L.S.	U.S.	L.S.	U.S.	L.S.	U.S.	L.S.
.05	.3218	.0011	.5141	.0629	.5541	-.0049					.5174	.1499	.5211	.1415
.10	.2982	.0290	.4381	.0572	.5595	.0672			.6860	.1389	.5160	.1334	.4623	.1146
.15	.2924	.0486	.3989	.0499	.5182	.0704			.7126	.1385	.5186	.1230	.4123	.1005
.20	.2834	.0527							.7160	.1407	.5229	.1185		
.25	.2670	.0494	.3488	.0455	.4659	.0677	.6582	-.1182	.7100	.1416			.3802	.0827
.30	.1247	-.0407	.3281	.0401	.4350	.0592	.6486	-.1243	.6923	.1433	.5454	.1167	.3619	.0807
.40	.0255		.0525	-.0853	.4424	.0772	.6036	-.1214	.6546	.1383	.5510	.1108	.3369	.0751
.50	.0092	-.0156	.0254	-.0864			.1934	-.0542	.3837	-.0272	.4555	-.0081	.2781	-.0162
.60	.0059	-.0473	.0201	-.0789	.1130	-.0705	-.0469	-.1553	-.0267	-.1482	-.0209	-.1363	-.0893	-.1388
.70			.0083	-.0816	-.0864	-.1390	-.0673	-.1349	-.0275	-.1464	-.0503	-.1319	-.1023	-.1395
.80	-.1368	-.1133	-.1301	-.1369	-.1037	-.1319	-.0746	-.1305					-.0989	-.1769
.90	-.1587	-.1449	-.1367	-.1355	-.1089	-.1309	-.0837	-.1303	-.0558	-.1321	-.0674	-.1263	-.0830	-.1818
.95			-.1363	-.1360	-.1141	-.1317	-.0929	-.1293	-.0621	-.1323	-.0775	-.1303		

TAIL 1

Cp at y/b of														
x/c	0.02		0.22		0.44		0.56		0.67		0.83		0.98	
	U.S.	L.S.	U.S.	L.S.	U.S.	L.S.	U.S.	L.S.	U.S.	L.S.	U.S.	L.S.	U.S.	L.S.
.05			.2636	-.0095	.3017	.0054	.5518	.0447	.6628	.1876	.4827	.1444		
.10	.1161	.0026	.2321	-.0025	.2733	.0182					.4864	.1286	.4366	.1204
.15	.1494	-.0046	.2157	.0009	.2456	.0174			.5682	.2002	.5170	.1213	.4204	.1066
.20							.4325	.1014	.5288	.1672	.5384	.1184	.3895	.0894
.25	.1802	-.0260	.1724	.0036	.1910	.0186	.4189	.1113	.5019	.1463	.5474	.1239	.3726	.0809
.30	.0981	-.0760	.1454	.0012	.1773	.0216	.3960	.1080	.4752	.1259	.5450	.1321	.3605	.0690
.40	.1069	-.0670			.1552	.0202	.3574	.1077	.4377	.1189	.5209	.1409	.3474	.0529
.50			.0468	-.1004			.0635	-.0642					.2969	-.0377
.60	.1053	-.0609	.0677	-.0875	-.0602	-.0973	-.1159	-.1368	-.0844	-.1586	-.0488	-.1422	-.0877	-.1476
.70			.0614	-.0673			-.1410	-.1506	-.1103	-.1533	-.0775	-.1556		
.80			-.0864	-.1481	-.1337	-.1465	-.1511	-.1452	-.1181	-.1459	-.0841	-.1385	-.0997	-.1312
.90					-.1225	-.1499	-.1507	-.1440	-.1265	-.1443	-.0863	-.1349	-.0912	-.1363
.95			-.0984	-.1261					-.1332	-.1440	-.0903	-.1349	-.0925	-.1302

TAIL 2

TABLE XX. - CONTINUED
(i) $\alpha = 11.86^\circ$

Cp at γ/b of														
x/c	0.02		0.22		0.44		0.56		0.67		0.83		0.98	
	U.S.	L.S.	U.S.	L.S.	U.S.	L.S.	U.S.	L.S.	U.S.	L.S.	U.S.	L.S.	U.S.	L.S.
.05	.3024	.0165	.4741	.1062	.4955	-.0100					.4969	.1860	.4970	.1840
.10	.2721	.0444	.3977	.0973	.5008	.1107			.5191	.1747	.4960	.1702	.4399	.1516
.15	.2654	.0630	.3515	.0891	.4663	.1126			.5502	.1744	.4938	.1601	.3934	.1375
.20	.2515	.0689							.5741	.1742	.4912	.1569		
.25	.2306	.0681	.3078	.0814	.4226	.1107	.5851	.1647	.5840	.1737			.3639	.1169
.30	.0884	-.0215	.2875	.0738	.4005	.0924	.5817	.1730	.5870	.1753	.4857	.1555	.3472	.1145
.40	-.0120		.0256	-.0673	.3981	.1158	.5459	.1717	.5796	.1726	.4702	.1499	.3242	.1077
.50	-.0202	.0264	.0074	-.0684			.1648	-.0247	.3406	-.0059	.3767	.0180	.2673	.0052
.60	-.0234	-.0324	-.0107	-.0585	.0857	-.0477	-.0588	-.1471	-.0425	-.1451	-.0674	-.1348	-.0878	-.1314
.70			-.0204	-.0610	-.1002	-.1533	-.0770	-.1338	-.0432	-.1430	-.0944	-.1246	-.1061	-.1257
.80	-.1528	-.0982	-.1468	-.1339	-.1179	-.1322	-.0856	-.1240					-.0902	-.1620
.90	-.1670	-.1348	-.1482	-.1290	-.1233	-.1288	-.0933	-.1232	-.0749	-.1253	-.1013	-.1188	-.0785	-.1807
.95			-.1384	-.1290	-.1261	-.1298	-.1012	-.1223	-.0810	-.1248	-.1096	-.1224		

TAIL 1

Cp at γ/b of														
x/c	0.02		0.22		0.44		0.56		0.67		0.83		0.98	
	U.S.	L.S.	U.S.	L.S.	U.S.	L.S.	U.S.	L.S.	U.S.	L.S.	U.S.	L.S.	U.S.	L.S.
.05			.2060	.0040	.2164	.0147	.3999	.0723	.5225	.2662	.3568	.1895		
.10	.1156	-.0067	.1917	.0061	.1929	.0249					.3475	.1740	.3447	.1605
.15	.1499	-.0156	.1830	.0055	.1664	.0246			.4381	.2236	.3633	.1686	.3320	.1471
.20							.2990	.1245	.4044	.1893	.3888	.1697	.3075	.1292
.25	.1828	-.0370	.1507	.0019	.1183	.0221	.2878	.1375	.3795	.1766	.4040	.1808	.2905	.1226
.30	.0854	-.0810	.1281	-.0020	.1050	.0261	.2691	.1358	.3505	.1644	.4143	.1924	.2765	.1109
.40	.0851	-.0762			.0782	.0216	.2239	.1315	.3105	.1595	.4066	.2006	.2615	.0947
.50			.0651	-.1002			-.0050	-.0507					.2207	-.0131
.60	.0956	-.0735	.0714	-.0819	-.0765	-.0980	-.1351	-.1394	-.1224	-.1502	-.0817	-.1339	-.1106	-.1508
.70			.0734	-.0666			-.1699	-.1698	.1468	-.1663	-.1093	-.1526		
.80			-.0759	-.1503	-.1491	-.1520	-.1552	-.1546	-.1540	-.1582	-.1167	-.1377	-.1020	-.1284
.90					-.1491	-.1518	-.1515	-.1526	-.1557	-.1469	-.1188	-.1294	-.1011	-.1284
.95			-.0902	-.1335					-.1515	-.1453	-.1212	-.1286	-.1033	-.1264

TAIL 2

TABLE XX. - CONTINUED
(j) $\alpha = 15.85^\circ$

Cp at y/b of															
x/c	0.02		0.22		0.44		0.56		0.67		0.83		0.98		
	U.S.	L.S.	U.S.	L.S.	U.S.	L.S.	U.S.	L.S.	U.S.	L.S.	U.S.	L.S.	U.S.	L.S.	
.05	.3489	.0805	.5134	.1989	.5220	-.0274					.4888	.2931	.4902	.2824	
.10	.3209	.1133	.4313	.1849	.5186	.2133				.5055	.2763	.4927	.2749	.4325	.2413
.15	.3083	.1332	.3802	.1742	.4823	.2152				.5221	.2772	.4906	.2626	.3900	.2225
.20	.2881	.1399								.5452	.2792	.4863	.2582		
.25	.2601	.1398	.3191	.1611	.4268	.2137	.5815	.2824	.5602	.2793			.3635	.1961	
.30	.1044	.0389	.2923	.1526	.3916	.1941	.5741	.2947	.5669	.2822	.4793	.2552	.3489	.1925	
.40	-.0106		.0223	-.0194	.3883	.2221	.5355	.2928	.5674	.2806	.4611	.2467	.3277	.1842	
.50	-.0276	.1104	-.0064	-.0124			.1522	.0423	.3428	.0573	.3670	.0835	.2721	.0603	
.60	-.0392	.0218	-.0214	-.0004	.0710	.0136	-.0629	-.1135	-.0461	-.1200	-.0760	-.1178	-.0785	-.1018	
.70			-.0417	-.0054	-.1083	-.1294	-.0840	-.1269	-.0464	-.1185	-.1037	-.0976	-.1069	-.0936	
.80	-.1572	-.0538	-.1574	-.1185	-.1275	-.1384	-.0940	-.1047					-.0714	-.1167	
.90	-.1648	-.0964	-.1428	-.1216	-.1300	-.1170	-.1025	-.0975	-.0844	-.0942	-.1086	-.0923	-.0536	-.1623	
.95			-.1373	-.1191	-.1212	-.1137	-.1079	-.0963	-.0896	-.0931	-.1060	-.0937			

TAIL 1

Cp at y/b of														
x/c	0.02		0.22		0.44		0.56		0.67		0.83		0.98	
	U.S.	L.S.	U.S.	L.S.	U.S.	L.S.	U.S.	L.S.	U.S.	L.S.	U.S.	L.S.	U.S.	L.S.
.05			.1101	.0005	.0612	.0263	.1425	.1132	.2357	.3485	.1035	.2477		
.10	.1454	-.0483	.1033	-.0009	.0460	.0251					.0936	.2518	.1276	.2347
.15	.1826	-.0610	.0925	-.0036	.0283	.0193					.0989	.2685	.1172	.2254
.20							.0874	.1424	.1215	.2238	.1157	.2811	.1033	.2130
.25	.1576	-.0847	.0762	-.0119	-.0097	.0140	.0654	.1506	.0994	.2137	.1251	.2848	.0926	.2185
.30	.0531	-.1181	.0781	-.0159	-.0246	.0160	.0509	.1439	.0777	.1973	.1302	.2826	.0826	.2148
.40	.0470	-.1129			-.0483	.0090	.0184	.1357	.0447	.1855	.1288	.2631	.0682	.2000
.50			.0434	-.0868			-.1206	-.0453					.0392	.0600
.60	.0724	-.1049	.0516	-.0627	-.0940	-.1053	-.1514	-.1456	-.1804	-.1437	-.1599	-.1186	-.1644	-.1314
.70			.0461	-.0588			-.1714	-.1760	-.1754	-.1618	-.1770	-.1368		
.80			-.1051	-.1470	-.1716	-.1664	-.1709	-.1826	-.1739	-.1665	-.1684	-.1399	-.1418	-.1248
.90					-.1697	-.1664	-.1702	-.1723	-.1723	-.1675	-.1585	-.1447	-.1411	-.1264
.95			-.1165	-.1477					-.1738	-.1732	-.1563	-.1492	-.1376	-.1281

TAIL 2

TABLE XX. - CONCLUDED
(k) $\alpha = 19.88^\circ$

Cp at y/b of														
x/c	0.02		0.22		0.44		0.56		0.67		0.83		0.98	
	U.S.	L.S.	U.S.	L.S.	U.S.	L.S.	U.S.	L.S.	U.S.	L.S.	U.S.	L.S.	U.S.	L.S.
.05	.4037	.1702	.5598	.3224	.5785	-.0423					.5018	.4460	.4868	.3985
.10	.3755	.2042	.4722	.3034	.5607	.3517			.5306	.4108	.5063	.4252	.4302	.3457
.15	.3570	.2299	.4168	.2832	.5223	.3509			.5416	.4123	.5011	.4095	.3925	.3204
.20	.3328	.2388							.5649	.4160	.4963	.4039		
.25	.2997	.2402	.3508	.2586	.4618	.3411	.6142	.4601	.5803	.4227			.3689	.2866
.30	.1318	.1219	.3206	.2497	.4236	.3253	.6063	.4672	.5867	.4301	.4866	.3977	.3572	.2806
.40	.0178		.0348	.0389	.4220	.3593	.5611	.4605	.5886	.4320	.4672	.3849	.3397	.2708
.50	-.0107	-.0826	.0020	.0430			.1637	.1298	.3514	.1492	.3711	.1758	.2858	.1210
.60	-.0327	-.0817	-.0149	.0643	.0789	.0901	-.0588	-.0682	-.0427	-.0731	-.0770	-.0960	-.0700	-.0738
.70			-.0301	.0668	-.1052	-.0935	-.0817	-.0866	-.0434	-.0724	-.1017	-.0719	-.0994	-.0618
.80	-.1526	.0106	-.1527	-.0717	-.1244	-.1138	-.0913	-.0930					-.0474	-.0640
.90	-.1507	-.0490	-.1341	-.0739	-.1049	-.1107	-.0935	-.0785	-.0773	-.0546	-.0659	-.0618	-.0655	-.1155
.95			-.1278	-.0748	-.0985	-.0988	-.0715	-.0655	-.0605	-.0474	-.0662	-.0621		

TAIL 1

Cp at y/b of														
x/c	0.02		0.22		0.44		0.56		0.67		0.83		0.98	
	U.S.	L.S.	U.S.	L.S.	U.S.	L.S.	U.S.	L.S.	U.S.	L.S.	U.S.	L.S.	U.S.	L.S.
.05			-.0244	.0095	-.0213	.0520	.0014	.1575	.1057	.3806	.0091	.3183		
.10	.1122	-.0470	.0210	.0013	-.0233	.0452					.0013	.3389	-.0016	.2939
.15	.1482	-.0623	.0056	-.0048	-.0341	.0346			.0122	.2749	.0042	.3304	-.0081	.3039
.20							.0118	.1664	-.0006	.2501	.0112	.3149	-.0199	.3026
.25	.1064	-.0894	-.0136	-.0115	-.0634	.0261	-.0042	.1806	-.0084	.2391	.0131	.3030	-.0292	.3013
.30	.0125	-.1241	-.0056	-.0153	-.0771	.0272	-.0172	.1675	-.0187	.2188	.0105	.2913	-.0377	.2910
.40	.0084	-.1204			-.0963	.0167	-.0418	.1551	-.0381	.2032	-.0074	.2668	-.0474	.2666
.50			-.0166	-.0597			-.1509	-.0374					-.0695	.0946
.60	.0338	-.1205	-.0125	-.0464	-.1243	-.0829	-.1601	-.1482	-.1935	-.1345	-.1871	-.1044	-.1945	-.1161
.70			-.0215	-.0490			-.1887	-.1726	-.1888	-.1553	-.1815	-.1280		
.80			-.1405	-.1457	-.1798	-.1384	-.1869	-.1658	-.1878	-.1626	-.1806	-.1368	-.1766	-.1337
.90					-.1793	-.1434	-.1807	-.1602	-.1855	-.1683	-.1796	-.1441	-.1815	-.1365
.95			-.1523	-.1616					-.1897	-.1738	-.1787	-.1500	-.1771	-.1395

TAIL 2

TABLE XXI. - PRESSURE COEFFICIENTS, $\phi = 45^\circ$, $\delta = -15^\circ$, $M = 3.70$.
(a) $\alpha = -4.00^\circ$

Cp at y/b of														
x/c	0.02		0.22		0.44		0.56		0.67		0.83		0.98	
	U.S.	L.S.	U.S.	L.S.	U.S.	L.S.	U.S.	L.S.	U.S.	L.S.	U.S.	L.S.	U.S.	L.S.
.05	.1443	-.0127	.6519	-.0392							.8334	.0110	.8127	.0118
.10	.1043	-.0114	.5899	-.0443	.6838	-.0337			1.0030	.0074	.8430	-.0064	.7772	-.0009
.15	.1088	-.0098	.5616	-.0471	.6476	-.0411			.9777	-.0025	.8731	-.0159	.7456	-.0006
.20	.1182	-.0098							.9498	-.0011	.8950	-.0209		
.25	.1314	-.0165	.5517	-.0454	.6013	-.0323	.8965	-.0227	.9125	-.0056			.6879	-.0103
.30	.0984	-.0370	.5569	-.0498	.5707	-.0095	.8873	-.0241	.8750	-.0062	.9078	-.0213	.6690	-.0102
.40	.0959		.2856	-.0486	.5766	-.0374	.8431	-.0284	.8340	-.0129	.8807	-.0282	.6537	-.0139
.50	.1225		.2561	-.0552			.3909	-.0506	.5433	-.0399	.7443	-.0467	.5731	-.0331
.60	.1408	-.0467	.2449	-.0510	.2563	-.0483	.1150	-.0482	.1340	-.0422	.1526	-.0542	.0949	-.0589
.70			.2521	-.0540	.0781	-.0471	.0779	-.0477	.1351	-.0380	.1213	-.0542	.0638	-.0569
.80	.0196	-.0581	.0518	-.0482	.0660	-.0480	.0607	-.0457					.0533	-.0587
.90	-.0155	-.0470	.0378	-.0555	.0605	-.0481	.0522	-.0479	.0881	-.0387	.1134	-.0506	.0446	-.0597
.95			.0351	-.0553	.0522	-.0316	.0485	-.0437	.0769	-.0549	.1092	-.0522		

TAIL 1

Cp at y/b of														
x/c	0.02		0.22		0.44		0.56		0.67		0.83		0.98	
	U.S.	L.S.	U.S.	L.S.	U.S.	L.S.	U.S.	L.S.	U.S.	L.S.	U.S.	L.S.	U.S.	L.S.
.05			.7228	-.0293	.7907	-.0299	1.1346	.0042	1.0188	-.0065	.8142	.0165		
.10	.5331	-.0349	.6782	-.0406	.7545	-.0310					.8014	-.0016	.7270	.0128
.15	.4462	-.0282	.6522	-.0448	.7205	-.0370			1.0053	-.0185	.8049	-.0099	.6988	-.0030
.20							.9495	-.0037	.9783	-.0200	.8217	-.0161	.6607	-.0086
.25	.4265	-.0372	.6067	-.0486	.6601	-.0389	.9388	-.0238	.9583	-.0209	.8385	-.0182	.6357	-.0099
.30	.3380	-.0520	.5822	-.0503	.6583	-.0426	.9113	-.0268	.9346	-.0220	.8545	-.0199	.6129	-.0107
.40	.2655	-.0429			.6552	-.0175	.8616	-.0320	.8922	-.0195	.8603	-.0215	.5794	-.0134
.50			.2680	-.0539			.4178	-.0546					.5113	-.0334
.60	.2627	-.0188	.2634	-.0547	.2746	-.0389	.0388	-.0462	.1860	-.0457	.1737	-.0415	.0698	-.0426
.70			.2455	-.0537			.0903	-.0486	.1538	-.0461	.1331	-.0399		
.80			.0545	-.0569	.0864	-.0379	.0739	-.0483	.1406	-.0387	.1195	-.0411	.0378	-.0388
.90					.0763	-.0502	.0666	-.0498	.1236	-.0314	.1091	-.0416	.0394	-.0413
.95			.0349	-.0532					.1153	-.0420	.1013	-.0398	.0371	-.0302

TAIL 2

TABLE XXI. - CONTINUED
(b) $\alpha = -2.00^\circ$

Cp at y/b of														
x/c	0.02		0.22		0.44		0.56		0.67		0.83		0.98	
	U.S.	L.S.	U.S.	L.S.	U.S.	L.S.	U.S.	L.S.	U.S.	L.S.	U.S.	L.S.	U.S.	L.S.
.05	.1774	-.0138	.6180	-.0308							.7484	.0218	.7352	.0214
.10	.1464	-.0119	.5611	-.0374	.6550	-.0261					.7385	.0021	.7026	-.0082
.15	.1464	-.0104	.5321	-.0406	.6216	-.0349			.9100	.0122	.7441	-.0067	.6692	-.0069
.20	.1589	-.0113							.8971	.0022	.7557	-.0117		
.25	.1785	-.0171	.5040	-.0401	.5785	-.0286	.8367	-.0142	.8709	-.0027			.6121	-.0023
.30	.1272	-.0377	.4938	-.0447	.5527	-.0064	.8320	-.0153	.8477	-.0025	.7810	-.0137	.5852	-.0017
.40	.0997		.2314	-.0484	.5603	-.0322	.7877	-.0201	.8049	-.0073	.7860	-.0190	.5552	-.0047
.50	.1107		.2135	-.0539			.3650	-.0484	.5364	-.0363	.6809	-.0413	.4811	-.0283
.60	.1494	-.0448	.2051	-.0491	.2530	-.0475	.0993	-.0469	.1357	-.0414	.1391	-.0519	.0521	-.0564
.70			.1903	-.0512	.0642	-.0456	.0678	-.0463	.1369	-.0373	.1069	-.0520	.0267	-.0546
.80	.0279	-.0570	.0290	-.0457	.0491	-.0460	.0537	-.0440					.0222	-.0564
.90	-.0173	-.0460	.0136	-.0532	.0465	-.0464	.0433	-.0461	.0823	-.0370	.0849	-.0488	.0202	-.0563
.95			.0124	-.0527	.0410	-.0297	.0380	-.0419	.0738	-.0526	.0795	-.0504		

TAIL 1

Cp at y/b of														
x/c	0.02		0.22		0.44		0.56		0.67		0.83		0.98	
	U.S.	L.S.	U.S.	L.S.	U.S.	L.S.	U.S.	L.S.	U.S.	L.S.	U.S.	L.S.	U.S.	L.S.
.05			.6439	-.0274	.7101	-.0251	1.0168	.0101	.8296	-.0019	.7366	.0226		
.10	.3525	-.0299	.5992	-.0387	.6764	-.0281					.7256	.0036	.6657	.0165
.15	.2935	-.0234	.5759	-.0430	.6452	-.0341			.9052	-.0140	.7237	-.0049	.6425	-.0002
.20							.8707	-.0146	.8927	-.0163	.7249	-.0108	.6070	-.0060
.25	.3143	-.0326	.5354	-.0474	.5891	-.0377	.8528	-.0213	.8768	-.0164	.7300	-.0133	.5826	-.0071
.30	.2375	-.0526	.5163	-.0490	.5880	-.0406	.8265	-.0243	.8564	-.0179	.7435	-.0150	.5608	-.0074
.40	.1855	-.0476			.5822	-.0255	.7875	-.0295	.8202	-.0168	.7509	-.0180	.5259	-.0099
.50			.2274	-.0569			.3745	-.0579					.4604	-.0343
.60	.1938	-.0098	.2200	-.0572	.2399	-.0458	.0259	-.0500	.1622	-.0483	.1467	-.0449	.0518	-.0482
.70			.2027	-.0578			.0686	-.0524	.1254	-.0488	.1124	-.0446		
.80			.0295	-.0594	.0625	-.0409	.0548	-.0525	.1122	-.0441	.1021	-.0459	.0147	-.0438
.90					.0491	-.0545	.0465	-.0528	.0989	-.0371	.0925	-.0461	.0146	-.0466
.95			.0107	-.0554					.0910	-.0463	.0849	-.0450	.0144	-.0368

TAIL 2

TABLE XXI. - CONTINUED
(c) $\alpha = -0.01^\circ$

Cp at y/b of														
x/c	0.02		0.22		0.44		0.56		0.67		0.83		0.98	
	U.S.	L.S.	U.S.	L.S.	U.S.	L.S.	U.S.	L.S.	U.S.	L.S.	U.S.	L.S.	U.S.	L.S.
.05	.2219	-.0159	.5748	-.0237							.6762	.0334	.6732	.0332
.10	.1951	-.0144	.5261	-.0309	.6146	-.0191			.7576	.0186	.6667	.0125	.6389	.0186
.15	.1856	-.0123	.4986	-.0344	.5845	-.0280			.7897	.0098	.6666	.0031	.6046	.0148
.20	.1932	-.0114							.8034	.0095	.6668	-.0022		
.25	.2102	-.0160	.4658	-.0343	.5440	-.0237	.7645	-.0061	.8009	.0044			.5517	.0043
.30	.1437	-.0388	.4528	-.0388	.5297	-.0038	.7619	-.0065	.7901	.0041	.6720	-.0049	.5305	.0044
.40	.1090		.2093	-.0469	.5224	-.0262	.7291	-.0113	.7619	-.0002	.6698	-.0092	.4978	.0008
.50	.1105		.1862	-.0536			.3394	-.0464	.5110	-.0333	.5739	-.0365	.4314	-.0244
.60	.1364	-.0450	.1741	-.0484	.2162	-.0480	.0881	-.0470	.1239	-.0416	.1028	-.0521	.0309	-.0567
.70			.1586	-.0498	.0506	-.0455	.0552	-.0460	.1253	-.0374	.0782	-.0524	.0046	-.0550
.80	.0246	-.0566	.0153	-.0443	.0331	-.0459	.0436	-.0437					-.0031	-.0568
.90	-.0200	-.0457	-.0041	-.0520	.0285	-.0460	.0342	-.0457	.0797	-.0373	.0644	-.0491	-.0072	-.0566
.95			-.0064	-.0517	.0304	-.0305	.0286	-.0416	.0714	-.0525	.0596	-.0505		

TAIL 1

Cp at y/b of														
x/c	0.02		0.22		0.44		0.56		0.67		0.83		0.98	
	U.S.	L.S.	U.S.	L.S.	U.S.	L.S.	U.S.	L.S.	U.S.	L.S.	U.S.	L.S.	U.S.	L.S.
.05			.5624	-.0214	.6298	-.0195	.9072	.0135	.7004	.0092	.6758	.0331		
.10	.2149	-.0199	.5206	-.0319	.6018	-.0223					.6644	.0134	.6129	.0260
.15	.1956	-.0151	.4976	-.0362	.5734	-.0290			.7886	-.0029	.6607	.0043	.5929	.0081
.20									.7928	-.0091	.7946	-.0054	.6563	-.0015
.25	.2247	-.0219	.4650	-.0402	.5225	-.0326	.7701	-.0121	.7965	-.0058	.6531	-.0044	.5368	-.0003
.30	.1617	-.0437	.4499	-.0414	.5211	-.0349	.7427	-.0151	.7803	-.0070	.6581	-.0059	.5166	-.0007
.40	.1243	-.0427			.5165	-.0231	.7115	-.0199	.7438	-.0075	.6630	-.0091	.4832	-.0021
.50			.1849	-.0558			.3330	-.0543					.4209	-.0280
.60	.1325	-.0185	.1739	-.0559	.2113	-.0465	.0152	-.0495	.1325	-.0471	.1090	-.0455	.0363	-.0495
.70			.1588	-.0568			.0496	-.0501	.1011	-.0478	.0807	-.0453		
.80			.0087	-.0580	.0380	-.0404	.0382	-.0504	.0890	-.0436	.0757	-.0466	-.0012	-.0456
.90					.0239	-.0537	.0296	-.0513	.0766	-.0370	.0694	-.0468	-.0034	-.0483
.95			-.0075	-.0533					.0686	-.0462	.0635	-.0455	-.0027	-.0382

TAIL 2

TABLE XXI. - CONTINUED
(d) $\alpha = 1.99^\circ$

Cp at γ/b of														
x/c	0.02		0.22		0.44		0.56		0.67		0.83		0.98	
	U.S.	L.S.	U.S.	L.S.	U.S.	L.S.	U.S.	L.S.	U.S.	L.S.	U.S.	L.S.	U.S.	L.S.
.05	.2569	-.0171	.5320	-.0143							.6025	.0446	.6070	.0458
.10	.2544	-.0154	.4853	-.0221	.5677	-.0094			.6298	.0277	.5910	-.0238	.5729	.0300
.15	.2093	-.0116	.4567	-.0256	.5427	-.0190			.6618	.0205	.5947	.0144	.5411	-.0248
.20	.2119	-.0087							.6804	.0203	.5935	-.0095		
.25	.2277	-.0114	.4294	-.0252	.5071	-.0167	.6934	.0044	.6871	.0154			.4922	.0122
.30	.1516	-.0375	.4158	-.0299	.4901	.0004	.6953	.0053	.6896	.0148	.5917	.0063	.4755	-.0116
.40	.1019		.1811	-.0438	.4835	-.0175	.6671	.0015	.6886	.0105	.5816	.0024	.4484	.0080
.50	.0981		.1560	-.0522			.2963	-.0415	.4569	-.0284	.4939	-.0300	.3851	-.0191
.60	.1125	-.0451	.1479	-.0472	.1976	-.0459	.0739	-.0462	.0887	-.0411	.0695	-.0519	.0145	-.0555
.70			.1362	-.0480	.0368	-.0447	.0443	-.0451	.0906	-.0370	.0402	-.0521	-.0101	-.0550
.80	.0123	-.0560	.0061	-.0420	.0196	-.0448	.0357	-.0425					-.0171	-.0570
.90	-.0256	-.0449	-.0142	-.0501	.0165	-.0450	.0265	-.0447	.0593	-.0374	.0317	-.0487	-.0200	-.0562
.95			-.0174	-.0499	.0191	-.0304	.0211	-.0405	.0509	-.0520	.0279	-.0503		

TAIL 1

Cp at γ/b of														
x/c	0.02		0.22		0.44		0.56		0.67		0.83		0.98	
	U.S.	L.S.	U.S.	L.S.	U.S.	L.S.	U.S.	L.S.	U.S.	L.S.	U.S.	L.S.	U.S.	L.S.
.05			.4777	-.0124	.5455	-.0122	.7991	.0181	.6166	.0216	.6109	.0453		
.10	.1397	-.0089	.4433	-.0223	.5247	-.0155					.5995	.0258	.5581	.0367
.15	.1358	-.0063	.4209	-.0265	.5013	-.0216			.6790	.0103	.5957	.0162	.5412	.0183
.20							.7025	-.0003	.6841	.0075	.5911	.0105	.5116	.0091
.25	.1538	-.0124	.3865	-.0296	.4565	-.0246	.6940	.0004	.6957	.0075	.5850	.0076	.4902	.0073
.30	.1055	-.0347	.3735	-.0306	.4549	-.0265	.6656	-.0021	.6955	.0051	.5854	.0064	.4717	.0062
.40	.0813	-.0366			.4506	-.0184	.6417	-.0064	.6686	.0042	.5843	.0035	.4409	.0039
.50			.1373	-.0534			.2975	-.0497					.3826	-.0259
.60	.0923	-.0245	.1246	-.0537	.1757	-.0468	.0027	-.0492	.1012	-.0463	.0763	-.0445	.0249	-.0476
.70			.1114	-.0541			.0289	-.0491	.0701	-.0478	.0515	-.0446		
.80			-.0116	-.0554	.0191	-.0384	.0190	-.0490	.0585	-.0433	.0492	-.0457	-.0109	-.0443
.90					.0043	-.0513	.0116	-.0491	.0499	-.0373	.0462	-.0461	-.0140	-.0470
.95			-.0235	-.0515					.0421	-.0463	.0421	-.0446	-.0119	-.0378

TAIL 2

TABLE XXI. - CONTINUED
(e) $\alpha = 3.99^\circ$

Cp at γ/b of														
x/c	0.02		0.22		0.44		0.56		0.67		0.83		0.98	
	U.S.	L.S.	U.S.	L.S.	U.S.	L.S.	U.S.	L.S.	U.S.	L.S.	U.S.	L.S.	U.S.	L.S.
.05	.2945	-.0139	.4851	-.0041							.5520	.0603	.5586	.0618
.10	.2664	-.0128	.4479	-.0116	.5095	-.0001			.5498	.0393	.5366	.0393	.5243	.0440
.15	.2430	-.0075	.4183	-.0147	.4938	-.0084			.5614	.0332	.5382	.0294	.4925	.0369
.20	.2252	-.0035							.5708	.0332	.5354	.0245		
.25	.2407	-.0045	.3839	.0142	.4663	-.0076	.6205	.0179	.5771	.0287			.4470	.0225
.30	.1576	-.0344	.3703	-.0189	.4569	-.0071	.6275	.0198	.5823	.0280	.5307	.0202	.4304	.0212
.40	.0941		.1514	-.0399	.4443	-.0062	.6111	.0166	.5833	.0238	.5188	.0165	.4071	.0166
.50	.0837		.1294	-.0498			.2652	-.0350	.3976	-.0221	.4368	-.0216	.3481	-.0143
.60	-.0836	-.0447	.1205	-.0457	.1753	-.0423	.0525	-.0456	.0665	-.0406	.0496	-.0512	.0039	-.0545
.70			.1097	-.0468	.0231	-.0440	.0297	-.0441	.0687	-.0365	.0165	-.0512	-.0179	-.0548
.80	-.0041	-.0553	-.0053	-.0403	.0065	-.0439	.0233	-.0413					-.0198	-.0582
.90	-.0314	-.0440	-.0224	-.0480	.0039	-.0439	.0153	-.0434	.0368	-.0373	.0052	-.0477	-.0212	-.0559
.95			-.0253	-.0479	.0096	-.0298	.0113	-.0392	.0265	-.0512	.0012	-.0495		

TAIL 1

Cp at γ/b of														
x/c	0.02		0.22		0.44		0.56		0.67		0.83		0.98	
	U.S.	L.S.	U.S.	L.S.	U.S.	L.S.	U.S.	L.S.	U.S.	L.S.	U.S.	L.S.	U.S.	L.S.
.05			.3961	-.0024	.4632	-.0029	.6879	.0264	.5398	.0367	.5462	.0582		
.10	.0931	-.0033	.3670	-.0115	.4491	-.0063					.5343	.0390	.5038	.0488
.15	.0935	-.0023	.3437	-.0152	.4301	-.0122			.5748	.0260	.5297	.0296	.4882	.0306
.20							.6132	.0112	.5853	.0233	.5250	.0238	.4631	.0198
.25	.0955	-.0083	.3006	-.0174	.3905	-.0146	.6090	.0160	.5914	.0233	.5182	.0215	.4452	.0170
.30	.0566	-.0300	.2822	-.0190	.3901	-.0151	.5841	.0135	.6013	.0215	.5169	.0206	.4282	.0139
.40	.0428	-.0325			.3863	-.0111	.5643	.0100	.5880	.0208	.5125	.0183	.3930	.0089
.50			.0715	-.0500			.2443	-.0433					.3443	-.0225
.60	.0760	-.0289	.0568	-.0502	.1384	-.0457	-.0086	-.0490	.0727	-.0454	.0496	-.0439	.0142	-.0463
.70			.0463	-.0507			.0113	-.0469	.0420	-.0461	.0255	-.0442		
.80			-.0300	-.0525	.0003	-.0370	.0028	-.0472	.0346	-.0425	.0238	-.0454	-.0197	-.0427
.90					-.0154	-.0494	-.0038	-.0475	.0306	-.0369	.0222	-.0458	-.0233	-.0462
.95			-.0315	-.0498					.0219	-.0457	.0194	-.0446	-.0192	-.0378

TAIL 2

TABLE XXI. - CONTINUED
(f) $\alpha = 6.00^\circ$

Cp at γ/b of														
x/c	0.02		0.22		0.44		0.56		0.67		0.83		0.98	
	U.S.	L.S.	U.S.	L.S.	U.S.	L.S.	U.S.	L.S.	U.S.	L.S.	U.S.	L.S.	U.S.	L.S.
.05	.3017	-.0062	.4509	.0101							.5234	.0798	.5337	.0822
.10	.2592	-.0053	.4166	.0031	.4571	.0131			.5098	.0554	.5063	.0587	.4992	.0624
.15	.2521	.0012	.3899	.0003	.4464	.0051			.5152	.0505	.5080	.0486	.4663	.0537
.20	.2226	.0054							.5157	.0502	.5054	.0439		
.25	.2345	.0067	.3480	.0003	.4286	.0050	.5503	.0358	.5148	.0462			.4230	.0363
.30	.1532	-.0279	.3305	-.0041	.4221	.0163	.5617	.0384	.5154	.0452	.4998	.0396	.4075	.0346
.40	.0758		.1238	-.0344	.4051	.0079	.5534	.0356	.5130	.0411	.4866	.0355	.3837	.0301
.50	.0585		.0982	-.0452			.2335	-.0273	.3367	-.0134	.4067	-.0100	.3280	-.0059
.60	.0534	-.0420	.0895	-.0418	.1530	-.0372	.0396	-.0459	.0447	-.0407	.0395	-.0530	-.0032	-.0536
.70			.0764	-.0454	.0115	-.0435	.0184	-.0434	.0476	-.0367	.0064	-.0512	-.0190	-.0545
.80	-.0184	-.0536	-.0166	-.0396	-.0038	-.0430	.0122	-.0400					-.0181	-.0622
.90	-.0365	-.0433	-.0326	-.0468	-.0074	-.0432	.0046	-.0422	.0184	-.0369	-.0070	-.0476	-.0204	-.0594
.95			-.0347	-.0467	-.0000	-.0294	.0020	-.0378	.0075	-.0504	-.0108	-.0496		

TAIL 1

Cp at γ/b of														
x/c	0.02		0.22		0.44		0.56		0.67		0.83		0.98	
	U.S.	L.S.	U.S.	L.S.	U.S.	L.S.	U.S.	L.S.	U.S.	L.S.	U.S.	L.S.	U.S.	L.S.
.05			.3097	.0064	.3686	.0087	.5646	.0386	.4597	.0532	.4729	.0728		
.10	.0601	-.0034	.2757	-.0016	.3596	.0047					.4617	.0545	.4414	.0623
.15	.0701	-.0032	.2479	-.0048	.3448	.0001			.4698	.0441	.4565	.0454	.4273	.0458
.20							.5123	.0241	.4807	.0410	.4523	.0398	.4062	.0347
.25	.0850	-.0097	.1973	-.0078	.3094	-.0021	.5158	.0329	.4879	.0420	.4457	.0376	.3916	.0300
.30	.0488	-.0302	.1741	-.0098	.3086	-.0012	.4964	.0316	.4956	.0398	.4432	.0374	.3765	.0250
.40	.0521	-.0317			.3035	-.0013	.4734	.0318	.4922	.0388	.4381	.0355	.3506	.0172
.50			.0174	-.0479			.1980	-.0364					.3002	-.0185
.60	.0594	-.0314	.0286	-.0472	.0936	-.0432	-.0193	-.0521	.0454	-.0464	.0271	-.0442	.0032	-.0478
.70			.0341	-.0485			-.0067	-.0485	.0151	-.0470	.0039	-.0443		
.80			-.0234	-.0518	-.0170	-.0364	-.0137	-.0479	.0109	-.0424	.0009	-.0454	-.0281	-.0435
.90					-.0332	-.0484	-.0199	-.0479	.0088	-.0370	-.0003	-.0458	-.0319	-.0460
.95			-.0291	-.0495					-.0004	-.0457	-.0024	-.0447	-.0259	-.0377

TAIL 2

TABLE XXI. - CONTINUED
(g) $\alpha = 8.00^\circ$

Cp at y/b of														
x/c	0.02		0.22		0.44		0.56		0.67		0.83		0.98	
	U.S.	L.S.	U.S.	L.S.	U.S.	L.S.	U.S.	L.S.	U.S.	L.S.	U.S.	L.S.	U.S.	L.S.
.05	.3208	.0057	.4569	.0285							.5170	.1054	.5248	.1089
.10	.2732	.0073	.4240	.0219	.4477	.0313			.5001	.0769	.4975	.0839	.4893	.0867
.15	.2671	.0155	.3957	.0189	.4372	.0243			.5040	.0729	.4981	.0735	.4559	.0764
.20	.2381	.0202							.5024	.0723	.4951	.0690		
.25	.2460	.0230	.3491	.0187	.4230	.0234	.5309	.0598	.4993	.0686			.4145	.0568
.30	.1576	-.0178	.3287	.0141	.4128	.0297	.5416	.0629	.4980	.0676	.4893	.0647	.3993	.0545
.40	.0711		.1185	-.0268	.4023	.0276	.5357	.0600	.4936	.0635	.4760	.0607	.3755	.0493
.50	.0499		.0898	-.0387			.2240	-.0181	.3231	-.0019	.3976	.0062	.3208	.0080
.60	.0407	-.0369	.0777	-.0351	.1489	-.0295	.0363	-.0473	.0364	-.0416	.0344	-.0519	-.0053	-.0503
.70			.0656	-.0402	.0079	-.0434	.0142	-.0428	.0395	-.0376	.0023	-.0484	-.0157	-.0536
.80	-.0273	-.0504	-.0226	-.0389	-.0078	-.0420	.0084	-.0390					-.0176	-.0621
.90	-.0406	-.0435	-.0385	-.0451	-.0124	-.0420	.0011	-.0413	.0098	-.0356	-.0123	-.0442	-.0215	-.0609
.95			-.0404	-.0449	-.0049	-.0293	-.0009	-.0371	-.0007	-.0484	-.0163	-.0461		

TAIL 1

Cp at y/b of														
x/c	0.02		0.22		0.44		0.56		0.67		0.83		0.98	
	U.S.	L.S.	U.S.	L.S.	U.S.	L.S.	U.S.	L.S.	U.S.	L.S.	U.S.	L.S.	U.S.	L.S.
.05			.2239	.0106	.2638	.0189	.4274	.0525	.3682	.0724	.3945	.0894		
.10	.0574	-.0093	.1908	.0037	.2564	.0145					.3838	.0727	.3754	.0782
.15	.0779	-.0085	.1662	-.0005	.2429	.0110			.3647	.0638	.3784	.0643	.3631	.0640
.20							.3905	.0409	.3705	.0613	.3739	.0592	.3455	.0526
.25	.1117	-.0161	.1418	-.0042	.2104	.0083	.3920	.0558	.3772	.0630	.3676	.0575	.3334	.0469
.30	.0733	-.0346	.1292	-.0053	.2087	.0104	.3772	.0581	.3833	.0608	.3649	.0578	.3215	.0415
.40	.0603	-.0344			.2053	.0091	.3621	.0572	.3807	.0604	.3589	.0562	.2990	.0300
.50			.0167	-.0480			.1359	-.0211					.2537	-.0113
.60	.0616	-.0327	.0240	-.0468	.0406	-.0395	-.0333	-.0570	.0187	-.0550	.0053	-.0476	-.0085	-.0522
.70			.0313	-.0474			-.0276	-.0542	-.0094	-.0530	-.0152	-.0460		
.80			-.0307	-.0543	-.0344	-.0393	-.0328	-.0520	-.0130	-.0459	-.0195	-.0463	-.0362	-.0461
.90					-.0493	-.0519	-.0377	-.0520	-.0126	-.0386	-.0211	-.0465	-.0404	-.0486
.95			-.0417	-.0511					-.0233	-.0479	-.0224	-.0451	-.0326	-.0392

TAIL 2

TABLE XXI. - CONTINUED
(h) $\alpha = 10.01^\circ$

Cp at γ/b of														
x/c	0.02		0.22		0.44		0.56		0.67		0.83		0.98	
	U.S.	L.S.	U.S.	L.S.	U.S.	L.S.	U.S.	L.S.	U.S.	L.S.	U.S.	L.S.	U.S.	L.S.
.05	.3503	.0198	.4836	.0507							.5252	.1356	.5301	.1393
.10	.2989	.0231	.4491	.0438	.4593	.0539			.5080	.1042	.5036	.1136	.4928	.1133
.15	.2913	.0333	.4194	.0408	.4485	.0477			.5114	.1010	.5049	.1029	.4583	.1018
.20	.2658	.0389							.5089	.1006	.5012	.0983		
.25	.2695	.0423	.3683	.0401	.4357	.0459	.5359	.0890	.5049	.0970			.4171	.0808
.30	.1700	-.0053	.3452	.0354	.4213	.0465	.5476	.0930	.5019	.0959	.4943	.0942	.4023	.0779
.40	.0764		.1245	-.0179	.4145	.0510	.5410	.0900	.4965	.0917	.4808	.0897	.3784	.0722
.50	.0527		.0927	-.0300			.2247	-.0061	.3253	.0134	.4024	.0247	.3238	.0224
.60	.0418	-.0306	.0800	-.0265	.1542	-.0194	.0388	-.0456	.0355	-.0397	.0341	-.0501	-.0041	-.0472
.70			.0674	-.0320	.0090	-.0414	.0155	-.0398	.0385	-.0357	.0015	-.0451	-.0124	-.0501
.80	-.0300	-.0460	-.0235	-.0360	-.0077	-.0386	.0035	-.0351					-.0168	-.0590
.90	-.0418	-.0427	-.0398	-.0411	-.0127	-.0385	.0022	-.0375	.0073	-.0332	-.0133	-.0402	-.0202	-.0603
.95			-.0413	-.0410	-.0065	-.0268	.0002	-.0331	-.0030	-.0446	-.0178	-.0422		

TAIL 1

Cp at γ/b of														
x/c	0.02		0.22		0.44		0.56		0.67		0.83		0.98	
	U.S.	L.S.	U.S.	L.S.	U.S.	L.S.	U.S.	L.S.	U.S.	L.S.	U.S.	L.S.	U.S.	L.S.
.05			.1653	.0123	.1766	.0238	.2944	.0630	.2634	.0914	.3026	.1051		
.10	.0645	-.0164	.1304	.0044	.1695	.0203					.2913	.0912	.2984	.0955
.15	.0858	-.0159	.1134	-.0002	.1559	.0167			.2535	.0844	.2857	.0836	.2877	.0832
.20							.2773	.0649	.2560	.0826	.2808	.0793	.2733	.0712
.25	.1182	-.0254	.1019	-.0040	.1263	.0148	.2621	.0780	.2610	.0849	.2754	.0781	.2635	.0670
.30	.0743	-.0408	.0900	-.0056	.1208	.0164	.2579	.0793	.2654	.0830	.2726	.0790	.2537	.0603
.40	.0517	-.0396			.1155	.0172	.2398	.0762	.2645	.0826	.2667	.0774	.2351	.0524
.50			.0224	-.0484			.0740	-.0174					.1968	.0014
.60	.0572	-.0362	.0219	-.0465	-.0023	-.0359	-.0457	-.0572	-.0107	-.0536	-.0139	-.0487	-.0214	-.0524
.70			.0226	-.0457			-.0487	-.0619	-.0347	-.0605	-.0306	-.0485		
.80			-.0362	-.0585	-.0403	-.0424	-.0524	-.0573	-.0339	-.0498	-.0356	-.0470	-.0428	-.0465
.90					-.0532	-.0557	-.0543	-.0566	-.0276	-.0411	-.0372	-.0473	-.0456	-.0484
.95			-.0474	-.0535					-.0408	-.0509	-.0374	-.0465	-.0354	-.0388

TAIL 2

TABLE XXI. - CONTINUED
(i) $\alpha = 12.00^\circ$

Cp at γ/b of														
x/c	0.02		0.22		0.44		0.56		0.67		0.83		0.98	
	U.S.	L.S.	U.S.	L.S.	U.S.	L.S.	U.S.	L.S.	U.S.	L.S.	U.S.	L.S.	U.S.	L.S.
.05	.3879	.0389	.5230	.0781							.5408	.1728	.5416	.1761
.10	.3314	.0440	.4856	.0710	.4828	.0813			.5263	.1370	.5179	.1500	.5025	.1462
.15	.3211	.0560	.4530	.0678	.4712	.0760			.5292	.1349	.5187	.1393	.4668	.1330
.20	.3004	.0628							.5258	.1342	.5155	.1346		
.25	.2996	.0662	.3958	.0667	.4594	.0738	.5551	.1238	.5212	.1309			.4261	.1103
.30	.1859	.0118	.3701	.0621	.4397	.0698	.5669	.1285	.5178	.1298	.5078	.1304	.4110	.1069
.40	.0857		.1341	-.0056	.4375	.0797	.5615	.1254	.5113	.1254	.4937	.1256	.3864	.1004
.50	.0597		.1006	-.0181			.2325	.0085	.3348	.0317	.4139	.0491	.3311	.0414
.60	.0478	-.0205	.0869	-.0143	.1652	-.0064	.0432	-.0432	.0374	-.0374	.0341	-.0446	-.0015	-.0399
.70			.0729	-.0200	.0125	-.0393	.0184	-.0359	.0402	-.0333	.0016	-.0383	-.0104	-.0421
.80	-.0308	-.0391	-.0226	-.0313	-.0053	-.0343	.0122	-.0307					-.0165	-.0541
.90	-.0413	-.0408	-.0393	-.0353	-.0111	-.0337	.0045	-.0328	.0053	-.0280	-.0146	-.0331	-.0113	-.0579
.95			-.0400	-.0350	-.0053	-.0240	.0026	-.0284	-.0045	-.0379	-.0192	-.0351		

TAIL 1

Cp at γ/b of														
x/c	0.02		0.22		0.44		0.56		0.67		0.83		0.98	
	U.S.	L.S.	U.S.	L.S.	U.S.	L.S.	U.S.	L.S.	U.S.	L.S.	U.S.	L.S.	U.S.	L.S.
.05			.1042	.0122	.1287	.0257	.2206	.0655	.1871	.1033	.2115	.1164		
.10	.0562	-.0172	.0821	.0044	.1223	.0239					.1985	.1049	.2168	.1112
.15	.0813	-.0174	.0737	-.0001	.1103	.0203			.1730	.0968	.1918	.0985	.2062	.1000
.20							.1936	.0778	.1708	.0958	.1851	.0947	.1940	.0903
.25	.1074	-.0261	.0702	-.0052	.0838	.0187	.1826	.0928	.1710	.0976	.1781	.0944	.1855	.0853
.30	.0647	-.0430	.0598	-.0068	.0779	.0202	.1725	.0888	.1702	.0953	.1736	.0955	.1765	.0811
.40	.0397	-.0409			.0717	.0213	.1564	.0877	.1622	-.0941	.1658	.0941	.1605	.0731
.50			.0068	-.0475			.0230	-.0048					.1305	.0179
.60	.0449	-.0385	.0092	-.0445	-.0205	-.0338	-.0515	-.0564	-.0361	-.0507	-.0320	-.0480	-.0342	-.0521
.70			.0117	-.0434			-.0582	-.0638	-.0518	-.0624	-.0446	-.0539		
.80			-.0416	-.0586	-.0431	-.0455	-.0582	-.0636	-.0466	-.0550	-.0490	-.0512	-.0480	-.0495
.90					-.0572	-.0590	-.0574	-.0614	-.0390	-.0441	-.0480	-.0496	-.0498	-.0505
.95			-.0518	-.0575					-.0509	-.0543	-.0452	-.0484	-.0380	-.0403

TAIL 2

TABLE XXI. - CONTINUED
(j) $\alpha = 16.01^\circ$

Cp at γ/b of														
x/c	0.02		0.22		0.44		0.56		0.67		0.83		0.98	
	U.S.	L.S.	U.S.	L.S.	U.S.	L.S.	U.S.	L.S.	U.S.	L.S.	U.S.	L.S.	U.S.	L.S.
.05	.4816	.0882	.6332	.1478							.5934	.2633	.5809	.2642
.10	.4126	.0977	.5849	.1401	.5572	.1510			.5870	.2212	.5673	.2386	.5368	.2250
.15	.3984	.1150	.5411	.1365	.5443	.1475			.5892	.2212	.5679	.2269	.4982	.2087
.20	.3882	.1251							.5839	.2206	.5637	.2220		
.25	.3769	.1268	.4702	.1344	.5345	.1454	.6235	.2115	.5782	.2172			.4587	.1818
.30	.2342	.0564	.4391	.1292	.5049	.1211	.6366	.2182	.5735	.2161	.5551	.2177	.4438	.1771
.40	.1153		.1653	.0260	.5085	.1532	.6328	.2145	.5665	.2112	.5398	.2119	.4186	.1683
.50	.0848		.1295	.0140			.2748	.0482	.3707	.0780	.4547	.1052	.3613	.0872
.60	.0695	.0129	.1132	.0188	.2007	.0294	.0580	-.0323	.0475	-.0280	.0423	-.0339	.0128	-.0250
.70			.0941	.0127	.0249	-.0326	.0309	-.0247	.0500	-.0239	.0085	-.0246	-.0008	-.0255
.80	-.0277	-.0201	-.0162	-.0197	.0029	-.0219	.0232	-.0169					-.0001	-.0422
.90	-.0357	-.0340	-.0335	-.0202	-.0039	-.0197	.0152	-.0182	.0114	-.0180	-.0088	-.0187	-.0038	-.0519
.95			-.0279	-.0195	-.0021	-.0147	.0124	-.0144	.0029	-.0245	-.0135	-.0192		

TAIL 1

Cp at γ/b of														
x/c	0.02		0.22		0.44		0.56		0.67		0.83		0.98	
	U.S.	L.S.	U.S.	L.S.	U.S.	L.S.	U.S.	L.S.	U.S.	L.S.	U.S.	L.S.	U.S.	L.S.
.05			.0218	.0255	.0292	.0462	.0937	.0899	.0916	.1232	.0980	.1334		
.10	.0068	-.0015	.0100	.0168	.0300	.0418					.0889	.1258	.0892	.1319
.15	.0322	-.0036	.0088	.0109	.0272	.0372			.0870	.1184	.0867	.1208	.0817	.1243
.20							.1058	.0974	.0860	.1196	.0851	.1182	.0755	.1173
.25	.0345	-.0064	.0105	.0053	.0204	.0306	.0859	.1105	.0859	.1229	.0830	.1186	.0724	.1181
.30	.0078	-.0357	.0042	.0007	.0191	.0304	.0835	.1148	.0839	.1226	.0816	.1200	.0686	.1146
.40	.0053	-.0362			.0300	.0281	.0753	.1131	.0783	.1240	.0770	.1183	.0622	.1050
.50			-.0269	-.0382			-.0087	.0092					.0439	.0372
.60	.0053	-.0384	-.0239	-.0344	-.0302	-.0303	-.0569	-.0552	-.0512	-.0466	-.0464	-.0446	-.0495	-.0490
.70			-.0188	-.0326			-.0633	-.0621	-.0617	-.0589	-.0530	-.0544		
.80			-.0520	-.0552	-.0453	-.0490	-.0607	-.0648	-.0513	-.0548	-.0517	-.0560	-.0515	-.0547
.90					-.0606	-.0646	-.0607	-.0657	-.0430	-.0475	-.0507	-.0558	-.0528	-.0559
.95			-.0586	-.0589					-.0547	-.0584	-.0495	-.0537	-.0409	-.0435

TAIL 2

TABLE XXI. - CONCLUDED
(k) $\alpha = 20.01^\circ$

Cp at γ/b of														
x/c	0.02		0.22		0.44		0.56		0.67		0.83		0.98	
	U.S.	L.S.	U.S.	L.S.	U.S.	L.S.	U.S.	L.S.	U.S.	L.S.	U.S.	L.S.	U.S.	L.S.
.05	.5939	.1563	.7633	.2389							.6549	.3839	.2443	.2348
.10	.5123	.1693	.6986	.2313	.6541	.2458			.6608	.3535	.6254	.3585	.2163	.1997
.15	.4957	.1875	.6416	.2268	.6423	.2439			.6611	.3556	.6244	.3449	.2091	.1872
.20	.4772	.2045							.6544	.3512	.6161	.3382		
.25	.4512	.2073	.5522	.2220	.6318	.2423	.7129	.3300	.6480	.3428			.2492	.1764
.30	.2789	.1172	.5166	.2155	.5960	.2135	.7280	.3374	.6438	.3390	.5977	.3325	.2599	.1775
.40	.1747		.1999	.0714	.5908	.2532	.7286	.3315	.6371	.3270	.5757	.3267	.2587	.1778
.50	.1230		.1634	.0608			.3263	.1108	.4201	.1421	.4849	.1819	.2020	.0890
.60	.0904	.0271	.1416	.0687	.2420	.0855	.0779	-.0095	.0629	-.0090	.0463	-.0175	.0205	-.0130
.70			.1206	.0633	.0400	-.0144	.0471	-.0172	.0655	-.0044	.0106	-.0181	-.0102	-.0115
.80	-.0169	.0089	-.0061	-.0083	.0147	-.0063	.0379	.0007					-.0118	-.0129
.90	-.0282	-.0166	-.0224	-.0020	.0062	-.0001	.0291	.0026	.0219	-.0008	-.0073	-.0020	-.0021	-.0172
.95			-.0102	-.0003	.0052	.0013	.0253	.0059	.0148	-.0032	-.0106	-.0019		

TAIL 1

Cp at γ/b of														
x/c	0.02		0.22		0.44		0.56		0.67		0.83		0.98	
	U.S.	L.S.	U.S.	L.S.	U.S.	L.S.	U.S.	L.S.	U.S.	L.S.	U.S.	L.S.	U.S.	L.S.
.05			-.0194	.0454	-.0268	.0722	.0047	.1371	.0202	.1516	.0389	.1600		
.10	-.0367	.0224	-.0264	.0345	-.0256	.0668					.0262	.1540	.0368	.1599
.15	-.0112	.0204	-.0273	.0279	-.0273	.0561			.0076	.1626	.0203	.1500	.0281	.1554
.20							.0292	.1326	.0059	.1660	.0149	.1480	.0208	.1510
.25	-.0195	.0270	-.0295	.0223	-.0276	.0467	.0021	.1512	.0054	.1697	.0115	.1492	.0156	.1510
.30	-.0341	-.0120	-.0331	.0192	-.0301	.0470	.0018	.1451	.0046	.1654	.0081	.1517	.0100	.1474
.40	-.0252	-.0190			-.0067	.0408	-.0009	.1373	.0035	.1623	.0034	.1523	.0012	.1339
.50			-.0468	-.0240			-.0385	.0238					-.0101	.0533
.60	-.0256	-.0392	-.0464	-.0184	-.0392	-.0211	-.0579	-.0521	-.0629	-.0379	-.0571	-.0355	-.0585	-.0435
.70			-.0415	-.0174			-.0646	-.0598	-.0633	-.0525	-.0568	-.0476		
.80			-.0596	-.0486	-.0480	-.0473	-.0635	-.0623	-.0535	-.0515	-.0568	-.0506	-.0537	-.0531
.90					-.0640	-.0629	-.0641	-.0648	-.0454	-.0474	-.0567	-.0518	-.0575	-.0569
.95			-.0617	-.0550					-.0574	-.0588	-.0557	-.0521	-.0448	-.0454

TAIL 2

TABLE XXII. - PRESSURE COEFFICIENTS, $\phi = 90^\circ$, $\delta_{1,3} = -15^\circ$, $M = 1.60$.
 (a) $\alpha = -2.85^\circ$

Cp at γ/b of														
x/c	0.02		0.22		0.44		0.56		0.67		0.83		0.98	
	U.S.	L.S.	U.S.	L.S.	U.S.	L.S.	U.S.	L.S.	U.S.	L.S.	U.S.	L.S.	U.S.	L.S.
.05	.5374	-.1099	.9091								1.3726	-.4012	1.1653	-.3585
.10	.4905	-.0821	.8532	-.4352					1.3293	-.1159	1.2807	-.3636		
.15	.4973	-.1121	.8093	-.3985	.9316	-.4518	1.1513	-.4514			1.1982	-.3211	.9320	-.2847
.20	.5399	-.1220							1.1570	-.2505	1.1281	-.2751		
.25	.5719	-.0972	.7226	-.2849	.9349	-.4269			1.0895	-.2448			.7994	-.1089
.30	.3351	-.1964	.6495	-.2372			.9909	-.4263	1.0310	-.2038	1.0024	-.2300	.7284	-.0977
.40	.4953	-.1363					.8362	-.4072	.8764	-.2737	.8590	-.2189	.6143	-.0857
.50			.6096	-.2721			.1845	-.4208	.3319	-.3958	.5698	-.3183	.4111	-.1870
.60	.4516	-.1838	.6148	-.2412			-.1101	-.4038	-.1485	-.3817	-.1641	-.3936	-.2357	-.4178
.70			.5595	-.2215	-.0305	-.4464	-.0473	-.4151			-.1564	-.3982	-.2336	-.4181
.80	.0171	-.3122	.0130	-.3578	-.0221	-.4282	.0002	-.3398					-.2155	-.4342
.90	-.0733	-.2986	-.0016	-.3051	-.0200	-.4325	-.0127	-.3693	-.0635	-.3906	-.1224	-.3962	-.1986	-.4160
.95			-.0148	-.2368	-.0280	-.4249	.0060	-.2917	-.0718	-.4010	-.1285	-.3875		

TAIL 1

Cp at γ/b of														
x/c	0.02		0.22		0.44		0.56		0.67		0.83		0.98	
	U.S.	L.S.	U.S.	L.S.	U.S.	L.S.	U.S.	L.S.	U.S.	L.S.	U.S.	L.S.	U.S.	L.S.
.05			.3347	.3071	.4134	.3527	.0606	.0805			.8029	.7561		
.10	.1620	.1375	.2875	.2531	.3840	.3180					.7390	.6953	.5086	.5011
.15	.1614	.1355	.2674	.2256	.3561	.2894					.6898	.6624	.4669	.4506
.20					.3311	.2816			.6186	.5934	.6431	.6292	.4234	.4168
.25	.1654	.1291	.2375	.1991	.3188	.2785			.5842	.5664	.6037	.5990	.3961	.4007
.30	-.0074	.0452	.2244	.1889	.3370	.2938					.5632	.5687	.3671	.3852
.40	.2262	.1474					.4471	.4273	.4845	.4843	.4933	.4955	.3255	.3421
.50			.0420	.1224			.0007	-.0339					.2438	.0570
.60			.3012	.1851	-.1021	-.0388			-.2638	-.2493	-.2492	-.2509	-.2212	-.2298
.70			.3166	.3138			-.2779	-.2772	-.2697	-.2705	-.2179	-.2590		
.80			-.0724	-.0625	-.1992	-.1571	-.2499	-.2478	-.2312	-.2294	-.2168	-.2263	-.1388	-.1428
.90					-.1210	-.0527	-.2384	-.2375	-.2256	-.2197	-.2174	-.2167	-.1704	-.1784
.95			.2207	.1508	-.0860	-.0291			-.2269	-.2213	-.2170	-.2162		

TAIL 2

TABLE XXII. - CONTINUED
(b) $\alpha = -0.85^\circ$

Cp at y/b of															
x/c	0.02		0.22		0.44		0.56		0.67		0.83		0.98		
	U.S.	L.S.	U.S.	L.S.	U.S.	L.S.	U.S.	L.S.	U.S.	L.S.	U.S.	L.S.	U.S.	L.S.	
.05	.4773	-.0645	.8370								1.3470	-.3646	1.1376	-.3068	
.10	.4396	-.0414	.7746	-.3770						1.2908	-.0769	1.2473	-.3225		
.15	.4350	-.0796	.7322	-.3296	.8493	-.4168	1.0960	-.4332				1.1613	-.2500	.8952	-.2171
.20	.4618	-.0926								1.1145	-.1993	1.0887	-.2062		
.25	.4752	-.0772	.6572	-.1991	.8514	-.3780				1.0470	-.1987			.7645	-.0498
.30	.2472	-.1860	.5965	-.1641			.9329	-.3811	.9917	-.1651	.9649	-.1632	.6922	-.0374	
.40	.3856	-.1307					.7915	-.3578	.8442	-.2357	.8240	-.1569	.5831	-.0292	
.50			.4138	-.2516			.1590	-.4228	.3198	-.3764	.5447	-.2826	.3863	-.1467	
.60	.3549	-.1669	.5131	-.2151			-.1545	-.4008	-.1710	-.3797	-.1785	-.4120	-.2491	-.3777	
.70			.4990	-.1997	-.0556	-.4451	-.1025	-.4131			-.1803	-.4089	-.2550	-.3782	
.80	-.0008	-.3004	-.0131	-.3446	-.0556	-.4336	-.0393	-.3384					-.2387	-.4041	
.90	-.0827	-.2963	-.0437	-.3068	-.0596	-.4203	-.0495	-.3676	-.1208	-.3916	-.1616	-.3935	-.2216	-.4185	
.95			-.0429	-.2344	-.0682	-.3983	-.0269	-.2887	-.1324	-.4026	-.1689	-.3786			

TAIL 1

Cp at y/b of														
x/c	0.02		0.22		0.44		0.56		0.67		0.83		0.98	
	U.S.	L.S.	U.S.	L.S.	U.S.	L.S.	U.S.	L.S.	U.S.	L.S.	U.S.	L.S.	U.S.	L.S.
.05			.3209	.2897	.3951	.3265	.0623	.0816			.8024	.7503		
.10	.1511	.1297	.2776	.2396	.3684	.3001					.7342	.6912	.5154	.5054
.15	.1566	.1330	.2623	.2174	.3470	.2784					.6849	.6556	.4684	.4453
.20					.3310	.2722			.6108	.5783	.6435	.6210	.4206	.4091
.25	.1846	.1453	.2524	.2065	.3236	.2758			.5850	.5508	.6039	.5911	.3913	.3934
.30	.0262	.0654	.2434	.2010	.3413	.3011					.5660	.5623	.3611	.3725
.40	.2080	.1550					.4469	.4321	.4922	.4852	.4953	.4939	.3157	.3292
.50			.0117	.0832			-.0109	-.0323					.2311	.0449
.60			.2356	.1696	-.1148	-.0587			-.2711	-.2535	-.2706	-.2551	-.2485	-.2389
.70			.2474	.2413			-.3005	-.2959	-.2935	-.2797	-.2705	-.2826		
.80			-.1200	-.1004	-.2484	-.1967	-.2649	-.2668	-.2486	-.2629	-.2402	-.2446	-.1438	-.1365
.90					-.1550	-.0903	-.2566	-.2513	-.2392	-.2331	-.2365	-.2292	-.1696	-.1625
.95			.1677	.0511	-.1409	-.0847			-.2387	-.2282	-.2360	-.2284		

TAIL 2

TABLE XXII. - CONTINUED
(c) $\alpha = 1.18^\circ$

Cp at y/b of															
x/c	0.02		0.22		0.44		0.56		0.67		0.83		0.98		
	U.S.	L.S.	U.S.	L.S.	U.S.	L.S.	U.S.	L.S.	U.S.	L.S.	U.S.	L.S.	U.S.	L.S.	
.05	.4537	-.0400	.7616									1.3182	-.3153	1.1081	-.2483
.10	.4173	-.0054	.6967	-.3095					1.2494	-.0285	1.2118	-.2500			
.15	.4040	-.0444	.6552	-.2542	.7689	-.3720	1.0464	-.4001			1.1234	-.1699	.8577	-.1520	
.20	.4123	-.0614							1.0688	-.1396	1.0509	-.1306			
.25	.4198	-.0541	.5841	-.0901	.7872	-.3217			1.0019	-.1448			.7286	.0070	
.30	.1719	-.1760	.5297	-.0985			.8798	-.3220	.9475	-.1180	.9270	-.0933	.6573	.0034	
.40	.2891	-.1087					.7402	-.2960	.8063	-.1882	.7896	-.0857	.5515	.0063	
.50			.2300	-.2320			.1264	-.4174	.3035	-.3534	.5221	-.2418	.3645	-.1122	
.60	.2814	-.1488	.3959	-.1778			-.1986	-.3977	-.1924	-.3759	-.1928	-.4313	-.2602	-.3516	
.70			.4156	-.1647	-.0513	-.4274	-.1700	-.4098			-.2007	-.4078	-.2709	-.3369	
.80	-.0996	-.2855	-.0432	-.3326	-.0720	-.4148	-.1131	-.3352					-.2592	-.3789	
.90	-.1211	-.2931	-.0783	-.3014	-.0854	-.4008	-.1124	-.3611	-.1841	-.3966	-.1949	-.3883	-.2417	-.4112	
.95			-.0953	-.2368	-.0990	-.3809	-.0522	-.2788	-.2003	-.4036	-.2036	-.3773			

TAIL 1

Cp at y/b of														
x/c	0.02		0.22		0.44		0.56		0.67		0.83		0.98	
	U.S.	L.S.	U.S.	L.S.	U.S.	L.S.	U.S.	L.S.	U.S.	L.S.	U.S.	L.S.	U.S.	L.S.
.05			.3112	.2779	.3841	.3176	.0646	.0791			.8076	.7495		
.10	.1487	.1257	.2757	.2360	.3634	.2972					.7365	.6890	.5255	.5136
.15	.1638	.1390	.2684	.2235	.3423	.2802					.6894	.6507	.4771	.4517
.20					.3216	.2794			.5986	.5676	.6429	.6161	.4236	.4085
.25	.1804	.1550	.2564	.2176	.3080	.2792			.5701	.5462	.6046	.5899	.3884	.3907
.30	.0626	.0891	.2385	.2032	.3147	.2916					.5641	.5677	.3542	.3688
.40	.1889	.1576					.4319	.4159	.4769	.4787	.4926	.5019	.3016	.3233
.50			.0208	.0405			-.0142	-.0437					.2116	.0375
.60			.1803	.1669	-.1201	-.0573			-.2738	-.2551	-.2722	-.2528	-.2582	-.2442
.70			.1898	.1876			-.3021	-.2973	-.3003	-.2837	-.2969	-.2840		
.80			-.1622	-.1378	-.2564	-.2103	-.2713	-.2710	-.2549	-.2730	-.2529	-.2711	-.1590	-.1431
.90					-.1827	-.1165	-.2638	-.2574	-.2477	-.2399	-.2446	-.2400	-.1643	-.1448
.95			.0926	.0004	-.1753	-.1177			-.2471	-.2353	-.2443	-.2352		

TAIL 2

TABLE XXII. - CONTINUED
(d) $\alpha = 3.16^\circ$

Cp at y/b of														
x/c	0.02		0.22		0.44		0.56		0.67		0.83		0.98	
	U.S.	L.S.	U.S.	L.S.	U.S.	L.S.	U.S.	L.S.	U.S.	L.S.	U.S.	L.S.	U.S.	L.S.
.05	.4258	-.0286	.6937								1.2832	-.2567	1.0741	-.1886
.10	.4018	-.0298	.6295	-.2342					1.2043	.0276	1.1721	-.1598		
.15	.3820	-.0045	.5897	-.1428	.6832	-.3224	.9967	-.3496			1.0825	-.0911	.8173	-.0742
.20	.3814	-.0266							1.0238	-.0754	1.0117	-.0570		
.25	.3905	-.0297	.5219	-.0390	.7157	-.2679			.9591	-.0849			.6919	.0689
.30	.1300	-.1485	.4679	-.0536			.8364	-.2494	.9073	-.0681	.8884	-.0165	.6235	.0603
.40	.2048	-.0797					.7049	-.2211	.7729	-.1362	.7554	-.0188	.5237	.0524
.50			.1268	-.2074			.1077	-.3732	.2900	-.3251	.4997	-.2000	.3448	-.0675
.60	.2247	-.1308	.3236	-.1414			-.2164	-.3926	-.2061	-.3763	-.2076	-.4200	-.2674	-.3357
.70			.3454	-.1277	-.1454	-.4251	-.2442	-.4019			-.2183	-.4083	-.2552	-.3075
.80	-.1485	-.2745	-.0895	-.3228	-.0923	-.3950	-.1744	-.3300					-.2490	-.3667
.90	-.1963	-.2875	-.1062	-.3040	-.1069	-.3813	-.1813	-.3549	-.2248	-.3838	-.2186	-.3871	-.2458	-.3819
.95			-.1369	-.2520	-.1233	-.3571	-.1419	-.2756	-.2455	-.3880	-.2285	-.3792		

TAIL 1

Cp at y/b of														
x/c	0.02		0.22		0.44		0.56		0.67		0.83		0.98	
	U.S.	L.S.	U.S.	L.S.	U.S.	L.S.	U.S.	L.S.	U.S.	L.S.	U.S.	L.S.	U.S.	L.S.
.05			.3015	.2687	.3713	.3059	.0583	.0679			.7923	.7441		
.10	.1463	.1220	.2702	.2332	.3453	.2934					.7287	.6766	.5345	.5186
.15	.1577	.1350	.2625	.2224	.3208	.2777					.6777	.6414	.4795	.4574
.20					.2981	.2694			.5799	.5451	.6338	.6125	.4205	.4129
.25	.1626	.1421	.2432	.2097	.2811	.2602			.5521	.5239	.5943	.5904	.3790	.3940
.30	.0573	.0819	.2151	.1915	.2875	.2635					.5520	.5649	.3403	.3687
.40	.1576	.1349					.4132	.3960	.4531	.4706	.4825	.5026	.2836	.3166
.50			.0012	.0210			-.0315	-.0506					.1925	.0234
.60			.1462	.1422	-.1294	-.0651			-.2759	-.2577	-.2744	-.2543	-.2664	-.2541
.70			.1530	.1552			-.3099	-.2981	-.3071	-.2865	-.3025	-.2852		
.80			-.1891	-.1618	-.2667	-.2044	-.2803	-.2734	-.2676	-.2796	-.2623	-.2823	-.1969	-.2019
.90					-.1966	-.1381	-.2726	-.2618	-.2540	-.2447	-.2496	-.2478	-.1602	-.1401
.95			.0420	-.0675	-.1945	-.1412			-.2529	-.2397	-.2498	-.2404		

TAIL 2

TABLE XXII. - CONTINUED
(e) $\alpha = 5.15^\circ$

Cp at y/b of														
x/c	0.02		0.22		0.44		0.56		0.67		0.83		0.98	
	U.S.	L.S.	U.S.	L.S.	U.S.	L.S.	U.S.	L.S.	U.S.	L.S.	U.S.	L.S.	U.S.	L.S.
.05	.3700	-.0095	.6226								1.2371	-.1818	1.0294	-.1029
.10	.3597	.0559	.5617	-.1123					1.1472	-.0985	1.1250	-.0591		
.15	.3449	.0315	.5252	-.0253	-.6164	-.2472	-.9368	-.2659			1.0365	.0057	.7727	.0251
.20	.3431	.0094							.9720	-.0008	.9648	.0341		
.25	.3483	.0105	.4718	.0102	-.6337	-.1589			.9092	-.0197			.6530	.1031
.30	.1174	-.1244	.4210	-.0031			.7865	-.1590	.8605	-.0120	.8456	.0674	.5857	-.1122
.40	.1333	-.0576					.6655	-.1101	.7326	-.0750	.7193	.0539	.4915	-.1082
.50			.0577	-.1643			.0873	-.2850	-.2729	-.2875	.4753	-.1537	.3234	-.0247
.60	.1623	-.1179	.1646	-.0897			-.2309	-.3913	-.2212	-.3802	-.2215	-.4004	-.2679	-.3152
.70			.2576	-.0904	-.2312	-.4097	-.2655	-.3912			-.2370	-.4112	-.2550	-.2698
.80	-.1905	-.2660	-.1185	-.3095	-.1982	-.3748	-.2251	-.3096					-.2537	-.3228
.90	-.2442	-.2819	-.1288	-.3084	-.1570	-.3639	-.2366	-.3234	-.2479	-.3784	-.2405	-.3743	-.2525	-.3505
.95			-.1560	-.2716	-.1517	-.3456	-.1888	-.2415	-.2690	-.3812	-.2507	-.3652		

TAIL 1

Cp at y/b of														
x/c	0.02		0.22		0.44		0.56		0.67		0.83		0.98	
	U.S.	L.S.	U.S.	L.S.	U.S.	L.S.	U.S.	L.S.	U.S.	L.S.	U.S.	L.S.	U.S.	L.S.
.05			.3235	.2832	.3506	.2986	.0485	.0547			.7820	.7336		
.10	.1740	.1333	.2877	.2438	.3309	.2825					.7126	.6739	.5341	.5326
.15	.1737	.1343	.2722	.2294	.3077	.2591					.6605	.6416	.4741	.4677
.20					.2890	.2490			.5564	.5387	.6162	.6119	.4146	.4143
.25	.1626	.1259	.2387	.2099	.2773	.2398			.5270	.5212	.5796	.5842	.3696	.3885
.30	-.0272	.0093	.2091	.1883	.2802	.2425					.5412	.5595	.3300	.3599
.40	.0824	.0850					.3865	.3905	.4307	.4556	.4751	.4948	.2712	.3013
.50			-.0734	-.0400			-.0460	-.0560					.1785	.0128
.60			.1270	.1215	-.1535	-.0828			-.2788	-.2637	-.2732	-.2540	-.2740	-.2652
.70			.1533	.1475			-.3272	-.2998	-.3118	-.2922	-.3039	-.2850		
.80			-.1927	-.1718	-.2943	-.2307	-.2914	-.2780	-.2778	-.2863	-.2748	-.2916	-.2581	-.2330
.90					-.2260	-.1482	-.2809	-.2685	-.2608	-.2522	-.2551	-.2544	-.1662	-.1725
.95			-.1585	-.1700	-.2027	-.1508			-.2587	-.2460	-.2548	-.2463		

TAIL 2

TABLE XXIII. - CONTINUED
(1) $\alpha = 7.15^\circ$

Cp at y/b of														
x/c	0.02		0.22		0.44		0.56		0.67		0.83		0.98	
	U.S.	L.S.	U.S.	L.S.	U.S.	L.S.	U.S.	L.S.	U.S.	L.S.	U.S.	L.S.	U.S.	L.S.
.05	.2964	.0182	.5246								1.1796	-.0712	.9787	-.0001
.10	.2845	.0658	.4688	.0222					1.0770	.1926	1.0667	.0623		
.15	.2754	.0578	.4397	.0506	.5497	-.1386	.8643	-.1604			.9791	.1193	.7177	.1161
.20	.2651	.0422							.9078	.0857	.9096	.1402		
.25	.2751	.0505	.4050	.0583	.5392	.0206			.8467	.0559			.6051	.1608
.30	.0810	-.0822	.3674	.0428			.7296	.0559	.8038	.0616	.7952	.1645	.5414	.1629
.40	.0633	-.0314					.6199	.1283	.6877	.0027	.6760	.1335	.4538	.1549
.50			-.0028	-.1037			.0640	-.1897	.2514	-.2312	.4472	-.1035	.2991	.0074
.60	.0963	-.1032	.0630	-.0297			-.2461	-.3571	-.2357	-.3717	-.2350	-.3788	-.2700	-.2915
.70			.1725	-.0616	-.2744	-.3906	-.2808	-.3783			-.2568	-.3911	-.2630	-.2401
.80	-.2153	-.2539	-.1555	-.2968	-.2582	-.3547	-.2454	-.2903					-.2553	-.2713
.90	-.2582	-.2695	-.1516	-.3052	-.2385	-.3498	-.2702	-.3019	-.2684	-.3457	-.2616	-.3543	-.2329	-.3223
.95			-.1708	-.2690	-.2308	-.3364	-.2122	-.2294	-.2882	-.3464	-.2714	-.3448		

TAIL 1

Cp at y/b of														
x/c	0.02		0.22		0.44		0.56		0.67		0.83		0.98	
	U.S.	L.S.	U.S.	L.S.	U.S.	L.S.	U.S.	L.S.	U.S.	L.S.	U.S.	L.S.	U.S.	L.S.
.05			.3534	.3082	.3509	.2836	.0491	.0523			.7561	.7264		
.10	.1763	.1299	.3029	.2496	.3275	.2704					.6933	.6632	.5292	.5334
.15	.1835	.1438	.2776	.2198	.3007	.2528					.6432	.6286	.4646	.4683
.20					.2767	.2494			.5333	.5208	.6009	.5942	.4059	.4073
.25	.1627	.1042	.2267	.1894	.2574	.2428			.5054	.5024	.5650	.5687	.3597	.3776
.30	-.0675	-.0538	.2018	.1765	.2566	.2461					.5272	.5465	.3170	.3480
.40	-.0192	.0226					.3708	.3734	.4159	.4370	.4649	.4880	.2560	.2871
.50			-.1127	-.0832			-.0512	-.0643					.1613	-.0008
.60			-.0656	.0766	-.1626	-.1068			-.2806	-.2685	-.2769	-.2564	-.2831	-.2738
.70			.1519	.1444			-.3330	-.3054	-.3153	-.2965	-.3090	-.2897		
.80			-.1920	-.1491	-.3084	-.2617	-.2957	-.2839	-.2907	-.2929	-.2784	-.2986	-.2899	-.2425
.90					-.2844	-.1693	-.2840	-.2746	-.2666	-.2589	-.2618	-.2621	-.2054	-.2216
.95			-.2034	-.1866	-.2500	-.1508			-.2634	-.2523	-.2608	-.2540		

TAIL 2

TABLE XXIII. - CONTINUED
(g) $\alpha = 9.15^\circ$

Cp at γ/b of														
x/c	0.02		0.22		0.44		0.56		0.67		0.83		0.98	
	U.S.	L.S.	U.S.	L.S.	U.S.	L.S.	U.S.	L.S.	U.S.	L.S.	U.S.	L.S.	U.S.	L.S.
.05	.2190	.0401	.4277								1.1061	.0623	.9085	.1161
.10	.2045	.0732	.3726	.0949					.9943	.3095	.9956	.2033		
.15	.1981	.0794	.3469	.0996	.4709	.0872	.7720	.1381			.9115	.2542	.6514	.1807
.20	.1912	.0761							.8336	.1768		.8459	.2786	
.25	.1968	.0955	.3234	.1042	.4368	.1156			.7797	.1551			.5469	.2120
.30	.0303	-.0250	.2949	.0906			.6609	.2233	.7414	.1882	.7398	.2672	.4912	.2162
.40	-.0136	.0219					.5699	.2128	.6366	.2038	.6278	.2149	.4125	.2044
.50			-.0557	-.0275			.0388	-.1398	.2286	-.1136	.4128	-.0511	.2726	.0463
.60	.0479	-.0805	-.0073	.0192			-.2612	-.3355	-.2474	-.3317	-.2474	-.3540	-.2649	-.2809
.70			.1011	-.0385	-.3090	-.3679	-.2957	-.3584			-.2745	-.3452	-.2704	-.2227
.80	-.2244	-.2382	-.1954	-.2816	-.2999	-.3342	-.2590	-.2768					-.2474	-.2284
.90	-.2592	-.2589	-.1735	-.2928	-.2878	-.3239	-.2795	-.2849	-.2828	-.3030	-.2809	-.3111	-.2245	-.2665
.95			-.1882	-.2595	-.2788	-.3208	-.2064	-.2215	-.3036	-.3094	-.2798	-.3008		

TAIL 1

Cp at γ/b of														
x/c	0.02		0.22		0.44		0.56		0.67		0.83		0.98	
	U.S.	L.S.	U.S.	L.S.	U.S.	L.S.	U.S.	L.S.	U.S.	L.S.	U.S.	L.S.	U.S.	L.S.
.05			.3799	.3368	.3546	.3002	.0539	.0474			.7360	.7138		
.10	.1688	.1113	.3253	.2535	.3278	.2818					.6737	.6527	.5236	.5368
.15	.1479	.0942	.2820	.2107	.3038	.2616					.6272	.6173	.4593	.4682
.20					.2821	.2532			.5269	.5126	.5885	.5840	.3978	.4045
.25	.1433	.0612	.2142	.1724	.2664	.2447			.5021	.4933	.5526	.5607	.3521	.3735
.30	-.0556	-.0745	.1903	.1712	.2697	.2533					.5188	.5442	.3089	.3404
.40	-.0484	-.0083					.3770	.3774	.4133	.4362	.4586	.4894	.2484	.2765
.50			-.1692	-.1477			-.0462	-.0615					.1525	-.0105
.60			-.1255	-.0980	-.1518	-.1045			-.2811	-.2674	-.2776	-.2565	-.2896	-.2820
.70			-.0044	.1225			-.3348	-.3040	-.3155	-.2941	-.3097	-.2888		
.80			-.2004	-.1670	-.3161	-.2944	-.3003	-.2783	-.3127	-.3007	-.2774	-.2990	-.2906	-.2457
.90					-.3132	-.2570	-.2862	-.2704	-.2760	-.2753	-.2618	-.2637	-.2630	-.2503
.95			-.1843	-.1814	-.3043	-.2262			-.2705	-.2628	-.2598	-.2540		

TAIL 2

TABLE XXII. - CONTINUED
(h) $\alpha = 11.15^\circ$

Cp at y/b of														
x/c	0.02		0.22		0.44		0.56		0.67		0.83		0.98	
	U.S.	L.S.	U.S.	L.S.	U.S.	L.S.	U.S.	L.S.	U.S.	L.S.	U.S.	L.S.	U.S.	L.S.
.05	.1168	.0621	.3327								1.0075	.2603	.8128	.2600
.10	.1369	.0954	.2847	.1524					.8863	.4532	.9054	.4106		
.15	.1503	.1147	.2666	.1509	.3793	.1853	.6465	.3307			.8279	.4463	.5669	.2706
.20	.1346	.1188							.7357	.3852	.7692	.4281		
.25	.1255	.1429	.2423	.1534	.3438	.1834			.6873	.3778			.4847	.2958
.30	-.0441	.0286	.2183	.1361			.5711	.3314	.6601	.3837	.6703	.3949	.4354	.2905
.40	-.0780	.0736					.5003	.3191	.5723	.3435	.5700	.3556	.3659	.2516
.50			-.1129	.0277			.0087	-.0983	.1976	-.0422	.3744	.0415	.2436	.0781
.60	.0140	-.0586	-.0699	.0677			-.2776	-.3109	-.2628	-.2977	-.2621	-.3085	-.2624	-.2689
.70			.0229	-.0086	-.3389	-.3315	-.3123	-.3376			-.2914	-.3260	-.2733	-.1700
.80	-.2266	-.2212	-.2305	-.2604	-.3126	-.3027	-.2661	-.2622					-.2622	-.2688
.90	-.2517	-.2436	-.2156	-.2777	-.2976	-.2497	-.2627	-.2675	-.2938	-.2804	-.2669	-.2780	-.1892	-.2656
.95			-.2190	-.2535	-.2947	-.2569	-.2004	-.2064	-.2913	-.2844	-.2540	-.2742		

TAIL 1

Cp at y/b of														
x/c	0.02		0.22		0.44		0.56		0.67		0.83		0.98	
	U.S.	L.S.	U.S.	L.S.	U.S.	L.S.	U.S.	L.S.	U.S.	L.S.	U.S.	L.S.	U.S.	L.S.
.05			.3861	.3447	.3914	.3506	.0413	.0354			.7201	.7090		
.10	.1558	.0819	.3445	.2811	.3548	.3148					.6622	.6469	.5236	.5359
.15	.1453	.0786	.2876	.2093	.3231	.2782					.6164	.6120	.4571	.4655
.20					.2934	.2628			.5222	.5193	.5766	.5777	.3931	.4009
.25	.1100	.0552	.1689	.1258	.2710	.2502			.4959	.5044	.5449	.5557	.3487	.3677
.30	-.0896	-.0821	.1293	.1016	.2701	.2569					.5117	.5353	.3067	.3361
.40	-.0621	-.0351					.3838	.3942	.4116	.4403	.4565	.4816	.2416	.2692
.50			-.2055	-.1916			-.0395	-.0489					.1466	-.0166
.60			-.1905	-.1580	-.1395	-.0913			-.2794	-.2651	-.2756	-.2557	-.2941	-.2855
.70			-.1646	-.1192			-.3302	-.3132	-.3116	-.2906	-.3074	-.2875		
.80			-.2709	-.2071	-.3269	-.3281	-.3261	-.3262	-.3149	-.2981	-.2717	-.2959	-.2844	-.2503
.90					-.3163	-.3103	-.3018	-.3001	-.2776	-.2912	-.2577	-.2590	-.2867	-.2529
.95			-.2049	-.1558	-.3220	-.2894			-.2686	-.2705	-.2563	-.2499		

TAIL 2

TABLE XXII. - CONTINUED
(1) $\alpha = 13.15^\circ$

Cp at y/b of														
x/c	0.02		0.22		0.44		0.56		0.67		0.83		0.98	
	U.S.	L.S.	U.S.	L.S.	U.S.	L.S.	U.S.	L.S.	U.S.	L.S.	U.S.	L.S.	U.S.	L.S.
.05	.0569	.0981	.2364								.8301	.6497	.6759	.4593
.10	.0789	.1250	.1999	.2061					.7499	.6630	.7679	.6320		
.15	.0885	.1408	.1802	.2012	.2858	.2692	.5009	.4818			.7131	.5949	.4777	.3879
.20	.0586	.1580							.6145	.5460	.6657	.5705		
.25	.0274	.1945	.1622	.2170	.2481	.2621			.5743	.5215			.4151	.3504
.30	-.1521	.0893	.1439	.1947			.4601	.4606	.5549	.5185	.5841	.5229	.3766	.3353
.40	-.1409	.1178					.4150	.4099	.4871	.4567	.4976	.4548	.3187	.2895
.50			-.1651	.0973			-.0289	-.0572	.1561	.0036	.3232	.0969	.2104	.0998
.60	-.0114	-.0332	-.1231	.1000			-.2954	-.2955	-.2813	-.2775	-.2800	-.2850	-.2654	-.2575
.70			-.0371	.0159	-.3596	-.2796	-.3293	-.3189			-.3103	-.3049	-.2723	-.2575
.80	-.2436	-.2019	-.2625	-.2468	-.3185	-.2394	-.2700	-.2443					-.2372	-.1748
.90	-.2451	-.2275	-.2607	-.2641	-.3163	-.2299	-.2617	-.2552	-.2706	-.2761	-.2592	-.2612	-.1829	-.1866
.95			-.2489	-.2420	-.3119	-.2409	-.2011	-.1996	-.2737	-.2754	-.2559	-.2565		

TAIL 1

Cp at y/b of														
x/c	0.02		0.22		0.44		0.56		0.67		0.83		0.98	
	U.S.	L.S.	U.S.	L.S.	U.S.	L.S.	U.S.	L.S.	U.S.	L.S.	U.S.	L.S.	U.S.	L.S.
.05			.3690	.3145	.4685	.4346	.0331	.0313			.7191	.7119		
.10	.1485	.0929	.3074	.2479	.4231	.3749					.6640	.6554	.5275	.5402
.15	.1289	.0851	.2733	.2016	.3699	.3199					.6240	.6189	.4621	.4750
.20					.3218	.2870			.5462	.5431	.5872	.5902	.4002	.4109
.25	.1037	.0391	.1501	.0756	.2823	.2594			.5141	.5223	.5564	.5689	.3553	.3772
.30	-.0928	-.1078	.0842	.0348	.2712	.2545					.5263	.5506	.3151	.3441
.40	-.0710	-.0624					.3899	.4007	.4287	.4533	.4703	.4946	.2487	.2762
.50			-.2401	-.2230			-.0358	-.0435					.1499	-.0143
.60			-.2274	-.2115	-.1632	-.1302			-.2733	-.2561	-.2711	-.2493	-.2885	-.2842
.70			-.2249	-.2006			-.3232	-.3049	-.3061	-.2804	-.3006	-.2777		
.80			-.3292	-.2839	-.3651	-.3464	-.3391	-.3241	-.3091	-.2877	-.2633	-.2887	-.2643	-.2483
.90					-.3261	-.3382	-.3147	-.3210	-.2710	-.2878	-.2481	-.2566	-.2618	-.2537
.95			-.2728	-.2398	-.3186	-.3226			-.2623	-.2682	-.2471	-.2434		

TAIL 2

TABLE XXII. - CONTINUED
(j) $\alpha = 17.15^\circ$

Cp at y/b of														
x/c	0.02		0.22		0.44		0.56		0.67		0.83		0.98	
	U.S.	L.S.	U.S.	L.S.	U.S.	L.S.	U.S.	L.S.	U.S.	L.S.	U.S.	L.S.	U.S.	L.S.
.05	-.0745	.1483	.0075								.2940	.9997	.3047	.8035
.10	-.0411	.1767	.0485	.3150					.4080	.9155	.3870	.9098		
.15	-.0466	.2034	.0468	.3263	.1235	.4125	.2535	.7045			.4173	.8293	.3031	.5735
.20	-.1129	.2453							.2575	.7618	.4066	.7709		
.25	-.1683	.3095	.0348	.3121	.0997	.3698			.2749	.7154			.2896	.4636
.30	-.2964	.1702	.0181	.2573			.2267	.6138	.3045	.6890	.3369	.6870	.2654	.4310
.40	-.2368	.1805					.2045	.5263	.2672	.5968	.2837	.5825	.2170	.3562
.50			-.2425	.2037			-.1338	-.0013	.0124	-.0641	-.1763	.1532	-.1303	-.1165
.60	-.0652	.0214	-.1805	.1451			-.3447	-.2572	-.3364	-.2445	-.3301	-.2559	-.2962	-.2529
.70			-.1120	.0776	-.3816	-.1656	-.3718	-.2650			-.3531	-.2719	-.2902	-.2522
.80	-.2645	-.1772	-.3080	-.2116	-.3601	-.1819	-.2774	-.2011					-.2246	-.2315
.90	-.2778	-.2052	-.3086	-.2230	-.3559	-.2002	-.3004	-.2111	-.3093	-.2768	-.3077	-.2816	-.2973	-.1935
.95			-.2821	-.2111	-.3362	-.2149	-.2378	-.1620	-.3166	-.2934	-.3060	-.2870		

TAIL 1

Cp at y/b of														
x/c	0.02		0.22		0.44		0.56		0.67		0.83		0.98	
	U.S.	L.S.	U.S.	L.S.	U.S.	L.S.	U.S.	L.S.	U.S.	L.S.	U.S.	L.S.	U.S.	L.S.
.05			.3084	.2207	.4717	.3605	.0225	.0327			.7851	.8104		
.10	.1063	.0604	.2515	.1628	.4931	.3614					.7492	.7556	.5426	.5769
.15	.0966	.0531	.2148	.1233	.4759	.3650					.7047	.7190	.4832	.5125
.20					.4329	.3266			.6267	.6278	.6623	.6810	.4284	.4512
.25	.0794	.0197	.1468	.0825	.3514	.2726			.5792	.5816	.6207	.6468	.3863	.4200
.30	-.1015	-.1188	.1190	.0645	.2641	.2183					.5792	.6171	.3460	.3880
.40	-.0904	-.0774					.2539	.2567	.4193	.4514	.5050	.5389	.2853	.3220
.50			-.2335	-.2398			-.1338	-.1352					.1844	.0163
.60			-.2425	-.2382	-.2950	-.3034			-.2946	-.2716	-.2682	-.2433	-.2799	-.2657
.70			-.2340	-.2185			-.3786	-.3574	-.3310	-.3045	-.3008	-.2765		
.80			-.3518	-.3093	-.4212	-.4253	-.3929	-.3731	-.3428	-.3176	-.2941	-.2900	-.2732	-.2228
.90					-.4139	-.4118	-.3750	-.3731	-.3180	-.3221	-.2575	-.2787	-.2469	-.2130
.95			-.3114	-.2708	-.4107	-.4072			-.3037	-.3133	-.2538	-.2609		

TAIL 2

TABLE XXII. - CONCLUDED
(k) $\alpha = 21.15^\circ$

Cp at γ/b of														
x/c	0.02		0.22		0.44		0.56		0.67		0.83		0.98	
	U.S.	L.S.	U.S.	L.S.	U.S.	L.S.	U.S.	L.S.	U.S.	L.S.	U.S.	L.S.	U.S.	L.S.
.05	-.1905	.2019	-.2468								-.0402	1.1422	-.0139	.9549
.10	-.1686	.2343	-.1830	.4420					.1594	1.0601	.0502	1.0397		
.15	-.2390	.2819	-.1252	.4503	-.2480	.4884	-.1994	.8601			.0984	.9546	.1120	.7066
.20	-.3336	.3578							.0262	.8898		.1218	.8901	
.25	-.3263	.4031	-.0662	.3910	-.1336	.4608			-.0029	.8338			.1518	.5677
.30	-.3657	.2391	-.0901	.3325			-.1276	.7319	.0031	.7959	.1221	.7913	.1527	.5228
.40	-.3149	.2505					-.0758	.6256	-.0630	.6902	.0837	.6723	.1297	.4247
.50			-.2761	.2532			-.2667	.0562	-.2111	.0944	-.0060	.1913	.0682	.1457
.60	-.1241	.0726	-.2167	.1782			-.3868	-.2080	-.3575	-.2138	-.3943	-.2226	-.3197	-.2727
.70			-.1863	.1546	-.3926	-.1278	-.3699	-.1815			-.3804	-.2329	-.2978	-.2478
.80	-.2893	-.1392	-.3416	-.1711	-.3913	-.1507	-.2999	-.1261					-.2750	-.2414
.90	-.2817	-.1627	-.3458	-.1573	-.3812	-.1546	-.3101	-.1352	-.3546	-.2090	-.3685	-.2380	-.2937	-.2259
.95			-.2892	-.1348	-.3506	-.1421	-.2405	-.0984	-.3599	-.2182	-.3607	-.2428		

TAIL 1

Cp at γ/b of														
x/c	0.02		0.22		0.44		0.56		0.67		0.83		0.98	
	U.S.	L.S.	U.S.	L.S.	U.S.	L.S.	U.S.	L.S.	U.S.	L.S.	U.S.	L.S.	U.S.	L.S.
.05			.2638	.1571	.3037	.1507	.0574	.0615			.6358	.7405		
.10	.0952	.0337	.2157	.1126	.3493	.1800					.6048	.6701	.4860	.5559
.15	.0878	.0281	.1675	.0680	.3650	.2240					.6040	.6323	.4868	.5234
.20					.3523	.2775			.5464	.5085	.6133	.6528	.4535	.5029
.25	.0660	-.0144	.0980	.0128	.2997	.2662			.5210	.4932	.6007	.6301	.4465	.4839
.30	-.1175	-.1510	.0655	-.0047	.2282	.2241					.5851	.6007	.4302	.4668
.40	-.1109	-.1190					.2082	.1870	.3453	.3465	.5204	.5241	.4083	.4282
.50			-.2576	-.2730			-.1730	-.1902					.3117	.0994
.60			-.2613	-.2580	-.3054	-.3164			-.3265	-.3163	-.2675	-.2538	-.2168	-.2055
.70			-.2387	-.2240			-.4023	-.3948	-.3666	-.3534	-.3067	-.2905		
.80			-.3578	-.3282	-.4551	-.4509	-.4206	-.4137	-.3834	-.3717	-.3226	-.3126	-.1420	-.1404
.90					-.4472	-.4450	-.4193	-.4157	-.3858	-.3795	-.3102	-.3069	-.1608	-.1498
.95			-.3611	-.3270	-.4406	-.4399			-.3720	-.3726	-.2920	-.2922		

TAIL 2

TABLE XXIII. - PRESSURE COEFFICIENTS, $\phi = 90^\circ$, $\delta_{1,3} = -15^\circ$, $M = 2.36$.
(a) $\alpha = -4.05^\circ$

Cp at y/b of														
x/c	0.02		0.22		0.44		0.56		0.67		0.83		0.98	
	U.S.	L.S.	U.S.	L.S.	U.S.	L.S.	U.S.	L.S.	U.S.	L.S.	U.S.	L.S.	U.S.	L.S.
.05	.4317	-.0764	.8504	-.1737							1.4689	-.1356	1.2785	-.0909
.10	.3667	-.0482	.7911	-.1624	.8407	-.1770			1.3442		1.3482	-.0878	1.1205	-.0532
.15	.3560	-.0617	.7533	-.1574	.8141	-.1719			1.2740		1.2653	-.0680	1.0136	-.0338
.20	.3906	-.0756							1.2163		1.1985	-.0598		
.25	.4408	-.0848	.7009	-.1488	.7570	-.1561	1.1466		1.1536				.8868	-.0167
.30	.2769	-.1358	.6718	-.1506	.7253	-.1276	1.0998		1.1070		1.0891	-.0539	.8193	-.0034
.40	.3321	-.0982	.2415	-.1795			.9834		1.0115		.9701	-.0525	.7244	-.0056
.50			.3034	-.1791			.3737	-.1905	.5744		.7255	-.1198	.5665	-.0773
.60	.3710	-.1045	.2991	-.1776	.2983	-.1761	.0497	-.1858	.0625	-.1862	.0697	-.1735	.0001	-.1970
.70			.3363	-.1722	.0893	-.1888	.0211	-.1863	.0596	-.1836	.0732	-.1737	-.0138	-.1946
.80	.0530	-.1494	.0546	-.1962	.0765	-.1890	.0146	-.1858					-.0161	-.1965
.90	-.0490	-.1519	.0508	-.1889	.0712	-.1866	.0230	-.1871	.0243	-.1808	.0763	-.1679	-.0173	-.1929
.95			.0568	-.1875	.0625	-.1804	.0154	-.1837	.0155	-.1831	.0654	-.1758		

TAIL 1

Cp at y/b of														
x/c	0.02		0.22		0.44		0.56		0.67		0.83		0.98	
	U.S.	L.S.	U.S.	L.S.	U.S.	L.S.	U.S.	L.S.	U.S.	L.S.	U.S.	L.S.	U.S.	L.S.
.05			.2738	.2242	.2891	.2280	.4280	.3025	.3153	.2988	.3084	.3061		
.10	.1168	.0991	.2447	.2015	.2869	.2251					.2953	.2912	.2511	.2643
.15	.1146	.0936	.2231	.1838	.2744	.2171			.3054	.2912	.2925	.2860	.2307	.2442
.20							.3604	.3237	.3144	.2959	.2890	.2820	.2096	.2191
.25	.1076	.0778	.1904	.1613	.2460	.2120	.3621	.3397	.3233	.3043	.2815	.2840	.1959	.2067
.30	.0072	-.0154	.1747	.1538	.2377	.2169	.3546	.3283	.3316	.3108	.2793	.2846	.1822	.1954
.40	-.0171	-.0147			.2314	.2244	.3380	.3281	.3309	.3140	.2728	.2819	.1632	.1778
.50			-.0417	-.0435			.0630	.0479					.1274	.0196
.60	.0689	.0850	.0440	.0309	-.0129	-.0188	-.0886	-.0811	-.1004	-.0995	-.1214	-.1148	-.1080	-.1191
.70			-.0239	-.0152			-.1315	-.1253	-.1246	-.1184	-.1246	-.1335		
.80			-.1168	-.1062	-.1092	-.1292	-.1080	-.1285	-.1184	-.1190	-.1100	-.1199	-.0993	-.1045
.90					-.1105	-.1126	-.1005	-.1108	-.0994	-.1025	-.1075	-.1082	-.1110	-.1074
.95			-.1070	-.0959					-.0956	-.0948	-.1065	-.1058	-.1258	-.1070

TAIL 2

TABLE XXIII. - CONTINUED
(b) $\alpha = -2.05^\circ$

Cp at y/b of														
x/c	0.02		0.22		0.44		0.56		0.67		0.83		0.98	
	U.S.	L.S.	U.S.	L.S.	U.S.	L.S.	U.S.	L.S.	U.S.	L.S.	U.S.	L.S.	U.S.	L.S.
.05	.3877	-.0567	.7854	-.1442							1.4045	-.0832	1.1893	-.0410
.10	.3360	-.0294	.7173	-.1342	.7888	-.1525			1.2830		1.2784	-.0415	1.0492	-.0187
.15	.3289	-.0408	.6795	-.1309	.7581	-.1450			1.2078		1.1999	-.0333	.9481	-.0043
.20	.3542	-.0581							1.1497		1.1365	-.0331		
.25	.3795	-.0695	.6266	-.1251	.7035	-.1310	1.0723		1.0915				.8309	-.0018
.30	.2194	-.1237	.6021	-.1270	.6626	-.1289	1.0359		1.0470		1.0360	-.0342	.7704	-.0017
.40	.2627	-.0981	.1972	-.1709			.9348		.9661		.9251	-.0343	.6836	-.0120
.50			.2329	-.1671			.3550	-.1786	.5551		.6981	-.1075	.5409	-.0665
.60	.2875	-.1016	.2238	-.1664	.2520	-.1701	.0366	-.1807	.0482	-.1831	.0553	-.1709	-.0114	-.1790
.70			.2643	-.1593	.0369	-.1826	.0033	-.1803	.0456	-.1803	.0466	-.1704	-.0298	-.1851
.80	.0100	-.1456	.0143	-.1888	.0322	-.1859	-.0132	-.1788					-.0344	-.2022
.90	-.0728	-.1532	.0111	-.1805	.0293	-.1833	-.0142	-.1792	.0093	-.1794	.0503	-.1627	-.0382	-.2018
.95			.0129	-.1780	.0216	-.1784	-.0197	-.1760	.0005	-.1823	.0394	-.1706		

TAIL 1

Cp at y/b of														
x/c	0.02		0.22		0.44		0.56		0.67		0.83		0.98	
	U.S.	L.S.	U.S.	L.S.	U.S.	L.S.	U.S.	L.S.	U.S.	L.S.	U.S.	L.S.	U.S.	L.S.
.05			.2633	.2161	.2857	.2270	.4341	.3016	.3118	.2952	.3076	.3029		
.10	.1048	.0882	.2323	.1908	.2796	.2214					.2953	.2881	.2553	.2658
.15	.1035	.0839	.2114	.1725	.2651	.2121			.3109	.2897	.2916	.2846	.2356	.2463
.20							.3575	.3233	.3253	.2979	.2889	.2809	.2113	.2222
.25	.0975	.0708	.1795	.1513	.2322	.2033	.3567	.3410	.3362	.3080	.2821	.2819	.1967	.2095
.30	.0022	-.0148	.1659	.1449	.2231	.2064	.3499	.3249	.3429	.3148	.2799	.2837	.1838	.1968
.40	-.0146	-.0089			.2177	.2111	.3308	.3205	.3400	.3187	.2743	.2811	.1630	.1765
.50			-.0436	-.0441			.0582	.0406					.1251	.0175
.60	.0959	.1070	.0518	.0337	-.0200	-.0271	-.0874	-.0805	-.1023	-.0978	-.1200	-.1136	-.1045	-.1193
.70			-.0188	-.0150			-.1368	-.1289	-.1271	-.1172	-.1241	-.1326		
.80			-.1202	-.1108	-.1143	-.1288	-.1163	-.1359	-.1224	-.1198	-.1081	-.1214	-.0967	-.1009
.90					-.1149	-.1165	-.1090	-.1215	-.1019	-.1055	-.1051	-.1082	-.1022	-.1086
.95			-.1180	-.0822					-.0974	-.0964	-.1038	-.1053	-.1043	-.1121

TAIL 2

TABLE XXIII. - CONTINUED
(c) $\alpha = -0.05^\circ$

Cp at γ/b of														
x/c	0.02		0.22		0.44		0.56		0.67		0.83		0.98	
	U.S.	L.S.	U.S.	L.S.	U.S.	L.S.	U.S.	L.S.	U.S.	L.S.	U.S.	L.S.	U.S.	L.S.
.05	.3583	-.0456	.7076	-.1076							1.3000	-.0135	1.0620	-.0033
.10	.3119	-.0178	.6390	-.1016	.7244	-.1207			1.1947		1.1829	-.0009	.9551	-.0033
.15	.3019	-.0217	.6004	-.1003	.6942	-.1123			1.1269		1.1148	-.0066	.8617	-.0125
.20	.3162	-.0368							1.0721		1.0636	-.0113		
.25	.3287	-.0509	.5487	-.0949	.6426	-.1008	.9839		1.0139				.7618	-.0126
.30	.1757	-.1118	.5277	-.0972	.6018	-.1074	.9601		.9748		.9767	-.0148	.7112	-.0098
.40	.1830	-.0936	.1584	-.1554			.8731		.9050		.8803	-.0148	.6359	-.0162
.50			.1726	-.1496			.3263	-.1577	.5264		.6711	-.0939	.5096	-.0629
.60	.2171	-.0988	.1594	-.1463	.2100	-.1578	.0193	-.1739	.0350	-.1794	.0434	-.1674	-.0227	-.1775
.70			.1727	-.1429	.0009	-.1749	-.0140	-.1731	.0326	-.1767	.0245	-.1664	-.0454	-.1845
.80	-.0237	-.1419	-.0227	-.1845	-.0078	-.1758	-.0313	-.1713					-.0532	-.2071
.90	-.0922	-.1523	-.0238	-.1760	-.0109	-.1757	-.0408	-.1712	-.0021	-.1752	.0239	-.1587	-.0583	-.2129
.95			-.0238	-.1711	-.0175	-.1735	-.0472	-.1677	-.0115	-.1770	.0138	-.1659		

TAIL 1

Cp at γ/b of														
x/c	0.02		0.22		0.44		0.56		0.67		0.83		0.98	
	U.S.	L.S.	U.S.	L.S.	U.S.	L.S.	U.S.	L.S.	U.S.	L.S.	U.S.	L.S.	U.S.	L.S.
.05			.2523	-.2106	.2790	.2277	.4339	.3031	.3096	.2939	.3042	.3021		
.10	.0876	.0778	.2179	-.1817	.2687	.2195					.2932	.2860	.2573	.2661
.15	.0887	.0750	.1976	-.1635	.2518	.2060			.3185	.2943	.2893	.2827	.2390	.2485
.20							.3545	.3265	.3366	.3055	.2869	.2795	.2140	.2250
.25	.0837	.0642	.1677	-.1426	.2180	.1931	.3497	.3424	.3453	.3141	.2800	.2805	.1985	.2131
.30	-.0029	-.0070	.1540	-.1370	.2096	.1949	.3390	.3224	.3511	.3207	.2781	.2823	.1839	.1994
.40	-.0037	.0092			.2033	-.1983	.3191	.3157	.3418	.3247	.2731	.2806	.1619	.1769
.50			-.0431	-.0391			.0529	.0376					-.1223	.0149
.60	.1048	.1142	.0395	.0335	-.0258	-.0286	-.0942	-.0865	-.1039	-.0978	-.1180	-.1123	-.1038	-.1226
.70			-.0120	-.0144			-.1405	-.1313	-.1282	-.1184	-.1251	-.1305		
.80			-.1229	-.1069	-.1217	-.1340	-.1214	-.1398	-.1227	-.1217	-.1077	-.1235	-.0975	-.1021
.90					-.1196	-.1218	-.1125	-.1260	-.1028	-.1085	-.1035	-.1070	-.1035	-.1070
.95			-.1093	-.0899					-.0986	-.0984	-.1016	-.1024	-.1056	-.1108

TAIL 2

TABLE XXIII. - CONTINUED
(d) $\alpha = 1.95^\circ$

Cp at y/b of															
x/c	0.02		0.22		0.44		0.56		0.67		0.83		0.98		
	U.S.	L.S.	U.S.	L.S.	U.S.	L.S.	U.S.	L.S.	U.S.	L.S.	U.S.	L.S.	U.S.	L.S.	
.05	.3170	-.0428	.6219	-.0675							1.1250	.0392	.8942	.0358	
.10	.2783	-.0114	.5586	-.0656	.6501	-.0805				1.0787		1.0494	.0255	.8346	.0208
.15	.2703	-.0046	.5220	-.0656	.6208	-.0744				1.0162		1.0047	.0153	.7650	.0241
.20	.2795	-.0125								.9718		.9699	.0116		
.25	.2815	-.0250	.4708	-.0612	.5735	-.0669	.8742			.9248				.6854	.0279
.30	.1402	-.0969	.4530	-.0627	.5415	-.0779	.8554			.8854		.9075	.0107	.6457	.0261
.40	.1128	-.0863	.1234	-.1357			.7911			.8262		.8294	.0110	.5845	.0211
.50			.1214	-.1302			.2855	-.1330	.4851		.6419	-.0745	.4764	-.0560	
.60	.1531	-.0991	.1116	-.1259	.1650	-.1410	.0019	-.1718	.0213	-.1791	.0309	-.1602	-.0377	-.1689	
.70			.1067	-.1248	-.0290	-.1685	-.0326	-.1680	.0197	-.1767	.0050	-.1584	-.0634	-.1694	
.80	-.0537	-.1383	-.0644	-.1803	-.0436	-.1683	-.0497	-.1665					-.0724	-.1850	
.90	-.1123	-.1508	-.0619	-.1707	-.0465	-.1693	-.0621	-.1660	-.0129	-.1683	-.0060	-.1514	-.0768	-.1926	
.95			-.0604	-.1662	-.0515	-.1682	-.0699	-.1622	-.0221	-.1696	-.0151	-.1568			

TAIL 1

Cp at y/b of														
x/c	0.02		0.22		0.44		0.56		0.67		0.83		0.98	
	U.S.	L.S.	U.S.	L.S.	U.S.	L.S.	U.S.	L.S.	U.S.	L.S.	U.S.	L.S.	U.S.	L.S.
.05			.2441	.2051	.2730	.2284	.4305	.3086	.3084	.2915	.3033	.2991		
.10	.0742	.0710	.2078	.1740	.2590	.2154					.2914	.2835	.2598	.2649
.15	.0763	.0682	.1863	.1555	.2402	.1999			.3348	.3008	.2882	.2809	.2430	.2489
.20							.3502	.3256	.3495	.3138	.2860	.2776	.2183	.2274
.25	.0723	.0588	.1578	.1347	.2062	.1824	.3431	.3382	.3559	.3224	.2815	.2797	.2017	.2163
.30	-.0053	-.0013	.1459	.1287	.1982	.1842	.3334	.3174	.3558	.3282	.2797	.2821	.1874	.2025
.40	.0047	.0180			.1935	.1839	.3120	.3087	.3418	.3302	.2779	.2814	.1630	.1782
.50			-.0433	-.0475			.0487	.0400					.1218	.0146
.60	.0881	.0962	.0179	.0214	-.0338	-.0292	-.1009	-.0924	-.1059	-.0991	-.1138	-.1103	-.1018	-.1254
.70			-.0116	-.0083			-.1418	-.1340	-.1296	-.1193	-.1272	-.1271		
.80			-.1206	-.0955	-.1228	-.1368	-.1209	-.1422	-.1241	-.1235	-.1117	-.1224	-.0962	-.1041
.90					-.1205	-.1230	-.1146	-.1268	-.1044	-.1120	-.1021	-.1042	-.0997	-.1043
.95			-.1007	-.0901					-.1005	-.1014	-.0984	-.0981	-.1018	-.1054

TAIL 2

TABLE XXIII, - CONTINUED
(e) $\alpha = 3.94^\circ$

Cp at y/b of														
x/c	0.02		0.22		0.44		0.56		0.67		0.83		0.98	
	U.S.	L.S.	U.S.	L.S.	U.S.	L.S.	U.S.	L.S.	U.S.	L.S.	U.S.	L.S.	U.S.	L.S.
.05	.2455	-.0325	.5229	-.0276							.7971	.0764	.6956	.0697
.10	.2378	-.0054	.4673	-.0267	.5738	-.0355			.9447		.8363	.0578	.6463	.0489
.15	.2261	.0085	.4353	-.0282	.5453	-.0317			.8963		.8506	.0480	.5978	.0446
.20	.2418	.0055							.8578		.8464	.0448		
.25	.2373	.0023	.3981	-.0247	.4990	-.0278	.7614		.8197				.5806	.0378
.30	.1093	-.0792	.3775	-.0270	.4723	-.0374	.7470		.7862		.8185	.0440	.5655	.0375
.40	.0618	-.0802	.0830	-.1159			.6943		.7348		.7705	.0429	.5336	.0327
.50			.0819	-.1080			.2375	-.1068	.4302		.6157	-.0541	.4412	-.0473
.60	.0960	-.1012	.0786	-.1043	.1242	-.1189	-.0219	-.1730	.0074	-.1743	.0163	-.1564	-.0512	-.1588
.70			.0697	-.1072	-.0581	-.1655	-.0546	-.1603	.0059	-.1720	-.0176	-.1530	-.0799	-.1578
.80	-.0800	-.1356	-.0977	-.1692	-.0747	-.1615	-.0705	-.1578					-.0825	-.1765
.90	-.1292	-.1508	-.0963	-.1598	-.0771	-.1613	-.0821	-.1578	-.0302	-.1615	-.0353	-.1465	-.0851	-.1719
.95			-.0951	-.1560	-.0805	-.1617	-.0902	-.1555	-.0370	-.1619	-.0448	-.1511		

TAIL 1

Cp at y/b of														
x/c	0.02		0.22		0.44		0.56		0.67		0.83		0.98	
	U.S.	L.S.	U.S.	L.S.	U.S.	L.S.	U.S.	L.S.	U.S.	L.S.	U.S.	L.S.	U.S.	L.S.
.05			.2439	.2070	.2633	.2233	.4223	.3060	.3082	.2909	.3049	.2968		
.10	.0792	.0797	.2113	.1790	.2515	.2098					.2942	.2828	.2612	.2651
.15	.0778	.0743	.1912	.1616	.2347	.1936			.3471	.3095	.2905	.2799	.2453	.2496
.20							.3478	.3197	.3590	.3205	.2870	.2768	.2213	.2300
.25	.0691	.0571	.1633	.1412	.2040	.1783	.3406	.3333	.3619	.3279	.2830	.2793	.2049	.2202
.30	-.0146	-.0176	.1510	.1350	.1977	.1808	.3290	.3139	.3571	.3306	.2827	.2819	.1904	.2070
.40	-.0258	-.0144			.1946	.1817	.3074	.3037	.3369	.3288	.2842	.2826	.1662	.1821
.50			-.0461	-.0502			.0457	.0430					.1241	.0154
.60	.0747	.0716	.0036	.0019	-.0364	-.0315	-.1074	-.1002	-.1047	-.0982	-.1083	-.1074	-.1039	-.1211
.70			-.0235	-.0238			-.1432	-.1364	-.1285	-.1189	-.1257	-.1236		
.80			-.1224	-.1103	-.1278	-.1323	-.1332	-.1424	-.1273	-.1244	-.1163	-.1193	-.0970	-.1012
.90					-.1224	-.1200	-.1237	-.1251	-.1066	-.1152	-.1006	-.1013	-.1015	-.1033
.95			-.1147	-.0985					-.1020	-.1041	-.0958	-.0947	-.1044	-.1076

TAIL 2

TABLE XXIII. - CONTINUED
(f) $\alpha = 5.94^\circ$

Cp at y/b of														
x/c	0.02		0.22		0.44		0.56		0.67		0.83		0.98	
	U.S.	L.S.	U.S.	L.S.	U.S.	L.S.	U.S.	L.S.	U.S.	L.S.	U.S.	L.S.	U.S.	L.S.
.05	.1822	-.0135	.4280	.0191							.6374	.1204	.5873	.1140
.10	.1737	.0063	.3751	.0178	.4940	-.0131			.7942		.6082	.1006	.5439	.0863
.15	.1718	.0190	.3485	.0165	.4624	.0151			.7678		.6201	.0910	.4943	.0773
.20	.1835	.0197							.7379		.6450	.0872		
.25	.1868	.0238	.3171	.0130	.4188	.0156	.6463		.7092				.4489	.0579
.30	.0628	-.0566	.3076	.0085	.4045	.0012	.6342		.6841		.6853	.0853	.4246	.0553
.40	.0173	-.0659	.0422	-.0972			.5892		.6429		.6753	.0824	.4010	.0480
.50			.0390	-.0885			.1868	-.0752	.3743		.5543	-.0279	.3477	-.0403
.60	.0370	-.0931	.0347	-.0840	.0842	-.0940	-.0527	-.1704	-.0103	-.1664	-.0042	-.1525	-.0781	-.1532
.70			.0286	-.0861	-.0854	-.1709	-.0762	-.1588	-.0115	-.1638	-.0368	-.1452	-.0804	-.1490
.80	-.0976	-.1260	-.1209	-.1657	-.1009	-.1540	-.0906	-.1514					-.0724	-.1522
.90	-.1366	-.1452	-.1251	-.1579	-.1049	-.1535	-.1012	-.1511	-.0508	-.1560	-.0615	-.1394	-.0715	-.1617
.95			-.1236	-.1477	-.1073	-.1540	-.1090	-.1491	-.0589	-.1557	-.0722	-.1427		

TAIL 1

Cp at y/b of														
x/c	0.02		0.22		0.44		0.56		0.67		0.83		0.98	
	U.S.	L.S.	U.S.	L.S.	U.S.	L.S.	U.S.	L.S.	U.S.	L.S.	U.S.	L.S.	U.S.	L.S.
.05			.2447	.2096	.2578	.2166	.4190	.2991	.3126	.2903	.3076	.2967		
.10	.0912	.0887	.2229	.1908	.2496	.2039					.2960	.2836	.2631	.2652
.15	.0852	.0811	.2083	.1766	.2368	.1903			.3583	.3130	.2928	.2806	.2505	.2515
.20							.3494	.3166	.3651	.3226	.2906	.2770	.2272	.2340
.25	.0690	.0543	.1816	.1551	.2102	.1810	.3433	.3314	.3629	.3281	.2864	.2797	.2115	.2247
.30	-.0232	-.0321	.1653	.1485	.2063	.1859	.3334	.3133	.3551	.3274	.2875	.2833	.1968	.2112
.40	-.0464	-.0449			.2061	.1901	.3169	.3064	.3346	.3241	.2918	.2852	.1718	.1866
.50			-.0519	-.0541			.0509	.0449					.1289	.0179
.60	.0229	.0017	.0013	-.0076	-.0304	-.0261	-.1111	-.1074	-.1017	-.0972	-.1043	-.1051	-.1094	-.1232
.70			-.0506	-.0519			-.1424	-.1360	-.1254	-.1175	-.1239	-.1215		
.80			-.1346	-.1356	-.1333	-.1390	-.1405	-.1447	-.1266	-.1236	-.1143	-.1171	-.0994	-.1008
.90					-.1234	-.1262	-.1272	-.1289	-.1071	-.1155	-.0959	-.0972	-.1039	-.1027
.95			-.1222	-.1154					-.1023	-.1046	-.0921	-.0916	-.1042	-.1049

TAIL 2

TABLE XXIII. - CONTINUED
(g) $\alpha = 7.95^\circ$

Cp at y/b of														
x/c	0.02		0.22		0.44		0.56		0.67		0.83		0.98	
	U.S.	L.S.	U.S.	L.S.	U.S.	L.S.	U.S.	L.S.	U.S.	L.S.	U.S.	L.S.	U.S.	L.S.
.05	.1157	.0041	.3428	.0724							.5243	.1687	.4951	.1627
.10	.1134	.0197	.2922	.0689	.4059	.0663			.6081		.5077	.1484	.4579	.1295
.15	.1171	.0311	.2643	.0615	.3786	.0658			.6290		.4991	.1388	.4143	.1171
.20	.1256	.0342							.6216		.4981	.1357		
.25	.1286	.0418	.2374	.0485	.3407	.0665	.5321		.5997				.3720	.0899
.30	.0136	-.0329	.2299	.0419	.3238	.0520	.5249		.5807		.5160	.1341	.3543	.0844
.40	-.0306	-.0407	.0085	-.0788			.4879		.5469		.5352	.1300	.3172	.0732
.50			-.0038	-.0702			.1340	-.0420	.3065		.4579	.0052	.2575	-.0251
.60	-.0123	-.0769	-.0085	-.0645	-.0361	-.0701	-.0817	-.1567	-.0457	-.1528	-.0382	-.1523	-.1089	-.1459
.70			-.0170	-.0629	-.1117	-.1653	-.1014	-.1630	-.0461	-.1508	-.0615	-.1354	-.1085	-.1447
.80	-.1085	-.1151	-.1424	-.1540	-.1243	-.1447	-.1102	-.1449					-.1013	-.1274
.90	-.1342	-.1364	-.1442	-.1537	-.1290	-.1419	-.1192	-.1421	-.0828	-.1465	-.0811	-.1269	-.0936	-.1549
.95			-.1329	-.1447	-.1312	-.1429	-.1262	-.1412	-.0899	-.1451	-.0923	-.1310		

TAIL 1

Cp at y/b of														
x/c	0.02		0.22		0.44		0.56		0.67		0.83		0.98	
	U.S.	L.S.	U.S.	L.S.	U.S.	L.S.	U.S.	L.S.	U.S.	L.S.	U.S.	L.S.	U.S.	L.S.
.05			.2372	.2001	.2570	.2163	.4126	.2990	.3184	.2947	.3135	.2996		
.10	.0880	.0762	.2231	.1852	.2477	.2023					.3010	.2878	.2677	.2695
.15	.0800	.0689	.2112	.1751	.2357	.1893			.3624	.3171	.2964	.2837	.2552	.2557
.20							.3439	.3138	.3654	.3240	.2932	.2811	.2334	.2401
.25	.0644	.0453	.1881	.1606	.2147	.1831	.3386	.3268	.3589	.3277	.2891	.2832	.2177	.2311
.30	-.0279	-.0435	.1746	.1545	.2149	.1909	.3299	.3102	.3485	.3258	.2901	.2862	.2030	.2189
.40	-.0566	-.0605			.2285	.2011	.3174	.3051	.3281	.3215	.2942	.2875	.1775	.1934
.50			-.0585	-.0552			.0596	.0467					.1336	.0239
.60	-.0277	-.0395	.0090	-.0004	-.0104	-.0062	-.1114	-.1086	-.1030	-.0987	-.1043	-.1046	-.1187	-.1255
.70			-.0849	-.0822			-.1363	-.1300	-.1253	-.1194	-.1249	-.1214		
.80			-.1404	-.1300	-.1466	-.1348	-.1425	-.1382	-.1214	-.1239	-.1108	-.1163	-.1021	-.1005
.90					-.1279	-.1437	-.1240	-.1257	-.1057	-.1106	-.0951	-.0965	-.1054	-.1033
.95			-.1346	-.1268					-.1007	-.1009	-.0923	-.0913	-.1064	-.1005

TAIL 2

TABLE XXIII. - CONTINUED
(h) $\alpha = 9.95^\circ$

Cp at y/b of														
x/c	0.02		0.22		0.44		0.56		0.67		0.83		0.98	
	U.S.	L.S.	U.S.	L.S.	U.S.	L.S.	U.S.	L.S.	U.S.	L.S.	U.S.	L.S.	U.S.	L.S.
.05	.0489	.0211	.2525	.1312							.4255	.2258	.4105	.2194
.10	.0489	.0333	.2091	.1153	.3213	.1271			.4380		.4151	.2048	.3786	.1794
.15	.0563	.0429	.1831	.0986	.2934	.1256			.4620		.4052	.1951	.3381	.1629
.20	.0652	.0458							.4818		.3998	.1916		
.25	.0590	.0575	.1661	.0814	.2580	.1233	.4234		.4799				.2980	.1289
.30	-.0367	-.0117	.1586	.0734	.2479	.1084	.4181		.4695		.3982	.1900	.2851	.1213
.40	-.0695	-.0086	-.0259	-.0603			.3880		.4434		.3965	.1852	.2488	.1046
.50			-.0443	-.0494			.0793	-.0093	.2326		.3266	.0440	.1957	-.0051
.60	-.0472	-.0638	-.0471	-.0415	-.0052	-.0482	-.1063	-.1399	-.0830	-.1344	-.0785	-.1449	-.1241	-.1238
.70			-.0546	-.0310	-.1358	-.1560	-.1261	-.1563	-.0826	-.1326	-.0970	-.1233	-.1282	-.1205
.80	-.1133	-.1058	-.1554	-.1386	-.1468	-.1497	-.1322	-.1527					-.1275	-.1224
.90	-.1292	-.1290	-.1385	-.1500	-.1493	-.1368	-.1394	-.1370	-.1128	-.1312	-.1064	-.1120	-.1298	-.1276
.95			-.1369	-.1478	-.1432	-.1351	-.1394	-.1314	-.1187	-.1305	-.1165	-.1161		

TAIL 1

Cp at y/b of														
x/c	0.02		0.22		0.44		0.56		0.67		0.83		0.98	
	U.S.	L.S.	U.S.	L.S.	U.S.	L.S.	U.S.	L.S.	U.S.	L.S.	U.S.	L.S.	U.S.	L.S.
.05			.2094	.1704	.2510	.2078	.4037	.2905	.3250	.3013	.3160	.3040		
.10	.0766	.0615	.1982	.1582	.2474	.2000					.3040	.2919	.2704	.2733
.15	.0693	.0521	.1871	.1511	.2393	.1889			.3499	.3118	.2995	.2872	.2588	.2600
.20							.3385	.3068	.3544	.3180	.2964	.2840	.2375	.2439
.25	.0570	.0333	.1604	.1334	.2202	.1858	.3352	.3232	.3495	.3194	.2907	.2865	.2213	.2353
.30	.0247	-.0518	.1406	.1228	.2189	.1947	.3300	.3084	.3411	.3173	.2905	.2891	.2065	.2230
.40	-.0546	-.0624			.2301	.2107	.3196	.3058	.3230	.3140	.2917	.2887	.1816	.1978
.50			-.0754	-.0765			.0629	.0437					.1375	.0253
.60	-.0285	-.0435	.0175	.0073	-.0254	.0111	-.1069	-.1061	-.1057	-.1017	-.1069	-.1057	-.1215	-.1151
.70			-.1031	-.0985			-.1227	-.1250	-.1261	-.1199	-.1250	-.1224		
.80			-.1648	-.1643	-.1412	-.1275	-.1285	-.1244	-.1067	-.1144	-.1025	-.1082	-.1008	-.0941
.90					-.1469	-.1407	-.1160	-.1132	-.0980	-.0982	-.0920	-.0924	-.1032	-.0951
.95			-.1574	-.1522					-.0946	-.0929	-.0903	-.0892	-.1033	-.0941

TAIL 2

TABLE XXIII. - CONTINUED
(i) $\alpha = 11.95^\circ$

Cp at y/b of														
x/c	0.02		0.22		0.44		0.56		0.67		0.83		0.98	
	U.S.	L.S.	U.S.	L.S.	U.S.	L.S.	U.S.	L.S.	U.S.	L.S.	U.S.	L.S.	U.S.	L.S.
.05	-.0052	.0402	.1658	.1822							.3312	.2911	.3120	.2776
.10	-.0045	.0496	.1359	.1527	.2321	.2009				.3261	.3224	.2700	.2894	.2327
.15	.0035	.0581	.1161	.1317	.2124	.1924				.3342	.3156	.2599	.2558	.2123
.20	.0090	.0631								.3466	.3103	.2567		
.25	-.0065	.0755	.1002	.1127	.1830	.1745	.3221			.3524			.2236	.1727
.30	-.0840	.0158	.0962	.1041	.1806	.1562	.3204			.3529	.3051	.2548	.2134	.1639
.40	-.0998	.0323	-.0615	-.0425			.2951			.3404	.2969	.2490	.1855	.1443
.50			-.0780	-.0283			.0301	.0258		.1703	.2307	.0871	.1404	.0196
.60	-.0504	-.0487	-.0823	-.0143	-.0387	-.0257	-.1322	-.1264	-.1120	-.1110	-.1148	-.1301	-.1359	-.1190
.70			-.0868	.0069	-.1549	-.1442	-.1501	-.1411	-.1111	-.1095	-.1325	-.1388	-.1414	-.1140
.80	-.1088	-.0976	-.1416	-.1231	-.1572	-.1556	-.1524	-.1459					-.1362	-.1113
.90	-.1264	-.1210	-.1407	-.1410	-.1393	-.1543	-.1406	-.1497	-.1256	-.1358	-.1160	-.1073	-.1328	-.1097
.95			-.1406	-.1431	-.1369	-.1438	-.1324	-.1422	-.1176	-.1284	-.1127	-.1106		

TAIL 1

Cp at y/b of															
x/c	0.02		0.22		0.44		0.56		0.67		0.83		0.98		
	U.S.	L.S.	U.S.	L.S.	U.S.	L.S.	U.S.	L.S.	U.S.	L.S.	U.S.	L.S.	U.S.	L.S.	
.05			.1559	.1209	.2116	.1660	.3949	.2779	.3313	.3041	.3241	.3074			
.10	.0663	.0491	.1501	.1149	.2101	.1617					.3121	.2945	.2761	.2754	
.15	.0606	.0410	.1416	.1074	.2009	.1511				.3371	.3046	.3084	.2900	.2649	.2624
.20							.3177	.2850		.3442	.3108	.3041	.2874	.2447	.2466
.25	.0473	.0228	.1121	.0869	.1838	.1495	.3217	.3013	.3420	.3129	.2990	.2896	.2294	.2387	
.30	-.0350	-.0577	.0917	.0758	.1816	.1566	.3176	.2926	.3361	.3134	.2984	.2921	.2145	.2264	
.40	-.0621	-.0688			.1877	.1718	.3107	.2902	.3258	.3125	.2969	.2918	.1895	.2016	
.50			-.1030	-.1024			.0516	.0274					.1450	.0262	
.60	-.0386	-.0517	.0213	.0104	.0116	-.0332	-.1087	-.1065	-.1068	-.1051	-.1089	-.1066	-.1270	-.1277	
.70			-.1138	-.1117			-.1265	-.1338	-.1269	-.1238	-.1267	-.1235			
.80			-.1739	-.1744	-.1417	-.1273	-.1138	-.1239	-.1017	-.1111	-.1053	-.1111	-.1017	-.0971	
.90					-.1574	-.1334	-.1093	-.1054	-.0962	-.0966	-.0939	-.0944	-.1035	-.0972	
.95			-.1645	-.1663					-.0937	-.0922	-.0920	-.0910	-.1036	-.0971	

TAIL 2

TABLE XXIII. - CONTINUED
(j) $\alpha = 15.96^\circ$

Cp at y/b of														
x/c	0.02		0.22		0.44		0.56		0.67		0.83		0.98	
	U.S.	L.S.	U.S.	L.S.	U.S.	L.S.	U.S.	L.S.	U.S.	L.S.	U.S.	L.S.	U.S.	L.S.
.05	-.0650	.0770	-.0042	.2398							.1536	.4196	.1573	.4022
.10	-.0759	.0849	-.0235	.2023	.0709	.3016			.1685		.1440	.3986	.1420	.3481
.15	-.0831	.0947	-.0374	.1783	.0621	.2801			.1744		.1391	.3867	.1162	.3193
.20	-.1062	.0974							.1829		.1357	.3836		
.25	-.1369	.1130	-.0071	.1595	.0522	.2500	.1357		.1778				.0890	.2637
.30	-.1628	.0611	-.0035	.1489	.0720	.2226	.1365		.1699		.1443	.3968	.0779	.2595
.40	-.1276	.0830	-.1137	-.0071			.1234		.1536		.1466	.4033	.0631	.2343
.50			-.1262	.0295			-.0607	-.0872	.0311		.0968	.2003	.0294	.0805
.60	-.0271	-.0266	-.1163	.0487	-.1032	.0181	-.1712	-.0946	-.1613	-.0727	-.1575	-.0680	-.1559	-.1283
.70			-.1167	.0705	-.1579	-.1174	-.1580	-.1111	-.1594	-.0721	-.1520	-.0791	-.1621	-.1267
.80	-.1118	-.0825	-.1609	-.0974	-.1536	-.1280	-.1541	-.1191					-.1482	-.1202
.90	-.1146	-.1184	-.1591	-.1232	-.1522	-.1245	-.1544	-.1274	-.1511	-.1037	-.1351	-.0892	-.1414	-.1162
.95			-.1539	-.1243	-.1491	-.1270	-.1521	-.1322	-.1535	-.1062	-.1395	-.0987		

TAIL 1

Cp at y/b of														
x/c	0.02		0.22		0.44		0.56		0.67		0.83		0.98	
	U.S.	L.S.	U.S.	L.S.	U.S.	L.S.	U.S.	L.S.	U.S.	L.S.	U.S.	L.S.	U.S.	L.S.
.05			.0876	.0529	.0432	.0180	.1982	.1532	.2713	.2324	.3496	.3211		
.10	.0375	.0215	.0818	.0475	.0401	.0047					.3391	.3060	.2982	.2919
.15	.0279	.0127	.0814	.0480	.0315	-.0005			.2497	.2227	.3380	.3045	.2890	.2786
.20							.1567	.1302	.2499	.2203	.3331	.3010	.2658	.2629
.25	.0075	-.0102	.0679	.0450	.0177	-.0043	.1396	.1254	.2437	.2193	.3279	.3051	.2501	.2539
.30	-.0680	-.0815	.0528	.0419	.0131	-.0018	.1332	.1251	.2368	.2158	.3233	.3066	.2350	.2420
.40	-.0933	-.0944			.0169	.0113	.1143	.1065	.2246	.2141	.3190	.3055	.2092	.2177
.50			-.1239	-.1179			-.0630	-.0715					.1651	.0401
.60	-.0763	-.0806	.0232	.0149	-.1323	-.1363	-.1312	-.1277	-.1399	-.1371	-.1080	-.1054	-.1331	-.1310
.70			-.1452	-.1355			-.1847	-.1800	-.1625	-.1558	-.1310	-.1258		
.80			-.1955	-.1906	-.1796	-.1794	-.1866	-.1845	-.1663	-.1602	-.1322	-.1312	-.1112	-.1088
.90					-.1836	-.1826	-.1766	-.1791	-.1496	-.1539	-.1092	-.1201	-.1096	-.1087
.95			-.1819	-.1802					-.1472	-.1507	-.1036	-.1100	-.1083	-.1070

TAIL 2

TABLE XXIII. - CONCLUDED
(K) $\alpha = .19, 96^\circ$

Cp at γ/b of														
x/c	0.02		0.22		0.44		0.56		0.67		0.83		0.98	
	U.S.	L.S.	U.S.	L.S.	U.S.	L.S.	U.S.	L.S.	U.S.	L.S.	U.S.	L.S.	U.S.	L.S.
.05	-.0585	.1394	-.0240	.3170							.1284	.5727	.1315	-.5562
.10	-.0696	.1518	-.0402	.2773	.0027	.3891			.1294		.1183	.5511	.1199	-.4908
.15	-.0822	.1603	-.0551	.2537	-.0117	.3662			.1387		.1100	.5604	.0953	-.4537
.20	-.1251	.1651							.1346		.1005	.5888		
.25	-.1678	.1827	-.0819	.2349	-.0275	.3319	.0329		.1148				.0706	.3960
.30	-.1918	.1213	-.0931	.2241	-.0106	.3113	.0320		.0924		.0914	.6178	.0611	-.3870
.40	-.1727	.1542	-.1665	.0563			.0162		.0597		.0800	.6139	.0460	-.3705
.50			-.1600	.0957			-.1194	.1503	-.0431		.0337	.3304	.0130	-.1800
.60	-.0796	.0085	-.1554	.1239	-.1501	.0548	-.1572	-.0626	-.1551	-.0356	-.1682	-.0173	-.1635	-.0865
.70			-.1609	.1522	-.1628	-.0887	-.1559	-.0816	-.1531	-.0355	-.1576	-.0369	-.1733	-.0929
.80	-.1199	-.0507	-.1832	-.0713	-.1647	-.0804	-.1552	-.0956					-.1390	-.0753
.90	-.1303	-.0950	-.1805	-.0955	-.1659	-.0634	-.1559	-.1038	-.1557	-.0733	-.1478	-.0543	-.1602	-.0703
.95			-.1705	-.0970	-.1618	-.0594	-.1536	-.1080	-.1577	-.0790	-.1535	-.0625		

TAIL 1

Cp at γ/b of														
x/c	0.02		0.22		0.44		0.56		0.67		0.83		0.98	
	U.S.	L.S.	U.S.	L.S.	U.S.	L.S.	U.S.	L.S.	U.S.	L.S.	U.S.	L.S.	U.S.	L.S.
.05			.0046	-.0123	-.0095	-.0244	.0532	.0303	.0392	.0303	.1238	.1097		
.10	.0044	-.0038	.0041	-.0116	-.0115	-.0322					.1037	.0929	.2457	.2270
.15	-.0099	-.0137	.0042	-.0106	-.0174	-.0372			.0323	.0245	.1054	.0880	.2214	.2041
.20							.0265	.0264	.0282	.0223	.0980	.0831	.2013	.1816
.25	-.0342	-.0410	-.0076	-.0148	-.0266	-.0361	.0157	.0177	.0249	.0201	.0896	.0828	.1848	.1699
.30	-.0996	-.1060	-.0157	-.0180	-.0325	-.0343	.0116	.0123	.0201	.0175	.0828	.0806	.1640	.1589
.40	-.1220	-.1186			-.0291	-.0254	.0002	.0055	.0105	.0158	.0672	.0732	.1444	.1433
.50			-.1486	-.1409			-.1182	-.1191					-.1078	-.0015
.60	-.1073	-.1111	.0277	.0168	-.1496	-.1509	-.1452	-.1419	-.1874	-.1841	-.1779	-.1735	-.1436	-.1414
.70			-.1660	-.1567			-.1988	-.1959	-.1998	-.1964	-.1919	-.1868		
.80			-.2022	-.1996	-.1926	-.1918	-.1948	-.1961	-.1926	-.1923	-.1965	-.1930	-.1377	-.1395
.90					-.1949	-.1931	-.1895	-.1898	-.1834	-.1821	-.1911	-.1903	-.1624	-.1655
.95			-.1913	-.1898					-.1862	-.1849	-.1877	-.1868	-.1751	-.1703

TAIL 2

TABLE XXIV.- PRESSURE COEFFICIENTS, $\phi = 90^\circ$, $\delta_{1,3} = -15^\circ$, $M = 3.70$.
 (a) $\alpha = -4.15^\circ$

Cp at y/b of														
x/c	0.02		0.22		0.44		0.56		0.67		0.83		0.98	
	U.S.	L.S.	U.S.	L.S.	U.S.	L.S.	U.S.	L.S.	U.S.	L.S.	U.S.	L.S.	U.S.	L.S.
.05	.2678	-.0246	.7481	-.0377							.9149	.0070	.8571	-.0046
.10	.2326	.0256	.6817	-.0420	.7559	-.0319			1.0970		.9288	-.0113	.8065	-.0059
.15	.2056	-.0241	.6508	-.0456	.7256	-.0396			1.0643		.9643	-.0200	.7576	-.0029
.20	.2169	-.0291							1.0348		.9840	-.0247		
.25	.2711	-.0341	.6157	-.0460	.6802	-.0279	.9934		1.0019				.7112	-.0131
.30	.2174	-.0460	.6002	-.0498	.6515	-.0014	.9826		.9670		.9825	-.0227	.6966	-.0128
.40	.1570	-.0367	.2830	-.0449			.9214		.9146		.9463	-.0310	.6928	-.0145
.50			.2919	-.0515			.4320	-.0250	.6038		.7968	-.0453	.6184	-.0333
.60	.2700	-.0380	.2808	-.0474	.2836	-.0409	.1368	-.0425	.1634	-.0235	.1813	-.0475	.1104	-.0503
.70			.2595	-.0508	.1080	-.0429	.0992	-.0433	.1641	-.0212	.1424	-.0478	.0757	-.0486
.80	.0713	-.0480	.0683	-.0433	.0940	-.0438	.0812	-.0409					.0645	-.0500
.90	.0152	-.0373	.0542	-.0528	.0893	-.0439	.0729	-.0431	.1214	-.0289	.1343	-.0438	.0549	-.0499
.95			.0512	-.0522	.0843	-.0229	.0670	-.0383	.1128	-.0478	.1301	-.0459		

TAIL 1

Cp at y/b of														
x/c	0.02		0.22		0.44		0.56		0.67		0.83		0.98	
	U.S.	L.S.	U.S.	L.S.	U.S.	L.S.	U.S.	L.S.	U.S.	L.S.	U.S.	L.S.	U.S.	L.S.
.05			.1748	.1436	.1693	.1406	.2526	.2168	.2291	.2149	.2320	.2341		
.10	.0788	.0679	.1667	.1384	.1690	.1373					.2168	.2154	.2032	.2106
.15	.0790	.0658	.1621	.1333	.1657	.1328			.2107	.2066	.2124	.2093	.1885	.1967
.20							.2219	.2069	.2077	.2042	.2085	.2053	.1730	.1832
.25	.0749	.0574	.1519	.1280	.1547	.1301	.2222	.2154	.2061	.2039	.2034	.2056	.1627	.1755
.30	.0275	.0083	.1457	.1270	.1567	.1375	.2182	.2109	.2034	.2046	.2005	.2067	.1524	.1677
.40	.0082	.0065			.1573	.1484	.2132	.2084	.1973	.2043	.1956	.2047	.1373	.1529
.50			.0041	-.0008			.0563	.0427					.1115	.0604
.60	.0046	.0019	.0201	.0124	.0198	.0167	-.0397	-.0385	-.0312	-.0290	-.0276	-.0248	-.0314	-.0295
.70			-.0040	-.0065			-.0430	-.0454	-.0463	-.0447	-.0422	-.0399		
.80			-.0386	-.0416	-.0239	-.0248	-.0341	-.0381	-.0316	-.0329	-.0361	-.0394	-.0326	-.0370
.90					-.0320	-.0311	-.0320	-.0329	-.0228	-.0228	-.0327	-.0335	-.0331	-.0354
.95			-.0332	-.0331					-.0309	-.0308	-.0311	-.0307	-.0307	-.0265

TAIL 2

TABLE XXIV. - CONTINUED
(b) $\alpha = -2.16^\circ$

C _p at γ/b of														
x/c	0.02		0.22		0.44		0.56		0.67		0.83		0.98	
	U.S.	L.S.	U.S.	L.S.	U.S.	L.S.	U.S.	L.S.	U.S.	L.S.	U.S.	L.S.	U.S.	L.S.
.05	.2557	-.0205	.6736	-.0307							.7894	.0195	.7609	.0180
.10	.2150	-.0205	.6105	-.0373	.6874	-.0249			.9530		.7730	-.0000	.7191	.0055
.15	.2040	-.0182	.5811	-.0410	.6568	-.0346			.9578		.7673	-.0091	.6712	.0063
.20	.2196	-.0220							.9396		.7784	-.0138		
.25	.2523	-.0267	.5442	-.0414	.6157	-.0263	.8826		.9140				.6265	-.0033
.30	.1855	-.0441	.5324	-.0458	.6000	-.0014	.8716		.8909		.8133	-.0145	.5936	-.0030
.40	.1401	-.0374	.2549	-.0457			.8257		.8504		.8287	-.0212	.5637	-.0057
.50			.2407	-.0526			.3927	-.0250	.5587		.7256	-.0406	.4941	-.0268
.60	.1965	-.0389	.2295	-.0480	.2492	-.0419	.1155	-.0442	.1560	-.0258	.1597	-.0480	.0580	-.0517
.70			.2093	-.0507	.0815	-.0439	.0782	-.0447	.1567	-.0235	.1177	-.0486	.0329	-.0498
.80	.0470	-.0494	.0404	-.0433	.0672	-.0447	.0626	-.0421					.0296	-.0501
.90	.0021	-.0391	.0236	-.0528	.0635	-.0449	.0533	-.0447	.1043	-.0305	.0938	-.0437	.0281	-.0494
.95			.0220	-.0522	.0618	-.0247	.0481	-.0403	.0956	-.0487	.0887	-.0465		

TAIL 1

C _p at γ/b of														
x/c	0.02		0.22		0.44		0.56		0.67		0.83		0.98	
	U.S.	L.S.	U.S.	L.S.	U.S.	L.S.	U.S.	L.S.	U.S.	L.S.	U.S.	L.S.	U.S.	L.S.
.05			.1662	.1363	.1618	.1341	.2474	.2100	.2244	.2108	.2263	.2281		
.10	.0651	.0567	.1580	.1306	.1610	.1312					.2104	.2098	.1970	.2051
.15	.0663	.0560	.1538	.1260	.1584	.1271			.2058	.2018	.2054	.2034	.1831	.1913
.20							.2187	.2020	.2036	.2004	.2016	.1995	.1676	.1777
.25	.0641	.0497	.1434	.1209	.1483	.1241	.2182	.2116	.2023	.2009	.1966	.1999	.1569	.1712
.30	.0219	.0078	.1368	.1196	.1495	.1317	.2146	.2092	.2003	.2016	.1940	.2014	.1472	.1637
.40	.0069	.0048			.1505	.1407	.2110	.2071	.1956	.2007	.1896	.1996	.1320	.1489
.50			.0016	-.0026			.0612	.0523					.1060	.0572
.60	.0099	.0046	.0419	.0201	.0180	.0143	-.0378	-.0372	-.0303	-.0295	-.0291	-.0265	-.0343	-.0324
.70			-.0051	-.0086			-.0446	-.0464	-.0464	-.0451	-.0432	-.0415		
.80			-.0396	-.0423	-.0255	-.0276	-.0355	-.0398	-.0325	-.0344	-.0370	-.0414	-.0333	-.0378
.90					-.0337	-.0338	-.0335	-.0346	-.0245	-.0258	-.0340	-.0354	-.0345	-.0368
.95			-.0334	-.0344					-.0324	-.0331	-.0325	-.0328	-.0261	-.0269

TAIL 2

TABLE XXIV. - CONTINUED
(c) $\alpha = -0.14^\circ$

Cp at y/b of														
x/c	0.02		0.22		0.44		0.56		0.67		0.83		0.98	
	U.S.	L.S.	U.S.	L.S.	U.S.	L.S.	U.S.	L.S.	U.S.	L.S.	U.S.	L.S.	U.S.	L.S.
.05	.2308	-.0164	.5857	-.0216							.6792	.0331	.6642	.0314
.10	.2014	-.0147	.5304	-.0291	.6035	-.0166			.7528		.6719	.0121	.6299	.0173
.15	.1887	-.0125	.5027	-.0332	.5803	-.0268			.7978		.6622	.0031	.5883	.0151
.20	.2015	-.0149							.8061		.6557	-.0019		
.25	.2198	-.0181	.4683	-.0331	.5408	-.0213	.7748		.8002				.5503	.0046
.30	.1507	-.0402	.4567	-.0377	.5320	.0012	.7666		.7882		.6610	-.0044	.5262	.0051
.40	.1137	-.0369	.2098	-.0437			.7260		.7629		.6640	-.0091	.4880	.0017
.50			.1901	-.0521			.3449	-.0243	.5074		.5784	-.0354	.4248	-.0232
.60	.1373	-.0402	.1766	-.0476	.2155	-.0410	.0888	-.0447	.1291	-.0266	.1077	-.0496	.0320	-.0534
.70			.1600	-.0500	.0556	-.0435	.0556	-.0446	.1302	-.0243	.0829	-.0501	.0047	-.0523
.80	.0249	-.0502	.0163	-.0426	.0398	-.0443	.0436	-.0419					-.0031	-.0533
.90	-.0107	-.0406	-.0035	-.0515	.0344	-.0447	.0343	-.0443	.0812	-.0327	.0656	-.0451	-.0064	-.0520
.95			-.0056	-.0507	.0352	-.0258	.0296	-.0398	.0718	-.0501	.0603	-.0486		

TAIL 1

Cp at y/b of														
x/c	0.02		0.22		0.44		0.56		0.67		0.83		0.98	
	U.S.	L.S.	U.S.	L.S.	U.S.	L.S.	U.S.	L.S.	U.S.	L.S.	U.S.	L.S.	U.S.	L.S.
.05			.1609	.1319	.1571	.1300	.2428	.2036	.2248	.2104	.2270	.2274		
.10	.0534	.0472	.1538	.1264	.1567	.1275					.2121	.2110	.1988	.2054
.15	.0563	.0474	.1494	.1218	.1539	.1232			.2069	.2019	.2075	.2047	.1854	.1916
.20							.2196	.2020	.2045	.1998	.2037	.2010	.1702	.1782
.25	.0556	.0432	.1378	.1147	.1442	.1207	.2194	.2114	.2037	.2000	.1986	.2015	.1593	.1720
.30	.0195	.0095	.1302	.1125	.1453	.1280	.2165	.2065	.2017	.2005	.1960	.2030	.1495	.1648
.40	.0098	.0068			.1465	.1364	.2118	.2047	.1966	.2016	.1913	.2007	.1332	.1500
.50			-.0003	-.0037			.0599	.0504					.1066	.0576
.60	.0199	.0170	.0447	.0274	.0164	.0137	-.0379	-.0374	-.0311	-.0289	-.0285	-.0270	-.0358	-.0353
.70			-.0062	-.0078			-.0460	-.0475	-.0479	-.0447	-.0433	-.0427		
.80			-.0410	-.0423	-.0268	-.0281	-.0371	-.0410	-.0345	-.0366	-.0364	-.0422	-.0332	-.0386
.90					-.0353	-.0346	-.0350	-.0352	-.0252	-.0271	-.0334	-.0357	-.0350	-.0380
.95			-.0346	-.0345					-.0327	-.0341	-.0319	-.0331	-.0257	-.0280

TAIL 2

TABLE XXIV. - CONTINUED
(d) $\alpha = 1.85^\circ$

Cp at y/b of														
x/c	0.02		0.22		0.44		0.56		0.67		0.83		0.98	
	U.S.	L.S.	U.S.	L.S.	U.S.	L.S.	U.S.	L.S.	U.S.	L.S.	U.S.	L.S.	U.S.	L.S.
.05	.1889	-.0119	.4933	-.0098							.5862	.0505	.5758	.0500
.10	.1799	-.0092	.4486	-.0176	.5201	-.0055			.6070		.5811	.0300	.5483	.0343
.15	.1565	-.0059	.4235	-.0206	.5023	-.0152			.6265		.5756	.0202	.5124	.0292
.20	.1671	-.0076							.6512		.5680	.0153		
.25	.1777	-.0081	.3940	.0202	.4705	-.0124	.6638		.6602				.4753	.0164
.30	.1128	-.0331	.3863	-.3247	.4660	-.0055	.6642		.6613		.5642	.0115	.4628	.0158
.40	.0734	-.0336	.1623	-.0393			.6326		.6540		.5562	.0078	.4221	.0124
.50			.1414	-.0482			.2891	-.0200	.4468		.4795	-.0254	.3665	-.0164
.60	.0814	-.0406	.1309	-.0448	.1833	-.0394	.0648	-.0456	.0850	-.0318	.0587	-.0494	.0128	-.0521
.70			.1185	-.0486	.0356	-.0432	.0345	-.0450	.0870	-.0288	.0355	-.0492	-.0119	-.0524
.80	.0026	-.0502	.0000	-.0420	.0187	-.0437	.0265	-.0420					-.0197	-.0564
.90	-.0222	-.0413	-.0212	-.0499	.0134	-.0447	.0181	-.0445	.0517	-.0332	.0276	-.0445	-.0232	-.0561
.95			-.0243	-.0495	.0168	-.0267	.0138	-.0400	.0414	-.0495	.0239	-.0477		

TAIL 1

Cp at y/b of														
x/c	0.02		0.22		0.44		0.56		0.67		0.83		0.98	
	U.S.	L.S.	U.S.	L.S.	U.S.	L.S.	U.S.	L.S.	U.S.	L.S.	U.S.	L.S.	U.S.	L.S.
.05			.1587	.1300	.1523	.1274	.2407	.1973	.2234	.2098	.2264	.2258		
.10	.0450	.0410	.1526	.1253	.1532	.1261			.2113	.2106	.2113	.2106	.1992	.2083
.15	.0479	.0417	.1473	.1202	.1503	.1215			.2056	.2018	.2068	.2041	.1869	.1943
.20							.2172	.1999	.2037	.2003	.2023	.2006	.1719	.1812
.25	.0482	.0372	.1312	.1110	.1401	.1191	.2187	.2113	.2032	.2007	.1975	.2011	.1620	.1754
.30	.0167	.0092	.1229	.1090	.1422	.1261	.2157	.2050	.2020	.2022	.1950	.2024	.1519	.1687
.40	.0106	.0076			.1440	.1348	.2116	.2059	.1972	.2025	.1906	.2005	.1359	.1548
.50			-.0037	-.0062			.0563	.0471					.1090	.0594
.60	.0234	.0188	-.0287	-.0151	.0164	.0136	-.0401	-.0390	-.0319	-.0291	-.0300	-.0275	-.0379	-.0370
.70			-.0091	-.0092			-.0492	-.0482	-.0494	-.0461	-.0449	-.0434		
.80			-.0424	-.0442	-.0280	-.0294	-.0392	-.0440	-.0358	-.0388	-.0384	-.0428	-.0362	-.0391
.90					-.0364	-.0366	-.0365	-.0364	-.0268	-.0283	-.0350	-.0360	-.0371	-.0379
.95			-.0366	-.0367					-.0344	-.0351	-.0337	-.0335	-.0277	-.0281

TAIL 2

TABLE XXIV. - CONTINUED
(e) $\alpha = 3.85^\circ$

Cp at y/b of														
x/c	0.02		0.22		0.44		0.56		0.67		0.83		0.98	
	U.S.	L.S.	U.S.	L.S.	U.S.	L.S.	U.S.	L.S.	U.S.	L.S.	U.S.	L.S.	U.S.	L.S.
.05	.1641	-.0061	.3991	.0044							.4974	.0715	.4878	.0709
.10	.1518	-.0052	.3664	-.0020	.4262	.0078			.5021		.4894	.0516	.4674	.0533
.15	.1272	-.0006	.3452	-.0046	.4178	-.0006			.5062		.4885	.0418	.4366	.0467
.20	.1335	-.0001							.5132		.4812	.0371		
.25	.1442	.0015	.3171	-.0036	.3958	.0004	.5561		.5224				.3983	.0299
.30	.0856	-.0247	.3069	-.0085	.3949	.0143	.5597		.5280		.4760	.0327	.3914	.0279
.40	.0433	-.0321	.1224	-.0335			.5440		.5297		.4684	.0295	.3591	.0226
.50			.0958	-.0431			.2292	-.0138	.3609		.4000	-.0124	.3065	-.0110
.60	.0424	-.0414	.0885	-.0399	.1297	-.0353	.0376	-.0472	.0569	-.0351	.0305	-.0506	-.0023	-.0505
.70			.0787	-.0450	.0131	-.0429	.0136	-.0443	.0595	-.0318	.0069	-.0490	-.0238	-.0509
.80	-.0164	-.0501	-.0137	-.0412	-.0031	-.0432	.0073	-.0410					-.0279	-.0551
.90	-.0310	-.0420	-.0329	-.0486	-.0078	-.0436	.0000	-.0432	.0226	-.0333	-.0021	-.0444	-.0304	-.0552
.95			-.0354	-.0484	-.0000	-.0264	-.0022	-.0387	.0112	-.0490	-.0059	-.0476		

TAIL 1

Cp at y/b of														
x/c	0.02		0.22		0.44		0.56		0.67		0.83		0.98	
	U.S.	L.S.	U.S.	L.S.	U.S.	L.S.	U.S.	L.S.	U.S.	L.S.	U.S.	L.S.	U.S.	L.S.
.05			.1555	.1300	.1491	.1262	.2389	.1925	.2224	.2084	.2247	.2236		
.10	.0521	.0440	.1504	.1251	.1502	.1247					.2098	.2096	.1989	.2080
.15	.0533	.0428	.1466	.1206	.1474	.1203			.2051	.1998	.2049	.2031	.1872	.1942
.20							.2168	.1997	.2033	.1984	.2008	.1993	.1728	.1813
.25	.0489	.0353	.1352	.1131	.1372	.1174	.2192	.2114	.2028	.1996	.1957	.1998	.1632	.1763
.30	.0124	.0023	.1283	.1114	.1394	.1245	.2168	.2060	.2014	.2014	.1935	.2014	.1542	.1701
.40	.0031	.0012			.1413	.1325	.2134	.2068	.1968	.2024	.1892	.1992	.1387	.1564
.50			-.0014	-.0058			.0591	.0478					.1111	.0610
.60	.0016	-.0030	.0178	.0089	.0162	.0139	-.0429	-.0426	-.0316	-.0288	-.0302	-.0287	-.0383	-.0395
.70			-.0100	-.0128			-.0523	-.0499	-.0496	-.0458	-.0452	-.0446		
.80			-.0450	-.0485	-.0307	-.0344	-.0451	-.0512	-.0386	-.0413	-.0386	-.0448	-.0373	-.0414
.90					-.0392	-.0408	-.0410	-.0439	-.0282	-.0312	-.0356	-.0376	-.0373	-.0400
.95			-.0385	-.0393					-.0356	-.0375	-.0337	-.0351	-.0279	-.0302

TAIL 2

TABLE XXIV. - CONTINUED
(f) $\alpha = 5.85^\circ$

Cp at y/b of														
x/c	0.02		0.22		0.44		0.56		0.67		0.83		0.98	
	U.S.	L.S.	U.S.	L.S.	U.S.	L.S.	U.S.	L.S.	U.S.	L.S.	U.S.	L.S.	U.S.	L.S.
.05	.1168	-.0019	.3022	-.0245							.4048	-.0945	-.3972	.0936
.10	.0919	-.0008	.2815	-.0199	.3281	-.0258			.4127		.3940	-.0759	-.3806	-.0739
.15	.0762	-.0045	.2644	-.0172	.3222	-.0189			.4166		.3967	-.0667	-.3540	-.0660
.20	.0906	.0079							.4152		.3926	-.0626		
.25	.1037	.0101	.2398	-.0174	.3107	-.0193	.4394		.4163				.3183	.0462
.30	.0534	-.0132	.2299	-.0125	.3191	-.0286	.4465		.4177		.3885	-.0593	-.3068	-.0423
.40	.0135	-.0280	.0783	-.0240			.4383		.4190		.3830	-.0555	.2915	-.0339
.50			.0535	-.0354			.1784	-.0027	.2738		.3238	-.0039	.2423	-.0051
.60	.0093	-.0413	.0475	-.0322	.0943	-.0278	.0114	-.0482	.0238	-.0366	.0088	-.0523	-.0163	-.0499
.70			.0405	-.0382	-.0068	-.0451	-.0070	-.0453	.0271	-.0330	-.0132	-.0498	-.0318	-.0501
.80	-.0315	-.0489	-.0270	-.0407	-.0208	-.0431	-.0111	-.0410			-.0132	-.0498	-.0321	-.0516
.90	-.0363	-.0420	-.0437	-.0474	-.0250	-.0434	-.0172	-.0428	-.0010	-.0336	-.0211	-.0444	-.0339	-.0533
.95			-.0454	-.0469	-.0133	-.0273	-.0175	-.0385	-.0135	-.0489	-.0248	-.0473		

TAIL 1

Cp at y/b of														
x/c	0.02		0.22		0.44		0.56		0.67		0.83		0.98	
	U.S.	L.S.	U.S.	L.S.	U.S.	L.S.	U.S.	L.S.	U.S.	L.S.	U.S.	L.S.	U.S.	L.S.
.05			.1561	.1292	.1504	.1279	.2387	.1910	.2210	.2102	.2219	.2204		
.10	.0629	.0508	.1485	.1230	.1510	.1260					.2078	.2079	.1971	.2067
.15	.0602	.0458	.1438	.1179	.1479	.1210			.2053	.2017	.2031	.2018	.1861	.1933
.20							.2186	.2023	.2034	.2009	.1991	.1984	.1728	.1812
.25	.0507	.0330	.1371	.1142	.1369	.1174	.2216	.2143	.2031	.2025	.1943	.1989	.1639	.1776
.30	.0085	-.0041	.1313	.1135	.1391	.1246	.2192	.2063	.2019	.2037	.1926	.2007	.1556	.1713
.40	-.0055	-.0061			.1403	.1317	.2155	.2096	.1974	.2037	.1884	.1990	.1413	.1588
.50			-.0007	-.0044			.0587	.0516					.1133	.0624
.60	-.0172	-.0163	.0171	.0112	.0156	.0129	-.0448	-.0428	-.0308	-.0284	-.0307	-.0289	-.0388	-.0401
.70			-.0116	-.0144			-.0536	-.0490	-.0494	-.0452	-.0457	-.0447		
.80			-.0454	-.0515	-.0374	-.0375	-.0522	-.0521	-.0411	-.0424	-.0389	-.0450	-.0375	-.0410
.90					-.0445	-.0478	-.0454	-.0484	-.0298	-.0330	-.0353	-.0377	-.0374	-.0396
.95			-.0417	-.0434					-.0370	-.0391	-.0335	-.0350	-.0282	-.0300

TAIL 2

TABLE XXIV. - CONTINUED
(g) $\alpha = 7.85^\circ$

Cp at y/b of														
x/c	0.02		0.22		0.44		0.56		0.67		0.83		0.98	
	U.S.	L.S.	U.S.	L.S.	U.S.	L.S.	U.S.	L.S.	U.S.	L.S.	U.S.	L.S.	U.S.	L.S.
.05	.0696	.0089	.1982	.0453							.3339	.1226	.3382	.1229
.10	.0396	.0050	.1876	.0413	.2383	.0472			.3073		.3188	.1050	.3234	.1011
.15	.0321	.0096	.1810	.0385	.2338	.0420			.3102		.3178	.0959	.2998	.0913
.20	.0426	.0135							.3106		.3127	.0920		
.25	.0472	.0160	.1674	.0379	.2266	.0420	.3343		.3125				.2648	.0697
.30	.0102	-.0049	.1582	.0327	.2499	.0450	.3407		.3152		.3035	.0885	.2515	.0652
.40	-.0130	-.0221	.0368	-.0160					.3316		.3158	.0848	.2393	.0550
.50			.0182	-.0275				.1167	.0041	.1954	.2399	.0229	.1941	.0075
.60	-.0148	-.0405	.0148	-.0242	.0607	-.0185	-.0088	-.0464	.0008	-.0354	-.0116	-.0501	-.0269	-.0469
.70			.0077	-.0305	-.0204	-.0470	-.0241	-.0489	.0045	-.0316	-.0307	-.0512	-.0377	-.0485
.80	-.0388	-.0480	-.0378	-.0409	-.0330	-.0442	-.0272	-.0419					-.0399	-.0472
.90	-.0387	-.0416	-.0488	-.0461	-.0365	-.0430	-.0318	-.0426	-.0162	-.0331	-.0354	-.0428	-.0428	-.0510
.95			-.0452	-.0460	-.0212	-.0268	-.0311	-.0380	-.0316	-.0478	-.0395	-.0458		

TAIL 1

Cp at y/b of														
x/c	0.02		0.22		0.44		0.56		0.67		0.83		0.98	
	U.S.	L.S.	U.S.	L.S.	U.S.	L.S.	U.S.	L.S.	U.S.	L.S.	U.S.	L.S.	U.S.	L.S.
.05			.1390	.1094	.1511	.1270	.2418	.1929	.2234	.2110	.2224	.2192		
.10	.0531	.0400	.1317	.1045	.1510	.1254					.2087	.2079	.1967	.2062
.15	.0499	.0361	.1274	.0993	.1472	.1200			.2082	.2016	.2043	.2019	.1864	.1932
.20							.2194	.2024	.2064	.2006	.2003	.1985	.1736	.1821
.25	.0422	.0243	.1218	.0973	.1355	.1155	.2220	.2134	.2057	.2030	.1956	.1988	.1659	.1786
.30	.0036	-.0109	.1173	.0961	.1370	.1220	.2189	.2059	.2037	.2044	.1935	.2004	.1580	.1727
.40	-.0097	-.0119			.1389	.1313	.2142	.2077	.2000	.2052	.1896	.1988	.1438	.1606
.50			-.0090	-.0153			.0572	.0488					.1164	.0646
.60	-.0242	-.0244	.0204	.0148	.0150	.0121	-.0444	-.0430	-.0309	-.0296	-.0303	-.0295	-.0382	-.0402
.70			-.0211	-.0251			-.0531	-.0505	-.0491	-.0472	-.0454	-.0454		
.80			-.0570	-.0578	-.0409	-.0385	-.0536	-.0536	-.0419	-.0446	-.0383	-.0457	-.0372	-.0413
.90					-.0485	-.0523	-.0469	-.0505	-.0304	-.0341	-.0351	-.0382	-.0373	-.0400
.95			-.0502	-.0516					-.0374	-.0399	-.0334	-.0355	-.0280	-.0303

TAIL 2

TABLE XXIV. - CONTINUED
(h) $\alpha = 9.85^\circ$

Cp at y/b of														
x/c	0.02		0.22		0.44		0.56		0.67		0.83		0.98	
	U.S.	L.S.	U.S.	L.S.	U.S.	L.S.	U.S.	L.S.	U.S.	L.S.	U.S.	L.S.	U.S.	L.S.
.05	.0570	.0195	.1579	.0679							.2991	.1570	.3039	.1582
.10	.0264	.0163	.1403	.0638	.1784	.0709			.2707		.2851	.1399	.2897	.1336
.15	.0208	.0210	.1258	.0609	.1678	.0670			.2692		.2822	.1313	.2683	.1226
.20	.0236	.0249							.2642		.2768	.1272		
.25	.0197	.0277	.1029	.0586	.1551	.0671	.2506		.2586				.2337	.1000
.30	-.0096	-.0060	.0921	.0525	.1879	.0647	.2533		.2545		.2671	.1243	.2213	.0950
.40	-.0292	-.0138	.0093	-.0073			.2407		.2465		.2557	.1203	.2092	.0824
.50			-.0088	-.0182			.0687	.0144	.1440		.2054	.0465	.1672	.0243
.60	-.0284	-.0385	-.0092	-.0147	.0286	-.0073	-.0250	-.0425	-.0153	-.0327	-.0207	-.0454	-.0319	-.0434
.70			-.0157	-.0211	.0320	-.0444	-.0370	-.0494	-.0117	-.0291	.0384	-.0519	-.0409	-.0485
.80	-.0459	-.0454	-.0434	-.0434	-.0419	-.0477	-.0390	-.0444					-.0443	-.0448
.90	-.0402	-.0417	-.0468	-.0479	-.0441	-.0439	-.0421	-.0438	-.0267	-.0332	-.0423	-.0478	-.0471	-.0448
.95			-.0457	-.0463	-.0260	-.0272	-.0377	-.0384	-.0436	-.0477	-.0460	-.0444		

TAIL 1

Cp at y/b of														
x/c	0.02		0.22		0.44		0.56		0.67		0.83		0.98	
	U.S.	L.S.	U.S.	L.S.	U.S.	L.S.	U.S.	L.S.	U.S.	L.S.	U.S.	L.S.	U.S.	L.S.
.05			.0824	.0555	.1463	.1198	.2429	.1959	.2274	.2129	.2251	.2212		
.10	.0444	.0314	.0744	.0502	.1435	.1168					.2114	.2097	.1968	.2056
.15	.0391	.0247	.0709	.0472	.1391	.1125			.2098	.2029	.2065	.2036	.1870	.1932
.20							.2159	.1997	.2078	.2011	.2022	.1999	.1750	.1832
.25	.0272	.0107	.0626	.0429	.1299	.1090	.2154	.2098	.2064	.2016	.1975	.2001	.1678	.1797
.30	-.0072	-.0216	.0559	.0389	.1309	.1152	.2136	.2040	.2038	.2011	.1953	.2015	.1604	.1749
.40	-.0198	-.0204			.1320	.1260	.2090	.2031	.1982	.2023	.1908	.1994	.1470	.1636
.50			-.0345	-.0380			.0533	.0447					.1194	.0659
.60	-.0343	-.0355	.0228	.0182	.0104	.0087	-.0444	-.0432	-.0324	-.0305	-.0306	-.0297	-.0380	-.0399
.70			-.0394	-.0416			-.0546	-.0496	-.0511	-.0469	-.0454	-.0456		
.80			-.0601	-.0623	-.0425	-.0388	-.0553	-.0536	-.0423	-.0445	-.0385	-.0454	-.0376	-.0412
.90					-.0569	-.0567	-.0494	-.0521	-.0305	-.0347	-.0350	-.0382	-.0373	-.0400
.95			-.0556	-.0568					-.0372	-.0399	-.0334	-.0356	-.0284	-.0307

TAIL 2

TABLE XXIV. - CONTINUED
(1) $\alpha = 11.86^\circ$

Cp at y/b of														
x/c	0.02		0.22		0.44		0.56		0.67		0.83		0.98	
	U.S.	L.S.	U.S.	L.S.	U.S.	L.S.	U.S.	L.S.	U.S.	L.S.	U.S.	L.S.	U.S.	L.S.
.05	.0541	.0362	.1487	.0942							.2818	.1958	.2847	.1969
.10	.0236	.0336	.1301	.0896	.1645	.0983			.2549		.2683	.1786	.2709	.1707
.15	.0183	.0384	.1140	.0861	.1533	.0959			.2509		.2637	.1701	.2502	.1580
.20	.0166	.0422							.2450		.2576	.1659		
.25	.0083	.0451	.0881	.0815	.1397	.0964	.2298		.2399				.2158	.1340
.30	-.0215	.0209	.0739	.0744	.1500	.0952	.2319		.2348		.2472	.1630	.2053	.1285
.40	-.0387	.0029	-.0054	.0032			.2187		.2260		.2354	.1586	.1918	.1141
.50			-.0283	-.0072			.0558	.0322	.1257		.1867	.0710	.1517	-.0436
.60	-.0393	-.0341	-.0301	-.0030	.0112	.0083	-.0305	-.0379	-.0202	-.0291	-.0261	-.0420	-.0346	-.0416
.70			-.0355	-.0101	-.0391	-.0402	-.0416	-.0467	-.0164	-.0251	-.0427	-.0521	-.0428	-.0482
.80	-.0501	-.0410	-.0418	-.0409	-.0471	-.0486	-.0433	-.0460					-.0471	-.0463
.90	-.0422	-.0408	-.0483	-.0519	-.0452	-.0487	-.0441	-.0470	-.0313	-.0364	-.0446	-.0406	-.0489	-.0426
.95			-.0481	-.0491	-.0269	-.0301	-.0381	-.0403	-.0460	-.0498	-.0460	-.0437		

TAIL 1

Cp at y/b of														
x/c	0.02		0.22		0.44		0.56		0.67		0.83		0.98	
	U.S.	L.S.	U.S.	L.S.	U.S.	L.S.	U.S.	L.S.	U.S.	L.S.	U.S.	L.S.	U.S.	L.S.
.05			.0173	.0053	.1005	.0789	.2194	.1835	.2279	.2121	.2299	.2243		
.10	.0366	.0251	.0186	.0043	.0963	.0712					.2144	.2114	.2012	.2097
.15	.0316	.0178	.0211	.0060	.0913	.0657			.2068	.2019	.2082	.2040	.1912	.1969
.20							.1944	.1785	.2060	.2000	.2022	.1988	.1786	.1865
.25	.0187	.0032	.0186	.0058	.0800	.0617	.1916	.1821	.2044	.2015	.1950	.1971	.1708	.1823
.30	-.0145	-.0266	.0144	.0020	.0779	.0633	.1879	.1802	.2035	.2034	.1924	.1995	.1632	.1772
.40	-.0271	-.0254			.0805	.0791	.1818	.1771	.2001	.2055	.1911	.1939	.1481	.1638
.50			-.0434	-.0462			.0412	.0325					.1190	.0647
.60	-.0415	-.0421	.0259	.0223	-.0170	-.0143	-.0456	-.0461	-.0318	-.0301	-.0309	-.0295	-.0392	-.0401
.70			-.0481	-.0490			-.0571	-.0537	-.0506	-.0472	-.0464	-.0454		
.80			-.0643	-.0648	-.0492	-.0464	-.0598	-.0576	-.0454	-.0452	-.0389	-.0469	-.0367	-.0410
.90					-.0658	-.0651	-.0572	-.0591	-.0341	-.0370	-.0347	-.0396	-.0369	-.0397
.95			-.0612	-.0618					-.0411	-.0431	-.0332	-.0366	-.0283	-.0306

TAIL 2

TABLE XXIV. - CONTINUED
(j) $\alpha = 15.86^\circ$

Cp at y/b of														
x/c	0.02		0.22		0.44		0.56		0.67		0.83		0.98	
	U.S.	L.S.	U.S.	L.S.	U.S.	L.S.	U.S.	L.S.	U.S.	L.S.	U.S.	L.S.	U.S.	L.S.
.05	.0624	.0745	.1501	.1636							.2740	.2962	.2741	.2987
.10	.0325	.0773	.1284	.1579	.1604	.1713			.2514		.2614	.2788	.2604	.2680
.15	.0256	.0826	.1095	.1511	.1469	.1712			.2452		.2544	.2696	.2411	.2526
.20	.0195	.0871							.2368		.2466	.2655		
.25	.0069	.0910	.0810	.1391	.1319	.1703	.2180		.2299				.2091	.2232
.30	-.0279	.0547	.0659	.1286	.1344	.1387	.2196		.2247		.2353	.2622	.2024	.2164
.40	-.0450	.0564	-.0115	.0299			.2052		.2148		.2224	.2565	.1795	.1981
.50			-.0340	.0243			.0465	.0776	.1146		.1748	.1357	.1412	.0982
.60	-.0516	-.0238	-.0366	.0303	.0023	.0421	-.0337	-.0238	-.0230	-.0162	-.0298	-.0262	-.0360	-.0333
.70			-.0440	.0231	-.0428	-.0294	-.0444	-.0353	-.0192	-.0123	-.07459	-.0417	-.0437	-.0394
.80	-.0544	-.0276	-.0443	-.0293	-.0498	-.0417	-.0439	-.0359					-.0469	-.0423
.90	-.0432	-.0349	-.0521	-.0448	-.0459	-.0446	-.0415	-.0401	-.0288	-.0333	-.0355	-.0383	-.0436	-.0394
.95			-.0515	-.0463	-.0280	-.0291	-.0356	-.0369	-.0403	-.0460	-.0377	-.0380		

TAIL 1

Cp at y/b of														
x/c	0.02		0.22		0.44		0.56		0.67		0.83		0.98	
	U.S.	L.S.	U.S.	L.S.	U.S.	L.S.	U.S.	L.S.	U.S.	L.S.	U.S.	L.S.	U.S.	L.S.
.05			.0145	.0000	.0194	.0097	.0615	.0430	.0737	.0639	.1956	.1901		
.10	.0138	.0039	.0095	-.0050	.0179	.0036					.1807	.1738	.1949	.2036
.15	.0096	-.0019	.0065	-.0074	.0138	-.0007					.1760	.1665	.1855	.1915
.20							.0837	.0657	.0558	.0509	.1719	.1617	.1732	.1807
.25	-.0039	-.0165	.0007	-.0106	.0082	-.0020	.0384	.0354	.0525	.0475	.1668	.1619	.1656	.1772
.30	-.0286	-.0385	-.0034	-.0129	.0047	-.0036	.0352	.0321	.0473	.0435	.1623	.1602	.1578	.1716
.40	-.0354	-.0339			.0259	.0174	.0271	.0242	.0402	.0398	.1554	.1573	.1452	.1610
.50			-.0508	-.0530			-.0242	-.0301					.1197	.0661
.60	-.0481	-.0487	.0305	.0303	-.0308	-.0341	-.0539	-.0551	-.0578	-.0599	-.0383	-.0382	-.0382	-.0391
.70			-.0534	-.0542			-.0666	-.0674	-.0659	-.0667	-.0524	-.0516		
.80			-.0669	-.0675	-.0516	-.0526	-.0679	-.0693	-.0568	-.0587	-.0542	-.0560	-.0424	-.0410
.90					-.0686	-.0714	-.0676	-.0694	-.0440	-.0473	-.0542	-.0559	-.0456	-.0447
.95			-.0639	-.0647					-.0557	-.0584	-.0515	-.0542	-.0346	-.0353

TAIL 2

TABLE XXIV. - CONCLUDED
(k) $\alpha = 19.85^\circ$

Cp at γ/b of														
x/c	0.02		0.22		0.44		0.56		0.67		0.83		0.98	
	U.S.	L.S.	U.S.	L.S.	U.S.	L.S.	U.S.	L.S.	U.S.	L.S.	U.S.	L.S.	U.S.	L.S.
.05	.0821	.1357	.1669	.2584							.2879	.4239	.2850	.4293
.10	.0514	.1404	.1416	.2469	.1715	.2726			.2654		.2737	.4043	.2698	.3933
.15	.0419	.1454	.1211	.2324	.1555	.2726			.2583		.2646	.3942	.2506	.3751
.20	.0322	.1501							.2481		.2546	.3897		
.25	.0145	.1547	.0887	.2098	.1388	.2687	.2256		.2394				.2222	.3378
.30	-.0276	.0975	.0718	.1987	.1325	.2313	.2257		.2332		.2418	.3858	.2129	.3292
.40	-.0458	.1344	-.0098	.0696			.2096		.2218		.2281	.3785	.1842	.3054
.50			-.0336	.0685			.0465	.1447	.1198		.1793	.2171	.1467	.1714
.60	-.0547	-.0007	-.0364	.0780	.0052	.0888	-.0340	.0025	-.0233	.0091	-.0280	-.0004	-.0324	-.0175
.70			-.0439	.0750	.0431	-.0130	-.0453	-.0145	-.0194	.0127	-.0412	-.0215	-.0402	-.0235
.80	-.0516	-.0056	-.0441	-.0084	-.0494	-.0291	-.0405	-.0173					-.0402	-.0234
.90	-.0428	-.0239	-.0517	-.0286	-.0450	-.0335	.0386	-.0233	-.0227	-.0187	-.0261	-.0237	-.0353	-.0251
.95			-.0510	-.0323	-.0292	-.0238	-.0332	-.0222	-.0351	-.0273	-.0291	-.0270		

TAIL 1

Cp at γ/b of														
x/c	0.02		0.22		0.44		0.56		0.67		0.83		0.98	
	U.S.	L.S.	U.S.	L.S.	U.S.	L.S.	U.S.	L.S.	U.S.	L.S.	U.S.	L.S.	U.S.	L.S.
.05			-.0056	-.0148	-.0065	-.0152	.0299	.0145	.0262	.0216	.0494	.0487		
.10	-.0122	-.0195	-.0111	-.0202	-.0070	-.0178					.0452	.0413	.0530	.0578
.15	-.0145	-.0231	-.0136	-.0224	-.0100	-.0209			.0218	.0169	.0430	.0370	.0428	.0474
.20							.0308	.0174	.0197	.0143	.0396	.0349	.0342	.0383
.25	-.0263	-.0344	-.0182	-.0258	-.0108	-.0186	.0112	.0059	.0182	.0126	.0366	.0333	.0286	.0332
.30	-.0421	-.0483	-.0214	-.0280	-.0153	-.0215	.0095	.0031	.0159	.0104	.0341	.0322	.0225	.0285
.40	-.0435	-.0409			.0030	-.0058	.0038	-.0005	.0133	.0110	.0303	.0290	.0143	.0192
.50			-.0555	-.0571			-.0356	-.0408					.0030	-.0179
.60	-.0509	-.0521	.0522	.0444	-.0376	-.0414	-.0542	-.0552	-.0614	-.0619	-.0528	-.0541	-.0547	-.0558
.70			-.0559	-.0570			-.0682	-.0689	-.0676	-.0673	-.0588	-.0595		
.80			-.0675	-.0683	-.0526	-.0527	-.0693	-.0703	-.0588	-.0594	-.0611	-.0630	-.0524	-.0540
.90					-.0701	-.0720	-.0691	-.0707	-.0493	-.0494	-.0609	-.0627	-.0590	-.0602
.95			-.0638	-.0649					-.0614	-.0623	-.0589	-.0613	-.0445	-.0464

TAIL 2

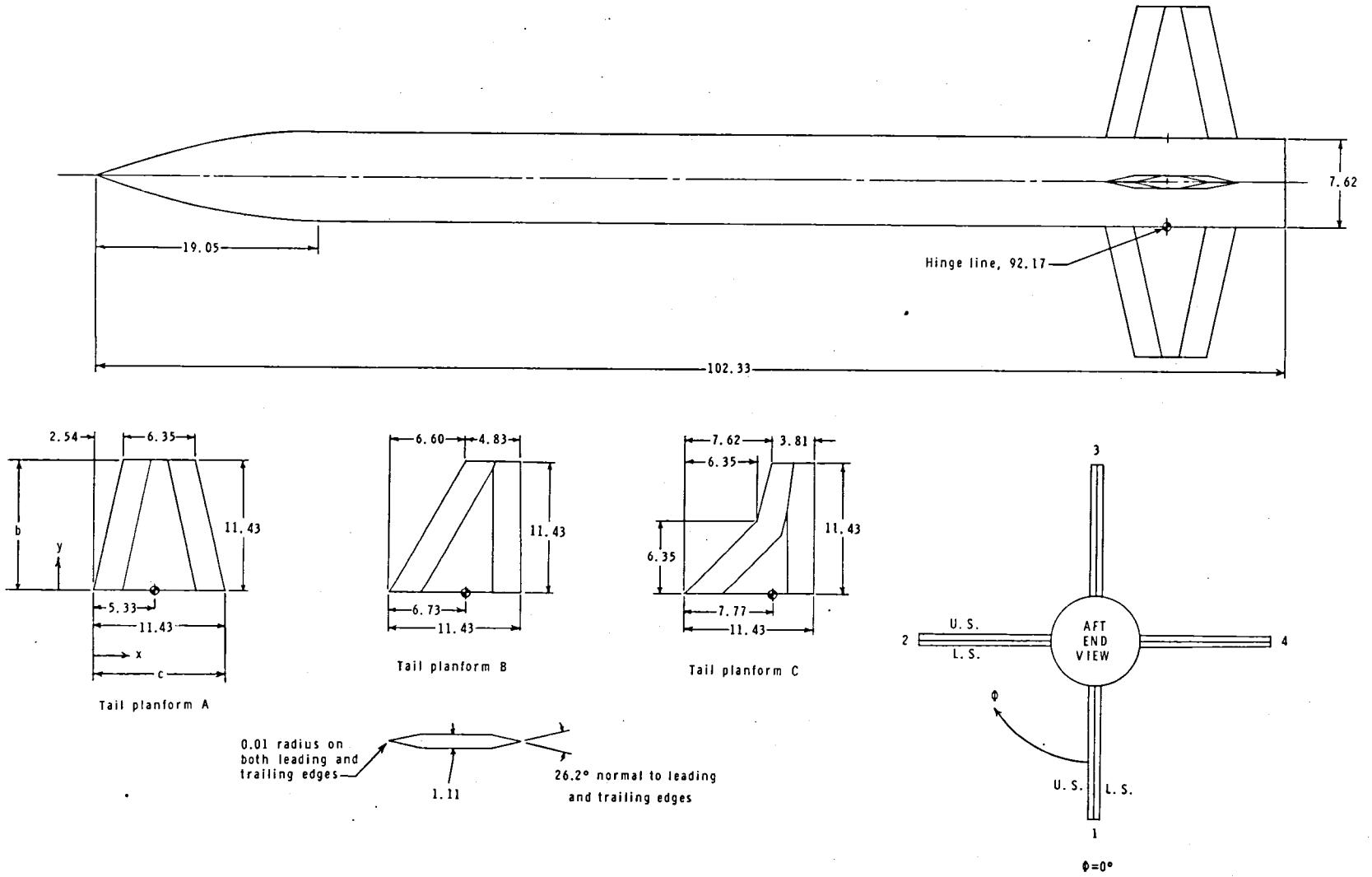
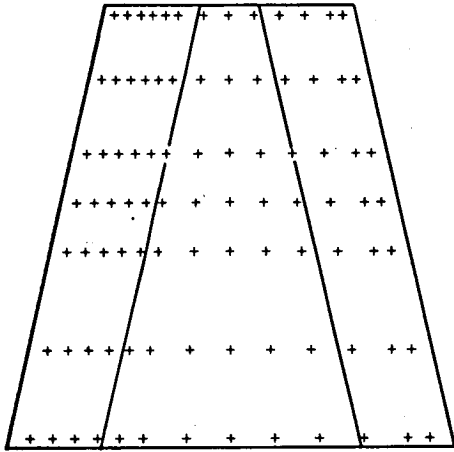
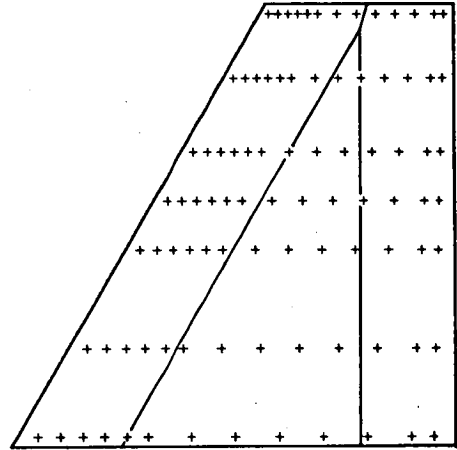

Figure 1.- Details of model. All linear dimensions are in centimeters.



Tail platform A



Tail platform B

+ pressure orifices

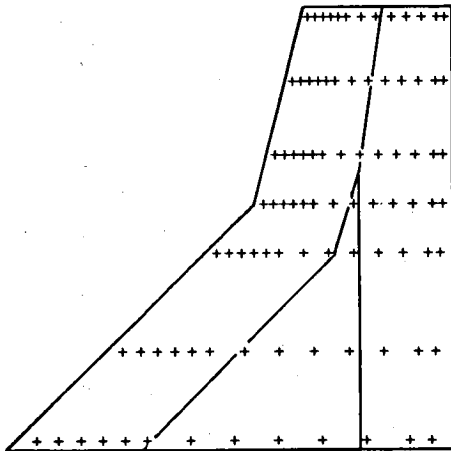

Tail platform C

x/c	y/b						
0.05	0.02	0.22	0.44	0.56	0.67	0.83	0.98
.10	.02	.22	.44	.56	.67	.83	.98
.15	.02	.22	.44	.56	.67	.83	.98
.20	.02	.22	.44	.56	.67	.83	.98
.25	.02	.22	.44	.56	.67	.83	.98
.30	.02	.22	.44	.56	.67	.83	.98
.40	.02	.22	.44	.56	.67	.83	.98
.50	.02	.22	.44	.56	.67	.83	.98
.60	.02	.22	.44	.56	.67	.83	.98
.70	.02	.22	.44	.56	.67	.83	.98
.80	.02	.22	.44	.56	.67	.83	.98
.90	.02	.22	.44	.56	.67	.83	.98
.95	.02	.22	.44	.56	.67	.83	.98

Figure 2.- Details of pressure orifice locations.

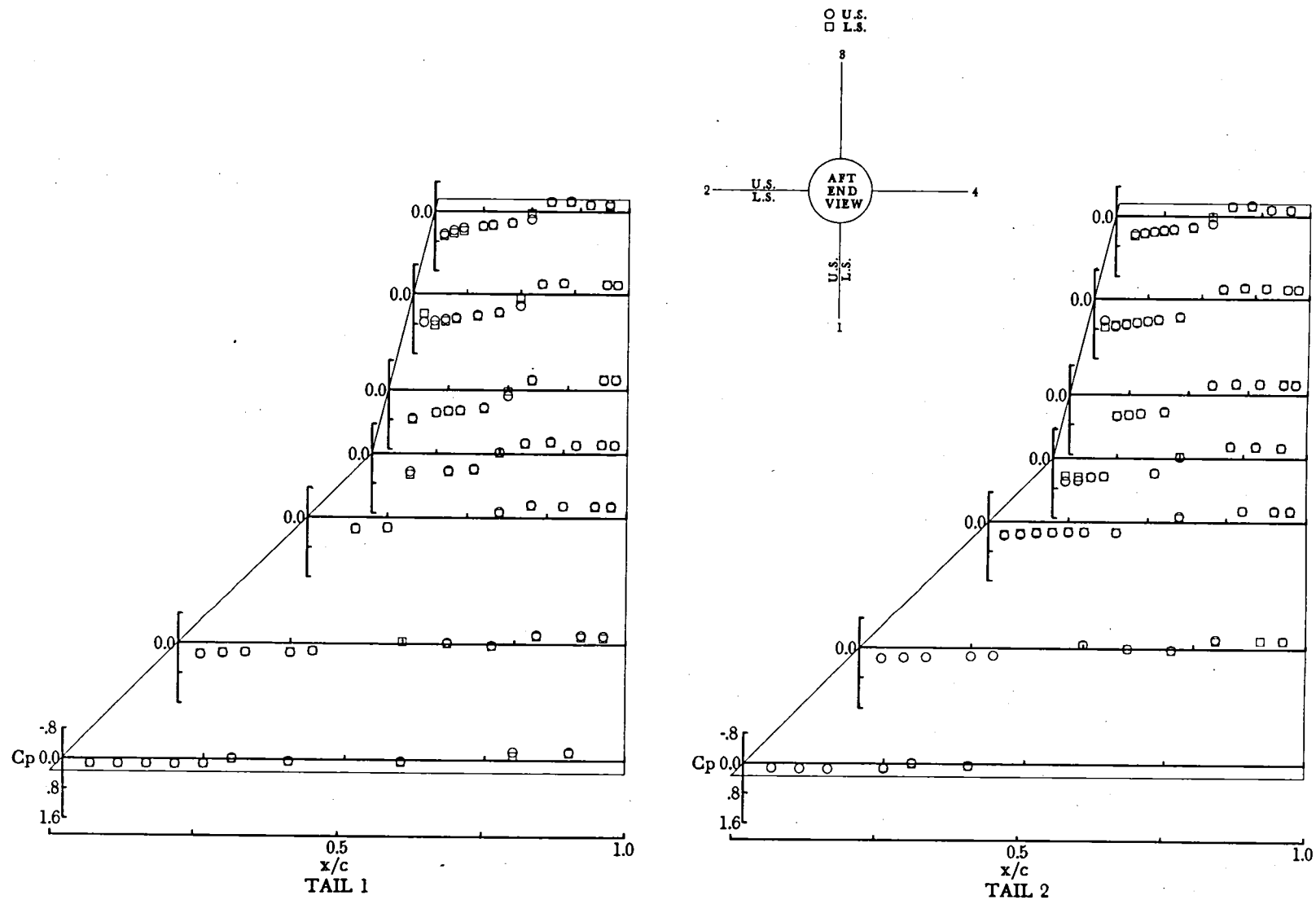
(a) $\alpha = 0.45^\circ$.Figure 3.- Pressure coefficients for tail planform C at $M = 1.60$, $\phi = 0^\circ$, and $\delta = 0^\circ$.

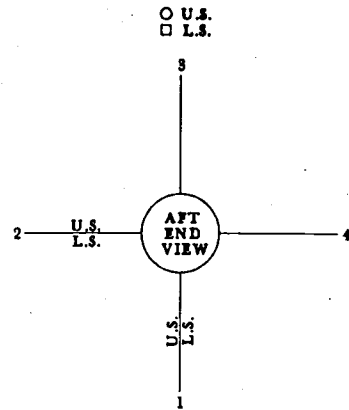
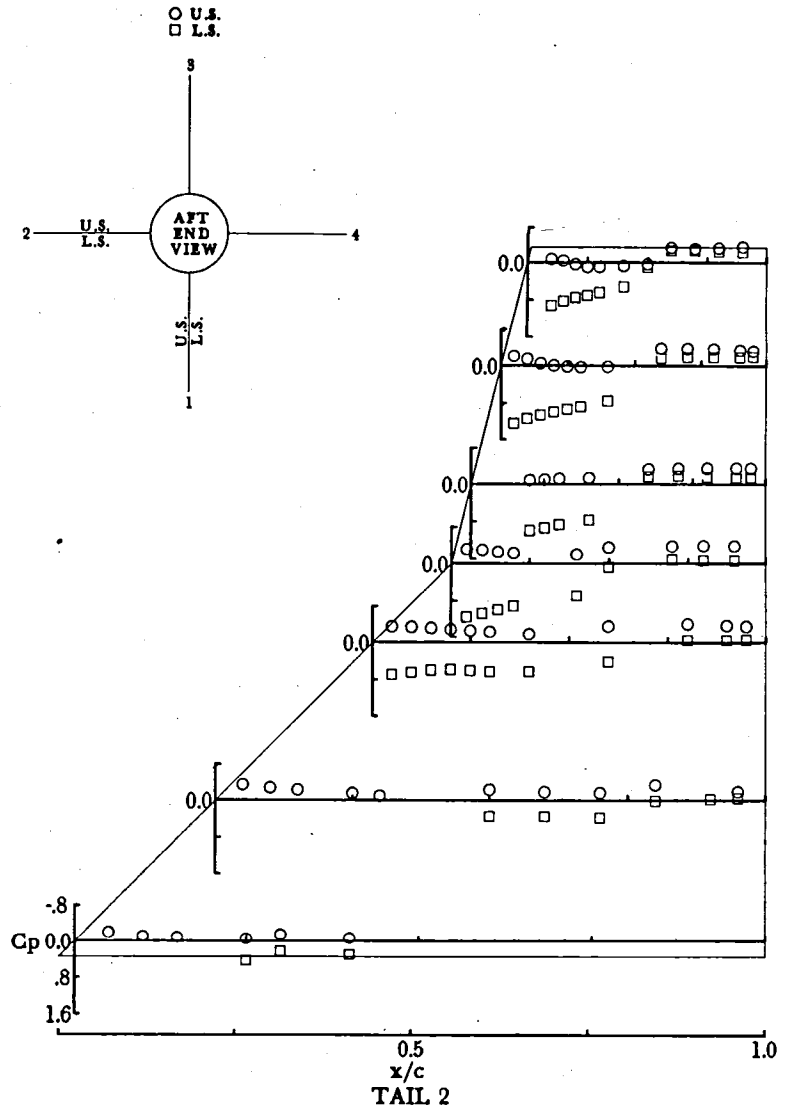
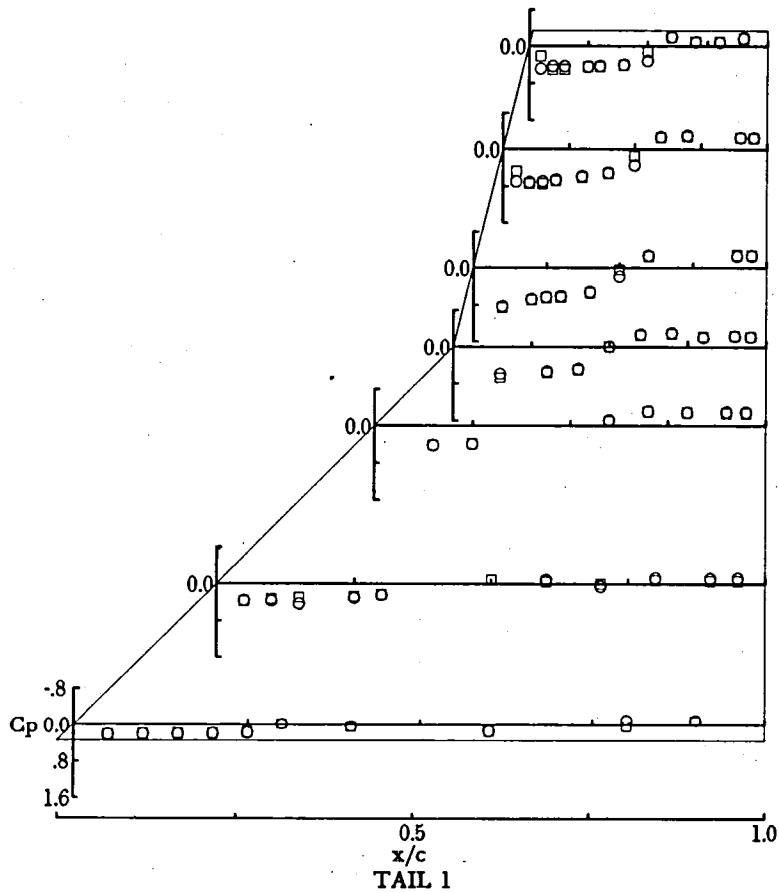

(b) $\alpha = 10.45^\circ$.

Figure 3.- Continued.

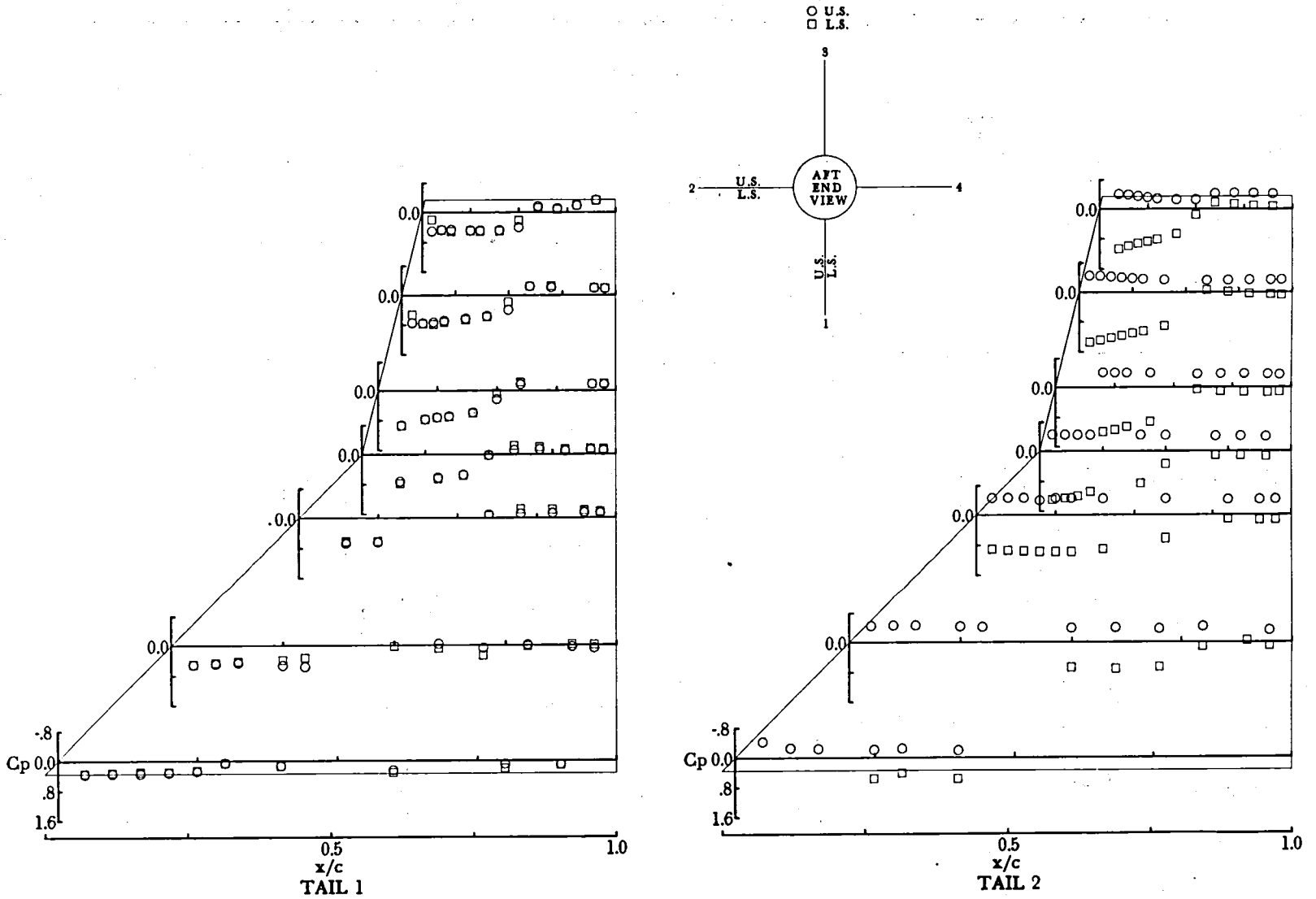

(c) $\alpha = 20.45^\circ$.

Figure 3.- Concluded.

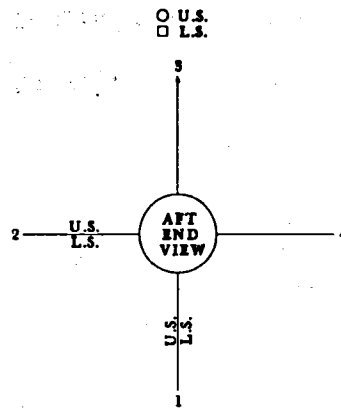
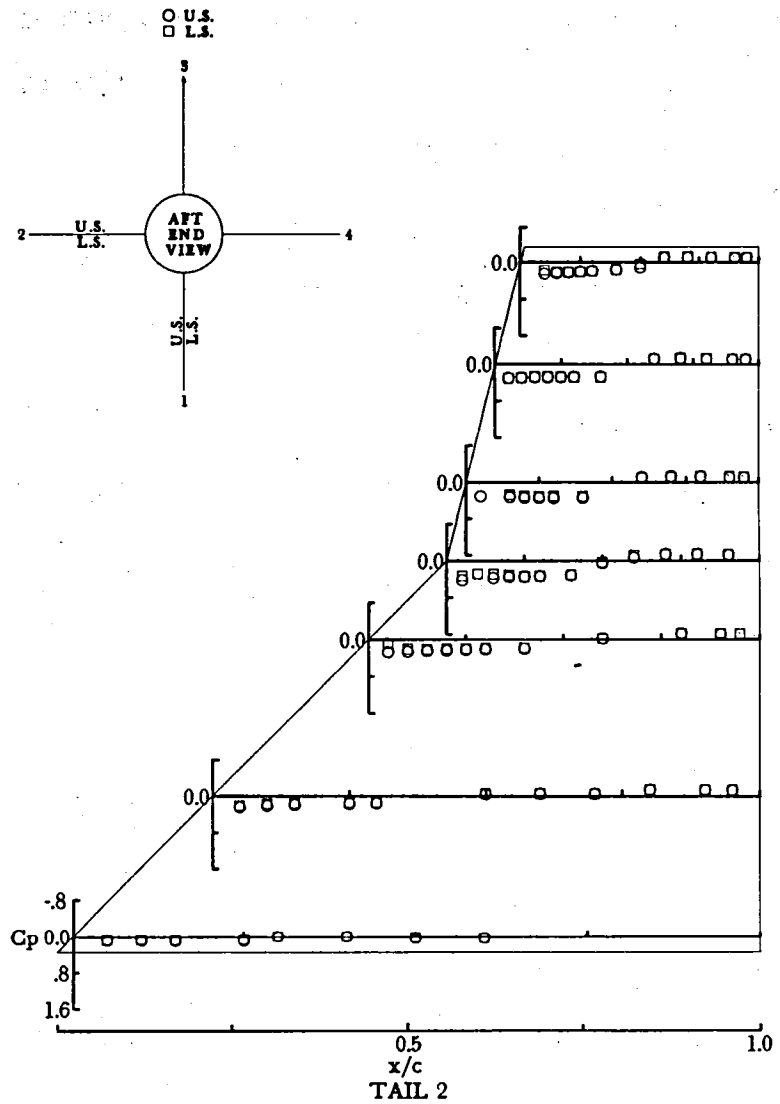
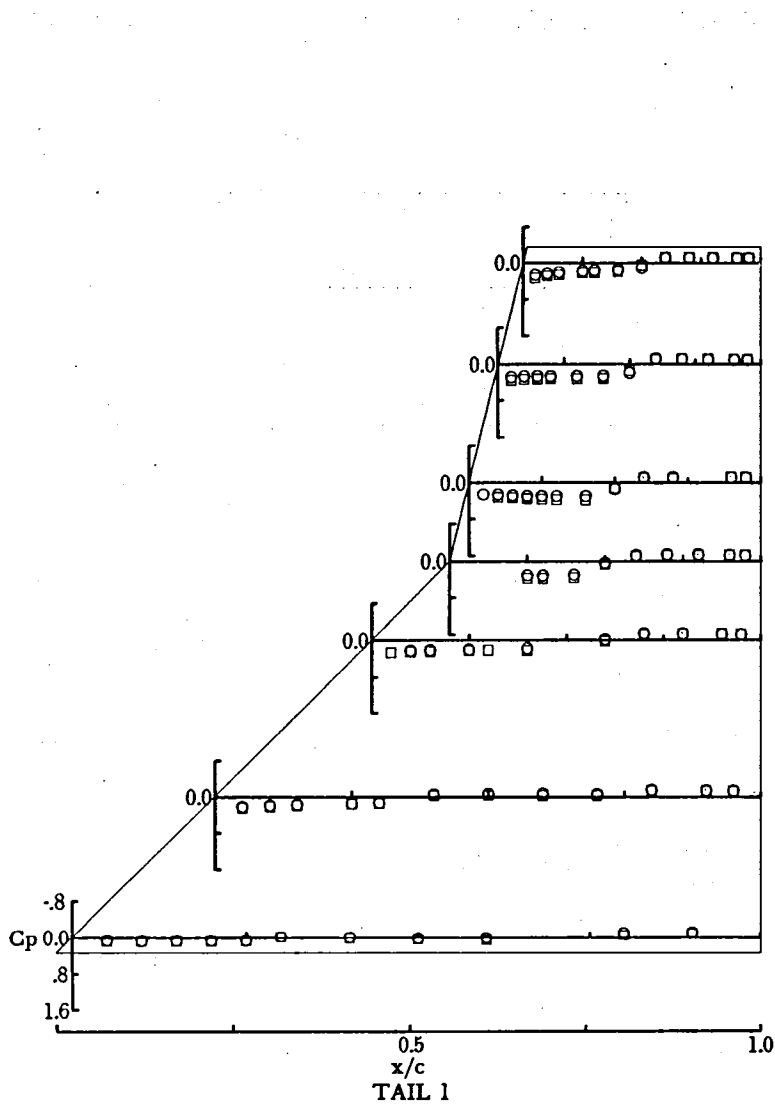

(a) $\alpha = -0.05^\circ$.

Figure 4.- Pressure coefficients for tail planform C at $M = 2.36$, $\phi = 0^\circ$, and $\delta = 0^\circ$.

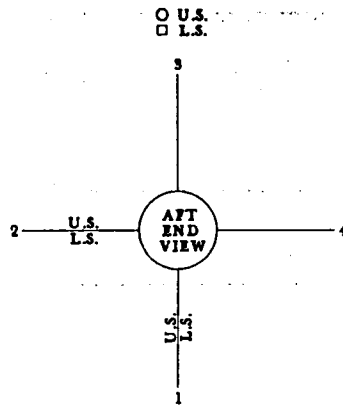
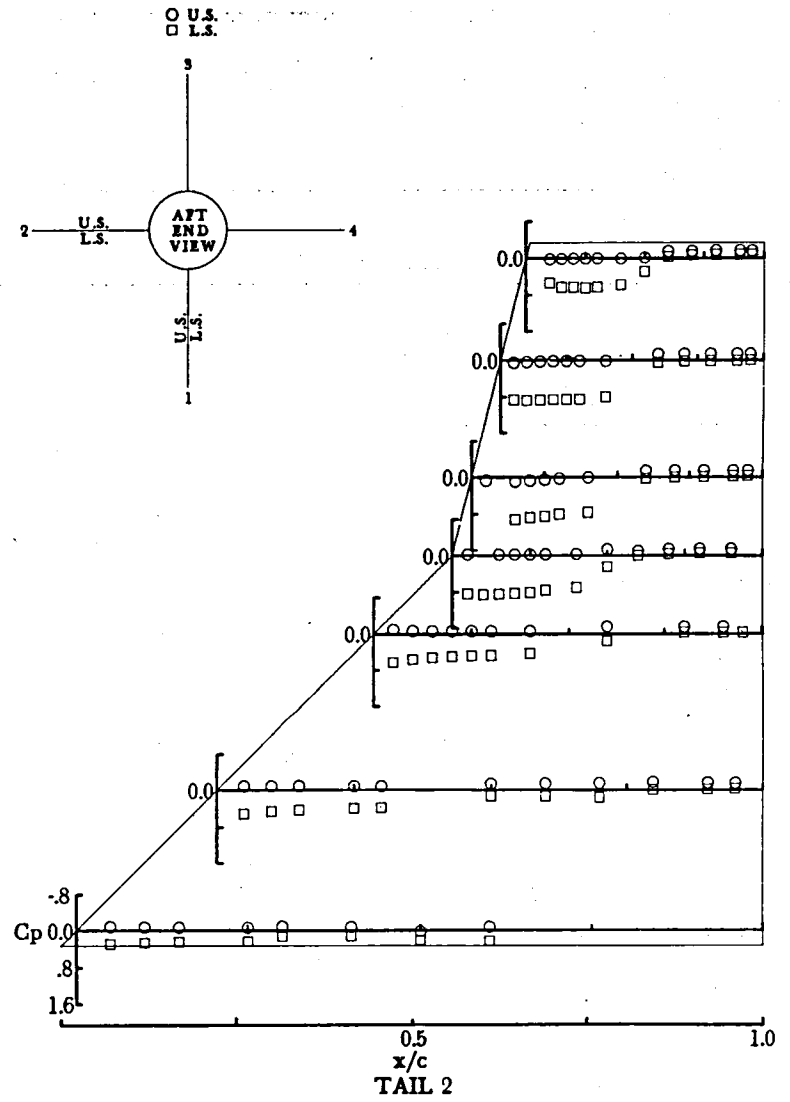
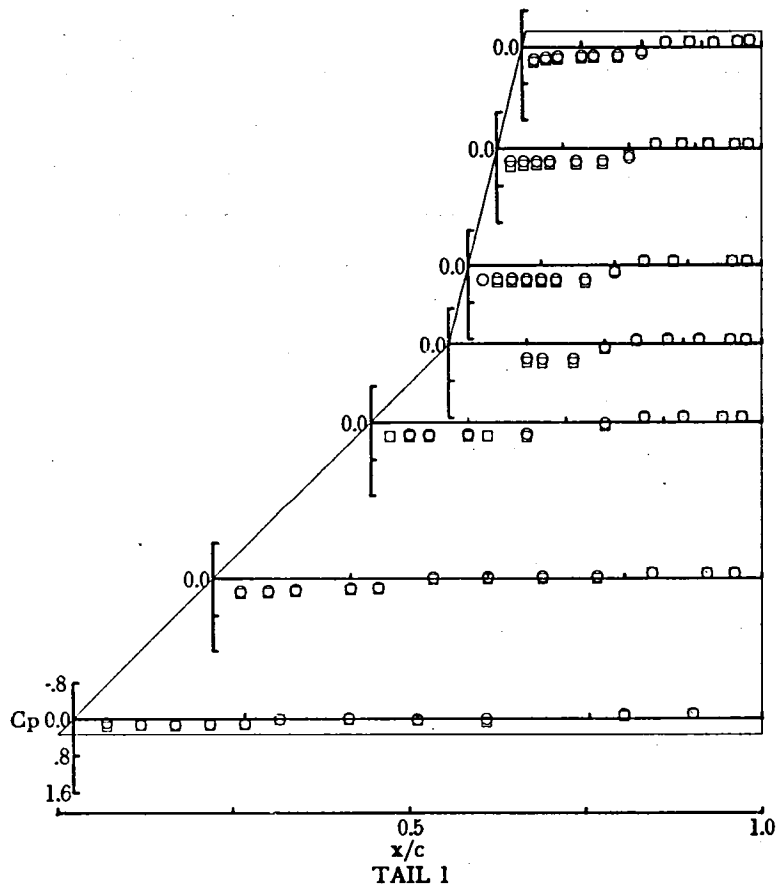

(b) $\alpha = 9.95^\circ$.

Figure 4.- Continued.

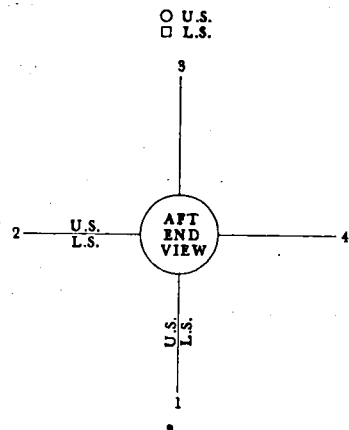
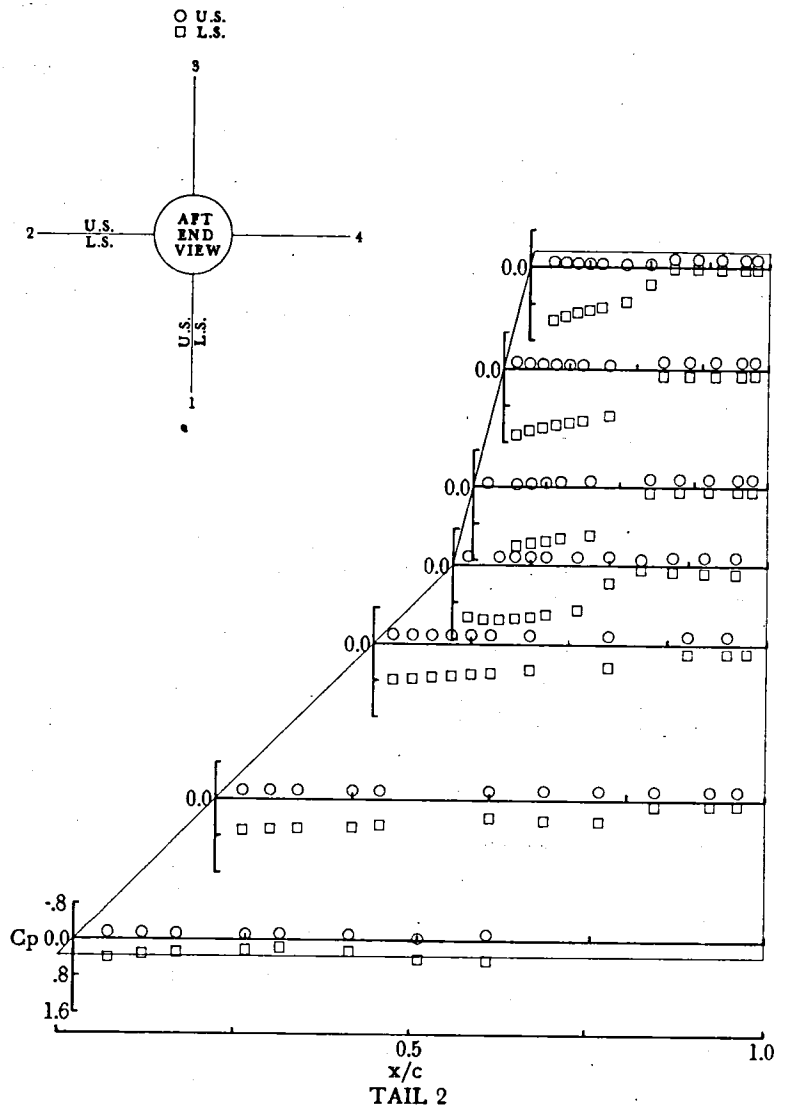
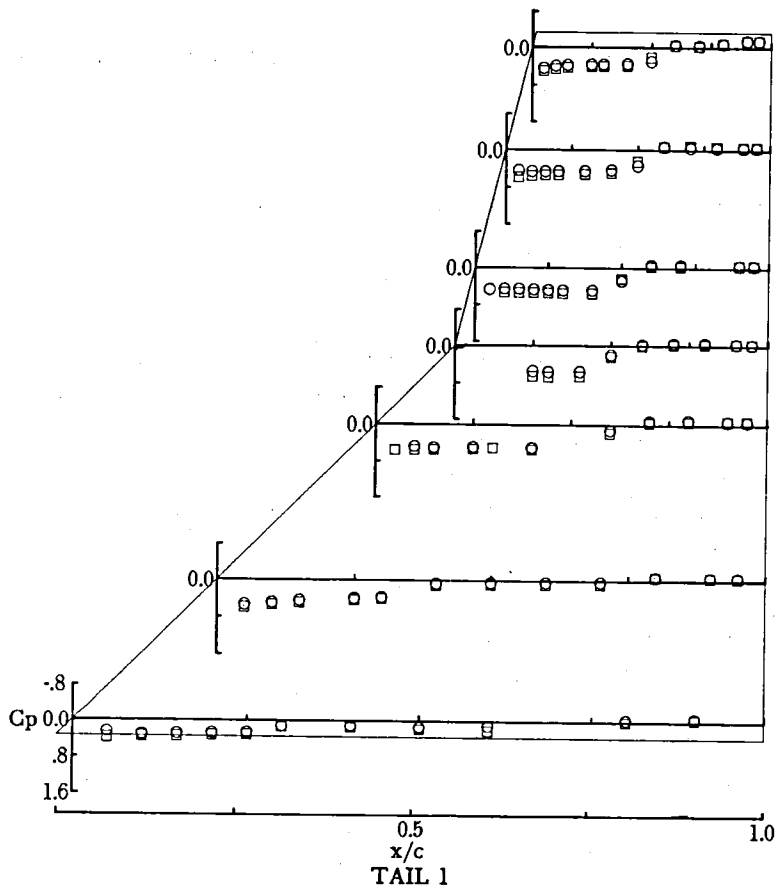

(c) $\alpha = 19.95^\circ$.

Figure 4.- Concluded.

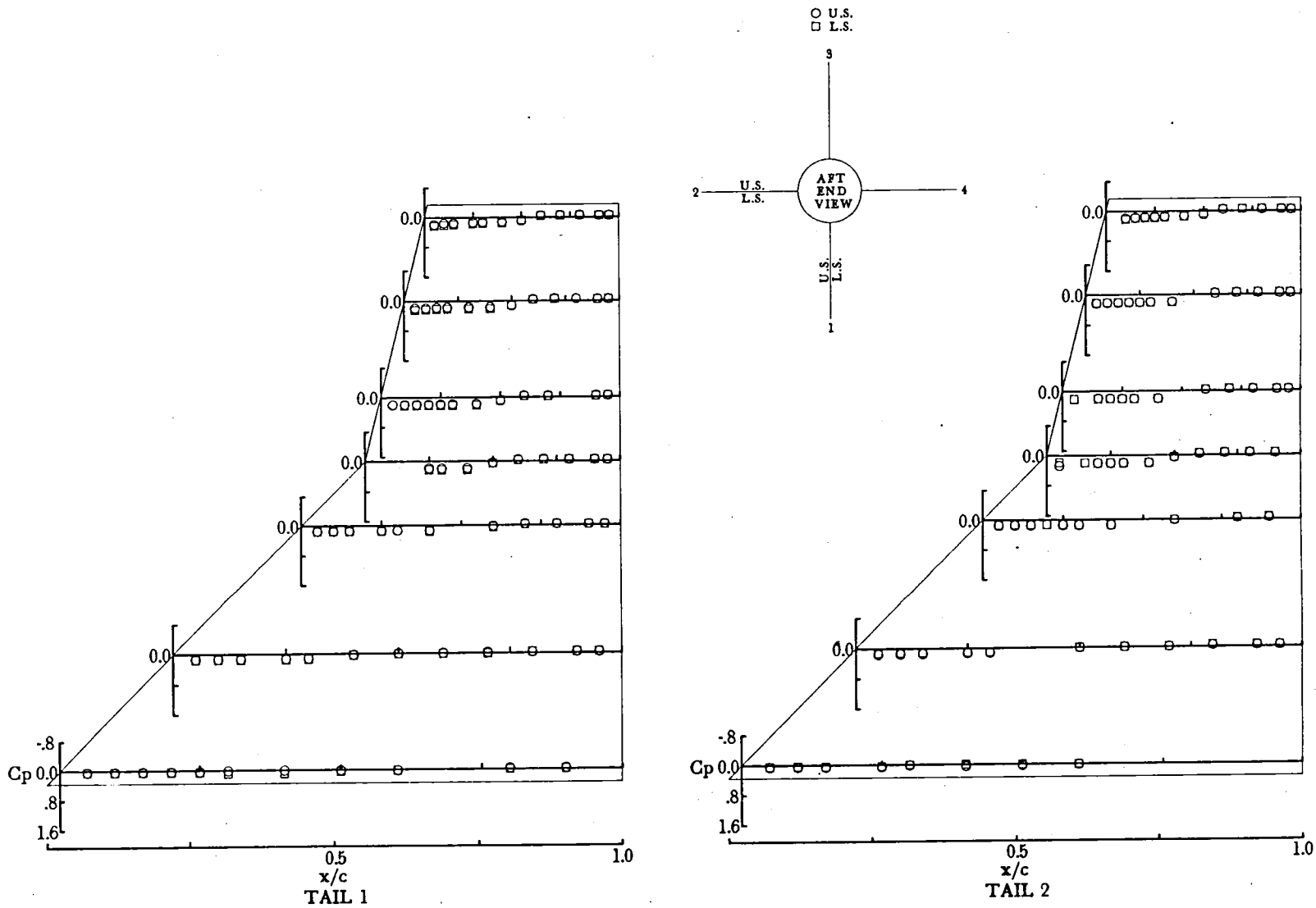

(a) $\alpha = -0.16^\circ$.

Figure 5.- Pressure coefficients for tail planform C at $M = 3.70$, $\phi = 0^\circ$, and $\delta = 0^\circ$.

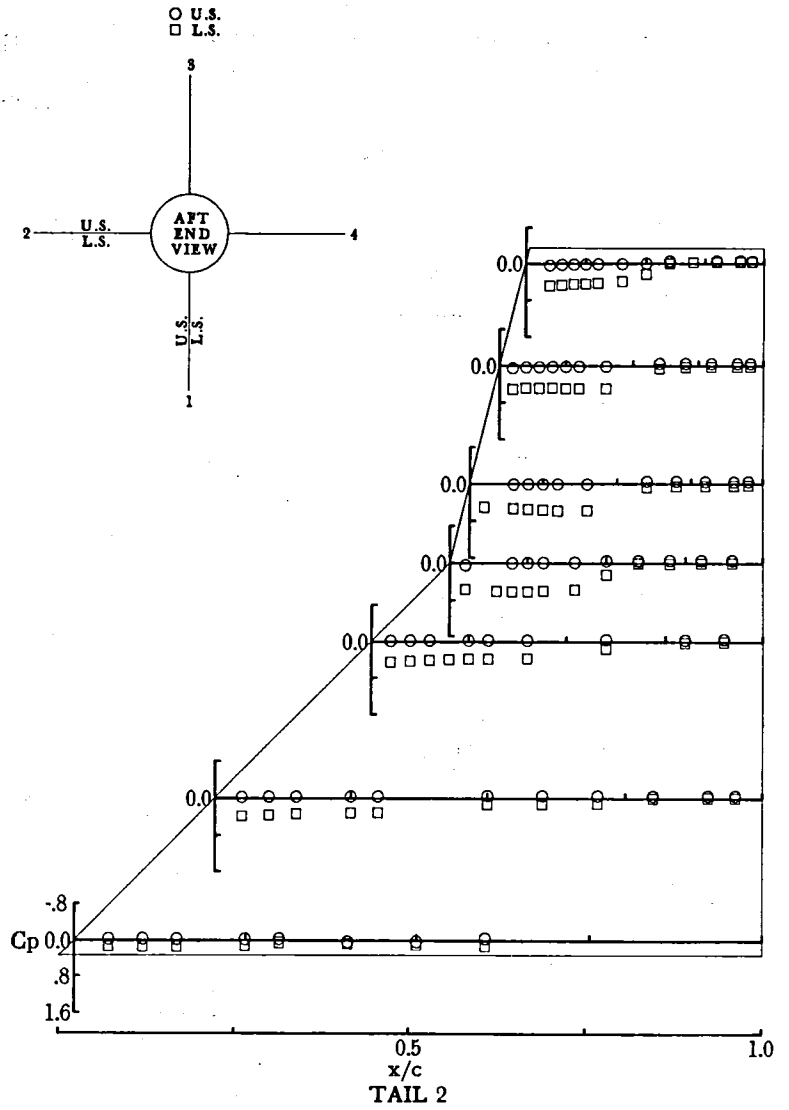
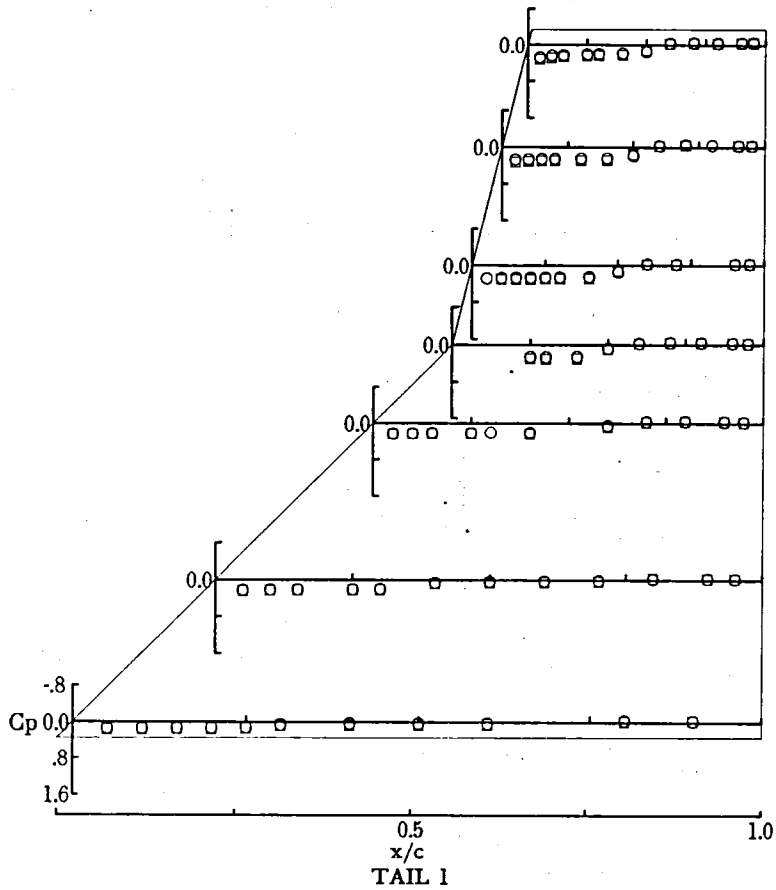

(b) $\alpha = 9.86^\circ$.

Figure 5.- Concluded.

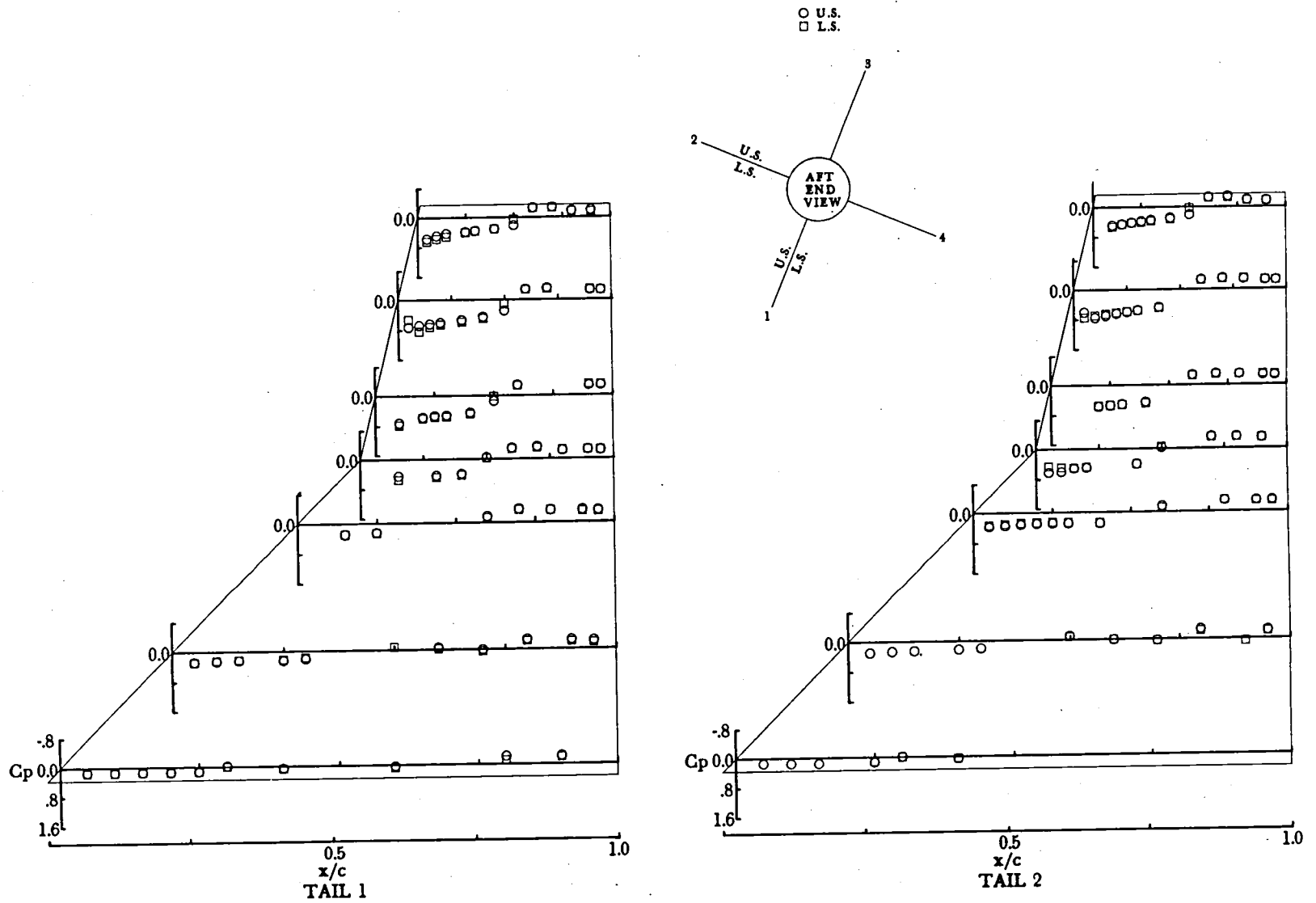
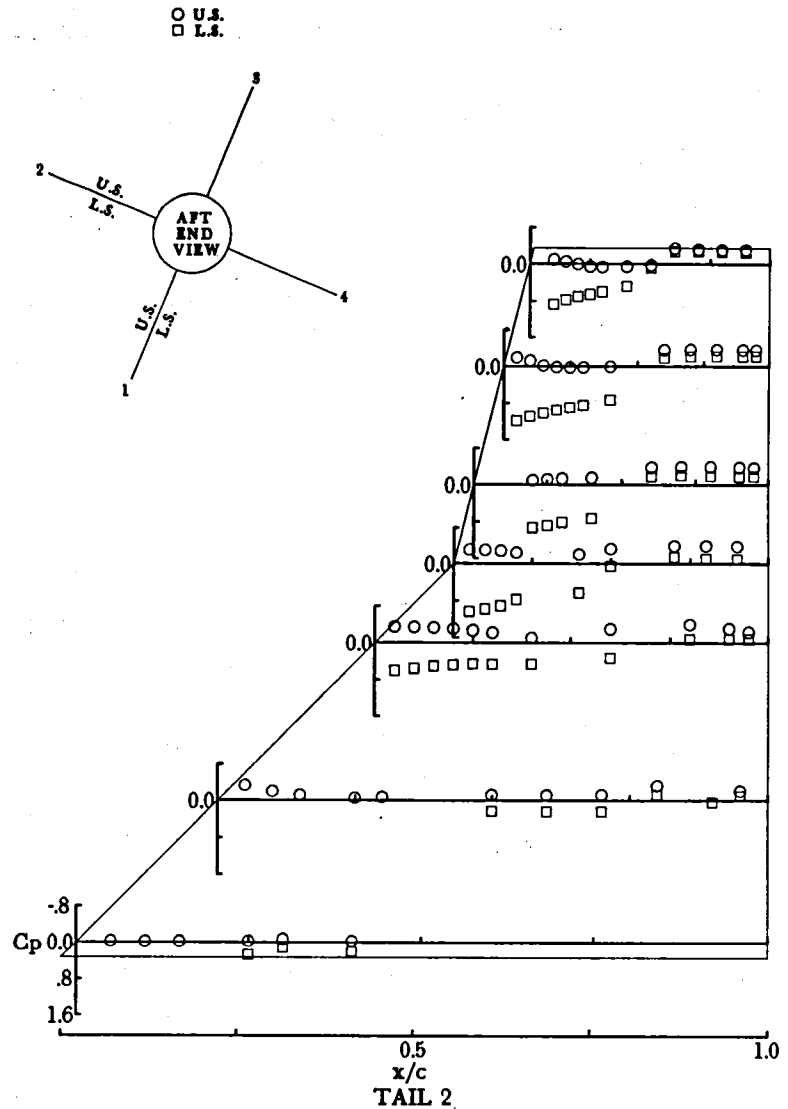
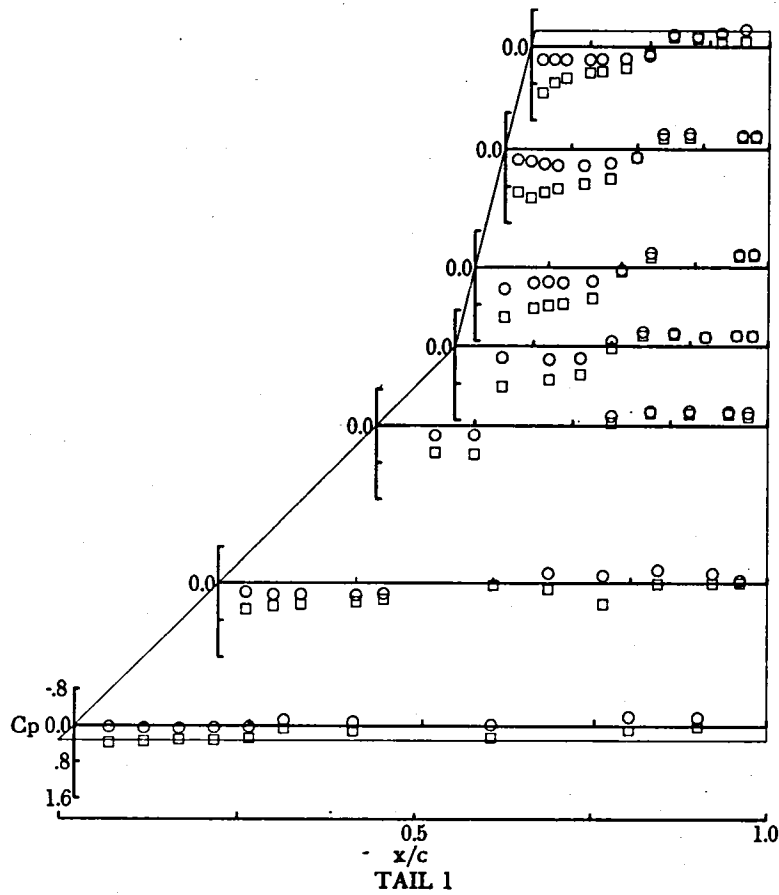
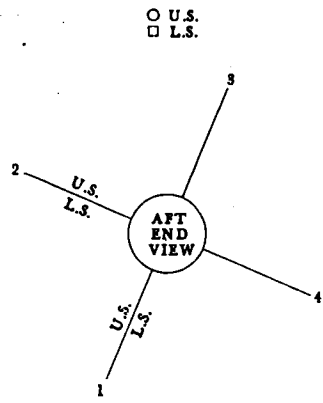
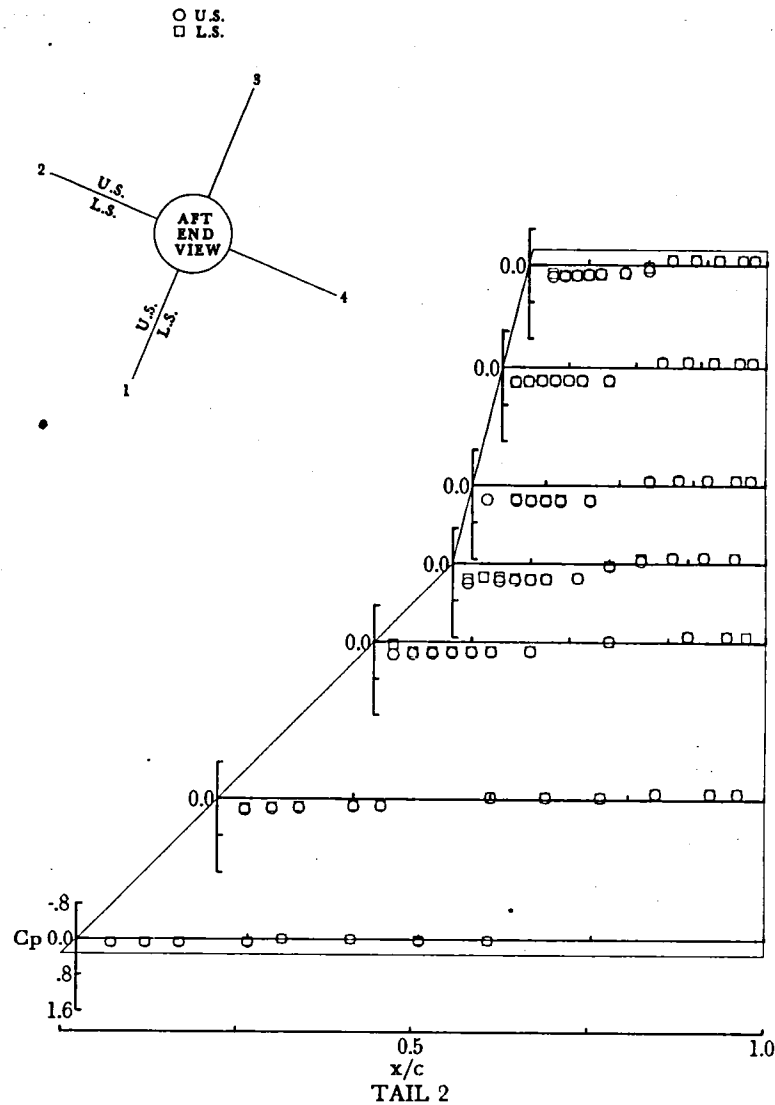
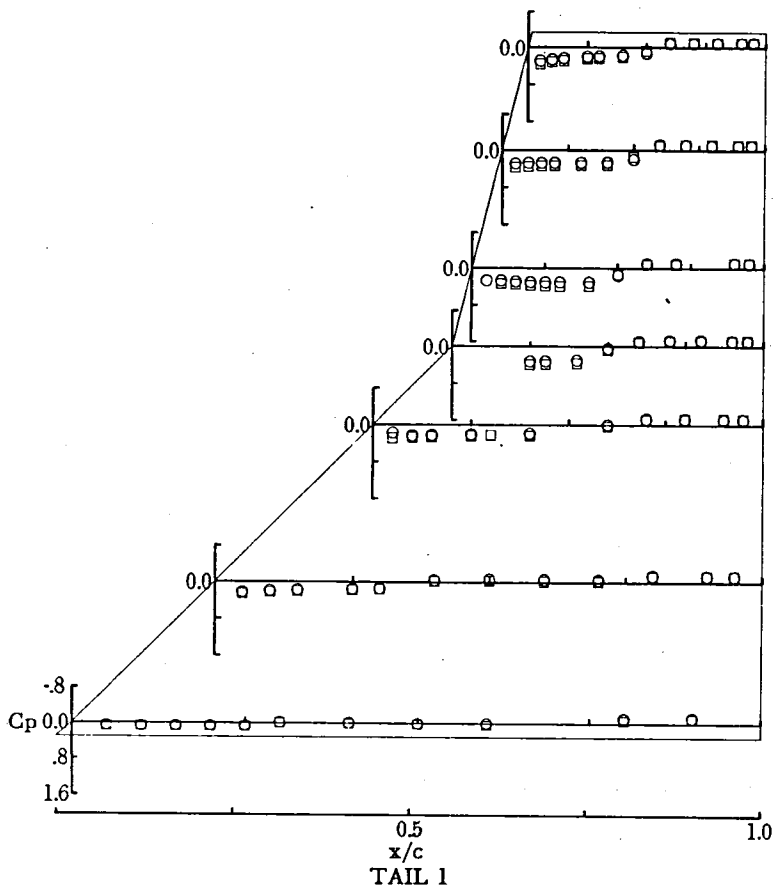

Figure 6.- Pressure coefficients for tail planform C at $M = 1.60$, $\phi = 22.5^\circ$, and $\delta = 0^\circ$.



(b) $\alpha = 10.86^\circ$.

Figure 6.- Continued.



(a) $\alpha = -0.20^\circ$.

Figure 7.- Pressure coefficients for tail planform C at $M = 2.36$, $\phi = 22.5^\circ$, and $\delta = 0^\circ$.

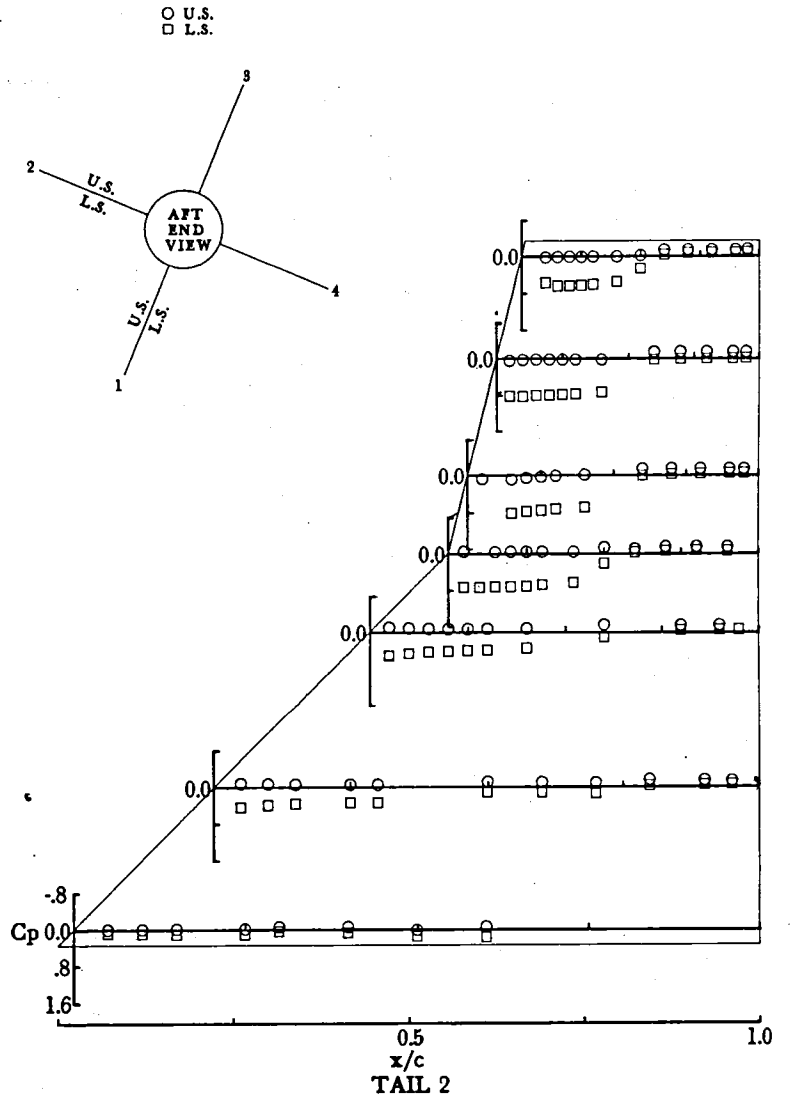
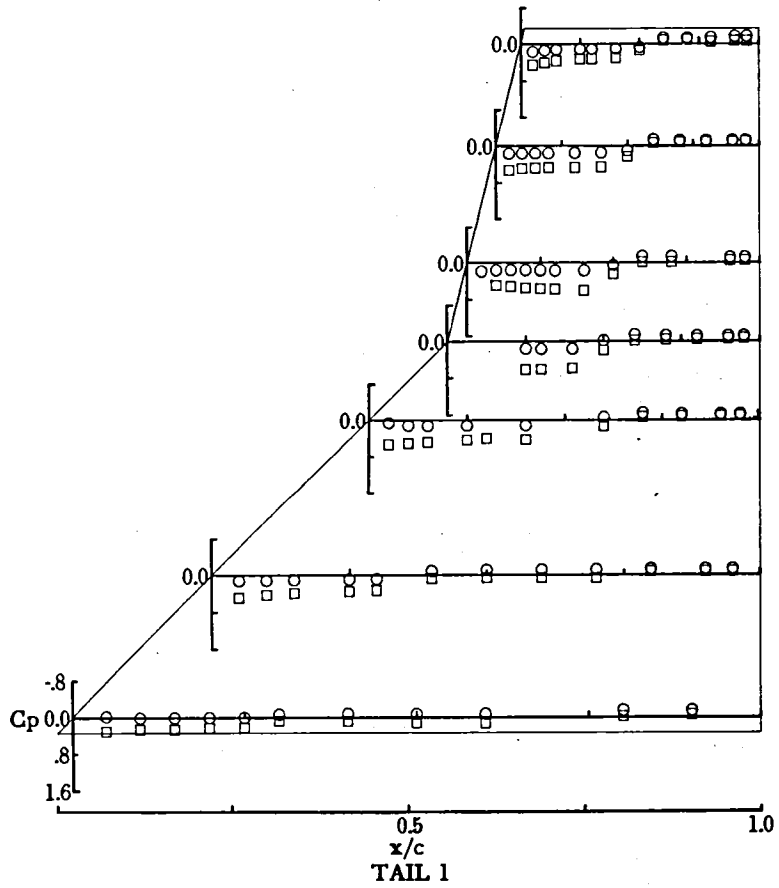

(b) $\alpha = 9.81^\circ$.

Figure 7.- Continued.

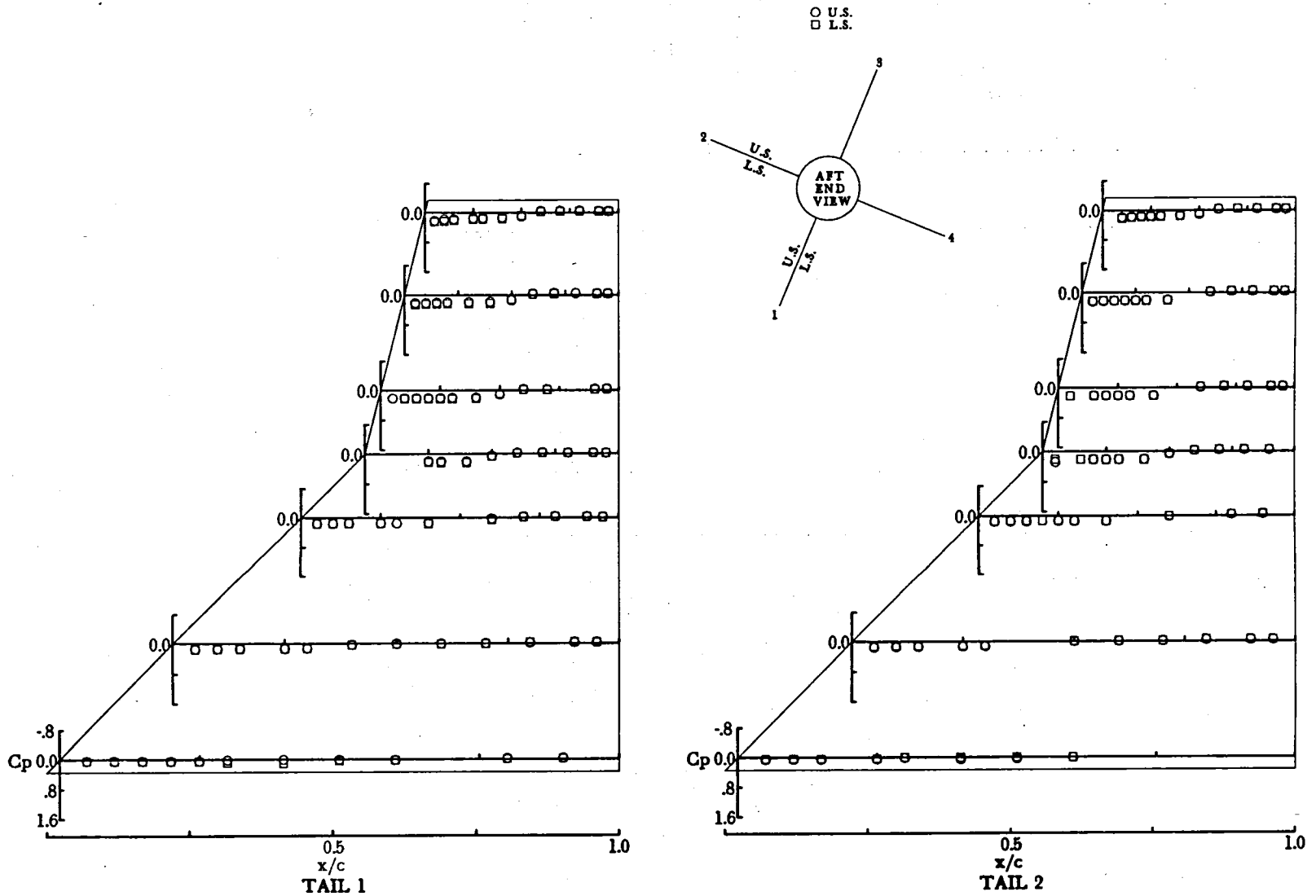
(a) $\alpha = 0.00^\circ$.Figure 8.- Pressure coefficients for tail planform C at $M = 3.70$, $\phi = 22.5^\circ$, and $\delta = 0^\circ$.

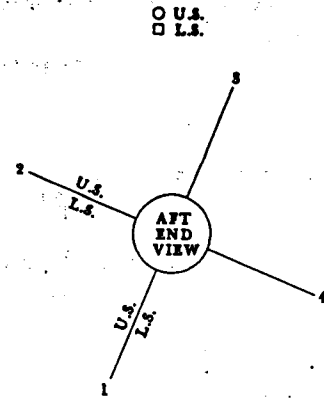
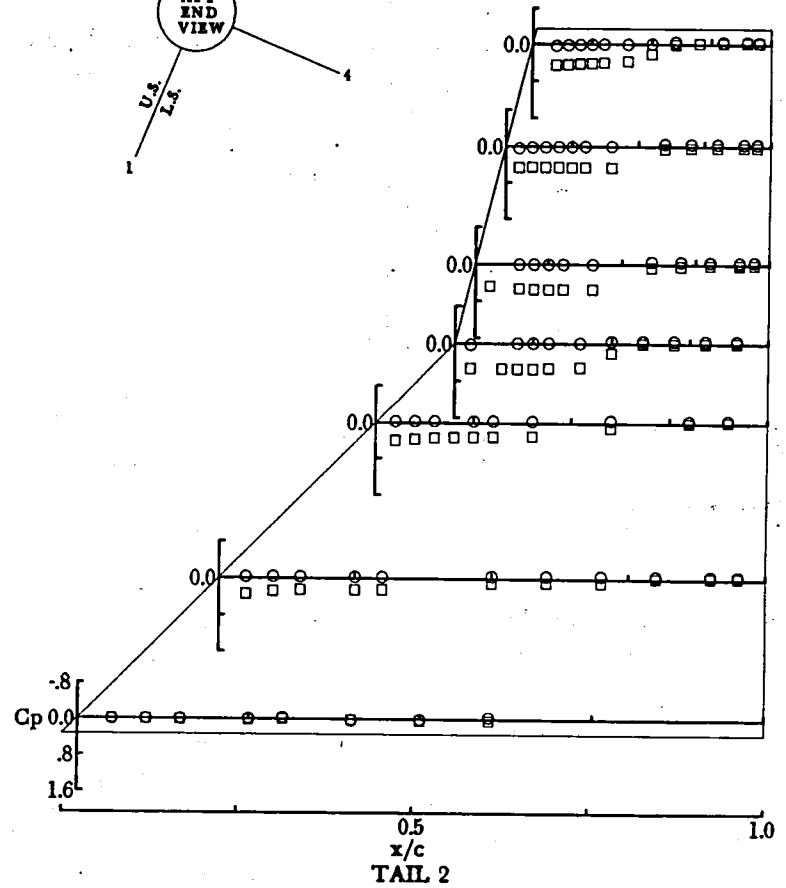
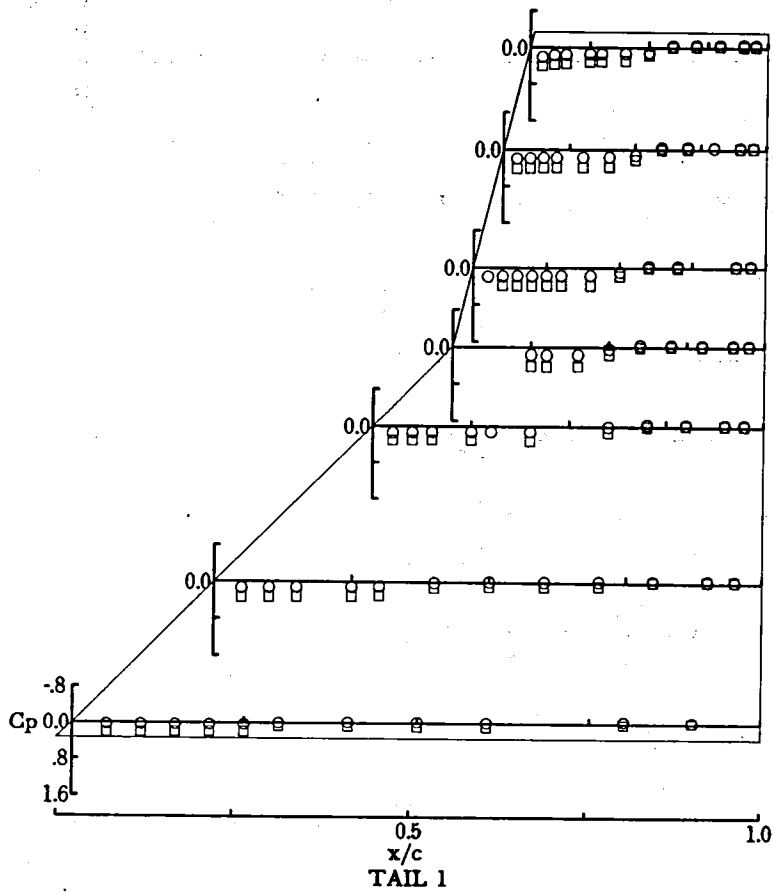

(b) $\alpha = 10.01^\circ$.

Figure 8.- Continued.

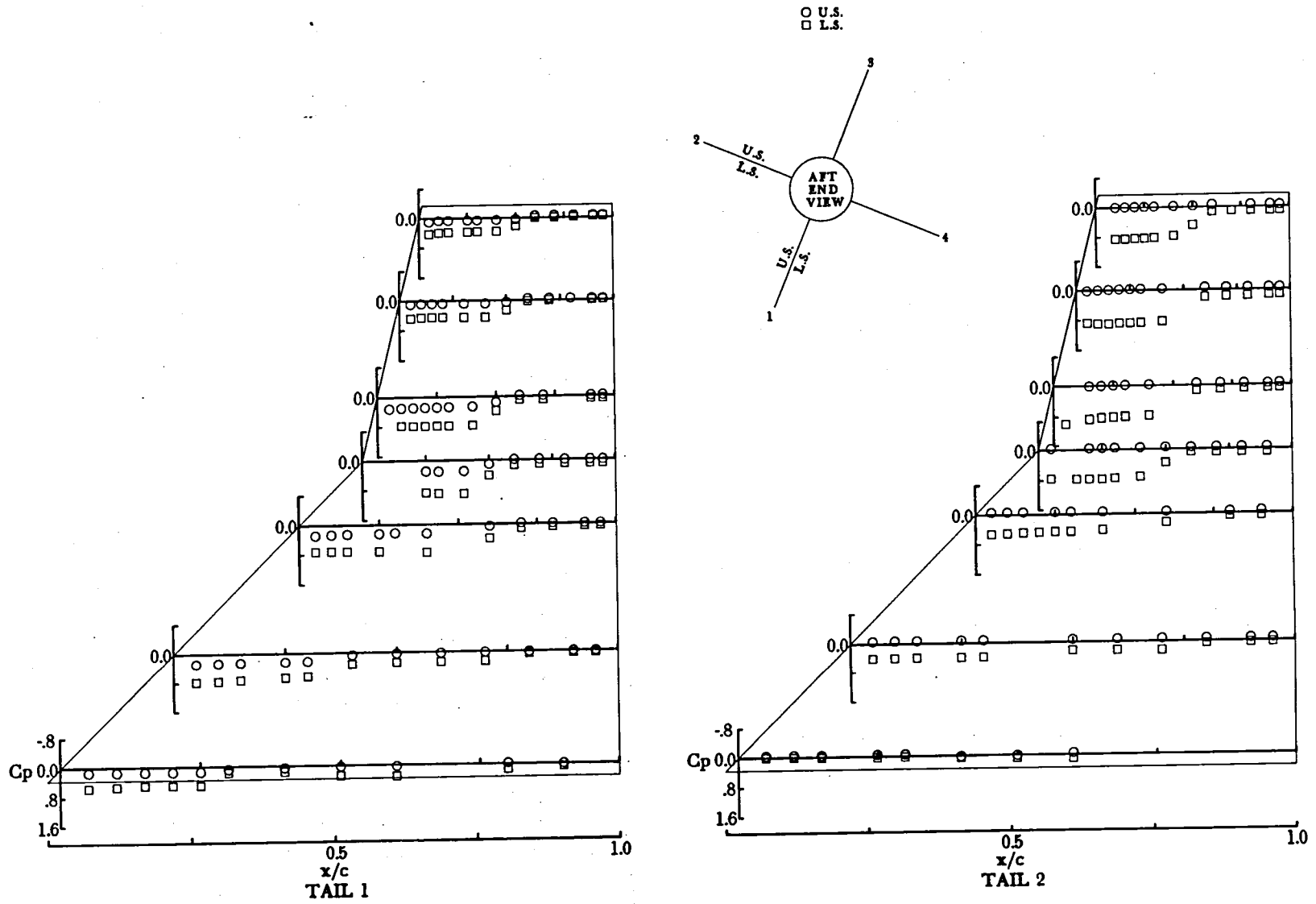

(c) $\alpha = 20.00^\circ$.

Figure 8.- Concluded.

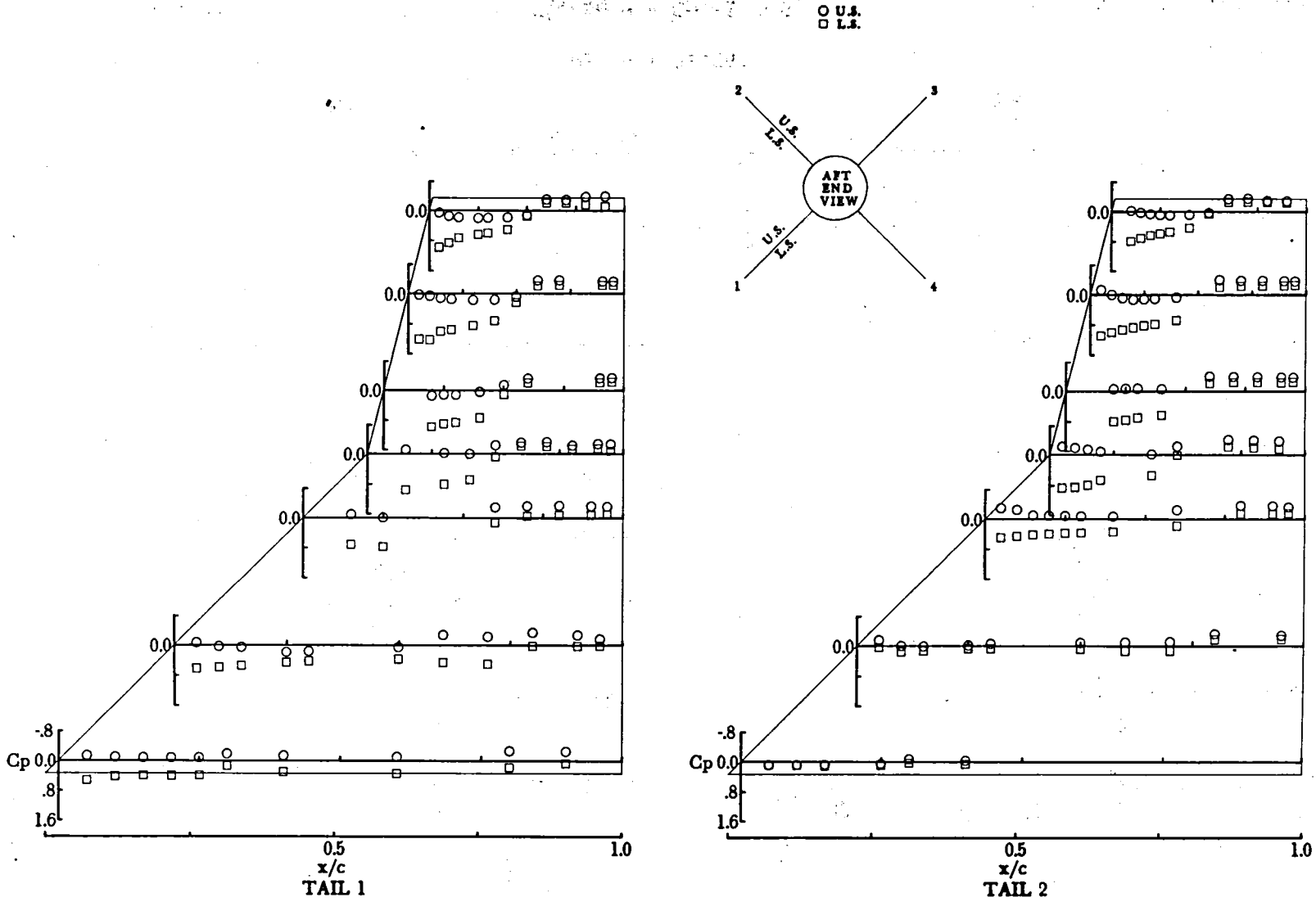

(b) $\alpha = 11.09^\circ$.

Figure 9.- Continued.

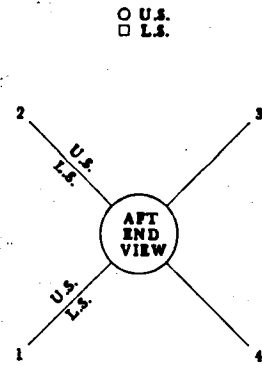
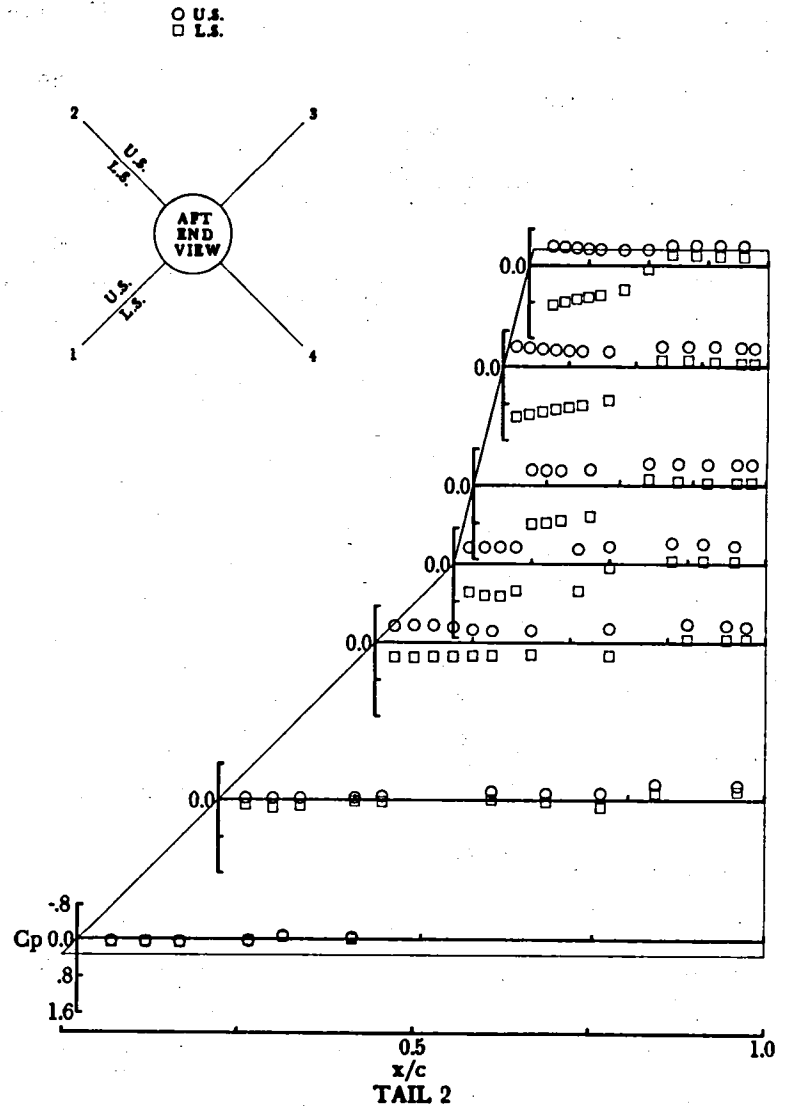
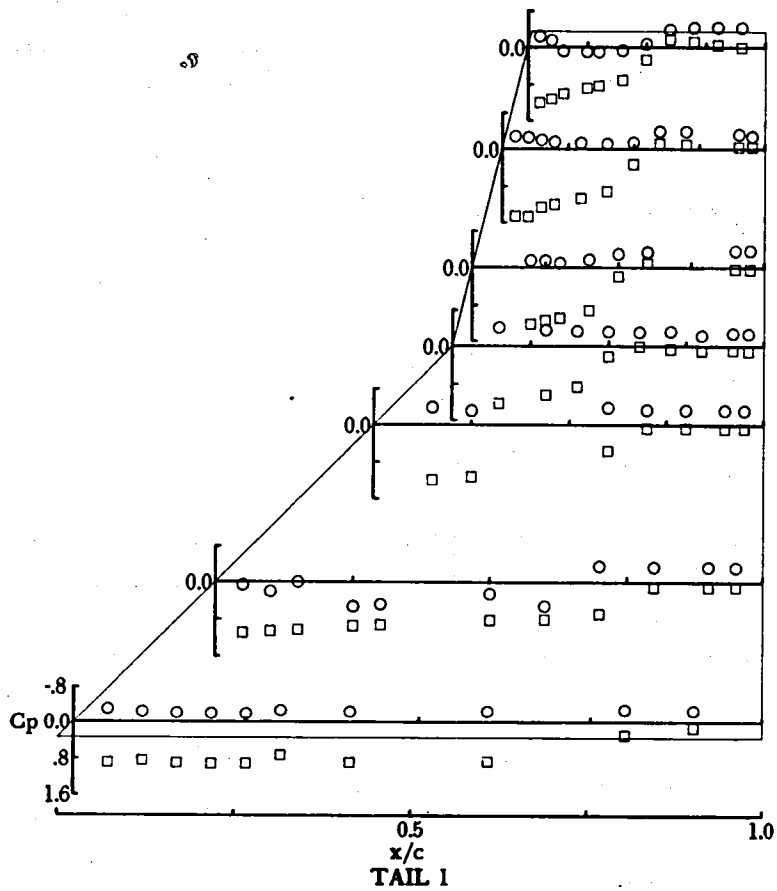

(c) $\alpha = 21.06^\circ$.

Figure 9.- Concluded.

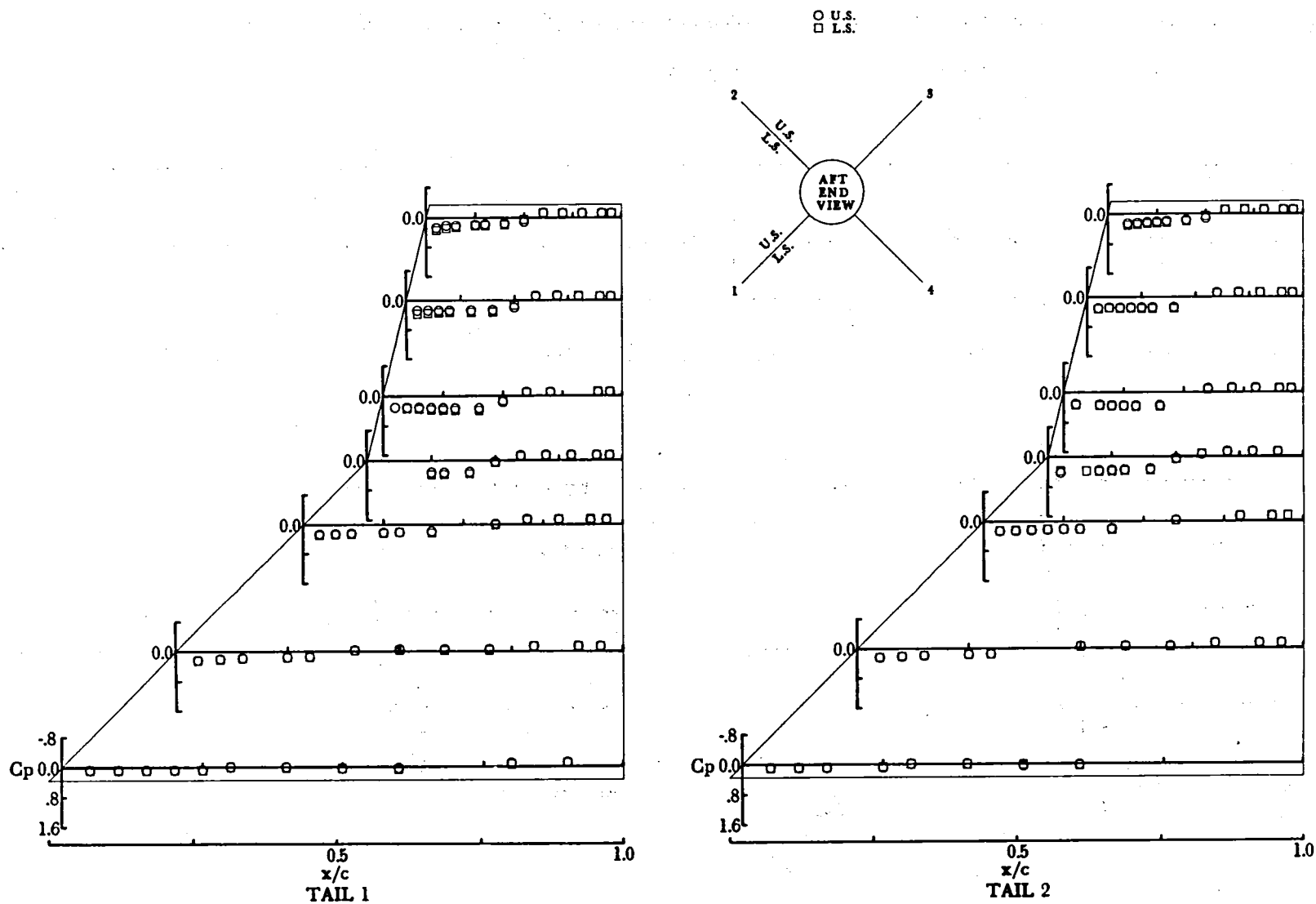
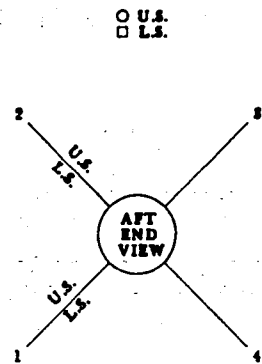
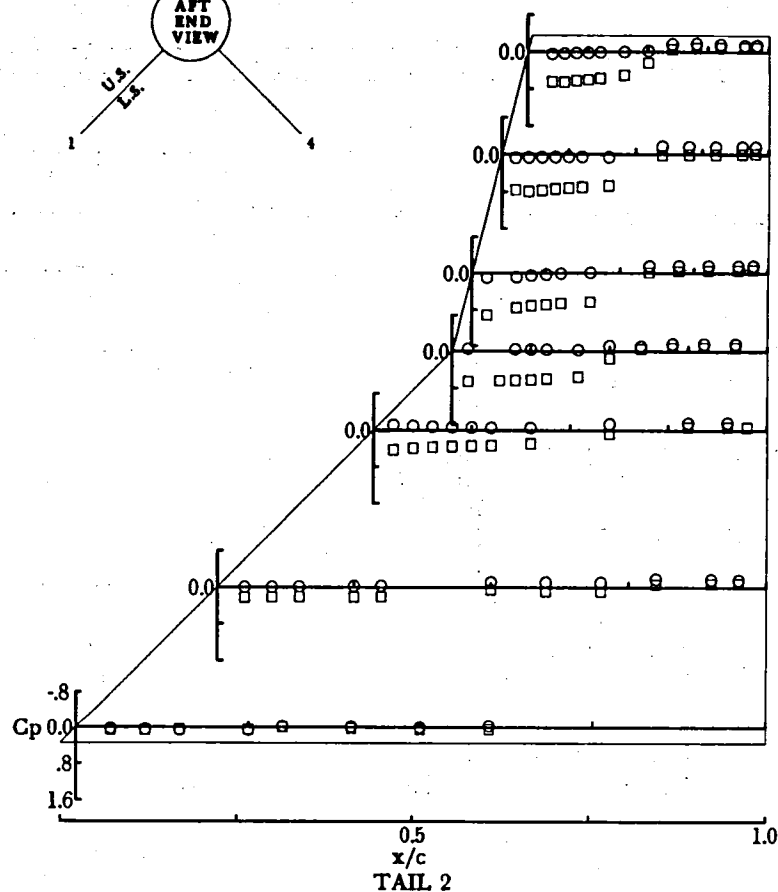
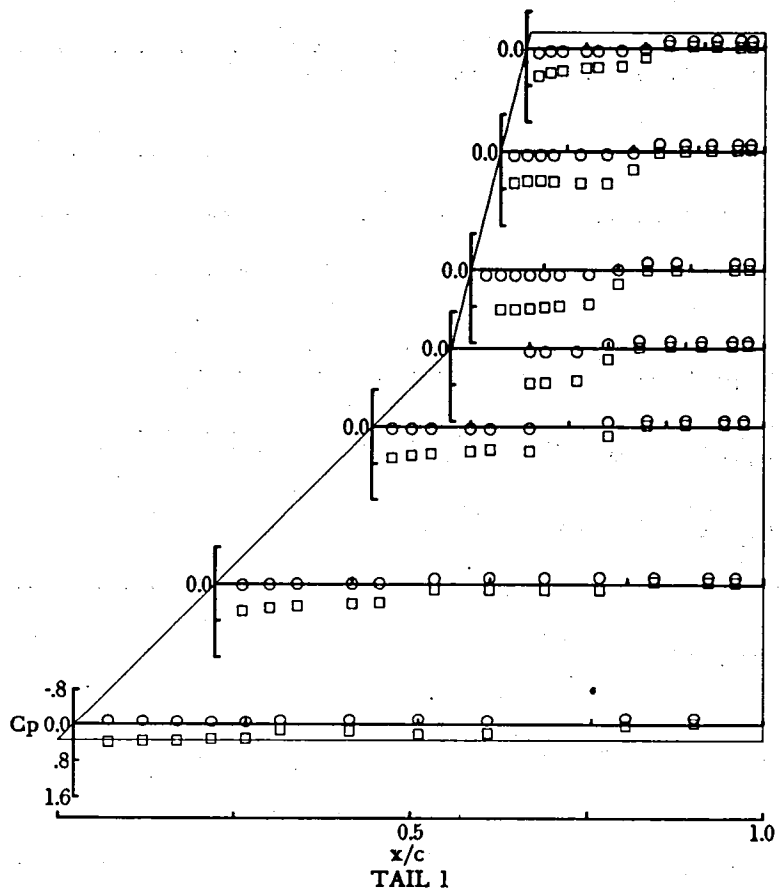
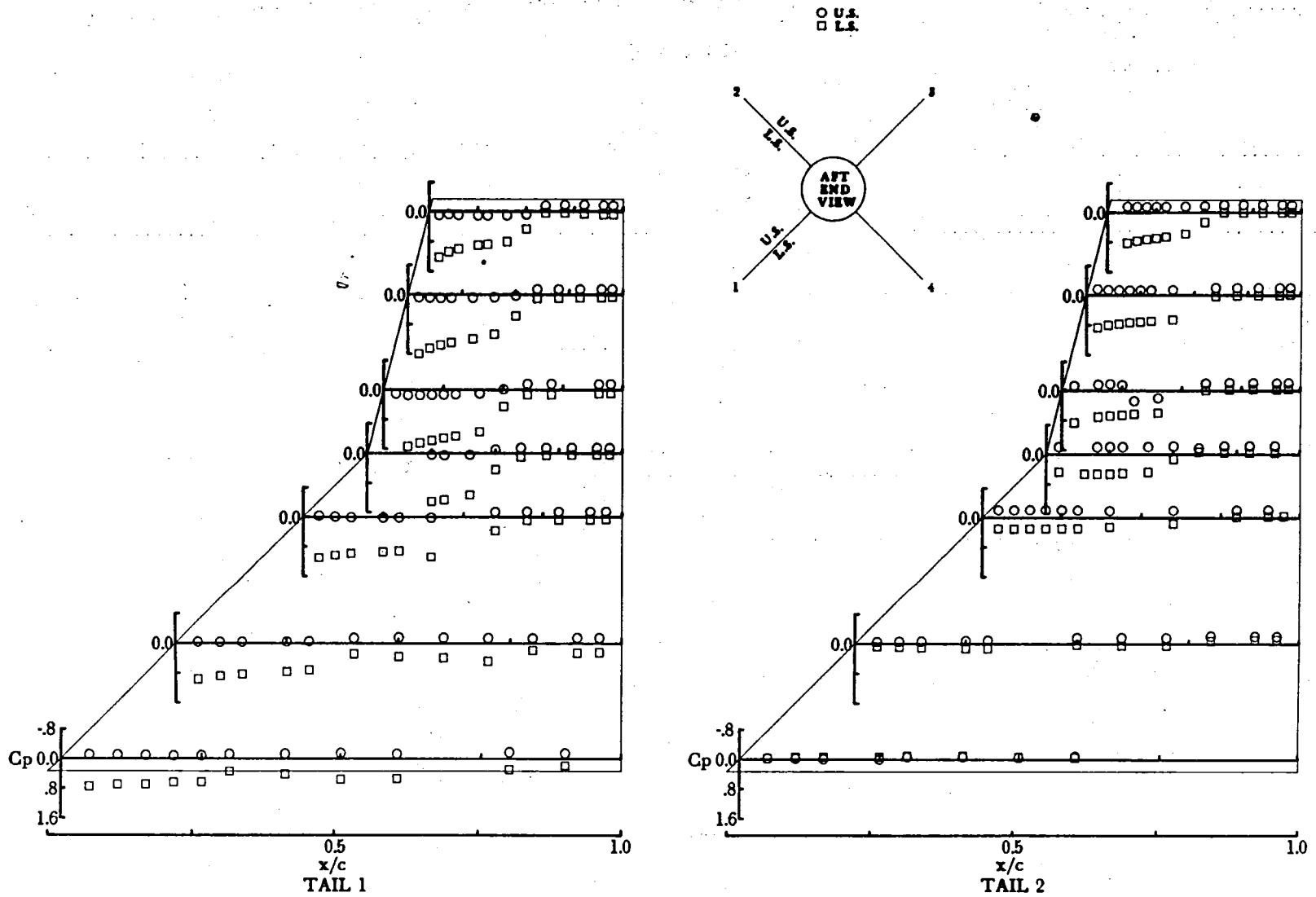

Figure 10.- Pressure coefficients for tail planform C at $M = 2.36$, $\phi = 45^\circ$, and $\delta = 0^\circ$.



(b) $\alpha = 9.85^\circ$.

Figure 10.- Continued.



(c) $\alpha = 19.85^\circ$.

Figure 10.- Concluded.

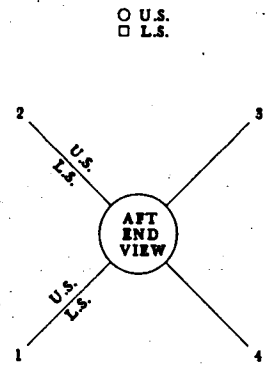
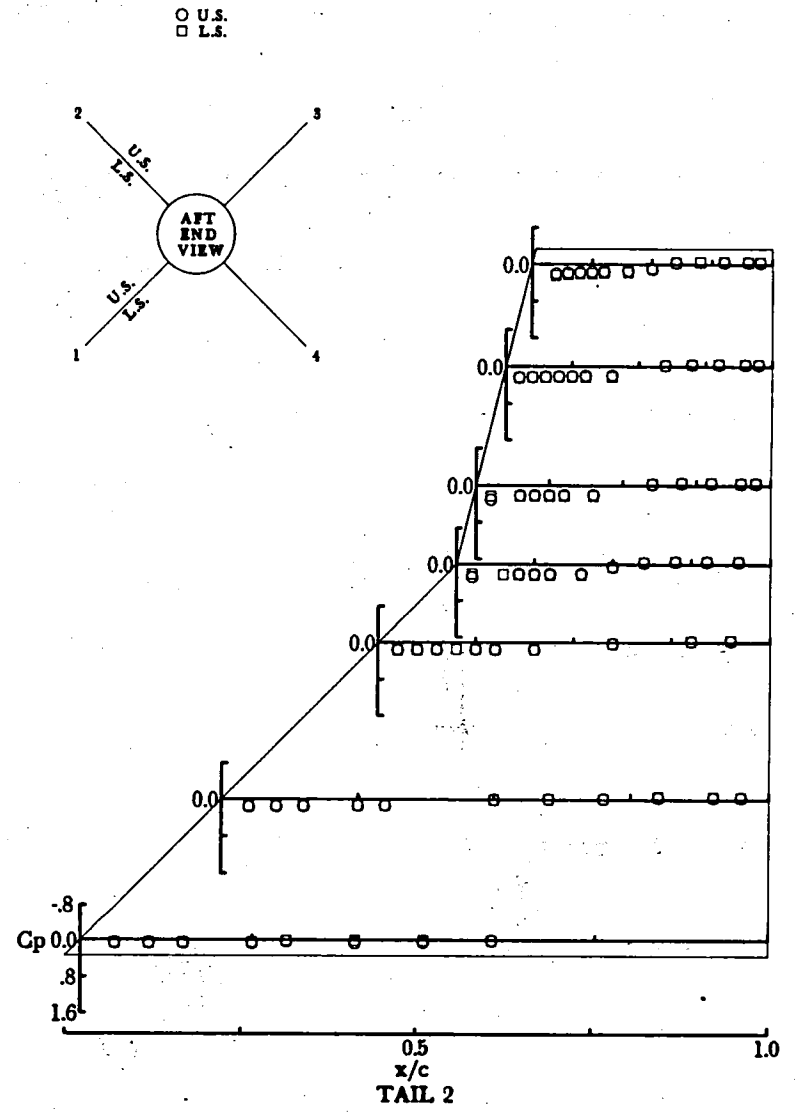
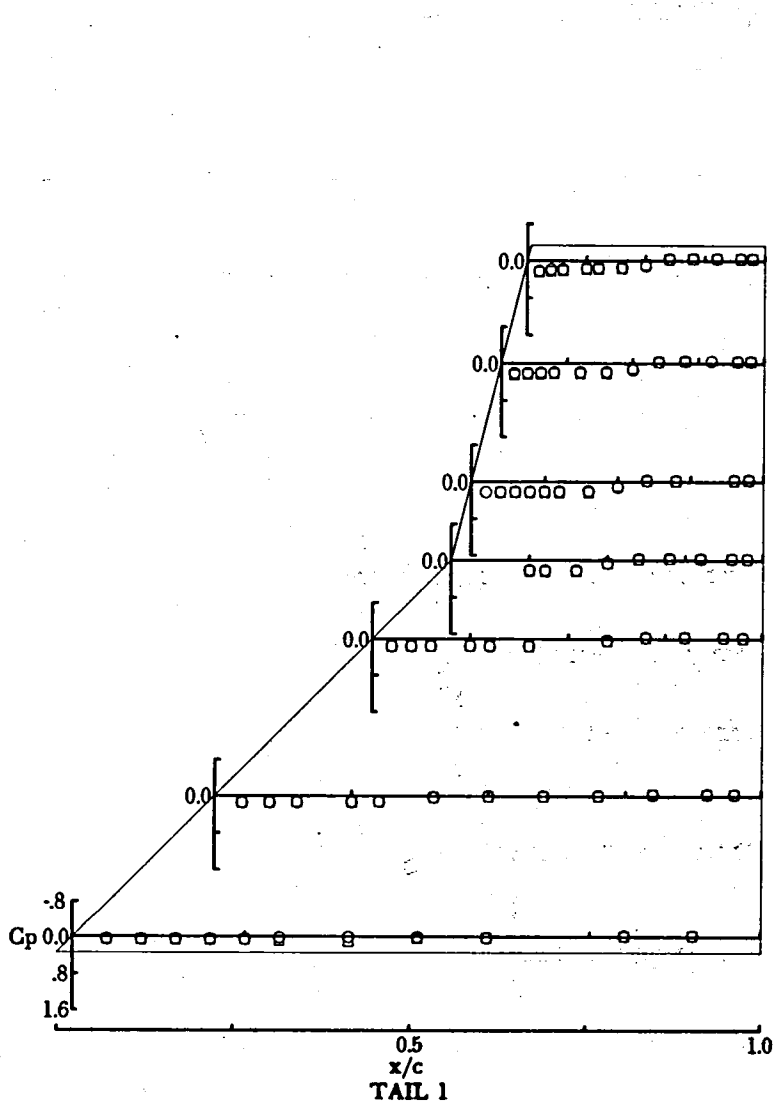

(a) $\alpha = 0.00^\circ$.

Figure 11.- Pressure coefficients for tail planform C at $M = 3.70$, $\phi = 45^\circ$, and $\delta = 0^\circ$.

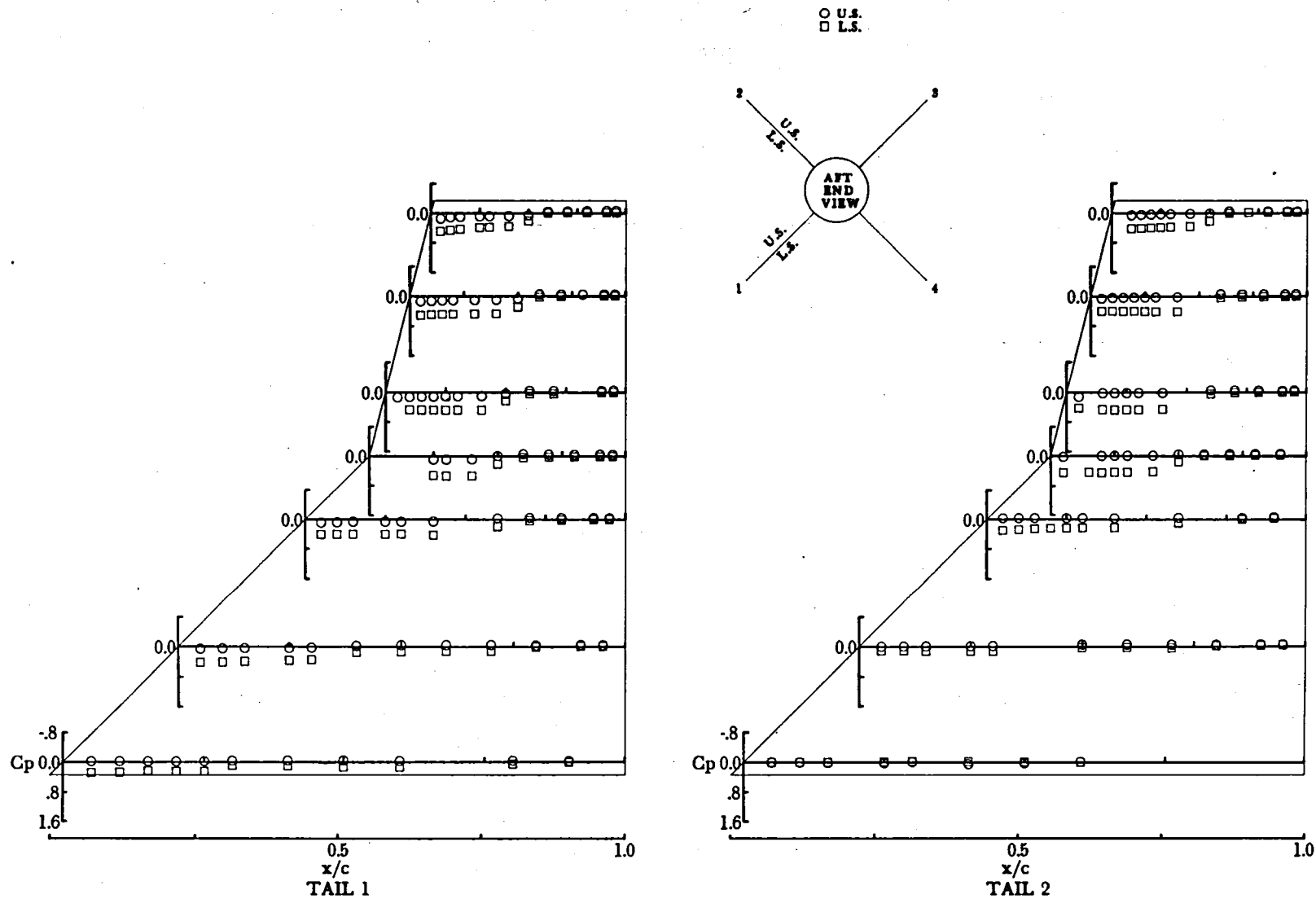

(b) $\alpha = 10.00^\circ$.

Figure 11.- Continued.

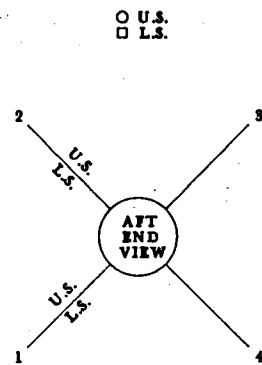
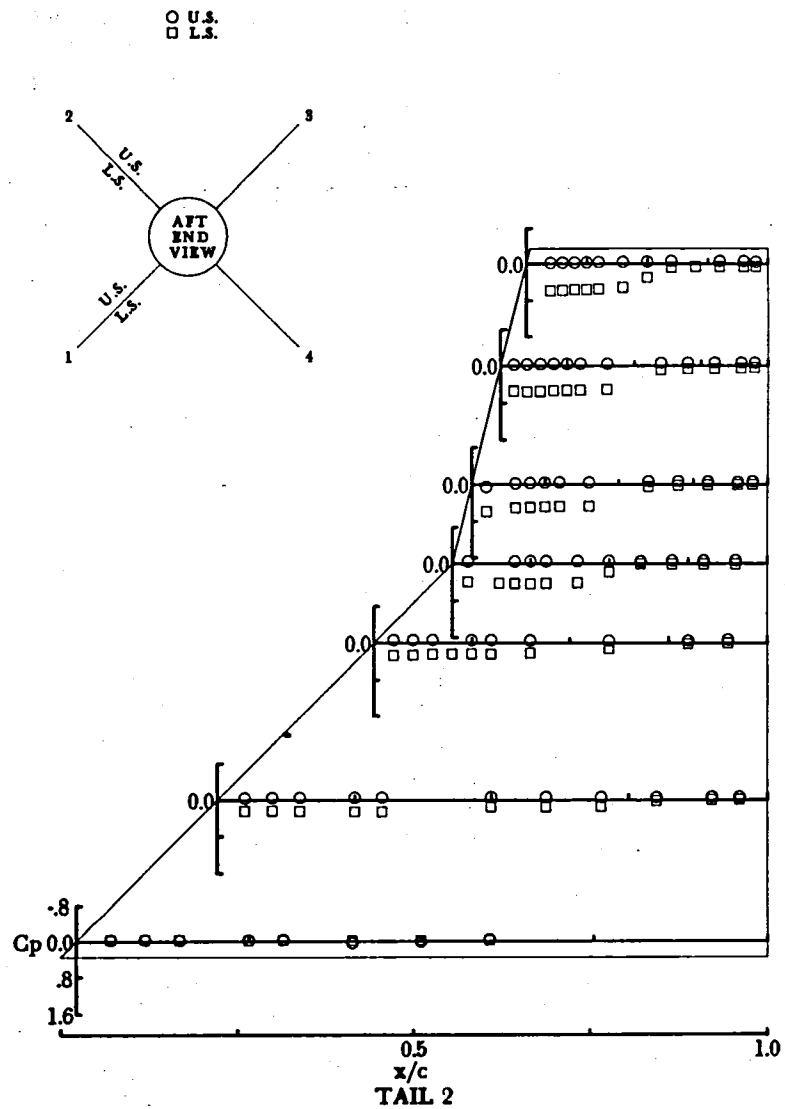
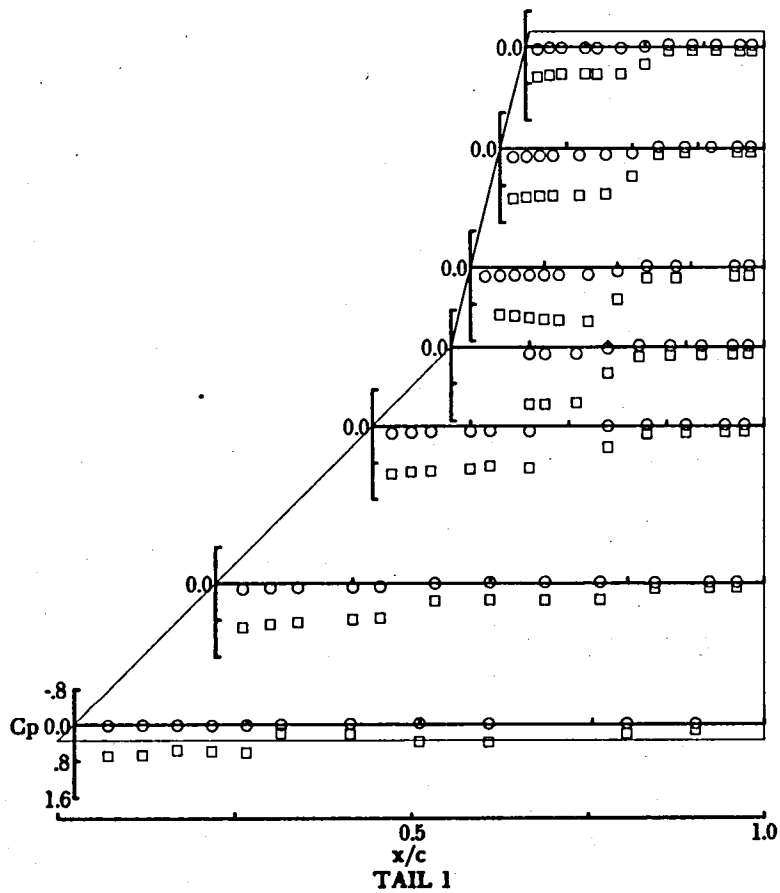

(c) $\alpha = 20.00^\circ$.

Figure 11.- Concluded.

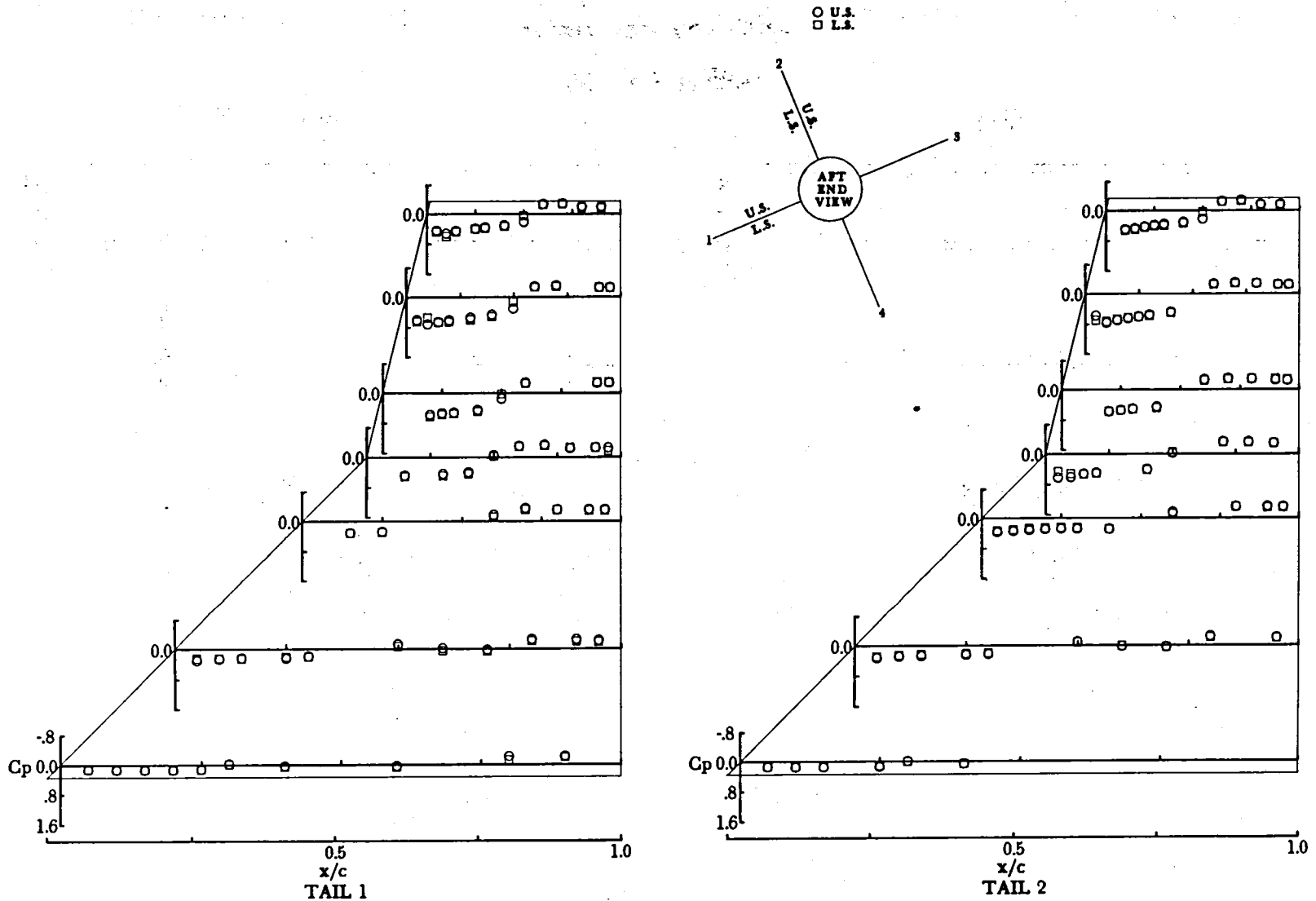

(a) $\alpha = 1.20^\circ$.

Figure 12.- Pressure coefficients for tail planform C at $M = 1.60$, $\phi = 67.5^\circ$, and $\delta = 0^\circ$.

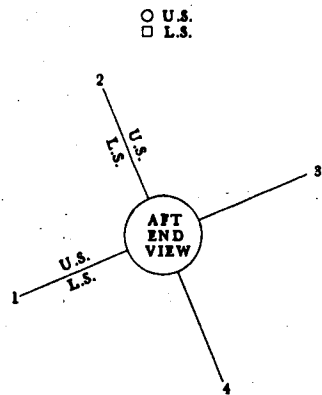
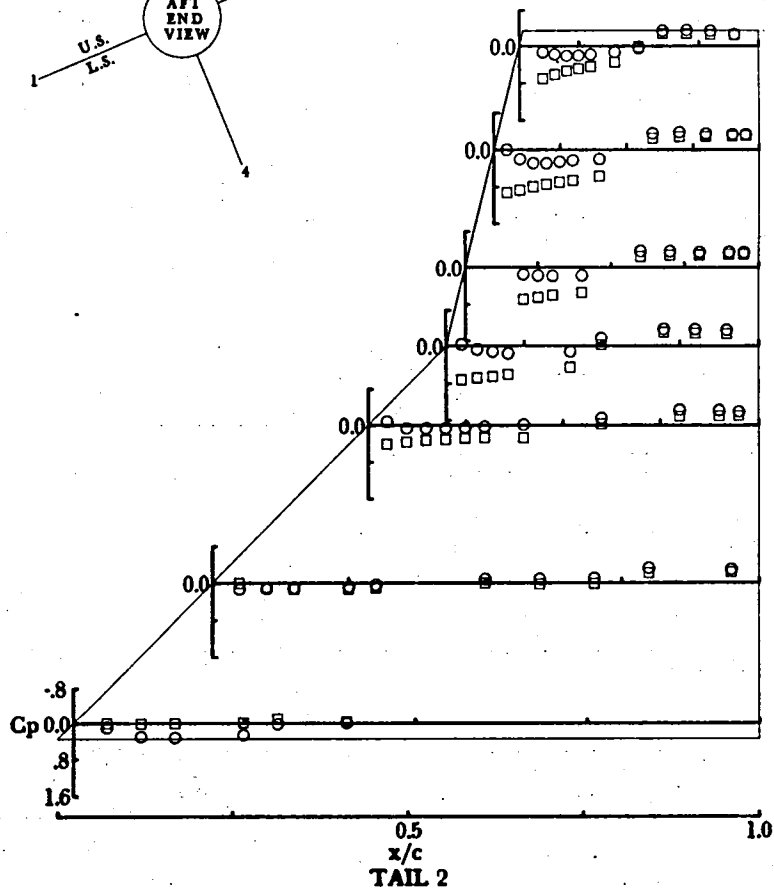
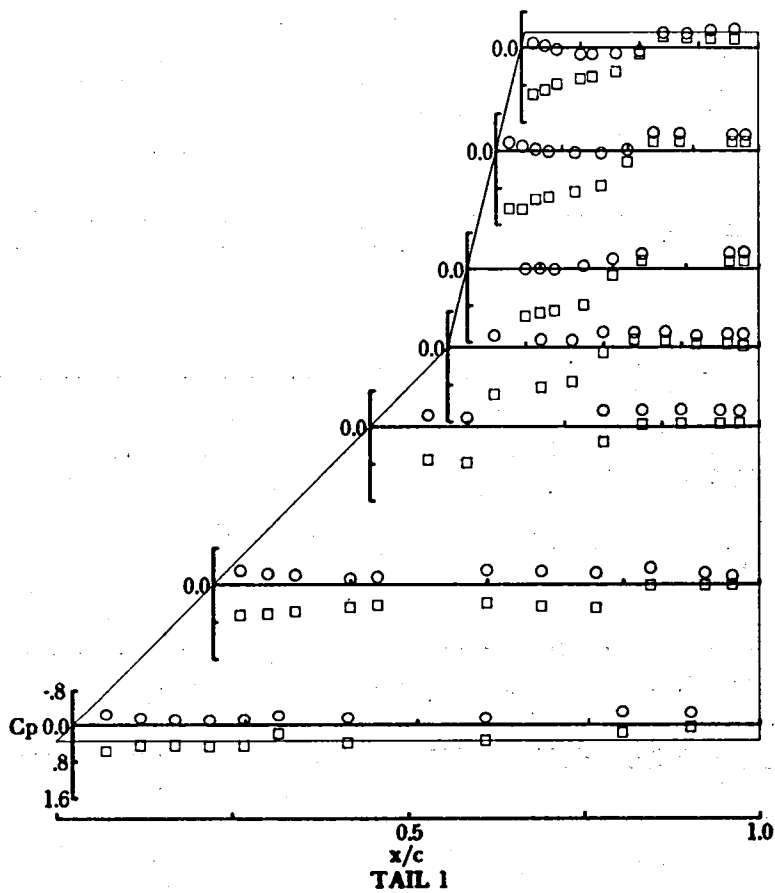

(b) $\alpha = 11.20^\circ$.

Figure 12.- Continued.

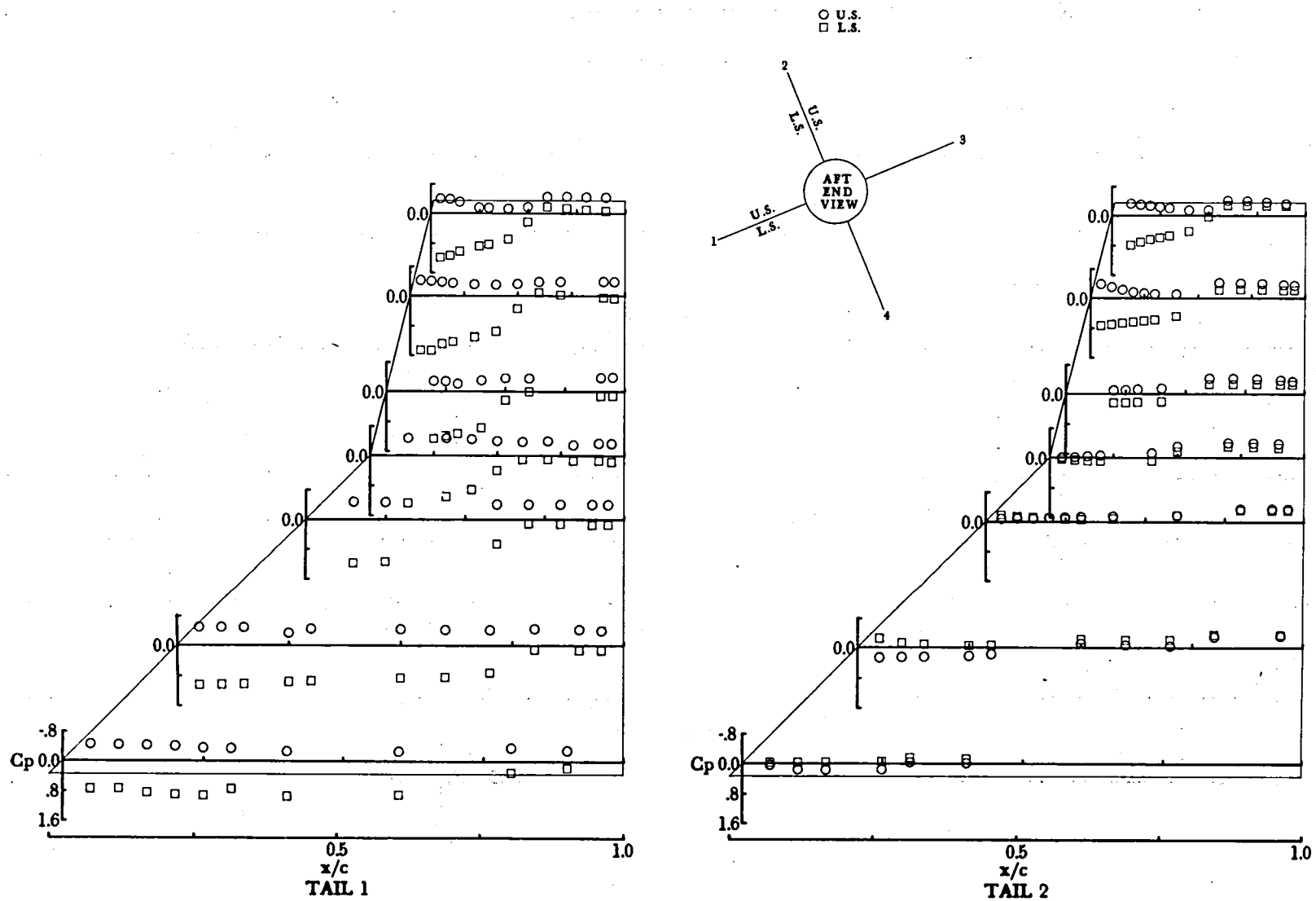

(c) $\alpha = 21.20^\circ$.

Figure 12.- Concluded.

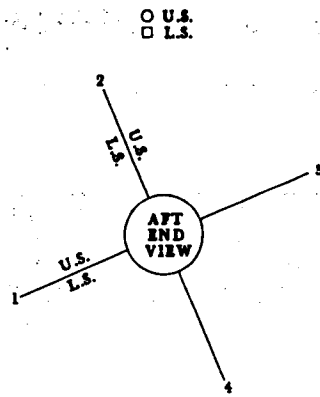
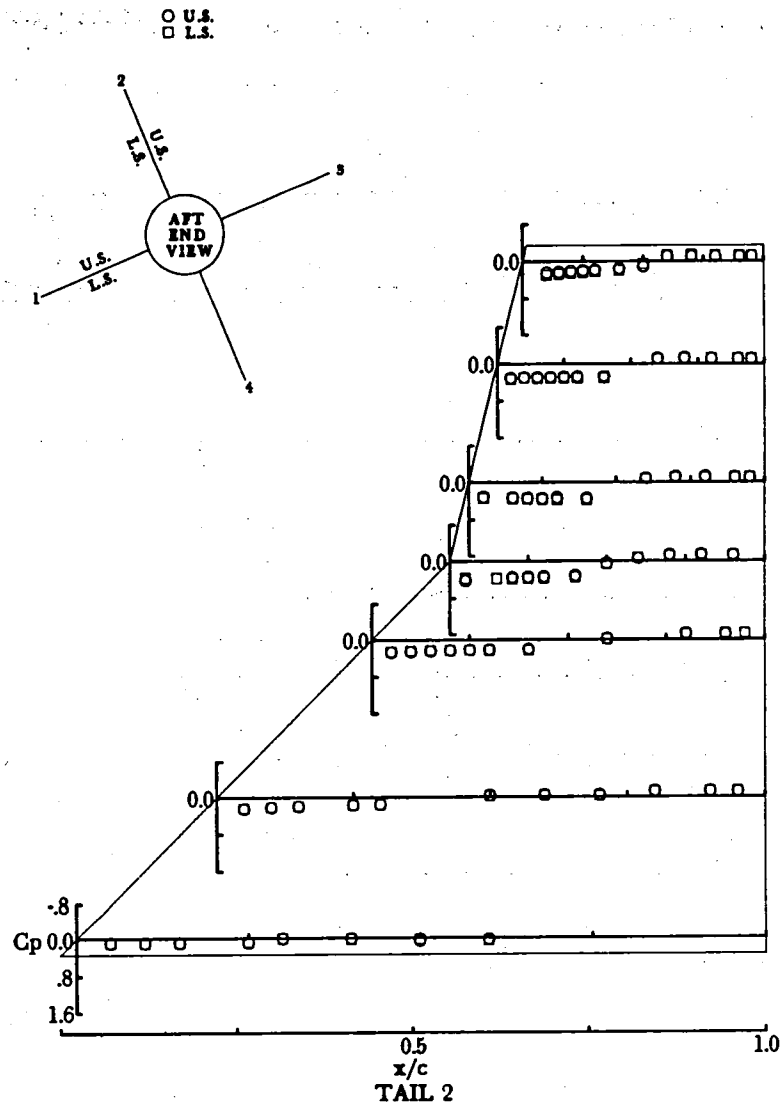
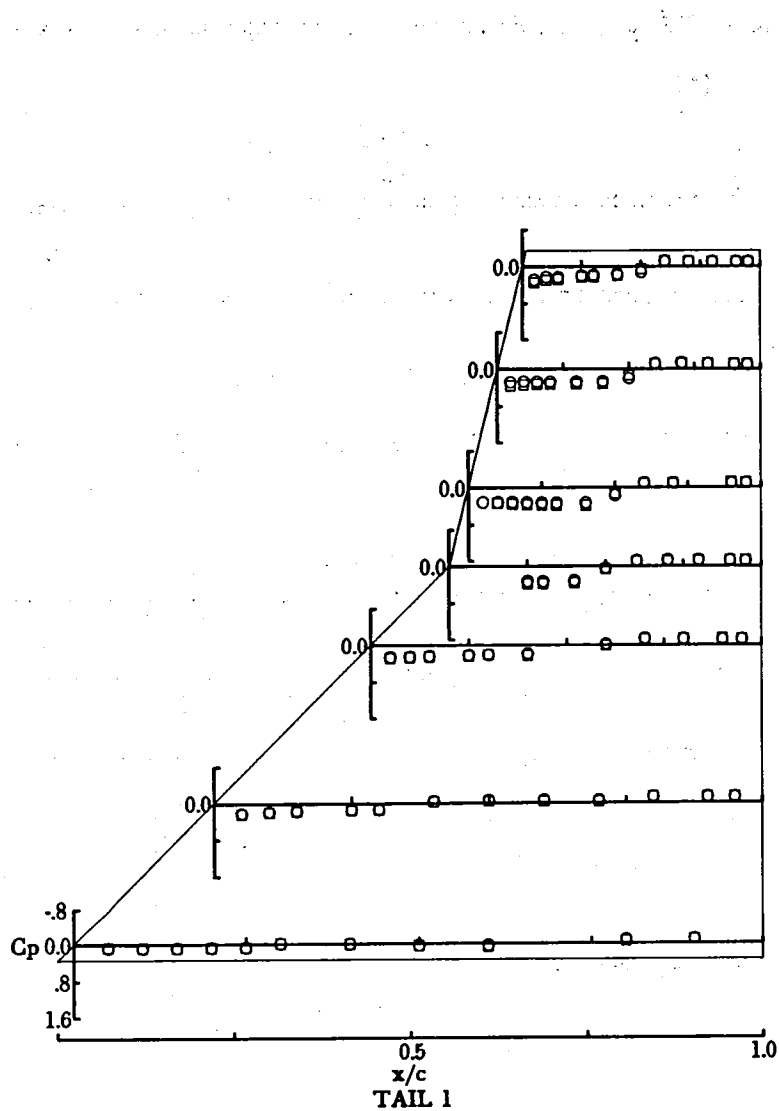

(a) $\alpha = -0.20^\circ$.

Figure 13.- Pressure coefficients for tail planform C at $M = 2.36$, $\phi = 67.5^\circ$, and $\delta = 0^\circ$.

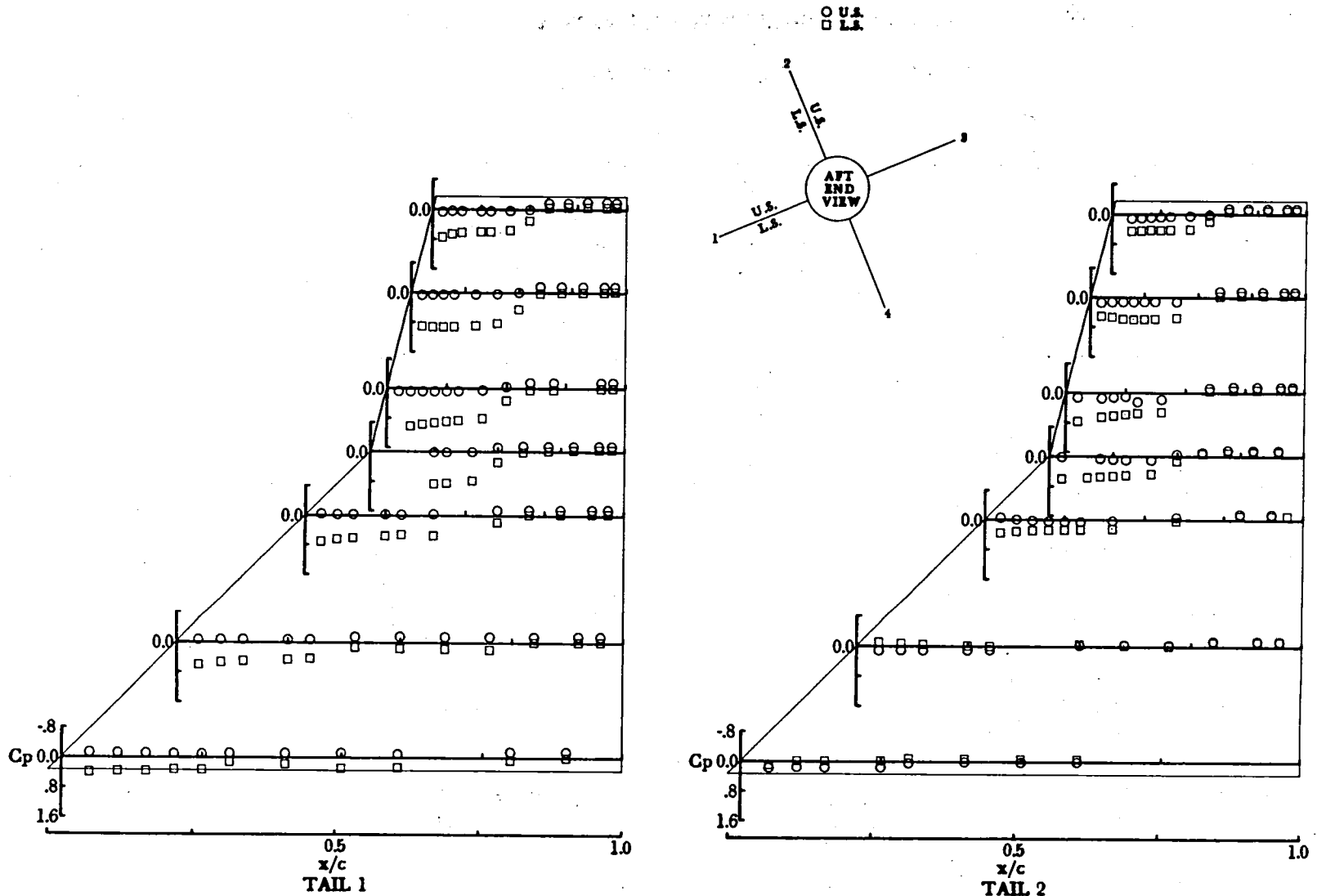

(b) $\alpha = 9.79^\circ$.

Figure 13.- Continued.

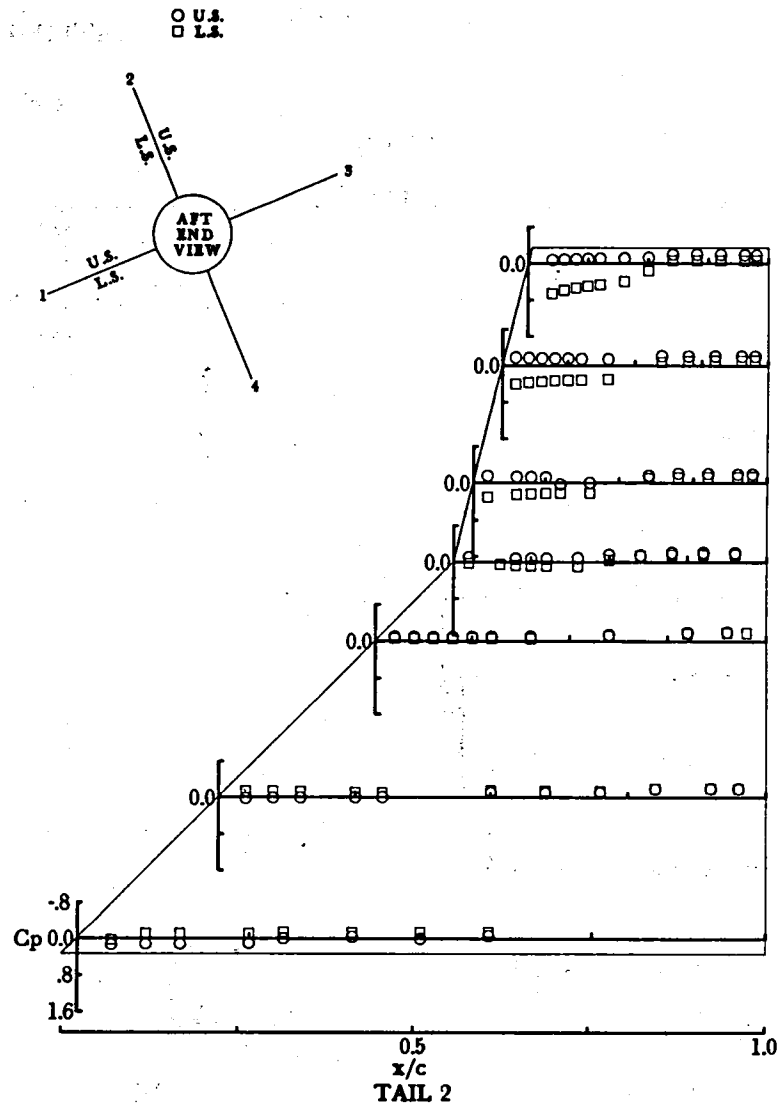
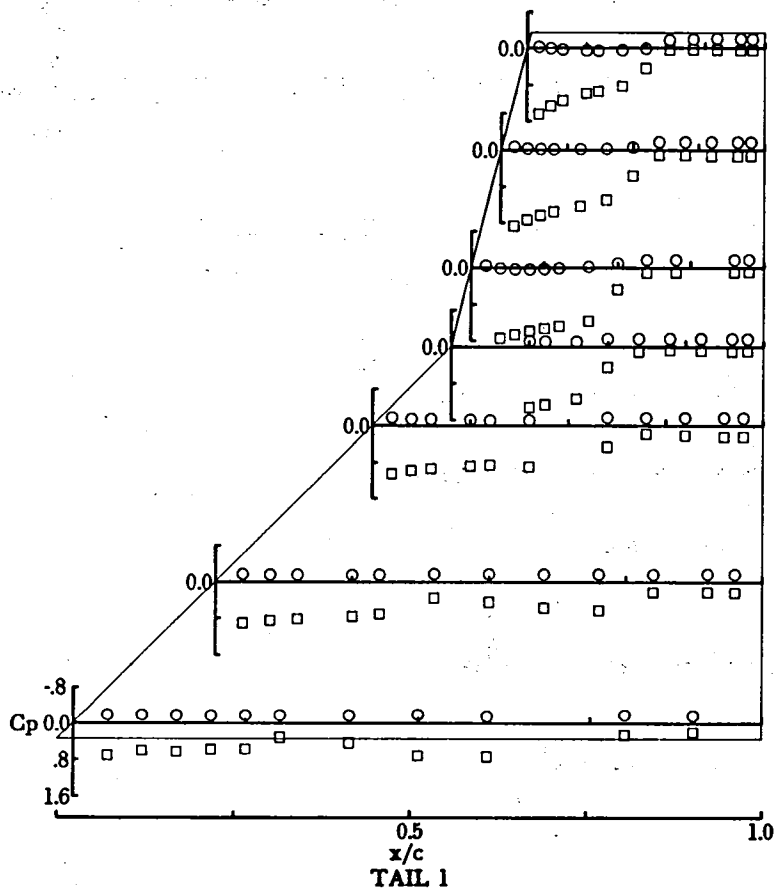

(c) $\alpha = 19.82^\circ$.

Figure 13.- Concluded.

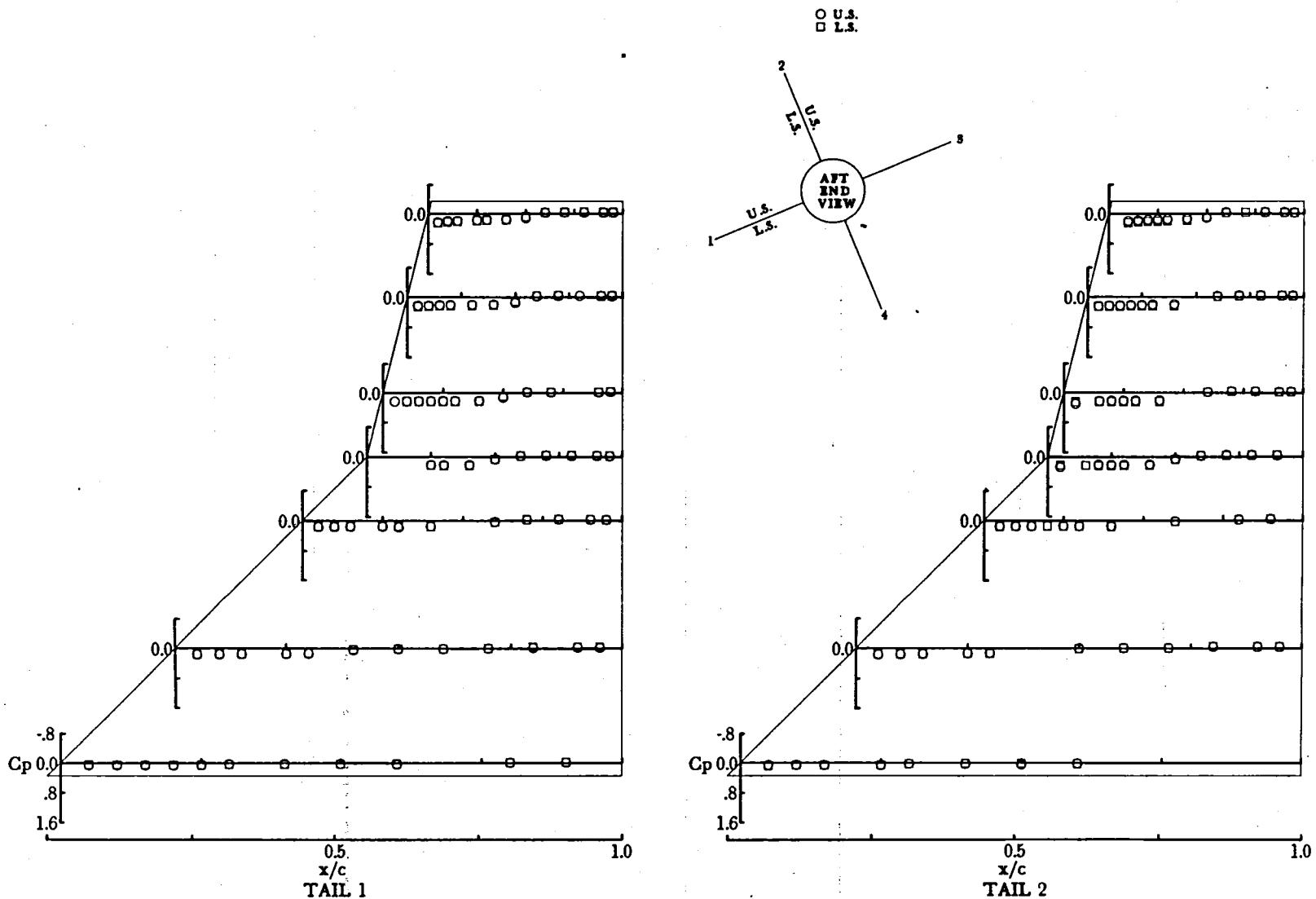

(a) $\alpha = -0.16^\circ$.

Figure 14.- Pressure coefficients for tail planform C at $M = 3.70$, $\phi = 67.5^\circ$, and $\delta = 0^\circ$.

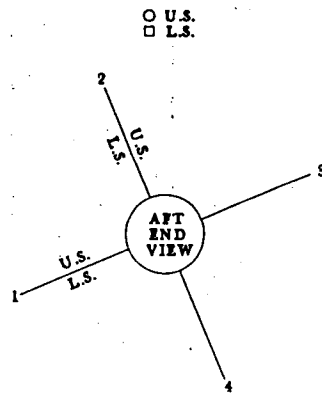
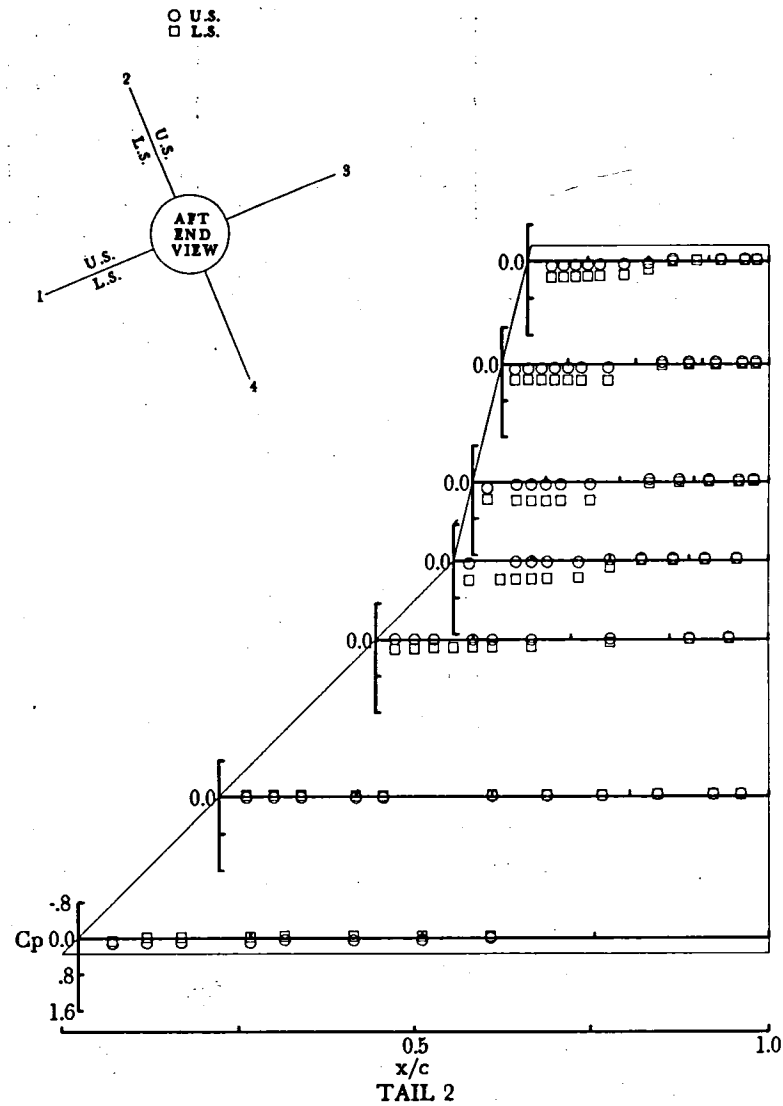
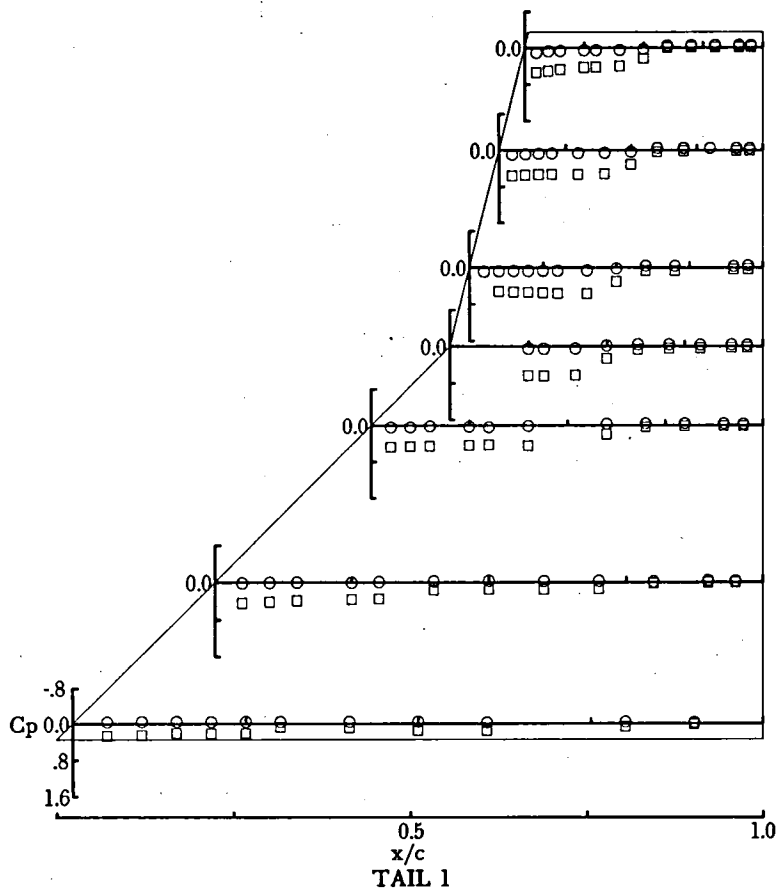

(b) $\alpha = 9.84^\circ$.

Figure 14.- Continued.

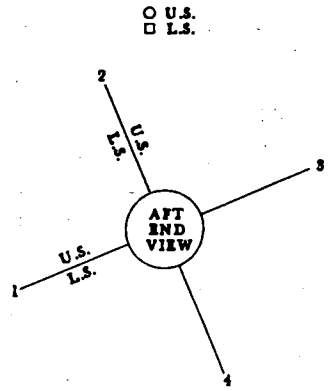
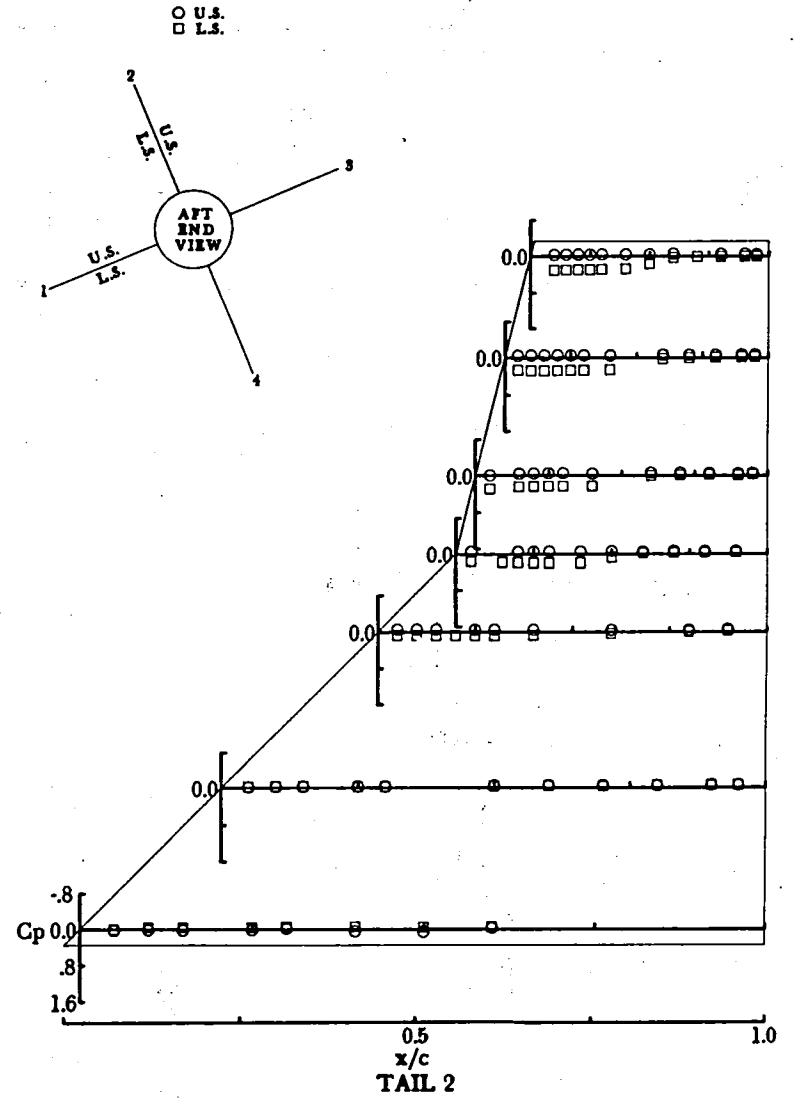
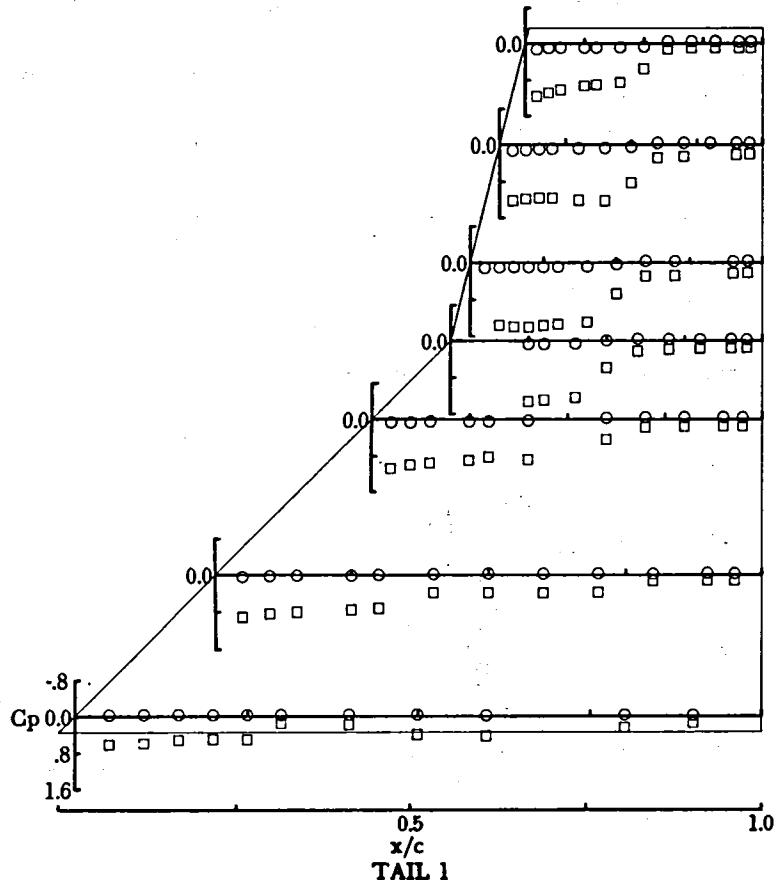

(c) $\alpha = 19.84^\circ$.

Figure 14.- Concluded.

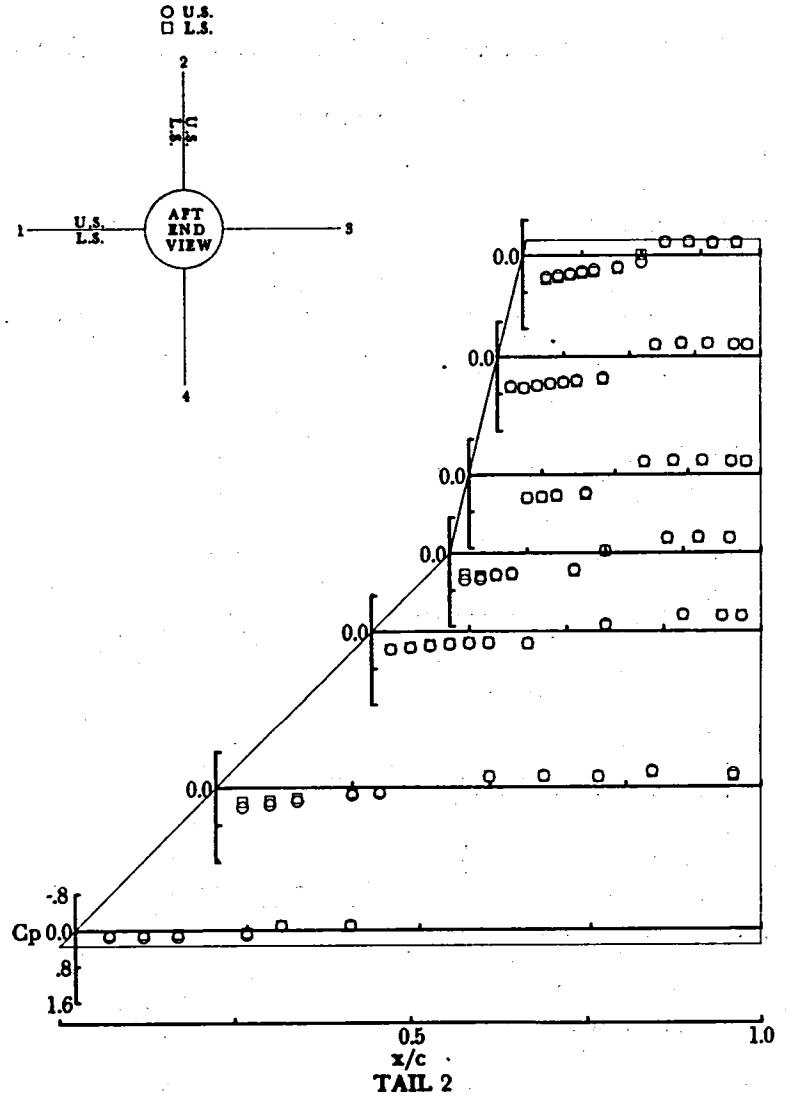
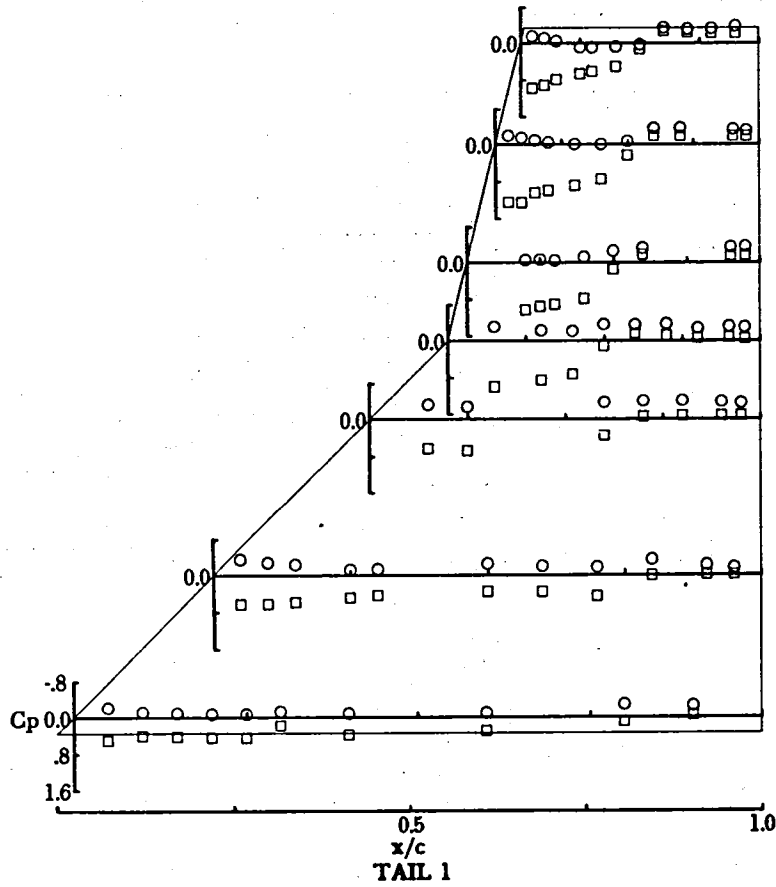

(b) $\alpha = 11.16^\circ$.

Figure 15.- Continued.

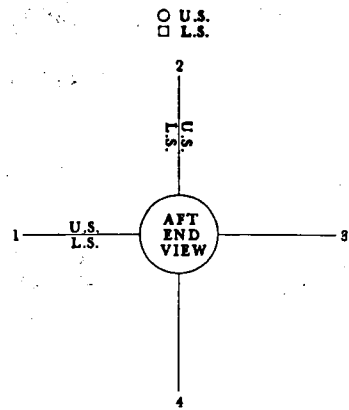
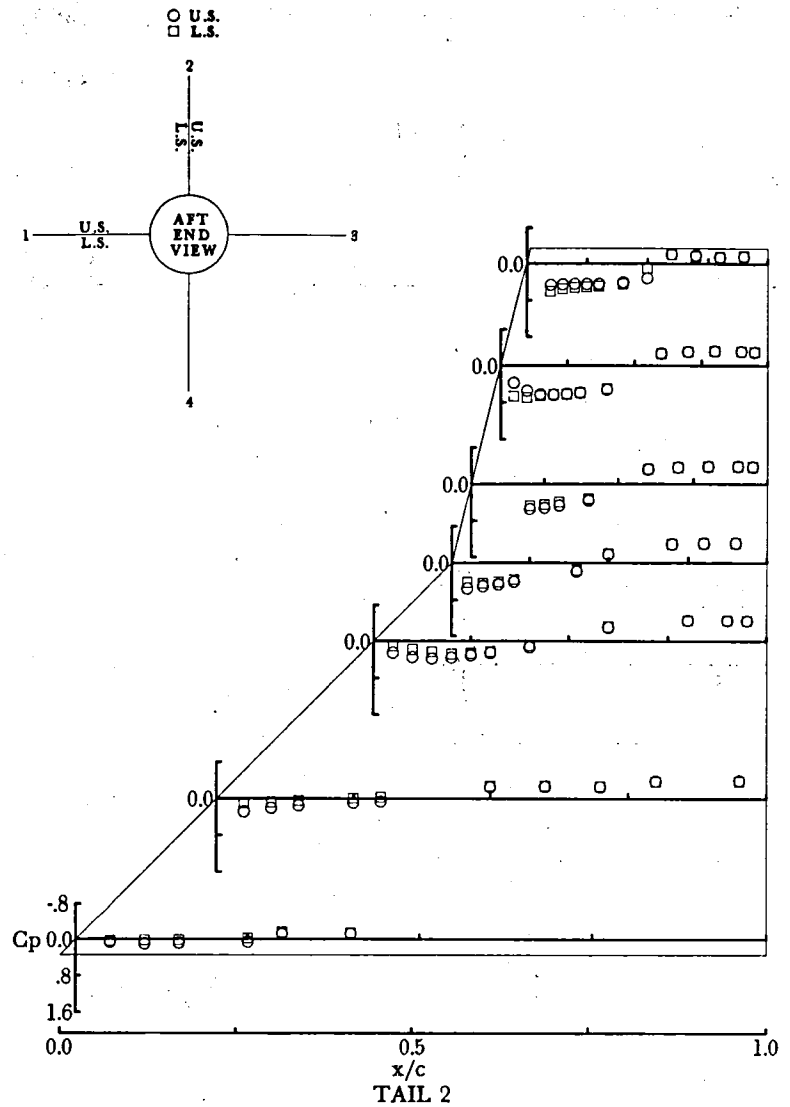
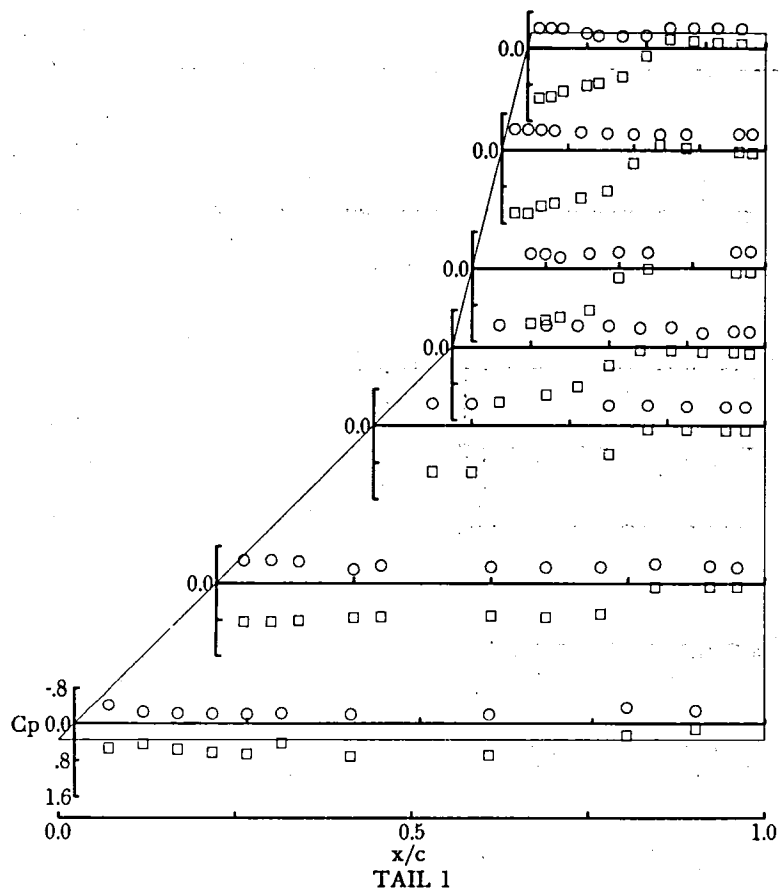

(c) $\alpha = 21.15^\circ$.

Figure 15.- Concluded.

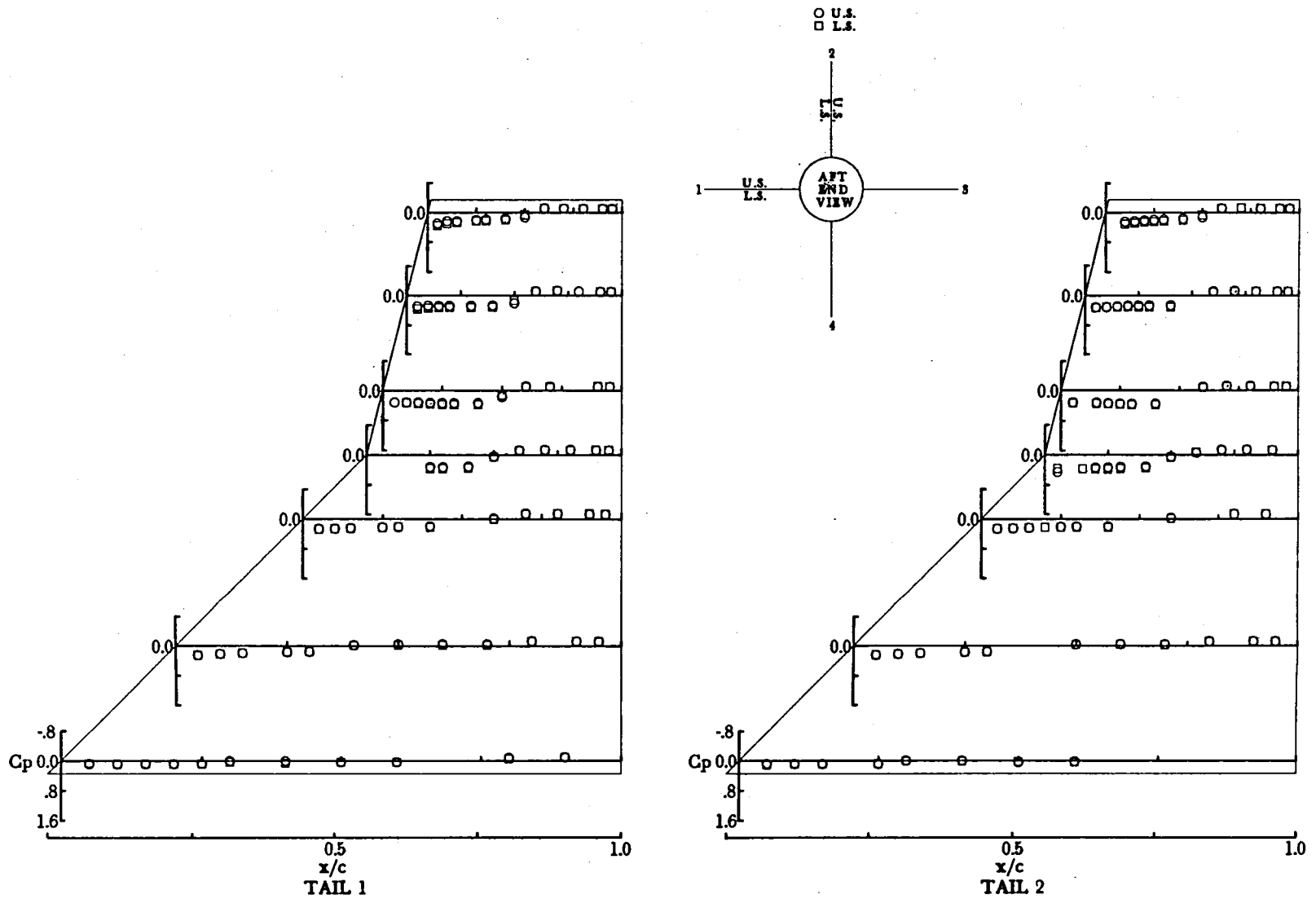
(a) $\alpha = -0.15^\circ$.Figure 16.- Pressure coefficients for tail planform C at $M = 2.36$, $\phi = 90^\circ$, and $\delta = 0^\circ$.

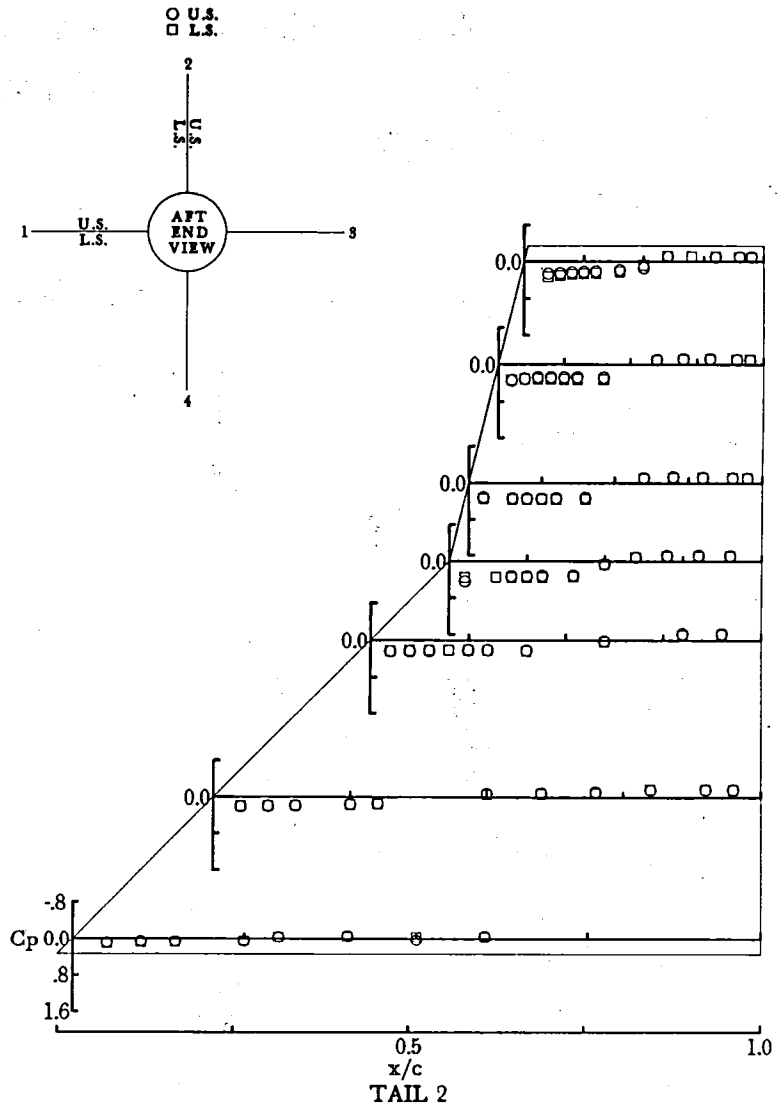
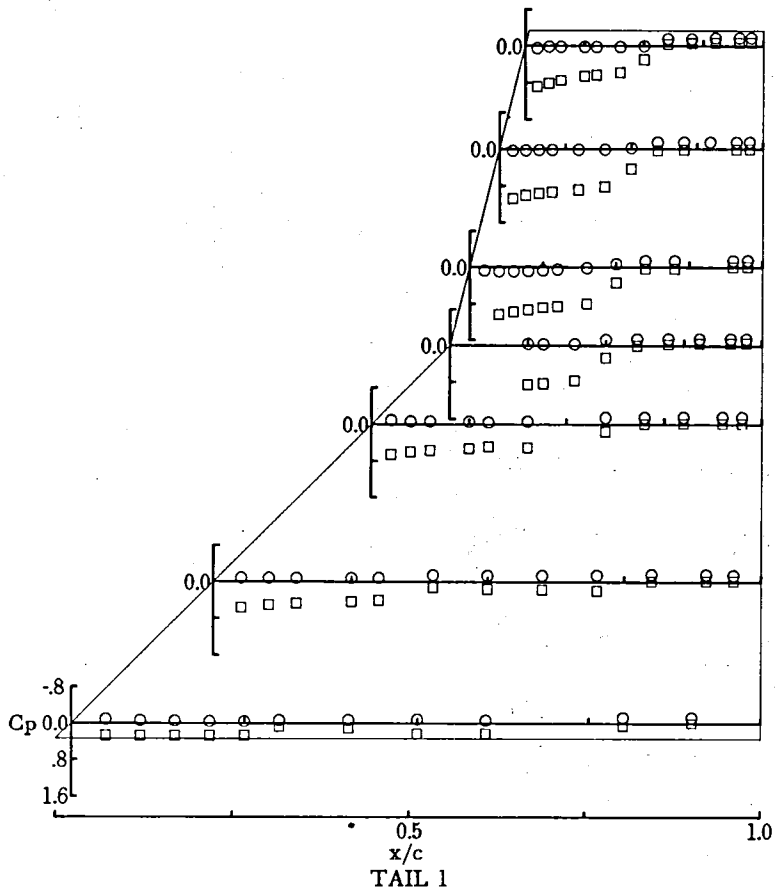

(b) $\alpha = 9.95^\circ$.

Figure 16.- Continued.

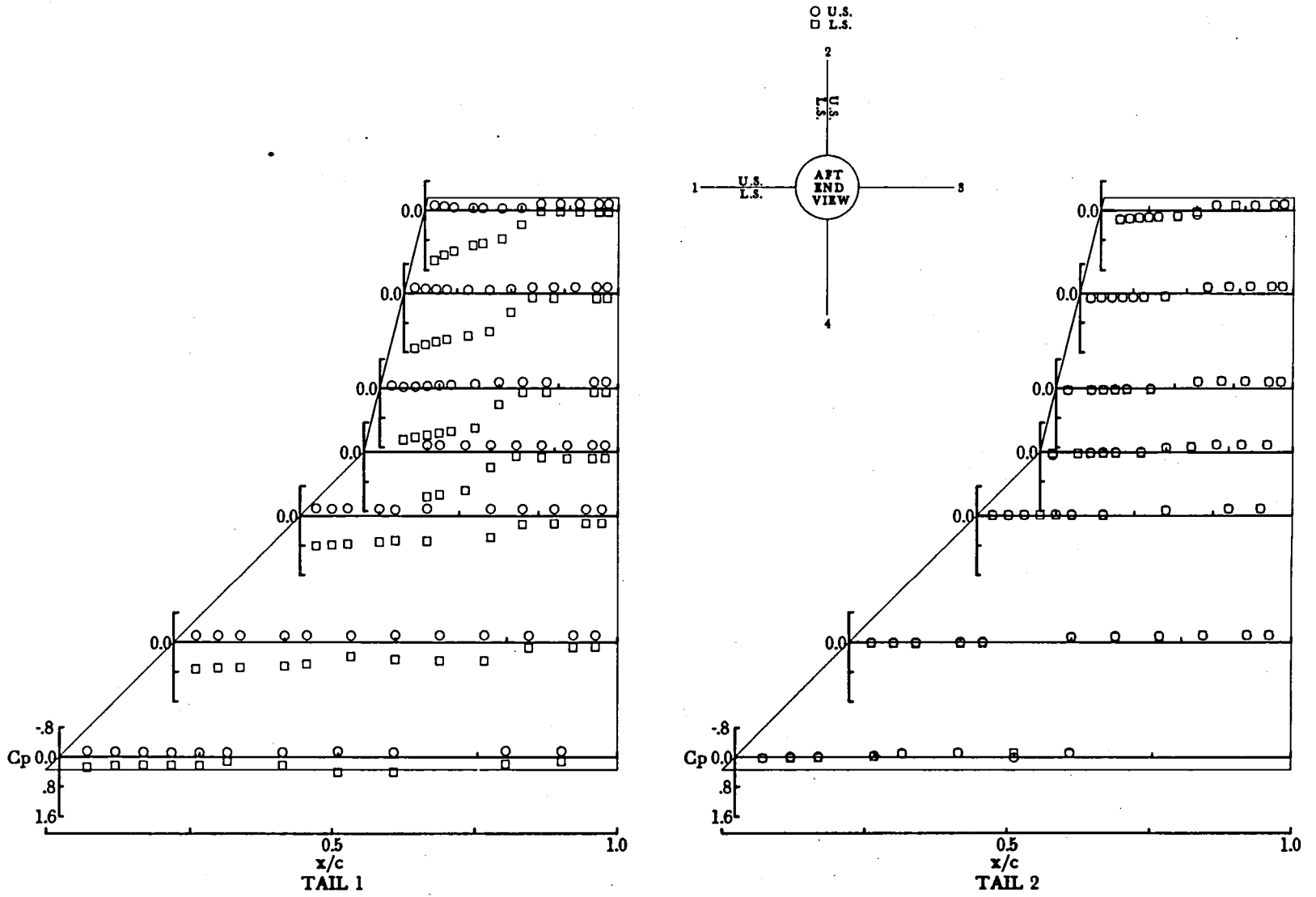

(c) $\alpha = 19.95^\circ$.

Figure 16.- Concluded.

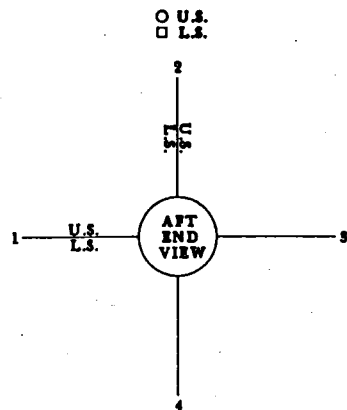
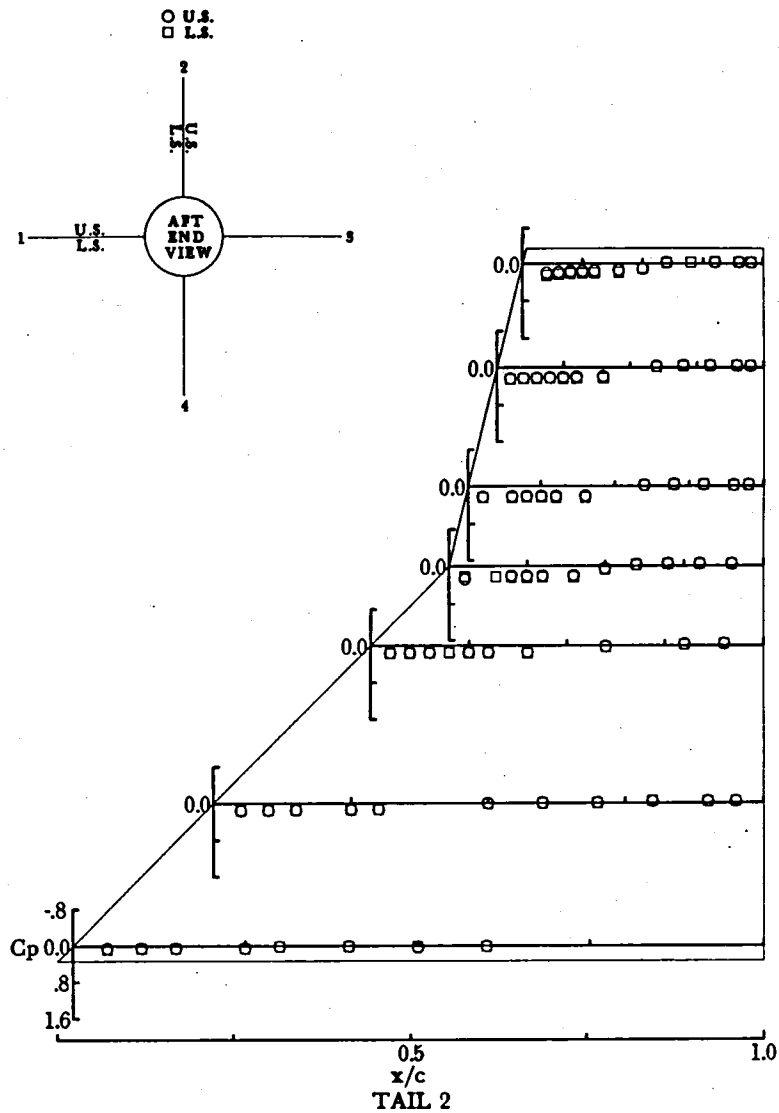
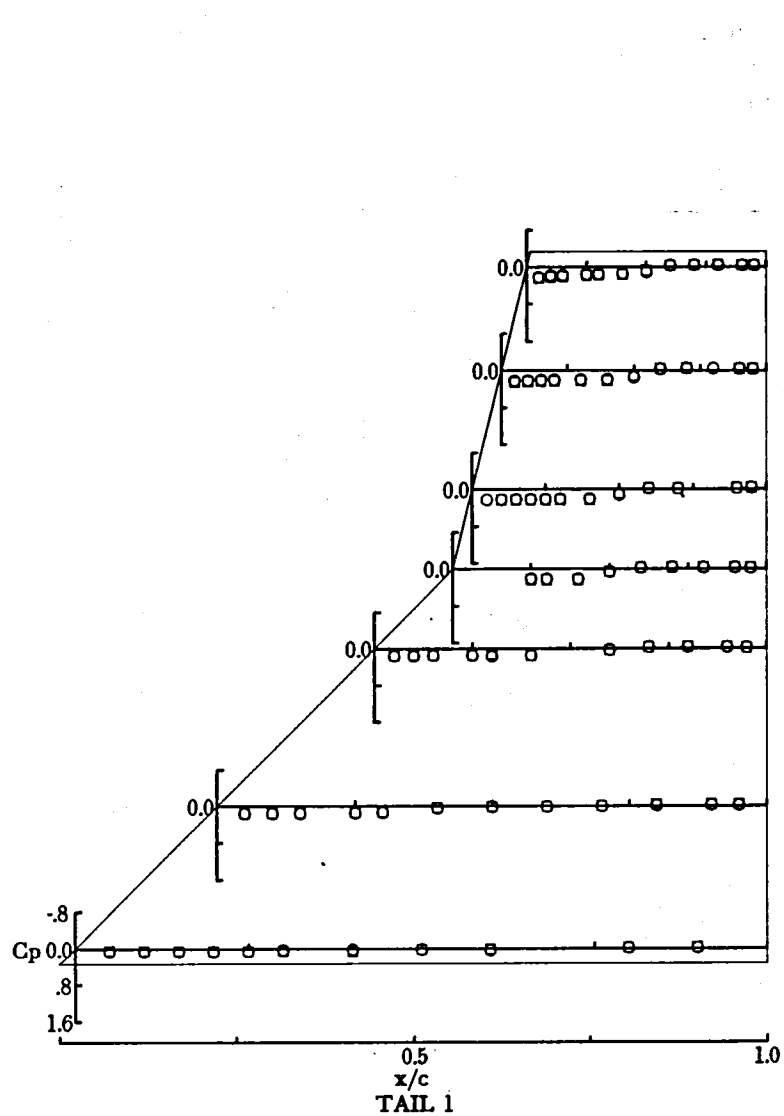

(a) $\alpha = -0.15^\circ$.

Figure 17.- Pressure coefficients for tail planform C at $M = 3.70$, $\phi = 90^\circ$, and $\delta = 0^\circ$.

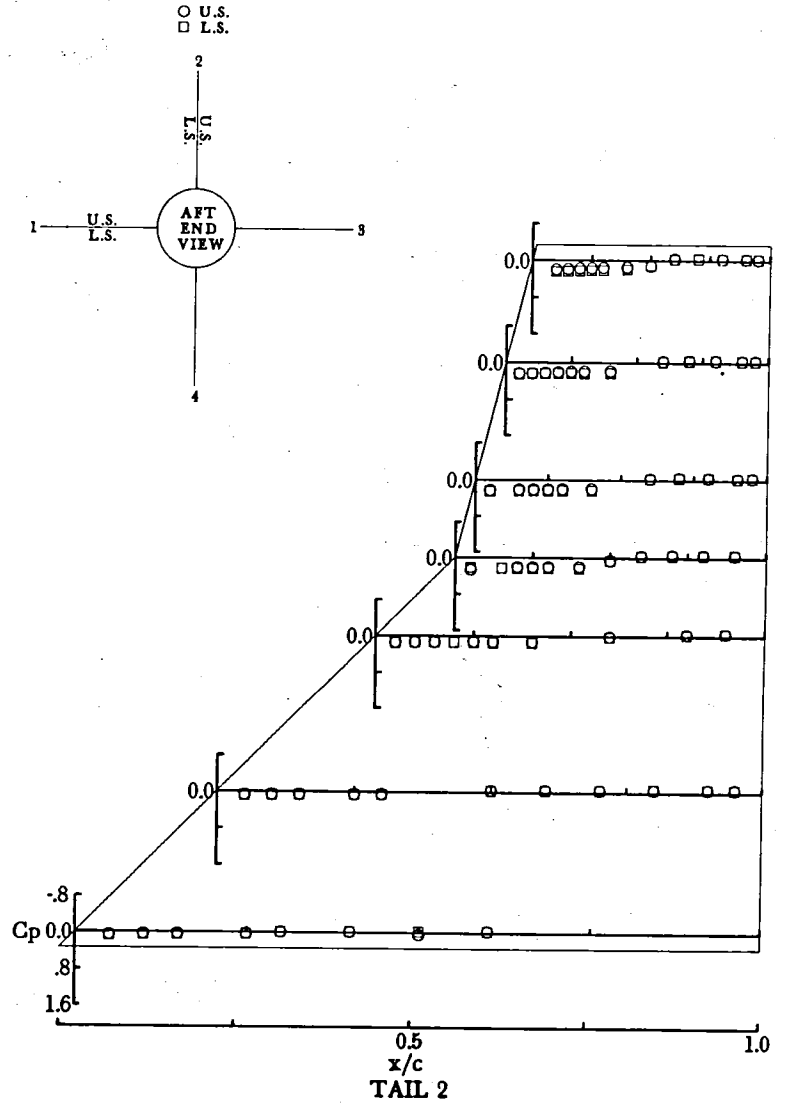
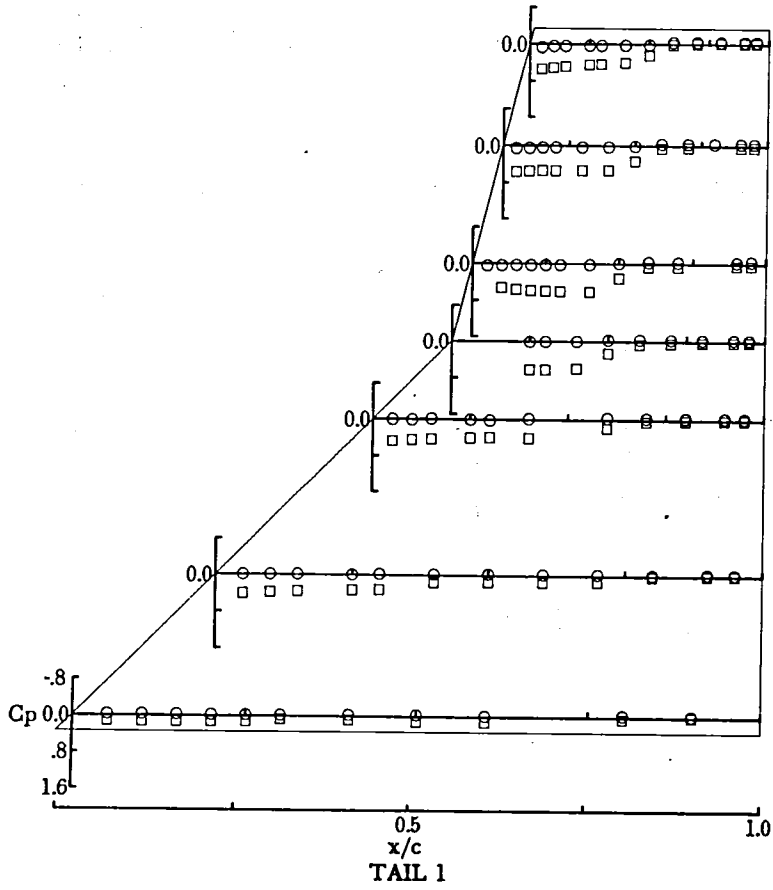

(b) $\alpha = 9.85^\circ$.

Figure 17.- Continued.

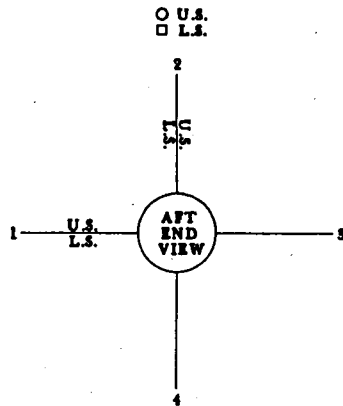
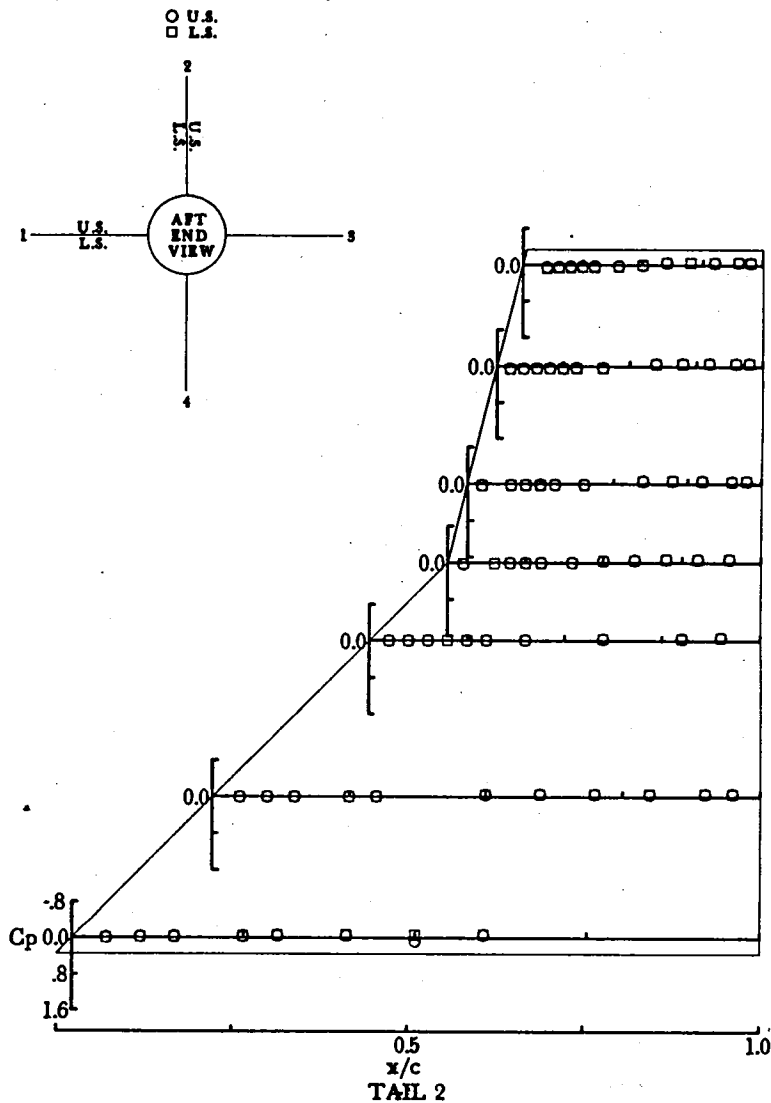
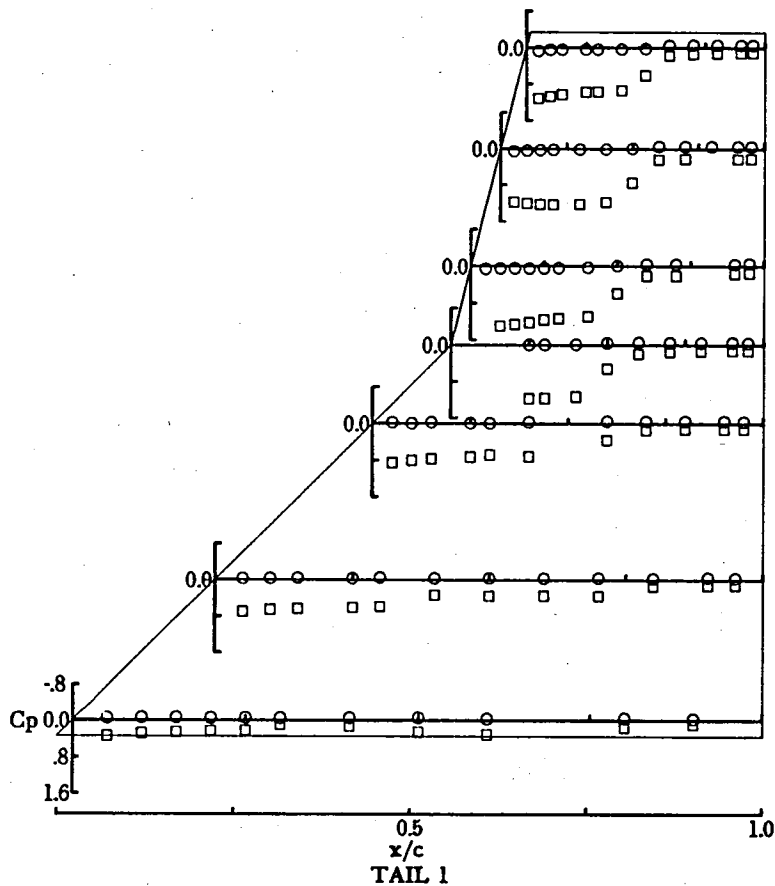

(c) $\alpha = 19.84^\circ$.

Figure 17.- Concluded.

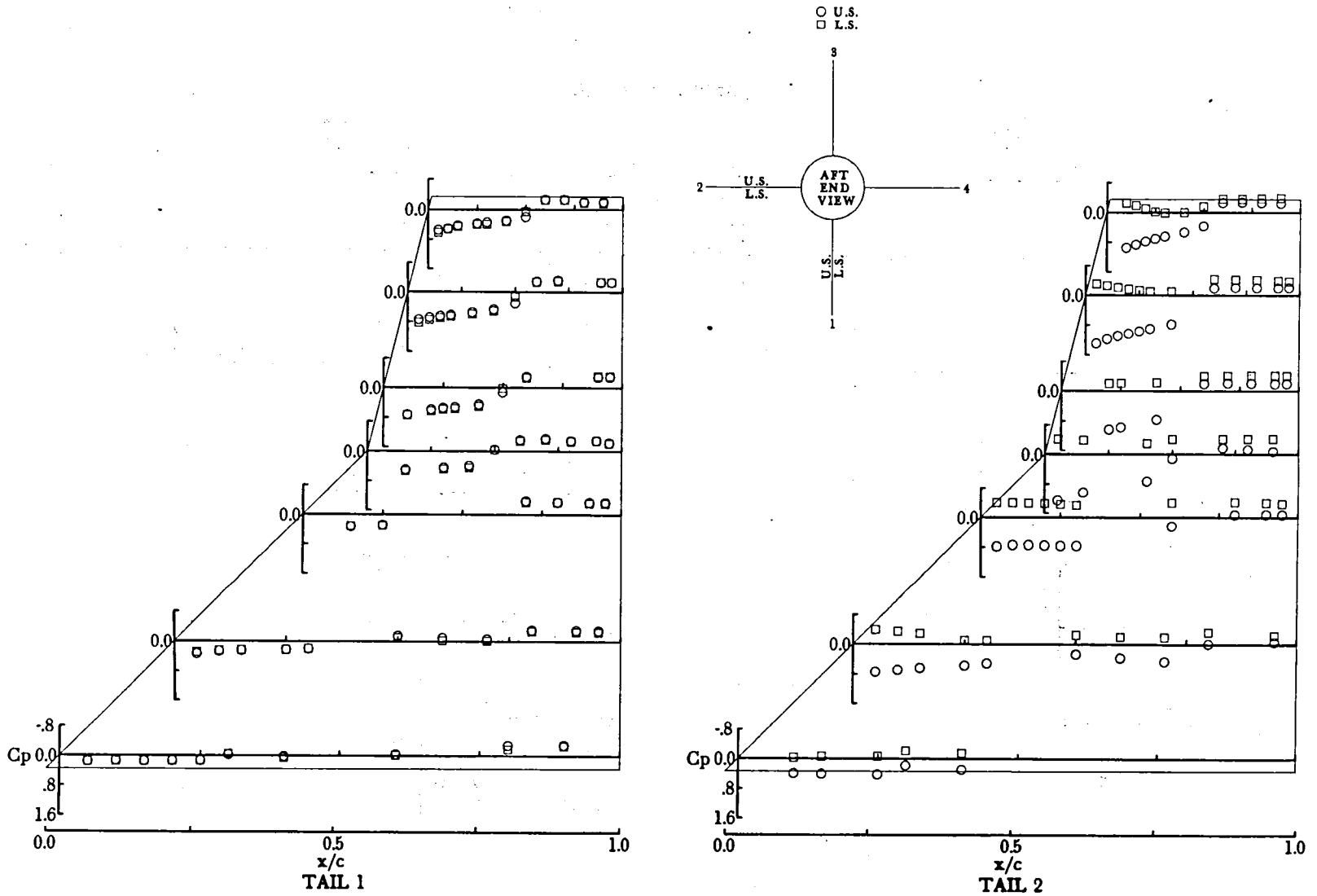

(a) $\alpha = 0.47^\circ$.

Figure 18.- Pressure coefficients for tail planform C at $M = 1.60$, $\phi = 0^\circ$, and $\delta_{2,4} = -15^\circ$.

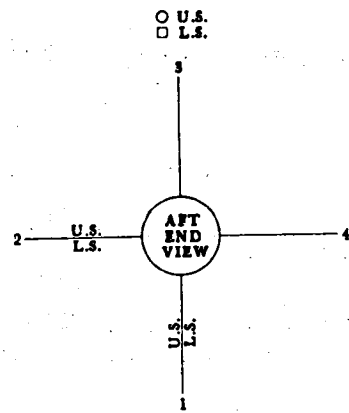
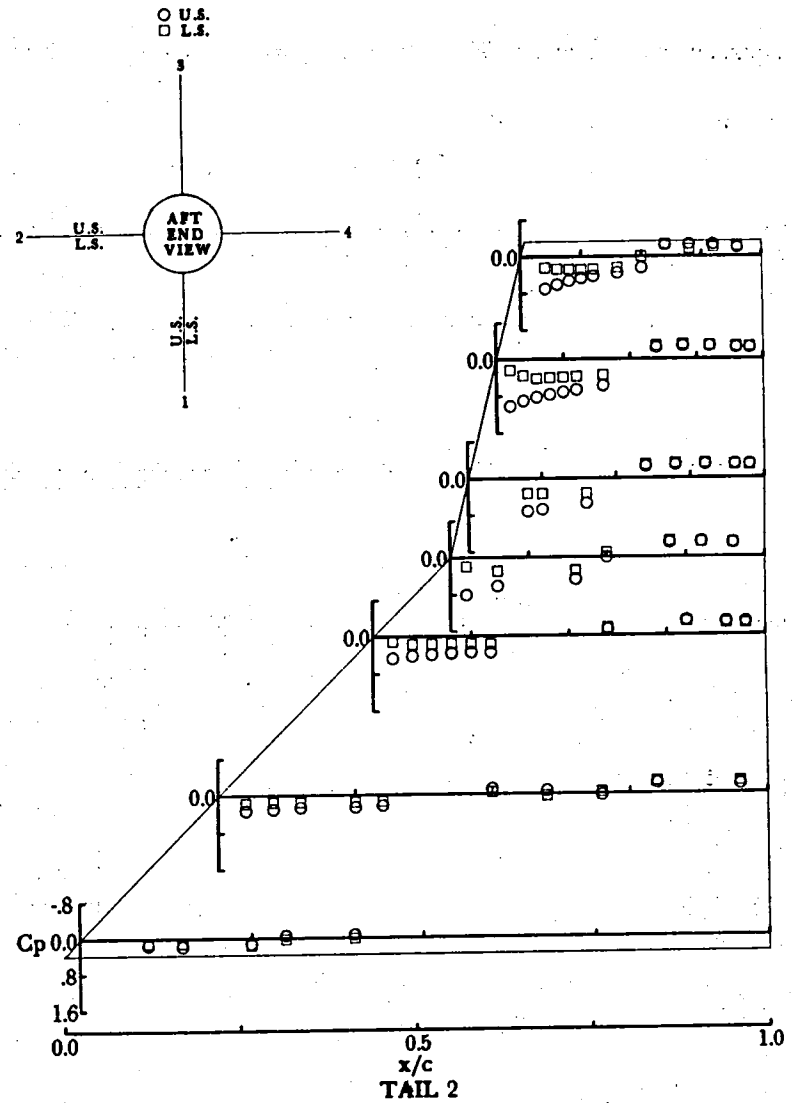
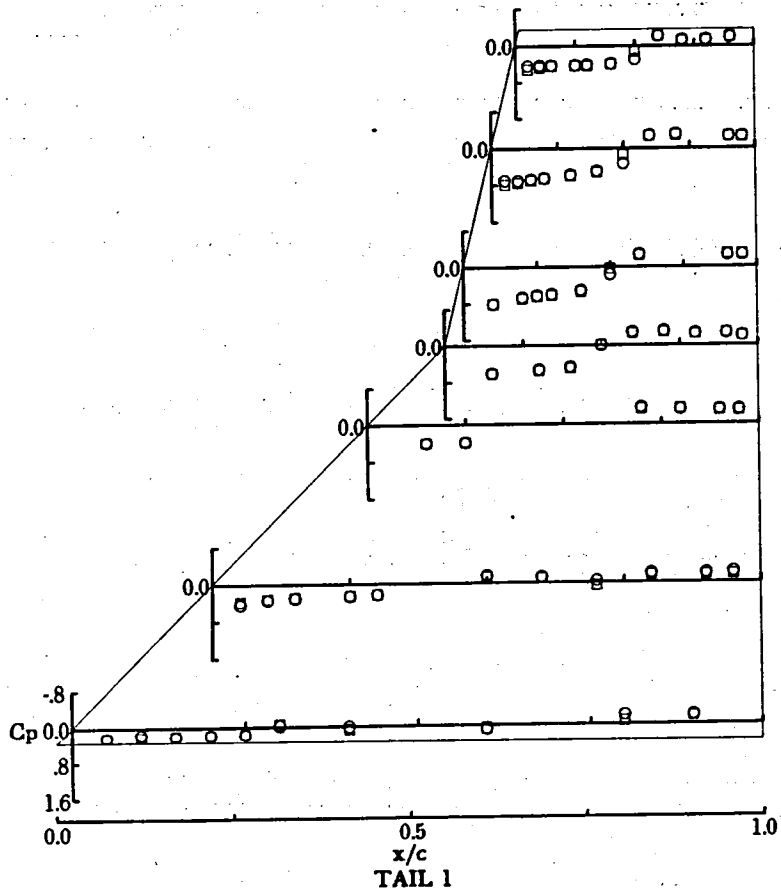

(b) $\alpha = 10.45^\circ$.

Figure 18.- Continued.

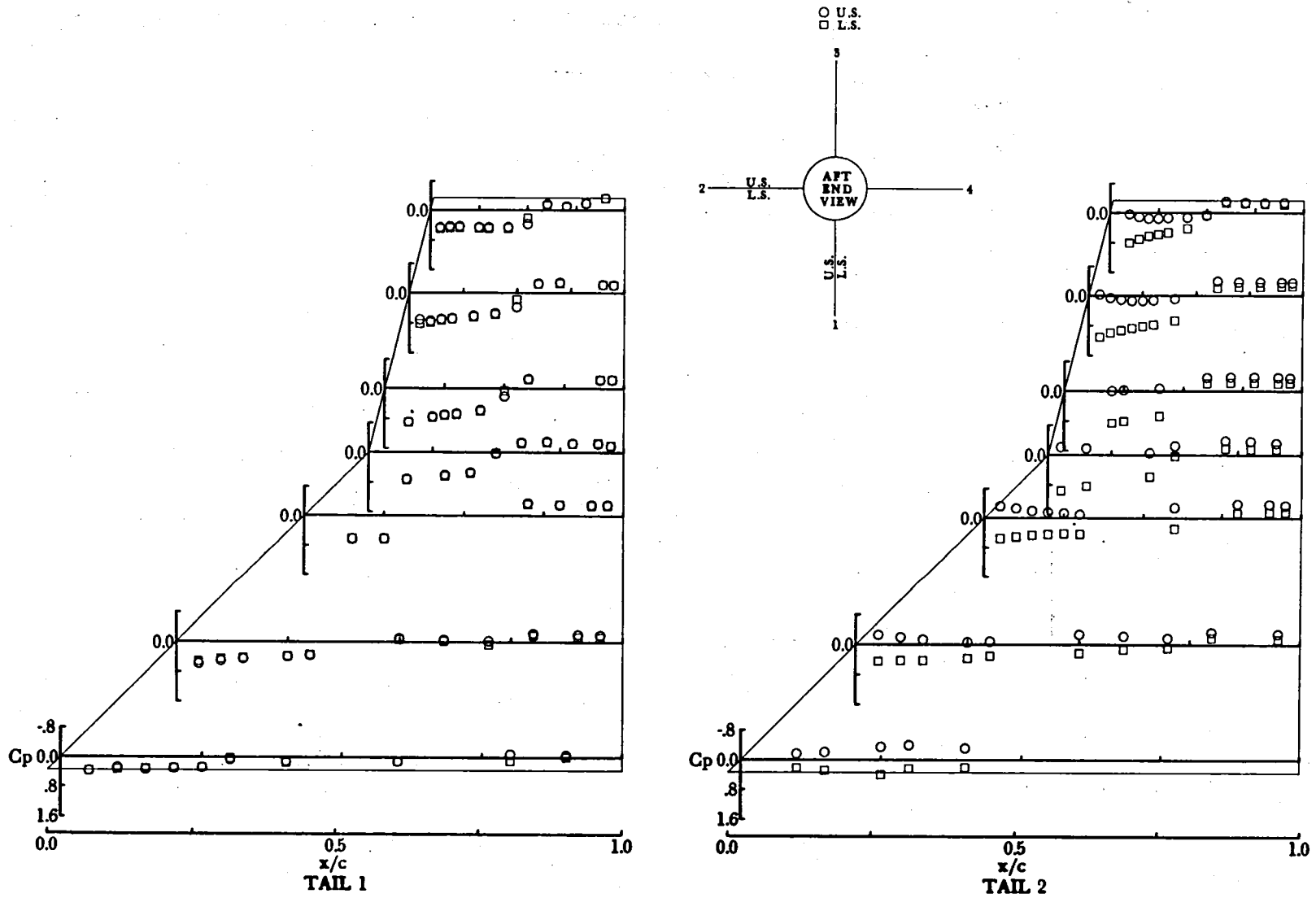

(c) $\alpha = 20.45^\circ$.

Figure 18.- Concluded.

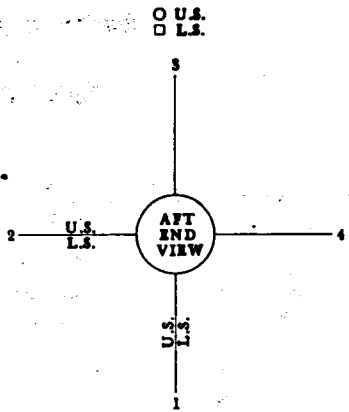
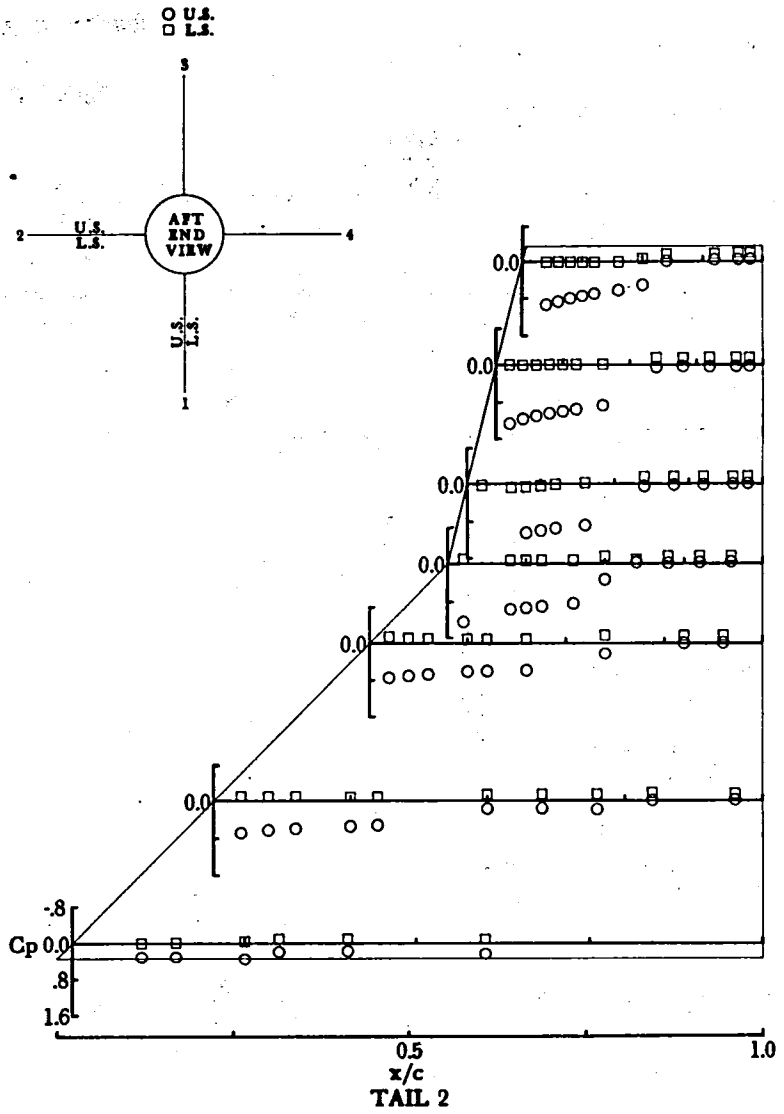
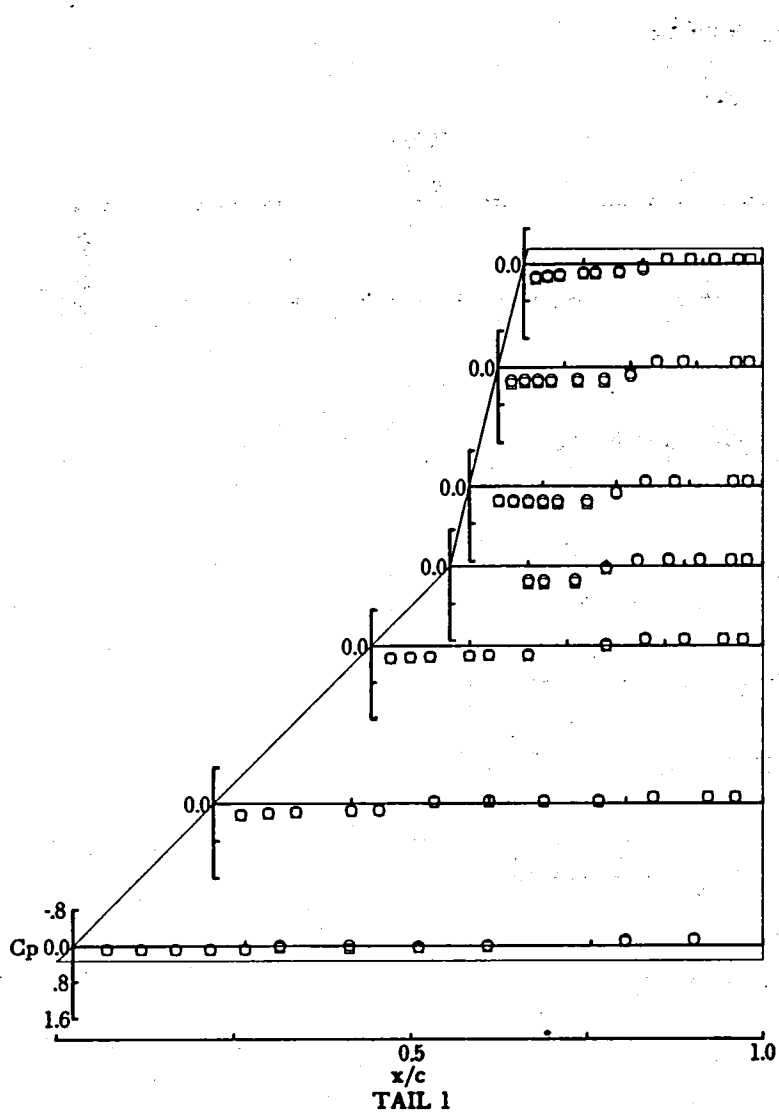

(a) $\alpha = -0.04^\circ$.

Figure 19.- Pressure coefficients for tail planform C at $M = 2.36$, $\phi = 0^\circ$, and $\delta_{2,4} = -15^\circ$.

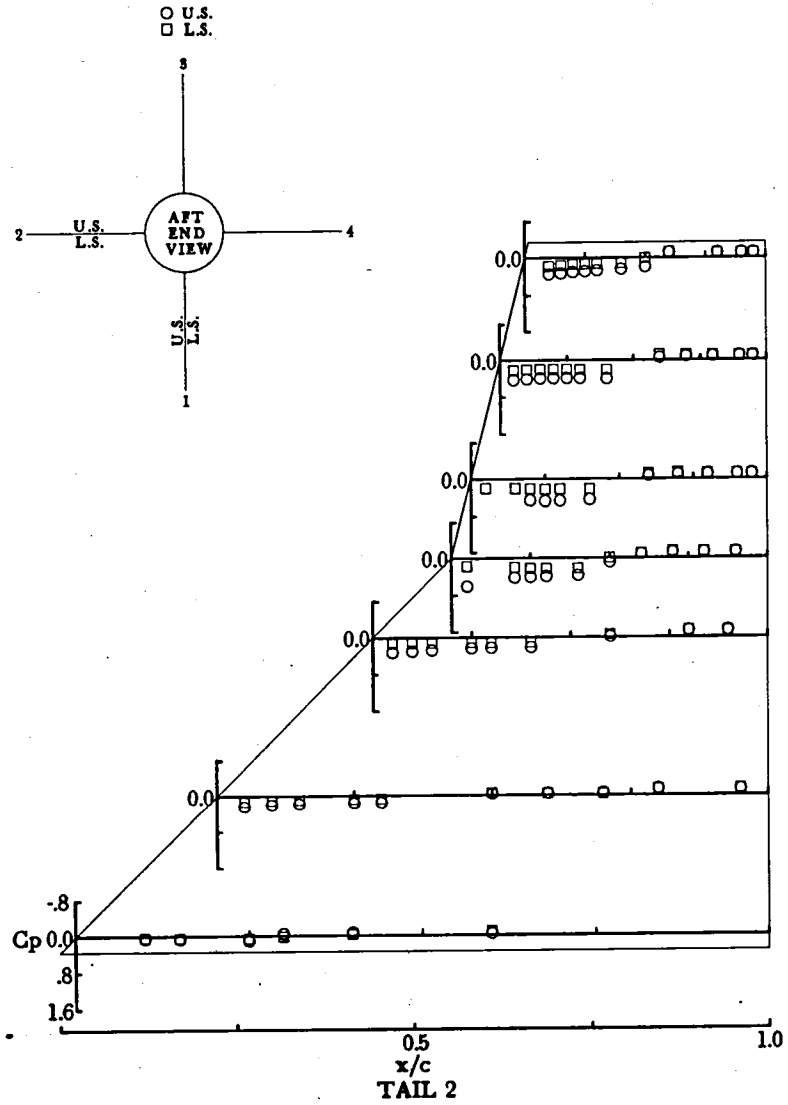
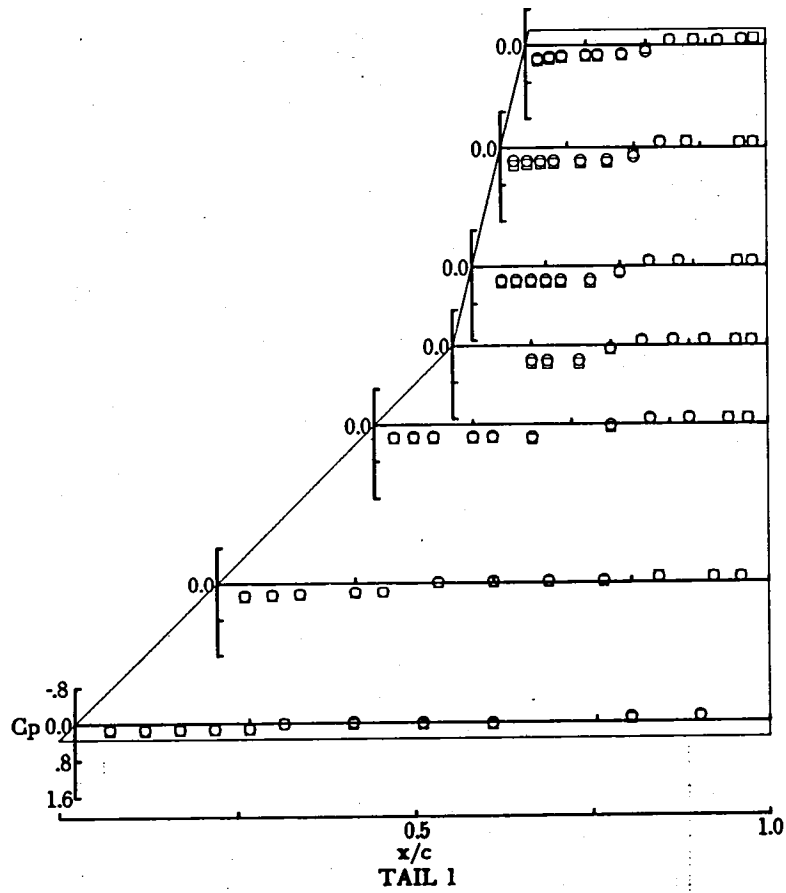

(b) $\alpha = 9.96^\circ$.

Figure 19.- Continued.

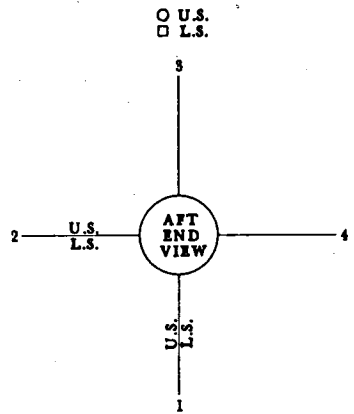
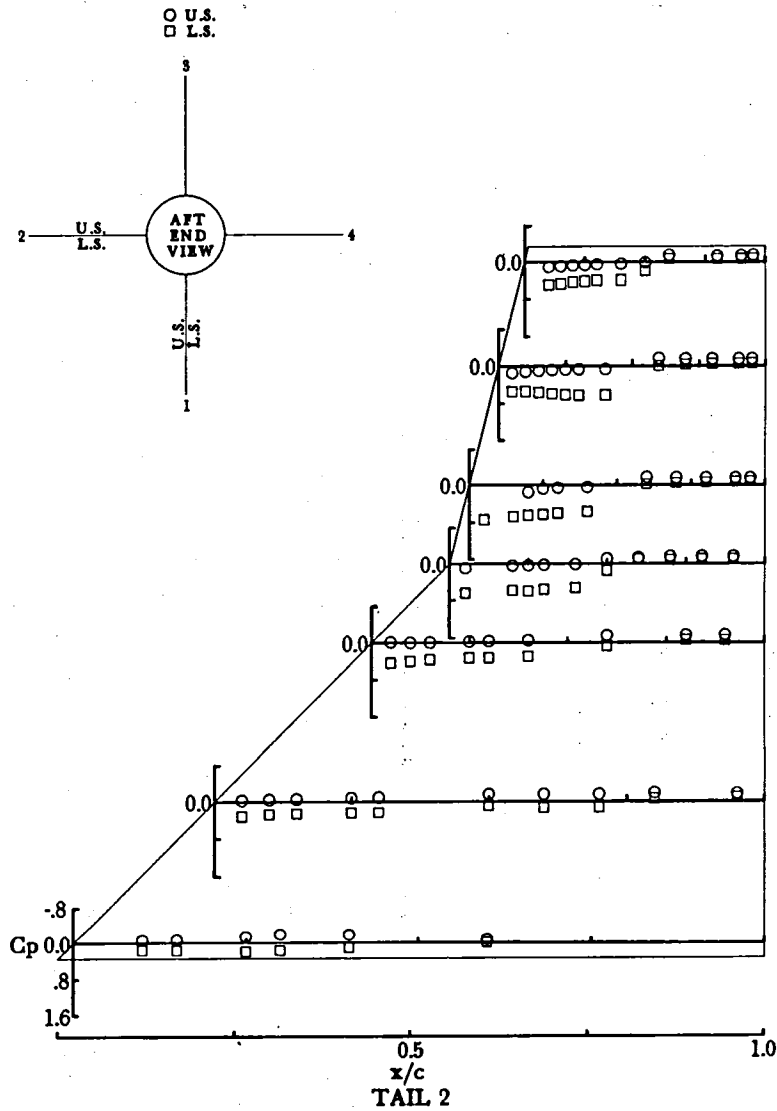
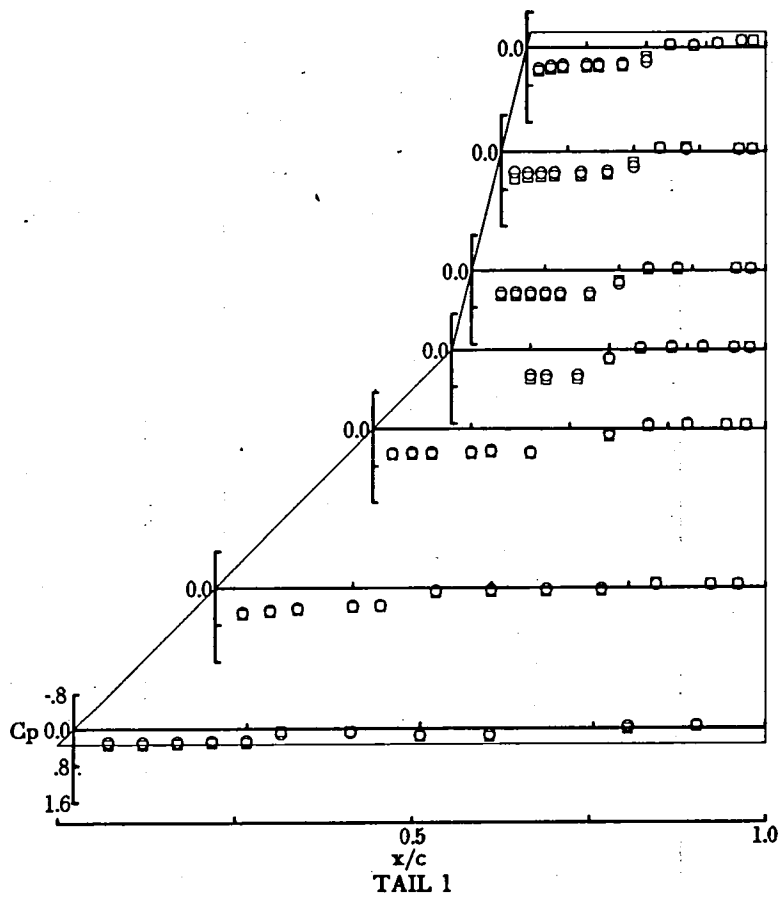

(c) $\alpha = 19.94^\circ$.

Figure 19.- Concluded.

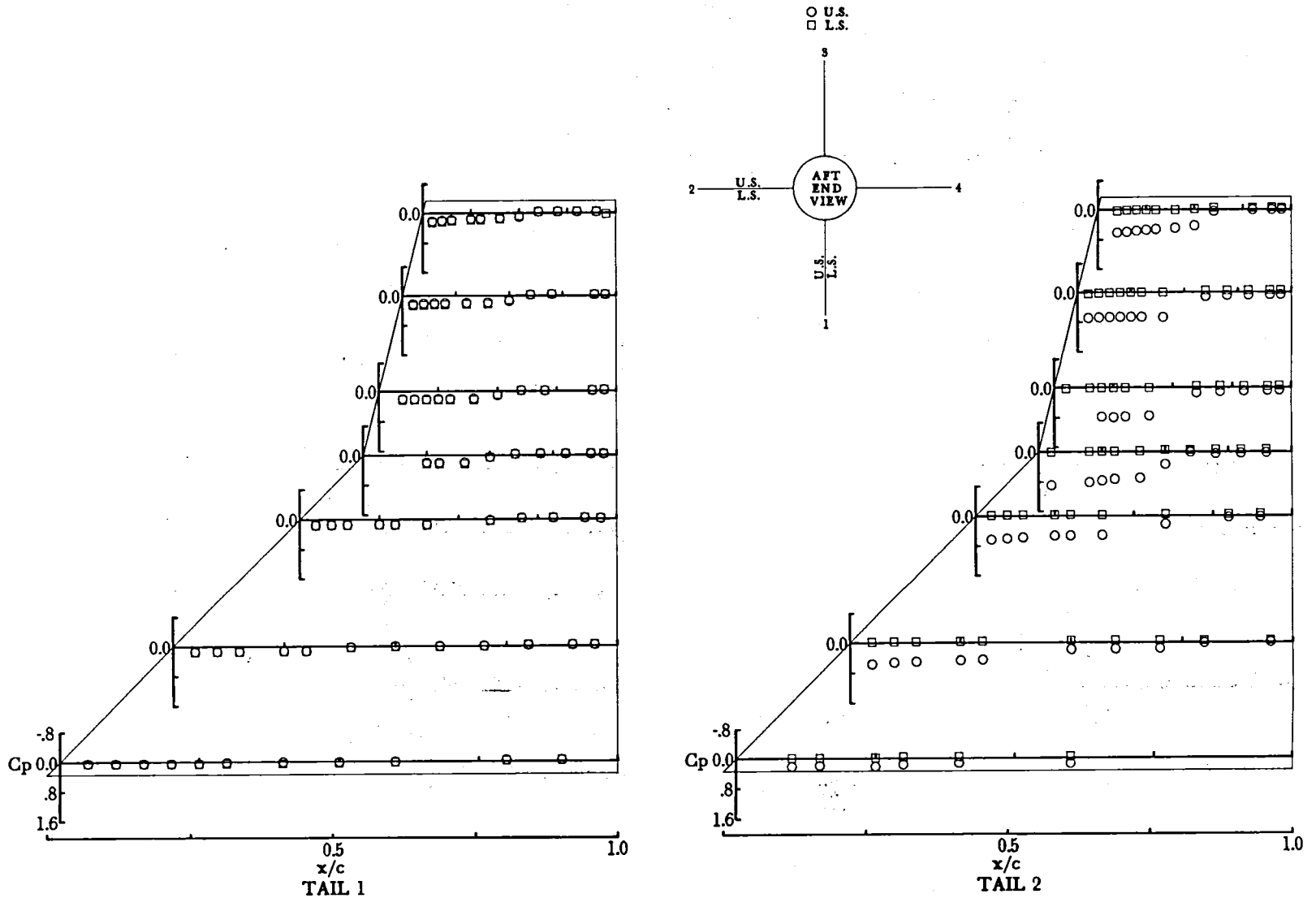

(a) $\alpha = -0.15^\circ$.

Figure 20.- Pressure coefficients for tail planform C at $M = 3.70$, $\phi = 0^\circ$, and $\delta_{2,4} = -15^\circ$.

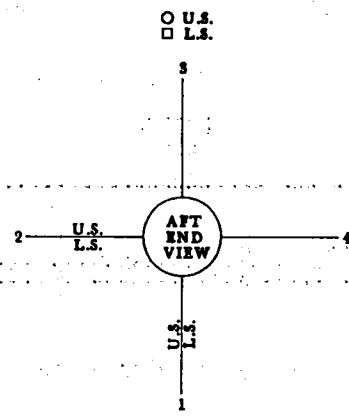
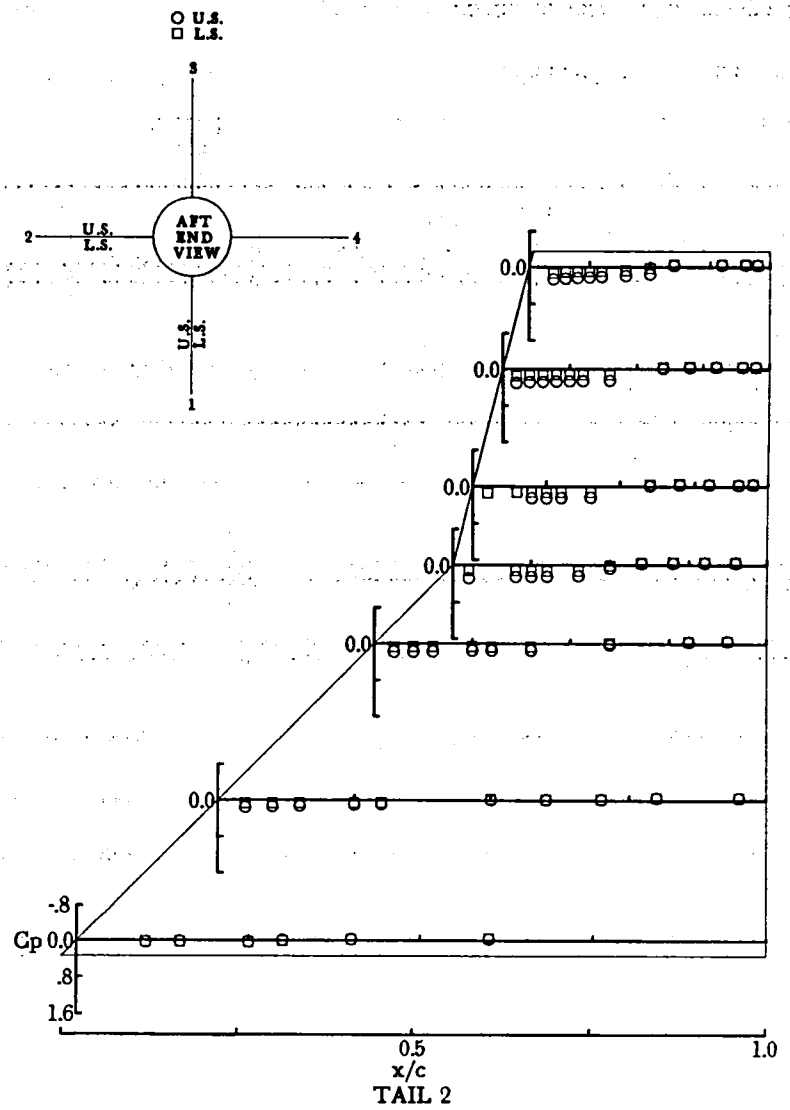
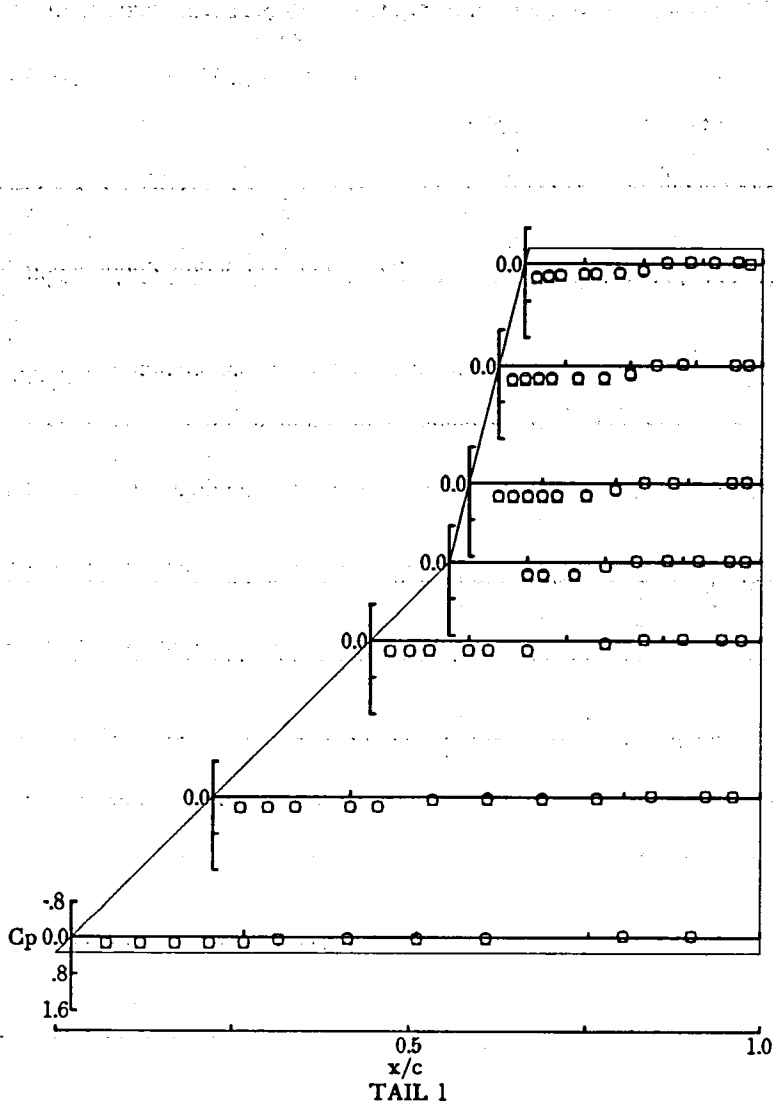

(b) $\alpha = 9.85^\circ$.

Figure 20.- Continued.

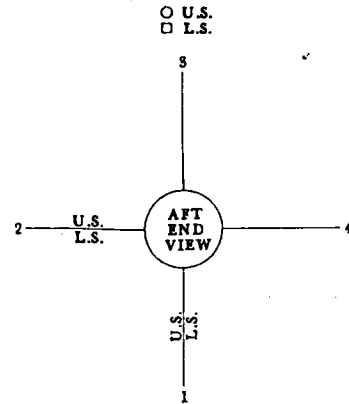
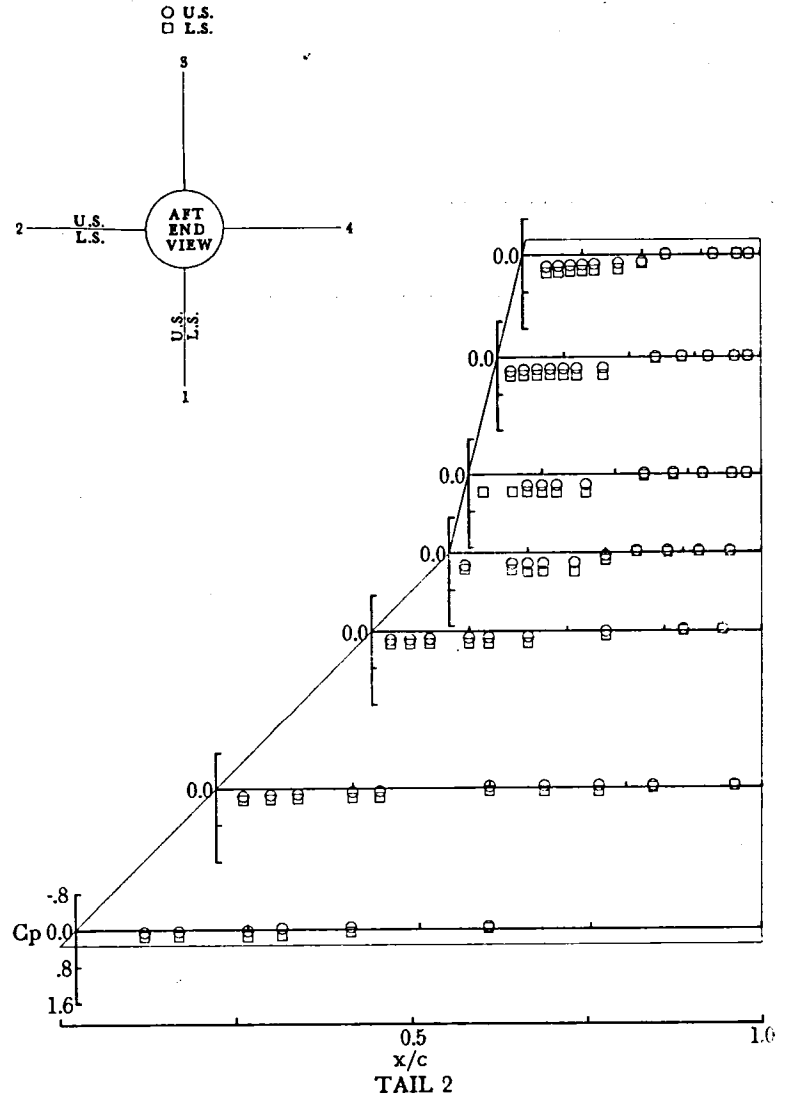
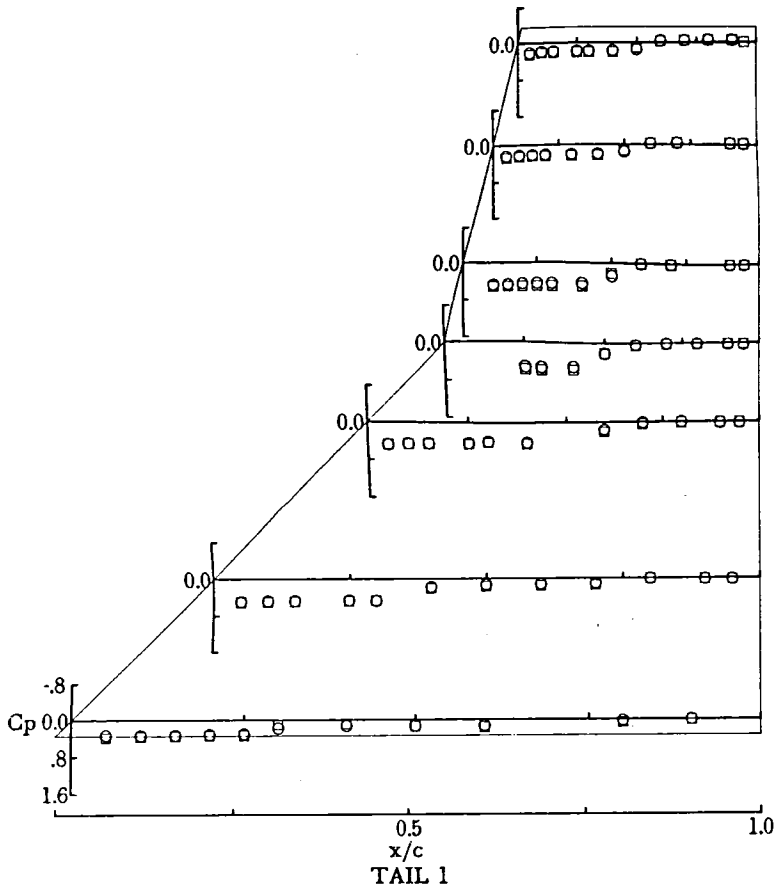

(c) $\alpha = 19.85^\circ$.

Figure 20.- Concluded.

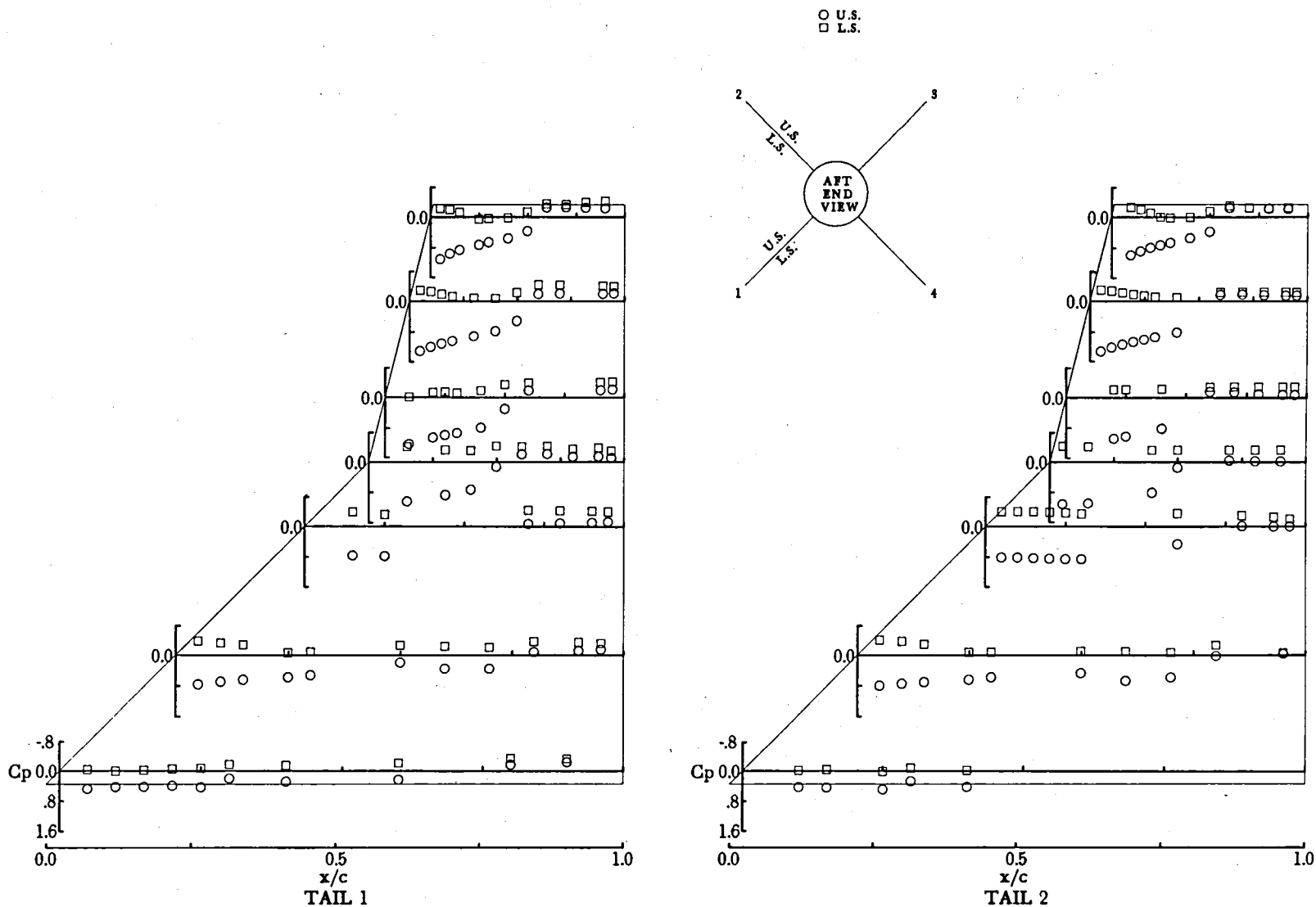

(a) $\alpha = 1.05^\circ$.

Figure 21.- Pressure coefficients for tail planform C at $M = 1.60$, $\phi = 45^\circ$, and $\delta = -15^\circ$.

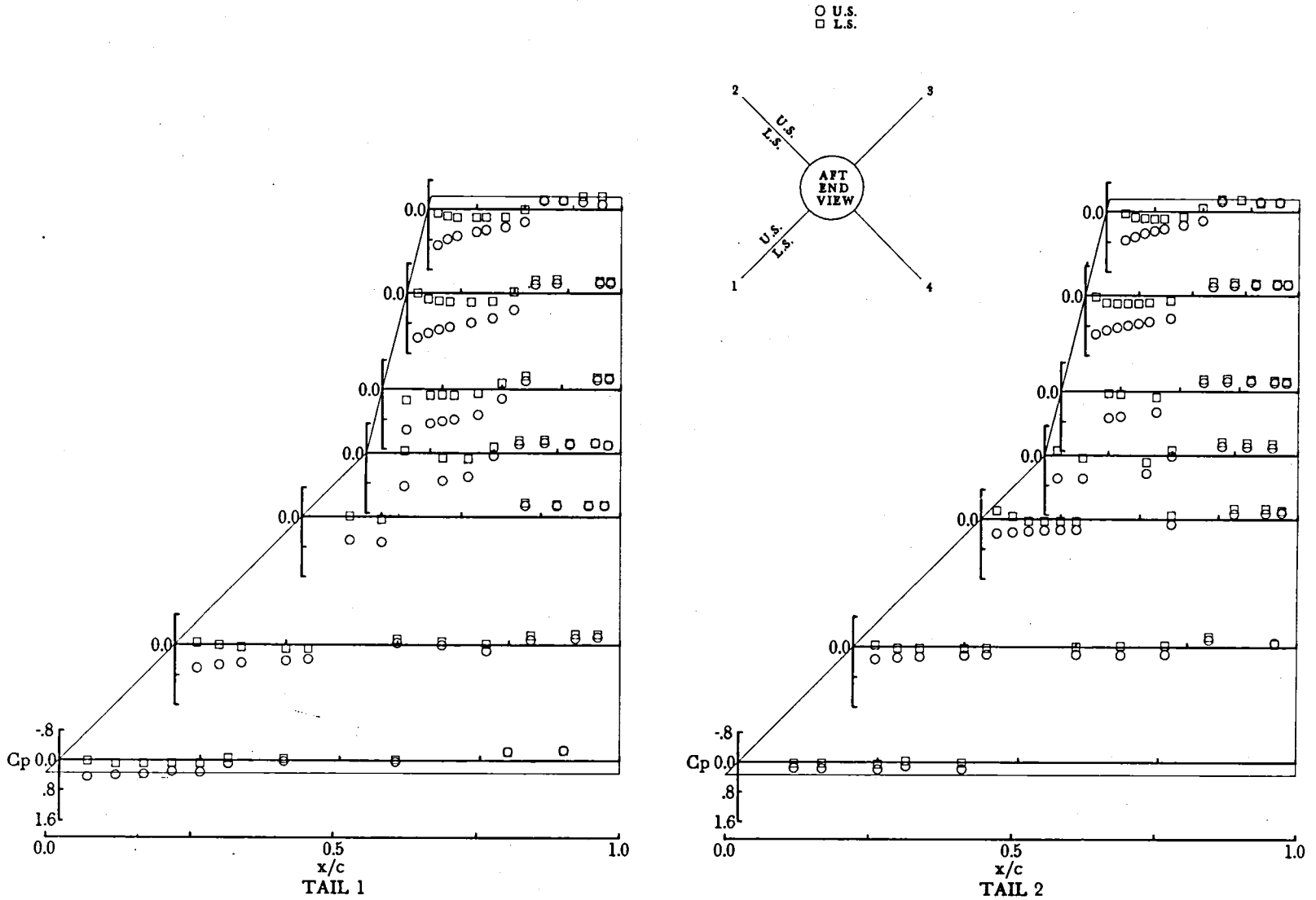

(b) $\alpha = 11.05^\circ$.

Figure 21.- Continued.

○ U.S.
 □ L.S.

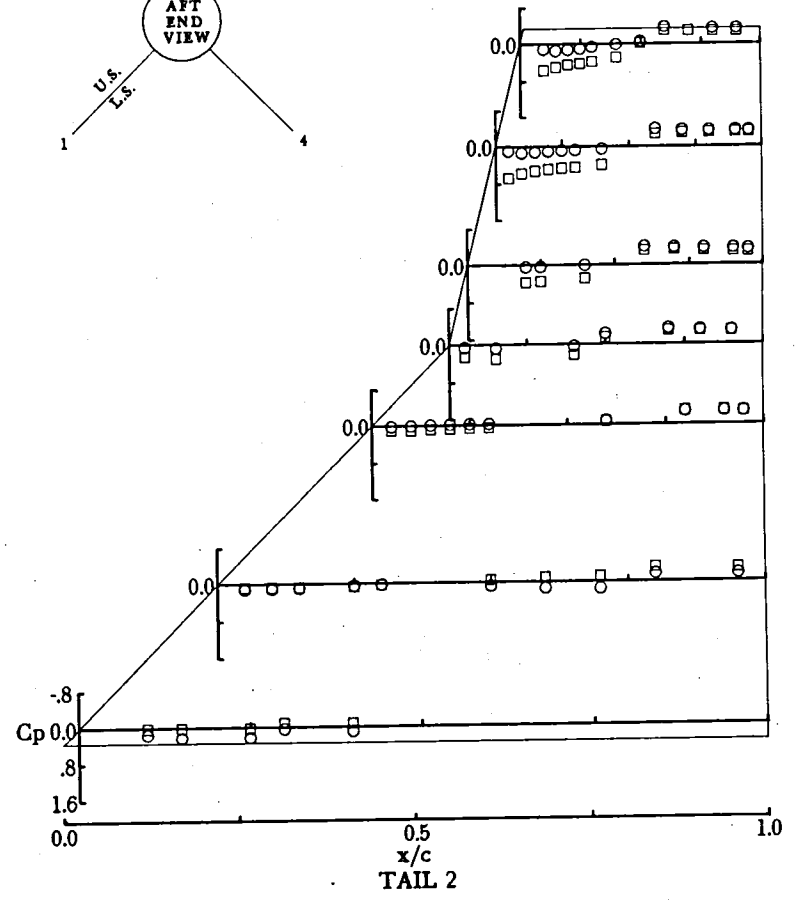
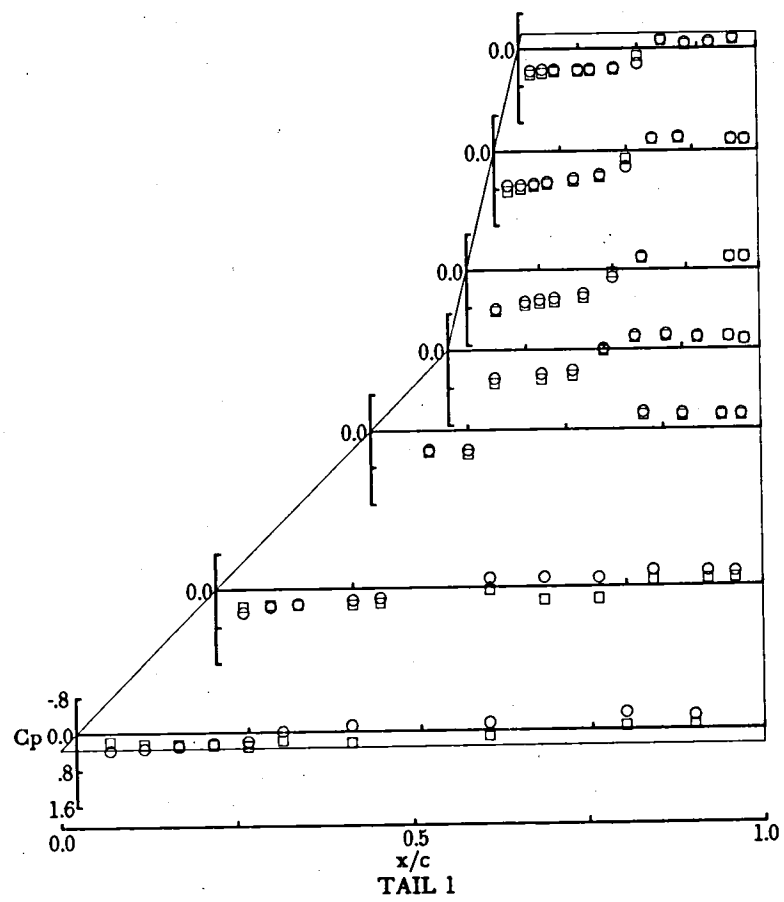
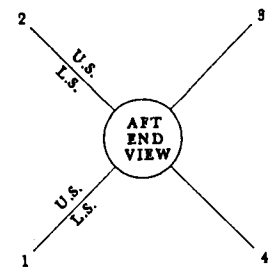

(c) $\alpha = 21.05^\circ$.

Figure 21.- Concluded.

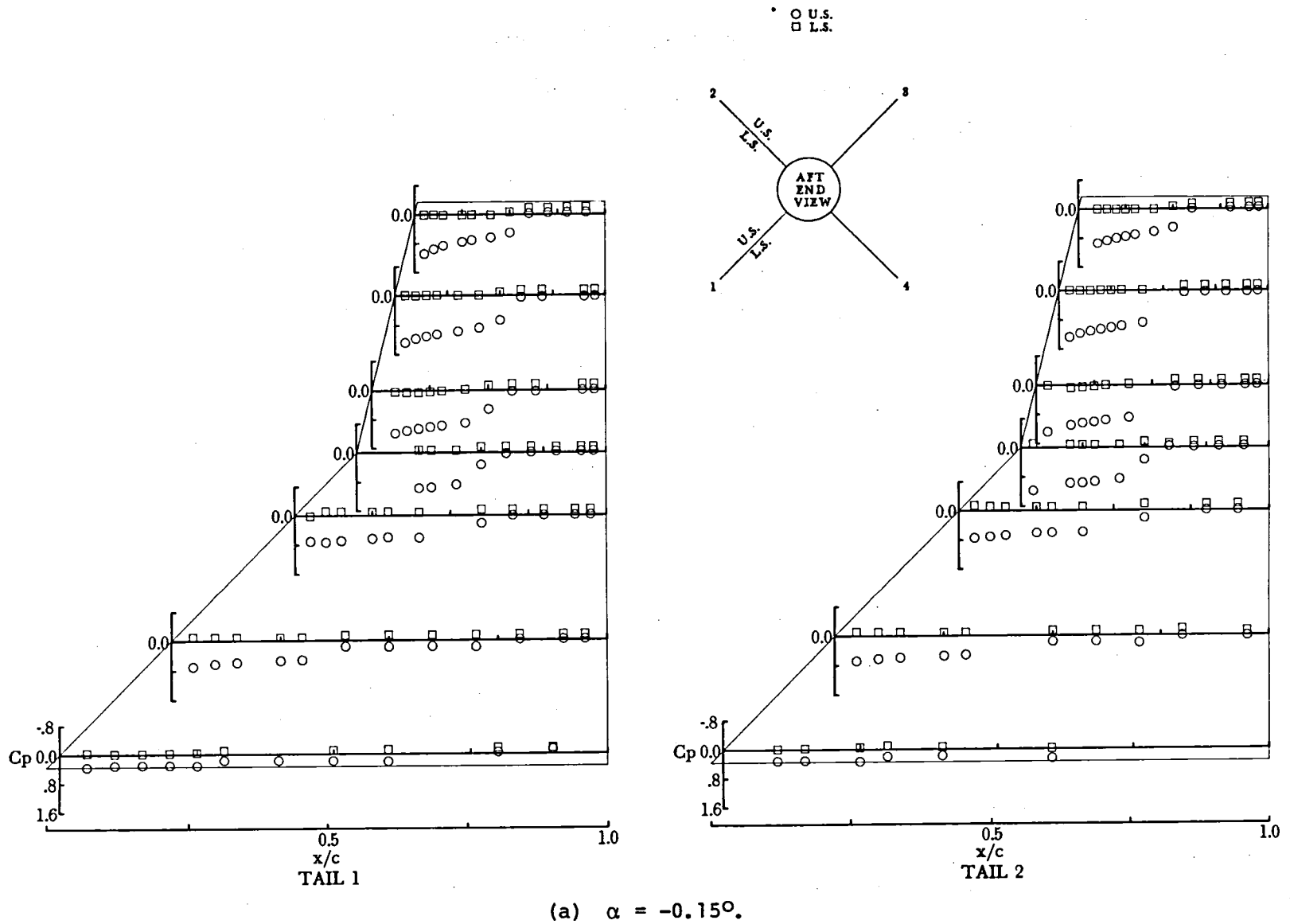
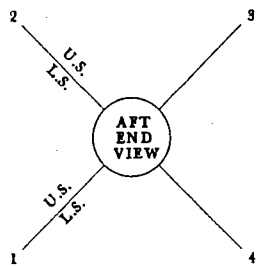
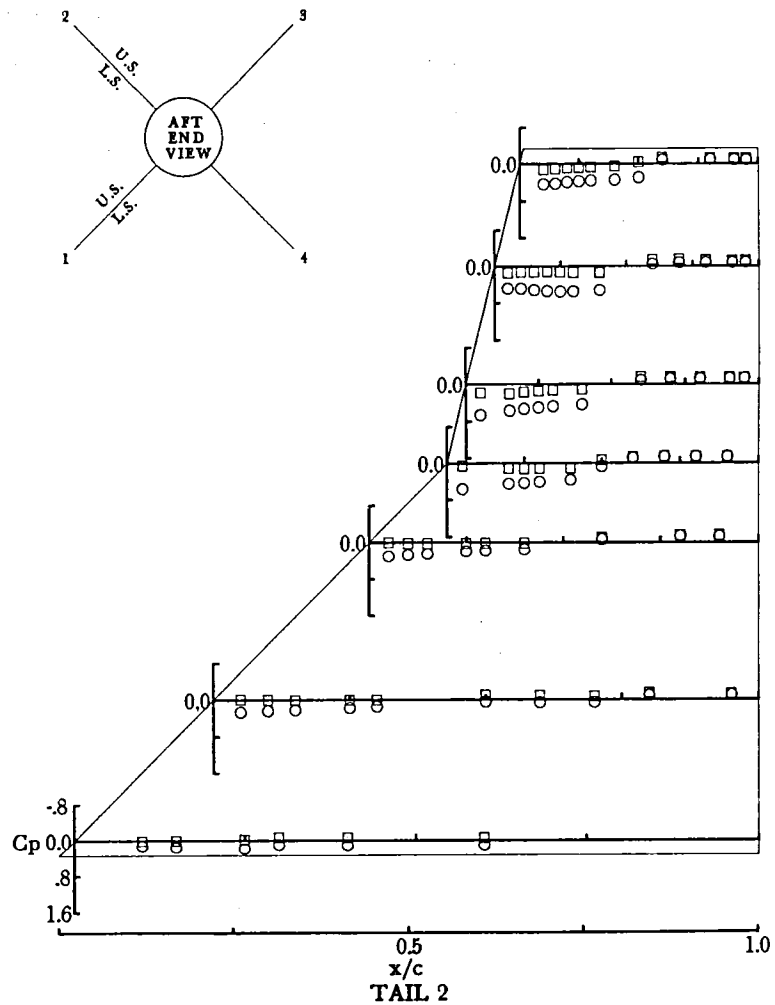
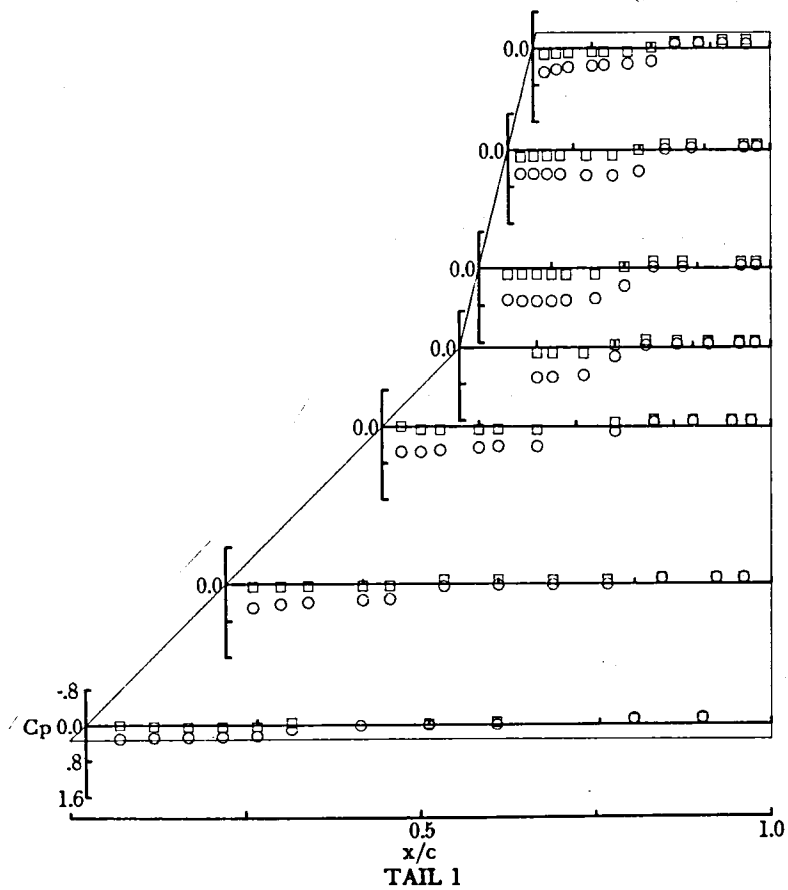

Figure 22.- Pressure coefficients for tail planform C at $M = 2.36$, $\phi = 45^\circ$, and $\delta = -15^\circ$.

○ U.S.
□ L.S.



(b) $\alpha = 9.84^\circ$.

Figure 22.- Continued.

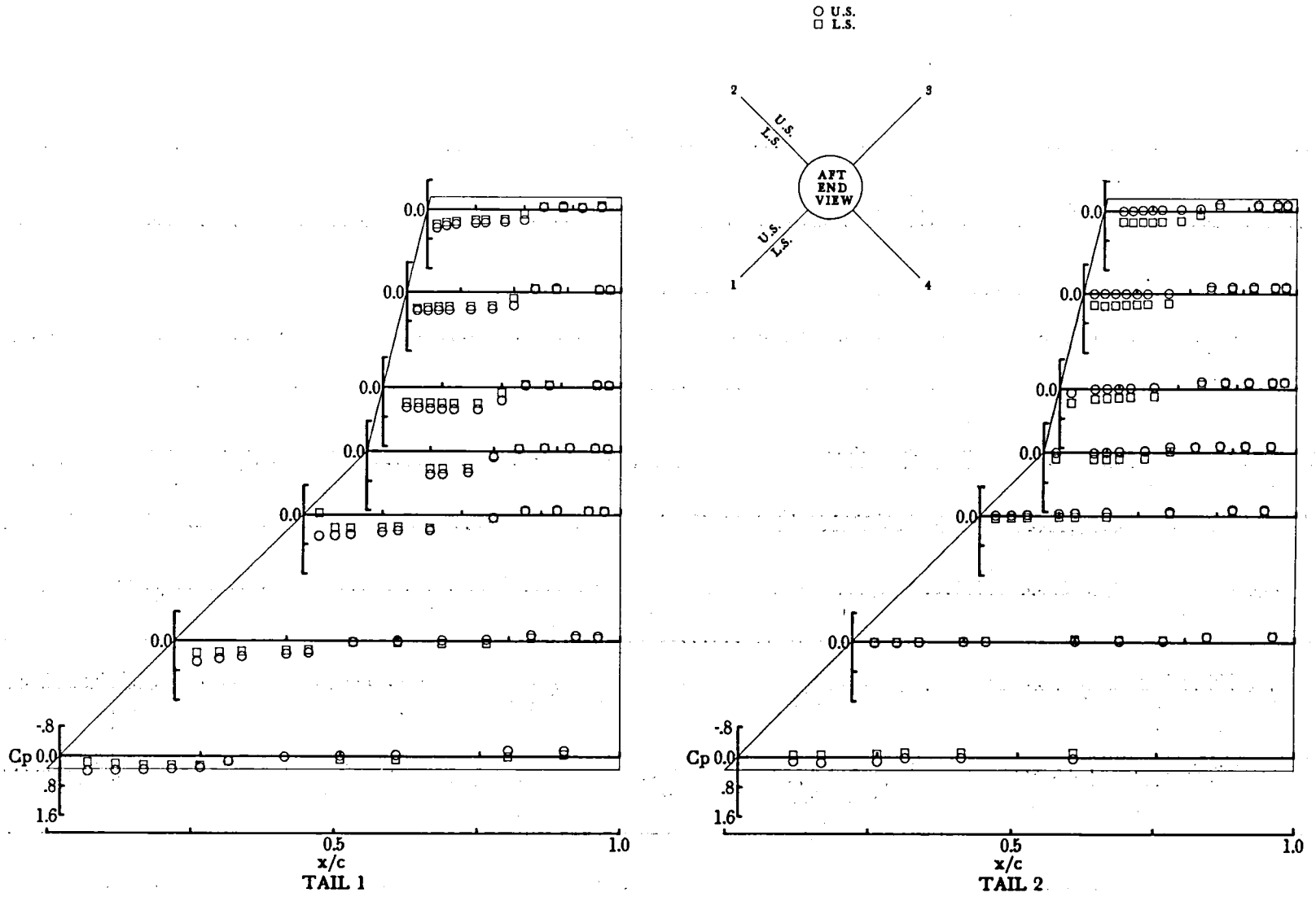

(c) $\alpha = 19.88^\circ$.

Figure 22.- Concluded.

○ U.S.
 □ L.S.

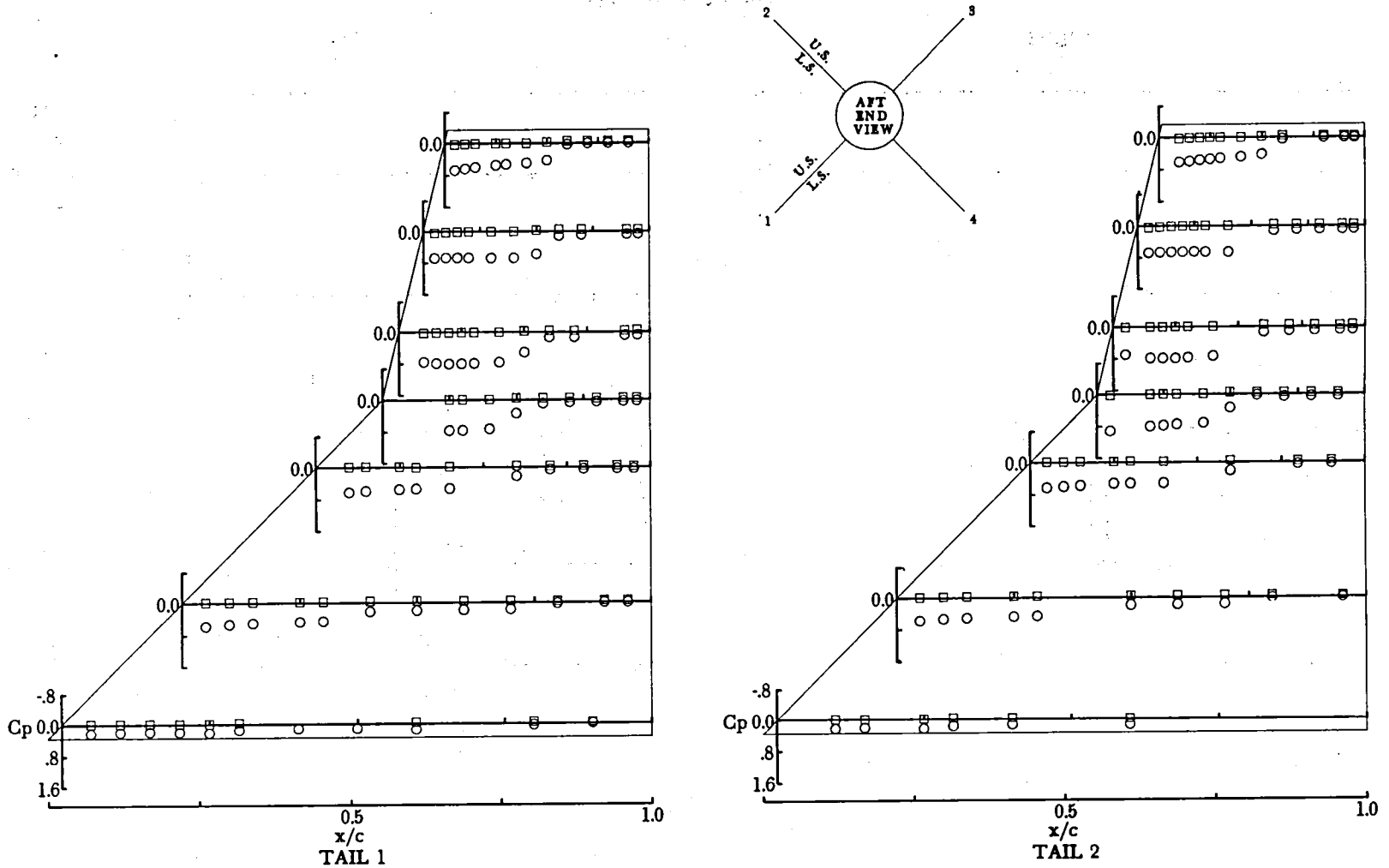

(a) $\alpha = 0.01^\circ$.

Figure 23.- Pressure coefficients for tail planform C at $M = 3.70$, $\phi = 45^\circ$, and $\delta = -15^\circ$.

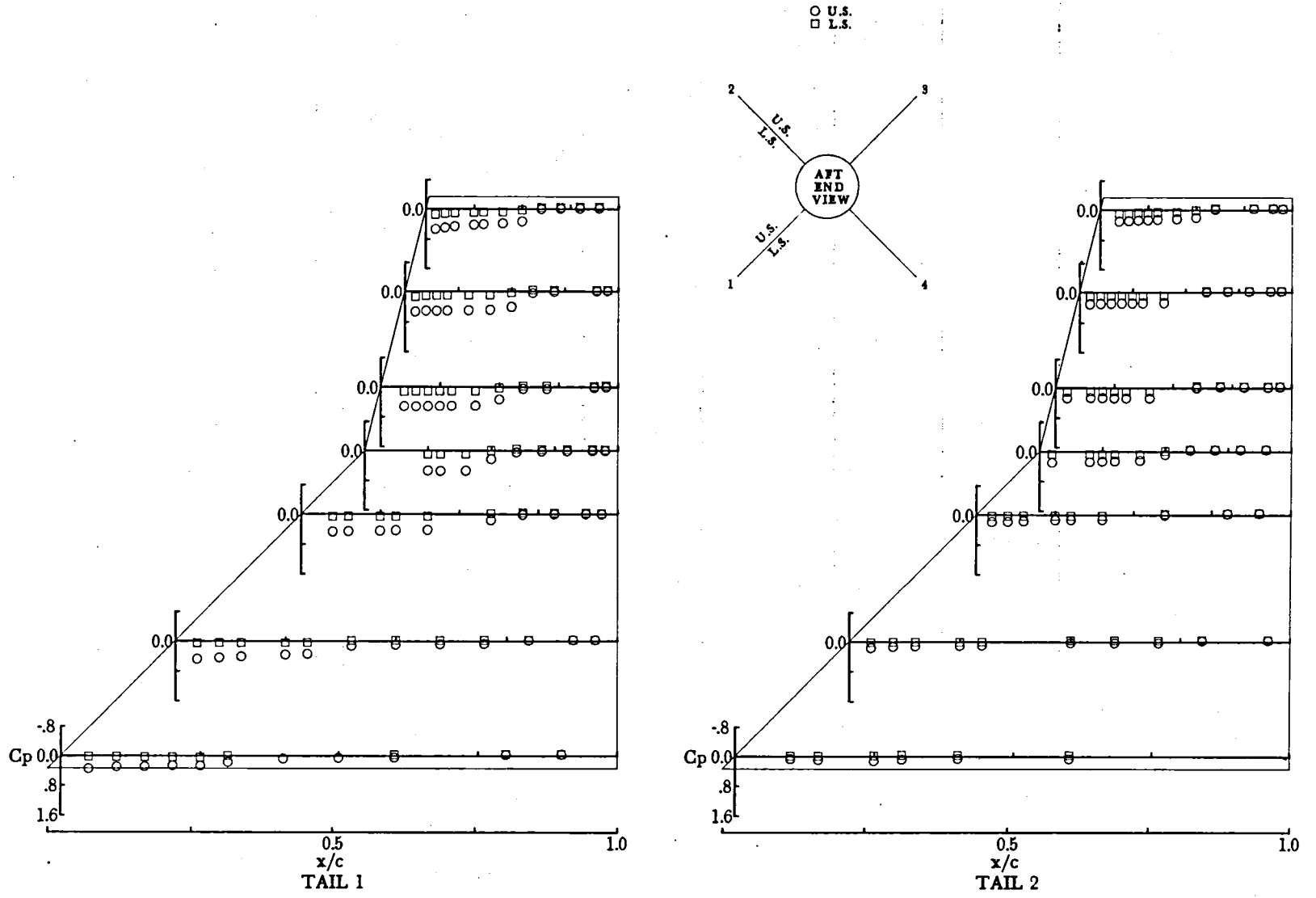

(b) $\alpha = 10.01^\circ$.

Figure 23.- Continued.

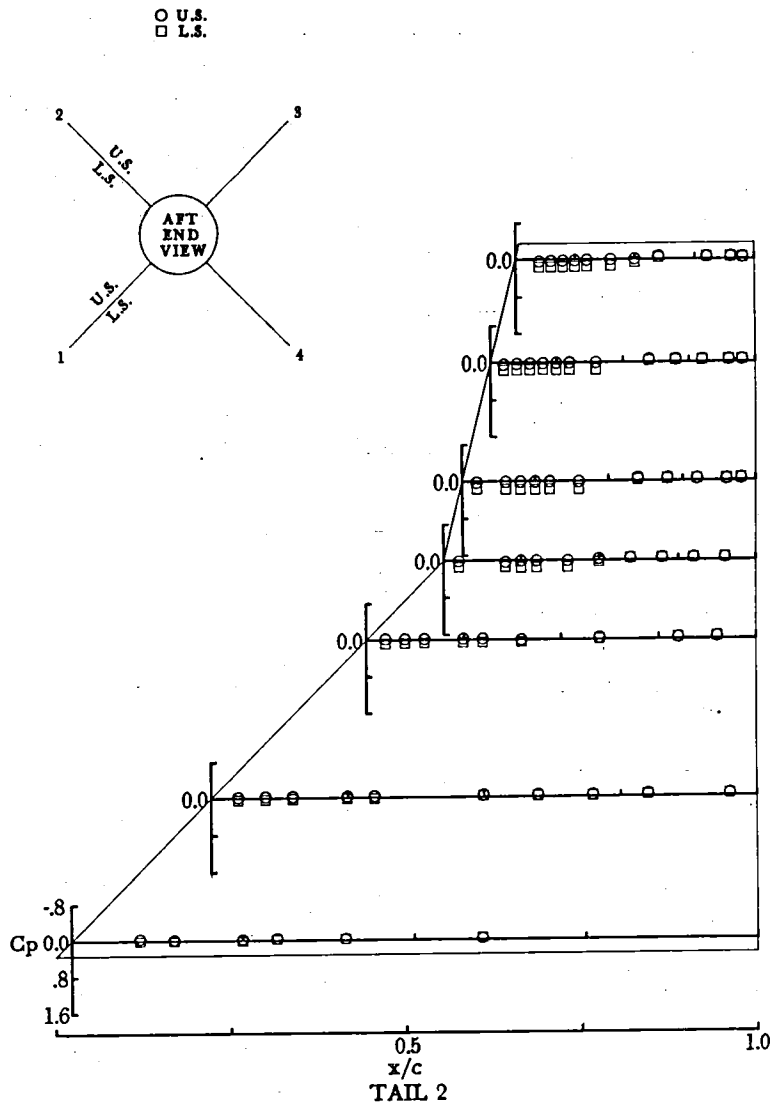
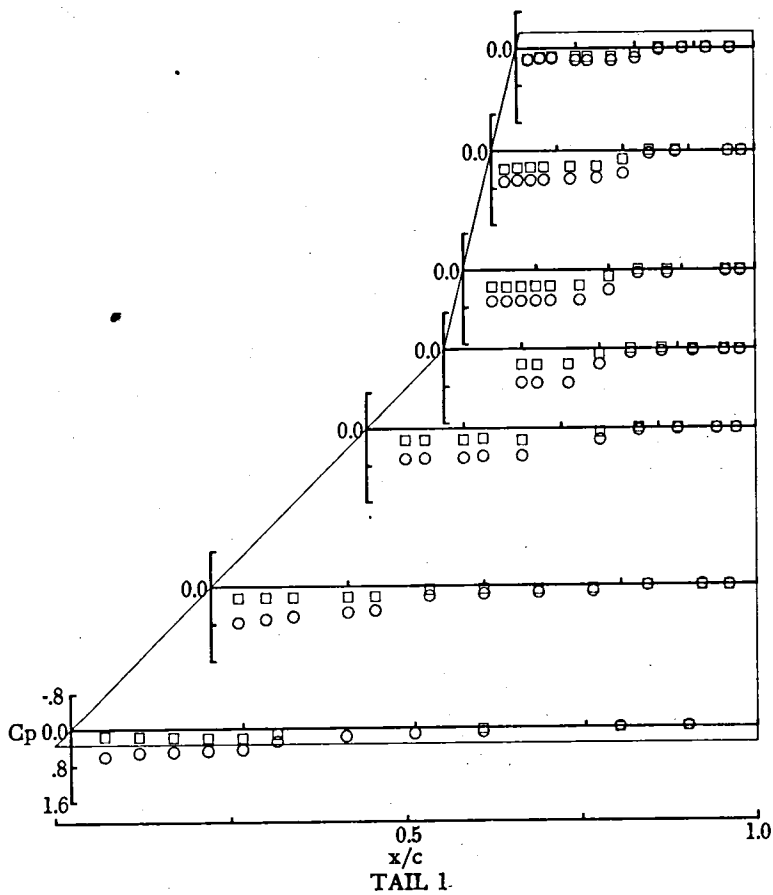

(c) $\alpha = 20.01^\circ$.

Figure 23.- Concluded.

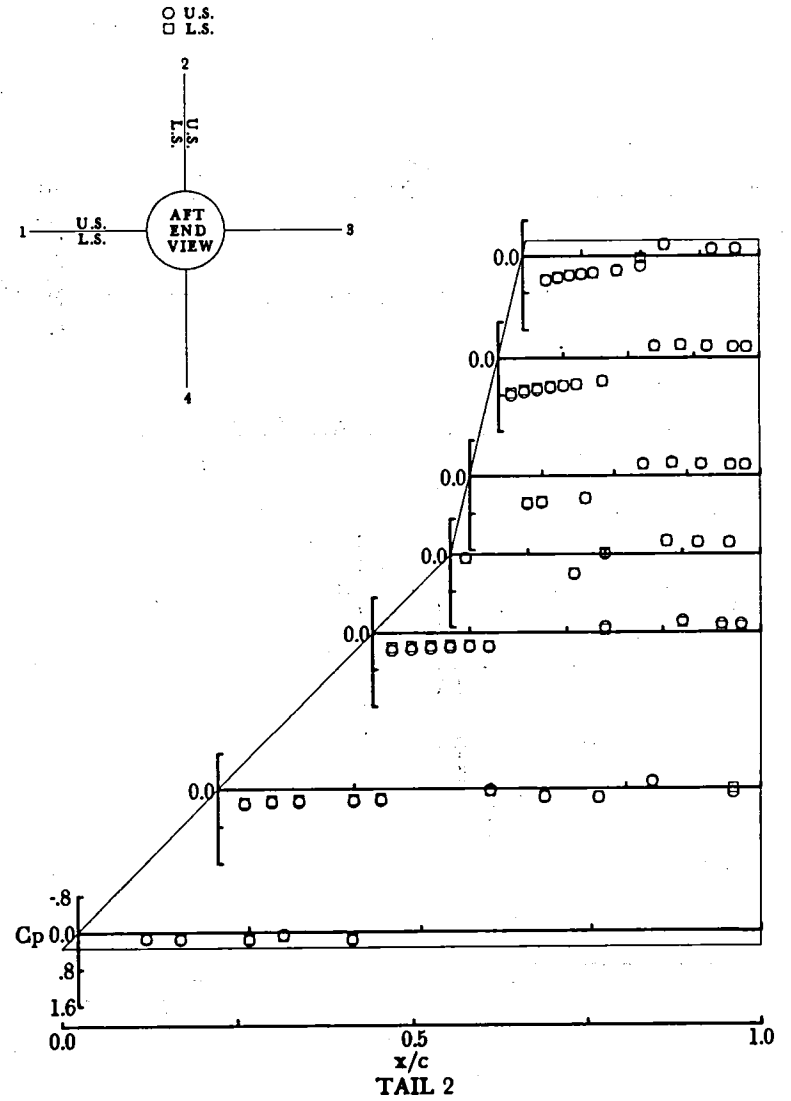
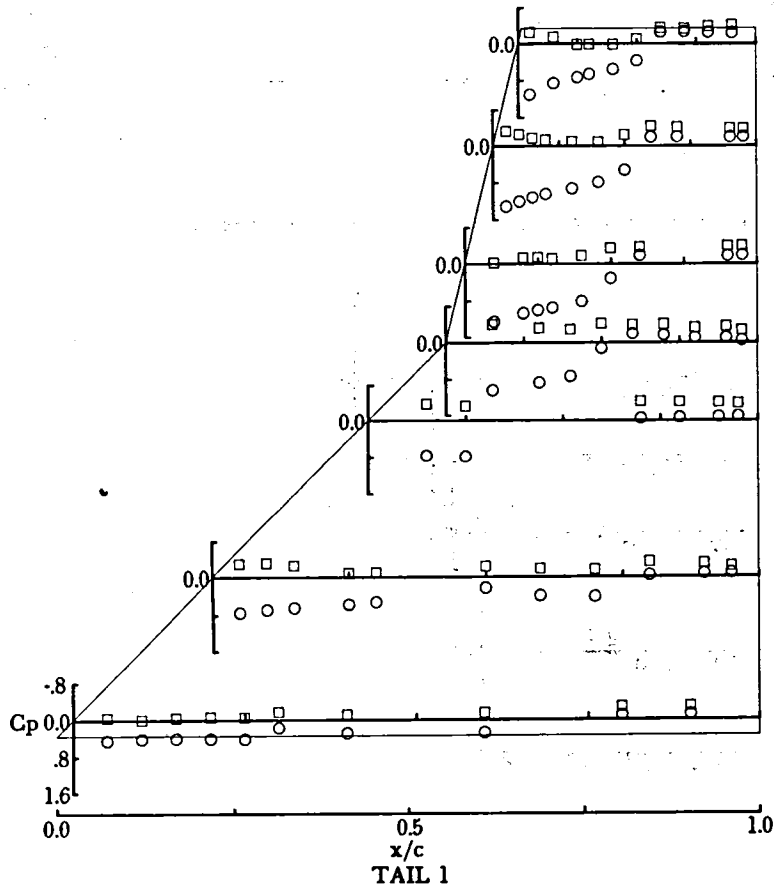

(a) $\alpha = 1.18^\circ$.

Figure 24.- Pressure coefficients for tail planform C at $M = 1.60$, $\phi = 90^\circ$, and $\delta_{1,3} = -15^\circ$.

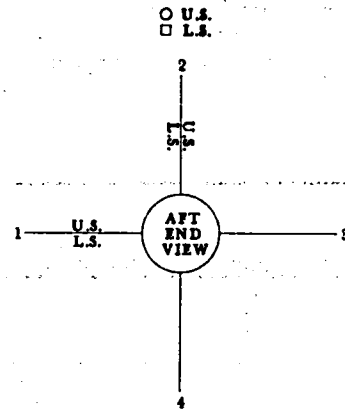
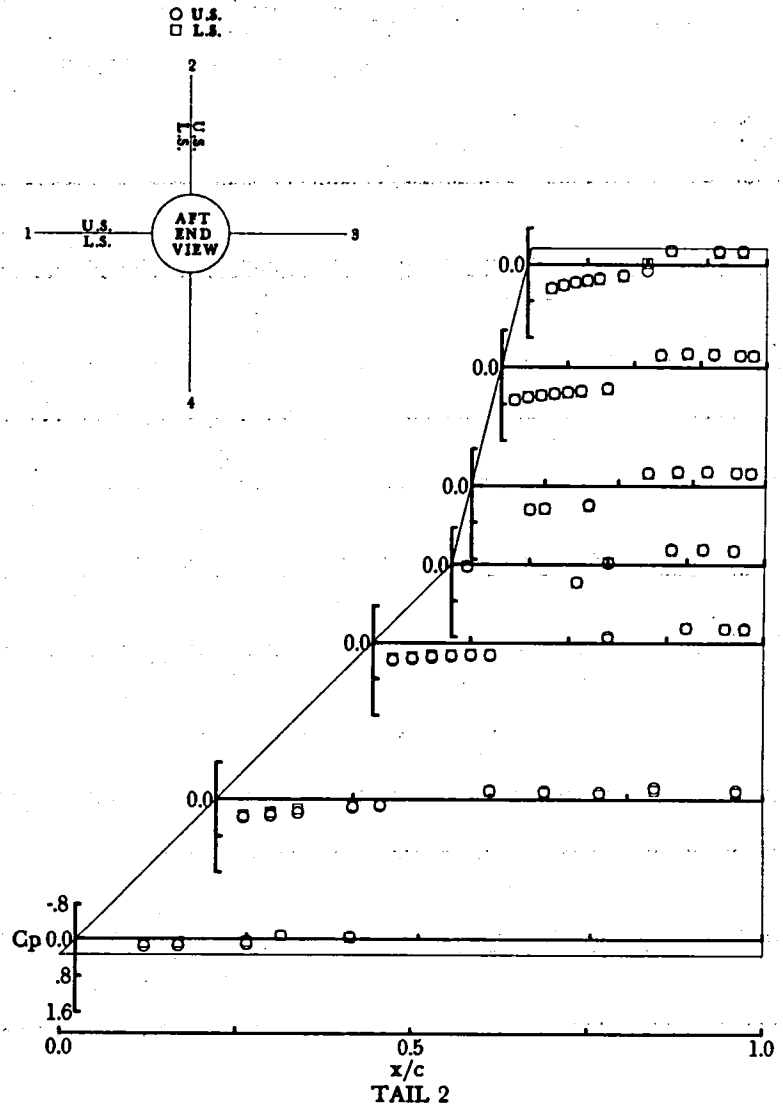
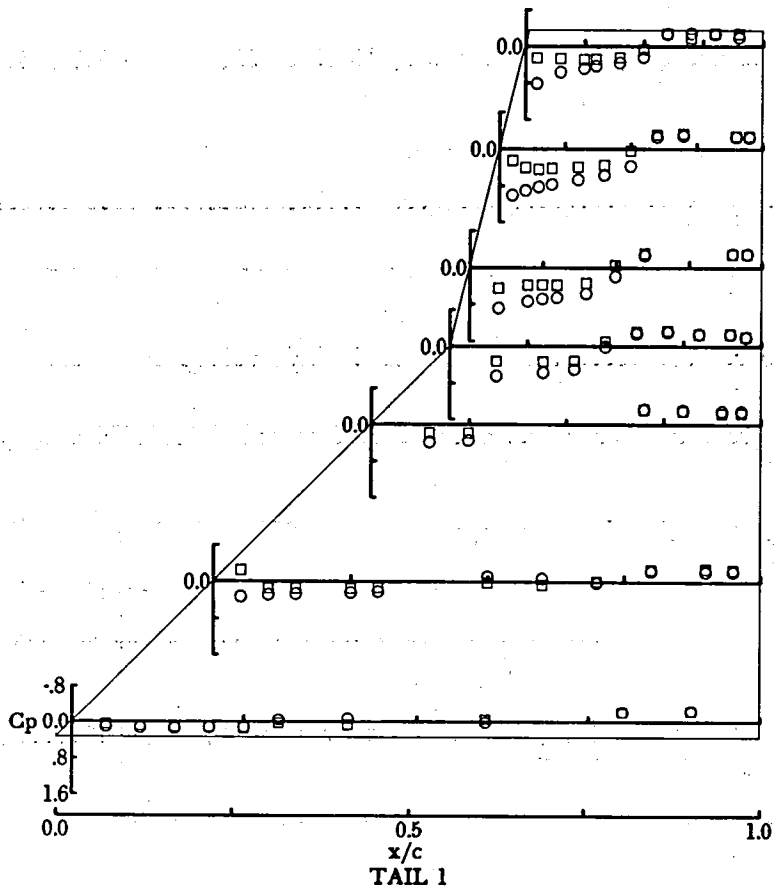

(b) $\alpha = 11.15^\circ$.

Figure 24.- Continued.

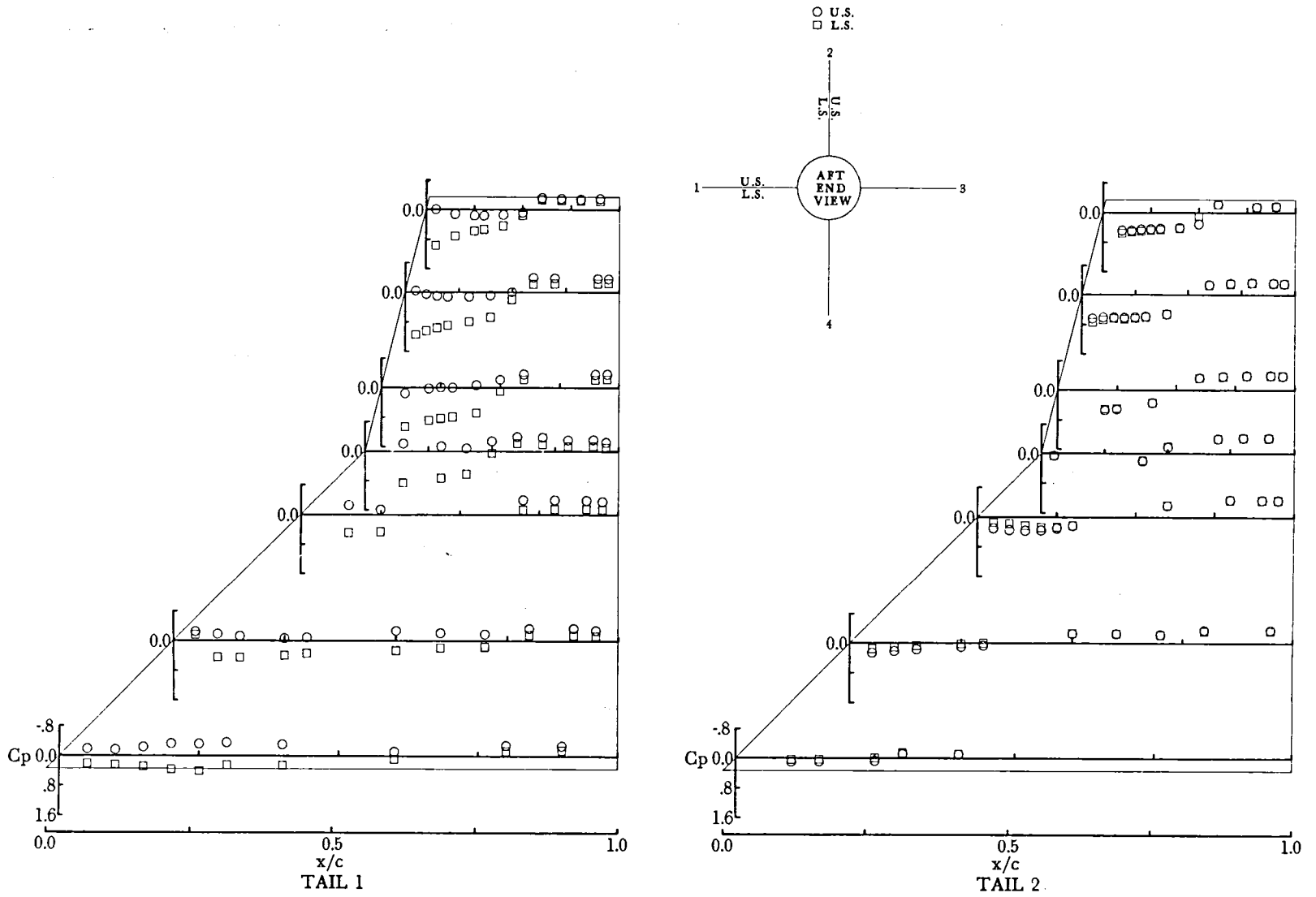

(c) $\alpha = 21.15^\circ$.

Figure 24.- Concluded.

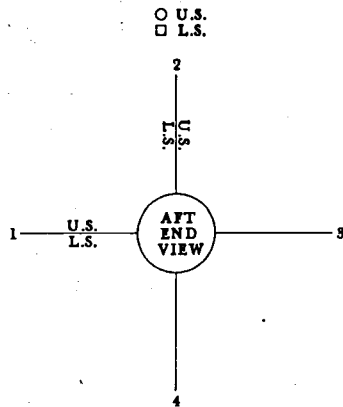
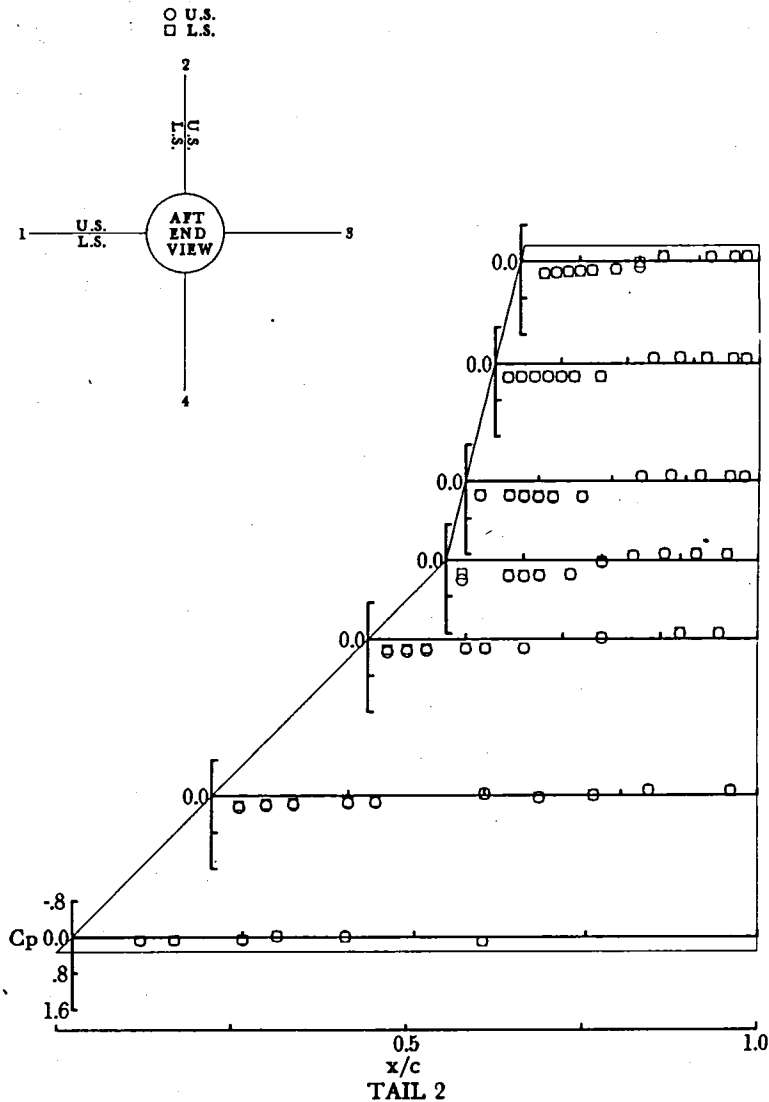
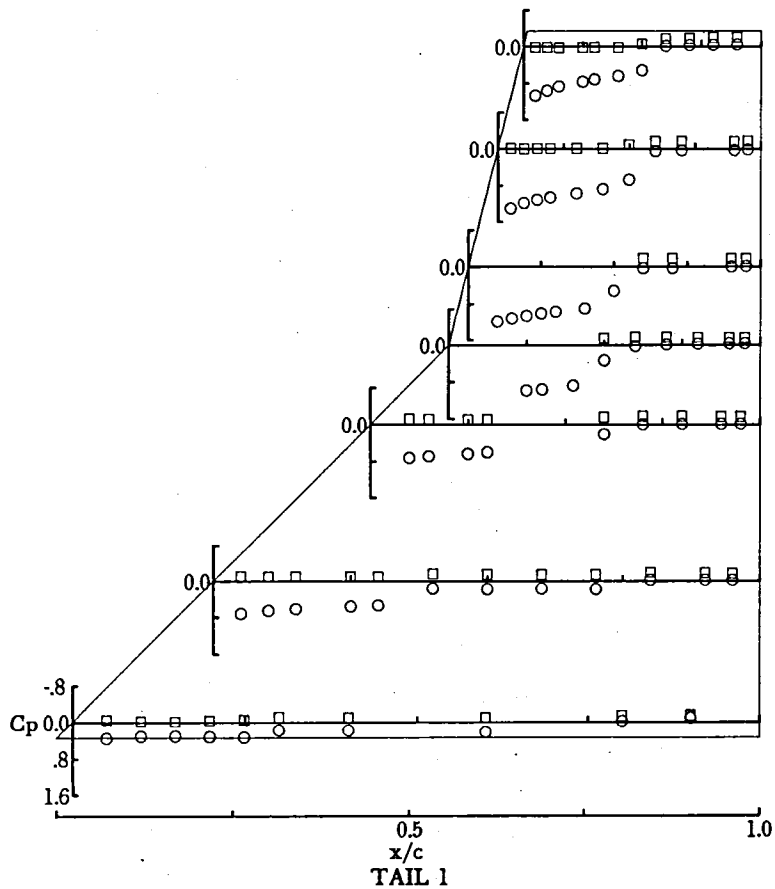

(a) $\alpha = -0.05^\circ$.

Figure 25.- Pressure coefficients for tail planform C at $M = 2.36$, $\phi = 90^\circ$, and $\delta_{1,3} = -15^\circ$.

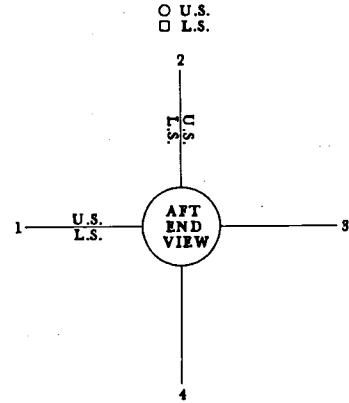
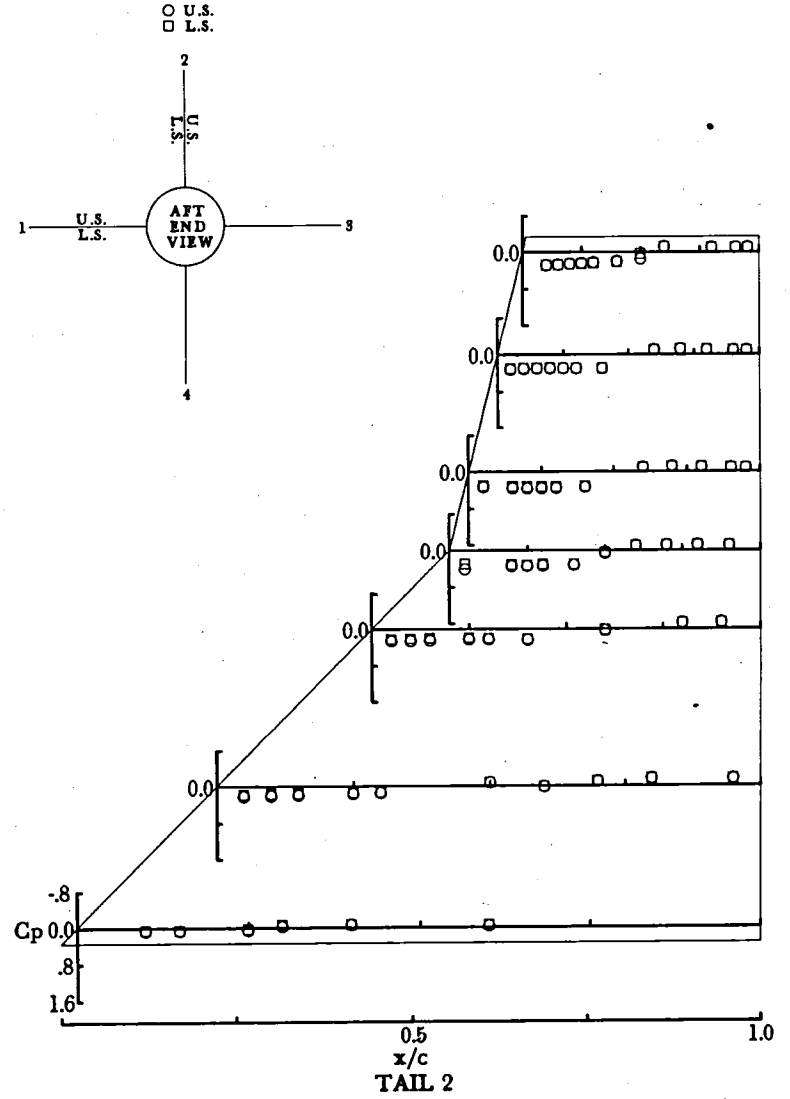
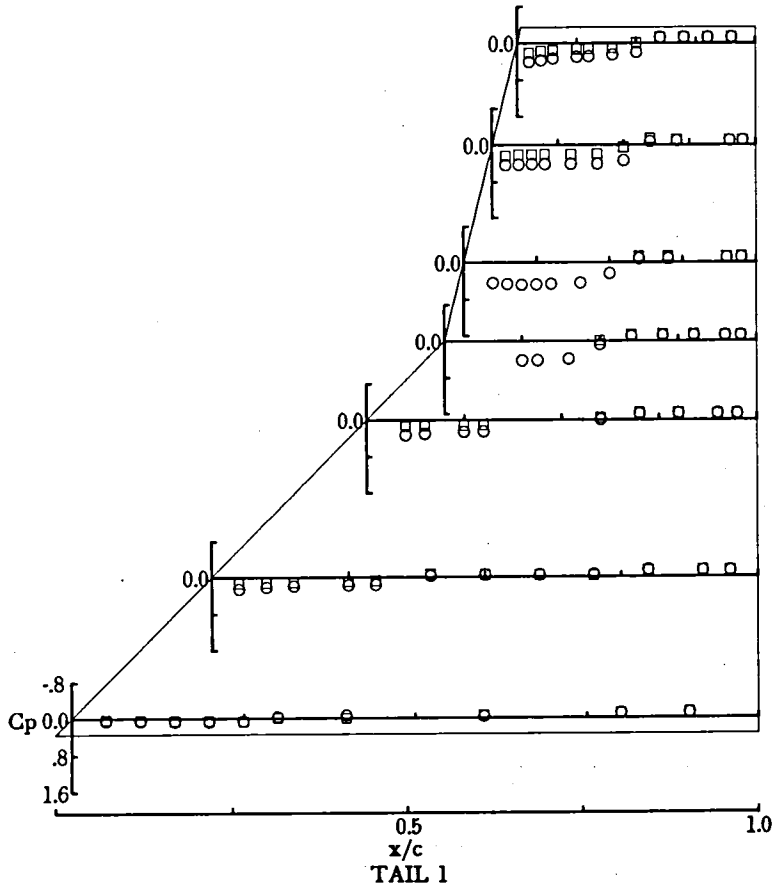

(b) $\alpha = 9.95^\circ$.

Figure 25.- Continued.

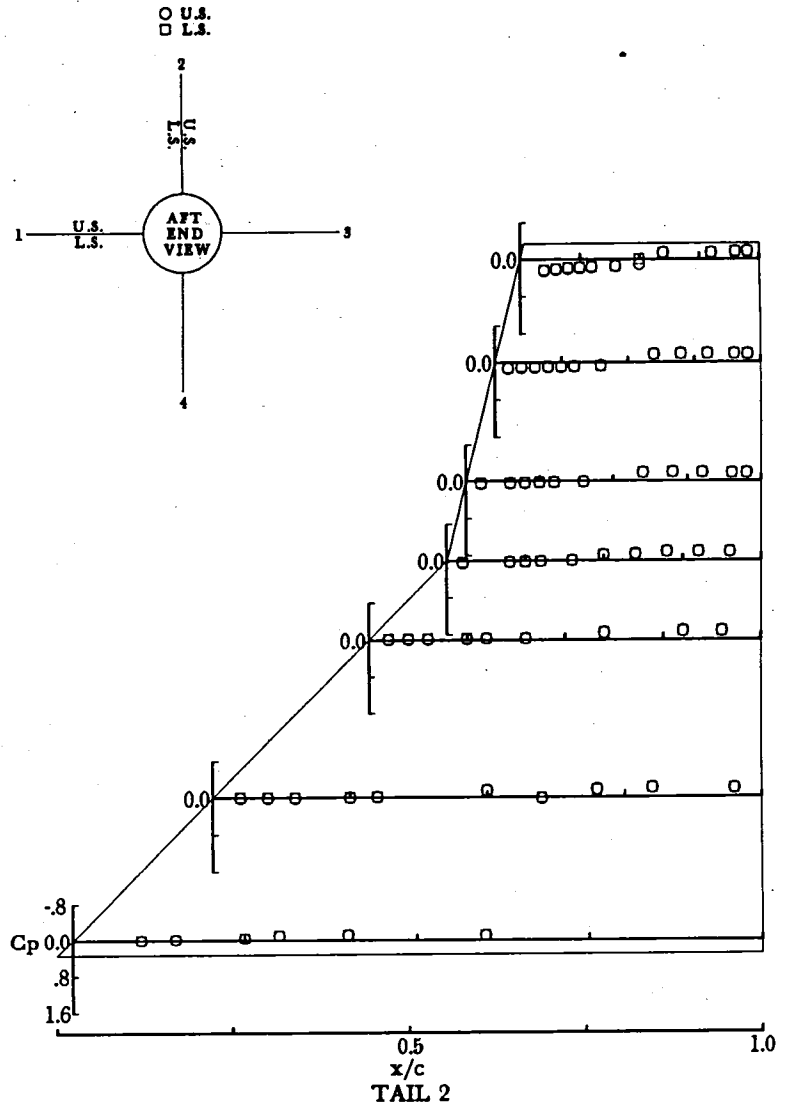
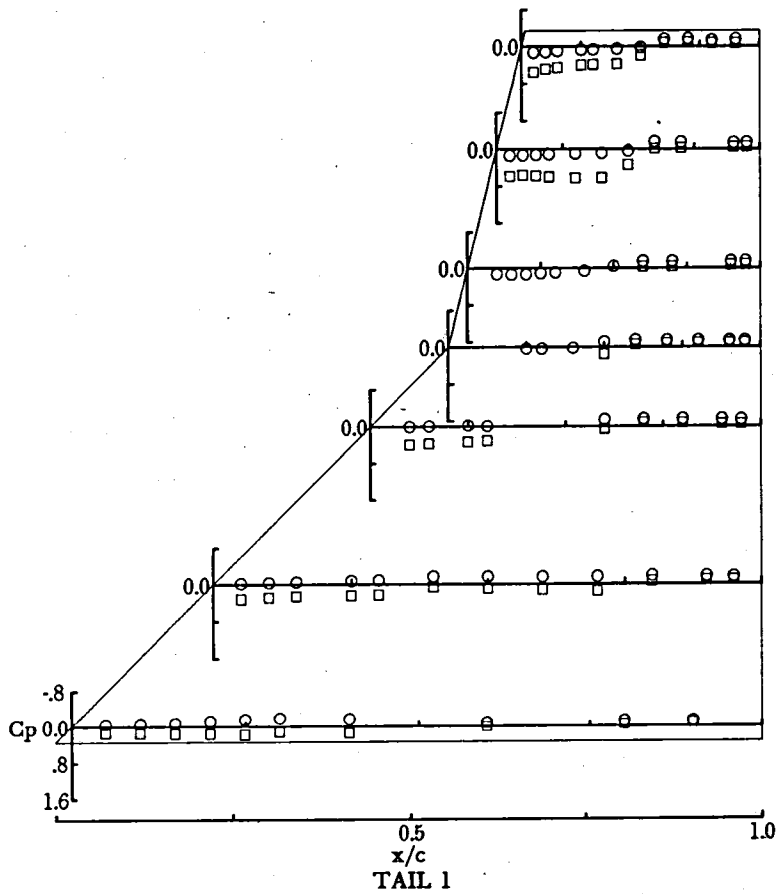

(c) $\alpha = 19.96^\circ$.

Figure 25.- Concluded.

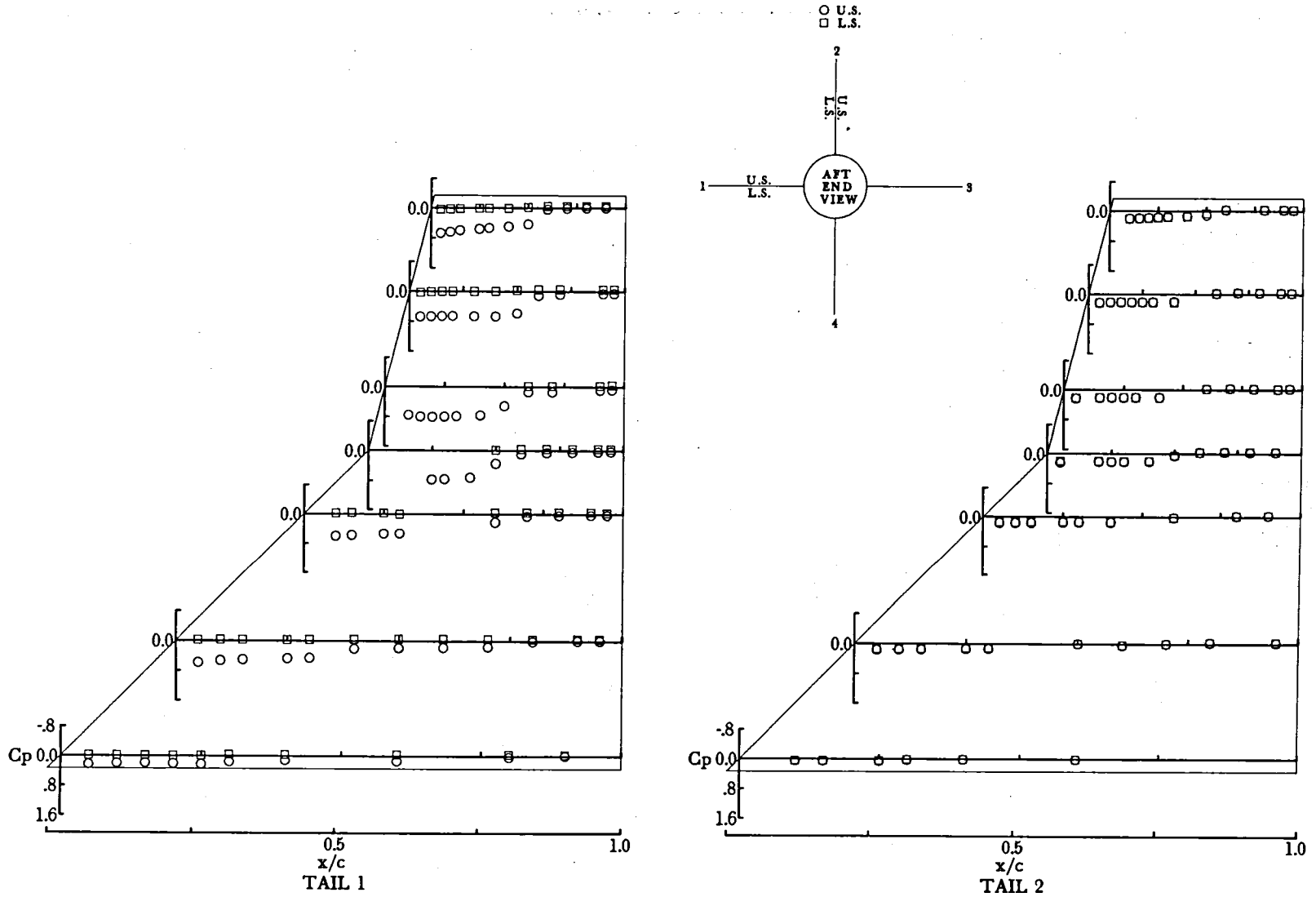

(a) $\alpha = -0.14^\circ$.

Figure 26.- Pressure coefficients for tail planform C at $M = 3.70$, $\phi = 90^\circ$, and $\delta_{1,3} = -15^\circ$.

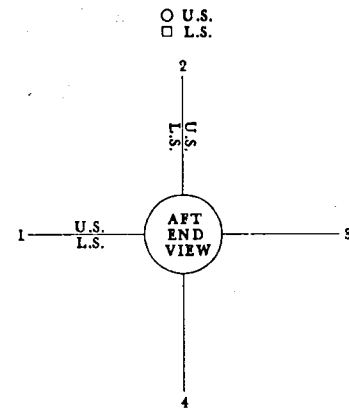
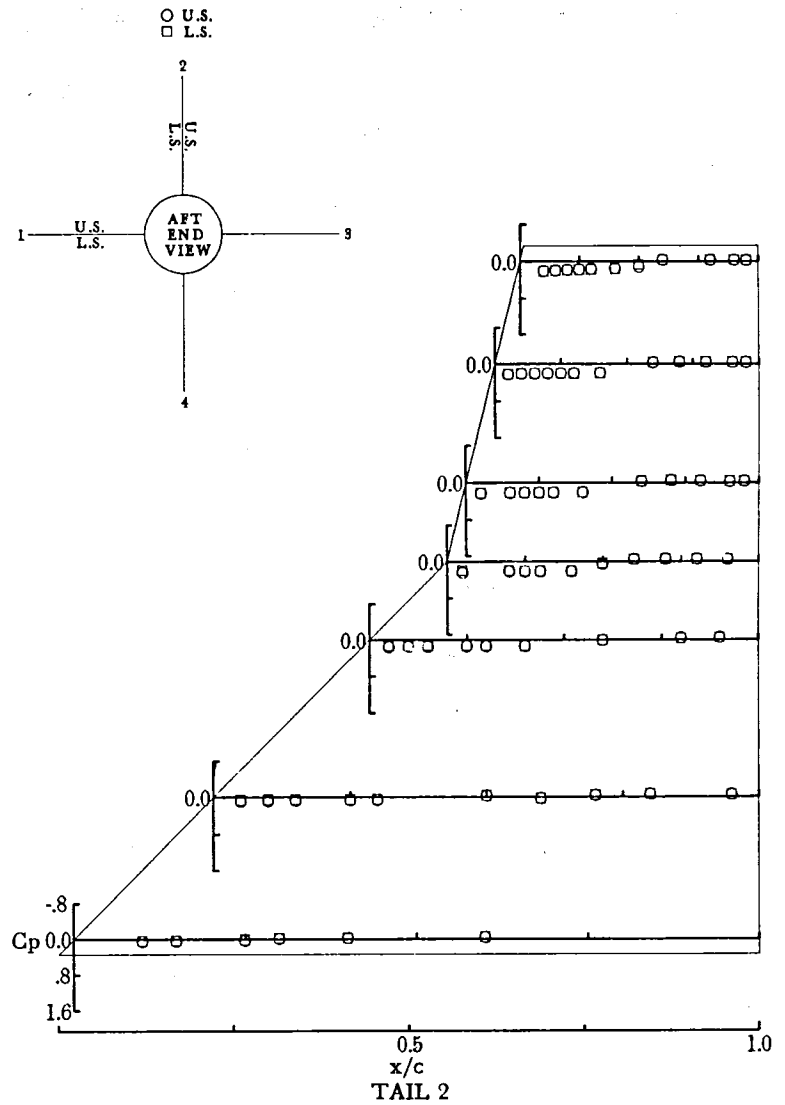
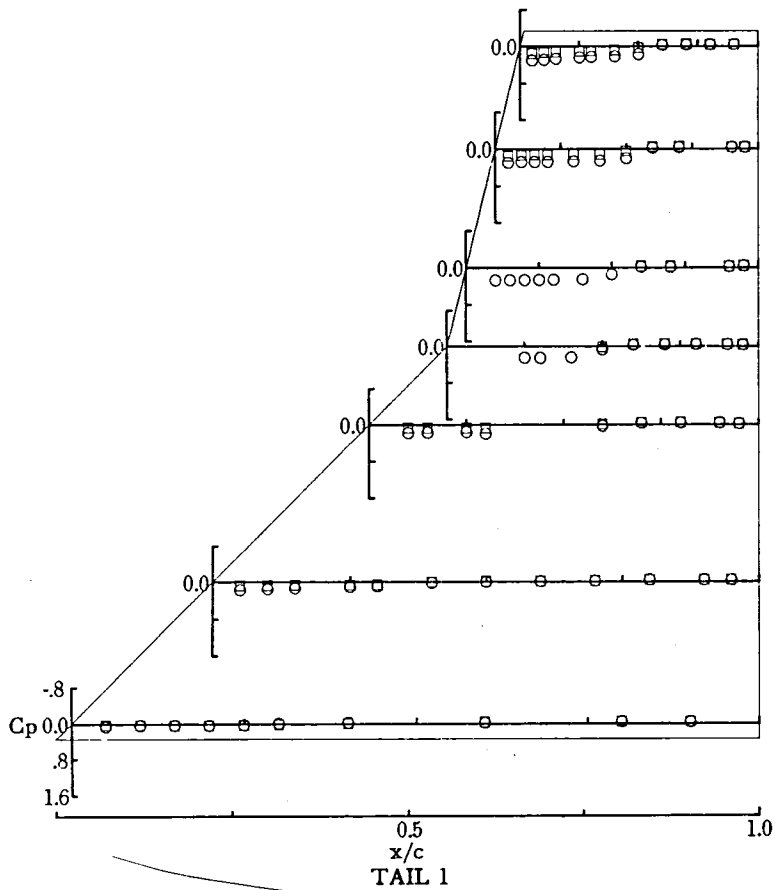

(b) $\alpha = 9.85^\circ$.

Figure 26.- Continued.

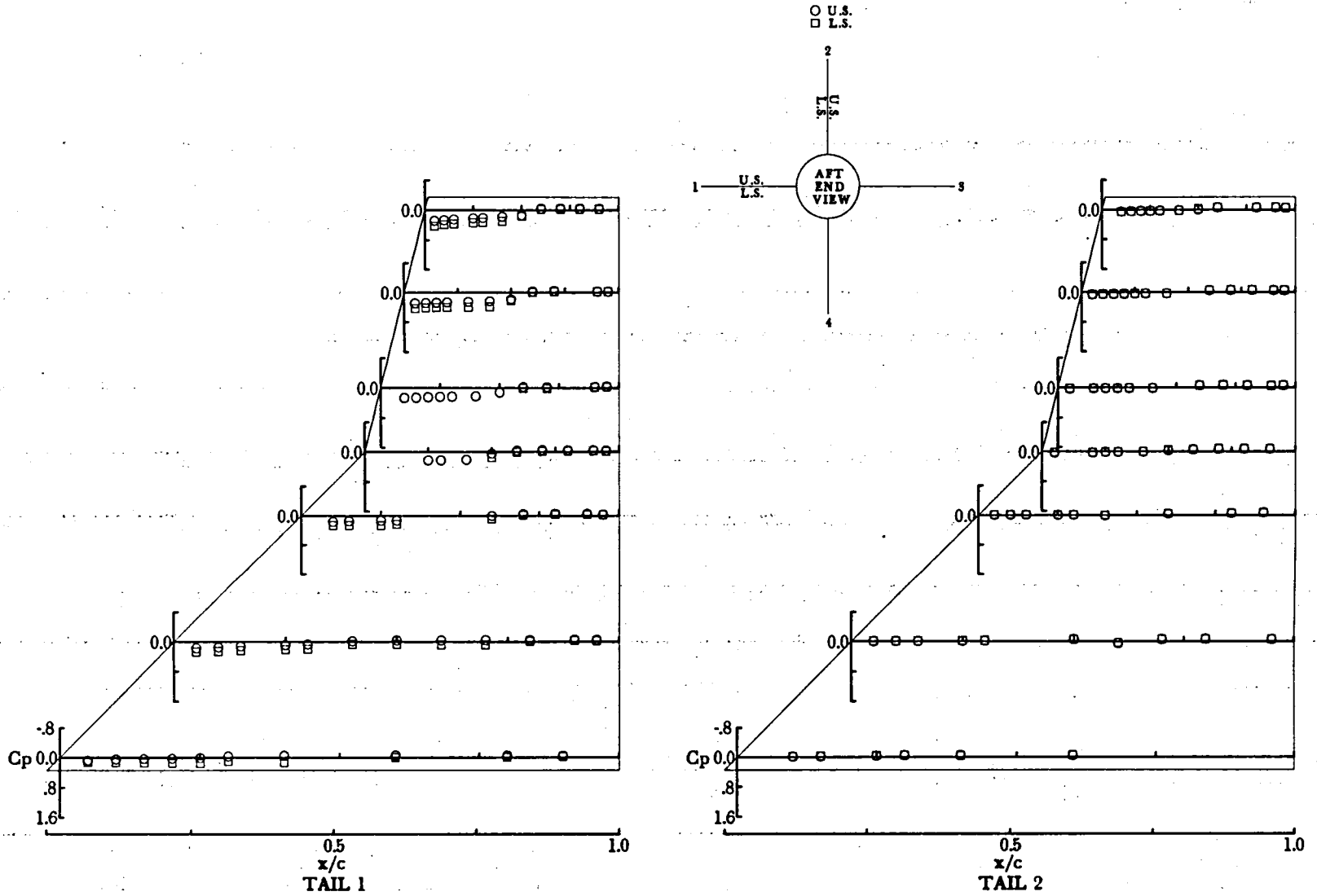

(c) $\alpha = 19.85^\circ$.

Figure 26.- Concluded.

1. Report No. NASA TM-80097		2. Government Accession No.		3. Recipient's Catalog No.	
4. Title and Subtitle PRESSURE DISTRIBUTIONS ON THREE DIFFERENT CRUCIFORM AFT-TAIL CONTROL SURFACES OF A WINGLESS MISSILE AT MACH 1.60, 2.36, AND 3.70 - VOLUME III - CRANKED TAIL				5. Report Date July 1979	
				6. Performing Organization Code	
7. Author(s) Milton Lamb, Wallace C. Sawyer, Donald L. Wassum, and C. Donald Babb				8. Performing Organization Report No. L-12993	
				10. Work Unit No. 505-11-23-03	
9. Performing Organization Name and Address NASA Langley Research Center Hampton, VA 23665				11. Contract or Grant No.	
				13. Type of Report and Period Covered Technical Memorandum	
12. Sponsoring Agency Name and Address National Aeronautics and Space Administration Washington, DC 20546				14. Sponsoring Agency Code	
15. Supplementary Notes					
16. Abstract The results of pressure distribution tests conducted in the Langley Unitary Plan wind tunnel are presented without analysis. The data were obtained for three sets of cruciform aft-tail control surfaces on a wingless missile model at Mach numbers of 1.60, 2.36, and 3.70 for angles of attack from -4° to 20° , model roll angles from 0° to 90° , and tail deflections of 0° and -15° . The test Reynolds number used was 6.6×10^6 per meter.					
17. Key Words (Suggested by Author(s)) Pressure distributions Missile tails Supersonic speeds			18. Distribution Statement Unclassified - Unlimited Subject Category 02		
19. Security Classif. (of this report) Unclassified		20. Security Classif. (of this page) Unclassified		21. No. of Pages 340	22. Price* \$12.00

End of Document