

NASA
CR
3130
c.1

NASA Contractor Report 3130

LOAN COPY: RETURN TO
AFWL TECHNICAL
KIRTLAND AFB, TEXAS



Hypersonic Airframe Structures Technology Needs and Flight Test Requirements

J. E. Stone and L. C. Koch

CONTRACT NAS1-14924
JULY 1979





NASA Contractor Report 3130

Hypersonic Airframe Structures Technology Needs and Flight Test Requirements

J. E. Stone and L. C. Koch
McDonnell Douglas Corporation
St. Louis, Missouri

Prepared for
Langley Research Center
under Contract NAS1-14924

NASA

National Aeronautics
and Space Administration

Scientific and Technical
Information Branch

1979

FOREWORD

The overall objectives of this study were to identify the technological advances required in airframe structures for hypersonic vehicle applications and to define the role that flight testing can play in accomplishing these advances. The study was conducted, in 1977, in accordance with the requirements and instructions of NASA RFP 1-16-2700.0042 and McDonnell Technical Proposal Report MDC A4748. Customary units were used for the principal measurements and calculations and converted to the International System of Units (S.I.) for the final report.

James E. Stone was the MCAIR Program Manager and Principal Investigator for this study. Leland C. Koch served as the MCAIR Technical Advisor and contributed greatly to the study. Numerous MCAIR personnel contributed, within their fields of expertise, to the report. Two eminent professors, E. E. Sechler of the California Institute of Technology and R. H. Miller of the Massachusetts Institute of Technology, also served as Technical Advisors for this study.

TABLE OF CONTENTS

<u>Section</u>	<u>Title</u>	<u>Page</u>
1.	SUMMARY	1
2.	INTRODUCTION.	5
3.	HYPERSONIC VEHICLE APPLICATIONS	7
	3.1 Potential Applications	7
	3.2 Selection of Most Promising Applications	8
	3.3 Thermal/Structural Characteristics of Selected Applications. . .	10
4.	CANDIDATE THERMAL/STRUCTURAL CONCEPTS	13
	4.1 Concepts Applicable for General Usage.	13
	4.2 Leading Edge Concepts.	18
	4.3 Cryogenic Fuel Tankage Thermal/Structural Concepts	20
	4.4 Air Induction System Concepts.	24
	4.5 Internal/Protected Structure	25
	4.6 Concept Applicability.	25
5.	THERMAL/STRUCTURAL TECHNOLOGY STATUS AND GOALS.	29
	5.1 Status of Analytical Methods	29
	5.2 Status of Materials.	29
	5.3 Status of Manufacturing Techniques	36
	5.4 Status of Concept Development.	37
	5.5 Technology Goals	37
6.	TECHNOLOGY NEEDS.	41
	6.1 General Assessment	41
	6.2 Specific Needs	46
7.	TECHNOLOGICAL ADVANCES ACHIEVABLE WITHOUT FLIGHT TESTING.	51
	7.1 Material Properties Research	51
	7.2 Fabrication Development and Element Testing.	51
	7.3 Full Scale Structural Testing.	52
8.	ROLE OF FLIGHT TESTING IN ADVANCING TECHNOLOGY.	55
	8.1 The Necessity for Flight Testing	55
	8.2 The Benefits of a Flight Research Vehicle.	56
	8.3 A Flight Test Program to Advance Thermal/Structural Technology .	57
9.	HYPERSONIC RESEARCH AIRCRAFT THERMAL/STRUCTURAL DESIGN CONSIDERATIONS	63
	9.1 Mass Analysis.	64
	9.2 Aerodynamic Ramifications.	65
	9.3 Cost Comparison.	66
	9.4 Summary.	66

TABLE OF CONTENTS (Continued)

<u>Section</u>	<u>Title</u>	<u>Page</u>
10.	PROGRAMS FOR ADVANCING THERMAL/STRUCTURAL TECHNOLOGY	69
	10.1 Program Schedules and Options.	69
	10.2 Program Costs.	78
11.	CONCLUSIONS AND RECOMMENDATIONS.	83
12.	REFERENCES	84
	APPENDIX A - SPECIFIC TECHNOLOGY NEED DESCRIPTIONS	89
	APPENDIX B - STUDY APPRAISALS	119

LIST OF ILLUSTRATIONS

<u>Figure</u>	<u>Title</u>	<u>Page</u>
1	Hot Structure	13
2	Radiative Metallic Thermal Protection System	14
3	Externally Insulated Structure	15
4	Water Cooled Structure	16
5	Phase Change Material Cooled Structure	16
6	Actively Cooled Structure	17
7	Hot Structure - Leading Edge	18
8	Externally Insulated Structure - Leading Edge	19
9	Phase Change Material Cooled Structure - Leading Edge	19
10	Actively Cooled Structure - Leading Edge	20
11	LH ₂ , Internal Insulation, TPS Concept	21
12	LH ₂ , Evacuated Insulation, TPS Concept	22
13	LH ₂ , Layered External Insulation, TPS Concept	23
14	LH ₂ , Active, TPS Concepts	23
15	Modular Propulsion System	24
16	Hot Structure Air Induction System Designs	26
17	Insulated Structure Air Induction System Designs	27
18	Actively Cooled Structure Air Induction System Designs	27
19	Status of Candidate Metallic Materials for Hypersonic Airframe Structures	30
20	Status of Candidate Advanced Composites for Hypersonic Airframe Structures	33
21	Candidate Structural Materials Related to Selected Hypersonic Applications	42
22	Components Available for Thermal/Structural Testing	58
23	Flight Test Program Objectives and Schedule	59
24	Technology Advancement - Plan A	71
25	Technology Advancement - Plan B	72
26	Technology Advancement - Plan C	74
27	Plan D Flight Test Program Objectives and Schedule	75
28	Technology Advancement - Plan D	77

LIST OF TABLES

<u>Table</u>	<u>Title</u>	<u>Page</u>
1	Promising Hypersonic Applications	9
2	Mach 4.5 Aircraft Requirements	10
3	Space Transportation System Requirements	11
4	Mach 6.0 Aircraft Requirements	12
5	Thermal/Structural Concept Applicability	25
6	Metallic Material Property Data Requirements	29
7	Composite Material Property Data Requirements	30
8	Technology Needs	38
9	Flight Test Program Procedure and Vehicle Configuration	60
10	Hypersonic Vehicle Development Milestone Goals	70
11	Identification of High Priority Needs	73
12	Alternate Flight Test Program Procedure and Vehicle Configuration	76
13	Individual Technology Assessment Costs.	79

LIST OF ABBREVIATIONS AND SYMBOLS

ABLV	Air Breathing Launch Vehicle
Al	Aluminum
ASTF	Aeropropulsion Systems Test Facility
ASTS	Advanced Space Transportation System
B	Boron
Be	Beryllium
Bi	Bismuth
Bsc	Borsic
Btu	British thermal unit
Cb	Columbium
C_d	Coefficient of drag
cm	Centimeter
CO ₂	Carbon dioxide
CONUS	Continental United States
$C_{\eta\beta}$	Yawing Moment Derivative Due to Sideslip
C_p	Specific heat
Cr	Chromium
da/dn	Crack growth rate
E	Young's modulus of elasticity in tension
E_c	Young's modulus of elasticity in compression
ELI	Extra low interstitials
E_t	Tangent modulus
F_{bru}	Ultimate bearing stress
F_{bry}	Yield bearing stress
F_{cu}	Compression ultimate stress
F_{cy}	Compression yield stress
F_{su}	Ultimate shear stress

LIST OF ABBREVIATIONS AND SYMBOLS (Continued)

F_{tu}	Tensile ultimate stress
F_{ty}	Tensile yield stress
ft	Feet
$^{\circ}F$	Degrees Fahrenheit
Gr	Graphite
hr	Hour
HST	Hypersonic transport
HYFAC	Hypersonic Research Facilities Study
in	Inch
IOC	Initial Operation Capability
K	Kelvin
k	Thermal conductivity
K_c	Plane stress fracture toughness
kg	Kilogram
K_{IC}	Plane strain fracture toughness
km	Kilometer
kW	Kilowatt
LH_2	Liquid hydrogen
lbm	Pounds mass
m	Meter
MCAIR	McDonnell Aircraft Company
Mg	Megagram
min	Minute
mm	Millimeter
Mo	Molybdenum
N_2	Nitrogen

LIST OF ABBREVIATIONS AND SYMBOLS (Continued)

NASA	National Aeronautics and Space Administration
NDE	Nondestructive evaluation
NHFRF	National Hypersonic Flight Research Facility
Ni	Nickel
N.M.	Nautical Mile
PCM	Phase Change Material
RSI	Reusable Surface Insulation
s, sec	Second
Si	Silicon
SiC	Silicon Carbide
Sr	Tin
SST	Supersonic transport
SSTO	Single Stage To Orbit
Ta	Tantalum
TD	Thoria Dispersed
Ti	Titanium
TPS	Thermal Protection System
V	Vanadium
V_{\max}	Maximum velocity
Zr	Zirconium
α	Coefficient of thermal expansion
ΔK	Stress intensity factor difference
ω	Density

1. SUMMARY

Military and civil applications for hypersonic vehicles have been identified and studied. Many technological advances must be made before such vehicles can become operational. The greatest development challenges are expected to be those concerned with the propulsion and thermal/structural technologies. The objectives of this study were to identify required hypersonic thermal/structural technology advancements, to define an orderly process for pursuing these advancements, and to define the role of flight testing in that process.

The severe thermal environment encountered in hypersonic flight will place unique demands on vehicles required to repeatedly operate at these speeds. Accurate analytical methods will be needed. Detailed knowledge of the high temperature and long life characteristics of candidate structural materials will be required. Unconventional design concepts that require demonstration to prove their viability must be considered. While many thermal/structural concepts have been studied for hypersonic applications, few have been tested and none can be considered developed.

Since the study had to address a number of controversial issues, an effort was made to obtain opinions from many qualified individuals. Both NASA and the Air Force assigned monitors to the study. Other members of the aerospace community including Boeing, Lockheed, and Rockwell participated in the study. Dr. E. E. Sechler of the California Institute of Technology and Prof. R. H. Miller of the Massachusetts Institute of Technology were employed as study advisors. In many instances, the study results reflect a consensus from these participants.

The first task was to identify which hypersonic vehicles had the greatest potential for operational status in the next 20 to 25 years. Only manned hypersonic vehicles designed to conduct multiple flights were considered. There were strong arguments for the development of strategic reconnaissance aircraft to cruise at Mach 4.5 and, possibly, Mach 6.0. Most participants agreed that an advanced space transportation system will be developed. Some support was expressed for tactical strike aircraft and fleet air defense interceptors, both designed for about Mach 4.5. Finally, a Mach 6.0 class transport aircraft was considered a possibility. All of these applications would involve long flights at maximum speed with service life conditions that are much more demanding than those associated with current aircraft.

Previous studies were reviewed to identify candidate thermal/structural concepts suitable for the selected applications. Concepts considered include those hot structure, protected structure, and cooled structure concepts that can be employed over large surface areas, such as the fuselage, wings, and control surfaces. Also concepts applicable to leading edges, to thermal protection for cryogenic fuel tankage, and to air induction systems were considered. The advantages and disadvantages/limitations of each concept were assessed, its current status defined, and its applicability to the selected hypersonic vehicles established. Only two concepts, hot structure and radiative metallic thermal protection systems, were found to be adaptable to all of the proposed vehicle applications.

The status of thermal/structural technology was reviewed. This investigation covered analytical methods needed to evaluate the candidate concepts, materials that may be used, manufacturing techniques envisioned, and development of thermal/structural concepts. The analytical methods were found to be basically

adequate. However, better techniques for evaluating the effects of spectrum thermal/mechanical loading and more complete correlations of aerodynamic heating effects in complex flow regions would permit reduction of currently employed conservatisms. Also a lot of property data are available for the candidate metallic materials, but not much information is available regarding the effects of extended exposure to high temperatures. Since advanced composite materials are largely undeveloped, large data gaps exist.

No particular technical problems in manufacturing simple structures from conventional materials such as aluminum, graphite/epoxy, titanium, and superalloys were identified. However, fabricating complex assemblies, as required by some of the candidate concepts, from these materials will be expensive using existing techniques. Since little experience has been obtained with the more advanced composite materials, major advancements may be required. The materials must be developed to the point where they can be obtained in production quantities with proven quality control.

None of the candidate thermal/structural concepts can be considered developed. Efficient designs to alleviate thermal stresses in hot structure are not proven. Solutions to the inherent boundary layer air leakage problem associated with radiative metallic thermal protection systems have been proposed. However, extended tests to verify the solutions are required. Insulation durability remains a major concern with insulated structure concepts. Complex concepts, such as water cooled structure and actively cooled structure, require further development and demonstrations to prove their viability. The multimission capabilities of cryogenic tankage thermal protection designs are unknown. Numerous design problems are known to exist for the candidate air induction system concepts.

Examinations of previous programs showed that any required technology advances should be accomplished five to six years before the vehicles' initial operation capability date. Historical trends and engineering judgment were used to define "acceptable" levels of technology for each phase of a typical design program. This information, along with the technology status assessment, was used to identify technology gaps.

Twenty-eight specific technology needs were identified, each of which will represent a major technological advancement. These include four analytical advancements; six advancements to extend the knowledge of existing, or to develop new, materials; and eighteen advancements to further the development of thermal/structural design concepts. Plans were formulated which outline the necessary steps to fulfill each need.

Existing facilities were surveyed to establish their capabilities for the required ground testing. Nearly all the testing can be accomplished in existing facilities without major modifications. The only major deficiency is the lack of a facility in which to obtain meaningful thermal/structural data on full scale air induction systems. The only major new facility under construction, the Aeropropulsion Systems Test Facility being built at Arnold Engineering Development Center, may alleviate this situation when completed, but it will be limited to simulating Mach 3.8, or lower, speeds.

Flight testing was also addressed. Study participants agreed that flight testing of proposed thermal/structural concepts will be essential. Ground testing cannot result in the level of confidence derived from flight testing and cannot

duplicate all of the environmental aspects of flight. History shows that not all problems can be foreseen in advance. Most importantly, the hypersonic flight regime represents a major advancement and many unknowns may exist. This point was emphasized by the unanticipated test results obtained during hypersonic flights of the X-15.

The approach to flight testing was, therefore, examined. Obviously, delaying tests until they can be performed on a preproduction or prototype aircraft is risky. If a severe problem is uncovered at that time, a large investment may be endangered. Alternatively, large risks could be avoided through the use of flight research vehicles to obtain the necessary design confidence in advanced thermal/structural concepts. It was the consensus of the study participants that the latter approach, using a multipurpose vehicle on which various concepts could be evaluated simultaneously, would be cost effective despite the large cost associated with research vehicles and flight test programs. However, although thermal/structural technology can best be advanced with a flight research vehicle, meaningful advances are possible without such a vehicle.

A flight test program was outlined to illustrate how flight research vehicles could be used to advance technology. The availability of two research aircraft, similar to the National Hypersonic Flight Research Facility, was assumed. It was concluded that the replaceable structural sections of the aircraft afforded the means to accomplish the testing required by the technology needs. However, if research vehicles are not available until 1985, aircraft benefitting from flight research technology advancements could not be operational much before 1995. In the case of a Mach 4.5 strategic reconnaissance aircraft, this delay may be unacceptable. It appears, then, that near-term Mach 4.5 technology needs must be satisfied without the benefit of a flight research program or that plans for hypersonic research vehicles must be expedited and schedules compressed.

If hypersonic research vehicles are funded, a significant effort will be required to develop the thermal/structural concept for the test vehicle itself. An assessment of the basic test vehicle design philosophy was conducted. Recent studies, emphasized a minimum initial cost approach relying on insulated structure concepts, using RSI or ablation materials, and heat sink structure concepts, using Lockalloy or beryllium materials. These concepts have only limited applicability on future operational vehicles. Other concepts, such as hot structure and radiative metallic TPS concepts, have widespread applicability for future aircraft and should be included as candidates for research vehicle designs. Differences in initial cost, aerodynamic performance and vehicle mass were found to be small between these concepts and those with limited applicability. The benefits realized by developing a thermal protection system that has future application would be valuable in advancing technology at reasonable cost and risk.

Finally, the schedules and costs required to advance the technology were examined. To satisfy the 28 specific technology needs, including the preparation of flight test articles and test support requires a total investment of 16.3 million (1977) dollars per year for 16 years. Reduced scope options were also investigated including efforts devised to satisfy only higher priority needs. In any event, the required investments are substantial. Future planning should begin with the goal of satisfying three specific needs as required by near-term Mach 4.5 aircraft. This effort would require an investment of about 31 million (1977) dollars to obtain an acceptable development level through ground testing. An additional 22.2 million,

(1977) dollars, in addition to a substantial investment in flight research vehicles, would be required to prepare flight test programs to obtain the desired additional confidence in these three designs.

2. INTRODUCTION

There is a distinct possibility that a vehicle designed to fly hypersonically, i.e., in excess of Mach 4.0, will be produced in the not too distant future. A military aircraft with hypersonic speed capabilities may be required to insure our nation's security by providing an integral link in our defense structure or by providing a formidable offensive capability. Based on the technological success, to date, of the Concorde supersonic transport (SST), development of a commercial hypersonic transport (HST) is a definite possibility. An advanced space transportation system (ASTS) with long life capabilities and operational flexibilities typical of aircraft rather than reentry vehicles will probably need to be developed when the Space Shuttle program is concluded.

However, substantial advancements in certain technologies are required before these vehicles can become realities. It is generally acknowledged, as concluded in Reference (1), that the major existing technological deficiencies are the lack of proven airbreathing propulsion systems and thermal/structural concepts.

The basic objectives of this study were to:

- o Identify promising vehicle applications (Section 3)
- o Establish candidate thermal/structural concepts (Section 4)
- o Assess the technology state of the art (Section 5)
- o Identify technology needs (Section 6)
- o Define existing capabilities to satisfy these needs. (Section 7)
- o Examine the role that flight testing can fill in advancing the technology (Section 8)
- o Compare research aircraft design alternatives (Section 9)
- o Outline technology advancement programs (Section 10).

A concerted effort was made to keep the study as comprehensive and objective as possible, and both NASA and the Air Force assigned study monitors to the program. In addition, two distinguished experts were employed to critique the effort. Ernest E. Sechler, Professor of Aeronautics - California Institute of Technology, provided many helpful suggestions particularly on the subject of structural design for which he is eminently qualified. Rene H. Miller, Head of the Department of Aeronautics and Astronautics - Massachusetts Institute of Technology and currently President of the American Institute of Aeronautics and Astronautics (AIAA), assisted by sharing his knowledge of the broad subject of future aviation considerations for which he is uniquely qualified.

Finally, invitations were extended to members of the aerospace community to express their views and opinions regarding the more controversial subjects addressed in the study. Meetings were held with each company that expressed a desire to participate. These companies were Boeing Aerospace Co., Lockheed Aircraft Corp., and Rockwell International Aircraft Division. As a result, many of the study results reflect a consensus from a broad base of qualified participants.

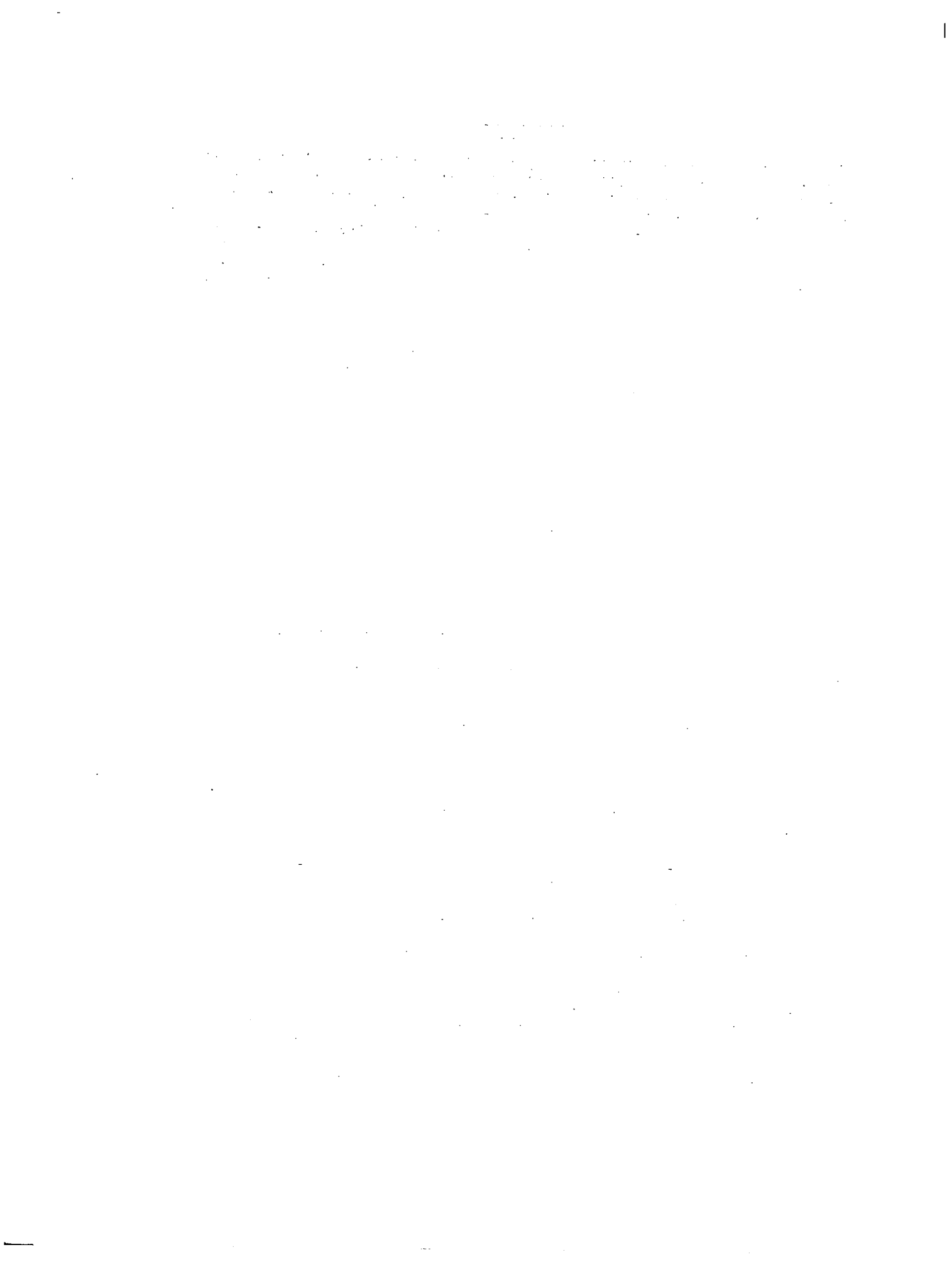

3. HYPERSONIC VEHICLE APPLICATIONS

The first step in this study was to identify which potential hypersonic vehicle applications offer the greatest promise of achieving operational status in the next 20 to 25 years. By selecting the most promising applications and characterizing their requirements, specific thermal/structural needs could be established.

3.1 POTENTIAL APPLICATIONS

Reference (2) provides a basic list of potential hypersonic vehicle applications. Additional applications were identified by examining recent MCAIR in-house studies, the Reference (1) and (3) studies, and opinions expressed by the other aerospace firms participating in the study.

Only manned vehicles designed to conduct multiple hypersonic flights were addressed. This eliminated hypersonic cruise missiles and unmanned booster vehicles from consideration. These applications involve only one flight, imposing no reuse requirements, which simplifies thermal/structural design. No major technological advances are necessary since conventional heat sink concepts, including those that employ ablative materials, are adequate.

Potential military hypersonic vehicle applications which were identified are discussed in the subsequent paragraphs:

A. Strategic Reconnaissance Aircraft - Aircraft that can fly higher and faster than the SR-71's currently used in this role. These vehicles will be required if the United States is to maintain a flexible crisis management reconnaissance capability. Enemy defensive capabilities have advanced to where SR-71's are quite vulnerable. This application was unanimously acknowledged as having the highest justification for hypersonic flight and being of the highest priority.

B. Tactical Strike Aircraft - Fighters with hypersonic speed capabilities to supplement a tactical force comprised primarily of supersonic strike fighters. Conventional fighters have adequate survivability against nonnuclear missile defenses unless their electronic warfare systems are rendered ineffective. In this event, hypersonic fighters, which would be less dependent on electronic countermeasures, could provide an offensive capability until the necessary adjustments are made to improve the conventional systems' effectiveness.

C. Fleet Air Defense Interceptor - Deck launched interceptors to protect aircraft carriers from direct targeting by enemy supersonic bombers. With airborne early warning capabilities, hypersonic interceptors could reach and kill enemy bombers before they reached an effective weapon release range. The strongest argument for this application is the high value placed upon the target it would protect.

D. Long Range Logistics Transport - High productivity transports to move equipment and troops long distances in short times. Hypersonic speeds can reduce logistic turnaround times and, hence, increase productivity. Major economic obstacles must be overcome to make this application viable.

E. CONUS Defense Interceptor - CONUS based interceptors to defend the North American continent against enemy supersonic bomber attacks. Hypersonic interceptors could afford protection of high value continental targets and force enemy bombers to carry longer range missiles. However, this protection is effective only against the

bomber threat, which is secondary to the ballistic missile threat, and therefore of questionable value.

F. Strategic Strike Aircraft - Bombers to serve as long range missile launchers. By launching missiles at hypersonic speeds the weapon size can be reduced. Bombers are recallable and reusable. In addition, the political implications of possessing a visible, credible offensive threat cannot be ignored. Still, the hypersonic bomber has some major disadvantages in that it is quite vulnerable to nuclear-tipped surface-to-air missiles and is more costly than missiles.

G. Theater Air Defense Interceptor - Aircraft to protect military targets near the battle area from enemy bombers. These interceptors could provide protection similar to the fleet air defense interceptor. However, the bomber is less of a threat, since land based military targets will not have the high value associated with aircraft carriers. The enemy has more attractive offensive threats, such as short range missiles, and probably would not use bombers in this role.

H. Anti-Submarine Warfare, Close Air Support, and Air Superiority Fighter Aircraft - Hypersonic versions of these traditional aircraft applications. Studies have not identified any particular advantages for these systems. In fact, since long endurance and high maneuverability are desirable traits for these applications, high speeds are likely to be detrimental.

Potential non-military hypersonic vehicle applications which were identified are as follows:

A. Advanced Space Transportation System (ASTS) - Manned space vehicles phasing into service as the Space Shuttle program ends. There is general agreement that, as long as the Shuttle program is successful, a Shuttle follow-on vehicle will be developed. The advanced system will be designed for lower operating costs, no throw-away structure, and more operational flexibility. How these goals can best be achieved is still debatable.

The major difference in proposed system approaches involves the means used to achieve orbital velocities. Two stage systems which employ a reusable air breathing launch vehicle (ABLV) for an orbiter vehicle have been investigated, References (4) and (5). Single-stage-to-orbit (SSTO) vehicle concepts with horizontal landing capability have also been the subject of recent studies, References (6) and (7). A novel concept consisting of an orbiter vehicle boosted by small, reusable turbojet-powered boosters is presently being examined by NASA.

B. Hypersonic Transport (HST) - A commercial airliner to reduce block times on long routes such as New York to Tokyo, etc. The potential advantages of Mach 6.0 speeds include appeal to business travelers and new market opportunities for airlines.

3.2 SELECTION OF MOST PROMISING APPLICATIONS

The potential hypersonic applications identified in Section 3.1 were scrutinized to select those applications having the greatest potential to fulfill

foreseeable needs. The earliest possible initial operation capability (IOC) dates were estimated for each application. Opinions were solicited from NASA and Air Force personnel as well as from the study advisors and participants from other aerospace companies. No dramatic increases in aerospace funding due to national emergencies or policies were assumed. At the same time, it was assumed that sufficient justification will be identified to continue aerospace progress into the hypersonic flight regime in the near future.

The development of hypersonic strategic reconnaissance aircraft is a nearly certain need. A Mach 4.5 version should be developed as soon as possible to regain the speed/altitude margin required to be invulnerable to enemy defenses. A Mach 6.0 version will probably be required by the year 2000 to retain this advantage. It is also quite likely that an advanced space transportation system will be developed to be operational by 1995, after the Space Shuttle program phases out.

While there is near unanimity expressed about the strategic reconnaissance aircraft and advanced space transportation systems, opinions about other promising applications are more diverse. Nevertheless, some additional applications were selected for thermal/structural planning. These include two additional Mach 4.5 military aircraft: a tactical strike aircraft and a fleet air defense interceptor, with possible IOC dates of 1990 and 1995 respectively. Finally, a Mach 6.0 transport that might satisfy both military and civil applications was selected, with an IOC date of 2000.

Table 1 provides a summary of the hypersonic applications selected as being most promising. The requirements of these applications formed the bases for thermal/structural planning.

Table 1
Promising Hypersonic Applications

APPLICATION	EARLIEST IOC DATE
Mach 4.5 Strategic Reconnaissance Aircraft	As soon as possible
Mach 4.5 Tactical Strike Aircraft	1990
Advanced Space Transportation System	1995
Mach 4.5 Fleet Air Defense Interceptor	1995
Mach 6.0 Strategic Reconnaissance Aircraft	2000
Mach 6.0 Transport	2000

3.3 THERMAL/STRUCTURAL CHARACTERISTICS OF SELECTED APPLICATIONS

Each of the selected hypersonic applications, listed in Table 1, was examined to establish typical thermal/structural requirements imposed by the vehicular class operating characteristics. These requirements formed the basis upon which candidate thermal/structural concepts could be determined.

Table 2, which summarizes typical Mach 4.5 vehicle requirements, emphasizes the similarities among the three vehicles. Since these aircraft will be designed to cruise at approximately the same altitude, the maximum surface temperatures will be similar. The only significant differences involved are (1) the time, per mission, spent at maximum speeds (hence temperatures) and (2) the acceleration requirements.

Table 2
Mach 4.5 Aircraft Requirements

	STRATEGIC RECONNAISSANCE AIRCRAFT CLASS	TACTICAL STRIKE AIRCRAFT CLASS	FLEET AIR DEFENSE INTERCEPTOR CLASS
Earliest Initial Operation Capability (IOC) Date	As soon as possible	1990	1995
Cruise Altitude, km (ft)	30.5 (100,000)	26 (85,000)	26 (85,000)
Range, Mm (N.M)	9.26 (5000)	2.78 (1500)	2.22 (1200)
Mission Time at Vmax, min.	90	30	25
Rapid Acceleration	Desirable	Necessary	Necessary
Surface Temperatures, K(°F):			
Upper Fuselage	644-700 (700-800)	Same	Same
Lower Fuselage	755-866 (900-1100)		
Upper Wing	672-728 (750-850)		
Lower Wing	783-866 (950-1100)		
Tail	755-811 (900-1000)		
Leading Edges	811-978 (1000-1300)		
Engine Inlet Walls	950-1061 (1250-1450)		
Service Life, hr.	4000	Same	Same
Accumulated Time at Maximum Surface Temperatures, hr.	3000	Same	Same

The strategic reconnaissance aircraft may have a requirement to cruise at V_{max} for as long as 90 minutes, which is three to four times longer than for the other Mach 4.5 aircraft. In most thermal/structural concepts this will result in additional mass to absorb the additional heat. On the other hand, the tactical strike aircraft and the fleet air defense interceptor will need more rapid acceleration. This will produce larger temperature gradients through the structure, and the design provisions required to accommodate the resulting thermal deformations may have a significant effect on thermal/structural mass.

Consistent with existing requirements for military aircraft, it was assumed that these vehicles must be designed for a service life of 4000 hours. However, while current aircraft are seldom required to perform missions involving their maximum speed capabilities, hypersonic aircraft will spend large fractions of their service life at maximum speeds. It was estimated that 3000 hours at V_{max} could be accumulated by these hypersonic aircraft. As a result, the effects of long time temperature exposures will be a unique design consideration for these advanced thermal/structural concepts.

Advanced space transportation system (ASTS) requirements are more difficult to define since, as discussed in Section 3.1, various configuration options are still being examined. However, information from Reference (6) is believed to be representative and is presented in Table 3. Maximum heating is expected to occur during reentry at a velocity of approximately 6500 m/s (21,300 ft/sec) and an altitude of 60 km (197,000 ft).

Table 3
Space Transportation System Requirements

Earliest Initial Operation Capability (IOC) Date	1995
Surface Temperatures, K (°F)	
Upper Fuselage	589-644 (600-700)
Lower Fuselage	1144-1533 (1600-2300)
Upper Wing	589-811 (600-1000)
Lower Wing	1200-1533 (1700-2300)
Tail	755-922 (900-1200)
Leading Edges	1089-1866 (1500-2900)
Service Life, Missions	500
Accumulated Time at Elevated Surface Temperatures, hr.	250

Mach 6.0 vehicle requirements are estimated in Table 4. Many of the Mach 6.0 strategic reconnaissance aircraft requirements are like those of the Mach 4.5 aircraft. The mission time at V_{max} is lower for the Mach 6.0 version since the range requirements are unchanged. Temperatures for Mach 6.0 leading edges and engine inlet walls are much higher than those associated with Mach 4.5 designs. However, fuselage and wing temperatures should remain below 1089 K (1500°F).

Mach 6.0 long range logistic/hypersonic transports will probably be designed for long service life. As shown in Table 4, a service life of 40,000 hours has been estimated, along with an accumulated time at V_{max} of 20,000 hours. This may have a significant influence on the types of thermal/structural concepts that can be considered. Table 4 also presents cooled surface heating rates for the Mach 6.0 vehicles since cooled structure concepts are logical candidates for these applications.

Table 4
Mach 6.0 Aircraft Requirements

	STRATEGIC RECONNAISSANCE AIRCRAFT CLASS	TRANSPORT CLASS
Earliest Initial Operation Capability (IOC) Date	2000	2000
Cruise Altitude, km (ft)	35 (115,000)	30.5 (100,000)
Range, Mm (N.M.)	9.26 (5000)	Same
Mission Time at V_{max} , min.	75	60
Rapid Acceleration	Desirable	Unnecessary
Surface Temperatures, K(°F):		Same
Upper Fuselage	700-811 (800-1000)	
Lower Fuselage	811-1089 (1000-1500)	
Upper Wing	700-755 (800-900)	
Lower Wing	866-978 (1100-1300)	
Tail	783-839 (950-1060)	
Leading Edges	1255-1422 (1800-2100)	
Engine Inlet Walls	1589-1700 (2400-2600)	
Cooled Surface Heating Rates, kW/m ² (Btu/ft ² sec.):		Same
Upper Fuselage	17-45 (1.5-4)	
Lower Fuselage	45-277 (4-20)	
Upper Wing	17-34 (1.5-3)	
Lower Wing	57-91 (5-8)	
Tail	40-51 (3.5-4.5)	
Leading Edges	113-454 (10-40)	
Engine Inlet Walls	113-5675 (10-500)	
Service Life, hr.	4000	40,000
Accumulated Time at Maximum Surface Temperatures, hr.	3000	20,000

4. CANDIDATE THERMAL/STRUCTURAL CONCEPTS

Previous hypersonic vehicle studies were examined to identify those concepts that merit consideration as candidates for the applications selected in Section 3.2. Concepts that employ ablative materials were not considered for these applications. These concepts are attractive only for short missions and present problems in vehicle mission turnaround considerations.

The concepts addressed in this study are those readily identifiable as airframe structure, including the fuselage, wings, tails, empennage, control surfaces, leading edges, internal structure, fuel tankage, and air induction system. Radomes and transparencies, areas with specialized requirements, were not included in the study.

4.1 CONCEPTS APPLICABLE FOR GENERAL USAGE

Many thermal/structural concepts are candidates for use over large areas of the fuselage, wings, empennage, and control surfaces. These concepts are described in this section.

A. Hot Structure - Concepts in which the moldline structure serves as the primary load-carrying structure and is permitted to attain a radiation equilibrium temperature dependent upon the aerodynamic heating environment are referred to as "hot structure". Such concepts are employed in supersonic aircraft design. Many hot structure configurations have been proposed for hypersonic applications as indicated in Figure 1. They have many advantages, but can be heavy when designed for severe temperature environments.

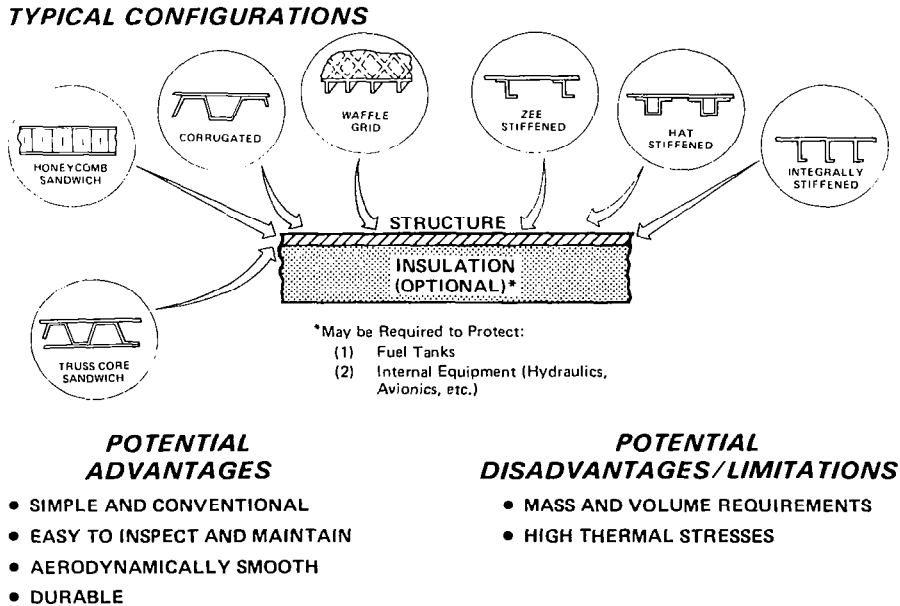
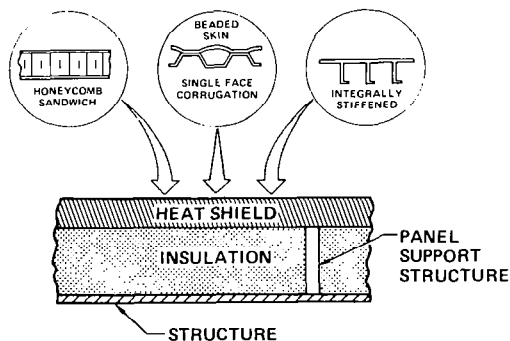

FIGURE 1
HOT STRUCTURE

B. Radiative Metallic Thermal Protection System (TPS) - As shown in Figure 2, this concept includes a moldline heat shield and insulation to protect the primary structure. The concept has been selected in various hypersonic aircraft studies, including Reference (8), and was considered for the Space Shuttle, Reference (9). Testing has been conducted to demonstrate its performance, as reported in References (10) and (11). By varying the heat shield material and configuration and employing different insulating materials, this concept can be used for a wide range of conditions. However, the design is somewhat complex since it must allow for thermal expansion while restricting boundary layer leakage to the structure.

TYPICAL HEAT SHIELD CONFIGURATIONS



POTENTIAL ADVANTAGES

- VERSATILITY, COMPETITIVE OVER WIDE RANGE OF DESIGN CONDITIONS
- REASONABLE INSPECTABILITY AND MAINTAINABILITY
- DURABLE AND REUSABLE

POTENTIAL DISADVANTAGES/LIMITATIONS

- MUST BE DESIGNED TO RESTRICT BOUNDARY AIR LEAKAGE YET PROVIDE FOR THERMAL EXPANSION
- ROUGHNESS OF SOME CONCEPTS DEGRADES AERODYNAMIC PERFORMANCE
- COMPLEX ARRANGEMENT
- HEAT SHORTS

FIGURE 2
RADIATIVE METALLIC THERMAL PROTECTION SYSTEM

C. Externally Insulated Structure - This concept protects the primary structure by bonding an insulation material to it as indicated in Figure 3. Reusable surface insulation (RSI) materials are currently being developed for the Space Shuttle, which employs this concept extensively. The performance of RSI materials in simulated hypersonic environments has been demonstrated, as discussed in Reference (12). Silicone elastomeric materials have also been examined for hypersonic flight research vehicle applications, as discussed in Reference (13). This concept's major advantage is its simplicity. However, the lack of durable insulation materials could pose a problem for long life hypersonic vehicles.

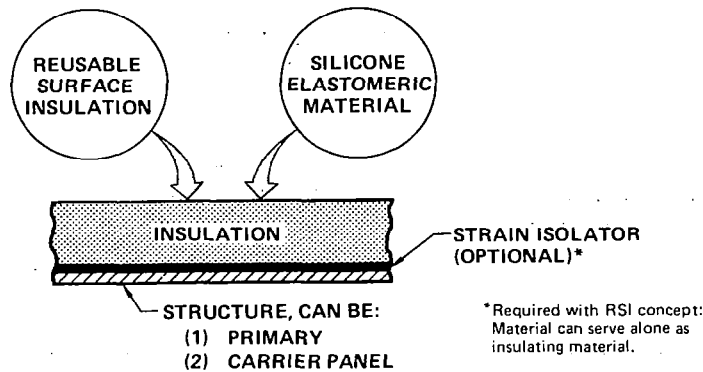

POTENTIAL ADVANTAGES

- SIMPLE STRUCTURE USING LOW TEMPERATURE MATERIALS
- CONCEPT EXPERIENCE FROM SPACE SHUTTLE (RSI)
- HIGH TEMPERATURE CAPABILITY (RSI)

POTENTIAL DISADVANTAGES/LIMITATIONS

- LIMITED REUSABILITY OF INSULATION
- DIFFICULT TO INSPECT STRUCTURE
- MISSION TURNAROUND TIME IS RESTRICTED
- MATERIAL BRITTLENESS (RSI)

**FIGURE 3
EXTERNALLY INSULATED STRUCTURE**

D. Water Cooled Structure - Vehicle studies reported in References (14) and (15) have indicated that this concept, shown in Figure 4, is significantly lighter than other thermal/structural concepts sized for extended hypersonic cruise missions. The concept takes advantage of the extraordinary heat capacity afforded by water. Heat shield and insulation materials, similar to those required for the radiative metallic TPS concept (Figure 2), are used to reduce the heat transferred to the water which is retained in a wicking material covering the structure. When heated, the water boils and is vented overboard. The primary disadvantages associated with this concept are operational and can be resolved only by testing.

E. Heat Sink Structure - This concept is basically a hot structure concept, as described in Figure 1, since the moldline structure serves as the primary load-carrying structure. However, sufficient material mass is included to limit the maximum temperature to a level compatible with the chosen material's capabilities. Materials that possess high heat capacities, such as beryllium and Lockalloy, are well suited for use as heat sink materials, although, as on the Space Shuttle, even aluminum is adaptable to this concept. The concept is attractive for short flights such as those envisioned for hypersonic research aircraft, References (16) and (17), and re-entry vehicles. The long cruise times projected for operational hypersonic aircraft may create excessive mass requirements for this concept.

F. Phase Change Material (PCM) Cooled Structure - As shown in Figure 5, this concept employs a phase change material, positioned in the cells of a honeycomb panel to restrict structural temperatures. Insulation, bonded to the panel external surface reduces the heat that must be absorbed by the PCM. Preliminary studies of this concept as a candidate for the Space Shuttle, reported in Reference (18), indicated a lower weight than concepts using only insulation to protect the structure.

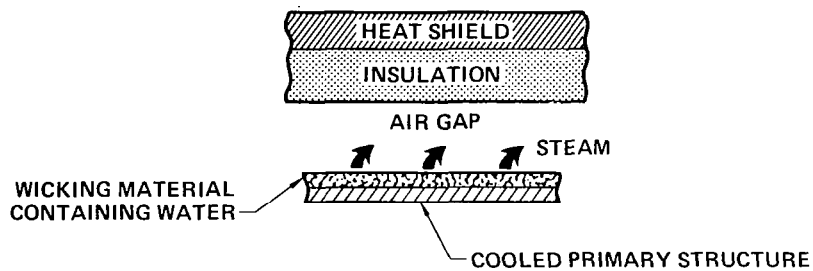

**POTENTIAL
ADVANTAGES**

- LOW WEIGHT
- VOLUMETRIC EFFICIENCY
- TOLERANCE TO OFF-DESIGN HEATING
- LOW STRUCTURAL TEMPERATURES

**POTENTIAL
DISADVANTAGES/LIMITATIONS**

- COMPLEX SYSTEM ARRANGEMENT
- LOCALIZED LOSSES OF WATER
- COMPATIBILITY WITH STRUCTURAL MATERIALS
- MISSION TURNAROUND TIME IS RESTRICTED
- DIFFICULT TO MONITOR

**FIGURE 4
WATER COOLED STRUCTURE**

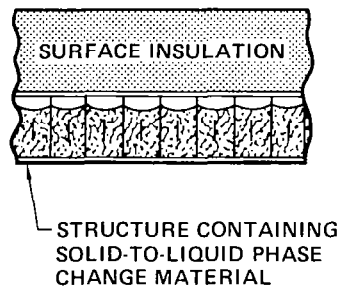

**POTENTIAL
ADVANTAGES**

- LOW WEIGHT
- TOLERANCE TO OFF DESIGN HEATING
- LOW STRUCTURAL TEMPERATURES

**POTENTIAL
DISADVANTAGES/LIMITATIONS**

- MISSION TURNAROUND TIME IS RESTRICTED
- LOCALIZED LOSSES OF PHASE CHANGE MATERIAL
- COMPATIBILITY WITH STRUCTURAL MATERIALS
- DIFFICULT TO MONITOR AND INSPECT

**FIGURE 5
PHASE CHANGE MATERIAL COOLED STRUCTURE**

Although this concept was not investigated further, it merits consideration for advanced space transportation systems.

G. Actively Cooled Structure - The use of external aluminum structure, which is actively cooled to allowable temperatures, was proposed in Reference (19). By flowing a liquid coolant through passages in the panel, as indicated in Figure 6, the aerodynamic heat load can be absorbed. A closed loop system is employed to circulate the coolant to a heat exchanger where the heat is rejected to cryogenic fuel, which is delivered to the propulsion system. A number of analytical studies, References (20), (21), (22), (23) and (24), evaluated various aspects of this design approach. In addition, as reported in Reference (25), efforts are underway to fabricate and test the various panel configurations indicated in Figure 6. Since one of the major concerns with this concept involves the complexities of matching air-frame heat loads to the available fuel heat sink, means of limiting the heat to be absorbed by using additional thermal protection have also been investigated as reported in Reference (26). The potential problems associated with the large "plumbing system" required to route coolant and fuel over large distances have not yet been investigated in adequate detail. Also, the possibility of employing a gas as the transport fluid in applications and/or designs that produce reasonably low heat fluxes may merit consideration. The results from studies to date have established this concept as a viable candidate for hypersonic vehicle applications.

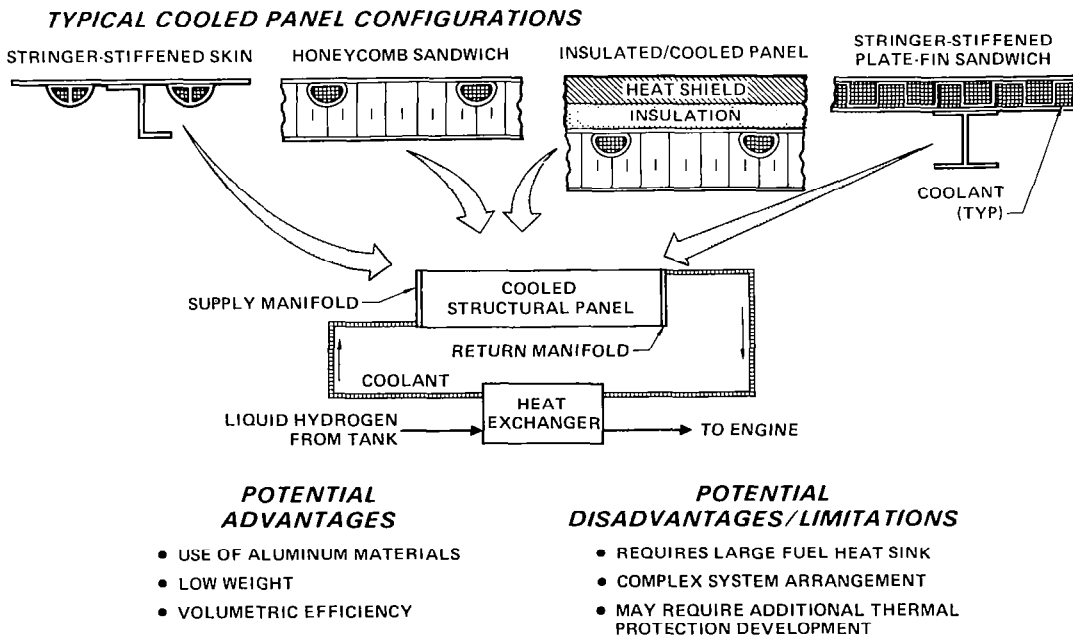

**FIGURE 6
ACTIVELY COOLED STRUCTURE**

4.2 LEADING EDGE CONCEPTS

Wing and tail leading edges attain significantly higher temperatures than other surface areas, and also pose design complications due to surface curvature and small section height. Leading edge temperatures can be lowered by increasing the radius. However, larger radii also increase aerodynamic drag which makes design compromises necessary. Candidate concepts are discussed in the following paragraphs.

A. Hot Structure - Conventional leading edge designs, as shown in Figure 7, are desirable until temperatures force the use of heavy materials, such as refractories and ceramics, which may result in large mass penalties.

B. Externally Insulated Structure - One means of keeping leading edge structure at reasonable temperatures is to insulate it, as indicated in Figure 8. The major drawback to this approach is finding an insulation material that is sufficiently durable and reusable.

C. Phase Change Material Cooled Structure - This concept, shown in Figure 9, employs rows of heat pipes brazed to the structural skin to distribute heat evenly over the surface, thus eliminating local hot spots along the flow stagnation line. The concept was studied for Space Shuttle applications as discussed in Reference (18) and has recently been tested as reported in Reference (27).

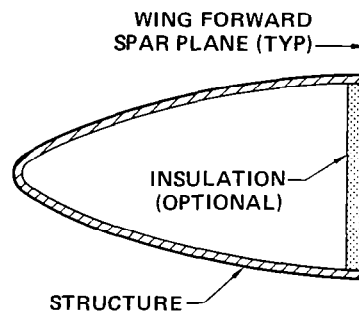

POTENTIAL ADVANTAGES

- SIMPLE STRUCTURE
- EASY TO INSPECT AND MAINTAIN

POTENTIAL DISADVANTAGES/LIMITATIONS

- TEMPERATURE LIMITED

**FIGURE 7
HOT STRUCTURE - LEADING EDGE**

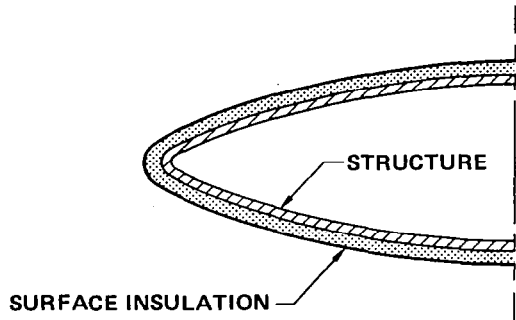

POTENTIAL ADVANTAGES

- CAN WITHSTAND HIGH TEMPERATURES
- SIMPLE STRUCTURE

POTENTIAL DISADVANTAGES/LIMITATIONS

- DURABILITY AND REUSABILITY
- DIFFICULT TO INSPECT STRUCTURE
- HEAVY FOR LONG DURATION MISSIONS

FIGURE 8
EXTERNALLY INSULATED STRUCTURE - LEADING EDGE

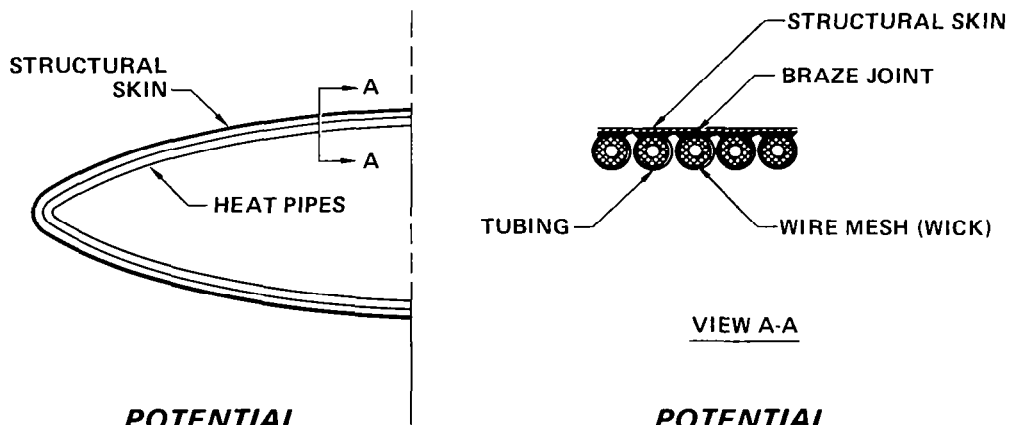

POTENTIAL ADVANTAGES

- USE OF LOW TEMPERATURE METALS
- REASONABLE COST

POTENTIAL DISADVANTAGES/LIMITATIONS

- WEIGHT
- RELIABILITY
- LEADING EDGE RADIUS REQUIREMENT

FIGURE 9
PHASE CHANGE MATERIAL COOLED STRUCTURE - LEADING EDGE

D. Actively Cooled Structure - Actively cooled leading edge structures merit consideration because they permit the use of conventional materials. A typical concept shown in Figure 10 supplies coolant, via a spray bar arrangement, to the interior of an end cap to absorb the maximum heat loads. The coolant then passes through panels adjacent to the end cap and is routed to a heat exchanger to reject the absorbed heat. These panels can be fabricated of aluminum or, possibly, they can be superplastically formed and diffusion bonded using titanium, despite the low thermal conductivity of titanium, as indicated in Figure 10. This concept would be compatible with an overall actively cooled structure airframe design. Actively cooled leading edge concepts have not been developed beyond the preliminary design and test stages.

4.3 CRYOGENIC FUEL TANKAGE THERMAL/STRUCTURAL CONCEPTS

Many of the future hypersonic vehicles will use cryogenic fuels. Liquid hydrogen (LH₂) is mentioned most frequently due to its high heat of combustion and its large cooling capacity. Since the design problems associated with LH₂ storage are typical of, or more severe than those encountered with other cryogenic fuels, designs addressing LH₂ considerations specifically are of the greatest interest.

There are numerous problems associated with the storage of LH₂. Extreme temperature differences between the vehicle surface structure and the fuel can result in excessive fuel boiloff unless heat transfer can be minimized. These differences also complicate structural design by presenting the potential for high thermal stresses. Also, unless a means can be provided to insure that air cannot reach the tank walls, the air will cryopump to the walls and condense, producing excessive fuel boiloff.

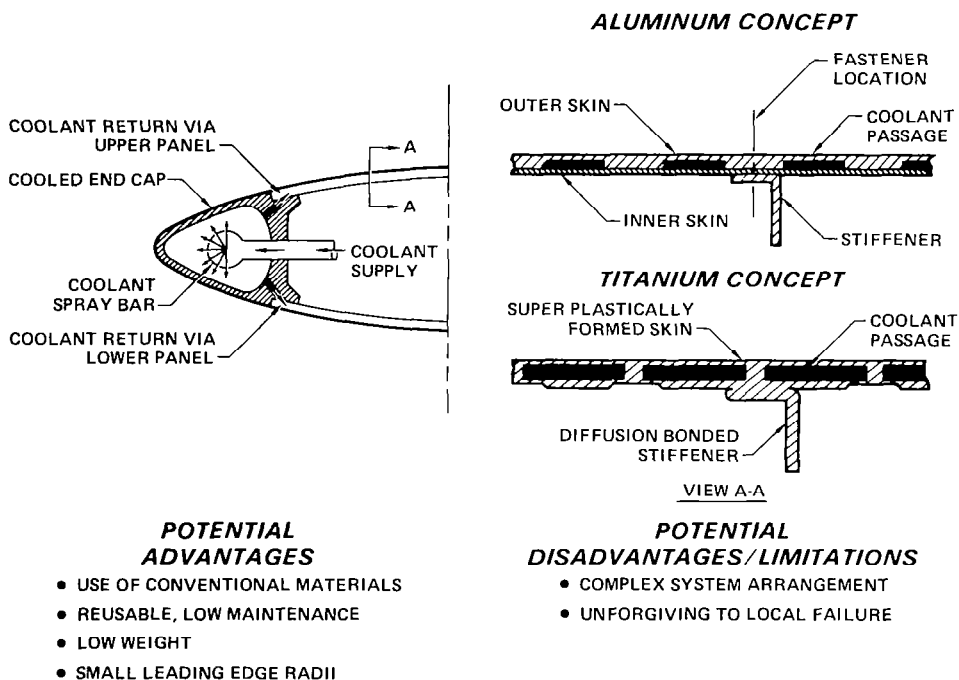

FIGURE 10
ACTIVELY COOLED STRUCTURE - LEADING EDGE

The safety of handling hydrogen, which has low energy requirements for ignition, is also a concern. Other problems, such as pressure containment, hydrogen embrittlement, cost, etc., have also been identified. Although tank shaping and configuring, to be either integral or non-integral structurally, are also design issues, these considerations are relatively independent of thermal protection concerns.

LH₂ thermal protection system concepts that have been studied are as follows:

A. Internal Insulation - Positioning low density cryogenic foam insulations inside the tank walls offers a simple approach to prevent cryopumping. A gap through which a purge gas may pass, as shown in Figure 11, would be required to prevent leakage gaseous buildups. However these systems were shown, in References (28) and (22), to be inefficient because hydrogen gas permeates these insulations, increasing their thermal conductivities. If a vapor barrier material, shown in Figure 11, could be developed to prevent hydrogen gas permeation of the insulations, the internal insulated concept would be attractive. However, to date, little progress has been made.

B. Evacuated Insulation - Thermal protection for land-based cryogenic fuel storage is often provided by enclosing the tank in a vacuum. Attempts have been made to develop flight-weight sealed systems based on this principle. Figure 12 shows a typical proposed design, which uses a multilayer evacuated insulation wrapped around the tankage. Potentially this design approach should be highly efficient. However, systems that have been fabricated and tested have been found to be unreliable, References (29) and (30). They tend to develop leaks and lose their insulating qualities.

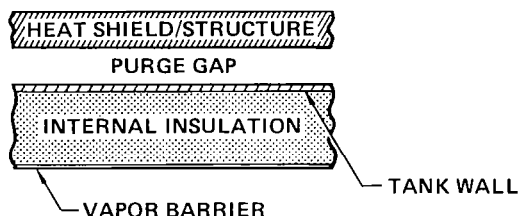

POTENTIAL ADVANTAGES

- SIMPLICITY
- MINIMIZES THERMAL GRADIENTS BETWEEN EXTERNAL STRUCTURE AND TANK WALL

POTENTIAL DISADVANTAGES/LIMITATIONS

- LIGHTWEIGHT AND RELIABLE GH₂ VAPOR BARRIER MATERIAL HAS NOT BEEN DEVELOPED

FIGURE 11
LH₂ INTERNAL INSULATION, TPS CONCEPT

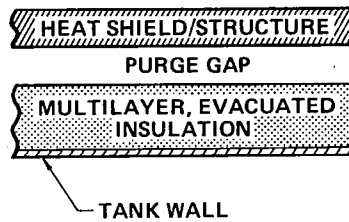

POTENTIAL ADVANTAGES

- HIGH THERMAL EFFICIENCY
- SIMPLICITY

POTENTIAL DISADVANTAGES/LIMITATIONS

- SEALING REQUIREMENTS MAY BE TOO SEVERE TO ACHIEVE WITH FLIGHT WEIGHT STRUCTURE

FIGURE 12
LH₂. EVACUATED INSULATION, TPS CONCEPT

C. External Insulation - Early attempts to design LH₂ TPS concepts with cryogenic insulation located on the tankage exterior concluded that the obvious way to prevent excessive cryopumping was to purge the region surrounding the tankage with helium, which does not liquify at LH₂ temperatures. However, while this approach is simple it was found to be both inefficient (due to helium's high thermal conductivity) and costly (due to the expense of helium) as discussed in Reference (31). A recent study, summarized in Reference (32), offers an alternate design approach, using a layered external insulation system. As indicated in Figure 13, two different insulations are wrapped around the tankage in layers and nitrogen (N₂) is used as a purge gas. A closed-cell insulation is located adjacent to the tankage and is protected, in turn, by a high temperature insulation. The insulations are sized to maintain the interface between layers above the N₂ freezing point which prevents the formation of cryodeposits. Nitrogen gas is inexpensive and readily available.

D. Active - At least two LH₂ TPS designs that can be classified as "active" have been investigated. These concepts, shown in Figure 14, are referred to as the carbon dioxide (CO₂) frost system and the water heat sink system. The CO₂ frost system, described in References (33) and (34), uses frost, which is deposited in fibrous insulation around the tankage prior to flight, to absorb heat during flight and, simultaneously, provide a purging capability. This purge capability is produced as the CO₂ frost sublimates when absorbing heat. The water heat sink system, described in Reference (1), uses a similar principle. Water is distributed in fibrous insulation around the tankage and freezes prior to takeoff. During flight, the water absorbs incoming heat and passes overboard as steam, thereby providing a purge capability. Each of these concepts has unique advantages as indicated in Figure 14.

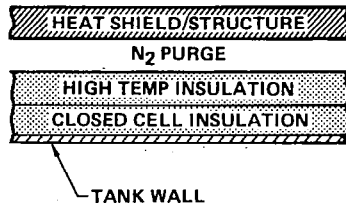

POTENTIAL ADVANTAGES

- CAN USE AVAILABLE INSULATIONS
- PURGING CAN BE ACCOMPLISHED AT REASONABLE COST

POTENTIAL DISADVANTAGES/LIMITATIONS

- CLOSED CELL INSULATION TEMPERATURE LIMITATIONS
- DIFFICULT INSPECTION

FIGURE 13
LH₂. LAYERED EXTERNAL INSULATION, TPS CONCEPT

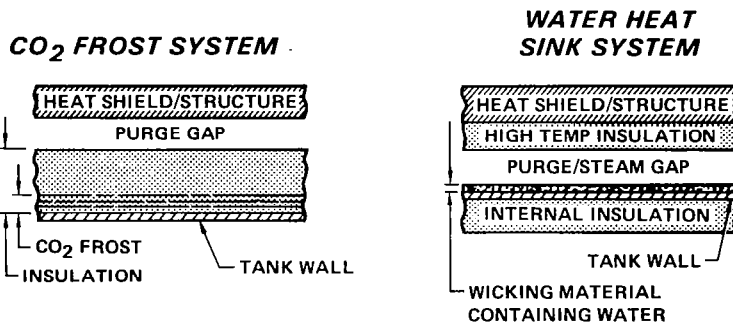

POTENTIAL ADVANTAGES

- | | |
|---|---|
| <ul style="list-style-type: none"> • LIMITS LH₂ BOILOFF AND PROVIDES PURGE CAPABILITY SIMULTANEOUSLY • NO LIQUID PHASE | <ul style="list-style-type: none"> • LIMITS LH₂ BOILOFF AND PROVIDES PURGE CAPABILITY SIMULTANEOUSLY • SIMILAR TO WATER COOLED STRUCTURE USED IN NON-TANKAGE AREAS |
|---|---|

POTENTIAL DISADVANTAGES/LIMITATIONS

- | | |
|--|--|
| <ul style="list-style-type: none"> • COMPLEX PREFLIGHT GROUND HANDLING REQUIREMENTS • DIFFICULT INSPECTION | <ul style="list-style-type: none"> • INSPECTION AND MAINTENANCE REQUIREMENTS • COMPATIBILITY WITH STRUCTURAL MATERIALS |
|--|--|

FIGURE 14
LH₂. ACTIVE, TPS CONCEPTS

4.4 AIR INDUCTION SYSTEM CONCEPTS

Another region that requires special attention is the air induction system required for airbreathing propulsion installations. Thermal/structural arrangements are exposed to both high temperatures (heat cannot be radiated away from the internal surfaces) and pressures. Air leakage through the structure must be controlled and movable ramps are incorporated in the designs. The problems associated with air induction systems are definitely more difficult to solve than those associated with other regions of the vehicle.

These systems can be structurally integrated within the overall airframe design or can be modular designs attached to the airframe structure. Hypersonic studies have favored the modular design, based on the rationale presented in Figure 15. Thermal/structural considerations acknowledged in this study were based on modular design requirements although, in most cases, the considerations are also applicable to air induction systems that are structurally integrated.

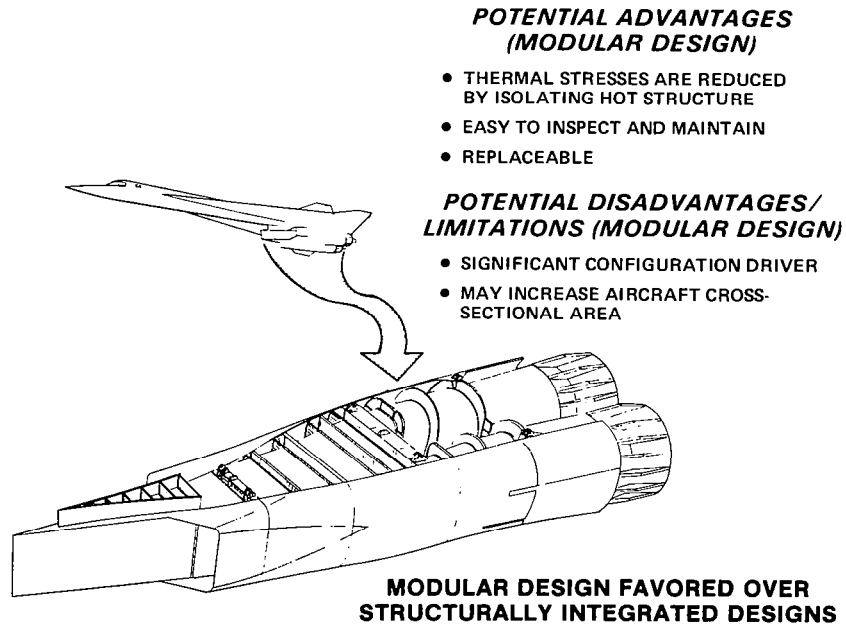

**FIGURE 15
MODULAR PROPULSION SYSTEM**

Movable components of air induction systems, such as ramps, present unique design considerations. However, the thermal stresses in the non-movable structure, from the inlet duct liner to the external moldline structure, normally dictate the selection of thermal/structural concepts. Concepts that have been investigated for hypersonic vehicle applications include the following:

A. Hot Structure - As indicated in Figure 16, a number of structural arrangements in which temperatures rapidly achieve steady state levels within the imposed thermal environment have been investigated. The major difference between these concepts is the manner in which thermal stresses are alleviated. All of these concepts are reasonably easy to fabricate, compared to the alternate concepts discussed in the following paragraphs. The study discussed in Reference (35) concluded that hot superalloy structure is the most viable choice for hypersonic aircraft designed for speeds up to about Mach 4.5.

B. Insulated Structure - Air induction system structure design requirements are normally most critical during acceleration. Therefore, insulated concepts, as shown in Figure 17, have been investigated to determine if mass can be reduced by delaying the temperature response of the structure. These concepts must provide for a floating metallic duct liner, which is complicated, or a hard insulation duct liner, which would require an extremely durable material. In addition, insulated structure concepts require large quantities of insulation. This poses volumetric difficulties and would restrict operational capabilities, since it would be necessary to permit the insulation to cool off before conducting a second mission. Based on Reference (35), the insulated structure concept does not appear promising.

C. Actively Cooled Structure - Studies, including Reference (1), have shown that actively cooled air induction systems will probably be a necessity for aircraft intended to fly Mach 6.0 or above. The mass resulting from the use of hot refractory or ceramic materials over large surface areas such as an aircraft inlet becomes prohibitive.

Figure 18 shows two typical actively cooled structure concepts. These designs employ an intermediate coolant or, more directly, the fuel, to pass through the duct liner structure and absorb heat. They can be incorporated whether or not the remaining airframe structure is actively cooled. An actively cooled structure concept is being considered for scramjet propulsion modules. These designs are used to reduce structural temperatures at least to the point where superalloys can be used.

4.5 INTERNAL/PROTECTED STRUCTURE

Structure remote from the moldline surfaces, such as protected substructure, non-cryogenic fuel tanks, internal compartment walls, etc., do not impose severe problems to hypersonic vehicle design. The long life requirements of these vehicles may be significant in isolated instances. Developments in advanced composites with moderate temperature capabilities are warranted however, in order to reduce the mass requirements of these structural components.

4.6 CONCEPT APPLICABILITY

The applicability of candidate concepts to the promising vehicles identified in Table 1 was established. These vehicles could reasonably be grouped as (1) Mach 4.5 aircraft, (2) Advanced Space Transportation Systems, and (3) Mach 6.0 aircraft. Table 5 identifies the applicability, which was derived by examining the concept rationale provided in Sections 4.1 through 4.5 and considering the opinions expressed by other study participants.

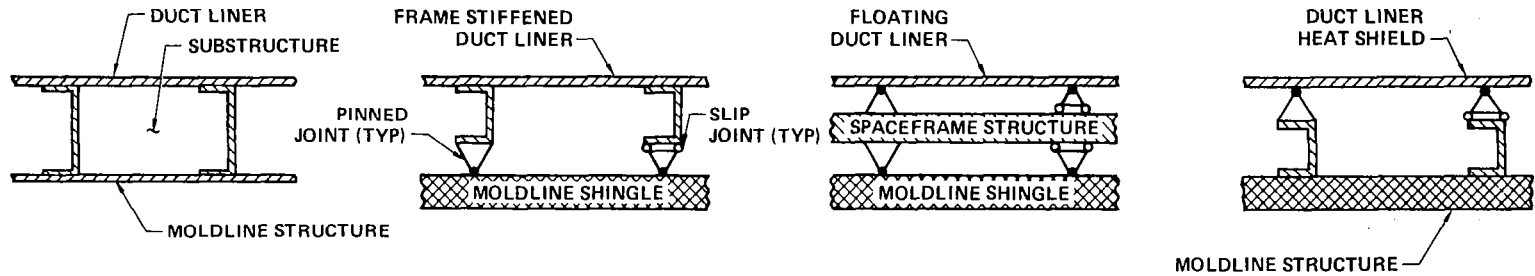

POTENTIAL ADVANTAGES

- BLEED-AIR-CONTROL COMPATIBILITY
- MULTIPURPOSE STRUCTURAL ELEMENTS

- EASY TO INSPECT AND MAINTAIN

- MINIMAL THERMAL STRESSES
- EASY TO INSPECT AND MAINTAIN

- EASY TO INSPECT AND MAINTAIN

POTENTIAL DISADVANTAGES/LIMITATIONS

- DIFFICULT TO INSPECT AND MAINTAIN

- LEAKAGE
- BLEED-AIR-CONTROL COMPATIBILITY

- LEAKAGE
- BLEED-AIR-CONTROL COMPATIBILITY

- LEAKAGE
- BLEED-AIR-CONTROL COMPATIBILITY

**FIGURE 16
HOT STRUCTURE AIR INDUCTION SYSTEM DESIGNS**

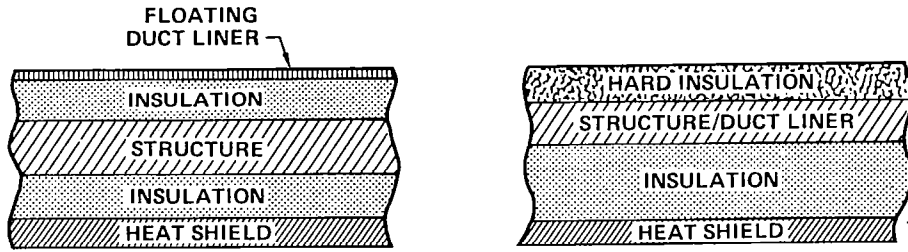

POTENTIAL ADVANTAGES

- REDUCED STRUCTURAL TEMPERATURES
- DURABLE DUCT LINER
- REDUCED STRUCTURAL TEMPERATURES
- BLEED-AIR-CONTROL COMPATIBILITY

POTENTIAL DISADVANTAGES/LIMITATIONS

- DIFFICULT TO INSPECT AND MAINTAIN
- RESTRICTS MISSION TURNAROUND TIME
- BLEED-AIR-CONTROL COMPATIBILITY
- INSULATION DURABILITY
- DIFFICULT TO INSPECT AND MAINTAIN
- RESTRICTS MISSION TURNAROUND TIME

**FIGURE 17
INSULATED STRUCTURE AIR INDUCTION SYSTEM DESIGNS**

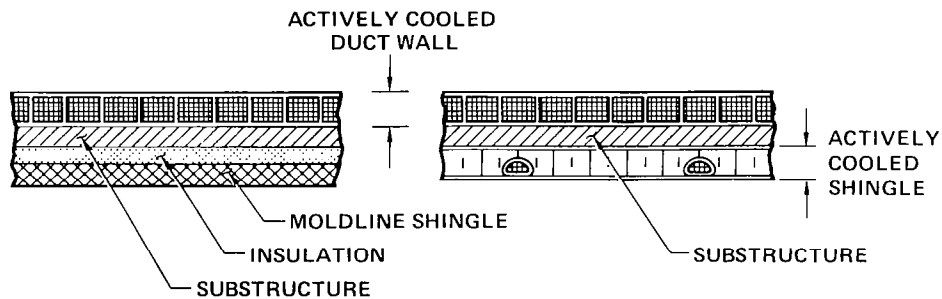

POTENTIAL ADVANTAGES

- REDUCED STRUCTURAL TEMPERATURES
- COOL SUBSYSTEMS
- REDUCED STRUCTURAL TEMPERATURES
- NO MISSION TURNAROUND RESTRICTION
- COOL SUBSYSTEMS

POTENTIAL DISADVANTAGES/LIMITATIONS

- HEAT SINK AVAILABILITY
- RESTRICTS MISSION TURNAROUND TIME
- HEAT SINK AVAILABILITY
- COMPLEX COOLING SYSTEM

**FIGURE 18
ACTIVELY COOLED STRUCTURE AIR INDUCTION SYSTEM DESIGNS**

Table 5
Thermal/Structural Concept Applicability

	MACH 4.5 AIRCRAFT	ADVANCED SPACE TRANSPORTATION SYSTEMS	MACH 6.0 AIRCRAFT
Concepts Applicable for General Usage:			
Hot Structure	x	x	x
Radiative Metallic TPS	x	x	x
Externally Insulated Structure	-	x	-
Water Cooled Structure	-	x	x
Heat Sink Structure	-	x	-
PCM Cooled Structure	-	x	-
Actively Cooled Structure	-	-	x
Leading Edge Concepts:			
Hot Structure	x	x	x
Externally Insulated Structure	-	x	-
PCM Cooled Structure	-	x	-
Actively Cooled Structure	-	-	x
Cryogenic Fuel Tankage Thermal/Structural Concepts	-	x	x
Air Induction System Concepts:			
Hot Structure	x	-	-
Insulated Structure	-	-	-
Actively Cooled Structure	-	-	x
Internal/Protected Structure	x	x	x

Note: X denotes applications for which concept's potential advantages establish it as a logical candidate.

The only debatable issue was whether or not to consider air induction system concepts for advanced space transportation systems. The Single-Stage-to-Orbit vehicle configurations recently studied, References (6) and (7), use hydrogen-fueled rocket engine propulsion. The proposed concept of using small turbojet-powered boosters to accelerate an orbiter to approximately Mach 3.5 before staging has no need for an air induction system designed for higher speeds. Therefore, the only proposed ASTS concept that would require hypersonic air induction system development would be the air breathing launch vehicle (ABLV) approach. The ABLV first stage would be expected to attain Mach 8.0 to 10.0 using air breathing propulsion before releasing the orbiter vehicle.

Although this design approach cannot be discounted, it appears that the alternate approaches studied recently are the current leading candidates for an ASTS. In addition, a Mach 6.0 thermal/structural air induction system concept, if developed, would solve many of the problems associated with ABLV system design.

5. THERMAL/STRUCTURAL TECHNOLOGY STATUS AND GOALS

Before thermal/structural technology needs could be identified, it was necessary to define the current technological status and establish the goals that should be attained. This includes the analytical methods required to evaluate hypersonic vehicle thermal/structural designs, the materials and manufacturing techniques required, and the conceptual development required prior to production commitments. Thermal/structural testing capabilities and requirements, which also contribute to the technology assessment, are discussed in Sections 7 and 8.

5.1 STATUS OF ANALYTICAL METHODS

In general, the analytical methods required to evaluate hypersonic vehicle structures already exist. However, some of these methods are based on data correlations which may not be sufficiently complete to insure efficient and safe hypersonic designs. The severe thermal environments may create complications that are only secondary effects in supersonic aircraft design and are simply overpowered in current spacecraft design.

The effects of repeated exposures to extreme temperatures as well as the effects of spectrum thermal/mechanical loading must be considered. Current techniques do not adequately account for these effects.

Aerodynamic heating effects dictate most of the thermal considerations involved with hypersonic thermal/structural design. Existing techniques used to predict aerodynamic heating are adequate for supersonic aircraft and spacecraft, since conservatism employed to account for complications or unknowns have only a minor impact on structural design. However, similar conservatism applied to hypersonic cruise vehicle analyses could significantly affect structural design. In particular, the data correlations used to predict heating in regions subject to interference heating and to estimate the extent of boundary layer transition are not refined and require improvement.

5.2 STATUS OF MATERIALS

The status of materials that may be considered for the hypersonic thermal/structural concepts identified in Table 5 was surveyed. The survey included materials now in early stages of development which show potential for high strength and environmental durability, new material systems which are in advanced stages of development, and materials that are now used in aerospace vehicles. The review was concerned primarily with materials which would experience temperature extremes in areas such as cryogenic tankage or external surfaces. However, materials such as aluminum and composites which are useful to only moderately elevated temperatures were included, because of their weight saving potential in substructure.

5.2.1 METALS - Figure 19 summarizes available property data for candidate metals. It differentiates among low, room, and elevated temperature data for most properties. Data on the effect of service environment are also included. This encompasses a variety of characteristics, such as stress corrosion susceptibility, moisture effects, and metallurgical instabilities. These metals are discussed in the following paragraphs.

A. Aluminum Alloys - Although the aluminum alloys are useful to only moderately elevated temperatures, they will continue to make up a significant portion of

MATERIAL	USEFUL TEMP RANGE - K (°F), BASED ON ≈ 100 HR EXPOSURE AT TEMP	STRENGTH PROPERTIES			RESIDUAL STRENGTH AFTER HIGH TEMP EXPOSURE	CREEP	FRACTURE TOUGHNESS			FATIGUE			EFFECT OF SERVICE ENVIRONMENT	PHYSICAL PROPERTIES		
		LOW TEMP	ROOM TEMP	HIGH TEMP			LOW TEMP	ROOM TEMP	HIGH TEMP	LOW TEMP	ROOM TEMP	HIGH TEMP		LOW TEMP	ROOM TEMP	HIGH TEMP
ALUMINUM ALLOYS (2XXX SERIES) (6061)	20(-423) TO 477 (400)	●	●	○	○	○	●	●	○	⊗	●	○	●	●	●	
TITANIUM ALLOYS																
6Al-4V, 6Al-4V ELI	20(-423) TO 672 (750)	●	●	○	○	○	○	●	○	⊗	●	○	○	●	●	
5Al-2.5Sn, 5Al-2.5 Sn, ELI	20(-423) TO 589 (600)	○	●	○	○	○	○	○	○	○	○	○	○	●	●	
Ti-6242	? TO 866 (1100)	○	●	○	○	○	○	○	○	○	○	○	○	○	○	
Ti-5522S	? TO 866 (1100)	○	○	○	○	○	○	○	○	○	○	○	○	○	○	
Ti-11	? TO 866 (1100)	○	○	○	○	○	○	○	○	○	○	○	○	○	○	
Ti-5621S	? TO 922 (1200)	○	⊗	○	○	○	○	○	○	○	○	○	○	○	○	
TITANIUM ALUMINIDES																
Ti-Al-Cb Alloys	? TO 1033 (1400)	○	⊗	○	○	○	○	○	○	○	○	○	○	○	○	
Ti-Al-Cb Alloys	? TO 1033 (1400)	○	⊗	○	○	○	○	○	○	○	○	○	○	○	○	
SUPERALLOYS																
A-286	78(-320) TO 922 (1200)	○	●	○	○	○	○	○	○	○	○	○	○	○	○	
INCONEL 718	20(-423) TO 978 (1300)	●	●	○	○	○	○	○	○	○	○	○	○	○	○	
RENE'41	20(-423) TO 1144 (1600)	●	●	○	○	○	○	○	○	○	○	○	○	○	○	
UDIMET 500	? TO 1144 (1600)	○	●	○	○	○	○	○	○	○	○	○	○	○	○	
L605	20(-423) TO 1255 (1800)	○	●	○	○	○	○	○	○	○	○	○	○	○	○	
HASTELLOY X	? TO 1255 (1800)	○	●	○	○	○	○	○	○	○	○	○	○	○	○	
HS-188	20(-423) TO 1366 (2000)	○	●	○	○	○	○	○	○	○	○	○	○	○	○	
TD-NiCr	? TO 1366 (2000)	○	●	○	○	○	○	○	○	○	○	○	○	○	○	
REFRACTORY ALLOYS																
TZM (MOLYBDENUM BASE)	294 (70) TO 1589 (2400)	○	●	○	○	○	○	○	○	○	○	○	○	○	○	
FS-85 (COLUMBIUM BASE)	78(-320) TO 1589 (2400)	○	●	○	○	○	○	○	○	○	○	○	○	○	○	
T-222 (TANTALUM BASE)	78(-320) TO 1811 (2800)	○	●	○	○	○	○	○	○	○	○	○	○	○	○	

Legend:

- - Substantial amount of data available, little or no additional testing required.
- - Significant amount of data available, additional testing required.
- ⊗ - Preliminary data only.
- - No significant amount of data available.

FIGURE 19
STATUS OF CANDIDATE METALLIC MATERIALS FOR
HYPERSONIC AIRFRAME STRUCTURES

hypersonic airframes. They will be used extensively in substructure and for fuel tankage, including cryogenic tankage. More general usage will be possible with actively cooled structure concepts.

B. Titanium Alloys - Currently, titanium alloys are not used in structural applications above 811 K (1000°F) and data at higher operating temperatures are limited. Alloys that are weldable and have good corrosion resistance, developed for service in jet engines, are applicable to hypersonic airframe structures. The basic Ti-6Al-2Sn-4Zr-2Mo (Ti-6242) alloy, developed in 1966, and its derivatives are prime candidates. A silicon modified version (Ti-6242S) is replacing the basic alloy because it has better high temperature properties.

Several additional alloys are being developed to improve the elevated temperature capability of the titanium alloys; three of these are:

- (1) Ti-5Al-5Sn-2Zr-2Mo-0.25Si (Ti-5522S)
- (2) Ti-6Al-2Sn-1.5Zr-1Mo-0.35Bi-0.1Si (Ti-11)
- (3) Ti-5Al-6Sn-2Zr-1Mo-0.1Si (Ti-5621S)

All three alloys are super alpha alloys developed for high-temperature long-time creep applications in jet engines. These alloys are in the developmental stage and currently none are used in operational systems. Limited data (both tensile and short-time creep) are available at test temperatures above 811 K (1000°F). Typical tensile data developed on sheet material show the high temperature properties of Ti-11 and Ti-5522S are significantly better than the basic Ti-6242 alloy. Both of these new alloys have good strength up to 922 K (1200°F). Limited short-time creep data have been developed on sheet material at 811 K (1000°F), 922 K (1200°F) and 1033 K (1400°F) with exposure time up to 30 minutes. Again, the advanced alloys show better properties than the Ti-6242 alloy. Ti-5522S, in particular, has excellent short-time creep properties up to 922 K (1200°F).

Developmental work has also been conducted on titanium aluminide intermetallic compounds. These compounds provide excellent properties at temperatures in excess of 922 K (1200°F). However, they are inherently brittle at room temperature and do not achieve any appreciable ductility until they are heated to 922 K (1200°F) or 978 K (1300°F). This lack of ductility implies poor toughness, poor thermal-shock properties and poor fabrication characteristics.

Research and development over the past two years has not solved the ductility problem for the aluminides. Breakthroughs or technical approaches which would solve the problem are not apparent. Consequently, these newly developed materials may find only limited usage as hypersonic airframe structures. This is also true of the newly developed Ti-Al-Cb alloys which have low ductility and probably will have limited fabricability.

C. Superalloys - Superalloys are nickel, iron or cobalt-based alloys which are used efficiently up to 1366 K (2000°F). The highest strength superalloys are those which respond to heat treatments. However, the repeated usage service temperatures of these alloys are limited by their aging temperatures. High strength can also be obtained, in some alloys, by cold working. However, these alloys cannot be exposed to temperatures above their recrystallization temperatures without a loss of strength.

The superalloys in sheet, plate and forgings have been well characterized and have wide use in the aerospace industry. Of the commonly used superalloys, Inconel 718 provides the best combination of strength and fabricability. The other alloys have either limited properties or limited fabricability. The cobalt base alloy (L605) provides excellent properties in the cold worked condition; however, its use is limited in section sizes that can be cold worked. Also, in cold worked sections requiring welding, the properties are reduced locally by the welding heat.

D. Refractory Metals - Refractory metals, primarily columbium (Cb) and tantalum (Ta) alloys, are used in aerospace applications at temperatures above 1366 K (2000°F) where the strength of nickel and cobalt based superalloys is low. Generally, Cb alloys have a maximum operating temperature of 1589 K (2400°F) and Ta alloys have a maximum use temperature of 1811 K (2800°F).

The commercially available Cb and Ta alloys possess reasonable strength at room temperature, and are easy to fabricate and weld. The Cb alloys have about half the density of the Ta alloys. Of the Cb alloys, FS-85 provides the best combination of strength, high temperature capability, and fabricability. Of the Ta alloys, T-222 provides the best overall combination of properties.

Cb and Ta alloys oxidize rapidly when operated above 922 K (1200°F) without special coatings. Several coating systems have been developed which are suitable for hypersonic environments and for relatively long use times. For example, in the F100 engine afterburner, a silicide coating is used on the C-103 Cb alloy. It is providing excellent service, in F-15 aircraft installations, with nominal operating temperatures of 1255 K (1800°F) to 1311 K (1900°F) and hot spots as high as 1533 K (2300°F). Fused slurry silicide coatings on columbium alloys have been shown to be capable of withstanding more than 100 simulated Space Shuttle flights. Each cycle of the test program involved maintaining the coating temperature at 1644 K (2500°F) for 30 minutes. Size of the parts which can be coated is limited only by the size of the vacuum furnace available for processing. However as part size and complexity increase, it becomes more difficult to maintain the required coating thickness on all surfaces.

5.2.2 ADVANCED COMPOSITES - Available property data for candidate composites are summarized in Figure 20. These materials are finding increased acceptance in aerospace structure and may save weight in many applications.

A. Moderate Temperature Resin Matrix Composites - Currently, graphite/epoxy is the most highly developed composite. However, it is generally limited to about 394 K (250°F) when moisture effects are considered. Its application to hypersonic airframes will probably be limited to internal structure. Graphite/epoxy represents the most mature advanced composite and provides a basis for comparison with other composite materials regarding data availability.

B. High Temperature Resin Matrix Composites - The temperature range for resin matrix composites can be extended by the choice of matrix materials. The polyimides are projected for use at 533 K (500°F) while graphite/polybenzimidazole and graphite/polyimidazoquinazoline may be useful up to 755 K (900°F). These materials are in the early stages of development and their potential has not been consistently attained. Also, they require special processing, and optimum fabrication techniques have not been developed.

MATERIAL	USEFUL TEMP RANGE - K (°F). BASED ON ≈ 100 HR EXPOSURE AT TEMP	STRENGTH PROPERTIES			RESIDUAL STRENGTH AFTER HIGH TEMP EXPOSURE	CREEP	FRACTURE TOUGHNESS			FATIGUE			EFFECT OF SERVICE ENVIRONMENT	PHYSICAL PROPERTIES			
		LOW TEMP	ROOM TEMP	HIGH TEMP			LOW TEMP	ROOM TEMP	HIGH TEMP	LOW TEMP	ROOM TEMP	HIGH TEMP		LOW TEMP	ROOM TEMP	HIGH TEMP	
MODERATE TEMPERATURE RESIN MATRIX	20(-423) TO 394 (250)	⊗	●	○	○	○	○	○	⊗	⊗	●	○	○	○	○	○	○
HIGH TEMPERATURE RESIN MATRIX																	
GRAPHITE-POLYIMIDE	? TO 533 (500)	○	⊗	⊗	○	○	○	○	○	○	○	○	○	○	○	○	○
GRAPHITE-POLYBENZIMIDAZOLE	? TO 755 (900)	○	⊗	⊗	○	○	○	○	○	○	○	○	○	○	○	○	○
GRAPHITE-POLYIMIDAZOQUINAZOLINE	? TO 755 (900)	○	⊗	⊗	○	○	○	○	○	○	○	○	○	○	○	○	○
METAL MATRIX																	
BORON OR BORSIC-ALUMINUM	? TO 589 (600)	○	●	○	○	⊗	○	⊗	○	○	⊗	○	⊗	○	○	○	⊗
TITANIUM-REINFORCED BORON-ALUMINUM	? TO 700 (800)	○	⊗	⊗	○	○	○	○	○	○	○	○	○	○	○	○	○
GRAPHITE-ALUMINUM	? TO 589 (600)	○	⊗	⊗	○	○	○	○	○	○	○	○	○	○	○	○	○
BORSIC OR SILICON CARBIDE-TITANIUM	? TO 922 (1200)	○	○	⊗	⊗	○	○	○	○	○	○	○	○	○	○	○	○
TUNGSTEN, GRAPHITE, OR SILICON CARBIDE-SUPERALLOY MATRIX	? TO 1366 (2000)	○	⊗	⊗	⊗	○	○	○	○	○	○	○	○	○	○	○	○
CERAMIC MATRIX																	
BORON, GRAPHITE OR AL ₂ O ₃ -CERAMIC MATRIX	? TO 1644 (2500)	○	⊗	⊗	○	○	○	○	○	○	○	○	○	○	○	○	○
CARBON MATRIX																	
CARBON-CARBON	? TO >1922 (3000)	○	○	○	○	○	○	○	○	○	○	○	○	○	○	○	○
PARTICULATE																	
Be-38Al (LOCKALLOY)	78(-320) TO 589 (600)	○	○	○	○	○	○	⊗	○	○	⊗	○	○	○	○	○	○

Legend:

- - Substantial amount of data available, little or no additional testing required.
- - Significant amount of data available, additional testing required.
- ⊗ - Preliminary data only.
- - No significant amount of data available.

FIGURE 20
STATUS OF CANDIDATE ADVANCED COMPOSITES FOR
HYPERSONIC AIRFRAME STRUCTURES

C. Particulates - Lockalloy, a composite consisting of 62% beryllium and 38% aluminum, combines high modulus and low density with high specific heat. These properties make it attractive for design conditions involving short-term high heat load, where weight and temperature increase should be minimized. Of the hypersonic applications identified, the usage of this material probably will be limited to heat sink structure concepts for advanced space transportation systems.

D. Metal Matrix Composites - Boron/aluminum (B/Al) and borsic/aluminum (Bsc/Al) are the most mature metal matrix composite systems. Most of the advances in B/Al technology have been made since 1968. These advances have resulted in a significant data bank of material properties. Manufacturing techniques for making the basic material and structural components have been developed. Large, complex structures have been designed, fabricated, and tested.

Boron-aluminum may be useful up to 589 K (600°F). Large, complex structural components have been tested successfully at this temperature. Titanium interleaving may increase the useful temperature range to 700 K (800°F) or higher. B/Al can be interleaved with titanium either by diffusion bonding, roll-bonding, or by low-temperature liquid phase bonding. The liquid phase technique offers greater versatility for fabricating complex, thick cross-section structures. Such structures have been fabricated and tested successfully at 589 K (600°F).

Interest in the graphite-aluminum composite system has been spurred by the high cost of boron and borsic filaments and certain characteristics of their tungsten substrate. However, this system is not as developed as boron-aluminum and the potential of the mechanical properties offered by the graphite/aluminum combination, based on the rule of mixtures, has not yet been realized. Also, there has been no significant success in developing the techniques that will be needed to fabricate major structural components from this material.

Titanium (Ti) matrix composites are superior to B/Al from the standpoint of shear strength, temperature capability, and erosion resistance. However, the Ti-matrix technology is not as advanced as B/Al. Various titanium alloys have been evaluated as matrix materials in combination with boron, borsic, or silicon carbide (SiC) filaments. In general, borsic fiber yields higher strength than the uncoated boron. Boron and borsic are superior to SiC fibers for room temperature properties, but this advantage is greatly reduced at elevated temperatures and disappears at about 811 K (1000°F). The high temperature behavior of SiC makes it an attractive candidate filament for hypersonic applications, and it also has the potential for being more economical than either boron or borsic.

Composites utilizing superalloys as matrix materials are the least developed metal matrix systems. Interest in these materials has been directed toward engine applications. The principal concern has been degradation of properties resulting from fiber/matrix interaction during extended exposure to elevated temperatures. Methods for fabricating structural components have not been developed.

E. Ceramic Matrix Composites - Development of ceramic matrix composite materials has been very limited. Preliminary mechanical property data have been developed for aluminum phosphate reinforced with a variety of fibers. This effort has been directed toward radomes. There has not been enough experience with these materials to state with certainty that they can be used effectively on hypersonic vehicles.

F. Carbon Matrix Composites - Carbon/carbon composites are under development for use at operating temperatures in excess of 1922 K (3000°F) in reentry vehicles, nose caps and leading edges, rocket motor nozzles, and ramjet combustor cases. Basically, the interest in carbon/carbon is its superior structural properties at 1922 K (3000°F) and above compared to other materials. Because of the excellent high temperature properties, carbon/carbon composites are attractive candidates for hypersonic airframe leading edges.

5.2.3 INSULATIONS - Nearly all hypersonic vehicles will use insulation either as an integral component of the primary thermal/structural concept or to protect internal vehicle components such as avionics, passenger compartments, fuel tankage, hydraulics, landing gear, etc.

Insulation materials are commercially available in a variety of densities and maximum temperature capabilities. Most common insulation material properties (thermal conductivity, specific heat, etc.) are readily available, or can be obtained by simple testing. Exceptions include the effects of ambient pressure, compression loads, and the service environment. The only applications where an adequate insulation material would appear to be a problem would be where temperature extremes are involved.

A. High Temperature Insulations - High temperature insulations are based primarily on fibrous forms of refractory oxides, usually in the amorphous state. Even the rigid or block form of such insulations is most commonly based on bonded fibers. Other forms of refractory oxides, such as powders or foams have been less successful, due to high densities and high thermal conductivities.

High temperature fibers used for high temperature service include silica, alumina-silica (1:1), and chromia modified alumina-silica. Higher melting temperature oxides would be desirable, but have seldom been obtained due to inability to fiberize them in an amorphous state (polycrystalline fibers are usually extremely brittle and fragile and thus not amenable to the stress of handling, installation, and flight environments). However, recent advances have been made in alumina fibers, zirconia fibers, and alumina-boria-silica fibers, in the amorphous state. Vendor literature on these products claims maximum use temperatures of 1672 K (2550°F), 1866 K (2900°F), and 1478 K (2200°F), respectively.

For long-time hypersonic service, the insulation problem may not consist of lack of materials or property data, but rather a method of containment. Some insulations must be encased in thin metal foil packages. Unfortunately, the oxidation resistance of the superalloys normally employed is such that exposures of several thousand hours would restrict the use of foil to about 1255 K (1800°F).

B. Cryogenic Insulations - The problems involved with cryogenic insulations for the protection of liquid hydrogen fuel tanks on hypersonic vehicles was discussed previously in Section 4.3. Cryogenic insulations developed for spacecraft applications are lightweight foam materials. When applied on fuel tank inner surfaces, LH₂ gas can permeate the material and render it ineffective by drastically increasing thermal conductivity. When installed on tank outer surfaces, air can permeate the material and, upon becoming supercooled at the tank wall, condense and result in fuel boiloff. The development of a vapor barrier material to prevent gaseous hydrogen permeation of the foam insulation material is desirable but does not appear promising.

Multilayer, evacuated insulations similar to those used to protect land-based cryogenic fuel storage tanks have been investigated. Unfortunately, these insulations have not, to date, been fabricated to retain the necessary vacuum and be sufficiently lightweight for aerospace vehicles.

The use of proven, low density foam insulations to protect hypersonic vehicle cryogenic fuel tankage is desirable. It seems that the ultimate solution lies in finding a system arrangement that minimizes the negative characteristics of these materials. The layered external insulation design approach discussed in Section 4.3 offers a potentially acceptable solution that merits further consideration.

5.3 STATUS OF MANUFACTURING TECHNIQUES

Hot structure and radiative metallic TPS heat shield configurations, indicated in Figures 1 and 2, represent the degree of fabrication complexities involved. Fabricating structures of these types from conventional metals is considered to be within the state of the art. Currently, manufacturing research and development emphasis is on cost reduction. Research along these lines has been fruitful. For example, studies have been initiated to develop superplastic forming and superplastic forming in combination with diffusion bonding for low cost fabrication of complex titanium assemblies. When combined with innovative design concepts, superplastic forming and diffusion bonding can result in more efficient structures at lower costs.

The high-temperature titanium alloys can be fabricated by conventional processes. Available data indicate that these alloys are readily weldable, with weld ductility as good or better than Ti-6Al-4V alloy. The more advanced materials, such as the titanium aluminides and Ti-Al-Cb alloys, are expected to be difficult to fabricate.

Advanced composite fabrication cannot be considered routine, due primarily to lack of experience. However, it has been shown that complex graphite epoxy composite shapes can be made with minimum machining and material waste, using specialized tape layup and curing techniques. These same general approaches may be applicable to the high temperature resin matrix composites. It will be necessary to make allowances for processing differences, such as temperatures and intermediate curing cycles, which may result in more manufacturing complexities with the high temperature composites. Structural panels can be fabricated with resin matrix composites by building panel details and adhesive bonding the assembly. These materials also offer the potential to form some panel configurations, such as integrally stiffened designs, in a single operation.

Boron and boron-aluminum composites can be made into structural shapes by two techniques. Details may be made by diffusion bonding and then assembled by resistance spotwelding. If part complexity precludes diffusion bonding, components can be built-up from monolayer foils and then joined using a liquid phase process, such as diffusion brazing. Application of liquid phase bonding permits the fabrication of integrally stiffened panels. Also, these materials can be brazed, provided that precautions are taken to avoid fiber degradation due to high temperature or attack by molten braze alloy. These problems may be avoided by using low temperature brazing systems and by cladding the aluminum with a thin titanium foil.

Graphite-aluminum is produced by the infiltration of graphite yarn with molten aluminum. This approach will limit the forms in which Gr/Al will be made available. Little is known about the fabricability of structural components of the type that

can be used on hypersonic airframes. This is also true of ceramic matrix components.

Titanium matrix composites can be fabricated by diffusion bonding the details and joining them by resistance welding or brazing. Brazing techniques now being applied to titanium also can be applied to titanium matrix composites. The titanium matrix composite will be less versatile than the aluminum matrix materials if diffusion brazing techniques cannot be developed. Processes developed for titanium alloys have not been applied to composites to evaluate such factors as fiber degradation, etc. If diffusion brazing is not developed, the cost of fabricating complex parts, such as integrally stiffened panels, by laying up and bonding monolayer foils will be high. On the other hand, this disadvantage may be offset by powder metallurgy techniques which are under development.

Although the basic manufacturing processes are developed for existing and many advanced, composites, the manufacturing technology needed for hypersonic airframe fabrication is not complete. These structures will be unique because of the severe operating conditions and their need to alleviate thermal stresses. Consequently, these structures will challenge manufacturing skills. It may be necessary to fabricate and structurally test typical structures to demonstrate the adequacy of the basic processes. Repeated quality control has not yet been fully established for composites, and additional effort is warranted to determine standard manufacturing and testing methods.

5.4 STATUS OF CONCEPT DEVELOPMENT

Before a thermal/structural concept for a hypersonic vehicle can be committed to production, its fabricability, structural integrity, and thermodynamic performance must be demonstrated. That means, at least, that full size parts and assemblies must be fabricated and ground tested. The test articles should incorporate all the complexities and problem areas (i.e., material, size, shape, joint details, surface finishes, and tolerances) of the real article. All of the thermal/structural designs discussed previously have potential disadvantages and limitations that must be addressed. In most cases, development will also be required to achieve the potential advantages listed for each.

Some radiative metallic TPS concepts and the phase change material cooled structure leading edge concept have recently been ground tested, References (11) and (27). Ground tests of actively cooled structure concepts are to be conducted in the near future. Heat sink structure, a Lockalloy ventral fin, has been flown on the SR71 aircraft. However, demonstrations of this nature represent only a fraction of the development required for operational hypersonic vehicles.

Externally insulated concepts have been ground tested, Reference (12), and will soon be flown on the Space Shuttle. Hot leading edge structure concepts, fabricated from carbon/carbon composites, will also be installed on the Shuttle. The experience will be very beneficial for development of similar concepts for advanced space transportation systems.

5.5 TECHNOLOGY GOALS

To plan for specific technological advances, it is necessary to comprehend the maturity required for full commitment to the development of operational flight vehicles. It was necessary to rely heavily on engineering judgment in establishing the levels of technology required.

There are three fundamental design phases in the evolution of a typical flight vehicle. Each phase represents a step change in design refinement, as additional design accomplishments are realized at the completion of each phase, and "acceptable" levels of technology may increase with each phase. These design phases are preliminary design, configuration definition, and detail design and development. The specific accomplishments from each phase is as follows:

<u>DESIGN PHASE</u>	<u>DESIGN ACCOMPLISHMENTS</u>
Preliminary Design	<ul style="list-style-type: none"> o Mission and Payload Established o Operational Requirements Defined o Propulsion System Selected
Configuration Definition	<ul style="list-style-type: none"> o Design Concepts Selected o Materials Selected o Mass Estimated o Propulsion System Defined o Performance Determined
Detail Design and Development	<ul style="list-style-type: none"> o Structural Development Tests Performed o Designs Finalized o Drawings Released

Analytical methods employed to evaluate thermal/structural concepts must be developed to the degree where meaningful trade studies can be confidently conducted during both preliminary design and configuration definition. Hopefully, by detail design and development, these methods can be refined using program generated information.

The material development status required for each of these design phases were established by examining historical trends. The data requirements for metals and advanced composites are presented in Tables 6 and 7. Where applicable, material property value definitions obtained from Reference (36) are quoted. These definitions, which reflect the statistical confidence in the value are as follows:

- o Typical basis value - an average value with no associated statistical assurance.
- o B basis value - a value above which 90% of the population of values is expected to fall, with a confidence of 95%.
- o A basis value - a value above which 99% of the population of values is expected to fall, with a confidence of 95%.
- o S basis value - the minimum value specified by the governing specification for the material with no associated statistical assurance.

Alternate criteria that could be followed in an idealized program would call for typical basis values for preliminary design, B basis values for configuration definition, and A or S basis values for detail design and development. However, this would require an extensive amount of testing. Previous aircraft and spacecraft programs have been conducted without such complete data, and the requirements defined in Tables 6 and 7 are believed to be adequate for future programs.

**Table 6
Metallic Material Property Data Requirements**

	DESIGN PHASE		
	PRELIMINARY DESIGN	CONFIGURATION DEFINITION	DETAIL DESIGN AND DEVELOPMENT
MECHANICAL PROPERTIES	Typical basis F_{tu} , F_{ty} and E at temperature after short time exposure to temperature.	B basis F_{tu} , F_{ty} , F_{cy} , E and E_c at room temperature and elevated temperatures for long exposure times.	A or S basis F_{tu} , F_{ty} , F_{cy} , E , E_c , F_{su} , F_{bru} , F_{bry} at room temperature and elevated temperatures for long exposure times.
PHYSICAL PROPERTIES	Typical basis ω , α , k and C_p at temperature after short-time exposure to temperature.	Same as required for preliminary design.	Same as required for preliminary design.
CREEP PROPERTIES	Not required.	Typical basis time for finite creep strain vs. exposure temperature and stress. Emphasis on long time at high temperatures.	Same as required for configuration definition.
FATIGUE PROPERTIES	Constant life diagrams (or equivalent) for failure vs. exposure temperature.	Constant life diagrams (or equivalent) for failure and for finite creep strain vs. exposure temperature.	Same as required for configuration definition plus element tests of details subjected to spectrum thermal and mechanical loading.
FRACTURE TOUGHNESS AND CRACK PROPAGATION	General Information	Typical basis K_{Ic} , K_{Ic} (da/dn) vs. ΔK at temperatures of interest.	Same as required for configuration definition plus element tests of structural details under spectrum thermal and mechanical loading.
ENVIRONMENTAL EFFECTS	General Information	Effects quantified.	Effects quantified.
STRESS VS. STRAIN	Tension and compression stress vs. strain in elastic range at various temperatures.	Tension and compression stress vs. strain up to yield stress at various temperatures.	Tension and compression stress vs. strain up to failure at various temperatures.

Insulation properties generated during material evolution are normally adequate for preliminary design and configuration definition of a flight vehicle development program. Data refinements regarding the effect of pressure on thermal properties and the materials compatibility with the anticipated service environment are desirable for detail design and development.

Table 7
Composite Material Property Data Requirements

	DESIGN PHASE		
	PRELIMINARY DESIGN	CONFIGURATION DEFINITION	DETAIL DESIGN AND DEVELOPMENT
MECHANICAL PROPERTIES	Typical basis F_{tu} , E_t , F_{cu} , E_c in longitudinal and transverse direction for tape* vs. temperature.	B basis F_{tu} , E_t , F_{cu} , E_c in longitudinal and transverse direction for tape* vs. temperature for long exposure times.	A or S basis F_{tu} , E_t , F_{cu} , E_c in longitudinal and transverse direction for tape* vs. temperature for long exposure times.
PHYSICAL PROPERTIES	Matrix content, filament content, and density for monolayer and laminates.	Matrix content, filament content, density, resin flow, tack, working life, storage life and thermal properties.	Same as required for configuration definition.
CREEP PROPERTIES	Not required.	Typical basis time for rupture and for finite creep strain vs temperature and stress for similar laminates, including life data.	Same as required for configuration definition.
FATIGUE PROPERTIES	Not required.	Constant life diagrams (or equivalent) for failure vs. exposure temperature for similar laminates.	Real time exposure and spectrum load effect on design stress in actual laminates.
FRACTURE TOUGHNESS AND CRACK PROPAGATION	General Information	Static and fatigue test data for actual laminates with stress concentrations and manufacturing defects.	Same as required for configuration definition.
ENVIRONMENTAL EFFECTS	General Information	Effects quantified.	Effects quantified.
STRESS VS. STRAIN	Typical basis stress vs. strain to failure for tape* vs. exposure temperature.	Same as required for preliminary design.	Same as required for preliminary design.

* Same for broadgoods and woven products

During preliminary design, the required manufacturing techniques envisioned must be judged to be achievable and not excessively costly. By the time that the configuration definition is completed, the basic manufacturing techniques should have been demonstrated and proven to be economically acceptable. In addition, the required production capabilities must be understood and considered acceptable. During detail design and development, a production status must be developed and quality control demonstrated to satisfaction.

Conceptual development requirements at each of the three fundamental design phases vary widely, based on historical trends. In most cases, during preliminary design, a concept needs to be judged reasonable, requiring only normal engineering solutions to known problem areas. By the completion of configuration development, solutions to major conceptual problem areas should be demonstrated via elemental testing or identified by similarity to a known solution. Component level testing, providing confidence that all significant problems are eliminated, is conducted during detail design and development.

6. TECHNOLOGY NEEDS

A general assessment of thermal/structural technology needs was made based on the information summarized in Sections 3, 4, and 5. To assessment was then reviewed to identify the specific needs judged most important to insure success in the eventual development of hypersonic vehicles.

6.1 GENERAL ASSESSMENT

The assessment revealed that many technological deficiencies, particularly in the area of concept development, currently exist.

6.1.1 ANALYTICAL METHODS - As discussed in Section 5.1, existing methodologies are considered sufficient, but some of the techniques employed must be refined or modified to avoid undue conservatism and still insure safe designs. The most obvious deficiencies exist in capabilities to account for the effects of spectrum thermal/mechanical loading in structural analyses and to predict aerodynamic heating in regions of complex flow.

For example, it is essential to determine the combined effects of fatigue loading and transient heating spectra on material allowables and structural details. This presents a real problem because exposure time can have a big effect on the results. Real-time tests are highly desirable but may take too long. Development of accurate techniques for predicting the fatigue life and fracture characteristics of these structures would solve this problem.

Ideally, these techniques would allow the designer to predict the effect of cumulative long-time thermal exposure and spectrum loading from accelerated or short-time tests. These techniques would have to be developed early to be useful on future aircraft, because they would undoubtedly require a real-time test data base. At least, real-time tests would be required for verification. These real-time element tests should also be used to determine the effect of the hypersonic environment on oxidation, corrosion, and creep.

6.1.2 MATERIALS - Hypersonic airframe applications identified in this study, together with their associated thermal/structural concepts, highlight the need for materials with long term reusability while operating over a wide range of temperatures, as shown in Figure 21. Surface temperatures will range up to 1866 K (2900°F), while the storage of liquid hydrogen will require materials to operate at temperatures as low as 20 K (-423°F). The low temperature conditions will be the least troublesome. A number of aluminum, titanium, and nickel base alloys are known to have good low-temperature properties and are suitable for cryogenic tankage.

The structural materials described in Section 5.2 can operate within the higher temperature ranges defined in this study provided the exposure times are relatively short. This is illustrated in Figure 21 which relates the various candidate material groups to the operating temperatures predicted for the hypersonic vehicle applications.

This figure also indicates relative stages of material development. Materials listed as "developed" are those for which substantial amounts of data exist and for which a considerable amount of actual flight experience has been realized. These "developed" materials are substantially more advanced than the other materials but, in all cases, should be advanced still further for hypersonic vehicle applications.

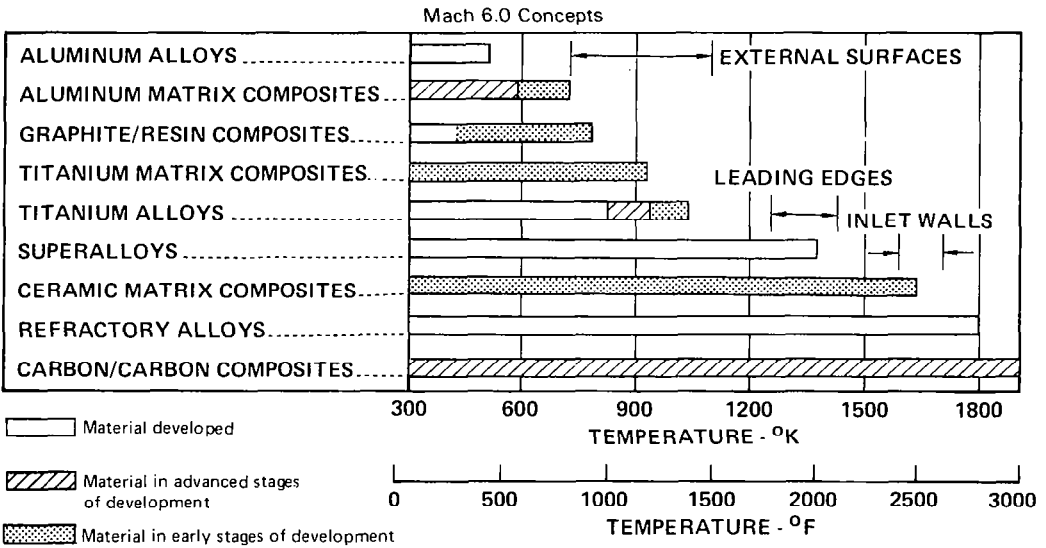
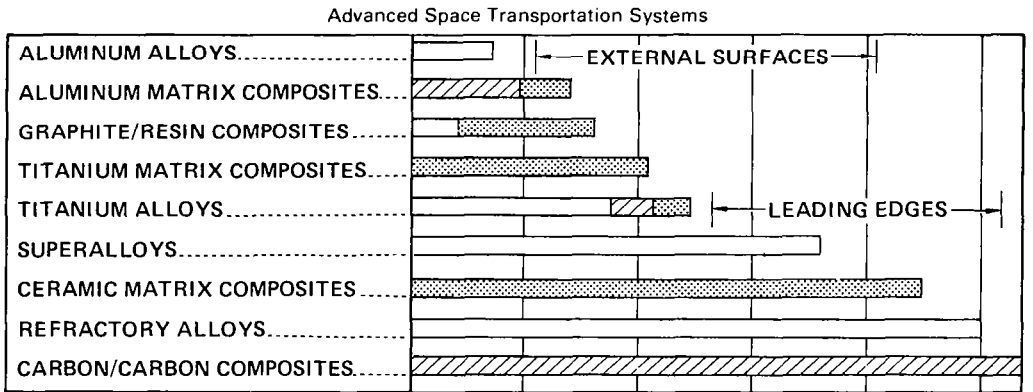
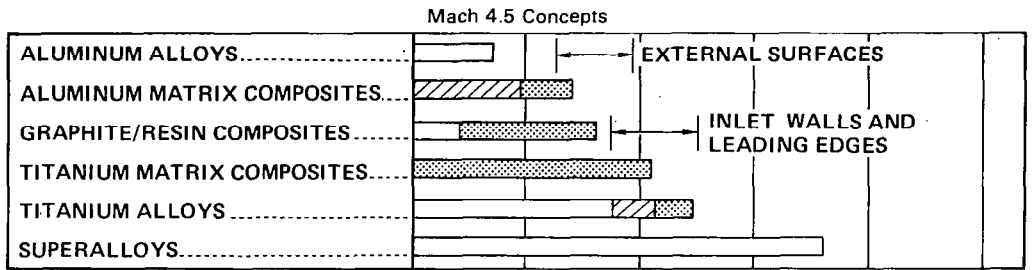

FIGURE 21
CANDIDATE STRUCTURAL MATERIALS RELATED TO
SELECTED HYPERSONIC APPLICATIONS

The basic conclusion derived from Figure 21 is that maximum temperature requirements do not, by themselves, pose severe material problems. In terms of these requirements, materials already considered developed would suffice in most cases although newer materials may permit more efficient, lower mass, designs. However, the long exposure to temperature times associated with the selected hypersonic applications cannot be ignored. These exposure times could reduce the useful temperature ranges indicated in Figure 21. Defining these effects on all of the candidate materials represents a major technological need.

The principal material advancement requirements can be recognized by noting the large data gaps in Figures 19 and 20. Even for the familiar superalloys, there are incomplete data on the effects of loading and thermal exposure on residual strength, creep strength, and fatigue life.

These data gaps are largely attributable to the extended service life that will be required. While exposures will be relatively short for advanced space transportation systems (500 missions with less than one hour exposure per mission), the Mach 4.5 and Mach 6.0 aircraft will accumulate from 3,000 to 20,000 hours at maximum service temperatures. Additional high temperature data need to be obtained.

As noted in Section 5.2.3, insulations compatible with the required temperature environments are available and, for the most part, sufficient property data exist. The only significant problems anticipated involve the suitability of materials to use for insulation packaging.

6.1.3 MANUFACTURING TECHNIQUES - Techniques already developed for conventional materials are adequate for reasonably simple parts, although advancements to reduce manufacturing costs are highly desirable. Manufacturing technological advancements are definitely required to make sure that the new metals and composites identified in Sections 5.2.1 and 5.2.2 can be made available in production quantities with reliable quality control. Advancements will also be required to insure that structural parts from these newer materials can be processed, fabricated, and assembled without large mass and cost penalties.

Advancements for currently available materials should be considered first. This would benefit the initial hypersonic vehicle development programs that will have to be made of aluminum, graphite/epoxy composites, titanium, and nickel base superalloys that are available today, or are well along in development. The biggest problem with these materials is the high cost of structures made from the latter three materials. Specific advancements that would help solve this problem are:

- o Superplastic formed titanium
- o Superplastic formed/diffusion bonded titanium
- o Room temperature formable titanium
- o Isothermal forging of titanium
- o Powder metallurgy titanium, aluminum, and superalloys
- o Stress relief and thermal treatment of high strength titanium and superalloy weldments
- o Thermoplastic composites

- o Non-autoclave curing of composites
- o Laser cutting of titanium and composites
- o Automated handling of composite laminates
- o Reliable bonding techniques that eliminate the need for rivets and other features.
- o Improved inspection techniques

Similar manufacturing technology developments will be required for materials envisioned for subsequent programs, including the high temperature resin and metal matrix composites. However, a major effort will also be required in order to develop the materials to the point where they can be obtained in production quantities. Whether or not this is accomplished will depend on the material demand. It may be necessary to find other, non-aerospace, uses for these materials before the demand is sufficient to reduce production costs to acceptable levels.

6.1.4 CONCEPT DEVELOPMENT - Although previous structural panel fabrication and ground test programs have provided useful design and manufacturing information, none of the concepts described in Section 4 can be considered completely developed. Thermal stresses are the big problem with hot structure concepts. The structure is hot and has to carry all the primary shell loads. This requires continuous load paths. As a result, its mass is greater than structure that only takes local airloads. The designer's options for alleviating thermal stresses are, therefore, limited and he must rely on design innovation to minimize mass. Beads and corrugations have been used in the past to alleviate thermal stresses. Additional development is required to determine how well they withstand repeating loading and thermal cycling.

The advanced high temperature composites may offer a solution because the laminates ply orientation can be tailored to vary stiffness and coefficient of expansion in different directions. This characteristic may be used to reduce thermal stresses.

There have been numerous analytical and experimental investigations of radiative metallic thermal protection systems during the past 15 years. Many concepts have been proposed to reduce weight and solve the thermal stress problem. Most use very thin gage materials to minimize weight and slip points to reduce thermal stresses. The primary concern is that boundary layer air might leak through the joints and circulate behind the heat shields. This could be catastrophic to unprotected internal structure. Tests are urgently needed to characterize this problem and develop concepts that will operate safely and efficiently in the hypersonic environment.

Insulation durability and primary structure inspectability are the major problems with externally insulated structure concepts. The Space Shuttle program will provide some answers to the durability problem.

Water cooled structure concepts have the potential for very low weight, and can use low temperature materials for the primary load carrying members. They have been demonstrated in the laboratory for short times under high temperature exposure. Concepts with external heat shields and insulation will require the same advancements as the radiative metallic thermal protection systems described above. In addition, the water distribution system would have to be developed and demonstrated.

Heat sink structure concepts require advancements similar to those described above for hot structure. Phase change material cooled structure concepts must undergo the same type of developments as the water cooled structure concept.

Actively cooled structure offers a number of advantages to a vehicle that has adequate cryogenic fuel for a heat sink. The structure could be aluminum, and internal components such as actuators, landing gear, etc., could be based on current state-of-the-art technology.

Actively cooled structure is not state of the art; neither are the active cooling system components. Structural design concepts need to be developed, along with manufacturing methods, for integrating the coolant system loops in large compound curved shell structure. Proposed solutions to interference heating and system failures have to be demonstrated.

The problems of using liquid hydrogen fuel in a hypersonic environment are well known. The performance capabilities of proposed tankage designs discussed in Section 4.3 are not known. They can only be proved by testing under realistic service conditions. Many of the structural elements required for the proposed LH₂ tankage TPS concepts will have to be developed and tested. Additional work will also be required to develop the insulations required and to integrate the elements into a working unit. Service life demonstrations will be required. Flight testing to demonstrate total system performance and solve operational and maintenance problems is very desirable. A research vehicle would be extremely useful for this purpose.

The environment is more severe, and design requirements more demanding, on the air induction system than on any other structural area. This structure is subjected to aerodynamic heating inside the duct and on the outer moldline. Heating rates inside the duct are extremely high. Inlet airflow is at high pressure and has to be precisely controlled by movable ramps and bleed air vents.

Preliminary design studies of Mach 4.5 air induction systems indicate that the most efficient and practical design would be a modular propulsion system using hot structure, as described in Section 4.4. Temperatures are less than 1061 K (1450°F) throughout. This allows the use of the more efficient superalloys in the high strength condition. Major problems that have to be resolved are related to:

- o High thermal stresses and deflections
- o Seals for ramp hingelines and sliding surfaces
- o Control of bleed air in substructure cavities
- o High temperature ramp pivot bearings and actuating systems
- o Integration with the rest of the airplane

Element and component test programs could be relied on to evaluate various solutions to the problems that exist in hypersonic air induction systems. Proof of the concept can only come from operation of the complete system in a realistic environment. This will be extremely difficult to accomplish by ground testing due to the complexities of simulating such an environment.

Similar problems exist with Mach 6.0 air induction systems except that the problems are even more severe because the temperatures are higher. Hot structure duct liner temperatures are too high for the superalloys. Refractory materials would have to be used. These materials are not very efficient and require coatings to prevent oxidation. Active cooling, to get structure temperatures down at least as low as the superalloy operating range, will probably be necessary for Mach 6.0 designs, as discussed in Section 4.4. Integration of the active cooling system plumbing with the inlet primary structure is the major technical advancement required.

The desire to minimize weight and cost is the primary reason for advancing internal/protected structure technology. Aluminum, resin matrix composites, and aluminum matrix composites are likely to be used extensively. There is a need to develop lightweight, low cost, structural concepts, incorporating the materials and manufacturing technology advancements mentioned previously.

A number of specialized technology advancements are also required. These include:

- o Coatings for the protection of some materials
- o Seals to minimize boundary layer air leakage
- o Purge gas systems for LH₂ tankage concepts
- o High temperature hinges and bearings for movable components such as control surfaces and air induction system ramps
- o High temperature hydraulic systems and lubricants

Rather than identify specific advancement plans for each of these specialized technologies, it was decided to consider their requirements as part of the advancements defined for thermal/structural concepts which are discussed in the following section.

6.2 SPECIFIC NEEDS

To provide a rational plan for advancing a thermal/structural technology for the projected hypersonic vehicle applications, it was necessary to establish specific needs. These needs were defined by examining the general assessment provided in Section 6.1 and establishing criteria upon which to base selections. To qualify for consideration, fulfillment of a need must:

- o Contribute to the fundamental knowledge of materials, manufacturing techniques, and methods of analysis to the extent that overdesign penalties resulting from uncertainties may be avoided.
- o Increase the confidence level in a design concept by confirming the adequacy of considerations incorporated to solve potential problem areas.
- o Improve the chances of uncovering design problems early in the development process, thus avoiding costly and time-consuming corrective measures.

Twenty eight technology needs, listed in Table 8, were identified to advance hypersonic airframe thermal/structural technology. These needs include four to improve analytical methods; six to extend the existing knowledge of, or to develop new, materials; and eighteen to develop thermal/structural design concepts. While each of these needs meets the established criteria, not all must be satisfied to permit the development of hypersonic vehicles. This list provides the results of a screening to identify needs that merit consideration in technology planning. Need priorities are discussed in Section 10.

For each of the selected needs, a Technology Need Justification and a Technological Advancement Objective was defined. A Plan for Advancing Technology was also prepared. These generalized plans were of sufficient depth to permit realistic estimates of the effort involved to satisfy the need, including ground and flight tests, to be made. This information is presented in Appendix A with separate need descriptions furnished in the same order as the Table 8 listing. These need descriptions were used to formulate the research programs discussed in Sections 7 and 8 and, ultimately to derive program costs and schedules, as discussed in Section 10.

Each of the analytical advancements, Needs A1 through A4, requires considerable analytical effort followed by testing to obtain data for correlation to verify the derived techniques. They all involve some ground testing while Needs A3 and A4 specify the additional desirability of flight testing.

Material advancements Needs B1 through B6 all require preliminary studies, followed by experimentation with numerous samples to obtain basic data and processing experience. Detailed testing on a limited number of samples to obtain refined data and experience, is also required.

The plans outlined to provide thermal/structural concept advancements, Need C1 through C18, also include preliminary studies as the initial step. Programs to obtain basic material data, develop fabrication techniques, and evaluate structural details for the specific requirements of the subject concept are recognized. These plans, in all cases, also specify ground testing of full scale structural sections plus flight testing of representative structure.

Two important assumptions should be recognized. First these needs, with only three exceptions, were considered to be independent, and not assumed to benefit from advances made to satisfy other needs. Although this is unlikely to be the case, the task of addressing all possible combinations of needs actually satisfied and the timing in which needs are satisfied would involve far too much speculation. The exceptions referred to are Needs C2, C6, and C17 which are applicable to advanced Mach 4.5 aircraft. These needs were defined assuming that the advances required to develop initial Mach 4.5 aircraft (Needs C1, C5, and C16) were completed.

The second assumption involves the depth of effort involved to satisfy Needs B1 through B6, and Needs C1 through C18. The material advancements specified are intended to result in development to the extent that properties necessary for configuration definition studies are obtained to the levels defined in Tables 6 and 7.

Table 8
Technology Needs

ANALYTICAL ADVANCEMENTS

- A1. Improve Methods for Predicting Creep, Fatigue Life, and Crack Propagation in High Temperature Designs Under Spectrum Thermal/Mechanical Loading
- A2. Improve Methods for Predicting Acoustic Fatigue Life of High Temperature Structure Designs
- A3. Improve Methods for Predicting Aerodynamic Heating Effects on Advanced Space Transportation Systems
- A4. Improve Methods for Predicting Aerodynamic Heating Effects on Mach 6.0 Aircraft

MATERIAL ADVANCEMENTS

- B1. Extend Knowledge of High Temperature Titaniums
- B2. Extend Knowledge of Superalloys
- B3. Extend Knowledge of Boron/Borsic-Aluminum Composites
- B4. Develop Advanced Composite Materials for Mach 4.5 Aircraft
- B5. Develop Advanced Composite Materials for Advanced Space Transportation Systems and Mach 6.0 Aircraft
- B6. Improve Reusable Surface Insulation Materials

THERMAL/STRUCTURAL CONCEPT ADVANCEMENTS

- C1. Develop and Verify Hot Structure Design Concepts for Near-Term Mach 4.5 Aircraft
- C2. Develop Hot Structure Design Concepts for Advanced Mach 4.5 Aircraft
- C3. Develop Hot Structure Design Concepts for Advanced Space Transportation Systems
- C4. Develop Hot Structure Design Concepts for Mach 6.0 Aircraft
- C5. Develop and Verify Radiative Metallic TPS Design Concepts for Near-Term Mach 4.5 Aircraft
- C6. Develop Radiative Metallic TPS Design Concepts for Advanced Mach 4.5 Aircraft
- C7. Develop Radiative Metallic TPS Design Concepts for Advanced Space Transportation Systems
- C8. Develop Radiative Metallic TPS Design Concepts for Mach 6.0 Aircraft
- C9. Develop Externally Insulated Structure Design Concepts for Advanced Space Transportation Systems
- C10. Develop and Verify Water Cooled Structure Design Concepts for Advanced Space Transportation Systems

**Table 8 (Continued)
Technology Needs**

- | | |
|------|---|
| C11. | Develop Water Cooled Structure Design Concepts for Mach 6.0 Aircraft |
| C12. | Develop Heat Sink Structure Design Concepts for Advanced Space Transportation System |
| C13. | Develop and Verify Phase Change Material Cooled Structure Design Concepts for Advanced Space Transportation Systems |
| C14. | Develop and Verify Actively Cooled Structure Design Concepts for Mach 6.0 Aircraft |
| C15. | Develop and Verify Liquid Hydrogen Tankage Thermal/Structural Concepts for Mach 6.0 Aircraft |
| C16. | Develop and Verify Hot Structure Air Induction System Design Concepts for Near-Term Mach 4.5 Aircraft |
| C17. | Develop Hot Structure Air Induction System Design Concepts for Advanced Mach 4.5 Aircraft |
| C18. | Develop and Verify Actively Cooled Structure Air Induction System Design Concepts for Mach 6.0 Aircraft |

Concept advancements were defined with the goal of realizing sufficient development through the steps including ground testing that the concept is considered "flightworthy" and commitments to production are justifiable. The final step in each of these plans (C1-C18) was prepared assuming that a hypersonic flight research vehicle will be available to test full scale structural sections. The effort involved in each of these steps includes designing and fabricating sufficient flight test articles to provide the design confidence desired. Obviously, if a flight research aircraft is not available, this confidence cannot be realized until flight tests with pre-production or prototype flight vehicles are performed.



7. TECHNOLOGICAL ADVANCES ACHIEVABLE WITHOUT FLIGHT TESTING

One of the study's goals was to determine the extent to which thermal/structural technology can be advanced without flight testing at hypersonic speeds. The plans formulated to advance each specific need, listed in Appendix A, were examined to estimate the scope of the effort involved and facility requirements. It was assumed that the analytical studies involved could be performed satisfactorily by any major aerospace company. The following paragraphs provide an assessment of existing capabilities to perform the necessary material properties research, fabrication development, element testing, and full scale structural section testing.

7.1 MATERIAL PROPERTIES RESEARCH

Advancements have been identified in Table 8 to extend the knowledge of materials currently in various stages of development, Technology Needs B1, B2, B3 and B6, and to develop advanced composite materials, Needs B4 and B5. All of these advancements involve obtaining large amounts of material property data. In addition, for each of the advancements defined to develop thermal/structural concepts, Needs C1 through C18, material property research is required.

Tables 6 and 7 provide guidelines to understand which material properties require evaluation and the depth to which each property must be determined. In the case of advanced material development it may be necessary to determine only those properties required for preliminary design studies. However, for the more promising advanced materials and those materials already partially developed, the goal will be material properties sufficient for configuration definition studies.

Once there is a firm commitment to an operational hypersonic vehicle program, material properties should be further advanced for detail design and development studies. These refined property data advances were not considered as part of these programs defined to advance thermal/structural technology.

Most of the materials properties tests envisioned are basically standard tests that can be performed at numerous test facilities and companies. The only difficulties would be in conducting some of the tests at higher temperatures and for the required lifetimes. At MCAIR, for example, some minor facility modifications or additions would be required to perform high temperature testing. However, utilization of commercial testing laboratories known to possess the required capabilities could offer a cost effective solution.

7.2 FABRICATION DEVELOPMENT AND ELEMENT TESTING

Section 6.1.3 identified specific advancements in manufacturing that could help reduce the cost of fabricating structures from currently available titaniums, superalloys, and composite materials. Basic fabrication techniques will have to be developed for advanced materials. These techniques would include forming, machining, chemical milling, fastening, welding, brazing, heat treating, surface preparation, inspection, etc. All of these fabrication technique advancements have been considered and judged to be within the capabilities of major aerospace companies. In general, these efforts could be accomplished by laboratory engineering with support from laboratory and production shops.

During the development of any thermal/structural concept, element testing would be performed to evaluate critical structural details. These tests would require specimens of sufficient size to permit evaluations of structural splice options (mechanical attachment versus welded joint), for example. Element testing of small representative structural sections would also be conducted to verify capabilities to sustain design loading. The size of the specimens would be dictated primarily by specific test objectives and could, in instances, be sufficiently large to pose difficulties in existing facilities. However, the testing envisioned to satisfy the subject advancements does not involve any test specimens that are obviously too large. Based on current MCAIR element testing capabilities, it is anticipated that all of the required testing can be accomplished using available facilities.

7.3 FULL SCALE STRUCTURAL TESTING

All of the concept advancements require ground tests of full scale structural sections, to verify design performance and structural integrity. The hypersonic research facilities study (HYFAC), summarized in Reference (1), discussed structural research facility requirements in detail. The primary objective of HYFAC was to assess all research requirements for hypersonic aircraft and define several desirable hypersonic research facilities based on these requirements.

The study recommended two flight research vehicles and five ground research facilities. One of the ground facilities was an integrated structural/fluid systems facility, incorporating thermal, mechanical, acoustic, altitude simulation, and cryogenic flow capabilities. Although none of these facilities were built, the study provided many enlightening findings that are worthy of consideration.

No existing ground test facility has the capabilities to simultaneously simulate the thermal, mechanical, altitude, and acoustic aspects of a hypersonic flight environment that are significant in thermal/structural design. In addition, existing test facilities are limited as to the size of the test article they can accommodate. The HYFAC study included an examination of test article size and acknowledged that with any specimen size other than complete vehicular structure, sacrifices in test confidence levels must be made. However, it was concluded that component or major section size test articles can be used to verify ultimate strength, fatigue life, and flightworthiness.

After the HYFAC study, Reference (37), which summarizes the status of ground research facilities circa 1971, was released. To insure that current thermal/structural ground testing capabilities were understood, a survey was conducted. The intent was to determine current capabilities and identify any significant changes since Reference (37) was issued. In addition to reviewing test facility capabilities afforded by NASA and McDonnell Douglas Corporation, we contacted personnel at the following locations to discuss their capabilities:

- o Air Force Flight Dynamic Laboratory; Dayton, Ohio
- o Arnold Engineering Development Center; Tullahoma, Tennessee
- o Boeing Corporation; Seattle, Washington
- o General Dynamics Corporation; Fort Worth, Texas
- o Grumman Corporation; Bethpage, New York

- o LTV Aerospace Co.; Dallas, Texas
- o Sandia Laboratories; Sandia, New Mexico
- o Wyle Laboratories; Huntsville, Alabama

The survey encompassed 45 major testing facilities. All of the facilities were considered "active". Even though some facilities are not currently operational, they can be made operational if required. In many cases, the facilities have been upgraded since 1971. Most of the upgrading is related to improved data systems, which employ computers much more extensively. Other improvements included additional test area, newer and more equipment, computer control of test functions, etc.

It is reasonable to consider current structural ground testing capabilities approximately on a par, or slightly improved, from that reported in Reference (37). Structural testing can be accomplished more efficiently due to the data system and other improvements. Still, there have been no apparent facility improvements that significantly expand testing capabilities, in terms of providing for larger test articles, more realistic combined thermal/structural simulation, etc.

One major new ground test facility is under construction and scheduled to be operational by 1982. The aeropropulsion systems test facility (ASTF) at the Arnold Engineering Development Center will provide increased propulsion system testing capabilities. The facility will be capable of testing large air induction systems at simulated internal flow conditions representative of flight at altitudes up to 30.5 km (100,000 ft) and speeds to Mach 3.8. A description of this facility is provided in Reference (38).

Technology Needs C1 through C18 were reviewed to determine if currently available or slightly modified ground test facilities could fulfill the intent of the planned advancements; i.e., verify conceptual structural designs to the extent necessary to justify commitments to production vehicle programs.

All of the proposed advancements would necessitate strength and fatigue evaluations of full scale sections. This testing could be performed at various facilities, without modifications other than those normally encountered in adapting facility equipment for the specified testing requirements.

Structural testing of full scale sections at elevated temperatures will be necessary to evaluate each proposed concept. This type of testing could be accomplished, for example, at various transient heating facilities including NASA's Manned Spacecraft Center Structures Test Laboratory in Houston, Texas.

Testing required to evaluate heat shield panel flutter effects could be performed at facilities such as those at the NASA Ames Research Center. Acoustic fatigue life tests, envisioned to satisfy Technology Need A2, can be performed at Wyle Laboratories and major aerospace company facilities.

To satisfy Technology Need C15, LH₂ tankage thermal/structural concepts, a cryogenic facility is required. It was judged that this testing could be performed at a facility such as MCAIR's structures laboratory, which would employ a helium refrigerator to attain cryogenic temperatures. The refrigerator can produce temperatures as low as 14 K (-434°F) and thus is capable of simulating the LH₂ normal boiling point of 20 K (-423°F). This type facility eliminates the hazards of handling

LH₂ and thereby simplifies the testing. Any testing required to verify concept compatibility with LH₂ can be done at the NASA's Marshall Space Flight Center.

Tests to demonstrate the integrity and reusability of thermal/structural concepts in a simulated flight environment will be required to satisfy Technology Needs C1-C14 and C16-C18. NASA's 2.44 m (8 ft) high temperature structures tunnel can simulate combinations of aerodynamic heating and pressure loading representative of Mach 7.0 flight and can produce local Mach numbers from 4.0 to 7.0 on models mounted in the facility's panel holder, Reference (39). Test panels up to 108 cm (42.5 in.) by 152 cm (60 in.) can be accommodated, and a preheat capability is provided. Tests conducted in this type of facility, such as those reported in References (12), (40), and (41), provide the confidence required in thermal/structural concepts addressed in Technology Needs C1-C14.

Unfortunately, comparable facilities are not currently available to test articles of the size required for air induction system concepts as described in Technology Needs C16-C18. Full scale articles can be thermal tested, using existing radiant heat facilities. Structural tests of full scale air induction system configurations can also be conducted with existing capabilities. However, tests to simulate duct internal flow conditions, in terms of rate and temperature, cannot be realized with existing facilities. Presently, these concepts can be developed only by extensive test programs evaluating individual design considerations. When completed, the aeropropulsion systems test facility (ASTF) will provide the capability to do more meaningful air induction system thermal/structural testing. Although modifications will be required to simulate flight conditions above Mach 3.8, as necessary to completely satisfy Needs C16-C18, the potential of this facility should be thoroughly examined.

8. ROLE OF FLIGHT TESTING IN ADVANCING TECHNOLOGY

The role of flight testing in advancing hypersonic thermal/structural technology was examined. First, the basic issue of the necessity for flight testing was considered. Then the unique benefits afforded by a research flight vehicle were investigated. Finally, a flight test program, demonstrating how research aircraft could be utilized to satisfy the technology needs identified in this study, was prepared.

8.1 THE NECESSITY FOR FLIGHT TESTING

The primary benefit that can be derived by flight testing advanced thermal/structural concepts can be simply stated - CONFIDENCE. Concepts can be ground tested and analyzed to great extents, but there will always be a confidence gap until they are exposed to the actual flight environment.

No ground test facilities currently exist that can duplicate all of the environmental aspects of flight simultaneously and, realistically, such facilities may never be available. Historically, all flight vehicles undergo extensive structural verification testing prior to flight. Yet structural problems are frequently found after these vehicles are exposed to the operational flight environment. Even very severe structural problems, such as those encountered in the Comet and Electra aircraft, have gone undetected until the vehicles were flown.

When dealing with the large increase in design demands associated with hypersonic flight, it is logical to anticipate that potentially severe thermal/structural problems will not surface until hypersonic speeds are attained. One of the conclusions presented in Reference (42), which discusses the development of the Mach 3.0 YF-12A (SR-71) aircraft, is "It was proven again that it is absolutely impossible to foresee all problems in advance, when making large steps forward in the speed altitude regime."

To place the value of flight testing in a better perspective, the experience derived with the X-15, the only aircraft that has previously attained hypersonic speeds, should be recognized. Reference (2) discusses this subject and lists "unanticipated flight-test results", which include the following items pertaining to thermal/structural design:

- o Turbulent flow existed over much larger regions of the aircraft than predicted.
- o A variety of "hot spots" resulting from surface irregularities and shock impingements were found.
- o Permanent local buckling occurred due to "hot spots" and insufficient expansion provisions.
- o Extensive panel flutter indicated inadequacies in design criteria and analytical methods.
- o Hot boundary layer air leaked into the vehicle, causing serious damage to unprotected structure.
- o Unanticipated dynamic loads led to structural failure.

As noted in Reference (2), "Such unanticipated flight test results will not likely be discovered in the wind tunnel, yet each mentioned can cause catastrophic failure of a prototype airplane built without the advantage of full scale experimental flight experience."

Discussions held with other members of the aerospace community and the advisors assigned to this study inevitably led to the same conclusion -- flight test can yield a large increase in confidence in thermal/structural design. Flight test and demonstration offers the only reasonably sure way to discover design "unknowns" before production vehicles become operational. In the case of thermal/structural design, confidence is not only important in verifying performance, but is necessary for flight safety. In summary, flight testing of hypersonic thermal/structural designs, either with a research type aircraft or with preproduction or prototype vehicles, is an absolute necessity.

8.2 THE BENEFITS OF A FLIGHT RESEARCH VEHICLE

The required flight testing can be accomplished with preproduction or prototype vehicles. The risk involved with this approach is that large financial commitments may be made before potentially serious design problems are discovered. An alternate approach that merits consideration is the development of a flight research vehicle to provide the means of advancing numerous hypersonic technologies before large commitments are made toward production programs.

A flight research vehicle is quite desirable for advancing the thermal/structural technology. Some of the advantages that could be realized are as follows:

- o Concepts found to have serious problems can be discarded without large financial losses.
- o Routine design problems can be solved without production program scheduling pressures.
- o Alternate concepts can be evaluated simultaneously.
- o Flight test facility costs can be distributed over more than one program.
- o More pure research, such as consideration of potentially high payoff but high risk concepts, could be justified.
- o More emphasis can be placed on pilot safety.

The consensus of the study participants was that, ultimately, the development and use of a hypersonic flight research vehicle will be cost effective. Unfortunately, there is no way to place an absolute value on such a vehicle. However, a logical line of reasoning, as follows, deserves consideration. Based on previous experiences in high speed aircraft and spacecraft design, it is only reasonable to believe that if the six promising hypersonic applications identified in Table 1 were developed, at least one program would encounter an extremely severe thermal/structural design problem that could be identified only by exposure to the actual flight environment. This could result in a loss of life, but more tangibly, would also dramatically affect the program cost.

Since the engineering development costs associated with current aircraft programs are in the order of two billion dollars each, the potential fiscal impact of

a major redesign effort is huge. The tradeoff involved is whether or not the multi-million dollar cost of a research aircraft program is worth the potential cost savings in a multibillion dollar vehicle development program. This question cannot be quantitatively answered with either foresight or hindsight. Experience, logic, and judgment are the only sources of conviction. Experience has shown many payoffs from flight demonstration. Logic indicates that hypersonic flight could produce severe thermal/structural problems. The final judgment that the payoffs from a hypersonic flight research program would be large inevitably follows.

The feasibility of a hypersonic research aircraft has been investigated for a number of years by both the USAF and NASA, and various aerospace companies. In 1975, a joint USAF/NASA study developed a conceptual design, the X-24C, intended to provide an acceptable compromise between the opposite issues of maximum capabilities and minimum cost, Reference (43). A configuration development study of this design, conducted by Lockheed Aircraft Company for NASA, is reported in References (17), (44), and (45). These vehicles were designed to have the capability to cruise for 40 seconds at about Mach 6.6 with scramjet engines or approach a maximum speed of Mach 8.0 using onboard rocket propulsion. However, the aerodynamic configuration was limited by the necessity to use the existing knowledge of the handling and landing characteristics of the basic X-24 vehicle shape.

In order to examine potential improvements that could be realized by relaxing these restrictions, the research vehicle program was redesignated as the National Hypersonic Flight Research Facility (NHFRF) program. Rockwell International is presently defining a NHFRF concept and formulating plans to design and fabricate two vehicles for the USAF. Performance requirements for the NHFRF include at least 40 second cruise at Mach 6.0.

8.3 A FLIGHT TEST PROGRAM TO ADVANCE THERMAL/STRUCTURAL TECHNOLOGY

Flight tests of large structural sections are proposed as part of the plans defined to satisfy Technology Needs C1 through C18. A flight test program was formulated to satisfy operational vehicle development program needs as closely as possible. This program was predicated on the availability of a hypersonic research aircraft such as the NHFRF vehicle or the X-24C research aircraft described in Reference (45). Basic assumptions that were made during the formulation of the flight test program include the following:

- o The vehicle is air-launched from a B-52G and is of the 31.75 Mg (70,000 lbm) mass class.
- o The basic vehicle configuration and propulsion system are similar to those defined in Reference (45).
- o The vehicle is capable of 40 second cruise at approximately Mach 6.6 or a maximum velocity of approximately Mach 8.0.
- o As shown in Figure 22, a section of the fuselage is set aside as a payload bay and can be used for thermal/structural concept testing. The wings and the vertical tails are also replaceable and adaptable for testing.

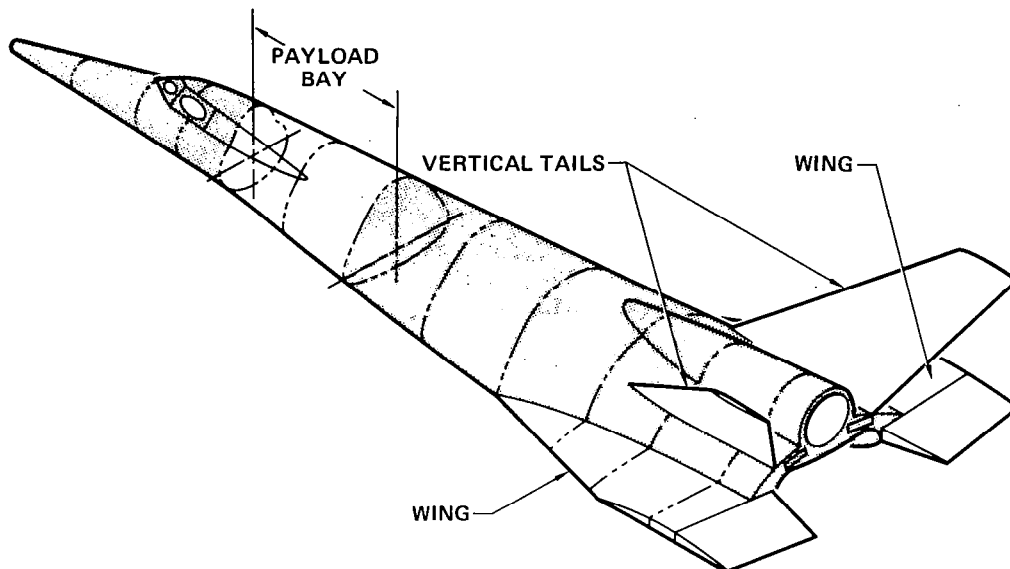

FIGURE 22
COMPONENTS AVAILABLE FOR THERMAL/STRUCTURAL TESTING

- o The remainder of the fuselage is non-replaceable and may be any one of many concepts designed for basic flight test vehicle design requirements. The thermal/structural design considerations for these regions of the fuselage are addressed in Section 9.
- o Two test aircraft will be built. The first aircraft will be operational by January 1985 and the second by July 1985.
- o Each vehicle will conduct at least one flight per month for about 10 years.
- o A six month period is allotted to reconfigure the aircraft for major thermal/structural or propulsion system modifications, but may not be required.

The formulated flight test program was established to satisfy the technology needs for, initially, the near-term Mach 4.5 aircraft, then the advanced Mach 4.5 aircraft, the Advanced Space Transportation Systems, and finally, the Mach 6.0 aircraft. Figure 23 defines the test program planned for each of the test vehicles. It should be noted that the initial testing conducted on Test Vehicle #1 will provide data on near-term Mach 4.5 thermal/structural concepts rather than check out the maximum speed capabilities of the vehicle. This checkout is accomplished in Phase A with Test Vehicle #2. This testing order was selected to reflect the earliest possible date by which near-term Mach 4.5 concept testing could be completed.

Table 9 describes the test procedure proposed to fulfill each objective. In addition, this figure indicates how, by locating specific thermal/structural articles at the various airframe test components (payload bay, wings, and vertical tails) during different test phases, each thermal/structural concept can be tested.

TEST PHASE	TEST OBJECTIVES	CALENDAR YEAR										
		1985	1986	1987	1988	1989	1990	1991	1992	1993	1994	
<u>Test Vehicle #1:</u>												
A	Demonstrate radiative metallic TPS fuselage and hot structure wings and tails for near-term Mach 4.5 aircraft.	█										
B	Demonstrate hot structure fuselage and air induction system for near-term Mach 4.5 aircraft. Extend evaluation of Phase A hot structure wings and tails.			█								
C	Demonstrate radiative metallic TPS fuselage, externally insulated wings with hot structure leading edges, and both hot and heat sink structure tails for ASTS application.					█						
D	Demonstrate water cooled fuselage, and PCM cooled wings including the leading edges for ASTS applications. Extend evaluation of tail concepts from Phase C.								█			
E	Demonstrate water cooled fuselage, hot structure wings, and water cooled tails for Mach 6.0 aircraft. Also, demonstrate an LH ₂ tankage TPS concept.									█		
<u>Test Vehicle #2</u>												
A	Check out basic vehicle thermal/structural concept to maximum speed capabilities. Obtain data as required for Technology Need A4.	█										
B	Demonstrate radiative metallic TPS fuselage, hot structure wings and tails, and hot structure air induction system for advanced Mach 4.5 aircraft.				█							
C	Demonstrate hot structure fuselage, radiative metallic TPS wings with hot structure leading edges, hot structure tails, and an actively cooled air induction system for Mach 6.0 aircraft. Also, demonstrate an LH ₂ tankage TPS concept.					█						
D	Demonstrate an actively cooled fuselage and wing leading edge, LH ₂ tankage TPS concept for Mach 6.0 aircraft. Extend evaluations of wing, tail, and air induction system concepts from Phase C.									█		

**FIGURE 23
FLIGHT TEST PROGRAM OBJECTIVES AND SCHEDULE**

Table 9
Flight Test Program Procedure and Vehicle Configuration

Test Vehicle No. 1

TEST PHASE	TEST PROCEDURE	TEST COMPONENT THERMAL/STRUCTURAL DESIGN			
		PAYLOAD BAY	WINGS	TAILS	MODULES
A.	Evaluate basic vehicle low speed handling and landing characteristics. Build-up speed to Mach 4.5, holding low dynamic pressures and load factors. Maintain Mach 4.5 speed and build-up dynamic pressures and load factors to design values.	Near-term Mach 4.5 radiative metallic TPS concept (C5)	Near-term Mach 4.5 hot structure concept, including leading edges (C1)	Near-term Mach 4.5 hot structure concept (C1)	None
B.	Build-up to Mach 4.5 speed, and design dynamic pressures and load factors similarly to Phase A. Emphasize ramjet engine test requirements.	Near-term Mach 4.5 hot structure concept, JP fuel tank (C1)	Same as Phase A	Same as Phase A	Near-term (C16) Mach 4.5 hot structure air induction system
C.	Build-up to maximum vehicle speed, holding low dynamic pressures and load factors. Maintain maximum speed and build-up dynamic pressures and load factors to design values. Tailor flight profiles to simulate re-entry vehicle flight as much as possible within the vehicle design flight envelope and safety constraints.	Advanced Space Transportation System (ASTS) radiative metallic concept (C7)	ASTS externally insulated structure concept, (C9) hot structure concept leading edges (C3)	One tail - ASTS hot structure concept (C3); one tail - ASTS heat sink structure concept (C12)	None
D.	Build-up to maximum vehicle speed and design dynamic pressures and load factors similarly to Phase C.	ASTS water cooled structure concept (C10)	ASTS phase change material cooled structure concepts, including leading edges (C13)	Same as Phase C	None
E.	Build-up to maximum vehicle speed holding low dynamic pressures and load factors. Maintain maximum speed and build-up dynamic pressures and load factors to design values. Emphasize scramjet engine test requirements.	Mach 6.0 water cooled structure concept (C11), LH ₂ tankage concept (C15)	Mach 6.0 hot structure concept, including leading edges (C4)	Mach 6.0 water cooled structure concept (C11)	Scramjet engine

Test Vehicle No. 2

TEST PHASE	TEST PROCEDURE	TEST COMPONENT THERMAL/STRUCTURAL DESIGN			
		PAYLOAD BAY	WINGS	TAILS	MODULES
A.	Evaluate basic vehicle low speed handling and landing characteristics. Build-up to maximum vehicle speed, holding low dynamic pressures and load factors. Maintain maximum speed and build-up dynamic pressures and load factors to design values.	Basic vehicle thermal/structural concept	Basic vehicle thermal/structural concept	Basic vehicle thermal/structural concept	None
B.	Build-up to Mach 4.5 speed, and design dynamic pressures and load factors similarly to Test Vehicle #1, Phase B.	Advanced Mach 4.5 radiative metallic TPS concept (C6)	Advanced Mach 4.5 hot structure concept, including leading edges (C2)	Advanced Mach 4.5 hot structure concept (C2)	Advanced Mach 4.5 hot structure air induction system (C17)
C.	Build-up to Mach 6.0 speed, holding low dynamic pressures and load factors. Maintain Mach 6.0 speed and build-up dynamic pressures and load factors to design values. Emphasize ramjet engine test requirements.	Mach 6.0 hot structure concept (C4), LH ₂ tankage concept (C15)	Mach 6.0 radiative metallic TPS concept (C8), hot structure leading edges (C4)	Mach 6.0 hot structure concept (C4)	Mach 6.0 actively cooled structure air induction system (C18)
D.	Build-up to Mach 6.0 speed, and design dynamic pressures and load factors similarly to Phase C.	Mach 6.0 actively cooled structure concept (C14), LH ₂ tankage concept (C15)	Same as Phase C except for actively cooled leading edges (C14)	Same as Phase C	Same as Phase C

The program summarized in Figure 23 and Table 9 reflects the versatility of a flight test vehicle configured with replaceable components for thermal/structural testing. Although all major thermal/structural concepts could be flight demonstrated, it should be recognized that this would probably not be necessary. Some concepts will undoubtedly be eliminated following analytical or ground test evaluations. Time allotted to test these rejected concepts could be used to accumulate additional data on the more promising concepts or to test concepts not presently envisioned.

Another objective was to assess the interaction of required thermal/structural experiments with probable flight experiments planned for other disciplines. As noted in Figure 23 and Table 9, propulsion system experiments were acknowledged during the flight test planning for thermal/structural experiments. However, many other experiments have been defined on a hypersonic research vehicle to satisfy technology needs of other disciplines. Using various previous studies, including Reference (46), as guidelines, these other experiments may involve the following:

- o Stability and Control
- o Radome Materials
- o Electromagnetic Radiation Distortion
- o Sonic Boom Intensity
- o Fuel Slosh Dynamics
- o Plume Physics
- o IR Spectrometer Data
- o Atmospheric Ozone
- o Reaction Controls
- o Radar Windows
- o Digital Avionics
- o Store Separation Dynamics

A cursory examination of the interactions between these other experiments and those planned for thermal/structural concepts was conducted. With the sole exception of store separation dynamics, no restrictive interactions could be identified. It would appear that any of these experiments could be compatible with thermal/structural and propulsion system testing.

In the case of store separation testing, it is likely that the payload bay would be dedicated to that primary objective. In addition, due to the inherent precautions necessary to conduct store separation tests, it is likely that a proven thermal/structural configuration would be required to minimize risks.



9. HYPERSONIC RESEARCH AIRCRAFT THERMAL/STRUCTURAL DESIGN CONSIDERATIONS

Basic thermal/structural design considerations for a hypersonic research aircraft were examined as part of this study. Preliminary studies conducted to develop the X-24C included a thermal/structural concept trade study. As reported in Reference (43), externally insulated structure concepts incorporating either (1) an ablation material or (2) reusable surface insulation material and heat sink structure concepts were identified as attractive candidates on the basis of mass and cost. The study summarized in References (17), (44), and (45) therefore considered only three thermal/structural concepts. Two externally insulated structure concepts (one using an elastomeric ablator and the other a reusable surface insulation material) and a heat sink structure concept employing Lockalloy were addressed. The latter concept was recommended based on considerations such as minimum refurbishment, flight safety, growth potential, etc., even though it had the highest initial material cost and was the heaviest of the concepts studied.

Table 5 indicates that externally insulated and heat sink structure concepts have little application for hypersonic aircraft. These concepts are candidates for small regions on advanced space transportation systems, but are not promising for the selected aircraft applications. Hot structure concepts and radiative metallic TPS concepts were rejected as candidates for research aircraft thermal/structural design in the Reference (43) study because of relatively high mass or cost. However, neither the mass and cost differences nor the assumptions that were used to derive costs are presented.

Since both hot structure and radiative metallic TPS concepts are identified, in Table 5, as candidates for numerous hypersonic applications, it seems that they merit serious consideration as the basic research aircraft thermal/structural concept. Unless significant disadvantages can be associated with hot structure or radiative metallic TPS thermal/structural concepts, it is more logical to design the research aircraft with one of these concepts to benefit from the experience. By designing an entire vehicle, rather than only vehicle sections, many additional secondary design considerations can be recognized and confronted. Experience could be gained, for example, in how to design the interface between the fuselage and wings, or how to integrate the cockpit provisions into the design, etc.

The differences in thermal/structural mass may not significantly impact total aircraft mass. Reference (45) states that, of the three different concepts considered, "all types resulted in approximately the same vehicle mass." Previous inhouse MCAIR studies have shown the radiative metallic TPS concept as being mass competitive with most other hypersonic thermal/structural concepts. Therefore, a mass analysis was conducted of the research aircraft configured with a radiative metallic TPS concept. This analysis is summarized in Section 9.1.

There are other considerations, such as the ramifications of thermal/structural design on aerodynamic characteristics unique to research aircraft, which were not addressed in the Reference (43) and (45) studies. This subject is discussed in Section 9.2. Cost considerations involved in comparing thermal/structural concepts were also investigated. These results are presented in Section 9.3.

The evaluations in this study were limited to comparisons between the radiative metallic TPS concept and the Lockalloy heat sink structure concept described in Reference (45). It is believed that the trends derived for the radiative metallic

TPS concept are similar to those for hot structure concepts. It should be recognized that a mixture of thermal/structural concepts (such as a radiative metallic TPS fuselage, a hot structure wing, and a heat sink tail) may be a better approach than using only one concept for the entire vehicle.

9.1 MASS ANALYSIS

The final configuration defined in Reference (45) was examined to provide a means of comparing thermal/structural concepts and their impact on vehicle mass and performance.

A thermal analysis was conducted to size the thermal protection required with radiative metallic TPS concept to meet the design mission described in Reference (45), which includes a 40 second cruise at Mach 6.6. By employing Rene' 41 heat shields and a 6.4 mm (1/4 in) layer of 56 kg/m^3 (3.5 lbm/ft^3) fibrous insulation, contained in metallic foil, over the entire vehicle (except for leading edges and control surfaces), aluminum substructure temperatures were maintained below 422 K (300°F). This information was used to compare thermal/structural concept mass requirements.

Structural items considered in this analysis included the fuselage, wings, tails, and engine section (thrust mounts). These items were assumed to be equivalent to the fuselage, wings, and tail components of the final group mass breakdown presented in Reference (45). All other items listed in the group mass breakdown were assumed to be applicable to both concepts.

There are inherent mass advantages associated with operating the primary structure at a lower temperature, such as reduced internal insulation and environmental control system masses. These differences, which would favor the radiative metallic TPS concept, were considered secondary and, therefore, were not determined.

Masses for the primary protected structure were based on a design mass equal to takeoff mass at 2.5g limit load factor. Standard estimating methods were used, considering the shingle masses to be dependent on surface temperature variations over the vehicle's surface. Insulation masses were based on the thermal analysis results discussed above. Some items which were considered too thin to thermally protect, such as leading edges and control surfaces, were assumed to employ hot structure concepts and were weighed using high temperature materials.

For the Lockalloy heat sink structure concept described in Reference (45), the structural grouping of the fuselage, wings, and tails totaled 5874 kg (12,950 lbm). The similar structural grouping mass calculated for the radiative metallic TPS concept was 5647 kg (12,450 lbm). This difference is reasonably small, so that the research vehicle will still be in the same basic weight class. However, these results indicate that the radiative metallic TPS concept may be superior to the Lockalloy heat sink structure concept on the basis of vehicle mass. The latter concept does possess a small advantage in volumetric efficiency that was not considered in this evaluation.

9.2 AERODYNAMIC RAMIFICATIONS

A high speed aircraft's aerodynamic characteristics are influenced by its thermal/structural design. Aircraft drag is sensitive to both the surface roughness characteristics and volume requirements of the TPS. Although a detailed examination of the ramifications of these effects on aerodynamic performance is beyond the scope of this study, some generalizations can be made.

The most obvious aerodynamic consideration is that of surface roughness differences between candidate TPS concepts. It is estimated that surface roughness effects, inherent to current supersonic aircraft designs, contribute about 5% to 8% of the aircraft's total drag. A Lockalloy heat sink structure concept would probably display surface roughness characteristics typical of current designs. However, the radiative metallic TPS concept's heat shields must be contained in a manner that permits thermal expansion. Various heat shield containment designs have been examined but each design includes local surface discontinuities wherever the shields are attached. It is reasonable to expect that these discontinuities would approximately double the surface roughness drag contribution.

Another aerodynamic consideration is the difference in wave drag due to thickness attributable to TPS requirements. For short flights at high speeds, the radiative metallic TPS concept's thickness requirements would be greater than the Lockalloy's. However, the required Lockalloy thickness increases rapidly with longer flight times, whereas the radiative metallic TPS thickness increase is more gradual. For hypersonic cruise aircraft, it is reasonable to expect the Lockalloy concept's thickness to be greater than that of the radiative metallic TPS concept. As a result, the Lockalloy concept's wave drag would be higher.

Significant increases in either the surface roughness or wave drag would be detrimental to hypersonic cruise aircraft performance. Small changes in the (lift/drag) ratio and, hence, range factor can have a large impact on vehicle size as the cruise leg is the major fuel consuming mission segment. A detailed aerodynamic analyses would be required to quantify this impact but the effect is certain to be significant.

Conversely, drag increases resulting from advanced thermal/structural designs will not impose large performance restrictions on a hypersonic research aircraft. Research aircraft do not cruise for extended times so the cruise (lift/drag) ratio is not critical. The acceleration segment of the research aircraft's mission is most important. If, as anticipated, the research aircraft is powered by off-the-shelf rocket engines, drag effects are unlikely to impact the number of engines required.

The thermal/structural design can also influence aerodynamic factors other than the drag characteristic. For example, preliminary studies of research aircraft with a Lockalloy heat sink structure concept have shown that the aircraft's trajectory may require tailoring. To avoid excessive heat sink material requirements, it may be necessary to follow the high speed dash with a climb to high altitudes before starting to descend. This maneuver reduces the maximum structural temperature. At the high altitudes considered in these preliminary studies, the aircraft's aerodynamic control capabilities are a concern since dynamic pressures are very low. A similar maneuver would not be required for a radiative metallic TPS concept.

9.3 COST COMPARISON

Thermal protection system (TPS) costs for the X-24C research aircraft were reported in Reference (44) for the three design approaches considered. The cost (in 1976 dollars) of TPS panels, ready for installation, were summarized as follows:

o Lockalloy panels	\$16,430/m ² (\$1526/ft ²)
o Reusable Surface Insulation Panels	\$14,080/m ² (\$1308/ft ²)
o Ablator Panels	\$5870/m ² (\$454/ft ²)

MCAIR conducted a study, also in 1976 dollars, to determine the cost of configuring a research aircraft with a radiative metallic TPS. Heat shield panels, fabricated from Rene' 41, were assumed to be 0.61 m x 0.61 m (2 ft x 2 ft) and the cost/panel was based on producing sufficient panels for two research aircraft. Heat shield costs were also based on a corrugation stiffened, beaded skin design. Insulation costs were based on lightweight fibrous insulation encased in metallic foil.

The costs for tooling, rather than material or fabrication costs, were found to drive the total cost involved. Tooling costs were influenced by the number of flat and curved panels required, and the degree of commonality afforded by the tooling. Initially, a ratio of 55% curved panels to 45% flat panels was assumed. Assuming that a separate tool was required to fabricate each panel, the cost was \$9957/m² (\$925/ft²). Assuming that common tooling could be used for at least 40% of the panels, the cost was reduced to \$6630/m² (\$616/ft²).

An alternate aircraft configuration, designed to maximize flat panel usage, was then examined. This configuration resulted in only 10% curved panels. Panel costs of \$5156/m² (\$479/ft²) and \$2723/m² (\$253/ft²) were determined based on tooling commonalities of 40% and 85%, respectively. It was concluded that the radiative metallic TPS concept was definitely competitive for research aircraft on the basis of cost.

Other cost aspects were addressed in Reference (44) that justified the ultimate selection of Lockalloy panels for the X-24C. These included the benefits afforded by heat sink structure whereby the TPS material also serves as primary structure and the resuability associated with metallic surfaces. These considerations are valid, but require a lot of speculation and assumptions for a meaningful result. The radiative metallic TPS approach also provides the advantages of reusability, but does require a separate primary structure. It was judged that a detailed cost study of the radiative metallic TPS concept for a research aircraft program was not warranted since the difference between this design approach and the heat sink structure design approach would not be apparent without an effort beyond the scope of the study.

9.4 SUMMARY

The Lockalloy heat sink structure and radiative metallic TPS concepts, as applicable to a hypersonic research aircraft, have been examined on the comparative bases of mass, aerodynamic ramifications, and cost. No large differences were found but the small differences that can be identified tend to favor the radiative metallic TPS concept. Most importantly, no significant disadvantages can be associated with the radiative metallic TPS concept.

The participants in this study agreed that it is logical and preferable to design the hypersonic research aircraft around a promising thermal/structural concept. Radiative metallic TPS and hot structure concepts fit this definition. Since no real disadvantages exist with these concepts, it does not seem reasonable to eliminate them from consideration as candidates for hypersonic research aircraft. It is illogical to design and develop a thermal/structural concept specifically for the research aircraft that has very limited future applicability. It is logical to design the research aircraft around the radiative metallic TPS and/or hot structure concepts.



10. PROGRAMS FOR ADVANCING THERMAL/STRUCTURAL TECHNOLOGY

Programs, integrating the planning outlined to satisfy each specific technology need, were formulated to comprehend schedule ramifications and costs. Since the needs are, in many cases, associated with specific hypersonic vehicles, the development program scheduling for the promising applications identified in Table 1 was examined. Initial Operation Capability (IOC) dates were estimated, as discussed in Section 3, for each of the projected hypersonic applications. However, to be of benefit, technological advances must be made well in advance of these IOC dates. As noted in Section 5, there are typically three distinct study phases - preliminary design, configuration definition, and detail design and development. It is necessary to relate these phases to IOC dates to recognize the critical milestones in technology development.

Numerous flight vehicle development programs were examined to establish scheduling trends. Historically, scheduling is heavily influenced by factors such as need, available funding, etc., rather than anticipated design complexity. Some meaningful trends were observed, however, which permitted development goal dates to be established. For example, preliminary design studies conducted at a dedicated, yet not urgent, level of effort can be completed in two to three years. Configuration definition study phases are normally accomplished in one year. A five to six year interval between the initial of a detail design and development study phase and the eventual IOC date is typical. As a result it can be expected that preliminary studies will be initiated 8 to 10 years before the IOC dates previously estimated.

The urgency of the development of a Mach 4.5 reconnaissance aircraft was emphasized earlier. Therefore, it was assumed that an attempt may be made to initiate this program in the near future and to progress as soon as practical (8 years) to an early IOC date. Milestones for the remaining hypersonic vehicles were derived by assuming a more extended development program (10 years). Table 10 summarizes the significant milestone goals for each design phase required to develop these vehicles and meet their estimated IOC date.

10.1 PROGRAM SCHEDULES AND OPTIONS

A program devised to satisfy each of the technology needs identified in Table 8, assuming that hypersonic flight research vehicle were available, was investigated first. This program, designated Plan A, was scheduled around the flight test program summarized in Figure 23, and is shown in Figure 24. A one and one-half year period was assumed to develop the flight test articles required for Needs C1-C15. A two year period was assumed to develop the more complex air induction system flight test articles for Needs C16-C18. In all cases, two years each was allotted to perform the required analyses, and fabricate and test structural sections in ground facilities.

It was obvious that none of the material advancements to satisfy Technology Needs B1-B6 could be completed in time for the near-term Mach 4.5 concept development programs, even if they were initiated in 1979. Therefore, the advancements to satisfy Needs B1-B4 were planned to be completed prior to the initiation of advanced Mach 4.5 concept advancements, and the advancements for Needs B5 and B6 are to be completed in time for the ASTS and Mach 6.0 concept advancements. The schedule reflects that three years were assumed to satisfy Needs B1, B2, B3, and B6 and four years to satisfy Needs B4 and B5, which involve more advanced materials.

Table 10
Hypersonic Vehicle Development Milestone Goals

APPLICATION	START PRELIMINARY DESIGN	START CONFIGURATION DEFINITION	START DETAIL DESIGN AND DEVELOPMENT	IOC DATE
Mach 4.5 Strategic Reconnaissance Aircraft	1979	1981	1982	1987
Mach 4.5 Tactical Strike Aircraft	1980	1983	1984	1990
Mach 4.5 Fleet Air Defense Interceptor	1985	1988	1989	1995
Advanced Space Transportation System	1985	1988	1989	1995
Mach 6.0 Strategic Reconnaissance Aircraft	1990	1993	1994	2000
Mach 6.0 Transport	1990	1993	1994	2000

Four years were assumed to achieve the goal of Need A1 which should be initiated as soon as possible. Only two years were considered necessary to satisfy Need A2 which can be completed before the advanced Mach 4.5 concept development programs. The schedule for Need A3 assumes that some flight testing on the Space Shuttle can be conducted during 1988-1990. Need A4 scheduling was based on flight testing during Phase A with test vehicle #2, Figure 23.

By examining Plan A and the flight test program outlined in Figure 23, it is obvious that the flight test dates are not compatible with the vehicle development milestone goals listed in Table 10. In order for the accomplishments made in satisfying needs to be beneficial, they must be realized by the vehicle configuration definition phase. Near-term Mach 4.5 needs would not be satisfied until about 1989, advanced Mach 4.5 needs by 1990, ASTS needs by about 1993, and Mach 6.0 needs by 1995. This would produce the following delays in attaining the desired initial operation capability (IOC) dates:

- o Mach 4.5 strategic reconnaissance aircraft, 8 year delay to 1995
- o Mach 4.5 tactical strike aircraft, 6 year delay to 1996
- o Mach 4.5 fleet air defense interceptor, 2 year delay to 1997
- o Advanced space transportation system, 5 year delay to 2000
- o Mach 6.0 strategic reconnaissance aircraft, 2 year delay to 2002
- o Mach 6.0 transport, 2 year delay to 2002

Particularly in the cases of the near-term Mach 4.5 aircraft and the ASTS, these delays are quite significant.

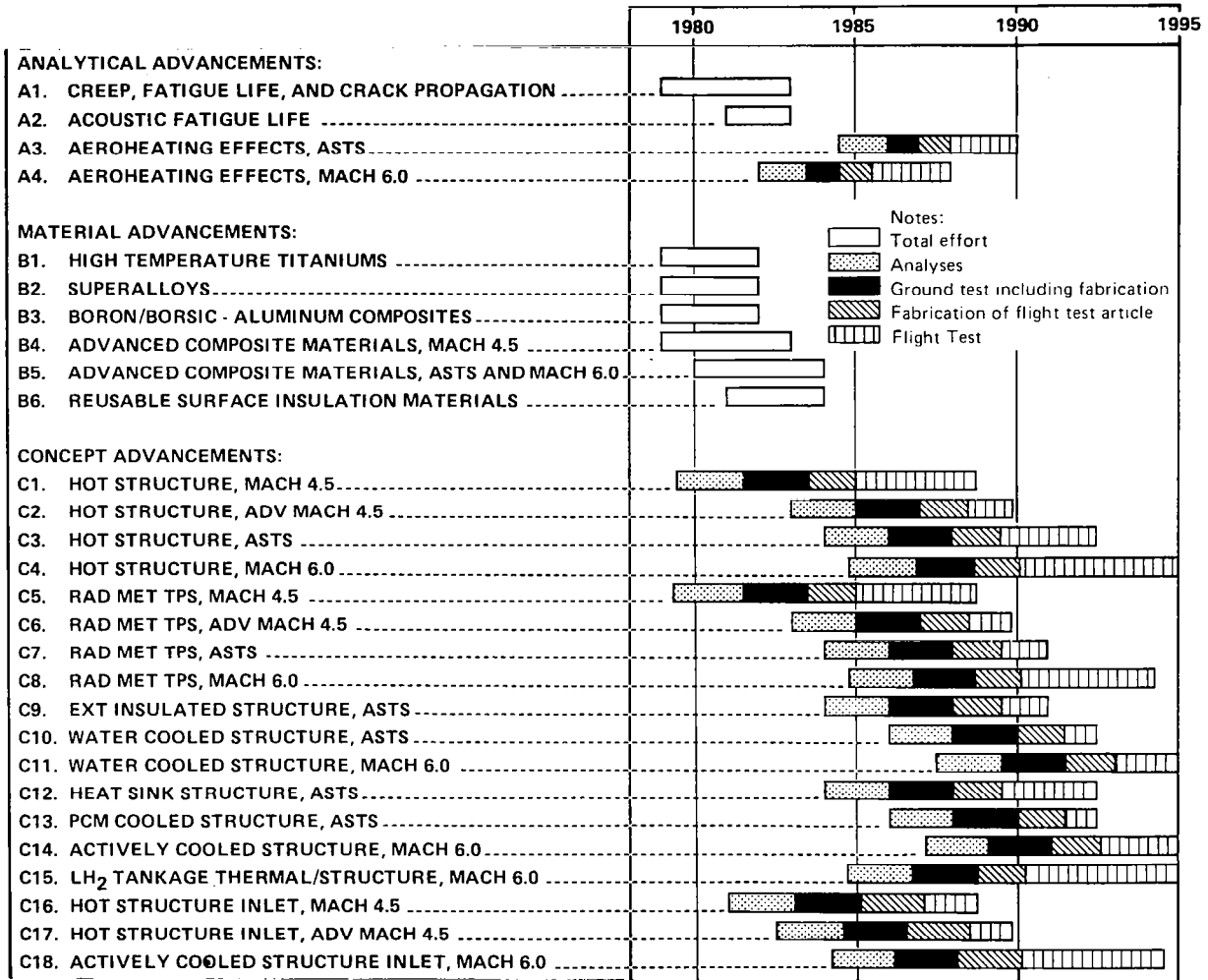

**FIGURE 24
TECHNOLOGY ADVANCEMENT - PLAN A**

An alternate plan, Plan B, using only ground testing to obtain design confidence, was also scheduled. Figure 25 indicates that the only flight testing assumed is that on the Space Shuttle to satisfy Technology Need A3. The time spans allotted to accomplish required tasks are the same as for Plan A. With Plan B, only the near-term Mach 4.5 needs (C1, C5 and C16) will not be satisfied by the configuration definition date goals in Table 10. This would delay by 2 years, to 1989, the Mach 4.5 reconnaissance aircraft's IOC.

The 28 Technology Needs identified in Table 8 were chosen based on a selective set of criteria defined in Section 6. However, the effort involved to satisfy all of these needs is quite ambitious. The expense involved to satisfy all needs will also be quite significant. Therefore it was decided to identify "high priority" needs, i.e. needs which are judged to offer the highest payoffs. Table 11 identifies these high priority needs.

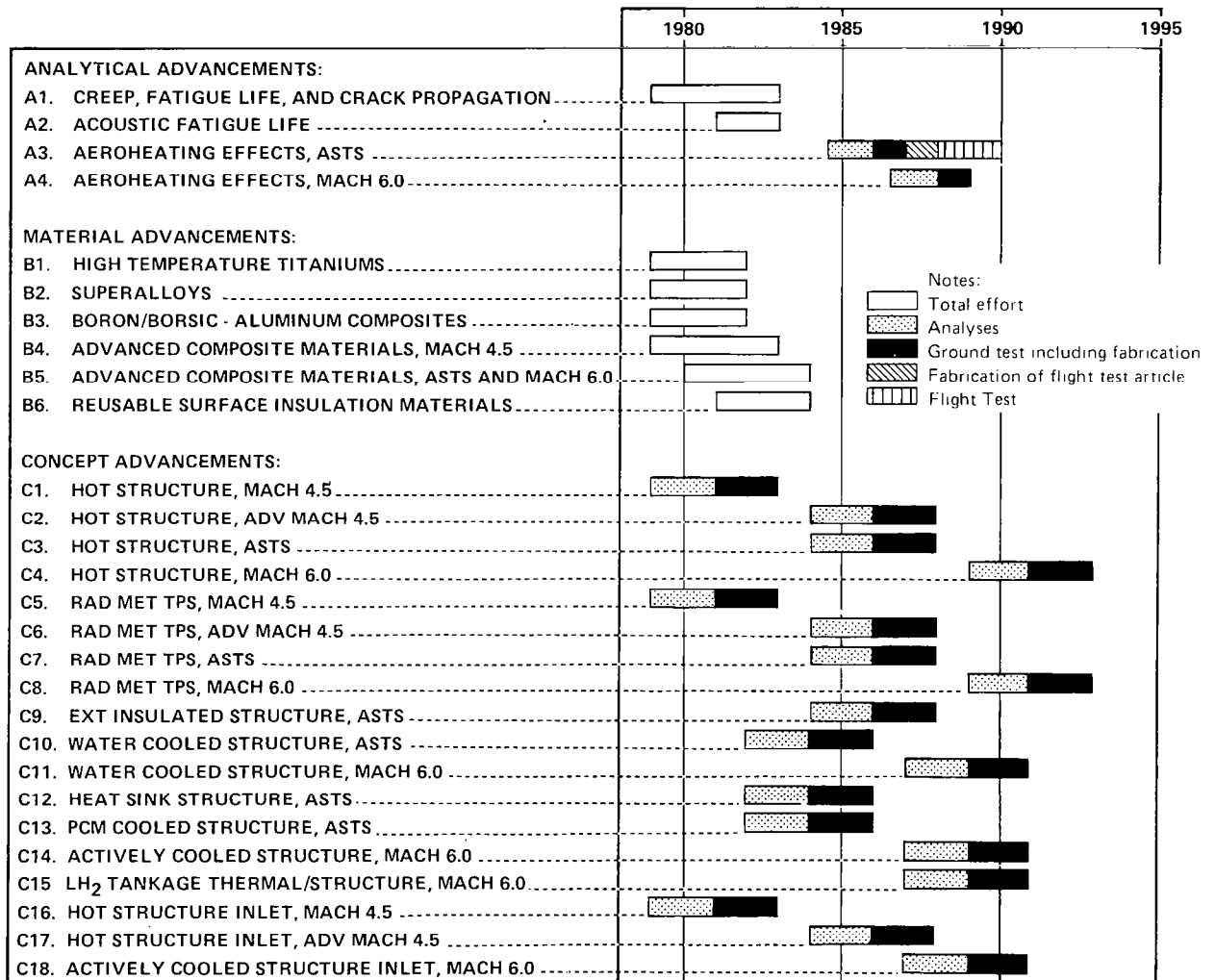

FIGURE 25
TECHNOLOGY ADVANCEMENT - PLAN B

Table 11
Identification of High Priority Needs

	RATIONALE	
	HIGH PRIORITY	LOWER PRIORITY
ANALYTICAL ADVANCEMENTS:		
A1. Creep, Fatigue Life, & Crack Propagation	Very High Potential Payoff	
A2. Acoustic Fatigue Life		Not Critical, Payoffs Would Be Reflected In Reduced Mass
A3. Aeroheating Effects, ASTS		
A4. Aeroheating Effects, M6.0		
MATERIAL ADVANCEMENTS:		
B1. High Temperature Titaniums		Not Critical, Payoffs Would Be Reflected In Reduced Mass
B2. Superalloys		
B3. Boron/Borsic-Aluminum Composites		
B4. Advanced Composite Materials, M4.5		
B5. Advanced Composite Materials, ASTS & M6.0		
B6. Reusable Surface Insulation Materials		Limited Application
CONCEPT ADVANCEMENTS:		
C1. Hot Structure, M4.5	Near Term Necessity	
C2. Hot Structure, Adv. M4.5		Can Rely on C1 Experience
C3. Hot Structure, ASTS		
C4. Hot Structure, M6.0	Advanced Necessity	
C5. Radiative Metallic TPS, M4.5	Near Term Necessity	
C6. Radiative Metallic TPS, Adv. M4.5		Can Rely on C5 Experience
C7. Radiative Metallic TPS, ASTS		
C8. Radiative Metallic TPS, M6.0	Advanced Necessity	
C9. Ext. Insulated Structure, ASTS		Can Rely on Shuttle Experience
C10. Water Cooled Structure, ASTS		Not Critical
C11. Water Cooled Structure, M6.0	Warranted, High Payoff Potential	
C12. Heat Sink Structure, ASTS	Warranted, High Payoff Potential	
C13. PCM Cooled Structure, ASTS	Leading Edge-Warranted	General Approach Not Critical
C14. Actively Cooled Structure, M6.0	Warranted, High Payoff Potential	
C15. LH ₂ Tankage Thermal/Structure, M6.0	Advanced Necessity	
C16. Hot Structure Inlet, M4.5	Near Term Necessity	
C17. Hot Structure Inlet, Adv. M4.5		Can Rely on C16 Experience
C18. Actively Cooled Structure Inlet, M6.0	Advanced Necessity	

Only one analytical advancement, Need A1, was judged as high priority. None of the material advances were considered critical. However, eleven concept advancements were felt to be essential. Figure 26 indicates the emphasis placed on developing concepts for near-term Mach 4.5 aircraft applications and, later, for Mach 6.0 aircraft applications.

The impact of reducing the scope of technological advances to these needs only, was examined. Plan C reflects an effort satisfying only high priority needs with no flight testing. These programs can be conducted a few at a time and, in the case of the Mach 6.0 advances, with some flexibility in timing, and still meet the Mach 6.0 development milestones. However, the near-term Mach 4.5 needs still cannot be accomplished in time to meet the reconnaissance aircraft's desired IOC date.

One other integrated program possibility was considered. Plan D acknowledges only high priority needs, but does consider the availability of a flight research vehicle by 1985. It was assumed that Mach 4.5 needs will be satisfied via ground testing only to avoid excessive delays. The research aircraft can concentrate on advancing ASTS and Mach 6.0 aircraft technology needs. An alternate flight test program similar to that discussed for Plan A is described in Figure 27. Table 12 provides the Plan D supplemental information. Figure 28 shows the Plan D scheduling. The Mach 4.5 reconnaissance aircraft IOC date is still delayed by 2 years, but the remaining milestones can be reached. Compared to Plan A, Plan D utilizes a research aircraft to advantage without causing long schedule delays. It would provide additional confidence in many of the high priority needs when compared to Plan B or C.

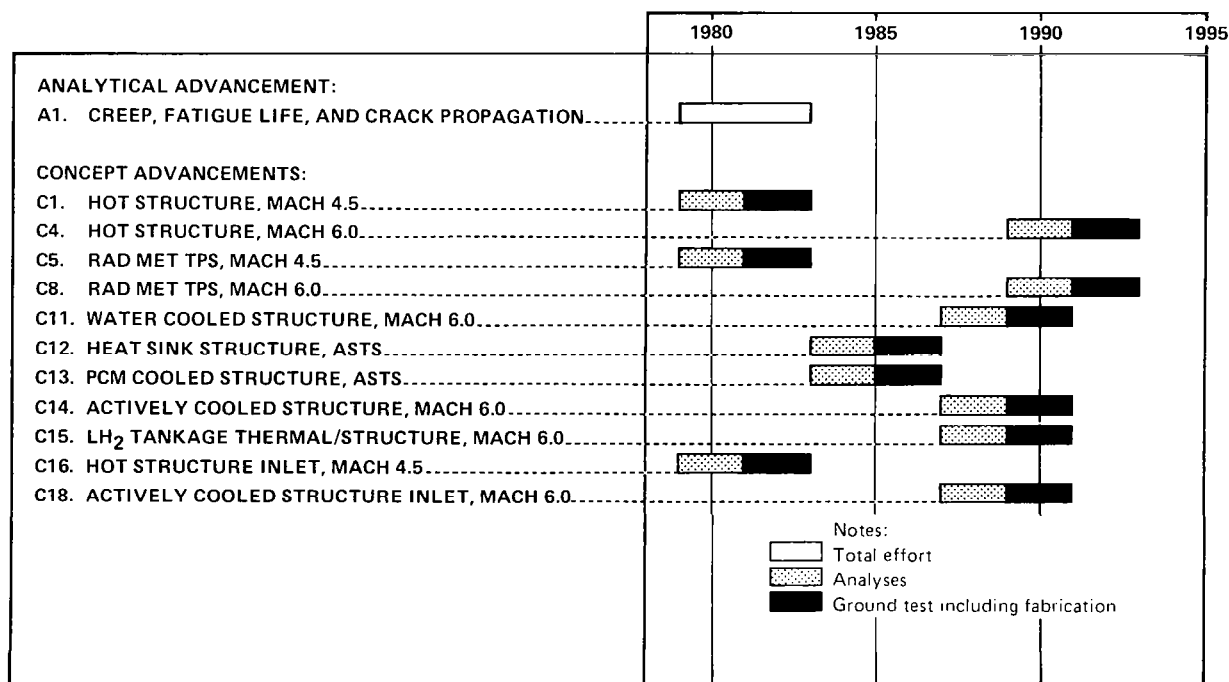

FIGURE 26
 TECHNOLOGY ADVANCEMENT - PLAN C

TEST PHASE	THERMAL/STRUCTURAL TEST OBJECTIVES	CALENDAR YEAR									
		1985	1986	1987	1988	1989	1990	1991	1992	1993	1994
<u>Test Vehicle #1:</u>											
A	Check out basic vehicle thermal/structural concept to maximum speed capabilities.										
B	Demonstrate water cooled fuselage, radiative metallic TPS wings with hot structure leading edges, and hot structure tails for Mach 6.0 aircraft. Also, demonstrate an LH ₂ tankage TPS concept.										
C	Extend evaluations of promising concepts from Phase B.										
<u>Test Vehicle #2:</u>											
A	Demonstrate hot structure fuselage and wings, and an actively cooled air induction system for Mach 6.0 aircraft. Demonstrate heat sink structure tails and PCM cooled wing leading edges for ASTS applications. Also, demonstrate an LH ₂ tankage TPS concept.										
B	Demonstrate actively cooled fuselage and wing leading edges, and water cooled tails for Mach 6.0 aircraft. Also, demonstrate an LH ₂ tankage TPS concept. Extend evaluations of wings and air induction system from Phase A.										
C	Extend evaluations of promising concepts from Phases A and B.										

FIGURE 27
PLAN D FLIGHT TEST PROGRAM OBJECTIVES AND SCHEDULE

Table 12
Alternate Flight Test Program Procedure and Vehicle Configuration

Test Vehicle No. 1

TEST PHASE	TEST PROCEDURE	TEST COMPONENT THERMAL/STRUCTURAL DESIGN			
		PAYLOAD BAY	WINGS	TAILS	MODULES
A.	Conduct subsonic evaluations of basic vehicle low speed handling and landing characteristics. Build-up to maximum vehicle speed, holding low dynamic pressures and load factors. maintain maximum speed and build-up dynamic pressures and load factors to design values.	Basic vehicle thermal/structural concept	Basic vehicle thermal/structural concept	Basic vehicle thermal/structural concept	None
B.	Build-up to maximum vehicle speed holding low dynamic pressures and load factors. Maintain maximum speed and build-up dynamic pressures and load factors to design values. Emphasize scramjet engine test requirements.	Mach 6.0 water cooled structure concept (C11), LH ₂ tankage concept (C15)	Mach 6.0 radiative metallic TPS concept (C8), hot structure leading edges (C4)	Mach 6.0 hot structure concept (C4)	Scramjet engine
C.	Dictated by scramjet engine evaluation requirements.	Optional	Optional	Optional	Scramjet engine

Test Vehicle No. 2

TEST PHASE	TEST PROCEDURE	TEST COMPONENT THERMAL/STRUCTURAL DESIGN			
		PAYLOAD BAY	WINGS	TAILS	MODULES
A.	Build-up to Mach 6.0 speed, holding low dynamic pressures and load factors. Maintain Mach 6.0 speed and build-up dynamic pressures and load factors to design values. Emphasize ramjet engine test requirements.	Mach 6.0 hot structure concept (C4), LH ₂ tankage concept (C15)	Mach 6.0 hot structure concept (C4), ASTS PCM cooled structure concept leading edge (C13)	ASTS heat sink structure concept (C12)	Mach 6.0 actively cooled structure air induction system (C18)
B.	Build-up to Mach 6.0 speed, and design dynamics pressures and load factors similarly to Phase A.	Mach 6.0 actively cooled structure concept (C14), LH ₂ tankage concept (C15)	Mach 6.0 hot structure concept (C4), actively cooled structure concept leading edge (C14)	Mach 6.0 water cooled structure concept (C11)	Same as Phase A
C.	Dictated by ramjet engine evaluation requirements.	Optional	Optional	Optional	Same as Phase A

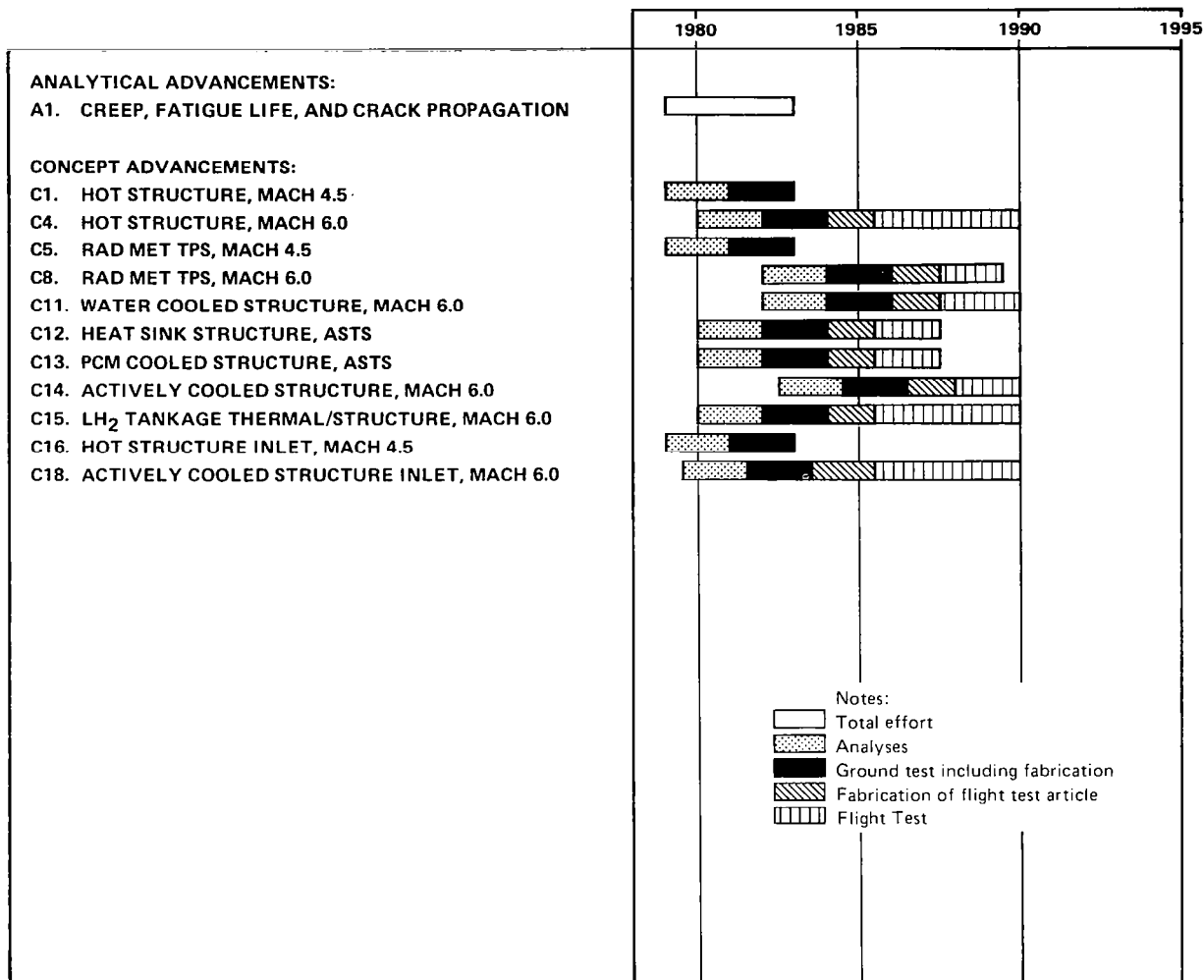

**FIGURE 28
 TECHNOLOGY ADVANCEMENT - PLAN D**

Plans A through D were devised to integrate the technology advancement plans required for the development of all the potential hypersonic applications identified in Table 1. The scheduling information indicated in these plans could be adapted to formulate a wide variety of alternate plans devised to advance thermal/structural technology for fewer applications. For example, the high priority needs identified for the near-term Mach 4.5 aircraft (C1, C5, and C16) could be satisfied in about four years exclusive of flight testing.

10.2 PROGRAM COSTS

The plans proposed to satisfy each of the Technology Needs described in Appendix A were used to estimate costs. The engineering effort, material developments, fabrication demonstrations, ground test hardware developments, ground testing, and flight test hardware development and support required for each plan were acknowledged. The resultant individual cost estimates are summarized in Table 13.

The costs are broken down to permit planning to be conducted independently of flight testing if desired. The costs referred to as "flight test" include the design, development, and fabrication of flight test articles as well as limited support of the flight test program.

General costing methods, derived from similar studies, were used. The costs were not based on the detailed estimating procedures used in contract pricing. Therefore, the dollars should be considered "Rough Order of Magnitude" and referenced accordingly.

Ground rules that were assumed include:

- o Constant 1977 dollars
- o No modifications to existing, or construction of new, ground test facilities are required
- o Flight research vehicles are available for thermal/structural testing
- o All "provisions" for the flight experiments are incorporated in the research vehicle
- o Vehicle operational costs not included
- o Flight test cost includes design and fabrication of test articles, and technical support for test article installation and check-out, and some support during the flight test program
- o Flight test costs benefit from accomplishments realized through planned ground testing
- o Design information regarding the research flight vehicle capabilities is available at no additional cost
- o A single contractor performs each test program; there are no provisions for multiple contractors on any one program

Many factors influenced the cost estimates. In the cases of concept developments, the number of candidate materials considered and their current development status were both factors.

The number of required test articles assumed also had a distinct impact on the program cost. For example, four test articles, representative of fuselage, wing, leading edge, and tail structural configurations, were considered for Needs C1 and C4. This number was selected since the differences in design requirements for each of these regions will probably necessitate unique hot structure designs. On the other hand, only one test article was considered for Needs C5-C8. It was judged that the radiative metallic TPS concept can be configured to any vehicle region once the basic design is developed.

Table 13
Individual Technology Assessment Costs
Millions of Dollars

	Exclusive of Flight Test	Flight Test	Total
<u>ANALYTICAL ADVANCEMENTS</u>			
A1 Creep, Fatigue Life, and Crack Propagation	3.5	-	3.5
A2 Acoustic Fatigue Life	0.5	-	0.5
A3 Aero-Heating Effects (ASTS)	0.6	0.8	1.4
A4 Aero-Heating Effects (M=6.0)	0.6	0.8	1.4
<u>MATERIAL ADVANCEMENTS</u>			
B1 High Temperature Titaniums	1.2	-	1.2
B2 Superalloys	1.2	-	1.2
B3 Boron/Borsic-Aluminum Composites	1.2	-	1.2
B4 Advanced Composite Materials (M=4.5)	2.6	-	2.6
B5 Advanced Composite Materials (ASTS & M=6.0)	2.2	-	2.2
B6 Reusable Surface Insulation Materials	0.7	-	0.7
<u>CONCEPT ADVANCEMENTS</u>			
C1 Hot Structure (M=4.5)	9.3	10.6	19.9
C2 Hot Structure (Adv. M=4.5)	3.8	6.7	10.5
C3 Hot Structure (ASTS)	3.4	3.5	6.9
C4 Hot Structure (M=6.0)	8.1	10.6	18.7
C5 Radiative Metallic TPS (M=4.5)	6.2	3.5	9.7
C6 Radiative Metallic TPS (Adv. M=4.5)	3.2	3.5	6.7
C7 Radiative Metallic TPS (ASTS)	3.9	3.5	7.4
C8 Radiative Metallic TPS (M=6.0)	3.9	3.5	7.4
C9 Ext. Insulated Structure (ASTS)	2.5	3.5	6.0
C10 Water Cooled Structure (ASTS)	5.2	3.7	8.9
C11 Water Cooled Structure (M=6.0)	7.4	6.4	13.8
C12 Heat Sink Structure (ASTS)	4.1	4.0	8.1
C13 PCM Cooled Structure (ASTS)	6.3	4.4	10.7
C14 Actively Cooled Structure (M=6.0)	6.9	7.9	14.8
C15 LH ₂ Tankage Thermal/Structure (M=6.0)	11.9	8.7	20.6
C16 Hot Structure Inlet (M=4.5)	15.5	8.1	23.6
C17 Hot Structure Inlet (Adv. M=4.5)	15.0	8.1	23.1
C18 Actively Cooled Structure Inlet (M=6.0)	18.6	10.3	28.9

In addition to the number of test articles, test article design complexities were considered. For example, leading edge test articles were not considered as expensive to develop as payload bay or wing test articles due to the large size differences.

The considerations involved in deriving the total costs required to satisfy Technology Need C1, Develop and Verify Hot Structure Design Concepts for Near Term Mach 4.5 aircraft, are discussed below. This example is representative of the effort involved to derive each total cost and actual values have been rounded off for simplicity.

The first five steps of the plan outlined to advance C1 constitute the effort involved exclusive of flight test. As shown in Table 13, the cost required to advance C1 through ground testing was estimated to be 9.3 million dollars. This total includes material and fabrication developments; design, fabrication, and testing of ground test articles; and program management.

It was assumed that four titanium alloys and four superalloys would be developed to the extent discussed in Section 5.5. Element tests to obtain mechanical, creep, and fatigue properties in addition to fracture toughness and crack propagation characteristics were defined in terms of the number of test specimens and test cycles required. To conduct these tests, an estimated 1.1 million dollars is required. To develop the fabrication techniques for hot structure concepts with these titanium alloys and superalloys, an investment of nearly 1.1 million dollars was estimated. The procurement of the materials required for the element tests and fabrication development was estimated at about 100,000 dollars. The engineering effort to support the materials and fabrication developments was also estimated at 1.1 million dollars.

As discussed in the plan outlined to satisfy Technology Need C1, a number of test articles will be necessary to evaluate hot structure concept design differences attributable to vehicular location. It was assumed that four structural designs, representative of a fuselage section, wing section, tail section, and leading edge structure were required. Two test articles for each of these designs (totaling eight test articles) were considered necessary to permit wind tunnel tests in addition to detailed structural/thermal testing accomplished in different facilities. As discussed earlier, complexity factors were employed to distinguish among the efforts required to fabricate the individual test articles. The engineering effort required to perform analyses and support the full scale section ground tests was determined to cost 1.8 million dollars. To fabricate the eight test articles and procure the materials required, an investment of 1.9 million dollars is required. An expense of 1.4 million dollars was estimated to conduct the ground testing.

An allotment of about 800,000 dollars for program management was determined. These expenses total up to the 9.3 million dollars estimated to advance the C1 technology through the ground testing required to develop flightworthy design concepts.

10.6 million dollars, Table 13, were estimated to build flight test hardware and support the test program to satisfy Technology Need C1. The engineering effort required to analyze and support the fabrication of the flight hardware was estimated at 3.3 million dollars. The flight hardware fabrication expenses, based on four test articles adjusted for complexity, were found to be about 4.9 million dollars. 900,000 dollars were judged necessary to perform hardware proof tests prior to flight. An allowance of 500,000 dollars was made for installation and checkout

of the articles on the test vehicle and for technical support during the tests. Program management required for the flight test phase was estimated at about 1 million dollars.

The cost information presented in Table 13 can be used to estimate total program costs. The program devised to completely satisfy all the Technology Needs, defined as Plan A in Section 10.1, would cost an estimated 262 million dollars. This would average out to about 16.3 million dollars per year for the 16 year schedule shown in Figure 24. By eliminating flight tests from the advancements, as proposed by Plan B, the total program cost would be 150 million dollars. This averages out to 10.7 million dollars per year for the 14 year schedule shown in Figure 25. Obviously, attempts to satisfy all the Technology Needs would require substantial funding.

Modifying the program scope by attempting to satisfy only the higher priority needs, as proposed by plans C and D, reduces costs. The Plan C total cost would be 102 million dollars or an average cost of 7.3 million dollars per year for 14 years. The more ambitious Plan D, which includes flight testing, would cost 158 million dollars. Since Plan D would be completed in 11 years, the average cost per year would be 14.3 million dollars. These modified programs still require large funding levels since most of the higher priority needs are among the more expensive individual technology advancements summarized in Table 13.

Ultimately, advancements that can be realized will be dependent on available funding. This makes arbitrary program planning without some knowledge of this funding little more than an exercise. Therefore, it is recommended that this funding be estimated and compared with the cost estimates provided in Table 13 and vehicle application priorities to comprehend what can be accomplished. In terms of application priorities, it is apparent that the Mach 4.5 strategic reconnaissance aircraft can be more easily justified than any other application. Funding the advancements identified for near-term Mach 4.5 aircraft (Technology Needs C1, C5, and C16) involves an estimated 31 million dollars to advance the concept developments through the ground tests. An additional 22.2 million dollars would be required to flight test these concepts.

In summary, it is apparent that satisfying Technology Needs C1, C5, and C16 would provide the greatest benefits in advancing hypersonic thermal/structural technology. Not only are these concepts directly applicable to the most promising hypersonic application, but both the hot structure (C1) and radiative metallic TPS (C5) concepts are also candidates for general usage on all of the identified vehicle applications. In addition, the development of a hot structure air induction system (C16) ranks as possibly the singularly most important technology need.

11. CONCLUSIONS AND RECOMMENDATIONS

This study was conducted to provide guidance in planning thermal/structural research as applicable to hypersonic aircraft. In particular, an attempt was made to resolve certain controversial issues by obtaining a consensus from a broad range of participants including various aerospace companies, the NASA, the Air Force, and the scientific community as represented by highly qualified advisors. The following major conclusions merit consideration in formulating these research plans:

- o The most promising projected hypersonic application is a Mach 4.5 strategic reconnaissance aircraft. The development of an advanced space transportation system is also considered likely.

- o The major technology deficiencies are the lack of development and verification of conceptual designs.

- o Significant gaps in candidate material properties exist due to insufficient data on long exposures to high temperatures.

- o Existing ground test capabilities are adequate to accomplish most required advancements. The most obvious deficiency is the current inability to realistically test full scale air induction systems.

- o Flight testing will be necessary to obtain an acceptable level of confidence in thermal/structural designs for operational hypersonic vehicles.

- o Hypersonic flight research vehicles would be extremely useful in advancing thermal/structural technology and are believed to be cost effective.

- o In order to obtain the technology required to develop hypersonic aircraft for the years 1990-2000, many of the programs devised to advance technology must be initiated within the next 2 to 3 years.

The following recommendations are presented:

- o Efforts to satisfy the technology needs for the development of Mach 4.5 strategic reconnaissance aircraft should be given highest priority and be initiated as soon as possible.

- o The basic thermal/structural design of a flight research vehicle should be representative of a concept with widespread potential application.



12. REFERENCES

1. "Hypersonic Research Facilities Study," Volumes I-VI, NASA CR-114322-114331, 1970.
2. Hearth, D. P., and Preyss, A. E., "Hypersonic Technology - Approach to an Expanded Program," *Astronautics and Aeronautics*, December 1976.
3. Cornick, D. E., and Chamberlain, R. A., "Hypersonic Vehicle Applications Study (U)," ASD-TR-77-27, April 1977 (SECRET).
4. "A Study of Airbreathing Launch Vehicles with Cruise Capability," Volumes I-VI, NASA CR-73194-73199, 1968.
5. "Design Considerations of Reusable Launch Vehicles," NASA CR-73055, 1966.
6. Haefeli, R. C., Littler, E. G., Hurley, J. B., and Winter, M. G., "Technology Requirements for Advanced Earth-Orbital Transportation Systems," NASA CR-2866-2868, June 1977.
7. "Technology Requirements for Advanced Earth-Orbital Transportation Systems," NASA CR-2878-2879, 1977
8. Altis, H. D. and Wall, D. E., "Comparative Propulsion Systems Concepts Study (U)," AFAPL-TR-69-91, October 1969 (SECRET).
9. Stein, B. A., Bohon, H. L., and Rummeler, D. K., "An Assessment of Radiative Metallic Thermal Protection Systems for Space Shuttle," NASA TM X-2570, July 1972.
10. Crossley, W. P., "Mach 4.5 Aircraft Passive Thermal Protection System Analysis and Test," McDonnell Douglas Corp., MDC A2055, May 1973.
11. Bohon, H. L., Shiedler, J. L., and Rummeler, D. R., "Radiative Metallic Thermal Protection Systems - A Status Report," Presented at the ASME/AIAA/SAE 18th Structures, Structural Dynamics, and Materials Conference, March 1977.
12. Hunt, L. R., Shideler, J. L., and Weinstein, I., "Performance of LI-1542 Reusable Surface Insulation System in a Hypersonic Stream," NASA TN D-8150, March 1976.
13. Kirilin, R. L., "Development of Operational Techniques for Insulative X-24C Thermal Protection System (TPS)," AFFDL-TR-76-143, January 1977.
14. "Hypersonic Scramjet Vehicle Study (U)," McDonnell Aircraft Co. Report No. F666, October 1967 (SECRET).
15. Croker, W. D., "Advanced Air Defense Vehicle (U)," AFFDL-TR-70-61, June 1970 (SECRET).
16. Jackson, L. R., and Taylor, A. H., "A Structural Design for the Hypersonic X-24C Research Aircraft," AIAA Paper 76-906, September 1976.

17. Combs, H. G., "Configuration Development Study of the X-24C Hypersonic Research Airplane - Phase II," NASA CR-145074, January 1977.
18. "Study of Structural Active Cooling and Heat Sink Systems for Space Shuttle," McDonnell Douglas Corp., MDC E0638, June 1972.
19. Becker, J. V., "New Approaches to Hypersonic Aircraft," ICAS Paper presented at the 7th Congress of ICAS, Rome, Italy, September 1970.
20. Helenbrook, R. G., and Anthony, F. M., "Design of a Convective Cooling System for a Mach 6 Hypersonic Transport Airframe," NASA CR-1918, December 1971.
21. Anthony, F. M., Dukes, W. H., and Helenbrook, R. G., "Internal Convective Cooling Systems for Hypersonic Aircraft," NASA CR-2480, February 1975.
22. Pirrello, C. J., Baker, A. H., and Stone, J. E., "A Fuselage/Tank Structure Study for Actively Cooled Hypersonic Cruise Vehicles - Summary," NASA CR-2651, February 1976.
23. Pirrello, C. J., and Herring, R. L., "Study of a Fail-Safe Abort System for an Actively Cooled Hypersonic Aircraft," NASA CR-2652, August 1976.
24. Herring, R. L., and Stone, J. E., "Thermal Design for Areas of Interference Heating on Actively Cooled Hypersonic Aircraft," NASA CR-2828, December 1976.
25. Nowak, R. J., and Kelly, H. N., "Actively Cooled Airframe Structures for High-Speed Flight," Journal of Aircraft, March 1977.
26. Ellis, D. A., Pagel, L. L., and Schaeffer, D. M., "Design and Fabrication of a Radiative Actively Cooled Honeycomb Sandwich Structural Panel for a Hypersonic Aircraft," NASA CR-2957, April 1977.
27. Camarda, C. J., "Analysis and Radiant Heating Tests of a Heat-Pipe-Cooled Leading Edge," NASA TN D-8468, August 1977.
28. Hammond, M. B., Jr., "An Analytical Model for Determining the Thermal Conductivity of Closed Cell Foam Insulation," Advances in Cryogenic Engineering, Vol. 15, Plenum Press, 1970, pp 332-342.
29. Heathman, J. H., and Kelley, L. G., "Hydrogen Tankage for Hypersonic Cruise Vehicles," AIAA/ASME Seventh Structures and Materials Conference, April 1966.
30. Jackson, L. R., Davis, J. G. Jr., and Wichorek, G. R., "Structural Concepts for Hydrogen-Fueled Hypersonic Airplanes," NASA TN D-3162, 1966.
31. Norton, A. M., "Advanced Structural Concepts, Experimental Program - Project ASCEP," Volume II, AFFDL-TR-67-146, June 1968.
32. Helenbrook, R. G., and Colt, J. Z., "Development and Validation of Purged Thermal Protection Systems for Liquid Hydrogen Fuel Tanks of Hypersonic Vehicles," NASA CR-2829, June 1977.
33. Jackson, L. R., and Anderson, M. S., "A Carbon Dioxide Purge and Thermal Protection System for Liquid Hydrogen Tanks of Hypersonic Airplanes," Advances in Cryogenic Engineering, Volume 12, Plenum Press, Inc., 1967, pp 146-156.

34. Sharpe, E. L., and Jackson, L. R., "Performance of a Hypersonic Hot Fuselage Structure with a Carbon Dioxide Frost Protected, Nonintegral Cryogenic Tank," NASA TN D-7799, March 1975.
35. "Analytical Investigation of Structural Concepts for the Air Induction System of Advanced High Supersonic Aircraft (U)," AFFDL-TR-75-14, March 1975 (SECRET).
36. Military Standardization Handbook, "Metallic Materials and Elements for Aerospace Vehicle Structures," Department of Defense, MIL-HDBK-5B, September 1971.
37. Pirrello, C. J. Hardin, R. D., Heckart, M. V., and Brown, K. R., "An Inventory of Aeronautical Ground Research Facilities," NASA CR-1876, November 1971.
38. Bates, W. R., and Edwards, Z. B., "The Aeropropulsion Systems Test Facility (ASTF)," AIAA Paper No. 77-913, July 1977.
39. Bohon, H. L., Sawyer, J. W., Hunt, L. R., and Weinstein, I., "Performance of Thermal Protection Systems in a Mach 7 Environment," J. Spacecraft, Vol. 12, No. 12, December 1975.
40. Deveikis, W. D., Miserentino, R., Weinstein, I., and Shideler, J. L., "Aerothermal Performance and Structural Integrity of a Rene 41 Thermal Protection System at Mach 6.6," NASA TN D-7943, November 1975.
41. Johnson, R. Jr., and Kilpatrick, D. H., "Evaluation of Dispersion Strengthened Nickel-Base Alloy Heat Shields for Space Shuttle Application," NASA CR-2614, March 1976.
42. Johnson, C. L., "Some Development Aspects of the YF-12A Interceptor Aircraft," AIAA Paper No. 69-757, July 1969.
43. Kirkham, F. S., Jones, R. A., Buck, M. L., and Zima, W. P., "Joint USAF/NASA Hypersonic Research Aircraft Study," AIAA Paper 75-1039, August 1975.
44. Combs, H. G., "Configuration Development Study of the X-24C Hypersonic Research Airplane - Phase I," NASA CR-145032, December 1976.
45. Combs, H. G., "Configuration Development Study of the X-24C Hypersonic Research Airplane - Phase III," NASA CR-145103, January 1977.
46. Plank, P. P., Marcy, W. L., and Haefeli, R. C., "Experiments Impact on X-24C," AFFDL-TR-75-37, May 1975.
47. "NASA Flight Experiments X-24C - Final Briefing," McDonnell Douglas Corp., MDC A3265, January 1975.
48. Dill, H. D. Saff, C. R., "Effect of Fighter Attack Spectrum on Crack Growth," AFFDL-TR-76-112, March 1977.



APPENDIX A

SPECIFIC TECHNOLOGY NEED DESCRIPTIONS

Table 8, in Section 6.2, lists 28 specific technology needs to advance thermal/structural technology to the level required for commitment to operational flight vehicle development programs. Each of these needs is described within this appendix in the order listed in Table 8.



TECHNOLOGY NEED A1: Improve Methods for Predicting Creep, Fatigue Life, and Crack Propagation in Hot Structure Designs Under Spectrum Thermal/Mechanical Loading

TECHNOLOGY NEED JUSTIFICATION:

Aircraft operational readiness can be improved and life cycle costs can be reduced by designing a fatigue resistant, damage tolerant structure that requires less maintenance. To avoid undue design conservatism, the methods used to predict structural fatigue life and damage tolerance must accurately account for the effects of spectrum thermal/mechanical loading. Current methods for predicting fatigue life and crack growth for aluminum and titanium structures, such as those described in Reference (48), can be used at room temperature only.

TECHNOLOGICAL ADVANCEMENT OBJECTIVE:

Data reflecting the effects of transient heating in addition to spectrum loading must be obtained and correlated. Current analytical methods should be modified or new methods developed. These methods must then be verified by test. The ultimate goal is to be able to use accelerated test data, from short time thermal exposures and spectrum loadings, to predict the life for real time exposures and loadings.

PLAN FOR ADVANCING TECHNOLOGY:

1. Examine hypersonic aircraft missions and design requirements to derive representative thermal/mechanical loading conditions.
2. Conduct element tests to determine the effects of long and short time transient thermal exposures and constant amplitude and spectrum loading on fatigue life, crack initiation, crack propagation rate and residual static strength of one titanium alloy and one nickel base superalloy. Materials such as 6Al-4V titanium and Rene' 41 should be used for these initial tests, because they are prime candidates for hypersonic aircraft applications and their room temperature properties are well known. Both wide and narrow specimens of various thicknesses will be required. The specimens will be (1) undamaged or (2) initially flawed with drilled holes and other stress concentrations commonly found in aircraft structure.
3. Develop analytical methods and models to predict the combined effects of spectrum thermal/mechanical loading on structural fatigue life based on these data.
4. Conduct a real time ground test program to verify the derived methods.

TECHNOLOGY NEED A2: Improve Methods for Predicting Acoustic Fatigue Life of High Temperature Structure Designs

TECHNOLOGY NEED JUSTIFICATION:

Previous work has shown that fatigue life is dependent not only on material properties and temperature but also on the structural configuration. Methods used to predict sonic fatigue effects on hot structural configurations are not refined.

TECHNOLOGICAL ADVANCEMENT OBJECTIVE:

Methods for predicting the modeshape and frequency of heated surface panels and developing dynamic stress-strain and stress response curves are needed. In addition, reliable methods must be developed for predicting unsteady pressure fluctuation due to such aerodynamic flow conditions as shock impingement, separation, and boundary layer noise.

PLAN FOR ADVANCING TECHNOLOGY:

1. Review existing prediction methods for sonic fatigue of structure due to random stress levels considering hypersonic vehicle requirements.
2. Develop acoustic excitation math models to describe the anticipated forcing functions.
3. Establish random fatigue prediction criteria, combining the effects of structural arrangement, materials, temperatures, and pressures.
4. Conduct structural fatigue tests using elements representative of the materials and arrangements analyzed in Step 3.
5. Correlate the test data to verify the prediction technique developed.

TECHNOLOGY NEED A3: Improve Methods for Predicting Aerodynamic Heating Effects on Advanced Space Transportation Systems

TECHNOLOGY NEED JUSTIFICATION:

The high surface temperatures attained during reentry sometimes necessitate the development of special materials and place restrictions on flight trajectories. The complex analytical techniques should be improved to permit reduction of the margins now required to insure safe designs.

TECHNOLOGICAL ADVANCEMENT OBJECTIVE:

Due to a lack of experimental data at high Mach numbers (>10), many heat transfer effects for spacecraft are not well understood. Additional data and correlations are necessary in numerous areas. Conventional turbulent heating theories have provided inconsistent results at high speeds. Boundary layer transition criteria have long been difficult to define. The effects of surface roughness, such as that created by gaps between external surface insulation tile, have been the subject of recent Shuttle-related studies. Correlations from these studies have not yet been confirmed by actual flight data. Lee surface heating rate correlations, particularly those relating to the effects of flow separation and vortices, are based on very limited data. Interference heating, caused by geometric complexities, at high Mach numbers is not well understood. Each of these subjects merits examination to improve the currently available prediction methodologies.

PLAN FOR ADVANCING TECHNOLOGY:

1. Survey existing aerodynamic heating correlations and identify data deficiencies and inadequacies in the prediction techniques required to analyze advanced space transportation systems.
2. Conduct studies to establish how these deficiencies/inadequacies can benefit from tests conducted on the Space Shuttle.
3. Plan Shuttle flight tests recognizing that they are "tag-along" and must be kept simple.
4. Plan ground testing to provide additional data to supplement flight data and conduct correlations to modify prediction techniques.

TECHNOLOGY NEED A4: Improve Methods for Predicting Aerodynamic Heating Effects on Mach 6.0 Aircraft

TECHNOLOGY NEED JUSTIFICATION:

Aerodynamic heating effects at Mach 6.0 significantly impact aircraft design. If these effects are conservatively approximated, a large mass penalty results. On the other hand, an overlooked local, abnormally high heating rate could permit a catastrophic failure. Existing aerodynamic heating analytical techniques are not refined, and in some cases, may be considered inadequate for these problems.

TECHNOLOGICAL ADVANCEMENT OBJECTIVE:

Most existing analytical deficiencies involve lack of information regarding localized heating phenomena in the vicinity of geometric complexities. These considerations should be simulated via testing, and sufficient data should be obtained for data correlations to an acceptable accuracy for Mach 6.0 aircraft. The procedures used to predict interference heating locations and magnitudes must be refined. The heating effects produced by flow through gaps between adjacent aircraft surfaces must be examined. Surface roughness effects associated with the proposed Mach 6.0 moldline structure concepts should be better understood. For Mach 6.0, the techniques used to predict leeside heating and boundary layer transition should be refined.

PLAN FOR ADVANCING TECHNOLOGY:

1. Examine typical Mach 6.0 aircraft configurations and establish geometric models representative of regions subject to shock wave-boundary layer interactions, gap flow, and surface flow disturbances.
2. Use existing methods to predict local heating effects and flow characteristics in these regions.
3. Conduct wind tunnel tests with scaled models to obtain heating data and compare with predictions. Whenever possible, plan tests to provide data as required to improve existing techniques.
4. Plan flight test experiments for research aircraft to include specific investigations in regions of well defined flow and measurements in numerous other regions subject to flow complexities.

TECHNOLOGY NEED B1: Extend Knowledge of High Temperature Titaniums

TECHNOLOGY NEED JUSTIFICATION:

Most Mach 4.5 aircraft surfaces, and the upper surfaces of ASTS and Mach 6.0 vehicles, will not exceed 922 K (1200°F). Therefore, high temperature titanium alloys may have wide application. However, the most promising alloys are not yet completely developed and high temperature data on even the conventional alloys is incomplete.

TECHNOLOGICAL ADVANCEMENT OBJECTIVE:

The emerging high temperature alloys, Ti-5522S, Ti-11, and Ti-56215, must be advanced to identify which are most promising for flight vehicle usage. Additional high temperature and long life data on these alloys and Ti-6242 must be obtained. Manufacturing techniques required for titaniums should be improved to reduce costs.

PLAN FOR ADVANCING TECHNOLOGY:

1. Conduct element tests on samples of the Ti-5522S, Ti-11, and Ti-5621S alloys to obtain sufficient data for preliminary design studies as defined in Table 6.
2. Develop the basic fabrication techniques for each of the alloys and determine processing effects on mechanical properties.
3. Using the information obtained from Steps 1 and 2 conduct studies, based on typical hypersonic vehicle requirements, to select the alloy(s) most promising for these applications.
4. Conduct additional element tests with the selected alloy(s) and Ti-6242 to obtain sufficient data for configuration design studies as defined in Table 6.
5. Develop more advanced fabrication techniques for these alloys and investigate manufacturing cost reduction possibilities.

TECHNOLOGY NEED B2: Extend Knowledge of Superalloys

TECHNOLOGY NEED JUSTIFICATION:

Mach 4.5 air induction systems and leading edges, as well as large surface regions on ASTS and Mach 6.0 aircraft, experience temperatures which are compatible with superalloy material capabilities, 755 K (900°F) to 1366 K (2000°F). However, the superalloys that possess the strength required for these applications are difficult to machine and fabricate into complex parts economically.

TECHNOLOGICAL ADVANCEMENT OBJECTIVE:

The primary objective of this effort is to develop improved methods for machining, forming, welding, and brazing superalloys, thereby reducing costs and assuring optimum material properties. In addition, material property data gaps, identified in Figure 19, need to be filled. The solution treated and aged materials, like Rene'41, Udimet 500, and Udimet 700 should be emphasized.

PLAN FOR ADVANCING TECHNOLOGY:

1. Conduct a detailed technology assessment to determine the production status and product availability of superalloys that are prime candidates for these applications. This list will be limited to alloys that can be solution treated and aged to high yield and ultimate strengths. Select four of these alloys for manufacturing development efforts. Selected alloys should, in total, be capable of operating at various temperature ranges from 755 K (900°F) to at least 1255 K (1800°F).
2. Procure materials and evaluate machining and forming characteristics. Evaluate various cutter materials, geometries, and speeds to determine optimum machining parameters. Determine forming limitations, best forming tool concepts, and the temperatures and processing parameters needed to optimize material properties. Evaluations will be made on the basis of nondestructive evaluation (NDE) and element tests.
3. Develop welding and brazing processes, including thermal treatments, to achieve optimum properties. Various welding techniques and brazing materials will be evaluated along with tooling and fixtures necessary to avoid distortions and residual stresses. Element tests and NDE will be employed to determine the results.
4. Conduct element tests to determine material properties sufficient for configuration definition studies as outlined in Table 6.

TECHNOLOGY NEED B3: Extend Knowledge of Boron/Borsic-Aluminum Composites

TECHNOLOGY NEED JUSTIFICATION:

Structural materials used as internal/protected structure in hypersonic vehicle designs do not need high temperature capabilities. Aluminum alloys deserve consideration for these applications but boron/borsic-aluminum composites also merit consideration. Because of their density these materials offer a potential mass savings of 25% over most materials with comparable mechanical properties. Since these composites can be used as high as 589 K (600°F), they also have some advantages over aluminum. However, further development is required before these composites are considered sufficiently advanced for major structure on flight vehicles.

TECHNOLOGICAL ADVANCEMENT OBJECTIVE:

Aluminum matrix composite properties are relatively well known and various fabrication techniques have been developed. However, additional mechanical property data are needed as shown in Figure 20. Also, there is a need to lower the cost of both the raw material and fabrication.

PLAN FOR ADVANCING TECHNOLOGY:

1. Investigate the possibility of replacing the boron filament substrate (high-cost tungsten wire) with a carbon filament substrate, and improved methods of producing monolayer foils to reduce material costs.
2. Examine the 5xxx series alloys as matrix material candidates. These alloys have superior high temperature strength and have been shown to improve the room-temperature transverse direction properties of boron/aluminum. Also, they are amenable to low-temperature fabrication processing with little or no filament degradation.
3. Conduct element tests to obtain material property data to the detail defined for configuration definition studies in Table 7.
4. Develop low cost manufacturing techniques for fabricating structural components, including secondary processes such as resistance welding and brazing. Verify these techniques by conducting structural component tests.

TECHNOLOGY NEED B4: Develop Advanced Composite Materials for Mach 4.5 Aircraft

TECHNOLOGY NEED JUSTIFICATION:

A number of advanced composites are projected to have reasonably high temperature capabilities and have the potential to significantly reduce structural mass on Mach 4.5 aircraft applications. These materials include those with a high temperature resin matrix and graphite fibers which are projected for use up to 755 K (900°F); those with a titanium alloy matrix and silicon carbide fibers intended for use up to 922 K (1200°F), and some superalloy matrix materials which are projected for use to 1061 K (1450°F) and above. In addition, composites with a moderate temperature resin matrix and graphite fibers and those composed of graphite-aluminum have potential on Mach 4.5 aircraft as protected or internal structure. These materials are still in the early stages of development and cannot yet be seriously considered for design studies.

TECHNOLOGICAL ADVANCEMENT OBJECTIVE:

These advanced composites must be investigated sufficiently to distinguish which offer advantages for Mach 4.5 aircraft requirements and can conceivably be developed within a few years at reasonable expense. This involves obtaining a lot of mechanical property data and manufacturing experience on various advanced composite materials.

PLAN FOR ADVANCING TECHNOLOGY:

1. Conduct preliminary studies, using available information and reasonable projections, to approximate the potential cost effectiveness of developing these composites for Mach 4.5 aircraft applications. Screen the candidate materials to limit those selected for future development.
2. Conduct element tests to obtain sufficient material data for preliminary studies, Table 7.
3. Develop basic fabrication techniques for each material.
4. Obtain additional material properties, to the level defined for configuration definition in Table 7, for the most promising materials.
5. Conduct tests on representative large structural components to demonstrate the reliability of processing techniques and analytical methods.

TECHNOLOGY NEED B5: Develop Advanced Composite Materials for Advanced Space Transportation Systems and Mach 6.0 Aircraft

TECHNOLOGY NEED JUSTIFICATION:

Advanced composites, other than those developed by Technology Need B4, will be needed for Mach 6.0 aircraft and ASTS temperatures. Composite systems with the potential for reducing mass on these vehicles include superalloy matrix materials, for widespread surface applications, and ceramic matrix and carbon/carbon materials, for leading edges. To date, little progress has been made in the development of these higher temperature composites except for the carbon/carbon material.

TECHNOLOGICAL ADVANCEMENT OBJECTIVE:

Both the superalloy matrix and ceramic matrix materials must be advanced to a status where they can confidently be considered for future designs. Carbon/carbon composites are being developed for the Shuttle program and will require only modest advancements to establish its capabilities for long service life.

PLAN FOR ADVANCING TECHNOLOGY:

1. Develop superalloy and ceramic matrix materials in a procedure similar to that outlined in Steps 1 through 5 of Technology Need B4.
2. In the case of carbon/carbon material, only additional data to determine long life capabilities need be obtained.

TECHNOLOGY NEED B6: Improve Reusable Surface Insulation Materials

TECHNOLOGY NEED JUSTIFICATION:

Numerous problems have been encountered in the development of reusable surface insulation (RSI) for the Space Shuttle. These materials, which are basically low density ceramics, are inherently weak and brittle. Difficulties have occurred in attempts to economically fabricate tiles from RSI material. The tiles must also be handled with extreme caution, which complicates vehicle maintenance. There are still doubts concerning the reusability of RSI materials. Advanced space transportation system designs will impose more severe service life requirements than Shuttle (~ 500 flights compared to 100 flights) and, to operate cost effectively, will require external surface materials to be reusable, with minimal maintenance, for the vehicle life.

TECHNOLOGICAL ADVANCEMENT OBJECTIVE:

RSI materials with improved properties must be developed before the externally insulated structure design concept can be competitive with alternate approaches for ASTS. Lessons learned during the Shuttle material development programs must be applied to re-evaluate basic considerations.

PLAN FOR ADVANCING TECHNOLOGY:

1. Define representative design criteria for the advanced space transportation system and identify specific areas of improvement required, such as increased toughness and more resistance to water absorption.
2. Examine improvements that could be realized by furthering the development of Shuttle RSI materials. Assess the potential of other material compositions that have been identified as alternates.
3. Develop the promising materials to the status whereby meaningful element tests can be conducted to obtain basic material properties and evaluate fabrication requirements.
4. Conduct a trade study to select the most promising material and further its development to a level sufficient for vehicle configuration development.
5. Obtain sufficient data, via ground testing, to confirm the mechanical properties and life characteristics of the selected material.

TECHNOLOGY NEED C1: Develop and Verify Hot Structure Design Concepts for Near Term Mach 4.5 Aircraft

TECHNOLOGY NEED JUSTIFICATION:

Hot structure concepts, using titanium or superalloys, are logical design candidates for the fuselage, wings, empennage, leading edges, and control surfaces on Mach 4.5 aircraft. There is a general lack of hardware experience demonstrating that efficient, light-weight, and low cost structure concepts can be developed for these applications.

TECHNOLOGICAL ADVANCEMENT OBJECTIVE:

Material data and fabrication experience must be obtained on titaniums and superalloys. Efforts similar to those outlined in Technology Needs B1 and B2 are required. Design concepts must be developed sufficiently to demonstrate provisions to alleviate thermal stresses; low mass and low cost over large areas where the loading intensities are expected to require only minimum gage structure; and compatibility with requirements to contain and protect fuel. In addition, high temperature, mechanically fastened joint designs must be developed to satisfy requirements for a long maintenance-free, corrosion-free service life. Design considerations for sealing around external access doors should be proven.

PLAN FOR ADVANCING TECHNOLOGY:

1. Establish representative design criteria for applicable regions of the aircraft and conduct conceptual design studies. Consider design complexities imposed by volume limitations, curvatures, and interfaces.
2. Conduct trade studies comparing performance, mass, and costs with materials, structural arrangements, and manufacturing methods to select promising concepts for the fuselage, wings, empennage, leading edges, and control surfaces.
3. Develop fabrication techniques for the most promising design concepts using available titaniums and superalloys.
4. Conduct element tests to get configuration definition level material properties and evaluate structural details.
5. Design and fabricate full scale structural sections of selected design concepts for each of the regions mentioned in Step 2. Conduct ground tests under flight-simulated environments to verify design performance and structural integrity.
6. Design and fabricate full scale major assemblies for flight demonstration. These assemblies should include a fuselage section, wings including leading edge components, and control surfaces such as vertical tails. All design complexities characteristic of these regions shall be included in the test assemblies.

TECHNOLOGY NEED C2: Develop Hot Structure Design Concepts for Advanced Mach 4.5 Aircraft

TECHNOLOGY NEED JUSTIFICATION:

Advanced Mach 4.5 aircraft requirements may be more demanding than those for the near-term Mach 4.5 aircraft, due to increased acceleration, hence larger thermal gradients, etc. In order to perform efficiently, hot structural concepts may have to use advanced materials for which no hardware experience will have been demonstrated.

TECHNOLOGICAL ADVANCEMENT OBJECTIVE:

This objective is basically the same as that described for Technology Need C1 except that advanced materials such as those developed for Technology Need B4 must be considered.

PLAN FOR ADVANCING TECHNOLOGY:

1. Conduct studies to define potential design improvements that could be realized by modifying the concepts developed for near-term Mach 4.5 aircraft.
2. Develop these concepts using a procedure similar to that outlined in Steps 1 through 6 of Technology Need C1. However, in Step 6, select only two, rather than three, full scale major assemblies for flight test. Rely on the experience gained in developing a near-term Mach 4.5 aircraft to reduce this effort.

TECHNOLOGY NEED C3: Develop Hot Structure Design Concepts for Advanced Space Transportation Systems

TECHNOLOGY NEED JUSTIFICATION:

Hot structure designs will be considered for the upper surfaces and leading edges of advanced space transportation systems. Although the Space Shuttle will demonstrate hot structure leading edges the design requirements for the ASTS will be more demanding.

TECHNOLOGICAL ADVANCEMENT OBJECTIVE:

Studies must be made to identify advanced materials, manufacturing methods, and hot structure arrangements which have maximum potential for reducing the mass and cost of space transportation systems. Advanced materials such as those discussed in Technology Needs B1 through B5 should be considered. Concept developments similar to those described in Technology Need C1 must be realized.

PLAN FOR ADVANCING TECHNOLOGY:

1. Develop these concepts using a procedure similar to that outline in Steps 1 through 6 of Technology Need C1.
2. In Step 6, design and fabricate only two major assemblies for test on a flight research aircraft. Provide a tail assembly representative of a hot structure ASTS concept and a wing leading edge structure concept.

TECHNOLOGY NEED C4: Develop Hot Structure Design Concepts for Mach 6.0 Aircraft

TECHNOLOGY NEED JUSTIFICATION:

Hot structure concepts developed for Mach 4.5 aircraft and ASTS may be applicable for some Mach 6.0 aircraft applications. However, there are large areas on lower surfaces and leading edges where the temperature environment is much more severe and new or improved hot structure designs will be needed.

TECHNOLOGICAL ADVANCEMENT OBJECTIVE:

Structural arrangements and manufacturing techniques to minimize the weight and cost of hot structure concepts for Mach 6.0 applications must be developed. Advanced materials such as those discussed in Technology Needs B1 through B5 should be considered. Concept developments similar to those described in Technology Need C1 must be realized.

PLAN FOR ADVANCING TECHNOLOGY:

Develop these concepts using a procedure similar to that outlined in Steps 1 through 6 of Technology Need C1.

TECHNOLOGY NEED C5: Develop and Verify Radiative Metallic TPS Design Concepts for Near Term Mach 4.5 Aircraft

TECHNOLOGY NEED JUSTIFICATION:

Radiative metallic TPS concepts are an attractive design approach for both hypersonic aircraft and reentry vehicles. Programs have demonstrated the viability of radiative metallic TPS concepts. These programs have shown that potential disadvantages such as boundary layer air leakage, can be resolved. However, the designs tested have involved simple geometries and flat panels and much remains to be accomplished.

TECHNOLOGICAL ADVANCEMENT OBJECTIVE:

The state of the art of radiative metallic TPS concepts must be advanced by addressing design details. Designs must be developed that consider the complexities of curved surfaces, mating with adjacent structure, and interfaces with control surfaces. Durability and reusability must be proven for long life requirements. The design must be shown to accommodate expansion and still transmit surface pressure loads to the primary structure. Leakage of boundary layer air into the system must be limited to acceptable levels. Heat shield configurations must be examined to determine how surface drag and heating penalties resulting from surface irregularities can be minimized. Improved heat shield fabrication methods, to reduce mass and cost, should be developed. Heat shield supports should be studied to insure that these functions are accomplished efficiently. Insulation materials and arrangements should also be the subject of trade studies.

PLAN FOR ADVANCING TECHNOLOGY:

1. Select two representative aircraft locations, one requiring a titanium heat shield and another requiring a superalloy heat shield, and establish optimal configurations via trade studies. Consider the results reported in References (10) and (11). Strive to incorporate design details, as discussed above, in the configurations.
2. Conduct element tests to get configuration definition level material properties and evaluate structural details such as heat shield support members.
3. Design and fabricate full scale structural sections of each configuration for ground tests. These sections shall include lightweight heat shields and internal structure representative of Mach 4.5 primary structure. The tests shall be conducted in a manner similar to that reported in Reference (11). A test facility like NASA's high temperature structures tunnel shall be used to simulate transient heating and differential pressure effects. Make changes, if necessary, during the tests to improve design when possible. Conduct sufficient tests to verify design performance, structural integrity, and long life.
4. Design and fabricate a full scale major assembly, such as a fuselage section or wing, for flight demonstration. This assembly should be lightweight structure and incorporate all design details. Transitional structure, such as that required to interface with other sections like other fuselage arrangements or leading edge designs, shall be demonstrated.

TECHNOLOGY NEED C6: Develop Radiative Metallic TPS Design Concepts for Advanced Mach 4.5 Aircraft

TECHNOLOGY NEED JUSTIFICATION:

As noted in Technology Need C2 the advanced Mach 4.5 aircraft design requirements may be more demanding in terms of mass and cost. Since the radiative metallic TPS concepts developed for Technology Need C5 will represent a first generation of this design approach, it should be possible to improve Mach 4.5 aircraft designs considerably by incorporating design improvements and using advanced materials.

TECHNOLOGICAL ADVANCEMENT OBJECTIVES:

Lessons learned during the development of radiative metallic TPS concepts for near-term Mach 4.5 aircraft must be examined to simplify maintenance procedures, reduce manufacturing costs, etc. Advanced composites developed to satisfy Technology Need B4 must be considered. These designs must also address the design details described in Technology Need C5.

PLAN FOR ADVANCING TECHNOLOGY:

1. Conduct studies to identify potential design improvements in near-term Mach 4.5 designs and consider advanced composite materials.
2. Develop the concepts using a procedure similar to that outlined in Steps 1 through 4 of Technology Need C5. Rely on experience obtained in near-term Mach 4.5 designs to reduce effort when possible.

TECHNOLOGY NEED C7: Develop Radiative Metallic TPS Design Concepts for Advanced Space Transportation Systems

TECHNOLOGY NEED JUSTIFICATION:

The more demanding service life requirements imposed by advanced space transportation systems, relative to the Space Shuttle, make the radiative metallic TPS concept a logical candidate for the advanced application. These concepts will require materials with higher temperature capabilities than those used in Mach 4.5 aircraft. Some progress has been made toward developing these concepts, as reported in Reference (11).

TECHNOLOGICAL ADVANCEMENT OBJECTIVE:

The state-of-the-art of radiative metallic TPS concepts for re-entry vehicles must be extended beyond that described in Reference (11). Design considerations for Mach 4.5 aircraft, as described in Technology Need C5, must be reconsidered for ASTS. The concepts investigated for ASTS must consider a wide range of candidate materials, including those developed for Technology Needs B4 and B5.

PLAN FOR ADVANCING TECHNOLOGY:

Develop these concepts using a procedure similar to that outlined in Steps 1 through 4 of Technology Need C5. During Steps 1 through 3 consider at least two configurations with requirements for different high temperature heat shield materials.

TECHNOLOGY NEED C8: Develop Radiative Metallic TPS Design Concepts for Mach 6.0 Aircraft

TECHNOLOGY NEED JUSTIFICATION:

Radiative metallic TPS concepts are also a leading candidate for Mach 6.0 aircraft structural design. Mach 6.0 designs will require high temperature materials and have a requirement for a long service life. Significant technological advancements will be required before these concepts can be considered sufficiently mature for production Mach 6.0 aircraft.

TECHNOLOGICAL ADVANCEMENT OBJECTIVE:

Design details, discussed in Technology Need C5, must be examined for Mach 6.0 aircraft requirements. Advanced materials such as those developed for Technology Needs B4 and B5 must be considered in addition to superalloys and refractory materials to minimize heat shield mass and cost. The possibility of needing unique designs in regions exposed to interference heating effects must be investigated.

PLAN FOR ADVANCING TECHNOLOGY:

Develop these concepts using a procedure similar to that outlined in Steps 1 through 4 of Technology Need C5.

TECHNOLOGY NEED C9: Develop Externally Insulated Structure Design Concepts for Advanced Space Transportation Systems

TECHNOLOGY NEED JUSTIFICATION:

Externally insulated structure design concepts similar to those employed on the Space Shuttle will be considered for the advanced space transportation system. These concepts may be competitive only if design improvements are made and improved reusable surface insulation materials are developed, as discussed in Technology Need B6.

TECHNOLOGICAL ADVANCEMENT OBJECTIVE:

Since the externally insulated concept developed for Shuttle relies on bonding attachments, inspection and maintenance procedures are complicated. Alternate methods, such as mechanical fastening, must be evaluated. Potential design improvements afforded by the improved RSI materials must be exploited to attempt to increase tile size (reducing the number of surface gaps), minimizing the size of gaps between tiles, etc.

PLAN FOR ADVANCING TECHNOLOGY:

1. Conduct studies, based on improved RSI materials developed to satisfy Technology Need B6, to identify potential improvements over the Space Shuttle approach.
2. Design and fabricate full scale structural sections for ground tests. These sections shall be similar to those tested for the Shuttle as reported in Reference (12). The tests planned should also be similar to those described in the same reference. Tests should also be performed to evaluate any tile joining technique proposed that is different from the Shuttle approach.
3. Design and fabricate a full scale major assembly, such as a wing, for flight test demonstration on a research aircraft. While the research aircraft cannot duplicate the flight environmental conditions that influence ASTS designs, the test program can demonstrate the capability of improved RSI materials to withstand severe aerodynamic heating conditions. In addition, the experience gained in handling and maintaining the assembly will be beneficial in establishing the concept's tolerance for these considerations.

TECHNOLOGY NEED C10: Develop and Verify Water Cooled Structure Design Concepts for Advanced Space Transportation Systems

TECHNOLOGY NEED JUSTIFICATION:

As discussed in Section 4.1, water cooled structure concepts have repeatedly been shown to be significantly lighter than other thermal protection concepts for hypersonic applications. ASTS thermal/structural mass savings can be turned into increased payload. Limited tests have demonstrated the feasibility of the concept but there are many design and operational problems to be resolved before this system could be converted to production.

TECHNOLOGICAL ADVANCEMENT OBJECTIVE:

The primary objectives are to solve operational problems associated with water cooled structural concepts and to substantiate system performance and integrity by ground and flight tests. Major problems to be solved have to do with servicing and maintenance, uniformity of water distribution, freezing of water in insulation blankets and water distribution system, inspection of the structure, compatibility of water with internal structure, and effects of local hotspots. Heat shields, similar to those required for Technology Need C7, must also be developed.

PLAN FOR ADVANCING TECHNOLOGY:

1. Establish representative design criteria for various regions of a proposed ASTS configuration and conduct conceptual design studies. Provisions for a water distribution system and means for venting steam overboard must be defined.
2. Conduct element tests to get configuration definition level properties for heat shields and supporting structure. Develop fabrication techniques as required to produce lightweight heat shields of high temperature materials.
3. Perform simple tests under laboratory conditions, using representative components, to evaluate water distribution system schemes and establish the compatibility of water with associated structure materials. Include trade studies of candidate wicking materials.
4. Design and fabricate full scale structural sections, representative of at least two different ASTS vehicle locations, for ground tests to demonstrate design performance and structural integrity. These tests must be planned to consider the long life requirements of operational vehicles to confirm performance repeatability. These tests should also be planned to provide simulated pressure altitudes so freezing and thawing effects in the wicking material can be evaluated.
5. Design and fabricate a full scale major assembly, such as a fuselage section or wing, for flight test on a hypersonic research vehicle. While the ASTS flight environment cannot be duplicated, the operational aspects associated with this concept can be studied. The required design provisions for most anticipated problems can be verified by flight at high speeds and altitude.

TECHNOLOGY NEED C11: Develop Water Cooled Structure Design Concepts for Mach 6.0 Aircraft

TECHNOLOGY NEED JUSTIFICATION:

The justification for Technology Need C10 is basically applicable here also. The advantages associated with the water cooled structure concept should be even more pronounced with Mach 6.0 aircraft since the flight times are much longer. However, servicing requirements must be minimized for aircraft applications to insure rapid mission turnaround capabilities.

TECHNOLOGICAL ADVANCEMENT OBJECTIVE:

The objective for Technology Need C10, again, is basically applicable. However some additional considerations are unique to aircraft applications. These include demonstrating that the concept is suitable for long service life requirements and can perform adequately for long mission times. In addition, ground maintenance procedures must be examined to insure rapid turnaround times.

PLAN FOR ADVANCING TECHNOLOGY:

1. Develop these concepts using a procedure similar to that outlined in Steps 1 through 4 of Technology Need C10 to advance through the ground test phase. During Step 4, the tests with one article should be planned to demonstrate the concept's compatibility with a cryogenic tankage TPS as discussed in Technology Need C15.
2. Two flight test articles should be designed and fabricated. These articles should be full scale assemblies of a fuselage section and a wing. The fuselage assembly should be tested in conjunction with an LH₂ tankage experiment. Ground servicing techniques should be developed during the flight test phase.

TECHNOLOGY NEED C12: Develop and Verify Heat Sink Structure Design Concepts for Advanced Space Transportation Systems

TECHNOLOGY NEED JUSTIFICATION:

Heat sink structure concepts may have mass and cost advantages for advanced space transportation systems in areas of low heat flux since the time of exposure is short. A very simple Lockalloy, beryllium, or even aluminum structure might be used. A major effort will be required to develop efficient designs using these materials. Regardless of the material selected, structural designs will have to withstand large temperature gradients that will exist in all heat sink designs.

TECHNOLOGICAL ADVANCEMENT OBJECTIVE:

Heat sink concepts employing Lockalloy or beryllium must be designed to establish minimum cost features that will permit these approaches to be cost competitive. Means of attaching surface panels must be examined to derive arrangements that efficiently transmit loads and produce acceptable thermal stresses. Since heat sink concepts will be acceptable only in local regions, ways of interfacing the designs with other design concepts must be examined.

PLAN FOR ADVANCING TECHNOLOGY:

1. Conduct studies to determine which ASTS configurations have design conditions favorable to heat sink structures and conduct conceptual design studies.
2. Conduct trade studies to compare mass and cost requirements with hot and thermally protected structure concepts.
3. Perform element tests to acquire configuration definition level material data and evaluate critical structural details. Develop fabrication techniques for these materials emphasizing minimum cost approaches.
4. Design and fabricate full scale structural sections representative of ASTS upper surface structure. Conduct ground tests to verify design performance and structural integrity.
5. Design and fabricate a full scale major assembly, such as a vertical tail, for tests on a research aircraft. This assembly should consider the requirement of designing for an interface with adjacent structure. Although the ASTS environment will not be simulated, these tests can demonstrate the design's compatibility with an actual flight environment.

TECHNOLOGY NEED C13: Develop and Verify Phase Change Material Cooled Structure Design Concepts for Advanced Space Transportation Systems

TECHNOLOGY NEED JUSTIFICATION:

A preliminary study, conducted during the Space Shuttle program (Reference (18)), established that a significant mass reduction could be realized by using a structural concept which was cooled via a contained phase change material (PCM). However, this evaluation was limited and the concept has not been developed. The same study identified a passively cooled leading edge concept which employed sodium filled heat pipes. This concept has been tested, Reference (27), but needs more verification to be considered flightworthy.

TECHNOLOGICAL ADVANCEMENT OBJECTIVE

These PCM cooled structure concepts should be re-examined for ASTS applications. The inherent disadvantages of the PCM cooled panel concept included difficult inspection/maintenance requirements and the potential effects of a localized PCM failure. These aspects should be demonstrated and the concept must be shown to be compatible with multiple flight requirements. The program begun to demonstrate the viability of leading edge structures cooled via heat pipes must be broadened to consider operational considerations.

PLAN TO ADVANCE TECHNOLOGY:

1. Conduct studies, based on space transportation system requirements, to extend the knowledge as reported in References (18) and (27), by considering material advancements. Recent heat pipe technological advances should be evaluated for the leading edge design concept.
2. Perform trade studies to select promising configurations for both the structural panel with contained PCM and the heat pipe leading edge design. Consider various phase change materials and panel geometries.
3. Manufacturing processes to insure consistency in structural panel design must be developed so that each panel can be guaranteed to contain adequate quantities of PCM. Fabrication techniques required to produce and form heat pipes in production quantities must be demonstrated.
4. Design and fabricate full scale test articles representative of both the structural panel containing PCM and a leading edge assembly incorporating heat pipes. Ground tests should be conducted to demonstrate concept performance as well as structural integrity. Effects of transient temperatures and pressures shall be accounted for and the tests should verify that the concepts are capable of cyclic operation over long times.
5. Design and fabricate full scale major assemblies such as a wing and leading edge using these concepts. Flight test the assemblies on a research aircraft to demonstrate the concepts' tolerance to actual flight environments and durability to service conditions.

TECHNOLOGY NEED C14: Develop and Verify Actively Cooled Structure Design Concepts for Mach 6.0 Aircraft

TECHNOLOGY NEED JUSTIFICATION:

References (20) and (22) indicated that Mach 6.0 aircraft structure could be actively cooled, permitting the use of lightweight and inexpensive aluminums. The need for efficient and producible concepts has been demonstrated by the problems encountered when applying state of the art technology to three different actively cooled panel designs as discussed in Reference (25). A number of design and manufacturing problems were uncovered, where significant technological advancements are needed to achieve production status.

TECHNOLOGICAL ADVANCEMENT OBJECTIVE:

Concepts that are efficient and producible should be developed. Previous study results must be reviewed and potential design improvements, using new materials, must be evaluated. Designs for all external surface geometries, including leading edge designs, should be considered. Additional examinations of means of matching airframe heat loads to available heat sink are warranted. A detailed study of cooling system components is necessary to lend improved credibility to system evaluations. The preliminary studies conducted to assess failsafe requirements and interference heating effects, References (23) and (24), should be integrated with these evaluations.

PLAN FOR ADVANCING TECHNOLOGY:

1. Establish representative Mach 6.0 aircraft design requirements and optimize, via trade studies, designs for various regions of the aircraft including leading edges. Several designs should be considered for each region. Studies should identify mass and cost differences as well as the materials and manufacturing development required. Cooling system components such as heat exchangers, pumps, etc., shall also be evaluated.
2. Develop manufacturing techniques for the most promising designs. All techniques must be amenable to production of full size components.
3. Conduct element tests to get material properties and to evaluate critical thermal/structural design details. This includes tests of subsize panels.
4. Design and fabricate full scale actively cooled test articles. These test articles should incorporate complexities of an aircraft structure such as curvature, access provisions, substructure, edge closures, etc. Conduct ground tests to verify system performance and identify problem areas.
5. Design and fabricate full scale actively cooled assemblies for flight testing. These assemblies should include a fuselage section and a leading edge configuration. The testing should include active cooling system components demonstrations as well as structural verification. The test program should be similar to that described in Reference (47).

TECHNOLOGY NEED C15: Develop and Verify Liquid Hydrogen Tankage Thermal/Structural Concepts for Mach 6.0 Aircraft

TECHNOLOGY NEED JUSTIFICATION:

Mach 6.0 aircraft designs must address the problems associated with the containment of cryogenic fuel. Thermal protection systems (TPS) are required to minimize heat transfer from the vehicle surfaces to the fuel. As discussed in Section 4.3, many TPS concepts have been studied and a number of them remain as candidates since each has unique advantages. None of these concepts have been demonstrated by tests to the extent necessary for production vehicle program commitments.

TECHNOLOGICAL ADVANCEMENT OBJECTIVE:

The objectives of this program are to develop materials, manufacturing methods and thermal/structural design concepts for cryogenic tankage and conduct analyses and tests to validate performance, mass, and costs. Tank structure, insulations, and purge systems must be evaluated in their operating environment to determine physical and mechanical properties, chemical compatibility, thermal performance, manufacturing methods, processing parameters, and durability. In addition, concepts must be developed for joining and supporting subsystem components and providing access for assembly, maintenance, and repair.

PLAN FOR ADVANCING TECHNOLOGY:

1. Select representative Mach 6.0 blended-body and wing-body aircraft configurations to establish design requirements for tank geometries.
2. Develop optimized preliminary designs for candidate thermal/structural concepts as applied to integral and non-integral tankage. Identify high payoff advancements in materials and manufacturing methods.
3. Develop these high payoff materials and manufacturing methods by conducting the necessary element tests and fabrication studies.
4. Design and fabricate representative sections of tankage incorporating full scale design details, for thermal/structural ground tests. Consider up to three different TPS concepts through ground tests to verify concept designs.
5. Design and fabricate liquid hydrogen tankage experiment packages for flight test. These experiments can be flown in conjunction with propulsion system or active cooled structure experiments that are planned. As many as three different concepts may merit investigation. These packages and the testing involved would be similar to that discussed in Reference (47).

TECHNOLOGY NEED C16: Develop and Verify Hot Structure Air Induction System Design Concepts for Near-Term Mach 4.5 Aircraft

TECHNOLOGY NEED JUSTIFICATION:

The Reference (35) study indicated that hot superalloy structure is the only viable concept for the air induction system of near-term, hydrocarbon fueled Mach 4.5 cruise aircraft. However, there have been no hardware testing programs to prove the concept's integrity.

TECHNOLOGICAL ADVANCEMENT OBJECTIVE:

While existing superalloy material data are adequate for preliminary design, additional data must be obtained as noted in Technology Need B2. Methods for manufacturing complex, curved sandwich construction and stiffened skin duct liner structural concepts at low cost must be developed. The design concept must be proven to incorporate adequate provisions to alleviate thermal stresses and minimize adverse thermal expansion; seal against unnecessary air leakage around ramp edges, hinge-lines, and joints; and control boundary layer air bleed as required by the propulsion system.

PLAN FOR ADVANCING TECHNOLOGY:

1. Conduct preliminary studies of candidate Mach 4.5 air induction systems to establish representative design criteria and permit the selection of a promising system type and geometry for development.
2. Devise conceptual designs for each section of the inlet and conduct trade studies comparing performance, mass, and costs with various materials, structural arrangements, and manufacturing methods.
3. Develop fabrication techniques for the most promising design concepts.
4. Conduct element tests to get configuration definition level material properties on superalloys and evaluate structural details.
5. Design and fabricate a complete air induction system (full scale preferred). Conduct ground tests to verify design performance, structural integrity, and long life.
6. Design and fabricate a complete air induction system for flight demonstration. Although a subscale design may be required, all structural features must be incorporated.

TECHNOLOGY NEED C17: Develop Hot Structure Air Induction System Design Concepts for Advanced Mach 4.5 Aircraft

TECHNOLOGY NEED JUSTIFICATION:

Advanced Mach 4.5 air induction system requirements may permit the use of concepts similar to those developed for the near-term Mach 4.5 aircraft. However, it is more likely that improved designs will be necessary. To be more efficient, these designs will have to use advanced materials such as those discussed in Technology Need B4 and will require their own development program.

TECHNOLOGICAL ADVANCEMENT OBJECTIVE:

This objective is basically the same as that described for Technology Need C16 except that advanced materials developed to satisfy Technology Need B4 must be considered.

PLAN FOR ADVANCING TECHNOLOGY:

1. Conduct studies to define potential design improvements that can be realized by modifying the near-term Mach 4.5 concepts.
2. Develop these concepts using a procedure similar to that outlined in Steps 1 through 6 of Technology Need C16.

TECHNOLOGY NEED C18: Develop and Verify Actively Cooled Structure Air Induction System Design Concepts for Mach 6.0 Aircraft

TECHNOLOGY NEED JUSTIFICATION:

The 1478 K (2200^oF) to 1700 K (2600^oF) temperatures experienced in a Mach 6.0 air induction system are too high for efficient use of hot metallic structure since refractory metals would be required. Actively cooled structure concepts have been identified as being more efficient for this application. However, they have not been studied in significant detail and large advancements are required to advance this design approach to the maturity required for operational aircraft.

TECHNOLOGICAL ADVANCEMENT OBJECTIVES:

Many of the considerations defined, for Mach 4.5 aircraft hot structure air induction system concepts, in Technology Needs C16 and C17 must also be addressed here. However, additional complications are created by the necessity to cool the structure. Efficient structural configurations incorporating cooling provisions must be developed. Means of integrating a cooling system into the airframe must be evaluated. Studies to compare structural cooling and heat sink requirements must be performed to determine efficient balances.

PLAN FOR ADVANCING TECHNOLOGY:

Develop these concepts using a procedure similar to that outlined in Steps 1 through 6 of Technology Need C16. However, both ground and flight tests must be planned to confirm cooling system performance and effectiveness.

APPENDIX B
STUDY APPRAISALS

As discussed in Section 2, two distinguished professors, E. E. Sechler of the California Institute of Technology and R. H. Miller of the Massachusetts Institute of Technology, were employed as study advisors. In addition to providing assistance throughout the study, these gentlemen were requested to prepare a summary providing their evaluation of the study and any additional comments regarding the subject addressed. These summaries are presented herein.



STUDY APPRAISAL

by

E. E. Sechler

Professor of Aeronautics - Emeritus
California Institute of Technology

To begin with, I would like to state that I am convinced that, if the United States is to maintain a leadership position in both military and civil aviation, it will need to design and fly hypersonic aircraft in both categories by the beginning of the next century. The major question is then -- how can these aircraft be developed in the most efficient and economical manner. Since the major difference between hypersonic and slower speed aircraft is the thermal environment, the authors of this study (McDonnell Aircraft Co. - MCAIR) have wisely concentrated on this phase and have looked at it from the standpoint of 1) analytical methods, 2) materials, and 3) technological advancements.

The study is very complete and has been carried out in a competent manner. The state-of-the-art has been documented and the necessary advancements in knowledge are presented in a concise manner. Costs for each phase of needed research are estimated individually so that interested agencies can build various programs to meet budgetary and time limitations. Overall the study has been well done by very competent personnel.

My main criticism of the study lies with a difference of opinion concerning some of the conclusions and the recommendations. I do not agree that "existing ground test capabilities are adequate to accomplish most required advancements." At the very least I would change the word "most" to "many." In place of conclusions 4 and 5 I would rather see the statement on page 56 of the report, namely:

"Discussions held with other members of the aerospace community and the advisors assigned to this study inevitably led to the same conclusion -- flight test can yield a large increase in confidence in thermal/structural design. Flight test and demonstration offers the only reasonably sure way to discover design "unknowns" before production vehicles become operational. In the case of thermal/structural design, confidence is not only important in verifying performance, but is necessary for flight safety. In summary, flight testing of hypersonic thermal/structural designs will be an absolute necessity."

If the above conclusion is accepted, a recommendation to build one or more flight research vehicles (probably a minimum of two) should obviously follow. The only other way to obtain actual flight data would be to use a prototype or pre-production aircraft to obtain the required information. I personally think that this approach would be economically unsound for the following reasons:

- 1) The cost of a preproduction aircraft in any category would be approximately an order of magnitude higher than any of the programs proposed in this study for two research vehicles.
- 2) Changes to investigate new concepts would be more difficult and more expensive than they would be in a research airplane which was specifically designed to accept such changes.

Assuming a current need for a Mach 4.5 strategic reconnaissance aircraft, some of the programs presented in this study could be compressed by carrying out the various steps in parallel rather than serially. Although this would require a greater current allocation of manpower and budget, the overall cost of the program might very well be significantly reduced.

In summary, I think this has been an excellent study and it has convinced me, at least, that hypersonic research vehicles are essential to properly extend our engineering knowledge into this challenging future of hypersonic flight.

STUDY APPRAISAL

by

R. H. Miller

Professor of Aeronautics and Astronautics
Massachusetts Institute of Technology

The development of hypersonic aircraft will almost certainly be the next major step in aircraft design and development. The impetus for this advance will come from both military and civilian requirements. The military will need the fast reaction time, the ability to overfly enemy aircraft which the higher altitude associated with hypersonic flight provides, the low vulnerability and the ability to disengage successfully when indicated, which a hypersonic flight capability provides. The simplest way of visualizing the importance of a hypersonic capability to military aviation would be to consider the panic situation which would exist if our potential adversaries were known to have such an operational capability.

The need for hypersonic flight for civilian applications is less urgent, but also persuasive. Commercial jets have demonstrated the powerful effect of a doubling in speed on airline economics. Although costing five times as much per seat as the propeller aircraft, the commercial jets have dropped direct operating costs from over two cents to little over one cent a seat mile and turned the airlines from a heavily subsidized, unprofitable operation to one that, although not always profitable, at least operates free of subsidy. At the same time a phenomenal growth in both domestic and international airline traffic resulted.

Supersonic aircraft could provide at least another doubling in speed. The only one now flying operationally was designed 20 years ago and yet despite this obsolescence it is proving the appeal of higher speed to the traveling public. Although a successful supersonic aircraft operating at close to present fare levels could be built, it is unlikely that such a program will be initiated in the near future for political reasons. It is therefore more than likely that the next major advance in commercial aircraft will be in the development of hypersonic vehicles, providing that the technology has previously been developed through military application.

Although beyond the scope of the present report, it may be noted in passing that commercial operation using boost-cruise-glide techniques would provide flight times of half an hour across the Atlantic, one hour across the Pacific, and an hour and a half for antipodal distances. Except for the propulsion system, successful demonstration of the space shuttle will have demonstrated the technology required. Such advances may be anticipated during the next half century. The technology considered in this report should be viewed in the context of one step in such an overall advance in flight technology.

The report itself presents a comprehensive summary of the technology for hypersonic aircraft design. This comprehensiveness itself may leave the reader with the impression that the development of a Mach 6 hypersonic aircraft represents an overwhelmingly difficult undertaking. It is believed, however, that most of the possible designs can be ruled out for any particular mission and, of the many TPS systems considered, it is possible to select one "best" candidate system, probably the radiative metallic design for a first step. A flight test program could be oriented around such a system, but with, as fall-back, two alternates such as water-cooled or heat-sink structure.

The cost effectiveness of such structural concepts is greatly dependent on solutions to the detailed design problems. In fact, it is likely that these detailed design problems as demonstrated in the X-15 program will prove to be the pacing item in the development of hypersonic aircraft. It is believed that many of these problems cannot be solved except through flight tests. For example, structural distortion in the presence of flight loads, uneven thermal expansion and high dynamic pressures occur in flight in a way which would be impossible to duplicate on the ground. Flight tests are important to provide this proof of concept information.

However, many detailed design problems can as well be evaluated with ground test facilities, for example the optimum design of the support structure for the radiative metallic shield in order to avoid heat shorts and the method of joining panels so as to avoid leaks in the presence of distortion. Similarly the best manufacturing techniques for water-cooled and heat-sink structures can probably be determined on the ground rather than in flight.

In summary, the development of hypersonic aircraft through a well planned flight research program is believed to be in the national interest and should receive a high priority in aeronautical research planning of the future. Such a program should be developed in a logical basis, proceeding from ground tests to flight tests. Flight tests are essential to provide product assurance since failure of a component as important as the thermal protection system of an aircraft could be catastrophic. The flight tests could be conducted in such a manner as to provide forewarning of incipient failure so that an alternate backup system could be substituted. As evident from the report, there are several such viable alternatives. The problem will be to limit their choice by careful design and pretesting so as to minimize overall program costs.

As a final comment, it is believed that development of a successful TPS system for hypersonic aircraft is assured. The problem will be finding one that is both cost-effective and easily maintained.

1. Report No. NASA CR-3130		2. Government Accession No.		3. Recipient's Catalog No.	
4. Title and Subtitle Hypersonic Airframe Structures Technology Needs and Flight Test Requirements				5. Report Date July 1979	
				6. Performing Organization Code	
7. Author(s) J. E. Stone and L. C. Koch				8. Performing Organization Report No. MDC A4839	
				10. Work Unit No.	
9. Performing Organization Name and Address McDonnell Douglas Corporation Douglas Aircraft Company P. O. Box 516 St. Louis, Missouri 63166				11. Contract or Grant No. NAS1-14924	
				13. Type of Report and Period Covered Contractor Report	
12. Sponsoring Agency Name and Address National Aeronautics and Space Administration Washington, DC 20546				14. Army Project No.	
15. Supplementary Notes Langley Technical Monitor: H. Neale Kelly Final Report					
16. Abstract <p>Six hypersonic vehicles, that may be produced by the year 2000, are identified. Candidate thermal/structural concepts that merit consideration for these vehicles are described. The current status of analytical methods, materials, manufacturing techniques, and conceptual developments pertaining to these concepts are reviewed. Guidelines establishing meaningful technology goals are defined and twenty-eight specific technology needs are identified. The extent to which these technology needs can be satisfied, using existing capabilities and facilities without the benefit of a hypersonic research aircraft, is assessed. The role that a research aircraft can fill in advancing this technology is discussed and a flight test program is outlined. Research aircraft thermal/structural design philosophy is also discussed. Programs, integrating technology advancements with the projected vehicle needs, are presented. Program options are provided to reflect various scheduling and cost possibilities.</p>					
17. Key Words (Suggested by Author(s)) Hypersonics Thermodynamics Aircraft Structures Research Aircraft			18. Distribution Statement Unclassified - Unlimited Subject Category 05		
19. Security Classif. (of this report) Unclassified	20. Security Classif. (of this page) Unclassified	21. No. of Pages 144	22. Price* \$7.25		