

NASA
TP
1506
c.1

NASA Technical Paper 1506

LOAN COPY RETURN TO
AFWL TECHNICAL LIBRARY
KIRTLAND AFB, N. M.



Velocity Field of a Round Jet in a Cross Flow for Various Jet Injection Angles and Velocity Ratios

Richard L. Fearn and Robert P. Weston

OCTOBER 1979





NASA Technical Paper 1506

Velocity Field of a Round Jet in a Cross Flow for Various Jet Injection Angles and Velocity Ratios

Richard L. Fearn
University of Florida
Gainesville, Florida

Robert P. Weston
Langley Research Center
Hampton, Virginia

NASA

National Aeronautics
and Space Administration

**Scientific and Technical
Information Branch**

SUMMARY

An experimental investigation of a subsonic round jet injected from a flat plate into a subsonic crosswind of the same temperature has been conducted in the Langley V/STOL tunnel. Velocity and pressure measurements in planes perpendicular to the path of the jet are presented for nominal jet injection angles of 45° , 60° , 75° , 90° , and 105° and for jet/cross-flow velocity ratios of 4 and 8. These velocity measurements were obtained for the purpose of inferring the properties of the vortex pair that is associated with a jet in a cross flow. Jet centerline and vortex trajectories are determined and fit with an empirical equation that includes the effects of jet injection angle, jet core length, and jet/cross-flow velocity ratios.

INTRODUCTION

A V/STOL aircraft in transition from hover to conventional flight will encounter an interference effect between the jets providing direct lift and the aerodynamic surfaces of the aircraft. This jet/aerodynamic-surface interference causes a loss of lift and a nose-up pitching moment on specific aircraft configurations (refs. 1 to 5). One of the important tasks in V/STOL aerodynamics is to develop a quantitative description of jet/aerodynamic-surface interference effects and their influence on the pressure distribution and aerodynamic coefficients of V/STOL aircraft.

A reasonable approach to such a complicated problem is to study the simplest configuration that retains the essential features of transition from hover to conventional flight. The jet/aerodynamic-surface interference problem has thus motivated numerous studies of a round subsonic jet of air discharging through a large flat plate into a uniform subsonic cross flow of the same temperature (refs. 6 to 18). One such study has been conducted in an experimental program in the Langley V/STOL wind tunnel. The primary goal of this program was to provide experimental information upon which to base the development of models that would be used to predict the effects of jet/flat-plate interference. Measured pressures on the flat plate are presented in reference 19 for perpendicular jet injection over a range of jet/cross-flow velocity ratios from 2 to 10. Measured velocities in the jet plume are presented in reference 20 for perpendicular jet injection for a range of velocity ratios from 3 to 10. Based on velocity measurements, a contrarotating pair of diffuse vortices has been identified as a dominant feature of the flow field. A model for inferring the vortex properties has been developed and utilized to describe the vortex properties for perpendicular jet injection (ref. 21). A preliminary attempt to utilize the properties of the vortex pair to calculate the pressure distribution on the flat plate for a jet/cross-flow velocity ratio of 8 provides good agreement with experimentally determined lift and pitching-moment coefficients (ref. 22).

The present report extends the study of the jet plume for a round jet in a cross flow to include the effects of varying the jet injection angle. Velocity

and pressure measurements in the jet plume are presented for jet/cross-flow velocity ratios of 4 and 8 and for nominal jet injection angles into the cross flow of 45° , 60° , 75° , 90° , and 105° . The velocity measurements of the present study were acquired primarily for use in a model to infer the properties of the diffuse vortex pair associated with a jet in a cross flow, and the results have been presented in reference 23. A detailed description of the equations utilized to describe the jet centerline and vortex curve is provided in appendix A of the present report. The detailed velocity and pressure measurements in the jet plume are presented in tabular and graphical form in appendix B.

SYMBOLS

Values are given both in SI Units and U.S. Customary Units. The measurements and calculations were made in U.S. Customary Units.

A	area of jet orifice, m^2 (ft ²)
A _j	jet exit area corrected for nozzle boundary-layer thickness, m^2 (ft ²)
a,b,c,d	curve-fitting parameters
D	jet diameter, 10.16 cm (4.00 in.)
F	function defined by equation (3), cm (in.)
ℓ ₁	length of jet core for $\delta = 0^\circ$, cm (in.)
ℓ ₂	length of jet core for $\delta = 90^\circ$, cm (in.)
M	Mach number
R	effective velocity ratio, defined by equation (1)
s	arc distance along a jet path, m (ft)
U _¢	jet centerline speed, m/sec (ft/sec) (UC in computer-generated tables)
U _j	speed of jet fluid at jet orifice, m/sec (ft/sec)
U _∞	cross-flow speed, m/sec (ft/sec) (UINF in computer-generated tables)
W	Z component of velocity; denotes component in wind-tunnel system when no subscript is used, m/sec (ft/sec)
X,Y,Z	Cartesian coordinate system; denotes wind-tunnel coordinate system when no subscript is used (see fig. 1)
x,y,z	distances along X, Y, and Z axes, m (ft)
Γ	strength of each vortex, m^2/sec (ft ² /sec)

δ	jet injection angle relative to cross-flow velocity, deg (DELTA in computer-generated tables and figures)
ρ	mass density, kg/m ³ (slug/ft ³)
σ	standard deviation of points from a curve, cm (in.)
ϕ_c	angle between Z and Z _c axes (see fig. 5), deg (PHIC in computer-generated tables)
ϕ_v	angle between Z and Z _v axes (see fig. 5), deg (PHIV in computer-generated tables)

Subscripts:

c	refers to jet centerline
j	refers to condition at jet orifice
o	refers to end of jet core
v	refers to vortex curve
l	refers to point of reference curve (eq. (3)) where tangent is perpendicular to X-axis
∞	refers to cross-flow condition

PHYSICAL DESCRIPTION OF A JET IN A CROSS FLOW

From the numerous investigations of a round subsonic jet injected through a flat plate into a subsonic cross flow, there emerges a realistic qualitative description of the flow field. Most of the experiments upon which this qualitative description is based are for perpendicular jet injection into the cross flow, but it should be applicable for the range of jet injection angles studied in this report.

At the jet-nozzle exit plane, the velocity profile and turbulent intensity in the jet are characteristic of the jet nozzle. A shear layer exists at the boundary between the jet and cross-flow fluids, and this layer diffuses into a highly turbulent mixing region. A core of jet fluid, approximately conical in shape and maintaining the properties of the jet nozzle, extends a short distance from the nozzle exit plane. For a free subsonic jet (no cross flow), this core extends approximately six jet diameters (ref. 24) before it is eroded, and the flow becomes highly turbulent throughout the entire cross section of the jet. If a cross flow is introduced, the length of the jet core decreases with increasing cross-flow velocity. The flow in this initial region is complicated by a separation of the cross flow around the jet near the flat plate. This separation and the resulting wake region are clearly visible from oil-smear studies on the flat plate (ref. 15).

The jet plume itself is readily observable by flow visualization techniques such as smoke injection (ref. 8). The deflection and decay of the initial jet of fluid can be detected by total pressure or velocity measurements in the jet plume. The curve that traces the locations of maximum jet speed from the terminus of the jet core through subsequent cross sections of the jet plume is called the jet centerline (ref. 6). This curve can be determined to a location where the local maximum of the jet velocity is experimentally indistinguishable from the cross-flow velocity. This occurs 15 to 20 jet diameters downstream of the jet orifice (ref. 21) for the instrumentation currently in use (i.e., total pressure and hot wire).

Another feature of the flow field is a pair of diffuse contrarotating vortices which form near the jet orifice and are deflected and swept downstream along curved paths which lie to either side of the plane of flow symmetry ($y = 0$, see fig. 1) and on the concave side of the jet centerline (refs. 9, 10, and 20). These vortices are more persistent than the other distinguishing characteristics of a jet in a cross flow, and they dominate the flow field for distances greater than about 10 jet diameters downstream of the jet orifice. The vortex structure plays a primary role in determining the pressure distribution on the flat plate (ref. 22). Due to its persistence, the vortex pair has been observed as far as 1000 jet diameters downstream of the jet orifice (ref. 14).

Some of the pertinent features of the jet plume are sketched in figure 1 for a jet/cross-flow velocity ratio of about 8. The stippled area represents the plume of the jet as observed by flow visualization techniques (ref. 8). The flow exhibits mirror symmetry about the plane $y = 0$. Positions of the jet centerline and the pair of vortices relative to the jet plume are also indicated. The projection of the centers of the vortices onto the symmetry plane defines the vortex curve. No attempt has been made in figure 1 to display the jet core or the separated region near the flat plate.

APPARATUS

The present study reports on the third in a series of experiments conducted in the Langley V/STOL wind tunnel to determine the velocity field in the plume of a round jet in a cross flow. The first two experiments were studies of perpendicular jet injection through a flat plate into a cross flow. Most of the apparatus and techniques utilized in the present study were also utilized in the experiments for perpendicular jet injection and are described in reference 20, which should be used as a supplement to the present report.

Figure 2 is a photograph of the experimental arrangement for the present study, which used a new flat plate. The wind-tunnel structure restricted the installation of the jet plenum to a vertical position beneath the flat plate. To permit a range of jet injection angles, three deflecting nozzle extensions were constructed. Figure 3 is a sketch of the jet nozzle and plenum with one of the nozzle extensions. The extensions were designed to provide 15° , 30° , and 45° deflections of the jet from vertical and to have mean radii of curvature of 53.8, 25.4, and 16.5 cm, respectively, and a constant 10.16-cm diameter throughout the bend.

The flat plate is constructed of 0.64-cm-thick aluminum and measures 1.8 by 3.0 m (18D by 30D). It has circular inserts to accommodate the various nozzle extensions. The jet-exit plane is flush with the flat plate so that the exit orifice is actually an ellipse for the deflecting nozzle extensions. Each nozzle extension can be rotated 180° about a vertical axis to provide jet deflection upstream or downstream to the cross flow. The center of the jet orifice for the straight nozzle extension is 11.8D downstream of the leading edge of the flat plate.

TEST PROCEDURES AND CONDITIONS

The characteristics of the jet exhausting into still air were studied prior to the wind-tunnel experiment. Total pressure surveys across the jet exit are presented in figure 4 for each of the nozzle extensions. The boundary layer on the 0° azimuth side of the nozzle extensions becomes thinner with increasing deflection angle, and on the 180° azimuth side, it becomes thicker with increasing deflection angle. For the 45° nozzle extension, there is evidence of a region of separated flow on the 180° azimuth side of the nozzle extension. A yaw probe was used to measure the angle of the jet flow at a point centered in the orifice and at a point on the jet axis one jet diameter above the exit plane. For both points, nozzle extensions were found to deflect the flow through angles of -0.4°, 13.6°, 28.9°, and 46.5° instead of the nominal values of 0°, 15°, 30°, and 45°, respectively.

Flow-field measurements of velocity and pressure were made with a rake (see fig. 2) of seven parallel yaw-pitch probes having a 5.1-cm spacing between probes. Five pressure ports were located on the hemispherical tip of each probe, with a ring of six interconnected static ports located aft of the probe tip. A calibration scheme (ref. 20) was used that could compute the flow-field measurements through large angles (above 45°) relative to the individual probes. Based on the results of a calibration experiment conducted over an angle range of ±65°, it is estimated that errors in determining flow angularity are usually less than 1°, errors in determining airspeed rarely exceed 4 percent, and errors in determining static and total pressure are usually less than 10 percent of dynamic pressure. These error estimates are for uniform flow, with flow angularity within the range of the calibration experiment. They do not include the effects of high turbulent intensity such as are encountered throughout the jet plume or of large velocity gradients such as are encountered near the jet orifice. No estimates of the errors due to these effects have been made.

Test conditions are described by specifying the jet/cross-flow velocity ratio and jet injection angle. Early investigators utilized the ratio of jet velocity to cross-flow velocity as the basic parameter for describing the test conditions for perpendicular jet injection. This is appropriate under certain simplifying conditions. In general, however, it is the ratio of the momentum flux across the jet orifice to the momentum flux of the cross flow over an equal area that is the significant dimensionless parameter. In order to be consistent with the terminology of early investigations, it is convenient to define an effective velocity ratio as the square root of this ratio of momentum fluxes. If the density of the jet and cross-flow fluids is the same and if U_j

is constant over the jet orifice, then

$$R = \left(\frac{\int_A \rho_j U_j^2 dA}{\rho_\infty U_\infty^2 A_j} \right)^{1/2} \quad (1)$$

reduces to the ratio of jet velocity to cross-flow velocity. It should be noted that the reciprocal of equation (1) is used by some investigators and is usually referred to by the same name.

Other useful equations for the effective velocity ratio R can be obtained from equation (1). Some of these variations and their application to the present investigation are discussed in reference 19. For presentation of results in this report, the appropriate simplification of equation (1) is $R = M_j/M_\infty$. This relationship assumes a jet with a flat velocity profile expanding isentropically from plenum total pressure to the cross-flow static pressure. In comparison with the effective velocity ratio, jet Mach number is a parameter of secondary significance (ref. 19). Hence, both M_j and M_∞ have been varied in this report to obtain particular values of R .

Test procedures similar to those utilized in the first two wind-tunnel experiments of the series were followed (ref. 20). Primary among these is the acquisition of flow-field data in planes roughly perpendicular to the jet centerline or vortex curve. Additionally, some special-case measurements were taken very near to the jet orifice where probe vibration was so severe that guy wires were utilized to stiffen the probe support system.

The coordinate systems utilized for data acquisition and presentation are shown in figure 5. A wind-tunnel coordinate system (X, Y, Z) has its origin at the center of the jet orifice, with the X axis in the direction of the cross flow and the Z axis in the direction of the initial jet velocity for perpendicular jet injection. Jet centerline coordinate systems (X_C, Y_C, Z_C) and vortex-curve coordinate systems (X_V, Y_V, Z_V) are Cartesian coordinate systems for the flow. The angles ϕ_C and ϕ_V denote the rotation about the Y axis of the centerline and the vortex-curve coordinate systems from the wind-tunnel coordinate system.

EXPERIMENTAL RESULTS AND DISCUSSION

Scope of the Present Investigation

To ascertain the effects of jet injection angle on the flow field of a jet in a cross flow, results of velocity and pressure measurements in the jet plume are presented in figures 6 to 9 and in appendix B for a range of jet injection angles for the effective velocity ratios of 4 and 8. The flow field has been studied in cross sections of the jet plume to display most clearly its symmetry and other simplifying features. Measurements can be divided into three categories according to the purpose for obtaining them:

- (1) Velocity measurements in the plane of flow symmetry ($y = 0$) which are used to determine the jet centerline
- (2) Velocity measurements in the plane of flow symmetry which are used to determine the vortex curve
- (3) Velocity measurements extending out of the plane of flow symmetry which are used in the diffuse vortex model

There is overlap between categories (2) and (3) because the measurements for the diffuse vortex model include those in the plane of flow symmetry. The extent of measurements for the present study is summarized in table I.

Measured velocities, static pressures, and total pressures are presented in appendix B, and the results of utilizing the measured velocities in the diffuse vortex model are presented in reference 23.

Measurements in the Symmetry Plane

Discussion of measurements.- Some appreciation for the information contained in the symmetry plane data and for the shortcomings of the present study can be gained from figure 6. Shown in this figure are measured velocities displayed as vectors in the plane of flow symmetry for an effective velocity ratio of 8 and a nominal jet injection angle of 60° . For measurements near the jet orifice ($x/D < 2$), the pressure and velocity gradients are large enough to cause one or more of the following difficulties: (1) the probe spacing ($0.5D$) becomes too large to define the velocity profile adequately for determining the centerline or vortex-curve location at a cross section; (2) appreciable errors are introduced in the iterative technique used to determine the centerline and vortex curve; or (3) errors in the velocity determination itself are introduced because of large values of flow turbulence and significant pressure changes over distances comparable to the physical dimensions of the probe head.

In the region from $x/D \approx 2$ to $x/D \approx 12$, the pressure gradients are not too severe for the apparatus and techniques used in the present study. Within this region, the properties determining the jet centerline and vortex curve are apparent (e.g., the axial velocity in the jet is noticeably larger than the cross-flow speed, and the change in direction of the velocity vectors is discernible in the vicinity of the vortex curve). In this region, the span of the rake of probes is large enough and the probe spacing small enough to adequately describe the velocity profile determining either curve if the rake is well placed.

For the region $x/D > 12$, the axial velocity of the jet in the vicinity of the jet centerline has decayed to such a degree that it is difficult to determine the centerline location. Although the change in the direction of the velocity due to the contrarotating vortices is still evident, the span of the rake of probes is not large enough to provide an adequate description of the velocity profile locating the vortex curve. In addition to the broadening of the velocity profile which is used in determining the vortex curve, the initial placement of the rake of probes was not very accurate because of the lack of

prior knowledge about vortex structure as a function of jet injection angle. These observations for the test conditions of figure 6 apply qualitatively to the other test conditions studied.

The region very near the jet orifice ($x/D < 2$) is of particular importance because it is the region of initial vortex formation. An attempt to extend velocity measurements into this region has been made for selected test conditions. Figure 7 shows symmetry-plane velocity measurements acquired in the region of vortex formation for effective velocity ratios of 4 and 8 for perpendicular jet injection. The relatively fine measurement grids of $D/4$ and $D/16$ are achieved by multiple placements of the rake of probes. For both effective velocity ratios studied, the measurement cross section closest to the jet orifice passes through the region of the jet core where the measured velocity is equal in magnitude to that at the jet orifice. The velocity vectors in the jet core are deflected downstream approximately 5° for $R = 4$, whereas for $R = 8$, this deflection is less than 1° . This deflection of the jet core for low effective velocity ratios causes some problems in developing an equation for the jet centerline.

Jet centerline.- Determination of the jet centerline has been one of the primary objectives of many theoretical and experimental studies of a jet in a cross flow. Its determination is included in the present study to supplement the description of the vortex pair associated with the jet and to provide a basis for comparison with the results of other experiments.

An experimental determination of the jet centerline is straightforward. As the jet is deflected by the cross flow, the velocity in the jet decays to values comparable to the cross-flow velocity. This deflection and decay of the axial component of velocity in the jet can be detected by suitable placement of velocity measuring probes in the plane of flow symmetry. The jet centerline is the locus of the points of maximum axial component of velocity in each of the flow-field cross sections, with an iterative process (ref. 20) defining the final cross-section angles.

Table II presents the results of the jet centerline study. The location and orientation of the rake, the location of the jet centerline, the maximum axial velocity, and the final cross-section angle are presented for each cross section studied. The jet centerline decay properties are indicated in figure 8. In this figure, the quantity $(U_{\xi} - U_{\infty} \cos \phi_c) / (U_j - U_{\infty} \cos \phi_c)$ is plotted against arc distance along the jet centerline. This represents an attempt to display the jet centerline decay in a manner that would be compatible with a coflowing jet in the limit as ϕ_c approaches zero. A comparison with the results of reference 20 is included. For $R = 4$, there is a noticeably slower decay rate of the axial velocity component for $\delta = 45^\circ$ than for the other jet injection angles. For $R = 8$, there appears to be a gradual but smooth decrease in the decay rate with decreasing jet injection angle.

Vortex curve.- The vortex curve partially describes the location of the vortex system associated with a jet in cross flow. The pair of diffuse contra-rotating vortices which form near the jet orifice is carried downstream along trajectories which depend on the effective velocity ratio and jet injection angle. The vortex curve is the projection of these trajectories onto the

plane of flow symmetry. The vortex pair induces a velocity field in the plane of a vortex-curve cross section that can be detected experimentally. Note in figure 1 that there is a constructive interference in the region between the contrarotating vortices. This constructive interference can be displayed by plotting the vortex-induced variation of W_v along the Z_v -axis. This W_v distribution exhibits a maximum, as indicated in sketch (a). A point on the

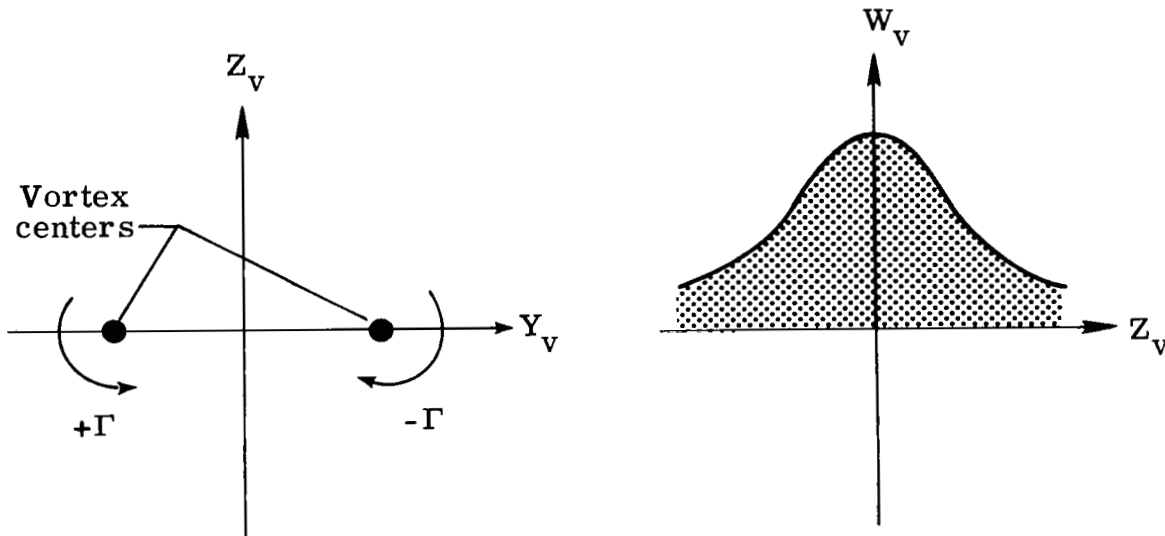

Sketch (a)

vortex curve is determined experimentally by locating this maximum "upwash," or Z_v component of velocity, in a vortex-curve cross section. A detailed description of the iterative procedure used to determine points on the vortex curve is presented in reference 20.

The results of the vortex-curve determination are shown in table III. The location and orientation of the rake, the location of the vortex curve, the arc length along the vortex curve, and the final cross-section angle are presented for each condition that resulted in useful information.

Equation describing the jet centerline and vortex curve.— The equation used to describe the jet centerline and vortex curve for perpendicular jet injection is

$$z/D = aR^b(x/D)^c \quad (2)$$

Separate values of the parameters a , b , and c which provide a least-squares best fit to the jet centerline and to the vortex curve for perpendicular jet injection are presented in reference 21. For a given effective velocity ratio, both the jet centerline and vortex curve as described by equation (2) intersect the plane of the flat plate ($z = 0$) perpendicularly at the center of the jet orifice, where $(x, y, z) = (0, 0, 0)$.

Equation (2) is modified in the present report to include the effects of jet injection angle. The primary assumptions are that the basic shape of the curve (given by a , b , and c) is not a function of jet injection angle and that the jet centerline and vortex curve intersect the flat plate at the jet injection angle δ . The basic generalization is to define a reference curve

$$F(x)/D = aR^b \left[(x/D) - (x_1/D) \right]^c \quad (3)$$

with separate values of a , b , and c to describe the jet centerline and vortex curve. The appropriate segment of this reference curve, utilized to describe either the jet centerline or vortex curve, is determined by the condition that each curve intersects the flat plate at the jet injection angle δ . The point $(x_0, F(x_0))$ in sketch (b) denotes the start point of this segment.

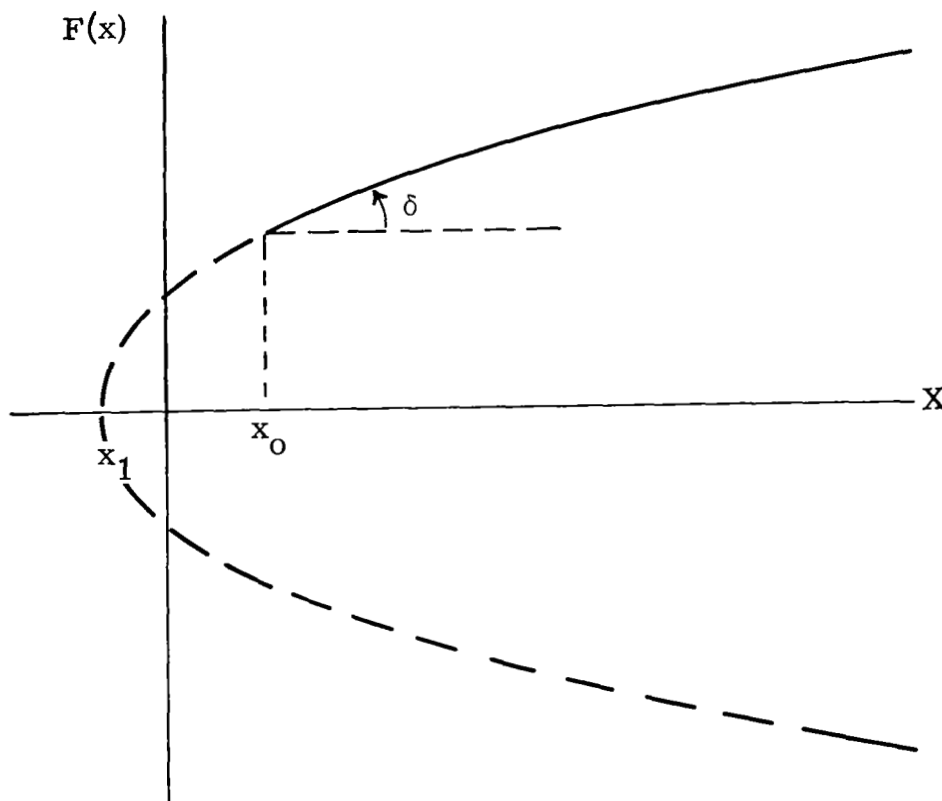

Sketch (b)

For the vortex curve, another minor modification is made to equation (2) based on velocity measurements from the present study in the region near the jet orifice. These measurements indicate that the vortex curve intersects the flat plate at approximately $x/D = 1/2$ instead of $x/D = 0$.

A least-squares fit of these extensions of equation (2) to the points on the jet centerline and vortex curve determines parameter values which are

listed in item 2 of table IV. Parameter values for fitting data for $R = 4$ and $R = 8$ separately are presented, as well as the parameters providing the best fit for all data. For purposes of comparison, similar results for perpendicular jet injection (ref. 20) are presented in item 1 of table IV. The last column of the table lists the standard deviation of the points from the curve. Note that this attempt to extend equation (2) to include the effects of jet injection angle causes a significant, though not serious, reduction in the quality of the fit to the data. For the centerline, the standard deviation for the present study is about three times as large as that for reference 20, and for the vortex curve, it is less than twice as large.

Physical descriptions of a jet in a cross flow usually consider two distinct regions of flow - a jet core extending a short distance from the orifice and the region of established flow downstream of the terminus of the jet core. This jet core, which is approximately conical in shape, is not noticeably deflected by the cross flow for effective velocity ratios greater than about 4. Downstream of the terminus of the jet core, the fluid is highly turbulent throughout the jet plume; deflection, deformation, and decay of the initial jet of fluid are readily observed. For perpendicular jet injection, equation (2) provides an adequate fit to the centerline for both regions of flow. Because the length of the jet core depends on jet injection angle, however, the two regions should be treated separately when extending equation (2) to include the effects of jet injection angle.

An attempt to improve the quality of the fit for the jet centerline is made by attempting to describe the length of the jet core. The jet centerline is described in the present study by a straight-line segment (representing the jet core) which is joined smoothly to a segment of the reference curve described by equation (3). The length of the straight-line segment is a function of jet injection angle. The equation chosen to model the behavior of the jet core length is an ellipse with one focus at the center of the jet orifice. Sketch (c) represents the variation of the length of the jet core s_0 with jet injection angle δ . The lengths l_1 and l_2 are interpreted as the jet core lengths for coflowing and perpendicular jet injection, respectively.

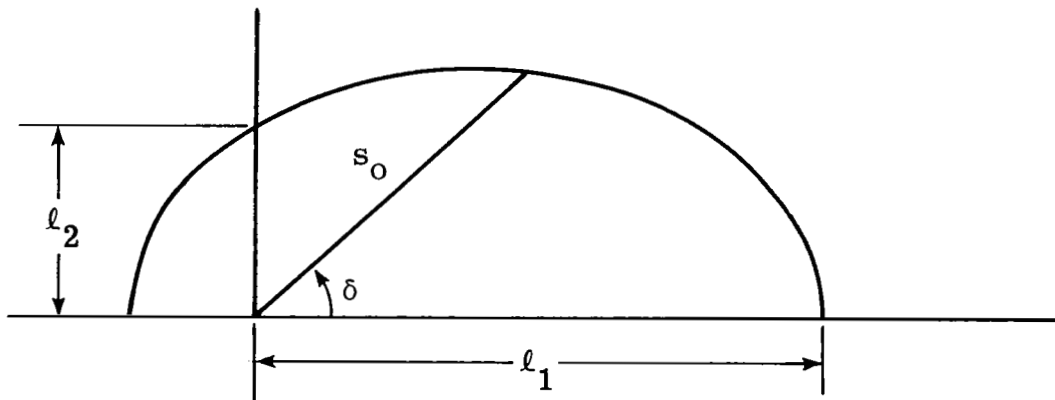

Sketch (c)

The equation for this elliptic variation of jet core length for a given effective velocity ratio is

$$\frac{s_0}{D} = \frac{\ell_2/D}{1 - \left(1 - \frac{\ell_2}{\ell_1}\right) \cos \delta} \quad (4)$$

To describe the shortening of the jet core with decreasing velocity ratio for perpendicular jet injection, the following equation is used:

$$\ell_2 = \ell_1 e^{-(d^2/R^2)} \quad (5)$$

where d is a parameter without physical significance that is determined in the curve-fitting process. The length ℓ_1 for a coflowing jet is assumed to be a constant that is equal to the jet core length for a free jet (i.e., $\ell_1/D = 6.2$). Although the jet core length for a coflowing jet is considered to be a function of effective velocity ratio (ref. 25), inclusion of this behavior does not lead to an improvement in the ability of the equation for the jet centerline to fit the experimental points defining this curve.

A least-squares fit of this two-segment curve to all of the jet centerline points determines the parameter values listed in item 3 of table IV. Note that there is a significant improvement in the quality of fit for $R = 8$ and a smaller improvement for $R = 4$. This reflects the physical observation that the jet core for perpendicular injection is significantly longer for $R = 8$ than for $R = 4$.

The steps for calculating points on the jet centerline and vortex curve are outlined in appendix A. Values for the resulting constants a , b , c , and d are listed in table IV.

To provide a better description of the jet centerline and vortex curve, the parameters for the fits to individual R groupings for the vortex curve (from item 2 of table IV) and the jet centerline with jet core (item 3 of table IV) are utilized in the present report. Figure 9 provides a visual indication of the quality of the fit of the extension of equation (2) to the points locating the jet centerline and vortex curve. Included in each figure is a comparison with the results of a previous study (ref. 20).

The velocity measurements in planes perpendicular to the jet path and extending out of the symmetry plane were acquired for use in the diffuse vortex model (ref. 21). Measured velocities and pressures are presented in appendix B, and the results of utilizing the projection of these velocities onto vortex-curve cross sections are presented in reference 23.

SUMMARY OF RESULTS

The primary purpose of the wind-tunnel experiment described in the present investigation is to determine the dependence on jet injection angle of the properties of the vortex pair associated with a round jet in a cross flow. Effective jet/cross-flow velocity ratios of 4 and 8 were studied for jet injection angles of 45° , 60° , 75° , 90° , and 105° .

Velocity and pressure measurements in the jet plume are the main subject of the present report, and the properties of the vortex pair inferred from these velocity measurements are presented in a separate paper by D. Krausche, R. L. Fearn, and R. P. Weston (AIAA J., vol. 16, no. 15, 1978). The measured values of total pressure, static pressure, and velocity are presented in tabular and graphical form for over 900 locations in the plane of flow symmetry and over 1000 additional locations in cross sections extending out of the plane of flow symmetry.

Additional results of the present study are:

1. The jet centerline location and decay of the jet centerline speed are determined and compared with the results of a previous experiment for perpendicular jet injection.
2. The vortex curve which partially locates the vortex system is determined.
3. An equation describing the jet centerline and vortex curve for perpendicular jet injection has been extended to include the effects of jet injection angle. It appears that the shape of each curve is determined primarily by the effective velocity ratio. The equation for the jet centerline is better able to fit the data if a straight-line jet core whose length depends on jet injection angle is included.

Langley Research Center
National Aeronautics and Space Administration
Hampton, VA 23665
July 19, 1979

APPENDIX A

EQUATIONS FOR THE JET CENTERLINE AND VORTEX CURVE

The following steps can be utilized to calculate points on the jet centerline or vortex curve and the associated cross-section angles. (See fig. 5.) The curves are modifications of equation (3):

$$F(x)/D = aR^b \left[(x/D) - (x_1/D) \right]^c$$

where values for a , b , and c are given in table IV. A straight-line segment representing the jet core is included in the description of the jet centerline.

1. For the jet centerline only, calculate the length of the jet core by using equation (4):

$$\frac{s_0}{D} = \frac{l_2/D}{1 - \left(1 - \frac{l_2}{l_1}\right) \cos \delta}$$

where $l_1/D = 6.2$ and $l_2 = l_1 e^{-(d^2/R^2)}$, with the value of d given in table IV.

2. Locate the end point of the reference curve.

Centerline

$$x_0 = s_0 \cos \delta; \quad z_0 = s_0 \sin \delta$$

Vortex curve

$$x_0 = 0.5D; \quad z_0 = 0.0$$

3. Locate the point on the reference curve that would correspond to (x_0, z_0) for perpendicular jet injection.

$$\underline{\delta = 90^\circ}$$

$$x_1 = x_0; \quad z_1 = z_0$$

$$\underline{\delta \neq 90^\circ}$$

$$x_1 = x_0 - D \left(\frac{caR^b}{|\tan \delta|} \right)^{\frac{1}{1-c}}; \quad z_1 = z_0 \pm F(x_0)$$

APPENDIX A

where the positive sign is used for $\delta > 90^\circ$ and the negative sign is used for $\delta < 90^\circ$.

4. Locate a point on the curve and calculate the cross-section angle.

$\delta \leq 90^\circ$ (The curve is single valued.)

For the centerline only, when $x \leq x_0$,

$$z = x \tan \delta; \quad \phi_c = \delta$$

For both curves for $x > x_0$,

$$z = z_1 + F(x); \quad \phi = \tan^{-1} \left[\frac{c(z - z_1)}{x - x_1} \right]$$

$\delta > 90^\circ$ (The curve is double valued for some values of x .)

For the centerline only, when $x_0 \leq x \leq 0$,

$$z^{(1)} = x \tan \delta; \quad \phi_c^{(1)} = \delta$$

$$z^{(2)} = z_1 + F(x); \quad \phi_c^{(2)} = \tan^{-1} \left[\frac{c(z^{(2)} - z_1)}{x - x_1} \right]$$

For both curves when $x \leq x_0$,

$$z^{(1)} = z_1 - F(x); \quad \phi^{(1)} = \tan^{-1} \left[\frac{c(z^{(1)} - z_1)}{x - x_1} \right]$$

$$z^{(2)} = z_1 + F(x); \quad \phi^{(2)} = \tan^{-1} \left[\frac{c(z^{(2)} - z_1)}{x - x_1} \right]$$

For both curves when $x > x_0$,

$$z = z_1 + F(x); \quad \phi = \tan^{-1} \left[\frac{c(z - z_1)}{x - x_1} \right]$$

This specification of the jet centerline and vortex curves for a range of effective velocity ratios and jet injection angles is more complicated than that for perpendicular jet injection, but the preceding equations can be programmed on a pocket calculator for convenient numerical calculations.

APPENDIX B

EXPERIMENTALLY DETERMINED VELOCITIES AND PRESSURES

Presentation of Results

The basic results of this investigation are the measured pressures and the velocities determined from them. For presentation, these measurements are arranged in four major groupings: (1) jet centerline data which consist of measurements in the plane of flow symmetry for the purposes of establishing the jet centerline; (2) vortex-curve data which consist of measurements in the plane of flow symmetry for the purpose of establishing the vortex curve and for use in the filament vortex model; (3) special-case measurements acquired in the symmetry plane very near the jet orifice with multiple rake placements to provide a relatively fine measurement grid (these measurements are used to determine points on the jet centerline and vortex curve near the jet orifice for perpendicular jet injection); and (4) extended cross sections which contain measurements taken out of the plane of flow symmetry. For each of these groups of data, the location of a cross section is given by the location of the tip of probe 4 of the rake in the wind-tunnel coordinate system $(X/D, 0, Z/D)$ and the inclination PHI of the rake with the Z -axis. The locations of points within a cross section are given by their coordinates (X_B, Y_B, Z_B) in a system obtained by rotating the wind-tunnel coordinate system through an angle PHI and locating the origin at the tip of probe 4 of the rake of seven yaw-pitch probes. (See sketch (d).) All coordinates are nondimensionalized by the jet diam-

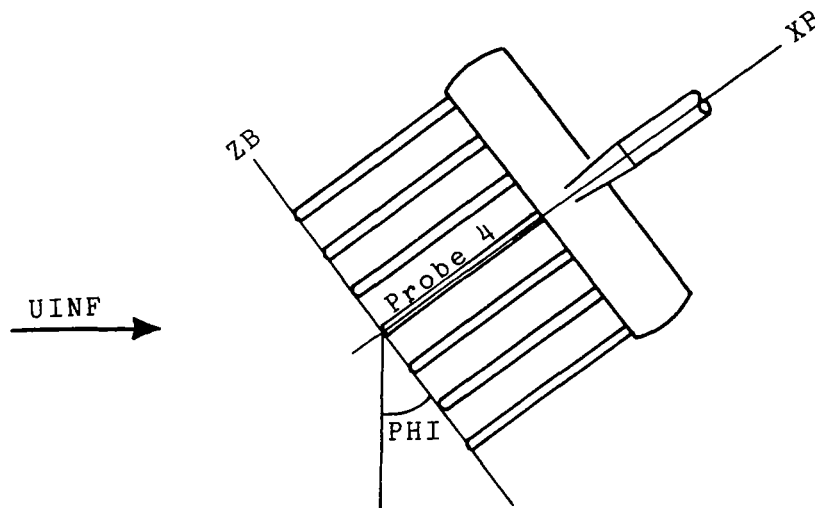

Sketch (d)

eter D . The velocity determined at each location in a cross section is specified by the three components (U_B, V_B, W_B) relative to the coordinate system (X_B, Y_B, Z_B) and is nondimensionalized by the cross-flow speed U_{INF} . The static and total pressures are presented as dimensionless coefficients C_P and C_{PT} .

APPENDIX B

Tables B1 to B13 contain the measured pressures and velocities. Tables B1 and B2 include a few measurements where the jet was hotter or colder than the cross flow. Figures B1 to B3 and part (a) of figures B4 to B13 graphically display the symmetry plane velocity vectors projected onto the X-Z symmetry plane. The length of the velocity vectors is proportional to U_{∞} , which is one jet diameter in length. Part (b) of figures B4 to B13 graphically displays the extended cross-section velocity vectors projected onto the YB-ZB measurement plane.

Symbols

CP	static pressure coefficient, $(p - p_{\infty})/q_{\infty}$
CPT	total pressure coefficient, $(p_t - p_{t,\infty})/q_{\infty}$
D	jet diameter, cm (in.)
DELTA	jet injection angle relative to cross-flow velocity, deg (same as δ in text)
PHI	angle between Z and ZB axes, deg
PHIC	angle between Z and Z_C axes, deg (same as ϕ_C in text)
PHIR	angle in symmetry plane between Z axis and cross section of measurement, deg
PHIV	angle between Z and Z_V axes, deg (same as ϕ_V in text)
p	static pressure, Pa (lb/ft ²)
p_t	total pressure, Pa (lb/ft ²)
q	dynamic pressure, Pa (lb/ft ²)
R	effective velocity ratio, defined by equation (1)
THETA	angle that local fluid velocity makes with probe, deg
TINF	temperature of cross flow, K (R)
TJ	temperature of jet fluid at jet orifice, K (R)
UB,VB,WB	XB, YB, and ZB components of velocity, m/sec (ft/sec)
UC	jet centerline speed, m/sec (ft/sec) (same as U_t in text)
UINF	cross-flow speed, m/sec (ft/sec) (same as U_{∞} in text and figures)
X,Y,Z	Cartesian coordinate system; denotes wind-tunnel coordinate system when no subscript is used

APPENDIX B

X_B, Y_B, Z_B Cartesian coordinate system fixed to rake of probes

Subscript:

∞ refers to cross-flow condition

Index to Figures

[Each figure has a corresponding table which contains tabulated data of velocities and pressures in the jet vicinity]

Figure	R	δ , deg	Data type
B1	4,8	45 to 105	Jet centerline
B2	4,8	45 to 105	Vortex curve
B3	4,8	90	Near jet
B4	4	45	Cross section
B5	4	60	Cross section
B6	4	75	Cross section
B7	4	90	Cross section
B8	4	105	Cross section
B9	8	45	Cross section
B10	8	60	Cross section
B11	8	75	Cross section
B12	8	90	Cross section
B13	8	105	Cross section

TABLE B1.- TABULATED VALUES OF SYMMETRY PLANE VELOCITIES
AND PRESSURES IN JET CENTERLINE VICINITY

TEST CONDITIONS	ZB/D								ZB/D							TEST CONDITIONS
	-1.5	-1.0	-0.5	0.0	0.5	1.0	1.5		-1.5	-1.0	-0.5	0.0	0.5	1.0	1.5	
R= 4.04 DELTA= 45 DEG UINF= 42.1 M/S X/D= 7.00 Z/D= 3.72 PHI= 15.0 DEG	1.05	1.23	1.27	1.61	1.70	1.08	0.94	UB/UINF	1.19	1.20	1.28	1.55	1.21	0.95	0.96	R= 4.05 DELTA= 60 DEG UINF= 42.1 M/S X/D= 6.50 Z/D= 4.88 PHI= 19.0 DEG
	0.04	0.01	-0.03	-0.01	-0.02	-0.02	0.01	VB/UINF	0.0	0.01	0.02	0.0	0.0	0.0	0.02	
	0.40	0.53	0.38	0.08	0.08	-0.05	-0.18	WB/UINF	0.58	0.48	0.18	0.01	-0.05	-0.17	-0.24	
	-0.16	-0.49	-0.39	-0.40	-0.38	-0.08	0.08	CP	-0.56	-0.43	-0.36	-0.31	-0.12	0.05	0.07	
	0.12	0.30	0.39	1.21	1.56	0.10	0.01	CPT	0.21	0.25	0.32	1.11	0.35	-0.01	0.05	
	20.9	23.3	17.2	4.3	4.3	4.8	11.2	THETA	26.2	21.8	8.3	2.6	3.5	10.6	14.4	
R= 4.05 DELTA= 45 DEG UINF= 42.0 M/S X/D= 9.88 Z/D= 4.44 PHI= 9.0 DEG	1.14	1.27	1.30	1.44	1.49	1.13	1.00	UB/UINF	1.21	1.21	1.21	1.31	1.25	1.07	0.99	R= 4.05 DELTA= 60 DEG UINF= 42.2 M/S X/D= 10.00 Z/D= 5.69 PHI= 14.0 DEG
	0.01	-0.03	-0.02	-0.01	0.0	-0.01	-0.01	VB/UINF	0.0	0.02	0.01	0.01	0.0	0.0	0.0	
	0.41	0.44	0.34	0.18	0.12	0.04	-0.06	WB/UINF	0.44	0.40	0.26	0.09	-0.01	-0.08	-0.15	
	-0.27	-0.33	-0.27	-0.22	-0.23	-0.10	0.0	CP	-0.38	-0.29	-0.22	-0.22	-0.14	-0.04	0.02	
	0.20	0.48	0.54	0.89	1.01	0.19	0.02	CPT	0.29	0.34	0.33	0.51	0.44	0.11	0.02	
	19.8	19.4	15.4	7.8	5.7	4.2	4.8	THETA	20.4	18.4	12.3	4.5	2.7	5.2	9.1	
R= 4.04 DELTA= 45 DEG UINF= 42.0 M/S X/D= 20.00 Z/D= 6.00 PHI= 5.0 DEG	1.17	1.23	1.29	1.31	1.25	1.18	1.09	UB/UINF	1.16	1.19	1.18	1.19	1.17	1.09	1.02	R= 4.05 DELTA= 60 DEG UINF= 42.2 M/S X/D= 20.00 Z/D= 7.50 PHI= 7.0 DEG
	-0.01	-0.04	-0.02	-0.02	-0.01	-0.02	0.0	VB/UINF	-0.01	-0.02	-0.01	-0.03	-0.01	-0.02	0.0	
	0.29	0.26	0.20	0.12	0.10	0.03	-0.01	WB/UINF	0.31	0.27	0.21	0.14	0.04	0.02	-0.05	
	-0.16	-0.17	-0.20	-0.14	-0.11	-0.06	-0.06	CP	-0.18	-0.19	-0.15	-0.14	-0.11	-0.07	-0.02	
	0.30	0.42	0.50	0.60	0.48	0.34	0.13	CPT	0.26	0.32	0.30	0.31	0.27	0.13	0.03	
	14.6	13.2	10.0	7.0	6.1	4.6	3.4	THETA	15.5	13.5	10.7	8.6	4.6	4.7	4.6	
R= 4.05 DELTA= 60 DEG UINF= 42.3 M/S X/D= 2.00 Z/D= 2.50 PHI= 39.0 DEG	1.05	1.08	1.01	3.56	0.83	0.76	0.76	UB/UINF	1.02	0.83	0.93	2.66	0.89	0.75	0.74	R= 4.06 DELTA= 75 DEG UINF= 41.8 M/S X/D= 2.00 Z/D= 3.42 PHI= 39.0 DEG
	-0.11	-0.05	0.07	0.03	0.02	0.01	0.03	VB/UINF	-0.11	0.07	0.08	0.07	0.02	0.03	0.03	
	0.44	1.04	0.54	0.14	-0.33	-0.45	-0.53	WB/UINF	0.83	0.86	0.18	0.10	-0.18	-0.40	-0.49	
	-0.56	-1.50	-0.83	-1.54	0.11	0.25	0.17	CP	-1.50	-1.33	-1.26	-1.73	-0.06	0.31	0.25	
	-0.26	-0.22	-0.51	10.81	-0.10	0.03	0.02	CPT	-0.75	-0.89	-1.35	4.55	-0.23	0.03	0.04	
	23.9	44.1	28.1	2.7	21.5	31.0	34.9	THETA	39.7	46.0	11.5	2.2	11.8	28.4	33.7	
R= 4.07 DELTA= 60 DEG UINF= 42.3 M/S X/D= 4.00 Z/D= 2.50 PHI= 40.0 DEG	0.87	0.97	1.06	1.23	1.09	1.99	1.74	UB/UINF	0.99	0.80	1.13	2.06	1.11	0.84	0.84	R= 4.06 DELTA= 75 DEG UINF= 42.2 M/S X/D= 3.00 Z/D= 4.13 PHI= 31.0 DEG
	0.0	-0.05	-0.07	0.01	0.05	0.01	0.04	VB/UINF	0.0	-0.06	-0.02	0.01	-0.03	0.0	0.01	
	-0.27	0.0	0.42	0.70	0.34	-0.44	-0.20	WB/UINF	0.72	0.55	0.0	0.0	-0.11	-0.31	-0.39	
	0.3	-0.16	-0.57	-1.12	-0.53	-1.19	-1.09	CP	-1.14	-0.81	-0.83	-1.04	-0.21	0.20	0.19	
	-0.17	-0.21	-0.25	-0.10	-0.22	2.05	1.02	CPT	-0.63	-0.86	-0.54	2.28	0.04	0.0	0.06	
	17.7	5.3	22.3	29.8	17.4	12.5	6.7	THETA	35.8	35.1	3.2	2.2	6.8	20.5	24.9	
R= 4.05 DELTA= 60 DEG UINF= 42.4 M/S X/D= 4.01 Z/D= 3.26 PHI= 40.0 DEG	1.04	1.27	1.26	1.18	2.24	1.15	0.79	UB/UINF	1.05	0.99	1.11	1.24	1.18	1.01	0.96	R= 4.03 DELTA= 75 DEG UINF= 42.3 M/S X/D= 7.53 Z/D= 5.88 PHI= 18.0 DEG
	-0.05	-0.05	0.01	0.01	0.02	0.03	0.02	VB/UINF	0.01	0.01	0.0	-0.01	0.0	-0.01	0.02	
	0.16	0.48	0.51	-0.04	-0.45	-0.29	-0.45	WB/UINF	0.31	0.18	0.01	-0.07	-0.11	-0.16	-0.22	
	-0.31	-0.93	-0.86	-0.62	-1.18	-0.31	0.19	CP	-0.44	-0.36	-0.27	-0.22	-0.17	-0.04	0.05	
	-0.20	-0.06	0.01	-0.22	3.15	0.12	0.02	CPT	-0.25	-0.33	-0.03	0.34	0.24	0.02	0.03	
	9.8	20.8	21.9	2.8	11.6	14.2	30.0	THETA	16.5	10.4	3.0	4.4	6.1	9.5	13.2	
R= 4.04 DELTA= 60 DEG UINF= 42.2 M/S X/D= 4.00 Z/D= 3.67 PHI= 26.0 DEG	1.09	1.09	1.05	2.02	1.39	0.91	0.88	UB/UINF	1.04	1.01	1.11	1.15	1.10	1.01	0.99	R= 4.07 DELTA= 75 DEG UINF= 42.3 M/S X/D= 10.00 Z/D= 6.67 PHI= 13.9 DEG
	0.04	0.02	0.01	0.0	-0.01	-0.01	0.02	VB/UINF	0.02	-0.01	0.01	0.01	0.01	0.0	0.0	
	0.66	0.83	0.39	-0.01	-0.02	-0.24	-0.33	WB/UINF	0.24	0.12	0.02	-0.03	-0.07	-0.12	-0.17	
	-0.73	-0.88	-0.47	-0.86	-0.42	0.12	0.16	CP	-0.32	-0.21	-0.18	-0.15	-0.10	-0.04	0.0	
	-0.11	0.03	-0.21	2.30	0.54	0.02	0.05	CPT	-0.17	-0.16	0.05	0.18	0.11	0.0	0.02	
	31.2	37.4	20.4	2.5	3.2	15.1	20.9	THETA	13.1	7.5	2.7	3.1	4.6	7.4	10.4	

APPENDIX B

TABLE B1.- Continued

TEST CONDITIONS	ZB/D								ZB/D							TEST CONDITIONS	
	-1.5	-1.0	-0.5	0.0	0.5	1.0	1.5		-1.5	-1.0	-0.5	0.0	0.5	1.0	1.5		
R= 4.04 DELTA= 90 DEG UINF= 42.0 M/S X/D= 4.00 Z/D= 5.50 PHI= 24.9 DEG	0.60	0.81	1.24	1.44	1.10	0.96	0.93	UB/UINF	0.54	0.55	0.71	0.94	1.07	1.15	1.11	R= 4.04 DELTA= 105 DEG UINF= 42.3 M/S X/D= 8.00 Z/D= 6.88 PHI= 16.0 DEG	
	0.01	-0.02	0.0	-0.01	-0.03	-0.02	-0.01	VB/UINF	-0.04	-0.01	-0.02	-0.01	-0.01	0.0	0.0		
	0.27	-0.03	-0.15	-0.11	-0.16	-0.24	-0.32	WB/UINF	0.07	-0.01	-0.11	-0.12	-0.14	-0.14	-0.16		
	-0.64	-0.64	-0.58	-0.48	-0.14	0.04	0.10	CP	-0.30	-0.28	-0.28	-0.30	-0.26	-0.21	-0.15		
	-1.20	-0.97	-0.02	0.64	0.11	0.03	0.06	CPT	-0.99	-0.98	-0.76	-0.40	-0.08	0.14	0.12		
	24.1	4.4	7.5	5.2	9.2	14.6	19.3	THETA	10.4	3.8	9.4	8.3	8.3	7.4	8.8		
a	R= 3.91 DELTA= 90 DEG UINF= 42.0 M/S X/D= 10.00 Z/D= 7.47 PHI= 14.0 DEG	0.90	1.01	1.12	1.12	1.07	1.01	0.99	UB/UINF	0.80	0.93	1.07	1.13	1.07	1.02	1.00	R= 4.07 DELTA= 105 DEG UINF= 42.3 M/S X/D= 7.99 Z/D= 8.10 PHI= 16.0 DEG
	0.0	0.0	0.0	0.0	0.0	0.0	0.0	VB/UINF	0.02	-0.02	-0.01	-0.02	-0.01	-0.01	-0.01		
	-0.06	-0.10	-0.13	-0.14	-0.15	-0.17	-0.20	WB/UINF	-0.12	-0.15	-0.16	-0.16	-0.17	-0.19	-0.23		
	-0.23	-0.21	-0.16	-0.14	-0.09	-0.03	0.0	CP	-0.29	-0.27	-0.23	-0.18	-0.13	-0.08	-0.03		
	-0.41	-0.18	0.11	0.13	0.08	0.02	0.02	CPT	-0.63	-0.38	-0.04	0.13	0.04	0.01	0.04		
	4.8	6.6	7.3	7.8	8.7	9.8	11.8	THETA	8.4	9.9	9.2	8.8	9.4	10.8	13.3		
	R= 4.02 DELTA= 90 DEG UINF= 42.0 M/S X/D= 10.00 Z/D= 7.47 PHI= 14.0 DEG	0.88	1.03	1.07	1.10	1.06	1.00	0.99	UB/UINF	0.64	0.70	0.80	0.94	1.03	1.10	1.06	R= 4.06 DELTA= 105 DEG UINF= 42.5 M/S X/D= 11.00 Z/D= 7.66 PHI= 13.1 DEG
	0.0	0.01	-0.01	-0.02	-0.01	0.0	0.0	VB/UINF	-0.01	0.0	-0.02	-0.01	-0.01	0.0	0.0		
	-0.02	-0.08	-0.12	-0.14	-0.15	-0.16	-0.20	WB/UINF	0.0	-0.02	-0.09	-0.12	-0.13	-0.13	-0.17		
	-0.27	-0.26	-0.20	-0.13	-0.09	-0.03	0.0	CP	-0.20	-0.21	-0.23	-0.18	-0.16	-0.17	-0.11		
	-0.50	-0.19	-0.04	0.11	0.07	0.0	0.02	CPT	-0.79	-0.71	-0.57	-0.29	-0.07	0.06	0.06		
	3.3	4.9	7.3	8.4	8.6	9.8	11.7	THETA	4.2	3.5	7.5	8.3	8.0	7.5	9.5		
b	R= 3.57 DELTA= 90 DEG UINF= 42.0 M/S X/D= 10.00 Z/D= 7.47 PHI= 14.0 DEG	0.92	1.03	1.10	1.09	1.03	1.00	0.99	UB/UINF	0.90	1.00	1.09	1.08	1.06	1.02	1.00	R= 4.13 DELTA= 105 DEG UINF= 42.3 M/S X/D= 10.94 Z/D= 9.07 PHI= 13.1 DEG
	0.0	0.0	-0.02	-0.01	-0.02	-0.01	0.0	VB/UINF	-0.01	-0.01	0.0	-0.01	-0.02	-0.01	0.0		
	-0.02	-0.08	-0.12	-0.13	-0.15	-0.18	-0.21	WB/UINF	-0.12	-0.13	-0.13	-0.14	-0.15	-0.16	-0.19		
	-0.29	-0.26	-0.19	-0.13	-0.09	-0.04	-0.01	CP	-0.19	-0.19	-0.16	-0.12	-0.08	-0.06	-0.01		
	-0.43	-0.19	0.04	0.08	0.0	0.0	0.02	CPT	-0.36	-0.16	0.03	0.06	0.07	0.0	0.02		
	3.0	5.5	7.6	7.9	9.1	10.9	12.3	THETA	8.5	8.2	7.2	8.0	9.0	9.7	11.2		
	R= 4.06 DELTA= 90 DEG UINF= 42.1 M/S X/D= 20.00 Z/C= 9.38 PHI= 7.5 DEG	0.99	1.04	1.05	1.02	1.04	1.03	1.00	UB/UINF	1.36	1.55	2.09	3.43	3.59	1.90	0.98	R= 7.97 DELTA= 45 DEG UINF= 37.9 M/S X/D= 7.00 Z/D= 5.38 PHI= 27.9 DEG
	0.01	0.0	0.0	0.0	-0.01	-0.01	-0.01	VB/UINF	0.01	0.0	-0.03	0.0	-0.02	-0.03	-0.01		
	-0.05	-0.05	-0.07	-0.09	-0.09	-0.10	-0.11	WB/UINF	0.39	0.53	0.26	0.12	0.24	0.16	-0.25		
	-0.09	-0.14	-0.08	-0.05	-0.06	-0.05	-0.01	CP	-0.50	-0.88	-1.39	-2.03	-1.99	-1.15	-0.16		
	-0.10	-0.06	0.03	0.01	0.03	0.02	0.02	CPT	0.50	0.82	2.11	9.16	10.53	1.54	-0.14		
	4.4	4.5	5.5	6.5	6.3	6.8	7.4	THETA	16.3	19.0	7.8	3.3	4.8	5.9	14.6		
	R= 4.04 DELTA= 105 DEG UINF= 42.3 M/S X/D= 2.00 Z/D= 6.00 PHI= 32.0 DEG	0.42	1.03	1.51	1.33	1.03	0.92	0.88	UB/UINF	1.45	1.66	2.17	2.84	2.67	2.00	1.26	R= 7.96 DELTA= 45 DEG UINF= 38.0 M/S X/D= 10.00 Z/D= 6.88 PHI= 23.1 DEG
	-0.01	0.01	0.0	-0.02	-0.03	-0.02	-0.01	VB/UINF	0.01	0.0	0.0	-0.01	-0.03	-0.03	-0.01		
	-0.11	-0.20	-0.15	-0.10	-0.23	-0.31	-0.39	WB/UINF	0.40	0.36	0.19	0.16	0.17	0.13	-0.08		
	-0.83	-0.91	-0.82	-0.44	-0.11	0.08	0.13	CP	-0.62	-0.80	-0.99	-1.30	-1.04	-0.76	-0.31		
	-1.64	-0.81	0.51	0.34	0.01	0.03	0.06	CPT	0.65	1.13	2.82	5.98	5.29	2.29	0.30		
	14.9	11.2	6.1	5.3	12.9	19.3	23.9	THETA	15.8	12.6	5.7	4.5	4.9	5.3	4.9		
	R= 4.06 DELTA= 105 DEG UINF= 42.3 M/S X/D= 4.00 Z/B= 7.06 PHI= 24.0 DEG	0.69	1.09	1.26	1.17	1.07	1.00	0.96	UB/UINF	1.28	1.44	1.58	1.85	1.89	1.76	1.52	R= 8.01 DELTA= 45 DEG UINF= 38.0 M/S X/D= 20.00 Z/D= 10.10 PHI= 15.1 DEG
	0.02	0.01	-0.01	-0.01	-0.01	-0.01	0.0	VB/UINF	0.0	-0.01	-0.01	-0.03	-0.03	-0.02	-0.02		
	-0.17	-0.18	-0.17	-0.18	-0.19	-0.26	-0.32	WB/UINF	0.28	0.16	0.09	0.06	0.03	0.02	-0.02		
	-0.51	-0.56	-0.42	-0.25	-0.15	-0.02	0.03	CP	-0.32	-0.45	-0.38	-0.48	-0.53	-0.40	-0.44		
	-1.00	-0.32	0.21	0.15	0.04	0.05	0.06	CPT	0.41	0.65	1.14	2.00	2.09	1.72	0.91		
	13.7	9.8	8.1	9.3	10.5	15.0	18.3	THETA	12.5	7.4	5.0	4.7	4.4	4.1	4.5		

a. Cold jet, $TJ/UINF = 0.90$ b. Hot jet, $TJ/UINF = 1.21$

TABLE B1.- Continued

TEST CONDITIONS	ZB/D								ZB/D							TEST CONDITIONS
	-1.5	-1.0	-0.5	0.0	0.5	1.0	1.5		-1.5	-1.0	-0.5	0.0	0.5	1.0	1.5	
R= 7.97 DELTA= 60 DEG UINF= 38.2 M/S X/D= 2.50 Z/D= 3.81 PHI= 53.0 DEG	1.04	1.36	1.64	5.51	2.29	0.56	0.50	UB/UINF	1.25	1.17	1.39	1.63	1.84	1.20	0.97	R= 8.04 DELTA= 75 DEG UINF= 21.1 M/S X/D= 10.00 Z/D= 11.90 PHI= 27.0 DEG
	0.16	0.07	-0.24	-0.31	-0.18	-0.01	-0.02	VB/UINF	0.03	0.03	-0.03	0.03	0.0	-0.04	-0.01	
	0.43	0.97	0.62	-0.22	0.11	-0.59	-0.67	WB/UINF	0.24	0.23	0.03	-0.04	-0.03	0.05	-0.16	
	-0.52	-1.92	-3.06	3.43	-2.14	0.26	0.26	CP	-0.85	-0.52	-0.59	-0.66	-0.75	-0.27	-0.03	
	-0.22	-0.11	-0.89	35.91	2.23	-0.07	-0.03	CPT	-0.23	-0.10	0.35	1.00	1.66	0.17	-0.06	
	23.3	35.6	22.5	5.4	6.7	46.7	53.1	THETA	10.7	11.1	4.4	2.3	3.0	5.3	10.2	
R= 8.00 DELTA= 60 DEG UINF= 37.9 M/S X/D= 4.00 Z/D= 5.44 PHI= 43.0 DEG	1.28	1.52	2.19	4.17	2.84	0.82	0.66	UB/UINF	1.21	1.19	1.40	1.59	1.57	1.30	1.08	R= 8.03 DELTA= 75 DEG UINF= 21.1 M/S X/D= 10.00 Z/D= 11.90 PHI= 27.0 DEG
	0.05	-0.04	-0.06	-0.02	-0.06	-0.07	-0.01	VB/UINF	0.07	0.04	0.01	0.07	-0.02	-0.03	-0.01	
	0.74	0.73	0.18	0.07	0.25	-0.30	-0.48	WB/UINF	0.25	0.16	0.07	-0.02	-0.04	-0.04	-0.13	
	-1.23	-1.61	-2.45	-2.99	-2.39	-0.26	0.31	CP	-0.68	-0.58	-0.49	-0.52	-0.50	-0.31	-0.11	
	-0.03	0.27	1.47	14.41	4.99	-0.49	-0.03	CPT	-0.15	-0.13	0.47	1.02	0.98	0.39	0.09	
	30.1	25.7	5.9	2.5	6.0	21.5	36.3	THETA	11.7	7.5	3.7	0.7	3.9	4.3	7.9	
R= 8.00 DELTA= 60 DEG UINF= 37.9 M/S X/D= 7.00 Z/D= 7.73 PHI= 33.0 DEG	1.46	1.62	2.11	2.78	2.47	1.41	0.83	UB/UINF	1.24	1.30	1.40	1.54	1.51	1.28	1.02	R= 8.07 DELTA= 75 DEG UINF= 31.5 M/S X/D= 10.00 Z/D= 11.90 PHI= 27.0 DEG
	0.02	-0.02	0.0	0.0	-0.02	-0.02	0.01	VB/UINF	-0.01	0.01	-0.02	0.03	-0.04	-0.02	-0.01	
	0.54	0.34	0.10	0.09	0.10	-0.01	-0.27	WB/UINF	-0.33	0.13	0.05	-0.05	-0.05	-0.07	-0.17	
	-1.11	-1.02	-1.17	-1.51	-1.20	-0.45	0.10	CP	-0.69	-0.55	-0.58	-0.42	-0.41	-0.28	-0.08	
	0.32	0.74	2.34	5.42	4.01	0.54	-0.14	CPT	-0.05	0.18	0.40	0.96	0.88	0.37	0.0	
	20.5	12.2	3.6	3.1	3.6	3.3	18.3	THETA	15.3	6.2	4.3	2.7	4.9	5.0	10.1	
R= 7.98 DELTA= 60 DEG UINF= 38.1 M/S X/D= 10.00 Z/D= 5.22 PHI= 24.0 DEG	1.33	1.35	1.68	1.96	2.03	1.70	1.23	UB/UINF	1.24	1.27	1.35	1.57	1.43	1.29	1.04	R= 8.01 DELTA= 75 DEG UINF= 37.8 M/S X/D= 10.00 Z/D= 11.90 PHI= 27.0 DEG
	-0.03	-0.03	-0.03	-0.04	-0.07	-0.01	0.0	VB/UINF	-0.01	0.01	-0.02	-0.01	-0.01	-0.02	-0.01	
	0.54	0.39	0.20	0.15	0.14	0.10	-0.04	WB/UINF	0.31	0.15	0.04	-0.01	-0.04	-0.08	-0.16	
	-0.78	-0.66	-0.75	-0.71	-0.71	-0.63	-0.29	CP	-0.62	-0.58	-0.43	-0.53	-0.32	-0.29	-0.10	
	0.28	0.31	1.15	2.21	2.51	1.31	0.22	CPT	0.01	0.07	0.39	0.97	0.72	0.38	0.02	
	22.4	16.6	6.9	5.9	6.2	4.5	3.4	THETA	14.2	7.1	4.1	3.1	3.6	5.3	9.5	
R= 7.99 DELTA= 60 DEG UINF= 38.0 M/S X/D= 20.00 Z/D= 13.09 PHI= 15.0 DEG	1.27	1.31	1.39	1.40	1.41	1.25	1.15	UB/UINF	1.12	1.13	1.18	1.16	1.19	1.14	1.09	R= 8.03 DELTA= 75 DEG UINF= 37.9 M/S X/D= 20.00 Z/D= 15.50 PHI= 18.0 DEG
	0.0	-0.04	-0.04	0.0	0.03	-0.03	-0.01	VB/UINF	-0.02	-0.03	-0.02	-0.01	-0.01	-0.01	-0.02	
	0.19	0.13	0.08	0.06	-0.01	-0.02	-0.04	WB/UINF	0.19	0.07	0.01	-0.02	-0.07	-0.09	-0.13	
	-0.37	-0.34	-0.28	-0.31	-0.25	-0.19	-0.16	CP	-0.31	-0.20	-0.21	-0.15	-0.18	-0.14	-0.12	
	0.30	0.41	0.68	0.67	0.75	0.38	0.17	CPT	-0.01	0.08	0.18	0.20	0.24	0.18	0.08	
	9.0	7.6	6.1	4.2	2.4	4.9	4.5	THETA	10.6	6.1	4.4	4.0	5.3	6.0	8.2	
R= 8.00 DELTA= 75 DEG UINF= 38.0 M/S X/D= 2.03 Z/D= 5.26 PHI= 55.0 DEG	1.31	1.29	1.90	4.72	2.67	0.52	0.38	UB/UINF	1.12	1.32	1.68	1.76	1.43	1.00	0.76	R= 8.00 DELTA= 90 DEG UINF= 38.1 M/S X/D= 4.00 Z/D= 10.31 PHI= 40.9 DEG
	-0.08	-0.01	0.07	0.0	0.03	-0.04	0.0	VB/UINF	0.03	0.01	0.02	0.01	-0.01	-0.01	0.01	
	1.05	0.99	0.22	0.01	0.25	-0.47	-0.61	WB/UINF	0.34	0.05	-0.04	-0.02	-0.02	-0.16	-0.33	
	-2.33	-2.27	-3.51	-2.63	-2.75	0.03	0.45	CP	-0.98	-0.89	-0.94	-0.75	-0.55	-0.08	0.21	
	-0.50	-0.59	-0.82	20.28	3.64	-0.47	-0.04	CPT	-0.61	-0.14	0.91	1.38	0.52	-0.05	-0.09	
	39.0	37.5	6.7	1.5	5.4	42.6	58.4	THETA	16.9	2.7	2.1	2.0	2.6	9.3	23.1	
R= 7.95 DELTA= 75 DEG UINF= 38.4 M/S X/D= 4.03 Z/D= 7.75 PHI= 45.0 DEG	1.37	1.40	1.92	2.74	2.24	1.06	0.67	UB/UINF	1.09	1.20	1.20	1.20	1.09	1.00	0.94	R= 8.02 DELTA= 90 DEG UINF= 21.1 M/S X/D= 9.50 Z/D= 14.01 PHI= 25.0 DEG
	0.05	0.04	0.05	0.02	0.04	-0.01	0.03	VB/UINF	-0.01	0.01	-0.01	0.0	-0.01	0.0	-0.01	
	0.75	0.47	0.08	0.04	0.14	-0.09	-0.38	WB/UINF	0.13	-0.02	-0.01	-0.06	-0.14	-0.14	-0.23	
	-1.65	-1.38	-1.45	-1.60	-1.29	-0.30	0.26	CP	-0.38	-0.36	-0.28	-0.25	-0.10	-0.03	0.09	
	-0.21	-0.18	1.31	5.11	2.83	-0.16	-0.15	CPT	-0.18	0.08	0.16	0.20	0.10	-0.01	0.02	
	28.5	18.5	2.3	1.8	3.5	5.3	29.6	THETA	7.2	2.3	3.2	4.0	8.1	8.5	14.1	

o. Cold jet, Tj/TINF = 0.90

TABLE B1.- Concluded

TEST CONDITIONS	ZB/D								ZR/D							TEST CONDITIONS
	-1.5	-1.0	-0.5	0.0	0.5	1.0	1.5		-1.5	-1.0	-0.5	0.0	0.5	1.0	1.5	
R= 8.04 DELTA= 90 DEG UINF= 21.1 M/S X/D= 9.50 Z/D= 14.01 PHI= 25.0 DEG	1.03	1.14	1.27	1.18	1.05	0.99	0.93	UB/UINF	1.01	1.11	1.08	1.02	1.00	0.96	0.93	R= 8.02 DELTA= 105 DEG UINF= 38.2 M/S X/D= 8.00 Z/D= 15.66 PHI= 26.0 DEG
	0.01	-0.01	0.01	-0.01	-0.02	-0.01	0.0	VB/UINF	-0.03	-0.01	-0.03	-0.01	0.0	-0.02	-0.01	
	0.05	0.01	-0.07	-0.04	-0.13	-0.16	-0.25	WB/UINF	0.0	-0.10	-0.15	-0.17	-0.23	-0.24	-0.29	
	-0.29	-0.31	-0.31	-0.19	-0.08	-0.02	0.08	CP	-0.31	-0.31	-0.22	-0.14	-0.05	0.01	0.06	
	-0.24	-0.02	0.31	0.20	0.05	0.0	0.01	CPT	-0.28	-0.07	-0.02	-0.06	0.01	0.0	0.01	
	3.4	3.3	3.9	3.5	8.1	9.9	15.2	THETA	4.1	5.8	6.7	9.9	13.1	14.3	17.4	
d R= 8.05 DELTA= 90 DEG UINF= 21.1 M/S X/D= 9.50 Z/D= 14.01 PHI= 25.0 DEG	1.21	1.26	1.28	1.27	1.11	0.98	0.94	UB/UINF	0.89	0.87	0.86	0.99	1.03	1.09	1.01	R= 7.97 DELTA= 105 DEG UINF= 39.4 M/S X/D= 11.00 Z/D= 15.05 PHI= 22.0 DEG
	0.02	0.02	0.0	0.01	0.0	0.0	-0.02	VB/UINF	-0.05	-0.01	-0.02	-0.03	-0.02	-0.01	-0.02	
	0.08	0.01	-0.06	-0.05	-0.09	-0.16	-0.24	WB/UINF	0.36	0.15	0.09	-0.02	-0.05	-0.10	-0.15	
	-0.54	-0.43	-0.33	-0.30	-0.14	-0.04	0.06	CP	-0.43	-0.38	-0.25	-0.27	-0.20	-0.21	-0.11	
	-0.06	0.15	0.32	0.32	0.10	-0.05	0.0	CPT	-0.50	-0.60	-0.50	-0.29	-0.14	-0.01	-0.06	
	4.3	2.0	3.8	3.3	5.7	9.6	14.8	THETA	23.0	10.5	7.2	5.0	4.8	6.1	9.3	
R= 7.93 DELTA= 90 DEG UINF= 21.6 M/S X/D= 9.50 Z/D= 14.01 PHI= 25.0 DEG	1.16	1.19	1.23	1.18	1.13	0.97	0.94	UB/UINF	0.84	0.94	0.99	0.97	1.05	1.00	0.99	R= 7.98 DELTA= 105 DEG UINF= 38.6 M/S X/D= 10.98 Z/D= 15.78 PHI= 22.0 DEG
	0.02	-0.02	-0.02	-0.02	0.0	-0.03	0.0	VB/UINF	-0.03	0.01	-0.02	-0.02	-0.03	0.0	0.0	
	0.04	-0.02	-0.08	-0.06	-0.12	-0.20	-0.23	WB/UINF	0.13	0.06	-0.04	-0.08	-0.14	-0.14	-0.21	
	-0.38	-0.34	-0.27	-0.21	-0.17	0.01	0.06	CP	-0.34	-0.31	-0.25	-0.20	-0.14	-0.05	-0.03	
	-0.03	0.10	0.25	0.19	0.13	-0.01	0.0	CPT	-0.61	-0.41	-0.28	-0.24	-0.03	-0.02	0.0	
	2.8	4.0	5.3	4.8	6.8	12.2	14.4	THETA	10.3	4.1	4.4	6.5	8.7	8.6	12.1	
R= 7.99 DELTA= 90 DEG UINF= 38.0 M/S X/D= 9.50 Z/D= 14.01 PHI= 25.0 DEG	1.03	1.17	1.20	1.22	1.10	0.97	0.95	UB/UINF	-0.03	0.02	-0.02	0.0	0.02	-0.02	0.01	
	0.13	0.02	-0.04	-0.06	-0.13	-0.18	-0.23	VB/UINF	0.13	0.06	-0.04	-0.08	-0.14	-0.14	-0.21	
	-0.32	-0.32	-0.25	-0.22	-0.14	0.0	0.05	WB/UINF	-0.34	-0.31	-0.25	-0.20	-0.14	-0.05	-0.03	
	-0.24	0.06	0.20	0.28	0.10	-0.03	0.02	CP	-0.61	-0.41	-0.28	-0.24	-0.03	-0.02	0.0	
	8.5	1.9	4.1	4.0	7.1	10.9	13.8	CPT								
								THETA								
R= 7.99 DELTA= 105 DEG UINF= 39.2 M/S X/D= 3.00 Z/D= 12.00 PHI= 43.1 DEG	0.96	1.06	1.28	1.23	1.12	0.94	0.83	UB/UINF	-0.03	-0.07	-0.02	-0.05	-0.02	-0.04	-0.02	
	-0.04	-0.17	-0.21	-0.19	-0.20	-0.27	-0.38	VB/UINF	-0.04	-0.17	-0.21	-0.19	-0.20	-0.27	-0.38	
	-0.71	-0.63	-0.54	-0.41	-0.30	-0.06	0.14	WB/UINF	-0.71	-0.63	-0.54	-0.41	-0.30	-0.06	0.14	
	-0.78	-0.48	0.16	0.15	-0.01	-0.10	-0.03	CP	-0.78	-0.48	0.16	0.15	-0.01	-0.10	-0.03	
	4.4	10.9	9.8	9.9	10.7	16.8	25.0	CPT								
								THETA								
R= 8.02 DELTA= 105 DEG UINF= 38.0 M/S X/D= 4.50 Z/D= 12.84 PHI= 34.0 DEG	0.89	1.04	1.12	1.22	1.17	0.99	0.95	UB/UINF	-0.02	-0.06	0.0	-0.02	-0.04	-0.01	-0.01	
	0.16	0.04	-0.04	-0.06	-0.12	-0.17	-0.23	VB/UINF	0.16	0.04	-0.04	-0.06	-0.12	-0.17	-0.23	
	-0.67	-0.55	-0.50	-0.42	-0.30	-0.11	-0.01	WB/UINF	-0.67	-0.55	-0.50	-0.42	-0.30	-0.11	-0.01	
	-0.84	-0.46	-0.24	0.07	0.10	-0.10	-0.05	CP	-0.84	-0.46	-0.24	0.07	0.10	-0.10	-0.05	
	10.9	5.9	3.3	4.4	7.1	10.3	14.1	CPT								
								THETA								
R= 7.97 DELTA= 105 DEG UINF= 38.0 M/S X/D= 8.00 Z/D= 13.78 PHI= 26.0 DEG	0.81	0.92	0.93	0.94	1.10	1.05	1.08	UB/UINF	-0.03	-0.07	0.0	-0.05	-0.04	-0.05	-0.03	
	0.35	0.18	0.0	-0.06	-0.05	-0.10	-0.17	VB/UINF	0.35	0.18	0.0	-0.06	-0.05	-0.10	-0.17	
	-0.55	-0.46	-0.40	-0.29	-0.29	-0.20	-0.16	WB/UINF	-0.55	-0.46	-0.40	-0.29	-0.29	-0.20	-0.16	
	-3.76	-0.59	-3.53	-0.39	-0.06	-0.08	0.04	CP	-3.76	-0.59	-3.53	-0.39	-0.06	-0.08	0.04	
	24.5	12.9	2.6	6.8	5.2	7.8	10.0	CPT								
								THETA								

d. Hot jet, TJ/TINF = 1.15

APPENDIX B

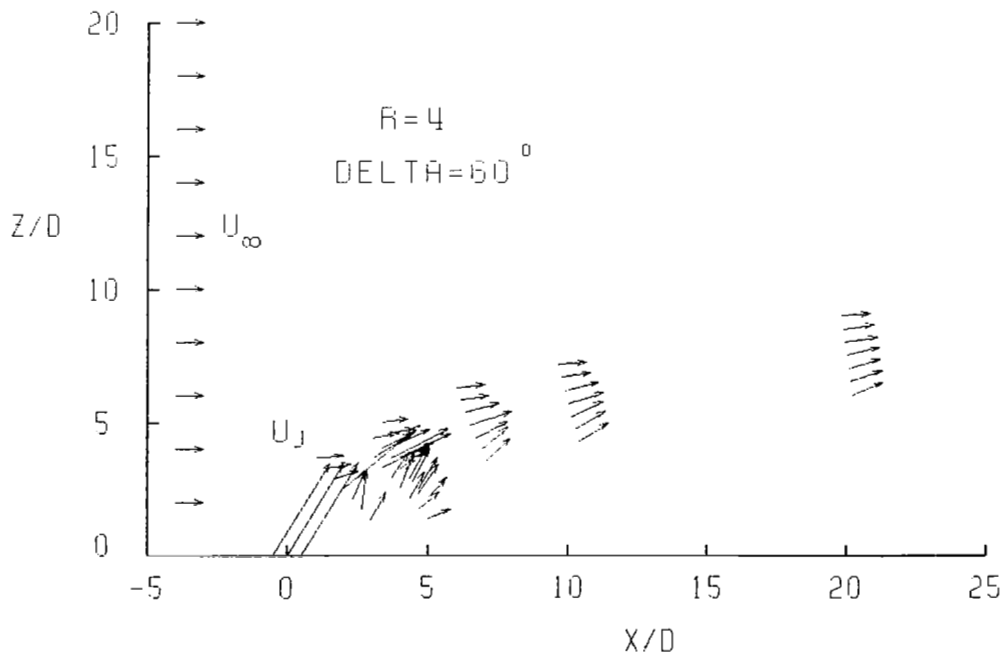
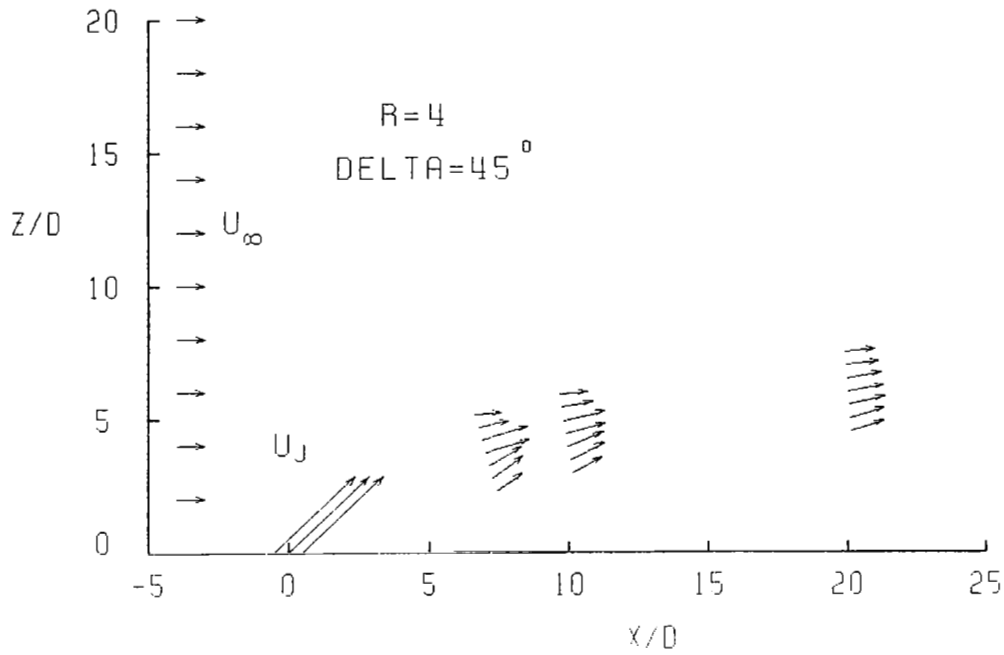

Figure B1.- Symmetry plane velocities in jet centerline vicinity.

APPENDIX B

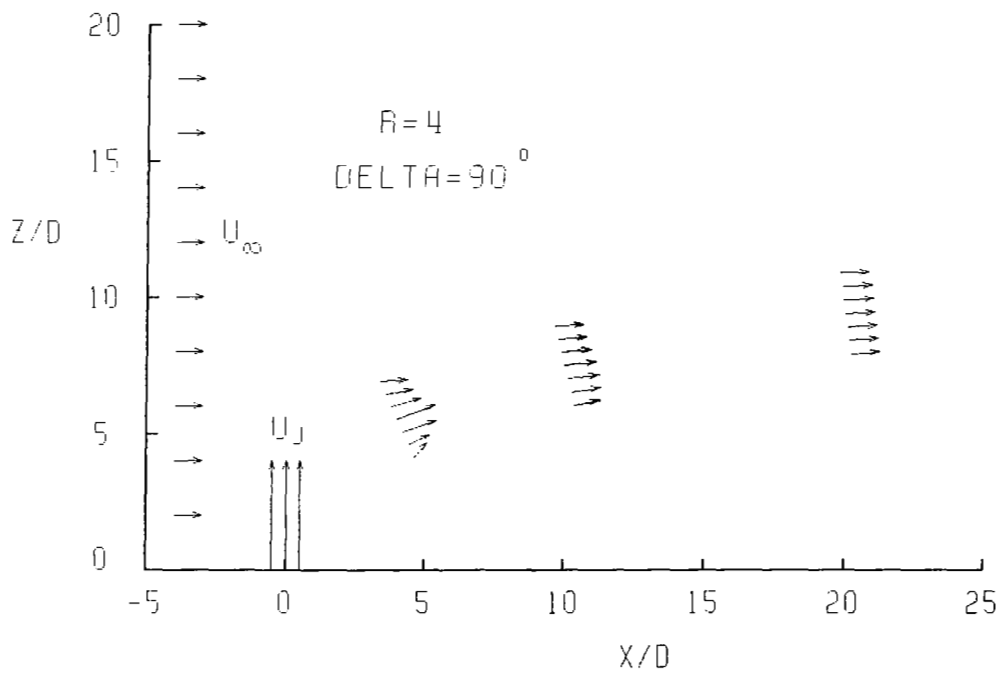
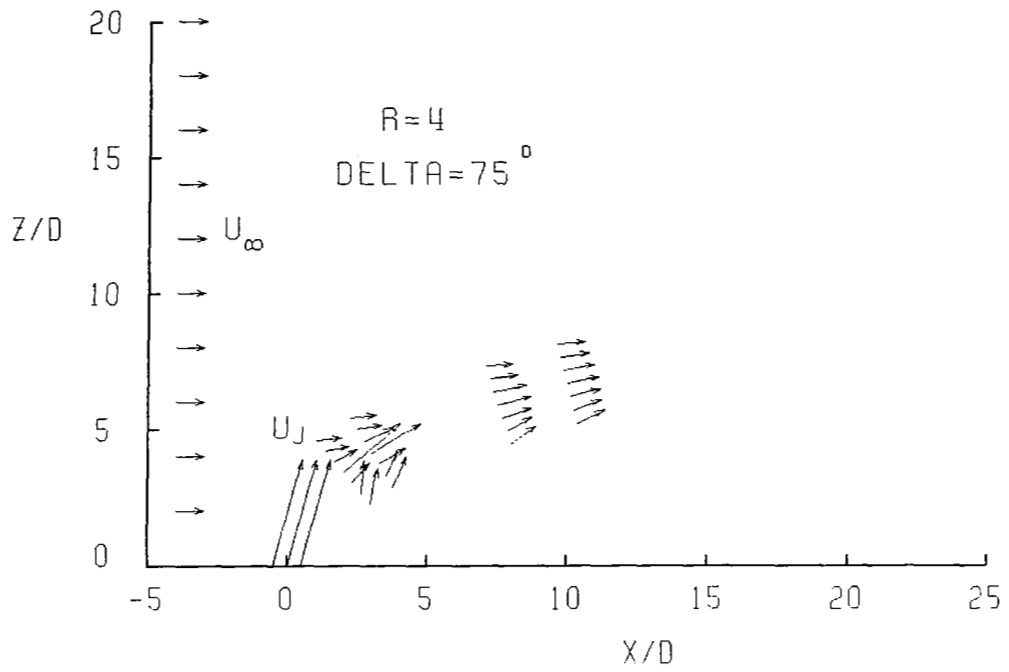

Figure B1.- Continued.

APPENDIX B

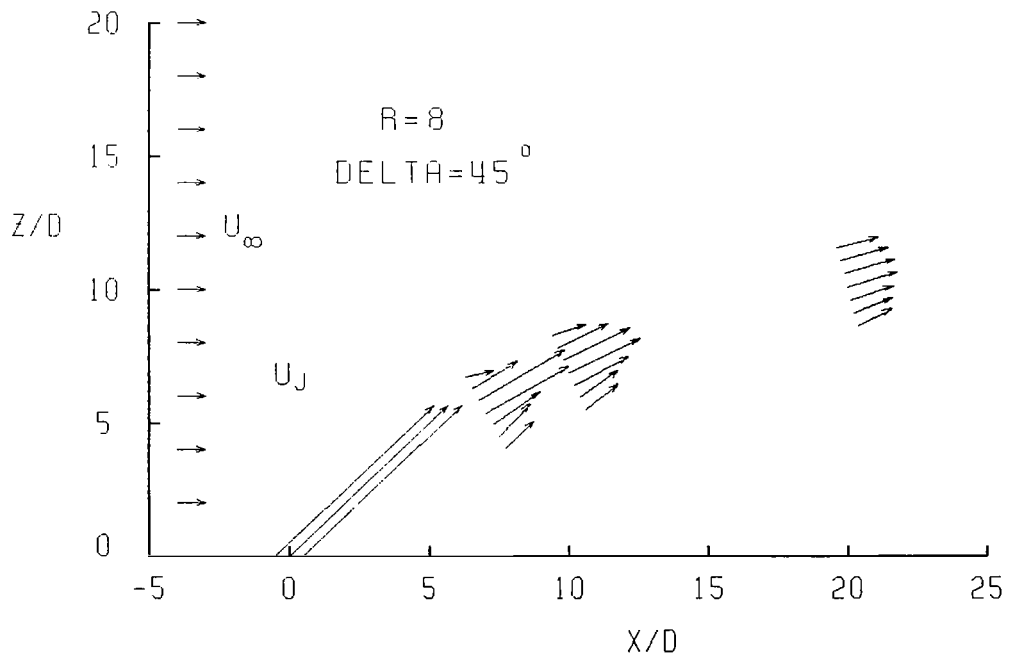
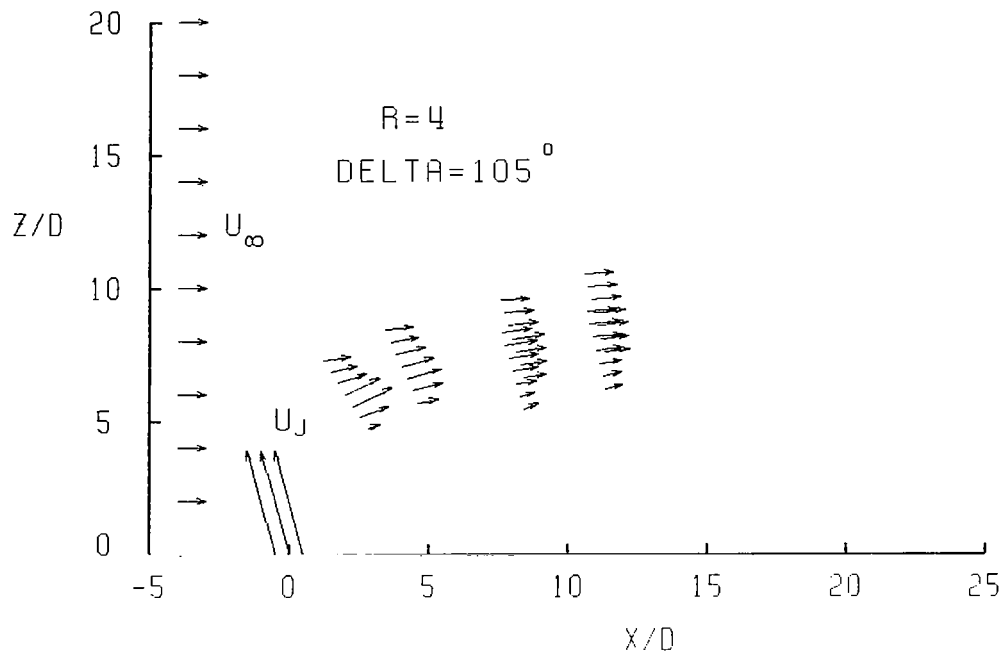

Figure B1.- Continued.

APPENDIX B

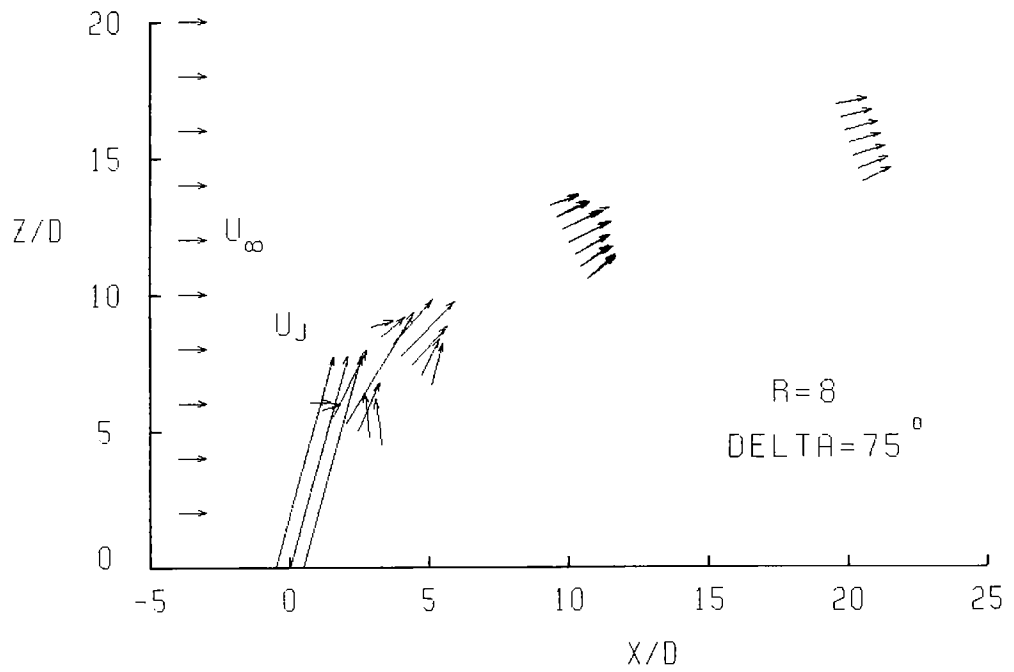
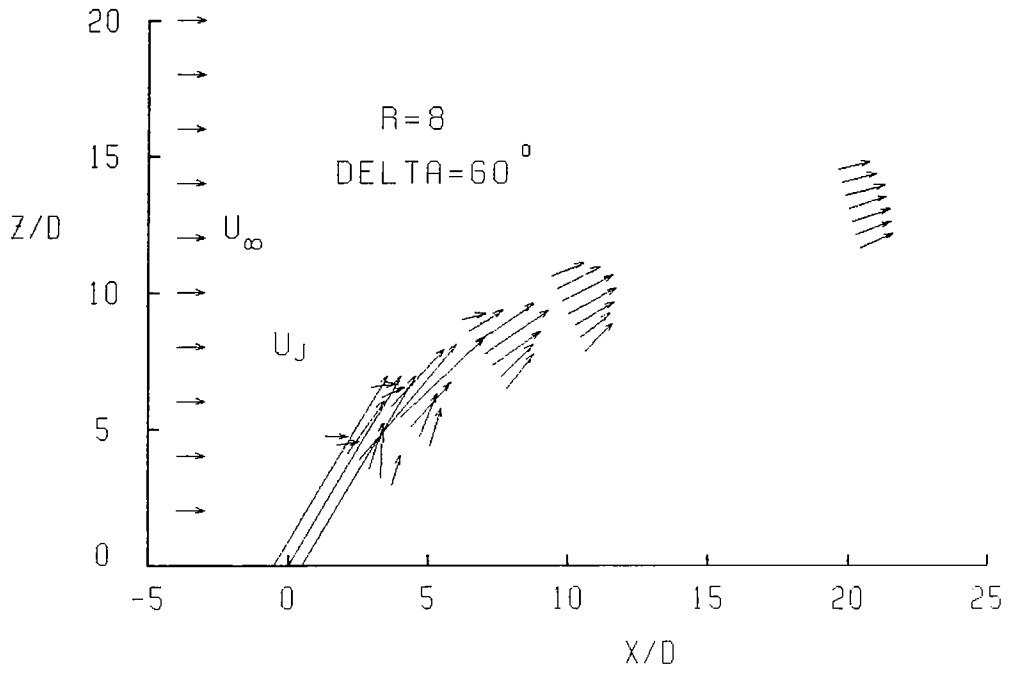

Figure B1.- Continued.

APPENDIX B

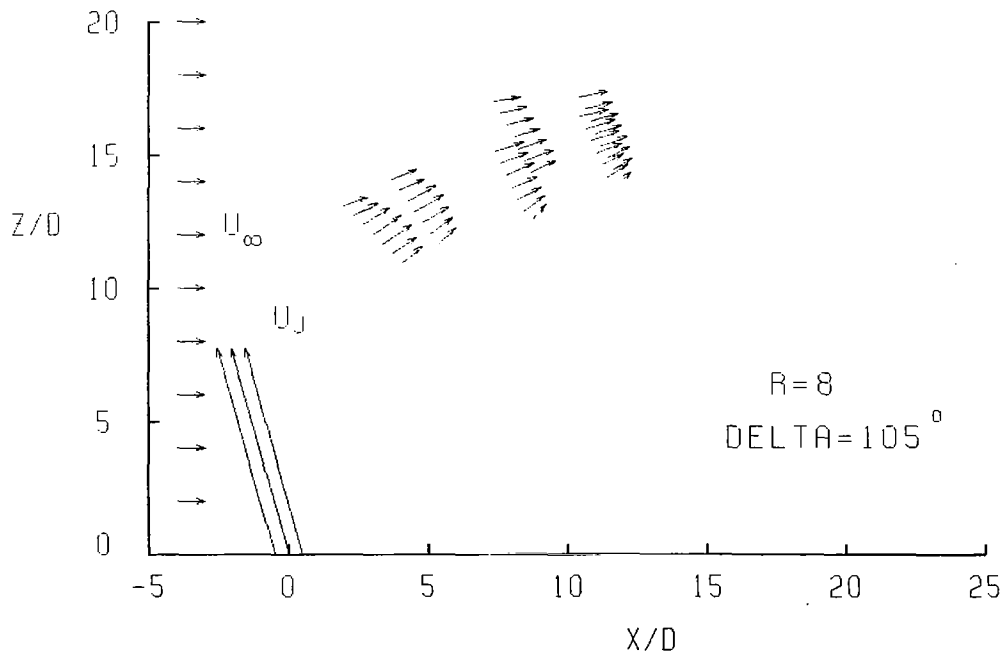
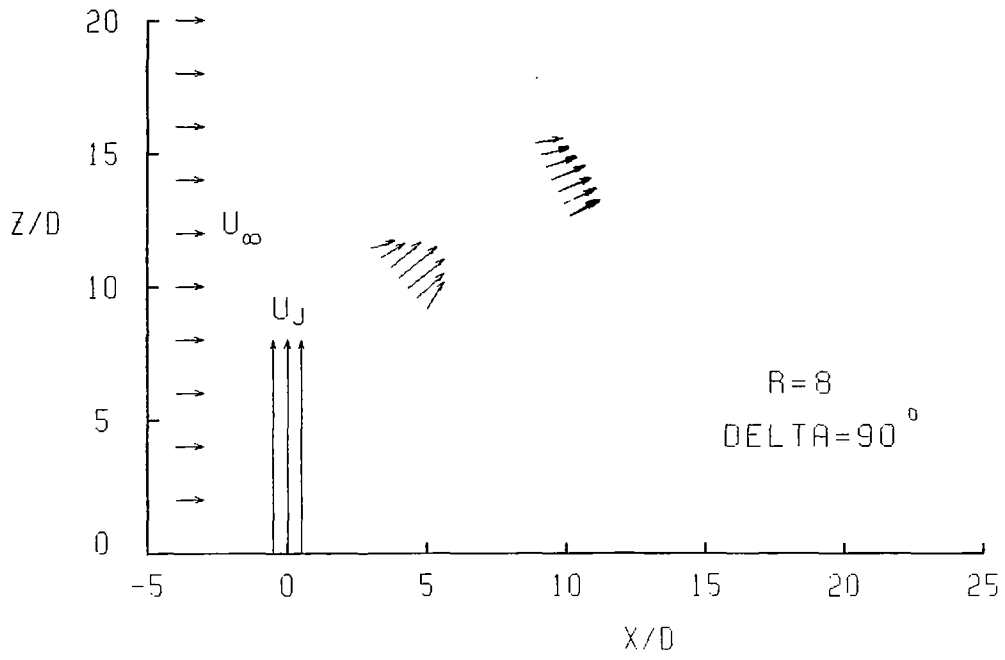

Figure B1.- Concluded.

TABLE B2.- TABULATED VALUES OF SYMMETRY PLANE VELOCITIES
AND PRESSURES IN VORTEX-CURVE VICINITY

TEST CONDITIONS	ZR/D								ZR/D							TEST CONDITIONS
	-1.5	-1.0	-0.5	0.0	0.5	1.0	1.5		-1.5	-1.0	-0.5	0.0	0.5	1.0	1.5	
R= 4.05 DELTA= 45 DEG UINF= 42.1 M/S X/D= 7.00 Z/C= 2.00 PHI= 11.0 DEG	0.84	0.93	0.94	1.01	1.10	1.26	1.40	UB/UINF VB/UINF WB/UINF CP CPT THETA	0.82	0.85	0.81	0.77	0.90	0.98	2.31	R= 4.05 DELTA= 60 DEG UINF= 42.1 M/S X/D= 4.00 Z/D= 2.08 PHI= 19.0 DEG
R= 4.05 DELTA= 45 DEG UINF= 42.3 M/S X/D= 7.00 Z/D= 2.00 PHI= 11.0 DEG	0.85	0.97	0.96	0.99	1.13	1.22	1.45	UB/UINF VB/UINF WB/UINF CP CPT THETA	0.91	0.94	0.95	1.02	1.09	1.14	1.63	R= 4.00 DELTA= 60 DEG UINF= 42.3 M/S X/D= 6.00 Z/D= 2.88 PHI= 13.0 DEG
R= 4.07 DELTA= 45 DEG UINF= 41.9 M/S X/D= 5.83 Z/D= 2.63 PHI= 9.0 DEG	0.96	0.98	1.01	1.09	1.13	1.29	1.41	UB/UINF VB/UINF WB/UINF CP CPT THETA	0.98	0.95	1.00	1.03	1.10	1.17	1.26	R= 4.03 DELTA= 60 DEG UINF= 42.3 M/S X/D= 10.00 Z/D= 3.38 PHI= 10.0 DEG
R= 4.06 DELTA= 45 DEG UINF= 42.1 M/S X/D= 20.00 Z/D= 3.80 PHI= 5.0 DEG	1.03	1.08	1.11	1.16	1.13	1.24	1.27	UB/UINF VB/UINF WB/UINF CP CPT THETA	0.98	0.99	1.04	1.08	1.19	1.19	1.22	R= 4.05 DELTA= 60 DEG UINF= 42.3 M/S X/D= 10.00 Z/D= 3.88 PHI= 10.0 DEG
R= 4.05 DELTA= 45 DEG UINF= 42.1 M/S X/D= 20.00 Z/C= 4.30 PHI= 5.0 DEG	1.05	1.11	1.12	1.16	1.21	1.23	1.31	UB/UINF VB/UINF WB/UINF CP CPT THETA	1.04	1.00	1.06	1.10	1.12	1.15	1.23	R= 4.06 DELTA= 60 DEG UINF= 42.1 M/S X/D= 19.84 Z/D= 4.75 PHI= 7.0 DEG
R= 4.06 DELTA= 60 DEG UINF= 42.3 M/S X/D= 2.00 Z/C= 2.20 PHI= 30.0 DEG	0.88	0.98	0.90	2.41	1.64	0.83	0.80	UB/UINF VB/UINF WB/UINF CP CPT THETA	0.69	0.55	0.65	0.50	0.95	2.75	0.79	R= 4.03 DELTA= 75 DEG UINF= 41.9 M/S X/D= 2.00 Z/D= 2.11 PHI= 28.0 DEG
R= 4.03 DELTA= 60 DEG UINF= 42.3 M/S X/D= 2.00 Z/C= 2.20 PHI= 30.0 DEG	0.90	0.93	0.93	2.43	1.57	0.81	0.82	UB/UINF VB/UINF WB/UINF CP CPT THETA	0.64	0.73	0.65	0.70	0.71	0.72	2.21	R= 4.07 DELTA= 75 DEG UINF= 42.2 M/S X/D= 3.00 Z/D= 2.19 PHI= 22.9 DEG

TABLE B2.- Continued

TEST CONDITIONS	ZB/D								ZB/D							TEST CONDITIONS
	-1.5	-1.0	-0.5	0.0	0.5	1.0	1.5		-1.5	-1.0	-0.5	0.0	0.5	1.0	1.5	
R= 4.07 DELTA= 75 DEG UINF= 42.5 M/S X/D= 7.56 Z/D= 3.39 PHI= 14.0 DEG	0.90	0.90	0.93	0.95	0.98	1.02	1.07	UB/UINF	0.95	0.95	0.91	0.89	0.89	0.89	0.89	R= 4.03 DELTA= 90 DEG UINF= 42.2 M/S X/D= 19.78 Z/D= 4.75 PHI= 7.5 DEG
	0.04	0.03	-0.01	-0.01	0.0	0.02	-0.02	VB/UINF	0.01	0.02	0.0	0.0	0.01	0.0	-0.01	
	0.01	0.15	0.32	0.43	0.47	0.46	0.25	WB/UINF	-0.04	-0.03	0.0	0.0	0.02	0.02	-0.01	
	-0.22	-0.27	-0.28	-0.33	-0.41	-0.47	-0.50	CP	-0.16	-0.19	-0.14	-0.13	-0.14	-0.15	-0.14	
	-0.40	-0.44	-0.31	-0.24	-0.23	-0.21	-0.29	CPT	-0.24	-0.28	-0.31	-0.33	-0.34	-0.35	-0.37	
	0.8	9.6	19.2	24.8	25.8	24.1	13.9	THETA	4.0	2.9	3.3	3.3	3.5	3.5	4.1	
R= 4.08 DELTA= 75 DEG UINF= 42.0 M/S X/D= 10.00 Z/D= 4.00 PHI= 8.9 DEG	0.89	0.95	0.96	1.01	0.98	1.00	1.02	UB/UINF	0.90	0.92	0.87	0.88	0.94	1.02	1.01	R= 4.08 DELTA= 90 DEG UINF= 42.3 M/S X/D= 19.88 Z/D= 7.00 PHI= 7.5 DEG
	0.03	0.06	0.03	0.04	0.03	0.0	0.0	VB/UINF	0.01	0.02	0.0	-0.01	-0.01	0.0	0.0	
	0.11	0.23	0.31	0.40	0.42	0.35	0.29	WB/UINF	0.03	0.04	0.0	-0.04	-0.02	-0.05	-0.10	
	-0.19	-0.22	-0.29	-0.34	-0.28	-0.31	-0.26	CP	-0.15	-0.20	-0.10	-0.10	-0.09	-0.13	-0.08	
	-0.38	-0.25	-0.26	-0.15	-0.14	-0.18	-0.12	CPT	-0.33	-0.35	-0.35	-0.32	-0.20	-0.08	-0.05	
	7.2	13.5	17.9	21.4	23.4	19.5	15.9	THETA	3.6	3.3	3.7	5.0	4.4	4.7	6.7	
R= 4.03 DELTA= 75 DEG UINF= 42.3 M/S X/D= 20.00 Z/D= 5.45 PHI= 8.0 DEG	0.97	1.01	1.02	1.01	1.04	1.05	1.07	UB/UINF	0.64	0.29	0.31	0.12	0.05	0.05	0.38	R= 4.05 DELTA= 105 DEG UINF= 42.3 M/S X/D= 2.00 Z/D= 2.50 PHI= 19.0 DEG
	0.02	0.0	0.01	0.0	-0.01	-0.02	-0.01	VB/UINF	0.03	-0.09	-0.06	-0.11	0.09	-0.23	-0.01	
	0.07	0.09	0.14	0.17	0.19	0.13	0.10	WB/UINF	0.35	0.62	0.68	0.65	0.35	-0.06	-0.04	
	-0.19	-0.14	-0.18	-0.15	-0.16	-0.16	-0.19	CP	-1.05	-1.07	-1.31	-1.16	-1.25	-1.07	-1.28	
	-0.15	-0.12	-0.11	-0.11	-0.04	-0.04	-0.02	CPT	-1.51	-1.59	-1.74	-1.71	-2.12	-2.01	-2.14	
	4.5	6.4	9.6	10.2	11.0	8.3	6.5	THETA	28.3	66.0	65.9	80.5	82.1	80.1	7.4	
R= 4.00 DELTA= 90 DEG UINF= 42.1 M/S X/D= 4.00 Z/D= 3.01 PHI= 18.1 DEG	0.74	0.73	0.65	0.54	0.45	0.47	1.11	UB/UINF	0.52	0.57	0.41	0.26	0.23	0.10	0.09	R= 4.04 DELTA= 105 DEG UINF= 42.4 M/S X/D= 4.00 Z/D= 3.13 PHI= 14.0 DEG
	-0.02	0.01	0.01	0.03	-0.05	-0.02	0.0	VB/UINF	0.05	-0.02	-0.01	0.17	-0.05	0.11	0.01	
	0.12	0.33	0.59	0.67	0.53	0.30	0.06	WB/UINF	0.25	0.35	0.60	0.61	0.45	0.27	0.12	
	-0.49	-0.57	-0.65	-0.73	-0.77	-0.71	-0.82	CP	-0.45	-0.65	-0.51	-0.45	-0.66	-0.67	-0.64	
	-0.92	-0.93	-0.87	-1.00	-1.28	-1.40	-0.59	CPT	-1.11	-1.20	-0.98	-0.98	-1.40	-1.57	-1.61	
	9.9	24.3	42.1	51.1	50.1	33.0	4.0	THETA	26.1	32.1	55.3	67.2	63.2	71.0	52.8	
R= 4.03 DELTA= 90 DEG UINF= 42.0 M/S X/D= 10.00 Z/D= 4.45 PHI= 11.1 DEG	0.82	0.82	0.82	0.76	0.79	0.78	0.90	UB/UINF	0.79	0.82	0.77	0.66	0.63	0.56	0.52	R= 4.08 DELTA= 105 DEG UINF= 42.4 M/S X/D= 8.00 Z/D= 3.97 PHI= 12.0 DEG
	0.02	0.01	0.04	0.0	-0.01	-0.02	-0.01	VB/UINF	0.05	0.03	0.07	-0.01	-0.01	-0.03	-0.02	
	0.10	0.17	0.17	0.24	0.22	0.11	0.04	WB/UINF	0.06	0.13	0.20	0.25	0.23	0.18	0.11	
	-0.23	-0.26	-0.29	-0.27	-0.30	-0.28	-0.27	CP	-0.23	-0.31	-0.35	-0.31	-0.39	-0.37	-0.34	
	-0.54	-0.56	-0.58	-0.63	-0.62	-0.67	-0.46	CPT	-0.59	-0.62	-0.72	-0.80	-0.93	-1.03	-1.06	
	7.2	12.0	11.6	17.3	15.9	8.8	4.4	THETA	4.5	9.0	15.0	21.1	20.4	18.5	12.6	
R= 4.06 DELTA= 90 DEG UINF= 42.1 M/S X/D= 10.00 Z/D= 4.45 PHI= 11.1 DEG	0.85	0.86	0.81	0.81	0.77	0.77	0.90	UB/UINF	0.88	0.85	0.81	0.76	0.67	0.61	0.60	R= 4.04 DELTA= 105 DEG UINF= 42.4 M/S X/D= 10.75 Z/D= 4.55 PHI= 10.0 DEG
	0.01	0.05	0.0	0.0	0.0	-0.02	-0.01	VB/UINF	0.04	0.01	-0.04	0.01	-0.02	-0.02	-0.03	
	0.06	0.13	0.15	0.20	0.18	0.17	0.02	WB/UINF	0.07	0.12	0.17	0.18	0.14	0.14	0.06	
	-0.26	-0.32	-0.29	-0.32	-0.29	-0.28	-0.29	CP	-0.20	-0.22	-0.20	-0.27	-0.22	-0.20	-0.22	
	-0.52	-0.56	-0.60	-0.61	-0.67	-0.65	-0.48	CPT	-0.42	-0.48	-0.51	-0.67	-0.75	-0.81	-0.85	
	4.5	8.5	11.0	13.9	13.7	13.2	3.7	THETA	4.4	8.0	13.1	13.8	13.1	13.2	9.3	
R= 4.07 DELTA= 90 DEG UINF= 42.1 M/S X/D= 10.00 Z/D= 4.45 PHI= 11.1 DEG	0.83	0.88	0.80	0.75	0.82	0.82	0.89	UB/UINF	0.85	0.79	0.83	0.78	0.69	0.63	0.62	R= 4.05 DELTA= 105 DEG UINF= 42.5 M/S X/D= 10.75 Z/D= 4.55 PHI= 10.0 DEG
	0.02	0.02	0.01	0.0	-0.01	-0.01	0.0	VB/UINF	0.03	0.03	-0.02	-0.04	-0.05	0.01	-0.03	
	0.02	0.10	0.21	0.23	0.18	0.09	0.04	WB/UINF	0.08	0.13	0.15	0.16	0.16	0.08	0.06	
	-0.32	-0.32	-0.32	-0.26	-0.37	-0.31	-0.28	CP	-0.18	-0.19	-0.24	-0.28	-0.24	-0.24	-0.22	
	-0.53	-0.53	-0.63	-0.64	-0.67	-0.63	-0.48	CPT	-0.46	-0.54	-0.53	-0.65	-0.73	-0.84	-0.83	
	1.9	6.8	14.6	17.0	12.7	6.9	3.7	THETA	5.7	9.1	11.2	12.9	15.0	7.4	7.9	

a. Cold jet, TJ/TINF = 0.90
b. Hot jet, TJ/TINF = 1.22

TABLE B2.- Continued

TEST CONDITIONS	ZB/D								ZB/D							TEST CONDITIONS
	-1.5	-1.0	-0.5	0.0	0.5	1.0	1.5		-1.5	-1.0	-0.5	0.0	0.5	1.0	1.5	
R= 4.06 DELTA= 105 DEG UINF= 42.5 M/S X/D= 20.34 Z/D= 5.97 PHI= 7.0 DEG	0.92	0.86	0.87	0.85	0.81	0.80	0.79	UB/UINF	0.97	0.95	1.04	1.10	1.35	1.38	2.04	R= 8.00 DELTA= 50 DEG UINF= 37.9 M/S X/D= 7.00 Z/D= 5.17 PHI= 29.0 DEG
	-0.01	-0.01	0.0	0.0	-0.01	-0.01	-0.02	VB/UINF	0.01	-0.01	-0.03	-0.01	0.01	-0.02	-0.02	
	0.04	0.05	0.05	0.05	0.03	0.0	-0.04	WB/UINF	0.02	0.23	0.41	0.70	0.78	0.68	0.37	
	-0.10	-0.09	-0.11	-0.14	-0.14	-0.13	-0.11	CP	0.0	-0.04	-0.41	-0.86	-1.27	-1.13	-1.66	
	-0.25	-0.34	-0.35	-0.42	-0.49	-0.49	-0.48	CPT	-0.06	-0.09	-0.08	-0.15	0.22	1.24	1.69	
	4.7	5.4	5.0	4.7	5.0	4.1	5.6	THETA	2.0	13.6	24.8	32.7	29.9	26.5	10.7	
R= 8.01 DELTA= 45 DEG UINF= 38.0 M/S X/D= 7.00 Z/D= 3.61 PHI= 25.0 DEG	0.95	0.99	1.04	1.20	1.46	1.94	3.52	UB/UINF	0.99	1.03	1.08	1.03	1.23	1.41	1.48	R= 8.00 DELTA= 60 DEG UINF= 38.2 M/S X/D= 9.93 Z/D= 6.50 PHI= 24.0 DEG
	0.01	0.0	0.04	0.06	0.01	-0.02	-0.03	VB/UINF	-0.01	-0.02	-0.02	0.02	-0.05	0.01	-0.04	
	-0.20	-0.08	0.11	0.45	0.69	0.49	0.31	WB/UINF	0.13	0.29	0.48	0.66	0.69	0.54	0.44	
	0.02	0.02	-0.02	-0.34	-0.88	-1.50	-3.14	CP	-0.07	-0.21	-0.41	-0.58	-0.79	-0.97	-0.84	
	-0.04	0.01	0.07	0.31	0.74	1.57	8.87	CPT	-0.07	-0.05	0.0	-0.07	0.29	0.32	0.56	
	11.9	5.4	6.3	20.3	25.3	14.5	5.9	THETA	8.0	16.2	24.3	32.5	29.5	20.9	17.1	
R= 8.01 DELTA= 45 DEG UINF= 37.6 M/S X/D= 10.00 Z/D= 4.73 PHI= 21.0 DEG	1.00	1.02	1.10	1.19	1.40	1.63	2.35	UB/UINF	0.97	1.02	1.04	1.06	1.27	1.34	1.48	R= 7.98 DELTA= 60 DEG UINF= 38.1 M/S X/D= 10.00 Z/D= 5.50 PHI= 24.0 DEG
	0.01	0.01	0.0	0.0	0.01	0.02	-0.01	VB/UINF	-0.02	0.03	-0.11	-0.01	-0.09	-0.04	-0.03	
	-0.10	0.01	0.18	0.38	0.51	0.45	0.29	WB/UINF	0.12	0.31	0.47	0.61	0.56	0.61	0.44	
	0.01	0.01	-0.12	-0.29	-0.57	-0.83	-1.54	CP	-0.01	-0.13	-0.35	-0.62	-0.94	-0.85	-0.85	
	0.01	0.06	0.13	0.27	0.66	1.04	3.17	CPT	-0.06	0.0	-0.04	-0.11	0.12	0.34	0.55	
	6.0	2.4	9.8	18.1	20.0	15.6	7.7	THETA	8.4	16.7	25.6	30.2	28.0	24.8	16.9	
R= 7.99 DELTA= 45 DEG UINF= 38.0 M/S X/D= 19.99 Z/D= 7.37 PHI= 15.1 DEG	1.06	1.07	1.09	1.12	1.17	1.25	1.38	UB/UINF	1.04	1.10	1.16	1.20	1.16	1.28	1.23	R= 8.02 DELTA= 50 DEG UINF= 38.1 M/S X/D= 19.98 Z/D= 9.66 PHI= 15.0 DEG
	-0.01	0.0	0.01	0.0	0.0	-0.01	-0.01	VB/UINF	-0.02	-0.09	-0.04	-0.08	-0.09	-0.05	-0.02	
	0.05	0.15	0.23	0.30	0.33	0.30	0.22	WB/UINF	0.26	0.36	0.39	0.45	0.46	0.37	0.29	
	-0.07	-0.12	-0.13	-0.20	-0.27	-0.33	-0.47	CP	-0.15	-0.23	-0.40	-0.41	-0.29	-0.36	-0.33	
	0.06	0.05	0.12	0.15	0.21	0.34	0.50	CPT	0.0	0.11	0.11	0.24	0.27	0.42	0.29	
	5.0	8.4	12.3	15.1	16.1	14.1	9.9	THETA	14.8	19.5	19.4	21.6	22.8	17.0	14.0	
R= 8.00 DELTA= 60 DEG UINF= 38.3 M/S X/D= 2.00 Z/D= 1.97 PHI= 41.0 DEG	0.80	0.95	1.09	1.16	5.63	4.77	0.67	UB/UINF	0.83	0.80	0.91	1.04	4.71	3.98	0.61	R= 8.04 DELTA= 75 DEG UINF= 38.0 M/S X/D= 2.00 Z/D= 3.88 PHI= 51.0 DEG
	0.01	-0.01	0.12	0.06	-0.40	-0.23	0.01	VB/UINF	0.0	-0.02	-0.01	-0.07	-0.03	-0.08	0.08	
	-0.52	-0.26	0.30	1.21	1.64	1.66	-0.47	WB/UINF	0.26	0.93	1.51	1.24	0.79	1.28	-0.48	
	-0.06	-0.11	-0.47	-1.84	4.89	3.29	0.29	CP	-0.56	-1.10	-2.71	-2.89	-5.15	-1.33	-0.19	
	-0.14	-0.13	-0.17	-0.02	42.21	29.94	-0.04	CPT	-0.81	-0.58	-0.59	-1.23	18.49	15.28	-0.58	
	33.3	15.5	15.9	46.2	17.3	19.6	35.3	THETA	17.8	49.4	58.9	50.1	9.7	18.5	38.5	
R= 8.01 DELTA= 60 DEG UINF= 38.2 M/S X/D= 2.00 Z/D= 1.97 PHI= 41.0 DEG	0.82	0.94	1.06	1.22	5.57	4.68	0.68	UB/UINF	0.82	0.89	0.89	0.99	1.04	1.22	3.02	R= 7.99 DELTA= 75 DEG UINF= 38.6 M/S X/D= 4.00 Z/D= 4.94 PHI= 42.8 DEG
	0.02	0.01	0.06	-0.05	-0.31	-0.14	-0.01	VB/UINF	0.01	0.03	0.04	0.01	0.02	-0.09	0.0	
	-0.53	-0.27	0.33	1.26	1.68	1.77	-0.46	WB/UINF	0.08	0.41	0.84	1.17	1.21	0.76	0.36	
	-0.08	-0.11	-0.43	-1.71	4.79	3.95	0.27	CP	-0.17	-0.47	-0.87	-1.76	-1.91	-1.97	-4.29	
	-0.13	-0.15	-0.40	0.40	41.36	29.99	-0.05	CPT	-0.48	-0.50	-0.36	-0.40	-0.32	-0.90	4.22	
	32.8	15.9	17.2	46.0	17.5	20.9	34.1	THETA	6.0	24.6	43.5	49.9	49.3	32.3	7.0	
R= 7.94 DELTA= 60 DEG UINF= 37.9 M/S X/D= 4.00 Z/D= 3.46 PHI= 37.0 DEG	0.91	0.96	0.95	0.93	1.17	2.48	5.06	UB/UINF	0.81	0.82	0.87	0.86	1.02	1.04	2.63	R= 8.02 DELTA= 75 DEG UINF= 38.6 M/S X/D= 4.00 Z/D= 4.94 PHI= 39.1 DEG
	0.02	0.03	0.06	0.03	-0.07	-0.04	-0.11	VB/UINF	-0.02	-0.01	0.04	0.03	-0.02	-0.07	0.02	
	-0.20	0.05	0.46	0.97	1.10	0.44	1.01	WB/UINF	0.09	0.42	0.80	1.20	1.25	0.97	0.46	
	0.02	-0.04	-0.27	-0.86	-1.77	-3.76	-4.10	CP	-0.19	-0.31	-0.90	-1.67	-2.05	-1.75	-3.76	
	-0.11	-0.11	-0.15	-0.04	-0.16	1.73	24.00	CPT	-0.51	-0.46	-0.49	-0.48	-0.42	-0.72	2.56	
	12.8	3.0	25.9	46.1	43.4	10.4	11.8	THETA	6.9	27.3	42.4	54.3	50.9	43.2	10.0	

TABLE B2.- Continued

TEST CONDITIONS	ZB/D								ZB/D							TEST CONDITIONS
	-1.5	-1.0	-0.5	0.0	0.5	1.0	1.5		-1.5	-1.0	-0.5	0.0	0.5	1.0	1.5	
R= 7.99 DELTA= 75 DEG UINF= 21.4 M/S X/D= 10.00 Z/D= 8.20 PHI= 19.1 DEG	0.96	0.96	0.93	0.98	0.97	0.93	1.09	UB/UINF	0.96	0.91	0.91	0.98	1.07	1.05	0.99	R= 8.00 DELTA= 90 DEG UINF= 21.0 M/S X/D= 9.50 Z/D= 9.70 PHI= 22.4 DEG
	0.99	0.11	0.31	0.12	-0.01	-0.01	0.02	VB/UINF	0.03	0.13	-0.06	0.02	0.01	-0.01	-0.07	
	0.41	0.55	0.73	0.81	0.88	0.83	0.67	WB/UINF	0.58	0.72	0.78	0.77	0.68	0.58	0.45	
	-0.25	-0.38	-0.50	-0.85	-0.70	-0.68	-0.69	CP	-0.47	-0.53	-0.60	-0.84	-0.85	-0.80	-0.57	
	-0.16	-0.14	-0.11	-0.21	0.04	-0.12	-0.06	CPT	-0.22	-0.16	-0.16	-0.29	-0.25	-0.36	-0.39	
	23.0	29.5	38.3	39.6	42.3	41.9	31.7	THETA	30.9	38.3	40.8	38.3	32.4	29.2	25.5	
R= 8.00 DELTA= 75 DEG UINF= 31.9 M/S X/D= 10.00 Z/D= 8.20 PHI= 19.1 DEG	0.95	0.97	0.96	0.97	0.99	1.02	1.16	UB/UINF	1.06	0.87	0.93	0.97	0.87	0.99	1.08	R= 8.07 DELTA= 90 DEG UINF= 21.1 M/S X/D= 9.50 Z/D= 9.70 PHI= 22.4 DEG
	0.01	0.0	-0.04	-0.04	-0.01	-0.01	0.01	VB/UINF	-0.04	-0.08	-0.08	-0.06	0.0	-0.04	-0.03	
	0.40	0.55	0.70	0.81	0.87	0.80	0.64	WB/UINF	0.49	0.73	0.78	0.75	0.75	0.61	0.37	
	-0.23	-0.46	-0.58	-0.80	-0.82	-0.75	-0.79	CP	-0.69	-0.34	-0.63	-0.80	-0.65	-0.63	-0.74	
	-0.17	-0.23	-0.16	-0.21	-0.07	-0.07	-0.02	CPT	-0.31	-0.05	-0.15	-0.29	-0.32	-0.29	-0.43	
	23.2	25.8	36.4	40.3	41.3	38.3	29.0	THETA	25.2	40.4	40.4	38.1	40.6	32.0	19.6	
R= 8.03 DELTA= 75 DEG UINF= 31.8 M/S X/D= 10.00 Z/D= 8.20 PHI= 19.1 DEG	0.99	0.94	0.96	1.03	0.99	1.00	1.17	UB/UINF	0.95	1.02	0.91	1.06	1.05	1.10	1.12	R= 8.02 DELTA= 90 DEG UINF= 31.5 M/S X/D= 9.50 Z/D= 9.70 PHI= 22.4 DEG
	0.07	0.10	0.02	0.07	-0.04	0.02	-0.06	VB/UINF	-0.02	-0.02	-0.08	-0.04	-0.03	-0.04	0.04	
	0.38	0.58	0.72	0.79	0.89	0.79	0.62	WB/UINF	0.57	0.70	0.77	0.75	0.68	0.57	0.45	
	-0.26	-0.36	-0.55	-0.89	-0.73	-0.76	-0.85	CP	-0.49	-0.67	-0.65	-0.89	-0.84	-0.80	-0.78	
	-0.12	-0.12	-0.11	-0.20	0.06	-0.15	-0.09	CPT	-0.26	-0.14	-0.20	-0.21	-0.26	-0.25	-0.32	
	20.8	31.5	37.0	37.3	42.2	38.3	28.5	THETA	31.0	34.5	40.8	35.4	33.1	27.7	21.8	
R= 8.00 DELTA= 75 DEG UINF= 38.2 M/S X/D= 10.00 Z/D= 8.20 PHI= 19.1 DEG	0.96	0.97	0.95	0.95	1.00	1.06	1.14	UB/UINF	0.95	0.93	0.99	0.98	1.01	1.01	1.01	R= 7.99 DELTA= 90 DEG UINF= 38.0 M/S X/D= 9.50 Z/D= 9.72 PHI= 22.4 DEG
	0.06	0.02	-0.08	0.04	0.0	0.02	-0.01	VB/UINF	-0.03	0.0	-0.05	0.0	-0.07	-0.01	-0.02	
	0.41	0.58	0.76	0.85	0.91	0.80	0.69	WB/UINF	0.58	0.70	0.77	0.78	0.77	0.68	0.50	
	-0.22	-0.39	-0.57	-0.77	-0.81	-0.84	-0.74	CP	-0.41	-0.61	-0.83	-0.82	-0.83	-0.76	-0.58	
	-0.13	-0.11	-0.08	-0.12	0.02	-0.07	0.05	CPT	-0.16	-0.24	-0.24	-0.25	-0.21	-0.28	-0.31	
	23.3	30.8	39.2	41.8	42.4	36.8	31.3	THETA	31.8	37.1	38.4	34.4	37.5	34.1	26.9	
R= 7.99 DELTA= 75 DEG UINF= 37.9 M/S X/D= 20.00 Z/D= 11.50 PHI= 17.0 DEG	1.06	1.12	1.06	1.11	1.17	1.06	1.11	UB/UINF	1.04	1.09	1.07	0.97	1.07	1.02	1.05	R= 8.00 DELTA= 90 DEG UINF= 38.1 M/S X/D= 20.01 Z/D= 14.00 PHI= 15.7 DEG
	-0.04	-0.05	-0.02	-0.08	-0.03	-0.03	0.01	VB/UINF	-0.05	-0.01	-0.01	-0.02	-0.01	-0.01	0.05	
	0.35	0.41	0.47	0.50	0.47	0.44	0.37	WB/UINF	0.44	0.45	0.42	0.38	0.31	0.21	0.08	
	-0.24	-0.38	-0.41	-0.42	-0.49	-0.33	-0.36	CP	-0.39	-0.42	-0.41	-0.26	-0.34	-0.32	-0.25	
	0.0	0.05	-0.04	0.06	0.10	-0.01	0.02	CPT	-0.11	-0.02	-0.10	-0.16	-0.09	-0.23	-0.13	
	18.9	20.8	24.4	25.2	22.4	23.1	18.6	THETA	23.5	22.8	21.8	21.7	16.6	12.0	4.2	
R= 7.93 DELTA= 90 DEG UINF= 38.1 M/S X/D= 4.00 Z/D= 6.56 PHI= 35.0 DEG	0.78	0.76	0.84	0.71	1.02	0.85	1.05	UB/UINF	0.98	1.02	1.02	1.03	1.00	1.09	1.12	R= 8.00 DELTA= 90 DEG UINF= 38.1 M/S X/D= 20.02 Z/D= 11.75 PHI= 15.7 DEG
	0.03	0.01	0.03	-0.03	-0.05	0.09	-0.02	VB/UINF	-0.03	-0.05	-0.03	-0.02	-0.02	0.0	-0.05	
	0.57	0.90	1.09	1.18	1.15	1.02	0.57	WB/UINF	0.29	0.37	0.43	0.44	0.51	0.45	0.43	
	-0.39	-0.57	-1.38	-1.60	-1.98	-1.35	-1.37	CP	-0.15	-0.21	-0.27	-0.37	-0.28	-0.50	-0.46	
	-0.43	-0.17	-0.47	-0.69	-0.61	-0.59	-0.93	CPT	-0.10	-0.04	-0.04	-0.10	-0.01	-0.10	-0.01	
	36.1	49.8	52.3	59.2	48.6	50.1	28.6	THETA	17.2	20.8	23.5	23.3	27.1	22.5	21.8	
R= 8.02 DELTA= 90 DEG UINF= 21.1 M/S X/D= 9.50 Z/D= 9.70 PHI= 22.4 DEG	0.98	1.00	1.00	0.96	0.99	0.91	1.05	UB/UINF	0.81	0.77	0.79	0.75	0.92	0.75	0.54	R= 8.02 DELTA= 105 DEG UINF= 38.3 M/S X/D= 3.00 Z/D= 7.50 PHI= 33.0 DEG
	-0.01	0.01	0.01	0.03	-0.04	-0.03	-0.01	VB/UINF	0.02	0.15	0.0	0.03	-0.04	0.0	-0.10	
	0.36	0.66	0.74	0.78	0.65	0.66	0.46	WB/UINF	0.79	0.92	1.13	1.15	0.93	0.88	0.77	
	-0.52	-0.75	-0.81	-0.82	-0.74	-0.64	-0.60	CP	-0.57	-1.31	-1.67	-1.81	-2.21	-1.63	-0.68	
	-0.24	-0.30	-0.27	-0.30	-0.32	-0.39	-0.28	CPT	-0.29	-0.85	-0.75	-0.90	-1.49	-1.29	-0.78	
	29.9	33.3	36.4	38.9	33.7	36.2	23.8	THETA	44.0	50.1	55.3	56.9	45.4	49.4	55.5	

c. Cold jet, TJ/TINF = 0.90
d. Hot jet, TJ/TINF = 1.15

TABLE B2.- Concluded

TEST CONDITIONS	ZB/D							
	-1.5	-1.0	-0.5	0.0	0.5	1.0	1.5	
R= 8.01 DELTA= 105 DEG UINF= 38.0 M/S X/D= 4.00 Z/D= 7.94 PHI= 28.0 DEG	0.90 0.08 0.59 -0.57 -0.40 33.1	0.61 -0.01 0.91 -0.55 -0.35 56.3	0.70 0.17 1.10 -0.83 -0.10 57.6	0.67 0.02 1.17 -1.14 -0.31 60.0	0.97 0.04 0.87 -2.02 -1.31 41.9	0.70 0.06 1.01 -1.37 -0.85 55.0	0.82 -0.14 0.78 -1.15 -0.83 44.5	UB/UIINF VB/UIINF WB/UIINF CP CPT THETA
R= 7.99 DELTA= 105 DEG UINF= 38.2 M/S X/D= 8.00 Z/D= 9.20 PHI= 23.0 DEG	0.90 0.02 0.37 -0.19 -0.24 22.3	0.98 0.03 0.49 -0.38 -0.18 26.6	0.90 0.02 0.69 -0.39 -0.10 37.3	0.85 0.02 0.73 -0.58 -0.32 41.0	0.91 -0.02 0.71 -0.82 -0.49 38.0	0.87 -0.03 0.68 -0.95 -0.72 37.9	0.75 -0.07 0.74 -0.64 -0.52 45.2	UB/UIINF VB/UIINF WB/UIINF CP CPT THETA
R= 8.00 DELTA= 105 DEG UINF= 38.1 M/S X/D= 8.03 Z/D= 9.82 PHI= 23.0 DEG	0.97 0.03 0.47 -0.44 -0.28 25.7	0.91 -0.09 0.63 -0.48 -0.25 35.3	0.87 0.0 0.70 -0.61 -0.35 38.8	0.97 -0.05 0.67 -0.86 -0.47 35.0	0.96 -0.10 0.65 -0.96 -0.60 34.8	0.85 -0.04 0.71 -0.89 -0.65 40.1	0.80 -0.05 0.59 -0.79 -0.80 36.8	UB/UIINF VB/UIINF WB/UIINF CP CPT THETA
R= 8.01 DELTA= 105 DEG UINF= 38.3 M/S X/D= 10.69 Z/D= 10.47 PHI= 19.0 DEG	0.92 0.03 0.43 -0.20 -0.17 25.1	0.97 0.04 0.52 -0.35 -0.13 28.1	0.91 -0.02 0.61 -0.37 -0.16 34.1	0.85 -0.03 0.67 -0.47 -0.28 38.3	1.00 0.0 0.62 -0.77 -0.37 32.1	1.04 -0.01 0.54 -0.89 -0.52 27.4	0.85 0.02 0.58 -0.61 -0.55 34.5	UB/UIINF VB/UIINF WB/UIINF CP CPT THETA
R= 7.99 DELTA= 105 DEG UINF= 38.4 M/S X/D= 10.69 Z/D= 10.47 PHI= 19.0 DEG	0.95 0.03 0.44 -0.22 -0.12 24.9	0.93 0.04 0.55 -0.31 -0.15 30.5	0.94 0.01 0.55 -0.51 -0.32 30.6	0.92 -0.03 0.66 -0.52 -0.22 36.0	0.89 -0.02 0.67 -0.59 -0.34 37.3	0.85 -0.04 0.75 -0.48 -0.18 41.8	1.03 -0.06 0.56 -0.80 -0.41 29.0	UB/UIINF VB/UIINF WB/UIINF CP CPT THETA
R= 7.99 DELTA= 105 DEG UINF= 38.4 M/S X/D= 10.75 Z/D= 10.47 PHI= 19.0 DEG	0.93 0.01 0.43 -0.25 -0.20 24.9	1.00 0.0 0.51 -0.46 -0.20 26.9	0.97 0.03 0.62 -0.40 -0.08 32.5	0.90 -0.04 0.63 -0.49 -0.28 35.6	0.83 0.02 0.72 -0.45 -0.23 40.9	0.86 -0.02 0.59 -0.64 -0.55 34.5	1.02 -0.04 0.52 -0.85 -0.53 27.4	UB/UIINF VB/UIINF WB/UIINF CP CPT THETA
R= 8.00 DELTA= 105 DEG UINF= 38.4 M/S X/D= 20.50 Z/D= 13.49 PHI= 14.0 DEG	1.03 0.01 0.33 -0.30 -0.13 18.2	0.94 -0.03 0.40 -0.20 -0.15 23.6	0.99 -0.01 0.41 -0.30 -0.14 22.9	0.96 -0.07 0.39 -0.34 -0.25 23.4	0.96 -0.03 0.44 -0.35 -0.24 25.0	0.91 0.0 0.39 -0.30 -0.33 23.6	0.93 0.0 0.35 -0.33 -0.34 20.8	UB/UIINF VB/UIINF WB/UIINF CP CPT THETA

APPENDIX B

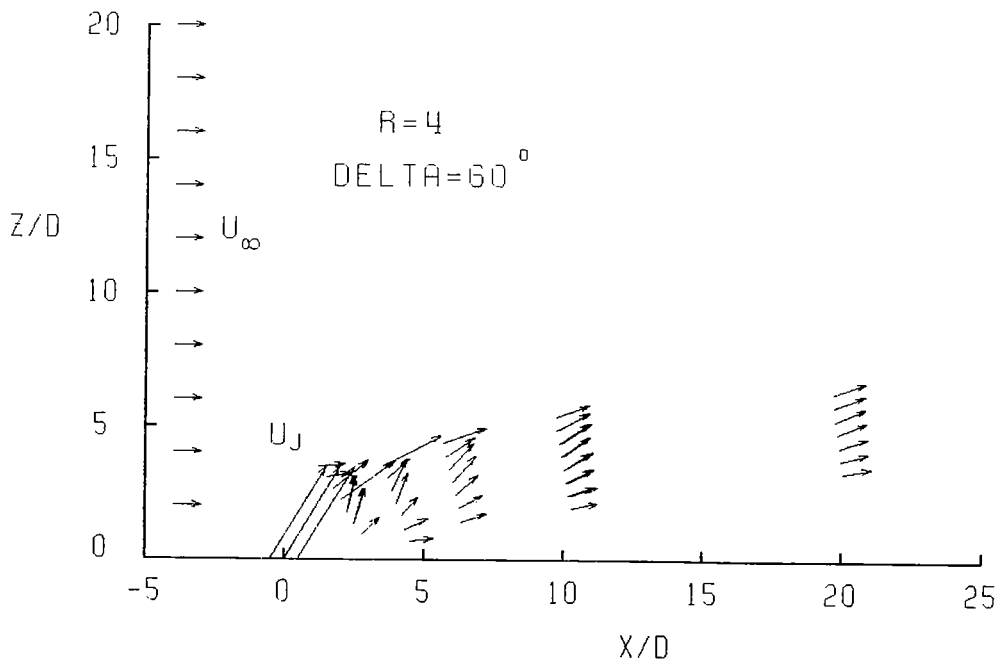
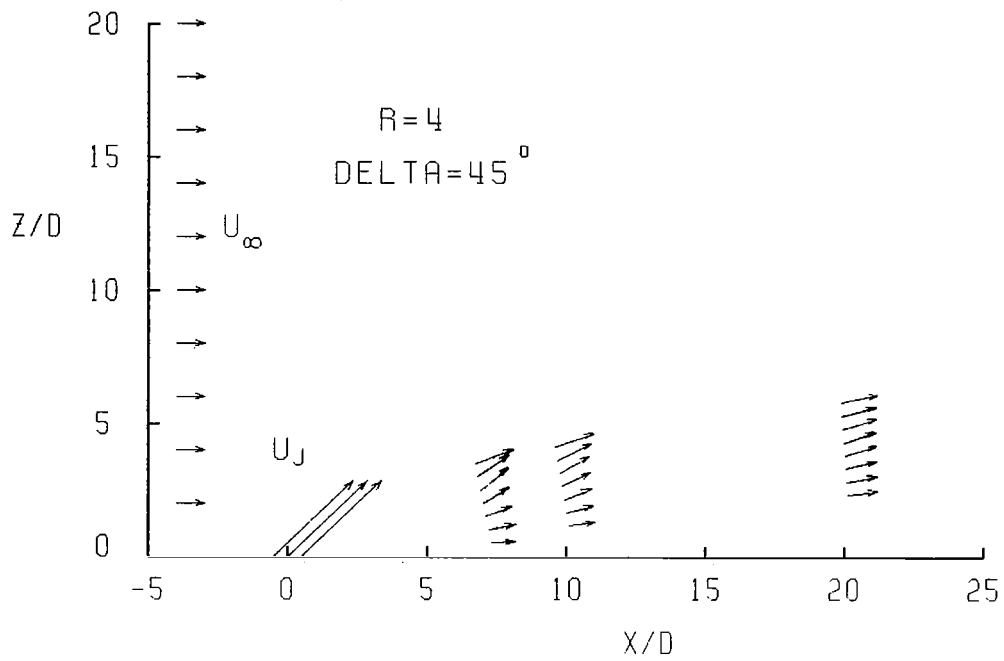

Figure B2.- Symmetry plane velocities in vortex-curve vicinity.

APPENDIX B

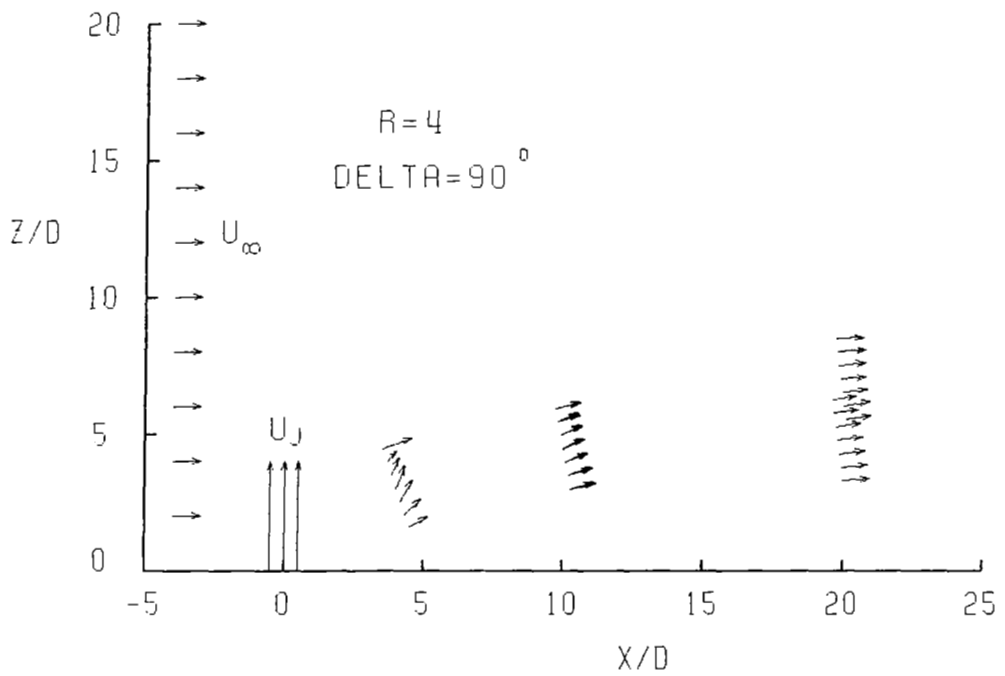
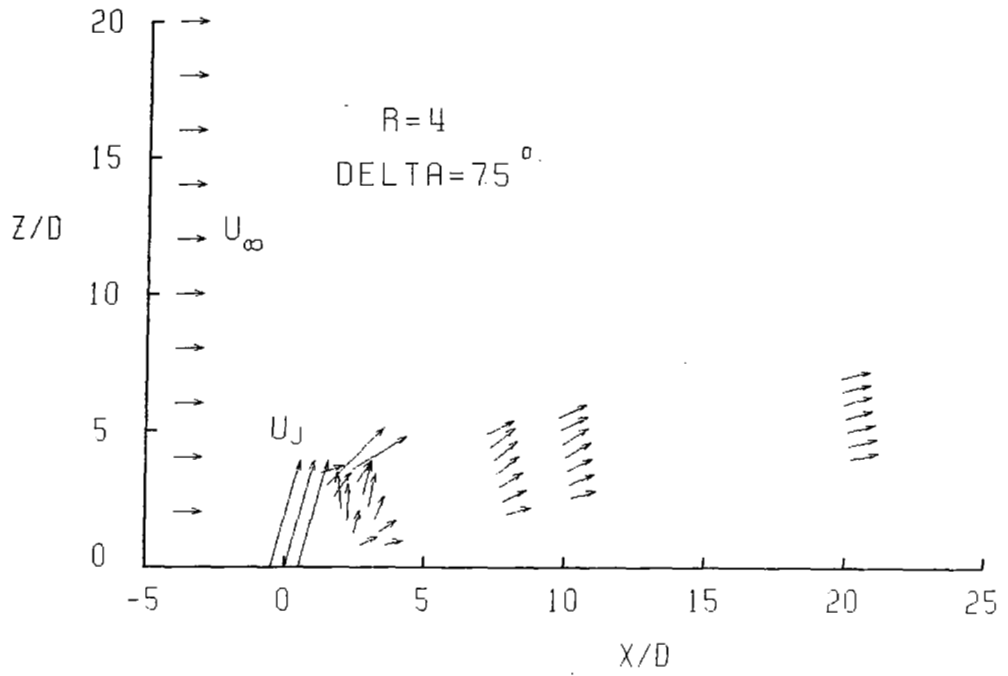

Figure B2.- Continued.

APPENDIX B

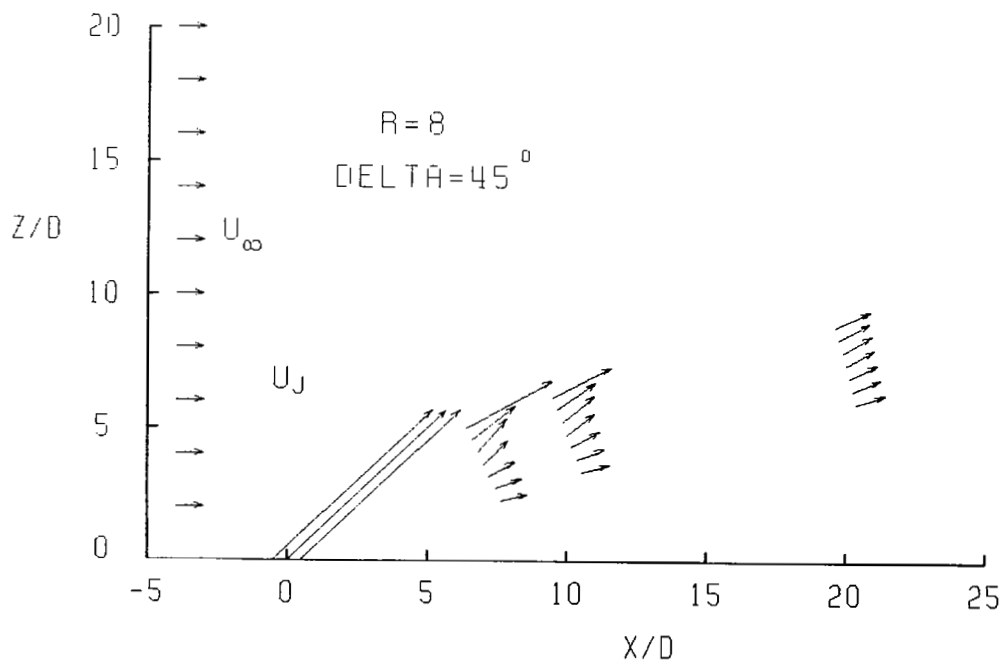
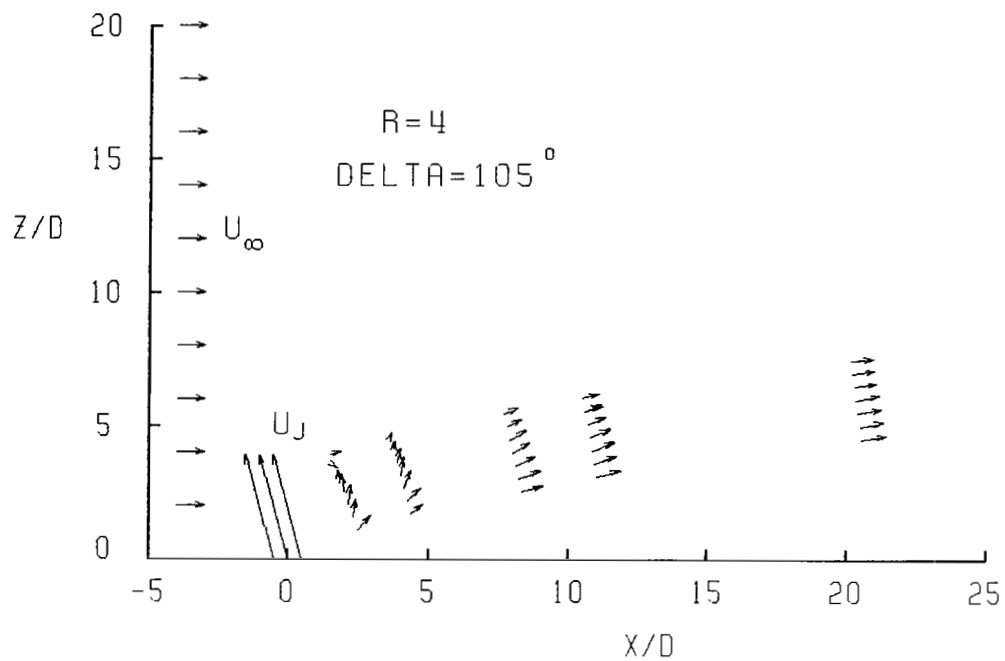

Figure B2.- Continued.

APPENDIX B

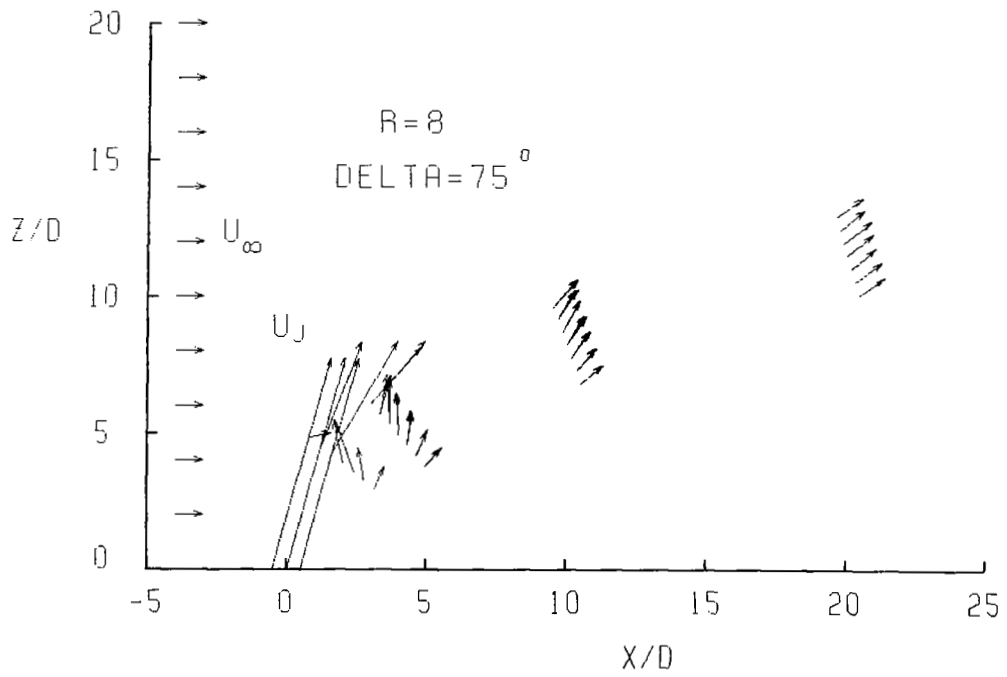
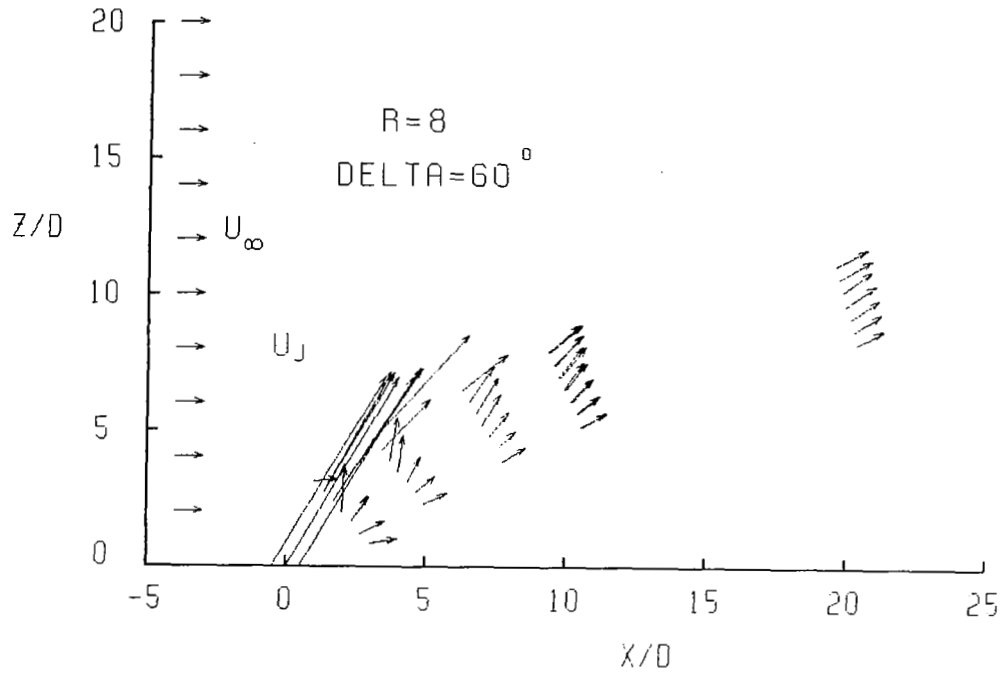

Figure B2.- Continued.

APPENDIX B

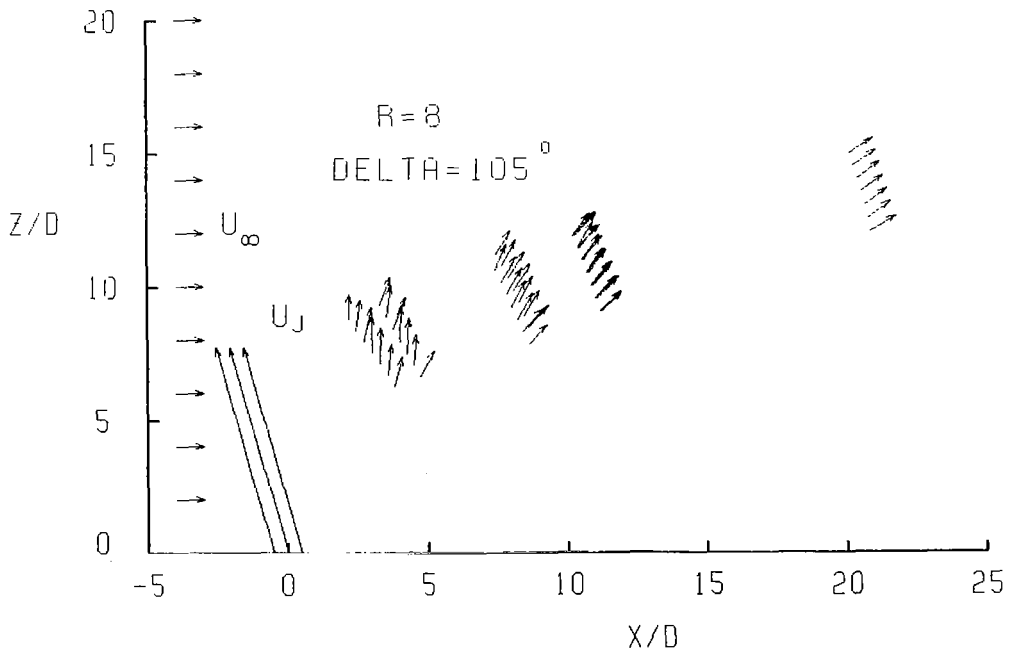
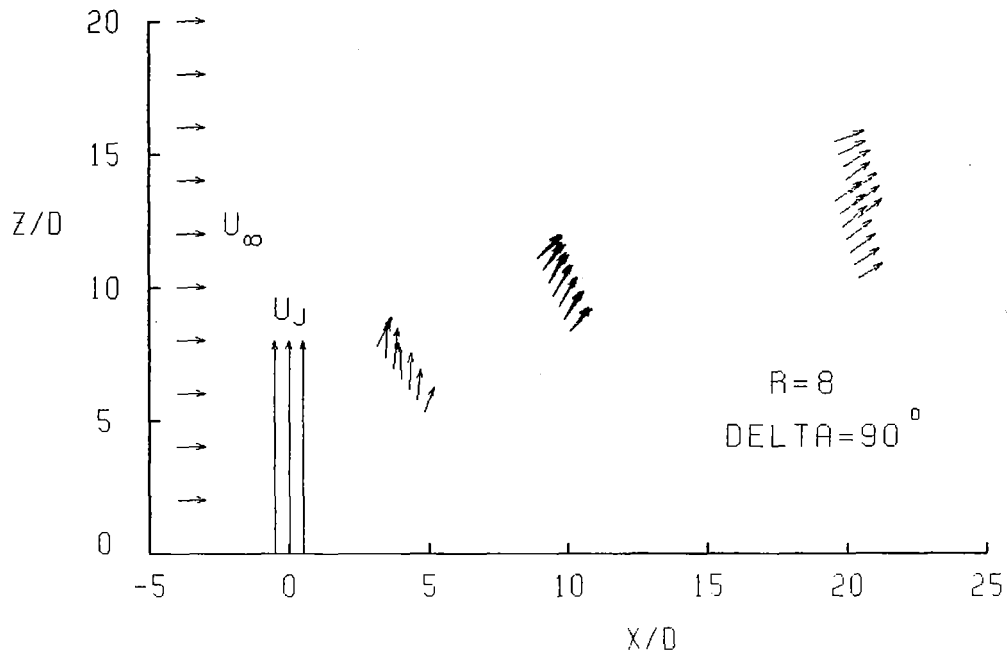

Figure B2.- Concluded.

TABLE B3.- TABULATED VALUES OF SYMMETRY PLANE VELOCITIES
AND PRESSURES NEAR JET ORIFICE

TEST CONDITIONS	ZE/D								ZB/D							TEST CONDITIONS
	-1.5	-1.0	-0.5	0.0	0.5	1.0	1.5		-1.5	-1.0	-0.5	0.0	0.5	1.0	1.5	
R= 4.01 DELTA= 90 DEG UINF= 43.2 M/S X/D= 1.07 Z/D= 0.97 PHI= 87.8 DEG	0.27	0.59	0.32	1.43	1.40	3.97	0.38	UB/UINF	0.28	0.44	0.59	0.80	1.19	1.91	4.02	R= 4.07 DELTA= 90 DEG UINF= 43.3 M/S X/D= 1.50 Z/D= 0.94 PHI= 87.8 DEG
	0.10	0.03	0.0	0.05	-0.04	-0.07	-0.08	VB/UINF	-0.02	-0.02	-0.14	-0.07	-0.05	0.08	0.05	
	-0.72	-0.62	-0.33	0.20	0.46	-0.61	-0.24	WB/UINF	-0.66	-0.66	-0.64	-0.35	0.34	0.04	-0.66	
	-0.54	-1.02	-1.74	-3.11	-4.34	-3.34	0.42	CP	-0.59	-0.83	-0.95	-1.62	-3.03	-4.14	-0.39	
	-0.93	-1.29	-1.03	-2.00	-2.85	15.80	-0.38	CPT	-1.07	-1.21	-1.16	-1.85	-2.48	-1.43	16.28	
	69.4	46.2	14.2	4.1	18.3	3.8	33.5	THETA	67.4	55.5	47.9	24.3	15.9	2.6	9.3	
R= 4.01 DELTA= 90 DEG UINF= 43.2 M/S X/D= 1.13 Z/D= 0.96 PHI= 87.8 DEG	0.36	0.52	0.02	1.13	1.28	4.07	1.23	UB/UINF	0.54	0.72	0.69	0.39	1.10	2.61	0.66	R= 4.04 DELTA= 90 DEG UINF= 42.4 M/S X/D= 1.09 Z/D= 1.87 PHI= 35.6 DEG
	-0.04	-0.03	-0.04	0.03	-0.01	-0.02	-0.08	VB/UINF	-0.12	0.01	-0.03	-0.10	-0.02	0.0	0.01	
	-0.71	-0.62	-0.38	0.12	0.69	-0.46	-0.09	WB/UINF	-0.06	0.65	1.22	1.03	0.59	1.43	-0.20	
	-0.53	-0.83	-1.56	-2.57	-3.83	-0.63	-0.07	CP	-0.84	-1.29	-2.34	-2.25	-2.32	-0.21	0.35	
	-0.89	-1.16	-1.57	-2.26	-2.70	15.86	0.46	CPT	-1.53	-1.35	-1.37	-2.07	-1.76	7.03	-0.13	
	63.4	50.1	22.4	6.1	28.3	6.5	5.4	THETA	15.7	42.3	60.6	65.3	28.2	28.8	16.5	
R= 4.01 DELTA= 90 DEG UINF= 43.3 M/S X/D= 1.19 Z/D= 0.96 PHI= 87.8 DEG	0.29	0.50	0.71	1.06	1.35	4.07	2.53	UB/UINF	0.22	0.78	0.71	0.45	0.41	3.10	1.02	R= 4.02 DELTA= 90 DEG UINF= 42.8 M/S X/D= 1.24 Z/D= 1.67 PHI= 35.6 DEG
	-0.06	-0.03	-0.02	-0.01	0.04	-0.04	-0.04	VB/UINF	-0.29	-0.02	0.02	0.06	0.02	0.03	-0.02	
	-0.75	-0.66	-0.50	0.09	3.71	-0.33	-0.19	WB/UINF	-0.39	0.22	0.95	1.25	0.77	1.23	0.34	
	-0.45	-0.90	-1.26	-2.36	-3.87	-0.91	-0.66	CP	-0.40	-1.20	-2.01	-2.30	-1.92	-2.54	-0.32	
	-0.79	-1.20	-1.51	-2.22	-2.42	15.90	4.95	CPT	-1.11	-1.55	-1.56	-1.52	-2.15	8.08	-0.17	
	68.8	52.8	35.0	4.7	27.2	4.6	4.3	THETA	66.6	16.0	53.0	70.2	61.6	21.8	18.6	
R= 4.01 DELTA= 90 DEG UINF= 43.4 M/S X/D= 1.26 Z/D= 0.96 PHI= 87.8 DEG	0.26	0.48	0.62	0.98	1.40	4.09	3.36	UB/UINF	-0.07	-0.03	0.0	0.0	-0.02	-0.04	-0.07	
	-0.07	-0.03	0.0	0.0	-0.02	-0.04	-0.07	VB/UINF	-0.74	-0.71	-0.57	-0.05	0.65	-0.21	-0.48	
	-0.40	-0.68	-1.15	-2.12	-3.78	-1.26	-0.71	WB/UINF	-0.40	-0.68	-1.15	-2.12	-3.78	-1.26	-0.71	
	-0.78	-0.95	-1.43	-2.16	-2.37	15.70	10.39	CP	-0.78	-0.95	-1.43	-2.16	-2.37	15.70	10.39	
	70.5	55.8	42.2	2.9	24.5	3.0	8.3	CPT								
								THETA								
R= 4.01 DELTA= 90 DEG UINF= 43.5 M/S X/D= 1.32 Z/D= 0.95 PHI= 87.8 DEG	0.28	0.48	0.48	1.00	1.43	4.07	3.73	UB/UINF	0.3	-0.05	-0.07	0.02	-0.02	-0.01	-0.03	
	0.3	-0.05	-0.07	0.02	-0.02	-0.01	-0.03	VB/UINF	-0.76	-0.54	-0.73	-0.14	0.62	-0.17	-0.75	
	-0.33	-1.00	-0.77	-2.08	-3.63	-2.29	-0.12	WB/UINF	-0.33	-1.00	-0.77	-2.08	-3.63	-2.29	-0.12	
	-0.67	-1.47	-1.00	-2.06	-2.18	14.41	14.16	CP	-0.67	-1.47	-1.00	-2.06	-2.18	14.41	14.16	
	69.6	48.7	57.0	7.8	23.4	2.5	11.4	CPT								
								THETA								
R= 4.06 DELTA= 90 DEG UINF= 43.3 M/S X/D= 1.37 Z/D= 0.95 PHI= 87.8 DEG	0.27	0.43	0.45	0.91	1.37	3.61	3.89	UB/UINF	-0.65	-0.64	-0.96	-0.05	-0.05	0.06	-0.03	
	-0.65	-0.64	-0.96	-0.05	-0.05	0.06	-0.03	VB/UINF	-0.78	-0.66	-0.71	-0.15	0.57	-0.24	-0.81	
	-0.31	-0.78	-0.78	-1.89	-3.37	-3.21	0.07	WB/UINF	-0.31	-0.78	-0.78	-1.89	-3.37	-3.21	0.07	
	-0.62	-1.15	-1.07	-2.03	-2.15	9.62	15.90	CP	-0.62	-1.15	-1.07	-2.03	-2.15	9.62	15.90	
	70.8	57.1	57.7	10.1	22.6	3.9	11.8	CPT								
								THETA								
R= 4.05 DELTA= 90 DEG UINF= 43.3 M/S X/D= 1.44 Z/D= 0.94 PHI= 87.8 DEG	0.28	0.41	0.58	0.63	1.35	2.67	3.94	UB/UINF	-0.12	-0.05	-0.10	-0.04	0.01	-0.03	0.03	
	-0.12	-0.05	-0.10	-0.04	0.01	-0.03	0.03	VB/UINF	-0.63	-0.81	-0.53	-0.33	0.38	-0.21	-0.76	
	-0.63	-0.81	-0.53	-0.33	0.38	-0.21	-0.76	WB/UINF	-0.70	-0.45	-1.11	-1.72	-3.24	-3.77	-0.16	
	-1.22	-0.61	-1.49	-2.21	-2.25	2.62	16.01	CP	-1.22	-0.61	-1.49	-2.21	-2.25	2.62	16.01	
	66.2	63.3	42.9	27.9	15.9	4.7	10.5	CPT								
								THETA								

TABLE B3.- Concluded

TEST CONDITIONS	ZB/D								ZB/D							TEST CONDITIONS
	-1.5	-1.0	-0.5	0.0	0.5	1.0	1.5		-1.5	-1.0	-0.5	0.0	0.5	1.0	1.5	
R= 8.04 DELTA= 90 DEG UINF= 21.7 M/S X/D= 1.01 Z/D= 0.97 PHI= 87.8 DEG	0.17	0.18	0.23	0.28	4.52	8.02	2.27	UB/UINF	0.15	0.19	0.20	0.23	0.24	7.38	8.12	R= 8.06 DELTA= 90 DEG UINF= 21.7 M/S X/D= 1.44 Z/D= 0.94 PHI= 87.8 DEG
	-0.06	-0.05	0.02	0.07	0.04	-0.01	-0.23	VB/UINF	0.08	-0.05	-0.03	-0.08	-0.19	0.07	0.0	
	-0.65	-0.65	-0.66	-0.54	-0.41	0.17	0.49	WB/UINF	-0.64	-0.73	-0.69	-0.61	-0.43	-0.11	0.12	
	-0.15	-0.22	-0.26	-0.38	-1.89	-0.27	-0.55	CP	-0.13	-0.04	-0.18	-0.31	-0.49	-4.14	-1.09	
	-0.70	-0.76	-0.77	-1.00	18.11	67.33	3.93	CPT	-0.69	-0.48	-0.67	-0.88	-1.21	52.37	68.34	
	75.4	74.8	70.6	62.5	5.3	1.2	13.4	THETA	77.2	75.6	73.6	69.3	62.9	0.9	0.8	
R= 8.05 DELTA= 90 DEG UINF= 21.7 M/S X/D= 1.07 Z/D= 0.97 PHI= 87.8 DEG	0.13	0.19	0.22	0.31	2.21	8.07	5.11	UB/UINF	0.17	0.17	0.19	0.23	0.30	4.54	8.08	R= 7.99 DELTA= 90 DEG UINF= 21.8 M/S X/D= 1.50 Z/D= 0.94 PHI= 87.8 DEG
	0.03	0.03	-0.05	0.07	0.09	-0.03	-0.19	VB/UINF	-0.10	-0.07	-0.06	-0.01	-0.05	0.04	0.02	
	-0.66	-0.71	-0.66	-0.50	-0.27	0.27	0.63	WB/UINF	-0.52	-0.69	-0.68	-0.71	-0.49	-0.53	0.19	
	-0.09	-0.12	-0.20	-0.42	-1.64	-0.80	-1.24	CP	-0.36	-0.09	-0.17	-0.16	-0.45	-2.00	-1.95	
	-0.64	-0.59	-0.71	-1.07	2.36	67.78	25.03	CPT	-1.05	-0.58	-0.67	-0.60	-1.11	18.29	66.69	
	78.5	75.1	71.8	58.8	7.3	1.9	7.4	THETA	72.2	76.3	74.1	72.1	58.3	6.6	1.3	
R= 8.01 DELTA= 90 DEG UINF= 21.8 M/S X/D= 1.13 Z/D= 0.96 PHI= 87.8 DEG	0.11	0.19	0.23	0.27	0.99	8.03	7.40	UB/UINF	0.52	0.82	1.03	1.31	7.57	1.86	0.19	R= 8.07 DELTA= 90 DEG UINF= 21.2 M/S X/D= 0.83 Z/D= 2.69 PHI= 66.6 DEG
	-0.01	-0.03	0.33	0.13	0.03	0.01	-0.01	VB/UINF	0.06	0.06	0.11	-0.20	-0.38	-0.19	-0.03	
	-0.64	-0.67	-0.72	-0.64	-0.64	0.36	0.29	WB/UINF	-0.33	0.40	1.32	1.33	2.33	0.64	-0.61	
	-0.12	-0.18	-0.14	-0.26	-1.64	-0.85	-2.17	CP	-0.35	-1.23	-2.65	-4.08	-2.02	-2.99	0.29	
	-0.70	-0.69	-0.57	-0.77	-1.66	67.04	54.69	CPT	-0.97	-1.20	-0.82	-1.55	63.88	-0.05	-0.31	
	79.9	73.9	72.0	67.6	2.9	2.6	2.3	THETA	32.7	26.4	51.9	46.0	17.5	20.0	72.5	
R= 8.03 DELTA= 90 DEG UINF= 21.8 M/S X/D= 1.19 Z/D= 0.96 PHI= 87.8 DEG	0.18	0.15	0.23	0.26	0.64	8.04	7.96	UB/UINF	0.59	0.85	0.91	1.06	3.34	6.67	0.33	R= 7.99 DELTA= 90 DEG UINF= 21.1 M/S X/D= 0.85 Z/D= 2.60 PHI= 66.7 DEG
	0.03	-0.07	-0.05	0.03	-0.15	0.12	-0.02	VB/UINF	-0.02	-0.02	-0.06	-0.03	-0.20	-0.19	0.01	
	-0.59	-0.75	-0.71	-0.68	0.07	0.44	-0.15	WB/UINF	-0.37	0.03	0.80	1.53	0.99	2.11	-0.60	
	-0.28	0.03	-0.15	-0.16	-1.35	-1.18	-0.67	CP	-3.35	-0.75	-1.56	-3.84	-7.07	-1.17	-0.51	
	-0.90	-0.38	-0.59	-0.63	-1.91	66.93	65.84	CPT	-0.87	-1.03	-1.10	-1.35	4.25	49.25	-1.03	
	73.3	78.5	72.3	68.8	14.5	3.2	1.1	THETA	32.2	3.0	41.4	55.3	17.0	17.7	61.0	
R= 8.13 DELTA= 90 DEG UINF= 21.7 M/S X/D= 1.26 Z/D= 0.96 PHI= 87.8 DEG	0.12	0.17	0.20	0.24	0.30	8.09	8.08	UB/UINF	0.63	0.66	0.83	0.83	3.60	5.10	0.71	R= 7.99 DELTA= 90 DEG UINF= 21.2 M/S X/D= 1.00 Z/D= 3.61 PHI= 57.1 DEG
	0.04	0.0	-0.02	-0.05	0.12	0.25	-0.04	VB/UINF	-0.07	0.10	0.17	-0.03	-0.10	-0.14	0.0	
	-0.74	-0.72	-0.69	-0.67	0.31	0.55	-0.16	WB/UINF	0.19	1.31	1.52	1.56	0.99	2.13	-0.05	
	0.15	-0.06	-0.16	-0.20	-0.94	-0.79	0.17	CP	-0.55	-0.97	-3.51	-3.67	-8.61	-5.76	-1.92	
	-0.28	-0.51	-0.65	-0.68	-1.74	68.47	68.85	CPT	-1.11	-0.50	-1.47	-1.53	4.52	24.78	-2.42	
	80.5	76.5	73.7	70.2	47.7	4.2	1.2	THETA	17.9	56.8	61.3	62.0	15.6	22.8	7.4	
R= 8.03 DELTA= 90 DEG UINF= 21.7 M/S X/D= 1.32 Z/D= 0.95 PHI= 87.8 DEG	0.12	0.21	0.22	0.24	0.35	7.97	8.04	UB/UINF	0.76	0.76	0.67	0.79	1.08	5.95	2.69	R= 8.01 DELTA= 90 DEG UINF= 21.4 M/S X/D= 1.22 Z/D= 3.45 PHI= 57.1 DEG
	-0.05	0.0	0.04	0.0	0.11	0.04	-0.04	VB/UINF	-0.05	0.03	0.06	-0.01	-0.12	-0.14	-0.14	
	-0.66	-0.65	-0.73	-0.69	-0.26	0.63	-0.11	WB/UINF	-0.05	0.51	1.34	1.66	1.25	1.93	1.37	
	-0.06	-0.23	-0.11	-0.18	-0.82	-0.59	-0.63	CP	-0.43	-0.89	-1.54	-4.16	-4.08	-9.15	-3.83	
	-0.61	-0.76	-0.53	-0.64	-1.62	66.49	67.28	CPT	-0.85	-1.05	-0.29	-1.77	-2.33	30.58	4.41	
	79.7	72.2	73.3	71.0	39.4	4.5	0.9	THETA	6.1	33.6	63.4	64.6	49.6	18.1	27.2	
R= 8.07 DELTA= 90 DEG UINF= 21.6 M/S X/D= 1.38 Z/D= 0.95 PHI= 87.8 DEG	0.13	0.20	0.19	0.23	0.31	7.95	8.10	UB/UINF	-0.04	-0.02	-0.02	-0.03	-0.03	0.05	0.05	
	-0.04	-0.02	-0.02	-0.03	-0.03	0.05	0.05	VB/UINF	-0.67	-0.72	-0.69	-0.72	-0.50	0.41	-0.01	
	-0.04	-0.12	-0.15	-0.16	-0.42	-1.97	-0.53	WB/UINF	-0.04	-0.12	-0.15	-0.16	-0.42	-1.97	-0.53	
	-0.57	-0.56	-0.68	-0.59	-1.08	64.53	68.38	CP								
	79.1	74.4	74.8	72.2	58.4	3.0	0.3	CPT								
								THETA								

APPENDIX B

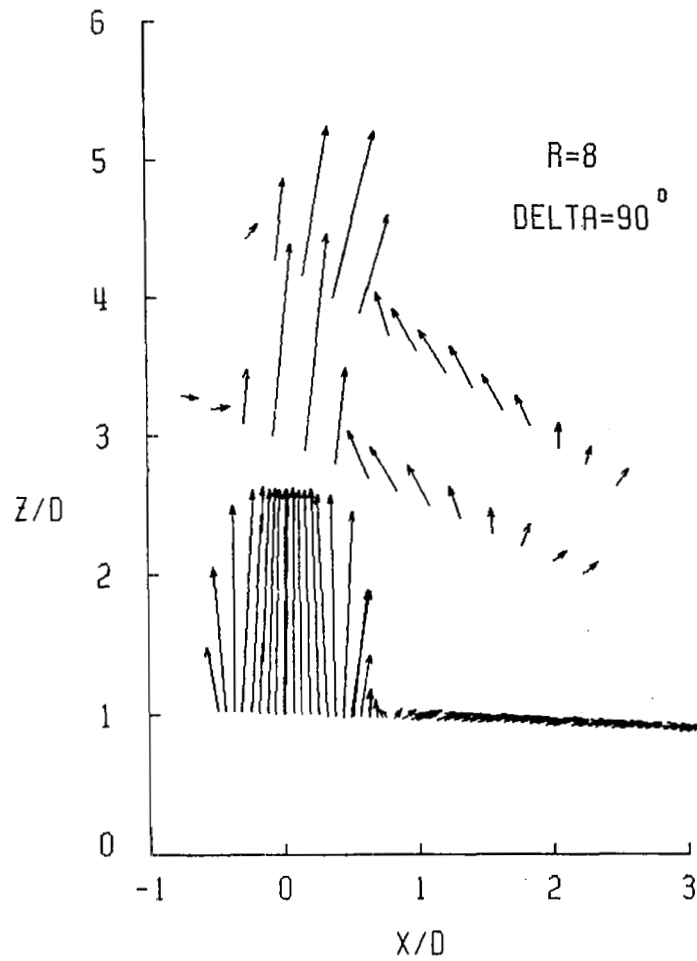
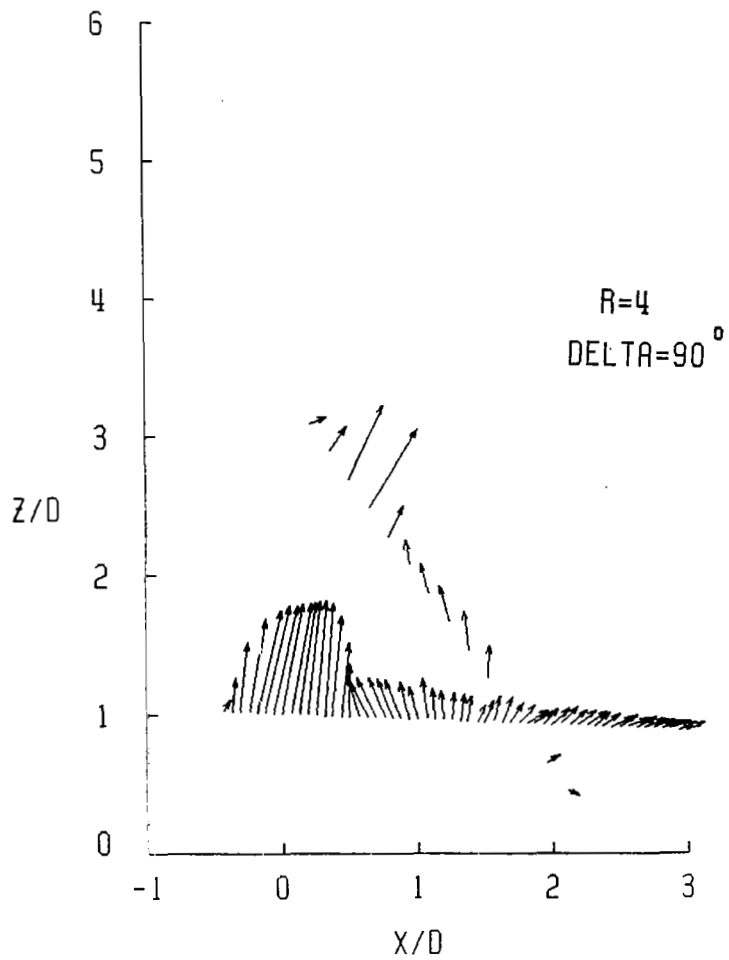

Figure B3.- Symmetry plane velocities near jet orifice.

TABLE B4.- TABULATED VALUES OF CROSS-SECTION VELOCITIES

AND PRESSURES FOR R = 4 AND DELTA = 45°

R= 4.05 DELTA= 45 DEG

R= 4.07 DELTA= 45 DEG

X/D= 6.96 UINF= 42.0 M/SEC
Z/D= 2.00 PHI= 11.0 DEG

X/D= 9.78 UINF= 41.9 M/SEC
Z/D= 2.63 PHI= 9.0 DEG

YB/D \ ZB/D		YB/D			
		0.0	0.93	1.73	
1.5		1.40	1.81	1.23	UB/UINF
		-0.05	0.25	0.25	VB/UINF
		0.27	0.02	-0.29	WB/UINF
		-0.39	-0.54	-0.36	CP
		0.66	1.83	0.30	CPT
	11.9	5.6	16.1	THETA	
1.0		1.26	1.77	1.41	UB/UINF
		-0.03	0.22	0.19	VB/UINF
		0.59	-0.06	-0.34	WB/UINF
		-0.51	-0.67	-0.44	CP
		0.43	1.54	0.73	CPT
	25.3	5.3	14.7	THETA	
0.5		1.10	1.97	1.43	UB/UINF
		-0.01	-0.04	0.03	VB/UINF
		0.65	0.0	-0.43	WB/UINF
		-0.34	-0.71	-0.49	CP
		0.30	2.24	0.76	CPT
	30.7	3.4	16.6	THETA	
0.0		1.01	1.55	1.14	UB/UINF
		0.07	-0.23	-0.23	VB/UINF
		0.39	0.04	-0.39	WB/UINF
		-0.15	-0.52	-0.25	CP
		0.03	0.96	0.26	CPT
	21.3	10.9	22.4	THETA	
-0.5		0.94	1.12	1.03	UB/UINF
		0.07	-0.28	-0.27	VB/UINF
		0.16	0.0	-0.27	WB/UINF
		0.02	-0.14	-0.12	CP
		-0.07	0.20	0.08	CPT
	10.0	16.3	21.6	THETA	
-1.0		0.93	0.98	1.02	UB/UINF
		0.06	-0.19	-0.20	VB/UINF
		-0.01	-0.07	-0.21	WB/UINF
		0.03	0.01	-0.07	CP
		-0.09	0.02	0.06	CPT
	0.9	13.8	17.0	THETA	
-1.5		0.84	0.98	1.01	UB/UINF
		0.04	-0.13	-0.16	VB/UINF
		-0.13	-0.13	-0.19	WB/UINF
		0.0	0.01	-0.03	CP
		-0.26	0.02	0.04	CPT
	8.9	12.4	14.8	THETA	

YB/D \ ZB/D		YB/D			
		0.0	1.12	2.22	
1.5		1.41	1.60	1.03	UB/UINF
		-0.02	0.22	0.16	VB/UINF
		0.29	-0.01	-0.29	WB/UINF
		-0.32	-0.33	-0.07	CP
		0.75	1.30	0.11	CPT
	12.3	5.5	17.4	THETA	
1.0		1.29	1.59	1.15	UB/UINF
		-0.02	0.12	0.10	VB/UINF
		0.43	-0.04	-0.31	WB/UINF
		-0.36	-0.36	-0.18	CP
		0.50	1.21	0.26	CPT
	19.1	2.7	15.5	THETA	
0.5		1.13	1.70	1.17	UB/UINF
		0.0	0.01	0.05	VB/UINF
		0.47	0.0	-0.37	WB/UINF
		-0.24	-0.35	-0.18	CP
		0.27	1.56	0.33	CPT
	22.9	1.7	17.5	THETA	
0.0		1.09	1.59	1.12	UB/UINF
		0.02	-0.13	-0.10	VB/UINF
		0.35	-0.02	-0.36	WB/UINF
		-0.21	-0.34	-0.13	CP
		0.12	1.23	0.27	CPT
	17.9	6.9	18.5	THETA	
-0.5		1.01	1.29	1.06	UB/UINF
		0.06	-0.25	-0.16	VB/UINF
		0.24	-0.03	-0.28	WB/UINF
		-0.06	-0.22	-0.09	CP
		0.02	0.51	0.14	CPT
	13.4	13.1	17.6	THETA	
-1.0		0.98	1.10	1.02	UB/UINF
		0.02	-0.21	-0.16	VB/UINF
		0.09	-0.05	-0.23	WB/UINF
		0.0	-0.09	-0.05	CP
		-0.02	0.17	0.07	CPT
	5.4	13.4	15.7	THETA	
-1.5		0.96	0.98	1.01	UB/UINF
		0.03	-0.13	-0.14	VB/UINF
		-0.03	-0.09	-0.19	WB/UINF
		0.0	0.0	-0.02	CP
		-0.07	0.0	0.05	CPT
	2.3	11.0	13.7	THETA	

APPENDIX B

TABLE B4.- Concluded

R= 4.05 DELTA= 45 DEG
 X/D= 19.93 UINF= 42.1 M/SEC
 Z/D= 4.30 PHI= 5.0 DEG

		YB/D	0.0	1.92	3.80	
ZB/D						
1.5		1.31	1.27	1.00	UB/UINF	
		-0.03	0.14	0.05	VB/UINF	
		0.17	-0.09	-0.16	WB/UINF	
		-0.19	-0.18	-0.01	CP	
		0.56	0.46	0.02	CPT	
	8.8	6.1	9.4	THETA		
1.0		1.23	1.25	1.01	UB/UINF	
		-0.03	0.10	0.02	VB/UINF	
		0.22	-0.11	-0.16	WB/UINF	
		-0.18	-0.16	-0.04	CP	
		0.40	0.43	0.01	CPT	
	11.4	5.8	9.2	THETA		
0.5		1.21	1.36	1.02	UB/UINF	
		-0.03	0.09	0.0	VB/UINF	
		0.27	-0.12	-0.17	WB/UINF	
		-0.17	-0.21	-0.06	CP	
		0.37	0.67	0.02	CPT	
	13.5	5.6	9.4	THETA		
0.0		1.16	1.38	1.02	UB/UINF	
		-0.01	0.01	-0.01	VB/UINF	
		0.28	-0.12	-0.18	WB/UINF	
		-0.14	-0.19	-0.07	CP	
		0.28	0.76	0.01	CPT	
	14.1	5.2	9.8	THETA		
-0.5		1.12	1.29	1.02	UB/UINF	
		0.02	-0.06	-0.02	VB/UINF	
		0.27	-0.15	-0.17	WB/UINF	
		-0.14	-0.20	-0.06	CP	
		0.20	0.50	0.01	CPT	
	13.8	7.8	9.3	THETA		
-1.0		1.11	1.23	1.02	UB/UINF	
		0.01	-0.09	-0.04	VB/UINF	
		0.19	-0.14	-0.16	WB/UINF	
		-0.14	-0.17	-0.06	CP	
		0.14	0.39	0.01	CPT	
	10.0	8.7	8.9	THETA		
-1.5		1.05	1.08	1.02	UB/UINF	
		0.02	-0.13	-0.04	VB/UINF	
		0.12	-0.10	-0.15	WB/UINF	
		-0.07	-0.08	-0.07	CP	
		0.05	0.12	0.01	CPT	
	7.2	9.9	8.8	THETA		

R= 4.05 DELTA= 45 DEG
 X/D= 19.92 UINF= 42.1 M/SEC
 Z/D= 2.55 PHI= 5.0 DEG

		YB/D	0.0	1.92	3.80	
ZB/D						
1.5		1.15	1.32	1.01	UB/UINF	
		0.0	-0.03	-0.01	VB/UINF	
		0.29	-0.15	-0.18	WB/UINF	
		-0.14	-0.16	-0.04	CP	
		0.26	0.63	0.02	CPT	
	14.6	7.2	10.1	THETA		
1.0		1.12	1.20	1.02	UB/UINF	
		0.01	-0.10	-0.04	VB/UINF	
		0.22	-0.13	-0.15	WB/UINF	
		-0.14	-0.14	-0.06	CP	
		0.17	0.34	0.0	CPT	
	11.7	8.8	8.7	THETA		
0.5		1.08	1.20	1.02	UB/UINF	
		0.02	-0.13	-0.04	VB/UINF	
		0.17	-0.13	-0.15	WB/UINF	
		-0.11	-0.14	-0.06	CP	
		0.08	0.34	0.01	CPT	
	9.5	9.9	8.5	THETA		
0.0		1.05	1.09	1.03	UB/UINF	
		0.01	-0.14	-0.04	VB/UINF	
		0.09	-0.10	-0.15	WB/UINF	
		-0.06	-0.10	-0.06	CP	
		0.05	0.13	0.02	CPT	
	5.5	10.3	8.5	THETA		
-0.5		1.03	1.06	1.03	UB/UINF	
		0.04	-0.11	-0.05	VB/UINF	
		0.03	-0.09	-0.13	WB/UINF	
		-0.03	-0.09	-0.07	CP	
		0.04	0.06	0.01	CPT	
	1.9	9.0	7.4	THETA		
-1.0		1.03	1.03	1.03	UB/UINF	
		0.03	-0.07	-0.05	VB/UINF	
		-0.02	-0.08	-0.12	WB/UINF	
		-0.07	-0.07	-0.07	CP	
		0.0	0.01	0.01	CPT	
	2.5	7.1	6.9	THETA		
-1.5		1.00	1.03	1.04	UB/UINF	
		0.02	-0.05	-0.04	VB/UINF	
		-0.06	-0.08	-0.11	WB/UINF	
		-0.08	-0.06	-0.07	CP	
		-0.07	0.01	0.02	CPT	
	4.4	6.0	6.3	THETA		

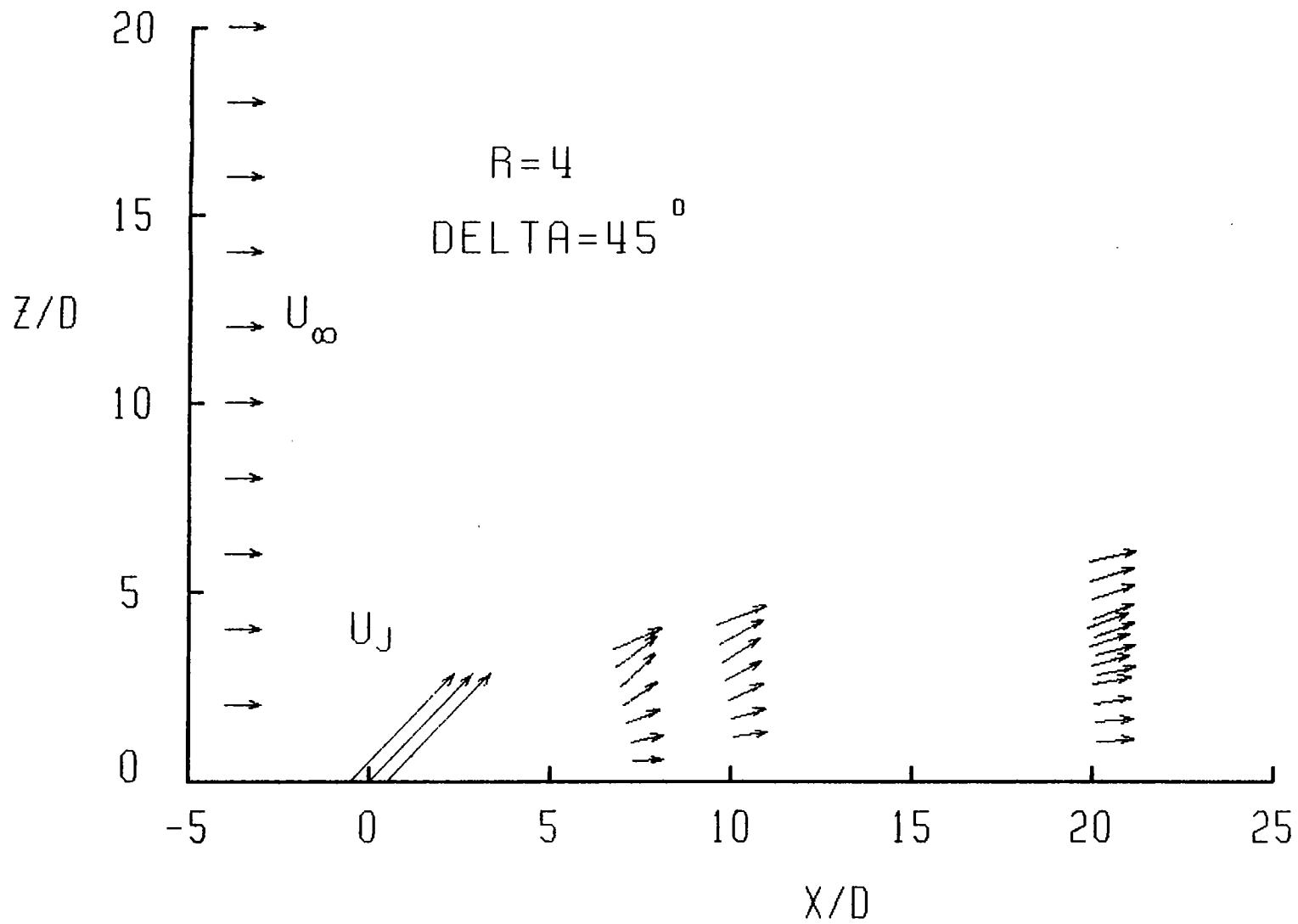

(a) Symmetry plane velocity plot locating cross sections of measurement.

Figure B4.- Cross-section velocities for $R = 4$ and $\text{DELTA} = 45^\circ$.

APPENDIX B

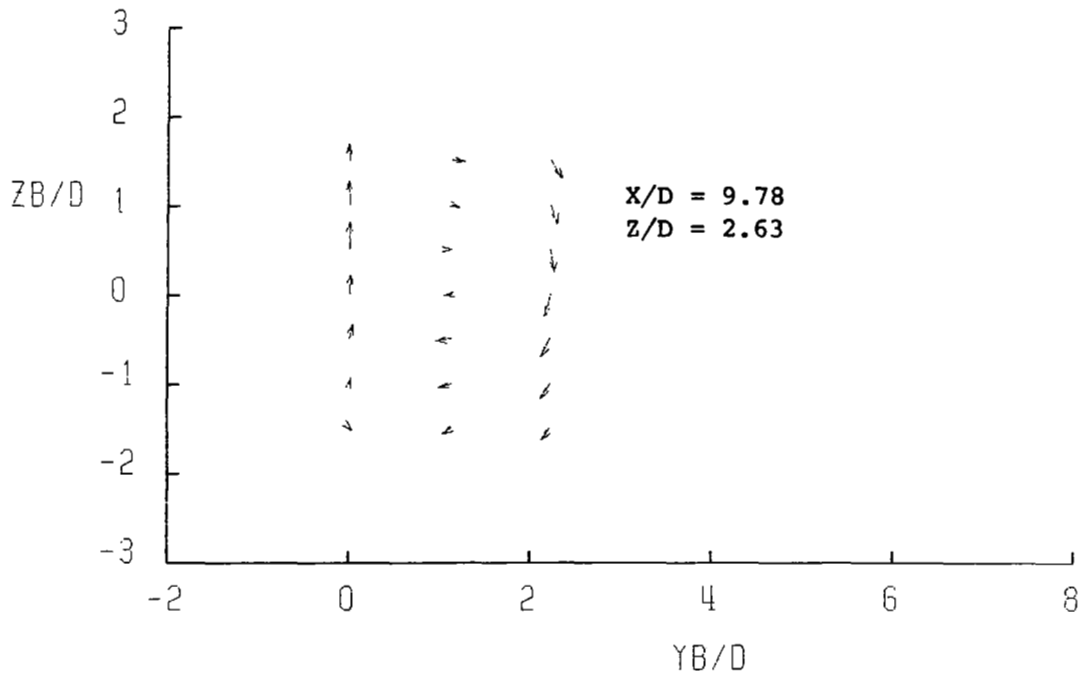
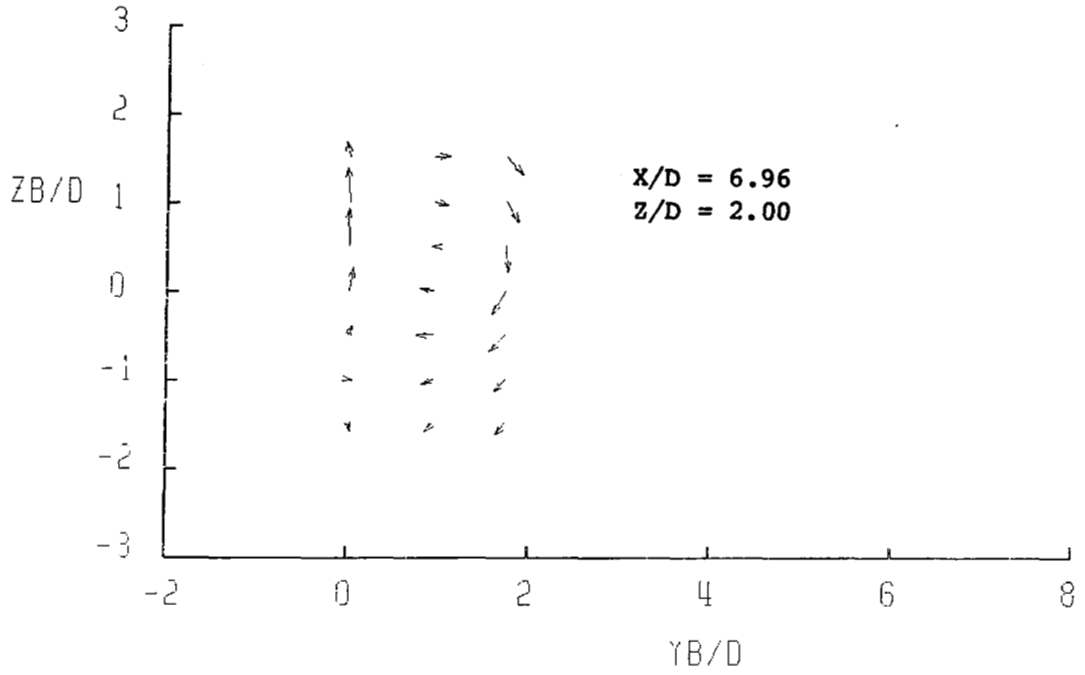

(b) Cross-section velocity plots.

Figure B4.- Continued.

APPENDIX B

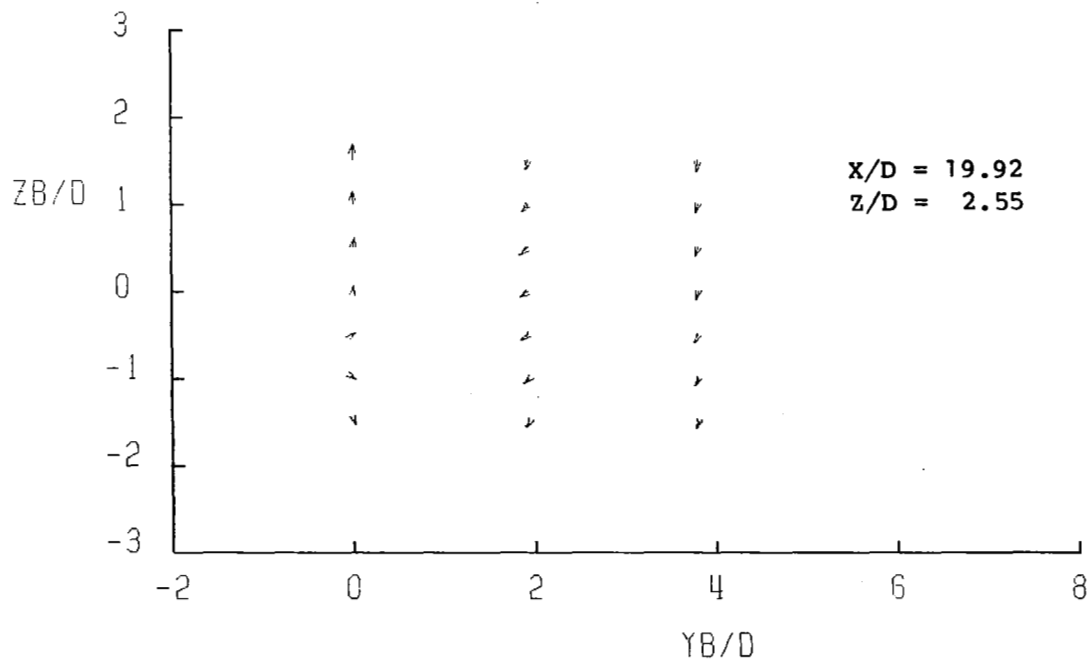
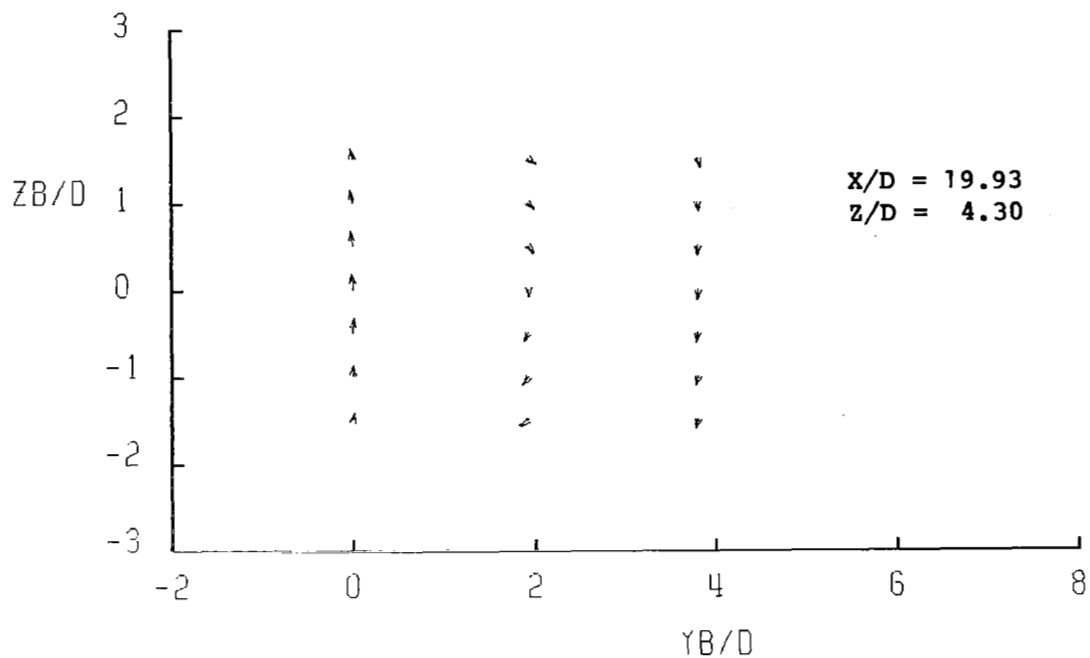

(b) Concluded.

Figure B4.- Concluded.

TABLE B5.- TABULATED VALUES OF CROSS-SECTION VELOCITIES

AND PRESSURES FOR R = 4 AND DELTA = 60°

R= 4.06 DELTA= 60 DEG					R= 4.00 DELTA= 60 DEG				
X/D= 1.96		UINF= 42.4 M/SEC			X/D= 5.96		UINF= 42.2 M/SEC		
Z/D= 2.20		PHI= 30.0 DEG			Z/D= 2.88		PHI= 13.0 DEG		
YB/D \ ZB/D	0.0	0.99	2.01		YB/D \ ZB/D	0.0	0.98	1.89	
1.5	0.80	0.82	0.84	UB/UINF	1.5	1.63	1.59	0.97	UB/UINF
	0.02	0.12	0.10	VB/UINF		0.0	0.31	0.19	VB/UINF
	-0.40	-0.44	-0.52	WB/UINF		0.22	0.05	-0.33	WB/UINF
	0.24	0.16	0.05	CP		-0.59	-0.52	-0.03	CP
	0.05	0.05	0.03	CPT		1.15	1.13	0.06	CPT
	26.6	28.8	31.8	THETA		8.2	9.3	21.1	THETA
1.0	0.83	0.83	0.86	UB/UINF	1.0	1.14	1.59	1.08	UB/UINF
	0.01	0.18	0.10	VB/UINF		-0.02	0.32	0.19	VB/UINF
	-0.29	-0.42	-0.53	WB/UINF		0.45	-0.05	-0.38	WB/UINF
	0.28	0.18	0.0	CP		-0.42	-0.69	-0.23	CP
	0.05	0.08	0.04	CPT		0.11	0.96	0.12	CPT
	19.3	28.2	31.8	THETA		21.9	9.5	20.8	THETA
0.5	1.64	0.85	0.88	UB/UINF	0.5	1.09	1.50	1.19	UB/UINF
	0.01	0.33	0.10	VB/UINF		-0.05	0.18	0.14	VB/UINF
	0.31	-0.44	-0.58	WB/UINF		0.77	-0.16	-0.45	WB/UINF
	-0.65	-0.02	-0.09	CP		-0.57	-0.87	-0.38	CP
	1.17	0.01	0.05	CPT		0.24	0.47	0.27	CPT
	10.8	32.0	33.6	THETA		35.6	7.7	21.1	THETA
0.0	2.41	2.18	0.88	UB/UINF	0.0	1.02	1.68	1.25	UB/UINF
	0.01	0.92	0.07	VB/UINF		-0.01	-0.16	0.0	VB/UINF
	0.31	-0.27	-0.66	WB/UINF		0.77	-0.09	-0.47	WB/UINF
	-2.12	-1.51	-0.19	CP		-0.49	-0.81	-0.45	CP
	2.91	3.31	0.02	CPT		0.13	1.10	0.35	CPT
	7.6	22.1	36.9	THETA		37.1	7.9	20.6	THETA
-0.5	0.90	2.93	0.88	UB/UINF	-0.5	0.95	1.64	1.05	UB/UINF
	0.0	0.69	-0.06	VB/UINF		0.0	-0.23	-0.20	VB/UINF
	1.05	-0.76	-0.74	WB/UINF		0.55	-0.05	-0.47	WB/UINF
	-1.34	-2.82	-0.29	CP		-0.26	-0.66	-0.21	CP
	-0.42	6.21	0.03	CPT		-0.04	1.13	0.16	CPT
	49.4	18.2	40.2	THETA		30.3	10.1	26.2	THETA
-1.0	0.98	1.77	0.92	UB/UINF	-1.0	0.94	1.17	1.02	UB/UINF
	-0.10	-0.40	-0.17	VB/UINF		0.02	-0.39	-0.24	VB/UINF
	0.94	-0.97	-0.71	WB/UINF		0.29	-0.08	-0.37	WB/UINF
	-1.13	-2.12	-0.34	CP		-0.09	-0.22	-0.13	CP
	-0.28	1.18	0.04	CPT		-0.12	0.31	0.12	CPT
	44.2	31.3	38.6	THETA		17.3	20.8	23.9	THETA
-1.5	0.88	1.00	0.93	UB/UINF	-1.5	0.91	0.97	0.99	UB/UINF
	-0.10	-0.59	-0.25	VB/UINF		0.01	-0.27	-0.22	VB/UINF
	0.23	-0.49	-0.64	WB/UINF		0.07	-0.08	-0.29	WB/UINF
	-0.19	-0.50	-0.29	CP		0.0	0.03	-0.05	CP
	-0.36	0.10	0.05	CPT		-0.16	0.05	0.06	CPT
	16.9	38.9	37.0	THETA		4.9	18.0	21.0	THETA

TABLE B5.- Continued

R= 4.03 DELTA= 60 DEG
 X/D= 9.94 UINF= 42.3 M/SEC
 Z/D= 3.38 PHI= 10.0 DEG

R= 4.05 DELTA= 60 DEG
 X/D= 9.95 UINF= 42.2 M/SEC
 Z/D= 3.88 PHI= 10.0 DEG

YB/D		0.0	1.54	3.10	
ZB/D					
1.5		1.26	1.33	0.99	UB/UINF
		-0.02	0.25	0.09	VB/UINF
		0.41	-0.19	-0.31	WB/UINF
		-0.36	-0.30	-0.04	CP
		0.40	0.58	0.05	CPT
	18.4	12.0	18.1	THETA	
1.0		1.17	1.37	1.01	UB/UINF
		0.02	0.10	0.03	VB/UINF
		0.53	-0.23	-0.32	WB/UINF
		-0.37	-0.38	-0.06	CP
		0.30	0.58	0.06	CPT
	24.6	9.9	17.7	THETA	
0.5		1.10	1.45	1.02	UB/UINF
		0.01	-0.04	-0.02	VB/UINF
		0.54	-0.19	-0.35	WB/UINF
		-0.30	-0.38	-0.07	CP
		0.22	0.78	0.10	CPT
	26.2	8.1	19.0	THETA	
0.0		1.03	1.46	1.01	UB/UINF
		0.03	-0.10	-0.07	VB/UINF
		0.44	-0.16	-0.32	WB/UINF
		-0.23	-0.38	-0.09	CP
		0.03	0.81	0.05	CPT
	23.3	8.6	17.9	THETA	
-0.5		1.00	1.30	1.01	UB/UINF
		0.02	-0.19	-0.10	VB/UINF
		0.32	-0.18	-0.30	WB/UINF
		-0.10	-0.27	-0.06	CP
		0.0	0.51	0.07	CPT
	17.6	12.8	17.4	THETA	
-1.0		0.95	1.07	1.01	UB/UINF
		-0.01	-0.27	-0.11	VB/UINF
		0.15	-0.19	-0.26	WB/UINF
		-0.04	-0.07	-0.05	CP
		-0.11	0.19	0.05	CPT
	9.7	18.3	15.8	THETA	
-1.5		0.58	1.02	1.01	UB/UINF
		0.04	-0.19	-0.12	VB/UINF
		0.04	-0.14	-0.23	WB/UINF
		-0.02	-0.02	-0.04	CP
		-0.06	0.08	0.05	CPT
	2.3	14.5	14.5	THETA	

YB/D		0.0	1.41	2.96	
ZB/D					
1.5		1.22	1.27	0.98	UB/UINF
		-0.04	0.28	0.11	VB/UINF
		0.22	-0.12	-0.27	WB/UINF
		-0.21	-0.22	0.0	CP
		0.34	0.50	0.04	CPT
	11.4	11.9	16.6	THETA	
1.0		1.19	1.34	1.01	UB/UINF
		0.0	0.21	0.07	VB/UINF
		0.46	-0.17	-0.28	WB/UINF
		-0.29	-0.36	-0.05	CP
		0.34	0.51	0.06	CPT
	21.3	10.0	16.0	THETA	
0.5		1.19	1.38	1.03	UB/UINF
		-0.01	0.10	0.05	VB/UINF
		0.54	-0.24	-0.32	WB/UINF
		-0.37	-0.39	-0.10	CP
		0.35	0.61	0.06	CPT
	24.7	10.0	17.4	THETA	
0.0		1.08	1.45	1.02	UB/UINF
		-0.03	-0.04	-0.02	VB/UINF
		0.54	-0.20	-0.31	WB/UINF
		-0.31	-0.42	-0.09	CP
		0.15	0.75	0.05	CPT
	26.7	8.3	17.0	THETA	
-0.5		1.04	1.48	1.01	UB/UINF
		0.05	-0.09	-0.04	VB/UINF
		0.45	-0.18	-0.32	WB/UINF
		-0.22	-0.38	-0.08	CP
		0.06	0.87	0.05	CPT
	23.3	8.7	17.6	THETA	
-1.0		0.99	1.26	1.02	UB/UINF
		0.05	-0.21	-0.09	VB/UINF
		0.31	-0.18	-0.29	WB/UINF
		-0.09	-0.18	-0.06	CP
		-0.01	0.48	0.06	CPT
	17.2	13.7	16.7	THETA	
-1.5		0.98	1.09	1.01	UB/UINF
		0.04	-0.24	-0.10	VB/UINF
		0.15	-0.16	-0.27	WB/UINF
		-0.07	-0.08	-0.06	CP
		-0.09	0.20	0.06	CPT
	8.7	16.3	16.0	THETA	

APPENDIX B

TABLE B5.- Continued

R= 4.06 DELTA= 60 DEG
 X/D= 19.78 UINF= 42.2 M/SEC
 Z/D= 4.75 PHI= 7.0 DEG

R= 4.03 DELTA= 60 DEG
 X/D= 19.70 UINF= 42.1 M/SEC
 Z/D= 3.44 PHI= 7.0 DEG

YB/D \ ZB/D		YB/D			
		0.0	1.94	3.93	
1.5		1.23	1.23	0.98	UB/UINF
		-0.01	0.13	0.04	VB/UINF
		0.29	-0.17	-0.23	WB/UINF
		-0.24	-0.18	0.0	CP
		0.37	0.38	0.03	CPT
	13.9	9.1	13.3	THETA	
1.0		1.15	1.21	1.02	UB/UINF
		-0.01	0.04	0.0	VB/UINF
		0.32	-0.15	-0.22	WB/UINF
		-0.20	-0.19	-0.04	CP
		0.22	0.31	0.05	CPT
	16.1	6.9	12.0	THETA	
0.5		1.12	1.20	1.01	UB/UINF
		0.03	-0.06	-0.02	VB/UINF
		0.32	-0.18	-0.21	WB/UINF
		-0.15	-0.15	-0.06	CP
		0.22	0.33	0.02	CPT
	15.8	9.4	11.8	THETA	
0.0		1.10	1.22	1.02	UB/UINF
		0.01	-0.09	-0.03	VB/UINF
		0.30	-0.15	-0.19	WB/UINF
		-0.16	-0.21	-0.10	CP
		0.14	0.31	-0.01	CPT
	15.4	9.0	10.5	THETA	
-0.5		1.06	1.15	1.00	UB/UINF
		0.0	-0.13	-0.05	VB/UINF
		0.22	-0.15	-0.21	WB/UINF
		-0.10	-0.14	-0.06	CP
		0.08	0.24	0.0	CPT
	12.2	10.8	11.8	THETA	
-1.0		1.00	1.11	1.01	UB/UINF
		0.04	-0.14	-0.06	VB/UINF
		0.13	-0.14	-0.19	WB/UINF
		-0.04	-0.10	-0.06	CP
		-0.01	0.17	0.0	CPT
	7.7	11.4	11.1	THETA	
-1.5		1.04	1.05	1.02	UB/UINF
		0.02	-0.13	-0.06	VB/UINF
		0.07	-0.13	-0.17	WB/UINF
		-0.08	-0.07	-0.08	CP
		0.03	0.08	0.01	CPT
	4.7	11.2	10.0	THETA	

YB/D \ ZB/D		YB/D			
		0.0	1.94	3.93	
1.5		1.11	1.19	1.00	UB/UINF
		-0.02	-0.08	-0.02	VB/UINF
		0.30	-0.19	-0.24	WB/UINF
		-0.16	-0.13	-0.02	CP
		0.17	0.34	0.04	CPT
	16.0	10.6	13.4	THETA	
1.0		1.08	1.19	1.00	UB/UINF
		0.03	-0.12	-0.05	VB/UINF
		0.24	-0.14	-0.20	WB/UINF
		-0.15	-0.15	-0.04	CP
		0.08	0.31	0.0	CPT
	12.8	10.0	11.5	THETA	
0.5		1.06	1.12	1.01	UB/UINF
		0.02	-0.15	-0.06	VB/UINF
		0.17	-0.16	-0.19	WB/UINF
		-0.14	-0.11	-0.05	CP
		0.02	0.19	0.01	CPT
	9.5	12.1	11.2	THETA	
0.0		1.04	1.10	1.02	UB/UINF
		0.02	-0.14	-0.06	VB/UINF
		0.13	-0.13	-0.17	WB/UINF
		-0.08	-0.12	-0.08	CP
		0.01	0.12	0.0	CPT
	7.5	11.0	9.7	THETA	
-0.5		1.03	1.05	1.02	UB/UINF
		0.02	-0.13	-0.06	VB/UINF
		0.03	-0.13	-0.17	WB/UINF
		-0.07	-0.09	-0.07	CP
		0.0	0.06	0.0	CPT
	3.2	11.0	9.9	THETA	
-1.0		1.00	1.03	1.02	UB/UINF
		0.03	-0.10	-0.05	VB/UINF
		-0.03	-0.12	-0.16	WB/UINF
		-0.04	-0.06	-0.07	CP
		-0.02	0.03	0.0	CPT
	2.5	9.7	8.9	THETA	
-1.5		1.00	1.02	1.03	UB/UINF
		0.01	-0.08	-0.05	VB/UINF
		-0.06	-0.12	-0.15	WB/UINF
		-0.05	-0.06	-0.08	CP
		-0.03	0.02	0.01	CPT
	4.6	9.0	8.6	THETA	

TABLE B5.- Concluded

R= 4.05 DELTA= 60 DEG
 X/D= 3.95 UINF= 42.2 M/SEC
 Z/D= 2.08 PHI= 19.0 DEG

YB/D \ ZB/D	0.0	1.07	1.74	3.46	
1.5	2.31	1.54	0.90	0.94	UB/UINF
	0.0	0.45	0.28	0.05	VB/UINF
	0.39	0.04	-0.44	-0.41	WB/UINF
	-1.39	-0.88	-0.04	0.01	CP
	3.20	0.70	0.04	0.06	CPT
	10.0	14.4	29.4	23.8	THETA
1.0	0.98	2.11	1.12	0.97	UB/UINF
	-0.04	0.39	0.30	0.02	VB/UINF
	0.43	-0.07	-0.50	-0.40	WB/UINF
	-0.59	-1.44	-0.52	-0.05	CP
	-0.43	2.24	0.08	0.06	CPT
	24.4	8.9	27.0	22.4	THETA
0.5	0.90	1.87	1.32	0.98	UB/UINF
	-0.04	0.22	0.16	-0.01	VB/UINF
	0.58	-0.45	-0.63	-0.42	WB/UINF
	-1.02	-1.57	-0.85	-0.07	CP
	-0.24	1.23	0.33	0.07	CPT
	47.5	14.1	25.9	23.5	THETA
0.0	0.77	2.11	1.20	0.99	UB/UINF
	0.09	-0.22	-0.15	-0.05	VB/UINF
	0.95	-0.37	-0.67	-0.41	WB/UINF
	-0.55	-1.43	-0.73	-0.09	CP
	-0.04	2.28	0.18	0.06	CPT
	51.2	12.7	30.1	22.7	THETA
-0.5	0.81	1.31	1.02	0.98	UB/UINF
	0.02	-0.51	-0.37	-0.08	VB/UINF
	0.47	-0.25	-0.54	-0.40	WB/UINF
	-0.09	-0.65	-0.32	-0.08	CP
	-0.20	0.40	0.15	0.06	CPT
	30.2	25.3	33.6	22.7	THETA
-1.0	0.86	0.99	0.98	0.99	UB/UINF
	0.02	-0.39	-0.32	-0.08	VB/UINF
	0.09	-0.18	-0.38	-0.38	WB/UINF
	0.01	-0.09	-0.12	-0.07	CP
	-0.23	0.09	0.09	0.06	CPT
	5.8	25.1	27.5	21.8	THETA
-1.5	0.82	0.96	0.97	0.99	UB/UINF
	0.04	-0.25	-0.25	-0.10	VB/UINF
	-0.16	-0.22	-0.33	-0.36	WB/UINF
	0.03	0.02	-0.05	-0.09	CP
	-0.27	0.07	0.06	0.05	CPT
	11.3	20.7	23.6	20.7	THETA

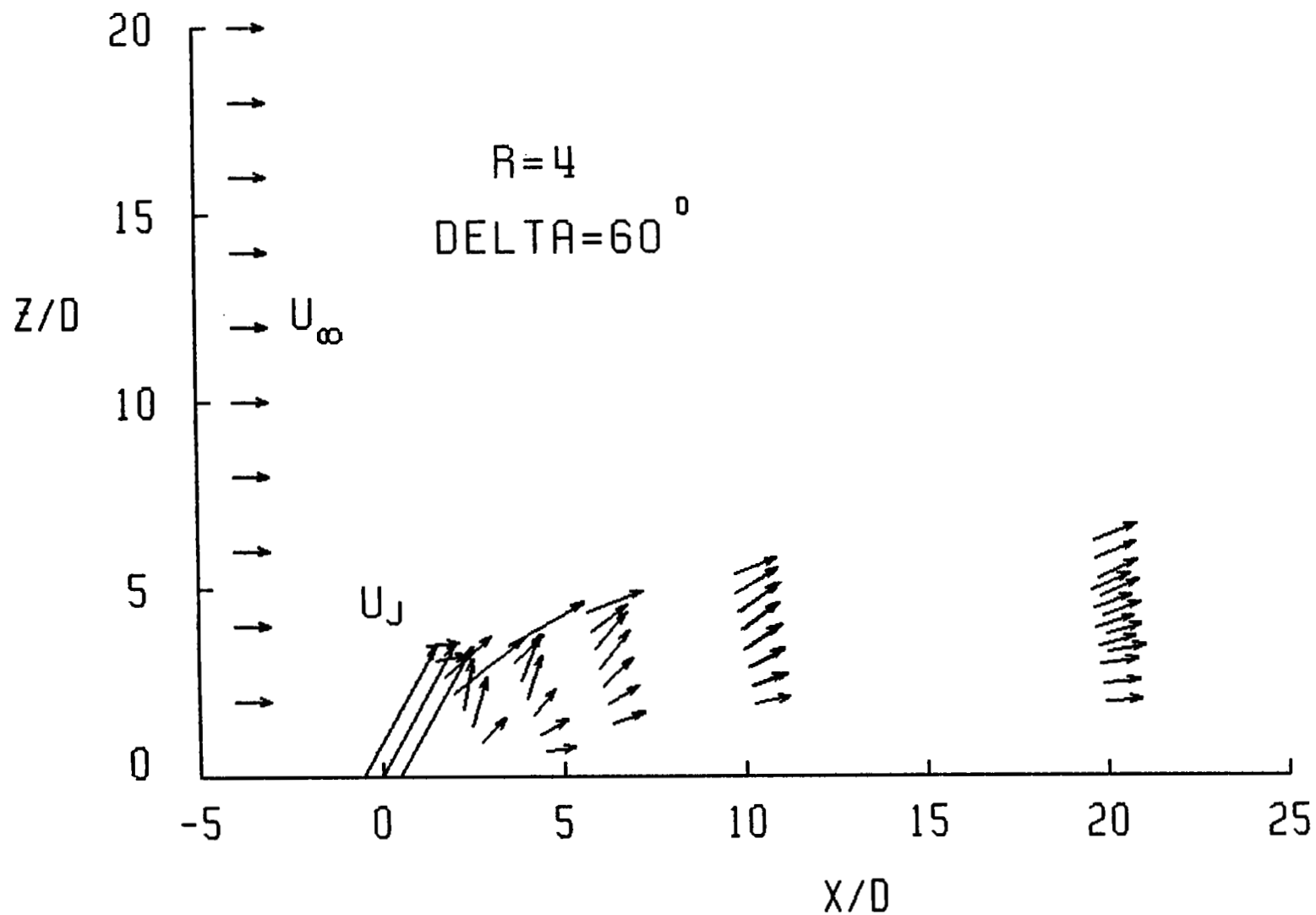

(a) Symmetry plane velocity plot locating cross sections of measurement.

Figure B5.- Cross-section velocities for $R = 4$ and $\text{DELTA} = 60^\circ$.

APPENDIX B

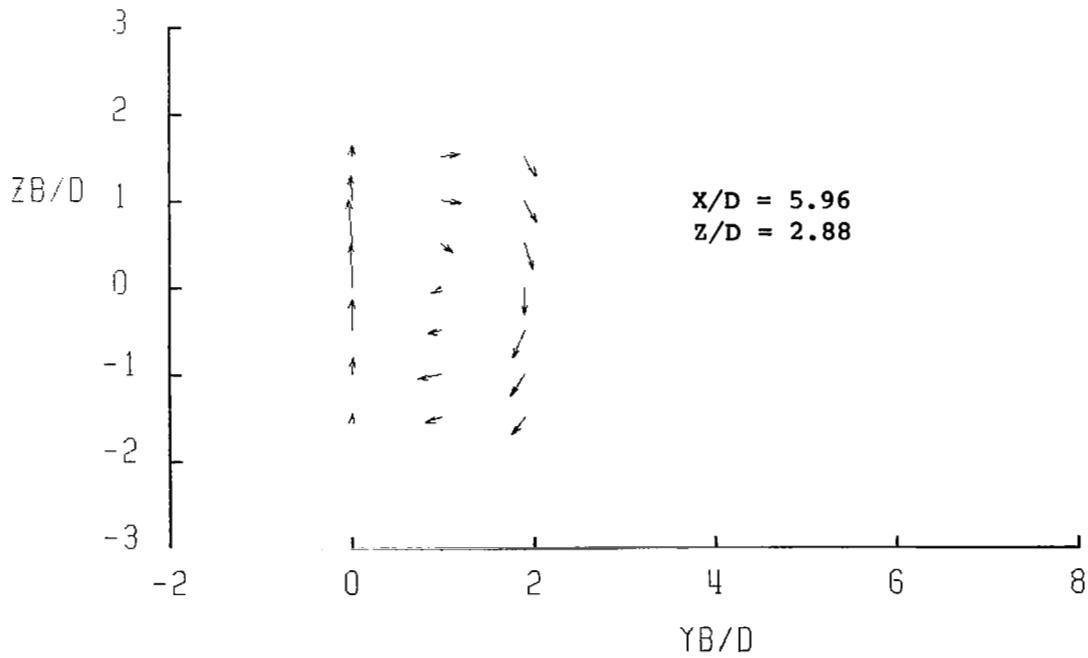
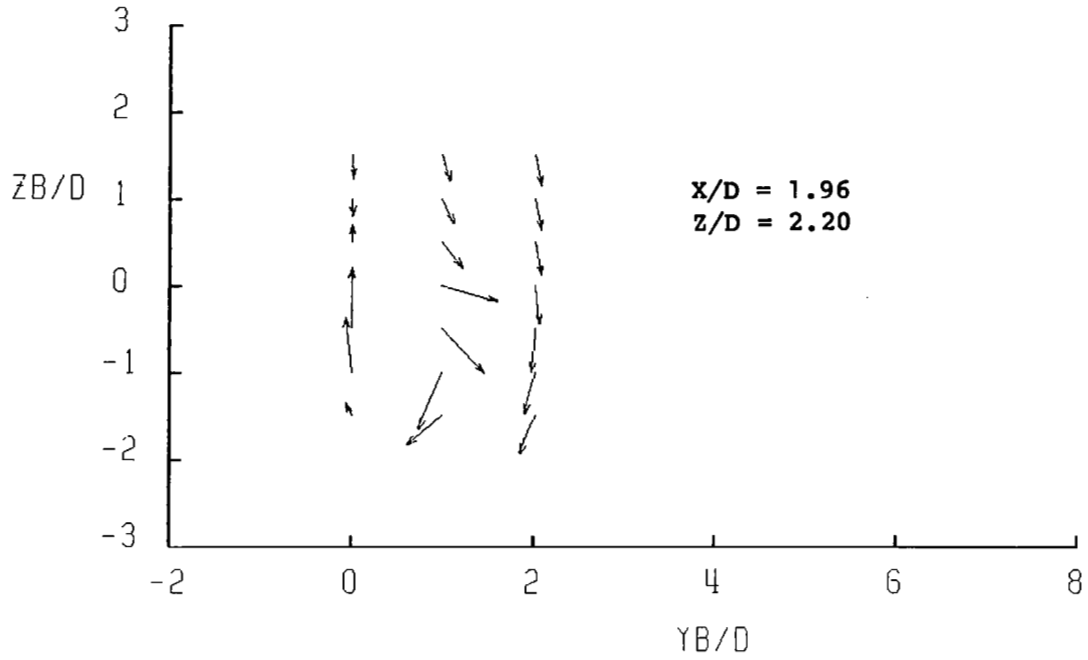

(b) Cross-section velocity plots.

Figure B5.- Continued.

APPENDIX B

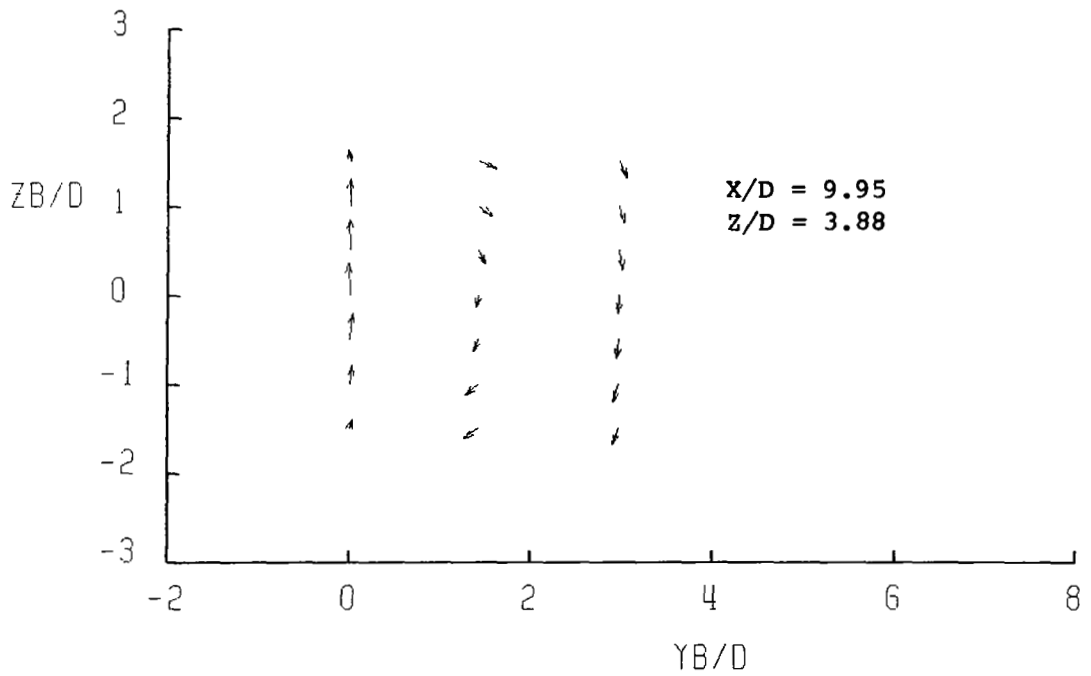
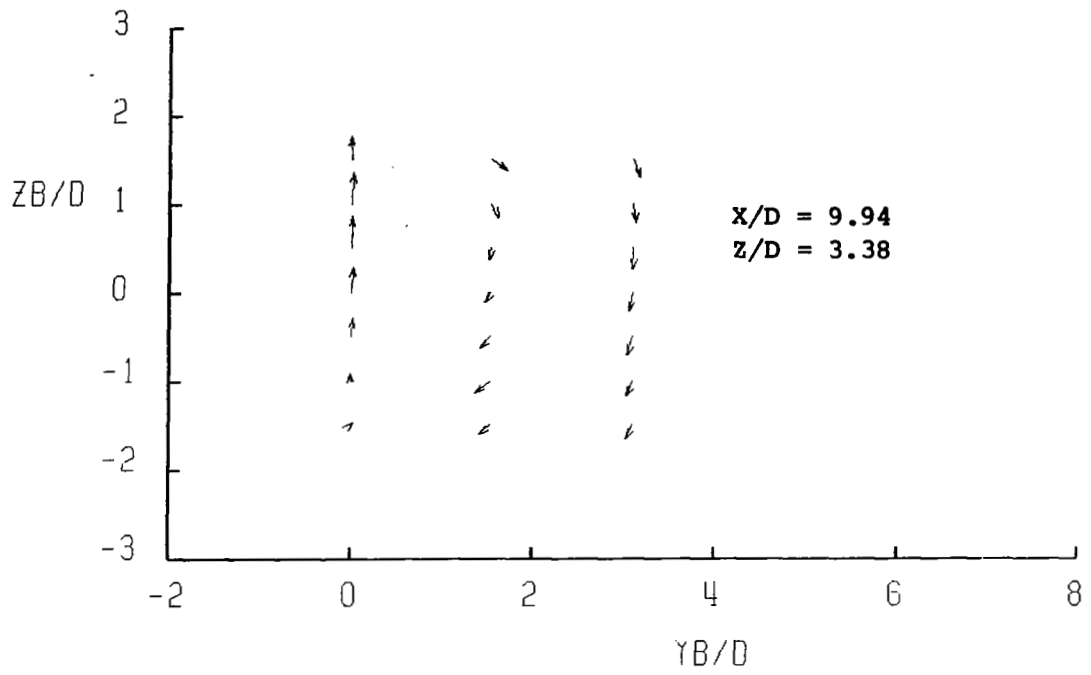

(b) Continued.

Figure B5.- Continued.

APPENDIX B

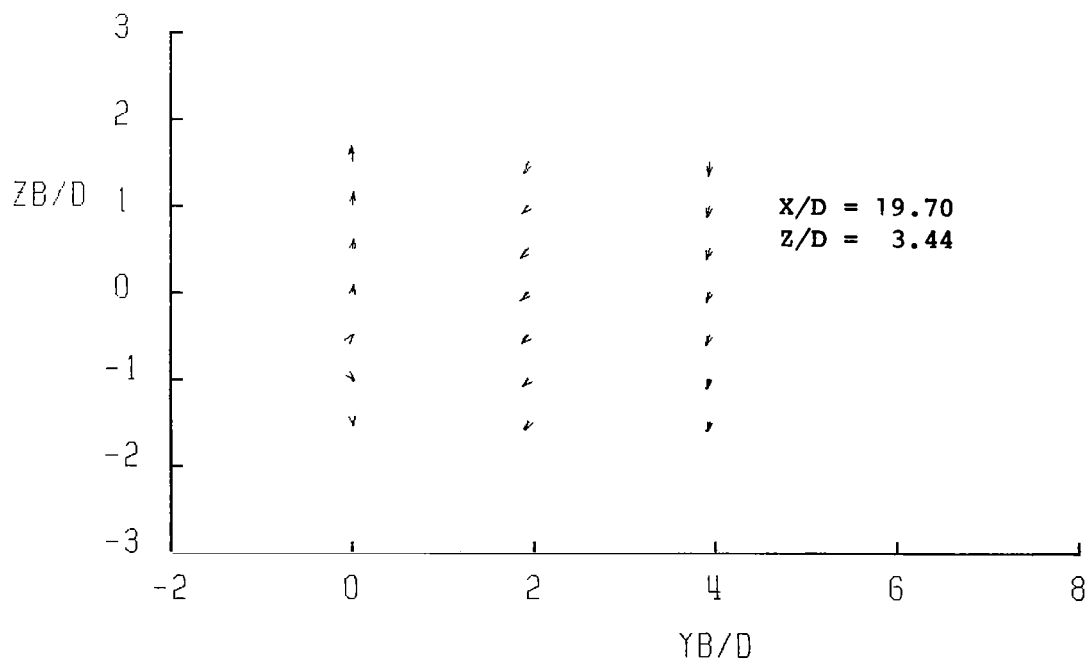
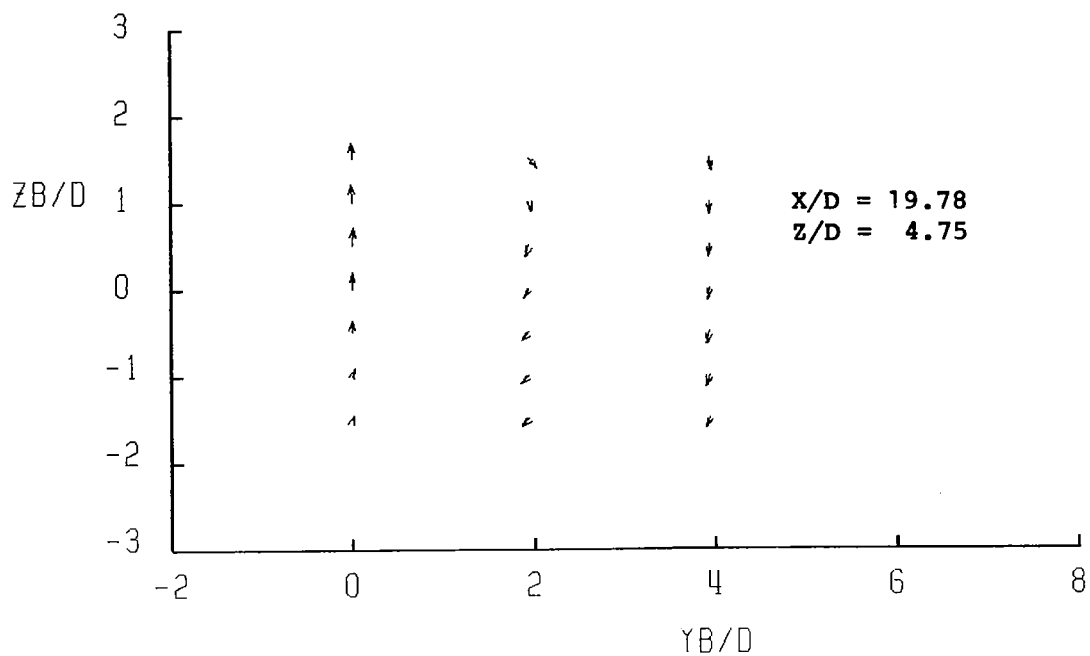

(b) Continued.

Figure B5.- Continued.

APPENDIX B

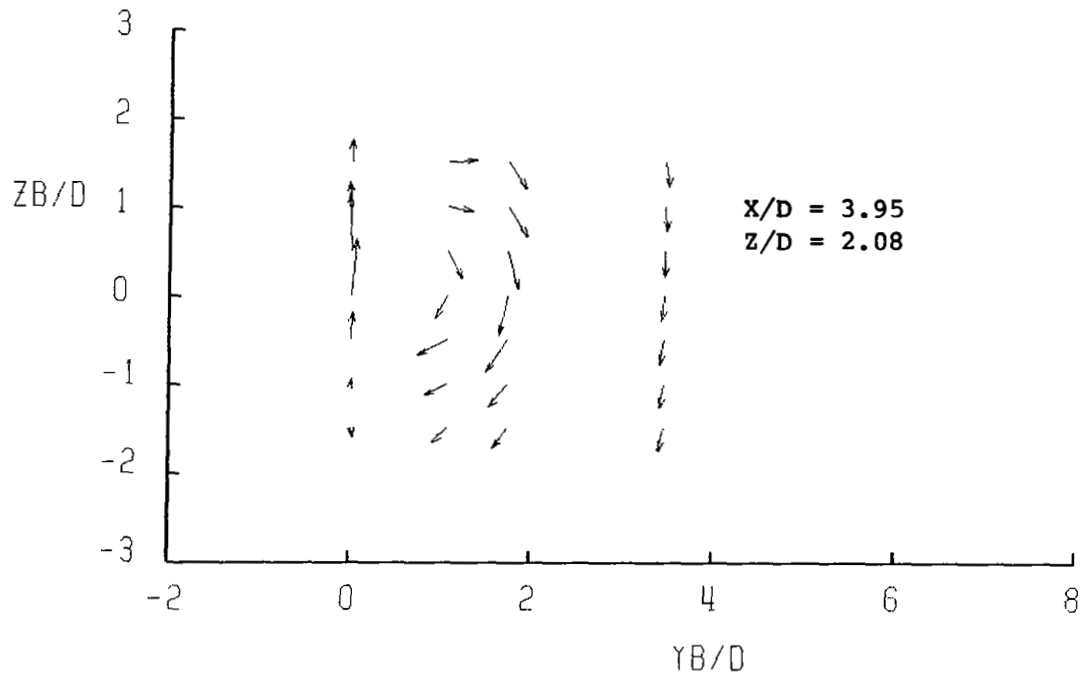

(b) Concluded.

Figure B5.- Concluded.

TABLE B6.- TABULATED VALUES OF CROSS-SECTION VELOCITIES

AND PRESSURES FOR R = 4 AND DELTA = 75°

R= 4.03 DELTA= 75 DEG
 X/D= 1.96 UINF= 42.0 M/SEC
 Z/D= 2.11 PHI= 28.0 DEG

R= 4.07 DELTA= 75 DEG
 X/D= 2.96 UINF= 42.2 M/SEC
 Z/D= 2.19 PHI= 22.9 DEG

YB/D \ ZB/D		YB/D			
		0.0	1.03	2.00	
1.5		0.79	0.78	0.82	UB/UINF
		0.03	0.29	0.18	VB/UINF
		-0.15	-0.37	-0.51	WB/UINF
		0.15	0.23	0.06	CP
		-0.20	0.06	0.04	CPT
	10.5	30.1	33.0	THETA	
1.0		2.75	1.04	0.87	UB/UINF
		0.01	0.52	0.20	VB/UINF
		0.90	-0.24	-0.58	WB/UINF
		-1.45	-0.59	-0.06	CP
		6.19	-0.18	0.07	CPT
	18.2	27.4	34.9	THETA	
0.5		0.95	2.48	0.90	UB/UINF
		0.0	0.83	0.14	VB/UINF
		0.48	0.07	-0.69	WB/UINF
		-1.72	-2.26	-0.28	CP
		-1.57	3.78	0.03	CPT
	26.6	16.9	37.8	THETA	
0.0		0.50	2.43	0.91	UB/UINF
		0.09	0.58	0.0	VB/UINF
		1.22	-0.40	-0.78	WB/UINF
		-1.83	-3.09	-0.45	CP
		-1.06	2.48	0.0	CPT
	67.5	14.7	40.7	THETA	
-0.5		0.65	1.88	0.92	UB/UINF
		-0.03	-0.19	-0.22	VB/UINF
		1.16	-0.76	-0.79	WB/UINF
		-1.60	-2.48	-0.44	CP
		-0.82	0.74	0.08	CPT
	60.7	23.1	42.1	THETA	
-1.0		0.55	1.03	0.97	UB/UINF
		-0.02	-0.68	-0.30	VB/UINF
		0.62	-0.50	-0.65	WB/UINF
		-0.52	-0.75	-0.38	CP
		-0.82	0.04	0.07	CPT
	48.7	41.0	37.0	THETA	
-1.5		0.69	1.00	0.97	UB/UINF
		0.0	-0.44	-0.30	VB/UINF
		-0.03	-0.41	-0.56	WB/UINF
		-0.38	-0.29	-0.25	CP
		-0.90	0.08	0.10	CPT
	3.5	32.5	33.8	THETA	

YB/D \ ZB/D		YB/D			
		0.0	0.93	1.78	
1.5		2.21	1.99	0.88	UB/UINF
		0.0	0.50	0.28	VB/UINF
		0.36	0.23	-0.50	WB/UINF
		-2.02	-1.51	-0.03	CP
		2.11	1.84	0.07	CPT
	9.6	13.9	32.8	THETA	
1.0		0.72	1.93	0.98	UB/UINF
		-0.02	0.41	0.27	VB/UINF
		0.51	0.0	-0.61	WB/UINF
		-1.02	-1.80	-0.40	CP
		-1.24	1.16	0.02	CPT
	35.5	10.1	34.0	THETA	
0.5		0.71	1.51	1.08	UB/UINF
		0.10	0.22	0.13	VB/UINF
		0.96	-0.26	-0.73	WB/UINF
		-1.58	-2.05	-0.73	CP
		-1.14	-0.62	0.01	CPT
	53.6	11.5	34.3	THETA	
0.0		0.70	1.63	1.01	UB/UINF
		0.06	-0.22	-0.17	VB/UINF
		1.02	-0.22	-0.79	WB/UINF
		-1.14	-1.80	-0.59	CP
		-0.59	0.0	0.09	CPT
	55.4	12.2	38.9	THETA	
-0.5		0.65	1.28	0.96	UB/UINF
		0.03	-0.53	-0.37	VB/UINF
		0.64	-0.21	-0.66	WB/UINF
		-0.53	-0.90	-0.35	CP
		-0.69	0.07	0.15	CPT
	44.5	26.0	38.8	THETA	
-1.0		0.73	0.90	0.98	UB/UINF
		0.01	-0.46	-0.33	VB/UINF
		0.14	-0.26	-0.47	WB/UINF
		-0.37	-0.14	-0.22	CP
		-0.82	-0.04	0.08	CPT
	11.1	32.0	31.4	THETA	
-1.5		0.64	0.93	0.97	UB/UINF
		0.07	-0.30	-0.28	VB/UINF
		-0.12	-0.28	-0.42	WB/UINF
		-0.21	-0.06	-0.13	CP
		-0.78	-0.02	0.07	CPT
	11.1	25.0	28.3	THETA	

APPENDIX B

TABLE B6.- Continued

R= 4.07 DELTA= 75 DEG
 X/D= 7.51 UINF= 42.5 M/SEC
 Z/D= 3.39 PHI= 14.0 DEG

YB/D		0.0	1.61	3.68	
ZB/D					
1.5		1.07	1.24	0.96	UB/UINF
		-0.02	0.25	0.07	VB/UINF
		0.25	-0.27	-0.35	WB/UINF
		-0.50	-0.33	0.0	CP
		-0.29	0.36	0.06	CPT
	13.9	15.6	20.6	THETA	
1.0		1.02	1.32	1.01	UB/UINF
		0.02	0.15	0.04	VB/UINF
		0.46	-0.29	-0.35	WB/UINF
		-0.47	-0.48	-0.04	CP
		-0.21	0.39	0.10	CPT
	24.1	13.4	19.3	THETA	
0.5		0.98	1.33	1.00	UB/UINF
		0.0	0.06	0.0	VB/UINF
		0.47	-0.34	-0.37	WB/UINF
		-0.41	-0.48	-0.06	CP
		-0.23	0.42	0.08	CPT
	25.8	14.3	20.6	THETA	
0.0		0.95	1.30	1.00	UB/UINF
		-0.01	-0.05	-0.03	VB/UINF
		0.43	-0.34	-0.36	WB/UINF
		-0.33	-0.40	-0.06	CP
		-0.24	0.41	0.08	CPT
	24.8	15.2	20.1	THETA	
-0.5		0.93	1.18	0.97	UB/UINF
		-0.01	-0.21	-0.07	VB/UINF
		0.32	-0.33	-0.37	WB/UINF
		-0.28	-0.27	-0.05	CP
		-0.31	0.29	0.04	CPT
	19.2	19.2	20.9	THETA	
-1.0		0.90	1.05	1.00	UB/UINF
		0.03	-0.25	-0.08	VB/UINF
		0.15	-0.29	-0.32	WB/UINF
		-0.27	-0.14	-0.05	CP
		-0.44	0.11	0.06	CPT
	9.6	21.1	18.3	THETA	
-1.5		0.90	1.00	1.00	UB/UINF
		0.04	-0.19	-0.08	VB/UINF
		0.01	-0.24	-0.30	WB/UINF
		-0.22	-0.07	-0.07	CP
		-0.40	0.02	0.03	CPT
	0.8	17.9	17.2	THETA	

R= 4.08 DELTA= 75 DEG
 X/D= 9.95 UINF= 42.0 M/SEC
 Z/D= 4.00 PHI= 8.9 DEG

YB/D		0.0	2.00	4.00	
ZB/D					
1.5		1.02	1.14	0.98	UB/UINF
		0.0	0.21	0.06	VB/UINF
		0.29	-0.18	-0.26	WB/UINF
		-0.26	-0.20	0.0	CP
		-0.12	0.18	0.04	CPT
	15.9	12.8	15.0	THETA	
1.0		1.00	1.19	1.01	UB/UINF
		0.0	0.13	0.04	VB/UINF
		0.35	-0.18	-0.25	WB/UINF
		-0.31	-0.29	-0.03	CP
		-0.18	0.17	0.06	CPT
	19.5	10.0	13.9	THETA	
0.5		0.98	1.23	1.02	UB/UINF
		0.03	0.07	0.02	VB/UINF
		0.42	-0.18	-0.26	WB/UINF
		-0.28	-0.32	-0.06	CP
		-0.14	0.25	0.06	CPT
	23.4	8.6	14.5	THETA	
0.0		1.01	1.28	1.03	UB/UINF
		0.04	-0.01	0.0	VB/UINF
		0.40	-0.20	-0.25	WB/UINF
		-0.34	-0.36	-0.08	CP
		-0.15	0.32	0.04	CPT
	21.4	9.2	13.9	THETA	
-0.5		0.96	1.19	1.01	UB/UINF
		0.03	-0.11	-0.04	VB/UINF
		0.31	-0.20	-0.26	WB/UINF
		-0.29	-0.24	-0.05	CP
		-0.26	0.24	0.05	CPT
	17.9	11.5	14.7	THETA	
-1.0		0.95	1.15	1.03	UB/UINF
		0.06	-0.16	-0.04	VB/UINF
		0.23	-0.20	-0.24	WB/UINF
		-0.22	-0.21	-0.07	CP
		-0.25	0.18	0.05	CPT
	13.5	13.6	13.4	THETA	
-1.5		0.89	1.05	1.02	UB/UINF
		0.03	-0.17	-0.05	VB/UINF
		0.11	-0.17	-0.22	WB/UINF
		-0.19	-0.12	-0.07	CP
		-0.38	0.06	0.03	CPT
	7.2	13.9	12.6	THETA	

TABLE B6.- Concluded

R= 4.03 DELTA= 75 DEG

X/D= 19.94 UINF= 42.2 M/SEC
 Z/D= 5.45 PHI= 8.0 DEG

YB/D \ ZB/D	0.0	2.45	4.90	
1.5	1.07	1.05	1.00	UB/UINF
	-0.01	0.10	0.04	VB/UINF
	0.10	-0.19	-0.21	WB/UINF
	-0.19	-0.09	-0.03	CP
	-0.02	0.06	0.03	CPT
	6.5	11.1	12.5	THETA
1.0	1.05	1.06	0.98	UB/UINF
	-0.02	0.06	0.01	VB/UINF
	0.13	-0.19	-0.20	WB/UINF
	-0.16	-0.14	-0.03	CP
	-0.04	0.02	-0.02	CPT
	8.3	10.3	11.9	THETA
0.5	1.04	1.09	1.01	UB/UINF
	-0.01	0.02	0.0	VB/UINF
	0.19	-0.20	-0.21	WB/UINF
	-0.16	-0.13	-0.06	CP
	-0.04	0.10	0.01	CPT
	11.0	10.2	11.7	THETA
0.0	1.01	1.11	1.00	UB/UINF
	0.0	-0.01	-0.01	VB/UINF
	0.17	-0.19	-0.21	WB/UINF
	-0.15	-0.17	-0.05	CP
	-0.11	0.10	0.01	CPT
	10.2	9.8	11.9	THETA
-0.5	1.02	1.09	0.99	UB/UINF
	0.01	-0.07	-0.02	VB/UINF
	0.14	-0.21	-0.20	WB/UINF
	-0.18	-0.13	-0.04	CP
	-0.11	0.10	-0.01	CPT
	8.6	11.6	11.6	THETA
-1.0	1.01	1.07	1.00	UB/UINF
	0.0	-0.08	-0.03	VB/UINF
	0.09	-0.19	-0.20	WB/UINF
	-0.14	-0.11	-0.06	CP
	-0.12	0.08	-0.01	CPT
	6.4	11.5	11.4	THETA
-1.5	0.97	1.05	1.00	UB/UINF
	0.02	-0.10	-0.03	VB/UINF
	0.07	-0.19	-0.19	WB/UINF
	-0.10	-0.09	-0.04	CP
	-0.15	0.06	0.0	CPT
	4.5	11.9	10.7	THETA

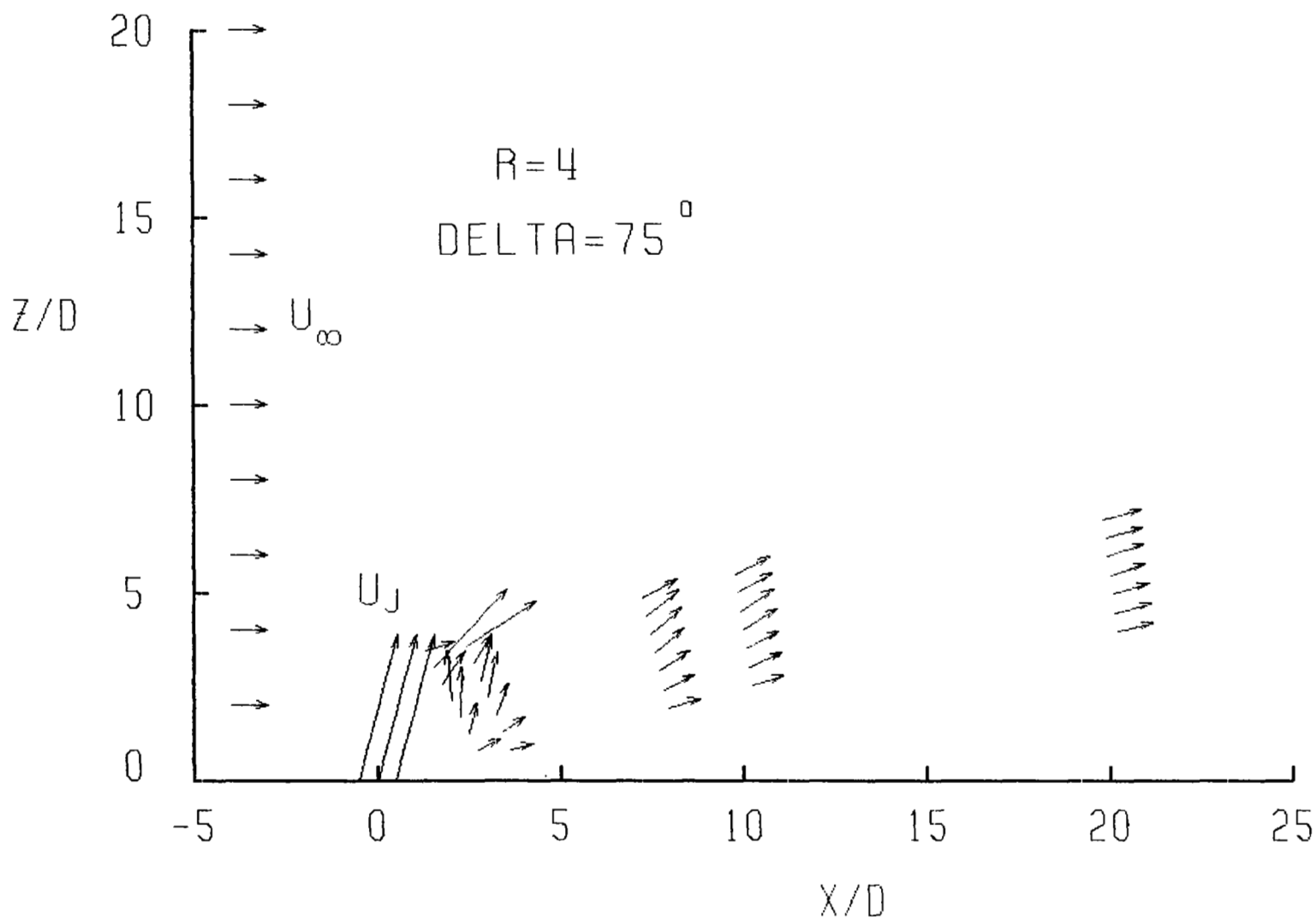

(a) Symmetry plane velocity plot locating cross sections of measurement.

Figure B6.- Cross-section velocities for $R = 4$ and $\Delta = 75^\circ$.

APPENDIX B

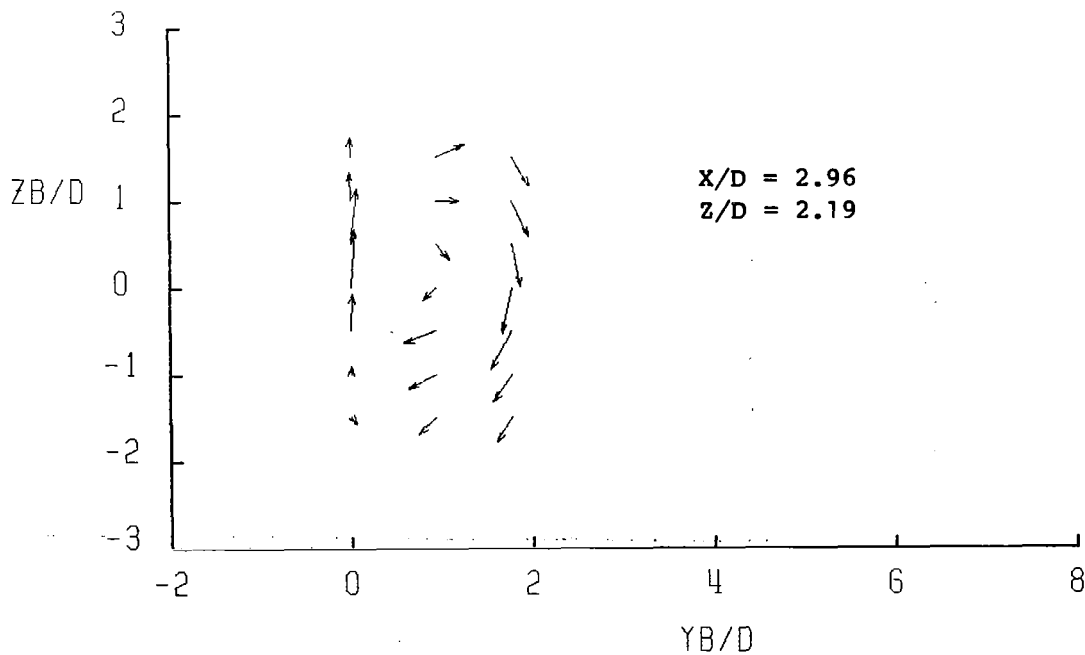
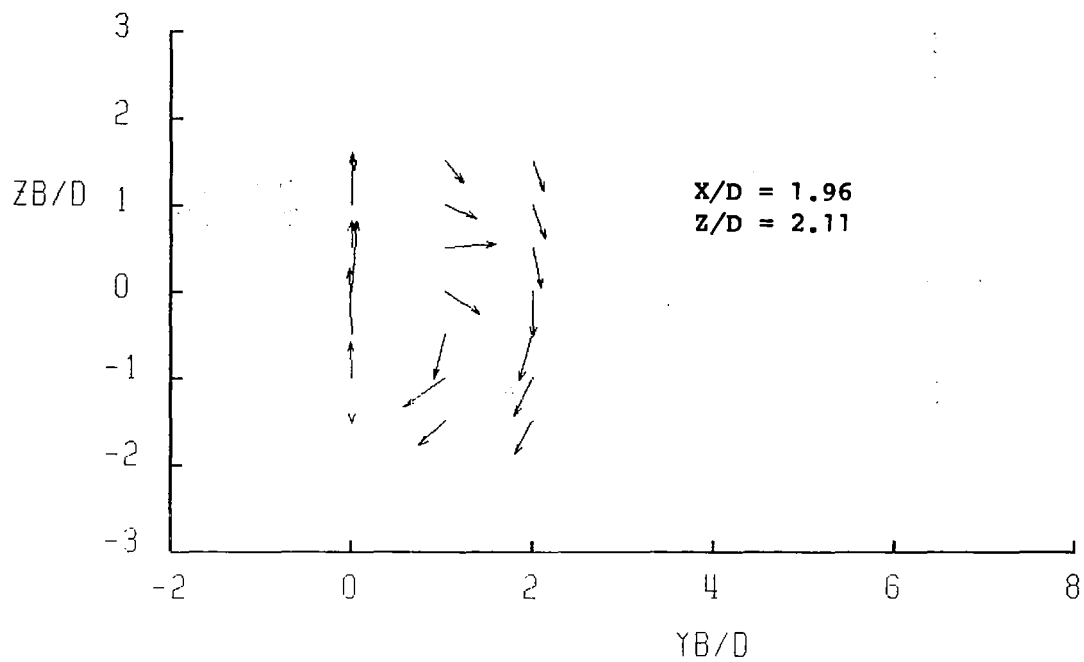

(b) Cross-section velocity plots.

Figure B6.- Continued.

APPENDIX B

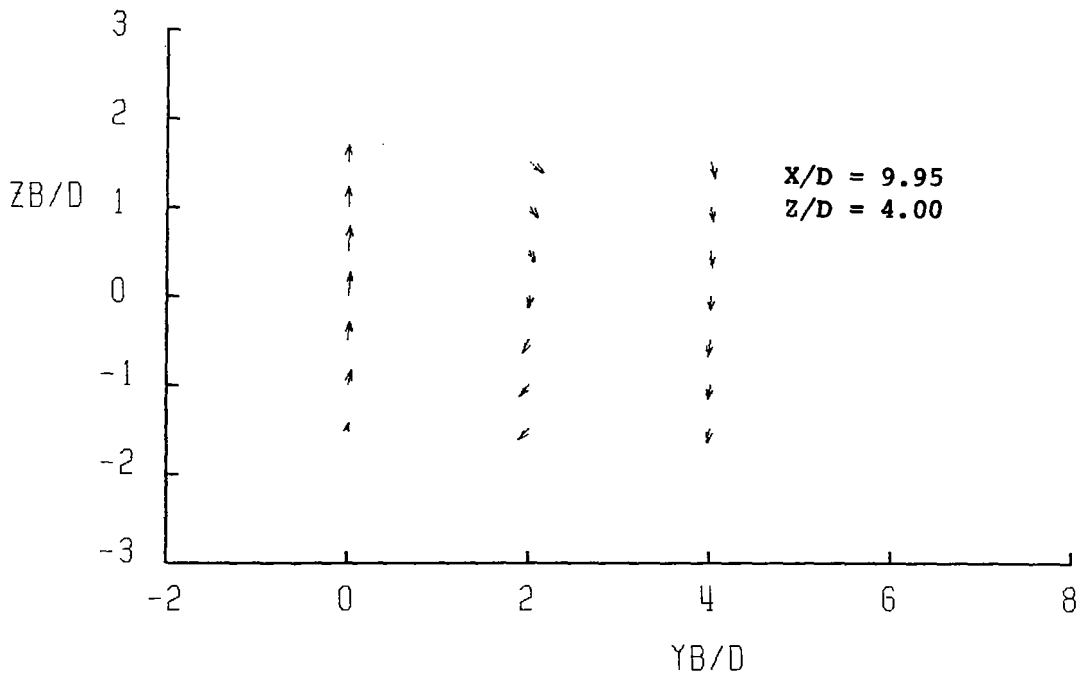
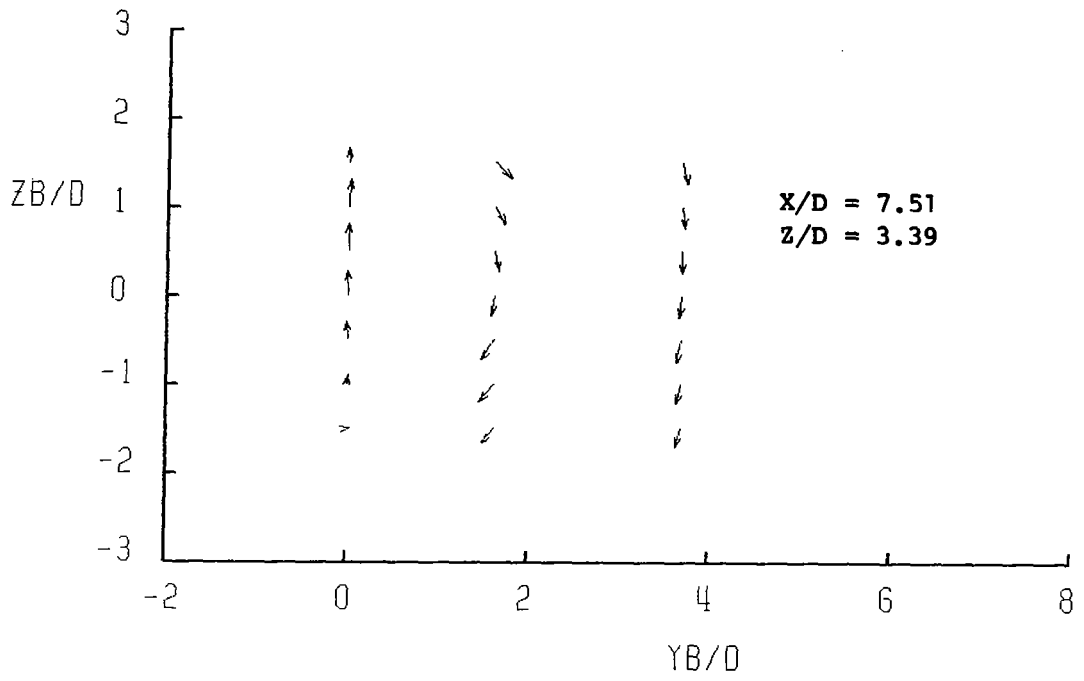

(b) Continued.

Figure B6.- Continued.

APPENDIX B

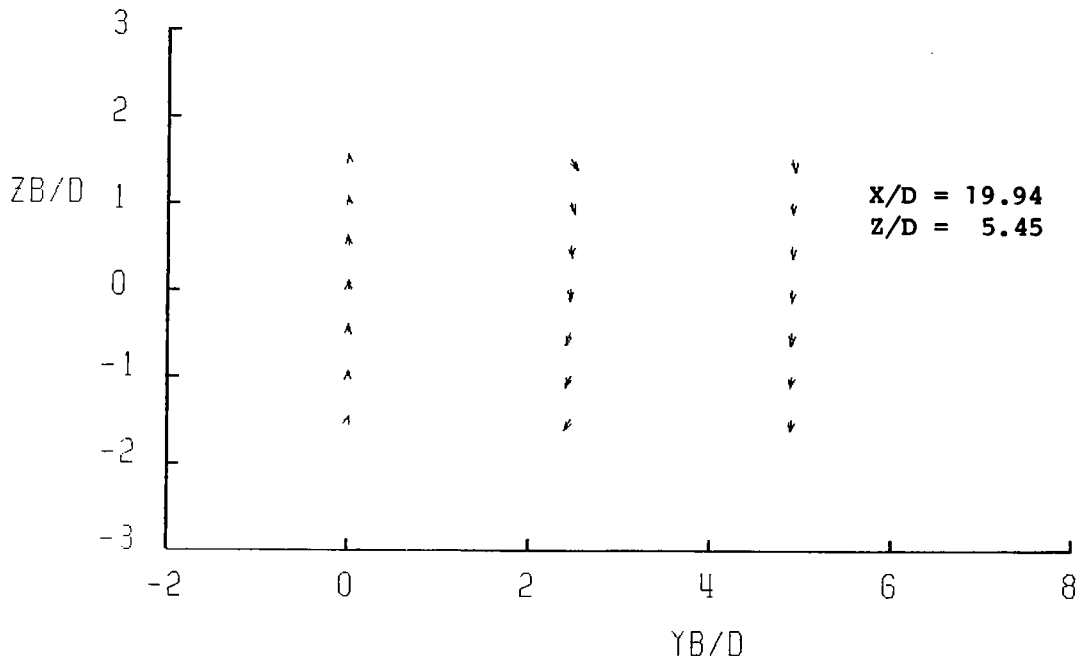

(b) Concluded.

Figure B6.- Concluded.

TABLE B7.- TABULATED VALUES OF CROSS-SECTION VELOCITIES

AND PRESSURES FOR R = 4 AND DELTA = 90°

R= 4.00 DELTA= 90 DEG					R= 4.06 DELTA= 90 DEG					
X/D= 3.96		UINF= 42.1 M/SEC			X/D= 9.94		UINF= 42.0 M/SEC			
Z/D= 3.01		PHI= 18.1 DEG			Z/D= 4.45		PHI= 11.1 DEG			
YB/D		0.0	1.22	2.51	ZB/D					
ZB/D					0.0	2.02	3.93			
1.5		1.11	1.48	0.95	UB/UINF	0.90	1.06	0.98	UB/UINF	
		0.0	0.24	0.22	VB/UINF	-0.01	0.13	0.08	VB/UINF	
		0.06	-0.02	-0.41	WB/UINF	0.02	-0.20	-0.28	WB/UINF	
		-0.82	-0.83	-0.10	CP	-0.29	-0.18	-0.01	CP	
		-0.59	0.42	0.01	CPT	-0.48	0.01	0.04	CPT	
	4.0	7.8	25.6	THETA	3.7	11.9	16.6	THETA		
1.0		0.47	1.22	1.03	UB/UINF	0.77	1.04	1.01	UB/UINF	
		-0.02	0.16	0.20	VB/UINF	-0.02	0.10	0.05	VB/UINF	
		0.30	-0.14	-0.47	WB/UINF	0.17	-0.19	-0.27	WB/UINF	
		-0.71	-0.88	-0.27	CP	-0.28	-0.21	-0.05	CP	
		-1.40	-0.35	0.06	CPT	-0.65	-0.08	0.06	CPT	
	33.0	8.8	26.1	THETA	13.2	10.8	15.3	THETA		
0.5		0.45	0.95	1.08	UB/UINF	0.77	1.02	1.02	UB/UINF	
		-0.05	0.06	0.09	VB/UINF	0.0	0.07	0.03	VB/UINF	
		0.53	-0.18	-0.53	WB/UINF	0.18	-0.18	-0.29	WB/UINF	
		-0.77	-0.99	-0.37	CP	-0.29	-0.28	-0.07	CP	
		-1.28	-1.04	0.09	CPT	-0.67	-0.21	0.05	CPT	
	50.1	10.8	26.2	THETA	13.7	10.4	15.9	THETA		
0.0		0.54	0.96	1.03	UB/UINF	0.81	0.92	1.01	UB/UINF	
		0.03	-0.09	-0.06	VB/UINF	0.0	-0.01	0.0	VB/UINF	
		0.67	-0.16	-0.57	WB/UINF	0.20	-0.19	-0.30	WB/UINF	
		-0.73	-1.07	-0.33	CP	-0.32	-0.21	-0.07	CP	
		-1.00	-1.12	0.06	CPT	-0.61	-0.32	0.05	CPT	
	51.1	11.8	29.0	THETA	13.9	11.9	16.5	THETA		
-0.5		0.65	1.03	0.99	UB/UINF	0.81	0.98	1.02	UB/UINF	
		0.01	-0.23	-0.17	VB/UINF	0.0	-0.06	-0.01	VB/UINF	
		0.59	-0.10	-0.53	WB/UINF	0.15	-0.18	-0.30	WB/UINF	
		-0.65	-0.83	-0.28	CP	-0.29	-0.22	-0.08	CP	
		-0.87	-0.71	0.01	CPT	-0.60	-0.21	0.06	CPT	
	42.1	15.2	29.6	THETA	11.0	11.2	16.2	THETA		
-1.0		0.73	1.00	0.99	UB/UINF	0.86	1.02	1.01	UB/UINF	
		0.01	-0.37	-0.22	VB/UINF	0.05	-0.11	-0.05	VB/UINF	
		0.33	-0.16	-0.45	WB/UINF	0.13	-0.15	-0.29	WB/UINF	
		-0.57	-0.43	-0.17	CP	-0.32	-0.20	-0.06	CP	
		-0.93	-0.27	0.07	CPT	-0.56	-0.13	0.05	CPT	
	24.3	23.4	27.4	THETA	8.5	11.3	16.0	THETA		
-1.5		0.74	0.96	0.98	UB/UINF	0.85	0.99	1.00	UB/UINF	
		-0.02	-0.32	-0.22	VB/UINF	0.01	-0.14	-0.05	VB/UINF	
		0.12	-0.20	-0.40	WB/UINF	0.06	-0.19	-0.27	WB/UINF	
		-0.49	-0.17	-0.11	CP	-0.26	-0.11	-0.05	CP	
		-0.92	-0.10	0.06	CPT	-0.52	-0.07	0.04	CPT	
	9.9	23.1	25.3	THETA	4.5	14.4	15.3	THETA		

TABLE B7.- Concluded

R= 4.03 DELTA= 90 DEG
 X/D= 19.71 UINF= 42.2 M/SEC
 Z/D= 4.75 PHI= 7.5 DEG

R= 4.08 DELTA= 90 DEG
 X/D= 19.82 UINF= 42.2 M/SEC
 Z/D= 7.00 PHI= 7.5 DEG

YB/D \ ZB/D		YB/D			
		0.0	2.25	4.39	
1.5		0.88	0.96	1.00	UB/UINF
		-0.01	0.04	0.05	VB/UINF
		-0.01	-0.13	-0.21	WB/UINF
		-0.14	-0.08	-0.04	CP
		-0.37	-0.14	0.02	CPT
	4.1	7.7	12.5	THETA	
1.0		0.89	1.02	1.01	UB/UINF
		0.0	0.0	0.0	VB/UINF
		0.02	-0.07	-0.19	WB/UINF
		-0.15	-0.15	-0.05	CP
		-0.35	-0.09	0.01	CPT
	3.5	4.2	11.0	THETA	
0.5		0.89	1.03	1.02	UB/UINF
		0.01	-0.03	-0.01	VB/UINF
		0.02	-0.09	-0.20	WB/UINF
		-0.14	-0.14	-0.07	CP
		-0.34	-0.07	0.01	CPT
	3.5	5.8	11.0	THETA	
0.0		0.89	1.00	1.03	UB/UINF
		0.0	-0.05	-0.03	VB/UINF
		0.0	-0.10	-0.16	WB/UINF
		-0.13	-0.08	-0.10	CP
		-0.33	-0.07	-0.01	CPT
	3.3	7.1	9.1	THETA	
-0.5		0.91	1.02	1.00	UB/UINF
		0.0	-0.05	-0.03	VB/UINF
		0.0	-0.10	-0.20	WB/UINF
		-0.14	-0.11	-0.04	CP
		-0.31	-0.06	0.01	CPT
	3.3	6.8	11.2	THETA	
-1.0		0.95	1.02	1.01	UB/UINF
		0.02	-0.07	-0.04	VB/UINF
		-0.03	-0.10	-0.18	WB/UINF
		-0.19	-0.10	-0.05	CP
		-0.28	-0.04	0.0	CPT
	2.9	7.3	10.1	THETA	
-1.5		0.95	1.01	1.02	UB/UINF
		0.01	-0.05	-0.03	VB/UINF
		-0.04	-0.11	-0.16	WB/UINF
		-0.16	-0.09	-0.06	CP
		-0.24	-0.04	0.01	CPT
	4.0	7.6	9.2	THETA	

YB/D \ ZB/D		YB/D			
		0.0	2.25	4.39	
1.5		1.01	1.04	1.00	UB/UINF
		0.0	0.06	0.05	VB/UINF
		-0.10	-0.11	-0.17	WB/UINF
		-0.08	-0.07	-0.01	CP
		-0.05	0.02	0.02	CPT
	6.7	6.5	10.4	THETA	
1.0		1.02	1.03	1.00	UB/UINF
		0.0	0.05	0.04	VB/UINF
		-0.05	-0.11	-0.16	WB/UINF
		-0.13	-0.08	-0.03	CP
		-0.08	-0.01	0.01	CPT
	4.7	6.1	9.7	THETA	
0.5		0.94	1.03	1.02	UB/UINF
		-0.01	0.06	0.04	VB/UINF
		-0.02	-0.10	-0.17	WB/UINF
		-0.09	-0.10	-0.05	CP
		-0.20	-0.03	0.02	CPT
	4.4	6.1	10.0	THETA	
0.0		0.88	0.99	1.01	UB/UINF
		-0.01	0.05	0.04	VB/UINF
		-0.04	-0.12	-0.16	WB/UINF
		-0.10	-0.09	-0.06	CP
		-0.32	-0.09	0.0	CPT
	5.0	6.9	9.7	THETA	
-0.5		0.87	1.01	1.01	UB/UINF
		0.0	0.04	0.03	VB/UINF
		0.0	-0.11	-0.19	WB/UINF
		-0.10	-0.11	-0.05	CP
		-0.35	-0.08	0.0	CPT
	3.7	6.2	10.8	THETA	
-1.0		0.92	1.01	0.99	UB/UINF
		0.02	0.04	0.02	VB/UINF
		0.04	-0.12	-0.18	WB/UINF
		-0.20	-0.14	-0.04	CP
		-0.35	-0.10	-0.02	CPT
	3.3	6.6	10.6	THETA	
-1.5		0.90	1.02	1.00	UB/UINF
		0.01	-0.01	0.0	VB/UINF
		0.03	-0.10	-0.19	WB/UINF
		-0.15	-0.11	-0.06	CP
		-0.33	-0.07	-0.03	CPT
	3.6	5.9	11.1	THETA	

APPENDIX B

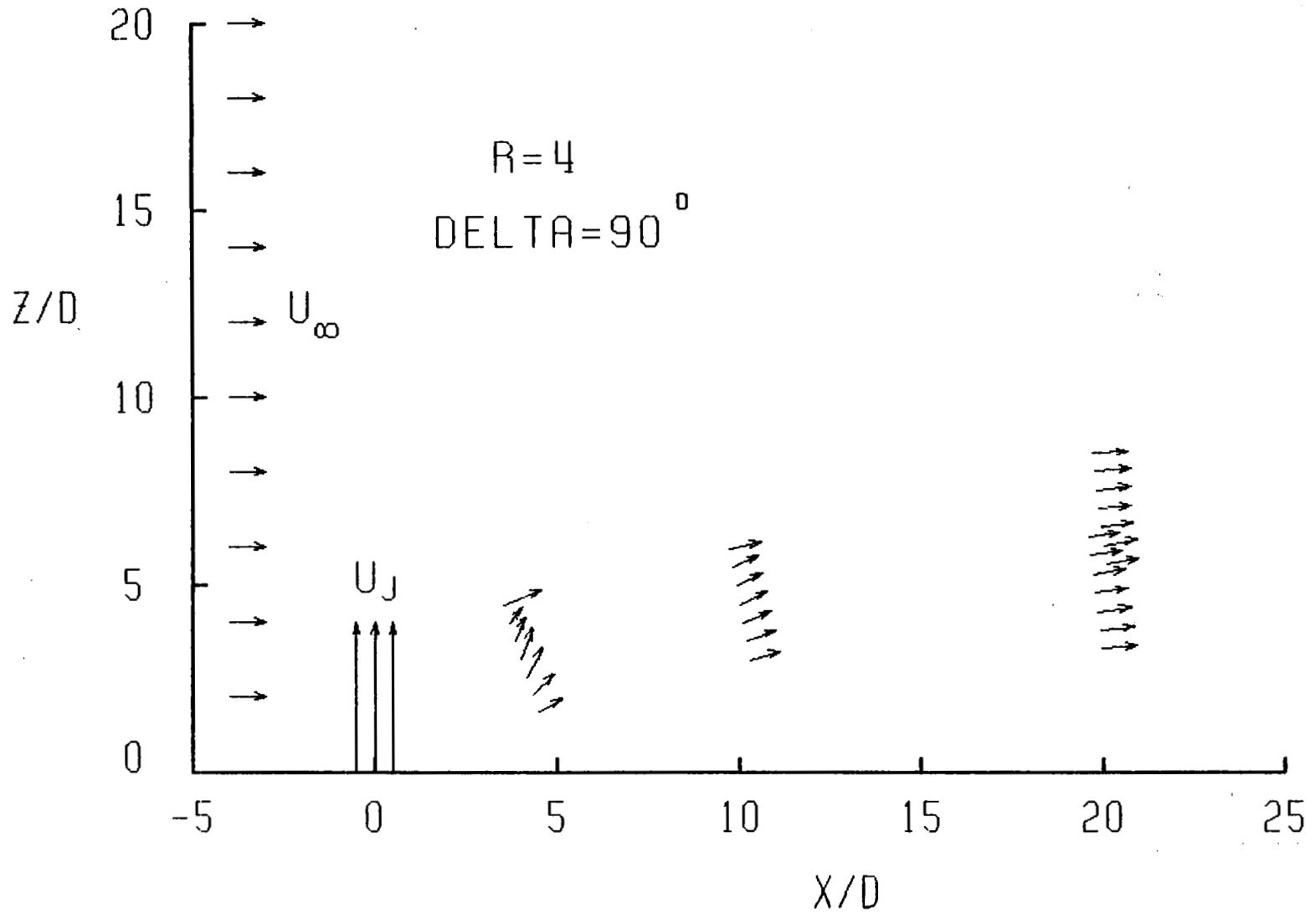

(a) Symmetry plane velocity plot locating cross sections of measurement.

Figure B7.- Cross-section velocities for $R = 4$ and $\text{DELTA} = 90^\circ$.

APPENDIX B

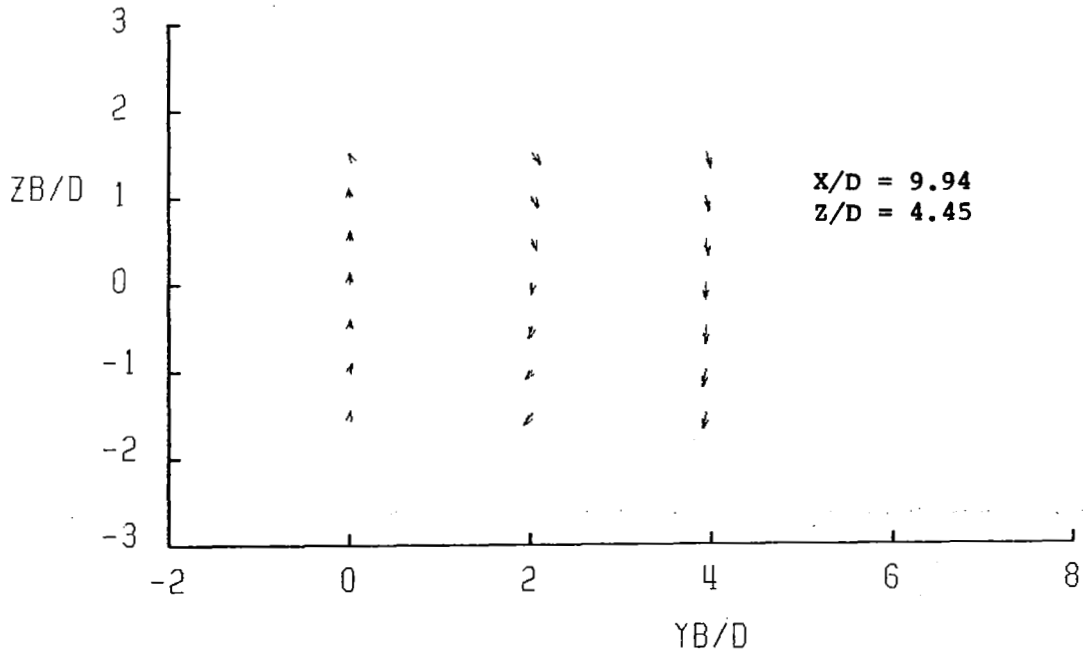
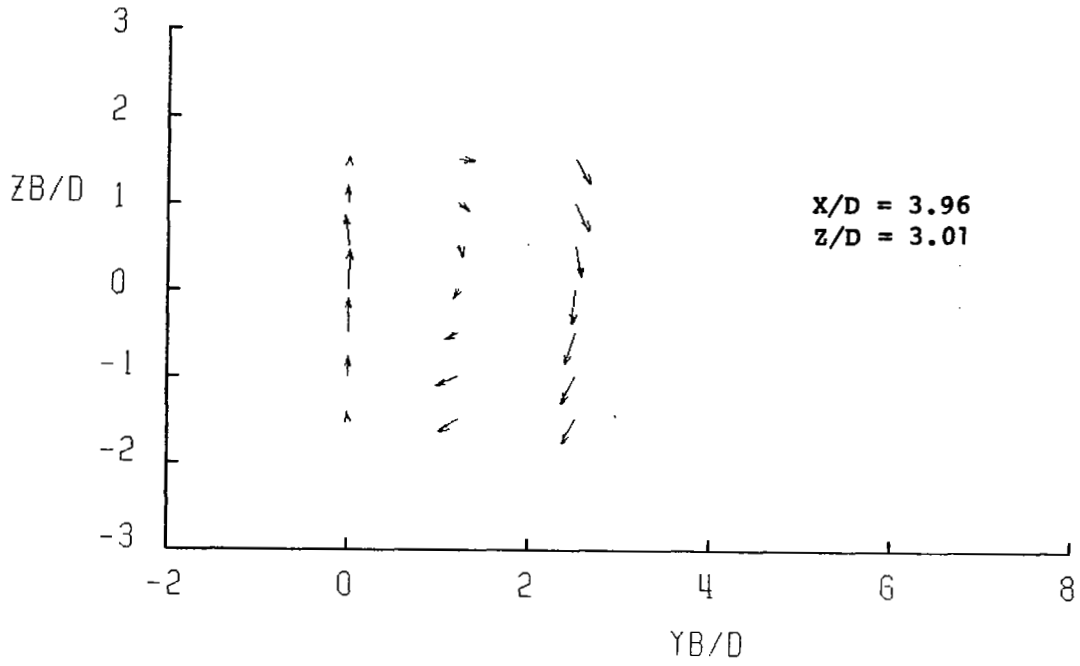

(b) Cross-section velocity plots.

Figure B7.- Continued.

APPENDIX B

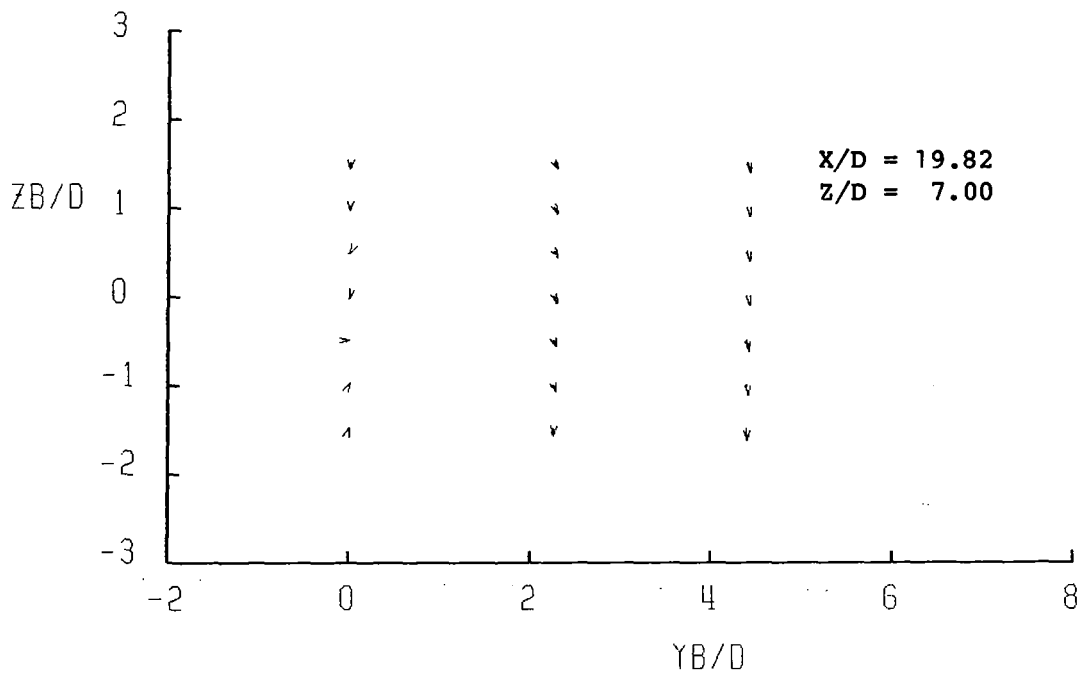
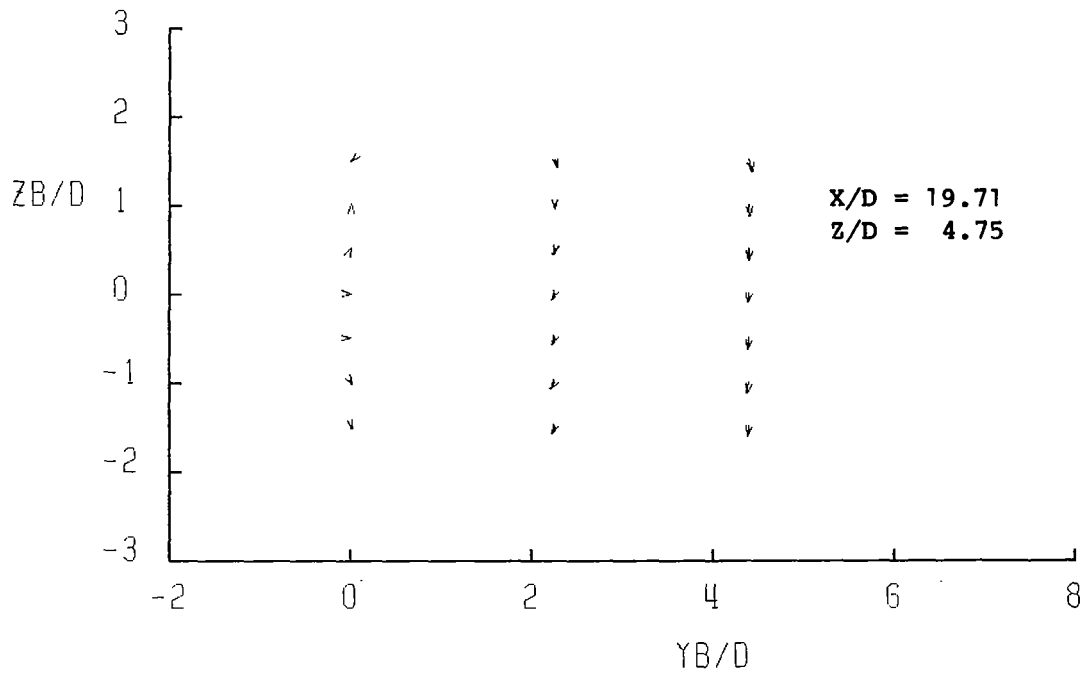

(b) Concluded.

Figure B7.- Concluded.

APPENDIX B

YB/D		0.0	1.81	3.55
ZB/D	1.07	1.09	0.09	0.09
UB/UINF	1.01	1.07	0.09	0.09
VB/UINF	0.07	0.07	0.01	0.01
WB/UINF	-0.39	-0.16	0.12	-0.07
CP	-0.12	-0.72	-0.64	-0.12
CPT	0.06	-0.55	-1.61	0.06
THETA	21.3	8.8	52.8	21.3
UB/UINF	1.04	0.87	0.10	0.10
VB/UINF	0.03	-0.03	0.11	0.11
WB/UINF	-0.39	-0.20	-0.27	-0.27
CP	-0.17	-0.67	-0.67	-0.17
CPT	0.05	-0.87	-1.57	0.05
THETA	20.5	13.3	71.0	20.5
UB/UINF	1.06	0.78	0.23	0.23
VB/UINF	-0.01	-0.13	-0.05	-0.05
WB/UINF	-0.40	-0.23	-0.45	-0.45
CP	-0.21	-0.68	-0.66	-0.21
CPT	0.07	-1.00	-1.40	0.07
THETA	20.6	19.4	63.2	20.6
UB/UINF	1.06	0.77	0.26	0.26
VB/UINF	-0.06	-0.28	0.17	0.17
WB/UINF	-0.39	-0.32	-0.61	-0.39
CP	-0.21	-0.52	-0.45	-0.21
CPT	0.07	-0.74	-0.98	0.07
THETA	20.3	29.6	67.2	20.3
UB/UINF	1.03	0.85	0.41	0.41
VB/UINF	-0.09	-0.27	-0.01	-0.01
WB/UINF	-0.37	-0.24	-0.60	-0.37
CP	-0.18	-0.55	-0.51	-0.18
CPT	0.05	-0.68	-0.98	0.05
THETA	20.4	24.2	55.3	20.4
UB/UINF	1.04	0.93	0.57	0.57
VB/UINF	-0.12	-0.30	-0.02	-0.02
WB/UINF	-0.34	-0.28	-0.35	-0.34
CP	-0.15	-0.42	-0.65	-0.15
CPT	0.06	-0.38	-1.20	0.06
THETA	19.1	24.9	32.1	19.1
UB/UINF	1.03	0.89	0.52	0.52
VB/UINF	-0.12	-0.32	0.05	0.05
WB/UINF	-0.33	-0.25	-0.25	-0.33
CP	-0.14	-0.19	-0.45	-0.14
CPT	0.05	-0.22	-1.11	0.05
THETA	18.6	25.5	26.1	18.6

X/D = 3.95 UINF = 42.3 M/SEC
 Z/D = 3.13 PHI = 14.0 DEG
 R = 4.04 DELTA = 105 DEG

YB/D		0.0	1.26	2.61
ZB/D	1.21	1.00	0.19	0.19
UB/UINF	0.38	1.21	0.19	0.19
VB/UINF	-0.01	0.11	0.11	0.11
WB/UINF	-0.04	0.11	-0.46	-0.04
CP	-1.28	-1.62	-0.24	-1.28
CPT	-2.14	-1.11	0.02	-2.14
THETA	7.4	6.2	26.4	7.4
UB/UINF	0.05	0.71	0.14	0.14
VB/UINF	-0.23	-0.05	0.14	0.14
WB/UINF	-0.06	-0.07	-0.52	-0.06
CP	-1.07	-1.50	-0.34	-1.07
CPT	-2.01	-1.98	0.05	-2.01
THETA	80.1	7.5	27.0	80.1
UB/UINF	0.05	0.43	1.10	1.10
VB/UINF	0.08	-0.11	0.04	0.04
WB/UINF	0.35	-0.11	-0.54	-0.35
CP	-1.25	-1.49	-0.49	-1.25
CPT	-2.12	-2.28	0.03	-2.12
THETA	82.1	21.4	26.3	82.1
UB/UINF	0.12	0.52	1.08	1.08
VB/UINF	-0.11	-0.27	-0.05	-0.05
WB/UINF	-0.65	-0.04	-0.55	-0.65
CP	-1.16	-1.49	-0.46	-1.16
CPT	-1.71	-2.15	0.03	-1.71
THETA	80.5	29.2	27.2	80.5
UB/UINF	0.31	0.60	1.09	1.09
VB/UINF	-0.06	-0.47	-0.13	-0.13
WB/UINF	-0.68	-0.08	-0.51	-0.68
CP	-1.31	-1.28	-0.42	-1.31
CPT	-1.74	-1.69	0.05	-1.74
THETA	65.9	39.8	26.1	65.9
UB/UINF	0.29	0.95	1.08	1.08
VB/UINF	-0.09	-0.43	-0.17	-0.17
WB/UINF	-0.62	-0.07	-0.47	-0.62
CP	-1.07	-1.09	-0.36	-1.07
CPT	-1.59	-1.00	0.07	-1.59
THETA	66.0	26.2	25.0	66.0
UB/UINF	0.64	0.95	1.06	1.06
VB/UINF	0.03	-0.44	-0.21	-0.21
WB/UINF	-0.35	-0.24	-0.42	-0.35
CP	-1.05	-0.78	-0.30	-1.05
CPT	-1.51	-0.62	0.05	-1.51
THETA	28.3	29.3	24.3	28.3

X/D = 1.96 UINF = 42.4 M/SEC
 Z/D = 2.50 PHI = 19.0 DEG
 R = 4.05 DELTA = 105 DEG

TABLE B8.-- TABULATED VALUES OF CROSS-SECTION VELOCITIES AND PRESSURES FOR R = 4 AND DELTA = 105°

				ZB/D					
				YB/D					
UB/UINF	1.00	0.89	0.79	0.0	4.95				
VB/UINF	0.04	-0.04	-0.02						
WB/UINF	-0.18	-0.14	-0.04						
CP	-0.02	-0.11	-0.48						
THETA	10.7	8.9	5.6						
UB/UINF	1.00	0.93	0.80	1.0					
VB/UINF	0.01	0.02	0.01						
WB/UINF	-0.17	-0.12	0.0						
CP	-0.05	-0.10	-0.13						
THETA	9.7	7.4	4.1						
UB/UINF	1.00	0.87	0.81	0.5					
VB/UINF	0.01	0.01	-0.01						
WB/UINF	-0.18	-0.12	0.03						
CP	-0.06	-0.14	-0.49						
THETA	10.4	8.2	5.0						
UB/UINF	1.01	0.91	0.85	0.0					
VB/UINF	0.0	0.0	0.0						
WB/UINF	-0.17	-0.12	0.05						
CP	-0.07	-0.14	-0.42						
THETA	9.9	7.5	4.7						
UB/UINF	1.00	0.89	0.87	-0.5					
VB/UINF	0.01	-0.01	0.0						
WB/UINF	-0.17	-0.12	0.05						
CP	-0.03	-0.11	-0.35						
THETA	9.9	8.0	5.0						
UB/UINF	0.98	0.87	0.86	-1.0					
VB/UINF	0.03	-0.06	-0.01						
WB/UINF	-0.18	-0.12	0.05						
CP	-0.05	-0.08	-0.34						
THETA	10.3	9.2	5.4						
UB/UINF	1.02	0.93	0.92	-1.5					
VB/UINF	0.03	-0.06	-0.01						
WB/UINF	-0.18	-0.10	0.04						
CP	-0.01	-0.11	-0.25						
THETA	10.1	7.8	4.7						

R = 4.06 DELTA = 105 DEG
 X/D = 20.28 UINF = 42.5 M/SEC
 Z/D = 5.97 PHI = 7.0 DEG

TABLE B8.-- Continued

				ZB/D					
				YB/D					
UB/UINF	1.00	0.90	0.52	0.0	4.05				
VB/UINF	0.05	0.05	-0.02						
WB/UINF	-0.33	-0.25	-0.11						
CP	-0.06	-0.26	-0.34						
THETA	18.5	15.5	12.6						
UB/UINF	1.01	0.83	0.56	1.0					
VB/UINF	0.02	0.02	0.0						
WB/UINF	-0.32	-0.23	0.18						
CP	-0.08	-0.29	-0.37						
THETA	17.4	15.8	18.5						
UB/UINF	1.02	0.88	0.63	0.5					
VB/UINF	-0.01	-0.05	-0.01						
WB/UINF	-0.33	-0.23	0.23						
CP	-0.10	-0.32	-0.39						
THETA	17.8	15.2	20.4						
UB/UINF	1.04	0.85	0.66	0.0					
VB/UINF	-0.02	-0.08	-0.01						
WB/UINF	-0.31	-0.18	0.25						
CP	-0.13	-0.30	-0.31						
THETA	16.9	13.7	21.1						
UB/UINF	1.02	0.74	0.77	-0.5					
VB/UINF	-0.06	-0.20	0.07						
WB/UINF	-0.32	-0.20	0.20						
CP	-0.09	-0.22	-0.36						
THETA	17.5	22.2	15.0						
UB/UINF	1.01	0.91	0.82	-1.0					
VB/UINF	-0.07	-0.17	0.03						
WB/UINF	-0.29	-0.20	0.13						
CP	-0.08	-0.16	-0.31						
THETA	16.2	16.7	9.0						
UB/UINF	1.00	0.96	0.79	-1.5					
VB/UINF	-0.08	-0.20	0.06						
WB/UINF	-0.28	-0.20	0.06						
CP	-0.07	-0.10	-0.23						
THETA	16.0	17.3	4.5						

R = 4.08 DELTA = 105 DEG
 X/D = 7.94 UINF = 42.3 M/SEC
 Z/D = 3.97 PHI = 12.0 DEG

TABLE B8.- Concluded

R = 4.09 DELTA = 105 DEG

X/D = 10.81 UINF = 42.4 M/SEC
Z/D = 4.55 PHI = 10.0 DEG

		YB/D		ZB/D	
UB/UINF	1.01	0.82	0.62	0.82	1.01
VB/UINF	-0.02	-0.05	-0.03	-0.05	-0.02
WB/UINF	-0.27	-0.17	-0.06	-0.17	-0.27
CP	-0.07	-0.14	-0.22	-0.20	-0.07
CPT	0.01	-0.50	-0.83	-0.49	0.04
THETA	16.7	14.6	7.9	14.6	16.7
UB/UINF	1.00	0.84	0.63	0.84	1.00
VB/UINF	-0.01	0.01	0.01	0.01	-0.01
WB/UINF	-0.26	0.08	0.08	-0.16	-0.26
CP	-0.08	-0.22	-0.24	-0.22	-0.08
CPT	-0.01	-0.84	-0.84	-0.49	-0.01
THETA	16.1	11.8	7.4	11.8	16.1
UB/UINF	1.01	0.74	0.69	0.74	1.01
VB/UINF	0.00	0.00	-0.06	0.00	0.00
WB/UINF	-0.26	0.18	0.16	-0.18	-0.26
CP	-0.08	-0.21	-0.24	-0.21	-0.08
CPT	0.01	-0.63	-0.73	-0.63	0.01
THETA	16.0	14.4	15.0	14.4	16.0
UB/UINF	1.00	0.86	0.78	0.86	1.00
VB/UINF	-0.02	0.06	-0.04	0.06	-0.02
WB/UINF	-0.25	-0.14	0.16	-0.14	-0.25
CP	-0.09	-0.23	-0.28	-0.23	-0.09
CPT	-0.03	-0.47	-0.65	-0.47	-0.03
THETA	15.2	9.0	12.9	9.0	15.2
UB/UINF	1.00	0.72	0.83	0.72	1.00
VB/UINF	0.06	0.09	-0.02	0.09	0.06
WB/UINF	-0.28	-0.18	0.15	-0.18	-0.28
CP	-0.07	-0.19	-0.24	-0.19	-0.07
CPT	0.01	-0.62	-0.53	-0.62	0.01
THETA	16.0	14.1	11.2	14.1	16.0
UB/UINF	0.99	0.78	0.79	0.78	0.99
VB/UINF	0.08	0.11	0.03	0.11	0.08
WB/UINF	-0.25	-0.16	0.13	-0.16	-0.25
CP	-0.08	-0.15	-0.19	-0.15	-0.08
CPT	-0.01	-0.50	-0.54	-0.50	-0.01
THETA	14.5	12.1	9.1	12.1	14.5
UB/UINF	1.00	0.87	0.85	0.87	1.00
VB/UINF	0.10	0.15	0.03	0.15	0.10
WB/UINF	-0.24	-0.14	0.08	-0.14	-0.24
CP	-0.07	-0.13	-0.18	-0.13	-0.07
CPT	0.01	-0.33	-0.46	-0.33	0.01
THETA	13.7	10.1	5.7	10.1	13.7
UB/UINF	1.02	0.94	0.85	0.94	1.02
VB/UINF	-0.08	-0.11	-0.01	-0.11	-0.08
WB/UINF	-0.23	-0.11	0.08	-0.11	-0.23
CP	-0.08	-0.15	-0.15	-0.08	-0.08
CPT	0.03	-0.24	-0.46	-0.24	0.03
THETA	13.4	10.5	5.7	10.5	13.4

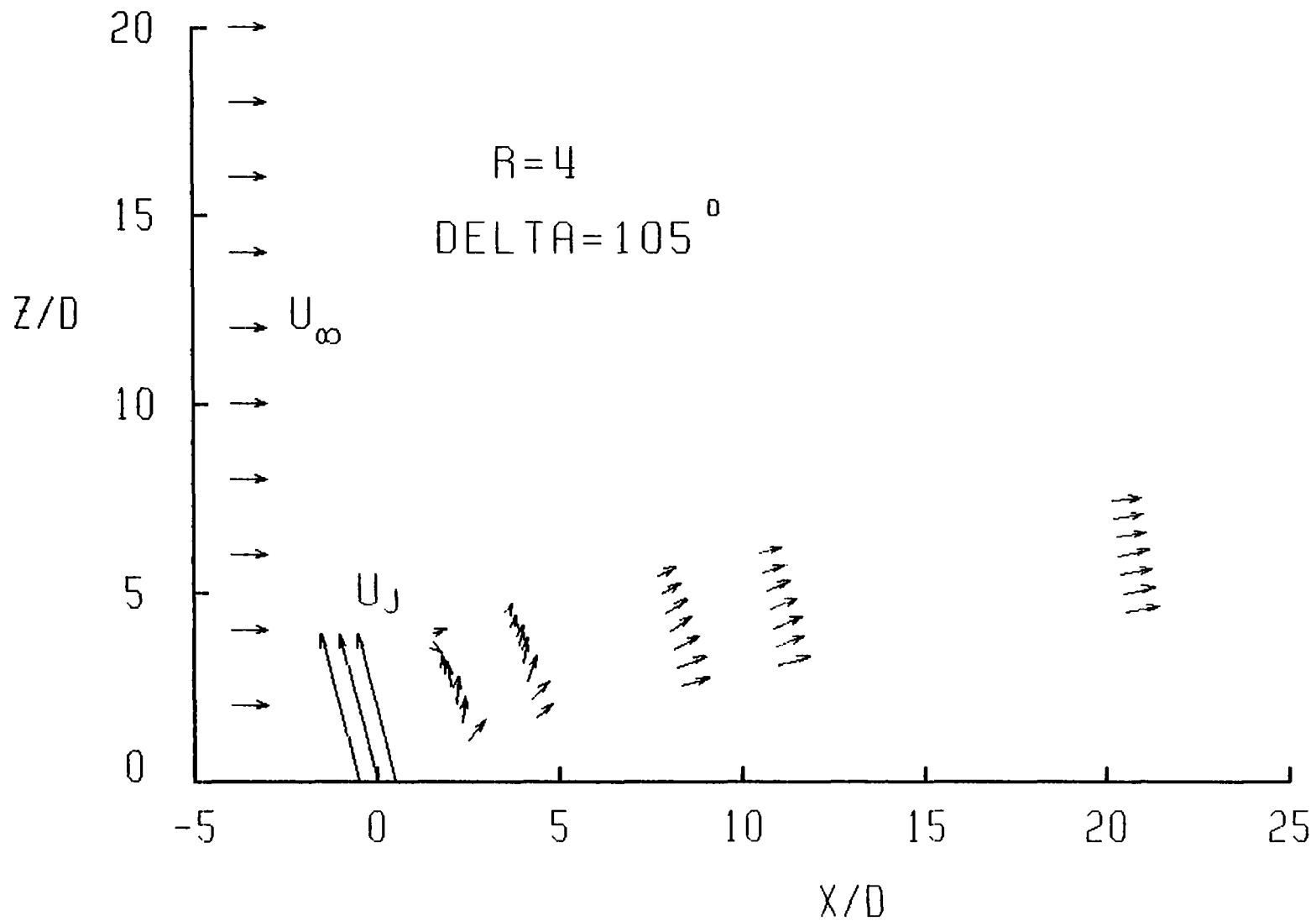

(a) Symmetry plane velocity plot locating cross sections of measurement.

Figure B8.- Cross-section velocities for $R = 4$ and $\text{DELTA} = 105^\circ$.

APPENDIX B

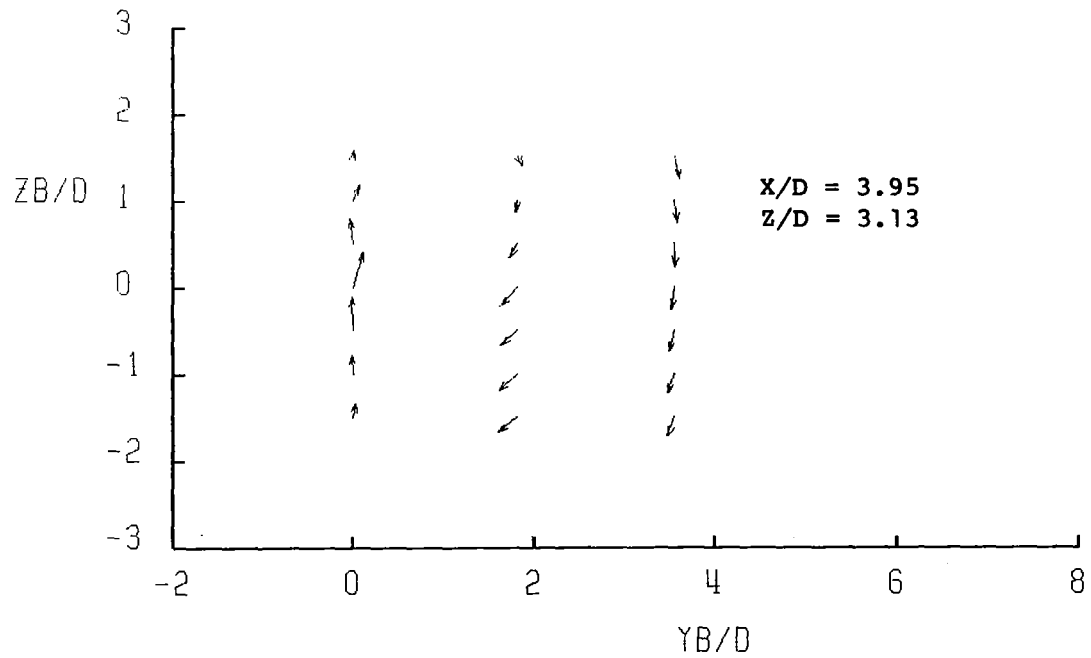
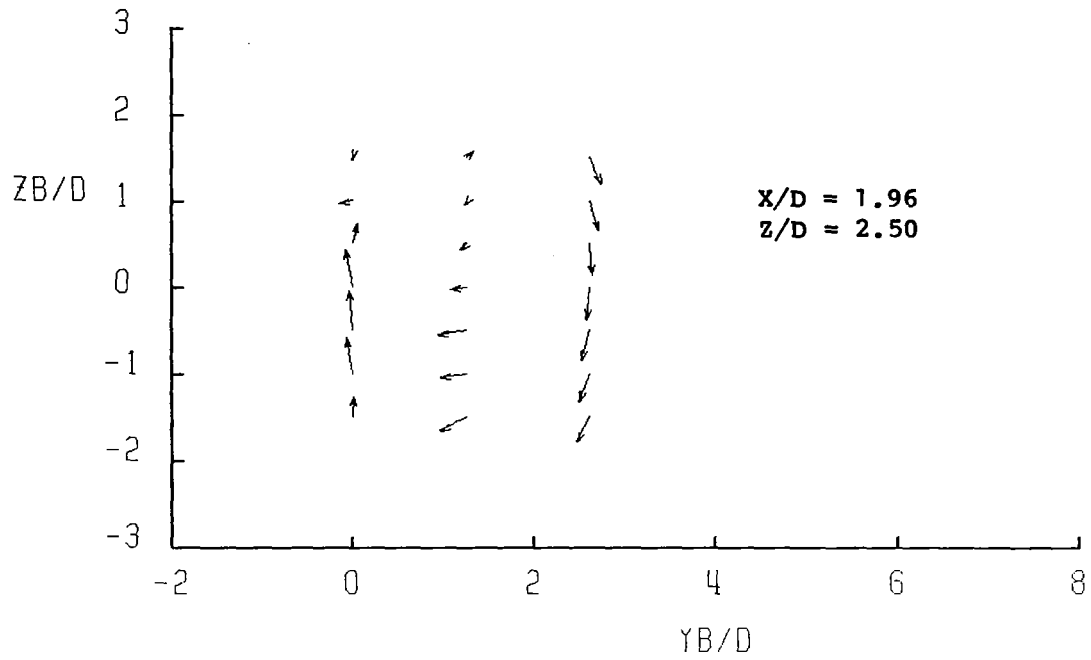

(b) Cross-section velocity plots.

Figure B8.- Continued.

Figure B8.-- Continued.

(b) Continued.

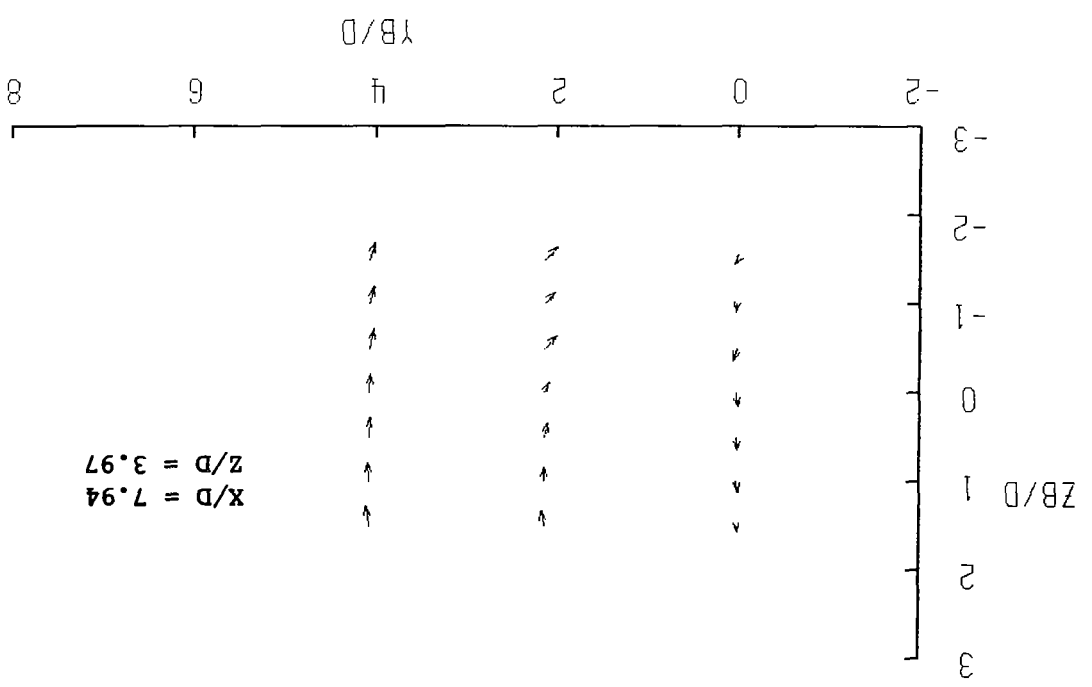
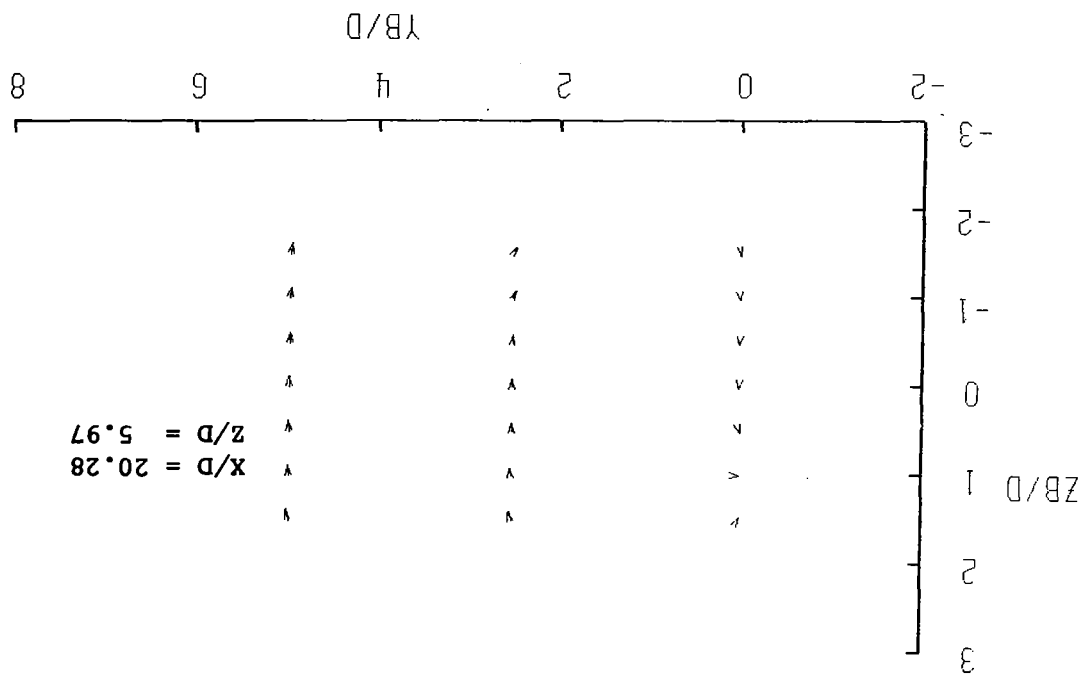

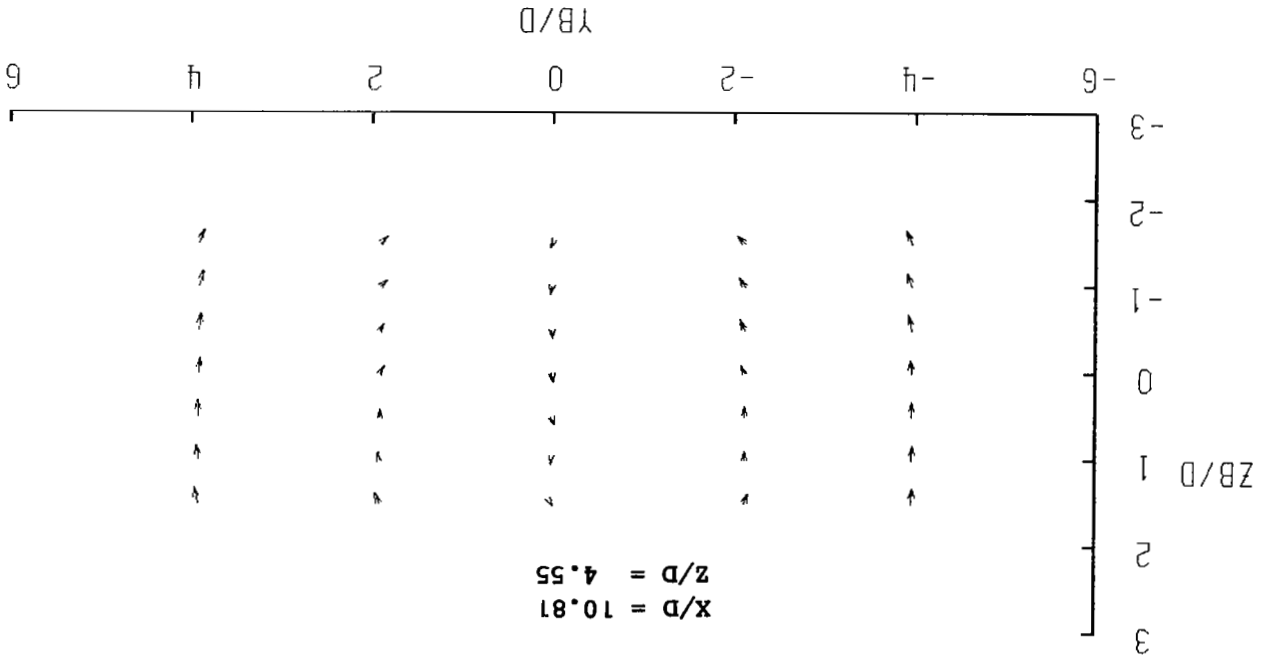

Figure B8.- Concluded.
(b) Concluded.

TABLE B9.- TABULATED VALUES OF CROSS-SECTION VELOCITIES

AND PRESSURES FOR $R = 8$ AND $\Delta = 45^\circ$

R= 8.01 DELTA= 45 DEG
 X/D= 6.95 UINF= 38.0 M/SEC
 Z/D= 3.61 PHI= 25.0 DEG

R= 8.01 DELTA= 45 DEG
 X/D= 9.94 UINF= 37.7 M/SEC
 Z/D= 4.73 PHI= 21.0 DEG

YB/D		0.0	1.23	2.55	
ZB/D					
1.5		3.52	3.44	0.87	UB/UINF
		-0.03	0.51	0.06	VB/UINF
		0.31	0.11	-0.68	WB/UINF
		-3.14	-3.40	-0.22	CP
		8.87	8.20	0.01	CPT
	5.9	6.9	37.9	THETA	
1.0		1.94	3.44	0.90	UB/UINF
		-0.02	0.39	-0.06	VB/UINF
		0.49	-0.06	-0.71	WB/UINF
		-1.50	-2.65	-0.38	CP
		1.57	8.81	-0.06	CPT
	14.5	4.8	38.3	THETA	
0.5		1.46	2.83	0.94	UB/UINF
		0.01	0.12	-0.17	VB/UINF
		0.69	-0.26	-0.71	WB/UINF
		-0.88	-2.17	-0.38	CP
		0.74	5.12	0.05	CPT
	25.3	5.3	38.1	THETA	
0.0		1.20	1.85	0.96	UB/UINF
		0.06	-0.36	-0.28	VB/UINF
		0.45	-0.35	-0.61	WB/UINF
		-0.34	-1.42	-0.29	CP
		0.31	1.29	0.10	CPT
	20.3	16.5	35.1	THETA	
-0.5		1.04	1.13	0.93	UB/UINF
		0.04	-0.49	-0.30	VB/UINF
		0.11	-0.29	-0.53	WB/UINF
		-0.02	-0.37	-0.17	CP
		0.07	0.24	0.08	CPT
	6.3	28.2	33.3	THETA	
-1.0		0.99	1.01	0.94	UB/UINF
		0.0	-0.30	-0.26	VB/UINF
		-0.08	-0.26	-0.46	WB/UINF
		0.02	-0.09	-0.09	CP
		0.01	0.10	0.08	CPT
	5.4	22.9	29.6	THETA	
-1.5		0.95	0.96	0.94	UB/UINF
		0.01	-0.20	-0.22	VB/UINF
		-0.20	-0.29	-0.43	WB/UINF
		0.02	0.0	-0.06	CP
		-0.04	0.05	0.06	CPT
	11.9	21.2	27.8	THETA	

YB/D		0.0	1.97	3.60	
ZB/D					
1.5		2.35	2.32	0.93	UB/UINF
		-0.01	0.42	0.04	VB/UINF
		0.29	-0.23	-0.55	WB/UINF
		-1.54	-1.46	-0.12	CP
		3.17	3.25	0.05	CPT
	7.7	10.6	30.8	THETA	
1.0		1.63	2.26	0.96	UB/UINF
		0.02	0.28	-0.03	VB/UINF
		0.45	-0.28	-0.54	WB/UINF
		-0.83	-1.34	-0.18	CP
		1.04	3.01	0.04	CPT
	15.6	9.0	29.1	THETA	
0.5		1.40	2.11	0.94	UB/UINF
		0.01	0.07	-0.12	VB/UINF
		0.51	-0.38	-0.55	WB/UINF
		-0.57	-1.46	-0.17	CP
		0.66	2.20	0.05	CPT
	20.0	10.1	30.9	THETA	
0.0		1.19	1.61	0.96	UB/UINF
		0.0	-0.26	-0.16	VB/UINF
		0.38	-0.42	-0.52	WB/UINF
		-0.29	-0.97	-0.16	CP
		0.27	0.88	0.07	CPT
	18.1	17.7	29.5	THETA	
-0.5		1.10	1.19	0.96	UB/UINF
		0.0	-0.42	-0.19	VB/UINF
		0.18	-0.39	-0.47	WB/UINF
		-0.12	-0.43	-0.13	CP
		0.13	0.32	0.05	CPT
	9.8	26.8	27.6	THETA	
-1.0		1.02	1.04	0.97	UB/UINF
		0.01	-0.35	-0.18	VB/UINF
		0.01	-0.28	-0.43	WB/UINF
		0.01	-0.16	-0.10	CP
		0.06	0.12	0.07	CPT
	2.4	24.4	25.5	THETA	
-1.5		1.00	0.99	0.96	UB/UINF
		0.01	-0.23	-0.17	VB/UINF
		-0.10	-0.27	-0.40	WB/UINF
		0.01	-0.05	-0.07	CP
		0.01	0.07	0.05	CPT
	6.0	20.6	24.5	THETA	

TABLE B9.- Concluded

R= 7.99 DELTA= 45 DEG

X/D= 19.93 UINF= 38.0 M/SEC
 Z/D= 7.37 PHI= 15.1 DEG

YB/D		0.0	3.01	5.91	
ZB/D					
1.5		1.38	1.59	0.95	UB/UINF
		-0.01	0.22	0.03	VB/UINF
		0.22	-0.31	-0.38	WB/UINF
		-0.47	-0.52	0.02	CP
		0.50	1.18	0.07	CPT
	9.9	13.1	22.3	THETA	
1.0		1.25	1.64	0.98	UB/UINF
		-0.01	0.16	-0.01	VB/UINF
		0.30	-0.31	-0.36	WB/UINF
		-0.33	-0.56	-0.03	CP
		0.34	1.26	0.07	CPT
	14.1	11.7	20.1	THETA	
0.5		1.17	1.68	0.99	UB/UINF
		0.0	0.06	-0.04	VB/UINF
		0.33	-0.36	-0.38	WB/UINF
		-0.27	-0.58	-0.05	CP
		0.21	1.40	0.07	CPT
	16.1	12.3	21.0	THETA	
0.0		1.12	1.52	0.97	UB/UINF
		0.0	-0.01	-0.06	VB/UINF
		0.30	-0.39	-0.36	WB/UINF
		-0.20	-0.53	-0.03	CP
		0.15	0.95	0.04	CPT
	15.1	14.5	20.5	THETA	
-0.5		1.09	1.26	0.98	UB/UINF
		0.01	-0.16	-0.07	VB/UINF
		0.23	-0.38	-0.36	WB/UINF
		-0.13	-0.38	-0.04	CP
		0.12	0.39	0.06	CPT
	12.3	18.3	20.1	THETA	
-1.0		1.07	1.24	0.98	UB/UINF
		0.0	-0.21	-0.08	VB/UINF
		0.15	-0.33	-0.34	WB/UINF
		-0.12	-0.32	-0.04	CP
		0.05	0.37	0.05	CPT
	8.4	17.6	19.1	THETA	
-1.5		1.06	1.11	0.99	UB/UINF
		-0.01	-0.26	-0.09	VB/UINF
		0.05	-0.29	-0.33	WB/UINF
		-0.07	-0.18	-0.07	CP
		0.06	0.21	0.04	CPT
	5.0	19.5	18.3	THETA	

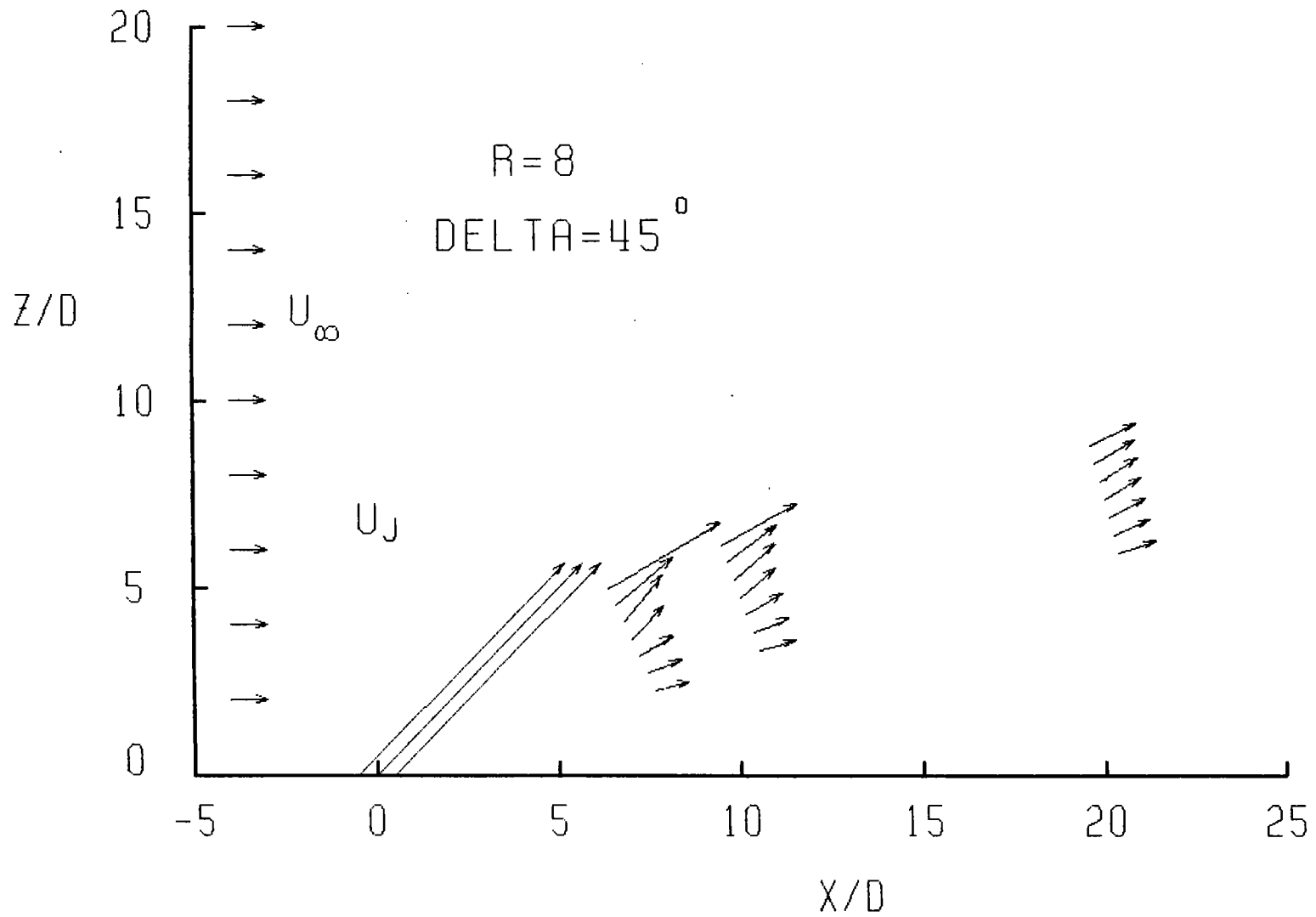

(a) Symmetry plane velocity plot locating cross sections of measurement.

Figure B9.- Cross-section velocities for $R = 8$ and $\text{DELTA} = 45^\circ$.

APPENDIX B

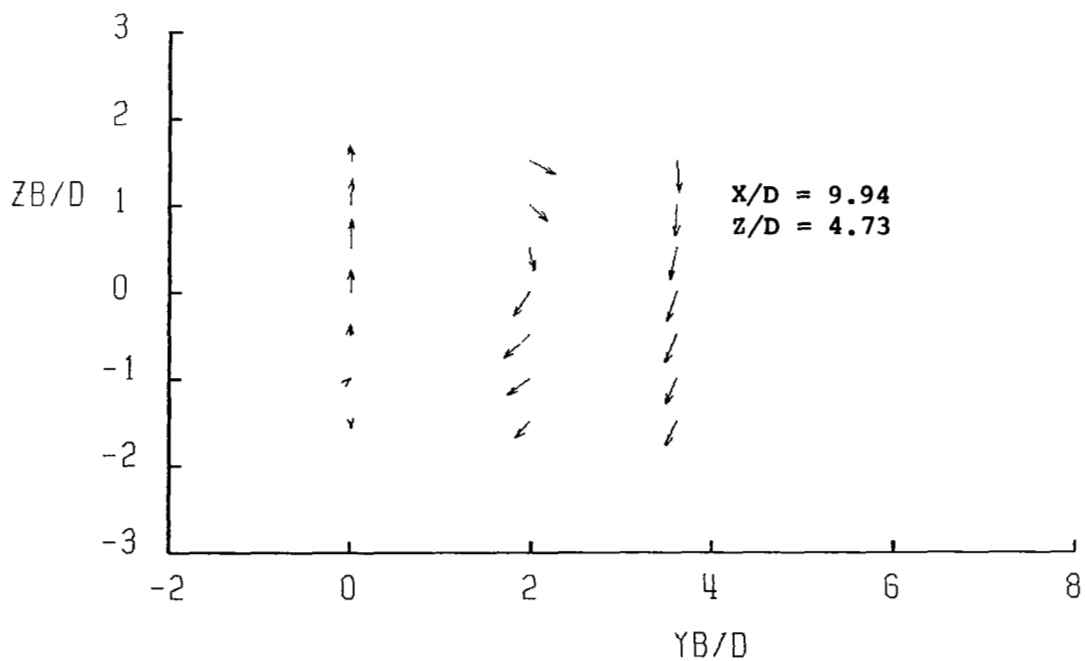
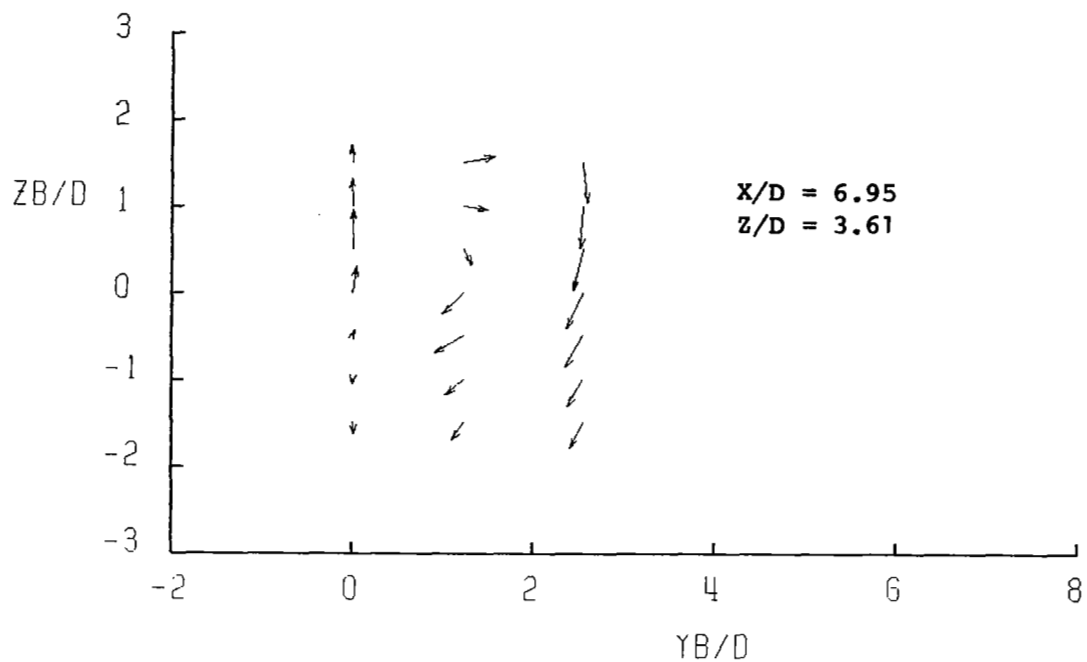

(b) Cross-section velocity plots.

Figure B9.- Continued.

APPENDIX B

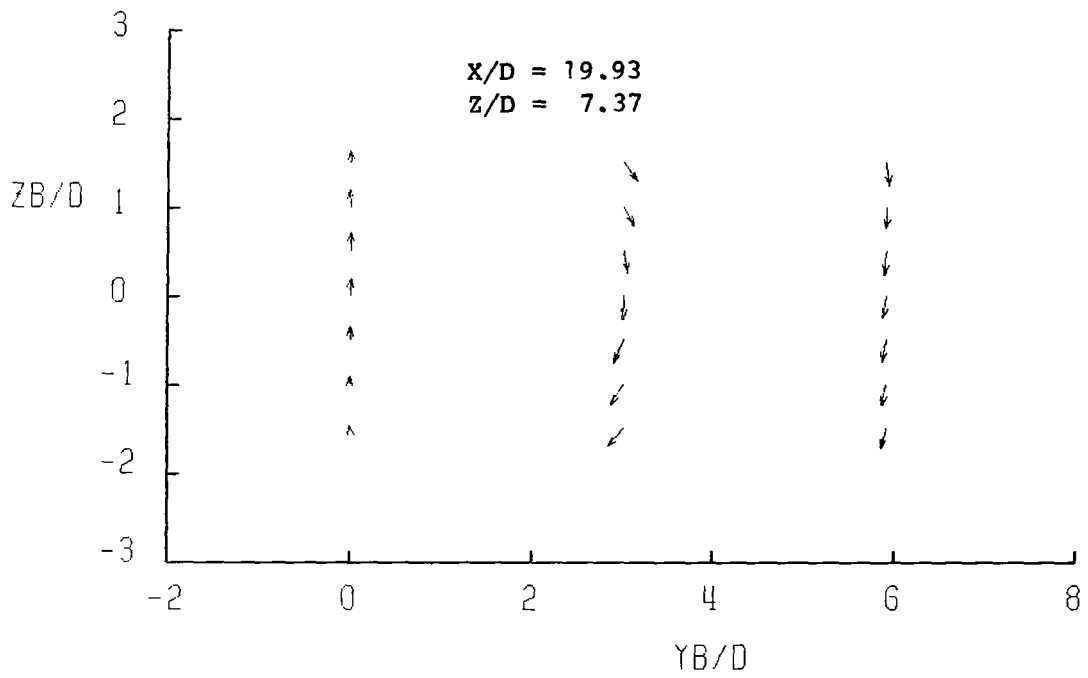

(b) Concluded.

Figure B9.- Concluded.

TABLE B10.- TABULATED VALUES OF CROSS-SECTION VELOCITIES

AND PRESSURES FOR R = 8 AND DELTA = 60°

R= 8.01 DELTA= 60 DEG
 X/D= 1.96 UINF= 38.2 M/SEC
 Z/D= 1.97 PHI= 41.0 DEG

R= 7.94 DELTA= 60 DEG
 X/D= 3.95 UINF= 37.9 M/SEC
 Z/D= 3.46 PHI= 37.0 DEG

YB/D		0.0	1.17	2.30	
ZB/D					
1.5		0.68	0.69	0.74	UB/UINF
		-0.01	0.21	0.06	VB/UINF
		-0.46	-0.74	-0.80	WB/UINF
		0.27	-0.08	-0.21	CP
		-0.05	0.0	-0.01	CPT
	34.1	47.7	47.2	THETA	
1.0		4.62	0.80	0.81	UB/UINF
		-0.14	0.35	0.0	VB/UINF
		1.77	-0.96	-0.85	WB/UINF
		3.95	-0.77	-0.40	CP
		29.99	-0.08	-0.02	CPT
	20.9	51.3	46.4	THETA	
0.5		5.57	1.36	0.85	UB/UINF
		-0.31	0.35	-0.07	VB/UINF
		1.68	-1.27	-0.89	WB/UINF
		4.79	-3.03	-0.53	CP
		41.36	-0.41	-0.01	CPT
	17.5	43.9	46.6	THETA	
0.0		1.22	1.21	0.95	UB/UINF
		-0.05	-0.59	-0.26	VB/UINF
		1.26	-1.35	-0.81	WB/UINF
		-1.71	-2.67	-0.64	CP
		0.40	0.0	-0.02	CPT
	46.0	51.1	42.2	THETA	
-0.5		1.06	1.04	0.90	UB/UINF
		0.06	-0.66	-0.26	VB/UINF
		0.33	-0.75	-0.80	WB/UINF
		-0.43	-1.07	-0.50	CP
		-0.20	0.03	0.03	CPT
	17.2	44.7	43.3	THETA	
-1.0		0.94	1.00	0.86	UB/UINF
		0.01	-0.46	-0.25	VB/UINF
		-0.27	-0.60	-0.73	WB/UINF
		-0.11	-0.46	-0.36	CP
		-0.15	0.12	-0.02	CPT
	15.9	37.9	41.9	THETA	
-1.5		0.82	0.94	0.82	UB/UINF
		0.02	-0.29	-0.26	VB/UINF
		-0.53	-0.62	-0.74	WB/UINF
		-0.08	-0.22	-0.23	CP
		-0.13	0.13	0.07	CPT
	32.8	36.7	43.9	THETA	

YB/D		0.0	1.71	3.43	
ZB/D					
1.5		5.06	0.79	0.74	UB/UINF
		-0.11	0.39	0.02	VB/UINF
		1.01	-0.83	-0.77	WB/UINF
		-4.10	-0.77	-0.10	CP
		24.00	-0.29	0.03	CPT
	11.8	48.7	46.1	THETA	
1.0		2.48	1.46	0.80	UB/UINF
		-0.04	0.43	-0.03	VB/UINF
		0.44	-0.83	-0.78	WB/UINF
		-3.76	-2.45	-0.23	CP
		1.73	-0.42	0.02	CPT
	10.4	32.2	44.3	THETA	
0.5		1.17	1.82	0.87	UB/UINF
		-0.07	0.21	-0.12	VB/UINF
		1.10	-0.52	-0.78	WB/UINF
		-1.77	-3.10	-0.33	CP
		-0.16	0.18	0.04	CPT
	43.4	27.3	42.2	THETA	
0.0		0.93	1.18	0.87	UB/UINF
		0.03	-0.51	-0.16	VB/UINF
		0.97	-1.06	-0.75	WB/UINF
		-0.86	-1.57	-0.29	CP
		-0.04	0.23	0.05	CPT
	46.1	45.5	41.4	THETA	
-0.5		0.95	0.95	0.85	UB/UINF
		0.06	-0.57	-0.20	VB/UINF
		0.46	-0.73	-0.76	WB/UINF
		-0.27	-0.72	-0.28	CP
		-0.15	0.05	0.07	CPT
	25.9	44.8	42.6	THETA	
-1.0		0.96	0.99	0.89	UB/UINF
		0.03	-0.42	-0.20	VB/UINF
		0.05	-0.54	-0.67	WB/UINF
		-0.04	-0.43	-0.28	CP
		-0.11	0.03	0.01	CPT
	3.0	35.2	38.2	THETA	
-1.5		0.91	0.84	0.87	UB/UINF
		0.02	-0.35	-0.19	VB/UINF
		-0.20	-0.49	-0.68	WB/UINF
		0.02	-0.07	-0.17	CP
		-0.11	0.01	0.07	CPT
	12.6	36.5	39.0	THETA	

APPENDIX B

TABLE B10.- Continued

R= 8.00 DELTA= 60 DEG

X/D= 6.95 UINF= 38.0 M/SEC
Z/D= 5.17 PHI= 29.0 DEG

YB/D \ ZB/D		YB/D			
		0.0	1.72	3.33	
1.5		2.04	2.41	0.81	UB/UINF
		-0.02	0.56	0.08	VB/UINF
		0.37	-0.26	-0.70	WB/UINF
		-1.66	-2.17	-0.15	CP
		1.69	3.12	0.02	CPT
	10.7	13.4	41.0	THETA	
1.0		1.38	2.39	0.85	UB/UINF
		-0.02	0.40	0.02	VB/UINF
		0.68	-0.37	-0.72	WB/UINF
		-1.13	-1.93	-0.27	CP
		0.24	3.20	-0.02	CPT
	26.5	11.9	40.4	THETA	
0.5		1.36	2.27	0.88	UB/UINF
		0.01	0.20	-0.06	VB/UINF
		0.78	-0.50	-0.74	WB/UINF
		-1.27	-2.09	-0.33	CP
		0.22	2.42	0.0	CPT
	29.8	12.9	40.1	THETA	
0.0		1.10	2.09	0.84	UB/UINF
		-0.01	-0.14	-0.18	VB/UINF
		0.70	-0.57	-0.73	WB/UINF
		-0.86	-2.11	-0.26	CP
		-0.15	1.66	0.01	CPT
	32.7	16.2	41.8	THETA	
-0.5		1.04	1.23	0.97	UB/UINF
		-0.03	-0.40	-0.24	VB/UINF
		0.48	-0.59	-0.66	WB/UINF
		-0.41	-1.22	-0.33	CP
		-0.08	-0.18	0.10	CPT
	24.8	30.9	35.8	THETA	
-1.0		0.95	1.10	0.90	UB/UINF
		-0.01	-0.54	-0.25	VB/UINF
		0.23	-0.40	-0.60	WB/UINF
		-0.04	-0.51	-0.20	CP
		-0.09	0.16	0.02	CPT
	13.6	32.4	35.9	THETA	
-1.5		0.97	0.98	0.90	UB/UINF
		0.01	-0.42	-0.24	VB/UINF
		0.02	-0.37	-0.57	WB/UINF
		0.0	-0.14	-0.13	CP
		-0.06	0.13	0.07	CPT
	2.0	30.5	34.7	THETA	

R= 8.02 DELTA= 60 DEG

X/D= 19.93 UINF= 38.1 M/SEC
Z/D= 9.66 PHI= 15.0 DEG

YB/D \ ZB/D		YB/D			
		0.0	2.83	5.89	
1.5		1.23	1.41	0.94	UB/UINF
		-0.02	0.26	0.07	VB/UINF
		0.29	-0.25	-0.39	WB/UINF
		-0.33	-0.31	0.01	CP
		0.29	0.82	0.06	CPT
	14.0	13.9	23.5	THETA	
1.0		1.28	1.54	0.98	UB/UINF
		-0.05	0.21	0.05	VB/UINF
		0.37	-0.26	-0.38	WB/UINF
		-0.36	-0.51	-0.05	CP
		0.42	0.98	0.06	CPT
	17.0	11.9	21.8	THETA	
0.5		1.16	1.59	0.98	UB/UINF
		-0.09	0.16	0.01	VB/UINF
		0.46	-0.28	-0.39	WB/UINF
		-0.29	-0.54	-0.07	CP
		0.27	1.12	0.05	CPT
	22.8	11.0	22.0	THETA	
0.0		1.20	1.58	1.00	UB/UINF
		-0.08	0.07	-0.03	VB/UINF
		0.45	-0.30	-0.39	WB/UINF
		-0.41	-0.58	-0.13	CP
		0.24	1.05	0.02	CPT
	21.6	10.8	21.3	THETA	
-0.5		1.16	1.51	0.99	UB/UINF
		-0.04	-0.02	-0.05	VB/UINF
		0.39	-0.33	-0.40	WB/UINF
		-0.40	-0.46	-0.09	CP
		0.11	0.94	0.06	CPT
	19.4	12.6	22.0	THETA	
-1.0		1.10	1.51	1.00	UB/UINF
		-0.09	-0.06	-0.06	VB/UINF
		0.36	-0.33	-0.39	WB/UINF
		-0.23	-0.50	-0.11	CP
		0.11	0.93	0.06	CPT
	19.5	12.8	21.4	THETA	
-1.5		1.04	1.38	1.00	UB/UINF
		-0.02	-0.20	-0.08	VB/UINF
		0.26	-0.28	-0.37	WB/UINF
		-0.15	-0.48	-0.09	CP
		0.0	0.55	0.06	CPT
	14.8	14.5	20.3	THETA	

TABLE B10.- Concluded

R= 8.00 DELTA= 60 DEG

X/D= 9.93 UINF= 38.1 M/SEC
Z/D= 6.50 PHI= 24.0 DEG

YB/D		0.0	0.0	2.01	3.89	4.09	7.86	
ZB/D								
1.5		1.48	1.48	1.99	0.89	0.85	0.91	UB/UINF
		-0.04	-0.03	0.42	0.09	0.07	0.01	VB/UINF
		0.44	0.44	-0.26	-0.61	-0.60	-0.47	WB/UINF
		-0.84	-0.85	-1.19	-0.16	-0.10	0.0	CP
		0.56	0.55	2.06	0.01	0.02	0.06	CPT
		17.1	16.9	12.9	34.6	35.2	27.6	THETA
1.0		1.41	1.34	2.15	0.90	0.89	0.93	UB/UINF
		0.01	-0.04	0.28	0.02	0.0	-0.01	VB/UINF
		0.54	0.61	-0.43	-0.62	-0.62	-0.45	WB/UINF
		-0.97	-0.85	-1.38	-0.20	-0.18	-0.03	CP
		0.32	0.34	2.57	0.0	0.0	0.05	CPT
		20.9	24.8	12.8	34.3	34.9	26.1	THETA
0.5		1.23	1.27	2.01	0.92	0.92	0.94	UB/UINF
		-0.05	-0.08	0.17	-0.06	-0.04	-0.03	VB/UINF
		0.68	0.66	-0.39	-0.66	-0.62	-0.46	WB/UINF
		-0.79	-0.94	-1.35	-0.25	-0.22	-0.04	CP
		0.20	0.12	1.94	0.05	0.01	0.05	CPT
		29.5	28.0	11.4	35.7	34.0	26.3	THETA
0.0		1.03	1.06	1.80	0.90	0.97	0.94	UB/UINF
		0.02	-0.01	-0.12	-0.16	-0.10	-0.02	VB/UINF
		0.66	0.61	-0.49	-0.60	-0.59	-0.44	WB/UINF
		-0.58	-0.62	-1.31	-0.23	-0.32	-0.07	CP
		-0.07	-0.11	1.23	-0.04	-0.01	0.01	CPT
		32.5	30.2	15.9	34.6	31.4	25.4	THETA
-0.5		1.08	1.04	1.54	0.91	0.92	0.92	UB/UINF
		-0.02	-0.11	-0.22	-0.17	-0.18	-0.04	VB/UINF
		0.48	0.47	-0.49	-0.60	-0.58	-0.45	WB/UINF
		-0.41	-0.35	-0.99	-0.20	-0.22	-0.02	CP
		0.0	-0.04	0.69	0.02	0.01	0.03	CPT
		24.3	25.6	19.8	34.3	33.3	26.3	THETA
-1.0		1.03	1.02	1.25	0.98	0.95	0.92	UB/UINF
		-0.02	0.03	-0.42	-0.16	-0.21	-0.06	VB/UINF
		0.29	0.31	-0.39	-0.52	-0.51	-0.46	WB/UINF
		-0.21	-0.13	-0.58	-0.21	-0.17	-0.01	CP
		-0.05	0.0	0.33	0.04	0.04	0.05	CPT
		16.2	16.7	25.5	28.8	30.1	26.5	THETA
-1.5		0.99	0.97	1.09	0.95	0.91	0.91	UB/UINF
		-0.01	-0.02	-0.43	-0.20	-0.21	-0.06	VB/UINF
		0.13	0.12	-0.32	-0.51	-0.52	-0.45	WB/UINF
		-0.07	-0.01	-0.30	-0.13	-0.11	-0.03	CP
		-0.07	-0.06	0.18	0.07	0.04	0.01	CPT
		8.0	8.4	27.1	29.9	31.3	26.3	THETA

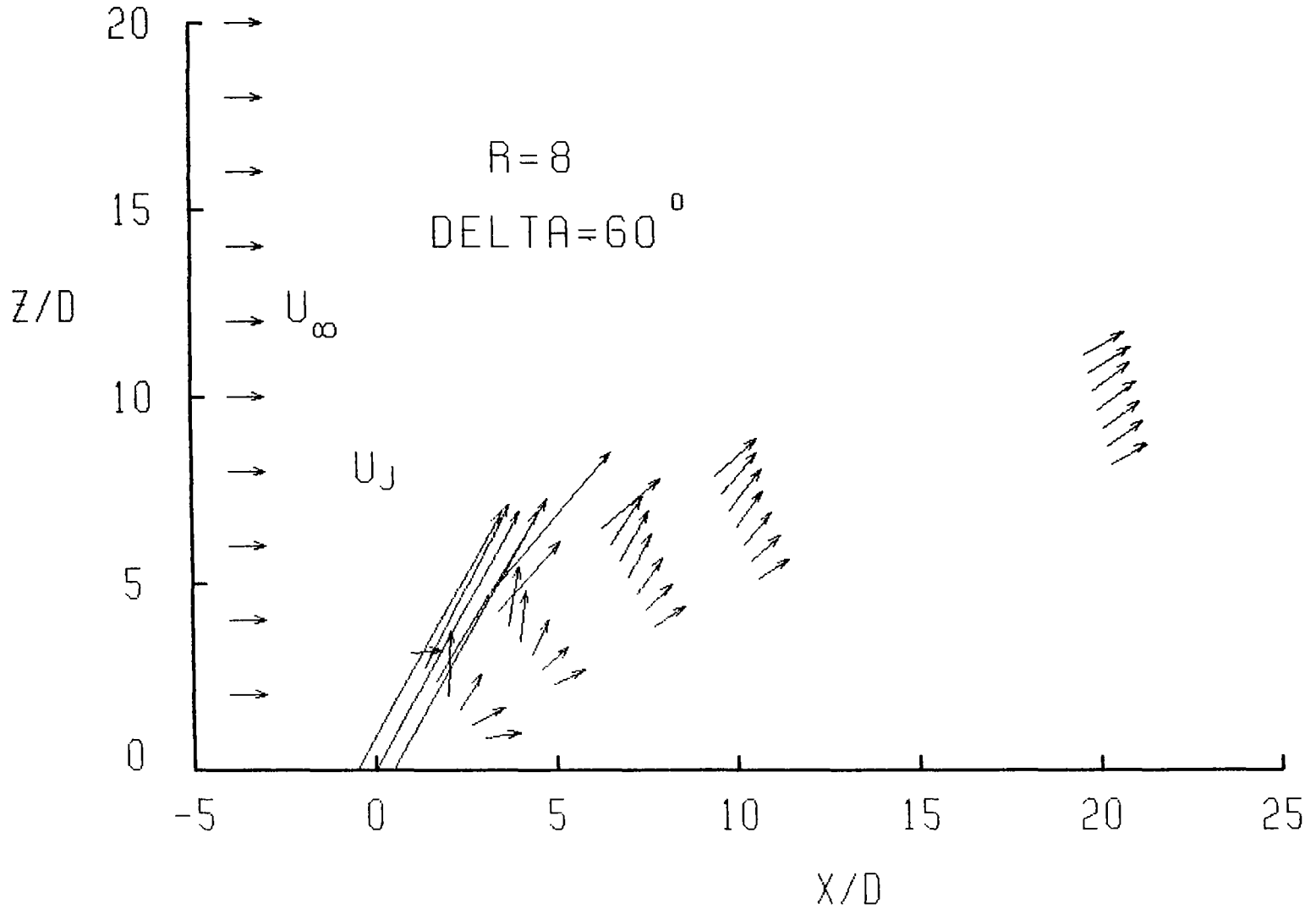

(a) Symmetry plane velocity plot locating cross sections of measurement.

Figure B10.- Cross-section velocities for $R = 8$ and $\text{DELTA} = 60^\circ$.

APPENDIX B

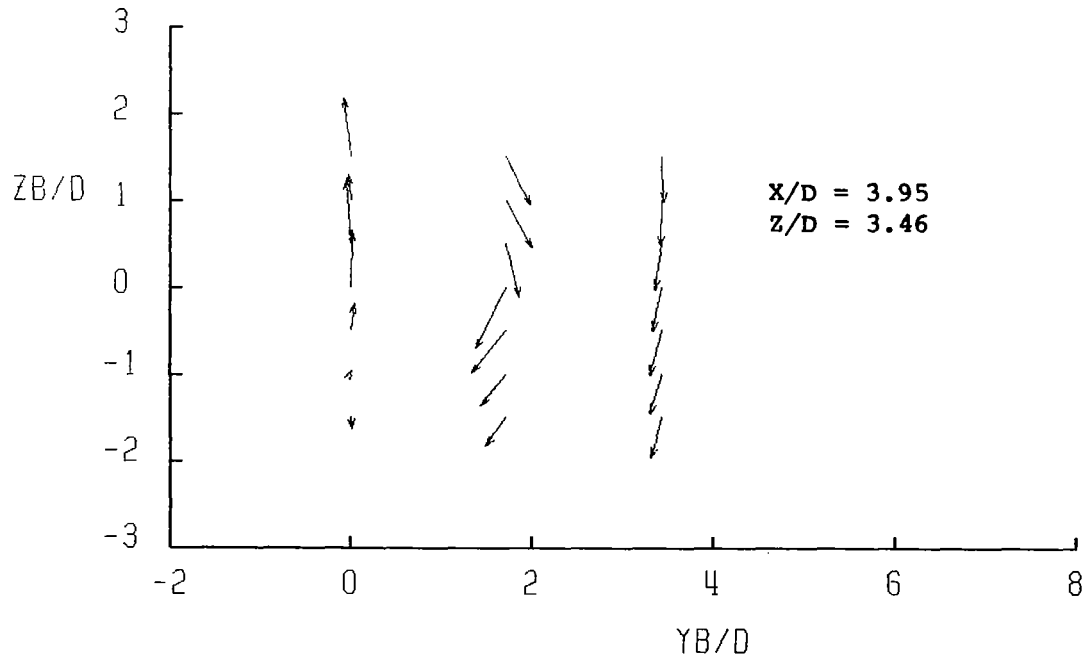
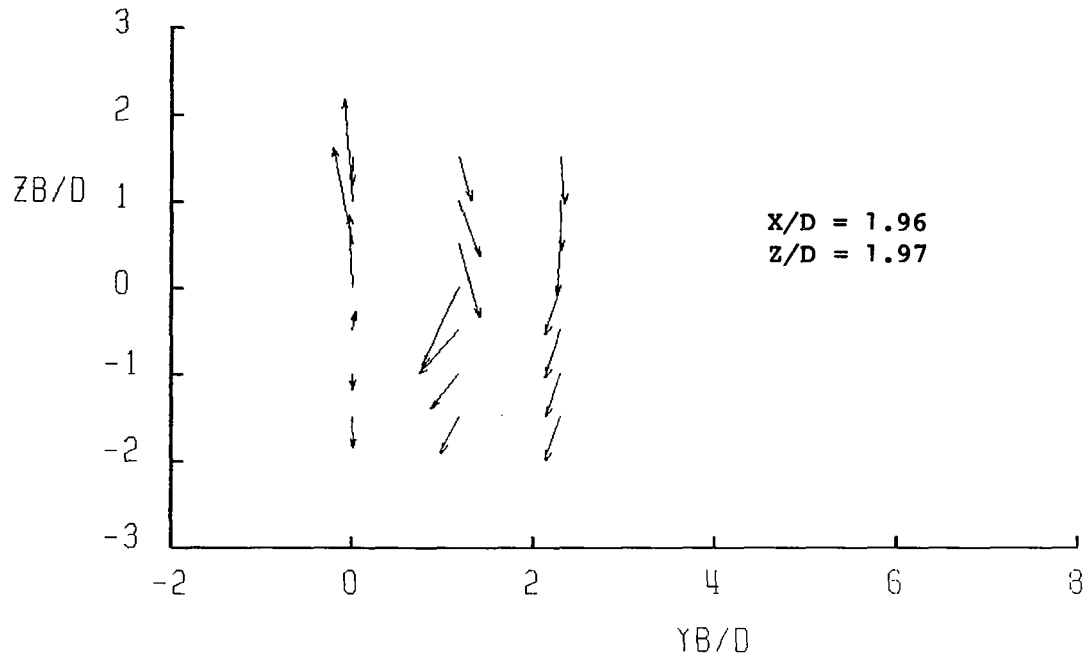

(b) Cross-section velocity plots.

Figure B10.- Continued.

APPENDIX B

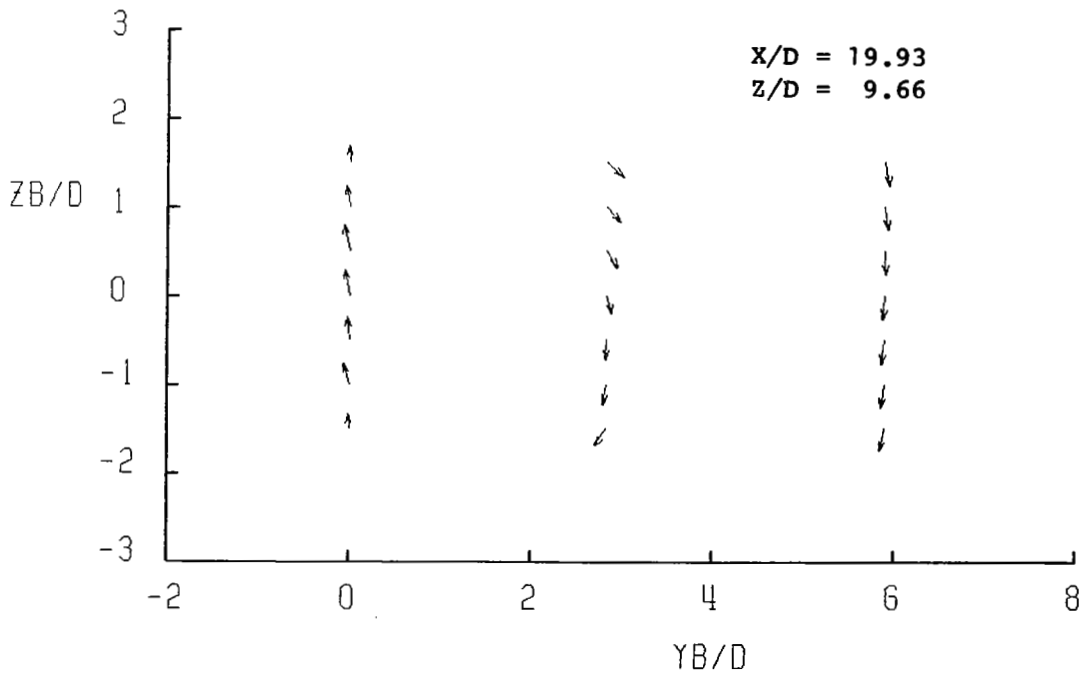
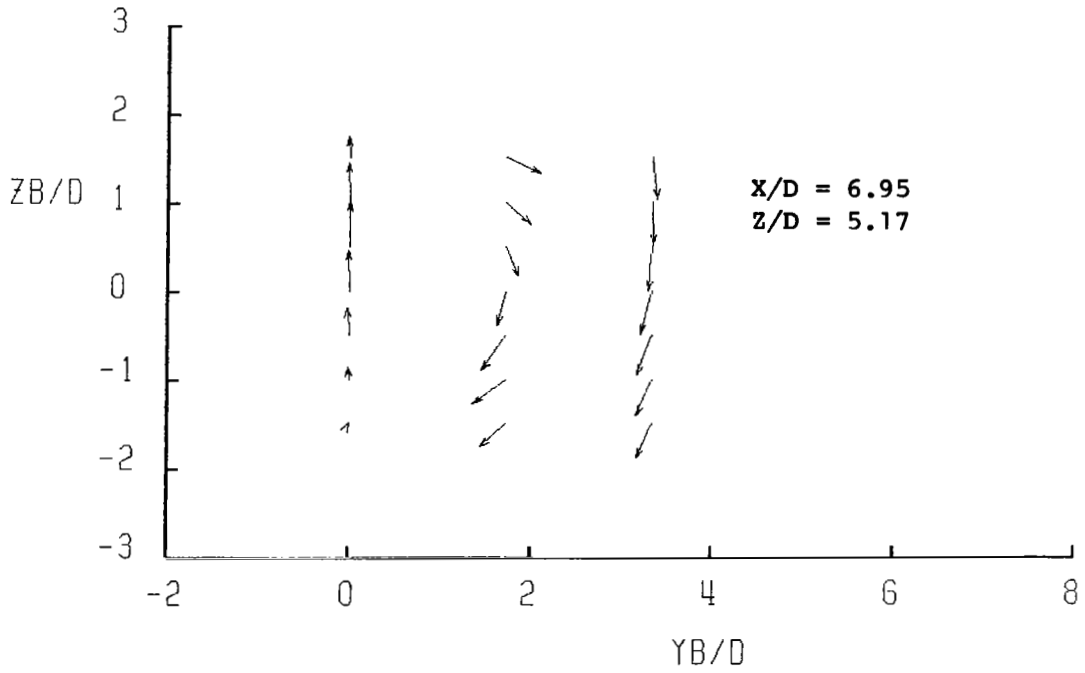

(b) Continued.

Figure B10.- Continued.

APPENDIX B

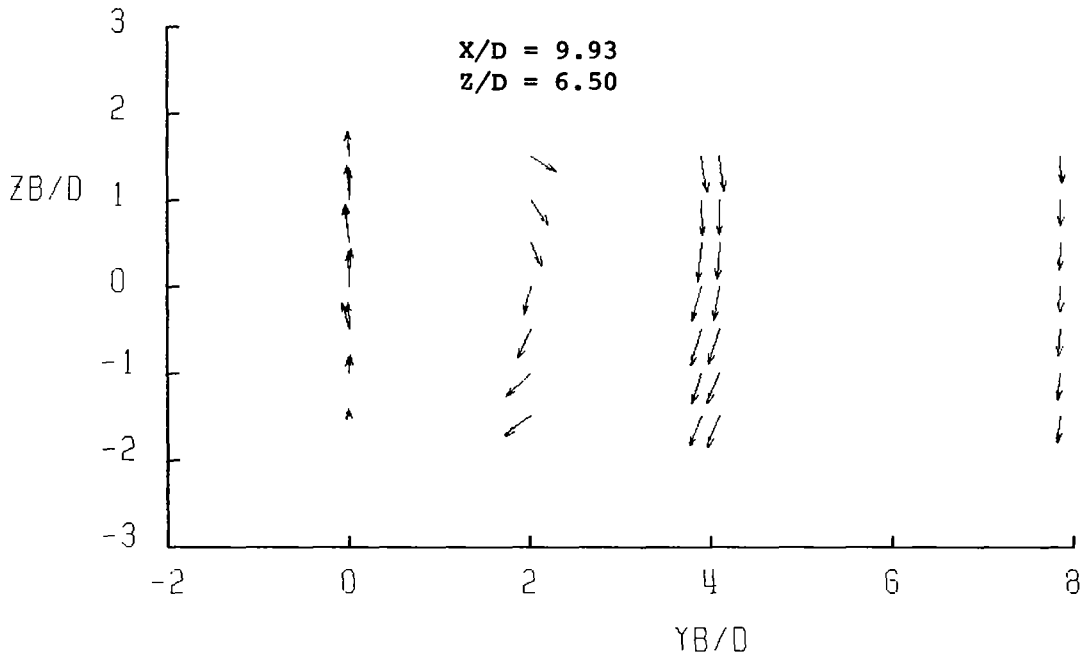

(b) Concluded.

Figure B10.- Concluded.

TABLE B11.- TABULATED VALUES OF CROSS-SECTION VELOCITIES

AND PRESSURES FOR R = 8 AND DELTA = 75°

R = 8.04 DELTA = 75 DEG				R = 7.99 DELTA = 75 DEG						
X/D = 1.96		UINF = 37.9 M/SEC		X/D = 3.95		UINF = 38.6 M/SEC				
Z/D = 3.88		PHI = 51.0 DEG		Z/D = 4.94		PHI = 42.8 DEG				
	YB/D	0.0	1.08	2.29		YB/D	0.0	1.50	3.47	
	ZB/D					ZB/D				
1.5		0.61	0.44	0.47	UB/UINF	3.02	2.33	0.61	UB/UINF	
		0.08	0.27	0.10	VB/UINF	0.0	0.75	0.09	VB/UINF	
		-0.48	-0.76	-0.89	WB/UINF	0.36	-0.24	-0.89	WB/UINF	
		-0.19	0.07	-0.06	CP	-4.29	-3.17	-0.16	CP	
		-0.58	-0.08	-0.03	CPT	4.22	1.99	0.03	CPT	
		38.5	60.9	62.0	THETA		7.0	17.5	55.6	THETA
1.0		3.88	0.72	0.56	UB/UINF	1.22	2.67	0.71	UB/UINF	
		-0.08	0.48	0.18	VB/UINF	-0.09	0.65	0.06	VB/UINF	
		1.28	-0.82	-0.96	WB/UINF	0.76	-0.41	-0.92	WB/UINF	
		-1.33	-1.13	-0.30	CP	-1.97	-3.41	-0.45	CP	
		15.28	-0.70	-0.02	CPT	-0.90	3.52	-0.08	CPT	
		18.5	52.6	60.0	THETA		32.3	15.1	52.2	THETA
0.5		4.71	2.19	0.63	UB/UINF	1.04	2.63	0.73	UB/UINF	
		-0.03	1.12	0.06	VB/UINF	0.02	0.40	-0.05	VB/UINF	
		0.79	-0.49	-1.03	WB/UINF	1.21	-0.67	-0.95	WB/UINF	
		-5.15	-3.64	-0.66	CP	-1.91	-3.46	-0.52	CP	
		18.48	1.80	-0.19	CPT	-0.32	3.23	-0.08	CPT	
		9.7	28.2	58.7	THETA		49.3	15.9	52.7	THETA
0.0		1.04	3.15	0.64	UB/UINF	0.99	2.15	0.73	UB/UINF	
		-0.07	0.97	-0.08	VB/UINF	0.01	-0.04	-0.17	VB/UINF	
		1.24	-0.84	-1.09	WB/UINF	1.17	-0.84	-0.96	WB/UINF	
		-2.89	-4.96	-0.85	CP	-1.76	-3.06	-0.46	CP	
		-1.23	6.03	-0.24	CPT	-0.40	1.36	0.03	CPT	
		50.1	21.3	59.8	THETA		49.9	21.6	53.1	THETA
-0.5		0.91	2.37	0.67	UB/UINF	0.89	1.58	0.77	UB/UINF	
		-0.01	0.14	-0.31	VB/UINF	0.04	-0.51	-0.30	VB/UINF	
		1.51	-1.30	-1.15	WB/UINF	0.84	-0.78	-0.90	WB/UINF	
		-2.71	-4.64	-0.68	CP	-0.87	-2.42	-0.44	CP	
		-0.59	1.87	0.20	CPT	-0.36	-0.03	0.08	CPT	
		58.9	28.9	60.8	THETA		43.5	31.3	51.0	THETA
-1.0		0.80	1.28	0.75	UB/UINF	0.89	1.15	0.79	UB/UINF	
		-0.02	-0.84	-0.33	VB/UINF	0.03	-0.67	-0.33	VB/UINF	
		0.93	-0.93	-0.99	WB/UINF	0.41	-0.58	-0.82	WB/UINF	
		-1.10	-2.32	-0.90	CP	-0.47	-1.08	-0.40	CP	
		-0.58	-0.07	-0.23	CPT	-0.50	0.04	0.01	CPT	
		49.4	45.1	54.6	THETA		24.6	38.6	48.5	THETA
-1.5		0.83	0.93	0.73	UB/UINF	0.82	0.90	0.87	UB/UINF	
		0.0	-0.67	-0.43	VB/UINF	0.01	-0.58	-0.30	VB/UINF	
		0.26	-0.67	-0.53	WB/UINF	0.08	-0.51	-0.76	WB/UINF	
		-0.56	-0.77	-0.44	CP	-0.17	-0.24	-0.41	CP	
		-0.81	0.0	0.14	CPT	-0.48	0.17	0.03	CPT	
		17.8	46.3	54.9	THETA		6.0	41.7	43.3	THETA

TABLE B11.- Continued

R= 7.99 DELTA= 75 DEG
 X/D= 9.94 UINF= 21.4 M/SEC
 Z/D= 8.20 PHI= 19.1 DEG

R= 8.00 DELTA= 75 DEG
 X/D= 9.94 UINF= 38.3 M/SEC
 Z/D= 8.20 PHI= 19.1 DEG

YB/D		0.0	2.65	5.14	
ZB/D					
1.5		1.09	1.61	0.91	UB/UINF
		0.02	0.43	0.11	VB/UINF
		0.67	-0.22	-0.52	WB/UINF
		-0.69	-0.84	-0.07	CP
		-0.06	0.98	0.05	CPT
	31.7	16.2	30.4	THETA	
1.0		0.93	1.66	0.83	UB/UINF
		-0.01	0.36	0.04	VB/UINF
		0.83	-0.27	-0.58	WB/UINF
		-0.68	-1.10	0.0	CP
		-0.12	0.88	0.03	CPT
	41.9	14.4	35.3	THETA	
0.5		0.97	1.72	0.93	UB/UINF
		-0.01	0.18	0.0	VB/UINF
		0.88	-0.38	-0.55	WB/UINF
		-0.70	-1.19	-0.12	CP
		0.04	0.95	0.04	CPT
	42.3	13.5	30.5	THETA	
0.0		0.98	1.63	1.06	UB/UINF
		0.12	0.10	0.09	VB/UINF
		0.81	-0.43	-0.49	WB/UINF
		-0.85	-1.23	-0.37	CP
		-0.21	0.61	0.01	CPT
	39.6	15.0	25.5	THETA	
-0.5		0.93	1.53	0.95	UB/UINF
		0.01	-0.18	-0.13	VB/UINF
		0.73	-0.45	-0.52	WB/UINF
		-0.50	-1.10	-0.14	CP
		-0.11	0.47	0.06	CPT
	38.3	17.9	29.1	THETA	
-1.0		0.96	1.39	1.01	UB/UINF
		0.11	-0.30	-0.06	VB/UINF
		0.55	-0.34	-0.48	WB/UINF
		-0.38	-1.14	-0.25	CP
		-0.14	0.0	0.0	CPT
	29.5	18.7	25.3	THETA	
-1.5		0.96	1.22	1.02	UB/UINF
		0.09	-0.36	-0.09	VB/UINF
		0.41	-0.31	-0.46	WB/UINF
		-0.25	-0.70	-0.22	CP
		-0.16	0.01	0.04	CPT
	23.0	22.1	24.4	THETA	

YB/D		0.0	2.66	5.16	
ZB/D					
1.5		1.14	1.64	0.93	UB/UINF
		-0.01	0.41	0.10	VB/UINF
		0.69	-0.22	-0.54	WB/UINF
		-0.74	-1.01	-0.13	CP
		0.05	0.92	0.05	CPT
	31.3	15.3	30.7	THETA	
1.0		1.06	1.74	0.90	UB/UINF
		0.02	0.29	0.06	VB/UINF
		0.80	-0.31	-0.57	WB/UINF
		-0.84	-1.07	-0.12	CP
		-0.07	1.17	0.02	CPT
	36.8	13.3	32.5	THETA	
0.5		1.00	1.68	0.98	UB/UINF
		0.0	0.25	0.0	VB/UINF
		0.91	-0.37	-0.55	WB/UINF
		-0.81	-1.06	-0.22	CP
		0.02	1.00	0.05	CPT
	42.4	14.5	29.1	THETA	
0.0		0.95	1.65	1.01	UB/UINF
		0.04	0.09	-0.03	VB/UINF
		0.85	-0.45	-0.52	WB/UINF
		-0.77	-1.13	-0.29	CP
		-0.12	0.85	0.01	CPT
	41.8	15.4	27.2	THETA	
-0.5		0.95	1.52	0.98	UB/UINF
		-0.08	-0.18	-0.14	VB/UINF
		0.76	-0.43	-0.52	WB/UINF
		-0.57	-1.08	-0.19	CP
		-0.08	0.47	0.06	CPT
	39.2	17.3	28.7	THETA	
-1.0		0.97	1.36	0.99	UB/UINF
		0.02	-0.31	-0.11	VB/UINF
		0.58	-0.38	-0.49	WB/UINF
		-0.39	-0.91	-0.22	CP
		-0.11	0.19	0.02	CPT
	30.8	20.4	26.6	THETA	
-1.5		0.96	1.18	0.98	UB/UINF
		0.06	-0.39	-0.13	VB/UINF
		0.41	-0.34	-0.46	WB/UINF
		-0.22	-0.59	-0.21	CP
		-0.13	0.08	-0.01	CPT
	23.3	24.3	25.6	THETA	

APPENDIX B

TABLE B11.- Continued

R= 7.99 DELTA= 75 DEG

X/D= 19.97 UINF= 38.0 M/SEC
Z/D= 11.50 PHI= 17.0 DEG

YB/D \ ZB/D	0.0	3.42	7.02	
1.5	1.11 0.01 0.37 -0.36 0.02 18.6	1.26 0.28 -0.36 -0.37 0.43 19.9	0.92 0.06 -0.42 0.0 0.04 25.5	UB/UINF VB/UINF WB/UINF CP CPT THETA
1.0	1.06 -0.03 0.44 -0.33 -0.01 23.1	1.28 0.19 -0.38 -0.39 0.44 18.4	0.93 0.03 -0.42 -0.02 0.03 24.6	UB/UINF VB/UINF WB/UINF CP CPT THETA
0.5	1.17 -0.03 0.47 -0.49 0.10 22.4	1.37 0.15 -0.41 -0.55 0.54 17.6	0.98 0.01 -0.42 -0.08 0.06 23.4	UB/UINF VB/UINF WB/UINF CP CPT THETA
0.0	1.11 -0.08 0.50 -0.42 0.06 25.2	1.33 0.07 -0.42 -0.48 0.48 17.8	0.97 -0.01 -0.41 -0.08 0.03 23.2	UB/UINF VB/UINF WB/UINF CP CPT THETA
-0.5	1.06 -0.02 0.47 -0.41 -0.04 24.4	1.33 0.02 -0.46 -0.41 0.59 19.1	0.95 -0.02 -0.42 -0.06 0.02 23.8	UB/UINF VB/UINF WB/UINF CP CPT THETA
-1.0	1.12 -0.05 0.41 -0.38 0.05 20.8	1.38 -0.08 -0.43 -0.54 0.56 17.5	0.98 -0.05 -0.41 -0.08 0.05 22.6	UB/UINF VB/UINF WB/UINF CP CPT THETA
-1.5	1.06 -0.04 0.35 -0.24 0.0 18.9	1.29 -0.15 -0.40 -0.43 0.43 18.4	0.98 -0.06 -0.40 -0.10 0.03 21.9	UB/UINF VB/UINF WB/UINF CP CPT THETA

TABLE B11.- Continued

R= 8.02 DELTA= 75 DEG

X/D= 3.95 UINF= 38.5 M/SEC
 Z/D= 4.93 PHI= 39.1 DEG

YB/D \ ZB/D	0.0	1.46	1.69	3.39	
1.5	2.63	2.68	2.12	0.72	UB/UINF
	0.02	0.73	0.68	0.10	VB/UINF
	0.46	0.08	-0.27	-0.84	WB/UINF
	-3.76	-3.44	-2.92	-0.28	CP
	2.56	3.50	1.17	-0.05	CPT
	10.0	14.1	18.0	49.8	THETA
1.0	1.04	2.74	2.53	0.78	UB/UINF
	-0.07	0.60	0.67	0.06	VB/UINF
	0.57	-0.17	-0.40	-0.90	WB/UINF
	-1.75	-3.55	-3.30	-0.43	CP
	-0.72	3.53	2.86	-0.01	CPT
	43.2	11.6	16.2	49.3	THETA
0.5	1.02	2.77	2.56	0.85	UB/UINF
	-0.02	0.35	0.37	-0.10	VB/UINF
	1.25	-0.44	-0.61	-0.89	WB/UINF
	-2.05	-3.69	-3.65	-0.61	CP
	-0.42	3.51	2.58	-0.08	CPT
	50.9	10.8	15.1	46.3	THETA
0.0	0.86	2.37	2.23	0.80	UB/UINF
	0.03	-0.12	-0.05	-0.18	VB/UINF
	1.20	-0.55	-0.78	-0.92	WB/UINF
	-1.67	-3.42	-3.33	-0.47	CP
	-0.48	1.66	1.36	0.05	CPT
	54.3	13.6	19.5	49.4	THETA
-0.5	0.87	1.69	1.36	0.78	UB/UINF
	0.04	-0.60	-0.67	-0.30	VB/UINF
	0.80	-0.54	-0.82	-0.90	WB/UINF
	-0.90	-2.50	-1.97	-0.37	CP
	-0.49	0.04	0.03	0.16	CPT
	42.4	26.4	38.5	50.4	THETA
-1.0	0.82	1.11	1.08	0.81	UB/UINF
	-0.01	-0.72	-0.70	-0.30	VB/UINF
	0.42	-0.41	-0.61	-0.80	WB/UINF
	-0.31	-0.92	-0.97	-0.31	CP
	-0.46	0.01	0.07	0.08	CPT
	27.3	37.8	41.5	46.8	THETA
-1.5	0.81	0.93	0.91	0.85	UB/UINF
	-0.02	-0.53	-0.53	-0.29	VB/UINF
	0.09	-0.38	-0.52	-0.74	WB/UINF
	-0.19	-0.19	-0.25	-0.28	CP
	-0.51	0.11	0.13	0.08	CPT
	6.9	36.1	40.1	43.3	THETA

APPENDIX B

TABLE B11.- Concluded

R= 7.99 DELTA= 75 DEG

X/D= 10.07 UINF= 31.9 M/SEC
Z/D= 8.20 PFI= 19.1 DEG

YB/D \ ZB/D	-4.93	-2.25	0.0	0.0	2.65	5.13	
1.5	0.95 -0.05 -0.56 -0.13 0.09 31.9	1.73 -0.41 -0.19 -0.89 1.34 19.3	1.16 0.01 0.64 -0.79 -0.02 29.0	1.17 -0.06 0.62 -0.85 -0.09 28.5	1.67 0.43 -0.25 -0.96 1.07 15.8	0.92 0.10 -0.53 -0.09 0.05 30.8	UB/UINF VB/UINF WB/UINF CP CPT THETA
1.0	0.90 0.0 -0.58 -0.15 0.01 33.7	1.82 -0.28 -0.24 -1.26 1.22 15.4	1.02 -0.01 0.80 -0.75 -0.07 38.3	1.00 0.02 0.79 -0.76 -0.15 38.3	1.68 0.34 -0.28 -1.11 0.94 14.1	0.85 0.05 -0.58 -0.08 -0.02 34.5	UB/UINF VB/UINF WB/UINF CP CPT THETA
0.5	0.98 0.05 -0.55 -0.21 0.07 29.7	1.83 -0.13 -0.27 -1.31 1.17 12.2	0.99 -0.01 0.87 -0.82 -0.07 41.3	0.99 -0.04 0.89 -0.73 0.06 42.2	1.72 0.19 -0.30 -1.30 0.81 11.2	0.97 -0.03 -0.56 -0.20 0.06 30.0	UB/UINF VB/UINF WB/UINF CP CPT THETA
0.0	1.01 0.15 -0.53 -0.29 0.03 27.6	1.70 0.02 -0.28 -1.37 0.61 10.3	0.97 -0.04 0.81 -0.80 -0.21 40.3	1.03 0.07 0.79 -0.89 -0.20 37.3	1.63 0.03 -0.40 -1.24 0.58 13.9	0.94 -0.01 -0.56 -0.24 -0.04 30.6	UB/UINF VB/UINF WB/UINF CP CPT THETA
-0.5	0.96 0.15 -0.54 -0.19 0.05 29.1	1.54 0.24 -0.35 -1.13 0.44 13.2	0.96 -0.04 0.70 -0.58 -0.16 36.4	0.96 0.02 0.72 -0.55 -0.11 37.0	1.39 -0.21 -0.43 -1.07 0.09 19.5	0.96 -0.12 -0.53 -0.17 0.05 29.5	UB/UINF VB/UINF WB/UINF CP CPT THETA
-1.0	0.99 0.22 -0.48 -0.21 0.06 26.0	1.32 0.40 -0.23 -0.92 0.05 15.2	0.97 0.0 0.55 -0.46 -0.23 29.8	0.94 0.10 0.58 -0.36 -0.12 31.5	1.31 -0.32 -0.37 -0.92 0.03 21.2	0.99 -0.10 -0.51 -0.22 0.02 27.4	UB/UINF VB/UINF WB/UINF CP CPT THETA
-1.5	1.00 0.23 -0.45 -0.21 0.06 24.5	1.13 0.49 -0.18 -0.48 0.09 20.3	0.95 0.01 0.40 -0.23 -0.17 23.2	0.99 0.07 0.38 -0.26 -0.12 20.8	1.15 -0.42 -0.31 -0.58 0.01 25.1	0.99 -0.13 -0.47 -0.21 0.01 25.8	UB/UINF VB/UINF WB/UINF CP CPT THETA

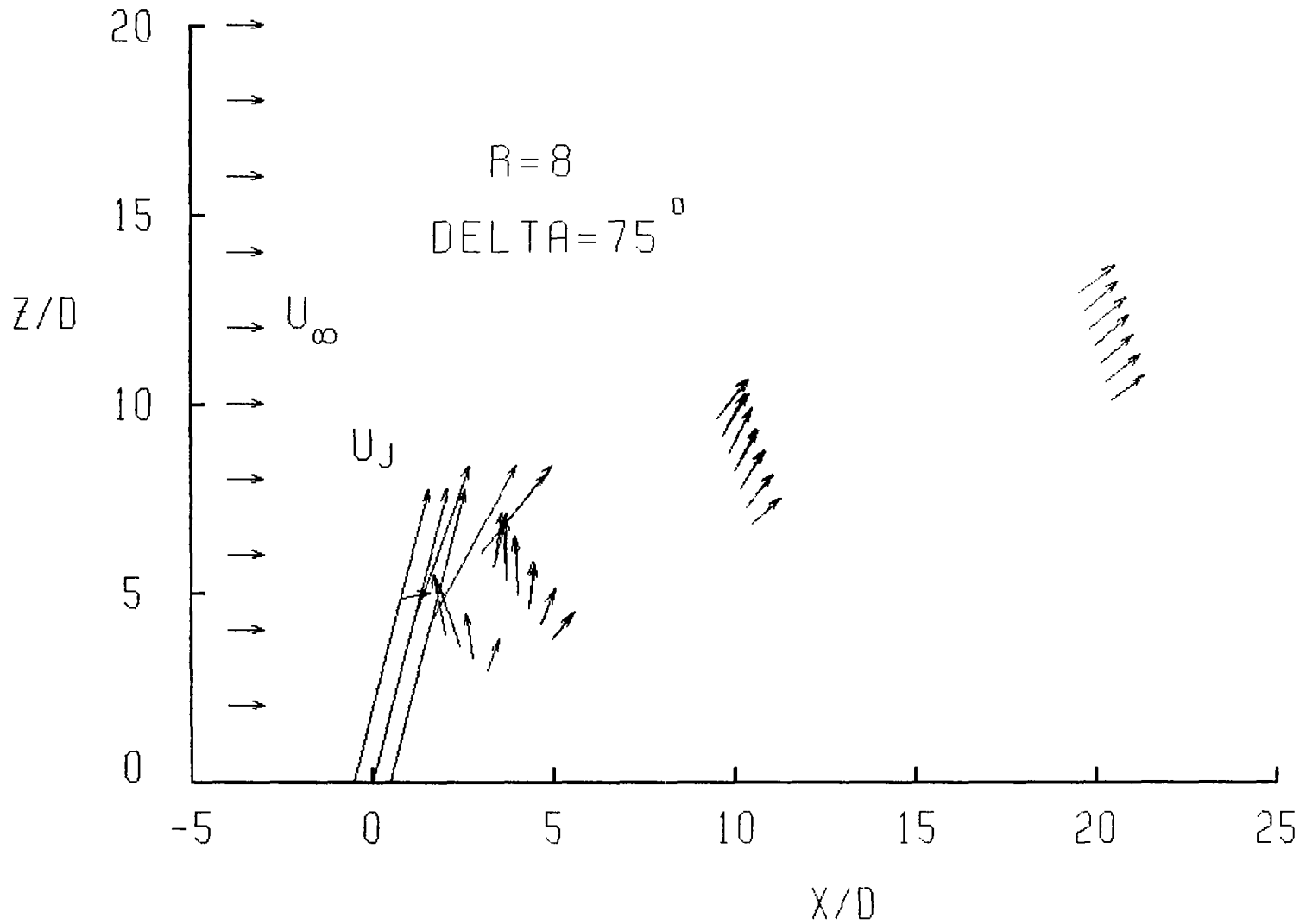

(a) Symmetry plane velocity plot locating cross sections of measurement.

Figure B11.- Cross-section velocities for $R = 8$ and $\text{DELTA} = 75^\circ$.

APPENDIX B

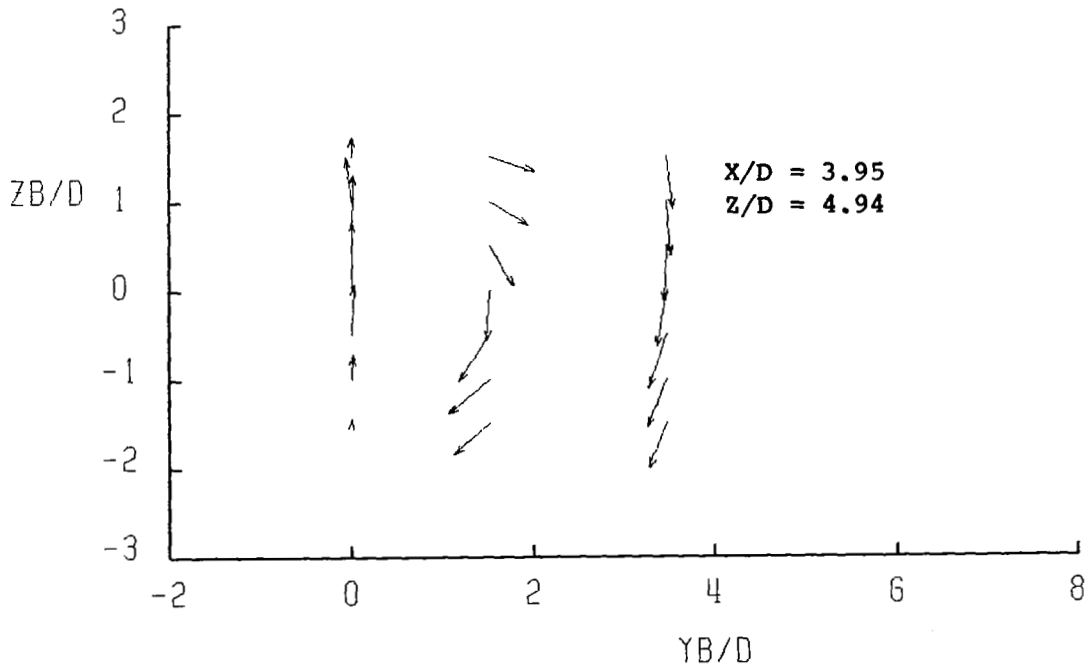
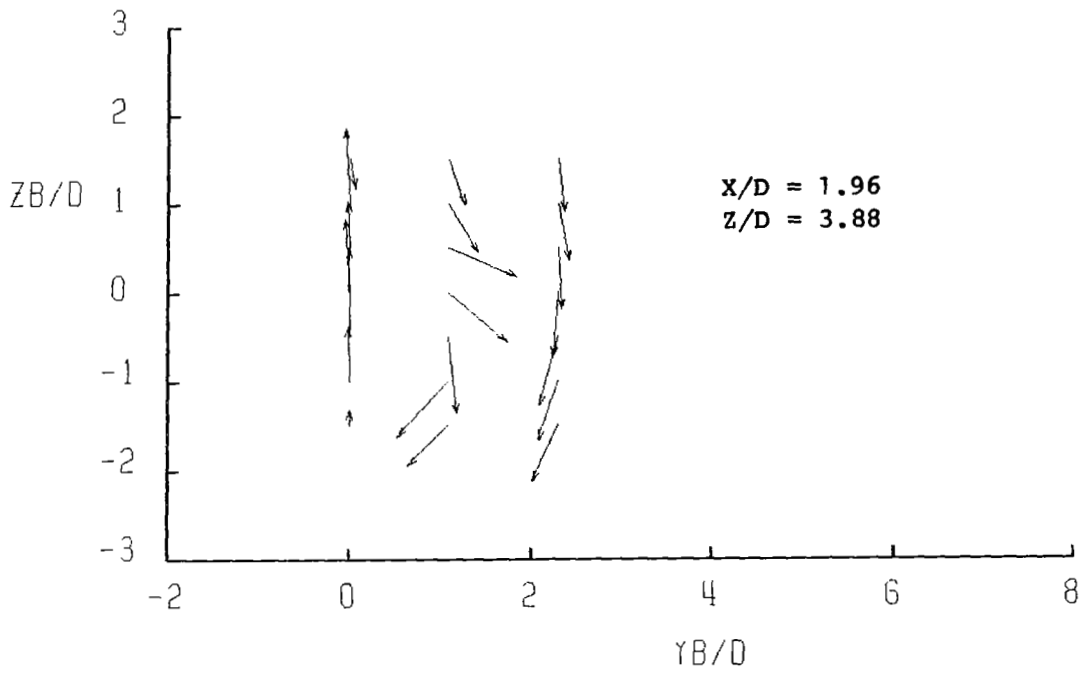

(b) Cross-section velocity plots.

Figure B11.- Continued.

APPENDIX B

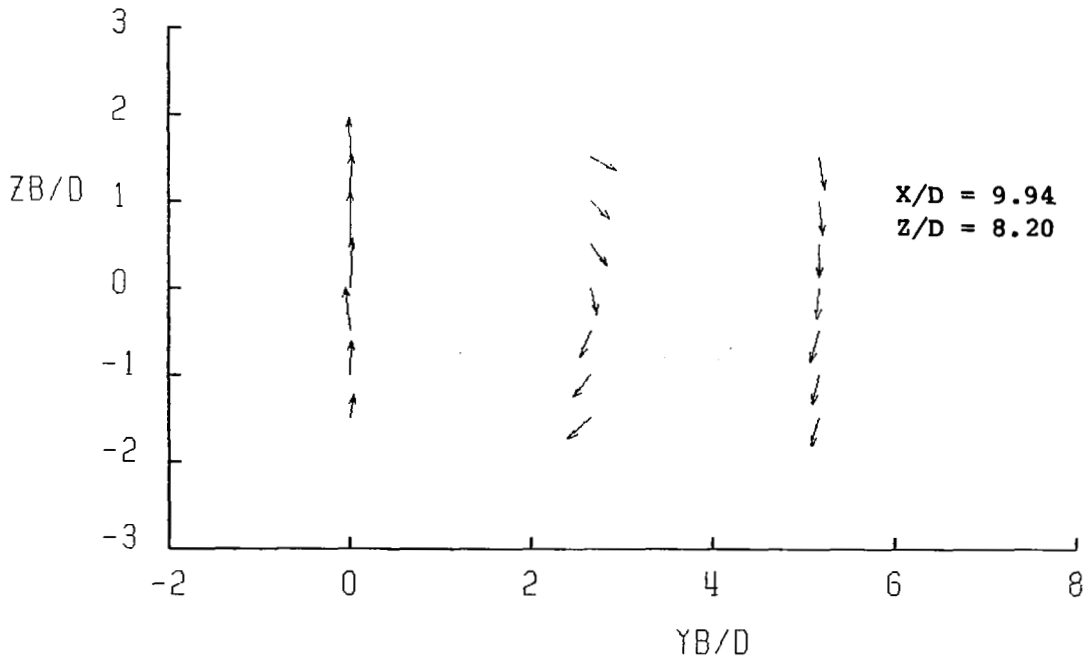
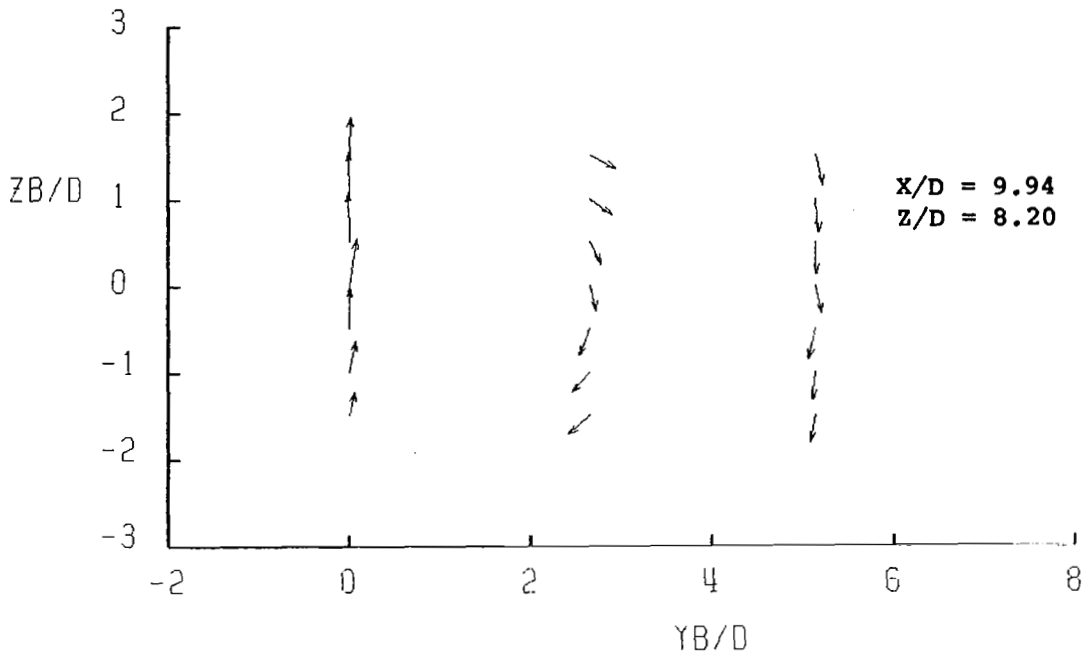

(b) Continued.

Figure B11.- Continued.

APPENDIX B

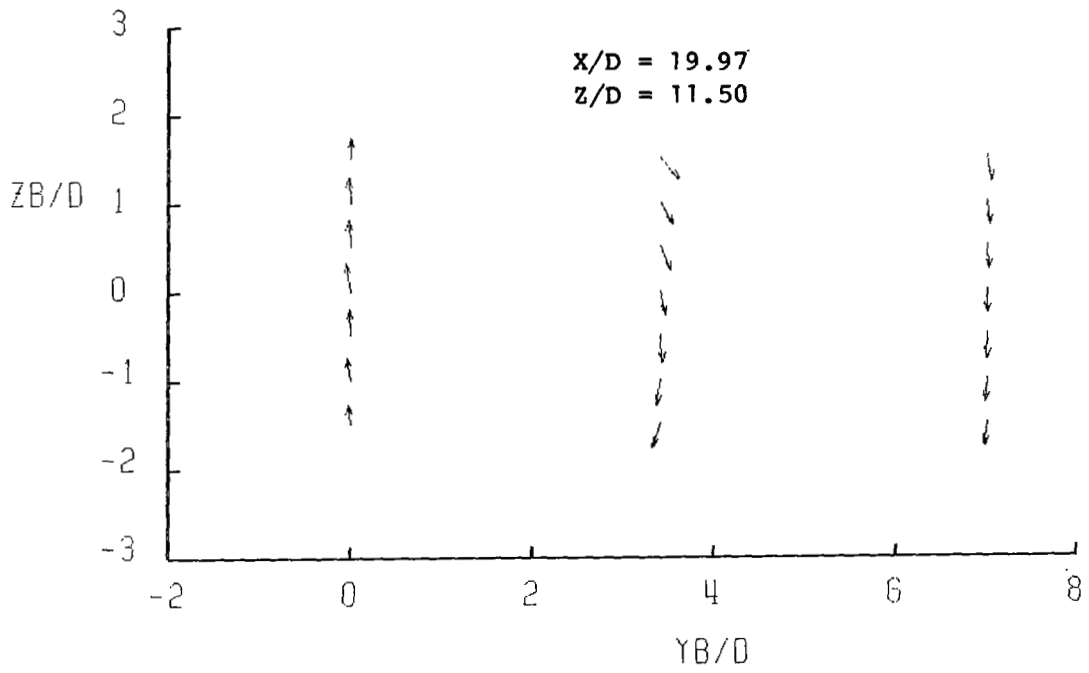

(b) Continued.

Figure B11.- Continued.

APPENDIX B

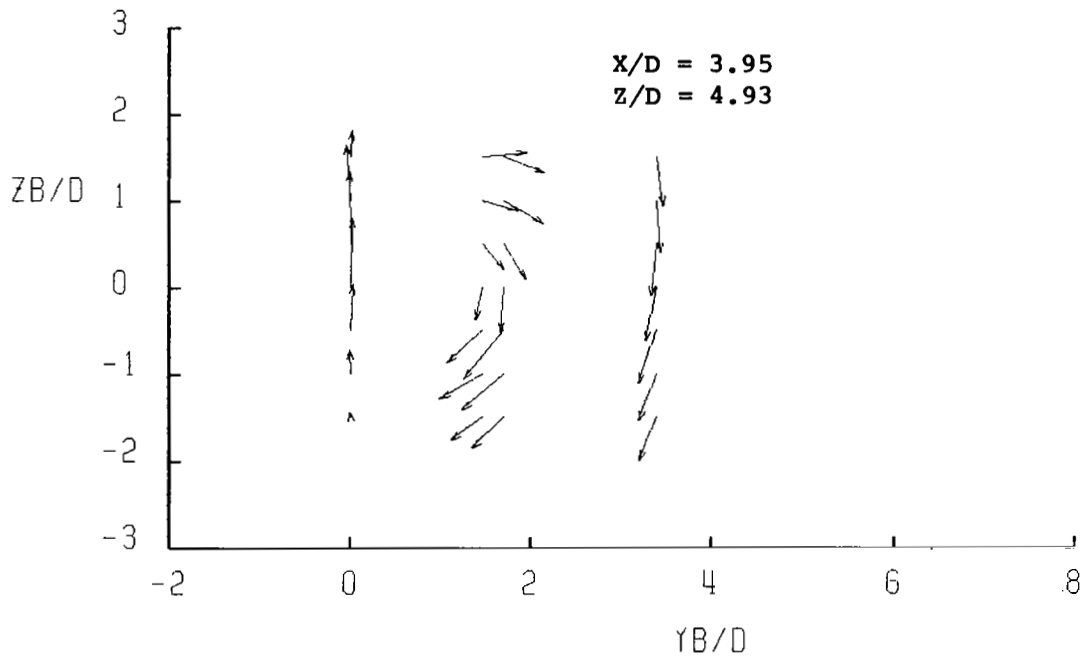

(b) Continued.

Figure B11.- Continued.

APPENDIX B

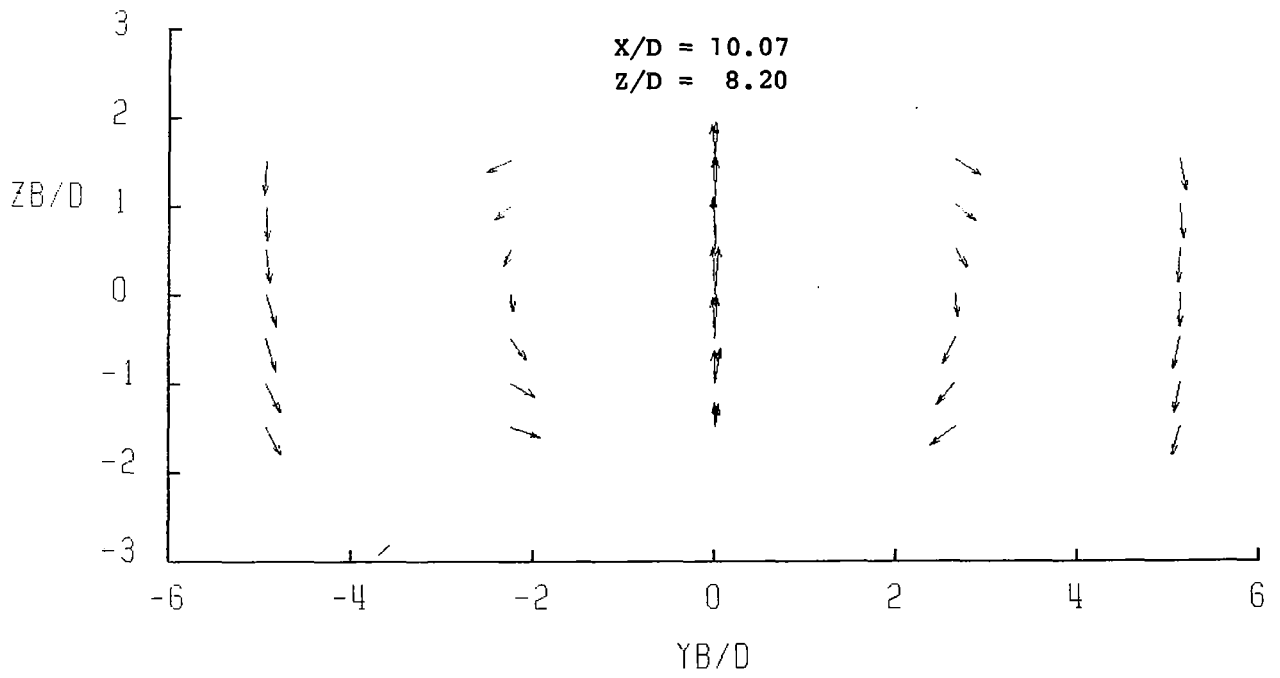

(b) Concluded.

Figure B11.- Concluded.

TABLE B12.- TABULATED VALUES OF CROSS-SECTION VELOCITIES

AND PRESSURES FOR R = 8 AND DELTA = 90°

R= 7.95 DELTA= 90 DEG					R= 7.98 DELTA= 90 DEG				
X/D=	3.96	UINF=	21.2 M/SEC		X/D=	3.95	UINF=	38.0 M/SEC	
Z/D=	6.56	PHI=	35.0 DEG		Z/D=	6.56	PHI=	35.0 DEG	
YB/D \ ZB/D	-0.33	1.88	3.95		YB/D \ ZB/D	0.0	1.88	3.95	
1.5	1.17	1.86	0.72	UB/UINF	1.5	1.05	1.99	0.73	UB/UINF
	-0.21	0.60	0.16	VB/UINF		-0.02	0.62	0.14	VB/UINF
	0.49	-0.03	-0.79	WB/UINF		0.57	-0.05	-0.82	WB/UINF
	-1.27	-1.92	-0.16	CP		-1.37	-2.13	-0.18	CP
	-0.62	0.90	0.01	CPT		-0.93	1.27	0.06	CPT
	25.4	16.8	48.0	THETA		28.6	16.4	49.0	THETA
1.0	0.98	2.00	0.78	UB/UINF	1.0	0.85	1.82	0.84	UB/UINF
	-0.30	0.48	0.10	VB/UINF		0.09	0.52	0.12	VB/UINF
	0.86	-0.26	-0.85	WB/UINF		1.02	-0.23	-0.82	WB/UINF
	-1.53	-2.33	-0.27	CP		-1.35	-2.13	-0.48	CP
	-0.73	0.99	0.06	CPT		-0.59	0.55	-0.07	CPT
	43.6	14.4	47.6	THETA		50.1	16.5	44.8	THETA
0.5	1.28	1.93	0.79	UB/UINF	0.5	1.02	2.08	0.83	UB/UINF
	-0.07	0.33	0.0	VB/UINF		-0.05	0.31	-0.02	VB/UINF
	0.90	-0.23	-0.88	WB/UINF		1.15	-0.36	-0.89	WB/UINF
	-2.27	-2.54	-0.42	CP		-1.98	-2.77	-0.51	CP
	-0.82	0.38	-0.03	CPT		-0.61	0.85	-0.03	CPT
	35.6	11.0	47.9	THETA		48.6	12.3	47.1	THETA
0.0	1.00	1.88	0.87	UB/UINF	0.0	0.71	1.90	0.81	UB/UINF
	0.14	0.15	-0.13	VB/UINF		-0.03	0.05	-0.11	VB/UINF
	1.13	-0.46	-0.66	WB/UINF		1.18	-0.47	-0.89	WB/UINF
	-1.86	-2.73	-1.01	CP		-1.60	-2.65	-0.54	CP
	-0.55	0.03	-0.80	CPT		-0.69	0.22	-0.09	CPT
	48.3	14.1	37.9	THETA		59.2	13.9	47.9	THETA
-0.5	0.93	1.69	0.82	UB/UINF	-0.5	0.84	1.75	0.83	UB/UINF
	0.35	-0.29	-0.17	VB/UINF		0.03	-0.27	-0.26	VB/UINF
	1.03	-0.48	-0.89	WB/UINF		1.09	-0.46	-0.90	WB/UINF
	-1.33	-2.61	-0.42	CP		-1.38	-2.59	-0.48	CP
	-0.28	-0.45	0.08	CPT		-0.47	-0.21	0.09	CPT
	48.6	18.9	47.7	THETA		52.3	17.6	48.3	THETA
-1.0	0.97	1.31	0.82	UB/UINF	-1.0	0.76	1.41	0.87	UB/UINF
	0.29	-0.57	-0.23	VB/UINF		0.01	-0.57	-0.28	VB/UINF
	0.74	-0.53	-0.84	WB/UINF		0.90	-0.50	-0.82	WB/UINF
	-0.90	-1.68	-0.35	CP		-0.57	-1.92	-0.43	CP
	-0.32	-0.36	0.09	CPT		-0.17	-0.34	0.09	CPT
	38.3	31.3	46.6	THETA		49.8	29.2	44.7	THETA
-1.5	0.91	1.13	0.85	UB/UINF	-1.5	0.78	1.13	0.90	UB/UINF
	0.27	-0.70	-0.34	VB/UINF		0.03	-0.68	-0.31	VB/UINF
	0.45	-0.37	-0.78	WB/UINF		0.57	-0.43	-0.76	WB/UINF
	-0.34	-1.00	-0.28	CP		-0.38	-0.99	-0.42	CP
	-0.23	-0.10	0.16	CPT		-0.43	-0.04	0.06	CPT
	28.6	35.9	44.9	THETA		36.1	36.3	42.1	THETA

APPENDIX B

TABLE B12.- Continued

R= 8.00 DELTA= 90 DEG
 X/D= 19.96 UINF= 38.1 M/SEC
 Z/D= 1.75 PHI= 15.7 DEG

ZB/D \ YB/D	YB/D			
	0.0	2.74	5.40	
1.5	1.12	1.13	0.99	UB/UINF
	-0.05	0.21	0.14	VB/UINF
	0.43	-0.14	-0.44	WB/UINF
	-0.46	-0.59	-0.15	CP
	-0.01	-0.25	0.06	CPT
	21.8	12.1	25.8	THETA
1.0	1.09	1.14	1.03	UB/UINF
	0.0	0.08	0.04	VB/UINF
	0.45	-0.20	-0.45	WB/UINF
	-0.50	-0.56	-0.18	CP
	-0.10	-0.22	0.10	CPT
	22.5	10.6	23.9	THETA
0.5	1.00	1.16	1.02	UB/UINF
	-0.02	-0.05	0.0	VB/UINF
	0.51	-0.17	-0.46	WB/UINF
	-0.28	-0.57	-0.19	CP
	-0.01	-0.18	0.07	CPT
	27.1	8.9	24.3	THETA
0.0	1.03	1.14	1.10	UB/UINF
	-0.02	-0.12	-0.05	VB/UINF
	0.44	-0.17	-0.35	WB/UINF
	-0.37	-0.40	-0.40	CP
	-0.10	-0.04	-0.05	CPT
	23.3	10.8	17.7	THETA
-0.5	1.02	1.15	1.02	UB/UINF
	-0.03	-0.16	-0.07	VB/UINF
	0.43	-0.15	-0.45	WB/UINF
	-0.27	-0.44	-0.17	CP
	-0.04	-0.06	0.09	CPT
	23.5	11.6	23.6	THETA
-1.0	1.02	1.17	1.01	UB/UINF
	-0.05	-0.16	-0.12	VB/UINF
	0.37	-0.19	-0.43	WB/UINF
	-0.21	-0.33	-0.14	CP
	-0.04	0.10	0.08	CPT
	20.8	12.6	23.3	THETA
-1.5	0.98	1.23	1.02	UB/UINF
	-0.03	-0.19	-0.12	VB/UINF
	0.29	-0.17	-0.42	WB/UINF
	-0.15	-0.42	-0.15	CP
	-0.10	0.17	0.08	CPT
	17.2	12.1	22.5	THETA

R= 8.00 DELTA= 90 DEG
 X/D= 19.95 UINF= 38.1 M/SEC
 Z/D= 14.00 PHI= 15.7 DEG

ZB/D \ YB/D	YB/D			
	0.0	2.74	5.40	
1.5	1.05	0.98	0.95	UB/UINF
	0.05	0.27	0.18	VB/UINF
	0.08	-0.16	-0.36	WB/UINF
	-0.25	-0.16	-0.01	CP
	-0.13	-0.09	0.05	CPT
	4.2	17.0	24.0	THETA
1.0	1.02	1.05	1.01	UB/UINF
	-0.01	0.25	0.15	VB/UINF
	0.21	-0.19	-0.35	WB/UINF
	-0.32	-0.28	-0.11	CP
	-0.23	-0.08	0.06	CPT
	12.0	16.0	21.3	THETA
0.5	1.07	1.10	1.03	UB/UINF
	-0.01	0.24	0.15	VB/UINF
	0.31	-0.14	-0.39	WB/UINF
	-0.34	-0.42	-0.14	CP
	-0.09	-0.12	0.09	CPT
	16.6	13.7	22.6	THETA
0.0	0.97	1.07	1.04	UB/UINF
	-0.02	0.23	0.14	VB/UINF
	0.38	-0.20	-0.34	WB/UINF
	-0.26	-0.43	-0.27	CP
	-0.16	-0.19	-0.05	CPT
	21.7	15.3	20.3	THETA
-0.5	1.07	1.12	1.00	UB/UINF
	-0.01	0.16	0.11	VB/UINF
	0.42	-0.19	-0.44	WB/UINF
	-0.41	-0.51	-0.16	CP
	-0.10	-0.20	0.04	CPT
	21.8	12.1	24.8	THETA
-1.0	1.09	1.10	1.02	UB/UINF
	-0.01	0.12	0.08	VB/UINF
	0.45	-0.19	-0.45	WB/UINF
	-0.42	-0.51	-0.20	CP
	-0.02	-0.24	0.05	CPT
	22.8	11.1	24.4	THETA
-1.5	1.04	1.17	1.04	UB/UINF
	-0.05	0.03	0.03	VB/UINF
	0.44	-0.21	-0.46	WB/UINF
	-0.39	-0.57	-0.22	CP
	-0.11	-0.15	0.07	CPT
	23.5	10.1	24.3	THETA

TABLE B12.- Concluded

R= 8.00 DELTA= 90 DEG

X/D= 9.60 UINF= 37.9 M/SEC
Z/D= 5.72 PHI= 22.4 DEG

YB/D \ ZB/D	-4.96	-2.53	0.0	2.48	5.01	
1.5	0.97 -0.16 -0.59 -0.21 0.10 34.6	1.34 -0.35 -0.31 -0.89 0.13 23.3	1.01 -0.02 0.50 -0.58 -0.31 26.9	1.26 0.42 -0.27 -0.79 0.06 20.9	0.92 0.19 -0.56 -0.15 0.06 33.0	UB/UINF VB/UINF WB/UINF CP CPT THETA
1.0	0.99 -0.13 -0.57 -0.37 -0.04 32.9	1.38 -0.34 -0.36 -0.95 0.21 23.4	1.01 -0.01 0.68 -0.76 -0.28 34.1	1.34 0.33 -0.27 -0.93 0.06 17.0	0.94 0.14 -0.58 -0.24 0.01 32.6	UB/UINF VB/UINF WB/UINF CP CPT THETA
0.5	1.00 -0.06 -0.63 -0.36 0.04 33.7	1.37 -0.21 -0.38 -0.99 0.08 20.5	1.01 -0.07 0.77 -0.83 -0.21 37.5	1.39 0.22 -0.35 -1.10 0.02 16.0	0.97 0.08 -0.62 -0.31 0.03 32.8	UB/UINF VB/UINF WB/UINF CP CPT THETA
0.0	0.99 -0.03 -0.64 -0.34 0.07 34.0	1.42 -0.13 -0.37 -1.01 0.17 17.8	0.98 0.0 0.78 -0.82 -0.25 38.4	1.50 0.11 -0.29 -1.19 0.17 11.4	0.96 0.03 -0.63 -0.30 0.04 33.5	UB/UINF VB/UINF WB/UINF CP CPT THETA
-0.5	0.98 0.06 -0.63 -0.38 -0.01 33.0	1.51 0.07 -0.39 -1.13 0.32 14.6	0.99 -0.05 0.77 -0.83 -0.24 38.4	1.48 -0.07 -0.38 -1.12 0.23 14.8	0.90 -0.07 -0.64 -0.24 0.0 35.6	UB/UINF VB/UINF WB/UINF CP CPT THETA
-1.0	0.99 0.09 -0.61 -0.37 0.01 31.9	1.46 0.17 -0.35 -1.10 0.21 13.5	0.93 0.0 0.70 -0.61 -0.24 37.1	1.47 -0.16 -0.32 -1.11 0.19 14.2	0.97 -0.08 -0.62 -0.32 0.02 32.7	UB/UINF VB/UINF WB/UINF CP CPT THETA
-1.5	0.94 0.21 -0.60 -0.29 0.0 32.3	1.28 0.34 -0.36 -0.89 0.02 18.3	0.95 -0.03 0.58 -0.41 -0.16 31.8	1.33 -0.31 -0.35 -0.90 0.11 19.7	0.94 -0.19 -0.59 -0.27 0.0 33.0	UB/UINF VB/UINF WB/UINF CP CPT THETA

APPENDIX B

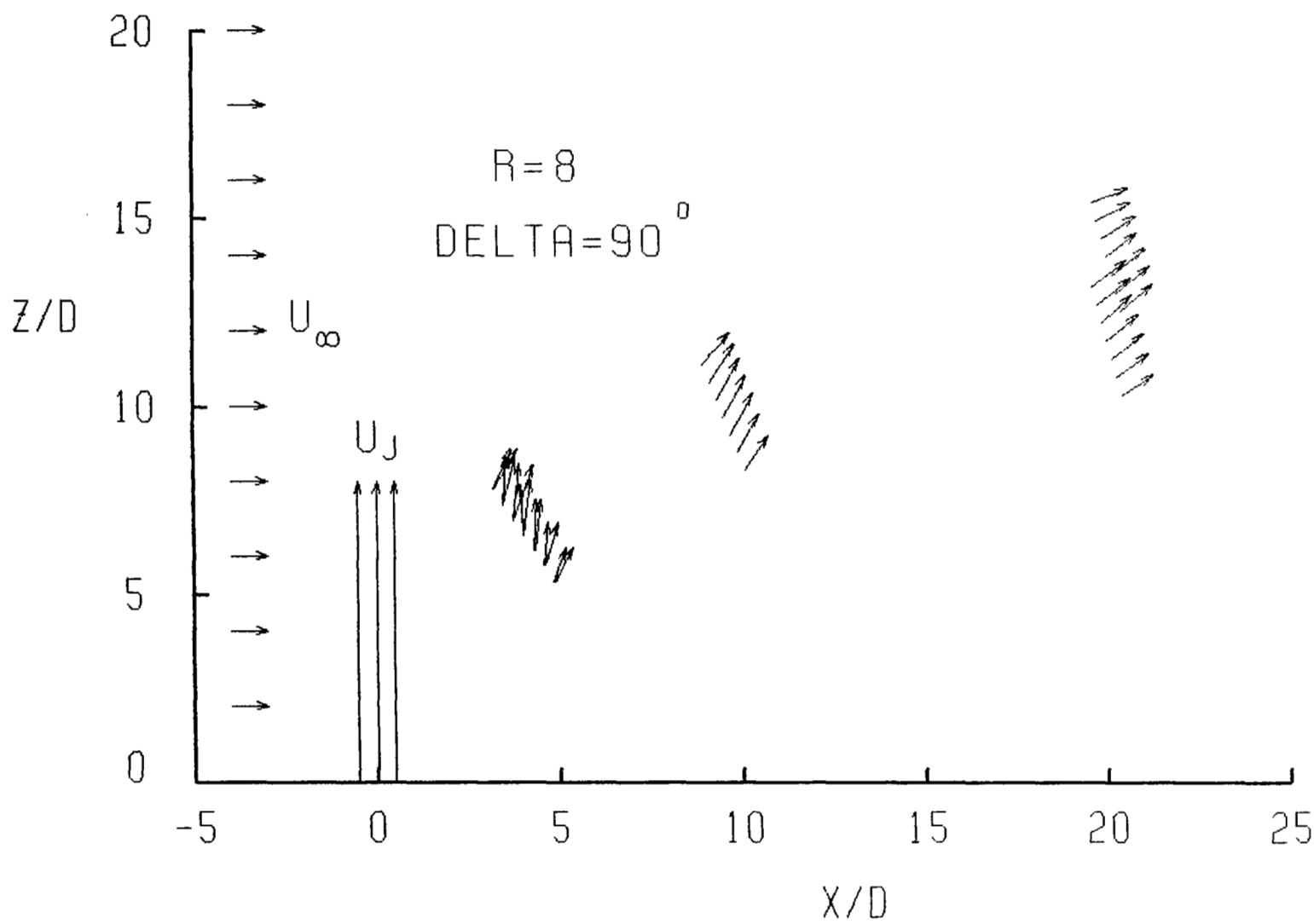

(a) Symmetry plane velocity plot locating cross sections of measurement.

Figure B12.- Cross-section velocities for $R = 8$ and $DELTA = 90^\circ$.

APPENDIX B

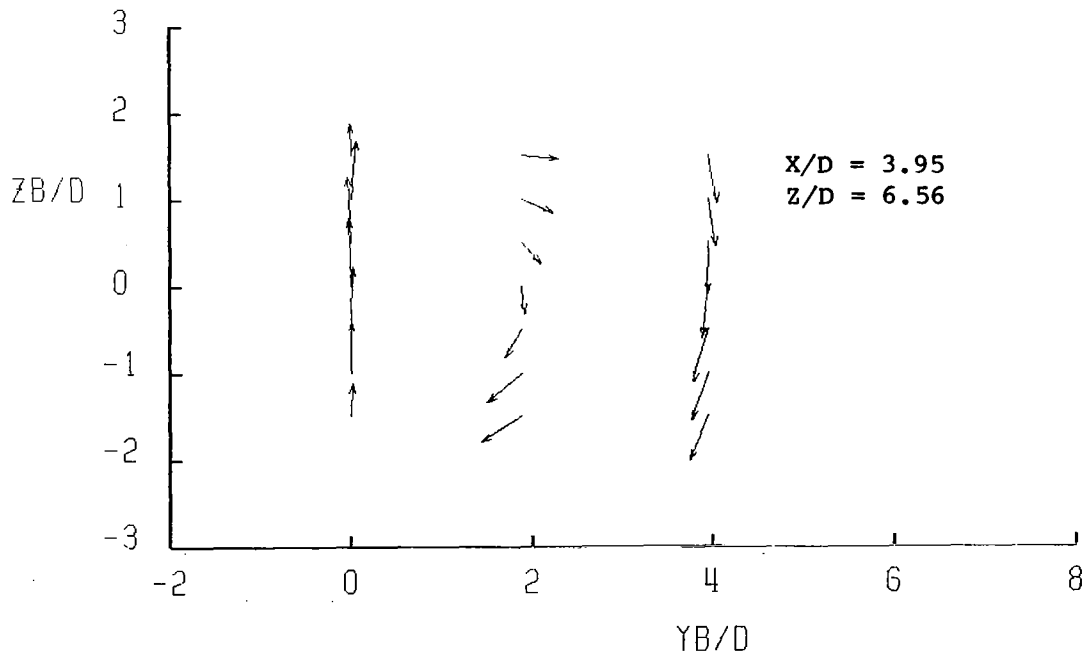
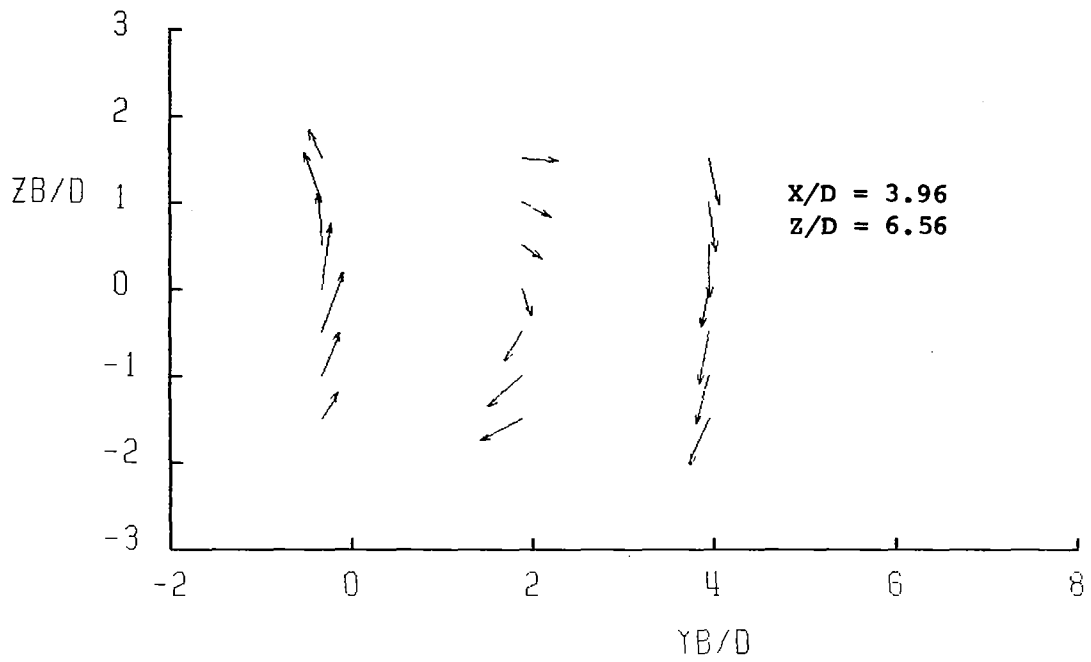

(b) Cross-section velocity plots.

Figure B12.- Continued.

APPENDIX B

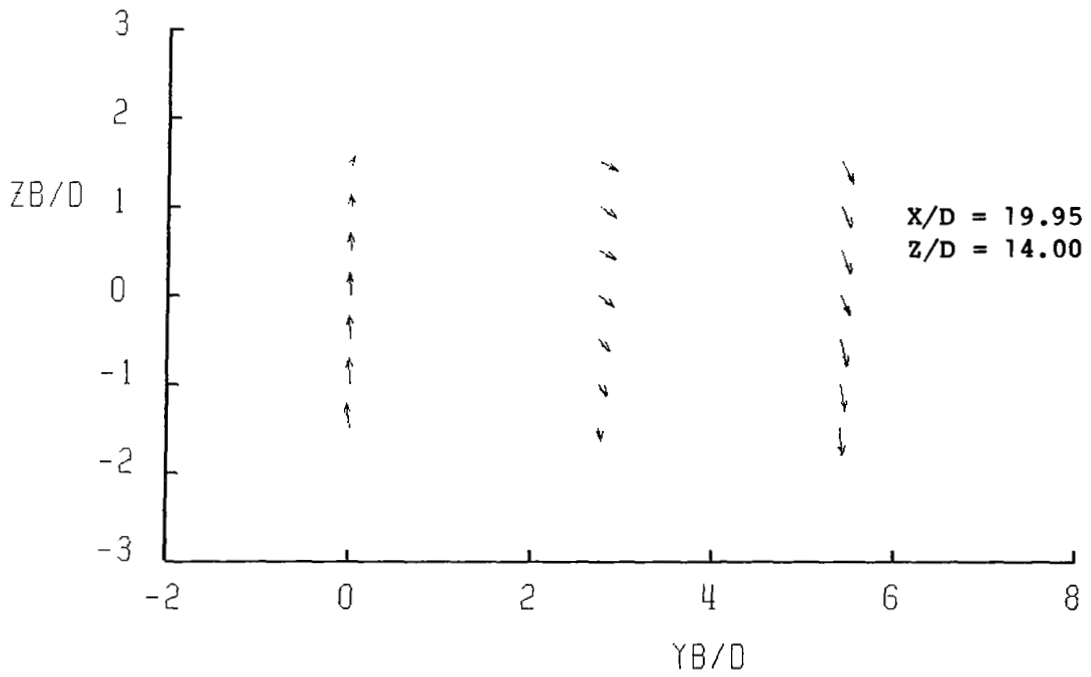
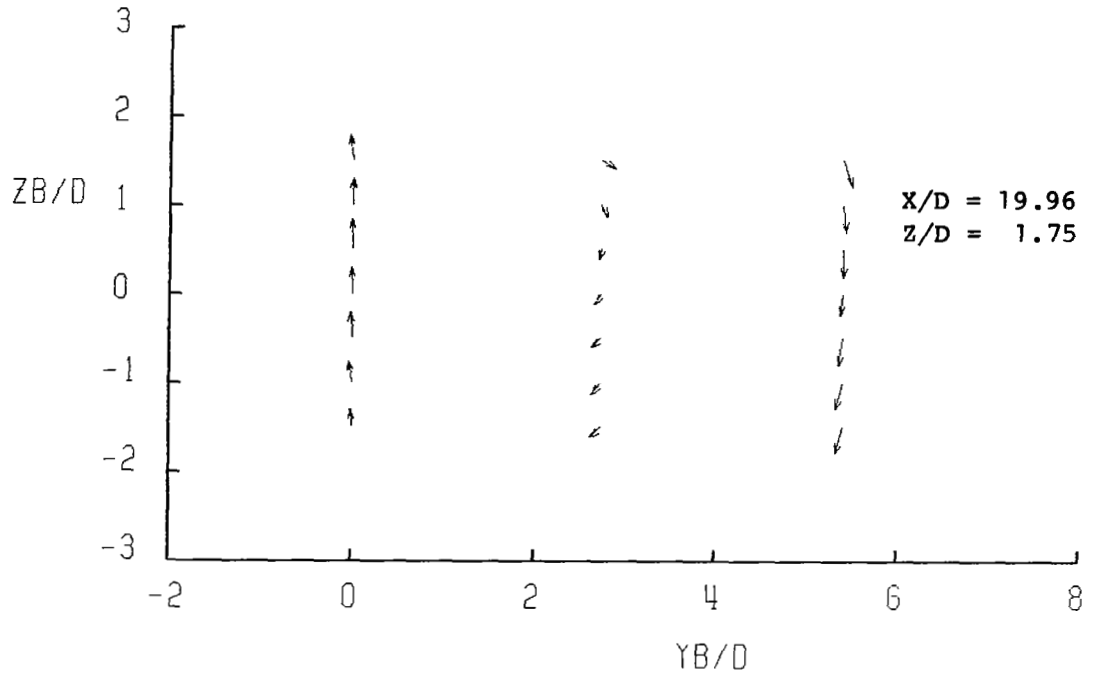

(b) Continued.

Figure B12.- Continued.

APPENDIX B

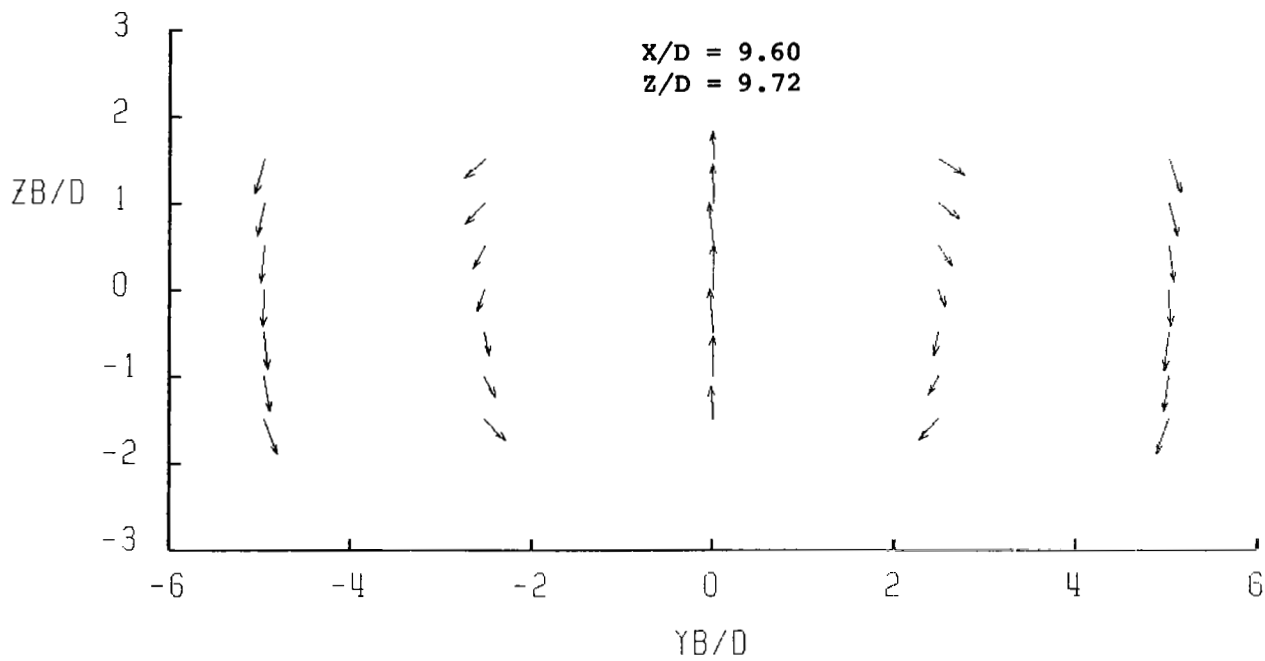

(b) Concluded.

Figure B12.- Concluded.

TABLE B13.- TABULATED VALUES OF CROSS-SECTION VELOCITIES

AND PRESSURES FOR R = 8 AND DELTA = 105°

R= 8.02 DELTA= 105 DEG				R= 8.01 DELTA= 105 DEG			
X/D= 2.95		UINF= 38.2 M/SEC		X/D= 3.96		UINF= 38.0 M/SEC	
Z/D= 7.50		PHI= 33.0 DEG		Z/D= 7.94		PHI= 28.0 DEG	
YB/D \ ZB/D	0.0	4.42	4.42	YB/D \ ZB/D	0.0	2.64	5.56
1.5	0.54	0.73	0.73	UB/UINF	0.82	1.43	0.84
	-0.10	0.21	0.21	VB/UINF	-0.14	0.45	0.14
	0.77	-0.76	-0.76	WB/UINF	0.78	-0.23	-0.65
	-0.68	-0.17	-0.17	CP	-1.15	-1.47	-0.15
	-0.78	-0.02	-0.02	CPT	-0.83	-0.15	0.0
	55.5	47.5	47.5	THETA	44.5	19.0	38.8
1.0	0.75	0.80	0.80	UB/UINF	0.70	1.38	0.88
	0.0	0.17	0.17	VB/UINF	0.06	0.38	0.06
	0.88	-0.83	-0.83	WB/UINF	1.01	-0.34	-0.67
	-1.63	-0.36	-0.36	CP	-1.37	-1.54	-0.24
	-1.29	0.0	0.0	CPT	-0.85	-0.35	-0.01
	49.4	46.9	46.9	THETA	55.0	19.8	37.7
0.5	0.92	0.89	0.89	UB/UINF	0.97	1.51	0.92
	-0.04	0.08	0.08	VB/UINF	0.04	0.24	0.0
	0.93	-0.83	-0.83	WB/UINF	0.87	-0.39	-0.68
	-2.21	-0.57	-0.57	CP	-2.02	-1.85	-0.32
	-1.49	-0.09	-0.09	CPT	-1.31	-0.33	-0.02
	45.4	43.2	43.2	THETA	41.9	16.7	36.5
0.0	0.75	0.81	0.81	UB/UINF	0.67	1.43	0.91
	0.03	-0.08	-0.08	VB/UINF	0.02	0.08	-0.03
	1.15	-0.90	-0.90	WB/UINF	1.17	-0.43	-0.70
	-1.81	-0.45	-0.45	CP	-1.14	-1.76	-0.31
	-0.90	0.04	0.04	CPT	-0.31	-0.52	0.01
	56.9	47.9	47.9	THETA	60.0	16.9	37.8
-0.5	0.79	0.84	0.84	UB/UINF	0.70	1.31	0.89
	0.0	-0.14	-0.14	VB/UINF	0.17	-0.14	-0.09
	1.13	-0.90	-0.90	WB/UINF	1.10	-0.52	-0.70
	-1.67	-0.48	-0.48	CP	-0.83	-1.72	-0.31
	-0.75	0.05	0.05	CPT	-0.10	-0.71	-0.02
	55.3	47.1	47.1	THETA	57.6	22.4	38.0
-1.0	0.77	0.86	0.86	UB/UINF	0.61	1.13	0.96
	0.15	-0.25	-0.25	VB/UINF	-0.01	-0.35	-0.13
	0.92	-0.84	-0.84	WB/UINF	0.91	-0.54	-0.66
	-1.31	-0.42	-0.42	CP	-0.55	-1.50	-0.35
	-0.85	0.09	0.09	CPT	-0.35	-0.79	0.02
	50.1	45.2	45.2	THETA	56.3	29.8	34.8
-1.5	0.81	0.85	0.85	UB/UINF	0.90	1.06	0.91
	0.02	-0.27	-0.27	VB/UINF	0.08	-0.51	-0.17
	0.79	-0.81	-0.81	WB/UINF	0.59	-0.53	-0.65
	-0.57	-0.39	-0.39	CP	-0.57	-1.05	-0.20
	-0.29	0.07	0.07	CPT	-0.40	-0.38	0.03
	44.0	45.2	45.2	THETA	33.1	35.2	36.0

TABLE B13.- Continued

R= 8.00 DELTA= 105 DEG
 X/D= 7.99 UINF= 38.1 M/SEC
 Z/D= 9.82 PHI= 23.0 DEG

R= 8.00 DELTA= 105 DEG
 X/D= 20.60 UINF= 38.5 M/SEC
 Z/D= 13.49 PHI= 14.0 DEG

YB/D \ ZB/D		YB/D			
		0.0	2.64	5.44	
1.5		0.80	1.02	0.89	UB/UINF
		-0.05	0.27	0.20	VB/UINF
		0.59	-0.20	-0.58	WB/UINF
		-0.79	-0.89	-0.14	CP
		-0.80	-0.74	0.02	CPT
	36.8	17.8	35.1	THETA	
1.0		0.85	1.08	0.94	UB/UINF
		-0.04	0.18	0.13	VB/UINF
		0.71	-0.29	-0.60	WB/UINF
		-0.89	-0.97	-0.23	CP
		-0.65	-0.69	0.03	CPT
	40.1	17.2	33.6	THETA	
0.5		0.56	1.14	0.94	UB/UINF
		-0.10	0.12	0.08	VB/UINF
		0.65	-0.29	-0.63	WB/UINF
		-0.96	-0.98	-0.27	CP
		-0.60	-0.58	0.02	CPT
	34.8	15.5	34.4	THETA	
0.0		0.97	1.19	0.96	UB/UINF
		-0.05	-0.01	0.03	VB/UINF
		0.67	-0.30	-0.61	WB/UINF
		-0.26	-1.09	-0.31	CP
		-0.47	-0.58	-0.01	CPT
	35.0	14.4	32.8	THETA	
-0.5		0.87	1.10	0.93	UB/UINF
		0.0	-0.05	-0.06	VB/UINF
		0.70	-0.22	-0.63	WB/UINF
		-0.61	-0.95	-0.29	CP
		-0.35	-0.69	-0.01	CPT
	38.8	12.0	34.2	THETA	
-1.0		0.91	1.17	0.98	UB/UINF
		-0.09	-0.23	-0.09	VB/UINF
		0.63	-0.32	-0.62	WB/UINF
		-0.48	-0.91	-0.34	CP
		-0.25	-0.39	0.02	CPT
	35.3	18.9	32.2	THETA	
-1.5		0.57	1.06	0.94	UB/UINF
		0.03	-0.34	-0.16	VB/UINF
		0.47	-0.32	-0.58	WB/UINF
		-0.44	-0.63	-0.28	CP
		-0.28	-0.27	-0.02	CPT
	25.7	24.2	32.1	THETA	

YB/D \ ZB/D		YB/D			
		0.0	6.63	10.06	
1.5		0.93	0.98	0.98	UB/UINF
		0.0	0.11	0.04	VB/UINF
		0.35	-0.38	-0.33	WB/UINF
		-0.33	-0.09	-0.02	CP
		-0.34	0.03	0.05	CPT
	20.8	23.0	20.7	THETA	
1.0		0.91	1.02	1.00	UB/UINF
		0.0	0.08	0.02	VB/UINF
		0.39	-0.36	-0.32	WB/UINF
		-0.30	-0.11	-0.03	CP
		-0.33	0.07	0.08	CPT
	23.6	20.7	19.3	THETA	
0.5		0.96	1.00	1.01	UB/UINF
		-0.03	0.06	0.02	VB/UINF
		0.44	-0.37	-0.33	WB/UINF
		-0.35	-0.12	-0.07	CP
		-0.24	0.02	0.07	CPT
	25.0	21.3	19.8	THETA	
0.0		0.96	1.04	1.00	UB/UINF
		-0.07	0.01	0.01	VB/UINF
		0.39	-0.34	-0.32	WB/UINF
		-0.34	-0.24	-0.04	CP
		-0.25	-0.04	0.06	CPT
	23.4	18.4	19.4	THETA	
-0.5		0.99	1.00	1.00	UB/UINF
		-0.01	-0.02	0.0	VB/UINF
		0.41	-0.38	-0.33	WB/UINF
		-0.30	-0.16	-0.04	CP
		-0.14	-0.01	0.06	CPT
	22.9	21.0	19.5	THETA	
-1.0		0.94	0.99	1.01	UB/UINF
		-0.03	-0.03	-0.01	VB/UINF
		0.40	-0.39	-0.33	WB/UINF
		-0.20	-0.13	-0.06	CP
		-0.15	0.01	0.08	CPT
	23.6	21.4	18.9	THETA	
-1.5		1.03	1.00	1.01	UB/UINF
		0.01	-0.05	-0.02	VB/UINF
		0.33	-0.38	-0.32	WB/UINF
		-0.30	-0.12	-0.07	CP
		-0.13	0.03	0.04	CPT
	18.2	20.7	18.4	THETA	

APPENDIX B

TABLE B13.- Concluded

R= 7.99 DELTA= 105 DEG

X/D= 10.82 UINF= 38.3 M/SEC
Z/D= 10.47 PHI= 19.0 DEG

YB/D \ ZB/D	-6.21	-3.09	0.0	2.95	4.03	6.05	
1.5	0.95 -0.11 -0.52 -0.09 0.09 32.3	0.97 -0.19 -0.29 -0.66 -0.59 23.3	1.02 -0.04 0.52 -0.85 -0.53 27.4	0.97 0.21 -0.29 -0.69 -0.62 20.1	1.11 0.15 -0.41 -0.67 -0.23 21.7	0.95 0.12 -0.50 -0.20 -0.03 29.4	UB/UINF VB/UINF WB/UINF CP CPT THETA
1.0	0.97 -0.07 -0.52 -0.14 0.07 30.6	1.08 -0.10 -0.30 -0.73 -0.45 18.8	0.86 -0.02 0.59 -0.64 -0.55 34.5	1.00 0.14 -0.24 -0.76 -0.67 15.1	1.05 0.12 -0.44 -0.56 -0.24 23.5	1.01 0.08 -0.50 -0.23 0.06 27.2	UB/UINF VB/UINF WB/UINF CP CPT THETA
0.5	1.01 -0.02 -0.51 -0.23 0.06 28.4	1.02 -0.02 -0.33 -0.70 -0.54 19.1	0.83 0.02 0.72 -0.45 -0.23 40.9	1.02 0.01 -0.32 -0.71 -0.56 17.3	1.11 0.05 -0.43 -0.60 -0.19 21.5	0.99 0.04 -0.53 -0.20 0.06 28.7	UB/UINF VB/UINF WB/UINF CP CPT THETA
0.0	1.03 0.01 -0.51 -0.22 0.11 27.8	1.07 0.07 -0.38 -0.70 -0.39 19.7	0.90 -0.04 0.63 -0.49 -0.28 35.6	1.11 -0.03 -0.33 -0.65 -0.31 16.6	1.11 -0.04 -0.47 -0.62 -0.17 22.9	0.97 -0.02 -0.54 -0.20 0.03 29.1	UB/UINF VB/UINF WB/UINF CP CPT THETA
-0.5	0.98 0.05 -0.52 -0.19 0.04 28.7	1.12 0.11 -0.34 -0.68 -0.30 17.1	0.97 0.03 0.62 -0.40 -0.08 32.5	1.06 -0.13 -0.34 -0.69 -0.44 19.0	1.03 -0.10 -0.51 -0.45 -0.11 26.6	0.97 -0.07 -0.53 -0.20 0.03 28.7	UB/UINF VB/UINF WB/UINF CP CPT THETA
-1.0	0.98 0.10 -0.51 -0.18 0.05 27.6	1.09 0.20 -0.33 -0.59 -0.25 17.5	1.00 0.0 0.51 -0.46 -0.20 26.9	1.07 -0.16 -0.34 -0.60 -0.30 19.5	1.06 -0.17 -0.45 -0.47 -0.11 24.4	0.95 -0.10 -0.52 -0.17 0.02 28.6	UB/UINF VB/UINF WB/UINF CP CPT THETA
-1.5	0.98 0.11 -0.48 -0.19 0.01 26.3	1.04 0.26 -0.33 -0.45 -0.19 19.2	0.93 0.01 0.43 -0.25 -0.20 24.9	1.05 -0.27 -0.32 -0.46 -0.18 22.1	1.04 -0.21 -0.42 -0.42 -0.11 24.3	1.00 -0.11 -0.49 -0.23 0.02 26.2	UB/UINF VB/UINF WB/UINF CP CPT THETA

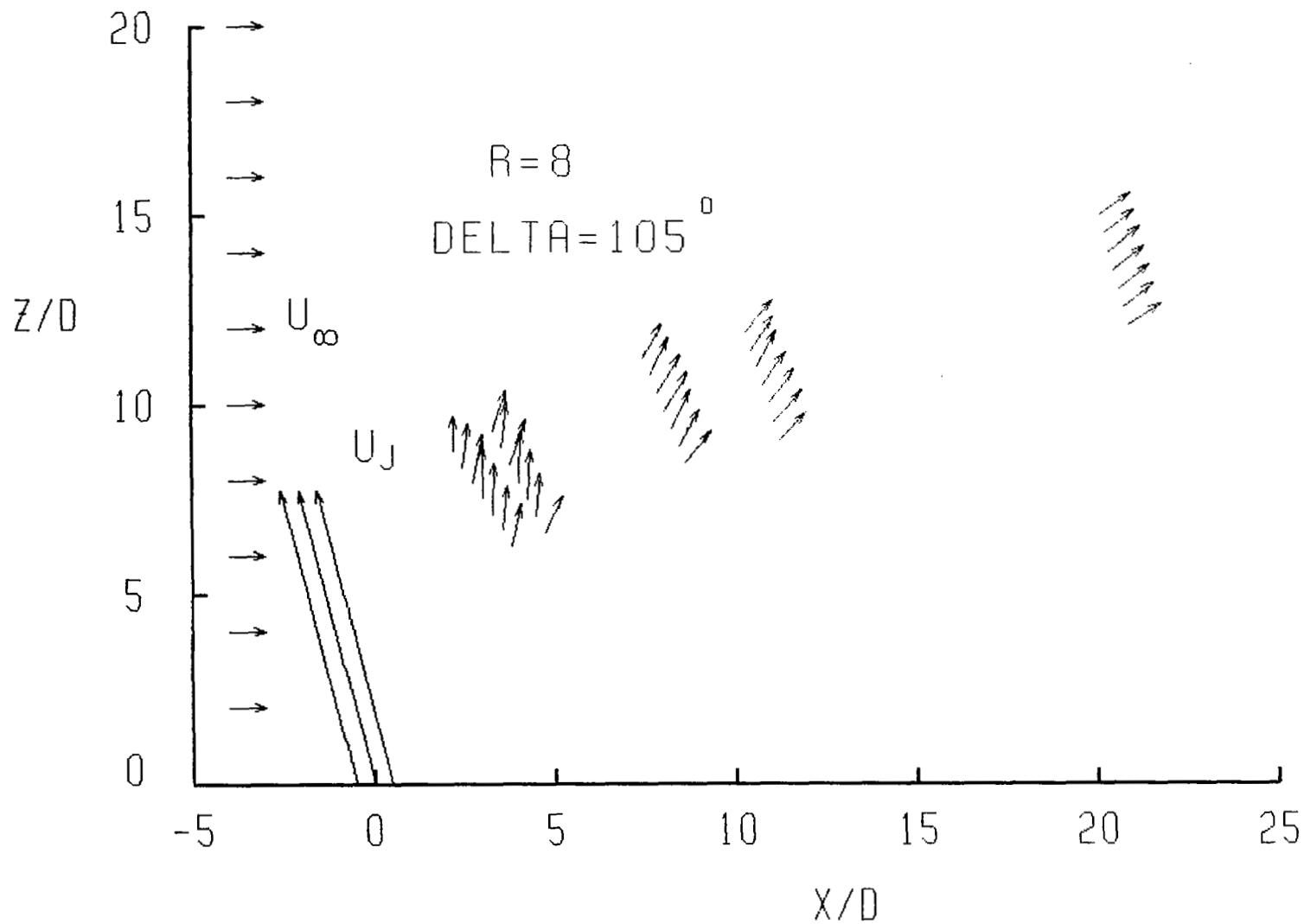

(a) Symmetry plane velocity plot locating cross sections of measurement.

Figure B13.- Cross-section velocities for $R = 8$ and $\text{DELTA} = 105^\circ$.

APPENDIX B

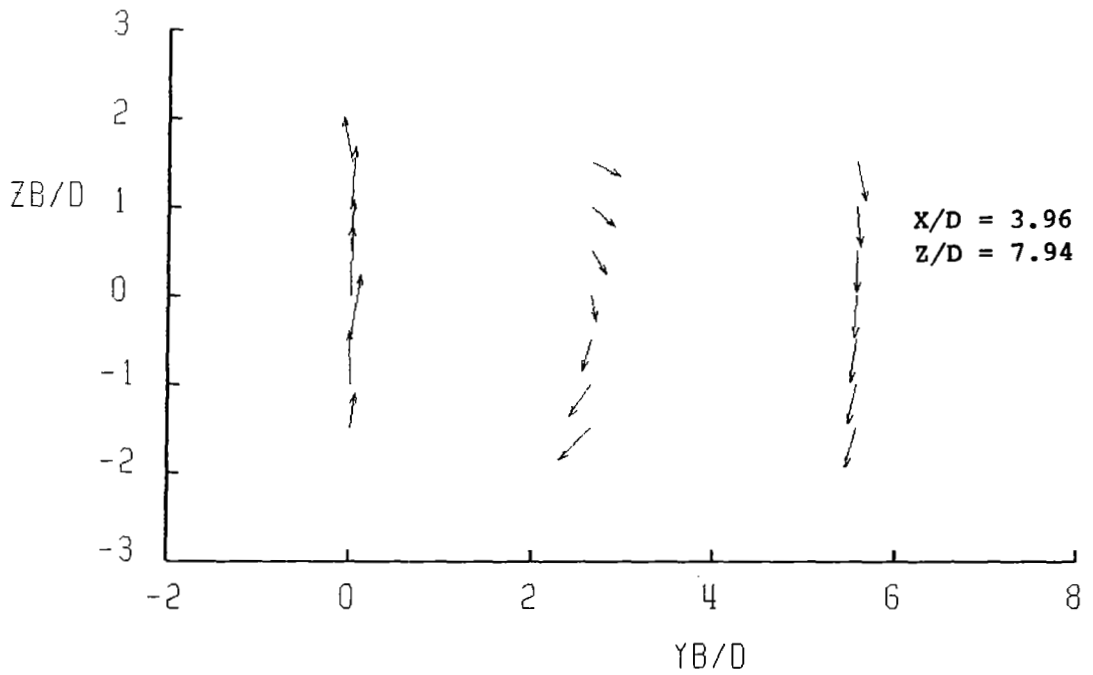
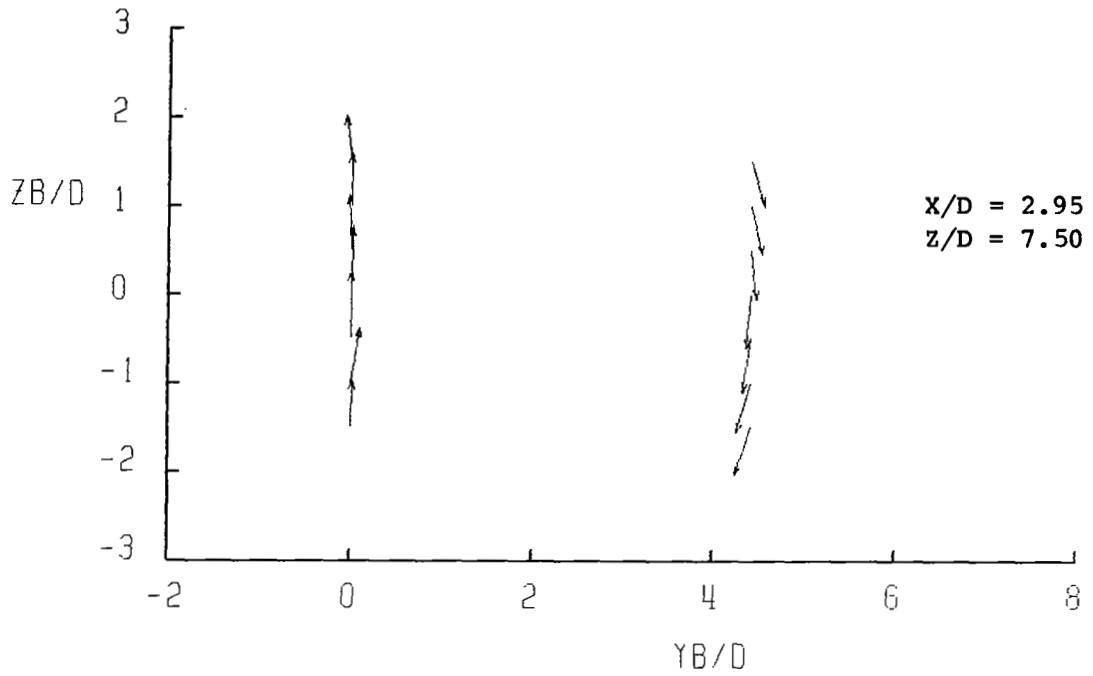

(b) Cross-section velocity plots.

Figure B13.- Continued.

APPENDIX B

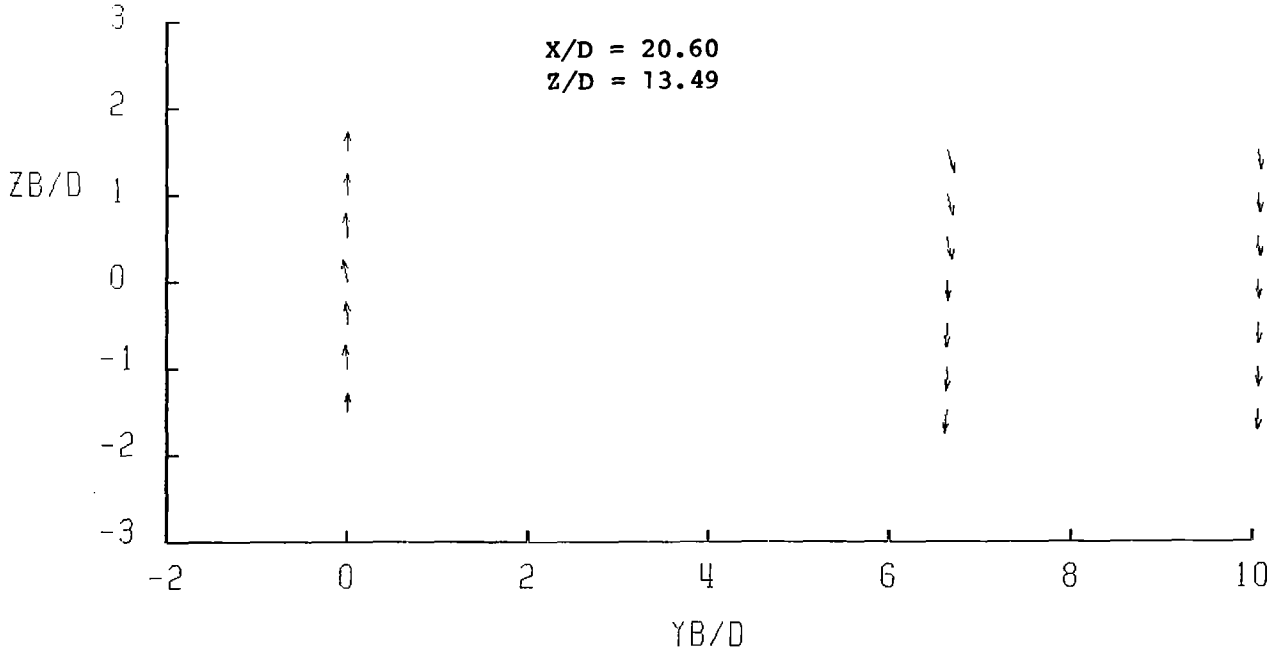
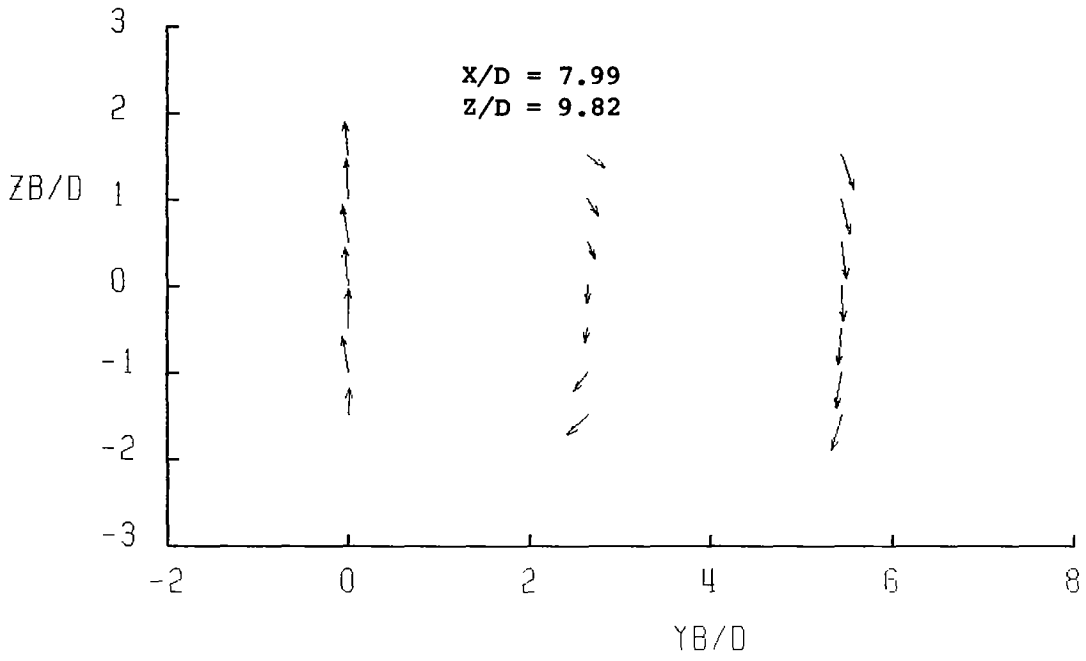

(b) Continued.

Figure B13.- Continued.

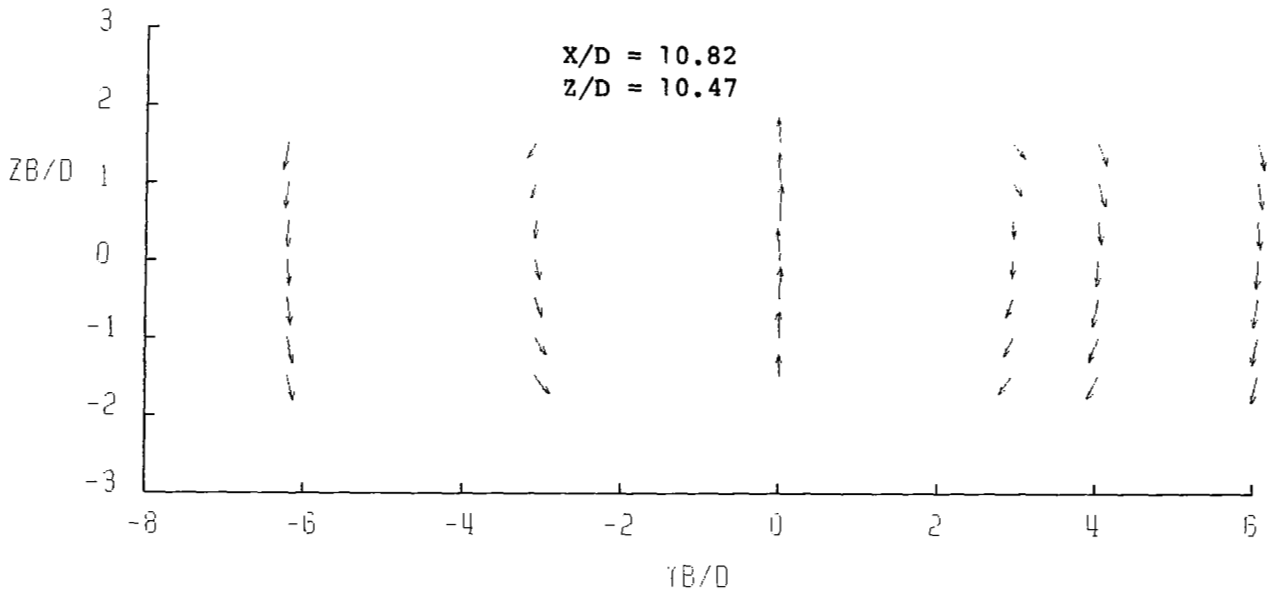

(b) Concluded.

Figure B13.- Concluded.

REFERENCES

1. Vogler, Raymond D.: Interference Effects of Single and Multiple Round or Slotted Jets on a VTOL Model in Transition. NASA TN D-2380, 1964.
2. Hickey, David H.; Kirk, Jerry V.; and Hall, Leo P.: Aerodynamic Characteristics of a V/STOL Transport Model With Lift and Lift-Cruise Fan Power Plants. NASA SP-116, 1966, pp. 81-96.
3. Winston, Matthew M.: Wind-Tunnel Data From a 0.16-Scale V/STOL Model With Direct-Lift and Lift-Cruise Jets. NASA TM X-1758, 1969.
4. Margason, Richard J.; Vogler, Raymond D.; and Winston, Matthew M.: Wind-Tunnel Investigation at Low Speeds of a Model of the Kestrel (XV-6A) Vectored-Thrust V/STOL Airplane. NASA TN D-6826, 1972.
5. Wooten, W. H.; and Hoff, G. E.: Deflected Exhaust Jet Effects on V/STOL Fighter Performance. Rep. No. R73AEG279 (Contract No. N00019-72-C0614), Aircraft Engine Group, General Electric Co., July 1973.
6. Jordinson, R.: Flow in a Jet Directed Normal to the Wind. R. & M. No. 3074, British A.R.C., 1958.
7. Keffer, J. F.; and Baines, W. D.: The Round Turbulent Jet in a Cross-Wind. J. Fluid Mech., vol. 15, pt. 4, Apr. 1963, pp. 481-497.
8. Margason, Richard J.: The Path of a Jet Directed at Large Angles to a Subsonic Free Stream. NASA TN D-4919, 1968.
9. Thompson, A. M.: The Flow Induced by Jets Exhausting Normally From a Plane Wall Into an Airstream. Ph. D. Thesis, Univ. of London, 1971.
10. Kamotani, Yasuhiro; and Greber, Isaac: Experiments on a Turbulent Jet in a Cross Flow. AIAA J., vol. 10, no. 11, Nov. 1972, pp. 1425-1429.
11. Vogler, Raymond D.: Surface Pressure Distributions Induced on a Flat Plate by a Cold Air Jet Issuing Perpendicularly From the Plate and Normal to a Low-Speed Free-Stream Flow. NASA TN D-1629, 1963.
12. Bradbury, L. J. S.; and Wood, M. N.: The Static Pressure Distribution Around a Circular Jet Exhausting Normally From a Plane Wall Into an Airstream. C.P. No. 822, British A.R.C., 1965.
13. Gelb, G. H.; and Martin, W. A.: An Experimental Investigation of the Flow Field About a Subsonic Jet Exhausting Into a Quiescent and a Low Velocity Air Stream. Can. Aeronaut. & Space J., vol. 12, no. 8, Oct. 1966, pp. 333-342.
14. Pratte, Bruce D.; and Baines, W. Douglas: Profiles of the Round Turbulent Jet in a Cross Flow. J. Hydraulics Div., Amer. Soc. Civil Eng., vol. 92, no. HY6, Nov. 1967, pp. 53-64.

15. Wu, J. C.; McMahon, H. M.; Mosher, D. K.; and Wright, M. A.: Experimental and Analytical Investigations of Jets Exhausting Into a Deflecting Stream. *J. Aircr.*, vol. 7, no. 1, Jan.-Feb. 1970, pp. 44-51.
16. Soullier, A.: Testing at S1.MA for Basic Investigations on Jet Interactions. Distribution of Pressures and Velocities in the Jet Using the Ideal Standard Nozzle (in Unheated State). NASA TT F-14072, 1972.
17. Soullier, A.: Testing at S1.MA for Basic Investigations on Jet Interactions Distribution of Pressures Around the Jet Orifice. NASA TT F-14066, 1972.
18. Harms, L.: Experimental Investigation of the Flow Field of a Hot Turbulent Jet With Lateral Flow. Part II. NASA TT F-15706, 1974.
19. Fearn, Richard L.; and Weston, Robert P.: Induced Pressure Distribution of a Jet in a Crossflow. NASA TN D-7916, 1975.
20. Fearn, Richard L.; and Weston, Robert P.: Induced Velocity Field of a Jet in a Crossflow. NASA TP-1087, 1978.
21. Fearn, Richard; and Weston, Robert P.: Vorticity Associated With a Jet in a Cross Flow. *AIAA J.*, vol. 12, no. 12, Dec. 1974, pp. 1666-1671.
22. Dietz, William E., Jr.: A Method for Calculating the Induced Pressure Distribution Associated With a Jet in a Crossflow. M.S. Thesis, Univ. of Florida, 1975. (Available as NASA CR-146434.)
23. Krausche, D.; Fearn, R. L.; and Weston, R. P.: Round Jet in a Cross Flow - Influence of Jet Injection Angle on Vortex Properties. *AIAA J.*, vol. 16, no. 15, June 1978, pp. 636-637.
24. Albertson, M. L.; Dai, Y. B.; Jensen, R. A.; and Rouse, Hunter: Diffusion of Submerged Jets. Paper No. 2409, *Trans. Amer. Soc. Civil Eng.*, vol. 115, 1950, pp. 639-664.
25. Abramovich, G. N.: *The Theory of Turbulent Jets*. M.I.T. Press, c.1963.

TABLE I.- SCOPE OF PRESENT STUDY

R	Nominal δ , deg	U_{∞} , m/sec	Symmetry plane cross sections				Extended cross sections	
			Centerline		Vortex curve		Number ^a	Measurements ^b
			Number ^a	Measurements ^b	Number ^a	Measurements ^b		
4	45	42	3	21	5	35	3	84
4	60	42	7	49	7	49	5	154
4	75	42	4	28	5	35	5	105
4	90	42	7	56	8	63	3	84
4	105	42	6	42	6	42	5	119
8	45	38	3	21	3	21	3	63
8	60	38	5	35	7	49	5	126
8	75	21, 32, 38	7	49	8	56	4	175
8	90	21, 32, 38	9	70	11	84	3	119
8	105	38	6	42	8	56	5	126
Totals			57	413	68	490	41	1155

^aTotal number of cross sections.

^bTotal number of points at which measurements were made.

TABLE II.- JET CENTERLINE LOCATIONS

RAKE LOCATION				JET CENTERLINE				RAKE LOCATION				JET CENTERLINE			
UINF (M/S)	X/D	Z/D	PHIR (DEG)	X/D	Z/D	UC/ UINF	PHIC (DEG)	UINF (M/S)	X/D	Z/D	PHIR (DEG)	X/D	Z/D	UC/ UINF	PHIC (DEG)
R = 4 , DELTA = 45 DEG															
42	7.00	3.72	15.0	6.95	3.91	1.67	17.1	42	20.00	6.00	5.0	20.01	5.87	1.27	8.7
41	9.88	4.44	9.0	9.90	4.34	1.41	13.7								
R = 4 , DELTA = 60 DEG															
42	2.00	2.50	39.0	2.01	2.49	3.56	35.4	42	6.50	4.88	19.0	6.51	4.84	1.51	17.7
*42	4.00	2.50	40.0	3.27	3.37	2.04	26.9	*42	10.00	5.69	14.0	10.11	5.23	1.24	13.4
*42	4.01	3.26	40.0	3.69	3.64	2.24	25.1	*42	20.00	7.50	7.0	20.06	6.99	1.17	6.7
42	4.00	3.67	26.0	3.98	3.72	2.03	24.0								
R = 4 , DELTA = 75 DEG															
41	2.00	3.42	39.0	2.00	3.42	2.66	34.9	42	7.53	5.88	18.0	7.53	5.87	1.15	16.1
42	3.00	4.13	31.0	3.00	4.13	2.06	28.0	42	10.00	6.67	13.9	9.99	6.69	1.08	13.5
R = 4 , DELTA = 90 DEG															
X 43	0.0	1.00	87.7	0.13	1.00	4.05	76.0	42	10.00	7.47	14.0	9.96	7.65	1.06	13.4
X 42	0.69	1.68	65.1	0.40	2.25	3.75	62.6	*41	10.00	7.47	14.0	9.99	7.52	1.08	13.4
42	4.00	5.50	24.9	3.93	5.64	1.30	23.6	*42	20.00	9.38	7.5	19.98	9.52	1.03	8.6
*42	10.00	7.47	14.0	9.98	7.57	1.11	13.4								
R = 4 , DELTA = 105 DEG															
42	2.00	6.00	32.0	2.15	5.76	1.45	30.8	42	7.99	8.10	16.0	7.91	8.39	1.10	15.2
42	4.00	7.06	24.0	3.96	7.15	1.20	22.6	*42	11.00	7.66	13.1	10.60	9.37	1.10	12.7
*42	8.00	6.88	16.0	7.61	8.24	1.14	15.5	42	10.94	9.07	13.1	10.90	9.25	1.08	12.5
R = 8 , DELTA = 45 DEG															
37	7.00	5.38	27.9	6.86	5.64	3.75	30.5	37	20.00	10.10	15.1	19.89	10.50	1.80	16.5
37	10.00	6.88	23.1	9.92	7.06	2.64	24.8								
R = 8 , DELTA = 60 DEG															
38	2.50	3.81	53.0	2.48	3.82	5.52	52.8	38	10.00	9.22	24.0	9.91	9.43	2.02	24.9
37	4.00	5.44	43.0	3.95	5.49	4.17	41.6	38	20.00	13.09	15.0	20.04	12.95	1.37	16.5
37	7.00	7.73	33.0	6.95	7.81	2.82	30.5								
R = 8 , DELTA = 75 DEG															
38	2.00	5.26	59.0	1.97	5.28	4.74	54.2	*31	10.00	11.90	27.0	10.06	11.79	1.50	24.1
38	4.00	7.75	45.0	3.95	7.80	2.75	39.5	37	10.00	11.90	27.0	10.05	11.81	1.48	24.1
*21	10.00	11.90	27.0	9.83	12.23	1.87	24.4	*37	20.00	15.50	18.0	19.96	15.63	1.15	16.3
*21	10.00	11.90	27.0	9.99	11.92	1.53	24.2								
R = 8 , DELTA = 90 DEG															
X 21	0.0	1.00	87.7	0.03	1.00	8.08	85.9	*21	9.50	14.01	25.0	9.64	13.70	1.19	24.0
X 21	0.50	2.59	66.6	0.18	2.77	7.90	78.1	*21	9.50	14.01	25.0	9.80	13.36	1.27	23.8
X 21	0.76	3.60	57.1	0.34	3.76	6.60	72.9	*31	9.50	14.01	25.0	9.78	13.41	1.21	23.8
38	4.00	10.31	40.9	4.15	10.13	1.70	36.3	38	9.50	14.01	25.0	9.63	13.73	1.20	24.0
*21	9.50	14.01	25.0	9.70	13.58	1.20	23.9								
R = 8 , DELTA = 105 DEG															
38	3.00	12.00	43.1	3.14	11.85	1.23	36.9	*38	8.00	15.66	26.0	8.38	14.88	1.12	24.5
37	4.50	12.84	34.0	4.48	12.87	1.18	32.3	*38	11.00	15.05	22.0	9.86	17.88	1.09	22.6
*38	8.00	13.78	26.0	7.15	15.52	1.09	26.4	*38	10.98	15.78	22.0	10.77	16.30	1.02	21.7

*Not used to determine coefficients in jet centerline equation.

+Cold jet, $TJ/TINF = 0.9$. Not used in jet centerline equation.

+Hot jet, $TJ/TINF = 1.2$. Not used in jet centerline equation.

*Special case for measurement near the jet orifice.

TABLE III.- VORTEX-CURVE LOCATIONS

RAKE LOCATION				VORTEX CURVE				RAKE LOCATION				VORTEX CURVE			
UINF (M/S)	X/D	Z/D	PHIR (DEG)	X/D	Z/D	S/D	PHIV (DEG)	UINF (M/S)	X/D	Z/D	PHIR (DEG)	X/D	Z/D	S/D	PHIV (DEG)
R= 4 , DELTA= 45 DEG															
42	7.00	2.00	11.0	6.88	2.64	6.93	13.8	*42	20.00	3.80	5.0	19.95	4.35	20.22	7.9
*42	7.00	2.00	11.0	6.87	2.65	6.92	13.8	42	20.00	4.30	5.0	19.99	4.39	20.26	7.9
41	9.83	2.63	9.0	9.73	3.23	9.85	11.5								
R= 4 , DELTA= 60 DEG															
42	2.00	2.20	30.0	2.35	1.59	2.33	25.2	42	10.00	3.38	10.0	9.88	4.05	10.20	11.6
*42	2.00	2.20	30.0	2.35	1.59	2.34	25.2	*42	10.00	3.88	10.0	9.98	4.01	10.29	11.6
42	4.00	2.08	19.0	3.92	2.31	4.04	19.1	42	19.84	4.75	7.0	19.75	5.47	20.21	8.0
42	6.00	2.88	13.0	5.96	3.05	6.17	15.3								
R= 4 , DELTA= 75 DEG															
41	2.00	2.11	28.0	2.12	1.88	2.28	27.6	42	10.00	4.00	8.9	9.94	4.40	10.47	11.7
42	3.00	2.19	22.9	2.90	2.42	3.15	23.1	42	20.00	5.45	8.0	19.97	5.68	20.64	8.0
42	7.56	3.39	14.0	7.45	3.84	7.91	13.7								
R= 4 , DELTA= 90 DEG															
X 43	0.0	1.00	87.8	0.74	1.00	0.0	0.0	42	10.00	4.45	11.1	10.00	4.45	10.73	11.7
X 42	0.59	1.87	35.6	1.05	1.35	0.0	0.0	-42	10.00	4.45	11.1	10.00	4.43	10.74	11.7
42	4.00	3.01	18.1	4.02	2.96	4.58	19.3	42	19.78	4.75	7.5	19.71	5.28	20.56	8.1
+ 42	10.00	4.45	11.1	10.03	4.32	10.76	11.7	*42	19.88	7.00	7.5	20.31	3.76	20.90	8.0
R= 4 , DELTA=105 DEG															
42	2.00	2.50	19.0	2.14	2.09	2.96	27.3	*42	10.75	4.55	10.0	10.75	4.56	11.94	11.2
42	4.00	3.13	14.0	4.03	3.01	5.00	19.2	42	10.75	4.55	10.0	10.77	4.43	11.96	11.2
42	8.00	3.97	12.0	7.98	4.16	9.09	13.2	42	20.34	5.97	7.0	20.41	5.38	21.73	7.9
R= 8 , DELTA= 45 DEG															
38	7.00	3.61	25.0	6.75	4.16	7.46	24.9	38	19.99	7.37	15.1	19.87	7.82	21.36	15.4
37	10.00	4.73	21.0	9.78	5.31	10.75	21.4								
R= 8 , DELTA= 60 DEG															
*38	2.00	1.97	41.0	1.84	2.15	2.17	44.9	*38	9.93	6.50	24.0	9.76	8.87	11.45	22.8
38	2.00	1.97	41.0	1.84	2.15	2.17	44.9	38	10.00	6.50	24.0	9.81	8.94	11.51	22.7
37	4.00	3.46	37.0	3.40	4.25	4.75	34.6	38	19.98	9.66	15.0	19.95	9.75	22.22	15.9
37	7.00	5.17	29.0	6.78	5.56	8.17	27.0								
R= 8 , DELTA= 75 DEG															
37	2.00	3.88	51.0	2.30	3.64	3.51	45.8	*31	10.00	8.20	19.1	9.87	8.57	12.46	23.3
*38	4.00	4.94	42.8	3.80	5.15	5.51	37.0	*31	10.00	8.20	19.1	9.88	8.54	12.47	23.3
38	4.00	4.94	39.1	3.79	5.20	5.49	37.1	38	10.00	8.20	19.1	9.88	8.55	12.47	23.3
*21	10.00	8.20	19.1	9.86	8.61	12.44	23.4	37	20.00	11.50	17.0	19.98	11.57	23.16	16.1
R= 8 , DELTA= 90 DEG															
X 21	0.0	1.00	87.8	0.72	0.97	0.0	0.0	+21	9.50	9.70	22.4	9.55	9.57	13.37	24.0
X 21	0.85	2.60	66.7	0.88	2.59	0.0	0.0	*31	9.50	9.70	22.4	9.60	9.45	13.40	23.9
X 21	1.24	3.60	57.0	1.31	3.54	0.0	0.0	37	9.50	9.72	22.4	9.54	9.65	13.34	24.0
38	4.00	8.56	35.0	3.98	6.59	7.00	37.1	*38	20.01	14.00	15.7	20.31	12.92	24.64	16.1
+ 21	9.50	9.70	22.4	9.55	9.58	13.36	24.0	38	20.02	11.75	15.7	19.88	12.24	24.23	16.3
*21	9.50	9.70	22.4	9.61	9.44	13.41	23.9								
R= 8 , DELTA=105 DEG															
38	3.00	7.50	33.0	3.05	7.42	7.79	40.8	*38	10.69	10.47	19.0	10.60	10.74	16.49	22.5
38	4.00	7.94	28.0	4.13	7.69	9.16	35.7	*38	10.69	10.47	19.0	10.32	10.96	16.41	22.6
*38	8.00	9.20	23.0	7.70	9.90	13.31	26.5	38	10.75	10.47	19.0	10.67	10.71	16.49	22.5
38	8.03	9.82	23.0	7.92	10.07	13.55	26.1	38	20.50	13.49	14.0	20.48	13.58	26.93	15.9

*Not used to determine coefficients in vortex-curve equation.

+Cold jet, $TJ/TINF = 0.9$. Not used in vortex-curve equation.

+Hot jet, $TJ/TINF = 1.2$. Not used in vortex-curve equation.

*Special case for measurement near the jet orifice.

TABLE IV.- PARAMETER VALUES FOR JET CENTERLINE AND VORTEX-CURVE EQUATIONS

Investigation	a	b	c	d	ℓ_2/D (R = 4)	ℓ_2/D (R = 8)	σ/D
1. Reference 20: ^a							
Centerline, equation (2)	0.975	0.909	0.339	----	----	----	0.19
Vortex curve, equation (2)	.352	1.122	.429	----	----	----	.26
2. Present study: ^b							
Centerline (without jet core) -							
R = 4 and 8	0.866	0.858	0.438	----	----	----	0.62
R = 4	.866	.924	.393	----	----	----	.42
R = 8	.866	.845	.451	----	----	----	.66
Vortex curve -							
R = 4 and 8	.311	1.153	.444	----	----	----	.44
R = 4	.311	1.114	.466	----	----	----	.38
R = 8	.311	1.158	.439	----	----	----	.49
3. Present study: ^b							
Centerline (with jet core) -							
R = 4 and 8	1.482	0.520	0.395	8.09	0.13	2.52	0.36
R = 4	1.482	.521	.353	----	.59	----	.35
R = 8	1.482	.527	.405	----	----	2.17	.28

^avalues obtained at R = 3, 4, 5, 6, 8, and 10 and at $\delta = 90^\circ$.

^bvalues obtained at $\delta = 45^\circ, 60^\circ, 75^\circ, 90^\circ, \text{ and } 105^\circ$.

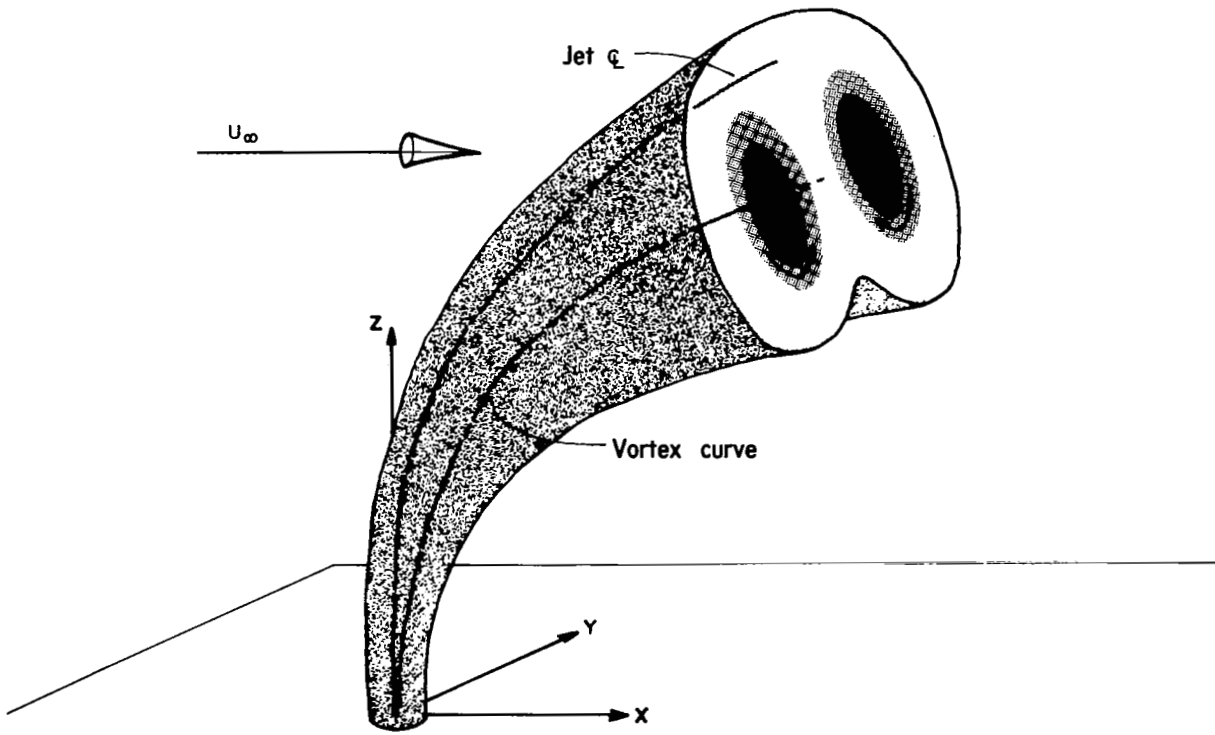
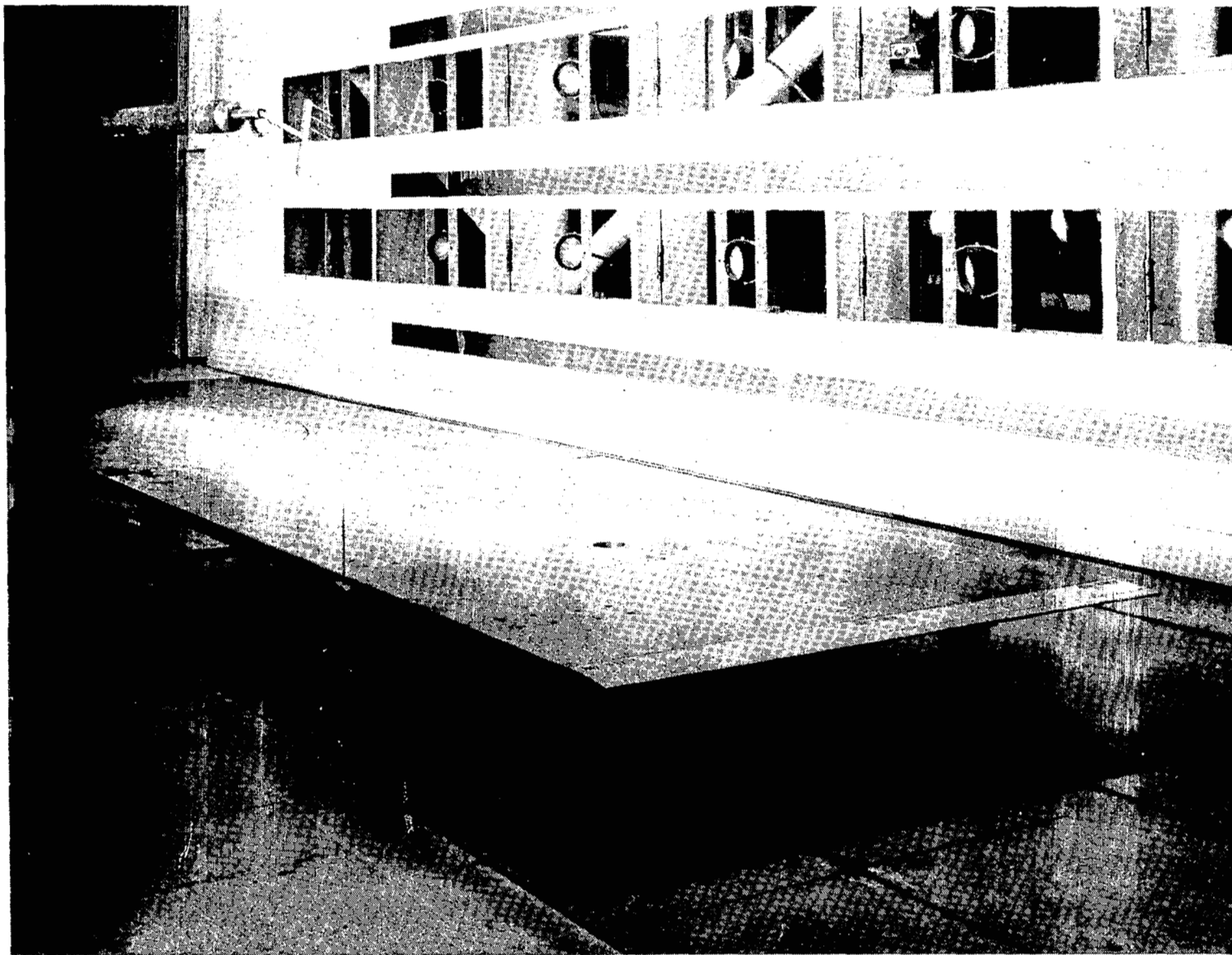

Figure 1.- Sketch of the jet plume.



L-75-2984

Figure 2.- Experimental arrangement in V/STOL tunnel for jet in cross-flow experiment.

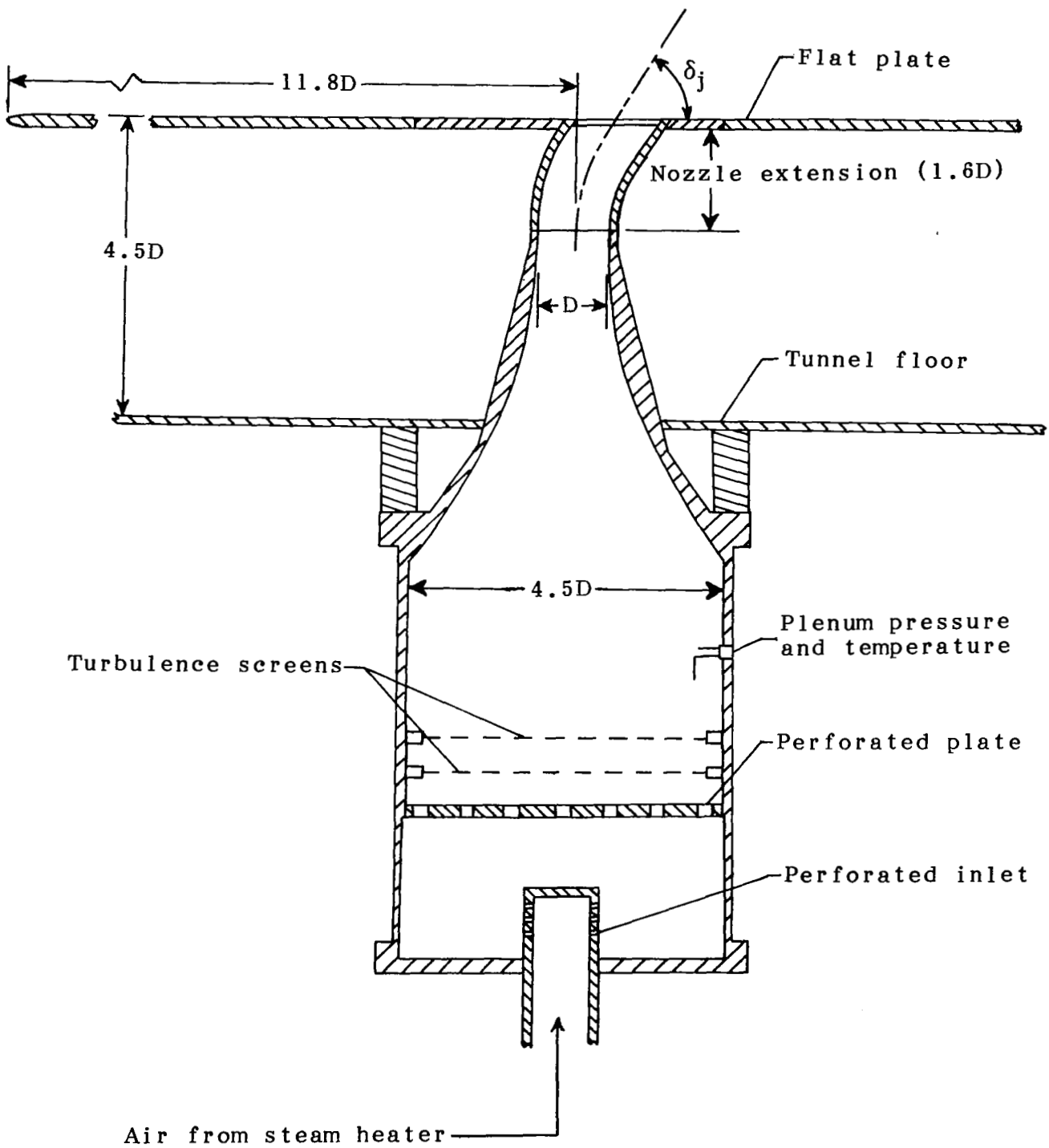
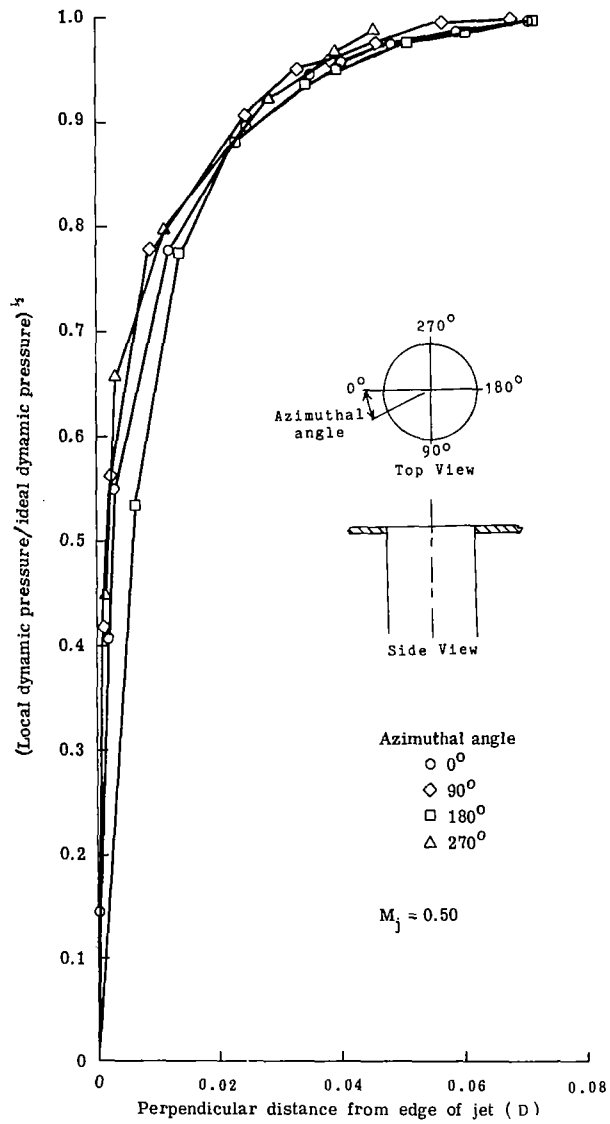
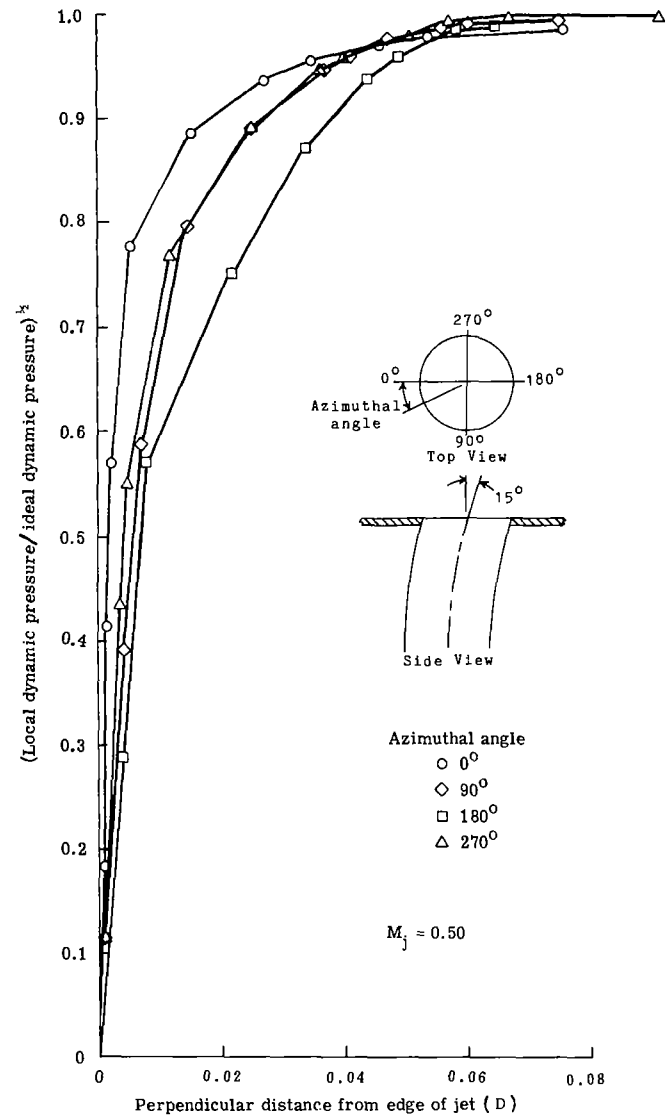

Figure 3.- Jet plenum and nozzle.



(a) 0° deflection nozzle.



(b) 15° deflection nozzle.

Figure 4.- Exit plane boundary-layer profiles.

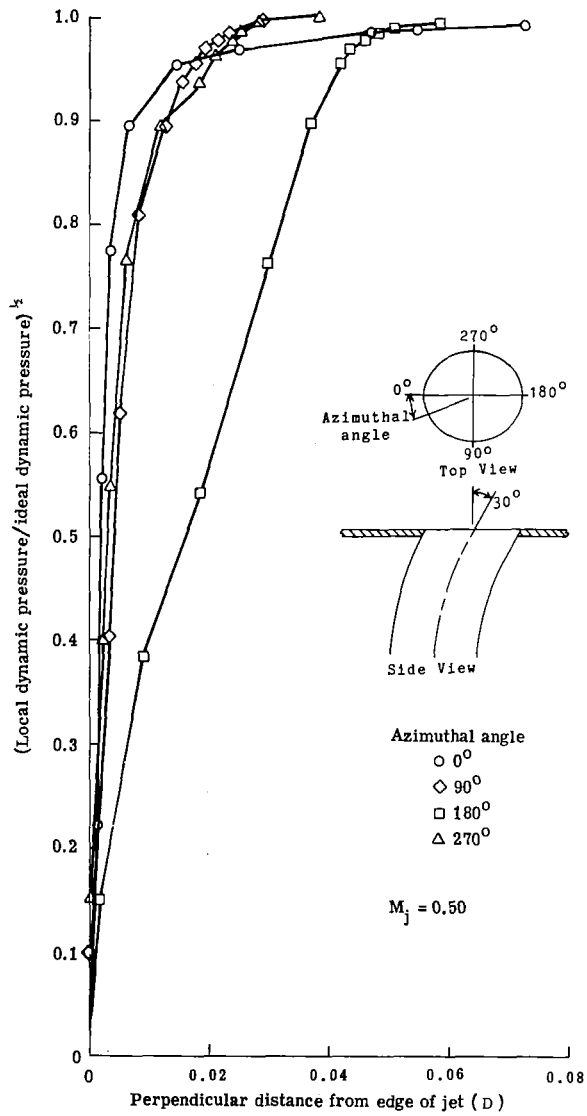

(c) 30° deflection nozzle.

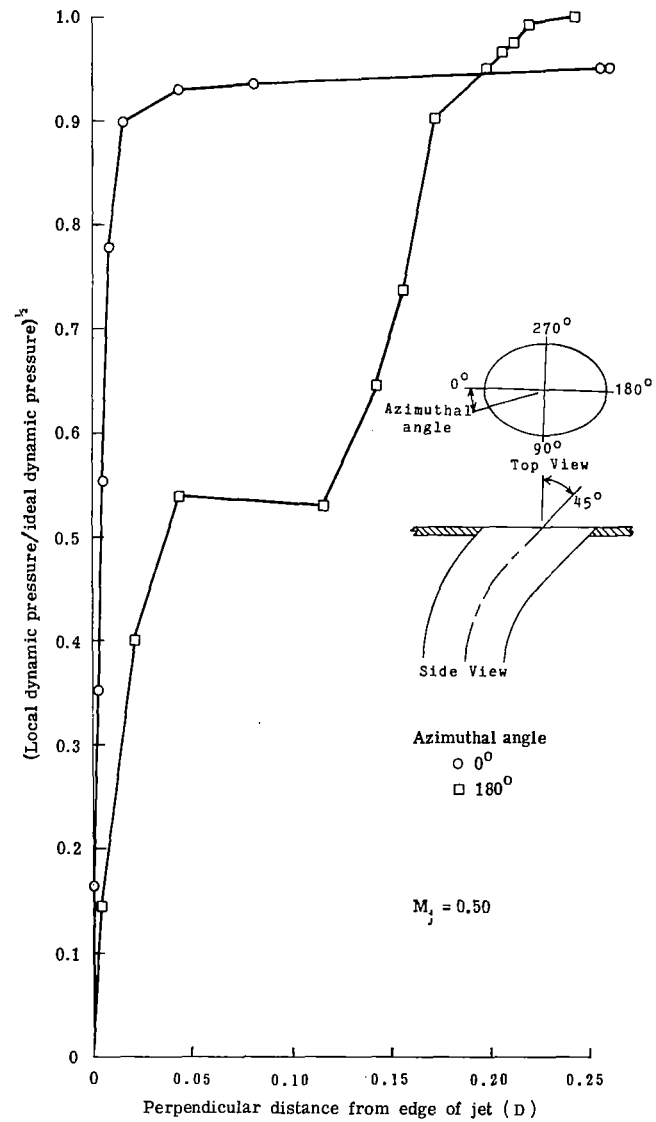

(d) 45° deflection nozzle.

Figure 4.- Concluded.

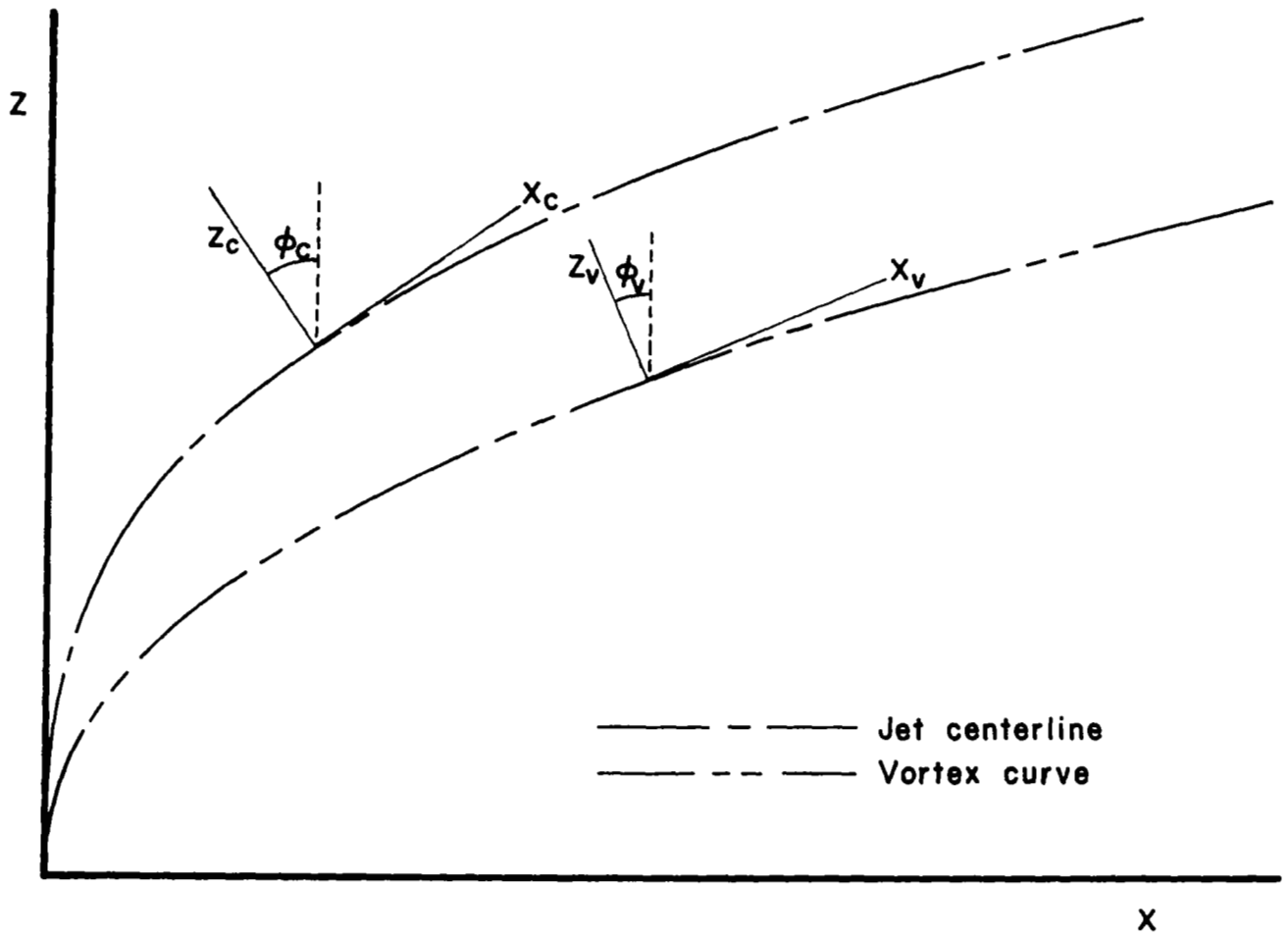

Figure 5.- Jet centerline and vortex curve with associated coordinate systems.

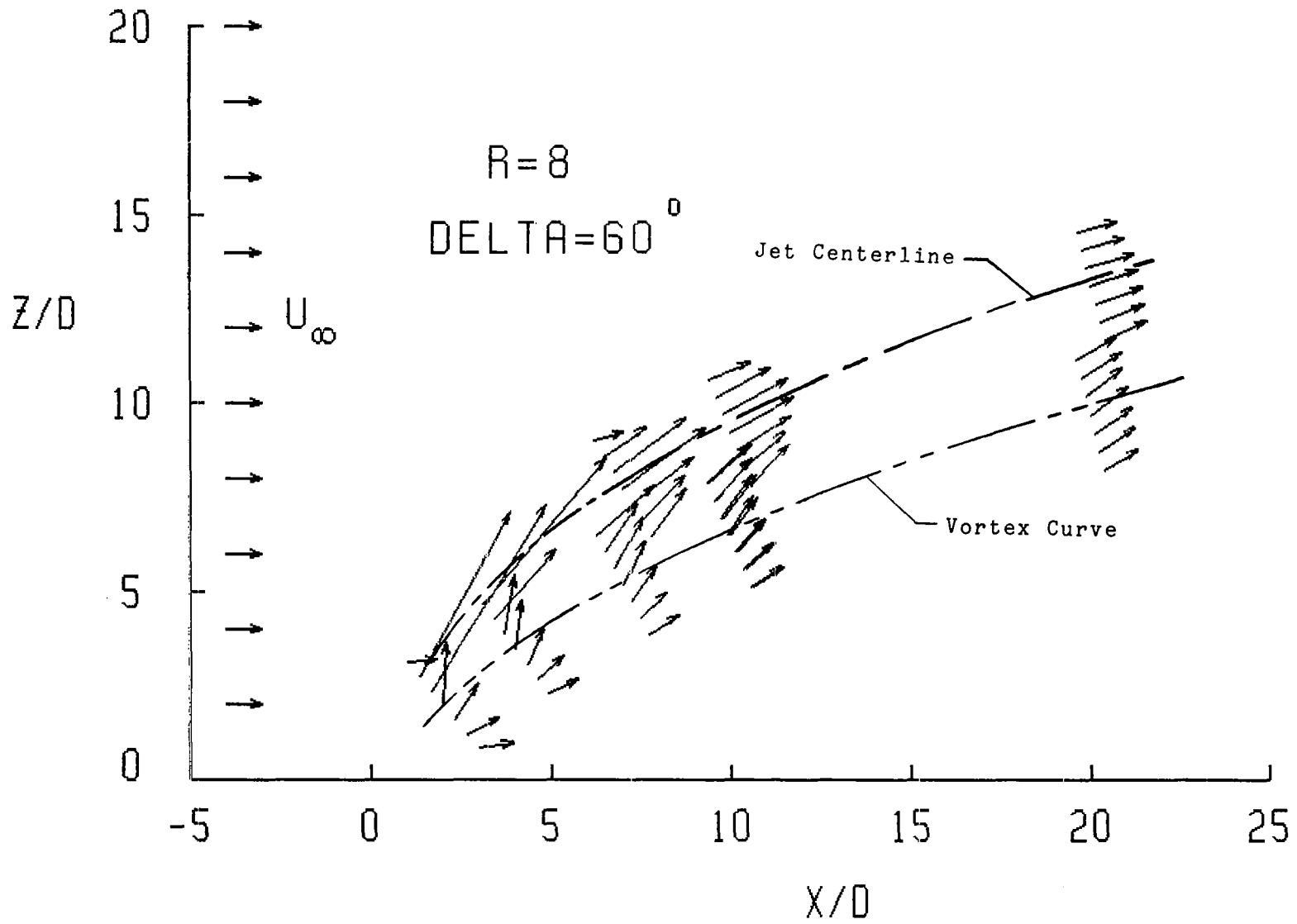
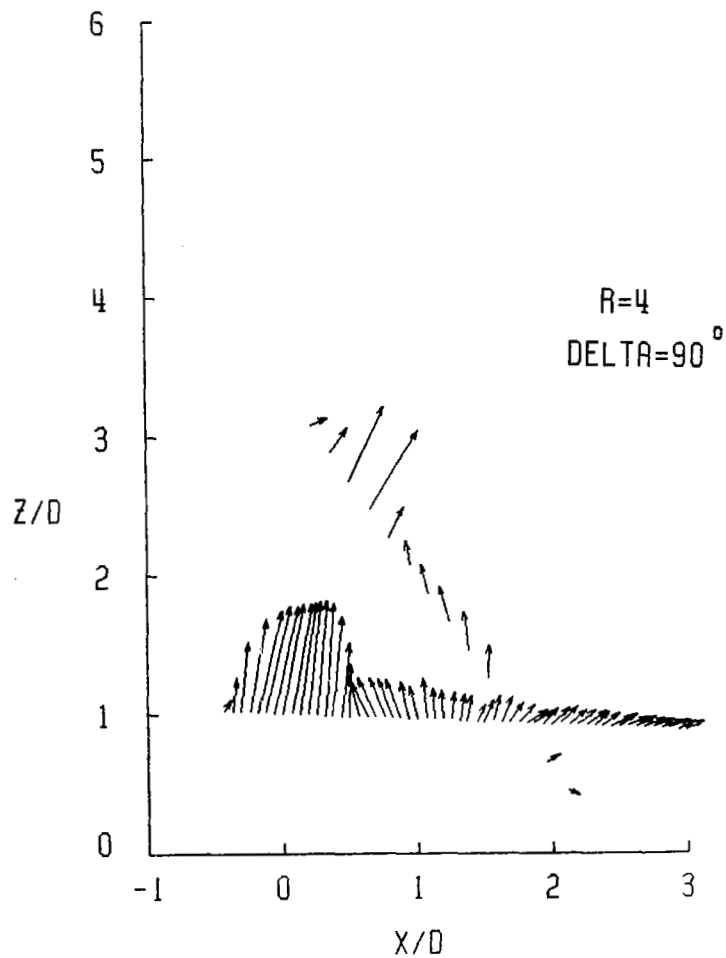
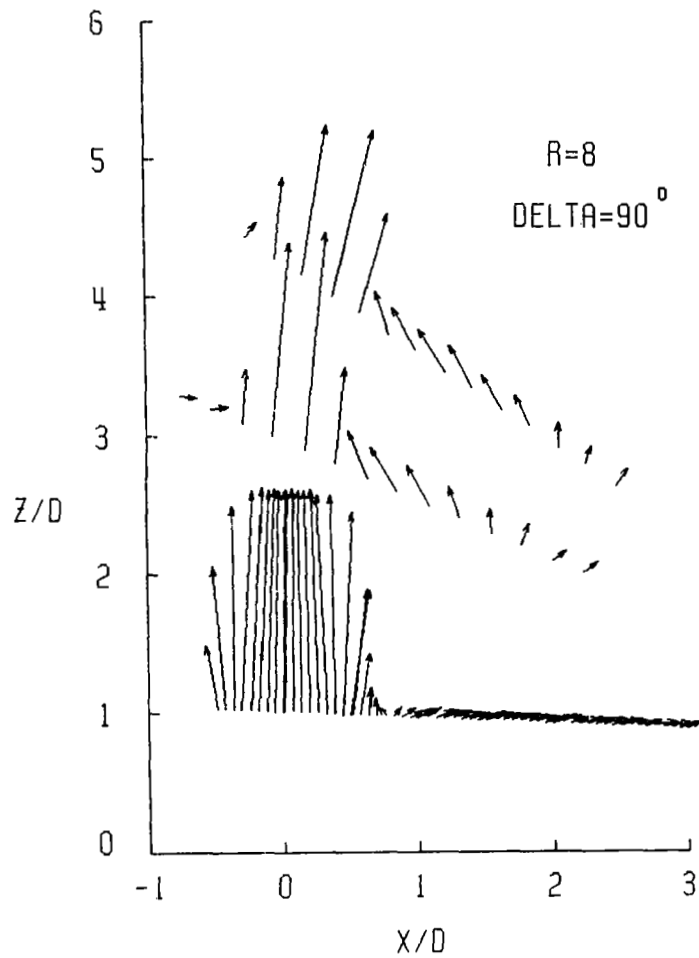

Figure 6.- Symmetry plane velocities.



(a) Effective velocity ratio of 4.



(b) Effective velocity ratio of 8.

Figure 7.- Symmetry plane velocities (near-jet region).

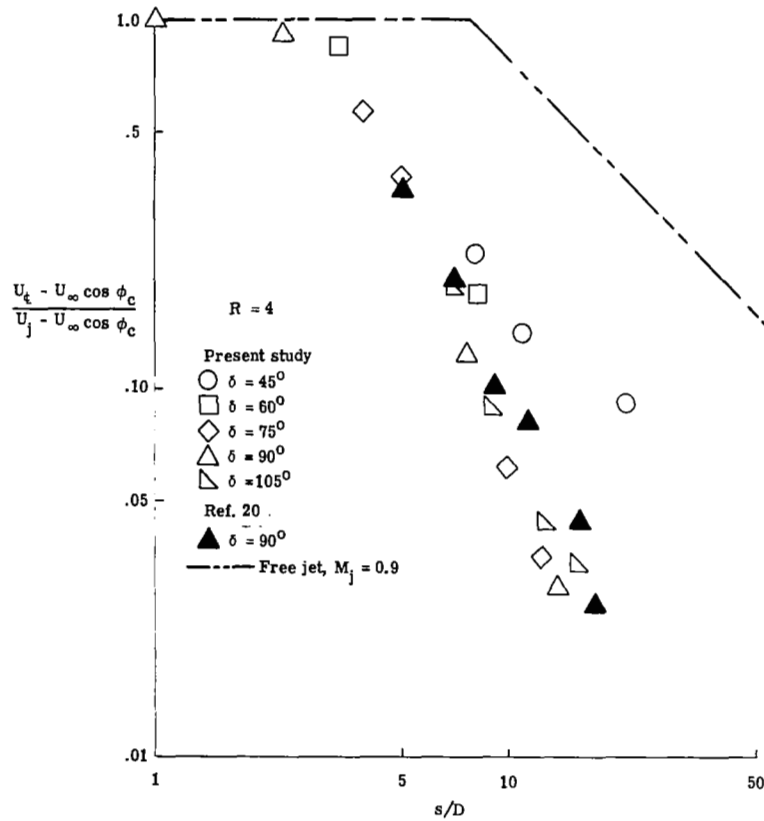

(a) Effective velocity ratio of 4.

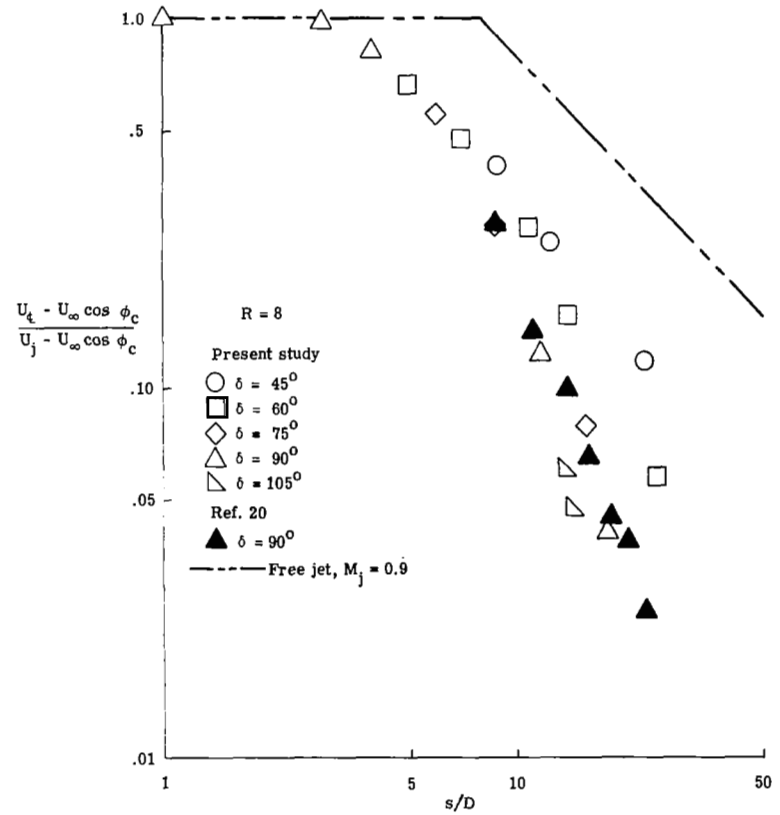

(b) Effective velocity ratio of 8.

Figure 8.- Decay of jet centerline speed.

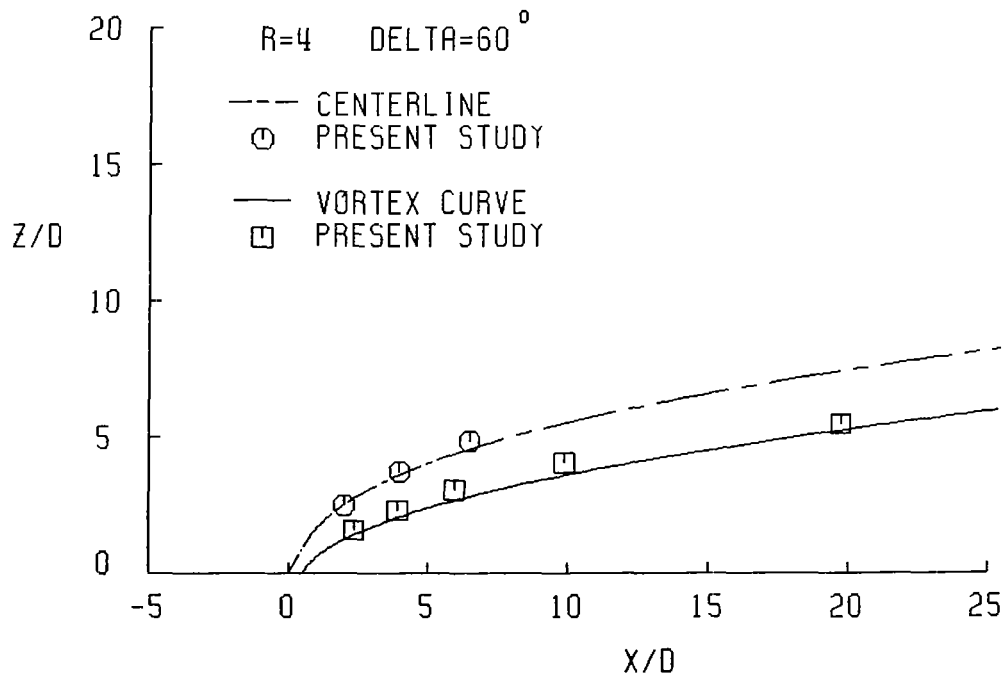
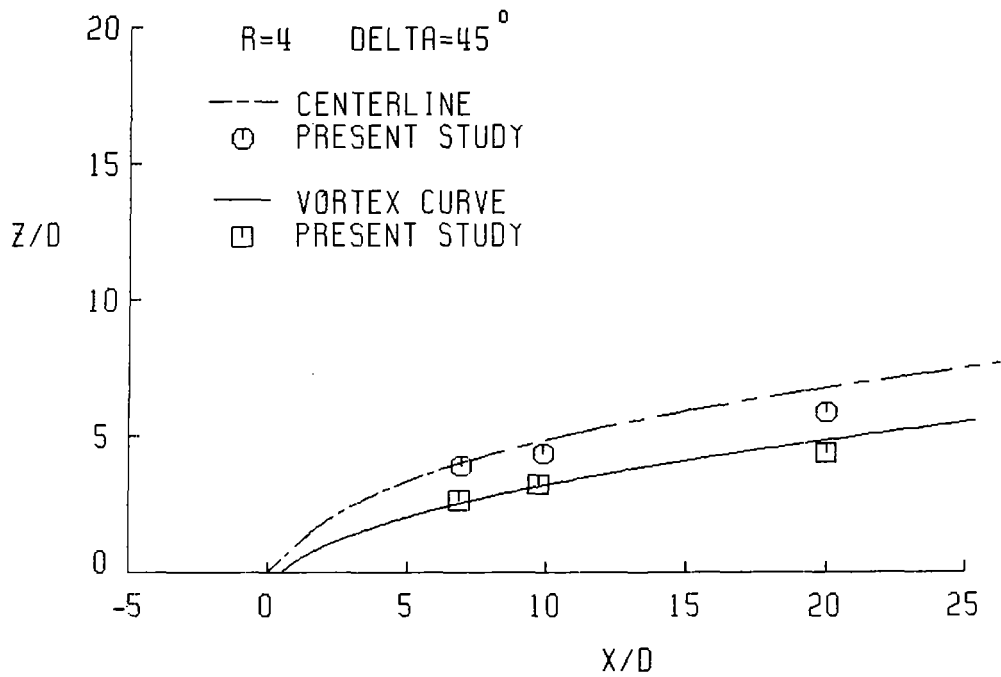

(a) Effective velocity ratio of 4.

Figure 9.- Jet centerlines and vortex curves.

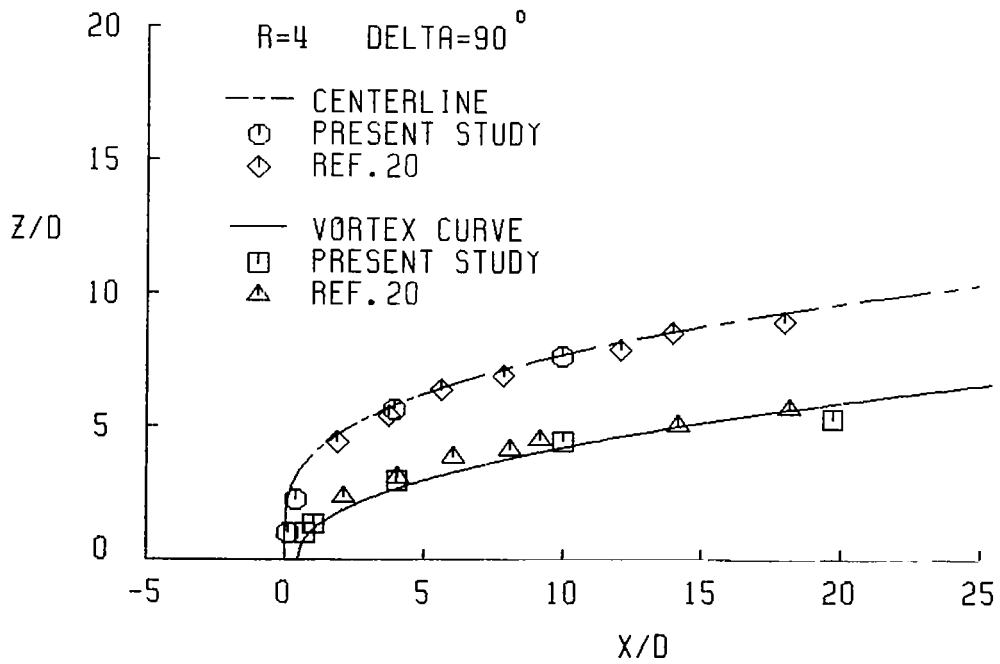
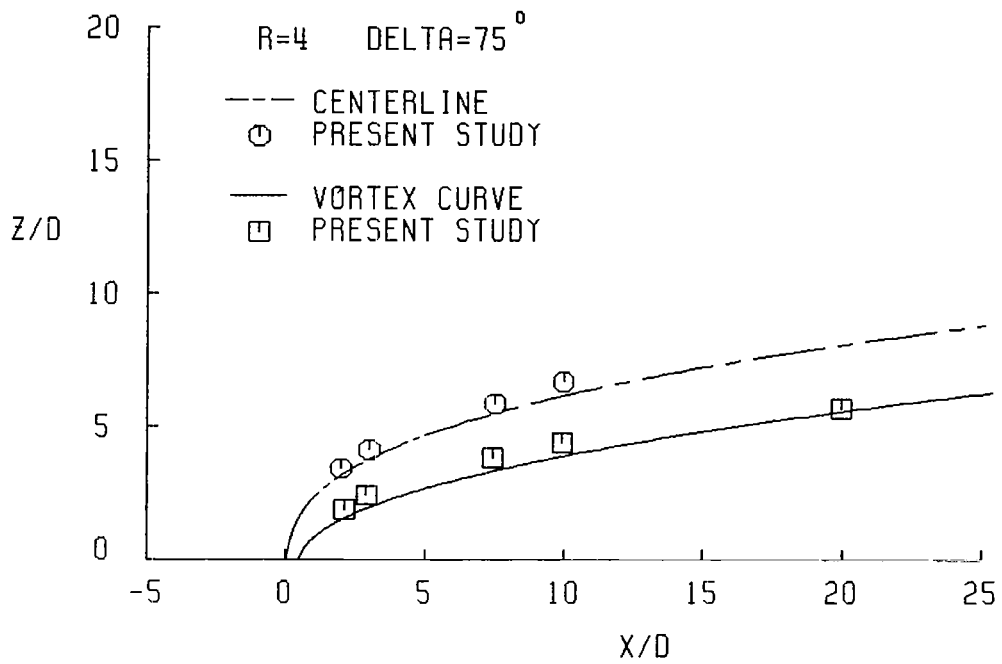

(a) Continued.

Figure 9.- Continued.

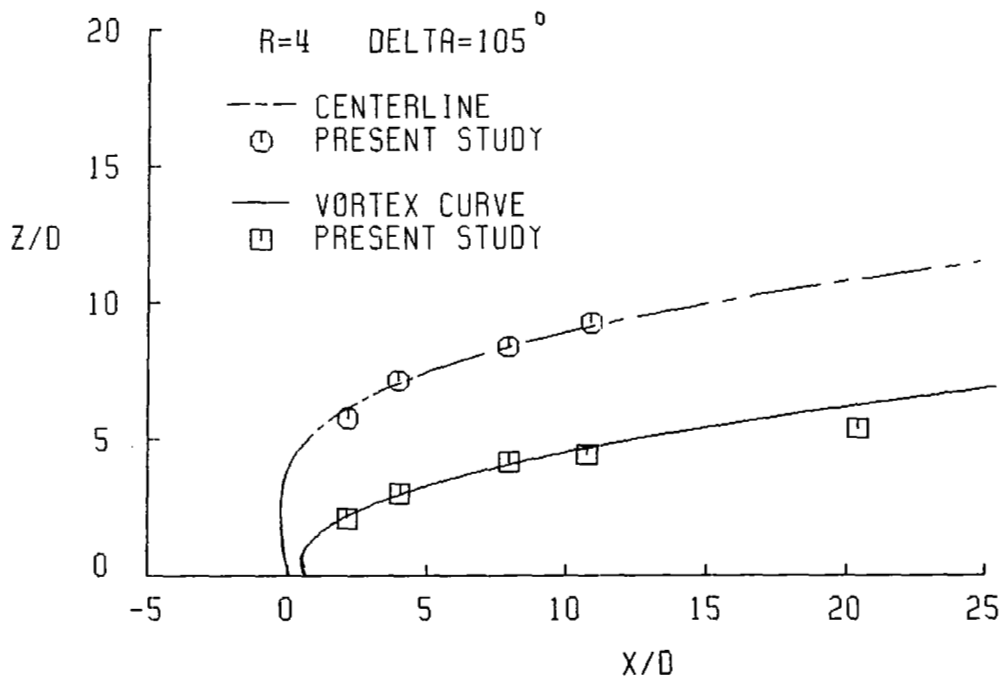

(a) Concluded.

Figure 9.- Continued.

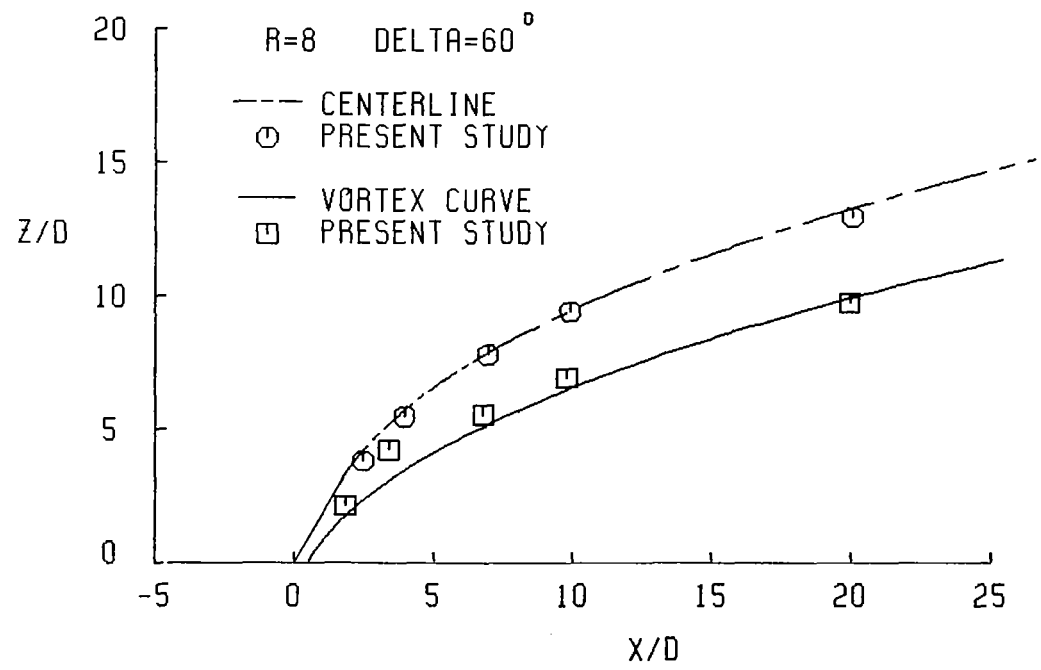
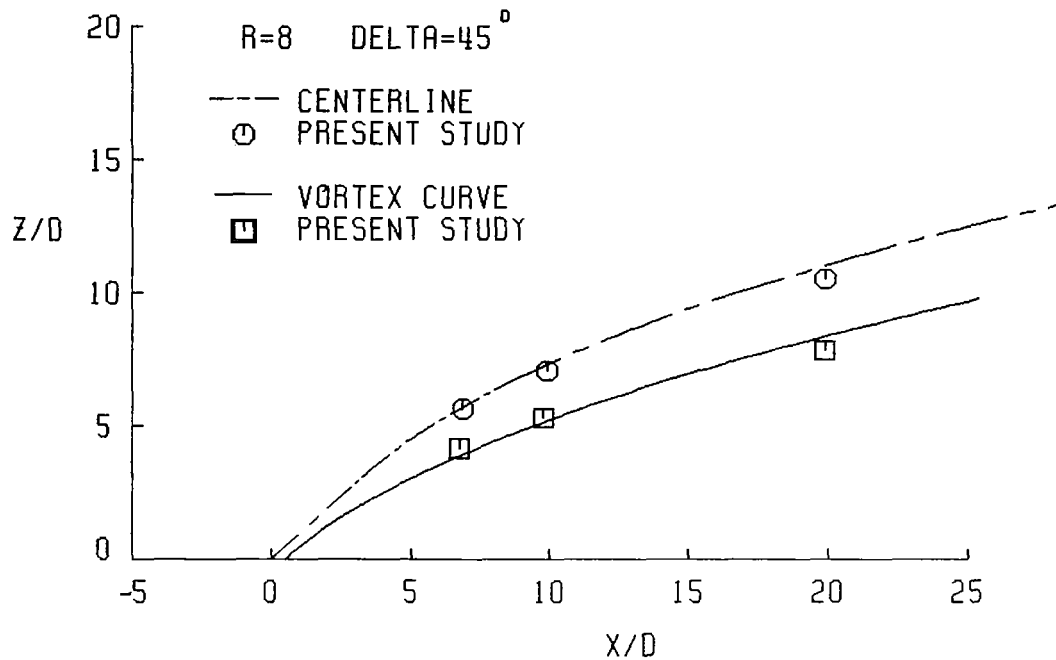

(b) Effective velocity ratio of 8.

Figure 9.- Continued.

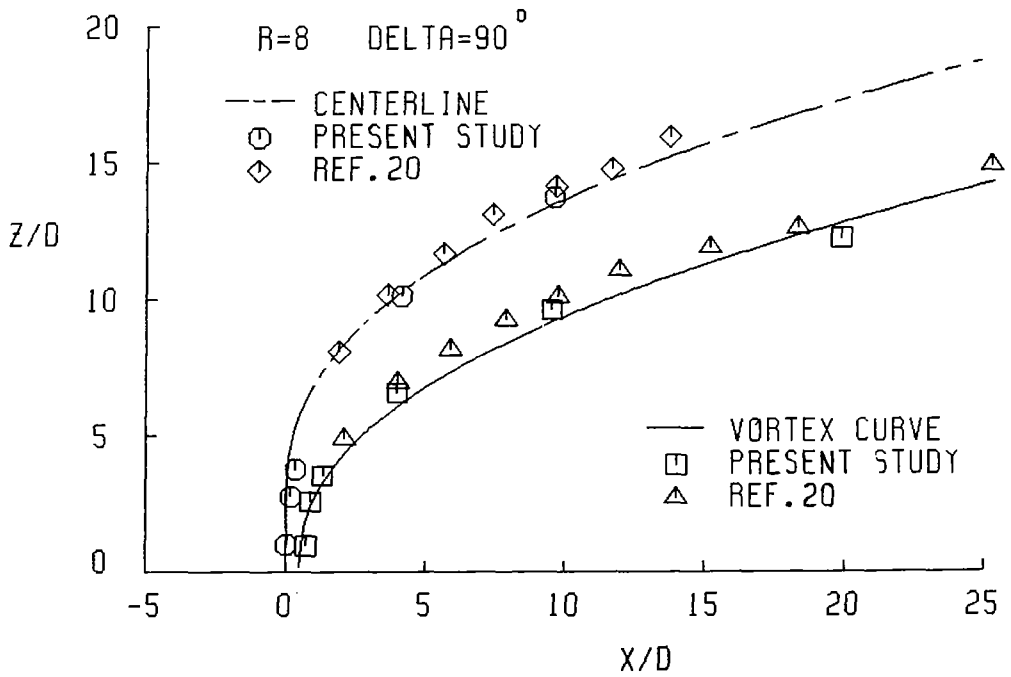
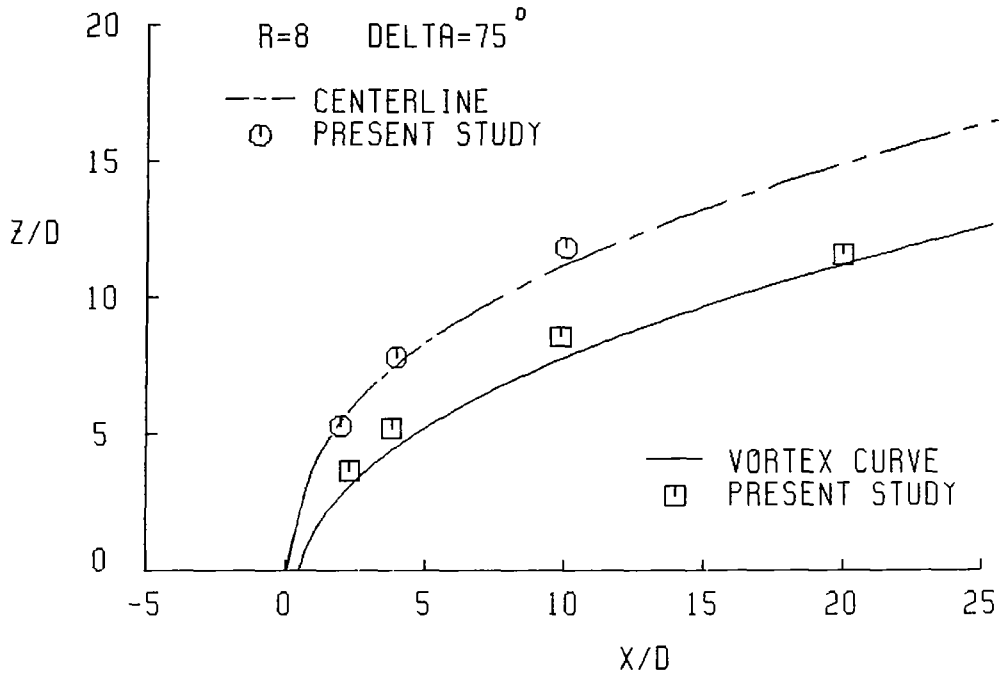

(b) Continued.

Figure 9.- Continued.

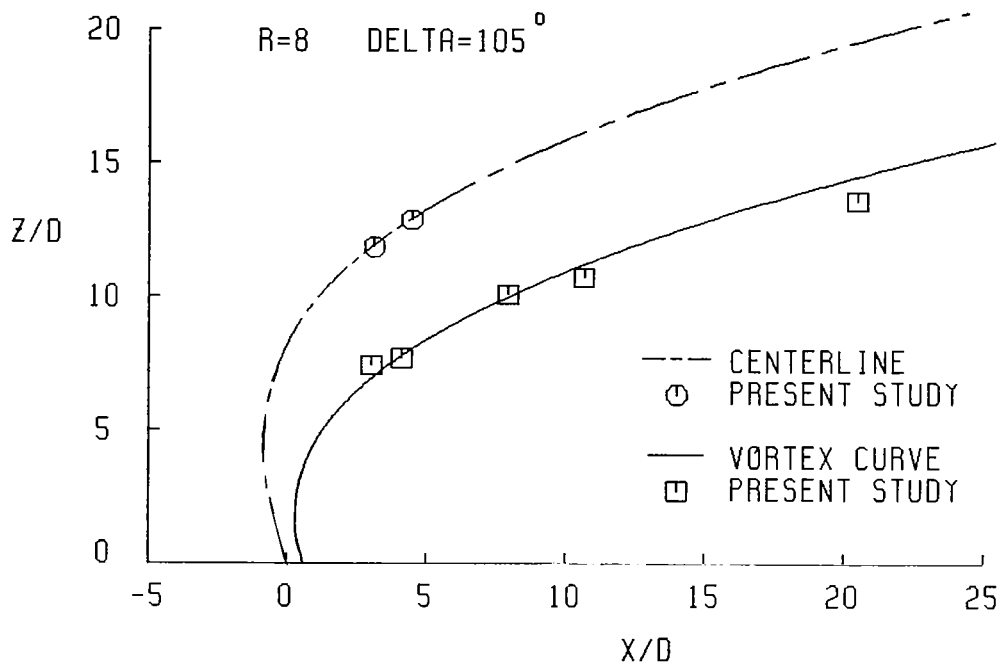

(b) Concluded.

Figure 9.- Concluded.

1. Report No. NASA TP-1506		2. Government Accession No.		3. Recipient's Catalog No.	
4. Title and Subtitle VELOCITY FIELD OF A ROUND JET IN A CROSS FLOW FOR VARIOUS JET INJECTION ANGLES AND VELOCITY RATIOS				5. Report Date October 1979	
				6. Performing Organization Code	
7. Author(s) Richard L. Fearn and Robert P. Weston				8. Performing Organization Report No. L-12775	
9. Performing Organization Name and Address NASA Langley Research Center Hampton, VA 23665				10. Work Unit No. 505-11-23-05	
				11. Contract or Grant No.	
12. Sponsoring Agency Name and Address National Aeronautics and Space Administration Washington, DC 20546				13. Type of Report and Period Covered Technical Paper	
				14. Sponsoring Agency Code	
15. Supplementary Notes Richard L. Fearn, University of Florida, Gainesville, Florida. Robert P. Weston, Langley Research Center.					
16. Abstract An experimental investigation of a subsonic round jet injected from a flat plate into a subsonic crosswind of the same temperature has been conducted in the Langley V/STOL tunnel. Velocity and pressure measurements in planes perpendicular to the path of the jet are presented for nominal jet injection angles of 45°, 60°, 75°, 90°, and 105° and for jet/cross-flow velocity ratios of 4 and 8. These velocity measurements were obtained for the purpose of inferring the properties of the vortex pair that is associated with a jet in a cross flow. Jet centerline and vortex trajectories are determined and fit with an empirical equation that includes the effects of jet injection angle, jet core length, and jet/cross-flow velocity ratios.					
17. Key Words (Suggested by Author(s)) Jet in a cross flow Velocity field Subsonic cross flow Jet plane			18. Distribution Statement Unclassified - Unlimited Subject Category 34		
19. Security Classif. (of this report) Unclassified		20. Security Classif. (of this page) Unclassified		21. No. of Pages 131	22. Price* \$7.25