

KSC K-STSM-14.1
K-STSM-09, Volume VI
March 14, 1978

KSC Space Transportation System Launch Site Accommodations Handbook for STS Payloads

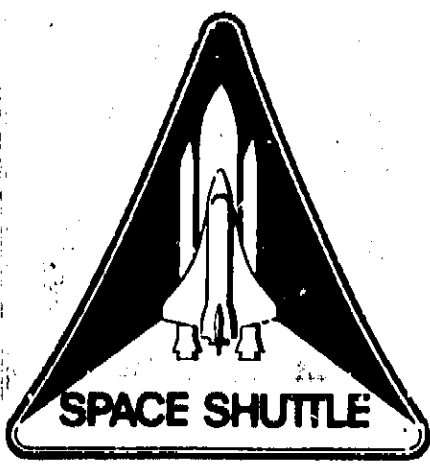

National Aeronautics and
Space Administration

John F. Kennedy Space Center

JOHN F. KENNEDY SPACE CENTER LIBRARY
CIRCULATION UNIT
OCT 10 1978



APPROVAL

K-STS-14.1
K-STS-09, Volume VI
March 14, 1978

KSC
LAUNCH SITE ACCOMMODATIONS HANDBOOK
FOR STS PAYLOADS

Prepared by:

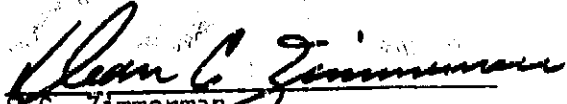

D.C. Zimmerman
Automated Payloads Project
Payload Integration Office, SP-PAY-A
Phone: 305-867-3921 4163 9044

APPROVALS:

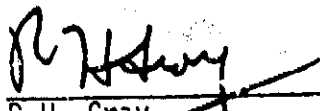
H.E. McCoy
Chief, Payload Integration Office
Phone: 305-867-3644

R.H. Gray
Manager, Shuttle Projects Office

CONCURRENCE by LSSM Offices:

J. W. Johnson
Manager, Automated Payloads Programs
Phone: 305-867-3921

Dr. G. W. Sharp
Manager, Spacelab Payload Missions
Phone: 305-867-3193

FOREWORD

The Space Transportation System (STS) is designed to make Space Operations available and economically attractive to many users. This dictates efficient management including documented and controlled interfaces, system capabilities and support services. Toward this end, a series of User Handbooks is presented to describe various elements of the STS (i.e., Orbiter, Spacelab, Upper Stages, etc.).

This Handbook describes the basic Launch Site Accommodations available for STS Payload owners (users) at the Kennedy Space Center (KSC) Florida, and at Vandenberg Air Force Base (VAFB) California.

The objective of this Handbook is to provide optimum matchup of STS User(s) payload requirements with the available launch site capabilities. The accommodation information is presented to assist and guide STS User(s) in the launch site operational planning. The Handbook, used as a planning tool, should enable efficient and timely integration of all payload requirements into the STS and launch site capabilities.

The International System of Units (SI) will be incorporated in this Handbook at a later date, to conform to NASA Publication SP-7012.

TABLE OF CONTENTS

| <u>Section</u> | <u>Title</u> | <u>Page</u> |
|---------------------------------------|-----------------------------------------------------|-------------|
| I INTRODUCTION | | |
| 1.1 | Purpose | 1-1 |
| 1.2 | Scope | 1-1 |
| 1.3 | Authority | 1-4 |
| 1.4 | Deviations | 1-4 |
| 1.5 | Revisions | 1-4 |
| II MANAGEMENT AND ORGANIZATION | | |
| 2.1 | KSC Organizations | 2-1 |
| 2.1.1 | Shuttle Projects Office (SP) | 2-1 |
| 2.1.2 | Space Vehicle Operations (VO) | 2-1 |
| 2.1.3 | Design Engineering (DE) | 2-1 |
| 2.1.4 | Technical Support (TS) | 2-4 |
| 2.1.5 | Safety, R&QA, and Protective Services (SF) | 2-4 |
| 2.1.6 | Administrative and Management Operations (AM) | 2-4 |
| 2.2 | Launch Site Host Role | 2-4 |
| 2.3 | Launch Site Payload Processing Guidelines | 2-4 |
| 2.4 | Launch Site Support Planning | 2-5 |
| 2.4.1 | Launch Site Support Manager (LSSM) | 2-5 |
| 2.4.2 | Launch Site Support Team | 2-6 |
| 2.4.3 | Payload Planning Process..... | 2-6 |
| 2.4.4 | Launch Site Support Plan (LSSP)..... | 2-6 |
| 2.5 | Responsibilities | 2-6 |
| 2.5.1 | Launch Site | 2-6 |
| 2.5.2 | STS User | 2-7 |
| III PLANNED PAYLOAD OPERATIONS | | |
| 3.1 | General | 3-1 |
| 3.2 | Horizontally Integrated Payloads | 3-1 |
| 3.2.1 | Payload Receiving at the O&C Building | 3-1 |
| 3.2.2 | Mechanical Assembly of Payload | 3-4 |
| 3.2.3 | Horizontal Cargo Integration..... | 3-4 |
| 3.2.4 | Move from O&C Building to OPF | 3-6 |
| 3.2.5 | Cargo Installation into Orbiter at OPF..... | 3-6 |
| 3.2.6 | Orbiter Operations from OPF to Launch Pad | 3-7 |
| 3.2.7 | Launch Pad Servicing and Launch | 3-7 |
| 3.3 | Vertically Integrated Payloads | 3-8 |
| 3.3.1 | Receiving, Buildup and Off-Line Test | 3-8 |
| 3.3.2 | Move from PPF to Explosive Safe Area | 3-11 |
| 3.3.3 | Hazardous Operations & Testing | 3-11 |
| 3.3.4 | Movement from ESA to VPF | 3-12 |
| 3.3.5 | Receipt & Processing of Upper Stages | 3-12 |
| 3.3.6 | VPF Operations | 3-13 |
| 3.3.7 | Movement from VPF to PCR | 3-13 |
| 3.3.8 | PCR and Launch Pad Operations | 3-14 |
| 3.4 | Post Flight Operations | 3-15 |
| 3.4.1 | Removal of Payload from Orbiter | 3-15 |
| 3.4.2 | Disassembly of Cargo..... | 3-16 |
| 3.4.3 | Secondary/Contingency Landing Site Operations | 3-16 |

TABLE OF CONTENTS (Continued)

| <u>Section</u> | <u>Title</u> | <u>Page</u> |
|----------------------------------------------------------|-------------------------------------------------------------------------|-------------|
| III (Continued) | | |
| 3.5 | Payload Processing Variations | 3-17 |
| 3.5.1 | Processing of Get Away Special (GAS) Payloads | 3-17 |
| 3.5.2 | Processing of Life Sciences Payloads..... | 3-17 |
| 3.5.3 | Processing of USAF Payloads..... | 3-18 |
| IV STS PAYLOAD FACILITIES & SUPPORT EQUIPMENT | | |
| 4.1 | General | 4-1 |
| 4.2 | Facility Utilization | 4-1 |
| 4.3 | Payload Function vs Facility | 4-3 |
| 4.4 | Facility Capabilities | 4-3 |
| 4.5 | Launch Site Multiuse Mission Payload Support Equipment (MMPSE) | 4-3 |
| 4.5.1 | Category A MMSE | 4-3 |
| 4.5.1.1 | Payload Handling Fixture (Strongback) | 4-12 |
| 4.5.1.2 | Payload Canister | 4-12 |
| 4.5.1.3 | Payload Horizontal Canister Access Equipment | 4-12 |
| 4.5.1.4 | Payload Canister Horizontal Transporter | 4-13 |
| 4.5.1.5 | Transport Instrumentation Set | 4-13 |
| 4.5.1.6 | Environmental Conditioning Unit | 4-13 |
| 4.5.2 | Cargo Integration Test Equipment (CITE) | 4-14 |
| 4.5.3 | Intersite Transportation Equipment (ITE) | 4-14 |
| 4.6 | Payload Service Equipment (PSE) | 4-14 |
| 4.7. | Payload Unique Owner Supplied Equipment | 4-20 |
| 4.8. | Launch Processing System | 4-20 |
| 4.8.1 | CCMS..... | 4-20 |
| 4.8.2 | CDS..... | 4-20 |
| 4.8.3 | Use of LPS by STS Users..... | 4-20 |
| V SUPPORT SERVICES | | |
| 5.1 | General | 5-1 |
| 5.2 | Administrative Support Services | 5-3 |
| 5.2.1 | Housekeeping | 5-3 |
| 5.2.2 | Communications-Administrative | 5-3 |
| 5.2.3 | Logistics | 5-4 |
| 5.2.4 | Security | 5-5 |
| 5.2.5 | Safety | 5-7 |
| 5.2.6 | Transportation | 5-7 |
| 5.2.7 | Medical | 5-9 |
| 5.2.8 | Training | 5-10 |
| 5.2.9 | Photographic | 5-10 |
| 5.2.10 | Food Service | 5-10 |
| 5.2.11 | Reproduction | 5-10 |
| 5.2.12 | Mail Service | 5-11 |
| 5.2.13 | Fire Prevention and Protection | 5-11 |
| 5.3 | Technical Support Services | 5-12 |
| 5.3.1 | Clean Rooms | 5-12 |
| 5.3.2 | Cranes | 5-12 |
| 5.3.3 | Communications-Operational | 5-12 |

TABLE OF CONTENTS (Continued)

| <u>Section</u> | <u>Title</u> | <u>Page</u> |
|--------------------------------------------|---------------------------------------------------------------|-------------|
| V (Continued) | | |
| 5.3.4 | Instrumentation | 5-13 |
| 5.3.5 | Propellants, Liquids and Gases | 5-14 |
| 5.3.6 | Ordnance | 5-15 |
| 5.3.7 | Chemical Sampling and Analysis | 5-15 |
| 5.3.8 | Non-Destructive Evaluation (NDE) | 5-15 |
| 5.3.9 | Technical Shops | 5-16 |
| 5.3.10 | Laboratories | 5-17 |
| 5.3.11 | Photography | 5-19 |
| 5.3.12 | LRU Maintenance | 5-19 |
| VI SAFETY | | |
| 6.1 | General | 6-1 |
| 6.1.1 | Safety Requirements at Launch Site | 6-1 |
| 6.1.2 | Objectives | 6-1 |
| 6.2 | Responsibilities | 6-1 |
| 6.2.1 | KSC Director, Safety, R&QA, and Protective Services (SF)..... | 6-1 |
| 6.2.2 | Payload Owner/Operator | 6-2 |
| 6.2.3 | Operations | 6-2 |
| 6.3 | Operational Safety | 6-2 |
| 6.3.1 | Personnel Safety | 6-2 |
| 6.3.2 | Training, Certification and Medical Requirements..... | 6-2 |
| 6.3.3 | Accident Prevention | 6-3 |
| 6.4 | System Safety..... | 6-3 |
| 6.4.1 | Safety Analysis | 6-4 |
| 6.4.2 | Safety Assessment Reviews | 6-4 |
| 6.4.3 | Safety Compliance Data | 6-4 |
| 6.4.4 | Technical Operating Procedures..... | 6-5 |
| 6.5 | Hazardous Operations | 6-5 |
| 6.6 | Safety Requirements | 6-6 |
| 6.6.1 | Propellants and Explosive Safety..... | 6-7 |
| 6.6.2 | Pressure Systems Safety | 6-7 |
| 6.6.3 | Flex Hoses..... | 6-8 |
| 6.6.4 | Radiation Safety | 6-8 |
| 6.6.5 | Handling | 6-8 |
| 6.6.6 | Toxic, Combustible, Corrosive..... | 6-10 |
| 6.6.7 | Electrical | 6-10 |
| VII DOCUMENTATION AND SCHEDULES | | |
| 7.1 | Standard Functions | 7-1 |
| 7.1.1 | Transportation | 7-1 |
| 7.1.2 | Receiving/Receiving Inspection | 7-1 |
| 7.1.3 | Assembly | 7-1 |
| 7.1.4 | Functional Test | 7-1 |
| 7.1.5 | Servicing | 7-1 |
| 7.1.6 | Mate/Demate | 7-3 |
| 7.1.7 | Payload/Cargo Integration | 7-3 |
| 7.1.8 | Shuttle to Cargo Integration..... | 7-3 |

TABLE OF CONTENTS (Continued)

| <u>Section</u> | <u>Title</u> | <u>Page</u> |
|------------------------------------|---------------------------------------------------------------------|-------------|
| VII (Continued) | | |
| 7.1.9 | Launch Operations | 7-3 |
| 7.1.10 | Mission Operations | 7-3 |
| 7.1.11 | Refurbishment | 7-3 |
| 7.1.12 | Storage | 7-3 |
| 7.2 | Requirements Checklist | 7-3 |
| 7.3 | STS User Supplied Documentation | 7-6 |
| 7.3.1 | Facility Requirements..... | 7-6 |
| 7.3.2 | Payload Ground Operations & Checkout Procedures (Off-Line) | 7-6 |
| 7.3.3 | Support Services Requirements | 7-8 |
| 7.3.4 | On-Line STS Operations & Maintenance Requirements | 7-8 |
| 7.3.5 | Design Specifications | 7-8 |
| 7.3.6 | Safety Data | 7-8 |
| 7.3.7 | Other Launch Site Support Documentation | 7-8 |
| 7.4 | KSC Developed Documentation | 7-8 |
| 7.4.1 | Payload Launch Site Support Plan (LSSP) | 7-8 |
| 7.4.2 | On-Line STS Operations & Maintenance Documentation.... | 7-10 |
| 7.4.3 | Schedules..... | 7-10 |
| 7.4.3.1 | Operational Schedules..... | 7-10 |
| 7.4.3.2 | Modification Schedule..... | 7-12 |
| VIII VAFB UNIQUE OPERATIONS | | |
| 8.1 | General | 8-1 |
| 8.2 | On-Line Shuttle Operations | 8-5 |
| 8.2.1 | Landing Activity | 8-5 |
| 8.2.2 | Safing & Deservice Activity | 8-5 |
| 8.2.3 | Orbiter Maintenance and Checkout Activity | 8-5 |
| 8.2.4 | Vertical Assembly Prelaunch & Launch Activity | 8-5 |
| 8.3 | Payload Operations | 8-9 |
| 8.3.1 | General | 8-9 |
| 8.3.2 | Automated Payload Preparations | 8-9 |
| 8.3.3 | Spacelab Preparation | 8-9 |
| 8.4 | Facilities Descriptions | 8-12 |
| 8.4.1 | Payload Processing Facilities (PPFs) | 8-12 |
| 8.4.1.1 | PPF 1 | 8-12 |
| 8.4.1.2 | PPF 2 | 8-14 |
| 8.4.1.3 | PPF 3 | 8-14 |
| 8.4.1.4 | Isotope Storage Building | 8-15 |
| 8.4.1.5 | Spin Test Facility | 8-16 |
| 8.4.2 | Payload Processing Facility Constraints | 8-16 |
| 8.4.3 | STS Processing Facilities | 8-18 |
| 8.4.3.1 | Safing and Deservicing Facility (SDF) | 8-19 |
| 8.4.3.2 | Orbiter Maintenance and Checkout Facility (OMCF) .. | 8-21 |
| 8.4.3.3 | Hypergolic Service Facility (HSF) | 8-22 |
| 8.4.3.4 | Launch Pad Facilities | 8-23 |
| 8.4.4 | Base Support Facilities | 8-25 |
| 8.5 | VAFB Support Laboratories & Services | 8-27 |
| 8.5.1 | Metrology .. | 8-27 |
| 8.5.2 | Component Cleaning Facility | 8-27 |

TABLE OF CONTENTS (Continued)

| <u>Section</u> | <u>Title</u> | <u>Page</u> |
|-----------------------------------------|-----------------------------------------------------------------------------|-------------|
| VIII (Continued) | | |
| 8.5.3 | Propellants and Gases | 8-28 |
| 8.5.4 | Fuels Analysis Laboratory | 8-29 |
| 8.5.5 | Ordnance Storage | 8-29 |
| 8.5.6 | Launch Operations Communications | 8-30 |
| 8.5.7 | Wind Information | 8-30 |
| 8.5.8 | Data Processing | 8-30 |
| 8.5.9 | Range Timing | 8-31 |
| 8.5.10 | VAFB Timing Center | 8-31 |
| 8.5.11 | Shop Support | 8-31 |
| 8.5.12 | Mission Status Center (MSC) | 8-32 |
| 8.5.13 | Administrative Support | 8-32 |
| 8.6 | Support Equipment | 8-34 |
| 8.7 | VAFB Launch Processing System | 8-34 |
| IX PAYLOAD DESIGN CONSIDERATIONS | | |
| 9.1 | General Design Considerations | 9-1 |
| 9.2 | Materials | 9-1 |
| 9.3 | Electrical | 9-2 |
| 9.4 | Mechanical/Structural | 9-2 |
| 9.5 | Fluid Systems | 9-2 |
| X USER CHARGE | | |
| 10.1 | General | 10-1 |
| 10.2 | Payload Processing Facilities | 10-2 |
| 10.3 | Support Services | 10-2 |
| XI PUBLIC AFFAIRS | | |
| 11.1 | General | 11-1 |
| 11.2 | Responsibilities | 11-1 |
| 11.2.1 | Public Information Branch | 11-1 |
| 11.2.2 | Visitor Services Branch | 11-1 |
| 11.2.3 | Educational Programs Staff | 11-1 |
| 11.3 | Operations | 11-1 |
| 11.3.1 | News Releases | 11-1 |
| 11.3.2 | News Photographs | 11-1 |
| 11.3.3 | Visiting Media Representatives | 11-1 |
| 11.3.4 | Tours | 11-2 |
| 11.3.5 | Launching and Landing Viewing | 11-2 |
| 11.3.6 | Educational Programs | 11-2 |
| APPENDICES: | | |
| A | REFERENCED DOCUMENTS | |
| B | SAFETY REQUIREMENTS FOR HAZARDOUS GROUND OPERATIONS/ CHECKOUT PROCEDURES | |
| C | GLOSSARY | |
| D | USER-ORIENTED DOCUMENTS | |

LIST OF ILLUSTRATIONS

| <u>Figure</u> | <u>Title</u> | <u>Page</u> |
|---------------|--------------------------------------------------------------|-------------|
| 1-1 | Launch Site Payload Planning Process | 1-2 |
| 2-1 | Relationship of Shuttle Projects Office to KSC | 2-2 |
| 2-2 | Relationship of Payload Integration Office to KSC-SP | 2-3 |
| 3-1 | Standard Payload Processing Flows | 3-2 |
| 3-2 | Typical Timeline for Horizontally Integrated Payloads | 3-3 |
| 3-3 | Orbiter - Pad Payload Cabling Interfaces | 3-9 |
| 3-4 | Typical Timeline for Vertically Integrated Payloads | 3-10 |
| 3-5 | Life Science Payload Flow | 3-19 |
| 4-1 | KSC/CCAFS Major Payload Facilities | 4-4 |
| 4-2 | Payload Facilities in KSC Industrial Area | 4-5 |
| 4-3 | Payload Facilities in CCAFS Industrial Area | 4-6 |
| 4-4 | Horizontal CITE | 4-15 |
| 4-5 | Vertical CITE | 4-16 |
| 4-6 | CITE Avionics Functional Diagram for Payloads | 4-17 |
| 4-7 | ITE - Single Pallet Container | 4-18 |
| 4-8 | ITE - Modular Container | 4-19 |
| 4-9 | Launch Processing System Architecture | 4-21 |
| 7-1 | Typical Schedule for Launch Site Payload Documentation | 7-2 |
| 7-2 | Typical Implementing Schedule | 7-11 |
| 8-1 | VAFB STS Siting Arrangement | 8-2 |
| 8-2a | VAFB STS Ground Flow | 8-3 |
| 8-2b | VAFB STS Ground Flow | 8-4 |
| 8-3a | VAFB STS Ground Operations Functional Flow | 8-6 |
| 8-3b | VAFB STS Ground Operations Functional Flow | 8-7 |
| 8-4 | VAFB STS Processing Timeline (Assessment) | 8-8 |
| 8-5 | Typical Automated Payload Flow at WRT | 8-10 |
| 8-6 | Typical Spacelab Flow at VAFB | 8-11 |
| 8-7 | Payload Processing Facilities in Bldg. 836 | 8-13 |
| 8-8 | Isotope Storage Building | 8-15 |
| 8-9 | STS Processing at VAFB | 8-18 |
| 8-10 | Safing and Deservicing Facility | 8-20 |
| 8-11 | Orbiter Maintenance and Checkout Facility | 8-21 |
| 8-12 | Hypergolic Service Facility | 8-22 |
| 8-13 | VAFB STS Launch Facilities | 8-24 |

LIST OF TABLES

| <u>Table</u> | <u>Title</u> | <u>Page</u> |
|--------------|----------------------------------------------------|-------------|
| 4-1 | Facilities vs Payloads | 4-2 |
| 4-2 | Payload Function vs Facility | 4-7 |
| 4-3 | Launch Site Facilities Capabilities | 4-8 |
| 4-4 | Category A MMSE Capabilities | 4-11 |
| 5-1 | Matrix of Available Services | 5-2 |
| 7-1 | Payload Processing Requirements Checklist | 7-4 |
| 7-2 | Typical Format for Procedure(s) Contents | 7-7 |
| 7-3 | Launch Site Support Plan - Table of Contents | 7-9 |
| 8-1 | Existing Facilities Limitations | 8-17 |

LIST OF ABBREVIATIONS AND ACRONYMS

The following abbreviations and acronyms are used in this Handbook (complete listings of STS and Associated Payloads glossary, acronyms, and abbreviations are contained in KSC Document GP-1052).

| | |
|--------|------------------------------------------------------------|
| A&E | Architectural and Engineering |
| AC | Alternating Current |
| ADP | Automatic Data Processing |
| AFETR | Air Force Eastern Test Range |
| AFM | USAF Manual |
| AM | Administration and Management Operations (KSC Directorate) |
| ANSI | American National Standards Institute |
| AOA | Abort Once Around |
| API | Auxiliary Power Unit |
| ASME | American Society of Mechanical Engineers |
| ATE | Automatic Test Equipment |
| | |
| C | Centigrade |
| CADS | Communications and Data Integration |
| C&W | Caution and Warning |
| C of F | Cost of Facilities |
| CCAFS | Cape Canaveral Air Force Station |
| CCTV | Closed Circuit Television |
| CDBFR | Common Data Buffer |
| CDS | Control Data System (Central Data System) |
| CITE | Cargo Integration Test Equipment |
| CLS | Contingency Landing Site |
| CRT | Cathode-Ray Tube |
| CTSG | Central Timing Generator |
| | |
| DC | Direct Current |
| DE | Design Engineering (KSC Directorate) |
| DOD | Department of Defense |
| DOT | Department of Transportation |
| DPO | Drop Out (relay) |
| DRS | Data Relay Station |
| DST | Delta Spin Test |
| DSTF | Delta Spin Test Facility |
| | |
| EAFB | Edwards Air Force Base (California) |
| EMC | Electromagnetic Compatibility |
| ESA | Explosive Safe Area (CCAFS) |
| | European Space Agency |
| ET | External Tank |
| | |
| F | Fahrenheit |
| FCAC | Frequency Control and Analysis Center (VAFB, CA) |
| FEP | Front End Processor |
| FM | Frequency Modulation |
| FIS | Federal Telecommunications System |
| | |
| GAS | Get Away Special (Payloads) |
| G&C | Guidance and Control |
| GHe | Gaseous Helium |

| | |
|------------------|----------------------------------------------|
| GMT | Greenwich Mean Time |
| GN ₂ | Gaseous Nitrogen |
| GN&C | Guidance, Navigation & Control |
| GO ₂ | Gaseous Oxygen |
| GORP | Ground Operations Review Panel |
| GP | KSC General Publication |
| GSA | General Services Administration |
| GSE | Ground Support Equipment |
| GSFC | Goddard Space Flight Center |
| H ₂ O | Water |
| HEPA | High Efficiency Particle Accumulator |
| HIM | Hardware Interface Module |
| HSF | Hypergolic Service Facility |
| HZ | Hertz (cycles per second) |
| ID | Identification |
| I/F | Intermediate Frequency |
| IRFNA | Inhibited Red Fuming Nitric Acid |
| IRIG | Inter Range Instrumentation Group |
| ITE | Intersite Transportation Equipment |
| IUS | Interium Upper Stage |
| JPL | Jet Propulsion Laboratory |
| JSC | Johnson Space Center |
| K | One Thousand |
| KBPS | Kilobits per Second |
| KHB | Kennedy Handbook |
| KHZ | Kilohertz |
| KMI | Kennedy Management Instruction |
| K-SM | Kennedy Shuttle Projects Management Document |
| KSC | Kennedy Space Center |
| LaRC | Langley Research Center |
| LC | Launch Complex |
| LCC | Launch Control Center |
| LDB | Launch Data Bus |
| LDEF | Long Duration Exposure Facility |
| LH ₂ | Liquid Hydrogen |
| LORAN | Long Range Navigation |
| LOX | Liquid Oxygen |
| LPS | Launch Processing System |
| LRU | Line Replacable Unit |
| LSSM | Launch Site Support Manager |
| LVR | Low Voltage Release (Relay) |
| MBPS | Megabits Per Second |
| MCD | Mission Control Data |
| MDM | Multiplexer/Demultiplexer |
| MET | Mission Elapsed Time |
| MGR | Manager |
| MHZ | Megahertz (megacycles per second) |
| MILA | Merritt Island Launch Area |

| | |
|------------|----------------------------------------------------------------------------------------------------|
| MIL-STD | Military Standard |
| MIS | Management Information System |
| MMPSE | Multiuse Mission Payload Support Equipment |
| MMSE | Multiuse Mission Support Equipment |
| MOPS/MITOC | Missile Operating Phone System/Multiple Intercommunications Technical Operations Communications |
| MSC | Mission Status Center (VAFB, CA) |
| MSFC | Marshall Space Flight Center |
| MSS | Mission Specialist Station |
| MST | Mobile Service Tower |
| NASA | National Aeronautics and Space Administration |
| NASCOM | NASA Communication (Network) |
| NDE | Non-Destructive Evaluation |
| NDI | Non-Destructive Inspection |
| NEC | National Electrical Code |
| NFPA | National Fire Prevention Association |
| NHB | NASA Handbook |
| NMI | NASA Management Instruction |
| NSN | National Stock Number |
| NVAFB | North Vandenberg Air Force Base |
| O&C | Operations and Checkout |
| OIA | Orbiter Interface Adapter |
| OIS | Operational Intercommunication System |
| OIT | Orbiter Integrated Test |
| O&M | Operations and Maintenance |
| OMCF | Orbiter Maintenance and Checkout Facility |
| OMS | Orbiter Maneuvering System |
| OPF | Orbiter Processing Facility |
| OPT | Optics |
| OSHA | Occupational Safety and Health Administration |
| OTV | Operational Television |
| PA | Public Address and Paging |
| PAM | Payload Assist Module |
| PAM-A | Atlas-Centaur Class Spacecraft PAM |
| PAM-D | Delta Class Spacecraft PAM |
| PCM | Pulse Code Modulated |
| PCR | Payload Changeout Room |
| PER | Preliminary Engineering Report |
| PGHM | Payload Ground Handling Mechanism |
| PIV | Payload Interface Verification |
| P/L | Payload |
| PMEL | Precision Measurements Equipment Laboratory |
| POCC | Payload Operations Control Center |
| PPF | Payload Processing Facility |
| PPM | Parts Per Million |
| PPR | Payload Preparation Room |
| PSE | Payload Service Equipment |
| PRSD | Power Reactant Supply and Distribution |
| QA | Quality Assurance |
| QD | Quick Disconnect |

| | |
|-----------------|--------------------------------------------------------|
| RCS | Reaction Control System |
| RF | Radio Frequency |
| RFI | Radio Frequency Interference |
| R.H. | Relative Humidity |
| RMS | Remote Manipulator Subsystem |
| RP ₁ | Rocket Propellant No. 1 (refined kerosene) |
| RPS | Record and Playback Subsystem |
| R&QA | Reliability and Quality Assurance |
| RTG | Radioisotope Thermal Generation |
| RTLS | Return To Launch Site |
| R&QA | Reliability and Quality Assurance |
| SAEF | Spacecraft Assembly and Encapsulation Facility |
| SAMTEC | Space and Missile Test Center (VAFB, CA) |
| SAR | Safety Assessment Review (Report) |
| SCI | Switch Closure In |
| SDF | Safing and Deservicing Facility |
| SF | Safety, R&QA and Protective Services (KSC Directorate) |
| SFOP | Safety Operation Procedure |
| SF-SOO | SF-Safety Operations Office |
| SIT | Software Integration Test |
| S/L | Spacelab |
| SLP | Spacelab Payload |
| SLS | Secondary Landing Site |
| SMAB | Solid Motor Assembly Building |
| SP | KSC Shuttle Projects Office |
| SP-OPN | SP-Operations Planning Office |
| SP-PAY | SP-Payload Integration Office |
| SPA | Signal Processor Assembly |
| SPF | Spacelab Processing Facility |
| SRB | Solid Rocket Booster |
| SRS | Support Requirements System |
| STAR | Shuttle Turnaround Analysis Report |
| STS | Space Transportation System |
| SSUS | Spinning Solid Upper Stage |
| SSUS-A | SSUS-Atlas Centaur Class Spacecraft |
| SSUS-D | SSUS-Delta Class Spacecraft |
| SSV | Space Shuttle Vehicle |
| SVAFB | South Vandenberg Air Force Base |
| TACAN | Tactical Air Navigation |
| TBD | To Be Determined (Developed) |
| TEMS | Transport Environment Monitoring System |
| TS | Technical Support (KSC Directorate) |
| TV | Television |
| TWX | Teletype Wire Transmission |
| UDMH | Unsymmetrical Dimethyl Hydrazine |
| UDS | Universal Documentation System |
| UTS | Universal Time Coordinated |

| | |
|------|---------------------------------------------|
| V | Volt |
| V&DA | Video and Data Acquisition |
| VAB | Vehicle Assembly Building |
| VAFB | Vandenberg Air Force Base |
| VDC | Volts, Direct Current |
| VIB | Vertical Integration Building |
| VO | Space Vehicle Operations (KSC Directorate) |
| VPF | Vertical Processing Facility (also SAEF #1) |
| VPHD | Vertical Payload Handling Device |
| W/B | Wideband |
| WTR | Western Test Range |

SECTION I INTRODUCTION

1.1 PURPOSE

This Handbook provides information concerning planned Payload Launch Site Accommodations for Space Transportation System (STS) operations at the Kennedy Space Center (KSC) Florida, and at Vandenberg Air Force Base (VAFB) Western Test Range (WTR) California. This handbook is one of the user-oriented documents required by the STS User Handbook (see Appendix D for complete listing of user-oriented documents), and is also Volume VI to the KSC STS Ground Operations Plan, K-STSM-09. The information contained herein provides the STS User(s) with available launch site capabilities, and processing requirements for launch site accommodations.

The Handbook is intended to be used as a guide to the STS User(s) for payload operations planning, and as a basis for negotiating payload processing plans with the launch site organization(s). This should ultimately enable the STS User(s) to achieve the primary goal of an efficient Payload Processing Plan at the launch site which provides an effective means of matching the requirements to capabilities.

1.2 SCOPE

Payload Processing has two key phases, planning and operations. This Handbook addresses the planning phase, which spans those events from the initial contact between the STS User and the Launch Site personnel and through the period until the preparation of Detail Plans for processing the payload at the launch site. These are the plans which will be implemented in the operations phase. (The operations phase spans those events from receipt of a payload (and its unique support equipment) at the launch site, through the satisfactory completion of the mission.) Figure 1-1 illustrates this planning phase, and references the applicable handbook paragraphs.

The following overview describes the contents of this Handbook, and the format used to assist the STS User(s) to locate pertinent needed information for launch site payload planning operations:

- a. Section II introduces the KSC Organizations and key personnel who are responsible for coordinating with the STS User(s) during the formulation of the launch site processing plans. It identifies the KSC organizations that will interface with the STS User during the on-site and off-site payload operations. It also presents an overview of the planning process, leading to the commitment of launch site resources to meet the STS User payload requirements.
- b. Section III describes the Standard Ground Processing Flows for both horizontally and vertically integrated payloads. It also identifies some of the variations to these standard flows which can be accommodated.

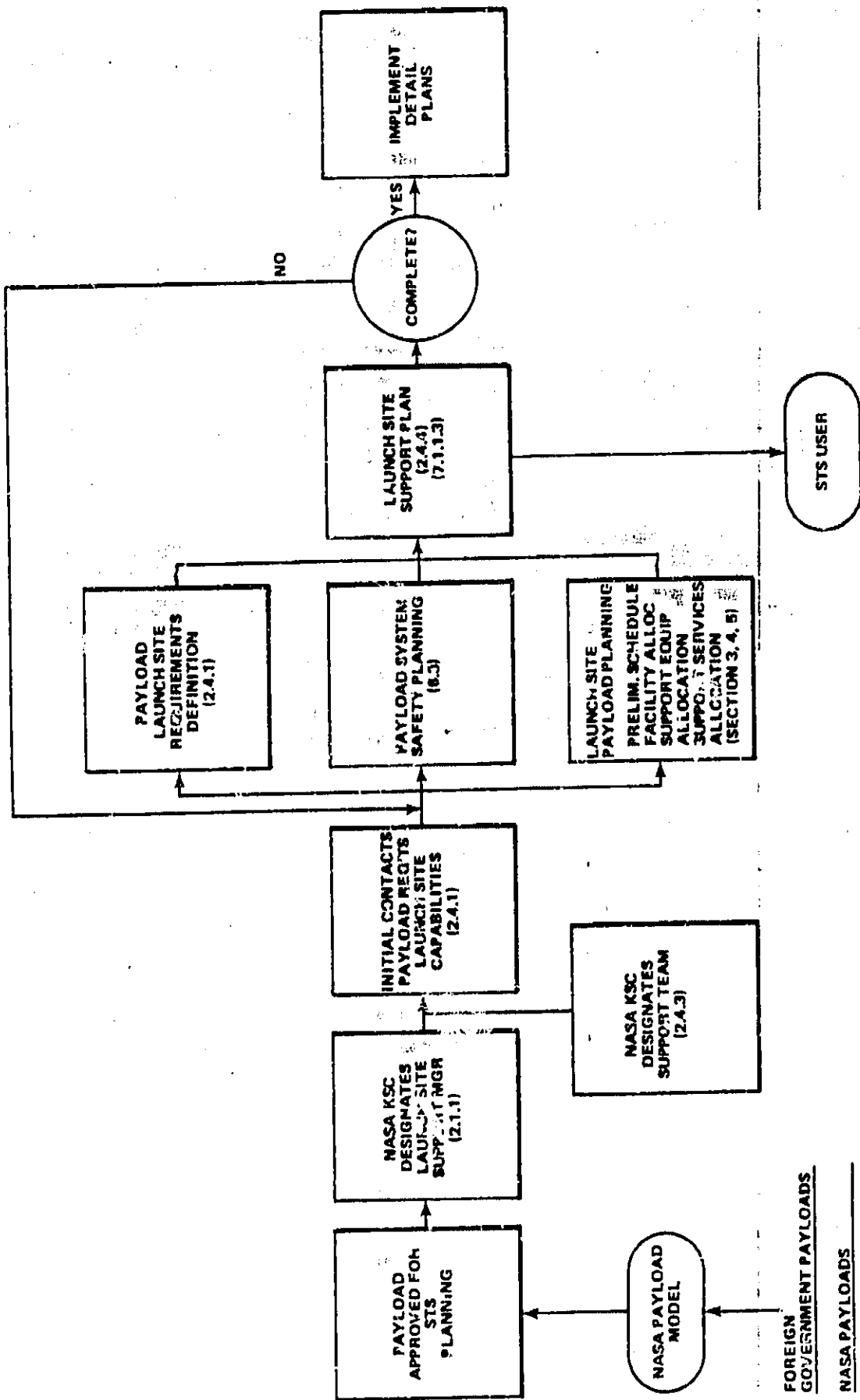

FOREIGN GOVERNMENT PAYLOADS
NASA PAYLOADS
DOD PAYLOADS
COMMERCIAL PAYLOADS

NOTE: NOS. IN () ARE APPLICABLE HANDBOOK SECTIONS
BSG 1249

Figure 1-1. Launch Site Payload Planning Process

- c. Section IV presents a summary of Facilities Capabilities and an abbreviated description of available support equipment at KSC that are candidates for utilization by the STS User(s). Summary information is presented in matrix format, to assist potential STS User(s) in the selection of viable candidates.
- d. Section V describes the Administrative and Technical Support and abbreviated description of their capabilities, available to an STS User. The planning process includes the determination of required services, and a commitment of those services to a specific payload or STS User.
- e. Section VI contains mandatory Safety requirements for ground operations, and design of payload unique ground support equipment. It also describes the constraints/guidelines to assist the STS User in meeting all the requirements.
- f. Section VII includes a Payload Processing Requirements Checklist (using representative functions) to assist the STS User and Launch Site personnel in establishing the Payload processing requirements. It also discusses the required Documentation to be provided by the STS User, and the documentation which will be provided by the Launch Site to the STS User. It also describes the Schedules, ranging from top program level to daily working level. The STS User will contribute to the development of these schedules, throughout the complete payload processing cycle at the launch site.
- g. Section VIII specifically addresses the Payload Processing Accommodations at VAFB. This includes operations, facilities, services, and typical flows for payload processing operations at Vandenberg Air Force Base.
- h. Section IX presents some considerations for the STS User payload design, which are based on launch operations experience and requirements, and will contribute to a smooth flow without waivers or lost time.
- i. Section X describes the User Charges associated with payload processing facilities and support services at KSC. The User Charges for VAFB facilities and support services are TBD.
- j. Section XI describes the STS User interface with KSC's Public Affairs Office.
- k. Appendices:
 - (1) Appendix A contains a list of all documents referenced in this Handbook.
 - (2) Appendix B contains the Safety Requirements for Hazardous Ground Operations/Checkout Procedures.
 - (3) Appendix C contains a Glossary of terms and definitions.

(4) Appendix D contains a listing of User-Oriented Documents.

1.3 AUTHORITY

This Handbook is the KSC Level III implementation required by the Mission and Payload Integration Office, NASA Headquarters, letter dated September 24, 1973. It is also required by the KSC Launch and Landing Project Plan (KSC Document K-SM-01), the KSC STS Ground Operations Plan (KSC Document K-STSM-09), the STS Users Guide and the NASA Headquarters Document, "Safety Policy and Requirements for Payloads Using the STS."

1.4 DEVIATIONS

Deviations (if required) from the standard operations and capabilities presented in this Handbook, should be discussed with the Launch Site organization. The Launch Site Support Manager (LSSM) is the STS User's single point of contact for assistance in planning payload operations, and is responsible to provide guidance and commitments on the launch site operations that can be accommodated.

1.5 REVISIONS

This Handbook is not presently under a configuration control system, however it will be periodically updated to remain useful to STS User(s). Recommendations should be submitted to J.F. Kennedy Space Center, Kennedy Space Center, Florida, 32899, Attention SP-PAY-A. Telephone (305) 867-3921. STS Users requiring copies of this Handbook should make their request on company, or Government letterhead, to this same address.

SECTION II MANAGEMENT AND ORGANIZATION

This section describes the management roles of KSC organizations, the launch site host role, payload processing guidelines, and the launch site planning process required for payload operations at KSC.

2.1 KSC ORGANIZATIONS

The following paragraphs describe the KSC management roles of KSC organizations and the interfaces required for KSC STS Payload operations.

2.1.1 Shuttle Projects Office (SP). The KSC Shuttle Projects Office is responsible for overall management and planning of all STS program activities, for which KSC is responsible. This includes management and planning associated with design and development of STS Facilities (including launch, landing, and refurbishment), Shuttle Ground Support Equipment (GSE), and STS ground operations. SP also provides support to the Johnson Space Center (JSC) Shuttle Program Manager for Systems Integration Reviews. The SP relationship to KSC is shown in Figure 2-1. The following SP Offices (Figure 2-2) shall provide the listed management roles.

- a. Operations Planning Office (SP-OPN) is the central contact between KSC and JSC Shuttle Payload Offices. SP-OPN and Payload Integration Office (SP-PAY) are directly involved in the Shuttle/Cargo Integration planning.
- b. Payload Integration Office (SP-PAY) will designate a Launch Site Support Manager (LSSM) for each STS Payload. SP-PAY, thru the LSSM, is the central contact between the STS User and KSC for coordinating the payload ground processing requirements. The central contact for the LSSM in payload integration into the Orbiter will be SP-OPN, thru the KSC designated Shuttle/Cargo Integration Manager.
- c. Flight & Ground Systems Office (SP-FGS) is the engineering office responsible for technical integration of on-line Shuttle accommodations. This includes facility interfaces for payload-supplied Ground Support Equipment (GSE), GSE as required, communications, etc., as well as required Payload-to-Vehicle testing compatibility analysis.

2.1.2 Space Vehicle Operations (VO). The VO Director is responsible for the management and technical direction of preflight, launch, and landing activities for STS vehicles and payloads at KSC.

2.1.3 Design Engineering (DE). The DE Director is responsible for the planning, development, design and acquisition of all STS facilities, systems and equipment, and for their modification and rehabilitation.

JOHN F. KENNEDY SPACE CENTER, NASA

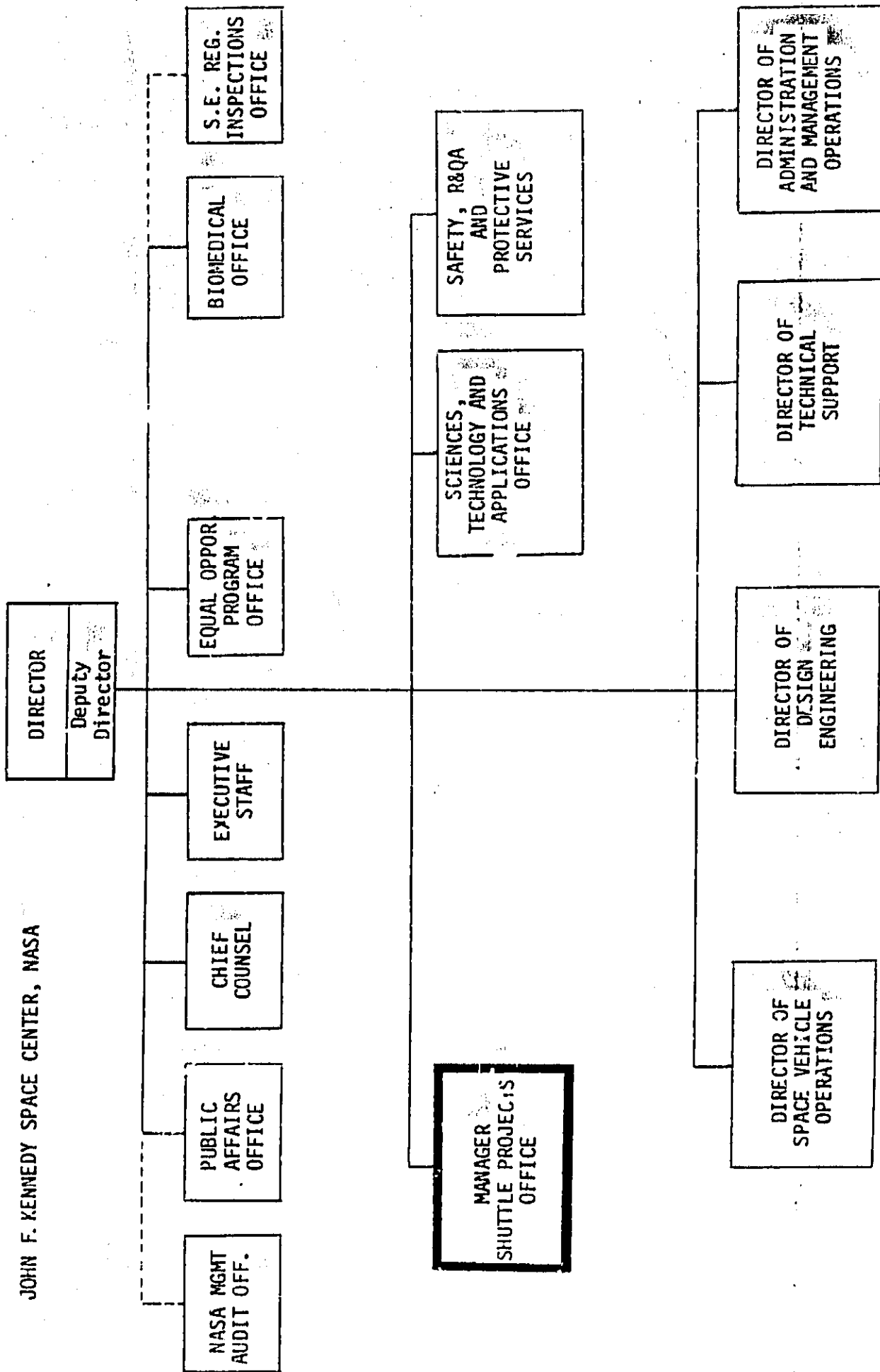

Figure 2-1. Relationship of Shuttle Projects Office to KSC

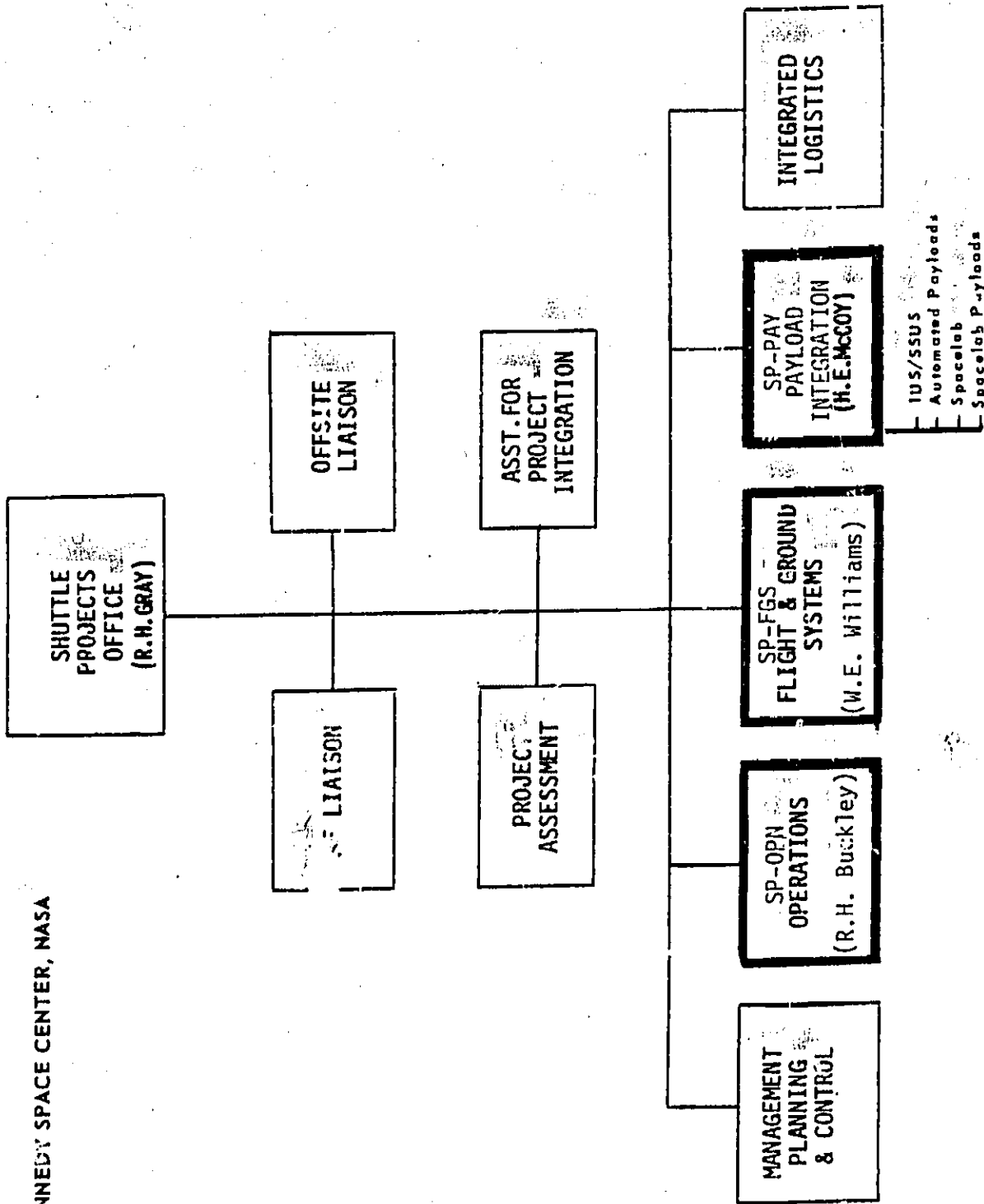

Figure 2-2. Relationship of Payload Integration Office to KSC-SP

2.1.4 Technical Support (TS). The TS Director provides (or makes arrangements for the provision) of all technical support required in the conduct of KSC STS launches and tests. This includes management and direction of overall maintenance of the KSC facilities, test and launch complexes, and all ground instrumentation systems.

2.1.5 Safety, R&QA, and Protective Services (SF). The SF Director is responsible for the safety, reliability and quality assurance programs, and the protective services (security and fire/rescue) at KSC. Additionally, the SF Director is responsible for KSC activities at Cape Canaveral Air Force Station (CCAFS) and Vandenberg Air Force Base (VAFB).

2.1.6 Administration and Management Operations (AM). The AM Director provides the following centerwide services: resources management, financial management, civil service personnel service, industrial and management engineering services, physical space utilization and assignment, manpower and organization, printing and distribution, library, graphic arts, publications storage and issue, non-appropriated fund activities, janitorial services, and maintenance of roads and grounds (exclusive of launch areas).

2.2 LAUNCH SITE HOST ROLE

In performing pre and post launch operations for any payload, a wide variety of facilities and services are required. Utilization of required services by any one payload is normally less than the total capability. In order to eliminate duplication between users, and provide optimum use of available/required capabilities, KSC has identified a "host" concept applicable to all STS users. This concept means that payload interfaces and services required at the launch site are made available to all STS users. The user retains primary responsibility for payload performance, and off-line processing (see Section III) of their respective payloads.

Fulfilling this role requires that various payload operations be integrated by KSC with STS and other users which have commitments for launch site resources. This involves negotiating any new capability required for cost and schedule impact; scheduling available facilities, support equipment, support services, and personnel.

This "host" concept applies to one-of-a-kind payloads, and to multi-use variable configuration payloads. Rapid response by the Launch Site may be required to turn around facilities, support equipment and services from one payload operation (mission) to the next. This is significant to the "host" concept, in that resource commitments may vary dependent on the mission type and frequency.

2.3 LAUNCH SITE PAYLOAD PROCESSING GUIDELINES

These guidelines are presented to assist in the planning of an efficient and minimum cost operation without compromising requirements.

- a. The STS User is responsible for all off-site and off-line (see Appendix C for definitions) procedures and operations affecting only his hardware.

- b. The Launch Site Host is responsible for managing all payload to payload and payload to Orbiter operations.
- c. Operations should be planned to minimize turnovers/moves from one agency or test site to another.
- d. All possible operations should be accomplished off-line, to minimize potential impact on STS turnaround.
- e. Interfaces previously tested, that were demated for shipment, will be remated and subsequently reverified at the launch site. Those not demated will not require interface verification.

2.4 LAUNCH SITE SUPPORT PLANNING

The following paragraphs describe the payload planning process, and the roles of the LSSM and the Launch Site Support Team for the preparation of the Launch Site Support Plan (LSSP).

2.4.1 Launch Site Support Manager (LSSM). The LSSM is the STS User's point of contact for the launch site. He is assigned in the early conceptual phase of the payload program, and becomes the launch site "host" for the STS User. Individual LSSM assignments for each payload are contained in K-STM-03.2, "Payload Integration - Schedules and Status Summary" published monthly by SP-PAY. These assignments may also be obtained by calling (305) 867-3183 for Spacelab Payloads, or (305) 867-3921 for all other payloads. The role of the LSSM is as follows:

- a. The LSSM should become acquainted with the STS User organization, to initiate an exchange of information relevant to the anticipated launch site operations.
- b. Place emphasis initially on the long lead items requiring Construction of Facility (C of F), or items that could possibly affect payload design, and early resolution of items that could pose potential problems.
- c. Offer advice regarding techniques and procedures useful for flight preparation, drawing on the background and knowledge of the support team (or other organizational elements of the launch site).
- d. Interpret, as necessary, launch site requirements, operations and capabilities, and assist the STS User in developing requirements, and planning specific launch site operations. (Paragraph 2.5.1 further identifies those launch site responsibilities to be carried out by the LSSM.)
- e. When the STS User's requirements are identified, the LSSM will coordinate and transmit them to the appropriate KSC organization for implementation.
- f. When the internal implementation plans become firm, the LSSM will coordinate the preparation of the applicable Launch Site Support Plan (see paragraph 2.4.4).

2.4.2 Launch Site Support Team. Following assignment of the LSSM, a team of supporting personnel will be established to represent the various Center Directorates in the planning of specific payload accommodations. The Launch Site Support Team members will have expertise in all aspects of payload launch operations, and will be available to the STS User through the LSSM. This team will interface with SP-OPN personnel to ensure adequate integration of on-line operations.

2.4.3 Payload Planning Process. The launch site payload planning process is a chain of events which begin with initial contact between a STS user and the LSSM. This planning process ends when implementation of the detail plans begin at the launch site. Planning for launch site processing takes place in parallel with the planning for payload integration and cargo integration activities conducted by JSC (see STS/Payload Integration Activities Plan, for description of the payload/cargo integration activities).

- a. **Identification of Requirements.** During initial contacts with the LSSM, the STS user should identify the launch site support and test requirements that will be imposed on the launch site. Section VII of this Handbook provides a checklist to assist in the identification of these requirements. The Checklist is correlated to the appropriate Sections of this handbook.
- b. **Refinement of Requirements.** Upon completion of the requirement identification and transmittal, an iterative process ensues wherein the STS user refines his requirements and the LSSM begins preparation of the Launch Site Support Plan (see Figure 1-1). The four-stage safety assessment reviews (conducted by JSC in accordance with JSC 11123) are a part of this iterative process. This iterative process continues until the detailed Payload LSSP is approved by the LSSM and the STS User. Approval of the Launch Site Support Plan marks the beginning of the implementation phase of the STS user association with the NASA Space Transportation System.

2.4.4 Launch Site Support Plan (LSSP). The LSSP is prepared upon completion of coordination and negotiation between the STS User organization and the LSSM. The plan is a commitment of launch site facilities, support equipment, and services to the STS User for a given time period. A more detailed explanation of the support plan is contained in the documentation portion of Section VII.

2.5 RESPONSIBILITIES

The responsibilities of the Launch Site (host) and the STS User are described in the following paragraphs.

2.5.1 Launch Site. Launch site responsibilities during the planning stage include the following:

- a. Identification of launch site capabilities (Sections IV and V).
- b. Identification of launch site processing requirements (Sections III and VI).

- c. Provide guidance to STS User on design and checkout operations, as influenced by launch processing (Section IX).
- d. Provide advice to STS User on successful techniques and procedures for launch processing (Sections VI and IX).
- e. Provide Quality Assurance guidance to the STS User during launch processing operations (as required).
- f. Identify the required procedures control (Sections VI, VII, and Appendix B).
- g. Plan the integration of STS and Payload Elements into cargo.
- h. Plan the checkout of STS/Payload interfaces, prior to mate.
- i. Plan the integrated payload/STS launch operations.
- j. Define the overall payload flow through the launch site.
- k. Develop the Launch Site Support Plan (LSSP).
- l. Determine Facility Utilization Schedule to accommodate STS User requirements.
- m. Develop an Activation/Deactivation Plan for facilities and support equipment committed to the STS User.
- n. Identify cost and accounting methods of payload accommodations.

2.5.2 STS User. The responsibilities of the STS User organization during the planning phase, in support of the launch site organization, include the following:

- a. Establish specific test requirements (Sections III and VII).
- b. Identify facility support requirements.
- c. Identify a single point of contact for transmittal and receipt of launch site support requirements and plans.
- d. Identify activation/deactivation requirements, associated with unique support equipment.
- e. Identify support services and equipment requirements (Section V).
- f. Prepare procedures, and perform off-line processing (Section VII).
- g. Provide input to, and review of, integrated procedures for on-line STS testing (Section VII).
- j. Identify hazardous operations (Section VI).

- i. Perform a safety assessment (Section VI).
- j. Plan STS User test support for integrated operations (Section III).
- k. Ensure that costs to be incurred at the launch site are identified (Section X).

SECTION III PLANNED PAYLOAD OPERATIONS

3.1 GENERAL

This section describes typical operations which must be performed to ready a Payload for launch on the Space Shuttle Vehicle (SSV). Payloads for each Shuttle are manifested by JSC into a complete Shuttle cargo. KSC then prepares an integrated ground operations flow for each Shuttle flight. A part of the integration by KSC is to determine whether the payload will be installed in the Orbiter at the OPF or at the launch pad. Certain hazardous operations cannot be performed in the OPF; consequently, some payloads must be installed at the launch pad. The type of hazardous operations to be performed, is the most important criteria in deciding whether a payload will be installed in the OPF or at the launch pad.

In order to obtain the shortest possible Shuttle Turnaround Flow, KSC will perform simulated Orbiter to Cargo Interface Verification of the entire cargo prior to installation into the Orbiter. Cargo Interface Verification will be conducted in one of two facilities, the O & C Building or in the Vertical Processing Facility (VPF). (The VPF is also called the SAEF #1.) Figure 3-1 shows the standard flow of both horizontally and vertically integrated payloads at KSC.

Payloads which are integrated horizontally in the O & C Building are normally installed horizontally in the OPF. Payloads which are integrated vertically in the Vertical Processing Facility are normally installed vertically at the Launch Pad. These two types of functional flows are described in detail in subsequent paragraphs.

3.2 HORIZONTALLY INTEGRATED PAYLOADS

Horizontally integrated payloads are received, assembled and checked in the O & C Building prior to mating with the Orbiter at the Orbiter Processing Facility (OPF). Since most payloads which are integrated horizontally consist of Spacelab payloads, the terminology used to describe horizontal integration activity is tailored to Spacelab Operations. A typical Timeline for horizontally integrated payloads is shown in Figure 3-2. Specific timelines for the ground operations portion of each Shuttle Flight are prepared and published by KSC/SP-OPN, see the latest issue of the K-STSM-09, Volume II, Operations Processing Analysis.

3.2.1 Payload Receiving at the O & C Building. The STS User will be responsible for providing his own transportation to the launch site. Intersite Transportation Equipment (ITE) under the control of KSC may be used. The ITE is described in Section IV of this Handbook. KSC is capable of receiving payload elements shipped by air, overland or by sea. Horizontally integrated payload elements are received at the O & C Building. KSC will provide support (e.g. fork lift and operator) as agreed to in the Launch Site Support Plan (LSSP).

KSC STS/PAYLOAD OFF-LINE OPERATIONS MODEL

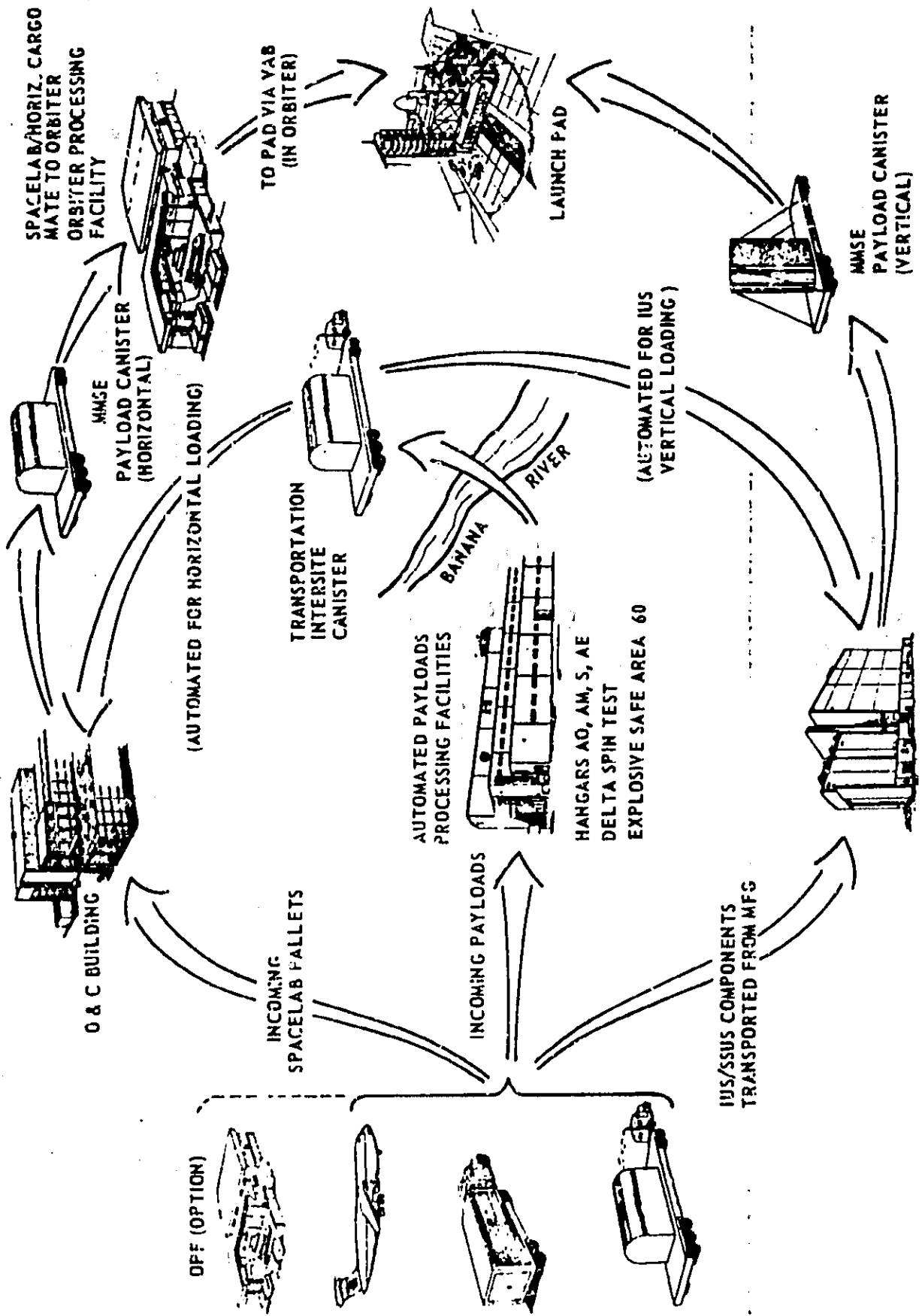

IUS/SSUS PROCESSING FACILITY (SAEF #1)

Figure 3-1. Standard Payload Processing Flows

STAR 914 LEVEL II TIMELINE SHUTTLE ASSESSMENT PAYLOAD INSTALLATION IN OFF

FIGURE 3

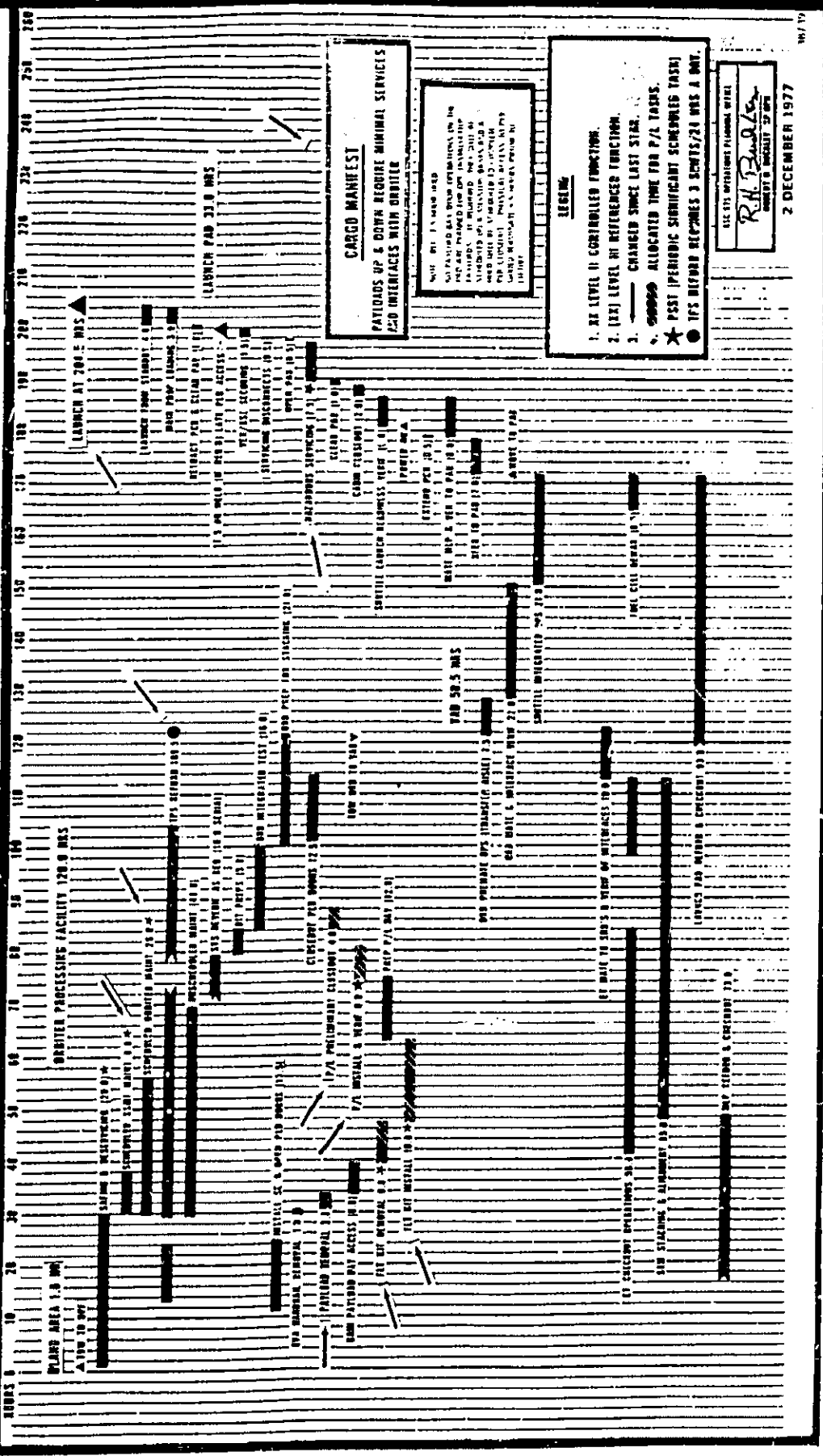

Figure 3-2. Typical Timeline for Horizontally Integrated Payloads

Receiving functions include off-loading the Spacelab pallets and other payload elements from the carrier to the receiving area of the O & C Building, post-shipment cleaning and removal of covers, and transfer to a work area in the O&C Building.

- a. Receiving functions and all subsequent operations in the O&C Building will be managed by KSC utilizing a payload integration contractor.
- b. The O & C Building environment is maintained at Class 100 K cleanliness, 75 ± 5 degrees F and 50% maximum relative humidity.

3.2.2 Mechanical Assembly of Payload. Payload processing will proceed according to previously prepared and approved plans, procedures and schedules which incorporate inputs supplied by the STS User. These plans, procedures and schedules are incorporated in a Work Control System which documents authorized work activity to be performed by the various disciplines (e.g., engineering, safety, R & QA, etc.). Daily planning and scheduling meetings will be held to update and modify plans, procedures, etc., as necessary, based on status of payload processing. STS Users will participate at these meetings (as required), to supply payload peculiar work-around solutions and authorizations for waivers/deviations to previously established work. It is important that any payload oriented work, problem resolutions, tests, ship-short hardware, etc., which are deferred from off-site integration be identified as early as possible for incorporation into work-around planning and scheduling to avoid impact to On-line STS processing. The mechanical assembly functions of Payloads in the O & C Building consist of the following:

- a. The Spacelab train of pallets and racks will be built-up in the O & C Building utilizing the pallet and/or rack stands. All work which can be accomplished prior to transfer to the Spacelab integration workstand will be done during this period. Bridge cranes, handling fixtures, slings, etc., will be available for transfer of payloads while integrated on Spacelab elements.
- b. Following mechanical build-up of the payload train, the Spacelab elements will be transferred to the Spacelab integration workstand for integration with the Spacelab module/igloo.
- c. Spacelab operational hardware will have been undergoing refurbishment and build-up in parallel with payload build-up. After build-up of the total Spacelab and payload configuration in the workstand, the module aft end cone will be installed, pallets will be positioned and utilities connected between pallets and module, and servicing performed, as necessary.
- d. The mechanical integration of the Spacelab elements includes:
 - (1) Mounting the racks on the rack floors
 - (2) Joining the pallets into trains
 - (3) Removing the transport instrumentation
 - (4) Installing the ship-short equipment
 - (5) Joining the rack floors
 - (6) Installing the interconnect lines
 - (7) Attaching handling GSE

- (8) Transferring to the workstand
- (9) Installing the rack set on the workstand
- (10) Removing handling GSE
- (11) Installing the rack set in the module
- (12) Installing the aft end cone on the workstand
- (13) Mating the cone to the module
- (14) Installing the pallet on the workstand
- (15) Removing handling GSE
- (16) Installing the PSS & MSS panels in GSE
- (17) Installing the experiment peculiar equipment in PSS & MSS Aft Flight Simulator

3.2.3 Horizontal Cargo Integration. The Horizontal Cargo Integration is planned to accomplish the following:

- Verification of Spacelab-to-payload utilizing ATE programs/procedures and payload peculiar software as appropriate.
- Mission sequence simulation of on-orbit operations utilizing OIA/ATE software.
- Simulated Shuttle Interface Verification test of a cargo consisting spacelab pallets, and an automated (or free flying) spacecraft.

Spacelab systems testing is conducted in one of the horizontal integration workstands. If the complete Shuttle cargo for a flight consists of a Spacelab module and/or pallets, all testing will be accomplished in the Spacelab horizontal workstands. This includes the simulated Orbiter to cargo interface testing. If the Shuttle cargo consists of Spacelab pallets and an automated spacecraft, the Spacelab pallets are moved from the Spacelab horizontal integration workstand to the horizontal CITE stand where it meets the rest of the Shuttle cargo. The test is then conducted in the horizontal CITE Stand. A functional diagram for CITE is contained in Section IV of this Handbook.

The Verification of Spacelab systems include the following:

- a. Verifying the experiment peculiar GSE interface
- b. Pre-power on bus isolation test
- c. Verifying the cooling system with power up
- d. Verifying the Spacelab to the GSE interface
- e. Loading of the software and verifying the routines
- f. Functional verification of interfaces with power up
- g. Functional test and calibration of experiments
- h. Spacelab to simulated Orbiter interface test
- i. Compatibility Test
- j. Man-machine interface test
- k. Spacelab Orbiter mission sequence test
- l. Stowing the non time critical items
- m. Removal of the PSS & MSS panels from GSE, for movement to the OPF for installation

- n. Payload service as required
- o. Disconnecting the GSE and the Orbiter simulator
- p. Shakedown inspection
- q. Weight and center of gravity test (if required)
- r. Verifying the Orbiter to payload interfaces
- s. End-to-end testing (if required)

3.2.4 Move from O & C Building to OPF. The Spacelab along with any other payload(s) will be hoisted by bridge cranes and strongback, installed into the payload canister, and moved to the OPF by the canister transporter. Environmental conditioning, via air purge and system monitoring, are provided during transport to the OPF. The canister, transporter, environmental conditioning unit, transportation instrumentation set and strongback are described in Section IV of this Handbook.

- a. Transportation operations are conducted by a payload integration contractor under the management of KSC.
- b. Transportation operations include:
 - (1) Payload preparation for movement
 - (2) Demating the Spacelab and the tunnel
 - (3) Attaching the strongback
 - (4) Installing the payload in the canister
 - (5) Removing the strongback
 - (6) Closing the canister
 - (7) Transporting to the OPF

3.2.5 Cargo Installation into Orbiter at OPF. Cargo removal from the canister and installation into the Orbiter will be accomplished in the OPF. The cargo to be installed will be hoisted, in a horizontal attitude, from its canister/transporter, positioned over the Orbiter, lowered and secured in the payload bay. The strongback and facility crane will support this operation.

After cargo installation, the Shuttle/cargo interfaces will be connected and verified. An Orbiter Integrated Test (OIT) will be conducted to complete the verification of interfaces between the cargo and the Orbiter. This will include validation of payload data via the Orbiter data system, where applicable.

End-to-end tests to verify the communications and data system links for the payload, Shuttle, TRDSS, MSS, POCC, and NASCOM, including verification of system operational software will be performed, only if previously scheduled.

Upon completion of testing, the inspection access platforms will be removed. Final closeout of the payload will include removal of any remaining environmental enclosure/covers and closing/latching of the payload bay doors. The payload bay environment with the doors closed will be maintained by providing a facility purge of Class 100, guaranteed Class 5000 air at 70 ± 5 degrees F temperature and 30 to 50 percent relative humidity after closure of the payload bay doors. At this point, the Orbiter will be powered down for move

to the VAB. (No power or purge are provided from this point until completion of the Shuttle vehicle assembly in the VAB.)

a. The OPF Operations will be conducted by a Shuttle integration contractor under KSC management.

b. OPF operations include:

- (1) Opening the canister
- (2) Attaching the strongback
- (3) Removing the Payload and installing it into the Orbiter
- (4) Installing the tunnel in the Orbiter
- (5) Mating the Spacelab to the Orbiter interfaces
- (6) Interface verification test
- (7) Integrated Orbiter/Spacelab test
- (8) Payload final servicing (as required)
- (9) Payload bay closeout

3.2.6 Orbiter Operations from OPF to Launch Pad. Upon completion of the OPF activities, the Orbiter will be towed to the VAB for transition from the horizontal to the vertical position. Environmental conditioning will not be provided during transit between OPF and VAB, or during Orbiter stacking operations. It will be supplied after the Orbiter is mated with the External Tank (ET) and during transit to the launch pad. The Orbiter's cargo is quiescent during VAB operations with no access planned. Premate activities will be accomplished to prepare the Orbiter for mate with the external tank and solid rocket boosters. Payload bay purge air downtime to accommodate the move from the OPF to the VAB, hoisting and mating operations, is a minimum of 14 hours (it may be as much as 40 hours during early flights). When mating of the Shuttle elements on the mobile launch platform (MLP) are complete in the VAB, the facility will provide a purge of Class 100, guaranteed Class 5000 air at 70 ± 5 degrees F temperature and 30 to 50 percent maximum relative humidity to the payload bay. Shuttle power will be available after the MLP and ET interfaces have been connected and verified.

Following the completion of mating and Shuttle system interface verification checks with the mobile launch platform, the stack will be rolled out on the crawler transporter to the pad while maintaining the air purge to the payload bay. The Orbiter will be powered down during transit to the pad; consequently, power will not be available to a payload during this time unless it is provided by the payload.

3.2.7 Launch Pad Servicing and Launch. After the MLP has been mated hard down on its mounts to the launch pad, and umbilicals connected, an interface verification test will be run to verify the integrity and serviceability of the pad/Shuttle system interfaces.

Access to payloads is not planned at the launch pad. However, the capability exists from the PCR, of opening the Orbiter payload doors and accessing the payload from the PGHM's extendable platforms. Payload Users requiring payload access at the pad must pay for additional Orbiter turnaround time.

The additional Orbiter turnaround time includes 6 hours to open and close the Orbiter payload bay doors, time to install and remove any GSE, and payload service time. Launch pad operations will be controlled from the LCC, similar to operations in the OPF. The Orbiter-Pad payload cabling interfaces are shown in Figure 3-3.

- a. After launch there are no planned routine or contingency in-flight activities involving STS User organizations at the launch site. Should a situation arise to warrant such support, arrangements would be handled through the LSSM.
- b. Launch pad servicing and launch operations include:
 - (1) Mating the MLP to the launch pad
 - (2) Orbiter power on
 - (3) Launch readiness verification
 - (4) Cabin closeout
 - (5) Payload servicing (as required)
 - (6) Vehicle closeout and secure GSE
 - (7) Launch countdown

3.3 VERTICALLY INTEGRATED PAYLOADS

Vertically Integrated Payloads are normally received in Payload Processing Facilities (PPFs), see Section IV for PPF location map. These payloads consist primarily of automated payloads involving upper stages; consequently, the terminology used to describe vertical payload integration is tailored to Automated Payloads and Upper Stages. These payloads normally involve hazardous operations which are conducted in Explosive Safe Areas (ESAs), which are located on CCAFS. Vertical integration into a complete Shuttle cargo is done in the VPF located on KSC. A typical flow for a vertically integrated payload was shown in Figure 3-1. A typical Timeline for Vertically Integrated Payloads is shown in Figure 3-4.

Specific timeliness for each Shuttle flight are contained in the "KSC Ground Operations Plan - Operations Planning Analysis," K-STSM-09, Volume II, published by KSC/SP-OPN.

3.3.1 Receiving, Buildup and Off-Line Test. The STS does not provide payload transportation to the launch site. ITE which is under KSC control, may be used on a reimbursement basis. ITE is described in Section IV of this Handbook. KSC is capable of receiving payloads shipped by air, overland, or by sea. Vertically integrated payloads are normally received in one of the following payload processing facilities; Buildings "AE", "AO", "AM", SAEF #2, or Hangar S.

- a. Receipt and physical inspection are the responsibility of the STS User. KSC will provide support (e.g. fork lift and operator, crane operator) if required and scheduled (via the launch site support plan).

**ORBITER - PAD
PAYLOAD CABLING
INTERFACES**

PCR SIDE 2/SIDE 4 TERMINATIONS

| LEVEL | RG-11 | TSP | TP | RG-214 | RG-319 |
|-------|-------|-------|-----|--------|--------|
| 5 | 5/5 | 2/2 | 2/2 | 2/0 | 0/1 |
| 4 | 6/6 | 2/2 | 2/2 | 2/0 | 0/1 |
| 3 | 12/12 | 42/42 | 2/0 | 2/0 | 0/1 |
| 2 | 2/2 | 2/2 | 2/0 | 2/0 | 0/1 |
| 1 | 5/5 | 2/2 | 2/2 | 2/0 | 0/1 |

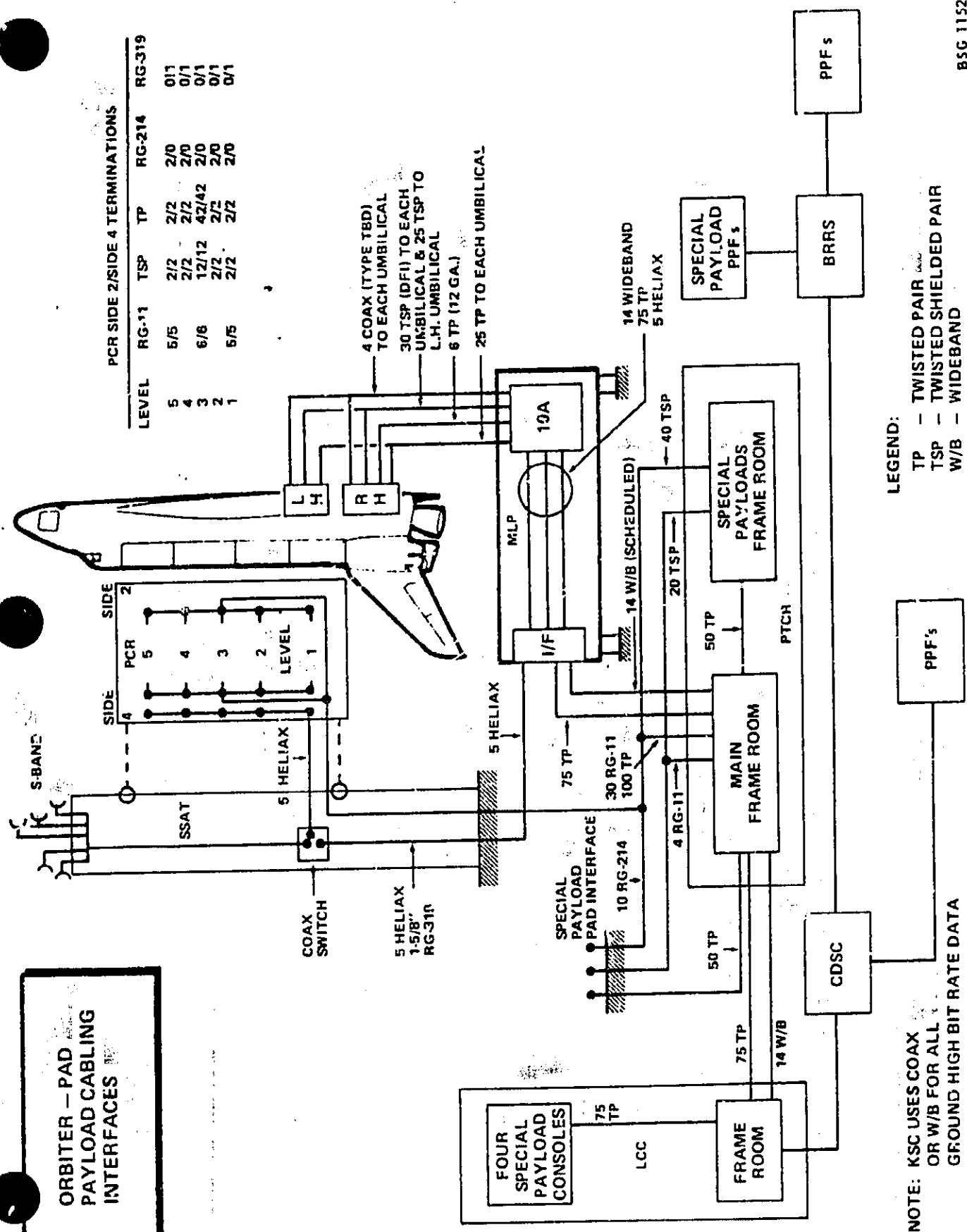

LEGEND:
 TP - TWISTED PAIR
 TSP - TWISTED SHIELDED PAIR
 W/B - WIDEBAND

**NOTE: KSC USES COAX
OR W/B FOR ALL
GROUND HIGH BIT RATE DATA**

BSC 1152

Figure 3-3. Orbiter - Pad Payload Cabling Interfaces

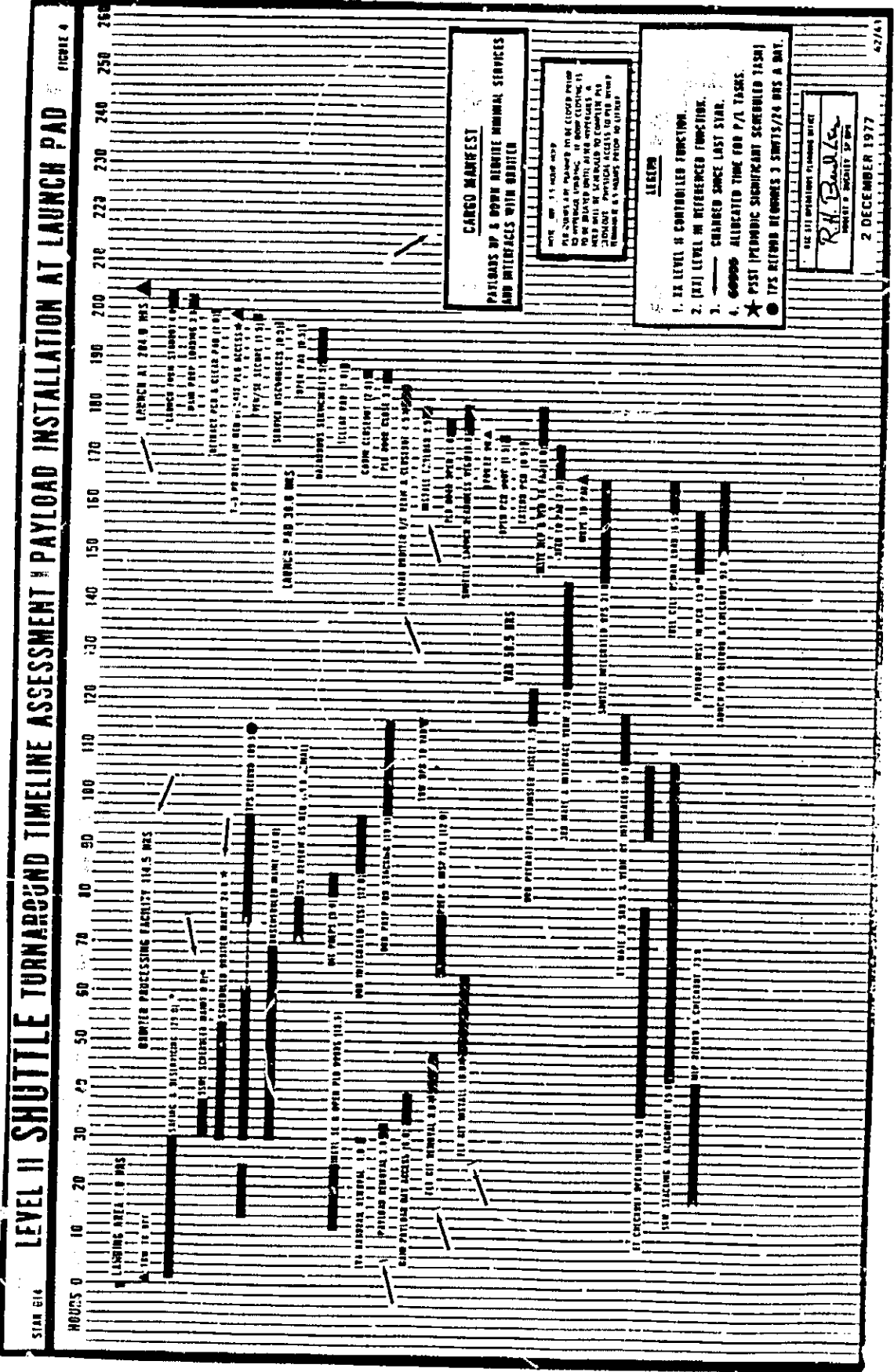

Figure 3-4. Typical Timeline for Vertically Integrated Payloads

- b. Following receiving operations, the Spacecraft will be "built-up" to its launch configuration. This "build-up" will include assembly of such things as solar panels, antennas, and other items which were shipped separately to the launch site. This build-up in the PPF will not include operations involving ordnance, cryogenics, or hypergols.
- c. Following the build-up operations, the Spacecraft Testing (Off-Line) will be conducted as requested (and planned) by the STS user. This testing will be conducted with all payload peculiar GSE being supplied by the STS user. When testing is complete and the spacecraft is ready to move to the next checkout area, the ground checkout equipment will normally remain in the PPF (which is usually "dedicated" to that particular spacecraft) until it is launched. Hardline, RF and OIS equipment is available to tie the spacecraft to its checkout equipment as the spacecraft progresses through such facilities as the explosive safe areas, vertical processing building, PCR and launch pad.

The receiving, build-up, and off-line test of a Vertically Integrated Payload includes:

- Off-loading from the carrier to the PPF
- Receiving inspection
- Post shipment cleaning
- Installation of payloads into work stands
- Build-up of ship separate items
- Hook-up of payload supplied GSE
- Functional testing as planned by the STS User

3.3.2 Move from PPF to Explosive Safe Area. After functional tests are completed the Spacecraft will be moved to an explosive safe area where any hazardous operations will be conducted. If the Spacecraft build-up and test involves no hazardous operations, the Spacecraft would go directly to the VPF. Movement will be the responsibility of the STS User. KSC will provide fork lift and crane operators as required and scheduled. Transportation containers and special carriers must be provided by the STS User. Any special environmental conditioning required must also be provided by the STS User. Transportation operations includes:

- Spacecraft preparation for move
- Placement of Spacecraft on/in special containers or transporters
- Movement to explosive safe area

3.3.3 Hazardous Operations & Testing. Upon arrival at an Explosive Safe Area (ESA), the Spacecraft will be removed from its transporter or container and installed in test or assembly stands provided by the STS User. The Delta Spin Test Facility or Explosive Safe Area 60, both located on CCAFS, are normally used for these hazardous operations. These facilities are described in Section IV of this Handbook. Activity in the explosive safe area includes installation of solid propellant apogee motors, hydrazine loading, ordnance separation devices, and any other items which are potentially explosive or hazardous.

Operations in an explosive safe area are normally conducted by the STS User with assistance by KSC only as planned in the Launch Site Support Plan. If Spacecraft to Upper Stage mating is scheduled to be performed at this point, the mating and all subsequent operations will be conducted by the Upper Stage contractor under KSC management. At present, Spacecraft to SSUS-D mating is planned to be accomplished in the Delta Spin Test Facility. All other Spacecraft to Upper Stage matings are planned to be accomplished in the VPF. When testing is complete in the explosive safe area, the Spacecraft is ready for movement to the VPF.

Hazardous operations and testing include:

- Removal of Spacecraft from transporter or containers
- Installation in test or assembly stands, as required
- Ordnance installation
- Hydrazine servicing
- Cryogenic servicing
- Solid motor installation, as required
- Mate with SSUS-D, if required
- Test & checkout

3.3.4 Movement from ESA to VPF. After completion of all hazardous operations, the Spacecraft is ready for movement to the VPF. This movement is again the responsibility of the STS User, with the exception of a Spacecraft mated to a SSUS-D where the SSUS integration contractor will be responsible for transportation to the VPF. Transportation operations include:

- Spacecraft preparation for move
- Placement of Spacecraft in or on special containers or transporters
- Movement to VPF

3.3.5 Receipt & Processing of Upper Stages. Upper stages consist of IUS, SSUS-A and SSUS-D. Processing of these upper stages is similar to, and is integrated with, launch site processing of spacecraft. For this reason, and to provide continuity in describing Spacecraft processing, the upper stage flows are described briefly. Specific information on processing of each type of upper stage can be obtained from the appropriate Upper Stage Ground Processing Handbook listed in Appendix D.

- a. SSUS-D. The SSUS-D, also called STS-PAM-D, is received at the Delta Spin Test Facility where it undergoes receiving, assembly and test. Spacecraft which are scheduled to fly on a SSUS-D are mated with the SSUS-D in this facility.
- b. SSUS-A. The SSUS-A, also called STS-PAM-A, is also received at the Delta Spin Test Facility. There it undergoes receiving, assembly and test. When these operations are complete, the SSUS-A is moved by the SSUS contractor to the VPF for mating with its Spacecraft.
- c. IUS. The IUS is received at the Solid Motor Assembly Building (SMAB) located on CCAFS where it undergoes receiving, assembly and test. Operations in the SMAB are under the management of the USAF. When operations in the SMAB are complete the IUS is moved by the USAF IUS integration contractor, under USAF management, to the VPF for mating

with its spacecraft. Installation into the PCR, and all subsequent operations, would be conducted by the Shuttle Integration contractor under KSC management.

3.3.6 VPF Operations. Operations in the VPF are conducted by a Payload Integration contractor under KSC management. Participation by the STS User is required for assistance in conducting tests, interpreting test results/data and in problem resolution. Processing of Spacecraft within the VPF varies, depending upon the type of Upper Stage involved. A Spacecraft already mated with a SSUS-D is installed directly into one of two workstands after removal from the transporter/container. Spacecraft utilizing a SSUS-A Upper Stage will be mated with the SSUS-A in the VPF high bay prior to installation in one of the two workstands. Spacecraft utilizing an IUS Upper Stage will be installed directly into one of the two workstands where it will be mated with an IUS which was previously installed. Regardless of where the Upper Stages are mated to their Spacecraft, the entire Shuttle Cargo will eventually be assembled in a single VPF workstand. Testing of individual payloads (spacecraft mated with an upper stage) will be accomplished prior to any combined cargo testing or simulated Orbiter to Cargo testing.

The last major test in the VPF is the CITE test (or Cargo Integration Test). A functional diagram for CITE is contained in section IV. Upon completion of the CITE test, the payload canister is moved vertically up to the workstand and positioned such that the vertical payload handling device in the workstand can transfer the entire Shuttle Cargo into the canister for movement to the PCR. A more detailed description of the VPF capabilities is contained in "Vertical Processing Facility Handbook" dated Oct. 17, 1977.

- a. Operations in the VPF are conducted under environmentally controlled conditions. The entire VPF is a class 100,000 clean room with temperature controlled at $75 \pm 3^{\circ}\text{F}$, and relative humidity controlled at 45 ± 5 percent.
- b. VPF operations include:
 - (1) Removal of Spacecraft from the transportation canister
 - (2) Mating of Spacecraft to Upper Stages
 - (3) Electrical systems test
 - (4) Mechanical systems test
 - (5) CITE testing
 - (6) Removal of PSS and MSS panels from GSE for movement to OPF for installation.
 - (7) Installation of complete cargo into canister

3.3.7 Movement from VPF to PCR. The entire Shuttle Cargo is inserted into the KSC supplied canister by the Vertical Payload Handling Device (VPHD). Environmental conditioning via air purge and system monitoring are provided during transport to the PCR. The canister transporter, environmental conditioning unit and transportation instrumentation set are described in Section IV of this Handbook.

- a. Transportation operations are conducted by a Payload Integration contractor under KSC management.

b. Transportation operations include:

- (1) Preparation of cargo for movement
- (2) Installation of cargo into canister
- (3) Closing canister
- (4) Transportation to PCR

3.3.8 PCR and Launch Pad Operations. Upon arrival at the PCR, the payload(s) are considered On-Line Shuttle. Operations at the PCR are conducted by the Shuttle integration contractor under KSC management. Ground Support Equipment required to support PCR or launch pad payload operations, will have been installed and validated (as required) in the PCR prior to arrival of the canister.

- a. Installation of the Payload into the PCR will occur prior to the Space Shuttle Vehicle (SSV) transfer to launch pad, and begins with the positioning of the canister below the retracted Payload Changeout Room. The canister will be hoisted to the proper elevation, locked into position and the environmental seals of the room inflated to seal against the sides of the canister. The space between the closed doors of the PCR and the canister will be purged with clean air to ensure the required cleanliness, prior to opening the doors of the PCR and the canister.
- b. After opening the doors of the PCR and the canister, the Payload Ground Handling Mechanism (PGHM) is rolled toward the canister and the attach/handling fittings of the payload are aligned, and attached to the PGHM. The PGHM is retracted into the PCR and the canister doors and the PCR doors are closed. The environmental seal is deflated and the canister is lowered onto the transporter and taken to the storage facility. The PCR will then be moved into position to enclose the Orbiter Payload Bay and establish environmental seals. The Payload Bay doors are opened, and the PGHM extends the Payload into the Orbiter.
- c. The Payload is then secured to the Orbiter, and the PGHM is retracted and secured. During this operation the PCR environmental control is maintained and the payload bay is purged with Class 100, guaranteed Class 500 air at 70 ± 5 degrees F and 30 to 50 percent relative humidity.
- d. During Payload Installation, the Shuttle/Payload Interfaces will be connected and verified as part of the Payload Interface Verification Test. Payload servicing will then be accomplished as part of total vehicle countdown preparation.

Operations at the launch pad after arrival of the Orbiter, are controlled from the LCC. Orbiter and pad payload cabling was shown in Figure 3-3. After launch there are no planned routine or contingency in flight activity expected to involve the STS User at the launch site. Should a situation arise to warrant STS User support, arrangements would be handled through the LSSM.

PCR and Launch Pad Operations include:

- Installation of GSE into PCR
- Hoisting canister into PCR
- Removal of Payload from canister
- Removal of canister from PCR
- Inspection, test & servicing of Payload prior to arrival of Orbiter at launch pad
- Insertion of Payload into Orbiter
- Connection of Payload to Orbiter Interfaces
- Interface verification test
- Final Payload servicing
- Payload bay closeout
- Retraction of PCR
- Launch countdown

3.4 POST FLIGHT OPERATIONS

Orbiter Post flight operations are essentially the same for all Payloads, regardless of whether they were installed vertically or horizontally.

- a. Payload ground operations will begin after touchdown and rollout of the vehicle on the runway. Payload bay purge from mobile ground support equipment will be established within 15 minutes after landing and will continue until switchover to a facility system in the OPF. Cooling for returned Payloads with RTGs will be provided within the same time frame as the Payload bay purge. Purge air will be Class 100, guaranteed Class 5000 (HEPA filtered) at 70 ± 5 degrees F and 30 to 50 percent relative humidity.
- b. If removal of time critical carry-off Payload items has been scheduled, contingency access can be provided via the cabin through the payload bay bulkhead hatch to the Payload while the Orbiter is still on the runway. The STS User will be responsible for providing any access equipment needed to allow removal of payload items at this time. This access equipment must also be taken through the cabin and the hatch into the payload bay. After crew exchange, and any carry-off payload items have been removed, the Orbiter is towed to the OPF for further processing.
- c. Post-landing operations at KSC after an abort (RTL or AOA) are very similar to those just described, except that operations occur at an accelerated pace. After the Orbiter lands, it is immediately deactivated and secured. All pyrotechnics are safed, both onboard and external to the ground vehicle, cooling units are connected and crew egress is performed.

3.4.1 Removal of Cargo from Orbiter. Upon arrival at the OPF, a series of safing tasks is performed to render the Orbiter and any hazardous payload safe. All cargo operations in OPF will be with the Orbiter in the horizontal position.

- a. After safing and deservicing, the payload bay door opening GSE will be installed and the payload bay doors opened. If not scheduled earlier (see para 3.4) time-critical payload access for removals and sensitive payload equipment servicing is planned after the payload bay doors have been opened in the OPF. Payload bay access stands and payload protective covers will be installed, lifting slings/strongbacks will be attached to the trunnions and electrical, fluid and mechanical interfaces will be disconnected. Access platforms will be removed and the cargo hoisted from the payload bay, and placed in the canister/transporter. Independent off-line Shuttle operations on the cargo will then be performed in other facilities.
- b. The Orbiter will complete post flight (planned and unscheduled) maintenance, and systems revalidation. Mission-peculiar payload accommodations equipment will be removed, and different equipment required for the next mission will be installed. Typical mission accommodations equipment includes power and avionics cables, fluid lines, PRSD tanks, RMS, etc.
- c. Finally, operations required to prepare the Orbiter for a new cargo will be performed including the cleaning of the payload bay, and liner installation if required.

Post Mission Cargo Operations in the OPF include:

- Payload bay purge
- Payload safing operations
- Opening the payload bay doors
- Installing any access GSE required
- Removing time critical experiments, as scheduled
- Removing the Cargo from the Orbiter and placing it in the canister, or other transporter
- Move to O & C Building, payload processing facility, or turn over to STS User.

3.4.2 Disassembly of Cargo. Returned Spacecraft are returned to their owner for disassembly. The Spacelab, with Payloads intact, will be removed and transported in the payload canister to the O & C Building where pallets and racks will be removed in the Spacelab workstand, and placed in respective pallet and rack stands. Payloads will be removed from the pallets and racks, for return to STS User. Racks and pallets will be reconfigured to the requirements of the subsequent user, and shipped to the off-site integration location.

3.4.3 Secondary/Contingency Landing Site Operations. A secondary and several contingency landing sites have been identified for use during the Shuttle development phase. The prime landing site for the first 4 development flights will be Edwards Air Force Base (EAFB), California. The secondary landing site for these 4 flights will be KSC. For the remainder of the development flights and during the operational phase, KSC will be the prime landing site, and EAFB will be the secondary landing site.

Payload operations at a secondary or contingency landing site is planned to be limited to preparing the cargo for return to the launch site in the Orbiter. KSC's baseline is to save the Orbiter and cargo, mount the Orbiter on the Shuttle Carrier Aircraft (SCA), and return both the Orbiter and Cargo to the launch site. Payloads would then be removed in the OPF as described earlier. Some Payloads cannot be returned in the Orbiter; either because the Payload weighs too much, or the Orbiter has landed at a contingency site beyond the carrier aircraft's capability to return to the launch site. Regardless of where the Orbiter lands, TBD will be responsible for returning the Payload to the Payload Owner. Secondary and contingency landing site kits are being designed to prepare the Orbiter for ferry operations. If the Cargo, or any portion thereof, must be removed prior to ferry operations, special slings, workstands, and shipping containers will be required. Prior to each launch, KSC will determine what Payload ground handling/deservicing hardware is available to remove, safe and ship a Payload from a Contingency Landing Site (CLS). The STS User ground handling and deservicing hardware should be air transportable, and should be designed for use with a single crane hook. This will ensure that the Payload can be removed and returned safely from a contingency landing site, if required.

3.5 PAYLOAD PROCESSING VARIATIONS

Figure 3-1 showed the standard flow for both horizontally and vertically integrated payloads. There are many variations from the standard flow which can be accommodated at KSC. STS Users should discuss proposed variations with the assigned LSSM. Agreements between the STS User and KSC, on the payload processing flow for any given payload, will be documented in the LSSP. Some specific variations from the standard flows which are being planned are discussed below.

3.5.1 Processing of Get Away Special (GAS) Payloads. KSC processing of GAS Payloads is a specific variation from the standard payload processing flow shown in Figure 3-1. Since these Payloads have limited interfaces with the Orbiter and since they are not installed in the Orbiter on trunions, they cannot be processed as Standard Payloads. At present the location for receiving and build-up of GAS Payloads is TBD. The GAS Payloads will, however, be installed in the Orbiter at the OPF. Each GAS Payload will be reviewed to determine the necessity of processing through the horizontal CITE facility in the O & C Building. Most GAS Payloads will not require a CITE test; therefore, they will be built-up, attached to a special bridge beam, and installed in the Orbiter much like any other bridge beam. Flight assignments for GAS Payloads will be determined by JSC. A generic Launch Site Support Plan will be prepared by KSC and approved by both KSC and GSFC (who is responsible for all GAS payloads). Addendums to the generic LSSP will be prepared as necessary for each GAS Payload. Additional detail on GAS Payload processing will be added, as it becomes available.

3.5.2 Processing of Life Sciences Payloads. KSC processing of life sciences payloads is a specific variation from the standard payload processing flow described in Figure 3-1. The flight hardware associated with life sciences payloads would normally follow the flow outlined for horizontally integrated payloads, see paragraph 3.2. However, live specimens for these payloads will be received at Hangar 'L' located on CCAFS. Technical activities in Hangar

'L' are managed by NASA's Ames Research Center and certain specimen associated STS User requirements must be coordinated with them. KSC will have operations and maintenance responsibility for Hangar 'L', and support requirements in these areas will be coordinated with KSC. Facility descriptions which would normally be contained in Section IV are TBD.

Life sciences specimens, or live specimens already in their flight containers, are installed at the launch pad by opening the payload bay doors and installing the specimens from a special access platform mounted on the PGHM, or through the crew ingress hatch for launch with the live specimens in their container(s) mounted in the Orbiter middeck area of the crew cabin.

Specific flows and timelines for each life science payload will be developed by KSC, and will be contained in the LSSP and the KSC Ground Operations Plan - Operations Processing Analysis (K-STSM-09, Volume II). A proposed flow for a typical life sciences payload is shown in Figure 3-5.

3.5.3 Processing of USAF Payloads. Processing of USAF Payloads for launch at KSC is a special variation from the standard flow for vertically integrated payloads (see paragraph 3.3). This flow is TBD.

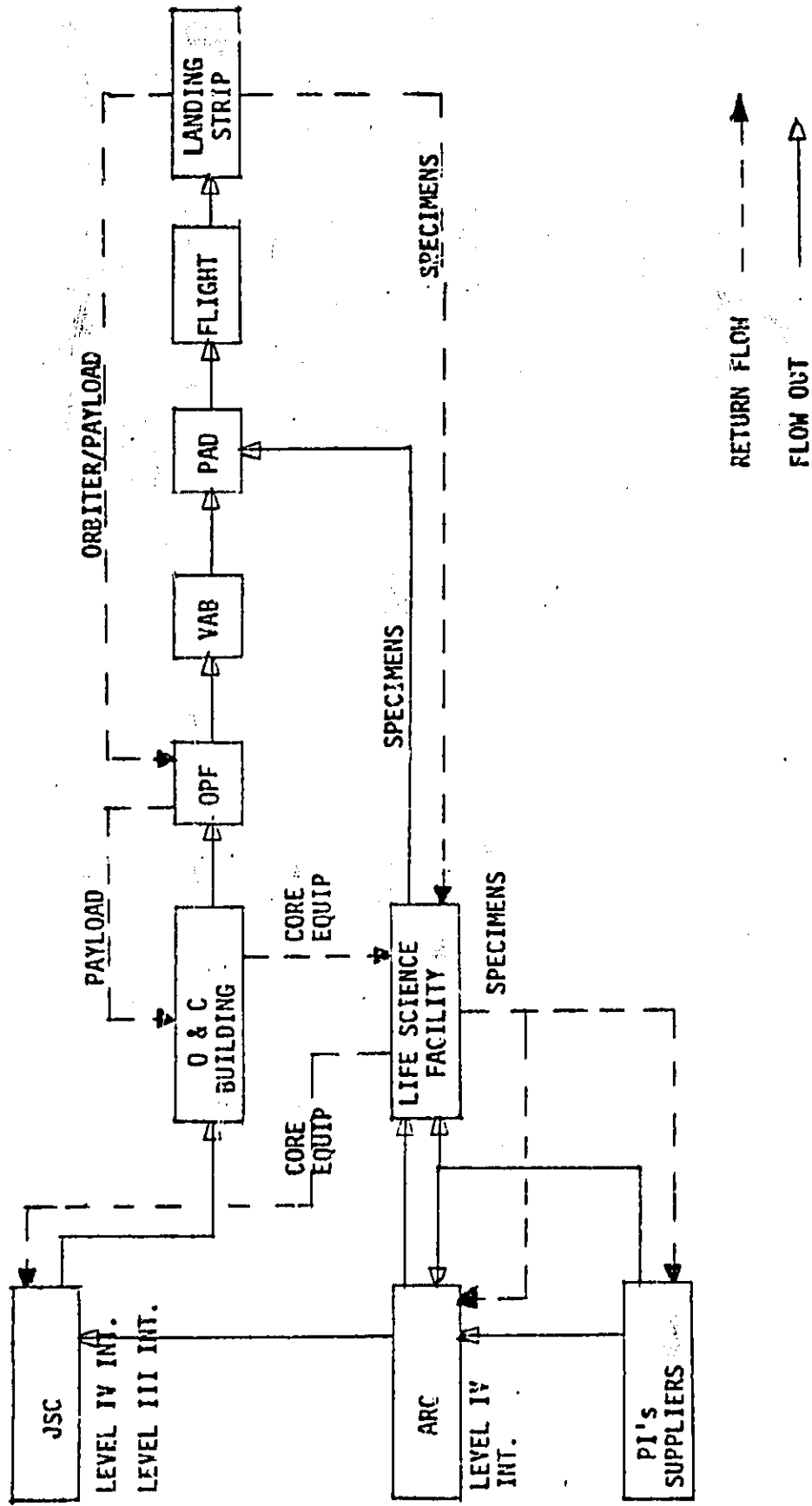

Figure 3-5. Life Science Payload Flow

SECTION IV
STS PAYLOAD FACILITIES & SUPPORT EQUIPMENT

4.1 GENERAL

This section describes the payload assembly and test areas, the launch complex, and other specialized facilities occupied by the Payload Projects during pre-launch preparations. The information is presented to familiarize the payload user(s) with the areas in which payload operations will be conducted, and to provide assistance in facility planning and establishment of requirements.

Launch Site facility utilization assignments for STS Payloads will be made by the Launch Site Support Manager (LSSM), in conjunction with his support team, and the STS User.

This section describes the Cape Canaveral Air Force Station (CCAFS) and KSC facilities planned for payload utilization. The detailed capabilities and standardized interfaces are contained in the following KSC Documents.

| <u>Facility</u> | <u>Building Number</u> | <u>Document</u> |
|-------------------------------------------|------------------------|-----------------|
| (CCAFS) | | |
| Building 'AE' | 60680 | K-STSM-14.1.1 |
| Building 'AO' | 60530 | K-STSM-14.1.2 |
| Building 'AM' | 60550 | K-STSM-14.1.3 |
| Hangar 'S' | 1726 | K-STSM-14.1.4 |
| Delta Spin Test Building | 67900 | K-STSM-14.1.5 |
| Delta Spin Test Control Bldg | 67901 | K-STSM-14.1.5 |
| *Spacecraft Assembly Building | 54445 | K-STSM-14.1.6 |
| *Propellant Laboratory | 54446 | K-STSM-14.1.6 |
| *Instrumentation Laboratory | 59922 | K-STSM-14.1.6 |
| *GSE Storage Building | 59925 | K-STSM-14.1.6 |
| Note: *Collectively referred to as ESA-60 | | |
| (KSC) | | |
| Ordnance Test Laboratory | M7-1417 | TR-1351 |
| RTG/Ordnance Storage Bldg | M7-1472 | TR-1351 |
| Cryogenic Test Building | M7-1412 | TR-1351 |
| SAEF #2 | M7-1210 | TR-1351 |
| SAEF #1 | M7-1469 | TR-1351 |
| O&C Building | M7-355 | TR-1351 |
| Orbiter Processing Facility | K6-894 | (TBD) |
| Payload Changeout Room | Pad 39A | (TBD) |

4.2 FACILITY UTILIZATION

- a. Facility Utilization Baseline. The baseline for payload facility utilization at KSC and Cape Canaveral Air Force Station (CCAFS) is listed in Table 4-1.

Table 4-1. Facilities vs. Payloads

| FACILITY FUNCTION | BUILDING 'AE' | BUILDING 'AO' | BUILDING 'AM' | HANGAR 'S' | EXPLOSIVE SAFE AREAS* | SAEF #1 | SAEF #2 | GAC BUILDING | PAYLOAD CHANGEOUT ROOM | ORBITER PROCESSING FACILITY |
|---------------------------------------------------------------|---------------|---------------|---------------|------------|-----------------------|---------|---------|--------------|------------------------|-----------------------------|
| OFF-LINE AUTOMATED PAYLOADS | X | X | X | X | X | | X | | | |
| ON-LINE STS AUTOMATED PAYLOADS | | | | | | X | | X | X | X |
| ON-LINE SPACELAB, CORE SEGMENT & EQUIPMENT SEGMENTS & PALLETS | | | | | | | | X | | X |
| ON-LINE IUS/SSUS | | | | | X | X | | | X | X |
| ON-LINE DOD PAYLOADS | | | | | | X | | | X | X |

NOTE: *INCLUDES DELTA SPIN TEST AND EXPLOSIVE SAFE AREA 60 FACILITIES

BSG 12.17

- b. KSC & CCAFS Areas. For orientation purposes, the KSC and CCAFS areas for payload operations are shown in Figures 4-1, 4-2, and 4-3.

4.3 PAYLOAD FUNCTION VS FACILITY

Table 4-2 lists the standard functions for each facility and its accommodation. The matrix is based largely on past experience with other space programs.

4.4 FACILITY CAPABILITIES

The summary information presented in Table 4-3 is intended to present an overview of launch site facilities capabilities. This will assist facility requirements identification, and will prove helpful during discussions with the LSSM. The LSSM will ensure that the launch site responsibility of assigning appropriate facilities is accomplished to meet the payload developer/owner needs.

4.5 LAUNCH SITE MULTIUSE MISSION PAYLOAD SUPPORT EQUIPMENT (MMPSE)

MMPSE is equipment which is required, or available, to accommodate certain standard payload or experiment requirements. This equipment is intended to support payload requirements for transportation, environmental control, interface verification testing, end-to-end functional testing, and installation of the payload into the Orbiter.

- a. The design of some MMPSE is still incomplete at this time. It cannot be assumed that a particular piece of MMPSE can be used to support a specific payload requirement, without first checking with the LSSM. The design concepts presented are the best available; but, until proper design reviews are conducted and contracts awarded, the configuration is subject to change.
- b. Requirements for use of MMPSE should be submitted to the LSSM.
- c. MMPSE is divided into the following categories, and described in paragraph 4.5.1 thru 4.5.3.

4.5.1 Category A MMSE. The primary function of Category A MMSE is transportation and handling of complete Shuttle Cargos, during Level II integration and on-line Shuttle processing. The design of some payloads may dictate the use of Category A MMSE; other payloads may have a choice in how the payloads are transported and handled, during on-line Shuttle processing.

A listing of Category A MMSE is presented in Table 4-4, and the equipment is described in paragraphs 4.5.1.1 thru 4.5.1.6.

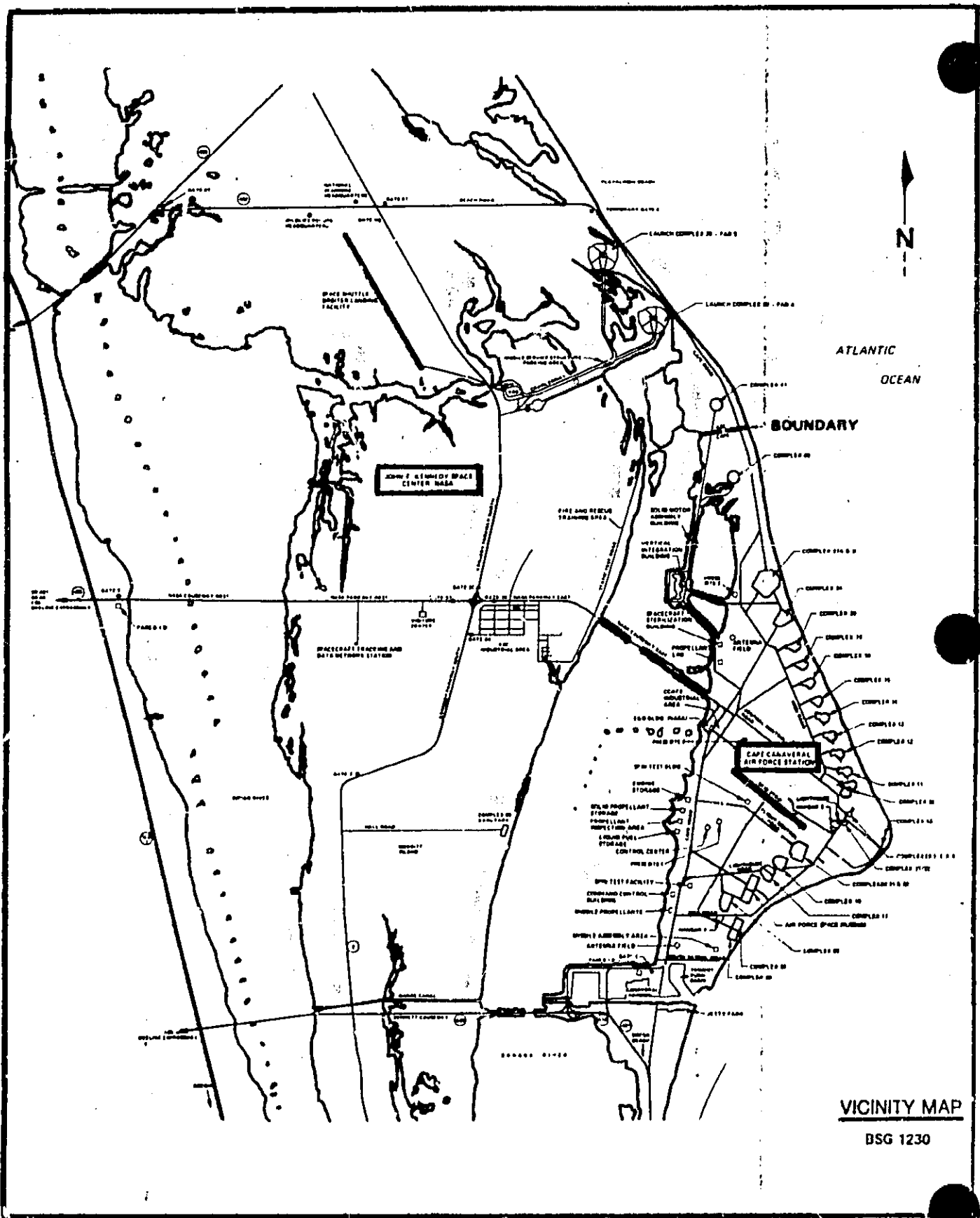

Figure 4-1. KSC/CCAFS Major Payload Facilities

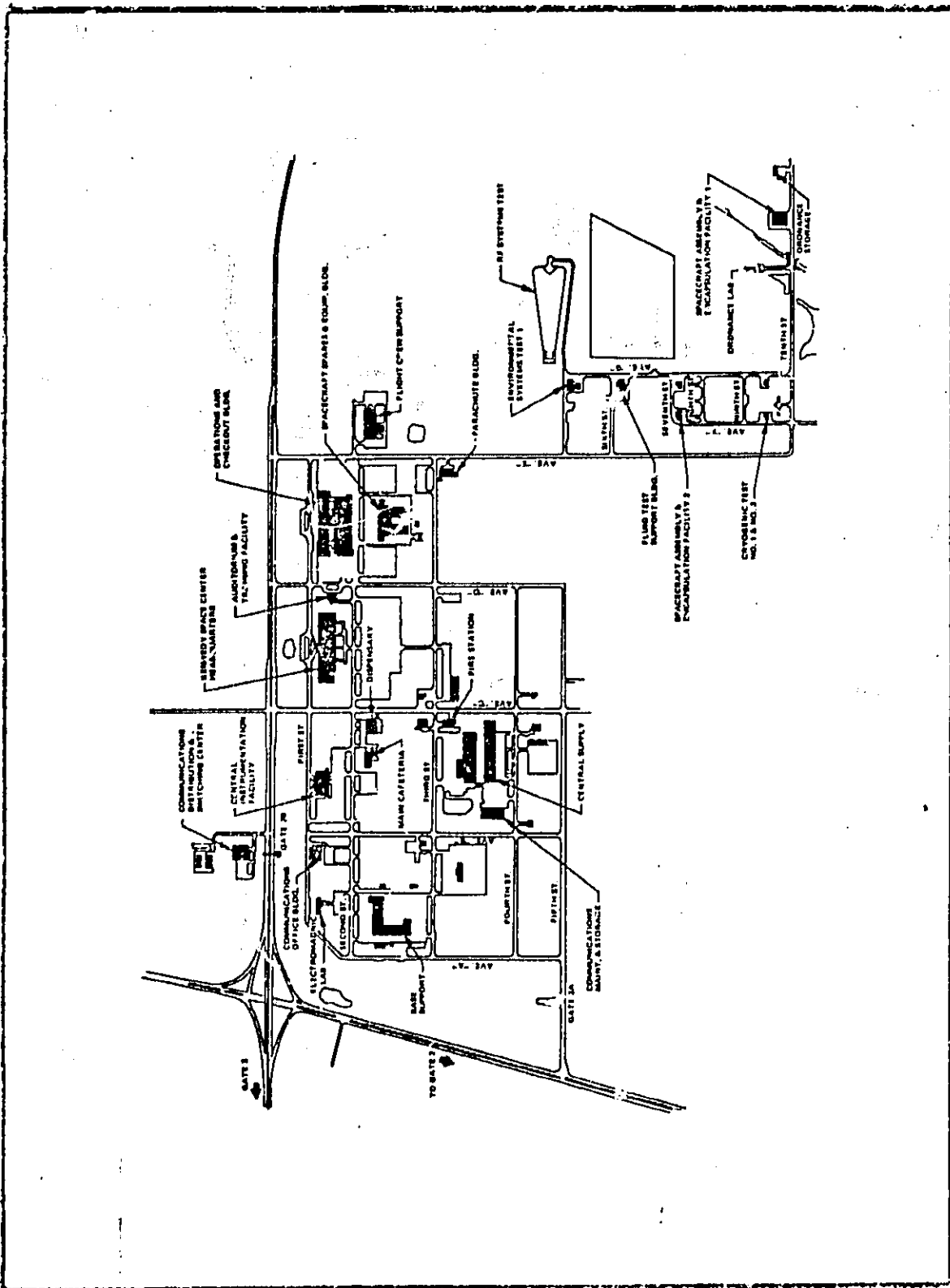

Figure 4-2. Payload Facilities in KSC Industrial Area

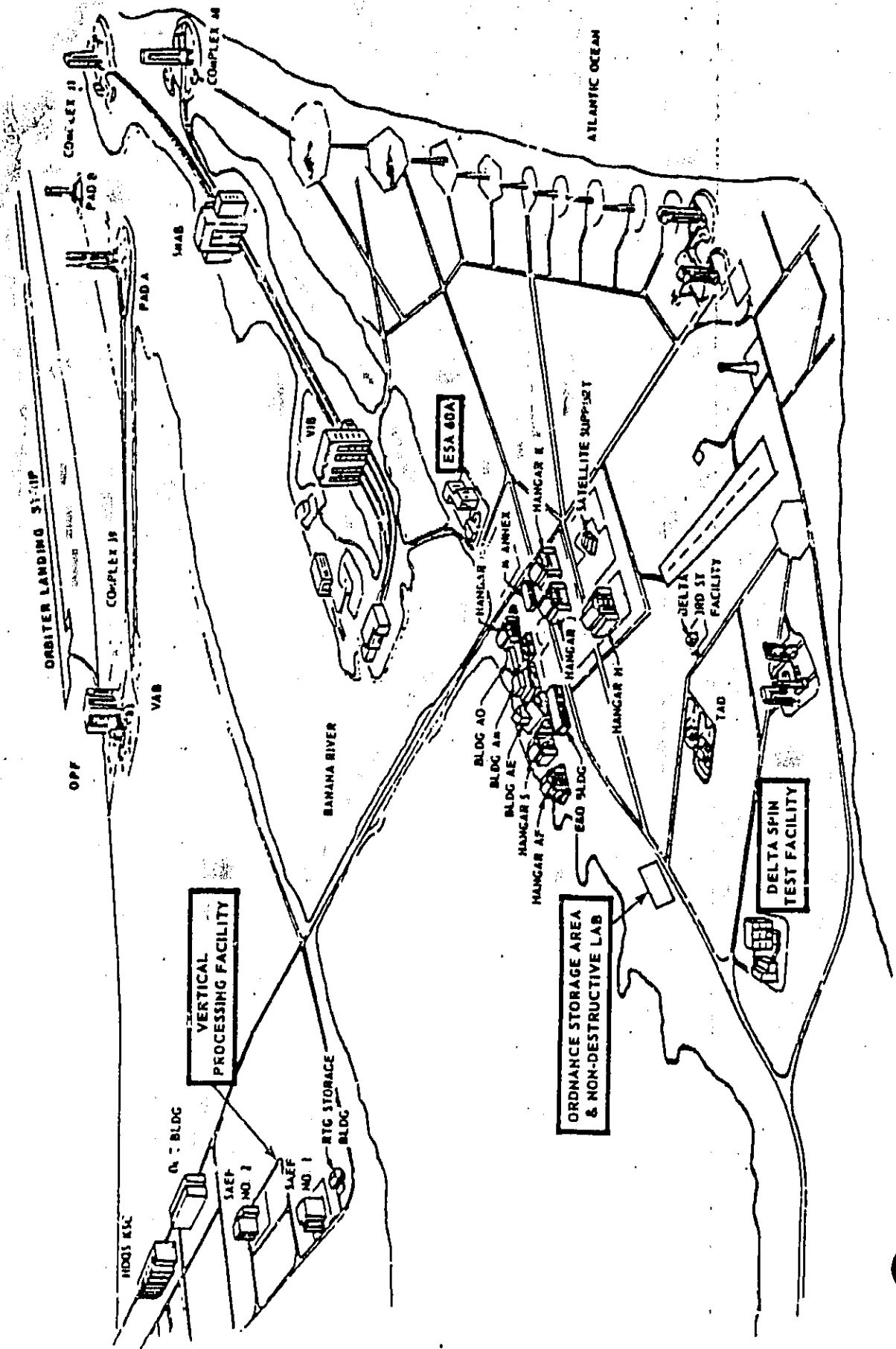

Figure 4-3. Payload Facilities in CCAFS Industrial Area

Table 4-2. Payload Function Vs. Facility

| FUNCTION FACILITY | TRANSPORTATION | RECEIVING/RECEIVING INSPECTION | ASSEMBLY | SYSTEM TEST | SERVICING | MATE/DEMATE | PAYLOAD-ORBITER INTERFACE VERIFICATION | POST-LANDING OPERATIONS | REFURBISHMENT | STORAGE | OTHER |
|--------------------------------------------------------------------|----------------|--------------------------------|----------|-------------|-----------|-------------|----------------------------------------|-------------------------|---------------|---------|-------------------|
| OPERATIONS & CHECKOUT (O&C) BLDG. #M7-355 | X | X | X | X | | X | USING SIMULATOR | | X | X | |
| SPACECRAFT ASSY. & ENCAPSULATION FACILITY (SAEF #1) BLDG. #M7-1469 | X | X | X | | | | USING SIMULATOR | | | | |
| SPACECRAFT ASSY. & ENCAPSULATION FACILITY (SAEF #2) BLDG. #M7-7210 | X | X | X | | | | | | | | |
| STG/ORDANCE STORAGE FACILITY BLDG. #M7-1472 | | | | | X | | | | | X | |
| BUILDING 'AO' BLDG. #60630 | X | X | | X | | | | | | | |
| BUILDING 'AE' BLDG. #60600 | X | X | X | X | | | | | | X | |
| BUILDING 'AM' BLDG. #60550 | X | X | | | | | | | | | |
| HANGAR 'S' BLDG. #1726 | X | X | | X | | | | | | | |
| DELTA SPIN TEST BUILDING BLDG. #67900 | X | X | X | X | | X | | | | | |
| DELTA SPIN TEST CONTROL BUILDING BLDG. #67901 | | | | X | | X | | | | | |
| CRYOGENIC TEST BLDG. BLDG. #M7-1412 | X | X | X | X | | | | | | | |
| SPACECRAFT ASSEMBLY BUILDING BLDG. #54445 | X | X | X | | | X | | | | | |
| PROPELLANTS LAB BLDG. #54446 | | | | | X | | | | X | | |
| INSTRUMENTATION LAB BLDG. #59922 | | | | | | | | | | | X |
| GROUND SUPPORT EQUIPMENT STORAGE BUILDING BLDG. #59923 | | X | | | | | | | | X | |
| VEHICLE ASSEMBLY BUILDING | | | | | | | | | | | CANISTER ROTATION |
| ORBITER PROCESSING FACILITY BLDG. #K6-894 | X | X | X | X | X | X | X | X | X | X | SAFING |
| PAYLOAD CHANGEOUT ROOM | | | | | X | X | X | | | | |
| LAUNCH PAD | | | | | | | | | | | LAUNCH |
| LANDING | | | | | | | | X | | | |

Table 4-3. Launch Site Facilities Capabilities (Sheet 1 of 3)

| CAPABILITY FACILITY | SPECIAL PURPOSE AREA | HANDBOOK DESCRIPTION | CLEAN AREA CLASS | CEILING HGT (feet) | HOOK HGT (feet) | BRIDGE (feet) | CRANES (TONS) | ENVIRONMENTAL CONTROL | USABLE FLOOR AREA (sq. ft.) | DOOR ACCESS (feet) | ELECTRICAL | | LIQUIDS | GASES | TEST CELL | EQUIP. AREA | LPS | COMMUNICATIONS | OFFICE SPACE |
|----------------------------------------------------------------------------|---------------------------------|-------------------------|-------------------------|--------------------|-----------------|---------------|---------------|--------------------------------------|----------------------------------------|-------------------------|--------------------|----------------|----------------|-------------------|-----------|---------------------|-----|--------------------------|--------------|
| | | | | | | | | | | | AC | DC | | | | | | | |
| INDUSTRIAL AREA | SHIPPING & RECEIVING | K-STM-14.1.12 (TR-1351) | 100K | 10 | 83 | 27K | | T 78.3°F 22.9-28.0°C RH 45-55% | 15000 | 20x12 AIRLOCK | 120/208 | | | | | | | ADMIN. OPS. | YES |
| | EXPERIMENT SHIPPING & RECEIVING | | 100K | 20 | 18 | | 4 | | 3500 | | | | | | | 2400 SQ. FT. | | ADMIN. OPS. | |
| | PALLET EXPERIMENT INSTALLATION | | 100K | 50 | 47 | 9K-27K | | | 41,278 28,343 LOW BAY (TOT AREA) | 85x20 PERISCOPE AIRLOCK | 120V 277/480 | 28VDC | | GM2 GM4 | | | | ADMIN. OPS. | |
| | ASSEMBLY & SC STATION | | 100K | 50 | 47 | 9K-27K | | | 13,200 1,278.3 | | 120/208 480V | | | GM2 GM4 GM2 | | | | ADMIN. OPS. | |
| | EXPERIMENT RACK ASSY. | | 100K | 50 | 47 | 9K-27K | | | 3600 304.4 | | 120/208 277/480 | 28VDC | | GM4 GM2 | | 5100 SQ. FT. | | | |
| | STAGING & TEMP. STORAGE | | 100K | 50 | 47 | 9K-27K | | | 2700 290.8 | | | | | | | | | | |
| | BIOLOGICAL EXPERIMENTATION LAB | | 100K | | | | | | 3210 298.2 | | | 120/208 | | | | BONDED STORAGE AREA | | | |
| | MISSION LAB | | 100K | | | | | | 2408 278.3 | | | | | | | BONDED STORAGE AREA | | | |
| | AIRLOCK | | K-STM-14.1.12 (TR-1351) | 100K | 70 | 65 | 10 | | T 78.3°F 22.2-28.0°C RH 45-55% | 3108 | 20x22 | 120 | | GM2 | | | | FAL ADMIN. OPS. | |
| | HIGH BAY | | | 100K | 100 | 96 | 25 | | T 78.3°F 22.2-28.0°C RH 50-55% | 10153 945 | 20x22 | 120/208 480 | | GM2 GM2 | | | | IRIG OIS | |
| EQUIPMENT CLEANING ROOM | | | 100K | 10 | 3 | 05 | | T 78.3°F 22.2-28.0°C RH 50-55% | 132 12.8 | 3x7 1x2.1 | 120 | | GM2 | | | | | | |
| SPACECRAFT ASSEMBLY AND ENCAPSULATION FACILITY (SAEF #1) BUILDING #M7-1481 | AIRLOCK | K-STM-14.1.13 (TR-1351) | 100K | 52 | 45 | 10 | | T 78.3°F 22.2-28.0°C RH 45-55% | 2378 | 22x42 | 120/208 | | COMP. AIR, GM2 | | | | | ADMIN. INTERNAL PA. SYS. | |
| | HIGH BAY | | 100K | 74 | 67 | 10 | | | 4851 481 | 3x7 1x2.1 | 120/208 480 | | | | | | | | |
| | LOW BAYS | | 100K | 22.5 | 20.4 | | | | 1081 178.1 CONGR. | | | | | | | | | | |
| | TEST CELLS | | | 52 | 15.8 | | | | 1309 127.2 | 22x40 0.7x12 | | | | | | | | | |
| | STERILIZATION OVEN AREA | | | | 16 | | | | 2544 238 | 21x27 6.4x8 | | | | | | | | | |
| ORD/RTG STORAGE FACILITY BUILDING #M7-1572 | | K-STM-14.1.8 | | 18 | 5.4 | | | T 78.3°F 22.2-28.0°C RH 45-55% | 3735 347 | 10x14 3x4.3 | 120 | | | | | | | | |

Table 4-3. Launch Site Facilities Capabilities (Sheet 2 of 3)

| CAPABILITY | SPECIAL PURPOSE AREA | HANDBOOK DESCRIPTION | CLEAN AREA | CEILING HGT. | HOOK | BRIDGE | MONO | ENVIRONMENTAL CONTROL | USABLE FLOOR AREA | DOOR ACCESS | ELECTRICAL | | LIQUIDS | GASES | TEST CELL | STORAGE EQUIP. AREA | LMS | COMMUNICATION |
|-----------------------------------|--------------------------------------|------------------------|----------------|----------------------|----------------------|----------------------|----------------------|-------------------------------------|----------------------|------------------------------------|------------|-------|----------------------|-----------|--------------|---------------------|-----|----------------------------------|
| | | | | | | | | | | | AC | DC | | | | | | |
| INDUSTRIAL AREA (CONT.) | | | | sq. ft. / sq. meters | sq. ft. / sq. meters | sq. ft. / sq. meters | sq. ft. / sq. meters | sq. ft. / sq. meters | sq. ft. / sq. meters | feet / meters | AC | DC | | | | | | |
| FACILITY | ORDNANCE TEST LAB BUILDING # M7-1417 | K-STM-14.1.9 (TR-1051) | | 14.1 | | | | T 782-39F 22.8-28°C RH 60-75% | 1860 | 8x7 | 120 240 | | | | | | | INTERCOM. PA. ADMIN. |
| | CRYOGENIC TEST BUILDING # M7-1012 | K-STM-14.1.2 | 100K | 81 | 48 | | | T 782-39F RH 40-50% | 1800 | 35x40 30x25 1' 6" | | | | COMP. AIR | | | | |
| BUILDING 'AD' BUILDING # M539 | AIRLOCK | K-STM-14.1.2 | 100K | 81 | 48 | | | T 782-39F 22.8-28°C RH 40-50% | 750 | 25x40 | | | | | | | | ADMIN. OPS. |
| | HIGH BAY | | 100K CLASS 100 | 18.5 | 13.7 | | 10 | | 88.5 | 7.8x12.1 | | | | | | | | |
| | SYSTEM TEST AREA | | 100K CLASS 100 | 15 | | 10 | 10 | | 3460 | EQUIP. AIR SHOWER | | | | | STORAGE AREA | | | |
| | SCIENTIFIC LABORATORY | | | 10 | | | | | 370.04 | | | | | | | | | |
| BUILDING 'AE' BUILDING # 06000 | SPACECRAFT LAB | K-STM-14.1.1 | CLASS 100 | 20 | | | 8 | | 2270 | AIR LOCK | | | | | | | | |
| | HIGH BAY COMPLEX | | 10K CLASS 100 | 42 | 39 | 10 | 3 | | 204.8 | 8x7 | | | | | | | | MOVIE MUSIC ADMIN. OPS. |
| | TELEMETRY GROUND STATION | | | 28 | | | | | 783 | 3x7 | | | | | | | | |
| | HIGH BAY SPACECRAFT LAB | K-STM-14.1.3 | | 42 | 26 | 8 | 8 | | 3460 | 18x24 | 120 240 | 20VDC | COMP. AIR GNS | | | | | ADMIN. OPS. |
| BUILDING 'AM' BUILDING # M579 | CLEAN ROOM COMPLEX | | 100K | 19 | | | | | 228 | 4.8x12.5 | | | | | | | | |
| | COMPUTER ROOMS | | | 9 | | | | | 21.7 | 8x7 | | | | | | | | |
| | CLEAN ROOM (2) | K-STM-14.1.4 | 200K | 24 | 29 | 8 | 2 | | 1290 | 3x7 | 120 480 | 20VDC | COMP. AIR GN2 316 | | | | | |
| | SYSTEM TEST AREA | | | 26 | | 8 | 2 | | 1170 | 18x27 18x27 18x27 3.0x3.8 | | | | | | | | |
| HANGAR 'B' BUILDING # 1728 | SUPPORT BUILDING | | | | | | | | | | | | | | | | | ADMIN. OPS. |
| | MC TELEMETRY GROUND STATION | | | 12 | | | | | 782 | 3x7 | | | | | | | | |
| | BONDED STORAGE AREA | | | 12 | | | | | 312 | 121 3x7 | | | | | | | | YES |
| | ELECTRONICS MAINTENANCE LAB | | | 12 | | | | | 420 | 3x7 | | | | | | | | |

BSG 1270B

① SOME USABLE FLOOR AREA TAKEN UP BY A CLASS 100 CLEAN TUNNEL

Table 4-3. Launch Site Facilities Capabilities (Sheet 3 of 3)

| CAPABILITY FACILITY | SPECIAL PURPOSE AREA | HANDOOK DESCRIPTION | CLEAN AREA, CLASS | CEILING HT. FT. MTRS. | HOOK HT. FT. MTRS. | CRANE (TONS) | ENVIRONMENTAL CONTROL | USABLE FLOOR AREA | DOOR ACCESS WIDTH X HEIGHT | ELECTRICAL | | LIQUIDS | GASES | TEST CELLS | STORAGE AREA | LPS | COMMUNICATIONS | OFFICE SPACE | |
|-----------------------------------------------------|----------------------------------------------------|------------------------|----------------------|-----------------------------|--------------------------|-----------------|-----------------------------------|-----------------------------------|----------------------------------------|-------------------------------|-------------------------------|--------------|--------------|------------|-----------------|-----|-----------------------------------|-------------------------------------|-----|
| | | | | | | | | | | AC | DC | | | | | | | | |
| EXPLOSIVE SAFE AREA (ESA) 88 EXPLOSIVE SAFE AREA | DELTA SPIN TEST | | | 41 | 34 | | T 75/20F 21-28.7°C RH 80/5% | 1189 | 11x30 | 120 | AC | | | | | | INTERCOM PA MITOC | YES | |
| | DELTA SPIN TEST CONTROL BUILDING # 87961 | HIGH BAY | K-STEM-14.1.8 | 12.5 | 10.4 | | | 109.9 | 3.3x9.1 | 208 | | | | | | | | | |
| | DELTA SPIN TEST BUILDING # 87966 | HIGH BAY | | 38 | 36 | | | 2190 | 16x30 | 120 | | | | | | | | MITOC CCTV | YES |
| | | AIRLOCK | | 11.5 | 10.8 | | | 202.9 | 8.1x6.1 | 480 | | | | | | | | MITOC CCTV | |
| | SPACECRAFT ASSEMBLY (S & A BLDG.) BUILDING # 54445 | HIGH BAYS 2 EACH | ① K-STEM-14.1.8 | 100K | 42 | 34 | 5 | T 75/20F 21-28.7°C RH 80/5% | 2128 | 18x36 | 120/15A 120/20A 120/20B | | COMP. AIR | | | | | ADMIN. MITOC CCTV | YES |
| | | AIRLOCK | | 100K | 12.8 | 10.4 | 5 | | 264.5 | 8.4x10.8 | 120/15A 120/20A 120/20B | | COMP. AIR | | | | | | |
| | PROPELLANT LABORATORY BUILDING # 54448 | REMOVABLE AIRLOCK | | 100K | 10.9 | 9.4 | | | 99.8 | 8x8.1 | 120/15A 120/20A 120/20B | | COMP. AIR | | | | | | |
| | | GARMENT ROOM | | 100K | 42 | 34 | 5 | | 1300 | 8x10 | | | | | | | | | |
| | | INSTRUMENTATION | | 100K | 12.8 | 10.4 | 10 | T 75/20F 21-28.7°C RH 80/5% | 1000 | 20x30 | 120/15A 120/20A 120/20B | | COMP. AIR | | | | | | |
| | | CLEANING | | 100K | 10.9 | 9.4 | | | 99.8 | 8x8.1 | | | | | | | | | |
| LAUNCH COMPLEX 28 | INSTRUMENTATION LABORATORY BUILDING # 53922 | | | 9 | | | T 75/20F 21-28.7°C RH 80/5% | 495 | 8x8 | 120/15A 120/20A 120/20B | | COMP. AIR | | | | | MITOC PHONES CCTV | YES | |
| | | GARMENT ROOM | | 2.7 | | | | 84 | 2.4x2.4 | | | | | | | | | | |
| | | INSTRUMENTATION | | 10 | | | | 244 | 6x7 | | | | | | | | | | |
| | | CLEANING | | 3.06 | | | | 24.3 | 2x2.1 | | | | | | | | | | |
| | | SHOP | | 10 | | | | 221 | 8x7 | | | | | | | | | | |
| | | | | 3.06 | | | | 20.3 | 2x2.1 | | | | | | | | | | |
| | GROUND SUPPORT EQUIPMENT STORAGE BUILDING # 58925 | | | 15 | | | T 75/20F 21-28.7°C RH 80/5% | 1500 | 20x10 | 120/20B | | COMP. AIR | | | | | | PA PHONES | YES |
| | | | | 4.5 | | | | 138.6 | 2.9x2.1 | | | | | | | | | | |
| | VEHICLE ASSEMBLY BUILDING | HIGH BAY | | 25 | 482 | 250 | | 22858 | 114x38 | 170 | | | | | | | | | |
| | | LOW BAY | | 1500 | 140.8 | | | 21,270.8 | 37x12 | | | | | | | | | | |
| LAUNCH COMPLEX 28 | ORBITER PROCESSING FACILITY BUILDING # 8E-84 | HIGH BAY | 100K | 210 | 168 | 15 | T 75/20F 21-28.7°C RH 80/5% | 121108 | 84x38 | 120 | | GN2 GO2 | | | | | | 127 HIGH BAYS | |
| | | | | 64.0 | 60.8 | | | 11,281.4 | 10.8x5.0 | 120 | | | | | | | | | |
| | PAYLOAD CHANGEOUT ROOM | | | 70 | 40 | 5 | T 75/20F 21-28.7°C RH 80/5% | | | 120 | | GN2 GN2 | | | | | | YES PHONES PA | |
| | LAUNCH PAD | | | 21.3 | | | | | | 120/20B | | | | | | | | YES PAGING CH' RA. DIO NET | |
| LANDING | | | | | | | | | 217/480 | | | | | | | | VOICE COMM. FACAN PFAIDS | | |

① EXPLOSIVE LOAD LIMIT SOLIDS 8000 LBS. CLASS #1 LIQUIDS 900 LBS.
② EXPLOSIVE LOAD LIMIT SOLIDS 4000 LBS. CLASS #1 LIQUIDS 20,000 LBS.

Table 4-4. Category A MMSE Capabilities

| CAPABILITIES | CONTROL | | HANDLING OR TRANSPORTATION | PRESSURIZE | SERVICING | TEST OR CHECKOUT | REMARKS |
|--------------------------------------------|---------|------|----------------------------|------------|-----------|------------------|---------|
| | MANUAL | AUTO | | | | | |
| SUPPORT EQUIPMENT | | | | | | | |
| PAYLOAD HANDLING FIXTURE | X | | X | | | | |
| PAYLOAD CANISTER | X | | X | | | | |
| PAYLOAD CANISTER HORIZON. ACCESS EQUIPMENT | X | | X | | X | | |
| PAYLOAD CANISTER, TRANSPORTER | X | | X | | | | |
| SET, TRANSPORTATION INSTRUMENTATION | X | X | X | | | X | |
| UNIT, ENVIRONMENTAL CONDITIONING | X | X | X | | X | X | |

BSG 1219

4.5.1.1 Payload Handling Fixture (Strongback).
The fixture will be a rigid frame device consisting of beams, cables, attach hook devices, and rings adjustable to accommodate varying lengths and shifting c.g.'s of payloads up to 15' diameter, 60' length, and 65,000 pounds weight. It will interface with the payload on a non-interference basis, such that engagement and load transference to attachment/retention points can occur while the handling fixture is still attached. It will support an IUS/SSUS with payload by attachment to the carrier only, and automated payload by attachment to the spacecraft or to a spacecraft-orbiter adapter. It will not induce any bending or twisting loads on any payload element.

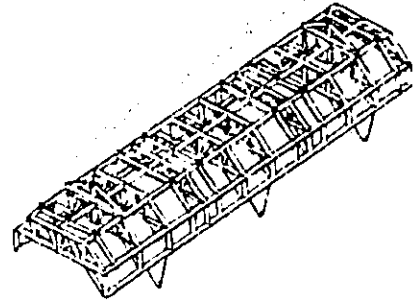

4.5.1.2 Payload Canister.
This canister will be sized equal to the Orbiter payload bay. Pickup points/retention fittings will be similar in type, quantity and location to the Orbiter. Access doors will be along the top of the container and operate identical to the Orbiter doors, relative to allowable envelopes and clearances. Viewports will be provided and provisions for personnel access to the interior from ground level. Included are service panels, tie downs, and lift points to allow rotation of the loaded/unloaded container. Its closure device and external sizing will be compatible with the PCR. One end is hinged to allow vertical P/L installation.

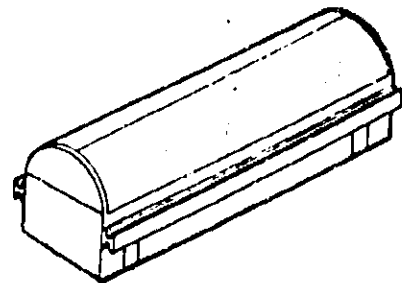

4.5.1.3 Payload Horizontal Canister Access Equipment.
This equipment consists of a bridge type structure to span the payload (or payload element) canister and walkway platforms along each side of the canister. The bridge will include the capability of being lowered or raised and, at its maximum elevation, will have sufficient height to clear all payloads. The walkway runs the entire length of each side of the canister and is mounted to the edge of the canister and supported by the open door. The walkway is sectioned for localized use and portability. Access to the walkway and to the exterior surface will be provided by general purpose access equipment.

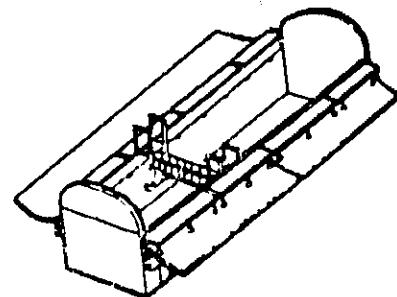

4.5.1.4 Payload Canister Horizontal Transporter.

The transporter will support the loaded or unloaded payload canister in the horizontal attitude. The unit will have a flat bed (approximately 18 feet wide by 65 feet long) with tie down provisions included. It will have steerable front and rear wheels, have self-contained breaking and stabilization jacking provisions, and a suspension system to minimize over the road shock and vibrations.

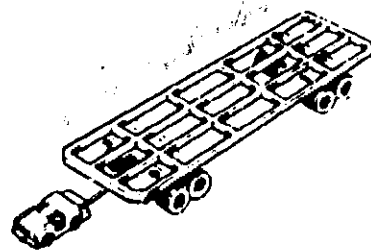

4.5.1.5 Transport Instrumentation Set.

The transport instrumentation set will monitor and record acceleration, temperature and humidity as experienced by the payload while installed in a container during transit. The set will be self contained, consisting of a power supply, transducers, signal conditioning equipment and interface cabling.

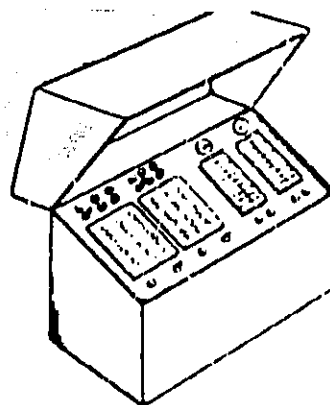

4.5.1.6 Environmental Conditioning Unit.

This unit will be towable from either end and contain the electrical generating system to power its air conditioning system. The air conditioning system will provide an air purge to the payload container at a flow rate of 0-94 cu/min., temperature will be maintained between 70 + 5°F, cleanliness nominally class 100, guaranteed class 5000 (HEPA filtered) air with 15 PPM or less hydrocarbons, and humidity between 30% and 50%.

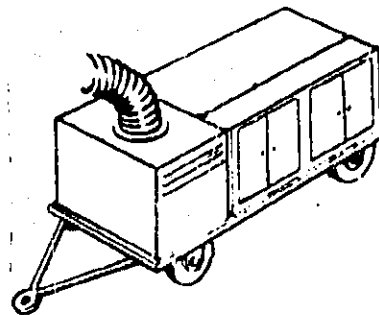

4.5.2 Cargo Integration Test Equipment (CITE). CITE consists of equipment which is capable of verifying compatibility between payloads and cargo to Orbiter mechanical and functional interfaces. This verification is done off-line from the Shuttle processing activity but is still considered on-line STS operations. Figure 4-4 shows the mechanical CITE equipment in the O&C Building for horizontally installed payloads. Figure 4-5 shows the mechanical CITE equipment in SAEF #1 for vertically installed payloads. Figure 4-6 is a block diagram of the functional CITE capability for both locations.

4.5.3 Intersite Transportation Equipment (ITE). ITE (see Figures 4-7 and 4-8) is designed to transport a payload between a payload development center and the launch site. ITE can be transported over the road, with special permits and escorts, or by air.

- a. ITE supports the payload by the flight trunnions; however, the keel fittings may have to be removed if the payload approaches the maximum payload bay diameter of 15 feet.
- b. Tie-downs, which interface with universal tie-down rings and commercial carrier tie-downs, are provided. A sling set is provided to be used with cranes or hydraulic hoists to handle the loaded containers and the self-contained environmental and power units. These same slings are used to rotate a payload on a pallet for horizontal transportation.
- c. A Transport Environment Monitoring System (TEMS) will sense shock, vibration, temperature, humidity and power levels during transit. An alarm will warn the driver if any critical parameters are out of tolerance.
- d. The insulated hard cover has doors on two sides for access without removal of the insulated cover. Lights and reflectors on the outside meet Interstate Commerce Commission regulations for highway movement.
- e. The container has its own environmental control system. Power is provided by its own auxiliary power unit (APU) or from facility power sources. A positive pressure filtered air purge is maintained during transit. A battery is included that could supply power to operate the TEMS for four hours if the APU becomes inoperative.

4.6 PAYLOAD SERVICE EQUIPMENT (PSE)

PSE consists of surplus GSE from past programs which has been held by KSC for possible use by payloads. This equipment consists of such items as cryogenic charging carts, portable vacuum pumps, hydrazine servicing carts, and battery chargers. Some of this equipment is ready for use, some must be refurbished prior to use. KSC document (TBD) is a catalog containing a list and description of the PSE. The condition and availability of any PSE must be determined prior to assuming that a piece of PSE can be used during payload processing activity.

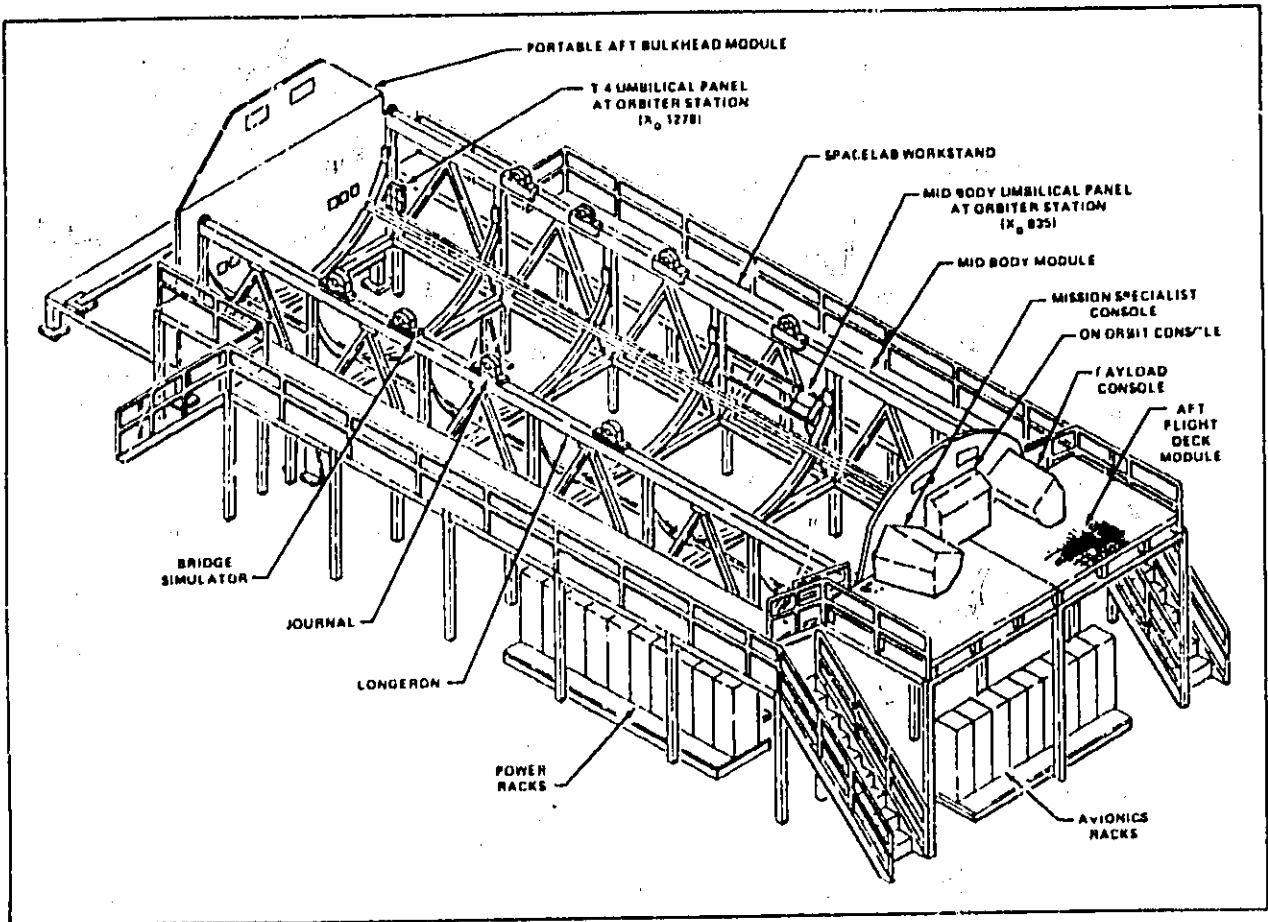

Figure 4-4. Horizontal CITE

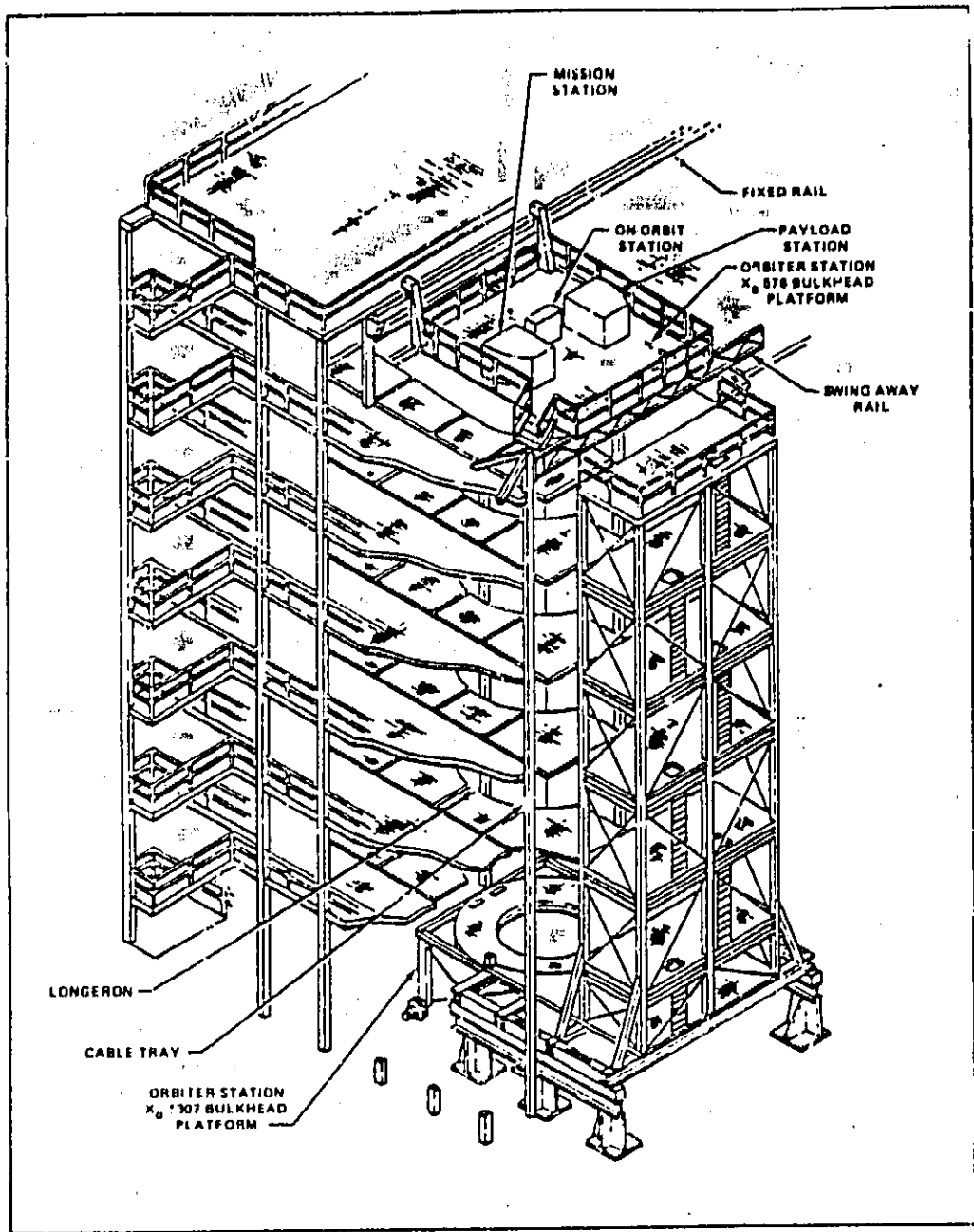
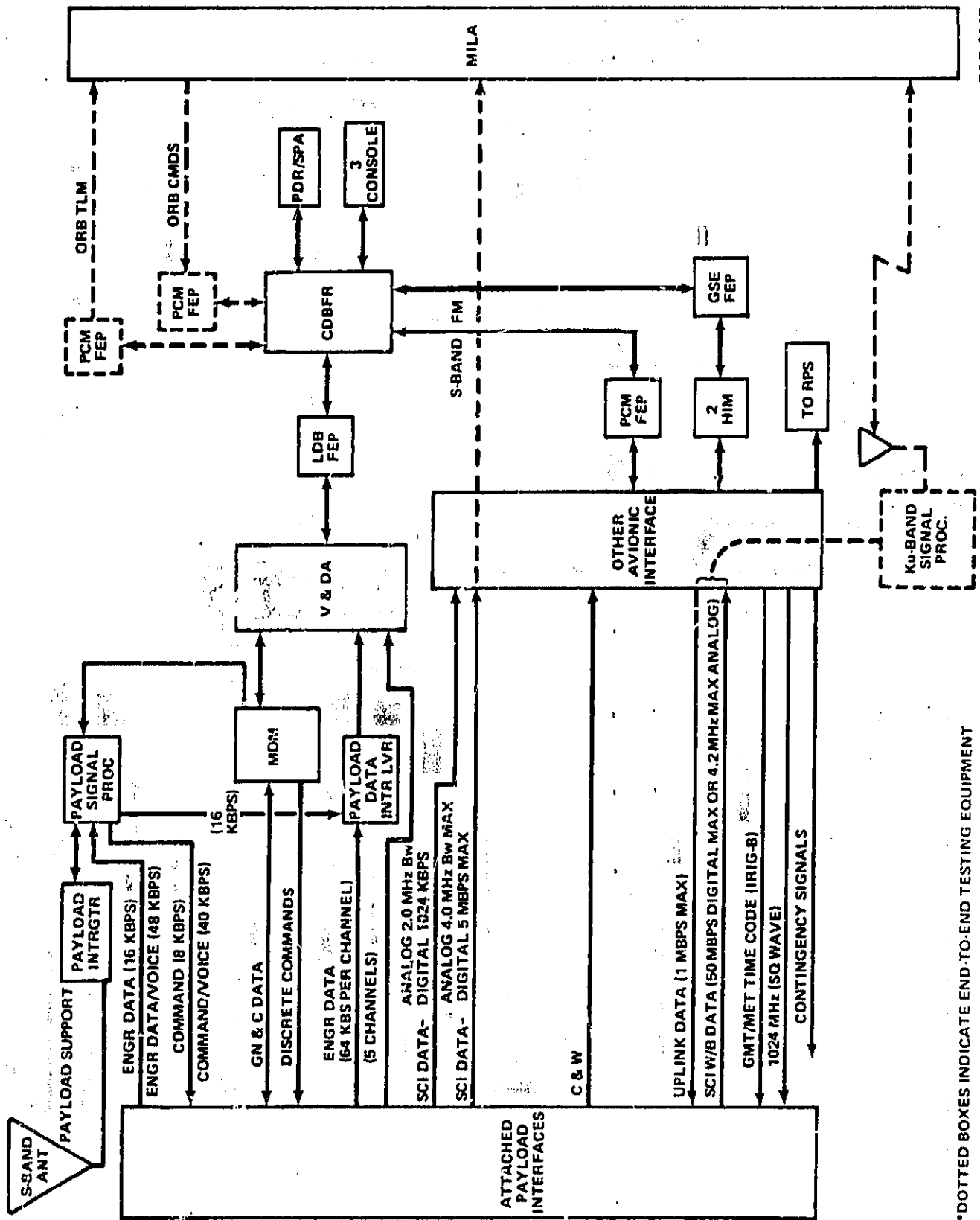

Figure 4-5. Vertical CITE

CITE AVIONICS FUNCTIONAL DIAGRAM FOR PAYLOADS



* DOTTED BOXES INDICATE END-TO-END TESTING EQUIPMENT

Figure 4-6. CITE Avionics Functional Diagram for Payloads

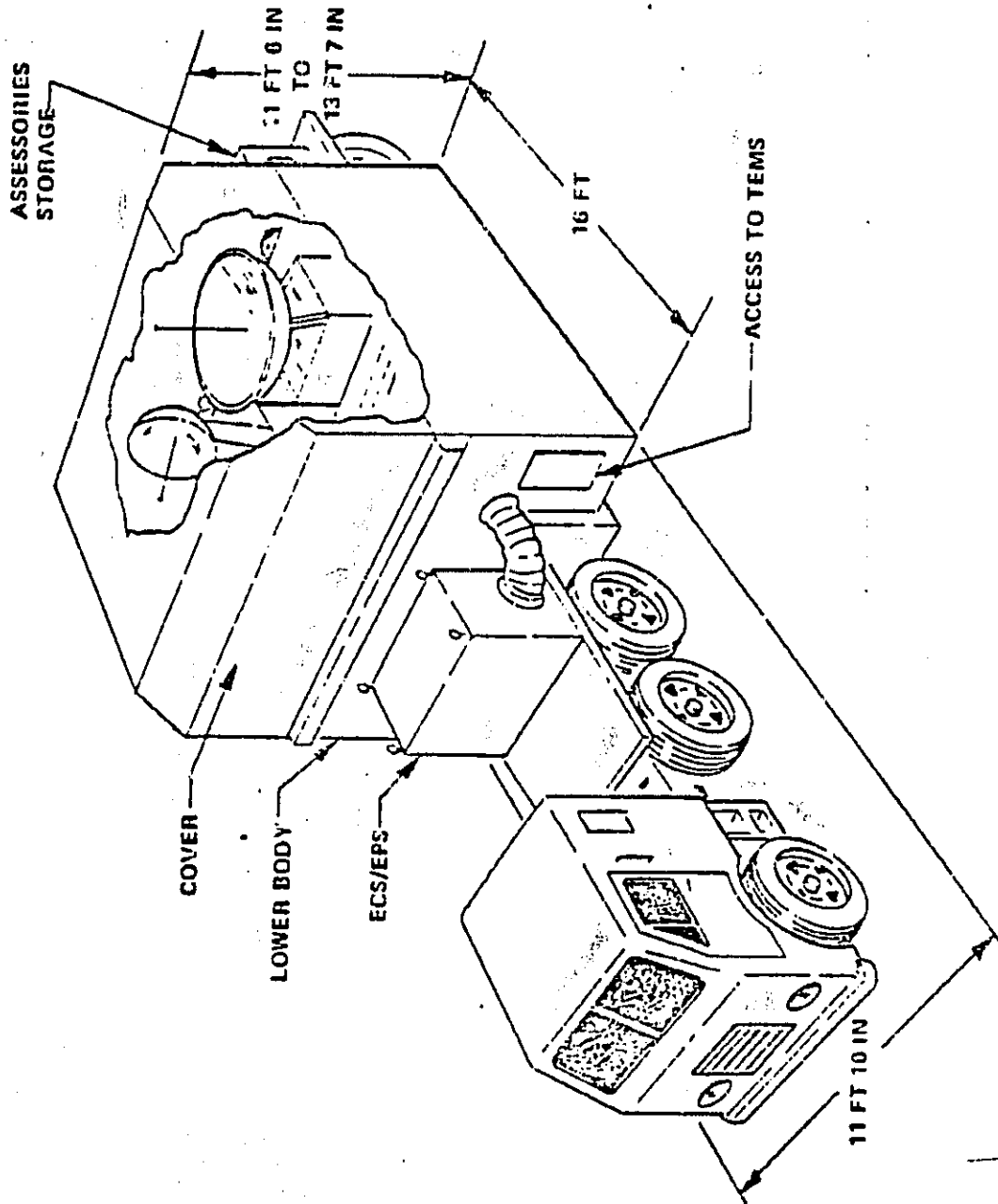

Figure 4-7. ITE - S...e Pallet Container

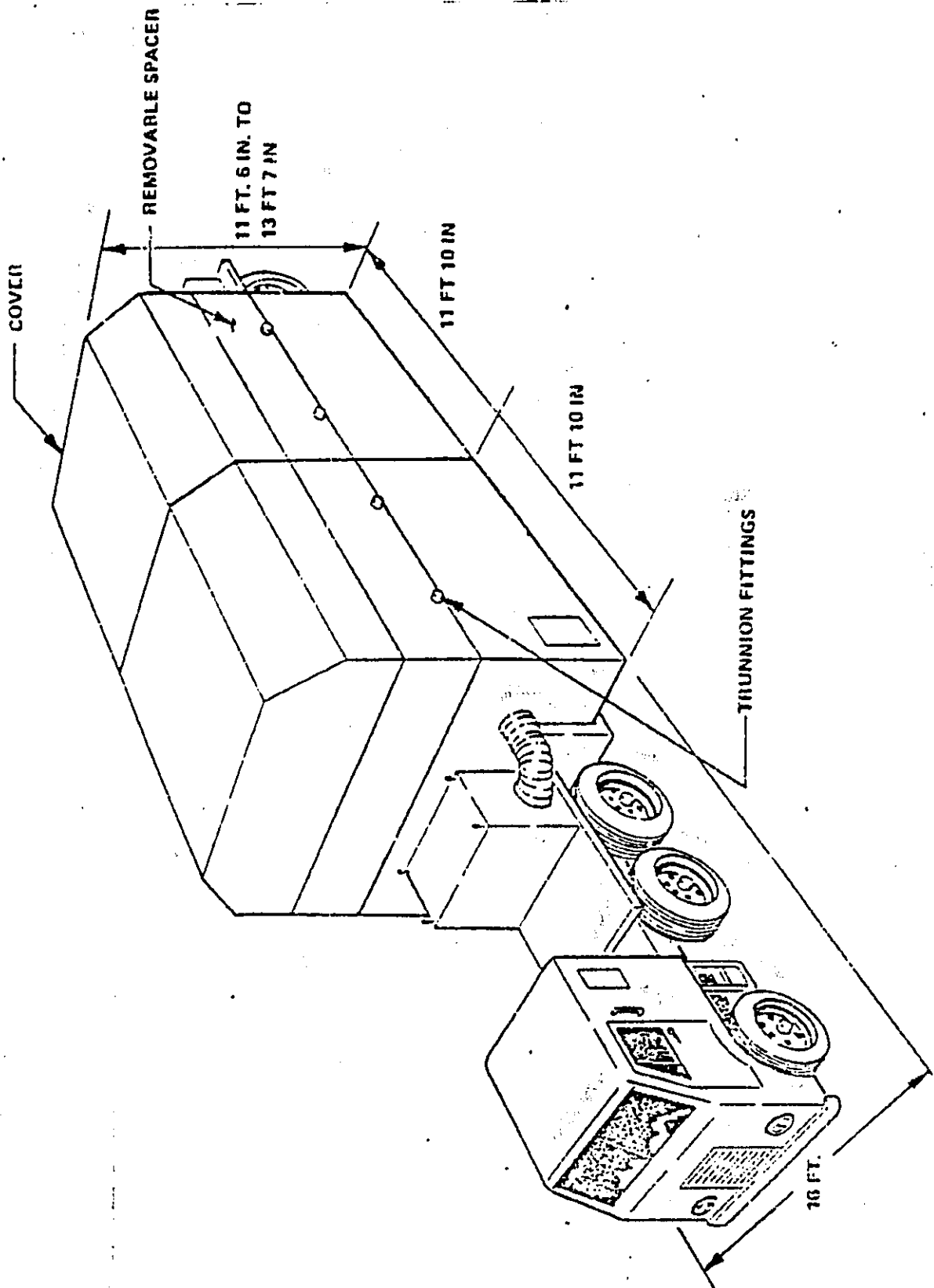

Figure 4-8. ITE - Modular Container

4.7 PAYLOAD UNIQUE OWNER SUPPLIED EQUIPMENT

This is ground support equipment supplied by the payload owner to the launch site for use during processing operations. This equipment must be identified, controlled, and funded by the STS User. A listing of this equipment must be provided to the LSSM. In addition an abbreviated description sheet will be required for each item specifying the required launch site interfaces, i.e., area, power, cooling, etc., which is required for use. It will be the STS User's responsibility to deliver this equipment to the launch site in time to allow sufficient installation and checkout prior to use with the payload. All shipments of GSE must be coordinated with the LSSM.

4.8 LAUNCH PROCESSING SYSTEM

The KSC Launch Processing System (LPS) is designed to meet Space Shuttle Requirements. It is used for systems testing, launch operations controls, and status monitoring of the Shuttle Vehicle and associated ground support equipment. The architecture of the system is shown in Figure 4-9. There are essentially two systems, the Checkout, Control and Monitor Subsystem (CCMS) and the Control Data Subsystem (CDS).

4.8.1 CCMS. The CCMS provides real time control and monitor of the Shuttle Vehicle and its support equipment. The Shuttle Vehicle interfaces include the Pulse Code Modulation (PCM) and the Launch Data Bus (LDB). Commands are initiated from the ground on the LDB and system responses via PCM or the LDB are evaluated and recorded. Thirty seven mini-computers and associated peripherals are assigned to this task. Of the entire complement of equipment, one computer, a printer, and a man/machine interface console are dedicated to payload work. Also, other equipment can be shared for payload operations. The dedicated LPS payload equipment is essentially used to monitor payload operations. The dedicated LPS payload equipment is essentially used to monitor payload health and status; however, additional capability can be provided, subject to an optional charge. Payload commands can be sent, and data can be evaluated and stored. If the STS User will utilize standard data formats that are routinely processed by the LPS, he may develop his own LPS program rather simply through use of a High Order Language (HOL) developed by KSC. If special data formats are required, systems software must be developed. This would necessitate a development charge. It is anticipated that a library of software payload programs will eventually be assembled, which will meet the needs of many STS Users.

4.8.2 CDS. The CDS provides many capabilities normally associated with large computers. KSC's computers are Honeywell Information Systems (HIS) 6680's. Its ability to store pre-processed data from the CCMS, is the one feature of most interest to STS Users. This data can be retrieved, for near real time review, from the dedicated payload console or from an engineering terminal. Standard data processing services are available at KSC, as well as a compiler for the previously mentioned HOL.

4.8.3 Use of LPS by STS Users. The LPS can provide a repertoire of services that can benefit STS Users. If the STS User feels that this equipment can meet his needs, he should investigate the standard services, conventional interfaces, HOL development, and other software that may require modification or development. Requests for information on the LPS should be directed to the LSSM.

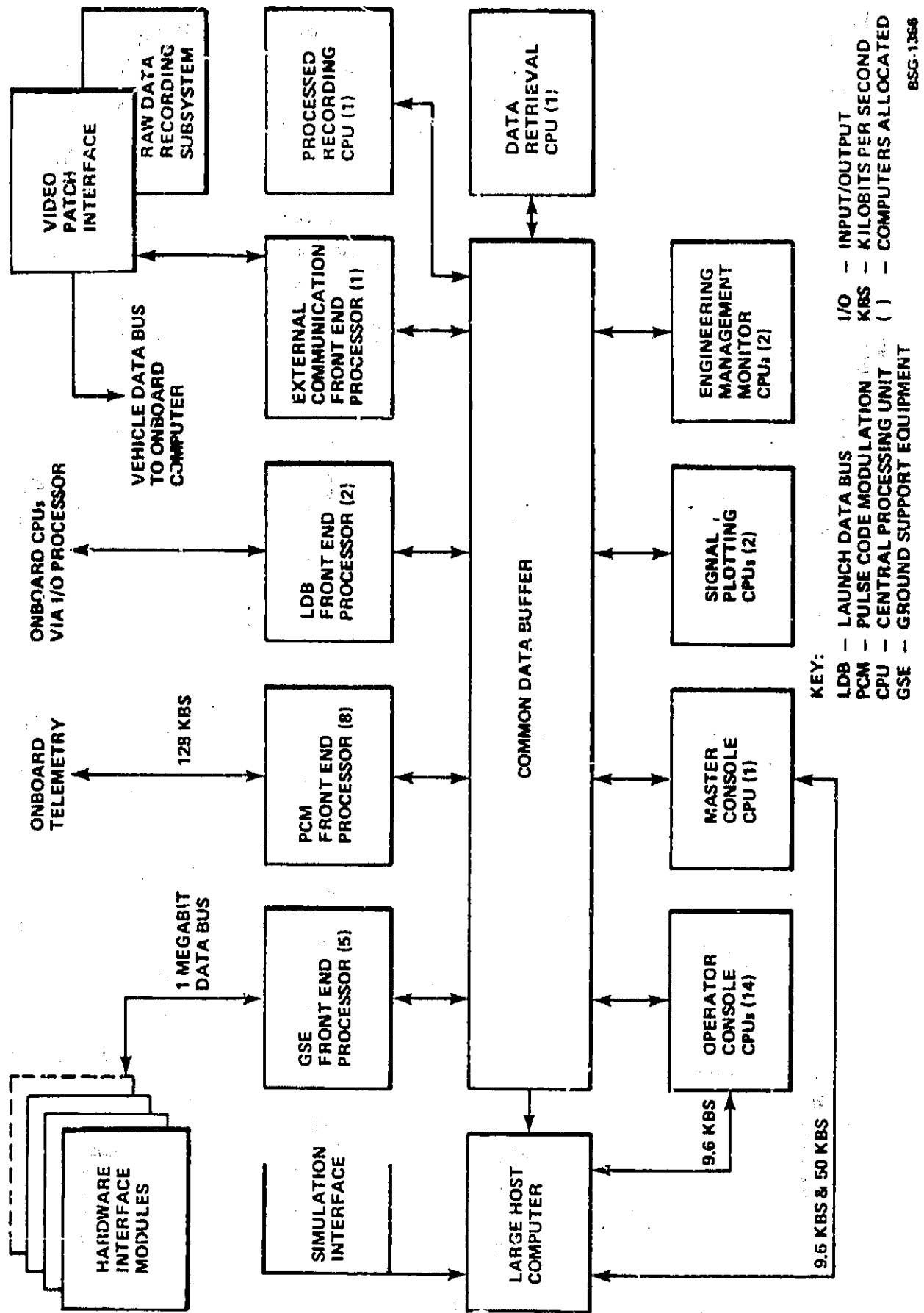

85G-1386

Figure 4-9. Launch Processing System Architecture

SECTION V SUPPORT SERVICES

Launch site support requirements received by the Launch Site Support Manager (LSSM) from the STS Users will be introduced into the KSC Support Requirements System (SRS) by way of the Universal Documentation System (UDS). The SRS (see K-STSM-09.5) provides a standardized KSC Management System for the planning and processing of STS Support Requirements (needed for Site Activation, Shuttle Turnaround, Flight Operations, and Shuttle launched Payload Processing). The SRS is compatible with the Universal Documentation System (UDS) and inputs received in UDS format would alleviate the resultant work effort necessary to translate the STS User requirements into the standardized format. The UDS is described in NMI 8610.10, "Space Transportation System Support Requirements Management and Documentation." After processing the requirements through the KSC SRS, a commitment (or exception) can be finalized via the Launch Site Support Plan for the requested support to the STS User.

5.1 GENERAL

This section describes the various KSC Support Services available to the STS User while in residence at the Launch Site. Some of the support services might be in the down mode or inactive, but the capability of reactivation still exists. Negotiated cost and schedules for reactivation must be considered in this case. Regardless of availability, the STS User is required to submit his requirements for services to the LSSM, who will provide a Launch Site Support Plan (LSSP) in response.

- a. Capabilities Matrix. Table 5-1 is a summary matrix of available support (subject to limitations noted above) by facility, which may be used by STS Users for payload processing at KSC.
- b. Administrative Support Services. Paragraph 5.2 describes the non-technical (administrative) support services that are available to fit the needs of STS Users at KSC. Administrative support services include housekeeping, communications-administrative, logistics, security, safety, transportation, medical, training, photographic, food service, reproduction, mail service, and fire prevention and protection.
- c. Technical Support Services. Paragraph 5.3 describes the technical support services that are available at KSC for STS Users. Although complete technical services exist, they are not manned to supplement work which should have been performed in the contractor's home plant. It is the responsibility to the STS User to assemble, service, and checkout his payload(s) to the maximum extent possible prior to delivery to KSC. Technical support services for payload processing include clean rooms, cranes, communications-operational, instrumentation, propellants/liquids/gases, ordnance, chemical sampling and analysis non-destructive evaluation, technical shops, laboratories, photography, and LRU maintenance.

Table 5-1. Matrix of Available Services

| SERVICES FACILITIES | ADMINISTRATIVE SUPPORT | | | | | | | | | | | | | TECHNICAL SUPPORT | | | | | | | | | | | | | |
|-----------------------------------|------------------------|-------------------------------|-----------|----------|--------|----------------|---------|----------|--------------|---------------|--------------|--------------|--------------------------------|-------------------|--------|---------------------------|-----------------|-------------------------------|----------|--------------------------------|----------------------------|--------------|-----------------|-------------|-----------------|--|--|
| | HOUSEKEEPING | ADMINISTRATIVE COMMUNICATIONS | LOGISTICS | SECURITY | SAFETY | TRANSPORTATION | MEDICAL | TRAINING | PHOTOGRAPHIC | FOOD SERVICES | REPRODUCTION | MAIL SERVICE | FIRE PREVENTION AND PROTECTION | CLEAN ROOMS | CRANES | OPERATIONAL COMMUNICATION | INSTRUMENTATION | PROPELLANTS LIQUIDS AND GASES | ORDNANCE | CHEMICAL SAMPLING AND ANALYSIS | NON DESTRUCTIVE EVALUATION | LABORATORIES | TECHNICAL SHOPS | PHOTOGRAPHY | LNU MAINTENANCE | | |
| OPERATIONS AND CHECKOUT BLDG. | | | | | | | | | | | | | | | | | | | | | | | | | | | |
| SAEF 1 | | | | | | | | | | | | | | | | | | | | | | | | | | | |
| SAEF 2 | | | | | | | | | | | | | | | | | | | | | | | | | | | |
| BUILDING AD | | | | | | | | | | | | | | | | | | | | | | | | | | | |
| BUILDING AM | | | | | | | | | | | | | | | | | | | | | | | | | | | |
| BUILDING AE | | | | | | | | | | | | | | | | | | | | | | | | | | | |
| HANGAR S | | | | | | | | | | | | | | | | | | | | | | | | | | | |
| HANGAR E | | | | | | | | | | | | | | | | | | | | | | | | | | | |
| HANGAR J | | | | | | | | | | | | | | | | | | | | | | | | | | | |
| HANGAR M | | | | | | | | | | | | | | | | | | | | | | | | | | | |
| DELTA SPIN FACILITY | | | | | | | | | | | | | | | | | | | | | | | | | | | |
| ESA 60 | | | | | | | | | | | | | | | | | | | | | | | | | | | |
| POD STORAGE FACILITY | | | | | | | | | | | | | | | | | | | | | | | | | | | |
| ORDNANCE TEST LAB | | | | | | | | | | | | | | | | | | | | | | | | | | | |
| DWF | | | | | | | | | | | | | | | | | | | | | | | | | | | |
| VAR | | | | | | | | | | | | | | | | | | | | | | | | | | | |
| LC 70 | | | | | | | | | | | | | | | | | | | | | | | | | | | |
| LNU MAINTENANCE SHOP | | | | | | | | | | | | | | | | | | | | | | | | | | | |
| LAUNCH EQUIP SHOP | | | | | | | | | | | | | | | | | | | | | | | | | | | |
| OCCUPATIONAL HEALTH FACILITY/CAFS | | | | | | | | | | | | | | | | | | | | | | | | | | | |
| CENTRAL SUPPLY | | | | | | | | | | | | | | | | | | | | | | | | | | | |
| KSC TRAINING BLDG | | | | | | | | | | | | | | | | | | | | | | | | | | | |

TO BE DEVELOPED

5.2 ADMINISTRATIVE SUPPORT SERVICES

The administrative support services (non-technical) available to the STS User are described in paragraph 5.2.1 through 5.2.13.

5.2.1 Housekeeping. The following housekeeping services are available:

- a. Office Allocate existing space to accommodate work force, modifying facilities as required.
- b. Furnishings Provides furnishings (desks, chairs, bookcases, etc.) and will coordinate special furnishings as required by site occupants.
- c. Janitorial Provides custodial services (maintenance of floors, walls, restrooms, etc.) in support of normal operations. Also provides special service to payload servicing/checkout areas (clean rooms, cryogenics lab, etc.) as requested.

5.2.2 Communications-Administrative. The following administrative communications services are available:

- a. Telephone:
 - (1) General The normal telephone system used in routine day-to-day communications, including commercial long distance communications and the Federal Telecommunications System (FTS).
 - (2) Admin Intercomm These intercommunications systems are provided to supplement the administrative telephone system in the conduct of day-to-day activities.
- b. Public Address (PA) and paging Used primarily for area warnings or administrative announcements.
- c. Portable PA & Paging Systems Provided for use on an emergency basis, in areas where permanent facilities do not exist.
- d. Telex/TWX Provides means of transmitting a written message to locations with Telex/TWX equipment, and a means of sending telegrams/cablegrams to locations not serviced by Telex/TWX.
- e. Data Fax/Facsimile Provides a network for sending and receiving diagrams, graphs, engineering designs and sketches, engineering and performance data, and other graphic material not adaptable to the teletyp. format.

f. Teletype:

- (1) Unclassified Provides a network for transmitting/receiving Teletype messages.
- (2) Classified Provides a network for encryption and transmission, reception and decryption, and storage of classified information.

5.2.3 Logistics. The following logistics support services are available:

a. Supply:

- (1) Provisioning for Equipment and Material Provisions to provide initial support to user O&M, based on sound engineering and maintenance judgement and the establishment of stock levels for standard items based on customers' requirements.
- (2) Issue of Stocked Items Equipment and materials are delivered to the customer from stock (standard items identified as recurring requirements.)
- (3) Special Order of Non-Stocked Items Non-stocked items are obtained and distributed as needs occur. If experience indicates that certain non-stocked items are repeatedly ordered, stock levels will be established accordingly.
- (4) Cataloging of Stocked Items Stock items are cataloged in microfilm form which lists items by National Stock number (NSN) and noun nomenclature sequence. Catalog data microfilm are periodically updated. Distribution of such data, including revisions, is determined from requirements submitted to the Supply Branch.
- (5) Maintenance of Central Supply Issue Predetermined items are located in strategic locations for immediate issue to customers. (Capabilities exist to transmit to these locations requirements for stock items stored in Central Supply).
- (6) Redistribution and Marketing of Excess Material The Materials Management Section fills orders with usable materials that has been declared excess. Serviceable items are made available to users by the circulation of an excess list.

b. Loan Tool Cribs

Loan tool cribs are located in strategic locations for user convenience. Each crib stock tools/equipment relative to work being performed in that locale.

5.2.4 Security. The following security support services are available:

a. Classification

Develops classification plans to protect sensitive information from compromise.

b. Classified Document Control

Develops plans to manage, regrade, and destroy classified documents (including arrangements for the mailing and shipment of classified material).

c. Repositories (Safes) for Classified Documents

Approves initial request for issuance of all Safes; for NASA offices, arranges for changes in combinations including the mandatory final factory combination setting prior-to-turn-in of safe no longer required. Furnishes technical assistance to other NASA offices as required.

d. Access

Individuals requiring unescorted access to KSC/CCAFS security areas are required to furnish evidence of a security clearance or a government investigation.

e. Badging:

(1) Visitors

Provides visitors (any person other than a NASA employee duty stationed at KSC) with the proper pass or badge for admittance to the Kennedy Space Center. The need for area access will be verified and controlled by the issuance of a picture or machine pass which will designate bearer's security clearance level, if applicable.

(2) NASA Employees

Provides NASA-KSC employees with the proper NASA ID which will designate bearer's security clearance or investigation. Will also provide NASA IDs as required.

f. Technical Security

Provides alarm systems, access control systems and other electronic countermeasures to protect security areas from unauthorized entry or electronic infiltration.

- g. **Security Education** Conducts a continual program of personnel education in security matters. This program will inform personnel of security regulations and procedures.
- h. **Security Violations:**
 - (1) **NASA Employees** Thoroughly investigates all irregularities, violations and infractions by NASA personnel. Investigation results will be the basis for recommendation of disciplinary action, or revisions to regulations and procedures.
 - (2) **Contractor Employees** Notifies contractor concerned of incidents coming to the attention of the Security Office and requests results of the Security Office and requests results of the contractor's investigation or corrective action taken.
- i. **Guard Service, Security Posts and Patrols Support** Provides guard service for visitor control, area access control, security surveillance, escort service, test operations, security posts and controls, and traffic control. Escort service is only provided for movement of special items. All security service requests will be reviewed and the Security Office will determine the service furnished.
- j. **Investigations** Performs general security investigations; i.e., thefts, drugs, breaking and entering, property damage, etc.
- k. **Property Removal from KSC/CCAFS** Provides authorization to remove property from KSC or CCAFS (Employee prepares KSC Form 1-27, Property Cargo Clearance).
- l. **Security Surveys/Briefings** Conducts surveys to ensure that all classified material at KSC is properly safeguarded under applicable NASA and Department of Defense regulations. Provides security briefing for newly designated classified material control clerks and continuing assistance thereafter.
- m. **Locks and Keys** Installs, repairs, and replaces security locks and/or keys at KSC; supplies security desk and cabinet locks and keys.

5.2.5 Safety. The following safety support services are available:

- a. Safety Office Develop and maintain Safety Plans and controls for all operations at KSC. These plans cover KSC components from arrival to final disposition.
- (1) Operators Safety Provides personnel to: develop and prepare safety documents; monitor (100 percent basis) all high-level hazard operations; spot-check less hazardous operations and perform industrial safety efforts within assigned areas.
- (2) Procedure Review & Approval All procedures developed for use at KSC or at the CCAFS will be subject to a review by the KSC Safety Office to ascertain that the hazardous operations are identified and appropriate cautions/warnings are specified.
- (3) Safety Technology Maintain criteria and standards for the safety program.

5.2.6 Transportation. The following transportation support services are available:

- a. General:
- (1) Shuttle Service Daily Shuttle service is provided during the normal work week, except on holidays.
- (2) Permanently Assigned Vehicles Effects procurement and assignment action for permanently assigned vehicles provided sufficient justification is furnished through appropriate channels.
- (3) Temporary Vehicles Procures and assigns vehicles on a temporary basis for supply of unforeseen special or emergency operations.
- (4) Driver's Licenses Authorizes issue of Government licenses by GSA Motor Pool. (Required of all persons operating government vehicles.)
- (5) Maintenance & Service Provides for lubrication, fueling, preventive maintenance, motor tuneup, and repair of all GSA Controlled vehicles.

- b. Special Air Transportation
- Secures landing and departure clearances for all aircraft utilized for transporting stages, spacecraft, and ground support equipment.
- (1) Special Type Schedules special type aircraft as required for shipment of space hardware or software from or to KSC/CCAFS.
 - (2) Commercial Type Charters commercial type aircraft from commercial airlines to support immediate requirements of KSC/CCAFS.
 - (3) NASA Aircraft Secures aircraft from other NASA Centers when available to support KSC/CCAFS requirements.
 - (4) Arrivals Coordinates aircraft arrivals with the contractor and the NASA organization at KSC/CCAFS.
 - (5) Load/Off-Load Performs liaison duties in relation to off-loading and loading of all space vehicles and components arriving at or departing from KSC/CCAFS by air.
 - (6) Advice Furnishes technical transportation and traffic advice (packing and preservation) in preparation of payloads and related components to payload owners and determine the best mode of shipment.
- c. Marine
- Arranges with the AFETR range contractor for the necessary personnel and equipment to support movement of special-purpose barges utilized to transport Payloads and Payloads GSE arriving or departing KSC/CCAFS.
- (1) Normal Operations Controls and monitors one government-owned river type barge and tug used to transport Payloads and Payloads GSE in the local river and Port Canaveral area.
 - (2) Special Operations Negotiates with other NASA agencies on the utilization of special purpose barges or a ship (the Point Barrow) to satisfy KSC requirements.

- d. **Freight Traffic** Service is available (TBD) hours per day. Provides traffic management support for the movement of materials, including explosives and propellants, to and from KSC.
- (1) **Receiving** Performs a complete central receiving (and shipping) function including freight checking loss and damage and claims service, carrier liaison (commercial, rail, air, motor and government), tracing, and expediting of material.
- (2) **Shipping** Assigns freight classifications, selects mode of transportation, determines freight rates, prepares bills of lading, accomplishes bills of lading, orders carrier equipment, and dispatches material.
- (3) **In-Processing** Performs material in-processing receipt functions including count, verification of materials, flow control, filling of due-outs, internal distribution of material, certification of receiving documents, pickup and processing of turn-in material.
- (4) **Monitor** Monitors rail service performed by Florida East Coast Railway.

5.2.7 Medical. The following medical services are available:

- a. **Occupational Health** This service provides emergency treatment, including ambulance service, and a preventive health program.
- b. **Environmental Health** Provides various types of engineering services such as industrial hygiene, monitoring environments and facilities for the control of health hazards with regard to sanitation, radiation, lighting, noise, industrial waste disposal, air and water pollution, food, and potable water.
- Environmental health engineering personnel are available to provide health consultation by telephone or active support on a 24-hour basis.
- c. **Cape Canaveral Air Force Station** The United States Air Force provides emergency medical services at CCAFS,

5.2.8 Training. The training support services are TBD.

5.2.9 Photographic. The Photographic services are:

Documentary
Photography

Provides both still and motion picture coverage of all phases of operations and developments of the Shuttle program at KSC and AFETR.

5.2.10 Food Service. The following food service support is available:

a. Cafeterias

Provides dining room and carry out food services to support KSC/CCAFS operations. Breakfast and lunch are served Monday thru Friday, however, there is operating capability to provide supplemental service as required.

b. Snack Bars

Snack bars are provided in working areas where the number of employees is insufficient to support a cafeteria, and in those areas where travel to a cafeteria is not feasible.

c. Mobile Van

A mobile van is provided to service working areas not supported by a snack bar or cafeteria.

d. Vending Machines

Vending services are provided in certain isolated areas where periods of occupancy will not support cafeteria or snack bar operation; and in selected locations for personnel convenience.

5.2.11 Reproduction. The following reproduction services are available:

a. Self Service

Provides office copying machines for quick copy reproduction.

b. Documentation
Services:

(1) General

Personnel and facilities provided for multiple copy/large volume reproduction, off-set printing, bindery services, etc.

(2) Technical

Personnel and facilities provided for reproduction of technical documents (engineering Drawings, Schematics, Specification documents etc.) from original documents, microfilm, aperture cards, etc.

(3) Classified
Material

Personnel and facilities provided for the reproduction of classified material. Each facility maintains a file of classified material and an authenticated signature of persons authorized to approve the reproduction of classified material.

5.2.12 Mail Service. The following mail service support is available:

- a. Routine Mail Provides a mail delivery and pickup service on a scheduled basis at KSC/CCAFS and at certain adjacent areas (i.e., Operational Support Group with off-site offices).
- b. Mail Service to Other NASA Centers Dispatches mail to and provides pickup of Mail from NASA organizations, and contractors, payload owner/operators located at the various other NASA Centers (i.e., JSC, MSFC, NASA Headquarters, etc.).
- c. Expedite Delivery Service This service ensures expeditions delivery of a document, parcel, or component necessary to support an imminent test or launch.
- d. Post Office A U.S. Postal facility for routine postal services, i.e., stamp sales, box rentals, (not available to individuals) money orders, etc.
- e. Classified Documents Provides a properly cleared person to receive, and control classified materials at KSC/CCAFS.

5.2.13 Fire Prevention and Protection. The following fire prevention and protection services are available:

- a. Fire Prevention Provides surveillance of facilities, structure and other areas at KSC/CCAFS to assure compliance of Fire Prevention Rules and Regulations and to ensure the reliability and operational capability of all installed fire protection systems. Also provides real time support during hazardous operations.
- b. Fire Protection Provides Around-The-Clock coverage by professional fire fighting personnel and provides strategically located and maintained fire suppression equipment.

5.3 TECHNICAL SUPPORT SERVICES

The technical support services available to the STS User are described in paragraphs 5.3.1 through 5.3.12.

5.3.1 Clean Rooms. (Reference Section IV, Table 4-3).

5.3.2 Cranes. (Reference Section IV, Table 4-3).

5.3.3 Communications-Operational. The following operational communications support is available:

- a. Operational Intercommunications System (OIS) The OIS will provide the typical user with one active channel and one monitor channel selected from a total number of (TBD) channels. Multiple monitor will be provided, number of channels (TBD), where required. Paging access via OIS stations is also provided (capability TBD).
- b. Point-to-Point Telephone Provides a direct-line service between two points in which the calling party has only to lift his handset or depress a button to ring the other phone.
- c. Operational Television (OTV):
 - (1) Independent Facilities Provides user with limited control functions of the OTV camera (pan, tilt, and zoom) and start-stop control of portable video recorders located in the facility. Provides an OTV technician to; set up and control the remaining camera functions (beam, target, iris, etc.) on an as required basis; support the video recorders (i.e., set up, change tapes, etc.); and respond to customer trouble calls.
 - (2) Interdependent Facilities (OPF, VAB, etc.) Provides user with a "hands free" TV operation for Shuttle/payload test/checkout and monitoring. All cameras in the facilities will have remote control capability and will be primarily controlled (pan, tilt, zoom, beam, target, etc.) by personnel in room 1P1 of the LCC. Capability also includes video recording.

(3) Wideband
Transmission
System

Provides closed loop transmission media for complex waveform electromagnetic signals within the (TBD) HZ to (TBD) HZ frequency spectrum, i.e., telemetry data, timing, video information, etc. This data can be transmitted to all KSC/CCAFS major operating/support sites and to other NASA Centers (JSC, MSFC, etc.)

(4) Audio Record-
ing System

Provides magnetic tape recorders for centralized audio communications recording.

5.3.4 Instrumentation. The following instrumentation support is available:

a. Telemetry Ground
Station

Provides the following services:

(1) The acquiring of telemetry signals RF radiated, or over data lines.

(2) The recording, reproducing, or copying of recorded telemetry signals and the conversion and processing of telemetry signals and data for display, retransmission, computer processing, and records.

b. RF Checkout Station

Provides RF checkout support for spacecraft, experiment, IUS, SSUS, Spacelab, and other payload elements.

c. Data Processing

Provides LPS/CDS support non-LPS computation support, Real-Time, Batch Processing, MIS and ADP.

d. Magnetic Tape
Certification

Provides Tape Certification capability for GSE and flight tapes.

e. Flight Sensor

Provides flight sensor calibration capability.

f. Remote Data
Transmission

Provides capability thru LPS/CDS or other methods for transmitting data, TV, timing, countdown to remote KSC or off-KSC locations.

g. Data Display

Provides capability for data display capabilities thru CRT, strip chart recorders, and event recorders for special purpose, one-time only, or recurring display needs. Data may be from LPS/CDS or other sources.

- h. Test Equipment Loan Pool Provides test equipment on a loan basis.
- i. Electro magnetic Compatibility Operations Portable and fixed capabilities are available for testing and verifying vehicle capability (element-to-element, payload-to-GSE, etc). Area and system electromagnetic monitoring as well as laboratory facilities for testing and verifying components and systems to established RFI and EMC standards are available.
- j. Facilities Monitoring Measurement Program Provides the capability to remotely measure, record and display critical facility parameters.
- k. Instrument Calibration and Repair Provides facilities to calibrate and repair test instrumentation used in launch and support operations.
- l. Timing Provides digital timing system to generate, distribute and display countdown timing signals from launch checkout or computer-controlled tests and to display GMT to test areas.
- m. Meteorological Provides specific weather data, both forecasts and observations, during Shuttle/Payload ground operations, countdown and launch, and abort and landing. This service requires monitoring of certain meteorological parameters such as lightning activities, and the tracking and monitoring of severe weather systems; ie., high winds, precipitation, etc.

5.3.5 Propellants, Liquids and Gases. The following propellant liquids and gases support is available.

- a. Propellants (TbD)
- b. Cryogenics Provides facilities for filling portable GSE dewars with LOX/LH2 for Shuttle/Payload servicing.
- c. Hypergolics Provides facilities for hypergolic flushing, inerting, loading and unloading.
- d. Pressure Gas-Mobile Supplies high pressure nitrogen, helium, hydrogen, oxygen, air and mixtures of oxygen and nitrogen. During unscheduled outages of all high-pressure gas facilities, support is provided solely by mobile gas.

5.3.6 Ordnance. The following ordnance support is available:

- a. Ordnance Test Provides a safe facility for test and checkout (receiving inspection, lot verification testing, etc.) of ordnance devices.
- b. Ordnance Storage Environmentally controlled storage for Shuttle/Payload ordnance items.

5.3.7 Chemical Sampling and Analysis. The following chemical sampling and analysis support is available:

- a. Sampling Provides sampling containers, sampling probes, etc. for obtaining representative quantities of material for specification conformance analysis.
- b. Chemical Analysis:
 - (1) Gas Analysis Provides analysis of gases such as hydrogen, oxygen, helium, nitrogen, breathing air, etc., to verify that gas purity conforms to specifications required by KSC and/or the payload owner/operator.
 - (2) Liquid Analysis Perform purity analysis of liquids such as hypergolic fuels and oxidizers, hydraulic oils, solvents, spacecraft coolants, cleaning chemicals, RP-1, water, hypergolic decontamination flush fluids, lubricant oils, etc., to verify that liquids conform to specifications required by KSC and/or the payload owner.

5.3.8 Non-Destructive Evaluation (NDE). The following NDE support is available:

- a. Non-Destructive Investigation (NDI) Provides for detection/analysis of material defects, i.e., cracks, porosity, electrical discontinuities, weld defects, etc. by methods which will not impair further use of the item tested.
- b. Leak Detection This service determines the existence or absence of leaks in payload system, subsystems, and unique GSE and facility checkout equipment.

5.3.9 Technical Shops. The following technical shop support is available:

a. Electronic Shops

The Electronic Shops provide facilities, equipment and personnel for electronic support for all KSC launch and checkout activities. The combined electronic shop capabilities include:

- (1) Fabrication of patch panels, distribution racks, printed circuit boards, black box prototypes, etc.
- (2) Troubleshooting, repair and maintenance of electronic equipment (excluding test equipment).

b. Electrical Shops

The Electrical Shops provide electrical facilities, equipment and personnel in support of KSC launches and checkout activities. The combined electrical shop capabilities include:

- (1) Fabrication and assembly of power and instrumentation cables, harnesses, multi-breakout boxes, etc.
- (2) Electrical field crews for on-site installation, repair, and operation of electric motors, generators, cables, etc.

c. Machine Shops

The Machine Shops provide machine facilities, equipment, and personnel to fabricate and repair equipment, assemblies, subassemblies, etc. The combined shop capabilities include machining, milling, grinding, shearing, painting, baking, engraving, welding, drilling, and sheet metal fabrication.

d. Mechanical Shops

The Mechanical Shops provide mechanical facilities, equipment and personnel in support of KSC launches and checkout activities. The combined mechanical shop capabilities include:

- a. Fabrication and testing wire rope, cable, slings, pneumatic hose, etc.
- b. Maintaining, repairing, refurbishing, and overhauling compressors, hydraulic units, swing arms, etc.
- c. Heavy equipment operators for transporting, erecting and checkout of space vehicles and associated equipment.

- e. Mobile Shops Mobile Shops provide mechanical, electrical, and electronic facilities, equipment, and personnel in the field where quick maintenance response is essential. These shops have capabilities to perform on-site maintenance minor repairs and checkout of components, providing repairs, and checkout of components, providing quick response in the event of system failures.

5.3.10 Laboratories. The following laboratories support is available:

- a. Solar Panel Provides facilities to electrically check payload solar panels and systems while using actual sunlight conditions.
- b. Guidance & Control Contains special test sets for accurate and efficient checkout of Guidance & Control systems, i.e., hydraulic actuators (electrical feedback, electrical-mechanical alignment, scale factors, etc.), inertial platform alignment, etc.
- c. Battery Contains consoles, sinks and GN₂ required in activation of flight batteries.
- d. Power Systems Facilities are provided for maintenance of flight batteries and power supplies.
- e. Mechanical Systems Utilized for fluid and gas samples analysis; component disassembly, cleaning & assembly in Laminar Flow Rooms, and functional testing in controlled environment rooms of mechanical and electro-mechanical components.
- f. Transducer Calibration Used for calibration, maintenance, repair and replacement of transducers and signal conditioners.
- g. Bio-Med Provides checkout of flight bio-medical instrumentation, flight experiments, astronaut physical examinations and technical assistance to the Occupational Health Facility.
- h. Calibration GSE Lab provides calibration of those devices not removed from and calibrated on the payload GSE.

- i. Proof Test Provides facility for periodic re-evaluation of handling devices (slings,, harnesses, etc.) and flex hoses to assure conformance to KSC/CCAFS and/or Payload Owner safety and reliability specifications.
- j. Cleaning and Testing Provides precision cleaning of components and systems; refurbishment of components; decontamination of hypergolic components and systems; proof and functional testing of components; and hydrogen peroxide passivation of parts.
- k. Materials Testing Provides capability for evaluation of plastics, elastomers, coating, metals, lubricants, and composites. Testing of the compatibility of these materials with oxygen and other fluids is also provided.
- l. Environmental Testing Performs both climatic and dynamic tests on components and systems. Conditions that can be simulated are: vibration, shock, acceleration, temperature, humidity, vacuum, pressure, and spray.
- m. Failure Analysis Provides a team of investigative specialist to meet the launch site requirements for investigative services, and operates and maintains a diversified and comprehensive laboratory and equipment facility. Included in this capability are metallurgical, electronics, and mechanical systems/fluids laboratories. (Ref. Capability Manual #GP-1032.)
- n. Microchemical Analysis Performs non-routine qualitative and quantitative chemical analysis of gases, liquids, and solids. A variety of spectrometric, chromatographic, and other instrumental methods as well as classical wet chemistry techniques are available for analyzing large down to microscopic samples.
- o. Developing Testing Provides a capability for development and fabrication of mechanical and electrical/electronic hardware, including "make work" type modifications. A wide ranging capability of electrical, electronics, mechanical wood-working, metalworking plastics technology, fabrication and system testing is available.

5.3.11 Photography. The following engineering photography services are available:

- a. General Provides filmed records of damaged components, wiring, mechanical and hydraulic configurations, etc.
- b. Documentary Provides photographic coverage of Shuttle/payload test and checkout (on an as required basis) and a filmed record of launch countdown and launch i.e., sequential events, attitude of Shuttle during liftoff, etc.

5.3.12 LRU Maintenance. Provides the capability to perform scheduled and unscheduled (off-line) LRU maintenance (i.e., modifications, repairs, revalidation, etc.).

SECTION VI SAFETY

6.1 GENERAL

The primary safety requirements document for STS Payloads is the "Safety Policy and Requirements for Payloads Using the Space Transportation System" published by NASA Headquarters, dated June 16, 1976. The safety requirements imposed by this handbook include KSC's implementation of this NASA Headquarters Document, and additional requirements which are unique to ground operations and GSE design. In the event of conflicts between this Handbook and the NASA Headquarters Document, the NASA Headquarters Document shall take precedence.

6.1.1 Safety Requirements at Launch Site. The Kennedy Management Issuance System is the method for imposing safety requirements at a launch site. This Issuance System includes KMIs, KHBS, and KSC Standards. The salient requirements from the Kennedy Management Issuances have been extracted and are included herein. The STS User is responsible for obtaining copies of the Kennedy Management Issuances listed in Appendix E which pertain to safety, if they are required for payload and GSE design or ground operations planning purposes.

6.1.2 Objectives. The objectives of the launch site safety program are to:

- a. Assure safety of personnel during their work at the launch site.
- b. Avoid accidental work interruptions.
- c. Prevent damage to property, supplies, and equipment.
- d. Assure proper protection of the public from hazards introduced by the space programs.
- e. Provide data whereby risks and loss factors in space technology can be evaluated.
- f. Provide design requirements and criteria for Payload Ground Support Equipment (see SW-E-0002).

6.2 RESPONSIBILITIES

6.2.1 KSC Director, Safety, R&QA, and Protective Services (SF). The Director, SF, has the responsibility for adequacy of safety planning and final authority on all matters of safety during NASA operations on KSC, CCAFS, or VAFB; however, his responsibility on CCAFS or VAFB do not abrogate the overall safety responsibility of the Commander of those installations.

The Director, SF, defines the launch site safety requirements and establishes procedures for implementation of these requirements.

6.2.2 Payload Owner/Operator. The STS User is responsible for the following, and for applying the provisions of the KSC Safety Program.

- a. Maintaining surveillance of operations in its assigned areas for detection and correction of unsafe practices and conditions.
- b. Coordinating with the KSC Safety Operations Office (SF-S00) on all matters pertaining to accident prevention.
- c. Submitting the required safety data (See paragraph 6.4.3).
- d. Ensuring that employees are provided with and use safety clothing and equipment necessary for their protection.
- e. Designating a Safety representative.

6.2.3 Operations. NASA operations on CCAFS or WTR areas, including those on NASA facilities located in those areas, will be conducted in accordance with local United States Air Force (USAF) safety regulations. However, STS personnel will ensure that such operations are conducted within the framework of the KSC Safety standards, referring any conflicting KSC or USAF safety procedures to the Chief, Safety Operations Office for resolution.

- a. The KSC Safety Operations Office (SF-S00) will perform safety surveillance of all NASA operations at KSC, VAFB, or CCAFS areas, including the "high Hazard" operations. These surveillance activities will be coordinated with USAF representatives to prevent duplication of effort and needless exposure of safety personnel. Such surveillance will be conducted as frequently as necessary to ensure that joint KSC and USAF safety measures are adequate.
- b. The KSC Safety Operations Office (SF-S00) will review operational procedures and design specifications for all NASA operations and facilities for compliance with NASA policies and procedures.
- c. The Director, SF, may allow a variance from normal operation by the issuance of an exemption, waiver, or authorized deviation. A record of all exemptions, waivers, and authorized deviations will be maintained by the Safety Operations Office and will be made available to all personnel with a need for the information.

6.3 OPERATIONAL SAFETY

6.3.1 Personnel Safety.

- a. The primary reason for having a safety program is to prevent the injury or death of personnel involved in operations where any hazard exists. A secondary reason is to prevent the destruction of property.
- b. All Government agencies have been directed to develop, support, and foster organized safety and health promotion in order to reduce the number of accidents and injuries to employees, encourage safe practices, and eliminate work hazards and health risks.

- c. All safety documents and operating procedures for hazardous operations issued by KSC or organizations using the facilities of KSC, including associated contractors, will include adequate personnel precautions.

6.3.2 Training, Certification and Medical Requirements.

- a. Certification that employees are trained and qualified for each hazardous system they work on is required. A brief summary of the training/certification program will be supplied to KSC Safety Operations.
- b. Specific safety training which is given at KSC is required for employees entering areas where hazardous operations are performed or where hazardous materials are present. Facility orientation, toxic propellants, protective breathing apparatus, and radioactive materials are examples and may be scheduled through the Launch Site Support Manager.
- c. Crane operators training, which is given at KSC is required for all employees operating KSC cranes/hoists.
- d. Propellant handlers are required to have up-to-date physical examinations which meet the requirements of KSC Biomedical Office. The examining requirements may be obtained from the KSC Biomedical Office, and the individual examination records must be furnished KSC Medical for review.

6.3.3 Accident Prevention. KHB 1710.2/SF, "Kennedy Space Center Safety Practices Handbook," contains minimum safety standards which must be put into practice to prevent the occurrence of accidents at KSC. The standards contained in this handbook are designed to cover average conditions and do not cover all exigencies that could occur in as broad an area as that covered by NASA operations. Subjects covered are accident prevention; shop safety (general, battery shop, welding, machine shop, paint shop, electrical and tool), construction and maintenance; health hazards and protection; material handling; fire prevention; pressure systems; motor vehicles; life support equipment, and electrical facilities, electronic equipment and radiation hazards. Specific safety operating procedures for hazardous operations, evacuation procedures and special safety requirements which pertain to a facility/area are found in the Facility/Area Ground Safety Plans. These plans will be furnished to the STS Users to aid in preparation of operating procedures.

6.4 SYSTEM SAFETY

System Safety requirements are described in paragraph 5.2 of the NASA Headquarters Document, "Safety Policy and Requirements for Payload Using the STS." Payload Ground Support Equipment (GSE) shall be designed fail safe; i.e., such that credible failure modes do not result in a hazard to personnel or to flight equipment. JSC Specification SW-E-0002, GSE General Design Requirements, shall be used to meet KSC safety requirements.

6.4.1 Safety Analysis. Specific safety analysis will be performed for each STS payload for ground and flight operations. JSC will perform the flight operations analysis and KSC will perform the ground operations analysis. KSC's ground operations analysis will include safety analysis of payload peculiar GSE design and operation, as well as the ground equipment and operations interfaces with the flight systems.

6.4.2 Safety Assessment Reviews. KSC safety reviews will be conducted at ground operations meetings called by the LSSM. These reviews, held for each payload and mutually planned with the NASA Center responsible for the experiment, payload or mission, will provide the necessary information for the KSC Safety Review Board to review and approve the payload GSE design, the payload/GSE/Orbiter interfaces, and overall ground operations. Data required at these reviews includes the Safety Compliance Data required in paragraph 6.4.3 plus other detail design, operation, and descriptive data. This other data shall consist of drawings, schematics, assembly and handling procedures, etc. A minimum of two ground operations reviews are planned. Specific schedules for these reviews will be determined on a payload by payload basis. The launch readiness review at KSC will include final assessment and disposition of all open safety issues and residual hazards.

6.4.3 Safety Compliance Data

6.4.3.1 Safety Compliance data, together with a certificate of safety compliance signed by the payload developer (see KMI TBD), shall accompany the payload and payload GSE when delivered. Three copies of this data is required for KSC Safety Operations, SF-S00. This data shall consist of the following:

- a. A safety assessment report, which documents the results of hazard analyses, including hazard identification, classification and resolution.
- b. Approved waivers to safety requirements.
- c. A listing of nonmetallic materials which are used in habitable pressurized environments and do not meet the requirements of NHB 8060.1A with test results or analysis which verify them safe for flight.
- d. A listing of radioactive materials by element, isotope, quantity and emission. Data submitted for radioactive material and radioactive material use requests, will be in accordance with KHB 1860.1 "Radiation Protection Handbook", and is required 6 months prior to hardware arrival of the launch site.
- e. A list of equipment capable of generating hazardous radiation (x-ray, radio frequency, etc.).
- f. "Certificate of Compatibility" of fluids used in the cleaning, test and operation of pressure vessels.
- g. A record of all safety related failures or accidents related to payload processing, test, and checkout, including an assessment of their potential impact to STS, elements of STS and to ground safety, together with action taken to prevent recurrence.

- h. Adequate data to assure compliance with safety requirements for payloads to be reflown.
- i. Listing of tests and/or analyses performed to show verification of the related safety requirements.
- j. Inspection certification for those safety requirements to be verified by inspection.

6.4.3.2 Data on payloads and payload peculiar GSE processed in CCAFS facilities, must meet the submittal requirements specified in AFETRM 127-1, "Range Safety Manual, Vol. 2."

6.4.4 Technical Operating Procedures. Technical operating procedures shall conform to KMI 1710.13, "Safety Review of Technical Operating Procedures". Format requirements for these procedures are contained in KHB 8610.4, "Operations & Maintenance Handbook." All technical operating procedures are required to be available at the launch site at least 30 days prior to first use. Some may be required much earlier, depending on the type of activity involved, see paragraph 6.4.3.1,d. and KHB 8610.4.

6.5 HAZARDOUS OPERATIONS

Section 3 of this handbook describes activities involved in the development of ground operations for processing of payloads at KSC. Comparison of the selected ground operations plan with the following list of hazardous operations should provide a guide to identify those portions of the work flow where specific and potential hazards may be present.

Hazardous Operations are activities which could result in damage to property or injury to personnel because it involves either singly or in combination, but is not limited to, the following:

- a. Working Area/Environment: Any operation requiring personnel to work in an enclosed or possibly hostile area such as proximity to pressure vessels, or any area in which the environment deviates from normal atmosphere (e.g., chemical composition, pressure, temperature, location, or combination thereof). This category includes the confinement of personnel within a closed spacecraft.
- b. Explosive Ordnance: Any operation involving the handling, transportation, installation, removal, closeout, or checkout of ordnance devices and any operation or checkout of an ordnance system after ordnance items have been installed or connected.
- c. Propellants: Any operation involving propellant loading, unloading or flow, hookup or disconnect, movement of loaded storage units, or opening of contaminated systems. This includes solid, liquid, hypergolic, or cryogenic propellants.
- d. Cryogenics: Any operation involving cryogenic loading, unloading, flow, hookup or disconnect, movement of loaded storage units, or repair of a system containing cryogenics.

- e. Handling: Any operation involving the hoisting, loading, or transporting of a payload flight item or GSE or other equipment of significant size or weight.
- f. Radiation:
 - (1) Ionizing Radiation: Any operation using an ionizing radiation source or radiographic equipment.
 - (2) RF Radiation:
 - (a) Any operation producing more than 10 milliwatts per square centimeter average power if the area of radiation can be entered by humans.
 - (b) Any operation producing 5 watts or greater per square centimeter peak power density at fuel transfer locations.
- g. Toxic/Combustible/Corrosive: Any operation involving hazards of significant risk in the use of toxic, combustible or corrosive liquids, gases or materials such as mercury, acids or solvents.
- h. Pressure: Operations involving the pressurization of pressure vessels (see paragraph 6.6.3).
- i. Electrical: Any operation involving an electrical hazard of significant risk because of the nature of the operation or the equipment involved.
- j. Other: Any operation not identified above which could endanger personnel and/or hardware (e.g., other high energy sources, work at heights, etc.).

6.6 SAFETY REQUIREMENTS

The wide variety of hazards which may endanger the safety of personnel and equipment involved in payload operations at KSC demands the establishment of specific standards for compliance by all personnel. These safety requirements are issued by the Director, SF (as indicated in paragraph 6.2.1), and are contained in Kennedy Management Instructions (KMIs), Kennedy Handbooks (KHBS, SPs and GPs) and Safety Standards (KSC-STDs). The following sections will briefly describe the salient features of the documents containing safety requirements pertaining to the several hazardous operations listed in paragraph 6.5. When performing operations within the scope of the hazards described you are responsible to become more familiar with the applicable safety requirements in order to reduce to a minimum or eliminate those conditions that could cause injury to personnel or damage to hardware or facilities. You are invited to make maximum use of the services of the KSC Safety Office for applicability or interpretation of safety requirements, for the review of design data and operating plans, and for discussion of all safety aspects of work tasks at KSC to assure minimum risk.

6.6.1 Propellants and Explosive Safety. Propellants are explosive, corrosive, toxic, or flammable, or combinations thereof. They require the establishment of explicit safety procedures and enforcement methods to ensure proper handling, storage, use, decontamination, or disposal. Individual safety parameters will be established for each operation to ensure that all necessary precautionary measures are taken by operating or support personnel, such as safety training, area familiarization, the use of protective clothing, and the use of approved procedures for storage, loading, transfer, testing, and disposition of propellants. Propellants safety requirements are contained in AFM 161-30, Vol. II, "Liquid Propellants" and AFM 127-100, "Explosive Safety."

6.6.2 Pressure Systems Safety.

- a. Pressure systems, due to stored energy, or because of the fluid contained within the system, pose potential hazards to personnel. Pressure system, and other GSE design requirements, are contained in SW-E-0002, "Space Shuttle Program Ground Support Equipment General Design Requirements." An operational requirement for all ground operations involving work on pressure systems is that they shall be depressurized before disconnection, repairs, or replacements are attempted. Pressure systems shall be considered hazardous until it is firmly ascertained that pressure has been released. Any pressurization exceeding 25% of design burst of any tubing, fittings, or other components excluding pressure vessels is considered hazardous.
- b. A pressure vessel as defined for KSC operations is any device containing a compressed fluid or gas with an energy equal to or exceeding 14.250 foot-pounds (0.01 pound TNT equivalent) based on the adiabatic expansion of a perfect gas. Special operational controls are required during pressurization of flight vessels until the system pressure has stabilized. These controls may be in the form of personnel clearance, remote pressurization, procedure control, etc. Two different approaches are used in designing flight pressure vessels. One is known as the fracture mechanics approach; the other is the factor of safety approach. Either approach is acceptable to KSC; however, the definition of an operational hazard is slightly different.
 - (1) Flight pressure vessels controlled by fracture mechanics are defined as:
 - (a) First pressurization exceeding 25% of design burst.
 - (b) Any pressurization above initial pressurization or above maximum design operating pressure.
 - (c) Any pressurization cycle which exceeds the design operating cycle life.
 - (d) Any pressurization exceeding 25% of design burst when the vessel contains hazardous fluids.

- (2) Hazardous operations associated with flight pressure vessels controlled by the factor-of-safety approach are defined as:
 - (a) First pressurization exceeding 25% of design burst.
 - (b) Any pressurization exceeding 25% of design burst for vessels containing hazardous fluids.
 - (c) Any pressurization exceeding first pressurization or 50% of design burst.

6.6.3 Flex Hoses. See SW-E-002 for design, securing & identification requirements.

6.6.4 Radiation Safety. See KHB 1860.1, Ch. 2 for Ionizing and RF Radiation.

- a. Ionizing Radiation. It is the policy of KSC to exercise centralized control over authorizations for exposure to ionizing radiations and the approval of operating procedures to ensure that exposure of personnel to ionizing radiation is restricted and kept as low as practicable. Safety requirements for the radiation protection program at KSC are contained in KMI 1860.1/IS, "Radiation Safety - Policies and General Procedures"; KHB 1860.1/IS, "Radiation Protection Handbook".

The payload operator is advised to become familiar with the requirements of KHB 1860.1 prior to shipment of any radioactive materials or radiation producing equipment to KSC.

- b. Microwave or Radio Frequency (RF) Radiation.

- (1) Liquid or gas fuels shall not be transferred within the maximum energy range (calculated or measured) of 5 watts per square centimeter peak power density of RF radiating equipment.
- (2) Personnel are not allowed to enter an RF radiation area exceeding 10 milliwatts per square centimeter average power.
- (3) RF silence will be directed for specific phases of operation, installations of electro-explosive devices, and during other hazardous operations. The test supervisor will notify the Systems Safety Supervisor that RF silence exists.

6.6.5 Handling. "Handling" at KSC generally refers to operations involving the use of overhead cranes or other hoisting devices with ground support equipment slings of wire, chain, brackets and/or beams to lift or transport heavy and/or valuable items of hardware. The hazards associated with these operations are:

- The load falling on or striking a person or another object causing injury or damage.
- A tool or component falling off the crane or load striking a person or causing injury.

- A part of the sling, lifting assembly or load breaking off with resultant high velocity due to the application of lifting force and striking a person causing injury.
 - Movement of the load striking a person or other material and causing injury or damage.
- a. Lifting Operations. To protect personnel from the dangers of hazardous lifting operations, a minimum radius centered on the lifting hook is cleared of non-essential personnel. Tag lines are attached to the load to assist in steadying it and all personnel in the work area are required to wear hard hats equipped with chin straps. In addition, a representative of the KSC Safety Operations Office (SF-S00) is required on the scene to authorize commencement of hazardous lifting operations.
- b. Proof tests. The Using Agency, on all equipment in its jurisdiction, shall perform periodic proof load testing and maintain a current historical records file, including the following information:
- (1) Drawing number and part number of the devices.
 - (2) Manufacturer.
 - (3) Fabrication date.
 - (4) Date of last proof load test.
 - (5) Date of rework or repair.
 - (6) Date of magnaflux, X-ray or penetrant dye check.
 - (7) Quality control verification inspection.
 - (8) Maximum safe working load if available.
- c. Proof Testing Requirements. Equipment which has been proof tested elsewhere and transported to KSC may be used without further proof testing under the following conditions:
- (1) Proof test documentation record is submitted to the KSC Safety Operations Office at least 30 days prior to first intended use date.
 - (2) Verification by KSC Safety Operations Office that documentation shows proof testing to the minimum requirements within the time period specified in paragraphs 4.6.1.2 and 4.6.1.3(c) has been accomplished and that all equipment/components are contained in the documentation.
 - (3) Inspection of equipment shows no evidence of damage, deterioration, or corrosion.
 - (4) All wire slings, hooks, eyebolts, wire ropes, and other rigging gear will be tested at 200 percent of rated lifting capacity. Each item must pass the test prior to placing in service, thereafter an annual test to maximum lifting load design is required.

- (5) Natural and synthetic fiber rope slings shall not be proof tested. In addition, a rigid inspection and maintenance routing is prescribed to assure the optimum safety in equipment usage. Payload contractors are encouraged to consult the KSC Safety Operations Office regarding the use of handling equipment as early in the design and operations planning phase as is feasible.
- d. Preventive Maintenance Inspection. KSC-STD-S-0001 - Preventive maintenance inspection will be performed in accordance with preventive maintenance work card requirements and approved technical operating procedures.
- (1) Crane operators will perform preoperation inspection and preoperation test prior to using equipment.
 - (2) Preventive maintenance inspection will be performed in accordance with preventive maintenance work card requirements and approved technical operating procedures.

6.6.6 Toxic, Combustible, Corrosive. The processing of hardware for space flight at KSC may involve potentially harmful chemicals. These chemicals may be used in large quantities as fuels or oxidizers or in small quantities as cleaning, degreasing or etching agents.

6.6.7 Electrical. The use of electrical power in launch site ground operations is a potential hazard to personnel and equipment. Significant hazardous conditions are: (1) Personnel hazards pertinent to electric shock due to (a) unit not being correctly grounded, (b) using power connectors not approved by OSHA or NEC, (c) exposed terminals, and (d) failing to remove power from connectors prior to connecting or disconnecting; (2) Personnel and equipment hazards due to human errors or lack of fail-safe design; (3) Personnel and equipment hazards due to ignition of gasses or vapors by electrically energized equipment.

Hazard proofing of electrically energized equipment will be in accordance with KSC Standard E-0002. This standard combines new techniques with accepted practices recognized by the National Electrical Code (NEC). It defines "Hazardous Areas" and describes approved methods of hazard proofing electrically energized equipment for all types of facilities at KSC. Hazards associated with the use of electrically energized equipment should be controlled or eliminated through careful attention to design, fabrication and application of appropriate factors in the Hazard Reduction Precedence Sequence.

SECTION VII DOCUMENTATION AND SCHEDULES

This Section describes payload related standard functions, the STS user supplied documentation, KSC developed documentation, and schedules for payload operations at the launch site.

A requirements checklist is presented in matrix form to assist STS Users during initial planning discussions with Launch Site Support Manager(s), and in the development of specific Payload Launch Site Requirements.

A typical schedule for launch site payload documentations is shown in Figure 7-1.

7.1 STANDARD FUNCTIONS

The functions described in paragraphs 7.1.1 through 7.1.12 are typical for the processing of any payload. The functions are defined to assist the STS User in the development of Payload Launch Site Requirements for a specific payload.

7.1.1 Transportation. Payloads may be transported to the launch site by any means deemed acceptable to the Payload User/Owner. KSC provides some transportation equipment, subject to a user charge, for transporting payloads from Payload User/Owner facility to KSC and from facilities on Cape Canaveral side to the KSC side, see KSC XXXX on (ITE). The launch site is capable of receiving payloads shipped by air, overland, or by water. However, the payload owner is responsible for transportation during off-line operations.

7.1.2 Receiving/Receiving Inspection. Receipt and physical inspection of the payload to verify its condition after transportation to the launch site is the responsibility of the STS User. Receiving inspection includes review of the documentation associated with the specific payload. Certain documentation will be required if the payload contains or involves hazardous materials (see Section VI on Safety Requirements).

7.1.3 Assembly. Assembly involves those operations necessary to build-up payload components/subsystems into module or element configurations. These operations are all conducted off-line. They may also be conducted off-site.

7.1.4 Functional Test. Tests performed in the Payload Processing Facility to verify spacecraft integrity, functional operation of components, subsystems and systems. These tests are conducted off-line and involve primarily GSE provided by the payload user.

7.1.5 Servicing. Servicing includes such tasks as propellant loading, battery charging/activation, film loading, installation of solid propellant motors, and explosive operation devices. Servicing functions are primarily conducted off-line. Many of the servicing functions involve hazardous operations and close coordination with KSC Safety must be maintained during these operations.

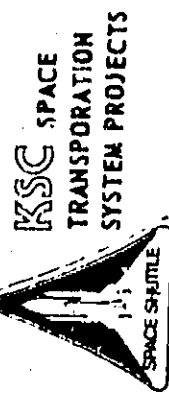

REQUIREMENTS DOCUMENTATION SCHEDULES

JOHNSON/SHARP

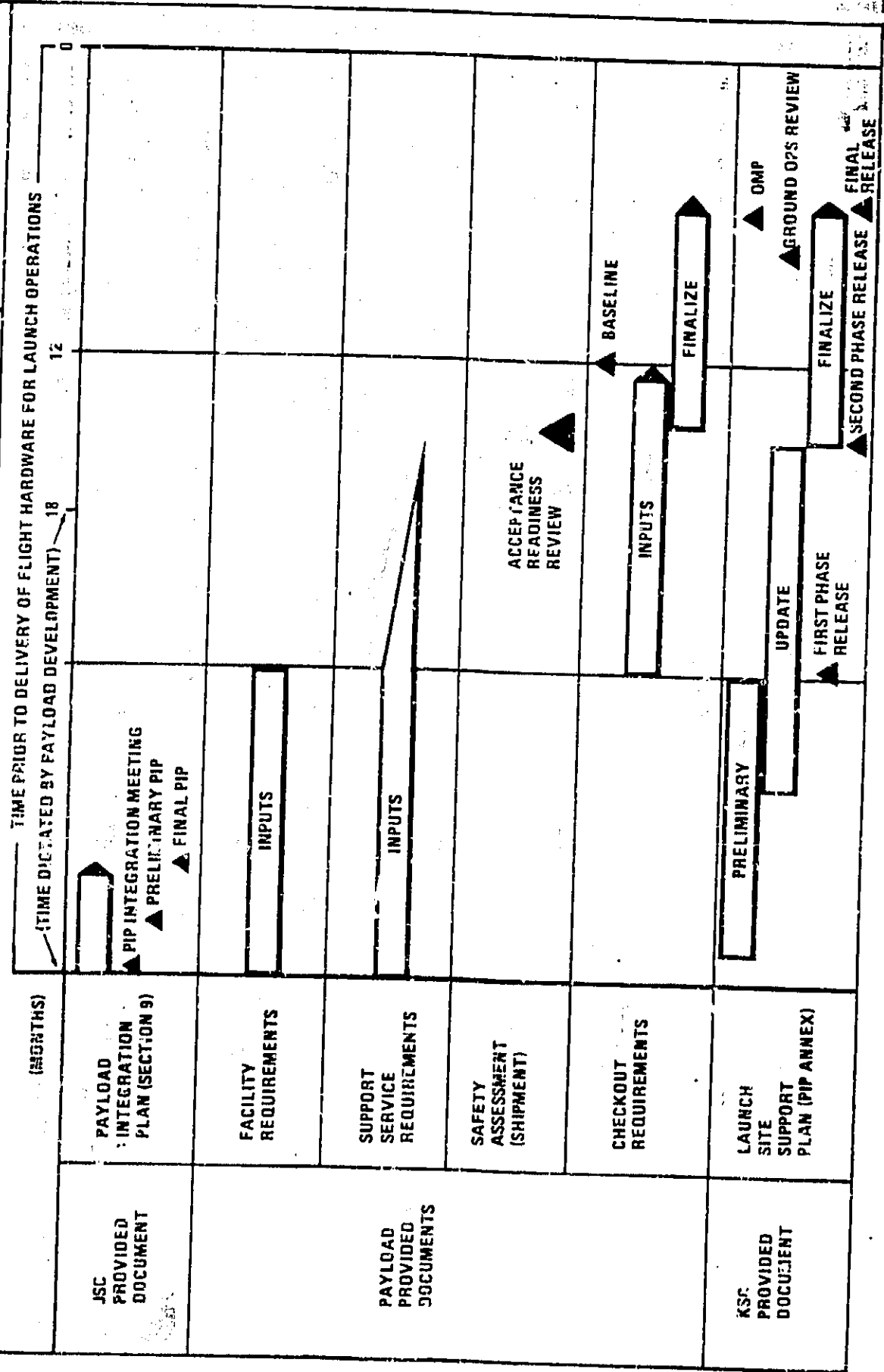

BSC 1306

Figure 7-1. Typical Schedule for Launch Site Payload Documentation

KSC FORM 12-83 (REV. 6/77)

7.1.6 Mate/Demate. Mating tasks involve physically connecting payload elements together to complete the cargo for a single Shuttle flight (e.g., pallets to core segments, payloads to upper stages, installing payloads or complete cargos into transport canisters). Demate operations involve the same operations as mating, except they are conducted for disassembly or post landing purposes. Most mating and demating operations are conducted on-line STS.

7.1.7 Payload/Cargo Integration. This integration operation verifies satisfactory operation of a complete Shuttle payload. The functional interfaces between payloads, and functional interfaces between the payload and a simulated Orbiter are verified during the operations. The Cargo Integration Test Equipment (CITE) is normally used to perform the cargo integration activity operations. These operations are always conducted on-line STS.

7.1.8 Orbiter to Cargo Integration. Installation of a cargo/payload in the Orbiter will occur in the OPF or at the launch pad. In either case, Orbiter integration testing will be accomplished to verify compatibility of the Orbiter with its installed cargo. Additional servicing and activation operations may take place during this period. Orbiter integration operations are always an On-Line Shuttle operation, and always terminate with the beginning of countdown for launch.

7.1.9 Launch Operations. Launch operations involve the countdown and launch operations. Only preplanned servicing operations can take place during the countdown.

7.1.10 Mission Operations. There are no routine or contingency in-flight operations expected to involve the Payload User/Owner organization at the launch site. Any required participation during the mission would have to be preplanned by the Payload User/Owner through the LSSM.

7.1.11 Refurbishment. Refurbishment involves activities associated with restoring a payload (element) to flight status for a subsequent mission. This could include off-site repair and modification and checkout as well as on-site maintenance, repair and checkout. The refurbished payload would re-enter a flow at the appropriate point in a subsequent flight.

7.1.12 Storage. Includes removal of perishable goods, addition of dessicants, protective covers, etc., to preserve the hardware during storage.

7.2 REQUIREMENTS CHECKLIST

A Payload Processing Requirements Checklist (Table 7-1) is presented in matrix form, and is intended to key typical processing requirements to standard functions. The checklist suggests requirements which may be imposed by STS User during launch site processing operations. Handbook references, which are keyed to typical requirements, are presented as an aid to the STS User(s).

Pertinent information relating to the STS User payload requirements should be entered on the checklist under the Function column opposite the Requirement(s). The completed checklist should be useful during initial planning discussions with the LSSM, and eventually would be incorporated in one of the STS User documents (or phased out, as applicable).

Table 7-1. Payload Processing Requirement Checklist (1 of 2)

| FUNCTION REQUIREMENTS | HANDBOOK REFERENCE | RECEIVING RECEIVING INSP | ASSY | SYS TESTING | SERVIC-ING | MATE DEMATE | PAYLOAD ORBITER U/F VERIF | POST LANDING OPS | REFURB | STOR | OTHER | REMARKS |
|------------------------------------------------------------------------------------------------------------------------------------------------------------|--------------------|--------------------------|------|-------------|------------|-------------|---------------------------|------------------|--------|------|-------|---------|
| WORK STATIONS AREA REQUIRED VERTICAL CLEARANCE NO. PERSONNEL REQUIRED SECURITY REQUIRED | SEC. IV | | | | | | | | | | | |
| HANDLING SIZE, WEIGHT OVERHEAD CRANE/HOOK HEIGHT SPECIAL REQUIREMENT | 6.5.5 TABLE 4.3 | | | | | | | | | | | |
| TRANSPORTATION NO. PIECES, SIZE, WEIGHT TYPE REQUIRED SPECIAL REQUIREMENT | 5.2.6 | | | | | | | | | | | |
| ELECTRICAL TYPE CAPACITY | 6.5.7 | | | | | | | | | | | |
| ENVIRONMENT TEMP/HUMIDITY CLEANLINESS LEVEL PURGE CLEAN ROOM REQUIREMENT | TABLE 4.3 | | | | | | | | | | | |
| PNEUMATICS TYPE PRESSURE FLOW RATE/DURATION CLEANLINESS/TEMP. | TABLE 4.3 | | | | | | | | | | | |
| FLUIDS TYPE QUANTITY FLOW RATE/CLEANLINESS LEVEL | 5.3.5 | | | | | | | | | | | |
| HAZARDOUS OPERATIONS PROPELLANT HANDLING ORDNANCE/EXPLOSIVES PRESSURIZATION RADIATION HANDLING TOXIC/COMBUSTIBLE/CORROSIVE ELECTRICAL | 5.3.5 SEC. VI | | | | | | | | | | | |
| COMMUNICATIONS TELEPHONE TELETYPE/DATA/FAX/ECT. RADIO FREQUENCY OIS WIDEBAND | 5.3.3 | | | | | | | | | | | |

Table 7-1. Payload Processing Requirement Checklist (2 of 2)

| FUNCTION REQUIREMENTS | HANDBOOK REFERENCE | RECEIVING RECEIVING INSP | ASSY | SYS TEST | SERVIC- ING | MATE- RELATE | PAYLOAD ORBITER I/F VERIF | POST LANDING OPS | REFURB \$TOR | OTHER | REMARKS |
|--------------------------------------------------------------------------------------------|--------------------|--------------------------|------|----------|-------------|--------------|---------------------------|------------------|--------------|-------|---------|
| INSTRUMENT CALIBRATION & REPAIR | 5.3.4 | | | | | | | | | | |
| LPS MONITOR & CONTROL | 4.8 | | | | | | | | | | |
| LOGISTICS SUPPLY & SUPPORT TYPE SERVICE LOAN TOOL CRIB LOAN TEST EQUIPMENT POOL | 5.2.3 | | | | | | | | | | |
| CENTRAL OFFICE AREA | 5.2.1 | | | | | | | | | | |
| NON-DESTRUCTIVE TESTING CHEMICAL SAMPLING LEAK TESTING (MASS SPEC) X-RAY OTHER | 5.3.8 | | | | | | | | | | |
| OPERATIONAL TELEVISION | 5.3.3 | | | | | | | | | | |
| PHOTOGRAPHIC REQUIREMENT | 5.2.9 5.3.11 | | | | | | | | | | |
| PROTECTIVE CLOTHING TYPE QUANTITY | 6.6.1 | | | | | | | | | | |
| REPRODUCTION | 5.2.11 | | | | | | | | | | |
| SPECIAL FACILITY SUPPORT | SEC. VIII | | | | | | | | | | |
| TELEMETRY GROUND STATION | 5.3.4 | | | | | | | | | | |
| TIMING | 5.3.4 | | | | | | | | | | |
| SUPPORT EQUIPMENT UNIQUE PAYLOAD SUPPLIED MMSE | 4.6 4.7 | | | | | | | | | | |
| OTHER | | | | | | | | | | | |
| NEXT OPERATION | | | | | | | | | | | |

7.3 STS USER SUPPLIED DOCUMENTATION

STS Users will be required to submit requirements for processing their payload at the launch site. Information, even though not complete, is desirable at the earliest possible date, particularly when a long lead time will be needed to provide support. As requirements develop, the original input is revised, and submitted as a revision to the basic requirements. As indicated in earlier sections of this handbook, the process of refining payload requirements and matching them to launch site capabilities is an iterative one handled between the LSSM and STS User Organization.

A description of the documentation required from the STS User is listed in paragraph 7.3.1 through 7.3.7. They may be combined into an Integrated Payload Requirements Document, if desired.

7.3.1 Facility Requirements. Early determination of facility requirements for each individual payload project is necessary for efficient operations at the launch site. This determination should be initiated in the conceptual phase of project planning. A lead time of up to 5 years is required when major new construction is contemplated (see paragraph 7.3). The STS User payload facility requirements will be evaluated by the Payload Launch Site Support Manager. Areas will be assigned to the STS Users that make optimum use of existing facilities which are adequate for the required task. If no such facility exists, or if modifications are required, a facility will be selected that is best suited for the task and which requires the least modification. When STS User facility requirements necessitate major modifications to existing buildings or the construction of a new facility, the STS User will assume funding responsibility. Coordination meetings will be held with STS User and launch site personnel to assure that all requirements have been met. Payload requirements in regard to the launch complex or on-line Shuttle facilities are coordinated and integrated by the appropriate Launch Site Payload Support Manager. On-line Shuttle requirements will be processed thru the appropriate STS Program by the launch site organization.

7.3.2 Payload Ground Operations & Checkout Procedures (Off-Line). The Off-Line payload ground operations and checkout procedures should be prepared by the STS User organization, to serve as the controlling and work authorization document for each test operation.

- a. The procedures should define, chronologically, the detailed step-by-step sequence of events in the performance of each specific test or operation leading to results accomplishing specified objectives.
- b. Although Off-Line operations and test procedures do not have to conform to the same content and format as On-Line procedures, the KSC Safety requirements still apply. For example, STS User Off-Line Procedures must be reviewed by the KSC Safety organization, and the identification of Hazardous Operations must comply with Appendix B. The recommended format for off-line ground operations and checkout procedures is presented in Table 7-2.

Table 7-2. Typical Format for Procedure(s) Contents

- FRONT MATTER
- SECTION I, PRE-OPERATION SETUP INSTRUCTIONS
- SECTION II, OPERATION INSTRUCTIONS
- SECTION III, POST-OPERATION INSTRUCTIONS
- APPENDICIES:
 - APPENDIX A, DATA SHEETS
 - APPENDIX B, EMERGENCY INSTRUCTIONS

FRONT MATTER

Includes cover page, approval page/change page, page showing total pages in procedure, table of contents, illustrations, tables, schedule of activities (bar chart), referenced instructions, computer programs, special tools/equipment/materials, support tools/equipment/materials, personnel/safety requirements, and special instructions.

SECTION I – PRE-OPERATION SETUP INSTRUCTIONS

Includes step by step instructions to establish the required test configuration. Also includes setup of additional equipment required for test.

SECTION II – OPERATION INSTRUCTIONS

Includes step by step instructions for each major division of work.

SECTION III – POST-OPERATION INSTRUCTIONS

Includes step by step instructions for securing of systems and equipment. Also includes instructions for standby or tear-down of test setups, if required.

APPENDIX A – DATA SHEETS

Includes the data sheets used to record test data (for multiple runs of the same instruction). Also used to record data developed through analysis after completion of test, and to record data which is required but was not available during the actual test.

APPENDIX B – EMERGENCY INSTRUCTIONS

Includes step by step instructions for compliance of safety requirements during emergencies, and which could arise during the particular test (e.g., Emergency Power Down, Emergency Drain).

7.3.3 Support Services Requirements. The anticipated support services that will be required during payload processing at the launch site should be identified, including the expected rate of usage. The requirements checklist in Table 7-1 and the Support Services capabilities described in Section V provide references for determining support requirements. STS Users should supply their support requirements in accordance with K-STSM-09.5, "KSC Support Requirements System," if at all possible. Receipt of requirements on standardized forms will eliminate the need for translation at KSC. The LSSM, supported by the Launch Site Support Team can provide assistance in identifying support requirements and completing the standard forms required for use at KSC. Regardless of how requirements are submitted, they should be transmitted to KSC as soon as they are identified.

7.3.4 On-Line STS Operation & Maintenance Requirements. STS User operation, maintenance & test requirements which affect the on-line STS must be provided to KSC. KSC will, after proper approval, incorporate these requirements into KSC generated Operation & Maintenance Instructions (OMIs). User requirements should be prepared & submitted in accordance with K-STSM-12.8 "STS and Associated Payloads Operations and Maintenance Documentation (OMD) Plan." The LSSM can assist in organizing your inputs into the format required by KSC's Operations & Maintenance Documentation System.

7.3.5 Design Specifications. Payload design specifications pertaining to the payload interfaces are required, to assure compatibility with STS hardware and launch operations.

7.3.6 Safety Data. Information and documentation involving the payload and payload unique GSE is required, to the extent specified in Paragraph 6.4, to confirm compliance with NASA Safety Requirements.

7.3.7 Other Launch Site Support Documentation. Documentation, as mutually agreed to, in the Launch Site Support Plan will be required to be submitted by the STS User, as specified in the Plan.

7.4 KSC DEVELOPED DOCUMENTATION

A description of the documentation developed by KSC and provided to the STS User is listed in paragraph 7.4.1 thru 7.4.3.

7.4.1 Payload Launch Site Support Plan (LSSP). The LSSP is the KSC response to the STS User requirements. It is the launch site commitment to provide specific facilities, support equipment, and support services to the STS User for a specified time period.

- a. The Table of Contents for the Plan is listed in Table 7-3.
- b. Section V will reflect those facilities assigned by KSC to the STS User for off-line payload operations, and where the integration with other flight elements will occur, see paragraph 7.3.1.
- c. Section VI responds to the STS User requirements by identifying the specific support which will be provided by the launch site host, see paragraph 7.3.3.

Table 7-3. Launch Site Support Plan -- Table of Contents

- I. INTRODUCTION
 - A. Purpose
 - B. Scope
- II. MISSION AND SPACECRAFT DESCRIPTION
 - A. Mission
 - B. Spacecraft and Major Systems
- III. GUIDELINES/ASSUMPTIONS
- IV. OPERATIONS
 - A. Off-Line
 - B. On-Line
 - C. Post-Landing and Refurbishment
- V. FACILITIES
 - A. Checkout Lab
 - B. Explosive Safe/Serviceing
 - C. Cargo Integration Test Equipment (CITE)
 - D. On-Line
- VI. SUPPORT REQUIREMENTS
 - A. Transportation
 - B. Handling Ground Support Equipment (GSE)
 - C. CITE
 - D. Launch Processing System (LPS)
 - E. Communications
 - F. Data
 - G. Security
 - H. Environmental Control
 - I. Propellants/Gases/Ordnance
 - J. Sampling and Analysis
 - K. Photographic Services
 - L. Radioactive Materials/Storage
 - M. Training
 - N. Documentation
 - O. Manpower
 - P. Safety
 - Q. Environmental/Occupational Health
 - R. Calibration
 - S. Power
 - T. Payload Support Equipment (PSE)
 - U. Payload Operations Control Center (POCC)
 - V. Mission Control Center (MCC)

7.4.2 On-Line STS Operation & Maintenance Documentation. On-line STS operations are controlled by KSC's Operation & Maintenance Documentation (OMD) System. Operation and Maintenance Instructions (OMIs) are prepared to control all on-line test and operations. These instructions contain detailed step-by-step procedures for performing each assembly, inspection, test, and operation. STS User requirements, supplied in accordance with paragraph 7.3.4, are included in these OMIs. KSC develops these OMIs in accordance with KHB 8610.4, "Operations and Maintenance Handbook." The following procedures are typical OMIs under KSC's OMD System:

- Integrated Test Procedures used during simulated Orbiter to cargo integration testing.
- Integrated Procedures for installing and verifying a cargo into the Orbiter.
- Countdown Manual.
- Recycle Procedures in case of a launch scrub.
- Post Landing Safing & Deservicing Procedures for both normal and aborted landing.

7.4.3 Schedules. The operational and modification schedules associated with STS payload operations at the launch site will become more specific as payload processing is defined, and will vary with the complexity and development time for various payloads.

7.4.3.1 Operational Schedules. Operational schedules are required to assist the STS User in providing required inputs for a payload to be incorporated into the overall Shuttle launch schedules. These schedules consists of two distinct timelines, namely an overall flow and working schedules.

- a. **Overall Flow** identifies the processing of a typical payload, from its arrival at the launch site to the launch of the Shuttle vehicle, and the post-landing operations (where applicable). The overall flow will show operations necessary to integrate the payload with other flight elements, and include simulated and actual interface verification. Scheduling and control of all on-line activities will be coordinated through the LSSM with responsible STS test management personnel.
- b. **Working Schedules** at the launch site will be two-week timelines, as illustrated in Figure 7-2. These schedules take a section of the Overall Flow and expand the detail to show all tasks planned and the required support during the two-week period. The first three days (of these schedules) are projected by shift/hour, and the last 11 days are utilized for planning purposes. Working schedules will be updated daily with coordination by all affected elements (i.e., payload(s), Orbiter, ET, SRB, Spacelab, etc.).

7.4.3.2 Modification Schedule. A modification schedule identifies those actions necessary to modify or alter an existing facility to support different payload requirements.

- a. The modification (or new construction) begins with a Preliminary Engineering Report (PER) which defines the requirements and capabilities of a particular facility for payload processing. Detail design, which may be contracted with an A&E concern, follows the PER.
- b. After design of the facility has been authenticated, the contract is awarded, thereby initiating the construction phase of the facility.
- c. The activation phase involves those actions necessary to outfit the facility, and validate its readiness to support payload processing.

Early identification for new or modified facilities requirements is essential. The STS User Need Date is critical for these requirements, because of lead times as long as five years (for design, construction, and activation).

SECTION VIII
VAFB UNIQUE OPERATIONS

8.1 GENERAL

Launch operations for the STS payload flights from the Vandenberg Air Force Base (VAFB) at the Western Test Range (WTR) are scheduled to begin in June 1983. The Vandenberg Air Force Base launch site will be activated for all polar launches. The payload requirements will cover the payload processing operations for both Automated Payloads and Spacelab Payloads beginning in 1982.

a. Responsibilities

- (1) The KSC/VAFB Program Liaison Office will be responsible for launch site support for all NASA and non-Department of Defense (DOD) payloads.
- (2) The United States Air Force (USAF) at VAFB will be responsible for the STS launches and DOD payloads.

b. Facilities. The siting arrangement of the STS facilities at VAFB is shown in Figure 8-1.

c. Ground Flow. The VAFB STS ground flow is shown in Figures 8-2a and 8-2b.

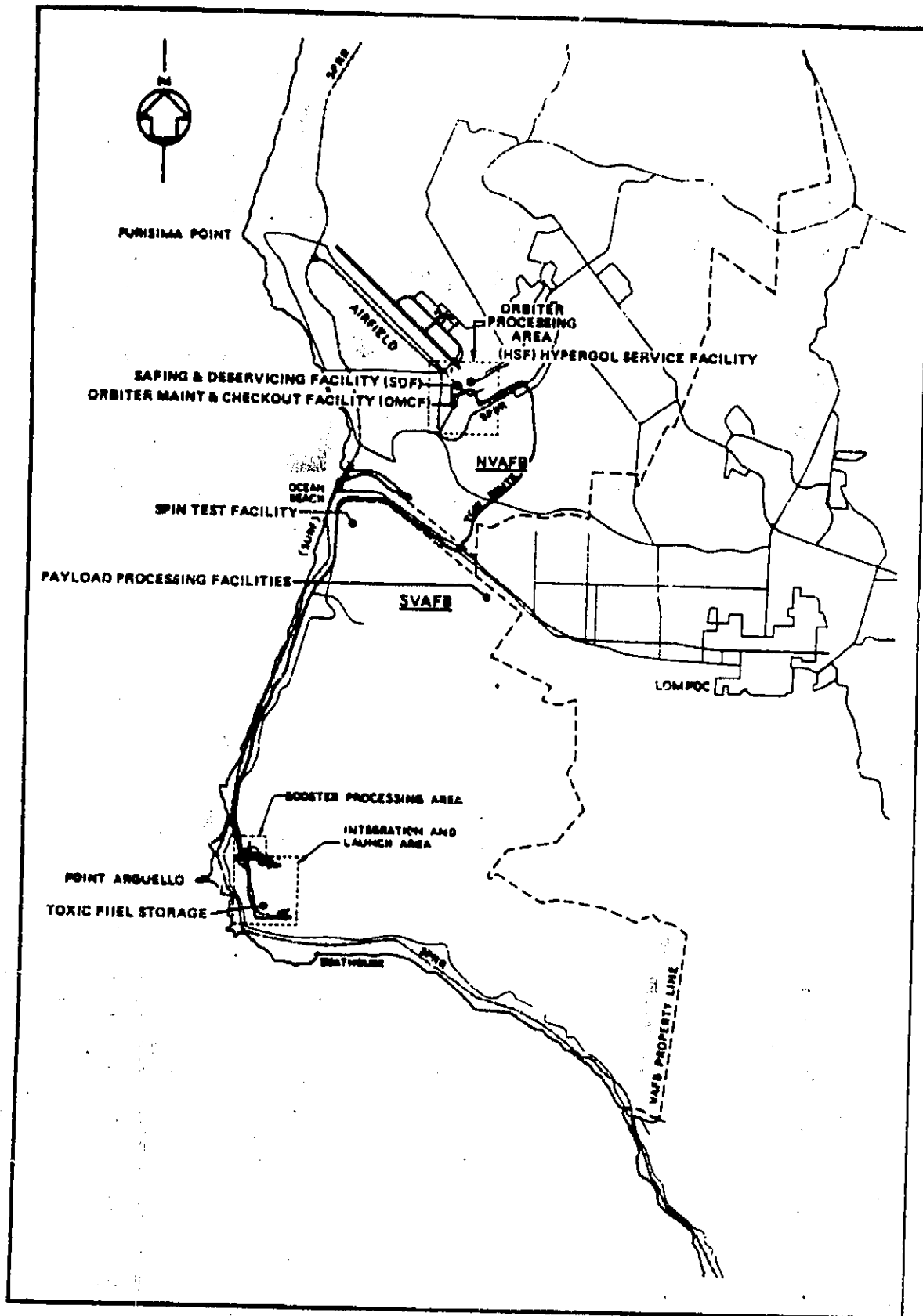

BSG 1195

Figure 8-1. VAFB STS Siting Arrangement

ORBITER PROCESSING

RUNWAY OPERATIONS
Secure Orbiter

HYPERSONIC SERVICE FACILITY

- Deserve AV & Modules
- Demate All RCS from OMS Pods
- Inspect, Service & Checkout OMS Pods
- Make All RCS & OMS Pods
- Inspect, Service & Checkout Fuel RCS
- Inspect, Service & Checkout API

SAFING & DE-SERVICING FACILITY

- Crew Removal
- Data Dump
- Ordnance & High Pressure Safing
- Remove OMS/RCS
- Propellant Drain

ORBITER MAINTENANCE & CHECK-OUT FACILITY

- Remove P/L & AV Rites
- Service Orbiter
- Install AV Ref & Decoding Module
- Install OMS/RCS & API Modules
- Orbiter System Check
- Install P/L Accommodation Rites

E.T. PROCESSING

TANK CHECKOUT FACILITY

- Receive & Inspect Tanks
- Checkout & Store Tanks

SRB PROCESSING

SRB DISASSEMBLY FACILITY

- Disassemble SRB
- Rinse & Apply Preservative
- Pack & Ship SRB Components
- Pack & Ship Parachutes

SRB RECEIVING & SUB ASSEMBLY FACILITY

- Receive & Inspect Segments, Closures, Skirts & Subassemblies
- Assemble & Test Recovery Section
- Assemble & Test Fuel & Air Sections
- Store Segments & Subassemblies

Point Inspection

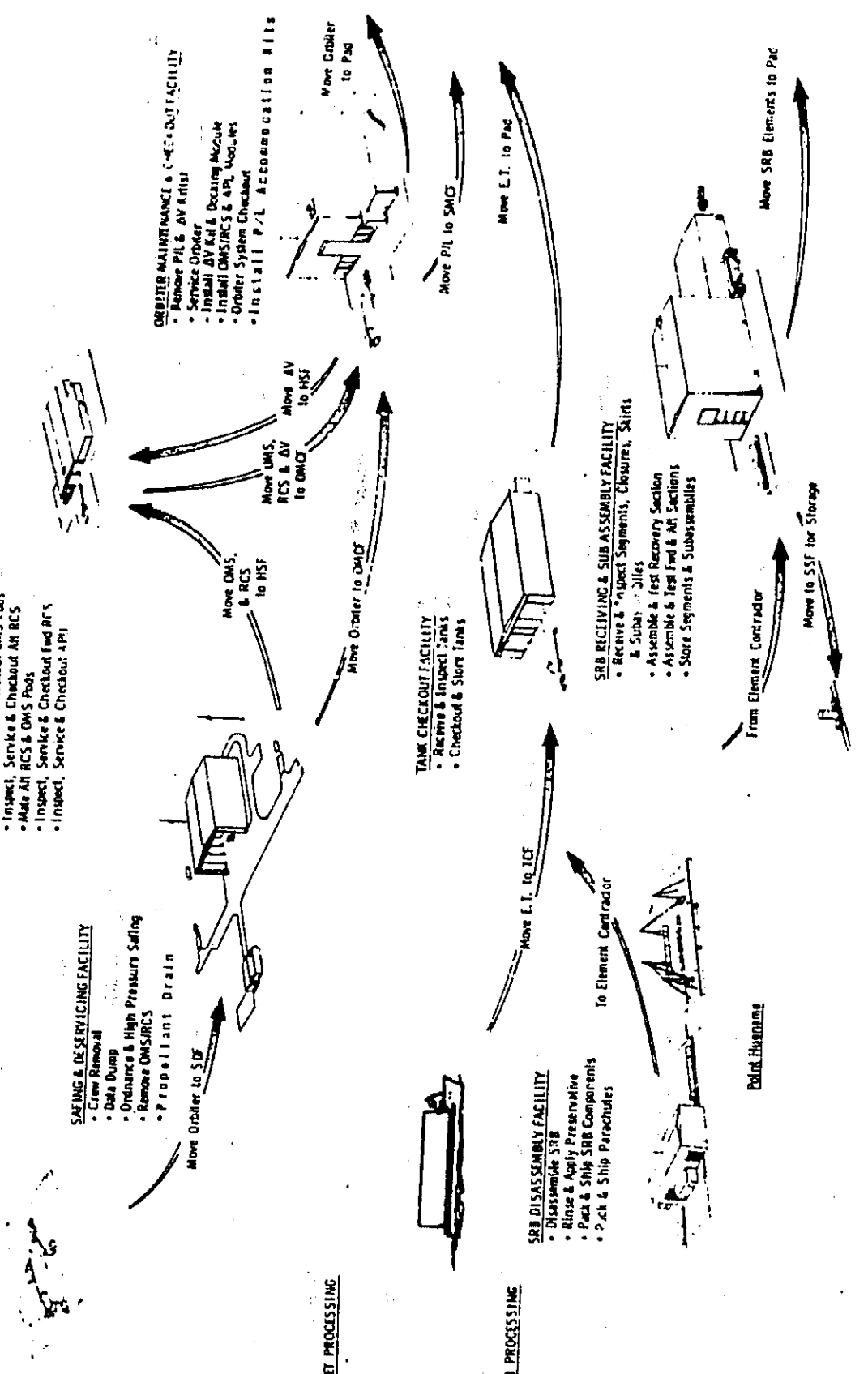

Figure 8-2a. VAFB STS Ground Flow (Sheet 1 of 2)

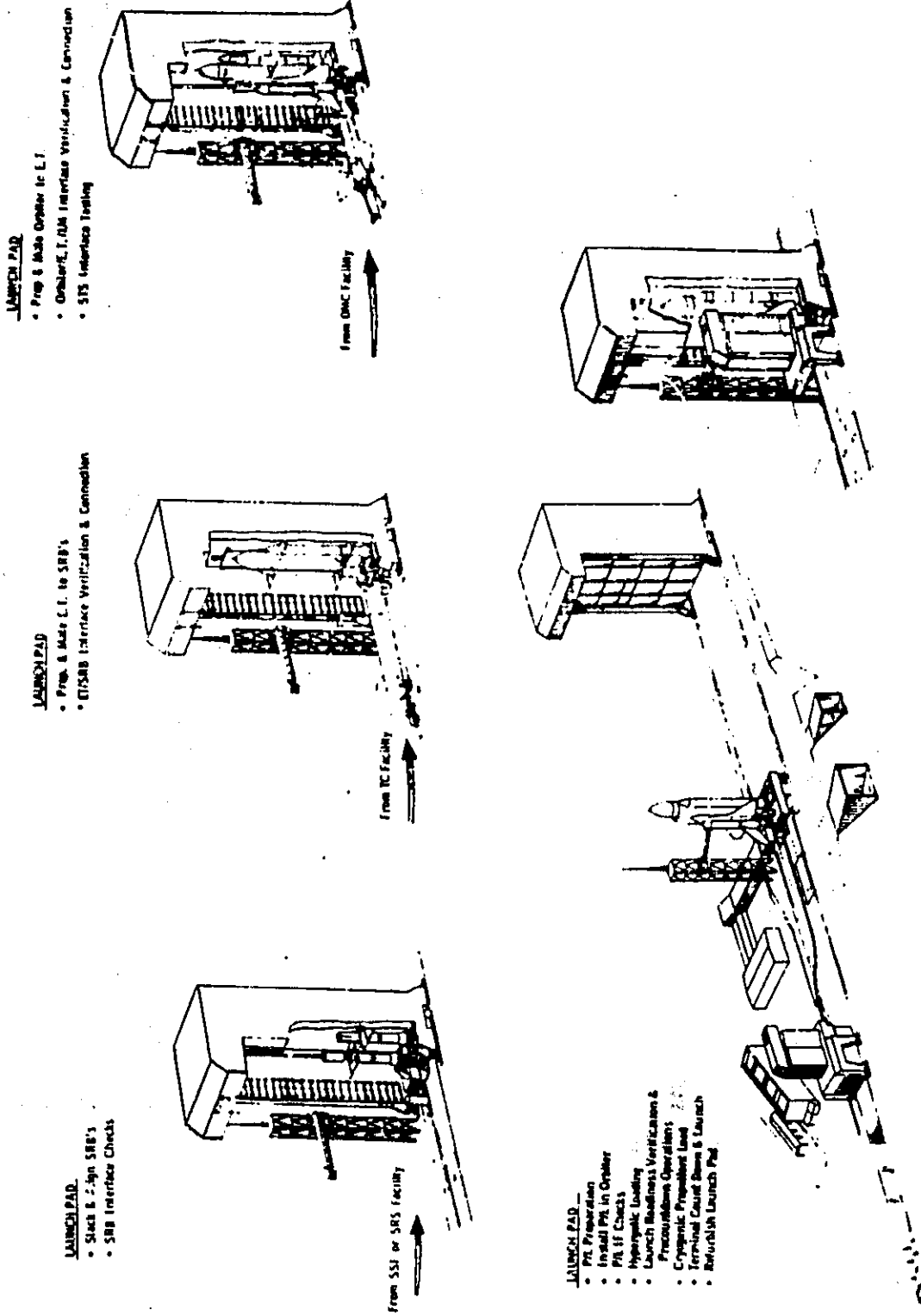

Figure 8-2b. VAFB Ground Flow (Sheet 2 of 2)

8.2 ON-LINE SHUTTLE OPERATIONS

The VAFB STS payload on-line Shuttle operations are very similar to those discussed in Section 3 for KSC. Only the differences between KSC and WTR are highlighted here. Combined STS/payload ground operations functional flow is shown in Figures 8-3a and 8-3b, and Figure 8-4 shows the VAFB STS Timeline.

8.2.1 Landing Activity. This phase of operations is identical to KSC (refer to Section 3).

8.2.2 Safing & Deservice Activity. This portion of the VAFB operation is similar to the KSC operation except that it occurs in a safing and deservicing facility located between the Landing Field and the Orbiter Maintenance and Checkout Facility (OMCF). (See Figure 8-2a). Returned payloads could be removed at this point in the flow if safety considerations preclude removal at OMCF.

8.2.3 Orbiter Maintenance and Checkout Activity. The Orbiter Maintenance and Checkout activity will be like that at KSC except that safing and deservicing will be accomplished in a separate facility as noted above. Payload installations at this point could be identical to those shown in OPF in Section 3, or would be conducted in the Payload Preparation Room/Payload Changeout Room (PPR/PCR) adjacent to the launch pad. In either case, Orbiter payload accommodation modifications (i.e. kit removal/installations) will be accomplished during this period.

8.2.4 Vertical Assembly Prelaunch & Launch Activity. After erection of the solid rocket boosters and the external tank on the launch pad mount, the Orbiter is towed to the pad, erected and mated to the ET/SRB combination. At this point, Space Shuttle Vehicle (SSV) to launch pad interfaces are connected and verified. The cargo, if not previously installed, would be installed at this point thru the PCR.

Vertical payload installation at VAFB is different than at KSC primarily due to the facility differences. At VAFB the payload may be delivered to the Launch Pad PPR (Refer to Section 8.4.3.4) where preparations for mating and checkout are completed. The cargo is then transferred to the PCR from the PPR. Operations to install the cargo using the PCR are very similar to those discussed for KSC in Section 3. Operations from this point are essentially identical to KSC launch operations.

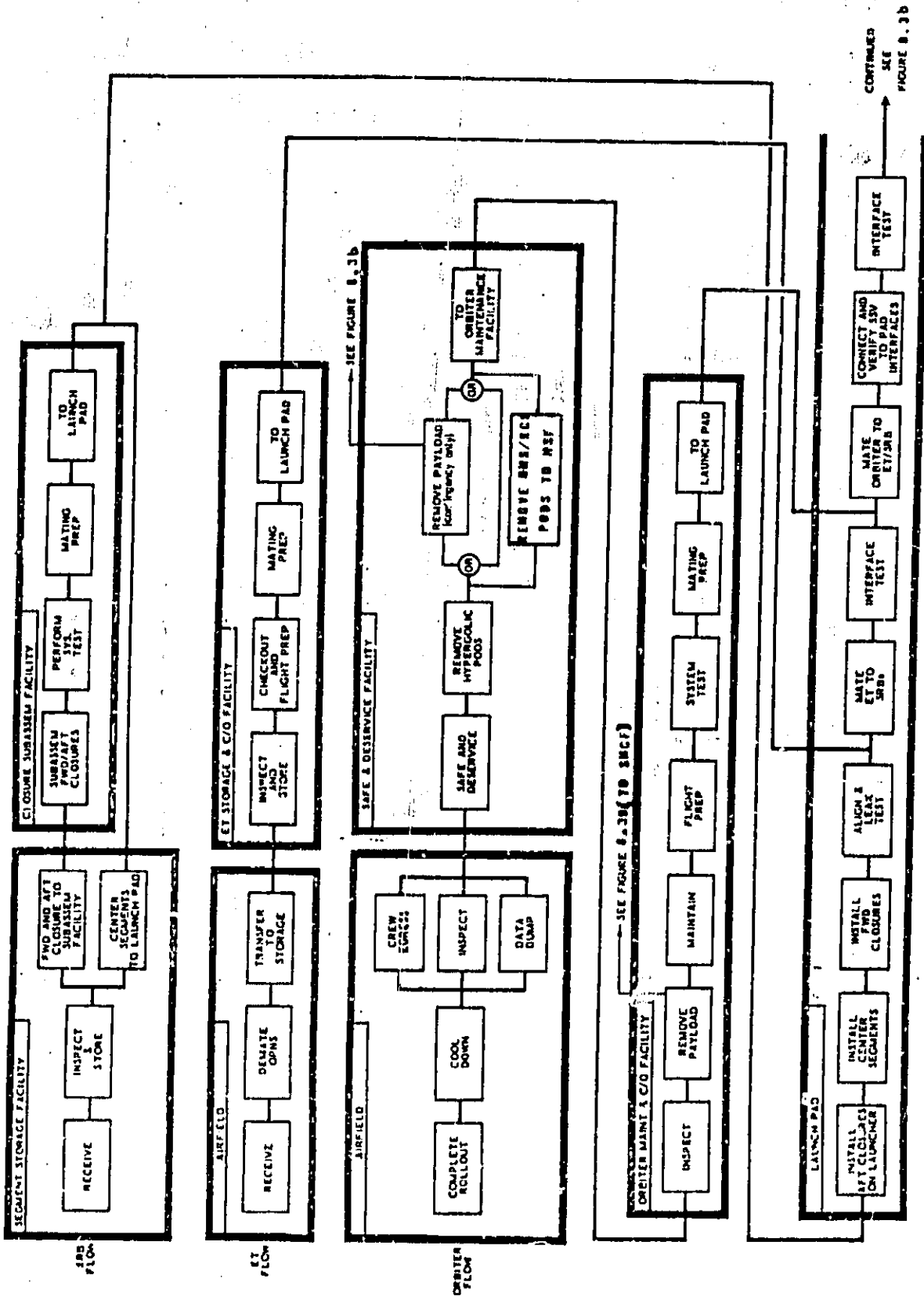

Figure 8-3a. VAFB STS Ground Operations Functional Flow (Sheet 1 of 2)

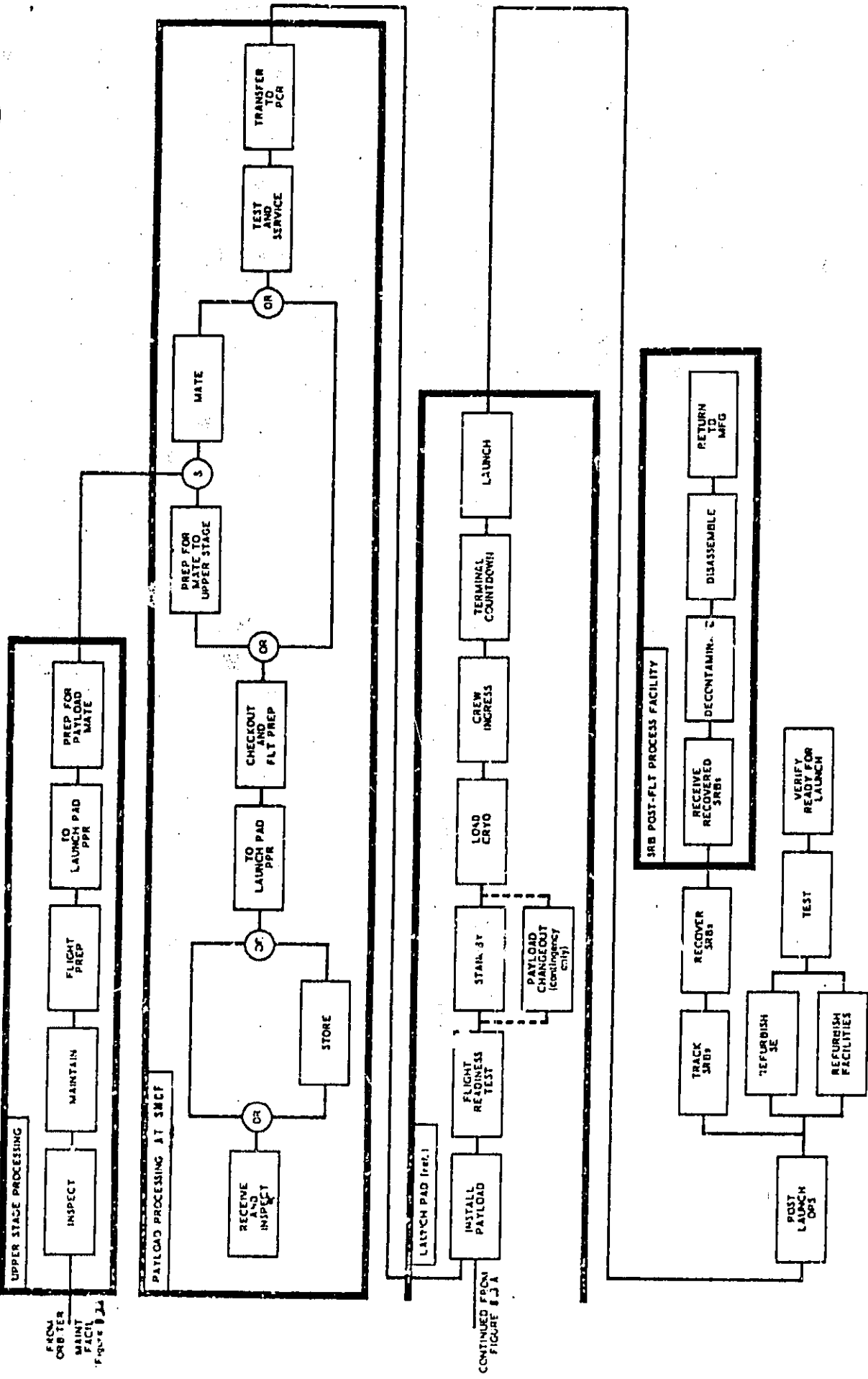
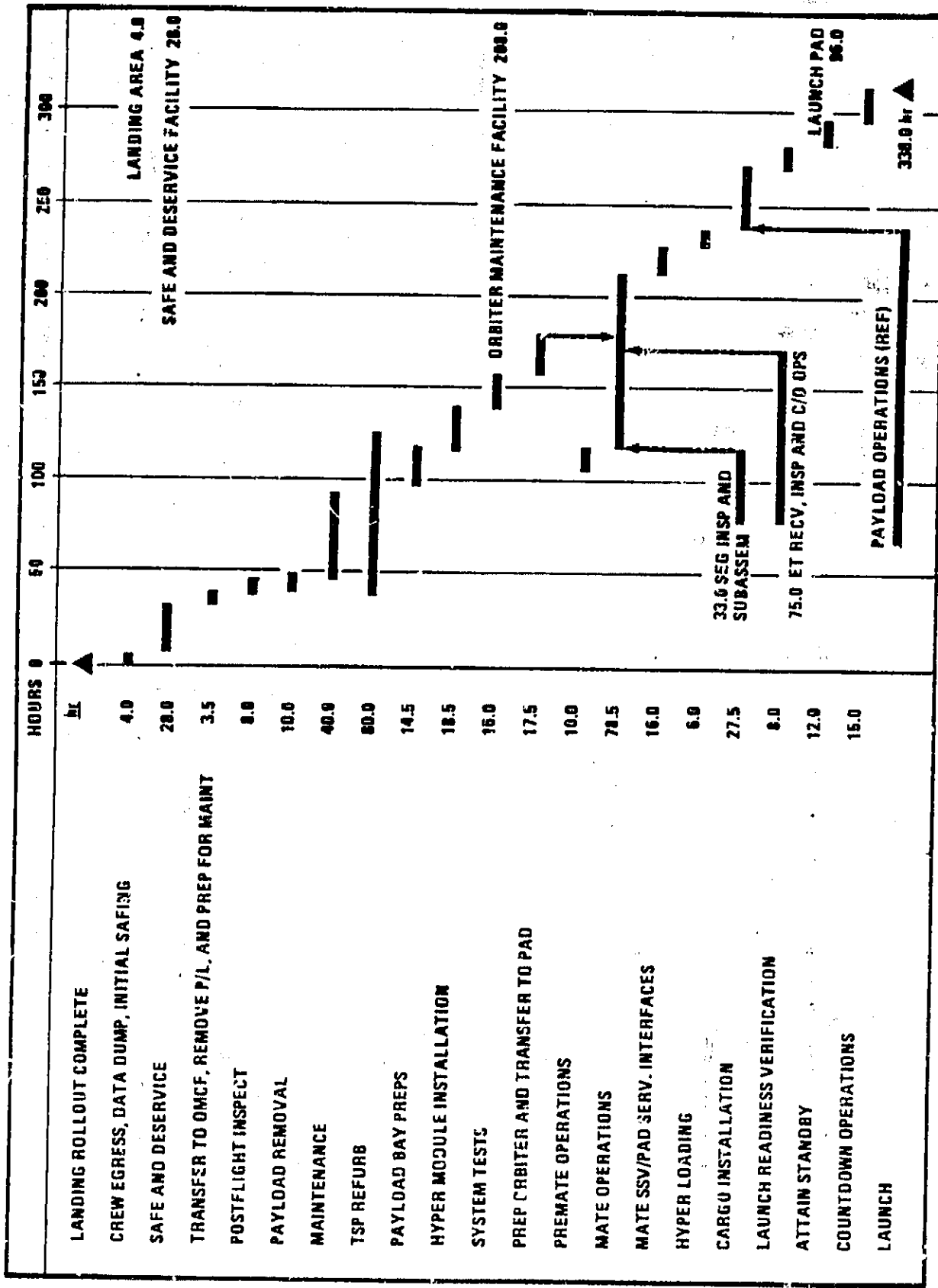

Figure 8-3b. VAFB STS Ground Operations Functional Flow (Sheet 2 of 2)



BSC 1310

Figure 8-4. VAFB STS Processing Timeline (Assessment)

8.3 PAYLOAD OPERATIONS

8.3.1 General. The primary responsibility of the KSC/VAFB Program Liaison Office in Payload Launch Operations will be to provide support to the STS User from arrival of the Payload at VAFB through the launch and recovery operations cycle. This includes supporting transient crews in verifying the operations of experiments, scientific equipment, and supporting systems, for that particular mission.

8.3.2 Automated Payload Preparations. The prelaunch preparations and testing of Automated Payloads at the Launch site will vary for the different types of payloads. The schedule of activities must be established prior to the arrival of the payload and Ground Support Equipment (GSE) at the Launch Site, to assure satisfactory completion of all prelaunch preparations.

- a. Payload checkout will be defined by the STS User. Planned operations will be integrated into the facility schedules with the end result being the Launch Site Support Plan.
- b. Initial payload operations will be performed in an assigned payload processing facility. After initial payload receiving, assembly and checkout operations are completed, and the payload will be transported to the Spin Test Facility for any hazardous operations (such as solid propellant installation, hydrazine loading, or spin balancing). If no hazardous operations are involved, the payload will go directly to either the Orbiter Maintenance & Checkout Facility (OMCF) (for horizontal installation), or to the Payload Preparation Room (for vertical installation). Typical flow of an Automated Payload is shown in Figure 8-5.

8.3.3 Spacelab Preparation. The Spacelab will arrive at VAFB in basically flight ready configuration. A holding area for Spacelab will be provided in Building (TBD). The Spacelab is mated to the Orbiter in the OMCF. Interfaces with the Orbiter are verified prior to moving to the pad. At the Launch Pad, expendables are loaded and countdown operations performed. A typical processing flow is shown in Figure 8-6.

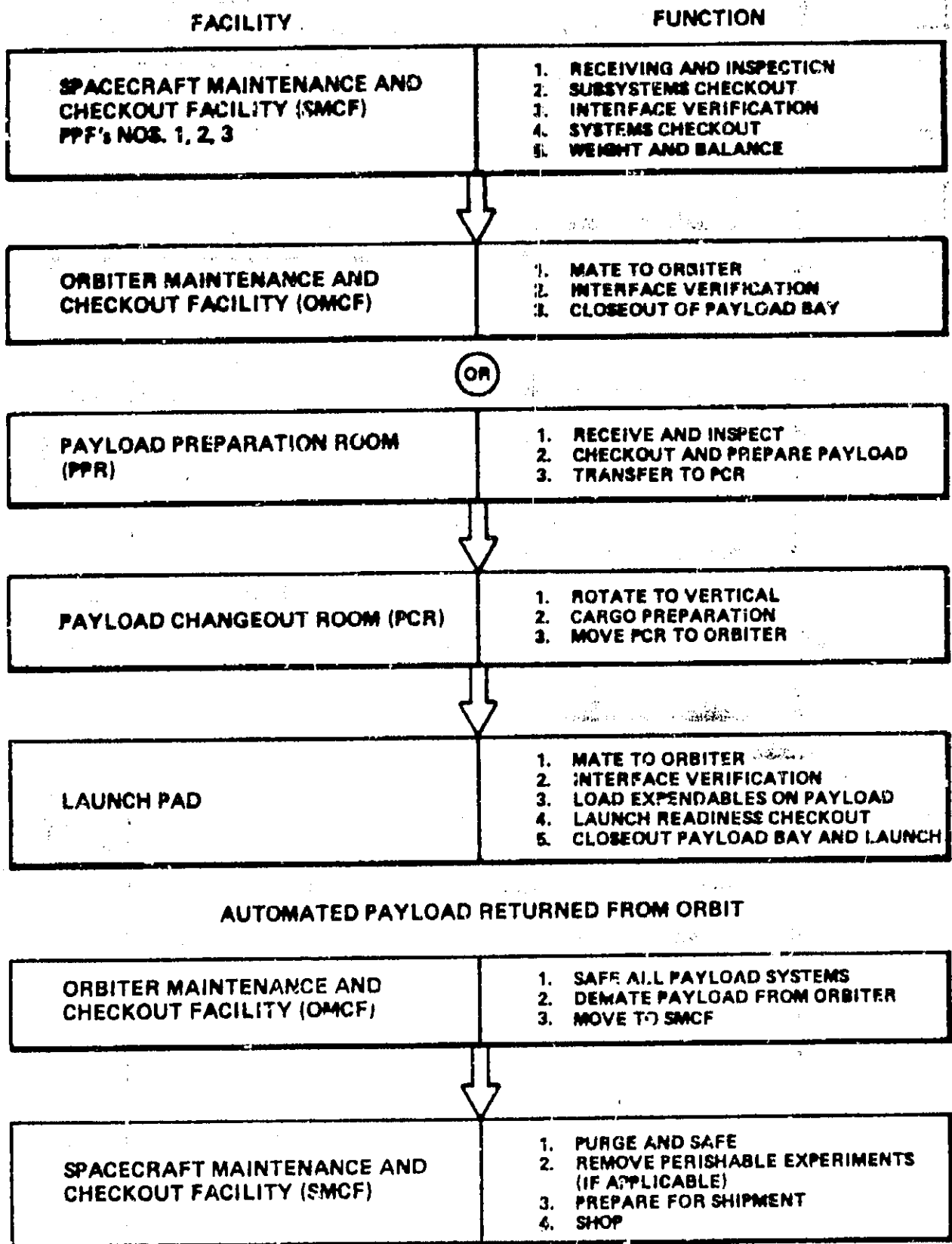

B3G 1188

Figure 8-5. Typical Automated Payload Flow at WTR

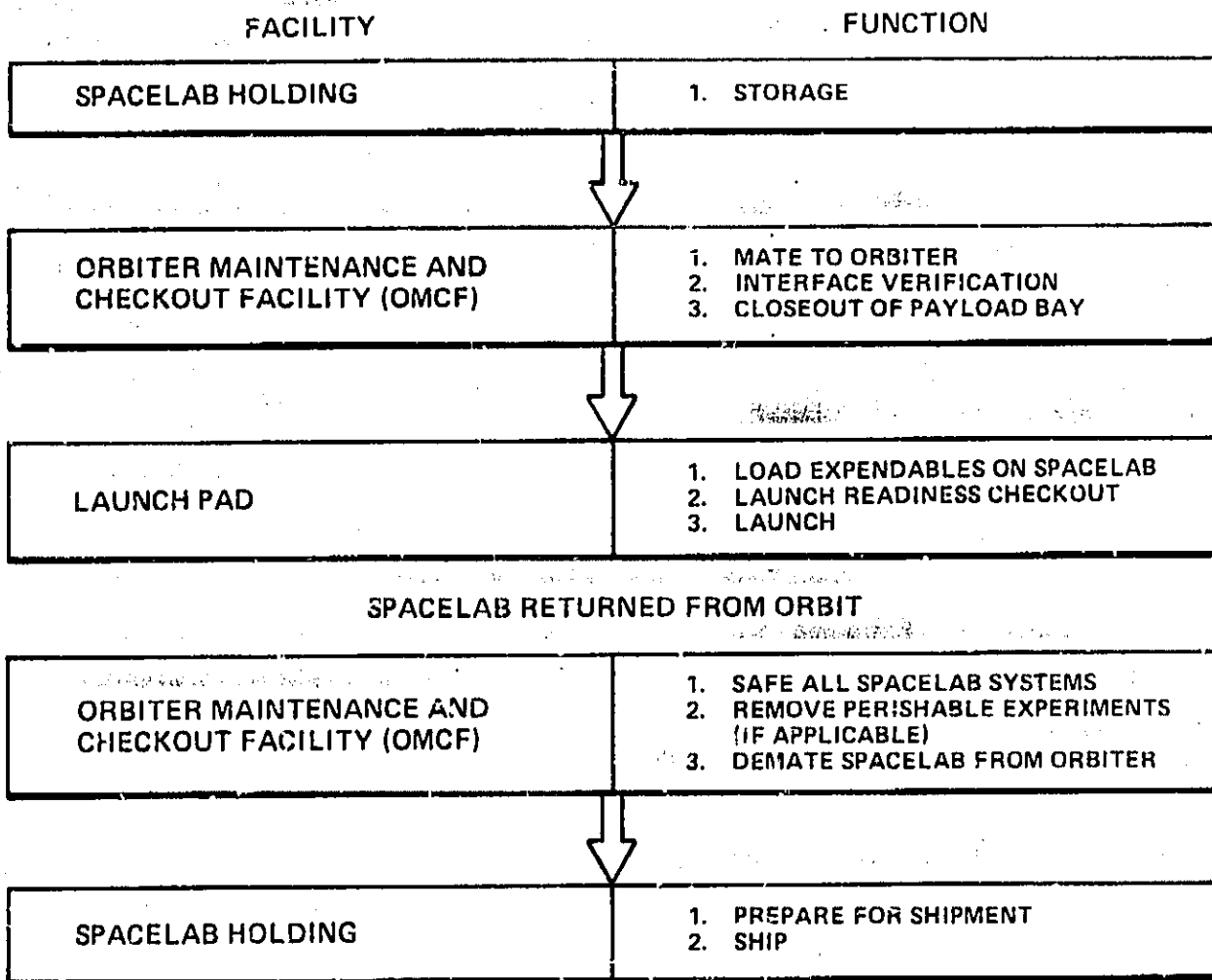

BSG 1199

Figure 8-6. Typical Spacelab Flow at VAFB

8.4 FACILITIES DESCRIPTIONS

8.4.1 Payload Processing Facilities (PPFs). To accommodate the Payload Processing at VAFB, checkout areas are planned in Building 836 and in the Spin Test Facility Buildings 1610 and 1605.

- a. Most payloads will be accommodated in one of the three Payload Processing Facilities within Building 836 (see Figure 8-7), subject to certain modification and constraints identified in paragraph 8.4.2 and Table 8-1.
- b. Hazardous operations associated with Spacecraft build-up and spin balancing, will be conducted in the Spin Test Facilities (Buildings 1610 and 1605).

8.4.1.1 PPF 1. Payload Processing Facility 1 consists of an 18,000 sq. ft. laboratory area, and a 32 by 35-foot high service bay containing a 20 by 25-foot Clean Room. Project team personnel offices are in 10 by 50-foot trailers.

a. Facility Capacity

Floor Area: 2240 sq ft (32 x 70 x 35 ft high) Service Bay, and 1800 sq ft Laboratory area.
Ceiling Height: 35 ft.
Cranes: ~~one~~ One 5-ton bridge crane
Hook Height: 30 ft.
Clean Room: 500 sq ft (20 x 25 x 14.5 ft high), class 100K;
Door Access: Door access 11.33 ft x 12 x 20 ft high
Compressed Air: Available at 150 psi
Lab Area Support: 1800 sq ft and 1 Data Processing Office
AC Elec Power: 120V 1-phase; 120/208V & 400V 3-phase; 60 Hz (Transformer Bank Power Support)
Envir Control: 65-70 degrees F, R.H. at 50% or less for all temperatures

b. Facility Usage

Automatic Payloads Checkout
Receiving and Inspection
Mate to GSE Checkout Equipment
Calibration of GSE/Spacecraft Systems
Functional Electrical Checkout of Experiments
Integrated Systems Tests

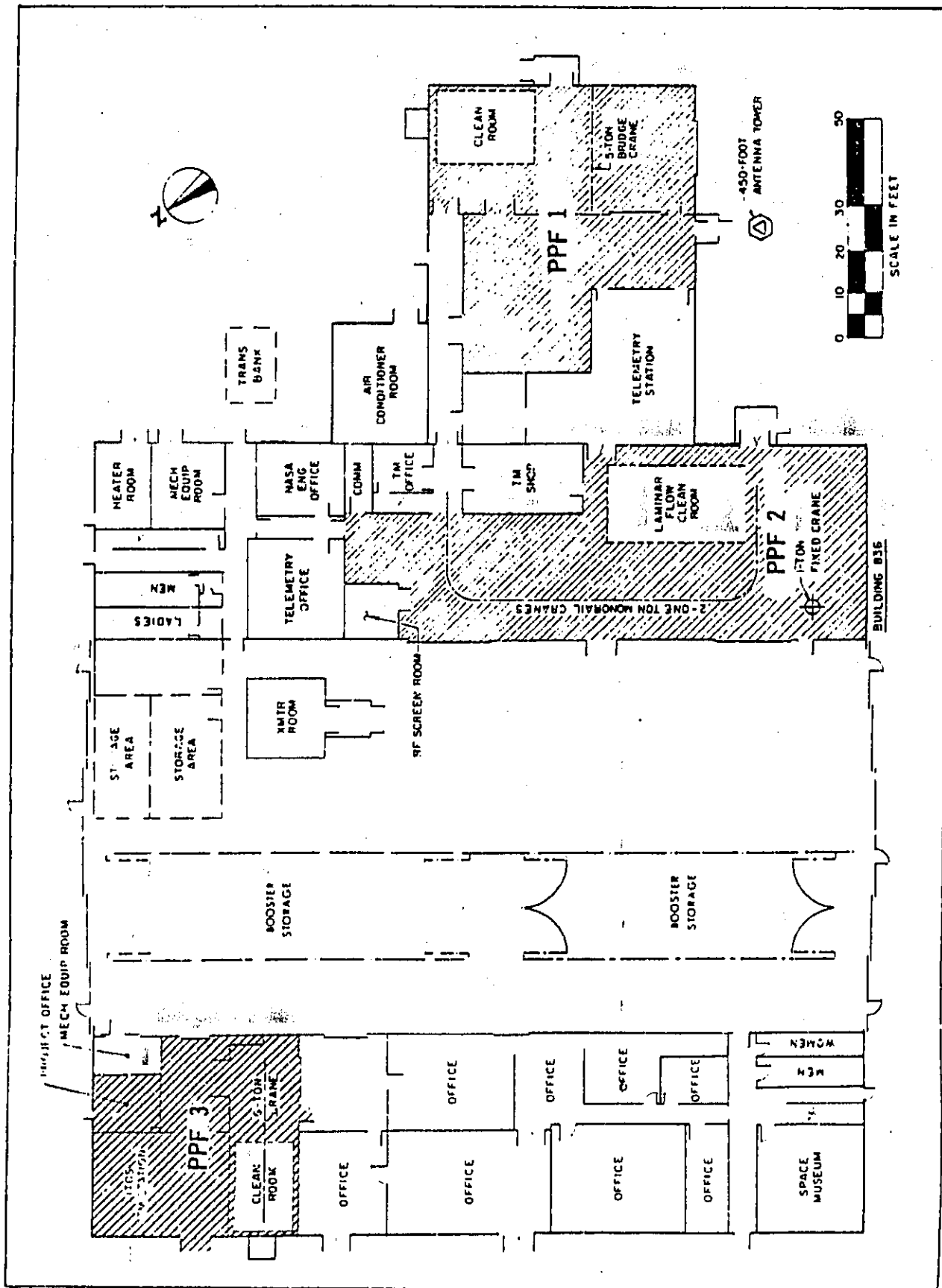

Figure 8-7. Payload Processing Facilities in Bldg 836

8.4.1.2 PPF 2. Payload Processing Facility 2 consists of a 16 by 30-foot Clean Room and 3700 sq ft work area.

a. Facility Capacity

Floor Area: 3700 sq ft, 45 x 82 x 35 ft high Service Bay
Ceiling Height: 17 feet usable
Cranes: One 1-ton fixed, two 1-ton monorail
Hook Height: 23 ft 6 in fixed crane, hook height 16 ft 5 in
Clean Room: 23 ft 6 in high, class 10K clean room, door access 16 x 17 ft
Door Access: Two doors into area from high bay service area (11 ft 6 in x 18 ft, and 18 ft x 18 ft high)
Compressed Air: Available at 150 psi
AC Electr Power: 120V 1-phase; 120/208V 3-phase; 60 Hz (Transformer Bank Power Support)
Lab Support: Telemetry Shop and Telemetry Office, and Mechanical Equipment and Transmitter Room
Envir Control: 73 ± 2 degrees F, approx 50% R.H.

b. Facility Usage

Automated Payloads Checkout
Receiving & Inspection
Mate to GSE Checkout
Calibration to GSE/Spacecraft Systems
Functional Electrical Checkout of Experiments
Integrated Systems Tests

8.4.1.3 PPF 3. Payload Processing Facility 3 consists of the following:

a. Facility Capacity

Floor Area: 2500 sq ft, 45 x 60 x 35 ft high Service Bay
Ceiling Height: 35 feet usable
Cranes: One 6-ton monorail (traverses into clean room)
Hook Height: 14 feet
Clean Room: 20 ft x 17 ft high, class 100K clean room, door access 10 x 15 ft high and 10 x 15 ft doors to clean room
Door Access: Two doors into high bay area 10 x 15 ft high
Compressed Air: Available at 150 psi
AC Electr Power: 120V 1-phase; 120/208V 3-phase; 60 Hz
Lab Support: Telemetry Shop and Telemetry Office, and Mechanical Equipment and Transmitter Room
Envir Control: 72 ± 5 degrees F, at 60% R.H. or less

b. Facility Usage

Automated Payloads Checkout
Receiving & Inspection
Mate to GSE Checkout
Calibration to GSE/Spacecraft Systems
Functional Electrical Checkout of Experiments
Integrated Systems Tests

8.4.1.4 Isotope Storage Building. An Isotope Storage Building (figure 8-8) is located adjacent to the PPFs (Bldg 836). This 10 by 14 foot building, having an entranceway measuring 7 feet 1-inch by 2 feet 8 inches, is constructed of concrete blocks, and is surrounded by a 6 foot chain link fence. For security purposes, the building area is illuminated during nighttime hours, and alarm sytem indicates when the vault is opened. Access is controlled by the KSC/VAFB Program Liaison Safety Engineers. The vault provides for storage of small calibration sources.

a. Facility Capacity

Floor Area: 70.5 sq ft, 10 x 7.5 ft vault, air conditioned
Ceiling Height: 8 ft 4 in
Crane: None
Door Access: 7 ft 1 in x 2 ft 8 in.
Security: Area is fenced, security alarm, and floodlighted.

b. Facility Usage

Isotope Storage
Small Calibration Source Storage

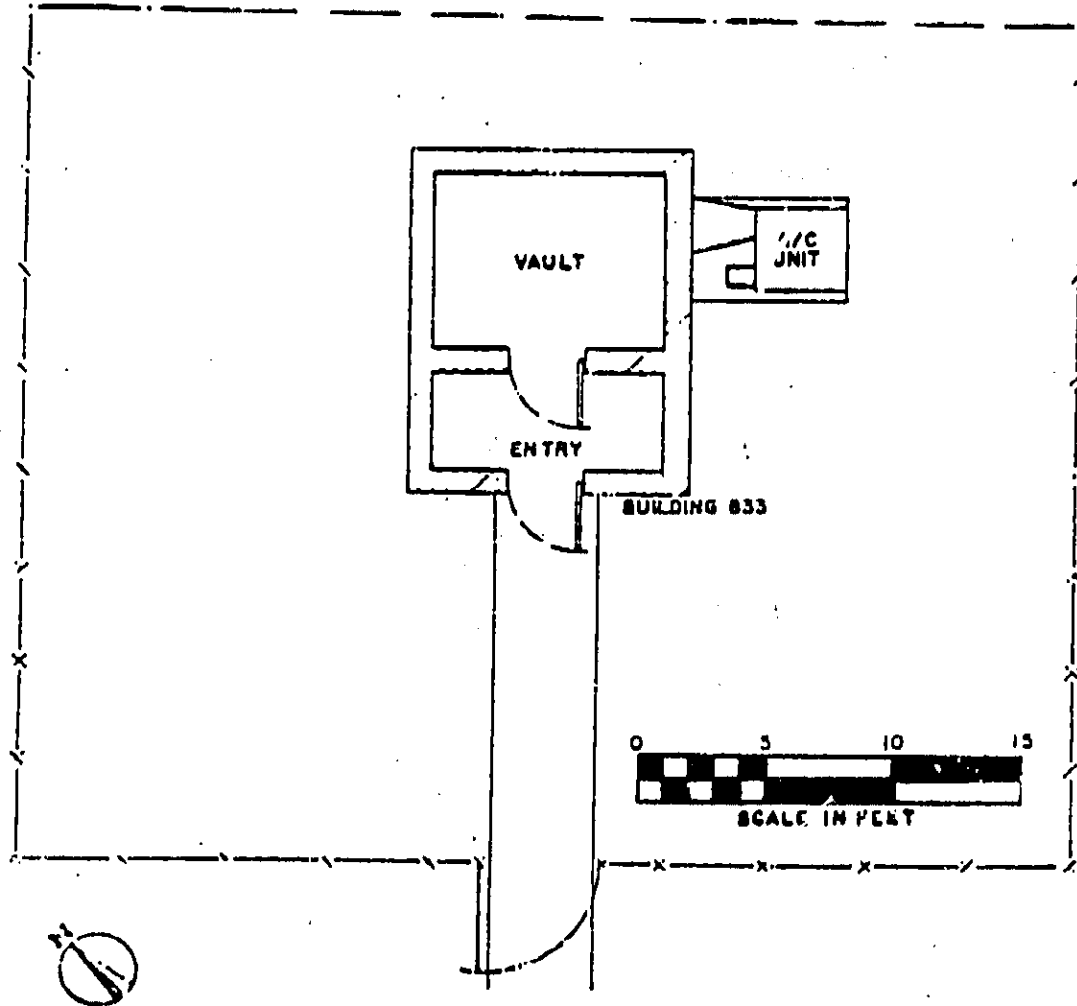

Figure 8-8. Isotope Storage Building

8.4.1.5 Spin Test Facility. The Spin Test Facility consists of the Spin Test Building, Control Building, Guardhouse, and Fire Pumping Station.

- a. Facility Capability. Balances pieces from 5 to 6,000 pounds, measuring 4 to 240 inches in diameter, 12 to 240 inches in height, with continuously variable speeds of 30 to 500 RPM.

Floor Area: 2135 sq ft (35 ft x 61 ft x 45 ft)
Ceiling Height: 35 ft usable
Cranes: Two 5-ton overhead bridge
Hock Height: 35 ft
Clean Room: None
Door Access: 17 ft wide 30 ft high
Compressed Air:
AC Electr Power:
Envir Control: 72 + 3 degrees F; R.H. 40 to 50% with control limits of + 5%

- b. Facility Usage.
Spin Balance Spacecrafts, Solid Motors, and combinations thereof
Spacecraft Buildup
Spacecraft Mating to Solid Upper Stages

8.4.2 Payload Processing Facility Constraints. Payload shipping container size, transporters, handling fixtures, and procedures should take into consideration the crane height limitations summarized in Table 8-1. If these limitations cannot be tolerated, utilization of the existing PPFs will be limited.

Table 8-1. Existing Facilities Limitations

PAYLOAD PROCESSING FACILITY 1

1. No hoist in Clean Room.
2. Maximum height of payload on dolly limited by Clean Room height of 14 ft 5 in.
3. Maximum height of 5-ton bridge crane is 30 ft.
4. Entry door is 12 ft wide x 20 ft high.

PAYLOAD PROCESSING FACILITY 2

1. Maximum height of payload and dolly limited by Clean Room height of 16 ft
2. No hoist in Clean Room
3. Shipping container and/or cover design must be such that it can be removed by one of the following:
 - a. Fixed 1-ton hoist, 23 ft 6 in high, 16ft 5 in hook height.
 - b. 1-ton monorail, 2 ea 18 ft high, 16 ft 5 in hook height.
 - c. 25-ton bridge crane in adjacent airlock area (non controlled environment), 25 ft 10 in high.
4. Shipping container-to-work dolly transfer (if required) limited by same hoists.

PAYLOAD PROCESSING FACILITY 3

All payload and container handling must be done by 6-ton monorail with 14 ft hook height or in an airlock with 25-ton bridge crane, 25 ft 10 in high.

SPIN TEST FACILITY

No Clean Room

8.4.3 STS Processing Facilities. The general STS flow thru the WTR processing facilities is shown in Figure 8-9. The Safing and Deservicing Facility (SDF), Orbiter Maintenance and Checkout Facility (OMCF), Hypergolic Service Facility (HSF), and the Launch Pad are described in paragraphs 8.4.3.1 thru 8.4.3.4.

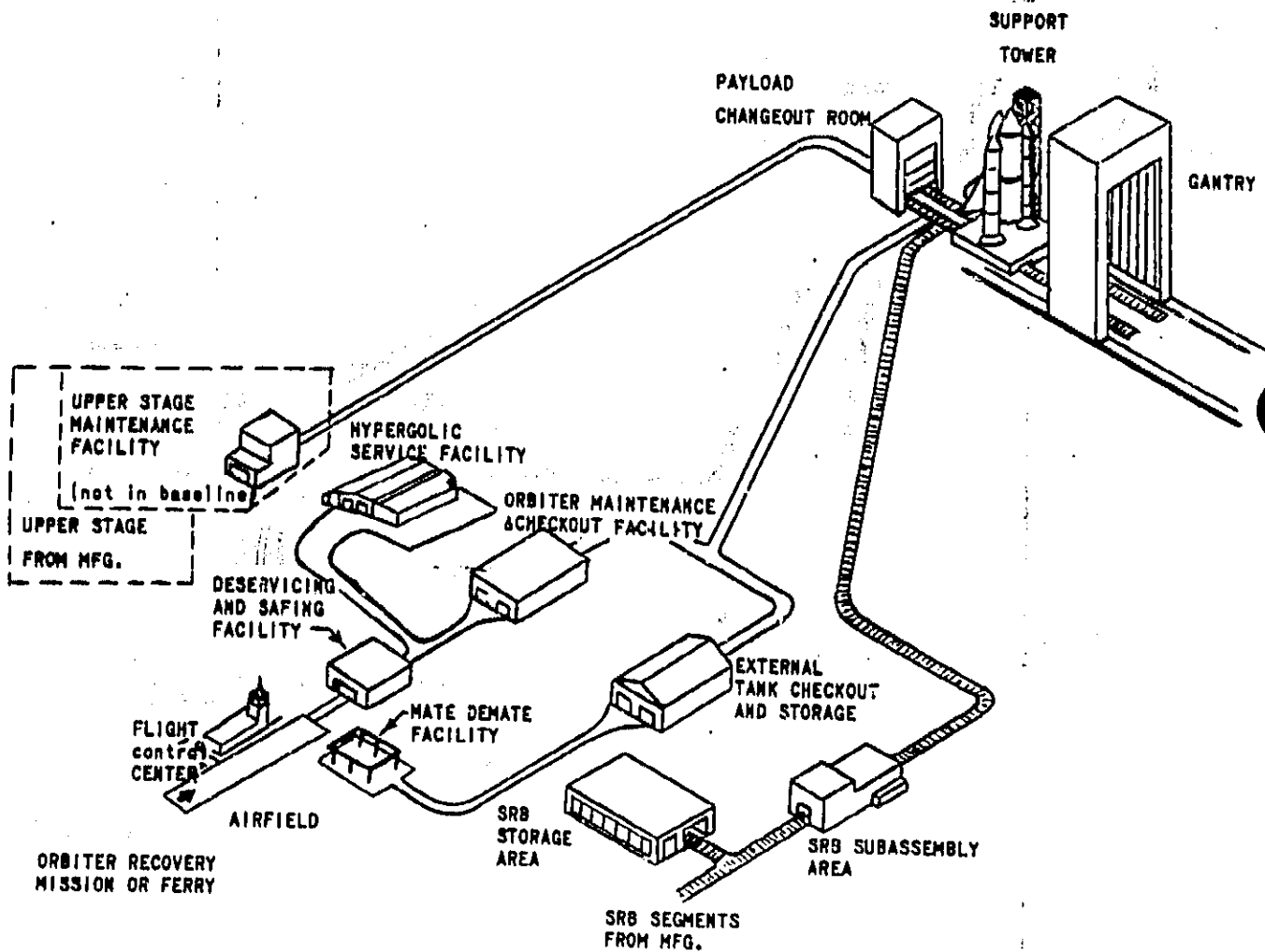

Figure 8-9. STS Processing at VAFB

8.4.3.1 Safing and Deservicing Facility (SDF). The SDF (Figure 8-10) provides post flight safing and deservicing capability for the Orbiter. Normal SDF operations include: Crew egress, Orbiter jacking, cooling of exterior surfaces and interstitial cavities, classified data purge, safing of ordnance items, venting, draining and purging of hypergolic modules and payload, venting of gas systems, preliminary Orbiter inspections and removal of external hypergolic modules.

Key features of the SDF are:

- a. 21,000 sq ft area
- b. Class 100,000 clean air to crew module at 75 ± 5 deg F, 50% R.H. max
- c. Cryogenic vent, burn stacks
- d. Hazard gas detection systems
- e. Two 5-ton bridge cranes
- f. Electrical power

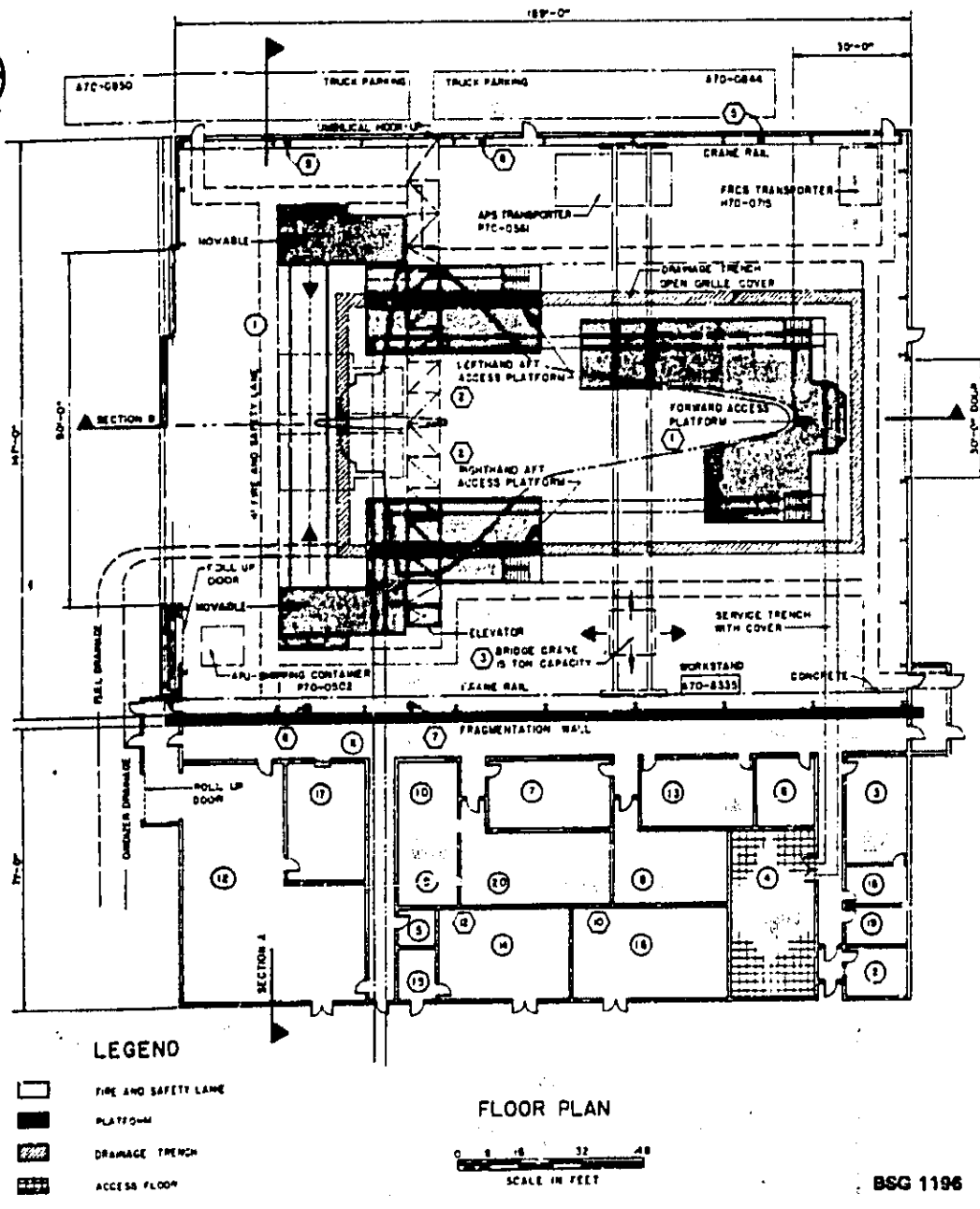

Figure 8-10. Safing and Deservicing Facility

8.4.3.2 Orbiter Maintenance and Checkout Facility (OMCF). The OMCF as shown in Figure 8-11, will be sized to house the Orbiter during maintenance and checkout. It will contain the maintenance shops, equipment rooms, LPS terminal room, and Support Equipment required to perform all post- and preflight operations required to ensure flight readiness of the Orbiter for a subsequent mission. In addition, the OMCF will provide the capability to load payloads requiring installation while the Orbiter is in a horizontal position. The OMCF may also provide for storage of the Orbiter when not required for a mission.

Key features of the OMCF are:

- a. 46,000 sq ft area
- b. Environmental controlled to 70 + 5 deg F and 45% R.H. max
- c. Class 100,000 level maintained in crew module platform and payload enclosure
- d. Fluid servicing system (non-hazardous)
- e. Two 20-ton bridge cranes
- f. Electrical power including 28 VDC and 400 Hz
- g. Hazard and lightning protection

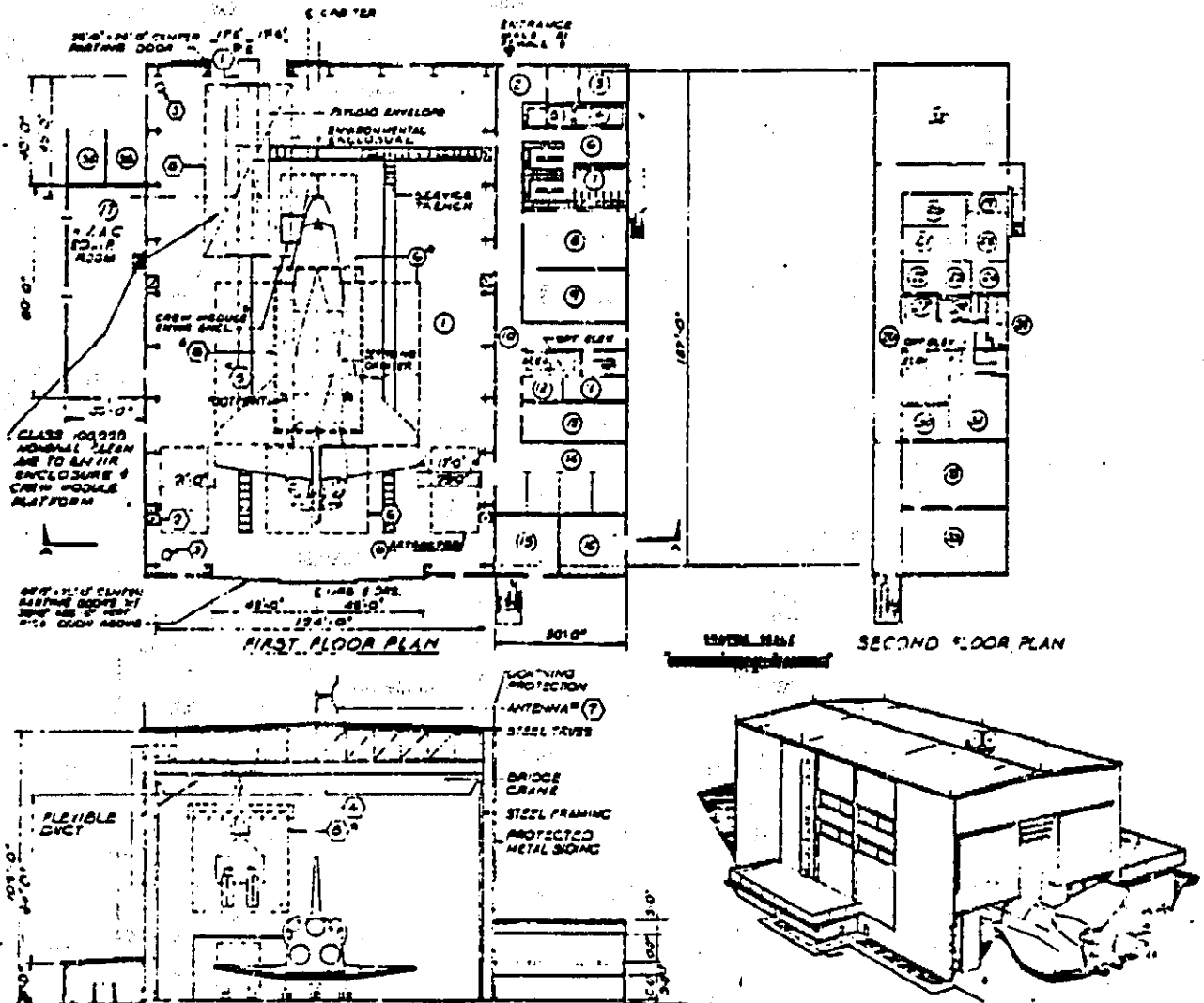

Figure 8-11. Orbiter Maintenance and Checkout Facility

8.4.3.3 Hypergolic Service Facility (HSF). The HSF (Figure 8-12) provides capability for inspection, maintenance and checkout of the Orbiter hypergolic systems, including Orbital Maneuvering System (OMS), Delta V Kits, Reaction Control Systems (RCS) forward and aft, and Auxiliary Power Units (APU).

Key features of the HSF are:

- a. 16,211 sq ft area
- b. Environmented controlled to class 100,000 at 75 ± 5 deg F and 50% R.H. max
- c. Gas distribution systems (GN_2 , GHe and Air)
- d. Three 5-ton hoists
- e. Electrical power including 28 VDC and 400 Hz

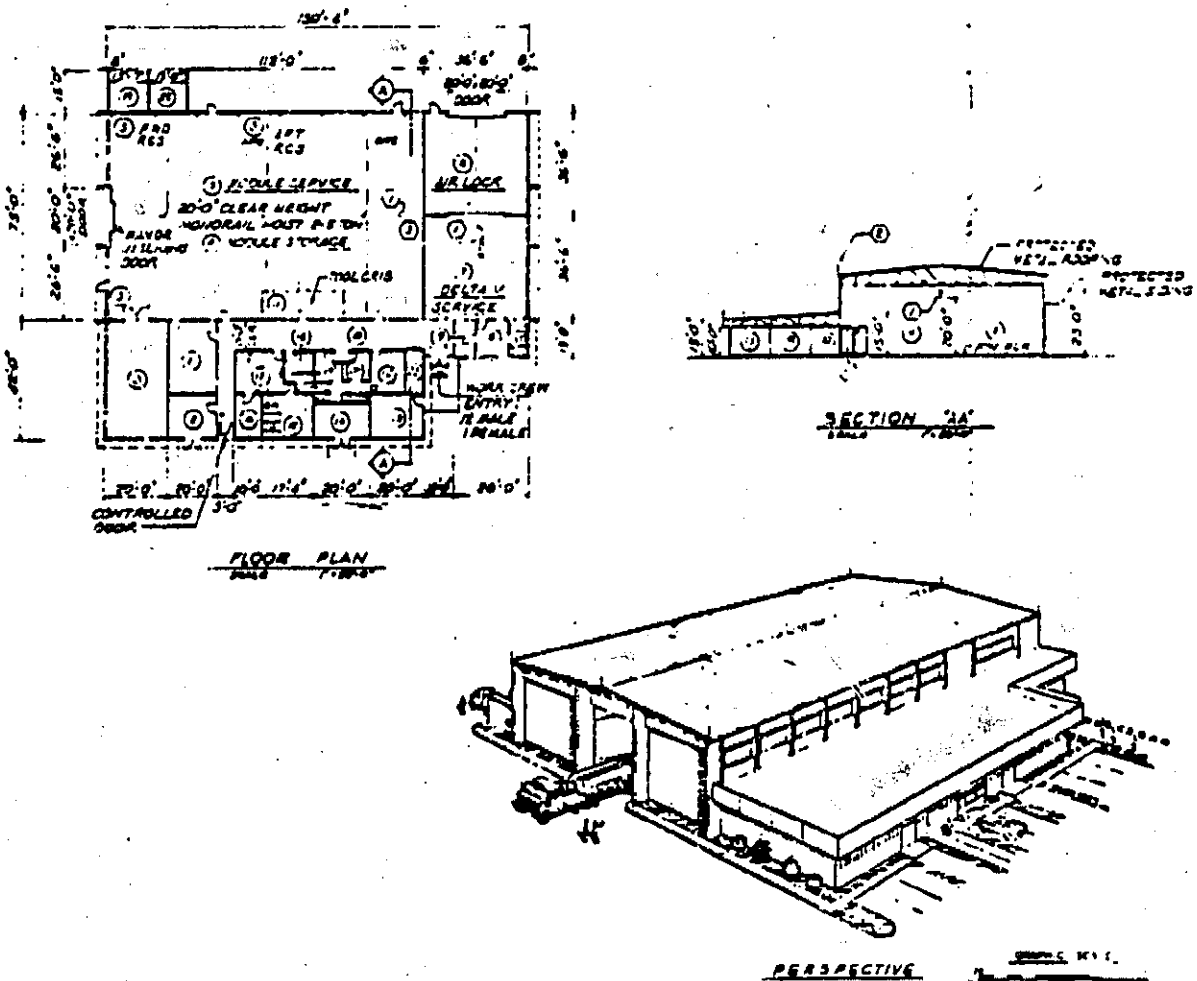

Figure 8-12. Hypergolic Service Facility

8.4.3.4 Launch Pad Facilities. Launch pad operations are defined as those operations required to integrate, test, service, load, checkout, and launch the Space Shuttle. The major facilities required at the launch pad to support these operations are shown in Figure 8-13. The three key facilities shown are the Mobile Service Tower (MST), the launch mount, and the payload facilities (PPR and PCR).

- a. The MST, shown in the parked (launch) position in Figure 8-10, provides the crane, work platforms, SE installations, and weather protection required to support the SSV integration and checkout operations. When employed for SSV integration and checkout operations, the MST is transported on rails, positioned, and tied down over the launch mount.
- b. The launch mount provides the base upon which the SSV is assembled and subsequently launched. The launch mount incorporates such features as the SRB hoistdowns and the Tail Service Masts (TSMs).
- c. The payload facilities are comprised of the Payload Preparation Room (PPR), located below grade, and a mobile Payload Changeout Room (PCR) both of which are environmentally controlled.
 - (1) The PPR and the PCR provide the capabilities for processing, servicing, and loading the cargo into the Orbiter.
 - (2) The PCR will provide capability for 360 degree payload access, multi-level decks, communications, GSE provisions, power, airlock, and environment/contamination control.

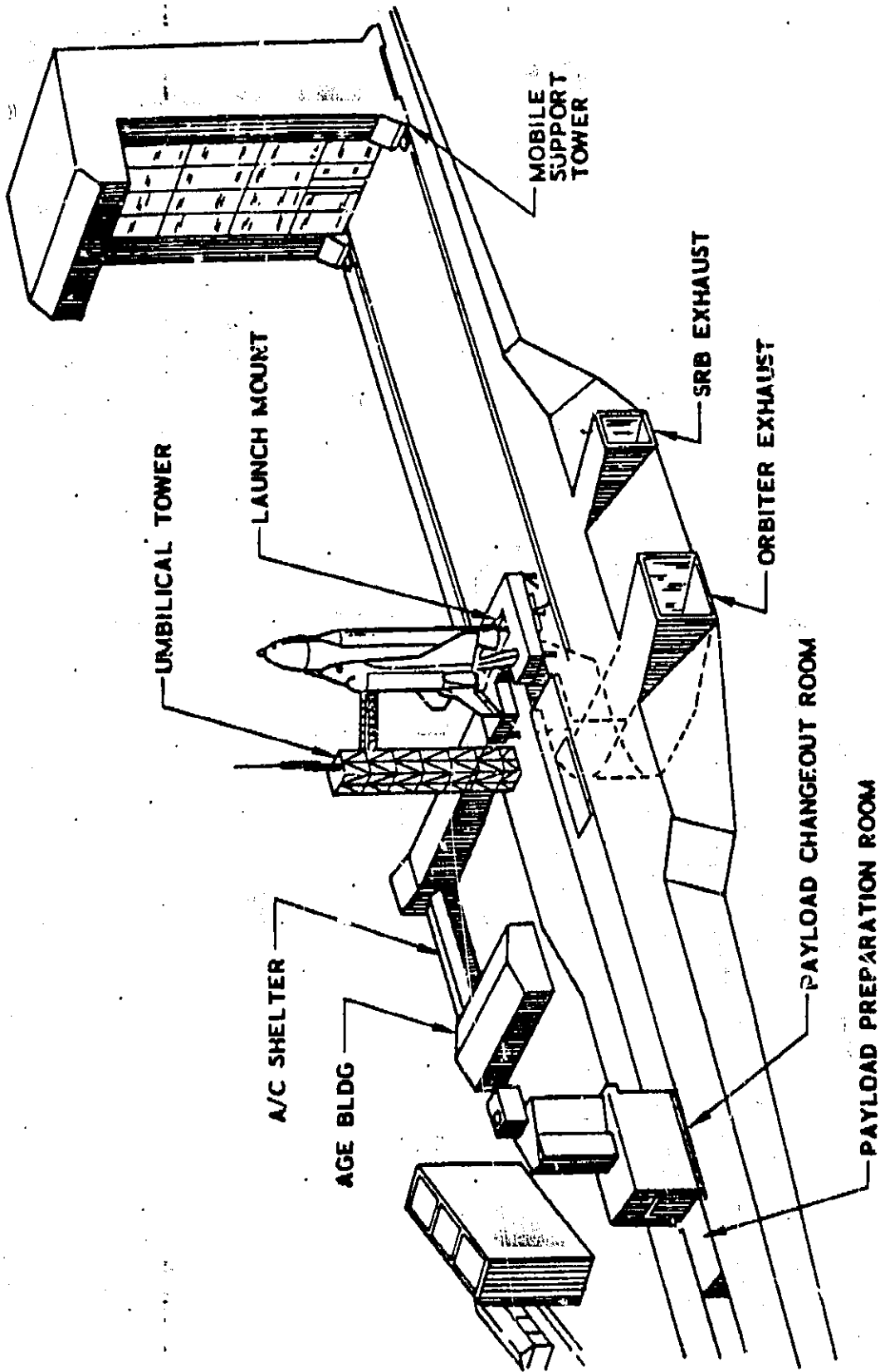

Figure 8-13. AFB STS Launch Facilities

8.4.4 Base Support Facilities. The following existing facilities are available to support STS operations. Base support facilities include administrative and technical offices, maintenance, logistic, ordnance, laboratories, communications, data, propellant support, hospital, security, and fire control support.

a. JP and Gasoline Storage and Transfer

Purpose of this facility is to provide intermediate storage of Jet Propulsion (JP) fuel and aviation gasolines for distribution to dispensing facilities. The facility will have the capacity to store a minimum of 50,000 gallons of fuel. A minimum of two tanks will be provided. Tanks shall be above ground, covered, and floating pan type.

b. Automotive, GSE, and Heavy Equipment Shops

This facility provides protected facilities for personnel and equipment associated with repair and maintenance of heavy equipment, assemblies, and components.

c. Communications and Data Processing (Existing Building 8510)

The Communication and Data Processing Facility consists of a building of 82,249 square feet, located in the industrial area. This facility includes instrumentation and accessories for distribution, control, processing, and/or storage of data for all facilities in the launch, landing, and industrial areas. These are part of Orbiter/Booster ground operations and flight operations support instrumentation, communications, and data network.

d. Payload, Ordnance Storage(Existing Building 1551)

Purpose of this facility is to provide storage for units and sub-assemblies of the payload, ordnance, and nuclear materials. The facility will be of the igloo magazine type, as described in Air Force Standard Facility Requirements (paragraph 442-264). The facility will be steel, arched, earth-covered structures to prevent propagating explosions, to maximize isolation and security, and to provide constant-temperature environment. The facility will be provided with adjustable vertical shelving and have adequately sized doors to permit access of standard loading and transport equipment. The gross area of the facility is 912 square feet, with 228 square feet for ordnance, 446 square feet for nuclear material, and 228 square feet for pyrotechnic materials. A minimum of four igloo structures is required.

e. Nuclear Materials Storage

The nuclear materials storage is included in the payload Ordnance Storage Facility. Of the total 912 square feet of igloo type, earthmound structures, 456 square feet are for nuclear material storage.

f. Precision Measurements Equipment Laboratory (PMEL)

The facility is required for the calibration and certification of gauges, meters, and instruments associated with facilities, facilities systems, ground support, and shop test equipment at regular and unscheduled intervals.

It is environmentally controlled and protected to assure that electrical and physical standards are maintained constant. The standards and calibration equipment will be in accordance with TO (Technical Order) 33-1-14.

g. Administrative and Technical Offices

The purpose of this facility is to provide for organizational and command structure of engineering and operations. Space may be made available to contractors associated with vehicles and payloads who are resident at the site and participate in launch maintenance and mission planning.

Air Force definitive design AD 30-02-63, Type VI is selected as meeting a size requirement of about 35,000 square feet, including other than purely administrative functions.

Photo services and data processing of an administrative or logistics nature are also accommodated within this building.

h. Medical Facility (Bldg. No. 13850)

The capability of the existing composite medical facility, Bldg. No. 13850, is adequate for support of the program and total base requirements.

8.5 VAFB SUPPORT LABORATORIES & SERVICES

The support laboratories and services provided at VAFB are described in paragraphs 8.5.1 thru 8.5.13.

8.5.1 Metrology. The Precision Measurement Equipment Laboratory, under contract to SAMTEC, provides repair, overhaul, and calibration of precision measuring equipment.

- a. **Electrical AC-DC:** Includes equipment for measurement of voltage, current, resistance, power and magnetic flux in the spectrum from DC to 100 KHz.
- b. **Electronic/Electromagnetic:** Includes capability for measuring waveforms, power voltage, current, frequency, timing, phase, power and radiation in the spectrum from 20 Hz to 40 GHz.
- c. **Mechanical/Optical:** Includes equipment for measurement of force, torque, length, direction, vibration, pressure, vacuum, optics, acoustics, and velocity.
- d. **Precise Time/Time Interval:** Capability for maintaining and distributing precise time and synchronization.

The laboratory is environmentally controlled with temperature maintained at 75 deg + 2 deg Fahrenheit in all calibration areas. Relative humidity for all areas is 30-50 percent.

A mobile calibration van is operated for in-place calibration at operational sites on VAFB. There is also a loan pool for sophisticated test equipment as a convenience to a user who may not desire to procure the equipment because of infrequent use.

8.5.2 Component Cleaning Facility. The Component Cleaning Facility provides cleaning, plating, repairs, testing, and inspection of Aerospace Ground Equipment, spacecraft, and missile equipment. Metal plating, hydropneumatic, hydrostatic testing and hydraulic flow tests can be conducted in accordance with required specifications. The services include:

- a. Disassembly, inspection, cleaning, and replacing components in proper chemical solutions. Processed parts are reassembled in an environmentally controlled Clean Room to achieve the required military or vendor specifications.
- b. Nickel, Silver, or Cadmium parts plated to the required thickness. (For example, renew electrical contacts on high voltage switchgear by building up silver on the contacts.)

- c. Hydraulic pressure testing of components up to 15,000 psig and at specified variable flow rates.
- d. Pneumatic testing of components up to 12,000 psig employing air or nitrogen.
- e. Hydrostatic testing up to 30,000 psig.

8.5.3 Propellants and Gases. The following propellants are routinely handled and stored in the quantities listed:

- a. Liquid Oxygen: 350 tons Ready Storage is maintained on base. Deliveries from the Union Carbide Division are made from Los Angeles with 24 hours notice.
- b. Liquid Nitrogen: 600 tons maintained at VAFB. Deliveries are regularly scheduled from the Union Carbide Division to maintain this level.
- c. RP Fuel: 50,000 gallons are stored on site. Delivery is made by truck from Lake Charles, Louisiana.
- d. Inhibited Red Fuming Nitric Acid (IRFNA): 104,000 pound storage capacity is maintained. Delivery is by truck from Buffalo, New York and requires 21 days after notification.
- e. Unsymmetrical Dimethyl Hydrazine (UDMH): 49,000 pound storage capacity exists at VAFB.
- f. Aerozine 50: The VAFB has a storage capacity of 165,000 pounds plus two trailers of 30,000 pounds each. The product is received by truck from Rocky Mountain Arsenal.
- g. Nitrogen Tetroxide: Storage capacity is 265,000 pounds plus two trailers of 65,000 pounds each. This oxidizer is received by commercial truck from Vicksburg, Mississippi.
- h. RJ-1: The base storage capability is 40,000 gallons. Normally the fuel is delivered by commercial truck from Los Angeles direct to the user.
- i. Helium: Bureau of Mines Helium is delivered by rail to a siding on base at the storage facility. The storage capacity is 548,000 SCF. In addition, there are six tube trailers on base which operate at 2200 psig.
- j. AVGAS 115/145: Two storage facilities, 1712 and 1713, each has a capacity of 50,000 gallons. Deliveries as required are made by truck from Norwalk, California.

- k. Jet Fuel JP-4: The VAFB two storage facilities, 1702 and 1703, having capacities of 5,000 barrels and 10,000 barrels are pickled presently.
- l. Vehicle Fuel: The base service stations have storage capacity of 85,000 gallons.
- m. Diesel Fuel: Facility 1701 maintains the capacity of 125,000 gallons of diesel fuel at all times. When required, it is resupplied by truck from San Diego, California.
- n. Nitrogen Tube Trailers: There are 5 Nitrogen tube banks available at VAFB for use at the various launch and launch support facilities. These operate at 2200 psig.
- o. Air Force MOGAS: There are two AF-owned facilities, 379 and 10745, which have a total capacity of 40,000 gallons.

Secure storage areas exist for unique gases and propellants required by a specific project; usually such propellants are shipped in advance by the vendor and held until required.

8.5.4 Fuels Analysis Laboratory. The Fuels Analysis Laboratory performs chemical and physical tests of propellants, gases, hydraulic oils, and fluids at VAFB. There are presently eight chemists assigned and it functions primarily as a quality control facility. The following products are routinely analyzed to required specifications.

- a. Liquid Oxygen
- b. Liquid Nitrogen
- c. Gaseous Nitrogen
- d. IRFNA
- e. UDMH
- f. Aerozine 50
- g. Nitrogen Tetroxide
- h. RJ-1
- i. RP-1
- j. Trichloroethylene
- k. Various cryogenics

8.5.5 Ordnance Storage. VAFB provides sufficient bunkers or other approved buildings for storage ordnance. Incompatible classes of explosives will be stored at separate locations.

8.5.6 Launch Operations Communications. VAFB provides the necessary voice, video and data transmission facilities for checkout, prelaunch, launch and early post launch support to Range users. The communications facilities at the individual launch sites interface with the SAMTEC Communications System for data transmission, data processing, down range clearances, timing, countdown, weather and voice coordination nets.

The Frequency Control and Analysis Center (FCAC) is the single point of contact for all elements and Range Users for Range Frequency matters. The FCAC ensures that requests for scheduling radio frequency operations are compatible in the VAFB and Southern California environment. The FCAC also coordinates the investigation and resolution of frequency compatibility and interference problems.

8.5.7 Wind Information. Wind towers as high as 300 feet are installed in 120 locations on VAFB. Each tower has sensors on the 12, 52 and 100-foot levels. Wind and temperature data is transmitted by wire to the weather center.

8.5.8 Data Processing. Data Processing Systems available at VAFB operated by SAMTEC are:

- a. IBM 7094 Data Processing System with peripheral equipment that includes 4 data channels, 16 tape recorders, 1 card reader, 1 printer, 1 desk storage unit.
- b. IBM 7044 Real Time Data Handling System with 6 magnetic tape drivers, one line printer, one desk storage unit with 36 K capability and memory protection.
- c. IBM 360-30 Data Processing System with 4 magnetic tape drive units, disk packs and disk drive, and one printer.
- d. IBM 360-65 Central Computer System with time sharing capability. Peripheral equipment includes 18 terminals for off line users, 2-Cathode Ray Tube Display units, one 3-pack disk drive, eight 9-track tape units, two 7-track tape units, 2 printers, and 4 card reader and key punch units.
- e. Four Sigma 2 computers are available to process and display Pulse Code Modulated (PCM) telemetry data. Each system includes display units, keyboard printers, and a time code translator. The line printers are capable of printing 1000 lines per minute and can accommodate up to 20 lines of data updated every 90 milliseconds.

- f. Two Sigma 7 computers located at VAFB are available for Range User batch processing. Their ancillary equipment includes 1 paper tape reader, two 7-track digital tape units, four 9-track tape units, four 6 megabit Disk Storage Units, and 2 Cathode Ray Tube display units.

Payloads being processed at VAFB will request computer time on the Data Processing Systems through normal Range scheduling procedures.

8.5.9 Range Timing. The Range Timing System provides a basic common denominator to the data gathering process, operational data, and data reduction activities. Timing is kept synchronized to Universal Time Coordinated (UTC).

8.5.10 VAFB Timing Center. The basic component of the Timing system is the Central Timing Signal Generator (CTSG) which generates a series of individual identifiable groups of electrical pulses held to extremely close time relationships. The pulses provide instrumentation sites with timing signals that are used to correlate data.

- a. The principal equipment consists of two identical but completely independent time code generators, each supplied from separate frequency standards, and powered by separate DC power supplies. The output signal from either of the two identical time code generators is manually switched to line drive amplifiers through a transfer and alarm panel. Coincidence-sense circuits continuously monitor the outputs of the time code generators and activate visual and aural alarms in event of an out-of-tolerance condition. The time code generators are controlled by primary atomic frequency standards and are kept on time to better than ± 10 microseconds relative to UTC.
- b. The complete GTSG includes one WWV receiver, a VLF receiver, a LORAN-C timing receiver, a transfer and alarm panel, primary atomic time base oscillators, time code generators, patch panels, line driver/amplifiers, power supplies, one monitor oscilloscope, and recording oscillographs.

8.5.11 Shop Support. A Technical Support Shop performs minor work in support of launch operations. Capabilities include mechanical, electrical, carpentry, painting, and machine work. Requests for work to be performed by the shop are submitted on a standard "Request for Support Services" for (WLOD Form 114, Rev May 1970) with each requestor responsible for providing the required information, and attaching drawings, schematics, and other documents, as necessary.

8.5.12 Mission Status Center (MSC). The MSC will provide the Mission Managers, Payload Owner/Operators, Principal Investigators, and NASA Operations/Management personnel with current mission processing and operations data from prelaunch through post launch. The MSC displays will present the detailed payload "waterfall" charts for current missions (automated or Spacelab) as well as those missions planned for the following twelve months. The STS "waterfall" chart will be included for each Mission Status Display incorporating all payload on-line Shuttle Operations.

- a. Displays (video and Printouts) will be available in the MSC for near real time viewing and status of tests on the payload and STS.
- b. The Launch Site Support Managers (LSSM) will be responsible for supplying information in a timely manner to keep the status displays current.
- c. Operations Center - The Operations Center will provide the necessary displays and communications required by the mission personnel from Payload/Orbiter Integrated Systems Test through liftoff, and on orbit and de-orbit operations, as required. These real time displays along with the Range and off Range (NASA Mission Agents) communications (voice, data, video, etc.) will permit mission personnel to directly monitor and participate in all their operations. The existing NASA Mission Director Center (MDC) and office space in the west wing (Building 840) can be readily adapted to the Mission Status Center requirements.

8.5.13 Administrative Support. The following services will be provided to NASA elements and their support contractors on VAFB. These services could be supplied to non-NASA payload contractors on a cost reimbursable basis.

a. Office Support

Telephone, teletype and facsimile, Mail pickup and delivery Graphics.

b. Security

NASA Contractor Guards will control access into the NASA Space Shuttle Payload Support Area. All private vehicles will be parked outside the fenced area. Access will be controlled by use of a personnel badge system specified by the NASA Security Office.

c. Purchasing

Purchases and contracts for specialized project requirements and inventory replenishment of non-listed items will be provided consistent with the Program Operating Plans.

d. Supply

Requisition, inventory and issue of supplies will be accomplished in support of WLOD maintenance and operation functions and Shuttle payload requirements.

e. Shipping, Receiving and Storage

The KSC/VAFB Program Liaison Office will provide shipping services (including packing and crating), receiving and closed storage facilities. Special arrangements will be made for hazardous shipments and support outside of normal working hours.

f. Reliability and Quality Assurance

The KSC/VAFB Program Liaison R&QA Office will perform surveillance of operations associated with the installation of either Automated or Spacelab Payloads into the Orbiter. (It is recognized that USAF personnel at WTR will have primary responsibility for this task with KSC/VAFB Program Liaison Office personnel and transient payload owner personnel acting in a supporting role).

g. Safety

The KSC/VAFB Program Liaison Safety Office directs the overall safety program and has responsibility for matters of safety during operations performed by NASA, NASA Contractor personnel, and other personnel using NASA facilities at VAFB. Overall safety must have SAMTEC Safety approval. Final authority rests with the SAMTEC Commander on safety matters pertaining to WTR operations.

h. Transportation

The GSE Interagency Motor Pool located on base provides passenger and general purpose vehicles to federal civilian agencies and authorized contractors. Vehicles are also available for TDY personnel.

Special mission airlift requirements will be programmed through joint management in accordance with current DOD regulations. Each payload owner will be responsible for the delivery of his payloads to the launch site. Transportation of payloads on VAFB is the responsibility of the STS User. Transportation can be arranged through the GSA Interagency Motor Pool if a payload can be transported on trucks or pickups. In any case, the STS User is responsible for transportation on VAFB, including any environmental controls required in transit.

i. Tracking and Data Network

The network support for NASA missions will normally be accomplished by NASA facilities. If requirements exist or in-flight problems develop, resources of both NASA and DOD will be made available.

8.6 SUPPORT EQUIPMENT

Unique support equipment for Automated or Spacelab payloads will be provided by the STS User. Multiuse Mission Support Equipment (MMSE) discussed in Section 4.7 may be candidates for use.

8.7 VAFB LAUNCH PROCESSING SYSTEM

Detailed information concerning the VAFB LPS is not available at this time. LPS data will be updated to include detailed information when the LPS interfaces have been identified and responsibilities defined. Capabilities should be similar to that for KSC discussed in Section 4.8.

SECTION IX PAYLOAD DESIGN CONSIDERATIONS

The purpose of this section is to express concerns of Launch site personnel for various payload features, based on experience from other programs. The considerations which follow can be treated as guidelines, in the absence of specific design requirements. They are presented in the interest of achieving reliable, efficient, and trouble free launch operations. The principal document for design of GSE to be used at the launch site is JSC Specification SW-E-0002, Space Shuttle Ground Support Equipment - General Design Requirements.

9.1 GENERAL DESIGN CONSIDERATIONS

- a. Human engineering criteria similar to MIL-STD-1472 are assumed to be a normal requirement. Specific concerns based on past experiences include the following:
 - (1) Indications should correspond to adjustment or control inputs.
 - (2) Accessibility to accomplish maintenance and checkout tasks.
 - (3) Sufficient clearance around connector or fluid line interfaces.
 - (4) For support equipment interfaces consider all areas of use and what connections must be made with units in place.
- b. The following considerations shall apply:
 - (1) Capability to verify redundant functions should be considered.
 - (2) Consider lighting requirements in restricted/closed areas with respect to known or contingency ground operations.
 - (3) Realistic cleanliness requirements should be specified. Considerable time and effort can be expended maintaining unnecessarily stringent requirements. Maximum immunity from contamination should be 'built in' by use of filters ahead of sensitive components, etc.
 - (4) Avoid traps where debris, loose hardware or other contaminants could collect and be difficult/impossible to remove.
 - (5) Standardize nomenclature between flight hardware and related support equipment. Avoid use of similar but different nomenclature which can lead to confusion in test operations.

9.2 MATERIALS

- a. Flammable materials should be avoided wherever possible because of the potential hazard environments in many areas, especially on O₂ enriched areas.

- b. Outgassing characteristics of materials should be evaluated for effect on systems/experiments, in addition to crew compatibility per NASA Handbook NHB 8060.1. This is especially true for any material used for flight closeout (sealing plugs, etc.) or standard repairs.

9.3 ELECTRICAL

- a. For umbilical or special connectors, avoid blind mating or special adjustments required to ensure satisfactory mate.
- b. Electrical connectors should be designed/labeled to preclude incorrect mating.
- c. Capability to power equipment from more than one source should be considered. Insensitivity to facility power transients, such as experienced in electrical storms, should be considered.
- d. Pyrotechnic systems should accommodate no-fault (unintentional firing) testing during combined systems ground operations.

9.4 MECHANICAL/STRUCTURAL

- a. Avoid use of non-standard fasteners. Specify torque values for all applicable installations.
- b. Assemblies requiring blind installation should be avoided.
- c. Provisions for electrical bonding verification of assemblies should be made.
- d. Panel mounted components should be removable from the front.

9.5 FLUID SYSTEMS

- a. Quick disconnects should have one of the following protective features:
 - (1) "Double Action" feature, i.e., internal poppets should seal prior to final collar release. A positive means of evaluating adequacy or internal seals before initiating final disconnection should be provided.
 - (2) If "Double Action" Quick Disconnects (QD's) are not available, positive valve closure should be provided on flight-half as closely coupled to the QD as practical.
- b. Fluid connections should be designed/labeled to preclude incorrect mating.

SECTION X USER CHARGE

10.1 GENERAL

NASA policy on reimbursement for use of the STS is contained in "STS Users Handbook" and "STS Reimbursement Guide" JSC 11802, latest issue. Policy on reimbursement for use of non-STs facilities, equipment, and services at KSC are contained in this handbook. Included herein are reimbursement policies on KSC payload processing facilities, and KSC launch site support services not covered by the basic STS charge. User charges for VAFB are TBD.

- a. The basic STS user charge covers the following launch site support services:
 - (1) Launch site participation in payload design reviews - subject to mutual agreement.
 - (2) Review of all payload specifications and test data required by NASA to reasonably determine safety and compatibility of the payload to launch and launch site processing operations.
 - (3) Transportation of STS User payload from the location where the simulated orbiter to payload interface verification test (normally CITE) is conducted, to the OPF or PCR.
 - (4) Installation of STS User payload into the CITE facility, if required, and installation into the orbiter.
 - (5) Simulated orbiter to payload interface verification and compatibility testing in the CITE facility. This will not include end-to-end functional testing, unless specifically included in the Launch Site Support Plan.
 - (6) Orbiter to payload interface verification either in the OPF or on the Pad prior to launch. This testing may not include end-to-end functional testing. Requirements for end-to-end functional testing will be determined on a payload by payload basis, and included in the Launch Site Support Plan. Costs for these tests will be negotiated with the STS User and included in the basic STS user charge.
 - (7) Launch operations.
 - (8) Removal of a payload which returns to the prime landing site.
 - (9) Removal of a payload from the Orbiter if it cannot be ferried in the Orbiter from the secondary or a contingency landing site. Responsibility for returning removed payloads is TBD.

- b. Launch site support services for optional flight systems (flight kits, upper stages, spacelab) are included in the price negotiated for use of these optional systems. See the "STS Reimbursement Guide" for user charges for these options.
- c. User charges for special testing, like end-to-end functional testing, which is over and above that which is required to verify interface compatibility must be negotiated as a part of the basic STS charge, or as a part of the charge for one of the optional flight systems.

10.2 PAYLOAD PROCESSING FACILITIES

All STS Users will pay an operation and maintenance charge of \$1,326.00 per day for use of the following Payload Processing Facilities:

- a. Hangar S
- b. SAEF-2
- c. Delta Spin Test
- d. Building AM
- e. Hangar AE
- f. Hangar AO
- g. ESA 60

This price includes the utilities and basic janitorial support. Commercial users of these facilities will pay an additional \$1,007.00 per day. This additional charge is a "use charge" (in lieu of depreciation, or replacement cost recovery), and is properly viewed as rent.

10.3 SUPPORT SERVICES

The price for support services will be determined by the amount and type of services required. These services are identified in Section V of this Handbook. Certain of these services will be covered, in whole or in part, by the operation and maintenance charge for use of a facility, e.g., housekeeping, mail service, food service, etc. A list of the support services that KSC views as necessary, will be priced at the time a Preliminary Payload Integration Plan is issued.

- a. This list will indicate those services which are, or will be, covered by either:
 - (1) The basic charge for use of the STS
 - (2) The charge for an optional flight system
 - (3) The charge for a payload processing facility
- b. Support services which do not fall into any of the above categories will be negotiated directly with KSC, and will be listed in the Launch site Support Plan.

SECTION XI PUBLIC AFFAIRS

11.1 GENERAL

This section outlines functions of the NASA KSC Public Affairs Office and its Public Information Branch, Visitor Services Branch and Educational Programs Staff related to STS User public affairs activities.

11.2 RESPONSIBILITIES

11.2.1 Public Information Branch. The Public Information Branch is responsible for KSC's relations with the various news media, the preparation of news releases on NASA programs and activities at KSC, and the development and conduct of programs to inform the public concerning Center activities and operations.

11.2.2 Visitor Services Branch. The Visitor Services Branch is responsible for programs to accommodate distinguished visitors to KSC and for operation of the Kennedy Visitors Center and NASA Tours for the general public.

11.2.3 Educational Programs Staff. The Educational Programs Staff is responsible for KSC relations with members of the educational community and the planning and conduct of space-related seminars, lectures and other educational activities.

11.3 OPERATIONS

11.3.1 News Releases. NASA encourages STS Users to release information to news media concerning their activities. The Public Information Branch will work with STS Users to develop an information plan for launches. In most cases information about STS User payload also will be included in NASA press materials. Each STS User should provide the name of its Public Relations Officer to KSC's Public Information Branch at least six months before launch, or its designee for clearing news releases and answering questions from reporters.

11.3.2 News Photographs. Photographs on the preparation of payloads may be desired to accompany news releases. Since access to payload preparation areas for photography is limited to personnel of the KSC/AFETR photographic support contractor, STS User management or public relations representatives should request such photographic support well in advance of the need date through the KSC Public Information Branch.

11.3.3 Visiting Media Representatives. The KSC Public Information Branch will cooperate with STS User management or public relations personnel to assure Center access for news media representatives covering their activities. When a STS User desires Center access for a media representative, such access should be requested throughout the KSC Public Information Branch. Access to KSC Public Information offices at the Complex 39 Press Site or the Headquarters Building will be arranged, and the STS User representative may meet the news media representative at one of those locations.

11.3.4 Tours. It is recognized that STS User officials and distinguished visitors to their operations at KSC may desire orientation tours of the Space Center. Requests for such tours should be directed to the KSC Visitor Services Branch.

11.3.5 Launching and Landing Viewing. The demand for accommodations for guest viewing of launchings and landings is expected to exceed available facilities. However, an attempt will be made to provide guest viewing for as many STS User officials and distinguished visitors as possible. Requests for guest viewing allocations should be forwarded to the Visitor Services Branch as far in advance as possible.

11.3.6 Educational Programs. STS User plans for activities involving the educational community should be coordinated with the KSC Educational Programs Staff.

APENDIX A
REFERENCED DOCUMENTS

APPENDIX A

REFERENCED DOCUMENTS

This appendix contains the listing of documents which are referenced in this Handbook.

E.1 NASA HEADQUARTERS

- | | |
|--------------|---------------------------------------------------------------------------------------------------------------------------|
| (Unnumbered) | Space Transportation System User Handbook |
| (Unnumbered) | Safety Policy and Requirements for Payloads Using the Space Transportation System, June 16, 1975 |
| NHB 8060.1A | Flammability, Odor and Off-Gassing Requirements and Test Procedures for Materials in Environments that Support Combustion |
| NMI 8060.10 | Space Transportation System Support Requirements Management and Documentation |

E.2 KENNEDY SPACE CENTER (KSC)

- | | |
|---------------|-------------------------------------------------------------------|
| GP-1037 | KSC Maintenance Capability Laboratories and Shops |
| GP-1052 | Glossary, Acronyms, Abbreviations for STS and Associated Payloads |
| FR-1351 | Handbook KSC Payload Facilities Capabilities |
| (Unnumbered) | KSC Payload Support Equipment List |
| (Proposed) | KSC/MDC STS-PAM-D Ground Operations Plan |
| (Proposed) | KSC/MDC STS-PAM-A Ground Operations Plan |
| (Proposed) | IUS Ground Operations Plan |
| (Proposed) | Vertical Payload Integration Operations Plan |
| (Unnumbered) | Vertical Payload Facility Handbook, October 17, 1977 |
| (Unnumbered) | VAFB Ground Operations Plan |
| KMI 1710.13 | Safety Review of KSC Technical Operating Procedures |
| KMI 1860.1/IS | Radiation Safety Policies and General Procedures |
| KHB 1710.2/SF | Kennedy Space Center Safety Practices Handbook |
| KHB 1860.1/SF | Radiation Protection Handbook |

| | |
|------------------|----------------------------------------------------------------------|
| KHB 8610.4 | Operations and Maintenance Handbook |
| K-SM-01 | Launch and Landing Project Plan |
| K-STSM-09 | KSC STS Ground Operations Plan, Volumes I thru VI |
| K-STSM-09.5 | KSC Support Requirements System |
| K-STSM-14.1.1 | Facilities Handbook for Building 'AE' |
| K-STSM-14.1.2 | Facilities Handbook for Building 'AO' |
| K-STSM-14.1.3 | Facilities Handbook for Building 'AM' |
| K-STSM-14.1.4 | Facilities Handbook for Hangar 'S' |
| K-STSM-14.1.5 | Facilities Handbook for Delta Spin Test Facility |
| K-STSM-14.1.6 | Facilities Handbook for Explosive Safe Area 60 |
| KSC-STD-SF-0001C | Safety Standards for Cranes, Slings, Hoists and Hooks |
| KSC-STD-DE-0002 | Hazard Proofing of Electrically Energized Equipment, Standard for |
| (Latest Issue) | Shuttle Turnaround Analysis Report (STAR) |

E.3 JOHNSON SPACE CENTER (JSC)

| | |
|----------------------|-------------------------------------------------------------------------------------------|
| JSC 07700, Vol. XIV | Space Shuttle System Payload Accommodations |
| JSC 07700-14-PIV-01 | Space Shuttle System Payload Interface Verification, General Approach and Requirements |
| JSC 10615 | Shuttle EVA Description and Design Criteria |
| JSC 11123 | Payloads Safety Guidelines |
| JSC 11801 (Proposed) | STS User Management Procedures and Planning Schedules |
| JSC 11802 (Proposed) | STS Reimbursement Guide |
| JSC 11804 (Proposed) | Attached Payloads Johnson Space Center |
| SW-E-0002 | Space Shuttle Ground Support Equipment, General Design Requirements |

E.4 MARSHALL SPACE FLIGHT CENTER (MSFC)

(Unnumbered) Interim Upper Stage User's Guide (Proposed)

E.5 GODDARD SPACE FLIGHT CENTER (GSFC)

(Unnumbered) Multimission Modular Spacecraft User's Guide

GSFC STD 101.2 TDRSS User's Guide

(Unnumbered) Earth Orbiting Automated Payloads, GSFC (Proposed)

E.6 LANGLEY RESEARCH CENTER (LaRC)

(Unnumbered) Long Duration Exposure Facility, Guide for Experiment Accommodations

E.7 JET PROPULSION LABORATORY (JPL)

(Unnumbered) Planetary Payloads, JPL

E.8 OTHERS

MIL-STD-1472 Human Engineering

AFETR-M-127-1 Range Safety Manual, Volume II

AFM 127-100 Explosive Safety

AFM 161-30 Liquefied Propellants, Volume I

APPENDIX B
SAFETY REQUIREMENTS FOR
HAZARDOUS GROUND OPERATIONS/CHECKOUT PROCEDURES

APPENDIX B
SAFETY REQUIREMENTS FOR
HAZARDOUS GROUND OPERATIONS/CHECKOUT PROCEDURES

B.1 HAZARDOUS PROCEDURES

Hazardous procedures will include a Safety Requirements section containing the following information:

- a. The specific hazard(s) encountered during the procedure.
- b. Safety equipment required for each specific hazard.
- c. Safety rules, regulations or criteria unique to a specific hazardous operation (e.g., flex hose restraints, safe air O₂ content, use of tag lines).

B.2 HAZARDOUS WORK AUTHORIZATION DOCUMENTS

All hazardous work authorization documents will include applicable portions of the following safety provisions:

- a. Support Required From Other Agencies, such as Security, Fire Department, Environmental Health, Medical Department notification, System/Pad Safety, etc.
- b. Safety Equipment Required, such as toxic vapor detection, aspirators, H₂ leak sensors, safety showers and eye washes, explosimeters, fire hoses, and protective equipment to be worn by operating personnel, e.g., fire retardant suits, face shields, gloves, leg and wrist stats, etc.
- c. Safety Notations, will be inserted to call attention to hazardous steps or sequences in accordance with the following instructions:
 - (1) Caution and Warning notes will be used as required. They will not be numbered within the document, but will be set apart from the text by placing them in the center of the page immediately preceding the procedural step or sequence to which they apply.
 - (a) Caution notes will be used as an alert of an operation, situation, or requirement which, if not strictly adhered to or observed, could result in damage to equipment.
 - (b) Warning notes will be used as an alert of an operation, situation or requirement which, if not strictly adhered to or observed, could result in injury to personnel.

(2) Cautions and Warnings may be divided into two categories:

(a) Informative or Descriptive

Those cautions/warnings which identify critical safety requirements or which alert personnel that certain safety measures or prescribed actions must be accomplished at a particular time in the operations.

This type caution/warning shall be included in a document whenever it is judged necessary for safety reasons to place special emphasis on an operation, situation or requirement.

(b) Hazardous Step Identification

Those cautions/warnings which alert personnel that a hazardous procedural step or sequence follows immediately.

Whenever a step or sequence in a document increases the hazard level, this type of caution/warning must be used to identify the specific step or sequence.

(3) There are two formats which may be used for hazardous step identification:

(a) The hazardous step or sequence will be immediately preceded by an "opening" caution/warning and immediately followed by a "closing" caution/warning:

CAUTION

THE FOLLOWING STEPS ARE HAZARDOUS

(numbered procedural step or sequence which is hazardous)

CAUTION

RESUME PREVIOUS HAZARD LEVEL - END OF CAUTION

(b) The hazardous step or sequence will be immediately preceded by a caution/warning which identifies the hazardous steps by number:

WARNING

STEPS 5, 8, 10 AND 16 THRU 23 ARE HAZARDOUS

No "closing" caution/warning is required if this method is used.

- (4) It is acceptable to utilize one caution/warning preceding a series of steps even though there may be non-hazardous steps intermingled.
- (5) The type of hazard does not need to be identified other than in the Safety Requirements section. However, if it is judged desirable to do so, the type of hazard may also be briefly identified in the caution/warning preceding the hazardous step or sequence:

WARNING

DUE TO (reason for hazard)

THE FOLLOWING STEPS ARE HAZARDOUS

B.3 AREA CLEARANCE REQUIREMENTS

When personnel are required in the controlled area to perform specific tasks, they will each be identified by call sign, station code, or other positive means. Clearing of an area and identification of essential personnel will be a procedural step and not part of a safety notation.

B.4 SAFETY CONCURRENCE PROVISIONS

KSC Safety will be notified prior to initiating a Hazardous Operation or Test.

B.5 TEST OPERATIONS ENGINEERING SAFETY INSPECTION REQUIREMENTS

An independent inspection will be performed by Test Operations Engineering and Safety for selected hazardous fluid/pressure operations. Initial inspection for a given test will be called out as a procedural sequence following Quality Assurance (QA) verification of configuration. Additional inspections may be requested when conditions warrant (e.g., following any major configuration change).

B.6 EMERGENCY INSTRUCTIONS

Emergency instructions will be included for those hazards unique to the operation and to provide rapid shutdown or revert of the operation for the protection of personnel and equipment. The applicable emergency instructions will be available to operating personnel at all times during the operation.

APPENDIX C
GLOSSARY

APPENDIX C GLOSSARY

This appendix contains a glossary of terms used in this Handbook, and their definitions.

Automated Payloads

Those payloads which are supported by an unmanned spacecraft capable of operating independently of the STS. Automated payloads are detached from the Orbiter during their operational phase of their flights.

Cargo

The total compliment of payloads (one or more) on any one flight. It includes everything contained in the Orbiter cargo bay, plus other equipment, hardware, and consumables located elsewhere in the Orbiter that are user-unique, and are not carried as a part of the basic Orbiter payload support.

Dedicated Spacelab

An extension module devoted to a single discipline which may fly more than once a year for several years, and which may be assigned to a payload development center.

Experiment

The system of hardware, software, and procedures for performance of a scientific or applications investigation undertaken to discover unknown phenomena, establish the basis of known laws, or evaluate applications process and/or equipment.

Flight

That portion of a mission encompassing the period from launch to landing, or launch to termination, of the active life of a spacecraft. The term Shuttle "flight" means a single Shuttle round trip -- its launch, orbital activity and return. One flight might deliver more than one payload. More than one flight might be required to accomplish one mission.

Free Flyer

Any payload that is detached from the Orbiter during the operational phase of that payload and is capable of independent operations (same as Automated Payloads).

Integration

A combination of activities and processes to assembly payload and STS components, subsystems, and system elements into a desired configuration, and to verify compatibility among them.

Interface

The mechanical, electrical, and operational common boundary between two elements of a system.

Inertial Upper State (IUS)

The IUS, an element of the STS, is an expendable solid propellant multistage vehicle. It extends the STS performance capability beyond that of the Shuttle alone. The IUS with its payload(s) will be taken to low earth orbit in the Orbiter cargo bay.

Launch Pad

The pad area from which the Space Shuttle will be launched. The stacked Space Shuttle will undergo final prelaunch checkout and countdown at the launch pad.

Launch Processing System (LPS)

A high speed digital computer operated checkout system used to support test, checkout, launch control and operational management of launch site ground operations at KSC.

Mission

The performance of a coherent set of investigations or operations in space to achieve program goals. A single mission might require more than one flight, or more than one mission might be accomplished on a single flight.

Mobile Launch Platform (MLP)

The structure on which the elements of the Space Shuttle are stacked in the Vertical Assembly Building. The MLP and the Space Shuttle are then moved to the launch pad for launch.

Multiple Payloads

More than one payload carried in the cargo bay. Multiple payloads involve multiple Payload Mission Managers.

Off-Line

An activity conducted independent of any STS element (i.e., IUS/SSUS, Spacelab, or Shuttle). This normally means the activity is conducted in a separate facility as well.

On-Line STS

Payload activity which involves another payload or an STS element. This includes the following:

On-Line Shuttle - An activity encompassing a payload, its carrier and the Shuttle Vehicle.

On-Line Spacelab - An activity encompassing a payload and its Spacelab.

On-Line IUS/SSUS - An activity involving a payload and the IUS/SSUS.

Orbiter Processing Facility

This is a building at KSC with two bays in which the Orbiter undergoes post flight inspection, maintenance, and pre-mate checkout prior to payload installation. Payloads are installed horizontally in this building.

Pallet

An unpressurized platform, designed for installation in the Orbiter cargo bay, for mounting instruments and equipment requiring direct space exposure.

Payload

The total complement of specific instruments, space equipment, support hardware, and consumables carried in the Orbiter (but not included as a part of the basic Orbiter payload support) to accomplish a discrete activity in space.

Payload Changeout Room

An environmentally controlled room, on a moveable support structure, which includes a manipulator system for transferring a payload vertically between a transport canister and the Orbiter payload bay.

Program

An activity, involving manpower, material, funding and scheduling, necessary to achieve desired goals. (Example: Shuttle Program, Solar Astronomy Program.)

Space Transportation System (STS)

An integrated system consisting of the Space Shuttle (Orbiter, External Tank, Solid Rocket Boosters, and Flight Kits), Upper Stage (IUS or SSUS), Spacelab, and any associated flight hardware and software.

STS User

An organization or individual requiring the services of the Space Transportation System.

Spacelab

A general-purpose orbiting laboratory for manned and automated activities in near-earth orbit. It includes both module and pallet sections, which can be used separately or in several combinations.

Spinning Solid Upper Stage (SSUS)

The SSUS an element of the STS, is an expendable spin stabilized solid propellant stage. It extends the STS performance capability beyond that of the Shuttle alone. Several SSUSs with their respective payloads may be taken to low earth orbit in the Orbiter cargo bay.

Upper Stage

A small propulsion unit used with a payload when required. One or more of these units may be used with a payload to provide the additional velocity required to place a payload in the desired orbit or trajectory. Also, a propulsion system that is used to provide mid-course trajectory corrections, braking maneuvers, and/or orbital adjustment.

APPENDIX D
USER-ORIENTED DOCUMENTS

APPENDIX D

USER - ORIENTED DOCUMENTS

Selected STS references have been prepared to assist STS Users in obtaining information on use of the STS. These publications are listed below and in accordance to the Part of the STS User Handbook (which they support).

THE USER
REVIEWS THE
HANDBOOK,
IS DIRECTED
TO THE PROPER
FOLLOWUP
DOCUMENTATION,

AND, BASED ON
THE EXPERIMENT
DISCIPLINE AREA
AND FLIGHT
TYPE, SELECTS
THE PROPER
USERS' GUIDE
FROM THE
LISTED
REFERENCES.

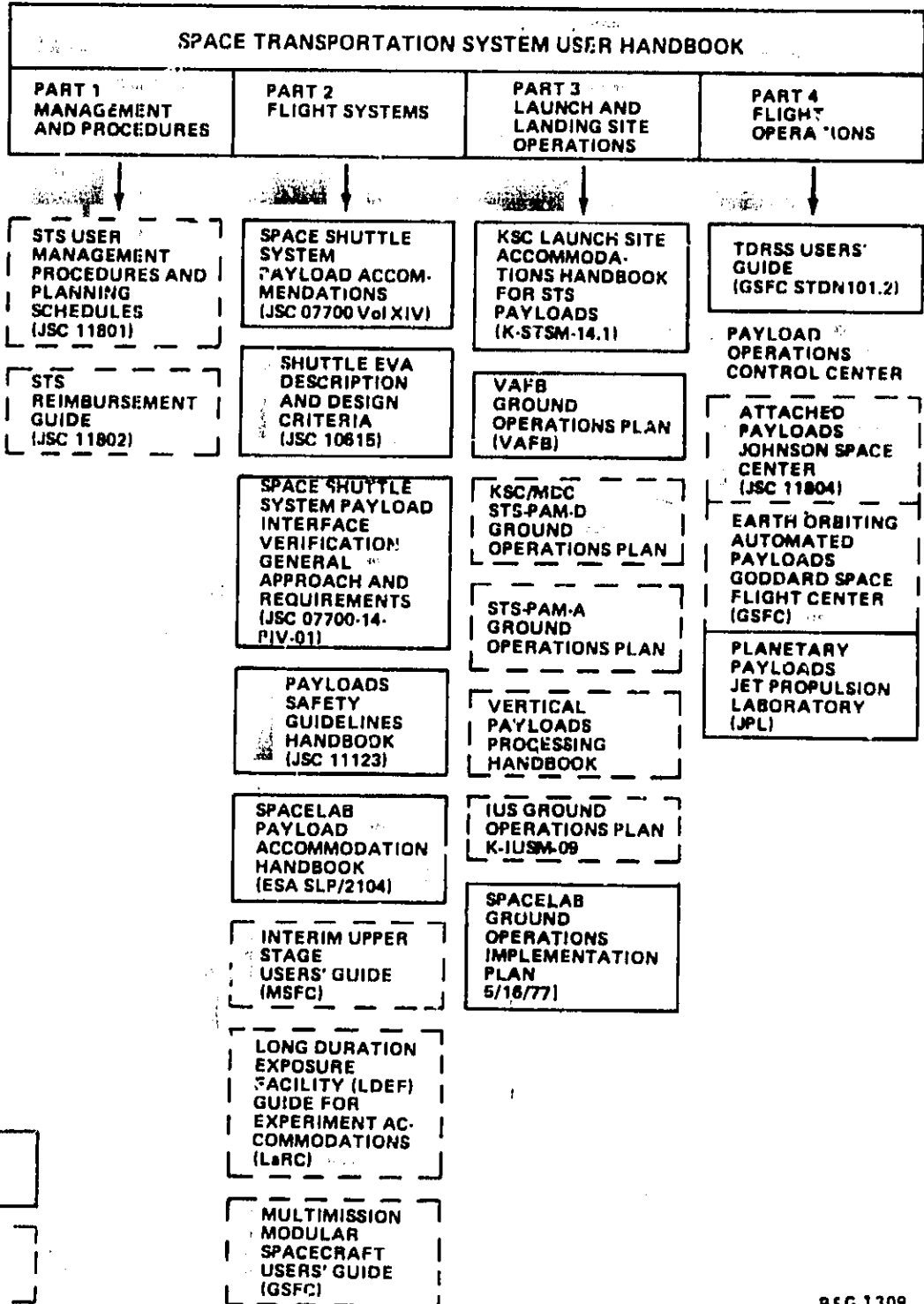

LEGEND:

EXISTING

IN WORK

BSG 1309

K-STSM-14.1 KSC LAUNCH SITE ACCOMMODATIONS HANDBOOK FOR STS PAYLOADS

AD-CBO-3FM 100
 AD-RNO D. Capone
 AP-SAT-2 J. Merring
 UU D. Buchanan
 LE R. Clark
 DF R. Dodd
 DY-SPE R. Lyon
 DL M. Paul
 FN-80 A. Scholz
 CDC J. Gardner
 IBM-D47 J. Owens
 IN W. Ruck
 IN-PLM R. Mayle
 JPL M. Levy
 NDAC-ADSS R. Durkin
 NDAC-NA-104 P. Kramer
 MNC-B J. Guff
 MNC-1 K. Trout
 MWSI-D KSC Library-Docs. 2
 PA C. Mollinshead 3
 PRC-1000 P. Fahey 2
 SF J. Atkins
 SF-LMG A. Smith
 SF-SOO R. Sweet
 SO R. Gorman
 SO-EMG E. Smith
 SO-LAB J. Gay
 SO-OPN D. Stinson
 SP R. Gray
 SP-ACT C. Gay
 SP-AP LTC Green 5
 SP-FGS W. Williams
 SP-ILS W. Beckus
 SP-MPC W. Bainwater
 SP-OPN R. Buckley 5
 SP-PAY M. McCoy 6
 SP-PAY J. Regusa
 SP-PAY G. Sharp 6
 SP-PAY-A J. Johnson 7
 SP-PAY-BL J. Dickinson 5
 SP-PAY-T W. Clark 3
 SP-SAF S. Beddingfield
 TMW P. Polansky
 Td P. Hinderman
 TH-MTS R. Ricks
 VE C. Sasseen
 VL G. Page
 VO W. Sapryan
 VP I. Rigell
 VP-AVD H. Edwards 5
 VP-EAP J. Twigg 5
 VP-NPS L. Fannin
 VP-VFO R. Gaskins
 VP-PFC R. Moser
 VT P. Donnelly
 VT J. Gerding
 VT-VFO-1 H. Widick
 WSK A. Morse
 2K-22 A. Carey
ALCOJET LIQUID ROCKET CO.
 * Attn.: G. Gerst
 * Tech. Inf. Cent.
 * P. O. Box 1323 (77-171)
 * Sacramento, CA 95611
AEROSPACE MUSEUM LIBRARY
 * Attn.: J. Carter
 * 105 Hackwood Dr.
 * Durham, NC 27105
ANES 202-1 Library
ANES 202-11 M. Bader
ANES 236-5 M. Johnson 2
ANES 236-5 K. Souza
ANES 247 J. Murphy 6
ANES 247-12 T. Harnount
ARO, INC.
 * Attn.: J. Kesser
 * Suite 722
 * 1625 Eye St., N. W.
 * Washington, DC 20006
BALL BROTHERS RESEARCH CORP.
 * Attn.: R. Scott
 * P. O. Box 1043
 * Boulder, CO 80302
BELL LABORATORIES
 * Attn.: W. Benden,
 * Satellite Systems Group
 * Holmdel, NJ 07733
BOEING AEROSPACE CO.
 * Attn.: C. Brown
 * M/S 87-76, Org. 2-3911
 * P. O. Box 3999
 * Seattle, WA 98124
COMBUSTION ENGINEERING, INC.
 * Attn.: E. Krume
 * P. O. Box 372
 * Melville, NY 14695
DEPARTMENT OF COMMUNICATION
 * Attn.: R. Werten
 * 300 Slater Street
 * Ottawa, Ontario
 * KIA-OC-8 LSAN/
 * (VIA AIR MAIL)
DFRC Library
EUROPEAN RES. & TECH. CENTER
 * Attn.: W. Mason, Spacelab Div.
 * Domselweg
 * Noordwijk, Netherlands
 * (VIA AIR MAIL)
EUROPEAN SPACE AGENCY/ESTEC
 * Attn.: J. Fourquet
 * Sacota Project Office
 * Domselweg
 * Noordwijk Aan Zee
 * The Netherlands
 * (VIA AIR MAIL)

FAIRCHILD SPACE & ELEC. CO.
 * Attn.: W. Jarvey, E-3
 * Germantown, MD 20767
FAIRCHILD SPACE & ELEC. CO.
 * Tech. Inf. Ser. Library 3-18
 * Sherman Fairchild Tech. Cen.
 * Germantown, MD 20767
FLORIDA INSTITUTE OF TECHNOLOGY
 * Attn.: J. Angelo
 * Physics & Space Sci. Dept.
 * P. O. Box 1150
 * Melbourne, FL 32901
FLORIDA INSTITUTE OF TECHNOLOGY
 * Attn.: S. Sistrunk
 * Physics & Space Sci. Dept.
 * P. O. Box 1150
 * Melbourne, FL 32901
GENERAL ELECTRIC
 * Attn.: S. Blisan
 * P. O. Box 8555
 * Philadelphia, PA 19101
GRUMMAN AEROSPACE CORP.
 * Attn.: D. Shergalis
 * 071/961
 * 2852 Kelvin Avenue
 * Irvine, CA 92714
GSFC 252 Library
GSFC 420 D. Grimes
GSFC 420 W. Moggard
GSFC 420 G. Keller
GSFC 430 E. Howle
GSFC 440 J. Brahm
GSFC 450 M. Pedulsky
GSFC 470 W. Medenica
GSFC 701.1 S. Omler
GSFC 731 R. Gunton
GSFC 740.1 J. Guidotti
GSFC 742 J. Barrowman
HAWRO SIDDELEY DYNAMICS, LTD.
 * Attn.: D. McLaurin
 * Gunnelwood Road Stevenage
 * Herbs, England
 * (VIA AIR MAIL)
HERMANN-OBERTH-GESELLSCHAFT
 * LANDESGRUPPE SCHWEIZ
 * Attn.: O. Walcher
 * Adligensacker 1
 * CH-4826 Ebenbrücke,
 * Switzerland
 * (VIA AIR MAIL)
JONES AIRCRAFT CO.
 * Attn.: S. Blevins
 * Space & Comm. Group
 * P. O. Box 92919 Airport Sta.
 * Los Angeles, CA 90009
(THE) HUNTSVILLE TIMES
 * Attn.: D. Boelling
 * Memorial Parkway
 * Huntsville, AL
[INGENIEURBURO]
 * Attn.: R. Ellett
 * Josef-Schwarz - Weg 11
 * 8000 Muenchen 71
 * Germany
 * (VIA AIR MAIL)
**INSTITUT FUER LUFT - UND
 * BAUMFAHRT**
 * TECHNISCHE UNIVERSITAET
 * MUEENCHEN
 * Attn.: E. Ingengerger
 * 8000 Muenchen 2 Arcisstr. 21
 * (VIA AIR MAIL)
INTERNATIONAL BUS. MACH. CORP.
 * Attn.: S. Kidd
 * Advanced Missions Dept.
 * 1322 Space Park Drive
 * Houston, TX 77058
INTERNATIONAL BUS. MACH. CORP.
 * FEDERAL SYST. DIV. LIBRARY
 * Attn.: D. Kidwell
 * 18100 Frederick Pike
 * Gaithersburg, MD 20760
JPL 111-113 Library
JPL 150-224 C. Sasaki
JPL 169-414 D. Klindt
JPL 179-203 R. Appleby 3
JPL 180-402 P. Barnett
JPL 180-805 R. Rieder
JPL 223-208 P. Bennett
JSC JMS Library
JSC JMS 20
LARC 54-5 G. Chomos
LARC 158 F. Allaby
LARC 158 C. Tynan 10
LARC 185 Library
LOCKHEED 60-3 Library
LOCKHEED MISSILES & SPACE CO.
 * Attn.: R. Cretcher
 * Dept. 61-63, Bldg. 104
 * P. O. Box 504
 * Sunnyvale, CA 94088
LOCKHEED MISSILES & SPACE CO.
 * Attn.: L. Vreugde
 * Dept. 61-63, Bldg. 104
 * P. O. Box 504
 * Sunnyvale, CA 94088
NSFC A224 M. Garrett
NSFC JA01 J. Jean
NSFC JA11 R. Pace
NSFC JA41 P. Hall 3
NSFC JA41 L. Lawson
NSFC JA61 M. Nixon
NSFC NA01 J. Lee 5

NSFC PD34 J. Price
NSFC PF02 W. Tier
NSFC PF05 J. Cristler
NSFC PF05 W. Keathley
NASA HQ D W. Williams
NASA HQ 8B D. McConnell
NASA HQ 81 G. Zsanzwein
NASA HQ 81 W. Goldaby
NASA HQ 8E M. Felsher
NASA HQ 83A-10 Library
NASA HQ M P. Culbertson
NASA HQ M J. Yasdley
NASA HQ MDI P. Neuser
NASA HQ MF D. Laird
NASA HQ MKS-7 Hammettsmith
NASA HQ ML7-9 J. Wild
NASA HQ MKS S. Drausch
NASA HQ MO W. Armstrong
NASA HQ MO C. Lee
NASA HQ MO D. Turner
NASA HQ MQ H. Cohen
NASA HQ NR-4 J. Scheller
NASA HQ MV J. Mahon
NASA HQ MVU H. Schaefer
NASA HQ RS E. Gabris
NASA HQ SA P. Martin
NASA HQ TBS Chambers
NASA HQ SL D. Herman
NASA HQ ST Kennedy
NASA HQ 5T A. Tirath
NASA HQ 7A Bryant
NASA KSC C. Fuentes
 * Attn.: VL-NSO
 * P. O. Box 475
 * Longoc, CA 92436
NAVAL RESEARCH LABORATORY
 * Attn.: R. Hutchkiss
 * Code 71498
 * Washington, DC 20375
OPERATIONS RESEARCH, INC.
 * Attn.: J. Levy
 * 1400 Spring Street
 * Silver Spring, MD 20910
RCA SATCON PROGRAM
 * Attn.: J. Prochbieter
 * P. O. Box 800
 * Princeton, NJ 08540
OCWELL-DWY 871
 * Attn.: D. Anderson
ROYAL AIRCRAFT ESTABLISHMENT
 * Main Library
 * Attn.: P. Turner
 * Farnborough
 * Hants, England
 * (VIA AIR MAIL)
SANSCO LUCA Tech. Inf. Center
 * Attn.: S. Brown
 * P. O. Box 92960
 * Los Angeles, CA 90009
SANSCO LV2E
 * P. O. Box 92960
 * Los Angeles, CA 90009
SANDIA LABORATORIES
 * Attn.: W. Wilson
 * Solar Tech. Div. 8111
 * P. O. Box 969
 * Livermore, CA 94550
SED SYSTEMS, LTD.
 * Attn.: D. Bassett
 * P. O. Box 1464
 * Saskatoon
 * Saskatchewan, Canada
 * S7K 3P7
 * (VIA AIR MAIL)
TRW SYSTEMS GROUP
 * Attn.: C. Orr
 * 1 Space Park
 * Bldg. M-3, Rm. 2143
 * Redondo Beach, CA 90278
WALLOPS FLIGHT CENTER
 * Attn. Tech. Library
 * Wallops Island, VA 21337
 * Edward I. Brown, V
 * General Delivery
 * Burbank, CA 91505
 * Andrew Dimitron
 * 225 1/2 W. Luz
 * W. Lafayette, IN 47907
 * Robert Dotson
 * 4523 Mt. Vista
 * Las Vegas, NV 89121
 * Thomas E. Hanes
 * 4060 Barclare Lane
 * Encino, CA 91436
 * Malcolm S. McMutt
 * 237 Bearne Avenue
 * Cincinnati, OH 45229
 * Norman Meisan
 * 3191 Maquire Blvd.
 * Suite 106
 * Orlando, FL 32803
 * Neal J. Sperling
 * 5343 Yarrowth Avenue
 * Encino, CA 91316

Total..... 369