

NASA Technical Memorandum 81152

Pilot Control Through the TAFCOS Automatic Flight Control System

William R. Wehrend, Jr.

(NASA-TM-81152) PILOT CONTROL THROUGH THE
TAFCOS AUTOMATIC FLIGHT CONTROL SYSTEM
(NASA) 42 p HC A03/MF A01 CSCL 01C

N80-14138

Unclas

G3/08 46419

December 1979



National Aeronautics and
Space Administration

NASA Technical Memorandum 81152

Pilot Control Through the TAF COS Automatic Flight Control System

William R. Wehrend, Jr., Ames Research Center, Moffett Field, California

NASA

National Aeronautics and
Space Administration

Ames Research Center
Moffett Field, California 94035

SYMBOLS

A_{vs}^t	direction cosine matrix, inertial to velocity axis
$C_{L\alpha}$	lift curve slope
$E_i(I)$	direction cosine matrix, single rotation about axis i
$E_i^t(I)$	transpose of $E_i(I)$
g	acceleration due to gravity
K_{throt}	gain constant for throttle control
L_c	lift command from stick input
M	aircraft mass
T_c	thrust command from throttle input
t	time
W	aircraft weight
w	aircraft vertical velocity component
w_c	commanded vertical velocity
\dot{w}_c	commanded vertical acceleration
x_i, y_i, z_i	inertial coordinate system
$\ddot{x}_{ATC}, \dot{x}_{ATC}, x_{ATC}$	acceleration, velocity, and position commands from ATC command generator
$\ddot{x}_c, \dot{x}_c, x_c$	acceleration, velocity, and position commands in inertial space
V_c	commanded velocity from mode-select panel
V_t	true airspeed
α	angle of attack
γ_c	flightpath angle command from mode-select panel
γ_v	flightpath angle
δ_{stick}	stick input by pilot

δ_{throt}	throttle input by pilot
δ_{wheel}	wheel input by pilot
ϕ, θ, ψ	Euler angles for aircraft attitude
ϕ_c, θ_c, ψ_c	commanded Euler angles
$\dot{\phi}_c, \dot{\theta}_c, \dot{\psi}_c$	commanded Euler angle rates
$\phi_v, \dot{\phi}_v$	roll angle and roll rate about velocity vector
ψ_v	heading angle of velocity vector
ψ_{sw}	heading angle for switching logic

PILOT CONTROL THROUGH THE TAFCOS AUTOMATIC
FLIGHT CONTROL SYSTEM

William R. Wehrend, Jr.

Ames Research Center

SUMMARY

The fully automatic operation of a new flight control concept -- TAFCOS -- was evaluated in a recently completed flight-test program. In the present work, the TAFCOS concept is extended to provide a multilevel pilot interface; verification of system performance is through a computer simulation. Two specific levels of pilot control were studied: (1) a stick-wheel-throttle type input that essentially duplicates the input provided for a velocity-control-wheel-steering mode in which the pilot controls the aircraft in a conventional manner through the TAFCOS control logic; and (2) a mode of operation that uses a device called the mode-select panel, in which the pilot has the capability of calling up conventional autopilot modes, such as airspeed, altitude, flightpath angle, and heading hold-select. The objective of the study was to evaluate the feasibility of providing these capabilities through the TAFCOS structure. The study was performed using an unmanned simulation on an IBM 360 which used the set of flight control logic used in the flight tests of the automatic system. The simulations showed that the control logic does provide for the desired level of control.

INTRODUCTION

Recently, a flight program was conducted at Ames Research Center to evaluate a new flight control concept called TAFCOS (Total Automatic Flight Control System) in which the controller operation was evaluated in a fully automatic mode. A theoretical development of the controller concept is given in reference 1, and the flight-test results are presented in reference 2. The prime objective in the development of TAFCOS is to provide an integrated flight control system that controls all the vehicle states; special emphasis is on control of vehicles with highly nonlinear flight characteristics and difficult operational requirements. Flight-test verifications have shown that TAFCOS performs satisfactorily. The structure of TAFCOS as developed thus far is limited, however, to fully automatic three-dimensional and four-dimensional modes of operation, in which the aircraft is required to fly over an arbitrary but preset trajectory defined in terms of a series of way points.

In order to make the TAFCOS design methodology applicable to a wider class of problems, it is necessary that some means of pilot input or of direct pilot control through TAFCOS be provided. This report presents a scheme that will permit such control; pilot input can be made either through TAFCOS with a

conventional stick-wheel-throttle control or by permitting the selection of conventional autopilot modes.

The basis for the present study comes from the work done in setting up the TAF COS controller for flight test in the automatic mode. The flight evaluation was performed with the Ames DHC-6 Twin Otter aircraft, which is equipped with a digital flight control system called STOLAND (see ref. 3 for details). The Twin Otter has been used by Ames for a number of STOL flight evaluations and its STOLAND avionics system made it an excellent vehicle for the TAF COS experiment. The STOLAND system provides a full set of avionics equipment for the researcher; it has servo-controlled aircraft control surfaces, computer-driven cockpit displays, and a number of other functions. A Sperry 1819A digital computer is used as the central processor for the system. The software package supplied with the 1819A computer contains a complete set of logic for flight control of the aircraft in a variety of modes and includes a complementary filter navigator, an autopilot, an SAS, and computation sections to drive the displays. TAF COS used this software package for the automatic-mode flight evaluation by inserting a new set of control functions that operationally replaced the autopilot and SAS sections within STOLAND. In addition to a fully automatic mode (similar to the TAF COS operation), however, the STOLAND software contains a means for direct pilot control.

The purpose of this report is to demonstrate how these same pilot control options, which as a matter of convenience essentially duplicate the STOLAND modes, can be integrated into the TAF COS concept, thereby making TAF COS into an operationally complete system.

The presentation that follows uses an IBM 360 simulation of the operation of the pilot control of TAF COS to demonstrate the performance of the concept. The version of TAF COS used is an exact FORTRAN equivalent of the structure used in the DHC-6 Twin Otter flight tests. The results presented show the structure of a possible form of the control input as applied to the Twin Otter and demonstrate how the stick-wheel-throttle inputs can be interfaced with TAF COS. A complete definition of the pilot control structure would require a piloted simulation to set up system gains and otherwise verify that the technique is acceptable to a pilot. The piloted simulation was beyond the scope of the present work. The concept does appear feasible, however, and in conjunction with the demonstrated performance of TAF COS, can be expected to provide the desired level of pilot control.

GENERAL PROBLEM DESCRIPTION

The objective in the construction of a manual control option that can operate with TAF COS is to provide a structure that will permit the inclusion of some form of direct pilot control through a control stick-wheel-throttle input or other equivalent device. Conventional autopilot modes that are available in other designs should also be made available. Because the flight evaluation of the automatic mode of operation of TAF COS was performed in the Ames Twin Otter aircraft, and because the Otter's STOLAND avionics system was used, the choice was made to construct the TAF COS manual control logic to

control through this same set of logic and to essentially duplicate the modes provided by STOLAND. Other options are possible, but the STOLAND system provides for most piloting modes and hence the duplication will cover most options. In addition, the STOLAND control logic has been shown to be acceptable to pilots and to be compatible with the aircraft performance as demonstrated through numerous simulation and flight tests. As background for the TAFICOS construction, a brief description of the STOLAND pilot interface follows. The STOLAND information, which comes principally from references 3 and 4, is supplemented with data from the flight program and other documents.

STOLAND permits direct pilot control of the aircraft by two operational modes: (1) a stick-wheel input, called control wheel steering (CWS), and (2) by use of a push button panel to call up specific autopilot modes, called the mode-select panel (MSP). With the CWS mode, the pilot is able to control the aircraft by using the control column as the input device in which the control is through the attitude, or SAS logic, within STOLAND. The handling behavior of the aircraft through the CWS operation is conventional, with the stick providing pitch attitude control and the wheel the roll control. Handling qualities improvement is provided through the SAS logic. The MSP is used by the pilot as the main autopilot mode-select controller for the STOLAND system. Various levels of automation and the STOLAND three-dimensional and four-dimensional modes are selectable with the MSP. The various control buttons on the MSP are shown in figure 1. Items on the MSP that are of interest to the present discussion are the four selectable autopilot modes. These consist of a hold and select mode for airspeed, altitude, flightpath angle, and heading. The pilot may select any combination of the modes with the exception that flightpath angle and altitude modes are mutually exclusive.

When the pilot controls the aircraft through the STOLAND CWS mode of operation, the stick-wheel motion generates an attitude rate, attitude-hold type of command. Fore and aft stick motion calls for a pitch rate, the time rate of change of the pitch Euler angle θ ; the wheel motion calls for the equivalent roll rate. The rudder pedals are not operative in the CWS mode. For the stick command, the following control law is used to generate the pitch rate commands:

$$\left. \begin{aligned} \dot{\theta}_c &= \left(\frac{15.0}{V_t} \right) \delta_{stick} \\ \text{and} \\ \theta_c &= \int \dot{\theta}_c dt \quad -10^\circ \leq \theta \leq 10^\circ \end{aligned} \right\} \quad (1)$$

The quantity δ_{stick} , the motion of the control column, is a linear measure (in centimeters) for the movement of the top of the column. The output is the commanded pitch angle θ_c . This command is summed with the measured aircraft attitude and processed by the SAS logic to generate a delta elevator command. The lateral control of the aircraft through the CWS logic is similar to the above where roll commands are generated from wheel motion by the following logic:

$$\dot{\phi}_c = 0.64 \delta_{\text{wheel}}$$

and

(2)

$$\phi_c = \int \dot{\phi}_c dt \quad -45^\circ \leq \phi_c \leq 45^\circ$$

Here the term δ_{wheel} is the rotation of the control wheel measured in degrees. As with the pitch command, the roll command is processed through the SAS logic, where both delta aileron and rudder commands are generated.

As can be seen from equations (1) and (2), the CWS mode provides the pilot with a two-control operation that allows for control of the aircraft attitude. Looking forward to the TAF COS construction where the command inputs are in the form of trajectory variables, it is worthwhile to consider the operation of the STOLAND controls in terms of the trajectory response.

Considering the wheel input first, it can be seen from equations (2) that the operation of the wheel part of the CWS mode is conventional as compared with the pilot's cable controls. A wheel input results in a roll-rate command and the bank angle is held constant when the wheel is returned to a zero position. The effect of the roll CWS is, therefore, to generate a radial acceleration for turning by tipping the lift vector. The result is, of course, a change in the direction or heading of the velocity vector so that lateral CWS operation can be viewed as either an attitude control or trajectory control.

The operation of the CWS stick control is somewhat different from the normal aircraft control through the stick. STOLAND commands a pitch rate, pitch-attitude-hold command rather than pitch acceleration. The relation of the CWS control to trajectory variables can be seen from the following set of equations. Writing the vertical velocity in terms of the glide slope gives

$$w = V_t \sin \gamma_v \approx V_t \gamma_v \quad (3)$$

Expressing γ_v in terms of pitch attitude and angle of attack, equation (3) can be written in the following form:

$$w = V_t (\theta - \alpha) \quad (4)$$

Assuming a stick input in the form of a pulse, equation (1) shows that STOLAND will call for a change in pitch attitude in proportion to the duration and magnitude of the pulse. For a constant airspeed, V_t , the value of the angle of attack, will be very nearly the same after the pitch change, assuming a constant $C_{L\alpha}$, so that the vertical velocity response from equation (4) can be written as

$$\dot{w} = 15.0 \delta_{\text{stick}} \quad (5)$$

Therefore, the stick control also provides for direct trajectory control with the commanded vertical velocity proportional to the pulse input from the stick.

Coupling the stick and wheel control with a throttle input to effect changes in the magnitude of the velocity vector gives complete control over the trajectory of the aircraft through the STOLAND control wheel steering.

The operation of the mode-select panel provides a means of control by the pilot that is equivalent to that provided by the CWS inputs where a different input device is used. The details of the input panel button arrangement are shown in figure 1, where the function of each is labeled. In operation, if the hold button is pushed for any of the functions to be controlled, the autopilot will lock onto the measured aircraft value at the time the button is pushed (there are some minor exceptions for small roll and flightpath angles where a zero value is used as the hold value). If a new value is to be selected, say a speed change, the slew knob is rotated to change the indicated value in the window display on the MSP. During this operation, the hold value continues to be used by the control operations. To switch to the new value, the select button is pushed and the aircraft changes to the new setting according to control logic for such transfers; it will then revert to the hold mode and track the new setting. The commands generated from the MSP by the STOLAND logic are either attitude commands as inputs to the SAS logic or commands to the autothrottle system.

The operation of the MPS commands can be viewed in a manner similar to the CWS operation where the commanded inputs are controlling the aircraft airspeed vector. The command quantities of airspeed, heading, and flightpath angle are a polar coordinate definition of the commanded velocity. Hence, command of these quantities to either hold a present value or to move to a new value provides for control over both the magnitude and direction of the airspeed; therefore, as with the CWS operation, it provides trajectory control. The altitude hold-select command can also be included in this definition where the command is for a zero flightpath angle with the addition of an altitude constraint.

The problem to be considered next is how to provide a similar set of pilot input commands through TAF COS. Where the STOLAND system operates through a set of attitude commands to the SAS logic with separate autothrottle inputs, the TAF COS commands are to be in the form of an integrated trajectory command. From the description of the CWS and MSP inputs, it can be seen that the STOLAND commands can be treated either as attitude commands or as trajectory commands; hence, they are equally usable with STOLAND or TAF COS. Therefore, what is required is the definition of a software interface between the cockpit control devices and the TAF COS logic that will permit a level of control similar to that provided by STOLAND.

INTERFACE OF TAF COS AND THE MANUAL CONTROLLER

To see how the manual controller would function with the TAF COS system, it is first necessary to take a brief look at the way in which TAF COS operates. The block diagram shown in the sketch below shows the basic functional blocks of TAF COS as used in the automatic mode. The diagram is a greatly

oversimplified description of TAFCOS; details on the construction and operation of each block are given in references 1 and 2.

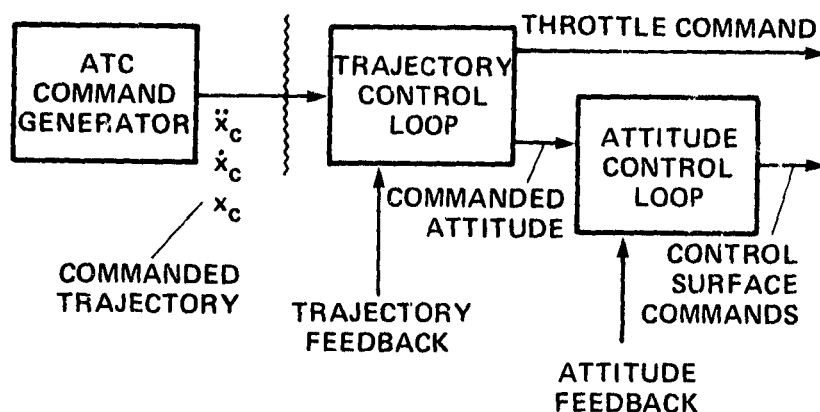

As shown in the block diagram, TAFCOS can be considered to be made up of three main sections: the ATC (air traffic control) command generator, the trajectory control loop, and the attitude control loop. In operation, the basic command to the controller comes from the ATC command generator where the trajectory to be followed is generated from a stored set of way points. These way points define the three-dimensional track for the aircraft to follow and also define the velocity profile, which may be interpreted as either a three-dimensional track or a four-dimensional command. The outputs of the ATC command generator are the position, velocity, and acceleration required to follow the desired path; they are defined in a ground or inertial coordinate system. TAFCOS can be considered as an acceleration controller so that the commanded path acceleration is taken as the principal command signal. The general idea of the controller is that the commanded acceleration implies a commanded force because the aircraft can be considered a simple mass object. Knowing the characteristics of the aircraft, one can then compute the control settings required to generate that force. Then with the application of the force, the aircraft will follow the commanded path.

At the heart of the TAFCOS concept is a computational device called the trimmap. For the acceleration controller concept to function well it is necessary that the control logic contain a fairly detailed a priori knowledge of the aircraft characteristics. This information is contained in the trimmap - a computational section of TAFCOS. The trimmap is essentially an inverse model of the aircraft that permits the conversion of commanded force to commanded attitude in the trajectory control loop and converts commanded moment to commanded control settings in the attitude loop. The trimmap concept, which will function well for all aircraft, is especially useful for aircraft that have complex control characteristics or perhaps highly nonlinear flight characteristics that would present a difficulty to the more conventional controller designs. Feedback of measured aircraft states is also provided in each loop so that the operation of each is a blend of available a priori knowledge and feedback control. The assumption made in the construction of the manual control addition to the TAFCOS system is that the vehicle to be

controlled requires the full operation of a controller, such as TAF COS, and in particular requires the use of both trimmap computations. This means that both the trajectory and attitude blocks must remain a part of the manual controller and the pilot inputs must enter TAF COS proper, as do the ATC commands, as suitably appropriate commanded trajectories.

Based on the previous discussion, the way in which the manual controller ties into the TAF COS structure is shown in the block diagram of figure 2. Only the ATC and manual control input blocks are shown (not the main section of TAF COS). Since the input to TAF COS from the ATC command generator is in the form of the commanded path acceleration, in like manner the manual control input must also be the commanded path acceleration. The associated velocity and trajectory inputs are also required. The objective structure of the pilot control inputs is that insofar as TAF COS is concerned, the ATC commands and the pilot commands are essentially of the same type. TAF COS has been shown in previous work (ref. 2) to be capable of accurately following the ATC commands, the only requirement being that the command ask for a "flyable" trajectory for the aircraft to follow. The performance with the pilot inputs should be essentially the same under the same set of restrictions, where the requirement is again a "flyable" set of inputs by the manual control logic. The term "flyable" simply means that the aircraft is capable of performing the commanded maneuver.

TAF COS CONTROL WHEEL STEERING

The construction of a control-wheel-steering (CWS) mode to operate through TAF COS requires that the inputs from the pilot through the stick, wheel, and throttle be translated into a trajectory command for the TAF COS logic to track. It will be assumed that the type of pilot input will be essentially the same as that used by STOLAND, where the stick provides for pitch or vertical commands and the wheel for roll or lateral commands. In STOLAND, the throttle handle is not mechanized to provide for a CWS-type operation, so that no direct comparison is possible. STOLAND speed control would be through the autothrottle controls on the MSP, which can be used with the CWS mode. For use with TAF COS, it will be assumed that a throttle mechanization is provided for a CWS mode and the throttle commands will be through this device.

Following the example of the STOLAND CWS logic, the equivalent structure for TAF COS can be readily constructed on intuitive grounds. The assumption will be made that the pilot will control vertical motion with the stick and that the wheel and throttle will control the ground track of the path to be followed. STOLAND's stick control of the pitch Euler angle effectively creates the same separation of the control logic. The lateral control inputs are also separated into independent inputs from the standpoint of vehicle response. Based on the above assumptions, the acceleration command required for TAF COS can be written as follows:

$$\ddot{x}_{sc} = E_3^t(\psi_v) \begin{bmatrix} \frac{T_c}{M} \\ g\phi_v \\ -\frac{L_c}{M} \end{bmatrix} \quad (6)$$

The inputs to the acceleration equation are the quantities T_c/M , ϕ_v , and L_c/M . The first of the control quantities, T_c/M , is the thrust acceleration called for by the throttle input; it commands a change in the magnitude of the horizontal component of the aircraft velocity vector. The quantity ϕ_v is the roll-angle command; it generates the lateral acceleration for turning. In the construction of the roll command it has been assumed that the lateral acceleration, parallel to the ground, is generated by rolling a lift vector whose magnitude is equal to the weight of the aircraft. The last term, L_c/M , is the vertical acceleration; it is the input due to the stick commands. The three acceleration commands given above form a total command acceleration vector defined in a velocity coordinate system. TAFCOS requires that the accelerations be in the inertial or ground frame, hence the need for the heading transformation shown.

The justification for the form of equation (6), and a derivation of a more general form of the equation, can be shown from the following. The sketch below shows the various acceleration quantities used in equation (6); for convenience, they are shown in the sketch as forces. No assumption is

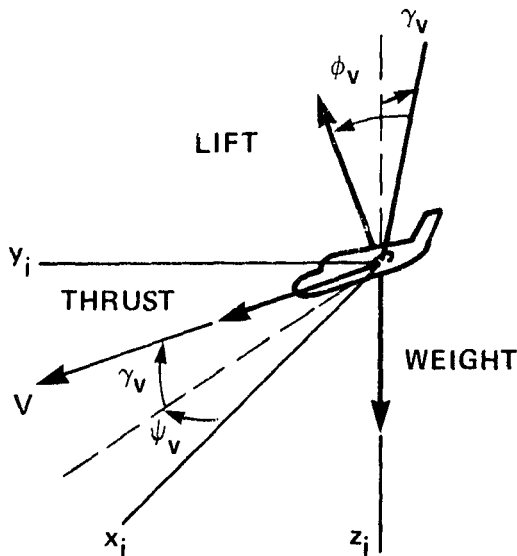

made on ground track or on the vertical placement of each. The location of the velocity vector with the thrust command aligned along this vector is defined in terms of the heading of the vector ψ_v and the glide slope γ_v . The roll ϕ_v is defined as roll about the velocity vector and the lift as the sum of the force required to support the aircraft plus an additional component for the pilot input from the stick. The equivalent to equation (6) can now be written as

$$\ddot{x}_{sc} = A_{VS}^t \begin{bmatrix} \frac{T_c}{M} \\ 0 \\ -g - \frac{L_c}{M} \end{bmatrix} + g\delta_3 \quad (7)$$

In the above equation the term A_{VS}^t is defined as

$$A_{VS}^t = E_3^t(\psi_V) E_2^t(\gamma_V) \quad (8)$$

The thrust acceleration is given by T_c/M and the lift as the aircraft weight plus a control input L_c/M .

To reduce equation (7) to the form of equation (6) requires a series of assumptions. These assumptions are based mainly on recognition of the fact that the aircraft is a transport-type vehicle and that the maneuvers expected from it will be limited. The main simplification comes from assuming that the glide slope flown by the aircraft is always a small angle, of the order of -6° to $+3^\circ$ for the Twin Otter, and the matrix $E_2^t(\gamma_V)$ in A_{VS}^t can be replaced by the identity. Further, $\sin \phi_V$ and $\cos \phi_V$ in the matrix $E_1^t(\phi_V)$ are replaced by ϕ_V and 1, respectively. With these assumptions, equation (7) can be written as follows:

$$\ddot{x}_{SC} = E_3^t(\psi_V) \begin{bmatrix} \frac{T_c}{M} \\ g + \frac{L_c}{M} \phi_V \\ -g - \frac{L_c}{M} \end{bmatrix} + g\delta_3 \quad (9)$$

The gravity term $g\delta_3$ can now be combined with the other terms and, finally, it will be assumed that the stick input term, L_c/m , in the roll input portion can be neglected relative to g . With these last assumptions, the equation reduces to that of equation (6), repeated below for convenience of reference.

$$\ddot{x}_{SC} = E_3^t(\psi_V) \begin{bmatrix} \frac{T_c}{M} \\ g\phi_V \\ -\frac{L_c}{M} \end{bmatrix}$$

The next consideration is to connect the pilot's controls to the control terms shown in equation (6). The general meaning of all the terms has already been discussed; the intent will be to make the connection to duplicate the STOLAND equivalent control usage.

The first control considered is the lateral or roll control through the pilot's control wheel. As shown by equation (2), STOLAND uses the wheel input to directly command a roll angle, in this case the aircraft roll Euler angle. The control term for the TAF COS CWS, as shown in equation (6), is also a roll

angle ϕ_v , except in this case the roll angle is about the velocity vector. The difference is small and so it is assumed that the STOLAND control equation can be used directly with TAF COS. Therefore, for the lateral control,

$$\left. \begin{aligned} \dot{\phi}_v &= 0.64(\delta_{\text{wheel}}) \\ \text{and} \\ \phi_v &= \int \dot{\phi}_v dt, \quad \|\phi_{\text{max}}\| \leq \phi_{\text{limit in TAF COS}} \end{aligned} \right\} \quad (10)$$

The gain term has been assumed to be the same as that used with the STOLAND control law. However, the dynamic behavior through TAF COS and STOLAND may be somewhat different and thus require a variation based on pilot opinion from simulation runs. In addition, there is a limit imposed on ϕ_v which is the same as the internal limit in TAF COS. TAF COS requires that the commands be flyable by the aircraft and that if they are not flyable that they impose saturation limits on the commands. This saturation would cause an error buildup between the command and the aircraft flight trajectory. In order to prevent such a buildup of error, the internal limits within TAF COS have been imposed on the wheel input.

The vertical control with the pilot's control stick is considered next. STOLAND commands pitch angle in accordance with equation (1); however, it has been shown that this command is equivalent to commanding vertical acceleration as shown by equation (5). Using this equation directly, the vertical acceleration term in equation (6) is of the following form:

$$\left. \begin{aligned} \frac{L_c}{M} = \dot{w}_c &= (15.0)\delta_{\text{stick}} \\ \text{with the limits} \\ \|\dot{w}_{c_{\text{max}}}\| &\leq \dot{w}_{\text{limit in TAF COS}} \end{aligned} \right\} \quad (11)$$

As in the case of the roll command, the limits are those internal to TAF COS.

The form of the command given in equation (11) differs from the equivalent STOLAND command where the above equation commands \dot{w} instead of $\dot{\theta}$. The quantity \dot{w} was chosen primarily because it results in a much simpler form of the control law. A command using $\dot{\theta}$ could have been devised by use of a knowledge of the short-period dynamics of the aircraft but would have been more complex and less desirable from the standpoint of computer programming. Another reason for the choice of \dot{w} is that since the end objective of the control is to command vertical velocity, the acceleration is the logical and direct choice as the control variable. This intuitive choice is backed by extensive tests by Langley Research Center in its TCV program. In those tests, the utility of the direct control of vertical velocity and acceleration was evaluated with piloted simulation studies and flight tests in a Boeing 737 aircraft. It was concluded from those that what Langley calls a velocity-CWS mode provided for improved aircraft handling qualities and reduced pilot

workload. The velocity CWS was viewed as a natural successor to attitude CWS when navigation data are available for the mechanization (information from unpublished data).

The internal limits within TAF COS must be further discussed with regard to the vertical acceleration command given above (eq. (11)). This type of command can present a stall problem for the aircraft unless proper safeguards are used. By limiting ϕ_c , STOLAND effectively controls the stall problem. The limits within TAF COS provide for a similar type of safeguard by imposing a series of limits on a number of internal variables. Of specific interest to the problem at hand, a limit is imposed on the magnitude of the commanded angle of attack; this limit prevents the command from calling for a flight condition in which the aircraft might stall. This means that the aircraft will neither follow the "nonflyable" command nor exceed a safe angle of attack limit. Another safety feature derives from the integrated nature of the control logic in which the throttle is controlled automatically so that the airspeed will not be allowed to decay during a climb. In addition, some form of envelope-limiting can also be included in the trimmap for further protection.

The final input variable to be considered is that of the throttle or speed control. The control input provided for the simulation study will assume a control mechanization where there is an input that is proportional to either commanded or desired acceleration. The resultant control, therefore, produces an acceleration command, velocity-hold operation. The control input is then of the form shown below:

$$\frac{T_c}{M} = K_{throt} * \delta_{throt} \quad \left\| \frac{T_c}{M} \right\|_{max} \leq \frac{T_c}{M_{limit \text{ in TAF COS}}} \quad (12)$$

All inputs required for the use of equation (6) have now been defined and the commanded change in acceleration in the ground coordinate system can be computed. Because the accelerations are in the inertial frame, they can be integrated directly to provide the commanded velocity and position as a function of time; the total required input to TAF COS is now available. The block diagram in figure 3 summarizes the complete control-law structure.

It was mentioned earlier in the report that the form of the control presented was only one of several options that are available. Referring to the block diagram in figure 3, some of these options can now be mentioned. The principal area for change is the section shown on the diagram by the dashed lines. The main objective of that portion of the control law is to convert pilot control inputs into velocity axis accelerations. Perhaps the most obvious area for change is in the form of the throttle control law. The choice made for the control shown was to command acceleration directly for acceleration command, velocity-hold operations. A velocity-error input, such as is used in most autothrottle systems, could also be readily mechanized. The movable pointer on the airspeed indicator could then be used as the input device. However, with the current construction of these indicators, the option of summing with the ATC command would no longer be possible. Another possible change is in the structure of the roll-control law. It has been suggested in the literature that an input in which the roll command ϕ_c was

directly proportional to the wheel position would be desirable. Such a mechanization could be quite simply done by removing the integral in the roll logic. Logic for shaping the handling qualities of the controls could also be included without difficulty. A major control change could also be made by replacing the entire set of logic with a complete aircraft model, such as the equations used in the aircraft model portion of the simulation. This sort of control logic would provide for control response that duplicated the actual aircraft, or some idealized version of the vehicle. This scheme was tried on some simulation runs; it worked quite well but was computationally complex.

TAFCOS CONTROL-WHEEL-STEERING SIMULATION RESULTS

The simulation study for the manual control operation of TAFCOS was performed using an unmanned computer simulation on an IBM 360. The version of TAFCOS used for this simulation was a FORTRAN duplicate of the program used in the flight-test evaluation of the automatic mode of TAFCOS with the Ames DHC-6 Twin Otter aircraft. The TAFCOS program used in this flight test was an assembly language program included as a part of the STOLAND avionics system; it was specifically tailored for control of the Twin Otter. The FORTRAN version of this program was an exact duplicate of the assembly language program with a one-to-one translation between the two computer languages. The model of the Twin Otter was a six-degree-of-freedom, fully nonlinear description of the aircraft characteristics. The manual control logic was tied into TAFCOS as shown in figure 2, where all modes previously discussed could be exercised.

The performance of the manual control scheme in which the input is from the pilot's control only is shown in figures 4 through 7. The limitation of pilot input only means that the command is not summed with an ATC command but that all commands come from stick-wheel-throttle inputs. Each of the figures shows only a few of the aircraft states to demonstrate the performance.

The first three figures (figs. 4-6) show the response of the aircraft to step inputs from each of the pilot controls where only one at a time is moved. Figure 4 shows a step doublet with the stick where the command can be essentially considered to be asking for a change in altitude by commanding a vertical speed change over a period of time. The plots on the figure, from bottom to top, show the stick input, the position command as generated by the manual control logic (the input to TAFCOS that duplicates the manual control input because the ATC command is zero), and the vehicle response to the command. Figure 5 shows a similar set of data for a wheel input. In this case, the command is a double-doublet commanding an "S" turn by the aircraft in order to move laterally by some amount. The order of the data is same as before with the control input on the bottom and the vehicle response at the top. Figure 6 shows a throttle command in which the aircraft is asked to change speed. The data are again similar, except that the velocity data are shown rather than the position time history.

From these first three figures (figs. 4-6) it is clear that the manual control does provide the desired response from the vehicle. Although not shown in any of the data, an input in any one axis does not disturb the motion

about any of the others, because of the input and TAF COS structures. Also, it should be noted that the control inputs were steps in each case and thus more abrupt than would be the case for an input by the pilot; still, they generated a smooth response.

Figure 7, which is composed of three separate plots, shows the aircraft response to a command for a climbing 360° turn. The input was intentionally chosen to command a turn that exceeded 360° by a small amount to make sure that there were no problems because of the passage through the 360° or repeat-zero point. In this case, the control inputs are not shown on the plots, they were simply step inputs to the stick and the wheel to set up the turn and the climb and then reverse inputs to stop the maneuver. The first of the plots (fig. 7(a)) shows the commanded X-Y trajectory from the control inputs; the second (fig. 7(b)) shows the vehicle response again as an X-Y plot. The third plot (fig. 7(c)) shows the vertical response of the aircraft, due to the stick input, as a plot of altitude vs time. As with the figures showing the vehicle response to single input commands, the performance for the complex maneuver is good and the vehicle response is as expected.

The second group of figures, figures 8 through 11, presents a set of data for the case in which the manual control is summed with the ATC commands to provide a perturbation about the ATC track. The first two figures are essentially a duplicate of figures 4 and 5, where TAF COS is asked to follow first a step-doublet stick input and then the double-doublet wheel input. The plots differ from the first two in that the command from the manual control logic is different from the input to TAF COS, because the TAF COS input is the sum of the manual control signal and the ATC command. Note that for the same stick-wheel input, however, in each case the vehicle response is identical.

Figures 10 and 11 show the response of the TAF COS system to a manual control input that is added to a complete ATC trajectory. The trajectory shown is the reference flightpath used in the Twin Otter flight test. The figures show a situation in which the manual input asked for a translation of the entire trajectory upward (on fig. 10), and a case in which an increase in speed over the entire trajectory was wanted (fig. 11). The vehicle response is satisfactory, thus demonstrating that in the situation that requires large control changes while the ATC commands are acting, the manual control functions as wanted.

MODE-SELECT PANEL OPERATION OF TAF COS

The other form of manual control through TAF COS that is to be mechanized is the inclusion of the autopilot modes available by use of the mode-select panel (MSP). The main features of the panel and its operation with the STOLAND system have already been discussed. The objective here is to take these same inputs of airspeed, flightpath angle, altitude, and heading and convert them into acceptable inputs to TAF COS. The desired conversion turns out to be quite straightforward because the inputs from the MSP are already in the form of trajectory variables, which is the form required for TAF COS. The computations are carried out by noting that the airspeed, flightpath angle, and heading

commands are a polar-coordinate definition of the commanded airspeed vector. The altitude-hold-select command is simply a special case of the flightpath angle command in which the commanded angle is zero and a constraint is placed on the vertical position command. The major task of the computations is the generation of a smooth and flyable trajectory command when changes in command variables are asked for by the selected mode of operation. The operation with the hold-mode commands will be considered first and then the select-mode transition logic will be built up from a combination of information from TAF COS ATC computations and those used by the STOLAND MSP commands.

The main feature of the hold-mode computations is that the hold mode is a steady-state condition, from the standpoint of velocity and acceleration commands. The acceleration commands are in fact zero at all times and the components of velocity in the inertial frame are constant. Integration of the velocity commands will provide the required position signals. In equation form, these requirements produce the following commands to TAF COS:

$$\ddot{x}_c = 0$$

$$\dot{x}_c = \begin{vmatrix} V_c \cos \gamma_c \cos \psi_c \\ V_c \cos \gamma_c \sin \psi_c \\ V_c \sin \gamma_c \end{vmatrix} \quad (13)$$

$$x_c = \int \dot{x}_s dt + x_s(0)$$

In the above equations, the quantities V_c , γ_c , and ψ_c are read directly from the MSP (see fig. 1) and are the values shown to the pilot in the windows. If altitude hold is commanded, γ_c is set to zero and the window value is the vertical position command. The initial conditions on the position equation integration are simply taken to be the aircraft position from the navigation routine at the time of system turn-on. If x, y navigational data are not available, the command will dead reckon from a zero value for the ground track command. (TAF COS must also be in a dead-reckoning mode to be compatible.)

The select mode of operation requires a slightly more complex logic in order to provide for a smooth transition from one state to another. When the MSP is used to generate the commands, the pilot sets the desired value into the display window by twisting a knob, called a slew knob that is located just to the right of the display window (fig. 1). While the display is being changed, the aircraft remains at the previously set hold values. When the select button is pushed, the command system is required to track the new value and reset to the hold mode when it has reached the target value. The problem for TAF COS in the operation of the select mode is that although the system will track a step change in an input command, the controller will do so with some overshoot and possibly, from the pilot's viewpoint, some rough performance. Therefore, some sort of smoothing or guidance from one state to the next is required of the control logic.

To generate the necessary select-mode commands, it seems appropriate to view these commands in a manner similar to that used by the TAF COS ATC (air traffic control) command generator section. The ATC command generator outputs the drive signals in the form of position, velocity, and acceleration commands generated from a stored set of way points that define the track to be flown. The commanded track is output in the form of a series of straight-line segments and circular arcs as a three-dimensional path in space; in addition, it provides speed control commands for flight along that path. The MSP outputs can be viewed in a similar manner where flight in the hold mode is simply a flight along a straight path at constant speed. The select-mode operation can be broken down into cases where commands that call for small angular changes in either flightpath angle or heading can be handled by defining a new straight-line segment with an appropriate transition command; larger heading changes will call for the definition of a circular arc path for the aircraft to fly. Velocity changes are quite straightforward with a direct variation of commanded V_c . In all cases, however, the commands must be such that they are flyable by the aircraft in a manner acceptable to the pilot.

The structure of the transition command logic is shown in figure 12. The method shown is essentially that used in the TAF COS ATC command section for transitions at way-point changes. Figure 12(a) shows the switching logic for commands that call for a small angular change in the flightpath. This would apply to flightpath angle changes that are always small angles and to a small heading change (small will be defined later). An altitude change would also call for a small-angle change. Figure 12(b) shows the method for constructing a flightpath for a large heading change.

For the small-angle change commands, the general idea is that the input command will simply switch from one straight-line segment to another with an appropriate lead on the change that will provide for a smooth transition. The lead distance is a function of airspeed and is the distance flown in 4 sec. The constant time of 4 sec was determined in the ATC analysis and shown to be satisfactory for all airspeeds. In operation, if a select button is pushed when the aircraft is at point A (fig. 12(a)), the lead distance will be computed based on the commanded airspeed and the aircraft trajectory command stepped to point A with a nonstraight-line path as shown. Computationally, this means re-initializing equations (13) at point A with the new values of heading and flightpath, and treating the new values as a hold command.

If the heading change is large, the switching logic of figure 12(b) is used. In this case, instead of switching to a straight-line segment aligned with the new heading, a circular arc is generated to guide the aircraft to the new heading with the radius determined for a desired roll angle for the maneuver. As with the small-angle changes, the 4-sec lead time is used to allow for smooth transition. Now, however, the command equations given by equations (13) are no longer used until the aircraft is at the new heading and switched out of the circular-arc command mode. During the circular-arc maneuver, the equations given below are used to command TAF COS:

Turn radius = $V_c^2/g \tan \phi$

$$\ddot{x}_c = \begin{vmatrix} -K_{\text{accel}}(\sin \psi_c) \\ K_{\text{accel}}(\cos \psi_c) \\ 0.0 \end{vmatrix} \quad (15)$$

where $K_{\text{accel}} = g \tan \phi = \text{const.}$

$$\dot{x}_c = \int \ddot{x}_c \rightarrow x_c(0)$$

$$x_c = \int \dot{x}_c \rightarrow x_c(0)$$

It is now possible to define what is meant by a small heading change. The 4-sec lead time can be interpreted as the angle ψ_{sw} shown in figure 12(b). Generally, it appears that this angle, which is a function of airspeed, is of the order of 10° to 15° for the Twin Otter. If the heading change command is less than this figure, it is assumed to be a small-angle command, and the straight-line segment is used. Flightpath angle commands, whether direct commands, or ones generated from an altitude change command, will always be small-angle command for most transport-type aircraft.

Limits also must be applied to the command values in equations (13) and (14) in order that the overall commands to TAF COS be "flyable." As with the direct pilot control, the limits should be such that TAF COS can follow the commands; therefore, they must reflect any limits imposed within TAF COS. Following the example of the STOLAND system, the following set of limits has been used in the simulation study.

Flightpath angle $\pm 6^\circ$

Altitude change Set up a flightpath angle such that
 $\pm 1^\circ \leq |\text{flightpath angle}| \leq \pm 6^\circ$ with the maneuver completed in 60 sec;
 flightpath angle = $\tan^{-1} (\text{alt. change}/V_i 60.0)$
 $\approx (\text{alt. change}/V_i 60.0)$

Airspeed change Acceleration of $\pm 0.5 \text{ m/sec}^2$

Heading change Turn radius such that the roll angle is fixed at 15°

Programming of the MSP commands within TAF COS can be done in one of two ways. This option provides for a trade-off between computer time used and the amount of memory used. In the preceding discussion, the logic used in the TAF COS ATC section was relied on heavily. One way of programming the MSP commands would be to use the hold-select commands from the MSP panel to create a set of phantom way points for the aircraft to follow and then to generate the command trajectory through the existing ATC logic. A hold command would

call for (1) a way point to be located at the start point where the hold buttons were pushed, (2) the initial conditions on the integration, and (3) another way point some arbitrary distance ahead of the aircraft and computed from an extension of the hold values. A select command would call for a similar way-point definition to define the new straight-line path for small changes and to define the circular-arc end points for the large-angle change. The alternating form of computation would be to define a completely new logic section that is completely independent of the ATC logic so that the system would use either the MSP logic or the ATC logic for this type of command. The programming technique that used the ATC logic would likely be more compact because the MSP-only computations duplicate those done in the ATC section. However, the special MSP section would be more time-efficient because the computations would not require all of the features included in the ATC logic.

MODE-SELECT PANEL — SIMULATION RESULTS

A series of simulation runs was performed with the MSP commands in a manner similar to those done for the pilot control inputs. The results of these runs are shown in figures 13(a) through 13(d). Each of the figures shows an input command and the equivalent output for each of the MSP input commands. As with the previous presentation of simulation data, only a few of the variables are presented to document the performance (in order to keep the amount of data within reasonable limits).

Figures 13(a) and 13(b) show the MSP performance for small-angle commands in which the type of transition logic called for was the straight-line-segment to straight-line-segment variety. Figure 13(a) is an X-Y plot of position for an input command that called for a 10° heading change to the right; figure 13(b) is an X-Z plot for a 100-m altitude change. In both cases, it is clear that the vehicle response followed the command and that the overall performance was as expected. It should be noted that since the altitude change command is done with a commanded flightpath angle, this run checks out both altitude-select and flightpath-angle-select logic. Note also the jump in the position command at the switch point that is called for by the logic sequence shown in figure 3.

The third set of data in figure 13(c) shows similar data for a velocity command that asks for a speed increase of 5 m/sec. The plots show the commanded velocity and the vehicle response as a function of time. The simulation runs shown in figure 13(a) were performed using equations (13) directly; the commanded acceleration was set to zero. It was assumed that the acceleration value was low enough to be neglected and that the smoothing action of TAF COS would handle the inconsistency. Because the simulation results show good performance, it appears that the simplification of the control logic is reasonable; however, a higher limit on acceleration would likely require that at some point the acceleration inputs be included.

The last of the four sets of data shows a pair of X-Y plots for a large heading change (fig. 13(d)). The command for this run was a turn to the right of 135° ; it called for the use of the circular-arc commands, as shown in figure 12(b). The vehicle response was again smooth, demonstrating that the

inclusion of the circular-arc commands provides for satisfactory large-angle performance. This same heading change was also performed in combination with the other MSP inputs to verify that simultaneous operation of the MSP commands would not cause a problem. There appeared to be no problems and the performance was virtually indistinguishable from that of the single control runs.

CONCLUDING REMARKS

The simulation data on the performance of the pilot input to TAF COS and the MSP command show that satisfactory control through TAF COS can be achieved with both of these methods. The generation of the appropriate command signals to TAF COS can be carried out in a reasonably simple manner that should present no problem for the STOLAND 1819A flight computer. With the inclusion of these input modes, TAF COS can now operate in all modes required of a typical auto-pilot system in which all levels of operation from direct pilot control to fully automatic operation can be used. Because the simulation work was limited to an IBM 360 evaluation, work remains to be done on the handling-qualities aspect of the pilot interface. However, the control structure should permit the required performance qualities to be built in without difficulty. For the manned simulation work, the flight director problem for command display to the pilot must also be considered. The results of prior and ongoing NASA research programs should be directly applicable and provide the necessary display concepts.

REFERENCES

1. Meyer, George; and Cicolani, Luigi: A Formal Structure for Advanced Automatic Flight Control Systems. NASA TN D-7940, 1975.
2. Wehrend, William R., Jr.; and Meyer, George: Flight Tests of the Total Automatic Flight Control System (TAF COS) Concept on a DHC-6 Twin Otter Aircraft. (To be published as NASA TP-1513, 1980.)
3. Grugurich, John; and Bradbury, Peter: STOLAND Final Report, NASA CR-137972, 1976.
4. Neuman, Frank; Watson, D. M.; and Bradbury, Peter: Operational Description of an Experimental Digital Avionics System for STOL Airplanes. NASA TM X-62,448, 1975.

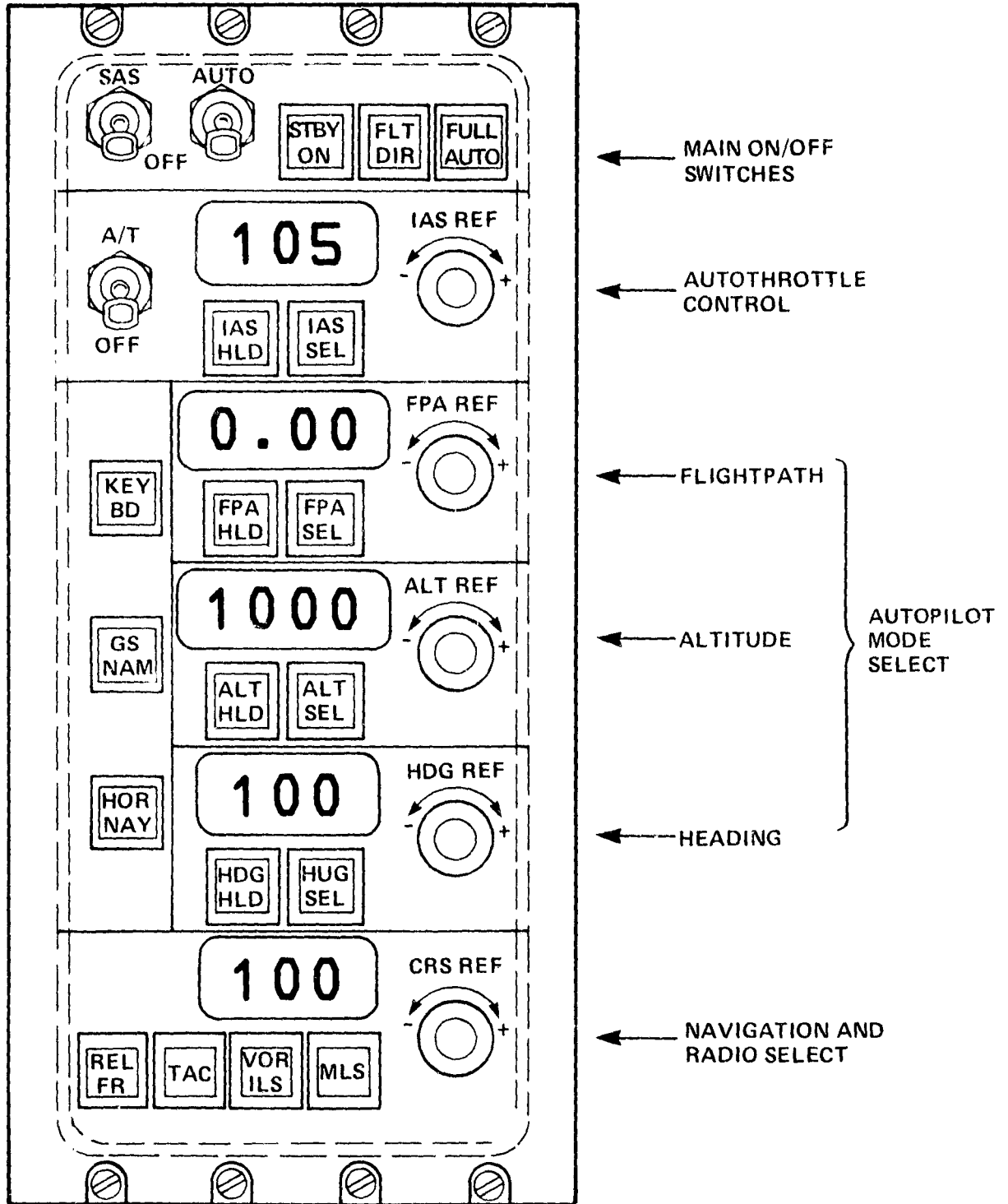

Figure 1.- STOLAND mode-select panel.

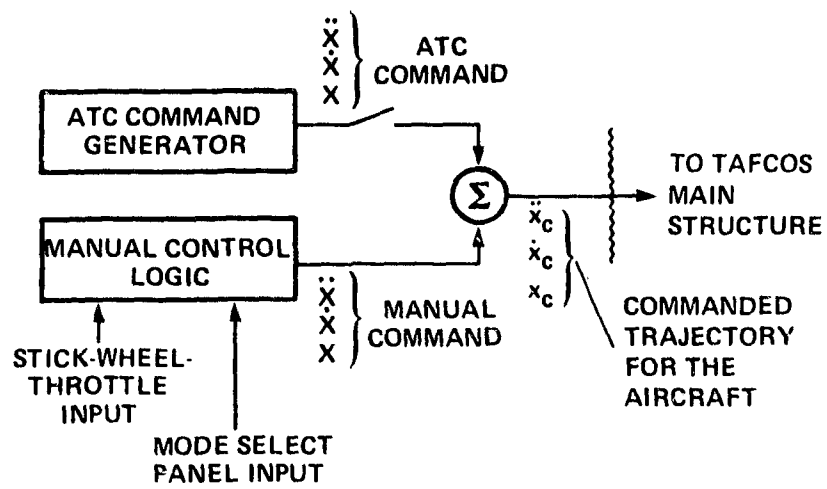

Figure 2.- Manual control input to TAF COS.

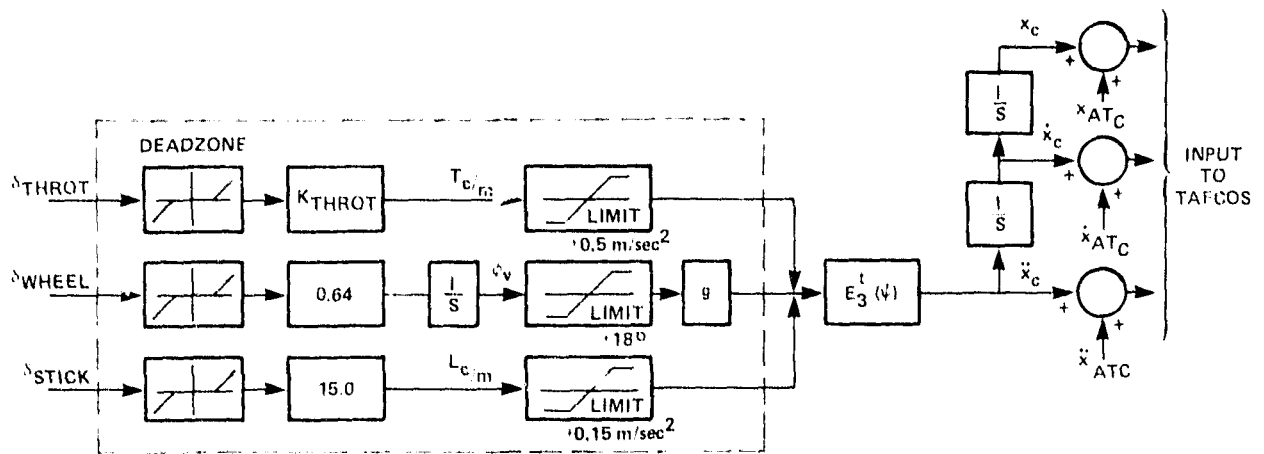

Figure 3.- Block diagram of manual control logic.

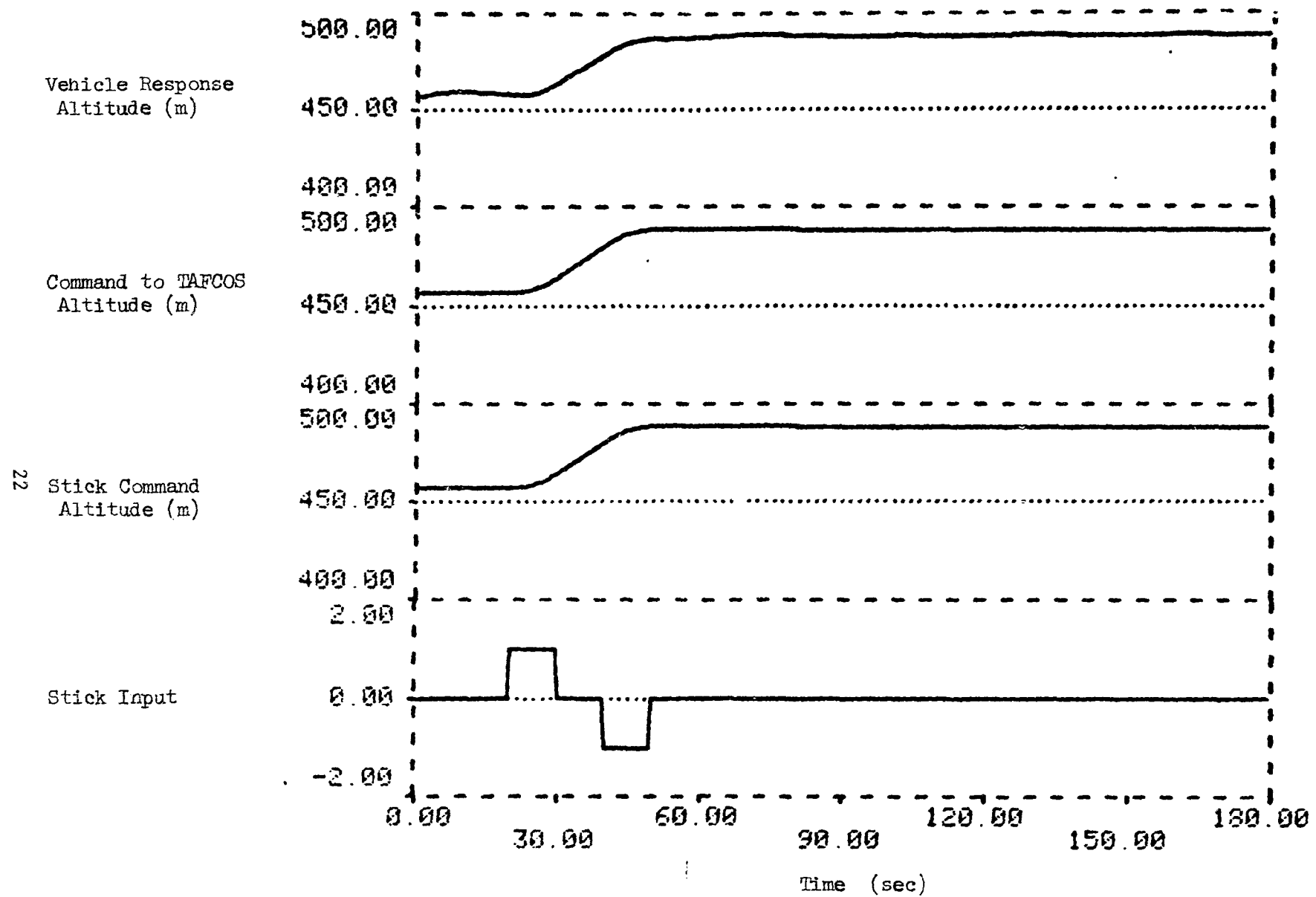

Figure 4.- Commanded altitude change, TAF COS ATC off.

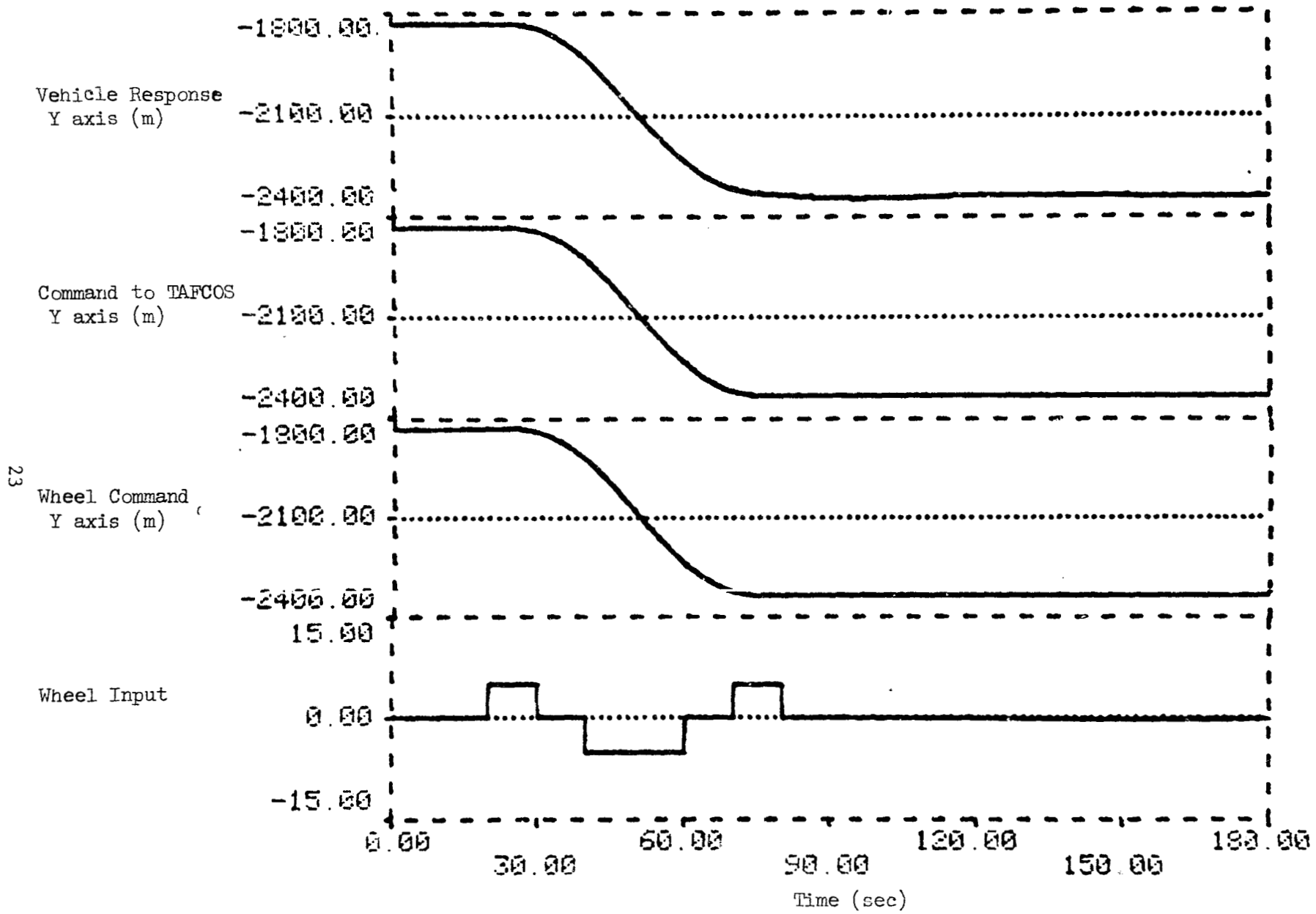

Figure 5.- Commanded "S" turn, TAF COS ATC off.

24

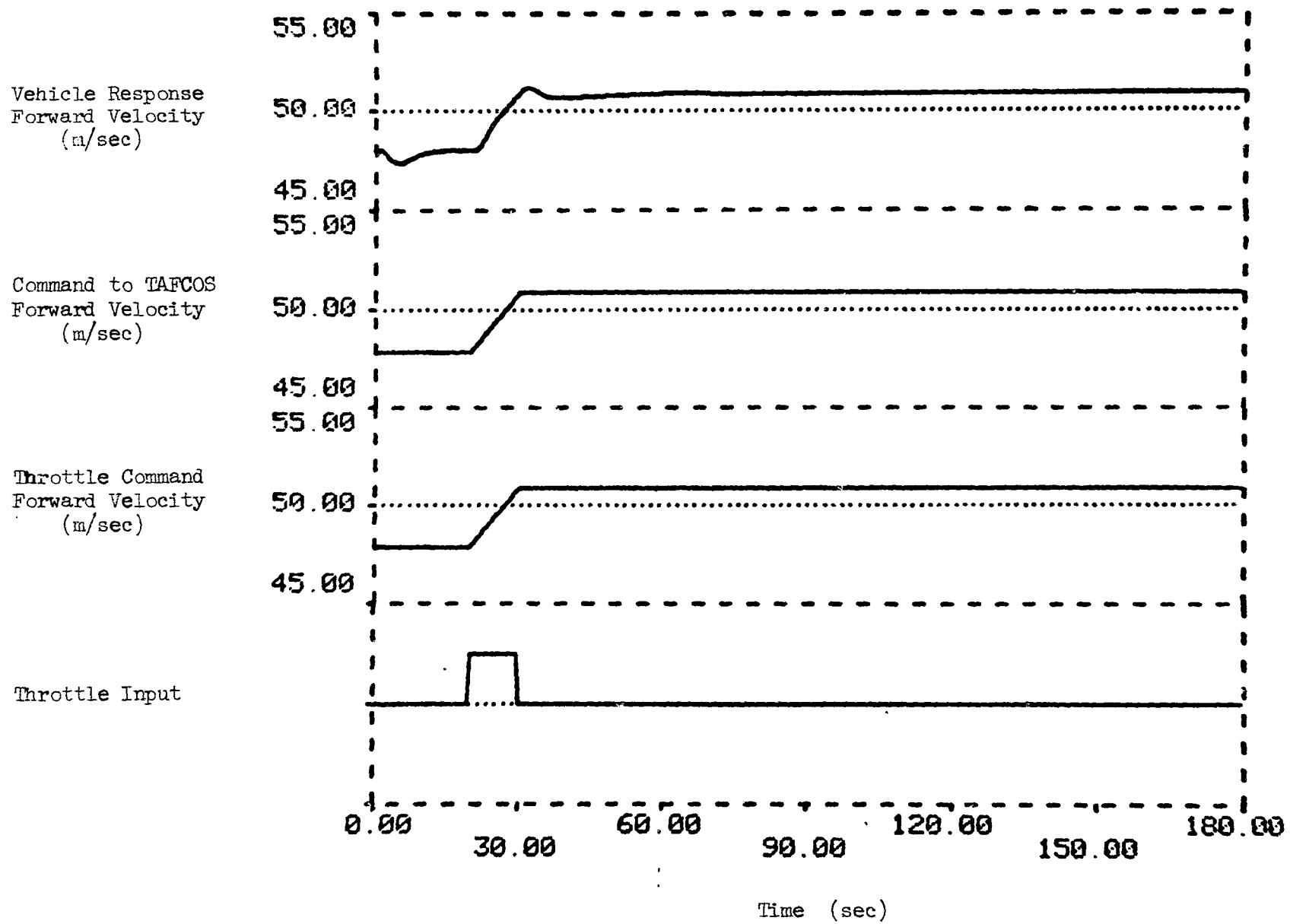
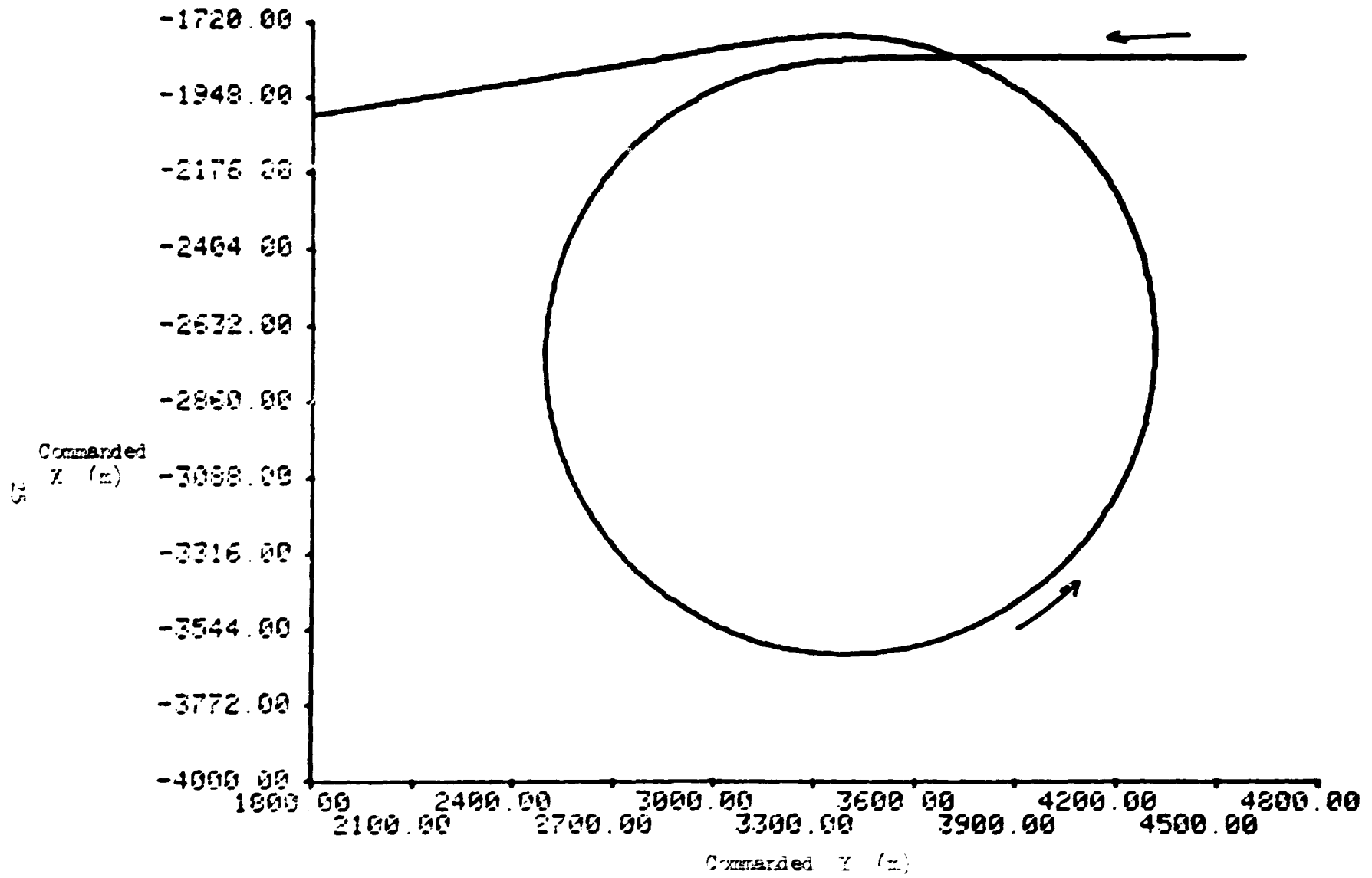
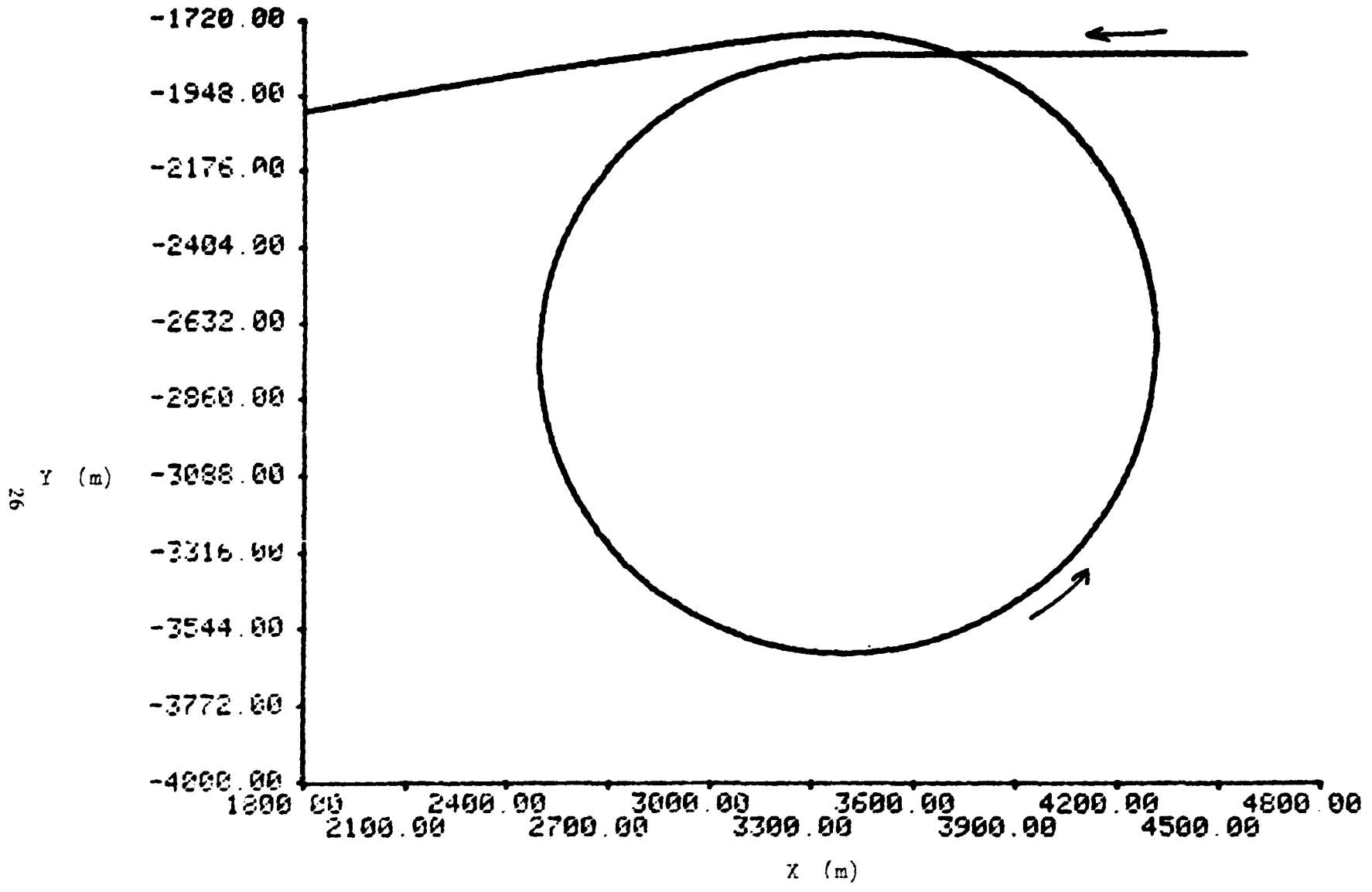

Figure 6.- Commanded speed increase, TAF COS ATC off.



(a) X-Y commanded trajectory: TAFCOS ATC off.

Figure 7.- Full-circle climbing turn.



(b) X-Y trajectory flown: TAFOS ATC off.

Figure 7.- Continued.

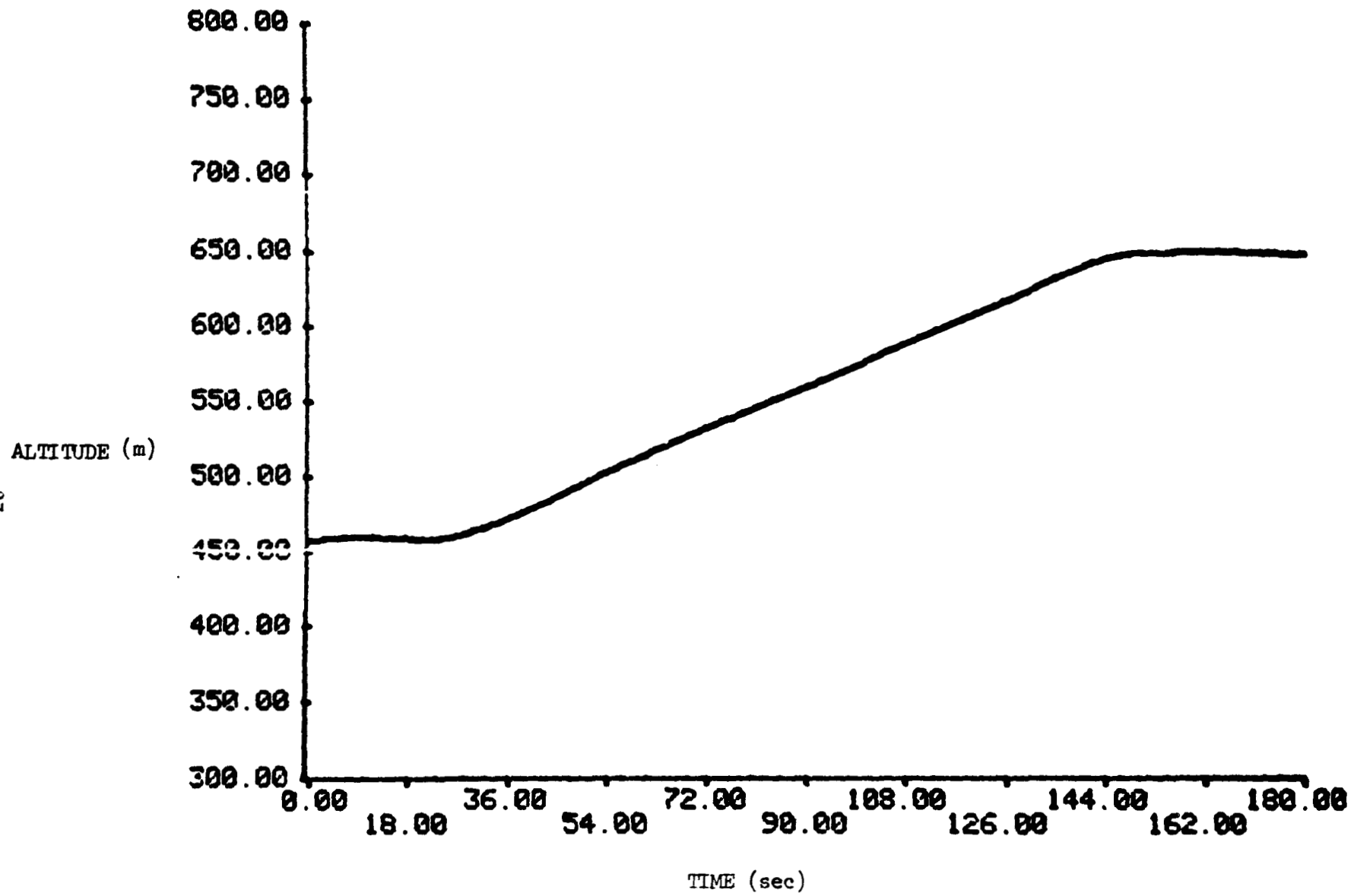

(c) Altitude path flown: TAF COS ATC off.

Figure 7.- Concluded.

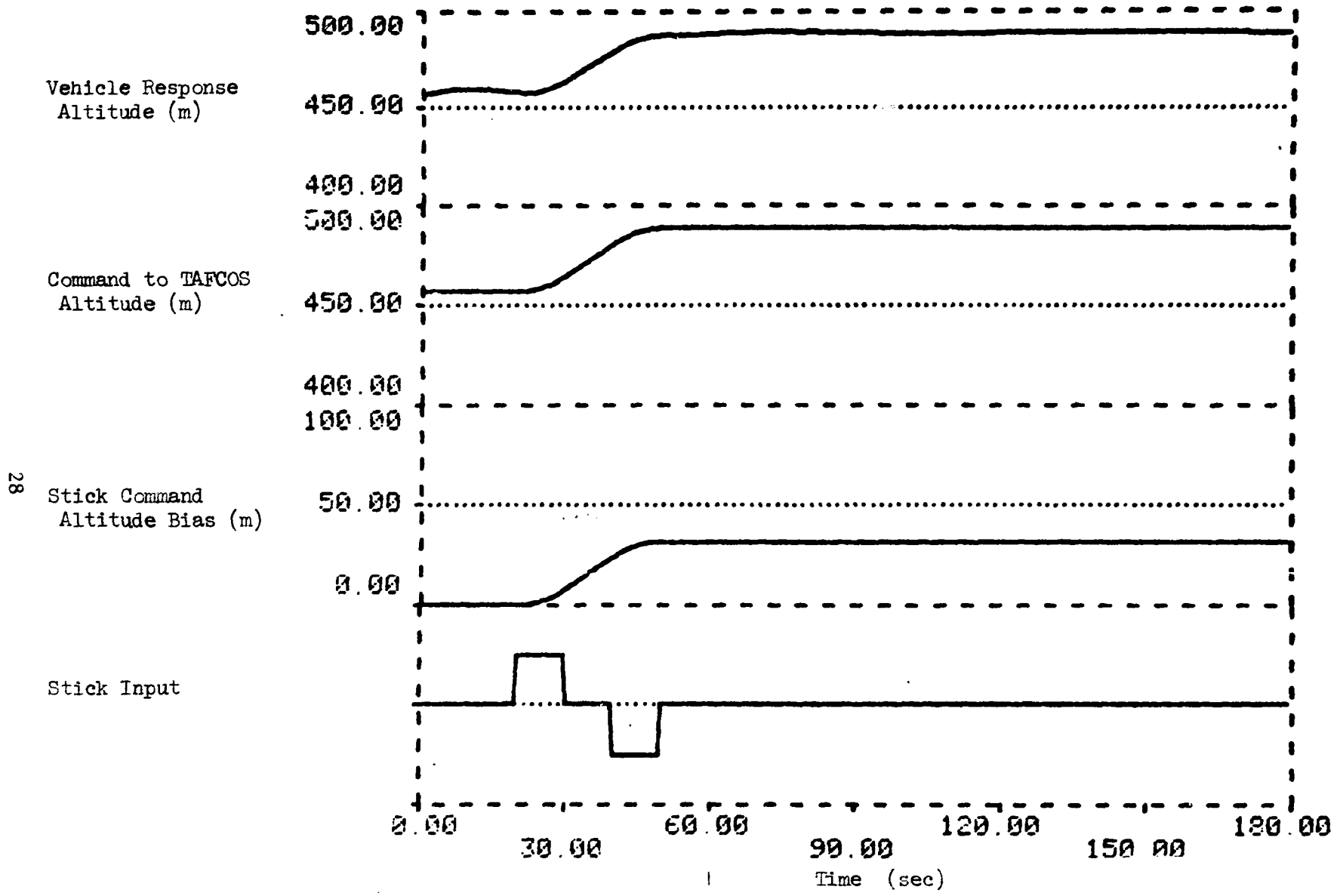

Figure 8.- Commanded altitude change, pilot input summed with ATC.

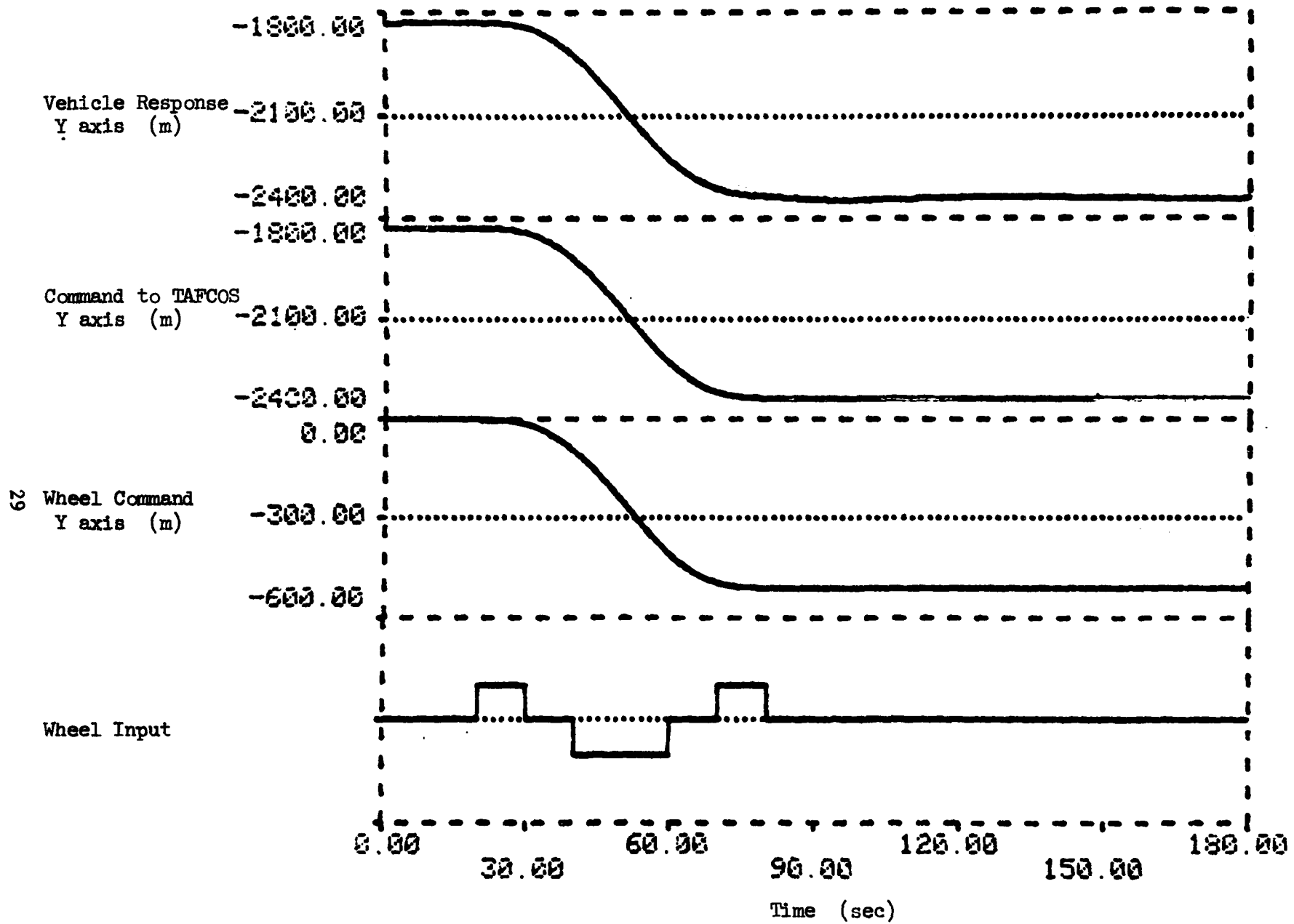
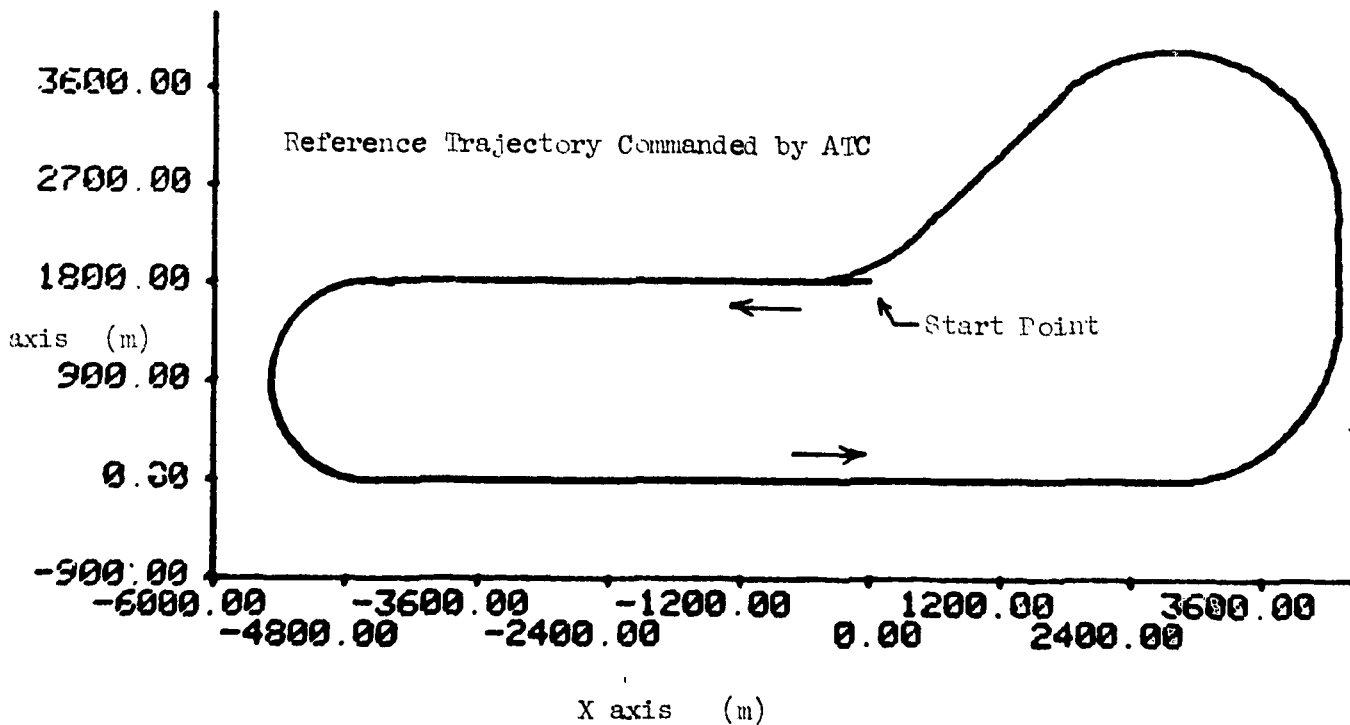
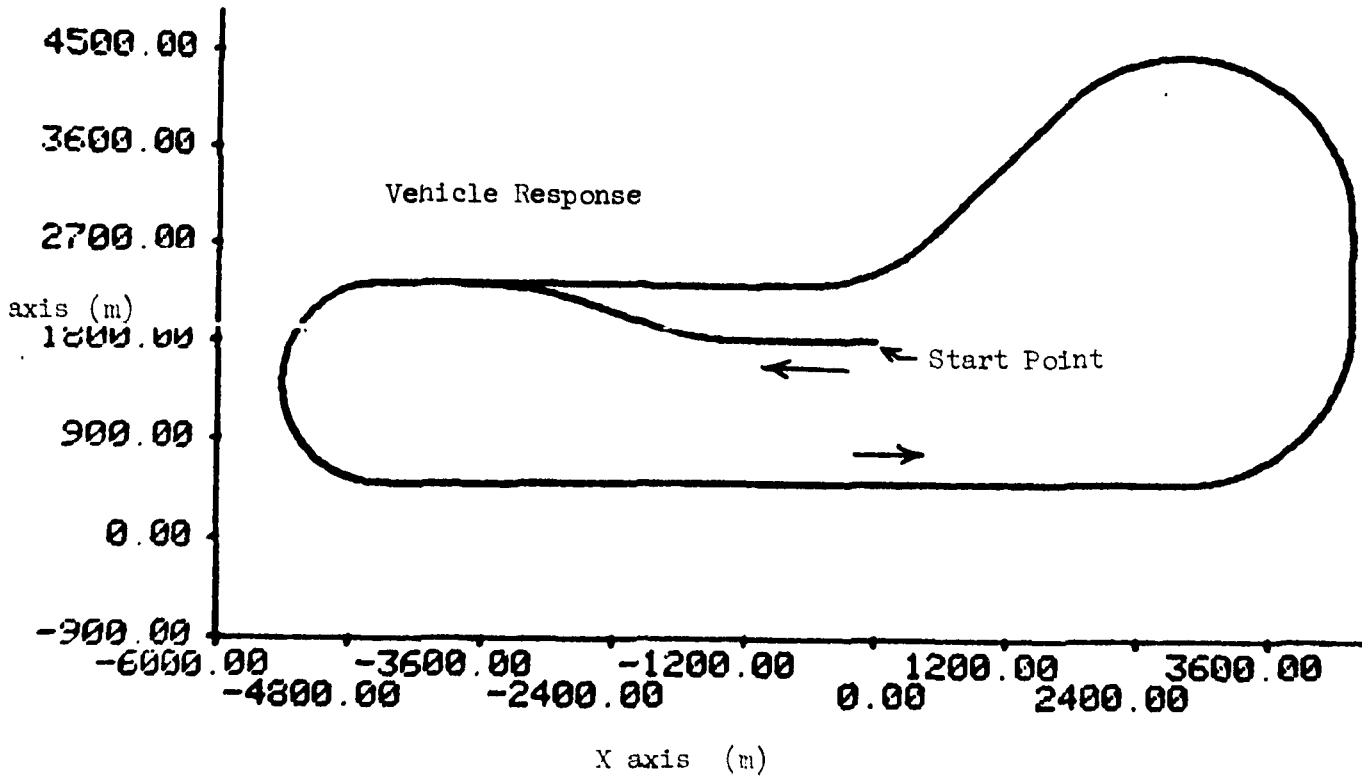
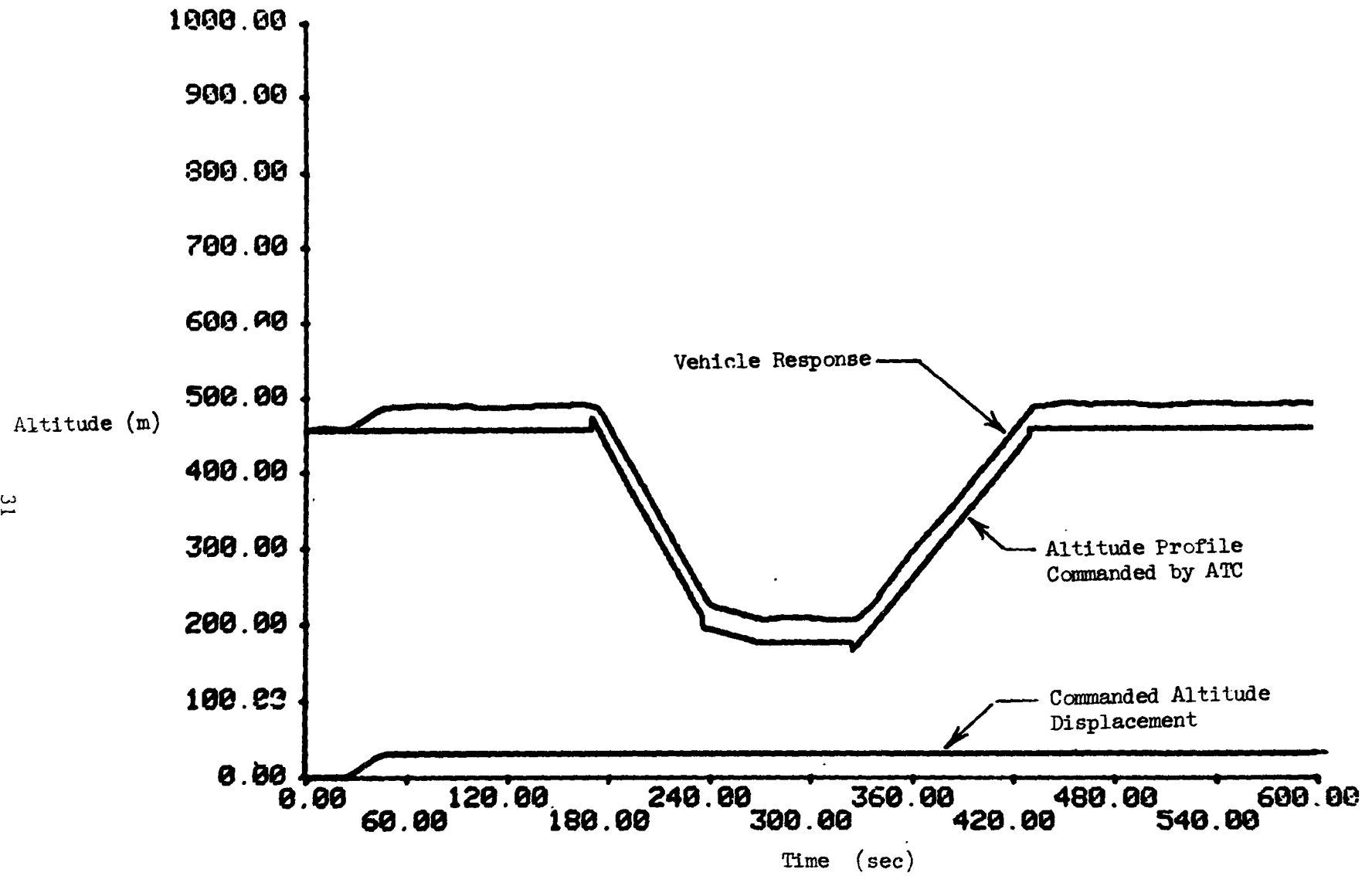

Figure 9.- Commanded "S" turn, pilot input summed with ATC.



(a) X-Y plots.

Figure 10.- Lateral and vertical displacement of a reference flightpath.



(b) Altitude plots.
Figure 10.- Concluded.

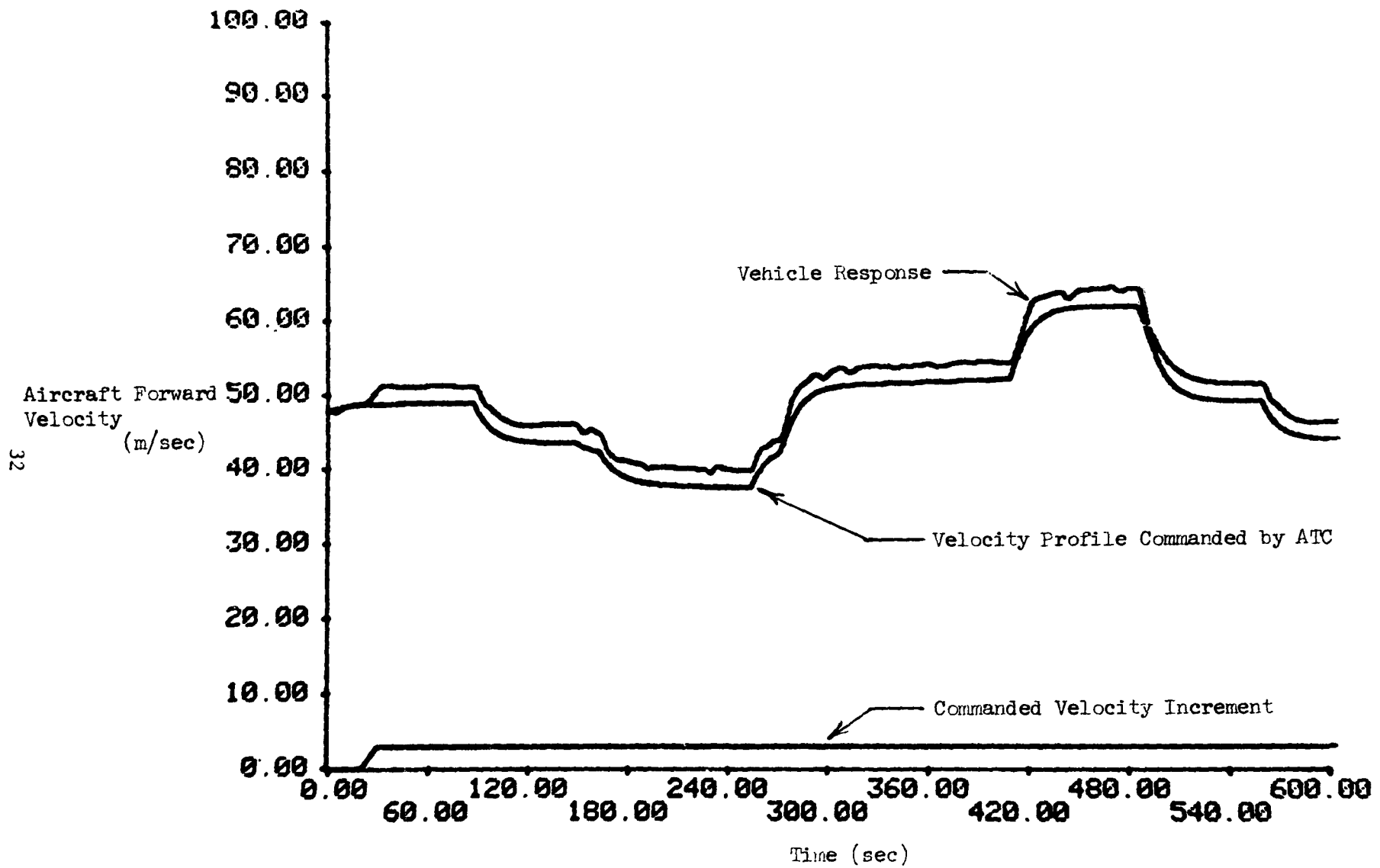
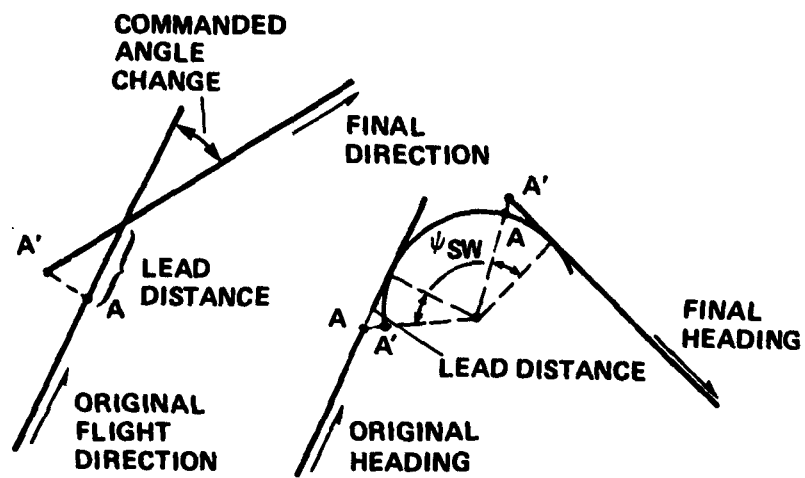
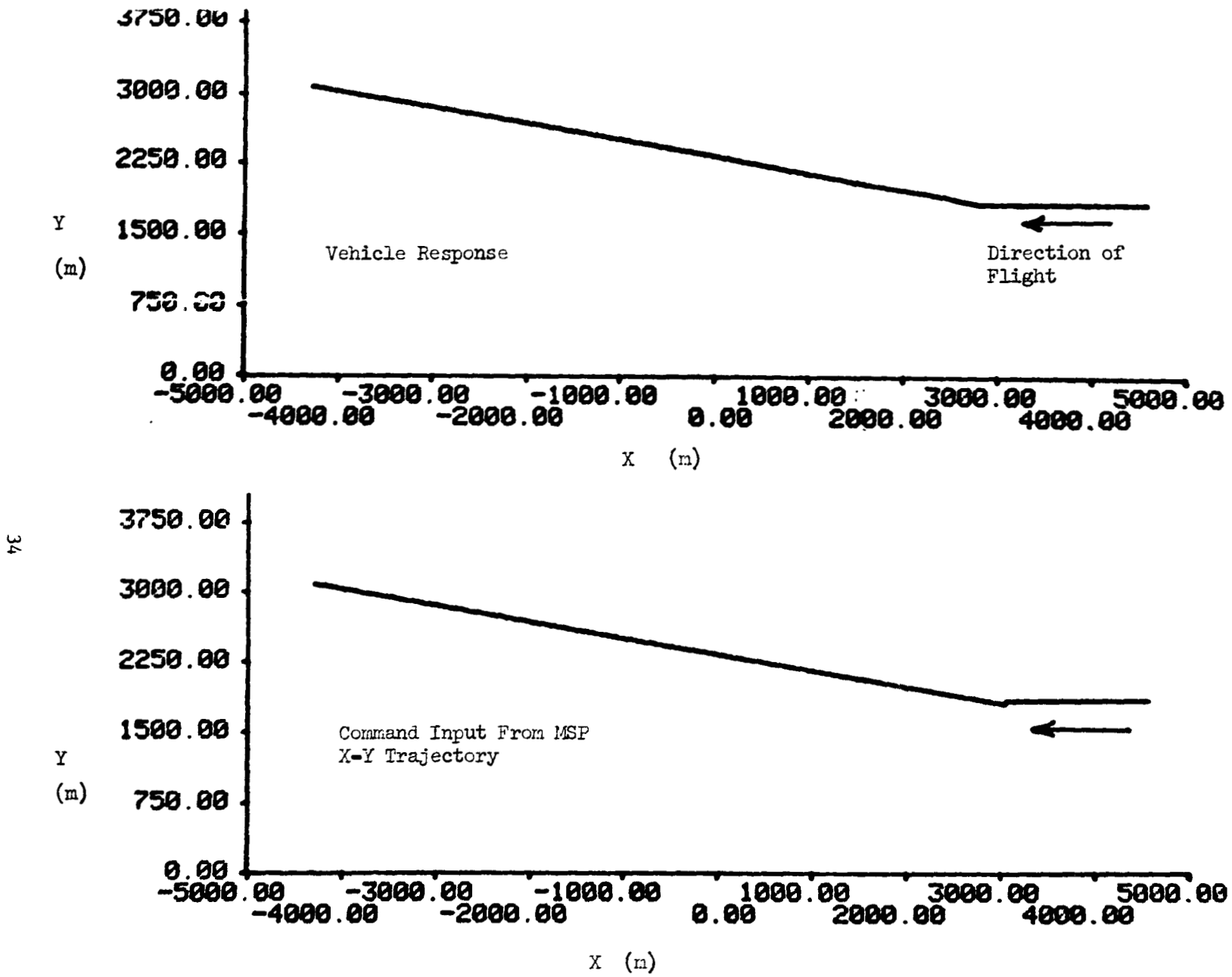

Figure 11.- Speed increment added to reference flightpath velocity profile.



(a) Small angle change. (b) Large heading change.

Figure 12.- Segment switching logic.



(a) Small heading on command, $\psi = 180^\circ$ to 190° .

Figure 13.- Mode select panel commands.

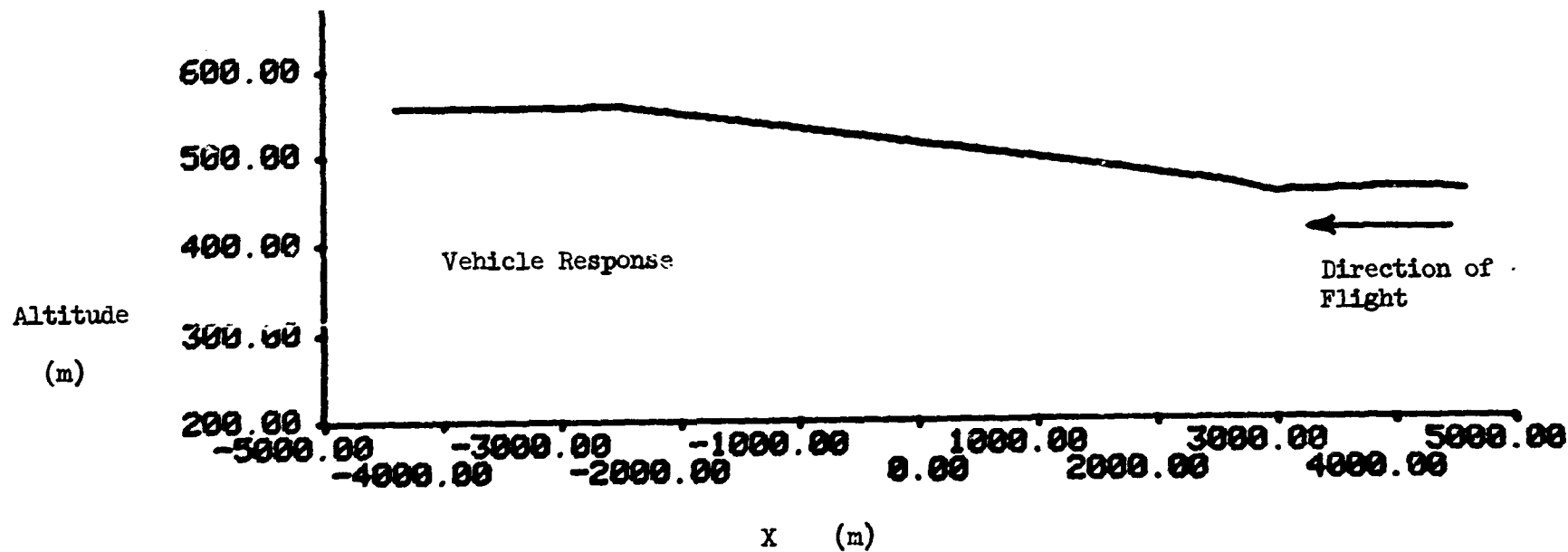

35

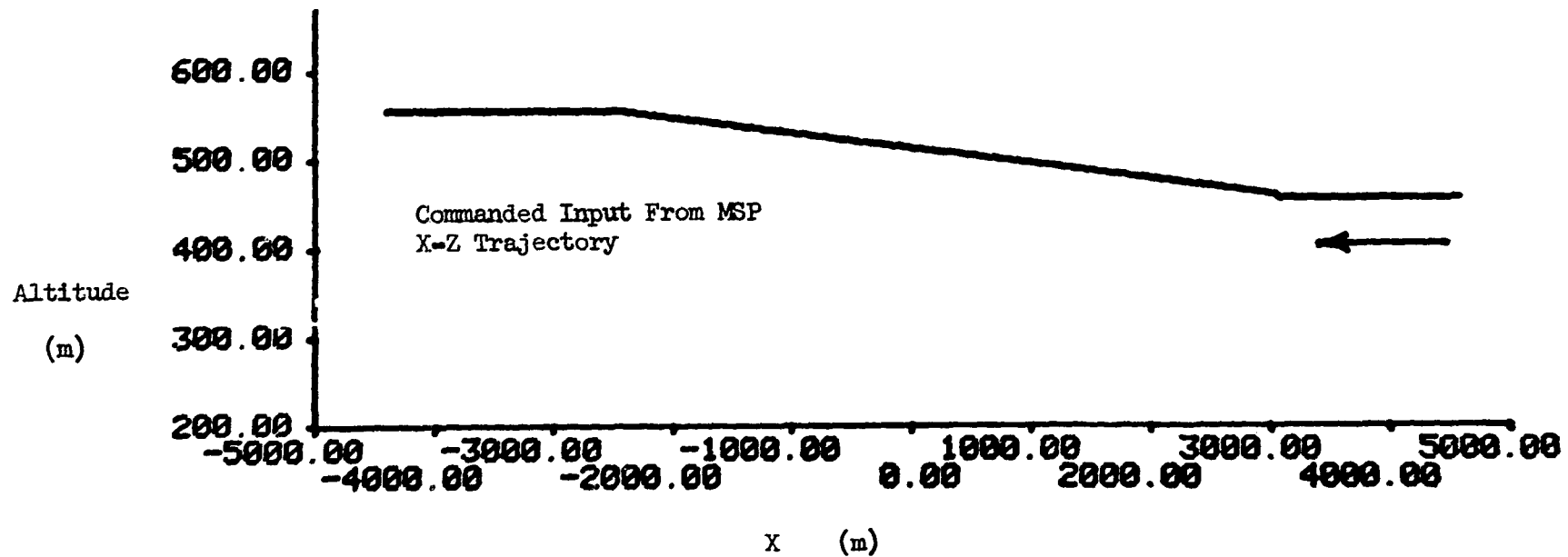

(b) Commanded altitude change, +100 m.

Figure 13.- Continued.

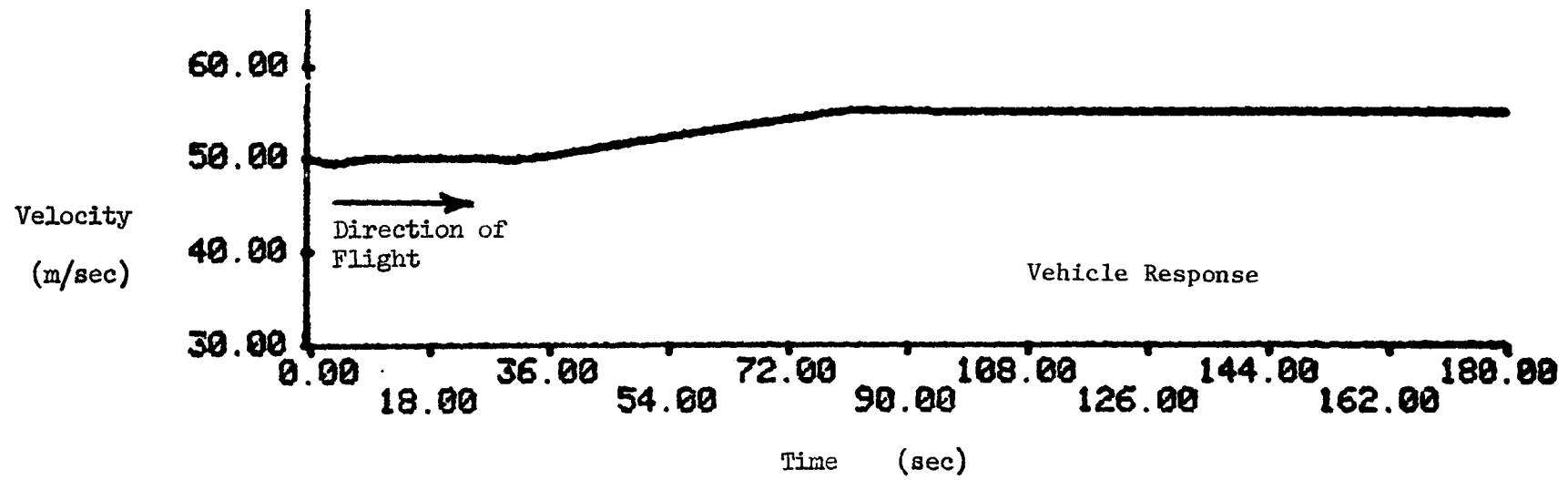

36

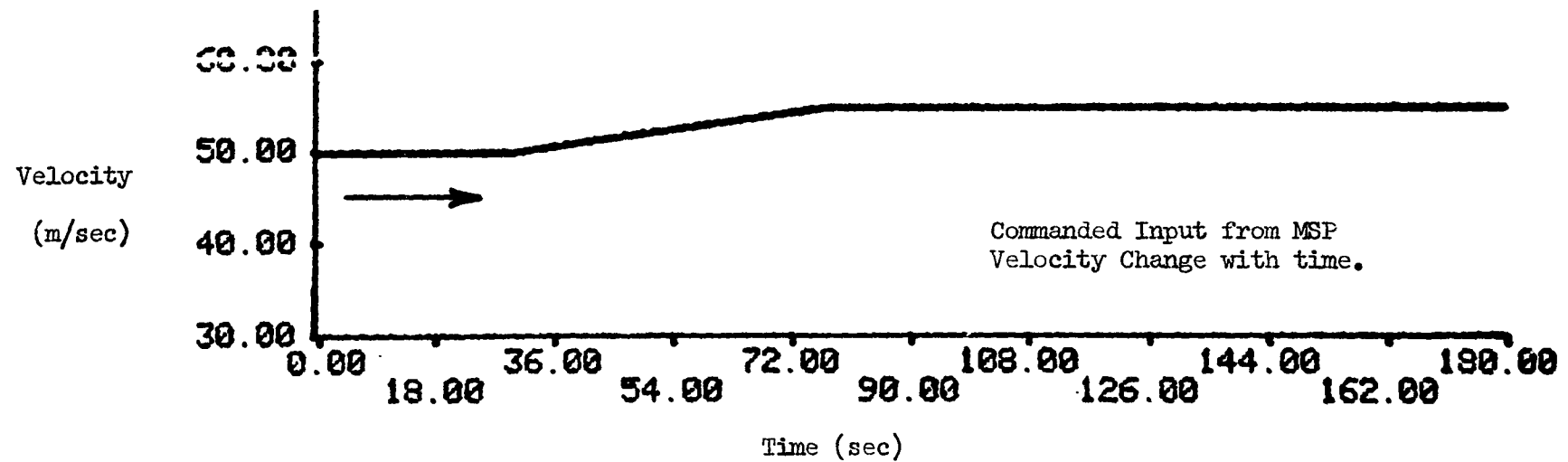

(c) Commanded velocity change, +5 m/sec.

Figure 13.- Continued.

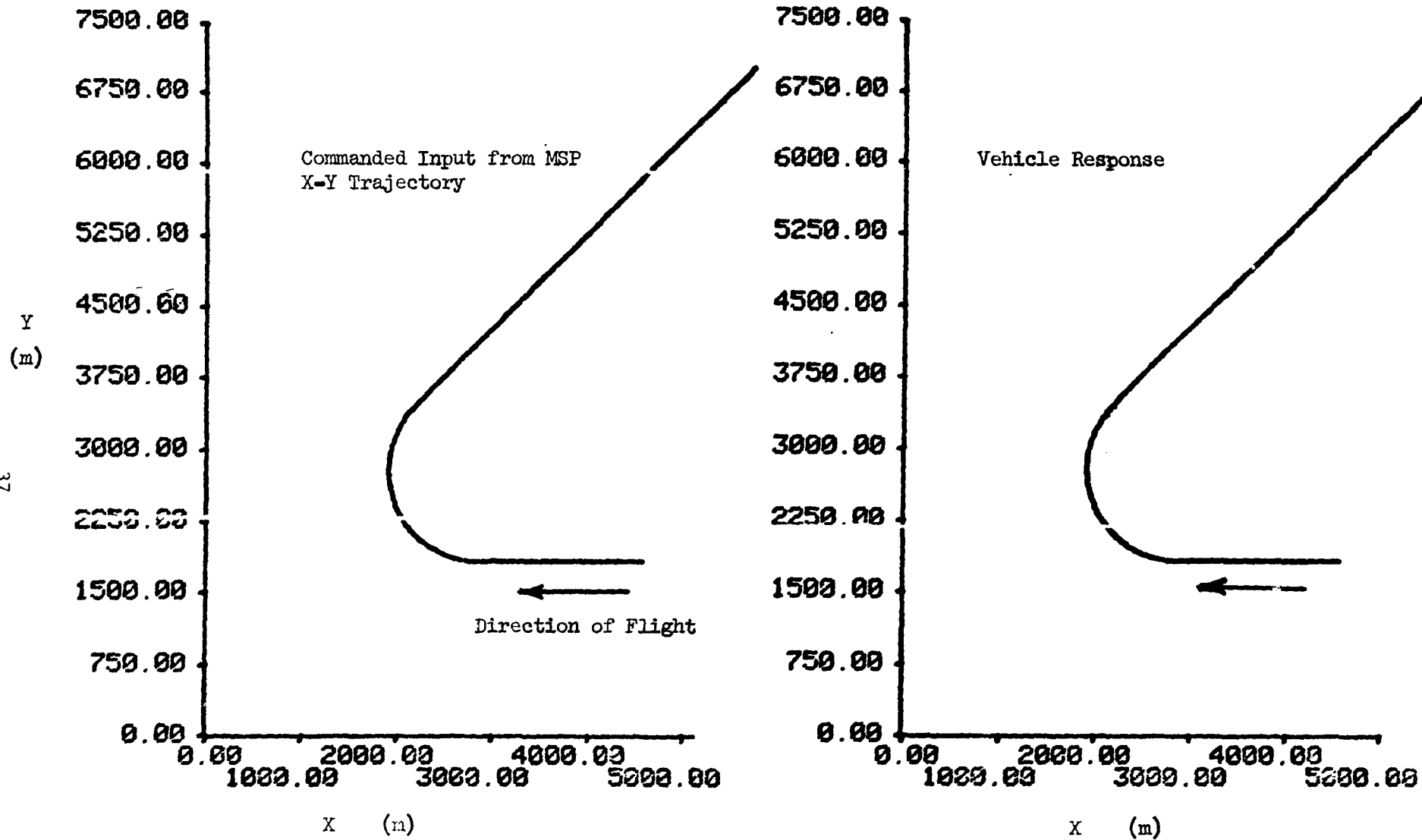

(d) Commanded heading change, large angle, $\psi = 180^\circ$ to 315° .

Figure 13.- Concluded.