



3 1176 00140 1414

NASA-TM-81430 19800011217

NASA Technical Memorandum 81430

FERROGRAPHIC AND SPECTROMETRIC
ANALYSIS OF OIL SAMPLED BEFORE
AND AFTER FAILURE OF A JET ENGINE

William R. Jones, Jr.
Lewis Research Center
Cleveland, Ohio

February 1980

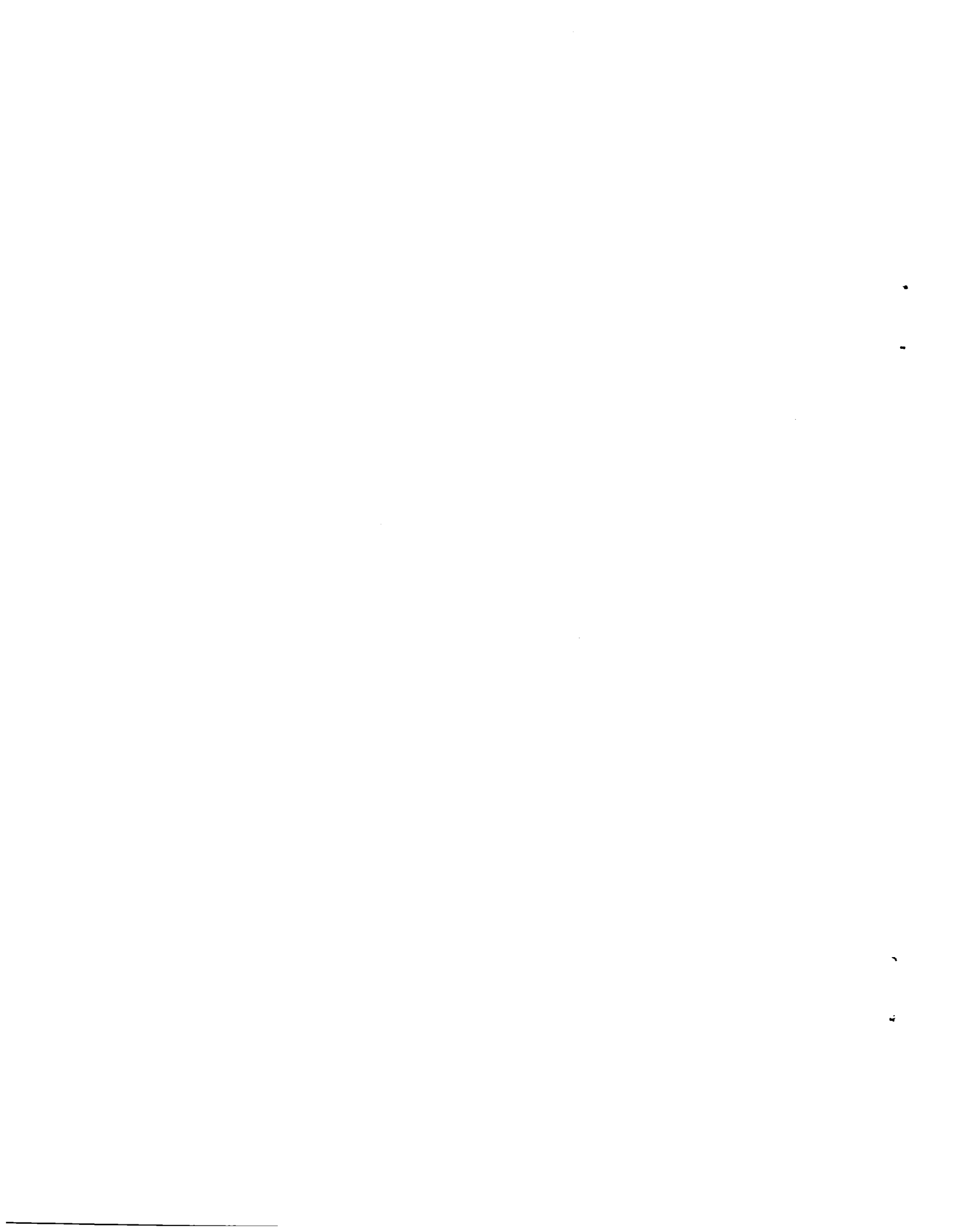

SUMMARY

An experimental gas turbine engine was destroyed as a result of the combustion of its titanium components. The failure investigation board concluded that a severe surge may have caused interference between rotating and stationary compressor parts that either directly or indirectly ignited the titanium components. Several engine oil samples (before and after the failure) were analyzed with a Ferrograph, a plasma, an atomic absorption and an emission spectrometer to see if this additional information would aid in the engine failure diagnosis.

The analyses indicated that a lubrication system failure was not a causative factor in the engine failure. Neither an abnormal wear mechanism, nor a high level of wear debris was detected in the oil sample from the engine just prior to the test in which the failure occurred. However, low concentrations (0.2 - 0.5 ppm) of titanium were evident in this sample and samples taken earlier. After the failure, higher titanium concentrations (>2 ppm) were detected in oil samples taken from different engine locations. Ferrographic analysis indicated that most of the titanium was contained in spherical metallic debris after the failure. Attempts to pinpoint the failure initiation site were inconclusive, but the oil analyses did eliminate a lubrication system bearing or shaft seal failure as the cause of the engine failure.

E-353

INTRODUCTION

In 1976, an experimental gas turbine engine was being tested as part of the Full Scale Engine Research Program at the Lewis Research Center. While exploring a region of fan flutter, the engine appeared to encounter a stall, caught on fire and was destroyed.

The failure investigation board concluded that the severe surge may have caused interference between rotating and stationary compressor parts that either ignited titanium by friction or caused structural failure with the resulting debris igniting the titanium.

The goals of engine oil analysis are to diagnose the condition of the oil wetted components (such as bearings and shaft seals) of the engine and to give early warnings of any future problems. A variety of different techniques (ref. 1) are being employed to effect these goals. These include spectrometric oil analysis (SOAP) using emission, atomic absorption and plasma spectrometers. These devices measure the concentration of various elements in the oil (both dissolved and in particulate form) but are not able to distinguish among the various wear modes that can occur.

Another instrument, the Ferrograph, has been developed which magnetically precipitates wear debris from used lubricants onto a glass

N 80 - 19497 #

slide to yield a Ferrogram (refs. 2 to 4). The precipitated particles range from approximately 0.02 to a few micrometers and are arranged according to size on the slide. Individual particles may be observed with a unique bichromatic microscope (the Ferroscope) or with a conventional scanning electron microscope.

The objective of this investigation was to determine if analyses of the engine lubricant using the Ferrograph and the various spectrometers would provide any insight into the diagnosis of the above-mentioned engine failure.

Mr. Vernon Westcott of Foxboro Analytical, Burlington, Massachusetts, obtained the electron micrographs from the National Engineering Laboratory of Scotland, East Kilbride, Glasgow. Mr. Forrest Handshaw of the Army Oil Analysis Laboratory, Ft. Campbell, Kentucky, provided the emission spectrometric analysis. Dr. Kent Eisentraut of the Air Force Materials Laboratory, Wright-Patterson Air Force Base, Ohio, provided the plasma and atomic absorption spectrometric analyses.

APPARATUS AND PROCEDURE

Ferrograph

The Ferrograph (refs. 2 to 4) is an instrument used to magnetically precipitate wear particles from a used oil onto a specially prepared glass slide. A mixture of 3 ml of used oil and 1 ml of solvent is prepared. This mixture is then slowly pumped over the slide as shown in figure 1. A solvent wash and fixing cycle follows which removes residual oil and permanently attaches the particles to the slide. The resulting slide with its associated particles is called a Ferrogram.

Energy Dispersive X-ray Analysis

The elemental composition of the different types of wear debris was determined using energy dispersive X-ray analysis (EDX). In order to prevent charging in the scanning electron microscope, the Ferrogram slides were coated with either a thin layer (2×10^{-8} m, 200 Å) of carbon or gold.

Spectrometers

Basically, there are two methods for spectrometric oil analysis. One method uses the emission spectrograph where metallic atoms are excited by an electric arc to emit characteristic spectra. The intensity

of these spectral lines is used to measure the metal concentration in the sample. The second method uses the atomic absorption spectrophotometer where the sample is burned in a flame. The ground state atoms in the flame absorb a portion of a light beam transmitted through the flame. The amount of light absorbed is a measure of the metal concentration.

A recent innovation in emission spectrometers is the use of a "plasma" to excite the sample rather than the traditional arc or spark (ref. 5). This system provides a clear background, improved stability and minimal matrix interference.

The emission spectrometer used in this study was a Baird Atomic AE3503. The plasma spectrometer was a Spectraspan III manufactured by Spectrametrics, Inc. A Perkin-Elmer 305B atomic absorption spectrophotometer was used for the particle size independent titanium analysis. The particle size independent technique (ref. 6) involved mixing the used lubricant with an acid-solvent mixture in order to solubilize the wear particles.

RESULTS AND DISCUSSION

There were five oil samples (two prior to failure and three after failure) analyzed by various techniques. These included two engine oil samples dated May 27, 1976, and September 10, 1976 (before failure). Three other samples (after failure) were an engine oil sample dated September 14, 1976, a sample from the oil cooler and one from the oil filter.

Elemental analysis. - The above samples were spectroscopically analyzed for Fe, Ag, Al, Cr, Cu, Mg, Ni, Si and Ti by routine emission spectrographic techniques (SOAP) (ref. 1) and by a newer plasma spectroscopic technique (ref. 5). Results for these analyses are shown in table I. In the two samples taken before the failure, low concentrations of Fe, Al, Cu, Si and Ti were detected. There is nothing unusual in these results. In the September 14, 1976, engine oil sample taken after failure, there are definite increases in the concentrations of Fe, Al, Cr, Ni, Si and Ti. Similar increases were noted for the two other after failure samples.

Since the ordinary emission spectroscopic techniques are somewhat dependent on the particle size of the debris present in the sample, a special atomic absorption technique (particle size independent) was used for titanium analysis (ref. 6). Analytical results for four samples using this technique appear in table II. Higher titanium concentrations were detected in all four samples compared to the plasma spectrometer results of table I. This technique is considered to be more accurate than the plasma emission analysis.

Ferrographic analysis (before failure). - Oil samples were also analyzed using the Ferrograph and selected areas of Ferrograms were further analyzed in a scanning electron microscope. An electron micrograph of wear debris from the engine oil sample (September 10, 1976) appears in figure 2(a). Two particles (A and B) are analyzed by X-ray dispersive energy analysis (EDX) in figures 2(b) and (c), respectively. Particle A is predominantly titanium and iron with lesser amounts of chromium, manganese and nickel. Particle B is essentially copper with a small amount of iron. It should be noted that in any small particle analysis using EDX, there may be surrounding particle interference. This means that contributions to some of the EDX peaks may be from surrounding or underlying particles, since the analyzing depth or volume may, in some cases, be greater than the size of the analyzed particle.

The particle morphology of figure 2(a) is essentially that of normal rubbing wear particles or a benign form of wear (ref. 7). However, there were spherical particles evident in the prefailure sample and an electron micrograph appears in figure 3(a). EDX analysis of the spheres appears in figure 3(b) and the background analysis of the glass Ferrogram appears in figure 3(c). The presence of gold is due to the evaporated gold film to prevent charging in the SEM. These spheres are essentially pure iron. At least no other element (beside the background elements) are detected by EDX. These large 10 to 15 μm diameter spheres are probably contaminants in the oil. Spherical particles have been related to bearing fatigue (refs. 7-9), but spheres from these sources are usually much smaller (1-5 μm in diameter) and have analyses similar to bearing steel.

Essentially the same area on the Ferrogram that appears in figure 3(a) is mapped for the distribution of Fe, Ti, Cu and Si in figures 4(b) to (e). As can be seen, the majority of the particles contain Fe, while one particle contains Ti. Most of the Si and Cu is from the background.

Ferrographic analysis (after failure). - Figure 5 shows the type of particles present in the oil taken from the oil filter after the failure. As can be seen, the majority are spherical or spheroidal in nature. In reflected white light, the spherical particles have a variety of colors from white, to straw-colored, to deep blue. There is also evidence of tear-shaped or globular particles. These shapes, combined with the variety of colors, would be indicative of a high temperature melting and resolidification process. These particles are shown at higher magnification in figures 6(a) and (b).

Electron micrographs of debris from the engine oil sample (September 14, 1976) show similar particle types. These are shown in figures 7(a) and (c) with their accompanying EDX analysis in figures 7(b) and (d), respectively. The particles are predominantly titanium and iron with lesser amounts of chromium and nickel.

Another micrograph of debris from engine sample September 14, 1976, is shown in figure 8(a). X-ray distribution maps for Ti, Fe, Ni, Cr and Si appear in figures 8(b) through (f), respectively. In support of the previous figure, the debris consists of titanium and iron with small amounts of Ni and Cr. The silicon is essentially from the Ferrogram slide.

Wear severity index. - A parameter, the wear severity index, has been advocated by Bowen and Westcott (ref. 7). This parameter is calculated from optical density measurements made at the entry position of the Ferrogram (A_L) and at the 50-millimeter position (A_S). These are the areas covered by the large and small particles. Their sum ($A_L + A_S$) yields the general level of wear, while their difference ($A_L - A_S$) gives an indication of abnormality. These two quantities multiplied together ($A_L + A_S$)($A_L - A_S$) yield the wear severity index $A_L^2 - A_S^2$, usually abbreviated I_S .

I_S values for all of the oil samples, including the mean of six engine samples from 1974, are shown in figure 9. The I_S increased from about 10 to 140 from the May 27, 1976, sample to the September 10, 1976, sample. Although this is a large increase, prior to failure, it is not significant when compared to the range of I_S values obtained from this engine in the past (i.e., 1974 samples). After failure, I_S values increase dramatically. This, of course, is expected. An especially large value was obtained from the oil filter sample.

Failure initiation site. - One of the more plausible failure modes discussed by the failure review board was the ignition of titanium by friction between moving and stationary components in the high pressure compressor. There were two possibilities: A rotor/shroud source in which the titanium rotor blades would interfere with their shrouds (Metco 301, an abradable nickel-chromium-iron alloy). The second possibility involves a stator/spacer source in which the titanium knife edges on the spacers interfere with the labyrinth material (AMS 430, a stainless steel).

These types of failures would generate debris in the gas path of the engine. Conceivably, this debris could enter the bearing compartments through the seals and eventually find its way into the lubrication system.

It was hoped that analysis of this debris might indicate the location of the high speed rub. The nominal composition of the shroud material (Metco 301) is: 69 percent Ni, 14 percent Cr, 8 percent Fe, 5.5 percent BN and 3.5 percent Al. The labyrinth material is AMS 430 which has a composition of 83 percent Fe, 17 percent Cr and 1 percent Mn. Examining figure 7 for both the area analyses (7(b)) and an individual particle analysis (7(d)) is inconclusive. Neither analysis would match the above compositions. This is not surprising considering the manner in which the particles were formed. In addition, the particle analysis from figure 7(d) is very similar to the analysis of the

particle in figure 2(b) which was from a sample taken prior to the failure. There definitely appear to be titanium containing particles in the engine lubricant prior to the engine failure.

CONCLUDING REMARKS

It was concluded that a failure in the lubrication system was not involved and, therefore, did not contribute to the engine failure. Attempts to pinpoint the possible failure initiation site in the high pressure compressor were inconclusive.

SUMMARY OF RESULTS

The Ferrograph, an emission spectrometer, a plasma spectrometer and an atomic absorption spectrophotometer were used to analyze engine oil samples from a failed gas turbine engine. The major results are summarized as follows:

1. No abnormal wear mechanisms nor high levels of were were detected in engine oil samples taken prior to engine failure.
2. However, low concentrations of titanium (0.2 to 0.5 ppm) were evident in the engine oil prior to failure. Higher titanium concentrations (>2 ppm) were detected after failure.
3. Ferrographic analysis indicated that most of the titanium was contained in spherical metallic debris after the failure. Some titanium debris was present before the failure.

REFERENCES

1. Beerbower, A.: Spectrometry and Other Analysis Tools for Failure Prognosis. Lubr. Eng., vol. 32, no. 6, June 1976, pp. 285-293.
2. Seifert, W. W. and Westcott, V. C.: A Method for the Study of Wear Particles in Lubricating Oil. Wear, vol. 21, 1972, pp. 27-42.
3. Westcott, V. C. and Seifert, W. W.: Investigation of Iron Content of Lubricating Oil Using Ferrograph and an Emission Spectrometer. Wear, vol. 23, 1973, pp. 239-249.
4. Scott, D.; Seifert, W. W.; and Westcott, V. C.: Ferrography - An Advanced Design Aid for the 80's. Wear, vol. 34, 1975, pp. 251-260.

5. Ward, Arthur F.: Inductively Coupled Argon Plasma Spectroscopy, Development, Technique, and Applications. Am. Lab., vol. 10, no. 11, Nov. 1978, pp. 79-87.
6. Saba, Costandy S. and Eisentraut, Kent J.: Determination of Titanium in Aircraft Lubricating Oils by Atomic Absorption Spectrophotometry. Anal. Chem., vol. 49, no. 3, Mar. 1977, pp. 454-457.
7. Bowen, E. Roderic and Westcott, Vernon C.: Wear Particle Atlas. Naval Air Engineering Center, July 1976.
8. Jones, William R., Jr. and Parker, Richard J.: Characterization of Wear Debris Generated in Accelerated Rolling-Element Fatigue Tests. NASA TP-1203, 1978.
9. Jones, William R., Jr. and Loewenthal, Stuart H.: Ferrographic Analysis of Wear Debris from Full-Scale Bearing Fatigue Tests. NASA TP-1511, 1979.

TABLE I. - ELEMENTAL ANALYSIS OF OIL SAMPLES USING ORDINARY
SOAP PROCEDURE AND A PLASMA SPECTROMETER

Sample		Elements, ppm								
		Fe	Ag	Al	Cr	Cu	Mg	Ni	Si	Ti
Engine oil samples:										
5/27/76 Before failure	Soap ^a (plasma spect.) ^b	1 (0.5)	0 (0.1)	0 (0.5)	0 (0.1)	2 (1.1)	0 (0.2)	c (0.1)	5 (2.2)	0 (0.2)
9/10/76 Before failure	Soap (plasma)	1 (0.5)	0 (0)	0 (0.3)	0 (0.1)	2 (0.6)	0 (0.1)	c (0)	4 (0.8)	0 (0.3)
9/14/76 After failure	Soap (plasma)	5 (2.5)	0 (0)	4 (1.6)	2 (0.9)	3 (0.6)	0 (0)	c (0.9)	0 (10.6)	2 (2.2)
Oil Cooler after failure	Soap (plasma)	3 -	0 -	3 -	0 -	3 -	0 -	c -	5 -	2 -
Oil Filter after failure	Soap (plasma)	- (4.1)	- (0)	- (2.6)	- (1.0)	- (1.6)	- (0.5)	- (1.2)	- (49.3)	- (3.1)

^aArmy Oil Analysis Lab, Ft. Campbell, KY

^bAir Force Materials Lab, WPAFB, OH 45433

^cNot determined

TABLE II. - ANALYSIS OF OIL SAMPLES FOR TITANIUM
USING PARTICLE SIZE INDEPENDENT ATOMIC
ABSORPTION SPECTROPHOTOMETRY^c

Sample	Titanium concentration, ppm
From engine:	
5/27/76	0.4 ^a (0.2)
9/10/76	0.5 ^a (0.3)
9/14/76	3.1 ^a (2.2)
Oil Filter	^b 11.5 ^a (3.1)

^aPlasma data from table I.

^bSample contained large particles which settled to bottom of bottle.

^cReference 6.

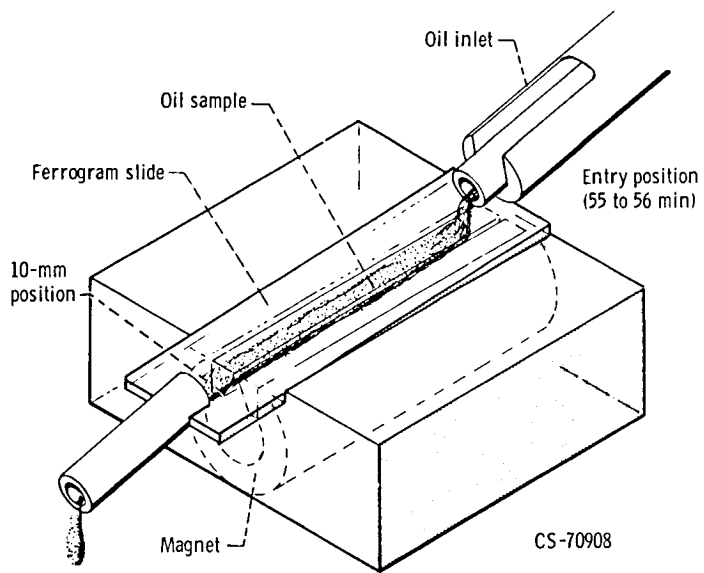
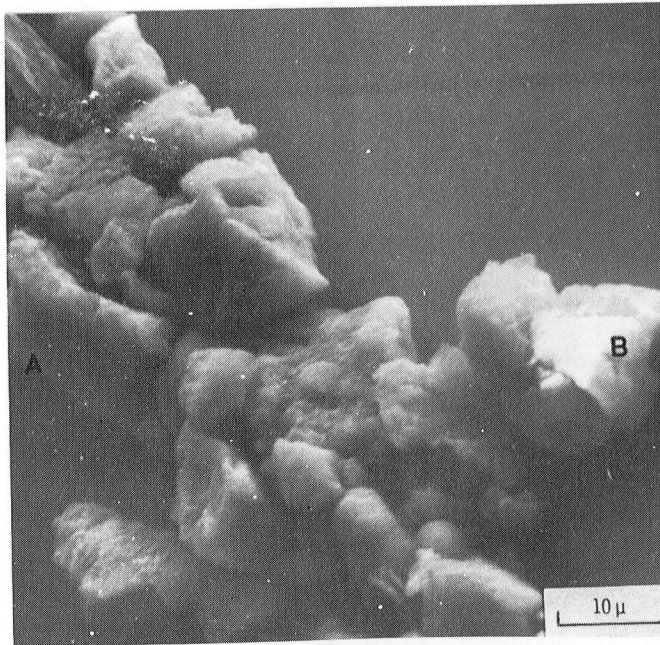
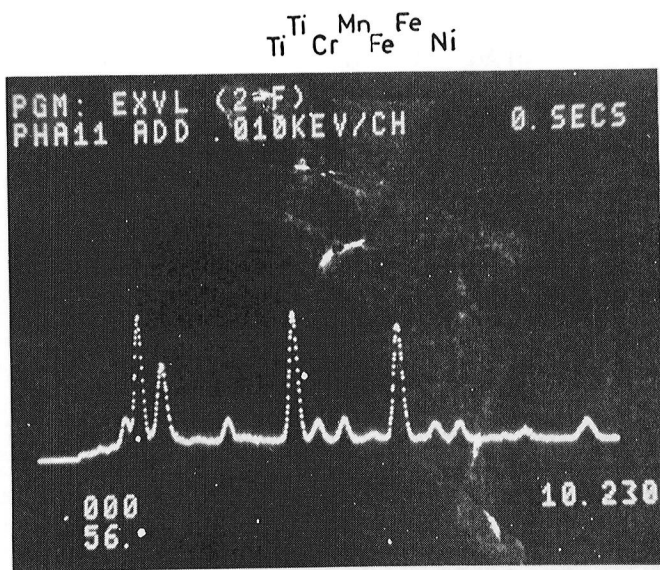

Figure 1. - Ferrograph analyzer.



(a) Electron micrograph of wear debris.



(b) EDX analysis of particle A.

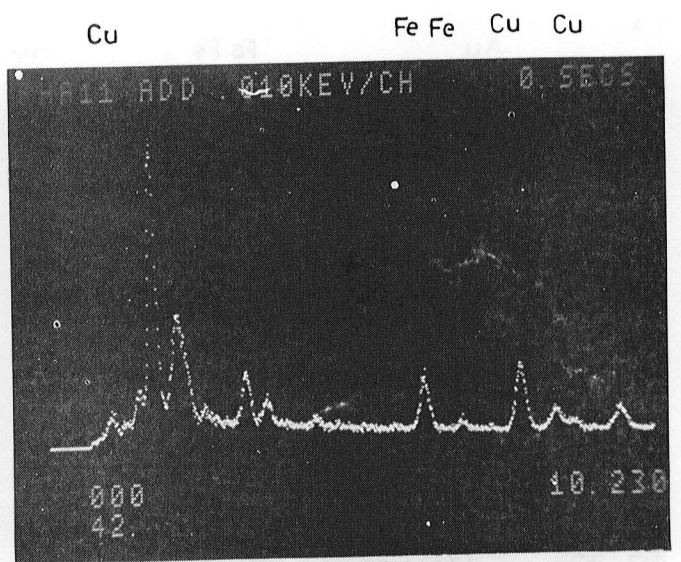

(c) EDX analysis of particle B.

Figure 2. - Wear debris from oil sample 9/10/76 (before failure).

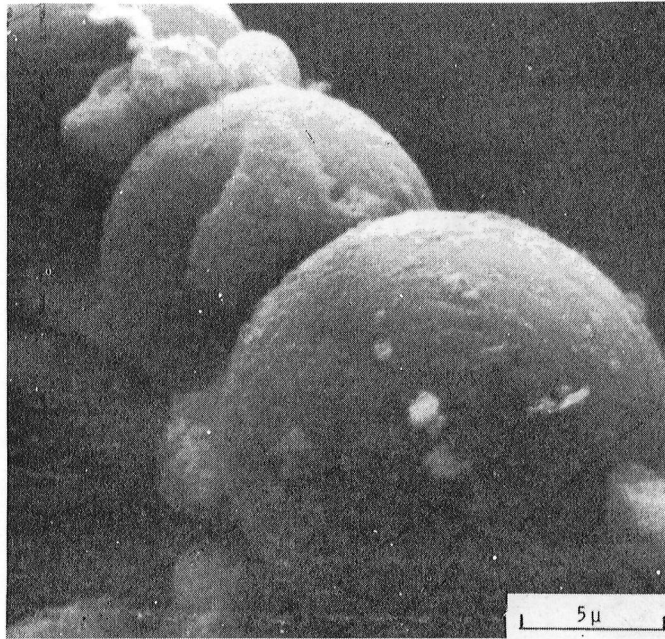

(a) Electron micrograph of spherical particles.

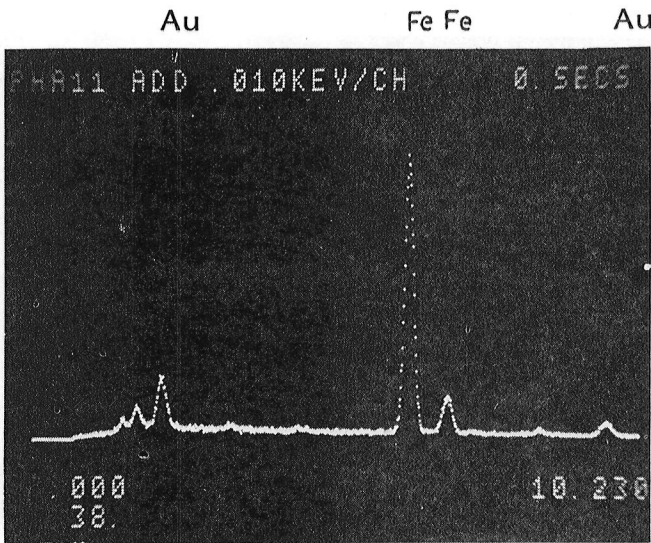

(b) Energy dispersive X-ray analysis (EDX) of spheres.

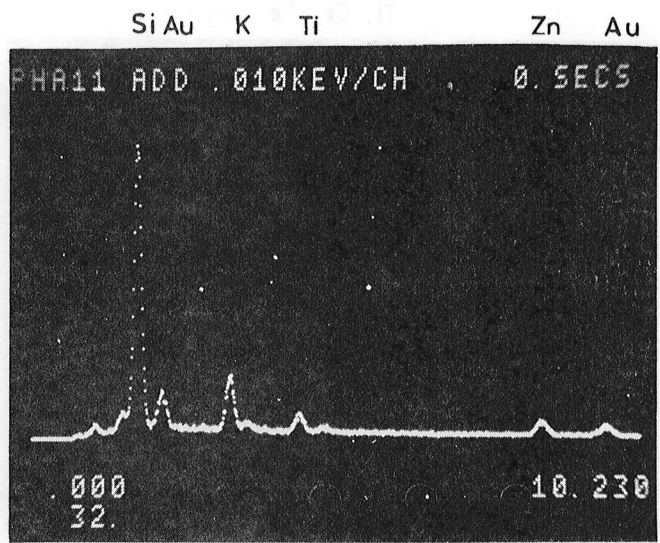

(c) Background EDX of ferrogram.

Figure 3. - Spherical particles from oil sample 9/10/76 (before failure).

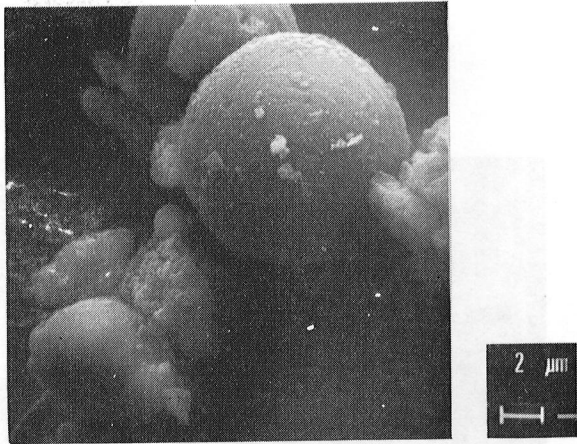

(a) Electron micrograph of spherical particles and debris.

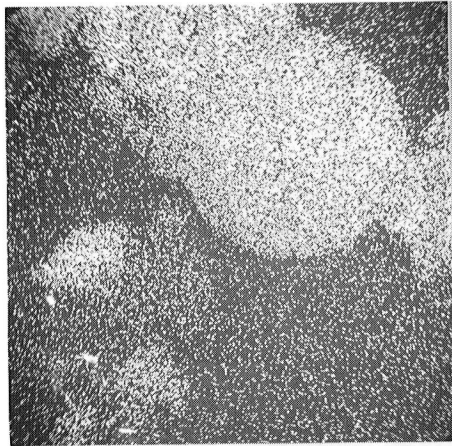

(b) X-ray distribution of Fe.

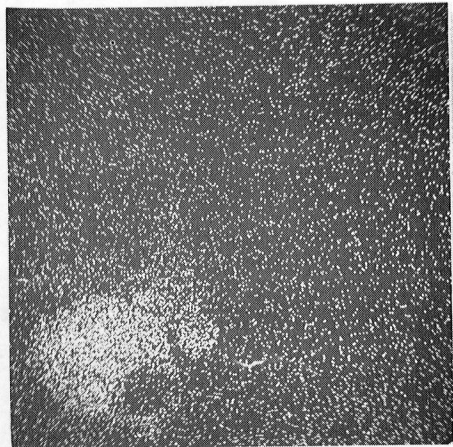

(c) X-ray distribution of Ti.

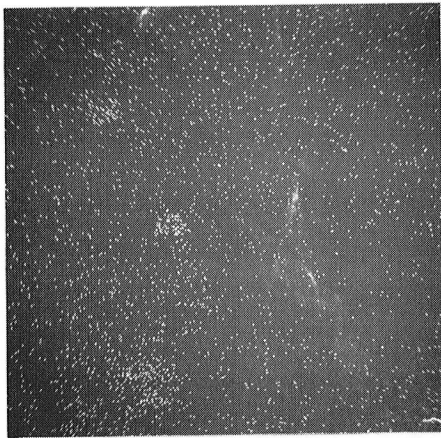

(d) X-ray distribution of Cu.

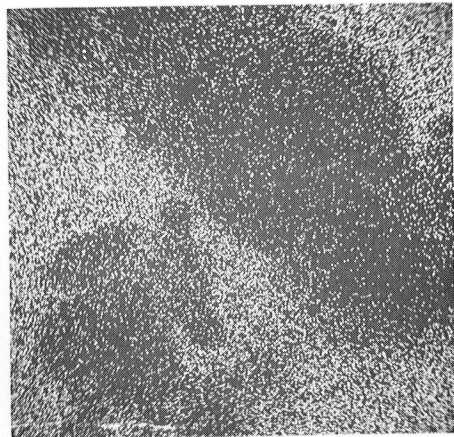

(e) X-ray distribution of Si.

Figure 4. - Spherical particles and debris from oil sample 9/10/76 (before failure) and accompanying elemental X-ray maps.

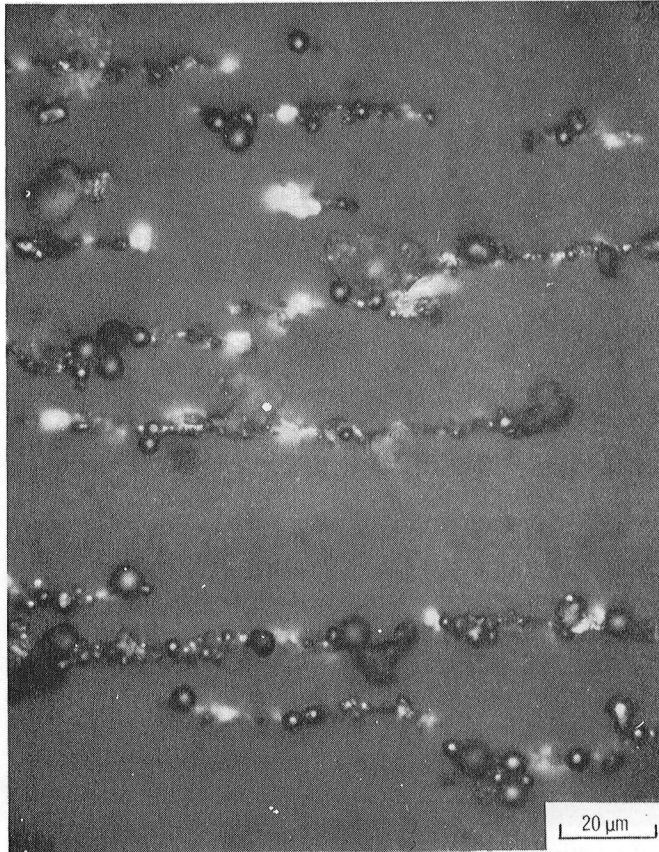
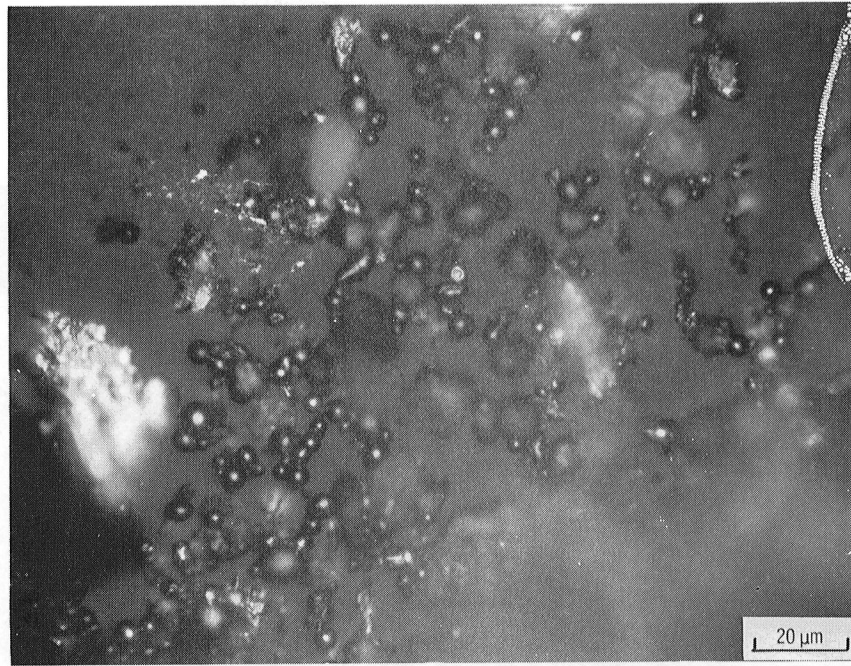
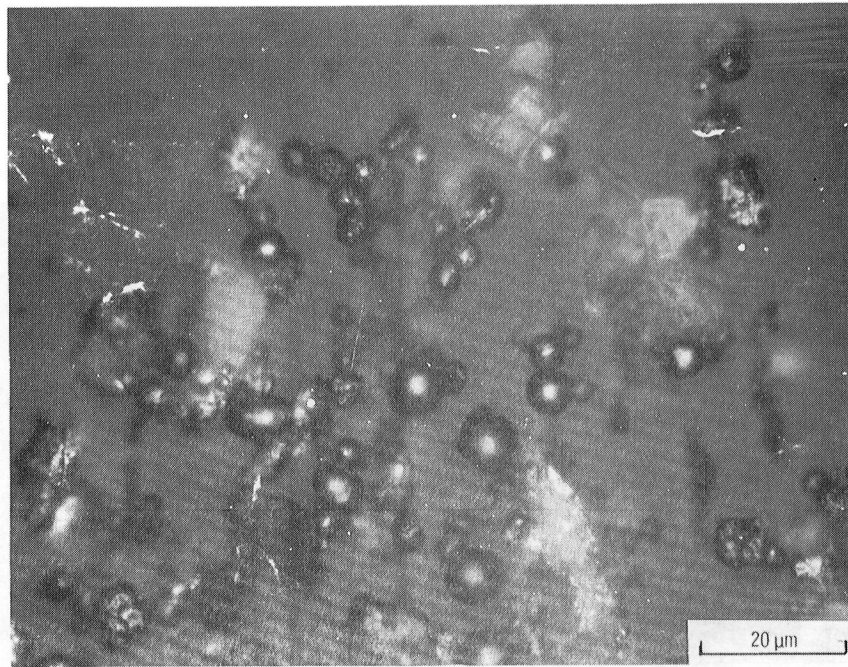

Figure 5. - Optical micrograph of spherical particles and debris from oil in oil filter (after failure).



(a) Magnification, 645X.



(b) Area (a) at 896X magnification.

Figure 6. - Debris from oil sample from oil filter (after failure).

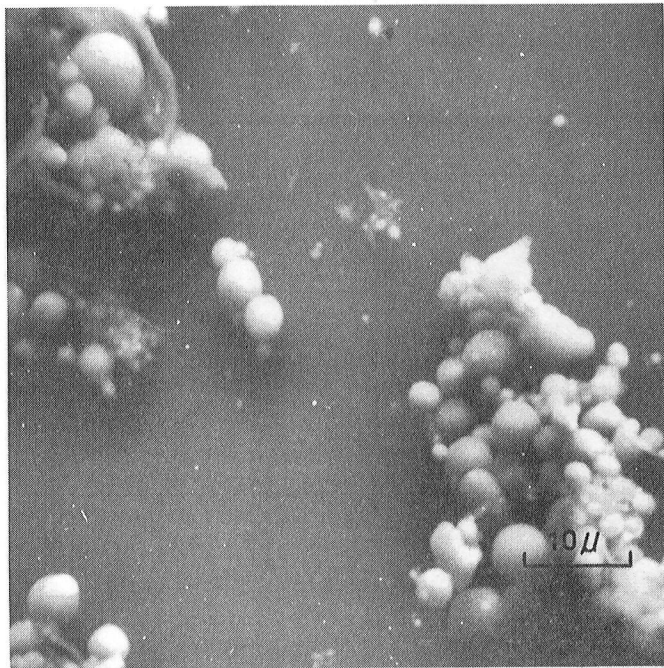

(a) Electron micrograph of debris.

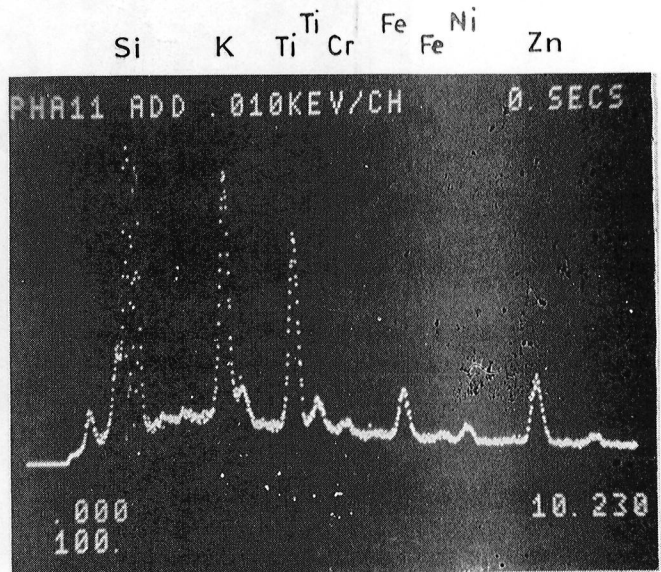

(b) EDX analysis of (a).

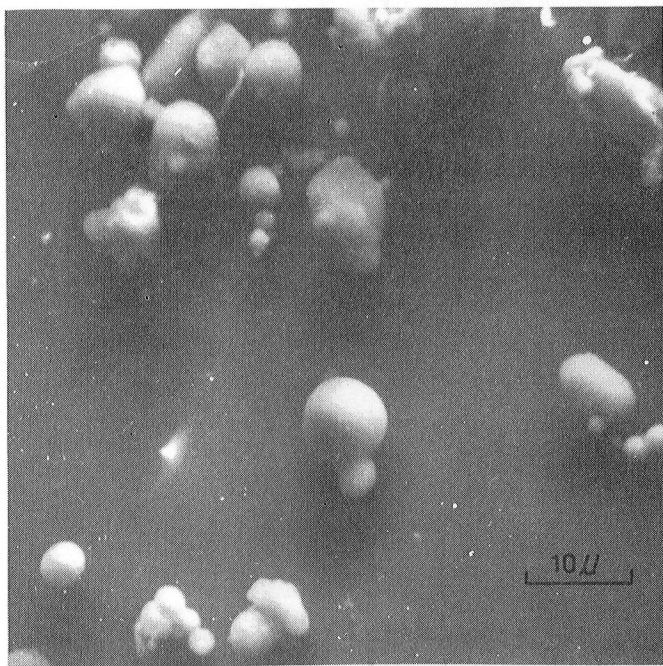

(c) Electron micrograph of debris.

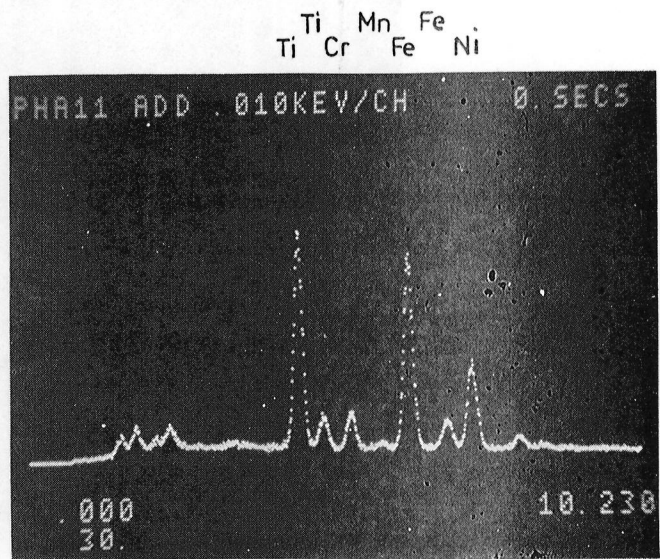

(d) EDX analysis of central spherical particle of (c).

Figure 7. - Debris from oil sample 9/14/78 (after failure).

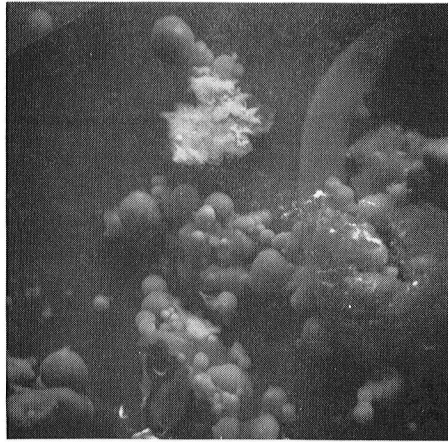

(a) Electron micrograph of debris.

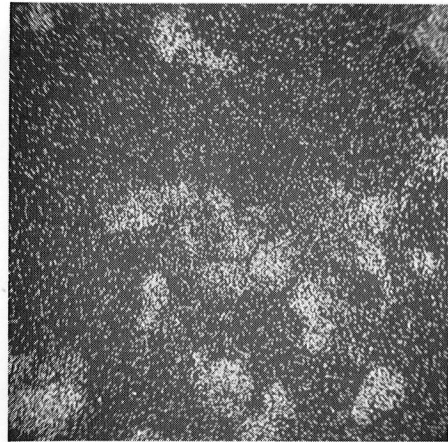
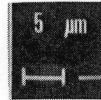

(b) X-ray distribution of Ti.

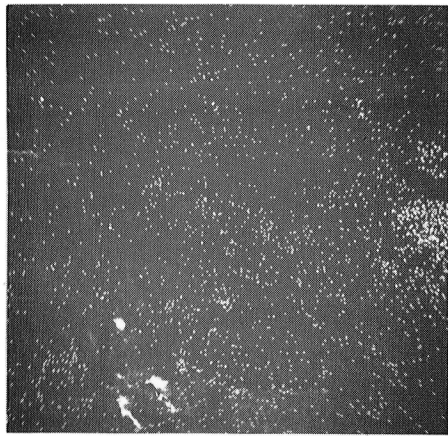

(c) X-ray distribution of Fe.

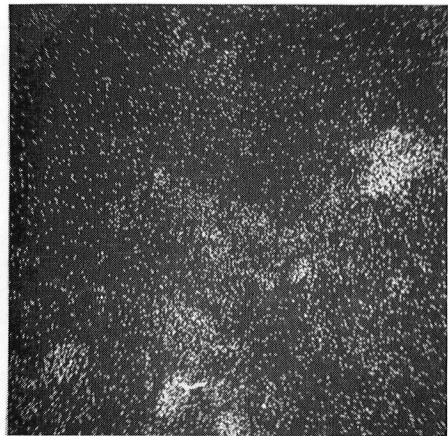

(d) X-ray distribution of Ni.

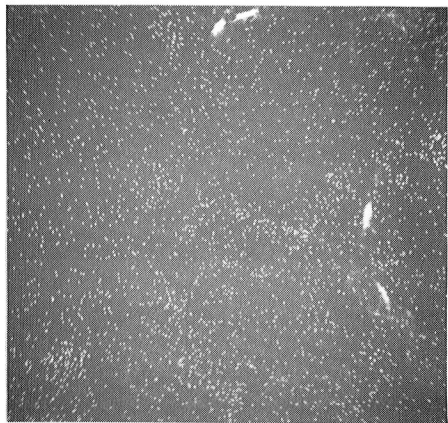

(e) X-ray distribution of Cr.

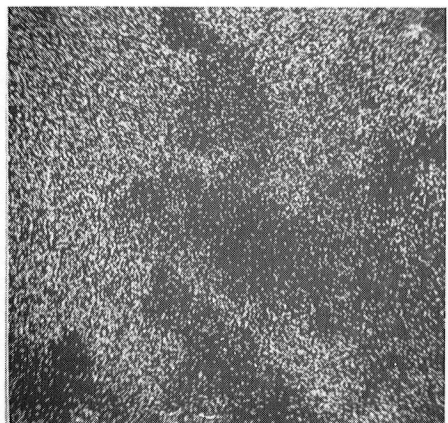

(f) X-ray distribution of Si.

Figure 8. - Debris from oil sample 9/14/76 (after failure) and accompanying elemental X-ray maps.

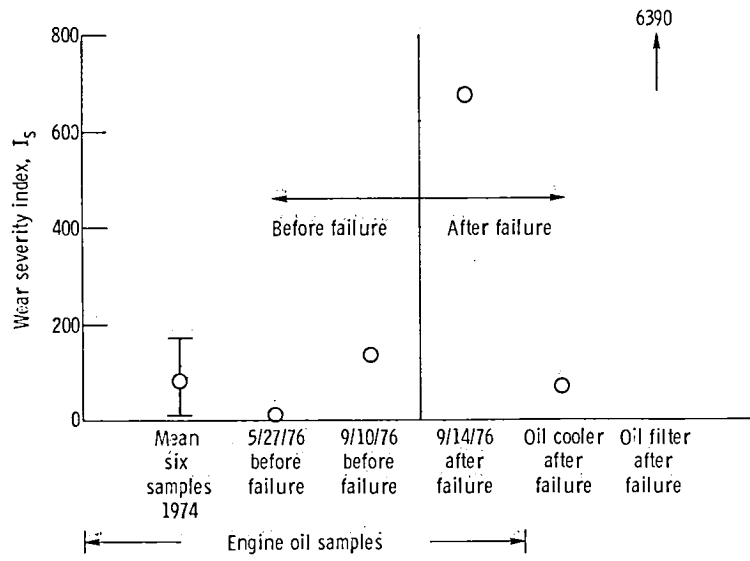

Figure 9: - Wear severity index (I_s) for various oil samples.



1. Report No. NASA TM-81430	2. Government Accession No.	3. Recipient's Catalog No.	
4. Title and Subtitle FERROGRAPHIC AND SPECTROMETRIC ANALYSIS OF OIL SAMPLED BEFORE AND AFTER FAILURE OF A JET ENGINE		5. Report Date February 1980	6. Performing Organization Code
		8. Performing Organization Report No. E-353	10. Work Unit No.
7. Author(s) William R. Jones, Jr.		11. Contract or Grant No.	
9. Performing Organization Name and Address National Aeronautics and Space Administration Lewis Research Center Cleveland, Ohio 44135		13. Type of Report and Period Covered Technical Memorandum	
		14. Sponsoring Agency Code	
12. Sponsoring Agency Name and Address National Aeronautics and Space Administration Washington, D. C. 20546		15. Supplementary Notes	
16. Abstract <p>An experimental gas turbine engine was destroyed as a result of the combustion of its titanium components. The failure investigation board concluded that a severe surge may have caused interference between rotating and stationary compressor parts that either directly or indirectly ignited the titanium components. Several engine oil samples (before and after the failure) were analyzed with a Ferrograph, a plasma, an atomic absorption and an emission spectrometer to see if this additional information would aid in the engine failure diagnosis. The analyses indicated that a lubrication system failure was not a causative factor in the engine failure. Neither an abnormal wear mechanism, nor a high level of wear debris was detected in the oil sample from the engine just prior to the test in which the failure occurred. However, low concentrations (0.2 - 0.5 ppm) of titanium were evident in this sample and samples taken earlier. After the failure, higher titanium concentrations (>2 ppm) were detected in oil samples taken from different engine locations. Ferrographic analysis indicated that most of the titanium was contained in spherical metallic debris after the failure. Attempts to pinpoint the failure initiation site were inconclusive, but the oil analyses did eliminate a lubrication system bearing or shaft seal failure as the cause of the engine failure.</p>			
17. Key Words (Suggested by Author(s)) Ferrographic analysis Spectrometric oil analysis Jet engine failure		18. Distribution Statement Unclassified - unlimited STAR Category 37	
19. Security Classif. (of this report) Unclassified	20. Security Classif. (of this page) Unclassified	21. No. of Pages	22. Price*

* For sale by the National Technical Information Service, Springfield, Virginia 22161



National Aeronautics and
Space Administration

Washington, D.C.
20546

Official Business
Penalty for Private Use, \$300

SPECIAL FOURTH CLASS MAIL
BOOK

Postage and Fees Paid
National Aeronautics and
Space Administration
NASA-451



NASA

POSTMASTER: If Undeliverable (Section 158
Postal Manual) Do Not Return