

(NASA-CR-160580) SPACE CONSTRUCTION SYSTEM ANALYSIS. PART 2: COST AND PROGRAMMATICS Final Report (Rockwell International Corp., Downey, Calif.) 76 p HC A05/MF A01 C5CL 22A

N60-22376

Unclas G3/12 16692

NASA CR-

160580

SPACE CONSTRUCTION SYSTEM ANALYSIS

PART 2 FINAL REPORT COST AND PROGRAMMATICS

APRIL 1980

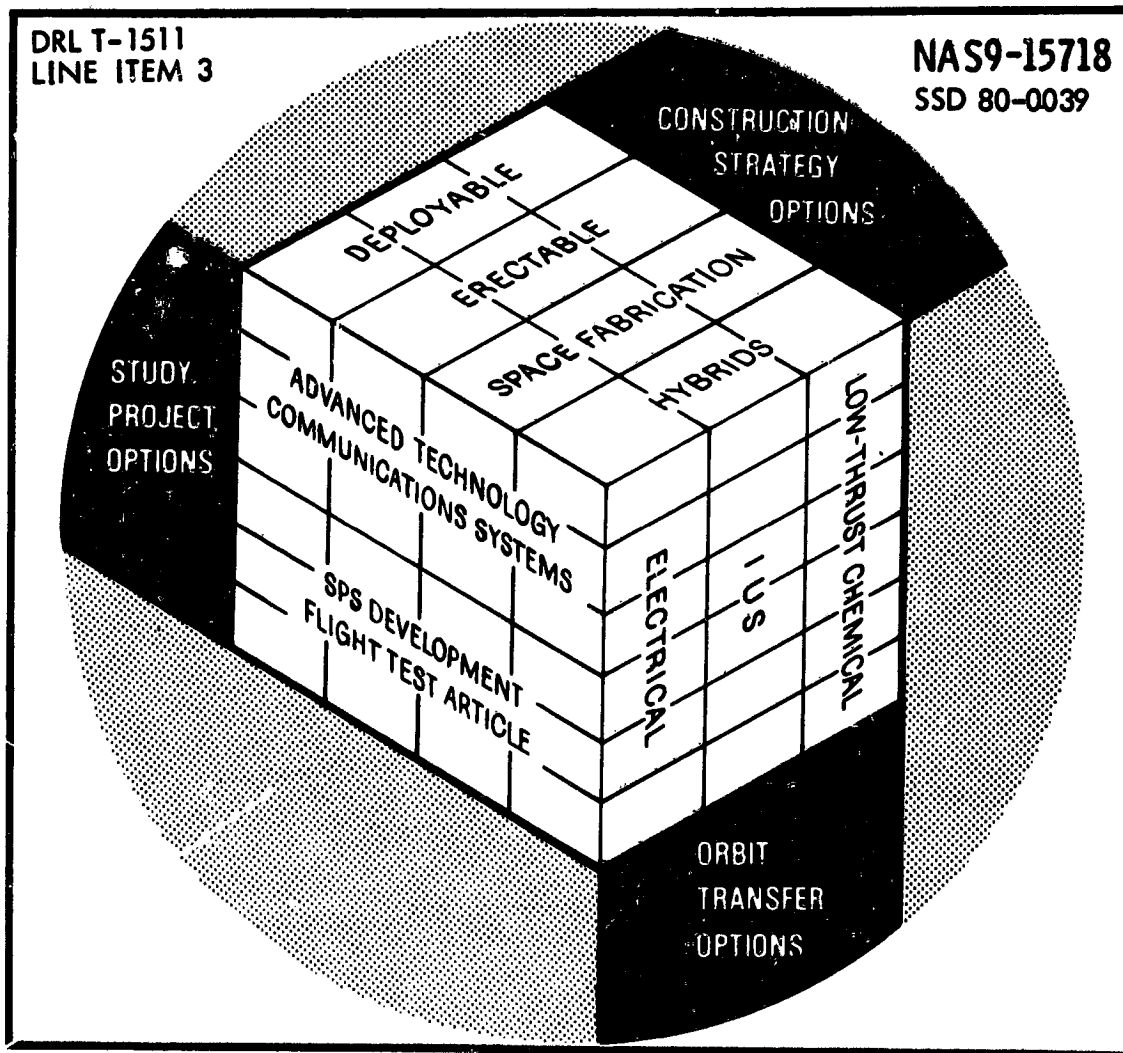

Rockwell International

Space Operations and
Satellite Systems Division
Space Systems Group
12214 Lakewood Boulevard
Downey, CA 90241



DRL T-1511
MA-744T

SSD 80-0039

SPACE CONSTRUCTION SYSTEM ANALYSIS
PART 2, FINAL REPORT
Cost and Programmatic

APRIL 1980

NAS9-15718

Principal Authors: F. W. Von Flue
W. Cooper

Satellite Systems Division
Space Systems Group



Rockwell
International

FOREWORD

This volume of the final report covers Cost and Programmatic for the Engineering Technology Verification Platform, resulting from a two-part study of space construction concepts and processes. The Space Construction System Analysis Study was conducted by the Space Operations and Satellite Systems Division, Space Operations Group, of Rockwell International Corporation for the National Aeronautics and Space Administration, Johnson Space Center. This report is responsive to the data requirements of NASA/JSC Contract NAS9-15718.

The work was administered under the technical direction of the Contracting Officer Representative (COR), Mr. Sam Nassiff, Spacecraft Systems Office, Spacecraft Design Division, Johnson Space Center.

The study was conducted under the direction of Ellis Katz, Study Manager. All members of the study team supported various aspects of the cost and programmatic activity as completed by Frank W. Von Flue, Task Leader, with significant contribution by W. Cooper.

Major documents of the Part II study contract activity are:

Space Construction System Analysis, Part 2, Platform Definition,
Final Report SSD 80-0037

Space Construction System Analysis, Part 2, Construction Analysis,
Final Report SSD 80-0038

Space Construction System Analysis, Part 2, Cost and Programmatics, Final Report SSD 80-0039

Space Construction System Analysis, Final Report, Space Construction
Experiments Concepts SSD 80-0040

Space Construction System Analysis, Part 2, Executive Summary,
Final Report SSD 80-0041

CONTENTS

Section		Page
1.0	COST AND PROGRAMMATICS	1-1
	1.1 INTRODUCTION	1-1
	1.2 GUIDELINES AND GROUND RULES	1-3
2.0	PROGRAMMATICS	2-1
	2.1 INTRODUCTION	2-1
	2.2 CONSTRUCTION SYSTEM REQUIREMENTS	2-2
	Introduction	2-2
	Orbiter Construction Base	2-2
	Construction Fixture System	2-3
	Construction Station No. 1	2-3
	Construction Station No. 2	2-7
	Construction Support Equipment	2-7
	Remote Manipulator System (RMS) Modification	2-8
	Modified Cherry Picker and Astronaut Maneuvering Arm	2-11
	Beam Builder Machine Modifications	2-11
	EVA Suit and Life Support Systems	2-13
	Manned Maneuvering Unit (MMU)	2-13
	Miscellaneous Tools and Devices	2-14
	2.3 TECHNOLOGY REQUIREMENTS.	2-15
	Introduction	2-15
	Technology Issues	2-15
	Platform, Construction, and Logistics Technologies	2-16
	Software Technology Requirements	2-16
	Technology Schedule	2-19
	2.4 SCS DEVELOPMENT PLANNING	2-21
	Introduction	2-21
	Development Schedules	2-21
	ETVP Program Development Schedule	2-22
	Flight Experiment Program Schedule	2-24
	ETVP Mission Scenario	2-25
	Leo Operations	2-25
	LEO-to-GEO Transfer	2-25
	GEO Operation	2-26
	Mission Summary	2-26
	2.5 FLIGHT TEST PLAN	2-28
	Introduction	2-28
	Space Construction Flight Experiments	2-28
	Deployed/Assembled Structural Dynamics Experiment	2-29
	Construction Equipment Effectiveness Experiment	2-30
	Space Fabrication/Assembly Experiment	2-31
	Deployed Boom Experiment	2-32
	Large Space Antenna Experiment	2-33
	Conclusion	2-34

Section		Page
3.0	COST ANALYSIS	3-1
3.1	INTRODUCTION	3-1
3.2	WORK BREAKDOWN STRUCTURE AND DICTIONARY, ENGINEERING TECHNOLOGY VERIFICATION PLATFORM (ETVP)	
	IXX-00-00 PLATFORM SYSTEM	3-4
	1XX-01-00 Platform Structure	3-6
	1XX-02-00 System Control Module	3-6
	1XX-03-00 Rotary Joint Assembly	3-6
	1XX-04-00 Solar Array Assembly	3-7
	1XX-05-00 Reaction Control Modules	3-7
	1XX-06-00 Orbit Transfer Propulsion Module	3-7
	1XX-07-00 Integration and Operations	3-7
	1XX-08-00 ETVP Payload	3-7
	2XX-00-00 CONSTRUCTION SYSTEM	3-8
	2XX-01-00 Construction Fixture System (Sta. 1)	3-8
	2XX-02-00 Construction Fixture System (Sta. 2)	3-8
	2XX-03-00 Construction Support Equipment	3-8
	2XX-04-00 Flight Support Equipment (FSE)	3-9
	2XX-05-00 Operations and Integration	3-9
	3XX-00-00 OPERATIONS AND LOGISTICS SYSTEM	3-9
	3XX-01-00 Standard Space Shuttle Services	3-9
	3XX-02-00 Optional Flight Hardware and Services	3-10
	3XX-03-00 LEO and GEO Logistics/Mission Support	3-10
3.3	ETVP COSTING	3-11
	Cost Methodology	3-11
	Platform and Construction System Costing	3-14
	Operations and Logistic System Costing	3-16
	Space Transportation and Flight Hardware Services	3-18
	STS Charges	3-20
	Payload-Related Services	3-21
	Flight Kits	3-21
	ETVP Servicing	3-22
	ETVP Cost Summations	3-23
	DDT&E and Acquisition Costs	3-23
	Cost Estimates through IOC	3-24
	WBS Line Item Costs	3-25
	Program Funding Plan	3-25
	SPREAD-PAD	3-25
	ETVP Costs by Year	3-25
4.0	CONCLUSIONS	4-1
	CONSTRUCTION SYSTEM EVALUATION	4-1
	ETVP SCHEDULE ASSESSMENT	4-2
	ETVP MISSIONS	4-3

ILLUSTRATIONS

Figure		Page
1-1	Engineering and Technology Verification Platform (ETVP) .	1-1
1-2	Program Development Activities and Outputs	1-2
2-1	ETVP Programmatic	2-1
2-2	Key Construction Support Equipment for Third Mission .	2-5
2-3	Construction Station No. 1	2-6
2-4	Construction Support Equipment	2-9
2-5	Remote Manipulator System Modifications	2-10
2-6	Cherry Picker Modifications	2-12
2-7	SCS Technology Development Sequence	2-15
2-8	Control and Software Interfaces	2-18
2-9	Technology Development Schedule	2-20
2-10	ETVP Summary Program Schedule	2-21
2-11	ETVP Program Development Schedule	2-22
2-12	ETVP Construction Fixture (Station 1) Program Schedule .	2-23
2-13	Flight Experiment Program	2-24
2-14	Flight Experiment Program	2-29
2-15	Deployed/Assembled Structural Dynamics Experiment . . .	2-30
2-16	Construction Equipment Effectiveness Experiment	2-31
2-17	Space Fabrication/Assembly Experiment	2-32
2-18	Deployed Boom Experiment	2-33
2-19	Large Antenna Experiment	2-34
3-1	ETVP Cost and Programmatic	3-3
3-2	Work Breakdown Structure	3-4
3-3	Cost Analysis Input Data	3-12
3-4	Parametric Costing Methodology	3-13
3-5	Supporting Cost Data	3-17
3-6	Categories of STS Costing	3-19
3-7	Construction System Costs through Platform IOC	3-24
3-8	SPREAD-PAD Computer Outputs	3-27
3-9	ETVP Funding Plan through IOC (Recurring/Non-Recurring) .	3-28
3-10	ETVP Funding Plan through IOC	3-28
3-11	Operations and Logistics System Funding Plan	3-29

TABLES

Table		Page
2-1	Orbiter Modifications and Provisions Summary	2-3
2-2	Construction Support Equipment Usage—First Mission	2-4
2-3	Construction Support Equipment	2-8
2-4	Technology Issues	2-17
2-5	ETVP Mission Plan for Cost Analysis	2-27
3-1	ETVP Work Breakdown Structure Matrix	3-5
3-2	Glossary of Parametric Cost Model Elements	3-14
3-3	Integration and Operations (WBS 1XX-07-00) Cost Base.	3-15
3-4	Integration and Operations (WBS 2XX-05-00) Cost Base.	3-15
3-5	Space Shuttle System Payload Accommodations/Ground Rules	3-20
3-6	Standard Space Shuttle Services and Charges	3-20
3-7	PRSD/EPS Kit	3-22
3-8	ETVP Servicing and Redundancy Guidelines	3-22
3-9	DDT&E and Acquisition Costs (Millions \$1979)	3-23
3-10	ETVP Costing through IOC	3-25
3-11	ETVP WBS Cost Matrix	3-26
4-1	ETVP Program Costs	4-1

1.0 COST AND PROGRAMMATICS

1.1 INTRODUCTION

With the advent of the Space Transportation System to provide launch, deployment, and support of payloads, a wide range of advanced programs offers potential benefits to space exploitation. As an aid in determining which new program may satisfy the interests and objectives of future space operations, a two-part contract was awarded to the Space Operations and Satellite Systems Division of Rockwell International to analyze the process of constructing large systems in space. Part I efforts of this contract defined and developed equipment and operational techniques required to construct several types of large operational systems in the space environment. The second part of this study has focused on the end-to-end definition of a total construction system and supporting operations for an Engineering Technology Verification Platform (ETVP) program.

The purpose of this volume is to document program development results that were established from technical definitions for the ETVP as shown in Figure 1-1. Part I results were used in the development of a Part II ETVP construction system and associated Space Shuttle requirements in an iterative manner as the program evolved. The flow diagram of Figure 1-2 illustrates the logic sequence of program development tasks and the interactions. A listing of study outputs at each process step is indicative of the results to be found in this volume. A conclusions section addresses cost and programmatic items pertinent to the overall activity.

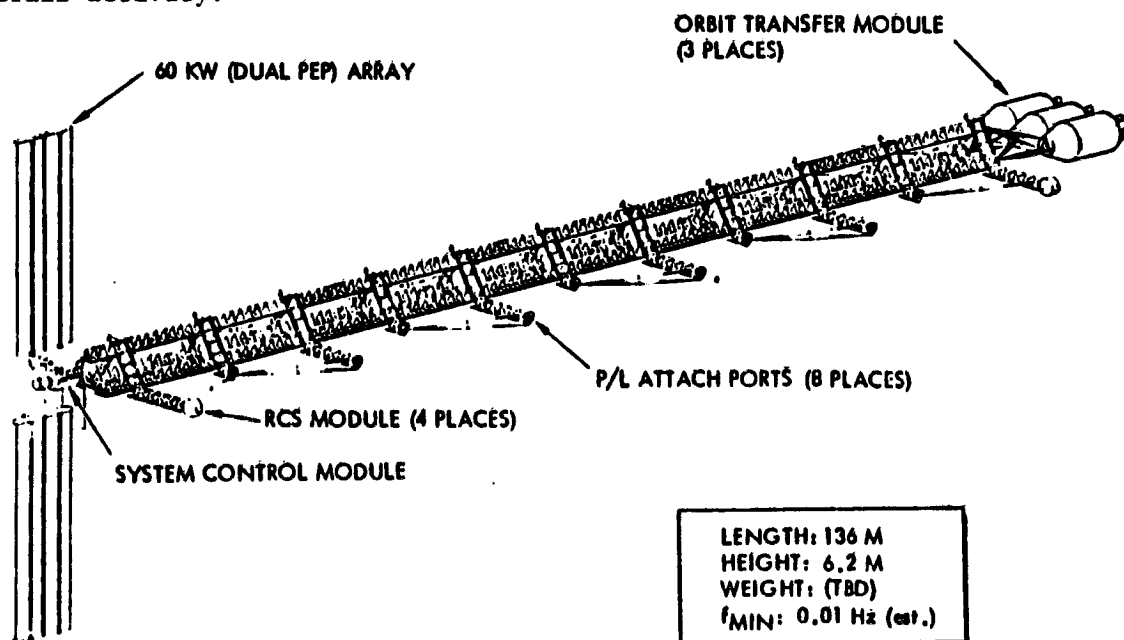

Figure 1-1. Engineering and Technology Verification Platform (ETVP),

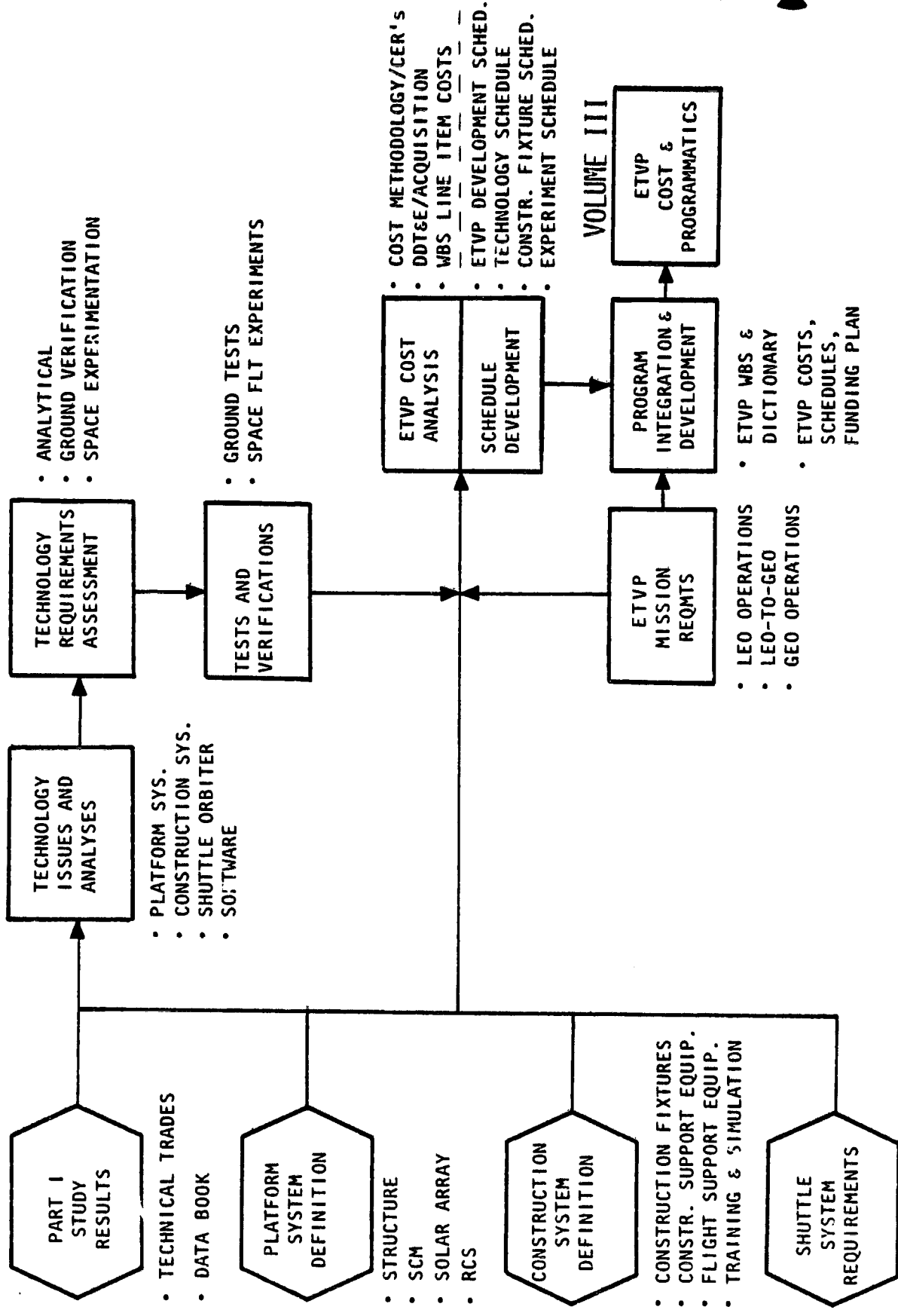

Figure 1-2. Program Development Activities and Outputs

1.2 GUIDELINES AND GROUND RULES

A series of ground rules and guidelines was used during the study to provide a common reference point for the uniform development of cost and programmatic elements of the Space Construction Systems Analysis Study.

- The ETVP WBS of Section 3.0 was developed as the framework of program hardware/software/operations, definitions, costs and schedules, and program planning activities.
- Maximum use of the Shuttle system was considered, including the use of supporting programs—Beam Builder, MRWS.
- Development schedules are in years from go-ahead.
- Cost estimates are presented in 1979 dollars and past studies, along with other applicable data, were used during the study.
- Costs/schedules are presented at WBS levels in terms of:
 - Development and TFU (theoretical first unit)
 - Platform, construction, and logistics systems
 - ETVP funding profile
- A useful ETVP lifetime of 20 years was projected for maintenance.

2.0 PROGRAMMATICS

2.1 INTRODUCTION ^{PRECEDING PAGE BLANK NOT FILMED}

Programmatic aspects of the ETVP program are covered in this section of the report to define a comprehensive plan for the development of a space platform, its construction system, and Space Shuttle operations/logistics requirements.

A definition of construction system requirements describes the interfaces and interrelationships of construction-associated equipment with the ETVP, orbiter, and construction support equipments. These definitions aided in (1) the development of program and system schedules, (2) the identification of technical parameters for cost estimates, and (3) the determination of technology advancement needs.

Figure 2-1 illustrates main items covered within each of the topical areas of this section. Emphasis is placed on (1) technology issues and the requirement for resolution, (2) phasing schedules for each of the WBS systems, and (3) a description of the missions supporting construction and operations of the ETVP.

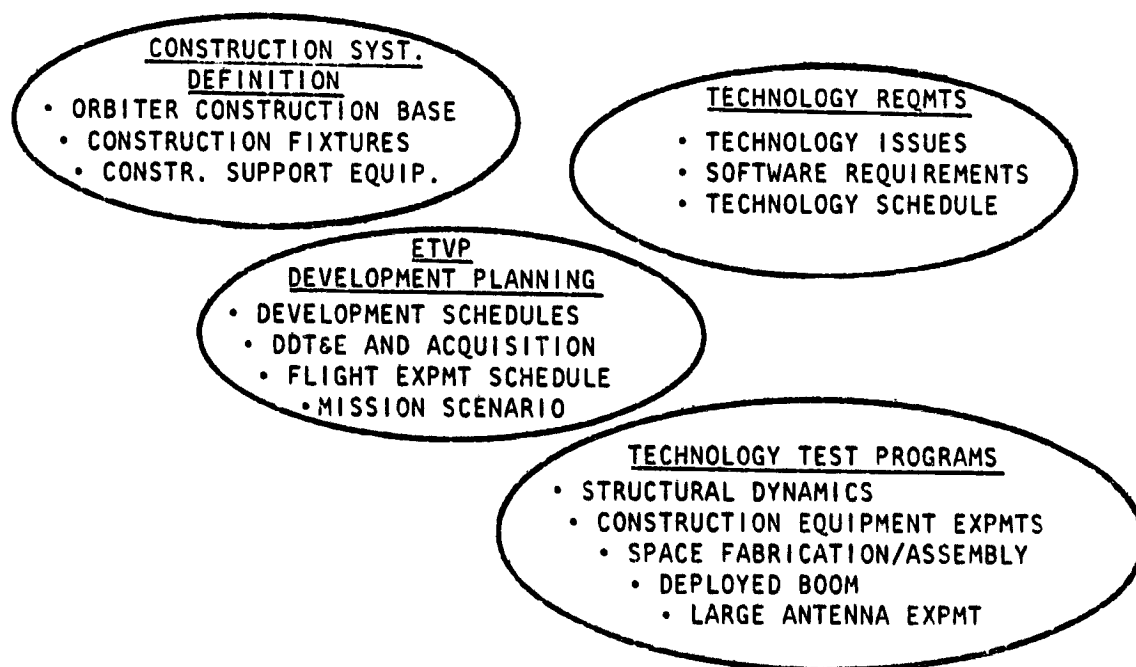

Figure 2-1. ETVP Programmatics

2.2 CONSTRUCTION SYSTEM REQUIREMENTS

INTRODUCTION

This section is concerned with the interfaces and interrelationships of construction-associated items necessary to perform ETVP fabrication, assembly, and checkout operations. The items include those required of the orbiter, which serves as the central construction base; the construction fixture and its associated equipment; and the necessary construction support equipment such as the beam builder, the manned remote work station (MRWS), and others. Modifications to construction support equipment concepts required to perform their functions are also identified. The following paragraphs are definitions of design/development and manufacturing/test requirements that will be required during program formulation and construction planning.

ORBITER CONSTRUCTION BASE

ETVP construction analyses identified three areas of concern regarding orbiter interfaces and modification requirements—nitrogen tank installation for airlock repressurizations, the RMS mobility enhancement, and the 8-psi suit support provisions.

Additional nitrogen tanks are required to support the multiple repressurizations required for EVA. This installation requires special plumbing and tank attachments beyond standard baseline orbiter accommodations. However, provisions for such modifications have been incorporated into the STS program.

The most expensive and complex of modifications identified above involves the RMS. Specifically, changes would be required to provide the capability for an upper-arm roll joint, a wrist camera and light mount with tilt and pan capability, anti-collision software, and provisions to control the RMS from the open cherry picker.

The use of an 8-psi suit in the orbiter is likely to require (1) new suit support provisions in the form of brackets for a larger, bulkier suit, (2) new piping and control valves for the pressure connections, and (3) some provision for a two-gas supply system for the portable life support system. In addition, some added storage capacity may be required for the larger number of suits implied in the six-person crew concept.

In addition to these orbiter modifications, one additional cryo kit is required for the added electrical power, plus an aft flight deck displays and controls panel configured for specific use during construction operations. Additional seats and restraints, garments, crew accessories, personal equipment, and rescue equipment for accommodating the six-man crew are also needed. Pallets, bridge fittings, keel fittings, trunnion fittings and the wire harness to control the payload latches will be required to support the cargo manifest for each flight. Table 2-1 summarizes orbiter modifications and provisions required to perform the function of a construction base.

Table 2-1. Orbiter Modifications and Provisions Summary

- | | |
|-------------------------------------|---|
| • Nitrogen tanks and supply systems | • Bridge fittings—longeron |
| • Remote manipulator system (RMS) | • Keel fittings |
| • 8-psi EVA suit | • Trunnion fittings—controlled latch type |
| • Cryogenic fuel tanks and supports | • Trunnion fittings—fixed |
| • Garments | • Wire harness—payload latching controls |
| • Seats and restraints | • MMU flight support station |
| • Garments | |
| • Accessories (crew) | |
| • Personal equipment (crew) | |
| • Rescue equipment (crew) | |

Construction support equipment required in the first mission is identified in Table 2-2 as it pertains to a series of construction activities. This degree of visibility has served to identify multiple uses for equipment as needed to complete a functional element of the construction process.

Figure 2-2 identifies construction equipment and platform systems as used by the orbiter to install RCS modules with the RMS.

CONSTRUCTION FIXTURE SYSTEM

Two principal construction stations were identified during the study. Station No. 1 is the primary fabrication and assembly fixture and contains the majority of the construction equipments as attached to the main yoke-shaped framework. The second station performs the fabrication and assembly of the crossbeams and is the equivalent of a subassembly station. A description of each piece of equipment associated with Stations 1 and 2 and their operational process has been developed and recorded as illustrated in Figure 2-3. Many of these items are involved in new technology requirements and are identified in Section 2.3.

Construction Station No. 1

The concept for this key construction station (which has also been referred to as the *construction fixture*) sets major activity patterns and enables on-orbit construction out of the orbiter bay. The station includes a basic building fixture having a yoke shape to accommodate the tri-beam configuration of the ETV cross-section; and roller supports which grip the longitudinal beams after they are fabricated and cut off from the beam builder machine. Centrally located in the yoke is a removable cross-bridge structure incorporating a rotating head which accepts several types of auxiliary devices, including an EVA work station as well as the beam builder machine. Considering the multiplicity of fabrication and assembly functions performed at this station, it may be thought of as a small satellite space factory. It is designed for cost effectiveness and power conservation, using the concept of a compact, efficient work space through which the structure is moved in either of two directions (and later rotated) to accomplish the construction.

OF POOR QUALITY

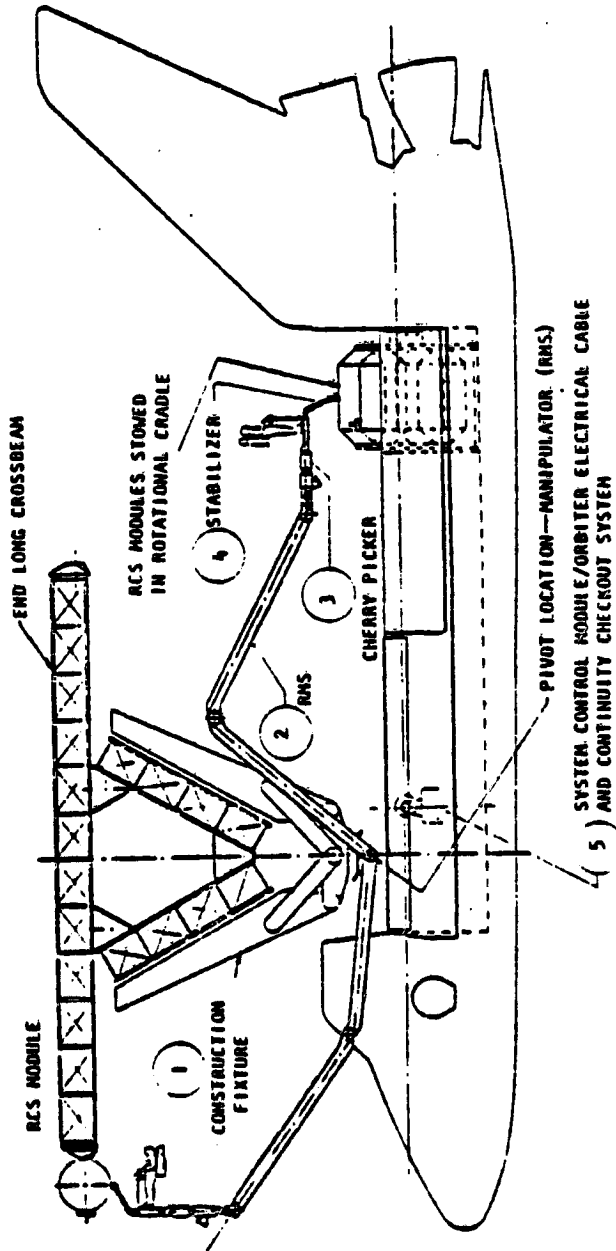

I.P.	DESCRIPTION:
1	<u>CONSTRUCTION FIXTURE</u>
2	<u>RMS.</u>
3	<u>MODIFIED CHERRY PICKER.</u>
4	STABILIZER. THIS BOOM IS UTILIZED FOR STABILIZING THE CHERRY PICKER DURING WORK ASSIGNMENTS. IT WILL ALSO BE USED TO TRANSPORT AND BERTH THE RCS PODS AND LARGE PAYLOAD MODULES ONTO THE PLATFORM.
5	SYSTEM CHECKOUT MODULE. THIS MODULE IS USED TO VERIFY THE SCM OPERATIONS AND ELECTRICAL CONTINUITY OF THE ENGINEERING AND TECHNOLOGY VERIFICATION PLATFORM. IT ALSO CONDITIONS POWER PROVIDED FROM THE ORBITER TO THE PLATFORM FOR SYSTEM ACTIVATION AND OVERALL SYSTEM CHECKOUT.

Figure 2-2 . Key Construction Support Equipment for Third Mission

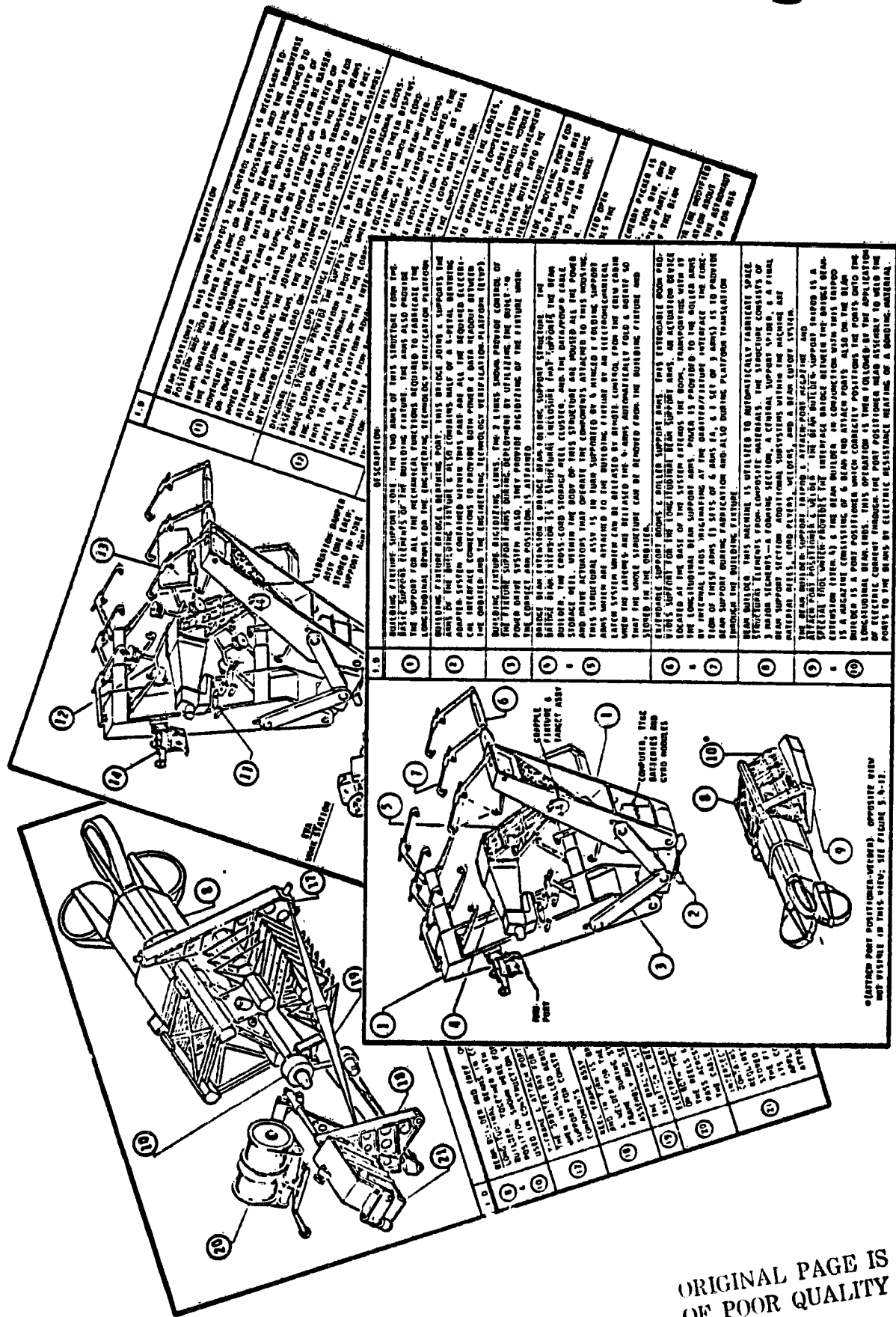

Figure 2-3 . Construction Station No. 1

ORIGINAL PAGE IS
OF POOR QUALITY

This concept permits a minimum of power for illumination and TV services, maximizes use of a single Shuttle RMS for handling and installation of components, minimizes EVA travel time and fuel/power demand, and provides for extraordinary flexibility in scheduling installations and in LEO servicing of individual payload modules and spacecraft modules (e.g., RCS pods and control modules). It is designed to be stowed in the orbiter bay in a relatively compact manner, permitting initial removal and setup on a docking port as if it were a standard orbiter payload package. The major portion of the station is designed for semi-automatic, remotely controlled deployment which takes place within a relatively short time. Selective reconfigurations are required during the first mission. The major item of removable equipment is the central cross-structure/rotary joint complex to which are attached a beam positioner, wire-laying reel, and astronaut maneuvering arm/cherry picker. During the initial setup, the beam builder on its tripod support (and carrying the attachment port installation device) is also attached. This central complex of machinery must be removed after attaching the transverse beams and crossbeams in order to permit freedom of translation of the yoke along the longitudinal axis of the platform for later installation work. Such removal activity is accomplished during the stowage of items prior to separation and return of the orbiter to the ground.

During unattended operations (between construction periods), this station also provides libration damping and TT&C. It has solar arrays and batteries for power during this period. Thus, it functions as a part of an active satellite, controllable from the ground.

Construction Station No. 2

This station consists of a number of important separate equipment items of special-purpose nature which assist in automatic fabrication of assemblies of crossbeams and transverse beams. The station includes a beam builder support and control, the dispensers for attachment ports, the devices for installing intersection fittings and remote servicing (teleoperator) docking ports, reels, and installation devices for electrical lines, and supporting/translating rollers for beam translation when beyond the beam builder machine. Use of such devices facilitates rapid construction and high productivity of the crew. The location assist in achieving simultaneous production of beams and installation of beams, hookup of cross-brace cords, and electrical connections on the platform.

Design of this secondary station includes use of a structure (Y-frame) which acts both as a support cradle during launch and return and a construction fixture for on-orbit operations. There is also a separate, more specialized reel assembly fixture to which is also attached the dispenser for intersection fittings and teleoperator docking ports.

CONSTRUCTION SUPPORT EQUIPMENT

The construction support equipment identified in this section are those items that are unique in performing construction functions, possess capabilities that are general purpose, and can be utilized for other orbiter mission functions. Table 2-3 lists these equipment items.

Table 2-3. Construction Support Equipment

- Remote manipulator system (RMS)
- Manned remote work station (MRWS)
- EVA suit and life support systems
- Manned maneuvering unit (MMU)
- Beam builder

In addition to the items listed in the table are some miscellaneous tools and devices, lighting, and CCTV. These items include special end effectors for use on the RMS, hand tools, lights and TV camera systems, etc. These items have been identified with a description of each item and its function (see Figure 2-4). Design characteristics and modifications to the RMS, MRWS, and beam builder have been identified as a result of the construction analysis.

Remote Manipulator System (RMS) Modifications

Figure 2-5 illustrates potential changes to the RMS. The standard orbiter RMS is to be modified to perform the construction as defined in this study. An upper-arm roll joint, or its equivalent capability, and associated software are required to provide the upward reach needed to install crossbeams, transverse beams, RCS modules, and payloads. This is primarily required by the location of the height of the apex beam of the ETVP above the RMS shoulder joint, but is also driven by the overall close-in location and limited clearances of the construction fixture work stations. This new mobility capability is considered by Rockwell to be of fundamental importance for space construction and highly useful for transfer of payloads to potential on-orbit stations.

The current arm has only 145-degree shoulder rotation, thus limiting the possible range of upper-arm motion angles to no less than 35 degrees above the plane of the payload bay door hinges when the RMS is reaching upward. With the upper-arm rotary joint concept, the upper arm could be oriented in a plane parallel with the payload bay door hinges when reaching upward. As a practical operational consideration, the upper-arm rotary joint greatly simplifies the number of motions and time to accomplish removal of items from the payload bay and their subsequent transport and installation to structure above the payload bay (such as the primary construction fixture).

Another highly desirable modification to the RMS hardware is tilt and pan capability for the wrist camera and lights. Although this feature is not specifically identified as a requirement for the construction process, there are several operations which it could enhance. Among these are the setting up of the construction stations, moving the beam builder machine, and transporting beams.

Certain software changes are essential for implementing the upper-arm rotation joint concept. A current concept for the use of this joint is that it would be limited to a single-joint rotation mode. Other joints would be braked when the upper-arm joint is rotated and vice versa. This could simplify the software changes and prevent confusions resulting from multiple solutions to specific resolved motion calculations. Other RMS software improvements are

I.D.	DESCRIPTION
<p>① AND ②</p>	<p>HIGH-PRESSURE SUIT & EXTENDED PORTABLE LIFE SUPPORT SYSTEM. THESE ITEMS PROVIDE CAPABILITY FOR EVA FROM THE ORBITER WITHOUT PREBREATHING OF 100% OXYGEN AND PERMIT 8 HOURS OF EVA WORKING TIME. THE SUIT OPERATING PRESSURE IS APPROX. 8 PSI FOR ORBITERS OPERATING AT THE 14.7-PSI BASELINE PRESSURE; IT MAY BE A 2-GAS SUIT. SEVERAL OPTIONS EXIST TO PROVIDE FOR 8 HOURS EVA CAPABILITY; ONE IS A NEW PORTABLE LIFE SUPPORT BACKPACK. AN ALTERNATIVE (NOT SHOWN) IS A "PLUG-IN" SUPPLY SYSTEM AT THE EVA WORK STATION (CHERRY PICKER).</p>
	<p>MISCELLANEOUS TOOLS AND DEVICES</p>
<p>③</p>	<p>X-BRACE CORD-HANDLING TETHER. TETHER WITH HOOKS TO GRIP FITTINGS AT ENDS OF X-BRACE CORDS AND ATTACH TO CHERRY PICKER. CONTROLS ENDS OF X-BRACE CORDS DURING CROSSOVER AND HOOKUP.</p>
<p>④</p>	<p>BEAM-HANDLING END EFFECTOR. SPECIAL END EFFECTOR FOR GRIPPING SPACE-FABRICATED BEAMS WITH CONTROLLED FORCE. ATTACHES MECHANICALLY AND ELECTRICALLY TO RMS STANDARD END EFFECTOR.</p>
<p>⑤</p>	<p>CORD-TENSIONING TOOL. MANUAL POWER TOOL TO APPLY PRESET TENSION (BY TORQUE CONTROL) TO X-BRACE CORDS</p>
<p>⑥</p>	<p>STRUCTURAL ALIGNMENT MEASURING DEVICE. ELECTRO-OPTICAL DEVICE TO RECORD LOCATION OF THE FRAME JOINTS AS CONSTRUCTION PROCEEDS; MOUNTS ON BUILDING FIXTURE.</p>
<p>⑦</p>	<p>MANNED MANEUVERING UNIT (MMU). PERSONAL TRANSPORT DEVICE FOR EVA ASTRONAUTS. FACILITATES ACCESS FOR INSPECTION AND FOR STORAGE OF SMALLER CARGO ITEMS.</p>
<p>⑧</p>	<p>LIGHTS AND TV CAMERA SYSTEMS. LIGHTS AND TV CAMERAS MOUNTED ON TILT AND PAN MECHANISMS WHICH ARE REMOTELY CONTROLLED FROM THE ORBITER CABIN. LOCATED ON THE BUILDING FIXTURE YOKE AND BEAM BUILDER.</p>

ORIGINAL PAGE IS
OF POOR QUALITY

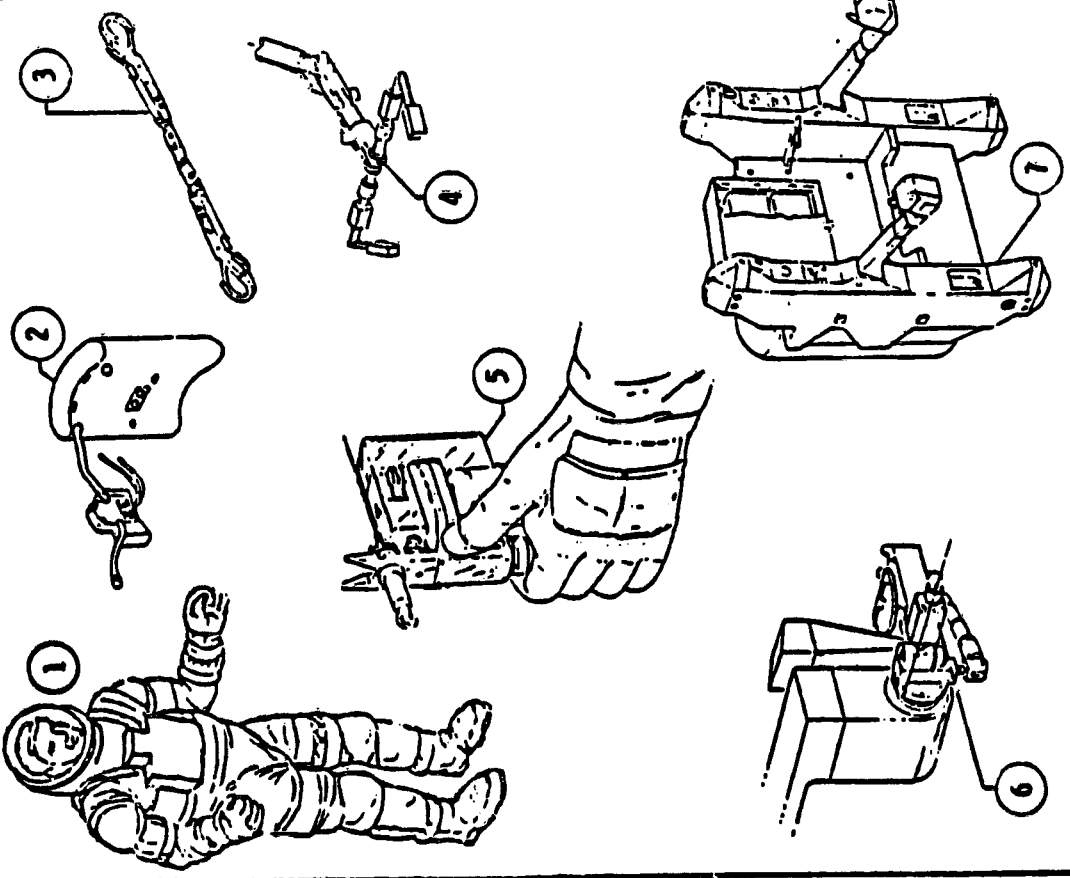

Figure 2-4 . Construction Support Equipment

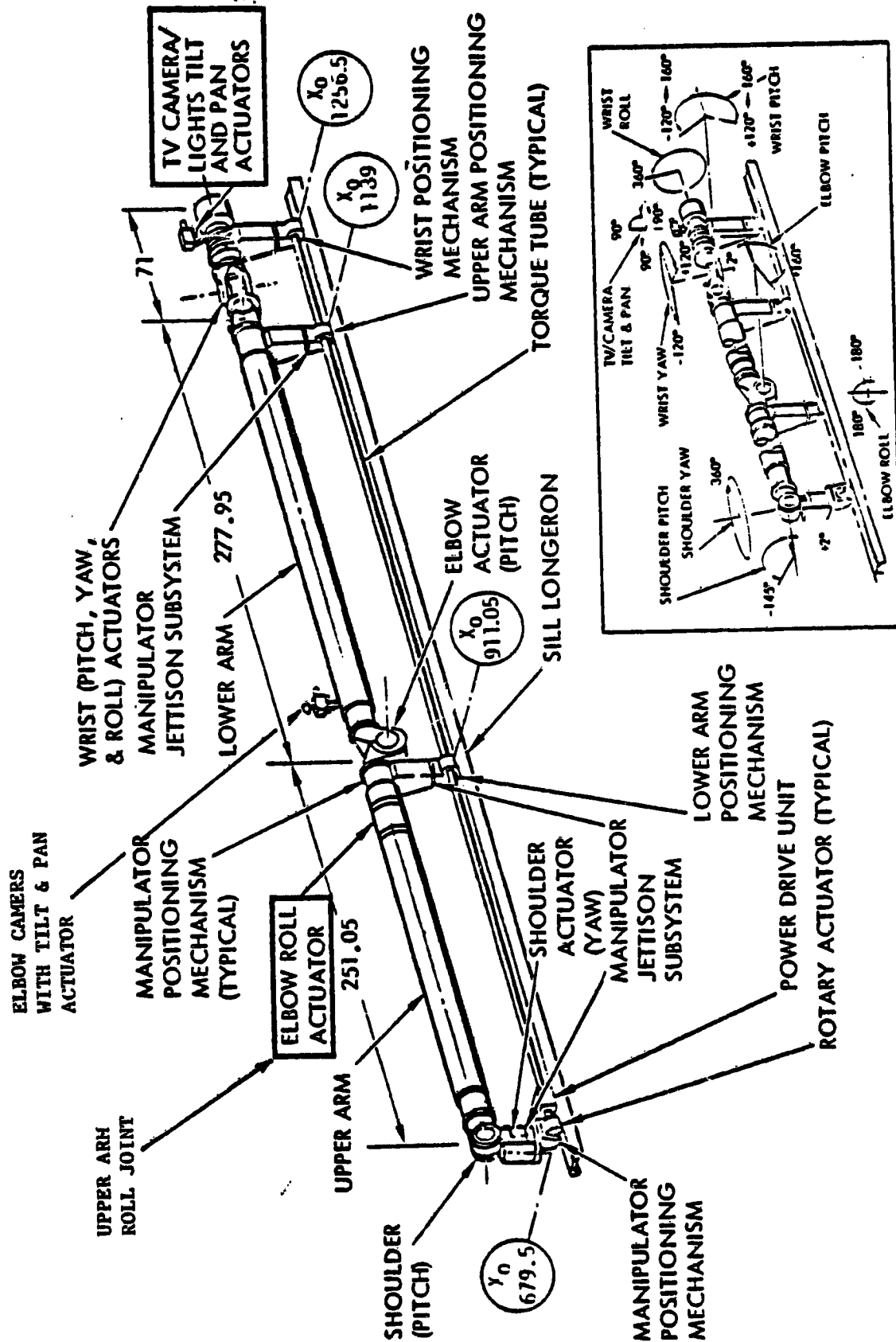

Figure 2-5 . Remote Manipulator System Modifications

also desirable to aid construction. In particular, collision-avoidance warning signals and/or disabling signals would greatly increase operational safety for handling large modules, struts, and beams in the vicinity of the construction stations.

Modified Cherry Picker and Astronaut Maneuvering Arm

The modifications are applicable to the Grumman concept of an open cherry picker platform and are illustrated in Figure 2-6. The first-mission requirements include removal of a stabilizer arm, a tool bin, and two light stanchions. Also, relocation of miscellaneous features is planned to minimize workspace volume requirements. It is currently assumed that there will be three 60-watt lamps on this unit and a minimal tool storage capability. The cherry picker control/display panel is used to control the astronaut maneuvering arm and to control the beam positioner.

The astronaut positioning arm concept is an entirely new piece of machinery, although it performs many of the same functions as the RMS. It would be much smaller in extended length and would incorporate a telescoping arm link to facilitate maneuvering within the confined space of the tri-beam platform. The mass handling capability is also severely scaled down from that of the RMS, since only the EVA crewman and modified open cherry picker are to be transported. Consequently, the power demands for driving this device are assumed to be much less than for the RMS. Also, it is presumed to require minimal (or none) heating of its drive mechanisms by virtue of its relatively short useful life and lowered requirements for accuracy in positioning.

At the end of the first mission, the cherry picker is to be returned to earth for rework. These changes, required to support the second mission, include a stabilizer arm and tool holder as well as added light stanchions.

Beam Builder Machine Modifications

An essential element of space fabrication technology is the automatic beam builder machine which is defined for this study as a derivation of the General Dynamics design. The construction concept developed herein requires serial use of the beam builder in the two construction stations, and requires selective modifications of the baseline software to provide for double cross-members (side by side) at selected points along the longitudinal beam which carries the electrical wiring. These special situations occur adjacent to the long crossbeams in order to provide stiffness and strength for supporting breakouts and connectors for the electrical wiring which is routed to the crossbeams. Software revisions are also required to provide for special end configurations on transverse beams and crossbeams. The transverse beams configurations require that one cross-member be deleted (together with adjacent cross-brace cords) at each end. Also, a shorter spacing between cross-members is needed at the end bays, in order to avoid interference with adjacent beams at the ends. This change permits the crossbeams and transverse beams to be located in the same plane at each frame station of the platform and simplifies construction procedures over an offset plane configuration. These software modifications have been reviewed by General Dynamics and verbal agreement received regarding their feasibility.

MODIFIED MRWS NO. 1

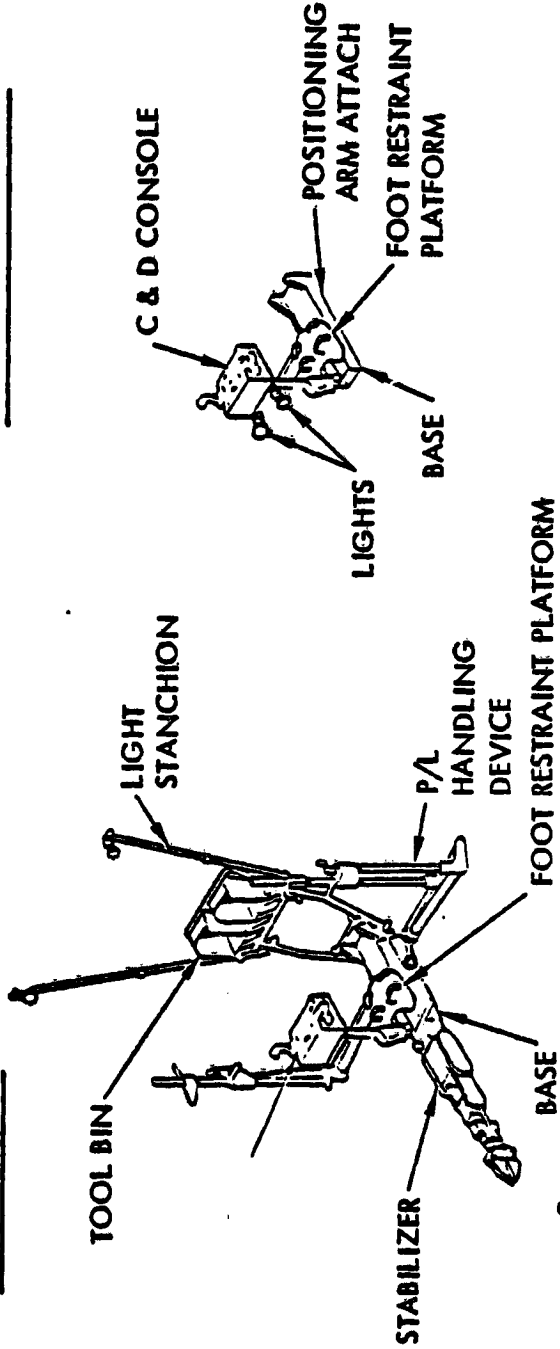

MODIFIED MRWS NO. 2

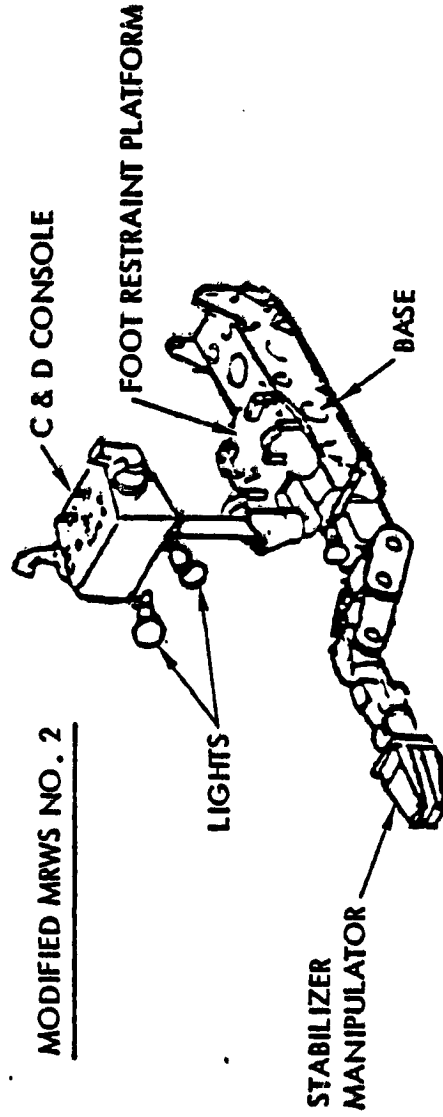

Figure 2-6 . Cherry Picker Modifications

Other basic modifications include use of thicker cap materials and larger-diameter cross-brace cords. These thicker materials will require somewhat more power for heating and welding (the power estimates used in this study have been set higher to account for these differences). Another requirement for materials stored in the beam builder machine is the provision of Velcro strips on selected cross-members to support electrical wiring. Preliminary investigation has indicated space is available for these provisions.

In order to provide structural mounting points and pickup points for transport, some modifications to the beam builder machine framework will also be required. In a similar category are installation points for a device which installs attachment ports on the ends of the fabricated longitudinal beams and crossbeams, and targets for guiding the RMS to a favorable grapple position.

Finally, provisions are required for electrical wiring, connectors, and mechanical attachments for remote control of the beam builder, for the attachment port installation devices, for lights, and for a TV camera and its associated tilt and pan mechanisms and heaters. The TV camera, heaters, and mechanism systems are currently assumed to be identical or highly similar to those specified for the RMS elbow. It is assumed that the camera and lights can aid in observation of beam fabrication, attachment port installation, and beam handling (grappling and initial transport phases) at Construction Station No. 2.

In the construction analysis and fixture design concepts adapted for this study, the beam builder machine would be part of an assembly which includes the attachment port installation device, lights, and TV camera. Initially, it would also have attached to it a support tripod which mates with the rotating head on the central portion of the primary construction fixture. This mating interface would have both mechanical attachments and electrical power and signal connections. It would be designed to facilitate interface alignment when using the RMS as a transporting device. Design features would include latches which are normally remotely controlled from the orbiter and manually operated in contingency modes (by EVA). Also needed are alignment guides and targets. Ideally, the joining interface would be visible using both the RMS and a separate TV camera mounted on the construction fixture.

EVA Suit and Life Support Systems

Baseline crew schedules for the first mission are tied to the use of a new high-pressure suit (5 to 8 psi) for an eight-hour EVA life support system. Until such a suit system is designated as an inherent and integral part of the Shuttle development program, it may be considered as special-purpose construction support equipment.

Manned Maneuvering Unit (MMU)

As currently planned, all the construction of the ETVP could be performed without the aid of an MMU. However, the MMU is included here as a construction support device which facilitates EVA crew transport for inspection and miscellaneous manual functions at the beginning and the end of the EVA work period in the first mission. As a facilitator, it saves crew transport time by deleting hand-over-hand translation by the crew along rails and handholds. The most

valuable contribution of the MMU could lie in its usage for dealing with unforeseen contingencies. Examples might be manual deployment or retraction of elements with motor or solenoid failures, release of latches which hang up, assisting with alignment of parts for assembly or stowage, making repairs to loosened fasteners, or replacement of failed parts. Initial usage could be merely visual assessment of a problem to gain information for decisions on how to deal with it.

Another subsidiary, but important, usage could be photographic coverage of key construction operations. If necessary, EVA transport of structural elements could also be performed in the unlikely case of failure of an RMS drive motor or other transport device.

As a means to facilitate rapid response by the EVA crew, the design of the construction fixture incorporates a fixture for holding an MMU in close proximity to the EVA work station. This holding fixture is similar to the flight support station for the MMU in the orbiter payload bay, but it has no recharge facilities.

Miscellaneous Tools and Devices

Included in this group of construction support equipment are the special end effector for handling crossbeams and transverse beams with the RMS, and the hand tool for tensioning cross-brace cords. Also included is the tether used to assist handling of cross-brace cords hookup and crossover.

A set of EVA hand tools will also be required for contingency usage in the construction operations. Although unspecified at the preliminary analysis of this study, experience gives certainty that they will be needed. Illumination devices and TV cameras are also significant aids to productivity in manned construction activities. Although they have no direct physical impact on actual assembly of parts, they must be carefully located and selected due to their potential impact on power demands.

The electro-optical system for performing structural alignment checks of the platform is another item of rather indirect relationship to the construction operations. Its function is in the nature of inspection and reporting rather than fabrication or assembly. Yet, like diameter gauges and micrometers for machining operations, it is a piece of construction support equipment.

2.3 TECHNOLOGY REQUIREMENTS

INTRODUCTION

During the course of the Space Construction System Analysis Study, certain items were identified as having unique or new technology characteristics for the construction of a large platform. Some of these items required only a design development effort, while others required that additional knowledge and behavioral characteristics be defined and generated before the design could be developed. This latter category are those items that will be discussed in this section.

Technology requirements and their definition were developed in conjunction with the design and evolution of equipments or systems for the platform, construction, or logistics phase of the ETV program. This continuous technology assessment started with a state-of-the-art assessment for the multiple disciplines of each equipment system. This assessment began in "boiler room" sessions where key issues (areas of concern) were identified and discussed for a resolution or statement of the technical requirement and a definition of the need. The process of this activity is illustrated in Figure 2-7.

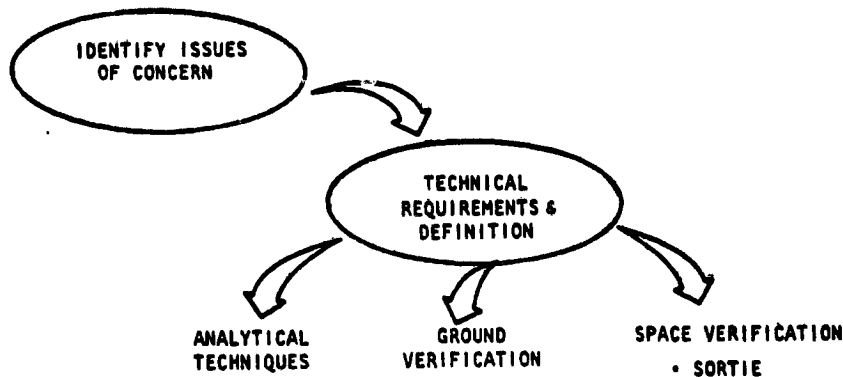

Figure 2-7. SCS Technology Development Sequence

TECHNOLOGY ISSUES

In the assessment of technology, specialists from Rockwell and other knowledgeable sources projected the degree of technology development required to support the space construction scenario and schedule shown in Section 2.4—SCS Development Plan. One of the main criteria considered in this analysis acknowledged a technology item as where the hardware, software, or service falls outside the bounds of our experience for the periods of need.

Platform, Construction, and Logistics Technology

Technology issues and a summary of the requirements for the ETV systems are classified as shown in Table 2-4. Further technical study in these areas will offer potential solutions to problems or identify more specifically the requirement for further analysis or testing. For example, critical functions of the construction process—assembly, positioning, aligning, or operations—may be alleviated by systematic analysis. In other areas, further study can eliminate potential technology requirements through modeling and computer simulation.

In the area of ground test and validation of basic designs, interface problems of construction equipment elements may be resolved through specific methods of ground testing and assembly. For example, hardware models can be used to duplicate equipment alignment operations in a chamber under thermal/vacuum conditions. Projected trends of technology advancement, in the NASA and throughout industry, indicate that ground testing capabilities and, perhaps, test results that verify equipment design requirements, may be available by the need dates established for ETV space construction technologies.

Software Technology Requirements

Functional relationships and software interfaces for the control of ETV construction operations are illustrated in Figure 2-8.

The system is managed from the aft flight deck payload and mission stations. Executive control of elements located in the cargo bay is from the construction fixture assembly (Station 1). The executive controller manages and statuses the processors which are located throughout the Station 1 and Station 2 construction mechanisms. The mechanism processors status and control their functions in performance of particular tasks, operations, or processes in accordance with command instructions received from the Station 1 executive controller. When addressed by the executive controller, the mechanism processors provide status information as requested which is routed back to the executive controller in Station 1.

An orbiter multiplex-demultiplex-multiplex (MDM) interface exists with the general-purpose computer (GPC) and Station 1 and the checkout subsystem for the revisit system (located on the Station 1 construction fixture). The GPC/Station 1 interface is the path for payload/mission station instructions from the GPC as controlled by keyboard entries on the GPC/CRT keyboard. These instructions may be software sequences from the GPC or monitor, status, or command instructions. The checkout subsystem MDM interface is used to verify readings of the revisit subsystem prior to departure of the Shuttle at the completion of a mission. This control and interrogation is via the GPC/CRT keyboard.

Several construction support items play a major role in the platform construction—the beam builder, the remote manipulator system (RMS), and the manned remote work station (cherry picker). The beam builder contains its own processor and, therefore, interfaces directly with the Station 1 executive controller. The RMS and cherry picker have MDM interfaces with the orbiter/GPC. The RMS is controlled through the aft crew station and may be controlled directly by the



ORIGINAL PAGE IS
OF POOR QUALITY

Table 2-4. Technology Issues

WBS NO.	ISSUE	REQUIREMENT
1XX-01-01	STRUCTURAL COMPOSITE MATERIAL	DEVELOP COMPOSITE MATERIAL FOR FAB OF BEAMS VIA THE AUTOMATIC BEAM-BUILDING DEVICE—MATERIAL TO POSSESS ACCEPTABLE STRENGTH CAPABILITY, BE THERMALLY STABLE, CAPABLE OF MAKING BONDED JOINTS, AND BE REPAIRABLE.
-01-01	BEAM-TO-BEAM JOINT MATERIAL	DEVELOP JOINT MATERIAL COMPATIBLE WITH BEAM MATERIAL AND POSSESSING GOOD STRENGTH, LONG LIFE, AND BE THERMALLY STABLE.
-01-01	BEAM-TO-BEAM JOINT	DEVELOP A JOINT CONCEPT & METHOD OF ASSEMBLY THAT TRANSMITS LOADS AND HAS REPAIR CAPABILITY.
-01-01	ATTACH PORT	DEVELOP A STANDARD PORT FOR REMOTE ATTACH OF MODULES/PAYLOADS TO PLATFORM WITH CAPABILITY TO ACCEPT REMOTE ELECTRICAL CONNECTORS, AND VARIOUS LOCATIONS FOR ATTACH OF STRUTS.
-01-01	GRAPHITE COMPOSITE CABLES OR STRAPS	DEVELOP GRAPHITE COMPOSITE MATERIAL IN A CABLE OR STRAP SHAPE WITH CAPABILITY OF ACCEPTING END FITTINGS EXPERIENCING TENSION LOADS OF APPROX. 2400 N (540 LB).
-01-04	ELECTRICAL POWER & DATA CONNECTORS—EVA OPERATIONS	DEVELOP A CONNECTOR FOR EVA MAKE/BREAK OPERATIONS COMPATIBLE WITH GLOVED OPERATIONS, GUIDED AND SELF-INSERTING CAPABILITY.
-01-04	ELEC. PWR & DATA CONNECTORS—AUTOMATIC OPS.	DEVELOP A CONNECTOR FOR REMOTE ASSEMBLY OPERATIONS COMPATIBLE WITH REMOTE INSERTION DEVICES AND GUIDED INTO FINAL CONTACT.
-02-03	SOFTWARE	DEVELOP SOFTWARE WITH CONTROL & MONITORING CAPABILITY OF ALL PLATFORM SYSTEMS AND PAYLOADS.
-02-04	ELECTRICAL SWITCHING GEAR	DEVELOP SWITCHES CAPABLE OF TRANSFERRING APPROX. 35 KW OF POWER IN A SPACE ENVIR. WITH LONG LIFE AND SERVICING CAPABILITY.
-03-00	ROTARY ELECTRICAL TRANSFER JOINT	DEVELOP A ROTARY JOINT THAT IS CAPABLE OF TRANSFERRING APPROX. 64 KW OF POWER, HAS MAINTENANCE/SERVICING CAPABILITY, AND LONG LIFE.
-03-01	SOLAR ARRAY DELIVERY PKG.	DEVELOP PACKAGING CONCEPT OF SOLAR ARRAY THAT PERMITS INITIAL INSTALLATION ON SYSTEM CONTROL MODULE, IS FOLDABLE WITHIN ORBITER PAYLOAD BAY ENVELOPE, AND EXTENDIBLE IN ORBIT ON COMMAND.
-04-00	SOLAR ARRAY	DEVELOP SOLAR ARRAY CAPABLE OF EXTENSION AND RETRACTION, DELIVERING 230 V, 20-YEAR LIFE, AND SERVICABLE.
-07-02	SYSTEM EQUIPMENT PACKAGING	DEVELOP PACKAGING CONCEPT OF EQUIPMENT TO PERMIT REMOTE SERVICING AND REPLACEMENT IN LEO AND GEO ALTITUDES.
2XX-01-01	COMPOSITE STRUCTURE FOR FIXTURE	DEVELOP COMPOSITE MATERIAL AND FABRICATION TECHNIQUE TO PROVIDE A DIMENSIONALLY STABLE FIXTURE FOR LEO ASSEMBLY OPERATIONS.
-01-09	LIBRATION DAMPING SYSTEM	DEVELOP A COLD-GAS REACTION CONTROL ARRANGEMENT WITH SOLAR ARRAY/BATTERY POWER, PACKAGEABLE WITHIN ENVELOPE OF CONSTR. FIXTURE.
-03-02	OCF STABILIZER/MANIPULATOR ARM	DEVELOP STABILIZER/MANIPULATOR ARM FOR THE OPEN CHERRY PICKER (OCP) WITH THE CONTROL CAPABILITY ON THE OCP CONSOLE—THE ARM TO BE CAPABLE OF ACCEPTING VARIOUS END EFFECTORS.
-03-03	UPPER-ARM RMS ROTARY JOINT	DEVELOP A ROTARY JOINT IN THE RMS UPPER ARM TO PERMIT RELOCATION OF ELBOW JOINT DURING OPERATION.
-03-05	ATTACH PORT ALIGNMENT ASSESSMENT DEVICE	DEVELOP AN IMU PACKAGE WITH CAPABILITY TO RECORD THE ORIENTATION OF EACH PLATFORM ATTACH PORT; PACKAGE TO BE SELF-CONTAINED—IMU, POWER, RECORDER, TIMER, CONTROLS.
-03-05	CABLE-TENSIONING TOOL	DEVELOP A HAND-HELD EVA-OPERATING TOOL WITH CAPABILITY TO PRE-TENSION THE PLATFORM DIAGONAL CORDS, WITH TENSION SELECTION CAPABILITY, SELF-POWERED, AND LONG LIFE.
-03-05	STRUT LENGTH ADJUSTING TOOL	DEVELOP A HAND-HELD EVA-OPERATING TOOL WITH CAPABILITY TO ADJUST STRUT LENGTH TO PERMIT INSTALLATION OF END ATTACHMENTS; TOOL TO BE SELF-POWERED AND HAVE LONG-LIFE CAPABILITY.
-03-05	END EFFECTOR FOR TRANSPORTING BEAMS	DEVELOP A SOFT END EFFECTOR CAPABLE OF GRASPING COMPLETED BEAM AND TRANSPORTING WITH THE RMS.
-03-06	SOFTWARE	DEVELOP SOFTWARE WITH CAPABILITY TO CONTROL & MONITOR THE CONSTRUCTION ACTIVITIES OF STATIONS 1 & 2, THE EVA STATION, AND OTHER FUNCTIONS SUCH AS LIGHTS, ETC.
-04-01	BERTHING PLATFORM	DEVELOP A BERTHING PLATFORM TO BE LOCATED IN THE ORBITER BAY TO ACCEPT THE CONSTR. FIXTURE, BE CAPABLE OF 360° ROTATION, RETRACTION TO MINIMIZE PAYLOAD VOLUME, AND CAPABLE OF EXTENSION FOR CONSTRUCTION AND, AGAIN, FOR REVISIT BERTHING.
-04-05	RCS ROTARY CANISTER	DEVELOP A ROTARY CANISTER TO CONTAIN THE RCS MODULES WITH THE CAPABILITY TO INDEX A SINGLE RCS MODULE FOR RMS PICKUP.
-05-01	ALIGNMENT PACKAGE REF. PLATFORM	DEVELOP A REFERENCE PLATFORM TO ACCEPT THE IMU ALIGNMENT PACKAGES FOR INITIAL AND FINAL SETTING.
-05-01	8-PSI PRESSURE SUIT	DEVELOP AN 8-PSI PRESSURE SUIT FOR EVA OPERATIONS HAVING GOOD MOBILITY, TEAR-RESISTANT, ETC.
3XX-03-02	FLIGHT DECK AFT CONTROL CONSOLE	DEVELOP AFT CONTROL CONSOLE TO CONTAIN CONTROLS AND MONITORING EQUIPMENT FOR THE SPACE CONSTRUCTION OPERATIONS.

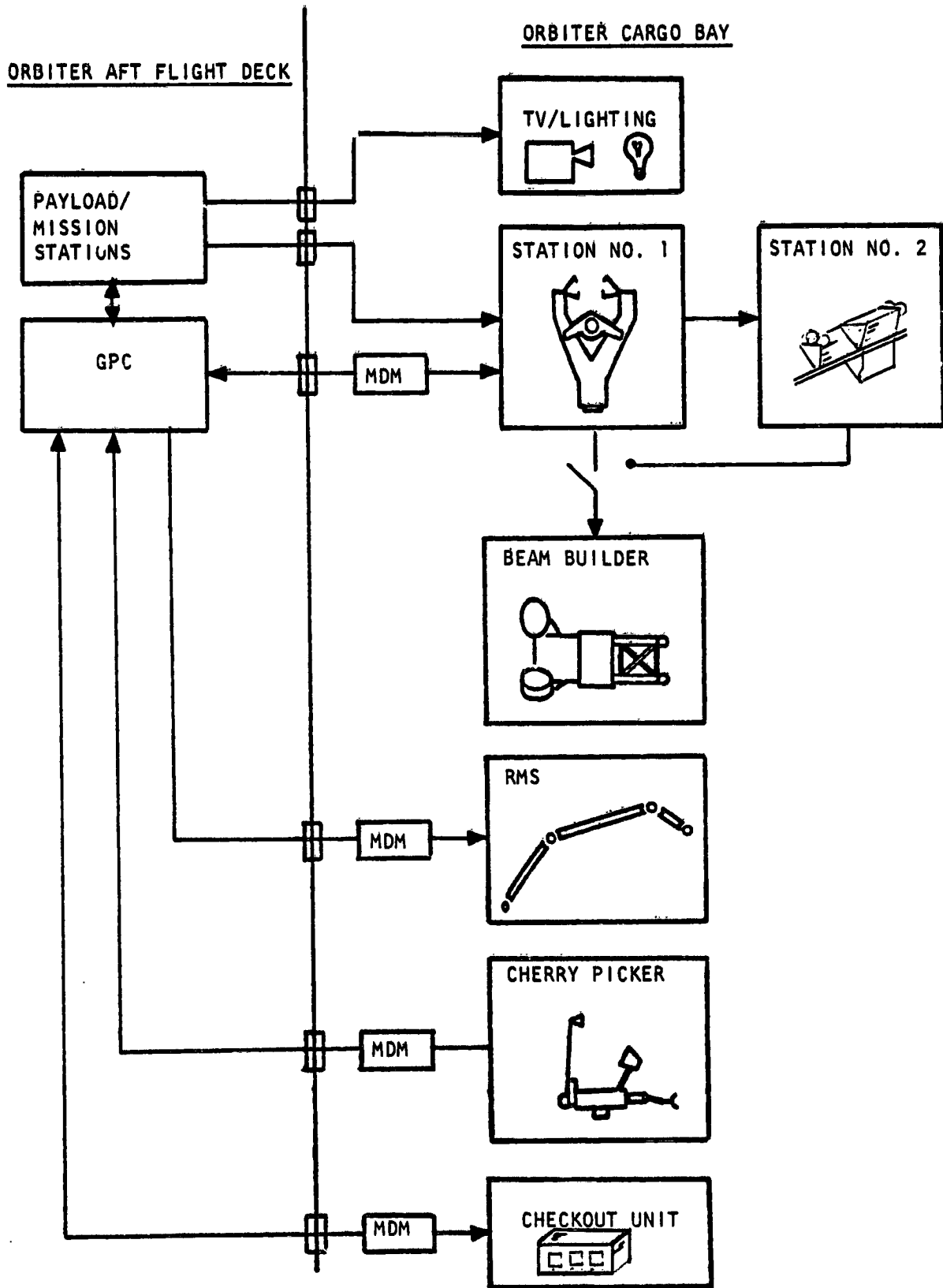

Figure 2-8. Control and Software Interfaces

GPC or through GPC supervision or by direct command. The cherry picker controls the RMS through its MDM/GPC interface.

A high reliance will be placed on use of the RMS to assemble the construction system. During construction operations, the emphasis is placed upon the EVA crewman control of the cherry picker/RMS to position the crewman so he can perform tasks of installation and assembly or adjustment and monitoring.

RMS collision avoidance is predicted to be a very difficult and costly programming task because of the multitude of unique configurations and involvement of many equipments. The GPC will be required to status the mechanical protrusion status of each construction subsystem through the Station 1 and Station 2 processors, and the mechanism processors. This status will form the basis for a continually changing avoidance configuration for which the software must respond.

Software can be broken out in the following categories:

Construction System

- Station 1
 - Executive programs
 - Program modules
- Station 2
 - Executive programs
 - Program modules
- Beam Builder
 - Executive programs
 - Program modules

GPC Support

- Operations command and monitor
- RMS task support
- RMS/cherry picker task support
- Collision avoidance
- Revisit systems checkout

Historically, software has been a cost growth area; as the microprocessor and computer technology grows, hardware costs are lowering. Yet, the software cost continues to grow. It is apparent that a new approach to software development is needed. Software technology development for large space construction is flagged in advance of the required need. This is planned to allow time for the sound design of a software system that will ultimately reduce costs as well as provide the flexibility to make changes that can substantially reduce overall lead times and turnaround times when problem areas are surfaced.

Technology Schedule

A schedule of technology developments and tests are shown in Figure 2-9, to illustrate technology activities as compared with early DDT&E milestones of the ETVP program. It is important to consider that spin-off technologies and

associated equipment or systems such as the beam machine, manned remote work station, and the modified RMS, plus needed materials, be available to provide a smooth transition from phase to phase of this program.

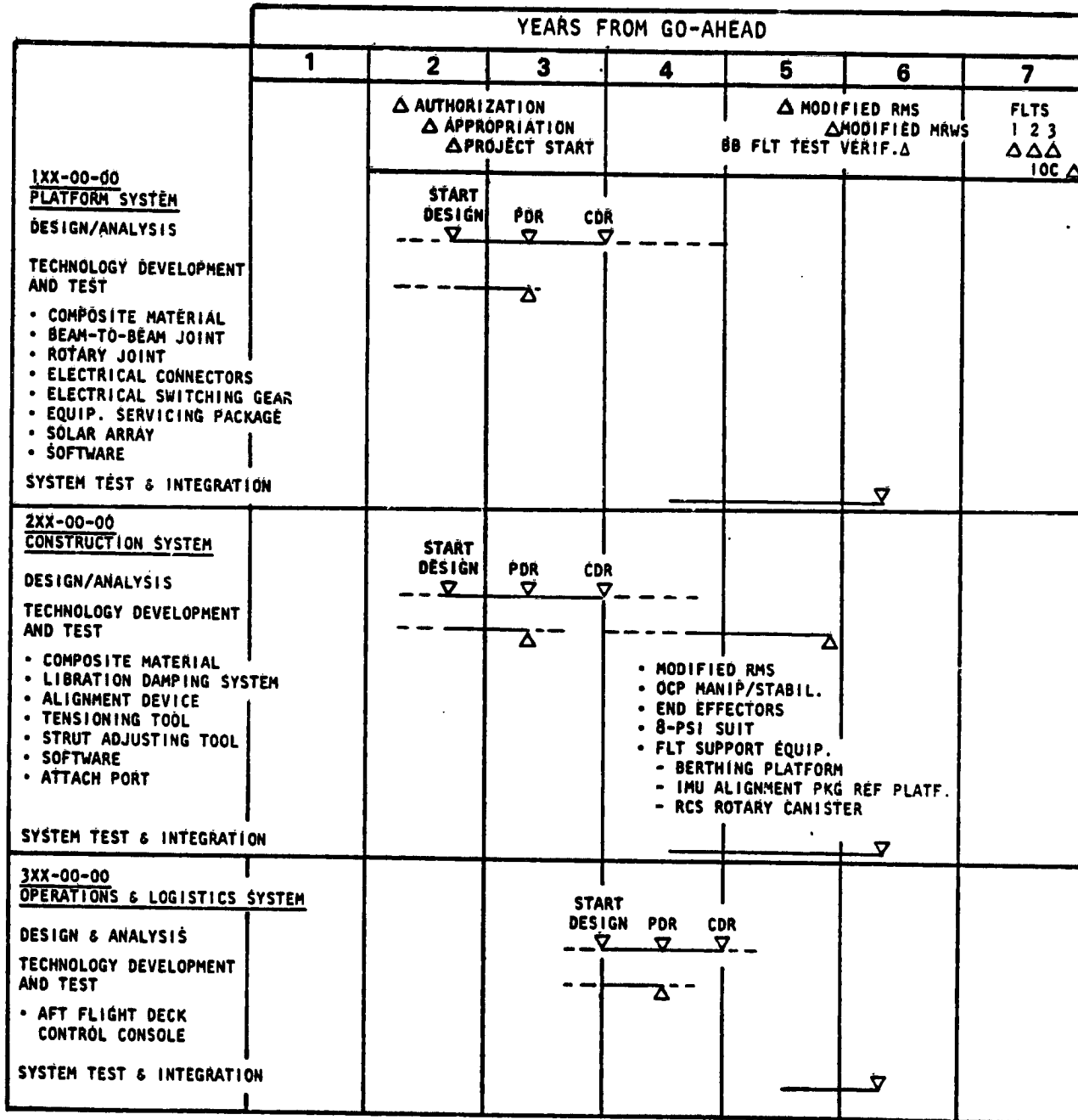

Figure 2-9. Technology Development Schedule

2.4 SCS DEVELOPMENT PLANNING

ORIGINAL PAGE IS
OF POOR QUALITY

INTRODUCTION

In the preceding sections, the discussion concentrated on a definition of ETVP construction systems and their technical characteristics. An analysis was also presented to summarize unique technology needs as they apply to the platform, construction, and logistics/operational systems. This section will (1) describe a comprehensive approach and sequential flow of scheduling activities on ETVP systems, (2) identify principal phases of program development, and (3) present the ETVP mission plan. Space flight tests proposed to support ETVP construction and large space payload experiments are presented in the next section.

DEVELOPMENT SCHEDULES

A summary program schedule for the platform, construction, and operations/logistics systems phases of the ETVP program is shown in Figure 2-10. DDT&E and acquisition phases of the program are highlighted through IOC and for the two-year period of ETVP test and operational verification in LEO. The phase of construction simulation and training is shown along with flight experiments and operations that precede ETVP construction missions.

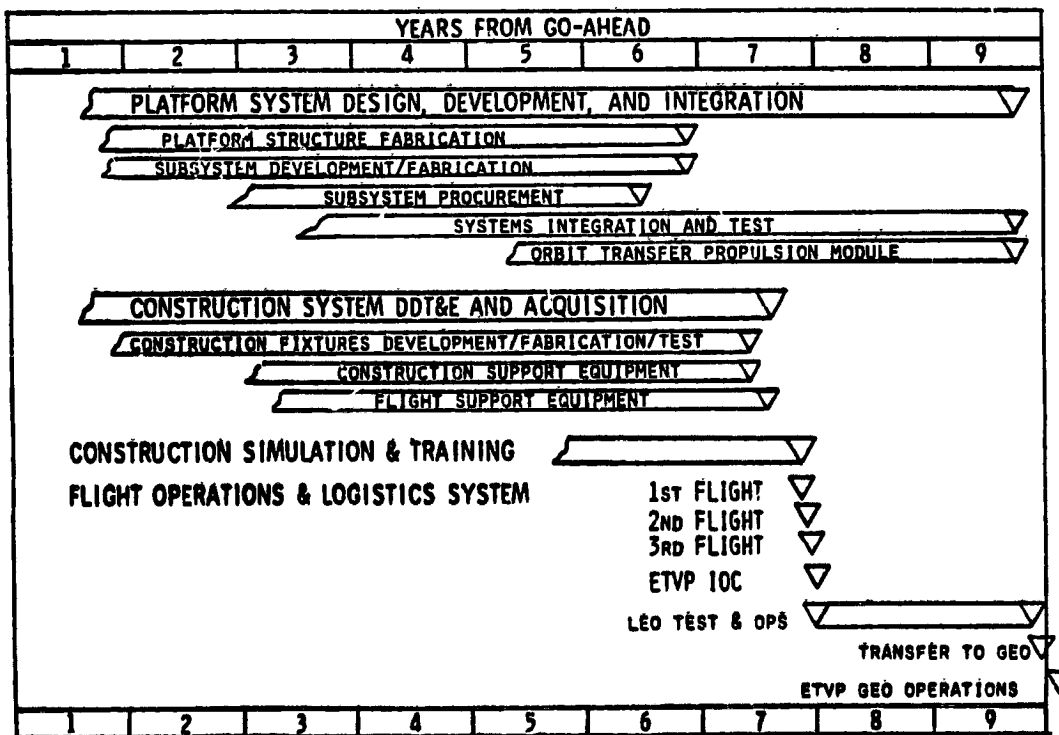

Figure 2-10. ETVP Summary Program Schedule

ETVP Program Development Schedule

An overall ETVP phasing schedule is submitted as Figure 2-11 acknowledging the steps of technology advancement, DDT&E, procurement, fabrication/assembly acceptance testing, and preparations for flight. ETVP systems analyses and

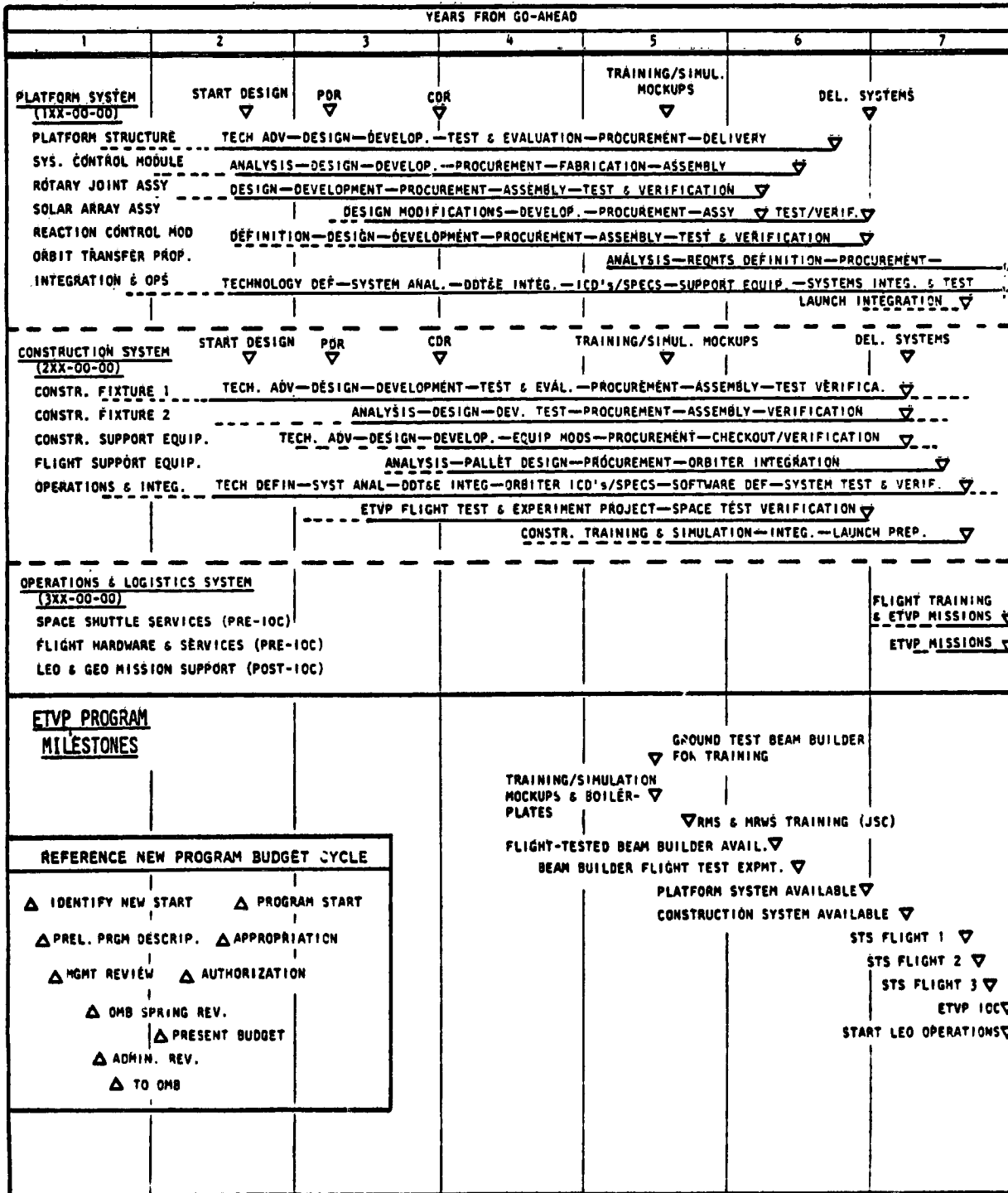

Figure 2-11. ETVP Program Development Schedule

technology definitions will be followed by the start of platform and construction system design activities leading to PDR and CDR milestones. Early subsystem developments on the platform system will focus on the system control module and the definition of total system requirements involving the rotary joint/solar array and the EPS, thermal control, RCS, TT&C, attitude control, and station-keeping systems.

Construction system activities are paced by the definition and design of the main construction fixture (Station 1) and its operational systems. Figure 2-12 illustrates the schedule and steps of fixture yoke development, stressing (1) the sequences of needed mechanisms, cable reels, crossbeam positioner, deployment mechanisms, and libration damping systems; (2) the activity of software development for operational systems; and (3) the required systems analysis, integration, and verification tests leading to final delivery.

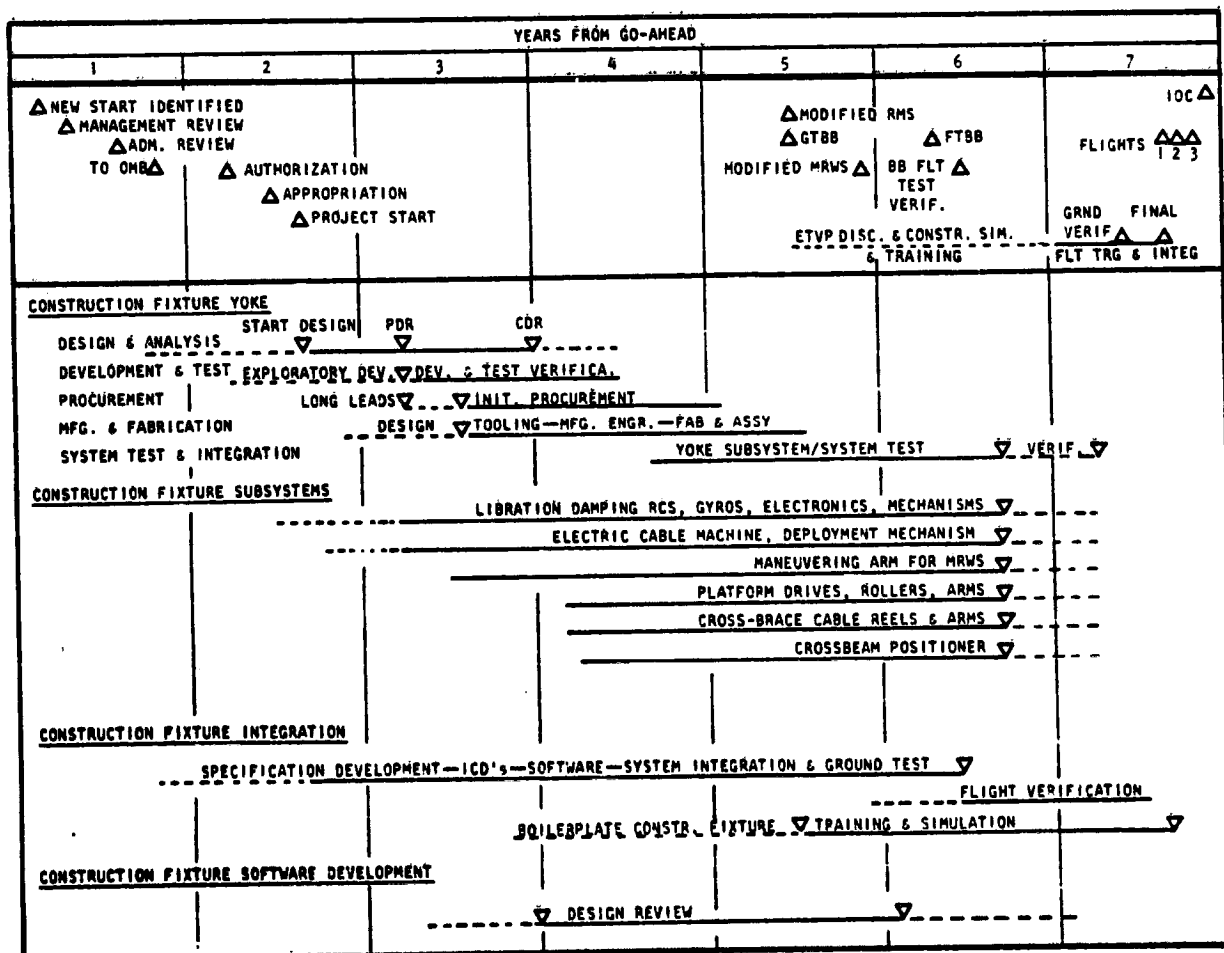

Figure 2-12. ETVP Construction Fixture (Station 1) Program Schedule

Technology definitions (see Section 2.3) will be incorporated into basic design requirements as the work continues through PDR and CDR cycles. As the designs become firm, mockups and "boilerplate" versions of construction equipment are scheduled for fabrication and subsequent use in the training and

simulation activity. In this regard, the use of existing facilities, such as those at JSC, are planned for construction training and simulation use to satisfy requirements on the modified RMS and MRWS. Technology spin-offs from other programs, such as those dealing with composites and space hardware development, are contemplated. This includes current contract activity on the beam builder and manned remote work station. Accordingly, ETVP milestones identify need dates for ground test and flight test beam builders for use in training/simulation activities, experiments, and ETVP construction missions.

An integrated program of software definition, design/development, and usage covers both construction fixtures, construction support equipment, and the training/simulation activities for ETVP flights.

Flight Experiment Program Schedule

The selection of final launch dates requires the confidence of confirming space flight tests and experiments as planned for the period of Year 3 through Year 6. Five orbiter flights are scheduled, with three experiments required to support the development of large space platform technology. The five remaining experiments will support large antenna and advanced control technology. All five experiments (Figure 2-13) relate to construction and assembly tasks utilizing orbiter systems interfaces, the RMS, and crew EVA/MMU capability to perform, assist, or monitor work tasks.

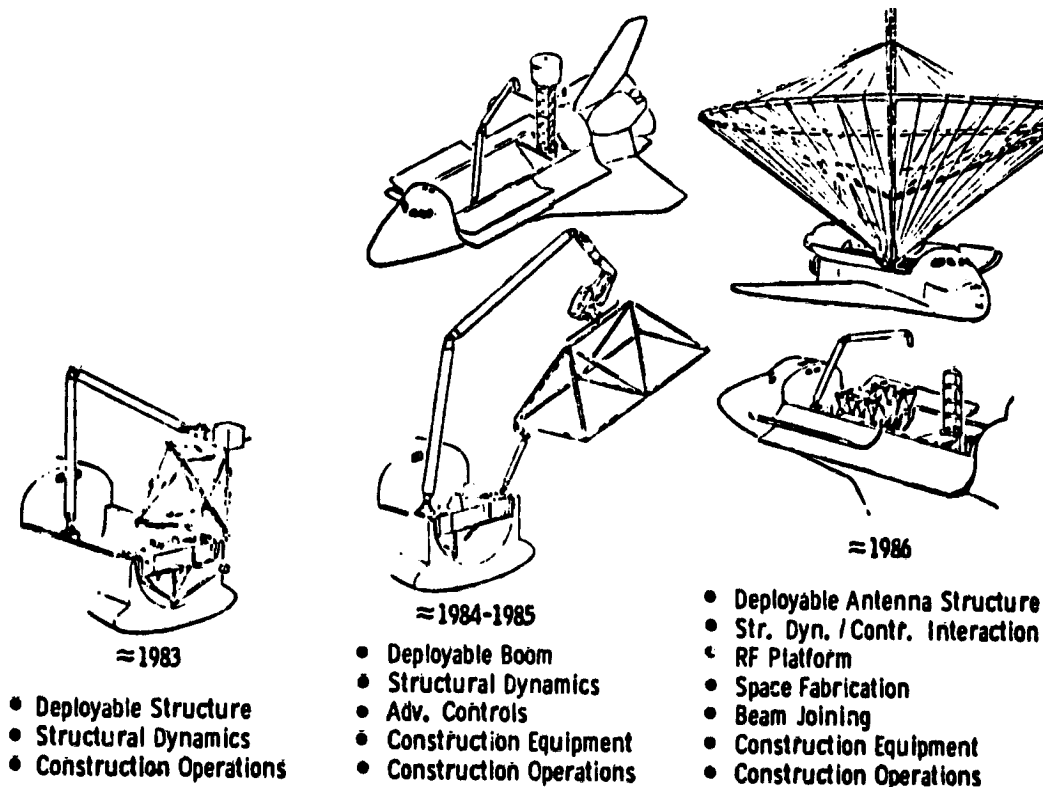

Figure 2-13. Flight Experiment Program

ETVP MISSION SCENARIO

In the late 1980 time period, systems and components of the ETVP and construction systems will have been fabricated and available for the first platform construction mission to LEO. A series of missions will then follow to support the completion of platform construction and subsequent technology development operations. This includes consumables resupply and payload changeouts for LEO test missions, delivery of GEO payloads and related platform equipment/consumables for GEO test missions, delivery of LEO-to-GEO orbit transfer propulsion units and, later, the GEO servicing and resupply provisions for on-going GEO operations.

LEO Operations

ETVP construction and operational requirements at LEO will involve platform construction/assembly, test/verification, payload installation, and maintenance/servicing. ETVP construction activities will require the services of almost three STS missions. Mission 1 will transport the construction fixture, initial platform materials, the beam machine/construction equipment, items needed by the astronauts, and supporting facilities. The second mission will carry construction items, support equipment, ETVP subsystems, system control module, rotary joint, and solar arrays. Mission 3 will transport the RCS modules, construction fixture docking port, support/safety equipment, and project payloads. Missions 1 and 2 are dedicated flights, chargeable to the ETVP and construction. ETVP cargo for Mission 3 requires approximately 23 feet of bay length and over half of the payload weight capability. According to the Payload-Sharing Nomograph (STS Reimbursement Guide, NASA/JSC, JSC-11802), the charge factor approximates two-thirds of the price for a dedicated flight. Allowances for potential contingencies could drive the total to a 75% load factor, where the cost assessment would become the same as for a dedicated flight. Therefore, three missions have been costed in the model to construct, test, and verify the platform for payload performance.

After ETVP construction and IOC, the next two-year period will require three missions at six-month intervals. It is envisioned as an operational and testing period for the platform and payloads—such as the communication antennas or instrument packages for experiments. The orbiter will dock to the ETVP construction fixture for the servicing of subsystems, RCS propellant, or payloads as required.

LEO-to-GEO Transfer

At two years, a series of four flights are planned to prepare the ETVP for transfer and operations to GEO. The first mission will (1) service the ETVP and make changeouts (RCS, CMG's, etc.), and (2) make a complete test/checkout of the platform before transfer to GEO. The next three flights will be needed to carry the three orbit transfer propulsion modules to LEO, where the orbiter would again dock to the platform construction fixture and install the propulsion modules. Although not included in this analysis, flights are contemplated for new ETVP (GEO) payloads during this same period.

After confirming that the ETVP and payloads are operational and ready for transfer to GEO, the orbiter crew will remove the construction fixture and prepare for the return flight.

A two-week time period has been assumed for the trip from LEO to GEO including final orbit seeking, drift into position, and the verification procedures to confirm performance and operational characteristics.

GEO Operations

After ETVP positioning and subsequent operations at GEO for seven years, an unmanned mission is planned to service ETVP RCS propellants and provide LRU equipment changeouts as needed, and update the complement of communication technology payloads. Two servicing missions at seven-year intervals are planned to extend ETVP operations. These activities will (1) deliver the systems/equipment to LEO for ETVP changeout at GEO (RCS and propellant, LRU's, and teleoperator), and (2) deliver the transfer vehicle that would be used to transfer materials to GEO.

Mission Summary

Fourteen Shuttle missions are required for the ETVP project. They are summarized in Table 2-5 to identify main items of hardware and services required of the STS system during construction, LEO tests and operations, orbit buildup and transfer to GEO, and GEO operations and servicing.



ORIGINAL PAGE IS
OF POOR QUALITY

Table 2-5. ETVP Mission Plan for Cost Analysis

OPERATIONAL PHASE				MISSION NUMBER	MISSION DESCRIPTION	OPTIONAL FLIGHT HARDWARE & SERVICES							ETVP TESTS & LEO/GEO OPERAT.		
ETVP CONSTRUCTION	LEO TESTS & OPERATIONS	ORBIT (LEO TO GEO) BUILD-UP/TRANSFER	GEO OPERATIONS AND SERVICING			NO.	DAYS	PER-SON	PER-FLY	UNIT	UNIT	UNIT	UNIT	UNIT	UNIT
						1 PER FLT									
X				1	ORBITER BASELINE PROVISIONS	1	4	6	8	1	1	1			
X				2	CONSTRUCTION MISSION WITH FIXTURE AND PLATFORM COMPONENTS	1	5	6	7		1	1			
X				3	CONSTRUCTION MISSION WITH PLATFORM SYSTEMS AND CONSTRUCTION EQUIPMENT	1	3	4	3						
	X			4	ETVP—LEO OPERATIONAL TEST SUPPORT MISSIONS	1	4	6	2						102
	X			5	RCS AND LRU CHANGE-OUTS	1	4	6	2						102
	X			6	TRANSFER OF RCS, LRU'S FOR CHANGE-OUT/TEST (MISSION 7)	1	4	6	2						102
		X		7	TRANSFER OF ORBIT TRANSFER PROPULSION MODULES TO LEO FOR ENGINEERING TECHNOLOGY VERIFICATION PLATFORM (ETVP)—MISSIONS 8, 9, 10	1	5	6	2						252
		X	X	8	DELIVER RCS AND LRU'S FOR ETVP AND ORBIT TRANSFER PROP. MOD. FOR MATERIAL TRANSFER TO GEO AT 7 YEARS	1	1	3							252
		X	X	9	DELIVER RCS AND LRU'S FOR ETVP AND ORBIT TRANSFER PROP. MOD. FOR MATERIAL TRANSFER TO GEO AT 7 YEARS	1	2	3							252
				10	DELIVER RCS AND LRU'S FOR ETVP AND ORBIT TRANSFER PROP. MOD. FOR MATERIAL TRANSFER TO GEO AT 7 YEARS	1	1	3							252
				11	DELIVER RCS AND LRU'S FOR ETVP AND ORBIT TRANSFER PROP. MOD. FOR MATERIAL TRANSFER TO GEO AT 7 YEARS	1	1	3							252
				12	DELIVER RCS AND LRU'S FOR ETVP AND ORBIT TRANSFER PROP. MOD. FOR MATERIAL TRANSFER TO GEO AT 7 YEARS	1	2	3							252
				13	DELIVER RCS AND LRU'S FOR ETVP AND ORBIT TRANSFER PROP. MOD. FOR MATERIAL TRANSFER TO GEO AT 14 YEARS	1	1	3							252
				14	DELIVER RCS AND LRU'S FOR ETVP AND ORBIT TRANSFER PROP. MOD. FOR MATERIAL TRANSFER TO GEO AT 14 YEARS	1	2	3							252

2.5 FLIGHT TEST PLAN

INTRODUCTION

The Large Space Construction Analysis study has exposed the requirements for an entirely new technology category. These technologies are involved very heavily in the functions of operations as contrasted to hardware. The fabrication and assembly of large space platforms in orbit with the Shuttle orbiter draw heavily upon orbiter support functions, equipment, EVA crew members, and EVA crew members supplemented with manned maneuvering units (MMU's) or the manned remote work station (MRWS). Additionally, these new functions and tasks are programmed with an entire new family of supporting fabrication and assembly fixtures. This new methodology drives the operations' methods, timelines, procedures, software, and mission planning technology very hard. For example, in the engineering and technology verification platform (ETVP), all of the construction fixtures, tools, and material for fabrication of the platform structure are carried aloft on the first Shuttle flight. The stature of the operations' technology has occupied in the past.

Hardware technology for the ETVP is listed in Table 2-4. The hardware technology items that interface heavily with the operations technology are the 8-psi pressure suit, the software supporting the MRWS activities, and the collision-avoidance software for all phases of platform construction using the RMS and the RMS/MRWS.

The ETVP flight test program has been prepared by evaluating the technology and verification needs of the technical community. The planned flight test experiments described in this experiment test program support these technology requirements as expressed in the experiment operations.

SPACE CONSTRUCTION FLIGHT EXPERIMENTS

Task 13 of this study defined an integrated set of flight experiment objectives that, when assigned to experiment groups, define a five-experiment flight test program as a precursor to design and development of the ETVP. This flight experiment program is outlined in Figure 2-14.

Three flights have been programmed to support ETVP construction, design, development, and operations:

- Deployed/Assembled Structural Dynamics Experiment
- Construction Equipment Effectiveness Experiment
- Space Fabrication/Assembly Experiment

Two additional flight experiments have been proposed to support the large space payloads:

- Deployed Boom Experiment
- Large Antenna Experiment

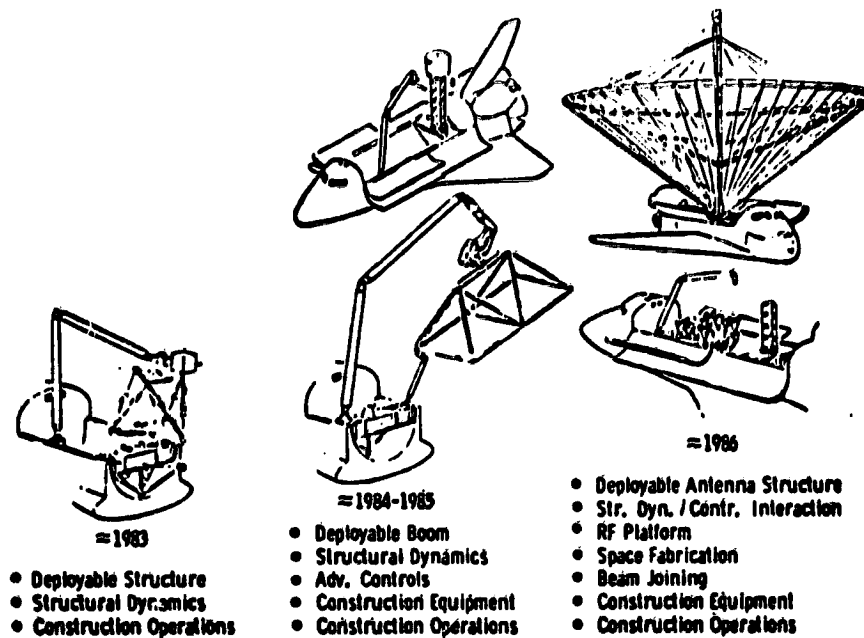

Figure 2-14. Flight Experiment Program

These experiments will yield the data and technology to proceed into development of the ETVP large space platform or similar large space platforms. The experiment program is described flight by flight in the following paragraphs.

Deployed/Assembled Structural Dynamics Experiment

This experiment is an early flight experiment in support of large space platform development. The experiment test article will be modeled to closely resemble the forward load distribution structure attaching the ETVP systems control module (SCM) to the ETVP structure. Experiment objectives are:

- Demonstrate deployment/assembly of a load distribution-type structure (typical for a large space platform).
- Demonstrate three-point berthing using the RMS.
- Demonstrate RMS installation and removal of a subsystem module to an attach port, including electrical connection.
- Perform structural vibration test to provide data defining the dynamic characteristics of structural member joints.
- Evaluate orbiter and construction induced dynamics under attitude-hold and free-drift modes of control.

The experiment configurations and partial sequence are illustrated in Figure 2-15. Shown are (1) the berthing of the deployed structure, (2) installation of a subsystem module to an attach port, and (3) the structural vibration test providing data supporting the dynamic characteristics of structural joints of various types.

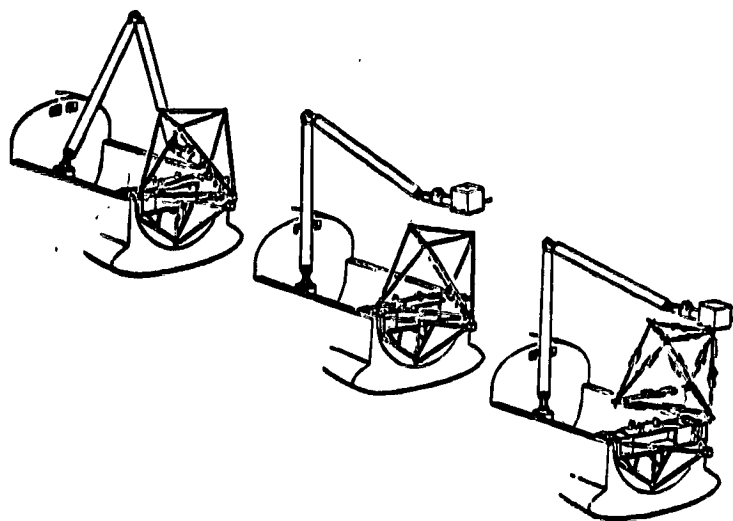

Figure 2-15. Deployed/Assembled Structural Dynamics Experiment

Construction Equipment Effectiveness Experiment

This experiment is the second early flight experiment. It will provide a test bed to test and evaluate some of the initial space construction tools and aids:

- Holding and positioning aid
- Manned remote work station (MRWS)—cherry picker
- Manned maneuvering unit (MMU)
- RMS end effectors

The experiment objectives are:

- Evaluate the holding and positioning aid
- Demonstrate the deployment/assembly of a large open-frame structure
- Demonstrate the deployment and attachment of a module attach port
- Evaluate the RMS special end effector
- Evaluate the MMU and MRWS in performance of space construction tasks
- Demonstrate installation of electrical and mechanical lines
- Demonstrate the installation and removal of modules on payload attach ports

Figure 2-16 illustrates (1) the deployed structure being positioned by the holding and positioning aid, (2) EVA crewman operations with an open MRWS installing an electrical line, and (3) an MRWS/EVA crewman installing a module to a payload attach port.

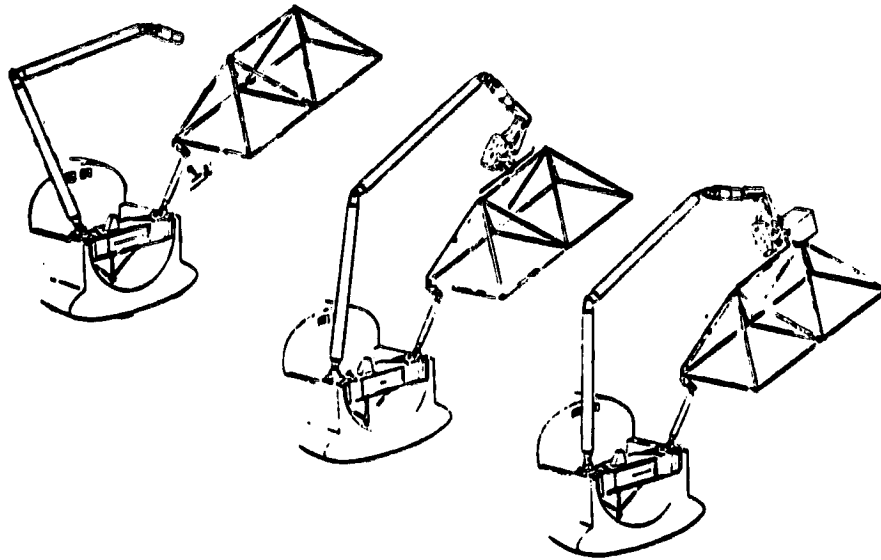

Figure 2-16. Construction Equipment Effectiveness Experiment

Space Fabrication/Assembly Experiment

This experiment is a flight experiment that will function as a final qualification test in space environmental and zero-g conditions for fabrication with the beam builder and joining of composite structures. Two critical operations would be baselined: (1) space fabrication of composite beam using the beam-builder process, and (2) joining of the crossbeam to the main longitudinal beams. It would be programmed to be flown in the 1986 time period. The objectives of this experiment are:

- Fabricate a composite crossbeam with the beam builder.
- Evaluate fabricated beam tolerances and characteristics.
- Position crossbeam for joining operation with EVA crewman participation.
- Demonstrate crossbeam/longitudinal beam-joining process.
- Evaluate crossbeam/longitudinal beam joint structural integrity.
- Evaluate installation and connection of electrical cables and transducers.
- Evaluate construction dynamics under a free-drift mode and an attitude-hold mode.

Figure 2-17 illustrates the configurations and sequences of the flight test: (1) the fabrication of a crossbeam structure by the beam-builder machine; (2) then positioning the newly fabricated crossbeam onto a simulated longitudinal beam segment; and (3) beam being joined and tested. The test article would be returned with the Shuttle for complete laboratory analysis of the fabricated beam and of the attach joint to the simulated longitudinal beams.

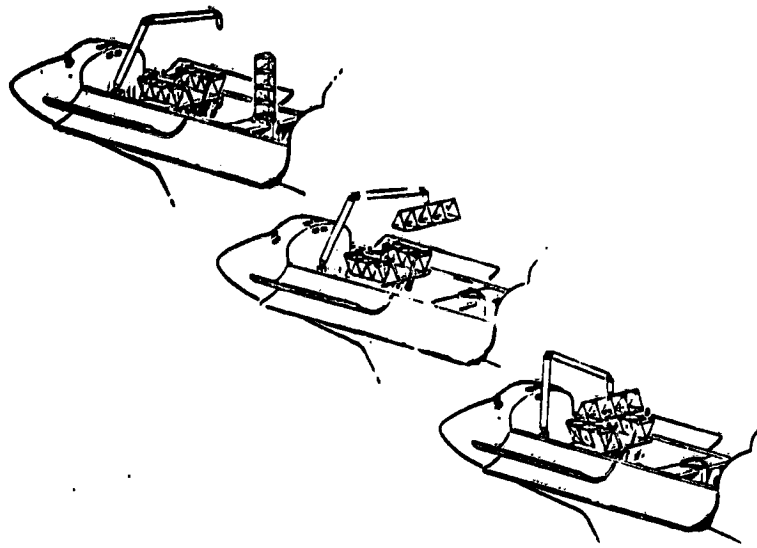

Figure 2-17. Space Fabrication/Assembly Experiment

Deployed Boom Experiment

A deployed boom experiment is a large space construction payload-oriented experiment providing a test mechanism to evaluate large booms simulating a large antenna feed mast. It also provides a test bed for evaluating advanced control techniques required for construction and control of large space payloads. This experiment is programmed for the 1984-1985 time period; its objectives are:

- Evaluate deployment of a large deployed boom.
- Demonstrate RMS installation of simulated antenna feed electronics
- Demonstrate the deployment of large electrical cable bundles under EVA crewman supervision.
- Evaluate alignment and thermal distortion characteristics of boom.
- Determine dynamic characteristics of deployed boom.
- Evaluate boom/orbiter interaction during active firing of orbiter RCS under various attitude control conditions.
- Evaluate active contouring controls for controlling beam shape and alignment.
- Evaluate advanced control techniques for unsymmetrical moment-of-inertia and center-of-gravity conditions.

Figure 2-18 illustrates the various flight experiment conditions: (1) RMS installation of a simulated antenna feed electronics package; (2) active deployment of the boom; (3) EVA supervision of large cable bundles during boom deployment; (4) thermal distortion evaluation; and (5) boom modal vibration survey to determine beam dynamic characteristics. Sketches (6) and (7) depict evaluation of advanced control techniques under varied moment-of-inertia and center-of-gravity conditions.

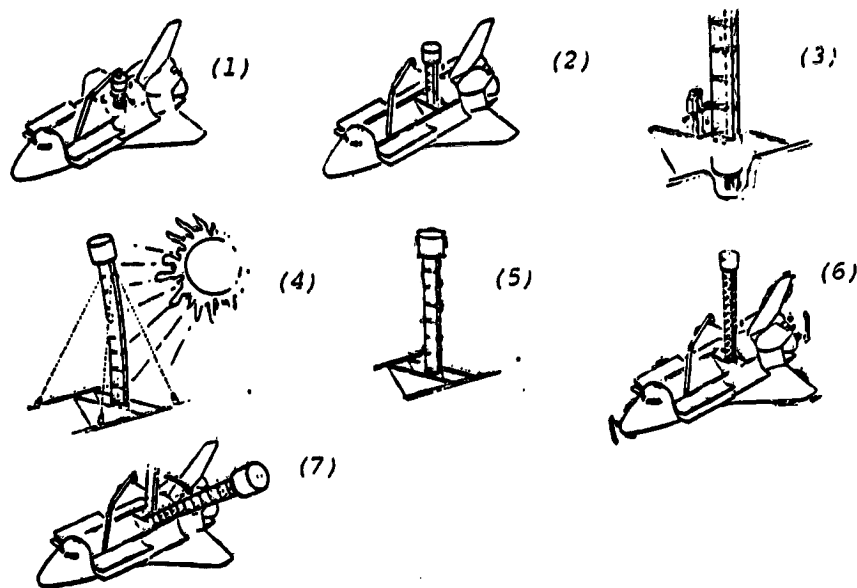

Figure 2-18. Deployed Boom Experiment

These experiment results will have application to any large space structure appendage.

Large Space Antenna Experiment

The final flight for the large space construction ETVF flight experiment program is the large space antenna experiment. This is a large space platform payload-oriented experiment. It would be flown in the 1986 time periods; its objectives are:

- Demonstrate the deployment of a large space antenna
- Evaluate the deployed physical tolerances
- Evaluate the effectiveness of active contouring
- Evaluate antenna/orbiter control/dynamic interaction
- Evaluate advanced control techniques
- Evaluate antenna RF characteristics

The sequence of the experiment, as illustrated in Figure 2-19, is as follows:

- Antenna is deployed (1)
- Antenna alignment and active contouring are verified physically (2)
- Interaction between the orbiter and the antenna is tested as well as advanced control techniques under orbiter control (3)
- Antenna is pointed using the orbiter guidance and control, and RF checks are completed with ground stations evaluating the RF characteristics of the antenna (4)

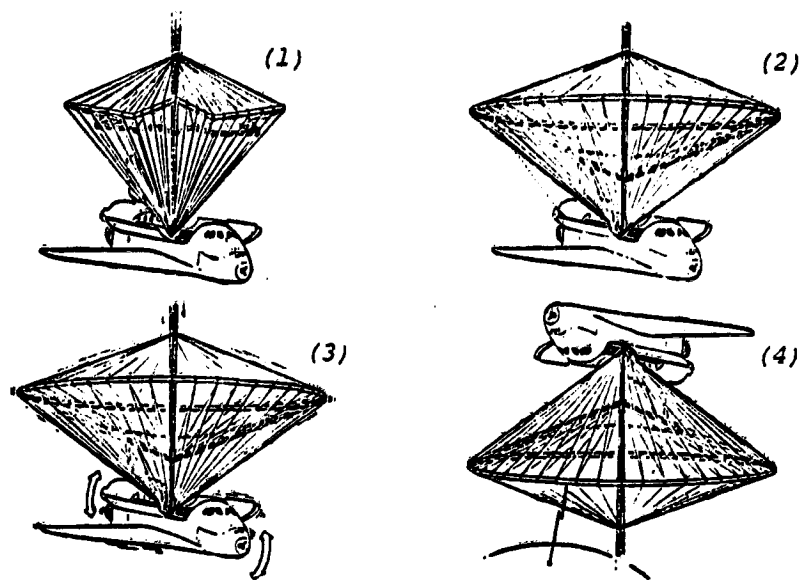

Figure 2-19. Large Antenna Experiment

CONCLUSION

With the completion of these five experiments and the associated ground testing programs, the necessary technical and operational data will be available to support the design and development of a large space platform such as the ETVP. In addition, the orbiter system will be capable of supporting the construction and installation tasks for large space payloads. These experiments could support an early IOC, if desired.

3.0 COST ANALYSIS

3.1 INTRODUCTION

This section of the report identifies costs for the ETVP program to aid in planning. It also provides funding levels and isolates significant items of cost on ETVP development, ground, and flight segments and then details the item of space construction equipment and operations.

The following paragraphs document criteria and considerations that were followed in developing hardware and construction support equipment cost estimates for the Engineering and Technology Verification Platform (ETVP). The platform of operational subsystems and payloads is a structure to be fabricated and assembled in space. This means that raw materials and components will be delivered by a logistics system having the capability to accommodate the fabrication/assembly process that will use specialized construction support equipment to build an operational system. As a new venture in space, little history precedes the current contract activity and, as a result, the costing of systems and equipment requires careful analysis to develop results tailored to the hardware/equipment procedures and approach of constructing space projects.

General points on the development of a cost model and supporting cost estimating relationships are identified in the following statements:

- A specifically developed work breakdown structure (WBS) was prepared and used as the framework for costs of hardware, software, and activities required for the design, development, production, assembly, transportation, operations, and maintenance of the ETVP project; and, accordingly, cost analysis complies with elements of this structure and is further grouped into recurring and nonrecurring costs for the ETVP.
- Non-recurring costs include design and development, initial tooling and test equipment, and pre-mission operations such as ground and sortie tests plus other precursor activity for proof of concept on the platform, construction support equipment, and new requirements for the logistics system.
- Recurring costs include ETVP hardware and software, construction support equipment, assembly and checkout requirements, space transportation vehicles, and operational costs of construction including spares and maintenance requirements for a 20-year lifetime.
- The two categories of cost—recurring and non-recurring—are presented in 1979 dollars for budgetary and planning purposes.

- The cost analysis was developed in accordance with the cost model, Rockwell estimating procedures interacting with cost estimating relationships (CER's), historical aerospace program data, commercial business/industry cost projections, engineering estimates, and published guides such as that for the manned maneuvering unit (MMU).
- Logistics system costs were developed using the STS Reimbursement Guide and associated documentation.
- Technology development costs are included as a part of the DDT&E effort.
- Maximum use was made of available space construction data including programmatic/technology documentation on system advancements and plans for the Space Transportation System, manned maneuvering unit, manned remote work station, the beam machine, and man/system requirements for weightless environments.

Several conversion factors were identified to aid in the extrapolation of costs for construction support equipment. These factors were incorporated into the cost model and cover the areas of complexity, specification requirements, scaling, and learning. Complexity adjustments were made when the item being estimated was considered to be either less or more complex than the data base. A specification (space rating) factor was projected to adjust data base costs for the more stringent specification requirements of space applications. Learning factors were applied for multiple equipment requirements, and scaling adjustments were incorporated to compensate for variability of the parameters as compared with the data base.

A summary of ETVP cost and programmatic is illustrated in Figure 3-1, providing a synopsis of cost estimates in main areas of the WBS; and a funding plan developed in concert with the program schedule. Cost estimates and the time-phased expenditure plan reflect costs associated with the platform through its initial operational capability and availability for the installation of required payloads.

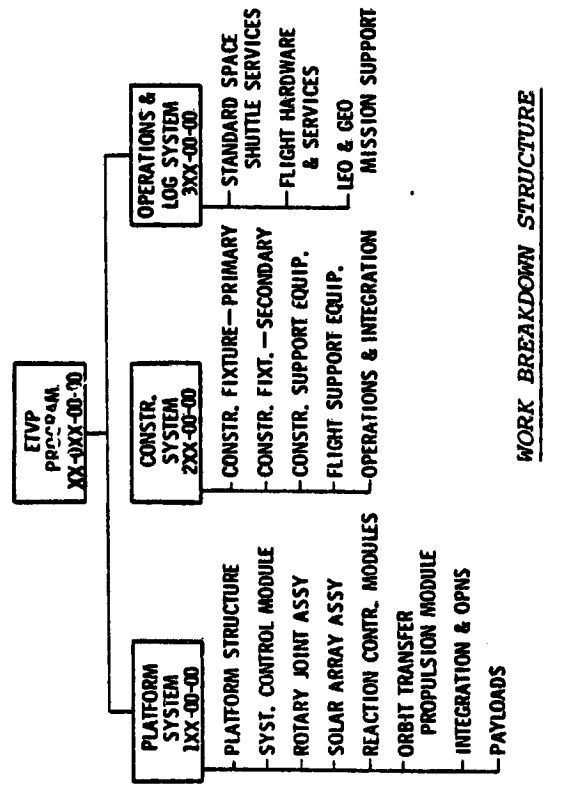
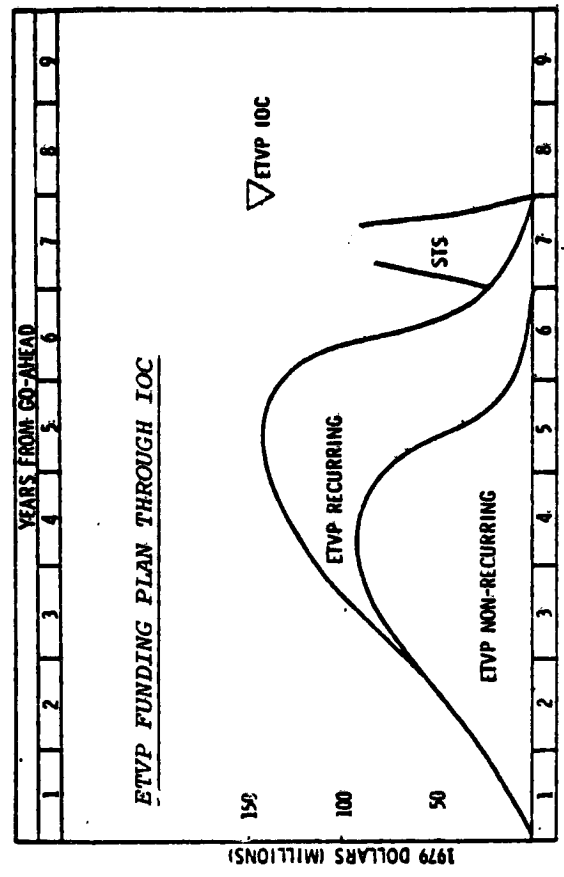
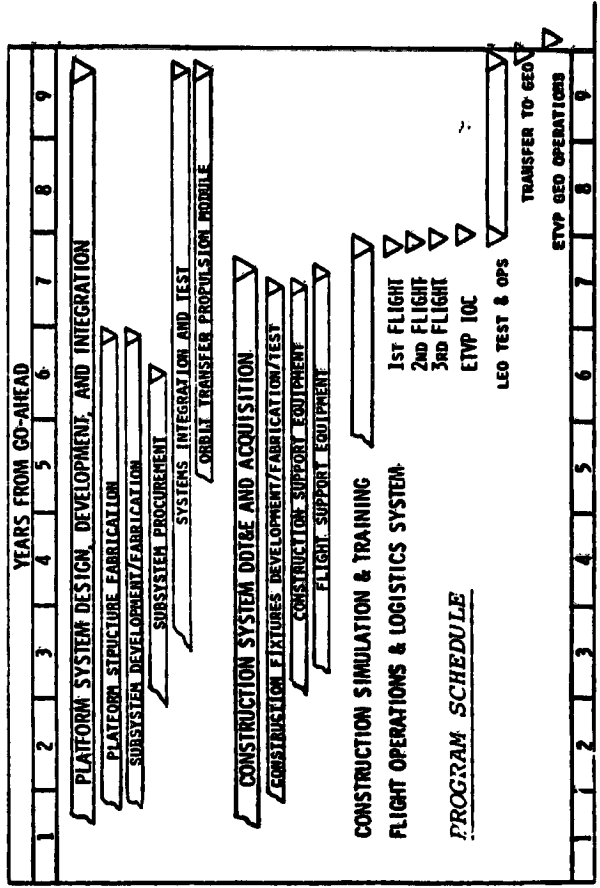

ETVP COSTING THROUGH IOC

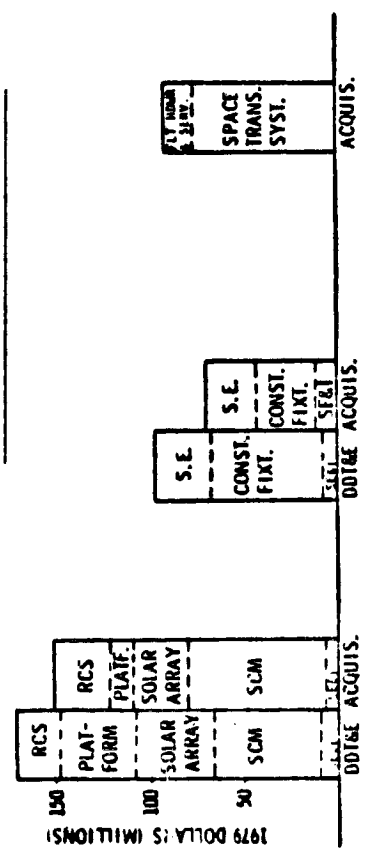

Figure 3-1. ETVP Cost and Programmatic

3.2 WORK BREAKDOWN STRUCTURE AND DICTIONARY ENGINEERING TECHNOLOGY VERIFICATION PLATFORM (ETVP)

The framework of the ETVP work breakdown structure (WBS) is developed to provide NASA with an organized arrangement of ETVP hardware, software, and services for the grouping of estimated costs and the organization of planning data on ETVP design, space fabrication requirements, construction equipment, support services, and the operations and logistics system.

A graphic display of the ETVP WBS is shown in Figure 3-2. It identifies three main areas as the platform system, construction system, and operations and logistics system. A further breakdown of these elements is provided in Table 3-1 along with a numerical code to identify sub-level items. Main elements of this breakdown are described in the WBS Dictionary presented below.

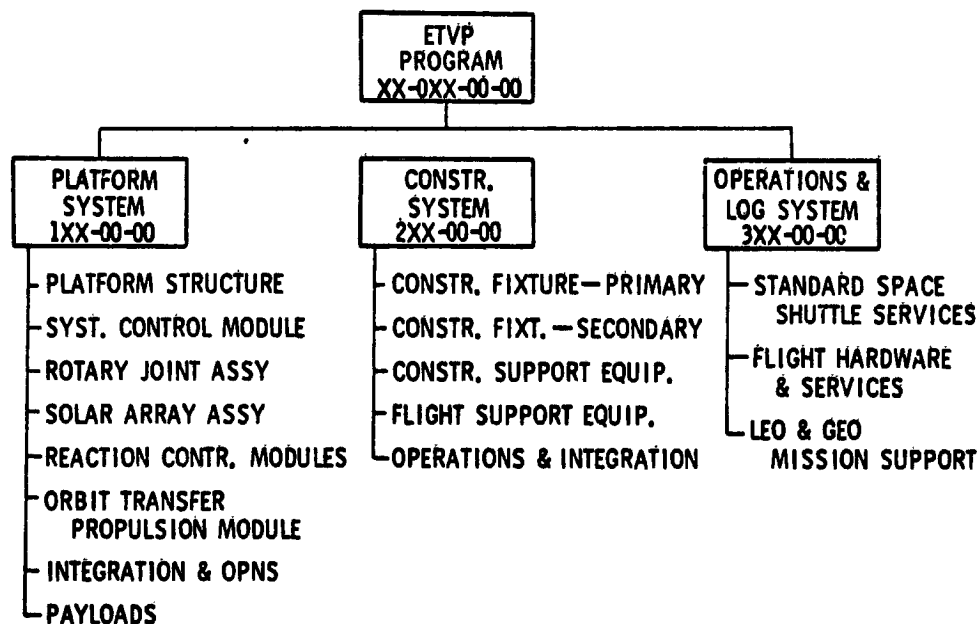

Figure 3-2. Work Breakdown Structure

1XX-00-00 PLATFORM SYSTEM

This element covers hardware and software requirements of the ETVP system that will serve as a demonstration project and versatile development facility capable of supporting a variety of test payloads. It includes the elements of operational systems, project integration, and supporting activities. The platform segment of the WBS consists of subsystems such as the structure, system control module, rotary joint, solar array, reaction control modules, orbit transfer propulsion, payloads, and integration and operations.

Table 3-1. ETVP Work Breakdown Structure Matrix

WBS NO.	DESCRIPTION	WBS NO.	DESCRIPTION	WBS NO.	DESCRIPTION
1XX-00-00	PLATFORM SYSTEM	2XX-00-00	CONSTRUCTION SYSTEM	3XX-00-00	OPERATIONS & LOGISTICS SYSTEM
-01-00	PLATFORM STRUCTURE	-01-00	CONSTR. FIXTURE SYS. (STATION 1)	-01-00	STD SPACE SHUTTLE SERVICES
-01-01	STRUCTURE & MECHANISMS	-01-01	MAIN YOKE AND SUPPORTS	-01-01	FLT PLANNING & OPS SUPPORT
-01-02	ATTITUDE CONTROL	-01-02	BRIDGE BEAM	-01-02	ENGINEERING INTEGRATION
-01-03	TT&C	-01-03	LONG BEAM ROLLER SUPPORT	-01-03	LAUNCH SITE SUPPORT
-01-04	EPS & DISTRIBUTION	-01-04	BEAM BUILDER POSITIONER	-01-04	SPACE TRANSPORTATION SYSTEM
-02-00	SYSTEM CONTROL MODULE	-01-05	SUPPORT TRIPOD & MAGAZINE	-02-00	OPTIONAL FLT HDW & SERVICES
-02-01	STRUCTURE & MECHANISMS	-01-06	CABLE REEL	-02-01	PRSD/EPS TANK SET UNITS
-02-02	ATTITUDE CONTROL	-01-07	FIXTURE MOUNTS & BRACKETS	-02-02	ADDITIONAL TIME ON ORBIT
-02-03	TT&C	-01-08	FIXTURE DEPL. SYSTEMS	-02-03	CREW MEMBERS
-02-04	EPS & DISTRIBUTION	-01-09	REACTION CONTROL SYSTEM	-02-04	EVA-NMU
-02-05	THERMAL CONTROL	-01-10	EPS & DISTRIBUTION	-02-05	BEAM BUILDER
-03-00	ROTARY JOINT ASSEMBLY	-01-11	ATTITUDE CONTROL SYSTEM	-02-06	MANNED REMOTE WORK STATION
-03-01	STRUCTURES & MECHANISMS	-01-12	TT&C	-03-00	LEO & GEO LOG./MISSION SUPPORT
-03-02	EPS & DISTRIBUTION	-01-13	CONSTRUCTION MINI-COMPUTER	-03-01	STD SPACE SHUTTLE SERVICES
-04-00	SOLAR ARRAY ASSEMBLY	-02-00	CONSTR. FIXTURE SYS. (STATION 2)	-03-02	OPTIONAL FLT HDW & SERVICES
-05-00	REACTION CONTROL MODULES	-02-01	SUPPORT STRUCTURE	-03-03	ETVP SPACE TESTS & VERIF.
-06-00	ORBIT TRANSFER PROPULSION MOD.	-02-02	INTERSECTION FITTING CANISTER		
-07-00	INTEGRATION AND OPERATIONS	-02-03	WIRE HARNESS REEL		
-07-01	PECULIAR SUPPORT EQUIPMENT	-03-00	CONSTRUCTION SUPPORT EQUIPMENT		
-07-02	FLIGHT SUPPORT OPS & SERVICES	-03-01	BEAM BUILDER MODS		
-07-03	GROUND TEST & EVALUATION	-03-02	MANNED REMOTE WORK STA. MODS		
-07-04	SYSTEM ENGR. & INTEGRATION	-03-03	RMS MODS		
-07-05	PROJECT MANAGEMENT	-03-04	LIGHTING & CCTV		
-07-06	DATA	-03-05	SPL TOOLS & INSTR, IAU, C/O EQ.		
-07-07	FLIGHT OPS TO GEO	-03-06	CSE COMPUTER/SOFTWARE		
-08-00	ETVP PAYLOAD	-04-00	FLIGHT SUPPORT EQUIPMENT		
		-04-01	BERTHING PLATFORM		
		-04-02	FWD CRADLE PALLETS		
		-04-03	CENTER PALLETS		
		-04-04	AFT PALLETS		
		-04-05	RCS AFT PALLET		
		-04-06	PALLET SUPPORTS		
		-05-00	OPERATIONS & INTEGRATION		
		-05-01	PECULIAR SUPPORT EQUIPMENT		
		-05-02	FLIGHT SUPPORT OPS/SERVICES		
		-05-03	GROUND TEST & EVALUATION		
		-05-04	SYSTEM ENGR. & INTEGRATION		
		-05-05	PROJECT MANAGEMENT		
		-05-06	DATA		
		-05-07	TRAINING & SIMULATION		
		-05-08	FLIGHT TEST PROGRAM		

ORIGINAL PAGE 1
OF POOR QUALITY

1XX-01-00 Platform Structure

This element includes all necessary structural and support members needed to fabricate the ETVP and to support the selected payloads and subsystems. It includes (1) space-fabricated tri-beam members, (2) bracing struts, (3) fore and aft space truss structures that provide a passive interface attachment for the system control module and orbit transfer modules, and (4) attach ports plus platform mechanisms/latches.

Components of the attitude control and stationkeeping system plus the tracking, telemetry, and command (K-band) assemblies located on the platform system are included in this element. In addition, power and data distribution components positioned on the platform system for operations and payload usage are included.

1XX-02-00 System Control Module (SCM)

The SCM will serve as the housing for the attitude control, TT&C, and electrical power subsystems and components. The service module is located between the space truss structure and the rotary joint. The module consists of a structural frame (including a female attach port, electromechanical latches, and electromechanical connectors) with electrical harnesses and connectors for subsystem interfaces plus integral thermal control and environmental protection components required for radiation protection. Berthing port provisions will be provided to accommodate teleoperator servicing during platform operation.

Elements of the attitude control and stationkeeping system in the SCM include the precision attitude reference packages, computer, control moment gyros, and integral wire harness, plus system components needed to rendezvous and dock the teleoperator. Components of the TT&C system include S-band electronics—transponders, processors, amplifiers, transmitters, and switch assemblies.

The SCM includes a thermal control system to modify the temperature of subsystem components. It consists of a coolant loop, pumps, heat transfer devices and radiator surfaces/deployment mechanisms, insulation, and thermal control coatings/finishes. Excluded are paints or finishes applied to components during their manufacturing sequence. Thermal control provisions will be designed to maintain ETVP operation during construction periods and operational lifetime.

Hardware for electric power conditioning, operation, switching, regulation, and storage is included in the SCM. Storage batteries and the charging equipment are a main item.

1XX-03-00 Rotary Joint Assembly

This element includes the structure, mechanisms, and electrical components for the transfer of electrical power from the solar arrays to the service control module. It includes slip rings; brush assemblies; feeders for power transfer; a structural housing; linkage arms that interface with the solar arrays; and universal joints, gears, and drive mechanisms to maintain solar array orientation.

1XX-04-00 Solar Array Assembly

This element includes solar array assemblies necessary to provide required electrical power for ETVP operation including payload allocations. The solar array assembly consists of the main housing, photovoltaic solar cells, array deployment arms, and mechanisms.

1XX-05-00 Reaction Control Modules

Hardware and propellant requirements for the RCS are included in this element. The hardware consists of propulsion subsystems (propellant tanks, pressurization tanks, thrusters), microprocessor controls, structural frame, harnesses/lines, and attach/connector assemblies. The RCS is used to maintain ETVP attitude control and orbital position.

1XX-06-00 Orbit Transfer Propulsion Module

This element covers propulsion modules required to transfer the ETVP from LEO to GEO. A thrust engine module of an advanced propulsion design will be used as the major system to accomplish this transfer. It consists of the structure, propulsion subsystems, microprocessor control, and attach/connector devices.

1XX-07-00 Integration and Operations

This element includes project management and engineering required to direct, manage, and control the project to ensure that overall objectives are accomplished. It includes the engineering effort to establish and maintain a technical baseline covering requirements analysis and integration, ETVP system and specification definition, interfaces, safety, reliability and maintainability, plus the effort to monitor ETVP system development and qualification tests. Flight operations and support from orbiter ETVP separation through initiation of GEO operations are included in this element along with unique ground operations activities to support this activity. LEO transportation system requirements are included in 3XX-00-00.

The following items are also included in this element:

- *Peculiar Support Equipment*—ground handling and checkout equipment; special items for materials handling.
- *Flight Support Operations and Services*—activities to ship hardware to the launch site for checkout before launch; services to conduct unique bay system checkouts; necessary procedures, test instructions, and handbooks.
- *Ground Test and Evaluation*—special ground test articles/units for test and evaluation.

1XX-08-00 ETVP Payload

This element includes payload hardware and software requirements to be mounted on the ETVP for use at LEO or for transfer to and operation at GEO.

Candidate payloads include a communications system, SPS technology advancement payloads, space-based radar, high-resolution radiometry, and large optical systems and their applications. Current construction planning requirements have focused on an advanced communications project with a consideration of design requirements imposed by other potential payloads.

2XX-00-00 CONSTRUCTION SYSTEM

This category covers construction equipment used to build the ETVP in space. It includes the space construction facility, construction fixture and work stations, construction support equipment, flight support equipment, and the integration/operations unique to this segment of the overall construction activity. The Space Shuttle orbiter shall serve as the central construction facility for the construction fixture and equipment to fabricate, assemble, and test the ETVP.

2XX-01-00 Construction Fixture System (Station 1)

This element covers the main construction fixture designed to operate from the bay of the Shuttle orbiter and to be used as the main construction base for the ETVP. It consists of the main structural yoke and docking port, bridge beam, work stations, positioning/translation devices, drives and sensors, cable reel, power supply, mounts/brackets, and the mechanisms to deploy the fixture for orbital construction. A libration damping system is included for control of large-amplitude motions that can develop during untended operations. This system consists of a reaction control system, electrical power and data distribution system, attitude control components, and a TT&C subsystem. A master computer control processor is also included for control and sequencing of construction operations.

2XX-02-00 Construction Fixture System (Station 2)

The Station 2 construction fixture houses a beam machine for the construction of transverse and crossbeam members' devices for the placement of intersection fittings and ports, plus a deploying mechanism for the installation of wiring. Elements include the structural support frame, latching mechanisms, canisters, cable reel, and electromechanical systems.

2XX-03-00 Construction Support Equipment

This element includes hardware and software required to support the construction process of building projects in space. Included are modifications to the beam machine, cherry picker (MRWS), and orbiter remote manipulator system (RMS). In addition, this element includes end effectors, special tools and instruments such as the inertial alignment unit, lighting and CCTV, holding devices and construction aids, plus CSE software and computer provisions. Special instrumentation and orbiter control center stations for use during construction are in this element.

2XX-04-00 Flight Support Equipment (FSE)

Flight support equipment serves as the interface between the orbiter and its cargo. FSE includes the berthing platform; forward, central, and aft pallets; pallet segments; and the necessary brackets, fittings, and latches.

2XX-05-00 Operations and Integration

This element includes functional requirements for construction such as project management and systems engineering on construction systems, and their integration with ETVP and logistics elements. Construction system specifications, system planning and scheduling, and design integration of equipment are included in this item. Unique ground systems, facilities, and equipment needed to provide ground integration of the project are included. Also, simulation and training requirements are covered in this element, along with flight operations and the support requirements of on-orbit activities during platform construction, excluding payload installation. A boilerplate construction fixture and appropriate software for use in training and simulation activities fall into this category. Flight tests and experiments to verify materials, processes, or space construction simulations are included in this element.

3XX-00-00 OPERATIONS AND LOGISTICS SYSTEM

This element covers the Space Transportation System, optional flight hardware and services, and the hardware/software and services needed to construct the ETVP and support platform LEO tests and GEO space operations. The logistics system is the Space Shuttle Transportation System outfitted with selected flight hardware and associated services to deliver payloads to earth orbits and perform/support on-orbit operations and experiments. This element is divided into the following categories:

- Standard Space Shuttle Services
- Optional Flight Hardware and Services
- LEO and GEO Logistics/Mission Support

3XX-01-00 Standard Space Shuttle Services

This element includes standard services before ETVP IOC, associated with the use of the Space Transportation System as covered in the NASA launch services agreement, the payload integration plan, and the launch site support plan. Flight planning and operations are provided as part of the standard Space Shuttle transportation charge. This anticipates a flight from KSC where three crew members are provided on orbit to handle orbiter bay payloads for one day. Flight planning and operations support include utilization planning, flight operations planning, crew activity planning, training, flight simulation, and Mission Control Center (MCC) operations.

Standard engineering integration services are provided as part of the transportation charge to ensure the compatibility of cargo elements and orbiter bay provisions. Launch site planning and standard ground operations are a part of the services provided to Shuttle users.

3XX-02-00 Optional Flight Hardware and Services

Optional flight systems before ETVP IOC are defined as hardware end items that can be integrated into the Shuttle orbiter to provide extended capabilities. Optional services are orbiter payload-related tasks performed in the users' behalf by NASA using their existing internal or external NASA capabilities.

Hardware end items applicable to the ETVP project include a remote manipulator, the power reactant supply and distribution/electrical power supply (PRSD/EPS), EVA/MMU provisions, delta crew/support systems, and additional time on orbit. PRSD/EPS kits are required to provide additional electrical power for payloads. Two EVA/MMU excursions are within orbiter baseline provisions.

Optional services include additional time on orbit, the JSC operations control center, and crew member requirements.

The cherry picker (MRWS) and the beam builder are items covered by this element to acknowledge their need for modification and usage within the construction system project.

3XX-03-00 LEO and GEO Logistics/Mission Support

This element covers those elements of work after ETVP IOC, including the logistics system, flight hardware/services, and logistics' needs to support LEO and GEO missions, tests, and operations. The three elements within this category include (1) standard Space Shuttle services after IOC, (2) optional flight hardware and services after IOC, and (3) ETVP space tests and verification activities. Maintenance and spares requirements are part of this element—including special equipment, such as the teleoperator, to carry out servicing operations.

3.3 ETVP COSTING

The ETVP WBS was used as a framework for the development of cost estimates on the platform system, construction system, and Space Transportation System. This section presents (1) the cost methodology followed in preparing cost estimates for each line item of the WBS; (2) cost detail on the platform, construction, and transportation/logistics systems segmented into non-recurring and recurring costs; and (3) a time-phased funding plan for the project. The initial discussion presents the cost model and describes costing parameters and technical characteristics used in the estimating relationships.

A major thrust of the ETVP study was to provide parametric estimates for the costing of ETVP systems/modules, space construction equipment, and flight support requirements. Costing relationships (CER's) were derived from a data base of historical program data on similar systems where the results were tailored to specific ETVP design requirements and technical characteristics such as mass, power, and design specification.

Technical personnel responsible for the design and development of the system furnished sizing and performance data supplemented with blueprint designs and equipment specifications. These parameters were defined to a level compatible with lower-level line items of the WBS and in sufficient detail for the application of estimating relationships or grass-roots quotations. The correlation of these data was summarized on cost analysis sheets for each platform, construction and logistics support item (Figure 3-3). Over 382 line items were analyzed in this way and grouped into 16 main WBS categories.

COST METHODOLOGY

ETVP costs were generated by a parametric cost model that utilizes CER's and mathematical "pipeline" processing equations. The CER's are mathematical relationships between the cost of an item and a variable technical characteristic (parameter) which has a valid relationship to the cost of the item. In most cases, the CER's were derived from selected historical cost data from the Rockwell data bank for items with like or similar variable characteristics (see Figure 3-4).

Historical program parameters were reviewed and selected for costing use on the ETVP program by experienced space project cost analysts, responsible ETVP engineers, and with specialist support as required. Data were developed on the basis of the ETVP WBS requirements. Both design, development, test and evaluation (DDTSE) or non-recurring data and recurring data were prepared. These data include parameters, CER's, allowances for development benefits (off the shelf), selected scaling slopes, learning curves, escalation and complexity factors, and programmatic requirements such as ground test articles, ground test programs, and peculiar support equipment. Potential supplier component cost data were utilized in the cost model to the extent such cost data were available during the course of the study. The source of these costs is identified as *engineering* in the supporting cost data.

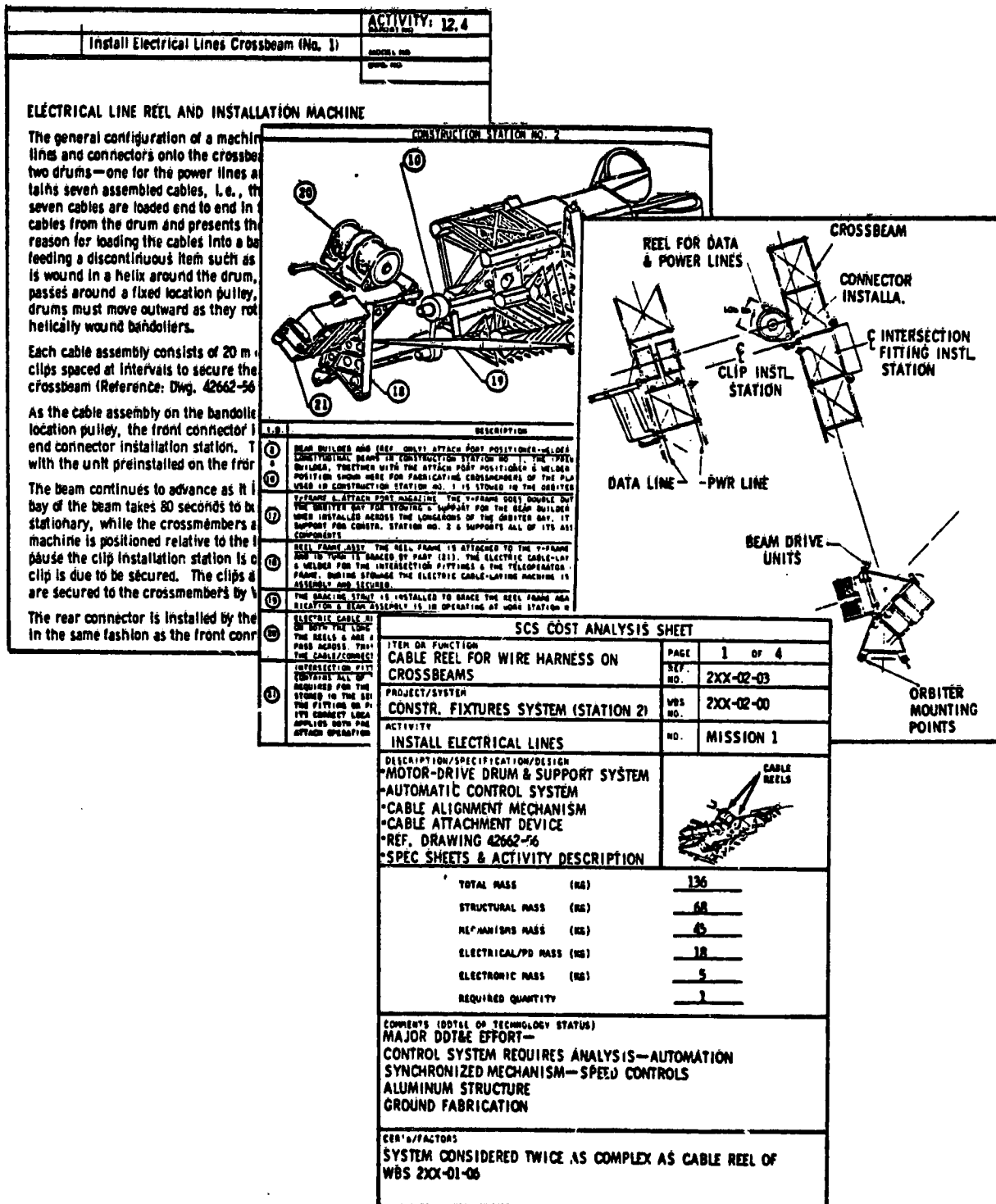
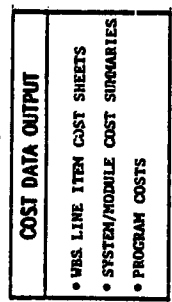
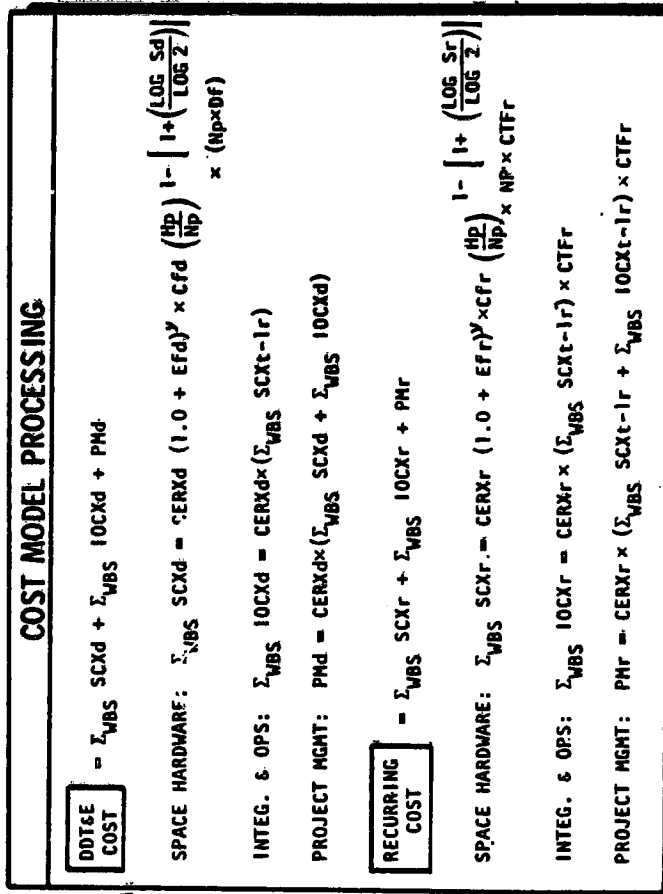
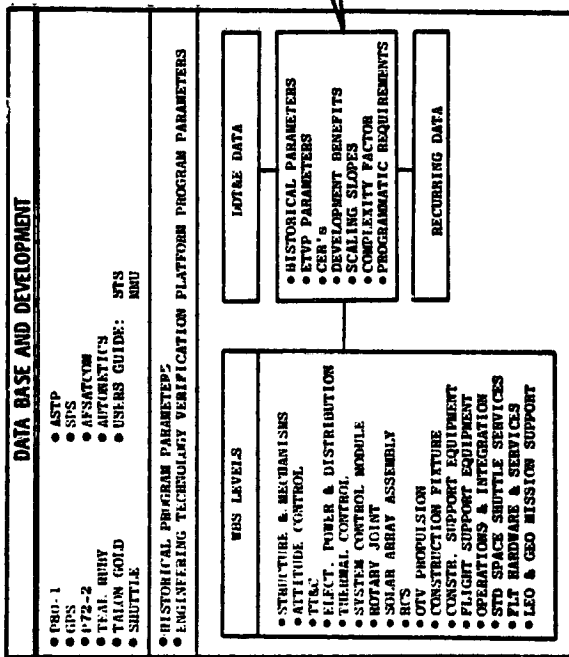

Figure 3-3. Cost Analysis Input Data



ORIGINAL PAGE IS
OF POOR QUALITY

Figure 3-4. Parametric Costing Methodology

The cost model mathematical processing equations allow the cost estimator to normalize the historical cost data CER's to reflect the impact on ETVP cost for any differences between the program requirements of the historical data and the projected ETVP requirements. These modifications include adjustments for the differences in complexity of design, allowances for carryover development benefits, scaling for size differences, regression for learning curve quantity benefits, and economic escalation to adjust historical cost year dollars to current year dollars. Table 3-2 defines the normalization factors and other components of the cost model.

Table 3-2. Glossary of Parametric Cost Model Elements

Element	Definition
CERXd	DDT&E (Non-Recurring) CER for WBS Item "X"
CERXr	Recurring CER for WBS Item "X" (TFU CER)
Cfd	DDT&E Complexity Factor
Cfr	Recurring Complexity Factor
CTFr	Recurring learning curve cumulative Total Factor for quantity required
Df	Development factor
Efd	DDT&E escalation factor
Efr	Recurring escalation factor
Hp	Historical parameter (characteristic)
IOCXd	DDT&E Integration and Operations cost for WBS Item "X"
IOCXr	Recurring Integration and Operations cost for WBS Item "X"
IOCXt-1r	TFU (Theoretical First Unit—recurring) Integration and Operations cost for WBS Item "X"
LOG Sd	Log of DDT&E scaling slope
LOG Sr	Log of recurring scaling slope
Np	New (ETVP) parameter (characteristic)
PMd	DDT&E Project Management cost
PMr	Recurring Project Management cost
SCXd	Space Hardware DDT&E cost for WBS Item "X"
SCXr	Space Hardware recurring cost for WBS Item "X"
SCX t-1r	TFU (Theoretical First Unit—recurring) space hardware cost for WBS Item "X"
Σ WBS	Sum of all WBS items in a related category of cost where the element is used, excluding project management
y	Number of years of escalation

PLATFORM AND CONSTRUCTION SYSTEM COSTING

The cost model reflects three basic methods (equations) for processing both DDT&E and recurring costs. These methods apply to space hardware, integration and operations, and project management. The principal equation is the one which generates the cost of space hardware (see Figure 3-4) for both the DDT&E and recurring categories. These equations normalize the historical cost data to make it compatible with ETVP requirements. The space hardware costs generated by these equations become the bases for calculating the cost of Integration and Operations and Project Management. The theoretical first unit (TFU) recurring

ORIGINAL PAGE IS
OF POOR QUALITY

space hardware costs becomes the basis for generating DDT&E and recurring cost for integration and operations (see Tables 3-3 and 3-4). Table 3-3 reflects TFU space hardware cost at \$40.204 million. The cost model is structured to use this value as the base value for calculating the integration and operations DDT&E cost. The rationale for this approach is based upon the belief that the DDT&E costs are dependent to a large extent upon the design complexity and the functional capabilities of the TFU space hardware. Project management cost is generated in much the same manner as integration and operations, but utilizes a different base to which the CER is applied. The DDT&E project management cost base is the total DDT&E space hardware and integration and operations cost less project management DDT&E cost; the same is true for generating recurring project management cost. The base to compute these costs is the total space hardware and integration and operations recurring cost less project management recurring cost.

Table 3-3. Integration and Operations (WBS 1XX-07-00) Cost Base

WBS No.	Description	Millions of Dollars	
		TFU	Recurring
1XX-00-00	PLATFORM SYSTEM	40.204	93.653
-01-00	Platform Structure	6.672	9.928
-01-01	Structure and Mechanisms	0.813	3.148
-01-02	Attitude Control	0.271	0.289
-01-03	TT&C	2.557	3.298
-01-04	EPS and Distribution	3.031	3.193
-02-00	System Control Module	23.701	57.676
-02-01	Structure and Mechanisms	1.924	2.077
-02-02	Attitude Control	10.526	20.370
-02-03	TT&C	2.483	3.478
-02-04	EPS and Distribution	2.204	21.790
-02-05	Thermal Control	6.564	9.961
-03-00	Rotary Joint Assembly	3.655	3.754
-04-00	Solar Array Assembly	-	-
-05-00	Reaction Control Modules	6.176	22.295

Table 3-4. Integration and Operations (WBS 2XX-05-00) Cost Base

WBS No.	Description	Millions of Dollars	
		TFU	Recurring
2XX-00-00	CONSTRUCTION BASE	22.872	37.018
-01-00	Construction Fixture Systems	14.485	24.015
-01-01	Main Beams	0.228	0.434
-01-01	Base Beams	0.429	0.455
-01-01	Jack	0.0	-
-02-03	Wire Harness Reel (Crossbeam)	2.077	2.077
2XX-04-00	Flight Support Equipment	8.387	13.003
-04-01	Berthing Platform	0.561	0.561
-04-02	Forward Cradle Pallet	0.566	0.938
-04-03	Center Pallet	0.825	1.534
-04-04	Aft Pallet	0.887	1.596

The cost model procedure employed to generate space hardware costs utilizes specific CER's, slopes, factors, and complexities applicable to each line item of the WBS (see Figure 3-5). However, the slopes, factors, and complexities may be applicable to more than one item of the WBS. Generally, the CER is different for each item of the WBS such as structure, electrical power, RCS, and TT&C. Yet, the same CER may be utilized for common or like elements within a WBS item. In these cases, where the same CER is used for common or like elements, it may be noted that the scaled CER resulting from the cost model normalization, which is applied to the ETVP parameter, is different for each element—depending upon the parameter value of each element.

The principal source of data for costing the ground-fabricated ETVP elements was the P80-1 program in that the P80-1 is a single vehicle program designed for space experiment purposes. However, as shown in the supporting data (Figure 3-5), other program data were considered to be more suitable for use in costing certain ETVP program elements. These program data include Satellite Power Systems (SPS) studies, Teal Ruby (TR), P73-2, Talon Gold (T-G), Global Positioning System (GPS), Apollo-Soyuz Test Project (ASTP), AFSATCOM, Shuttle Orbiter, and Rockwell Autometrics (A/N) Division data on electronics. In a few cases, solar arrays and QTV data were used from the Rockwell data bank from sources associated with those programs. Items with data source labeled "ENGR" indicate an engineering estimate based upon potential supplier informal cost data. In addition, cost projections for ETVP transportation system and operations were derived from Shuttle data and the Space Transportation System Reimbursement Guide.

OPERATIONS AND LOGISTIC SYSTEM COSTING

ETVP mission requirements used in the projection of cost estimates are based on a series of ground rules and assumptions associated with STS missions.

• Mission No. 1

1. ETVP mission time is sufficiently below the orbiter basic 28 man-days—six men for 4 days results. Thus, no consumables are added for crew life support.
2. Six additional EVA airlock repressurizations are required over orbiter baseline from a costing standpoint.
3. Fixed life support items are costed for three additional crewmen.
4. One PRSD/EPs power plant is to be included in costing.

• Mission No. 2

1. Construction Mission 2 requires six crewmen for five days.
2. Five additional EVA airlock repressurizations are required over cost baselines for a total of seven.

ORIGINAL PAGE IS
OF POOR QUALITY

Historical Data			ETVP Data			Non-Recur Amounts (P-2)	
UNIT	Year	Cost	UNIT	Year	Cost	1979	1980
SYSTEM CENTRAL ASSEMBLY COST Electrical Fuel & Batteries Fanless (2000) Satt. Gens - Battery (1)							
UNIT	1979	1980	UNIT	1979	1980	1979	1980
1	1.122	1.122	1	1.122	1.122	1.122	1.122
SYSTEM CONTROL MODULE Structure & Mechanisms Primary Structure Equipment Support Structure (100) Support Truss - Structure (2) Attach Part (1) Pendulum, Base Electing Adaptor							
UNIT	1979	1980	UNIT	1979	1980	1979	1980
1	2.122	2.122	1	2.122	2.122	2.122	2.122
2	1.000	1.000	2	1.000	1.000	1.000	1.000
3	1.122	1.122	3	1.122	1.122	1.122	1.122
SYSTEM CONTROL MODULE Structure & Mechanisms Primary Structure Equipment Support Structure (100) Support Truss - Structure (2) Attach Part (1) Pendulum, Base Electing Adaptor							
UNIT	1979	1980	UNIT	1979	1980	1979	1980
1	2.122	2.122	1	2.122	2.122	2.122	2.122
2	1.000	1.000	2	1.000	1.000	1.000	1.000
3	1.122	1.122	3	1.122	1.122	1.122	1.122

DESCRIPTION	QTY	MASS (KG)	UNIT	YEAR	1979	1980	RECURRING	ETVP - Construction	Support Equipment	Total	1979	1980
MECHANICAL ASSEMBLY	1	187.7	1	1979	187.7	187.7				187.7	187.7	187.7
Support Structure	1	187.7	1	1979	187.7	187.7				187.7	187.7	187.7
MECHANICAL ASSEMBLY	1	187.7	1	1979	187.7	187.7				187.7	187.7	187.7
Support Structure	1	187.7	1	1979	187.7	187.7				187.7	187.7	187.7
MECHANICAL ASSEMBLY	1	187.7	1	1979	187.7	187.7				187.7	187.7	187.7
Support Structure	1	187.7	1	1979	187.7	187.7				187.7	187.7	187.7
MECHANICAL ASSEMBLY	1	187.7	1	1979	187.7	187.7				187.7	187.7	187.7
Support Structure	1	187.7	1	1979	187.7	187.7				187.7	187.7	187.7
MECHANICAL ASSEMBLY	1	187.7	1	1979	187.7	187.7				187.7	187.7	187.7
Support Structure	1	187.7	1	1979	187.7	187.7				187.7	187.7	187.7
MECHANICAL ASSEMBLY	1	187.7	1	1979	187.7	187.7				187.7	187.7	187.7
Support Structure	1	187.7	1	1979	187.7	187.7				187.7	187.7	187.7
MECHANICAL ASSEMBLY	1	187.7	1	1979	187.7	187.7				187.7	187.7	187.7
Support Structure	1	187.7	1	1979	187.7	187.7				187.7	187.7	187.7
MECHANICAL ASSEMBLY	1	187.7	1	1979	187.7	187.7				187.7	187.7	187.7
Support Structure	1	187.7	1	1979	187.7	187.7				187.7	187.7	187.7
MECHANICAL ASSEMBLY	1	187.7	1	1979	187.7	187.7				187.7	187.7	187.7
Support Structure	1	187.7	1	1979	187.7	187.7				187.7	187.7	187.7

Figure 3-5. Supporting Cost Data

3. One PRSD/EPS power plant is to be costed for supplying electrical power.
4. Fixed life support items are added for additional crewmen.

• Mission No. 3

1. Mission 3 will not exceed the orbiter baseline provisions for 28 man-days.
2. Two additional days of on-orbit time are required.
3. One additional EVA is needed.

EVA provisions¹ exceeding the orbiter baseline EVA accommodations are those in excess of two 2-man EVA's of 8 hours duration each and any payload-unique ancillary transfer and worksite support hardware. The EVA systems cost model used in quantifying the costing of EVA on the payloads is provided in terms of weight, volume, and consumables/expendables—not on dollar cost. However, the Shuttle program assumes all costs of the development and purchase of the EVA equipment, orbiter EVA provisions, and basic training of crew members. EVA cost elements contained in the model are:

- Pressure garment assembly (PGA) and support equipment
- Primary life support system
- EVA worksite supporting equipment
- Crewman translation and cargo transfer aids
- Consumables and expendables (crew equipment)
- Tools
- Orbiter configuration options
 - tunnel adapter
 - EVA airlock
- Pre- and post-EVA crew time

Space Transportation and Flight Hardware Services

ETVP WBS elements of hardware and services associated with the Space Transportation System (STS) and logistics support (WBS 3XX-00-00) identify requirements and activities needed during construction, platform test/verification, orbit transfer, and GEO operations. The STS element encompasses all hardware systems and support equipment, facilities, and manpower to deliver payloads to earth orbits and perform on-orbit operations and experiments. The Space Shuttle provides transportation to and from near-earth orbit. These elements form the basis of a "standard price" to users. Optional flight systems are also available at prices that would be added to this basic amount. Figure 3-6 identifies the categories of costing associated with the STS logistics system and references the documents used for cost and system definition that were used in arriving at mission charges.

¹Shuttle EVA Description and Design Criteria, Document JSC-10615, NASA/JSC, Houston, Texas, May 1976.

STANDARD SPACE SHUTTLE SERVICES
(CIVILIAN U.S. GOVERNMENT)

- CHARGE FOR EVERY PAYLOAD

OPTIONAL FLIGHT HARDWARE SYSTEMS				
SPINNING SOLID UPPER STAGE (DELTA CLASS)	SPINNING SOLID UPPER STAGE (ATLAS-CENTAUR)	INERTIAL UPPER STAGE	SPACELAB	FLIGHT KITS

- OPTIONAL CHARGE AS REQUIRED

OPTIONAL PAYLOAD RELATED SERVICES						
EXTRA-VEHICULAR ACTIVITY	PAYLOAD SPECIALIST	ADDITIONAL TIME ON ORBIT	PAYLOAD REVISIT	JSC POCC	LAUNCH SITE SERVICES	UNIQUE SERVICES

- OPTIONAL CHARGE AS REQUIRED

REFERENCES:
 STS REIMBURSEMENT GUIDE (JSC-11802)
 SHUTTLE EVA AND DESIGN CRITERIA (JSC-10615)
 SHUTTLE PAYLOAD ACCOMMODATIONS (JSC-07700, VOL. XIV, F)

Figure 3-6. Categories of STS Costing

STS Charges

Standard services, as summarized in Table 3-5, will be detailed in the launch services agreement, the payload integration plan, and the launch site support plan. STS services and charges are identified in Table 3-6.

Table 3-5. Space Shuttle System Payload Accommodations/Ground Rules

<p>For dedicated flights—one day (24 hr from launch to landing) is included in standard charge.¹</p> <ul style="list-style-type: none"> • Normal on-orbit Shuttle orbiter mission is capable of supporting 7-day mission (up to 30 days with flight extension kits)^{1, 2} • Standard support provisions—three crewmen, remote manipulator system, RMS support to EVA, standard support equipment (tools, restraints, lights, television), and voice communications¹ • EVA—orbiter flight provides crew, equipment, and consumables for two STS EVA operations (user pays EVA crew training that is payload-specific)¹ • Baseline orbiter has 1530 kWh of energy and orbiter itself typically uses 204 kWh/day.¹ • 50-kWh electrical power for total payload complement on 7-day mission.² • KSC launch¹—65,000 lb (29,484 kg) at 28.5 deg. orbit inclination —57,000 lb (25,855 kg) at 56 deg. orbit inclination • Shuttle cargo bay length—720 inches (18.29 meters)¹ • On a normal schedule, the user identifies desired launch three years before flight.¹
<p>¹STS Reimbursement Guide (JSC-11802) ²Shuttle Payload Accommodations (JSC-07700, Vol. XIV, F)</p>

Table 3-6. Standard Space Shuttle Services and Charges

SERVICES	
<ul style="list-style-type: none"> • MANAGEMENT RESPONSIBILITIES <ul style="list-style-type: none"> • NASA AND USER • FLIGHT PLANNING & OPS SUPPORT <ul style="list-style-type: none"> • FLIGHT PLANNING & OPS • CREW TRAINING & OPS • FLIGHT SIMULATION • PAYLOAD INTEGRATION • MISSION PLANNING & OPS 	<ul style="list-style-type: none"> • ENGINEERING INTEGRATION • LAUNCH SITE SUPPORT <ul style="list-style-type: none"> • LAUNCH SITE PLANNING • GROUND OPERATIONS • SAFETY • INTERFACE VERIFICATION • DEDICATED FLIGHT COVERS 24 HOURS FROM LAUNCH TO LANDING
CHARGES (1979 DOLLARS)	
<ul style="list-style-type: none"> • DEDICATED STS FLIGHT = $\\$18\bar{M} \times 1.412$ (ESCALATION FACTOR) = $\\$25.42\bar{M}$ • ADDITIONAL DAYS ON ORBIT + \$494,200/DAY • CREW MEMBERS & CONSTRUCTION SPECIALISTS = \$106,000/PERSON • EVA/MMU ACTIVITY = \$141,200 	

Payload-Related Services

Optional payload-related services are specific tasks performed in the user's behalf by NASA using existing internal or external NASA capabilities. These tasks are outside the scope of currently defined standard STS services and are more custom-tailored to specific ETVP project requirements.

Optional services for the ETVP include such items as extravehicular activity, payload specialists and training, and additional time on orbit.

Additional Time On Orbit—

One day of mission operations is included in the standard services to a payload as a part of STS charges. This is defined as a 24-hour period from launch to landing. Any situation involving the need for more than one standard day of on-orbit time would be charged from \$423,600 to \$494,200 in 1979 dollars. The price for payload operations will then be determined at the time of a more detailed requirements definition.

Crew Members and Construction Specialists—

All orbiter crew members will be trained as part of an operations/construction team where each member carries out assigned duties during mission activities. Trained personnel will be charged at the individual rate of \$105,900 to \$141,200 for as many as seven days on orbit. This charge includes the cost of preflight training, in-flight equipment, and supplies (food, biomedical needs, and personal items). As the trained specialist will make repeated flights during construction and LEO operations, the average cost per crewman has been identified at \$105,900 per person.

Extravehicular Activity (EVA)—

EVA includes all activities for which crew members don space suits and life support systems and perform operations internal or external to the cargo bay. Two EVA's are standard in every orbiter flight and include equipment and consumables for EVA operations, each lasting a maximum of eight hours as planned for the ETVP construction program.

The following functions and hardware will be performed or provided by NASA: extravehicular mobility unit, manned maneuvering unit, communications equipment, flight design, flight operations support, crew activity planning, and training. However, the user assumes costs for EVA systems, provisions, EVA support equipment, and EVA crew training that are payload-specific.

Flight Kits

Optional flight hardware kits to extend on-orbit capabilities are available at extra charge to the mission. ETVP construction analyses require one power reactant supply and distribution/electrical power supply (PKSD/EPS) system to provide additional electrical power. Table 3-7 identifies the cost for this system and its required installation charges.

Table 3-7. PRSD/EPS Kit

• INSTALLATION AT FLIGHT NO. 1 AND REMOVAL AT END OF FLIGHT 2	
INSTALLATION TIME	
• 225 - 16 (ADJUSTMENT FACTOR)	= 209 HOURS
• REMOVAL TIME	
• 105 - 8 (ADJUSTMENT FACTOR)	= 97 HOURS
TOTAL	<u>306 HOURS</u>
• COSTING (1979 DOLLARS)	
• 306 HOURS × \$19,415/HR	= \$5.941×10 ⁶
• PRSD/EPS USER'S FEE	
2 FLIGHTS @ \$155,320	= \$0.311×10 ⁶
GRAND TOTAL	= \$6.252×10 ⁶

ETVP Servicing

Cost estimates for replacement hardware were based on a maintenance factor times the recurring cost of selected items. At the onset of the study, an engineering review board projected maintenance factors after establishing a set of servicing and redundancy guidelines (Table 3-8). The cost of replacement items and LRU's including RCS modules, TT&C, and GN&C units totaled \$191.076×10⁶ for the required missions.

Table 3-8. ETVP Servicing and Redundancy Guidelines

SERVICING
<ul style="list-style-type: none"> • THE ETVP DESIGN CONCEPT SHALL BE COMPATIBLE WITH UNMANNED REMOTE SERVICING APPROACHES. • SPECIAL OPERATING MODES OR CONDITIONS SHALL BE PERMITTED DURING SERVICING OPERATIONS • RCS DESIGN SERVICING INTERVAL BASED ON LEO-GEO OTV DELIVERY CAPABILITY
REDUNDANCY
<ul style="list-style-type: none"> • ETVP SHALL HAVE ONE TIER OF REDUNDANCY AS IT IS DESIGNED TO BE SERVICED IN SPACE. • DESIGN TO A FAIL-SAFE REQUIREMENT WITH A STRONG CONSIDERATION FOR ADDED COST.

ETVP COST SUMMATIONS

Total ETVP costs were developed by WBS sub-level elements to identify DDT&E (non-recurring) and acquisition (recurring) cost categories. This section presents summarized cost data and makes comparisons in each phase of the project.

DDT&E and Acquisition Costs

Table 3-9 summarizes costs by main elements of the ETVP WBS grouped into categories of DDT&E and acquisition. DDT&E cost data cover design development, test/evaluation, and other non-recurring costs such as tooling and test equipment. The cost estimate for integration and operations covers systems engineering, peculiar support equipment, flight support operations, ground test and evaluation, data, and project management. This means that integration and operations requirements for all line items of the WBS category are included in this line item. Acquisition costs are presented in the same fashion, but they include the cost of training and simulation requirements.

Table 3-9. DDT&E and Acquisition Costs (Millions \$1979)

WBS NO.	DESCRIPTION	DDT&E (NON-RECUR)	ACQUISITION (RECURRING)	TOTAL
1XX-00-00	PLATFORM SYSTEM	247.258	240.738	487.996
-01-00	PLATFORM STRUCTURE	26.696	9.928	36.624
-02-00	SYSTEM CONTROL MODULE	36.909	57.676	94.585
-03-00	ROTARY JOINT ASSEMBLY	5.014	3.754	8.768
-04-00	SOLAR ARRAY ASSEMBLY	21.917	17.686	39.603
-05-00	REACTION CONTROL MODULES	15.677	22.295	37.972
-06-00	ORBIT TRSF. PROPUL. MODULE	75.000	90.050	165.050
-07-00	INTEGRATION & OPERATIONS	66.045	39.349	105.394
-08-00	ETVP PAYLOADS	TBD	TBD	TBD
2XX-00-00	CONSTRUCTION SYSTEM	97.048	69.591	166.639
-01-00	CONSTR. FIXTURE (STATION 1)	28.513	21.924	50.437
-02-00	CONSTR. FIXTURE (STATION 2)	5.104	2.936	8.040
-03-00	CONSTR. SUPPORT EQUIPMENT	9.733	6.374	16.107
-04-00	FLIGHT SUPPORT EQUIPMENT	7.629	15.136	22.765
-05-00	OPERATIONS & INTEGRATION	46.069	23.221	69.290
3XX-00-00	OPERATIONS & LOGISTICS SYSTEM	0	575.136	575.136
-01-00	STD SPACE SHUTTLE SERVICES	0	76.260	76.260
-02-00	OPT. FLT. HARDWARE & SERV.	0	14.518	14.518
-03-00	LEO & GEO LOGISTICS/MISSIONS	0	484.358	484.358

A distribution of DDT&E and acquisition costs for the ETVP construction system is illustrated in Figure 3-7 where, in this case, the estimated costs of integration and operations (reference Table 3-9) have been mathematically prorated in a simplified fashion to provide some perspective within each system line item. In this comparison, the construction fixtures represent nearly 50% of the combined DDT&E and acquisition costs. When adding the modification cost and cost of acquiring construction support equipment, about 70% of the cost is

attributable to space construction related hardware and software. The other 30% is required for (1) flight support equipment (pallets and fixture mounts in the orbiter bay, and brackets needed to carry the equipment to orbit); (2) construction systems engineering/integration; and (3) the program of crew training and simulation.

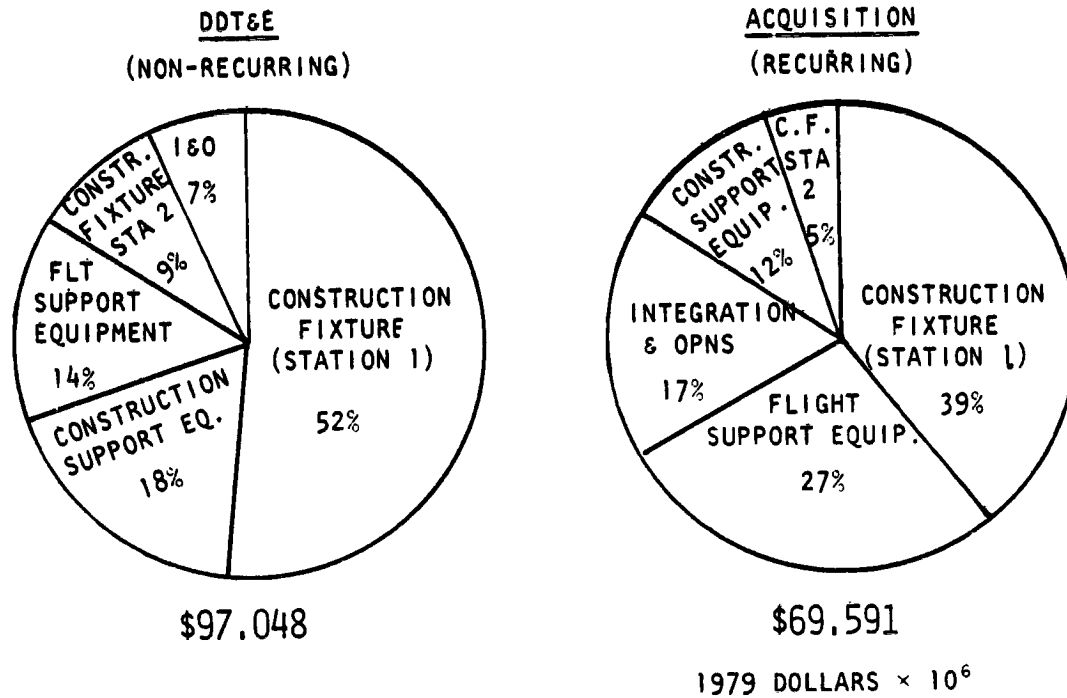

Figure 3-7. Construction System Costs through Platform IOC

Cost Estimates through IOC

ETVP costing through IOC falls into three main categories—the construction system, the platform system, and the transportation and logistics system. A cost comparison of these categories is shown in Table 3-10, where the construction system is equal to about 30% of the total project cost, with 55% for the platform system design and hardware/software, and approximately 15% for the Space Shuttle transportation system to carry out the space construction process and to make an operational performance check of the ETVP.

Other similar comparisons can be drawn for the program phases that follow ETVP IOC. For example, the projected mission plan envisions a two-year test and evaluation period at LEO with payloads attached. The platform/payloads will then be readied for transfer to GEO in another phase to be followed by a 20-year operational period with two servicing missions at seven-year intervals. Costs for these activities were developed and are included in this report for any subsequent evaluation.

Table 3-10. ETVP Costing through IOC

WBS NO.	ITEM DESCRIPTION	DDT&E	ACQUISITION	TOTAL
		1979 DOLLARS $\times 10^6$		
	TOTAL COST THROUGH IOC	\$269.306	\$311.057	\$580.363
1XX-00-00	PLATFORM SYSTEM	29.7%	25.9%	55.6%
2XX-00-00	CONSTRUCTION SYSTEM	16.7%	12.0%	28.7%
3XX-00-00	TRANSPORTATION AND LOGISTICS SYSTEM	0	15.7%	15.7%
	TOTAL PERCENT	46.4%	53.6%	100.0%

WBS Line Item Costs

In a prior section, detail line item and component level cost sheets illustrated the CER's, factors, and parameters used in arriving at estimates for the hardware, software, and services. Table 3-11 represents a summary and identifies non-recurring and recurring costs of WBS elements covering each subsystem or module of the ETVP project. Supportive detail exists for each of these items and was obtained during the Part II study, capitalizing on the work of Part I as contained in the Space Construction Data Base document, SSD 79-0125, dated June, 1979.

PROGRAM FUNDING PLAN

Based on program schedules presented in an earlier section of this volume, an analysis was conducted to establish time-phased costing of each WBS item. A spread function curve (ojive) was used in the calculation of time-phased costs against each main line item of the WBS at a subsystem level. The cost spreading was projected for DDT&E and acquisition phasing by using various functions between 20/80 and 80/20 for the curve spread. This approach provided distributions supporting a low front-end buildup with the flexibility to shift costs in a manner suitable to the phasing of subsystem development and start-up requirements.

SPREAD-PAD

A general-purpose computer program (SPREAD-PAD) was developed and used to apportion ETVP line item costs over the appropriate periods. Figure 3-8 illustrates copies of computer tabulations and final summation sheets of recurring and non-recurring costs plus line item spreads

ETVP Costs by Year

The ETVP funding plan shown in Figures 3-9 and 3-10 displays an incremental cost buildup to the fourth year after go-ahead. Years 4 and 5 are peak expenditure periods in preparation for the sixth year when hardware and software are

Table 3-11. ETVP WBS Cost Matrix

WBS NO.	DESCRIPTION	DDT&E	ACQUISITION	TOTAL
		1979 DOLLARS X 10 ⁶		
1XX-00-00	PLATFORM SYSTEM	247.258	240.738	487.996
-01-00	PLATFORM STRUCTURE	26.696	9.928	36.624
-01-01	STRUCTURE & MECHANISMS	17.063	3.148	20.211
-01-02	ATTITUDE CONTROL	0.334	0.289	0.623
-01-03	TT&C	6.640	3.298	9.938
-01-04	EPS & DISTRIBUTION	2.659	3.193	5.852
-02-00	SYSTEM CONTROL MODULE	36.909	57.676	94.585
-02-01	STRUCTURE & MECHANISMS	3.888	2.077	5.965
-02-02	ATTITUDE CONTROL	14.734	20.370	35.104
-02-03	TT&C	4.174	3.478	7.652
-02-04	EPS & DISTRIBUTION	7.019	21.790	28.809
-02-05	THERMAL CONTROL	7.094	9.961	17.055
-03-00	ROTARY JOINT ASSEMBLY	5.014	3.754	8.768
-03-01	STRUCTURES & MECHANISMS	3.978	3.307	7.285
-03-02	EPS & DISTRIBUTION	1.036	0.447	1.483
-04-00	SCALAR ARRAY ASSEMBLY	21.917	17.686	39.603
-05-00	REACTION CONTROL MODULES	15.677	22.295	37.972
-06-00	ORBIT TRANSFER PROPULSION MODULE	75.000	90.050	165.050
-07-00	INTEGRATION & OPERATIONS	66.045	39.349	105.394
-07-01	PECULIAR SUPPORT EQUIPMENT	9.730	0.750	10.480
-07-02	FLIGHT SUPPORT OPERATIONS & SERVICES	3.458	8.616	12.074
-07-03	GROUND TEST & EVALUATION	23.962	8.710	32.672
-07-04	SYSTEM ENGINEERING & INTEGRATION	17.047	10.489	27.536
-07-05	PROJECT MANAGEMENT	9.556	8.817	18.373
-07-06	DATA	2.292	1.967	4.259
-07-07	FLIGHT OPERATIONS TO GEO	TBD	TBD	
-08-00	ETVP PAYLOAD	TBD	TBD	
2XX-00-00	CONSTRUCTION SYSTEM	97.048	69.591	166.639
-01-00	CONSTRUCTION FIXTURE SYSTEM (STATION 1)	28.513	21.924	50.437
-01-01	MAIN YOKE & SUPPORTS	2.519	1.025	3.544
-01-02	BRIDGE BEAM	3.836	4.541	8.377
-01-03	LONG BEAM ROLLER SUPPORT	1.852	3.635	5.487
-01-04	BEAM BUILDER POSITIONER	2.192	1.143	3.335
-01-05	SUPPORT TRIPOD & MAGAZINE	1.587	0.697	2.284
-01-06	CABLE REEL	1.998	1.259	3.257
-01-07	FIXTURE MOUNTS AND BRACKETS	1.195	1.193	2.388
-01-08	FIXTURE DEPL. SYSTEMS	3.062	1.787	4.849
-01-09	REACTION CONTROL SYSTEM	2.673	3.118	5.791
-01-10	EPS & DISTRIBUTION	1.163	0.967	2.130
-01-11	ATTITUDE CONTROL SYSTEM	1.061	1.156	2.217
-01-12	TT&C	0.315	0.558	0.873
-01-13	CONSTRUCTION MINI-COMPUTER/SOFTWARE	5.060	0.845	5.905
-02-00	CONSTRUCTION FIXTURE SYSTEM (STATION 2)	5.104	2.936	8.040
-02-01	SUPPORT STRUCTURE	0.706	0.397	1.103
-02-02	INTERSECTION FITTING CANISTER	0.627	0.462	1.089
-02-03	WIRE HARNESS REEL	3.771	2.077	5.848
-03-00	CONSTRUCTION SUPPORT EQUIPMENT	9.733	6.374	16.107
-03-01	BEAM BUILDER MODS	0.800	0.200	1.000
-03-02	MANNED REMOTE WORK STATION MODS	1.104	0.514	1.618
-03-03	RMS MODS	0.950	0.810	1.760
-03-04	LIGHTING & CCTV	0.400	0.210	0.610
-03-05	SPEC. TOOLS & INSTR., IAU, C/C EQUIP.	5.479	4.473	9.952
-03-06	CSE COMPUTER/SOFTWARE	1.000	0.167	1.167
-04-00	FLIGHT SUPPORT EQUIPMENT	7.629	15.136	22.765
-04-01	BERTHING PLATFORM	0.905	0.561	1.466
-04-02	FORWARD CRADLE PLATFORM	0.947	0.938	1.885

Table 3-11. ETVP WBS Cost Matrix (Cont.)

WBS NO.	DESCRIPTION	1979 DOLLARS X 10 ⁶		
		DDT&E	ACQUISITION	TOTAL
-04-03	CENTER PALLETS	0.937	1.534	2.471
-04-04	AFT PALLETS	1.309	1.660	2.969
-04-05	RCS AFT PALLET	1.798	3.103	4.901
-04-06	PALLET SUPPORTS	1.733	7.340	9.073
-05-00	OPERATIONS & INTEGRATION	46.069	23.221	69.290
-05-01	PECULIAR SUPPORT EQUIPMENT	5.535	0.296	5.831
-05-02	FLIGHT SUPPORT OPERATIONS/SERVICES	1.967	3.406	5.373
-05-03	GROUND TEST & EVALUATION	13.632	3.443	17.075
-05-04	SYSTEM ENGINEERING & INTEGRATION	19.396	4.146	23.542
-05-05	PROJECT MANAGEMENT	4.235	3.485	7.720
-05-06	DATA	1.304	0.777	2.081
-05-07	TRAINING & SIMULATION	Ø	7.668	7.668
-05-08	FLIGHT TEST PROGRAM	TBD	TBD	
3XX-00-00	OPERATIONS & LOGISTICS SYSTEM			
-01-00	STANDARD SPACE SHUTTLE SERVICES	Ø	575.136	575.136
-01-01	FLIGHT PLANNING & OPNS SUPPORT		76.260	76.260
-01-02	ENGINEERING INTEGRATION		-	-
-01-03	LAUNCH SITE SUPPORT		-	-
-01-04	SPACE TRANSPORTATION SYSTEM		-	-
-02-00	OPTIONAL FLIGHT HARDWARE & SERVICES			
-02-01	PRSD/EPS TANK SET UNITS		14.518	14.518
-02-02	ADDITIONAL TIME ON ORBIT		6.252	6.252
-02-03	CREW MEMBERS		4.942	4.942
-02-04	EVA-MMU ACTIVITY		1.696	1.696
-02-05	BEAM BUILDER		1.128	1.128
-02-06	MANNED REMOTE WORK STATION		0.500	0.500
-03-00	LEO & GEO LOGISTICS/MISSION SUPPORT			
-03-01	STANDARD SPACE SHUTTLE SERVICES		484.358	484.358
-03-02	OPTIONAL FLT HARDWARE & SERVICES		279.620	279.620
-03-03	ETVP SPACE TESTS & VERIFICATION	Ø	13.662	13.662
			191.076	191.076

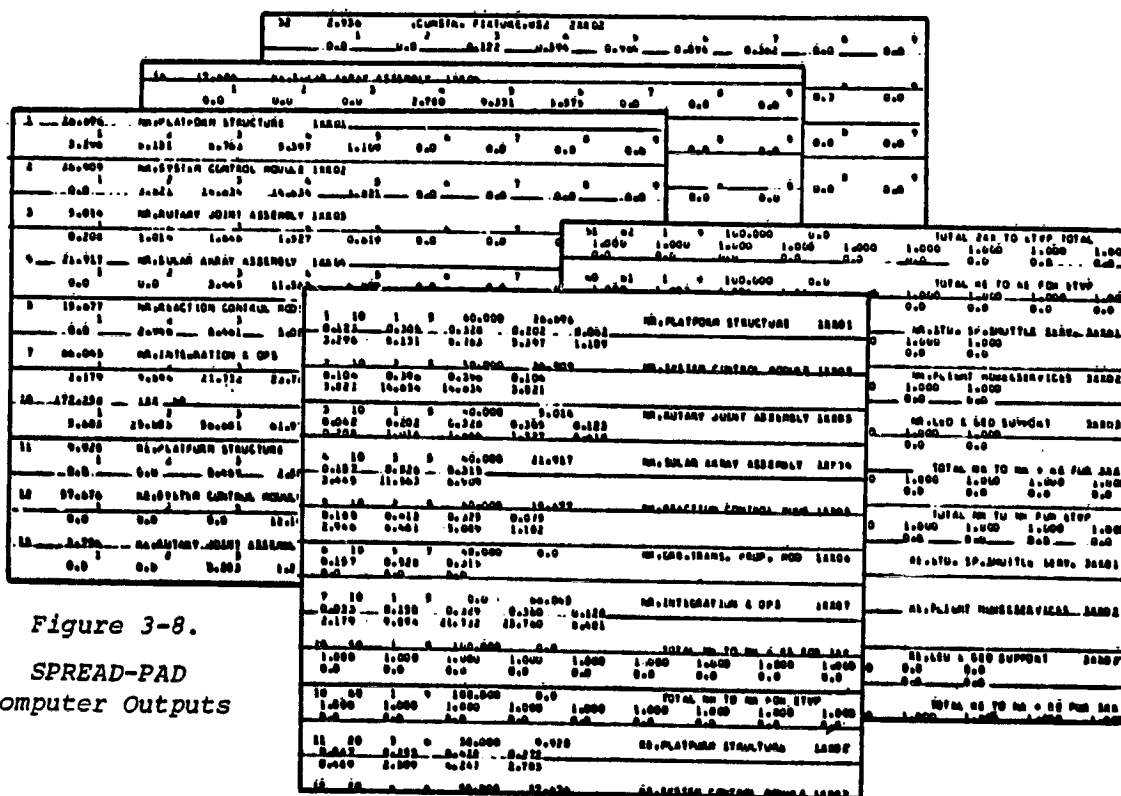

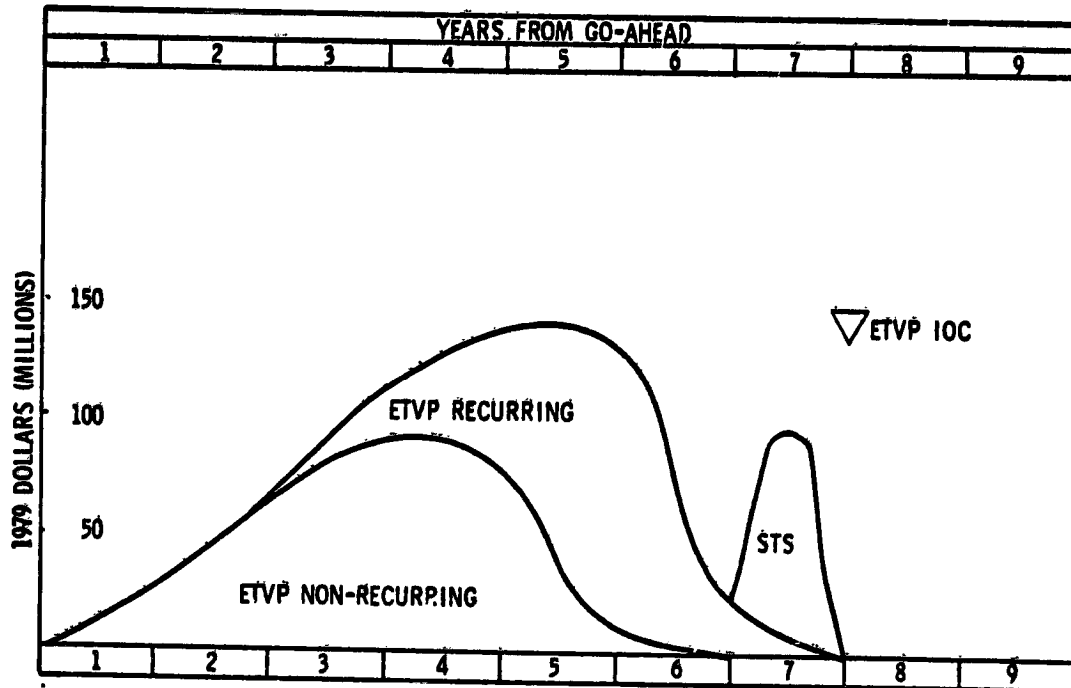

Figure 3-9. ETVP Funding Plan through IOC (Recurring/Non-Recurring)

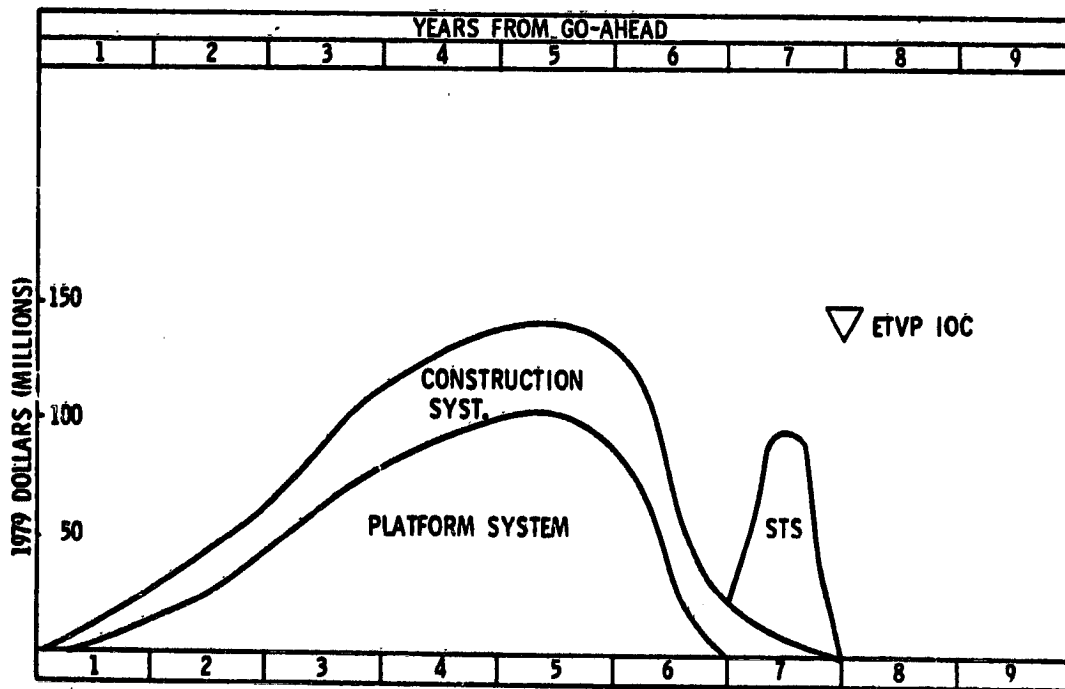

Figure 3-10. ETVP Funding Plan through IOC

needed to satisfy the training and simulation, plus flight test phases of the project. IOC is scheduled for the seventh year and accounts for expenditures associated with space transportation, logistics, and space construction of the ETVP. Figure 3-11 presents a funding plan developed on the Space Transportation System requirements and operational support at LEO and GEO.

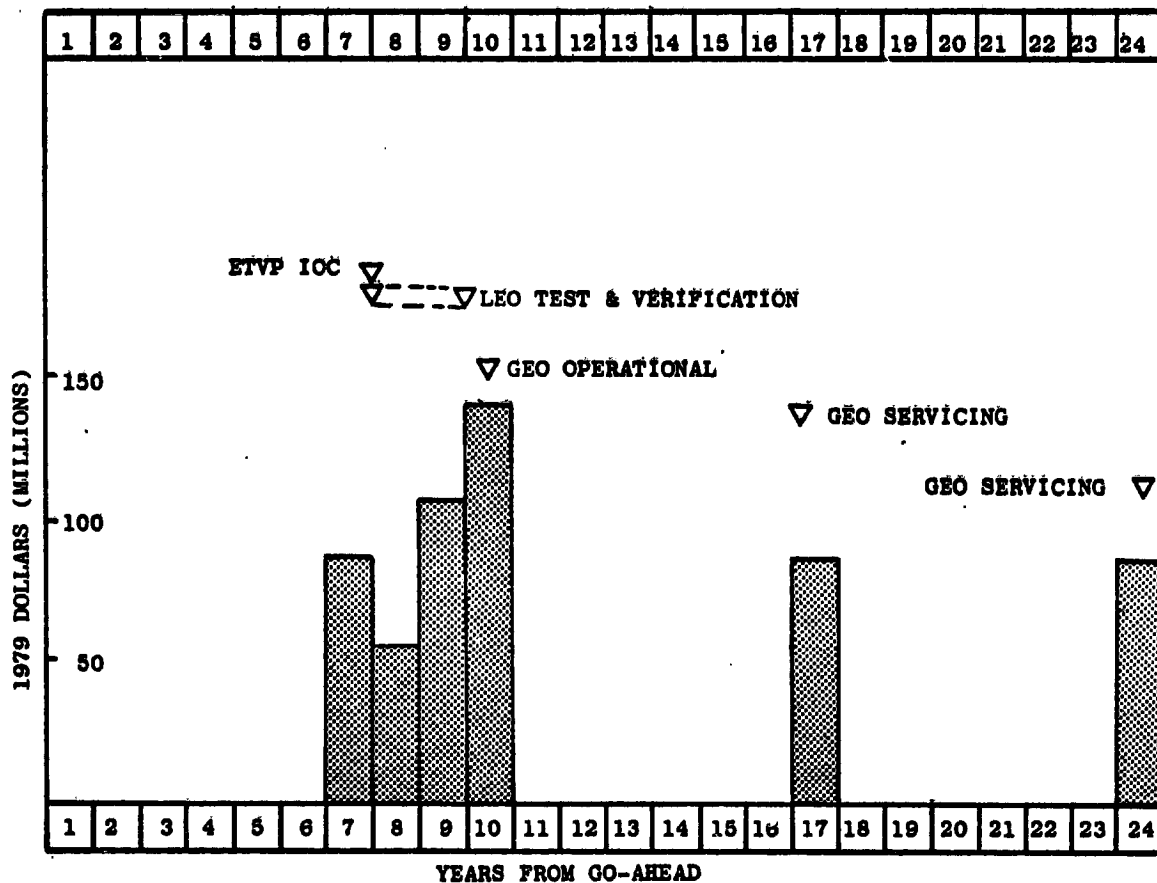

Figure 3-11. Operations and Logistics System Funding Plan

PRECEDING PAGE BLANK NOT FILMED

4.0 CONCLUSIONS

Several assessments are presented in this section on ETVP cost and programmatic areas.

CONSTRUCTION SYSTEM EVALUATION

A distribution of ETVP program costs are illustrated in Table 4-1 as they occur before and after IOC, which means that those elements to build the ETVP are separate from those to maintain and operate the platform over 20 years. Of the costs to build an ETVP, about 30 percent is required for DDT&E and acquisition of the construction system. These costs of \$166.639×10⁶ were "scrubbed" after their initial development to (1) confirm complexity impacts on costs, (2) acknowledge considerations for technology development, and (3) make a comparative assessment of the cost estimate by conducting a sensitivity analysis of variables and then to recompute their costs.

Table 4-1. ETVP Program Costs

	PROGRAM COSTS		% OF PROGRAM COST	
	PRE-IOC	POST-IOC	PRE-IOC	POST-IOC
• PLATFORM SYSTEM 1XX	322.946	165.050	55.6%	25.4%
• CONSTRUCTION SYSTEM 2XX	166.639	0	28.7%	0
• STS/OPERATIONS 3XX	90.778	484.357	15.7%	74.6%
TOTAL	580.363	649.407	100%	100%

CONSTRUCTION SYSTEM ITEMS (COSTS ARE PRE-IOC EXPENDITURES—58.2% DDT&E, 41.8% ACQUISITION)

• CONSTRUCTION FIXTURE 1	\$50.437	30.3%
• CONSTRUCTION FIXTURE 2	8.040	4.8%
• CONSTR. SUPPORT EQUIP.	16.107	9.6%
• FLIGHT SUPPORT EQUIP.	22.765	13.7%
• OPERATIONS & INTEGRATION PSE, GSE, GRD. TEST/EVAL, PROJ. MGMT/SYS. ENGR., TRAINING & SIMULATION	69.290	41.6%
		100%

MAIN COST CONTRIBUTORS

1. CONSTRUCTION FIXTURE BRIDGE BEAM
2. SPECIAL TOOLS AND PLATFORM CHECKOUT EQUIPMENT
3. PALLET SUPPORTS
4. GROUND TEST & EVALUATION
5. TRAINING & SIMULATION

1979 DOLLARS IN MILLIONS

After this analysis, main cost contributors (over \$6 million each for DDT&E and acquisition) were singled out and are identified as Items 1 through 5 in Table 4-1, excluding system engineering and integration/management activities. These five items (from a total of 36) represent 34% of DDT&E and 44% of acquisition costs on the construction system. Further analysis leads to the following:

1. Two-thirds of bridge beam cost is driven by design complexities of the mechanisms-gear train and rotating shafts. The other one-third is basic structure.
2. Special tools and checkout equipment are those required to verify operational alignment of the platform after construction. The alignment unit represents 75% of the cost.
3. Pallet supports include a majority of the unique structure/braces, latches, and mechanisms that hold construction items in the orbiter bay for transfer to LEO, each designed separately.
4. Ground test and evaluation costs are factored as a percentage of first-unit cost based on Rockwell program experience.
5. Training and simulation costs cover labor associated with a planned two-year program, whereas training equipment and facilities are GFE or are included in the cost of ETVP hardware.

AREAS OF SENSITIVITY APPLICABLE TO THE FIVE ITEMS

1. DESIGN COMPLEXITY
2. PLATFORM ALIGNMENT ACCURACY REQUIREMENTS
3. DESIGN COMPLEXITY VERSUS MULTI-PURPOSE USAGE
4. NEED FOR DESIGN DEFINITION
5. DEGREE OF TRAINING ACTUALLY NEEDED

First-unit costs of the ETVP construction system ($\$166,639 \times 10^6$) represent 52% of the platform cost estimate ($\$322.946 \times 10^6$). A similar comparison with first-unit costs of the Rockwell reference Satellite Power System (SPS), from work under a NASA/MSFC contract, shows this same ratio at 100%. However, the SPS is a more complex construction activity with larger investments, and the construction process is carried out at GEO. Another SPS comparison showed that the construction system is 23% of the average satellite cost over a total of 60 satellites.

ETVP SCHEDULE ASSESSMENT

An analysis of ETVP schedules shows that potential sensitivities exist in several areas of the ETVP program: (1) the platform and construction fixture systems; (2) construction and flight support equipment; (3) training and simulation; and (4) supporting programs, such as the Space Transportation System and the Beam Builder. These assessments revealed the following:

- Program planning and scheduling of platform systems and construction equipment are adequate to support design reviews, tests/evaluations, delivery of mockups and boilerplates, and final hardware for platform construction.
- The most schedule-constraining item reflected in ETVP planning appears to be the beam builder. A two-machine alternative program¹ was selected to provide (1) a ground test beam builder (GTBB) for ETVP training and simulation requirements, and (2) a flight test beam builder (FTBB) for the ETVP flight test program. The GTBB can be slightly advanced from the currently scheduled ETVP need date of mid-year 5, but the training and simulation activity is adequately supported by the present schedule. The flight-ready unit (FTBB) is scheduled¹ for the fourth month of year 6. This precedes ETVP scheduled flight test experiments by some two months and provides a relatively short turnaround time if some concerning problem requires attention. This test will function as a final qualification in the space environment and zero-g conditions for ETVP fabrication with the beam builder.
- Initial technology assessments and basic material/mechanism developments for the platform and construction system will be available at 2-1/2 years after go-ahead. This appears sufficient for design conclusions on composite materials, joining process, electrical connectors and switching gear, plus supporting solar array designs, special tooling, and platform components.
- The 8-psi suit (EMU) is a technology and development item that would be undertaken in parallel with the ETVP program, or as an alternative special item for the ETVP, based on further studies of interfaces with the Shuttle orbiter. In any event, a three-year period appears adequate for EMU development based on the analysis of similar 4-psi EMU projects.
- Sufficient time was allowed for the planning and implementation of (1) modifications to the RMS for the addition of an upper-arm rotational capability; (2) modifications to the open cherry picker (MRWS) design; and (3) procurement activities on end effectors, items of construction and flight equipment, the IMU alignment package, and the RCS rotary canister/pallet.

ETVP MISSIONS

ETVP program activities involve 11 STS flights in the post-IOC time frame, whereas three flights are needed for pre-IOC construction activities. Some optimizations of on-orbit operations and construction processes offer a potential reduction in the number of required flights. Two areas that could benefit from further study are (1) orbiter packaging and construction activity sequences, and (2) the use of kits and provisions for extended on-orbit durations for longer construction periods.

¹Space Construction Automated Fabrication Experiment Definition Study (SCAFEDS), General Dynamics Convair, NASA/JSC, NAS9-15310, January 1980.