



3 1176 00140 1026

# NASA Technical Memorandum 81796

NASA-TM-81796 19800013919

EFFECTS OF METHOD OF LOADING AND SPECIMEN  
CONFIGURATION ON COMPRESSIVE STRENGTH OF  
GRAPHITE/EPOXY COMPOSITE MATERIALS **FOR REFERENCE**

NOT TO BE TAKEN FROM THIS ROOM

RONALD K. CLARK AND W. BARRY LISAGOR

APRIL 1980

**LIBRARY COPY**

APR 1 1980

LANGLEY RESEARCH CENTER  
LIBRARY, NASA  
HAMPTON, VIRGINIA



National Aeronautics and  
Space Administration

Langley Research Center  
Hampton, Virginia 23665



EFFECTS OF METHOD OF LOADING AND SPECIMEN CONFIGURATION  
ON COMPRESSIVE STRENGTH OF GRAPHITE/EPOXY COMPOSITE MATERIALS

By

Ronald K. Clark and W. Barry Lisagor  
NASA-Langley Research Center  
Hampton, Virginia

SUMMARY

The focus of this investigation was to provide results that will support the selection of a reliable method of compressive testing coupon specimens of filament-reinforced polymer-matrix composite materials. Three test schemes were examined for testing graphite/epoxy (Narmco T300/5208) composite material specimens to failure in compression, including an adaptation of the IITRI "wedge grip" compression fixture, a face-supported-compression fixture, and an end-loaded-coupon fixture. The effects of specimen size, specimen support arrangement and method of load transfer on compressive behavior of Gr/Ep were investigated.

Compression tests with the modified IITRI and face-supported fixture were conducted on specimens of 12.5-, 25-, and 50-mm widths; of 8-, 16-, and 24-ply thicknesses; and of [0], [+45], and [0/+45/90] fiber orientations. The end-loaded-coupon fixture was used to test 16-ply [0/+45/90] specimens.

Compressive stress-strain, strength, and modulus data obtained with the three fixtures are presented with evaluations showing the effects of all test parameters, including fiber orientation. The IITRI fixture has the potential to provide good stress/strain data to failure for unidirectional and quasi-isotropic laminates. The face supported fixture was found to be the most desirable for testing [+45]<sub>s</sub> laminates.

N 80-22406 #

## INTRODUCTION

The efficient use of filament reinforced composite materials in aerospace applications requires that their thermal, physical, and mechanical properties be established accurately. Because of the inhomogeneity and brittle nature of these composites, the properties measured are more sensitive to testing equipment and procedures than are those for isotropic, homogeneous materials possessing some ductility. Reliable compressive properties for composite materials are the most difficult of all mechanical properties to acquire because of the sensitivity of compression tests to a range of factors including test method, quality of material and uneven loading of specimens (ref. 1). The importance of good compression test methods is related to the fact that compression loads are often a dominant factor when composites degrade under cyclic loading and environmental exposure (ref. 2) and the fact that compressive strength is the property most severely affected when composites experience environmental degradation.

Compression test methods currently in use generally are of three types: sandwich beam compression test method, unsupported compression coupon test methods, and supported compression coupon test methods. Reference 1 gives an evaluation of the sandwich beam compression test method, which has been highly regarded as a dependable means of testing composite materials in compression, although questions have been raised regarding the effects of the honeycomb on performance of the laminate. Drawbacks include the relatively high cost of the sandwich beam specimen and its general unsuitability for environmental testing. A host of fixtures have been employed to test specimens that are unsupported in the gage length. Reference 3 presents a good description of the IITRI wedge-grip compression test fixture which is perhaps the most widely used fixture of this class. The supported compression coupon test methods include those procedures in which the specimen is fully supported in the gage

length to prevent buckling during loading. References 4 and 5 contain good descriptions of fixtures of this class.

Three ASTM approved standard test procedures for compression tests of composite materials include "Test for Compressive Properties of Rigid Plastics" (ref. 6), "Test for Compressive Properties of Oriented Fiber Composites" (ref. 7), and "Flexure Test of Flat Sandwich Constructions" (ref. 8).

This paper presents results from an evaluation of three schemes for compression testing coupons of graphite/epoxy composite material. These results are presented for the purpose of identifying sensitivity of individual test techniques to laminate, specimen, and test parameters and comparing results from the three test schemes. The test fixtures utilized included an adaptation of the IITRI compression fixture, a face-supported compression fixture, and an end-loaded-coupon fixture.

## PROCEDURE

Compression tests of Narmco T300/5208 graphite-fiber reinforced epoxy-resin matrix (Gr/Ep) composite material specimens were conducted using three test fixtures. Table 1 defines the number and type of specimens tested. Preliminary tests were conducted with each fixture using 2024-T4 aluminum alloy sheet specimens to verify the experimental procedures. All tests were conducted at a nominal strain rate of  $17 \times 10^{-5} \text{ (sec)}^{-1}$ .

### IITRI Compression Test Fixture

The IITRI compression test fixture, shown in figure 1 was modified to permit testing of 12.5-, 25-, and 50-mm wide specimens. Figure 1 also shows a sketch of the IITRI specimen. Tabs for the specimen were fabricated from a glass-reinforced epoxy-matrix material (fiberglass) and were bonded to the specimen

using a 392 K cure adhesive. The wedge grips are bolted to each tabbed end of the specimen. This prestressed the tabs transverse to the plane of the specimen and prevented slippage of the tabs under low axial loads. The outer surfaces of the wedge grips react with mating surfaces in the upper and lower bolsters to transmit compression loads to the specimen. The lower bolster has two parallel alignment shafts that fit into two roller bushings in the upper bolster to insure lateral alignment of the upper and lower units. Axial alignment of the upper and lower units is verified by gaging the parallelism of the matching surfaces. Axial alignment was adjusted as necessary by shimming between the contact surfaces of the test machine and the bolsters.

Considerable attention to detail was directed toward achieving precision in fabricating specimens for the IITRI fixture. One of the most critical details was to ensure that the opposing tab surfaces which are gripped during loading are flat within  $\pm 25 \mu\text{m}$ .

#### Face-Supported Compression Test Fixture

Figure 2 shows an exploded view of the face-supported compression fixture with a 50-mm wide specimen and a sketch of the specimen. The specimen was mounted in the fixture with about 0.1 mm clearance between the specimen and the inner platens. Strain gages were positioned on the specimen such that when the specimen was mounted in the fixture, the gages were located within the gap in the inner platens. Tests with this fixture were conducted in a universal hydraulic testing machine with hydraulic grips. Compression loads are transmitted to the specimen through the specimen tabs. Considerable precaution was taken in installing the fixture and specimen in the testing machine to ensure alignment of the specimen and testing machine axes.

## End-Loaded-Coupon Compression Test Fixture

The end-loaded-coupon compression fixture (fig. 3) consists of two end blocks with provisions to anchor the ends of coupon specimens and a guide cylinder which ensures alignment of the end blocks. The mating surfaces of the guide cylinder and the end blocks are lubricated to minimize frictional loading of the cylinder. Load is transmitted to the specimen by the end blocks. The end blocks have retainers for anchoring the specimens to the end blocks which also provide support of the specimen transverse to the load axis and prevent failure of the specimen by "brooming." Specimen width up to 25 mm may be accommodated.

### Instrumentation and Data Collection

Load-strain data were obtained for each specimen throughout the test by monitoring the output of a load-cell mounted in the load train of the testing machine and by monitoring the output from resistance strain gages positioned on the specimen as shown in figure 4. Note the numbering sequence used to identify the gages - gages one and three were on opposite sides of the specimen from gages two and four. The output from gage number two was compared with the average output from gages one and three to measure out-of-plane bending in each specimen. An indication of in-plane bending was obtained from the strain differences on each side of the specimen. The output from gage number four was compared with the output from other gages to identify large strain gradients at the specimen edge. The nominal strain in a specimen at a given load was determined as the average of the strains at the midpoint of the two sides, where the strain at the midpoint of the side containing gages 1 and 3 is the average of readings from those gages.

Data for each specimen were collected throughout the test using an on-line digital computer. These data were stored on magnetic tape.

## MATERIALS

Specimens were fabricated from three lots of Narmco T300/5208, graphite/epoxy composite prepreg, which was purchased and processed to conform to prepreg and laminate specification requirements for commercial aircraft applications (ref. 9). Each lot of prepreg underwent quality control checks which compared prepreg and unidirectional laminate properties to specification requirements. Prepreg properties examined included resin content, volatile content, gel time, and fiber area<sup>1</sup> weight. Laminate properties examined included resin content, flexure strength, flexure modulus, shear strength, void content, ply thickness, and fiber volume. Table 2 shows quality control results for each lot of material. The quality of panels from which specimens were machined was verified with ultrasonic C-scan and by making measurements of resin content by weight, fiber volume, density, and void content on samples from two regions of each panel. Table 3 shows quality control results for each panel.

Specimens were stored in a laboratory environment, 21-27°C and about 70 percent relative humidity, for 6 to 12 months prior to being tested.

## RESULTS AND DISCUSSION

Results are presented from compression tests of coupons of T300/5208 graphite/epoxy composite material with the IITRI compression test fixture, a face-supported compression test fixture, and an end-loaded-coupon compression test fixture. Data are analyzed to identify sensitivities of techniques to laminate, specimen, and test parameters.

Modulus data from fixture checkout tests on 2024-T4 aluminum alloy sheet specimens tested in compression with the three fixtures were within six percent of the published data (ref. 10) and the coefficient of variation of the data was 0.9 percent,



0.4 percent, and 4 percent, respectively, for the IITRI, face-supported, and end-loaded-coupon compression test fixtures. These results suggest that test procedures for each fixture were satisfactory.

Table 4 shows compression test results for T300/5208 Gr/Ep composite material specimens. The ultimate compressive strength was based on the maximum load applied to the specimen. The ultimate strain was the highest strain indicated by any gage at maximum load. The secant modulus is the secant of the stress-strain curve at an average compressive strain of 0.004 which is in the range of strain encountered in applications of Gr/Ep composites. The strain variations due to out-of-plane bending and in-plane bending were also determined at an average compressive strain of 0.004.

#### Uniformity of Load Transfer

The effect of nonuniform load transfer during compression testing is to induce out-of-plane bending or in-plane bending with accompanying strain variations. In extreme cases the bending can result in failure by buckling. Table 4 shows the average strain variations due to out-of-plane bending and in-plane bending for each series of specimens tested. Out-of-plane and in-plane strain variations were as high as 27 percent and 45 percent, 34 percent and 11 percent, and 12 percent and 30 percent for specimens tested with the IITRI, face-supported, and end-loaded-coupon fixtures, respectively.

The sensitivity of IITRI-specimen stress-strain curves to flatness and parallelism of opposing tab surfaces of specimens was confirmed early in the program. Figure 5 shows stress-strain curves for a 25-mm wide 24-ply quasi-isotropic IITRI specimen (specimen 52, Table 4a). The data in figure 5(a), which were obtained by preloading the specimen in the as-fabricated condition, show strong evidence of out-of-plane and in-plane

bending. In view of these data the tabs of the specimen were ground to be "flat and parallel" and the data in figure 5(b) were obtained. Examination of the specimen disclosed significant variations in flatness of the tabs, indicated by the inset in figure 5(b), which resulted from grinding error. These variations were sufficient to produce the significant strain differences across the specimen shown here. The specimen was ground a second time to be flat within  $\pm 25 \mu\text{m}$ . Figure 5(c) shows the stress-strain curves for the specimen loaded to failure. Note the uniformity of strain across the specimen.

In light of results like those in figure 5, the tabs of a number of IITRI specimens were machined to be flat and parallel. In Table 4a the specimens that were machined are indicated with an asterisk by their number.

Figure 6 shows representative "best" and "worst" stress-strain curves for the three fixtures. Figure 6(a) shows representative stress-strain curves for the specimens tested with the IITRI fixture. Figures 6(b) and 6(c) show similar curves for specimens tested with the face-supported fixture and the end-loaded-coupon fixture, respectively. The characteristics of the curves shown here are typical in that stress-strain curves for IITRI specimens were generally continuous from start of testing to failure, while the curves for face-supported specimens frequently exhibited large changes in slope particularly as the stress in the specimens neared ultimate. This characteristic with the face-supported fixture is no doubt related to the fact that the longer gage length specimens, even when supported by the fixture, experience some out-of-plane buckling. This buckling, which might not precipitate catastrophic failure, produces assymetry in the specimen and may result in total failure at an average stress less than the compressive ultimate stress. The stress-strain curves for end-loaded-coupon specimens were similar to those for the IITRI specimens.

Figure 7 shows the effect of total strain variation on compressive strength of Gr/Ep composite specimens tested with the IITRI fixture, where total strain is the sum of the in-plane strain variation and the out-of-plane strain variation. These data show a consistent trend toward lower strength with higher strain variations. Note the linear relationship between strength and strain variation for 12.5- and 50-mm wide unidirectional specimens with higher strength occurring at lower strain variation. Also note the strong effect of specimen width. Similar data for 25-mm wide unidirectional specimens did not show this trend. The quasi-isotropic data show the trend toward lower strength with greater strain variation; however, the effects of specimen width and thickness were not evident. Compressive strength versus total strain variation data for specimens tested with the end-loaded-coupon fixture and the face-supported fixture do not show the consistent trends noted for the IITRI fixture data which is probably due to the lesser precision of these fixtures in producing compressive strength failures in composite material specimens.

#### Ultimate Compressive Strength

Specimen width effects. - Figure 8 shows average ultimate compressive strength as a function of specimen width for 16-ply Gr/Ep composite material in three fiber orientations. Data are shown for the IITRI fixture and the face-supported fixture. The most noteworthy point here is the difference in results from the two fixtures for the  $[\pm 45/\mp 45]_{2S}$  laminate. The ultimate compressive strength results from the face-supported fixture are nearly constant at about 200 MPa as compared to the results from the IITRI fixture which vary linearly from 190 to 330 MPa over a range of specimen widths from 12.5 mm to 50 mm. The wide range in strength of  $[\pm 45/\mp 45]_{2S}$  specimens tested with the IITRI fixture probably result from the biaxial state of stress present in low-aspect-ratio specimens of high Poisson's ratio under load.

The ultimate compressive strength of quasi-isotropic specimens tested with the IITRI fixture and the face-supported fixture were independent of specimen width with the IITRI fixture producing consistently higher strength results than the face-supported fixture (fig. 8).

Note the substantially lower strength of the 50-mm wide unidirectional specimens tested with the face-supported fixture compared to other data for unidirectional specimens (fig. 8). The face-supported fixture was examined after testing the 50-mm wide specimens and was found to be bent. This explains the lower strength obtained for that series of specimens and points to the importance of fabricating the test fixture from high-yield-strength materials when very high loads are expected.

Specimen thickness effects.- Figure 9 shows the variation in average ultimate compressive strength with specimen thickness for quasi-isotropic specimens tested with the face-supported fixture and for quasi-isotropic specimens tested with the IITRI fixture. The significant point here is the lower average strengths of 8-ply specimens tested with each fixture. Examination of stress-strain data for individual specimens represented by the data in figure 9 showed some evidence of buckling in 8-ply specimens tested in each fixture.

Comparison of strength by fixtures. - Figure 10 shows a comparison of ultimate compressive strength data for 16-ply, quasi-isotropic, 25-mm wide specimens tested with the end-loaded-coupon fixture, the IITRI fixture, and the face-supported fixture. The shaded region of each bar represents the range of values. The IITRI fixture produced the highest average strength at 552 MPa followed by the end-loaded-coupon fixture at 531 MPa. The data obtained with the face-supported fixture exhibits less scatter than the data with the other fixtures. The higher strength of specimens tested with the IITRI fixture is the result of greater precision in alignment and loading of specimens with that fixture compared to the other two fixtures.

## Compressive Stiffness

Figures 11(a) and 11(b) show average secant modulus as a function of specimen width and thickness for specimens tested with the IITRI fixture and the face-supported fixture. The noteworthy fact shown here is that modulus is independent of specimen width for every case except for the  $[\pm 45/\mp 45]$  specimens tested with the IITRI fixture where modulus is linear with width and shows a 17% change over the width range from 12.5 to 50 mm. As noted earlier in discussion of the strength data for  $[\pm 45/\mp 45]$  specimens tested with the IITRI fixture, change in modulus with specimen width is probably due to the biaxial state of stress present in low aspect ratio specimens of high Poisson's ratio under load.

Figure 12 shows a comparison of secant modulus data for 16-ply, quasi-isotropic, 25-mm wide specimens tested with the end-loaded-coupon fixture, the IITRI fixture, and the face-supported fixture. The shaded region of each bar represents the range of values. The average modulus was approximately the same for all fixtures. Variability in modulus for the specimens tested was satisfactorily low; even the face-supported fixture data which have the most scatter have a coefficient of variation of only 5.6 percent.

## Failure Modes

Failures in the quasi-isotropic and  $[\pm 45/\mp 45]_s$  specimens tested with the IITRI fixture were always centered in the gage length of the specimens, whereas fractures of the unidirectional specimens were generally located nearer the tab ends. Failures in specimens tested with the face-supported fixture were generally 25 mm or more away from the tab ends; however, the unidirectional specimens tended to fail nearer the tab ends than

did the other specimen types. The quasi-isotropic specimens tested with the end-loaded-coupon fixture failed in the center of the gage length with no evidence of brooming at the specimen ends.

Figure 13 consists of photographs of failed IITRI specimens having the three fiber orientations tested. The types of failure shown here are typical of the failures experienced throughout the test program. Figure 13(a) is a photograph of a unidirectional specimen (specimen 10, Table 4a) with numerous splits in the gage length parallel to the fibers in addition to a fracture across the specimen normal to the fiber direction. Examination of failed specimens showed little evidence of delamination in this or similar specimens. Figures 13(b) and 13(c) are photographs of quasi-isotropic and  $[\pm 45/\mp 45]_S$  specimens (specimens 38 and 71, Table 4a), respectively. Both of these specimens experienced extensive interlaminar failures between neighboring dissimilar plies. In general, the failed  $[\pm 45/\mp 45]_S$  specimens showed very little evidence of fiber fractures whereas the failed quasi-isotropic specimens showed extensive evidence of fiber fractures.

To gain more insight into the mode of failure of specimens tested in this program, consider that reference 11 states that since the microbuckling strength of Gr/Ep composite material is approximately equal to the shear modulus of the composite and specimens tested in compression fail at a fraction of that level, the mode of failure must be something other than microbuckling. Reference 11 further states that the critical parameter which is responsible for the low compressive strength of Gr/Ep composites is the transverse tensile strength and that, if composite materials have sufficiently high transverse tensile strength, the compressive strength of unidirectional composites approaches their tensile strength. Note that the average ultimate compressive strength of all unidirectional specimens tested with the IITRI fixture was 1500 MPa compared to an ultimate

tensile strength of 1450 MPa (ref. 12). Furthermore, following the assumption of reference 11 that the tensile and compressive strength and stiffness of graphite fibers are the same, the average of all strain-to-failure data for unidirectional specimens tested with the IITRI fixture is 1.43 percent compared to the 1.32 percent strain-to-failure for T300 graphite fibers obtained from published data (ref. 13). These points indicate that unidirectional specimens tested with the IITRI fixture failed by compressive strength failure rather than by microbuckling or general buckling, that compressive strength failure of unidirectional Gr/Ep composite material is governed by fiber behavior, and that the fiber failure mode is similar to the tensile failure of the fiber. Additionally these results suggest that the IITRI fixture produces near maximum compressive strength data for unidirectional Gr/Ep composite material.

Comparison of compressive strength and stiffness data for unidirectional face-supported specimens with tensile data for Gr/Ep strength and fiber stiffness were less favorable than for the IITRI specimens. These specimens failed at lower stress levels than the IITRI specimens as a result of the greater instability of the longer gage length specimens.

The average strain-to-failure of 16-ply and greater thickness quasi-isotropic specimens tested with the IITRI fixture, the face-supported fixture, and the end-loaded-coupon fixture compares favorably with the estimated fiber maximum-strain-to-failure. This suggests that the compressive behavior of quasi-isotropic composites tested in these fixtures is primarily governed by the unidirectional fibers.

Failure of the  $[\pm 45/\mp 45]_{2S}$  specimens occurred in the form of delamination of the plies. In light of this fact, the maximum fiber strain for the  $[\pm 45/\mp 45]_{2S}$  specimens should be less than the strains encountered in the unidirectional and quasi-isotropic specimens. The strain-to-failure of specimens tested with the face-supported fixture was quite constant at about

2.2%, which, assuming uniform compression over the length and width of the specimen, is equivalent to 0.22% fiber strain or about 1/6 the maximum fiber strain encountered in the unidirectional and quasi-isotropic specimens.

The strain-to-failure of the  $[\pm 45/\mp 45]_S$  specimens tested with the IITRI fixture varied approximately linearly with specimen width ranging from 3.3% at a width of 12.5 mm to 4.9% at a width of 50 mm. This wide range of failure strain and accompanying failure stresses is probably the result of the biaxial state of stress that exists in loading low-aspect-ratio specimens of high Poisson's ratio.

#### CONCLUDING REMARKS

Compression tests of T300/5208 Gr/Ep composite material were performed using a modified IITRI fixture, a face-supported fixture, and an end-loaded-coupon fixture to determine the effects of loading, specimen width, specimen thickness, and fiber orientation on the compressive behavior of graphite/epoxy composite material. Each specimen was instrumented with four longitudinal strain gages to determine the extent of strain variation in the specimen during the test.

Based on results reported herein, no single test fixture appears universally adequate for compression testing. However, each of the three fixtures has the potential to provide reliable compressive properties data in certain instances. For example, the IITRI fixture provided the most consistent data for unidirectional composite specimens while the face-supported fixture provided the most consistent results for  $[\pm 45/\mp 45]_S$  specimens.

The IITRI fixture was found to be sensitive to flatness and parallelism of opposing tab surfaces of specimens. Specimen variances of this type produced significant strain variations in the specimens. Specimens experiencing large strain variations



during testing had lower compressive strengths than did more uniformly strained specimens. Tests of 16- and 24-ply unidirectional and quasi-isotropic specimens using the IITRI fixture produced high strength values with specimen failures governed by 0-degree fibers in both cases. Tests of 8-ply specimens showed evidence of failure by buckling and correspondingly lower strengths.

The strength data from  $[\pm 45/\mp 45]_S$  specimens tested with the IITRI fixture showed a strong dependence on specimen width which is probably the result of the biaxial state of stress that exists in low-aspect-ratio specimens of high Poisson's ratio under axial load. These specimens failed by delamination of the plies.

Unidirectional and quasi-isotropic specimens tested with the face-supported fixture experienced a small amount of strain variation at low loads; however, at loads approaching failure the long gage length specimens experienced varying amounts of general instability which resulted in failure at lower stresses than were achieved in specimens tested with the IITRI fixture. This strength differential is greatest for unidirectional specimens. These data were independent of specimen width, but dependent on specimen thickness to the extent that 8-ply specimens failed at much lower stress levels than did thicker specimens.

Tests of 16-ply  $[\pm 45/\mp 45]_S$  specimens with the face-supported fixture produced results independent of width. Failure of these specimens was by delamination of plies.

Modulus data from the three fixtures were not significantly different except for tests of  $[\pm 45/\mp 45]$  specimens with the IITRI fixture which showed a strong variation with specimen width. The coefficient of variation of the modulus data was less than nine percent for every series of test.

Data obtained with the end-loaded-coupon fixture are not substantially different from the data obtained with the IITRI and face-supported fixtures. In view of this and the simplicity

of the specimen and the fixture, further study of the end-loaded-coupon fixture is justified.

#### REFERENCES

1. Shuart, Mark J.; and Herakovich, Carl T.: An Evaluation of the Sandwich Beam in Four-point Bending as a Compressive Test Method for Composites. NASA TM 78783, Sept. 1978.
2. Haskins, J.F.; Kerr, J.R., and Stein, B. A.: Time-Temperature Stress Capabilities of Composites for Supersonic Cruise Aircraft Applications. Proceedings of the SCAR Conference, Nov. 9-12, 1976. NASA CP-001.
3. Hofer, K. E., Jr.; and Rao, P. N.: "A New Static Compression Fixture for Advanced Composite Materials." Journal of Testing and Evaluation. JTEVA, vol. 5, no. 4, July 1977, pp. 278-283.
4. Ryder, J.T. and Black, E.D.: "Compression Testing of Large Gage Length Composite Coupons. Composite Materials: Testing and Design (Fourth Conference), ASTM STP 617, American Society for Testing and Materials, 1977, pp. 170-189.
5. Lauraitis, K.N.: Effect of Environment on the Compressive Strengths of Laminated Epoxy Matrix Composites. Interim Technical Quarterly Rpt., LR 28508-1, Lockheed California Company, Burbank, CA, Feb. 1975.
6. D695-69, "Test for Compressive Properties of Rigid Plastics," 1977 Annual Book of ASTM Standards, Part 35.

7. D3410-75, "Test for Compressive Properties of Oriented Fiber Composites," 1977 Annual Book of ASTM Standards, Part 36.
8. C393-62, "Flexure Test of Flat Sandwich Constructions," 1977 Annual Book of ASTM Standards, Part 25.
9. Douglas Material Specification, DMS1936C, McDonnell Douglas Corporation, Sept. 23, 1975.
10. Metals Handbook, Vol. 1 Properties and Selection of Metals. American Society for Metals, 1961.
11. Greszczuk, L. B.: Failure Mechanics of Composites Subjected to Compressive Loading. AFML-TR-72-107, August 1972.
12. Advanced Composites Design Guide, Vol. IV, Third Edition, Third Revision. January 1977.
13. Lauraitis, K. N.: Effect of Environment on the Compressive Strengths of Laminated Epoxy Matrix Composites. Interim Technical Quarterly Rpt., LR 28508-3, Lockheed California Company, Burbank, CA, June 1978.

TABLE 1.- NUMBER AND TYPE OF SPECIMENS TESTED

FIBER ORIENTATION	[0]			[0/±45/90]			[±45]		
	8	16	24	8	16	24	8	16	24
NO. PLYES									
TYPE/NO. SPEC									
IITRI -									
12.5 mm	-	6	-	5	5	5	-	5	-
25 mm	-	4	-	5	5	5	-	6	-
50 mm	-	5	-	6	5	6	-	5	-
FACE SUPPORTED -									
12.5 mm	-	-	-	-	6	-	-	-	-
25 mm	-	6	-	5	5	6	-	5	-
50 mm	-	4	-	-	4	-	-	5	-
END LOADED -									
25 mm	-	-	-	-	10	-	-	-	-

TABLE 2.- QUALITY CONTROL RESULTS FOR T300/5208 Gr/Ep PREPREG.

PROPERTY		SPECIFICATION REQUIREMENT	LOT NO.		
PREPREG	LAMINATE		859	1071	1081
Resin Content, %		42.0	42.3	40.4	41.5
	Resin Content, %	-	19.7	24.9	25.3
Volatile Content, Wt %		3	1.04	0.58	0.84
Gel Time, Min		19.9	18.7	20.5	20.5
Fiber Wt, gm m <sup>2</sup>		147 - 157	157.5	148.9	152.2
	Flex. Strength, MPa	2096	2096	2165	2089
	Flex. Modulus, GPa	158	150	169	146
	Shear Strength, MPa	128	137	154	145
	Void Content, Vol %	-	-	0.95	0.62
	Ply Thickness, mm	-	-	0.12	0.13
	Fiber Vol, %	-	-	68.1	67.8

TABLE 3.- QUALITY CONTROL RESULTS FOR T300/5208 Gr/Ep PANELS

PANEL NO.	RESIN CONTENT, WT. %	FIBER VOL. %	DENSITY, kg/m <sup>3</sup>	VOID CONTENT, VOL. %
A	28.54	64.25	1565	0.48
B	27.54	65.54	1574	0.23
C	27.66	65.20	1568	0.54
E	27.02	65.65	1565	0.96
F	26.92	65.46	1571	0.66
G	27.13	65.58	1566	0.86
H	28.50	64.34	1566	0.41
I	27.79	64.83	1562	0.90
J	29.45	63.36	1563	0.30
L	28.64	64.14	1564	0.49
M	28.41	64.26	1562	0.80
N	28.93	63.71	1560	0.66
1	29.17	63.31	1555	0.87
3	26.62	66.47	1516	0.39
6	27.79	64.93	1565	0.74
8	25.74	67.39	1579	0.52
9	26.32	66.40	1568	1.01
10	25.42	67.61	1577	0.72
11	26.71	65.81	1563	1.18
12	24.38	61.77	1580	0.90
14	26.35	66.59	1573	0.66
16	26.19	66.50	1568	1.08
16A	26.38	66.62	1574	0.60
17/19	24.62	68.31	1577	1.00
22	27.41	65.44	1569	0.61
23/25	25.81	67.55	1584	0.16
26/27/28	27.16	65.80	1572	0.49
29/31	27.76	65.14	1569	0.48
32/34	25.72	67.34	1577	0.63
35/37	25.75	67.36	1578	0.55

TABLE 4.- COMPRESSION TEST RESULTS FOR T300/5208 GRAPHITE EPOXY MATERIAL

(a) 11TRI COMPRESSION TEST FIXTURE

SPEC. NO.	TAB TOL., $\pm\mu\text{m}$	LOT NO.	PANEL NO.	FIBER ORIENTATION	THICKNESS, PLYS	WIDTH, mm	ULT. STRENGTH, MPa	ULT. STRAIN, %	ELASTIC MODULUS, GPa	% STRAIN VARIATION	
										OUT-OF-PLANE	IN-PLANE
1	19	1071	35/37	[0]	16	12.5	1296	1.1	131	10	15
2	19	1071	35/37	[0]	16	12.5	1400	1.3	136	9	0
3	13	1071	35/37	[0]	16	12.5	1400	1.4	132	12	2
4	38	1071	35/37	[0]	16	12.5	1413	1.2	137	3	4
5	13	1071	35/37	[0]	16	12.5	1503	1.3	135	10	3
6	6	1071	35/37	[0]	16	12.5	1448	1.4	123	3	0
AVERAGE				[0]	16	12.5	1413	1.3	132	8	4
7*	25	1081	N	[0]	16	25	(1)	(1)	130	3	5
8*	38	1081	N	[0]	16	25	1710	1.6	129	10	5
9*	25	1081	N	[0]	16	25	1620	2.0	134	0	8
10*	25	1081	N	[0]	16	25	1455	1.4	132	8	9
AVERAGE				[0]	16	25	1593	1.7	131	5	7
11		1071	35/37	[0]	16	50	1551	1.5	143	2	34
12		1071	35/37	[0]	16	50	1565	1.7	129	14	18
13		1071	35/37	[0]	16	50	1620	-	145	2	8
14		1071	35/37	[0]	16	50	1434	1.3	135	12	36
15		1071	35/37	[0]	16	50	1420	1.4	135	15	43
AVERAGE				[0]	16	50	1517	1.5	137	9	28
16	25	1081	H	[0/±45/90]	8	12.5	545	1.3	52	1	1
17	38	1081	H	[0/±45/90]	8	12.5	352	0.8	51	10	6
18	38	1081	H	[0/±45/90]	8	12.5	524	1.5	50	3	5
19	64	1081	H	[0/±45/90]	8	12.5	476	1.1	51	5	3
20	38	1081	17/19	[0/±45/90]	8	12.5	524	1.1	54	2	4
AVERAGE				[0/±45/90]	8	12.5	483	1.2	52	4	4

\*TABS GROUND TO BE PARALLEL

(1) SPEC. SLIPPED IN GRIPS - DID NOT FAIL

TABLE 4.- COMPRESSION TEST RESULTS FOR T300/5208 GRAPHITE EPOXY MATERIAL (CONT'D)

## (a) 11TRI COMPRESSION TEST FIXTURE

SPEC. NO.	TAB TOL., $\pm\mu\text{m}$	LOT NO.	PANEL NO.	FIBER ORIENTATION	THICKNESS, PLY	WIDTH, mm	ULT. STRENGTH, MPa	ULT. STRAIN, %	ELASTIC MODULUS, GPa	% STRAIN VARIATION	
										OUT-OF-PLANE	IN-PLANE
21*	38	1081	H	[0/ $\pm$ 45/90]	8	25	490	1.5	50	19	18
22*	50	1081	H	[0/ $\pm$ 45/90]	8	25	448	1.1	48	10	3
23*	25	1081	H	[0/ $\pm$ 45/90]	8	25	510	1.4	48	9	0
24*	19	1081	H	[0/ $\pm$ 45/90]	8	25	476	1.3	50	10	5
25*	13	1081	H	[0/ $\pm$ 45/90]	8	25	510	1.1	50	13	25
AVERAGE				[0/ $\pm$ 45/90]	8	25	490	1.3	49	12	10
26		1081	H	[0/ $\pm$ 45/90]	8	50	448	1.1	52	4	19
27		1081	H	[0/ $\pm$ 45/90]	8	50	476	1.1	52	19	31
28		1081	H	[0/ $\pm$ 45/90]	8	50	448	1.2	47	5	28
29		1081	H	[0/ $\pm$ 45/90]	8	50	524	1.5	52	3	15
30		1081	H	[0/ $\pm$ 45/90]	8	50	531	1.3	53	27	15
31		1081	H	[0/ $\pm$ 45/90]	8	50	517	1.3	52	4	16
AVERAGE				[0/ $\pm$ 45/90]	8	50	490	1.3	52	10	21
32*	32	1081	I	[0/ $\pm$ 45/90]	16	12.5	607	1.5	52	20	5
33*	38	1081	I	[0/ $\pm$ 45/90]	16	12.5	400	1.0	44	13	8
34*	13	1081	I	[0/ $\pm$ 45/90]	16	12.5	552	1.4	46	-	3
35*	38	1081	I	[0/ $\pm$ 45/90]	16	12.5	545	1.3	48	3	1
36*	50	1081	I	[0/ $\pm$ 45/90]	16	12.5	565	1.5	48	7	6
AVERAGE				[0/ $\pm$ 45/90]	16	12.5	531	1.3	48	11	5
37*	25	1081	I	[0/ $\pm$ 45/90]	16	25	586	1.5	47	5	10
38*	64	1081	I	[0/ $\pm$ 45/90]	16	25	627	1.6	46	7	4
39*	25	1081	I	[0/ $\pm$ 45/90]	16	25	476	1.3	48	11	45
40*	25	1081	I	[0/ $\pm$ 45/90]	16	25	517	1.4	48	5	28
41*	19	1081	I	[0/ $\pm$ 45/90]	16	25	593	1.5	50	8	15
AVERAGE				[0/ $\pm$ 45/90]	16	25	558	1.5	48	7	20

\*TABS GROUND TO BE PARALLEL



TABLE 4.- COMPRESSION TEST RESULTS FOR T300/5208 GRAPHITE EPOXY MATERIAL (CONT'D)

(a) 11TRI COMPRESSION TEST FIXTURE

SPEC. NO.	TAB TOL., $\pm\mu\text{m}$	LOT NO.	PANEL NO.	FIBER ORIENTATION	THICKNESS, PLYS	WIDTH, mm	ULT. STRENGTH, MPa	ULT. STRAIN, %	ELASTIC MODULUS, GPa	% STRAIN VARIATION	
										OUT-OF-PLANE	IN-PLANE
42*	25	1081	I	[0/ $\pm$ 45/90]	16	50	579	1.4	51	8	4
43*	50	1081	I	[0/ $\pm$ 45/90]	16	50	579	1.3	48	3	15
44*		1081	I	[0/ $\pm$ 45/90]	16	50	565	1.4	49	2	15
45*	25	1071	22	[0/ $\pm$ 45/90]	16	50	538	1.3	52	6	6
46*	50	1081	I	[0/ $\pm$ 45/90]	16	50	607	1.6	48	4	11
AVERAGE				[0/ $\pm$ 45/90]	16	50	572	1.4	50	5	10
47*	50	1071	23/25	[0/ $\pm$ 45/90]	24	12.5	558	1.5	48	1	3
48*	50	1071	23/25	[0/ $\pm$ 45/90]	24	12.5	558	1.2	52	0	6
49*	50	1081	J	[0/ $\pm$ 45/90]	24	12.5	538	1.4	47	7	4
50*	100	1081	J	[0/ $\pm$ 45/90]	24	12.5	627	1.6	51	8	9
51*	75	1081	J	[0/ $\pm$ 45/90]	24	12.5	641	1.5	52	3	4
AVERAGE				[0/ $\pm$ 45/90]	24	12.5	586	1.4	50	4	5
52*	25	1081	J	[0/ $\pm$ 45/90]	24	25	607	1.4	49	4	1
53*	50	1081	J	[0/ $\pm$ 45/90]	24	25	558	1.4	48	3	4
54*	25	1081	J	[0/ $\pm$ 45/90]	24	25	620	1.5	49	8	0
55*		1081	J	[0/ $\pm$ 45/90]	24	25	607	1.5	48	7	3
56*	25	1081	J	[0/ $\pm$ 45/90]	24	25	503	1.5	40	3	16
AVERAGE				[0/ $\pm$ 45/90]	24	25	579	1.5	47	5	5
57		1071	23/25	[0/ $\pm$ 45/90]	24	50	552	1.3	54	0	9
58		1071	23/25	[0/ $\pm$ 45/90]	24	50	579	1.5	54	0	23
59		1071	23/25	[0/ $\pm$ 45/90]	24	50	621	1.5	53	13	20
60		1071	23/25	[0/ $\pm$ 45/90]	24	50	613	1.4	54	8	6
61		1071	23/25	[0/ $\pm$ 45/90]	24	50	558	1.3	53	16	25
62		1071	23/25	[0/ $\pm$ 45/90]	24	50	552	1.4	53	11	33
AVERAGE				[0/ $\pm$ 45/90]	24	50	579	1.4	54	8	19

23 \*TABS GROUND TO BE PARALLEL

TABLE 4.- COMPRESSION TEST RESULTS FOR T300/5208 GRAPHITE EPOXY MATERIAL (CONT'D)

(a) 11TRI COMPRESSION TEST FIXTURE

SPEC. NO.	TAB TOL., $\pm\mu\text{m}$	LOT NO.	PANEL NO.	FIBER ORIENTATION	THICKNESS, PLYS	WIDTH, mm	ULT. STRENGTH, MPa	ULT. STRAIN, %	ELASTIC MODULUS, GPa	% STRAIN VARIATION	
										OUT-OF-PLANE	IN-PLANE
63*	50	1081	H	[ $\pm 45$ ]	16	12.5	187	3.1	17.2	6	0
64*	13	1081	H	[ $\pm 45$ ]	16	12.5	183	3.3	17.2	0	13
65*	25	1081	H	[ $\pm 45$ ]	16	12.5	197	3.2	15.9	2	4
66*	13	1071	17/19	[ $\pm 45$ ]	16	12.5	195	3.3	17.2	1	0
67*	50	1081	H	[ $\pm 45$ ]	16	12.5	197	3.7	15.9	1	0
AVERAGE		<del>X</del>	<del>X</del>	[ $\pm 45$ ]	16	12.5	192	3.3	16.5	2	3
68*	25	1081	L	[ $\pm 45$ ]	16	25	208	3.5	16.5	13	13
69*	38	1081	L	[ $\pm 45$ ]	16	25	214	3.5	16.5	10	15
70*	38	1081	L	[ $\pm 45$ ]	16	25	222	3.8	16.5	10	15
71*	19	1081	L	[ $\pm 45$ ]	16	25	215	4.4	17.2	7	5
72*	50	1081	L	[ $\pm 45$ ]	16	25	220	4.0	17.9	15	20
73*	50	1081	L	[ $\pm 45$ ]	16	25	225	3.8	18.6	9	18
AVERAGE		<del>X</del>	<del>X</del>	[ $\pm 45$ ]	16	25	217	3.8	17.2	11	14
74	32	1071	29/31	[ $\pm 45$ ]	16	50	352	4.9	18.6	5	0
75	38	1071	29/31	[ $\pm 45$ ]	16	50	297	4.9	20.0	58	5
76	75	1071	29/31	[ $\pm 45$ ]	16	50	311	4.9	18.6	6	8
77	50	1071	29/31	[ $\pm 45$ ]	16	50	330	4.9	19.3	1	9
78	38	1071	29/31	[ $\pm 45$ ]	16	50	364	4.7	20.7	3	18
AVERAGE		<del>X</del>	<del>X</del>	[ $\pm 45$ ]	16	50	331	4.9	19.3	5	8

\*TABS GROUND TO BE PARALLEL

TABLE 4.- COMPRESSION TEST RESULTS FOR T300/5208 GRAPHITE EPOXY MATERIAL (CONT'D)

(b) FACE-SUPPORTED-COUPON COMPRESSION TEST FIXTURE

SPEC. NO.	LOT NO.	PANEL NO.	FIBER ORIENTATION	THICKNESS, PLYS	WIDTH, mm	ULT. STRENGTH, MPa	ULT. STRAIN, %	ELASTIC MODULUS, GPa	% STRAIN VARIATION	
									OUT-OF-PLANE	IN-PLANE
1	1081	G	[0]	16	25	1358	1.3	128	8	2
2	1081	G	[0]	16	25	1386	1.2	128	-	7
3	1081	G	[0]	16	25	(1)	(1)	132	9	1
4	1081	G	[0]	16	25	1296	1.1	136	5	3
5	1081	G	[0]	16	25	1289	1.3	133	6	1
6	1081	G	[0]	16	25	1255	1.1	125	6	2
AVERAGE	<del>X</del>	<del>X</del>	[0]	16	25	1317	1.2	130	7	3
7	1071	16	[0]	16	50	1158	1.0	135	14	2
8	1071	16	[0]	16	50	1158	1.2	127	11	2
9	1071	16	[0]	16	50	1227	1.3	133	34	2
10	1071	16	[0]	16	50	1172	.8	132	24	3
AVERAGE	<del>X</del>	<del>X</del>	[0]	16	50	1179	1.1	132	21	2
11	1081	A	[0/±45/90]	8	25	434	1.1	48	1	2
12	1081	A	[0/±45/90]	8	25	331	.7	49	1	6
13	1081	A	[0/±45/90]	8	25	365	.8	49	0	1
14	1081	A	[0/±45/90]	8	25	441	1.0	50	2	1
15	1081	A	[0/±45/90]	8	25	524	1.2	50	6	11
AVERAGE	<del>X</del>	<del>X</del>	[0/±45/90]	8	25	421	1.0	50	2	4
16	1081	B	[0/±45/90]	16	12.5	503	1.4	49	5	1
17	1081	B	[0/±45/90]	16	12.5	558	-	48	-	-
18	1081	B	[0/±45/90]	16	12.5	517	1.3	46	1	1
19	1081	B	[0/±45/90]	16	12.5	462	1.2	46	1	4
20	1081	B	[0/±45/90]	16	12.5	524	1.5	48	1	0
21	1081	B	[0/±45/90]	16	12.5	510	1.3	47	1	1
AVERAGE	<del>X</del>	<del>X</del>	[0/±45/90]	16	12.5	510	1.3	47	2	1

(1) SPEC. SLIPPED IN GRIPS- DID NOT FAIL

TABLE 4.- COMPRESSION TEST RESULTS FOR T300/5208 GRAPHITE EPOXY MATERIAL (CONT'D)

## (b) FACE-SUPPORTED-COUPON COMPRESSION TEST FIXTURE

SPEC. NO.	LOT NO.	PANEL NO.	FIBER ORIENTATION	THICKNESS, PLYS	WIDTH, mm	ULT. STRENGTH, MPa	ULT. STRAIN, %	ELASTIC MODULUS, GPa	% STRAIN VARIATION	
									OUT-OF-PLANE	IN-PLANE
22	1081	B	[0/±45/90]	16	25	524	1.0	54	0	1
23	1081	B	[0/±45/90]	16	25	524	1.3	51	5	2
24	1081	B	[0/±45/90]	16	25	545	1.3	48	5	0
25	1081	B	[0/±45/90]	16	25	483	-	-	-	-
26	1081	B	[0/±45/90]	16	25	510	1.4	48	4	3
AVERAGE	⊗	⊗	[0/±45/90]	16	25	517	1.3	50	4	2
27	1071	6	[0/±45/90]	16	50	490	1.3	46	10	2
28	1071	6	[0/±45/90]	16	50	545	1.3	41	0	3
29	1071	6	[0/±45/90]	16	50	517	1.3	50	6	4
30	1071	6	[0/±45/90]	16	50	496	1.4	45	0	1
AVERAGE	⊗	⊗	[0/±45/90]	16	50	510	1.3	46	4	3
31	1081	C	[0/±45/90]	24	25	565	1.3	48	4	0
32	1081	C	[0/±45/90]	24	25	407	1.0	48	7	1
33	1081	C	[0/±45/90]	24	25	510	1.2	48	1	3
34	1081	C	[0/±45/90]	24	25	531	1.4	48	1	3
35	1081	C	[0/±45/90]	24	25	538	1.4	48	7	2
36	1081	C	[0/±45/90]	24	25	483	1.3	46	2	2
AVERAGE	⊗	⊗	[0/±45/90]	24	25	503	1.3	48	4	2
37	1071	16	[±45]	16	25	207	2.0	16.5	3	3
38	1071	16	[±45]	16	25	183	1.9	17.9	6	0
39	1071	16	[±45]	16	25	193	2.4	17.9	4	1
40	1071	16	[±45]	16	25	197	2.2	17.9	4	3
41	1071	16	[±45]	16	25	199	2.4	18.6	2	0
AVERAGE	⊗	⊗	[±45]	16	25	196	2.2	17.9	4	1

TABLE 4.- COMPRESSION TEST RESULTS FOR T300/5208 GRAPHITE EPOXY MATERIAL (CONT'D)

(b) FACE-SUPPORTED-COUPON COMPRESSION TEST FIXTURE

SPEC. NO.	LOT NO.	PANEL NO.	FIBER ORIENTATION	THICKNESS, PLYS	WIDTH, mm	ULT. STRENGTH, MPa	ULT. STRAIN, %	ELASTIC MODULUS, GPa	% STRAIN VARIATION	
									OUT-OF-PLANE	IN-PLANE
42	1071	12	[±45]	16	50	203	2.4	17.9	3	2
43	1071	12	[±45]	16	50	203	2.5	18.6	5	2
44	1071	12	[±45]	16	50	202	2.4	17.9	5	5
45	1071	12	[±45]	16	50	204	2.1	18.6	4	2
46	1071	12	[±45]	16	50	214	1.9	15.9	3	6
AVERAGE	<del>X</del>	<del>X</del>	[±45]	16	50	205	2.3	17.9	4	3

TABLE 4.- COMPRESSION TEST RESULTS FOR T300/5208 GRAPHITE EPOXY MATERIAL (CONT'D)

(c) END-LOADED-COUPON COMPRESSION TEST FIXTURE

SPEC. NO.	LOT NO.	PANEL NO.	FIBER ORIENTATION	THICKNESS, PLYS	WIDTH, mm	ULT. STRENGTH, MPa	ULT. STRAIN, %	ELASTIC MODULUS, GPa	% STRAIN VARIATION	
									OUT-OF-PLANE	IN-PLANE
1	859	1	[0/±45/90]	16	25	441	1.0	50	3	5
2	859	1	[0/±45/90]	16	25	545	1.5	50	6	5
3	859	1	[0/±45/90]	16	25	572	1.5	48	1	16
4	859	1	[0/±45/90]	16	25	579	1.4	49	5	0
5	859	1	[0/±45/90]	16	25	517	1.4	48	12	11
6	859	1	[0/±45/90]	16	25	552	1.4	50	1	30
7	859	1	[0/±45/90]	16	25	538	1.5	51	11	3
8	859	1	[0/±45/90]	16	25	510	1.3	48	6	5
9	859	1	[0/±45/90]	16	25	538	1.4	50	3	18
10	859	1	[0/±45/90]	16	25	496	1.2	50	7	6
AVERAGE	⊗	⊗	[0/±45/90]	16	25	531	1.4	50	6	10

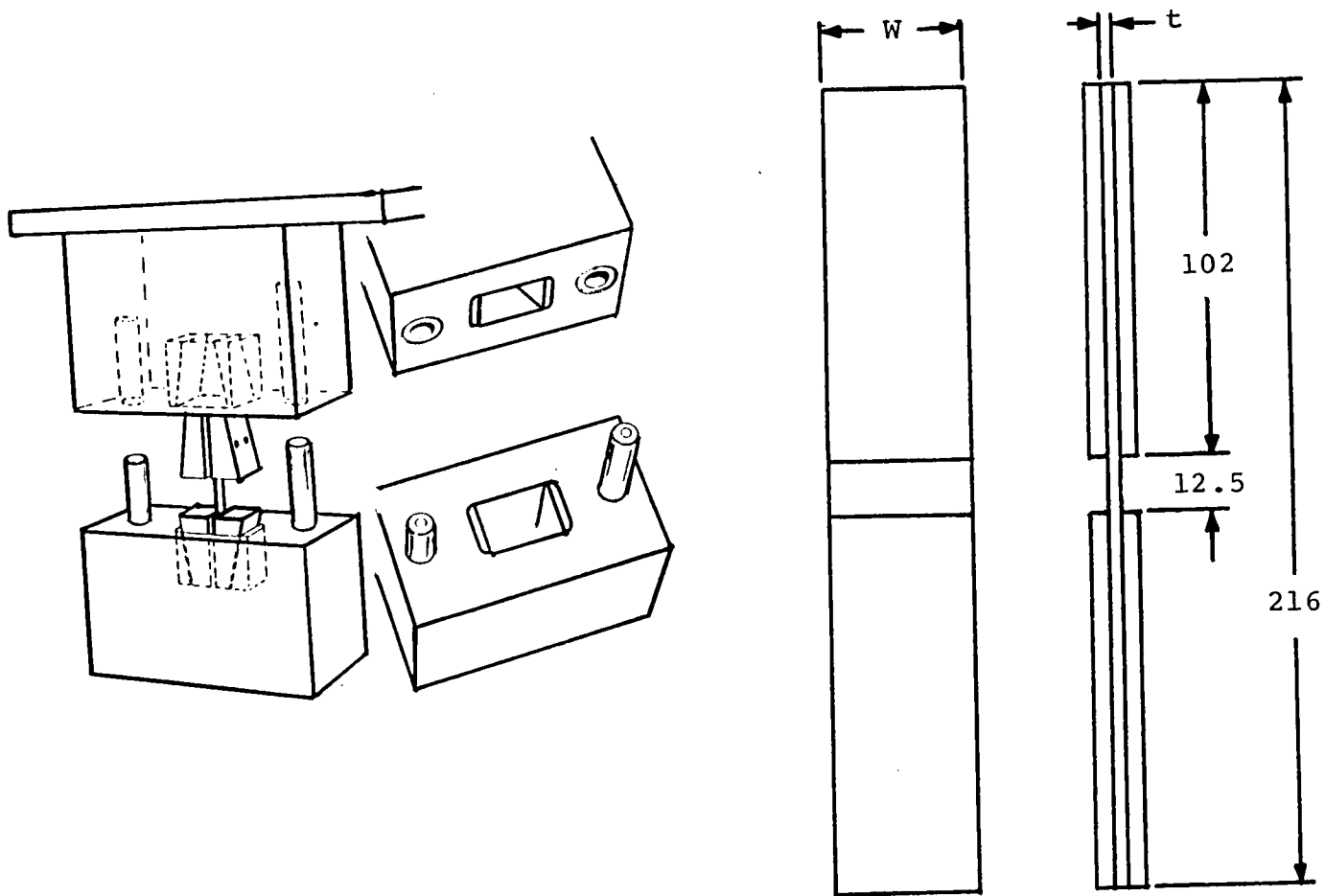

Figure 1.- Schematic of IITRI fixture and sketch of specimen.

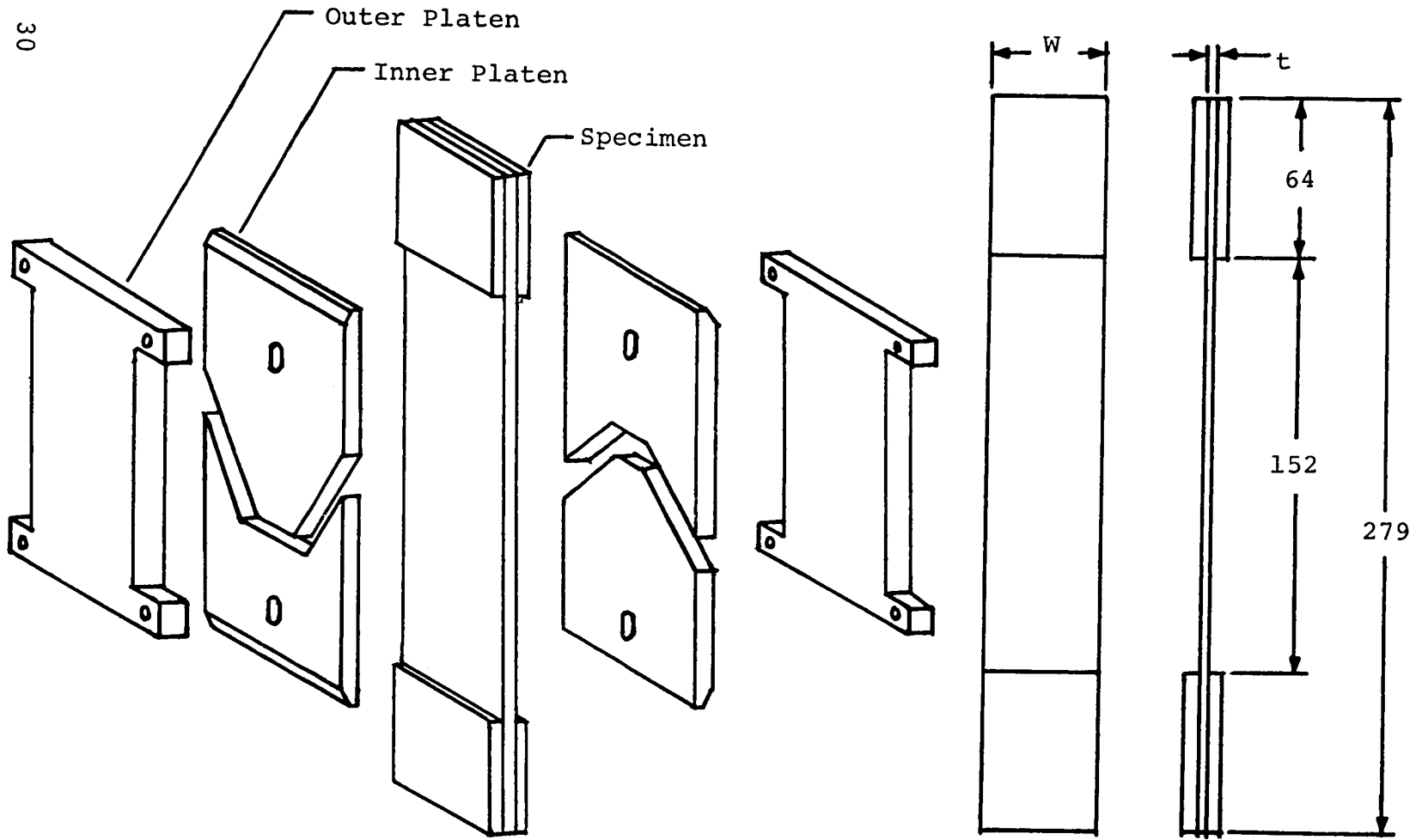

Figure 2.- Exploded view of face-supported fixture with specimen and sketch of specimen.



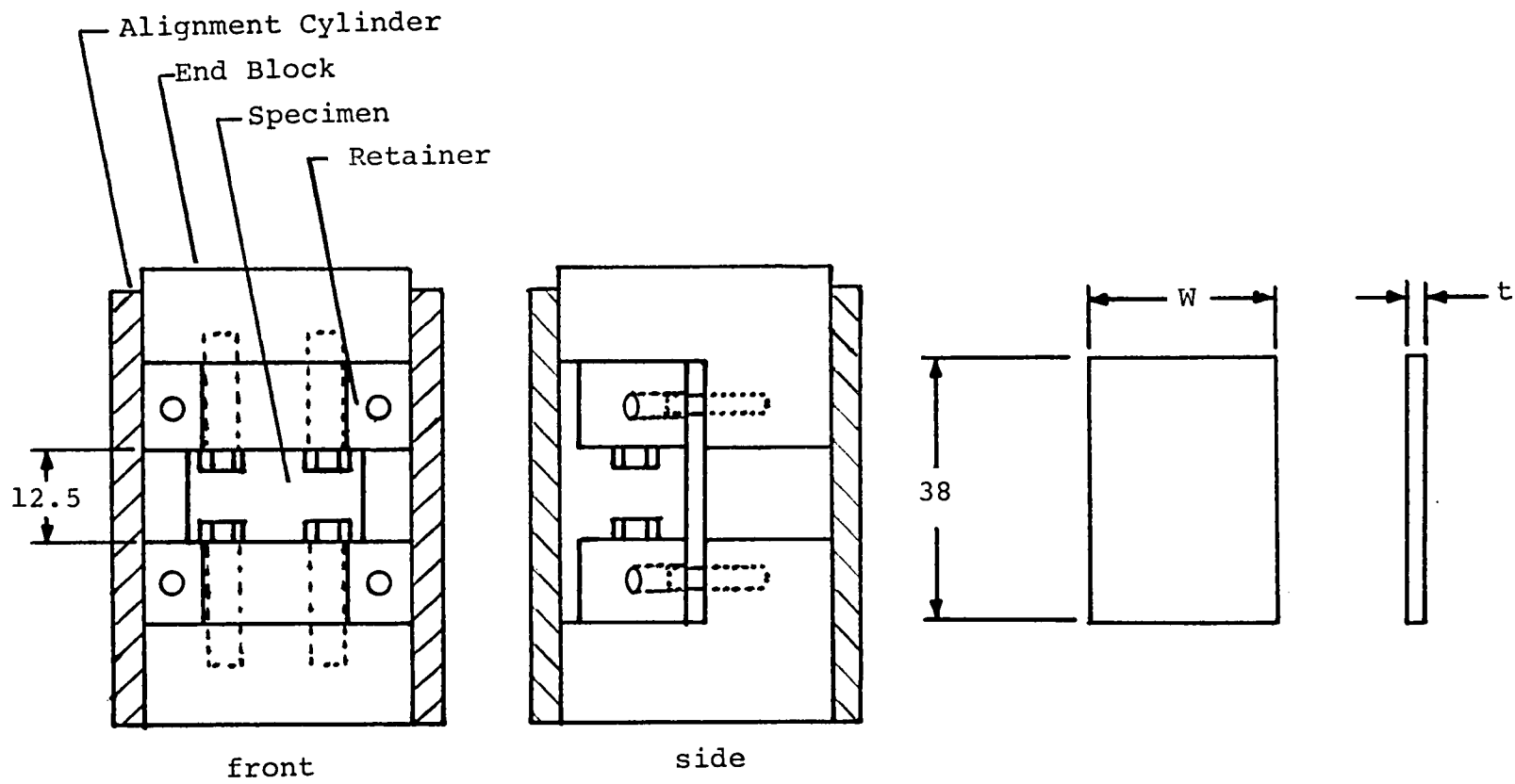

Figure 3.- Sketch of end-loaded-coupon fixture and specimen.

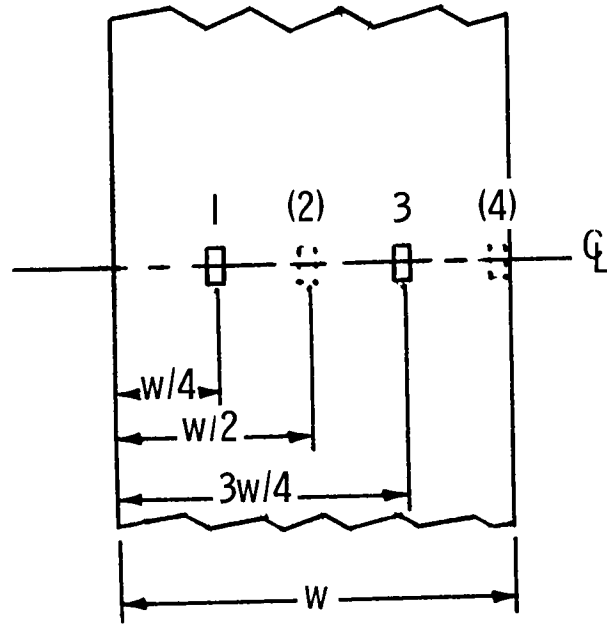
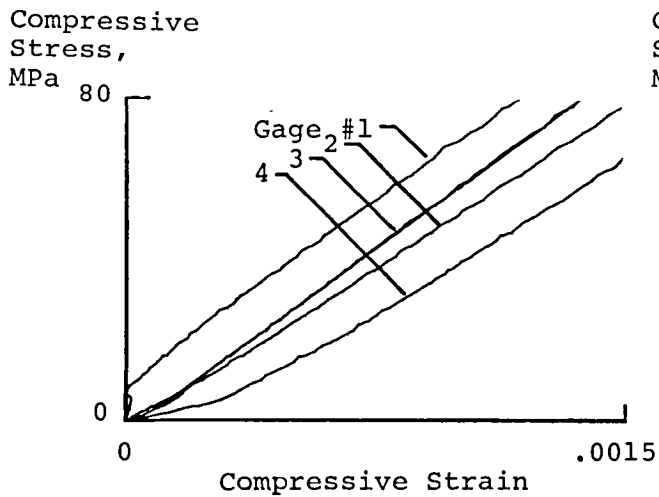
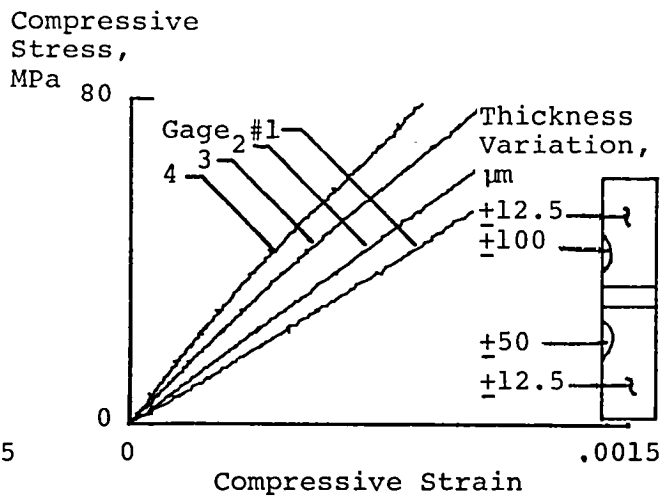

Figure 4.- Location of strain gages on specimen.



(a) Preload of as-fabricated specimen.



(b) Preload of specimen as-ground.

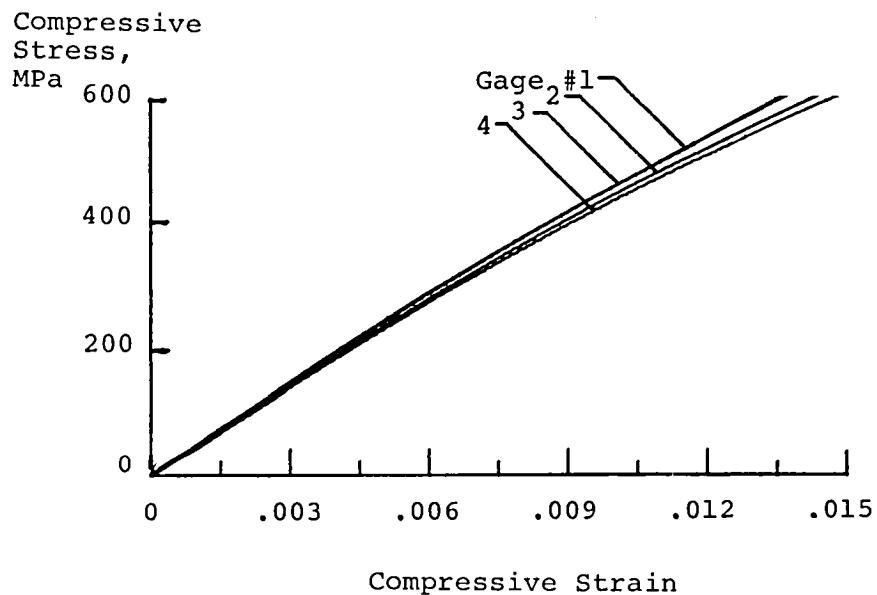

(c) Load-to-failure after second grinding

Figure 5.- Compressive stress-strain curves for 25-mm wide, 24-ply thick, quasi-isotropic specimen tested with the IITRI fixture (Spec #52- Table 4a).

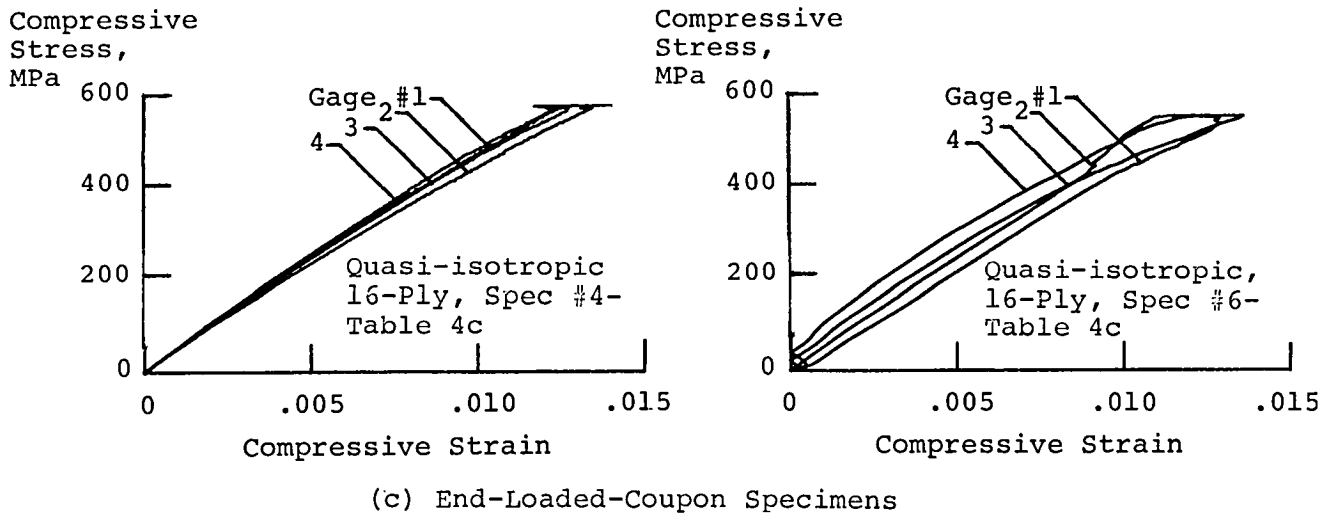
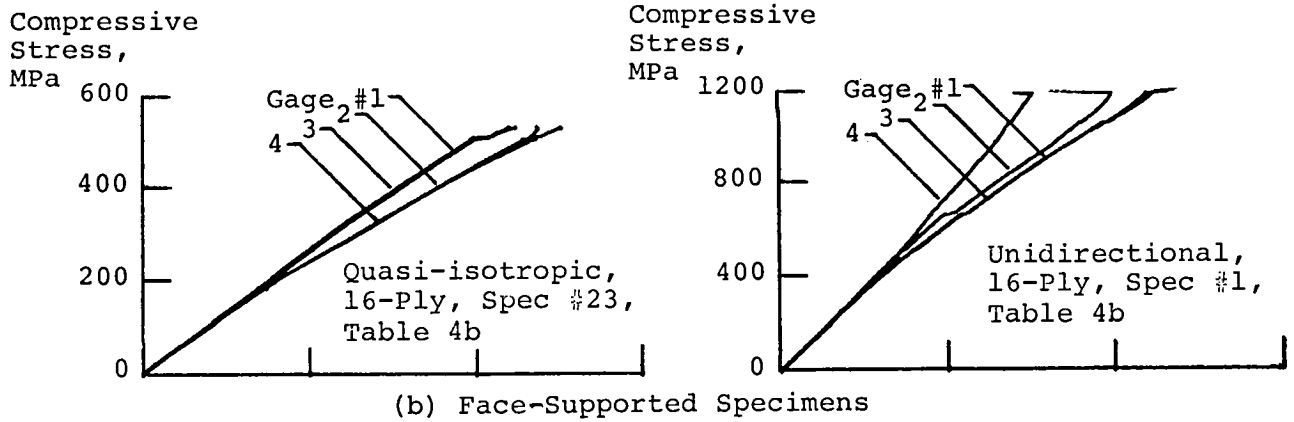
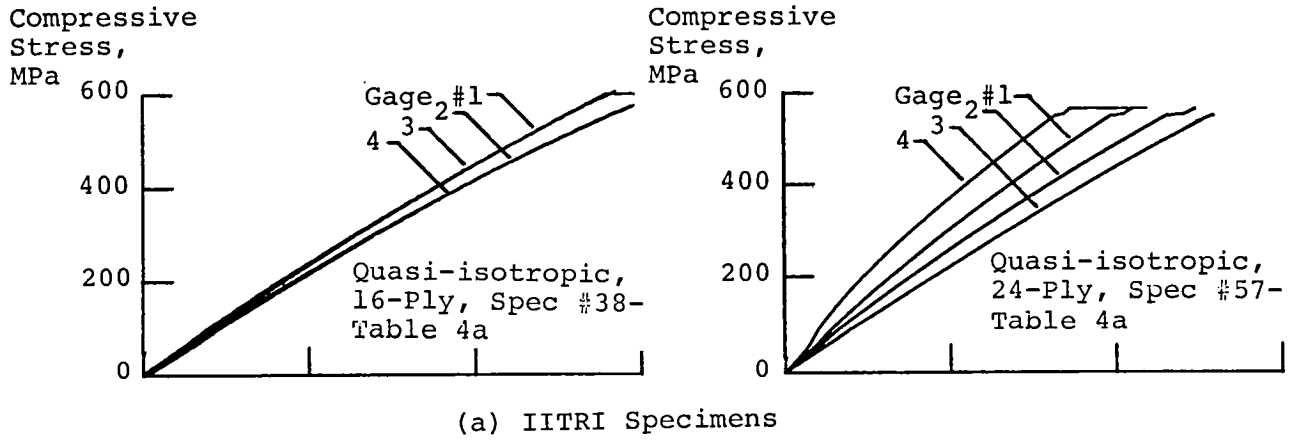

Figure 6.- Representative best and worst compressive stress-strain curves for Gr/Ep composite material specimens.

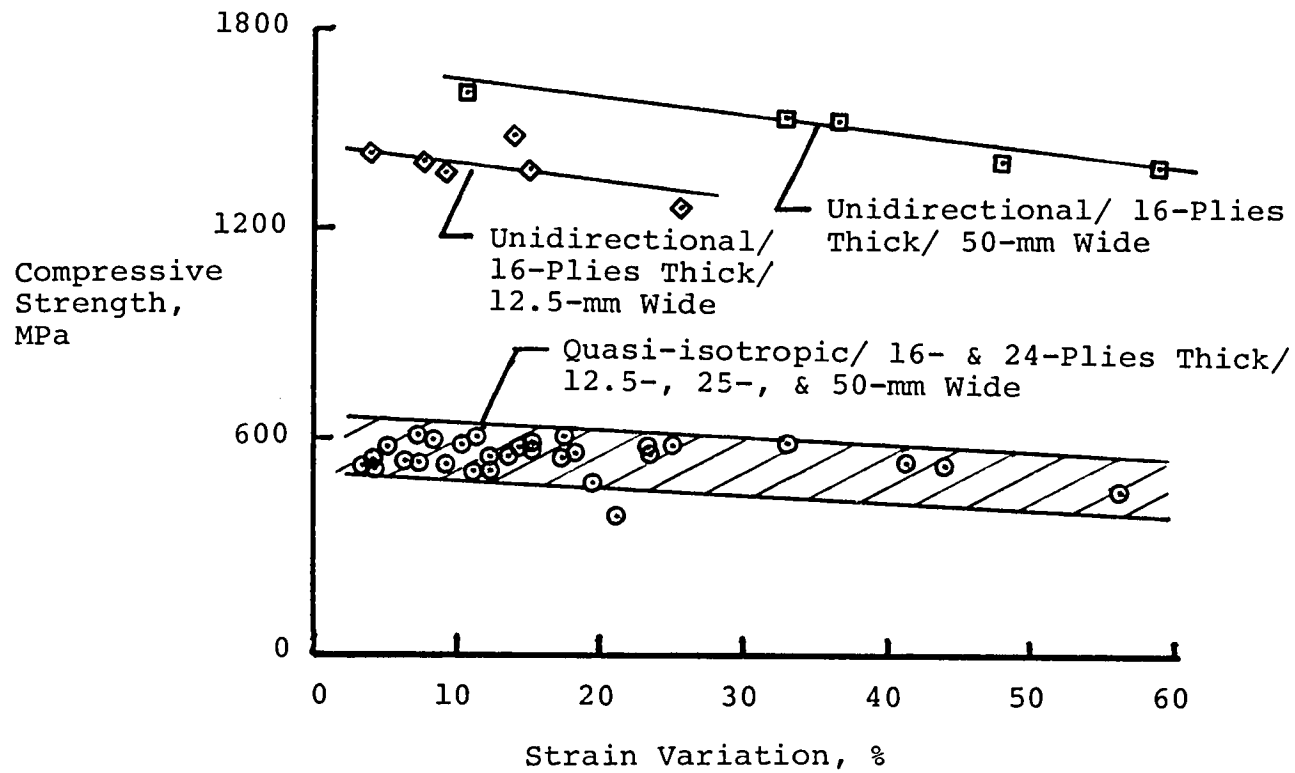

Figure 7.- Effect of strain variation on compressive strength of Gr/Ep specimens tested with the IITRI fixture.

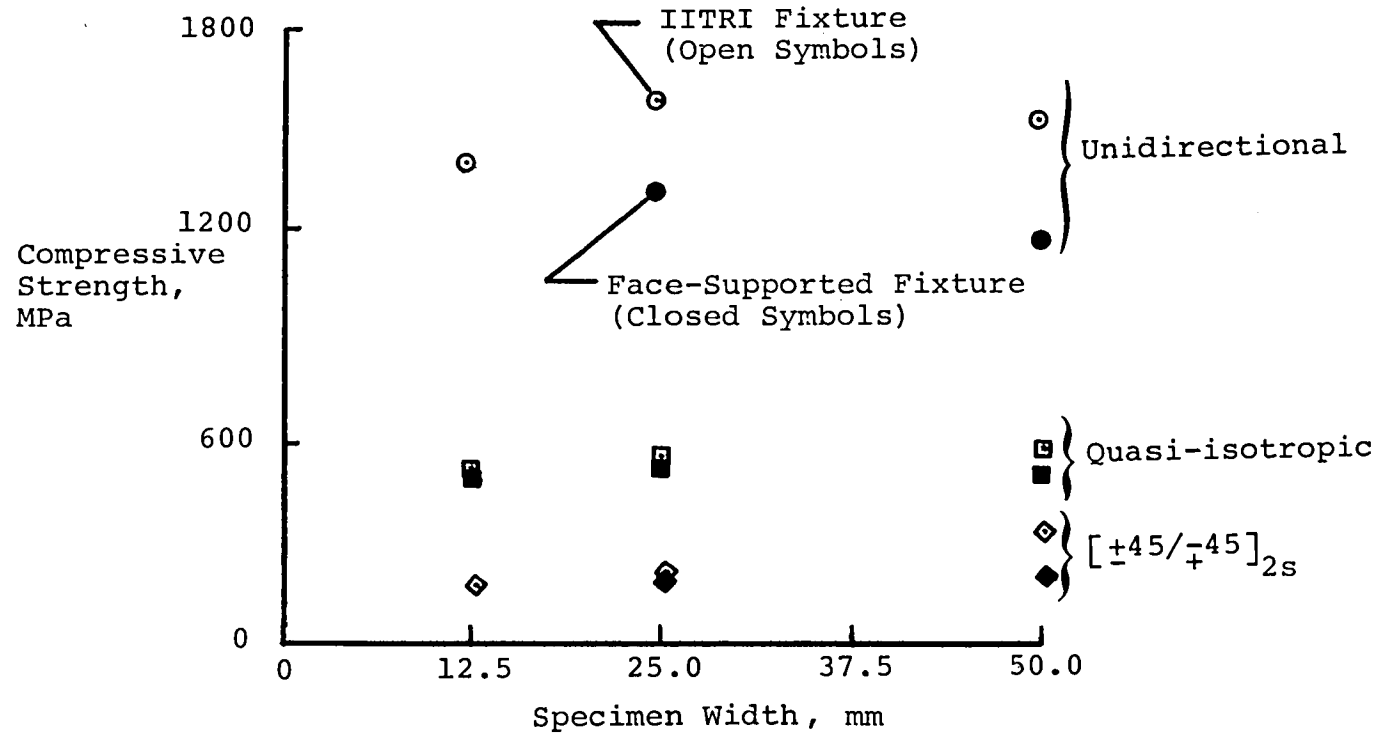

Figure 8.- Average compressive strength of 16-ply Gr/Ep composite material as a function of specimen width.

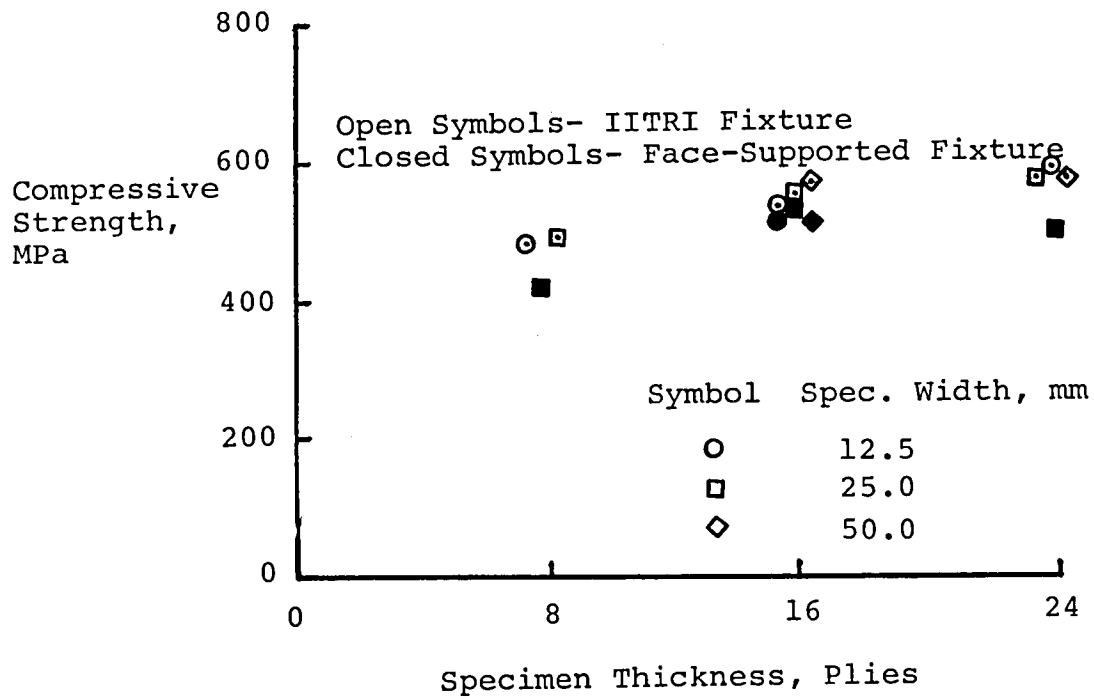

Figure 9.- Average compressive strength of quasi-isotropic Gr/Ep composite material as a function of specimen thickness.

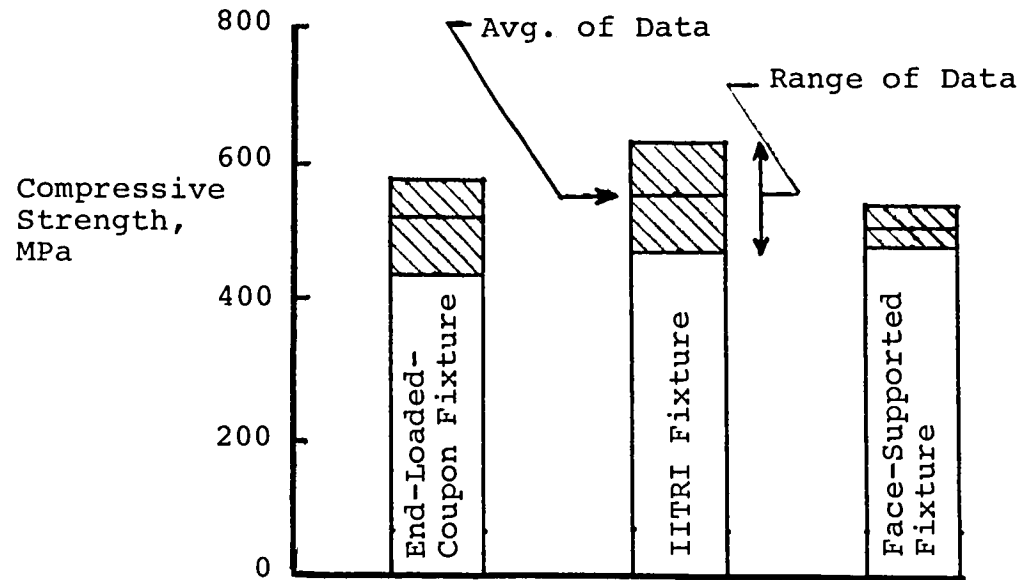

Figure 10.- Compressive strength of 25-mm wide 16-ply quasi-isotropic Gr/Ep specimens tested with the end-loaded, IITRI, and face-supported fixtures.



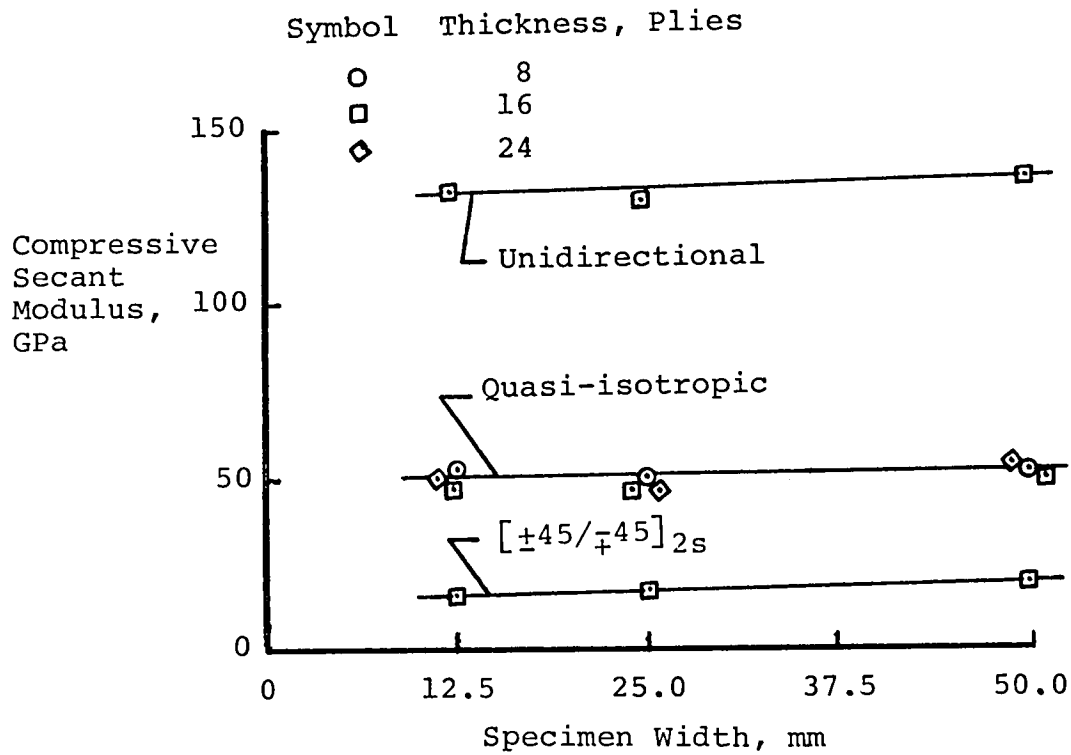

Figure 11(a).- Secant modulus at .004 strain of Gr/Ep composite material as a function of specimen width and thickness for specimens tested with the IITRI fixture.

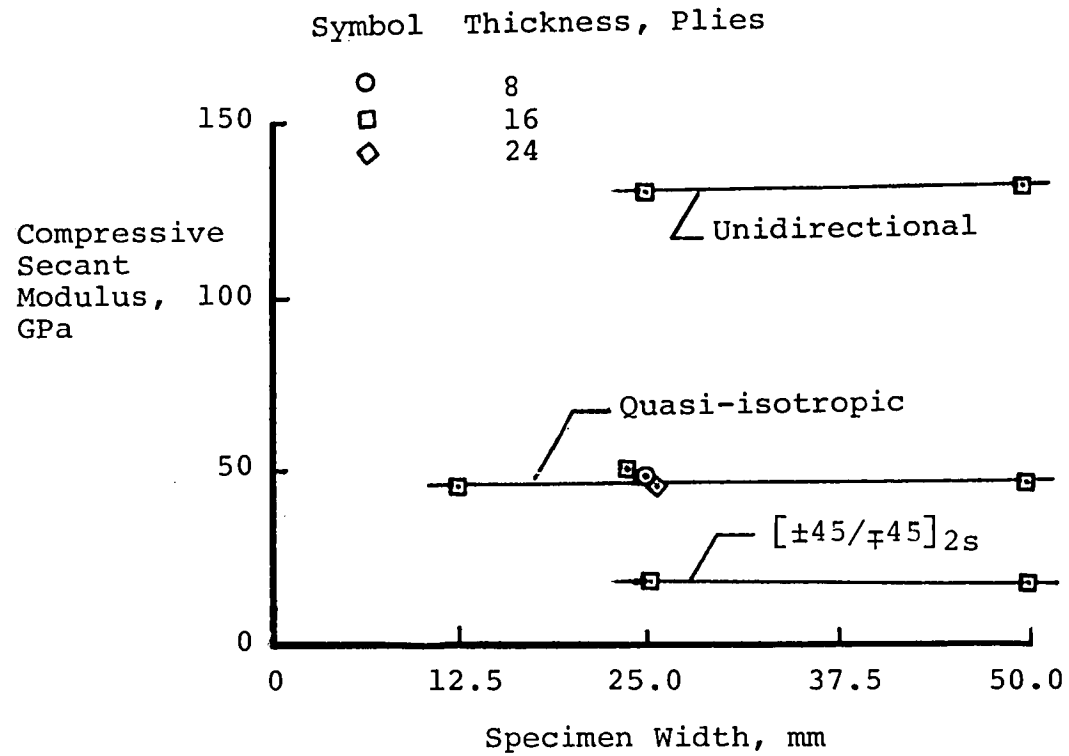

Figure 11(b).- Secant modulus at .004 strain of Gr/Ep composite material as a function of specimen width and thickness for specimens tested with the face-supported fixture.

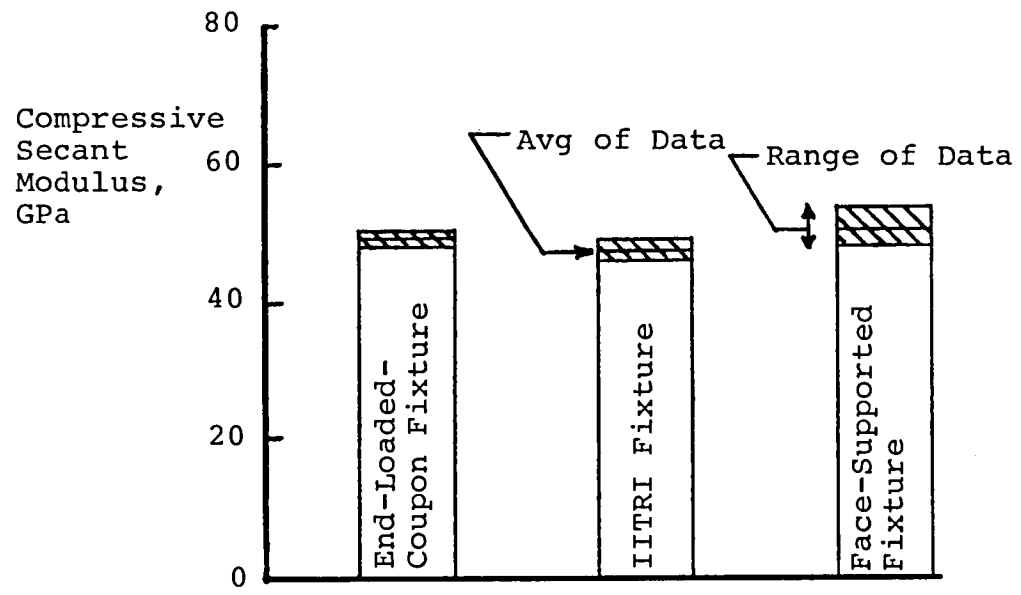

Figure 12.- Secant modulus at .004 strain of 25-mm wide 16-ply thick quasi-isotropic Gr/Ep specimens tested with the end-loaded, IITRI, and face-supported fixtures.

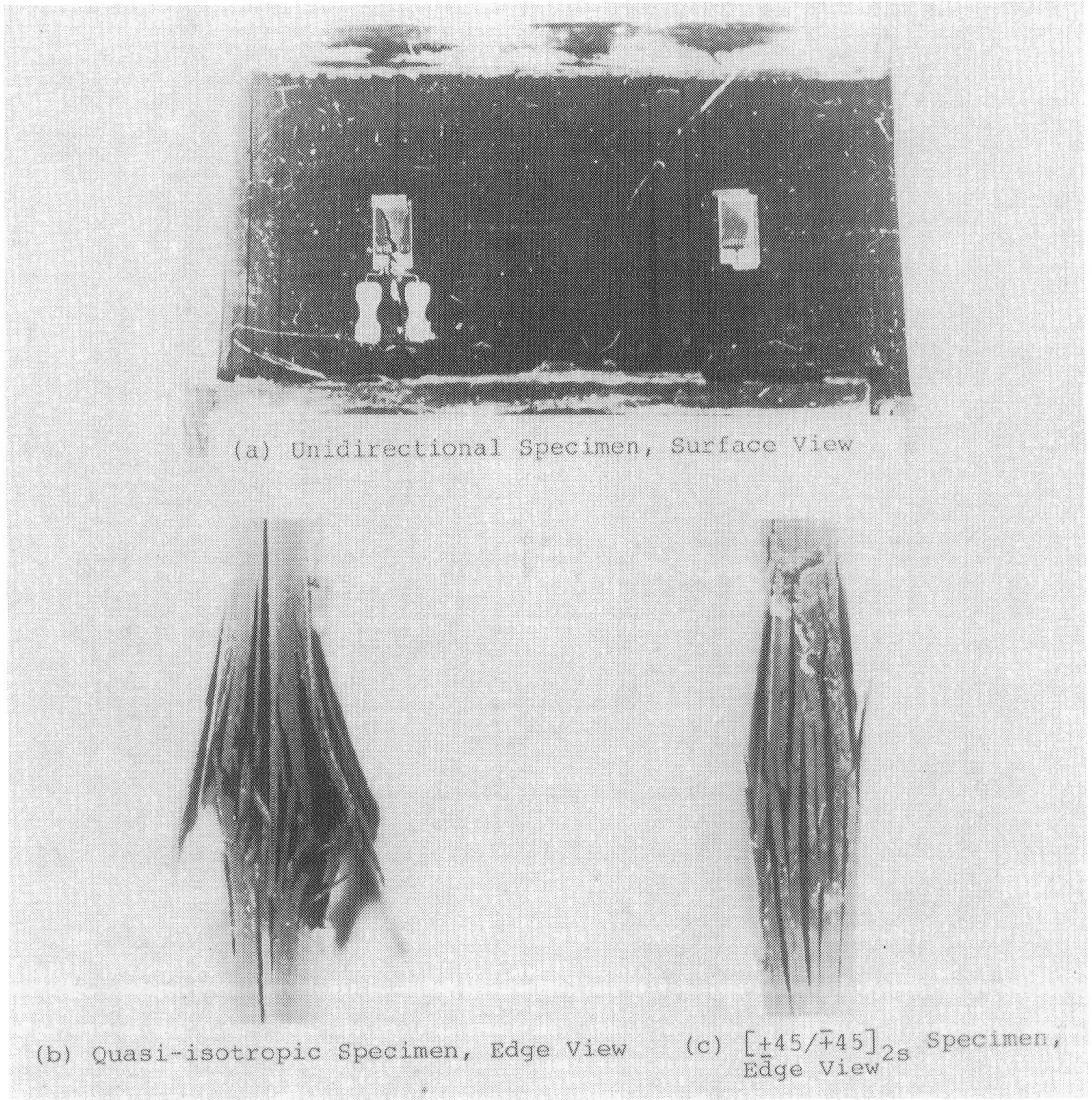

Figure 13.- Photographs of failed 16-ply 25-mm-wide specimens tested in IITRI fixture.



1. Report No. NASA TM-81796		2. Government Accession No.		3. Recipient's Catalog No.	
4. Title and Subtitle EFFECTS OF METHOD OF LOADING AND SPECIMEN CONFIGURATION ON COMPRESSIVE STRENGTH OF GRAPHITE/EPOXY COMPOSITE MATERIALS				5. Report Date April 1980	
				6. Performing Organization Code	
7. Author(s) Ronald K. Clark and W. Barry Lisagor				8. Performing Organization Report No.	
9. Performing Organization Name and Address NASA Langley Research Center Hampton, VA 23665				10. Work Unit No.	
				11. Contract or Grant No.	
12. Sponsoring Agency Name and Address National Aeronautics and Space Administration Washington, DC 20546				13. Type of Report and Period Covered Technical Memorandum	
				14. Army Project No.	
15. Supplementary Notes This paper is based on data presented at the ASTM Symposium on Test Methods and Design Allowables for Fibrous Composites, Dearborn, Michigan, Oct. 2-3, 1979. Use of commercial products or names of manufacturers in this report does not constitute official endorsement of such products or manufacturers, either expressed or implied, by the National Aeronautics and Space Administration.					
16. Abstract  Three test schemes were examined for testing graphite/epoxy (Narmco T300/5208) composite material specimens to failure in compression, including an adaptation of the IITRI "wedge grip" compression fixture, a face-supported-compression fixture, and an end-loaded-coupon fixture. The effects of specimen size, specimen support arrangement and method of load transfer on compressive behavior of Gr/Ep were investigated. Compression tests with the modified IITRI and face-supported fixture were conducted on specimens of 12.5-, 25-, and 50-mm widths, of 8-, 16-, and 24-ply thicknesses; and of [0], [+45], and [0/+45/90] fiber orientations. The end-loaded-coupon fixture was used to test 16-ply [0/+45/90] specimens. Compressive stress-strain, strength, and modulus data obtained with the three fixtures are presented with evaluations showing the effects of all test parameters, including fiber orientation. The IITRI fixture has the potential to provide good stress/strain data to failure for unidirectional and quasi-isotropic laminates. The face supported fixture was found to be the most desirable for testing [+45] <sub>s</sub> laminates.					
17. Key Words (Suggested by Author(s)) Composite Materials, Mechanical Properties, Compression Testing Graphite/Epoxy, Compressive Strength, Compressive Modulus, Failure Modes				18. Distribution Statement Unclassified - Unlimited  Subject Category 24	
19. Security Classif. (of this report) Unclassified		20. Security Classif. (of this page) Unclassified		21. No. of Pages 42	22. Price* \$4.50

\* For sale by the National Technical Information Service, Springfield, Virginia 22161

NASA-Langley, 1980



