

NASA  
TP  
1683  
c.1

# NASA Technical Paper 1683

LOAN COPY RETURN  
AFWL TECHNICAL  
WRIGHT-PATTERSON AFB, OH



## Effect of Reynolds Number on Stability Characteristics of a Cruciform Wing-Body at Supersonic Speeds

Robert L. Stallings, Jr., Milton Lamb,  
and Carolyn B. Watson

JULY 1980





NASA Technical Paper 1683

# Effect of Reynolds Number on Stability Characteristics of a Cruciform Wing-Body at Supersonic Speeds

Robert L. Stallings, Jr., Milton Lamb,  
and Carolyn B. Watson  
*Langley Research Center  
Hampton, Virginia*

**NASA**

National Aeronautics  
and Space Administration

**Scientific and Technical  
Information Office**

1980

## SUMMARY

An experimental investigation has been conducted to determine the effect of Reynolds number on the stability characteristics of a cruciform wing-body configuration at angles of attack up to  $50^\circ$ . Force balance (axial force not measured) and pressure tests were conducted at Mach numbers of 1.60 and 2.70; Reynolds numbers based on body diameter from approximately  $1.3 \times 10^5$  to  $28 \times 10^5$ ; and roll angles of  $0^\circ$ ,  $22.5^\circ$ , and  $45^\circ$ .

Normal-force, pitching-moment, side-force, yawing-moment, and rolling-moment coefficients were found to be essentially independent of Reynolds number for the complete range of test conditions. Also, no significant effects of Reynolds number on pressure coefficient distributions were observed in the windward wing-body interaction region.

Pressure and flow visualization data indicate the existence of wing choking between the two windward wings at large angles of attack for a roll angle of  $22.5^\circ$ . These data, together with the force balance data, suggest a direct relationship between wing choking and the onset of a nonlinear lateral stability variation with angle of attack.

## INTRODUCTION

The high maneuverability requirements of missiles often necessitate flight at large angles of attack. At these large angles of attack, potential flow methods and linear theories have very limited application, and the missile designer generally resorts to semiempirical methods based on wind-tunnel data for preliminary design purposes. Because most supersonic wind tunnels have a limited Reynolds number capability, and because of the small model scale generally required for high angle-of-attack testing, most of the existing data for high angles of attack at supersonic speeds have been obtained at less than flight Reynolds numbers. Since viscosity can significantly affect the missile flow field at large angles of attack, the effects of Reynolds number on missile stability characteristics must be established before wind-tunnel data can be used with confidence. Therefore, an experimental investigation was initiated by the NASA Langley Research Center to determine the effect of Reynolds number on the stability characteristics of a cruciform wing-body configuration at large angles of attack.

Force balance and pressure measurements were obtained at Mach numbers of 1.60 and 2.70, angles of attack to  $50^\circ$ , and Reynolds numbers based on body diameter ranging from approximately  $1.3 \times 10^5$  to  $28 \times 10^5$ . The high Reynolds number pressure tests (ref. 1) were conducted at the New York University Aerospace and Energetics Laboratory (NYU). Sample results from the force balance tests conducted in the High Speed Wind Tunnel (HSWT) at Vought Corporation and the Langley Unitary Plan Wind Tunnel (UPWT) as well as results from the low Reynolds number pressure tests conducted at the UPWT are presented and discussed

in reference 2. The present report completes the documentation of the force balance data, the UPWT pressure data, and the flow visualization data, which consist of schlieren and vapor screen photographs.

### SYMBOLS

Symbols in the second column are used in the computer-generated tables.

A		body cross-sectional area, $\frac{\pi}{4}d^2$
$C_l$		rolling-moment coefficient, $\frac{\text{Rolling moment}}{qAd}$
$C_m$		pitching-moment coefficient, $\frac{\text{Pitching moment}}{qAd}$
$C_n$		yawing-moment coefficient, $\frac{\text{Yawing moment}}{qAd}$
$C_N$		normal-force coefficient, $\frac{\text{Normal force}}{qA}$
	CP	pressure coefficient, $\frac{P-P_{INF}}{q}$
$C_y$		side-force coefficient, $\frac{\text{Side force}}{qA}$
d		body diameter, cm
	FIN	wing number (figs. 2(a) and 2(b))
M		free-stream Mach number
	P	measured surface pressure, kPa
	PINF	free-stream static pressure, kPa
$P_t$		free-stream stagnation pressure, kPa
$P_{t,2}$	PT2	pressure behind normal shock at free-stream Mach number, kPa

q		free-stream dynamic pressure, kPa
R		free-stream Reynolds number based on body diameter
	TUBE	orifice number (see fig. 2 and data tables)
x/c	X/C	chordwise distance from wing leading edge nondimensionalized by local chord
x/d	X/D	axial distance from nose nondimensionalized by body diameter
y/s	Y/S	spanwise distance from wing root nondimensionalized by exposed semispan
$\alpha$		angle of attack, deg
$\theta$	THETA	angular location of pressure orifices, deg (see fig. 2(a))
$\phi$		roll angle, deg (see fig. 1)

Facility Abbreviations:

HSWT	High Speed Wind Tunnel at Vought Corporation
NYU	New York University Aerospace and Energetics Laboratory
UPWT	Langley Unitary Plan Wind Tunnel

APPARATUS AND METHODS

Tunnels

Langley Unitary Plan Wind Tunnel.- This facility is a variable-density, continuous-flow tunnel that has two test sections 1.2 m by 1.2 m. The test sections provide a range in Mach number from 1.5 to 4.6. The present tests were conducted in the low Mach number test section, which has a range of Mach number from 1.5 to 2.9. The facility is described in more detail in reference 3.

Vought High Speed Wind Tunnel.- This facility is an atmospheric exhaust, blowdown tunnel with a test section 1.2 m by 1.2 m and a Mach number range from 0.5 to 5.0. Air is stored in six tanks at a maximum pressure of 4137 kPa and a nominal temperature of 311 K. A more complete description of the facility may be found in reference 4.

New York University Aerospace and Energetics Laboratory.- The facility used at this laboratory was a blowdown tunnel having a test section 0.261 m by 0.203 m. The tunnel stagnation temperature was maintained at 295 K.

## Models and Instrumentation

The force and pressure models used in the tests are shown in figures 1 and 2. The force model (fig. 1) has an overall length of 48.26 cm and a diameter of 3.81 cm. Force and moment measurements were obtained with a strain-gage balance housed within the model and rigidly fastened to a sting support system. Different balances were used for the UPWT and the HSWT tests. The balance used in the UPWT test had a normal-force capacity of 1779 N, whereas the balance used in the HSWT tests had a normal-force capacity of 8896 N. Since the larger capacity balance did not have an axial-force capability and since stability measurements were the primary objective of these tests, axial-force measurements were not obtained in either facility.

The pressure model was instrumented with 208 pressure orifices in the locations shown in figure 2. Because large pressure gradients were expected to occur in the windward wing-body interaction area, this was the most densely instrumented region. The pressures were measured by electrical transducers connected to a pressure scanning system. A total of 6 scanners were used; tubing from approximately 35 orifices was connected to each scanner. The pressure range of the electrical transducers for each scanner was selected to match the maximum anticipated pressure for the orifices connected to the scanner. Up to four reference pressures were connected to the scanners to provide transducer calibrations for each test point. These reference pressures and tunnel free-stream pressures were measured independently by precision mercury manometers.

Vapor-screen photographs of the pressure model were obtained at selected angles of attack. The vapor in the test section is obtained by injecting water into the tunnel system. The water vaporizes at the low ambient temperature of the test section. A vertical plane of light is passed through the test section at the desired model station; the amount of reflected light varies directly with the amount of vapor present in a particular region. For example, strong vortex formations show up as dark regions because the vapor content has decreased as a result of fluid density change and centrifugal effects from the vortex core region. Since the vapor-screen photographs of the present tests are used only to indicate the presence or location of vortices, shock waves, and similar phenomena rather than their strengths, the results should not be significantly affected by any extraneous effects that may be created by the presence of vapor in the flow field. The photographs presented in this paper were obtained with the camera looking downstream at an angle of about  $45^\circ$  to the plane of light (see fig. 3).

## Test Conditions

The UPWT force tests were conducted at Mach numbers of 1.60 and 2.70 for Reynolds numbers based on body diameter ranging from  $1.3 \times 10^5$  to  $9.0 \times 10^5$ . The UPWT pressure tests were also conducted at Mach numbers of 1.60 and 2.70 and for Reynolds numbers ranging from  $1.3 \times 10^5$  to  $3.8 \times 10^5$ . Both the UPWT pressure tests and force tests were conducted at roll angles of  $0^\circ$ ,  $22.5^\circ$ , and  $45^\circ$  for angles of attack from  $0^\circ$  to  $50^\circ$ .

The HSWT tests were also conducted at Mach numbers of 1.60 and 2.70. The Reynolds number was varied from  $9.4 \times 10^5$  to  $17.5 \times 10^5$  at  $M = 1.60$  and from  $10.0 \times 10^5$  to  $27.5 \times 10^5$  at  $M = 2.70$ . Data were obtained at roll angles of  $0^\circ$ ,  $22.5^\circ$ , and  $45^\circ$ . Since the HSWT angle-of-attack sector was limited to a range of approximately  $35^\circ$ , these tests were conducted through an  $\alpha$  range from approximately  $15^\circ$  to  $50^\circ$ .

For both facilities all tests were conducted with natural boundary-layer transition.

## RESULTS AND DISCUSSION

Since there was no effect of Reynolds number on the data obtained in either the UPWT or the HSWT, the results from each facility are presented for one Reynolds number only. The UPWT results are presented for a nominal Reynolds number of  $2.5 \times 10^6$  and the HSWT results are presented for the maximum test Reynolds number at each Mach number.

### Force Tests

Shown in figure 4 is the effect of Reynolds number on normal-force and pitching-moment coefficients for the present wing-body configuration for roll angles of  $0^\circ$ ,  $22.5^\circ$ , and  $45^\circ$ . The data shown in figure 4 are representative of the results obtained for the complete Reynolds number range of each facility and indicate little, if any, effect of Reynolds number on  $C_N$  or  $C_m$  throughout the range of test conditions. This lack of Reynolds number effect is consistent with results from the NYU pressure tests (ref. 1); however, the lack of detailed pressure instrumentation on the small NYU model precluded any firm conclusions about the effects of Reynolds number on its stability characteristics.

There was also little discernible effect of Reynolds number on the model lateral aerodynamic characteristics, as shown in figure 5. For  $\phi = 0^\circ$  and  $45^\circ$  (figs. 5(a) and 5(c)), the model geometry is symmetrical about the vertical plane of symmetry and, therefore, the lateral forces are essentially zero throughout the angle-of-attack range. At  $\phi = 22.5^\circ$  (fig. 5(b)), the symmetry no longer exists and the data show large nonlinear variations with angle of attack for both test Mach numbers. This effect has been observed by other investigators, (for example, ref. 5). The onset of this nonlinear variation occurs at an angle of attack ( $\alpha \approx 15^\circ$ ,  $M = 1.60$ ;  $\alpha \approx 35^\circ$ ,  $M = 2.70$ ) corresponding to the onset of a "wing-choking" phenomenon that occurs between the two windward wings as determined from both pressure measurements and schlieren photographs. This phenomenon will be discussed in more detail in the subsequent section.

### Pressure Tests

Schlieren and vapor-screen studies previously conducted in the UPWT on a cruciform wing-body configuration have shown a very complex flow field and strong shock wave interactions in the windward wing-body region at large angles

of attack. Since local panel loadings in such wing-body regions make large contributions to the overall body forces, any effect of Reynolds number on the local flow field in this region could result in large effects on the aerodynamics of such a body. Therefore, one objective of the present investigation was to determine the effect of Reynolds number on the local pressure distributions and flow field in the windward wing-body interaction region of a cruciform wing-body configuration at large angles of attack. Tabulations of the pressure measurements for  $R = 2.5 \times 10^5$  are presented in tables I to VI.

Shown in figure 6 are longitudinal pressure distributions measured on the body in the wing-body interaction region. The data are from the instrumentation ray located at an equal distance between wings 3 and 4 ( $\theta = 225^\circ$ ; fig. 2(a)). Results are presented for Mach numbers of 1.60 and 2.70 and angles of attack of  $20^\circ$  and  $50^\circ$ . The UPWT data are presented for a Reynolds number of  $2.5 \times 10^5$  but are also representative of the data obtained at Reynolds numbers of  $1.3 \times 10^5$  and  $3.8 \times 10^5$ . The NYU data ( $M = 2.70$  only) are presented for  $R = 22.5 \times 10^5$ . The data show that at large angles of attack, large adverse pressure gradients occur on the body in the vicinity of the wing-root leading edge ( $x/d = 7.6$ ). However, the pressure distributions are relatively insensitive to Reynolds number through the range of test conditions. This lack of Reynolds number effect may result from the dominance over the flow in this region by the large, favorable cross flow pressure gradient on the body ahead of the wing. This gradient vents the large pressures associated with the wing-body interaction region to the lower pressures occurring away from the stagnation line.

Although the primary objective of the present investigation was to determine the effect of Reynolds number on the stability characteristics and flow field of a cruciform wing-body configuration at large angles of attack, the detailed pressure measurements combined with the force balance measurements offer an explanation for the nonlinear lateral stability data that were shown in figure 5 and that have also been observed by other investigators (for example, ref. 5).

Shown in figure 7 are schlieren photographs and windward pressure contours from the UPWT tests for the wing-body interaction region of the present configuration. The values shown on the pressure contours are the local pressures nondimensionalized by free-stream pitot pressure and multiplied by a factor of 10. The contours were determined from a pressure orifice matrix consisting of approximately 100 orifices with locations which are indicated by the dots on the contour sketches. The body contours shown are for the windward half of the configuration extending through  $\pm 90^\circ$  expansion from the windward stagnation line. The body area shown is the actual surface area rather than a projected area. The wing contours shown are for the windward side of the windward wings. The wings have been rotated about their root chord so that the true wing planform area is displayed.

For  $\phi = 45^\circ$  and  $M = 2.70$  (fig. 7(a)), the pressure contours on the windward wing surfaces at  $\alpha \leq 30^\circ$  show maximum pressures occurring in the wing leading-edge region with somewhat smaller pressures occurring on the body between the two wings. This type of pressure distribution generally occurred when the wing shock was attached. For  $\alpha \geq 40^\circ$ , a detached shock, as shown in



the schlieren photographs, occurs ahead of the wings, and the pressure contours representative of this condition extend from wing to wing across the body as shown by the pressure measurements. The maximum measured pressures in the wing-body interaction region at  $\alpha \geq 40^\circ$  are slightly greater than free-stream pitot pressure. The similarity of the detached shock shown in the schlieren photographs for  $\alpha \geq 40^\circ$  to the shock formation ahead of a choked inlet has caused this flow phenomenon to be referred to as "fin choking" or "wing choking." (See, for example, ref. 6.) The initial onset of wing choking for  $M = 2.70$  and  $\phi = 45^\circ$  occurred at  $\alpha \sim 35^\circ$  as determined from both schlieren photographs and pressure measurements.

Data obtained at  $\phi = 22.5^\circ$  and  $M = 2.70$  are shown in figure 7(b). At  $\alpha \leq 30^\circ$  an attached shock occurs on both windward wings; the greater pressure, as would be expected, occurs on the wing located  $67.5^\circ$  from the stagnation line (wing 4; see fig. 2) as compared to the wing located  $22.5^\circ$  from the stagnation line (wing 3). The effective angle of attack of wing 3 (angle between plane of wing and the free-stream velocity vector) at  $\alpha = 30^\circ$  is  $11.0^\circ$  and  $27.5^\circ$  for wing 4. At  $\alpha = 40^\circ$  the effective angle of attack for wing 3 is  $14.2^\circ$  and  $36.4^\circ$  for wing 4. Therefore, from a flow-turning angle criterion, a detached shock and resulting larger pressures should occur on wing 4 and an attached shock with corresponding lower pressures on wing 3. However, pressure measurements on both wings 3 and 4 at  $\alpha \geq 40^\circ$  are representative of a detached shock (shown in fig. 7 (b)), even though wing 3 for  $\alpha \leq 50^\circ$  is at an effective angle of attack much less than required for shock detachment. The pressure data indicate that for  $\phi = 22.5^\circ$  and  $M = 2.70$ , this wing-choking phenomenon first occurs at  $\alpha \sim 35^\circ$ . This occurrence is similar to the results obtained at  $\phi = 45^\circ$ . The increase in pressure on the windward side of wing 3 associated with wing-choking results in an increase in normal force for wing 3 which results in an increase in rolling moment. The force balance data at  $M = 2.70$  (fig. 5(b)) show this increase in rolling moment for  $\alpha \geq 35^\circ$ . It should be noted that although pressure data are presented in figure 7 for only the windward sides of wings 3 and 4, the data from the remaining surfaces (see tables) have also been examined and do not indicate any anomalous variation with angles of attack that would significantly contribute to this nonlinear variation in rolling moment.

Shown in figure 7(c) are data obtained at  $\phi = 0^\circ$  for  $M = 2.70$ . At this roll angle, wing 3 is located on the stagnation line and wing 4 is  $90^\circ$  from the stagnation line. Therefore, the effective angle of attack for wing 3 is always  $0^\circ$ ; for wing 4, it is equal to the body angle of attack. Although shock detachment occurs for wing 4 at the larger angles of attack, wing choking between wings 3 and 4 does not occur at  $M = 2.70$  for the range of angles of attack of the present tests. The pressure contours and schlieren photographs indicate that an attached shock occurs on wing 4 for  $\alpha \leq 30^\circ$  and a detached shock occurs for  $\alpha \geq 40^\circ$ . Wing 3 is intersected by the body shock at the larger angles of attack. This phenomenon results in large pressure gradients in the intersection region. For  $\alpha \geq 40^\circ$ , this large pressure gradient apparently creates a pair of vortices, one from each side of wing 3. These vortices persist downstream of the wing on the windward side of the body, as shown in the vapor-screen photographs of figure 8(a) at  $x/d = 12$  ( $\alpha = 40^\circ$ ). This apparent

vortex formation can also be seen in the schlieren photographs of figure 7(c) for  $\alpha \geq 40^\circ$ . The vapor-screen photographs shown in figure 8(a) for  $\alpha = 30^\circ$  do not show any vortex formations in this region.

The vapor-screen photographs for  $\phi = 22.5^\circ$  (fig. 8(b)) also indicate the existence of a pair of vortices downstream of wing 3 for  $\alpha = 40^\circ$ . These vortex formations are somewhat different from the pair formed at  $\phi = 0^\circ$  in that they appear to wrap around the body at short distances downstream of the wing. At  $\alpha = 30^\circ$ , the vapor-screen photographs do not show vortex formations in this region. This is similar to the results obtained at  $\phi = 0^\circ$ .

Pressure contours and schlieren photographs at  $M = 1.60$  are shown in figures 7(d), 7(e), and 7(f) for  $\phi = 45^\circ$ ,  $22.5^\circ$ , and  $0^\circ$ , respectively. A major effect of decreasing Mach number is to reduce the angle of attack at which both wing choking and shock detachment occur. The onset of the nonlinear variation in lateral stability shown in figure 5(b) for  $\phi = 22.5^\circ$  and  $M = 1.60$  also occurs at a much smaller angle of attack compared to the  $M = 2.70$  results. This agreement between the schlieren photographs, contour plots, and force balance data strongly suggests a direct relationship between wing choking and the nonlinear variation in lateral stability observed for the cruciform configuration tested.

#### CONCLUDING REMARKS

An experimental investigation has been conducted to determine the effect of Reynolds number on the stability characteristics of a cruciform wing-body configuration at angles of attack up to  $50^\circ$ . Force balance (axial force not measured) and pressure tests were conducted at Mach numbers of 1.60 and 2.70; Reynolds numbers based on body diameter from approximately  $1.3 \times 10^5$  to  $28 \times 10^5$ ; and roll angles of  $0^\circ$ ,  $22.5^\circ$ , and  $45^\circ$ . Results from these tests lead to the following concluding remarks:

1. Normal-force, pitching-moment, side-force, yawing-moment, and rolling-moment coefficients were found to be essentially independent of Reynolds number for the complete range of test conditions.
2. No significant Reynolds number effects on pressure coefficient distributions in the windward wing-body interaction region were obtained.
3. The pressure, force, and flow visualization data of the present investigation strongly suggest a direct relationship between wing choking and the onset of a nonlinear lateral stability variation with angle of attack.

Langley Research Center  
National Aeronautics and Space Administration  
Hampton, VA 23665  
May 12, 1980

#### REFERENCES

1. Agnone, A. M.; Zakkay V.; Tory, E.; and Stallings, R.: Aerodynamics of Slender Finned Bodies at Large Angles of Attack. AIAA Paper 77-666, June 1977.
2. Stallings, R. L., Jr.: Reynolds Number Effects on Aerodynamic Characteristics at Large Angles of Attack. Spacecr. & Rockets, vol. 17, no. 2, Mar.-Apr. 1980, pp. 129-133.
3. Manual for Users of the Unitary Plan Wind Tunnel Facilities of the National Advisory Committee for Aeronautics. NASA, 1956.
4. Arnold, J. W.: High Speed Wind Tunnel - Facility Handbook. Publ. No. AER-EIR-13552-C, Vought Corp., Feb. 1970 (Revised Mar. 1976).
5. Monta, William J.: Supersonic Aerodynamic Characteristics of a Sparrow III Type Missile Model With Wing Controls and Comparison With Existing Tail-Control Results. NASA TP-1078, 1977.
6. Nielsen, Jack N.: Nonlinearities in Missile Aerodynamics. AIAA Paper 78-20, Jan. 1978.

TABLE I.- BODY PRESSURE LISTING FOR  $\phi = 0^\circ$  AND  $R = 2.5 \times 10^5$

(a)  $M = 1.60$ ;  $\alpha = 0^\circ$

$p_t = 54.5 \text{ kPa}$

TUBE	THETA	X/D	P/PINF	P/PT2	CP	TUBE	THETA	X/D	P/PINF	P/PT2	CP
1	0.0	1.333	1.1427	.3003	.0797	59	225.0	8.333	1.1776	.3095	.0991
2	90.0	1.333	1.1671	.3067	.0933	60	45.0	8.667	1.1848	.3114	.1031
3	180.0	1.333	1.1614	.3052	.0901	61	135.0	8.667	1.1877	.3121	.1047
4	270.0	1.333	1.1564	.3039	.0873	62	202.5	8.667	1.1773	.3094	.0990
5	0.0	2.667	.8895	.2338	-.0617	63	225.0	8.667	1.1720	.3080	.0960
6	90.0	2.667	.8919	.2344	-.0603	64	247.5	8.667	1.1922	.3133	.1072
7	180.0	2.667	.8915	.2343	-.0605	65	315.0	8.667	1.1785	.3097	.0996
8	270.0	2.667	.8903	.2340	-.0612	66	225.0	9.000	1.1838	.3111	.1025
9	0.0	4.000	.9504	.2498	-.0277	67	45.0	9.333	1.0363	.2723	.0202
10	10.0	4.000	.9514	.2500	-.0271	68	135.0	9.333	1.0104	.2656	.0058
11	20.0	4.000	.9517	.2501	-.0270	69	202.5	9.333	1.0325	.2713	.0181
12	30.0	4.000	.9480	.2491	-.0290	70	225.0	9.333	1.0441	.2744	.0246
13	40.0	4.000	.9468	.2488	-.0297	71	247.5	9.333	1.0499	.2759	.0279
14	50.0	4.000	.9465	.2488	-.0298	72	315.0	9.333	.9984	.2624	-.0009
15	60.0	4.000	.9455	.2485	-.0304	73	225.0	9.667	.9698	.2549	-.0168
16	70.0	4.000	.9455	.2485	-.0304	74	45.0	10.000	.9111	.2394	-.0496
17	80.0	4.000	.9457	.2485	-.0303	75	135.0	10.000	.8642	.2271	-.0758
18	90.0	4.000	.9472	.2489	-.0295	76	202.5	10.000	.8886	.2335	-.0622
19	180.0	4.000	.9409	.2473	-.0330	77	225.0	10.000	.9022	.2371	-.0546
20	270.0	4.000	.9554	.2511	-.0249	78	247.5	10.000	.8890	.2336	-.0619
21	0.0	5.333	.9835	.2585	-.0092	79	315.0	10.000	.8366	.2199	-.0912
22	90.0	5.333	.9778	.2570	-.0124	80	0.0	10.667	.9330	.2452	-.0374
23	180.0	5.333	.9861	.2592	-.0078	81	45.0	10.667	.8621	.2266	-.0770
24	270.0	5.333	.9841	.2586	-.0089	82	90.0	10.667	.9418	.2475	-.0325
25	0.0	6.200	.9918	.2607	-.0046	83	135.0	10.667	.9024	.2372	-.0545
26	10.0	6.200	.9928	.2609	-.0040	84	180.0	10.667	.9490	.2494	-.0285
27	20.0	6.200	1.0020	.2633	.0011	85	225.0	10.667	.8943	.2350	-.0590
28	30.0	6.200	.9974	.2621	-.0014	86	270.0	10.667	.9485	.2493	-.0287
29	40.0	6.200	.9988	.2625	-.0007	87	315.0	10.667	.8922	.2345	-.0602
30	50.0	6.200	.9948	.2615	-.0029	88	0.0	11.330	1.0006	.2630	.0003
31	60.0	6.200	.9958	.2617	-.0023	89	45.0	11.330	.8621	.2266	-.0770
32	70.0	6.200	.9867	.2593	-.0074	90	90.0	11.330	.9833	.2584	-.0093
33	80.0	6.200	.9877	.2596	-.0069	91	135.0	11.330	1.0000	.2628	-.0000
34	90.0	6.200	.9871	.2594	-.0072	92	180.0	11.330	.9745	.2561	-.0143
35	135.0	6.200	.9951	.2615	-.0027	93	225.0	11.330	.9676	.2543	-.0181
36	180.0	6.200	1.0060	.2644	.0034	94	270.0	11.330	.9838	.2585	-.0091
37	225.0	6.200	1.0008	.2630	.0004	95	315.0	11.330	.9887	.2598	-.0063
38	270.0	6.200	.9975	.2622	-.0014	96	0.0	12.000	.9907	.2604	-.0052
39	315.0	6.200	.9881	.2597	-.0067	97	45.0	12.000	.9893	.2600	-.0060
40	0.0	7.333	.9947	.2614	-.0030	98	90.0	12.000	.9877	.2596	-.0068
41	45.0	7.333	1.0014	.2632	.0008	99	135.0	12.000	.9914	.2605	-.0048
42	90.0	7.333	1.0037	.2638	.0021	100	180.0	12.000	.9906	.2604	-.0052
43	135.0	7.333	1.0105	.2656	.0058	101	225.0	12.000	.9899	.2602	-.0056
44	180.0	7.333	.9991	.2626	-.0005	102	270.0	12.000	.9799	.2575	-.0112
45	202.5	7.333	.9757	.2564	-.0136	103	315.0	12.000	.9876	.2595	-.0069
46	225.0	7.333	.9650	.2536	-.0195	104	0.0	13.333	1.8573	.4881	.4784
47	247.5	7.333	1.0121	.2660	.0067	105	45.0	13.333	1.0217	.2685	.0121
48	270.0	7.333	1.0146	.2666	.0081	106	90.0	13.333	1.0358	.2722	.0200
49	315.0	7.333	1.0022	.2634	.0012	107	135.0	13.333	1.0305	.2708	.0170
50	202.5	7.667	1.0548	.2772	.0306	108	180.0	13.333	1.0356	.2722	.0199
51	225.0	7.667	1.0218	.2685	.0122	109	225.0	13.333	1.0171	.2673	.0095
52	247.5	7.667	1.0502	.2760	.0280	110	270.0	13.333	1.0266	.2698	.0149
53	45.0	8.000	1.0707	.2814	.0394	111	315.0	13.333	1.0137	.2664	.0076
54	135.0	8.000	1.0592	.2784	.0330	112	0.0	14.400	1.0325	.2713	.0181
55	202.5	8.000	1.0822	.2844	.0459	113	90.0	14.400	1.0244	.2692	.0136
56	225.0	8.000	1.0508	.2762	.0283	114	180.0	14.400	1.0292	.2705	.0163
57	247.5	8.000	1.0804	.2839	.0449	115	270.0	14.400	1.0222	.2686	.0124
58	315.0	8.000	1.0740	.2823	.0413						

TABLE I.- Continued

(b)  $M = 1.60$ ;  $\alpha = 10^\circ$

$P_t = 54.6$  kPa

TUBE	THETA	X/D	P/PINF	P/PT2	CP	TUBE	THETA	X/D	P/PINF	P/PT2	CP
1	0.0	1.333	.9556	.2511	-.0248	59	225.0	8.333	1.4701	.3864	.2623
2	90.0	1.333	1.0785	.2834	.0438	60	45.0	8.667	.8401	.2208	-.0892
3	180.0	1.333	1.4739	.3874	.2644	61	135.0	8.667	1.4715	.3867	.2631
4	270.0	1.333	1.0774	.2832	.0432	62	202.5	8.667	1.4579	.3832	.2555
5	0.0	2.667	.8508	.2236	-.0832	63	225.0	8.667	1.5257	.4010	.2933
6	90.0	2.667	.7558	.1986	-.1363	64	247.5	8.667	1.6692	.4387	.3734
7	180.0	2.667	1.0687	.2809	.0383	65	315.0	8.667	.8232	.2164	-.0986
8	270.0	2.667	.7682	.2019	-.1294	66	225.0	9.000	1.5569	.4092	.3108
9	0.0	4.000	.9994	.2626	-.0004	67	45.0	9.333	.7153	.1880	-.1589
10	10.0	4.000	1.0022	.2634	.0012	68	135.0	9.333	1.2446	.3271	.1365
11	20.0	4.000	.9922	.2608	-.0043	69	202.5	9.333	1.3605	.3576	.2012
12	30.0	4.000	.9292	.2442	-.0395	70	225.0	9.333	1.3453	.3536	.1927
13	40.0	4.000	.8755	.2301	-.0695	71	247.5	9.333	1.4480	.3806	.2500
14	50.0	4.000	.8132	.2137	-.1043	72	315.0	9.333	.7241	.1903	-.1540
15	60.0	4.000	.8040	.2113	-.1094	73	225.0	9.667	1.2623	.3318	.1464
16	70.0	4.000	.8008	.2105	-.1112	74	45.0	10.000	.5764	.1515	-.2364
17	80.0	4.000	.7918	.2081	-.1162	75	135.0	10.000	1.1704	.3076	.0951
18	90.0	4.000	.7724	.2030	-.1270	76	202.5	10.000	1.2183	.3202	.1218
19	180.0	4.000	1.0199	.2680	.0111	77	225.0	10.000	1.2038	.3164	.1137
20	270.0	4.000	.7780	.2045	-.1239	78	247.5	10.000	1.2089	.3177	.1166
21	0.0	5.333	1.0146	.2667	.0082	79	315.0	10.000	.5562	.1462	-.2477
22	90.0	5.333	.8467	.2225	-.0856	80	0.0	10.667	.7642	.2008	-.1316
23	180.0	5.333	1.0228	.2688	.0127	81	45.0	10.667	.7632	.2006	-.1321
24	270.0	5.333	.8409	.2210	-.0888	82	90.0	10.667	.9234	.2427	-.0428
25	0.0	6.200	1.0151	.2668	.0084	83	135.0	10.667	1.1608	.3051	.0897
26	10.0	6.200	1.0168	.2672	.0094	84	180.0	10.667	1.2969	.3408	.1657
27	20.0	6.200	1.0097	.2654	.0054	85	225.0	10.667	1.1115	.2921	.0622
28	30.0	6.200	.9499	.2496	-.0280	86	270.0	10.667	.9476	.2490	-.0292
29	40.0	6.200	.8520	.2239	-.0826	87	315.0	10.667	.7510	.1974	-.1390
30	50.0	6.200	.8530	.2242	-.0820	88	0.0	11.330	.9389	.2468	-.0341
31	60.0	6.200	.8867	.2330	-.0633	89	45.0	11.330	.7632	.2006	-.1321
32	70.0	6.200	.8827	.2320	-.0655	90	90.0	11.330	1.0003	.2629	.0001
33	80.0	6.200	.8715	.2290	-.0717	91	135.0	11.330	1.1368	.2988	.0763
34	90.0	6.200	.8702	.2287	-.0724	92	180.0	11.330	1.1514	.3026	.0845
35	135.0	6.200	.9278	.2439	-.0403	93	225.0	11.330	1.0628	.2793	.0350
36	180.0	6.200	1.0390	.2731	.0217	94	270.0	11.330	.9945	.2614	-.0031
37	225.0	6.200	.9339	.2455	-.0369	95	315.0	11.330	.9166	.2409	-.0466
38	270.0	6.200	.8712	.2290	-.0719	96	0.0	12.000	1.0164	.2671	.0092
39	315.0	6.200	.8566	.2251	-.0800	97	45.0	12.000	.9975	.2622	-.0014
40	0.0	7.333	.9977	.2622	-.0013	98	90.0	12.000	.9021	.2371	-.0546
41	45.0	7.333	.8984	.2361	-.0567	99	135.0	12.000	1.0357	.2722	.0199
42	90.0	7.333	.9054	.2379	-.0528	100	180.0	12.000	1.1103	.2918	.0616
43	135.0	7.333	.9635	.2532	-.0204	101	225.0	12.000	1.0054	.2642	.0030
44	180.0	7.333	1.0415	.2737	.0231	102	270.0	12.000	.9111	.2394	-.0496
45	202.5	7.333	1.0069	.2646	.0039	103	315.0	12.000	.9861	.2592	-.0078
46	225.0	7.333	.9349	.2457	-.0363	104	0.0	13.333	1.8807	.4943	.4915
47	247.5	7.333	.8881	.2334	-.0624	105	45.0	13.333	1.0171	.2673	.0095
48	270.0	7.333	.9049	.2378	-.0531	106	90.0	13.333	.9072	.2384	-.0518
49	315.0	7.333	.9097	.2391	-.0504	107	135.0	13.333	.9298	.2444	-.0392
50	202.5	7.667	1.0516	.2764	.0288	108	180.0	13.333	1.0109	.2657	.0061
51	225.0	7.667	.9820	.2581	-.0100	109	225.0	13.333	.9084	.2388	-.0511
52	247.5	7.667	1.0010	.2631	.0005	110	270.0	13.333	.9296	.2443	-.0393
53	45.0	8.000	.9113	.2395	-.0495	111	315.0	13.333	1.0095	.2653	.0053
54	135.0	8.000	1.1152	.2931	.0643	112	0.0	14.400	1.0132	.2663	.0074
55	202.5	8.000	1.1026	.2898	.0573	113	90.0	14.400	.9694	.2548	-.0171
56	225.0	8.000	1.0869	.2857	.0485	114	180.0	14.400	.9816	.2580	-.0102
57	247.5	8.000	1.1420	.3001	.0792	115	270.0	14.400	.9716	.2554	-.0158
58	315.0	8.000	.9254	.2432	-.0416						

TABLE I.- Continued

(c) M = 1.60;  $\alpha = 20^\circ$

$p_t = 54.6 \text{ kPa}$

TUBE	THETA	X/D	P/PINF	P/PT2	CP	TUBE	THETA	X/D	P/PINF	P/PT2	CP
1	0.0	1.333	.8733	.2295	-.0707	59	225.0	8.333	1.6926	.4448	.3865
2	90.0	1.333	.8637	.2270	-.0761	60	45.0	8.667	.5702	.1498	-.2399
3	180.0	1.333	1.8791	.4938	.4906	61	135.0	8.667	1.8091	.4755	.4515
4	270.0	1.333	.8822	.2318	-.0658	62	202.5	8.667	1.8150	.4770	.4548
5	0.0	2.667	.8543	.2245	-.0813	63	225.0	8.667	1.8679	.4909	.4843
6	90.0	2.667	.5023	.1320	-.2777	64	247.5	8.667	1.8266	.4801	.4613
7	180.0	2.667	1.3764	.3617	.2100	65	315.0	8.667	.5878	.1545	-.2300
8	270.0	2.667	.5491	.1443	-.2516	66	225.0	9.000	1.9231	.5054	.5151
9	0.0	4.000	.9153	.2406	-.0472	67	45.0	9.333	.5141	.1351	-.2711
10	10.0	4.000	.8983	.2361	-.0567	68	135.0	9.333	1.5983	.4201	.3339
11	20.0	4.000	.7944	.2088	-.1147	69	202.5	9.333	1.6590	.4360	.3677
12	30.0	4.000	.4534	.1192	-.3050	70	225.0	9.333	1.6760	.4405	.3772
13	40.0	4.000	.4409	.1159	-.3120	71	247.5	9.333	1.7446	.4585	.4155
14	50.0	4.000	.4502	.1183	-.3068	72	315.0	9.333	.5094	.1339	-.2738
15	60.0	4.000	.5877	.1544	-.2301	73	225.0	9.667	1.6578	.4357	.3671
16	70.0	4.000	.5991	.1575	-.2237	74	45.0	10.000	.4610	.1211	-.3008
17	80.0	4.000	.5976	.1571	-.2246	75	135.0	10.000	1.5569	.4092	.3108
18	90.0	4.000	.5955	.1565	-.2258	76	202.5	10.000	1.5434	.4056	.3032
19	180.0	4.000	1.2931	.3398	.1635	77	225.0	10.000	1.5641	.4111	.3148
20	270.0	4.000	.5603	.1472	-.2454	78	247.5	10.000	1.5072	.3961	.2831
21	0.0	5.333	.8034	.2111	-.1097	79	315.0	10.000	.4411	.1159	-.3119
22	90.0	5.333	.6808	.1789	-.1781	80	0.0	10.667	.6374	.1675	-.2023
23	180.0	5.333	1.2748	.3350	.1533	81	45.0	10.667	.7013	.1843	-.1667
24	270.0	5.333	.7036	.1849	-.1654	82	90.0	10.667	.9331	.2452	-.0374
25	0.0	6.200	.7769	.2042	-.1245	83	135.0	10.667	1.3768	.3618	.2103
26	10.0	6.200	.7731	.2032	-.1266	84	180.0	10.667	1.6513	.4340	.3634
27	20.0	6.200	.7368	.1936	-.1469	85	225.0	10.667	1.3739	.3611	.2086
28	30.0	6.200	.7265	.1909	-.1526	86	270.0	10.667	.9249	.2431	-.0419
29	40.0	6.200	.7209	.1895	-.1558	87	315.0	10.667	.6547	.1721	-.1927
30	50.0	6.200	.7137	.1876	-.1598	88	0.0	11.330	.6749	.1774	-.1814
31	60.0	6.200	.7002	.1840	-.1673	89	45.0	11.330	.7013	.1843	-.1667
32	70.0	6.200	.7141	.1877	-.1595	90	90.0	11.330	.8832	.2321	-.0652
33	80.0	6.200	.7164	.1883	-.1583	91	135.0	11.330	1.2108	.3182	.1177
34	90.0	6.200	.7171	.1885	-.1578	92	180.0	11.330	1.4466	.3802	.2492
35	135.0	6.200	.9023	.2371	-.0545	93	225.0	11.330	1.1489	.3019	.0831
36	180.0	6.200	1.2681	.3333	.1496	94	270.0	11.330	.9335	.2453	-.0371
37	225.0	6.200	.9561	.2513	-.0245	95	315.0	11.330	.8196	.2154	-.1007
38	270.0	6.200	.7521	.1977	-.1383	96	0.0	12.000	1.0331	.2715	.0185
39	315.0	6.200	.6526	.1715	-.1939	97	45.0	12.000	.9464	.2487	-.0299
40	0.0	7.333	.7756	.2038	-.1252	98	90.0	12.000	.7174	.1885	-.1577
41	45.0	7.333	.7446	.1957	-.1425	99	135.0	12.000	1.0395	.2732	.0220
42	90.0	7.333	.7847	.2062	-.1202	100	180.0	12.000	1.2833	.3373	.1581
43	135.0	7.333	.9211	.2421	-.0441	101	225.0	12.000	1.0346	.2719	.0193
44	180.0	7.333	1.2406	.3261	.1343	102	270.0	12.000	.6648	.1747	-.1871
45	202.5	7.333	1.1390	.2993	.0776	103	315.0	12.000	.8320	.2187	-.0937
46	225.0	7.333	.9289	.2441	-.0397	104	0.0	13.333	1.9228	.5053	.5150
47	247.5	7.333	.7373	.1938	-.1466	105	45.0	13.333	.8514	.2238	-.0829
48	270.0	7.333	.7919	.2081	-.1162	106	90.0	13.333	.6111	.1606	-.2170
49	315.0	7.333	.7440	.1955	-.1429	107	135.0	13.333	.9086	.2388	-.0510
50	202.5	7.667	1.1826	.3108	.1019	108	180.0	13.333	1.1731	.3083	.0966
51	225.0	7.667	.9526	.2504	-.0265	109	225.0	13.333	.8588	.2257	-.0788
52	247.5	7.667	.8616	.2265	-.0772	110	270.0	13.333	.5857	.1539	-.2312
53	45.0	8.000	.7563	.1988	-.1360	111	315.0	13.333	.8433	.2216	-.0875
54	135.0	8.000	1.1636	.3058	.0913	112	0.0	14.400	.9006	.2367	-.0555
55	202.5	8.000	1.2191	.3204	.1223	113	45.0	14.400	.7620	.2003	-.1328
56	225.0	8.000	1.0684	.2808	.0382	114	90.0	14.400	1.1191	.2941	.0665
57	247.5	8.000	1.1818	.3106	.1014	115	180.0	14.400	.7062	.1856	-.1640
58	315.0	8.000	.7686	.2020	-.1291		270.0	14.400			

TABLE I.- Continued

(d)  $M = 1.60$ ;  $\alpha = 30^\circ$

$P_t = 54.6 \text{ kPa}$

TUBE	THETA	X/D	P/PINF	P/PT2	CP	TUBE	THETA	X/D	P/PINF	P/PT2	CP
1	0.0	1.333	.7641	.2008	-.1316	59	225.0	8.333	2.2471	.5906	.6959
2	90.0	1.333	.7153	.1880	-.1589	60	45.0	8.667	.3897	.1024	-.3406
3	180.0	1.333	2.3661	.6219	.7623	61	135.0	8.667	2.3089	.6068	.7304
4	270.0	1.333	.7548	.1984	-.1368	62	202.5	8.667	2.4152	.6348	.7897
5	0.0	2.667	.5460	.1435	-.2533	63	225.0	8.667	2.4061	.6324	.7846
6	90.0	2.667	.4228	.1111	-.3221	64	247.5	8.667	2.1820	.5734	.6596
7	180.0	2.667	1.8025	.4737	.4478	65	315.0	8.667	.4160	.1093	-.3259
8	270.0	2.667	.4888	.1285	-.2853	66	225.0	9.000	2.2978	.6039	.7242
9	0.0	4.000	.5506	.1447	-.2508	67	45.0	9.333	.2782	.0731	-.4028
10	10.0	4.000	.5146	.1352	-.2709	68	135.0	9.333	2.0565	.5405	.5896
11	20.0	4.000	.4423	.1162	-.3112	69	202.5	9.333	2.0461	.5377	.5837
12	30.0	4.000	.4440	.1167	-.3103	70	225.0	9.333	2.0422	.5367	.5816
13	40.0	4.000	.4377	.1150	-.3138	71	247.5	9.333	1.9352	.5086	.5219
14	50.0	4.000	.4760	.1251	-.2924	72	315.0	9.333	.2517	.0661	-.4176
15	60.0	4.000	.5044	.1326	-.2766	73	225.0	9.667	2.0262	.5325	.5726
16	70.0	4.000	.5070	.1332	-.2751	74	45.0	10.000	.3020	.0794	-.3895
17	80.0	4.000	.5100	.1340	-.2735	75	135.0	10.000	1.9802	.5204	.5470
18	90.0	4.000	.4997	.1313	-.2792	76	202.5	10.000	1.9787	.5200	.5461
19	180.0	4.000	1.6910	.4444	.3856	77	225.0	10.000	1.9243	.5057	.5158
20	270.0	4.000	.4492	.1181	-.3073	78	247.5	10.000	1.7933	.4713	.4427
21	0.0	5.333	.5823	.1530	-.2331	79	315.0	10.000	.2550	.0670	-.4157
22	90.0	5.333	.5684	.1494	-.2409	80	0.0	10.667	.4287	.1127	-.3188
23	180.0	5.333	1.6808	.4417	.3799	81	45.0	10.667	.5306	.1394	-.2620
24	270.0	5.333	.5372	.1412	-.2582	82	90.0	10.667	.9146	.2404	-.0476
25	0.0	6.200	.6256	.1644	-.2089	83	135.0	10.667	1.6602	.4363	.3684
26	10.0	6.200	.6171	.1622	-.2136	84	180.0	10.667	2.0212	.5312	.5698
27	20.0	6.200	.5678	.1492	-.2412	85	225.0	10.667	1.6400	.4310	.3572
28	30.0	6.200	.5570	.1464	-.2472	86	270.0	10.667	.8473	.2227	-.0852
29	40.0	6.200	.5644	.1483	-.2431	87	315.0	10.667	.5309	.1395	-.2618
30	50.0	6.200	.5600	.1472	-.2455	88	0.0	11.330	.9617	.2527	-.0214
31	60.0	6.200	.5664	.1488	-.2420	89	45.0	11.330	.5306	.1394	-.2620
32	70.0	6.200	.5738	.1508	-.2378	90	90.0	11.330	.5661	.1488	-.2421
33	80.0	6.200	.5830	.1532	-.2327	91	135.0	11.330	1.3887	.3650	.2169
34	90.0	6.200	.5846	.1536	-.2318	92	180.0	11.330	1.7433	.4582	.4148
35	135.0	6.200	1.0934	.2873	.0521	93	225.0	11.330	1.3222	.3475	.1798
36	180.0	6.200	1.6680	.4384	.3728	94	270.0	11.330	.5175	.1360	-.2693
37	225.0	6.200	1.1841	.3112	.1027	95	315.0	11.330	.6286	.1652	-.2073
38	270.0	6.200	.5592	.1470	-.2460	96	0.0	12.000	.8250	.2168	-.0976
39	315.0	6.200	.5394	.1418	-.2570	97	45.0	12.000	.6593	.1733	-.1901
40	0.0	7.333	.6838	.1797	-.1765	98	90.0	12.000	.3911	.1028	-.3398
41	45.0	7.333	.6103	.1604	-.2175	99	135.0	12.000	1.1867	.3119	.1042
42	90.0	7.333	.6599	.1734	-.1898	100	180.0	12.000	1.5734	.4135	.3200
43	135.0	7.333	1.1242	.2955	.0693	101	225.0	12.000	1.1394	.2995	.0778
44	180.0	7.333	1.6303	.4285	.3917	102	270.0	12.000	.3942	.1036	-.3381
45	202.5	7.333	1.4608	.3839	.2572	103	315.0	12.000	.5606	.1473	-.2452
46	225.0	7.333	1.1320	.2975	.0737	104	0.0	13.333	1.9680	.5172	.5402
47	247.5	7.333	.6766	.1778	-.1805	105	45.0	13.333	.3832	.1007	-.3442
48	270.0	7.333	.6586	.1731	-.1905	106	90.0	13.333	.4369	.1148	-.3142
49	315.0	7.333	.5912	.1554	-.2281	107	135.0	13.333	1.0782	.2834	.0436
50	202.5	7.667	1.5256	.4009	.2933	108	180.0	13.333	1.4583	.3833	.2558
51	225.0	7.667	1.3057	.3432	.1706	109	225.0	13.333	1.0060	.2644	.0034
52	247.5	7.667	1.0147	.2667	.0082	110	270.0	13.333	.5389	.1416	-.2573
53	45.0	8.000	.6162	.1619	-.2142	111	315.0	13.333	.4680	.1262	-.2902
54	135.0	8.000	1.6465	.4327	.3607	112	0.0	14.400	.5761	.1514	-.2366
55	202.5	8.000	1.5995	.4204	.3345	113	90.0	14.400	.5246	.1379	-.2653
56	225.0	8.000	1.5494	.4072	.3066	114	180.0	14.400	1.4518	.3816	.2521
57	247.5	8.000	1.6428	.4317	.3587	115	270.0	14.400	.6270	.1648	-.2082
58	315.0	8.000	.5910	.1593	-.2283						

TABLE I.- Continued

(e)  $M = 1.60$ ;  $\alpha = 40^\circ$

$P_t = 54.7 \text{ kPa}$

TUBE	THETA	X/D	P/PINF	P/PT2	CP	TUBE	THETA	X/D	P/PINF	P/PT2	CP
1	0.0	1.333	.5272	.1385	-.2639	59	225.0	8.333	2.8611	.7519	1.0385
2	90.0	1.333	.6527	.1715	-.1938	60	45.0	8.667	.1782	.0468	-.4586
3	180.0	1.333	2.8631	.7525	1.0397	61	135.0	8.667	2.8256	.7426	1.0188
4	270.0	1.333	.7085	.1862	-.1627	62	202.5	8.667	2.8223	.7417	1.0169
5	0.0	2.667	.3618	.0951	-.3561	63	225.0	8.667	2.8619	.7521	1.0390
6	90.0	2.667	.4187	.1100	-.3244	64	247.5	8.667	2.8021	.7364	1.0056
7	180.0	2.667	2.3041	.6055	.7277	65	315.0	8.667	.2129	.0560	-.4392
8	270.0	2.667	.4985	.1310	-.2799	66	225.0	9.000	2.7246	.7161	.9624
9	0.0	4.000	.4454	.1171	-.3095	67	45.0	9.333	.1370	.0360	-.4816
10	10.0	4.000	.4309	.1132	-.3176	68	135.0	9.333	2.5848	.6793	.8844
11	20.0	4.000	.3654	.0960	-.3541	69	202.5	9.333	2.5976	.6827	.8915
12	30.0	4.000	.3556	.0934	-.3596	70	225.0	9.333	2.5739	.6764	.8783
13	40.0	4.000	.3654	.0960	-.3542	71	247.5	9.333	2.5318	.6654	.8548
14	50.0	4.000	.3943	.1036	-.3380	72	315.0	9.333	.1589	.0418	-.4693
15	60.0	4.000	.4005	.1053	-.3345	73	225.0	9.667	2.5648	.6741	.8732
16	70.0	4.000	.4058	.1067	-.3316	74	45.0	10.000	.2053	.0540	-.4435
17	80.0	4.000	.4008	.1053	-.3344	75	135.0	10.000	2.4545	.6451	.8117
18	90.0	4.000	.3634	.0955	-.3553	76	202.5	10.000	2.5969	.6625	.8912
19	180.0	4.000	2.1727	.5710	.6544	77	225.0	10.000	2.4542	.6450	.8115
20	270.0	4.000	.4487	.1179	-.3077	78	247.5	10.000	2.2950	.6032	.7226
21	0.0	5.333	.4974	.1307	-.2805	79	315.0	10.000	.2412	.0634	-.4235
22	90.0	5.333	.4174	.1097	-.3251	80	0.0	10.667	.4300	.1130	-.3181
23	180.0	5.333	2.1560	.5666	.6451	81	45.0	10.667	.2882	.0757	-.3972
24	270.0	5.333	.4251	.1117	-.3208	82	90.0	10.667	.6791	.1785	-.1791
25	0.0	6.200	.4852	.1275	-.2873	83	135.0	10.667	1.9133	.5028	.5096
26	10.0	6.200	.4457	.1171	-.3093	84	180.0	10.667	2.3389	.6147	.7472
27	20.0	6.200	.3971	.1044	-.3364	85	225.0	10.667	1.9280	.5067	.5179
28	30.0	6.200	.4128	.1085	-.3277	86	270.0	10.667	.6377	.1676	-.2022
29	40.0	6.200	.4297	.1129	-.3182	87	315.0	10.667	.4195	.1102	-.3239
30	50.0	6.200	.4287	.1127	-.3188	88	0.0	11.330	.4580	.1204	-.3025
31	60.0	6.200	.4407	.1158	-.3121	89	45.0	11.330	.2882	.0757	-.3972
32	70.0	6.200	.4535	.1192	-.3049	90	90.0	11.330	.5267	.1384	-.2641
33	80.0	6.200	.4495	.1181	-.3072	91	135.0	11.330	1.6029	.4213	.3364
34	90.0	6.200	.4199	.1104	-.3237	92	180.0	11.330	2.0610	.5417	.5921
35	135.0	6.200	1.3735	.3610	.2084	93	225.0	11.330	1.5558	.4089	.3102
36	180.0	6.200	2.1501	.5651	.6418	94	270.0	11.330	.4938	.1298	-.2825
37	225.0	6.200	1.4918	.3921	.2744	95	315.0	11.330	.3069	.0807	-.3868
38	270.0	6.200	.4418	.1161	-.3115	96	0.0	12.000	.3924	.1031	-.3391
39	315.0	6.200	.4579	.1203	-.3025	97	45.0	12.000	.4304	.1131	-.3178
40	0.0	7.333	.4592	.1207	-.3018	98	90.0	12.000	.4342	.1141	-.3157
41	45.0	7.333	.5503	.1446	-.2509	99	135.0	12.000	1.4224	.3738	.2357
42	90.0	7.333	.5913	.1554	-.2281	100	180.0	12.000	1.9251	.5059	.5162
43	135.0	7.333	1.4119	.3711	.2299	101	225.0	12.000	1.3829	.3634	.2137
44	180.0	7.333	2.1136	.5555	.6214	102	270.0	12.000	.4155	.1092	-.3262
45	202.5	7.333	1.8482	.4857	.4733	103	315.0	12.000	.3309	.0870	-.3734
46	225.0	7.333	1.4049	.3692	.2259	104	0.0	13.333	1.9744	.5189	.5438
47	247.5	7.333	.8401	.2208	-.0892	105	45.0	13.333	.4468	.1174	-.3087
48	270.0	7.333	.6037	.1586	-.2212	106	90.0	13.333	.4262	.1120	-.3202
49	315.0	7.333	.6301	.1656	-.2064	107	135.0	13.333	1.3630	.3582	.2026
50	202.5	7.667	2.0161	.5299	.5670	108	180.0	13.333	1.8643	.4900	.4823
51	225.0	7.667	1.8541	.4873	.4766	109	225.0	13.333	1.2876	.3384	.1605
52	247.5	7.667	2.1112	.5548	.6201	110	270.0	13.333	.3796	.0998	-.3462
53	45.0	8.000	.3664	.0963	-.3536	111	315.0	13.333	.3629	.0954	-.3555
54	135.0	8.000	2.4704	.6493	.8205	112	0.0	14.400	.4037	.1061	-.3328
55	202.5	8.000	2.4323	.6393	.7993	113	90.0	14.400	.4090	.1075	-.3298
56	225.0	8.000	2.4032	.6316	.7831	114	180.0	14.400	1.8859	.4957	.4944
57	247.5	8.000	2.4592	.6463	.8143	115	270.0	14.400	.4001	.1052	-.3348
58	315.0	8.000	.3942	.1036	-.3380						



TABLE I.- Continued

(f) M = 1.60;  $\alpha = 50^\circ$

$P_t = 54.7$  kPa

TUBE	THETA	X/D	P/P1NF	P/PT2	CP	TUBE	THETA	X/D	P/P1NF	P/PT2	CP
1	0.0	1.333	.3753	.0986	-.3486	59	225.0	8.333	3.2280	.8484	1.2433
2	90.0	1.333	.6208	.1632	-.2116	60	45.0	8.667	.2483	.0653	-.4195
3	180.0	1.333	3.2991	.8670	1.2830	61	135.0	8.667	3.2509	.8544	1.2561
4	270.0	1.333	.6880	.1808	-.1741	62	202.5	8.667	3.2054	.8424	1.2307
5	0.0	2.667	.3405	.0895	-.3680	63	225.0	8.667	3.2207	.8464	1.2392
6	90.0	2.667	.4344	.1142	-.3156	64	247.5	8.667	3.2886	.8643	1.2771
7	180.0	2.667	2.8135	.7394	1.0120	65	315.0	8.667	.2211	.0581	-.4346
8	270.0	2.667	.5343	.1404	-.2599	66	225.0	9.000	3.1332	.8234	1.1904
9	0.0	4.000	.3567	.0937	-.3590	67	45.0	9.333	.2942	.0773	-.3938
10	10.0	4.000	.3341	.0878	-.3716	68	135.0	9.333	3.0220	.7942	1.1283
11	20.0	4.000	.2865	.0753	-.3982	69	202.5	9.333	3.0362	.7980	1.1363
12	30.0	4.000	.2904	.0763	-.3960	70	225.0	9.333	2.9951	.7872	1.1134
13	40.0	4.000	.2964	.0779	-.3926	71	247.5	9.333	2.9996	.7883	1.1158
14	50.0	4.000	.3199	.0841	-.3795	72	315.0	9.333	.2656	.0698	-.4098
15	60.0	4.000	.3236	.0850	-.3775	73	225.0	9.667	2.9228	.7682	1.0730
16	70.0	4.000	.3289	.0864	-.3745	74	45.0	10.000	.2808	.0738	-.4013
17	80.0	4.000	.2880	.0757	-.3973	75	135.0	10.000	2.7435	.7210	.9730
18	90.0	4.000	.3921	.1030	-.3392	76	202.5	10.000	2.8874	.7588	1.0532
19	180.0	4.000	2.6932	.7078	.9449	77	225.0	10.000	2.7283	.7170	.9644
20	270.0	4.000	.5021	.1320	-.2778	78	247.5	10.000	2.5725	.6761	.8775
21	0.0	5.333	.3533	.0928	-.3609	79	315.0	10.000	.2979	.0783	-.3918
22	90.0	5.333	.3791	.0996	-.3465	80	0.0	10.667	.3593	.0944	-.3576
23	180.0	5.333	2.6487	.6961	.9200	81	45.0	10.667	.3091	.0812	-.3855
24	270.0	5.333	.4818	.1266	-.2892	82	90.0	10.667	.7083	.1862	-.1628
25	0.0	6.200	.3656	.0961	-.3540	83	135.0	10.667	2.1517	.5655	.6427
26	10.0	6.200	.3630	.0954	-.3555	84	180.0	10.667	2.6046	.6845	.8955
27	20.0	6.200	.3609	.0948	-.3566	85	225.0	10.667	2.1711	.5706	.6535
28	30.0	6.200	.3706	.0974	-.3513	86	270.0	10.667	.6831	.1795	-.1768
29	40.0	6.200	.3841	.1010	-.3437	87	315.0	10.667	.3483	.0915	-.3637
30	50.0	6.200	.3988	.1048	-.3355	88	0.0	11.330	.4245	.1116	-.3212
31	60.0	6.200	.4108	.1080	-.3288	89	45.0	11.330	.3091	.0812	-.3855
32	70.0	6.200	.4102	.1078	-.3291	90	90.0	11.330	.6066	.1594	-.2195
33	80.0	6.200	.4142	.1089	-.3269	91	135.0	11.330	1.8479	.4856	.4731
34	90.0	6.200	.3800	.0999	-.3460	92	180.0	11.330	2.3637	.6212	.7610
35	135.0	6.200	1.6543	.4348	.3651	93	225.0	11.330	1.7925	.4711	.4423
36	180.0	6.200	2.6488	.6961	.9201	94	270.0	11.330	.5677	.1492	-.2412
37	225.0	6.200	1.8222	.4789	.4588	95	315.0	11.330	.4240	.1114	-.3214
38	270.0	6.200	.4923	.1294	-.2833	96	0.0	12.000	.4771	.1254	-.2918
39	315.0	6.200	.4140	.1088	-.3270	97	45.0	12.000	.4790	.1259	-.2907
40	0.0	7.333	.6341	.1667	-.2042	98	90.0	12.000	.4930	.1296	-.2829
41	45.0	7.333	.6377	.1676	-.2022	99	135.0	12.000	1.6861	.4431	.3829
42	90.0	7.333	.7181	.1887	-.1573	100	180.0	12.000	2.2724	.5972	.7100
43	135.0	7.333	1.9507	.5127	.5305	101	225.0	12.000	1.6537	.4346	.3648
44	180.0	7.333	2.9082	.7643	1.0648	102	270.0	12.000	.4798	.1261	-.2903
45	202.5	7.333	2.5573	.6721	.8690	103	315.0	12.000	.4762	.1252	-.2923
46	225.0	7.333	1.8815	.4945	.4919	104	0.0	13.333	2.0342	.5346	.5771
47	247.5	7.333	1.1133	.2926	.0632	105	45.0	13.333	.5525	.1452	-.2497
48	270.0	7.333	.6884	.1809	-.1739	106	90.0	13.333	.5274	.1386	-.2637
49	315.0	7.333	.6757	.1776	-.1810	107	135.0	13.333	1.6382	.4305	.3561
50	202.5	7.667	2.8471	.7482	1.0307	108	180.0	13.333	2.2982	.6040	.7244
51	225.0	7.667	2.3015	.6049	.7263	109	225.0	13.333	1.5899	.4179	.3292
52	247.5	7.667	2.6824	.7050	.9389	110	270.0	13.333	.5361	.1409	-.2589
53	45.0	8.000	.2442	.0642	-.4217	111	315.0	13.333	.5561	.1462	-.2477
54	135.0	8.000	2.9309	.7703	1.0775	112	0.0	14.400	.6294	.1654	-.2068
55	202.5	8.000	3.0644	.8054	1.1520	113	45.0	14.400	.6038	.1587	-.2211
56	225.0	8.000	2.8868	.7587	1.0529	114	90.0	14.400	2.4059	.6323	.7845
57	247.5	8.000	3.3331	.8760	1.3020	115	180.0	14.400	.6123	.1609	-.2164
58	315.0	8.000	.2776	.0729	-.4031		270.0	14.400			

TABLE I.- Continued

(g)  $M = 2.70$ ;  $\alpha = 0^\circ$

$P_t = 90.3 \text{ kPa}$

TUBE	THETA	X/D	P/P1NF	P/P1T2	CP	TUBE	THETA	X/D	P/P1NF	P/P1T2	CP
1	0.0	1.333	1.4307	.1451	.0844	59	225.0	8.333	1.0292	.1044	.0057
2	90.0	1.333	1.4729	.1493	.0927	60	45.0	8.667	1.1234	.1139	.0242
3	180.0	1.333	1.3738	.1393	.0732	61	135.0	8.667	1.0357	.1050	.0070
4	270.0	1.333	1.4452	.1465	.0872	62	202.5	8.667	1.0625	.1077	.0123
5	0.0	2.667	.8853	.0898	-.0225	63	225.0	8.667	1.0412	.1056	.0081
6	90.0	2.667	.9013	.0914	-.0193	64	247.5	8.667	1.1001	.1115	.0196
7	180.0	2.667	.8404	.0852	-.0313	65	315.0	8.667	1.1201	.1136	.0235
8	270.0	2.667	.8901	.0903	-.0215	66	225.0	9.000	1.0622	.1077	.0122
9	0.0	4.000	.9133	.0926	-.0170	67	45.0	9.333	1.1508	.1167	.0295
10	10.0	4.000	.9169	.0930	-.0163	68	135.0	9.333	1.0502	.1065	.0098
11	20.0	4.000	.9165	.0929	-.0164	69	202.5	9.333	1.0524	.1067	.0103
12	30.0	4.000	.9137	.0926	-.0169	70	225.0	9.333	1.0622	.1077	.0122
13	40.0	4.000	.9118	.0925	-.0173	71	247.5	9.333	1.0785	.1094	.0154
14	50.0	4.000	.9102	.0923	-.0176	72	315.0	9.333	1.1425	.1158	.0279
15	60.0	4.000	.9083	.0921	-.0180	73	225.0	9.667	1.0238	.1038	.0047
16	70.0	4.000	.9072	.0920	-.0182	74	45.0	10.000	.9618	.0975	-.0075
17	80.0	4.000	.9049	.0918	-.0186	75	135.0	10.000	.9017	.0914	-.0193
18	90.0	4.000	.9054	.0918	-.0185	76	202.5	10.000	.9288	.0942	-.0139
19	180.0	4.000	.8440	.0856	-.0306	77	225.0	10.000	.9353	.0948	-.0127
20	270.0	4.000	.9042	.0917	-.0188	78	247.5	10.000	.9552	.0969	-.0088
21	0.0	5.333	.9503	.0964	-.0097	79	315.0	10.000	.9366	.0950	-.0124
22	90.0	5.333	.9420	.0955	-.0114	80	0.0	10.667	1.0658	.1081	.0129
23	180.0	5.333	.8777	.0890	-.0240	81	45.0	10.667	.8457	.0858	-.0302
24	270.0	5.333	.9412	.0954	-.0115	82	90.0	10.667	1.0596	.1074	.0117
25	0.0	6.200	.9612	.0975	-.0076	83	135.0	10.667	.8518	.0864	-.0290
26	10.0	6.200	.9639	.0977	-.0071	84	180.0	10.667	1.0433	.1058	.0085
27	20.0	6.200	.9667	.0980	-.0065	85	225.0	10.667	.8306	.0842	-.0332
28	30.0	6.200	.9677	.0981	-.0063	86	270.0	10.667	1.1066	.1122	.0209
29	40.0	6.200	.9681	.0982	-.0062	87	315.0	10.667	.8074	.0819	-.0377
30	50.0	6.200	.9683	.0982	-.0062	88	0.0	11.330	.9794	.0993	-.0040
31	60.0	6.200	.9652	.0979	-.0068	89	45.0	11.330	.8457	.0858	-.0302
32	70.0	6.200	.9652	.0979	-.0068	90	90.0	11.330	1.0020	.1016	.0004
33	80.0	6.200	.9566	.0970	-.0085	91	135.0	11.330	.9637	.0977	-.0071
34	90.0	6.200	.9605	.0974	-.0077	92	180.0	11.330	.9814	.0995	-.0037
35	135.0	6.200	.9491	.0962	-.0100	93	225.0	11.330	.9100	.0923	-.0176
36	180.0	6.200	.8937	.0906	-.0208	94	270.0	11.330	1.0297	.1044	.0058
37	225.0	6.200	.8966	.0909	-.0203	95	315.0	11.330	.9503	.0964	-.0097
38	270.0	6.200	.9496	.0963	-.0099	96	0.0	12.000	.9537	.0967	-.0091
39	315.0	6.200	.9586	.0972	-.0081	97	45.0	12.000	.9863	.1000	-.0027
40	0.0	7.333	.9895	.1003	-.0021	98	90.0	12.000	.9741	.0988	-.0051
41	45.0	7.333	.9867	.1000	-.0026	99	135.0	12.000	1.0079	.1022	.0015
42	90.0	7.333	.9941	.1008	-.0012	100	180.0	12.000	.9422	.0955	-.0113
43	135.0	7.333	.9927	.1007	-.0014	101	225.0	12.000	.9556	.0969	-.0087
44	180.0	7.333	.9437	.0957	-.0110	102	270.0	12.000	.9671	.0981	-.0065
45	202.5	7.333	.9440	.0957	-.0110	103	315.0	12.000	.9952	.1009	-.0009
46	225.0	7.333	.9401	.0953	-.0117	104	0.0	13.333	.9541	.0967	-.0090
47	247.5	7.333	.9958	.1010	-.0008	105	45.0	13.333	.9951	.1009	-.0010
48	270.0	7.333	1.0007	.1015	.0001	106	90.0	13.333	1.0102	.1024	.0020
49	315.0	7.333	.9965	.1010	-.0007	107	135.0	13.333	1.0261	.1040	.0051
50	202.5	7.667	.9915	.1005	-.0017	108	180.0	13.333	.9716	.0985	-.0056
51	225.0	7.667	.9897	.1003	-.0020	109	225.0	13.333	.9488	.0962	-.0100
52	247.5	7.667	1.0435	.1058	.0085	110	270.0	13.333	1.0186	.1033	.0036
53	45.0	8.000	1.0909	.1106	-.0178	111	315.0	13.333	.9992	.1013	-.0002
54	135.0	8.000	.9966	.1010	-.0007	112	0.0	14.400	1.0265	.1041	.0052
55	202.5	8.000	1.0223	.1037	.0044	113	90.0	14.400	1.0195	.1034	.0038
56	225.0	8.000	1.0248	.1039	.0049	114	180.0	14.400	.9810	.0995	-.0037
57	247.5	8.000	1.0707	.1086	.0138	115	270.0	14.400	1.0170	.1031	.0033
58	315.0	8.000	1.0885	.1104	.0173						

TABLE I.- Continued

(h)  $M = 2.70$ ;  $\alpha = 10^\circ$

$P_t = 90.5 \text{ kPa}$

TUBE	THETA	X/D	P/PINF	P/PT2	CP	TUBE	THETA	X/D	P/PINF	P/PT2	CP
1	0.0	1.333	.9591	.0972	-.0080	59	225.0	8.333	1.1070	.1122	-.0210
2	90.0	1.333	1.3249	.1343	.0637	60	45.0	8.667	.6588	.0668	-.0669
3	180.0	1.333	2.1994	.2230	.2350	61	135.0	8.667	1.4368	.1457	.0856
4	270.0	1.333	1.3173	.1336	.0622	62	202.5	8.667	1.2108	.1226	.0413
5	0.0	2.667	.6958	.0706	-.0596	63	225.0	8.667	1.3395	.1358	.0665
6	90.0	2.667	.7184	.0728	-.0552	64	247.5	8.667	1.4452	.1465	.0872
7	180.0	2.667	1.2743	.1292	.0537	65	315.0	8.667	.6708	.0680	-.0645
8	270.0	2.667	.7400	.0750	-.0510	66	225.0	9.000	1.6656	.1689	.1304
9	0.0	4.000	.8752	.0887	-.0245	67	45.0	9.333	.5902	.0598	-.0803
10	10.0	4.000	.8501	.0862	-.0294	68	135.0	9.333	1.6015	.1624	-.1179
11	20.0	4.000	.7092	.0719	-.0570	69	202.5	9.333	1.2865	.1304	.0561
12	30.0	4.000	.6316	.0640	-.0722	70	225.0	9.333	1.5874	.1610	.1151
13	40.0	4.000	.6500	.0659	-.0686	71	247.5	9.333	1.7274	.1751	.1425
14	50.0	4.000	.6479	.0657	-.0690	72	315.0	9.333	.5715	.0579	-.0840
15	60.0	4.000	.6437	.0653	-.0698	73	225.0	9.667	1.4818	.1502	.0944
16	70.0	4.000	.6400	.0649	-.0706	74	45.0	10.000	.4811	.0488	-.1017
17	80.0	4.000	.6082	.0617	-.0768	75	135.0	10.000	1.2843	.1302	.0557
18	90.0	4.000	.6153	.0624	-.0754	76	202.5	10.000	1.2382	.1255	.0467
19	180.0	4.000	1.1643	.1181	.0322	77	225.0	10.000	1.3579	.1377	.0701
20	270.0	4.000	.6305	.0639	-.0724	78	247.5	10.000	1.5133	.1534	.1006
21	0.0	5.333	.9335	.0947	-.0130	79	315.0	10.000	.4597	.0466	-.1059
22	90.0	5.333	.6372	.0646	-.0711	80	0.0	10.667	.7854	.0796	-.0421
23	180.0	5.333	1.1586	.1175	.0311	81	45.0	10.667	.5590	.0567	-.0864
24	270.0	5.333	.6341	.0643	-.0717	82	90.0	10.667	.9487	.0962	-.0101
25	0.0	6.200	.9348	.0948	-.0128	83	135.0	10.667	1.2151	.1232	.0422
26	10.0	6.200	.9199	.0933	-.0157	84	180.0	10.667	1.5427	.1564	.1064
27	20.0	6.200	.8360	.0848	-.0321	85	225.0	10.667	1.2314	.1249	.0453
28	30.0	6.200	.6619	.0671	-.0662	86	270.0	10.667	.9901	.1004	-.0019
29	40.0	6.200	.6730	.0682	-.0641	87	315.0	10.667	.5451	.0553	-.0891
30	50.0	6.200	.6789	.0688	-.0629	88	0.0	11.330	.7107	.0721	-.0567
31	60.0	6.200	.6795	.0689	-.0628	89	45.0	11.330	.5590	.0567	-.0864
32	70.0	6.200	.6833	.0693	-.0621	90	90.0	11.330	.9493	.0963	-.0099
33	80.0	6.200	.6820	.0692	-.0623	91	135.0	11.330	1.2097	.1227	.0411
34	90.0	6.200	.6706	.0680	-.0645	92	180.0	11.330	1.4771	.1498	.0935
35	135.0	6.200	.9686	.0982	-.0062	93	225.0	11.330	1.1589	.1175	.0311
36	180.0	6.200	1.1849	.1201	.0362	94	270.0	11.330	.9749	.0989	-.0049
37	225.0	6.200	.9470	.0960	-.0104	95	315.0	11.330	.6463	.0655	-.0693
38	270.0	6.200	.6754	.0685	-.0636	96	0.0	12.000	.6894	.0699	-.0609
39	315.0	6.200	.6762	.0686	-.0634	97	45.0	12.000	.8078	.0819	-.0377
40	0.0	7.333	.9015	.0914	-.0193	98	90.0	12.000	.8229	.0834	-.0347
41	45.0	7.333	.6971	.0707	-.0594	99	135.0	12.000	1.1612	.1177	.0316
42	90.0	7.333	.7218	.0732	-.0545	100	180.0	12.000	1.3413	.1360	.0669
43	135.0	7.333	.9627	.0976	-.0073	101	225.0	12.000	1.0923	.1107	.0181
44	180.0	7.333	1.1449	.1161	.0284	102	270.0	12.000	.8041	.0815	-.0384
45	202.5	7.333	1.0771	.1092	.0151	103	315.0	12.000	.8393	.0851	-.0315
46	225.0	7.333	.9131	.0926	-.0170	104	0.0	13.333	.6875	.0697	-.0612
47	247.5	7.333	.7128	.0723	-.0563	105	45.0	13.333	.9097	.0922	-.0177
48	270.0	7.333	.7433	.0754	-.0503	106	90.0	13.333	.7526	.0763	-.0485
49	315.0	7.333	.7128	.0723	-.0563	107	135.0	13.333	1.0817	.1097	.0160
50	202.5	7.667	1.1157	.1131	.0227	108	180.0	13.333	1.2577	.1275	.0505
51	225.0	7.667	.9149	.0928	-.0167	109	225.0	13.333	.9575	.0971	-.0083
52	247.5	7.667	.8556	.0868	-.0283	110	270.0	13.333	.7474	.0758	-.0495
53	45.0	8.000	.6969	.0707	-.0594	111	315.0	13.333	.8846	.0897	-.0226
54	135.0	8.000	.9413	.0954	-.0115	112	0.0	14.400	.9105	.0923	-.0175
55	202.5	8.000	1.1279	.1144	.0251	113	90.0	14.400	.7282	.0738	-.0533
56	225.0	8.000	.9456	.0959	-.0107	114	180.0	14.400	1.1982	.1215	.0388
57	247.5	8.000	1.0348	.1049	.0068	115	270.0	14.400	.7488	.0759	-.0492
58	315.0	8.000	.7099	.0720	-.0569						

TABLE I.- Continued

(i)  $M = 2.70$ ;  $\alpha = 20^\circ$

$P_t = 90.5 \text{ kPa}$

TUBE	THETA	X/D	P/PINF	P/PT2	CP	TUBE	THETA	X/D	P/PINF	P/PT2	CP
1	0.0	1.333	.7238	.0734	-.0541	59	225.0	8.333	1.4595	.1480	.0900
2	90.0	1.333	1.1325	.1148	.0260	60	45.0	8.667	.3856	.0391	-.1204
3	180.0	1.333	3.4364	.3484	.4774	61	135.0	8.667	2.1585	.2189	.2270
4	270.0	1.333	1.1742	.1191	.0341	62	202.5	8.667	1.8684	.1894	.1702
5	0.0	2.667	.5913	.0599	-.0801	63	225.0	8.667	1.7365	.1761	.1443
6	90.0	2.667	.5688	.0577	-.0845	64	247.5	8.667	2.3357	.2368	.2617
7	180.0	2.667	2.0932	.2122	.2142	65	315.0	8.667	.3601	.0365	-.1254
8	270.0	2.667	.6354	.0644	-.0714	66	225.0	9.000	2.5072	.2542	.2954
9	0.0	4.000	.5309	.0538	-.0919	67	45.0	9.333	.3134	.0318	-.1346
10	10.0	4.000	.4817	.0488	-.1016	68	135.0	9.333	2.3361	.2369	.2618
11	20.0	4.000	.3775	.0383	-.1220	69	202.5	9.333	1.9888	.2016	.1938
12	30.0	4.000	.3637	.0389	-.1208	70	225.0	9.333	2.4401	.2474	.2822
13	40.0	4.000	.4049	.0411	-.1166	71	247.5	9.333	2.3431	.2376	.2632
14	50.0	4.000	.3967	.0402	-.1182	72	315.0	9.333	.2810	.0285	-.1409
15	60.0	4.000	.4085	.0414	-.1159	73	225.0	9.667	2.3220	.2354	.2591
16	70.0	4.000	.3969	.0402	-.1182	74	45.0	10.000	.3167	.0321	-.1339
17	80.0	4.000	.3557	.0361	-.1263	75	135.0	10.000	2.1189	.2148	.2193
18	90.0	4.000	.4445	.0451	-.1089	76	202.5	10.000	2.0613	.2090	.2080
19	180.0	4.000	1.9058	.1932	-.1775	77	225.0	10.000	2.1954	.2226	.2343
20	270.0	4.000	.5069	.0514	-.0966	78	247.5	10.000	2.2826	.2315	.2514
21	0.0	5.333	.5065	.0514	-.0967	79	315.0	10.000	.3062	.0310	-.1360
22	90.0	5.333	.3985	.0404	-.1179	80	0.0	10.667	.3804	.0386	-.1214
23	180.0	5.333	1.8866	.1913	-.1737	81	45.0	10.667	.4145	.0420	-.1147
24	270.0	5.333	.4474	.0454	-.1083	82	90.0	10.667	.8995	.0912	-.0197
25	0.0	6.200	.4977	.0505	-.0984	83	135.0	10.667	2.0026	.2031	.1965
26	10.0	6.200	.4945	.0501	-.0991	84	180.0	10.667	2.6174	.2654	.3170
27	20.0	6.200	.4683	.0475	-.1042	85	225.0	10.667	1.9696	.1997	.1900
28	30.0	6.200	.4654	.0472	-.1048	86	270.0	10.667	.8855	.0898	-.0224
29	40.0	6.200	.4637	.0470	-.1051	87	315.0	10.667	.4191	.0425	-.1138
30	50.0	6.200	.4736	.0480	-.1032	88	0.0	11.330	.5127	.0520	-.0955
31	60.0	6.200	.4727	.0479	-.1033	89	45.0	11.330	.4145	.0420	-.1147
32	70.0	6.200	.4744	.0481	-.1030	90	90.0	11.330	.9606	.0974	-.0077
33	80.0	6.200	.4700	.0477	-.1039	91	135.0	11.330	1.9795	.2007	.1920
34	90.0	6.200	.4214	.0427	-.1134	92	180.0	11.330	2.4325	.2466	.2807
35	135.0	6.200	1.2595	.1277	.0509	93	225.0	11.330	1.8688	.1895	.1703
36	180.0	6.200	1.8884	.1915	.1741	94	270.0	11.330	.7732	.0784	-.0444
37	225.0	6.200	1.3058	.1324	.0599	95	315.0	11.330	.4962	.0503	-.0987
38	270.0	6.200	.4709	.0477	-.1037	96	0.0	12.000	.7439	.0754	-.0502
39	315.0	6.200	.4640	.0470	-.1050	97	45.0	12.000	.5090	.0516	-.0962
40	0.0	7.333	.5423	.0550	-.0897	98	90.0	12.000	.6583	.0667	-.0670
41	45.0	7.333	.4855	.0492	-.1008	99	135.0	12.000	1.8049	.1830	.1577
42	90.0	7.333	.4632	.0470	-.1092	100	180.0	12.000	2.1755	.2206	.2304
43	135.0	7.333	1.3163	.1335	.0620	101	225.0	12.000	1.6589	.1682	.1291
44	180.0	7.333	1.8510	.1877	.1668	102	270.0	12.000	.5569	.0565	-.0868
45	202.5	7.333	1.6625	.1686	.1298	103	315.0	12.000	.4673	.0474	-.1044
46	225.0	7.333	1.2612	.1279	.0512	104	0.0	13.333	.7462	.0757	-.0497
47	247.5	7.333	.7879	.0799	-.0416	105	45.0	13.333	.3431	.0348	-.1287
48	270.0	7.333	.4683	.0475	-.1042	106	90.0	13.333	.4967	.0504	-.0986
49	315.0	7.333	.4867	.0493	-.1006	107	135.0	13.333	1.5774	.1599	.1132
50	202.5	7.667	1.7060	.1730	.1384	108	180.0	13.333	1.9870	.2015	.1934
51	225.0	7.667	1.2539	.1271	.0498	109	225.0	13.333	1.3910	.1410	.0766
52	247.5	7.667	.9429	.0956	-.0112	110	270.0	13.333	.4646	.0471	-.1049
53	45.0	8.000	.4924	.0499	-.0995	111	315.0	13.333	.3488	.0354	-.1276
54	135.0	8.000	1.2383	.1256	.0467	112	0.0	14.400	.5883	.0597	-.0807
55	202.5	8.000	1.7720	.1797	.1513	113	90.0	14.400	.4528	.0459	-.1072
56	225.0	8.000	1.2543	.1272	.0498	114	180.0	14.400	1.8314	.1857	.1629
57	247.5	8.000	1.3061	.1324	.0600	115	270.0	14.400	.4865	.0493	-.1006
58	315.0	8.000	.4761	.0483	-.1027						

TABLE I.- Continued

(j) M = 2.70;  $\alpha = 30^\circ$

$p_t = 90.5$  kPa

TUBE	THETA	X/D	P/PINF	P/PT2	CP	TUBE	THETA	X/D	P/PINF	P/PT2	CP
1	0.0	1.333	.4969	.0504	-.0986	59	225.0	8.333	2.2176	.2248	.2386
2	90.0	1.333	1.0675	.1082	.0132	60	45.0	8.667	.2387	.0242	-.1492
3	180.0	1.333	4.8786	.4947	.7601	61	135.0	8.667	3.4618	.3510	.4824
4	270.0	1.333	1.1409	.1157	.0276	62	202.5	8.667	3.0079	.3050	.3935
5	0.0	2.667	.2851	.0289	-.1401	63	225.0	8.667	3.0019	.3044	.3923
6	90.0	2.667	.5687	.0577	-.0845	64	247.5	8.667	4.0985	.4156	.6072
7	180.0	2.667	3.2907	.3337	.4489	65	315.0	8.667	.2387	.0242	-.1492
8	270.0	2.667	.6703	.0680	-.0646	66	225.0	9.000	3.9899	.4045	.5859
9	0.0	4.000	.3550	.0360	-.1264	67	45.0	9.333	.2387	.0242	-.1492
10	10.0	4.000	.3368	.0341	-.1300	68	135.0	9.333	3.5868	.3637	.5069
11	20.0	4.000	.2975	.0302	-.1377	69	202.5	9.333	3.4163	.3464	.4735
12	30.0	4.000	.2939	.0298	-.1384	70	225.0	9.333	3.6453	.3696	.5184
13	40.0	4.000	.2987	.0303	-.1374	71	247.5	9.333	3.3967	.3444	.4697
14	50.0	4.000	.2991	.0303	-.1373	72	315.0	9.333	.2387	.0242	-.1492
15	60.0	4.000	.2962	.0300	-.1379	73	225.0	9.667	3.5432	.3593	.4984
16	70.0	4.000	.2734	.0277	-.1424	74	45.0	10.000	.2485	.0252	-.1473
17	80.0	4.000	.3014	.0306	-.1369	75	135.0	10.000	3.3841	.3431	.4672
18	90.0	4.000	.4637	.0470	-.1051	76	202.5	10.000	3.4203	.3468	.4743
19	180.0	4.000	3.0750	.3118	.4066	77	225.0	10.000	3.4435	.3492	.4788
20	270.0	4.000	.5704	.0578	-.0842	78	247.5	10.000	3.0534	.3096	.4024
21	0.0	5.333	.3632	.0368	-.1248	79	315.0	10.000	.2399	.0243	-.1490
22	90.0	5.333	.4306	.0437	-.1116	80	0.0	10.667	.3146	.0319	-.1343
23	180.0	5.333	3.0487	.3091	.4015	81	45.0	10.667	.2820	.0286	-.1407
24	270.0	5.333	.5348	.0542	-.0912	82	90.0	10.667	1.3807	.1400	.0746
25	0.0	6.200	.3772	.0382	-.1220	83	135.0	10.667	3.0389	.3081	.3995
26	10.0	6.200	.3567	.0362	-.1261	84	180.0	10.667	4.1464	.4204	.6166
27	20.0	6.200	.3274	.0332	-.1318	85	225.0	10.667	3.0364	.3079	.3991
28	30.0	6.200	.3288	.0333	-.1315	86	270.0	10.667	1.2844	.1302	.0557
29	40.0	6.200	.3314	.0336	-.1310	87	315.0	10.667	.2978	.0302	-.1376
30	50.0	6.200	.3416	.0346	-.1290	88	0.0	11.330	.4896	.0496	-.1000
31	60.0	6.200	.3458	.0351	-.1282	89	45.0	11.330	.2820	.0286	-.1407
32	70.0	6.200	.3416	.0346	-.1290	90	90.0	11.330	1.0702	.1085	.0138
33	80.0	6.200	.2982	.0302	-.1375	91	135.0	11.330	3.0620	.3105	.4041
34	90.0	6.200	.4183	.0424	-.1140	92	180.0	11.330	3.7832	.3836	.5454
35	135.0	6.200	1.8644	.1890	.1694	93	225.0	11.330	2.9524	.2993	.3826
36	180.0	6.200	3.0856	.3129	.4087	94	270.0	11.330	1.0884	.1104	.0173
37	225.0	6.200	2.0220	.2050	.2003	95	315.0	11.330	.2405	.0244	-.1488
38	270.0	6.200	.5661	.0574	-.0850	96	0.0	12.000	.4628	.0469	-.1053
39	315.0	6.200	.3451	.0350	-.1283	97	45.0	12.000	.2839	.0288	-.1403
40	0.0	7.333	.3694	.0375	-.1236	98	90.0	12.000	.8174	.0829	-.0358
41	45.0	7.333	.3498	.0355	-.1274	99	135.0	12.000	2.7319	.2770	.3394
42	90.0	7.333	.4691	.0476	-.1040	100	180.0	12.000	3.5100	.3559	.4919
43	135.0	7.333	1.9639	.1991	.1889	101	225.0	12.000	2.5391	.2574	.3016
44	180.0	7.333	3.0188	.3061	.3956	102	270.0	12.000	.7766	.0787	-.0438
45	202.5	7.333	2.7098	.2747	.3350	103	315.0	12.000	.2820	.0286	-.1407
46	225.0	7.333	1.9547	.1982	.1871	104	0.0	13.333	.4609	.0467	-.1056
47	247.5	7.333	1.0977	.1113	.0191	105	45.0	13.333	.3556	.0361	-.1263
48	270.0	7.333	.5067	.0514	-.0967	106	90.0	13.333	.6952	.0705	-.0597
49	315.0	7.333	.3756	.0381	-.1224	107	135.0	13.333	2.4008	.2434	.2745
50	202.5	7.667	2.7746	.2813	.3477	108	180.0	13.333	3.1740	.3218	.4260
51	225.0	7.667	1.9597	.1987	.1881	109	225.0	13.333	2.1672	.2197	.2287
52	247.5	7.667	1.2720	.1290	.0533	110	270.0	13.333	.6510	.0660	-.0684
53	45.0	8.000	.3004	.0305	-.1371	111	315.0	13.333	.3353	.0340	-.1303
54	135.0	8.000	1.9264	.1953	.1815	112	0.0	14.400	.3328	.0337	-.1307
55	202.5	8.000	2.8537	.2893	.3632	113	90.0	14.400	.6309	.0640	-.0723
56	225.0	8.000	1.8555	.1881	.1676	114	180.0	14.400	2.9816	.3023	.3883
57	247.5	8.000	1.8906	.1917	.1745	115	270.0	14.400	.5552	.0563	-.0872
58	315.0	8.000	.3272	.0332	-.1318						

TABLE I.- Continued

(k) M = 2.70;  $\alpha = 40^\circ$

$p_t = 90.5 \text{ kPa}$

TUBE	THETA	X/D	P/PINF	P/PT2	CP	TUBE	THETA	X/D	P/PINF	P/PT2	CP
1	0.0	1.333	.3459	.0351	-.1282	59	225.0	8.333	3.2839	.3330	.4476
2	90.0	1.333	1.0652	.1080	.0128	60	45.0	8.667	.2389	.0242	-.1491
3	180.0	1.333	6.4273	.6517	1.0635	61	135.0	8.667	5.5189	.5596	.8855
4	270.0	1.333	1.1655	.1182	.0324	62	202.5	8.667	4.3271	.4387	.6520
5	0.0	2.667	.2402	.0244	-.1489	63	225.0	8.667	5.3053	.5379	.8437
6	90.0	2.667	.6169	.0626	-.0751	64	247.5	8.667	5.9380	.6021	.9677
7	180.0	2.667	4.7461	.4812	.7341	65	315.0	8.667	.2389	.0242	-.1491
8	270.0	2.667	.7536	.0764	-.0483	66	225.0	9.000	5.8126	.5694	.9431
9	0.0	4.000	.2579	.0262	-.1454	67	45.0	9.333	.2389	.0242	-.1491
10	10.0	4.000	.2429	.0246	-.1484	68	135.0	9.333	4.9385	.5007	.7718
11	20.0	4.000	.2389	.0242	-.1491	69	202.5	9.333	5.1102	.5181	.8055
12	30.0	4.000	.2389	.0242	-.1491	70	225.0	9.333	5.2867	.5360	.8400
13	40.0	4.000	.2389	.0242	-.1491	71	247.5	9.333	4.9663	.5036	.7773
14	50.0	4.000	.2435	.0247	-.1482	72	315.0	9.333	.2389	.0242	-.1491
15	60.0	4.000	.2396	.0243	-.1490	73	225.0	9.667	5.1475	.5219	.8127
16	70.0	4.000	.2389	.0242	-.1491	74	45.0	10.000	.2556	.0259	-.1459
17	80.0	4.000	.3242	.0329	-.1324	75	135.0	10.000	5.0774	.5148	.7990
18	90.0	4.000	.5440	.0552	-.0894	76	202.5	10.000	5.2149	.5288	.8260
19	180.0	4.000	4.5584	.4622	.6973	77	225.0	10.000	5.0571	.5128	.7950
20	270.0	4.000	.6895	.0699	-.0608	78	247.5	10.000	4.2862	.4346	.6440
21	0.0	5.333	.2548	.0258	-.1460	79	315.0	10.000	.2503	.0254	-.1469
22	90.0	5.333	.5318	.0539	-.0918	80	0.0	10.667	.2799	.0284	-.1411
23	180.0	5.333	4.5557	.4619	.6968	81	45.0	10.667	.2887	.0293	-.1394
24	270.0	5.333	.6734	.0683	-.0640	82	90.0	10.667	1.9651	.1992	.1891
25	0.0	6.200	.2525	.0256	-.1465	83	135.0	10.667	4.6752	.4740	.7202
26	10.0	6.200	.2538	.0257	-.1462	84	180.0	10.667	6.0881	.6173	.9971
27	20.0	6.200	.2517	.0255	-.1466	85	225.0	10.667	4.6667	.4732	.7185
28	30.0	6.200	.2533	.0257	-.1463	86	270.0	10.667	1.7619	.1786	.1493
29	40.0	6.200	.2565	.0260	-.1457	87	315.0	10.667	.2922	.0296	-.1387
30	50.0	6.200	.2575	.0261	-.1455	88	0.0	11.330	.3116	.0316	-.1349
31	60.0	6.200	.2554	.0259	-.1459	89	45.0	11.330	.2887	.0293	-.1394
32	70.0	6.200	.2389	.0242	-.1491	90	90.0	11.330	1.3986	.1418	.0781
33	80.0	6.200	.3394	.0344	-.1294	91	135.0	11.330	4.2475	.4307	.6364
34	90.0	6.200	.5349	.0542	-.0911	92	180.0	11.330	5.7149	.5795	.9240
35	135.0	6.200	2.6477	.2685	.3229	93	225.0	11.330	3.9357	.3991	.5753
36	180.0	6.200	4.5487	.4612	.6954	94	270.0	11.330	1.3415	.1360	.0669
37	225.0	6.200	2.9719	.3013	.3864	95	315.0	11.330	.3055	.0310	-.1361
38	270.0	6.200	.7504	.0761	-.0489	96	0.0	12.000	.3597	.0365	-.1255
39	315.0	6.200	.2655	.0269	-.1439	97	45.0	12.000	.3687	.0374	-.1237
40	0.0	7.333	.2667	.0270	-.1437	98	90.0	12.000	1.0900	.1105	.0176
41	45.0	7.333	.2774	.0281	-.1416	99	135.0	12.000	3.7327	.3785	.5355
42	90.0	7.333	.6039	.0612	-.0776	100	180.0	12.000	5.3442	.5419	.8513
43	135.0	7.333	2.7961	.2835	.3520	101	225.0	12.000	3.4111	.3459	.4725
44	180.0	7.333	4.4404	.4502	.6742	102	270.0	12.000	.9897	.1003	-.0020
45	202.5	7.333	3.9178	.3972	.5718	103	315.0	12.000	.3693	.0374	-.1236
46	225.0	7.333	2.8443	.2884	.3614	104	0.0	13.333	.3595	.0365	-.1255
47	247.5	7.333	1.5170	.1538	.1013	105	45.0	13.333	.3839	.0389	-.1207
48	270.0	7.333	.6560	.0665	-.0674	106	90.0	13.333	.7665	.0777	-.0458
49	315.0	7.333	.2775	.0281	-.1416	107	135.0	13.333	3.4742	.3523	.4849
50	202.5	7.667	4.0779	.4135	.6032	108	180.0	13.333	4.5830	.4647	.7021
51	225.0	7.667	2.7579	.2796	.3445	109	225.0	13.333	3.3540	.3401	.4613
52	247.5	7.667	1.9887	.2016	.1938	110	270.0	13.333	.6644	.0674	-.0658
53	45.0	8.000	.2479	.0251	-.1474	111	315.0	13.333	.3896	.0395	-.1196
54	135.0	8.000	2.8250	.2864	.3576	112	0.0	14.400	.3344	.0339	-.1304
55	202.5	8.000	4.1617	.4220	.6196	113	90.0	14.400	.7939	.0805	-.0404
56	225.0	8.000	2.8287	.2868	.3584	114	180.0	14.400	3.7799	.3833	.5448
57	247.5	8.000	2.8051	.2844	.3537	115	270.0	14.400	.7538	.0764	-.0482
58	315.0	8.000	.2518	.0255	-.1466						

TABLE I.- Concluded

(1) M = 2.70;  $\alpha = 50^\circ$

$P_t = 90.0$  kPa

TUBE	THETA	X/D	P/PINF	P/PT2	CP	TUBE	THETA	X/D	P/PINF	P/PT2	CP
1	0.0	1.333	.2941	.0298	-.1383	59	225.0	8.333	6.6707	.6764	1.1113
2	90.0	1.333	1.0863	.1101	.0169	60	45.0	8.667	.2353	.0239	-.1499
3	180.0	1.333	8.0004	.8112	1.3718	61	135.0	8.667	7.5762	.7682	1.2887
4	270.0	1.333	1.2161	.1233	-.0423	62	202.5	8.667	7.5659	.7671	1.2867
5	0.0	2.667	.2353	.0239	-.1499	63	225.0	8.667	7.8347	.7944	1.3394
6	90.0	2.667	.6980	.0708	-.0592	64	247.5	8.667	7.3144	.7418	1.2374
7	180.0	2.667	6.3935	.6483	1.0569	65	315.0	8.667	.2353	.0239	-.1499
8	270.0	2.667	.8776	.0890	-.0240	66	225.0	9.000	7.7416	.7849	1.3211
9	0.0	4.000	.2353	.0239	-.1499	67	45.0	9.333	.2353	.0239	-.1499
10	10.0	4.000	.2353	.0239	-.1499	68	135.0	9.333	7.3237	.7426	1.2392
11	20.0	4.000	.2353	.0239	-.1499	69	202.5	9.333	7.4720	.7576	1.2663
12	30.0	4.000	.2353	.0239	-.1499	70	225.0	9.333	7.2061	.7307	1.2162
13	40.0	4.000	.2353	.0239	-.1499	71	247.5	9.333	6.4627	.6553	1.0705
14	50.0	4.000	.2353	.0239	-.1499	72	315.0	9.333	.2353	.0239	-.1499
15	60.0	4.000	.2353	.0239	-.1499	73	225.0	9.667	7.1534	.7253	1.2058
16	70.0	4.000	.2353	.0239	-.1499	74	45.0	10.000	.2353	.0239	-.1499
17	80.0	4.000	.3749	.0380	-.1225	75	135.0	10.000	7.1667	.7267	1.2085
18	90.0	4.000	.6433	.0652	-.0696	76	202.5	10.000	7.8565	.7966	1.3436
19	180.0	4.000	6.1811	.6267	1.0153	77	225.0	10.000	7.0969	.7196	1.1948
20	270.0	4.000	.8457	.0857	-.0302	78	247.5	10.000	6.5376	.6629	1.0852
21	0.0	5.333	.2353	.0239	-.1499	79	315.0	10.000	.2353	.0239	-.1499
22	90.0	5.333	.6538	.0663	-.0679	80	0.0	10.667	.2485	.0252	-.1473
23	180.0	5.333	6.1046	.6190	1.0003	81	45.0	10.667	.2353	.0239	-.1499
24	270.0	5.333	.8473	.0859	-.0299	82	90.0	10.667	2.5012	.2536	.2942
25	0.0	6.200	.2456	.0249	-.1478	83	135.0	10.667	5.7868	.5867	.9380
26	10.0	6.200	.2464	.0250	-.1477	84	180.0	10.667	8.9741	.9099	1.5626
27	20.0	6.200	.2447	.0248	-.1480	85	225.0	10.667	5.6233	.5702	.9060
28	30.0	6.200	.2456	.0249	-.1478	86	270.0	10.667	2.2231	.2254	.2397
29	40.0	6.200	.2464	.0250	-.1477	87	315.0	10.667	.2353	.0239	-.1499
30	50.0	6.200	.2479	.0251	-.1474	88	0.0	11.330	.3223	.0327	-.1328
31	60.0	6.200	.2357	.0239	-.1498	89	45.0	11.330	.2353	.0239	-.1499
32	70.0	6.200	.2353	.0239	-.1499	90	90.0	11.330	1.2653	.1283	.0520
33	80.0	6.200	.4044	.0410	-.1167	91	135.0	11.330	4.9659	.5035	.7772
34	90.0	6.200	.6500	.0659	-.0686	92	180.0	11.330	7.0882	.7187	1.1931
35	135.0	6.200	3.5147	.3564	.4928	93	225.0	11.330	4.5294	.4592	.6916
36	180.0	6.200	6.1390	.6224	1.0070	94	270.0	11.330	1.1104	.1126	.0216
37	225.0	6.200	3.9756	.4031	.5831	95	315.0	11.330	.3129	.0317	-.1346
38	270.0	6.200	.9211	.0934	-.0155	96	0.0	12.000	.3295	.0334	-.1314
39	315.0	6.200	.2643	.0268	-.1442	97	45.0	12.000	.3539	.0359	-.1266
40	0.0	7.333	.2851	.0289	-.1401	98	90.0	12.000	.9582	.0972	-.0082
41	45.0	7.333	.2575	.0261	-.1455	99	135.0	12.000	6.8589	.4927	.7562
42	90.0	7.333	1.0457	.1060	.0090	100	180.0	12.000	6.1457	.6231	1.0084
43	135.0	7.333	3.7039	.3755	.5299	101	225.0	12.000	4.7371	.4803	.7323
44	180.0	7.333	6.0074	.6091	.9813	102	270.0	12.000	.7109	.0721	-.0567
45	202.5	7.333	5.2405	.5313	.8310	103	315.0	12.000	.3461	.0351	-.1281
46	225.0	7.333	3.7501	.3802	.5389	104	0.0	13.333	.3291	.0334	-.1315
47	247.5	7.333	1.9462	.1973	.1854	105	45.0	13.333	.3156	.0320	-.1341
48	270.0	7.333	1.0005	.1014	.0001	106	90.0	13.333	1.3270	.1345	.0641
49	315.0	7.333	.2808	.0285	-.1409	107	135.0	13.333	4.3034	.4363	.6474
50	202.5	7.667	5.4068	.5482	.8636	108	180.0	13.333	3.8994	.3954	.5682
51	225.0	7.667	4.1209	.4178	.6116	109	225.0	13.333	3.8660	.3920	.5616
52	247.5	7.667	2.9642	.3005	.3849	110	270.0	13.333	1.2616	.1279	.0513
53	45.0	8.000	.2353	.0239	-.1499	111	315.0	13.333	.3042	.0308	-.1364
54	135.0	8.000	4.2832	.4343	.6434	112	0.0	14.400	.2805	.0284	-.1410
55	202.5	8.000	5.6640	.5743	.9140	113	90.0	14.400	1.7067	.1733	.1385
56	225.0	8.000	4.2401	.4299	.6349	114	180.0	14.400	2.7150	.2753	.3361
57	247.5	8.000	5.3781	.5453	.8579	115	270.0	14.400	1.4687	.1489	.0918
58	315.0	8.000	.2353	.0239	-.1499						

TABLE II.- BODY PRESSURE LISTING FOR  $\phi = 22.5^\circ$  AND  $R = 2.5 \times 10^5$

(a)  $M = 1.60$ ;  $\alpha = 0^\circ$

$p_t = 54.6$  kPa

TUBE	THETA	X/D	P/PINF	P/PT2	CP	TUBE	THETA	X/D	P/PINF	P/PT2	CP
1	0.0	1.333	1.1537	.3032	.0858	59	225.0	8.333	1.1723	.3081	.0961
2	90.0	1.333	1.1602	.3049	.0894	60	45.0	8.667	1.1922	.3133	.1072
3	180.0	1.333	1.1509	.3025	.0842	61	135.0	8.667	1.1744	.3086	.0973
4	270.0	1.333	1.1558	.3038	.0870	62	202.5	8.667	1.1703	.3076	.0951
5	0.0	2.667	.8900	.2339	-.0614	63	225.0	8.667	1.1667	.3066	.0930
6	90.0	2.667	.8895	.2338	-.0617	64	247.5	8.667	1.1779	.3096	.0993
7	180.0	2.667	.8897	.2338	-.0615	65	315.0	8.667	1.1794	.3100	.1001
8	270.0	2.667	.8921	.2345	-.0602	66	225.0	9.000	1.1779	.3096	.0993
9	0.0	4.000	.9462	.2487	-.0300	67	45.0	9.333	1.0440	.2744	.0245
10	10.0	4.000	.9510	.2499	-.0273	68	135.0	9.333	.9939	.2612	-.0034
11	20.0	4.000	.9518	.2501	-.0269	69	202.5	9.333	1.0239	.2691	.0134
12	30.0	4.000	.9473	.2490	-.0294	70	225.0	9.333	1.0388	.2730	.0217
13	40.0	4.000	.9461	.2486	-.0301	71	247.5	9.333	1.0377	.2727	.0210
14	50.0	4.000	.9473	.2490	-.0294	72	315.0	9.333	.9969	.2620	-.0017
15	60.0	4.000	.9462	.2487	-.0300	73	225.0	9.667	.9626	.2530	-.0209
16	70.0	4.000	.9461	.2487	-.0301	74	45.0	10.000	.9177	.2412	-.0459
17	80.0	4.000	.9456	.2485	-.0304	75	135.0	10.000	.8500	.2234	-.0837
18	90.0	4.000	.9404	.2471	-.0333	76	202.5	10.000	.8846	.2325	-.0644
19	180.0	4.000	.9408	.2473	-.0330	77	225.0	10.000	.8953	.2353	-.0585
20	270.0	4.000	.9545	.2509	-.0254	78	247.5	10.000	.8819	.2318	-.0659
21	0.0	5.333	.9781	.2571	-.0122	79	315.0	10.000	.8335	.2191	-.0929
22	90.0	5.333	.9756	.2564	-.0136	80	0.0	10.667	.9380	.2465	-.0346
23	180.0	5.333	.9856	.2590	-.0080	81	45.0	10.667	.8693	.2285	-.0730
24	270.0	5.333	.9872	.2595	-.0071	82	90.0	10.667	.9403	.2471	-.0333
25	0.0	6.200	.9897	.2601	-.0057	83	135.0	10.667	.9062	.2382	-.0523
26	10.0	6.200	.9931	.2610	-.0038	84	180.0	10.667	.9542	.2508	-.0256
27	20.0	6.200	1.0000	.2628	-.0000	85	225.0	10.667	.8930	.2347	-.0597
28	30.0	6.200	.9959	.2617	-.0023	86	270.0	10.667	.9448	.2483	-.0308
29	40.0	6.200	.9962	.2618	-.0021	87	315.0	10.667	.8881	.2334	-.0624
30	50.0	6.200	.9942	.2613	-.0032	88	0.0	11.330	.9951	.2615	-.0027
31	60.0	6.200	.9940	.2612	-.0033	89	45.0	11.330	.8693	.2285	-.0730
32	70.0	6.200	.9914	.2606	-.0048	90	90.0	11.330	.9765	.2566	-.0131
33	80.0	6.200	.9790	.2573	-.0117	91	135.0	11.330	.9976	.2622	-.0014
34	90.0	6.200	.9836	.2585	-.0092	92	180.0	11.330	.9711	.2552	-.0161
35	135.0	6.200	.9925	.2609	-.0042	93	225.0	11.330	.9770	.2568	-.0129
36	180.0	6.200	1.0044	.2640	.0025	94	270.0	11.330	.9868	.2593	-.0074
37	225.0	6.200	.9990	.2625	-.0006	95	315.0	11.330	.9933	.2610	-.0037
38	270.0	6.200	.9942	.2613	-.0032	96	0.0	12.000	.9896	.2601	-.0058
39	315.0	6.200	.9904	.2603	-.0053	97	45.0	12.000	.9881	.2597	-.0067
40	0.0	7.333	.9942	.2613	-.0033	98	90.0	12.000	.9817	.2583	-.0102
41	45.0	7.333	1.0005	.2630	.0003	99	135.0	12.000	.9887	.2598	-.0063
42	90.0	7.333	.9996	.2627	-.0002	100	180.0	12.000	.9895	.2601	-.0058
43	135.0	7.333	1.0055	.2643	.0031	101	225.0	12.000	.9908	.2604	-.0051
44	180.0	7.333	.9968	.2620	-.0018	102	270.0	12.000	.9789	.2573	-.0118
45	202.5	7.333	.9685	.2545	-.0176	103	315.0	12.000	.9857	.2590	-.0080
46	225.0	7.333	.9628	.2530	-.0208	104	0.0	13.333	.9900	.2602	-.0056
47	247.5	7.333	1.0040	.2639	.0023	105	45.0	13.333	1.0271	.2699	.0151
48	270.0	7.333	1.0086	.2651	.0048	106	90.0	13.333	1.0267	.2698	.0149
49	315.0	7.333	.9974	.2621	-.0015	107	135.0	13.333	1.0216	.2685	.0121
50	202.5	7.667	1.0553	.2774	.0309	108	180.0	13.333	1.0305	.2708	.0170
51	225.0	7.667	1.0224	.2687	.0125	109	225.0	13.333	1.0231	.2689	.0129
52	247.5	7.667	1.0450	.2747	.0251	110	270.0	13.333	1.0274	.2700	.0153
53	45.0	8.000	1.0712	.2815	.0397	111	315.0	13.333	1.0158	.2670	.0088
54	135.0	8.000	1.0474	.2753	.0264	112	0.0	14.400	1.0309	.2709	.0172
55	202.5	8.000	1.0802	.2839	.0447	113	90.0	14.400	1.0226	.2688	.0126
56	225.0	8.000	1.0509	.2762	.0284	114	180.0	14.400	1.0304	.2708	.0170
57	247.5	8.000	1.0694	.2811	.0387	115	270.0	14.400	1.0230	.2688	.0128
58	315.0	8.000	1.0717	.2817	.0400						



TABLE II.- Continued

(b) M = 1.60;  $\alpha = 10^\circ$

$P_t = 54.7$  kPa

TUBE	THETA	X/D	P/PINF	P/PT2	CP	TUBE	THETA	X/D	P/PINF	P/PT2	CP
1	0.0	1.333	.9699	.2549	-.0168	59	225.0	8.333	1.5806	.4154	.3240
2	90.0	1.333	.9960	.2618	-.0022	60	45.0	8.667	.8474	.2227	-.0851
3	180.0	1.333	1.4229	.3740	.2360	61	135.0	8.667	1.2604	.3313	.1453
4	270.0	1.333	1.2048	.3166	.1143	62	202.5	8.667	1.7044	.4479	.3931
5	0.0	2.667	.8133	.2138	-.1042	63	225.0	8.667	1.6909	.4444	.3856
6	90.0	2.667	.7716	.2028	-.1275	64	247.5	8.667	1.7827	.4685	.4368
7	180.0	2.667	1.0287	.2704	.0160	65	315.0	8.667	.9366	.2461	-.0354
8	270.0	2.667	.8620	.2266	-.0770	66	225.0	9.000	1.7211	.4523	.4024
9	0.0	4.000	.9696	.2548	-.0170	67	45.0	9.333	.7407	.1947	-.1447
10	10.0	4.000	.9947	.2614	-.0030	68	135.0	9.333	1.0810	.2841	.0452
11	20.0	4.000	1.0063	.2645	.0035	69	202.5	9.333	1.4837	.3899	.2699
12	30.0	4.000	.9914	.2606	-.0048	70	225.0	9.333	1.4871	.3908	.2718
13	40.0	4.000	.9752	.2563	-.0138	71	247.5	9.333	1.5720	.4131	.3192
14	50.0	4.000	.9680	.2544	-.0179	72	315.0	9.333	.8267	.2173	-.0967
15	60.0	4.000	.8675	.2280	-.0740	73	225.0	9.667	1.3900	.3653	.2177
16	70.0	4.000	.8003	.2103	-.1114	74	45.0	10.000	.6039	.1587	-.2210
17	80.0	4.000	.8024	.2109	-.1103	75	135.0	10.000	.9907	.2604	-.0052
18	90.0	4.000	.8010	.2105	-.1111	76	202.5	10.000	1.3146	.3455	.1756
19	180.0	4.000	.9785	.2572	-.0120	77	225.0	10.000	1.3258	.3484	.1818
20	270.0	4.000	.8238	.2165	-.0983	78	247.5	10.000	1.2943	.3402	.1642
21	0.0	5.333	.9690	.2547	-.0173	79	315.0	10.000	.6859	.1803	-.1753
22	90.0	5.333	.8523	.2240	-.0824	80	0.0	10.667	.7609	.2000	-.1334
23	180.0	5.333	.9826	.2583	-.0097	81	45.0	10.667	.6617	.1739	-.1888
24	270.0	5.333	.8495	.2233	-.0840	82	90.0	10.667	.8311	.2184	-.0943
25	0.0	6.200	.9703	.2550	-.0166	83	135.0	10.667	1.0946	.2877	.0528
26	10.0	6.200	1.0103	.2655	.0057	84	180.0	10.667	1.2871	.3383	.1602
27	20.0	6.200	1.0345	.2719	.0193	85	225.0	10.667	1.1265	.2961	.0706
28	30.0	6.200	1.0240	.2691	.0134	86	270.0	10.667	1.0701	.2812	.0391
29	40.0	6.200	1.0174	.2674	.0097	87	315.0	10.667	.8568	.2252	-.0799
30	50.0	6.200	.9567	.2514	-.0242	88	0.0	11.330	.9176	.2412	-.0460
31	60.0	6.200	.8658	.2275	-.0749	89	45.0	11.330	.6617	.1739	-.1888
32	70.0	6.200	.8782	.2308	-.0680	90	90.0	11.330	.9393	.2469	-.0339
33	80.0	6.200	.9101	.2392	-.0501	91	135.0	11.330	1.0616	.2790	.0344
34	90.0	6.200	.9164	.2409	-.0466	92	180.0	11.330	1.1266	.2961	.0707
35	135.0	6.200	.8570	.2252	-.0798	93	225.0	11.330	1.0808	.2841	.0451
36	180.0	6.200	1.0004	.2629	.0002	94	270.0	11.330	1.0261	.2697	.0146
37	225.0	6.200	1.0082	.2650	.0046	95	315.0	11.330	.9222	.2424	-.0434
38	270.0	6.200	.8625	.2267	-.0767	96	0.0	12.000	1.0053	.2642	.0030
39	315.0	6.200	.8808	.2315	-.0665	97	45.0	12.000	1.0280	.2702	.0156
40	0.0	7.333	.9539	.2507	-.0257	98	90.0	12.000	.9301	.2444	-.0390
41	45.0	7.333	.9557	.2512	-.0247	99	135.0	12.000	.9899	.2602	-.0056
42	90.0	7.333	.9348	.2457	-.0364	100	180.0	12.000	1.0733	.2821	.0409
43	135.0	7.333	.8854	.2327	-.0640	101	225.0	12.000	.9978	.2622	-.0012
44	180.0	7.333	1.0178	.2675	.0099	102	270.0	12.000	.9507	.2499	-.0275
45	202.5	7.333	1.0363	.2723	.0202	103	315.0	12.000	.9428	.2478	-.0319
46	225.0	7.333	1.0024	.2635	.0014	104	0.0	13.333	1.0065	.2645	.0036
47	247.5	7.333	.9508	.2499	-.0275	105	45.0	13.333	1.0347	.2719	.0194
48	270.0	7.333	.9069	.2383	-.0520	106	90.0	13.333	.9685	.2545	-.0176
49	315.0	7.333	.9182	.2413	-.0456	107	135.0	13.333	.9418	.2475	-.0325
50	202.5	7.667	1.1011	.2894	.0564	108	180.0	13.333	.9898	.2601	-.0057
51	225.0	7.667	1.0647	.2798	.0361	109	225.0	13.333	.9290	.2442	-.0396
52	247.5	7.667	1.0715	.2816	.0399	110	270.0	13.333	.9283	.2440	-.0400
53	45.0	8.000	.9816	.2580	-.0103	111	315.0	13.333	.9750	.2562	-.0140
54	135.0	8.000	.9782	.2571	-.0121	112	0.0	14.400	1.0004	.2629	.0002
55	202.5	8.000	1.2943	.3402	.1642	113	90.0	14.400	.9810	.2578	-.0106
56	225.0	8.000	1.1999	.3154	.1116	114	180.0	14.400	.9801	.2576	-.0111
57	247.5	8.000	1.2929	.3398	.1635	115	270.0	14.400	.9674	.2542	-.0182
58	315.0	8.000	.9076	.2385	-.0516						

TABLE II.- Continued

(c)  $M = 1.60$ ;  $\alpha = 20^\circ$

$P_t = 54.6$  kPa

TUBE	THETA	X/D	P/PINF	P/P2	CP	TUBE	THETA	X/D	P/PINF	P/P2	CP
1	0.0	1.333	.7365	.1936	-.1471	59	225.0	8.333	2.3029	.6052	.7271
2	90.0	1.333	.6842	.1798	-.1762	60	45.0	8.667	.7685	.2020	-.1292
3	180.0	1.333	1.7563	.4616	.4220	61	135.0	8.667	1.3218	.3474	.1796
4	270.0	1.333	1.2038	.3164	.1137	62	202.5	8.667	2.4237	.6370	.7945
5	0.0	2.667	.5749	.1511	-.2372	63	225.0	8.667	2.3685	.6225	.7637
6	90.0	2.667	.5015	.1318	-.2782	64	27.5	8.667	2.4191	.6358	.7919
7	180.0	2.667	1.2712	.3341	.1513	65	315.0	8.667	.5329	.1401	-.2606
8	270.0	2.667	.8219	.2160	-.0994	66	225.0	9.000	2.1729	.5711	.6545
9	0.0	4.000	.5902	.1551	-.2287	67	45.0	9.333	.5485	.1442	-.2520
10	10.0	4.000	.8746	.2299	-.0700	68	135.0	9.333	1.1948	.3140	.1087
11	20.0	4.000	.9245	.2430	-.0421	69	202.5	9.333	1.8659	.4904	.4832
12	30.0	4.000	.9044	.2377	-.0533	70	225.0	9.333	1.8824	.4947	.4924
13	40.0	4.000	.8266	.2172	-.0968	71	247.5	9.333	2.0514	.5391	.5867
14	50.0	4.000	.5877	.1544	-.2301	72	315.0	9.333	.5260	.1382	-.2645
15	60.0	4.000	.5083	.1336	-.2744	73	225.0	9.667	1.8055	.4745	.4495
16	70.0	4.000	.5233	.1375	-.2660	74	45.0	10.000	.4151	.1091	-.3264
17	80.0	4.000	.5710	.1501	-.2394	75	135.0	10.000	1.1909	.3130	.1065
18	90.0	4.000	.5752	.1512	-.2371	76	202.5	10.000	1.6921	.4447	.3862
19	180.0	4.000	1.1860	.3117	.1038	77	225.0	10.000	1.6858	.4431	.3827
20	270.0	4.000	.7298	.1918	-.1508	78	247.5	10.000	1.6921	.4447	.3862
21	0.0	5.333	.6489	.1705	-.1959	79	315.0	10.000	.4954	.1302	-.2816
22	90.0	5.333	.6795	.1786	-.1788	80	0.0	10.667	.6213	.1633	-.2113
23	180.0	5.333	1.1443	.3007	.0805	81	45.0	10.667	.6409	.1684	-.2004
24	270.0	5.333	.6761	.1777	-.1807	82	90.0	10.667	.8598	.2260	-.0782
25	0.0	6.200	.7302	.1919	-.1506	83	135.0	10.667	1.2541	.3296	.1418
26	10.0	6.200	.7507	.1973	-.1391	84	180.0	10.667	1.5130	.3976	.2863
27	20.0	6.200	.7838	.2060	-.1207	85	225.0	10.667	1.3525	.3554	.1967
28	30.0	6.200	.7594	.1996	-.1342	86	270.0	10.667	1.0771	.2831	.0431
29	40.0	6.200	.6661	.1803	-.1752	87	315.0	10.667	.7865	.2067	-.1192
30	50.0	6.200	.6736	.1770	-.1822	88	0.0	11.330	.8828	.2320	-.0554
31	60.0	6.200	.6769	.1779	-.1803	89	45.0	11.330	.6409	.1684	-.2004
32	70.0	6.200	.6572	.1727	-.1913	90	90.0	11.330	.9257	.2433	-.0415
33	80.0	6.200	.7108	.1866	-.1614	91	135.0	11.330	1.1706	.3077	.0952
34	90.0	6.200	.7259	.1906	-.1529	92	180.0	11.330	1.2751	.3351	.1535
35	135.0	6.200	.7139	.1876	-.1597	93	225.0	11.330	1.0767	.2830	.0428
36	180.0	6.200	1.1492	.3020	.0832	94	270.0	11.330	.7533	.1980	-.1377
37	225.0	6.200	1.1943	.3139	.1084	95	315.0	11.330	.8485	.2230	-.0845
38	270.0	6.200	.6691	.1759	-.1846	96	0.0	12.000	.9703	.2550	-.0166
39	315.0	6.200	.7067	.1857	-.1637	97	45.0	12.000	1.0254	.2695	.0142
40	0.0	7.333	.7317	.1923	-.1497	98	90.0	12.000	.8658	.2275	-.0749
41	45.0	7.333	.7487	.1968	-.1402	99	135.0	12.000	.9993	.2626	-.0004
42	90.0	7.333	.7344	.1930	-.1482	100	180.0	12.000	1.1349	.2983	.0753
43	135.0	7.333	.7378	.1939	-.1463	101	225.0	12.000	.9243	.2429	-.0422
44	180.0	7.333	1.1483	.3018	.0827	102	270.0	12.000	.6939	.1824	-.1708
45	202.5	7.333	1.2249	.3219	.1255	103	315.0	12.000	.8139	.2139	-.1039
46	225.0	7.333	1.1398	.2996	.0780	104	0.0	13.333	.9712	.2592	-.0161
47	247.5	7.333	.9083	.2387	-.0512	105	45.0	13.333	.8866	.2330	-.0633
48	270.0	7.333	.7445	.1957	-.1426	106	90.0	13.333	.8432	.2216	-.0875
49	315.0	7.333	.7547	.1983	-.1369	107	135.0	13.333	.9108	.2394	-.0498
50	202.5	7.667	1.3290	.3493	.1836	108	180.0	13.333	.9521	.2502	-.0267
51	225.0	7.667	1.2322	.3238	.1296	109	225.0	13.333	.7977	.2097	-.1129
52	247.5	7.667	1.1162	.2934	.0649	110	270.0	13.333	.7043	.1851	-.1650
53	45.0	8.000	.8392	.2206	-.0897	111	315.0	13.333	.8344	.2193	-.0924
54	135.0	8.000	.7909	.2078	-.1167	112	0.0	14.400	.8343	.2193	-.0925
55	202.5	8.000	1.6943	.4453	.3874	113	90.0	14.400	.7808	.2052	-.1223
56	225.0	8.000	1.6173	.4250	.3445	114	180.0	14.400	.9316	.2448	-.0382
57	247.5	8.000	1.8720	.4920	.4866	115	270.0	14.400	.7644	.2009	-.1315
58	315.0	8.000	.7356	.1933	-.1476						

TABLE II.- Continued

(d) M = 1.60;  $\alpha = 30^\circ$

$p_t = 54.6 \text{ kPa}$

TUBE	THETA	X/D	P/PINF	P/PT2	CP	TUBE	THETA	X/D	P/PINF	P/PT2	CP
1	0.0	1.333	.3859	.1014	-.3427	59	225.0	8.333	2.9486	.7749	1.0874
2	90.0	1.333	.4291	.1128	-.3186	60	45.0	8.667	.5620	.1477	-.2444
3	180.0	1.333	2.1748	.5716	.6556	61	135.0	8.667	1.4578	.3831	.2555
4	270.0	1.333	1.2661	.3327	.1485	62	202.5	8.667	2.8379	.7458	1.0256
5	0.0	2.667	.3641	.0957	-.3549	63	225.0	8.667	2.25.0	2.8184	.7407
6	90.0	2.667	.4153	.1091	-.3263	64	247.5	8.667	2.7681	.7275	.9867
7	180.0	2.667	1.6358	.4299	.3548	65	315.0	8.667	.3608	.0948	-.3567
8	270.0	2.667	.9001	.2366	-.0558	66	225.0	9.000	2.6094	.6858	.8981
9	0.0	4.000	.4414	.1160	-.3117	67	45.0	9.333	.3961	.1041	-.3370
10	10.0	4.000	.4578	.1203	-.3026	68	135.0	9.333	1.3109	.3445	.1735
11	20.0	4.000	.5441	.1430	-.2544	69	202.5	9.333	2.3888	.6278	.7750
12	30.0	4.000	.5276	.1387	-.2636	70	225.0	9.333	2.3766	.6246	.7682
13	40.0	4.000	.4543	.1194	-.3045	71	247.5	9.333	2.3884	.6277	.7748
14	50.0	4.000	.4525	.1189	-.3055	72	315.0	9.333	.3291	.0865	-.3744
15	60.0	4.000	.4478	.1177	-.3081	73	225.0	9.667	2.3176	.6091	.7353
16	70.0	4.000	.4689	.1232	-.2964	74	45.0	10.000	.3536	.0929	-.3607
17	80.0	4.000	.4973	.1307	-.2805	75	135.0	10.000	1.4192	.3730	.2339
18	90.0	4.000	.4995	.1313	-.2793	76	202.5	10.000	2.1349	.5611	.6333
19	180.0	4.000	1.5147	.3981	.2872	77	225.0	10.000	2.1461	.5640	.6396
20	270.0	4.000	.8081	.2124	-.1071	78	247.5	10.000	2.1006	.5521	.6141
21	0.0	5.333	.5032	.1322	-.2772	79	315.0	10.000	.3425	.0900	-.3669
22	90.0	5.333	.5428	.1427	-.2551	80	0.0	10.667	.4849	.1274	-.2875
23	180.0	5.333	1.4714	.3867	.2631	81	45.0	10.667	.6131	.1611	-.2159
24	270.0	5.333	.7581	.1992	-.1350	82	90.0	10.667	.9592	.2521	-.0228
25	0.0	6.200	.5373	.1412	-.2582	83	135.0	10.667	1.3885	.3649	.2168
26	10.0	6.200	.5730	.1506	-.2383	84	180.0	10.667	1.6699	.4389	.3738
27	20.0	6.200	.6365	.1673	-.2028	85	225.0	10.667	1.4711	.3866	.2629
28	30.0	6.200	.6361	.1672	-.2031	86	270.0	10.667	.5880	.1545	-.2299
29	40.0	6.200	.5719	.1503	-.2389	87	315.0	10.667	.4818	.1266	-.2892
30	50.0	6.200	.5471	.1438	-.2527	88	0.0	11.330	.7085	.1862	-.1627
31	60.0	6.200	.5544	.1457	-.2486	89	45.0	11.330	.6131	.1611	-.2159
32	70.0	6.200	.5468	.1437	-.2529	90	90.0	11.330	.7349	.1932	-.1479
33	80.0	6.200	.5670	.1490	-.2416	91	135.0	11.330	1.3277	.3489	.1829
34	90.0	6.200	.5776	.1518	-.2357	92	180.0	11.330	1.3795	.3626	.2118
35	135.0	6.200	.6305	.1657	-.2062	93	225.0	11.330	1.1212	.2947	.0676
36	180.0	6.200	1.4708	.3865	.2627	94	270.0	11.330	.4165	.1095	-.3256
37	225.0	6.200	1.5381	.4042	.3003	95	315.0	11.330	.4597	.1208	-.3015
38	270.0	6.200	.7349	.1931	-.1480	96	0.0	12.000	.5856	.1539	-.2313
39	315.0	6.200	.5676	.1492	-.2413	97	45.0	12.000	.8731	.2295	-.0708
40	0.0	7.333	.5714	.1502	-.2392	98	90.0	12.000	.5534	.1454	-.2492
41	45.0	7.333	.5701	.1498	-.2399	99	135.0	12.000	1.1153	.2931	.0644
42	90.0	7.333	.6043	.1588	-.2208	100	180.0	12.000	1.2082	.3175	.1162
43	135.0	7.333	.6748	.1774	-.1814	101	225.0	12.000	1.0265	.2698	.0148
44	180.0	7.333	1.4924	.3922	.2746	102	270.0	12.000	.3883	.1021	-.3413
45	202.5	7.333	1.5973	.4198	.3333	103	315.0	12.000	.4931	.1033	-.3387
46	225.0	7.333	1.4767	.3881	.2660	104	0.0	13.333	.5839	.1535	-.2322
47	247.5	7.333	1.1534	.3031	.0856	105	45.0	13.333	.6799	.1787	-.1786
48	270.0	7.333	.7992	.2100	-.1120	106	90.0	13.333	.5348	.1405	-.2596
49	315.0	7.333	.6855	.1802	-.1755	107	135.0	13.333	.7892	.2074	-.1176
50	202.5	7.667	1.9731	.5186	.5430	108	180.0	13.333	1.1266	.2961	.0706
51	225.0	7.667	1.8592	.4886	.4795	109	225.0	13.333	1.0454	.2747	.0253
52	247.5	7.667	2.0907	.5495	.6087	110	270.0	13.333	.6680	.1756	-.1852
53	45.0	8.000	.6200	.1629	-.2121	111	315.0	13.333	.5651	.1485	-.2427
54	135.0	8.000	.7810	.2053	-.1222	112	0.0	14.400	.5952	.1564	-.2259
55	202.5	8.000	2.7474	.7221	.9751	113	90.0	14.400	.4446	.1169	-.3099
56	225.0	8.000	2.7115	.7126	.9551	114	180.0	14.400	1.2307	.3235	.1288
57	247.5	8.000	2.7394	.7199	.9706	115	270.0	14.400	.6719	.1766	-.1831
58	315.0	8.000	.3576	.0940	-.3585						

TABLE II.- Continued

(e)  $M = 1.60$ ;  $\alpha = 40^\circ$

$p_t = 54.7$  kPa

TUBE	THETA	X/D	P/PINF	P/P12	CP	TUBE	THETA	X/D	P/PINF	P/P12	CP
1	0.0	1.333	.3233	.0850	-.3776	59	225.0	8.333	3.4122	.8968	1.3461
2	90.0	1.333	.3040	.0799	-.3884	60	45.0	8.667	.2733	.0718	-.4055
3	180.0	1.333	2.5847	.6793	.8843	61	135.0	8.667	1.6588	.4360	.3677
4	270.0	1.333	1.3585	.3570	.2001	62	202.5	8.667	3.2493	.8540	1.2552
5	0.0	2.667	.3144	.0826	-.3826	63	225.0	8.667	3.2482	.8537	1.2546
6	90.0	2.667	.3296	.0866	-.3741	64	247.5	8.667	3.2704	.8595	1.2670
7	180.0	2.667	2.0546	.5400	.5885	65	315.0	8.667	.2094	.0550	-.4412
8	270.0	2.667	1.0263	.2697	.0147	66	225.0	9.000	3.0518	.8021	1.1450
9	0.0	4.000	.3456	.0908	-.3652	67	45.0	9.333	.2156	.0567	-.4377
10	10.0	4.000	.3611	.0949	-.3565	68	135.0	9.333	1.5123	.3975	.2859
11	20.0	4.000	.4531	.1191	-.3052	69	202.5	9.333	2.8491	.7488	1.0319
12	30.0	4.000	.4362	.1146	-.3146	70	225.0	9.333	2.8298	.7437	1.0211
13	40.0	4.000	.3475	.0913	-.3641	71	247.5	9.333	2.8660	.7532	1.0413
14	50.0	4.000	.3408	.0896	-.3678	72	315.0	9.333	.1190	.0313	-.4917
15	60.0	4.000	.3403	.0894	-.3681	73	225.0	9.667	2.7062	.7112	.9521
16	70.0	4.000	.3749	.0985	-.3488	74	45.0	10.000	.2115	.0556	-.4400
17	80.0	4.000	.3846	.1011	-.3434	75	135.0	10.000	1.9124	.5026	.5091
18	90.0	4.000	.3914	.1029	-.3396	76	202.5	10.000	2.3918	.6286	.7767
19	180.0	4.000	1.9204	.5047	.5136	77	225.0	10.000	2.4320	.6392	.7991
20	270.0	4.000	.9548	.2509	-.0252	78	247.5	10.000	2.3786	.6251	.7693
21	0.0	5.333	.3980	.1046	-.3359	79	315.0	10.000	.1802	.0474	-.4575
22	90.0	5.333	.4422	.1462	-.3113	80	0.0	10.667	.4990	.1311	-.2796
23	180.0	5.333	1.8799	.4941	.4910	81	45.0	10.667	.2778	.0730	-.4030
24	270.0	5.333	.9193	.2416	-.0450	82	90.0	10.667	.7150	.1879	-.1591
25	0.0	6.200	.4177	.1098	-.3250	83	135.0	10.667	1.6518	.4341	.3637
26	10.0	6.200	.4360	.1146	-.3147	84	180.0	10.667	1.8589	.4885	.4793
27	20.0	6.200	.4935	.1297	-.2827	85	225.0	10.667	1.6572	.4355	.3668
28	30.0	6.200	.4813	.1265	-.2894	86	270.0	10.667	.5635	.1481	-.2436
29	40.0	6.200	.4068	.1069	-.3310	87	315.0	10.667	.3742	.0983	-.3492
30	50.0	6.200	.4022	.1057	-.3336	88	0.0	11.330	.3654	.0960	-.3541
31	60.0	6.200	.4298	.1130	-.3182	89	45.0	11.330	.2778	.0730	-.4030
32	70.0	6.200	.4297	.1129	-.3183	90	90.0	11.330	.4748	.1248	-.2931
33	80.0	6.200	.4425	.1163	-.3111	91	135.0	11.330	1.5537	.4083	.3090
34	90.0	6.200	.4519	.1188	-.3058	92	180.0	11.330	1.5434	.4056	.3032
35	135.0	6.200	.7581	.1992	-.1350	93	225.0	11.330	1.3640	.3585	.2031
36	180.0	6.200	1.8808	.4943	.4915	94	270.0	11.330	.4873	.1281	-.2861
37	225.0	6.200	1.9857	.5219	.5501	95	315.0	11.330	.4285	.1126	-.3189
38	270.0	6.200	.8892	.2337	-.0618	96	0.0	12.000	.3421	.0899	-.3671
39	315.0	6.200	.4667	.1227	-.2976	97	45.0	12.000	.1981	.0521	-.4475
40	0.0	7.333	.5819	.1529	-.2333	98	90.0	12.000	.4326	.1137	-.3166
41	45.0	7.333	.4216	.1108	-.3227	99	135.0	12.000	1.1667	.3066	.0930
42	90.0	7.333	.5771	.1517	-.2360	100	180.0	12.000	1.3798	.3626	.2119
43	135.0	7.333	.9833	.2584	-.0093	101	225.0	12.000	1.3304	.3496	.1844
44	180.0	7.333	2.2933	.6027	.7217	102	270.0	12.000	.5000	.1314	-.2790
45	202.5	7.333	2.4388	.6409	.8029	103	315.0	12.000	.5274	.1386	-.2637
46	225.0	7.333	2.2653	.5953	.7061	104	0.0	13.333	.3420	.0899	-.3672
47	247.5	7.333	1.6614	.4366	.3691	105	45.0	13.333	.2396	.0630	-.4243
48	270.0	7.333	1.0556	.2774	.0310	106	90.0	13.333	.3647	.0959	-.3545
49	315.0	7.333	.6971	.1832	-.1690	107	135.0	13.333	.7634	.2006	-.1320
50	202.5	7.667	3.2769	.8612	1.2706	108	180.0	13.333	1.4960	.3932	.2768
51	225.0	7.667	3.0637	.8052	1.1516	109	225.0	13.333	1.4658	.3852	.2599
52	247.5	7.667	3.1065	.8164	1.1755	110	270.0	13.333	.5608	.1474	-.2451
53	45.0	8.000	.5367	.1410	-.2585	111	315.0	13.333	.5347	.1405	-.2596
54	135.0	8.000	1.0418	.2738	.0233	112	0.0	14.400	.3528	.0927	-.3612
55	202.5	8.000	3.4002	.8936	1.3394	113	90.0	14.400	.2720	.0715	-.4063
56	225.0	8.000	3.3375	.8771	1.3044	114	180.0	14.400	1.6665	.4380	.3719
57	247.5	8.000	3.5134	.9234	1.4025	115	270.0	14.400	.5930	.1559	-.2271
58	315.0	8.000	.2339	.0615	-.4275						

TABLE II.- Continued

(f) M = 1.60;  $\alpha = 50^\circ$

$p_t = 54.1$  kPa

TUBE	THETA	X/D	P/PINF	P/PT2	CP	TUBE	THETA	X/D	P/PINF	P/PT2	CP
1	0.0	1.333	.2469	.0649	-.4203	59	225.0	8.333	3.6403	.9567	1.4734
2	90.0	1.333	.2397	.0630	-.4243	60	45.0	8.667	.3003	.0789	-.3904
3	180.0	1.333	2.9790	.7829	1.1044	61	135.0	8.667	1.9397	.5098	.5244
4	270.0	1.333	1.4359	.3774	.2432	62	202.5	8.667	3.4875	.9166	1.3881
5	0.0	2.667	.2533	.0666	-.4167	63	225.0	8.667	3.4836	.9155	1.3859
6	90.0	2.667	.2533	.0666	-.4167	64	247.5	8.667	3.5228	.9258	1.4078
7	180.0	2.667	2.5079	.6591	.8415	65	315.0	8.667	.1519	.0399	-.4733
8	270.0	2.667	1.1841	.3112	.1027	66	225.0	9.000	3.2920	.8652	1.2790
9	0.0	4.000	.2964	.0779	-.3926	67	45.0	9.333	.2866	.0753	-.3981
10	10.0	4.000	.3155	.0829	-.3820	68	135.0	9.333	1.9165	.5037	.5114
11	20.0	4.000	.3715	.0976	-.3507	69	202.5	9.333	3.0771	.8087	1.1591
12	30.0	4.000	.3549	.0933	-.3600	70	225.0	9.333	3.0590	.8039	1.1490
13	40.0	4.000	.2946	.0774	-.3936	71	247.5	9.333	3.0921	.8127	1.1675
14	50.0	4.000	.2867	.0753	-.3981	72	315.0	9.333	.1291	.0339	-.4860
15	60.0	4.000	.2966	.0779	-.3925	73	225.0	9.667	2.8872	.7588	1.0531
16	70.0	4.000	.3242	.0852	-.3771	74	45.0	10.000	.3301	.0868	-.3738
17	80.0	4.000	.3264	.0858	-.3759	75	135.0	10.000	1.8085	.4753	.4512
18	90.0	4.000	.3274	.0861	-.3753	76	202.5	10.000	2.5009	.6573	.8376
19	180.0	4.000	2.3744	.6240	.7670	77	225.0	10.000	2.5546	.6714	.8675
20	270.0	4.000	1.1268	.2961	.0708	78	247.5	10.000	2.5029	.6578	.8387
21	0.0	5.333	.3344	.0879	-.3714	79	315.0	10.000	.1622	.0426	-.4675
22	90.0	5.333	.3600	.0946	-.3571	80	0.0	10.667	.3267	.0859	-.3757
23	180.0	5.333	2.3206	.6099	.7369	81	45.0	10.667	.2598	.0683	-.4131
24	270.0	5.333	1.0937	.2874	.0523	82	90.0	10.667	.7868	.2068	-.1190
25	0.0	6.200	.3724	.0979	-.3502	83	135.0	10.667	1.8516	.4866	.4752
26	10.0	6.200	.3665	.0963	-.3535	84	180.0	10.667	1.8990	.4991	.5017
27	20.0	6.200	.3801	.0999	-.3459	85	225.0	10.667	1.7710	.4654	.4303
28	30.0	6.200	.3794	.0997	-.3463	86	270.0	10.667	.6153	.1617	-.2147
29	40.0	6.200	.3699	.0972	-.3516	87	315.0	10.667	.3305	.0869	-.3736
30	50.0	6.200	.3755	.0987	-.3485	88	0.0	11.330	.3847	.1011	-.3434
31	60.0	6.200	.3865	.1016	-.3424	89	45.0	11.330	.2598	.0683	-.4131
32	70.0	6.200	.3989	.1048	-.3355	90	90.0	11.330	.7328	.1926	-.1491
33	80.0	6.200	.4130	.1085	-.3276	91	135.0	11.330	1.4977	.3936	.2777
34	90.0	6.200	.4234	.1113	-.3217	92	180.0	11.330	1.7608	.4625	.4245
35	135.0	6.200	.9462	.2487	-.0300	93	225.0	11.330	1.7619	.4631	.4252
36	180.0	6.200	2.4256	.6375	.7955	94	270.0	11.330	.6654	.1749	-.1867
37	225.0	6.200	2.5518	.6706	.8660	95	315.0	11.330	.4474	.1176	-.3084
38	270.0	6.200	1.1138	.2927	.0635	96	0.0	12.000	.3913	.1028	-.3397
39	315.0	6.200	.4148	.1090	-.3266	97	45.0	12.000	.3522	.0926	-.3615
40	0.0	7.333	.5541	.1456	-.2488	98	90.0	12.000	.5900	.1551	-.2288
41	45.0	7.333	.5560	.1461	-.2478	99	135.0	12.000	1.1063	.2908	.0593
42	90.0	7.333	.5709	.1500	-.2395	100	180.0	12.000	1.7642	.4637	.4265
43	135.0	7.333	1.1810	.3104	.1010	101	225.0	12.000	1.8182	.4779	.4566
44	180.0	7.333	3.0160	.7927	1.1250	102	270.0	12.000	.6888	.1810	-.1736
45	202.5	7.333	3.3521	.8810	1.3126	103	315.0	12.000	.4872	.1281	-.2861
46	225.0	7.333	3.1341	.8237	1.1909	104	0.0	13.333	.3874	.1018	-.3418
47	247.5	7.333	2.4786	.6514	.8251	105	45.0	13.333	.5592	.1470	-.2460
48	270.0	7.333	1.7701	.4652	.4297	106	90.0	13.333	.5794	.1523	-.2347
49	315.0	7.333	.5586	.1468	-.2463	107	135.0	13.333	.8332	.2190	-.0931
50	202.5	7.667	3.7004	.9725	1.5069	108	180.0	13.333	2.0217	.5313	.5701
51	225.0	7.667	3.4845	.9158	1.3865	109	225.0	13.333	2.0367	.5353	.5785
52	247.5	7.667	3.3536	.8814	1.3134	110	270.0	13.333	.8026	.2109	-.1101
53	45.0	8.000	.3264	.0858	-.3759	111	315.0	13.333	.8026	.2109	-.1101
54	135.0	8.000	1.2348	.3245	.1310	112	0.0	14.400	.5766	.1515	-.2363
55	202.5	8.000	3.7201	.9777	1.5179	113	90.0	14.400	.5965	.1568	-.2252
56	225.0	8.000	3.6263	.9530	1.4656	114	180.0	14.400	2.1806	.5731	.6588
57	247.5	8.000	3.7710	.9911	1.5463	115	270.0	14.400	.8160	.2145	-.1027
58	315.0	8.000	.2295	.0603	-.4300						

TABLE II.- Continued

(g) M = 2.70;  $\alpha = 0^\circ$

$P_t = 90.4 \text{ kPa}$

TUBE	THETA	X/D	P/PINF	P/PT2	CP	TUBE	THETA	X/D	P/PINF	P/PT2	CP
1	0.0	1.333	1.4358	.1456	.0854	59	225.0	8.333	1.0401	.1055	.0079
2	90.0	1.333	1.4750	.1496	.0931	60	45.0	8.667	1.1244	.1140	.0244
3	180.0	1.333	1.3678	.1387	.0721	61	135.0	8.667	1.0420	.1056	.0082
4	270.0	1.333	1.4346	.1455	.0852	62	202.5	8.667	1.0773	.1092	.0152
5	0.0	2.667	.8869	.0899	-.0222	63	225.0	8.667	1.0553	.1070	.0108
6	90.0	2.667	.9040	.0917	-.0188	64	247.5	8.667	1.1130	.1128	.0221
7	180.0	2.667	.8330	.0845	-.0327	65	315.0	8.667	1.1098	.1125	.0215
8	270.0	2.667	.8831	.0895	-.0229	66	225.0	9.000	1.0806	.1096	.0158
9	0.0	4.000	.9136	.0926	-.0169	67	45.0	9.333	1.1563	.1172	.0306
10	10.0	4.000	.9192	.0932	-.0158	68	135.0	9.333	1.0593	.1074	.0116
11	20.0	4.000	.9190	.0932	-.0159	69	202.5	9.333	1.0679	.1083	.0133
12	30.0	4.000	.9159	.0929	-.0165	70	225.0	9.333	1.0853	.1100	.0167
13	40.0	4.000	.9146	.0927	-.0167	71	247.5	9.333	1.1081	.1124	.0212
14	50.0	4.000	.9146	.0927	-.0167	72	315.0	9.333	1.1219	.1138	.0239
15	60.0	4.000	.9115	.0924	-.0173	73	225.0	9.667	1.0456	.1060	.0089
16	70.0	4.000	.9109	.0924	-.0175	74	45.0	10.000	.9656	.0979	-.0068
17	80.0	4.000	.9086	.0921	-.0179	75	135.0	10.000	.9012	.0914	-.0194
18	90.0	4.000	.9073	.0920	-.0182	76	202.5	10.000	.9395	.0953	-.0119
19	180.0	4.000	.8399	.0852	-.0314	77	225.0	10.000	.9564	.0970	-.0085
20	270.0	4.000	.8984	.0911	-.0199	78	247.5	10.000	.9774	.0991	-.0044
21	0.0	5.333	.9491	.0962	-.0100	79	315.0	10.000	.9324	.0945	-.0132
22	90.0	5.333	.9459	.0959	-.0106	80	0.0	10.667	1.0758	.1091	.0148
23	180.0	5.333	.8749	.0887	-.0245	81	45.0	10.667	.8487	.0860	-.0297
24	270.0	5.333	.9374	.0951	-.0123	82	90.0	10.667	1.0606	.1075	.0119
25	0.0	6.200	.9595	.0973	-.0079	83	135.0	10.667	.8513	.0863	-.0291
26	10.0	6.200	.9641	.0978	-.0070	84	180.0	10.667	1.0759	.1091	.0149
27	20.0	6.200	.9672	.0981	-.0064	85	225.0	10.667	.8489	.0861	-.0296
28	30.0	6.200	.9699	.0983	-.0059	86	270.0	10.667	1.1172	.1133	.0230
29	40.0	6.200	.9697	.0983	-.0059	87	315.0	10.667	.8102	.0622	-.0372
30	50.0	6.200	.9697	.0983	-.0059	88	0.0	11.330	.9875	.1001	-.0025
31	60.0	6.200	.9678	.0981	-.0063	89	45.0	11.330	.8487	.0860	-.0297
32	70.0	6.200	.9683	.0982	-.0062	90	90.0	11.330	.9995	.1013	-.0001
33	80.0	6.200	.9586	.0972	-.0081	91	135.0	11.330	.9652	.0979	-.0068
34	90.0	6.200	.9644	.0978	-.0070	92	180.0	11.330	.9893	.1003	-.0021
35	135.0	6.200	.9573	.0971	-.0084	93	225.0	11.330	.9229	.0936	-.0151
36	180.0	6.200	.8965	.0909	-.0203	94	270.0	11.330	1.0461	.1061	.0090
37	225.0	6.200	.8987	.0911	-.0199	95	315.0	11.330	.9627	.0976	-.0073
38	270.0	6.200	.9507	.0964	-.0097	96	0.0	12.000	.9626	.0976	-.0073
39	315.0	6.200	.9557	.0969	-.0087	97	45.0	12.000	.9804	.0994	-.0038
40	0.0	7.333	.9883	.1002	-.0023	98	90.0	12.000	.9731	.0987	-.0053
41	45.0	7.333	.9864	.1000	-.0027	99	135.0	12.000	1.0146	.1029	.0029
42	90.0	7.333	.9916	.1005	-.0017	100	180.0	12.000	.9463	.0960	-.0105
43	135.0	7.333	.9965	.1010	-.0007	101	225.0	12.000	.9615	.0975	-.0075
44	180.0	7.333	.9528	.0966	-.0092	102	270.0	12.000	.9742	.0988	-.0051
45	202.5	7.333	.9571	.0970	-.0084	103	315.0	12.000	1.0065	.1021	.0013
46	225.0	7.333	.9597	.0973	-.0079	104	0.0	13.333	.9614	.0975	-.0076
47	247.5	7.333	1.0094	.1023	.0018	105	45.0	13.333	.9977	.1012	-.0005
48	270.0	7.333	1.0138	.1028	.0027	106	90.0	13.333	1.0112	.1025	.0022
49	315.0	7.333	.9986	.1013	-.0003	107	135.0	13.333	1.0263	.1041	.0052
50	202.5	7.667	1.0055	.1020	.0011	108	180.0	13.333	.9691	.0983	-.0061
51	225.0	7.667	1.0059	.1020	.0011	109	225.0	13.333	.9510	.0964	-.0096
52	247.5	7.667	1.0587	.1073	.0115	110	270.0	13.333	1.0216	.1036	.0042
53	45.0	8.000	1.0929	.1108	.0182	111	315.0	13.333	1.0069	.1021	.0014
54	135.0	8.000	.9983	.1012	-.0003	112	0.0	14.400	1.0338	.1048	.0066
55	202.5	8.000	1.0365	.1051	.0072	113	90.0	14.400	1.0238	.1038	.0047
56	225.0	8.000	1.0391	.1054	.0077	114	180.0	14.400	.9792	.0993	-.0041
57	247.5	8.000	1.0829	.1098	.0162	115	270.0	14.400	1.0249	.1039	.0049
58	315.0	8.000	1.0816	.1097	.0160						

TABLE II.- Continued

(h) M = 2.70;  $\alpha = 10^\circ$

$P_t = 90.4 \text{ kPa}$

TUBE	THETA	X/D	P/PINF	P/PT2	CP	TUBE	THETA	X/D	P/PINF	P/PT2	CP
1	0.0	1.333	.9577	.0971	-.0083	59	225.0	8.333	1.3393	.1358	-.0665
2	90.0	1.333	1.1001	.1115	.0196	60	45.0	8.667	.6953	.0705	-.0597
3	180.0	1.333	2.1121	.2142	.2179	61	135.0	8.667	1.1264	.1142	-.0248
4	270.0	1.333	1.6189	.1641	.1213	62	202.5	8.667	1.6055	.1628	.1186
5	0.0	2.667	.6735	.0683	-.0640	63	225.0	8.667	1.6385	.1661	.1251
6	90.0	2.667	.6230	.0632	-.0739	64	247.5	8.667	1.3868	.1406	.0758
7	180.0	2.667	1.2120	.1229	.0415	65	315.0	8.667	.6666	.0676	-.0653
8	270.0	2.667	.9347	.0948	-.0128	66	225.0	9.000	2.0454	.2074	-.2049
9	0.0	4.000	.6523	.0661	-.0681	67	45.0	9.333	.5843	.0592	-.0815
10	10.0	4.000	.6222	.0834	-.0348	68	135.0	9.333	1.0974	.1113	-.0191
11	20.0	4.000	.8913	.0904	-.0213	69	202.5	9.333	1.6356	.1658	.1245
12	30.0	4.000	.8638	.0876	-.0267	70	225.0	9.333	1.9170	.1944	.1797
13	40.0	4.000	.7535	.0764	-.0483	71	247.5	9.333	2.0107	.2039	.1981
14	50.0	4.000	.6320	.0641	-.0721	72	315.0	9.333	.6689	.0678	-.0649
15	60.0	4.000	.6469	.0656	-.0692	73	225.0	9.667	1.7639	.1789	.1497
16	70.0	4.000	.6607	.0670	-.0665	74	45.0	10.000	.5020	.0509	-.0976
17	80.0	4.000	.6511	.0660	-.0684	75	135.0	10.000	1.0158	.1030	.0031
18	90.0	4.000	.6434	.0652	-.0699	76	202.5	10.000	1.5068	.1528	.0993
19	180.0	4.000	1.0959	.1111	.0188	77	225.0	10.000	1.5627	.1584	.1103
20	270.0	4.000	.8315	.0843	-.0330	78	247.5	10.000	1.7750	.1800	.1519
21	0.0	5.333	.6611	.0670	-.0664	79	315.0	10.000	.5493	.0557	-.0883
22	90.0	5.333	.6695	.0679	-.0648	80	0.0	10.667	.7487	.0759	-.0493
23	180.0	5.333	1.1010	.1116	.0198	81	45.0	10.667	.6100	.0619	-.0764
24	270.0	5.333	.7828	.0794	-.0426	82	90.0	10.667	.7965	.0808	-.0399
25	0.0	6.200	.7263	.0736	-.0536	83	135.0	10.667	1.0192	.1033	.0038
26	10.0	6.200	.9170	.0930	-.0163	84	180.0	10.667	1.2958	.1314	.0580
27	20.0	6.200	.9451	.0958	-.0108	85	225.0	10.667	1.4035	.1423	.0791
28	30.0	6.200	.9327	.0946	-.0132	86	270.0	10.667	.9313	.0944	-.0135
29	40.0	6.200	.8653	.0877	-.0264	87	315.0	10.667	.6274	.0636	-.0730
30	50.0	6.200	.6743	.0684	-.0638	88	0.0	11.330	.7361	.0746	-.0517
31	60.0	6.200	.6873	.0697	-.0613	89	45.0	11.330	.6100	.0619	-.0764
32	70.0	6.200	.6957	.0705	-.0596	90	90.0	11.330	.8340	.0846	-.0325
33	80.0	6.200	.6872	.0697	-.0613	91	135.0	11.330	1.1131	.1129	.0222
34	90.0	6.200	.6901	.0700	-.0607	92	180.0	11.330	1.3357	.1354	.0658
35	135.0	6.200	.7247	.0735	-.0539	93	225.0	11.330	1.0988	.1114	-.0194
36	180.0	6.200	1.1025	.1118	.0201	94	270.0	11.330	.7895	.0801	-.0412
37	225.0	6.200	1.1159	.1131	.0227	95	315.0	11.330	.8228	.0834	-.0347
38	270.0	6.200	.7514	.0762	-.0487	96	0.0	12.000	.8092	.0820	-.0374
39	315.0	6.200	.6911	.0701	-.0605	97	45.0	12.000	.8948	.0907	-.0206
40	0.0	7.333	.7223	.0732	-.0544	98	90.0	12.000	.8286	.0840	-.0336
41	45.0	7.333	.7269	.0737	-.0535	99	135.0	12.000	1.0808	.1096	.0158
42	90.0	7.333	.7586	.0769	-.0473	100	180.0	12.000	1.2200	.1237	.0431
43	135.0	7.333	.7274	.0738	-.0534	101	225.0	12.000	.9712	.0985	-.0056
44	180.0	7.333	1.0706	.1085	.0138	102	270.0	12.000	.7446	.0755	-.0501
45	202.5	7.333	1.1351	.1151	.0265	103	315.0	12.000	.8403	.0852	-.0313
46	225.0	7.333	1.0749	.1090	.0147	104	0.0	13.333	.8092	.0820	-.0374
47	247.5	7.333	.9375	.0951	-.0122	105	45.0	13.333	.9663	.0980	-.0066
48	270.0	7.333	.7306	.0741	-.0528	106	90.0	13.333	.7627	.0773	-.0465
49	315.0	7.333	.7335	.0744	-.0522	107	135.0	13.333	1.0388	.1053	.0076
50	202.5	7.667	1.2065	.1223	.0405	108	180.0	13.333	1.1184	.1134	.0232
51	225.0	7.667	1.0822	.1097	.0161	109	225.0	13.333	.9375	.0951	-.0123
52	247.5	7.667	.9941	.1008	-.0012	110	270.0	13.333	.8451	.0857	-.0304
53	45.0	8.000	.7271	.0737	-.0535	111	315.0	13.333	.8336	.0845	-.0326
54	135.0	8.000	.7790	.0790	-.0433	112	0.0	14.400	.9443	.0957	-.0109
55	202.5	8.000	1.2577	.1275	.0505	113	90.0	14.400	.7893	.0800	-.0413
56	225.0	8.000	1.1514	.1167	.0297	114	180.0	14.400	1.1043	.1120	.0204
57	247.5	8.000	1.2774	.1295	.0544	115	270.0	14.400	.7889	.0800	-.0414
58	315.0	8.000	.7148	.0725	-.0559						

TABLE II.- Continued

(i) M = 2.70;  $\alpha = 20^\circ$

$P_t = 89.7 \text{ kPa}$

TUBE	THETA	X/D	P/PINF	P/PT2	CP	TUBE	THETA	X/D	P/PINF	P/PT2	CP
1	0.0	1.333	.7403	.0751	-.0509	59	225.0	8.333	2.7541	.2792	-.3437
2	90.0	1.333	.8135	.0825	-.0365	60	45.0	8.667	.5186	.0526	-.0943
3	180.0	1.333	3.7665	.3819	.5421	61	135.0	8.667	1.4137	.1433	.0811
4	270.0	1.333	2.3197	.2352	.2586	62	202.5	8.667	3.4540	.3502	.4809
5	0.0	2.667	.3613	.0366	-.1252	63	225.0	8.667	3.5395	.3589	.4976
6	90.0	2.667	.3596	.0365	-.1255	64	247.5	8.667	3.5574	.3607	.5011
7	180.0	2.667	2.3513	.2384	.2648	65	315.0	8.667	.3712	.0376	-.1232
8	270.0	2.667	1.3352	.1354	.0657	66	225.0	9.000	4.2180	.4277	.6306
9	0.0	4.000	.4200	.0426	-.1137	67	45.0	9.333	.4120	.0418	-.1152
10	10.0	4.000	.4618	.0468	-.1055	68	135.0	9.333	1.6876	.1711	.1347
11	20.0	4.000	.6332	.0642	-.0719	69	202.5	9.333	3.6589	.3710	.5210
12	30.0	4.000	.6031	.0611	-.0778	70	225.0	9.333	3.9362	.3991	.5754
13	40.0	4.000	.4402	.0446	-.1097	71	247.5	9.333	4.0813	.4138	.6038
14	50.0	4.000	.4208	.0427	-.1135	72	315.0	9.333	.4185	.0424	-.1140
15	60.0	4.000	.4389	.0445	-.1100	73	225.0	9.667	3.7659	.3818	.5420
16	70.0	4.000	.4541	.0460	-.1070	74	45.0	10.000	.2896	.0294	-.1392
17	80.0	4.000	.4626	.0469	-.1053	75	135.0	10.000	1.5606	.1582	.1098
18	90.0	4.000	.4528	.0459	-.1072	76	202.5	10.000	3.5334	.3583	.4965
19	180.0	4.000	2.1083	.2138	.2172	77	225.0	10.000	3.5870	.3637	.5070
20	270.0	4.000	1.1458	.1162	.0286	78	247.5	10.000	3.6722	.3723	.5236
21	0.0	5.333	.5077	.0515	-.0965	79	315.0	10.000	.4174	.0423	-.1142
22	90.0	5.333	.5255	.0533	-.0930	80	0.0	10.667	.4487	.0455	-.1080
23	180.0	5.333	2.0557	.2084	.2069	81	45.0	10.667	.5108	.0518	-.0959
24	270.0	5.333	1.0746	.1090	.0146	82	90.0	10.667	1.0697	.1085	.0137
25	0.0	6.200	.5258	.0533	-.0929	83	135.0	10.667	1.7277	.1752	.1426
26	10.0	6.200	.5572	.0565	-.0868	84	180.0	10.667	2.2585	.2290	.2466
27	20.0	6.200	.5919	.0600	-.0800	85	225.0	10.667	3.2848	.3331	.4477
28	30.0	6.200	.5892	.0597	-.0805	86	270.0	10.667	1.0156	.1030	.0030
29	40.0	6.200	.5476	.0555	-.0886	87	315.0	10.667	.5316	.0539	-.0918
30	50.0	6.200	.5383	.0546	-.0905	88	0.0	11.330	.6177	.0626	-.0749
31	60.0	6.200	.5332	.0541	-.0915	89	45.0	11.330	.5108	.0518	-.0959
32	70.0	6.200	.5492	.0557	-.0883	90	90.0	11.330	1.0279	.1042	.0055
33	80.0	6.200	.5517	.0559	-.0879	91	135.0	11.330	1.8900	.1916	.1744
34	90.0	6.200	.5575	.0565	-.0867	92	180.0	11.330	2.3758	.2409	.2696
35	135.0	6.200	.9072	.0920	-.0182	93	225.0	11.330	2.2234	.2254	.2397
36	180.0	6.200	2.0889	.2118	.2134	94	270.0	11.330	.9470	.0960	-.0104
37	225.0	6.200	2.1882	.2219	.2329	95	315.0	11.330	.3759	.0381	-.1223
38	270.0	6.200	1.0366	.1051	.0072	96	0.0	12.000	.7214	.0731	-.0546
39	315.0	6.200	.5546	.0562	-.0873	97	45.0	12.000	.6497	.0659	-.0686
40	0.0	7.333	.5572	.0565	-.0868	98	90.0	12.000	.7138	.0724	-.0561
41	45.0	7.333	.5655	.0573	-.0851	99	135.0	12.000	1.7510	.1775	.1472
42	90.0	7.333	.6452	.0654	-.0695	100	180.0	12.000	2.1365	.2166	.2227
43	135.0	7.333	.9697	.0983	-.0059	101	225.0	12.000	1.7947	.1820	.1557
44	180.0	7.333	2.0903	.2119	.2137	102	270.0	12.000	.7095	.0719	-.0569
45	202.5	7.333	2.3033	.2335	.2554	103	315.0	12.000	.4037	.0409	-.1169
46	225.0	7.333	2.1162	.2146	.2187	104	0.0	13.333	.7196	.0730	-.0550
47	247.5	7.333	1.6012	.1624	.1178	105	45.0	13.333	.5911	.0599	-.0801
48	270.0	7.333	1.0098	.1024	.0019	106	90.0	13.333	.4951	.0502	-.0989
49	315.0	7.333	.5865	.0595	-.0810	107	135.0	13.333	1.3084	.1327	.0604
50	202.5	7.667	2.4742	.2509	.2889	108	180.0	13.333	1.8391	.1865	.1644
51	225.0	7.667	2.1259	.2156	.2206	109	225.0	13.333	1.7088	.1733	.1389
52	247.5	7.667	1.7017	.1725	.1375	110	270.0	13.333	.6677	.0677	-.0651
53	45.0	8.000	.5732	.0581	-.0836	111	315.0	13.333	.5503	.0558	-.0881
54	135.0	8.000	.8192	.0831	-.0354	112	0.0	14.400	.4455	.0452	-.1087
55	202.5	8.000	2.6972	.2735	.3326	113	90.0	14.400	.4746	.0481	-.1030
56	225.0	8.000	2.2284	.2259	.2407	114	180.0	14.400	1.9023	.1929	.1768
57	247.5	8.000	2.4476	.2482	.2837	115	270.0	14.400	.6539	.0663	-.0678
58	315.0	8.000	.5263	.0534	-.0928						



TABLE II.- Continued

(j)  $M = 2.70$ ;  $\alpha = 30^\circ$

$P_t = 90.4 \text{ kPa}$

TUBE	THETA	X/D	P/PINF	P/PT2	CP	TUBE	THETA	X/D	P/PINF	P/PT2	CP
1	0.0	1.333	.3559	.0361	-.1262	59	225.0	8.333	4.1917	.4250	.6255
2	90.0	1.333	.4857	.0492	-.1008	60	45.0	8.667	.2666	.0270	-.1437
3	180.0	1.333	4.3493	.4410	.6563	61	135.0	8.667	1.8255	.1851	.1618
4	270.0	1.333	2.1632	.2193	.2279	62	202.5	8.667	4.4298	.4491	.6721
5	0.0	2.667	.2643	.0268	-.1442	63	225.0	8.667	4.9824	.5052	.7804
6	90.0	2.667	.2364	.0240	-.1496	64	247.5	8.667	5.1432	.5215	.8119
7	180.0	2.667	2.8952	.2935	.3714	65	315.0	8.667	.3282	.0333	-.1317
8	270.0	2.667	1.3788	.1398	.0742	66	225.0	9.000	5.9245	.6007	.9650
9	0.0	4.000	.2816	.0286	-.1408	67	45.0	9.333	.2134	.0216	-.1541
10	10.0	4.000	.2910	.0295	-.1389	68	135.0	9.333	1.9009	.1927	.1766
11	20.0	4.000	.3599	.0365	-.1254	69	202.5	9.333	5.0054	.5075	.7849
12	30.0	4.000	.3536	.0359	-.1267	70	225.0	9.333	5.2245	.5297	.8278
13	40.0	4.000	.2992	.0303	-.1373	71	247.5	9.333	5.4467	.5523	.8714
14	50.0	4.000	.2946	.0299	-.1382	72	315.0	9.333	.3890	.0394	-.1197
15	60.0	4.000	.2994	.0304	-.1373	73	225.0	9.667	5.0460	.5116	.7929
16	70.0	4.000	.2935	.0298	-.1384	74	45.0	10.000	.2134	.0216	-.1541
17	80.0	4.000	.2979	.0302	-.1376	75	135.0	10.000	1.8541	.1880	.1674
18	90.0	4.000	.2840	.0288	-.1403	76	202.5	10.000	4.8185	.4886	.7483
19	180.0	4.000	2.6690	.2706	.3271	77	225.0	10.000	4.9153	.4984	.7672
20	270.0	4.000	1.2336	.1251	.0458	78	247.5	10.000	4.7687	.4835	.7385
21	0.0	5.333	.3038	.0308	-.1364	79	315.0	10.000	.3580	.0363	-.1258
22	90.0	5.333	.3381	.0343	-.1297	80	0.0	10.667	.3084	.0313	-.1355
23	180.0	5.333	2.6434	.2680	.3221	81	45.0	10.667	.2379	.0241	-.1493
24	270.0	5.333	1.1876	.1204	.0368	82	90.0	10.667	1.0023	.1016	.0005
25	0.0	6.200	.3274	.0332	-.1318	83	135.0	10.667	2.2514	.2283	.2452
26	10.0	6.200	.3392	.0344	-.1295	84	180.0	10.667	2.8579	.2898	.3641
27	20.0	6.200	.3804	.0386	-.1214	85	225.0	10.667	3.9213	.3976	.5725
28	30.0	6.200	.3781	.0383	-.1219	86	270.0	10.667	1.4417	.1462	.0866
29	40.0	6.200	.3354	.0340	-.1302	87	315.0	10.667	.3516	.0357	-.1271
30	50.0	6.200	.3310	.0336	-.1311	88	0.0	11.330	.3942	.0400	-.1187
31	60.0	6.200	.3314	.0336	-.1310	89	45.0	11.330	.2379	.0241	-.1493
32	70.0	6.200	.3450	.0350	-.1284	90	90.0	11.330	.7335	.0744	-.0522
33	80.0	6.200	.3495	.0354	-.1275	91	135.0	11.330	2.3449	.2378	.2635
34	90.0	6.200	.3506	.0355	-.1273	92	180.0	11.330	3.0435	.3086	.4004
35	135.0	6.200	.9915	.1005	-.0017	93	225.0	11.330	2.7375	.2776	.3405
36	180.0	6.200	2.6897	.2727	.3311	94	270.0	11.330	1.1553	.1171	.0304
37	225.0	6.200	2.8473	.2887	.3620	95	315.0	11.330	.2134	.0216	-.1541
38	270.0	6.200	1.1903	.1207	.0373	96	0.0	12.000	.2908	.0295	-.1390
39	315.0	6.200	.3437	.0349	-.1286	97	45.0	12.000	.3293	.0334	-.1314
40	0.0	7.333	.3496	.0354	-.1274	98	90.0	12.000	.6123	.0621	-.0760
41	45.0	7.333	.3392	.0344	-.1295	99	135.0	12.000	1.9523	.1980	.1866
42	90.0	7.333	.4245	.0430	-.1128	100	180.0	12.000	2.2532	.2285	.2456
43	135.0	7.333	1.0869	.1102	.0170	101	225.0	12.000	2.2992	.2331	.2546
44	180.0	7.333	2.7209	.2759	.3372	102	270.0	12.000	.8360	.0848	-.0321
45	202.5	7.333	3.0262	.3068	.3971	103	315.0	12.000	.2134	.0216	-.1541
46	225.0	7.333	2.7741	.2813	.3477	104	0.0	13.333	.2906	.0295	-.1390
47	247.5	7.333	1.9777	.2005	.1916	105	45.0	13.333	.2511	.0255	-.1468
48	270.0	7.333	1.1658	.1182	.0325	106	90.0	13.333	.6012	.0610	-.0782
49	315.0	7.333	.3773	.0383	-.1220	107	135.0	13.333	1.2725	.1290	.0534
50	202.5	7.667	3.2407	.3286	.4391	108	180.0	13.333	2.1324	.2162	.2219
51	225.0	7.667	2.7858	.2825	.3499	109	225.0	13.333	2.1219	.2151	.2198
52	247.5	7.667	2.2359	.2267	.2422	110	270.0	13.333	.7627	.0773	-.0465
53	45.0	8.000	.3440	.0349	-.1286	111	315.0	13.333	.3861	.0391	-.1203
54	135.0	8.000	.9603	.0974	-.0078	112	0.0	14.400	.2948	.0299	-.1382
55	202.5	8.000	3.8223	.3875	.5531	113	90.0	14.400	.3840	.0389	-.1207
56	225.0	8.000	2.9544	.2996	.3830	114	180.0	14.400	2.2009	.2232	.2353
57	247.5	8.000	2.9032	.2944	.3730	115	270.0	14.400	.7313	.0741	-.0527
58	315.0	8.000	.3348	.0339	-.1304						

TABLE II.- Continued

(k) M = 2.70;  $\alpha = 40^\circ$

$P_t = 90.4 \text{ kPa}$

TUBE	THETA	X/D	P/PINF	P/PT2	CP	TJBE	THETA	X/D	P/PINF	P/PT2	CP
1	0.0	1.333	.2552	.0259	-.1460	59	225.0	8.333	8.8337	.8957	1.5351
2	90.0	1.333	.3983	.0404	-.1179	60	45.0	8.667	.2104	.0213	-.1547
3	180.0	1.333	5.6416	.5720	.9096	61	135.0	8.667	2.5937	.2630	.3123
4	270.0	1.333	2.5173	.2552	.2973	62	202.5	8.667	9.8929	1.0031	1.7427
5	0.0	2.667	.2104	.0213	-.1547	63	225.0	8.667	9.6537	.9788	1.6958
6	90.0	2.667	.2104	.0213	-.1547	64	247.5	8.667	9.1598	.9287	1.5990
7	180.0	2.667	4.0795	.4136	.6035	65	315.0	8.667	.3336	.0338	-.1306
8	270.0	2.667	1.7554	.1780	-.1480	66	225.0	9.000	8.2473	.8362	1.4202
9	0.0	4.000	.2255	.0229	-.1518	67	45.0	9.333	.2104	.0213	-.1547
10	10.0	4.000	.2338	.0237	-.1501	68	135.0	9.333	2.7278	.2766	.3386
11	20.0	4.000	.2614	.0265	-.1447	69	202.5	9.333	6.2536	.6341	1.0295
12	30.0	4.000	.2543	.0258	-.1461	70	225.0	9.333	6.3659	.6455	1.0515
13	40.0	4.000	.2294	.0233	-.1510	71	247.5	9.333	6.7092	.6803	1.1188
14	50.0	4.000	.2286	.0232	-.1512	72	315.0	9.333	.3958	.0401	-.1184
15	60.0	4.000	.2386	.0242	-.1492	73	225.0	9.667	5.3249	.5399	.8475
16	70.0	4.000	.2503	.0254	-.1469	74	45.0	10.000	.2104	.0213	-.1547
17	80.0	4.000	.2449	.0248	-.1480	75	135.0	10.000	2.4394	.2473	.2821
18	90.0	4.000	.2114	.0214	-.1545	76	202.5	10.000	5.8010	.5882	.9408
19	180.0	4.000	3.9064	.3961	.5696	77	225.0	10.000	4.8690	.4937	.7582
20	270.0	4.000	1.6658	.1689	.1305	78	247.5	10.000	4.6283	.4693	.7110
21	0.0	5.333	.2514	.0255	-.1467	79	315.0	10.000	.3915	.0397	-.1193
22	90.0	5.333	.2446	.0248	-.1480	80	0.0	10.667	.2225	.0226	-.1524
23	180.0	5.333	3.8569	.3911	.5598	81	45.0	10.667	.2344	.0238	-.1500
24	270.0	5.333	1.6606	.1684	.1295	82	90.0	10.667	1.2167	.1234	.0425
25	0.0	6.200	.2539	.0257	-.1462	83	135.0	10.667	3.3982	.3446	.4700
26	10.0	6.200	.2545	.0258	-.1461	84	180.0	10.667	4.2330	.4292	.6336
27	20.0	6.200	.2585	.0262	-.1453	85	225.0	10.667	4.1403	.4198	.6154
28	30.0	6.200	.2612	.0265	-.1448	86	270.0	10.667	1.7403	.1765	.1451
29	40.0	6.200	.2575	.0261	-.1455	87	315.0	10.667	.4979	.0505	-.0984
30	50.0	6.200	.2562	.0260	-.1458	88	0.0	11.330	.3248	.0329	-.1323
31	60.0	6.200	.2593	.0263	-.1451	89	45.0	11.330	.2344	.0238	-.1500
32	70.0	6.200	.2610	.0265	-.1448	90	90.0	11.330	.9487	.0962	-.0100
33	80.0	6.200	.2697	.0273	-.1431	91	135.0	11.330	2.6092	.2646	.3153
34	90.0	6.200	.2407	.0244	-.1488	92	180.0	11.330	2.7757	.2814	.3480
35	135.0	6.200	1.3430	.1362	.0672	93	225.0	11.330	2.8986	.2939	.3721
36	180.0	6.200	3.8921	.3946	.5668	94	270.0	11.330	1.2742	.1292	.0537
37	225.0	6.200	4.1457	.4203	.6164	95	315.0	11.330	.2554	.0259	-.1459
38	270.0	6.200	1.6174	.1640	.1210	96	0.0	12.000	.2401	.0243	-.1489
39	315.0	6.200	.2191	.0222	-.1530	97	45.0	12.000	.3206	.0325	-.1331
40	0.0	7.333	.2673	.0271	-.1436	98	90.0	12.000	.7842	.0795	-.0423
41	45.0	7.333	.2809	.0285	-.1409	99	135.0	12.000	1.7776	.1802	.1524
42	90.0	7.333	.3412	.0346	-.1291	100	180.0	12.000	2.2335	.2265	.2417
43	135.0	7.333	1.4809	.1501	.0942	101	225.0	12.000	2.5330	.2568	.3004
44	180.0	7.333	3.9762	.4032	.5832	102	270.0	12.000	1.0035	.1017	.0007
45	202.5	7.333	4.4128	.4474	.6688	103	315.0	12.000	.2104	.0213	-.1547
46	225.0	7.333	4.0234	.4079	.5925	104	0.0	13.333	.2390	.0242	-.1491
47	247.5	7.333	2.8372	.2877	.3600	105	45.0	13.333	.3733	.0379	-.1228
48	270.0	7.333	1.5968	.1619	.1170	106	90.0	13.333	.6998	.0710	-.0588
49	315.0	7.333	.2386	.0242	-.1492	107	135.0	13.333	1.5694	.1591	.1116
50	202.5	7.667	4.7753	.4842	.7398	108	180.0	13.333	3.0126	.3055	.3944
51	225.0	7.667	4.0872	.4144	.6050	109	225.0	13.333	2.9501	.2991	.3822
52	247.5	7.667	3.3405	.3387	.4587	110	270.0	13.333	1.1638	.1180	.0321
53	45.0	8.000	.2505	.0254	-.1469	111	315.0	13.333	.2674	.0271	-.1436
54	135.0	8.000	1.2290	.1246	.0449	112	0.0	14.400	.3495	.0354	-.1275
55	202.5	8.000	6.1506	.6236	1.0093	113	90.0	14.400	.3591	.0364	-.1256
56	225.0	8.000	5.5126	.5589	.8843	114	180.0	14.400	3.0824	.3125	.4081
57	247.5	8.000	6.4193	.6509	1.0620	115	270.0	14.400	1.0900	.1105	.0176
58	315.0	8.000	.2403	.0244	-.1489						

TABLE II.- Concluded

(1)  $M = 2.70$ ;  $\alpha = 50^\circ$

$p_t = 90.4 \text{ kPa}$

TUBE	THETA	X/D	P/PINF	P/PT2	CP	TUBE	THETA	X/D	P/PINF	P/PT2	CP
1	0.0	1.333	.2363	.0240	-.1497	59	225.0	8.333	9.9335	1.0072	1.7506
2	90.0	1.333	.3603	.0365	-.1254	60	45.0	8.667	.2110	.0214	-.1546
3	180.0	1.333	6.8822	.6978	1.1527	61	135.0	8.667	3.2406	.3286	.4391
4	270.0	1.333	2.6487	.2888	.3623	62	202.5	8.667	8.9603	.9085	1.5599
5	0.0	2.667	.2110	.0214	-.1546	63	225.0	8.667	8.8797	.9003	1.5441
6	90.0	2.667	.2126	.0216	-.1543	64	247.5	8.667	8.9816	.9107	1.5641
7	180.0	2.667	5.4420	.5518	.8705	65	315.0	8.667	.4070	.0413	-.1162
8	270.0	2.667	2.1982	.2229	.2348	66	225.0	9.000	8.0461	.8158	1.3808
9	0.0	4.000	.2124	.0215	-.1543	67	45.0	9.333	.2110	.0214	-.1546
10	10.0	4.000	.2193	.0222	-.1530	68	135.0	9.333	2.9615	.3003	.3844
11	20.0	4.000	.2185	.0222	-.1531	69	202.5	9.333	7.7700	.7878	1.3267
12	30.0	4.000	.2179	.0221	-.1533	70	225.0	9.333	7.5673	.7673	1.2870
13	40.0	4.000	.2135	.0216	-.1541	71	247.5	9.333	7.7463	.7854	1.3220
14	50.0	4.000	.2114	.0214	-.1545	72	315.0	9.333	.3151	.0319	-.1342
15	60.0	4.000	.2147	.0218	-.1539	73	225.0	9.667	7.4477	.7551	1.2635
16	70.0	4.000	.2218	.0225	-.1525	74	45.0	10.000	.2110	.0214	-.1546
17	80.0	4.000	.2120	.0215	-.1544	75	135.0	10.000	3.3366	.3383	.4579
18	90.0	4.000	.2110	.0214	-.1546	76	202.5	10.000	6.6394	.6732	1.1051
19	180.0	4.000	5.2104	.5283	.8251	77	225.0	10.000	6.7221	.6816	1.1213
20	270.0	4.000	2.1465	.2176	.2247	78	247.5	10.000	6.6870	.6780	1.1144
21	0.0	5.333	.2258	.0229	-.1517	79	315.0	10.000	.2865	.0290	-.1398
22	90.0	5.333	.2110	.0214	-.1546	80	0.0	10.667	.2469	.0250	-.1476
23	180.0	5.333	5.1427	.5214	.8118	81	45.0	10.667	.2110	.0214	-.1546
24	270.0	5.333	2.1381	.2168	.2230	82	90.0	10.667	2.0846	.2114	.2125
25	0.0	6.200	.2500	.0254	-.1470	83	135.0	10.667	3.1809	.3225	.4274
26	10.0	6.200	.2513	.0255	-.1467	84	180.0	10.667	3.8672	.3921	.5619
27	20.0	6.200	.2526	.0256	-.1465	85	225.0	10.667	3.9280	.3983	.5738
28	30.0	6.200	.2534	.0257	-.1463	86	270.0	10.667	1.5030	.1524	.0986
29	40.0	6.200	.2513	.0255	-.1467	87	315.0	10.667	.3242	.0329	-.1324
30	50.0	6.200	.2511	.0255	-.1468	88	0.0	11.330	.2452	.0249	-.1479
31	60.0	6.200	.2526	.0256	-.1465	89	45.0	11.330	.2110	.0214	-.1546
32	70.0	6.200	.2563	.0260	-.1457	90	90.0	11.330	1.0864	.1102	.0169
33	80.0	6.200	.2597	.0263	-.1451	91	135.0	11.330	2.2671	.2299	.2483
34	90.0	6.200	.2110	.0214	-.1546	92	180.0	11.330	2.9798	.3021	.3880
35	135.0	6.200	1.7132	.1737	.1398	93	225.0	11.330	3.4187	.3466	.4740
36	180.0	6.200	5.2091	.5282	.8248	94	270.0	11.330	1.3603	.1379	.0706
37	225.0	6.200	5.5666	.5644	.8949	95	315.0	11.330	.2110	.0214	-.1546
38	270.0	6.200	2.0945	.2124	.2145	96	0.0	12.000	.2791	.0283	-.1413
39	315.0	6.200	.2508	.0254	-.1468	97	45.0	12.000	.3790	.0384	-.1217
40	0.0	7.333	.3169	.0321	-.1339	98	90.0	12.000	.7950	.0806	-.0402
41	45.0	7.333	.3167	.0321	-.1339	99	135.0	12.000	2.3101	.2342	.2567
42	90.0	7.333	.4382	.0444	-.1101	100	180.0	12.000	3.7729	.3825	.5434
43	135.0	7.333	1.9167	.1943	.1796	101	225.0	12.000	3.5788	.3629	.5054
44	180.0	7.333	5.3393	.5414	.8504	102	270.0	12.000	1.4301	.1450	.0843
45	202.5	7.333	5.8384	.5920	.9481	103	315.0	12.000	.2819	.0286	-.1407
46	225.0	7.333	5.3374	.5412	.8500	104	0.0	13.333	.2793	.0283	-.1412
47	247.5	7.333	3.7586	.3811	.5406	105	45.0	13.333	.3427	.0347	-.1288
48	270.0	7.333	2.6645	.2702	.3262	106	90.0	13.333	.4376	.0444	-.1102
49	315.0	7.333	.3628	.0368	-.1249	107	135.0	13.333	1.5934	.1616	.1163
50	202.5	7.667	9.5595	.9693	1.6773	108	180.0	13.333	4.1031	.4160	.6081
51	225.0	7.667	8.2600	.8375	1.4227	109	225.0	13.333	4.2396	.4299	.6349
52	247.5	7.667	7.2584	.7360	1.2264	110	270.0	13.333	1.6287	.1651	.1232
53	45.0	8.000	.2110	.0214	-.1546	111	315.0	13.333	.4796	.0486	-.1020
54	135.0	8.000	2.1080	.2137	.2171	112	0.0	14.400	.3970	.0403	-.1182
55	202.5	8.000	5.9821	1.0121	1.7602	113	90.0	14.400	.2747	.0278	-.1421
56	225.0	8.000	7.7171	.9852	1.7082	114	180.0	14.400	4.6098	.4674	.7074
57	247.5	8.000	1.9462	1.1099	1.9491	115	270.0	14.400	1.6124	.1635	.1200
58	315.0	8.000	.2523	.0286	-.1406						

TABLE III.- BODY PRESSURE LISTING FOR  $\phi = 45^\circ$  AND  $R = 2.5 \times 10^5$

(a)  $M = 1.60$ ;  $\alpha = 0^\circ$

$P_t = 54.7$  kPa

TUBE	THETA	X/D	P/PINF	P/PT2	CP	TUBE	THETA	X/D	P/PINF	P/PT2	CP
1	0.0	1.333	1.1521	.3028	.0849	59	225.0	8.333	1.1714	.3079	.0956
2	90.0	1.333	1.1698	.3074	.0948	60	45.0	8.667	1.1910	.3130	.1066
3	180.0	1.333	1.1564	.3039	.0873	61	135.0	8.667	1.1832	.3110	.1022
4	270.0	1.333	1.1573	.3042	.0878	62	202.5	8.667	1.1719	.3080	.0959
5	0.0	2.667	.8918	.2344	-.0604	63	225.0	8.667	1.1653	.3062	.0922
6	90.0	2.667	.8934	.2348	-.0595	64	247.5	8.667	1.1855	.3116	.1035
7	180.0	2.667	.8916	.2343	-.0605	65	315.0	8.667	1.1832	.3110	.1022
8	270.0	2.667	.8914	.2343	-.0606	66	225.0	9.000	1.1761	.3091	.0983
9	0.0	4.000	.9544	.2508	-.0254	67	45.0	9.333	1.0431	.2741	.0241
10	10.0	4.000	.9552	.2510	-.0250	68	135.0	9.333	1.0064	.2645	.0036
11	20.0	4.000	.9568	.2515	-.0241	69	202.5	9.333	1.0274	.2700	.0153
12	30.0	4.000	.9504	.2498	-.0277	70	225.0	9.333	1.0407	.2735	.0227
13	40.0	4.000	.9465	.2488	-.0299	71	247.5	9.333	1.0456	.2748	.0254
14	50.0	4.000	.9465	.2488	-.0299	72	315.0	9.333	.9952	.2616	-.0027
15	60.0	4.000	.9446	.2483	-.0309	73	225.0	9.667	.9668	.2541	-.0185
16	70.0	4.000	.9459	.2486	-.0302	74	45.0	10.000	.9227	.2425	-.0431
17	80.0	4.000	.9462	.2487	-.0300	75	135.0	10.000	.8580	.2255	-.0792
18	90.0	4.000	.9463	.2487	-.0300	76	202.5	10.000	.8879	.2334	-.0626
19	180.0	4.000	.9402	.2471	-.0334	77	225.0	10.000	.9006	.2367	-.0554
20	270.0	4.000	.9586	.2519	-.0231	78	247.5	10.000	.8884	.2335	-.0623
21	0.0	5.333	.9810	.2578	-.0106	79	315.0	10.000	.8288	.2178	-.0956
22	90.0	5.333	.9769	.2567	-.0129	80	0.0	10.667	.9357	.2459	-.0359
23	180.0	5.333	.9861	.2592	-.0078	81	45.0	10.667	.8659	.2276	-.0748
24	270.0	5.333	.9845	.2588	-.0086	82	90.0	10.667	.9390	.2468	-.0340
25	0.0	6.200	.9910	.2605	-.0050	83	135.0	10.667	.9083	.2387	-.0511
26	10.0	6.200	.9884	.2598	-.0065	84	180.0	10.667	.9451	.2484	-.0306
27	20.0	6.200	.9992	.2626	-.0005	85	225.0	10.667	.8871	.2331	-.0630
28	30.0	6.200	.9957	.2617	-.0024	86	270.0	10.667	.9415	.2475	-.0326
29	40.0	6.200	.9962	.2618	-.0021	87	315.0	10.667	.8879	.2333	-.0626
30	50.0	6.200	.9918	.2607	-.0046	88	0.0	11.330	.9927	.2609	-.0041
31	60.0	6.200	.9920	.2607	-.0044	89	45.0	11.330	.8659	.2276	-.0748
32	70.0	6.200	.9908	.2604	-.0051	90	90.0	11.330	.9823	.2582	-.0099
33	80.0	6.200	.9865	.2593	-.0075	91	135.0	11.330	1.0016	.2632	-.0009
34	90.0	6.200	.9852	.2589	-.0083	92	180.0	11.330	.9738	.2559	-.0146
35	135.0	6.200	.9913	.2605	-.0049	93	225.0	11.330	.9734	.2558	-.0149
36	180.0	6.200	1.0021	.2634	.0011	94	270.0	11.330	.9840	.2586	-.0089
37	225.0	6.200	1.0012	.2631	.0006	95	315.0	11.330	.9867	.2593	-.0074
38	270.0	6.200	.9997	.2627	-.0001	96	0.0	12.000	.9904	.2603	-.0053
39	315.0	6.200	.9951	.2615	-.0028	97	45.0	12.000	.9886	.2598	-.0064
40	0.0	7.333	.9946	.2614	-.0030	98	90.0	12.000	.9870	.2594	-.0072
41	45.0	7.333	.9963	.2618	-.0021	99	135.0	12.000	.9903	.2603	-.0054
42	90.0	7.333	1.0025	.2635	.0014	100	180.0	12.000	.9881	.2597	-.0066
43	135.0	7.333	1.0056	.2643	.0031	101	225.0	12.000	.9914	.2606	-.0048
44	180.0	7.333	.9969	.2620	-.0017	102	270.0	12.000	.9823	.2582	-.0099
45	202.5	7.333	.9672	.2542	-.0183	103	315.0	12.000	.9865	.2593	-.0075
46	225.0	7.333	.9615	.2527	-.0215	104	0.0	13.333	.9899	.2601	-.0057
47	247.5	7.333	1.0125	.2661	.0070	105	45.0	13.333	1.0211	.2684	.0118
48	270.0	7.333	1.0146	.2667	.0082	106	90.0	13.333	1.0270	.2699	.0151
49	315.0	7.333	1.0028	.2636	.0016	107	135.0	13.333	1.0252	.2694	.0140
50	202.5	7.667	1.0557	.2775	.0311	108	180.0	13.333	1.0340	.2717	.0189
51	225.0	7.667	1.0222	.2687	.0124	109	225.0	13.333	1.0263	.2697	.0147
52	247.5	7.667	1.0511	.2762	.0285	110	270.0	13.333	1.0288	.2704	.0161
53	45.0	8.000	1.0700	.2812	.0391	111	315.0	13.333	1.0147	.2667	.0082
54	135.0	8.000	1.0565	.2777	.0315	112	0.0	14.400	1.0258	.2696	.0144
55	202.5	8.000	1.0819	.2843	.0457	113	90.0	14.400	1.0202	.2681	.0113
56	225.0	8.000	1.0524	.2766	.0292	114	180.0	14.400	1.0287	.2704	.0160
57	247.5	8.000	1.0745	.2824	.0416	115	270.0	14.400	1.0204	.2682	.0114
58	315.0	8.000	1.0774	.2832	.0432						

TABLE III.- Continued

(b)  $M = 1.60$ ;  $\alpha = 10^\circ$

$p_t = 54.5$  kPa

TUBE	THETA	X/D	P/PINF	P/PT2	CP	TUBE	THETA	X/D	P/PINF	P/PT2	CP
1	0.0	1.333	.9606	.2525	-.0220	59	225.0	8.333	1.6046	.4217	-.3374
2	90.0	1.333	.9618	.2528	-.0213	60	45.0	8.667	.8736	.2296	-.0705
3	180.0	1.333	1.3096	.3442	.1728	61	135.0	8.667	1.0642	.2797	.0358
4	270.0	1.333	1.3244	.3481	.1810	62	202.5	8.667	1.8226	.4790	.4590
5	0.0	2.667	.7843	.2061	-.1204	63	225.0	8.667	1.7640	.4636	.4263
6	90.0	2.667	.7852	.2064	-.1199	64	247.5	8.667	1.7716	.4656	.4306
7	180.0	2.667	.9404	.2472	-.0333	65	315.0	8.667	1.0492	.2757	.0275
8	270.0	2.667	.9521	.2502	-.0267	66	225.0	9.000	1.8182	.4779	.4566
9	0.0	4.000	.8055	.2117	-.1085	67	45.0	9.333	.7931	.2084	-.1155
10	10.0	4.000	.8840	.2323	-.0648	68	135.0	9.333	.9250	.2431	-.0418
11	20.0	4.000	.9696	.2548	-.0170	69	202.5	9.333	1.5423	.4053	.3026
12	30.0	4.000	.9847	.2588	-.0085	70	225.0	9.333	1.5554	.4088	.3100
13	40.0	4.000	.9886	.2598	-.0063	71	247.5	9.333	1.6055	.4219	.3379
14	50.0	4.000	.9923	.2608	-.0043	72	315.0	9.333	.9689	.2546	-.0174
15	60.0	4.000	.9824	.2582	-.0098	73	225.0	9.667	1.4534	.3820	.2530
16	70.0	4.000	.9650	.2536	-.0195	74	45.0	10.000	.5935	.1560	-.2269
17	80.0	4.000	.8793	.2311	-.0674	75	135.0	10.000	.8489	.2231	-.0843
18	90.0	4.000	.8118	.2133	-.1050	76	202.5	10.000	1.3702	.3601	.2066
19	180.0	4.000	.6870	.2331	-.0631	77	225.0	10.000	1.3806	.3628	.2124
20	270.0	4.000	.9119	.2397	-.0492	78	247.5	10.000	1.3180	.3464	.1775
21	0.0	5.333	.8354	.2196	-.0918	79	315.0	10.000	.8473	.2227	-.0852
22	90.0	5.333	.8233	.2164	-.0986	80	0.0	10.667	.7902	.2077	-.1171
23	180.0	5.333	.8925	.2346	-.0600	81	45.0	10.667	.6462	.1698	-.1974
24	270.0	5.333	.9149	.2404	-.0475	82	90.0	10.667	.7841	.2061	-.1205
25	0.0	6.200	.8524	.2240	-.0823	83	135.0	10.667	1.0017	.2633	.0010
26	10.0	6.200	.8759	.2302	-.0693	84	180.0	10.667	1.1863	.3118	.1040
27	20.0	6.200	.9804	.2577	-.0109	85	225.0	10.667	1.1388	.2993	.0775
28	30.0	6.200	1.0119	.2660	.0067	86	270.0	10.667	1.1727	.3082	.0964
29	40.0	6.200	1.0205	.2682	.0115	87	315.0	10.667	.9689	.2546	-.0173
30	50.0	6.200	1.0172	.2673	.0096	88	0.0	11.330	.9257	.2433	-.0415
31	60.0	6.200	1.0122	.2660	.0068	89	45.0	11.330	.6462	.1698	-.1974
32	70.0	6.200	.9775	.2569	-.0126	90	90.0	11.330	.9272	.2437	-.0406
33	80.0	6.200	.8749	.2299	-.0698	91	135.0	11.330	.9957	.2617	-.0024
34	90.0	6.200	.8421	.2213	-.0881	92	180.0	11.330	1.0763	.2829	.0426
35	135.0	6.200	.8673	.2279	-.0741	93	225.0	11.330	1.0805	.2840	.0449
36	180.0	6.200	.9175	.2411	-.0461	94	270.0	11.330	1.0875	.2858	.0488
37	225.0	6.200	1.0362	.2723	.0202	95	315.0	11.330	.9959	.2617	-.0023
38	270.0	6.200	.9298	.2444	-.0392	96	0.0	12.000	.9812	.2579	-.0105
39	315.0	6.200	.8609	.2263	-.0776	97	45.0	12.000	1.0271	.2699	.0151
40	0.0	7.333	.8833	.2322	-.0651	98	90.0	12.000	.9740	.2560	-.0145
41	45.0	7.333	.9985	.2624	-.0008	99	135.0	12.000	.9525	.2503	-.0265
42	90.0	7.333	.9236	.2427	-.0426	100	180.0	12.000	1.0125	.2661	.0070
43	135.0	7.333	.8916	.2343	-.0605	101	225.0	12.000	1.0036	.2638	.0020
44	180.0	7.333	.9444	.2482	-.0310	102	270.0	12.000	1.0065	.2645	.0036
45	202.5	7.333	.9998	.2628	-.0001	103	315.0	12.000	.9515	.2501	-.0271
46	225.0	7.333	1.0180	.2675	.0100	104	0.0	13.333	.9829	.2583	-.0095
47	247.5	7.333	1.0107	.2656	.0060	105	45.0	13.333	1.0263	.2697	.0147
48	270.0	7.333	.9526	.2504	-.0264	106	90.0	13.333	.9917	.2606	-.0046
49	315.0	7.333	.8910	.2342	-.0608	107	135.0	13.333	.9620	.2528	-.0212
50	202.5	7.667	1.1201	.2944	.0670	108	180.0	13.333	.9618	.2528	-.0213
51	225.0	7.667	1.0878	.2859	.0490	109	225.0	13.333	.9703	.2550	-.0166
52	247.5	7.667	1.1082	.2912	.0604	110	270.0	13.333	.9588	.2520	-.0230
53	45.0	8.000	1.0658	.2801	.0367	111	315.0	13.333	.9531	.2505	-.0262
54	135.0	8.000	.8758	.2302	-.0693	112	0.0	14.400	.9944	.2613	-.0031
55	202.5	8.000	1.3872	.3646	.2161	113	90.0	14.400	.9891	.2599	-.0061
56	225.0	8.000	1.2155	.3194	.1202	114	180.0	14.400	.9860	.2591	-.0078
57	247.5	8.000	1.2263	.3223	.1263	115	270.0	14.400	.9662	.2539	-.0188
58	315.0	8.000	.9126	.2398	-.0488						

TABLE III.- Continued

(c)  $M = 1.60$ ;  $\alpha = 20^\circ$

$p_t = 54.8 \text{ kPa}$

TUBE	THETA	X/D	P/PINF	P/PT2	CP	TUBE	THETA	X/D	P/PINF	P/PT2	CP
1	0.0	1.333	.7331	.1927	-.1490	59	225.0	8.333	2.4357	.6401	.8012
2	90.0	1.333	.7356	.1933	-.1476	60	45.0	8.667	.9936	.2611	-.0036
3	180.0	1.333	1.4962	.3932	.2769	61	135.0	8.667	.8886	.2335	-.0622
4	270.0	1.333	1.5385	.4043	.3005	62	202.5	8.667	2.5192	.6621	.8478
5	0.0	2.667	.4837	.1271	-.2881	63	225.0	8.667	2.4638	.6475	.8169
6	90.0	2.667	.4753	.1249	-.2928	64	247.5	8.667	2.4969	.6562	.8353
7	180.0	2.667	1.0492	.2758	.0275	65	315.0	8.667	.9046	.2378	-.0532
8	270.0	2.667	1.0938	.2875	.0523	66	225.0	9.000	2.2527	.5920	.6991
9	0.0	4.000	.5520	.1451	-.2500	67	45.0	9.333	.7224	.1898	-.1549
10	10.0	4.000	.5239	.1377	-.2657	68	135.0	9.333	.8196	.2154	-.1007
11	20.0	4.000	.5337	.1403	-.2602	69	202.5	9.333	1.9375	.5092	.5232
12	30.0	4.000	.7951	.2090	-.1143	70	225.0	9.333	1.9560	.5141	.5335
13	40.0	4.000	.8780	.2307	-.0681	71	247.5	9.333	2.0624	.5420	.5929
14	50.0	4.000	.8958	.2354	-.0581	72	315.0	9.333	.8412	.2211	-.0886
15	60.0	4.000	.8431	.2216	-.0876	73	225.0	9.667	1.8939	.4977	.4988
16	70.0	4.000	.6311	.1659	-.2059	74	45.0	10.000	.5555	.1460	-.2480
17	80.0	4.000	.5079	.1335	-.2746	75	135.0	10.000	.7915	.2080	-.1163
18	90.0	4.000	.5285	.1389	-.2631	76	202.5	10.000	1.7822	.4684	.4365
19	180.0	4.000	.9434	.2479	-.0316	77	225.0	10.000	1.7723	.4658	.4310
20	270.0	4.000	1.0115	.2658	.0064	78	247.5	10.000	1.7468	.4591	.4168
21	0.0	5.333	.5737	.1508	-.2379	79	315.0	10.000	.8058	.2118	-.1084
22	90.0	5.333	.5981	.1572	-.2243	80	0.0	10.667	.8022	.2108	-.1104
23	180.0	5.333	.8963	.2356	-.0579	81	45.0	10.667	.5609	.1474	-.2451
24	270.0	5.333	.9757	.2564	-.0135	82	90.0	10.667	.7802	.2050	-.1227
25	0.0	6.200	.6786	.1784	-.1793	83	135.0	10.667	1.0460	.2749	.0257
26	10.0	6.200	.6879	.1808	-.1742	84	180.0	10.667	1.2710	.3340	.1512
27	20.0	6.200	.6492	.1706	-.1958	85	225.0	10.667	1.2478	.3279	.1383
28	30.0	6.200	.6709	.1763	-.1836	86	270.0	10.667	1.2530	.3293	.1412
29	40.0	6.200	.7638	.2007	-.1318	87	315.0	10.667	1.0340	.2718	.0190
30	50.0	6.200	.7732	.2032	-.1266	88	0.0	11.330	.9116	.2396	-.0493
31	60.0	6.200	.6914	.1817	-.1722	89	45.0	11.330	.5609	.1474	-.2451
32	70.0	6.200	.6261	.1645	-.2087	90	90.0	11.330	.9359	.2460	-.0358
33	80.0	6.200	.6721	.1766	-.1830	91	135.0	11.330	1.0208	.2683	.0116
34	90.0	6.200	.6861	.1803	-.1752	92	180.0	11.330	1.0470	.2752	.0263
35	135.0	6.200	.7585	.1993	-.1348	93	225.0	11.330	1.0202	.2681	.0113
36	180.0	6.200	.8961	.2355	-.0580	94	270.0	11.330	1.0535	.2769	.0299
37	225.0	6.200	1.2625	.3318	.1465	95	315.0	11.330	1.0019	.2633	.0011
38	270.0	6.200	.9423	.2476	-.0322	96	0.0	12.000	.9901	.2602	-.0055
39	315.0	6.200	.7469	.1963	-.1412	97	45.0	12.000	1.0625	.2792	.0349
40	0.0	7.333	.7531	.1979	-.1378	98	90.0	12.000	.9956	.2617	-.0024
41	45.0	7.333	.7767	.2041	-.1246	99	135.0	12.000	.8672	.2279	-.0741
42	90.0	7.333	.7678	.2018	-.1296	100	180.0	12.000	.9075	.2385	-.0516
43	135.0	7.333	.7828	.2057	-.1212	101	225.0	12.000	.9174	.2411	-.0461
44	180.0	7.333	.9244	.2430	-.0422	102	270.0	12.000	.9059	.2381	-.0525
45	202.5	7.333	1.1298	.2969	.0724	103	315.0	12.000	.8521	.2239	-.0826
46	225.0	7.333	1.2113	.3183	.1179	104	0.0	13.333	.9894	.2600	-.0059
47	247.5	7.333	1.1568	.3040	.0875	105	45.0	13.333	.9474	.2490	-.0294
48	270.0	7.333	.9414	.2474	-.0327	106	90.0	13.333	.9092	.2390	-.0507
49	315.0	7.333	.7750	.2037	-.1256	107	135.0	13.333	.8347	.2194	-.0923
50	202.5	7.667	1.3572	.3567	.1994	108	180.0	13.333	.8637	.2270	-.0760
51	225.0	7.667	1.3550	.3561	.1981	109	225.0	13.333	.9004	.2366	-.0556
52	247.5	7.667	1.3475	.3541	.1939	110	270.0	13.333	.8495	.2233	-.0840
53	45.0	8.000	.8031	.2111	-.1099	111	315.0	13.333	.8255	.2169	-.0974
54	135.0	8.000	.7615	.2001	-.1331	112	0.0	14.400	.8692	.2284	-.0730
55	202.5	8.000	2.0927	.5500	.6098	113	90.0	14.400	.8627	.2267	-.0766
56	225.0	8.000	2.0835	.5476	.6046	114	180.0	14.400	.9529	.2504	-.0263
57	247.5	8.000	1.9742	.5188	.5436	115	270.0	14.400	.9172	.2411	-.0462
58	315.0	8.000	.7573	.1990	-.1355						

TABLE III.- Continued

(d)  $M = 1.60$ ;  $\alpha = 30^\circ$

$P_t = 54.6 \text{ kPa}$

TUBE	THETA	X/D	P/PINF	P/P12	CP	TUBE	THETA	X/D	P/PINF	P/P12	CP
1	0.0	1.333	.4653	.1223	-.2984	59	225.0	8.333	3.0928	.8128	1.1678
2	90.0	1.333	.4728	.1243	-.2942	60	45.0	8.667	.9430	.2478	-.0318
3	180.0	1.333	1.7207	.4522	.4022	61	135.0	8.667	.6557	.1723	-.1922
4	270.0	1.333	1.8063	.4747	.4499	62	202.5	8.667	2.9586	.7776	1.0930
5	0.0	2.667	.4029	.1059	-.3332	63	225.0	8.667	2.9305	.7702	1.0773
6	90.0	2.667	.4063	.1068	-.3313	64	247.5	8.667	2.9335	.7710	1.0790
7	180.0	2.667	1.2563	.3302	.1430	65	315.0	8.667	.7201	.1893	-.1562
8	270.0	2.667	1.3307	.3497	.1845	66	225.0	9.000	2.7215	.7152	.9606
9	0.0	4.000	.4786	.1258	-.2909	67	45.0	9.333	.6332	.1664	-.2047
10	10.0	4.000	.4490	.1180	-.3075	68	135.0	9.333	.7224	.1698	-.1549
11	20.0	4.000	.4504	.1184	-.3067	69	202.5	9.333	2.5270	.6641	.8521
12	30.0	4.000	.4465	.1173	-.3089	70	225.0	9.333	2.5031	.6578	.8388
13	40.0	4.000	.5132	.1349	-.2717	71	247.5	9.333	2.5554	.6716	.8680
14	50.0	4.000	.5381	.1414	-.2578	72	315.0	9.333	.7136	.1876	-.1598
15	60.0	4.000	.4689	.1232	-.2964	73	225.0	9.667	2.4218	.6365	.7934
16	70.0	4.000	.4550	.1196	-.3041	74	45.0	10.000	.4223	.1110	-.3224
17	80.0	4.000	.4511	.1186	-.3063	75	135.0	10.000	.8382	.2203	-.0903
18	90.0	4.000	.4449	.1169	-.3098	76	202.5	10.000	2.1979	.5776	.6685
19	180.0	4.000	1.1299	.2970	.0725	77	225.0	10.000	2.2268	.5852	.6846
20	270.0	4.000	1.2424	.3265	.1353	78	247.5	10.000	2.2287	.5857	.6857
21	0.0	5.333	.5233	.1375	-.2660	79	315.0	10.000	.7747	.2036	-.1257
22	90.0	5.333	.5173	.1360	-.2694	80	0.0	10.667	.7759	.2039	-.1251
23	180.0	5.333	1.0890	.2862	.0496	81	45.0	10.667	.4978	.1308	-.2803
24	270.0	5.333	1.2133	.3189	.1190	82	90.0	10.667	.7261	.1908	-.1529
25	0.0	6.200	.5552	.1459	-.2482	83	135.0	10.667	.9025	.2372	-.0544
26	10.0	6.200	.5587	.1468	-.2463	84	180.0	10.667	.9807	.2578	-.0107
27	20.0	6.200	.5559	.1461	-.2478	85	225.0	10.667	1.3766	.3618	.2101
28	30.0	6.200	.5648	.1484	-.2429	86	270.0	10.667	.9896	.2601	-.0058
29	40.0	6.200	.6202	.1630	-.2120	87	315.0	10.667	.8909	.2341	-.0609
30	50.0	6.200	.6248	.1642	-.2094	88	0.0	11.330	.8123	.2135	-.1048
31	60.0	6.200	.5662	.1488	-.2421	89	45.0	11.330	.4978	.1308	-.2803
32	70.0	6.200	.5412	.1422	-.2560	90	90.0	11.330	.7813	.2053	-.1220
33	80.0	6.200	.5446	.1431	-.2541	91	135.0	11.330	.8722	.2292	-.0713
34	90.0	6.200	.5489	.1443	-.2517	92	180.0	11.330	.7718	.2028	-.1274
35	135.0	6.200	.5755	.1512	-.2369	93	225.0	11.330	.9747	.2562	-.0141
36	180.0	6.200	1.0887	.2861	.0495	94	270.0	11.330	.7866	.2068	-.1190
37	225.0	6.200	1.6545	.4348	.3652	95	315.0	11.330	.8559	.2249	-.0804
38	270.0	6.200	1.1704	.3076	.0951	96	0.0	12.000	.9050	.2378	-.0530
39	315.0	6.200	.5690	.1495	-.2405	97	45.0	12.000	.8797	.2312	-.0671
40	0.0	7.333	.5976	.1571	-.2245	98	90.0	12.000	.9042	.2376	-.0534
41	45.0	7.333	.6740	.1771	-.1819	99	135.0	12.000	.6739	.1771	-.1820
42	90.0	7.333	.6143	.1614	-.2152	100	180.0	12.000	.7144	.1877	-.1594
43	135.0	7.333	.6128	.1610	-.2161	101	225.0	12.000	.8848	.2325	-.0643
44	180.0	7.333	1.1407	.2998	.0785	102	270.0	12.000	.7019	.1845	-.1663
45	202.5	7.333	1.4697	.3863	.2621	103	315.0	12.000	.6783	.1783	-.1795
46	225.0	7.333	1.5927	.4186	.3307	104	0.0	13.333	.9034	.2374	-.0539
47	247.5	7.333	1.5840	.4163	.3259	105	45.0	13.333	.7042	.1851	-.1651
48	270.0	7.333	1.2523	.3291	.1408	106	90.0	13.333	.6639	.1745	-.1876
49	315.0	7.333	.6285	.1652	-.2073	107	135.0	13.333	.7832	.2058	-.1210
50	202.5	7.667	2.4829	.6525	.8275	108	180.0	13.333	.8479	.2229	-.0849
51	225.0	7.667	2.4739	.6502	.8225	109	225.0	13.333	1.1658	.3064	.0925
52	247.5	7.667	2.4190	.6358	.7919	110	270.0	13.333	.8677	.2280	-.0738
53	45.0	8.000	.7090	.1863	-.1624	111	315.0	13.333	.7781	.2045	-.1238
54	135.0	8.000	.3653	.0960	-.3542	112	0.0	14.400	.7916	.2080	-.1163
55	202.5	8.000	3.0204	.7938	1.1274	113	90.0	14.400	.7899	.2076	-.1173
56	225.0	8.000	3.0076	.7905	1.1203	114	180.0	14.400	1.0285	.2703	.0159
57	247.5	8.000	3.0645	.8054	1.1521	115	270.0	14.400	.9545	.2509	-.0254
58	315.0	8.000	.4486	.1179	-.3077						

TABLE III.- Continued

(e)  $M = 1.60$ ;  $\alpha = 40^\circ$

$p_t = 54.8 \text{ kPa}$

TUBE	THETA	X/D	P/PINF	P/PT2	CP	TUBE	THETA	X/D	P/PINF	P/PT2	CP
1	0.0	1.333	.3434	.0903	-.3664	59	225.0	8.333	3.5513	.9333	1.4237
2	90.0	1.333	.3484	.0916	-.3636	60	45.0	8.667	.3380	.0888	-.3694
3	180.0	1.333	1.9642	.5162	.5381	61	135.0	8.667	.7028	.1847	-.1659
4	270.0	1.333	2.0855	.5481	.6058	62	202.5	8.667	3.3665	.8848	1.3206
5	0.0	2.667	.3211	.0844	-.3788	63	225.0	8.667	3.3580	.8825	1.3158
6	90.0	2.667	.3383	.0889	-.3693	64	247.5	8.667	3.3557	.8819	1.3146
7	180.0	2.667	1.5117	.3973	.2855	65	315.0	8.667	.6781	.1782	-.1796
8	270.0	2.667	1.6376	.4304	.3558	66	225.0	9.000	3.1483	.8274	1.1988
9	0.0	4.000	.3878	.1019	-.3416	67	45.0	9.333	.2550	.0670	-.4158
10	10.0	4.000	.3590	.0943	-.3577	68	135.0	9.333	.7417	.1949	-.1441
11	20.0	4.000	.3501	.0920	-.3626	69	202.5	9.333	2.9229	.7682	1.0730
12	30.0	4.000	.3493	.0918	-.3631	70	225.0	9.333	2.9110	.7651	1.0664
13	40.0	4.000	.4155	.1092	-.3262	71	247.5	9.333	2.9383	.7722	1.0816
14	50.0	4.000	.4473	.1176	-.3084	72	315.0	9.333	.7634	.2006	-.1320
15	60.0	4.000	.3692	.0970	-.3520	73	225.0	9.667	2.7628	.7261	.9837
16	70.0	4.000	.3495	.0919	-.3630	74	45.0	10.000	.3224	.0847	-.3781
17	80.0	4.000	.3431	.0902	-.3665	75	135.0	10.000	.6767	.1778	-.1804
18	90.0	4.000	.3747	.0985	-.3489	76	202.5	10.000	2.4047	.6320	.7839
19	180.0	4.000	1.3608	.3629	.2125	77	225.0	10.000	2.4652	.6479	.8176
20	270.0	4.000	1.5379	.4042	.3002	78	247.5	10.000	2.4237	.6370	.7945
21	0.0	5.333	.4275	.1124	-.3195	79	315.0	10.000	.6848	.1800	-.1759
22	90.0	5.333	.4098	.1077	-.3294	80	0.0	10.667	.5528	.1453	-.2495
23	180.0	5.333	1.3395	.3520	.1894	81	45.0	10.667	.6212	.1633	-.2114
24	270.0	5.333	1.5175	.3988	.2888	82	90.0	10.667	.5532	.1454	-.2493
25	0.0	6.200	.4477	.1177	-.3082	83	135.0	10.667	.7342	.1930	-.1483
26	10.0	6.200	.4425	.1163	-.3111	84	180.0	10.667	.7887	.2073	-.1179
27	20.0	6.200	.4240	.1114	-.3214	85	225.0	10.667	1.4327	.3765	.2415
28	30.0	6.200	.4125	.1084	-.3278	86	270.0	10.667	.8048	.2115	-.1089
29	40.0	6.200	.4772	.1254	-.2917	87	315.0	10.667	.7073	.1859	-.1633
30	50.0	6.200	.4906	.1289	-.2843	88	0.0	11.330	.7080	.1861	-.1629
31	60.0	6.200	.4247	.1116	-.3210	89	45.0	11.330	.6212	.1633	-.2114
32	70.0	6.200	.4105	.1079	-.3289	90	90.0	11.330	.6838	.1797	-.1765
33	80.0	6.200	.4359	.1146	-.3148	91	135.0	11.330	.6598	.1734	-.1898
34	90.0	6.200	.4413	.1160	-.3118	92	180.0	11.330	.5577	.1466	-.2468
35	135.0	6.200	.4363	.1147	-.3146	93	225.0	11.330	1.1103	.2918	.0615
36	180.0	6.200	1.3543	.3559	.1977	94	270.0	11.330	.6196	.1628	-.2123
37	225.0	6.200	2.1436	.5634	.6382	95	315.0	11.330	.6842	.1798	-.1762
38	270.0	6.200	1.4772	.3882	.2663	96	0.0	12.000	.6166	.1621	-.2139
39	315.0	6.200	.4419	.1082	-.3282	97	45.0	12.000	.7093	.1864	-.1622
40	0.0	7.333	.6837	.1797	-.1765	98	90.0	12.000	.5811	.1527	-.2338
41	45.0	7.333	.4813	.1265	-.2894	99	135.0	12.000	.4754	.1249	-.2928
42	90.0	7.333	.7226	.1899	-.1548	100	180.0	12.000	.5603	.1473	-.2453
43	135.0	7.333	.6467	.1700	-.1972	101	225.0	12.000	1.1024	.2897	.0571
44	180.0	7.333	2.1326	.5605	.6320	102	270.0	12.000	.5867	.1542	-.2306
45	202.5	7.333	2.6521	.6970	.9219	103	315.0	12.000	.5231	.1375	-.2661
46	225.0	7.333	2.8949	.7608	1.0574	104	0.0	13.333	.6149	.1616	-.2149
47	247.5	7.333	2.7333	.7183	.9672	105	45.0	13.333	.5794	.1523	-.2347
48	270.0	7.333	2.1961	.5772	.6675	106	90.0	13.333	.5879	.1545	-.2299
49	315.0	7.333	.6409	.1684	-.2004	107	135.0	13.333	.5344	.1405	-.2598
50	0.0	7.667	3.4430	.9049	1.3633	108	180.0	13.333	.9830	.2583	-.0095
51	225.0	7.667	3.4338	.9024	1.3581	109	225.0	13.333	1.5092	.3966	.2842
52	247.5	7.667	3.4313	.9018	1.3568	110	270.0	13.333	1.2239	.3217	.1249
53	45.0	8.000	.6135	.1612	-.2157	111	315.0	13.333	.4937	.1297	-.2825
54	135.0	8.000	.4069	.1069	-.3310	112	0.0	14.400	.4144	.1089	-.3268
55	202.5	8.000	3.6197	.9513	1.4619	113	90.0	14.400	.4533	.1191	-.3051
56	225.0	8.000	3.5491	.9328	1.4225	114	180.0	14.400	1.3296	.3494	.1839
57	247.5	8.000	3.6242	.9525	1.4664	115	270.0	14.400	1.2277	.3227	.1271
58	315.0	8.000	.4369	.1148	-.3142						



TABLE III.- Continued

(f) M = 1.60;  $\alpha = 50^\circ$

$P_t = 54.8 \text{ kPa}$

TUBE	THETA	X/D	P/PINF	P/PT2	CP	TUBE	THETA	X/D	P/PINF	P/PT2	CP
1	0.0	1.333	.2535	.0666	-.4166	59	225.0	8.333	3.6895	.9696	1.5008
2	90.0	1.333	.2611	.0686	-.4123	60	45.0	8.667	.3864	.1015	-.3424
3	180.0	1.333	2.1737	.5713	.6550	61	135.0	8.667	.5280	.1388	-.2634
4	270.0	1.333	2.3188	.6094	.7359	62	202.5	8.667	3.5288	.9274	1.4112
5	0.0	2.667	.2533	.0666	-.4167	63	225.0	8.667	3.5109	.9227	1.4012
6	90.0	2.667	.2525	.0664	-.4171	64	247.5	8.667	3.5154	.9239	1.4037
7	180.0	2.667	1.7836	.4688	.4373	65	315.0	8.667	.6220	.1635	-.2110
8	270.0	2.667	1.9660	.5167	.5390	66	225.0	9.000	3.3106	.8701	1.2894
9	0.0	4.000	.3225	.0848	-.3780	67	45.0	9.333	.3753	.0986	-.3486
10	10.0	4.000	.3009	.0791	-.3901	68	135.0	9.333	.3660	.0962	-.3538
11	20.0	4.000	.2976	.0782	-.3920	69	202.5	9.333	3.0943	.8132	1.1687
12	30.0	4.000	.2878	.0756	-.3974	70	225.0	9.333	3.0852	.8108	1.1636
13	40.0	4.000	.3339	.0878	-.3717	71	247.5	9.333	3.1031	.8155	1.1736
14	50.0	4.000	.3585	.0942	-.3580	72	315.0	9.333	.4408	.1159	-.3120
15	60.0	4.000	.3071	.0807	-.3867	73	225.0	9.667	2.9041	.7632	1.0626
16	70.0	4.000	.2873	.0755	-.3977	74	45.0	10.000	.4231	.1112	-.3219
17	80.0	4.000	.2979	.0783	-.3918	75	135.0	10.000	.4123	.1084	-.3279
18	90.0	4.000	.3125	.0821	-.3837	76	202.5	10.000	2.4941	.6555	.8338
19	180.0	4.000	1.6525	.4343	.3641	77	225.0	10.000	2.5656	.6743	.8736
20	270.0	4.000	1.8762	.4931	.4889	78	247.5	10.000	2.5160	.6612	.8460
21	0.0	5.333	.3510	.0922	-.3622	79	315.0	10.000	.4359	.1146	-.3148
22	90.0	5.333	.3463	.0910	-.3648	80	0.0	10.667	.7217	.1897	-.1553
23	180.0	5.333	1.6101	.4231	.3404	81	45.0	10.667	.5142	.1351	-.2711
24	270.0	5.333	1.8609	.4891	.4804	82	90.0	10.667	.7450	.1958	-.1423
25	0.0	6.200	.4160	.1093	-.3259	83	135.0	10.667	.6712	.1764	-.1835
26	10.0	6.200	.4142	.1089	-.3269	84	180.0	10.667	.6936	.1823	-.1710
27	20.0	6.200	.4156	.1092	-.3261	85	225.0	10.667	1.5581	.4095	.3114
28	30.0	6.200	.4214	.1108	-.3229	86	270.0	10.667	.6893	.1812	-.1734
29	40.0	6.200	.4395	.1155	-.3128	87	315.0	10.667	.6854	.1801	-.1756
30	50.0	6.200	.4363	.1147	-.3146	88	0.0	11.330	.5655	.1486	-.2425
31	60.0	6.200	.4192	.1102	-.3241	89	45.0	11.330	.5142	.1351	-.2711
32	70.0	6.200	.4118	.1082	-.3282	90	90.0	11.330	.5522	.1451	-.2499
33	80.0	6.200	.4098	.1077	-.3294	91	135.0	11.330	.5976	.1570	-.2246
34	90.0	6.200	.4117	.1082	-.3283	92	180.0	11.330	.6733	.1770	-.1823
35	135.0	6.200	.4176	.1097	-.3250	93	225.0	11.330	1.4191	.3730	.2339
36	180.0	6.200	1.7854	.4692	.4383	94	270.0	11.330	.6896	.1812	-.1732
37	225.0	6.200	2.8393	.7462	1.0264	95	315.0	11.330	.5996	.1576	-.2234
38	270.0	6.200	1.9837	.5214	.5490	96	0.0	12.000	.4296	.1129	-.3183
39	315.0	6.200	.5179	.1361	-.2690	97	45.0	12.000	.6148	.1616	-.2150
40	0.0	7.333	.4893	.1286	-.2850	98	90.0	12.000	.3884	.1021	-.3413
41	45.0	7.333	.4951	.1301	-.2818	99	135.0	12.000	.3870	.1017	-.3421
42	90.0	7.333	.5268	.1385	-.2641	100	180.0	12.000	.8712	.2290	-.0719
43	135.0	7.333	.6169	.1621	-.2138	101	225.0	12.000	1.6425	.4317	.3585
44	180.0	7.333	2.5023	.6576	.8383	102	270.0	12.000	.8451	.2221	-.0865
45	202.5	7.333	3.1808	.8360	1.2170	103	315.0	12.000	.3958	.1040	-.3372
46	225.0	7.333	3.4579	.9088	1.3716	104	0.0	13.333	.4283	.1126	-.3191
47	247.5	7.333	3.2081	.8431	1.2322	105	45.0	13.333	.4500	.1183	-.3069
48	270.0	7.333	2.5233	.6631	.8500	106	90.0	13.333	.4019	.1056	-.3338
49	315.0	7.333	.6618	.1739	-.1887	107	135.0	13.333	.5016	.1318	-.2781
50	202.5	7.667	3.6643	.9630	1.4868	108	180.0	13.333	1.3034	.3426	.1693
51	225.0	7.667	3.7170	.9769	1.5162	109	225.0	13.333	2.1623	.5683	.6486
52	247.5	7.667	3.6611	.9622	1.4850	110	270.0	13.333	1.3220	.3474	.1797
53	45.0	8.000	.3264	.0858	-.3759	111	315.0	13.333	.4751	.1249	-.2929
54	135.0	8.000	.4313	.1133	-.3174	112	0.0	14.400	.3471	.0912	-.3643
55	202.5	8.000	3.7977	.9981	1.5612	113	90.0	14.400	.3638	.0956	-.3550
56	225.0	8.000	3.7508	.9858	1.5350	114	180.0	14.400	1.6150	.4244	.3432
57	247.5	8.000	3.8097	1.0012	1.5679	115	270.0	14.400	1.4960	.3932	.2768
58	315.0	8.000	.4334	.1139	-.3162						

TABLE III.- Continued

(g) M = 2.70;  $\alpha = 0^\circ$

$P_t = 90.3 \text{ kPa}$

TUBE	THETA	X/D	P/PINF	P/PT2	CP	TUBE	THETA	X/D	P/PINF	P/PT2	CP
1	0.0	1.333	1.4352	.1455	.0853	59	225.0	8.333	1.0203	.1035	.0040
2	90.0	1.333	1.4769	.1498	.0935	60	45.0	8.667	1.1249	.1141	.0245
3	180.0	1.333	1.3799	.1399	.0744	61	135.0	8.667	1.0435	.1058	.0085
4	270.0	1.333	1.4300	.1450	.0843	62	202.5	8.667	1.0504	.1065	.0099
5	0.0	2.667	.8849	.0897	-.0225	63	225.0	8.667	1.0326	.1047	.0064
6	90.0	2.667	.9012	.0914	-.0194	64	247.5	8.667	1.0970	.1112	.0190
7	180.0	2.667	.8360	.0848	-.0321	65	315.0	8.667	1.0999	.1115	.0196
8	270.0	2.667	.8788	.0891	-.0237	66	225.0	9.000	1.0559	.1071	.0109
9	0.0	4.000	.9057	.0918	-.0185	67	45.0	9.333	1.1601	.1176	.0314
10	10.0	4.000	.9122	.0925	-.0172	68	135.0	9.333	1.0548	.1069	.0107
11	20.0	4.000	.9130	.0926	-.0170	69	202.5	9.333	1.0486	.1063	.0095
12	30.0	4.000	.9118	.0924	-.0173	70	225.0	9.333	1.0635	.1078	.0124
13	40.0	4.000	.9122	.0925	-.0172	71	247.5	9.333	1.0925	.1108	.0181
14	50.0	4.000	.9124	.0925	-.0172	72	315.0	9.333	1.1103	.1126	.0216
15	60.0	4.000	.9111	.0924	-.0174	73	225.0	9.667	1.0283	.1043	.0055
16	70.0	4.000	.9115	.0924	-.0173	74	45.0	10.000	.9654	.0979	-.0068
17	80.0	4.000	.9097	.0922	-.0177	75	135.0	10.000	.8824	.0895	-.0230
18	90.0	4.000	.9101	.0923	-.0176	76	202.5	10.000	.9234	.0936	-.0150
19	180.0	4.000	.8433	.0855	-.0307	77	225.0	10.000	.9452	.0958	-.0107
20	270.0	4.000	.8924	.0905	-.0211	78	247.5	10.000	.9722	.0986	-.0055
21	0.0	5.333	.9459	.0959	-.0106	79	315.0	10.000	.9305	.0943	-.0136
22	90.0	5.333	.9475	.0961	-.0103	80	0.0	10.667	1.0670	.1082	.0131
23	180.0	5.333	.8766	.0889	-.0242	81	45.0	10.667	.8418	.0853	-.0310
24	270.0	5.333	.9280	.0941	-.0141	82	90.0	10.667	1.0550	.1070	.0108
25	0.0	6.200	.9558	.0969	-.0087	83	135.0	10.667	.8169	.0828	-.0359
26	10.0	6.200	.9606	.0974	-.0077	84	180.0	10.667	1.0751	.1090	.0147
27	20.0	6.200	.9648	.0978	-.0069	85	225.0	10.667	.8389	.0851	-.0316
28	30.0	6.200	.9657	.0980	-.0065	86	270.0	10.667	1.1022	.1118	.0200
29	40.0	6.200	.9673	.0981	-.0064	87	315.0	10.667	.8087	.0820	-.0375
30	50.0	6.200	.9667	.0980	-.0065	88	0.0	11.330	.9815	.0995	-.0036
31	60.0	6.200	.9660	.0979	-.0067	89	45.0	11.330	.8418	.0853	-.0310
32	70.0	6.200	.9654	.0979	-.0068	90	90.0	11.330	.9920	.1006	-.0016
33	80.0	6.200	.9592	.0973	-.0080	91	135.0	11.330	.9416	.0955	-.0114
34	90.0	6.200	.9654	.0979	-.0068	92	180.0	11.330	.9739	.0987	-.0051
35	135.0	6.200	.9525	.0966	-.0093	93	225.0	11.330	.9180	.0931	-.0161
36	180.0	6.200	.8948	.0907	-.0206	94	270.0	11.330	1.0391	.1054	.0077
37	225.0	6.200	.8922	.0905	-.0211	95	315.0	11.330	.9616	.0975	-.0075
38	270.0	6.200	.9416	.0955	-.0114	96	0.0	12.000	.9579	.0971	-.0083
39	315.0	6.200	.9521	.0965	-.0094	97	45.0	12.000	.9702	.0984	-.0058
40	0.0	7.333	.9851	.0999	-.0029	98	90.0	12.000	.9566	.0970	-.0085
41	45.0	7.333	.9861	.1000	-.0027	99	135.0	12.000	.9970	.1011	-.0006
42	90.0	7.333	.9858	.1000	-.0028	100	180.0	12.000	.9372	.0950	-.0123
43	135.0	7.333	.9822	.0996	-.0035	101	225.0	12.000	.9532	.0966	-.0092
44	180.0	7.333	.9405	.0954	-.0117	102	270.0	12.000	.9731	.0987	-.0053
45	202.5	7.333	.9427	.0956	-.0112	103	315.0	12.000	1.0074	.1021	.0014
46	225.0	7.333	.9423	.0955	-.0113	104	0.0	13.333	.9572	.0971	-.0084
47	247.5	7.333	.9975	.1011	-.0005	105	45.0	13.333	.9878	.1002	-.0024
48	270.0	7.333	1.0031	.1017	-.0006	106	90.0	13.333	.9915	.1005	-.0017
49	315.0	7.333	.9951	.1009	-.0010	107	135.0	13.333	1.0146	.1029	.0029
50	202.5	7.667	.9895	.1003	-.0021	108	180.0	13.333	.9699	.0983	-.0059
51	225.0	7.667	.9884	.1002	-.0023	109	225.0	13.333	.9456	.0959	-.0107
52	247.5	7.667	1.0407	.1055	.0080	110	270.0	13.333	1.0237	.1038	.0046
53	45.0	8.000	1.0928	.1108	.0182	111	315.0	13.333	1.0041	.1018	.0008
54	135.0	8.000	.9982	.1012	-.0004	112	0.0	14.400	1.0262	.1040	.0051
55	202.5	8.000	1.0199	.1034	.0039	113	90.0	14.400	1.0131	.1027	.0026
56	225.0	8.000	1.0178	.1032	.0035	114	180.0	14.400	.9768	.0990	-.0046
57	247.5	8.000	1.0668	.1082	.0131	115	270.0	14.400	1.0165	.1031	.0032
58	315.0	8.000	1.0726	.1088	.0142						

TABLE III.- Continued

(h)  $M = 2.70$ ;  $\alpha = 10^\circ$

$p_t = 90.4$  kPa

TUBE	THETA	X/D	P/PINF	P/PT2	CP	TUBE	THETA	X/D	P/PINF	P/PT2	CP
1	0.0	1.333	.9770	.0991	-.0045	59	225.0	8.333	1.4450	.1465	.0872
2	90.0	1.333	.9952	.1009	-.0009	60	45.0	8.667	1.0084	.1022	-.0016
3	180.0	1.333	1.8405	.1866	.1647	61	135.0	8.667	.8201	.0831	-.0353
4	270.0	1.333	1.9090	.1936	.1781	62	202.5	8.667	1.9371	.1964	.1836
5	0.0	2.667	.6471	.0656	-.0691	63	225.0	8.667	1.7088	.1733	.1389
6	90.0	2.667	.6541	.0663	-.0678	64	247.5	8.667	1.9027	.1929	.1769
7	180.0	2.667	1.0506	.1065	.0099	65	315.0	8.667	.7747	.0786	-.0441
8	270.0	2.667	1.1221	.1138	.0239	66	225.0	9.000	2.1314	.2161	.2217
9	0.0	4.000	.6511	.0660	-.0684	67	45.0	9.333	.8170	.0828	-.0359
10	10.0	4.000	.6576	.0667	-.0671	68	135.0	9.333	.8649	.0877	-.0265
11	20.0	4.000	.6367	.0646	-.0712	69	202.5	9.333	1.9422	.1969	.1846
12	30.0	4.000	.7644	.0775	-.0462	70	225.0	9.333	2.1882	.2219	.2329
13	40.0	4.000	.8559	.0868	-.0282	71	247.5	9.333	1.8934	.1920	.1751
14	50.0	4.000	.8695	.0882	-.0256	72	315.0	9.333	.7508	.0761	-.0488
15	60.0	4.000	.7960	.0807	-.0400	73	225.0	9.667	1.9212	.1948	.1805
16	70.0	4.000	.6407	.0650	-.0704	74	45.0	10.000	.6323	.0641	-.0721
17	80.0	4.000	.6407	.0650	-.0704	75	135.0	10.000	.7766	.0787	-.0438
18	90.0	4.000	.6545	.0664	-.0677	76	202.5	10.000	1.6882	.1712	.1349
19	180.0	4.000	.9388	.0952	-.0120	77	225.0	10.000	1.6588	.1682	.1291
20	270.0	4.000	1.0266	.1041	.0052	78	247.5	10.000	1.7872	.1812	.1543
21	0.0	5.333	.6649	.0674	-.0657	79	315.0	10.000	.6921	.0702	-.0603
22	90.0	5.333	.6547	.0664	-.0677	80	0.0	10.667	.8957	.0908	-.0204
23	180.0	5.333	.8964	.0909	-.0203	81	45.0	10.667	.6000	.6008	-.0784
24	270.0	5.333	.9858	.1000	-.0028	82	90.0	10.667	.8925	.0905	-.0211
25	0.0	6.200	.6742	.0684	-.0639	83	135.0	10.667	.7582	.0769	-.0474
26	10.0	6.200	.6675	.0677	-.0652	84	180.0	10.667	.9695	.0983	-.0060
27	20.0	6.200	.6719	.0681	-.0643	85	225.0	10.667	1.4985	.1519	.0977
28	30.0	6.200	.8832	.0895	-.0229	86	270.0	10.667	1.0500	.1065	.0098
29	40.0	6.200	.9319	.0945	-.0133	87	315.0	10.667	.7199	.0730	-.0549
30	50.0	6.200	.9303	.0943	-.0137	88	0.0	11.330	.8589	.0871	-.0277
31	60.0	6.200	.8771	.0889	-.0241	89	45.0	11.330	.6000	.6008	-.0784
32	70.0	6.200	.7033	.0713	-.0581	90	90.0	11.330	.8439	.0856	-.0306
33	80.0	6.200	.6605	.0670	-.0665	91	135.0	11.330	.9450	.0958	-.0108
34	90.0	6.200	.6753	.0685	-.0636	92	180.0	11.330	.9442	.0957	-.0109
35	135.0	6.200	.6886	.0698	-.0610	93	225.0	11.330	1.1436	.1159	.0281
36	180.0	6.200	.9069	.0920	-.0182	94	270.0	11.330	1.0122	.1026	.0024
37	225.0	6.200	1.1801	.1197	.0353	95	315.0	11.330	.9321	.0945	-.0133
38	270.0	6.200	.9802	.0994	-.0039	96	0.0	12.000	.8775	.0890	-.0240
39	315.0	6.200	.6705	.0680	-.0646	97	45.0	12.000	.8327	.0844	-.0328
40	0.0	7.333	.6949	.0705	-.0598	98	90.0	12.000	.8824	.0895	-.0230
41	45.0	7.333	.8959	.0908	-.0204	99	135.0	12.000	.9727	.0986	-.0353
42	90.0	7.333	.7109	.0721	-.0567	100	180.0	12.000	.9605	.0974	-.0077
43	135.0	7.333	.7343	.0745	-.0521	101	225.0	12.000	.8993	.0912	-.0197
44	180.0	7.333	.8997	.0912	-.0197	102	270.0	12.000	.9786	.0992	-.0042
45	202.5	7.333	1.0712	.1086	.0140	103	315.0	12.000	.9504	.0964	-.0097
46	225.0	7.333	1.1403	.1156	.0275	104	0.0	13.333	.8775	.0890	-.0240
47	247.5	7.333	1.1380	.1154	.0270	105	45.0	13.333	.9946	.1008	-.0011
48	270.0	7.333	.9626	.0976	-.0073	106	90.0	13.333	.8941	.0907	-.0208
49	315.0	7.333	.7330	.0743	-.0523	107	135.0	13.333	.8826	.0895	-.0230
50	202.5	7.667	1.1606	.1177	.0315	108	180.0	13.333	.9055	.0918	-.0185
51	225.0	7.667	1.1638	.1180	.0321	109	225.0	13.333	.9858	.1000	-.0028
52	247.5	7.667	1.1741	.1190	.0341	110	270.0	13.333	.9484	.0962	-.0101
53	45.0	8.000	.8850	.0897	-.0225	111	315.0	13.333	.8555	.0867	-.0283
54	135.0	8.000	.7007	.0710	-.0587	112	0.0	14.400	.9131	.0926	-.0170
55	202.5	8.000	1.3411	.1360	.0669	113	90.0	14.400	.9288	.0942	-.0140
56	225.0	8.000	1.2981	.1316	.0584	114	180.0	14.400	.9181	.0931	-.0160
57	247.5	8.000	1.4025	.1422	.0789	115	270.0	14.400	.9369	.0950	-.0124
58	315.0	8.000	.7724	.0783	-.0446						

TABLE III.- Continued

(i)  $M = 2.70$ ;  $\alpha = 20^\circ$

$p_t = 90.4$  kPa

TUBE	THETA	X/D	P/PINF	P/PT2	CP	TUBE	THETA	X/D	P/PINF	P/PT2	CP
1	0.0	1.333	.5590	.0567	-.0864	59	225.0	8.333	2.4221	.2456	.2787
2	90.0	1.333	.5662	.0574	-.0850	60	45.0	8.667	.6189	.0627	-.0747
3	180.0	1.333	2.4945	.2529	.2929	61	135.0	8.667	.6250	.0634	-.0735
4	270.0	1.333	2.5987	.2635	.3133	62	202.5	8.667	3.4054	.3453	.4714
5	0.0	2.667	.3552	.0360	-.1264	63	225.0	8.667	3.2464	.3292	.4402
6	90.0	2.667	.3634	.0368	-.1248	64	247.5	8.667	3.3410	.3387	.4587
7	180.0	2.667	1.4343	.1454	.0851	65	315.0	8.667	.6572	.0666	-.0672
8	270.0	2.667	1.5858	.1606	.1148	66	225.0	9.000	3.9881	.4044	.5856
9	0.0	4.000	.3847	.0390	-.1206	67	45.0	9.333	.6654	.0675	-.0656
10	10.0	4.000	.4034	.0409	-.1169	68	135.0	9.333	.6522	.0661	-.0682
11	20.0	4.000	.3826	.0388	-.1210	69	202.5	9.333	3.6618	.3713	.5216
12	30.0	4.000	.3784	.0384	-.1218	70	225.0	9.333	3.7011	.3753	.5293
13	40.0	4.000	.4888	.0496	-.1002	71	247.5	9.333	3.4993	.3548	.4889
14	50.0	4.000	.5273	.0535	-.0926	72	315.0	9.333	.6911	.0701	-.0605
15	60.0	4.000	.4101	.0416	-.1156	73	225.0	9.667	3.3998	.3447	.4703
16	70.0	4.000	.3876	.0393	-.1200	74	45.0	10.000	.4054	.0411	-.1165
17	80.0	4.000	.3814	.0387	-.1212	75	135.0	10.000	.6757	.0685	-.0635
18	90.0	4.000	.3929	.0398	-.1190	76	202.5	10.000	3.2907	.3337	.4489
19	180.0	4.000	1.2561	.1274	.0502	77	225.0	10.000	3.2228	.3268	.4356
20	270.0	4.000	1.4380	.1458	.0858	78	247.5	10.000	3.2972	.3343	.4502
21	0.0	5.333	.4473	.0454	-.1083	79	315.0	10.000	.6869	.0696	-.0614
22	90.0	5.333	.4428	.0449	-.1092	80	0.0	10.667	.7112	.0721	-.0566
23	180.0	5.333	1.1963	.1213	.0385	81	45.0	10.667	.4467	.0453	-.1084
24	270.0	5.333	1.3790	.1398	.0743	82	90.0	10.667	.6689	.0678	-.0649
25	0.0	6.200	.4645	.0471	-.1049	83	135.0	10.667	.7743	.0785	-.0442
26	10.0	6.200	.4563	.0463	-.1065	84	180.0	10.667	.7899	.0801	-.0412
27	20.0	6.200	.4572	.0464	-.1064	85	225.0	10.667	2.8793	.2919	.3683
28	30.0	6.200	.4670	.0474	-.1044	86	270.0	10.667	.8536	.0866	-.0287
29	40.0	6.200	.4959	.0503	-.0988	87	315.0	10.667	.6881	.0698	-.0611
30	50.0	6.200	.4999	.0507	-.0980	88	0.0	11.330	.7114	.0721	-.0565
31	60.0	6.200	.4662	.0473	-.1046	89	45.0	11.330	.4467	.0453	-.1084
32	70.0	6.200	.4618	.0468	-.1055	90	90.0	11.330	.7302	.0740	-.0529
33	80.0	6.200	.4588	.0465	-.1061	91	135.0	11.330	.9061	.0919	-.0184
34	90.0	6.200	.4598	.0466	-.1059	92	180.0	11.330	.7409	.0751	-.0508
35	135.0	6.200	.4268	.0433	-.1123	93	225.0	11.330	1.9251	.1952	.1813
36	180.0	6.200	1.1995	.1216	.0391	94	270.0	11.330	.7822	.0793	-.0427
37	225.0	6.200	1.8983	.1925	.1760	95	315.0	11.330	.8695	.0882	-.0256
38	270.0	6.200	1.3295	.1348	.0646	96	0.0	12.000	.7311	.0741	-.0527
39	315.0	6.200	.4199	.0426	-.1137	97	45.0	12.000	.7755	.0786	-.0440
40	0.0	7.333	.4821	.0489	-.1015	98	90.0	12.000	.7006	.0710	-.0587
41	45.0	7.333	.5376	.0545	-.0906	99	135.0	12.000	.6011	.0609	-.0782
42	90.0	7.333	.5161	.0523	-.0948	100	180.0	12.000	.6638	.0673	-.0659
43	135.0	7.333	.4593	.0462	-.1067	101	225.0	12.000	1.4433	.1463	.0869
44	180.0	7.333	1.2441	.1261	.0478	102	270.0	12.000	.6651	.0674	-.0656
45	202.5	7.333	1.6690	.1692	.1311	103	315.0	12.000	.5917	.0600	-.0800
46	225.0	7.333	1.8389	.1865	.1644	104	0.0	13.333	.7290	.0739	-.0531
47	247.5	7.333	1.7372	.1761	.1445	105	45.0	13.333	.8417	.0853	-.0310
48	270.0	7.333	1.3404	.1359	.0667	106	90.0	13.333	.6022	.0611	-.0779
49	315.0	7.333	.4538	.0460	-.1070	107	135.0	13.333	.4356	.0442	-.1106
50	202.5	7.667	1.8193	.1845	.1606	108	180.0	13.333	.7333	.0744	-.0523
51	225.0	7.667	1.8903	.1917	.1745	109	225.0	13.333	1.2043	.1221	.0400
52	247.5	7.667	1.7819	.1807	.1532	110	270.0	13.333	.7451	.0755	-.0499
53	45.0	8.000	.5416	.0549	-.0898	111	315.0	13.333	.4675	.0474	-.1044
54	135.0	8.000	.4896	.0496	-.1000	112	0.0	14.400	.6164	.0625	-.0752
55	202.5	8.000	2.2037	.2234	.2359	113	90.0	14.400	.5505	.0558	-.0881
56	225.0	8.000	2.1830	.2213	.2316	114	180.0	14.400	.8960	.0908	-.0204
57	247.5	8.000	2.2278	.2259	.2406	115	270.0	14.400	.9045	.0917	-.0187
58	315.0	8.000	.5338	.0541	-.0914						

TABLE III.- Continued

(j)  $M = 2.70$ ;  $\alpha = 30^\circ$

$p_t = 90.4$  kPa

TUBE	THETA	X/D	P/PINF	P/PT2	CP	TUBE	THETA	X/D	P/PINF	P/PT2	CP
1	0.0	1.333	.3395	.0344	-.1294	59	225.0	8.333	4.4757	.4538	.6811
2	90.0	1.333	.3472	.0352	-.1279	60	45.0	8.667	.3726	.0378	-.1229
3	180.0	1.333	3.2297	.3275	.4369	61	135.0	8.667	.6728	.0682	-.0641
4	270.0	1.333	3.4041	.3451	.4711	62	202.5	8.667	5.9451	.6028	.9691
5	0.0	2.667	.2612	.0265	-.1448	63	225.0	8.667	5.7312	.5811	.9271
6	90.0	2.667	.2674	.0271	-.1436	64	247.5	8.667	5.9537	.6037	.9708
7	180.0	2.667	2.0513	.2080	.2060	65	315.0	8.667	.7426	.0753	-.0505
8	270.0	2.667	2.2571	.2289	.2464	66	225.0	9.000	6.6265	.6719	1.1026
9	0.0	4.000	.2861	.0290	-.1399	67	45.0	9.333	.2381	.0241	-.1493
10	10.0	4.000	.2945	.0299	-.1383	68	135.0	9.333	.7865	.0797	-.0418
11	20.0	4.000	.2869	.0291	-.1397	69	202.5	9.333	5.8660	.5948	.9536
12	30.0	4.000	.2874	.0291	-.1397	70	225.0	9.333	5.9382	.6021	.9677
13	40.0	4.000	.3318	.0336	-.1310	71	247.5	9.333	5.9485	.6031	.9697
14	50.0	4.000	.3535	.0358	-.1267	72	315.0	9.333	.8452	.0857	-.0303
15	60.0	4.000	.2997	.0304	-.1372	73	225.0	9.667	5.6098	.5688	.9034
16	70.0	4.000	.2924	.0296	-.1387	74	45.0	10.000	.2381	.0241	-.1493
17	80.0	4.000	.2890	.0293	-.1393	75	135.0	10.000	.8350	.0847	-.0323
18	90.0	4.000	.2884	.0292	-.1394	76	202.5	10.000	5.9857	.6069	.9770
19	180.0	4.000	1.8209	.1846	.1609	77	225.0	10.000	6.5576	.6649	1.0891
20	270.0	4.000	2.0988	.2128	.2153	78	247.5	10.000	5.8414	.5923	.9487
21	0.0	5.333	.3290	.0334	-.1315	79	315.0	10.000	.9030	.0916	-.0190
22	90.0	5.333	.3231	.0328	-.1326	80	0.0	10.667	.4666	.0473	-.1045
23	180.0	5.333	1.7655	.1790	.1500	81	45.0	10.667	.3412	.0346	-.1291
24	270.0	5.333	2.0593	.2088	.2076	82	90.0	10.667	.4534	.0460	-.1071
25	0.0	6.200	.3397	.0344	-.1294	83	135.0	10.667	1.3285	.1347	.0644
26	10.0	6.200	.3305	.0335	-.1312	84	180.0	10.667	1.2936	.1312	.0575
27	20.0	6.200	.3271	.0332	-.1319	85	225.0	10.667	4.2355	.4294	.6340
28	30.0	6.200	.3309	.0336	-.1311	86	270.0	10.667	1.4465	.1467	.0875
29	40.0	6.200	.3659	.0371	-.1243	87	315.0	10.667	1.2482	.1266	.0486
30	50.0	6.200	.3734	.0379	-.1228	88	0.0	11.330	.3630	.0368	-.1248
31	60.0	6.200	.3271	.0332	-.1319	89	45.0	11.330	.3412	.0346	-.1291
32	70.0	6.200	.3253	.0330	-.1322	90	90.0	11.330	.3606	.0366	-.1253
33	80.0	6.200	.3285	.0333	-.1316	91	135.0	11.330	.8069	.0818	-.0378
34	90.0	6.200	.3352	.0340	-.1303	92	180.0	11.330	.9730	.0987	-.0053
35	135.0	6.200	.4234	.0429	-.1130	93	225.0	11.330	2.3704	.2403	.2685
36	180.0	6.200	1.8177	.1843	.1602	94	270.0	11.330	1.0386	.1053	.0076
37	225.0	6.200	3.1023	.3146	.4120	95	315.0	11.330	.8340	.0846	-.0325
38	270.0	6.200	2.0268	.2055	.2012	96	0.0	12.000	.4968	.0504	-.0986
39	315.0	6.200	.4890	.0496	-.1001	97	45.0	12.000	.7234	.0734	-.0542
40	0.0	7.333	.3653	.0370	-.1244	98	90.0	12.000	.4798	.0486	-.1019
41	45.0	7.333	.3594	.0364	-.1255	99	135.0	12.000	.5680	.0576	-.0847
42	90.0	7.333	.4213	.0427	-.1134	100	180.0	12.000	.9506	.0964	-.0097
43	135.0	7.333	.4730	.0480	-.1033	101	225.0	12.000	2.1096	.2139	.2174
44	180.0	7.333	1.9122	.1939	.1788	102	270.0	12.000	.9393	.0952	-.0119
45	202.5	7.333	2.6978	.2735	.3327	103	315.0	12.000	.5617	.0570	-.0859
46	225.0	7.333	2.9872	.3029	.3894	104	0.0	13.333	.4979	.0505	-.0984
47	247.5	7.333	2.7356	.2774	.3401	105	45.0	13.333	.5211	.0528	-.0938
48	270.0	7.333	2.0297	.2058	.2018	106	90.0	13.333	.3496	.0354	-.1275
49	315.0	7.333	.4880	.0495	-.1003	107	135.0	13.333	.3397	.0344	-.1294
50	202.5	7.667	2.9386	.2980	.3799	108	180.0	13.333	.7865	.0797	-.0418
51	225.0	7.667	3.0937	.3137	.4103	109	225.0	13.333	1.4888	.1510	.0958
52	247.5	7.667	2.8210	.2860	.3568	110	270.0	13.333	.8247	.0835	-.0343
53	45.0	8.000	.3686	.0374	-.1237	111	315.0	13.333	.3366	.0341	-.1300
54	135.0	8.000	.4004	.0406	-.1175	112	0.0	14.400	.3623	.0367	-.1250
55	202.5	8.000	3.5504	.3600	.4998	113	45.0	14.400	.3250	.0330	-.1323
56	225.0	8.000	3.9584	.3608	.5014	114	90.0	14.400	1.0389	.1053	.0076
57	247.5	8.000	3.4987	.3547	.4896	115	180.0	14.400	.9982	.1012	-.0003
58	315.0	8.000	.4445	.0451	-.1089		270.0	14.400			

TABLE III.- Continued

(k)  $M = 2.70$ ;  $\alpha = 40^\circ$

$P_t = 90.4 \text{ kPa}$

TUBE	THETA	X/D	P/PINF	P/PT2	CP	TUBE	THETA	X/D	P/PINF	P/PT2	CP
1	0.0	1.333	.2443	.0248	-.1481	59	225.0	8.333	10.1130	1.0254	1.7858
2	90.0	1.333	.2438	.0247	-.1482	60	45.0	8.667	.2399	.0243	-.1490
3	180.0	1.333	3.9877	.4043	.5855	61	135.0	8.667	.9750	.0989	-.0049
4	270.0	1.333	4.2722	.4332	.6412	62	202.5	8.667	9.9386	1.0077	1.7516
5	0.0	2.667	.2399	.0243	-.1490	63	225.0	8.667	9.4337	.9565	1.6527
6	90.0	2.667	.2399	.0243	-.1490	64	247.5	8.667	9.6760	.9811	1.7002
7	180.0	2.667	2.6225	.2862	.3571	65	315.0	8.667	1.0974	.1113	.0191
8	270.0	2.667	3.1078	.3151	.4130	66	225.0	9.000	8.0317	.8144	1.3779
9	0.0	4.000	.2403	.0244	-.1489	67	45.0	9.333	.2399	.0243	-.1490
10	10.0	4.000	.2401	.0243	-.1489	68	135.0	9.333	1.0671	.1082	.0131
11	20.0	4.000	.2399	.0243	-.1490	69	202.5	9.333	6.2315	.6318	1.0252
12	30.0	4.000	.2399	.0243	-.1490	70	225.0	9.333	6.2454	.6332	1.0279
13	40.0	4.000	.2422	.0246	-.1485	71	247.5	9.333	6.5018	.6592	1.0781
14	50.0	4.000	.2610	.0265	-.1448	72	315.0	9.333	1.2243	.1241	.0439
15	60.0	4.000	.2399	.0243	-.1490	73	225.0	9.667	5.5181	.5595	.8854
16	70.0	4.000	.2420	.0245	-.1485	74	45.0	10.000	.2399	.0243	-.1490
17	80.0	4.000	.2399	.0243	-.1490	75	135.0	10.000	1.0663	.1081	.0130
18	90.0	4.000	.2490	.0252	-.1472	76	202.5	10.000	5.4108	.5486	.8644
19	180.0	4.000	2.6278	.2664	.3190	77	225.0	10.000	5.5091	.5586	.8836
20	270.0	4.000	2.9638	.3005	.3848	78	247.5	10.000	5.4490	.5525	.8718
21	0.0	5.333	.2635	.0267	-.1443	79	315.0	10.000	1.1196	.1135	.0234
22	90.0	5.333	.2573	.0261	-.1455	80	0.0	10.667	.4892	.0496	-.1001
23	180.0	5.333	2.5774	.2613	.3091	81	45.0	10.667	.2598	.0263	-.1451
24	270.0	5.333	2.9557	.2997	.3832	82	90.0	10.667	.5404	.0548	-.0901
25	0.0	6.200	.2581	.0262	-.1454	83	135.0	10.667	2.1131	.2143	.2181
26	10.0	6.200	.2566	.0260	-.1457	84	180.0	10.667	2.7451	.2783	.3420
27	20.0	6.200	.2529	.0256	-.1464	85	225.0	10.667	4.8041	.4871	.7455
28	30.0	6.200	.2543	.0258	-.1461	86	270.0	10.667	3.0170	.3059	.3953
29	40.0	6.200	.2545	.0258	-.1461	87	315.0	10.667	1.6674	.1691	.1308
30	50.0	6.200	.2556	.0259	-.1459	88	0.0	11.330	.4361	.0442	-.1105
31	60.0	6.200	.2543	.0258	-.1461	89	45.0	11.330	.2598	.0263	-.1451
32	70.0	6.200	.2547	.0258	-.1460	90	90.0	11.330	.4265	.0432	-.1124
33	80.0	6.200	.2619	.0266	-.1446	91	135.0	11.330	1.0957	.1111	.0188
34	90.0	6.200	.2544	.0258	-.1461	92	180.0	11.330	1.5030	.1524	.0986
35	135.0	6.200	.5192	.0526	-.0942	93	225.0	11.330	2.4099	.2443	.2763
36	180.0	6.200	2.6485	.2685	.3230	94	270.0	11.330	1.6463	.1669	.1267
37	225.0	6.200	4.5054	.4566	.6869	95	315.0	11.330	1.1578	.1174	.0309
38	270.0	6.200	2.9155	.2956	.3754	96	0.0	12.000	.5344	.0542	-.0912
39	315.0	6.200	.6441	.0653	-.0698	97	45.0	12.000	.5731	.0581	-.0837
40	0.0	7.333	.2995	.0304	-.1373	98	90.0	12.000	.5578	.0566	-.0867
41	45.0	7.333	.2775	.0281	-.1416	99	135.0	12.000	.6025	.0611	-.0779
42	90.0	7.333	.4091	.0415	-.1158	100	180.0	12.000	1.2295	.1247	.0450
43	135.0	7.333	.6081	.0617	-.0768	101	225.0	12.000	2.2725	.2304	.2494
44	180.0	7.333	2.7906	.2829	.3509	102	270.0	12.000	1.2846	.1302	.0558
45	202.5	7.333	3.8681	.3922	.5620	103	315.0	12.000	.6646	.0674	-.0657
46	225.0	7.333	4.3509	.4411	.6567	104	0.0	13.333	.5350	.0542	-.0911
47	247.5	7.333	4.0014	.4057	.5882	105	45.0	13.333	.5373	.0545	-.0907
48	270.0	7.333	2.8737	.2914	.3672	106	90.0	13.333	.3723	.0378	-.1230
49	315.0	7.333	.6409	.0650	-.0704	107	135.0	13.333	.2733	.0277	-.1424
50	202.5	7.667	4.8177	.4885	.7481	108	180.0	13.333	1.3952	.1415	.0775
51	225.0	7.667	4.8254	.4893	.7496	109	225.0	13.333	2.5669	.2603	.3071
52	247.5	7.667	4.7742	.4841	.7396	110	270.0	13.333	1.4511	.1471	.0884
53	45.0	8.000	.2470	.0250	-.1476	111	315.0	13.333	.2729	.0277	-.1425
54	135.0	8.000	.4905	.0497	-.0998	112	0.0	14.400	.3265	.0331	-.1320
55	202.5	8.000	8.0224	.8134	1.3761	113	90.0	14.400	.3144	.0319	-.1344
56	225.0	8.000	8.4094	.8527	1.4520	114	180.0	14.400	1.7318	.1756	.1434
57	247.5	8.000	8.0699	.8182	1.3854	115	270.0	14.400	1.6323	.1659	.1239
58	315.0	8.000	.5845	.0593	-.0814						

TABLE III.- Concluded

(1) M = 2.70;  $\alpha = 50^\circ$

$P_t = 89.9$  kPa

TUBE	THETA	X/D	P/PINF	P/PT2	CP	TUBE	THETA	X/D	P/PINF	P/PT2	CP
1	0.0	1.333	.2654	.0269	-.1440	59	225.0	8.333	10.0106	1.0150	1.7657
2	90.0	1.333	.2407	.0244	-.1488	60	45.0	8.667	.2407	.0244	-.1488
3	180.0	1.333	4.7583	.4825	.7365	61	135.0	8.667	.9381	.0951	-.0121
4	270.0	1.333	5.1701	.5242	.8172	62	202.5	8.667	9.2048	.9333	1.6078
5	0.0	2.667	.2407	.0244	-.1488	63	225.0	8.667	9.0583	.9184	1.5791
6	90.0	2.667	.2407	.0244	-.1488	64	247.5	8.667	9.0770	.9203	1.5828
7	180.0	2.667	3.6544	.3705	.5202	65	315.0	8.667	1.0448	.1059	.0088
8	270.0	2.667	4.1111	.4168	.6097	66	225.0	9.000	8.4040	.8521	1.4509
9	0.0	4.000	.2407	.0244	-.1488	67	45.0	9.333	.2407	.0244	-.1488
10	10.0	4.000	.2407	.0244	-.1488	68	135.0	9.333	1.1800	.1196	.0353
11	20.0	4.000	.2407	.0244	-.1488	69	202.5	9.333	7.9385	.8049	1.3597
12	30.0	4.000	.2407	.0244	-.1488	70	225.0	9.333	7.8442	.7953	1.3412
13	40.0	4.000	.2407	.0244	-.1488	71	247.5	9.333	8.0677	.8180	1.3650
14	50.0	4.000	.2407	.0244	-.1488	72	315.0	9.333	1.2303	.1247	.0451
15	60.0	4.000	.2407	.0244	-.1488	73	225.0	9.667	7.7285	.7836	1.3185
16	70.0	4.000	.2407	.0244	-.1488	74	45.0	10.000	.2407	.0244	-.1488
17	80.0	4.000	.2407	.0244	-.1488	75	135.0	10.000	1.3396	.1358	.0665
18	90.0	4.000	.2407	.0244	-.1488	76	202.5	10.000	6.8784	.6974	1.1520
19	180.0	4.000	3.4684	.3517	.4837	77	225.0	10.000	6.9426	.7039	1.1645
20	270.0	4.000	3.9981	.4054	.5875	78	247.5	10.000	6.8986	.6995	1.1559
21	0.0	5.333	.2407	.0244	-.1488	79	315.0	10.000	1.3671	.1386	.0719
22	90.0	5.333	.2407	.0244	-.1488	80	0.0	10.667	.5534	.0561	-.0875
23	180.0	5.333	3.3985	.3446	.4700	81	45.0	10.667	.2662	.0270	-.1438
24	270.0	5.333	3.9633	.4019	.5807	82	90.0	10.667	.5739	.0582	-.0835
25	0.0	6.200	.2561	.0260	-.1458	83	135.0	10.667	1.3025	.1321	.0593
26	10.0	6.200	.2548	.0258	-.1460	84	180.0	10.667	1.9670	.1994	.1895
27	20.0	6.200	.2529	.0256	-.1464	85	225.0	10.667	3.9687	.4024	.5818
28	30.0	6.200	.2553	.0259	-.1459	86	270.0	10.667	2.1276	.2157	.2210
29	40.0	6.200	.2578	.0261	-.1454	87	315.0	10.667	1.3278	.1346	.0642
30	50.0	6.200	.2612	.0265	-.1448	88	0.0	11.330	.5774	.0585	-.0828
31	60.0	6.200	.2614	.0265	-.1447	89	45.0	11.330	.2662	.0270	-.1438
32	70.0	6.200	.2622	.0266	-.1446	90	90.0	11.330	.6284	.0637	-.0728
33	80.0	6.200	.2704	.0274	-.1430	91	135.0	11.330	1.0102	.1024	.0020
34	90.0	6.200	.2658	.0269	-.1439	92	180.0	11.330	1.5229	.1544	.1025
35	135.0	6.200	.6414	.0650	-.0703	93	225.0	11.330	3.2287	.3274	.4367
36	180.0	6.200	3.4962	.3545	.4892	94	270.0	11.330	1.6227	.1645	.1220
37	225.0	6.200	6.1019	.6187	.9998	95	315.0	11.330	.9813	.0995	-.0037
38	270.0	6.200	3.8591	.3913	.5603	96	0.0	12.000	.5412	.0549	-.3899
39	315.0	6.200	.8125	.0824	-.0368	97	45.0	12.000	.6517	.0661	-.0682
40	0.0	7.333	.3810	.0386	-.1213	98	90.0	12.000	.5844	.0592	-.0815
41	45.0	7.333	.3624	.0367	-.1249	99	135.0	12.000	.6259	.0635	-.0733
42	90.0	7.333	.5090	.0516	-.0962	100	180.0	12.000	1.7087	.1732	.1389
43	135.0	7.333	.9212	.0934	-.0154	101	225.0	12.000	3.3704	.3417	.4645
44	180.0	7.333	3.9012	.3955	.5685	102	270.0	12.000	1.7142	.1738	.1400
45	202.5	7.333	5.3739	.5449	.8571	103	315.0	12.000	.6140	.0623	-.0757
46	225.0	7.333	5.9023	.5984	.9607	104	0.0	13.333	.5414	.0549	-.0899
47	247.5	7.333	5.5007	.5577	.8820	105	45.0	13.333	.5498	.0557	-.0882
48	270.0	7.333	4.1081	.4165	.6091	106	90.0	13.333	.3257	.0330	-.1321
49	315.0	7.333	.9755	.0989	-.0048	107	135.0	13.333	.4140	.0420	-.1148
50	202.5	7.667	10.7511	1.0901	1.9109	108	180.0	13.333	2.3543	.2387	.2654
51	225.0	7.667	10.7262	1.0876	1.9060	109	225.0	13.333	4.1857	.4244	.6243
52	247.5	7.667	10.8214	1.0972	1.9246	110	270.0	13.333	2.3592	.2392	.2664
53	45.0	8.000	.2407	.0244	-.1488	111	315.0	13.333	.3712	.0376	-.1232
54	135.0	8.000	.7563	.0767	-.0478	112	0.0	14.400	.4027	.0408	-.1171
55	202.5	8.000	10.7595	1.0909	1.9125	113	90.0	14.400	.3786	.0384	-.1218
56	225.0	8.000	10.2150	1.0357	1.8058	114	180.0	14.400	2.9106	.2951	.3744
57	247.5	8.000	10.6464	1.0795	1.8903	115	270.0	14.400	2.6858	.2723	.3304
58	315.0	8.000	.8889	.0901	-.0218						

TABLE IV.- WING PRESSURE LISTING FOR  $\phi = 0^\circ$  AND  $R = 2.5 \times 10^5$

(a)  $M = 1.60$ ;  $\alpha = 0^\circ$

$p_t = 54.5$  kPa

FIN	TUBE	Y/S	X/C	P/PINF	P/PT2	CP	FIN	TUBE	Y/S	X/C	P/PINF	P/PT2	CP
1-	116	.125	.221	1.1489	.3019	.0831	3+	185	.500	.667	.7234	.1901	-.1544
1-	119	.125	.472	1.0873	.2898	.0487	3+	191	.500	.850	.7165	.1883	-.1582
1-	122	.125	.731	.9415	.2474	-.0326	3+	166	.625	.150	1.2284	.3228	.1275
1-	117	.272	.302	1.1165	.2934	.0650	3+	173	.625	.333	1.2283	.3228	.1274
1-	123	.375	.703	.8127	.2136	-.1045	3+	178	.625	.500	1.1729	.3083	.0965
1-	118	.625	.251	1.1217	.2948	.0679	3+	186	.625	.667	.7126	.1873	-.1604
1-	121	.625	.465	1.1547	.3035	.0863	3+	192	.625	.850	.7064	.1856	-.1638
1+	125	.125	.252	1.1418	.3001	.0792	3+	167	.749	.150	1.1765	.3092	.0985
1+	128	.125	.496	1.1359	.2985	.0758	3+	179	.749	.500	1.1510	.3025	.0843
1+	131	.125	.756	.9393	.2469	-.0339	3+	193	.749	.850	.7078	.1860	-.1630
1+	126	.375	.255	1.2336	.3242	.1304	3+	180	.873	.500	1.1179	.2938	.0658
1+	132	.375	.762	.8250	.2168	-.0977	4-	194	.862	.150	1.0913	.2868	.0510
1+	127	.625	.189	1.3058	.3432	-.1706	4-	201	.862	.333	1.1566	.3040	.0874
1+	130	.625	.408	1.2212	.3210	.1234	4-	214	.862	.667	.9595	.2522	-.0226
2-	134	.125	.221	1.1201	.2944	.0670	4-	195	.862	.150	1.1380	.2991	.0770
2-	137	.125	.472	1.1220	.2949	.0681	4-	202	.862	.333	1.1668	.3066	.0931
2-	140	.125	.731	.9508	.2499	-.0275	4-	207	.862	.500	1.1155	.2932	.0645
2-	136	.625	.251	1.2450	.3272	.1367	4-	215	.862	.667	.9251	.2431	-.0418
2-	139	.625	.465	1.1851	.3115	.1033	4-	196	.862	.150	1.1747	.3087	.0975
2+	143	.125	.221	1.1528	.3030	.0853	4-	203	.862	.333	1.1636	.3058	.0913
2+	146	.125	.472	1.1423	.3002	.0794	4-	208	.862	.500	1.1315	.2974	.0734
2+	149	.125	.731	.8898	.2339	-.0615	4-	216	.862	.667	.8347	.2194	-.0922
3-	155	.142	.433	1.1172	.2936	.0654	4-	222	.862	.150	.8504	.2235	-.0835
3-	158	.142	.802	.8568	.2252	-.0799	4-	197	.862	.375	1.2212	.3209	.1234
3-	156	.375	.414	1.0939	.2875	.0524	4-	204	.862	.333	1.1667	.3066	.0930
3-	159	.375	.770	.8228	.2162	-.0989	4-	209	.862	.500	1.1432	.3004	.0799
3-	157	.608	.425	1.0581	.2781	.0324	4-	217	.862	.667	.7609	.2000	-.1334
3-	160	.558	.746	.8611	.2263	-.0775	4-	223	.862	.850	.8034	.2111	-.1097
3+	161	.062	.150	1.1049	.2904	.0985	4-	198	.862	.150	1.2645	.3323	.1476
3+	168	.062	.333	1.1453	.3010	.0811	4-	205	.862	.333	1.1877	.3121	.1047
3+	181	.062	.667	.9578	.2517	-.0236	4-	210	.862	.500	1.1351	.2983	.0754
3+	187	.062	.850	.9449	.2483	-.0308	4-	218	.862	.667	.7440	.1955	-.1429
3+	162	.125	.150	1.1028	.2898	.0574	4-	224	.862	.850	.8051	.2116	-.1087
3+	182	.125	.667	.9155	.2406	-.0471	4-	211	.862	.500	1.1391	.2994	.0776
3+	188	.125	.850	.9204	.2419	-.0444	4-	219	.862	.667	.7170	.1884	-.1579
3+	170	.250	.333	1.1893	.3126	.1056	4-	225	.862	.850	.7896	.2075	-.1174
3+	175	.250	.500	1.1834	.3110	.1024	4-	200	.749	.150	1.3419	.3527	.1908
3+	183	.250	.667	.8230	.2163	-.0987	4-	212	.749	.500	1.1737	.3085	.0970
3+	189	.250	.850	.8429	.2215	-.0877	4-	226	.749	.850	.7607	.1999	-.1335
3+	164	.375	.150	1.1974	.3147	.1101	4-	213	.873	.500	1.0454	.2747	.0253
3+	171	.375	.333	1.2041	.3164	.1139	4+	227	.873	.267	1.1050	.2904	.0586
3+	176	.375	.500	1.1971	.3146	.1100	4+	230	.873	.450	1.1321	.2975	.0737
3+	184	.375	.667	.7529	.1979	-.1379	4+	233	.873	.695	.8632	.2269	-.0763
3+	190	.375	.850	.7757	.2039	-.1252	4+	234	.873	.778	.8243	.2166	-.0980
3+	165	.500	.150	1.1857	.3116	.1036	4+	232	.862	.634	.8122	.2135	-.1048
3+	172	.500	.333	1.2425	.3265	.1353	4+	235	.862	.808	.7442	.1956	-.1427
3+	177	.500	.500	1.2139	.3190	.1194	4+						



TABLE IV.- Continued

(b)  $M = 1.60$ ;  $\alpha = 10^\circ$

$P_t = 54.6 \text{ kPa}$

FIN	TUBE	Y/S	X/C	P/PINF	P/PI2	CP	FIN	TUBE	Y/S	X/C	P/PINF	P/PI2	CP
1-	116	.125	.221	1.1379	.2991	.0770	3+	185	.500	.667	.7721	.2029	-.1272
1-	119	.125	.472	.9094	.2390	-.0505	3+	191	.500	.850	.8631	.2268	-.0764
1-	122	.125	.731	.7062	.1856	-.1639	3+	166	.625	.150	1.3321	.3501	.1853
1-	117	.125	.302	1.0808	.272	.0451	3+	173	.625	.333	1.2868	.3382	.1600
1-	118	.375	.703	.6554	.1723	-.1923	3+	178	.625	.500	1.2294	.3231	.1280
1-	123	.625	.251	1.0860	.2854	.0480	3+	186	.625	.667	.7527	.1978	-.1380
1-	121	.625	.465	1.0727	.2819	.0406	3+	192	.625	.850	.7942	.2087	-.1148
1+	125	.125	.252	1.1073	.2910	.0599	3+	3414	.749	.150	1.2990	.3414	.1669
1+	128	.125	.496	.9233	.2427	-.0428	3+	179	.749	.500	1.2239	.3217	.1249
1+	131	.125	.756	.7161	.1882	-.1584	3+	193	.749	.850	.7674	.2017	-.1298
1+	126	.125	.295	1.1909	.3130	.1065	3+	180	.873	.500	1.1895	.3126	.1057
1+	132	.375	.762	.6630	.1742	-.1881	4-	194	.062	.150	1.6149	.4244	.3431
1+	127	.125	.189	1.2188	.3203	.1221	4-	201	.062	.333	1.6990	.4465	.3901
1+	130	.625	.408	1.1053	.2905	.0587	4-	214	.062	.667	1.3446	.3534	.1823
2-	134	.125	.221	.6164	.1620	-.2141	4-	195	.125	.150	1.6981	.4463	.3896
2-	137	.125	.472	.8292	.2179	-.0953	4-	202	.125	.333	1.7165	.4511	.3998
2-	140	.125	.731	.6895	.1812	-.1733	4-	207	.125	.500	1.5677	.4120	.3168
2-	136	.625	.251	.4688	.1232	-.2964	4-	215	.125	.667	1.3216	.3473	.1794
2-	139	.625	.465	.5141	.1351	-.2712	4-	196	.250	.150	1.7854	.4692	.4383
2+	143	.125	.221	1.6814	.4419	.3802	4-	203	.250	.333	1.7360	.4562	.4107
2+	146	.125	.472	1.5979	.4199	.3336	4-	208	.250	.500	1.5835	.4162	.3256
2+	149	.125	.731	1.2196	.3205	.1225	4-	216	.250	.667	1.2270	.3225	.1267
3-	155	.125	.433	1.2247	.3219	.1254	4-	222	.250	.850	1.2467	.2576	.1376
3-	158	.142	.802	1.1653	.142	.0923	4-	197	.375	.150	1.8509	.4865	.4749
3-	156	.375	.414	1.1430	.3004	.0798	4-	204	.375	.333	1.7685	.4648	.4288
3-	159	.375	.770	.9790	.2573	-.0117	4-	209	.375	.500	1.6337	.4294	.3536
3-	157	.608	.425	1.1337	.2980	.0746	4-	217	.375	.667	1.1325	.2976	.0740
3-	160	.598	.746	.9112	.2395	-.0495	4-	223	.375	.850	1.1770	.3093	.0988
3+	161	.062	.150	1.1590	.3046	.0888	4-	198	.500	.150	1.9066	.5011	.5059
3+	168	.062	.333	1.1977	.3148	.1103	4-	205	.500	.333	1.8158	.4772	.4352
3+	181	.062	.667	1.3007	.3418	.1678	4-	210	.500	.500	1.6580	.4358	.3672
3+	187	.062	.850	1.2702	.3338	.1508	4-	218	.500	.667	1.0560	.2775	.0312
3+	162	.125	.150	1.1538	.3032	.0858	4-	224	.500	.850	1.0855	.2853	.0477
3+	182	.125	.667	1.2291	.3230	.1278	4-	211	.625	.500	1.6729	.4397	.3755
3+	188	.125	.850	1.2637	.3321	.1472	4-	219	.625	.667	1.0374	.2726	.0209
3+	170	.250	.333	1.2428	.3266	.1355	4-	225	.625	.850	1.0272	.2700	.0152
3+	175	.250	.500	1.2728	.3345	.1522	4-	200	.749	.150	2.0280	.5356	.5793
3+	183	.250	.667	1.1115	.2921	.0622	4-	212	.749	.500	1.7257	.4535	.4049
3+	189	.250	.850	1.1336	.2979	.0746	4-	226	.749	.850	1.0690	.2809	.0385
3+	164	.375	.150	1.2547	.3297	.1421	4-	213	.873	.500	1.4732	.3872	.2641
3+	171	.375	.333	1.2455	.3273	.1370	4+	227	.125	.267	.6415	.1686	-.2001
3+	176	.375	.500	1.2403	.3260	.1341	4+	230	.125	.450	.8574	.2253	-.0796
3+	184	.375	.667	.9387	.3267	-.0342	4+	233	.125	.695	.6448	.1695	-.1982
3+	190	.375	.850	1.0389	.3270	.0217	4+	234	.125	.778	.5174	.1360	-.2693
3+	165	.500	.150	1.2729	.3345	.1523	4+	232	.625	.634	.4471	.1175	-.3086
3+	172	.500	.333	1.2949	.3403	.1646	4+	235	.625	.808	.4435	.1166	-.3105
3+	177	.500	.500	1.2581	.3306	.1440	4+	235	.625	.808	.4435	.1166	-.3105

TABLE IV.- Continued

(c)  $M = 1.60$ ;  $\alpha = 20^\circ$  $P_t = 54.6 \text{ kPa}$ 

FIN	TUBE	Y/S	X/C	P/PINF	P/P12	CP	FIN	TUBE	Y/S	X/C	P/PINF	P/P12	CP
1-	116	.125	.221	.7677	.2018	-.1296	3+	185	.500	.667	.8732	.2295	-.0708
1-	119	.125	.472	.5496	.1444	-.2513	3+	191	.625	.850	.9952	.2615	-.0027
1-	122	.125	.731	.3215	.0845	-.3786	3+	166	.625	.150	1.4905	.3917	.2737
1-	117	.272	.302	.7673	.2017	-.1298	3+	173	.625	.333	1.4329	.3766	.2416
1-	123	.375	.703	.4298	.1130	-.3182	3+	178	.625	.500	1.3659	.2590	.2042
1-	118	.625	.251	1.1787	.3098	.0997	3+	186	.625	.667	.8435	.2217	-.0873
1-	121	.625	.465	1.0845	.2850	.0471	3+	192	.625	.850	.9146	.2404	-.0476
1+	125	.125	.252	.7800	.2050	-.1227	3+	167	.749	.150	1.4499	.3811	.2511
1+	128	.125	.496	.5557	.1460	-.2479	3+	179	.749	.500	1.3658	.3589	.2041
1+	131	.125	.756	.3082	.0810	-.3860	3+	193	.749	.850	.8645	.2272	-.0756
1+	126	.375	.255	1.0946	.2877	.0528	3+	180	.873	.500	1.3194	.3468	.1782
1+	132	.375	.762	.4256	.1119	-.3205	4-	194	.862	.150	2.1514	.5654	.6425
1+	127	.625	.189	1.2925	.3397	.1632	4-	201	.862	.333	2.2396	.5886	.6917
1+	130	.625	.408	1.1433	.3005	.0799	4-	214	.862	.667	1.7760	.4668	.4330
2-	134	.125	.221	.2800	.0736	-.4018	4-	195	.125	.150	2.2557	.5928	.7007
2-	137	.125	.472	.5173	.1359	-.2694	4-	202	.125	.333	2.2633	.5948	.7050
2-	140	.125	.731	.5177	.1361	-.2691	4-	207	.125	.500	1.9752	.5191	.5442
2-	136	.625	.251	1.9000	.0499	-.4520	4-	215	.125	.667	1.7694	.4650	.4294
2-	139	.625	.465	1.1703	.0448	-.4630	4-	196	.250	.150	2.3295	.6122	.7419
2+	143	.125	.221	2.2385	.5893	.6911	4-	203	.250	.333	2.2245	.5846	.6833
2+	146	.125	.472	2.0069	.5275	.6199	4-	208	.250	.500	1.9299	.5072	.5189
2+	149	.125	.731	1.5586	.4096	.3117	4-	216	.250	.667	1.7043	.4479	.3930
3-	155	.142	.633	1.3710	.3603	.2070	4-	222	.250	.850	1.5845	.4164	.3261
3-	158	.142	.802	1.6196	.4257	.3458	4-	197	.375	.150	2.3670	.6221	.7628
3-	156	.375	.414	1.2356	.3247	.1315	4-	204	.375	.333	2.2458	.5902	.6952
3-	159	.375	.770	1.1788	.3098	.0998	4-	209	.375	.500	1.9571	.5143	.5341
3-	157	.608	.425	1.2566	.3302	.1432	4-	217	.375	.667	1.6431	.4318	.3589
3-	160	.608	.746	.9970	.2650	-.0017	4-	223	.375	.850	1.5503	.4074	.3071
3+	161	.062	.150	1.3438	.3532	.1918	4-	198	.500	.150	2.4039	.6318	.7834
3+	168	.062	.333	1.3737	.3610	.2085	4-	205	.500	.333	2.2589	.5937	.7025
3+	181	.062	.667	1.6013	.4208	.3355	4-	210	.500	.500	1.9424	.5105	.5299
3+	187	.062	.850	1.6220	.4263	.3471	4-	218	.500	.667	1.5909	.4181	.3297
3+	162	.125	.150	1.3326	.3502	.1856	4-	224	.500	.850	1.5404	.6048	.6048
3+	182	.125	.667	1.5851	.4166	.3265	4-	211	.625	.500	1.9366	.5090	.5227
3+	188	.125	.850	1.5937	.4188	.3313	4-	219	.625	.667	1.5596	.4099	.3123
3+	170	.250	.333	1.4011	.3682	.2238	4-	225	.625	.850	1.5638	.4110	.3146
3+	175	.250	.500	1.4517	.3815	.2521	4-	200	.749	.150	2.3958	.6297	.7789
3+	183	.250	.667	1.4012	.3683	.2239	4-	212	.749	.500	1.9633	.5160	.5376
3+	189	.375	.850	1.4533	.3820	.2530	4-	226	.749	.850	1.6270	.4276	.3499
3+	164	.375	.150	1.4261	.3748	.2378	4-	213	.873	.500	1.6577	.4357	.3670
3+	171	.375	.333	1.3911	.3656	.2183	4+	227	.873	.500	2.088	.4415	-.4415
3+	176	.375	.500	1.3782	.3622	.2111	4+	230	.873	.450	.5016	.1318	-.2781
3+	184	.375	.667	1.0627	.2793	.0350	4+	233	.873	.695	.4232	.1112	-.3219
3+	190	.375	.850	1.2603	.3312	.1452	4+	234	.873	.778	.2051	.0539	-.4436
3+	165	.500	.150	1.4499	.3811	.2511	4+	232	.625	.634	.2476	.0651	-.4199
3+	172	.500	.333	1.4378	.3779	.2443	4+	235	.625	.808	.2479	.0651	-.4197
3+	177	.500	.500	1.3846	.3639	.2146	4+	235	.625	.808	.2479	.0651	-.4197

TABLE IV.- Continued

(d) M = 1.60;  $\alpha = 30^\circ$

$P_t = 54.6 \text{ kPa}$

FIN	TUBE	Y/S	X/C	P/PINF	P/PI2	CP	FIN	TUBE	Y/S	X/C	P/PINF	P/PI2	CP
1-	116	.125	.221	.5104	.1341	-.2732	3+	185	.500	.667	1.2121	.3186	.1184
1-	119	.125	.472	.3540	.0930	-.3605	3+	191	.500	.850	1.3006	.3418	.1678
1-	122	.125	.731	.2256	.0593	-.4321	3+	166	.625	.150	1.8050	.4744	.4492
1-	117	.272	.302	.4594	.1207	-.3017	3+	173	.625	.333	1.8383	.4831	.4678
1-	123	.375	.703	.1753	.0461	-.4602	3+	178	.625	.500	1.8658	.4904	.4832
1-	118	.625	.251	.6960	.1829	-.1697	3+	186	.625	.667	1.1864	.3118	.1040
1-	121	.625	.465	.5417	.1424	-.2558	3+	192	.625	.850	1.2307	.3234	.1287
1+	125	.125	.252	.6592	.1733	-.1902	3+	167	.749	.150	1.7571	.4618	.4225
1+	128	.125	.496	.4062	.1068	-.3314	3+	179	.749	.500	1.7221	.4526	.4030
1+	131	.125	.756	.2098	.0551	-.4409	3+	193	.749	.850	1.1630	.3056	.0910
1+	126	.375	.255	.6256	.1644	-.2090	3+	180	.873	.500	1.6229	.4265	.3476
1+	132	.375	.762	.2081	.0547	-.4419	3+	194	.862	.150	2.6774	.7037	.9360
1+	127	.625	.189	.6497	.1707	-.1955	4-	201	.062	.333	2.6953	.7084	.9461
1+	130	.625	.408	.5474	.1439	-.2526	4-	214	.062	.667	2.1715	.5707	.6537
2-	134	.125	.221	.1395	.0367	-.4802	4-	195	.125	.150	2.8393	.7462	1.0264
2-	137	.125	.472	.3201	.0841	-.3794	4-	202	.125	.333	2.8003	.7360	1.0046
2-	140	.125	.731	.3502	.0920	-.3626	4-	207	.125	.500	2.3863	.6272	.6693
2-	136	.625	.251	.1305	.0343	-.4852	4-	215	.125	.667	2.1995	.5781	.6693
2-	139	.625	.465	.1394	.0366	-.4803	4-	196	.250	.150	2.8640	.7527	1.0402
2+	143	.125	.221	.27672	.17272	-.9861	4-	203	.250	.333	2.7397	.7200	.9708
2+	146	.125	.472	2.4176	.6354	.7911	4-	208	.250	.500	2.3811	.6256	.7707
2+	149	.125	.731	2.0661	.5430	.5949	4-	216	.250	.667	2.1331	.5606	.6323
3-	155	.142	.433	2.0598	.5413	.5914	4-	222	.250	.850	1.9996	.5255	.5578
3-	158	.375	.802	2.0210	.5312	.5698	4-	197	.375	.150	2.8042	.7370	1.0068
3-	156	.375	.414	1.6732	.4397	.3757	4-	204	.375	.333	2.6666	.7008	.9300
3-	159	.375	.770	1.5260	.4010	.2935	4-	209	.375	.500	2.3836	.6265	.7721
3-	157	.608	.425	1.5490	.4071	.3064	4-	217	.375	.667	2.1014	.5523	.6146
3-	160	.658	.746	1.3064	.3434	.1710	4-	223	.375	.850	1.9381	.5094	.5235
3+	161	.062	.150	1.7224	.4527	.4031	4-	198	.500	.150	2.7536	.7237	.9786
3+	168	.062	.333	1.9146	.5032	.5104	4-	205	.500	.333	2.6377	.6932	.9139
3+	181	.062	.667	1.9303	.5193	.5193	4-	210	.500	.500	2.3256	.6112	.7397
3+	187	.062	.850	1.9778	.5198	.5457	4-	218	.500	.667	2.0917	.5497	.6092
3+	182	.125	.150	1.7110	.4497	.3968	4-	224	.500	.850	1.9041	.5004	.5045
3+	182	.125	.667	1.8889	.4964	.4860	4-	211	.625	.500	2.3132	.6079	.7328
3+	188	.125	.850	1.9481	.5120	.5291	4-	219	.625	.667	2.1086	.6255	.6186
3+	170	.250	.333	1.9478	.5119	.5289	4-	225	.625	.850	1.9141	.5031	.5101
3+	175	.250	.500	2.1175	.5565	.6236	4-	200	.749	.150	2.6512	.6966	.9215
3+	183	.250	.667	1.6611	.4366	.3689	4-	212	.749	.500	2.3183	.6093	.7357
3+	189	.250	.850	1.8314	.4813	.4640	4-	226	.749	.850	1.9937	.5240	.5545
3+	164	.375	.150	1.7841	.4376	.4376	4-	213	.873	.500	2.1867	.5747	.6622
3+	171	.375	.333	1.9734	.5432	.5432	4+	227	.873	.267	.1358	.0357	-.4822
3+	176	.375	.500	2.0868	.5484	.6055	4+	230	.125	.625	.1502	.0395	-.4742
3+	184	.375	.667	1.2684	.3333	.1498	4+	233	.125	.695	.2744	.0721	-.4049
3+	190	.375	.850	1.6252	.4271	.3489	4+	234	.125	.778	.1100	.0289	-.4966
3+	165	.500	.150	1.7852	.4382	.4382	4+	232	.625	.634	.1638	.0431	-.4666
3+	172	.500	.333	1.9143	.5031	.5102	4+	235	.625	.808	.1273	.0335	-.4870
3+	177	.500	.500	1.9694	.5152	.5359	4+	235	.625	.808	.1273	.0335	-.4870

TABLE IV.- Continued

(e)  $M = 1.60$ ;  $\alpha = 40^\circ$

$P_t = 54.7$  kPa

FIN	TUBE	Y/S	X/G	P/PINF	P/PI2	CP	FIN	TUBE	Y/S	X/G	P/PINF	P/PI2	CP
1-	116	.125	.221	.5458	.1434	-.2535	3+	185	.500	.667	1.6678	.4383	.3726
1-	119	.125	.472	.3564	.0937	-.3592	3+	191	.500	.850	1.9754	.5192	.5443
1-	122	.125	.731	.2372	.0624	-.4256	3+	166	.625	.150	2.4137	.6344	.7889
1-	117	.272	.302	.4285	.1126	-.3189	3+	173	.625	.333	2.4431	.6421	.8053
1-	123	.375	.323	.2580	.0678	-.4141	3+	178	.625	.500	2.1494	.5649	.6414
1-	118	.625	.251	.3466	.0911	-.3646	3+	186	.625	.667	1.7161	.4510	.3996
1-	121	.625	.465	.3985	.1047	-.3357	3+	192	.625	.850	1.7263	.4537	.4053
1+	125	.125	.252	.3806	.1000	-.3456	3+	167	.749	.150	2.3498	.6176	.7533
1+	128	.125	.496	.2579	.0678	-.4141	3+	179	.749	.500	2.0862	.5483	.6061
1+	131	.125	.756	.1611	.0423	-.4681	3+	193	.749	.850	1.6754	.4403	.3769
1+	126	.375	.255	.3109	.0817	-.3845	3+	180	.873	.500	2.0646	.5426	.5941
1+	132	.375	.762	.1893	.0498	-.4242	4-	194	.873	.150	2.9411	.7730	1.0832
1+	127	.625	.189	.3666	.0902	-.3666	4-	201	.873	.333	3.2355	.8503	1.2475
1+	130	.625	.408	.3454	.0908	-.3653	4-	214	.873	.667	2.6732	.7025	.9337
2-	134	.125	.221	.1021	.0268	-.5011	4-	195	.125	.150	3.3370	.8823	1.3153
2-	137	.125	.472	.1501	.0395	-.4743	4-	202	.125	.333	3.2736	.8604	1.2688
2-	140	.125	.731	.1679	.0441	-.4644	4-	207	.125	.500	2.8852	.7583	1.0520
2-	136	.625	.251	.1064	.0280	-.4986	4-	215	.125	.667	2.6932	.7078	.9449
2-	139	.625	.465	.1092	.0287	-.4971	4-	196	.250	.150	3.3294	.8750	1.2999
2+	143	.125	.221	.32933	.0855	1.2797	4-	203	.250	.333	3.1520	.8284	1.2009
2+	146	.125	.472	2.9015	.7626	1.0611	4-	208	.250	.500	2.8485	.7486	1.0316
2+	149	.125	.731	2.5973	.6826	.8914	4-	216	.250	.667	2.6432	.6947	.9169
3-	155	.142	.433	2.4535	.6448	.8111	4-	222	.250	.850	2.4801	.6518	.8259
3-	158	.142	.802	2.6149	.6872	.9012	4-	197	.375	.150	3.1899	.8384	1.2220
3-	156	.375	.414	2.2891	.6042	.7449	4-	204	.375	.333	3.0625	.8049	1.1510
3-	159	.375	.770	2.2855	.6009	.7179	4-	209	.375	.500	2.8323	.7444	1.0225
3-	157	.508	.425	1.9744	.5189	.5437	4-	217	.375	.667	2.6046	.6845	.8954
3-	160	.558	.746	1.6419	.4315	.3582	4-	223	.375	.850	2.4167	.6351	.7906
3+	161	.062	.150	2.5506	.6703	.8653	4-	198	.500	.150	3.0951	.8134	1.1691
3+	168	.062	.333	2.8151	.7398	1.0129	4-	205	.500	.333	3.0182	.7932	1.1262
3+	181	.062	.667	2.5041	.6581	.8353	4-	210	.500	.500	2.7810	.7309	.9938
3+	187	.062	.850	2.5848	.6793	.8844	4-	218	.500	.667	2.5788	.6777	.8810
3+	162	.125	.150	2.5848	.6793	.8844	4-	224	.500	.850	2.3875	.7743	.9771
3+	182	.125	.667	2.4551	.6452	.8120	4-	211	.625	.500	2.7510	.7230	.9771
3+	188	.125	.850	2.5649	.6741	.8732	4-	219	.625	.667	2.5647	.6740	.8731
3+	170	.250	.333	2.6254	.6900	.9070	4-	225	.625	.850	2.3665	.6219	.7625
3+	175	.250	.500	2.3732	.6237	.7663	4-	200	.749	.150	2.9314	.7704	1.0778
3+	183	.250	.667	2.3763	.6245	.7660	4-	212	.749	.500	2.7246	.7161	.9624
3+	189	.250	.850	2.4954	.6558	.8345	4-	226	.749	.850	2.3868	.6273	.7739
3+	164	.375	.150	2.5615	.6732	.8713	4-	213	.873	.500	2.5807	.6782	.8821
3+	171	.375	.333	2.5418	.6680	.8604	4+	227	.873	.267	.1035	.0272	-.5003
3+	176	.375	.500	2.2638	.7052	.7052	4+	230	.125	.450	.1536	.0404	-.4723
3+	184	.375	.667	1.7077	.4488	.3949	4+	233	.125	.695	.2214	.0582	-.4345
3+	190	.375	.850	2.4717	.6496	.8213	4+	234	.125	.778	.1351	.0351	-.4826
3+	165	.500	.150	2.4959	.6559	.8347	4+	232	.625	.634	.1864	.0490	-.4540
3+	172	.500	.333	2.4793	.6516	.8255	4+	235	.625	.808	.1499	.0394	-.4744
3+	177	.500	.500	2.2501	.5913	.6976	4+	235	.625	.808	.1499	.0394	-.4744

TABLE IV.- Continued

(f) M = 1.60;  $\alpha = 50^\circ$

$p_t = 54.7$  kPa

FIN	TUBE	Y/S	X/C	P/PINF	P/PT2	CP	FIN	TUBE	Y/S	X/C	P/PINF	P/PT2	CP
1-	116	.125	.221	.2659	.0599	-.4097	3+	185	.500	.667	2.3121	.6077	.7322
1-	119	.472	.472	.2314	.0608	-.4289	3+	191	.500	.850	2.7039	.500	.9508
1-	122	.125	.731	.3587	.0943	-.3579	3+	166	.625	.150	2.6600	.6991	.9264
1-	117	.272	.302	.3175	.0834	-.3809	3+	173	.625	.333	2.6168	.6877	.9023
1-	123	.375	.703	.2909	.0765	-.3957	3+	178	.625	.500	2.2721	.5971	.7099
1-	118	.625	.251	.4275	.1124	-.3195	3+	186	.625	.667	2.0553	.5402	.5889
1-	121	.625	.465	.4683	.1231	-.2967	3+	192	.625	.850	2.6408	.6940	.9156
1+	125	.125	.252	.2782	.0731	-.4028	3+	1423	.749	.150	2.5423	.6682	.8607
1+	128	.125	.496	.3319	.0872	-.3728	3+	179	.749	.500	2.1949	.5769	.6668
1+	131	.125	.756	.3288	.0864	-.3745	3+	193	.749	.850	2.1698	.5703	.6528
1+	126	.375	.255	.3694	.0971	-.3519	3+	180	.873	.500	2.1640	.5687	.6496
1+	132	.375	.762	.3085	.0811	-.3859	4-	194	.062	.150	3.7671	.9901	1.5442
1+	127	.625	.189	.4827	.1268	-.2887	4-	201	.062	.333	3.6236	.9523	1.4641
1+	130	.625	.408	.4303	.1131	-.3179	4-	214	.062	.667	3.0766	.8086	1.1588
2-	134	.125	.221	.2011	.0528	-.4458	4-	195	.125	.150	3.7675	.9902	1.5444
2-	137	.125	.472	.2841	.0747	-.3995	4-	202	.125	.333	3.5713	.9386	1.4349
2-	140	.125	.731	.2975	.0782	-.3920	4-	207	.125	.500	3.2958	.8662	1.2812
2-	136	.625	.251	.3165	.0832	-.3814	4-	215	.125	.667	3.0819	.8100	1.1618
2-	139	.625	.465	.3024	.0795	-.3893	4-	196	.250	.150	3.5139	.9235	1.4029
2+	143	.125	.221	3.6361	.9556	1.4711	4-	203	.250	.333	3.4205	.8990	1.3507
2+	146	.125	.472	3.2923	.8653	1.2792	4-	208	.250	.500	3.2067	.8428	1.2314
2+	149	.125	.731	2.9755	.7820	1.1024	4-	216	.250	.667	3.0023	.7891	1.1174
3-	155	.142	.433	2.8950	.7609	1.0575	4-	222	.250	.850	2.7613	.7257	.9829
3-	158	.142	.802	2.9627	.7786	1.0952	4-	197	.375	.150	3.3976	.8929	1.3380
3-	156	.375	.414	2.6641	.7002	.9286	4-	204	.375	.333	3.3365	.8769	1.3039
3-	159	.375	.770	2.8246	.7423	1.0182	4-	209	.375	.500	3.1633	.8314	1.2072
3-	157	.608	.425	2.3163	.6088	.7346	4-	217	.375	.667	2.9391	.7724	1.0821
3-	160	.558	.746	2.7064	.7113	.9523	4-	223	.375	.850	2.6830	.7051	.9392
3+	161	.062	.150	3.1667	.8322	1.2091	4-	198	.500	.150	3.2958	.8662	1.2812
3+	168	.062	.333	3.1955	.8398	1.2252	4-	205	.500	.333	3.2760	.8610	1.2701
3+	181	.062	.667	2.9728	.7813	1.1009	4-	210	.500	.500	3.0976	.8141	1.1705
3+	187	.062	.850	2.9533	.7762	1.0900	4-	218	.500	.667	2.8893	.7594	1.0543
3+	162	.125	.150	3.1352	.8240	1.1915	4-	224	.500	.850	2.6324	.6918	.9109
3+	182	.125	.667	2.9216	.7679	1.0723	4-	211	.625	.500	3.0420	.7995	1.1395
3+	188	.125	.850	2.9098	.7647	1.0657	4-	219	.625	.667	2.8443	.7475	1.0292
3+	170	.250	.333	2.9789	.7829	1.1043	4-	225	.625	.850	2.5883	.6802	.8863
3+	175	.250	.500	2.7159	.7138	.9575	4-	200	.749	.150	3.0971	.8140	1.1703
3+	183	.250	.667	2.8590	.7514	1.0374	4-	212	.749	.500	2.9755	.7820	1.1024
3+	189	.250	.850	2.8342	.7449	1.0236	4-	226	.749	.850	2.5713	.6758	.8768
3+	164	.375	.150	2.9136	.7657	1.0678	4-	213	.873	.500	2.8051	.7372	1.0073
3+	171	.375	.333	2.8343	.7449	1.0236	4+	227	.873	.267	.2225	.0583	-.4339
3+	176	.375	.500	2.8211	.6626	.8488	4+	230	.125	.450	.2102	.0553	-.4407
3+	184	.375	.667	2.6718	.7022	.9329	4+	233	.125	.695	.2556	.0672	-.4154
3+	190	.375	.850	2.7621	.7259	.9833	4+	234	.125	.667	.2542	.0668	-.4162
3+	165	.500	.150	2.7922	.7338	1.0001	4+	232	.375	.634	.3296	.0866	-.3741
3+	172	.500	.333	2.7103	.7123	.9544	4+	235	.625	.808	.2853	.0750	-.3988
3+	177	.500	.500	2.4234	.6369	.7943	4+						

TABLE IV.- Continued

(g) M = 2.70;  $\alpha = 0^\circ$  $P_t = 90.3 \text{ kPa}$ 

FIN	TUBE	Y/S	X/C	P/PINF	P/PI2	CP	FIN	TUBE	Y/S	X/C	P/PINF	P/PI2	CP
1-	116	.125	.221	1.2800	.1298	-.0549	3+	185	.500	.667	.7590	.0770	-.0472
1-	119	.125	.472	14.5866	1.4790	2.6625	3+	191	.500	.850	.6970	.0707	-.0594
1-	122	.125	.731	.8225	.0834	-.0338	3+	166	.625	.150	1.5234	.1545	.1026
1-	117	.272	.302	1.2378	.1255	-.0466	3+	173	.625	.333	1.4408	.1333	.0864
1-	123	.375	.703	.7467	.0757	-.0496	3+	178	.625	.500	1.3745	.1394	.0734
1-	118	.625	.251	1.2964	.1314	.0581	3+	186	.625	.667	.7553	.0766	-.0480
1+	121	.625	.465	1.9438	.1971	.1850	3+	192	.625	.850	.7021	.0712	-.0584
1+	125	.125	.252	1.2385	.1256	-.0467	3+	167	.749	.150	1.4907	.1511	.0962
1+	128	.125	.496	1.1764	.1193	.0346	3+	179	.749	.500	1.3268	.1345	.0640
1+	131	.125	.756	.8196	.0831	-.0353	3+	193	.749	.850	.7058	.0716	-.0576
1+	126	.375	.255	1.4997	.1521	-.0979	3+	180	.873	.500	1.2855	.1303	.0559
1+	132	.375	.762	.7666	.0777	-.0457	4-	194	.062	.150	1.0920	.1107	.0180
1+	127	.625	.189	1.4827	.1503	.0946	4-	201	.062	.333	1.1576	.1174	.0309
1+	130	.625	.408	1.4206	.1440	.0824	4-	214	.062	.667	.8065	.0818	-.0379
2-	134	.125	.221	1.3054	.1324	-.0599	4-	195	.125	.150	1.1606	.1177	.0315
2-	137	.125	.472	1.1970	.1214	-.0386	4-	202	.125	.333	1.1779	.1194	.0349
2-	140	.125	.731	.8219	.0833	-.0349	4-	207	.125	.500	1.0677	.1083	.0133
2-	136	.625	.251	1.4507	.1471	.0883	4-	215	.125	.667	.7656	.0776	-.0459
2-	139	.625	.465	1.6033	.1423	.0790	4-	196	.250	.150	1.3321	.1351	.0651
2+	143	.125	.221	1.1678	.1184	.0329	4-	203	.250	.333	1.2133	.1230	.0418
2+	146	.125	.472	1.1351	.1151	.0265	4-	208	.250	.500	1.1399	.1156	.0274
2+	149	.125	.731	.7698	.0781	-.0451	4-	216	.250	.667	.7132	.0723	-.0562
3-	155	.142	.433	1.1754	.1182	.0344	4-	222	.250	.850	.7313	.0741	-.0527
3-	158	.142	.802	.7626	.0773	-.0465	4-	197	.250	.150	1.3801	.1399	.0745
3-	156	.375	.414	1.2757	.1293	.0540	4-	204	.375	.333	1.3048	.1323	.0597
3-	159	.375	.770	.7882	.0799	-.0415	4-	209	.375	.500	1.2277	.1245	.0446
3-	157	.608	.425	1.2278	.1245	.0446	4-	217	.375	.667	.6892	.0699	-.0609
3-	160	.558	.746	.8817	.0894	-.0232	4-	223	.375	.850	.7195	.0729	-.0550
3+	161	.062	.150	1.1816	.1198	.0356	4-	198	.500	.150	1.3981	.1418	.0780
3+	168	.062	.333	1.1995	.1216	.0391	4-	205	.500	.333	1.3340	.1353	.0634
3+	181	.062	.667	.8320	.0844	-.0329	4-	210	.500	.500	1.2528	.1270	.0495
3+	187	.062	.850	.8338	.0845	-.0326	4-	218	.500	.667	.7176	.0728	-.0553
3+	182	.125	.150	1.2140	.1231	.0419	4-	224	.500	.850	.6970	.0707	-.0594
3+	182	.125	.667	.7795	.0790	-.0432	4-	221	.625	.500	1.2661	.1284	.0521
3+	180	.250	.850	.8063	.0818	-.0380	4-	219	.625	.667	.7095	.0719	-.0569
3+	178	.250	.333	1.3488	.1368	.0684	4-	225	.625	.850	.6723	.0682	-.0642
3+	175	.250	.500	1.3142	.1332	.0616	4-	200	.749	.150	1.4206	.1440	.0824
3+	183	.250	.667	.7207	.0731	-.0547	4-	212	.749	.500	1.2967	.1315	.0581
3+	189	.250	.850	.7187	.0729	-.0551	4-	226	.749	.850	.7077	.0718	-.0573
3+	164	.375	.150	1.4229	.1443	.0829	4-	213	.873	.500	1.1008	.1116	.0198
3+	171	.375	.333	1.4162	.1436	.0816	4+	227	.873	.267	1.2680	.1286	.0525
3+	176	.375	.500	1.3764	.1396	.0738	4+	230	.873	.450	1.2373	.1255	.0465
3+	184	.375	.667	.7341	.0744	-.0521	4+	233	.873	.695	.7573	.0768	-.0476
3+	190	.375	.850	.6973	.0707	-.0593	4+	234	.873	.778	.7398	.0750	-.0510
3+	165	.500	.150	1.4233	.1443	.0829	4+	232	.625	.634	.8797	.0892	-.0236
3+	172	.500	.333	1.4419	.1462	.0866	4+	235	.625	.808	.7858	.0797	-.0420
3+	177	.500	.500	1.4382	.1458	.0859	4+	235	.625	.808	.7858	.0797	-.0420

TABLE IV.- Continued

(h)  $M = 2.70$ ;  $\alpha = 10^\circ$

$P_t = 90.5$  kPa

FIN	TUBE	Y/S	X/C	P/PINF	P/PT2	CP	FIN	TUBE	Y/S	X/C	P/PINF	P/PT2	CP	FIN	TUBE	Y/S	X/C	P/PINF	P/PT2	CP	
1-	116	.125	.221	1.2317	.1249	.0454	3+	185	.500	.667	.8139	.0825	-.0365								
1-	119	.125	.472	1.5835	1.4787	2.6619	3+	191	.500	.850	.7552	.0766	-.0480								
1-	122	.125	.731	.6258	.0634	-.0733	3+	166	.625	.150	1.8657	.1689	.1304								
1-	117	.272	.302	1.2725	.1290	.0534	3+	173	.625	.333	1.5746	.1597	.1126								
1-	123	.375	.703	.7486	.0759	-.0493	3+	178	.625	.500	1.5002	.1521	.0980								
1-	118	.625	.251	1.2358	.1253	.0462	3+	186	.625	.667	.8091	.0820	-.0374								
1-	121	.625	.465	1.9147	.1941	.1792	3+	192	.625	.850	.7500	.0760	-.0490								
1+	125	.125	.252	1.1491	.1165	.0292	3+	167	.749	.150	1.6411	.1664	.1256								
1+	128	.125	.496	1.0041	.1018	.0008	3+	179	.749	.500	1.4787	.1499	.0938								
1+	131	.125	.756	.5833	.0591	-.0816	3+	193	.749	.850	.7710	.0762	-.0449								
1+	126	.375	.255	1.4691	.1490	.0919	3+	180	.873	.500	1.4162	.1436	.0816								
1+	132	.375	.762	.7687	.0779	-.0453	4-	194	.062	.150	2.1578	.2188	.2269								
1+	127	.625	.189	1.4660	.1486	.0913	4-	201	.062	.333	2.2233	.2254	.2397								
1+	130	.625	.408	1.3937	.1413	.0771	4-	214	.062	.667	1.5341	.1555	.1047								
2-	134	.125	.221	4.913	.0498	-.0997	4-	195	.125	.150	2.3105	.2343	.2568								
2-	137	.125	.472	.4807	.0487	-.1018	4-	202	.125	.333	2.2582	.2290	.2466								
2-	140	.125	.731	.4340	.0440	-.1109	4-	207	.125	.500	2.0398	.2068	.2038								
2-	136	.625	.251	.5657	.0574	-.0851	4-	215	.125	.667	1.4786	.1499	.0938								
2-	139	.625	.465	.5279	.0535	-.0925	4-	196	.250	.150	2.6903	.2728	.3312								
2+	143	.125	.221	2.2159	.2247	.2383	4-	203	.250	.333	2.3741	.2407	.2693								
2+	146	.125	.472	2.0757	.2105	.2108	4-	208	.250	.500	2.1556	.2186	.2265								
2+	149	.125	.731	1.4731	.1494	.0927	4-	216	.250	.667	1.4234	.1443	.0830								
3-	155	.142	.433	1.2636	.1281	.0517	4-	222	.250	.850	1.3679	.1387	.0721								
3-	158	.142	.802	.8469	.0859	-.0300	4-	197	.375	.150	2.9007	.2941	.3725								
3-	156	.375	.414	1.4510	.1471	.0884	4-	204	.375	.333	2.5392	.2575	.3016								
3-	159	.608	.770	.8786	.0891	-.0238	4-	209	.375	.500	2.3358	.2368	.2618								
3-	157	.608	.425	1.3346	.1353	.0656	4-	217	.375	.667	1.3649	.1384	.0715								
3-	160	.558	.746	.9706	.0984	-.0058	4-	223	.375	.850	1.2450	.1262	.0480								
3+	161	.062	.150	1.3430	.1362	.0672	4-	198	.500	.150	3.0723	.3115	.4061								
3+	168	.062	.333	1.3523	.1371	.0690	4-	205	.500	.333	2.7051	.2743	.3341								
3+	181	.062	.667	.9028	.0915	-.0190	4-	210	.500	.500	2.4164	.2450	.2776								
3+	187	.062	.850	.9831	.0997	-.0033	4-	218	.500	.667	1.4227	.1442	.0828								
3+	162	.125	.150	1.4125	.1432	.0808	4-	224	.500	.850	1.2311	.1248	.0453								
3+	182	.125	.667	.8403	.0852	-.0313	4-	211	.625	.500	2.5613	.2597	.3060								
3+	188	.125	.850	.8783	.0890	-.0239	4-	219	.625	.667	1.4580	.1478	.0897								
3+	170	.250	.333	1.5597	.1581	.1097	4-	225	.625	.850	1.3293	.1348	.0645								
3+	175	.250	.500	1.4631	.1483	.0907	4-	200	.749	.150	3.3037	.3352	.4518								
3+	183	.250	.667	.7708	.0782	-.0449	4-	212	.749	.500	2.7332	.2771	.3396								
3+	189	.250	.850	.7964	.0807	-.0399	4-	226	.749	.850	1.5010	.1522	.0982								
3+	164	.375	.150	1.5839	.1606	.1144	4-	213	.873	.500	2.4226	.2456	.2788								
3+	171	.375	.333	1.5794	.1601	.1135	4+	227	.125	.267	.4785	.0483	-.1026								
3+	176	.375	.500	1.5527	.1574	.1083	4+	230	.125	.450	5.021	.0509	-.0976								
3+	184	.375	.667	.8136	.0825	-.0365	4+	233	.125	.695	.3986	.0404	-.1178								
3+	190	.375	.850	.7511	.0762	-.0488	4+	234	.375	.778	.4645	.0471	-.1049								
3+	165	.500	.150	1.5988	.1621	.1173	4+	232	.625	.634	.4730	.0480	-.1033								
3+	172	.500	.333	1.5891	.1611	.1154	4+	235	.625	.806	.4911	.0498	-.0997								
3+	177	.500	.500	1.5850	.1607	.1146	4+	235	.625	.806	.4911	.0498	-.0997								

TABLE IV.- Continued

(i)  $M = 2.70$ ;  $\alpha = 20^\circ$

$P_t = 90.5$  kPa

FIN	TUBE	Y/S	X/C	P/PINF	P/PI2	CP	FIN	TUBE	Y/S	X/C	P/PINF	P/PI2	CP
1-	116	.125	.221	.5797	.0598	-.0824	3+	185	.500	.667	1.2133	.1230	.0418
1-	119	.125	.472	.4128	.0419	-.1151	3+	191	.500	.850	1.1430	.1159	.0280
1-	122	.125	.731	.3037	.0308	-.1365	3+	166	.625	.333	2.3591	.2392	.2663
1-	117	.272	.302	.4587	.0465	-.1061	3+	173	.625	.500	2.2422	.2273	.2434
1-	123	.375	.703	.2829	.0287	-.1405	3+	178	.625	.500	2.1438	.2174	.2241
1-	118	.625	.251	1.2618	.1279	.0513	3+	186	.625	.667	1.1791	.1195	.0351
1-	121	.625	.465	1.3769	.1396	.0739	3+	182	.625	.850	1.1084	.1124	.0212
1+	125	.125	.252	.5746	.0583	-.0834	3+	167	.749	.150	2.2533	.2285	.2456
1+	128	.125	.496	.4507	.0457	-.1076	3+	179	.749	.500	2.0719	.2101	.2101
1+	131	.125	.756	.2677	.0271	-.1435	3+	193	.749	.850	1.0959	.1111	.0188
1+	126	.375	.255	.6364	.0645	-.0713	3+	180	.873	.500	1.5057	.1527	.0991
1+	132	.375	.762	.2879	.0292	-.1395	4-	194	.062	.150	3.1839	.3228	.4280
1+	127	.625	.189	1.4467	.1467	.0875	4-	201	.062	.333	3.5539	.3603	.5005
1+	130	.625	.408	1.3884	.1408	.0761	4-	214	.062	.667	2.4783	.2513	.2897
2-	134	.125	.221	.2374	.0241	-.1494	4-	195	.125	.150	3.4467	.3393	.4599
2-	137	.125	.472	.2374	.0241	-.1494	4-	202	.125	.333	3.5316	.3581	.4961
2-	140	.125	.731	.2636	.0267	-.1443	4-	207	.125	.500	3.4349	.3483	.4772
2-	136	.625	.251	2.2904	.2294	-.1391	4-	215	.125	.667	2.4065	.2440	.2756
2-	139	.625	.465	2.7556	.2756	-.1419	4-	196	.250	.150	3.8012	.3854	.5489
2+	143	.125	.221	3.3587	.3406	.4622	4-	203	.250	.333	3.5948	.3645	.5085
2+	146	.125	.472	3.4235	.3471	.4749	4-	208	.250	.500	3.4576	.3506	.4816
2+	149	.125	.731	2.4362	.2470	.2814	4-	216	.250	.667	2.4926	.2527	.2925
3-	155	.142	.433	1.9058	.1932	.1775	4-	222	.250	.850	2.4242	.2458	.2791
3-	158	.142	.802	1.2932	.1311	.0575	4-	197	.375	.150	4.1083	.4164	.6087
3-	156	.375	.414	2.1814	.2112	.2315	4-	204	.375	.333	3.7887	.3841	.5465
3-	159	.375	.770	1.3530	.1372	.0692	4-	209	.375	.500	3.6255	.3676	.5145
3-	157	.608	.425	1.9234	.1950	.1810	4-	217	.375	.667	2.3995	.2433	.2742
3-	160	.608	.746	1.4387	.1459	.0860	4-	223	.375	.850	2.2596	.2291	.2468
3+	161	.062	.150	2.0976	.2127	.2151	4-	198	.500	.150	4.3530	.4414	.6571
3+	168	.062	.333	2.0898	.2119	.2136	4-	205	.500	.333	3.9837	.4039	.5847
3+	181	.062	.667	1.4037	.1423	.0791	4-	210	.500	.500	3.7221	.3774	.5334
3+	187	.062	.850	1.5046	.1526	.0989	4-	218	.500	.667	2.4120	.2446	.2767
3+	162	.125	.150	2.1118	.2141	.2179	4-	224	.500	.850	2.2537	.2285	.2457
3+	182	.125	.667	1.3187	.1337	.0625	4-	211	.625	.500	3.9262	.3981	.5734
3+	188	.125	.850	1.3489	.1368	.0684	4-	219	.625	.667	2.4529	.2487	.2847
3+	170	.250	.333	2.3479	.2381	.2641	4-	225	.625	.850	2.3222	.2355	.2591
3+	175	.250	.500	2.2202	.2251	.2391	4-	200	.749	.150	4.8754	.4943	.7594
3+	183	.250	.667	1.2007	.1217	.0393	4-	212	.749	.500	4.1780	.4236	.6228
3+	189	.250	.850	1.1993	.1216	.0391	4-	226	.749	.850	2.5515	.2587	.3040
3+	164	.375	.150	2.3435	.2376	.2633	4-	213	.873	.500	3.7225	.3774	.5335
3+	171	.375	.333	2.3580	.2391	.2661	4+	227	.125	.667	2.374	.241	-.1494
3+	176	.375	.500	2.3260	.2358	.2598	4+	230	.125	.850	.2374	.0241	-.1494
3+	184	.375	.667	1.2595	.1277	.0509	4+	233	.125	.695	.2374	.0241	-.1494
3+	190	.375	.850	1.1368	.1153	.0268	4+	234	.375	.778	.2482	.0252	-.1473
3+	165	.500	.150	2.3211	.2353	.2589	4+	232	.625	.634	.2565	.0260	-.1457
3+	172	.500	.333	2.3230	.2355	.2593	4+	235	.625	.808	.2740	.0278	-.1423
3+	177	.500	.500	2.2835	.2315	.2515	4+	235	.625	.808	.2740	.0278	-.1423



TABLE IV.- Continued

(j) M = 2.70;  $\alpha = 30^\circ$

$P_t = 90.5$  kPa

FIN	TUBE	Y/S	X/C	P/PINF	P/PT2	CP	FIN	TUBE	Y/S	X/C	P/PINF	P/PT2	CP
1-	116	.125	.422	.4229	.0429	-.1131	3+	185	.500	.667	1.6326	.1655	.1240
1-	119	.125	.721	.2944	.0298	-.1383	3+	191	.500	.850	1.3586	.1377	.0703
1-	122	.125	.731	.2294	.0233	-.1510	3+	166	.625	.150	1.8225	.1645	.1220
1-	117	.272	.302	.3649	.0370	-.1245	3+	173	.625	.333	1.7616	.1786	.1492
1-	123	.375	.703	.1723	.0175	-.1622	3+	178	.625	.500	1.6887	.1712	.1350
1-	118	.625	.251	.6023	.0611	-.0779	3+	186	.625	.667	1.0691	.1084	.0135
1-	121	.625	.465	.6007	.0609	-.0782	3+	192	.625	.850	1.0126	.1027	.0025
1+	125	.125	.252	.3469	.0352	-.1280	3+	167	.749	.150	1.5534	.1575	.1084
1+	128	.125	.496	.2824	.0286	-.1406	3+	179	.749	.500	1.4445	.1465	.0871
1+	131	.125	.756	.2387	.0242	-.1492	3+	193	.749	.850	.8384	.0850	-.0317
1+	126	.375	.255	.4415	.0448	-.1094	3+	180	.873	.500	1.3742	.1393	.0733
1+	132	.375	.762	.2387	.0242	-.1492	4-	194	.062	.150	4.9249	.4994	.7691
1+	127	.625	.189	.6490	.0658	-.0688	4-	201	.062	.333	5.3690	.5444	.8562
1+	130	.625	.408	.4772	.0484	-.1024	4-	214	.062	.667	4.2642	.4324	.6397
2-	134	.125	.521	.2387	.0242	-.1492	4-	195	.125	.150	5.1953	.5268	.8221
2-	137	.125	.472	.2387	.0242	-.1492	4-	202	.125	.333	5.6604	.5739	.9133
2-	140	.125	.731	.2387	.0242	-.1492	4-	207	.125	.500	4.9483	.5017	.7737
2-	136	.625	.251	.2387	.0242	-.1492	4-	215	.125	.667	4.0094	.4065	.5897
2-	139	.625	.465	.2393	.0243	-.1491	4-	196	.250	.150	5.5630	.5641	.8942
2+	143	.125	.221	5.1032	.5174	.8041	4-	203	.250	.333	5.4900	.5566	.8799
2+	146	.125	.472	5.4865	.5563	.8792	4-	208	.250	.500	5.1859	.5258	.8203
2+	149	.125	.731	3.9971	.4053	.5873	4-	216	.250	.667	3.8627	.3917	.5610
3-	155	.142	.802	2.8619	.2902	.3649	4-	222	.250	.850	3.9475	.4003	.5776
3-	158	.142	.802	1.9532	.1980	.1868	4-	197	.375	.150	5.8621	.5944	.9528
3-	156	.375	.414	3.1890	.3233	.4290	4-	204	.375	.333	5.6668	.5746	.9145
3-	159	.375	.770	2.0303	.2059	.2019	4-	209	.375	.500	5.3991	.5474	.8621
3-	160	.608	.425	1.5959	.1618	.1168	4-	217	.375	.667	3.7664	.3819	.5421
3+	161	.062	.150	1.2875	.1305	.0563	4-	223	.500	.850	3.7143	.3766	.5319
3+	168	.062	.333	3.2866	.3332	.4481	4-	198	.500	.150	6.1673	.6253	1.0126
3+	181	.062	.667	3.2364	.3282	.4383	4-	205	.500	.333	5.9125	.5995	.9627
3+	187	.062	.850	2.2002	.2231	.2352	4-	210	.500	.500	5.5110	.5588	.8840
3+	182	.125	.150	3.1410	.3185	.4196	4-	218	.500	.667	3.7106	.3762	.5312
3+	188	.125	.667	3.2188	.3264	.4348	4-	224	.500	.850	3.5727	.3622	.5042
3+	170	.250	.850	2.0768	.2106	.2110	4-	211	.625	.500	5.6877	.5767	.9186
3+	175	.250	.333	3.4408	.3489	.4783	4-	225	.625	.667	3.6488	.3700	.5191
3+	177	.250	.500	3.2447	.3290	.4399	4-	200	.749	.850	3.6626	.3714	.5218
3+	183	.250	.667	1.8396	.1865	.1645	4-	212	.749	.150	6.6567	.6749	1.1085
3+	189	.250	.850	1.8992	.1926	.1762	4-	226	.749	.500	5.8740	.5956	.9551
3+	164	.375	.350	3.4625	.3511	.4626	4-	213	.749	.850	3.8218	.3875	.5530
3+	171	.375	.333	3.4670	.3515	.4834	4+	227	.125	.500	5.0047	.5074	.7848
3+	176	.375	.500	3.4034	.3451	.4710	4+	230	.125	.267	2.387	.0242	-1.492
3+	184	.375	.667	1.8367	.1862	.1640	4+	233	.125	.450	2.387	.0242	-1.492
3+	190	.375	.850	1.7221	.1746	.1415	4+	234	.125	.695	2.387	.0242	-1.492
3+	165	.500	.150	2.0894	.2119	.2135	4+	232	.625	.634	2.387	.0242	-1.492
3+	172	.500	.333	1.9839	.2011	.1928	4+	235	.625	.808	2.430	.0246	-1.463
3+	177	.500	.500	2.6087	.2645	.3152	4+						
3+	183	.250	.667	1.8396	.1865	.1645	4-	212	.749	.500	5.8740	.5956	.9551
3+	189	.250	.850	1.8992	.1926	.1762	4-	226	.749	.850	3.8218	.3875	.5530
3+	164	.375	.350	3.4625	.3511	.4626	4-	213	.749	.500	5.0047	.5074	.7848
3+	171	.375	.333	3.4670	.3515	.4834	4+	227	.125	.267	2.387	.0242	-1.492
3+	176	.375	.500	3.4034	.3451	.4710	4+	230	.125	.450	2.387	.0242	-1.492
3+	184	.375	.667	1.8367	.1862	.1640	4+	233	.125	.695	2.387	.0242	-1.492
3+	190	.375	.850	1.7221	.1746	.1415	4+	234	.125	.778	2.387	.0242	-1.492
3+	165	.500	.150	2.0894	.2119	.2135	4+	232	.625	.634	2.387	.0242	-1.492
3+	172	.500	.333	1.9839	.2011	.1928	4+	235	.625	.808	2.430	.0246	-1.463
3+	177	.500	.500	2.6087	.2645	.3152	4+						

TABLE IV.- Continued

(k) M = 2.70;  $\alpha = 40^\circ$

$P_t = 90.5 \text{ kPa}$

FIN	TUBE	Y/S	X/C	P/PINF	P/PT2	CP	FIN	TUBE	Y/S	X/C	P/PINF	P/PT2	CP	FIN	TUBE	Y/S	X/C	P/PINF	P/PT2	CP
1-	116	.125	.221	.3246	.0329	-1.1324	3+	185	.500	.667	1.0958	.1111	.0188							
1-	119	.125	.472	.2441	.0248	-1.1481	3+	191	.500	.850	1.1042	.1120	.0204							
1-	120	.125	.731	.2799	.0284	-1.1411	3+	166	.625	.150	1.6325	.1655	.1260							
1-	117	.272	.302	.2713	.0275	-1.1428	3+	173	.625	.333	1.6318	.1655	.1238							
1-	123	.375	.703	.2541	.0298	-1.1462	3+	178	.625	.500	1.5642	.1586	.1106							
1-	118	.429	.251	.4299	.0436	-1.1117	3+	186	.625	.667	.9068	.0919	-.0183							
1-	121	.625	.465	.5339	.0541	-0.913	3+	192	.625	.850	.9766	.0990	-.0046							
1+	125	.125	.252	.2586	.0262	-1.1453	3+	167	.749	.150	1.5467	.1568	.1071							
1+	128	.125	.496	.2393	.0243	-1.1491	3+	179	.749	.500	1.4260	.1446	.0835							
1+	131	.125	.756	.2449	.0248	-1.1480	3+	193	.749	.850	.9033	.0916	-.0190							
1+	126	.375	.255	.3212	.0326	-1.1330	3+	184	.873	.500	1.3844	.1404	.0753							
1+	132	.375	.762	.2563	.0260	-1.1457	4-	194	.062	.150	1.1802	.0280	1.2111							
1+	127	.625	.189	.4310	.0437	-1.1115	4-	201	.062	.333	7.2660	.7367	1.2279							
1+	130	.625	.408	.4232	.0429	-1.1130	4-	214	.062	.667	5.7490	.5829	.9306							
2-	134	.125	.221	.2389	.0242	-1.1491	4-	195	.125	.150	7.4873	.7592	1.2713							
2-	137	.125	.472	.2389	.0242	-1.1491	4-	202	.125	.333	7.6009	.7707	1.2935							
2-	140	.125	.731	.2389	.0242	-1.1491	4-	207	.125	.500	6.7099	.6803	1.1189							
2-	136	.625	.251	.2389	.0242	-1.1491	4-	215	.125	.667	6.0896	.6174	.9974							
2-	139	.625	.465	.2389	.0242	-1.1491	4-	196	.250	.150	7.7850	.7893	1.3296							
2+	143	.125	.221	7.6845	.7792	1.3099	4-	203	.250	.333	7.5417	.7647	1.2819							
2+	146	.125	.472	7.1362	.7236	1.2025	4-	208	.250	.500	7.0012	.7099	1.1760							
2+	149	.125	.731	5.2684	.5342	.8365	4-	216	.250	.667	6.0180	.6102	.9833							
3-	155	.142	.433	3.9478	.4003	.5777	4-	222	.250	.850	5.5797	.5657	.8975							
3-	158	.142	.802	3.2791	.3325	4.466	4-	197	.375	.150	7.9989	.7907	1.3323							
3-	156	.375	.414	2.3525	.2385	2.650	4-	204	.375	.333	7.7519	.7860	1.3231							
3-	159	.375	.770	1.5034	.1524	.0987	4-	209	.375	.500	7.0055	.7103	1.1769							
3-	157	.608	.425	1.3646	.1384	.0714	4-	217	.375	.667	5.8271	.5908	.9459							
3-	160	.558	.746	1.1736	.1190	.0340	4-	223	.375	.850	5.5260	.5603	.8869							
3+	161	.062	.150	4.7856	.4852	.7418	4-	198	.500	.150	8.0283	.8140	1.3773							
3+	168	.062	.333	4.6044	.4669	.7063	4-	205	.500	.333	7.9546	.8065	1.3628							
3+	181	.062	.667	3.5676	.3617	.5032	4-	210	.500	.500	6.9082	.7004	1.1578							
3+	187	.062	.850	5.2920	.5366	.8411	4-	218	.500	.667	5.7950	.5876	.9396							
3+	162	.125	.150	4.7043	.4770	.7259	4-	224	.500	.850	5.7392	.5819	.9287							
3+	182	.125	.667	3.2071	.3252	.4325	4-	211	.500	.500	6.9670	.7064	1.1693							
3+	188	.125	.850	5.0704	.5141	.7976	4-	219	.625	.667	6.0730	.6158	.9941							
3+	170	.250	.333	4.7260	.4792	.7302	4-	225	.625	.850	5.7612	.5841	.9330							
3+	175	.250	.500	4.4902	.4553	.6840	4-	200	.749	.150	6.2638	.6379	1.4234							
3+	183	.250	.667	2.8422	.2882	.3610	4-	212	.749	.500	7.4093	.7512	1.2560							
3+	189	.250	.850	2.6306	.2667	.3195	4-	226	.749	.850	5.5791	.5657	.8973							
3+	164	.375	.150	2.2710	.2303	.2491	4-	213	.873	.500	5.6277	.5706	.9069							
3+	171	.375	.333	3.3247	.3371	.4555	4+	227	.125	.267	.2389	.262	-.1491							
3+	176	.375	.500	2.8290	.2260	.2408	4+	230	.125	.450	.2389	.267	-.1491							
3+	184	.375	.667	1.4360	.1456	.0854	4+	233	.125	.695	.2389	.267	-.1491							
3+	190	.375	.850	1.4562	.1476	.0894	4+	234	.125	.778	.2389	.267	-.1491							
3+	165	.500	.150	1.7495	.1774	.1469	4+	232	.625	.634	.2389	.267	-.1491							
3+	172	.500	.333	1.9338	.1961	.1830	4+	235	.625	.808	.2389	.267	-.1491							
3+	177	.500	.500	1.7495	.1774	.1469	4+	235	.625	.808	.2389	.267	-.1491							

TABLE IV.- Concluded

(1)  $M = 2.70$ ;  $\alpha = 50^\circ$

$P_t = 90.0$  kPa

FIN	TUBE	Y/S	X/C	P/PINF	P/PIT2	CP	FIN	TUBE	Y/S	X/C	P/PINF	P/PIT2	CP
1-	116	.125	.221	.2990	.0303	-.1374	3+	185	.500	.667	1.3951	.1415	.0774
1-	119	.125	.472	.2150	.0218	-.1538	3+	191	.500	.850	1.5290	.1550	.1037
1-	122	.125	.731	.2407	.0244	-.1488	3+	186	.625	.150	1.6190	.1642	.1213
1-	117	.272	.302	.2020	.0205	-.1564	3+	173	.625	.333	1.6553	.1678	.1284
1-	123	.375	.703	.2113	.0214	-.1545	3+	178	.625	.500	1.5651	.1587	.1107
1-	118	.625	.251	.5047	.0512	-.0371	3+	186	.625	.667	1.4524	.1473	.0886
1-	121	.625	.465	.5325	.0540	-.0916	3+	192	.625	.850	1.4005	.1420	.0785
1+	125	.125	.252	.2353	.0239	-.1499	3+	167	.749	.150	1.5362	.1558	.1051
1+	128	.125	.496	.2353	.0239	-.1499	3+	179	.749	.500	1.4217	.1441	.0826
1+	131	.125	.756	.2353	.0239	-.1499	3+	193	.749	.850	1.4009	.1420	.0786
1+	126	.375	.295	.2436	.0247	-.1482	3+	180	.873	.500	1.4086	.1428	.0801
1+	132	.375	.762	.2353	.0239	-.1499	3+	194	.062	.150	7.4311	.17535	1.2603
1+	127	.625	.189	.4815	.0488	-.1016	4-	201	.062	.333	8.7164	.8838	1.5121
1+	130	.625	.408	.4341	.0440	-.1109	4-	214	.062	.667	7.5435	.7649	1.2823
2-	134	.125	.221	.2353	.0239	-.1499	4-	195	.125	.150	9.2194	.9348	1.6107
2-	137	.125	.472	.2353	.0239	-.1499	4-	202	.125	.333	9.6176	.9752	1.6887
2-	140	.125	.731	.2353	.0239	-.1499	4-	207	.125	.500	8.2334	.8348	1.4175
2-	136	.625	.251	.2353	.0239	-.1499	4-	215	.125	.667	7.6732	.7780	1.3077
2-	139	.625	.465	.2353	.0239	-.1499	4-	216	.125	.850	10.0209	1.0161	1.7678
2+	143	.125	.221	9.4134	.9545	1.6487	4-	203	.250	.333	10.1366	1.0278	1.7904
2+	146	.125	.472	8.9583	.9081	1.5591	4-	208	.250	.500	8.6216	.8742	1.4936
2+	149	.125	.731	7.4014	.7504	1.2544	4-	216	.250	.667	7.3285	.7431	1.2401
3-	155	.142	.433	5.5132	.5590	.8844	4-	222	.250	.850	6.8193	.6914	1.1404
3-	158	.142	.802	6.6966	.6790	1.1163	4-	197	.375	.150	10.2739	1.0417	1.8174
3-	156	.375	.414	2.0750	.2104	.2107	4-	204	.375	.333	9.6666	.9801	1.6983
3-	159	.375	.770	2.0203	.2048	.1999	4-	209	.375	.500	8.3404	.8457	1.4384
3+	157	.608	.425	1.3388	.1357	.0664	4-	217	.375	.667	6.9260	.7022	1.1613
3+	160	.558	.746	1.4338	.1454	.0850	4-	223	.375	.850	6.5347	.6626	1.0846
3+	161	.062	.150	6.3547	.6443	1.0493	4-	198	.500	.150	9.6598	.9794	1.6970
3+	168	.062	.333	6.0423	.6127	.9881	4-	205	.500	.333	9.0480	.9174	1.5771
3+	181	.062	.667	7.1883	.7288	1.2127	4-	210	.500	.500	7.6855	.7793	1.3101
3+	187	.062	.850	7.7389	.7847	1.3206	4-	218	.500	.667	6.7113	.6805	1.1192
3+	182	.125	.150	6.2004	.6287	1.0191	4-	224	.500	.850	6.3760	.6465	1.0535
3+	186	.125	.667	6.9166	.7013	1.1594	4-	211	.625	.500	7.2575	.7359	1.2262
3+	188	.125	.850	7.7077	.7815	1.3145	4-	219	.625	.667	6.5411	.6632	1.0859
3+	170	.250	.333	5.5862	.5667	.8993	4-	225	.625	.850	6.5258	.6617	1.0829
3+	175	.250	.500	3.6013	.3651	.5098	4-	200	.749	.150	7.6658	.7773	1.3062
3+	183	.250	.667	1.9286	.1955	.1820	4-	212	.749	.500	7.0965	.7195	1.1947
3+	189	.250	.850	2.3154	.2348	.2578	4-	226	.749	.850	6.7690	.6863	1.1305
3+	164	.375	.150	2.1532	.2183	.2260	4-	213	.873	.500	6.7446	.6839	1.1257
3+	171	.375	.333	2.1970	.2228	.2346	4+	227	.125	.267	.2353	.0239	-.1499
3+	176	.375	.500	2.1652	.2195	.2283	4+	230	.125	.450	.2353	.0239	-.1499
3+	184	.375	.667	1.6141	.1637	.1203	4+	233	.125	.695	.2353	.0239	-.1499
3+	190	.375	.850	2.2116	.2242	.2374	4+	234	.375	.778	.2353	.0239	-.1499
3+	165	.500	.150	1.6497	.1673	.1273	4+	232	.625	.634	.2353	.0239	-.1499
3+	172	.500	.333	1.9862	.2014	.1933	4+	235	.625	.808	.2353	.0239	-.1499
3+	177	.500	.500	1.7174	.1741	.1406	4+	235	.625	.808	.2353	.0239	-.1499

TABLE V.- WING PRESSURE LISTING FOR  $\phi = 22.5^\circ$  AND  $R = 2.5 \times 10^5$

(a)  $M = 1.60$ ;  $\alpha = 0^\circ$

$P_t = 54.6$  kPa

FIN	TUBE	Y/S	X/C	P/PINF	P/PIT2	CP	FIN	TUBE	Y/S	X/C	P/PINF	P/PIT2	CP
1-	116	.125	.221	1.1458	.3011	.0813	3+	185	.500	.667	.7222	.1898	-.1550
1-	119	.125	.472	1.0869	.2857	.0485	3+	191	.500	.850	.7248	.1905	-.1536
1-	122	.125	.731	.9423	.2477	-.0322	3+	166	.625	.150	1.2237	.3216	.1248
1-	117	.372	.302	1.1132	.2926	.0631	3+	173	.625	.333	1.2253	.3220	.1257
1-	123	.375	.703	.8106	.5130	-.1037	3+	178	.625	.500	1.1701	.3075	.0949
1-	118	.625	.251	1.1161	.2933	.0648	3+	186	.625	.667	.7120	.1871	-.1607
1-	121	.625	.465	1.1505	.3024	.0840	3+	192	.625	.850	.7047	.1852	-.1648
1+	125	.125	.252	1.1414	.3000	.0789	3+	167	.749	.150	1.1755	.3089	.0980
1+	128	.125	.496	1.1444	.3008	.0806	3+	179	.749	.500	1.1490	.3020	.0832
1+	131	.125	.756	.9481	.2492	-.0290	3+	193	.749	.850	.7048	.1852	-.1647
1+	126	.375	.255	1.2371	.3251	.1323	3+	180	.873	.500	1.1197	.2943	.0668
1+	132	.375	.762	.8318	.2186	-.0939	4-	194	.062	.150	1.0780	.2833	.0435
1+	127	.625	.189	1.3140	.3453	.1263	4-	201	.062	.333	1.1474	.3016	.0823
1+	130	.625	.408	1.2264	.3223	.1263	4-	214	.062	.667	.9542	.2508	-.0255
2-	134	.125	.221	1.1297	.2969	.0724	4-	195	.125	.150	1.1264	.2960	.0705
2-	137	.125	.472	1.1303	.2971	.0727	4-	202	.125	.333	1.1578	.3043	.0881
2-	140	.125	.731	.9567	.2514	-.0242	4-	207	.125	.500	1.1132	.2926	.0632
2-	136	.625	.251	1.2603	.3312	.1452	4-	215	.125	.667	.9243	.2429	-.0422
2-	139	.625	.465	1.1953	.3141	.1090	4-	196	.250	.150	1.1607	.3051	.0897
2+	143	.125	.221	1.1445	.3008	.0806	4-	203	.250	.333	1.1542	.3033	.0860
2+	146	.125	.472	1.1282	.2965	.0715	4-	208	.250	.500	1.1230	.2952	.0687
2+	149	.125	.731	.8741	.2297	-.0702	4-	216	.250	.667	.8204	.2156	-.1002
3-	155	.142	.433	1.1116	.2921	.0623	4-	222	.250	.850	.8488	.2231	-.0844
3-	158	.142	.802	.8428	.2215	-.0877	4-	217	.375	.150	1.2070	.3172	.1155
3-	156	.375	.414	1.0844	.2850	.0471	4-	204	.375	.333	1.1565	.3039	.0873
3-	159	.375	.770	.8057	.2117	-.1084	4-	209	.375	.500	1.1351	.2983	.0754
3-	157	.608	.425	1.0402	.2734	.0224	4-	223	.375	.667	.7578	.1992	-.1351
3-	160	.558	.746	.8254	.2169	-.0974	4-	223	.375	.850	.8013	.2106	-.1109
3+	161	.062	.150	1.1024	.2897	.0571	4-	198	.500	.150	1.2476	.3279	.1382
3+	168	.062	.333	1.1415	.3000	.0790	4-	205	.500	.333	1.1843	.3112	.1028
3+	181	.062	.667	.9510	.2499	-.0273	4-	210	.500	.500	1.1296	.2969	.0723
3+	187	.062	.850	.9380	.2465	-.0346	4-	218	.500	.667	.7414	.1949	-.1443
3+	162	.125	.150	1.0998	.2890	.0557	4-	224	.500	.850	.8112	.2132	-.1054
3+	182	.125	.667	.9079	.2386	-.0514	4-	211	.625	.500	1.1343	.2981	.0749
3+	188	.125	.850	.9140	.2402	-.0480	4-	219	.625	.667	.7150	.1879	-.1590
3+	170	.250	.333	1.1845	.3113	.1029	4-	225	.625	.850	.8011	.2105	-.1110
3+	175	.250	.500	1.1763	.3092	.0984	4-	200	.749	.150	1.3361	.3511	.1875
3+	183	.250	.667	.8158	.2144	-.1028	4-	212	.749	.500	1.1701	.3075	.0949
3+	189	.250	.850	.8322	.2187	-.0936	4-	226	.749	.850	.7615	.2001	-.1331
3+	164	.375	.150	1.1903	.3128	.1062	4-	213	.873	.500	1.0388	.2730	.0216
3+	171	.375	.333	1.1975	.3147	.1102	4+	237	.125	.267	1.1109	.2920	.0619
3+	176	.375	.500	1.1886	.3124	.1052	4+	230	.125	.450	1.1367	.2987	.0763
3+	184	.375	.667	.7486	.1967	-.1403	4+	234	.125	.695	.8596	.2259	-.0784
3+	190	.375	.850	.7687	.2020	-.1291	4+	233	.125	.778	.8286	.2259	-.0784
3+	165	.500	.150	1.1803	.3102	.1006	4+	232	.625	.634	.8038	.2112	-.1095
3+	172	.500	.333	1.2382	.3254	.1329	4+	235	.625	.808	.7517	.1976	-.1386
3+	177	.500	.500	1.2080	.3175	.1161	4+	235	.625	.808	.7517	.1976	-.1386

TABLE V.- Continued

(b)  $M = 1.60$ ;  $\alpha = 10^\circ$

$P_t = 54.7 \text{ kPa}$

FIN	TUBE	Y/S	X/C	P/PINF	P/PT2	CP	FIN	TUBE	Y/S	X/C	P/PINF	P/PT2	CP
1-	116	.125	.221	1.2162	.3196	-.1207	3+	185	.500	.667	1.0313	.2710	.0175
1-	119	.125	.472	.9989	.2625	-.0006	3+	191	.500	.850	1.1063	.2908	.0593
1-	122	.125	.731	.8430	.2216	-.0876	3+	166	.625	.150	1.6532	.4345	.3645
1-	117	.272	.302	1.2173	.3199	-.1212	3+	173	.625	.333	1.6125	.4236	.3418
1-	123	.375	.703	.7617	.2002	-.1330	3+	178	.625	.500	1.5629	.4107	.3141
1-	118	.625	.251	1.2967	.3408	-.1656	3+	186	.625	.667	1.0133	.2663	.0074
1-	121	.625	.465	1.6237	.3216	-.1248	3+	192	.625	.850	1.0274	.2700	.0153
1+	125	.125	.252	.9846	.2588	-.0086	3+	167	.749	.150	1.6176	.4251	.3446
1+	128	.125	.496	.8369	.2200	-.0910	3+	179	.749	.500	1.5226	.4002	.2916
1+	131	.125	.756	.6535	.1717	-.1934	3+	193	.749	.850	1.0023	.2634	.0013
1+	126	.375	.255	1.0329	.2714	-.0183	3+	180	.749	.500	1.5025	.3949	.2804
1+	132	.375	.762	.8723	.1504	-.2387	4-	194	.062	.150	1.6491	.4334	.3622
1+	127	.625	.189	.7939	.2087	-.1150	4-	201	.062	.333	1.7450	.4586	.4157
1+	130	.625	.408	.9825	.2582	-.0098	4-	214	.062	.667	1.4773	.3883	.2664
2-	134	.125	.221	.8193	.2153	-.1009	4-	195	.125	.150	1.7121	.4500	.3974
2-	137	.125	.472	.7827	.2037	-.1213	4-	202	.125	.333	1.8178	.4683	.4363
2-	140	.125	.731	.6495	.1707	-.1956	4-	207	.125	.500	1.6771	.4408	.3779
2-	136	.625	.251	.4628	.1216	-.2998	4-	215	.125	.667	1.4525	.3817	.2525
2-	139	.625	.465	.5119	.1345	-.2724	4-	196	.250	.150	1.7873	.4697	.4394
2+	143	.125	.221	1.5459	.4063	-.3046	4-	203	.250	.333	1.8178	.4777	.4564
2+	146	.125	.472	1.4308	.3760	-.2404	4-	208	.250	.500	1.6745	.4401	.3764
2+	149	.125	.731	1.0783	.2834	-.0437	4-	216	.250	.667	1.3497	.3547	.1951
3-	155	.375	.433	.9585	.2519	-.0232	4-	222	.250	.850	1.3376	.3515	.1884
3-	158	.375	.802	.9836	.2585	-.0091	4-	197	.375	.150	1.8713	.4862	.4862
3-	156	.625	.414	.8479	.2828	-.0849	4-	204	.375	.333	1.8477	.4856	.4731
3-	159	.625	.770	.7117	.1870	-.1609	4-	209	.375	.500	1.7241	.4531	.4040
3-	157	.608	.425	.8701	.2287	-.0725	4-	217	.375	.667	1.2298	.3232	.1282
3-	160	.558	.746	.7516	.1975	-.1386	4-	223	.375	.850	1.2659	.3327	.1484
3+	161	.062	.150	1.3947	.3665	-.2203	4-	198	.500	.150	1.9614	.5155	.5365
3+	168	.062	.333	1.4239	.3742	-.2358	4-	205	.500	.333	1.8926	.4974	.4981
3+	181	.062	.667	1.4226	.3739	-.2358	4-	210	.500	.500	1.7385	.4569	.4121
3+	187	.062	.850	1.3839	.3637	-.2142	4-	218	.500	.667	1.1114	.0622	.0622
3+	162	.125	.150	1.4029	.3687	-.2248	4-	224	.500	.850	1.1700	.3075	.0949
3+	182	.125	.667	1.3943	.3664	-.2200	4-	211	.625	.500	1.7468	.4591	.6168
3+	188	.125	.850	1.3608	.3576	-.2013	4-	219	.625	.667	1.0872	.2857	.0487
3+	170	.250	.333	1.5130	.3976	-.2863	4-	225	.625	.850	1.0831	.2847	.0464
3+	175	.250	.500	1.6342	.4295	-.3539	4-	200	.749	.150	2.1189	.5569	.6244
3+	183	.250	.667	1.2758	.3353	.1539	4-	212	.749	.500	1.7963	.4721	.4444
3+	189	.250	.850	1.2731	.3346	.1524	4-	226	.749	.850	1.1250	.2957	.0698
3+	164	.375	.150	1.5755	.4141	.3212	4-	213	.749	.500	1.5424	.4054	.3027
3+	171	.375	.333	1.5245	.4007	.2927	4+	227	.125	.267	.6021	.1582	-.2221
3+	176	.375	.500	1.6506	.4338	.3631	4+	230	.125	.450	.6530	.1716	-.1936
3+	184	.375	.667	1.1295	.2969	.0723	4+	233	.125	.695	.7163	.1883	-.1583
3+	190	.375	.850	1.1985	.3150	.1108	4+	234	.125	.778	.5064	.1331	-.2754
3+	165	.500	.150	1.5845	.4164	.3261	4+	232	.625	.634	.5182	.1362	-.2688
3+	172	.500	.333	1.6160	.4247	.3437	4+	235	.625	.808	.5288	.1390	-.2629
3+	177	.500	.500	1.6248	.4270	.3487	4+	235	.625	.808	.5288	.1390	-.2629

TABLE V.- Continued

(C) M = 1.60;  $\alpha = 20^\circ$

$P_t = 54.6 \text{ kPa}$

FIN	TUBE	Y/S	X/C	P/PINF	P/PT2	CP	FIN	TUBE	Y/S	X/C	P/PINF	P/PT2	CP
1-	116	.125	.221	.6053	.1594	-.2197	3+	185	.500	.667	1.2543	.3297	.1419
1-	119	.125	.472	.5901	.1551	-.2288	3+	191	.500	.850	1.3916	.3297	.2185
1-	122	.125	.731	.5962	.1567	-.2253	3+	166	.625	.150	2.4780	.6512	.8248
1-	117	.272	.302	.8899	.2339	-.0614	3+	173	.625	.333	2.3313	.6127	.7429
1-	123	.375	.703	.7333	.1927	-.1488	3+	178	.625	.500	2.0032	.5265	.5598
1-	118	.625	.251	1.4231	.3740	.2361	3+	186	.625	.667	1.2195	.3205	.1225
1-	121	.125	.465	1.3161	.3459	.1764	3+	192	.625	.850	1.2808	.3366	.1567
1+	125	.125	.252	1.0867	.2856	.0484	3+	167	.749	.150	2.4401	.6413	.8036
1+	128	.125	.496	.9079	.2386	-.0514	3+	179	.749	.500	1.8606	.5153	.5361
1+	131	.125	.756	.5561	.1461	-.2477	3+	193	.749	.850	1.2346	.3245	.1309
1+	126	.375	.255	.5484	1.441	-.2520	3+	180	.873	.500	1.9433	.5107	.5264
1+	132	.375	.762	.4283	.1126	-.3190	4-	194	.062	.150	2.4457	.6428	.8068
1+	127	.625	.189	.4539	.1193	-.3047	4-	201	.062	.333	2.6270	.6904	.9079
1+	130	.625	.408	.5074	.1334	-.2749	4-	214	.062	.667	2.0123	.5289	.5649
2-	134	.125	.221	.5154	.1354	-.2704	4-	195	.125	.150	2.5895	.6806	.8870
2-	137	.125	.472	.7560	.1987	-.1362	4-	202	.125	.333	2.5998	.6833	.8928
2-	140	.125	.731	.5269	.1385	-.2640	4-	207	.125	.500	2.2310	.5863	.6869
2-	136	.625	.251	.2286	.0691	-.4305	4-	215	.125	.667	1.9884	.5226	.5516
2-	139	.625	.465	.1840	.0484	-.4553	4-	196	.250	.150	2.6747	.7029	.9345
2+	143	.125	.221	1.8088	.4754	.4514	4-	203	.250	.333	2.4903	.6545	.8316
2+	146	.125	.472	1.6738	.4399	.3760	4-	208	.250	.500	2.0983	.5515	.6129
2+	149	.125	.731	1.2696	.3337	.1504	4-	216	.250	.667	1.8824	.4947	.4924
3-	155	.142	.433	.7783	.2046	-.1237	4-	222	.250	.850	1.7071	.4486	.3946
3-	156	.375	.802	.7161	.1882	-.1584	4-	197	.375	.150	2.6740	.7028	.9341
3-	157	.375	.770	.7298	.2028	-.1275	4-	204	.375	.333	2.4631	.6473	.8165
3-	159	.608	.425	.6221	.1635	-.2109	4-	209	.375	.500	2.1414	.5628	.6369
3-	160	.558	.746	.6686	.1757	-.1849	4-	217	.375	.667	1.8098	.4756	.4519
3+	161	.062	.150	1.8286	.4806	.4624	4-	223	.375	.850	1.6655	.4377	.3714
3+	168	.062	.333	2.4967	.6562	.8352	4-	198	.500	.150	2.6693	.7015	.9315
3+	181	.062	.667	1.7886	.4701	.4400	4-	205	.500	.333	2.4604	.6466	.8150
3+	187	.062	.850	1.7819	.4683	.4363	4-	210	.500	.500	2.1050	.5532	.6166
3+	162	.125	.150	1.9136	.5029	.5098	4-	218	.500	.667	1.7441	.4584	.4152
3+	182	.125	.667	1.7519	.4604	.4196	4-	224	.500	.850	1.6437	.4320	.3592
3+	188	.125	.850	1.7591	.4623	.4236	4-	211	.625	.500	2.1011	.5522	.6145
3+	170	.250	.333	2.3785	.6251	.7692	4-	219	.625	.667	1.6997	.4467	.3905
3+	175	.250	.500	2.1334	.5607	.6325	4-	225	.625	.850	1.6718	.4394	.3749
3+	183	.250	.667	1.5832	.4161	.3255	4-	212	.749	.150	2.6324	.6918	.9109
3+	189	.250	.850	1.6671	.4381	.3723	4-	226	.749	.333	2.1244	.5583	.6275
3+	164	.375	.150	2.4157	.6349	.7900	4-	213	.749	.500	1.7567	.4617	.4223
3+	171	.375	.333	2.3443	.6161	.7502	4+	227	.873	.267	1.7930	.4712	.4425
3+	176	.375	.500	2.0832	.5475	.6045	4+	230	.125	.267	.2209	.0581	-.4347
3+	184	.375	.667	1.4081	.3701	.2278	4+	233	.125	.450	.2302	.0605	-.4296
3+	190	.375	.850	1.5353	.4035	.2987	4+	234	.125	.695	.3889	.1022	-.3410
3+	165	.500	.150	2.4438	.6423	.8057	4+	232	.375	.778	.2007	.0528	-.4460
3+	172	.500	.333	2.3528	.6183	.7549	4+	235	.625	.634	.2082	.0547	-.4418
3+	177	.500	.500	2.0899	.5492	.6082	4+	235	.625	.808	.2130	.0560	-.4391

TABLE V.- Continued

(d) M = 1.60;  $\alpha = 30^\circ$

$P_t = 54.6 \text{ kPa}$

FIN	TUBE	Y/S	X/C	P/PINF	P/PIT2	CP	FIN	TUBE	Y/S	X/C	P/PINF	P/PIT2	CP
1-	116	.125	.221	.5469	.1437	-.2528	3+	185	.500	.667	1.7545	.4611	.4210
1-	119	.125	.472	.5096	.1339	-.2737	3+	191	.500	.850	2.1497	.5650	.6416
1-	122	.125	.731	.4126	.1084	-.3278	3+	166	.625	.150	2.9720	.625	1.1004
1-	117	.272	.302	.4903	.1288	-.2845	3+	173	.625	.333	2.7135	.7811	.9562
1-	123	.375	.703	.4457	.1171	-.3093	3+	178	.625	.500	2.2681	.5961	.7076
1-	118	.625	.251	.8777	.2307	-.0662	3+	186	.625	.667	1.6894	.4440	.3847
1-	121	.125	.465	.8718	.2291	-.0716	3+	192	.625	.850	1.7393	.4571	.4125
1+	125	.125	.252	.7411	.1948	-.1445	3+	167	.749	.150	2.9345	.7712	1.0795
1+	128	.125	.496	.6354	.1670	-.2034	3+	179	.749	.500	2.2340	.5871	.6886
1+	131	.125	.756	.3764	.0989	-.3480	3+	193	.749	.850	1.6341	.4295	.3538
1+	126	.125	.1185	.4511	.1185	-.3063	3+	180	.873	.500	2.2175	.5828	.6794
1+	132	.375	.762	.3137	.0824	-.3830	4-	194	.062	.150	3.1295	.8225	1.1883
1+	127	.625	.189	.2270	.0596	-.4314	4-	201	.062	.333	3.1151	.8187	1.1803
1+	130	.625	.408	.2705	.0711	-.4071	4-	214	.062	.667	2.4623	.6471	.8160
2-	134	.125	.221	.3954	.1039	-.3374	4-	195	.125	.150	3.2966	.8664	1.2816
2-	137	.125	.472	.4746	.1247	-.2932	4-	202	.125	.333	3.0865	.8112	1.1644
2-	140	.125	.731	.4474	.1176	-.3084	4-	207	.125	.500	2.6752	.7031	.9348
2-	136	.625	.251	.1305	.1305	-.4852	4-	215	.125	.667	2.4435	.6422	.8055
2-	139	.625	.465	.1290	.0339	-.4852	4-	196	.250	.150	3.2349	.8502	1.2472
2+	143	.125	.221	2.2475	.5907	.6962	4-	203	.250	.333	2.9761	.7822	1.1027
2+	146	.125	.472	1.9826	.5211	.5483	4-	208	.250	.500	2.5962	.6823	.8907
2+	149	.125	.731	1.4070	.3698	.2271	4-	216	.250	.667	2.3693	.6227	.7641
3-	155	.142	.433	.7865	.2067	-.1191	4-	222	.250	.850	2.1999	.5782	.6696
3-	158	.142	.802	.7954	.2091	-.1142	4-	197	.375	.150	3.1593	.8303	1.2050
3-	156	.375	.414	.6862	.1803	-.1751	4-	204	.375	.333	2.9307	.7702	1.0774
3-	159	.608	.770	.6760	.1776	-.1808	4-	209	.375	.500	2.6009	.6835	.8933
3-	157	.608	.425	.7601	.1998	-.1339	4-	217	.375	.667	2.3227	.6104	.7381
3-	160	.558	.746	.7126	.1873	-.1604	4-	223	.375	.850	2.1381	.5619	.6351
3+	161	.062	.150	2.8830	.7577	1.0508	4-	198	.500	.150	3.1172	.8192	1.1815
3+	168	.062	.333	2.8710	.7545	1.0441	4-	205	.500	.333	2.9083	.7643	1.0649
3+	181	.062	.667	2.2830	.6000	.7160	4-	210	.500	.500	2.5523	.6708	.8662
3+	187	.062	.850	2.2758	.5981	.7119	4-	218	.500	.667	2.2912	.6022	.7205
3+	162	.125	.150	2.49106	.7650	1.0662	4-	224	.500	.850	2.1117	.5550	.6204
3+	182	.125	.667	2.2617	.625	.7040	4-	211	.625	.500	2.5418	.6680	.8604
3+	188	.125	.850	2.2398	.5887	.6919	4-	219	.625	.667	2.2841	.6003	.7166
3+	170	.250	.333	2.17899	.7332	.9988	4-	225	.625	.850	2.1108	.5548	.6199
3+	175	.250	.500	2.43366	.6404	.8017	4-	200	.749	.150	3.0226	.7944	1.1287
3+	183	.250	.667	2.2021	.5787	.6708	4-	212	.749	.500	2.5506	.6703	.8653
3+	189	.250	.850	2.1427	.5631	.6377	4-	226	.749	.850	2.1835	.5739	.6604
3+	164	.375	.150	2.9923	.7864	1.1118	4-	213	.873	.500	2.3420	.6155	.7489
3+	171	.375	.333	2.7460	.7217	.9743	4+	227	.125	.267	1.4446	.0380	-.4774
3+	176	.375	.500	2.3479	.6171	.7522	4+	230	.125	.450	1.255	.0330	-.4680
3+	184	.375	.667	1.8512	.4865	.4750	4+	233	.125	.695	.1103	.0290	-.4965
3+	190	.375	.850	2.1222	.5577	.6262	4+	234	.375	.778	.1217	.0320	-.4901
3+	165	.500	.150	2.49816	.7836	1.1058	4+	232	.625	.634	.1579	.0415	-.4699
3+	172	.500	.333	2.17446	.7213	.9735	4+	235	.625	.808	.1578	.0415	-.4700
3+	177	.500	.500	2.3578	.6197	.7577	4+	235	.625	.808	.1578	.0415	-.4700

TABLE V.- Continued

(e)  $M = 1.60$ ;  $\alpha = 40$  $P_L = 54.7$  kPa

FIN	TUBE	Y/S	X/C	P/PINF	P/PT2	CP	FIN	TUBE	Y/S	X/C	P/PINF	P/PT2	CP
1-	116	.125	.221	.6984	.1835	-.1683	3+	185	.500	.667	2.3857	.6270	.7733
1-	119	.3424	.472	.3424	.0900	-.3670	3+	191	.500	.850	2.4041	.6318	.7835
1-	122	.125	.731	.2777	.0730	-.4031	3+	166	.625	.150	3.3689	.8854	1.3219
1-	117	.272	.302	.7316	.1923	-.1498	3+	173	.625	.333	3.0588	.8039	1.1489
1-	123	.375	.703	.4751	.1249	-.2929	3+	178	.625	.500	2.5407	.6677	.8598
1-	118	.625	.251	.7362	.1935	-.1472	3+	186	.625	.667	2.2733	.5975	.7106
1-	121	.625	.465	.7463	.1961	-.1416	3+	192	.625	.850	2.3279	.6118	.7410
1+	125	.125	.252	.4844	.1273	-.2877	3+	167	.749	.150	3.3177	.8719	1.2933
1+	128	.125	.496	.2947	.0774	-.3936	3+	179	.749	.500	2.4904	.6545	.8317
1+	131	.125	.756	.1823	.0479	-.4563	3+	193	.749	.850	2.2420	.5892	.6931
1+	126	.375	.255	.3490	.0917	-.3633	3+	180	.873	.500	2.4624	.6472	.8161
1+	132	.375	.762	.1832	.0482	-.4558	4-	194	.062	.150	3.7225	.9783	1.5193
1+	127	.625	.189	.2053	.0540	-.4435	4-	201	.062	.333	3.5035	.9208	1.3970
1+	130	.625	.408	.2529	.0665	-.4169	4-	214	.062	.500	2.8882	.7591	1.0537
2-	134	.125	.221	.2673	.1202	-.4089	4-	195	.125	.150	3.6866	.9689	1.4992
2-	137	.125	.472	.2911	.0702	-.3956	4-	202	.125	.333	3.4555	.9082	1.3703
2-	140	.125	.731	.2196	.0577	-.4355	4-	207	.125	.500	3.1084	.8169	1.1766
2-	136	.625	.251	.1376	.0362	-.4813	4-	215	.125	.667	2.8695	.7541	1.0432
2-	139	.625	.465	.1466	.0385	-.4762	4-	196	.125	.150	3.5931	.9443	1.4470
2+	143	.125	.221	2.4232	.6368	.7942	4-	203	.250	.333	3.3621	.8836	1.3182
2+	146	.125	.472	2.1619	.5682	.6484	4-	208	.250	.500	3.0424	.7996	1.1397
2+	149	.125	.731	1.7149	.4507	.3989	4-	216	.250	.667	2.8019	.7364	1.0055
3-	155	.142	.433	.9020	.2371	-.0547	4-	222	.250	.850	2.5633	.6737	.8724
3-	158	.142	.802	1.2916	.3395	.1627	4-	197	.375	.150	3.5229	.9259	1.4079
3-	156	.375	.414	.6105	.1604	-.2174	4-	204	.375	.333	3.3262	.8742	1.2981
3-	159	.375	.770	.9670	.2542	-.0184	4-	209	.375	.500	3.0324	.7970	1.1341
3-	157	.608	.425	.6769	.1779	-.1803	4-	217	.375	.667	2.7518	.7232	.9776
3-	160	.558	.746	.9156	.2406	-.0471	4-	223	.375	.850	2.5095	.6595	.8424
3+	161	.062	.150	3.4782	.9141	1.3829	4-	198	.500	.150	3.4726	.9126	1.3798
3+	168	.062	.333	3.3181	.8721	1.2936	4-	205	.500	.333	3.2951	.8660	1.2807
3+	181	.062	.667	2.7865	.7323	.9970	4-	210	.500	.500	2.9847	.7844	1.1075
3+	187	.062	.850	2.6407	.6940	.9156	4-	218	.500	.667	2.7157	.7137	.9374
3+	162	.125	.150	3.4623	.9099	1.3741	4-	224	.500	.850	2.4715	.6496	.8212
3+	182	.125	.667	2.7568	.7245	.9804	4-	211	.625	.500	2.9607	.7781	1.0941
3+	188	.125	.850	2.5991	.6831	.8924	4-	219	.625	.667	2.8966	.7087	.9468
3+	170	.250	.333	3.2027	.8417	1.2292	4-	225	.625	.850	2.4472	.6432	.8076
3+	175	.250	.500	2.8267	.7429	1.0194	4-	200	.749	.150	3.3451	.8791	1.3086
3+	183	.250	.667	2.6583	.6986	.9254	4-	212	.749	.500	2.9476	.7747	1.0868
3+	189	.250	.850	2.4972	.6563	.8355	4-	226	.749	.850	2.4949	.6557	.8342
3+	164	.375	.150	3.4347	.9027	1.3586	4-	213	.873	.500	2.7466	.7218	.9747
3+	171	.375	.333	3.1363	.8243	1.1922	4+	227	.125	.267	.1318	.0346	-.4845
3+	176	.375	.500	2.6973	.7089	.9472	4+	230	.125	.695	.1229	.0323	-.4895
3+	184	.375	.667	2.5113	.6600	.8434	4+	233	.125	.695	.1049	.0276	-.4992
3+	190	.375	.850	2.4500	.6439	.8091	4+	234	.375	.778	.1055	.0277	-.4992
3+	165	.500	.150	3.4023	.8942	1.3406	4+	232	.625	.667	.1334	.0350	-.4836
3+	172	.500	.333	3.1100	.8174	1.1775	4+	235	.625	.808	.1347	.0354	-.4828
3+	177	.500	.500	2.6636	.7000	.9284	4+	235	.625	.808	.1347	.0354	-.4828



TABLE V.- Continued

(F) M = 1.60;  $\alpha = 50^\circ$

$P_t = 54.1 \text{ kPa}$

FIN	TUBE	Y/S	X/C	P/PINF	P/PI2	CP	FIN	TUBE	Y/S	X/C	P/PINF	P/PI2	CP
1-	116	.125	.221	.2387	.0627	-.4248	3+	185	.500	.667	2.6953	.7084	.9461
1-	119	.125	.472	.2804	.0737	-.4016	3+	191	.500	.850	2.5312	.6652	.8545
1-	122	.125	.731	.1928	.0507	-.4505	3+	166	.625	.150	3.5313	.9281	1.4126
1-	117	.272	.302	.7074	.1859	-.1633	3+	173	.625	.333	3.2462	.8532	1.2535
1-	123	.375	.703	.5035	.1323	-.2770	3+	178	.625	.500	2.8183	.7407	1.0147
1-	118	.625	.251	.6597	.1734	-.1899	3+	186	.625	.667	2.6185	.6882	.9032
1-	121	.625	.465	.6781	.1782	-.1796	3+	192	.625	.850	2.4853	.6532	.8289
1+	125	.125	.252	.3255	.0856	-.3764	3+	167	.749	.150	3.5019	.9203	1.3961
1+	128	.125	.496	.2919	.0761	-.3952	3+	179	.749	.500	2.7793	.7304	.9929
1+	131	.125	.756	.2894	.0761	-.3965	3+	193	.749	.850	2.4203	.6361	.7926
1+	126	.375	.255	.2460	.0647	-.4207	3+	180	.873	.500	2.7767	.7297	.9914
1+	132	.375	.762	.3182	.0836	-.3805	4-	194	.062	.150	3.9242	1.0313	1.6318
1+	127	.625	.189	.1177	.0309	-.4923	4-	201	.062	.333	3.7265	.9794	1.5215
1+	130	.625	.408	.1504	.0395	-.4741	4-	214	.062	.667	3.1175	.8193	1.1817
2-	134	.125	.221	.2726	.0716	-.4059	4-	195	.125	.150	3.8866	1.0215	1.6108
2-	137	.125	.472	.3011	.0791	-.3900	4-	202	.125	.333	3.46777	.9666	1.4943
2-	140	.125	.731	.2952	.0776	-.3933	4-	207	.125	.500	3.3651	.8844	1.3198
2-	136	.625	.251	.3002	.0789	-.3905	4-	215	.125	.667	3.0955	.8135	1.1693
2-	139	.625	.465	.3021	.0794	-.3895	4-	196	.250	.150	3.7880	.9955	1.5558
2+	143	.125	.221	2.0877	.5487	.6070	4-	203	.250	.333	3.5806	.9410	1.4401
2+	146	.125	.472	2.3963	.6298	.7792	4-	208	.250	.500	3.2836	.8630	1.2743
2+	149	.125	.731	2.2340	.5871	.6886	4-	216	.250	.667	3.2828	.7944	1.1288
3-	155	.142	.433	.8746	.2299	-.0700	4-	222	.250	.850	2.7382	.7197	.9700
3-	158	.142	.802	1.1863	.3118	1.040	4-	197	.375	.150	3.7067	.9742	1.5104
3-	156	.375	.414	.9592	.2521	-.0227	4-	204	.375	.333	3.5220	.9256	1.4074
3-	159	.375	.770	1.1514	.3026	.0845	4-	209	.375	.500	3.2490	.8539	1.2550
3-	160	.608	.425	1.1542	.3033	.0860	4-	217	.375	.667	2.9649	.7792	1.0965
3+	161	.062	.150	3.7819	.9939	1.318	4-	223	.375	.850	2.6827	.7050	.9390
3+	168	.062	.333	3.5741	.9393	1.4364	4-	198	.500	.150	3.6173	.9507	1.4606
3+	181	.062	.667	3.0421	.7995	1.4364	4-	205	.500	.333	3.4650	.9107	1.3756
3+	187	.062	.850	2.8219	.7416	1.0167	4-	210	.500	.500	3.1881	.8379	1.2210
3+	162	.125	.150	3.7517	.9860	1.5355	4-	218	.500	.667	2.9286	.6967	1.0762
3+	182	.125	.667	3.0038	.7894	1.1182	4-	224	.500	.850	2.6446	.6950	.9178
3+	188	.125	.850	2.7716	.7894	1.1182	4-	211	.625	.500	3.1565	.8296	1.2034
3+	170	.250	.333	3.4217	.8993	.9886	4-	219	.625	.667	2.8935	.7631	1.0622
3+	175	.250	.500	3.0744	.8080	1.1576	4-	225	.625	.850	2.6209	.6888	.9045
3+	183	.250	.667	2.8895	.7594	1.0544	4-	200	.749	.150	3.4104	.8963	1.3451
3+	189	.250	.850	2.6505	.6966	.9210	4-	212	.749	.500	3.1280	.8221	1.1875
3+	164	.375	.150	3.6265	.9531	1.4657	4-	226	.749	.850	2.6504	.6966	.9210
3+	171	.375	.333	3.3341	.8762	1.3025	4-	213	.873	.500	2.9477	.7747	1.0869
3+	176	.375	.500	2.9595	.7778	1.0935	4+	227	.125	.267	1.486	.0390	-.4751
3+	184	.375	.667	2.7846	.7318	.9959	4+	230	.125	.450	1.419	.0378	-.4788
3+	190	.375	.850	2.5944	.6818	.8897	4+	233	.125	.695	1.362	.0358	-.4820
3+	165	.500	.150	3.5689	.9380	1.4335	4+	234	.375	.778	1.391	.0366	-.4804
3+	172	.500	.333	3.2941	.8657	1.2802	4+	232	.625	.850	2.4752	.0390	-.4752
3+	177	.500	.500	2.9209	.7676	1.0719	4+	235	.625	.808	1.469	.0391	-.4749

TABLE V.- Continued

(g) M = 2.70;  $\alpha = 0^\circ$

$P_t = 90.4$  kPa

FIN	TUBE	Y/S	X/C	P/PINF	P/PT2	CP	FIN	TUBE	Y/S	X/C	P/PINF	P/PT2	CP
1-	116	.125	.221	1.2624	.1280	.0514	3+	185	.500	.667	.7624	.0773	-.0466
1-	119	.125	.472	1.0869	.1102	.0170	3+	191	.500	.850	.6966	.0706	-.0595
1-	117	.125	.731	.7997	.0811	-.0393	3+	166	.625	.150	1.5199	.1541	.1019
1-	122	.272	.302	1.2252	.1242	.0441	3+	173	.625	.333	1.4449	.1399	.0872
1-	123	.375	.703	.7350	.0750	-.0511	3+	178	.625	.500	1.3800	.1465	.0745
1-	118	.625	.251	1.2903	.1308	.0569	3+	186	.625	.667	.7561	.0767	-.0478
1-	121	.625	.465	1.2944	.1312	.0577	3+	192	.625	.850	.7014	.0711	-.0585
1+	125	.125	.252	1.2514	.1269	.0493	3+	167	.749	.150	1.4884	.1509	.0957
1+	128	.125	.496	1.1852	.1202	.0363	3+	179	.749	.500	1.3257	.1344	.0638
1+	131	.125	.756	.8227	.0834	-.0347	3+	193	.749	.850	.7051	.0715	-.0578
1+	126	.375	.255	1.5171	.1538	.1013	3+	180	.873	.500	1.2856	.1304	.0560
1+	132	.375	.762	1.4972	.1518	.0784	4-	194	.062	.150	1.1113	.1127	.0218
1+	127	.625	.189	1.4302	.1450	.0974	4-	201	.062	.333	1.1855	.1202	.0363
1+	130	.625	.408	1.3295	.1450	.0843	4-	214	.062	.667	.8365	.0848	-.0320
2-	134	.125	.221	1.2995	.1318	.0387	4-	195	.125	.150	1.1899	.1206	.0372
2-	137	.125	.472	1.1895	.1206	.0371	4-	202	.125	.333	1.2138	.1231	.0419
2-	140	.125	.731	.8160	.0827	-.0360	4-	207	.125	.500	1.1039	.1119	.0204
2-	136	.625	.251	1.4375	.1457	.0357	4-	215	.125	.667	.7939	.0805	-.0404
2-	139	.625	.465	1.3864	.1406	.0757	4-	196	.250	.150	1.3724	.1392	.0730
2+	143	.125	.221	1.1753	.1221	.0344	4-	203	.250	.333	1.2685	.1286	.0526
2+	146	.125	.472	1.1416	.1157	.0277	4-	208	.250	.500	1.1899	.1206	.0372
2+	149	.125	.731	.7728	.0784	-.0445	4-	216	.250	.667	.7366	.0747	-.0516
3-	155	.142	.433	1.1846	.1201	.0362	4-	222	.250	.850	.7436	.0754	-.0502
3-	158	.142	.802	.7701	.0781	-.0450	4-	197	.375	.150	1.4334	.1453	.0849
3-	156	.375	.414	1.2860	.1304	.0561	4-	204	.375	.333	1.3713	.1390	.0728
3-	159	.375	.770	.7940	.0805	-.0404	4-	209	.375	.500	1.2799	.1298	.0548
3-	157	.608	.425	1.2369	.1254	.0464	4-	217	.375	.667	.7201	.0730	-.0548
3-	160	.608	.746	.8872	.0900	-.0221	4-	223	.375	.850	.7065	.0716	-.0575
3+	161	.062	.150	1.1787	.1195	.0350	4-	198	.500	.150	1.4580	.1478	.0898
3+	168	.062	.333	1.2039	.1221	.0400	4-	205	.500	.333	1.3981	.1418	.0780
3+	181	.062	.667	.8382	.0850	-.0317	4-	210	.500	.500	1.3144	.1333	.0616
3+	187	.125	.850	.8430	.0855	-.0308	4-	218	.500	.667	.7524	.0763	-.0485
3+	162	.125	.150	1.2065	.1223	.0405	4-	224	.500	.850	.6775	.0687	-.0632
3+	182	.125	.667	.7873	.0798	-.0417	4-	211	.625	.500	1.3280	.1346	.0643
3+	188	.125	.850	.8133	.0825	-.0366	4-	219	.625	.667	.7491	.0760	-.0492
3+	170	.250	.333	1.3525	.1371	.0691	4-	225	.625	.850	.6948	.0704	-.0598
3+	175	.250	.500	1.3231	.1342	.0633	4-	200	.749	.150	1.4881	.1509	.0957
3+	183	.250	.667	.7253	.0735	-.0538	4-	212	.749	.500	1.3618	.1381	.0709
3+	189	.250	.850	.7205	.0731	-.0548	4-	226	.749	.850	.7462	.0757	-.0497
3+	164	.375	.150	1.4182	.1438	.0820	4-	213	.749	.500	1.1543	.1170	.0302
3+	171	.375	.333	1.4167	.1436	.0817	4+	227	.125	.267	1.2547	.1272	.0499
3+	176	.375	.500	1.3870	.1406	.0758	4+	230	.125	.450	1.2238	.1241	.0438
3+	184	.375	.667	.7383	.0749	-.0513	4+	233	.125	.695	.7451	.0755	-.0500
3+	190	.375	.850	.7014	.0711	-.0585	4+	234	.125	.778	.7345	.0745	-.0520
3+	165	.500	.150	1.4241	.1444	.0831	4+	232	.625	.634	.8760	.0888	-.0243
3+	172	.500	.333	1.4449	.1465	.0872	4+	235	.625	.808	.7822	.0793	-.0427
3+	177	.500	.500	1.4405	.1461	.0863	4+	235	.625	.808	.7822	.0793	-.0427

TABLE V.- Continued

(h) M = 2.70;  $\alpha = 10^\circ$

$P_t = 90.4 \text{ kPa}$

FIN	TUBE	Y/S	X/C	P/PINF	P/PIZ	CP	FIN	TUBE	Y/S	X/C	P/PINF	P/PIZ	CP
1-	116	.125	.221	.9910	.1005	-.0018	3+	185	.500	.667	1.1132	.1129	.0222
1-	119	.125	.472	1.1341	.1150	-.0263	3+	191	.500	.850	1.0160	.1030	.0031
1-	122	.125	.731	.6868	.0696	-.0614	3+	166	.625	.150	2.1275	.2210	.2210
1-	117	.125	.302	1.5422	.1564	-.062	3+	173	.625	.333	2.0196	.2048	.1998
1-	123	.375	.703	.9541	.0967	-.0090	3+	178	.625	.500	1.9299	.1957	.1822
1-	118	.625	.251	1.7720	.1797	.1513	3+	186	.625	.667	1.0864	.1102	.0169
1-	121	.625	.465	1.6865	.1710	.1345	3+	192	.625	.850	1.0238	.1038	.0047
1+	125	.125	.252	.9622	.0976	-.0074	3+	167	.749	.150	2.0732	.2102	.2103
1+	128	.125	.496	.9448	.0958	-.0108	3+	179	.749	.500	1.8867	.1913	.1738
1+	131	.125	.756	.6145	.0623	-.0755	3+	193	.749	.850	1.0345	.1049	.0068
1+	126	.375	.255	.9456	.0959	-.0107	3+	180	.873	.500	1.8335	.1859	.1633
1+	132	.375	.762	.6043	.0613	-.0775	4-	194	.062	.150	2.2431	.2274	.2436
1+	127	.625	.189	.9697	.0983	-.0059	4-	201	.062	.333	2.2147	.2246	.2380
1+	130	.625	.408	.9115	.0924	-.0173	4-	214	.062	.667	1.6028	.1625	.1181
2-	134	.125	.221	.5410	.0549	-.0900	4-	195	.125	.150	2.3950	.2428	.2734
2-	137	.125	.472	.6000	.0608	-.0784	4-	202	.125	.333	2.2934	.2285	.2456
2-	140	.125	.731	.5379	.0545	-.0906	4-	207	.125	.500	1.9847	.2012	.1930
2-	136	.625	.251	.5538	.0562	-.0874	4-	215	.125	.667	1.5232	.1544	.1025
2-	139	.625	.465	.5308	.0538	-.0919	4-	196	.125	.150	2.7234	.2761	.3377
2+	143	.125	.221	1.9865	.2014	.1933	4-	203	.250	.333	2.3787	.2412	.2702
2+	146	.125	.472	1.9269	.1954	.1816	4-	208	.250	.500	2.1698	.2200	.2292
2+	149	.125	.731	1.2055	.1222	.0403	4-	216	.250	.667	1.3725	.1392	.0730
3-	155	.142	.433	.8668	.0879	-.0261	4-	222	.375	.850	1.3938	.1413	.0850
3-	158	.142	.802	.7062	.0716	-.0576	4-	197	.375	.150	2.9417	.2983	.3805
3-	156	.375	.414	1.0461	.1061	.0090	4-	204	.375	.333	2.5811	.2617	.3098
3-	159	.375	.770	.6647	.0674	-.0657	4-	209	.375	.500	2.3625	.2395	.2670
3-	157	.608	.425	1.0068	.1021	.0013	4-	217	.375	.667	1.3555	.1374	.0697
3-	160	.558	.746	.7008	.0711	-.0586	4-	223	.375	.850	1.2221	.1239	.0435
3+	161	.062	.150	1.8465	.1872	.1659	4-	198	.500	.150	3.0953	.3138	.4106
3+	168	.062	.333	1.7281	.1752	.1427	4-	205	.500	.333	2.7441	.2782	.3418
3+	181	.062	.667	1.1884	.1205	.0369	4-	210	.500	.500	2.4587	.2493	.2859
3+	187	.062	.850	1.4047	.1424	.0793	4-	218	.500	.667	1.4204	.1440	.0824
3+	182	.125	.150	1.8834	.1910	.1731	4-	224	.500	.850	1.2250	.1242	.0441
3+	188	.125	.667	1.1065	.1122	.0209	4-	211	.625	.500	2.5918	.2628	.3119
3+	170	.125	.850	1.1512	.1167	.0296	4-	219	.625	.667	1.4554	.1476	.0892
3+	175	.250	.333	2.0077	.2036	.1975	4-	225	.625	.850	1.3242	.1343	.0635
3+	172	.250	.500	1.8852	.1911	.1735	4-	200	.749	.150	3.1055	.3149	.4126
3+	183	.250	.667	1.0131	.1027	.0026	4-	212	.749	.500	2.7434	.2782	.3416
3+	189	.250	.850	.9934	.1009	-.0009	4-	226	.749	.850	1.5037	.1525	.0987
3+	164	.375	.150	2.0605	.2089	.2078	4-	213	.873	.500	2.3994	.2433	.2742
3+	171	.375	.333	2.0803	.2109	.2117	4+	227	.125	.267	.4404	.0447	-.1097
3+	176	.375	.500	2.0080	.2036	.1975	4+	230	.125	.450	.4639	.0470	-.1051
3+	184	.375	.667	1.0727	.1088	.0142	4+	233	.125	.695	.4753	.0482	-.1028
3+	190	.375	.850	.9685	.0982	-.0062	4+	234	.125	.778	.4687	.0475	-.1041
3+	165	.500	.150	2.0226	.2051	.2004	4+	232	.625	.634	.3715	.0377	-.1232
3+	177	.500	.333	2.0557	.2084	.2069	4+	235	.625	.808	.4656	.0472	-.1047
3+	172	.500	.500	2.0454	.2075	.2051	4+	235	.625	.608	.4656	.0472	-.1047

TABLE V.- Continued

(i) M = 2.70;  $\alpha = 20^\circ$

$P_t = 89.7 \text{ kPa}$

FIN	TUBE	Y/S	X/C	P/PINF	P/PT2	CP	FIN	TUBE	Y/S	X/C	P/PINF	P/PT2	CP	FIN	TUBE	Y/S	X/C	P/PINF	P/PT2	CP
1-	116	.125	.221	.5464	.0554	-.0889	3+	185	.500	.667	2.3974	.2431	-.0889	3+	185	.500	.667	2.3974	.2431	-.0889
1-	119	.125	.472	.6095	.0618	-.0765	3+	191	.500	.850	2.1995	.2230	-.0765	3+	191	.500	.850	2.1995	.2230	-.0765
1-	122	.125	.731	.4432	.0449	-.1091	3+	166	.625	.150	4.0593	.4116	-.1091	3+	166	.625	.150	4.0593	.4116	-.1091
1-	117	.272	.302	1.40274	.1042	.0054	3+	173	.625	.333	3.9431	.3998	.0054	3+	173	.625	.333	3.9431	.3998	.0054
1-	123	.375	.703	.6997	.0709	-.0589	3+	178	.625	.500	3.9076	.3962	-.0589	3+	178	.625	.500	3.9076	.3962	-.0589
1-	118	.625	.251	2.0554	.2084	.2068	3+	186	.625	.667	2.4045	.2436	.2068	3+	186	.625	.667	2.4045	.2436	.2068
1-	121	.625	.465	2.0459	.2074	.2050	3+	192	.625	.850	2.2825	.2314	.2050	3+	192	.625	.850	2.2825	.2314	.2050
1+	125	.125	.252	.7229	.0733	-.0543	3+	167	.749	.150	3.9309	.3986	-.0543	3+	167	.749	.150	3.9309	.3986	-.0543
1+	128	.125	.496	.6999	.0710	-.0588	3+	179	.749	.500	3.6996	.3751	-.0588	3+	179	.749	.500	3.6996	.3751	-.0588
1+	131	.125	.756	.4486	.0455	-.1081	3+	193	.749	.850	2.1888	.2219	-.1081	3+	193	.749	.850	2.1888	.2219	-.1081
1+	126	.375	.295	.5366	.0341	-.1300	3+	180	.873	.500	3.4304	.3478	-.1300	3+	180	.873	.500	3.4304	.3478	-.1300
1+	132	.625	.762	.3440	.0349	-.1286	4-	194	.062	.150	4.1599	.4218	-.1286	4-	194	.062	.150	4.1599	.4218	-.1286
1+	127	.625	.189	.4357	.0442	-.1106	4-	201	.062	.333	4.3342	.4395	-.1106	4-	201	.062	.333	4.3342	.4395	-.1106
1+	130	.625	.408	.4745	.0481	-.1030	4-	214	.062	.667	3.7769	.3830	-.1030	4-	214	.062	.667	3.7769	.3830	-.1030
2-	134	.125	.221	.2192	.0222	-.1930	4-	195	.125	.150	4.3424	.4403	-.1930	4-	195	.125	.150	4.3424	.4403	-.1930
2-	137	.125	.472	.3522	.0357	-.1270	4-	202	.125	.333	4.3498	.4410	-.1270	4-	202	.125	.333	4.3498	.4410	-.1270
2-	140	.125	.731	.2858	.0290	-.1399	4-	207	.125	.500	4.2392	.4298	-.1399	4-	207	.125	.500	4.2392	.4298	-.1399
2-	136	.625	.251	.2192	.0222	-.1930	4-	215	.125	.667	3.7135	.3765	-.1930	4-	215	.125	.667	3.7135	.3765	-.1930
2-	139	.625	.465	.2473	.0251	-.1475	4-	196	.250	.150	4.8540	.4922	-.1475	4-	196	.250	.150	4.8540	.4922	-.1475
2+	143	.125	.221	3.4141	.3462	.4731	4-	203	.250	.333	4.5316	.4595	.4731	4-	203	.250	.333	4.5316	.4595	.4731
2+	146	.125	.472	3.4195	.3467	.4741	4-	208	.250	.500	4.3179	.4378	.4741	4-	208	.250	.500	4.3179	.4378	.4741
2+	149	.125	.731	2.0676	.2096	.2092	4-	216	.250	.667	3.5366	.3586	.2092	4-	216	.250	.667	3.5366	.3586	.2092
3-	155	.142	.433	1.3311	.1350	.0649	4-	222	.250	.850	3.5620	.3612	.0649	4-	222	.250	.850	3.5620	.3612	.0649
3-	158	.375	.802	1.1213	.1137	.0238	4-	197	.375	.150	5.1954	.5222	.0238	4-	197	.375	.150	5.1954	.5222	.0238
3-	156	.625	.414	1.6199	.1642	.1215	4-	204	.375	.333	4.7689	.4835	.1215	4-	204	.375	.333	4.7689	.4835	.1215
3-	159	.625	.770	1.0657	.1081	.0129	4-	209	.375	.500	4.5316	.4595	.0129	4-	209	.375	.500	4.5316	.4595	.0129
3-	157	.608	.425	1.4749	.1495	.0931	4-	217	.608	.667	3.1958	.3240	.0931	4-	217	.608	.667	3.1958	.3240	.0931
3+	160	.558	.746	1.0550	.1070	.0108	4-	223	.558	.850	3.2881	.3334	.0108	4-	223	.558	.850	3.2881	.3334	.0108
3+	161	.062	.150	3.7281	.3780	.5346	4-	198	.062	.150	5.4627	.5539	.5346	4-	198	.062	.150	5.4627	.5539	.5346
3+	168	.062	.333	3.5706	.3620	.5037	4-	205	.062	.333	4.9983	.5068	.5037	4-	205	.062	.333	4.9983	.5068	.5037
3+	181	.062	.667	2.6173	.2654	.3169	4-	210	.062	.500	4.6826	.4748	.3169	4-	210	.062	.500	4.6826	.4748	.3169
3+	187	.062	.850	3.4422	.3490	.4786	4-	218	.062	.667	3.2328	.3278	.4786	4-	218	.062	.667	3.2328	.3278	.4786
3+	162	.125	.150	3.8046	.3858	.5496	4-	224	.125	.150	2.9248	.2966	.5496	4-	224	.125	.150	2.9248	.2966	.5496
3+	182	.125	.667	2.4069	.2440	.2757	4-	211	.125	.500	4.8097	.4877	.2757	4-	211	.125	.500	4.8097	.4877	.2757
3+	188	.125	.850	2.6936	.2731	.3319	4-	219	.125	.667	3.3041	.3350	.3319	4-	219	.125	.667	3.3041	.3350	.3319
3+	170	.250	.333	3.9597	.4015	.5800	4-	225	.250	.850	3.0580	.3101	.5800	4-	225	.250	.850	3.0580	.3101	.5800
3+	175	.500	.500	3.7545	.3807	.5398	4-	200	.500	.150	5.9606	.6044	.5398	4-	200	.500	.150	5.9606	.6044	.5398
3+	183	.250	.667	2.1856	.2216	.2323	4-	212	.250	.500	5.0834	.5154	.2323	4-	212	.250	.500	5.0834	.5154	.2323
3+	189	.250	.850	2.2863	.2318	.2521	4-	226	.250	.850	3.3816	.3429	.2521	4-	226	.250	.850	3.3816	.3429	.2521
3+	164	.375	.150	4.1866	.4245	.6245	4-	213	.375	.500	4.6431	.4708	.6245	4-	213	.375	.500	4.6431	.4708	.6245
3+	171	.375	.333	4.0877	.4145	.6051	4+	227	.375	.267	.3302	.0335	.6051	4+	227	.375	.267	.3302	.0335	.6051
3+	176	.375	.500	3.9584	.4014	.5797	4+	230	.375	.450	.3506	.0355	.5797	4+	230	.375	.450	.3506	.0355	.5797
3+	184	.375	.667	2.3078	.2340	.2563	4+	233	.375	.695	.3910	.0396	.2563	4+	233	.375	.695	.3910	.0396	.2563
3+	190	.375	.850	2.1039	.2133	.2163	4+	234	.375	.778	.3775	.0383	.2163	4+	234	.375	.778	.3775	.0383	.2163
3+	165	.500	.150	3.9851	.4041	.5850	4+	232	.500	.634	.3183	-.1336	.5850	4+	232	.500	.634	.3183	-.1336	.5850
3+	172	.500	.333	4.1260	.4183	.6126	4+	235	.500	.808	.4520	-.0458	.6126	4+	235	.500	.808	.4520	-.0458	.6126
3+	177	.500	.500	4.0928	.4150	.6061	4+	200	.500	.150	5.9606	.6044	.6061	4+	200	.500	.150	5.9606	.6044	.6061

TABLE V.- Continued

(j) M = 2.70;  $\alpha = 30^\circ$

$P_t = 90.4 \text{ kPa}$

FIN	TUBE	Y/S	X/C	P/PINF	P/P12	CP	FIN	TUBE	Y/S	X/C	P/PINF	P/P12	CP
1-	116	.125	.221	.5351	.0543	-.0911	3+	185	.500	.867	3.0085	.3050	.3936
1-	119	.125	.472	.3546	.1265	-.1265	3+	191	.500	.850	2.8727	.2913	.3670
1-	122	.125	.731	.3125	.0317	-.1347	3+	166	.625	.150	3.9562	.4011	.5793
1-	117	.272	.302	1.0198	.1034	.0039	3+	173	.625	.333	4.1937	.4252	.6258
1-	123	.375	.703	.6254	.0634	-.0734	3+	178	.625	.500	5.0912	.5162	.8017
1-	118	.625	.251	1.2322	.1249	.0455	3+	186	.625	.667	3.0486	.3091	.4014
1-	121	.625	.465	1.2218	.1239	.0435	3+	192	.625	.850	2.9411	.2982	.3804
1+	125	.125	.252	.3964	.0402	-.1183	3+	167	.749	.150	3.0441	.3086	.4006
1+	128	.125	.496	.3448	.0350	-.1284	3+	179	.749	.500	3.1636	.3208	.4240
1+	131	.125	.756	.2134	.0216	-.1541	3+	193	.749	.850	2.1147	.2144	.2184
1+	126	.375	.255	.2134	.0216	-.1541	3+	180	.873	.500	2.7077	.2745	.3346
1+	132	.375	.762	.2134	.0216	-.1541	4-	194	.062	.150	5.6338	.5712	.9081
1+	127	.625	.189	.2134	.0216	-.1541	4-	201	.062	.333	5.8535	.5935	.9511
1+	130	.625	.408	.2134	.0216	-.1541	4-	214	.062	.667	5.2215	.5294	.8273
2-	134	.125	.221	.2134	.0216	-.1541	4-	195	.125	.150	5.8599	.5942	.9524
2-	137	.125	.472	.2134	.0216	-.1541	4-	202	.125	.333	5.9097	.5992	.9621
2-	140	.125	.731	.2134	.0216	-.1541	4-	207	.125	.500	6.2289	.6316	1.0247
2-	136	.625	.251	.2134	.0216	-.1541	4-	215	.125	.667	5.1017	.5173	.8038
2-	139	.625	.465	.2134	.0216	-.1541	4-	196	.250	.150	6.4939	.6584	1.0766
2+	143	.125	.221	4.0008	.4056	.5880	4-	203	.250	.333	6.1805	.6267	1.0152
2+	146	.125	.472	3.8775	.125	.5639	4-	208	.250	.500	6.2228	.6309	1.0235
2+	149	.125	.731	2.4423	.2476	.2826	4-	216	.250	.667	4.7869	.4854	.7421
3-	155	.142	.433	1.5256	.1547	.1030	4-	222	.250	.850	5.0269	.5097	.7891
3-	158	.142	.802	1.1779	.1194	.0349	4-	197	.375	.150	6.9299	.7026	1.1620
3-	156	.375	.414	1.7091	.1733	.1390	4-	204	.375	.333	6.5302	.6621	1.0837
3-	159	.375	.770	1.1566	.1173	.0307	4-	209	.375	.500	6.6202	.6712	1.1014
3-	157	.608	.425	.8231	.0835	-.0347	4-	217	.375	.667	4.5262	.4589	.6910
3-	161	.558	.746	.6164	.0625	-.0752	4-	211	.375	.850	4.6491	.4714	.7151
3+	160	.062	.150	4.8481	.4916	.7541	4-	198	.500	.150	7.3070	.7409	1.2359
3+	168	.062	.333	4.5952	.4659	.7045	4-	205	.500	.333	6.9140	.7010	1.1589
3+	181	.062	.667	4.2072	.4266	.6285	4-	210	.500	.500	6.6821	.6775	1.1135
3+	187	.062	.850	4.8383	.4906	.7522	4-	218	.500	.667	4.3181	.4378	.6502
3+	162	.125	.150	4.9342	.5003	.7710	4-	224	.500	.850	4.4068	.4468	.6676
3+	182	.125	.667	3.3936	.3441	.4691	4-	211	.625	.500	6.7911	.6886	1.1348
3+	188	.125	.850	4.7896	.4856	.7426	4-	219	.625	.667	4.3986	.4460	.6660
3+	170	.250	.333	5.1245	.5196	.8083	4-	225	.625	.850	4.3364	.4397	.6538
3+	175	.250	.500	4.7668	.4833	.7382	4-	200	.749	.150	8.1563	.8270	1.4024
3+	183	.250	.667	2.9512	.2992	.3824	4-	212	.749	.500	6.9384	.7035	1.1637
3+	189	.250	.850	3.3784	.3425	.4661	4-	226	.749	.850	6.1427	.6200	.8159
3+	164	.375	.150	5.8336	.5915	.9472	4-	213	.873	.500	5.6538	.5733	.9120
3+	171	.375	.333	5.3440	.5418	.8513	4-	227	.125	.267	3.016	.0306	-.1369
3+	176	.375	.500	4.9870	.5057	.7813	4+	230	.125	.450	3.263	.0331	-.1320
3+	184	.375	.667	2.7991	.2838	.3526	4+	233	.125	.500	3.705	.0376	-.1234
3+	190	.375	.850	2.8050	.2844	.3537	4+	234	.125	.778	3.599	.0365	-.1254
3+	165	.500	.150	5.2979	.5372	.8422	4+	232	.625	.634	3.333	.0338	-.1306
3+	172	.500	.333	5.6006	.5476	.8624	4+	235	.625	.808	4.062	.0412	-.1164
3+	177	.500	.500	5.1893	.5262	.8210	4+	235	.625	.808	4.062	.0412	-.1164

TABLE V.- Continued

(k) M = 2.70;  $\alpha = 40^\circ$

$P_t = 90.4$  kPa

FIN	TUBE	Y/S	X/C	P/PINF	P/PT2	CP	FIN	TUBE	Y/S	X/C	P/PINF	P/PT2	CP
1-	116	.125	.221	.5175	.0225	-.0945	3+	185	.500	.667	4.8492	.4917	.7543
1-	119	.125	.472	.3476	.0352	-.1279	3+	191	.500	.850	5.3801	.5455	.8383
1-	122	.125	.731	.4408	.0447	-.1096	3+	166	.625	.150	7.3075	.7409	1.2360
1-	117	.272	.302	1.1918	.1208	.0376	3+	173	.625	.333	6.9320	.7029	1.1624
1-	123	.375	.703	.8007	.0812	-.0391	3+	178	.625	.500	5.9565	.6039	.9713
1-	118	.625	.251	1.2412	.1258	.0473	3+	186	.625	.667	4.3343	.4395	.6334
1-	121	.625	.465	1.3276	.1346	.0642	3+	192	.625	.850	4.5283	.4591	.6914
1+	125	.125	.252	.2345	.0238	-.1500	3+	167	.749	.150	5.5386	.5616	.8894
1+	128	.125	.496	.2104	.0213	-.1547	3+	179	.749	.500	6.2542	.6341	1.0296
1+	131	.125	.756	.2104	.0213	-.1547	3+	193	.749	.850	3.6949	.3746	.5281
1+	126	.375	.255	.2104	.0213	-.1547	3+	180	.873	.500	3.8026	.3856	.5492
1+	132	.375	.762	.2104	.0213	-.1547	4-	194	.062	.150	9.2542	.9383	1.6175
1+	127	.625	.189	.2104	.0213	-.1547	4-	201	.062	.333	11.1385	1.1294	1.9868
1+	130	.625	.408	.2104	.0213	-.1547	4-	214	.062	.667	6.6272	.6720	1.1027
2-	134	.125	.221	.2104	.0213	-.1547	4-	195	.125	.150	10.6632	1.0812	1.8936
2-	137	.125	.472	.2104	.0213	-.1547	4-	202	.125	.333	11.0766	1.1231	1.9746
2-	140	.125	.731	.2104	.0213	-.1547	4-	207	.125	.500	8.9741	.9099	1.5626
2-	136	.625	.251	.2104	.0213	-.1547	4-	215	.125	.667	6.4544	.6544	1.0689
2-	139	.625	.465	.2104	.0213	-.1547	4-	215	.125	.850	11.4092	1.1566	2.0398
2+	143	.125	.221	4.9608	.0213	-.1547	4-	196	.250	.150	7.8274	.7734	1.2987
2+	146	.125	.472	5.0780	.0300	.7762	4-	203	.250	.333	9.8335	.9970	1.7310
2+	149	.125	.731	3.3588	.0606	.4622	4-	208	.250	.500	7.6274	.7734	1.2987
3-	155	.142	.433	1.9874	.0215	.1935	4-	222	.250	.667	6.0201	.6104	.9837
3-	158	.142	.802	1.2276	.0245	.0446	4-	197	.375	.850	5.3618	.5436	.8548
3-	156	.375	.414	.9573	.0375	-.0084	4-	204	.375	.150	10.4926	1.0639	1.8602
3-	159	.375	.770	.6710	.0680	-.0645	4-	209	.375	.333	8.7586	.8881	1.5204
3-	157	.608	.425	.7663	.0777	-.0458	4-	217	.375	.667	5.6794	.5759	.9170
3-	160	.558	.746	.7625	.0773	-.0466	4-	223	.375	.850	5.3336	.5611	.8884
3+	161	.062	.150	6.9870	.7084	1.1732	4-	198	.500	.150	8.9030	.9027	1.5487
3+	168	.062	.333	10.3728	1.0517	1.8367	4-	205	.500	.333	8.1440	.8257	1.4000
3+	181	.062	.667	5.8640	.5946	.9532	4-	210	.500	.500	7.0294	.7127	1.1815
3+	187	.062	.850	5.1012	.5172	.8037	4-	218	.500	.667	5.3303	.5607	.8878
3+	162	.125	.150	7.2342	.7235	1.2217	4-	224	.500	.850	5.5235	.5600	.8864
3+	182	.125	.667	5.5903	.5668	.8995	4-	211	.625	.500	6.9837	.7081	1.1726
3+	188	.125	5.2596	.5333	.5333	.8347	4-	219	.625	.667	5.7095	.5789	.9429
3+	170	.250	.333	8.1741	.8288	1.4059	4-	225	.625	.850	6.0451	.6129	.9887
3+	175	.250	.500	7.3300	.7432	1.2405	4-	200	.749	.150	8.2197	.8334	1.4148
3+	183	.250	.667	4.7687	.4835	.7385	4-	212	.749	.500	6.9939	.7091	1.1746
3+	189	.250	.850	5.9889	.6072	.9776	4-	226	.749	.850	6.7395	.6833	1.1247
3+	164	.375	.150	8.3939	.8511	1.4489	4-	213	.873	.500	6.6103	.6702	1.0994
3+	171	.375	.333	7.7430	.7851	1.3214	4+	227	.125	.267	.2687	.0272	-.1433
3+	176	.375	.500	6.6713	.6764	1.1114	4+	230	.125	.450	.2832	.0282	-.1405
3+	184	.375	.667	5.1615	.5233	.8155	4+	233	.125	.695	.2687	.0272	-.1433
3+	190	.375	.850	5.6520	.5731	.9116	4+	234	.125	.778	.2479	.0251	-.1474
3+	165	.500	.150	7.9194	.8030	1.3560	4+	232	.625	.634	.2496	.0253	-.1471
3+	172	.500	.333	7.3051	.7408	1.2358	4+	235	.625	.808	.2423	.0246	-.1485
3+	177	.500	.500	6.2325	.6319	1.0254	4+	235	.625				

TABLE V.- Continued

(1) M = 2.70;  $\alpha = 50^\circ$

$P_t = 90.4$  kPa

FIN	TUBE	Y/S	X/C	P/PINF	P/PT2	CP	FIN	TUBE	Y/S	X/C	P/PINF	P/PT2	CP
1-	116	.125	.221	.9732	.0887	-.0052	3+	185	.500	.667	6.4410	.6531	1.0662
1-	119	.125	.472	.8784	.0891	-.0238	3+	191	.500	.850	6.2491	.6336	1.0286
1-	122	.125	.731	.5110	.0518	-.0958	3+	166	.625	.150	8.6292	.8749	1.4950
1-	117	.272	.302	1.4242	.1444	-.0831	3+	173	.625	.333	7.7691	.7877	1.3265
1-	123	.375	.703	.6728	.0682	-.0641	3+	178	.625	.500	6.5148	.6606	1.0807
1-	118	.625	.251	1.2166	.1234	-.0424	3+	186	.625	.667	5.9629	.6046	.9725
1-	121	.125	.465	1.1614	.1178	-.0316	3+	192	.625	.850	5.9610	.6044	.9722
1+	125	.125	.252	.2110	.0214	-.1546	3+	167	.749	.150	8.0616	.8174	1.3838
1+	128	.125	.496	.2110	.0214	-.1546	3+	179	.749	.500	6.2261	.6313	1.0241
1+	131	.125	.756	.2110	.0214	-.1546	3+	193	.749	.850	5.2595	.5333	.8347
1+	126	.375	.255	.2110	.0214	-.1546	3+	180	.873	.500	5.6480	.5727	.9108
1+	132	.375	.762	.2110	.0214	-.1546	4-	194	.062	.150	12.2956	1.2467	2.2135
1+	127	.625	.189	.2110	.0214	-.1546	4-	201	.062	.333	10.0988	1.0240	1.7830
1+	130	.625	.408	.2110	.0214	-.1546	4-	214	.062	.667	7.8279	.7937	1.3380
2-	134	.125	.221	.2110	.0214	-.1546	4-	195	.125	.150	11.6992	1.1862	2.0967
2-	137	.125	.472	.2110	.0214	-.1546	4-	202	.125	.333	9.7477	.9883	1.7142
2-	140	.125	.731	.2110	.0214	-.1546	4-	207	.125	.500	8.2196	.8334	1.4148
2-	136	.625	.251	.2110	.0214	-.1546	4-	215	.125	.667	7.8367	.7946	1.3397
2-	139	.625	.465	.2110	.0214	-.1546	4-	196	.250	.150	9.9959	1.0135	1.7629
2+	143	.125	.221	6.2984	.6386	1.0383	4-	203	.250	.333	9.0714	.9198	1.5817
2+	146	.125	.472	5.5402	.5617	.8897	4-	208	.250	.500	7.8780	.7988	1.3478
2+	149	.125	.731	3.6800	.3731	.5252	4-	216	.250	.667	7.0683	.7688	1.2898
3-	155	.142	.433	2.3435	.2376	.2633	4-	222	.250	.850	7.5820	.7167	1.1892
3-	158	.142	.802	1.5918	.1614	.1160	4-	197	.375	.150	9.2103	.9339	1.6089
3-	156	.375	.414	.8964	.0909	-.0203	4-	204	.375	.333	8.8984	.9022	1.5478
3-	159	.375	.770	.9888	1.007	-.0013	4-	209	.375	.500	8.1654	.8279	1.4042
3-	157	.608	.425	.9331	.1007	-.0013	4-	217	.375	.667	7.5337	.7639	1.2804
3+	160	.598	.746	1.0107	.1025	.0021	4-	223	.375	.850	6.8342	.6929	1.1433
3+	161	.062	.150	9.9626	1.0101	1.7563	4-	198	.500	.150	9.0335	.9159	1.5743
3+	168	.062	.333	7.0288	.9155	1.5733	4-	205	.500	.333	8.8466	.8970	1.5376
3+	181	.062	.667	7.3030	.7405	1.2351	4-	210	.500	.500	8.1309	.8244	1.3974
3+	187	.062	.850	7.1858	.7286	1.2122	4-	218	.500	.667	7.5171	.7622	1.2771
3+	162	.125	.150	9.4929	.9625	1.6643	4-	224	.500	.850	6.7389	.6833	1.1246
3+	182	.125	.667	7.4119	.7515	1.2565	4-	211	.625	.500	8.1262	.8239	1.3965
3+	188	.125	.850	6.9506	.7047	1.1661	4-	219	.625	.667	7.5529	.7658	1.2841
3+	170	.250	.333	8.5277	.8647	1.4752	4-	225	.625	.850	6.8018	.6896	1.1369
3+	175	.250	.500	7.5770	.7683	1.2889	4-	200	.749	.150	8.7874	.8910	1.5260
3+	183	.250	.667	7.2079	.7308	1.2165	4-	212	.749	.500	8.1235	.8237	1.3959
3+	189	.250	.850	6.6969	.6790	1.1164	4-	226	.749	.650	6.9773	.7074	1.1713
3+	164	.375	.150	9.0899	.9217	1.5853	4-	213	.873	.500	7.7136	.7821	1.3156
3+	171	.375	.333	8.2960	.8412	1.4297	4+	227	.125	.267	.2110	.0214	-.1546
3+	176	.375	.500	7.2472	.7348	1.2242	4+	230	.125	.450	.2110	.0214	-.1546
3+	184	.375	.667	6.8503	.6946	1.1464	4+	233	.125	.695	.2110	.0214	-.1546
3+	190	.375	.850	6.4903	.6581	1.0759	4+	234	.375	.778	.2110	.0214	-.1546
3+	165	.500	.150	8.9107	.9035	1.5502	4+	232	.625	.634	.2110	.0214	-.1546
3+	172	.500	.333	8.0810	.8194	1.3876	4+	235	.625	.808	.2110	.0214	-.1546
3+	177	.500	.500	7.0083	.7106	1.1174	4+	214	.749	.500	8.1235	.8237	1.3959

TABLE VI.- WING PRESSURE LISTING FOR  $\phi = 45^\circ$  AND  $R = 2.5 \times 10^5$

(a)  $M = 1.60$ ,  $\alpha = 0^\circ$

$P_t = 54.7$  kPa

FIN	TUBE	Y/S	X/C	P/PINF	P/PT2	CP	FIN	TUBE	Y/S	X/C	P/PINF	P/PT2	CP
1-	116	.125	.221	1.1505	.3024	.0840	3+	185	.500	.667	.7254	.1906	-.1533
1-	119	.125	.472	1.0900	.2865	.0502	3+	191	.500	.850	.7200	.1892	-.1562
1-	122	.125	.731	.9407	.2472	-.0331	3+	166	.625	1.150	1.2157	.3195	.1204
1-	117	.272	.302	1.1149	.2930	.0641	3+	173	.625	.500	1.2221	.333	.1239
1-	123	.375	.703	.8108	.2131	-.1056	3+	178	.625	.500	1.1690	.3072	.0943
1-	118	.625	.251	1.1186	.2940	.0662	3+	186	.625	.667	.7155	.1880	-.1568
1+	121	.625	.465	1.1491	.3020	.0832	3+	192	.625	.850	.7104	.1867	-.1616
1+	125	.125	.252	1.1411	.2999	.0787	3+	167	.749	1.1682	1.0938	.3070	.0938
1+	128	.125	.496	1.1462	.3012	.0816	3+	179	.749	.500	1.1489	.3019	.0831
1+	131	.125	.756	.9506	.2898	-.0275	3+	193	.749	.850	.7148	.1879	-.1591
1+	126	.375	.255	1.2376	.3253	.1326	3+	180	.873	.500	1.1214	.2947	.0677
1+	132	.375	.762	.8336	.2191	-.0929	4-	194	.873	.500	1.0877	.2977	.0677
1+	127	.625	.189	1.3160	.3459	.1763	4-	201	.873	.333	1.1491	.3020	.0832
1+	130	.625	.408	1.2335	.3242	.1303	4-	214	.873	.333	1.0834	.2847	.0466
2-	134	.125	.221	1.1294	.2968	.0722	4-	195	.125	.150	1.1296	.2969	.0723
2-	137	.125	.472	1.1302	.2970	.0726	4-	202	.125	.333	1.1596	.3047	.0890
2-	140	.125	.731	.9602	.2523	-.0222	4-	207	.125	.500	1.1119	.2922	.0624
2-	136	.625	.251	1.2522	.3291	.1407	4-	215	.125	.667	.9274	.2437	-.0405
2-	139	.625	.465	1.1905	.3129	.1063	4-	196	.125	.150	1.1632	.3057	.0911
2+	143	.125	.221	1.1470	.3015	.0821	4-	203	.250	.333	1.1557	.3037	.0869
2+	146	.125	.472	1.1380	.2991	.0770	4-	208	.250	.500	1.1259	.2959	.0703
2+	149	.125	.731	.8852	.2327	-.0640	4-	216	.250	.667	.8200	.2155	-.1005
3-	155	.142	.633	1.1149	.2930	.0641	4-	222	.250	.850	.8472	.2227	-.0853
3-	158	.142	.802	.8504	.2235	-.0835	4-	197	.375	.150	1.2065	.3171	.1152
3-	156	.375	.414	1.0897	.2864	.0500	4-	204	.375	.333	1.1581	.3044	.0862
3-	159	.375	.770	.8149	.2142	-.1033	4-	209	.375	.500	1.1390	.2993	.0775
3-	157	.608	.425	1.0458	.2748	.0255	4-	217	.375	.667	.7534	.1980	-.1376
3-	160	.608	.746	.8368	.2199	-.0911	4-	223	.375	.850	.7966	.2093	-.1135
3+	161	.062	.150	1.0981	.2886	.0548	4-	198	.500	.150	1.2452	.3273	.1368
3+	168	.062	.333	1.1422	.3002	.0793	4-	205	.500	.333	1.1810	.3104	.1010
3+	161	.062	.667	.9525	.2503	-.0265	4-	210	.500	.500	1.1265	.2961	.0706
3+	187	.062	.850	.9439	.2481	-.0313	4-	218	.500	.667	.7362	.1935	-.1472
3+	162	.125	.150	1.0957	.2880	.0534	4-	224	.500	.850	.8078	.2123	-.1072
3+	182	.125	.667	.9115	.2395	-.0494	4-	211	.625	.500	1.1295	.2968	.0722
3+	188	.125	.850	.9197	.2417	-.0448	4-	219	.625	.667	.7116	.1870	-.1609
3+	170	.250	.333	1.1856	.3116	.1036	4-	225	.625	.850	.7954	.2091	-.1142
3+	175	.250	.500	1.1786	.3097	.0996	4-	200	.749	.150	1.3258	.3484	.1818
3+	183	.250	.667	.8195	.2154	-.1007	4-	212	.749	.500	1.1647	.3061	.0919
3+	189	.250	.850	.8414	.2211	-.0885	4-	226	.749	.850	.7575	.1991	-.1353
3+	164	.375	.150	1.1831	.3109	.1022	4-	213	.873	.500	1.0364	.2724	.0203
3+	171	.375	.333	1.1983	.3149	.1107	4+	227	.873	.500	1.1179	.2938	.0658
3+	176	.375	.500	1.1905	.3129	.1063	4+	230	.873	.450	1.1437	.3006	.0802
3+	184	.375	.667	.7526	.1978	-.1380	4+	233	.873	.695	.8602	.2261	-.0780
3+	190	.375	.850	.7764	.2041	-.1248	4+	234	.873	.8189	.8189	.2152	-.1011
3+	165	.500	.150	1.1702	.3075	.0950	4+	232	.873	.634	.7974	.2096	-.1131
3+	172	.500	.333	1.2356	.3247	.1315	4+	235	.873	.808	.7495	.1970	-.1398
3+	177	.500	.500	1.2073	.3173	.1157	4+	235	.873	.808	.7495	.1970	-.1398



TABLE VI.- Continued

(b)  $M = 1.60$ ;  $\alpha = 10^\circ$

$p_t = 54.5$  kPa

FIN	TUBE	Y/S	X/C	P/PINF	P/PIT2	CP	FIN	TUBE	Y/S	X/C	P/PINF	P/PIT2	CP
1-	116	.125	.221	1.4144	.3717	.2313	3+	185	.500	.667	1.1032	.2899	.0576
1-	119	.125	.472	1.2123	.3186	.1185	3+	191	.500	.850	1.1935	.3137	.1080
1-	122	.125	.731	.9986	.2624	-.0008	3+	166	.625	.150	1.9573	.5144	.5342
1-	117	.125	.302	1.3606	.3576	.2012	3+	173	.625	.333	1.9498	.5124	.5300
1-	123	.375	.703	.8912	.2342	-.0607	3+	178	.625	.500	1.7686	.4648	.4289
1-	118	.625	.251	1.4856	.3904	.2710	3+	186	.625	.667	1.0849	.2851	.0474
1-	121	.625	.465	1.3963	.3670	.2211	3+	192	.625	.850	1.0996	.2890	.0556
1+	125	.125	.252	.8309	.2184	-.0943	3+	167	.749	.150	1.9671	.5170	.5397
1+	128	.125	.496	.7491	.1969	-.1400	3+	179	.749	.500	1.7358	.4562	.4106
1+	131	.125	.756	.6036	.1586	-.2212	3+	193	.749	.850	1.0799	.2838	.0446
1+	126	.375	.255	.8600	.2260	-.0781	3+	180	.873	.500	1.7165	.4511	.3998
1+	132	.375	.762	.5589	.2260	-.2462	4-	194	.062	.150	1.5368	.4039	.2996
1+	127	.625	.189	.5275	.1386	-.2637	4-	201	.062	.333	1.6746	.4401	.3764
1+	130	.625	.408	.6921	.1819	-.1718	4-	214	.062	.667	1.5450	.4061	.3041
2-	134	.125	.221	.8217	.2160	-.0995	4-	195	.125	.150	1.6078	.4225	.3392
2-	137	.125	.472	.7677	.2018	-.1296	4-	202	.125	.333	1.7105	.4495	.3965
2-	140	.125	.731	.6160	.1619	-.2143	4-	215	.125	.667	1.7193	.4519	.4014
2-	136	.625	.251	.5516	.1450	-.2502	4-	203	.125	.500	1.5247	.4007	.2928
2-	139	.625	.465	.7081	.1861	-.1629	4-	196	.250	.150	1.6966	.4459	.3887
2+	143	.125	.221	1.3811	.3630	.2127	4-	208	.250	.333	1.7683	.4647	.4287
2+	146	.125	.472	1.2534	.3294	.1414	4-	203	.250	.500	1.7080	.4489	.3951
2+	149	.125	.731	.9171	.2410	-.0462	4-	216	.250	.667	1.3941	.3664	.2199
3-	155	.142	.433	.7566	.1989	-.1358	4-	222	.250	.850	1.3780	.3622	.2109
3-	158	.142	.802	.9295	.2443	-.0394	4-	197	.375	.150	1.7752	.4666	.4326
3-	156	.375	.414	.6679	.1755	-.1853	4-	204	.375	.333	1.8044	.4742	.4489
3-	159	.375	.770	.6016	.1581	-.2223	4-	209	.375	.500	1.7507	.4601	.4189
3-	157	.608	.425	.6649	.1747	-.1870	4-	217	.375	.667	1.2590	.3309	.1445
3-	160	.558	.746	.6144	.1615	-.2152	4-	223	.375	.850	1.2888	.3387	.1612
3+	161	.062	.150	1.5728	.4134	.3196	4-	198	.500	.150	1.8475	.4856	.4729
3+	168	.062	.333	1.6338	.4294	.3537	4-	205	.500	.333	1.8613	.4892	.4807
3+	181	.062	.667	1.4853	.3904	.2708	4-	210	.500	.500	1.7541	.4610	.4208
3+	187	.062	.850	1.4390	.3782	.2450	4-	218	.500	.667	1.1219	.2948	.0680
3+	182	.125	.150	1.5929	.4186	.3308	4-	224	.500	.850	1.1758	.3090	.0981
3+	182	.125	.667	1.4565	.3828	.2547	4-	211	.625	.500	1.7563	.4616	.4220
3+	188	.125	.850	1.4143	.3717	.2312	4-	219	.625	.667	1.0947	.2877	.0528
3+	170	.250	.333	1.7785	.4674	.4344	4-	225	.625	.850	1.0754	.2826	.0421
3+	175	.250	.500	1.8048	.4743	.4491	4-	200	.749	.150	2.0586	.5410	.5907
3+	183	.250	.667	1.3560	.3564	.1987	4-	212	.749	.500	1.7960	.4720	.4442
3+	189	.250	.850	1.3156	.3458	.1761	4-	226	.749	.850	1.1238	.2954	.0691
3+	164	.375	.150	1.7926	.4711	.4623	4+	213	.873	.500	1.5528	.4081	.3085
3+	171	.375	.333	1.8344	.4821	.4656	4+	237	.125	.267	.7288	.1915	-.1513
3+	176	.375	.500	1.8261	.4799	.4610	4+	230	.125	.450	.7739	.2034	-.1262
3+	184	.375	.667	1.2196	.3205	.1226	4+	233	.125	.695	.6233	.2164	-.0986
3+	190	.375	.850	1.2653	.3325	.1480	4+	234	.125	.778	.6271	.1648	-.2081
3+	165	.500	.150	1.8033	.4739	.4483	4+	232	.625	.634	.6293	.1654	-.2068
3+	172	.500	.333	1.9437	.5108	.5266	4+	235	.625	.808	.6503	.1709	-.1952
3+	177	.500	.500	1.8938	.4819	.4653	4+	235	.625	.808	.6503	.1709	-.1952

TABLE VI.- Continued

(C) M = 1.60;  $\alpha = 20^\circ$

$P_t = 54.8$  kPa

FIN	TUBE	Y/S	X/C	P/PINF	P/PTZ	CP	FIN	TUBE	Y/S	X/C	P/PINF	P/PTZ	CP
1-	116	.125	.221	1.0940	.2875	.0325	3+	185	.500	.667	1.5350	.4037	.2991
1-	119	.125	.472	1.0479	.2754	.0267	3+	191	.500	.850	1.7220	.4526	.4029
1-	122	.125	.731	.9303	.2445	-.0389	3+	166	.625	.150	2.7267	.7166	.9636
1-	117	.272	.302	1.3750	.3614	.2092	3+	173	.625	.333	2.4754	.6506	.8233
1-	123	.375	.703	.9976	.2622	-.0014	3+	178	.625	.500	2.0556	.5403	.5891
1-	118	.625	.231	1.6504	.4338	.3630	3+	186	.625	.667	1.4494	.3809	.2508
1-	121	.625	.465	1.5179	.3989	.2890	3+	192	.625	.850	1.5950	.4192	.3321
1+	125	.125	.252	.8036	.2112	-.1096	3+	167	.749	.150	2.6503	.6965	.9209
1+	128	.125	.496	.7055	.1854	-.1643	3+	179	.749	.500	2.0167	.5300	.5674
1+	131	.125	.756	.5509	.1448	-.2506	3+	193	.749	.850	2.0167	.3985	.2881
1+	126	.375	.255	.3956	.1040	-.3373	3+	180	.873	.500	1.5163	.5286	.5644
1+	132	.375	.3035	.3035	.0798	-.3887	4-	194	.873	.150	2.4889	.6541	.8308
1+	127	.625	.189	.2335	.0614	-.4277	4-	201	.862	.333	2.5618	.6733	.8716
1+	130	.625	.408	.2160	.0568	-.4375	4-	214	.862	.667	2.0103	.5283	.5638
2-	134	.125	.221	.8246	.2167	-.0979	4-	195	.125	.150	2.5828	.6788	.8833
2-	137	.125	.472	.7275	.1912	-.1521	4-	202	.125	.333	2.5396	.6674	.8592
2-	140	.125	.731	.5756	.1466	-.2468	4-	207	.125	.500	2.1920	.5761	.6652
2-	136	.625	.251	.2229	.0586	-.4336	4-	215	.125	.667	1.9751	.5191	.5441
2-	139	.625	.465	.1978	.0520	-.4477	4-	196	.250	.150	2.6687	.7014	.9312
2+	143	.125	.221	1.0374	.2727	.0209	4-	203	.250	.333	2.4779	.6512	.8247
2+	146	.125	.472	1.0812	.2842	.0453	4-	208	.250	.500	2.0964	.5210	.6118
2+	149	.125	.731	.8442	.2219	-.0869	4-	216	.250	.667	1.8745	.4926	.4880
3-	155	.142	.333	.4766	.1252	-.2921	4-	222	.250	.850	1.7267	.4538	.4055
3-	158	.142	.802	.4394	.1155	-.3128	4-	197	.375	.150	2.6831	.7052	.9392
3-	156	.375	.414	.3686	.1021	-.3412	4-	204	.375	.333	2.4662	.6482	.8182
3-	159	.375	.770	.3650	.0959	-.3543	4-	209	.375	.500	2.1416	.5629	.6371
3-	157	.608	.425	.3734	.0981	-.3497	4-	217	.375	.667	1.7685	.4648	.4289
3-	160	.608	.746	.3753	.0986	-.3486	4-	223	.375	.850	1.6731	.4397	.3756
3+	161	.062	.150	2.4597	.6465	.8146	4-	198	.500	.150	2.6998	.7096	.9486
3+	168	.062	.333	2.5642	.6739	.8729	4-	205	.500	.333	2.4813	.6521	.8266
3+	181	.062	.667	1.8552	.4876	.4772	4-	210	.500	.500	2.1252	.5585	.6279
3+	187	.062	.850	1.8653	.4902	.4829	4-	218	.500	.667	1.6425	.4317	.3586
3+	162	.125	.150	2.9258	.6638	.8514	4-	224	.500	.850	1.6313	.4287	.3523
3+	182	.125	.667	1.6358	.4825	.4664	4-	211	.625	.500	2.1420	.5630	.6373
3+	188	.125	.850	1.8499	.4862	.4743	4-	219	.625	.667	1.5382	.4043	.3003
3+	170	.250	.333	2.5201	.6623	.8403	4-	225	.625	.850	1.6179	.4252	.3448
3+	175	.250	.500	2.2115	.5812	.6761	4-	200	.749	.150	2.7117	.7127	.9552
3+	183	.250	.667	1.7688	.4649	.4290	4-	212	.749	.500	2.1756	.5718	.6560
3+	189	.250	.850	1.7928	.4712	.4424	4-	226	.749	.850	1.5881	.4174	.3282
3+	164	.375	.150	2.7054	.37108	.9511	4-	213	.873	.500	1.8217	.4788	.4585
3+	171	.375	.333	2.4995	.6569	.8368	4+	227	.125	.267	.4314	.1134	-.3173
3+	176	.375	.500	2.1468	.5642	.6400	4+	230	.125	.450	.4532	.1191	-.3052
3+	184	.375	.667	1.6515	.4340	.3635	4+	233	.125	.695	.3307	.0869	-.3735
3+	190	.375	.850	1.7617	.4630	.4250	4+	234	.125	.778	.3886	.1021	-.3412
3+	165	.500	.150	2.7007	.7098	.9490	4+	232	.375	.634	.4234	.1113	-.3218
3+	172	.500	.333	2.5165	.6614	.8463	4+	235	.625	.808	.4112	.1081	-.3286
3+	177	.500	.500	2.1483	.5646	.6408	4+	235	.625	.808	.4112	.1081	-.3286

TABLE VI.- Continued

(d) M = 1.60;  $\alpha = 30^\circ$

$P_t = 54.6 \text{ kPa}$

FIN	TUBE	Y/S	X/C	P/PINF	P/PT2	CP	FIN	TUBE	Y/S	X/C	P/PINF	P/PT2	CP
1-	116	.125	.221	1.0989	.2888	.0552	3+	185	.500	.667	2.2801	.5992	.7143
1-	119	.125	.472	1.1245	.2955	.0695	3+	191	.500	.850	2.2547	.5926	.7002
1-	122	.125	.731	.9192	.2416	-.0451	3+	166	.625	.150	3.2066	.8427	1.2314
1-	117	.272	.302	1.2676	.3331	1.493	3+	173	.625	.333	2.9025	.7628	1.0617
1-	123	.375	.703	.9918	.2607	-.0046	3+	178	.625	.500	2.4357	.6401	.8011
1-	118	.625	.251	1.4904	.3917	.2737	3+	186	.625	.667	2.2402	.5888	.6921
1-	121	.625	.465	1.3999	.3679	.2232	3+	192	.625	.850	2.2200	.5835	.6808
1+	125	.125	.252	.5795	.1523	-.2346	3+	167	.749	.150	3.1216	.8204	1.1839
1+	128	.125	.496	.5578	.1466	-.2468	3+	179	.749	.500	2.4075	.6327	.7854
1+	131	.125	.756	.3853	.1013	-.3430	3+	193	.749	.850	2.1380	.5619	.6351
1+	126	.375	.255	1.927	.0507	-.4505	3+	180	.873	.500	2.3980	.6302	.7801
1+	132	.375	.762	1.955	.0514	-.4489	4-	194	.062	.150	3.2776	.8614	1.2710
1+	127	.625	.189	.0949	.0249	-.5051	4-	201	.062	.333	3.1040	.8158	1.1741
1+	130	.625	.408	.0959	.0252	-.5045	4-	214	.062	.667	2.5246	.6635	.8508
2-	134	.125	.221	.5696	.1497	-.2402	4-	195	.125	.150	3.2813	.8624	1.2730
2-	137	.125	.472	.5493	.1444	-.2515	4-	202	.125	.333	3.0582	.8038	1.1486
2-	140	.125	.731	.3810	.1001	-.3454	4-	207	.125	.500	2.6685	.7013	.9311
2-	136	.625	.251	1.031	.0271	-.5005	4-	215	.125	.667	2.4958	.6559	.8347
2-	139	.625	.465	.0952	.0250	-.5049	4-	196	.125	.150	3.2675	.8587	1.2653
2+	143	.125	.221	1.0863	.2855	.0481	4-	203	.250	.333	2.9791	.7829	1.1044
2+	146	.125	.472	1.1230	.2951	.0687	4-	208	.250	.500	2.5925	.6813	.8887
2+	149	.125	.731	.8465	.2225	-.0857	4-	216	.250	.667	2.4095	.6332	.7865
3-	155	.142	.433	3.007	.0790	-.3902	4-	222	.250	.850	2.2636	.5949	.7051
3-	158	.142	.802	.3626	.0953	-.3557	4-	197	.375	.150	3.2351	.8502	1.2473
3-	156	.375	.414	.2347	.0617	-.4270	4-	204	.375	.333	2.9577	.7773	1.0925
3-	159	.608	.770	.3337	.0877	-.3718	4-	209	.375	.500	2.5976	.6827	.8915
3-	157	.608	.425	.2550	.0670	-.4157	4-	217	.375	.667	2.3372	.6142	.7462
3-	160	.558	.746	.2841	.0747	-.3995	4-	223	.375	.850	2.1905	.5757	.6643
3+	161	.062	.150	3.2605	.8569	1.2615	4-	198	.500	.150	3.2249	.8475	1.2416
3+	168	.062	.333	3.0932	.8129	1.1681	4-	205	.500	.333	2.9519	.7758	1.0892
3+	181	.062	.667	2.4757	.6507	.8235	4-	210	.500	.500	2.5443	.6687	.8618
3+	187	.062	.850	2.3879	.6276	.7745	4-	218	.500	.667	2.2689	.5963	.7081
3+	162	.125	.150	3.2482	.8537	1.2546	4-	224	.500	.850	2.1199	.5571	.6250
3+	182	.125	.667	2.4611	.6468	.8154	4-	211	.625	.500	2.5316	.6653	.8547
3+	188	.125	.850	2.3508	.6178	.7538	4-	219	.625	.667	2.2301	.5861	.6865
3+	170	.250	.333	3.0007	.7886	1.1164	4-	225	.625	.850	2.0749	.5453	.5998
3+	175	.250	.500	2.6182	.6681	.9030	4-	200	.749	.150	3.1764	.8348	1.2145
3+	183	.250	.667	2.4044	.6319	.7837	4-	212	.749	.500	2.5421	.6681	.8606
3+	189	.375	.850	2.2732	.5974	.7105	4-	226	.749	.850	2.1470	.5643	.6401
3+	164	.375	.150	3.2475	.8535	1.2542	4-	213	.873	.500	2.2200	.5835	.6808
3+	171	.375	.333	2.9553	.7767	1.0911	4+	227	.125	.267	.2229	.0586	-.4337
3+	176	.375	.500	2.5290	.6647	.8532	4+	230	.125	.450	.2766	.0727	-.4037
3+	184	.375	.667	2.3388	.6147	.7471	4+	233	.125	.695	.2845	.0746	-.3993
3+	190	.375	.850	2.2667	.5957	.7069	4+	234	.125	.778	.3457	.0909	-.3651
3+	165	.500	.150	3.2144	.8448	1.2357	4+	232	.625	.634	.2833	.0745	-.3999
3+	172	.500	.333	2.9529	.7761	1.0898	4+	235	.625	.808	.3179	.0835	-.3807
3+	177	.500	.500	2.5307	.6651	.8542	4+	235	.625	.808	.3179	.0835	-.3807

TABLE VI.- Continued

(e) M = 1.60;  $\alpha = 40^\circ$

$P_t = 54.8$  kPa

FIN	TUBE	Y/S	X/C	P/PINF	P/PI2	CP	FIN	TUBE	Y/S	X/C	P/PINF	P/PI2	CP
1-	116	.125	.221	1.4033	.3688	.2250	3+	185	.500	.667	2.6769	.7035	.9328
1-	119	.125	.472	1.0437	.2743	.0244	3+	191	.500	.850	2.5272	.6642	.8522
1-	122	.125	.731	.8668	.2278	-.0743	3+	166	.625	.150	3.5793	.9407	1.4393
1-	117	.272	.302	1.4312	.3761	.2406	3+	173	.625	.333	2.2887	.8643	1.2772
1-	123	.375	.703	1.0317	.2711	.0177	3+	178	.625	.500	2.8482	.7486	1.0314
1-	118	.625	.251	1.4079	.3700	.2276	3+	186	.625	.667	2.6279	.6907	.9084
1-	121	.625	.465	1.2950	.3403	.1646	3+	192	.625	.850	2.4971	.6563	.8354
1+	125	.125	.252	.3625	.0953	-.3357	3+	167	.749	.150	3.4919	.9177	1.3906
1+	128	.125	.496	.2689	.0707	-.4080	3+	179	.749	.500	2.8051	.7372	1.0073
1+	131	.125	.756	.1879	.0494	-.4532	3+	193	.749	.850	2.4214	.6364	.7932
1+	126	.375	.255	.1395	.0367	-.4802	3+	180	.873	.500	2.7590	.7251	.9816
1+	132	.375	.762	.1502	.0395	-.4742	4-	194	.062	.150	3.7046	.8736	1.5093
1+	127	.625	.189	.1454	.0382	-.4769	4-	201	.062	.333	3.5045	.9210	1.3976
1+	130	.625	.408	.1625	.0427	-.4674	4-	214	.062	.667	2.9339	.6711	1.0792
2-	134	.125	.221	.3922	.1031	-.3392	4-	195	.125	.150	3.7004	.9725	1.5069
2-	137	.125	.472	.2915	.0766	-.3953	4-	202	.125	.333	3.4607	.9095	1.3732
2-	140	.125	.731	1.4904	.0500	-.4518	4-	207	.125	.500	3.1217	.8204	1.1840
2-	136	.625	.251	.1406	.0370	-.4796	4-	215	.125	.667	2.9047	.7634	1.0629
2-	139	.625	.465	.1542	.0405	-.4720	4-	196	.250	.150	3.6703	.9646	1.4901
2+	143	.125	.221	1.1897	.3127	.1059	4-	203	.250	.333	3.3916	.8914	1.3346
2+	146	.125	.472	.9539	.2507	-.0257	4-	208	.250	.500	3.0403	.7990	1.1385
2+	149	.125	.731	.8170	.2147	-.1021	4-	216	.250	.667	2.8175	.7405	1.0142
3-	155	.142	.433	.2997	.0788	-.3908	4-	222	.375	.850	2.5844	.6792	.8842
3-	158	.142	.802	.3462	.0910	-.3648	4-	197	.375	.150	3.6291	.9538	1.4671
3-	156	.375	.414	.3163	.0831	-.3815	4-	204	.375	.333	3.3648	.8843	1.3197
3-	159	.375	.770	.3350	.0880	-.3711	4-	209	.375	.500	3.0183	.7932	1.1263
3-	157	.608	.425	.3522	.0934	-.3598	4-	217	.375	.667	2.7385	.7197	.9702
3-	160	.608	.746	.3329	.0875	-.3723	4-	223	.375	.850	2.5068	.6588	.8408
3+	161	.062	.150	3.7152	.9764	1.5152	4-	198	.500	.150	3.6069	.9479	1.4547
3+	168	.062	.333	3.5018	.9203	1.3961	4-	205	.500	.333	3.3478	.8799	1.3102
3+	181	.062	.667	2.9025	.7628	1.0616	4-	210	.500	.500	2.9542	.7764	1.0905
3+	187	.062	.850	2.6942	.7081	.9454	4-	218	.500	.667	2.6714	.7021	.9327
3+	162	.125	.150	3.6894	.9696	1.5008	4-	224	.500	.850	2.4352	.6400	.8009
3+	182	.125	.667	2.8793	.7567	1.0487	4-	211	.625	.500	2.9275	.7694	1.0756
3+	188	.125	.850	2.6577	.6985	.9251	4-	219	.625	.667	2.6270	.6904	.9079
3+	170	.250	.333	3.4082	.8957	1.3438	4-	225	.625	.850	2.3815	.6259	.7709
3+	175	.250	.500	3.0500	.8016	1.1440	4-	200	.749	.150	3.5230	.9259	1.4079
3+	183	.250	.667	2.8071	.7377	1.0084	4-	212	.749	.500	2.9198	.7674	1.0713
3+	189	.250	.850	2.5761	.6770	.8795	4-	226	.749	.850	2.4361	.6402	.8014
3+	164	.375	.150	3.6424	.9573	1.4745	4-	213	.873	.500	2.6435	.6947	.9171
3+	171	.375	.333	3.3555	.8819	1.3145	4+	227	.125	.267	.2184	.0574	-.4362
3+	176	.375	.500	2.9631	.7787	1.0955	4+	230	.125	.450	.2422	.0637	-.4229
3+	184	.375	.667	2.7311	.7178	.9660	4+	233	.125	.695	.3056	.0803	.3056
3+	190	.375	.850	2.5523	.6708	.8662	4+	234	.375	.778	.3305	.0869	-.3736
3+	165	.500	.150	3.6029	.9469	1.4525	4+	232	.625	.634	.3476	.0914	-.3640
3+	172	.500	.333	3.3418	.8783	1.3068	4+	235	.625	.808	.3412	.0897	-.3676
3+	177	.500	.500	2.9463	.7743	1.0861	4+						

TABLE VI.- Continued

(f) M = 1.60;  $\alpha = 50^\circ$

$P_c = 54.8 \text{ kPa}$

FIN	TUBE	Y/S	X/C	P/PINF	P/P/T2	CP	FIN	TUBE	Y/S	X/C	P/PINF	P/P/T2	CP
1-	116	.125	.221	1.0015	.2632	.0098	3+	185	.500	.667	2.8922	.7601	1.0559
1-	119	.125	.472	1.0041	.2639	.0023	3+	191	.500	.850	2.6596	.6990	.9261
1-	122	.125	.731	.9041	.2376	.0023	3+	166	.625	.150	3.6226	.9521	1.4635
1-	117	.272	.302	1.5127	.3975	.2861	3+	173	.625	.333	3.4108	.8964	1.3453
1-	123	.375	.703	1.1926	.3134	.1075	3+	178	.625	.500	3.0801	.8095	1.1608
1-	118	.625	.251	1.3769	.3619	.2103	3+	186	.625	.667	2.8577	.7510	1.0367
1-	121	.625	.465	1.3052	.3430	.1703	3+	192	.850	.850	2.6466	.6956	.9189
1+	125	.125	.252	.3368	.0885	-.3701	3+	179	.749	.150	3.5651	.9370	1.4314
1+	128	.125	.496	.3492	.0918	-.3632	3+	179	.749	.500	3.0550	.8029	1.1467
1+	131	.125	.756	.3723	.0978	-.3503	3+	193	.749	.850	2.5913	.6810	.8880
1+	126	.375	.255	.3043	.0800	-.3882	3+	180	.873	.500	3.0188	.7934	1.1266
1+	132	.375	.762	.3448	.0906	-.3657	4-	194	.062	.150	3.8619	1.0150	1.5970
1+	127	.625	.189	.3371	.0886	-.3699	4-	201	.062	.333	3.6498	.9592	1.4787
1+	130	.625	.408	.3423	.0900	-.3670	4-	214	.062	.667	3.1049	.8160	1.1746
2-	134	.125	.221	.3012	.0792	-.3900	4-	195	.125	.150	3.8475	1.0112	1.5890
2-	137	.125	.472	.3819	.1204	-.3449	4-	202	.125	.333	3.6044	.9473	1.4533
2-	140	.125	.731	.3842	.1010	-.3436	4-	207	.125	.500	3.2981	.8668	1.2824
2-	136	.625	.251	.3459	.0909	-.3650	4-	215	.125	.667	3.0779	.8089	1.1595
2-	139	.625	.465	.3517	.0924	-.3618	4-	196	.250	.150	3.7845	.9946	1.4539
2+	143	.125	.221	.7525	.1978	-.1381	4-	203	.250	.333	3.5236	.9261	1.4083
2+	146	.125	.472	1.1205	.2945	.0672	4-	208	.250	.500	3.2218	.8467	1.2398
2+	149	.125	.731	.8722	.2592	-.0713	4-	216	.250	.667	3.0003	.7885	1.1162
3-	155	.142	.433	.3681	.0968	-.3526	4-	222	.250	.850	2.7282	.7170	.9644
3-	158	.142	.802	.3928	.1032	-.3388	4-	197	.375	.150	3.6965	.9715	1.5047
3-	156	.375	.414	.3786	.0995	-.3467	4-	204	.375	.333	3.4829	.9153	1.3855
3-	159	.375	.770	.3841	.1009	-.3437	4-	209	.375	.500	3.2014	.8414	1.2285
3-	157	.608	.425	.3948	.1038	-.3377	4-	217	.375	.667	2.9340	.7711	1.0792
3-	160	.608	.746	.3939	.1035	-.3382	4-	223	.375	.850	2.6556	.6979	.9239
3+	161	.062	.150	.38698	1.0170	1.6015	4-	198	.500	.150	3.6531	.9601	1.4805
3+	168	.062	.333	3.6486	.9589	1.4780	4-	205	.500	.333	3.4609	.9096	1.3732
3+	181	.062	.667	3.0828	.8102	1.1623	4-	210	.500	.500	3.1493	.8277	1.1994
3+	187	.062	.850	2.8362	.7454	1.0247	4-	218	.500	.667	2.8866	.7592	1.0539
3+	162	.125	.150	3.8409	1.0094	1.5853	4-	224	.500	.850	2.5971	.6826	.8912
3+	182	.125	.667	3.0581	.8037	1.1485	4-	211	.625	.500	3.1320	.8231	1.1897
3+	188	.125	.850	2.7982	.7354	1.0035	4-	219	.625	.667	2.8554	.7504	1.0354
3+	170	.250	.333	3.5361	.9293	1.4152	4-	225	.625	.850	2.5578	.6722	.8693
3+	175	.250	.500	3.2262	.8479	1.2423	4-	200	.749	.150	3.5880	.9430	1.4442
3+	183	.250	.667	2.9896	.7857	1.1103	4-	212	.749	.500	3.1337	.8236	1.1907
3+	189	.250	.850	2.7115	.7126	.9551	4-	226	.749	.850	2.6050	.6846	.8957
3+	164	.375	.150	3.7038	.375	1.5088	4-	213	.873	.500	2.9432	.7735	1.0844
3+	171	.375	.333	3.4745	.9131	1.3809	4+	227	.125	.267	.2795	.0735	-.4021
3+	176	.375	.500	3.1555	.8293	1.2028	4+	230	.125	.450	.3354	.0881	-.3709
3+	184	.375	.667	2.9256	.7889	1.0745	4+	233	.125	.695	.3926	.1032	-.3389
3+	190	.375	.850	2.6862	.7060	.9410	4+	234	.125	.778	.3999	.1051	-.3349
3+	165	.500	.150	3.6454	.9581	1.4762	4+	232	.625	.634	.4093	.1076	-.3297
3+	172	.500	.333	3.4513	.9071	1.3679	4+	235	.625	.808	.4078	.1072	-.3305
3+	177	.500	.500	3.1450	.8266	1.1970	4+	235	.625	.808	.4078	.1072	-.3305

TABLE VI.- Continued

(g) M = 2.70;  $\alpha = 0^\circ$

$P_t = 90.3 \text{ kPa}$

FIN	TUBE	Y/S	X/C	P/PINF	P/PTZ	CP	FIN	TUBE	Y/S	X/C	P/PINF	P/PTZ	CP
1-	116	.125	.221	1.2387	.1256	.0468	3+	185	.500	.667	.7456	.0756	-.0499
1-	119	.125	.472	1.0625	.1077	.0122	3+	191	.500	.850	.6899	.0700	-.0608
1-	122	.125	.731	1.0625	.0795	-.0423	3+	166	.625	.150	1.5047	.1526	.0989
1-	117	.375	.703	1.2022	.1219	.0396	3+	173	.625	.333	1.4235	.1443	.0830
1-	123	.272	.703	1.2022	.0734	-.0542	3+	178	.625	.500	1.3523	.1371	.0690
1-	118	.625	.251	1.2661	.1284	.0521	3+	186	.625	.667	.7452	.0756	-.0499
1-	121	.625	.465	1.2899	.1308	.0568	3+	192	.625	.850	.6951	.0705	-.0597
1+	125	.125	.252	1.2581	.1276	.0506	3+	167	.749	.150	1.4794	.1500	.0939
1+	128	.125	.496	1.1907	.1207	.0374	3+	179	.749	.500	1.3094	.1328	.0606
1+	131	.125	.756	1.8295	.0841	-.0334	3+	193	.749	.850	.7025	.0712	-.0583
1+	126	.375	.255	1.5252	.1546	.1029	3+	180	.873	.500	1.2707	.1288	.0530
1+	132	.375	.762	1.7806	.0791	-.0430	4-	194	.062	.150	1.0987	.1114	.0193
1+	127	.625	.189	1.4992	.1520	.0978	4-	201	.062	.333	1.1768	.1193	.0347
1+	130	.625	.408	1.4406	.1461	.0863	4-	214	.062	.667	.8296	.0841	-.0334
2-	134	.125	.221	1.2859	.1304	.0560	4-	195	.125	.150	1.1780	.1194	.0349
2-	137	.125	.472	1.1824	.1199	.0357	4-	202	.125	.333	1.2038	.1221	.0399
2-	140	.125	.731	1.8105	.0822	-.0371	4-	207	.125	.500	1.0932	.1108	.0183
2-	136	.625	.251	1.4223	.1442	.0827	4-	215	.125	.667	.7847	.0796	-.0422
2-	139	.625	.465	1.3736	.1393	.0732	4-	196	.250	.150	1.3737	.1393	.0732
2+	143	.125	.221	1.1794	.1196	.0351	4-	203	.250	.333	1.2594	.1277	.0508
2+	146	.125	.472	1.1350	.1151	.0255	4-	208	.250	.500	1.1824	.1199	.0357
2+	149	.125	.731	1.7512	.0762	-.0488	4-	216	.250	.667	.7312	.0741	-.0527
3-	155	.142	.433	1.1756	.1192	.0344	4-	222	.250	.850	.7379	.1456	.0855
3-	158	.142	.802	1.7571	.0768	-.0476	4-	197	.375	.150	1.4363	.1456	.0855
3-	156	.375	.414	1.2745	.1292	.0538	4-	204	.375	.333	1.3641	.1383	.0713
3-	159	.375	.770	1.7834	.0794	-.0425	4-	209	.375	.667	1.2760	.1294	.0941
3-	157	.608	.425	1.2253	.1242	.0441	4-	217	.375	.850	.7139	.0724	-.0561
3-	160	.598	.746	1.8781	.0890	-.0239	4-	223	.375	.667	.7084	.0718	-.0571
3+	161	.062	.150	1.1495	.1166	.0293	4-	198	.500	.150	1.4651	.1485	.0911
3+	168	.062	.333	1.1775	.1194	.0348	4-	205	.500	.333	1.4061	.1426	.0796
3+	181	.062	.667	1.8190	.0830	-.0355	4-	210	.500	.500	1.3143	.1333	.0616
3+	187	.062	.850	1.8302	.0842	-.0333	4-	218	.500	.667	.7471	.0737	-.0496
3+	162	.125	.150	1.1775	.1194	.0348	4-	224	.500	.850	.6800	.0689	-.0627
3+	182	.125	.667	1.7679	.0779	-.0455	4-	211	.625	.500	1.3320	.1351	.0651
3+	188	.125	.850	1.8015	.0813	-.0389	4-	219	.625	.667	.7445	.0755	-.0501
3+	170	.250	.333	1.3247	.1343	.0636	4-	225	.625	.850	.6910	.0701	-.0605
3+	175	.250	.500	1.2979	.1316	.0584	4-	200	.749	.150	1.4905	.1511	.0961
3+	183	.250	.667	1.7094	.0719	-.0569	4-	212	.749	.500	1.3659	.1385	.0717
3+	189	.250	.850	1.7165	.0726	-.0556	4-	226	.749	.850	.7397	.0750	-.0510
3+	164	.375	.150	1.3903	.1410	.0765	4-	213	.873	.500	1.1566	.1173	.0307
3+	171	.375	.333	1.3910	.1410	.0766	4+	227	.125	.267	1.2360	.1253	.0463
3+	176	.375	.500	1.3549	.1374	.0695	4+	230	.125	.500	1.2142	.1231	.0420
3+	184	.375	.667	1.7214	.0731	-.0546	4+	233	.125	.695	.7471	.0758	-.0496
3+	190	.375	.850	1.6936	.0703	-.0600	4+	234	.375	.778	.7376	.0748	-.0514
3+	165	.500	.150	1.4044	.1424	.0793	4+	232	.625	.634	.8777	.0890	-.0240
3+	172	.500	.333	1.4153	.1435	.0814	4+	235	.625	.808	.7852	.0796	-.0421
3+	177	.500	.500	1.4063	.1426	.0796	4+						

TABLE VI.- Continued

(h) M = 2.70;  $\alpha = 10^\circ$

$P_t = 90.4 \text{ kPa}$

FIN	TUBE	Y/S	X/C	P/PINF	P/P12	CP	FIN	TUBE	Y/S	X/C	P/PINF	P/P12	CP
1-	116	.125	.221	1.8074	.1833	.1582	3+	185	.500	.667	1.3518	.1371	.0689
1-	119	.125	.472	1.6654	.1689	.1304	3+	191	.500	.850	1.2180	.1235	.0427
1-	122	.125	.731	.9910	.1005	-.0018	3+	186	.625	.150	2.5672	.2603	.3071
1-	117	.125	.302	1.8784	.1905	.1721	3+	173	.625	.333	2.4897	.2524	.2919
1-	123	.375	.703	1.1370	.272	.0269	3+	178	.625	.500	2.4014	.2435	.2746
1-	118	.625	.251	2.1832	.2214	.2319	3+	186	.625	.667	1.3771	.1396	.0739
1-	121	.625	.465	2.0558	.2095	.2089	3+	192	.625	.850	1.2692	.1287	.0528
1+	125	.125	.252	.5939	.0602	-.0796	3+	167	.749	.150	2.4629	.2497	.2867
1+	128	.125	.496	.6030	.0611	-.0778	3+	179	.749	.500	2.2951	.2286	.2459
1+	131	.125	.756	.5100	.0517	-.0960	3+	193	.749	.850	1.2891	.1307	.0567
1+	126	.375	.255	.6566	.0666	-.0673	3+	180	.873	.500	2.1735	.2204	.2300
1+	132	.375	.762	.4678	.0474	-.1043	4-	194	.062	.150	2.0737	.2103	.2104
1+	127	.625	.189	.7137	.0724	-.0561	4-	201	.062	.333	2.0711	.2100	.2099
1+	130	.625	.408	.6508	.0660	-.0694	4-	214	.062	.667	1.4357	.1476	.0893
2-	134	.125	.221	.6032	.0576	-.0778	4-	202	.125	.150	2.2381	.2269	.2426
2-	137	.125	.472	.5679	.0576	-.0847	4-	202	.125	.333	2.1139	.2143	.2183
2-	140	.125	.731	.5002	.0507	-.0979	4-	207	.125	.500	1.8773	.1903	.1719
2-	136	.625	.251	.6599	.0669	-.0666	4-	215	.125	.667	1.3827	.1402	.0750
2-	139	.625	.465	.6202	.0629	-.0744	4-	196	.125	.150	2.6095	.2646	.3154
2+	143	.125	.221	1.7343	.1758	.1439	4-	203	.250	.333	2.2377	.2259	.2406
2+	146	.125	.472	1.6528	.1676	.1279	4-	208	.250	.500	2.0367	.2067	.2035
2+	149	.125	.731	.9067	.0919	-.0193	4-	222	.250	.667	1.2604	.1278	.0510
3-	155	.142	.433	.5741	.0582	-.0835	4-	226	.250	.850	1.2785	.1296	.0546
3-	158	.142	.802	.5908	.0599	-.0802	4-	197	.375	.150	2.7515	.2790	.3432
3-	156	.375	.414	.7380	.0748	-.0514	4-	204	.375	.333	2.4466	.2481	.2835
3-	159	.375	.770	.5741	.0582	-.0835	4-	209	.375	.500	2.2311	.2262	.2412
3-	157	.608	.425	.7382	.0748	-.0513	4-	217	.375	.667	1.2482	.1266	.0486
3-	160	.608	.746	.5525	.0560	-.0877	4-	223	.375	.850	1.1226	.1138	.0240
3+	161	.062	.150	2.1768	.2207	.2306	4-	198	.500	.150	2.6777	.2715	.3288
3+	168	.062	.333	2.0524	.2081	.2062	4-	205	.500	.333	2.5811	.2617	.3098
3+	181	.062	.667	1.4405	.1461	.0863	4-	210	.500	.500	2.3298	.2362	.2606
3+	187	.062	.850	1.6978	.1721	.1368	4-	218	.500	.667	1.3164	.1335	.0620
3+	162	.125	.150	2.2472	.2279	.2444	4-	224	.500	.850	1.1296	.1145	.0254
3+	182	.125	.667	1.3388	.1357	.0664	4-	211	.625	.500	2.4039	.2437	.2751
3+	188	.125	.850	1.4535	.1474	.0889	4-	219	.625	.667	1.3525	.1371	.0691
3+	170	.250	.333	2.3478	.2381	.2641	4-	225	.625	.850	1.2298	.1247	.0450
3+	175	.250	.500	2.2111	.2242	.2373	4-	200	.749	.150	2.5657	.2601	.3068
3+	183	.250	.667	1.2319	.1249	.0454	4-	212	.749	.500	2.3976	.2431	.2739
3+	189	.250	.850	1.2173	.1234	.0426	4-	226	.749	.850	1.3691	.1388	.0723
3+	164	.375	.150	2.6212	.2658	.3177	4-	213	.873	.500	2.0022	.2030	.1964
3+	171	.375	.333	2.4901	.2920	.2920	4+	227	.125	.267	.6298	.0639	-.0725
3+	176	.375	.500	2.3508	.2384	.2647	4+	230	.125	.450	.6024	.0611	-.0779
3+	184	.375	.667	1.2825	.1300	.0954	4+	233	.125	.695	.5878	.0596	-.0808
3+	190	.375	.850	1.1653	.1182	.0324	4+	234	.375	.778	.5729	.0581	-.0837
3+	165	.500	.150	2.4726	.2886	.3059	4+	232	.625	.634	.4930	.0500	-.0994
3+	172	.500	.333	2.5612	.2597	.3333	4+	235	.625	.808	.5496	.0557	-.0883
3+	177	.500	.500	2.5121	.2547	.2983	4+	235	.625	.808	.5496	.0557	-.0883

TABLE VI.- Continued

(i)  $M = 2.70$ ;  $\alpha = 20^\circ$

$P_t = 90.4 \text{ kPa}$

FIN	TUBE	Y/S	X/C	P/PINF	P/PI2	CP	FIN	TUBE	Y/S	X/C	P/PINF	P/PI2	CP
1-	116	.125	.221	1.5424	.1564	.1063	3+	185	.500	.667	2.3771	.2410	.2699
1-	119	.125	.472	1.6138	.1203	.1203	3+	191	.500	.850	2.2295	.2261	.2409
1-	122	.125	.731	1.0435	.1058	.0085	3+	166	.625	.150	4.8265	.4894	.7499
1-	117	.125	.302	1.9470	.1856	.1856	3+	173	.625	.333	4.5626	.4626	.6981
1-	123	.375	.703	1.1782	.1195	.0349	3+	178	.625	.500	4.2417	.4301	.6353
1-	118	.625	.251	2.3175	.2350	.2350	3+	186	.625	.667	2.4642	.2499	.2869
1-	121	.625	.465	2.2303	.2261	.2411	3+	192	.625	.850	2.3513	.2384	.2648
1+	125	.125	.252	.4567	.0463	-.1065	3+	167	.749	.150	4.6221	.4686	.7098
1+	128	.125	.496	.4081	.0414	-.1160	3+	179	.749	.500	4.1949	.4253	.6261
1+	131	.125	.756	.2884	.0292	-.1394	3+	193	.749	.850	4.1721	.2526	.2923
1+	126	.375	.255	.2385	.0242	-.1492	3+	180	.873	.500	4.1721	.4230	.6216
1+	132	.375	.762	.2385	.0242	-.1492	4-	194	.873	.150	3.4789	.3527	.4858
1+	127	.625	.189	.2385	.0242	-.1492	4-	201	.062	.333	3.5208	.3570	.4940
1+	130	.625	.408	.2385	.0242	-.1492	4-	214	.062	.667	2.8970	.2937	.3717
2-	134	.125	.221	.4725	.0479	-.1034	4-	195	.125	.150	3.7013	.3753	.5294
2-	137	.125	.472	.4012	.0407	-.1173	4-	202	.125	.333	3.5647	.3614	.5026
2-	140	.125	.731	.2790	.0283	-.1413	4-	207	.125	.500	3.2807	.3326	.4469
2-	136	.625	.251	.2385	.0242	-.1492	4-	215	.125	.667	2.7554	.2794	.3440
2+	139	.625	.465	.2385	.0242	-.1492	4-	196	.250	.150	4.2169	.4276	.6304
2+	143	.125	.221	1.4066	.1426	.0797	4-	203	.250	.333	3.7940	.3847	.5475
2+	146	.125	.472	1.4867	.1507	.0954	4-	208	.250	.500	3.5252	.3574	.4948
2+	149	.125	.731	.8676	.0880	-.0259	4-	216	.250	.667	2.3561	.2389	.2657
3-	155	.142	.433	.5640	.0572	-.0854	4-	222	.250	.850	2.5897	.2626	.3115
3-	158	.142	.802	.5683	.0576	-.0846	4-	197	.375	.150	4.5861	.4650	.7027
3-	156	.375	.414	.7557	.0766	-.0479	4-	204	.375	.333	4.1077	.4165	.6090
3-	159	.375	.770	.5536	.0561	-.0875	4-	209	.375	.500	3.8153	.3868	.5517
3-	157	.608	.425	.7383	.0749	-.0513	4-	217	.375	.667	2.2899	.2322	.2528
3-	160	.608	.746	.5882	.0596	-.0807	4-	223	.375	.850	2.1846	.2215	.2321
3+	161	.062	.150	3.6742	.3624	.5044	4-	198	.500	.150	4.8698	.4938	.7583
3+	168	.062	.333	3.4409	.3489	.4783	4-	205	.500	.333	4.3870	.4448	.6637
3+	181	.062	.667	2.9153	.2956	.3753	4-	210	.500	.500	3.9664	.4022	.5813
3+	187	.062	.850	3.4012	.3449	.4706	4-	243	.500	.667	2.3973	.2738	.2738
3+	162	.125	.150	3.6656	.3717	.5224	4-	224	.500	.850	2.0790	.2108	.2114
3+	182	.125	.667	2.6134	.2650	.3162	4-	211	.625	.500	4.1496	.4207	.6172
3+	188	.125	.3328	3.2826	.3328	.4473	4-	219	.625	.667	2.4518	.2486	.2845
3+	170	.250	.333	3.9194	.3974	.5721	4-	225	.625	.850	2.2516	.2283	.2455
3+	175	.250	.500	3.7502	.3802	.5389	4-	200	.749	.150	5.1683	.5240	.8168
3+	183	.250	.667	2.2583	.2290	.2466	4-	212	.749	.500	4.4059	.4467	.6674
3+	189	.375	.850	2.4860	.2521	.2912	4-	226	.749	.850	2.3548	.2590	.3047
3+	164	.375	.150	4.5356	.4599	.6929	4-	213	.873	.500	3.9235	.3978	.5729
3+	176	.375	.333	4.1725	.4231	.6217	4+	227	.125	.667	.6389	.0648	-.0708
3+	171	.375	.500	3.9591	.4014	.5799	4+	230	.125	.450	.5071	.5029	-.0857
3+	184	.375	.667	2.2967	.2329	.2541	4+	233	.125	.695	.6160	.0625	-.0752
3+	190	.375	.850	2.2144	.2245	.2380	4+	234	.375	.778	.5978	.0606	-.0788
3+	165	.500	.150	4.5858	.4650	.7027	4+	232	.625	.634	.4897	.0497	-.1000
3+	172	.500	.333	4.4933	.4556	.6846	4+	235	.625	.808	.6406	.0649	-.0704
3+	177	.500	.500	4.2904	.4350	.6448	4+						



TABLE VI.- Continued

(j) M = 2.70;  $\alpha = 30^\circ$

$P_t = 90.4 \text{ kPa}$

FIN	TUBE	Y/S	X/C	P/PINE	P/PT2	CP	FIN	TUBE	Y/S	X/C	P/PINE	P/PT2	CP
1-	116	.125	.221	2.8108	.2350	.3548	3+	185	.500	.667	3.5316	.3581	.4961
1-	119	.125	.472	2.0726	.2101	.2102	3+	191	.500	.850	3.7655	.3818	.5419
1-	122	.125	.731	1.3274	.1346	.0642	3+	166	.625	.150	7.0808	.7179	1.1916
1-	117	.272	.302	2.2542	.2286	.2458	3+	173	.625	.333	6.5030	.6594	1.0784
1-	123	.375	.703	1.3969	.1416	.0778	3+	178	.625	.500	5.9582	.6041	.9716
1-	118	.625	.251	2.5168	.2552	.2972	3+	186	.625	.667	3.5136	.3563	.4926
1-	121	.625	.465	2.4261	.2460	.2795	3+	192	.625	.850	3.6295	.3680	.5153
1+	125	.125	.252	.2381	.0241	-.1493	3+	167	.749	.150	6.9134	.7010	1.1588
1+	128	.125	.496	.2381	.0241	-.1493	3+	179	.749	.500	5.6407	.5719	.9094
1+	131	.125	.756	.2381	.0241	-.1493	3+	183	.749	.850	3.7425	.3795	.5374
1+	126	.375	.255	.2381	.0241	-.1493	3+	190	.873	.500	5.5539	.5631	.8924
1+	132	.375	.762	.2381	.0241	-.1493	4-	194	.062	.150	5.5408	.5618	.8898
1+	130	.625	.189	.2381	.0241	-.1493	4-	201	.062	.333	5.5215	.5598	.8861
1+	134	.125	.408	.2381	.0241	-.1493	4-	214	.062	.667	5.3158	.5390	.8457
2-	137	.125	.221	.2381	.0241	-.1493	4-	195	.125	.150	5.8944	.5977	.9591
2-	140	.125	.472	.2381	.0241	-.1493	4-	202	.125	.333	5.6038	.5682	.9022
2-	136	.125	.731	.2381	.0241	-.1493	4-	207	.125	.500	5.7763	.5857	.9360
2-	139	.625	.251	.2381	.0241	-.1493	4-	215	.125	.667	5.2532	.5326	.8335
2+	143	.125	.221	2.3879	.2421	.2720	4-	203	.250	.333	5.9171	.6000	.9636
2+	146	.125	.472	1.9000	.1926	.1764	4-	208	.250	.500	5.7699	.5850	.9347
2+	149	.125	.731	1.1058	.1121	.0207	4-	216	.250	.667	4.7342	.4800	.7318
3-	155	.142	.433	.7137	.0724	-.0561	4-	222	.250	.850	5.2519	.5325	.8332
3-	158	.142	.802	.7343	.0744	-.0521	4-	197	.375	.150	6.9887	.7086	1.1736
3-	156	.375	.414	.8886	.0901	-.0218	4-	204	.375	.333	6.3109	.6399	1.0407
3-	159	.375	.770	.7223	.0732	-.0544	4-	209	.375	.500	6.0927	.6178	.9980
3-	157	.608	.425	.8222	.0834	-.0348	4-	217	.375	.667	4.0291	.4085	.5936
3-	160	.608	.746	.7029	.0713	-.0582	4-	223	.375	.850	4.3299	.4390	.6525
3+	161	.062	.150	5.7107	.5790	.9231	4-	198	.500	.150	7.3818	.7485	1.1058
3+	168	.062	.333	5.5752	.5653	.8966	4-	205	.500	.333	6.6429	.6735	1.1058
3+	181	.062	.667	5.4303	.5506	.8682	4-	210	.500	.500	5.8616	.5943	.9527
3+	187	.062	.850	5.5688	.5646	.8953	4-	218	.500	.667	3.6339	.3684	.5161
3+	162	.125	.150	5.8497	.5931	.9504	4-	224	.500	.850	3.6332	.3684	.5160
3+	182	.125	.667	5.3498	.5424	.8524	4-	211	.625	.500	5.8274	.5909	.9460
3+	188	.125	.850	5.5718	.5649	.8959	4-	219	.625	.667	3.5967	.3647	.5088
3+	170	.250	.333	6.1297	.6215	1.0052	4-	225	.625	.850	3.5029	.3552	.4905
3+	175	.250	.500	5.9051	.5987	.9612	4-	200	.749	.150	7.1318	.7231	1.2016
3+	183	.250	.667	4.7215	.4787	.7293	4-	212	.749	.500	5.9299	.6013	.9661
3+	189	.250	.850	5.1900	.5262	.8211	4-	226	.749	.850	3.8504	.3904	.5586
3+	164	.375	.150	7.1313	.7231	1.2015	4-	213	.873	.500	4.9555	.5025	.7751
3+	173	.375	.333	6.4375	.6527	1.0655	4+	227	.125	.267	.7621	.0773	-.0466
3+	176	.375	.667	6.3312	.6419	1.0447	4+	230	.125	.500	.6956	.0705	-.0597
3+	184	.375	.850	3.9592	.4014	.5799	4+	233	.125	.695	.7523	.0763	-.0485
3+	190	.375	.667	4.5640	.4628	.6984	4+	234	.125	.778	.7583	.0769	-.0474
3+	165	.500	.150	7.2159	.7316	1.2181	4+	232	.375	.634	.5852	.6059	-.0813
3+	172	.500	.333	6.8554	.6951	1.1474	4+	235	.625	.808	.6280	.0637	-.0729
3+	177	.500	.500	6.2649	.6352	1.0317	4+	235	.625	.808	.6280	.0637	-.0729

TABLE VI.- Continued

(k) M = 2.70;  $\alpha = 40^\circ$

$P_t = 90.4 \text{ kPa}$

FIN	TUBE	Y/S	X/C	P/PIPF	P/PT2	CP	FIN	TUBE	Y/S	X/C	P/PIPF	P/PT2	CP
1-	116	.125	.221	3.0125	.3054	.3944	3+	185	.500	.667	5.4340	.5510	.8689
1-	119	.125	.472	2.2918	.2532	.2532	3+	191	.500	.850	6.6904	.6784	1.1151
1-	122	.125	.731	1.6546	.1283	.1283	3+	166	.625	.150	8.8637	.8987	1.5410
1-	117	.272	.302	2.7888	.2828	.3505	3+	173	.625	.333	8.0707	.8183	1.3856
1-	123	.375	.703	2.0078	.2036	.1975	3+	178	.625	.500	6.6174	.6710	1.1008
1-	118	.625	.251	3.3400	.3387	.4586	3+	186	.625	.667	6.2525	.6340	1.0293
1-	121	.125	.465	2.9901	.3032	.3900	3+	192	.625	.850	6.1376	.6223	1.0068
1+	125	.125	.252	.2399	.0243	-.1490	3+	167	.749	.150	8.6265	.8747	1.4945
1+	128	.125	.496	.2399	.0243	-.1490	3+	179	.749	.500	6.7088	.6802	1.1187
1+	131	.125	.756	.2399	.0243	-.1490	3+	193	.749	.850	5.9020	.5984	.9606
1+	126	.375	.255	.2399	.0243	-.1490	3+	180	.873	.500	6.7462	.6840	1.1260
1+	132	.375	.762	.2399	.0243	-.1490	4-	194	.062	.150	10.9357	1.0888	1.8470
1+	127	.625	.189	.2399	.0243	-.1490	4-	201	.062	.333	10.4714	1.0617	1.8560
1+	130	.625	.408	.2399	.0243	-.1490	4-	214	.062	.667	6.1674	.6253	1.0126
2-	134	.125	.221	.2399	.0243	-.1490	4-	195	.125	.150	11.6068	1.1768	2.0785
2-	137	.125	.472	.2399	.0243	-.1490	4-	202	.125	.333	10.0176	1.0157	1.7671
2-	140	.125	.731	.2399	.0243	-.1490	4-	207	.125	.500	7.9674	.8078	1.3654
2-	136	.125	.251	.2399	.0243	-.1490	4-	215	.125	.667	6.0615	.6146	.9919
2-	139	.125	.465	.2399	.0243	-.1490	4-	196	.250	.150	10.5756	1.0723	1.8765
2+	143	.125	.221	2.6117	.2648	.3158	4-	208	.250	.333	8.7244	.8846	1.5137
2+	146	.125	.472	2.5819	.2618	.3100	4-	203	.250	.500	7.3450	.7447	1.2434
2+	149	.125	.731	1.4518	.1472	.0885	4-	216	.250	.667	5.6707	.5750	.9153
3-	155	.142	.433	.9028	.0915	-.0190	4-	222	.250	.850	6.2468	.6334	1.0282
3-	158	.142	.802	.5684	.0576	-.0846	4-	197	.375	.150	9.0900	.9217	1.5854
3-	156	.375	.414	.6043	.0613	-.0775	4-	204	.375	.333	8.4049	.8522	1.4511
3-	159	.375	.770	.4549	.0461	-.1068	4-	209	.375	.500	7.2712	.7373	1.2289
3-	157	.608	.425	.4202	.0426	-.1136	4-	217	.375	.667	5.6660	.5745	.9144
3-	160	.658	.746	.4021	.0408	-.1172	4-	223	.375	.850	6.2661	.6353	1.0320
3+	161	.062	.150	10.8999	1.1052	1.9400	4-	198	.500	.150	8.9164	.9041	1.5513
3+	168	.062	.333	10.4763	1.0622	1.8570	4-	205	.500	.333	8.2821	.8398	1.4270
3+	181	.062	.667	5.9310	.6014	.9663	4-	210	.500	.500	7.0630	.7161	1.1881
3+	187	.062	.850	5.4325	.5508	.8686	4-	218	.500	.667	5.7765	.5857	.9360
3+	162	.125	.150	11.3121	1.1470	2.0208	4-	224	.500	.850	6.1014	.6186	.9997
3+	182	.125	.667	5.7679	.5848	.9383	4-	211	.625	.500	6.9697	.7067	1.1698
3+	188	.125	.850	5.2843	.5358	.8396	4-	219	.625	.667	6.2985	.6386	1.0383
3+	170	.250	.333	8.8495	.8973	1.5382	4-	225	.625	.850	5.6014	.5679	.9017
3+	175	.250	.500	7.7320	.7840	1.3192	4-	200	.749	.150	8.7589	.8881	1.5205
3+	183	.250	.667	5.3206	.5395	.8467	4-	212	.749	.500	7.0596	.7158	1.1875
3+	189	.250	.850	5.9155	.5998	.9633	4-	226	.749	.850	5.9118	.5994	.9625
3+	164	.375	.150	9.2212	.9350	1.6110	4-	213	.873	.500	6.3283	.6416	1.0442
3+	171	.375	.333	8.4378	.8555	1.4575	4+	227	.125	.267	.9397	.0953	-.0118
3+	176	.375	.500	7.3749	.7478	1.2493	4+	230	.125	.450	.8732	.0885	-.0248
3+	184	.375	.667	5.3150	.5389	.8456	4+	233	.125	.695	.6312	.0640	-.0723
3+	190	.375	.850	6.8067	.6902	1.1379	4+	234	.125	.778	.4201	.0426	-.1136
3+	165	.500	.150	8.8798	.9004	1.5442	4+	232	.625	.634	.4078	.0414	-.1160
3+	172	.500	.333	8.3342	.8450	1.4372	4+	235	.625	.808	.3925	.0398	-.1191
3+	177	.500	.500	7.1043	.7203	1.1962	4+	235	.625	.808	.3925	.0398	-.1191

TABLE VI.- Concluded

(1)  $M = 2.70$ ;  $\alpha = 50^\circ$

$P_t = 89.9$  kPa

FIN	TUBE	Y/S	X/C	P/PINF	P/PT2	CP	FIN	TUBE	Y/S	X/C	P/PINF	P/PT2	CP
1-	116	.125	.221	3.8047	.3858	.5496	3+	185	.500	.667	7.5417	.7647	1.2819
1-	119	.125	.472	2.2232	.2254	.2397	3+	191	.500	.850	6.7442	.7071	1.1707
1-	122	.125	.731	1.7013	.1725	.1374	3+	166	.625	.150	9.5245	.9657	1.6705
1-	117	.272	.302	2.8641	.2904	.3653	3+	173	.625	.333	8.9336	.9058	1.5547
1-	123	.375	.703	1.9452	.1972	.1852	3+	178	.625	.500	8.0142	.8126	1.3745
1-	118	.625	.251	2.8544	.2894	.3634	3+	186	.625	.667	7.4280	.7531	1.2596
1-	121	.625	.465	2.7506	.2789	.3431	3+	192	.625	.850	6.8926	.6989	1.1547
1+	125	.125	.252	2.407	.244	-.1488	3+	167	.749	.150	9.4627	.9594	1.6584
1+	128	.125	.496	2.407	.244	-.1488	3+	179	.749	.150	7.9562	.8067	1.3632
1+	131	.125	.756	2.407	.244	-.1488	3+	193	.749	.850	6.7212	.6815	1.1212
1+	126	.375	.255	2.407	.244	-.1488	3+	180	.873	.500	7.8926	.8003	1.3507
1+	132	.375	.762	2.407	.244	-.1488	4-	194	.062	.150	10.7638	1.0914	1.9133
1+	127	.625	.189	2.407	.244	-.1488	4-	201	.062	.333	9.5607	.9694	1.6776
1+	130	.625	.408	2.407	.244	-.1488	4-	214	.062	.667	8.0570	.8169	1.3829
2-	134	.125	.221	2.407	.244	-.1488	4-	195	.125	.150	10.3216	1.0465	1.8267
2-	137	.125	.472	2.407	.244	-.1488	4-	202	.125	.333	9.4028	.9534	1.6466
2-	140	.125	.731	2.407	.244	-.1488	4-	207	.125	.500	8.1192	.8232	1.3951
2-	136	.625	.251	2.407	.244	-.1488	4-	215	.125	.667	7.9747	.8086	1.3668
2-	139	.625	.465	2.407	.244	-.1488	4-	196	.250	.150	9.7034	.9839	1.7055
2+	143	.125	.221	3.4041	.3451	.4711	4-	203	.250	.333	9.0818	.9208	1.5837
2+	146	.125	.472	2.0983	.2128	.2152	4-	208	.250	.500	8.0903	.8203	1.3894
2+	149	.125	.731	1.5627	.1584	.1103	4-	216	.250	.667	7.7278	.7835	1.3184
3-	155	.142	.433	5.430	.0551	-.0896	4-	222	.250	.850	7.0919	.7191	1.1938
3-	158	.142	.802	4.513	.0458	-.1075	4-	197	.375	.150	9.5359	.9669	1.6727
3-	156	.375	.414	4.313	.0437	-.1114	4-	204	.375	.333	9.0409	.9167	1.5757
3-	159	.375	.770	4.365	.0443	-.1104	4-	209	.375	.500	8.2774	.84261	1.4261
3-	157	.608	.425	4.492	.0455	-.1079	4-	217	.375	.667	7.5884	.7694	1.2911
3-	160	.558	.746	4.542	.0461	-.1070	4-	223	.375	.850	6.8726	.6968	1.1508
3+	161	.062	.150	10.8100	1.0961	1.9224	4-	198	.500	.150	9.5349	.9668	1.6725
3+	168	.062	.333	9.5329	.9666	1.6721	4-	205	.500	.333	9.0494	.9175	1.5774
3+	181	.062	.667	7.7077	.7815	1.3145	4-	210	.500	.500	8.1740	.8288	1.4058
3+	187	.062	.850	7.4660	.7570	1.2671	4-	218	.500	.667	7.5234	.7628	1.2784
3+	162	.125	.150	10.1375	1.0279	1.7906	4-	224	.500	.850	6.7964	.6891	1.1359
3+	182	.125	.667	7.7887	.7897	1.3303	4-	221	.625	.500	8.1509	.8264	1.4019
3+	188	.125	.850	7.3301	.7432	1.2405	4-	219	.625	.667	7.4034	.7507	1.2548
3+	170	.250	.333	9.1313	.9259	1.5934	4-	225	.625	.850	6.6580	.6751	1.1088
3+	175	.250	.500	8.2322	.8347	1.4172	4-	200	.749	.150	9.4954	.9628	1.6648
3+	183	.250	.667	7.8538	.7963	1.3431	4-	212	.749	.500	8.1767	.8291	1.4064
3+	189	.250	.850	7.0208	.7119	1.1799	4-	226	.749	.850	6.7573	.6851	1.1282
3+	164	.375	.150	9.5925	.9726	1.6838	4-	213	.873	.500	7.6217	.7728	1.2976
3+	171	.375	.333	9.0353	.9161	1.5746	4+	227	.125	.267	3.464	.0351	-.1281
3+	176	.375	.500	8.0492	.8161	1.3814	4+	230	.125	.490	4.860	.0493	-.1007
3+	184	.375	.667	7.5760	.7681	1.2886	4+	233	.125	.695	3.530	.0358	-.1268
3+	190	.375	.850	6.9933	.7091	1.1745	4+	234	.125	.778	3.933	.0399	-.1189
3+	165	.500	.150	9.5150	.9648	1.6686	4+	232	.625	.634	4.574	.0464	-.1063
3+	172	.500	.333	9.0209	.9147	1.5718	4+	235	.625	.808	4.572	.0464	-.1064
3+	177	.500	.500	8.1678	.8282	1.4046	4+	233	.625	.808	4.572	.0464	-.1064

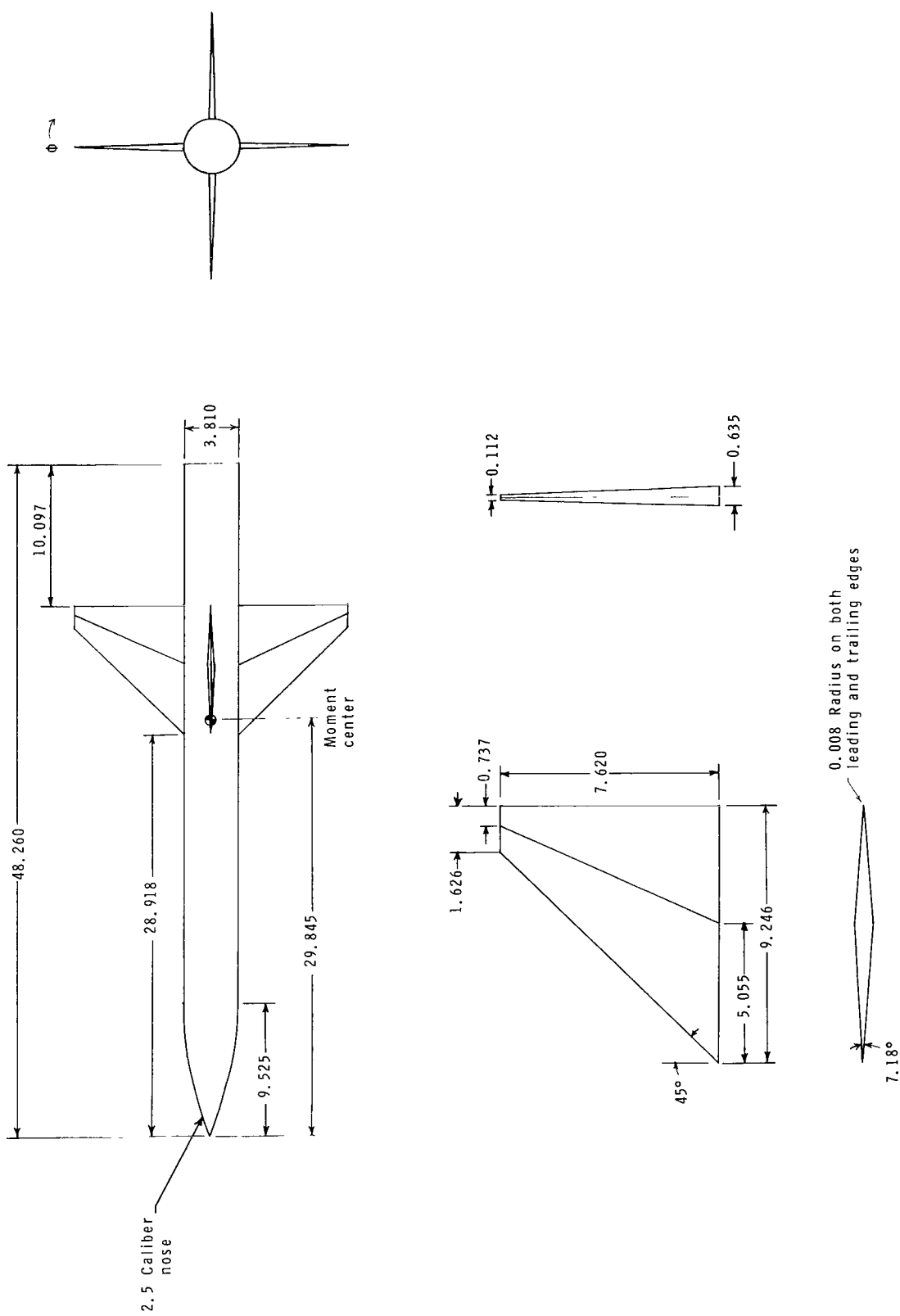
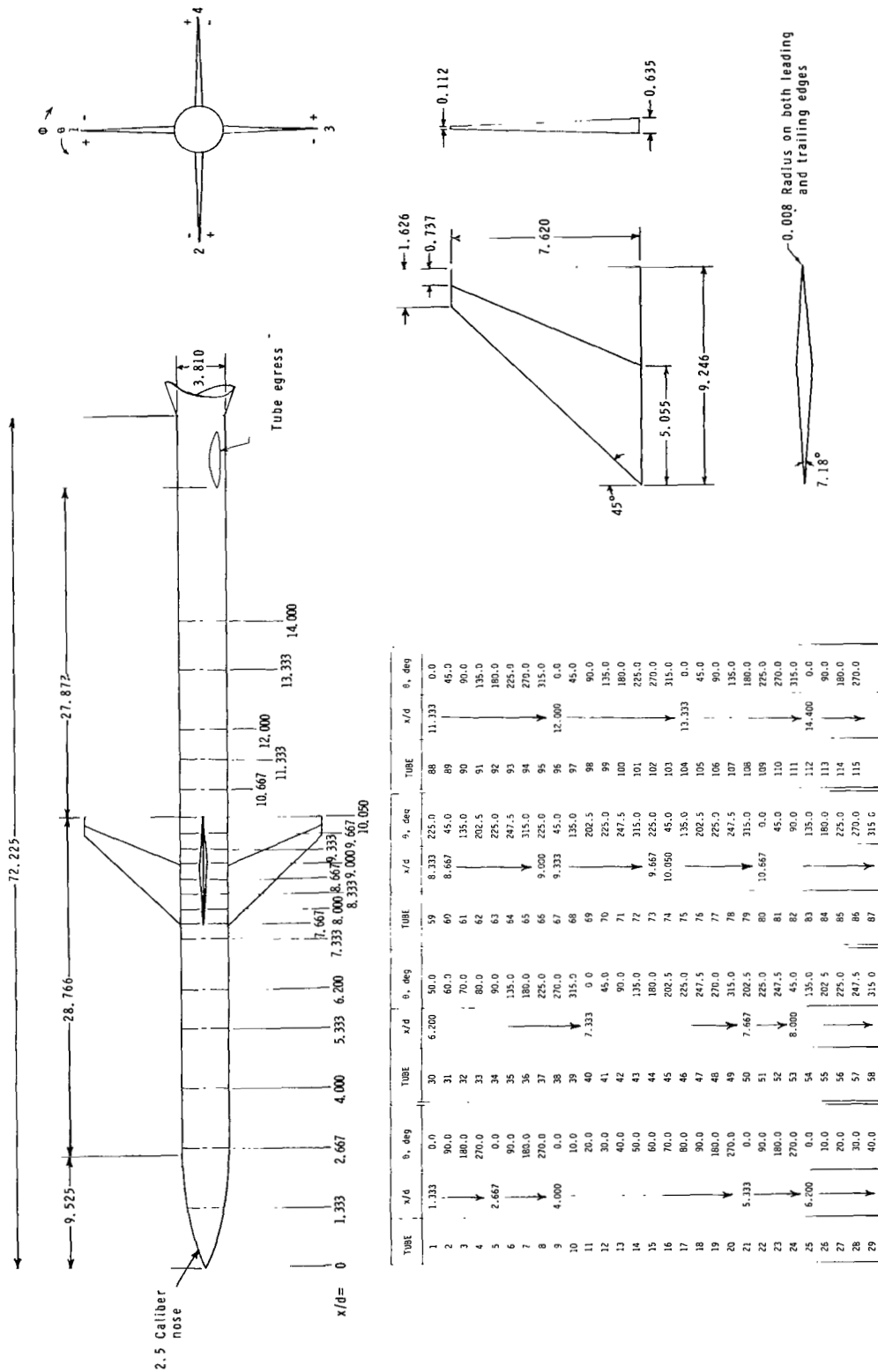
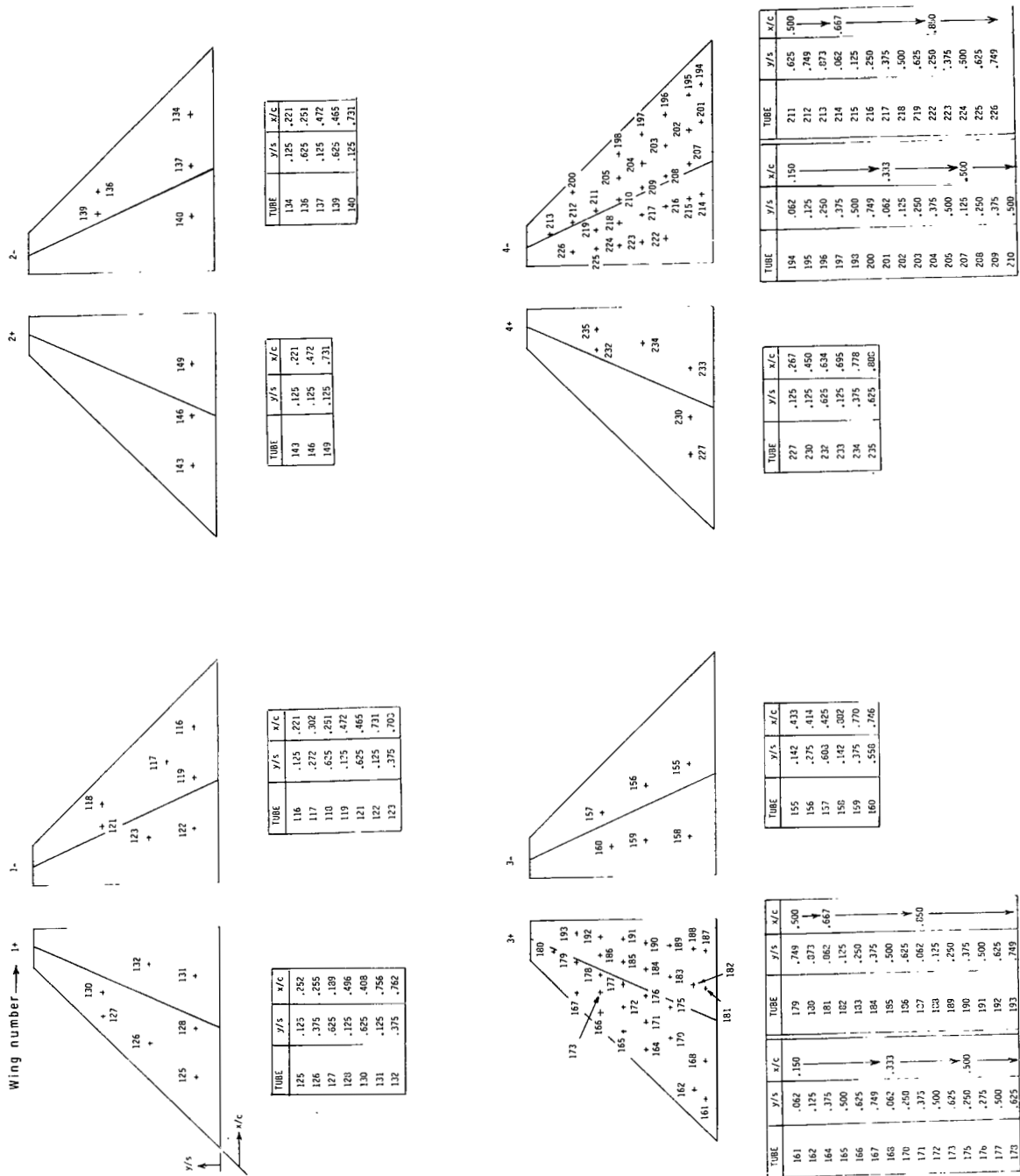

Figure 1.- Details of force model. All linear dimensions are in centimeters.



(a) Basic dimensions and locations of body pressure tubes.  
 Figure 2.- Details of pressure model. All linear dimensions are in centimeters.



(b) Locations of wing pressure tubes.  
Figure 2.- Concluded.

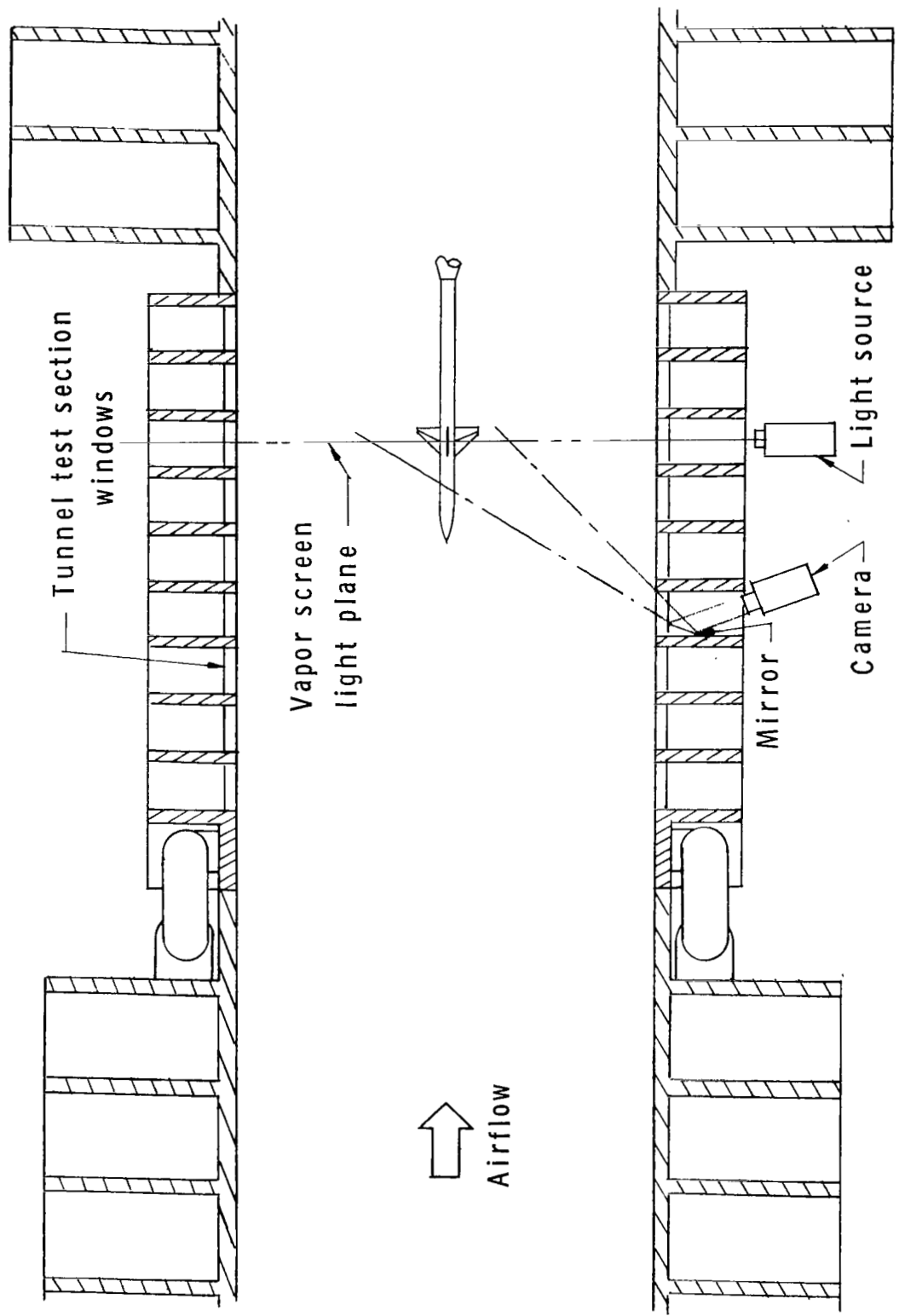
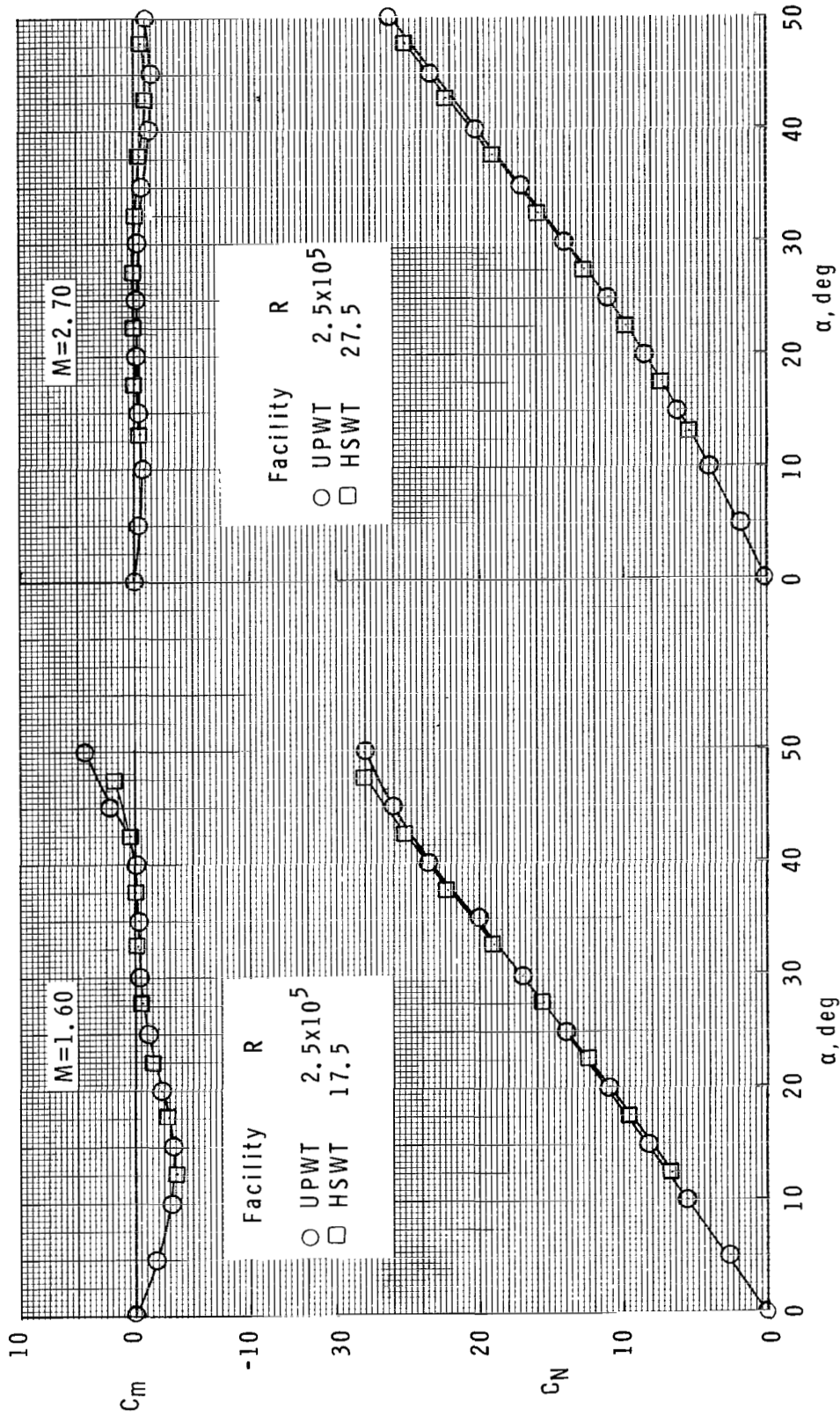

Figure 3.- Diagram of vapor screen setup (view looking down on test section).



(a)  $\phi = 0^\circ$ .

Figure 4.- Effect of Reynolds number on normal-force and pitching-moment coefficients.



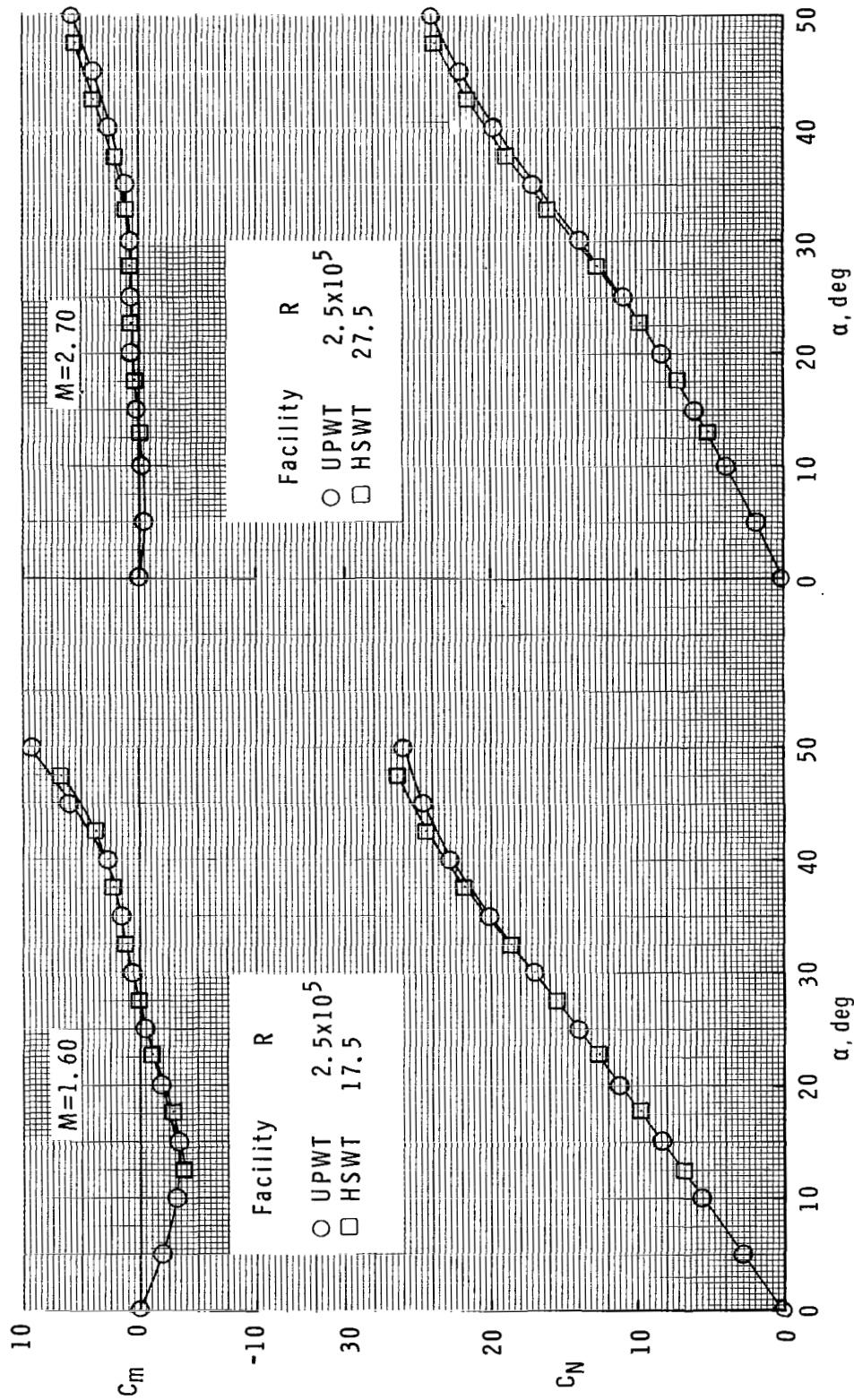

(b)  $\phi = 22.5^\circ$ .

Figure 4.- Continued.

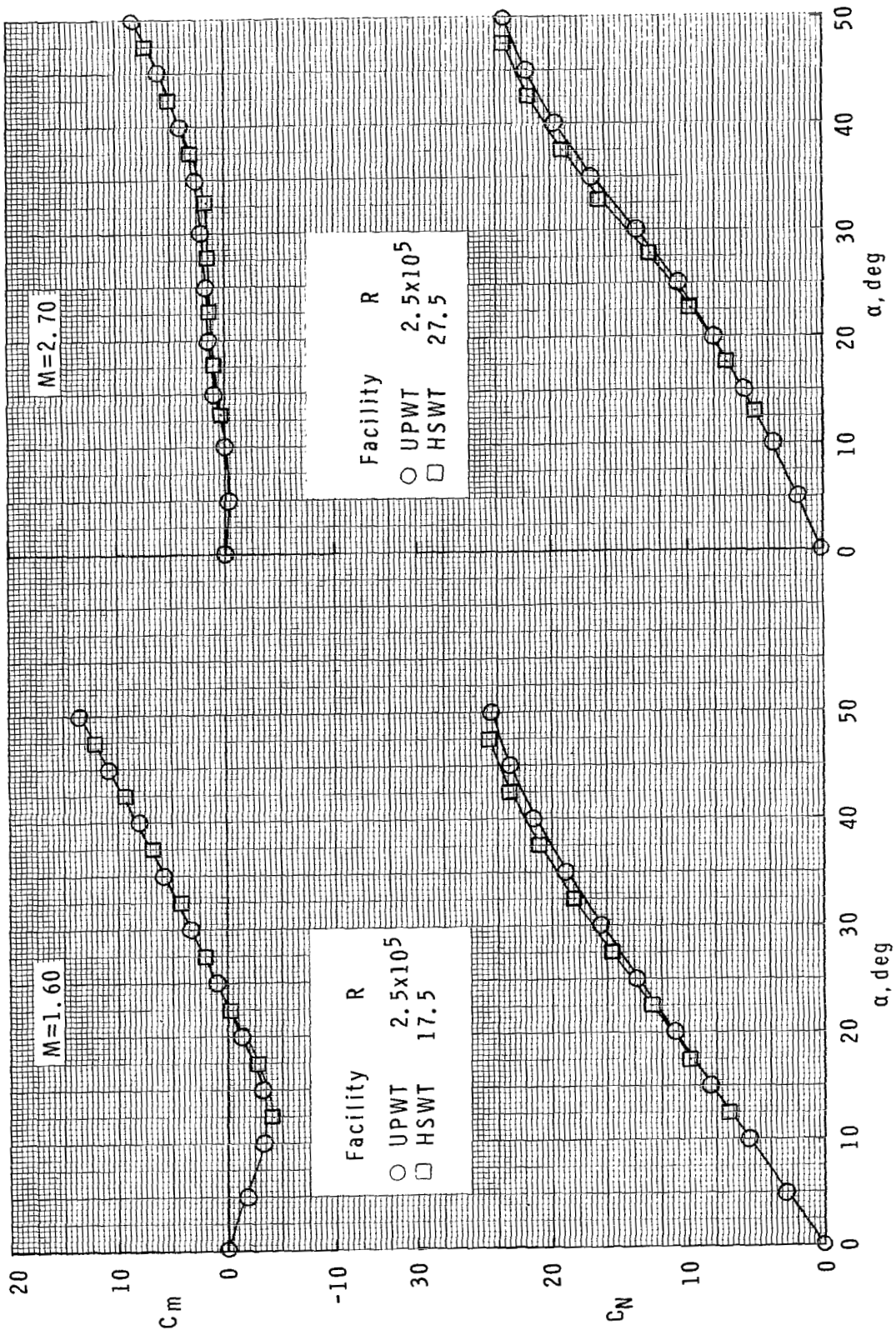

(c)  $\phi = 45^\circ$ .

Figure 4.- Concluded.

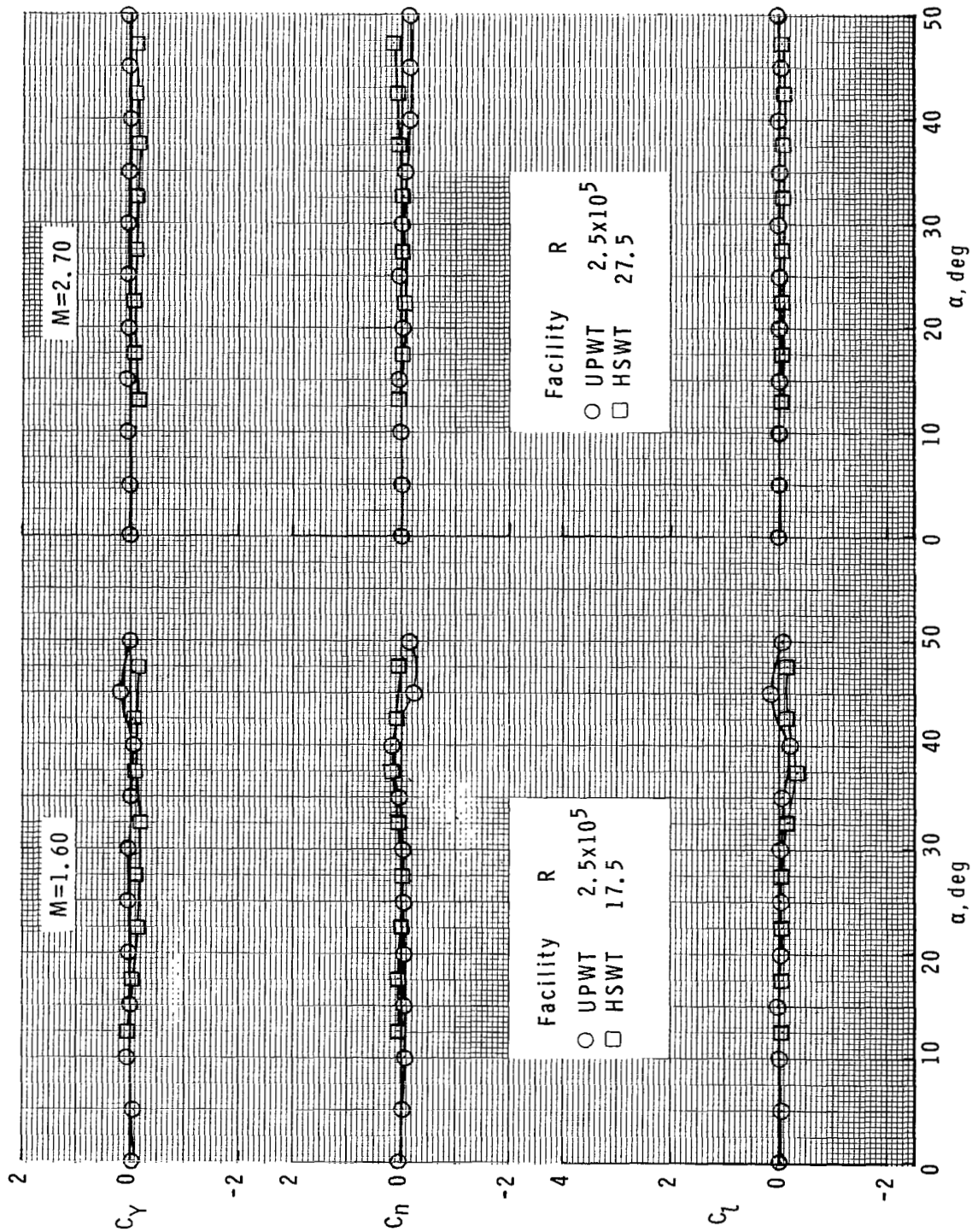

(a)  $\phi = 0^\circ$ .

Figure 5.- Effect of Reynolds number on lateral aerodynamic characteristics.

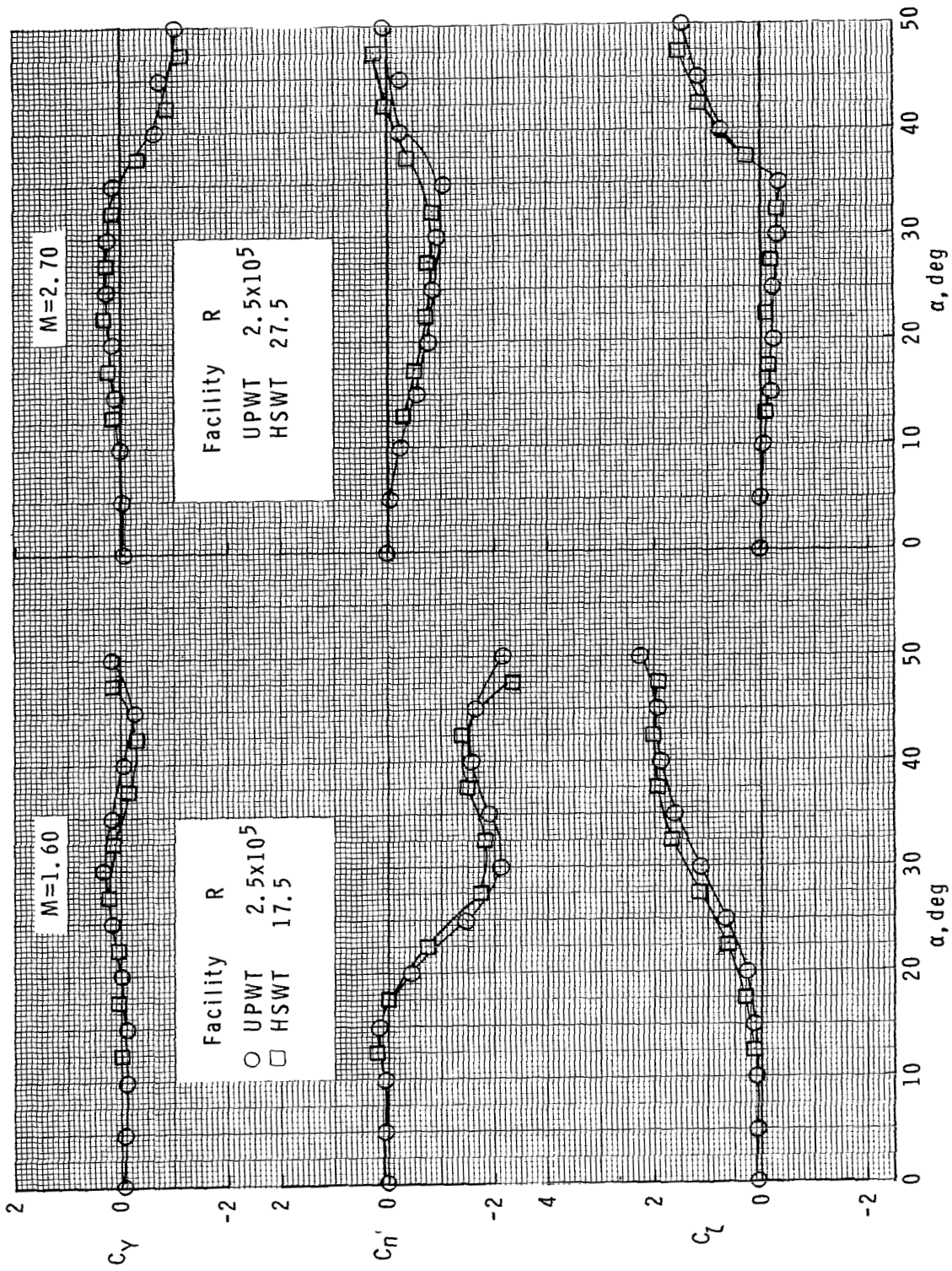

(b)  $\phi = 22.5^\circ$ .

Figure 5.- Continued.

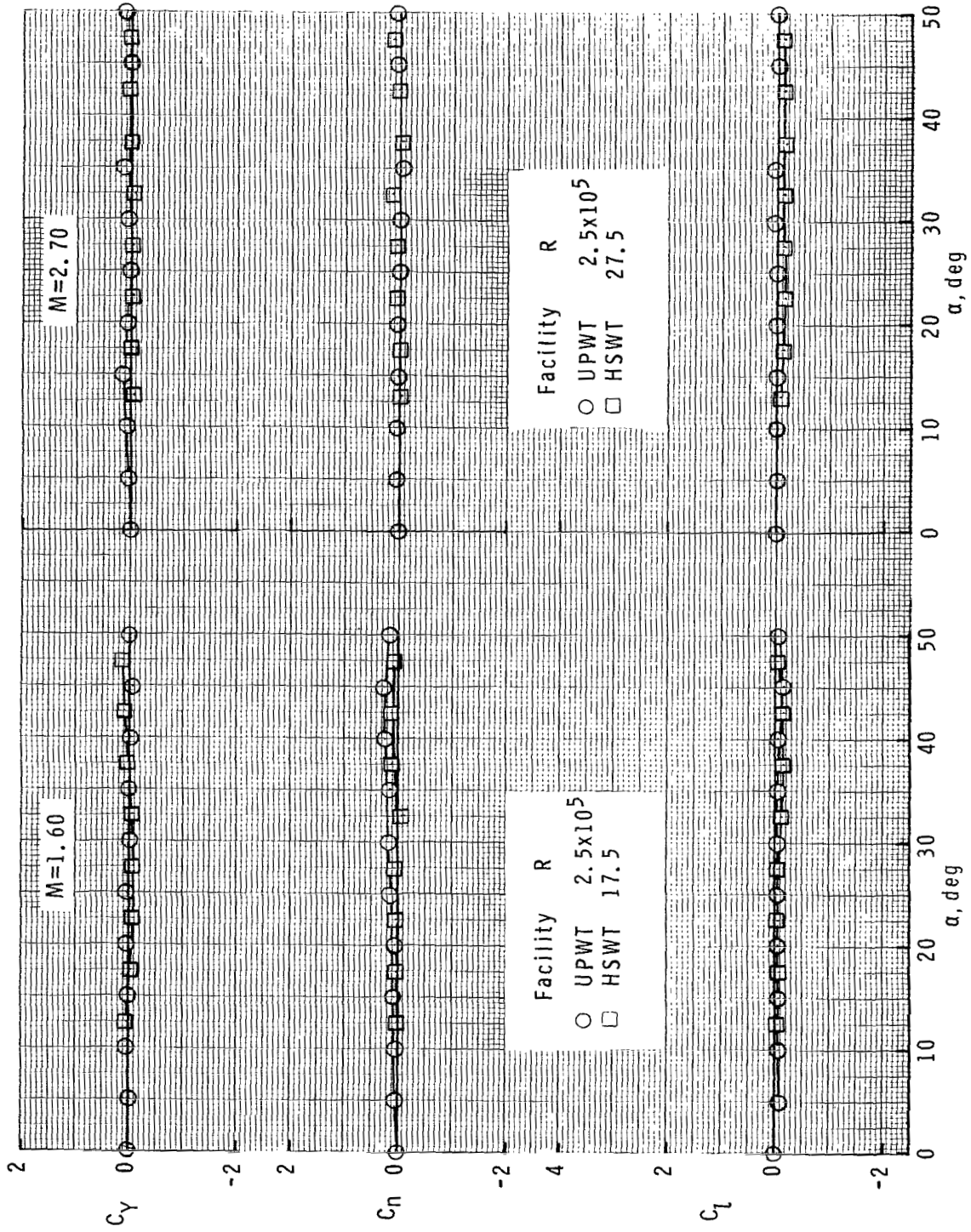

(c)  $\phi = 45^\circ$ .

Figure 5.- Concluded.

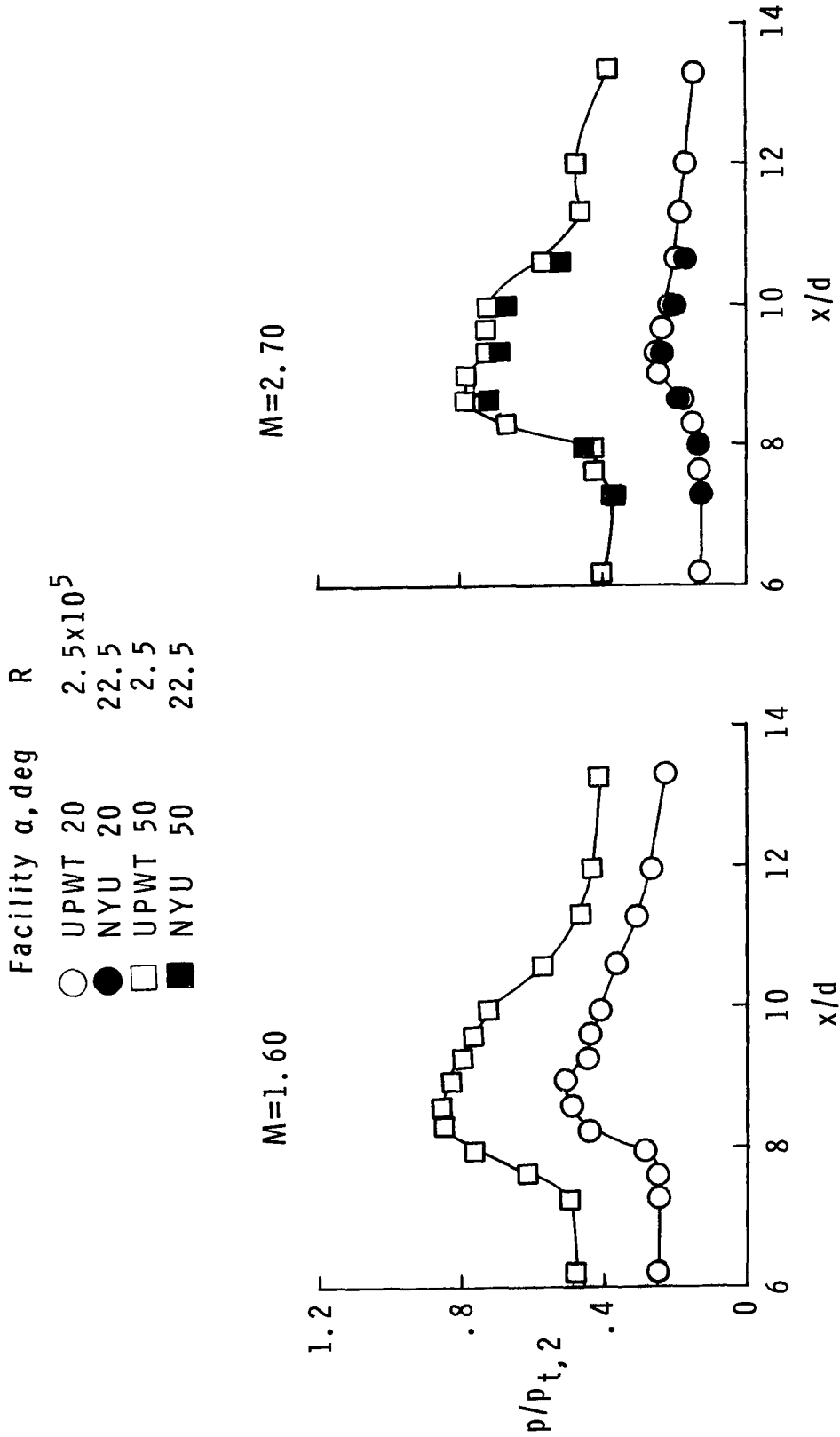

(a)  $\phi = 0^\circ$ .

Figure 6.- Pressure distributions in wing-body interaction region;  $\theta = 225^\circ$ .

Facility $\alpha$ , deg	R
○ UPWT 20	$2.5 \times 10^5$
● NYU 20	22.5
□ UPWT 50	2.5
▣ NYU 50	22.5

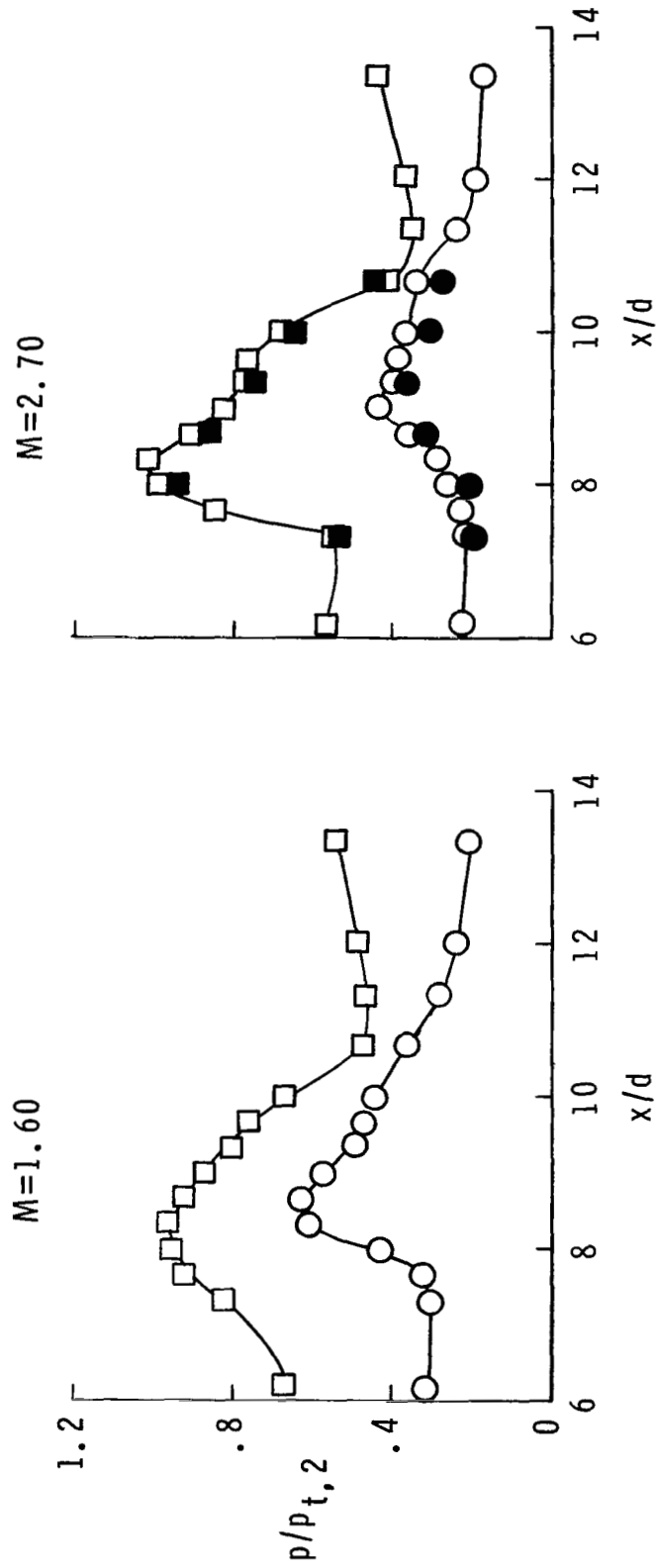

(b)  $\phi = 22.5^\circ$ .

Figure 6.- Continued.

Facility	$\alpha$ , deg	R
○	UPWT 20	$2.5 \times 10^5$
●	NYU 20	22.5
□	UPWT 50	2.5
■	NYU 50	22.5

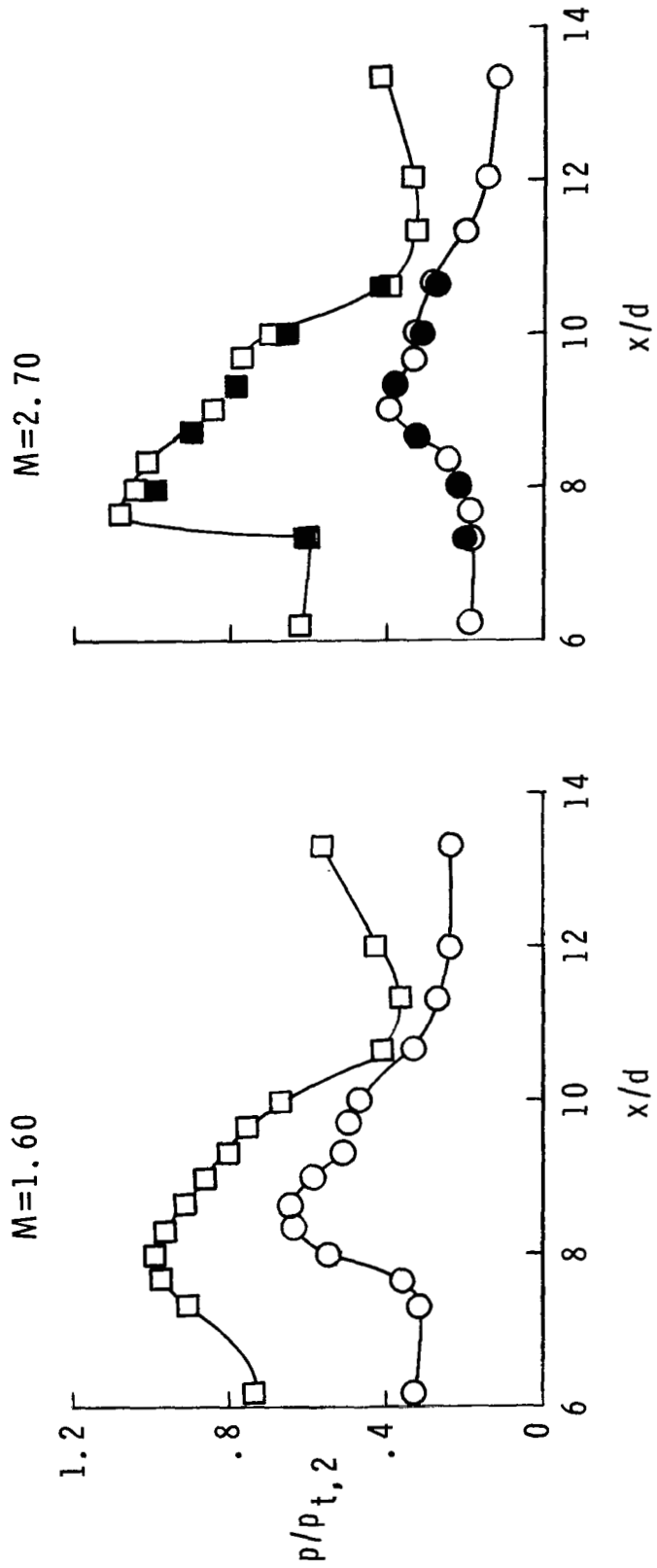

(c)  $\phi = 45^\circ$ .

Figure 6.- Concluded.



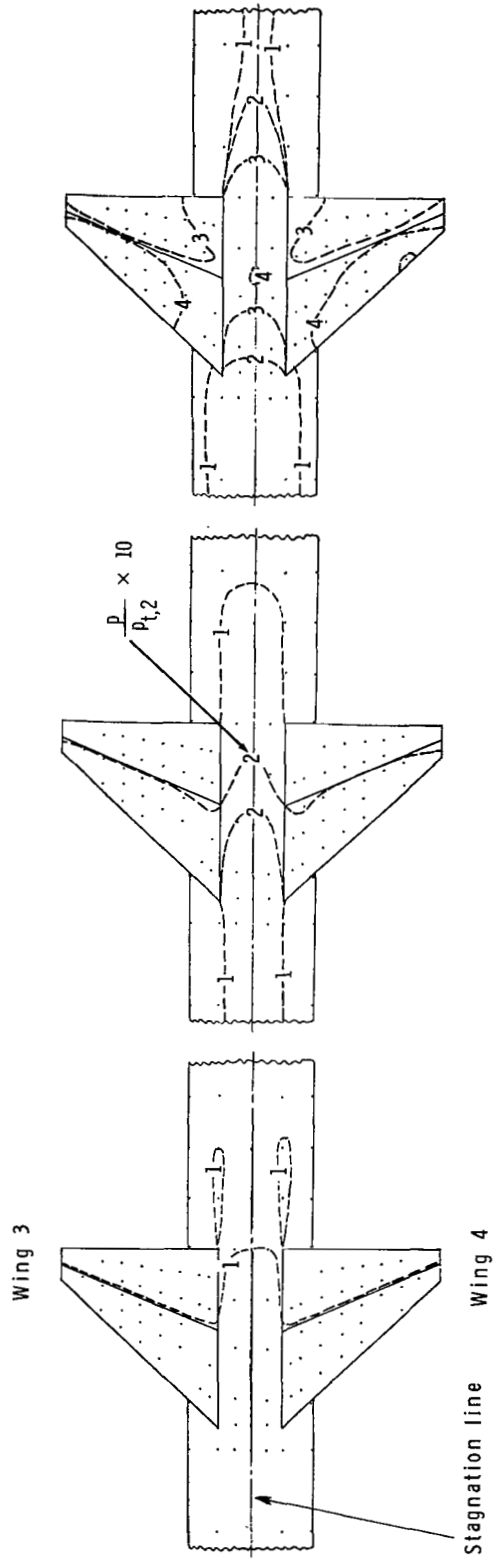
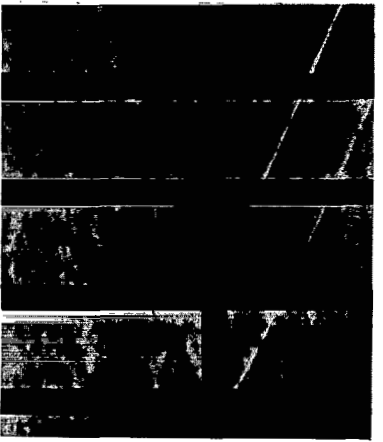
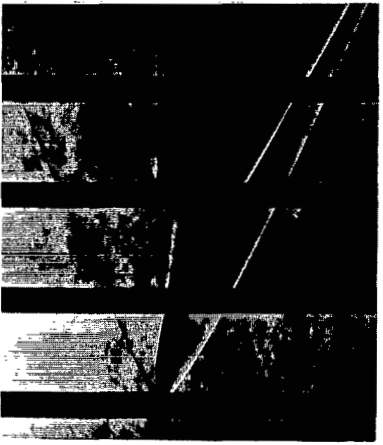
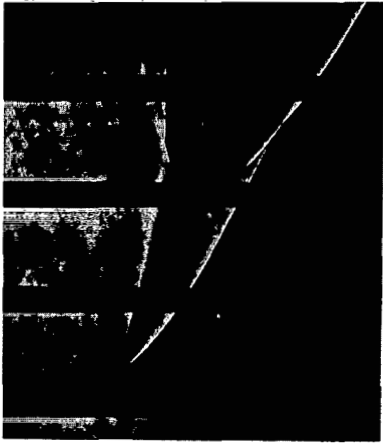

$\alpha = 0^\circ$

$\alpha = 10^\circ$

$\alpha = 20^\circ$

(a)  $\phi = 45^\circ$ ;  $M = 2.70$ .

L-80-135

Figure 7.- Pressure contours and schlieren photographs.

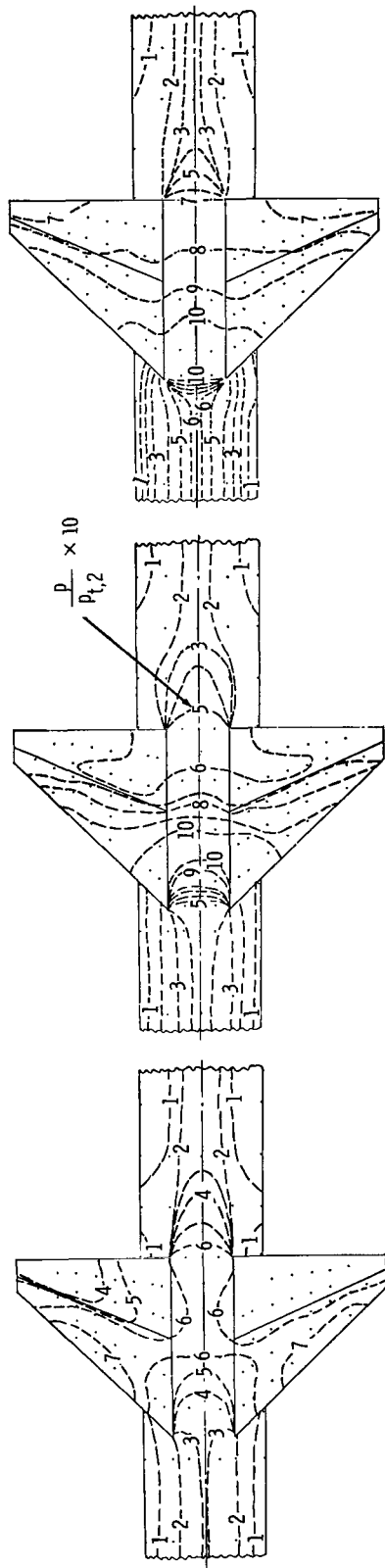
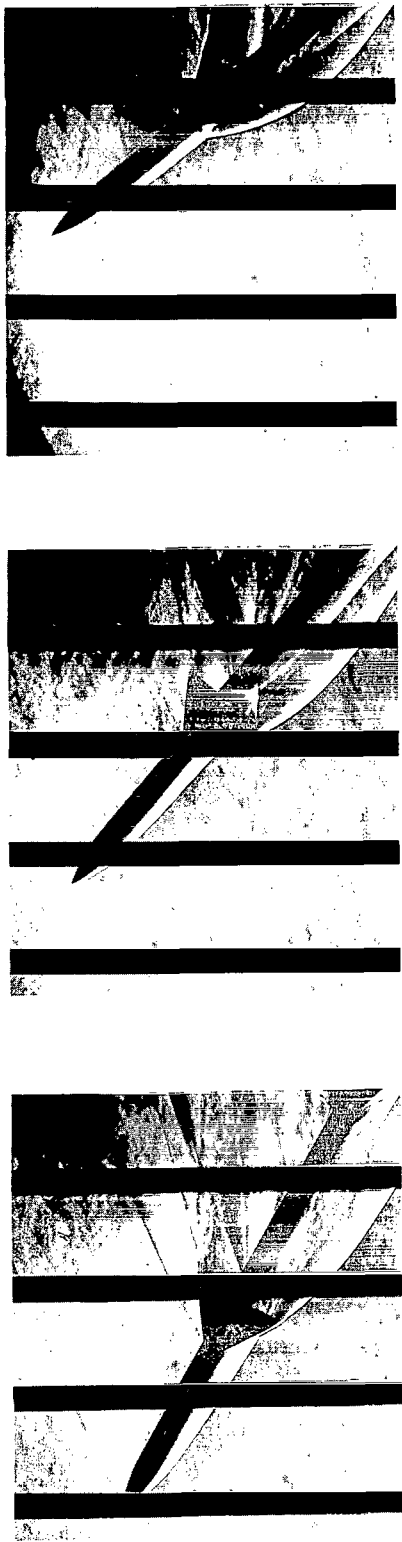

$\alpha = 30^\circ$

$\alpha = 40^\circ$

$\alpha = 50^\circ$

L-80-136

(a) Concluded.

Figure 7.- Continued.

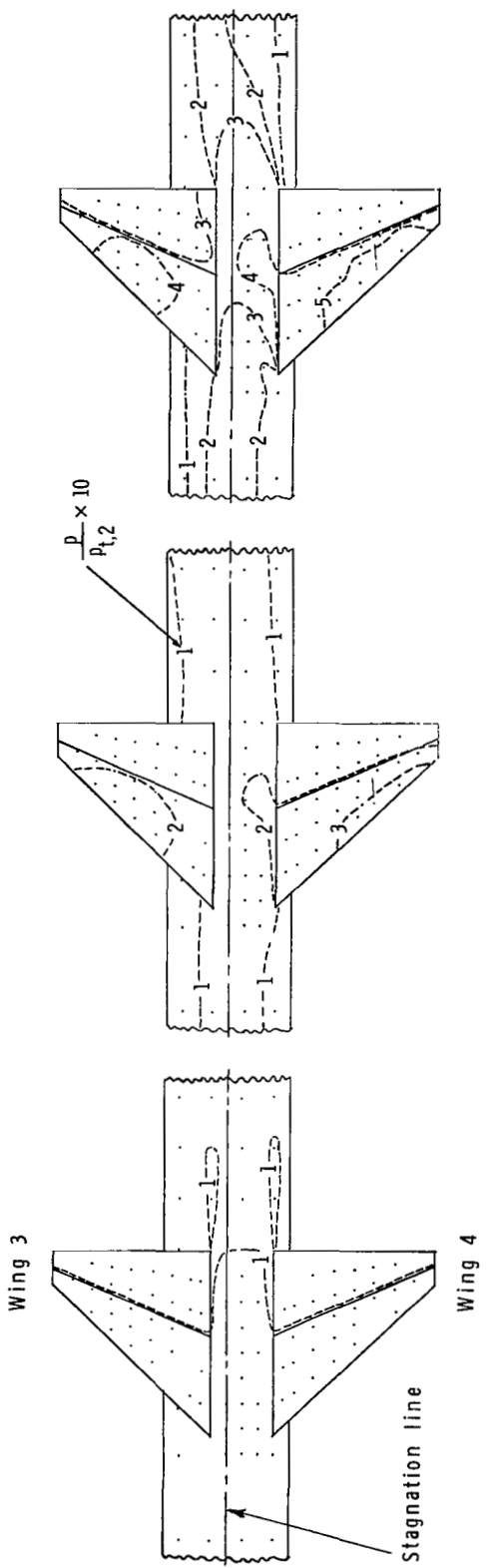
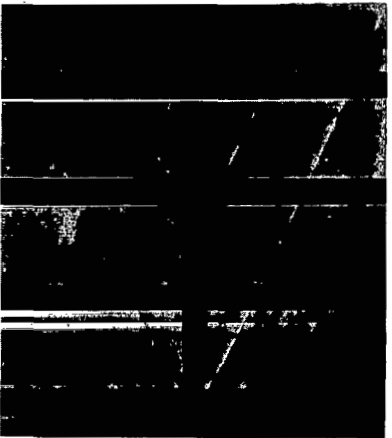
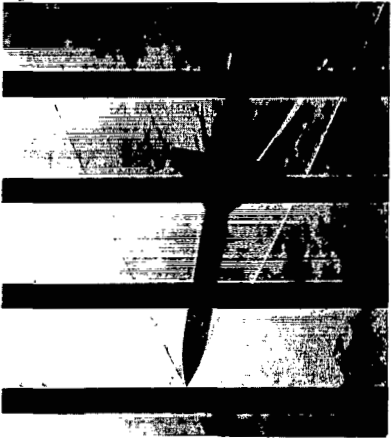
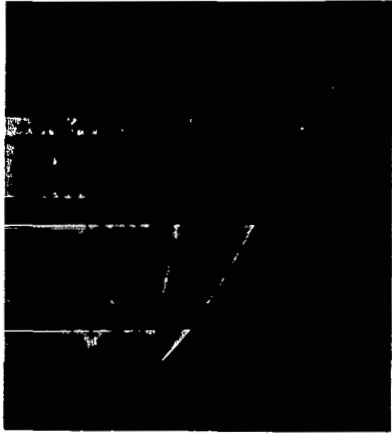

$\alpha = 0^\circ$

$\alpha = 10^\circ$

$\alpha = 20^\circ$

(b)  $\phi = 22.5$ ;  $M = 2.70$ .

I-80-137

Figure 7.- Continued.

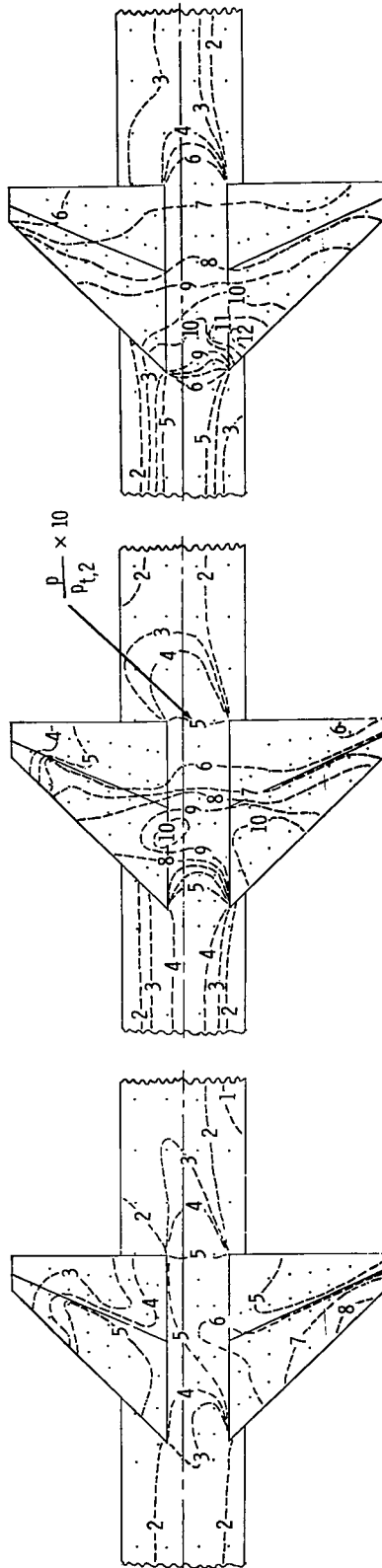
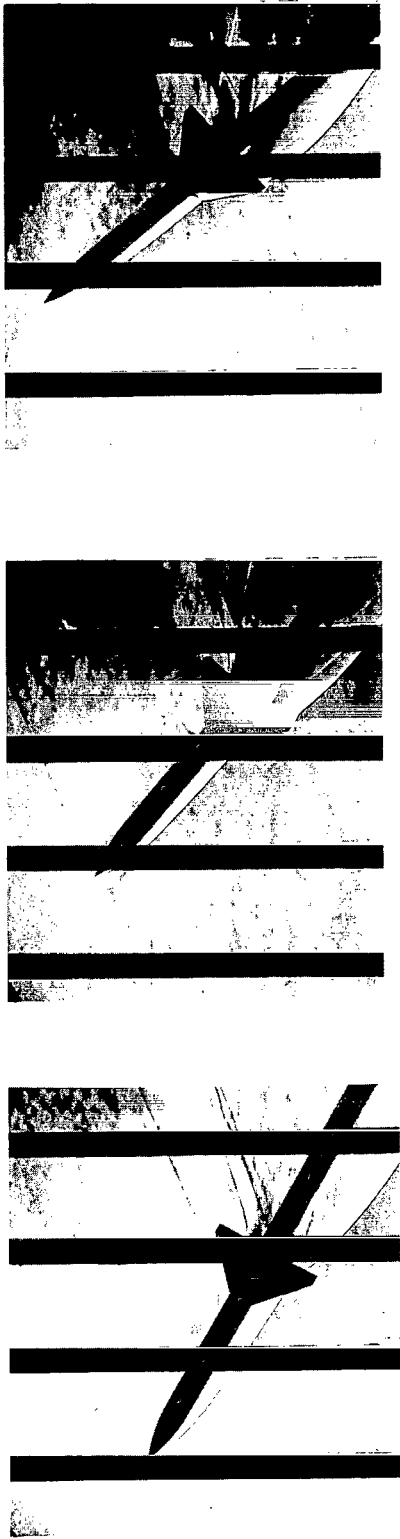

$\alpha = 30^\circ$

$\alpha = 40^\circ$

$\alpha = 50^\circ$

I-80-138

(b) Concluded.

Figure 7.- Continued.

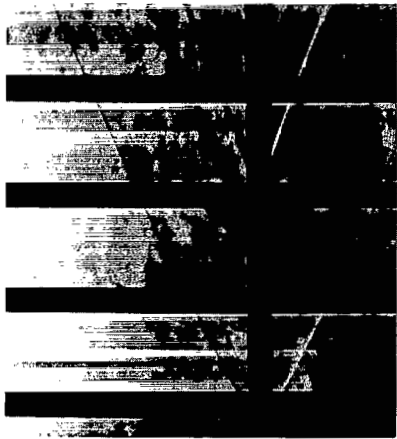

Wing 3

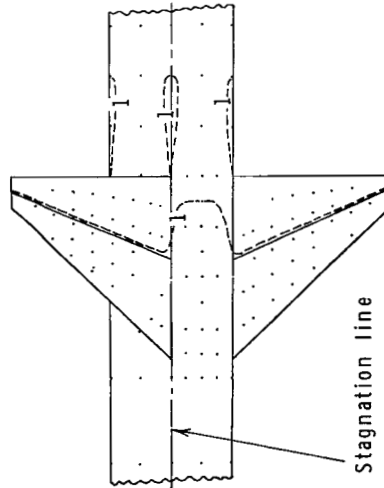

Wing 4

$\alpha = 0^\circ$

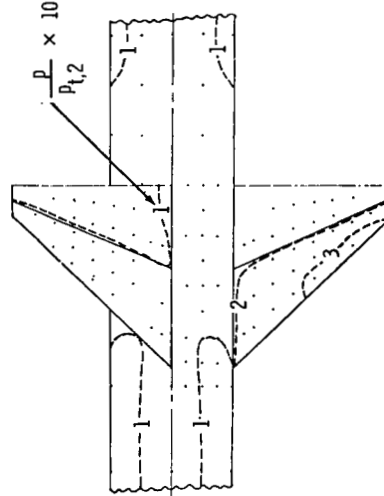

$\alpha = 10^\circ$

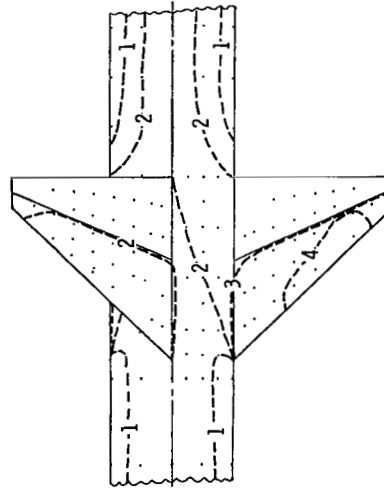

$\alpha = 20^\circ$

L-80-139

(c)  $\phi = 0^\circ$ ;  $M = 2.70$ .

Figure 7.- Continued.

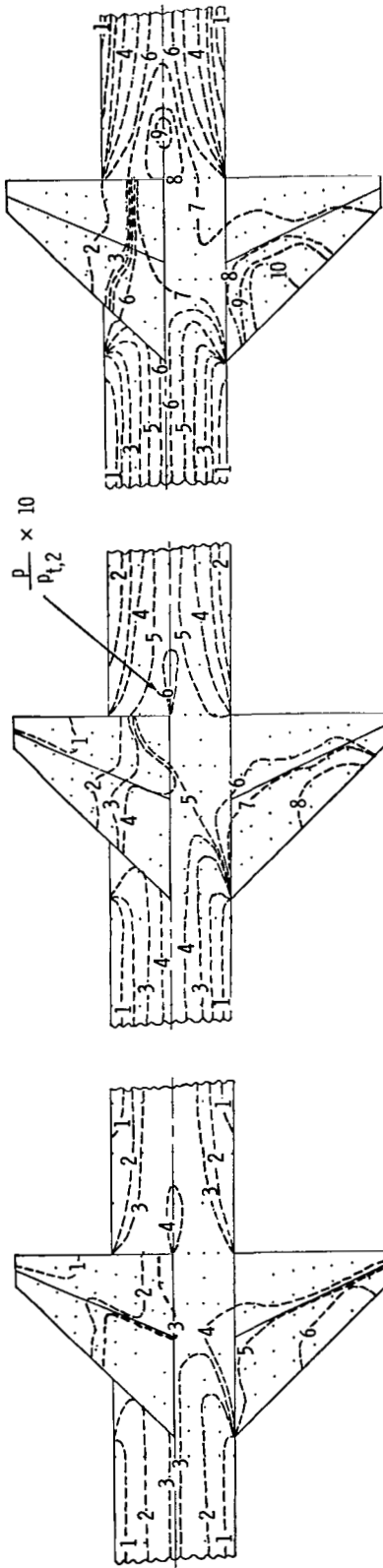
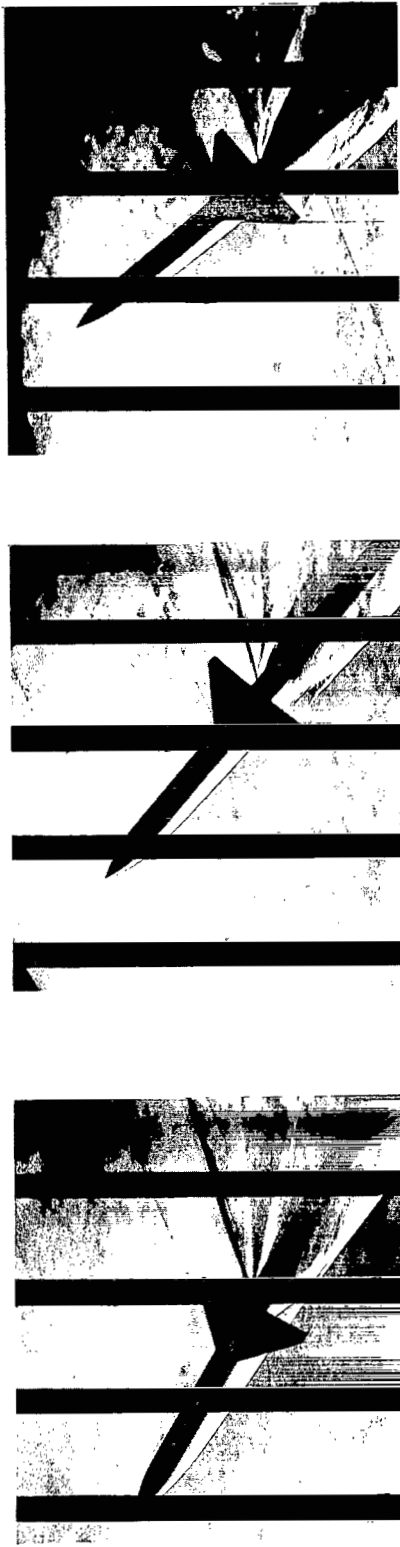

$\alpha = 30^\circ$

$\alpha = 40^\circ$

$\alpha = 50^\circ$

L-80-140

(c) Concluded.

Figure 7.- Continued.

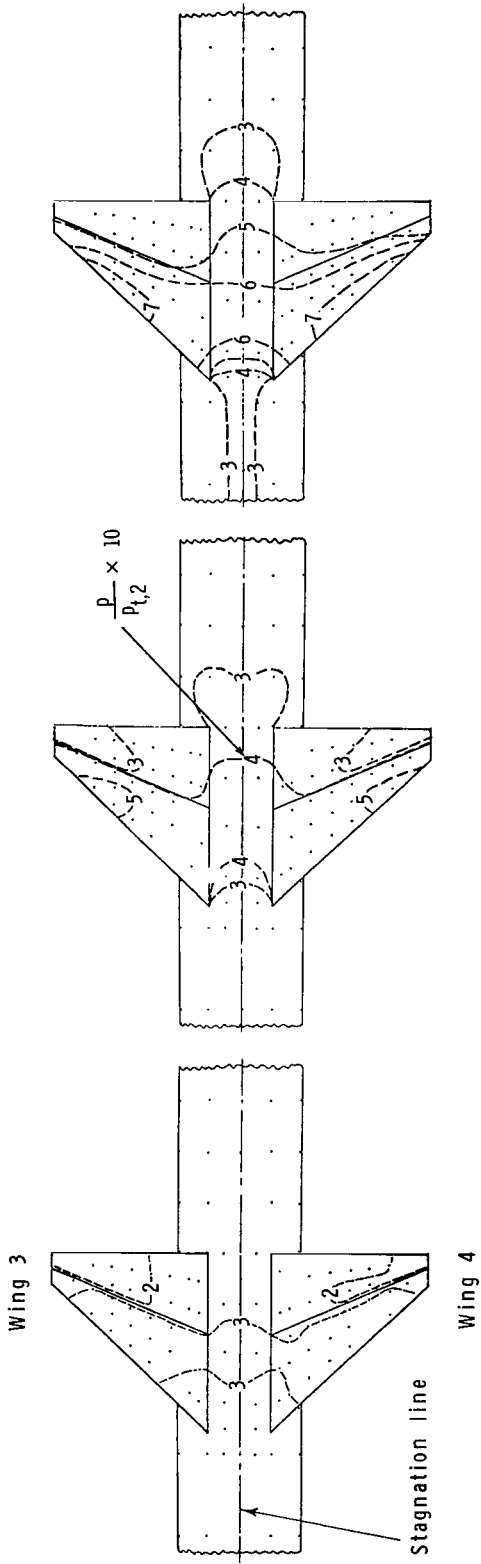
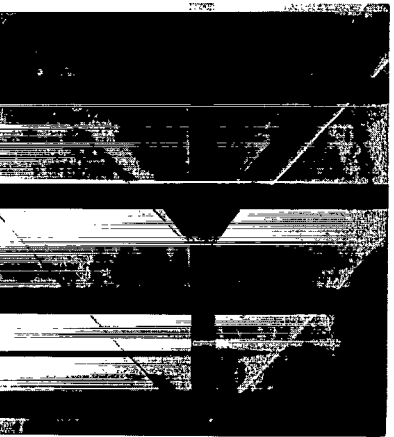
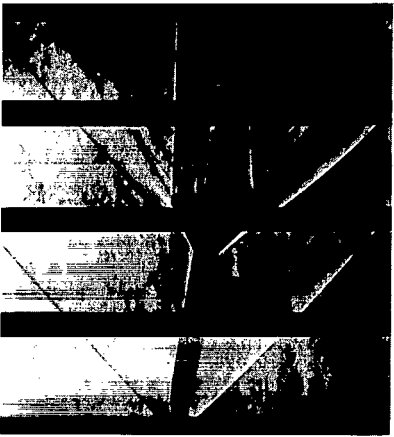
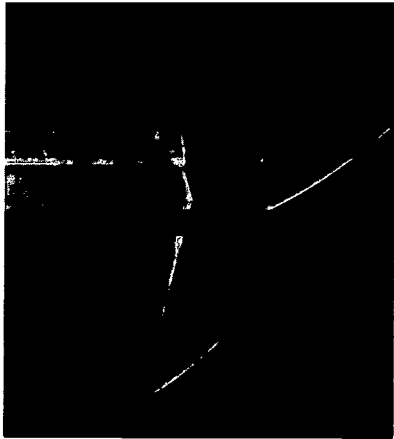

(d)  $\phi = 45^\circ$ ;  $M = 1.60$ .

Figure 7.- Continued.

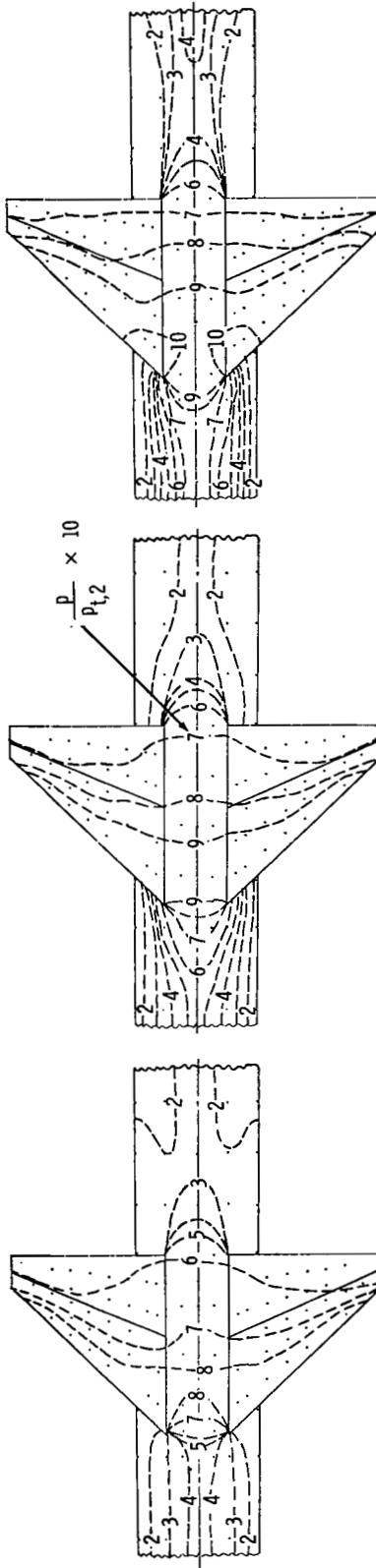
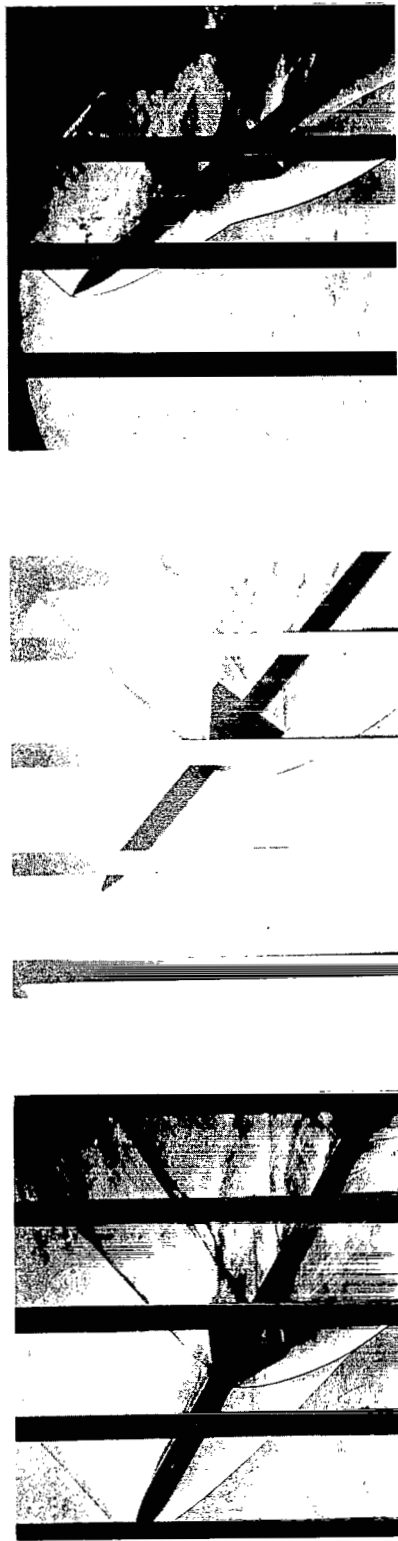

$\alpha = 30^\circ$

$\alpha = 40^\circ$

$\alpha = 50^\circ$

L-80-142

(d) Concluded.

Figure 7.- Continued.



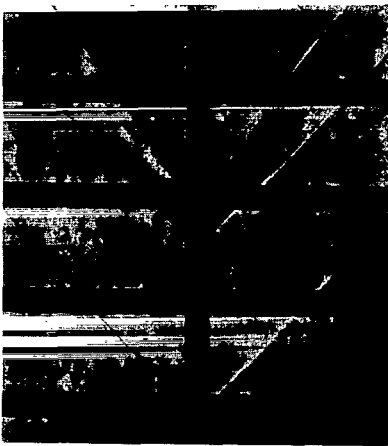

Wing 3

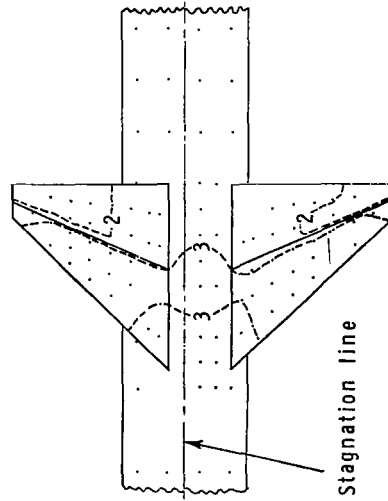

$\alpha = 0^\circ$

Wing 4

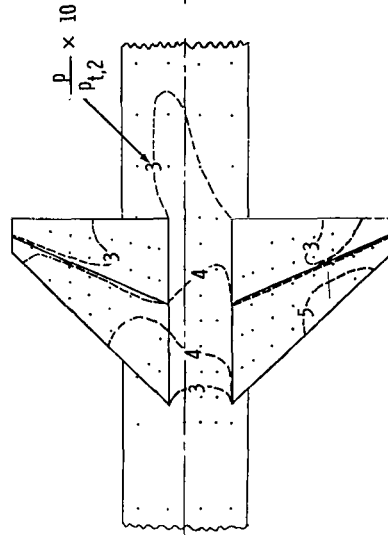

$\alpha = 10^\circ$

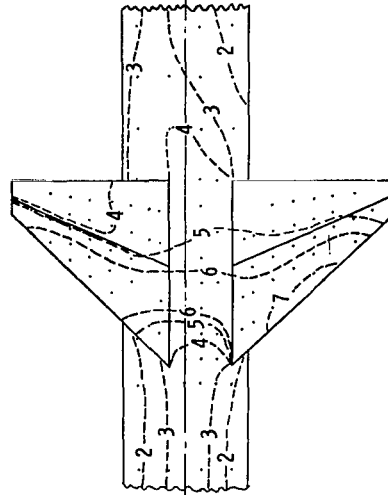

$\alpha = 20^\circ$

L-80-143

(e)  $\phi = 22.5$ ;  $M = 1.60$ .

Figure 7.- Continued.

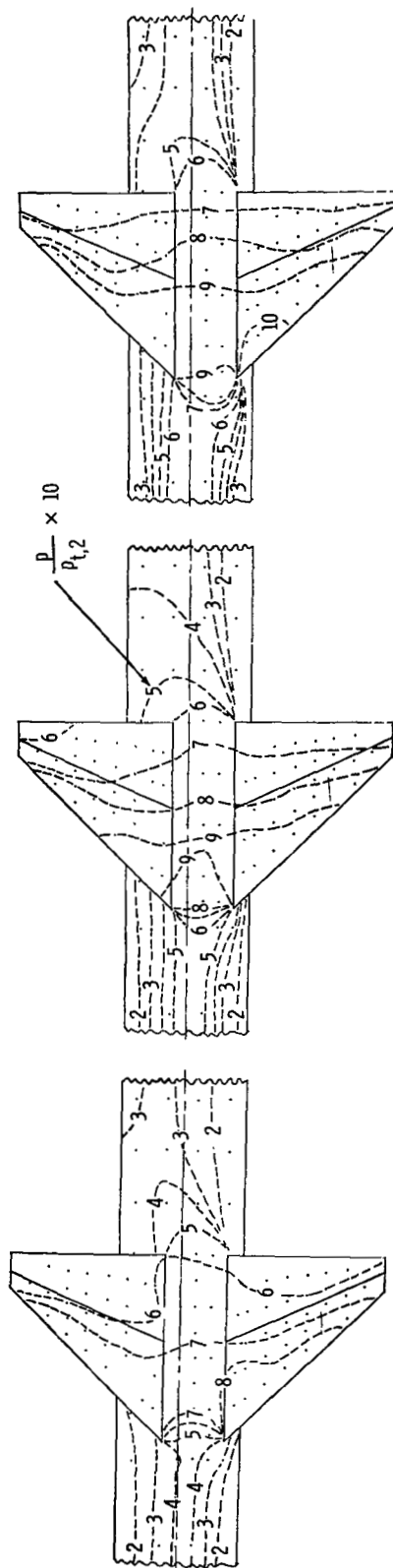

$\alpha = 30^\circ$

$\alpha = 40^\circ$

$\alpha = 50^\circ$

L-80-144

(e) Concluded.

Figure 7.- Continued.

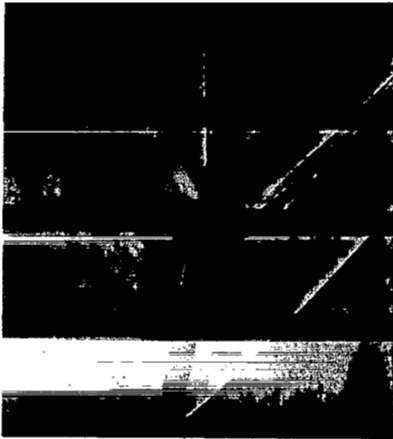

Wing 3

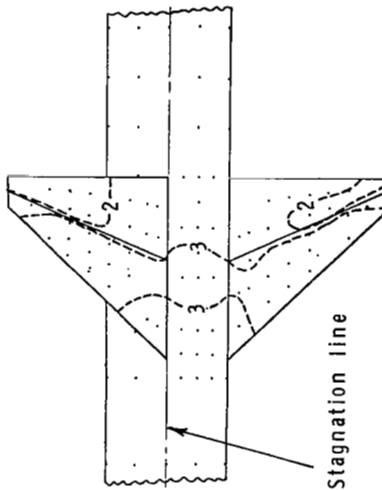

Wing 4

$\alpha = 0^\circ$

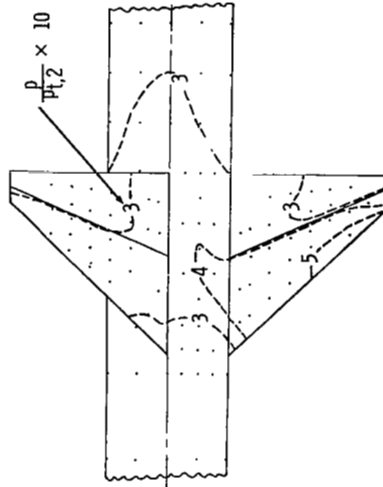

$\alpha = 10^\circ$

(F)  $\phi = 0^\circ$ ;  $M = 1.60$ .

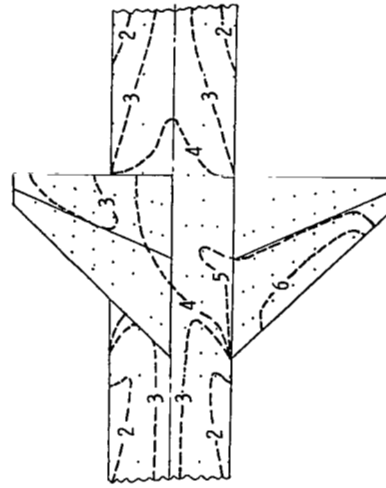

$\alpha = 20^\circ$

L-80-145

Figure 7.- Continued.

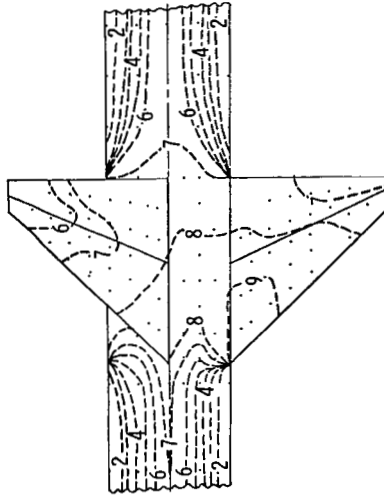
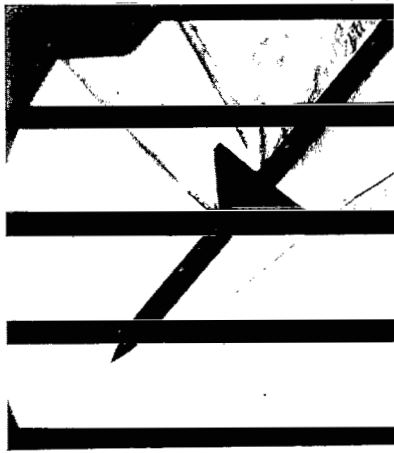

$\alpha = 50^\circ$

L-80-146

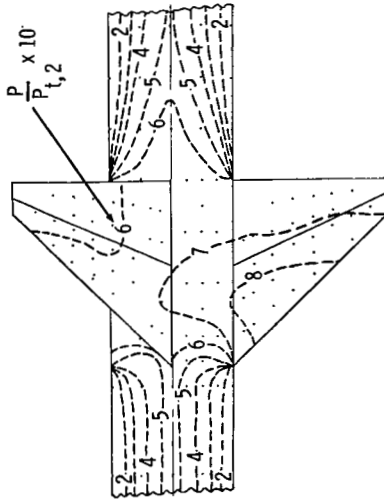

$\alpha = 40^\circ$

(F) Concluded.

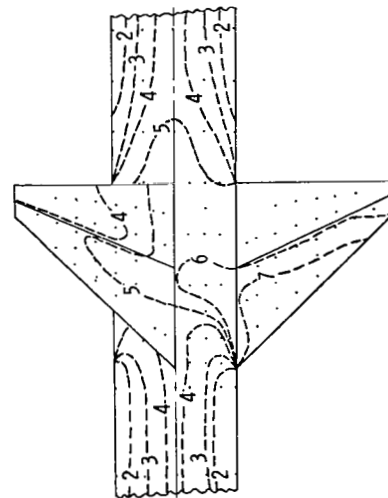

$\alpha = 30^\circ$

Figure 7.- Concluded.



$x/d = 8.3$

8.7

9.3

10.7

12.0

14.4



$x/d = 4.7$

7.3

8.7

9.3

10.7

12.0

L-80-147

(a)  $\phi = 0^\circ$ .

Figure 8.- Vapor-screen photographs;  $M = 2.70$ .

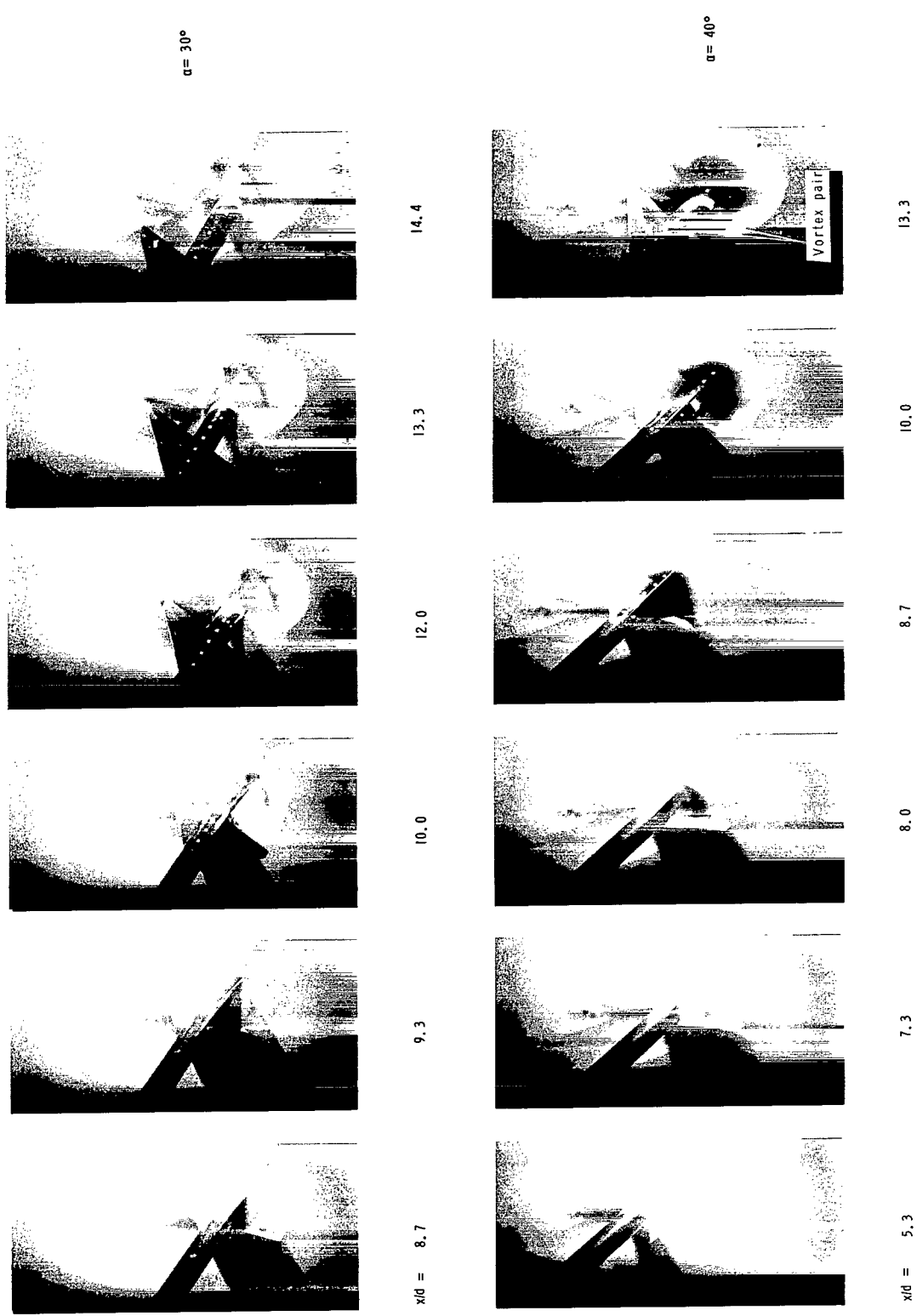

L-80-148

(b)  $\phi = 22.5^\circ$ .

Figure 8.- Concluded.

1. Report No. <b>NASA TP-1683</b>		2. Government Accession No.		3. Recipient's Catalog No.	
4. Title and Subtitle <b>EFFECT OF REYNOLDS NUMBER ON STABILITY CHARACTERISTICS OF A CRUCIFORM WING-BODY AT SUPERSONIC SPEEDS</b>				5. Report Date <b>July 1980</b>	
				6. Performing Organization Code	
7. Author(s) <b>Robert L. Stallings, Jr., Milton Lamb, and Carolyn B. Watson</b>				8. Performing Organization Report No. <b>L-13530</b>	
				10. Work Unit No. <b>505-43-23-02</b>	
9. Performing Organization Name and Address <b>NASA Langley Research Center Hampton, VA 23665</b>				11. Contract or Grant No.	
				13. Type of Report and Period Covered <b>Technical Paper</b>	
12. Sponsoring Agency Name and Address <b>National Aeronautics and Space Administration Washington, DC 20546</b>				14. Sponsoring Agency Code	
				15. Supplementary Notes	
16. Abstract <p>An experimental investigation has been conducted to determine the effect of Reynolds number on the stability characteristics of a body with cruciform wings at large angles of attack. Pressure distributions and force and moment data (axial force not measured) are presented for Mach 1.60 and 2.70, Reynolds numbers based on body diameter from approximately <math>1.3 \times 10^5</math> to <math>28 \times 10^5</math>, and angles of attack from <math>0^\circ</math> to <math>50^\circ</math>. In general, the data show only small effects of Reynolds number throughout the range of test conditions. Also discussed are force balance and pressure data that suggest a direct relationship between wing choking and the onset of a nonlinear stability variation with angle of attack.</p>					
17. Key Words (Suggested by Author(s)) <b>Reynold number effects Missile Large angle of attack Supersonic Wing-body interaction</b>			18. Distribution Statement <b>Unclassified - Unlimited</b>  <b>Subject Category 02</b>		
19. Security Classif. (of this report) <b>Unclassified</b>	20. Security Classif. (of this page) <b>Unclassified</b>	21. No. of Pages <b>108</b>	22. Price* <b>A06</b>		