

N O T I C E

THIS DOCUMENT HAS BEEN REPRODUCED FROM
MICROFICHE. ALTHOUGH IT IS RECOGNIZED THAT
CERTAIN PORTIONS ARE ILLEGIBLE, IT IS BEING RELEASED
IN THE INTEREST OF MAKING AVAILABLE AS MUCH
INFORMATION AS POSSIBLE

REMTECH INC.
2603 Artie Street, Suite 21
Huntsville, Alabama 35805
(205) 536-8581

RTR 014-6

SPT

(NASA-CR-161499) SSV GENERIC OFT FIRST STAGE ASCENT BASE N80-27630
CONVECTIVE HEATING ENVIRONMENTS (Remtech, Inc., Huntsville,
Ala.) 63 p

G3/34 Unclass
24920

SSV GENERIC OFT
FIRST STAGE ASCENT BASE
CONVECTIVE HEATING ENVIRONMENTS



October 31, 1978





RTR 014-6

SSV
GENERIC OFT
FIRST STAGE ASCENT BASE CONVECTIVE HEATING ENVIRONMENTS

Prepared by
Robert Lee Bender, Jr.
Young C. Lee

October 31, 1978

Prepared Under
Contract NAS8-29270

For
National Aeronautics and Space Administration
George C. Marshall Space Flight Center
Marshall Space Flight Center, Alabama 35812

REMTECH inc.



RTR 014-6

SSV
GENERIC OFT
FIRST STAGE ASCENT BASE CONVECTIVE HEATING ENVIRONMENTS

Prepared by
Robert Lee Bender, Jr.
Young C. Lee

October 31, 1978

Prepared Under
Contract NAS8-29270

For
National Aeronautics and Space Administration
George C. Marshall Space Flight Center
Marshall Space Flight Center, Alabama 35812

REMTECH inc.

SUMMARY

SSV base convective heating environments during the recirculated flow time segment of first stage ascent have been determined for the Generic OFT trajectory and performance conditions. These environments are presented in the attachments as cold wall convective heat transfer coefficients for individual or groups of design points for all affected SSV base surfaces. Two gas recovery temperatures applicable to upper and lower base region surfaces are also included. The environments were based upon magnitudes and trends from analysis of data taken during Base Heating Tests IH-39, IH-75, and IH-83. The plume heating trajectory and performance data were supplied by Rockwell International for both the OFT-1 Generic Mission A and Mission C.

ANALYSIS

A description of the methodology used to generate first stage ascent base convective heating environments for the Space Shuttle is contained in Reference 1. These methods were used to determine the Generic OFT environments. The principal difference in the OFT environment prediction and previous design environments was the availability of additional Base Heating Test Data from Tests IH-75 and IH-83. These tests which were performed in the fall of 1977 and winter of 1978 provided specific data simulating first stage at higher altitudes, SRB thrust mismatch and thrust tail-off with gimbaling, and vehicle pitch and sideslip which corresponded closely to the OFT-1 flight conditions.

As has been done in previous design predictions, two trajectories were used in the OFT convective heating predictions: a trajectory which stages at the lowest altitude (under OFT performance conditions) is necessary for the orbiter base region, while a trajectory which maximizes the staging altitude is needed for the external tank and SRB base regions. For this study, the

Plume Heating Trajectory Generic OFT Mission C Winter Launch was used for the Orbiter base environments. This trajectory stages at approximately 147,000 feet and is characterized by relatively large envelopes of SSME and SRB pitch and yaw gimbal from 103 to 125 seconds (90,000 to 140,000 feet altitude). Details of this trajectory along with vehicle pitch and yaw (sideslip) envelopes are included in the Appendix.

The Plume Heating Trajectory Generic OFT Mission A which stages at approximately 167,000 feet was used for all base components below the body flap. Details of the Mission A trajectory and SSME and SRB pitch and yaw gimbal envelopes used in the environment assessment are also included in the Appendix.

Detailed analyses of Base Heating Tests IH-39, IH-75, and IH-83 were reported in References 2 through 4 respectively. Data from Test IH-39 were used to establish the nominal trends with altitude, SRB thrust tailoff, pitch gimbal, and vehicle angle of attack. The IH-75 data were used to extend these nominal trends to higher altitudes at reduced SRB thrust and larger angle of attack. The IH-83 data provided extensive information on the effect of vehicle sideslip and SRB thrust mismatch on the base environments. Collectively these three tests closely simulated the range of predicted OFT flight conditions above 60,000 feet to staging, and also provided ample second stage data to verify compatibility with vacuum tank test data used in second stage predictions. The later two tests had additional instrumentation not available on IH-39 to more closely measure environments on the SRB cylinder and body flap. Several lower SSME nozzle orientations were also tested to better define the circumferential variation in the environment. Gas temperature probe data from the latest tests generally verified previous predictions although local high temperatures were recorded at specific locations for certain vehicle and SSME/SRB yaw and pitch combinations. The gas probe data are reported in References 5 and 6.

The OFT convective heating predictions are shown in Figures 1 through 44 and were grouped according to general base location as described in the List of Figures. The effect of the specific OFT conditions such as vehicle angle of attack and sideslip angle varied greatly over the base surfaces. In general, base convective heating increased with negative angle of attack at the lower test altitudes, 60 to 90 Kft, and increased with negative yaw at the middle test altitudes from 90 to 110 Kft. Certain combinations of vehicle yaw, negative engine pitch, and SRB thrust tailoff produced localized high heating above 110 Kft.

The Generic OFT Mission C trajectory staged at a higher altitude than the plume radiation design trajectory which tends to delay the increase in the orbiter center cluster region heating occurring during the transition from the five engine to three engine flow field. Although new model data indicated slightly higher heating at the lower altitudes than previously considered in the design environment definition, the comparison of Generic OFT environment with design shows little overall change in the upper base region.

Slight increases were also noted in the overall heating to the external tank, SRB, and aft attachment structure when comparing the Generic OFT environments with design. Environments to some locations, notable the SRB cylinder near the attach ring, are completely changed for the OFT-1 mission compared with design because of new model data obtained at these locations subsequent to the 1977 design predictions.

Maximum first stage ascent convective heating occurs near the upper SSME nozzle lip; within a circumferential region 45° to either side of the plane of symmetry intersection with the nozzle. Heating amplification factors should be applied to the top and aft facing surfaces of the nozzle hat bands as indicated in Tables 1 and 2.

REFERENCES

1. "Base Heating Prediction Methodology Used for the Space Shuttle," T. F. Greenwood, D. C. Seymour, and R. L. Bender; Paper presented at JANNAF 10th Plume Technology Meeting, September 1977.
2. MSFC Memo ED33-78-31, "IH-39 Shuttle Base Heating Test Analysis," D. C. Seymour, July 3, 1978.
3. MSFC Memo ED33-78-16, "IH-75 Shuttle Base Heating Test Analysis," D. C. Seymour, May 5, 1978.
4. MSFC Memo ED33-78-27, "IH-83 Shuttle Base Heating Test Analysis," D. C. Seymour, June 26, 1978.
5. REMTECH Report RTR 019-2, "Utilization of a Gas Temperature Recovery Probe on Space Shuttle Short Duration Base Heating Model Tests OH-78 and IH-39," C. E. Fuller, et. al.; July 1977.
6. REMTECH Report RTR 019-3, "Utilization of a Gas Recovery Temperature Probe on Space Shuttle Short Duration Base Heating Model Tests IH-75 and IH-83," C. E. Fuller et. al.; July 1978.

LIST OF FIGURES

<u>Figure (s)</u>	<u>Title (or Applicable SSV Base Location)</u>	<u>Page (s)</u>
1	Base Gas Recovery Temperature	7
2 to 4	Orbiter Heat Shield (Flat Surface)	8 to 10
5 to 7	Orbiter Heat Shield Bulge	11 to 13
8 to 11	SSME Heat Shield	14 to 17
12 to 16	SSME #1 Smooth Wall	18 to 22
17 to 24	SSME #2 Smooth Wall	24 to 31
25 to 27	OMS Pod & Nozzle	33 to 35
28 to 32	Body Flap	36 to 40
33 to 37	External Tank LH ₂ Dome	41 to 45
38 to 39	External Tank/Orbiter Attach Structure	46 to 47
40	External Tank/SRB Attach Structure	48
41 to 44	SRB Cylinder, Skirt & Skirt Curtain	49 to 52

APPENDIX

A-1	Trajectories (Time-Altitude)	54
A-2	Vehicle Angle of Attack and Yaw Envelopes	55 & 56
A-3	SRB Thrust Tailoff	57
A-4	SSME Gimbal Envelopes	58 & 59
A-5	SRB Gimbal Envelopes	60 & 61

LIST OF TABLES

<u>Table</u>	<u>Title</u>	<u>Page</u>
1	SSME #1 Protuberance Factors	23
2	SSME #2 Protuberance Factors	32

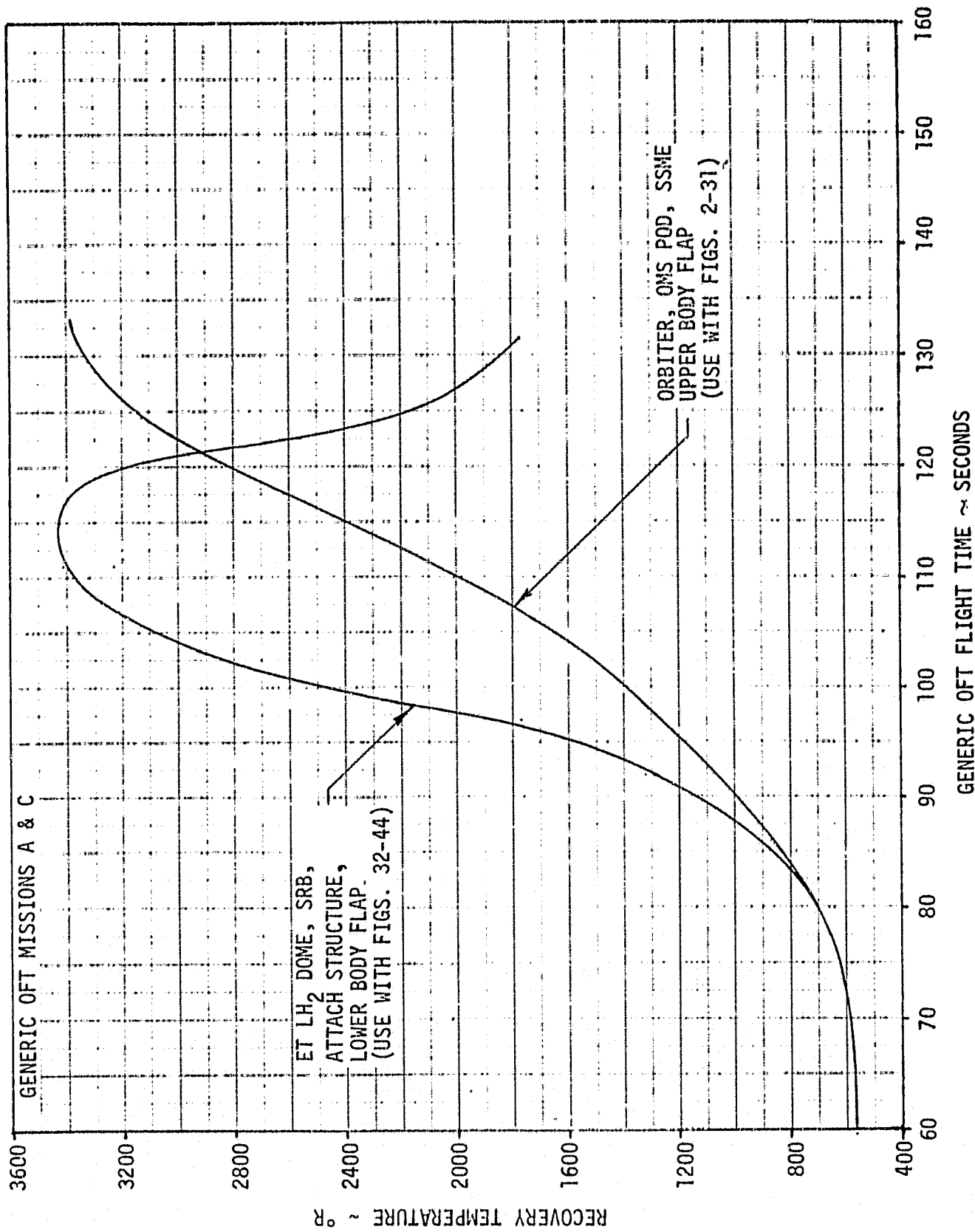

FIGURE 1. FIRST STAGE ASCENT BASE GAS RECOVERY TEMPERATURE

ORIGINAL PAGE IS
OF POOR QUALITY

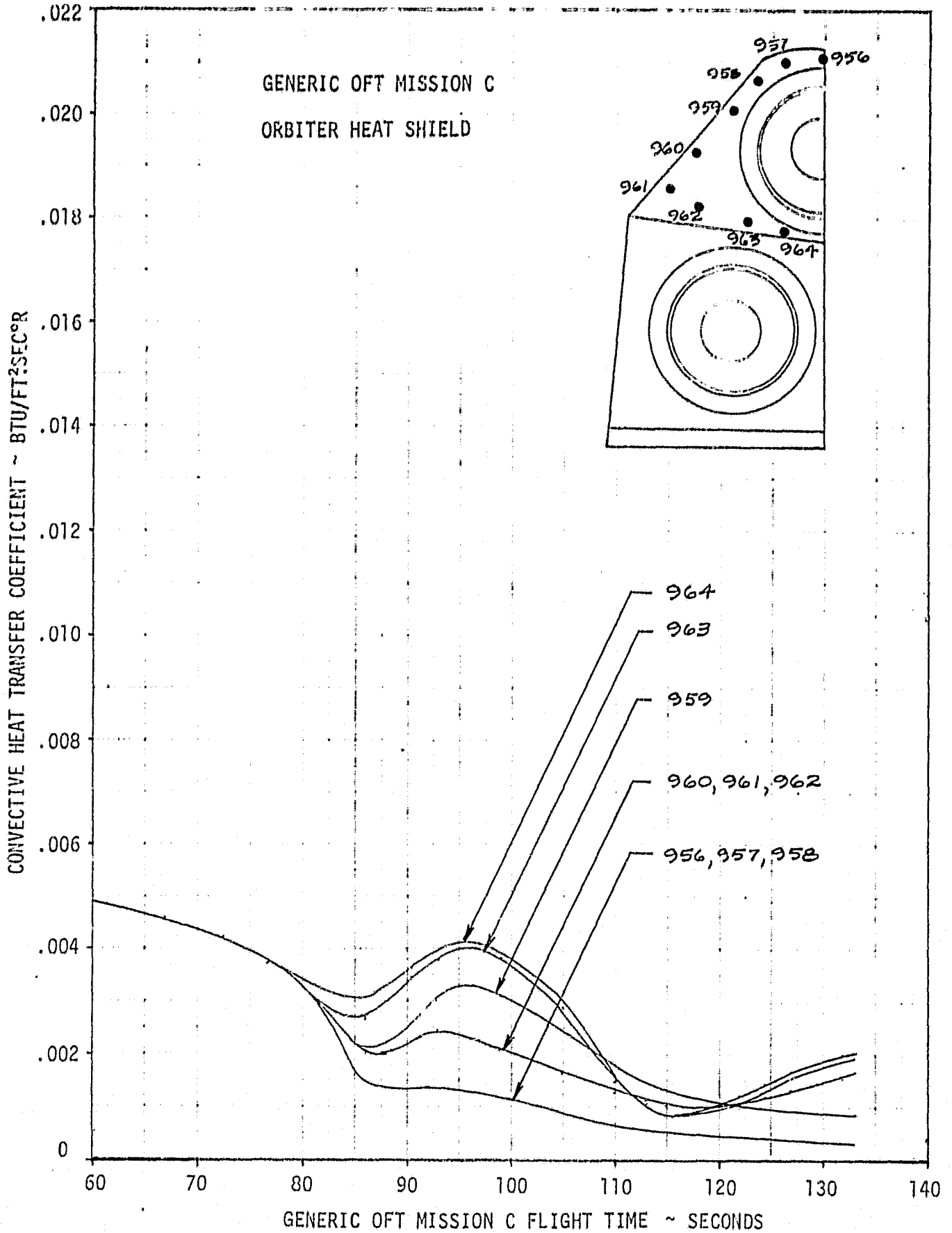

FIGURE 2 . FIRST STAGE ASCENT CONVECTIVE HEAT TRANSFER COEFFICIENT

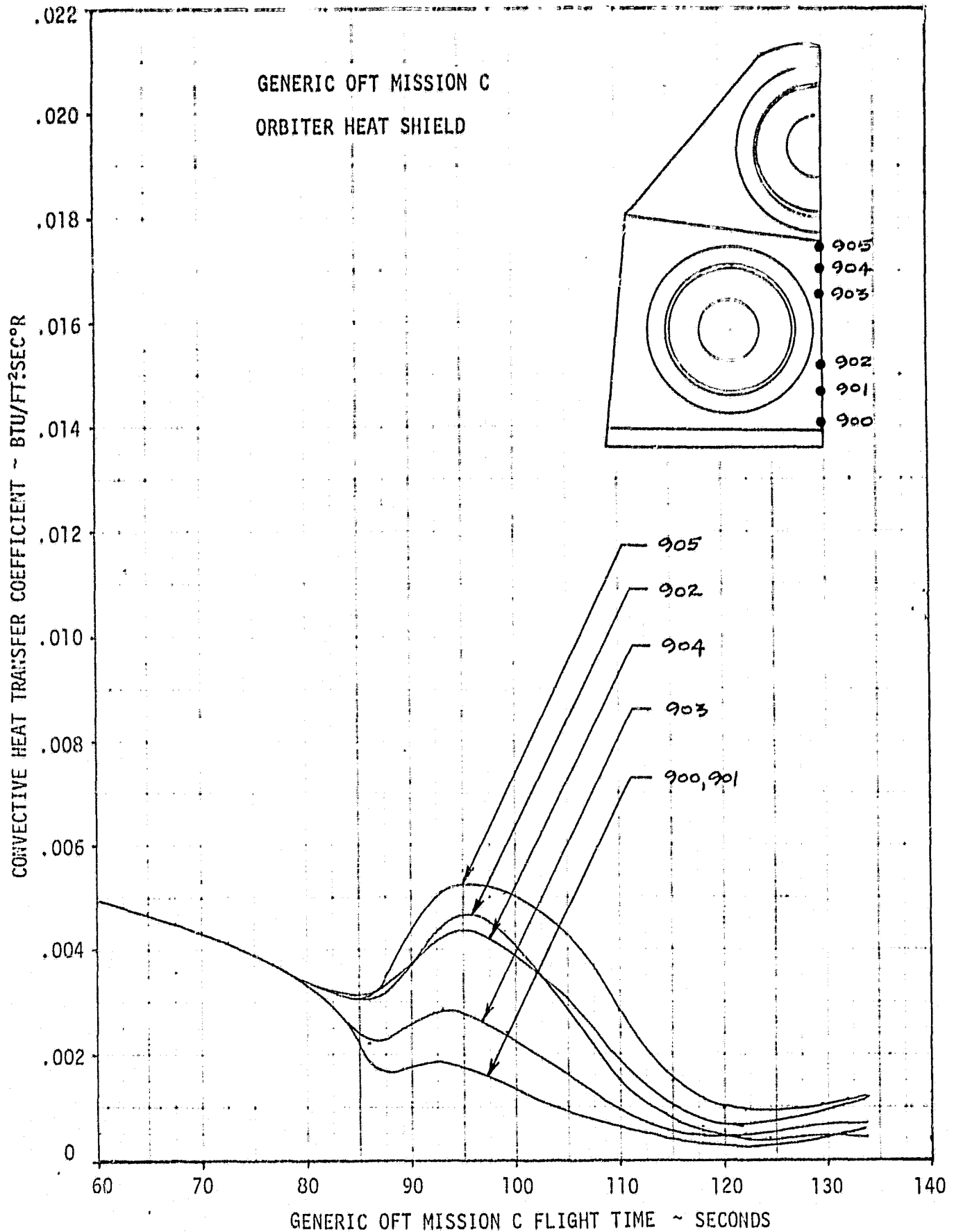

FIGURE 3 . FIRST STAGE ASCENT CONVECTIVE HEAT TRANSFER COEFFICIENT

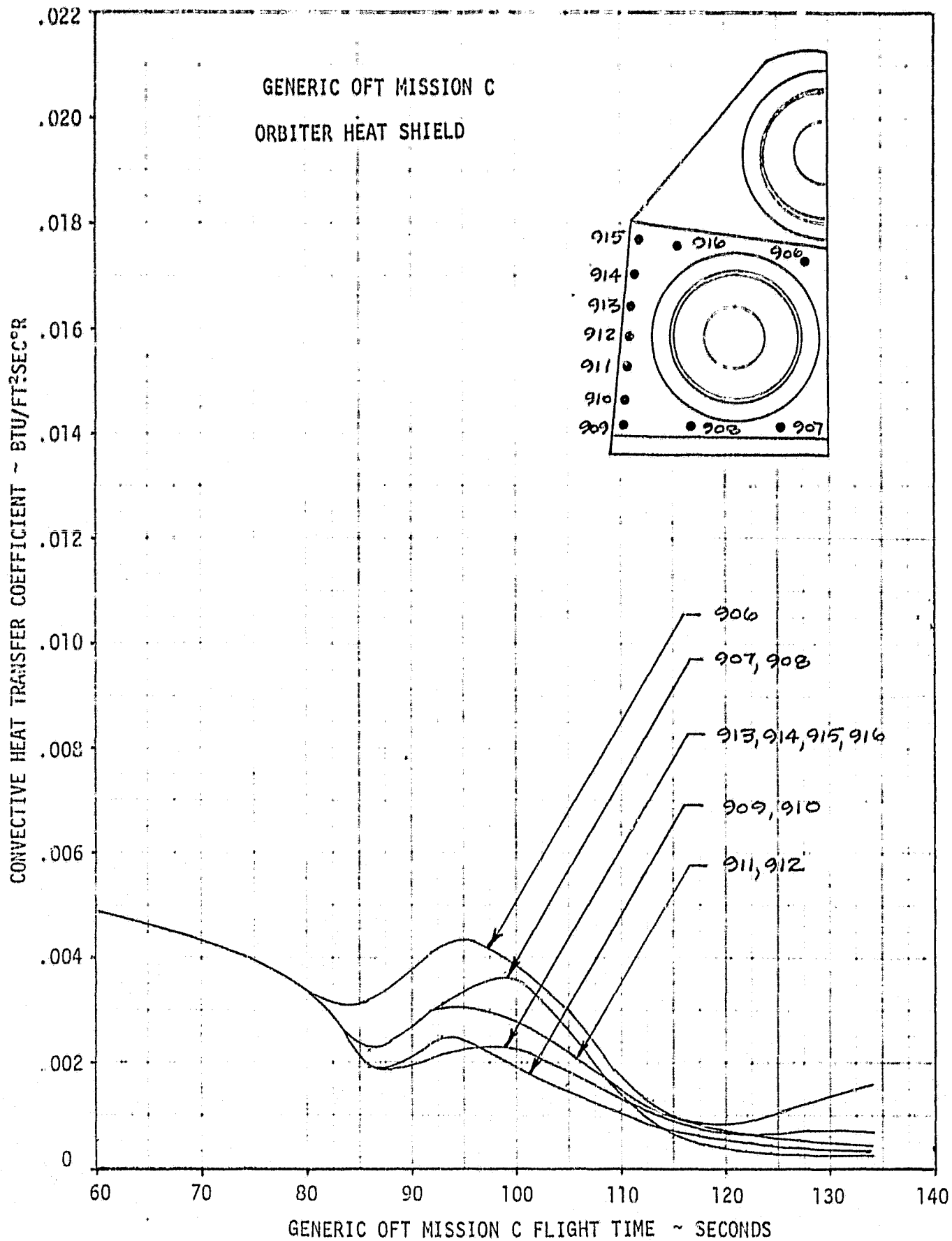

FIGURE 4. FIRST STAGE ASCENT CONVECTIVE HEAT TRANSFER COEFFICIENT

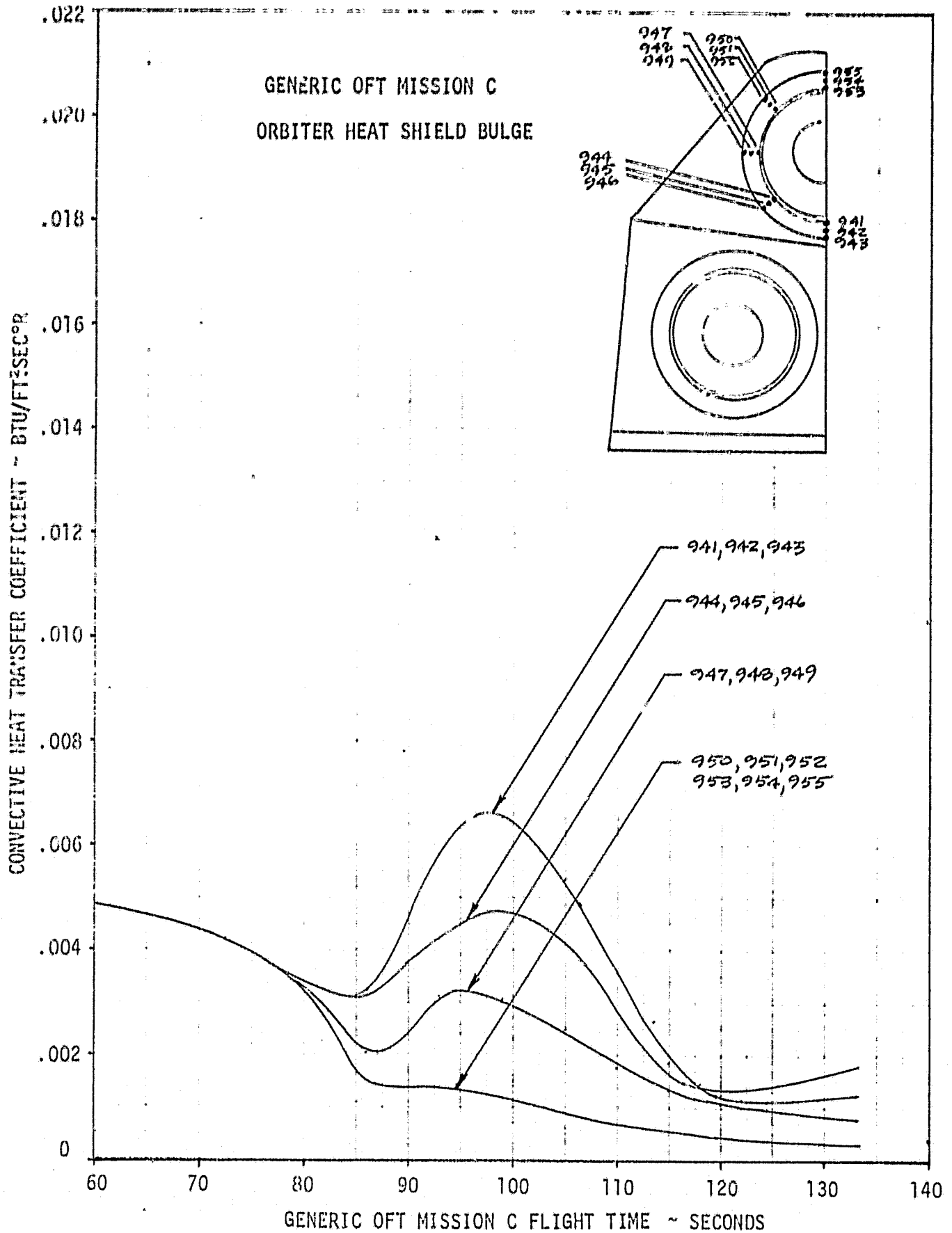

FIGURE 5. FIRST STAGE ASCENT CONVECTIVE HEAT TRANSFER COEFFICIENT

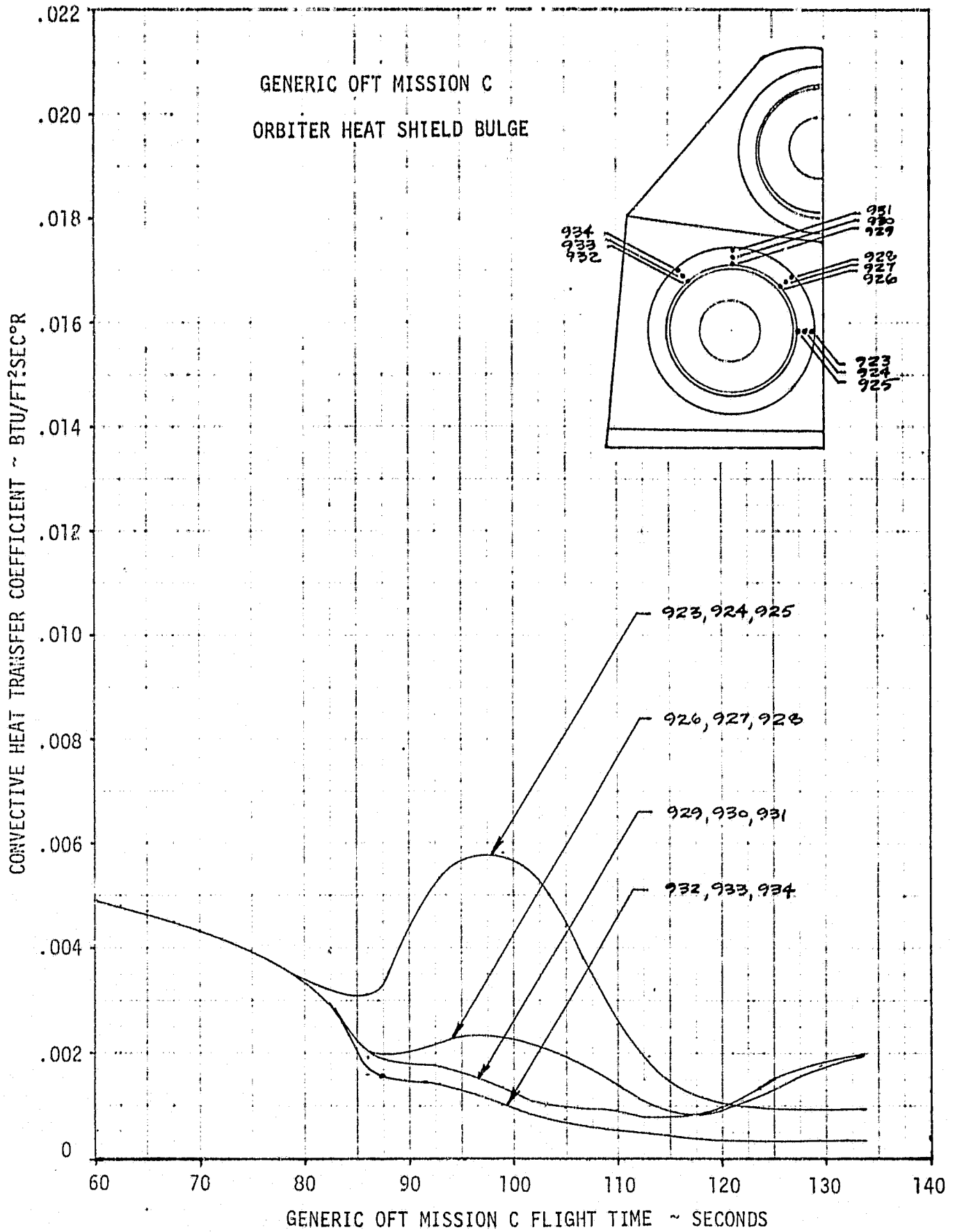

FIGURE 6. FIRST STAGE ASCENT CONVECTIVE HEAT TRANSFER COEFFICIENT

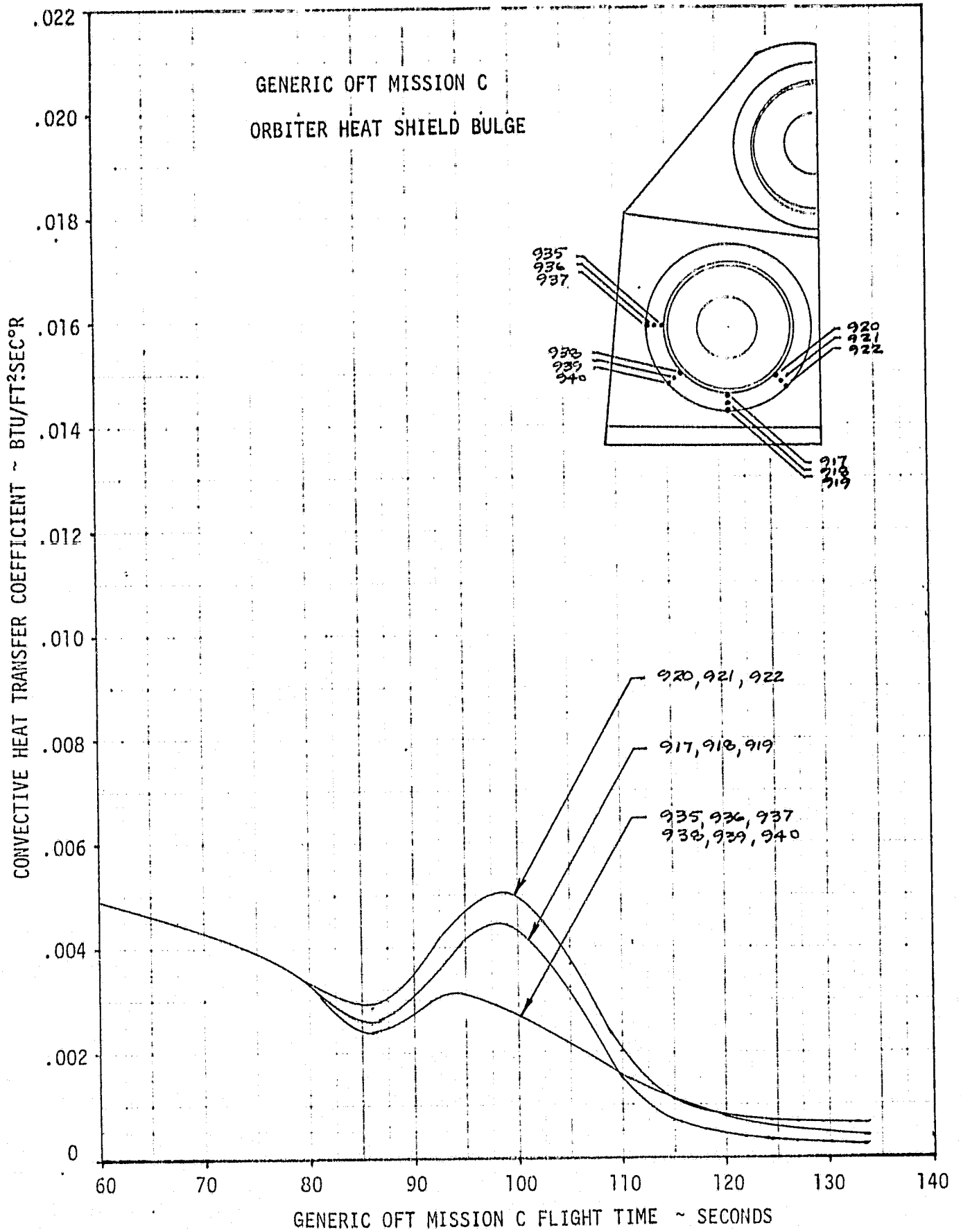

FIGURE 7. FIRST STAGE ASCENT CONVECTIVE HEAT TRANSFER COEFFICIENT

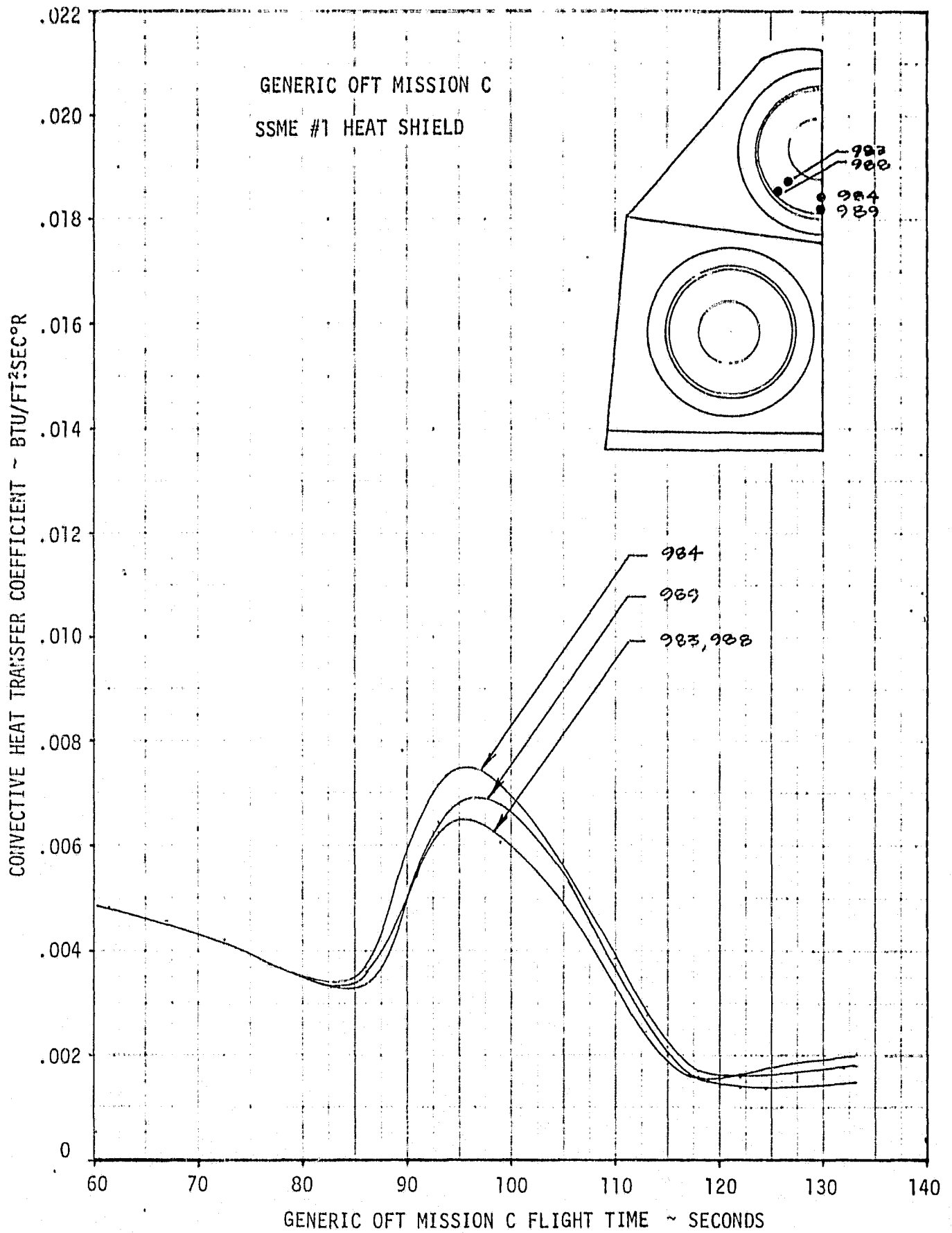

FIGURE 8. FIRST STAGE ASCENT CONVECTIVE HEAT TRANSFER COEFFICIENT

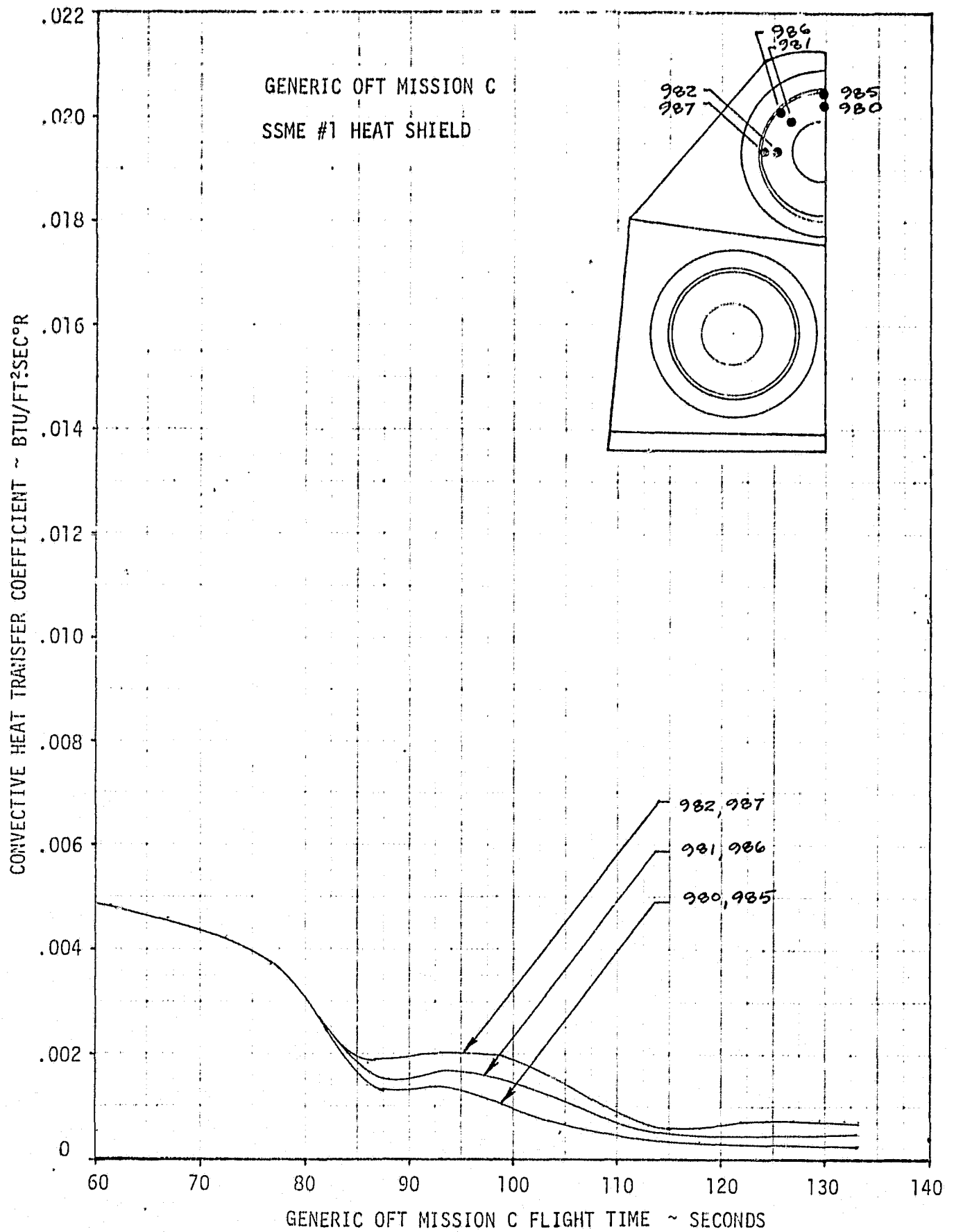

FIGURE 9. FIRST STAGE ASCENT CONVECTIVE HEAT TRANSFER COEFFICIENT

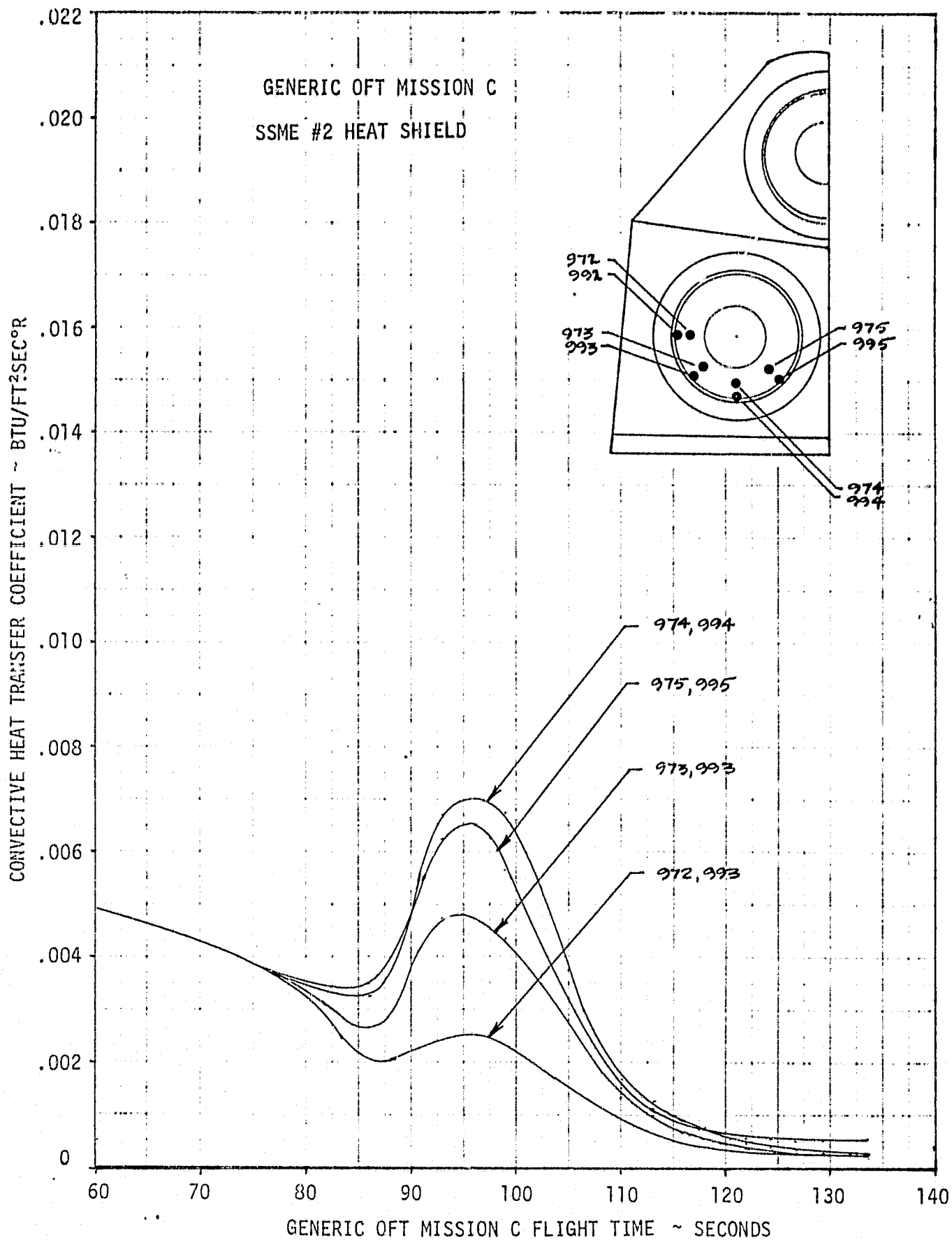

FIGURE 10. FIRST STAGE ASCENT CONVECTIVE HEAT TRANSFER COEFFICIENT

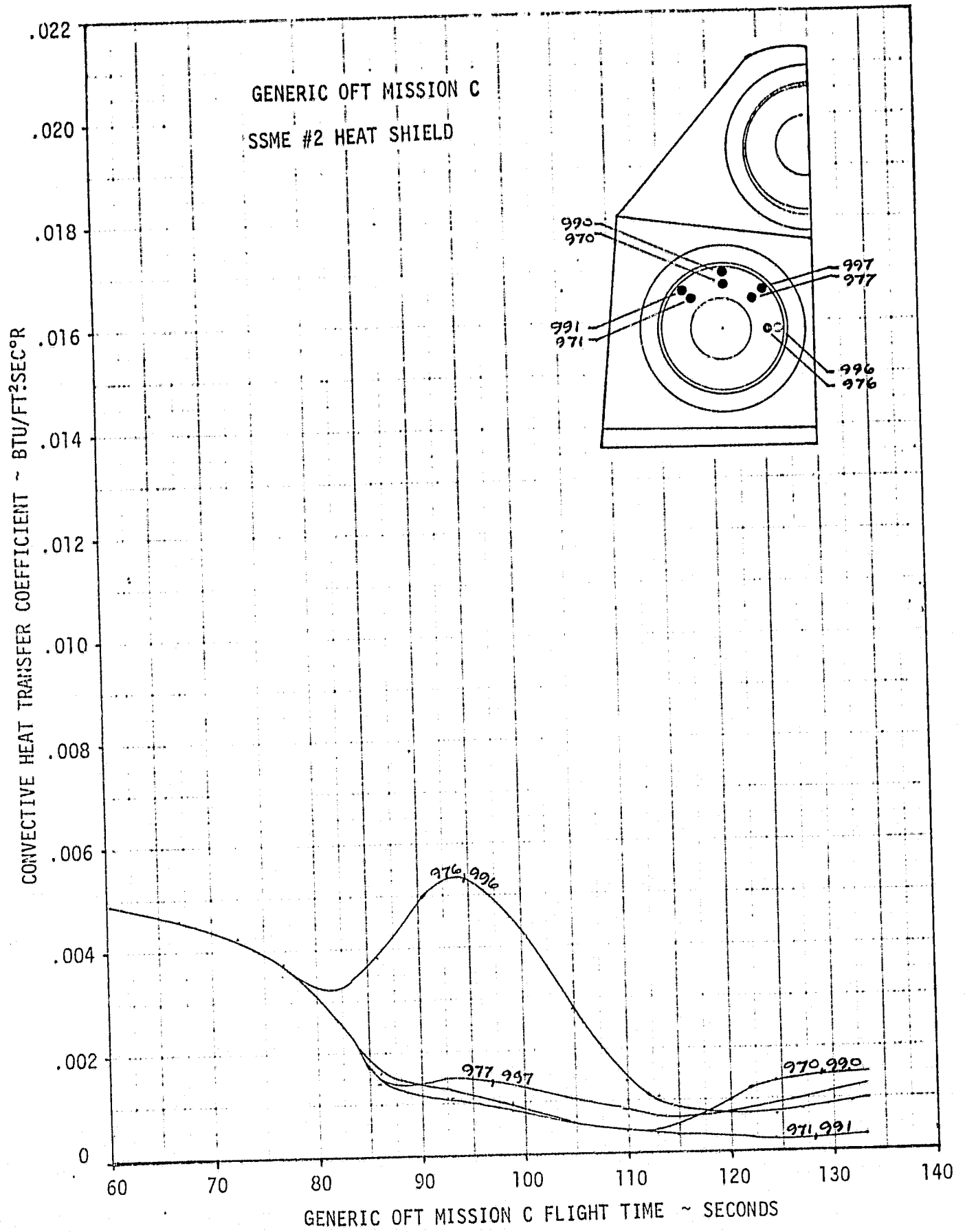

FIGURE 11. FIRST STAGE ASCENT CONVECTIVE HEAT TRANSFER COEFFICIENT

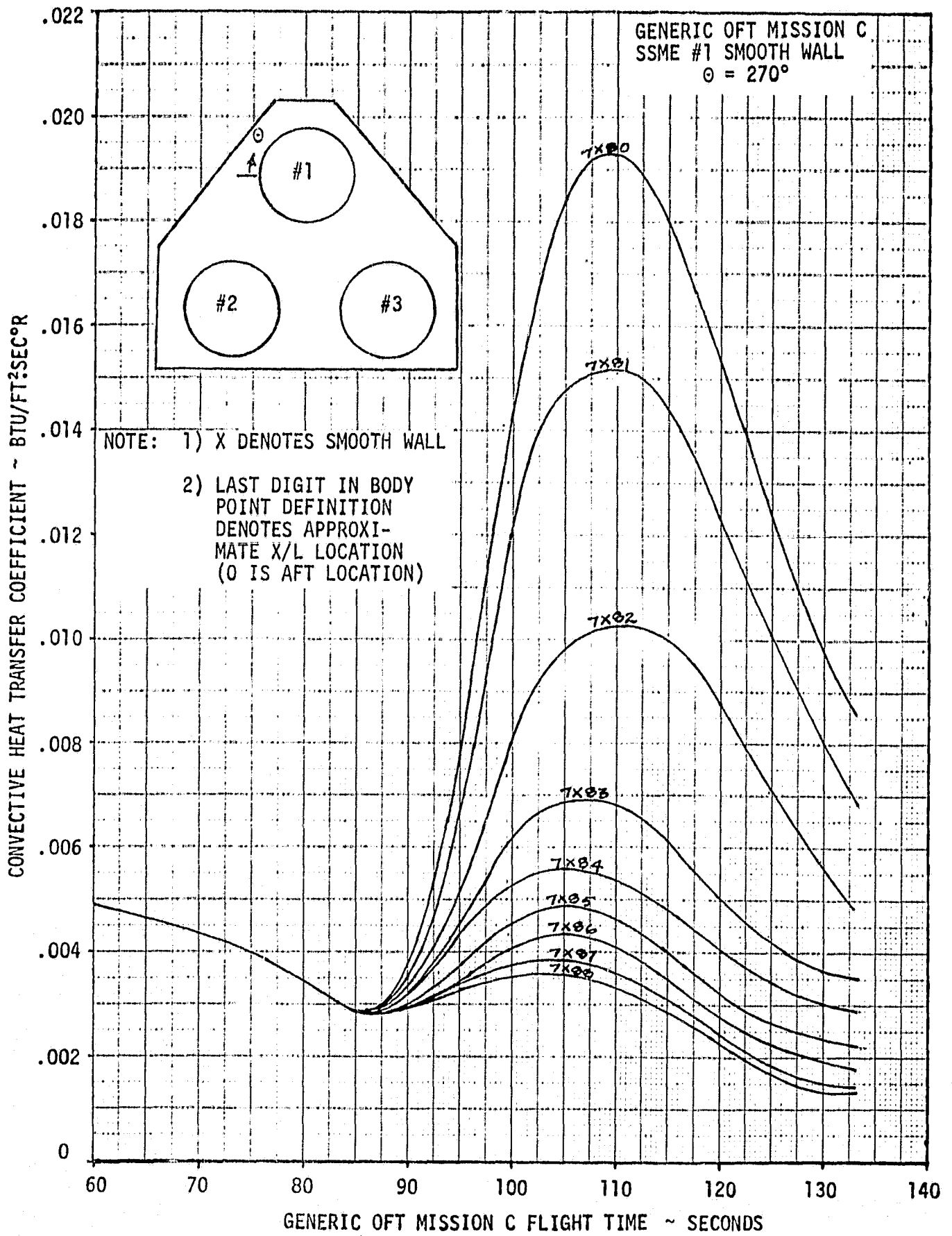

FIGURE 12. FIRST STAGE ASCENT CONVECTIVE HEAT TRANSFER COEFFICIENT

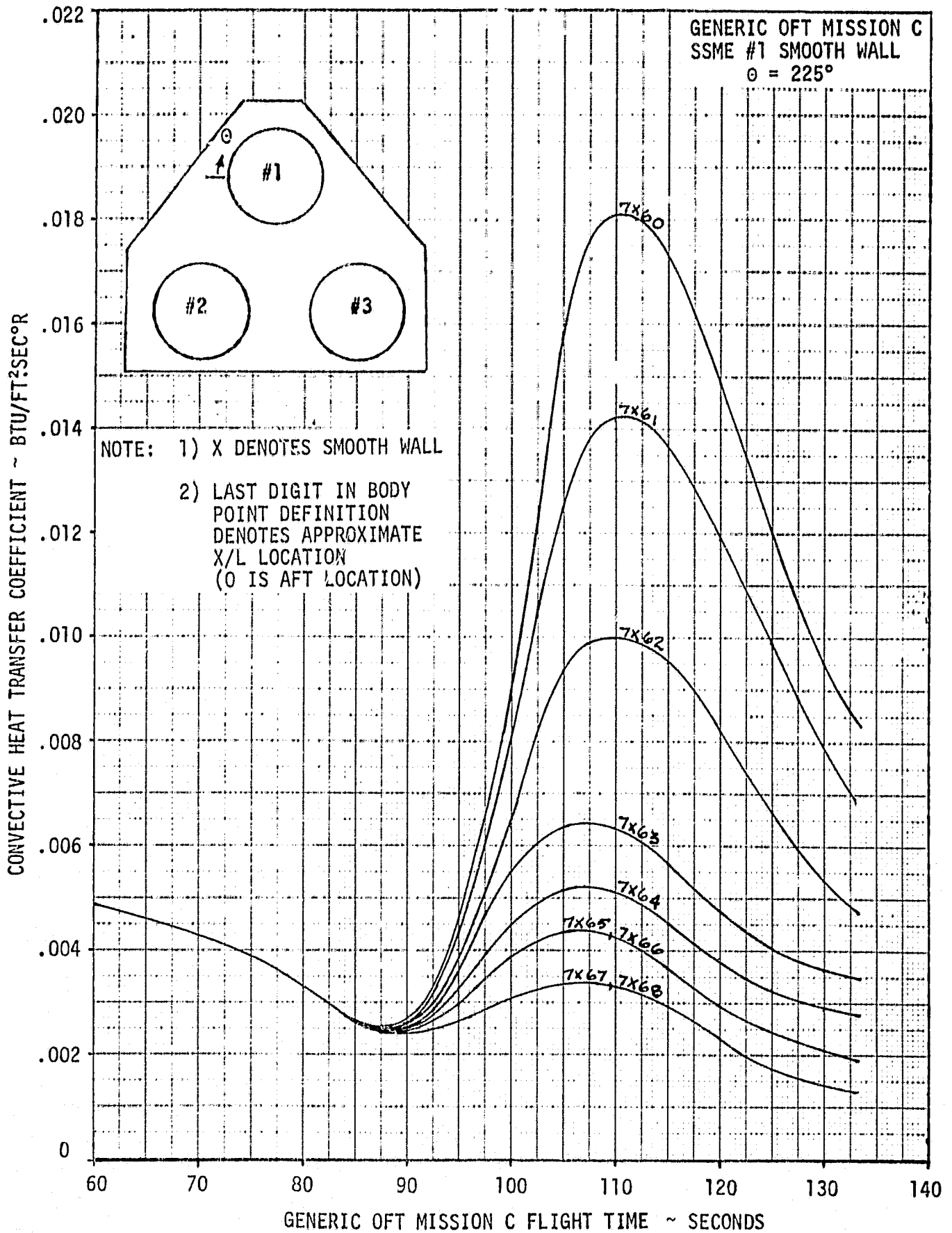

FIGURE 13. FIRST STAGE ASCENT CONVECTIVE HEAT TRANSFER COEFFICIENT

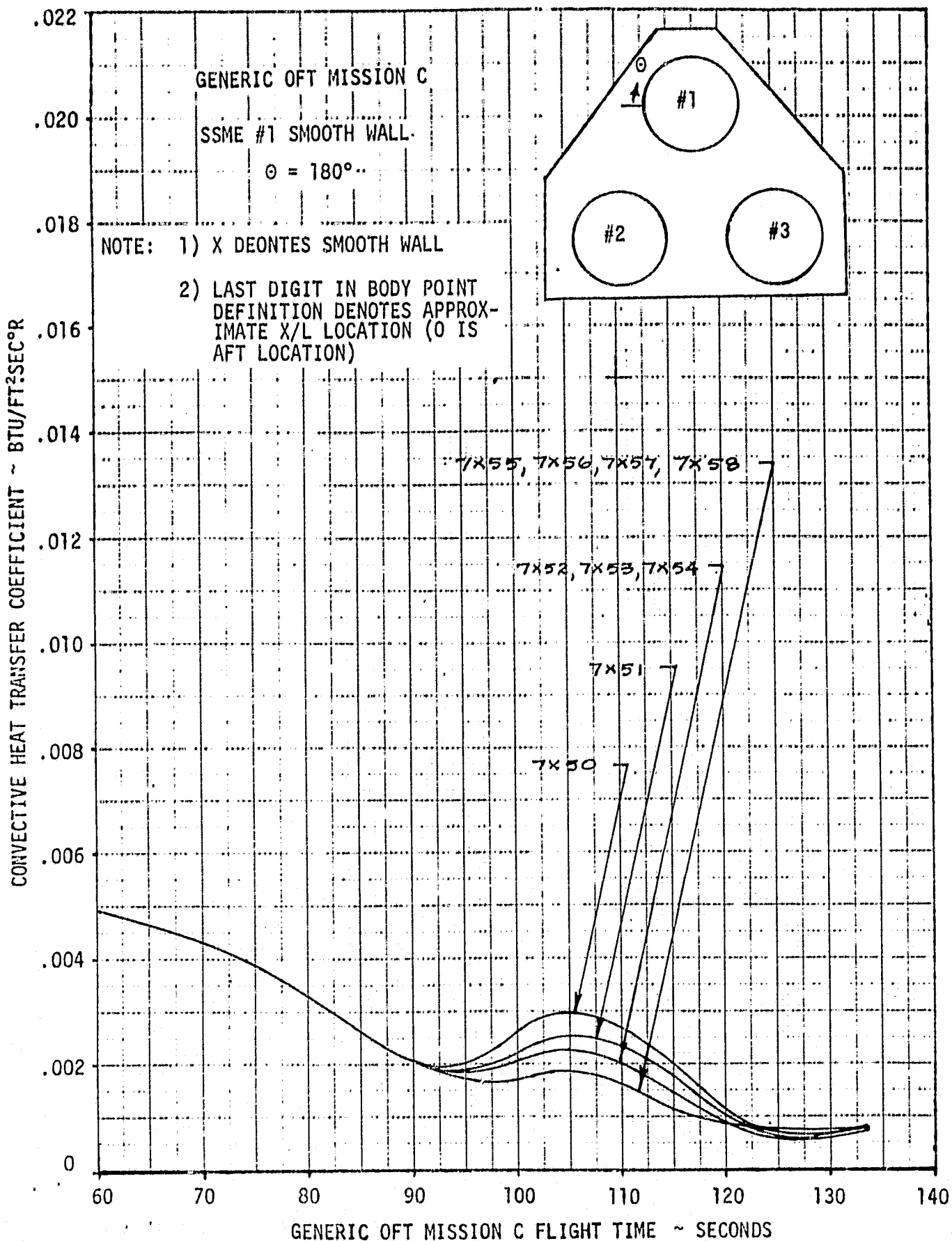

FIGURE 14 . FIRST STAGE ASCENT CONVECTIVE HEAT TRANSFER COEFFICIENT

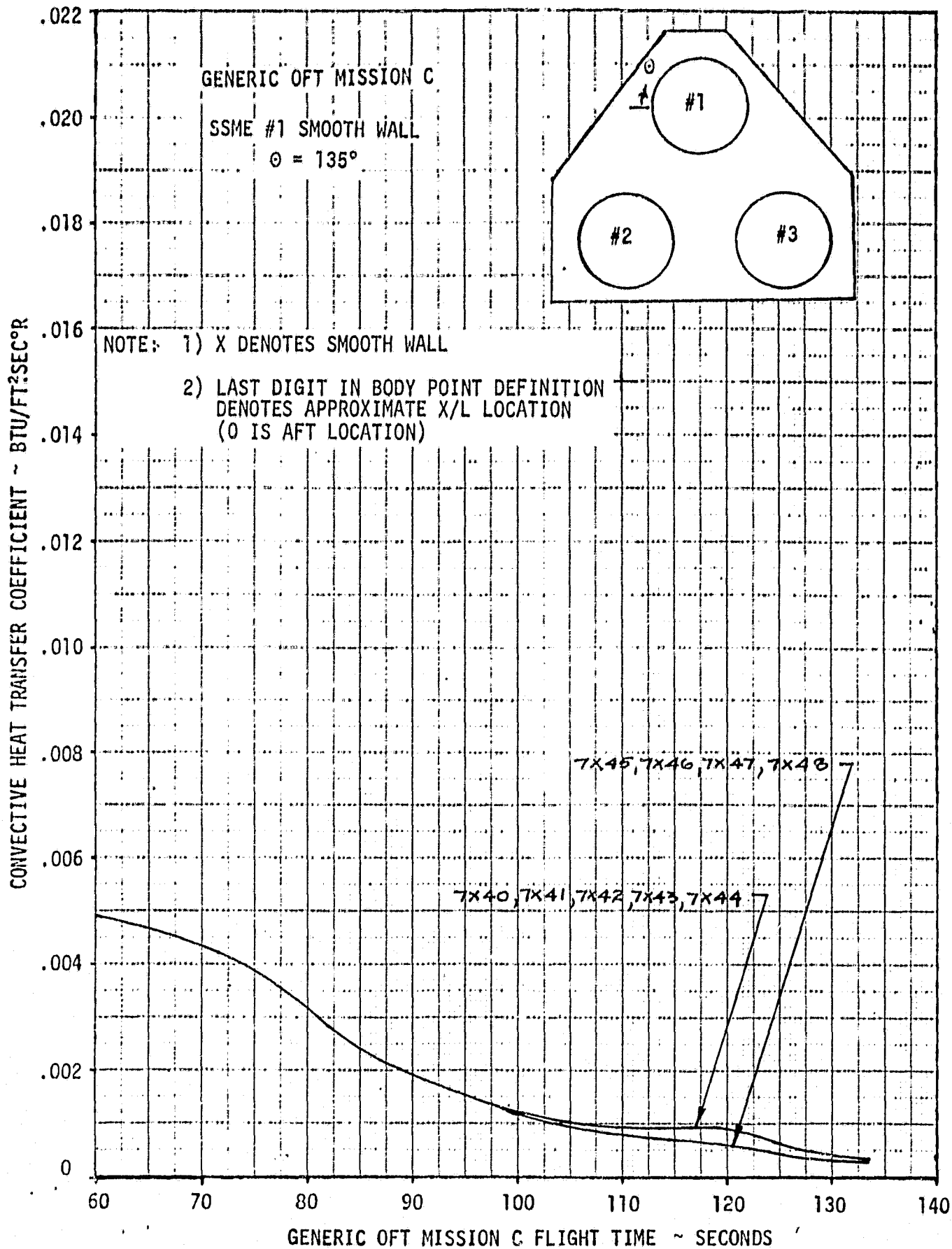

FIGURE 15. FIRST STAGE ASCENT CONVECTIVE HEAT TRANSFER COEFFICIENT

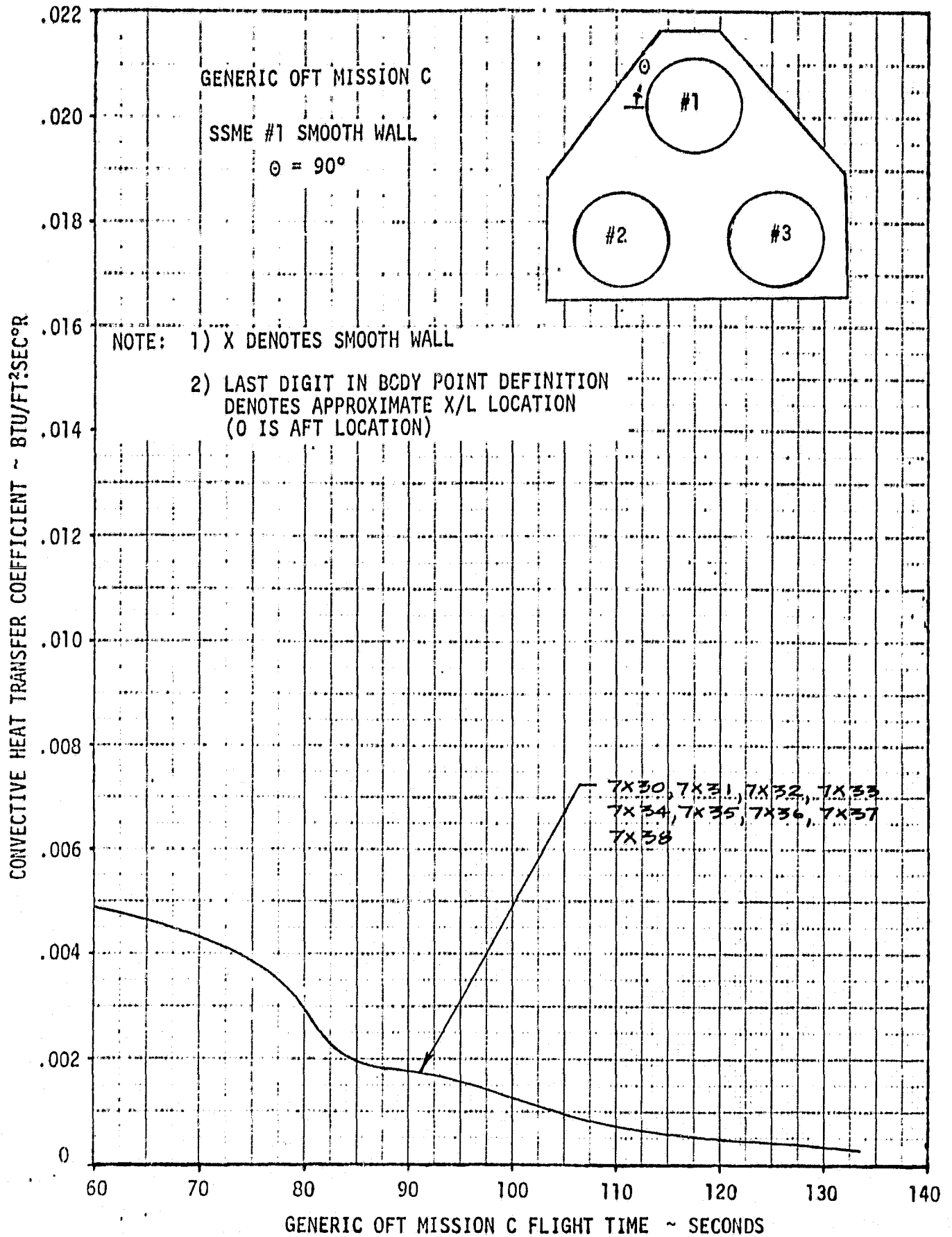

FIGURE 16. FIRST STAGE ASCENT CONVECTIVE HEAT TRANSFER COEFFICIENT

TABLE 1

SSME #1 PROTUBERANCE FACTORS

BODY POINT	TOP OF HAT BAND						FORWARD SIDE OF HAT BAND						AFT SIDE OF HAT BAND						
	FLIGHT TIME SECONDS						FLIGHT TIME SECONDS						FLIGHT TIME SECONDS						
	70	90	200	115	125	135	80	90	100	115	125	135	80	90	100	115	125	135	
$\theta = 270^\circ$	7466	1.1	1.7	1.9	1.6	1.3	7583	1.0	0.9	0.8	0.9	1.0	7587	1.2	1.8	2.0	1.7	1.3	
	7461	1.1	1.7	2.2	2.3	2.4	7581	1.0	0.9	0.8	0.8	0.7	7587	1.1	1.3	1.6	2.0	2.2	
	7462	1.1	1.4	1.8	2.0	2.1	7582	1.0	0.8	0.7	0.7	0.6	7582	1.1	1.4	2.1	2.4	2.6	
	7463	1.1	1.2	1.6	1.7	1.7	7583	1.0	0.8	0.7	0.7	0.6	7583	1.1	1.2	1.5	1.7	1.7	
	7464	1.0	1.1	1.2	1.2	1.2	7584	1.0	1.0	1.0	0.9	0.9	7587	1.1	1.2	1.3	1.3	1.2	
	7465	1.0	1.1	1.1	1.2	1.2	7585	1.0	0.9	0.9	0.9	1.0	7585	1.1	1.1	1.1	1.1	1.2	
	7466	1.0	1.1	1.1	1.1	1.2	7586	1.0	1.0	0.9	0.9	1.0	7586	1.0	1.1	1.1	1.1	1.2	
	7467	1.0	1.1	1.1	1.1	1.1	7587	1.0	1.0	0.9	0.9	1.0	7587	1.0	1.1	1.1	1.1	1.2	
	7468	1.0	1.1	1.1	1.1	1.1	7588	1.0	1.0	0.9	0.9	1.0	7588	1.0	1.1	1.1	1.1	1.1	
	7469	1.0	1.1	1.1	1.1	1.1	7589	1.0	1.0	0.9	0.9	1.0	7589	1.0	1.1	1.1	1.1	1.1	
$\theta = 225^\circ$	7460	1.1	1.2	1.5	1.3	1.2	7520	1.0	0.9	0.9	0.9	1.0	7520	1.1	1.3	1.5	1.4	1.9	
	7461	1.1	1.2	1.5	1.6	1.6	7521	1.0	0.9	0.9	0.9	1.0	7521	1.0	1.3	1.6	1.8	1.9	
	7462	1.1	1.2	1.4	1.4	1.4	7522	1.0	0.9	0.8	0.9	0.9	7522	1.0	1.3	1.6	1.8	1.9	
	7463	1.1	1.1	1.2	1.2	1.2	7523	1.0	0.9	0.8	0.9	0.9	7523	1.0	1.2	1.4	1.5	1.6	
	7464	1.0	1.1	1.0	1.0	1.0	7524	1.0	0.9	0.8	0.9	0.9	7524	1.0	1.0	1.2	1.2	1.2	
	7465	1.0	1.0	1.0	1.0	1.0	7525	1.0	0.9	0.8	0.9	0.9	7525	1.0	1.0	1.1	1.2	1.2	
	7466	1.0	1.0	1.0	1.0	1.0	7526	1.0	0.9	0.8	0.9	0.9	7526	1.0	1.0	1.1	1.2	1.2	
	7467	1.0	1.0	1.0	1.0	1.0	7527	1.0	0.9	0.8	0.9	0.9	7527	1.0	1.0	1.1	1.2	1.2	
	7468	1.0	1.0	1.0	1.0	1.0	7528	1.0	0.9	0.8	0.9	0.9	7528	1.0	1.0	1.1	1.2	1.2	
	7469	1.0	1.0	1.0	1.0	1.0	7529	1.0	0.9	0.8	0.9	1.0	7529	1.0	1.0	1.1	1.2	1.2	
H _L MANIFOLD	7927	1.1	1.3	1.7	1.7	1.6													
	7922	1.2	1.8	2.0	2.2	2.4													
	7923	1.1	1.3	1.7	1.7	1.6													
	7924	1.0	1.2	1.5	1.9	1.7													
	7925	1.0	1.2	1.5	1.5	1.3													
	7926	1.0	1.1	1.2	1.2	1.2													

NOTE: 1) F denotes forward surface

2) Protuberance Factor = 1.0 for all other body points

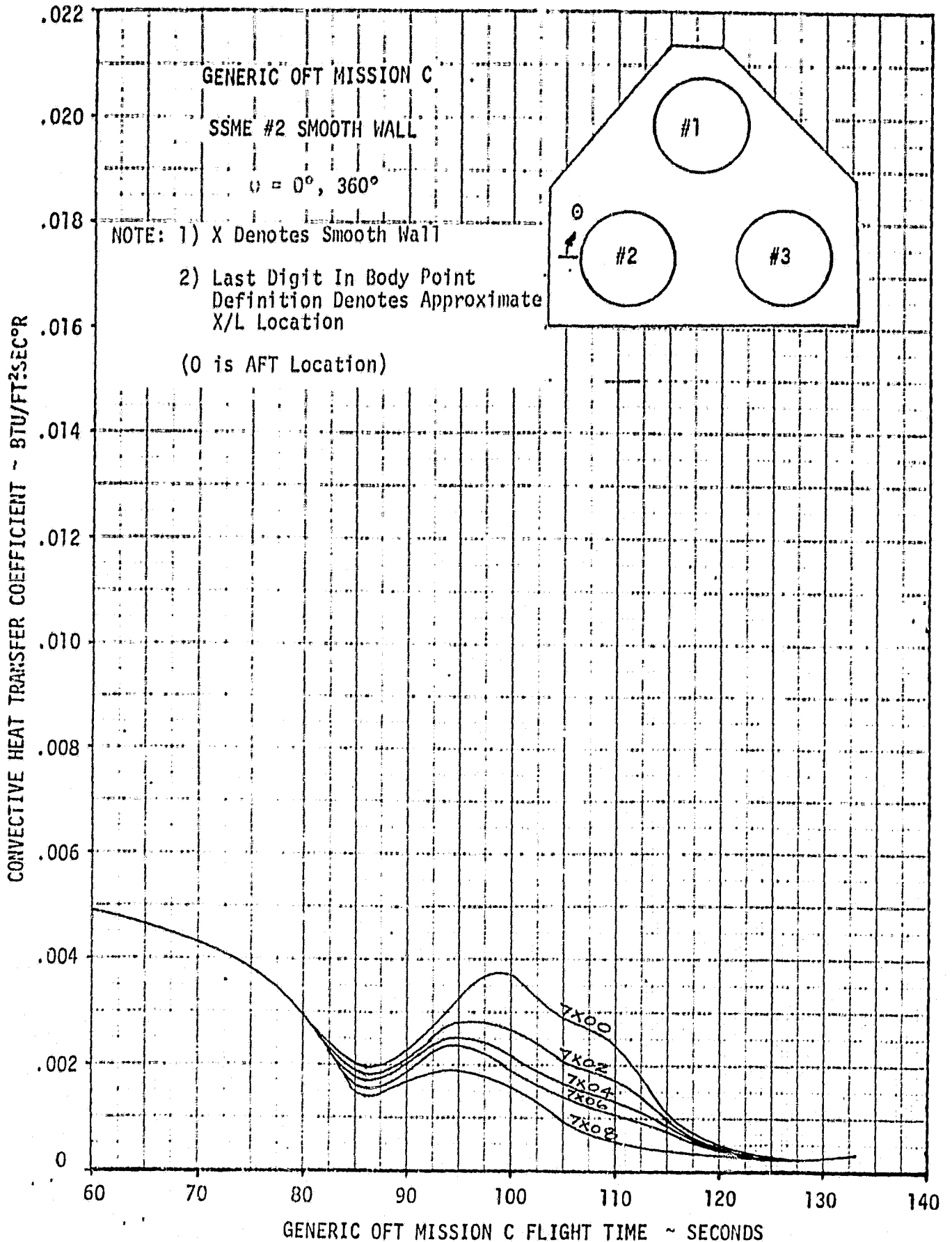

FIGURE 17. FIRST STAGE ASCENT CONVECTIVE HEAT TRANSFER COEFFICIENT

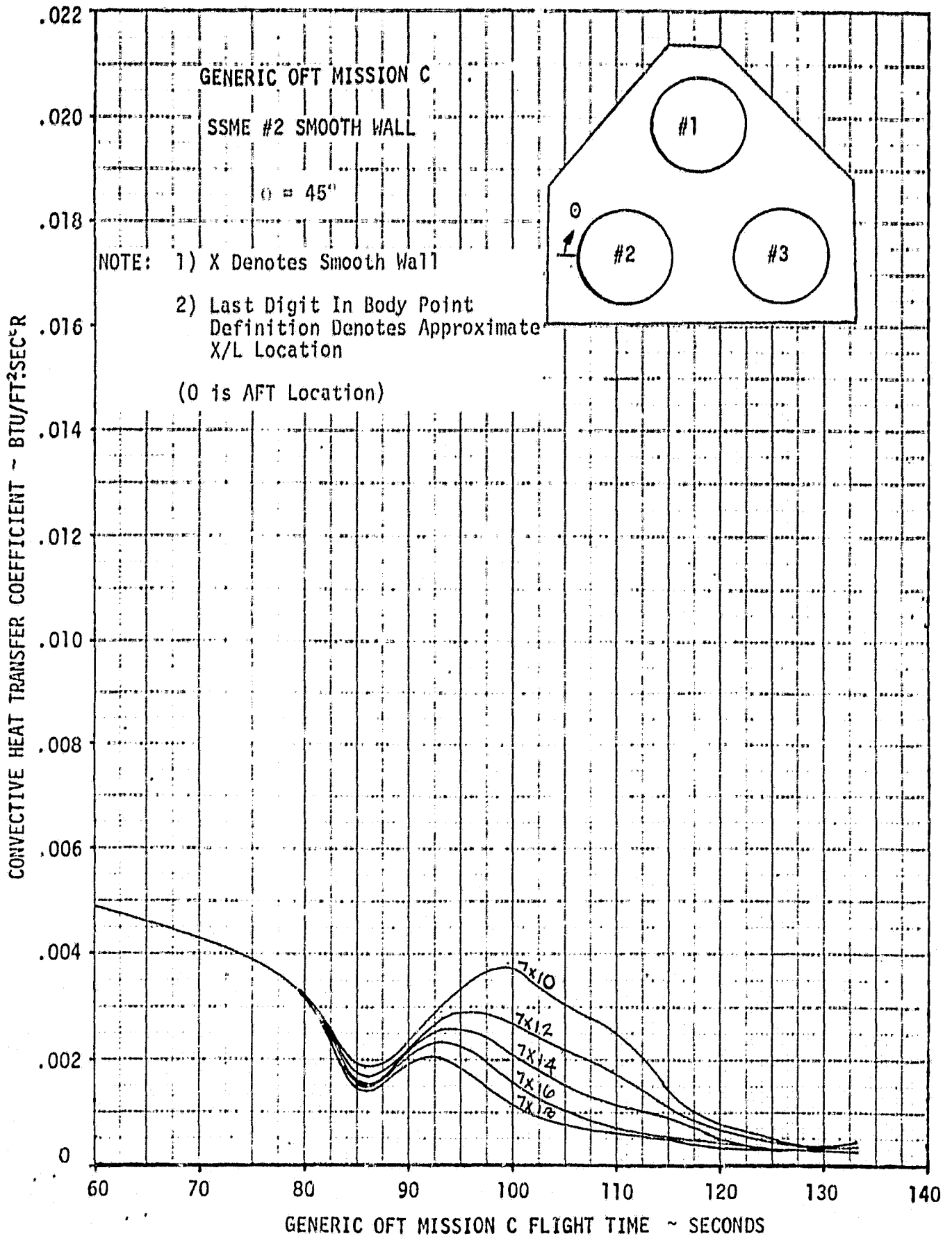

FIGURE 18. FIRST STAGE ASCENT CONVECTIVE HEAT TRANSFER COEFFICIENT

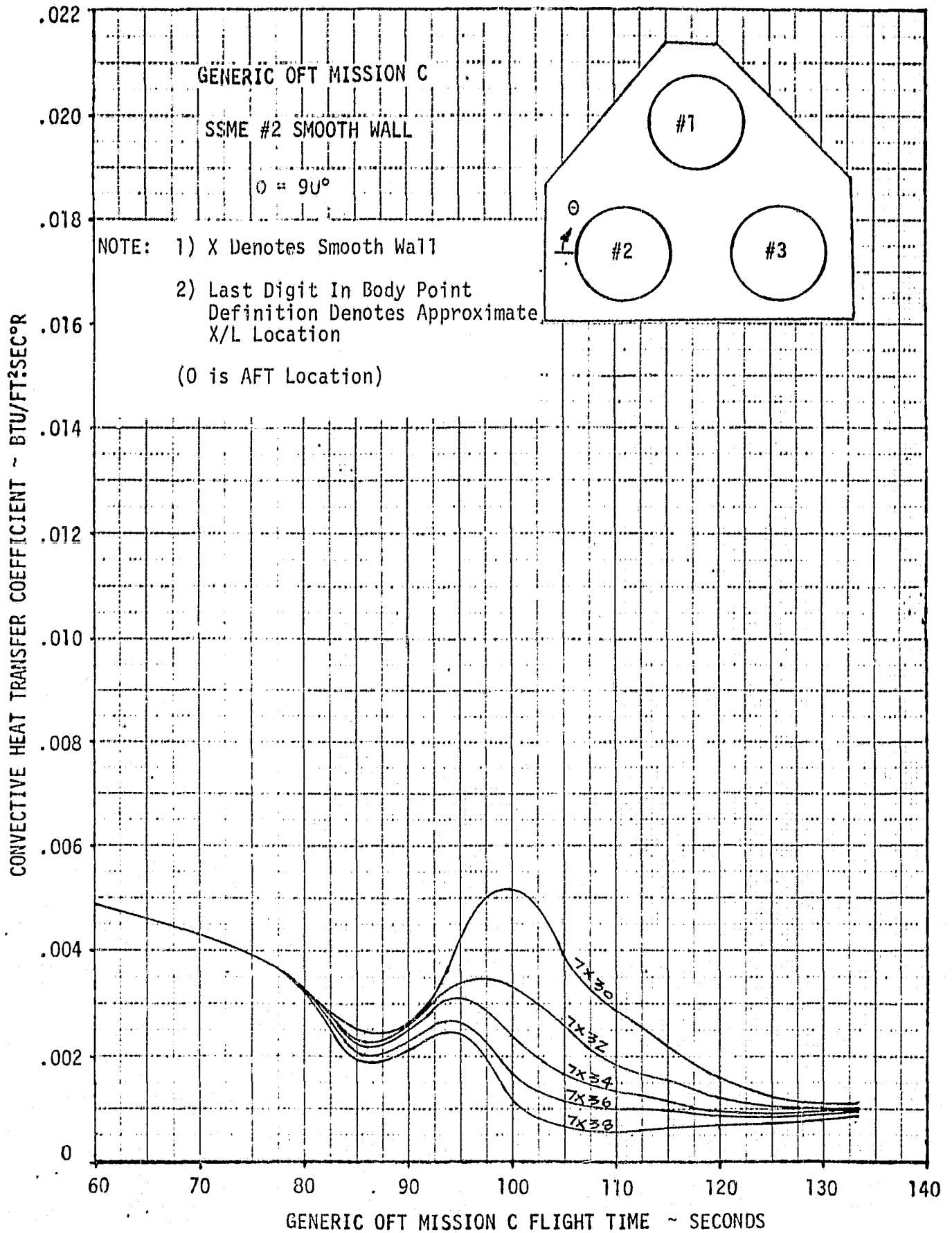

FIGURE 19. FIRST STAGE ASCENT CONVECTIVE HEAT TRANSFER COEFFICIENT

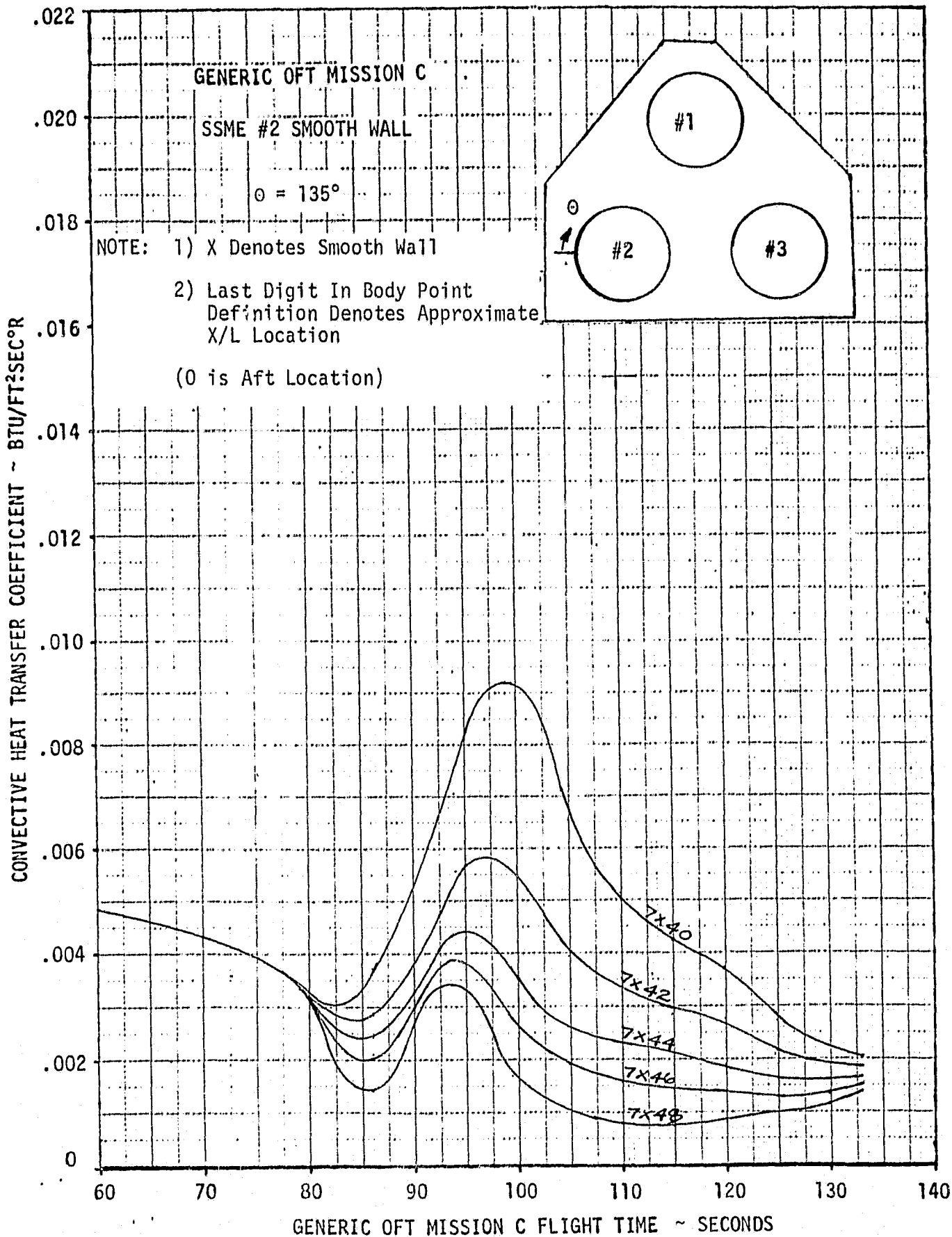

FIGURE 20. FIRST STAGE ASCENT CONVECTIVE HEAT TRANSFER COEFFICIENT

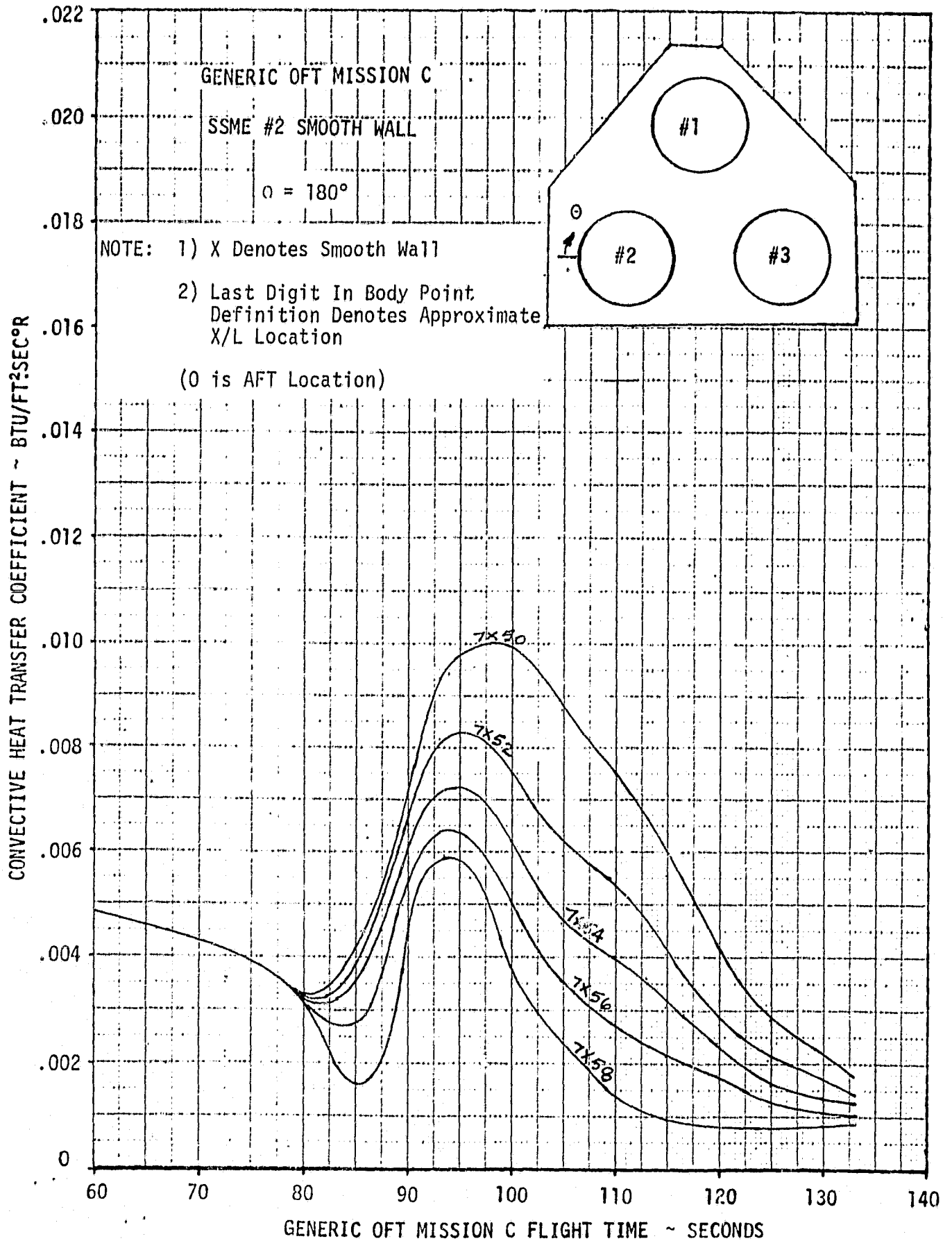

FIGURE 21. FIRST STAGE ASCENT CONVECTIVE HEAT TRANSFER COEFFICIENT

ORIGINAL PAGE IS
OF POOR QUALITY

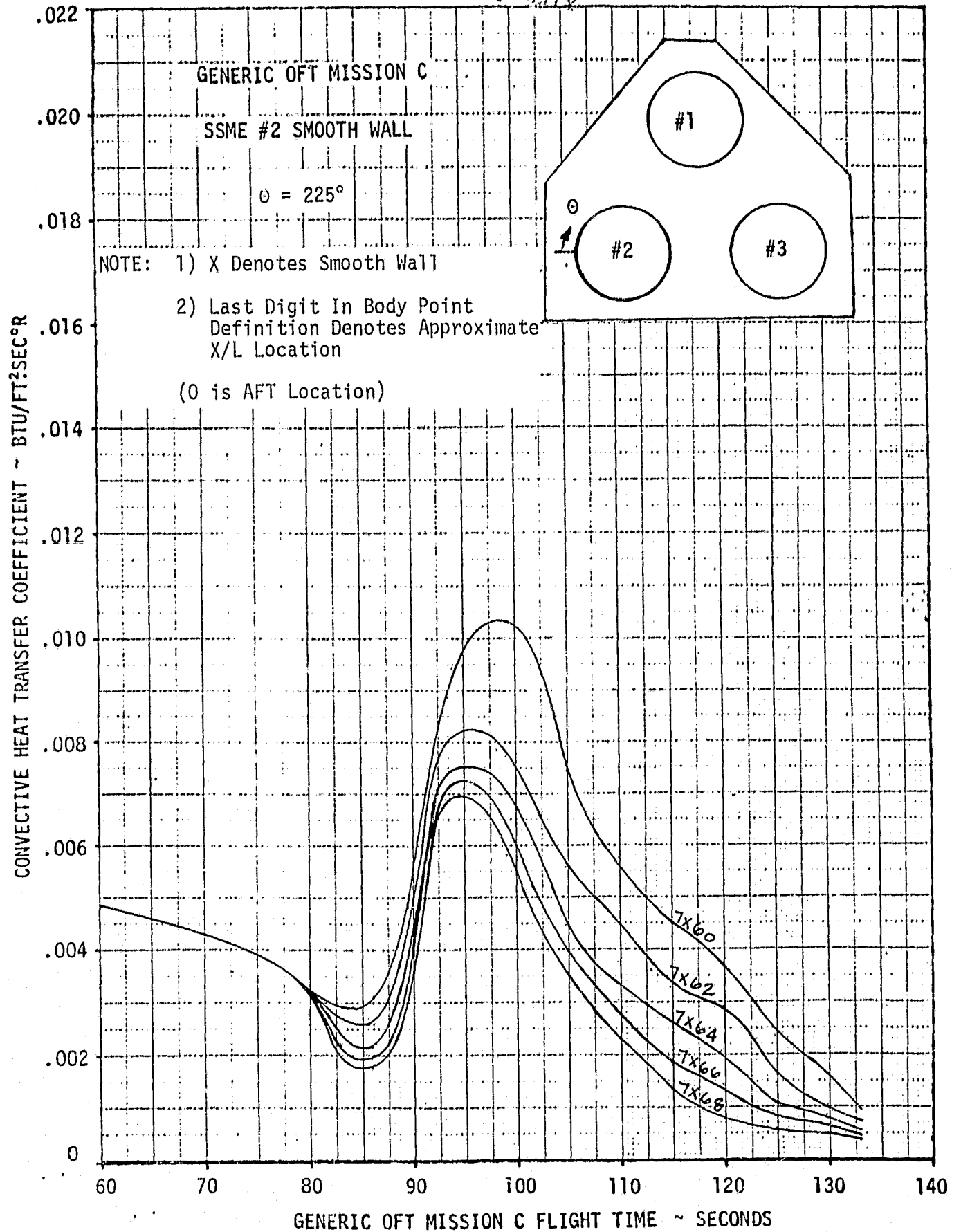

FIGURE 22. FIRST STAGE ASCENT CONVECTIVE HEAT TRANSFER COEFFICIENT

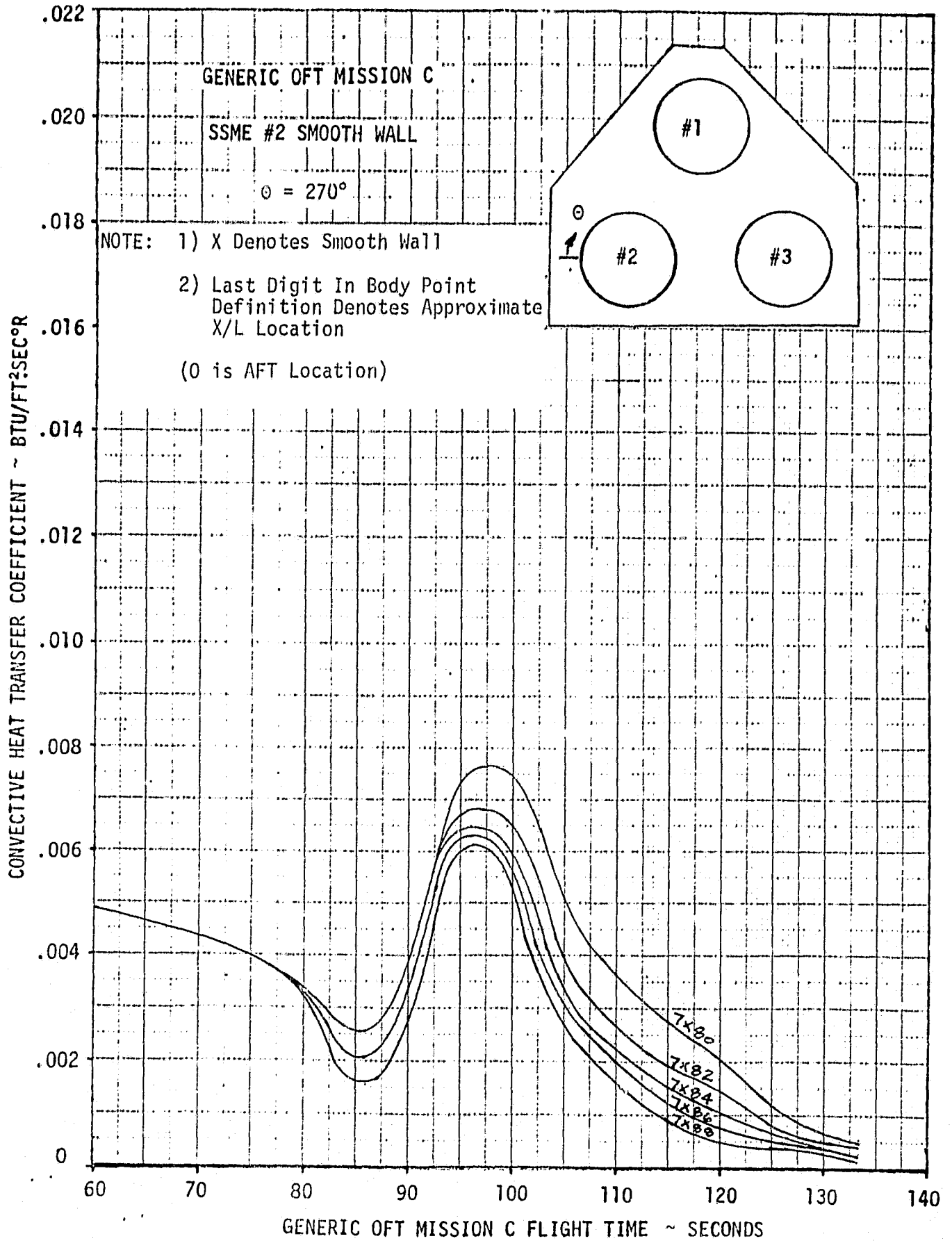

FIGURE 23. FIRST STAGE ASCENT CONVECTIVE HEAT TRANSFER COEFFICIENT

ORIGINAL PAGE IS
OF POOR QUALITY

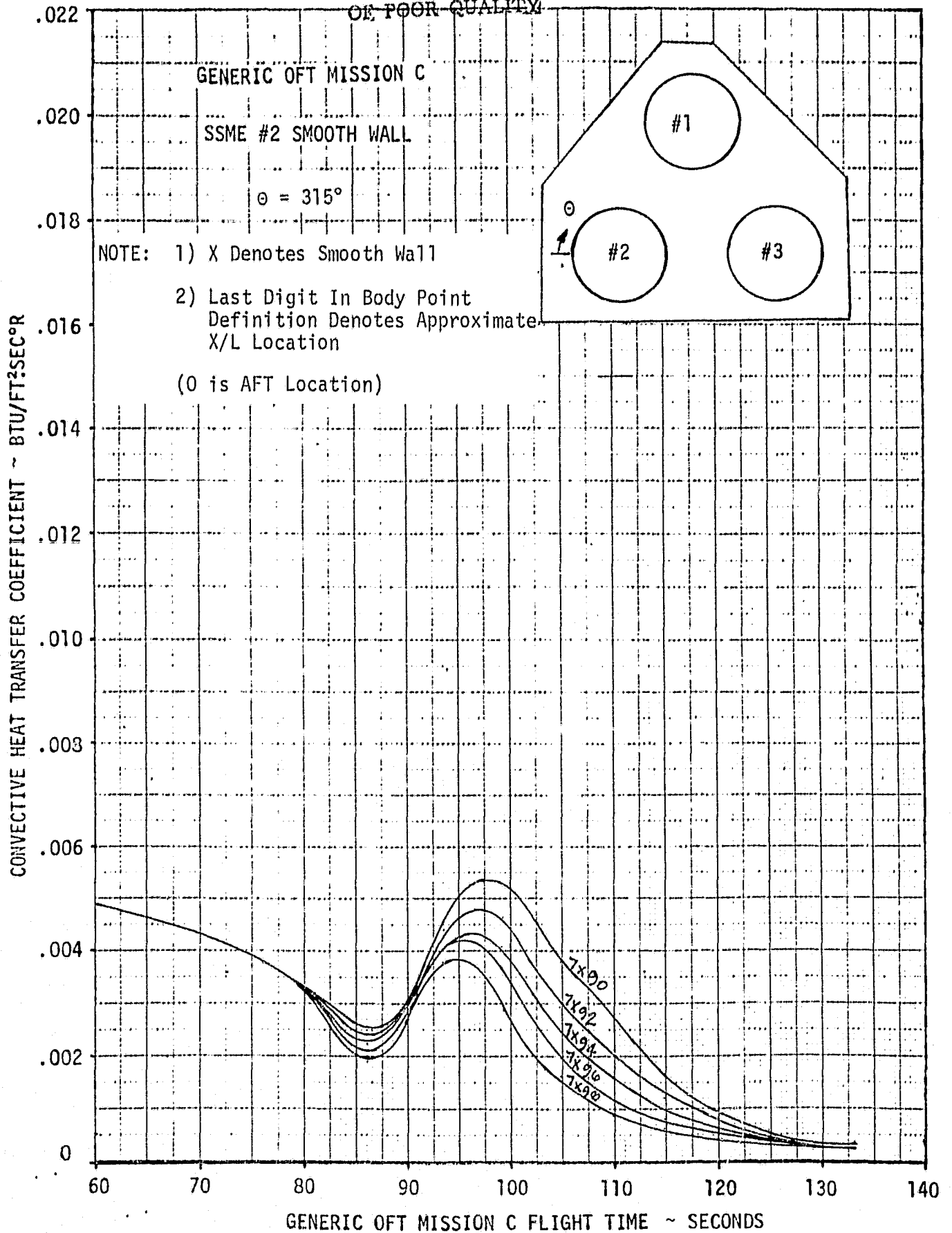

FIGURE 24. FIRST STAGE ASCENT CONVECTIVE HEAT TRANSFER COEFFICIENT

TABLE 2
SSME #2 PROTUBERANCE FACTORS

	TOP OF HAT BAND					REARWARD SIDE OF HAT BAND					AFT SIDE OF HAT BAND							
	BODY POINT	FLIGHT TIME, SECONDS				BODY POINT	FLIGHT TIME, SECONDS				BODY POINT	FLIGHT TIME, SECONDS						
		90	100	115	125		133	90	100	115		125	133	90	100	115	120	133
$\theta = 90^\circ$	7730	1.0	1.2	1.5	1.6	1.5	7F30	1.0	0.9	0.9	0.9	1.0	7E30	1.1	1.3	1.4	1.4	1.3
	7732	1.0	1.2	1.5	1.7	1.7	7F32	1.0	0.7	0.6	0.6	0.6	7E32	1.0	1.2	1.4	1.5	1.7
	7734	1.0	1.2	1.4	1.4	1.4	7F34	1.0	0.7	0.7	0.8	0.9	7E34	1.0	1.1	1.2	1.4	1.5
	7736	1.0	1.1	1.2	1.2	1.2	7F36	1.0	0.7	0.7	0.8	0.9	7E36	1.0	1.0	1.1	1.1	1.2
	7738	1.0	1.1	1.1	1.1	1.1	7F38	1.0	0.9	0.9	0.9	1.0	7E38	1.0	1.0	1.0	1.1	1.1
$\theta = 135^\circ, 180^\circ$	7740, 7750	1.0	1.4	1.6	1.6	1.5	7F40, 7F50	1.0	0.9	0.9	0.9	1.0	7E40, 7E50	1.2	1.7	1.7	1.5	1.2
	7742, 7752	1.0	1.4	1.7	1.7	1.8	7E42, 7F52	1.0	0.6	0.5	0.5	0.6	7E42, 7E52	1.2	1.5	1.7	1.8	1.9
	7744, 7754	1.0	1.3	1.4	1.4	1.4	7F44, 7F54	1.0	0.7	0.6	0.7	0.8	7E44, 7E54	1.1	1.2	1.4	1.6	1.8
	7746, 7756	1.0	1.2	1.2	1.3	1.3	7F46, 7F56	1.0	0.7	0.6	0.7	0.8	7E46, 7E56	1.0	1.1	1.2	1.3	1.3
	7748, 7758	1.0	1.1	1.1	1.1	1.2	7F48, 7F58	1.0	0.9	0.9	0.9	0.9	7E48, 7E58	1.0	1.0	1.0	1.1	1.1
$\theta = 225^\circ - 315^\circ$	7760, 7760, 7790	1.0	1.3	1.5	1.4	1.3	7F60, 7F60, 7F90	1.0	1.0	1.0	1.0	1.0	7E60, 7E60, 7E90	1.2	1.7	1.8	1.5	1.0
	7762, 7762, 7792	1.0	1.3	1.4	1.3	1.2	7F62, 7F62, 7F92	1.0	0.8	0.7	0.8	1.0	7E62, 7E62, 7E92	1.2	1.6	1.7	1.5	1.0
	7764, 7764, 7794	1.0	1.2	1.3	1.2	1.1	7F64, 7F64, 7F94	1.0	0.9	0.9	0.9	1.0	7E64, 7E64, 7E94	1.1	1.3	1.4	1.3	1.0
	7766, 7766, 7796	1.0	1.1	1.2	1.1	1.0	7F66, 7F66, 7F96	1.0	0.9	0.9	0.9	1.0	7E66, 7E66, 7E96	1.1	1.2	1.2	1.1	1.0
	7768, 7768, 7798	1.0	1.0	1.1	1.0	1.0	7F68, 7F68, 7F98	1.0	1.0	1.0	1.0	1.0	7E68, 7E68, 7E98	1.0	1.0	1.1	1.1	1.0

	SSME #2					SSME #3				
	BODY POINT	FACTORS				BODY POINT	FACTORS			
		$\theta = 61^\circ$	$\theta = 73^\circ$	$\theta = 81^\circ$	$\theta = 91^\circ$		$\theta = 31^\circ$	$\theta = 211^\circ$		
H ₂ MANIFOLDS	7933	1.5	7941	1.6	7951	1.2	7961	1.7	7981	1.2
		7942	1.7	7952	1.3	7962	1.9	7982	1.3	
		7943	1.6	7953	1.2	7963	1.7	7983	1.2	
		7944	1.4	7954	1.1	7964	1.5	7984	1.1	
		7945	1.3	7955	1.1	7965	1.3	7985	1.1	
7946	1.2	7956	1.1	7966	1.2	7986	1.1			
7947	1.1	7957	1.1	7967	1.1	7987	1.1			

NOTE: 1) F denotes forward surface
 2) Protuberance Factor = 1.0 for all other body points
 3) Factors for H₂ Manifolds are applicable to all times

ORIGINAL PAGE IS
OF POOR QUALITY

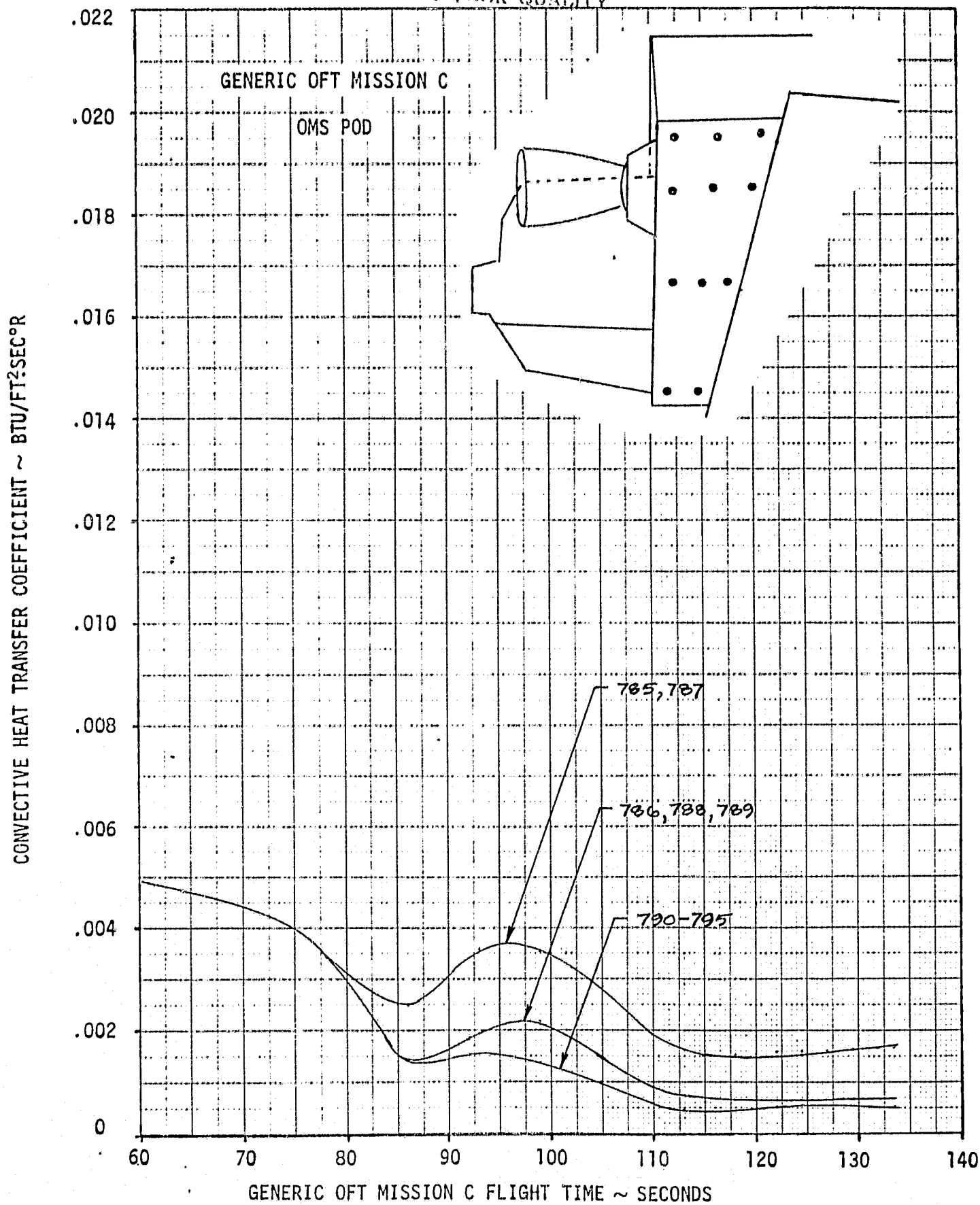

FIGURE 25. FIRST STAGE ASCENT CONVECTIVE HEAT TRANSFER COEFFICIENT

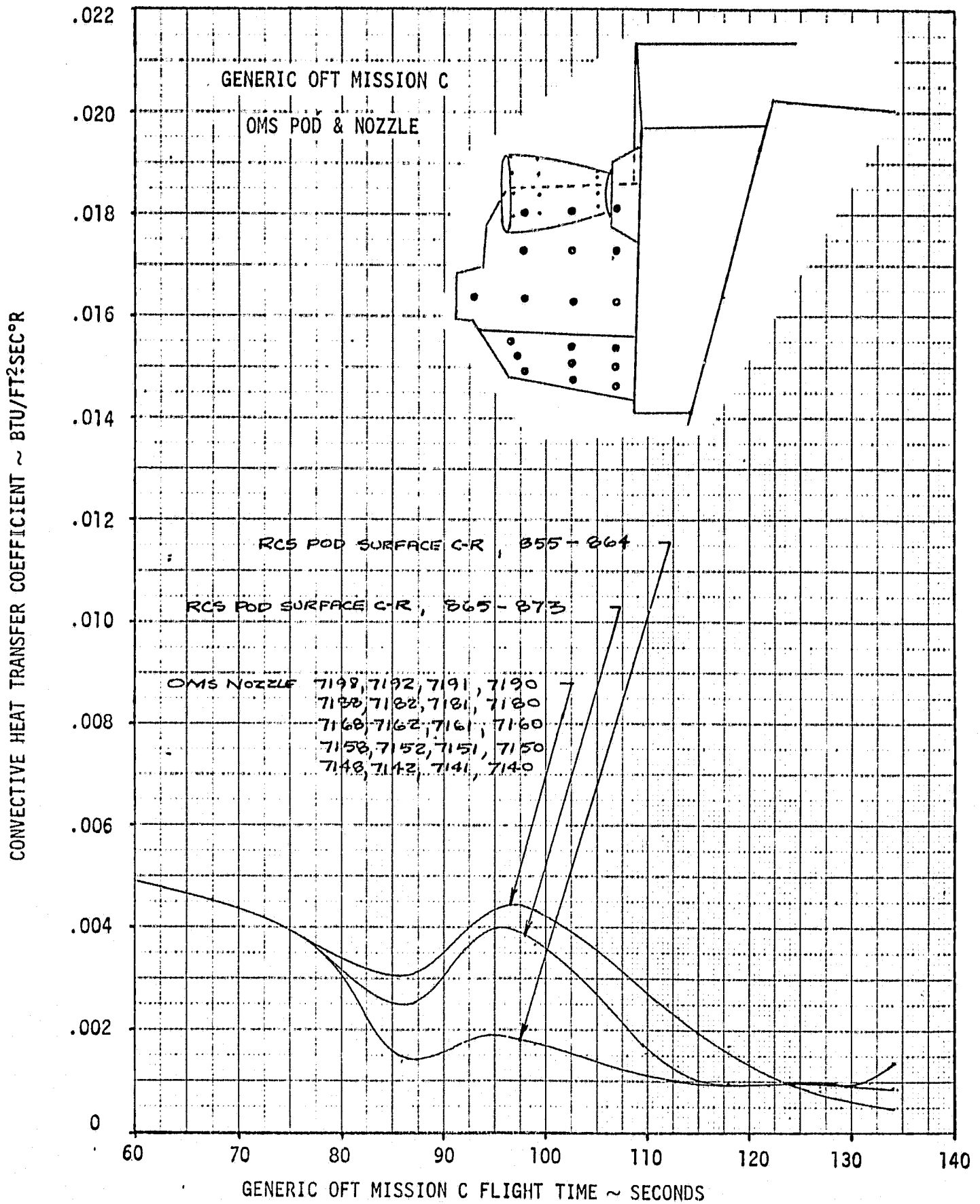

FIGURE 26 . FIRST STAGE ASCENT CONVECTIVE HEAT TRANSFER COEFFICIENT

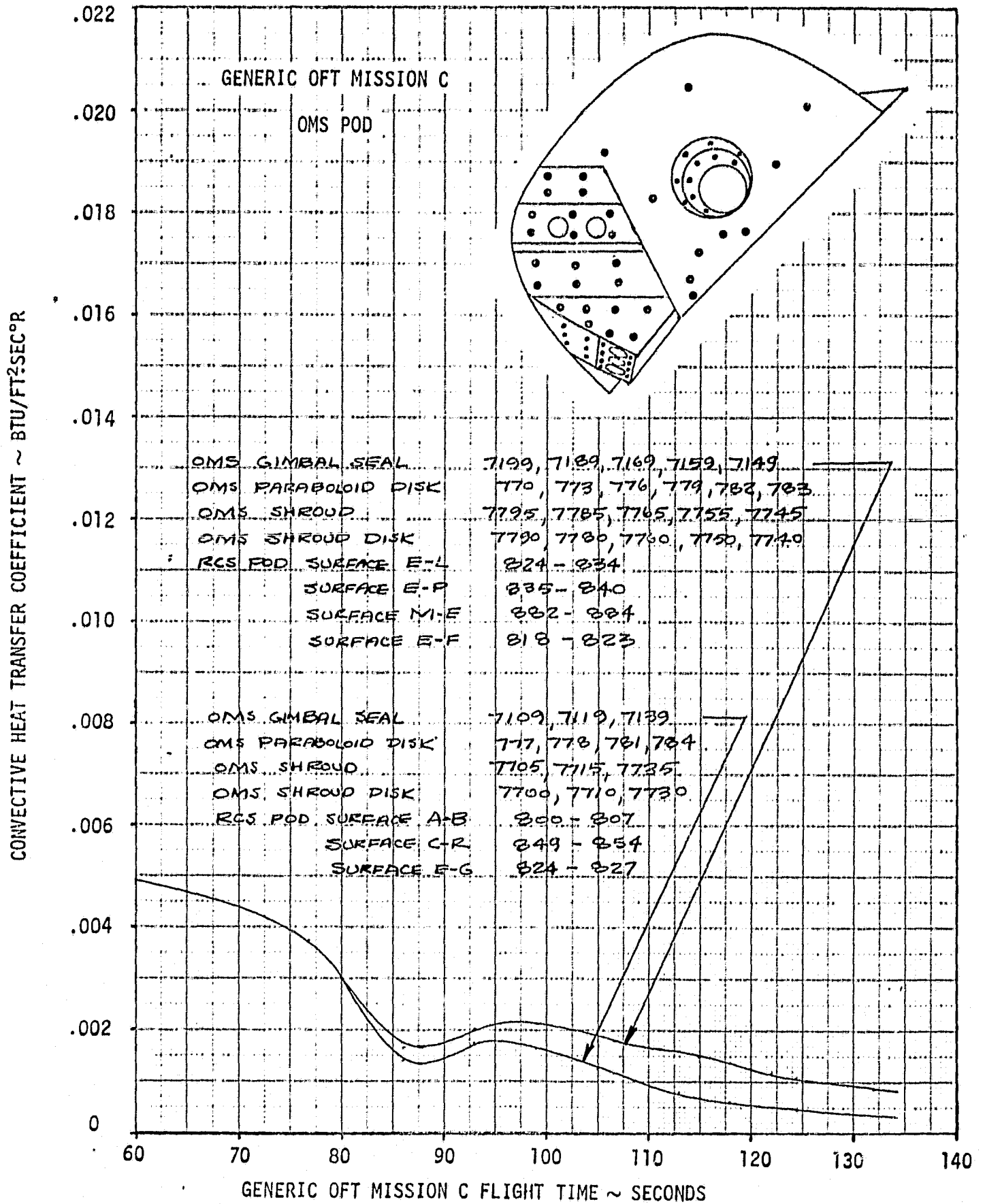

FIGURE 27. FIRST STAGE ASCENT CONVECTIVE HEAT TRANSFER COEFFICIENT

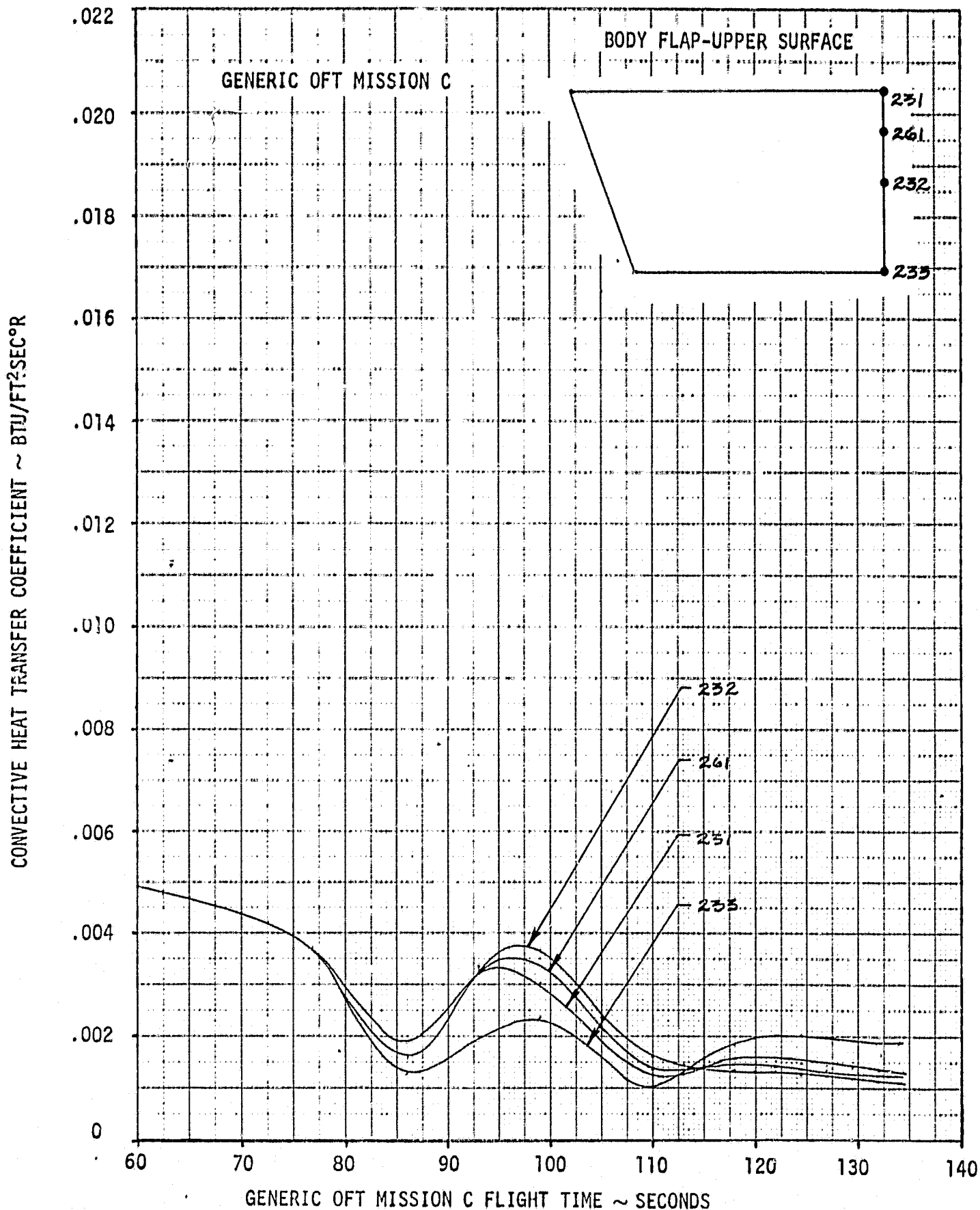

FIGURE 28. FIRST STAGE ASCENT CONVECTIVE HEAT TRANSFER COEFFICIENT

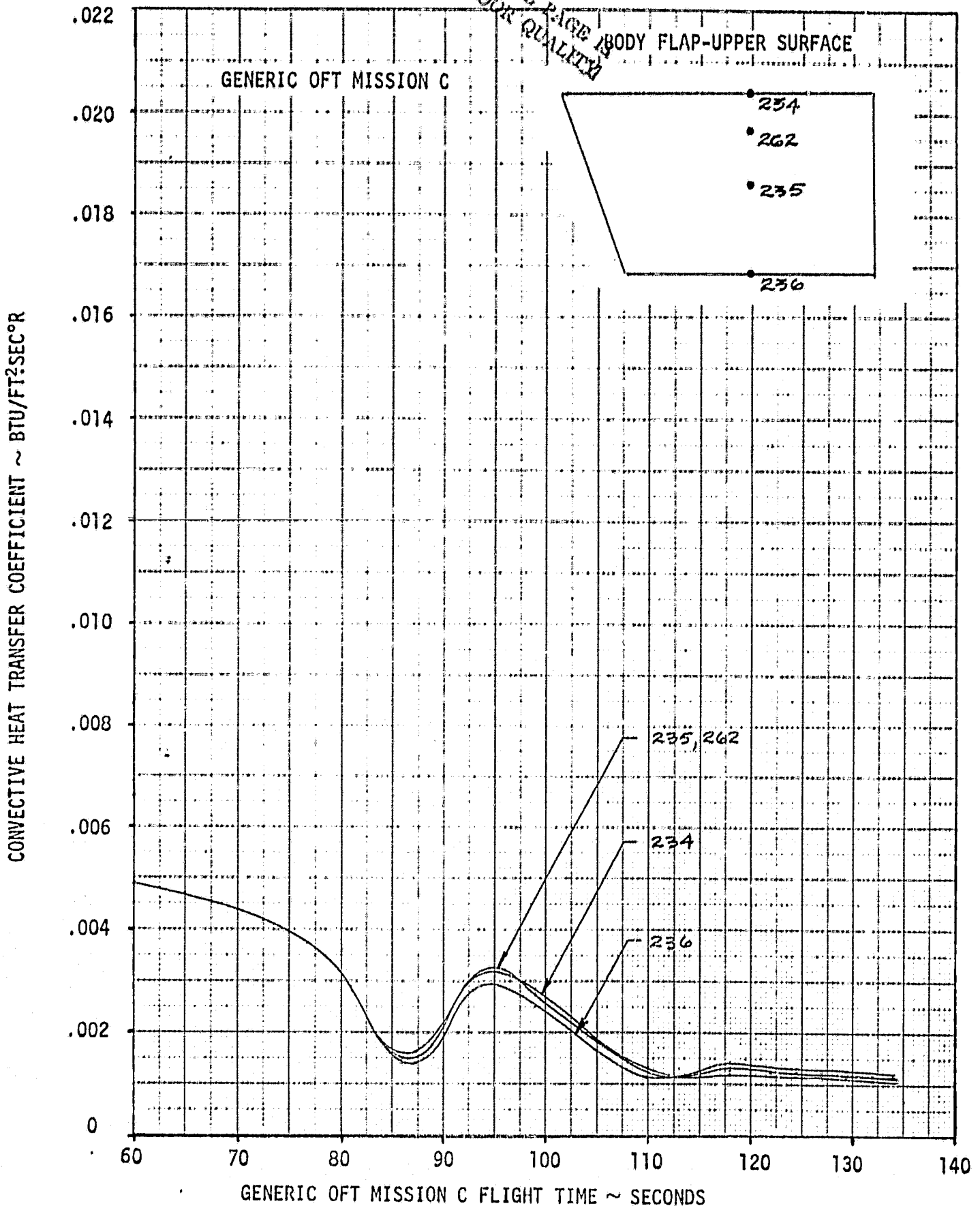

FIGURE 29. FIRST STAGE ASCENT CONVECTIVE HEAT TRANSFER COEFFICIENT

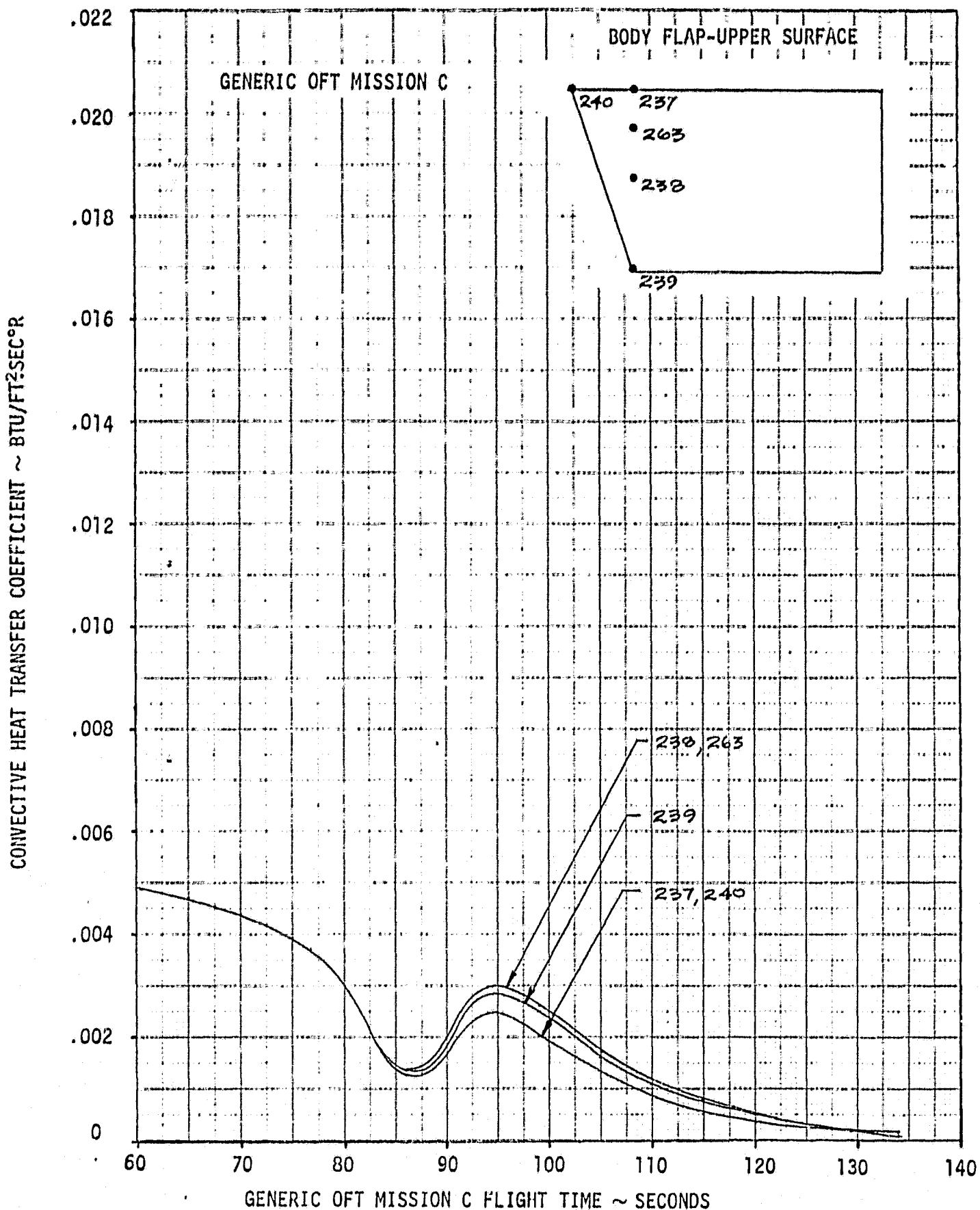

FIGURE 30. FIRST STAGE ASCENT CONVECTIVE HEAT TRANSFER COEFFICIENT

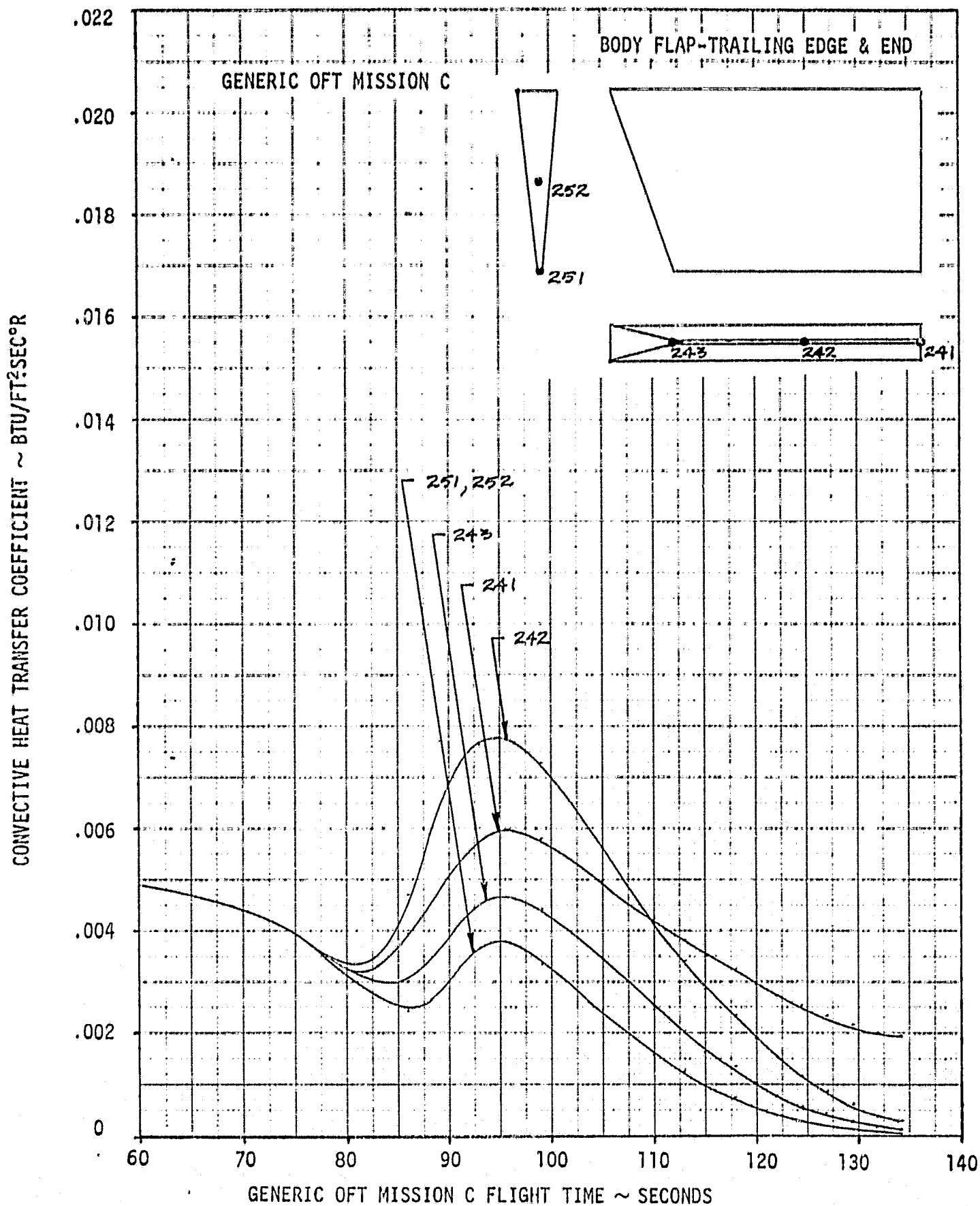

FIGURE 31. FIRST STAGE ASCENT CONVECTIVE HEAT TRANSFER COEFFICIENT

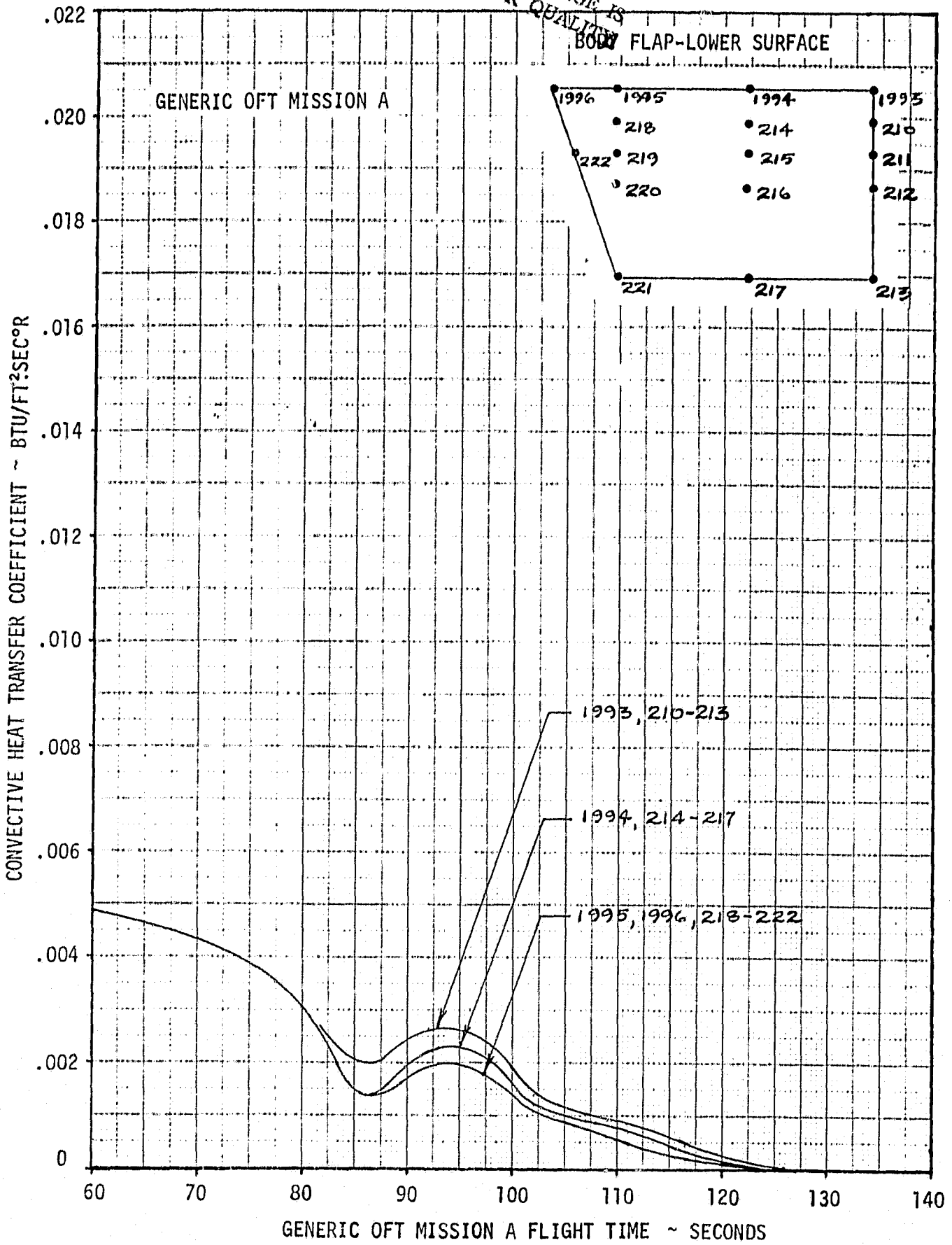

FIGURE 32. FIRST STAGE ASCENT CONVECTIVE HEAT TRANSFER COEFFICIENT

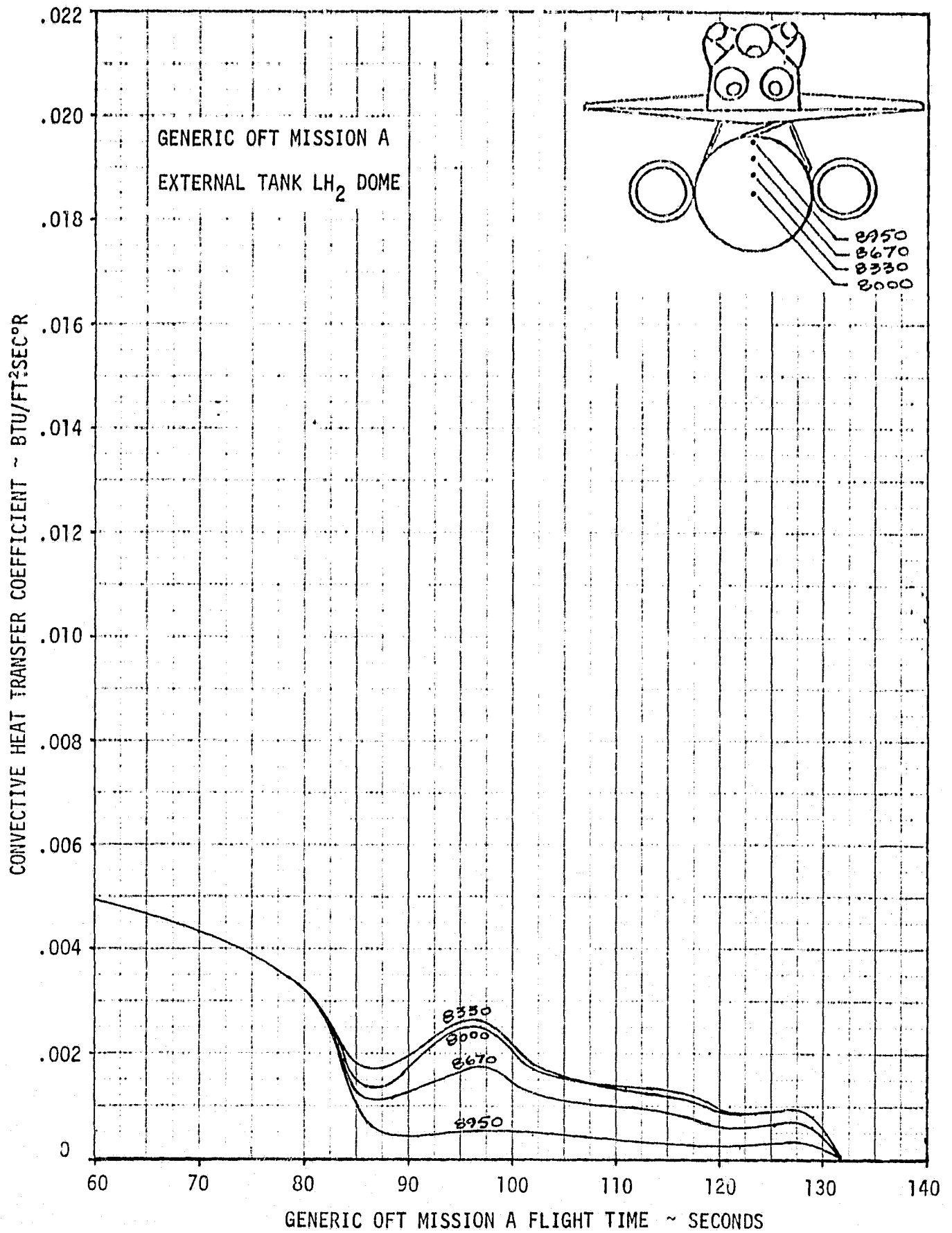

FIGURE 33. FIRST STAGE ASCENT CONVECTIVE HEAT TRANSFER COEFFICIENT

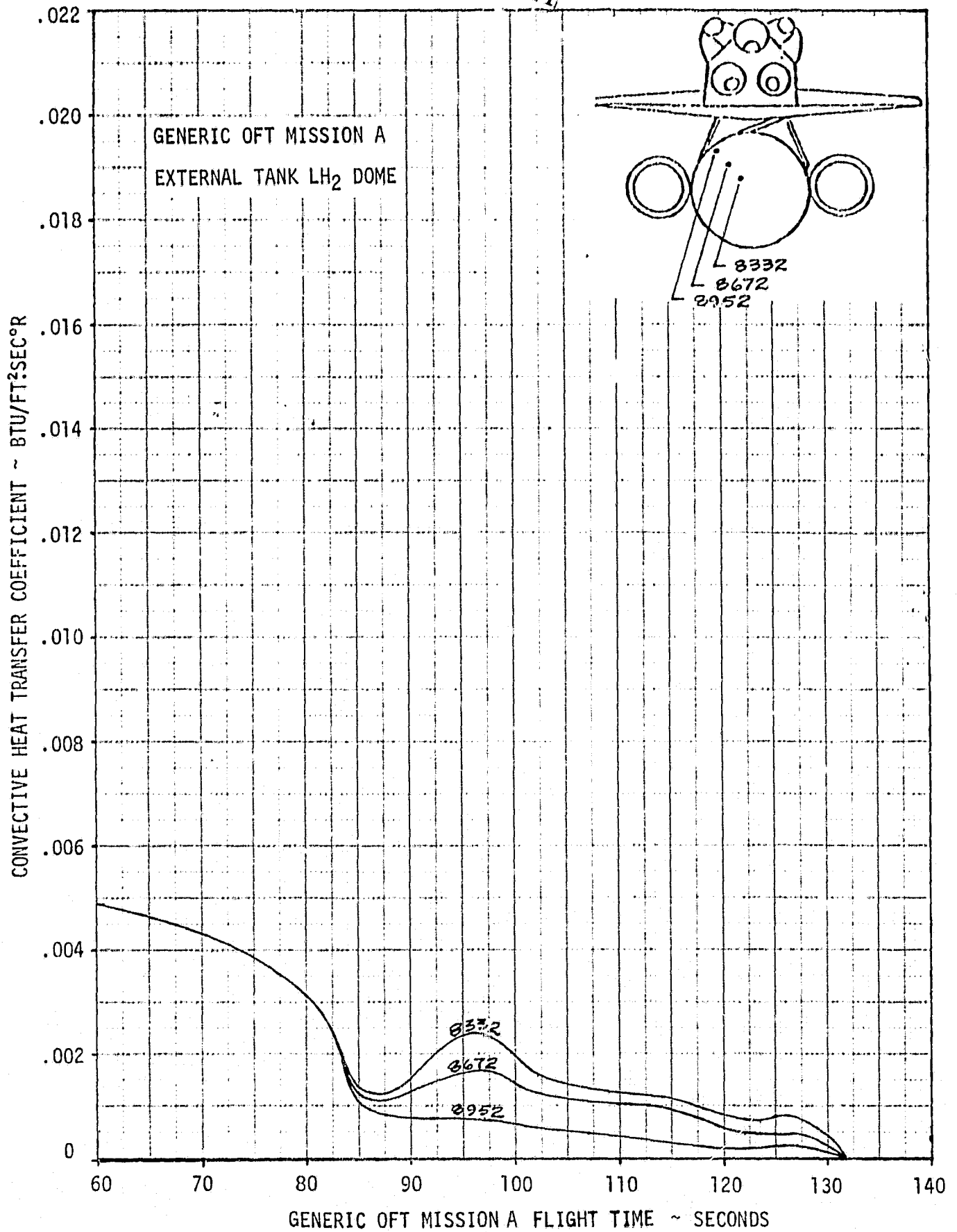

FIGURE 34. FIRST STAGE ASCENT CONVECTIVE HEAT TRANSFER COEFFICIENT

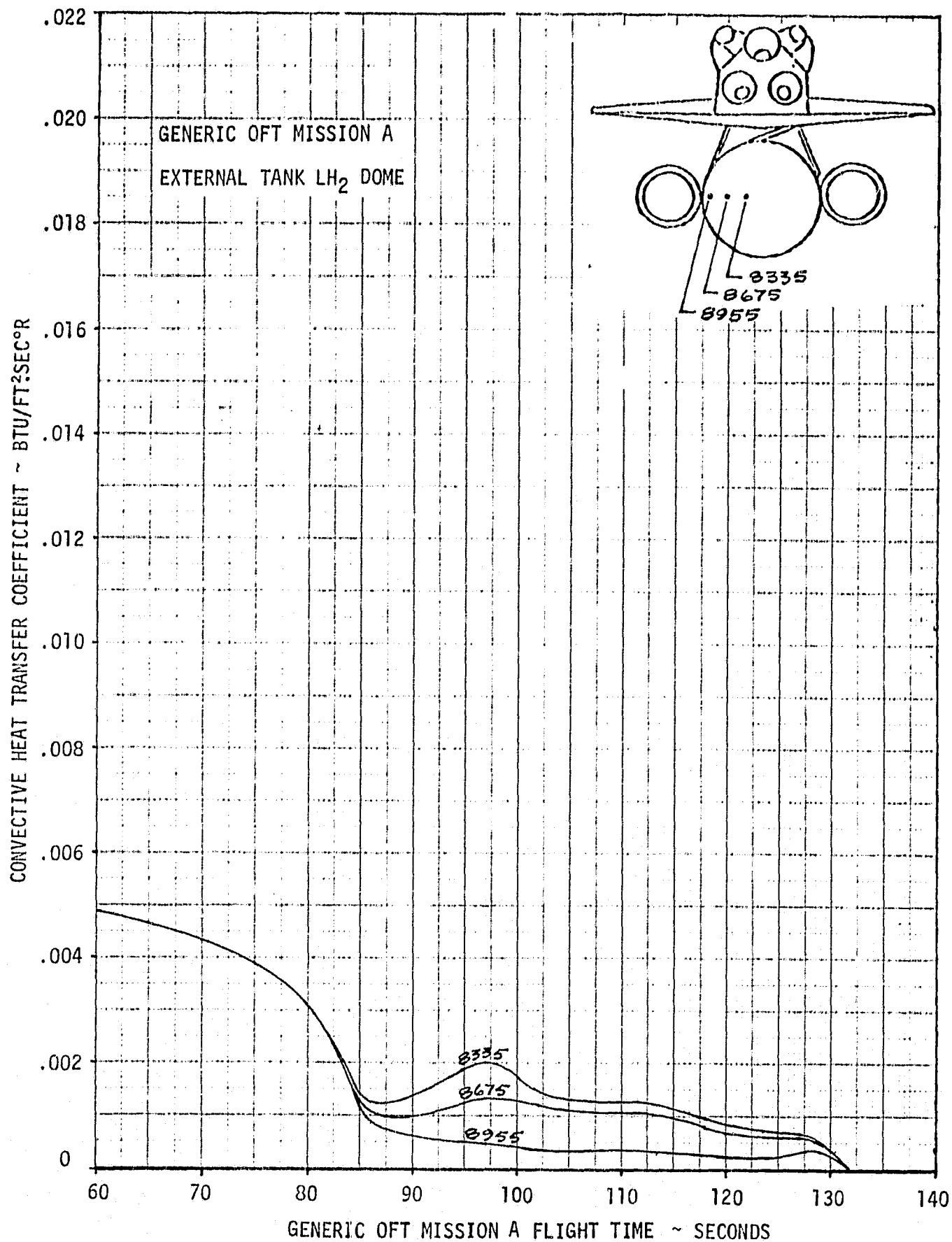

FIGURE 35, FIRST STAGE ASCENT CONVECTIVE HEAT TRANSFER COEFFICIENT

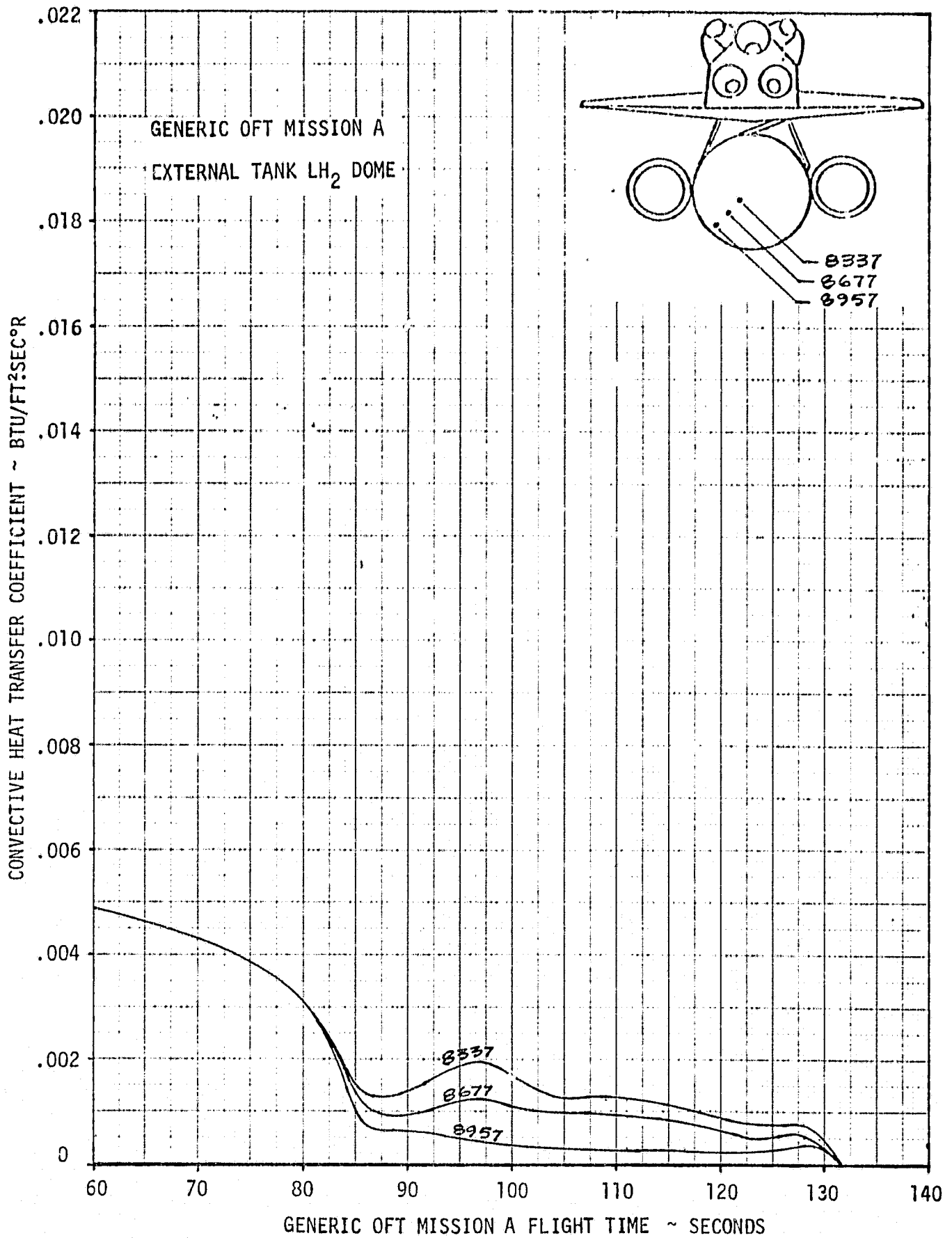

FIGURE 36. FIRST STAGE ASCENT CONVECTIVE HEAT TRANSFER COEFFICIENT

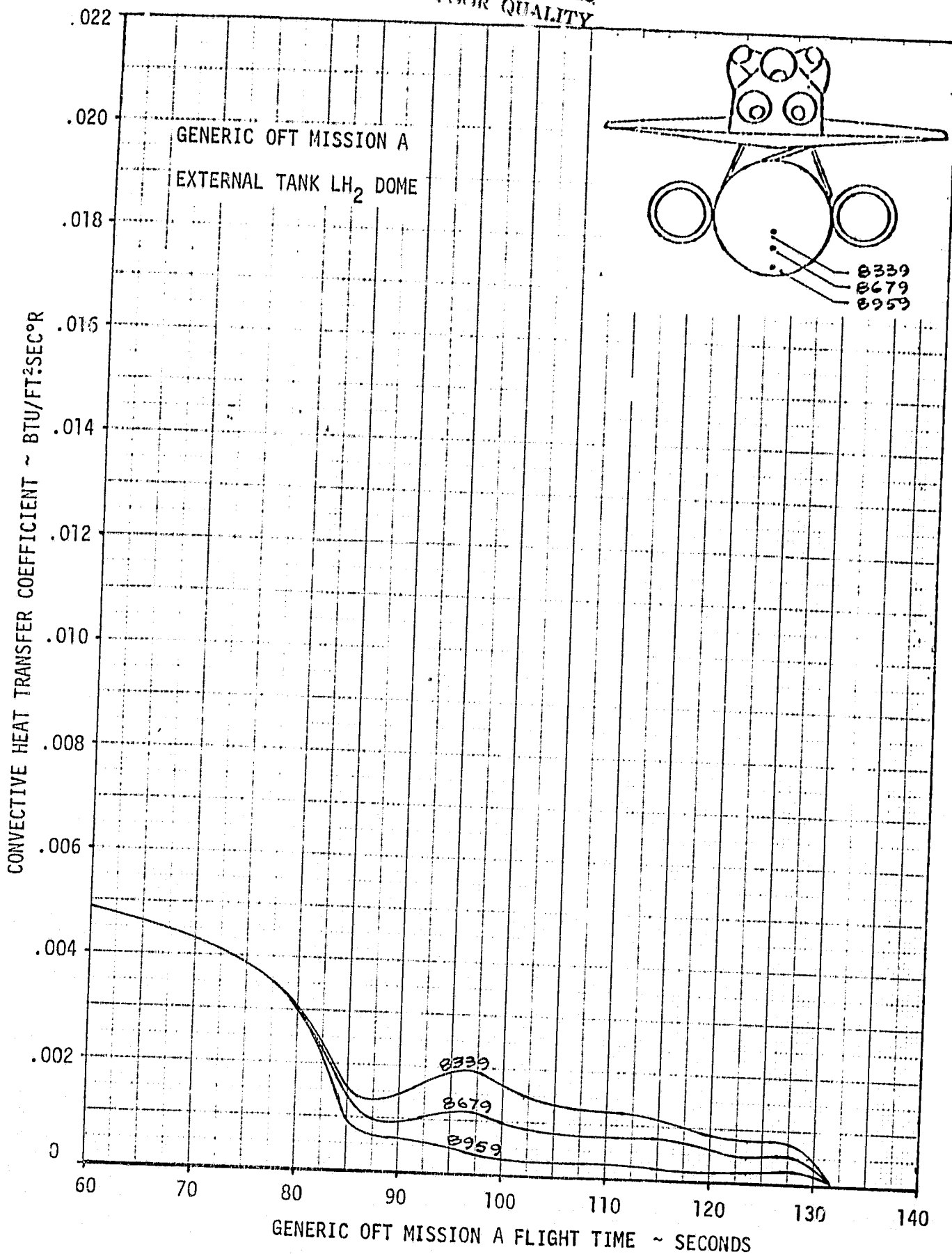

FIGURE 37. FIRST STAGE ASCENT CONVECTIVE HEAT TRANSFER COEFFICIENT

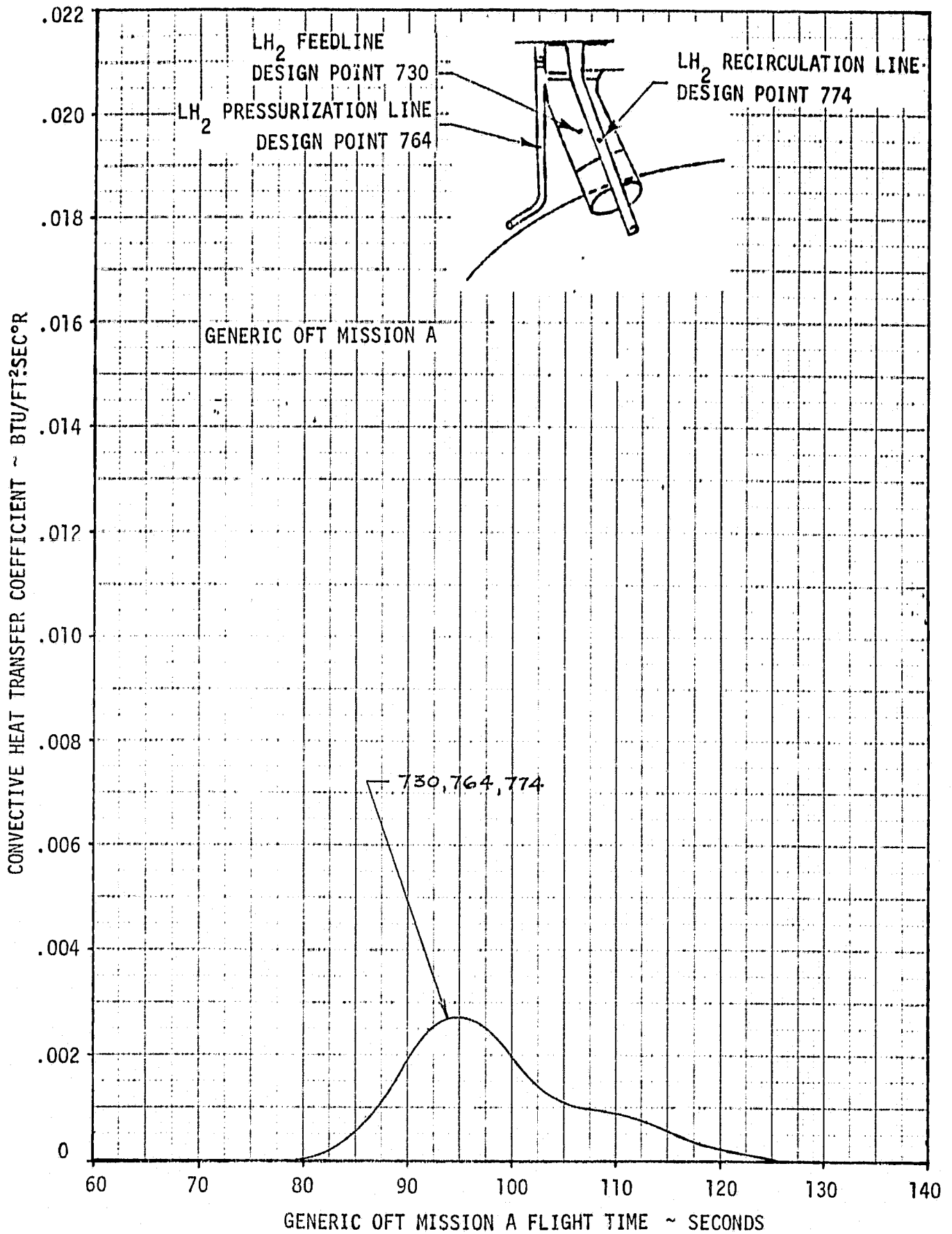

FIGURE 38. FIRST STAGE ASCENT CONVECTIVE HEAT TRANSFER COEFFICIENT

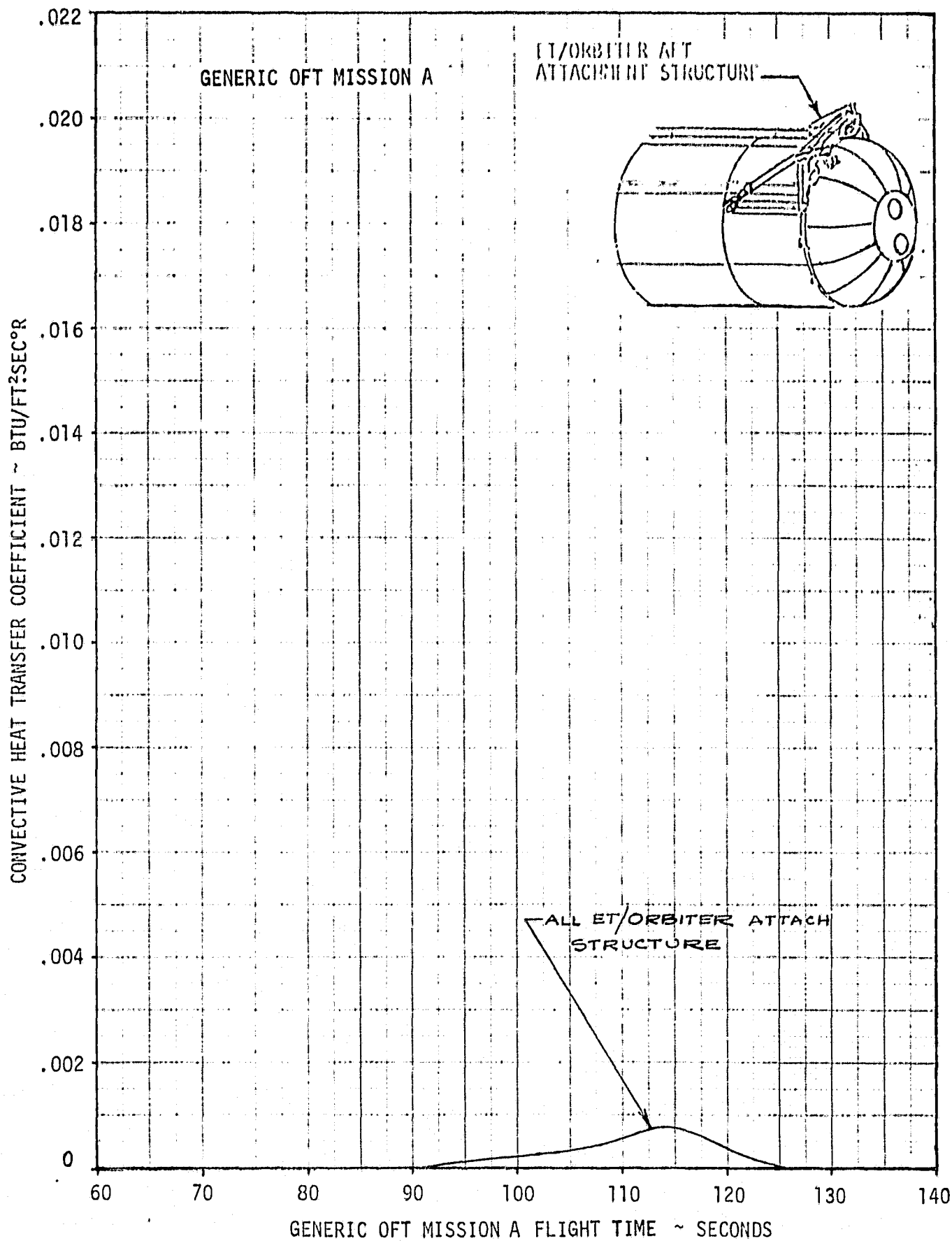

FIGURE 39. FIRST STAGE ASCENT CONVECTIVE HEAT TRANSFER COEFFICIENT

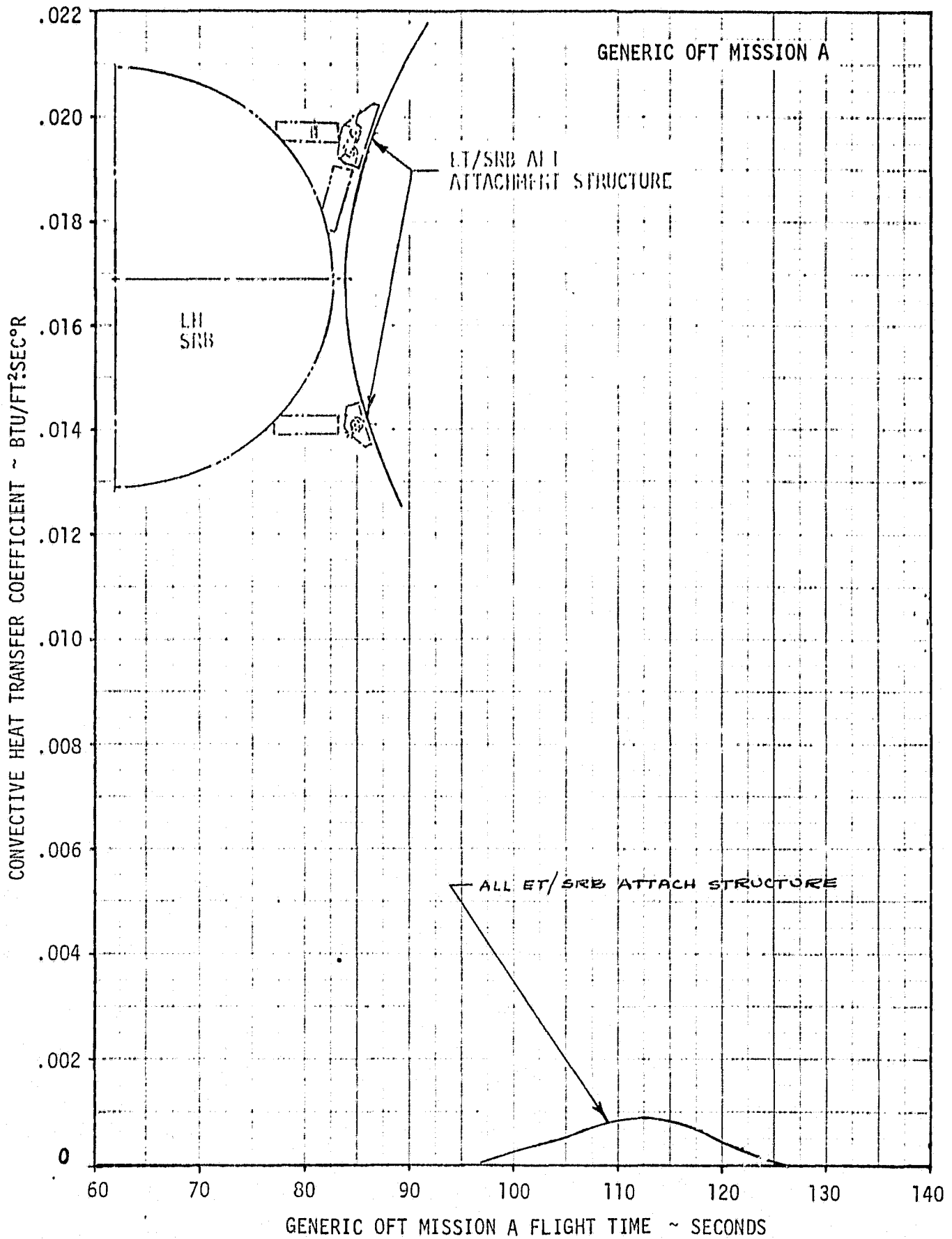

FIGURE 40. FIRST STAGE ASCENT CONVECTIVE HEAT TRANSFER COEFFICIENT

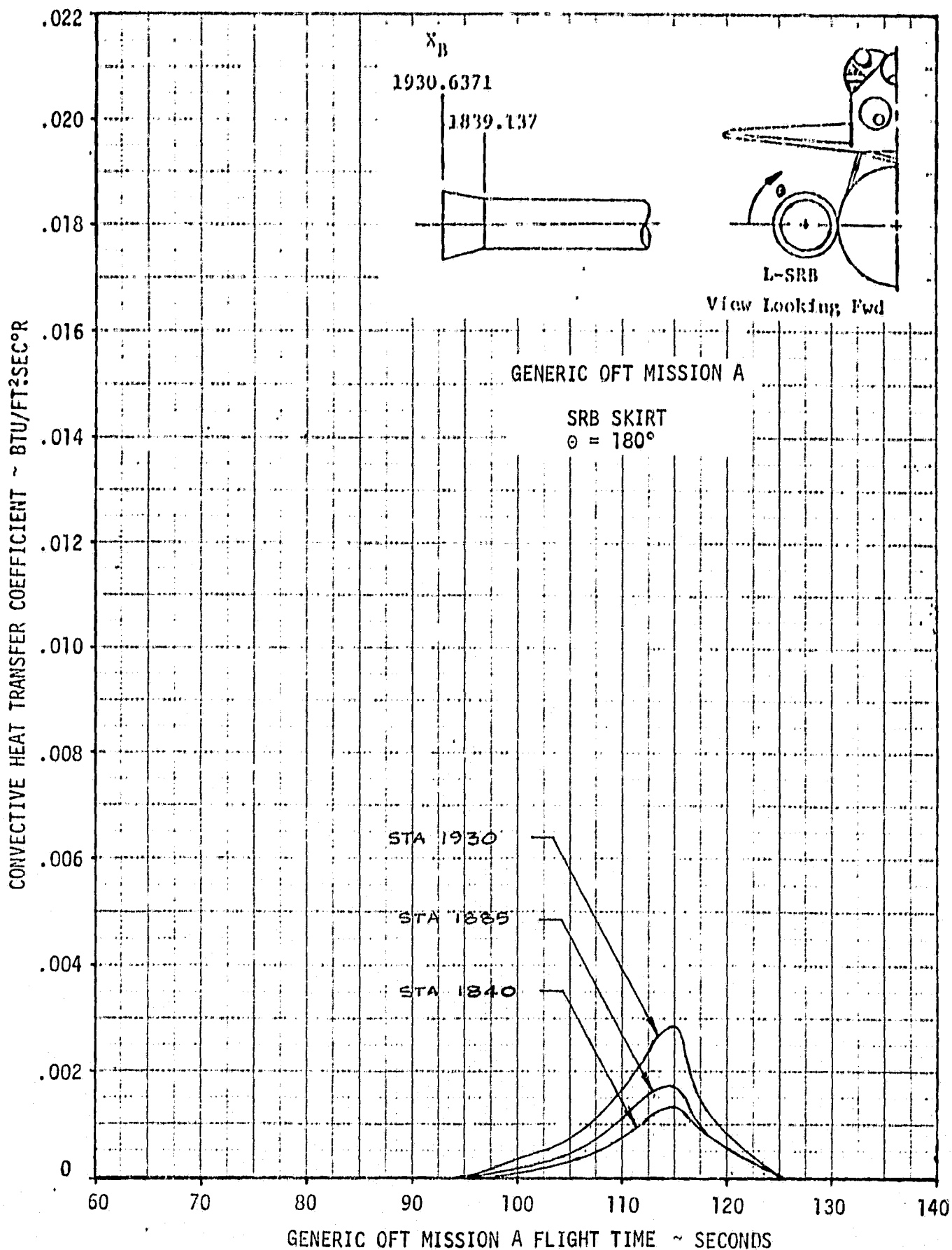

FIGURE 41. FIRST STAGE ASCENT CONVECTIVE HEAT TRANSFER COEFFICIENT

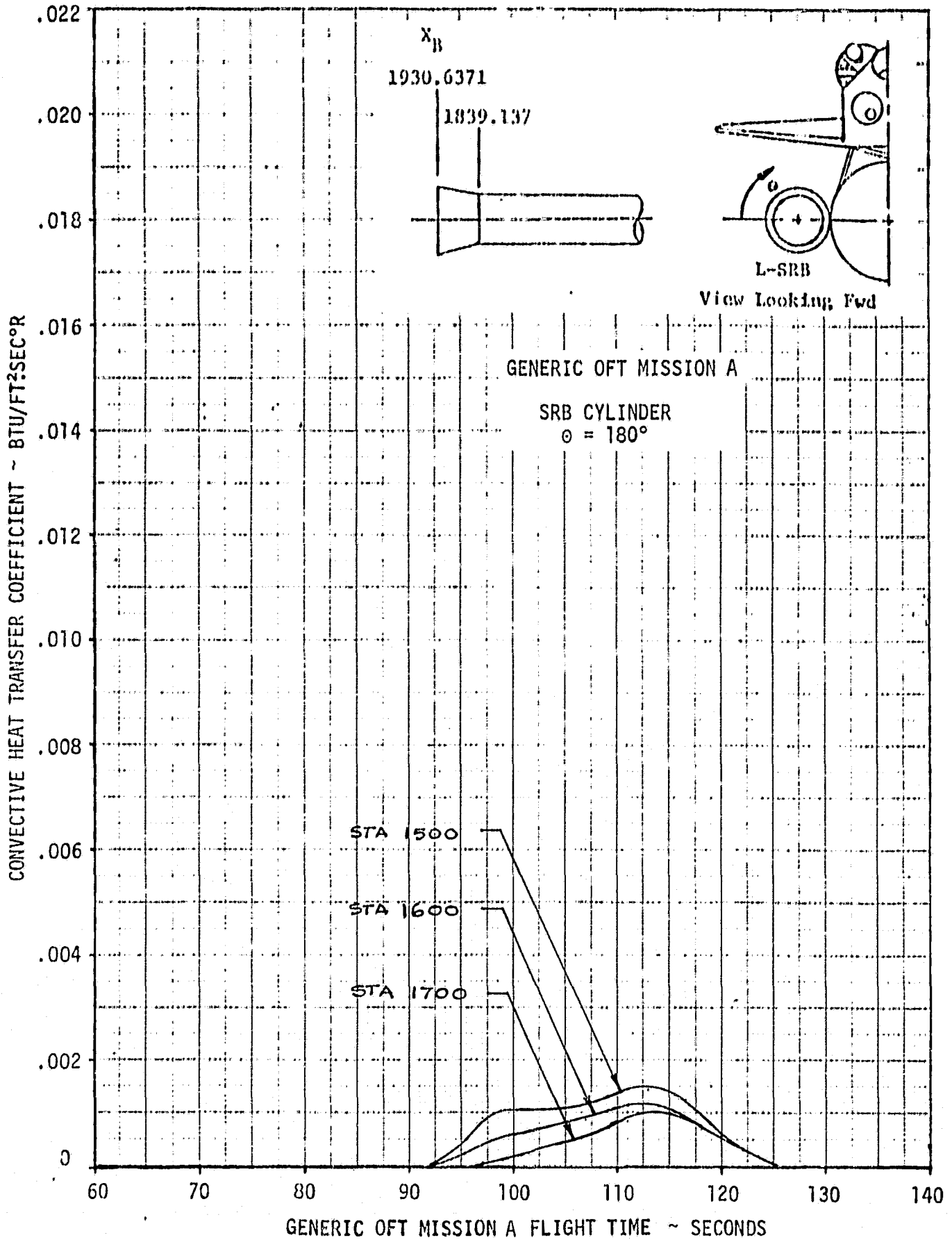

FIGURE 42. FIRST STAGE ASCENT CONVECTIVE HEAT TRANSFER COEFFICIENT

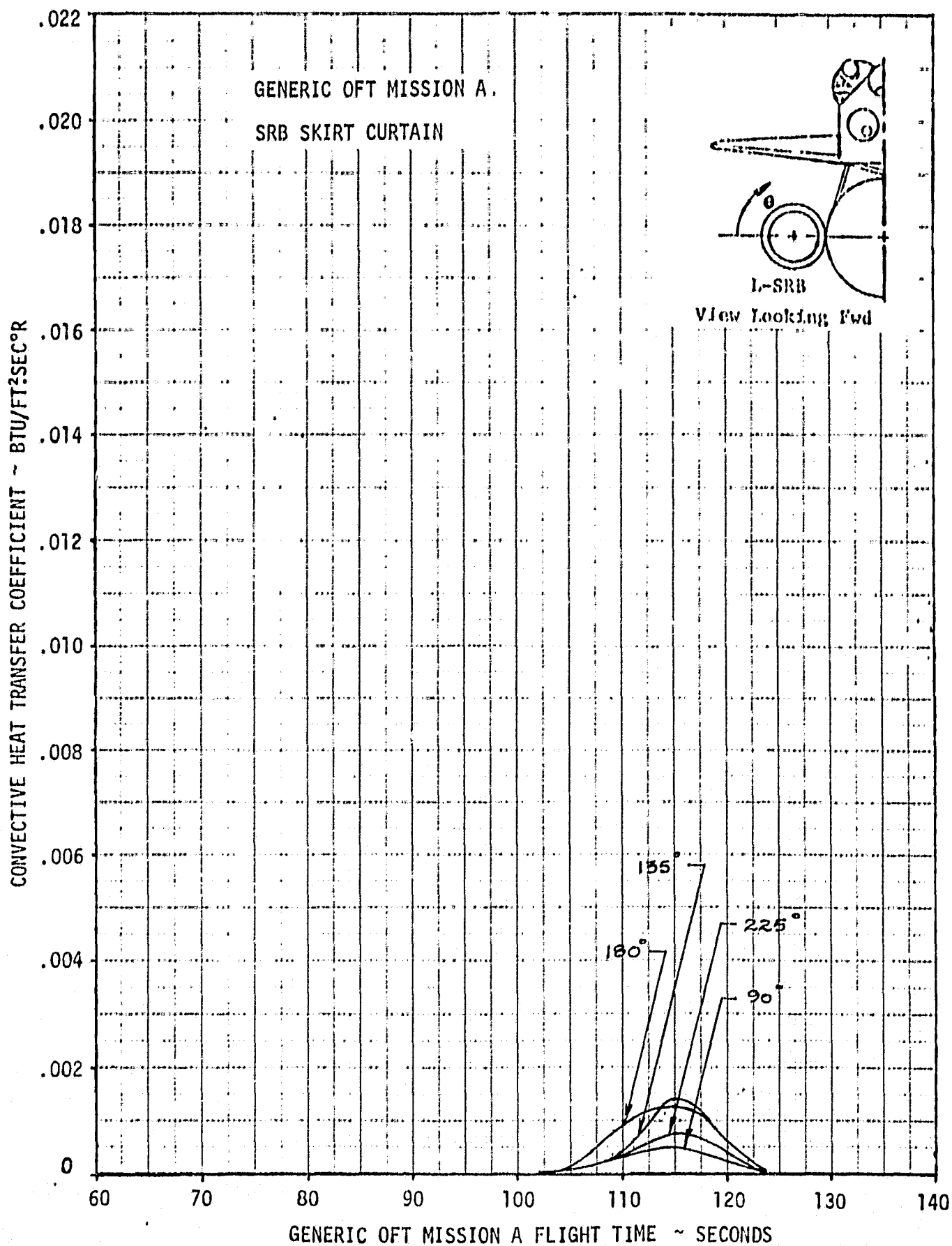
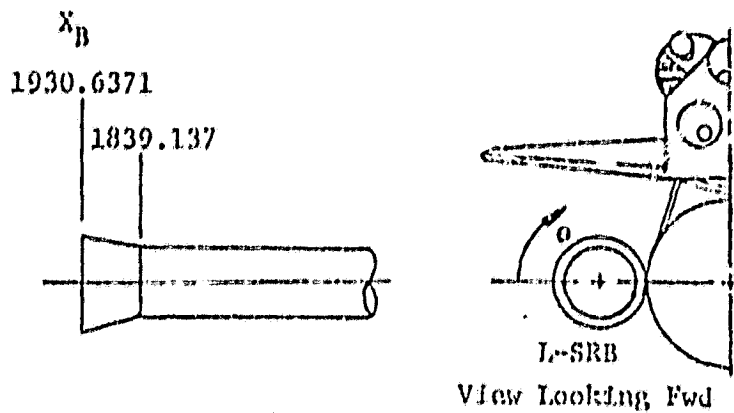

FIGURE 43. FIRST STAGE ASCENT CONVECTIVE HEAT TRANSFER COEFFICIENT

QUALITY IS
OF POOR QUALITY



NOTE : DISTRIBUTIONS APPLICABLE TO ALL FLIGHT
TIMES DURING PLUME RECIRCULATION
(APPROXIMATELY 100 TO 125 SECONDS)

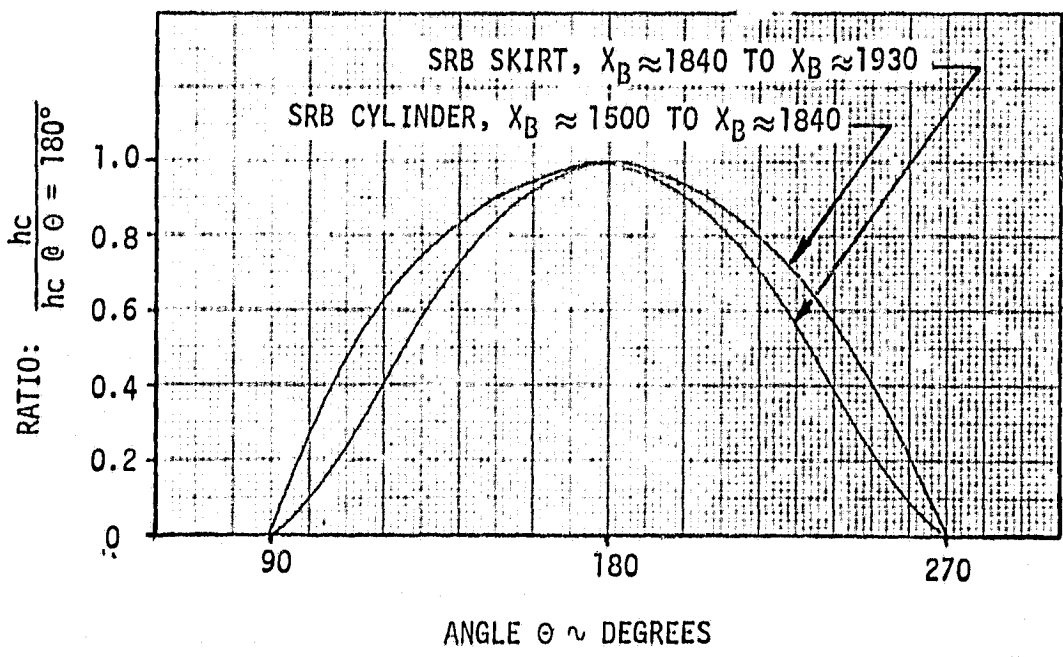

FIGURE 44. CIRCUMFERENTIAL DISTRIBUTION - SRB SKIRT & CYLINDER

APPENDIX

OFT Trajectory and Engine Position Data

ORIGINAL PAGE IS
OF POOR QUALITY

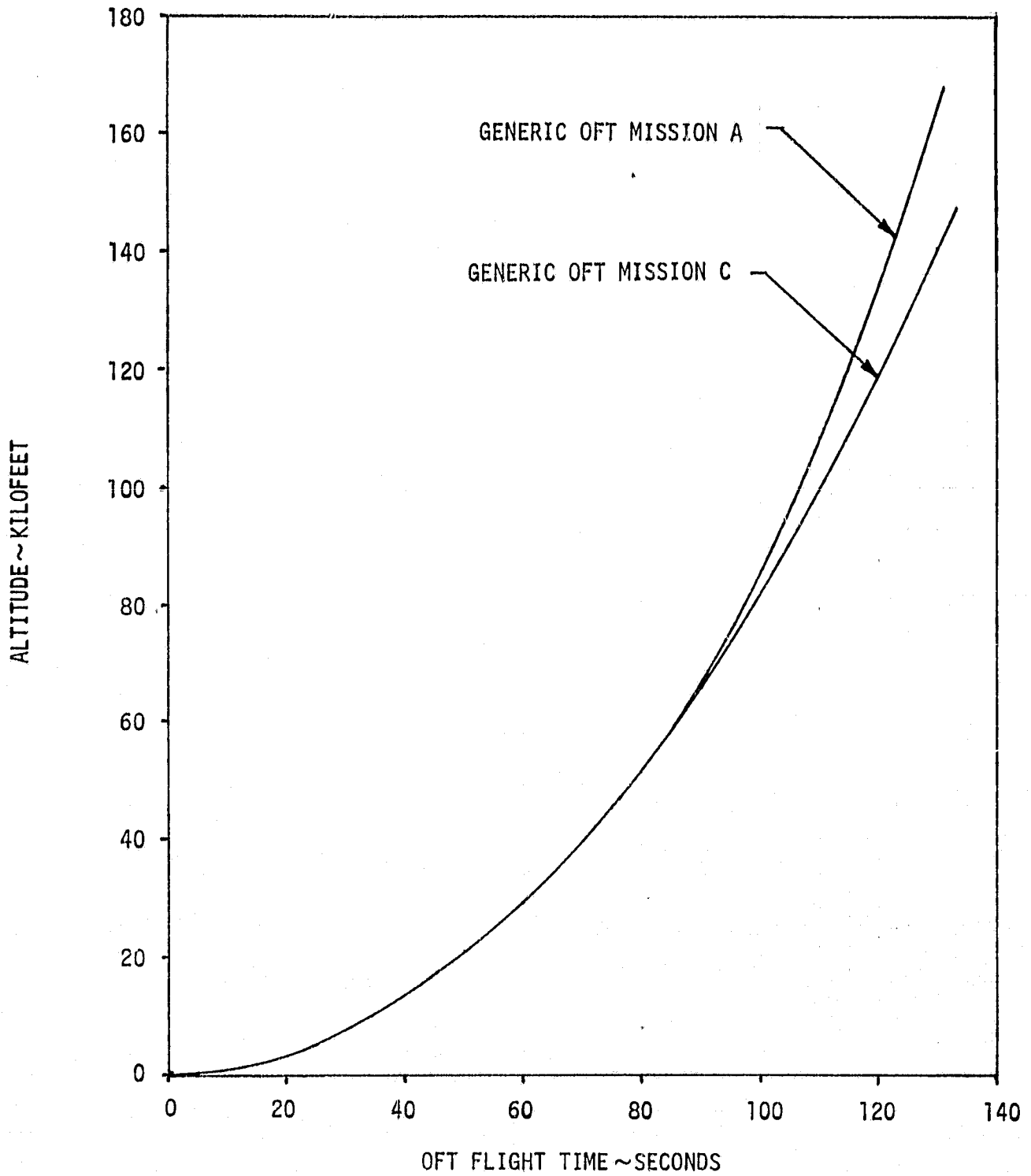

FIGURE A-1. OFT-1 GENERIC PLUME HEATING TRAJECTORIES MISSION A AND MISSION C.

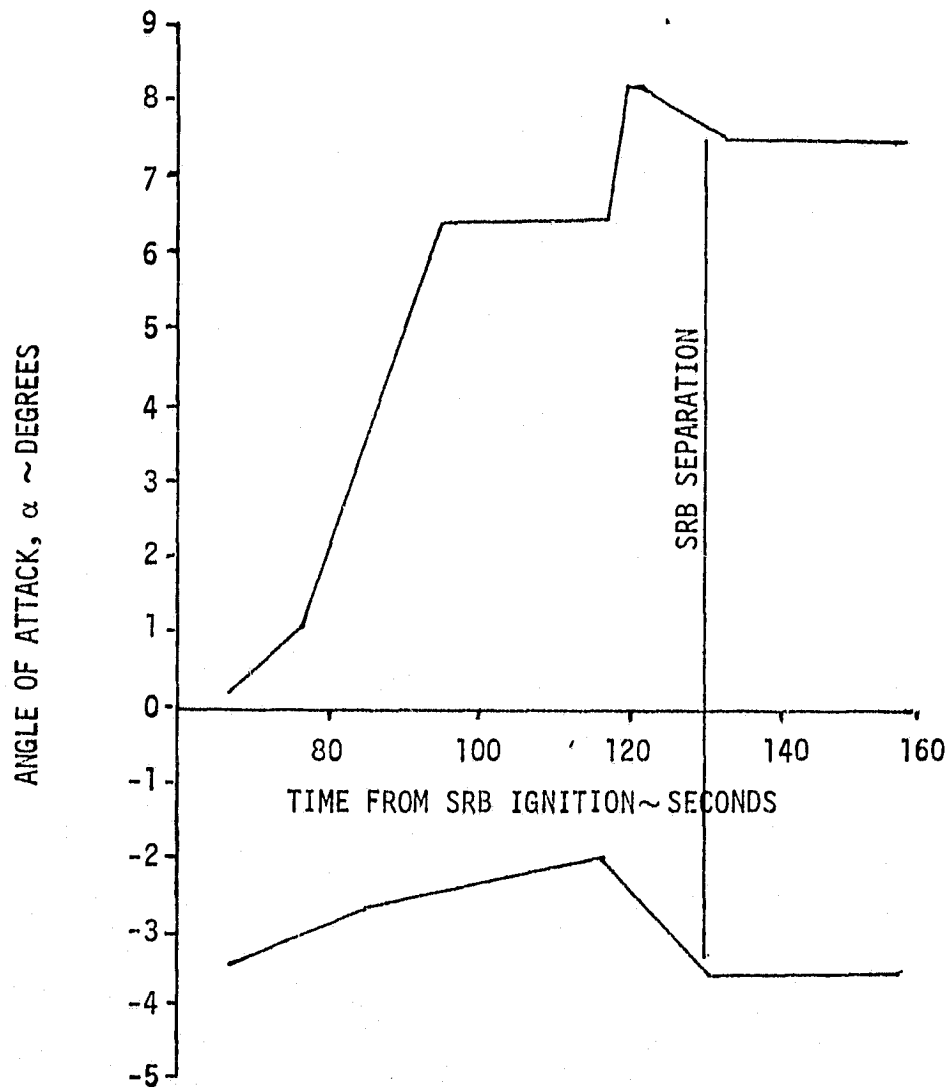

FIGURE A-2. ANGLE OF ATTACK ENVELOPE

ORIGINAL PAGE IS
OF POOR QUALITY

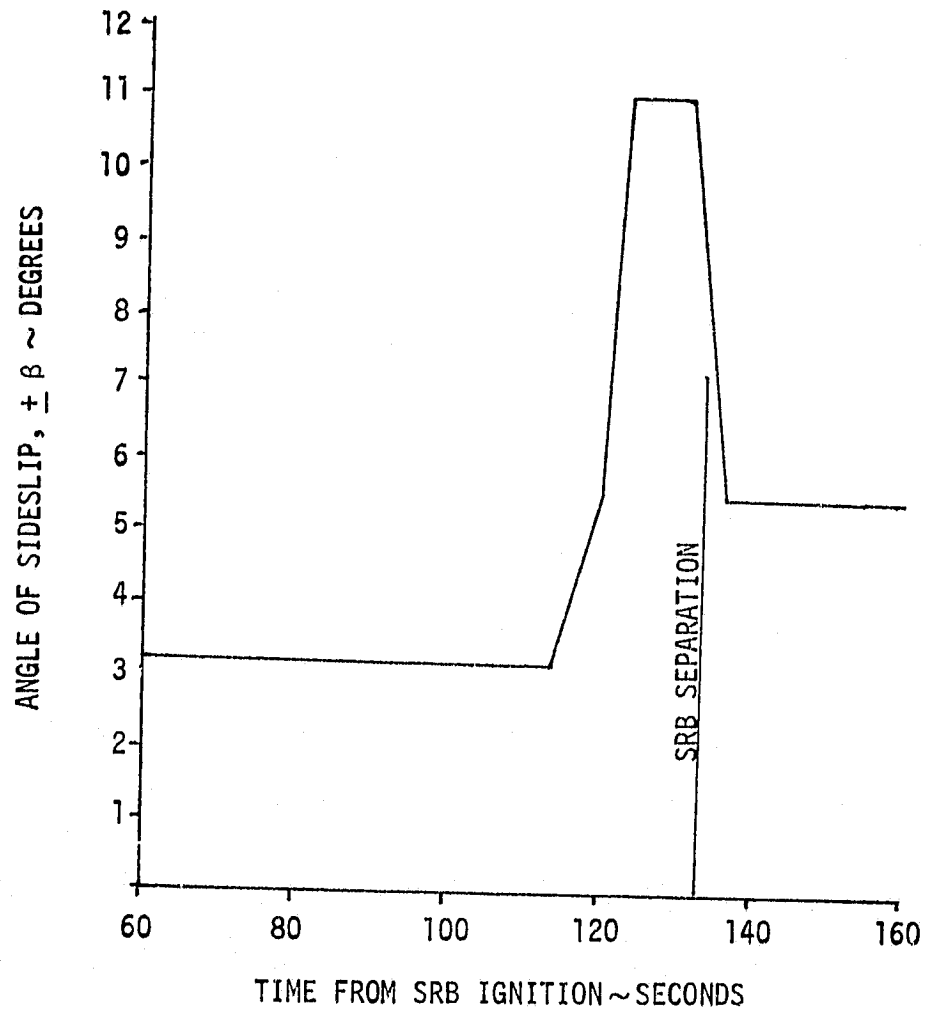

FIGURE A-2 (CONT). ANGLE OF SIDESLIP ENVELOPE

SRB THRUST TAILOFF

* NORMALIZED TO 100% @ 2.2×10^6 lbs

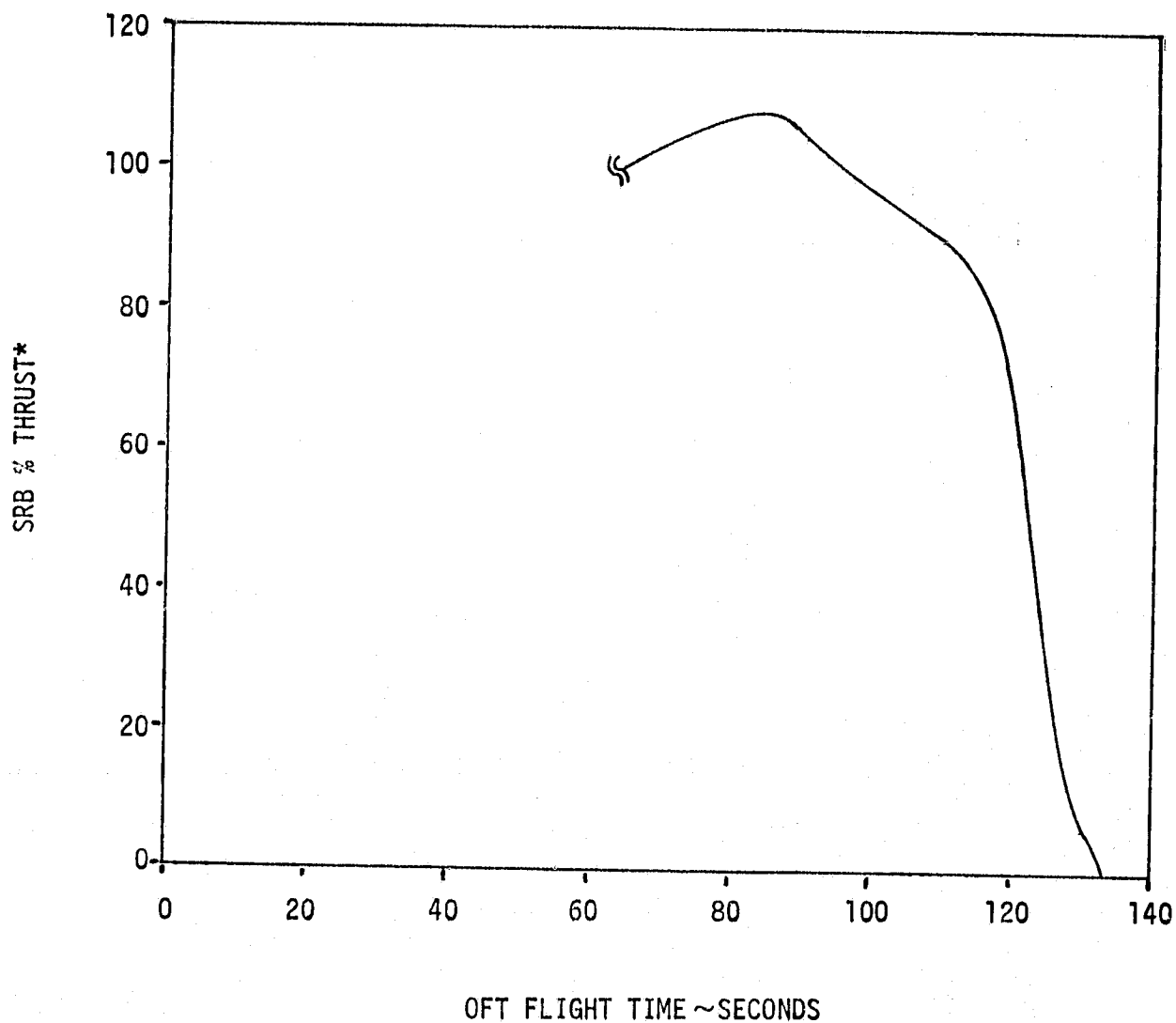

FIGURE A-3. GENERIC OFT-1 SRB THRUST TAILOFF

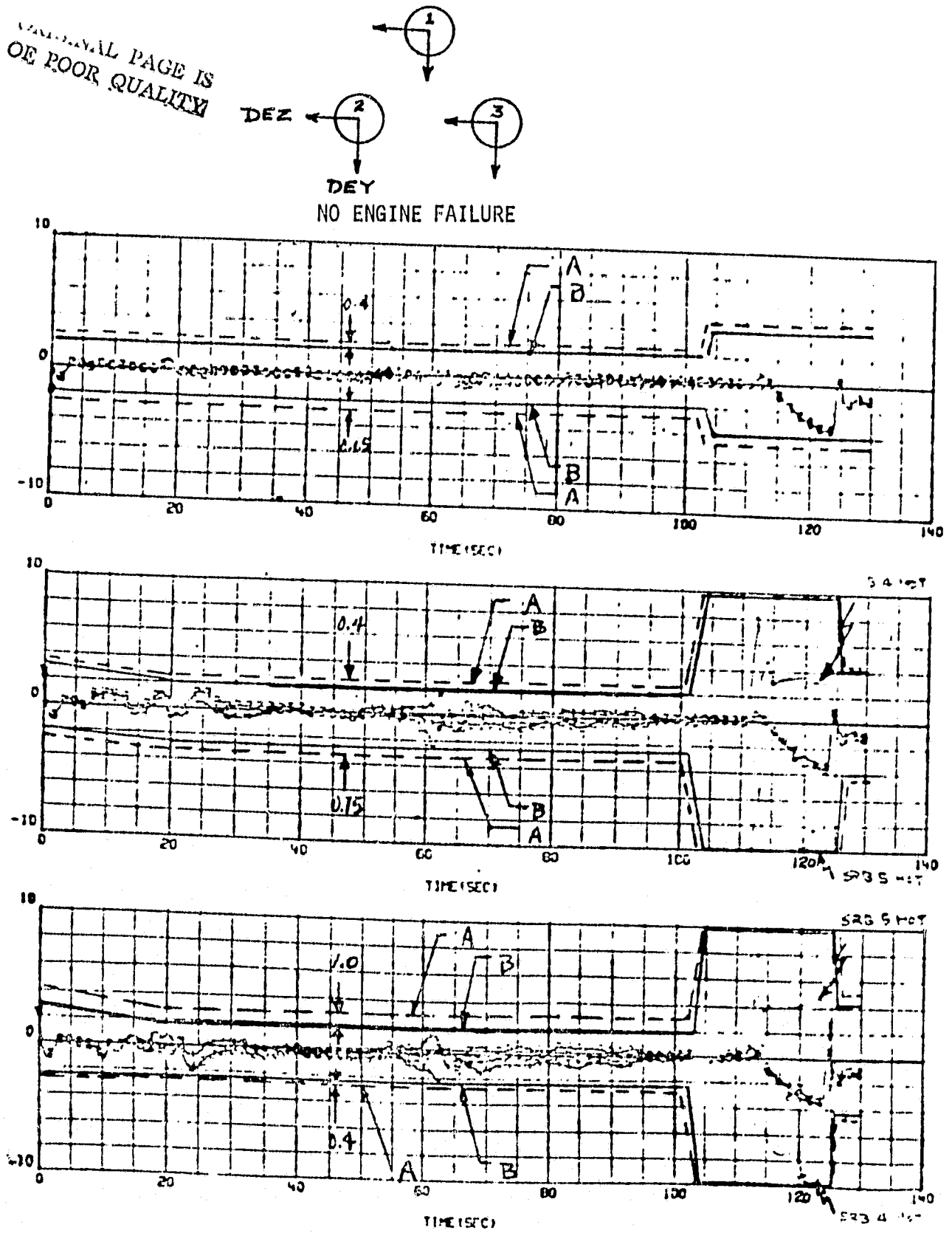

FIGURE A-4. SSME PITCH ACTUATOR DEFLECTIONS WITH RESPECT TO NULL, DEGREES

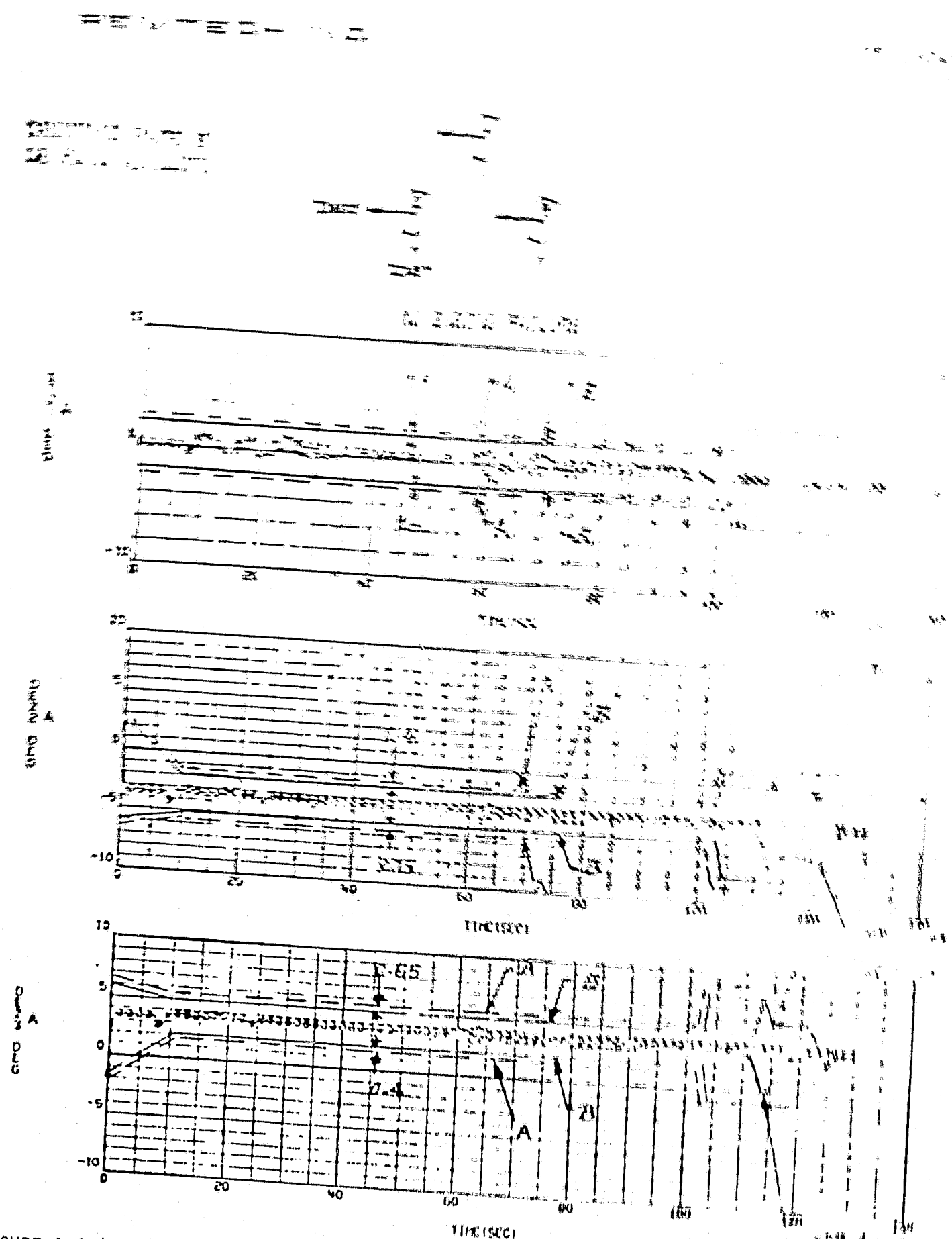
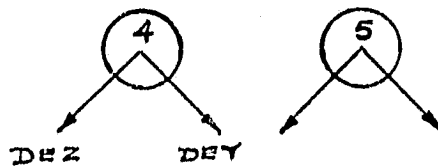

FIGURE A-4 (CONT). SSME YAW ACTUATOR DEFLECTIONS WITH RESPECT TO ACTUATOR HULL, DEGREE



NO ENGINE FAILURE

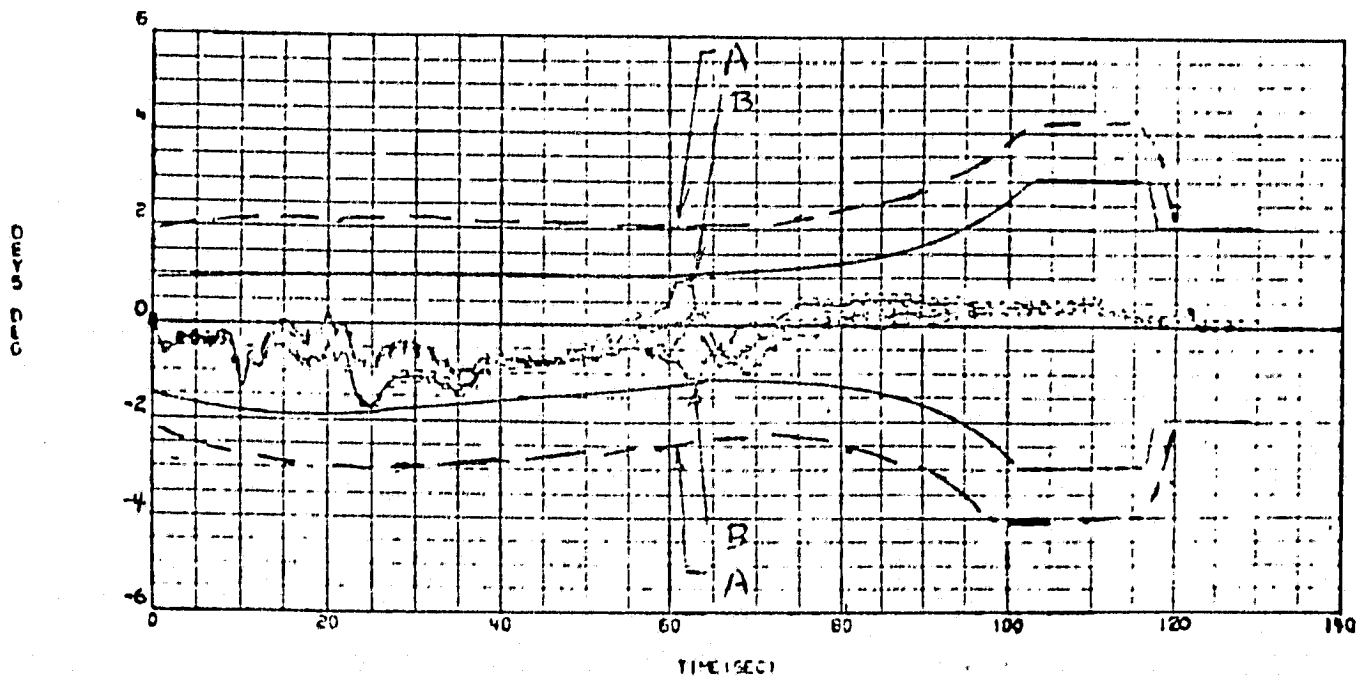
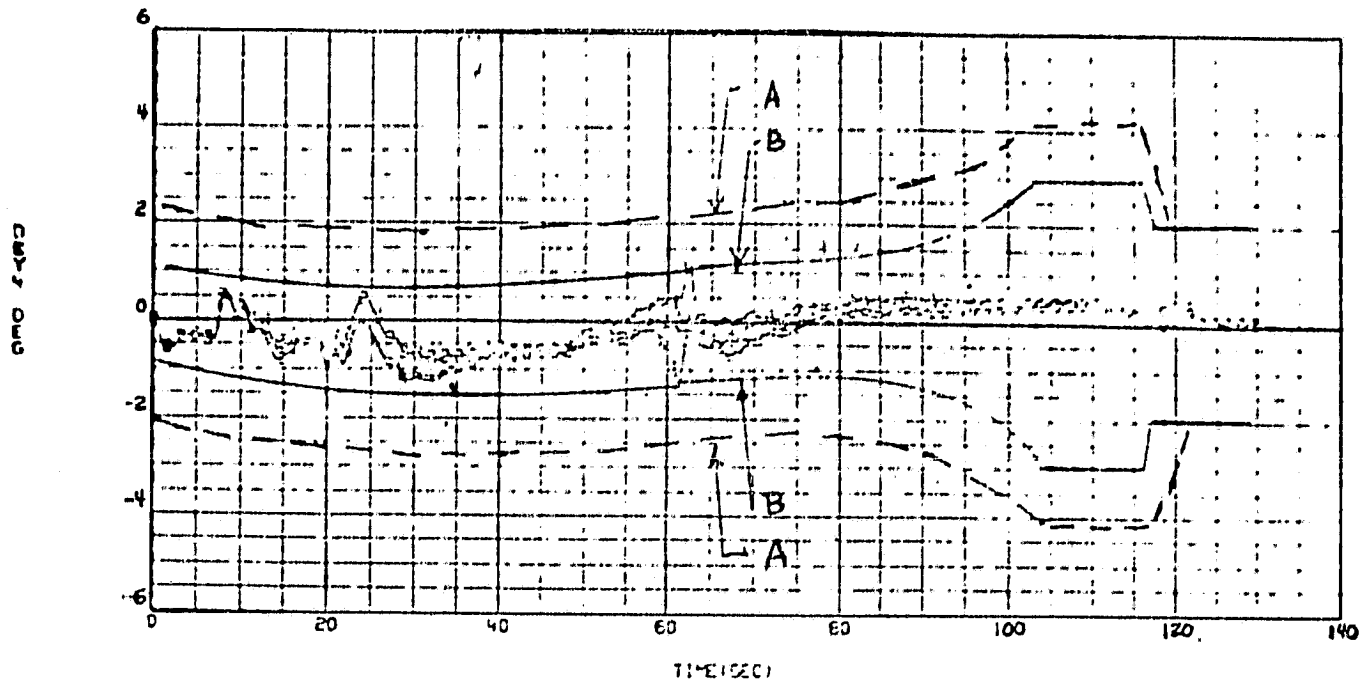
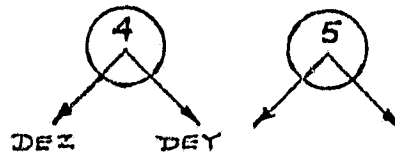

FIGURE A-5. SRB PITCH ACTUATOR DEFLECTIONS, DEGREES

ORIGINAL PAGE IS
OF POOR QUALITY



NO ENGINE FAILURE

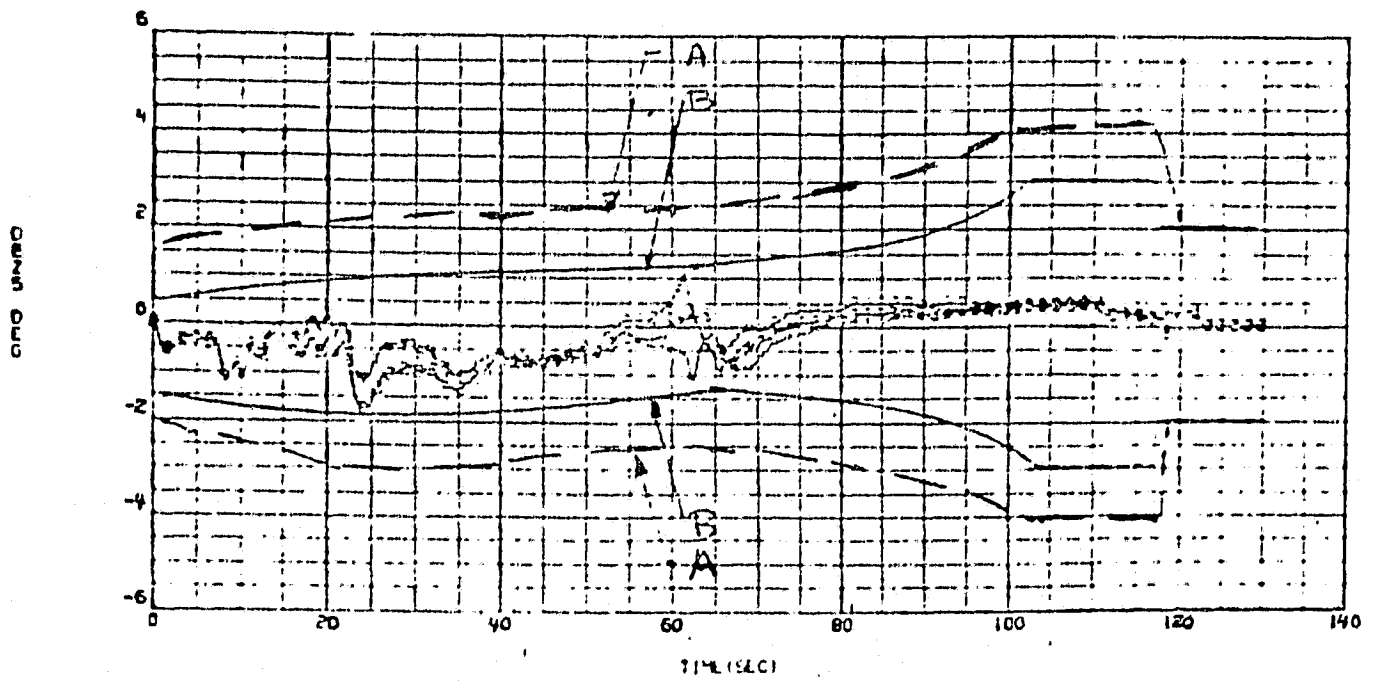
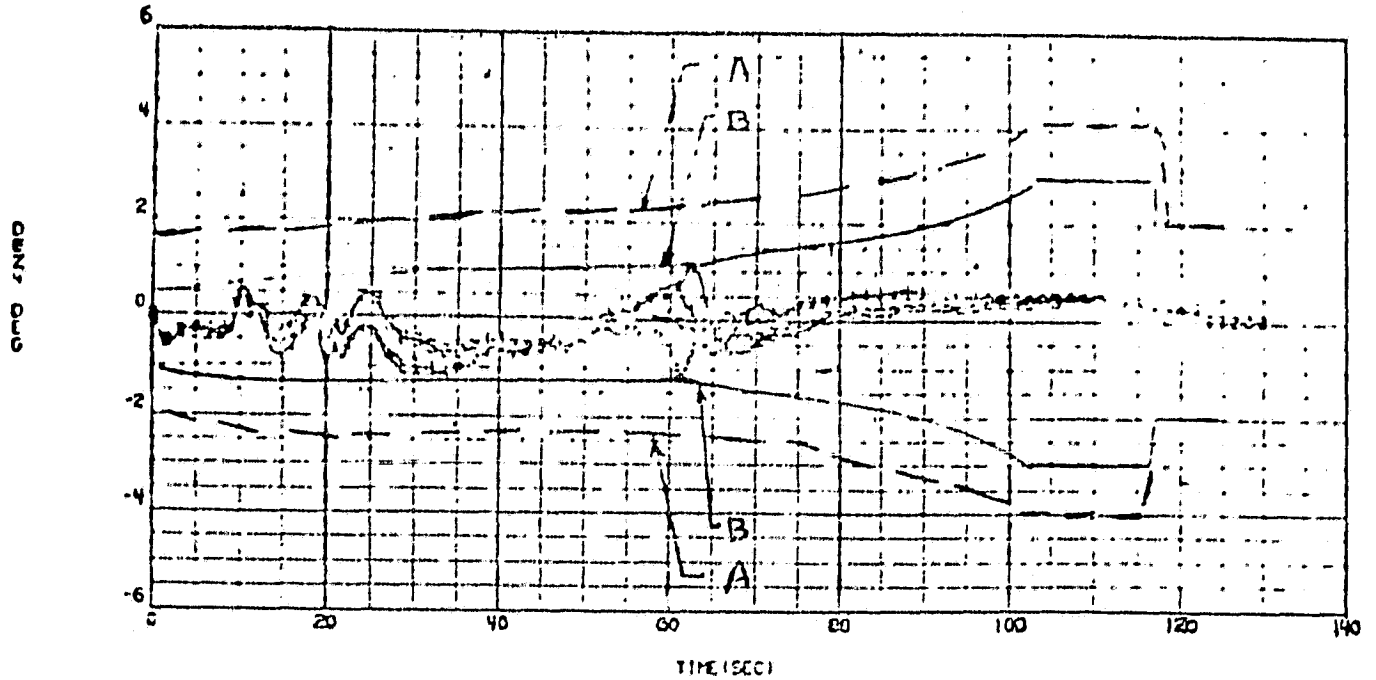

FIGURE A-5 (CONT). SRB YAW ACTUATOR DEFLECTIONS, DEGREES