

HIGH PRESSURE GAS LASER TECHNOLOGY FOR ATMOSPHERIC REMOTE SENSING

A. Javan*
Laser Development Corporation
Lexington, Mass.

ABSTRACT

High pressure gas laser technology offers the possibility for stable lasers at finely controlled tunable frequencies and power levels needed for atmospheric remote sensing. Broadly tunable precision CW lasers for LHS or CW DIAL measurements, or repetitively pulsed high intensity lasers with the required characteristics for high-resolution DIAL observation of pressure-broadened pollutant line-profiles (to obtain altitude discrimination) are possible. A fixed frequency chirp-free and highly stable intense pulsed laser can be made for Doppler wind velocity measurements with accurate ranging. The talk will review the related technologies in the 10 μm region. The review will be in the form of a progress report presenting an on-going research and engineering effort.

INTRODUCTORY REMARKS

This talk was presented in two parts. The first part gave the details of the work relating to the generation of intense IR laser pulses at highly stable (and chirp-free) single frequency for Doppler wind velocity measurements. It took place at a workshop (chaired by Dr. Robert Menzies) on the evening of March 26. The second talk presented the work addressed to energy extraction from a high pressure CO_2 laser at a tunable single-mode frequency. It took place on March 27 at the session on Coherent Applications (chaired by Dr. Frank Goodwin). Both talks reviewed the status of a project currently in progress. Future publications (and final reports to NASA) will give extensive details of the various phases when completed. For this proceeding, the viewgraphs shown in the two talks are submitted as figures along with detailed descriptions outlining the presentations.

GENERATION OF INTENSE CO_2 LASER PULSES AT A STABLE

CHIRP-FREE SINGLE FREQUENCY

Frequency Stabilization by Transient Injection Locking

With transient injection locking (TIL), the laser energy from an intense gain-switched CO_2 pulsed plasma can be extracted at a single-mode frequency triggered by an injected (weak-field) radiation. With an internal low pressure CO_2 gain cell, the TIL laser oscillation occurs on a single mode of the resonator lying near the center of a CO_2 amplifying transition. The identity of

*Permanent address: Massachusetts Institute of Technology, Cambridge, Massachusetts 02139.

the laser field inside the resonator as an oscillating sinusoidal field is established after two or three transits across the length of the resonator (after the gain onset). Subsequent oscillation buildup in the single mode (near the line-center) will occur as in a free-running oscillator, without an interference from the (weak) injected field.

In the course of transient oscillation buildup, the oscillating laser frequency ω is subject to time variations caused by refractive index changes of the medium. It is known that by far the dominant source of refractive index change arises from shock waves due to the intense current-pulse producing the high density CO₂ laser plasma. Rapid deposition of energy in the medium causes the shock waves, which propagate at sound speed. However, the onset of violent refractive index changes due to this cause generally occurs at late times (because of propagation at sound speed) exceeding tens of μsec after the current pulse. Accordingly, this effect can result in sizable chirping mainly at the tail of a long duration (several μsec) pulse. In practice, the magnitude of this chirping effect can be minimized by operating at a low plasma-current pulse; this, however, will be at the expense of a reduction in energy-deposition capacity and energy-conversion efficiency.

Another cause of frequency chirping is saturation of the amplifying transition. This effect occurs during a laser pulse if the resonator mode on which laser oscillation occurs is appreciably detuned from the transition center. This chirping effect is largest in the buildup portion (the leading edge) of the pulse. At line-center, however, there will be no contribution to chirping due to this source.

From the above it appears that the chirping will be at a minimum on line-center and for a moderate laser excitation (sacrificing energy-conversion efficiency), particularly for pulse durations below several μsec . However, the studies reported here have revealed additional causes leading to small time dependent refractive index changes during the pulse and, hence, frequency chirping. The dominant process arises from a time dependent change in molecular composition of the medium taking place during each laser pulse. The intense current pulse produces sizable molecular decomposition. The resultant unstable constituents of the gas subsequently evolve (after each current pulse) toward the equilibrium gas mixture. In addition, the effect of redistribution of populations in the low-lying excited molecular states also contributes to a time-varying refractive index change during the laser pulse. Although the refractive index variations due to these causes are small, the resultant frequency chirping can be sizable.

Under the best conditions, the chirping rate on line-center (for a several hundred millijoule laser) can be reduced to a fraction of one MHz/ μsec for pulses below one μsec duration. On the tail of the pulse, extensive heterodyne observations show that the chirp rate will build up to values larger than several MHz/ μsec at times beyond five or ten μsec after the onset of the leading edge of the laser pulse. At this stage of the art, it appears difficult to reduce the frequency chirping below this observed limiting value reported here. It is also to be noted that refractive index variations leading to frequency chirping will be larger in a higher energy laser.

Doppler wind velocity measurements (and other accurate Doppler Lidar applications) require a laser pulse of several μsec duration at a chirp rate below $100 \text{ kHz}/\mu\text{sec}$. A proposed method is described below, offering the possibility of removing the residual frequency chirping from the laser output pulse.

Figure 1 shows the experimental arrangement employed in heterodyne observations of TIL frequency characteristics. Two methods are employed. The first relates to the studies of single-mode TIL operation near line-center obtained with an internal low pressure CO_2 gain cell. In this case, the single-frequency laser output is heterodyned against an external CO_2 laser local oscillator to observe the frequency characteristics. For a variety of reasons, it is advantageous to achieve single-mode TIL energy extraction employing an external CW CO_2 laser master oscillator for TIL driver, as shown in figure 1. (In this case, the internal CW CO_2 gain cell is switched off). The advantages include the possibility of employing the CW TIL driver laser also as the local oscillator in heterodyne detection of the Lidar return signal.

If the external TIL driver laser is detuned from the peak of the resonator mode of the pulsed power oscillator, the TIL laser oscillation occurs at a frequency shifted to the peak of the resonator mode. In the extensive studies of frequency chirping and the related effects, the injected frequency, ω_{Inj} , is detuned by a known amount from the peak of the power oscillator resonator mode. The TIL laser output is heterodyned against the same CO_2 laser employed as the TIL driver laser (see fig. 1).

Detuning of the external TIL driver laser from the center frequency, ω_0 , of the power oscillator resonator mode is obtained as follows: With the intense pulsed plasma switched off, the internal CW CO_2 gain cell is employed to obtain CW laser oscillation at the center frequency ω_0 of the power oscillator resonator mode. (With PZT tuning, the mode is centered on the internal low-pressure CO_2 gain profile.) With heterodyne observation, the TIL driver laser is detuned from ω_0 by a preselected known amount. Rugged and stable resonator configurations are used to avoid appreciable long term drifts (as verified by frequent heterodyne observations in the course of an experiment). Once the known detuning is achieved, the internal CO_2 gain cell is switched off. The TIL energy extraction and heterodyne observations are then performed at the known detuned injected frequency.

It is necessary to decouple radiatively the power oscillator laser totally from LO (and external TIL driver). A ring resonator with appropriate suppressor-mirror (to avoid backward oscillation) and appropriate padding with attenuators are employed.

In accurate observation of frequency chirping, it is important to employ adequate optical isolation and electrical shielding of the high intensity plasma-current pulses (and the LO laser power supply); otherwise, the local oscillator will suffer (due to optical feedback or spurious electrical pickup currents) small frequency variations, rendering the measurements invalid. To verify the absence of such a spurious LO chirping, another LO is used to probe the frequency of the first LO during the short observation time (while the energy extraction from TIL power oscillator occurs). One arrangement to achieve this is shown in figure 1.

It is essential to study frequency chirping effect (due to refractive index variation) at late times (about 5-to-10 μsec). After the onset of TIL laser pulse the tail of the gain-switched pulse generally provides a weak, slowly decaying, laser output at such late times. Although the intensity on the tail is considerably below the main laser pulse, it can be readily detected with heterodyne detection and employed in the studies of frequency chirping. Figure 2 shows typical oscilloscope traces of a photopreionized single-mode TIL laser output (at several hundred millijoule energy per pulse) heterodyned with a CW LO; the heterodyne beatnote (in the MHz range) appears superimposed on the pulse profile. The main pulse is below one μsec and has a long tail. The upper figure is displayed to show the general features of the observation. In the lower trace, the oscilloscope is triggered at about five μsec after the main pulse. It shows an initial zero beat and a subsequent increase in beatnote. At about 10-to-11 μsec after the pulse, the chirp rate has increased to a value of about 3 MHz/ μsec . This displays the limiting chirp rate obtainable in a typical several hundred millijoule photopreionized TIL CO₂ laser. As noted, lasers at higher pulse energies will suffer larger chirp rates. At early times after the onset of the laser pulse, however, the chirp rate can be considerably below the value stated here. This can be obtained by carefully centering the power oscillator resonator mode near the line-center and at a somewhat reduced energy deposition efficiency and uniform excitation across the cross section of a (seed gas) photopreionized CO₂ laser. For a one μsec pulse, the chirp rate can be as low as a fraction of one MHz/ μsec .

Removal of Residual Frequency Chirping From Output Laser Pulse;

A Proposed Method

The proposed chirp removal method employs electro-optic modulation of the laser output at an rf frequency. The modulating rf voltage is obtained from a laser beatnote produced by mixing a small fraction of the intense laser pulse with the output of a stable CW laser. In one embodiment, the stable CW laser frequency (or the frequency of the high-energy pulsed laser) is tuned so that the beatnote appears at a convenient rf range. (This heterodyning is accomplished at large input radiation signals incident on the mixer element, hence the beat voltage across the mixer appears at a sizable signal level). The resultant beatnote, after amplification in a broadband rf amplifier (when necessary), is applied to an electro-optical modulator to produce frequency modulation of the output laser pulse. Inspection will show that one of the rf sidebands will be free from laser chirp. The block diagrams in figures 3 and 4 give a summary description. A variable optical delay is provided to make up for small delays in the rf amplifier circuit. It can be shown that if this delay is not totally corrected, the chirping effect, although reduced by orders of magnitude, will not be totally eliminated; the remaining chirp will be $(d\omega/dt)\tau$, where $(d\omega/dt)$ is the chirp rate at the output of the pulsed laser and τ is the delay time. (In practice, τ can be reduced to values below several nsec.)

In an ultimate design it is possible to employ single sideband e.o. modulation, converting more than 50 percent of a (e.g., ten joule) laser output pulse to a nearly chirp-free sideband. Depending on the laser intensity, it will also

be possible to use the e.o. modulator in the form of a thin (possibly waveguide type) sample to achieve high conversion efficiency at reduced modulator rf voltages.

Other applications require a pulsed chirp-free master-oscillator unit at a reasonably large output power level; the master-oscillator unit can then be used in a MOPA configuration to extract a chirp-free amplified output from a high energy power amplifier. If the master oscillator provides a reasonably large output power, the requirements for multipass power amplification will be enormously relaxed. (In the existing MOPA systems, multipass amplification with intricate isolation stages are needed because of low-level power outputs of the existing stable master oscillators. This is the main reason for complexities of the existing high energy MOPA systems.) A longitudinally excited low pressure Q-switched CO₂ laser, for example, can be used in the chirp-removal system suggested here. Such a Q-switched CO₂ laser, after chirp removal, can be used as a master oscillator at a relatively high peak intensity in a MOPA system.

This proposed method, yet to be developed, was presented in the conference workshop because of its potential application in generation of chirp-free radiation for accurate Doppler Lidar.

ENERGY EXTRACTION FROM GAIN-SWITCHED HIGH PRESSURE CO₂ LASER AT A STABLE TUNABLE MONOCHROMATIC FREQUENCY

Energy extraction by Transient Injection Locking (TIL) at a tunable frequency requires the utilization of an external tunable master oscillator, driving an intense pulsed power oscillator at the tunable frequency. In this system a weak radiation field (from the tunable master oscillator) is introduced in the resonator of the pulsed power oscillator at the frequency of a selected resonator mode. As the power oscillator gain is rapidly switched on, under appropriate conditions, laser oscillation buildup occurs at the single-mode selected by the frequency of the weak injected field. This is a transient process and appreciably differs from the previously known steady state injection locking. The transient injection locking under consideration in this talk is an extension of the well known art of superregenerative amplification in the microwave region, where enormously large gains are obtained with a (repetitively pulsed) gain-switched microwave (or rf) oscillator, driven by a weak (input) signal.

An important feature of the TIL process relates to its transient nature: the oscillation "buildup" at the selected single mode will "hold on" only for a limited time duration. The oscillator will switch after a short time interval (determined by the injected field) into its free-running oscillation mode.

If the weak-field injected radiation is introduced at the frequency of one of the resonator modes lying near the peak of a high-gain line - consider, e.g., a power oscillator with a grating resonator tuned to the high-gain line - the time duration of switchover (to the steady-state oscillating mode) is generally long. However, if the selected mode is appreciably detuned from the peak of the high-gain line, unless the injected field has sufficient intensity, the

switchover from the selected mode to the free-running oscillating mode (or modes) will occur in the early times during transient oscillation buildup.

For a power oscillator with a resonator employing broadband reflectors (without a grating), injection of a weak field at the frequency of a low-gain transition of the CO₂ amplifying band will cause initial oscillation buildup to occur on the selected mode of the low-gain line. The free-running oscillation (without the injected field), however, occurs on several modes of the high-gain line of the amplifying band. Accordingly, the switchover from the TIL on the low-gain line will generally occur to multimode oscillation on the line with the highest gain.

Energy extraction at the frequency of a resonator mode selected by TIL will be complete if the switchover time to free-running oscillation occurs at late times after the main pulse (i.e., it takes place on the decaying tail of the laser pulse). If appropriate conditions are not satisfied, the switchover time will be in the early buildup time (or at a time during the main pulse), in which case TIL energy extraction at the desired frequency will not be complete.

Complete-versus-partial TIL energy extraction is a subject requiring extensive scrutiny for a tunable TIL laser. This important problem is not encountered for a TIL gain-switched CO₂ laser with an internal low pressure gain cell (causing line-center TIL). The internal low pressure gain cell selects a mode near the center of a high-gain line and, hence, as noted previously, the switchover time to the free-running oscillating mode (which may be, e.g., another resonator mode adjacent to or in the vicinity of the selected mode) will take place at late times on the tail of the pulse. However, the switchover process can be an important effect if the injected radiation is introduced at a frequency where the gain of the medium is lower than the peak gain (even by as much as five or ten percent).

The switchover time duration critically depends on several parameters. They consist of: (a) Intensity of the injected radiation, (b) the gain-above-loss-factor at the mode selected by the injected field compared to the gain-above-loss factor in the region where free-running oscillation can occur, (c) the detuning of the frequency of the injected field from center-frequency of the selected resonator mode, and (d) the saturation parameters of the medium determined by pressure effect.

For the power-oscillator laser at a fixed pressure, and a given resonator loss factor, the condition for complete energy extraction by TIL can be described by a threshold intensity, I_{th} , of the injected field inside the resonator. This threshold is defined by the intensity of the injected radiation causing the switchover time to take place at times not shorter than two or three times the duration of the main pulse. Accordingly, the threshold intensity (for complete TIL energy extraction) will depend on the gain factor at the injected frequency, and the detuning of it from the peak of the selected resonator mode.

The work of colleagues (ref. 1) in Canada on TIL of a gain-switched CO₂ laser (and the other workers) have addressed the problem of line-center TIL on a high-gain line. Energy extraction in such a system is always in the "complete

regime". The previous works have not dealt with TIL energy extraction at a tunable frequency, requiring an understanding of the complete-versus-partial TIL energy extraction presented here (for the first time).

In the experimental studies discussed here, the TIL process is explored in the line-center region, as well as at frequencies appreciably detuned from the CO₂ line centers. In the line-center observations, an external line-tunable low pressure CW CO₂ laser is used as the TIL driver master oscillator. In this case, e.g., complete-versus-partial energy extraction on a low-gain line is explored by TIL of a gain-switched power oscillator employing a broadband resonator. In this case the switchover from line-center TIL on the low-gain line will take place to free-running multimode oscillation on the highest gain line.

The energy extraction at frequencies appreciably detuned from CO₂ line centers are studied employing an external line-tunable low pressure N₂O laser as the TIL driver master oscillator. It is known that the N₂O and CO₂ amplifying bands (in the 10.6 μm region) overlap one another. Several N₂O laser lines lie at known frequencies detuned from the center frequencies of nearby CO₂ lines. With a gain-switched CO₂ power oscillator at varying pressures (corresponding to varying collision broadened linewidths), off-line center TIL is studied employing the N₂O TIL driver laser. This process is also studied using the CO₂ power oscillator with a grating tunable resonator containing within it a low pressure N₂O gain cell.

Figure 5 is a schematic of well-known TIL with an internal low pressure gain cell. Observation of a smooth output pulse is a good indication of TIL. This is observed with the low pressure gain cell switched on. Without the low-pressure gain cell, the output is accompanied with beatnotes originating from multimode operation.

Figure 6 is schematic of a tunable TIL employing an external (tunable) master oscillator.

Figures 7, 8, and 9 relate to complete-versus-partial TIL energy extraction. The upper trace in figure 7 is a computer modeling theoretical estimate for a case in which an injected field at 20 mW intensity is introduced in the resonator of a gain-switched CO₂ power oscillator at the frequency of the P(10) line (with the power oscillator laser employing broadband resonator reflectors). The main pulse shows buildup and decay of the P(10) line. Full scale abscissa is 10 μsec. The gain-switched pulse is followed by a long tail (caused by transfer from N₂O to CO₂). The switchover to the free-running oscillation on the P(18), the high-gain line, is also displayed (the lower trace). In this case (which corresponds to a non-complete energy extraction), the total laser output will consist of a superposition of the two curves, with the main peak dominantly consisting of the P(10) line and an early switchover on the tail to the P(18) line. This figure 7 also shows experimentally observed near-complete TIL energy extraction with about one mW injected radiation in the P(12) line. The switchover occurs to the P(18) line on the tail of the pulse. When this occurs, the P(18) line appears (as in a free-running oscillator) with multimoding. The breaking into a multimode operation seen on the decaying portion of the observed pulse is due to the switchover from single mode TIL P(12) line to multimode free-running

P(18) line. For clarity of presentation, the lower figure is a hand drawing of the somewhat faint (high speed) oscilloscope picture of the experimental trace shown.

Figure 8 shows the observed pulses described in figure 7, except the injected field intensities are varied. The two traces in figure 8 show the control of switchover time by injected field intensity.

Figure 9 shows the observed pulses described in figure 7 for about 50 mW injected radiation, showing complete energy extraction (with the switchover time delayed to late times on the tail not appearing on the trace). The intensities of the injected field for figures 7, 8, and 9 correspond to the injected frequency, ω_{inj} , tuned to the center frequency of the power oscillator resonator mode (via the method described in the explanation of figure 1). Additional details of figures 7, 8, and 9 will be published by S. Nazemi and A. Javan.

Figure 10 lists several N₂O laser lines at frequencies differing by known amounts from CO₂ line centers.

Figure 11 illustrates that the threshold injected field intensity for complete energy extraction (I_{th}) depends on the parameter N given in the figure. As is seen, the parameter N in turn depends on pressure broadened linewidth as shown. I_{th} at a fixed detuned frequency is considerably lower for a broader line (higher pressure).

Figure 12 gives the TIL threshold intensity, I_{th} , for complete energy extraction at a detuned frequency employing the R(10) N₂O line (at 1980 MHz removed from P(16) CO₂ line center). The threshold injected intensity (value for inside resonator), I_{th} , is given at 3 different pressures. At about one atmosphere pressure, larger than 50 mW is required for complete TIL energy extraction. At about 2.5 atmospheres, on the other hand, 3 μ W is sufficient for complete energy extraction (at the detuned N₂O frequency). The threshold values are given for the injected field carefully tuned to the peak of the power oscillator resonator mode, with the method extensively described in the explanation of figure 1, employing CW N₂O lasers (and gain cell) instead of CW CO₂ lasers (and gain cell), see figure 1.

We mention here, with great emphasis, that an important aspect of engineering of a tunable TIL CO₂ laser is control of the power oscillator resonator mode with respect to the frequency of the tunable injected radiation. Based on extensive component-by-component experimental investigations, a frequency tracking unit, complete with fine control and calibration, has been designed and is under consideration by NASA LaRC for possible implementation. Future publications will describe the control system.

Tunable frequency energy extraction by TIL from an energetic gain switched CO₂ laser can be achieved with a TIL driver input consisting of a frequency tunable laser pulse (low energy) with a duration as short as about ten nsec (or longer). A grating tunable photopreionized high pressure CO₂ laser can be reliably operated (with seed gas photoionization) at output energies in the ten to fifty mj range. Such a high pressure laser can be tuned to frequencies appreciably detuned from CO₂ line centers. However, the spectrum of the grating

tunable high pressure pulsed CO₂ laser is generally broad. It consists of multimode oscillation spread over a range of about 2000 MHz. This laser, by itself, is inadequate for use as a driver TIL master oscillator. On the other hand, if it is followed by an appropriate Fabry-Perot filter, it is possible to reproducibly select one (or two) oscillating modes for use as a tunable TIL driver master oscillator. (Controlling the tuning can be achieved with simultaneous - ganged - laser grating and Fabry-Perot filter tuning.)

In the system employed, the selected (filtered) oscillating modes appeared (after the filter) at a pulse duration somewhat below 100 nsec at a peak intensity of about 0.1 to 1 kW. The CO₂ power oscillator was triggered at a (variable) delayed time with respect to the pulsed driver master oscillator. The pulsed injected field is introduced in the gain-switched CO₂ power oscillator during the early buildup time. By varying the delay, it is found that about 100 nsec time window is readily available to achieve TIL with the injected pulse. This experiment has been successfully performed. However, detailed observations (and the possible utilization in a remote sensing experiment) are presently postponed for a later date.

A short pulse TIL driver master oscillator cannot be used at the same time for heterodyne detection of the Lidar return signal. (The return signal arrives at a delayed time.) Such a system would require a separate LO laser (such as a tunable diode laser) in the Lidar detection system.

A gain-switched CO₂ power oscillator operating at a multiatmospheric pressure, driven with an appropriate TIL driver master oscillator, can offer frequency tunable output in ranges considerably detuned from CO₂ line centers. An isotopic high pressure CO₂ laser can be operated closed cycle (sealed off) with catalytic CO₂ regeneration. Such an isotopic CO₂ laser, reliably operating with seed gas photopreionization (refs. 2 and 3), offers broad frequency tuning at about 3 atmospheres pressure.

An important tunable master oscillator available for TIL driver is the system consisting of a line tunable CW CO₂ laser followed by a tunable microwave e.o. modulator (ref. 4). The tunable microwave sidebands have sufficient intensity for TIL energy extraction.

With a tight control of the power oscillator resonator mode and its centering on the injected frequency, it should also be possible to employ a tunable diode laser as the tunable TIL driver master oscillator.

Another possibility (suggested by A. Mooradian of Lincoln Laboratory) is parametric mixing of a CO and CO₂ laser to generate discretely tunable radiation (by about 150 MHz spacing) over a broad region in the 10 μ m range.

A tunable TIL in the CO₂ line center region (applied to an atmospheric differential remote sensing experiment) has been reported (ref. 5) by R. Menzies with a tunable (by several hundred MHz) waveguide CO₂ laser.

An ideal widely tunable master oscillator for a differential absorption (ref. 6) experiment, however, is a miniature e-beam sustained CO₂ laser currently under extensive development.

PRECISION MINI E-BEAM-SUSTAINED TUNABLE CW CO₂ LASER;

A COMPONENT-BY-COMPONENT DESIGN STUDY

A design-study project is in progress to construct a miniature e-beam sustained tunable CW CO₂ laser, with a thin pencil-like plasma volume (of about 10 cm × 1 (mm)²), capable of operating at pressures as high as 3 to 4 atmospheres. Such a laser will offer a fine frequency-tuning characteristic, with a single-mode output at a CW output power up to about 50 watts. The removal of deposited heat energy (necessary for CW operation) is achieved by rapid transverse gas flow. The thin cross-section of the pencil-like plasma facilitates the heat removal at a subsonic flow. The design calls for operation at a sustainer voltage below avalanche breakdown, where the totality of the electrons in the thin pencil-like CO₂ plasma is produced by the secondaries from the incident primary e-beam. The e-beam is in the form of a thin ribbon transmitted through a thin foil.

The operating pressure under consideration is up to 3 to 4 atmospheres, where broad tuning can be obtained, as in reference 3, with an isotopic CO₂ gas mixture.

It is necessary to employ a low-Fresnel number resonator with a short mirror spacing (13 cm in the present design).

The requirement for a short low-Fresnel number resonator together with the miniature nature of the device calls for novel design considerations within severe space limitations (of the miniature laser). The short resonator of the laser facilitates energy extraction at a minimum diffraction loss.

The electron gun is of the plasma cathode design. Figure 13 shows internal components of the electron gun made visible by removal of the anode. The hollow cathode and its concentric shield are precisely aligned inside the vacuum box (left) by means of two high voltage feedthroughs which are not seen in this view. The anode plate is 2 cm thick to allow for water cooling channels. A wide slot is cut out of the central portion of the anode. This is covered on the vacuum side by a thin narrowly slotted plate to permit electron passage into the 2 cm long field free region. A 0.3 mil thick aluminum window seals the outside of the wide anode slot. This device produces a uniform, stable, cw electron beam 9 cm long and 0.2 cm wide at a current density of 300 μA/cm² and energy of 30 keV.

Figure 14 is an electron gun similar to that shown in figure 13 in operation with the ribbon-like beam emerging into the atmosphere. In this view the two H.V. feedthroughs are visible emerging from the vacuum chamber. Also visible is the glow of ionized air in the path of the electron beam. The uniformity of the glow reflects the uniformity of the emergent beam.

The author expresses acknowledgment to the Spectroscopy Branch, LaRC, Virginia, headed by R. V. Hess, for continued encouragement and support. The program has extensively benefited from the modeling estimates and other investigations of the branch, specifying the various requirements.

REFERENCES

1. Lachambre, J.; Lavigne, P.; Otis, G.; and Noel, M.: Injection Locking and Mode Selection in TEA-CO₂ Laser Oscillators. IEEE J.Q.E., vol. QE-14, no. 3, p. 756, March 1978. Lachambre, J.; Lavigne, P.; Verreault, M.; and Otis, G.: Frequency and Amplitude Characteristics of a High Repetition Rate Hybrid TEA-CO₂ Laser IEE J.Q.E., vol. QE-14, no. 3, p. 170, March 1978.
2. Gibson, R. B.; Javan A.; and Boyer K.: Sealed Multiatmospheric CO₂ TEA Laser: Seed-Gas Compatible System Using Unheated Oxide Catalyst, Appl. Phys. Lett., vol 32 (726), 1978.
3. Gibson, R. B.; Javan, A.; and Boyer, K.: Mixed Isotope Multiatmospheric CO₂ Laser, IEEE J.Q.E., Nov. 1979.
4. Cheo, P. K.: Generation and Applications of 16 Ghz. Tunable Sidebands from a CO₂ Laser. Proceedings of 3rd International Conference on Laser Spectroscopy, Jackson Lake Wyoming, July 4-8, 1977. Sachse, G. W.; and Cheo, P. K.: A Microwave Tunable Laser Source for the Infrared. Conference on Laser and Electro Optical Systems, San Diego, California, February 26-28, 1980.
5. Menzies, R. T.; and Shumate, M. S.: Tropospheric Ozone Distributions Measured with an Airborne Laser Absorption Spectrometer. Journal of Geophysical Research, vol. 83, no. 18, August 20, 1978.
6. Brockman, P.; Hess, R. V.; Staton, L. D.; and Bair, C. H.: DIAL With Heterodyne Detection Including Speckle Noise: Aircraft/Shuttle Measurements of O₃, H₂O, and NH₃ With Pulsed Tunable CO₂ Lasers. Heterodyne Systems and Technology, NASA CP-2138, 1980. (Paper 39 of this compilation.)

Work reported is in part performed in collaboration with J. S. Levine, and M. Guerra, LDC, Lexington, Mass., and with S. Nazemi and C. Davis, MIT, Cambridge, Mass. The development and engineering of lasers for remote sensing is done at LDC under sponsorship of NASA LaRC; the MIT work has been under NSF support.

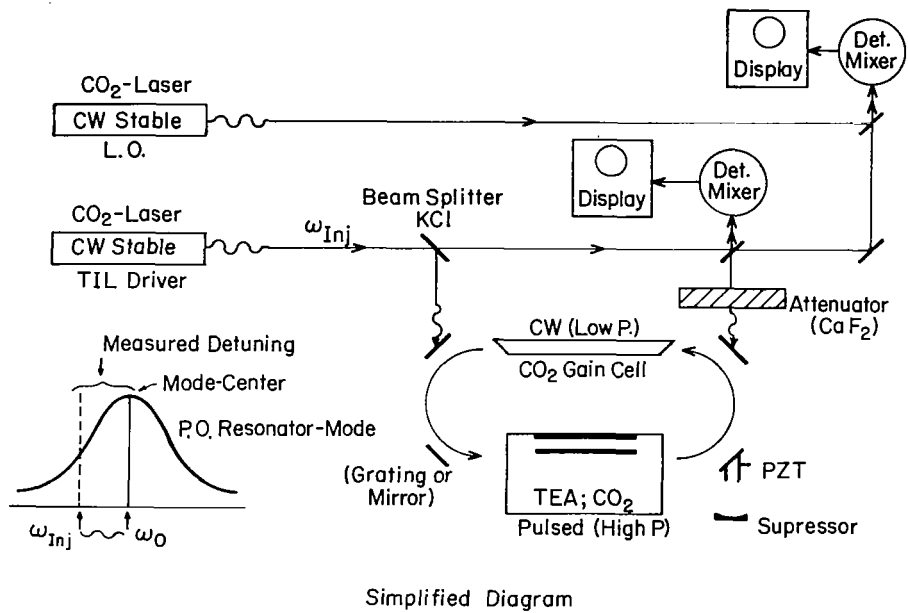
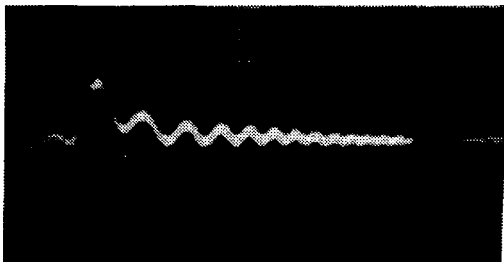
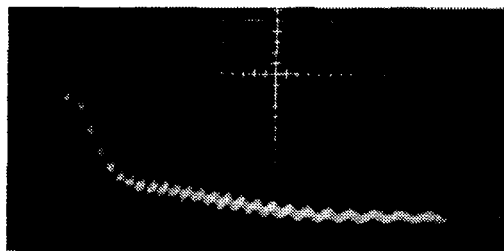
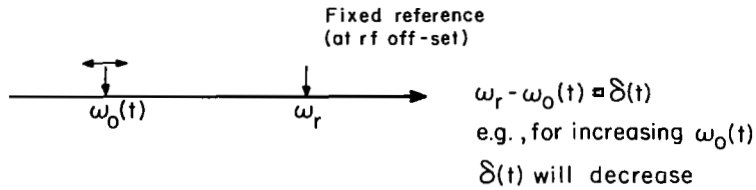
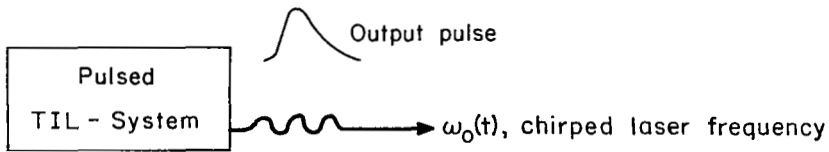

Figure 1.- TIL characteristics; heterodyne observations in the CO₂ line-center region.



1 μsec/cm

Figure 2.- Heterodyne signal ring power oscillator (TIL) display of chirping at late times.



Suppose could generate radiation exactly at $\omega_0(t) + \Delta(t)$; This will be chirp-free
 $\omega_0(t) + [\omega_r - \omega_0(t)] = \underline{\omega_r}$

Figure 3.- A method for removal of frequency chirp from a pulsed laser: concept.

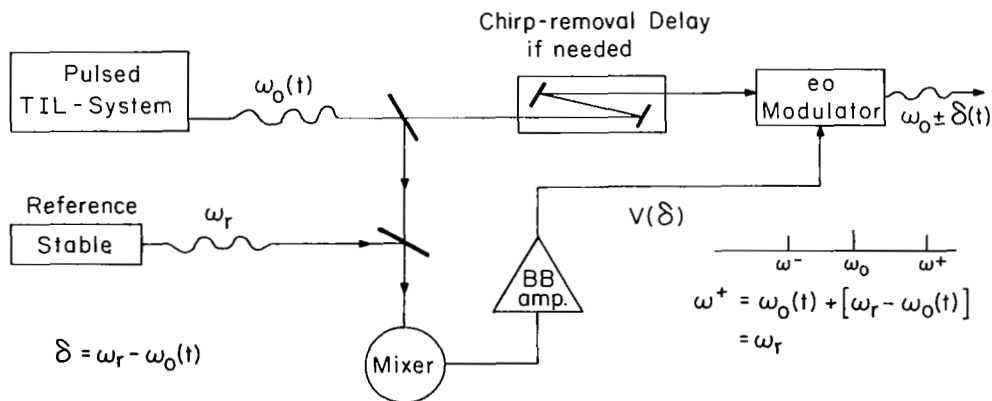

Can be shown that a delay $d\tau$ will leave a residual chirping:

$$\omega^+ = \omega_r + \frac{\partial \omega_0}{\partial t} \tau$$

e.g. for (conservative) $\frac{\partial \omega_0}{\partial t} = 1 \text{ MHz} / \mu\text{sec}$ and $\tau < 10 \text{ nsec}$

Figure 4.- A method for removal of frequency chirp from a pulsed laser: experimental arrangement.

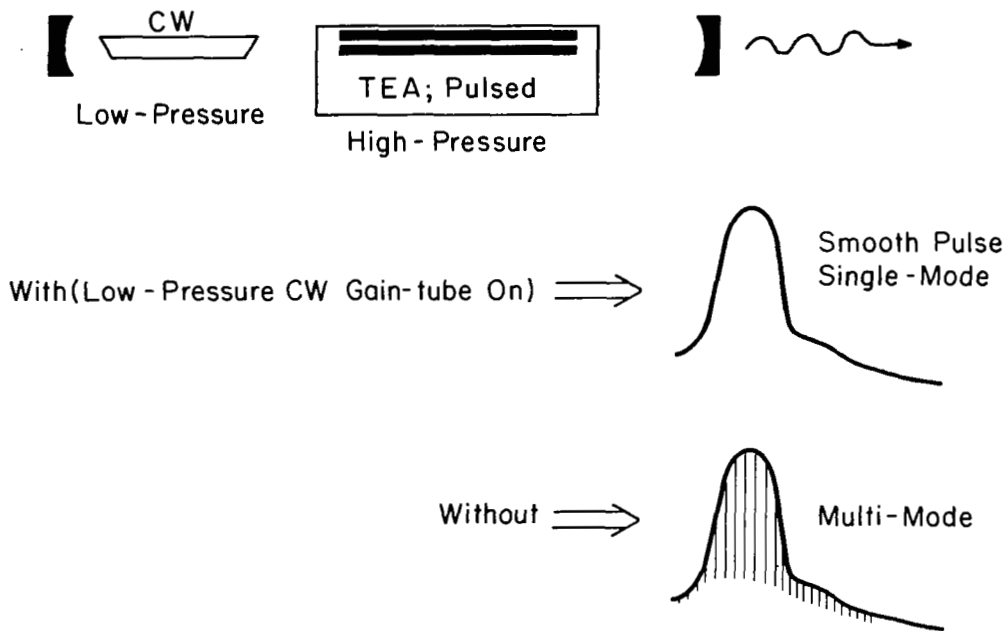
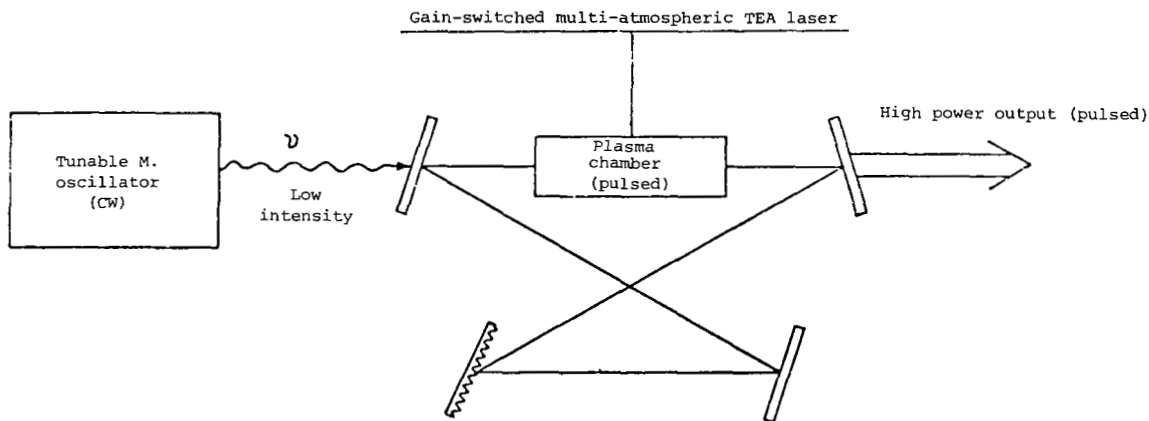

Figure 5.- Pulse-smoothing: TIL with an internal gain-tube.



Ring Resonator Grating Is Broadly Tuned To The Desired Frequency Region. The Injected Weak Input, Tuned To The Appropriate Frequency, Will Cause Near-Complete Energy Extraction At A Single-Mode Frequency (Close To The Injected Frequency)

Figure 6.- Schematic of tunable Transient Injection Locking.

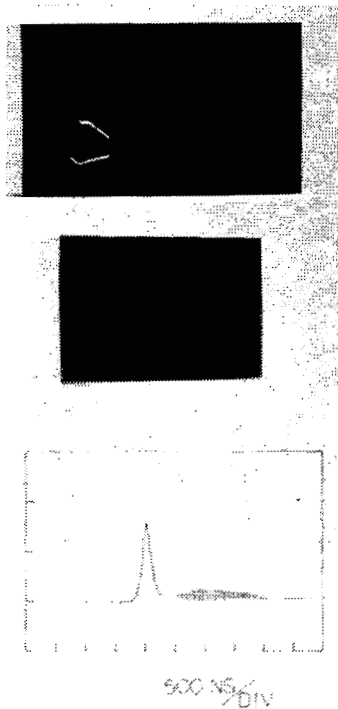

Figure 7.- Theoretical and experimental energy extraction by Transient Injection Locking.

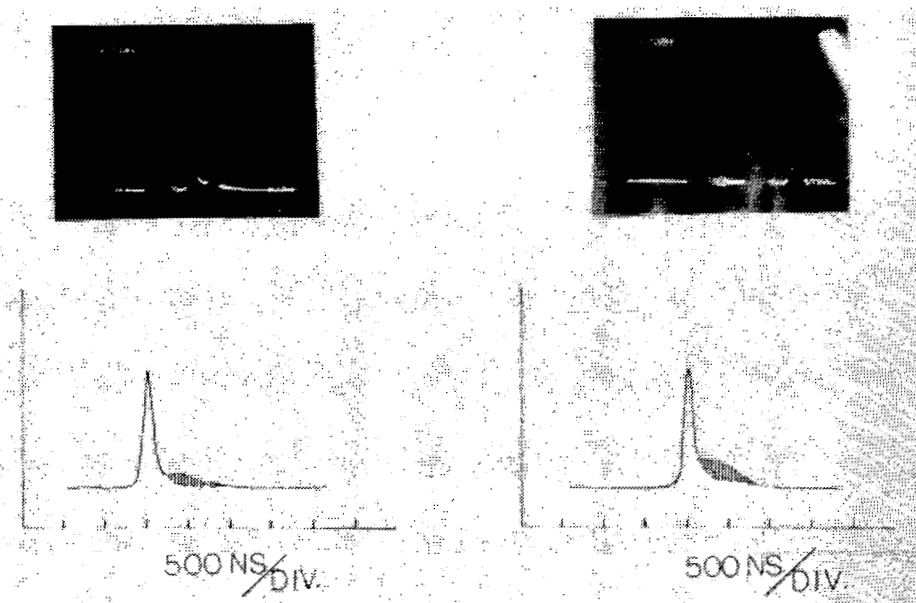
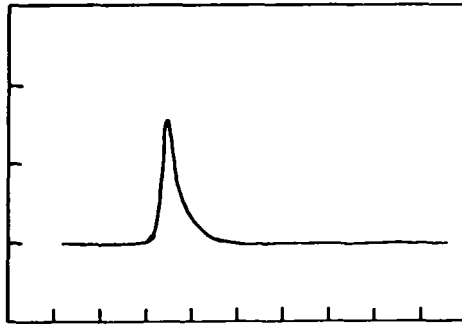
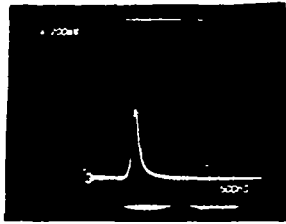

Figure 8.- Effect of varying injected power on the time-of-onset of multimoding.



500 NS/DIV

Figure 9.- Complete energy extraction by Transient Injection Locking for the case of strong injected radiation.

$$\delta = \nu(\text{N}_2\text{O}) - \nu(\text{CO}_2)$$

$$\left. \begin{array}{l} \text{N}_2\text{O} \text{ R}(10) \\ \text{CO}_2 \text{ P}(16) \end{array} \right\} \delta = 1986 \text{ MHz}$$

$$\left. \begin{array}{l} \text{N}_2\text{O} \text{ P}(7) \\ \text{CO}_2 \text{ P}(32) \end{array} \right\} \delta = -586 \text{ MHz}$$

$$\left. \begin{array}{l} \text{N}_2\text{O} \text{ R}(21) \\ \text{CO}_2 \text{ P}(6) \end{array} \right\} \delta = 4844 \text{ MHz}$$

$$\left. \begin{array}{l} \text{N}_2\text{O} \text{ R}(16) \\ \text{CO}_2 \text{ P}(10) \end{array} \right\} = -10891 \text{ MHz}$$

Figure 10.- Difference frequencies for some N₂O and CO₂ laser lines.

$$N = \frac{g(\omega_o) - g(\omega_{INJ})}{g(\omega_o)}$$

I_{TH} = THRESHOLD INJECTED INTENSITY FOR
COMPLETE ENERGY EXTRACTION BY TIL

I_{TH} DEPENDS ON N

(SWITCHOVER TIME DEPENDS ON N)

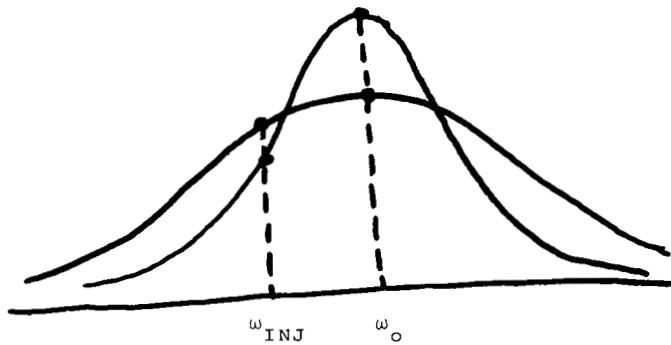

Figure 11.- Threshold for complete energy extraction versus detuning from line center.

I_{TH} VERSUS PRESSURE

$$\begin{aligned} \delta &= \omega - \omega_o \\ &= 1980 \text{ MHz} \end{aligned}$$

P (in PSI)	15	27	40
I_{th}	> 50 mW	3 mW	3 μ W

Figure 12.- TIL at detuned frequencies:
 I_{TH} versus pressure.

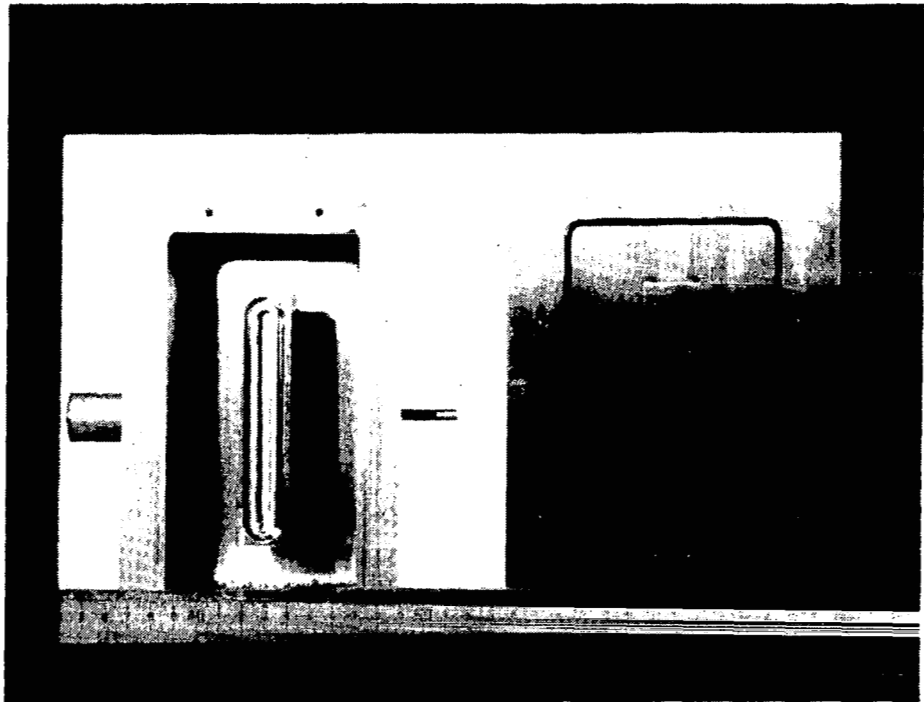

Figure 13.- Internal view of plasma cathode electron gun.

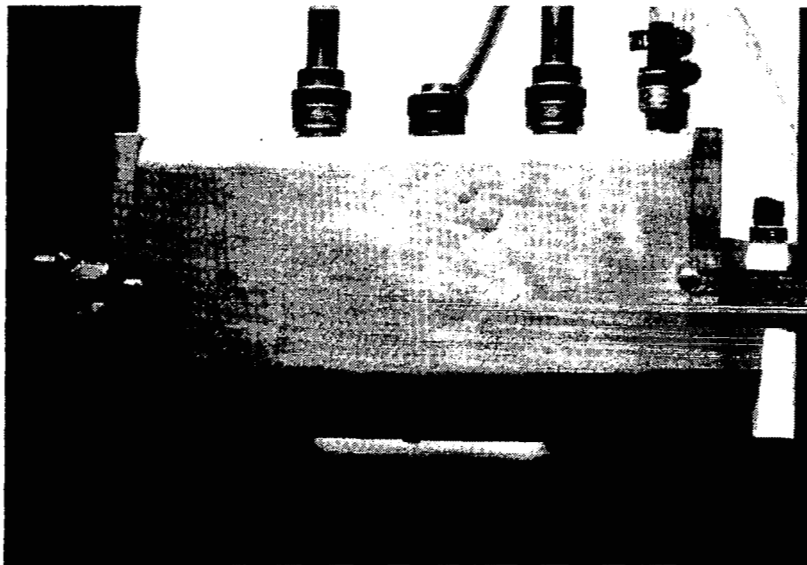

Figure 14.- Plasma cathode electron gun operating in air.