

## N O T I C E

THIS DOCUMENT HAS BEEN REPRODUCED FROM  
MICROFICHE. ALTHOUGH IT IS RECOGNIZED THAT  
CERTAIN PORTIONS ARE ILLEGIBLE, IT IS BEING RELEASED  
IN THE INTEREST OF MAKING AVAILABLE AS MUCH  
INFORMATION AS POSSIBLE

# NASA TECHNICAL MEMORANDUM

NASA TM-78288

(NASA-TM-78288) SHUTTLE TIME AND FREQUENCY  
TRANSFER EXPERIMENT (NASA) 32 p  
HC A03/MF A01 CSCL 22A

N80-30342

Unclas  
G3/12 28542

## SHUTTLE TIME AND FREQUENCY TRANSFER EXPERIMENT

By D. W. Allan, C. O. Alley, R. Decher,  
R. F. C. Vessot, and G. M. R. Winkler

June 1980

NASA

*George C. Marshall Space Flight Center  
Marshall Space Flight Center, Alabama*



## TABLE OF CONTENTS

	Page
I. INTRODUCTION .....	1
A. Background .....	1
B. Experiment Concept .....	1
II. NEED FOR GLOBAL HIGH-PRECISION CLOCK COMPARISON ..	5
A. Present High-Precision Timing Operations .....	5
B. Primary Frequency Standards .....	5
C. Capabilities of the Proposed Experiment .....	6
D. Comparison with Other Experiments or Existing Operational Capabilities .....	6
E. Potential Users and Future Requirements .....	9
III. EXPERIMENT DESCRIPTION .....	11
A. Objective .....	11
B. Space Clocks .....	11
C. The Laser Time Transfer System Concept .....	12
D. Previous Demonstration .....	15
E. Relation to Laser Range Measurement .....	17
F. System Description .....	17
G. The Microwave Technique for Simultaneous Frequency and Time Comparison .....	19
H. Performance of the Systems .....	21
IV. OPERATIONAL CONSIDERATIONS .....	25
V. CONCLUDING REMARKS .....	27

PRECEDING PAGE BLANK NOT FILMED

## LIST OF ILLUSTRATIONS

Figure No.	Title	Page
1	Shuttle time and frequency transfer experiment .....	3
2	Cost of portable clock method .....	8
3	User locations .....	10
4	Stability of spacecraft clocks .....	13
5	Space-time diagram for clock comparison .....	14
6	Laser comparison of atomic clocks .....	16
7	Laser system block diagram .....	18
8	Range distance versus time diagram showing propagation of signals between Earth and space stations .....	20
9	Schematic functional concept of Doppler cancelling frequency and time comparison system adapted to the NASA unified S-band system .....	22
10	Stability comparison .....	23

## NASA Technical Memorandum 78288

### I. INTRODUCTION

#### A. Background

The NASA Office of Space and Terrestrial Applications (OSTA) is considering a Space Shuttle experiment to demonstrate techniques for global high-precision comparison of clocks and primary frequency standards. The experiment will involve a hydrogen maser clock on board the Shuttle. Transmission of microwave and pulsed laser signals will be used to compare the space clock in the Shuttle with a clock in a ground station. The goal of the proposed experiment is to demonstrate time transfer with accuracies of 1 nsec or better, and frequency comparison of clocks at the  $10^{-14}$  accuracy level. The capability to compare frequencies with an accuracy of  $10^{-14}$  is a unique feature of the proposed experiment. No other technique or experiment in existence or planned has this capability.

This report outlines the concept of the experiment. The basic ideas of the experiment were developed by a small study team consisting of the authors of this report. Studies are in progress to define details of the experiment systems and operation. A more detailed technical report will be prepared in the future.

The stability and accuracy of precision clocks and primary frequency standards have improved far beyond present capabilities to transfer time and frequency information between widely separated standards. Primary standard laboratories exist in many nations around the world, and coordination of an international time scale with time transfer accuracy at levels commensurate with the stability of clocks is now a very serious problem. The most accurate time transfer method now in use is the transportable clock which can provide time transfer over intercontinental distances with an uncertainty of approximately 10 nsec. The transportable clock method has many logistic problems and is very expensive if high accuracies are required.

#### B. Experiment Concept

The proposed orbiting clock experiment can be viewed as an extension of the transportable clock methods to make time and frequency transfer available at frequent intervals

with worldwide coverage. A hydrogen maser clock will be carried on board the Space Shuttle, and simultaneous transmission of microwave and laser pulse signals will be used to compare these two techniques as well as the clocks themselves (Fig. 1).

The microwave system that provides time and frequency transfer will be similar to a system used with the Gravitational Probe A (GP-A) flown in 1976. Frequency comparison of a space clock and a ground station clock at the  $10^{-14}$  level was demonstrated during the GP-A mission. The same technique can be used for global frequency comparison of primary standards. The microwave system uses three continuous wave (CW), phase-coherent, S-band carrier frequencies that provide one-way and two-way Doppler measurements. The first-order Doppler effect and propagation disturbances are cancelled automatically (in real time) by proper processing of the signals. A time code modulation will be applied to the CW carriers to accomplish time transfer.

A pulsed laser timing system will be used in parallel with the microwave system. Transmission of pulsed laser signals is the most accurate technique in existence for time comparison of clocks. Accuracies around 0.05 nsec have been demonstrated. The main disadvantage of the laser technique is its sensitivity to weather conditions, which is a serious drawback for an operational system, while the microwave transmission is practically independent of weather conditions. Also, a direct frequency comparison of primary standards is not possible with laser techniques in the foreseeable future. The short-pulse laser timing system will provide a calibration of the microwave method. Simultaneous transmission of laser and microwave pulse signals will yield interesting data about wave propagation and other possible effects at very high precision. The on-board equipment of the laser timing system includes a corner reflector array combined with photodetectors and associated electronics to measure the arrival time of the laser pulses in the time frame given by the on-board clock. The laser ground terminal will measure the round-trip time of the laser pulse. This short-pulse laser technique has been used previously with other experiments.

Except for its relatively low orbital altitude, the Space Shuttle is ideal for this type of demonstration experiment. The experiment package will be mounted on a pallet in the Shuttle bay. The best locations for the microwave antenna and corner reflector array have yet to be

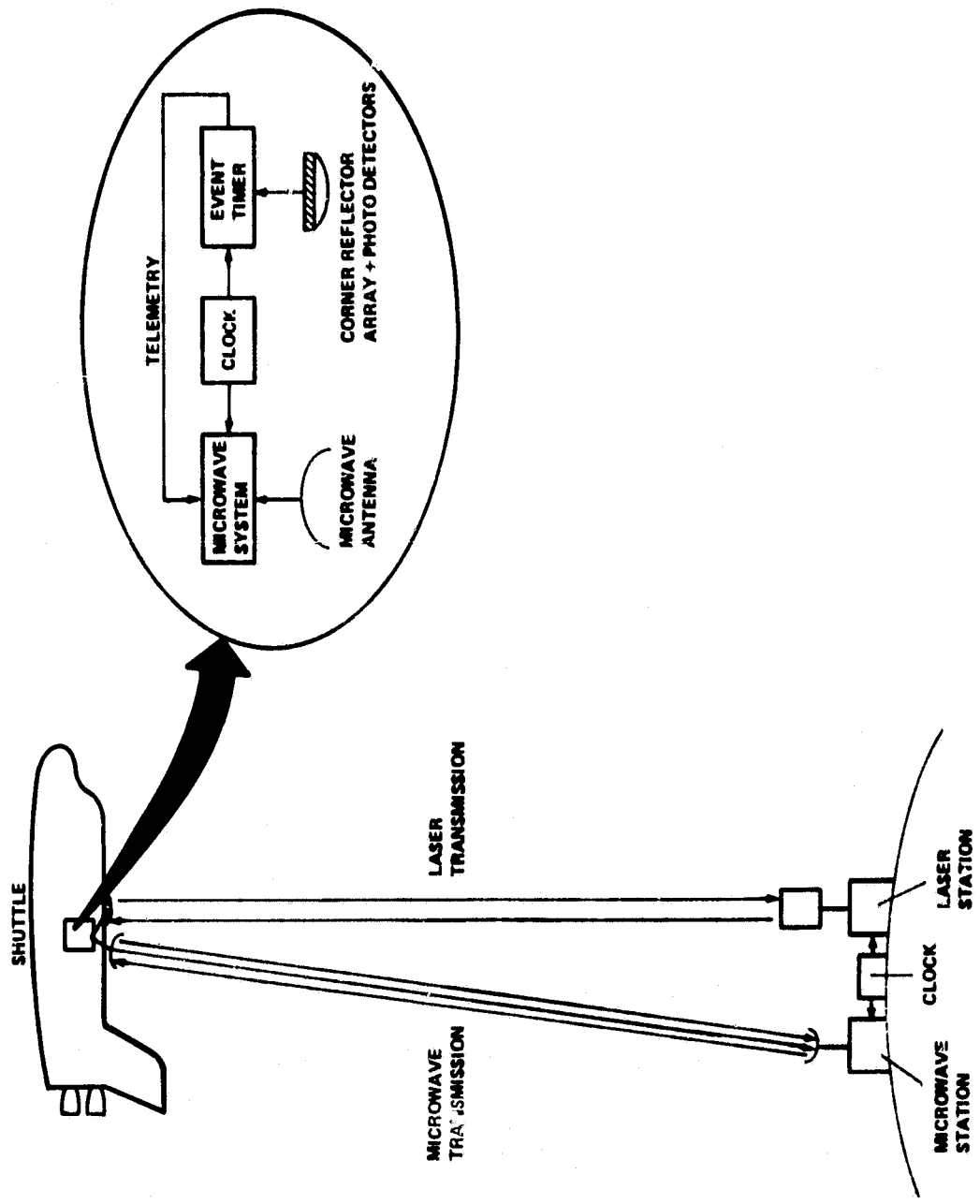

Figure 1. Shuttle time and frequency transfer experiment.

determined. While a single Shuttle mission will be sufficient to demonstrate the techniques and systems performance, return of the experiment hardware provides the possibility of reflight (and experiment modification), if desired, at minimum cost. Although the altitude of Shuttle orbits is lower than the optimum orbit desirable for a possible later operational system, reducing the time available for comparison of clocks during the pass over a ground station, the Shuttle orbits are adequate to demonstrate the capability of the proposed techniques and to predict the performance of an operational system. High inclination ( $57^\circ$ ) orbits planned for a variety of Shuttle missions will give adequate global coverage, including all of the primary standard laboratories and most of the other important stations, should any of these desire to participate in the demonstration experiment.

The proposed Shuttle demonstration experiment will use existing technology and off-the-shelf hardware to the greatest extent possible to minimize the cost. After a successful demonstration, the experiment could evolve into an operational system for global time and frequency transfer using a free-flyer or a space platform. There are indications of international interest in participating in the demonstration and a future operational system.



## II. NEED FOR GLOBAL HIGH-PRECISION CLOCK COMPARISON

The following discussion is focused on an operational time and frequency transfer system and describes the need and worldwide use of such a system. The proposed demonstration experiment on the Shuttle may use only one ground station, which is adequate to demonstrate the techniques.

### A. Present High-Precision Timing Operations

In the Western world alone there are at present more than 2000 cesium beam clocks in use. There are many more (in the order of 10 000) rubidium vapor cell clocks and approximately 50 hydrogen masers in use. All these high-precision clocks operate in reference to standards that make the clocks traceable to the various National Time Services which are, in turn, coordinated with the Bureau International de L'Heure (BIH) at the Paris Observatory. This coordination effort is supported through the synchronization of the various LORAN C chains to the U.S. Naval Observatory (USNO) master clock that serves as their time reference. The precision so far obtainable is approximately 200 nsec, but larger variations occur seasonally and necessitate regular calibrations with a portable clock. The portable clock technique represents currently the only high-precision operational link between the major national standards laboratories, three of which--the NBS (Boulder, Colorado), the NRC (Ottawa, Canada), and the PTB (Braunschweig, W. Germany)--provide the only input to the BIH regarding absolute rate accuracy of the international reference TAI (temps international atomique). Unfortunately, the coverage of LORAN C is limited to the Northern Hemisphere and, therefore, there are no Southern latitude National Time Services or standard laboratories in this BIH system.

In summary, there are two coordination links of importance to timekeeping: the intercomparison of approximately 90 clocks for the day-to-day computation of TAI and the links of the three standard labs that operate absolute frequency standards for the provision of high-precision frequency measurements of TAI for long-term calibration of this reference time scale.

### B. Primary Frequency Standards

Currently, there are three operating primary frequency standards throughout the world: one (NBS-6) located at NBS in Boulder, Colorado, another at NRC in Ottawa, Canada, and

a third at PTB in Braunschweig, W. Germany. The respective accuracies of these standards are  $8.5 \times 10^{-14}$ ,  $4 \times 10^{-14}$ , and  $6 \times 10^{-15}$ . The fractional frequency stability of each of these devices is at the level of one part in  $10^{14}$  for approximately 1 day averaging time. The current operational mode of comparing these standards is via the LORAN C navigation signal in a ground-wave propagation mode. Fluctuations in the propagation delay of these signals cause time variations on the order of  $1 \mu\text{sec}$  over 1 year of operation and frequency fluctuations that are about one order of magnitude worse than those achieved in the primary standards; that is, approximately one part in  $10^{13}$ . There are navigation, communication, and scientific users who need the stability and accuracy of the primary standards but currently cannot realize these via the current operating mode. It is projected that the stability and accuracy of primary standards will improve about one order of magnitude over roughly the next 7 years, which will clearly make the LORAN C mode of time and frequency transfer totally incompatible with the needs and capabilities within the community. In addition, significant research efforts in progress are exploring atomic frequency standards and have as a goal stabilities of the order of a part in  $10^{16}$ .

#### C. Capabilities of the Proposed Experiment

The proposed experiment will demonstrate the capability to make time comparisons between any two properly equipped stations as often as twice a day with an accuracy of better than 1 nsec. It will also demonstrate the capability to make frequency measurements between two such stations with a precision of one part in  $10^{14}$ . No other experiment proposed can obtain such results; they are unique to this experiment. The reasons for this are: the use of a hydrogen maser as a transfer clock in the orbiting space vehicle, the use of the three-link frequency comparison system with Doppler cancellation, and the use of a laser link to calibrate the propagation time delays in the instrumentation and the propagation path.

#### D. Comparison with Other Experiments or Existing Operational Capabilities

As has been mentioned previously, the present operational Loran C links have a precision of 200 nsec with much larger ( $1 \mu\text{sec}$ ) seasonal variations. Portable clocks with the capability to make time transfers approaching 1 nsec have been used but at a cost which makes the operational use

of such precisions prohibitive. Figure 2 gives an estimated dependence of cost versus precision for a single station. It is clear that cost is a major factor for the present operational limitation to 200 nsec in our timing operations, even if higher precision can and has been obtained in isolated cases.

A better measurement accuracy, at least in the major links (among NBS - USNO - NRC - Paris Observatory - PTB, etc.), would be extremely desirable because the uniformity and accuracy of TAI are limited by the insufficient precision obtainable at present. Very long baseline interferometry (VLBI) has also been used in isolated cases, and an internal precision of 1 nsec has been reached in some experiments. However, any use of such experiments for the purposes mentioned must of necessity be an isolated case depending upon the links from the observatories to the timing centers, schedules, delays of data processing, etc.

The Laser Synchronization from Synchronous Orbit (LASSO) experiment is the only experiment that is at this time competitive in regard to accuracy. However, the design of the LASSO experiment limits its utility to only a few selected laser stations that have sufficient power to reach the satellite and are within its coverage. In addition, it uses the laser not as a calibration tool but for all time transfers, which imposes very critical additional limitations on operations (weather, air traffic, etc.).

The Global Positioning System (GPS), even though it will become a most useful synchronization source, will nevertheless not be competitive in accuracy since it is only a one-way concept that requires the separate determination of propagation delay and involves orbital determination, propagation correction, etc.--factors that do not concern the proposed Shuttle experiment since the two-way, nearly simultaneous transmission of signals avoids their influence except, at most, in the form of small corrections.

Communications satellites such as HERMES and SYMPHONIE have been used for timing experiments of highest precision (approximately 1 nsec). However, the absolute delays and delay variations in the transmitters and receivers involved currently limit the absolute time transfer accuracy to several tens of nanoseconds. In addition, a practical difficulty has arisen in these experiments that limits their actual use. The links to the end-users have contributed several nanoseconds of inaccuracy and have prevented a full evaluation of total overall performance.

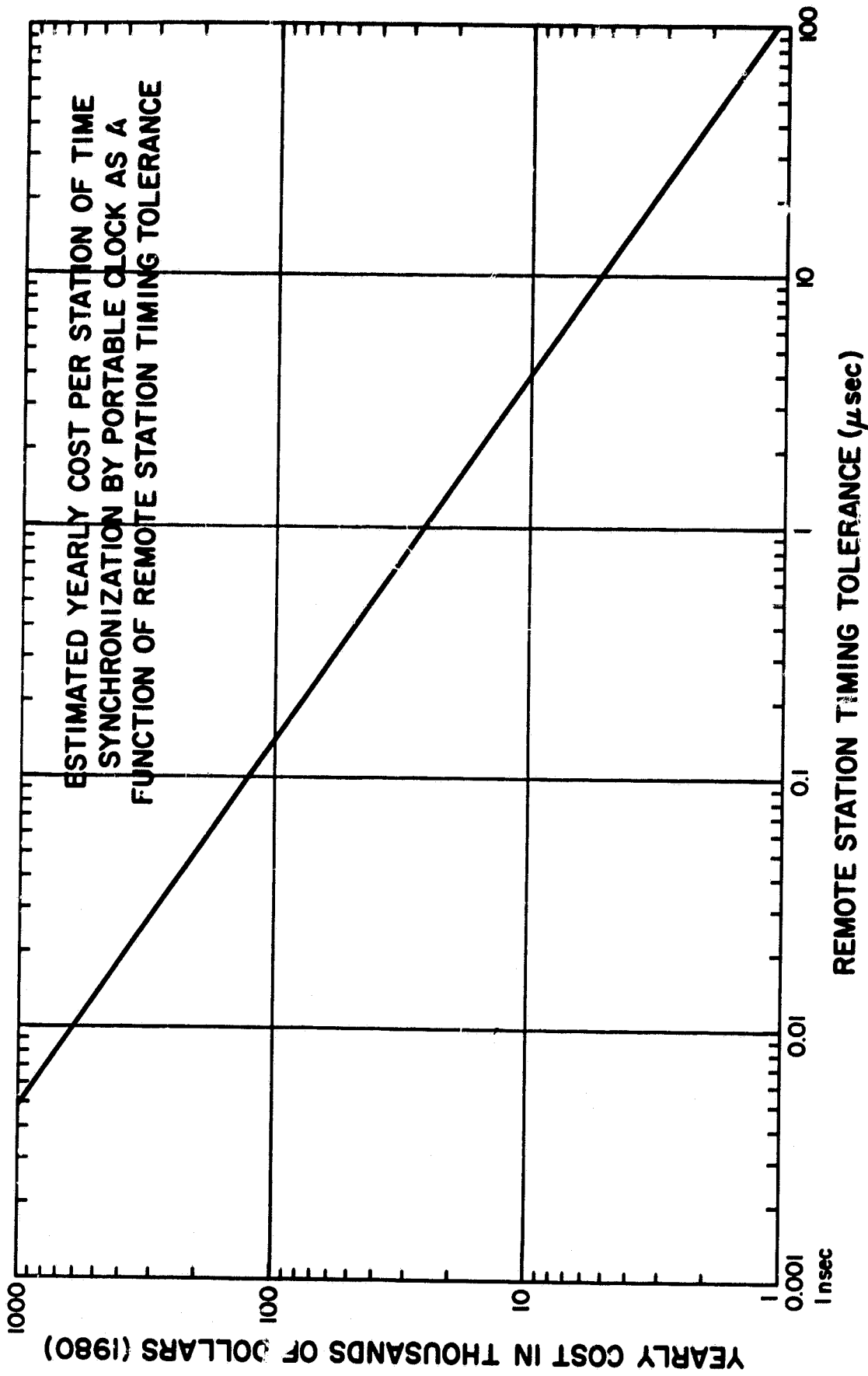

Figure 2. Cost of portable clock method.

### E. Potential Users and Future Requirements

As mentioned previously, the major benefits from an operational system employing the proposed techniques can be expected in the computation of TAI and in the improved coordination of the major BIH contributors. Both the very high accuracy time measurement and the frequency comparison between the three laboratories (NBS, NRC, and PTB) are important. In addition, such a system would also allow for the first time the intercomparison of time and frequency with stations and laboratories in the Southern Hemisphere, such as in Australia (Department of National Mapping and the CSIRO), Brazil, Argentina, New Zealand and also South Africa. None of these nations is presently included in the BIH system of TAI and UTC as contributors because of the coverage limitation of LORAN C. In addition to these benefits for the National Time Services, there will also be considerable direct benefits for a number of very demanding users of precision time.

One of the more stringent user requirements is that of the Deep Space Network (DSN) with stations located at Canberra, Australia; Madrid, Spain; and Goldstone, California. Because of the high accuracy needed for deep space probes, range and range rate measurements currently require that absolute frequency differences between the hydrogen masers at each of these sites be known to a few parts in  $10^{13}$ . There is no reasonable terrestrial means of reaching this accuracy. One solution, though very expensive, that is currently being planned is to use a deep space source to synchronize and syntonize the stations. Over the next decade, it would be highly desirable if an alternative route could be found to provide synchronization at the few nanoseconds level and syntonization at a part in  $10^{13}$  or better. Furthermore, all presently used methods and systems in precision timekeeping will benefit because the experiment will provide an extraordinary opportunity to evaluate and to calibrate the performance of existing routine timing systems such as LORAN C, the GPS, etc.

Figure 3 shows the locations of users of an operational system for time and frequency transfer, including primary standard laboratories, time service stations, and the NASA DSN. Once an operational system has been established, VLBI stations around the world can be counted among the users.

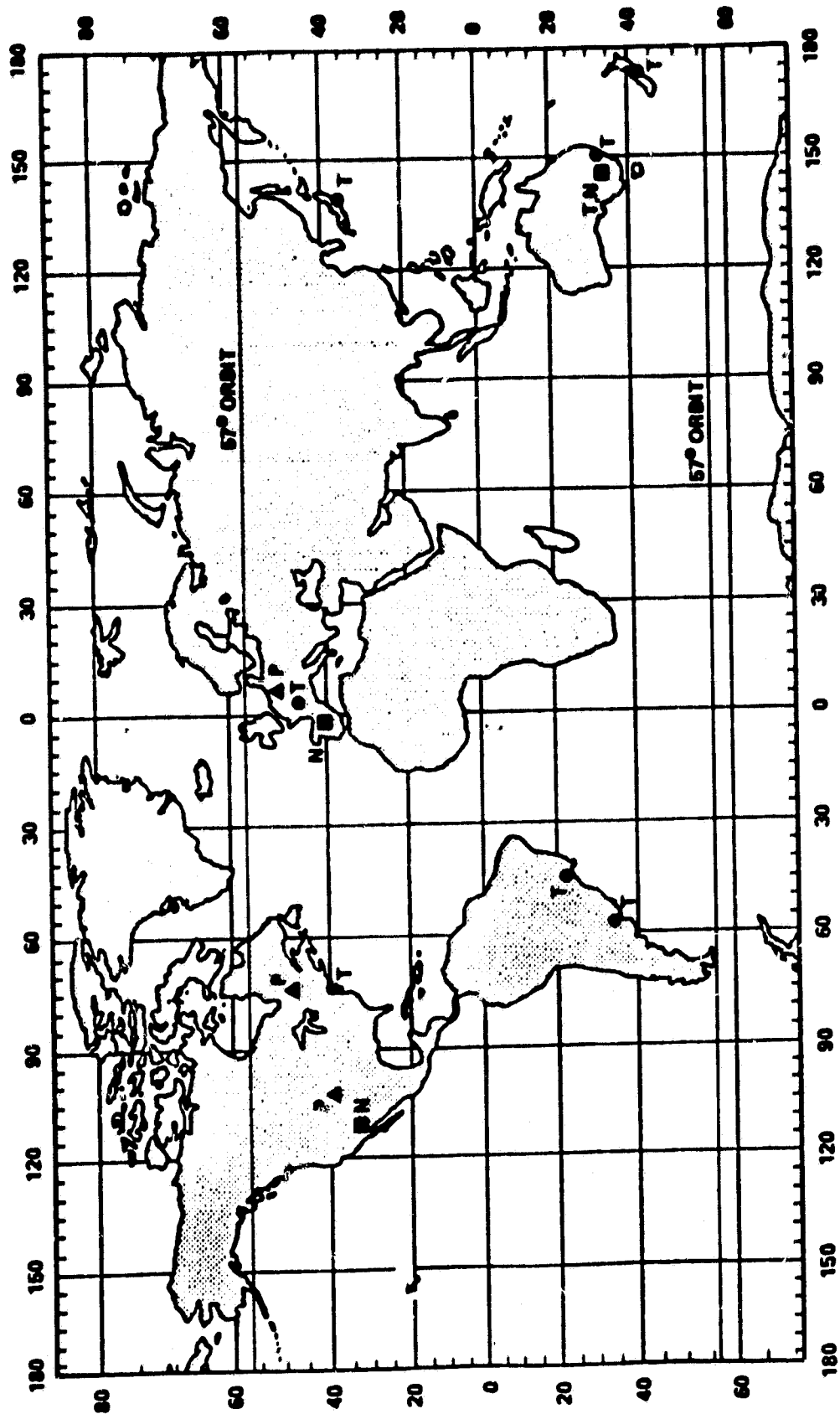

- N: NASA DSN
- ▲ P: PRIMARY STANDARD LAB.
- T: TIME SERVICE

Figure 3. User locations.

### III. EXPERIMENT DESCRIPTION

#### A. Objective

The objective of the Shuttle-borne experiment is to demonstrate that time and frequency information can be transferred to a ground station with a precision of 1 nsec in time and 1 part in  $10^{14}$  in  $\Delta f/f$  for frequency. This demonstration will use simultaneous microwave and laser techniques to evaluate the capability and usefulness of this method of time transfer. The microwave system will make frequency comparisons with the space clock during each pass. Data from the three systems (laser timing, microwave timing, and microwave frequency comparison) will be available to test the internal consistency of the techniques. It is sufficient for this demonstration to have only one ground station equipped with a hydrogen maser system serving both as clock and high-stability oscillator. For the time and frequency comparisons an existing S-band station from either the Jet Propulsion Laboratory (JPL) DSN or one of the unified S-band (USB) stations would be appropriate. The adaptation of the station for the experiment would follow very closely the work done in the 1976 GP-A redshift experiment for which two additional racks of equipment built by the Smithsonian Astrophysical Observatory (SAO) were tied into the existing equipment.

The laser time comparison will involve the use of a mobile laser tracking station brought to the USB or DSN station site.

#### B. Space Clocks

The experimental test of the Gravitational Redshift successfully made in June 1976 by NASA and SAO demonstrated the feasibility of placing an extremely high-stability oscillator into Earth orbit and of making frequency comparisons between it and an oscillator at the Earth's surface. This experiment required a hydrogen maser with highly specialized design to cope with the very traumatic changes from Earth's thermal, magnetic and gravitational environment to the environment of space. The short-duration mission did not provide sufficient time for thermal stabilization or magnetic readjustment. Although the space mission was limited to approximately 2 hr, the maser was designed for continuous operation through many months of testing.

The development of high-stability oscillator systems, or clocks, for use in space recently has had considerable impetus from the GPS, for which cesium beam and rubidium

vapor resonator devices have been developed and undergone tests in space. These devices are relatively small and lightweight compared to the 41 kg space maser used in the 1976 GP-A redshift experiment; however, they have substantially lower short-term stability than the maser. Figure 4 shows the fractional frequency stability  $\sigma_y(\tau)$  (giving the expected value of  $\Delta f/f$  between adjacent samples, each of duration  $\tau$ ) for cesium, rubidium and maser oscillators presently suitable for space. It is clear that for the time intervals of  $10^3$  to  $10^4$  sec involved in the proposed orbital clock timing systems, the hydrogen maser will be required on the spacecraft. In the case of the comparison or measurement of frequency during a single pass of, say, 8 min visibility, hydrogen masers will also be required at the ground stations.

As previously mentioned, there is increasing need for frequency calibration (syntonization) among the stations in the worldwide VLBI network, and these stations are normally equipped with hydrogen masers.

### C. The Laser Time Transfer System Concept

The short-pulse laser time transfer system utilizes techniques originally prescribed in 1905 by A. Einstein for the comparison of separated clocks. It can now be performed in a practical way drawing on the properties of lasers and precision timekeeping electronics. The space-time diagram shown in Figure 5 illustrates the technique for one spatial dimension.

Assuming that the speed of light,  $c$ , is the same in all directions, the laser pulse emission time,  $t_1$ , and the laser pulse reception time,  $t_3$ , at Earth are given by

$$t_1 = t_2 - \frac{r}{c}, \quad t_3 = t_2 + \frac{r}{c}. \quad (1)$$

The time  $t_2$  at the midpoint of  $t_1$  and  $t_3$  is obtained from equation (1) as

$$t_2 = t_1 + \frac{1}{2} (t_3 - t_1) = \frac{1}{2} (t_1 + t_3). \quad (2)$$

This is the time that can be assigned by the Earth station observer to the reflection of the pulse at the spacecraft. From equation (1) we obtain

$$r = \frac{c}{2} (t_3 - t_1), \quad (3)$$



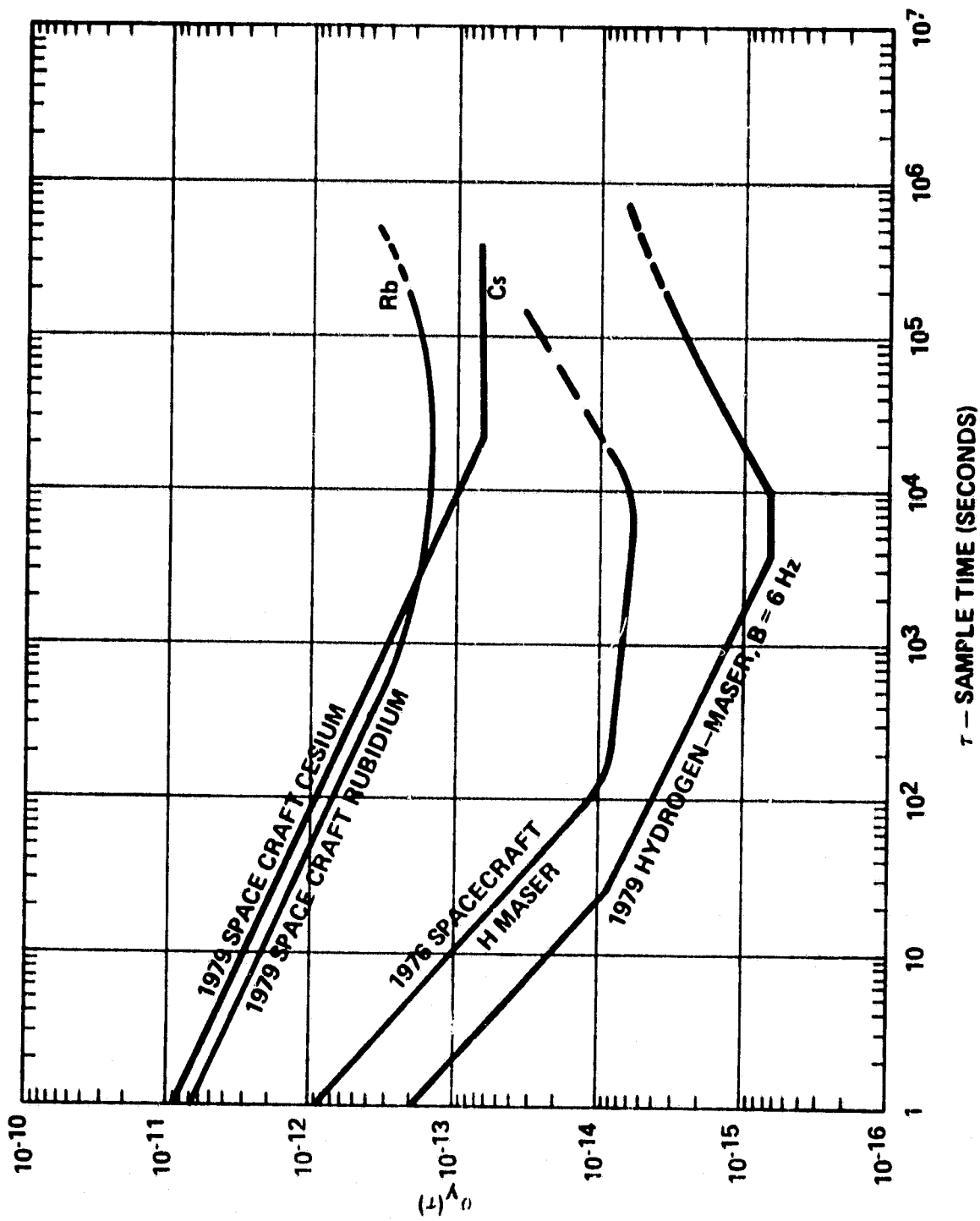

Figure 4. Stability of spacecraft clocks.

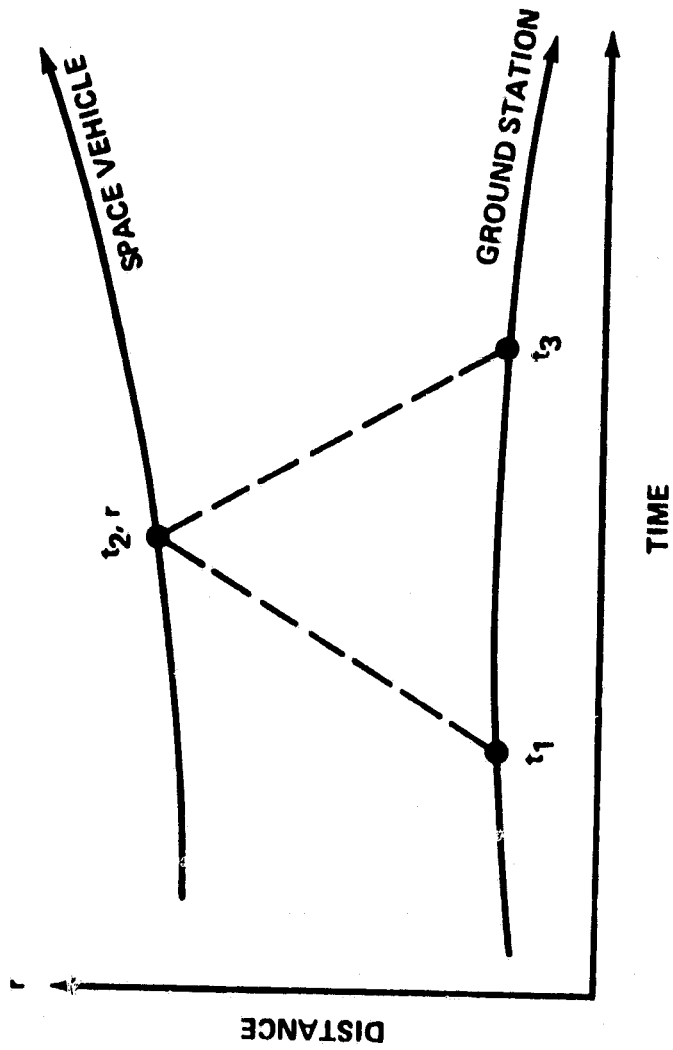

Figure 5. Space-time diagram for clock comparison.

which is the distance from the Earth station to the spacecraft. This is the basic equation used in measuring the distance to the corner reflectors on the Moon and on numerous artificial Earth satellites. If there is a fast photodetector located next to the corner reflector and an electronic event timer to register the epoch  $t_2'$  of the reflection event in the time scale established by the spacecraft clock, then equation (2) can be used to compare the epoch  $t_2'$  with the epoch  $t_2$  for the same reflection event by some form of radio communication such as telemetry.

Note that the relative velocity between the ground station and the spacecraft does not enter the comparison, nor does the value of the distance separating them. Thus, there are no Doppler effects associated with the short-pulse laser technique for comparison of separated clocks.

The effect of the Earth's atmosphere is to cause an additional delay in the transit time of the laser light pulse between ground and the Space Shuttle of approximately

$$\Delta t = \approx (6 \text{ nsec})/\cos \theta, \quad (4)$$

where  $\theta$  is the angle from the zenith. However, because this delay is almost the same for outgoing and incoming pulses, only the difference modifies equation (2),

$$t_2 = \frac{1}{2} (t_1 + t_3) + (\Delta t)_{\text{out}} - (\Delta t)_{\text{in}} \quad (5)$$

This correction is expected to be much less than 1 percent of  $\Delta t$ , or  $\ll (60 \text{ psec})/\cos \theta$ . The difference in delay is due to the relative motion of the satellite and the Earth's surface producing different physical paths through the atmosphere.

Another small correction term is produced by the acceleration of the ground station as a result of the Earth's rotation. It can be readily calculated to the needed accuracy.

#### D. Previous Demonstration

In a series of aircraft flights from the Patuxent Naval Air Test Center during the period May 1975 through January 1976, The University of Maryland with the support of the U.S. Navy measured the effects of general relativity on clock rates. During the flights, the airborne clocks were compared with the ground clocks using the short-pulse laser technique described previously. The results of one of the five 15-hour flights conducted are shown in Figure 6, where the time

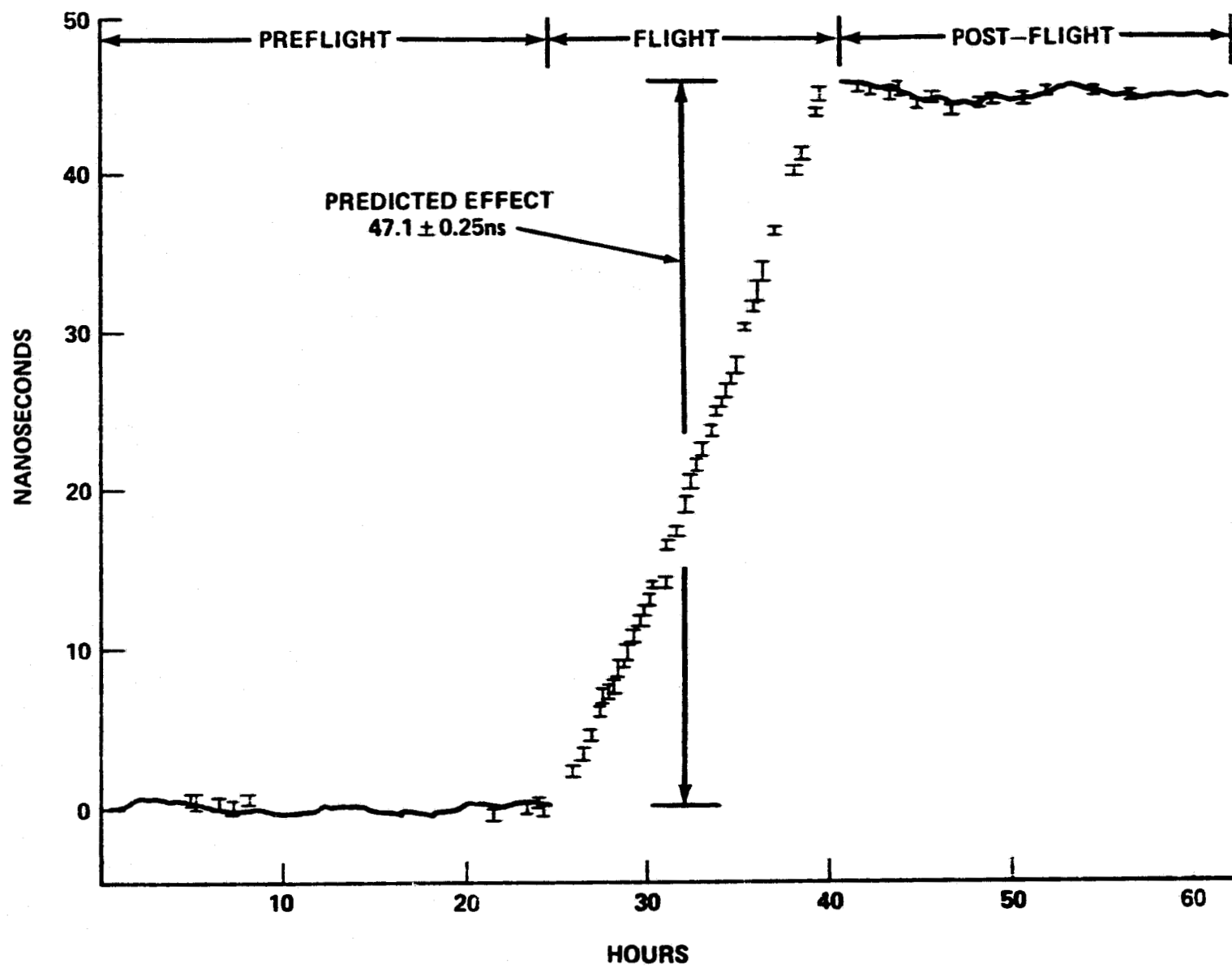

Figure 6. Laser comparison of atomic clocks.

difference between the airborne and ground clock sets is plotted as a function of time before, during, and after the flight. The points with error bars are the laser pulse time comparisons, typical uncertainties being  $\pm$  (200 to 300) psec.

#### E. Relation to Laser Range Measurement

Any laser ranging station can perform a time comparison with the suitably equipped Space Shuttle if it records the epochs of the transmitted and received pulses and combines them according to equation (2). At present, a number of stations record epochs; and others will, in the future, as more high repetition rate and single photo-electron detection systems are implemented. The conversion to epoch measurement of a laser ranging system using time interval measurement is not difficult.

There are now approximately 20 laser stations worldwide that potentially could participate in the proposed experiment. In the U.S. these include eight in the NASA network and three in the Smithsonian network. Additional stations are expected to come into existence in the next few years in various parts of the world.

The LASSO experiment will use the laser technique described previously with the SIRIO-2 synchronous satellite to be placed in orbit by the first operational launch of the European Space Agency ARIANE rocket in June 1981. Several European laser ranging stations will participate together with a station operated jointly by the U.S. Naval Observatory, The University of Maryland, and the NASA Goddard Space Flight Center.

#### F. System Description

A block diagram of the Space Shuttle and ground systems is shown in Figure 7. The corner reflector array would be of hemispherical geometry to eliminate the need for pointing. Each reflector would be accompanied by a fast photodetector, probably of the avalanche diode type. The constant-fraction discriminator, event timer, microprocessor, storage registers, and communication link will be similar to equipment developed earlier and adapted to the requirements of the Space Shuttle. With 10 to 30 laser pulses registered during a time transfer (to average the jitter in the detector-discrimination-event timer chain), a precision as high as 30 psec may be attainable using this laser technique.

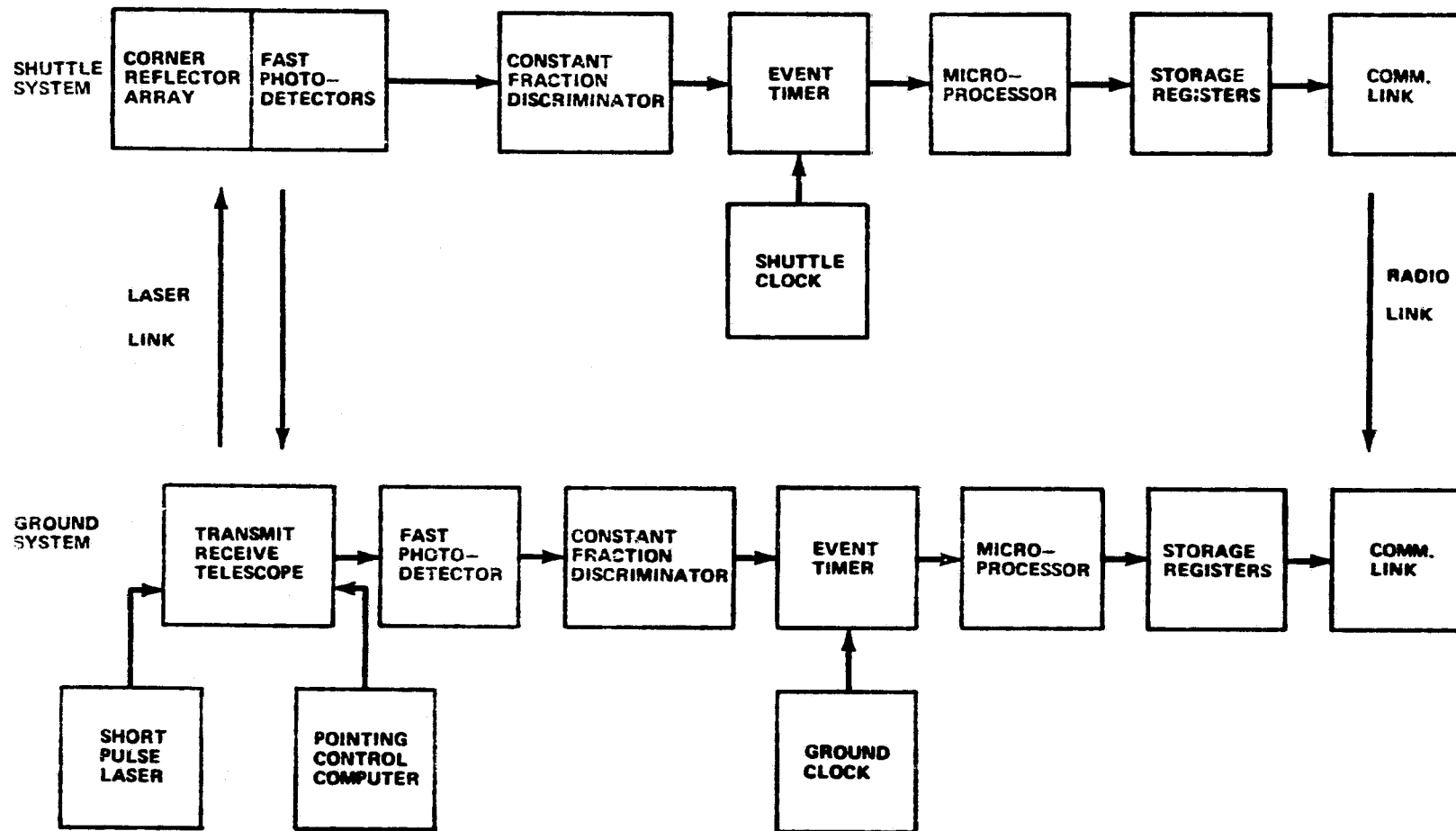

Figure 7. Laser system block diagram.

Simultaneous testing of the laser and microwave pulse system, in conjunction with the microwave frequency comparison method, will allow extremely high precision tests of these various methods of time transfer and an evaluation of their usefulness for worldwide coverage.

#### G. The Microwave Technique for Simultaneous Frequency and Time Comparison

The proposed technique for time and frequency comparison very closely parallels the methods used in the redshift test in which continuous wave signals at three separate frequencies were used in a combined two-way and one-way Doppler measurement system.

The experiment hardware used in 1976 was based on the USB system, which produces continuous wave and Doppler (range-rate) data and, by the use of pseudo-random noise (PRN) phase modulation and correlation techniques, also provides range distance. This information is obtained from the time delay between the transmitted PRN-coded phase modulation and its counterpart received from the spacecraft transponder. Since the frequencies of the uplinks and downlinks are separated, there is no restriction on the duration of the phase-coded signals other than the obvious one associated with the period of visibility of the satellite. Simultaneously with the phase data providing the two-way propagation delay, a third microwave carrier will be modulated to provide time-delay information between the satellite and ground clocks. The propagation delay in this measurement is accounted for using the transponded two-way data. To illustrate these techniques for time and frequency comparison, the light-time diagram shown in Figure 8 will be used to describe the ray paths. The X axis describes coordinate time with the range coordinate on the Y axis. This implies that relativistic effects of the relative motion and gravity potential between the Earth and ground stations have been included in the time and frequency comparisons from a knowledge of the spacecraft position and velocity obtained from tracking information.

In Figure 8 the time scales  $t_s$  and  $t_e$  representing the space vehicle and Earth stations, respectively, are coordinated for relativistic effects, and the objective in synchronizing them is to maintain a constant relationship in the epoch defined by each scale. This is done by determining the propagation time,  $\Delta T_{PROP}$ , by direct measurement of time pulses applied to the carrier signals using pseudo-random noise modulation in the form of a coded sequence of phase advances and retardations. This is the conventionally used

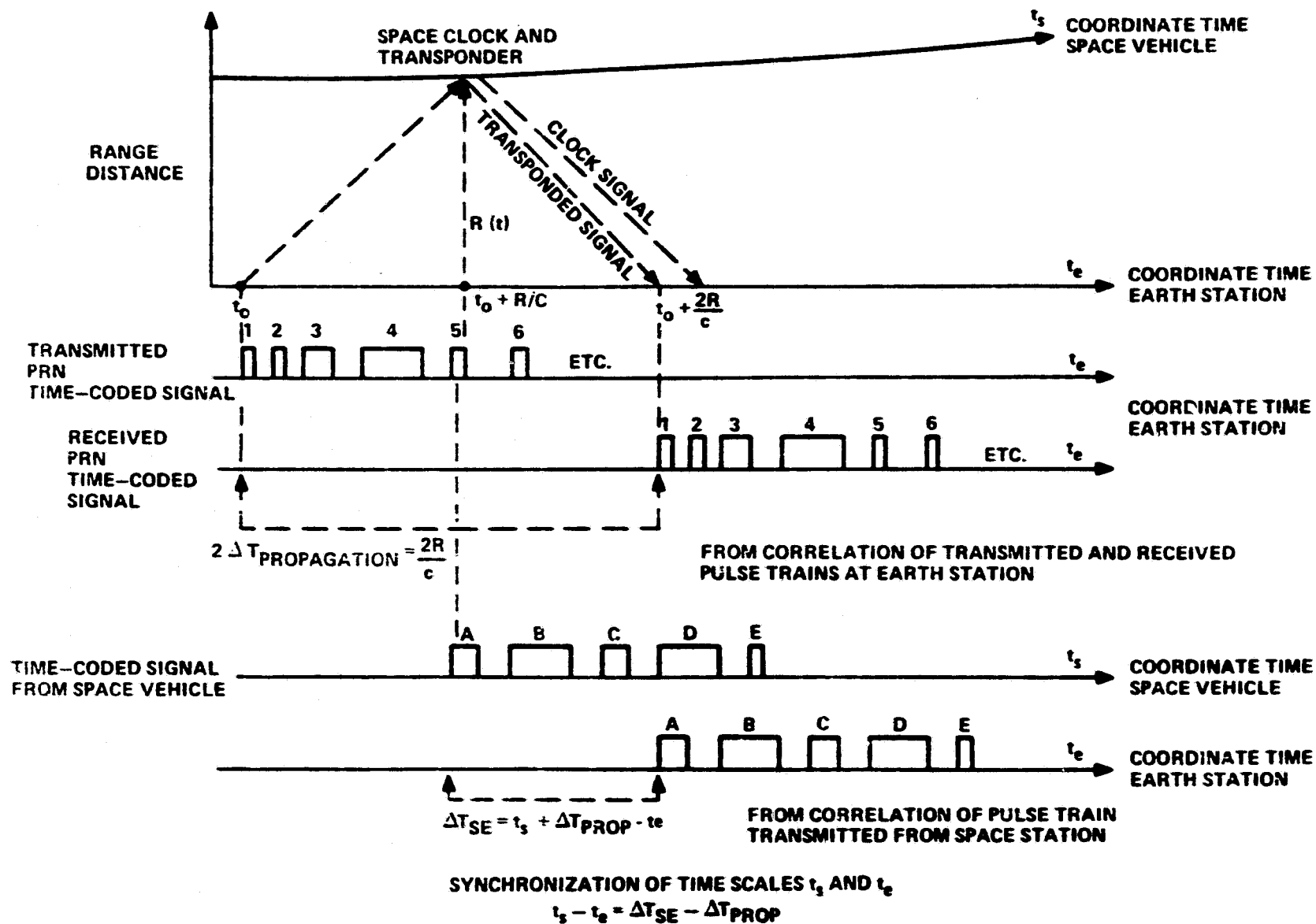

Figure 8. Range distance versus time diagram showing propagation of signals between Earth and space stations.



coding method for range measurement in the USB system and involves the use of a transponder that retains phase coherence in the retransmitted carrier signal (at an offset frequency given by the ratio 240/221 times the uplink frequency) and also reapplies the phase-coded modulation to this signal.

Time data between the space vehicle and Earth station are transmitted by a separate carrier at a third frequency, shown in Figure 8 as the "Clock Signal." Similar phase coding of this carrier is used in conjunction with the Earth station time scale to obtain

$$\Delta T_{SE} = t_s + \Delta T_{PROP} - t_e .$$

The time scales are synchronized by determining

$$t_s - t_e = \Delta T_{SE} - \Delta T_{PROP} .$$

Figure 9 shows a schematic functional diagram of the system. It is based on the successfully operated frequency comparison system used in the 1976 GP-A redshift experiment. The frequencies in this system are chosen to cancel the first-order ionospheric dispersion; the first-order Doppler effects, including tropospheric effects, are cancelled by the subtraction of one-half the two-way Doppler frequency shift from the one-way Doppler frequency shift of the clock downlink.

In this way it is possible to compare the frequency of two hydrogen masers despite variations in the path and in the transmitting medium, including the dispersion effects resulting from the necessary frequency separation in the three microwave links.

#### H. Performance of the Systems

The behavior of the microwave frequency comparison system used in the 1976 GP-A redshift experiment is shown in Figure 10. The plot gives the two-sample Allan variance,  $\sigma_y(\tau)$ , as a function of averaging time interval  $\tau$ . This is the presently accepted method of describing the stability of a single oscillator or of a comparison between oscillators. Essentially, the value of  $\sigma_y$  at a given time interval,  $\tau$ , is the one sigma probability of the difference in fractional frequency,  $\Delta f/f$ , between two adjacent samples of frequency

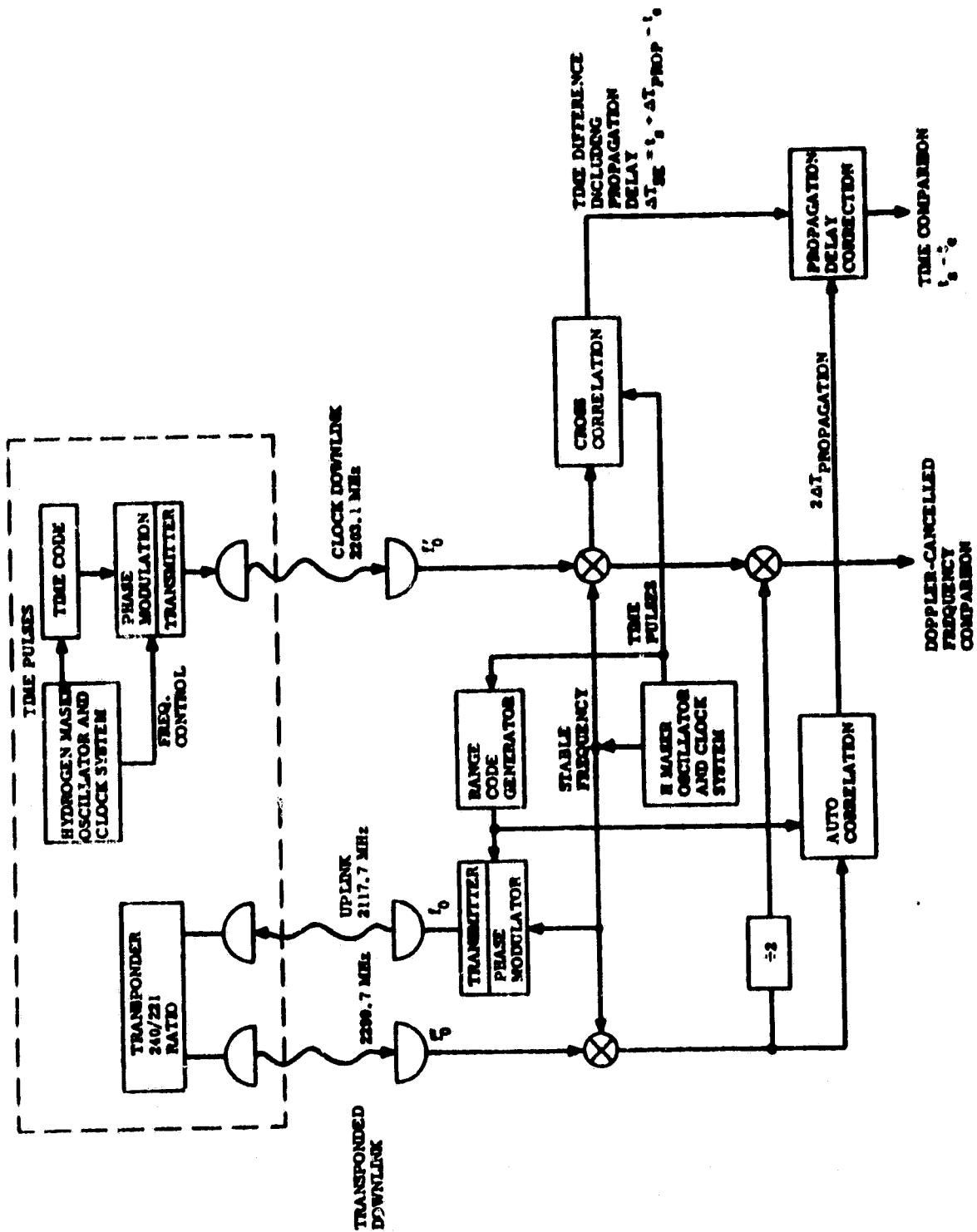

Figure 9. Schematic functional concept of Doppler cancelling frequency and time comparison system adapted to the NASA unified S-band system.

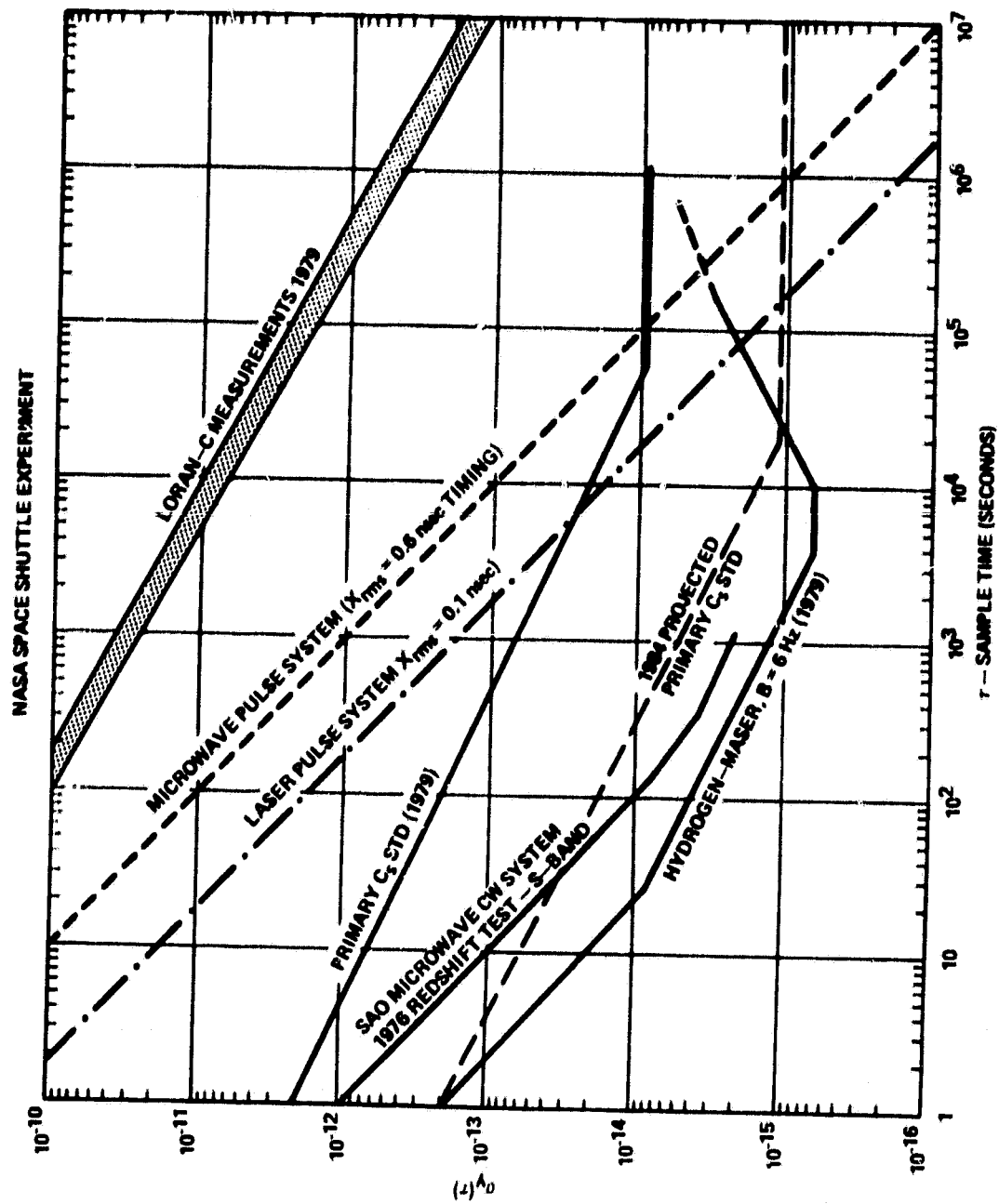

Figure 10. Stability comparison.

data, each averaged over the time interval,  $\tau$ . In measuring the value of  $\sigma$ , a sufficient number of adjacent pairs of second measurements are used to obtain a statistically significant average value.

In the case of the redshift comparison of the frequency difference between the Earth and space clocks, the value for 100 sec averages was  $1 \times 10^{-14}$ . This is at the limit of the stability of the masers used in the experiment in 1976. Shown on the same plot is the stability of the presently fabricated hydrogen masers (1979), the present primary cesium standard (1976), and the projected behavior of primary cesium standards in 1984.

Figure 10 can also be used to illustrate the effectiveness of timing accuracy in relation to frequency stability. The dotted lines show the effectiveness of timing accuracy at 0.6 nsec (microwave pulse system) and at 0.1 nsec (laser pulse system) for making frequency comparisons when the timing measurements are made at time intervals,  $\tau$ . This vividly shows the value of the frequency comparison technique as a means for comparing high stability standards and the need for sub-nanosecond timing for clock comparisons at repeated  $\tau = 10^4$  and  $10^5$  sec (hours to day) intervals if the precision of time comparison is to be comparable to the stability of present-day clocks. The current LORAN C capability is shown (shaded portion) and is seen to be grossly inadequate.

#### IV. OPERATIONAL CONSIDERATIONS

The first step toward a global time and frequency transfer system in space is the proposed Shuttle experiment. The purpose of this experiment is to demonstrate and evaluate the techniques for a later operational system that would use a space platform or a free flyer.

The microwave system of the Shuttle demonstration experiment will use S-band frequencies to utilize existing ground stations and transponder design. While S-band is a good frequency band for a global time transfer system, a different frequency band may have to be selected for an operational system because of frequency allocations in later years.

The intended approach for the demonstration experiment is to build one or more portable microwave ground terminals. A low-complexity, low-cost microwave ground station system using a simple omnidirectional antenna would be needed by every user of the later operational system. The key to an operational system is a low-cost microwave ground station that a variety of users can afford. For the demonstration experiment the ground terminal can be moved to the location of a potential user or an existing laser tracking station, and reflights of the Shuttle experiment would provide opportunities for several users to participate in the demonstration experiment with the transportable microwave ground station. Such a demonstration program would generate interest in an operational system, including perhaps financial participation by other organizations and countries.

It is worth noting that a laser ground station equipped with an atomic clock and suitable interface equipment can use the laser timing portion of the experiment during the Shuttle mission to coordinate the clock's time scale to the international time scale.

The experiment package mounted on a pallet inside the Shuttle bay will be essentially self-contained but will require electrical power from the Shuttle system. The corner reflector array and the microwave antenna will have to be pointed toward the ground for experiment operation while passing over a ground station. An ideal Shuttle mission for this experiment would be one performing Earth observations with the open Shuttle bay pointing toward Earth during most of the mission. The orbit of the Shuttle must be known to a certain degree of accuracy to determine altitude and relative

velocity between a ground station and the Shuttle. This information is needed for relativistic corrections (gravitational redshift and relativistic Doppler effect) to realize the maximum accuracy in time and frequency comparison possible with the experiment.

As mentioned earlier, Shuttle orbits have a relatively low altitude, which limits the time available for the experiment during a ground station pass. For an operational system a high-inclination (perhaps polar), medium-altitude orbit would be more ideal to obtain worldwide coverage and sufficient observation time from a ground station.

## V. CONCLUDING REMARKS

The need for an operational global time and frequency transfer system with accuracies comparable to the performance of modern standards has been outlined in Section II. The proposed microwave frequency and time transfer method can satisfy this need, providing the weather-independent operation required for an operational system. Quite a number of potential users, national and international, would benefit from such a system. Therefore, it can be expected that there would be a strong interest outside of NASA in the U.S. and in other countries in the implementation of such a system. The interest of the USNO and the NBS has been expressed clearly and is demonstrated by the participation of these organizations in the definition of the Shuttle demonstration experiment. There have been indications of interests from other countries. A successful demonstration of the proposed techniques should generate sufficient worldwide interest to lead to cost sharing for an operational system by several countries. With increasing accuracy and precision of primary standards in future years, the need for a high-precision time and frequency transfer system will become even more urgent.

APPROVAL

SHUTTLE TIME AND FREQUENCY TRANSFER EXPERIMENT

By D. W. Allan, C. O. Alley, R. Decher,  
R. F. C. Vessot, and G. M. R. Winkler

The information in this report has been reviewed for technical content. Review of any information concerning Department of Defense or nuclear energy activities or programs has been made by the MSFC Security Classification Officer. This report, in its entirety, has been determined to be unclassified.

*Charles A. Lundquist*

---

CHARLES A. LUNDQUIST  
Director, Space Sciences Laboratory