

NOTICE

THIS DOCUMENT HAS BEEN REPRODUCED FROM
MICROFICHE. ALTHOUGH IT IS RECOGNIZED THAT
CERTAIN PORTIONS ARE ILLEGIBLE, IT IS BEING RELEASED
IN THE INTEREST OF MAKING AVAILABLE AS MUCH
INFORMATION AS POSSIBLE

Data Acquisition Techniques for Exploiting the Uniqueness of the Time-of-Flight Mass Spectrometer: Application to Sampling Pulsed Gas Systems

Kenneth A. Lincoln

(NASA-TM-81224) DATA ACQUISITION TECHNIQUES
FOR EXPLOITING THE UNIQUENESS OF THE
TIME-OF-FLIGHT MASS SPECTROMETER:
APPLICATION TO SAMPLING PULSED GAS SYSTEMS
(NASA) 15 p HC A02/MF A01

N80-31775

Unclass
28612

CSSL 14B G3/35

August 1980



NASA

National Aeronautics and
Space Administration

Data Acquisition Techniques for Exploiting the Uniqueness of the Time-of-Flight Mass Spectrometer: Application to Sampling Pulsed Gas Systems

Kenneth A. Lincoln, Ames Research Center, Moffett Field, California

NASA

National Aeronautics and
Space Administration

Ames Research Center
Moffett Field, California 94035

DATA ACQUISITION TECHNIQUES FOR EXPLOITING THE UNIQUENESS OF THE TIME-OF-
FLIGHT MASS SPECTROMETER: APPLICATION TO SAMPLING PULSED GAS SYSTEMS

Kenneth A. Lincoln
Ames Research Center, NASA
Moffett Field, California 94035, U.S.A.

INTRODUCTION

The unique feature of the time-of-flight mass spectrometer (TOFMS) is best understood in terms of the operation of the more conventional mass spectrometers. In most of these instruments a spectrum, that is, ion abundance versus mass/charge ratio (m/z), is produced by sweeping a magnetic or electric parameter within the instrument as the sampled gases flow into the ion source. Thus, any fluctuation in composition or density of the gas stream during the sweep (mass scan) of the instrument will cause the output spectrum to be skewed in peak intensities with respect to its m/z values; it is apparent that to avoid this the scan time must be very short with respect to rate of change in gas flow.

One exception is the mass spectrograph in which all the ions are dispersed essentially simultaneously by a magnetic field according to their m/z values onto a photographic plate or some type of electron multiplier array [1]. This has worked very well for analysis of solids by spark-source mass spectrometry, although acquiring data from the photoplates tends to be laborious.

Another notable exception is the TOFMS. It is unique in its fast, repetitive mode of operation in which the ionization occurs in approximately 1 μ sec; all ions are ejected from the ion source simultaneously and produce a complete spectrum each cycle. Thus, the spectra inherently are not skewed despite rapidly changing gas pressure or composition in the ion source.

Unfortunately, the full data output capability of the TOFMS is rarely utilized, because state-of-the-art electronics have not been fast enough to capture and store TOFMS spectra at the rate they are generated by the instrument. Even the analog scanners that usually accompany the commercial TOFMS models have the same limitations as the conventional spectrometers — they effectively sample only one point in the spectrum during each cycle of the instrument, and, as a result, the scan times are long.

Extending the mass spectrometric capabilities for the dynamic sampling of vapor plumes produced by the laser heating of various

materials has necessitated overcoming these limitations in the typical electronic output system. This paper demonstrates several means of achieving this as simply as possible by exploiting the nonsweep-scan feature of the TOFMS and by employing a commercially available transient recorder and signal averager to capture the output spectra. The discussion here is limited to the instrumentation for acquiring and temporarily storing the spectra in digital memory; it excludes the equipment for subsequent steps of data processing or analysis.

EXPERIMENTAL

Figure 1 is the layout of the equipment (minus electronics) used in this work. The mass spectrometer is a CVC (Bendix) Model MA-2 with a cross-ion source housing in the horizontal plane. The vacuum is provided by sputter-ion pumps except for the optional 270 ℓ /sec turbomolecular pump on the ion source. The ion deflector in the ion source prevents any laser-induced ions from interfering with the spectra of neutral molecules.

Howarth et al. [2] have pointed out that the major drawback in applying the TOFMS to the study of fast reactions has been the problem of obtaining good quantitative data. Due to the pulsed mode of operation, any mass peak in a single spectrum often results from a small number of detected ions; as a result, statistical fluctuations in peak height occur which are superimposed on any change due to variations in gaseous species. For this reason, a spectrum from a single cycle of the TOFMS has little quantitative accuracy. We have attempted to overcome this problem by operating the instrument at an increased number of ions per cycle (high trap current and wide-aperture ion grids) and by employing four different instrument options for recording mass spectra from short events.

Multiple Spectra Stored in the Memory of a Transient Recorder

For capturing and digitally storing in real time a TOFMS spectrum, which is comprised of peaks of various amplitudes all with base widths of 40-50 nsec, a transient recorder must have as minimum requirements an input amplifier bandpass of 20 MHz and an A/D rate of one address point per 10 nsec (5 nsec would be much better) plus enough address points in the memory to cover the desired m/z range. Figure 2 is an example in which limited portions of the spectra from three successive cycles (25 μ sec apart) of the TOFMS were stored in a transient recorder having a 2K memory (Biomation, Model 8100). For the purpose of measuring the relative concentrations of vapors produced by a single laser shot, these spectra were recorded near the maximum of the total mass current (also shown in Fig. 2) which is a summation of the ions from all the masses arriving at the detector during each cycle and is a measure of the instantaneous gas density in the ion source. This latter signal was stored in the memory of a signal averager (Nicolet, Model 1170) operating in the transient record mode, and the averager was triggered by the laser flash-lamp. After the laser was fired, the contents of both memories were plotted simultaneously on a dual-pen strip-chart recorder.

To obtain better quantitative information from the single laser shot, the error from statistical fluctuations was reduced by averaging the three spectra of Fig. 2. In experiments in which the m/z range of

interest is different, we have recorded from two through six portions of successive spectra. Clearly, the trade-off is between m/z range and number of spectra in filling the available 2K memory. It is also possible to obtain a limited number of time-resolved spectra in this manner by merely adjusting the repetition rate of the TOFMS to correspond to the time of the event under study.

The block diagram for interconnecting the instruments to capture multiple spectra in the transient recorder is shown in Fig. 3. The total signal from the "scope" anode in the electron multiplier is ac coupled to the pulse amplifier ($\times 10$ gain) and thence to the unity-gain, fan-out amplifier. This is one of the key elements in the system, because the total mass spectra fed into it appear simultaneously at 16 separate, isolated outputs, and an operation performed at one has no influence on the signal appearing at the others. The dc component from the scope anode is fed via an isolating resistor either to a digital panel meter, which provides a very convenient gauge of the total ion current in the spectrometer, or to an amplifier and transient recorder to register the total gas pulse during a short event.

The TOFMS itself operates continually along with the pulse generator triggered by the delay generator at the 40-kHz repetition rate of the system. The width of this pulse occurring each cycle and its delay determine the mass range and portion of the spectra to be recorded by gating "ON" the 100-MHz pulse generator (BNC, Model 8020) which provides the external time base to the transient recorder. Thus, the 100-MHz pulse generator advances the time base (at the rate of 10 nsec/address) only during the interval of the preselected mass range. This process is then stopped until subsequent cycles of the spectrometer continue the process, which terminates when the 2000 addresses in the recorder are filled. Actually, the transient recorder is dormant until it is armed by a pulse from a delay generator so that the preceding train of events occurs only after a preselected time interval from the initiating event (in our case a pulsed laser).

In parallel with the above, the complete m/z range of the spectra is continually displayed on the oscilloscope and photographed by the camera, which has a flash-synchronized shutter that triggers the laser. Thus, for each firing of the laser a photograph of the total integrated spectrum is produced plus a dual graph, as in Fig. 2.

Gating-Out and Stretching of Preselected Mass Peaks

A technique for time resolving the intensities of several mass peaks simultaneously has been described previously [3]. It may be briefly outlined as follows: The gating pulses to the individual multiplier channels are positioned (in time delay) to the locations of the preselected mass peaks in the spectrum, and they are adjusted in a wide enough time window (about 50 nsec) to divert to its respective anode the entire electron packet corresponding to each selected mass peak. The outputs from the anodes are fed to the vertical inputs of a multitrace oscilloscope, with its horizontal sweep triggered by the laser (or other event under study). Although this technique has been very fruitful, there are some drawbacks: (1) those mass peaks gated out of the electron stream into multiplier channels ahead of the scope anode are missing from the spectrum displayed on the scope; (2) the sharp rise and fall of the

100-V gating pulses inside the multiplier induce severe "ringing" in the scope anode, which interferes with the display of the total spectrum (they also produce enough interference between multiplier channels to restrict amplification of those signals); and (3) the number of mass peaks that can be monitored simultaneously without multiplexing is limited to the number of channels built into the multiplier.

The system presented here uses the same approach to time resolving individual mass peaks, but achieves it without these drawbacks by performing all gating and other operations entirely external to the multiplier. As shown in Fig. 4 (which is a variation on Fig. 3) the total signal at the scope anode is fed from the mass spectrometer to a series of nuclear instrument modules (NIM), which are all off-the-shelf items; therefore, no new electronic equipment development is required.

In the present system the gated integrators are used to sort out the preselected m/z values from the spectra. (We are using EG&G Model LG 105 Linear Gate and Stretcher for this purpose.) These accept signals only for the duration of an externally applied gating pulse. Thus, the time delay from the reference trigger is adjusted to position the gate pulse at the desired m/z peak and the gate time-width is set at approximately 50 nsec (as in the earlier method) to bracket completely the mass peak. The gated integrator then produces a 3- μ sec output pulse with an amplitude directly proportional to the area of the preselected mass peak rather than to its height; this can improve the accuracy of the data, because it is a measure of the total number of charges corresponding to a mass peak — a more quantitative measurement than the peak height. Furthermore, it converts the somewhat poorly defined shape of the approximately 40- or 50-nsec-wide mass peaks to clean, flat-topped, 3- μ sec-wide pulses. Figure 5 is an example of a parallel set of the stretched pulses recorded by the transient recorder and corresponds to the time-varying intensities of the two mass peaks. As an optional substitute for the delay and gate generators, we have utilized the analog scanners that were a part of the original spectrometer by attenuating their -100-V pulses (normally fed to the multiplier) to the -750-mV level required by the gated amplifiers.

The salient features of this instrument option are as follows:

1. All gating and other operations are performed external to the multiplier.
2. No interference is coupled between the many types of output displays.
3. The number of mass peaks monitored is not limited by the multiplier.
4. A less complicated electron multiplier can be used.
5. The output pulse height is proportional to the area of the corresponding mass peak.

Enhancement of Spectra Via a Signal Averager

When the spectral acquisition time is of the order of tenths of seconds or longer, a signal averager can be a very useful device for accumulating and storing spectra from the TOFMS. However, no averager known to the author is fast enough to acquire the spectra in real time, and so it is necessary to place the transient recorder ahead of the signal averager, as shown in Fig. 6. The averager is a Nicolet, Model 1170 with a Model 178 plug-in unit specifically made for digital-to-digital interfacing with the Biomation Transient Recorder. In this option the spectra are fed directly into the transient recorder as in Fig. 3, where they are digitized and stored only long enough to be transferred to the memory in the signal averager. The rate-determining step is the approximately 3 msec required each cycle to dump the 2000-word memory of the transient recorder into the averager. This in effect reduces the repetition rate of the TOFMS to about 330 cycles/sec; nevertheless, this represents a much faster acquisition than 40,000 cycles/sec with an Analog Scanner unit, which samples only one point from the spectrum per cycle, because a complete spectrum is acquired each cycle and sent to the memory of the signal averager. Furthermore, this includes the benefits of the nonsweep-scan feature and of signal averaging over any desired period of time. Thus, spectra even with a low number of ions per cycle, can be acquired with greater accuracy because the statistical fluctuations are averaged out. Although this technique somewhat reduces the resolution, we use it to record spectra from calibration gases as well as samples.

Figure 7 is an example of a spectrum that results from the benefits of both signal averaging and the unique capability of the TOFMS, because it represents the sum of in situ measurement of vapors evolved at very nonuniform rates during an approximately 1-sec pyrolysis by the CW-laser beam. This figure is a digital-to-analog conversion of the contents of the memory for analog presentation, but the contents could be transferred directly to a computer in digital form for data reduction. Actually, the averaging could also be performed by an on-line computer that is sufficiently fast.

Another application of the same circuitry is the storing in the memory of the signal averager a limited number of time-resolved spectra from moderately fast events. With the 12K-memory option in the Model 1170, 6 individual 2K-word spectra can be stored or 12 individual 1K-word spectra can be stored at a minimum of about 2-msec increments by external electronic switching of the memory segments. When the event under study is of the order of a second or so, there is the added advantage of averaging a specific number of spectra in each of the memory segments. For example, 33 spectra can be averaged per 0.1-sec time increment, and the resulting averaged spectra (a total of 12 at 1K words each) will have considerably improved precision in mass peak intensities.

Modulated Inlet in Concert With a Signal Averager

It is well recognized that the periodic chopping of the incoming gas stream and synchronization of the detection system with the chopper is an effective means of discriminating between sample and background spectra in a mass spectrometer. This discrimination can be achieved in the TOFMS by employing the same arrangement as that shown in Fig. 6, with the averager operating in the add-subtract mode, and is demonstrated

with the aid of Fig. 8. Figure 8 shows the periodic intensity variations of the total ion current resulting from electrically pulsing a piezo-electric valve on the ion source - 0.75 msec open and 40 msec closed. This lacks the clean rectangular profile of a collimated, chopped beam, but the shape is of little consequence because the averager adds to its memory spectra taken at each maximum and subtracts spectra taken at each minimum; this is shown in the same figure by the location of the logic pulses to control the signal averager. After a suitable period of this addition and subtraction process, the net spectrum is free of both background and statistical fluctuations.

SUMMARY

Various means of exploiting the time-of-flight mass spectrometer to the fullest extent, by using presently available digital data acquisition systems to capture a greater portion or number of the spectral signals that appear at the output of the instrument, have been described. The emphasis has been on the application of the TOFMS to the study of fast events wherein gas compositions change over periods of tenths of milliseconds or longer. Given the present rate of advancement in microelectronic technology, which will soon make a vastly expanded memory in the transient recorder practical, the ultimate goal of capturing and storing each mass peak from every cycle of the TOFMS at a reasonable cost may be possible in the near future. For the present, however, we must be content to work within the constraints that we can capture all of the mass peaks some of the time, some of the mass peaks all of the time, but we cannot capture all of the peaks all of the time.

REFERENCES

1. G. J. Louter, A. J. H. Boerboom, P. F. M. Stalmeier, H. H. Tuithof, and J. Kistemaker, Int. J. Mass Spectrom. Ion Phys., 33, 335 (1980).
2. S. B. Howarth, J. H. Lippiatt, D. Price, G. B. Ward, and P. Meyers, Int. J. Mass Spectrom. Ion Phys., 9, 95 (1972).
3. K. A. Lincoln, Int. J. Mass Spectrom. Ion Phys., 2, 75 (1969).

ORIGINAL IMAGE IS
OF POOR QUALITY

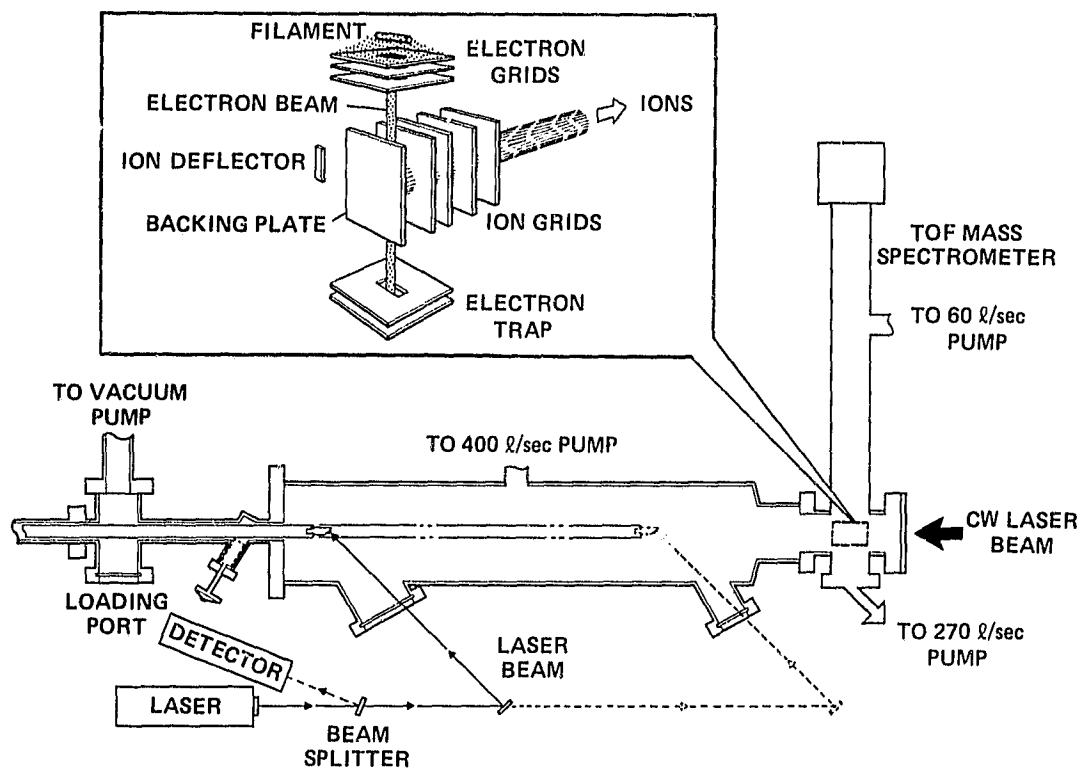

Figure 1. Mass spectrometer and vaporization chamber.

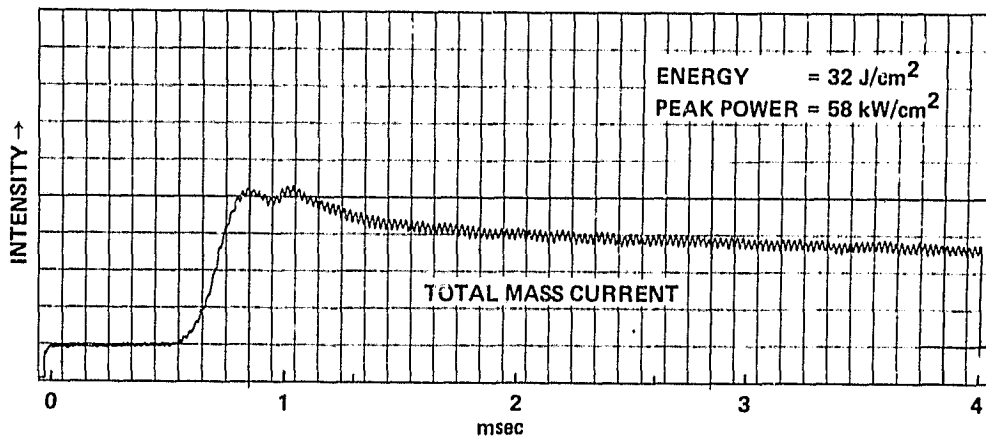
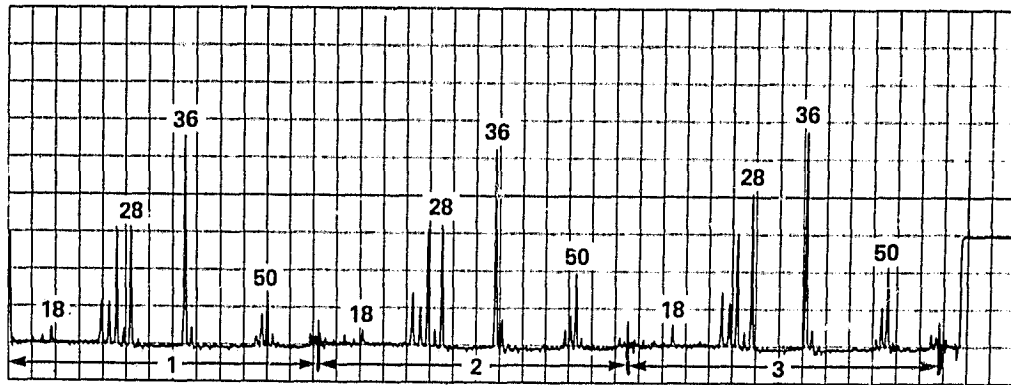

Figure 2. Mass spectra from pulsed laser-heated carbon phenolic composite.

ORIGINAL PAGE IS
OF POOR QUALITY

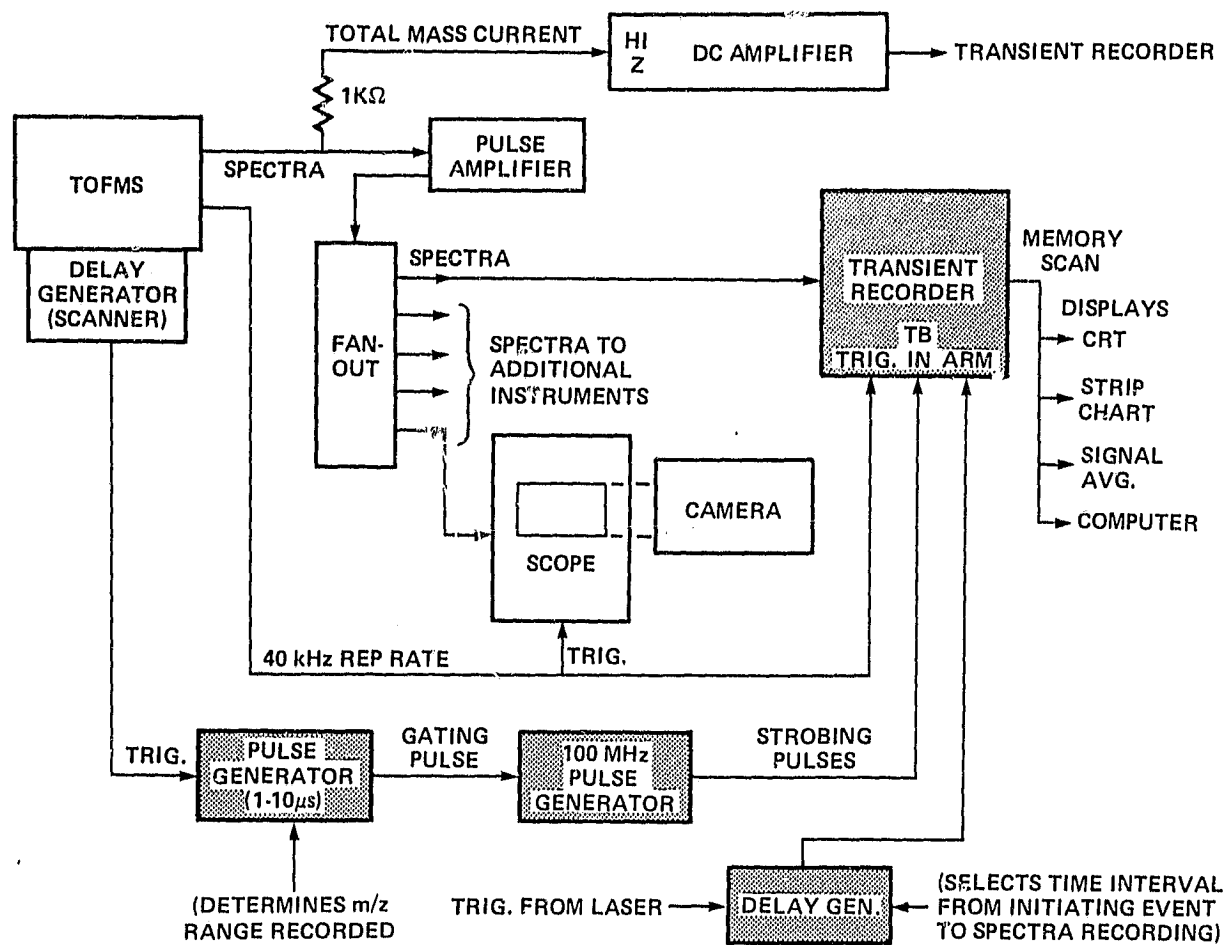

Figure 3. Instrumentation for recording multiple spectra in memory of transient recorder.

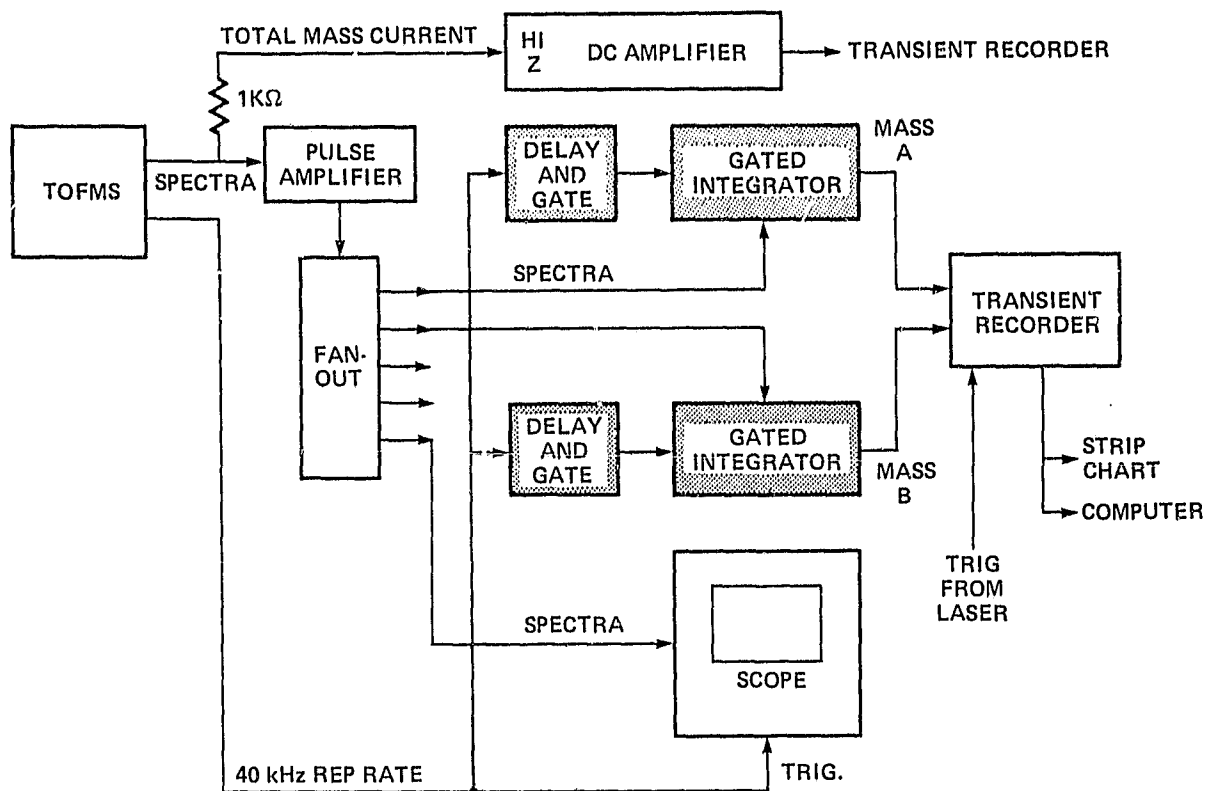

Figure 4. Instrumentation for gating-out and displaying preselected mass peaks.

ORIGINAL PAGE IS
OF POOR QUALITY

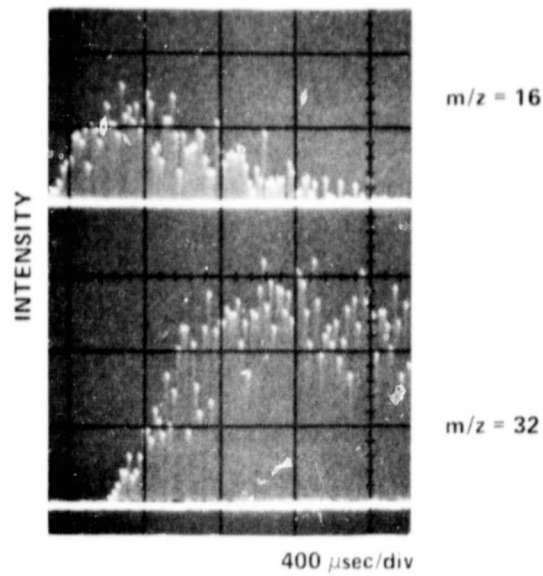

Figure 5. Two time-resolved masses from pulsed laser-heated Al_2O_3 .

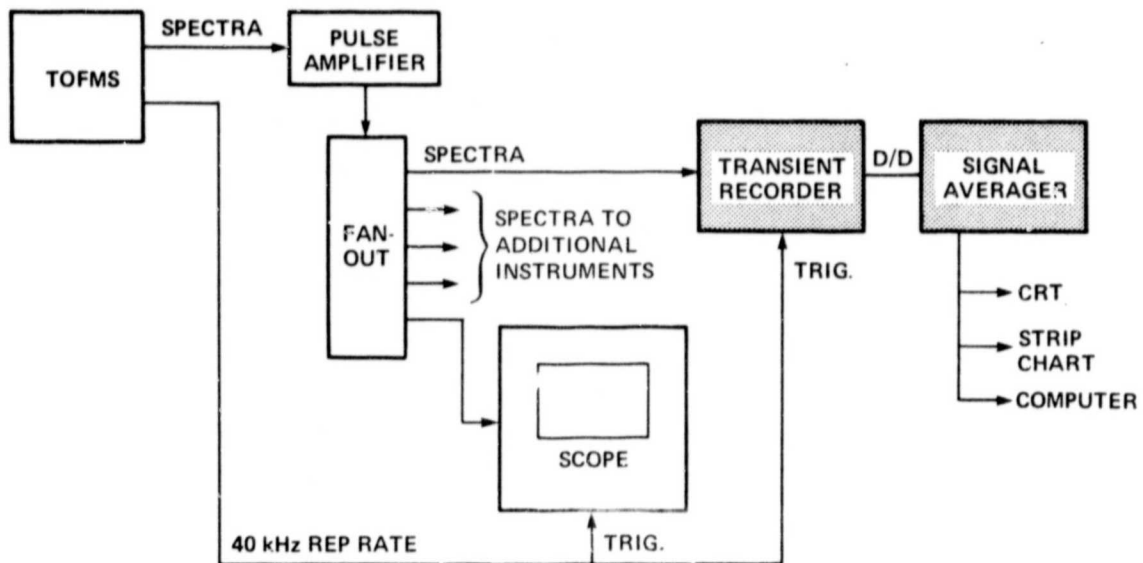

Figure 6. Instrumentation for accumulating spectra in signal averager.

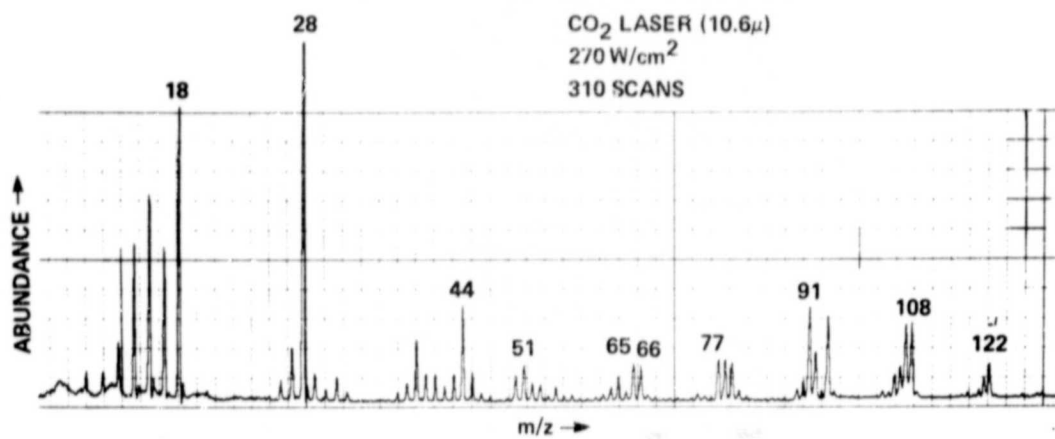
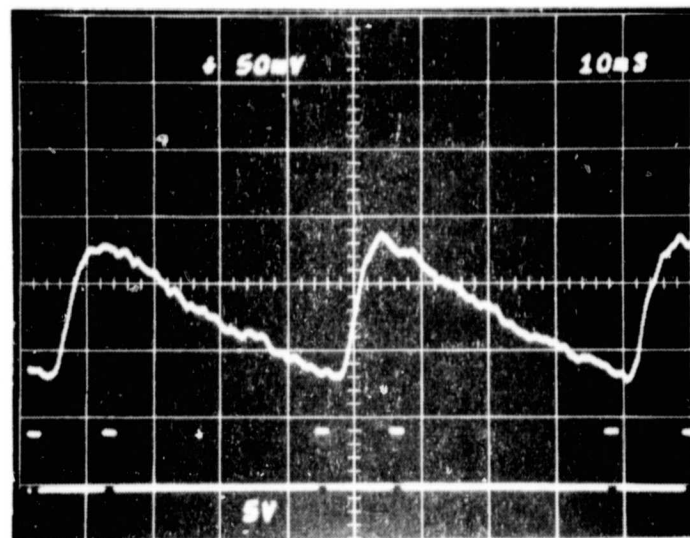

Figure 7. Averaged spectra from CW laser-heated carbon phenolic composite.



UPPER: TOTAL MASS CURRENT

LOWER: ADD/SUBTRACT LOGIC PULSES TO AVERAGER

Figure 8. Repetitively pulsed inlet to mass spectrometer: upper, total mass current; lower, add-subtract logic pulsers to averager.

1. Report No. NASA TM-81224	2. Government Accession No.	3. Recipient's Catalog No.	
4. Title and Subtitle DATA ACQUISITION TECHNIQUES FOR EXPLOITING THE UNIQUENESS OF THE TIME-OF-FLIGHT MASS SPECTROMETER: APPLICATION TO SAMPLING PULSED GAS SYSTEMS		5. Report Date	
		6. Performing Organization Code	
7. Author(s) Kenneth A. Lincoln		8. Performing Organization Report No. A-8308	
		10. Work Unit No. 506-53-31-05-00-21	
9. Performing Organization Name and Address Ames Research Center, NASA Moffett Field, CA 94035		11. Contract or Grant No.	
		13. Type of Report and Period Covered Technical Memorandum	
12. Sponsoring Agency Name and Address National Aeronautics and Space Administration Washington, D.C. 20546		14. Sponsoring Agency Code	
		15. Supplementary Notes This paper was presented at the Dynamic Mass Spectrometry Symposium, in Canterbury, England, July 7-10, 1980.	
16. Abstract <p>Mass spectra are produced in most mass spectrometers by sweeping some parameter within the instrument as the sampled gases flow into the ion source, and it is evident that any fluctuation in the gas during the sweep (mass scan) of the instrument will cause the output spectrum to be skewed in its mass-peak intensities. However, the TOFMS (time-of-flight mass spectrometer) with its uniquely fast, repetitive mode of operation produces spectra without slewing or varying instrument parameters; and because all ion species are ejected from the ion source simultaneously, the spectra are inherently not skewed despite rapidly changing gas pressure or composition in the source. This paper describes some recent methods of exploiting this feature by utilizing fast digital data acquisition systems, such as transient recorders and signal averagers which are commercially available. Applications of this technique are presented including TOFMS sampling of vapors produced by both pulsed and continuous laser heating of materials.</p>			
17. Key Words (Suggested by Author(s)) Mass spectrometry Laser effects Vapor sampling		18. Distribution Statement Unlimited STAR Category - 35	
19. Security Classif. (of this report) Unclassified	20. Security Classif. (of this page) Unclassified	21. No. of Pages 14	22. Price* \$4.00