

N O T I C E

THIS DOCUMENT HAS BEEN REPRODUCED FROM
MICROFICHE. ALTHOUGH IT IS RECOGNIZED THAT
CERTAIN PORTIONS ARE ILLEGIBLE, IT IS BEING RELEASED
IN THE INTEREST OF MAKING AVAILABLE AS MUCH
INFORMATION AS POSSIBLE

DOE/NASA/0124-3
NASA CR-159882

SMALL PASSENGER CAR TRANSMISSION TEST— CHEVROLET LUV TRANSMISSION

(NASA-CR-159882) SMALL PASSENGER CAR N80-31796
TRANSMISSION TEST; CHEVROLET LUV
TRANSMISSION Final Report (Eaton Corp.,
Southfield, Mich.) 428 p HC A19/MF A01
CSCL 13I G3/37 28596
Unclas

M.P. Bujold
Eaton Corporation
Engineering & Research Center

June 1980

Prepared for
NATIONAL AERONAUTICS AND SPACE ADMINISTRATION
Lewis Research Center
Under Contract DEN 3-124

for
U.S. DEPARTMENT OF ENERGY
Conservation and Solar Energy
Office of Transportation Programs

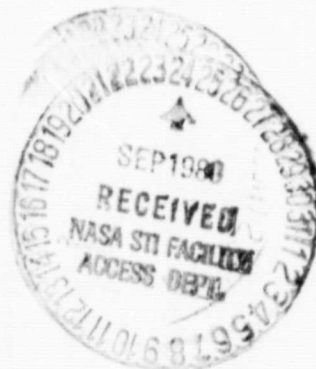

NOTICE

This report was prepared to document work sponsored by the United States Government. Neither the United States nor its agent, the United States Department of Energy, nor any Federal employees, nor any of their contractors, subcontractors or their employees, makes any warranty, express or implied, or assumes any legal liability or responsibility for the accuracy, completeness, or usefulness of any information, apparatus, product or process disclosed, or represents that its use would not infringe privately owned rights.

DOE/NASA/0124-3
NASA CR-159882

SMALL PASSENGER CAR TRANSMISSION TEST— CHEVROLET LUV TRANSMISSION

M.P. Bujold
Eaton Corporation
Engineering & Research Center
Southfield, Michigan 48037

June 1980

Prepared for
National Aeronautics and Space Administration
Lewis Research Center
Cleveland, Ohio 44135
Under Contract DEN 3-124

for
U.S. DEPARTMENT OF ENERGY
Conservation and Solar Energy
Office of Transportation Programs
Washington, D.C. 20545
Under Interagency Agreement EC-77-A-31-1044

PREFACE

The Electric and Hybrid Vehicle Research, Development, and Demonstration Act of 1976 (Public Law 94-413) authorized a Federal program of research and development designed to promote electric and hybrid vehicle technologies. The Energy Research and Development Administration, now the Department of Energy (DOE), which was given the responsibility for implementing the Act, established the Electric and Hybrid Vehicle Research, Development, and Demonstration Project within the Division of Transportation Energy Conservation to manage the activities required by Public Law 94-413.

The National Aeronautics and Space Administration under an Interagency Agreement (Number EC-77-A-31-1044) was requested by ERDA (DOE) to undertake research and development of propulsion systems for electric and hybrid vehicles. The Lewis Research Center was made the responsible NASA Center for this project. The work presented in this report is an early part of the Lewis Research Center program for propulsion system research and development for electric vehicles.

The work described in this report was conducted under Contract DEN 3-124 with the National Aeronautics and Space Administration (NASA) and sponsored by the Department of Energy through an agreement with NASA.

TABLE OF CONTENTS

	<u>PAGE</u>
SUMMARY.....	1
INTRODUCTION.....	2
EQUIPMENT TESTED.....	3
TEST APPARATUS.....	4
TEST PROCEDURE.....	15
TEST RESULTS.....	23
DRIVE PERFORMANCE COVER SHEET.....	24
Drive Performance 1st Gear Input Torque =	10 lb-ft ... 26
" " " " "	20 lb-ft ... 31
" " " " "	30 lb-ft ... 36
" " " " "	40 lb-ft ... 41
" " " " "	50 lb-ft ... 46
" " " " "	60 lb-ft ... 51
" " " " "	70 lb-ft ... 56
" " " " "	80 lb-ft ... 61
" " " " "	90 lb-ft ... 66
DRIVE PERFORMANCE COVER SHEET.....	71
Drive Performance 2nd Gear Input Torque =	10 lb-ft ... 73
" " " " "	20 lb-ft ... 78
" " " " "	30 lb-ft ... 83
" " " " "	40 lb-ft ... 88
" " " " "	50 lb-ft ... 93
" " " " "	60 lb-ft ... 98
" " " " "	70 lb-ft ... 103
" " " " "	80 lb-ft ... 108
" " " " "	90 lb-ft ... 113
DRIVE PERFORMANCE COVER SHEET.....	118
Drive Performance 3rd Gear Input Torque =	10 lb-ft ... 120
" " " " "	20 lb-ft ... 125
" " " " "	30 lb-ft ... 130
" " " " "	40 lb-ft ... 135
" " " " "	50 lb-ft ... 140
" " " " "	60 lb-ft ... 145
" " " " "	70 lb-ft ... 150
" " " " "	80 lb-ft ... 155
" " " " "	90 lb-ft ... 160
DRIVE PERFORMANCE COVER SHEET.....	165
Drive Performance 4th Gear Input Torque =	10 lb-ft ... 167
" " " " "	20 lb-ft ... 172
" " " " "	30 lb-ft ... 177
" " " " "	40 lb-ft ... 182

TABLE OF CONTENTS (cont'd.)

	<u>PAGE</u>
Drive Performance 4th Gear Input Torque = 50 lb-ft ...	187
" " " " " = 60 lb-ft ...	192
" " " " " = 70 lb-ft ...	197
" " " " " = 80 lb-ft ...	202
" " " " " = 90 lb-ft ...	207
CROSS SECTIONAL ROAD LOAD PERFORMANCE COVER SHEET.....	212
Cross Sectional Road Load Performance 4th Gear	
Output Torque = 10 lb-ft ...	214
" " " " " = 20 lb-ft ...	219
" " " " " = 30 lb-ft ...	224
" " " " " = 40 lb-ft ...	229
" " " " " = 50 lb-ft ...	234
" " " " " = 60 lb-ft ...	239
" " " " " = 70 lb-ft ...	244
" " " " " = 80 lb-ft ...	249
" " " " " = 90 lb-ft ...	254
COAST PERFORMANCE COVER SHEET.....	259
Coast Performance 1st Gear Engine Torque = 10 lb-ft ...	261
" " " " " = 20 lb-ft ...	266
" " " " " = 30 lb-ft ...	271
" " " " " = 40 lb-ft ...	276
COAST PERFORMANCE COVER SHEET.....	281
Coast Performance 2nd Gear Engine Torque = 10 lb-ft ...	283
" " " " " = 20 lb-ft ...	288
" " " " " = 30 lb-ft ...	293
" " " " " = 40 lb-ft ...	298
" " " " " = 50 lb-ft ...	303
" " " " " = 60 lb-ft ...	308
COAST PERFORMANCE COVER SHEET.....	313
Coast Performance 3rd Gear Engine Torque = 10 lb-ft ...	315
" " " " " = 20 lb-ft ...	320
" " " " " = 30 lb-ft ...	325
" " " " " = 40 lb-ft ...	330
" " " " " = 50 lb-ft ...	335
" " " " " = 60 lb-ft ...	340
" " " " " = 70 lb-ft ...	345
" " " " " = 80 lb-ft ...	350
COAST PERFORMANCE COVER SHEET.....	355
Coast Performance 4th Gear Engine Torque = 10 lb-ft ...	357
" " " " " = 20 lb-ft ...	362
" " " " " = 30 lb-ft ...	367
" " " " " = 40 lb-ft ...	372
" " " " " = 50 lb-ft ...	377
" " " " " = 60 lb-ft ...	382

TABLE OF CONTENTS (cont'd)

	<u>PAGE</u>
Coast Performance 4th Gear Engine Torque = 70 lb-ft ...	387
" " " " " " 80 lb-ft ...	392
" " " " " " 90 lb-ft ...	397
No Load Losses 1st Gear 	404
" 2nd Gear 	406
" 3rd Gear 	408
" 4th Gear 	410
APPENDIX.....	A-1

SUMMARY

The small passenger car transmission test was initiated to supply electric vehicle manufacturers with technical information regarding the performance of commercially available transmissions. This information would enable EV manufacturers to design a more energy efficient vehicle. With this information the manufacturers would be able to estimate vehicle driving range as well as speed and torque requirements for specific road load performance characteristics.

This report covers the 1978 Chevrolet Luv Truck manual transmission. This transmission was tested per a passenger car automatic transmission test code (SAE J651b) which required drive performance, coast performance, and no load test conditions. The portion of the test code which involved the throttle valve modulation and line pressure were deleted since they did not apply to the manual transmission. Under these test conditions the transmission attained maximum efficiencies in the upper ninety percent range at rated load for both drive performance tests and coast performance tests. The major results of this test are the torque speed and efficiency curves which are located in the data section of this report. These graphs map the complete performance characteristics for the Chevrolet Luv Truck Manual transmission. This information will facilitate the vehicle manufacturer in the design of a more energy efficient vehicle.

INTRODUCTION

The Chevrolet Luv Truck transmission is a commercially available manual transmission which is suited for a small passenger car installation. The transmission is equipped with four forward driving ranges, a neutral, and a reverse. Very little technical information in the area of torque, speed and efficiency data is currently available on this transmission. This lack of available information was the principal reason for the initiation of this test.

The principal object of this test was to map torque, speed, and efficiency curves of the test transmission in each gear range and in both drive performance and coast performance condition. The test was performed per the specifications of the Passenger Car Automatic Transmission Test Code - SAE J651b. The torque and speed limits of this test were governed by the torque and speed limits of an engine which would typically be supplied with this transmission. The test code specified that three basic tests were to be conducted which involved holding the torque constant and varying the transmission speed. The three specific tests were drive performance, coast performance, and no load losses which were conducted in first, second, third and fourth gear.

The test code specified an oil temperature requirement to ensure that a set oil viscosity level was attained throughout the tests. This temperature requirement was accomplished through the use of an immersion heater and a circulating pump. The lubricating oil was removed from the base of the transmission, passed through the circulation heater and returned through a fitting in the side of the transmission.

The determining factor in the amount of load which could be applied to the transmission was the capacity of the dynamometer. Characteristic load speed curves for the dynamometer and absorber are contained in the appendix. The data that were obtained from the torque and speed sensors were placed directly onto tape. The tape was then fed into a computer which reduced the data and generated the necessary graphs and technical information. The main advantage to this method of data reduction is that any fluctuation that may occur due to system resonance is averaged by the computer. This method minimizes the error and allows the data to be viewed after the tests are completed.

EQUIPMENT TESTED

The unit tested was a Chevrolet LUV truck manual transmission (Chevrolet Part No. 9402 6288). The transmission is a fully synchronized four-speed unit with block ring-type synchronizers and a sliding mesh type reverse gear. The unit consists primarily of a case with an integral clutch housing, center support, rear extension and gears. The top of the rear cover is a shifter cover containing the transmission control mechanism. The case, center support and rear extension are cast aluminum alloy which reduces the weight of the transmission.

TEST APPARATUS

The test apparatus used to operate the Chevrolet Luv Truck transmission consisted of the following basic items which are described and listed below. The apparatus was basically the same for drive and coast performance tests with the exception of the transmission which was indexed 180° for coast performance tests.

The driving dynamometer was used to power the transmission. A torque sensor was placed on the dynamometer shaft to accurately monitor the torque into the transmission. A speed pickup was placed on the dyno shaft to measure the speed into the transmission.

The output shaft of the transmission was coupled to a torque sensor which accurately measured its torque. An absorbing dynamometer was coupled to the rear torque sensor to apply load to the system. A speed pickup was mounted to the absorber shaft to measure output speed.

The transmission oil temperature was controlled through the use of a circulating pump and circulation heater. The temperature of the transmission was monitored at the sump and at the top of the case.

The transmission was shifted in each gear range by placing a shift rod in the shift forks located at the top of the case. These forks were then manipulated until the proper gear was attained.

The instrumentation for the setup consisted of the following basic items. The Lebow torque sensor was used in conjunction with a Daytronic signal conditioner (878). The Himmelstein torque sensor was matched with a Daytronic signal conditioner (878A). The magnetic speed pickup was used with an Airpax speed readout. These signals were then fed into a Sangamo 3500 tape recorder. The tape recorded data were then fed into a Hewlett Packard Analyzer which reduced the data.

DESCRIPTION

PART NO.

MANUFACTURER

Driving Dynamometer
Flexible Coupling
Torque Sensor
Pilot Bearing
Transmission
Rear Bearing
Flexible Coupling
Torque Sensor
Absorber
Circulation Heater

Model 26G308
226 SN
MCRT6-02T(2-3)
SFT-15
Luv Truck Manual
209-SFF
226 SN
1648-5K
1014DG
NWHO-2

General Electric
Thomas-Rexnord
Himmelstein
Sealmaster
Chevrolet
MRC
Thomas-Rexnord
Lebow
Dynamatic
Chromalox

INSTRUMENTATION

Torque Signal Conditioner
Torque Signal Conditioner
Speed Readout
Temperature Conditioner
Thermocouples

878A
878
761400110
810
6610WBA2

Daytronic
Daytronic
Airpax
Daytronic
Applied Instruments

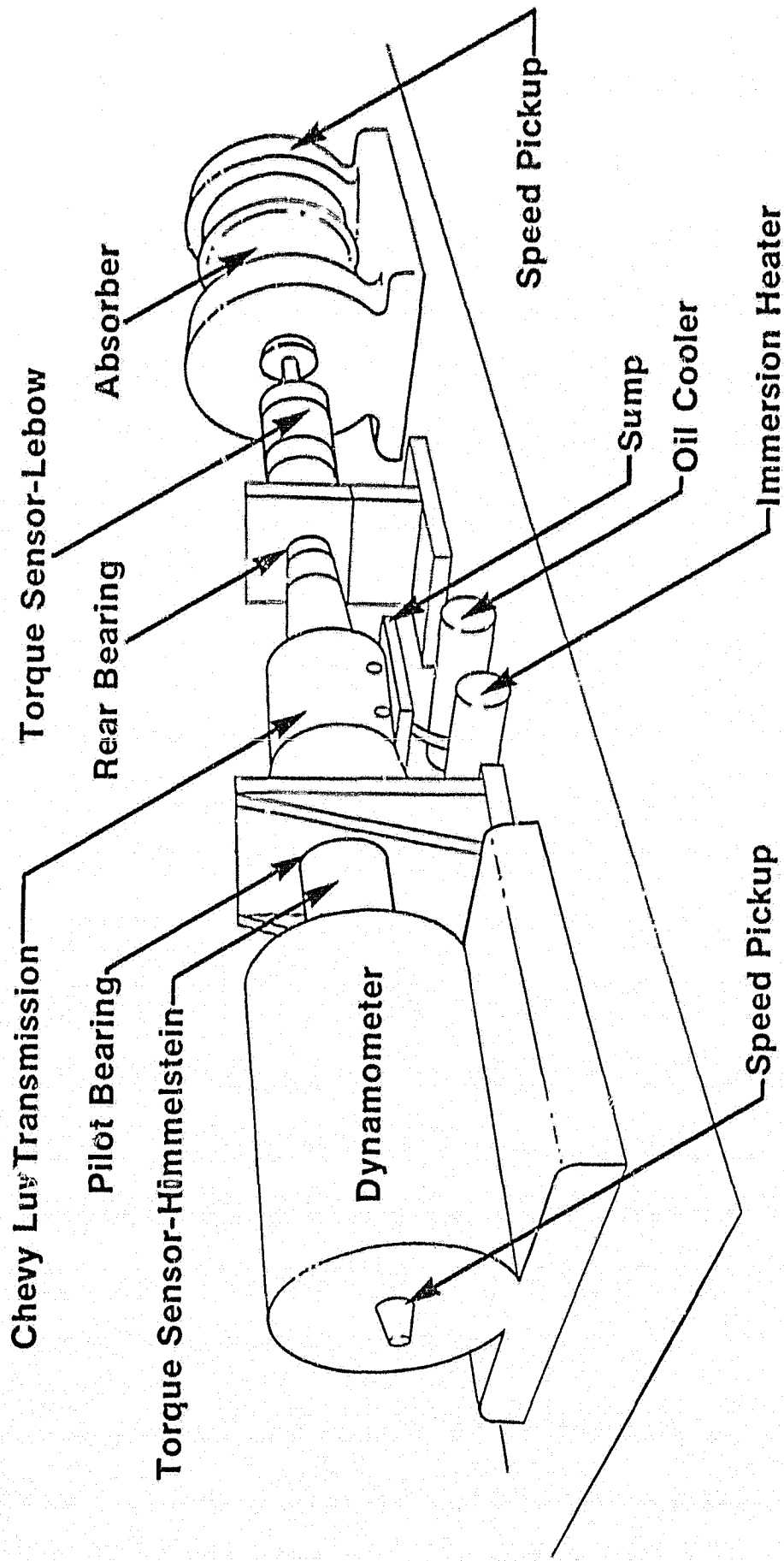

Drive Performance Test Setup DEN3-124

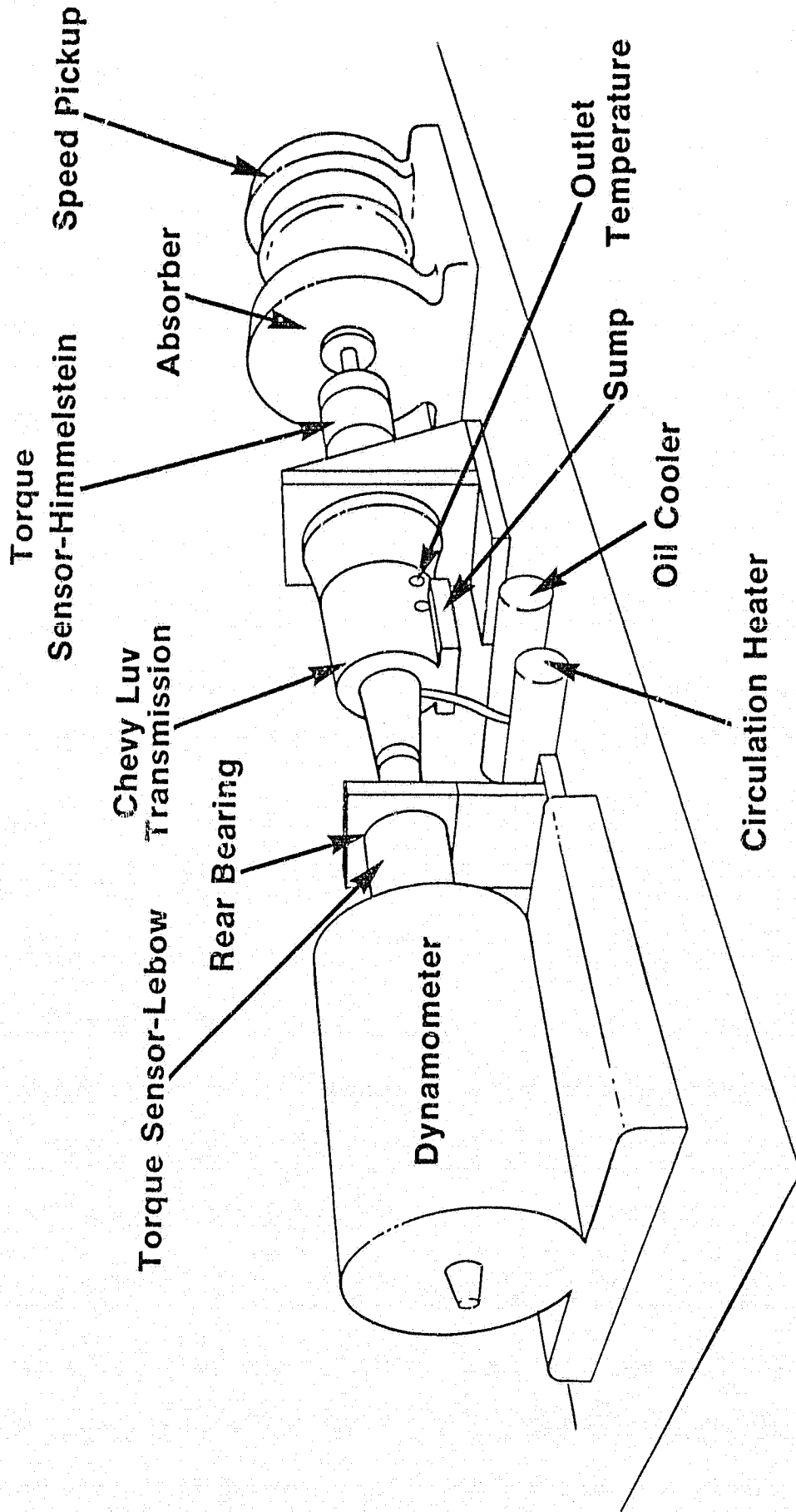

Coast Performance Test Setup

DEN3-124

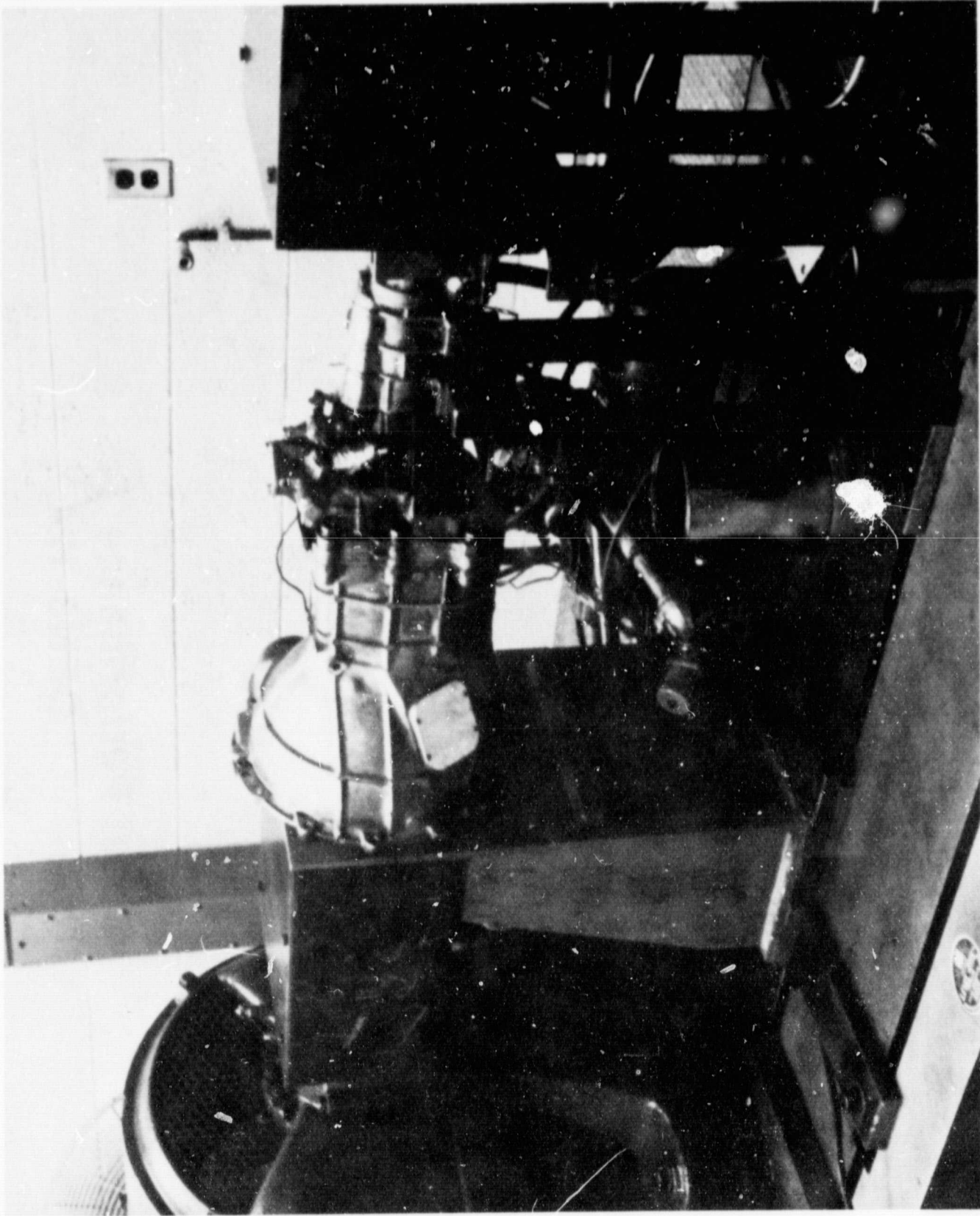

1978 Chevrolet Luv Truck Manual Transmission
Drive Performance (Back View)

ORIGINAL PAGE IS
OF POOR QUALITY

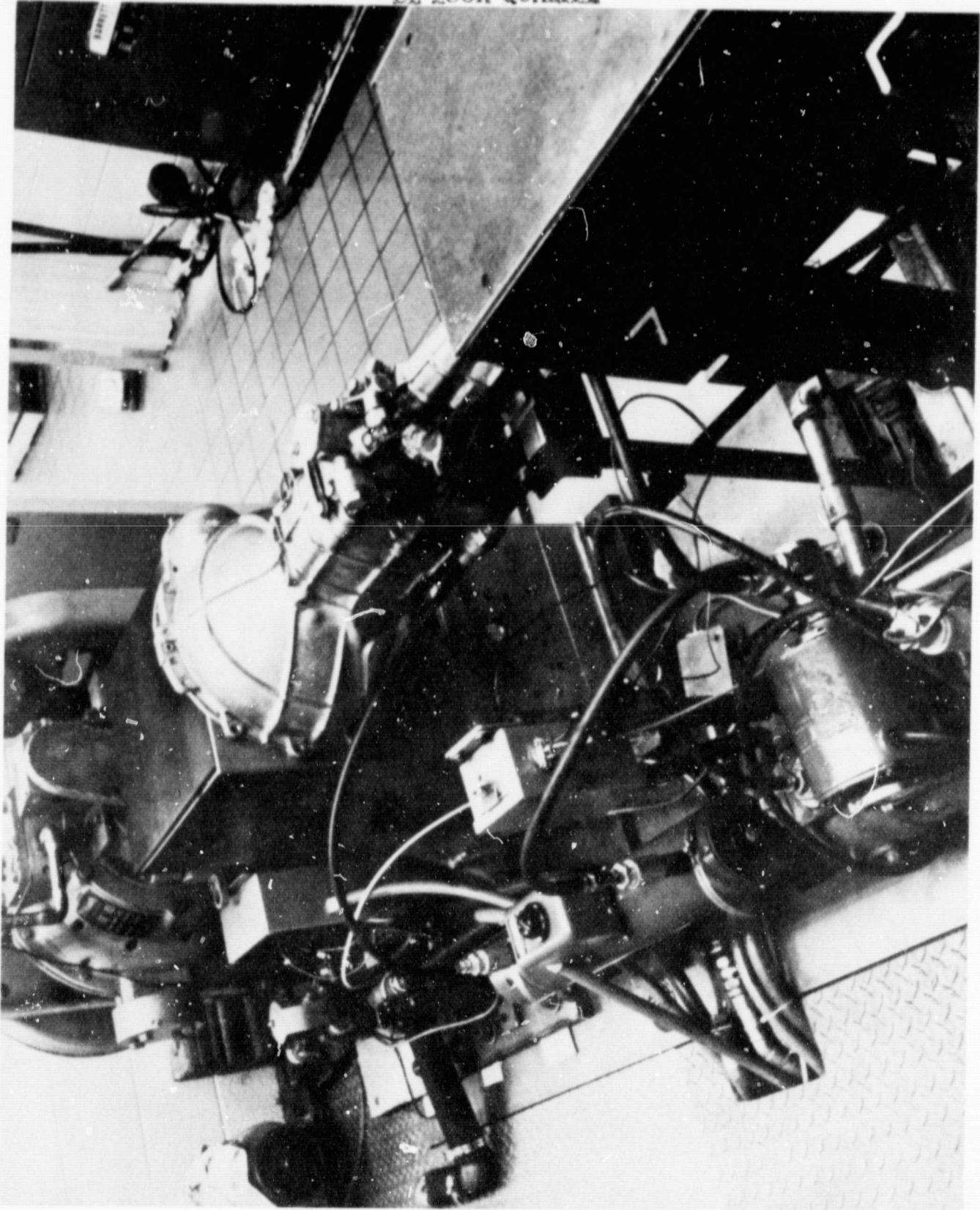

**1978 Chevrolet Luv Truck Manual Transmission
Drive Performance (Back View)**

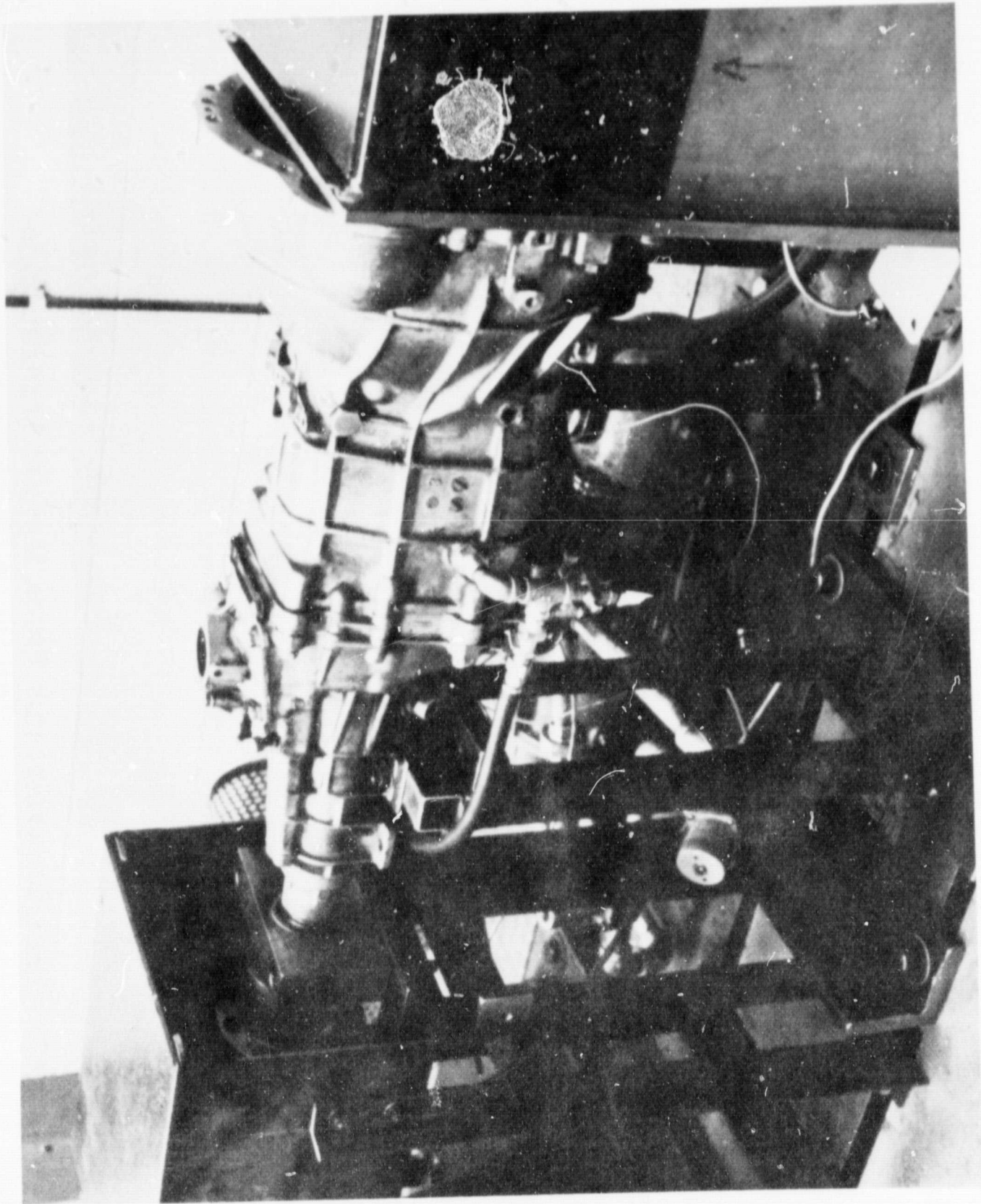

**1978 Chevrolet Luv Truck Manual Transmission
Drive Performance (Side View)**

ORIGINAL PAGE IS
OF POOR QUALITY

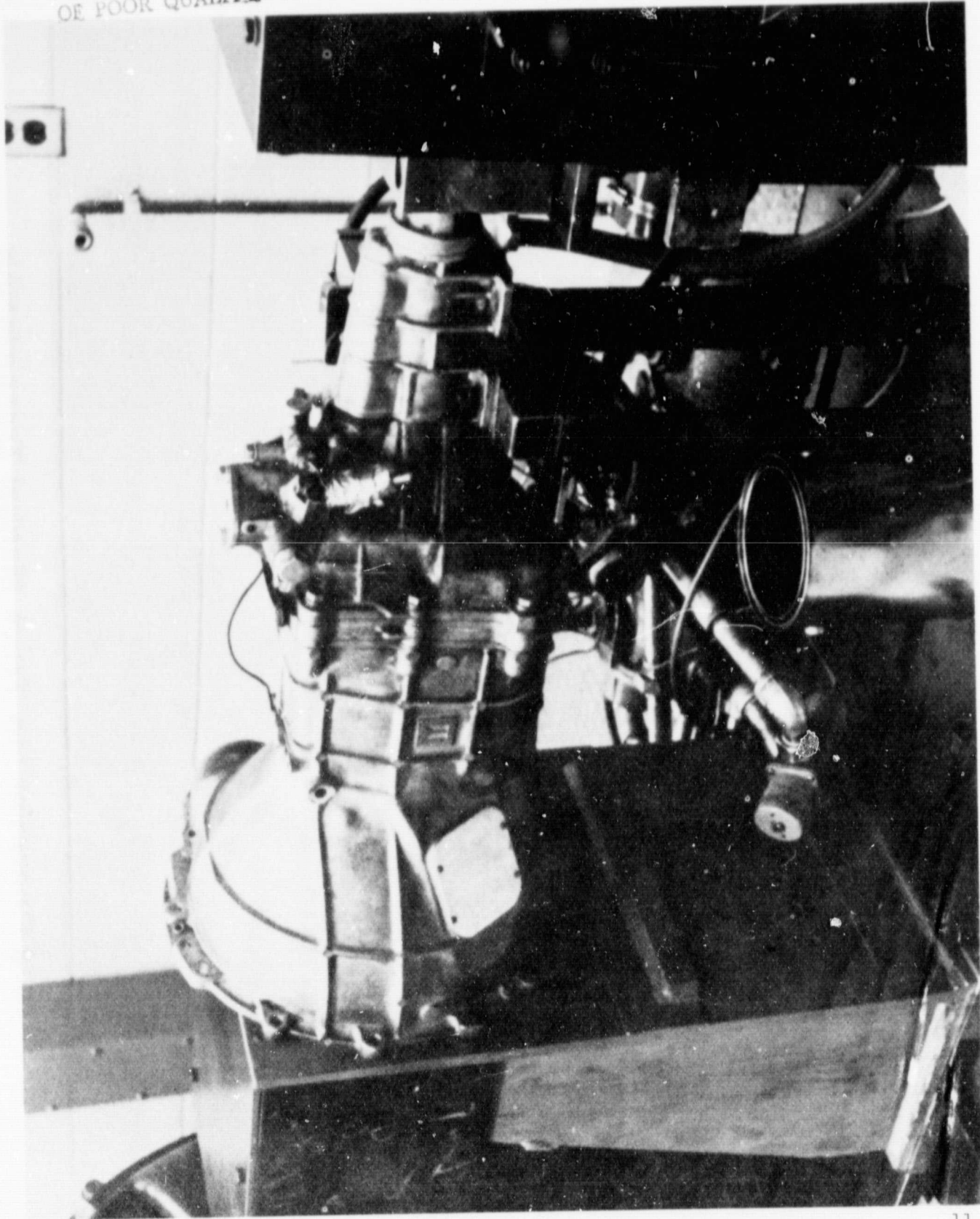

1978 Chevrolet Luv Truck Manual Transmission
Drive Performance (Side View)

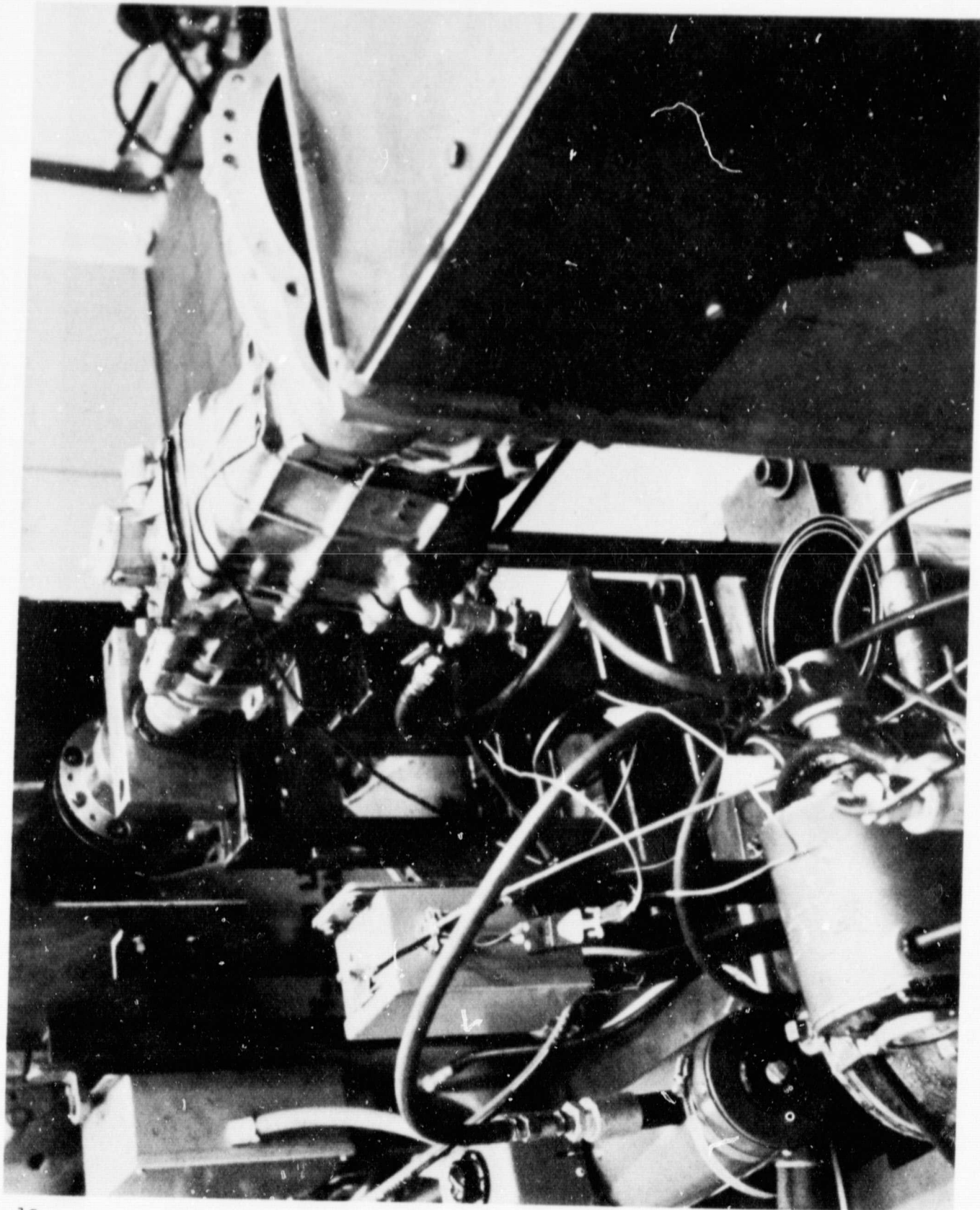

**1978 Chevrolet Luv Truck Manual Transmission
Drive Performance (Front View)**

ORIGINAL PAGE IS
OF POOR QUALITY

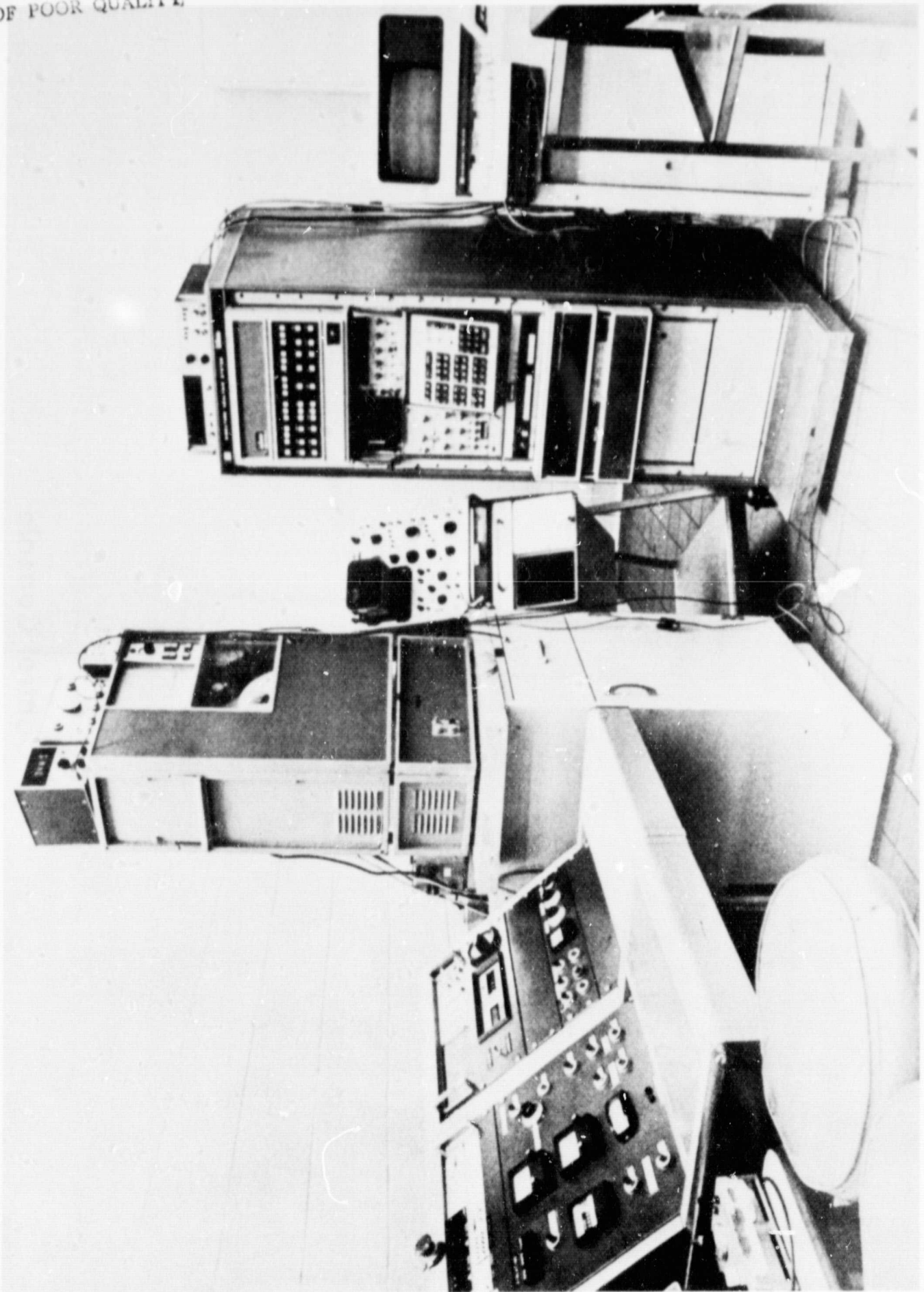

Control Console with Data Reduction Equipment

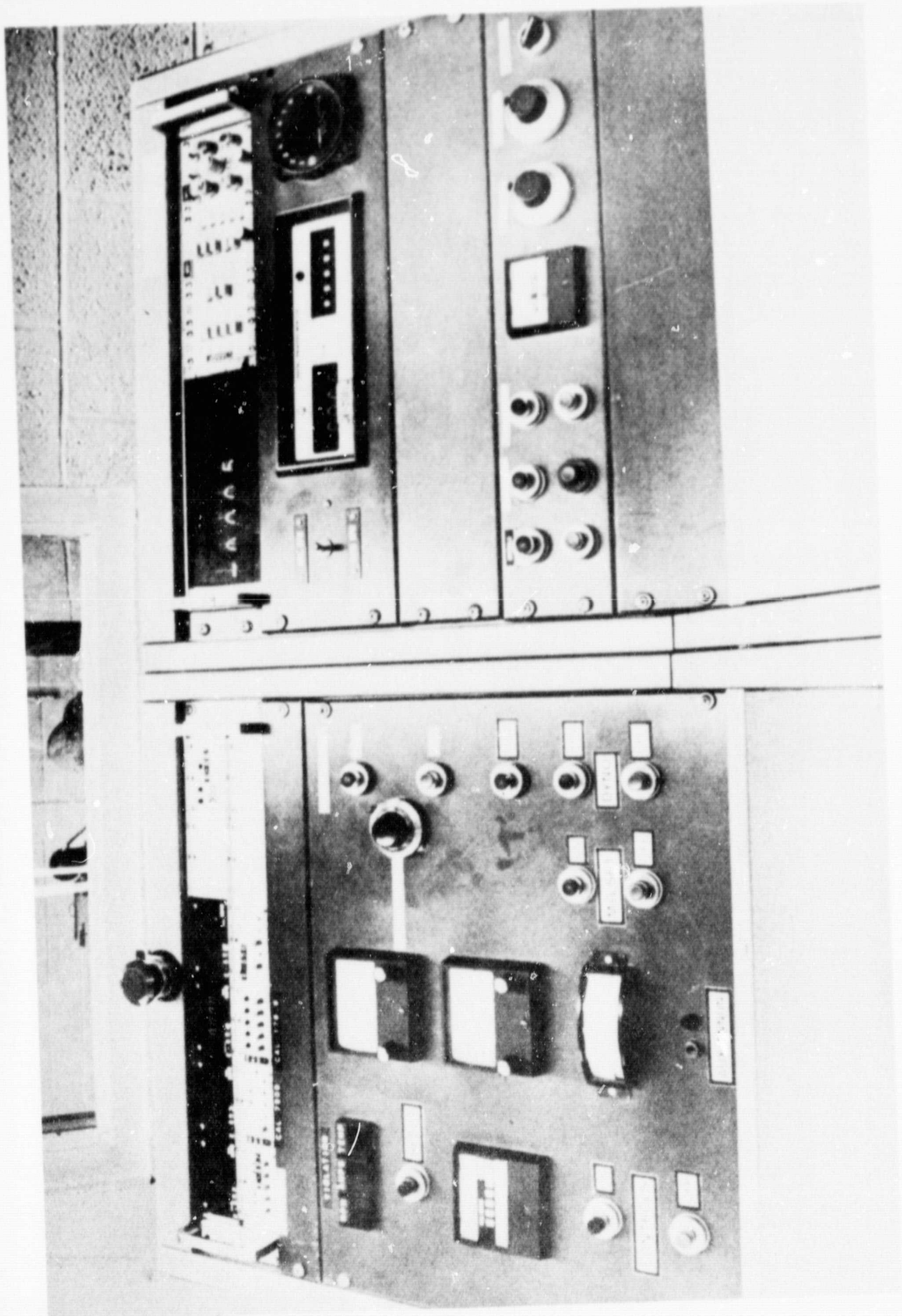

Control Console

TEST PROCEDURE

The test was conducted per the Passenger Car Automatic Transmission Test Code-SAE J651b. The code states that three basic tests should be performed on the transmission. These tests were drive performance, coast performance and no load losses. Each test was performed to the accuracies stated in the code.

The first test conducted was the drive performance test. The limits of the test were determined by the normal operating conditions of an engine typically supplied with this transmission. The torque limit was set to 90 lb-ft and the speed limit was set to 4000 rpm. The input shaft of the transmission was tested at a torque which ranged from 10-90 lb-ft on the input shaft of the transmission. The torque was incremented by 10 lb-ft for each test. The speed limits of the test ranged from 750 to 4000 rpm on the input shaft of the transmission.

Section 1 of the test code which is labeled Drive Performance - Constant Input Torque was conducted first. The input torque was held at 10 lb-ft and the speed was incremented from 750-4000 rpm. The torque was then set to 20 lb-ft and the transmission was run through the same speed range. This procedure was followed for input torques of 10, 20, 30, 40, 50, 60, 70, 80, and 90 lb-ft. The data recorded in this test were input and output speed, input and output torque, sump temperature, case hotspot temperature and ambient temperature.

This procedure was performed on the transmission in first, second, third, and fourth gear range. The transmission was held in each gear through the entire torque and speed range per the explanation given in the test apparatus section of this report.

The next portion of the test to be conducted was the Cross Sectional Road Load Performance Test. This test was conducted in third gear and involved holding the transmission output shaft at a constant torque while varying the input speed. The output torques selected were 10, 20, 30, 40, 50, 60, 70, 80 and 90 lb-ft. The speed range was from 750-4000 rpm on the input shaft. The data recorded in this test were input and output torque, input and output speed, sump temperature, case hotspot temperature, and ambient temperature.

The No Load Loss portion of the test was performed next. This test was run with the output shaft turning freely. The input torque and speed were recorded for an entire speed range which ran from 750 rpm to 4000 rpm. This test was performed in each gear range by disconnecting the output shaft and allowing it to turn freely.

The parameters recorded in this test were input torque and speed, sump temperature, case hotspot temperature, and ambient temperature.

The final set of tests performed were the coast performance tests. For this test the transmission was oriented in the reverse direction so that the dynamometer drove through the output shaft of the transmission and the power was taken up in the absorber. The test was operated by setting the clutch shaft torque at a constant level and varying its speed in the range set by the previous tests. The amount of torque which could be applied to the system was limited by the current limits of the dynamometer controller. The first gear coast performance tests reached the current limit at the 40 lb-ft run. The second, and third gear coast performance tests reached current limit at 60 lb-ft run and 80 lb-ft run respectively. This was due to the slow output speed in first, second and third gear which were beyond the dynamometer torque speed characteristics. The data recorded during this portion of the test were input and output torque, input and output speed, sump temperature, case hotspot temperature, and ambient temperature.

The transmission was filled with Arco Graphite 10-40 motor oil through the entire test schedule. This fluid was chosen over the manufacturer's recommended 80 W gear lube at the request of the Jet Propulsion Laboratory, for whom this test was being conducted. This oil was utilized in previous tests that were performed on the transmission, and it was decided to maintain these test conditions as closely as possible. The physical and chemical properties of the motor oil were monitored throughout the test. The color of the fluid did not appreciably change during the tests.

CALIBRATION

The test apparatus was calibrated before and after a major test was completed. The major components calibrated were the torque sensors and the speed readouts. The torque sensors were calibrated with their respective readouts and attaching cables so that a total system accuracy was obtained. The calibration was performed by placing a set of known weights at a known distance to produce the resultant torque. The weights were weighed on a Toledo Digital Scale Model No. 1070, which is calibrated to a set of weights traceable to the National Bureau of Standards. The calibration arm was measured to a length of 24.00 inches. This length was recalculated for each weight which was placed on the calibration arm due to the deflection in the arm. The calibration sheets contained in this section show the calculated torque and the actual torque which appeared on the readout (measured torque). The torque sensors were calibrated to the limits of the range over which they were to operate.

The speed readout was an AIRPAX counter (Model No. 761400110) which was calibrated in an operating range from 0 to 4500 rpm. The counter was calibrated with a Hewlett Packard electric counter (Model No. 5245L) used in conjunction with a WWVB frequency comparator (True Time, Inc. Model No. 60-TR). The accuracy of the digital readout was ± 1 count.

CALIBRATION SHEET
 HIMMELSTEIN TORQUE SENSOR #MCRT 6-02T (2-3)
 CAL VALUE = 58.5 lb-ft
 DRIVE PERFORMANCE TESTS TORQUE WAS POSITIVE
 DIRECTION OF TORQUE CLOCKWISE

3-27-80
 DEN3-124

CALCULATED TORQUE (lb-ft)	MEASURED TORQUE (lb-ft)
$(5.00) \times 2 \times (\cos 0) = +10.00$	+10.0
$(8.175) \times 2 \times (\cos 0) = +16.35$	+16.5
$(10.47) \times 2 \times (\cos 0) = +20.94$	+21.0
$(28.21) \times 2 \times (\cos .5) = +56.42$	+57.0
$(48.24) \times 2 \times (\cos .5) = +96.47$	+97.0
$(68.26) \times 2 \times (\cos 1) = +136.49$	+136.0
0	

COAST PERFORMANCE TESTS TORQUE WAS NEGATIVE
 DIRECTION OF TORQUE COUNTERCLOCKWISE

	0	0
$(-5.00) \times 2 \times (\cos 0) = -10.0$		-9.5
$(-8.175) \times 2 \times (\cos 0) = -16.35$		-16.5
$(-10.47) \times 2 \times (\cos .5) = -20.94$		-21.0
$(-28.21) \times 2 \times (\cos 1.0) = -56.41$		-57.0
$(-48.24) \times 2 \times (\cos 1.0) = -96.46$		-96.5
$(-68.26) \times 2 \times (\cos 1.0) = -136.49$		-136.0
0		0

CALIBRATION SHEET
 LEBOW TORQUE SENSOR #1648-5K
 CAL VALUE = 271
 COAST PERFORMANCE TESTS TORQUE WAS NEGATIVE
 DIRECTION OF TORQUE COUNTERCLOCKWISE

3-27-80
 DEN3-124

CALCULATED TORQUE (lb-ft) CLOCKWISE?		MEASURED TORQUE (lb-ft)	
$(-8.175) \times 2 \times (\cos 1^\circ)$	=	-16.35	-17.0
$(-28.21) \times 2 \times (\cos 1.5^\circ)$	=	-56.40	-56.5
$(-48.24) \times 2 \times (\cos 2.0^\circ)$	=	-96.42	-96.0
$(-68.26) \times 2 \times (\cos 2^\circ)$	=	-136.44	-136.0
$(-88.31) \times 2 \times (\cos 2^\circ)$	=	-176.51	-176.0
$(-108.31) \times 2 \times (\cos 2.5^\circ)$	=	-216.40	-216.4
$(-128.34) \times 2 \times (\cos 2.5^\circ)$	=	-256.43	-257.0
$(-148.42) \times 2 \times (\cos 2.5^\circ)$	=	-296.50	-296.5
$(-168.48) \times 2 \times (\cos 3.0^\circ)$	=	-336.49	-337.0
		0	0

DRIVE PERFORMANCE TESTS TORQUE WAS POSITIVE
 DIRECTION OF TORQUE CLOCKWISE

$(8.175) \times 2 \times (\cos 0)$	=	+16.35	+17.0
$(28.21) \times 2 \times (\cos 0)$	=	+56.42	+56.0
$(48.24) \times 2 \times (\cos .5)$	=	+96.47	+97.0
$(68.26) \times 2 \times (\cos .5)$	=	+136.51	+136.5
$(88.31) \times 2 \times (\cos .5)$	=	+176.6	+176.0
$(108.31) \times 2 \times (\cos 1.0)$	=	+216.58	+216.5
$(128.34) \times 2 \times (\cos 1.5)$	=	+256.59	+256.5
$(148.42) \times 2 \times (\cos 2.0)$	=	+296.66	+297.0
$(168.48) \times 2 \times (\cos 2.5)$	=	+336.64	+336.0
		0	0

SYSTEM ACCURACY

The instruments used in the test setup have been calibrated to insure the accuracy of the test data. The individual components utilized in the tests contain manufacturers specifications which guarantee the accuracy of the instrumentation. These accuracies are listed and combined in the appendix section to determine the total system accuracy. The three major components involved in the system accuracy are the torque signals, speed signals, and data reduction equipment. Worst case system accuracies for the torque sensors, cabling and readouts were determined from the calibration charts and are shown below.

TAPE RECORDER: Sangamo Model #3500
ACCURACY: $\pm 0.05\%$ of Full Scale

TORQUE SENSOR: Lebow (1648-5K) + Daytronic (878A)
ACCURACY: $((\text{Calculated Torque} - \text{Measured}) / \text{Full Scale Torque}) \times (100)$
 $((175.79 - 176.0) / 416.66) \times (100) = \pm 0.05\%$ of Full Scale

TORQUE SENSOR: Himmelstein (MCRT 6-62T(2-3)) + Daytronic (878)
ACCURACY: $((\text{Calculated Torque} - \text{measured}) / \text{Full Scale Torque}) \times (100)$
 $((56.26 - 55.9) / (166.66)) \times (100) = \pm 0.21\%$ of Full Scale

SPEED SENSOR: Speed Pickup + Airpax Counter
ACCURACY: Calibration was ± 1 Count $(1/4000) \times (100) = \pm 0.025\%$ of Full Scale

SPEED CONDITIONER (Frequency to Voltage Converter-Daytronic 840)
ACCURACY: 0.05% of Average DC Voltage $\pm 0.10\%$ of Full Scale

HEWLETT PACKARD ANALYZER (HP 5451B Fourier Analyzer)
ACCURACY: 12 Bits = $2^{11} = 2048$ Bits = 1 Volt
 $(1/2048) \times (100) = \pm 0.048\%$ of Full Scale

COMPUTER INTER NUMBER CALCULATION (Method of Program Calculation)
= 0.5% of Full Scale

The inter number calculation error resulted from the method that the computer used to average the acquired data. This method is explained in Appendix A.

From the instrument accuracy determined above, a system accuracy may be determined. There are two generally accepted methods for calculating a system error. These methods are the root mean square and the sum of the errors. Both methods are tabulated in the appendix and charted below for torque, speed, power and efficiency readings.

	<u>ROOT MEAN SQUARE METHOD % OF FULL SCALE</u>	<u>SUM OF ERRORS METHOD % OF FULL SCALE</u>	<u>FULL SCALE</u>
Torque Error (Lebow)	0.08%	0.15%	416 lb-ft
Torque Error (Himm.)	0.221%	0.31%	166 lb-ft
Speed Error	0.124%	0.223%	4000 RPM
Power Out Error	0.50%	0.70%	90 HP
Efficiency Error	0.58%	1.0%	100%

DATA REDUCTION

The signals obtained from the torque and speed transducers of the test stand were placed directly onto a Sangamo Tape Recorder Model No. 3500. The information on the tape was then fed into a computer which was used to compile the data. While in the computer, the data were reviewed to insure their accuracy and then a hard copy was printed out on a line printer.

The following procedure was used to record the input and output torque. The torque signals were placed on the tape recorder as voltage. A calibration value was determined in engineering units (lb-ft) for each torque sensor. The torques were recorded on channels one and two in the following manner:

CHANNEL 1: PRECALIBRATION ZERO CALIBRATION VOLTAGE PRERUN
ZERO DATA

CHANNEL 2: PRECALIBRATION ZERO CALIBRATION VOLTAGE PRERUN
ZERO DATA

This information was then fed into the computer which integrated and compiled a 2.5 second sample of data to obtain an average value in engineering units.

The frequency signals from the speed pickups were placed directly onto the tape recorder. The data on the tape were then fed into a frequency to voltage unit which turned the frequency into a dc voltage which in turn was fed into the computer. The method for recording speeds is shown below.

CHANNEL 3: ZERO FREQUENCY CALIBRATION FREQUENCY PRERUN ZERO
FREQUENCY DATA

CHANNEL 4: ZERO FREQUENCY CALIBRATION FREQUENCY PRERUN ZERO
FREQUENCY DATA

The data on these channels were then fed into the computer which integrated and compiled a 2.5 second sample of data to obtain an average speed value in engineering units.

The computer was programmed to take the values of torques and speeds and calculate efficiency and power from them. From the data it has generated, the computer would print out the required graphs and data per the contract specification. The main advantage to taking data in this manner was that the computer would calculate an integrated average which would minimize the error in a fluctuating signal. Any fluctuation due to system resonance or gear teeth meshing would be integrated and averaged.

TEST RESULTS

The data contained in this segment of the report has been divided into three major sections. These sections are drive performance, coast performance, and no load losses. There are five data sheets for each test condition in the drive performance and coast performance tests. The organization of this data is described and listed in the table of contents. Cover sheets for drive performance, coast performance and no load losses have been placed at the beginning of each section to describe the enclosed sheets.

DRIVE PERFORMANCE

1ST GEAR

Graphs Contained in This Section

- Torque Ratio -vs- Output Speed
- Output Torque -vs- Output Speed
- Input Speed -vs- Output Speed
- Efficiency -vs- Output Speed
- Efficiency -vs- Power Out

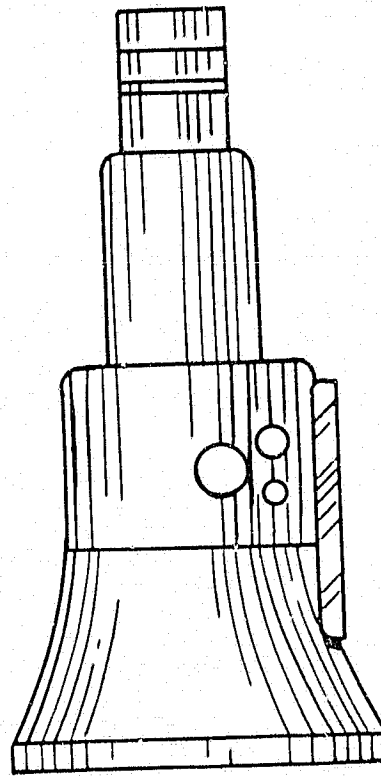

Torque In
Speed In

Torque Out
Speed Out

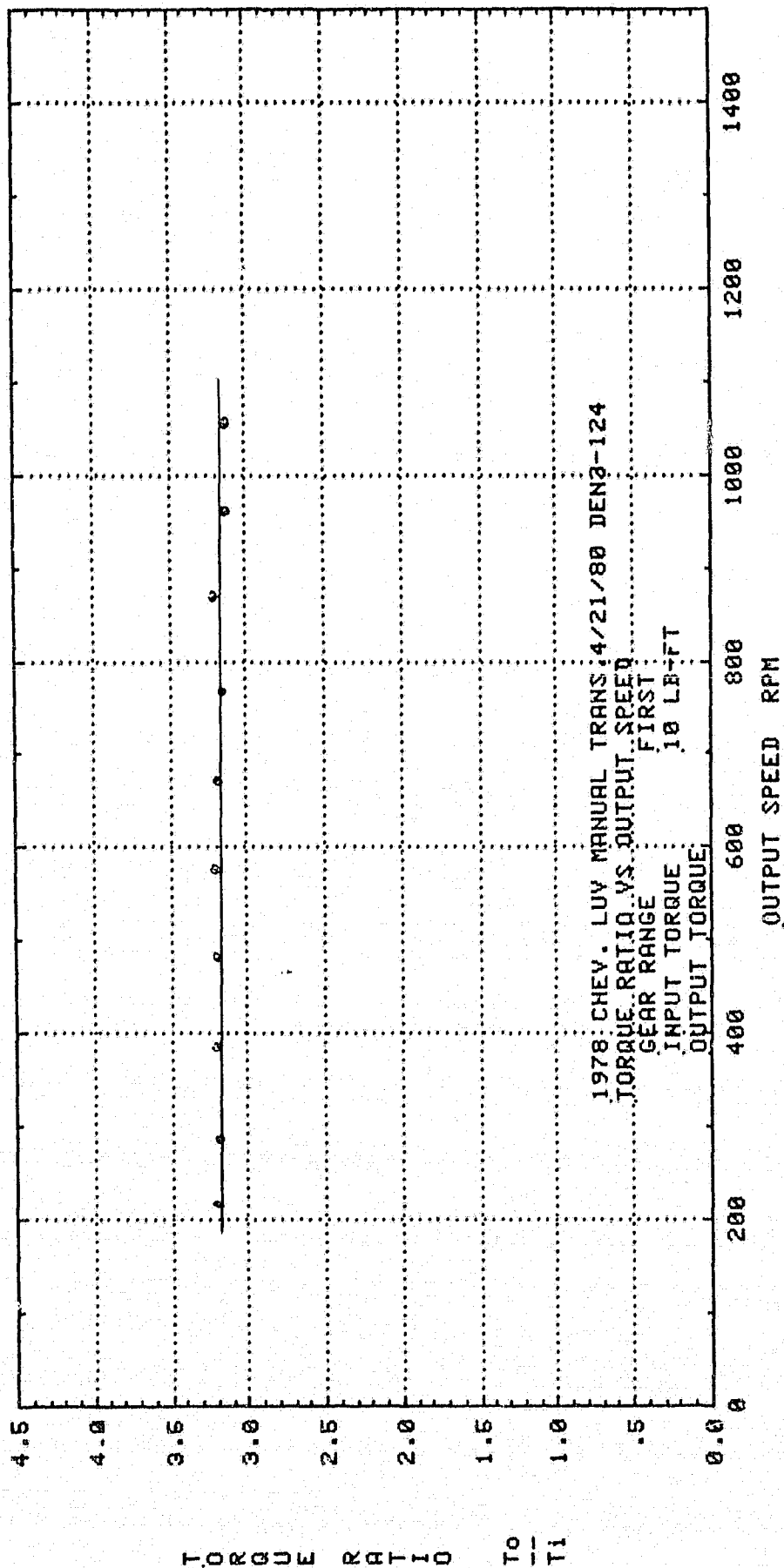

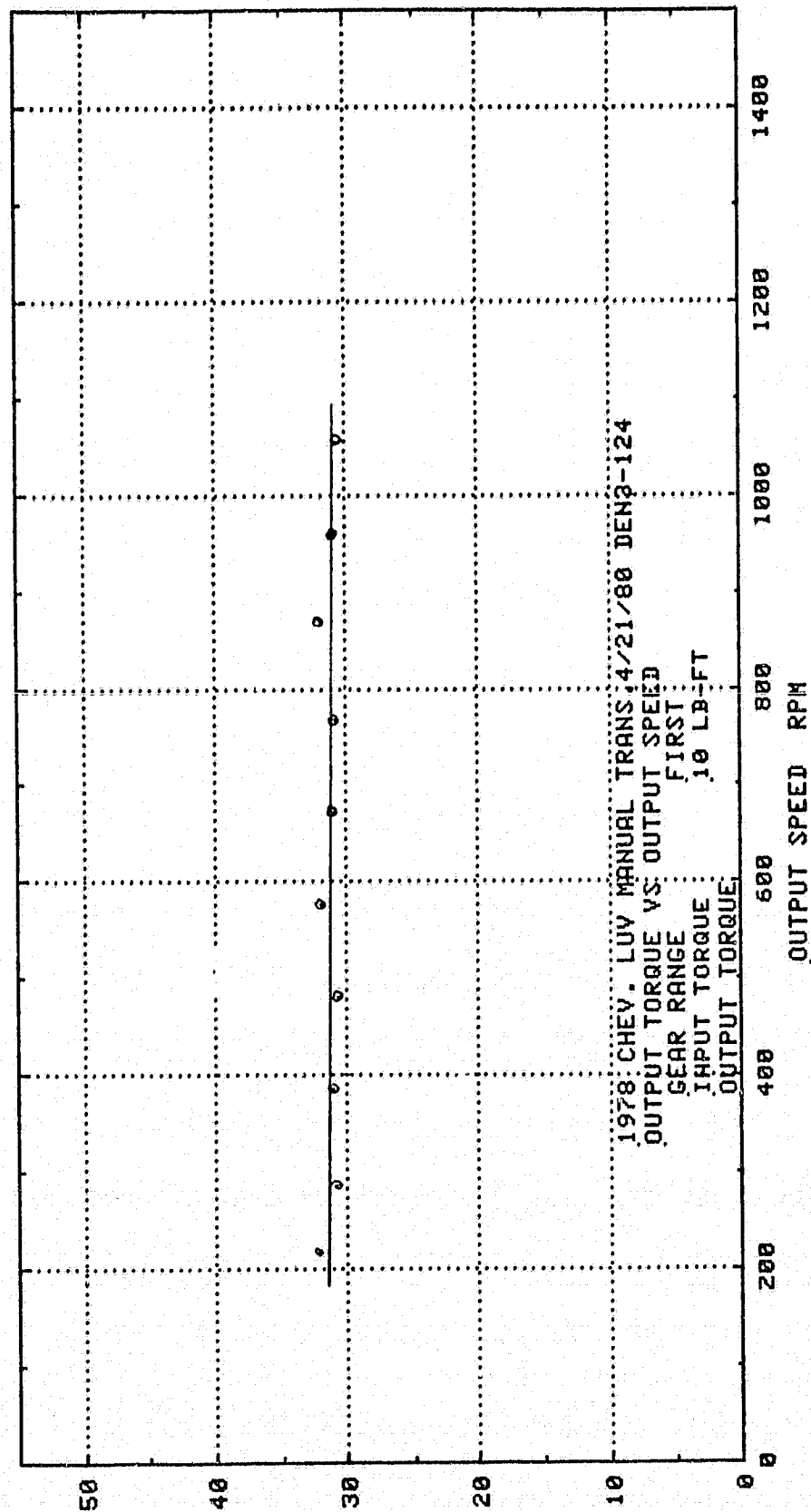

OUTPUT TORQUE LB FT

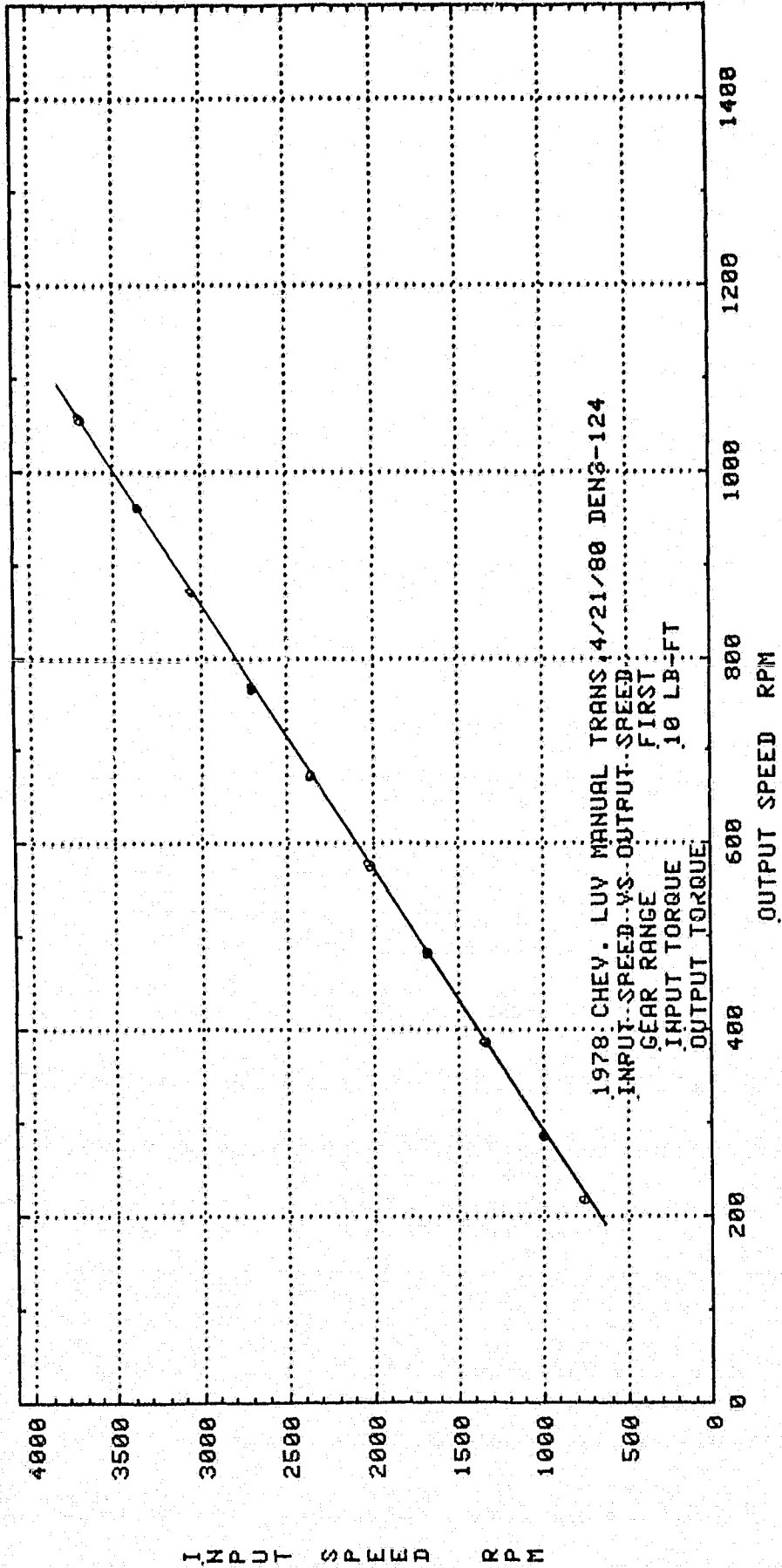

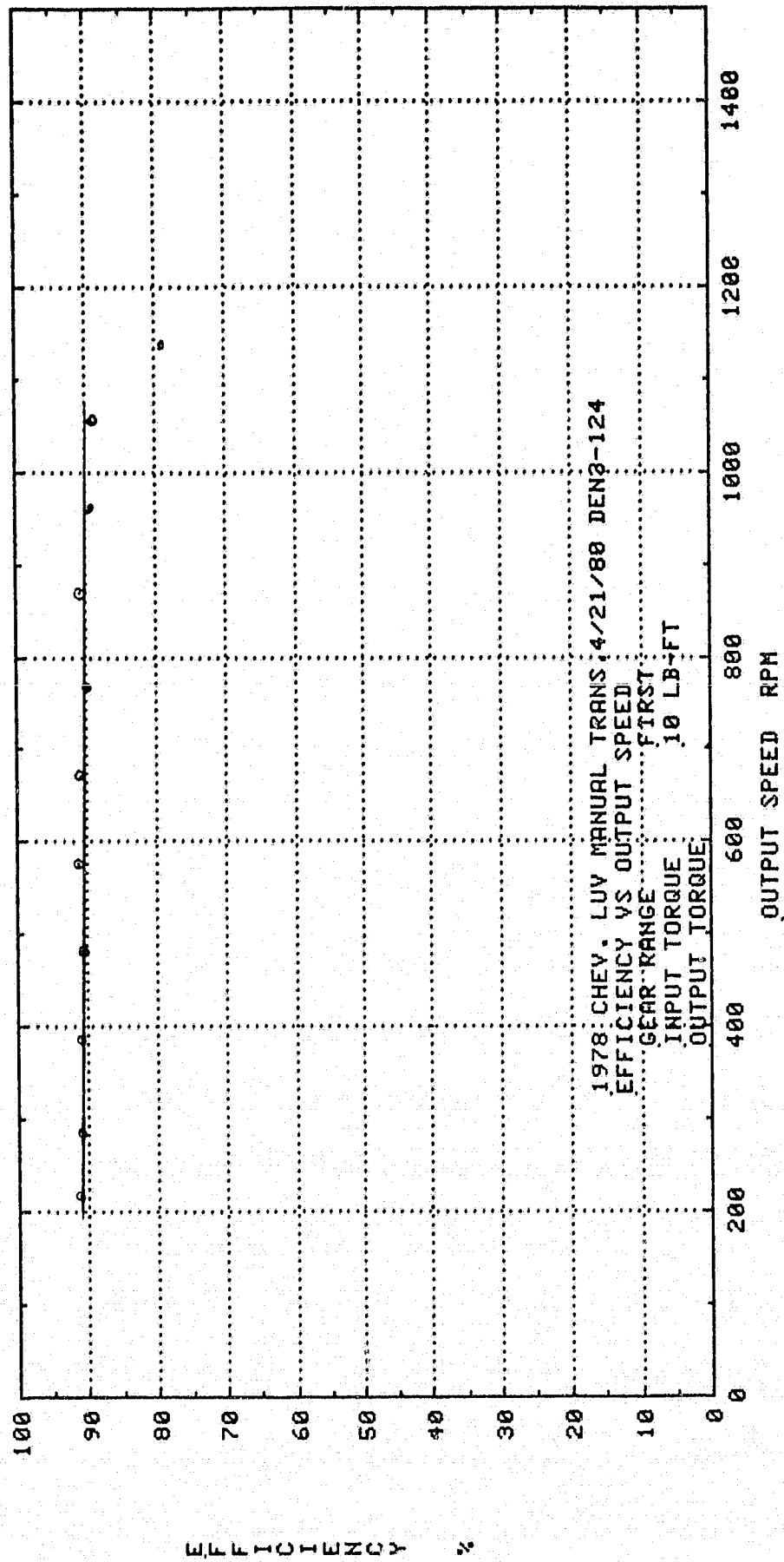

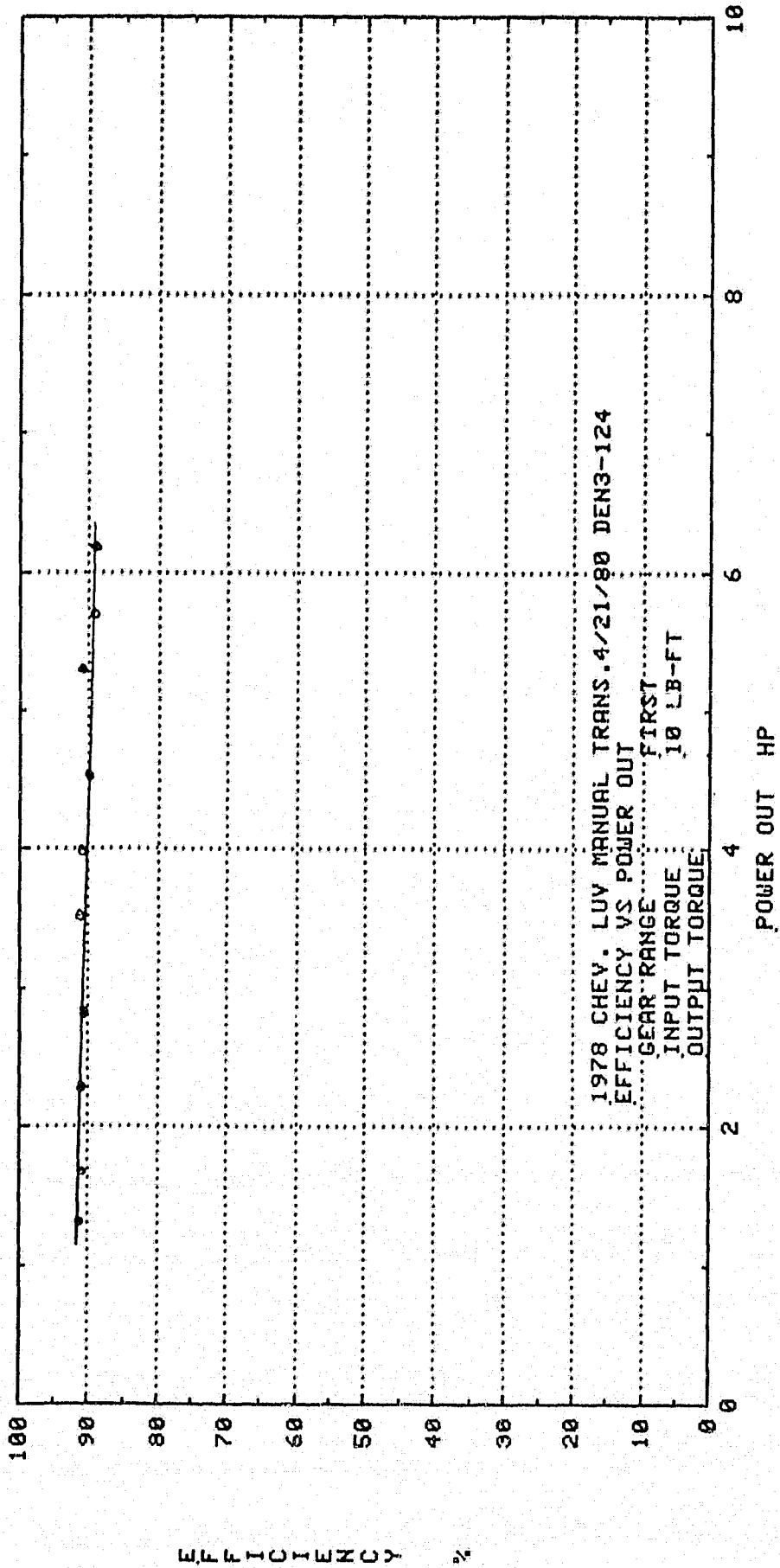

EFFICIENCY %

POWER OUT HP

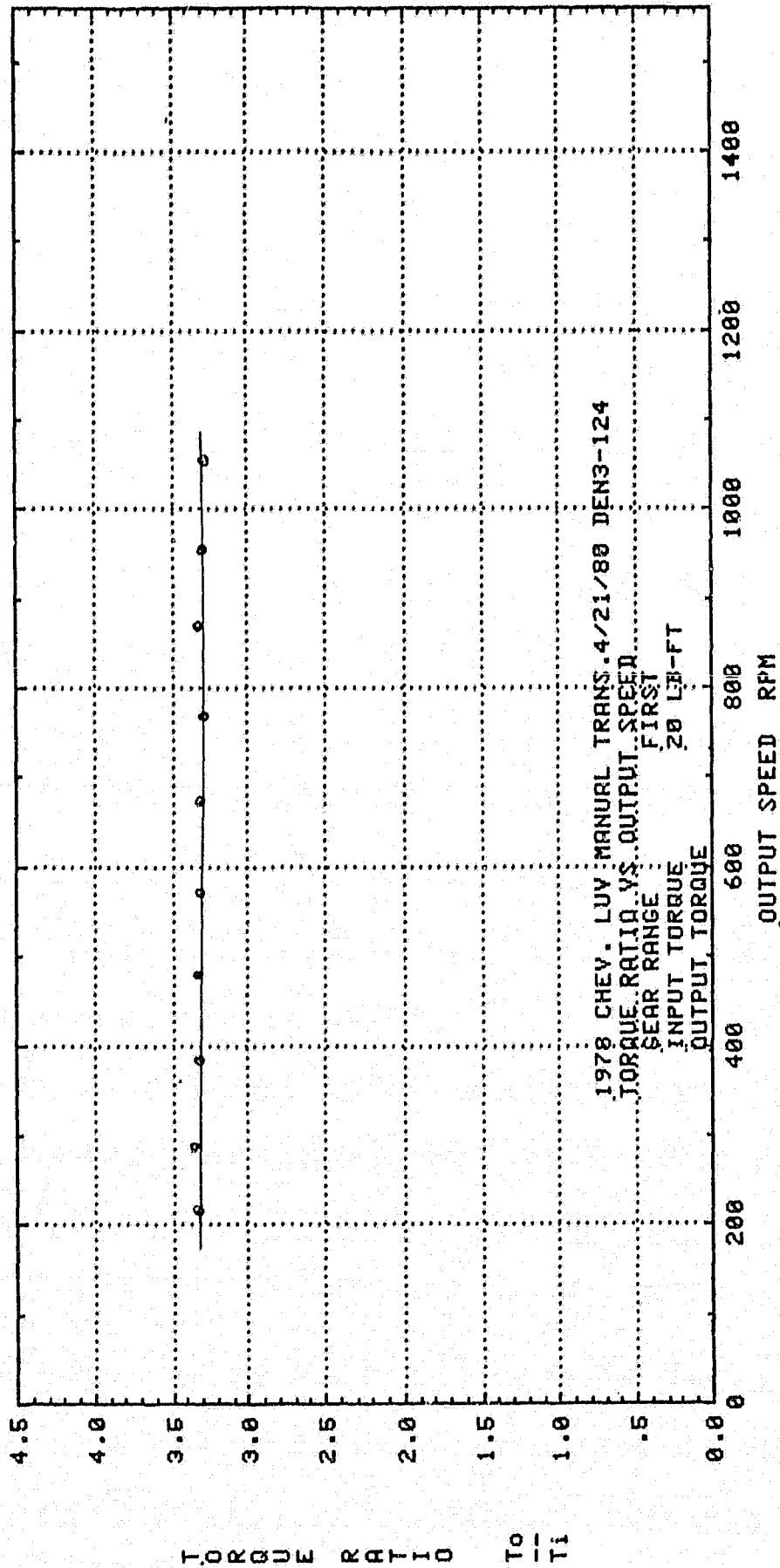

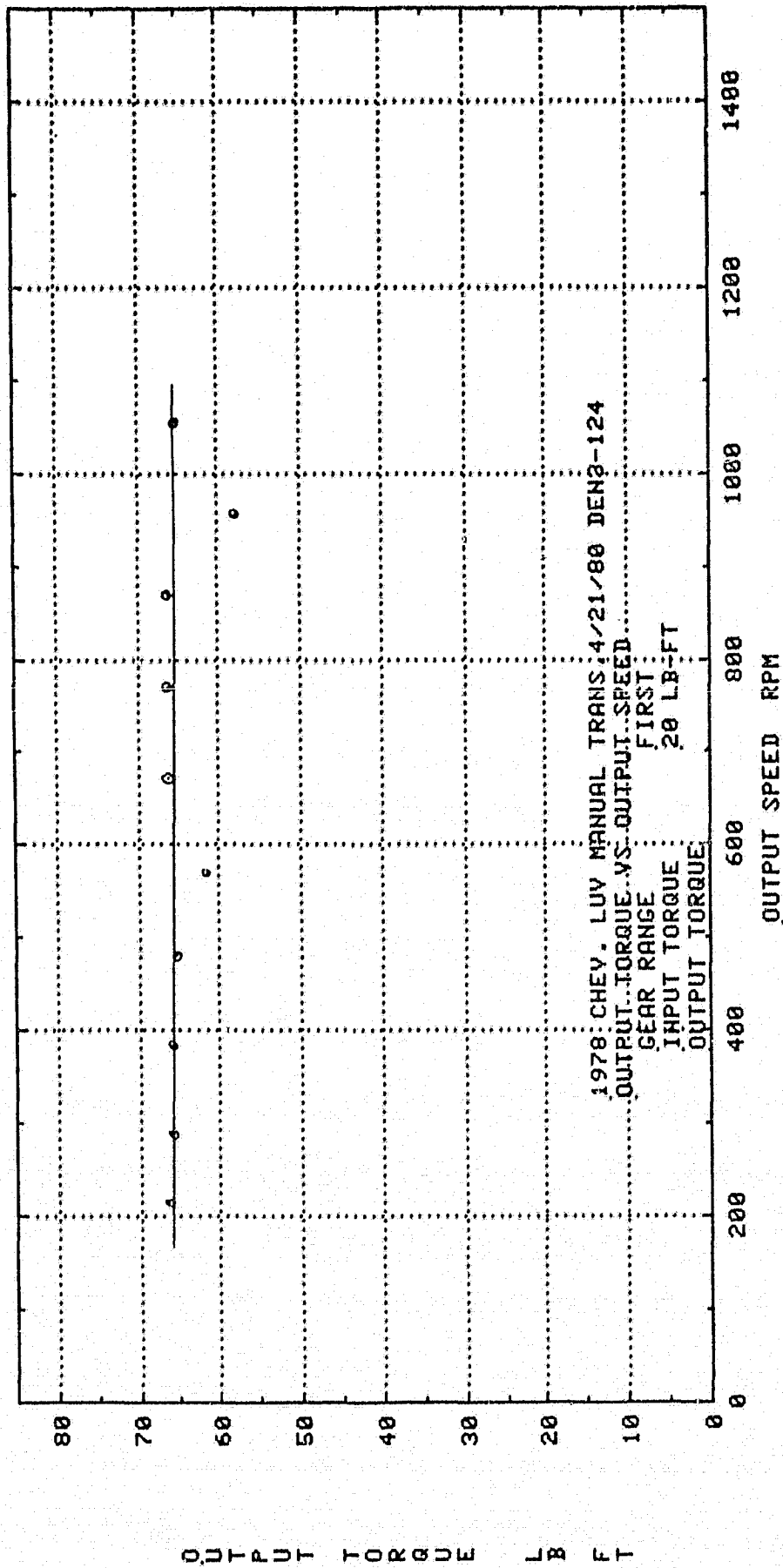

OUTPUT TORQUE LB FT

OUTPUT SPEED RPM

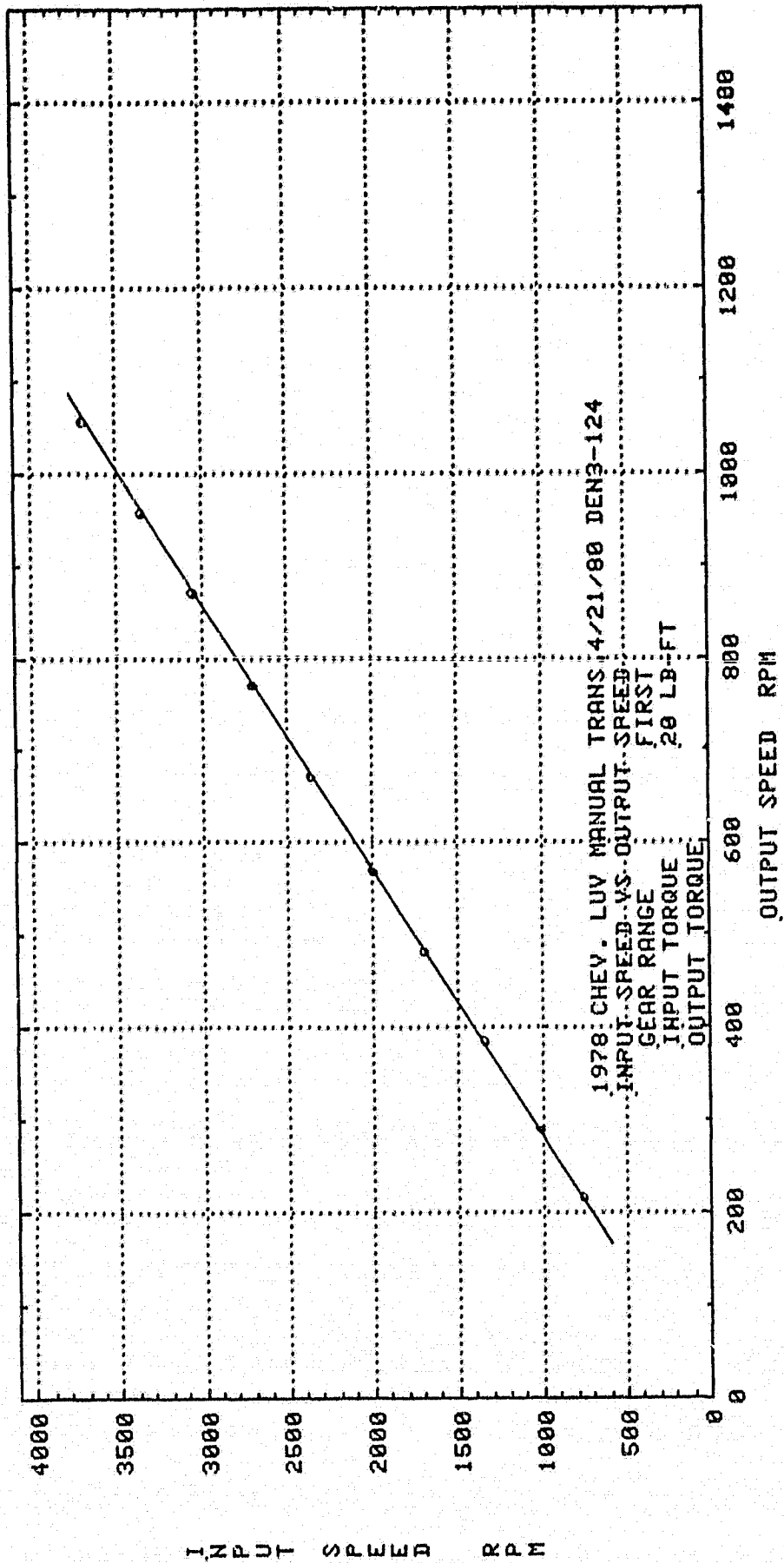

EFFICIENCY %

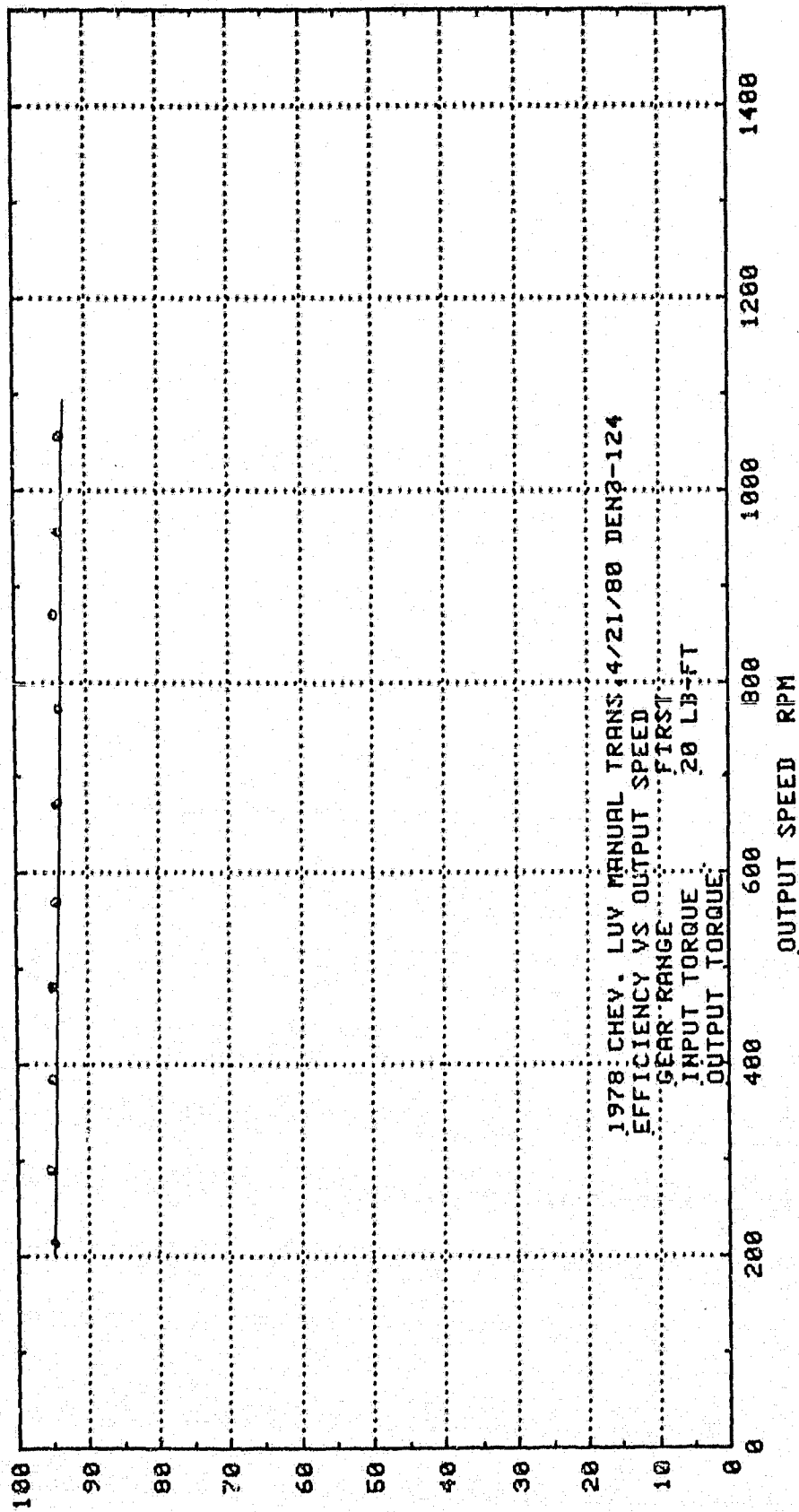

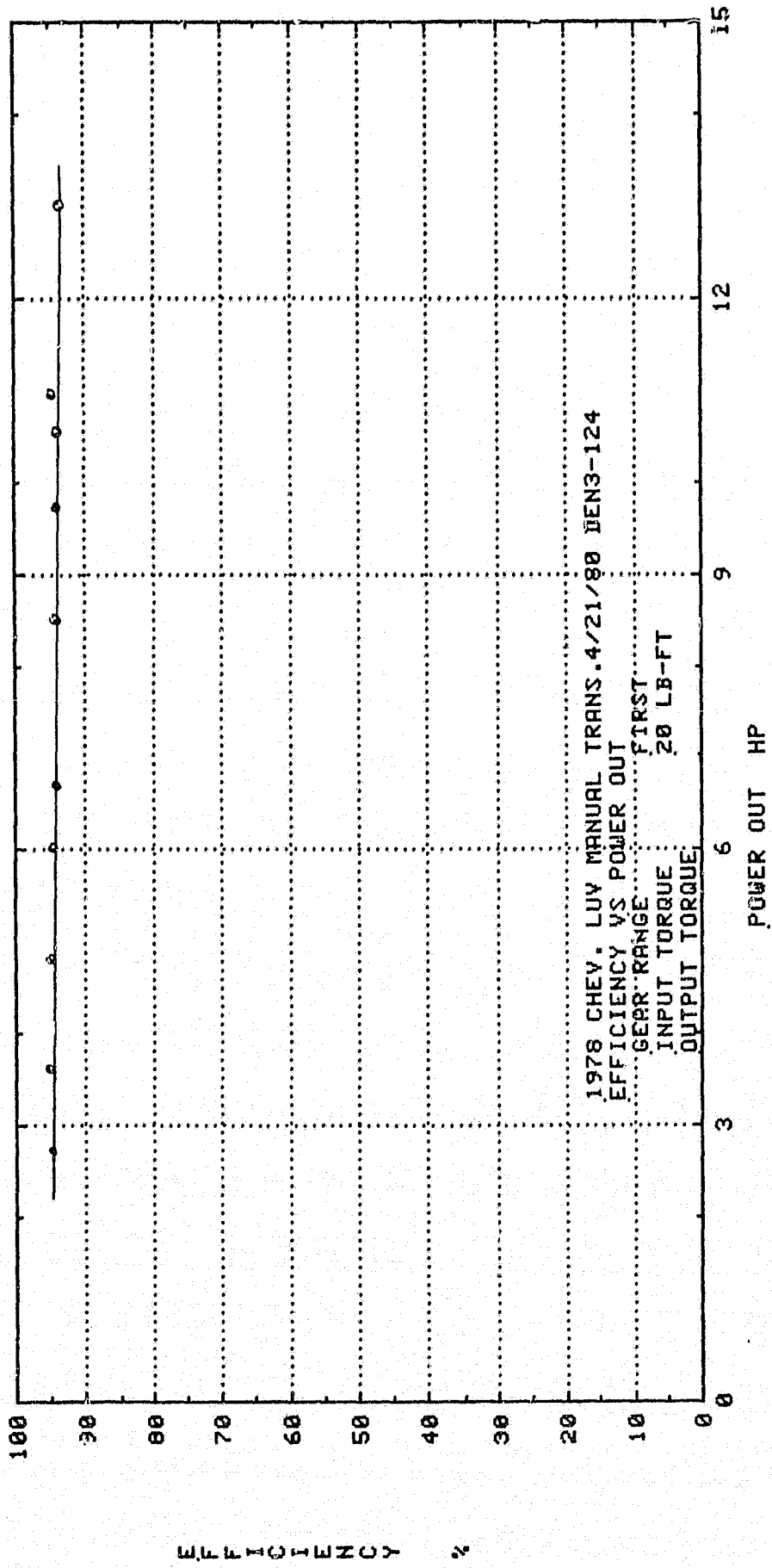

EFFICIENCY %

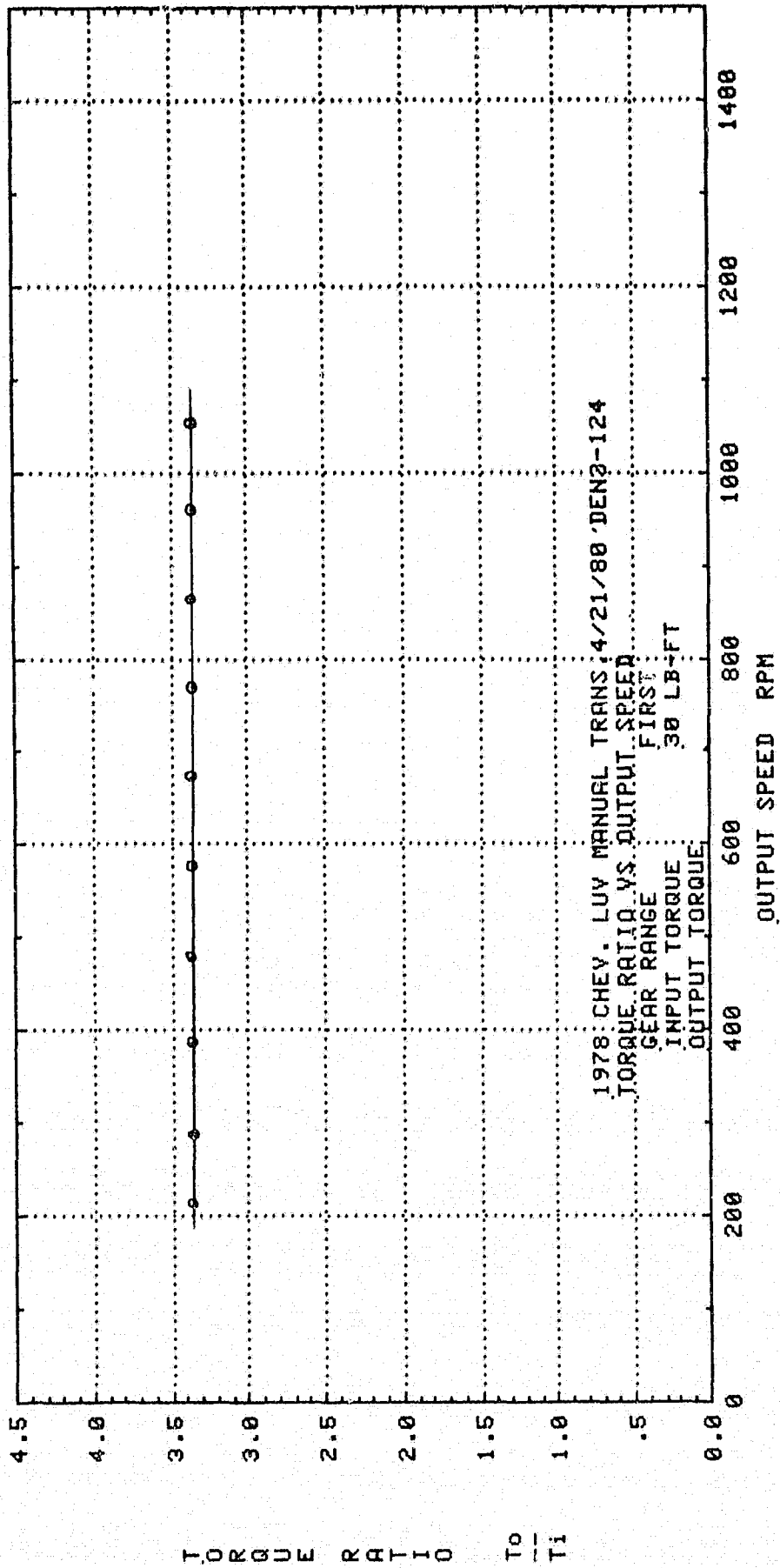

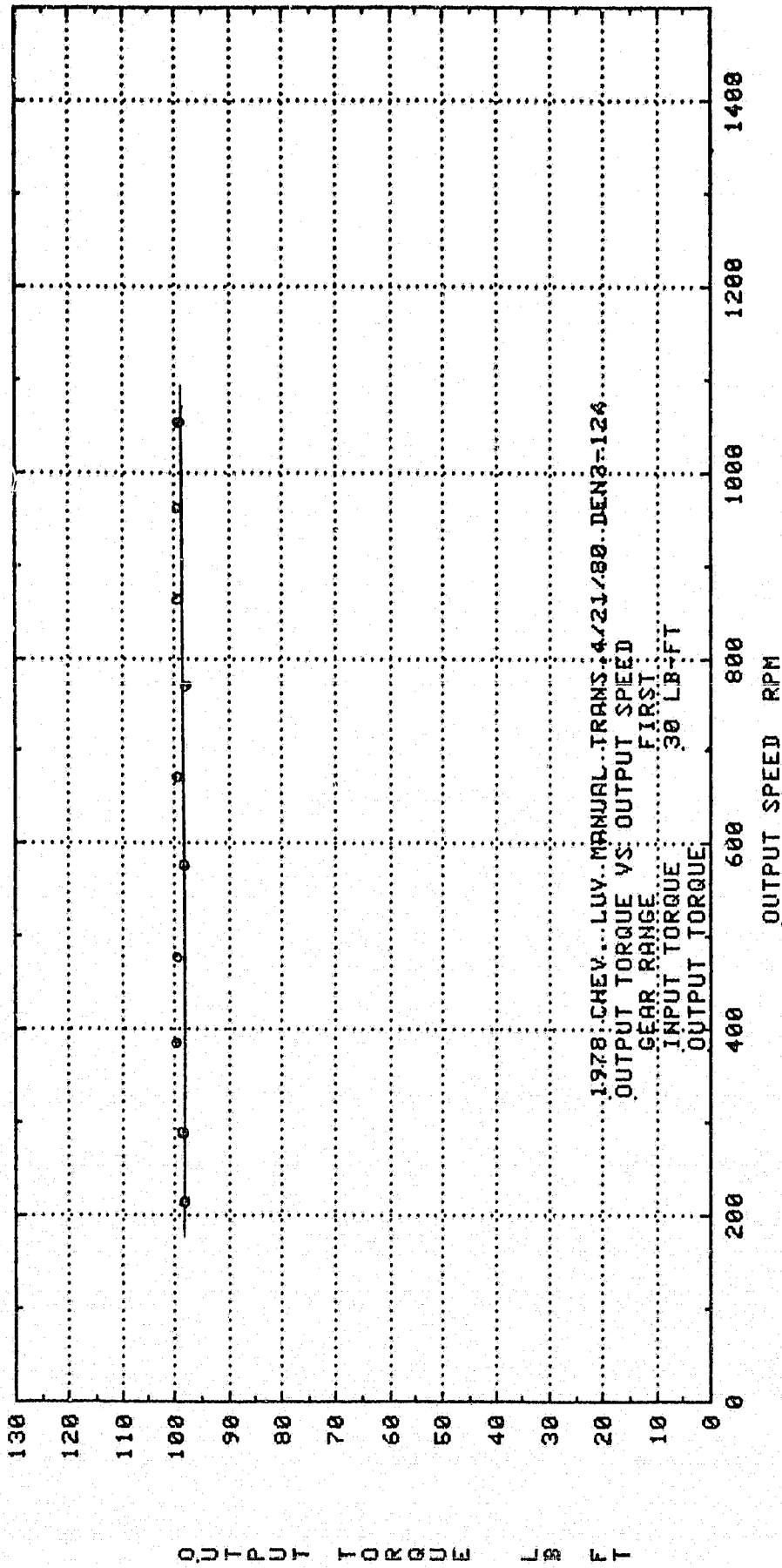

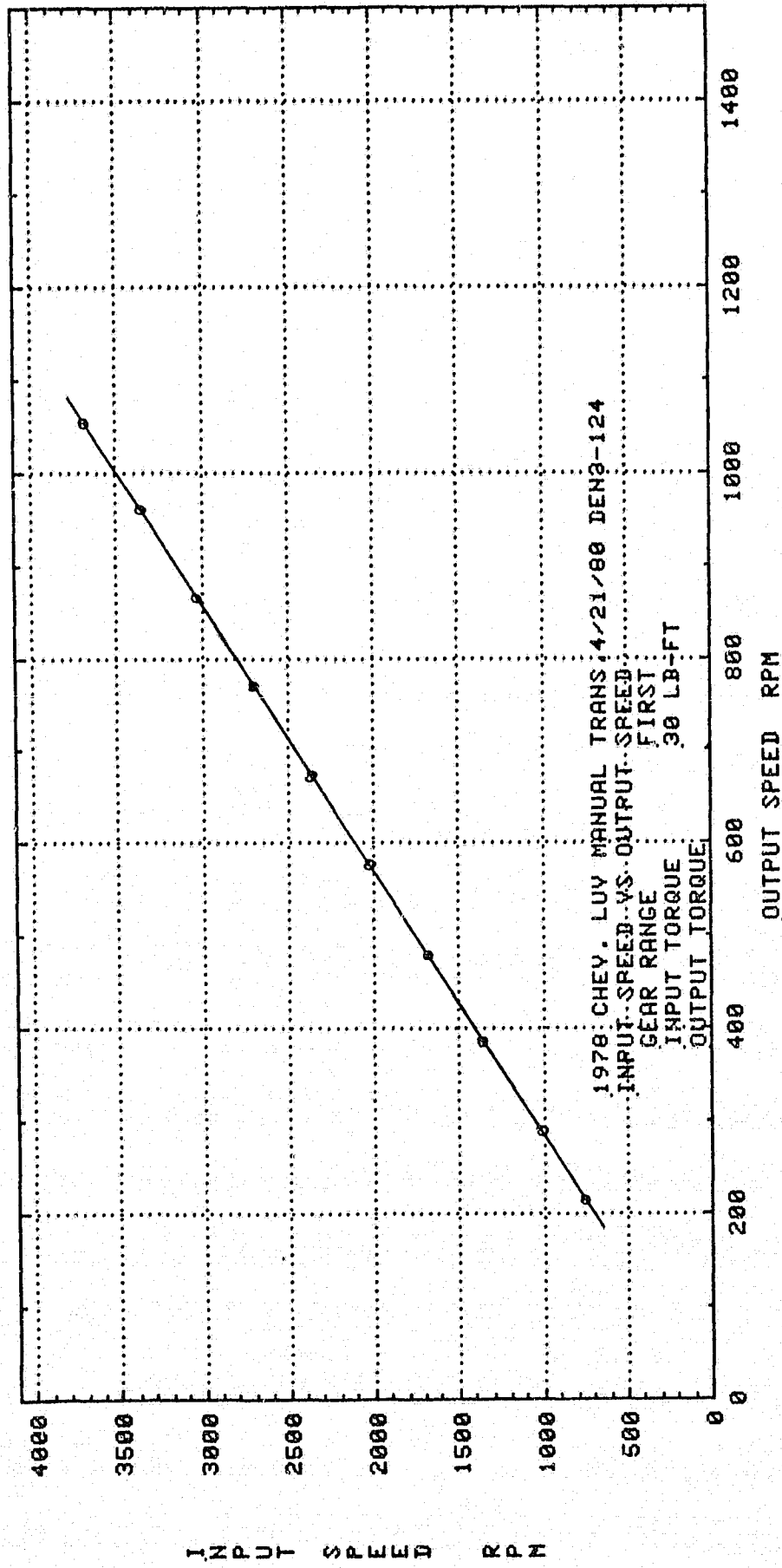

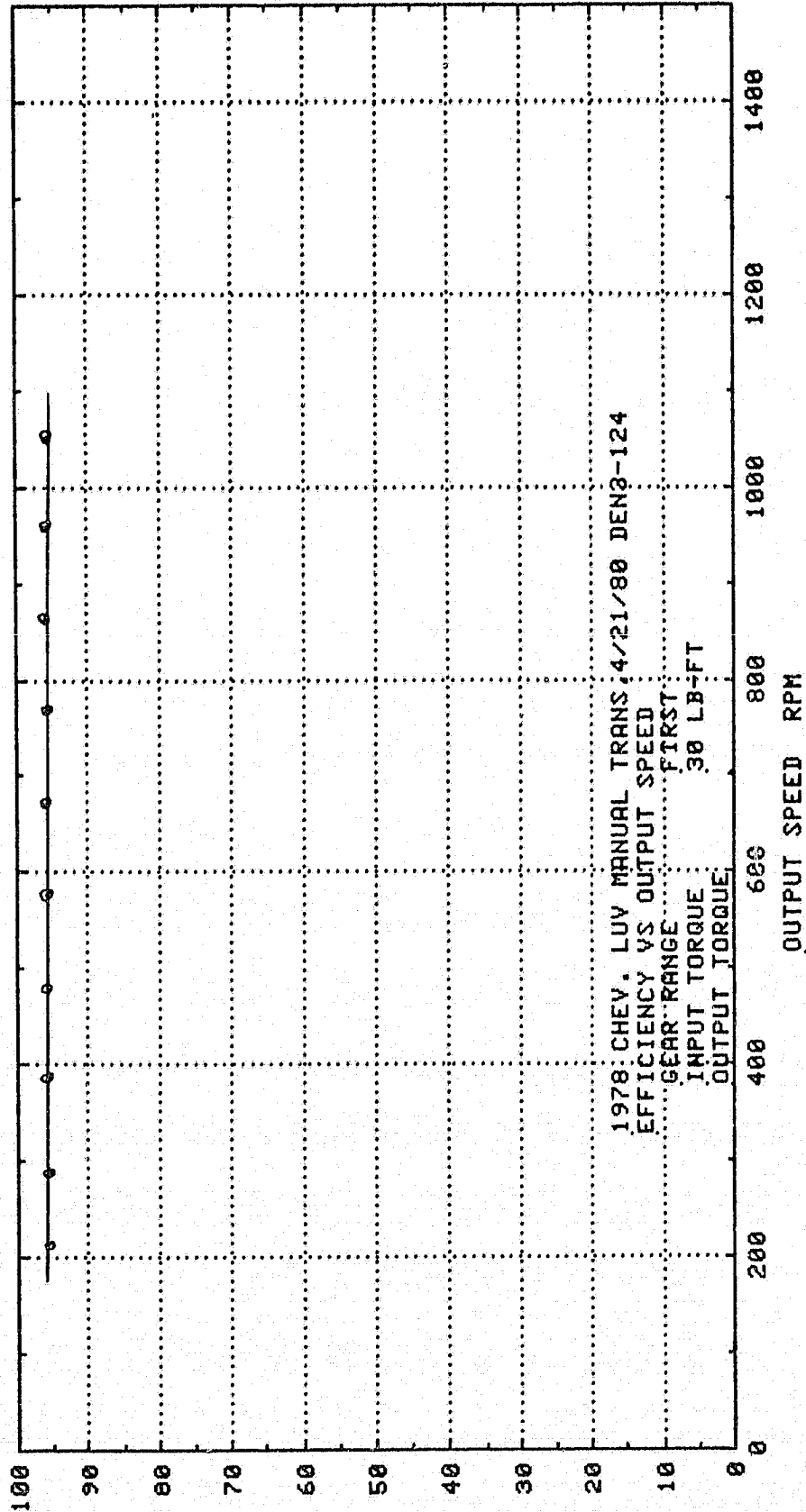

EFFICIENCY %

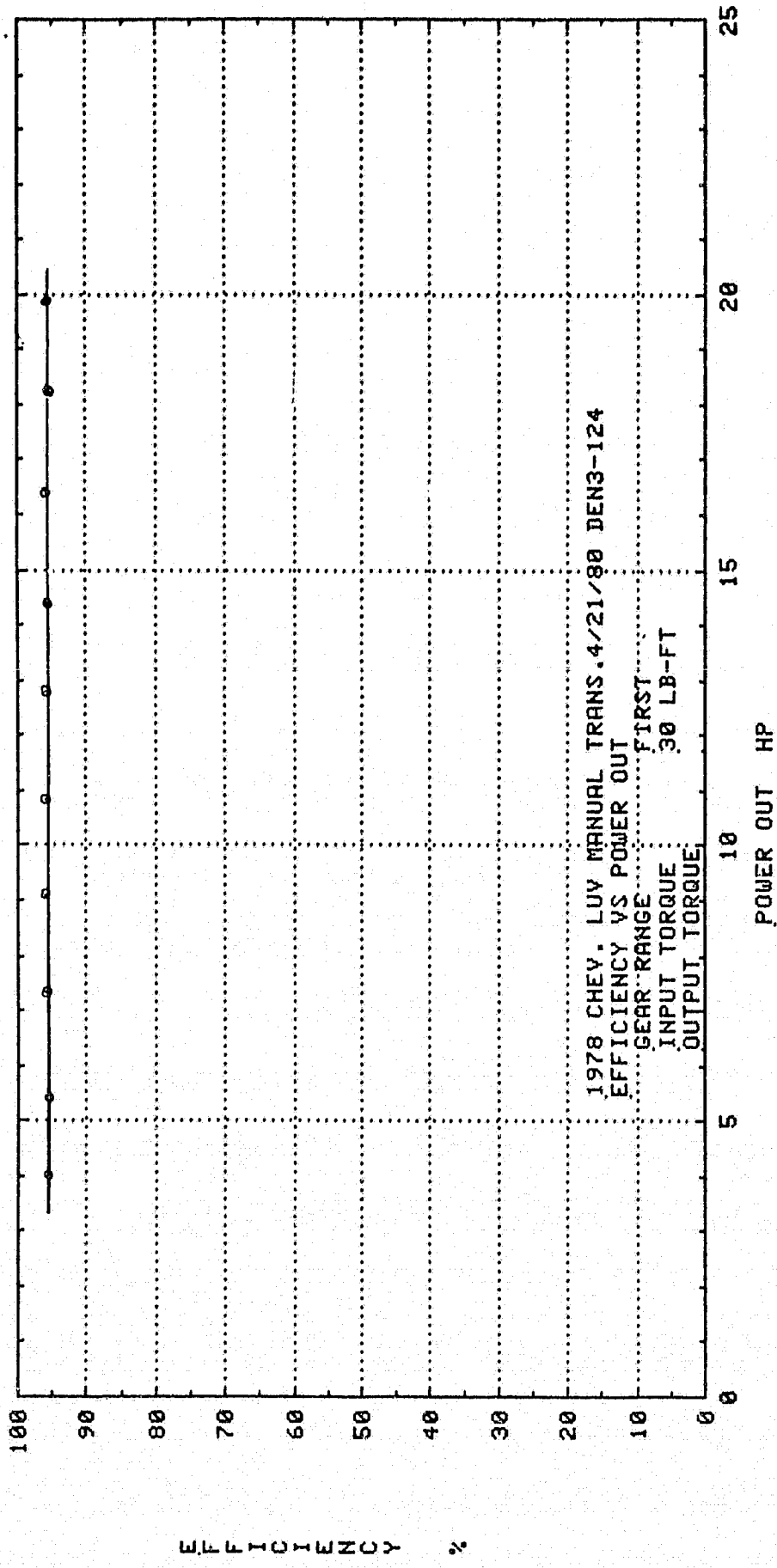

EFFICIENCY %

POWER OUT HP

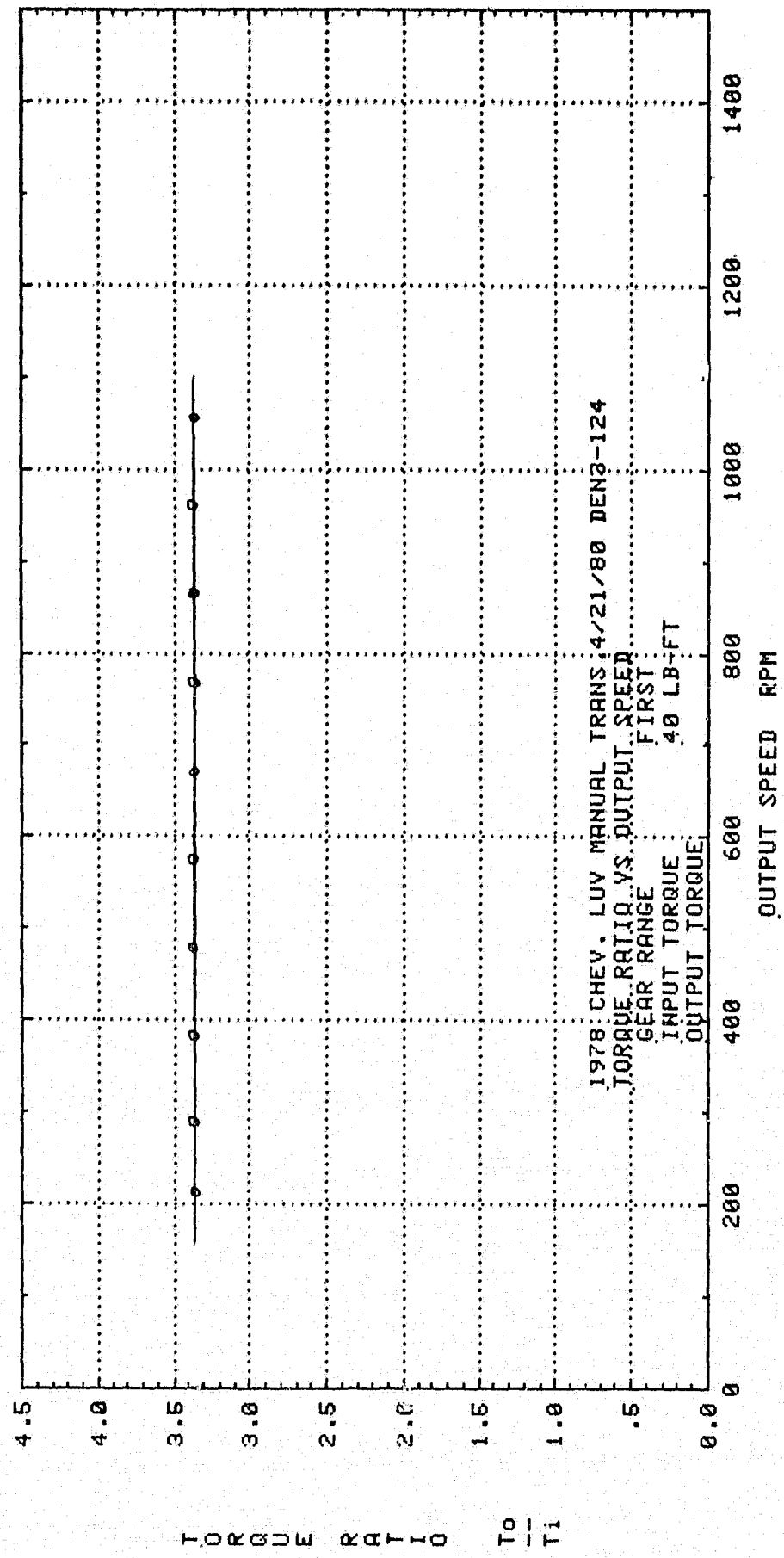

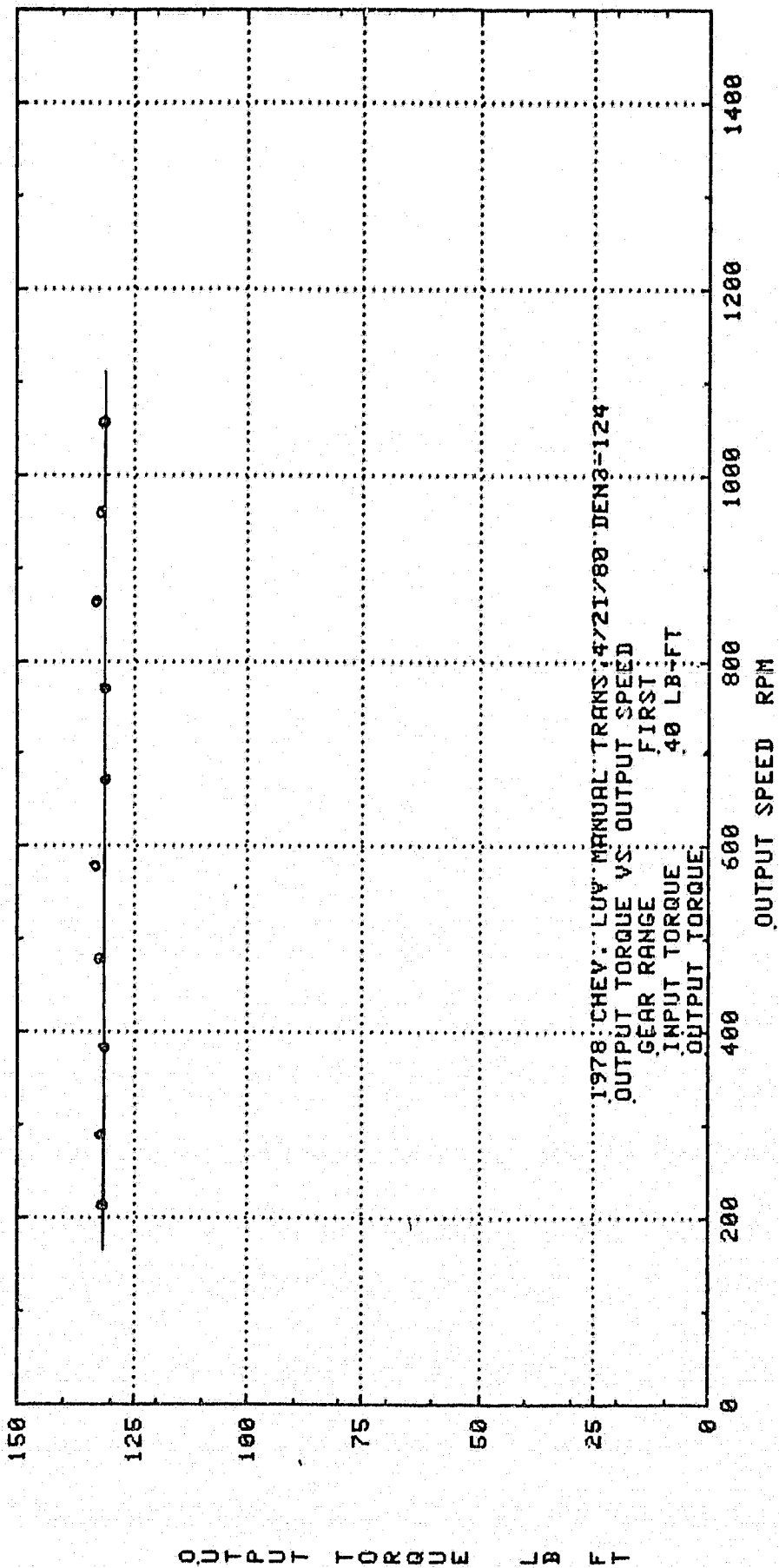

OUTPUT TORQUE LB FT

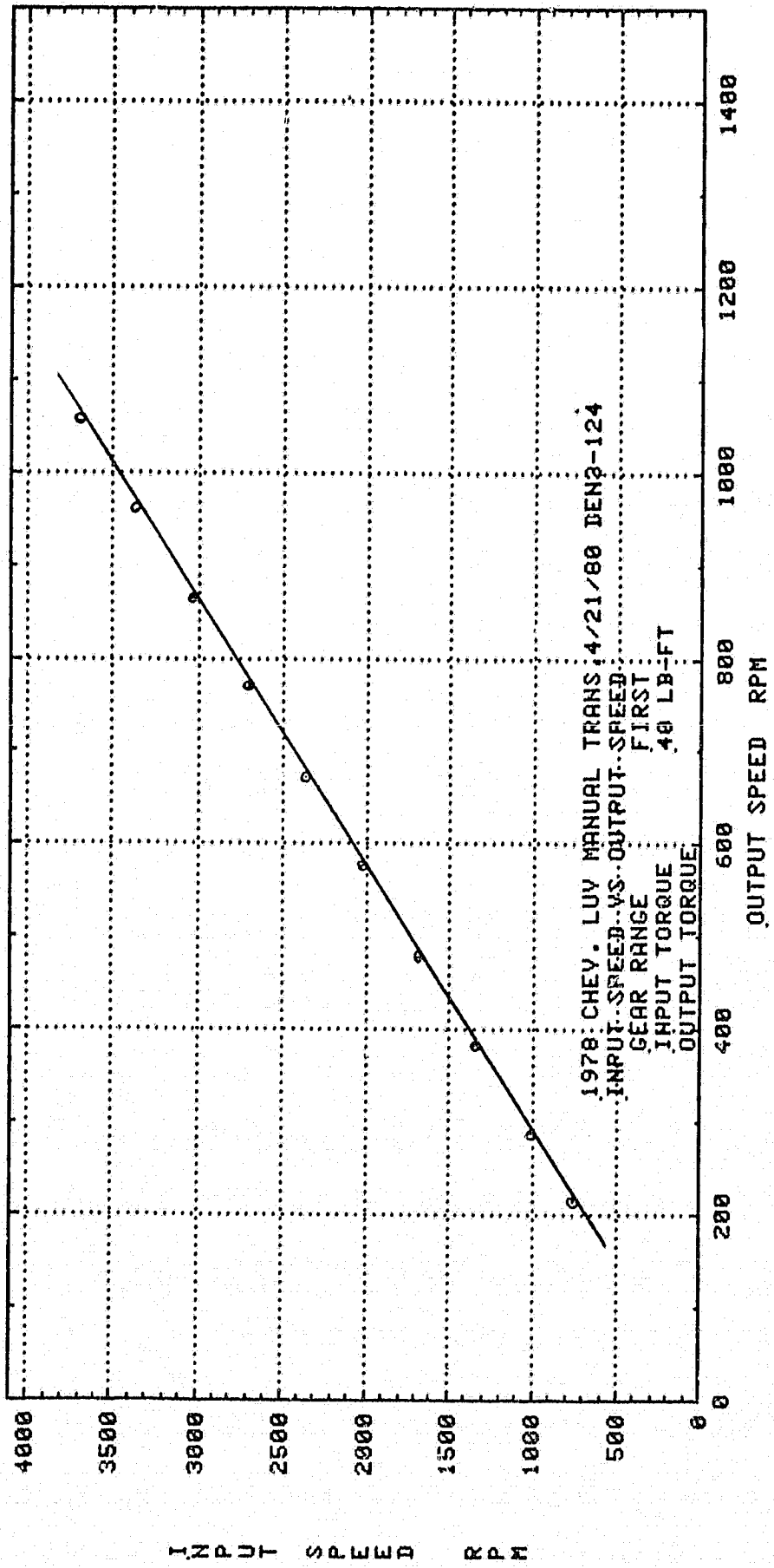

INPUT SPEED RPM

EFFICIENCY %

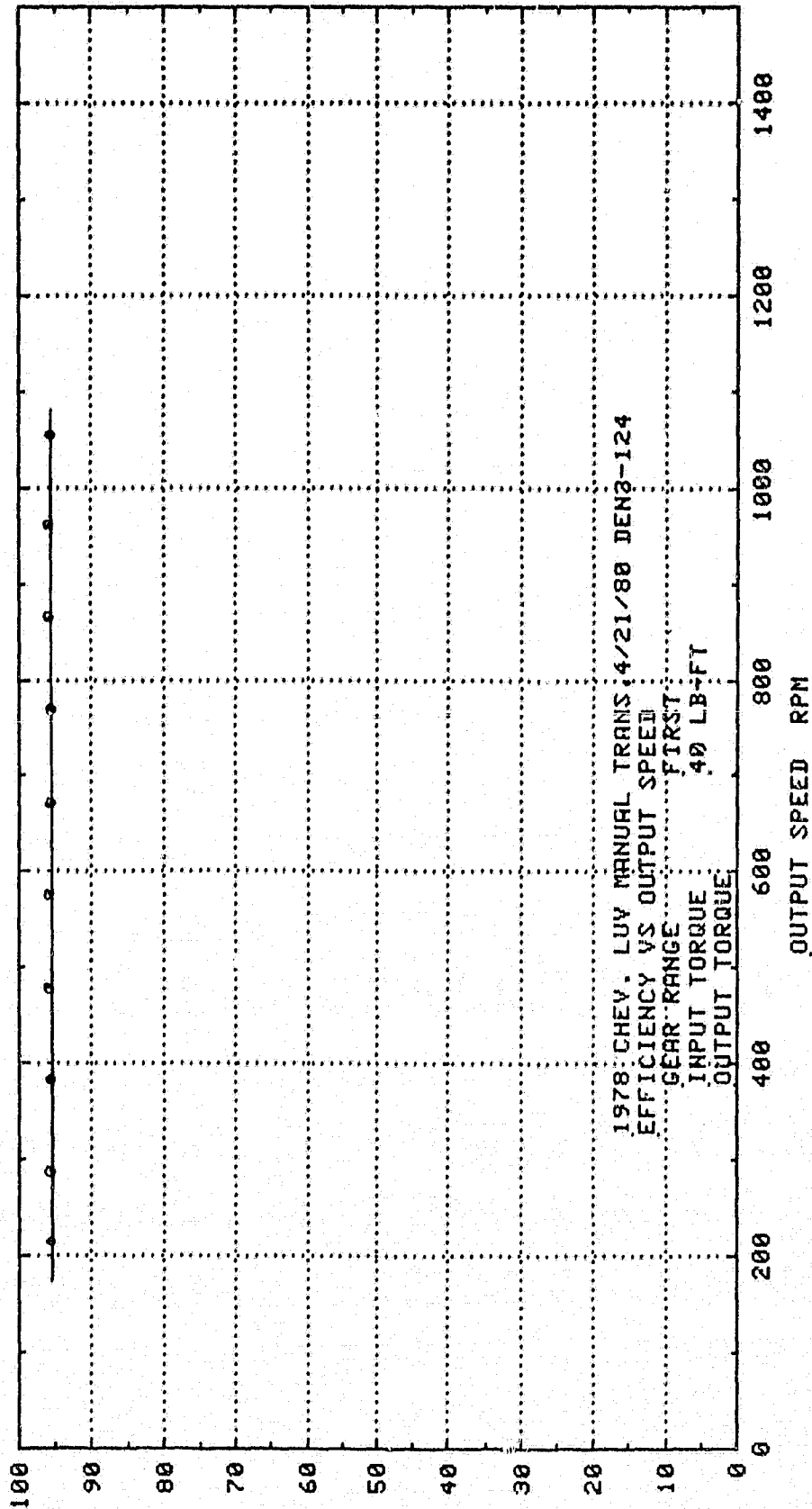

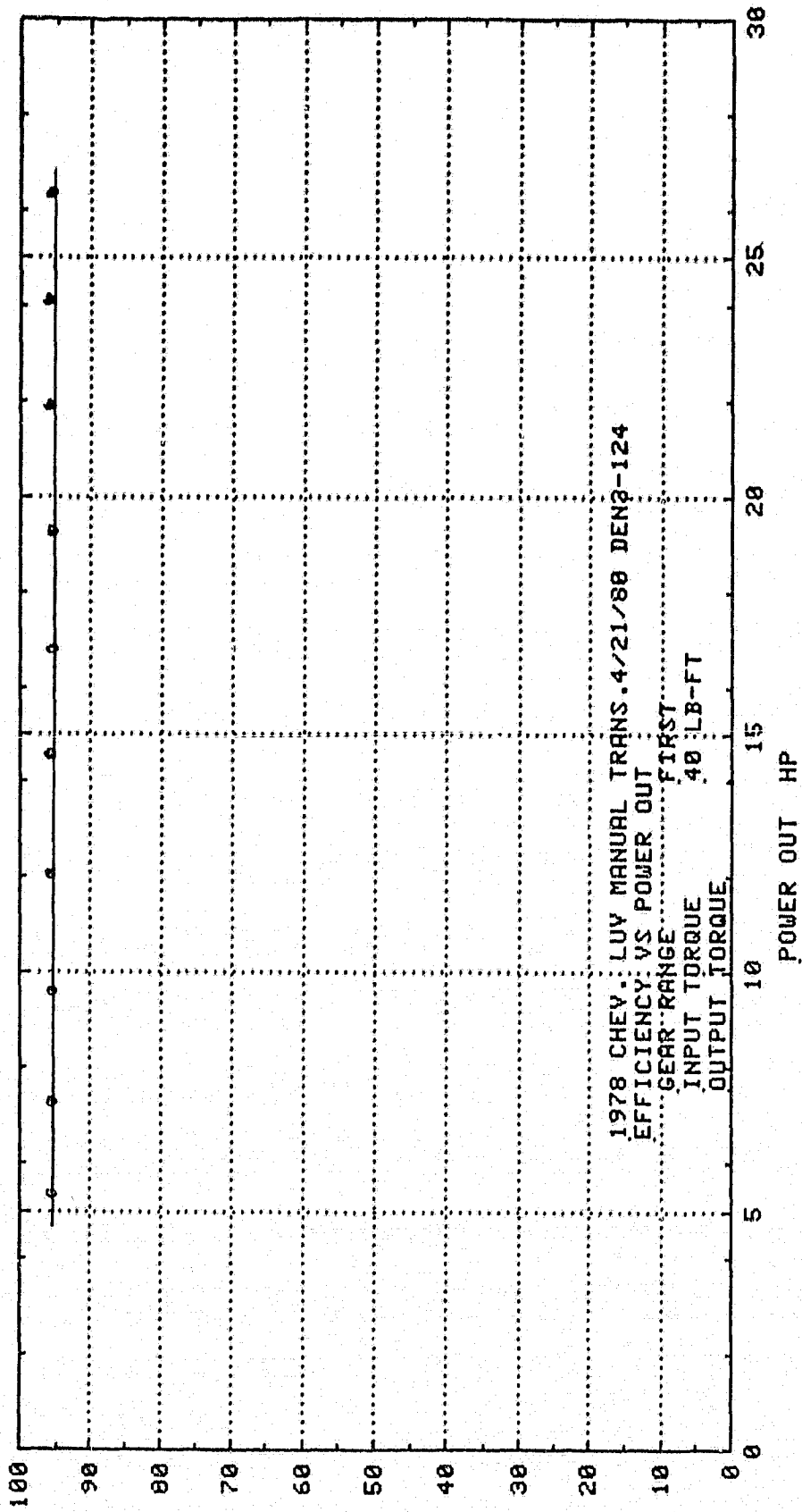

EFFICIENCY %

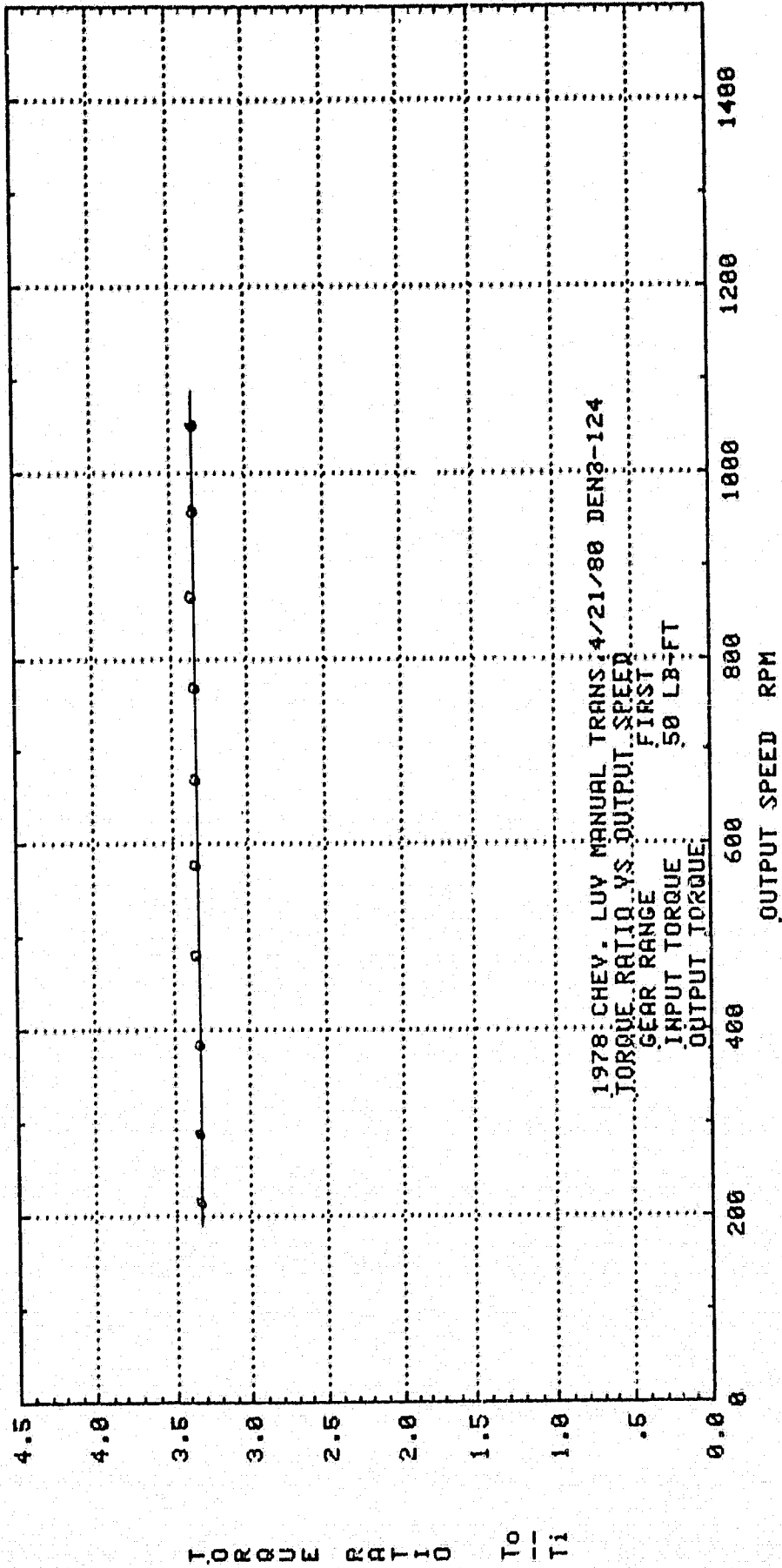

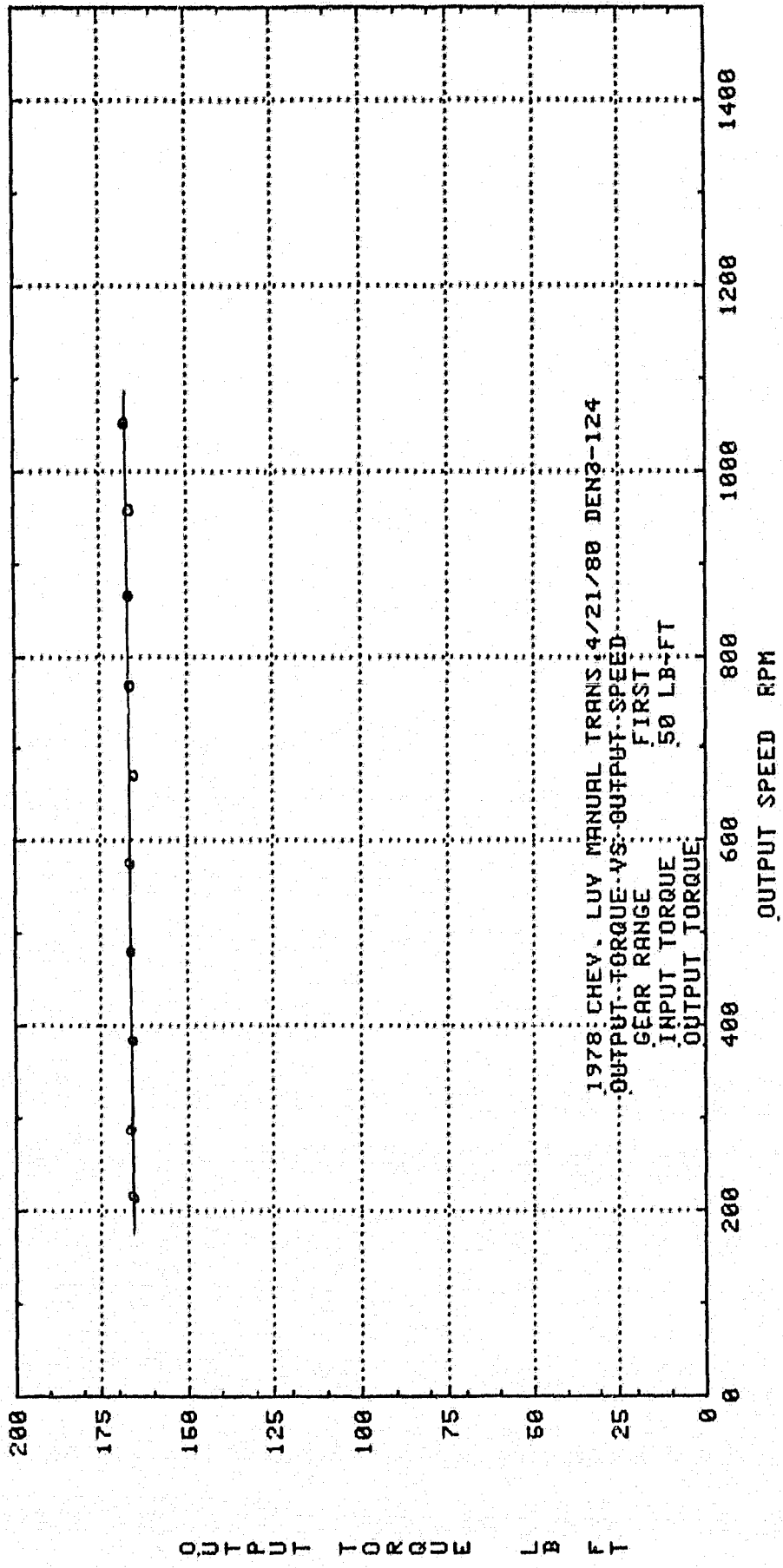

OUTPUT TORQUE LB FT

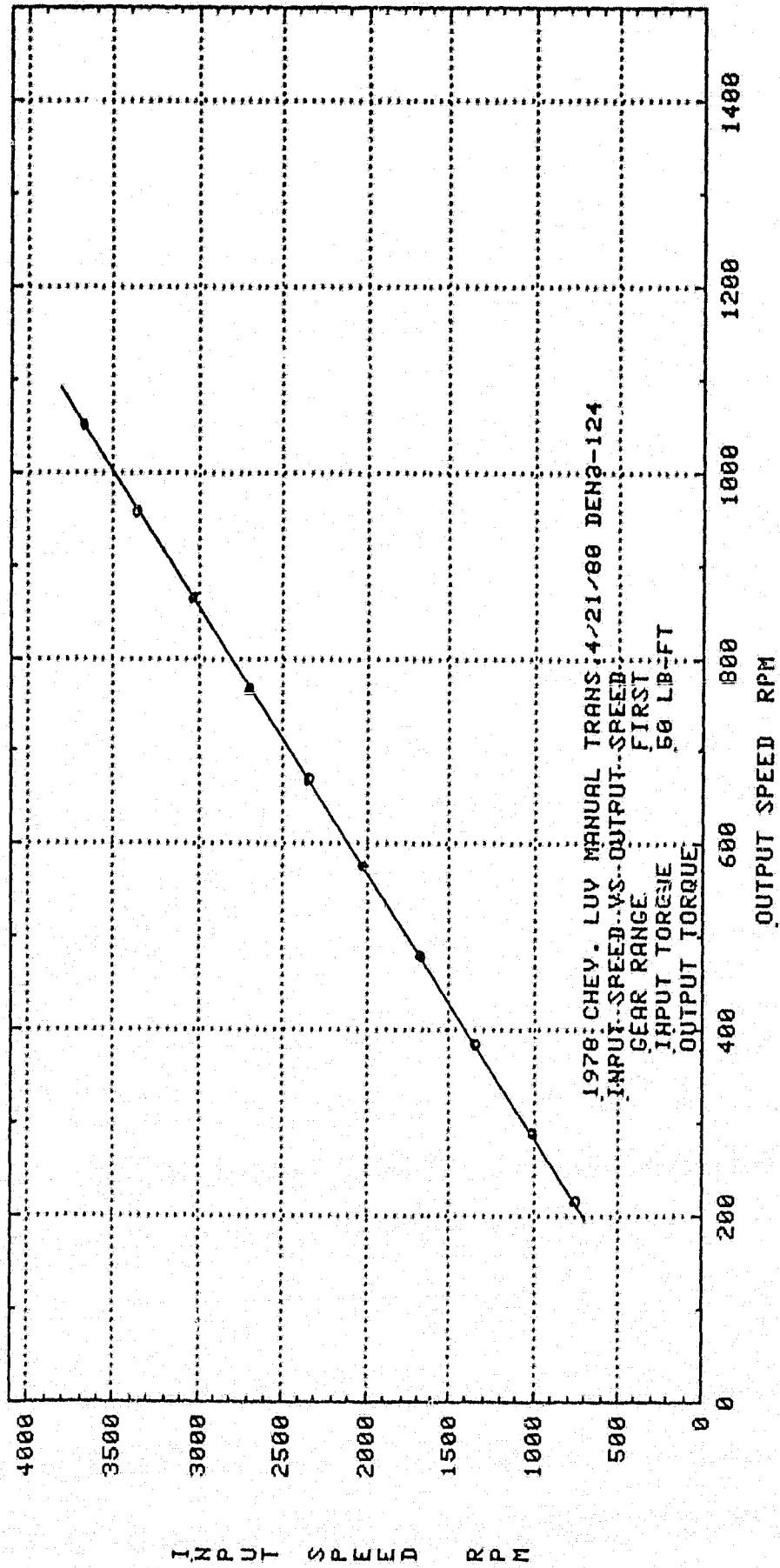

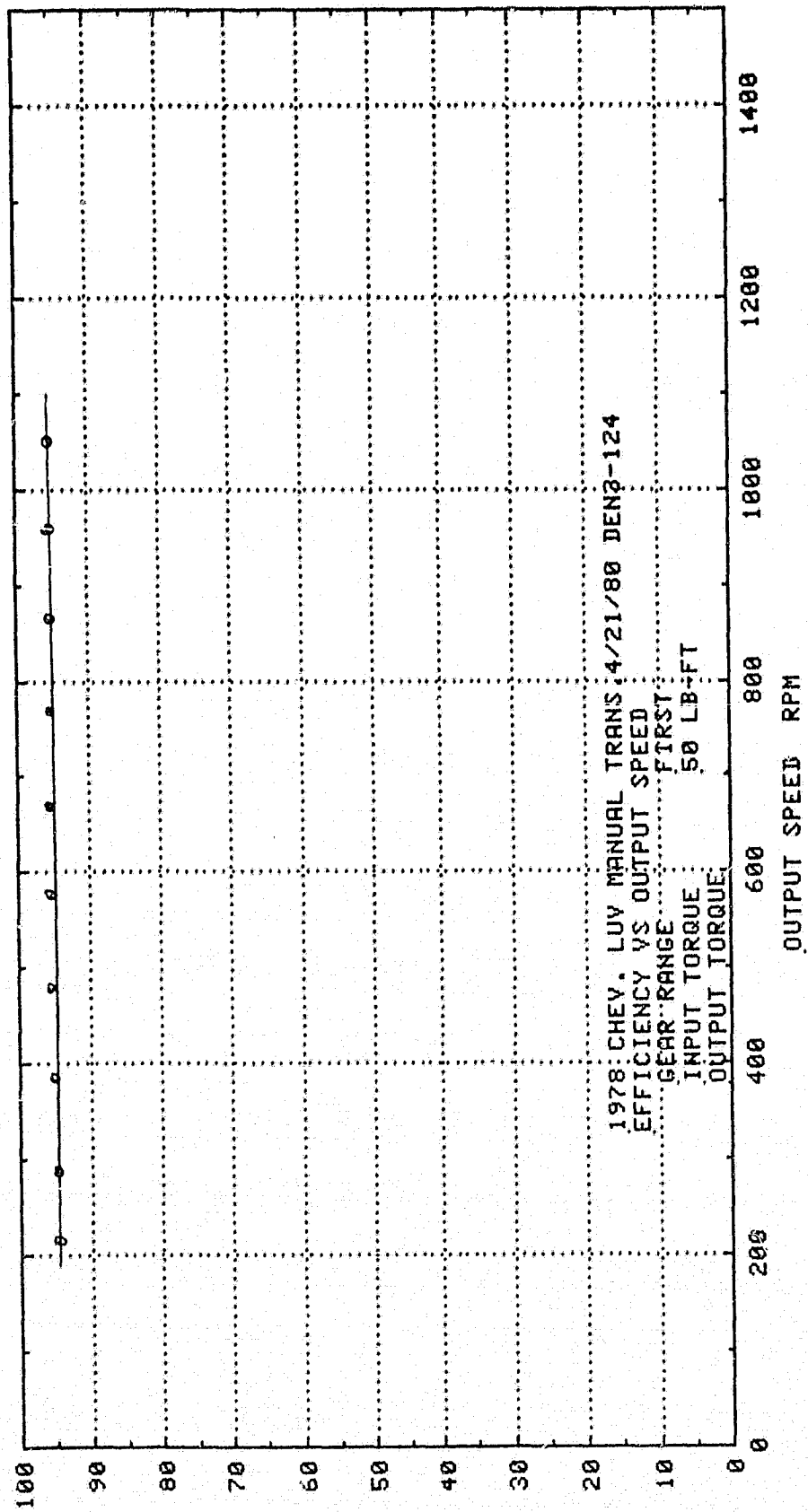

EFFICIENCY %

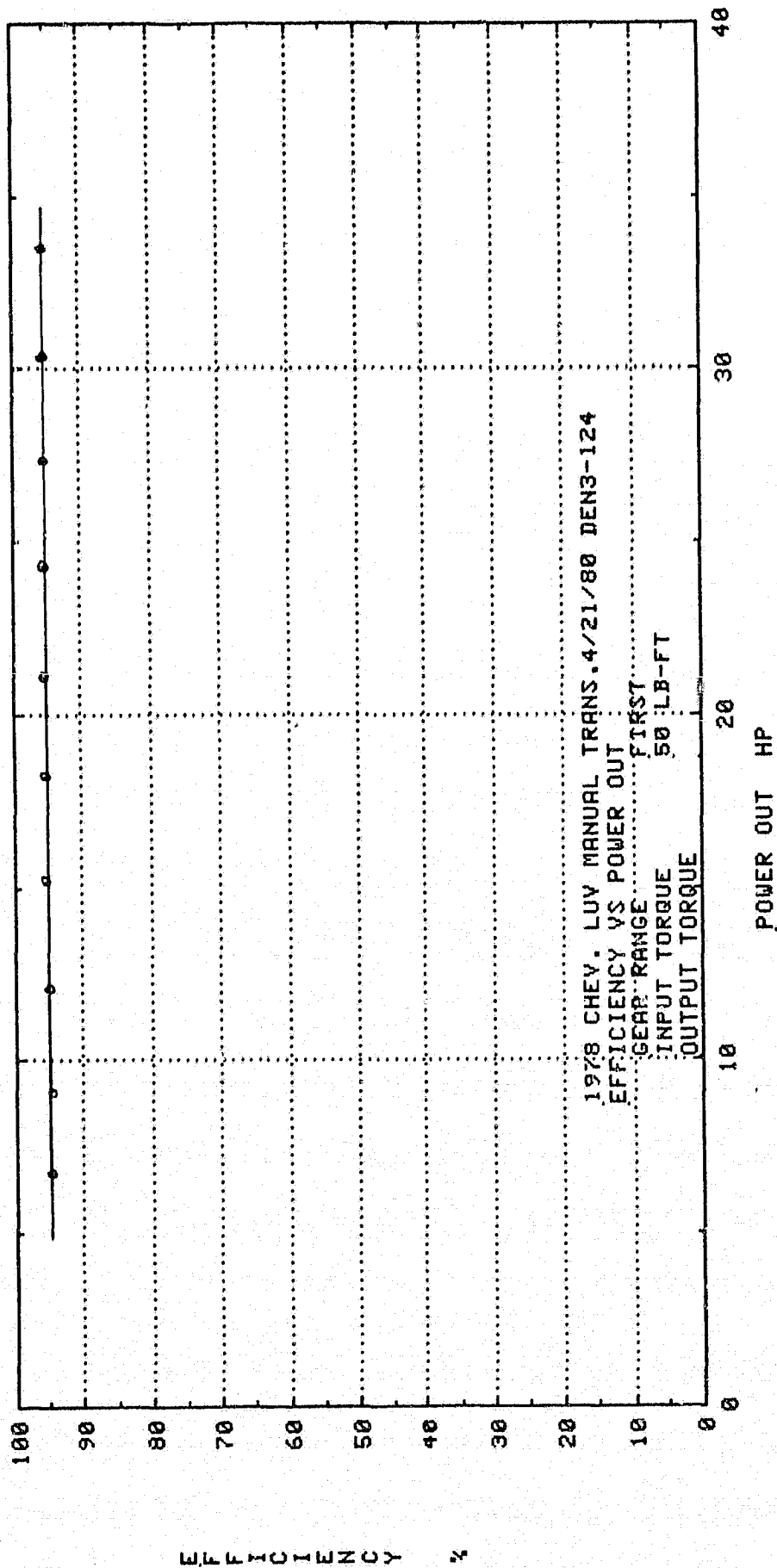

EFFICIENCY %

POWER OUT HP

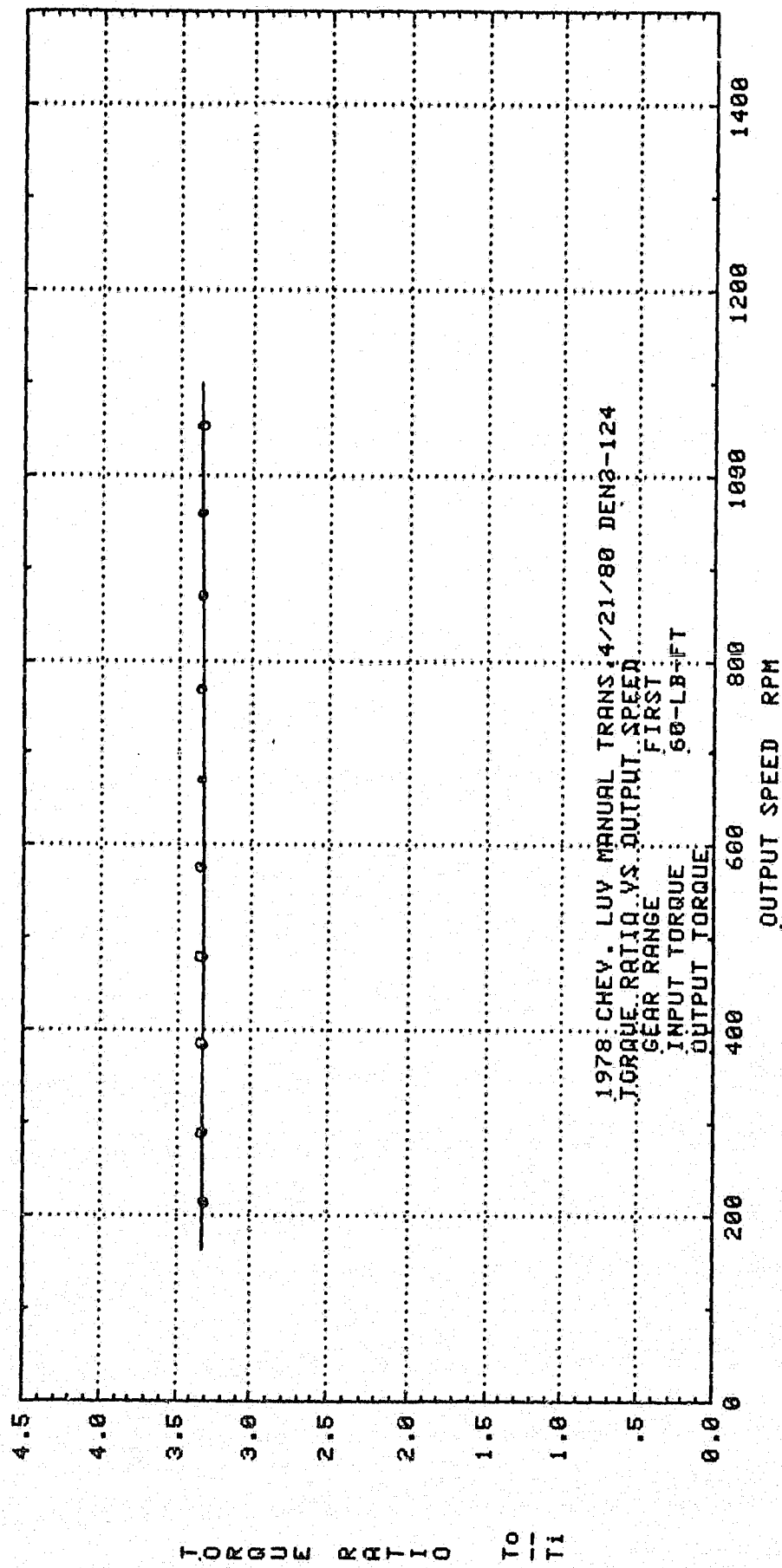

TORQUE RATIO $\frac{T_o}{T_i}$

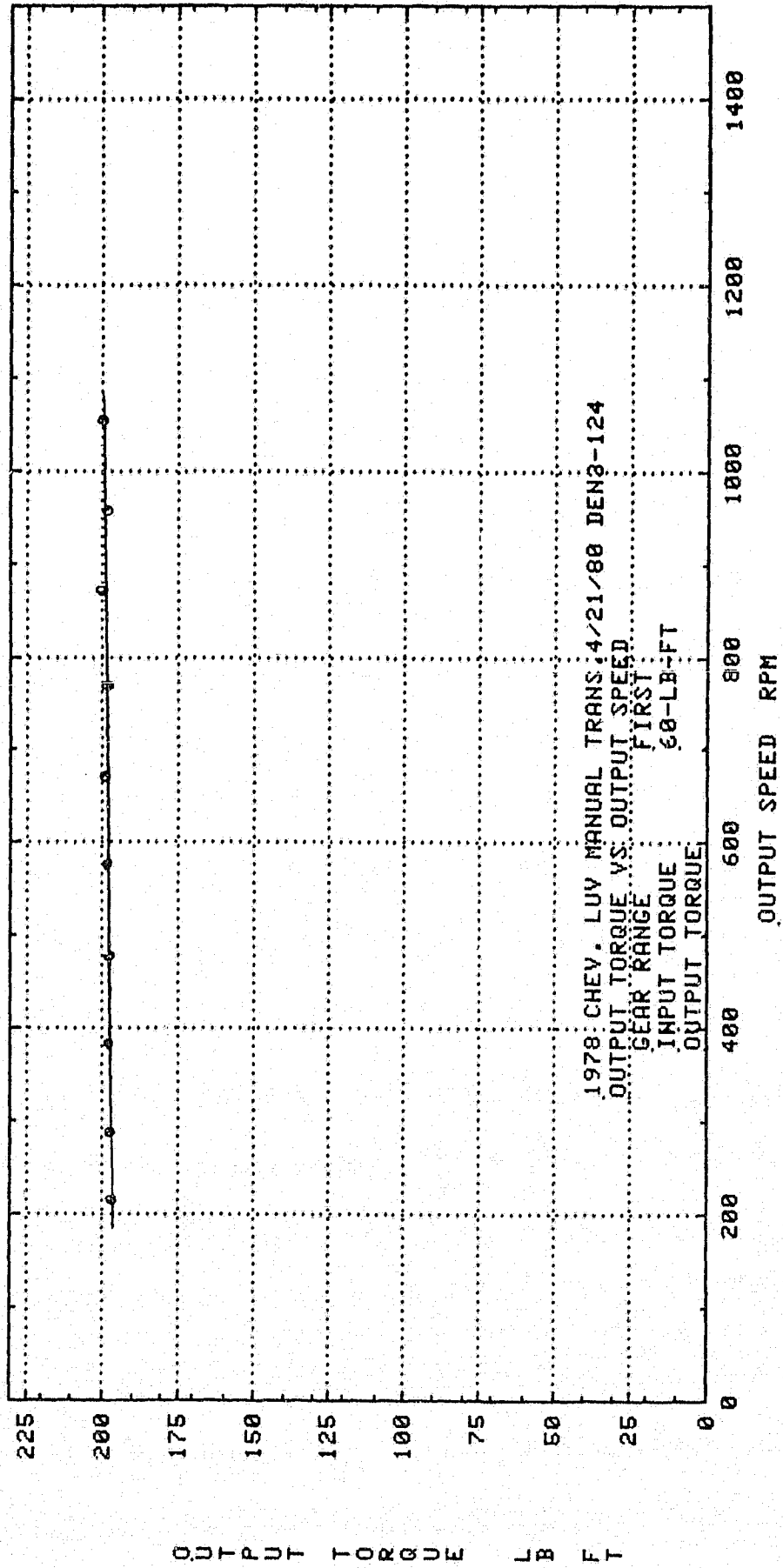

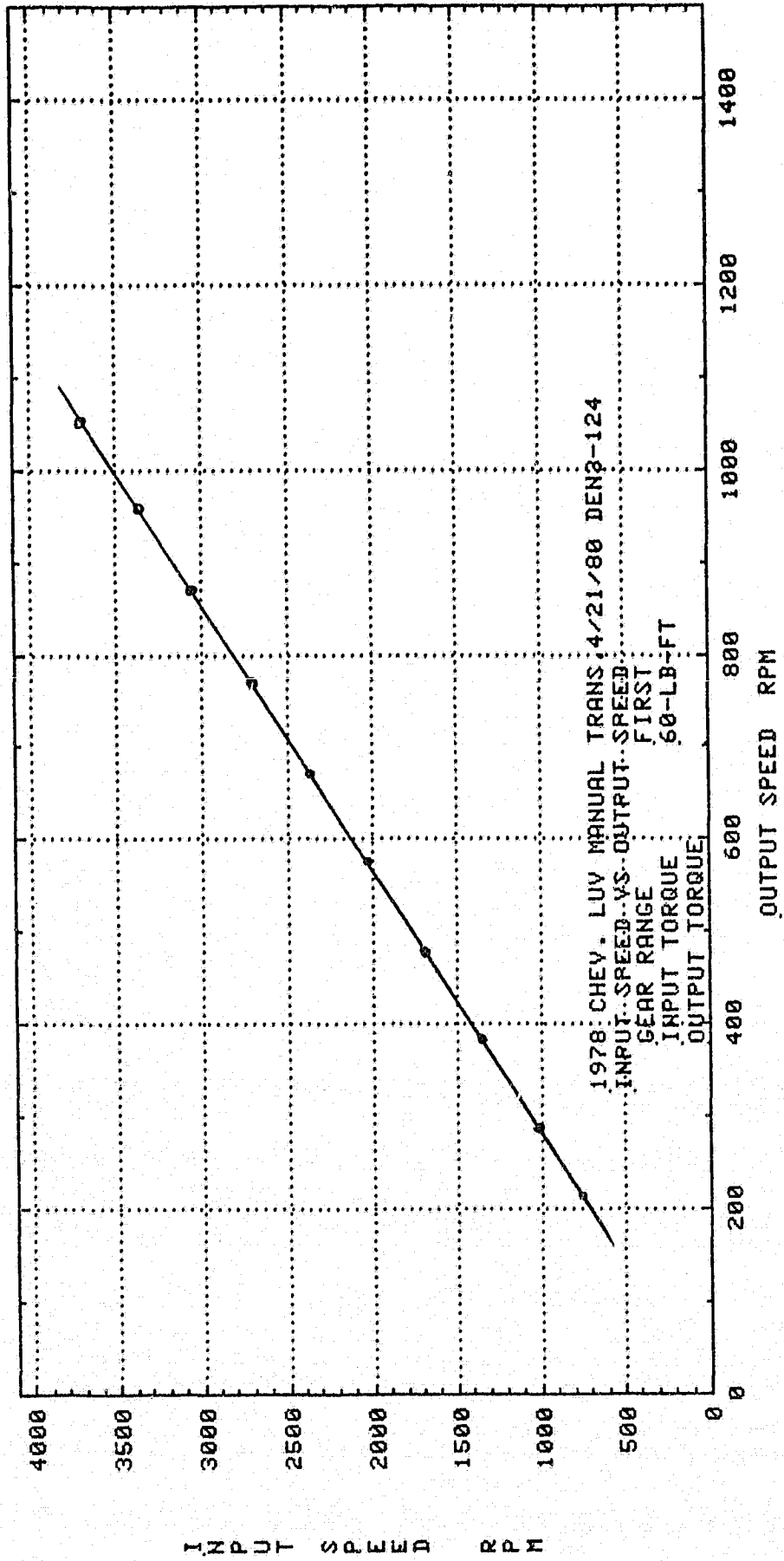

EFFICIENCY %

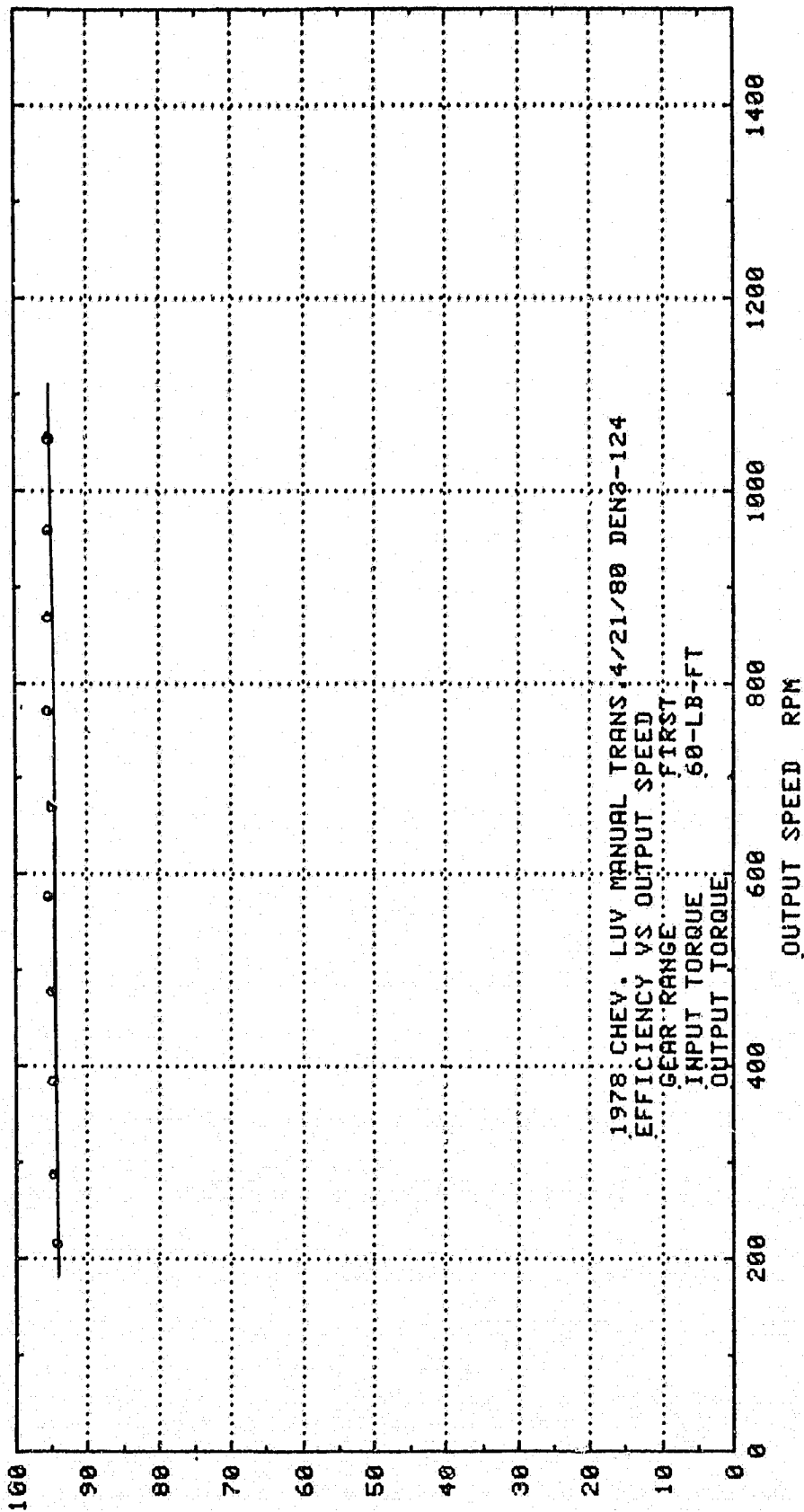

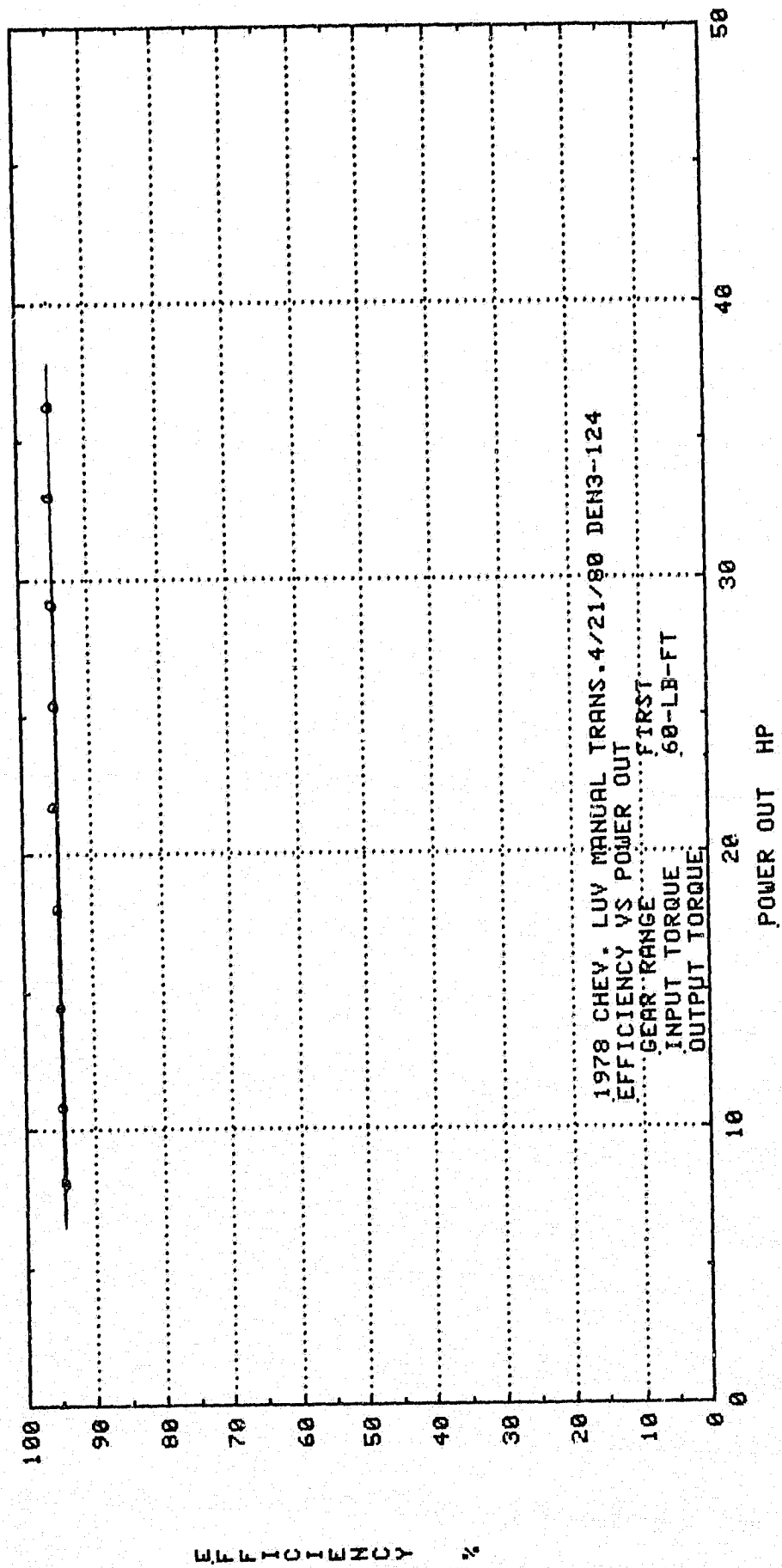

EFFICIENCY %

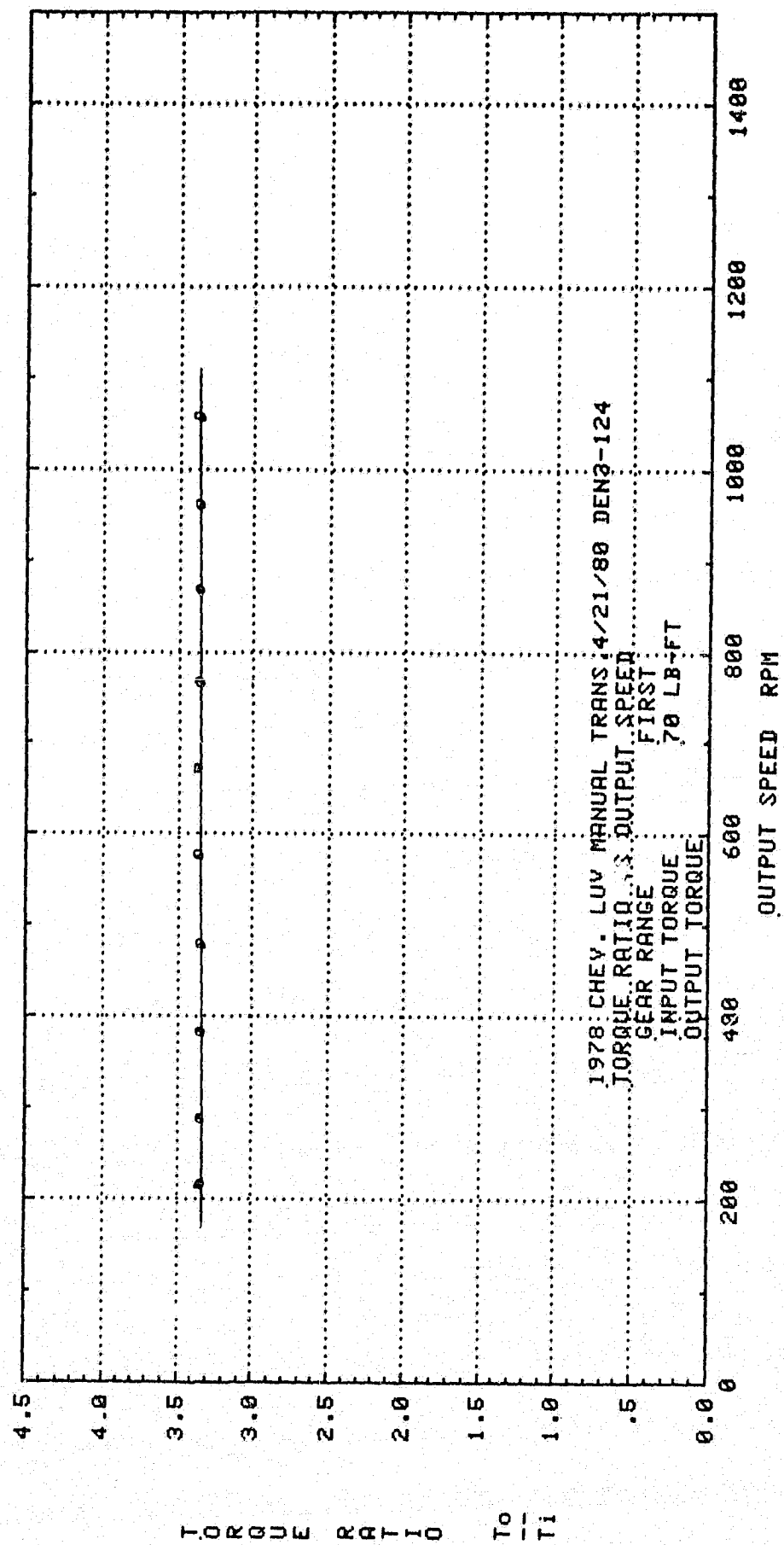

TORQUE RATIO $\frac{T_o}{T_i}$

OUTPUT SPEED RPM

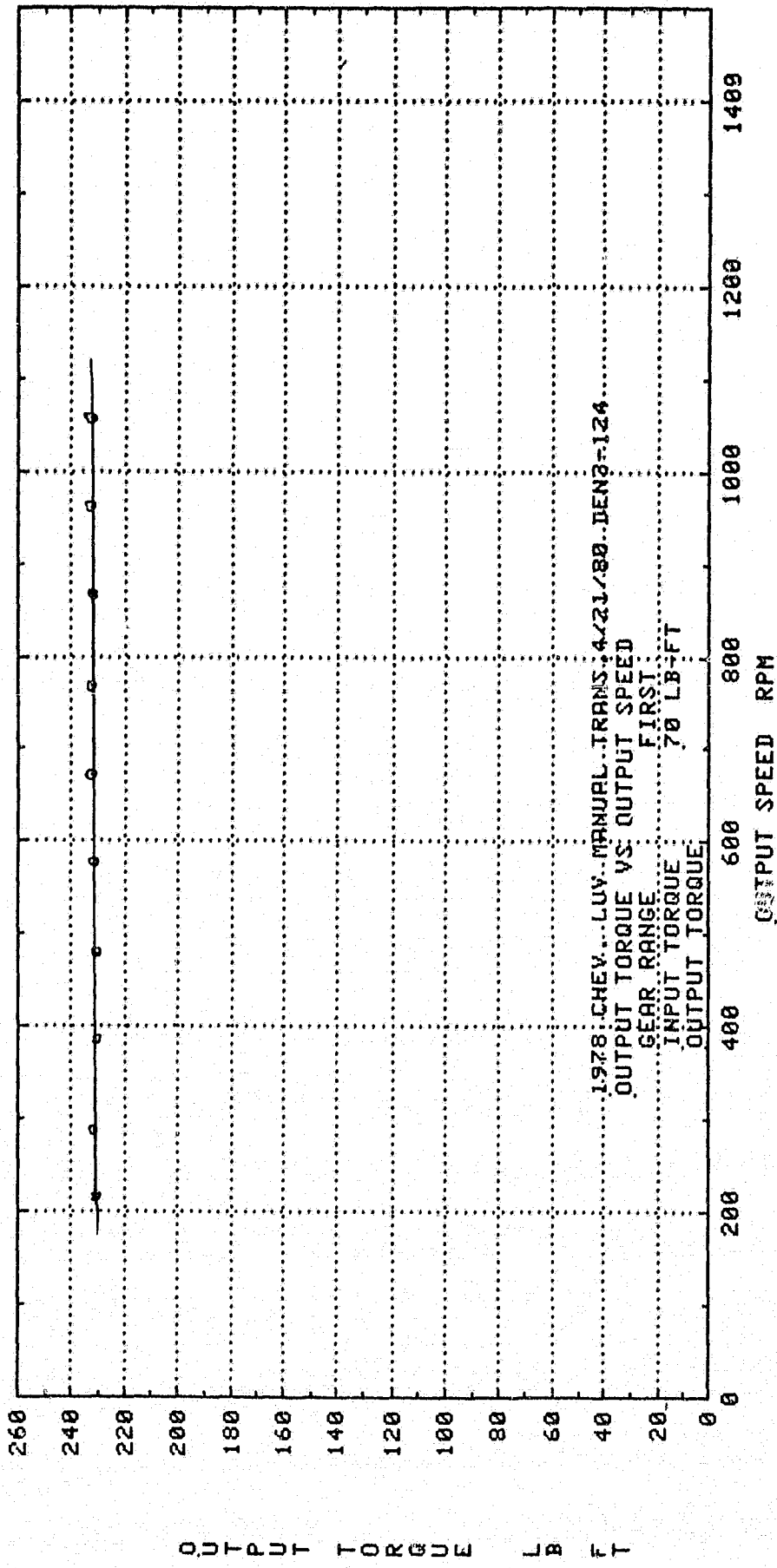

OUTPUT TORQUE LB FT

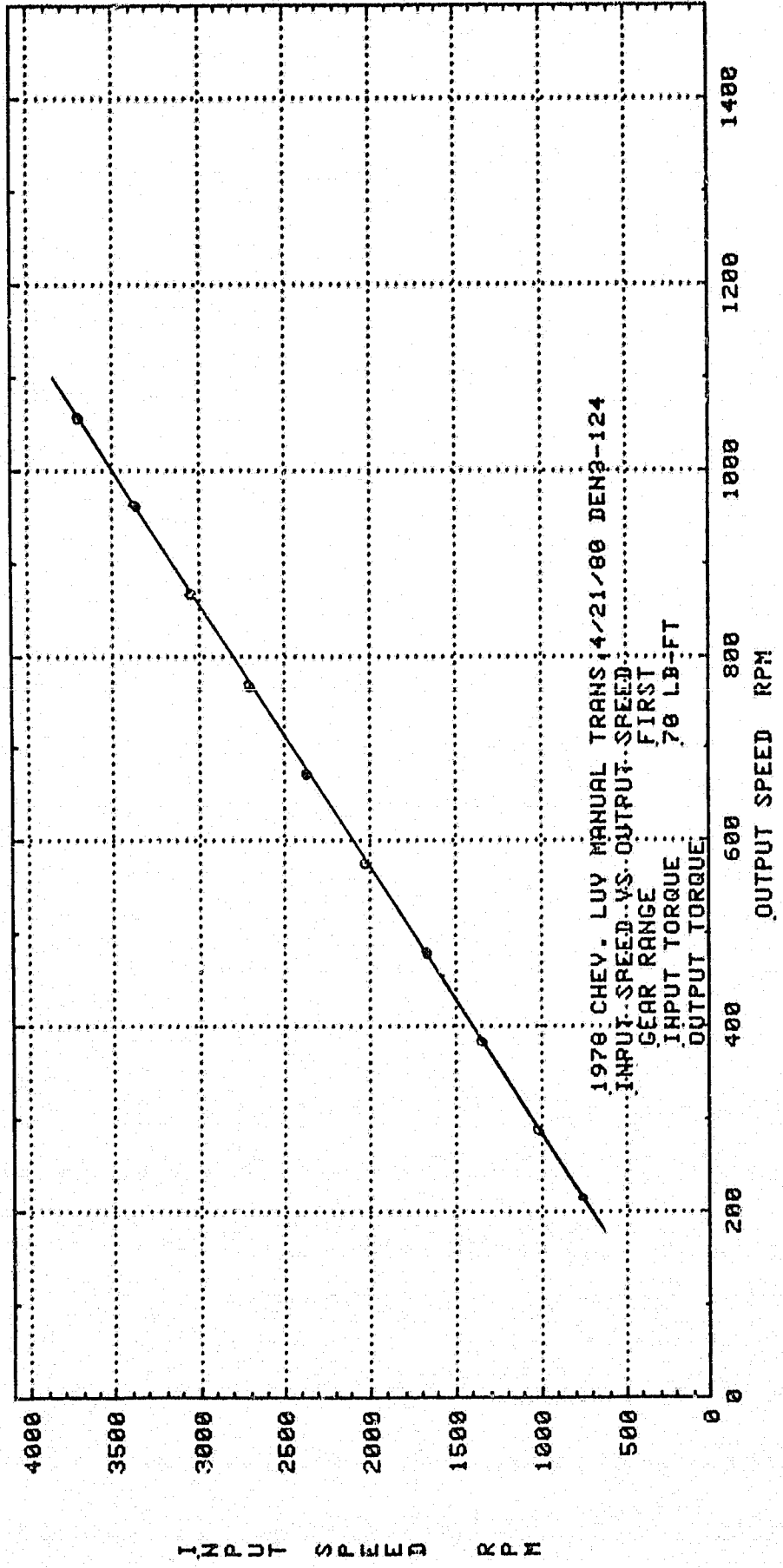

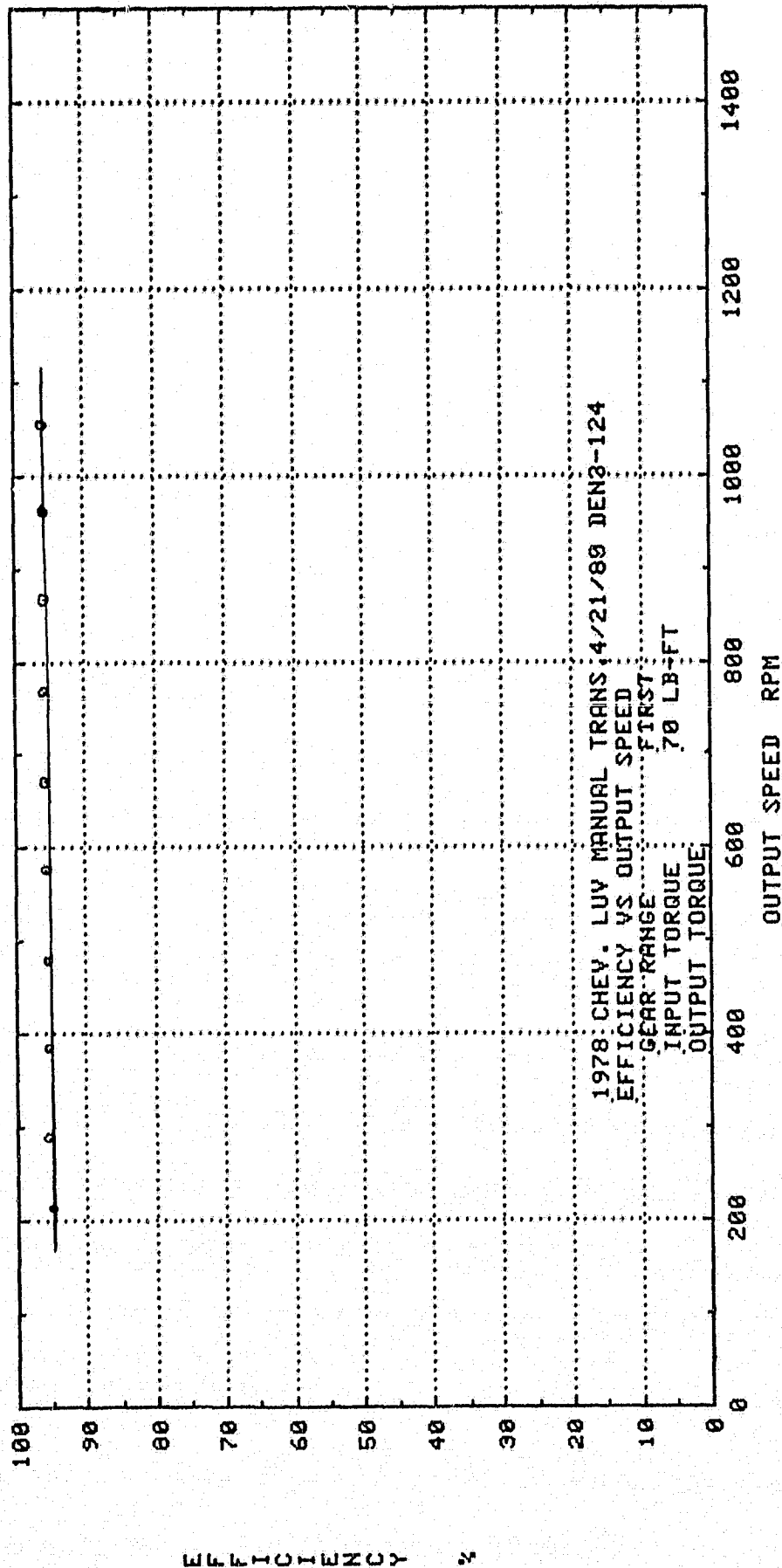

EFFICIENCY %

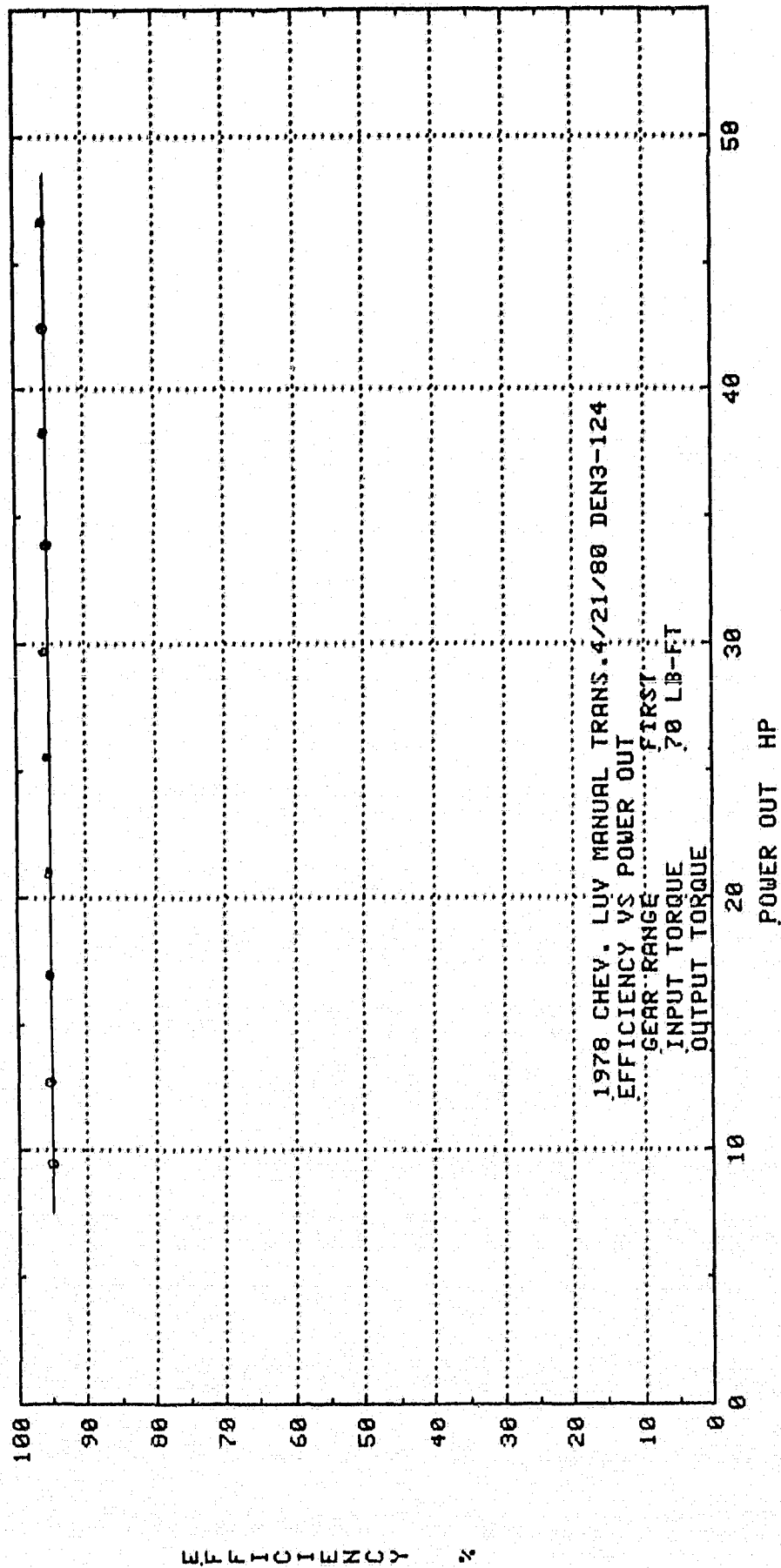

EFFICIENCY %

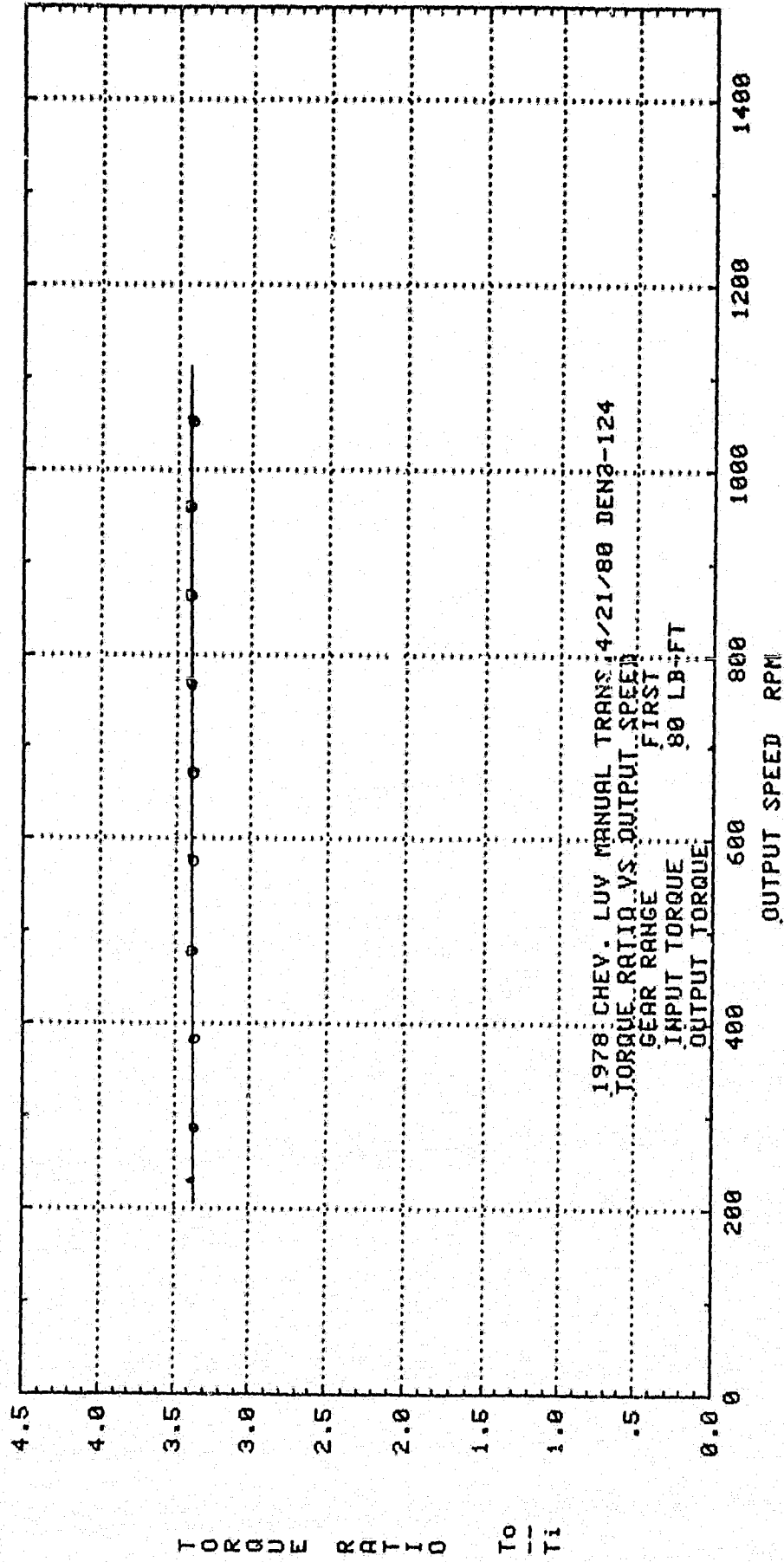

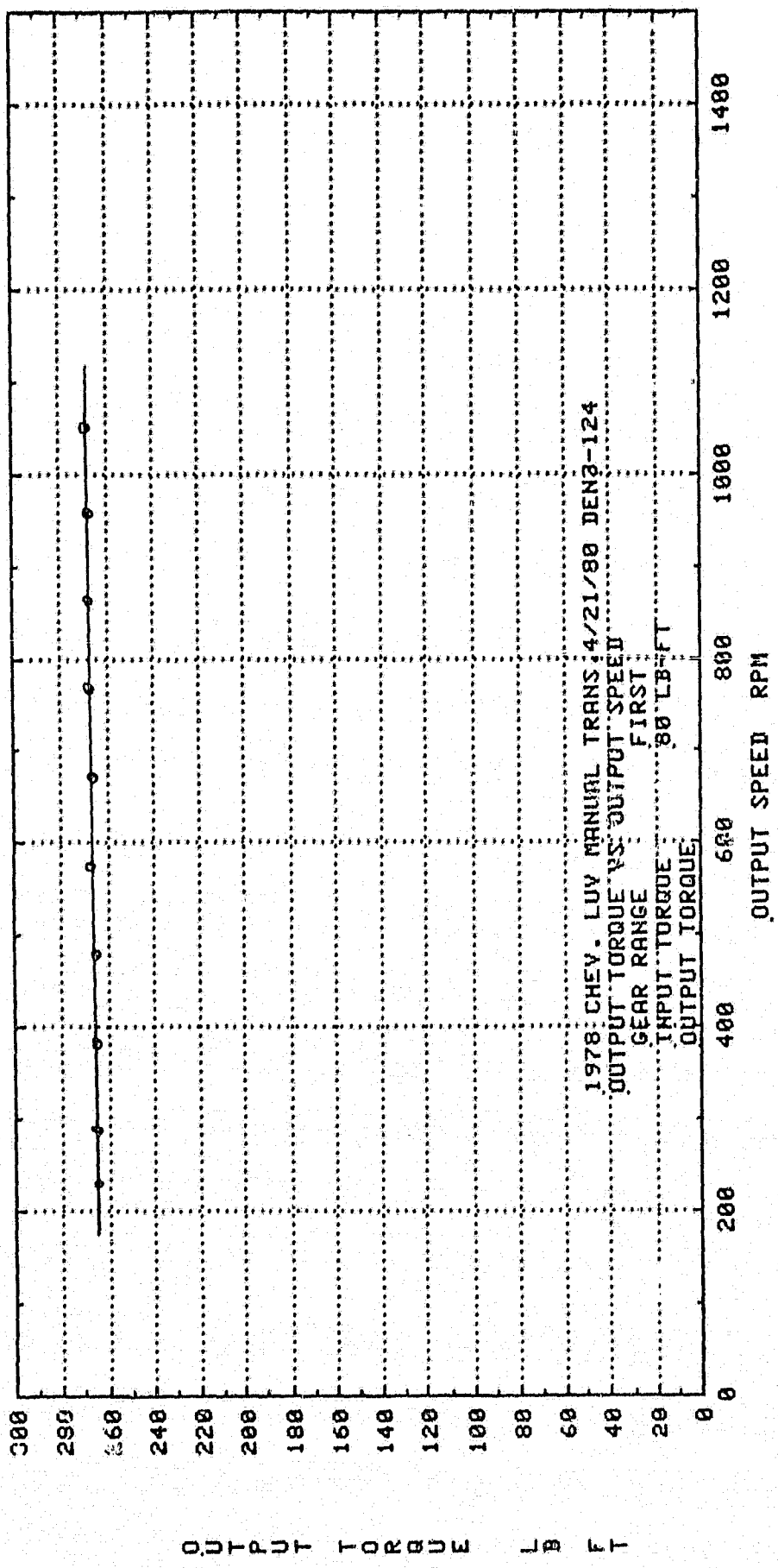

OUTPUT TORQUE LB FT

OUTPUT SPEED RPM

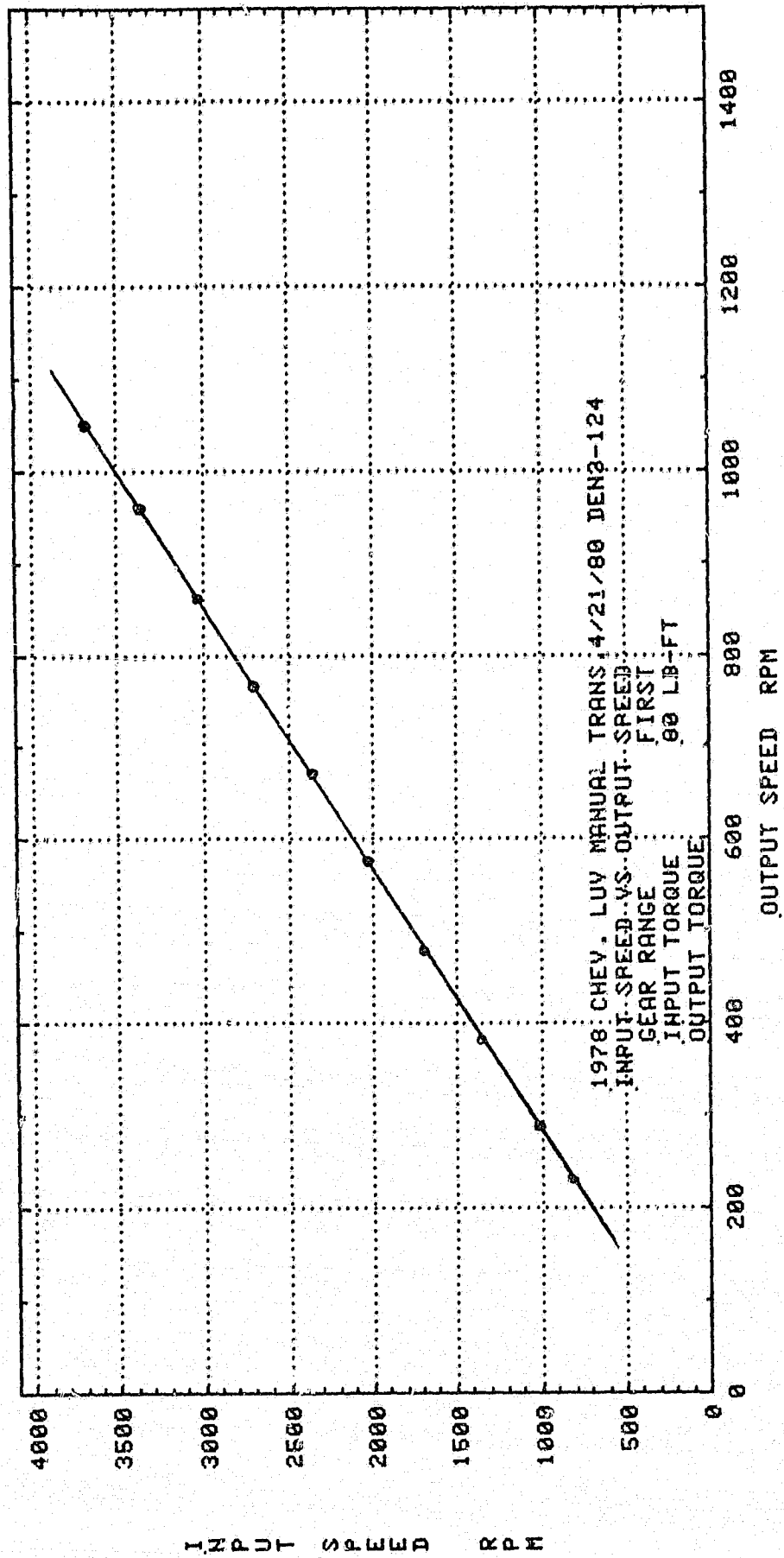

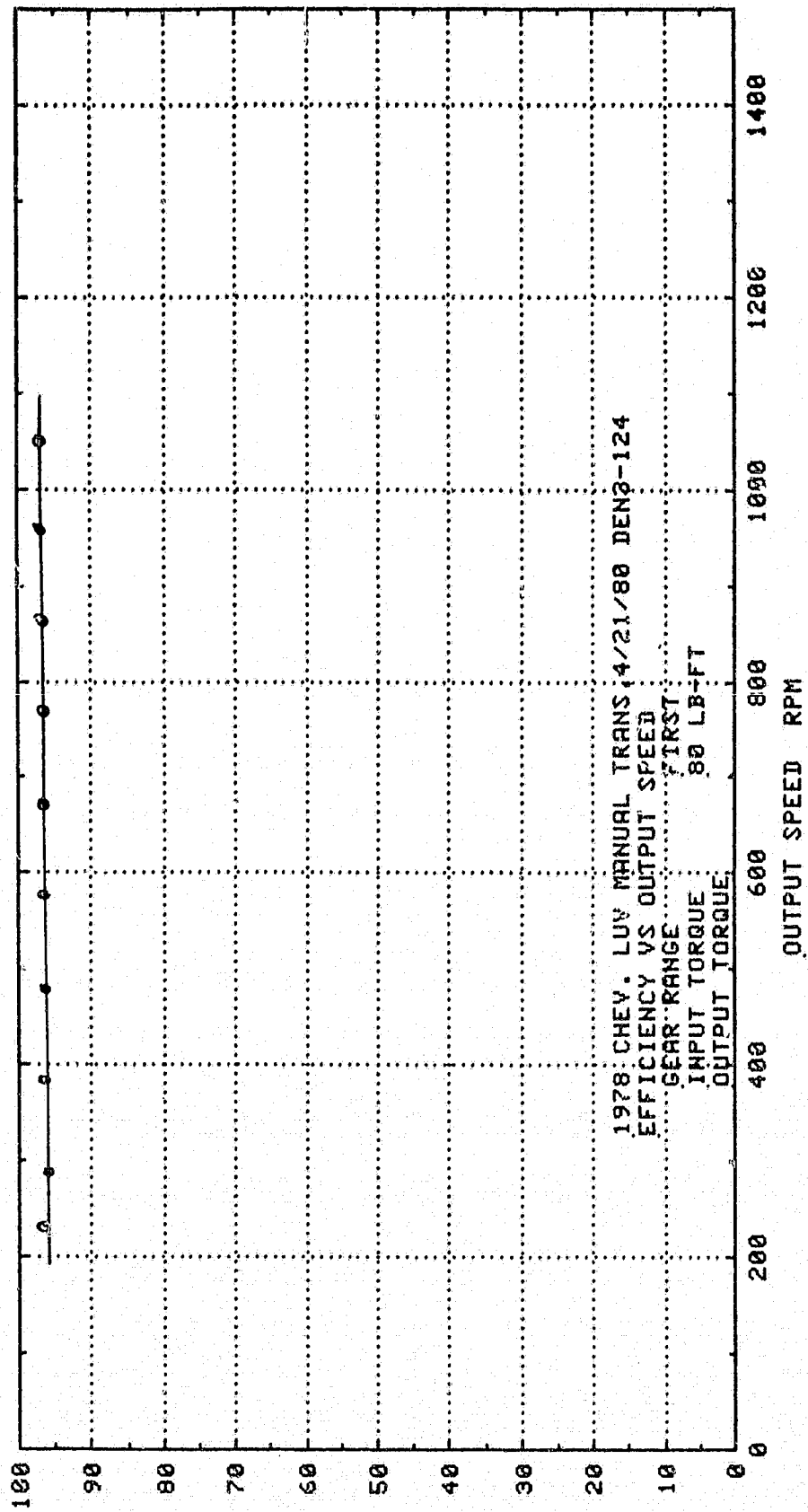

E.F.F I C I E N C Y %

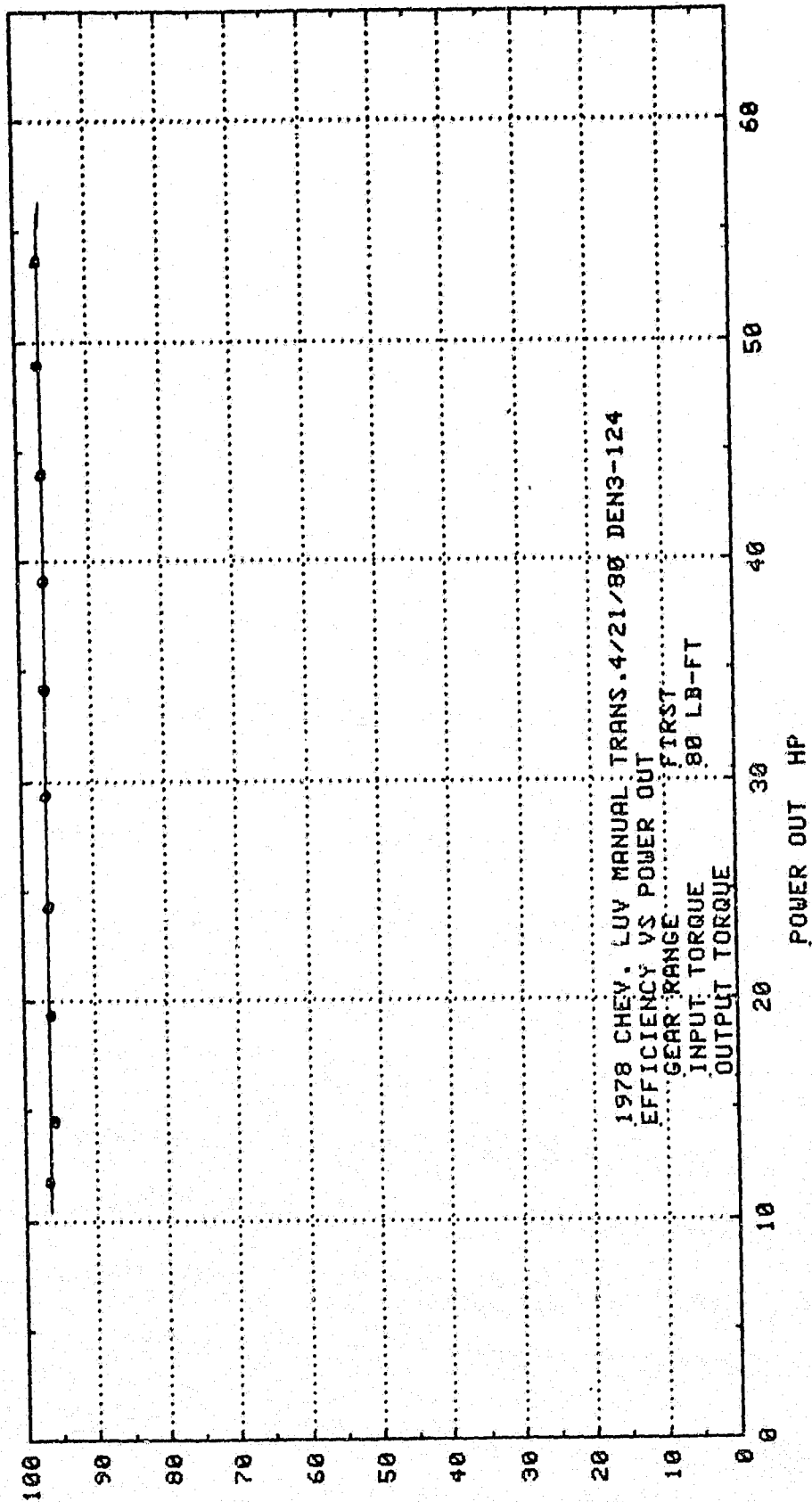

EFFICIENCY %

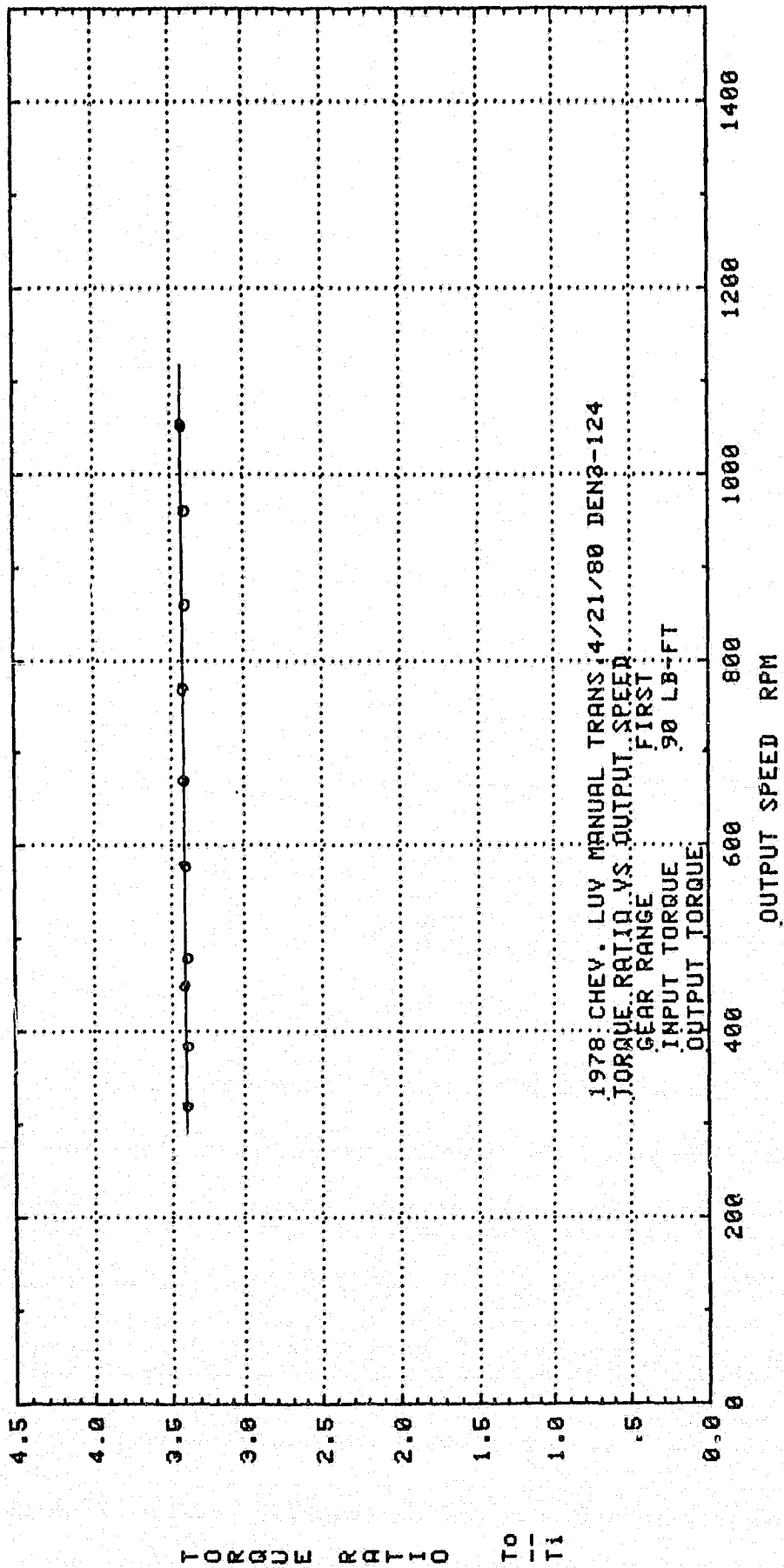

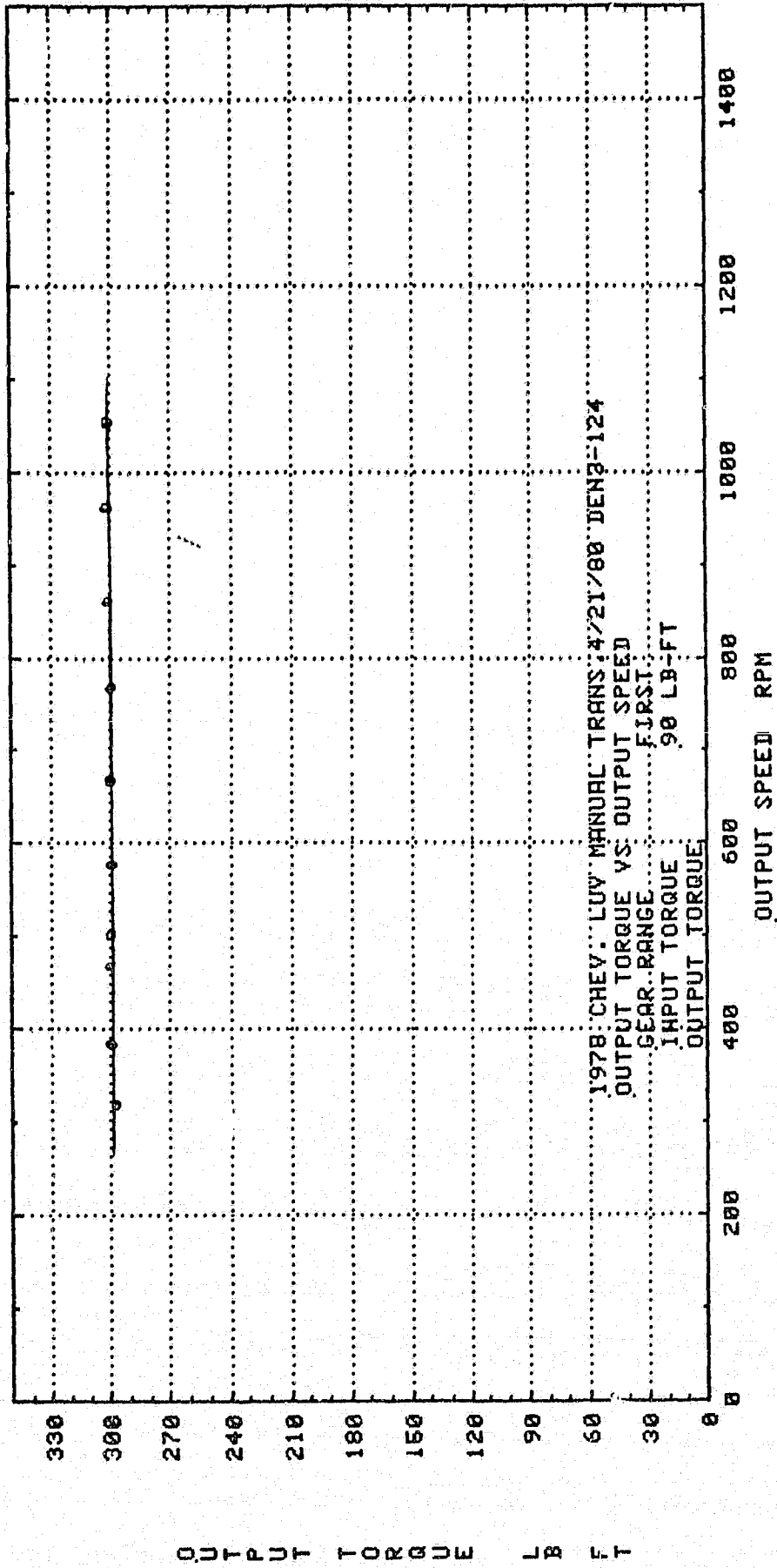

O U T P U T T O R Q U E L B F T

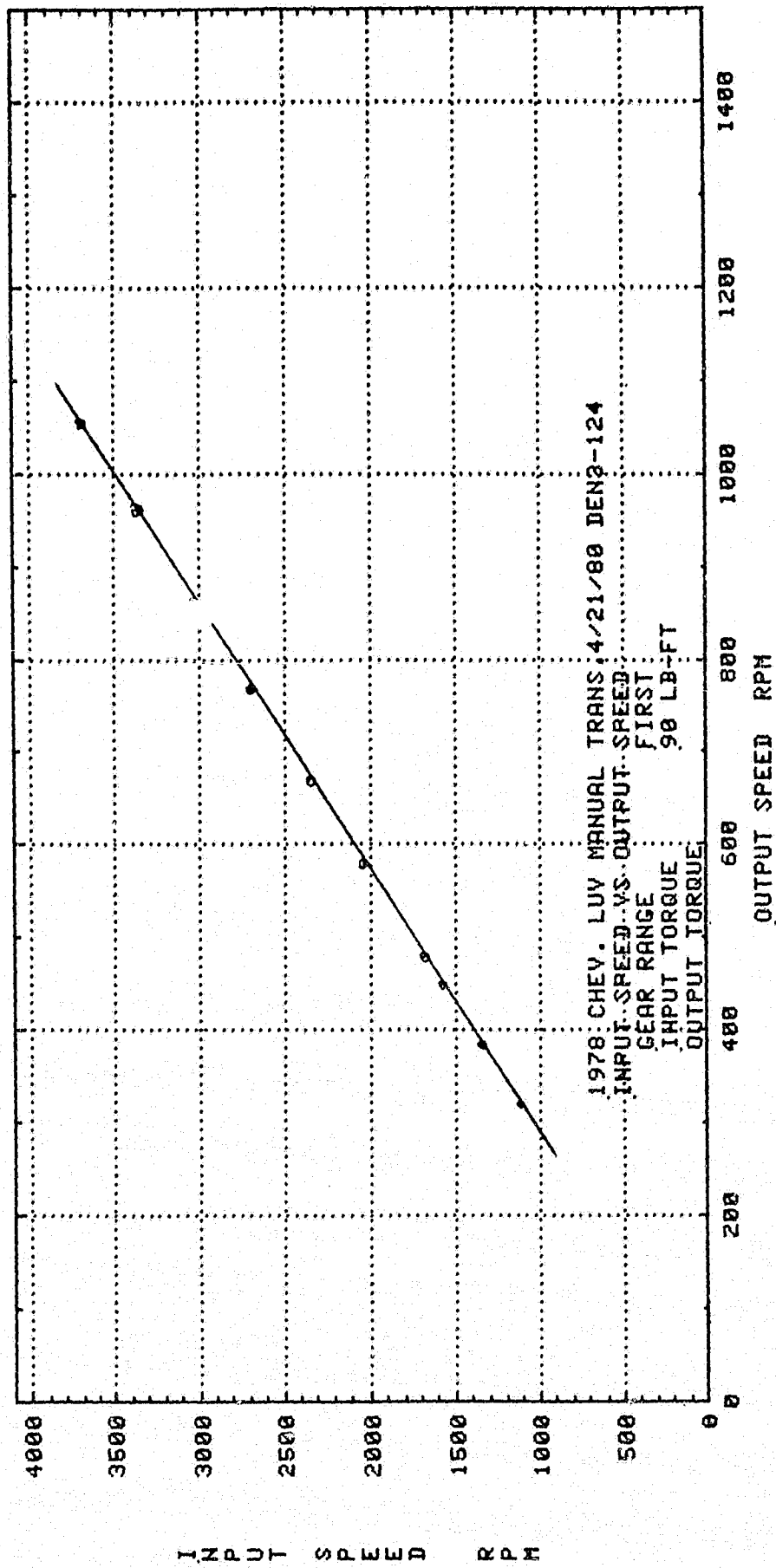

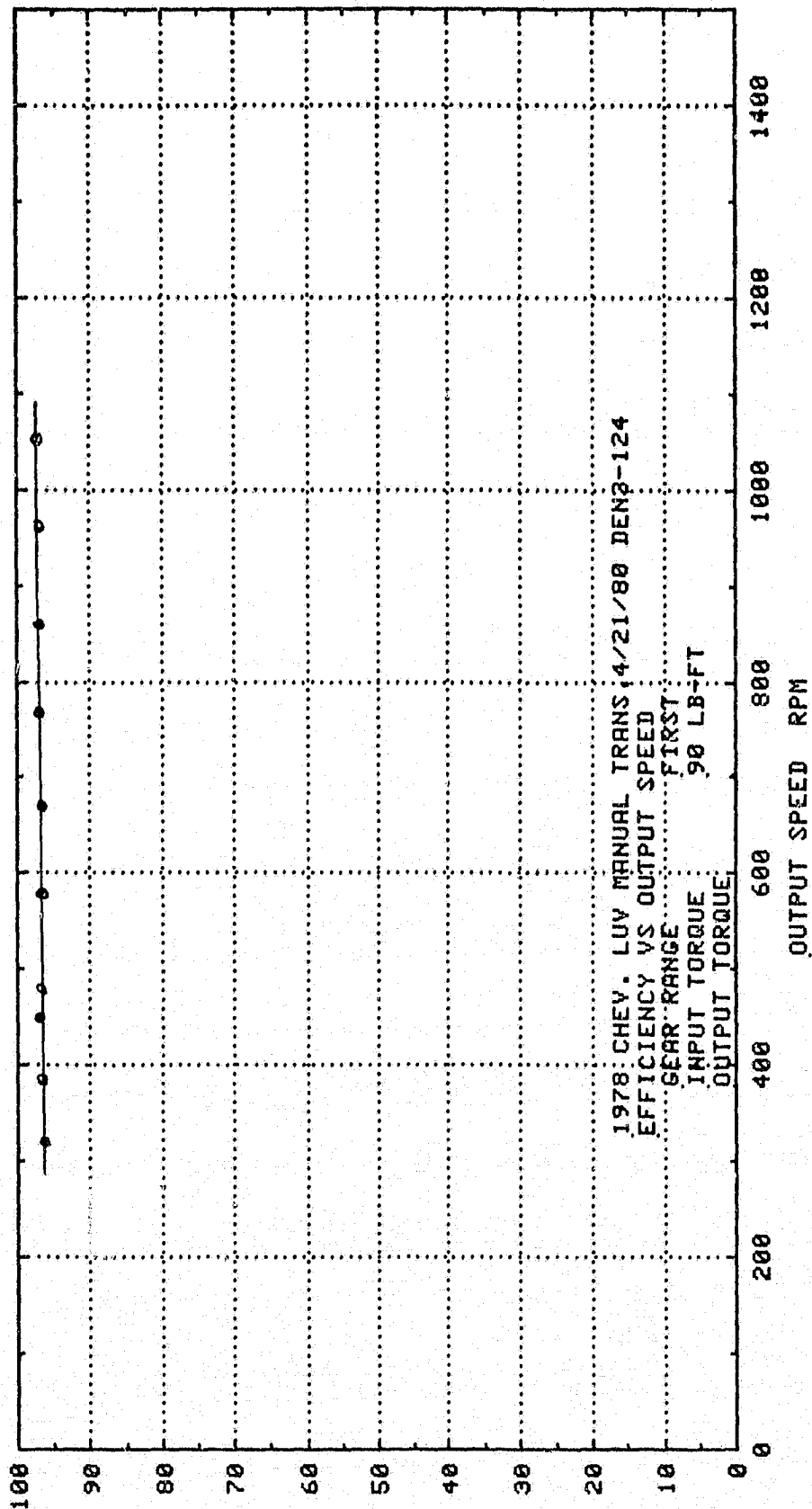

EFFICIENCY %

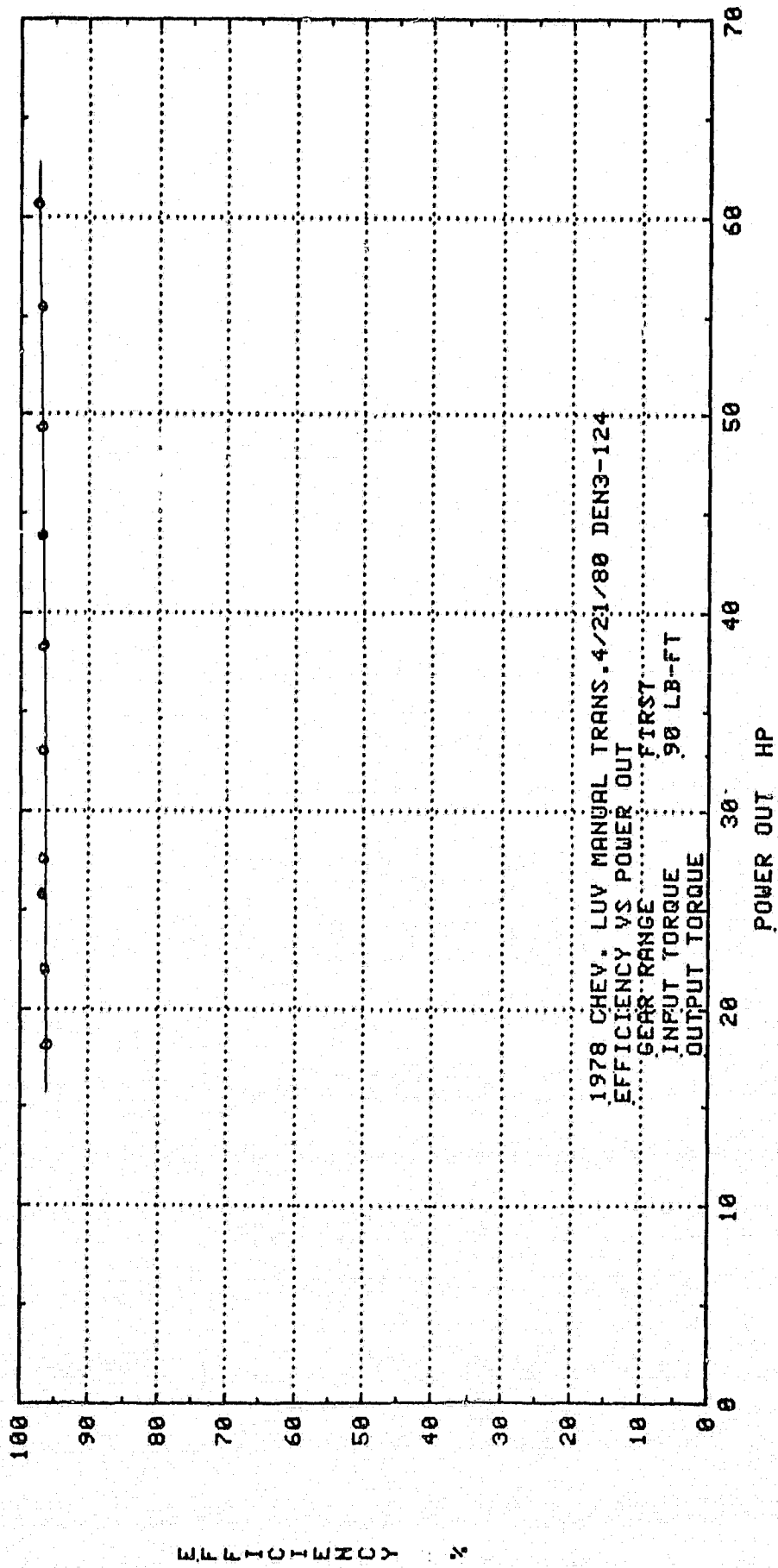

DRIVE PERFORMANCE

2ND GEAR

Graphs Contained in This Section

Torque Ratio -vs- Output Speed

Output Torque -vs- Output Speed

Input Speed -vs- Output Speed

Efficiency -vs- Output Speed

Efficiency -vs- Power Out

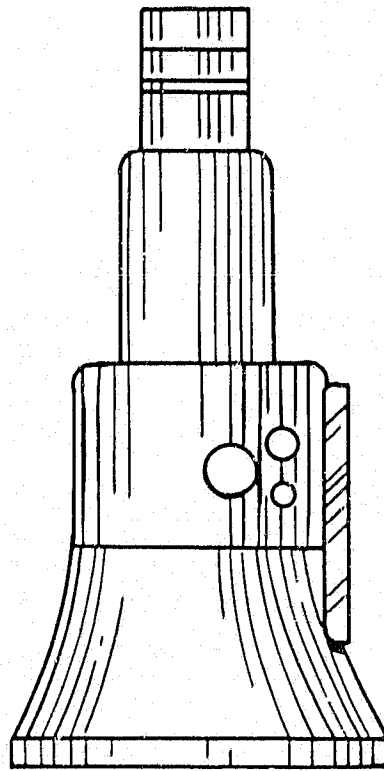

Torque In

Speed In

Torque Out

Speed Out

Drive Performance Tests

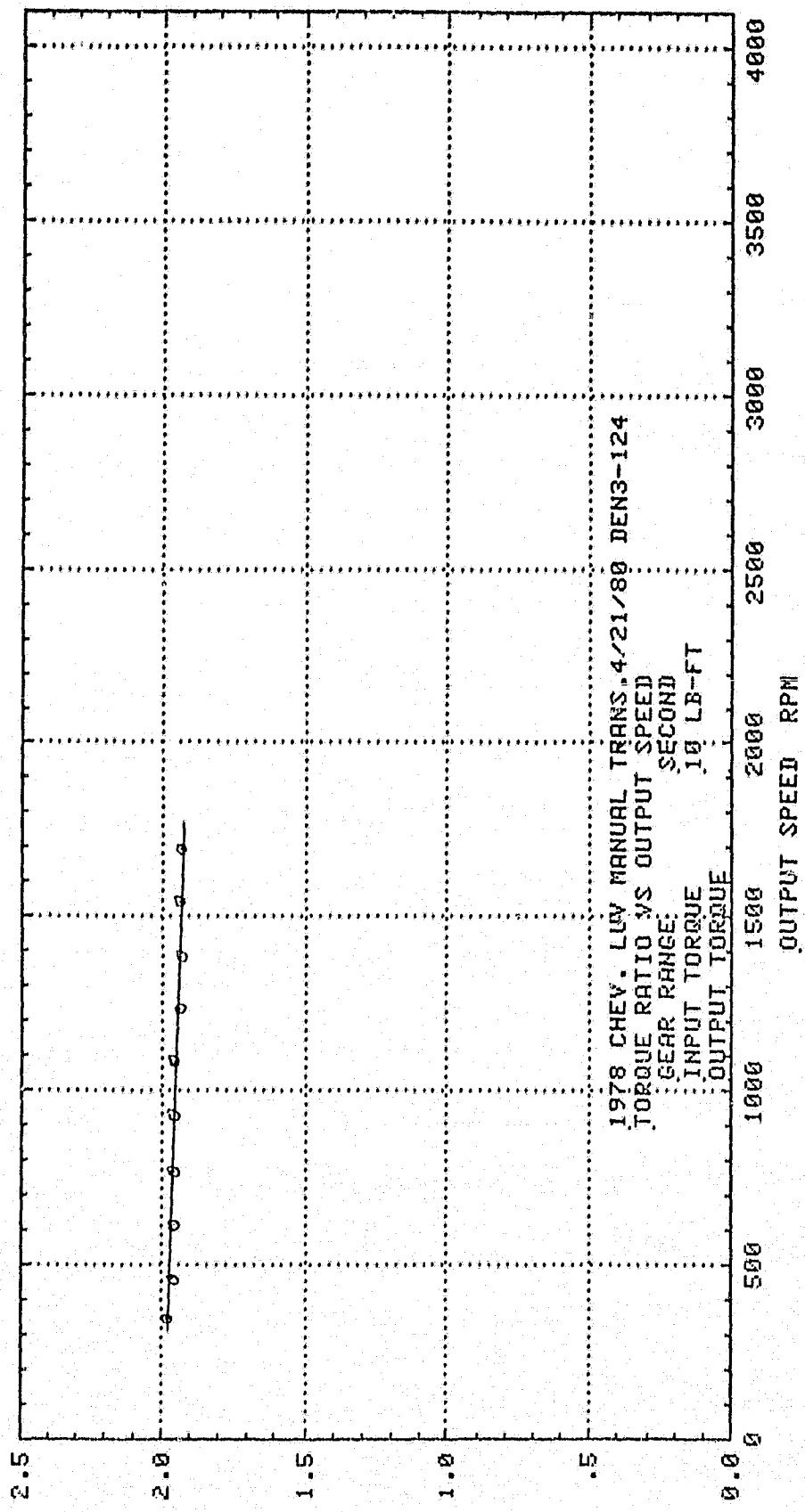

TORQUE RATIO $\frac{T_o}{T_i}$

OUTPUT TORQUE LB FT

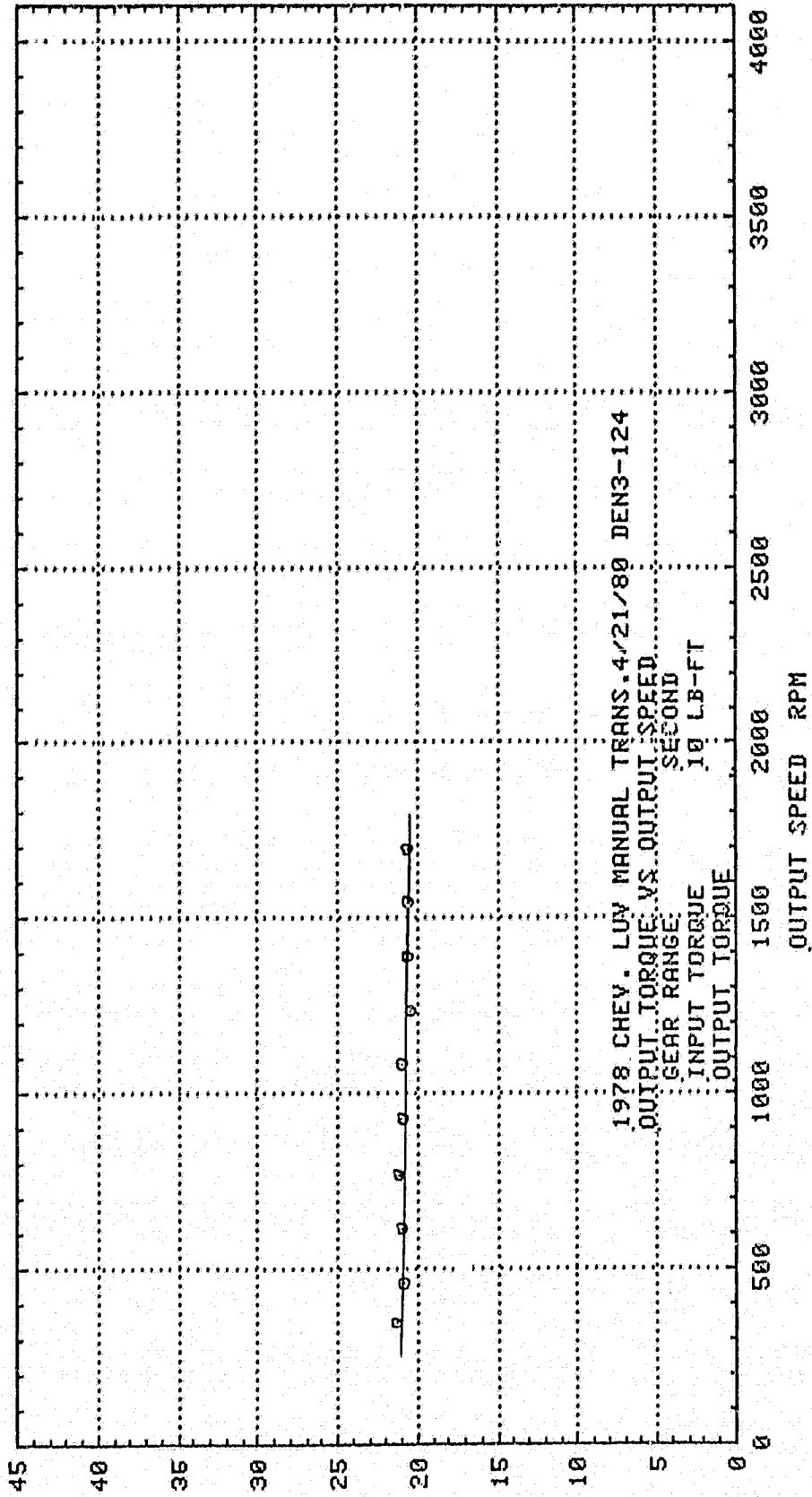

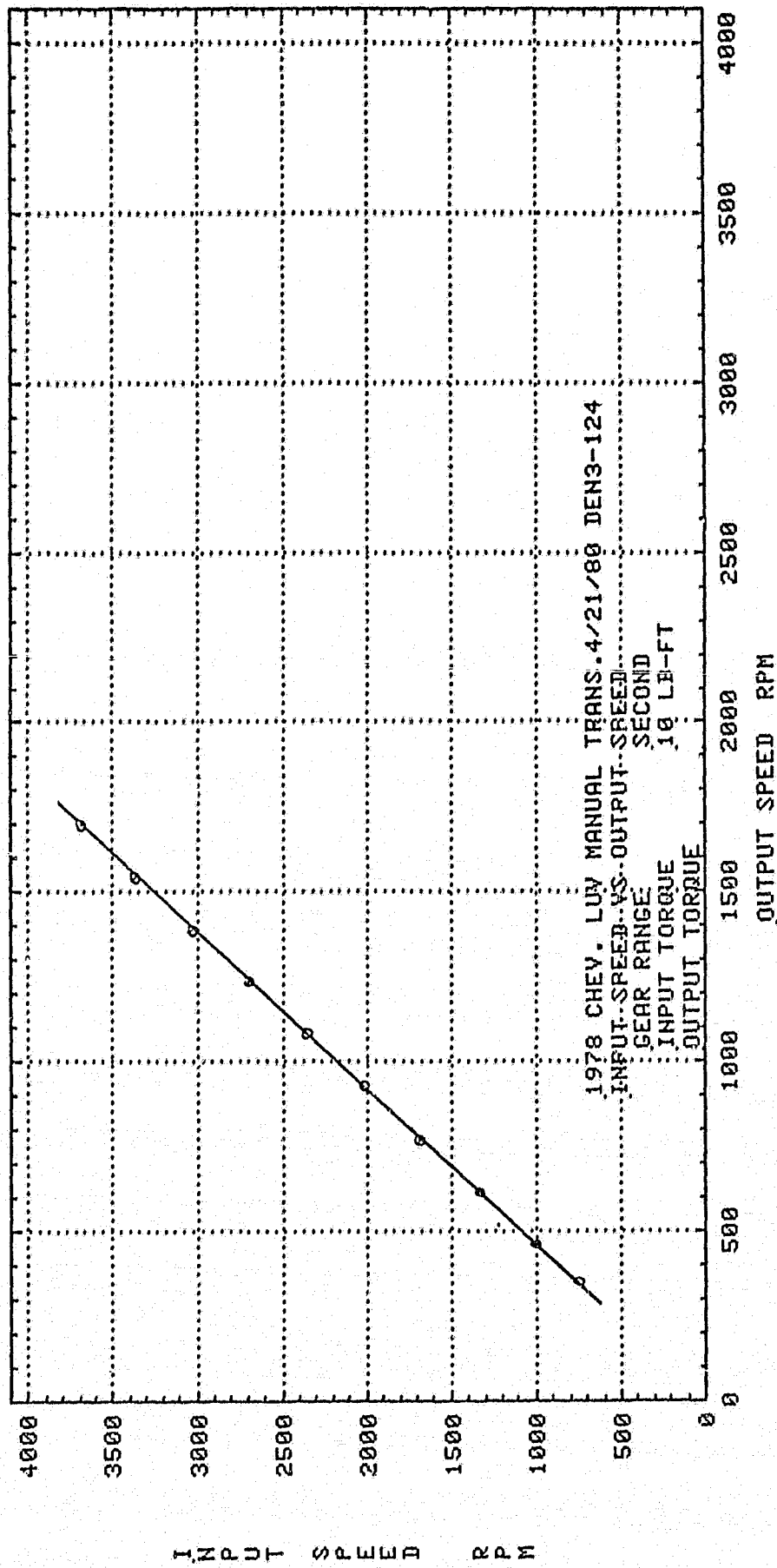

EFFICIENCY %

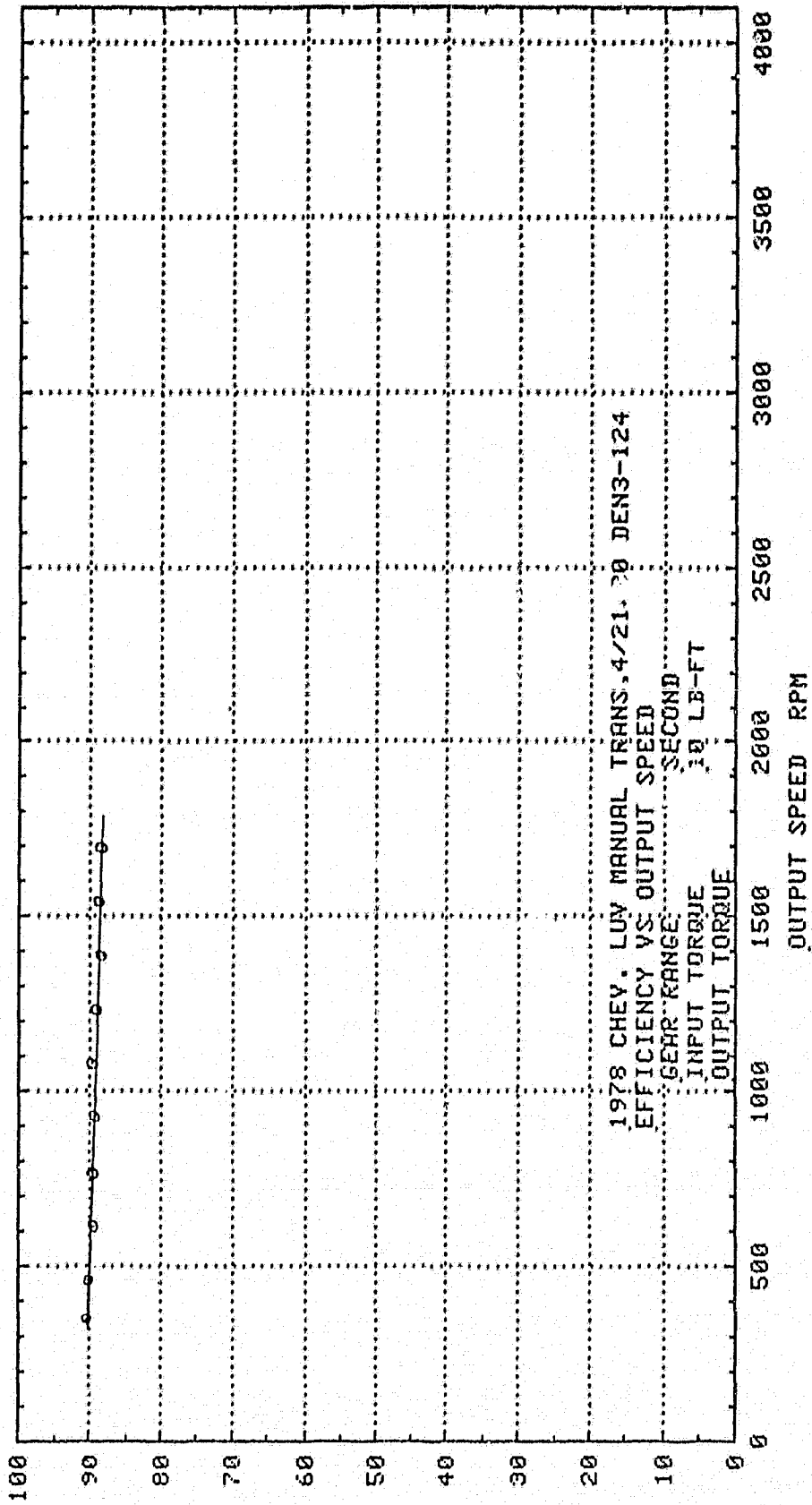

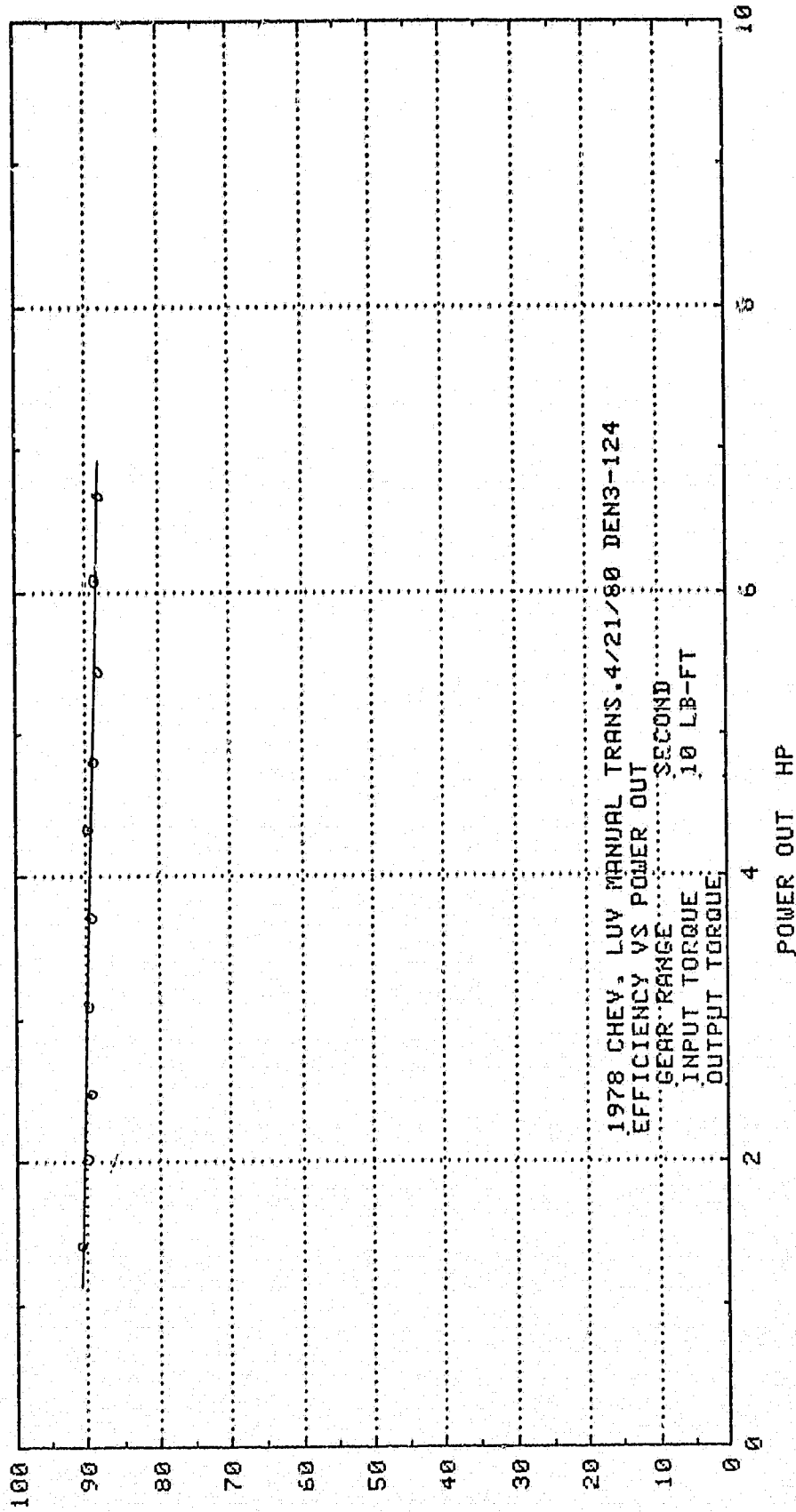

E F F I C I E N C Y %

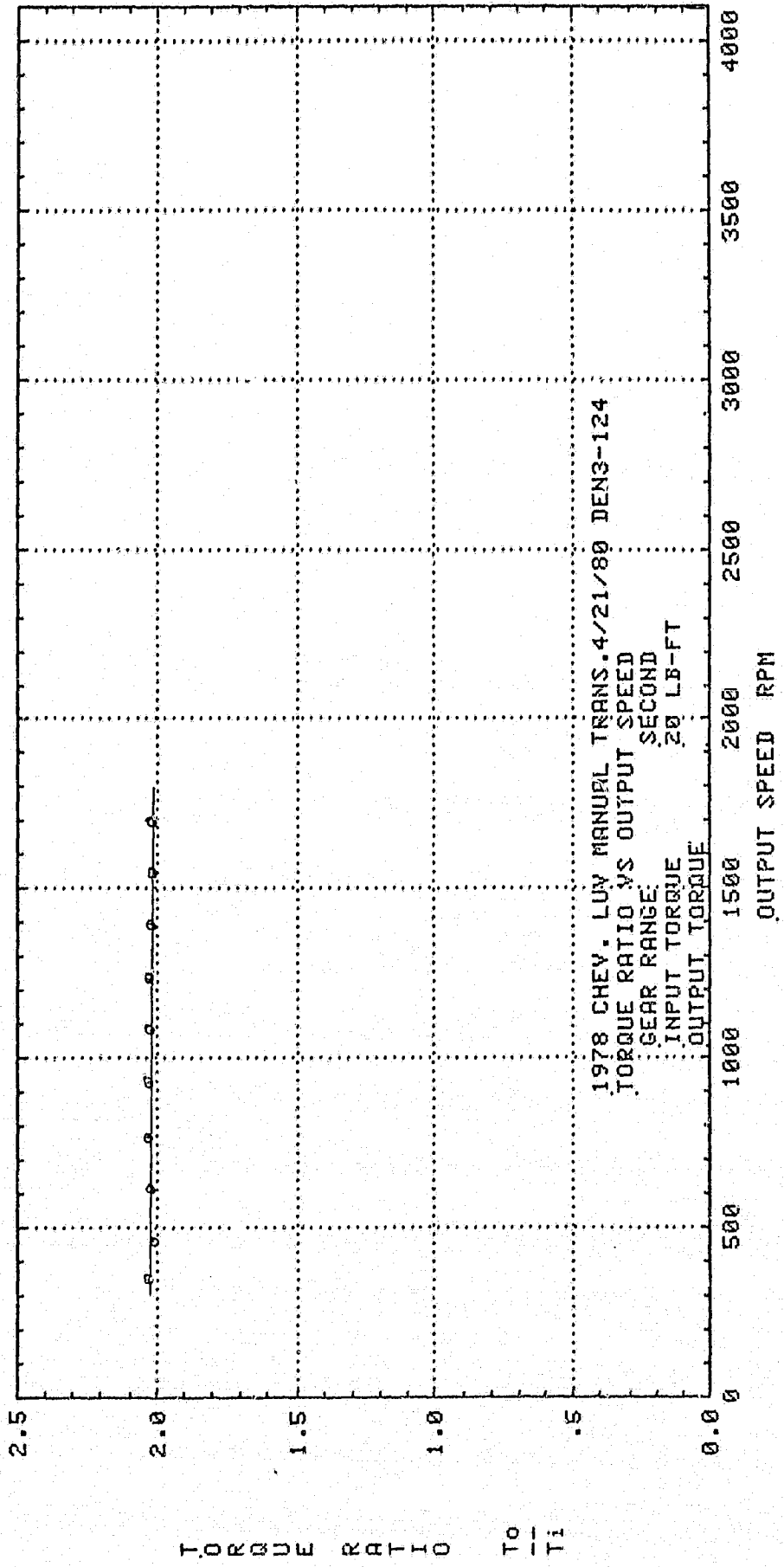

TORQUE RATIO $\frac{T_o}{T_i}$

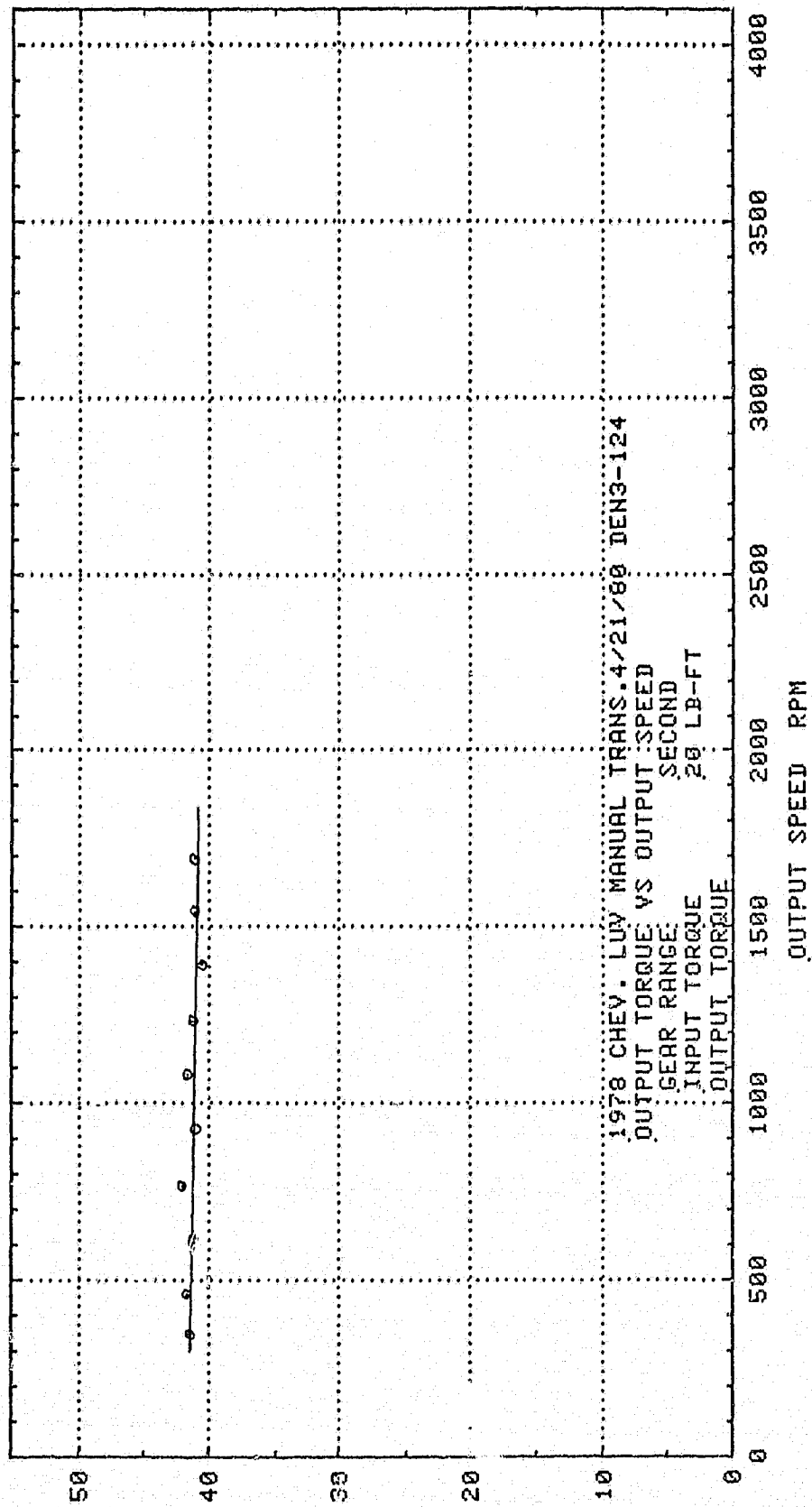

OUTPUT TORQUE LB FT

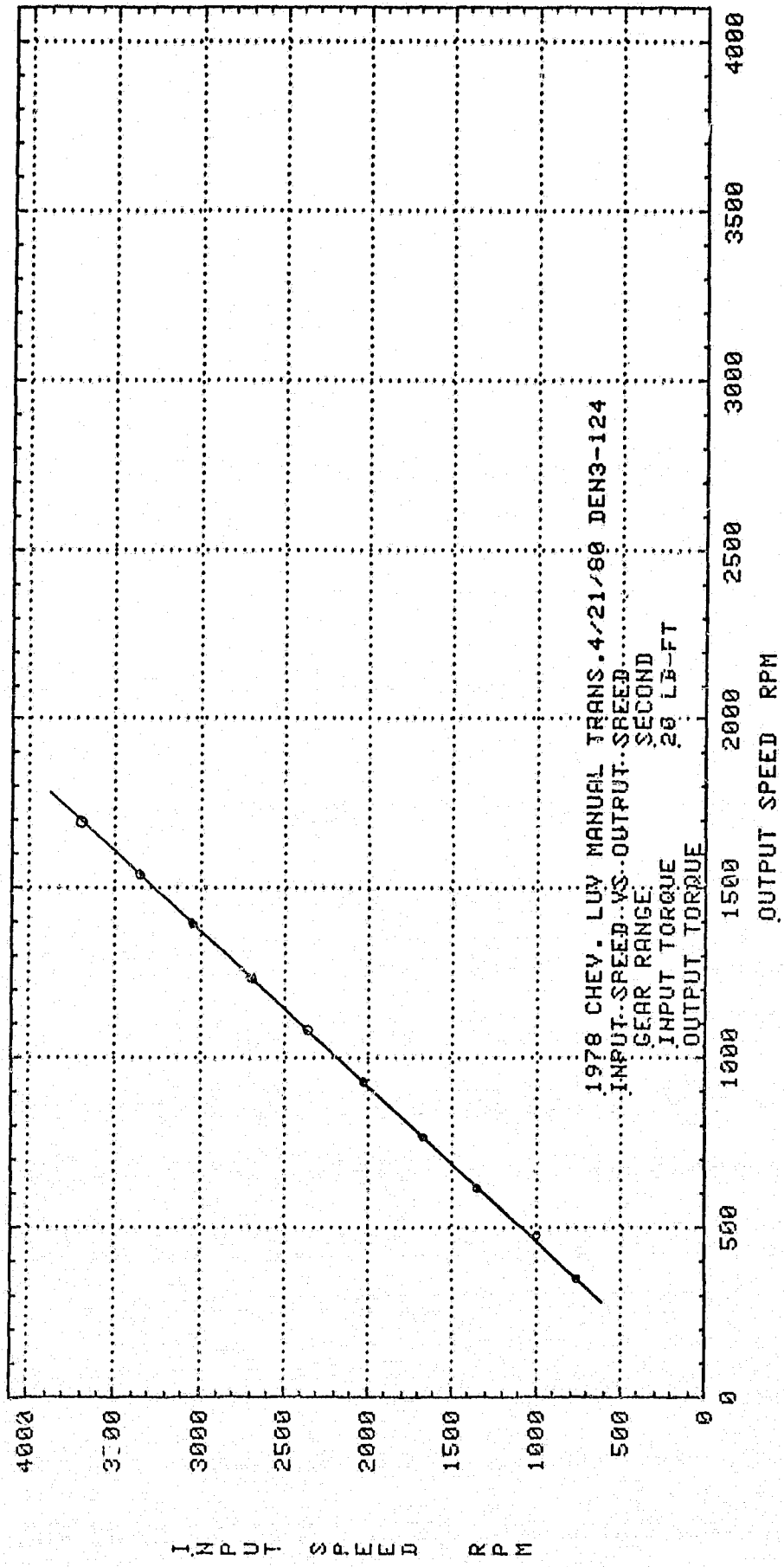

INPUT SPEED RPM

OUTPUT SPEED RPM

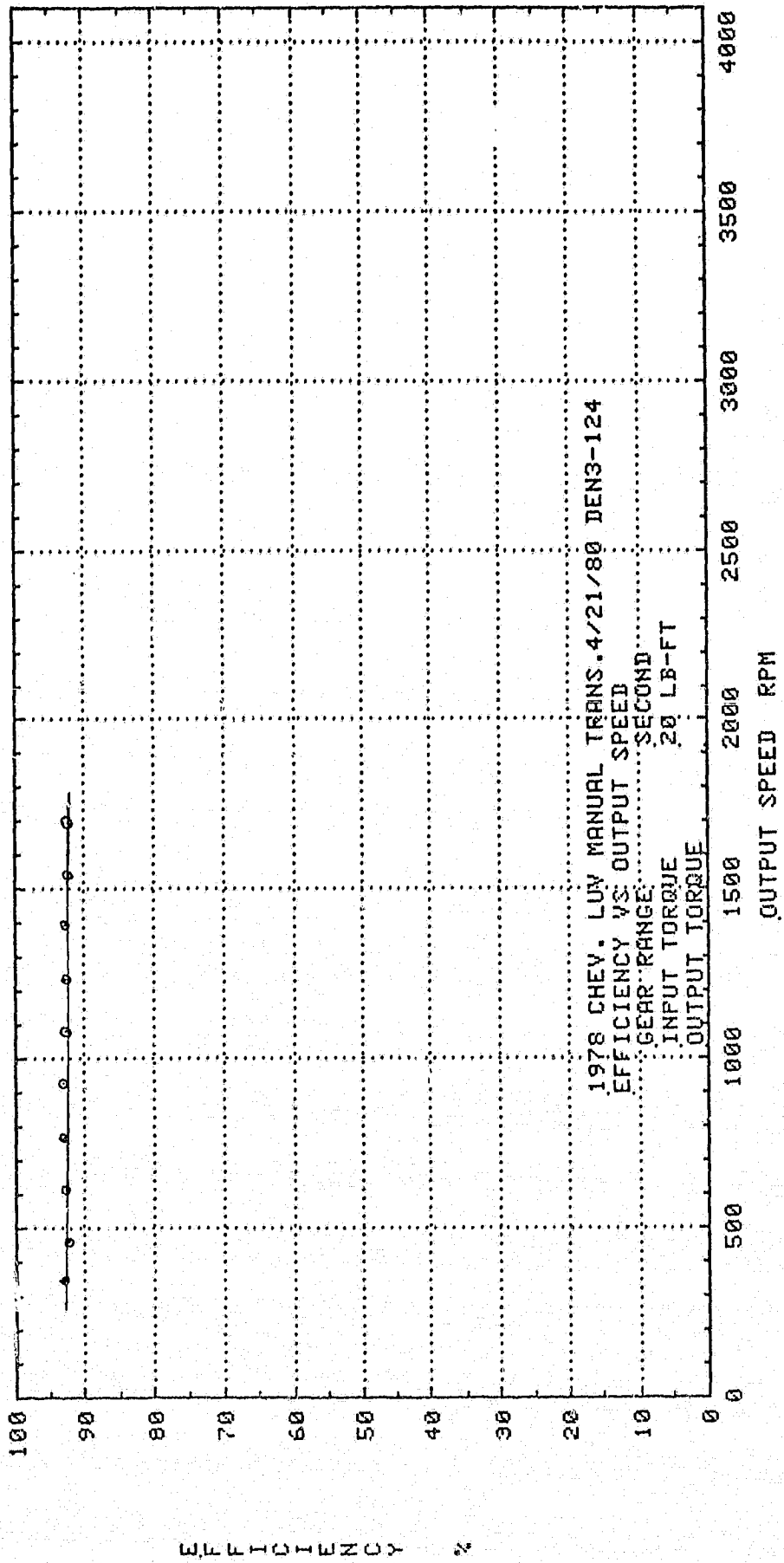

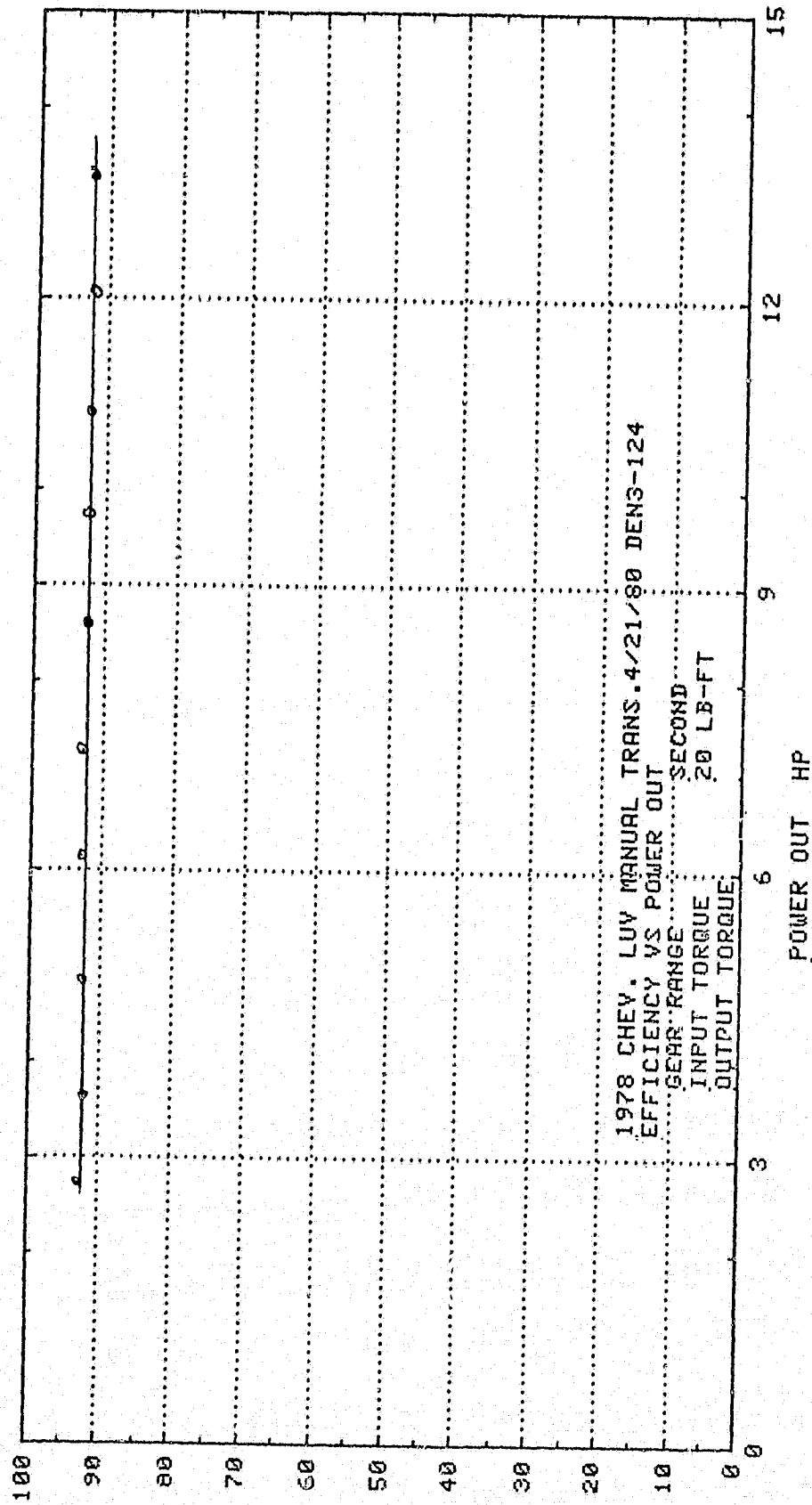

EFFICIENCY %

POWER OUT HP

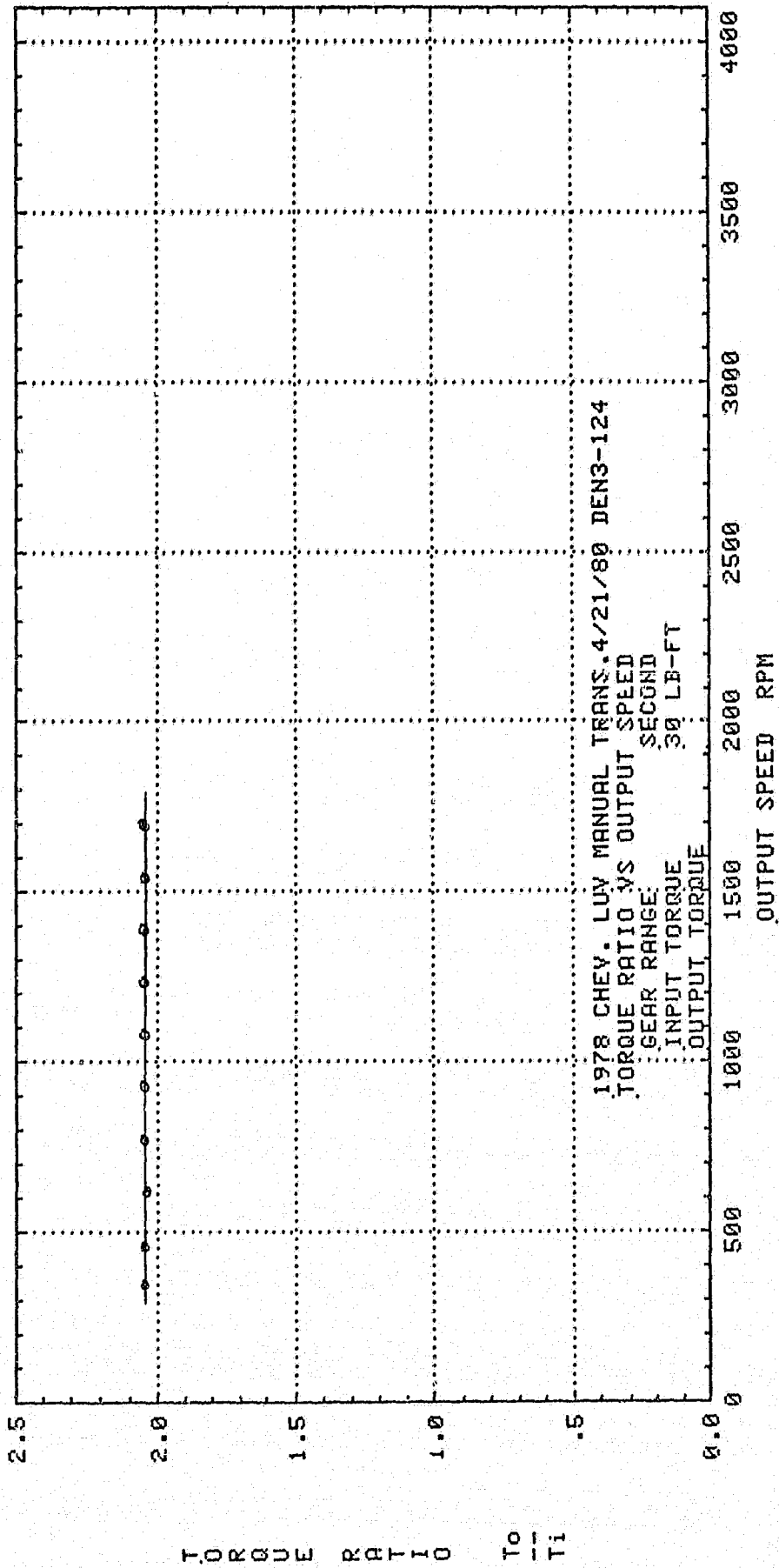

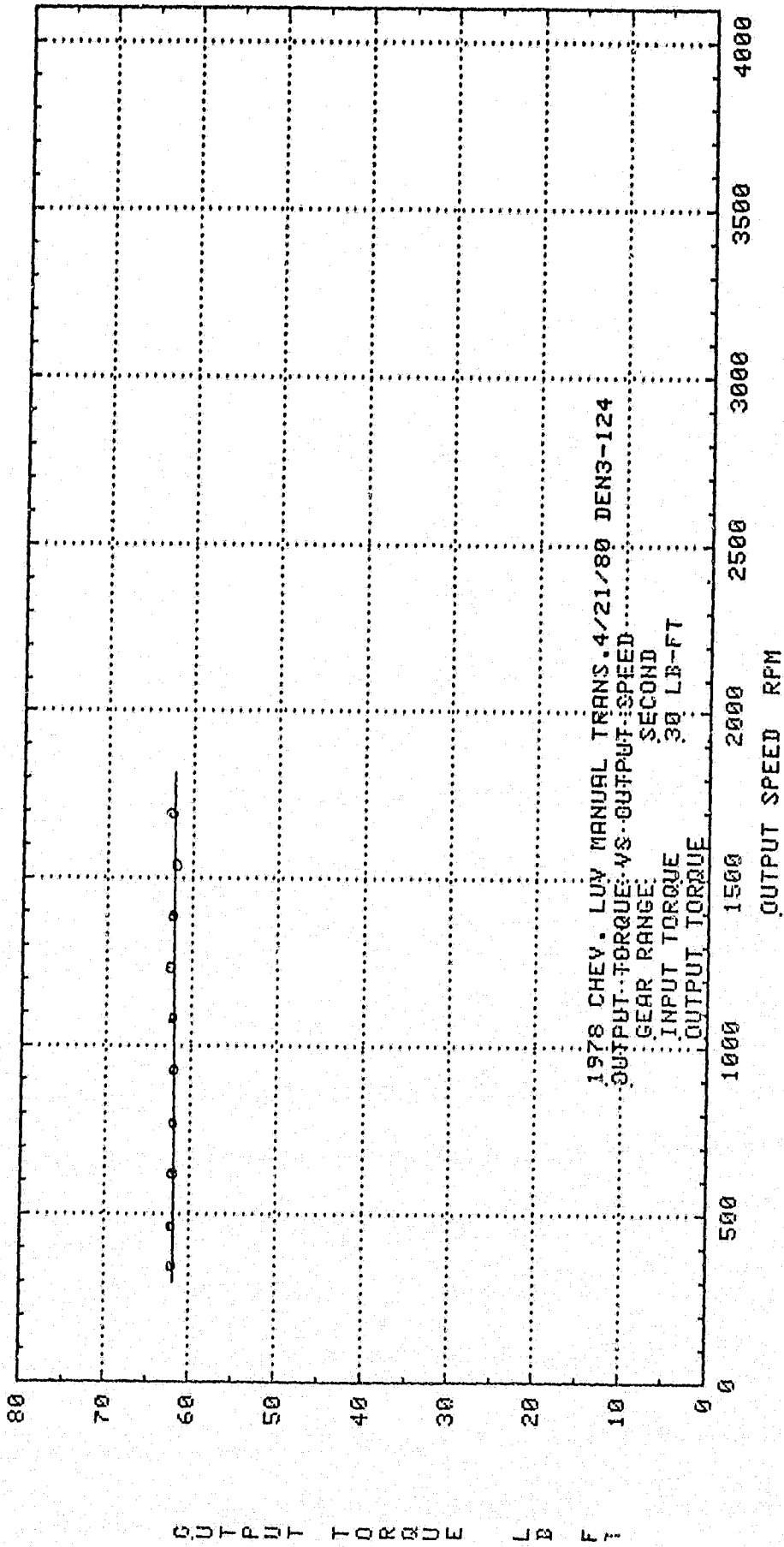

OUTPUT TORQUE LB FT

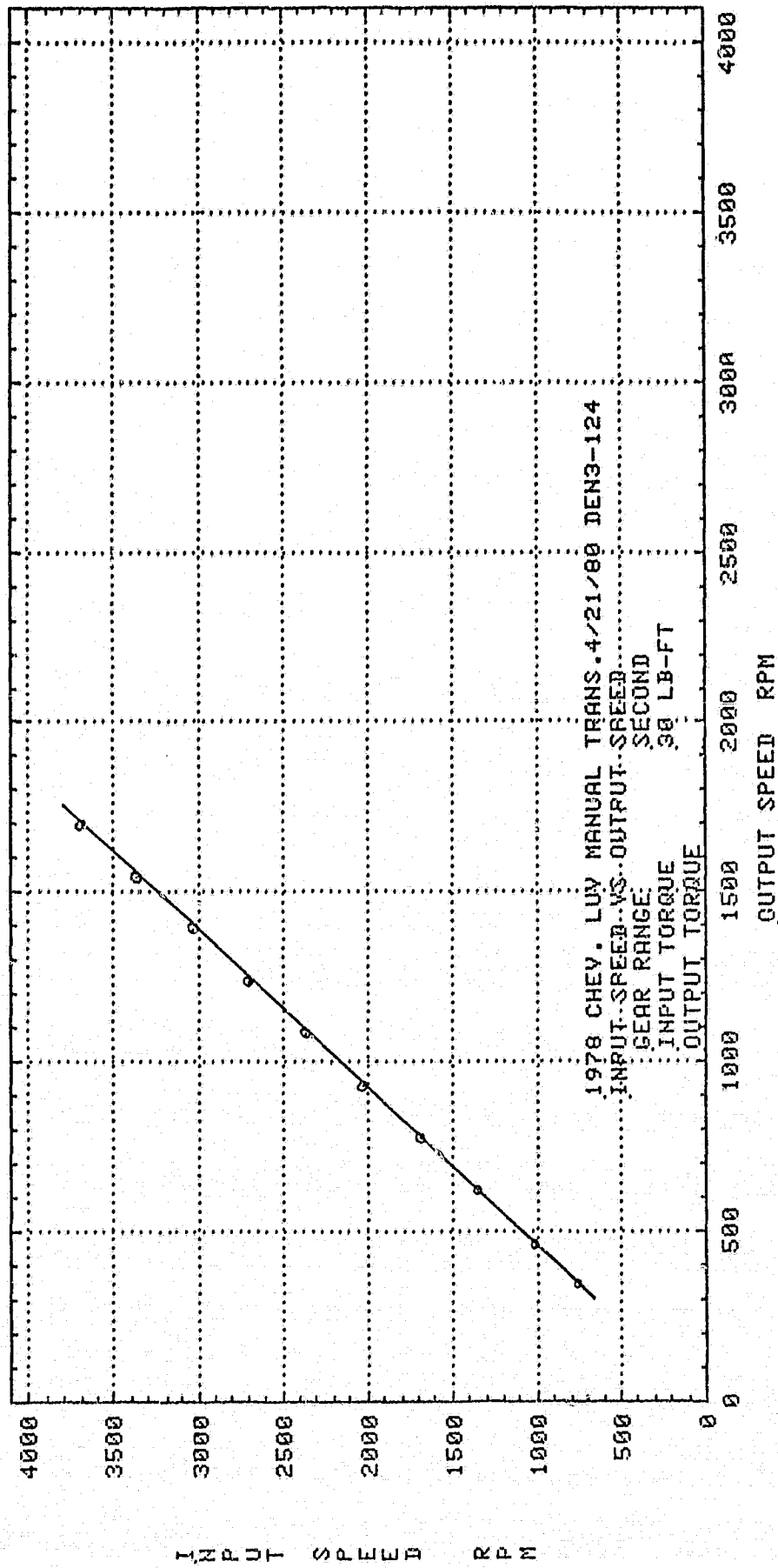

E F F I C I E N C Y %

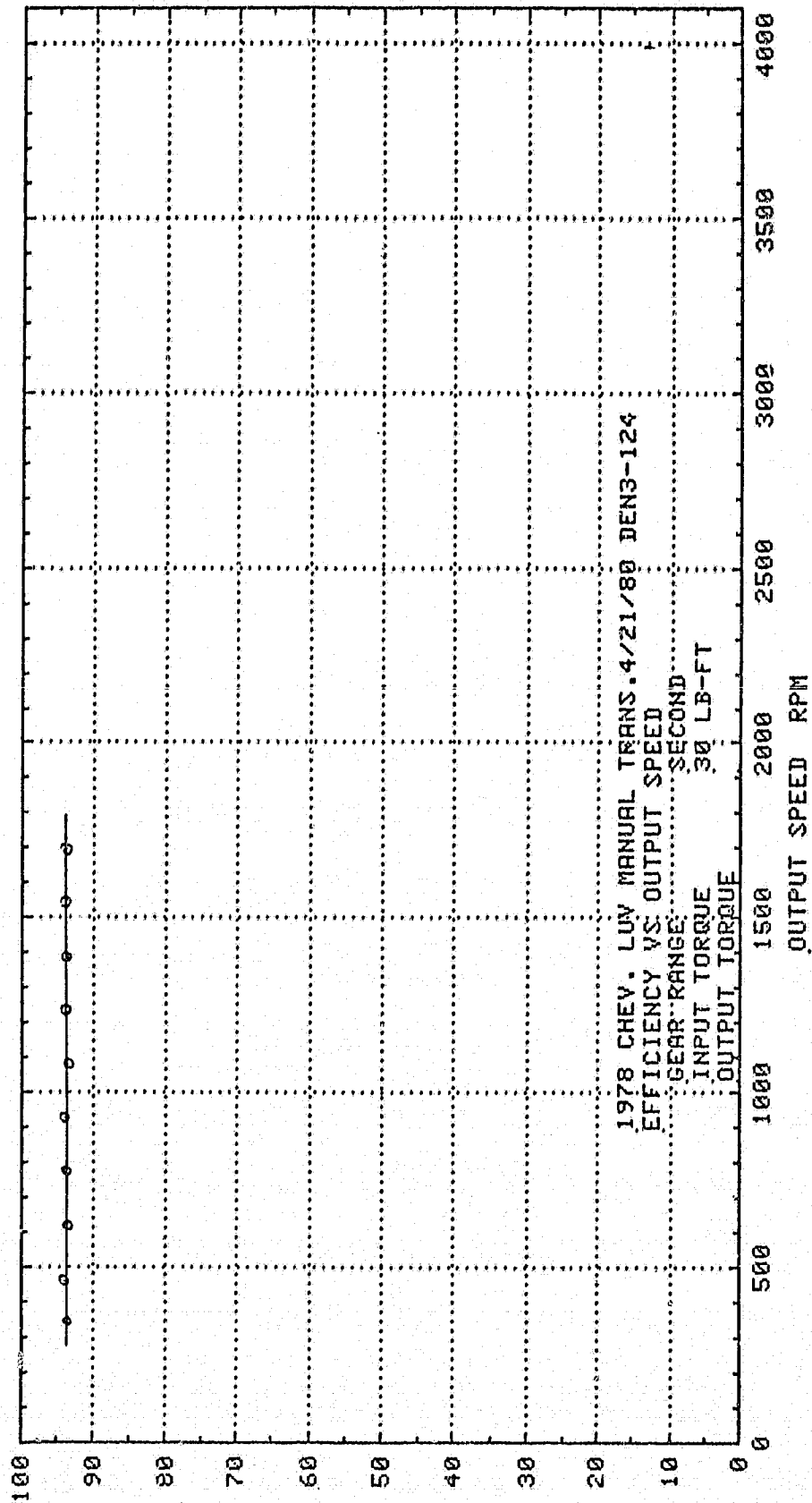

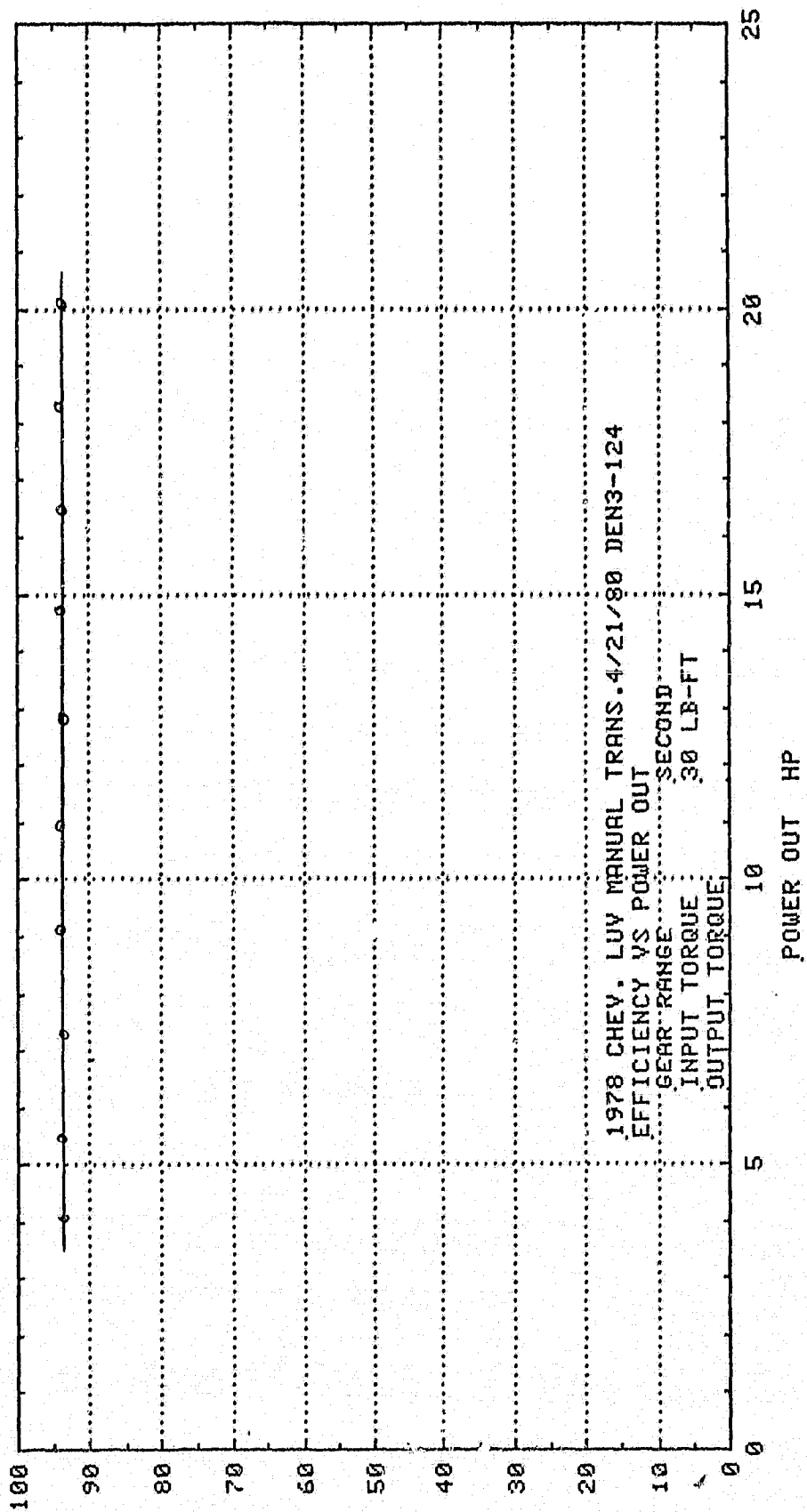

EFFICIENCY %

TORQUE RATIO $\frac{T_o}{T_i}$

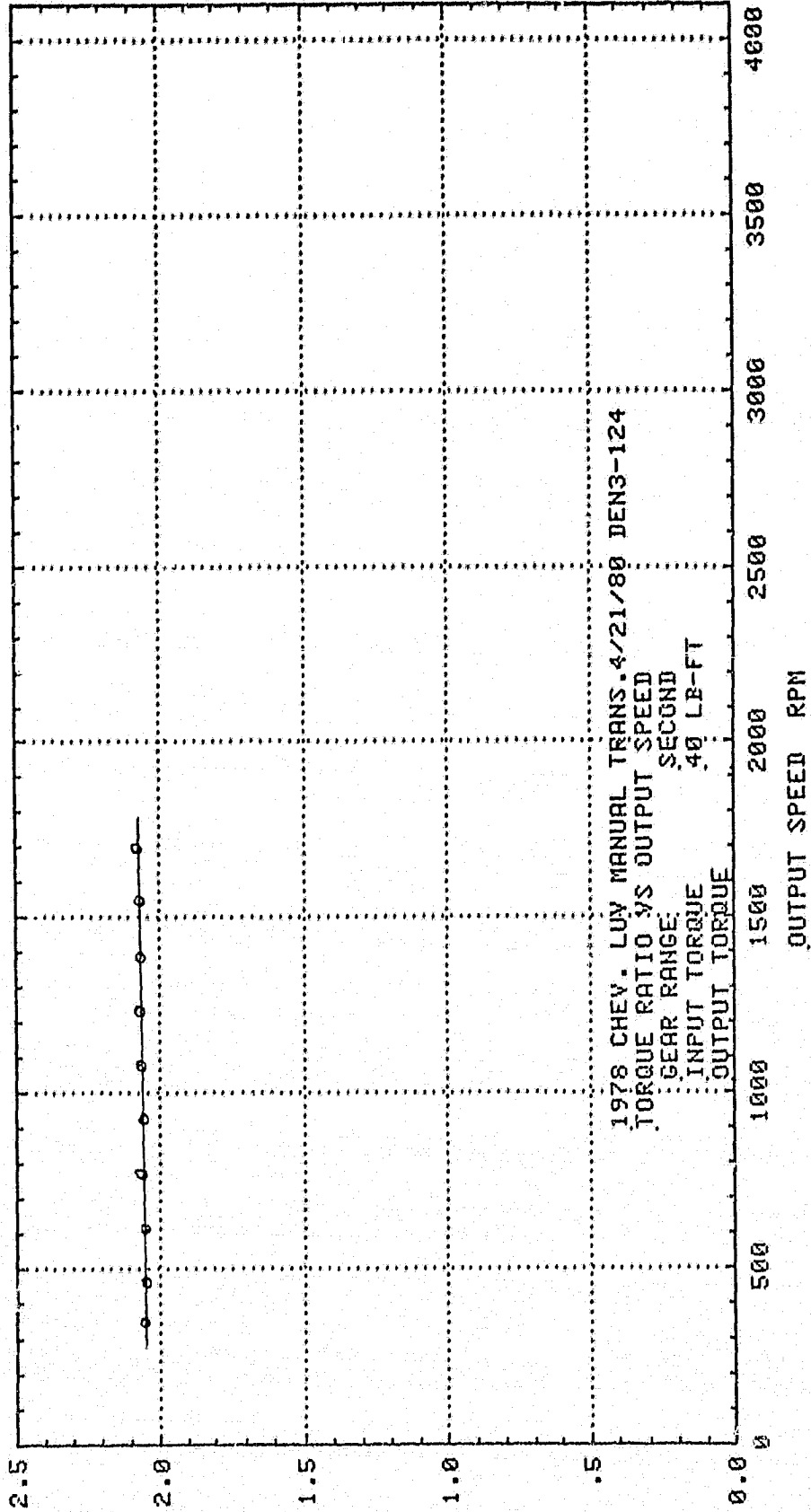

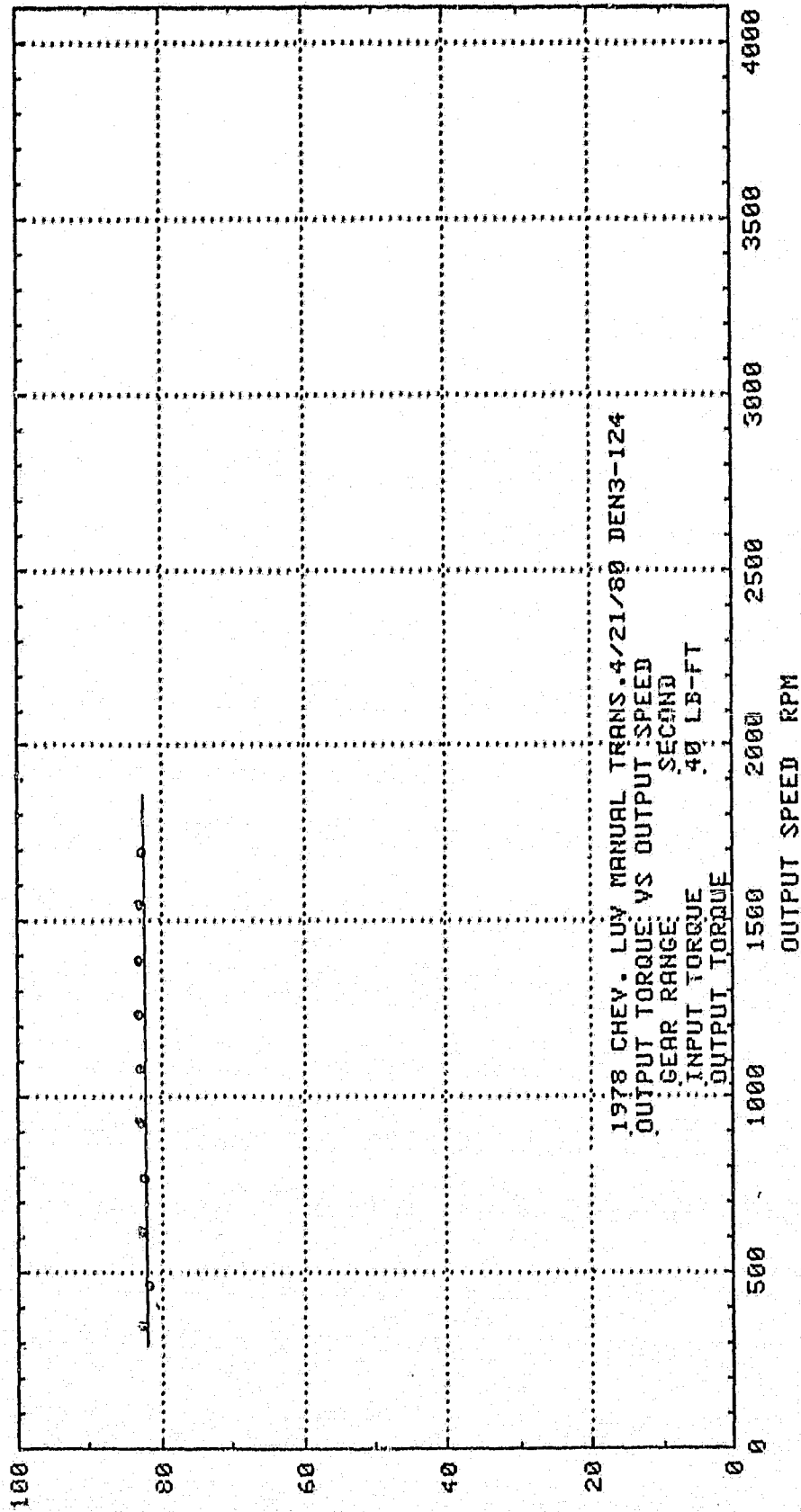

OUTPUT TORQUE LB FT

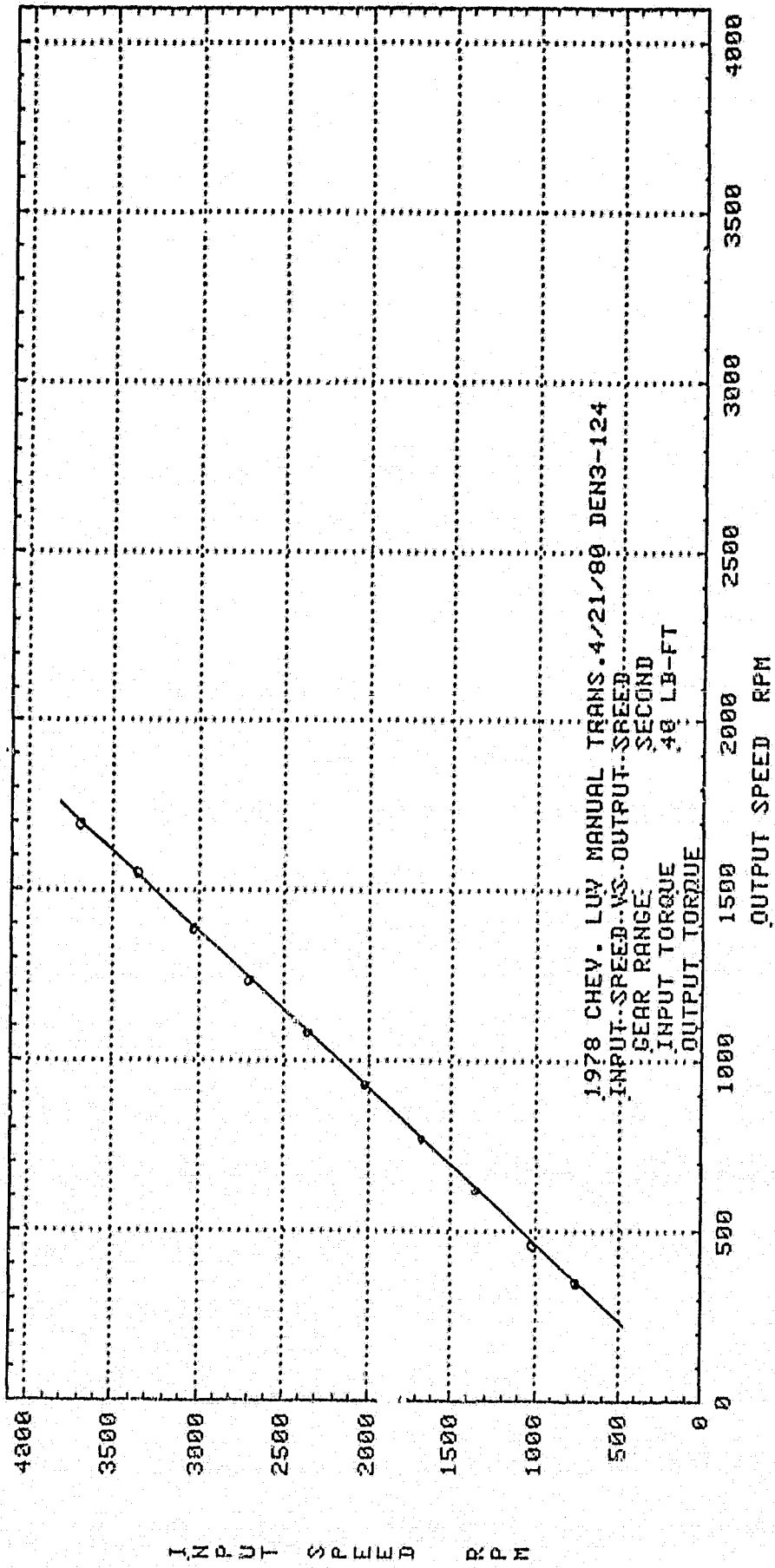

C-2

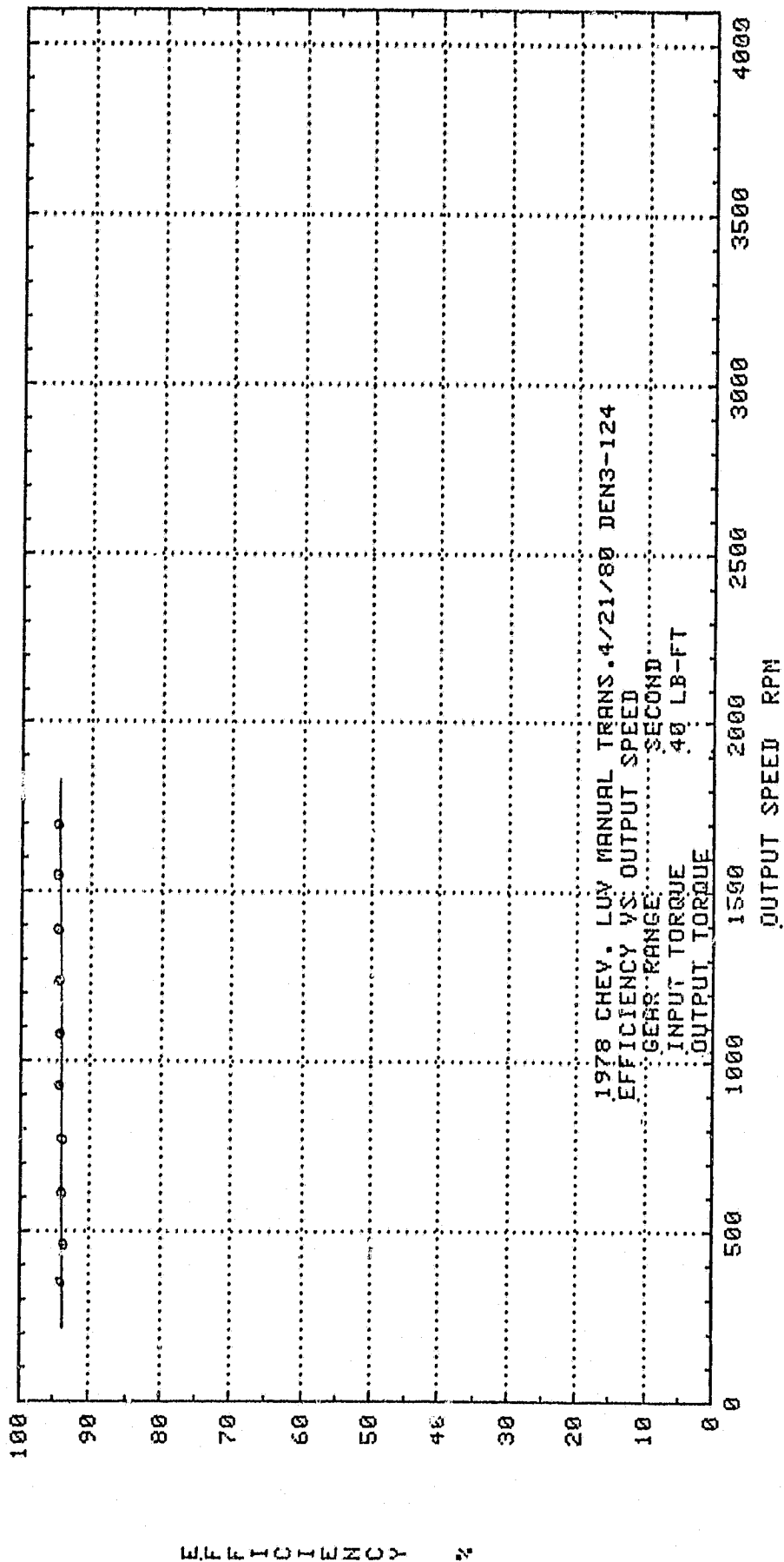

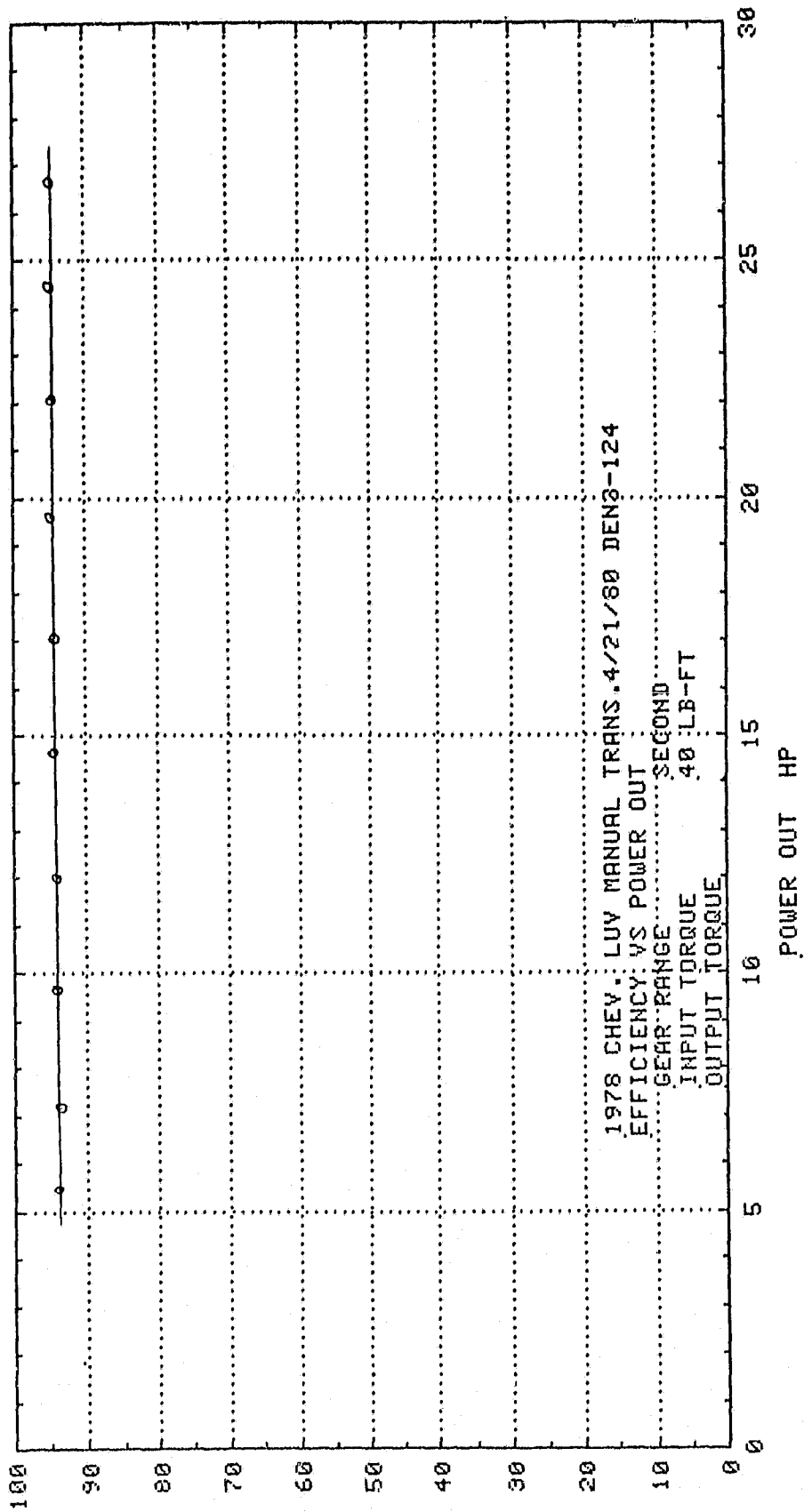

EFFICIENCY %

POWER OUT HP

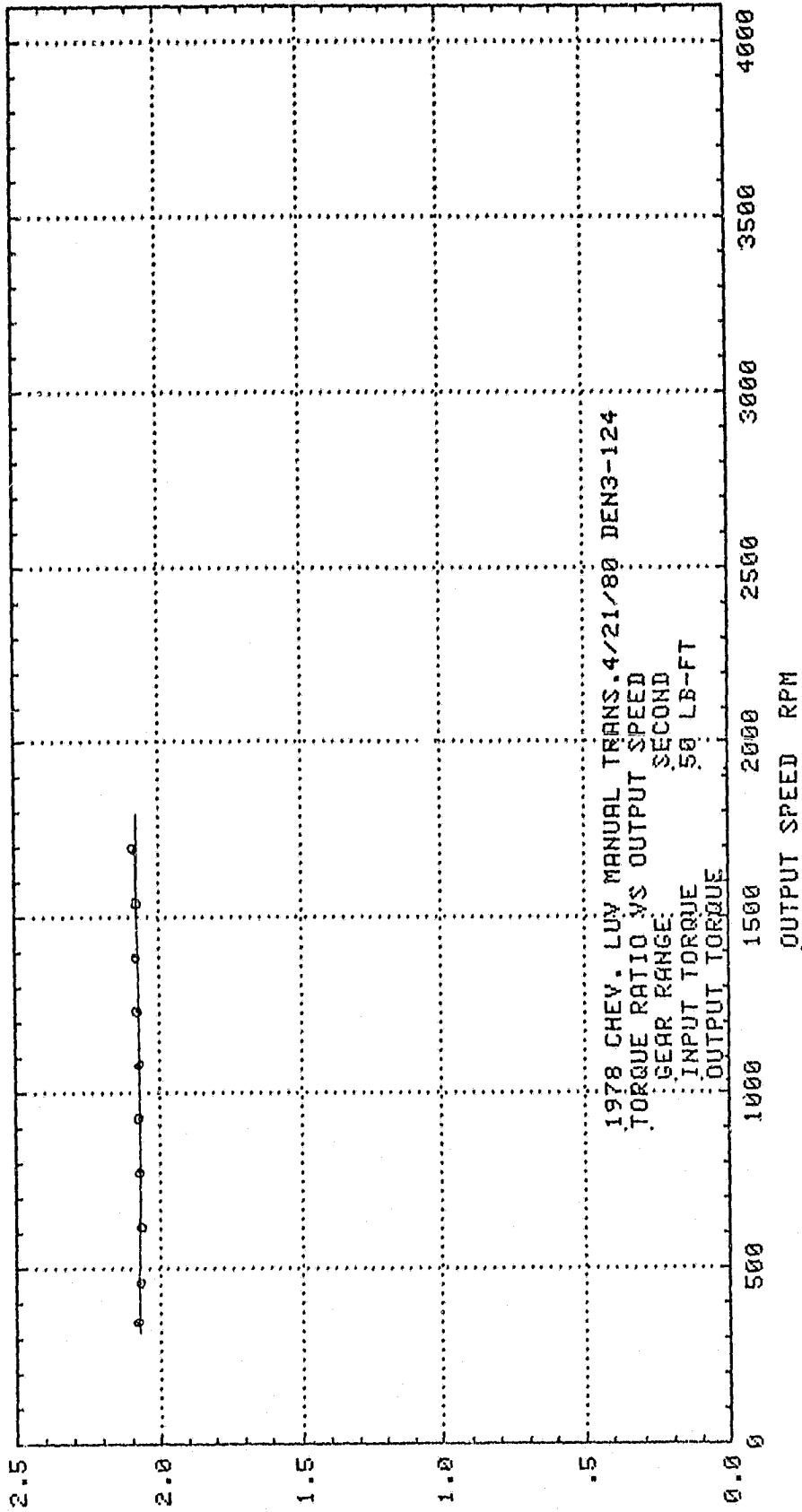

TORQUE RATIO

$$\frac{T_o}{T_i}$$

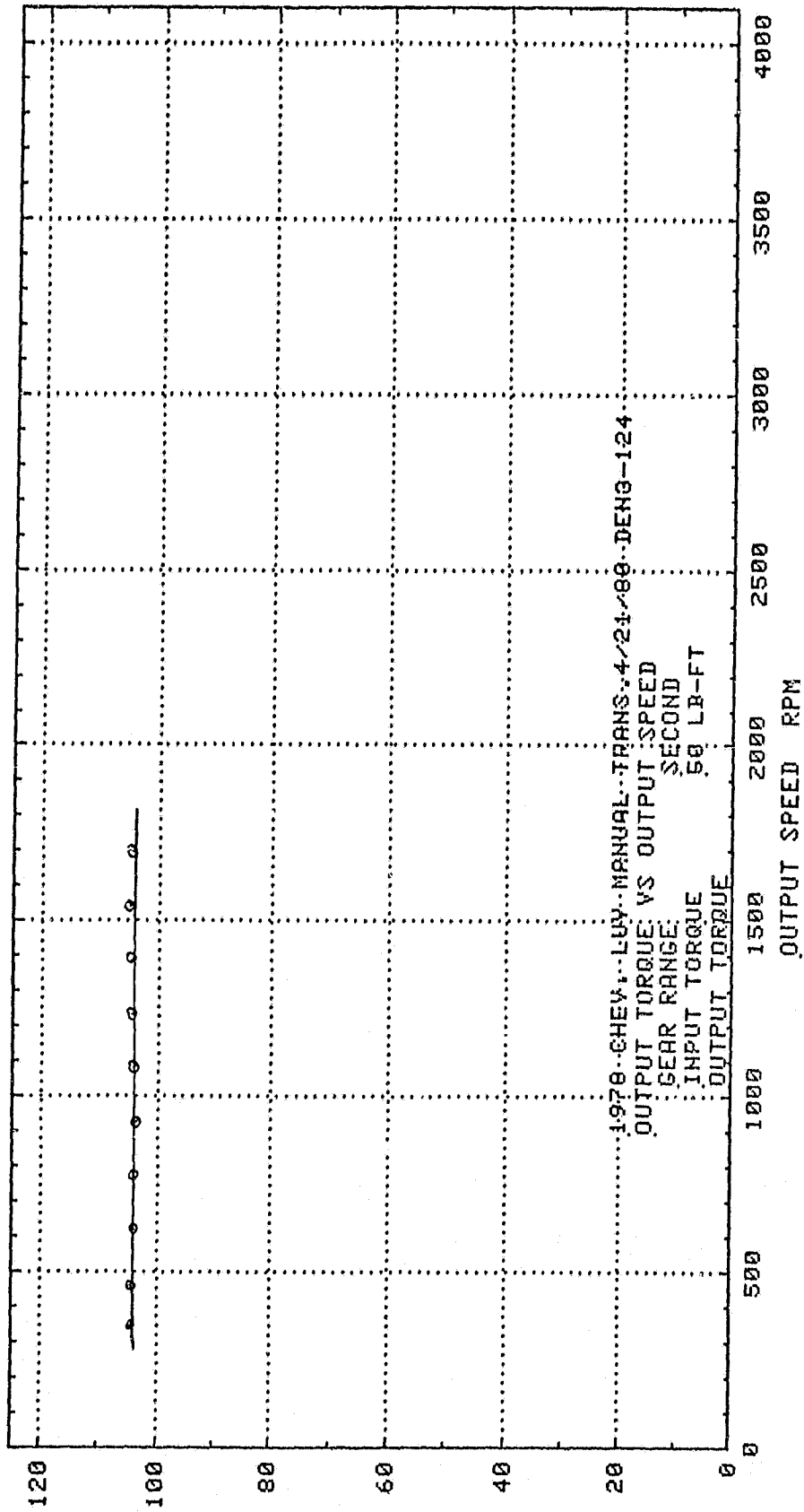

OUTPUT TORQUE LB FT

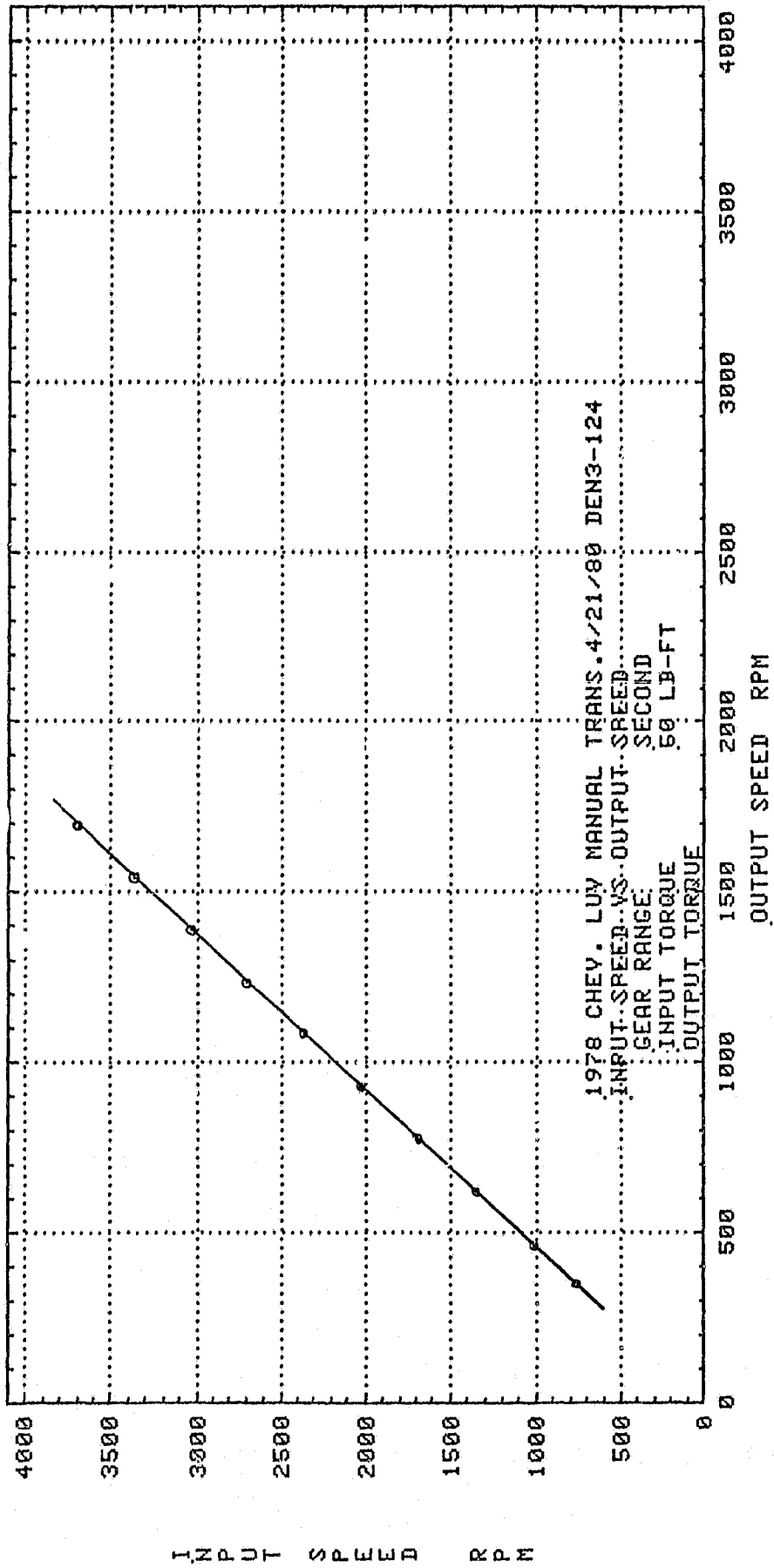

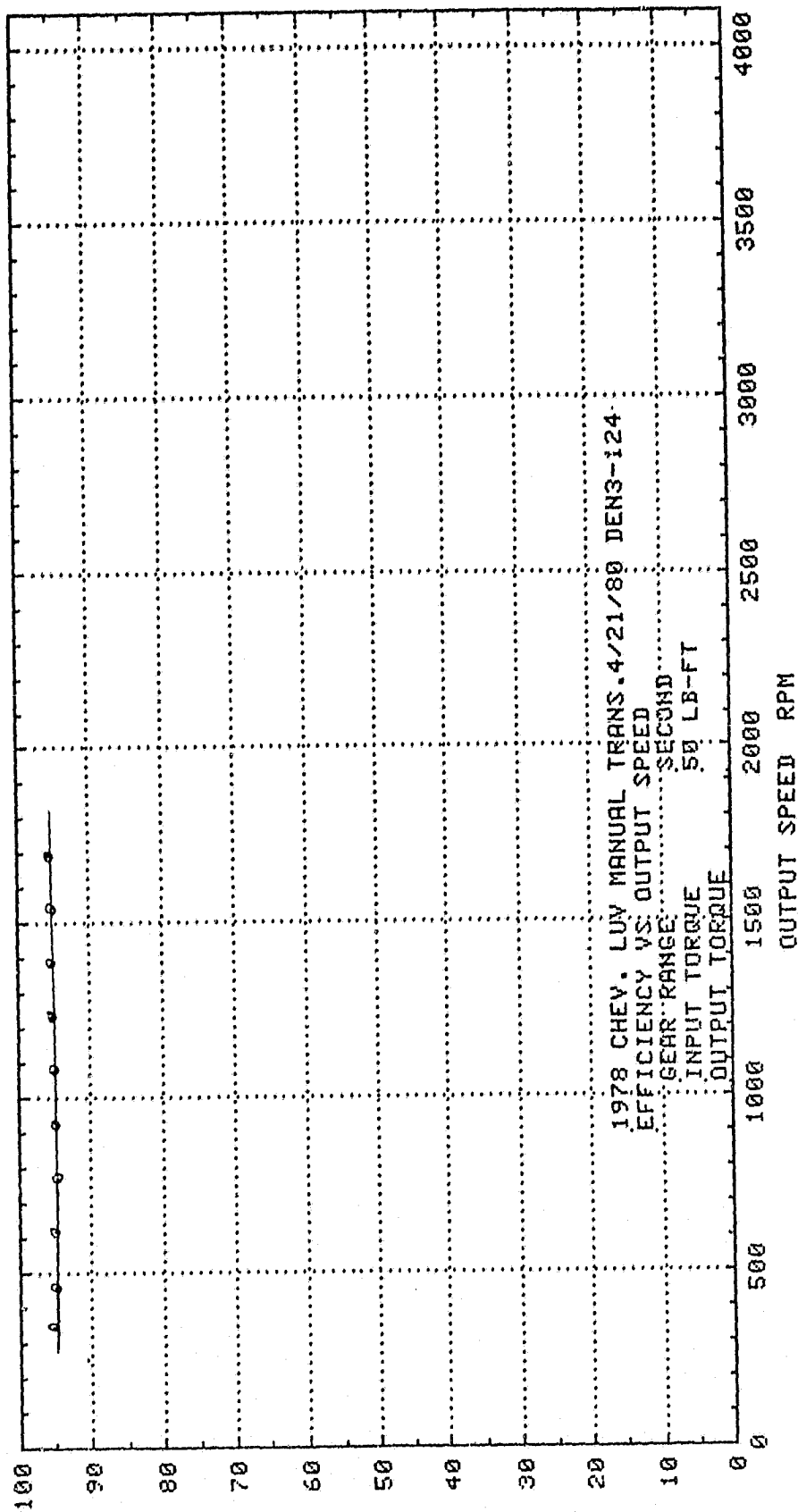

EFFICIENCY %

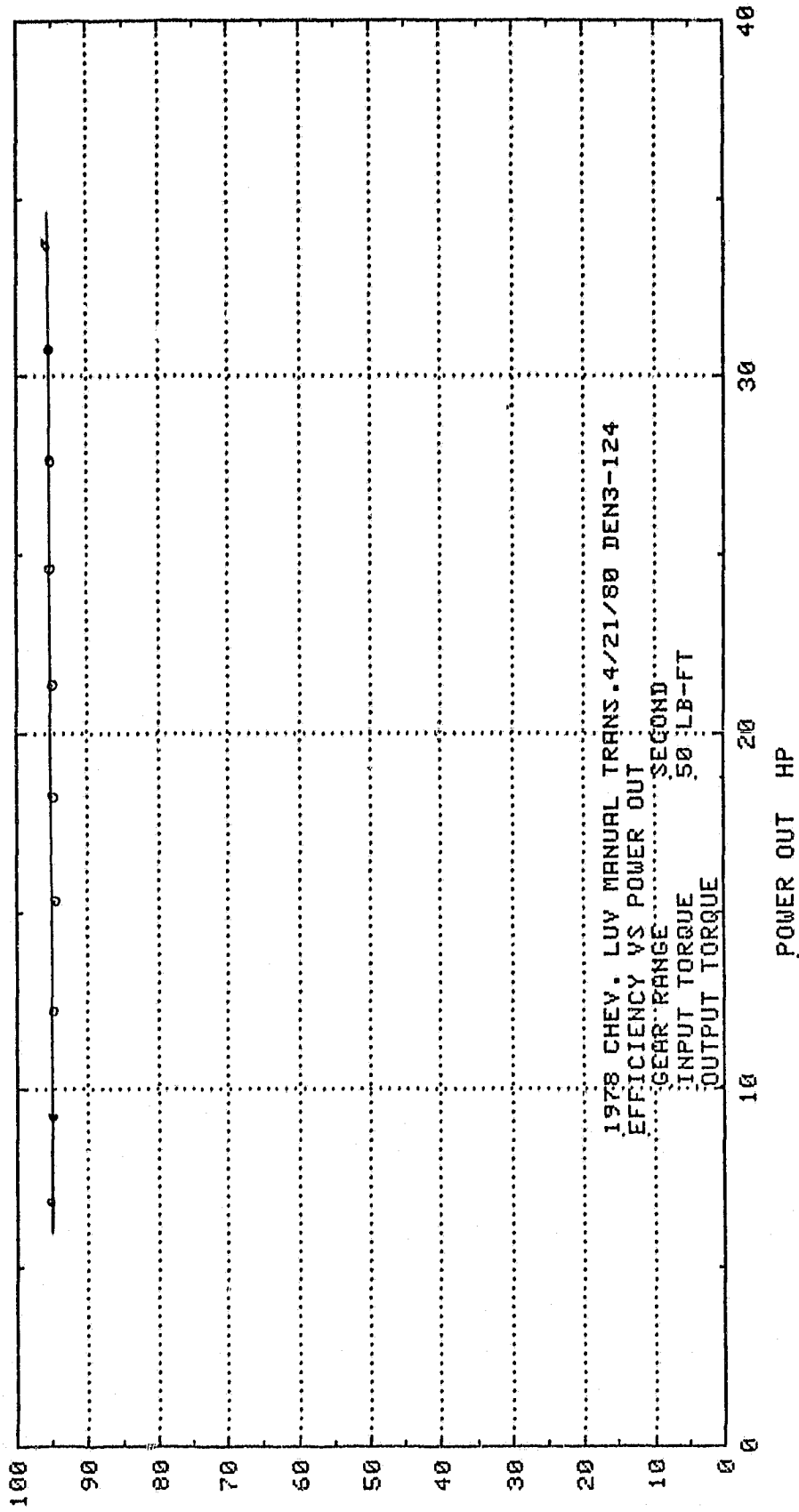

EFFICIENCY %

TORQUE RATIO $\frac{T_o}{T_i}$

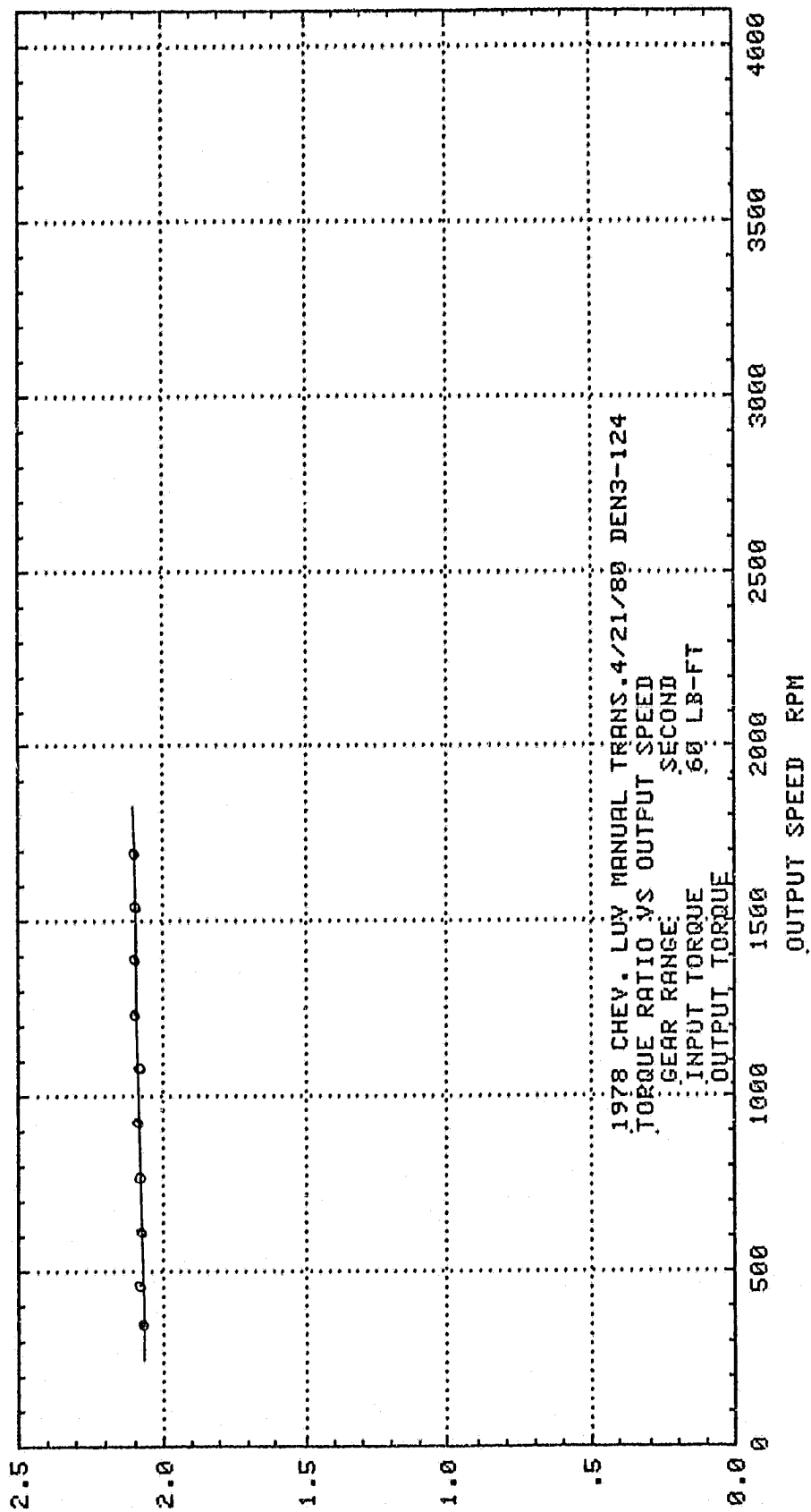

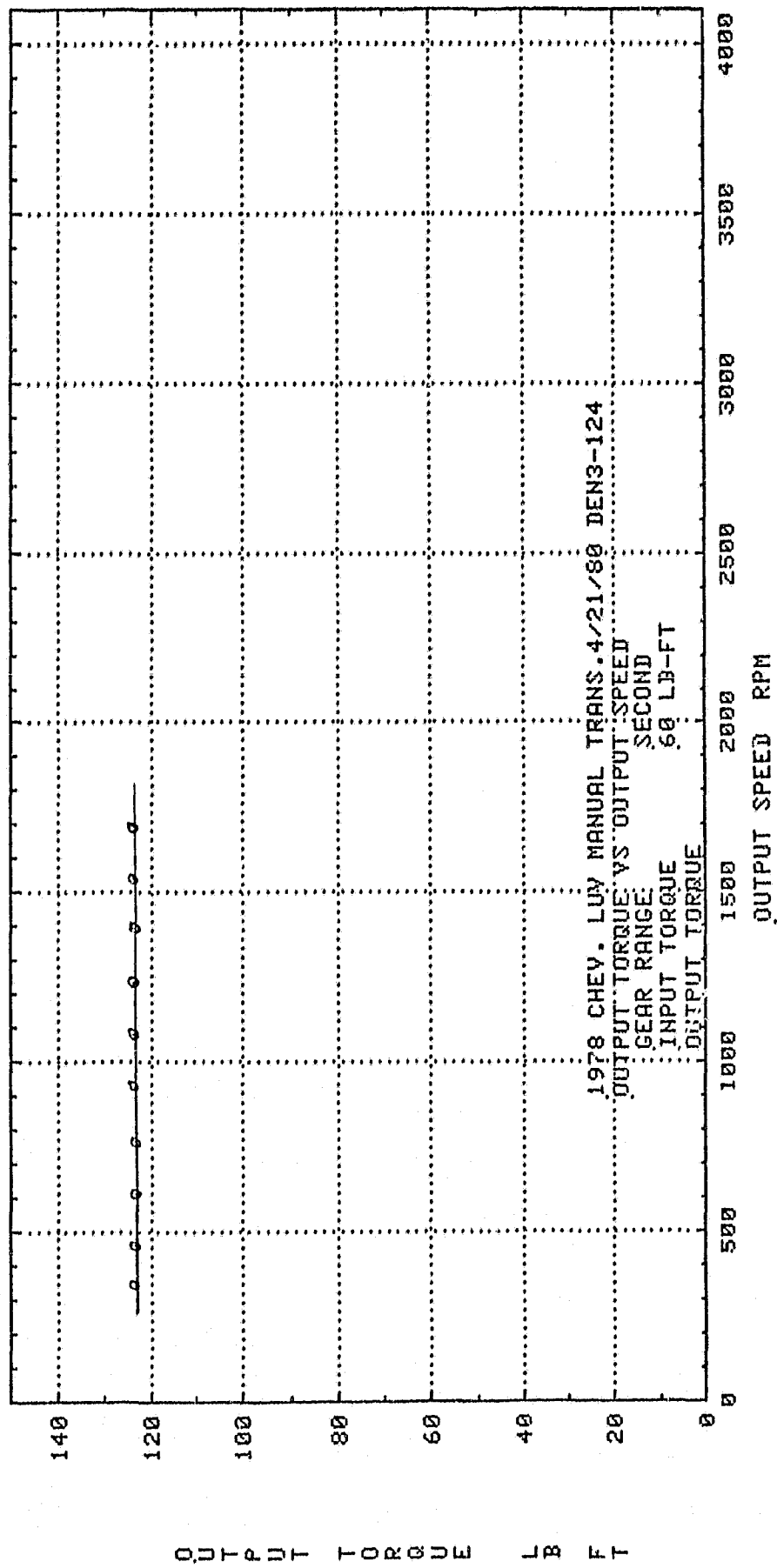

OUTPUT TORQUE LB FT

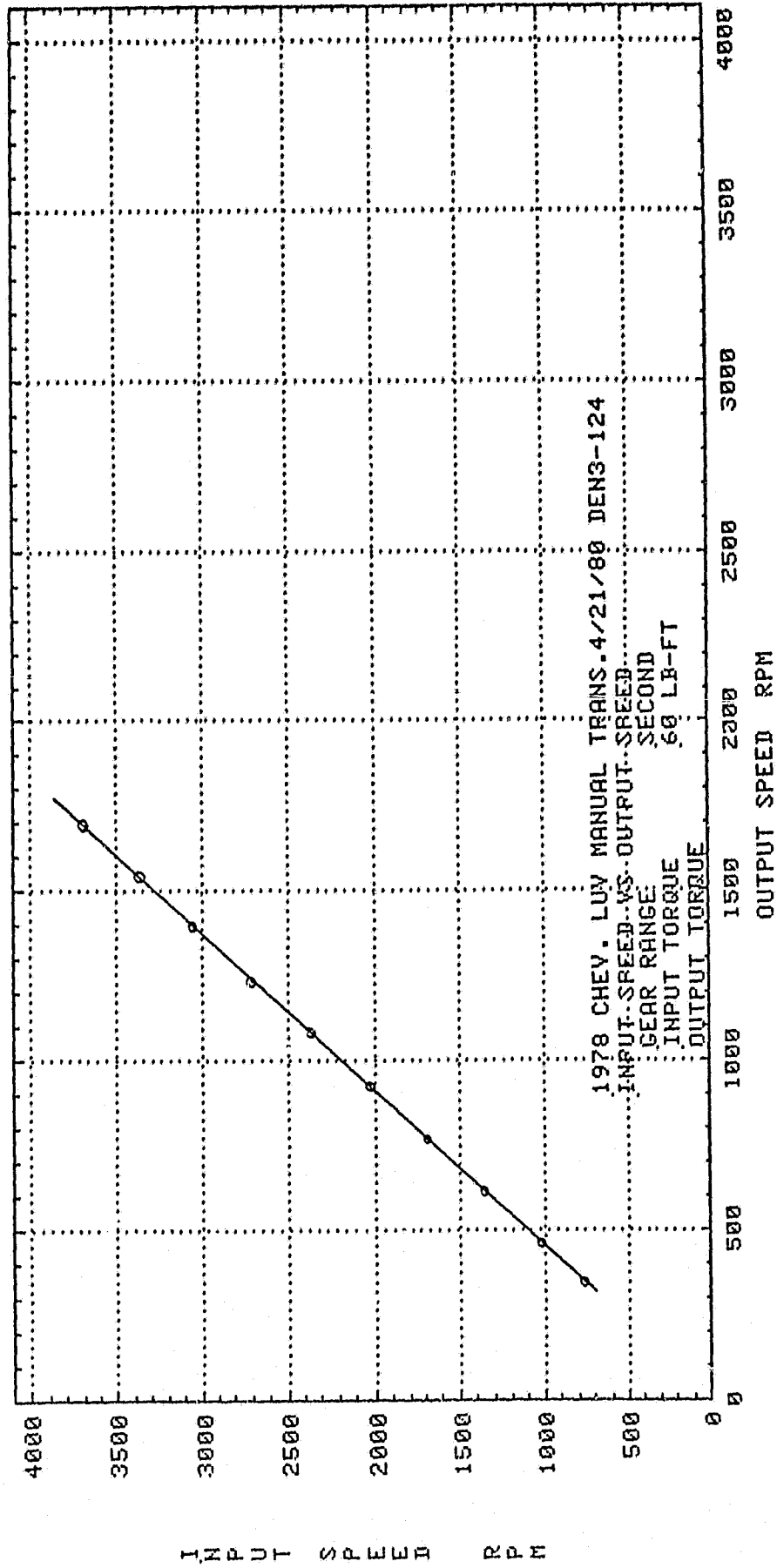

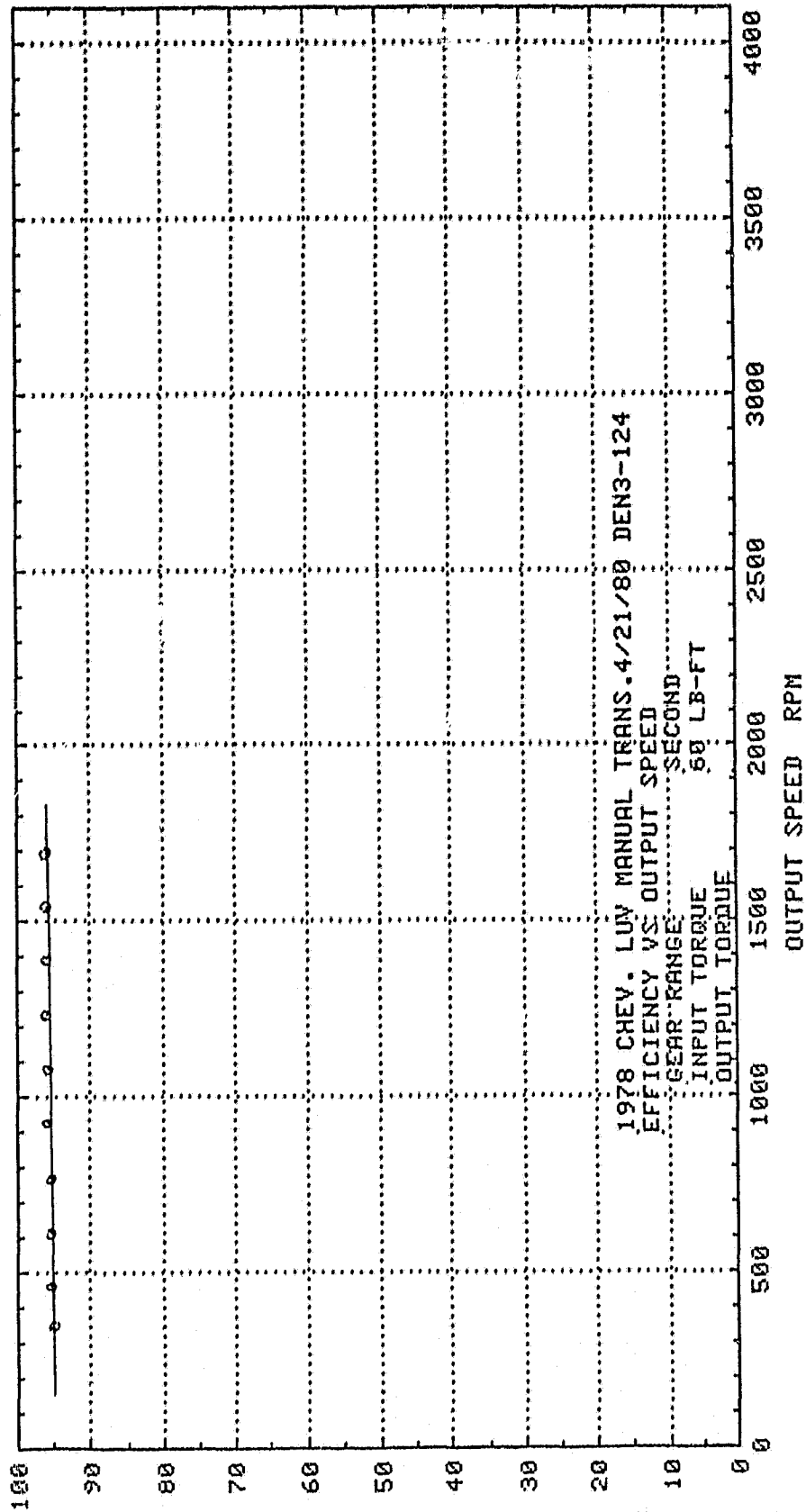

EFFICIENCY %

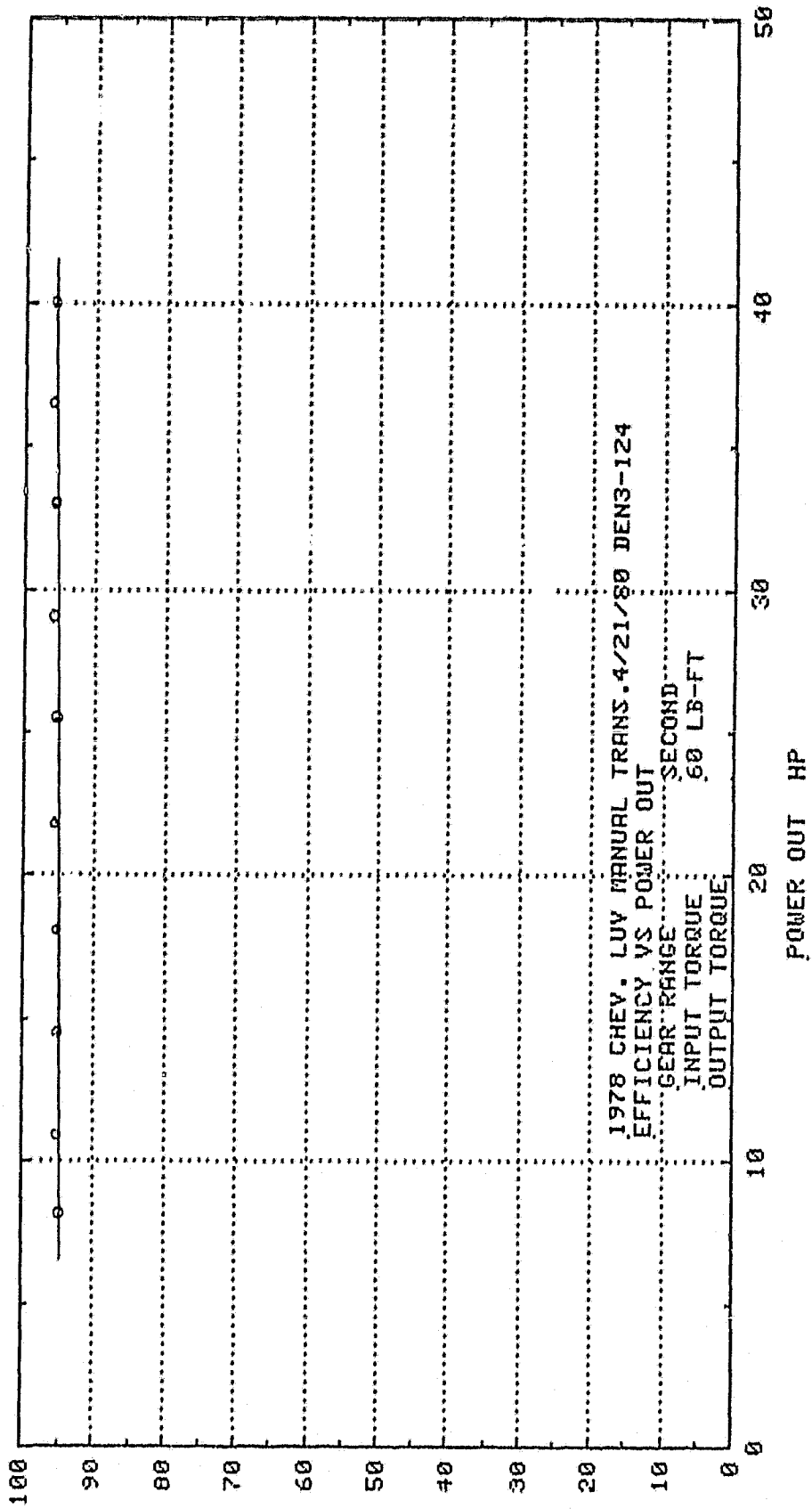

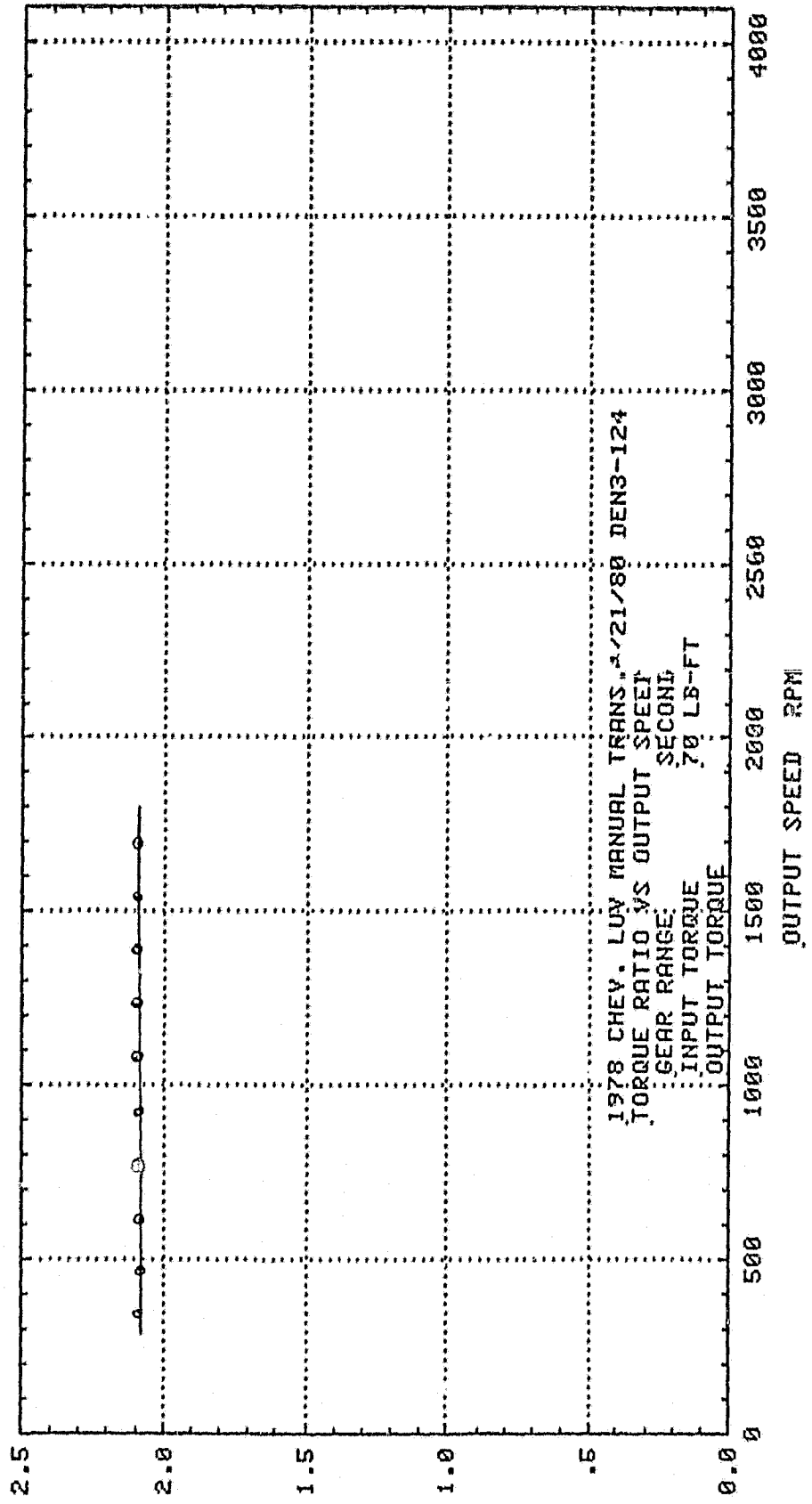

TORQUE RATIO

$$\frac{T_o}{T_i}$$

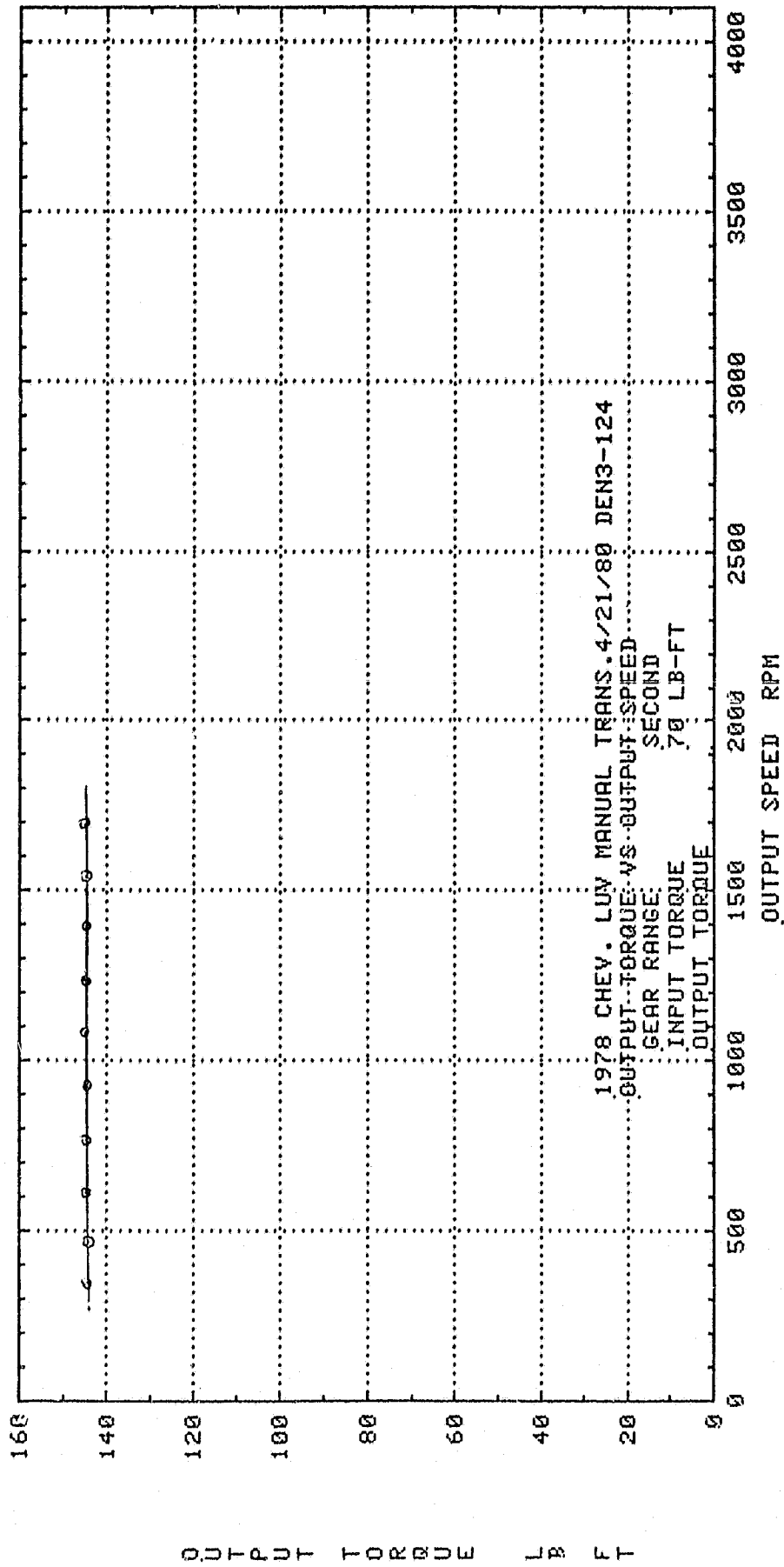

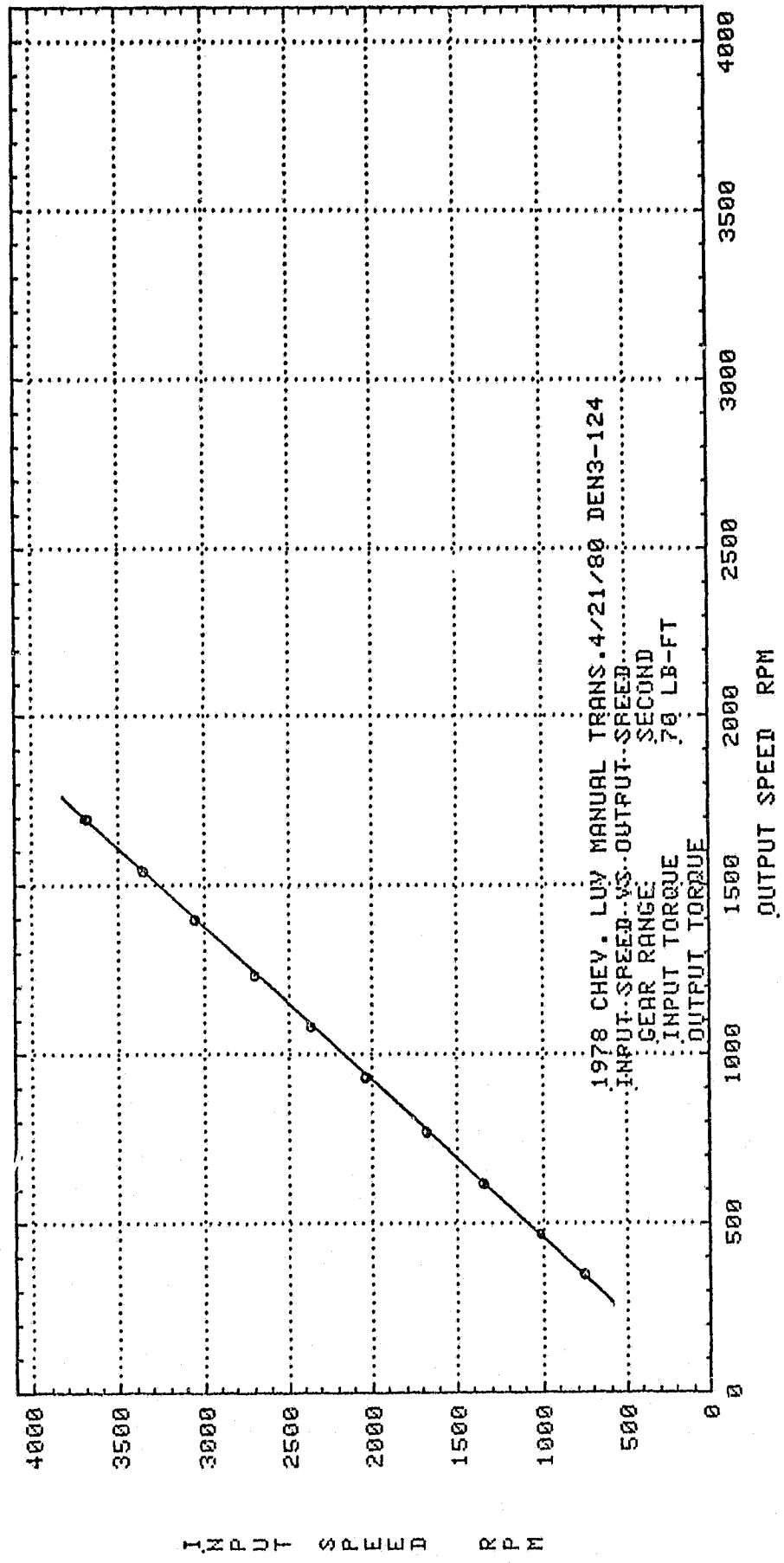

INPUT SPEED RPM

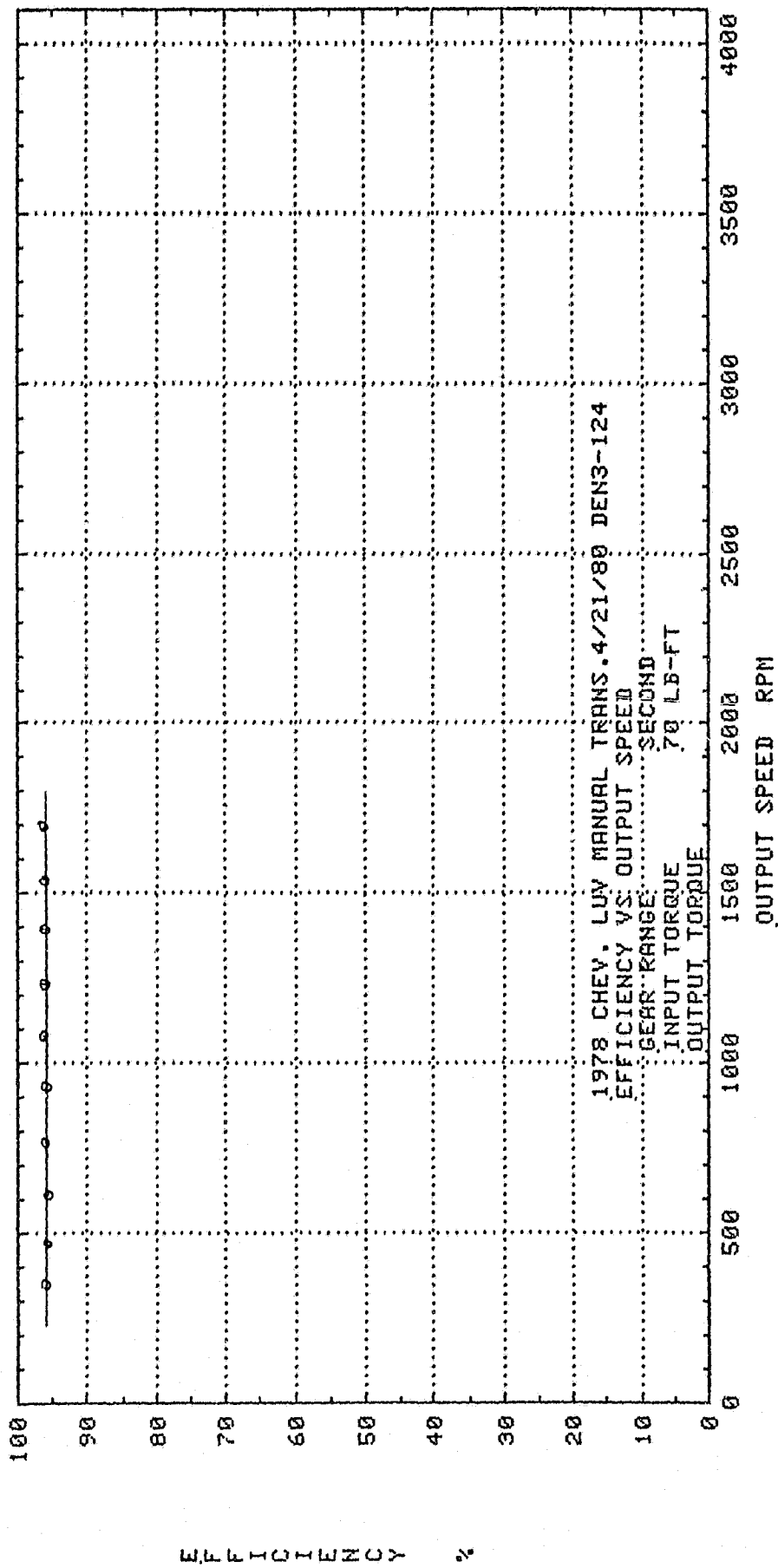

EFFICIENCY %

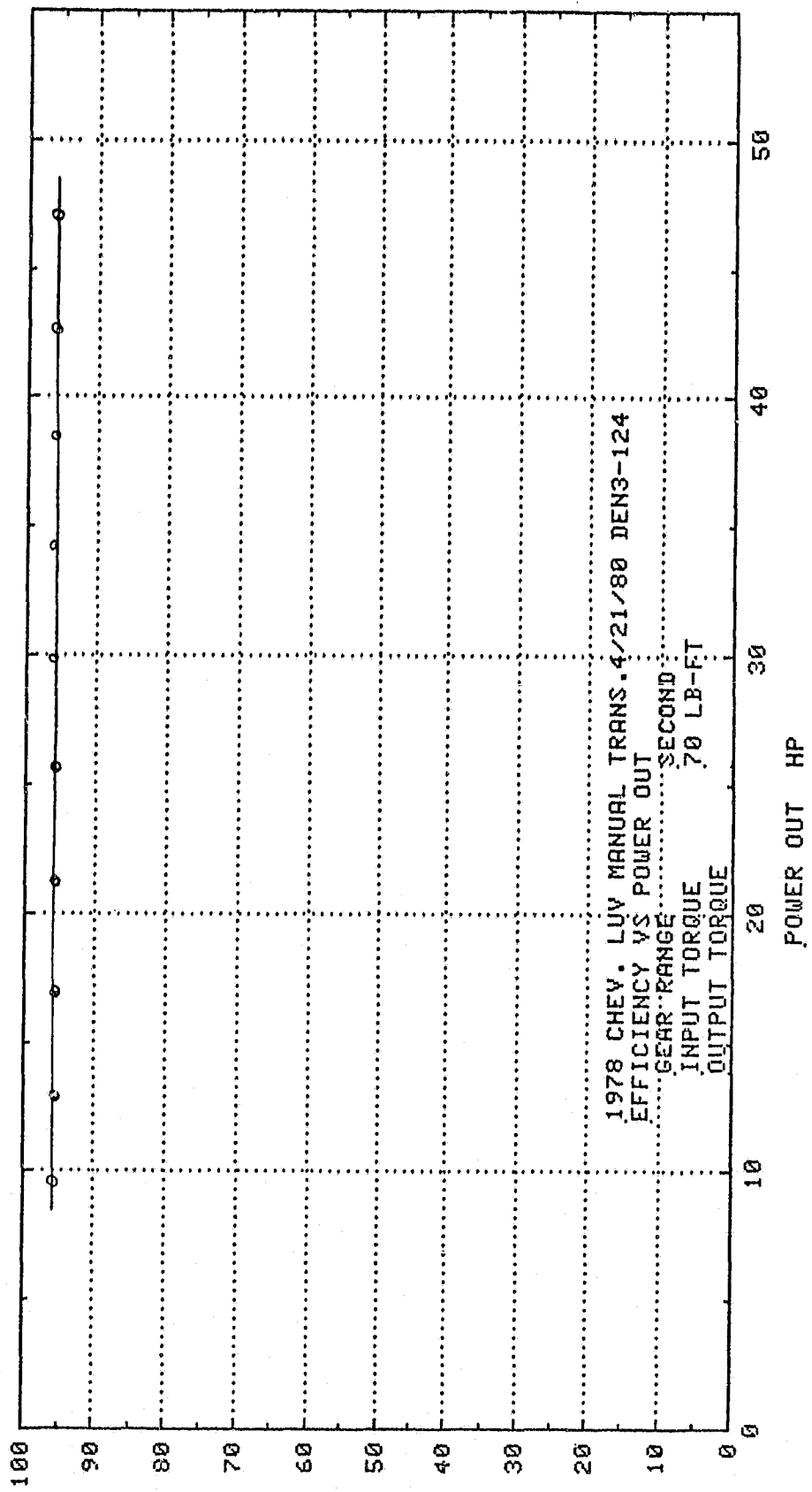

EFFICIENCY %

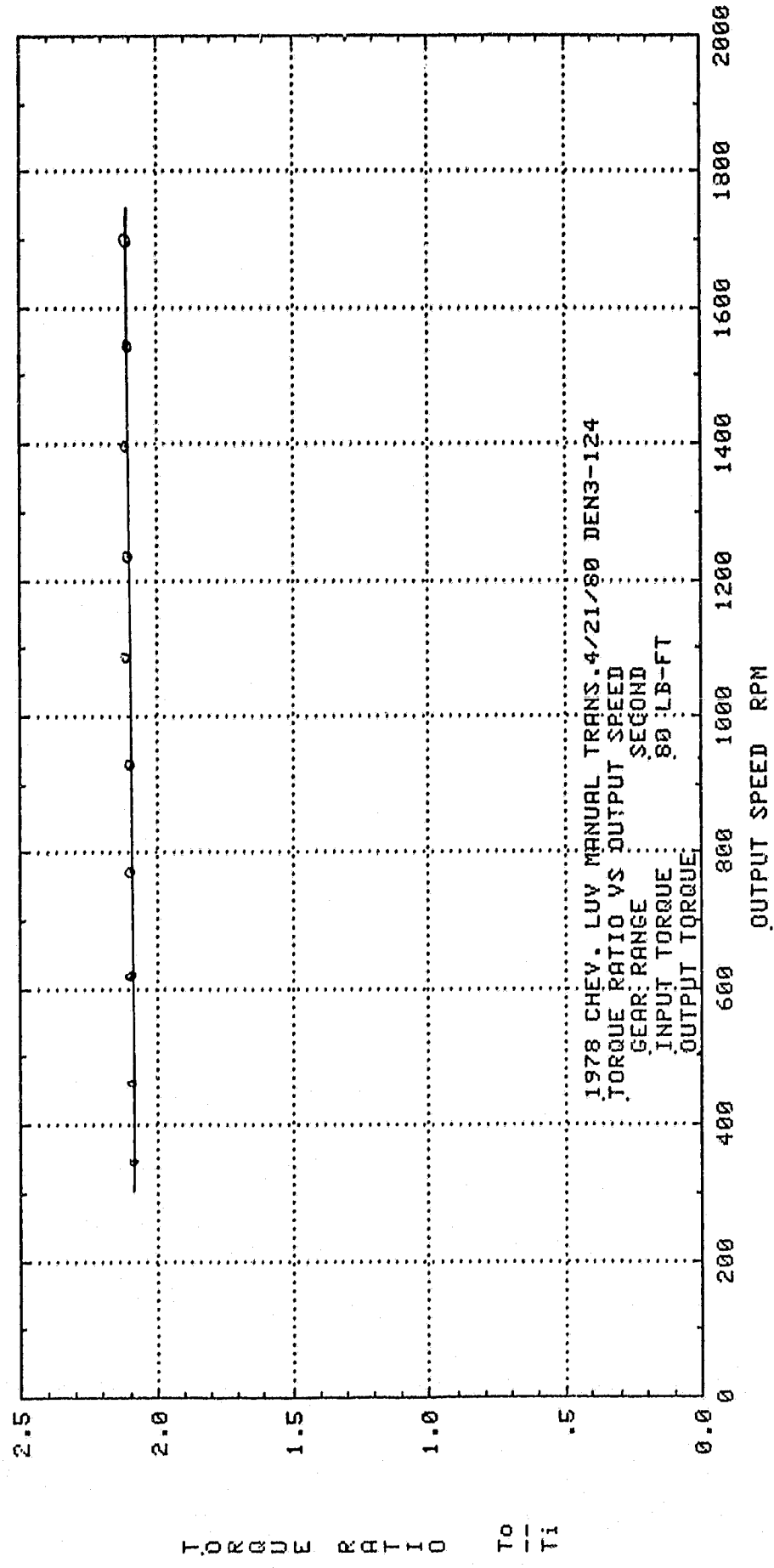

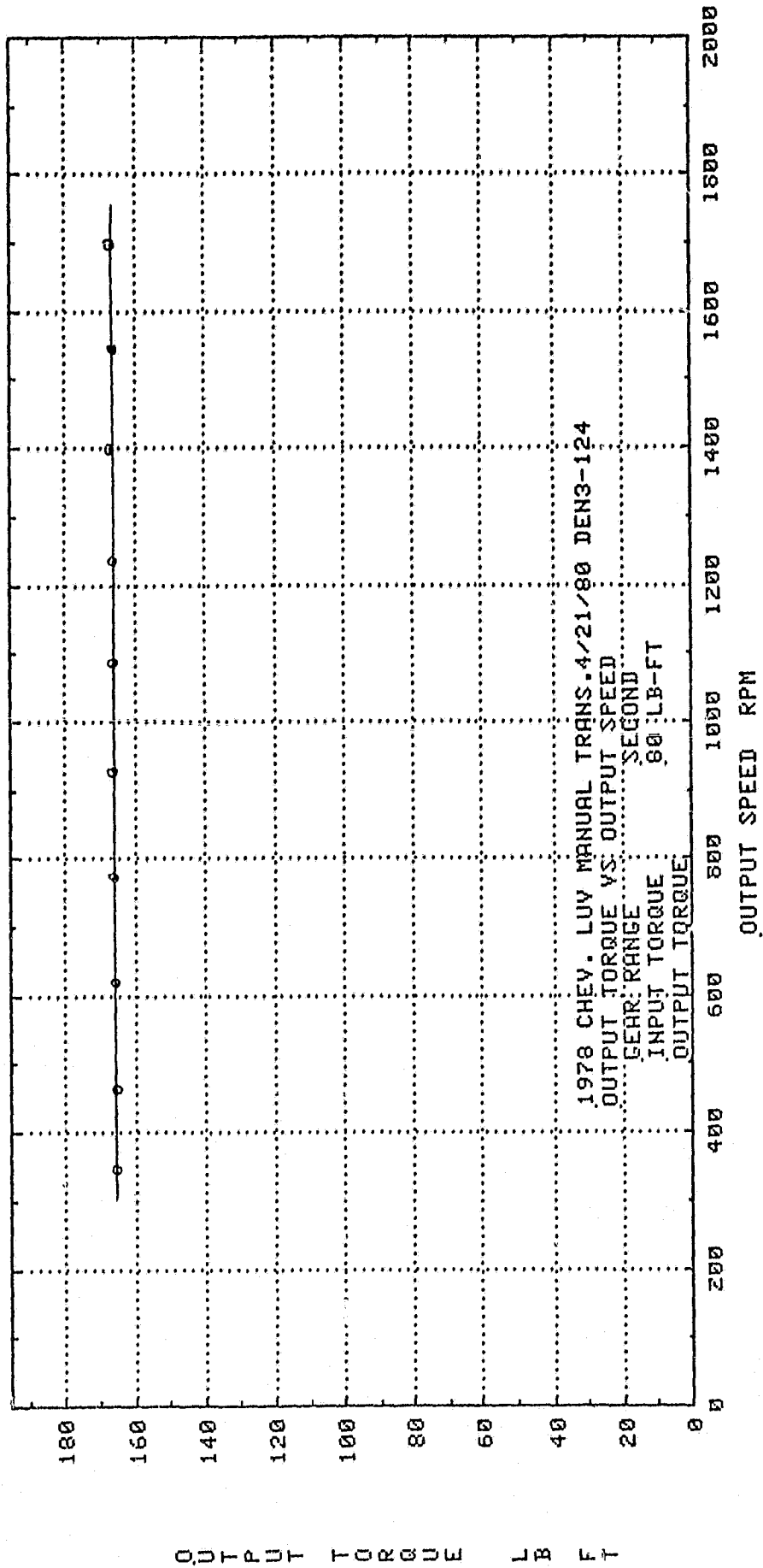

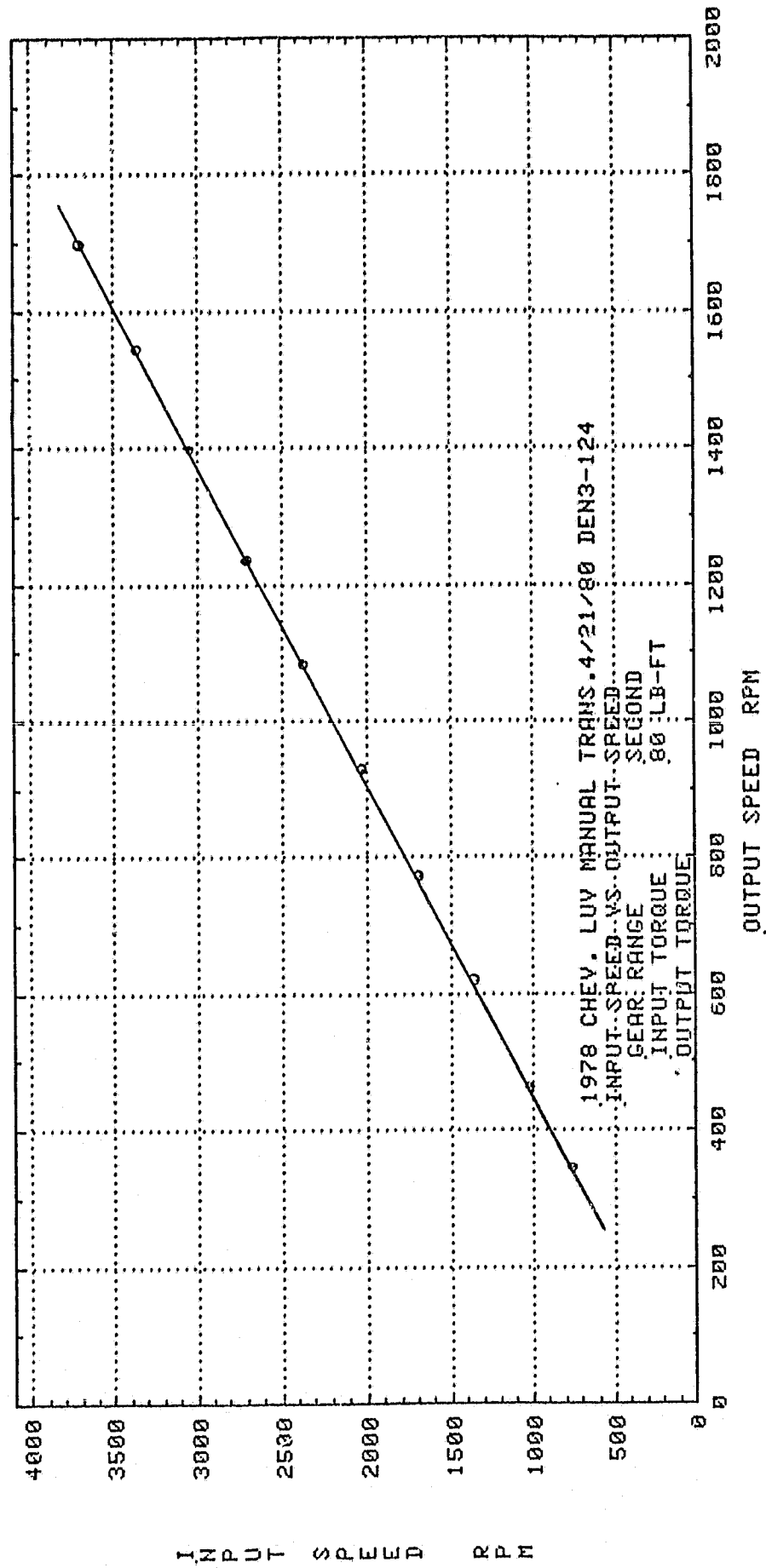

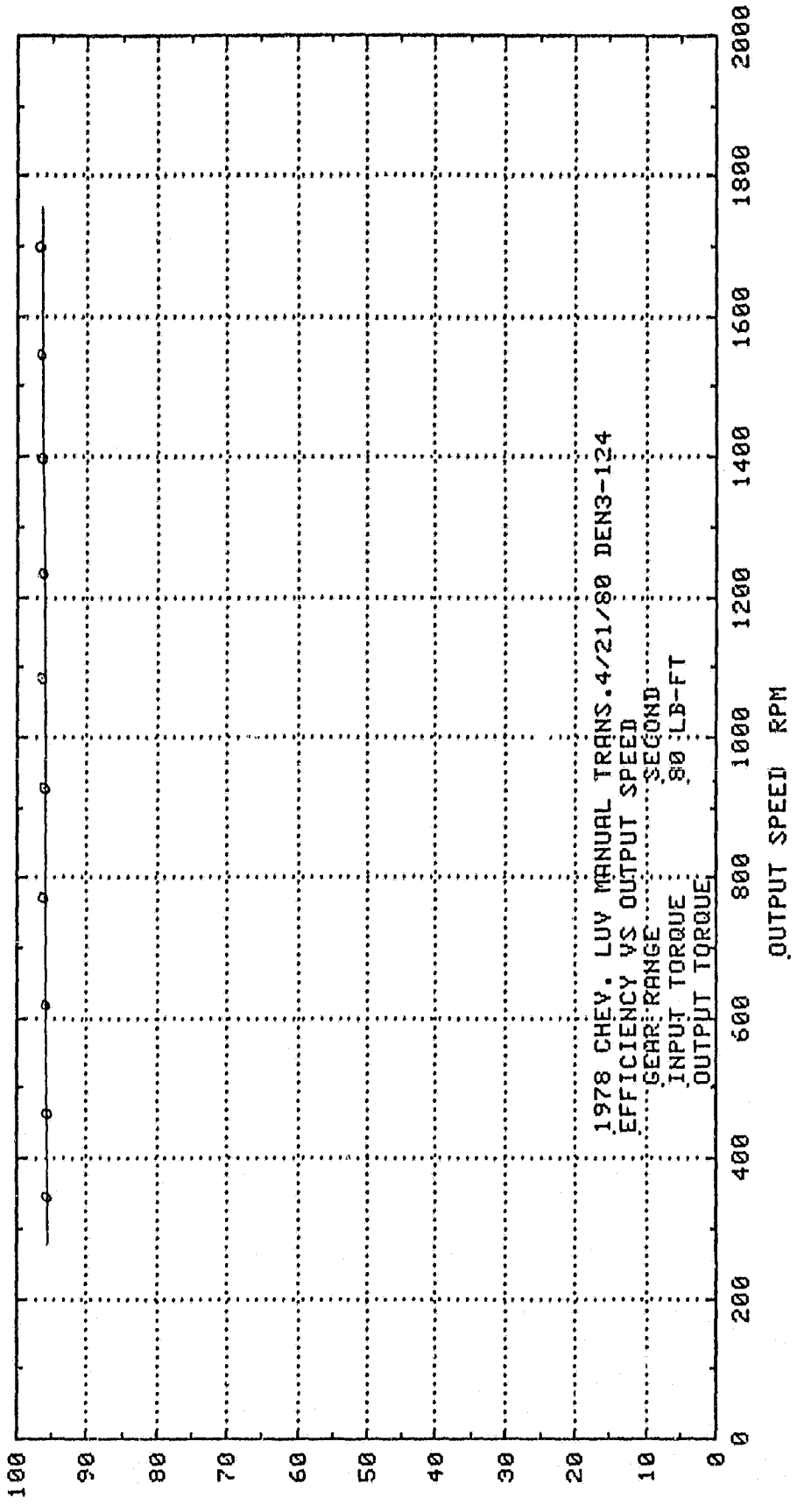

EFFICIENCY %

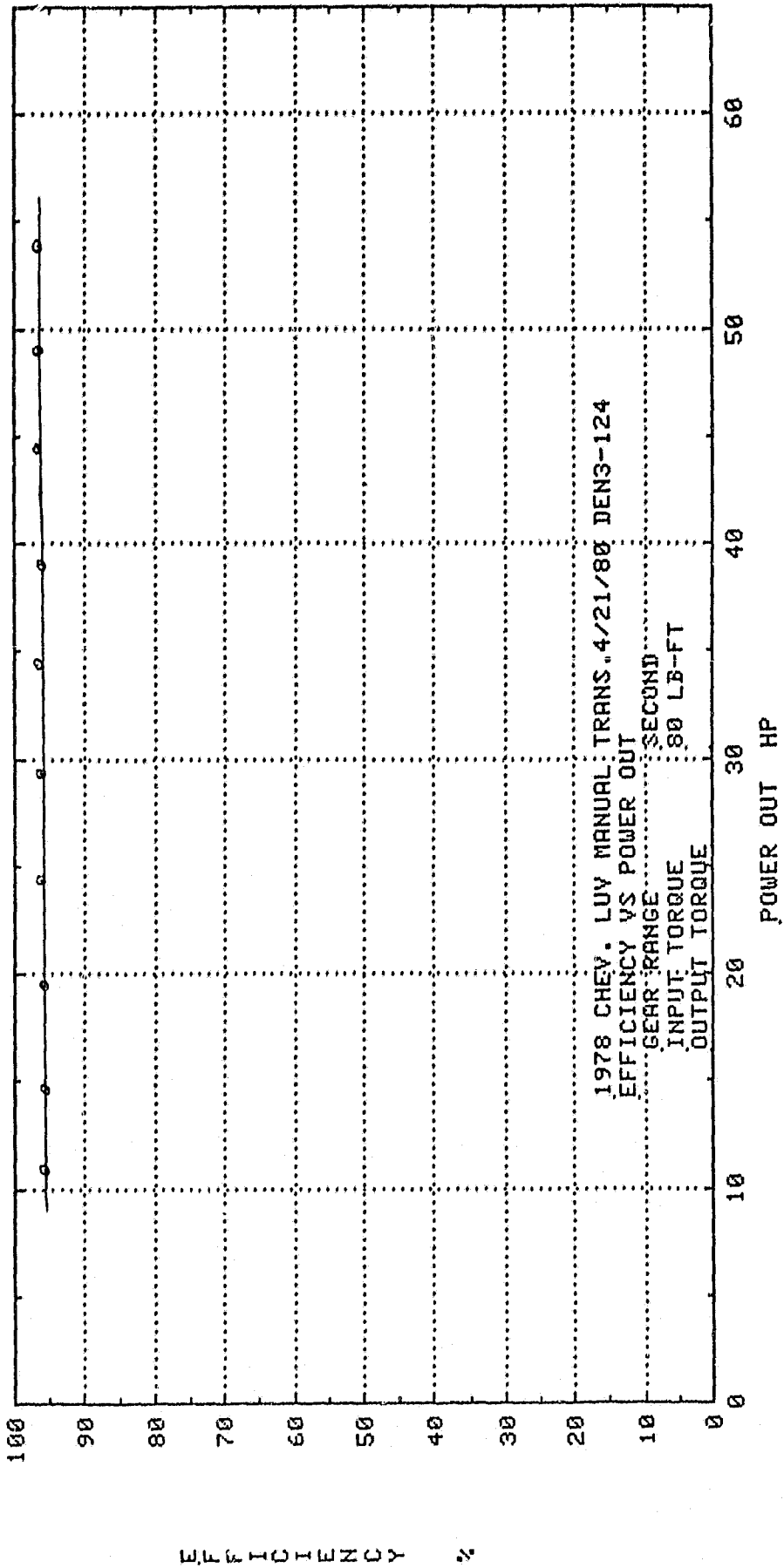

EFFICIENCY %

POWER OUT HP

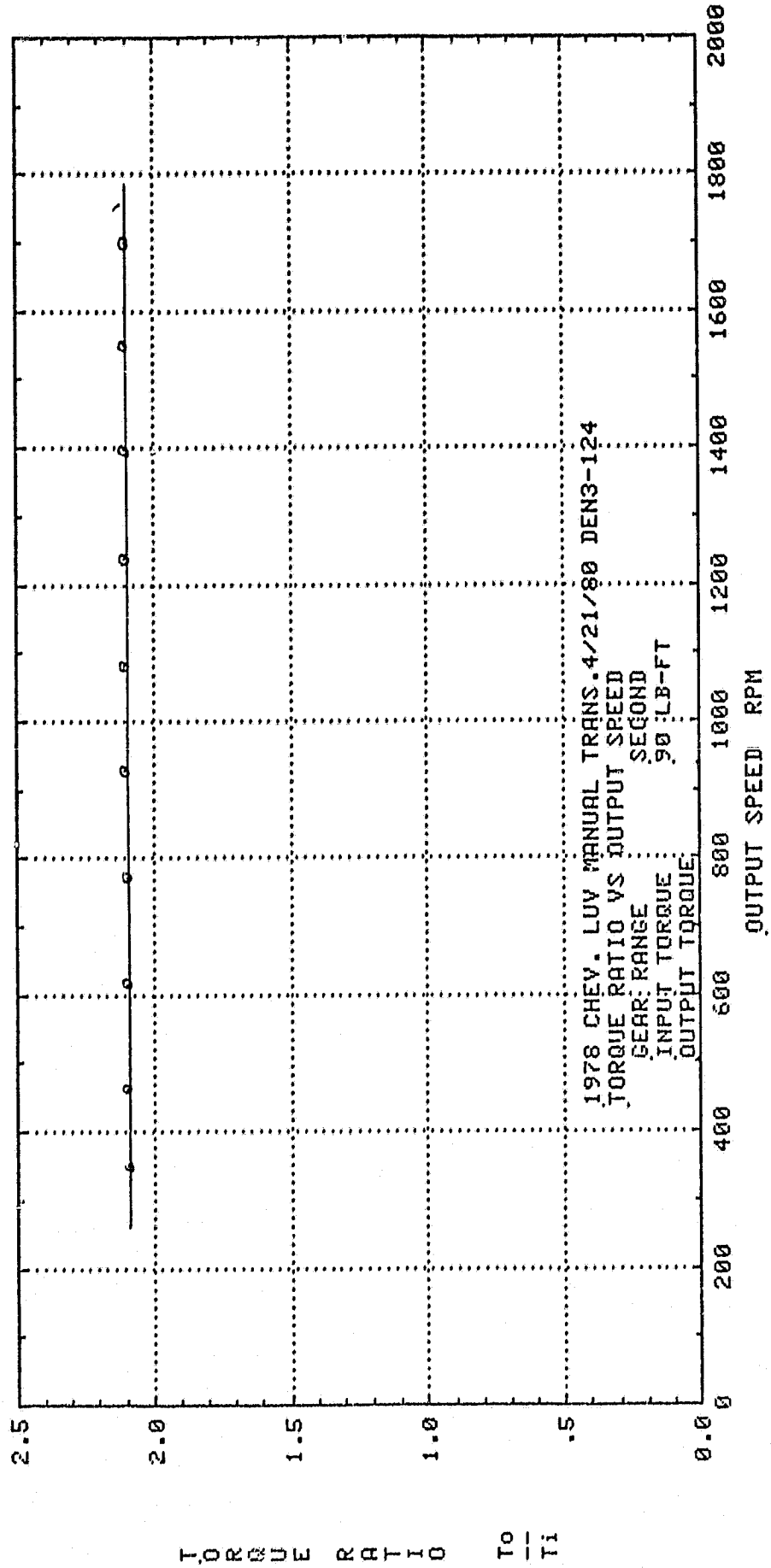

TORQUE RATIO $\frac{T_o}{T_i}$

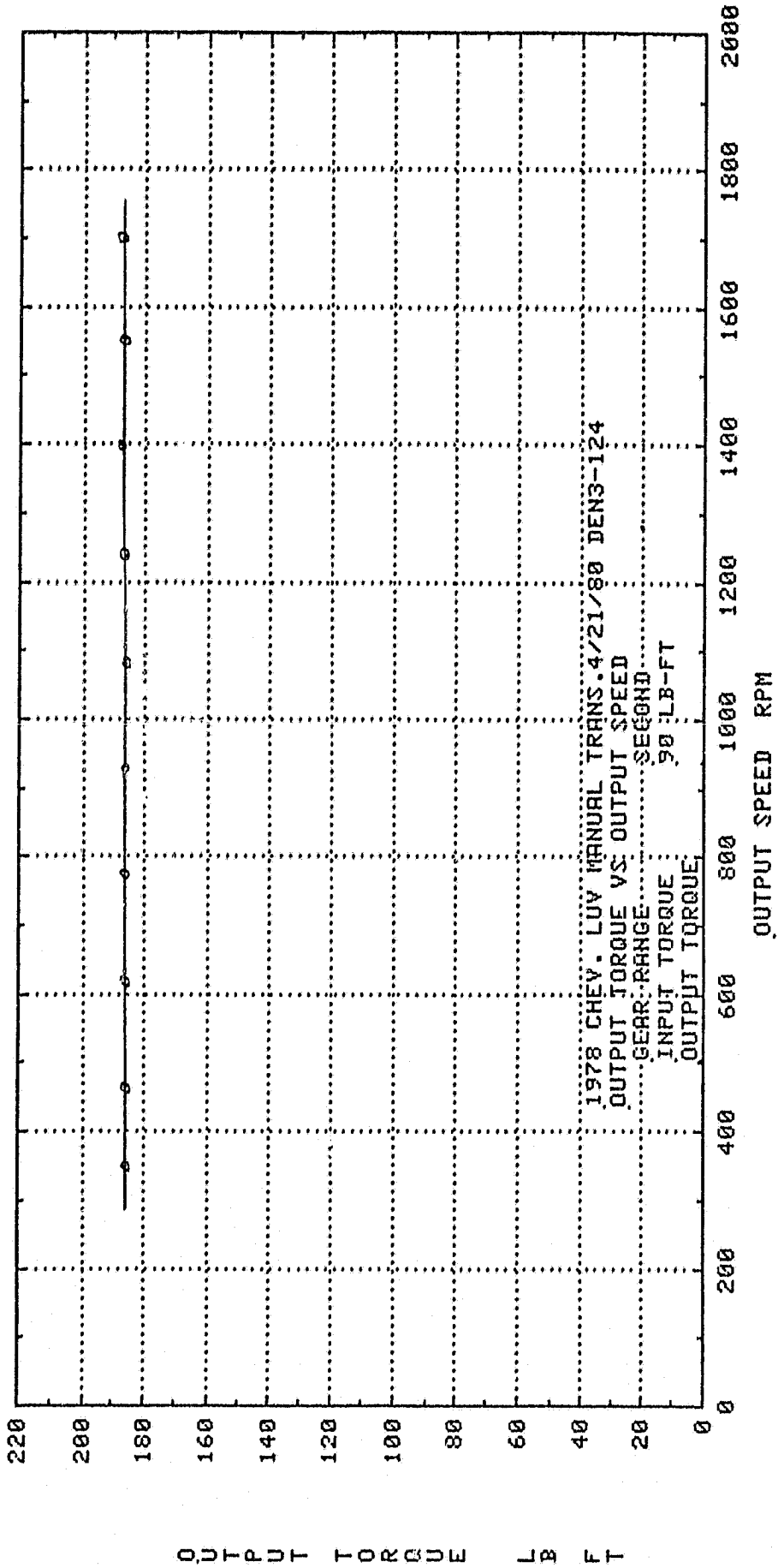

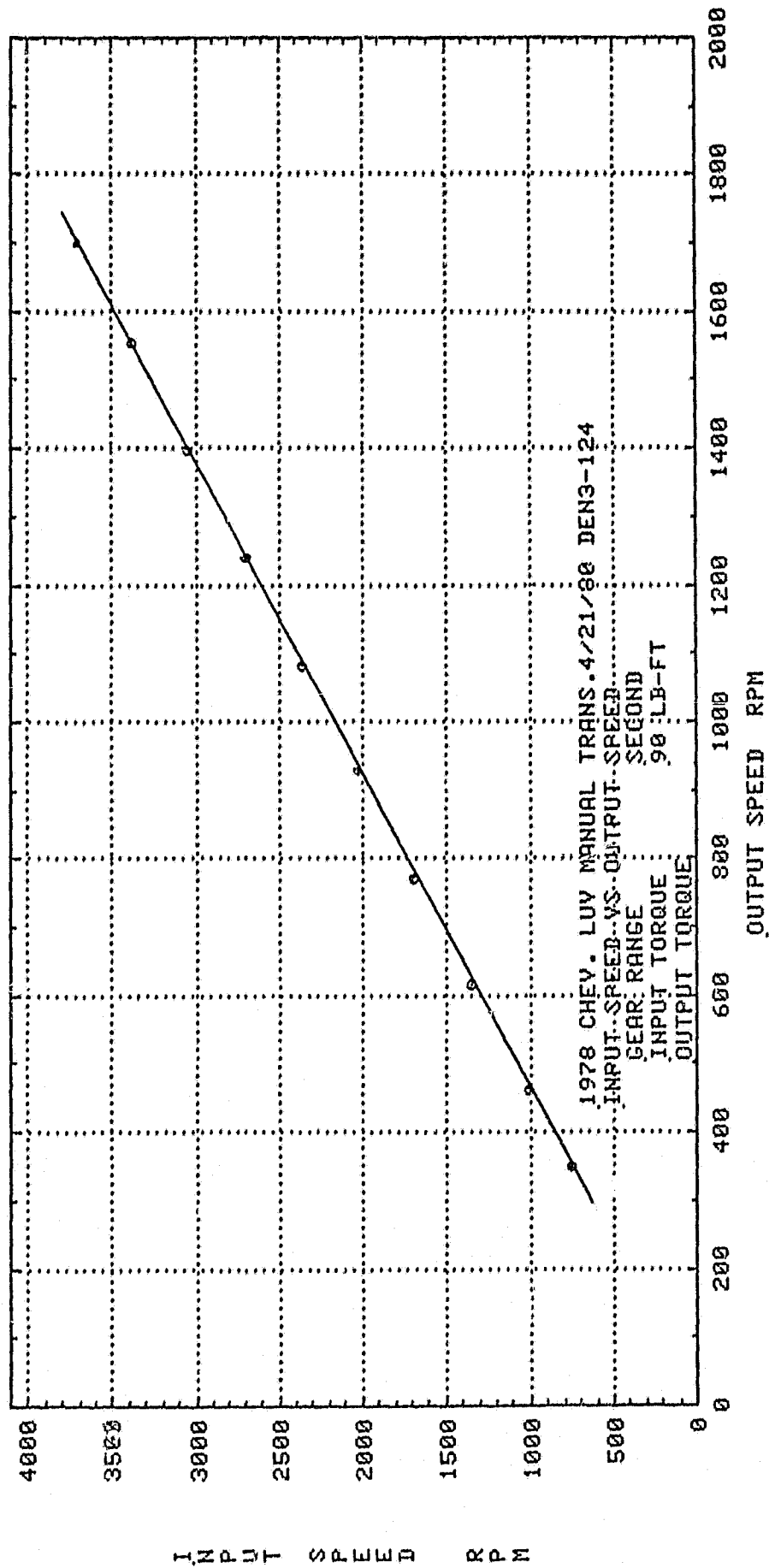

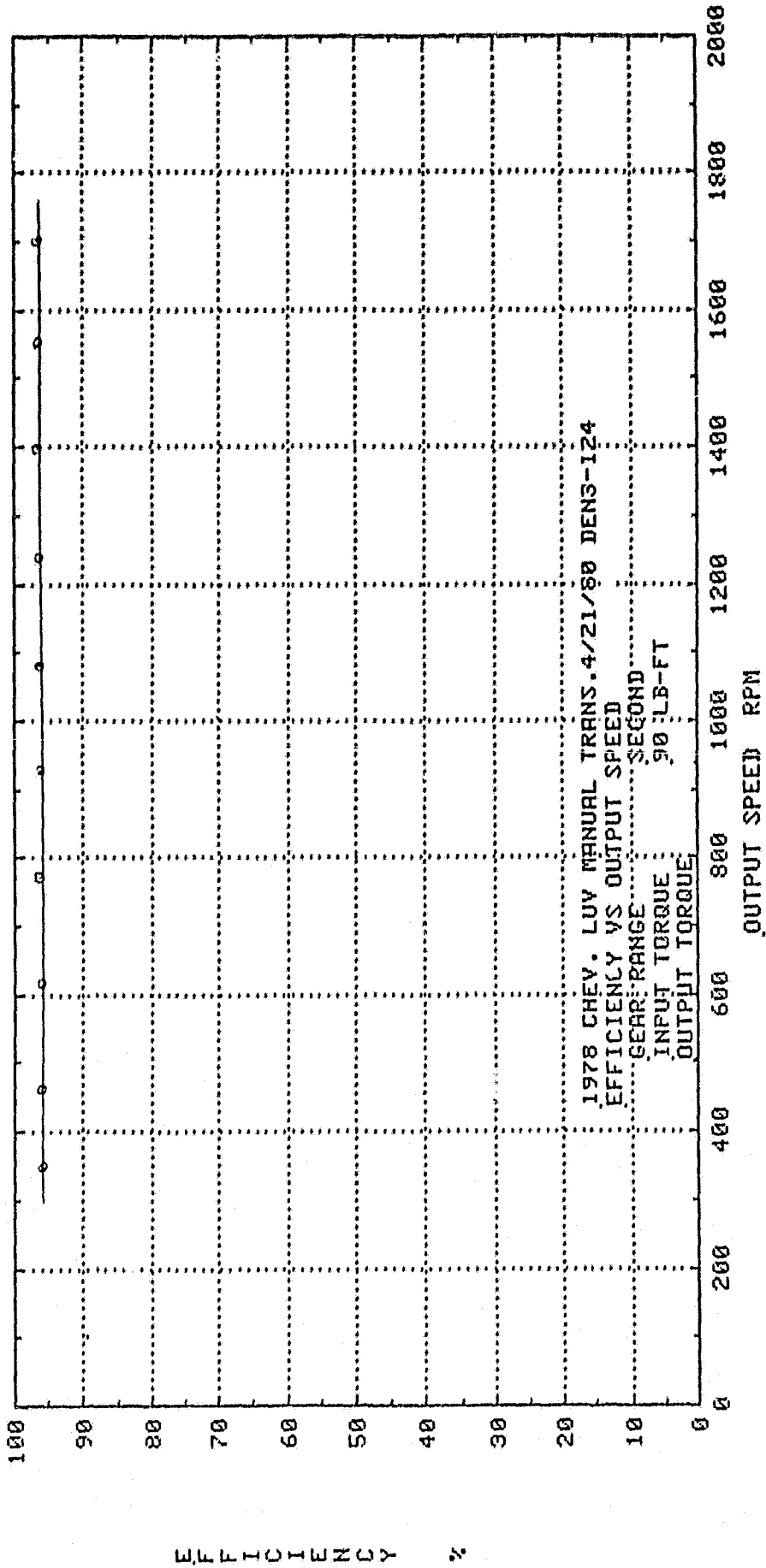

EFFICIENCY %

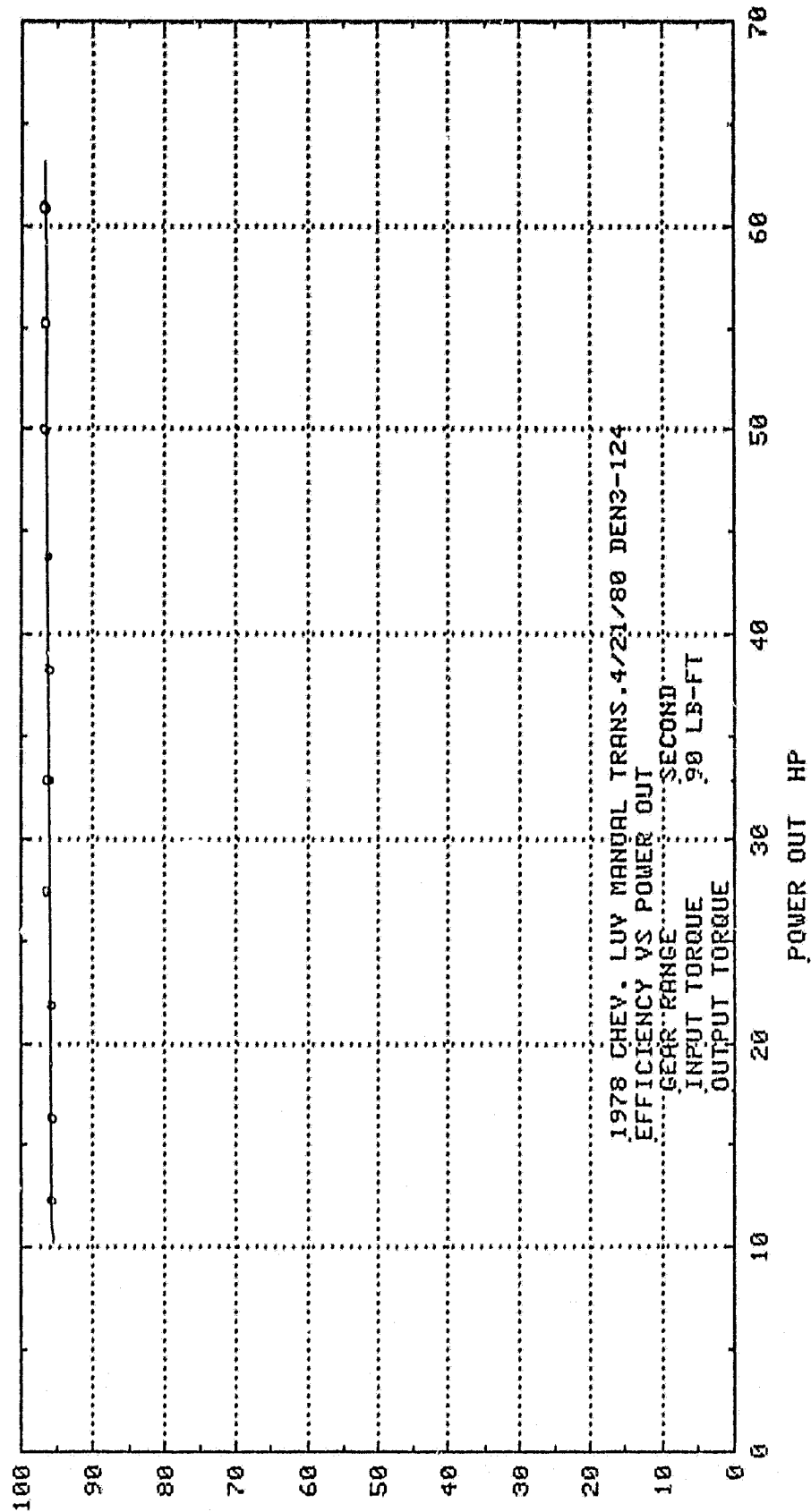

EFFICIENCY %

DRIVE PERFORMANCE

3RD GEAR

Graphs Contained in This Section

Torque Ratio -vs- Output Speed

Output Torque -vs- Output Speed

Input Speed -vs- Output Speed

Efficiency -vs- Output Speed

Efficiency -vs- Power Out

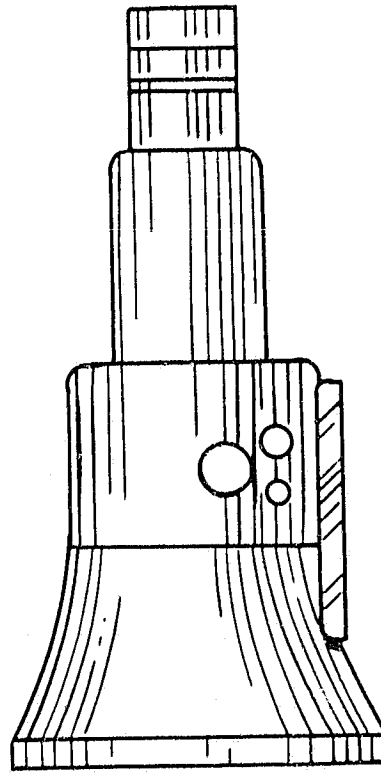

Torque In

Speed In

Torque Out

Speed Out

Drive Performance Tests

TORQUE RATIO $\frac{T_o}{T_i}$

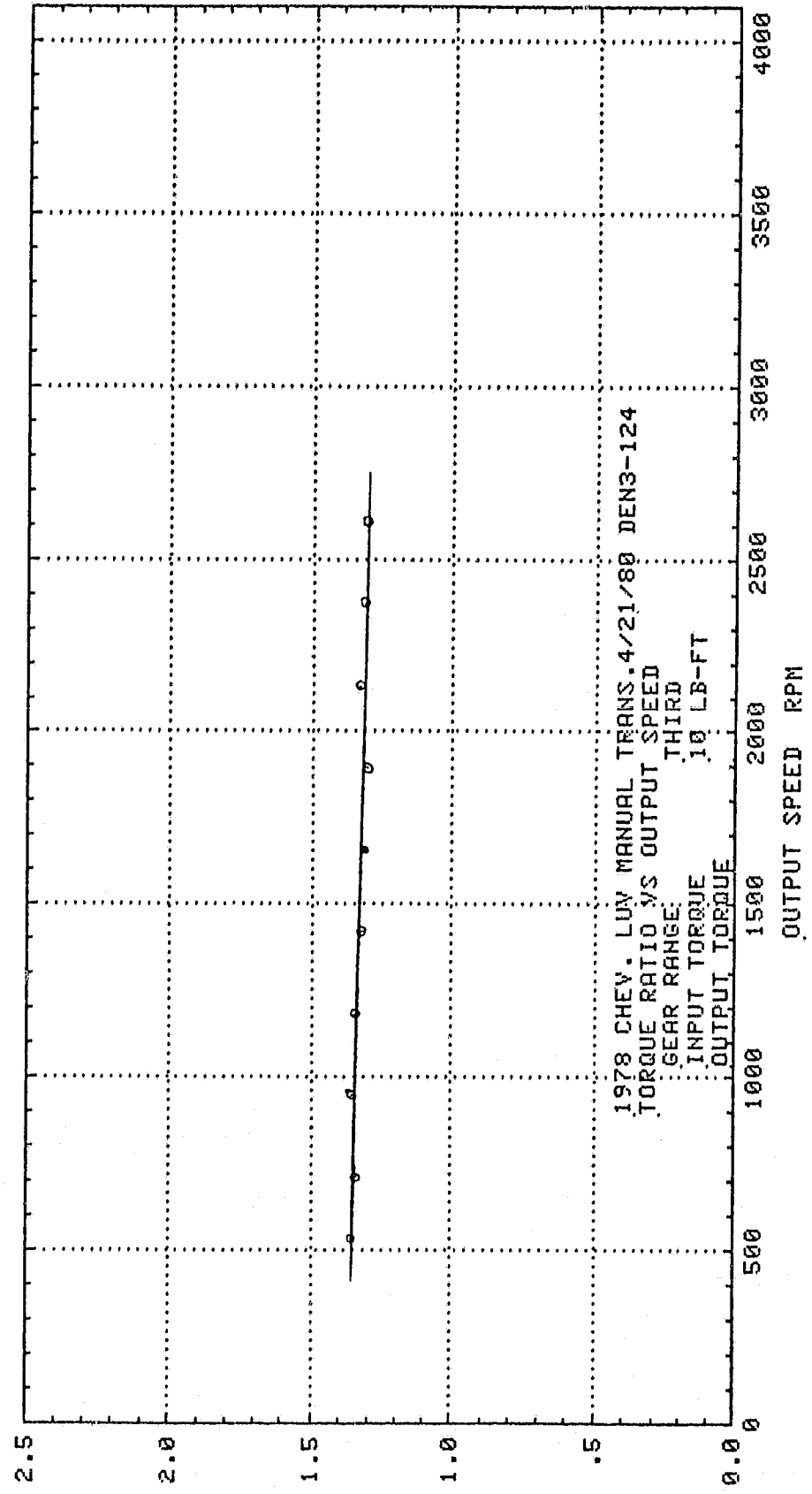

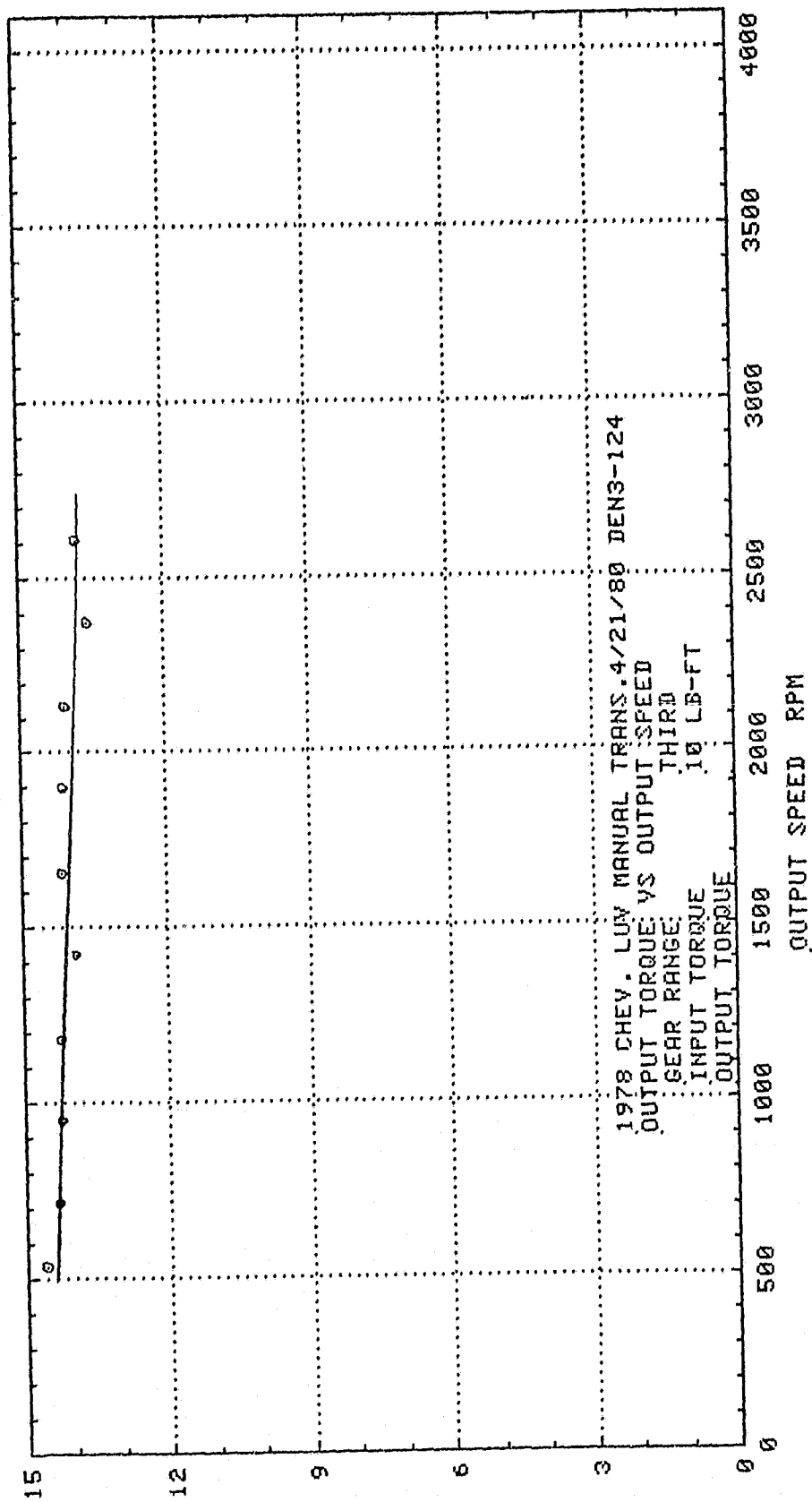

OUTPUT TORQUE LB FT

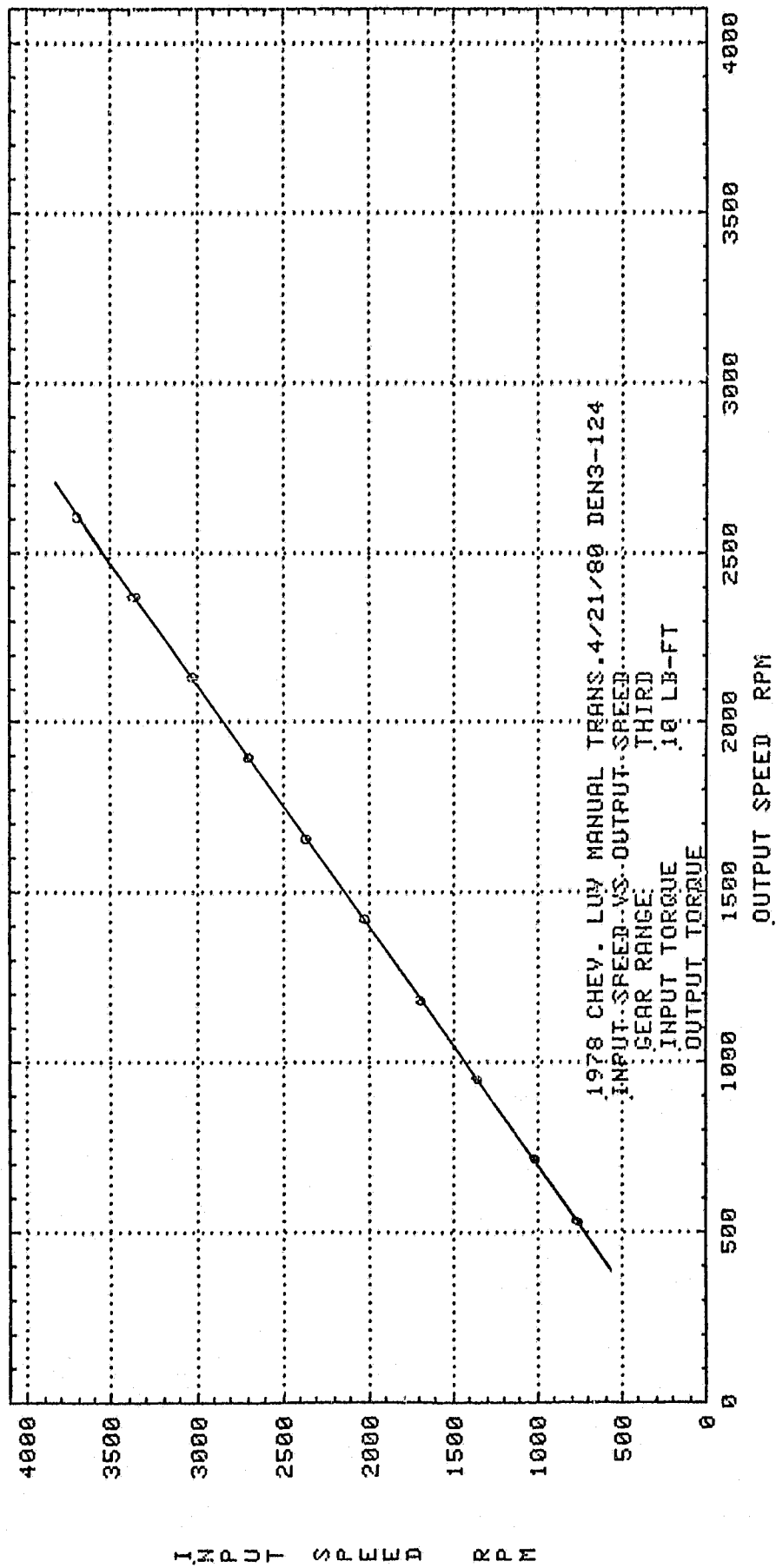

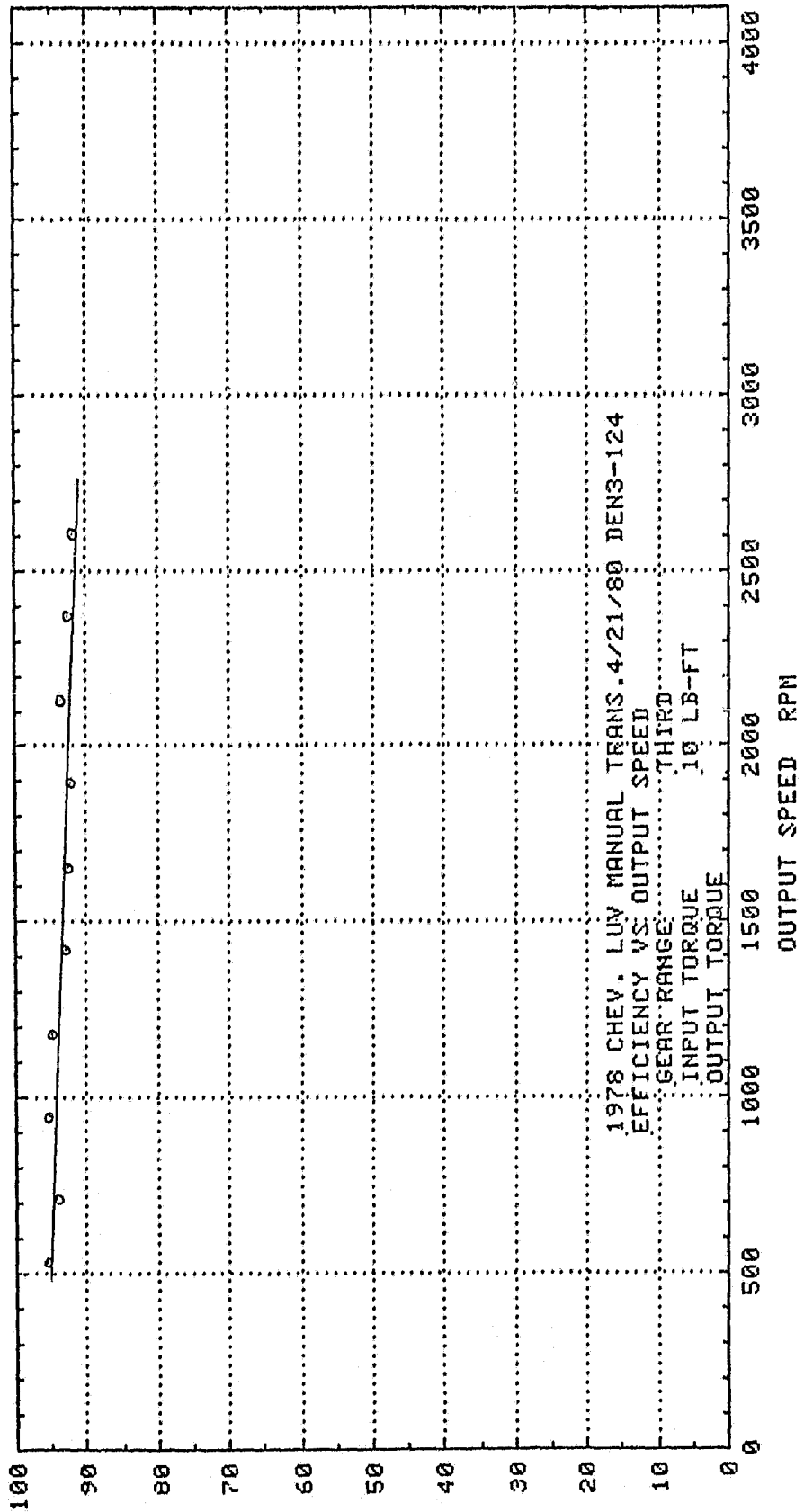

EFFICIENCY %

EFFICIENCY %

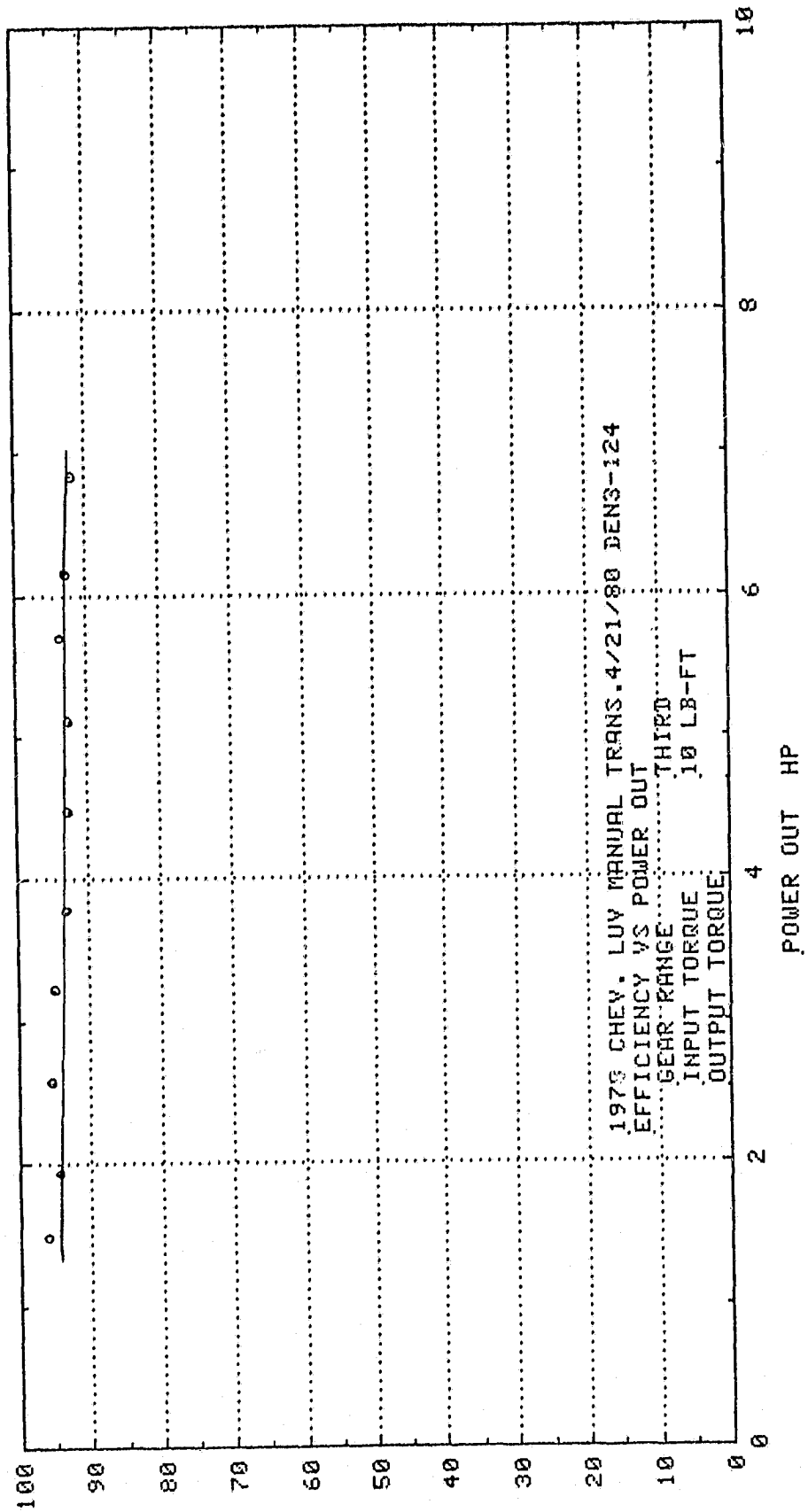

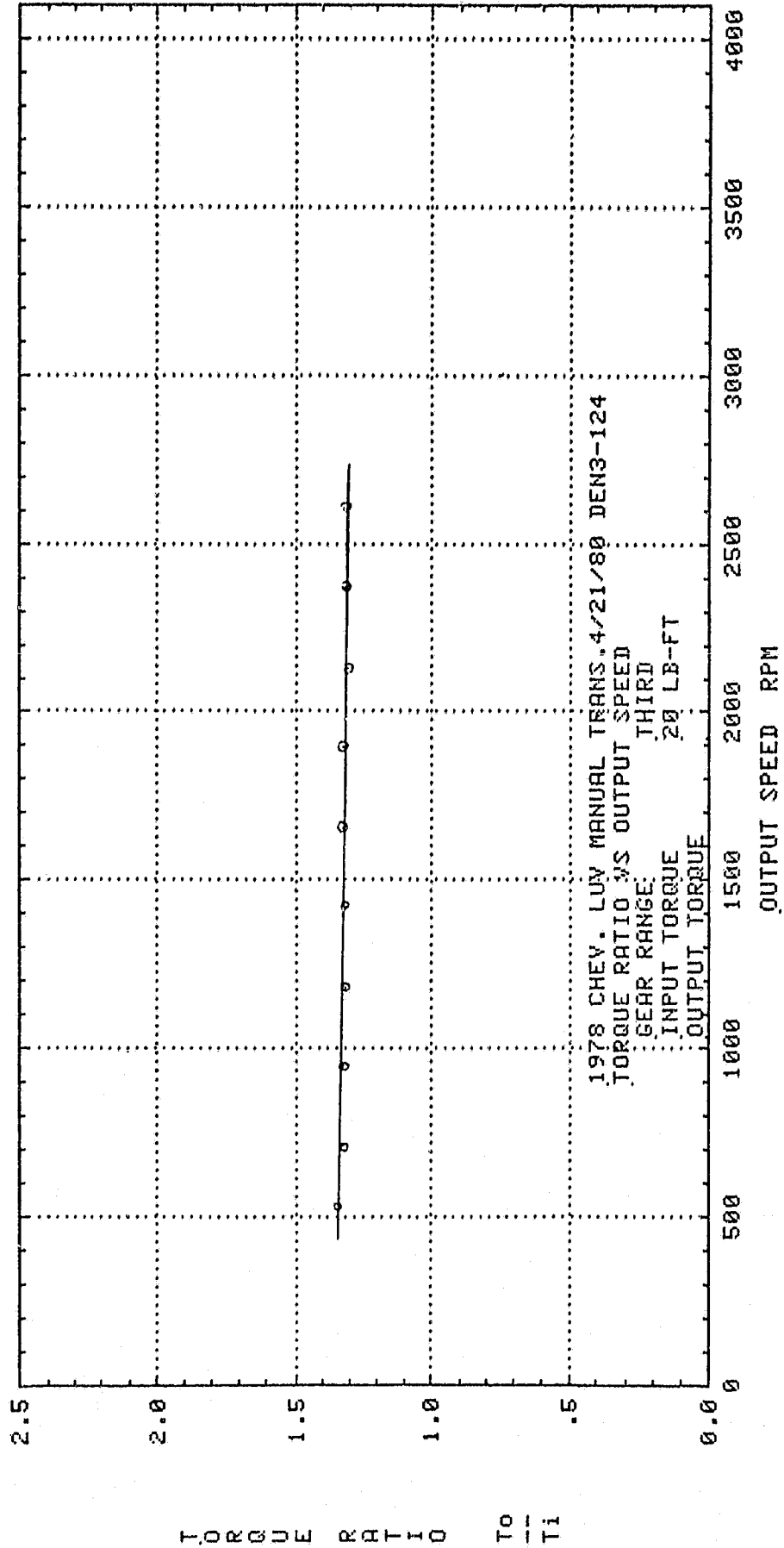

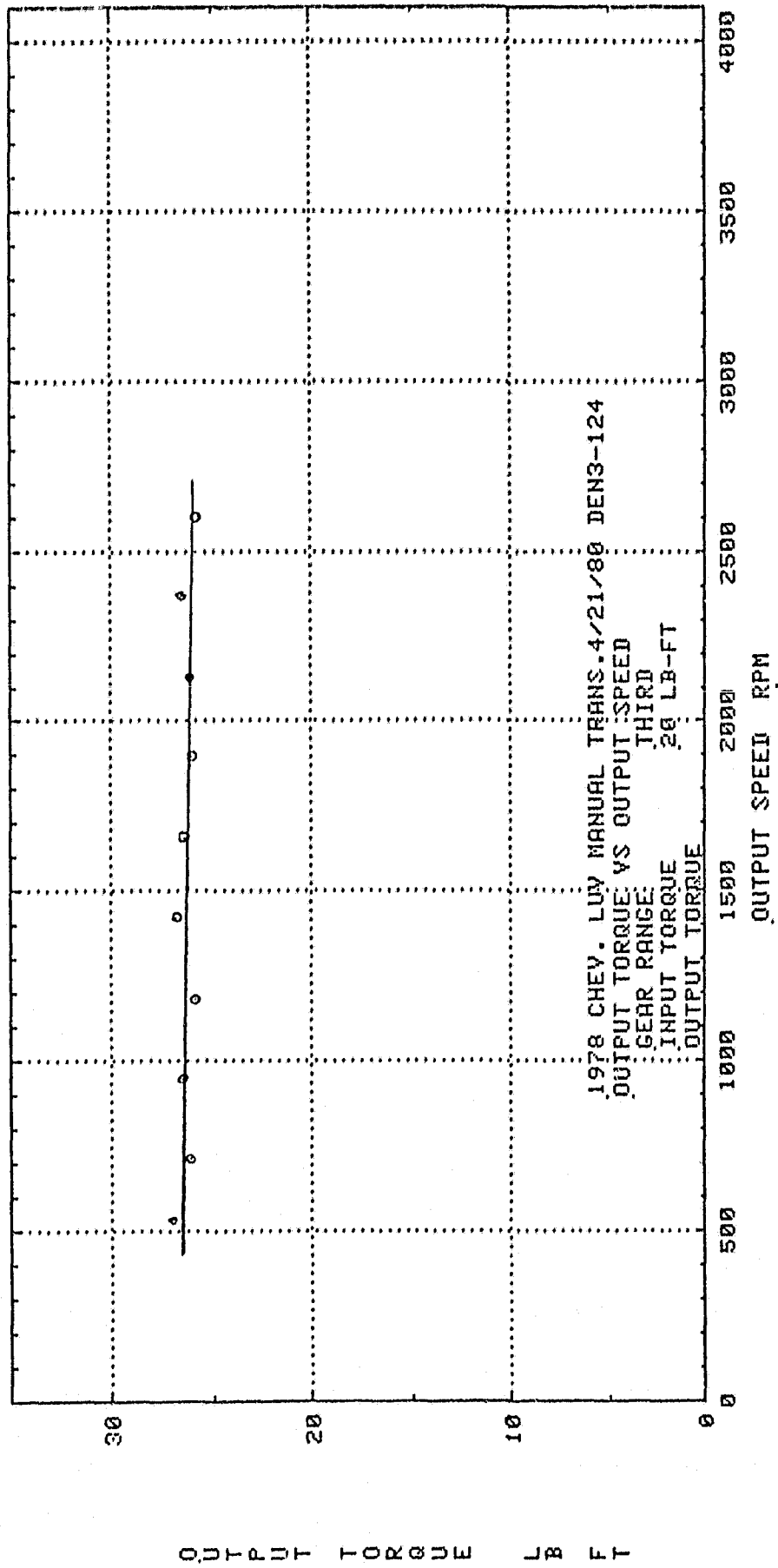

OUTPUT TORQUE LB FT

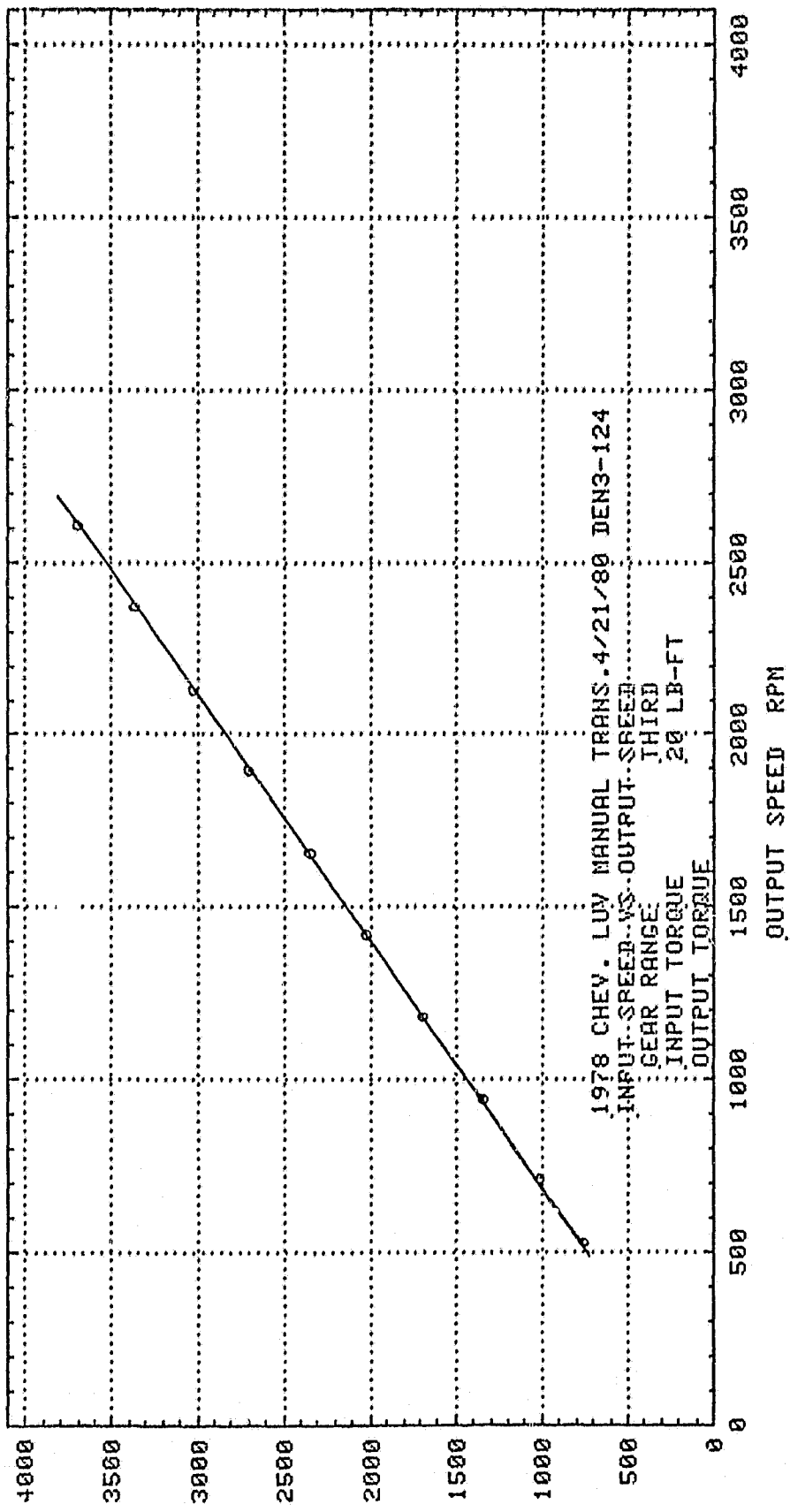

INPUT SPEED RPM

E F F I C I E N C Y %

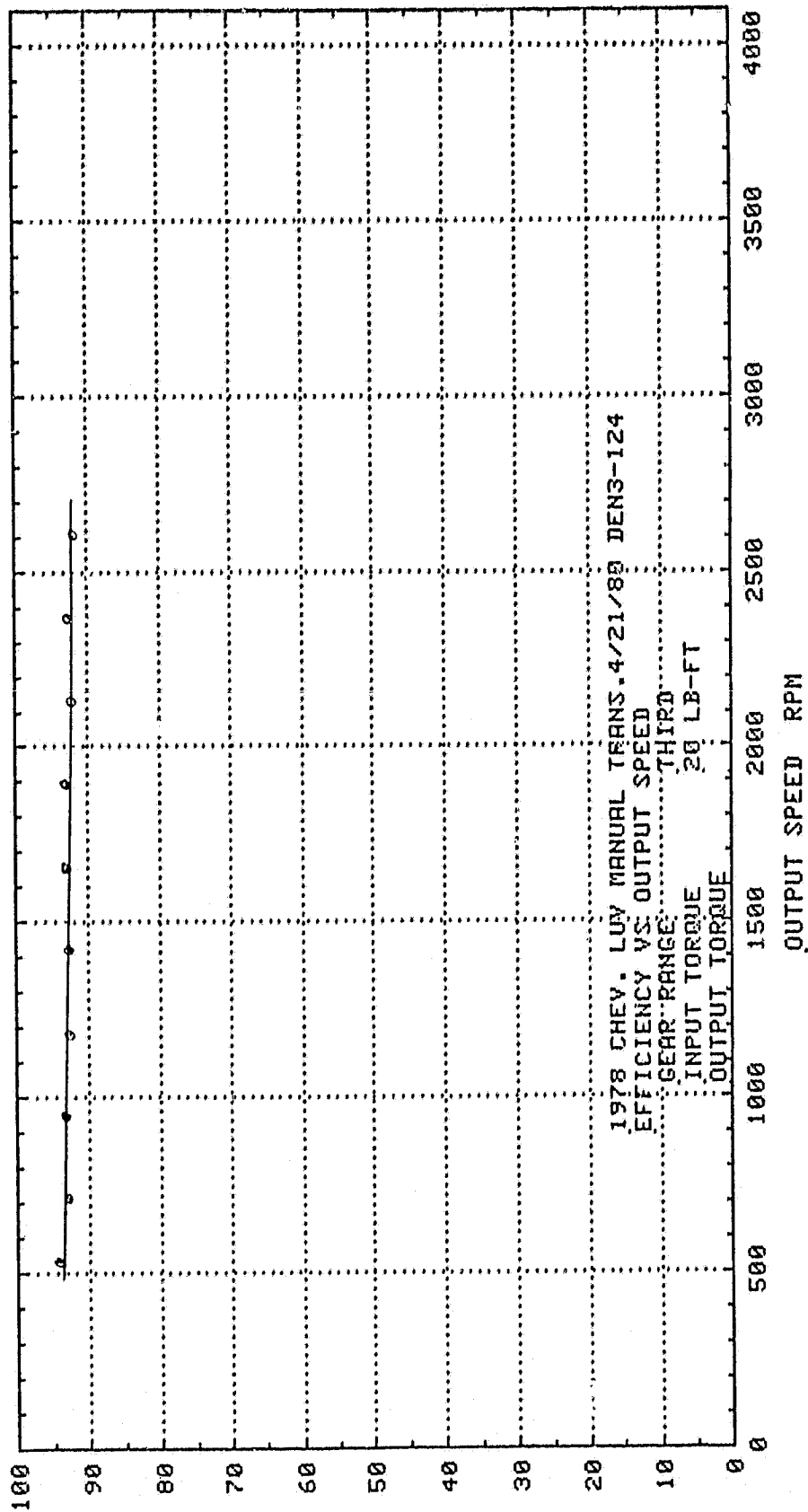

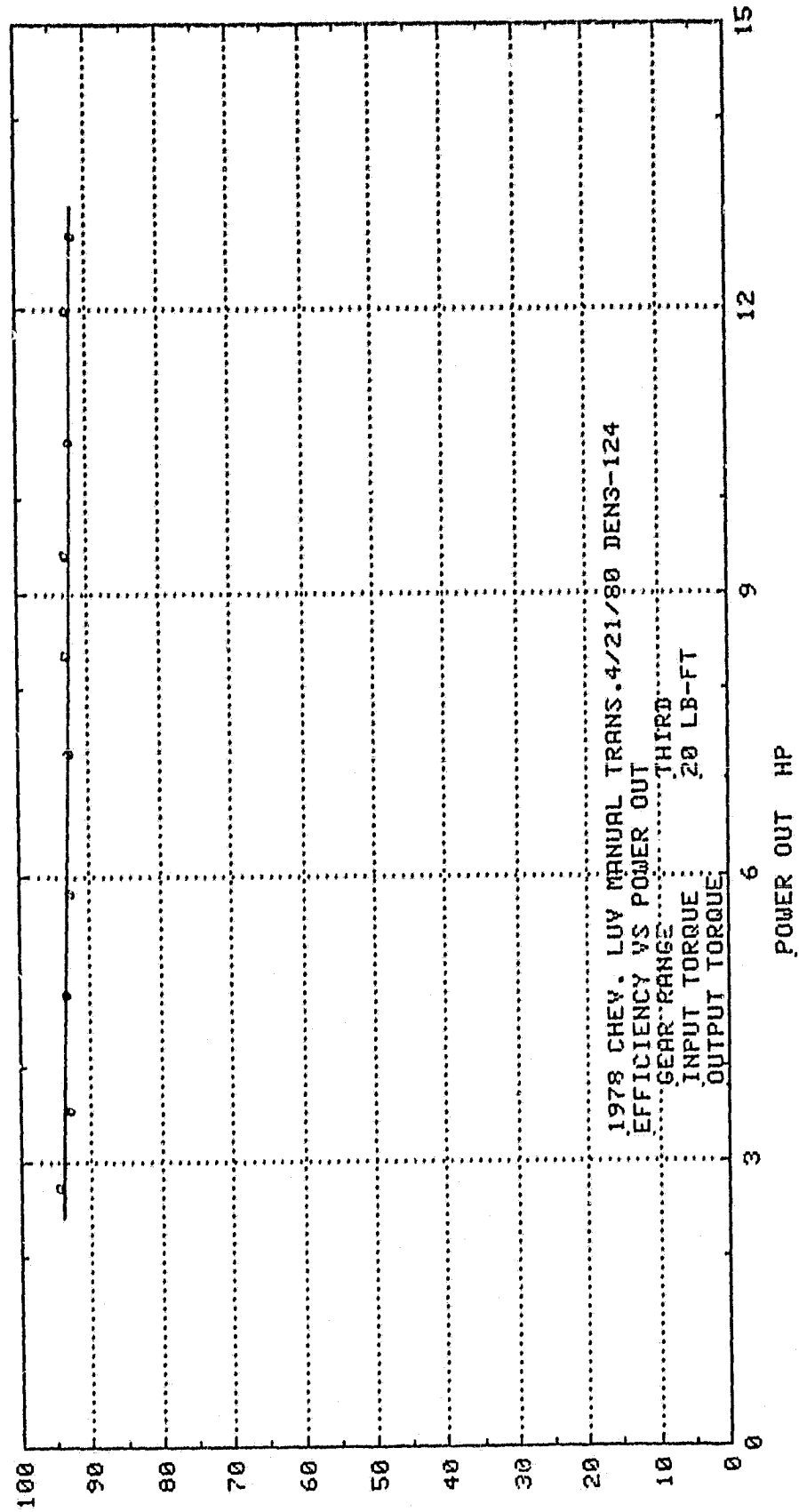

EFFICIENCY %

TORQUE RATIO $\frac{T_o}{T_i}$

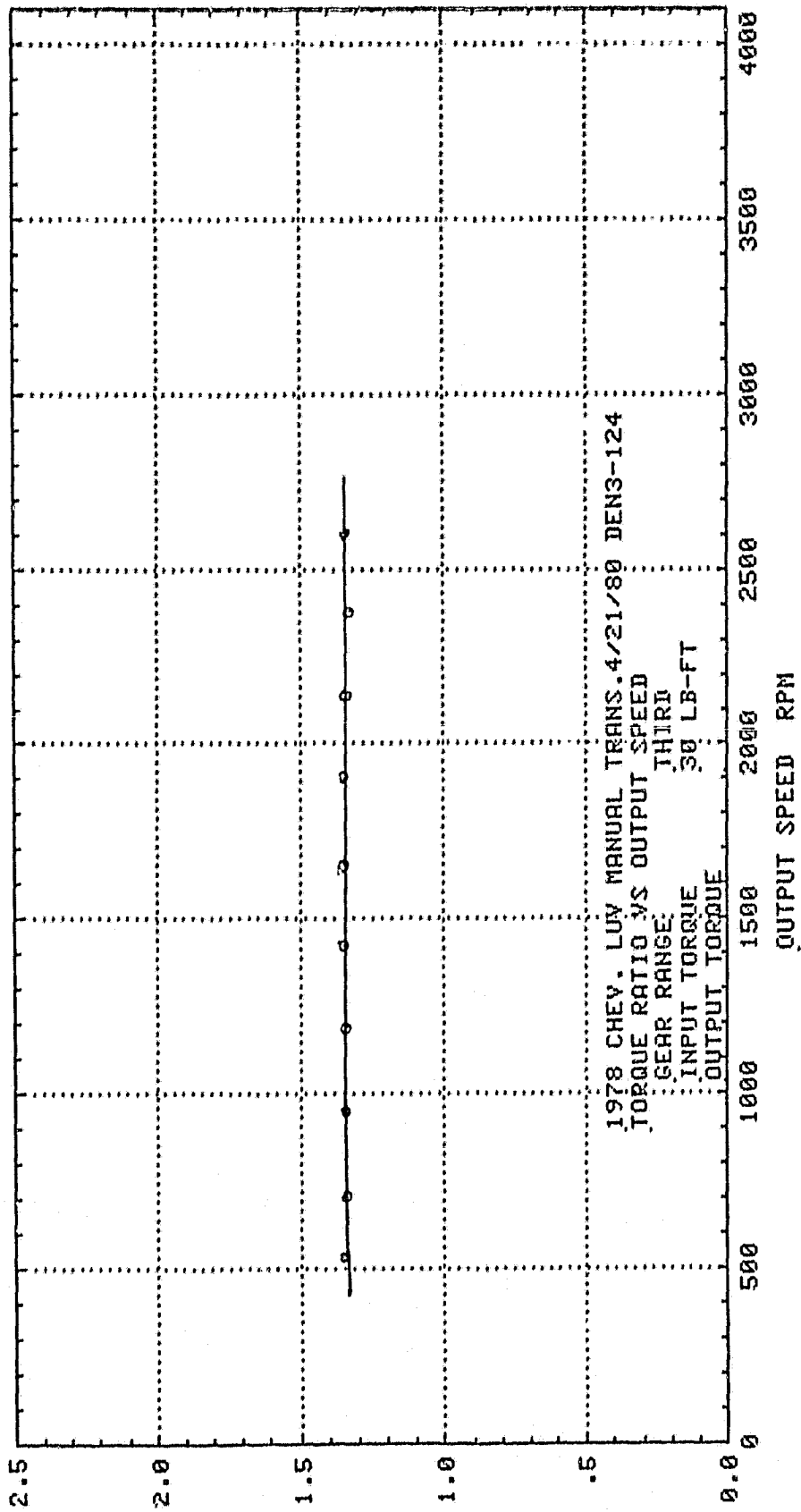

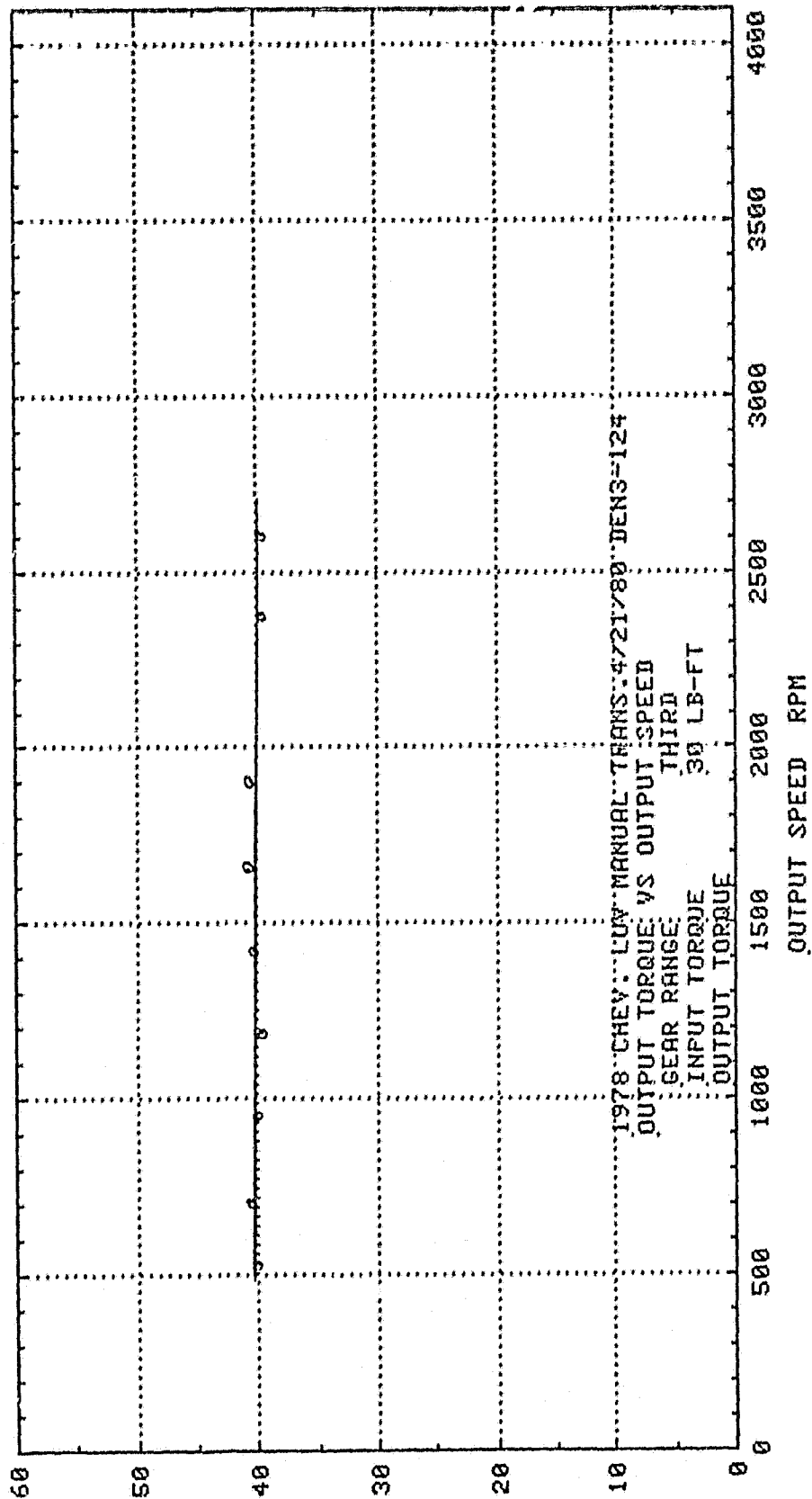

OUTPUT TORQUE LB FT

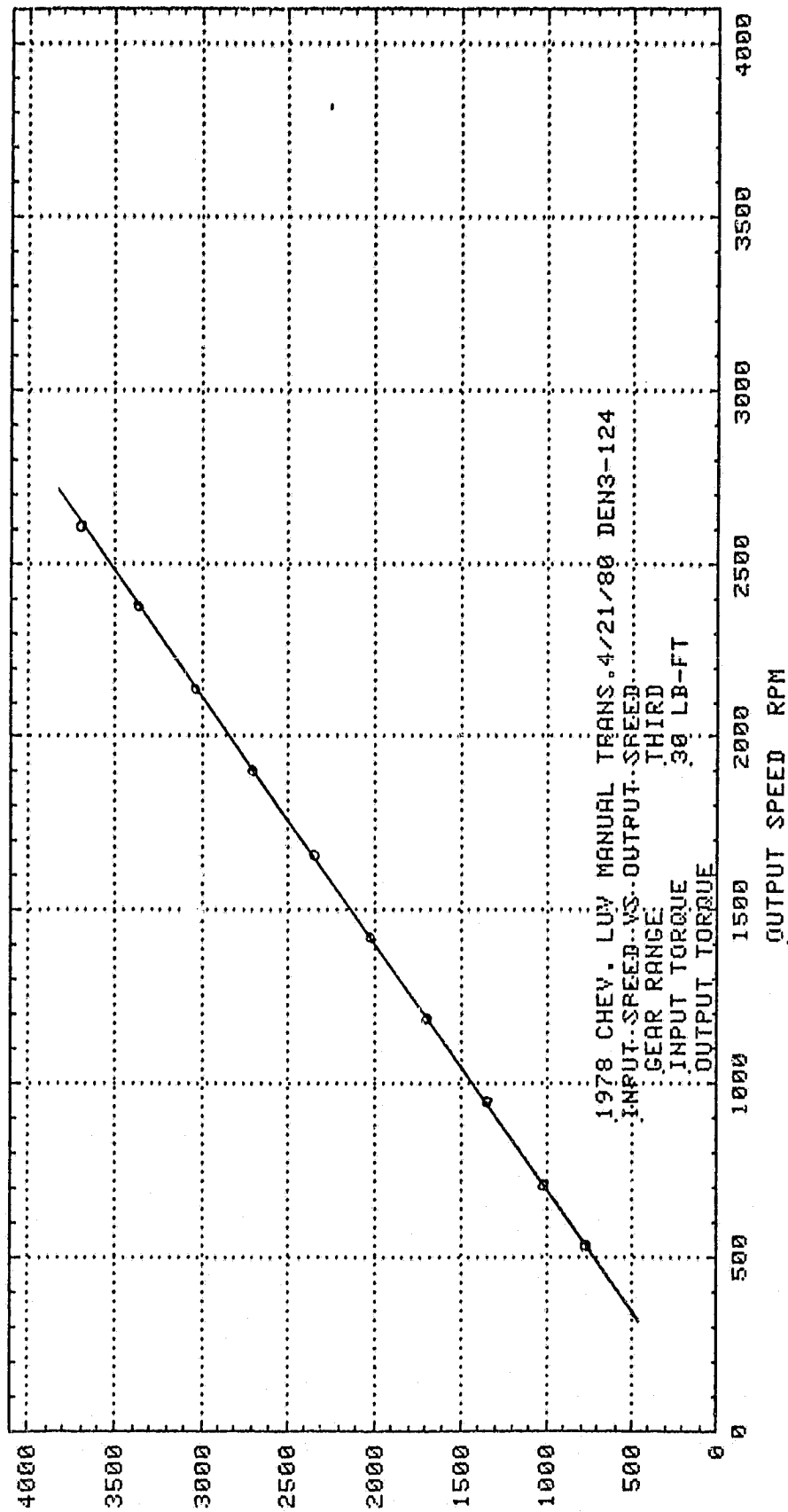

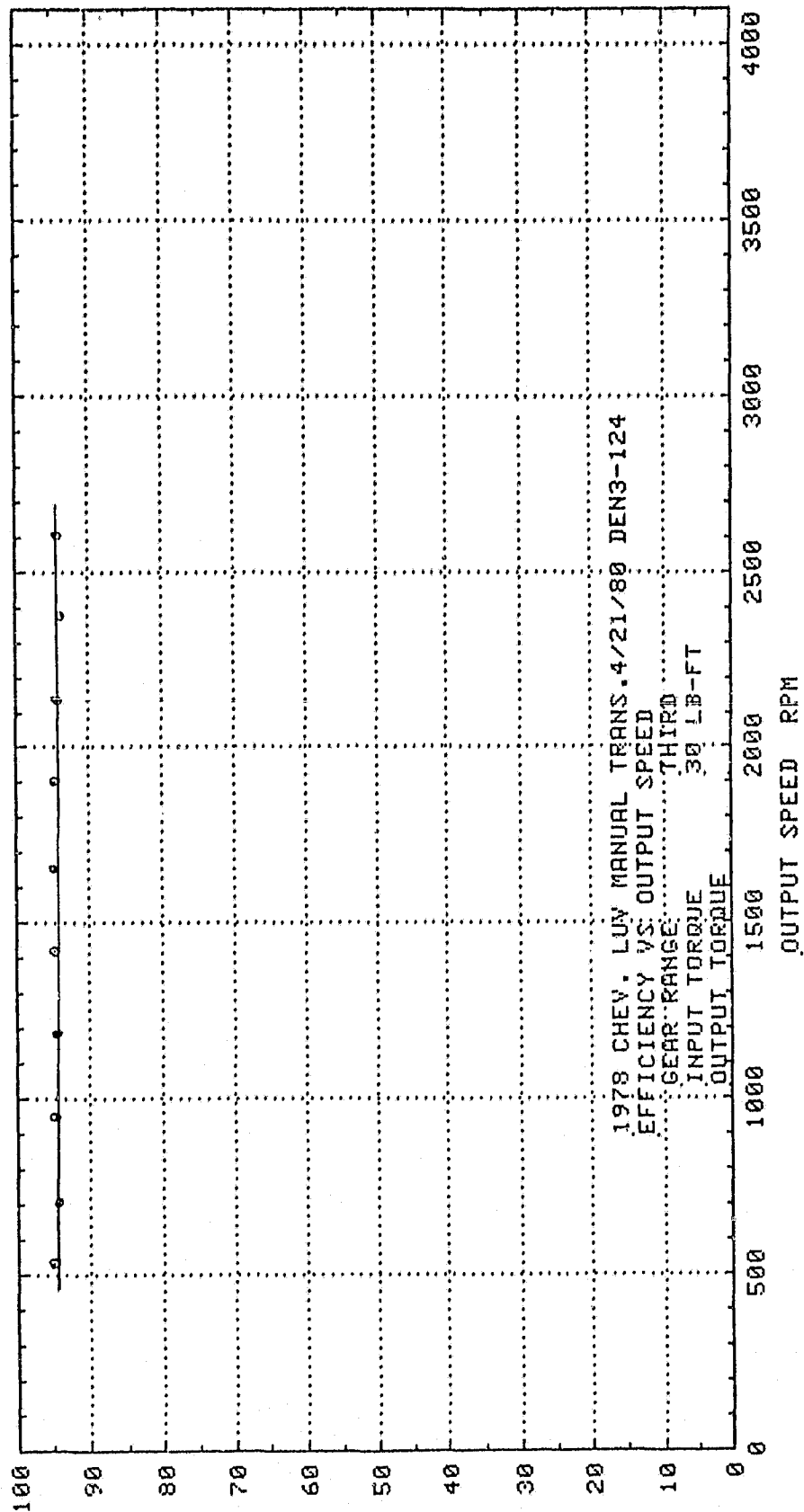

EFFICIENCY %

EFFICIENCY %

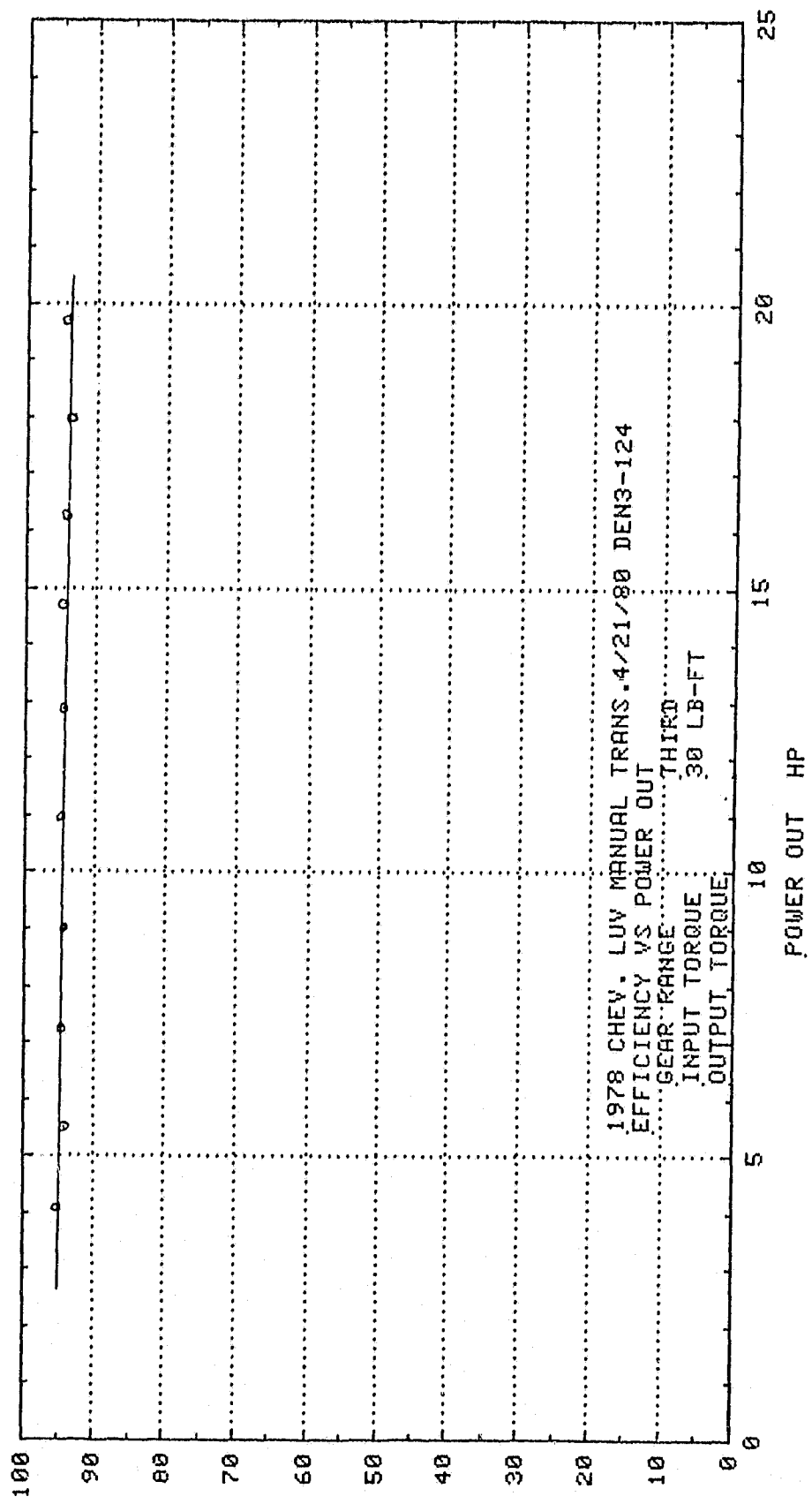

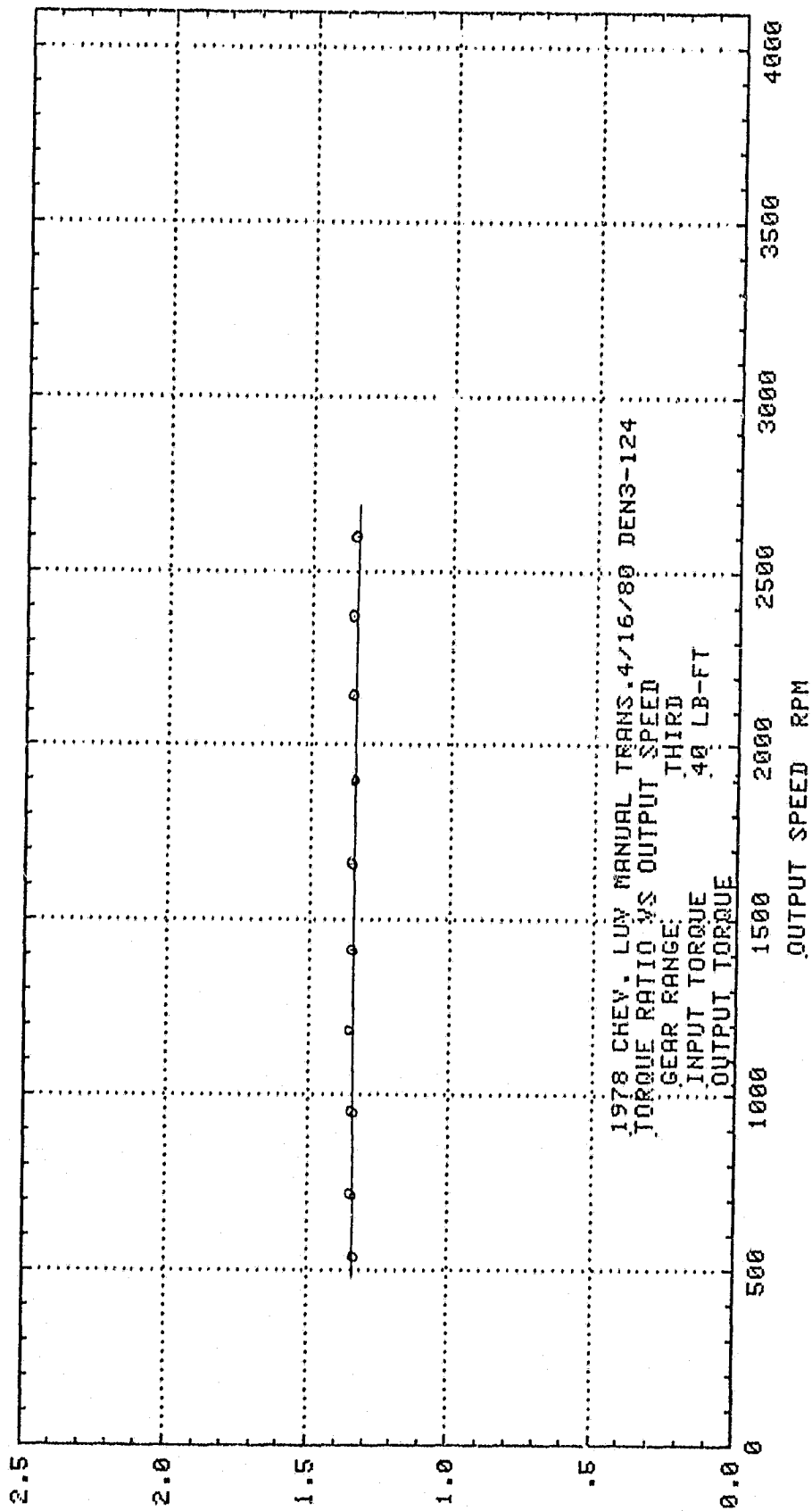

TORQUE RATIO $\frac{T_o}{T_i}$

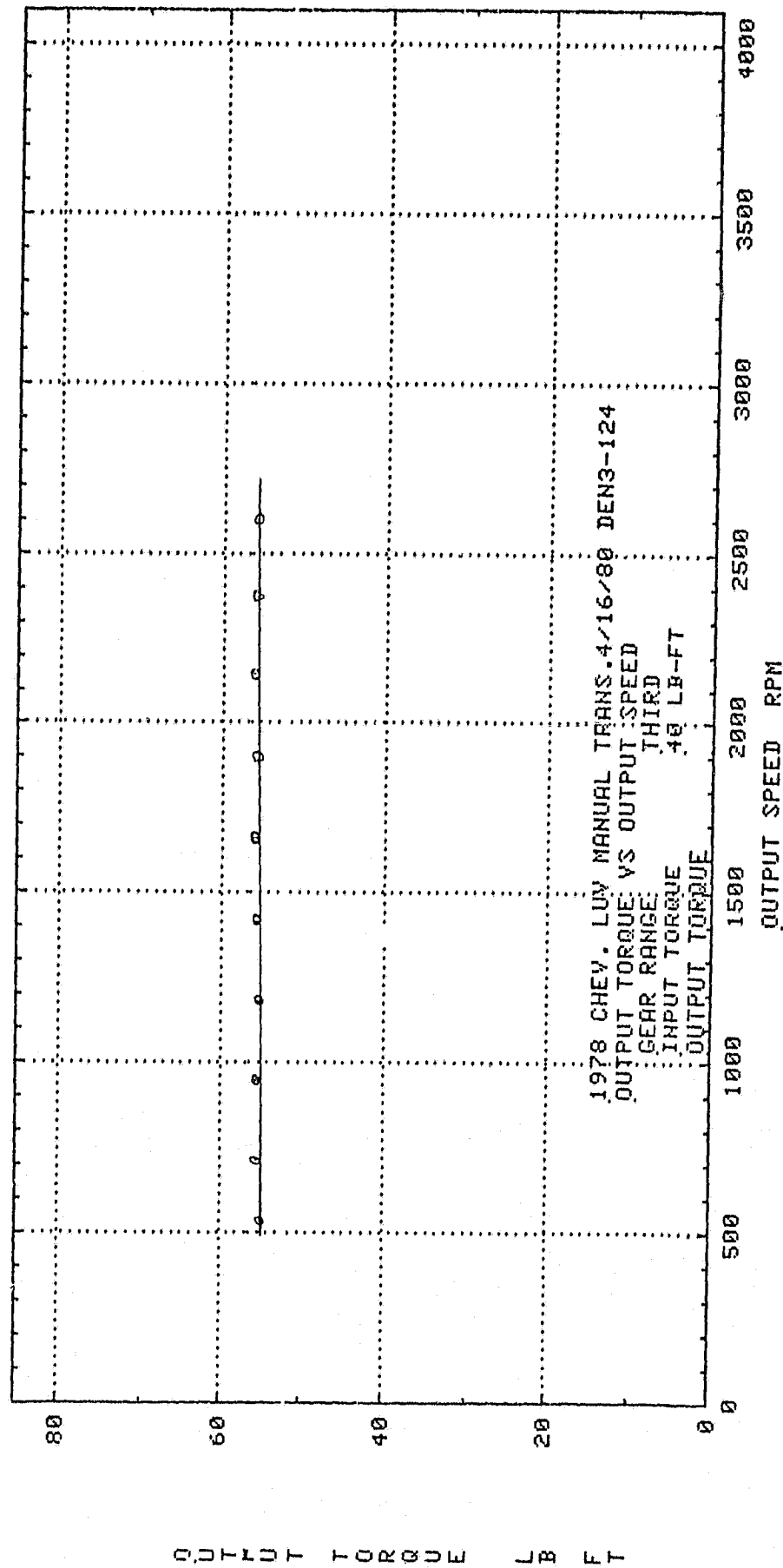

OUTPUT TORQUE LB FT

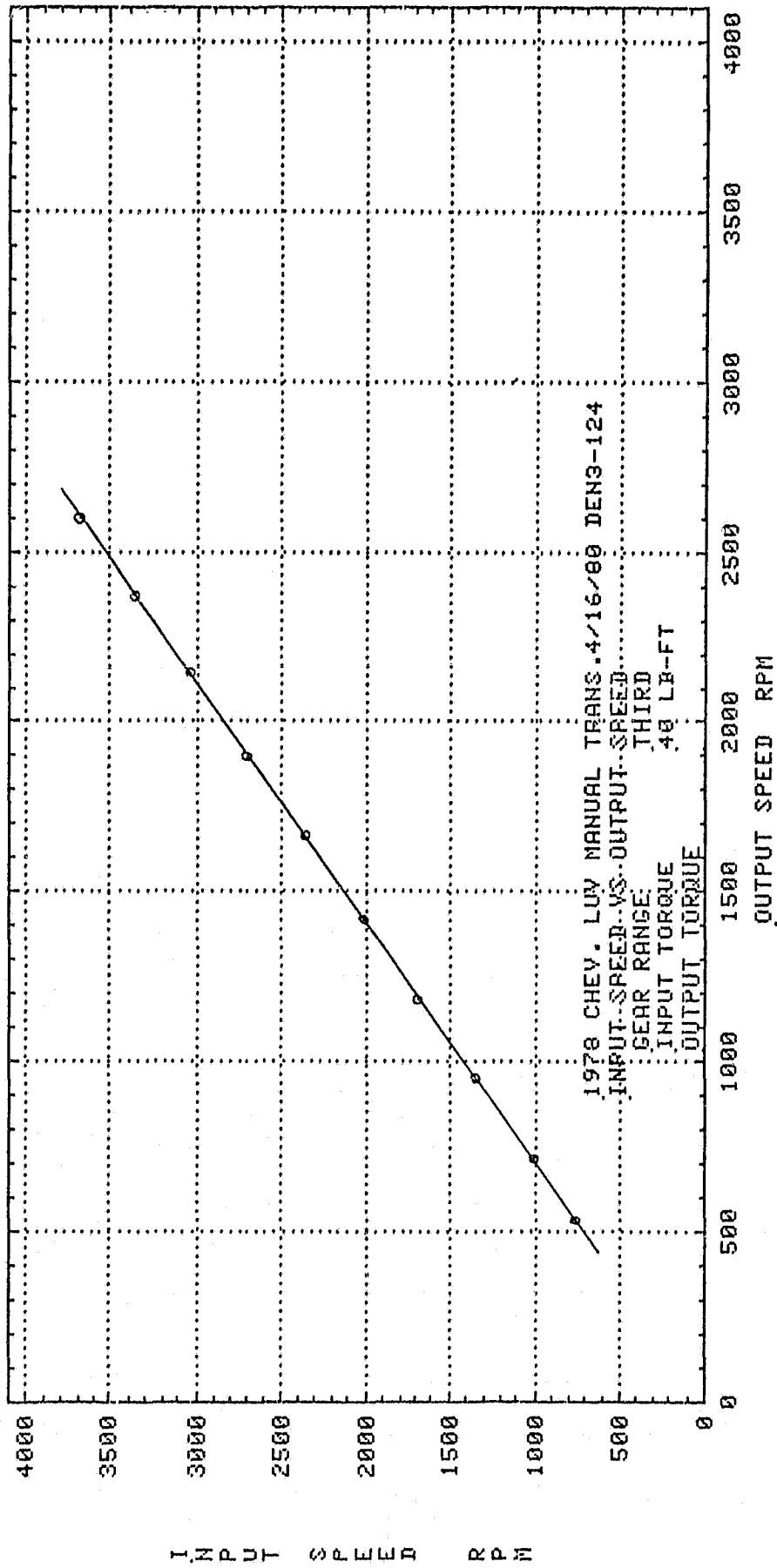

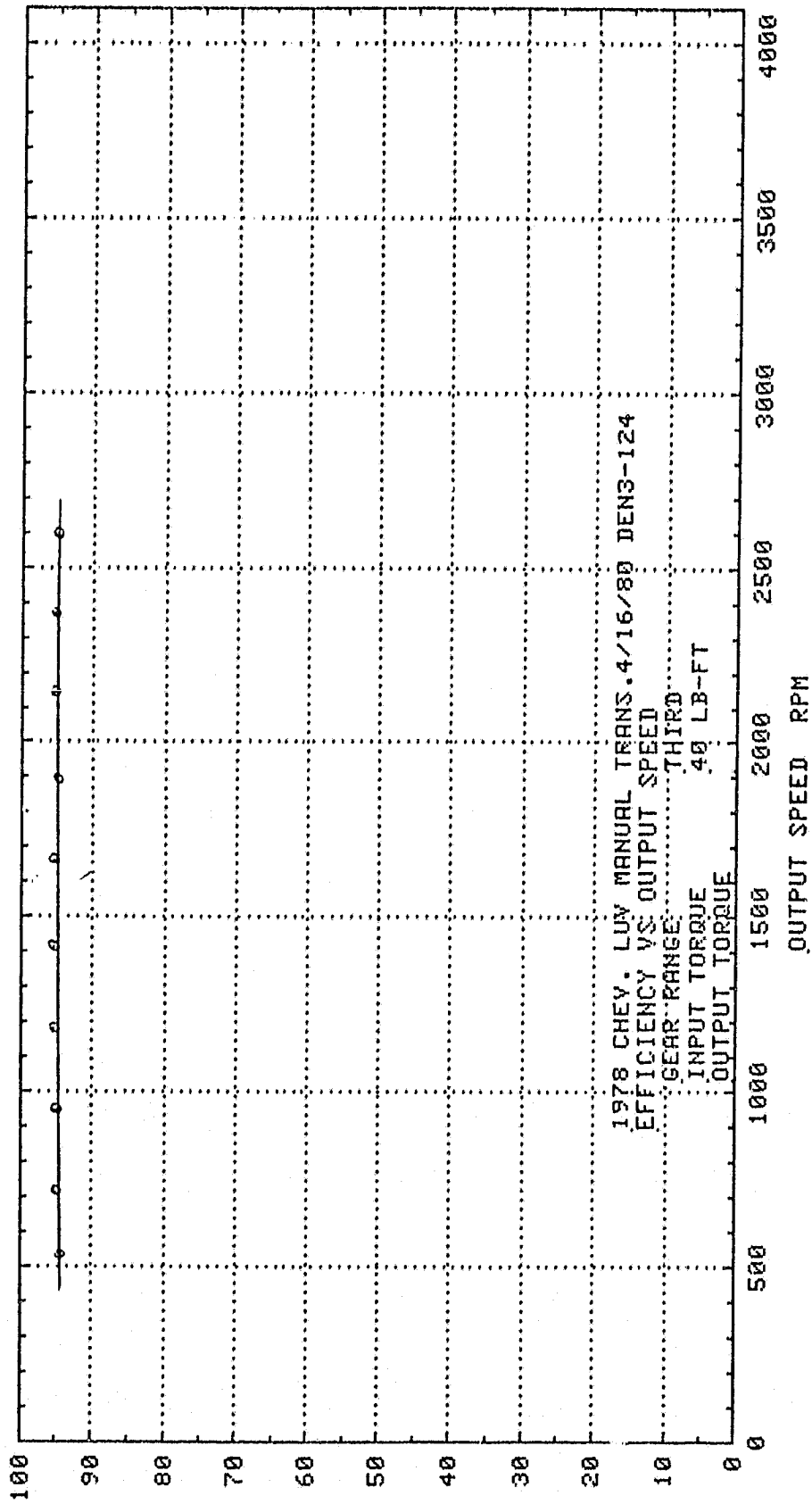

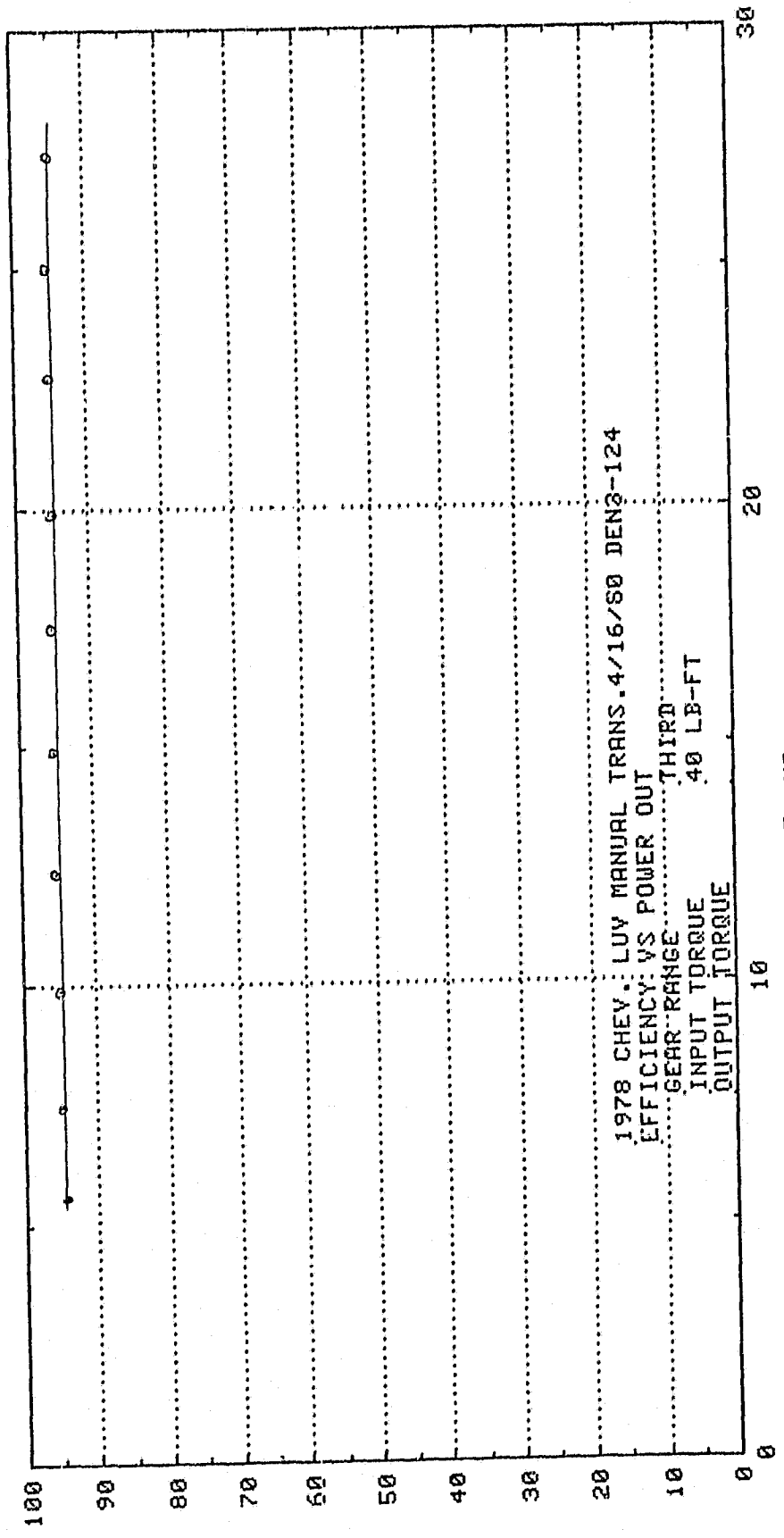

EFFICIENCY %

TORQUE RATIO

$$\frac{T_o}{T_i}$$

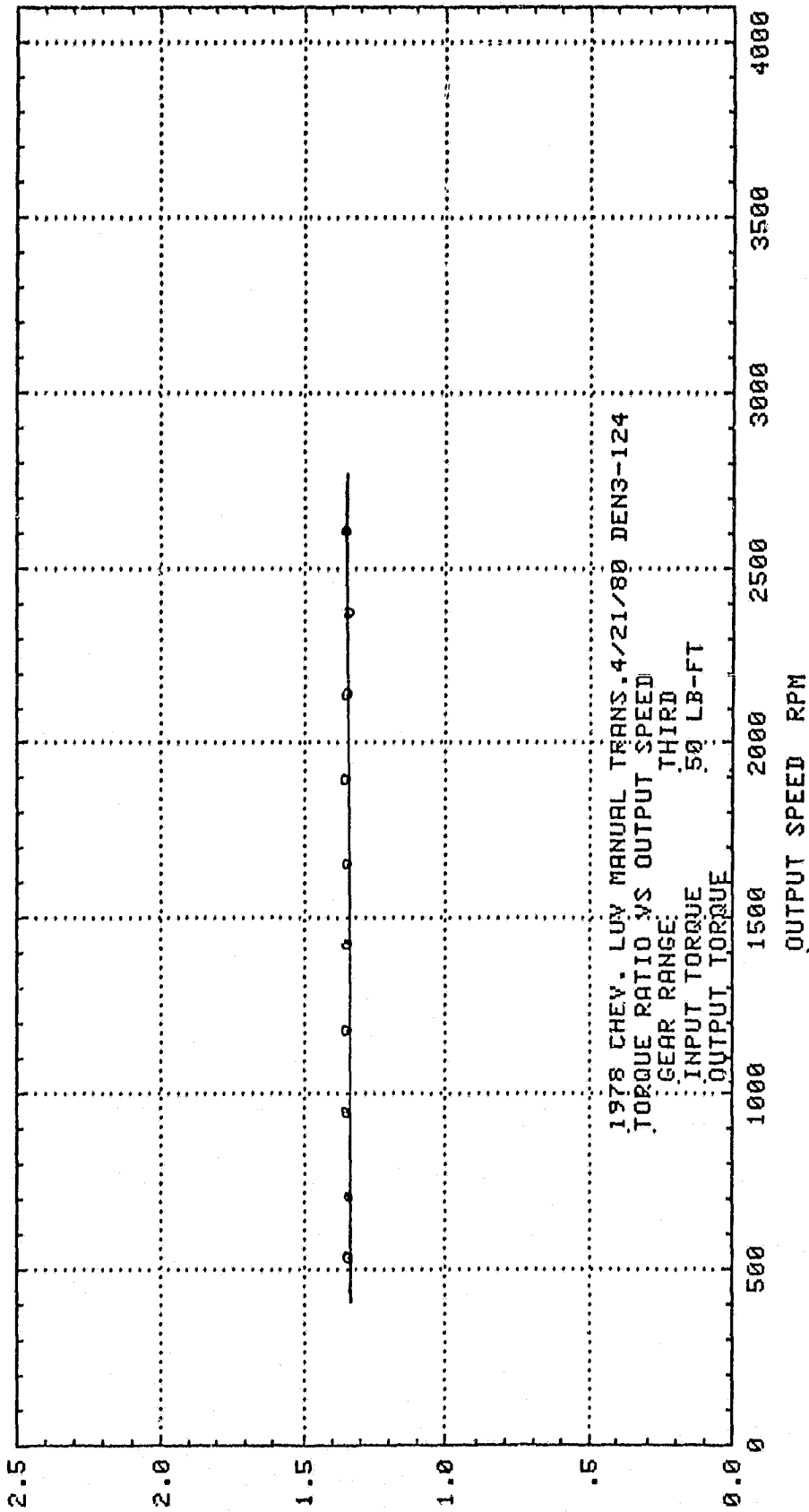

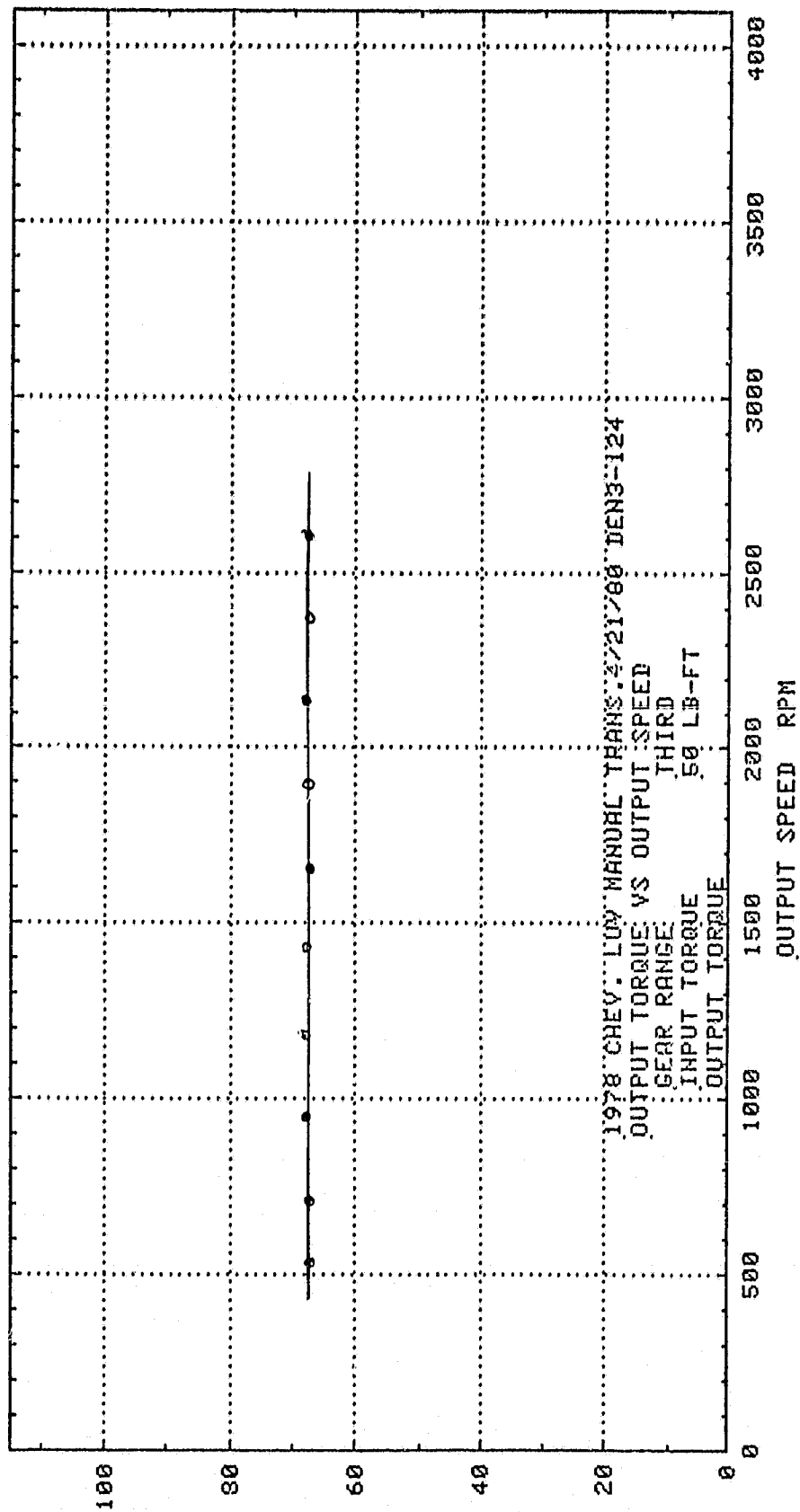

OUTPUT TORQUE LB FT

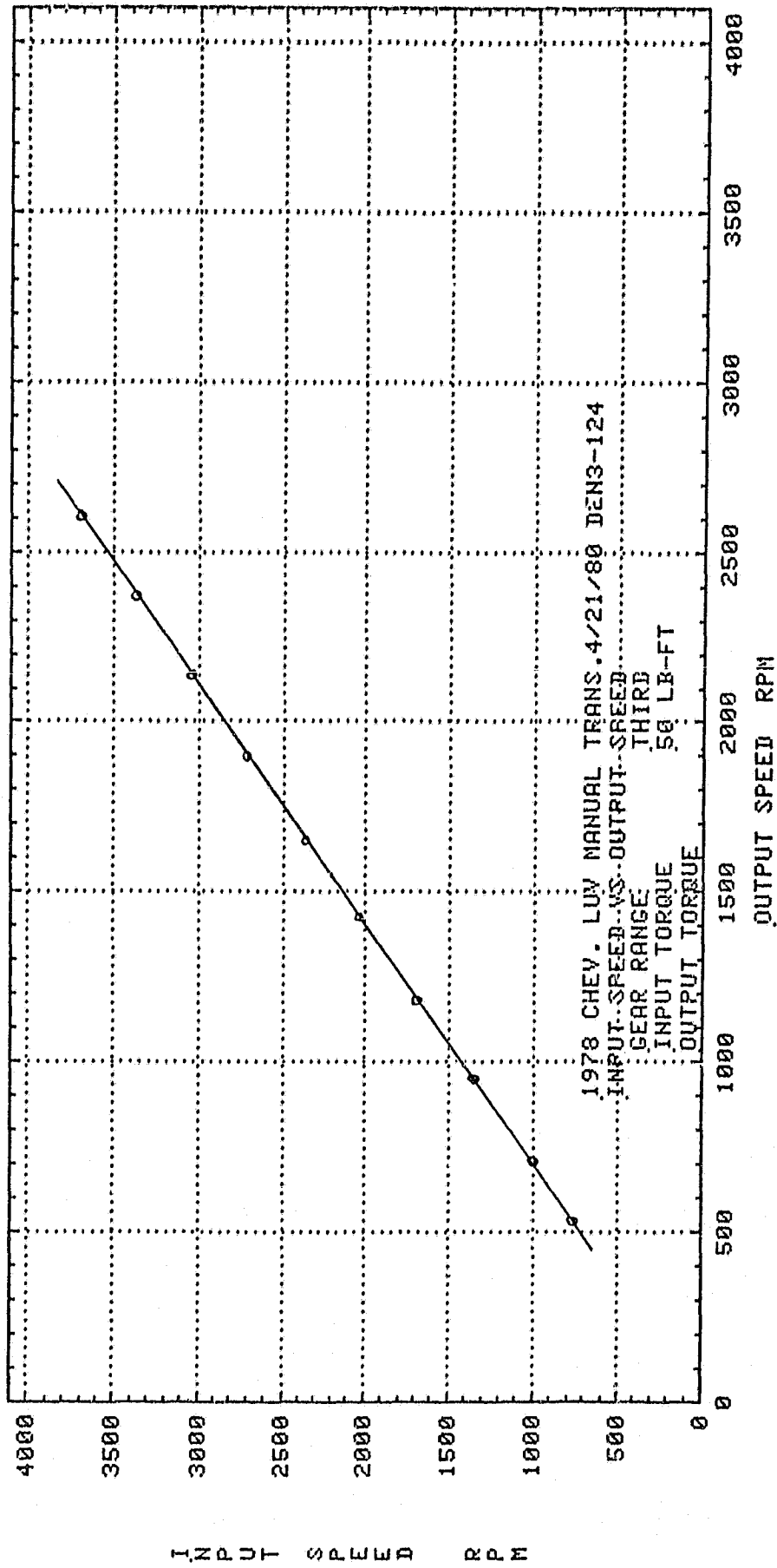

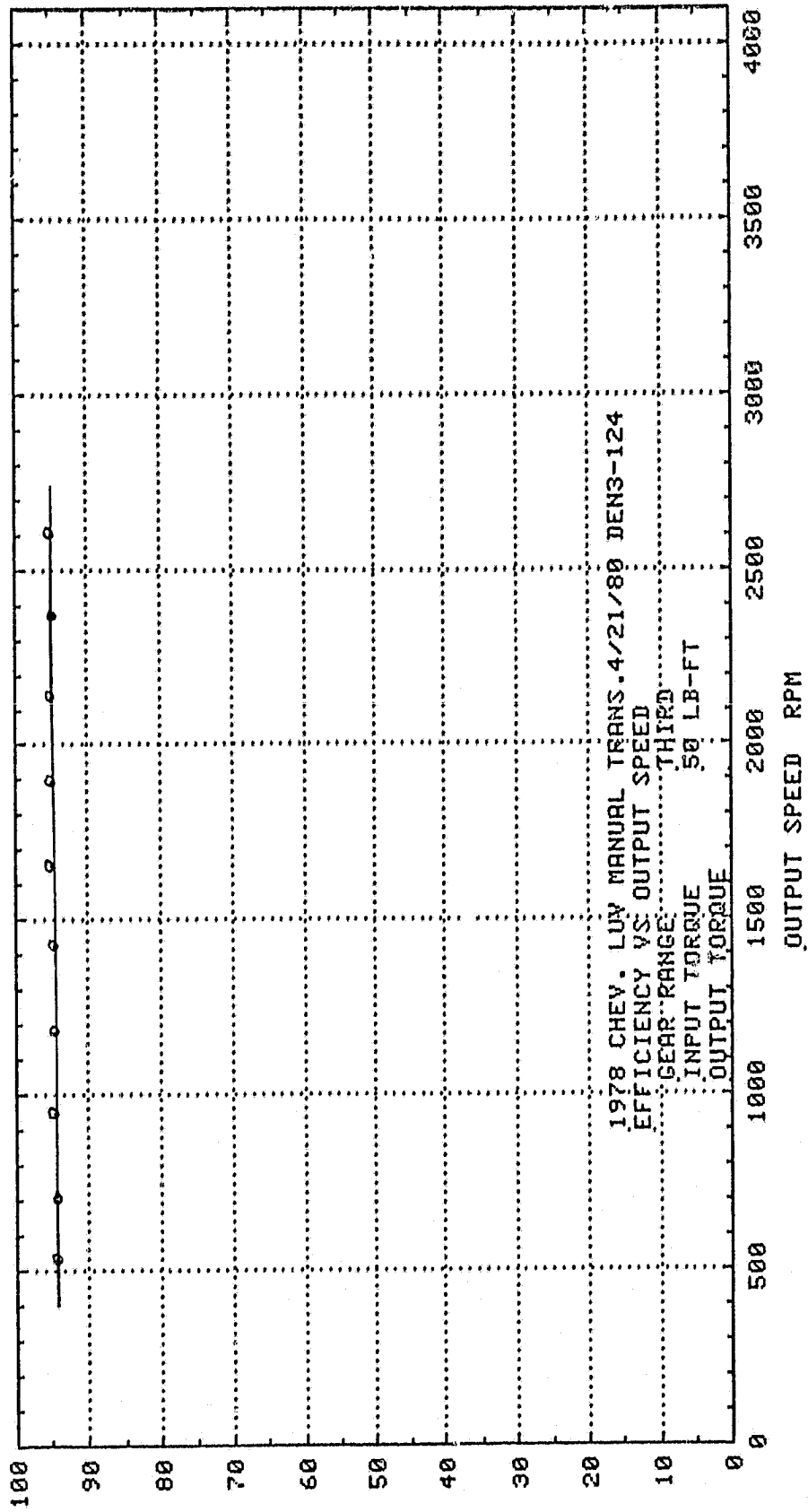

EFFICIENCY %

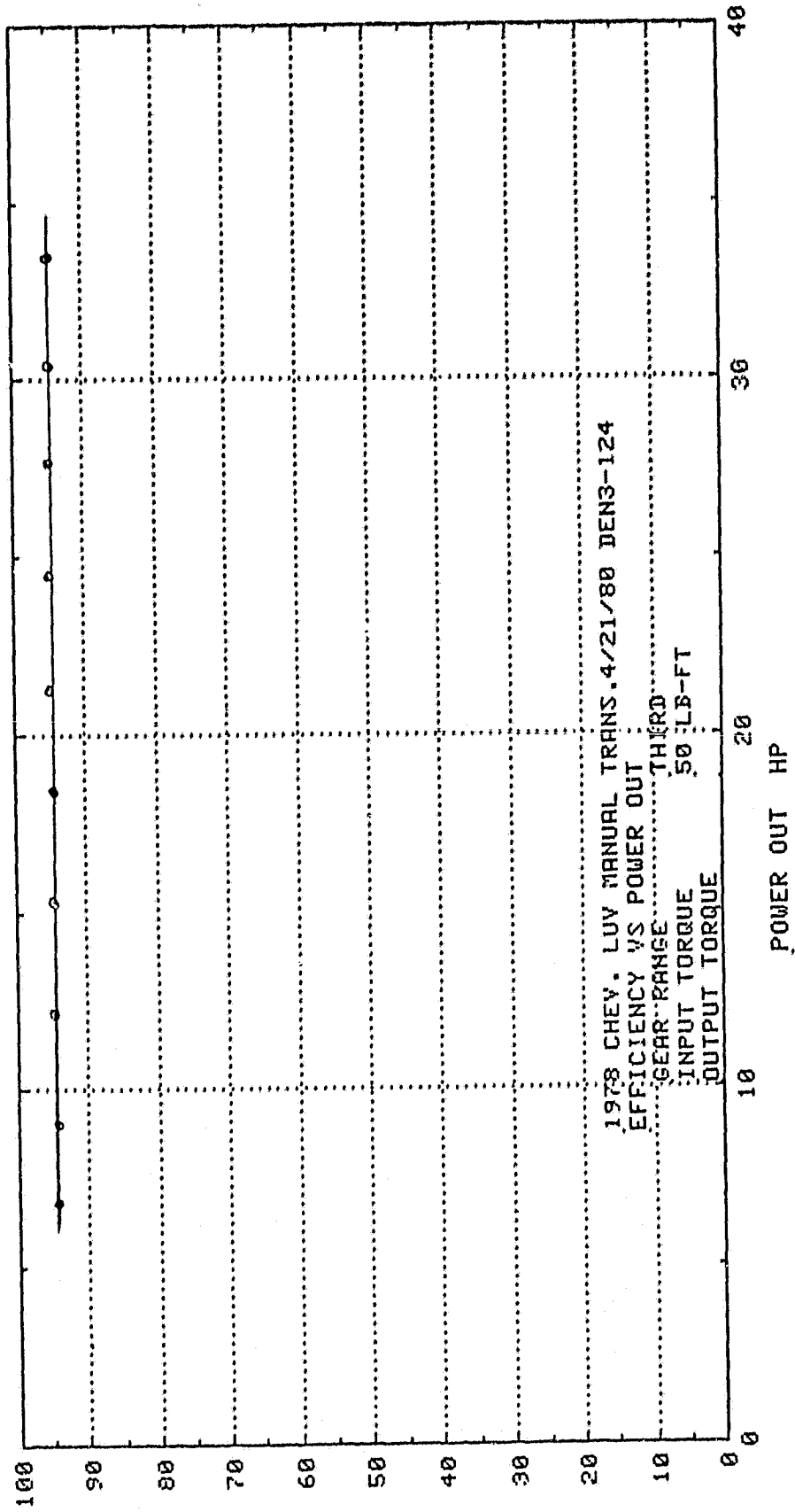

EFFICIENCY %

POWER OUT HP

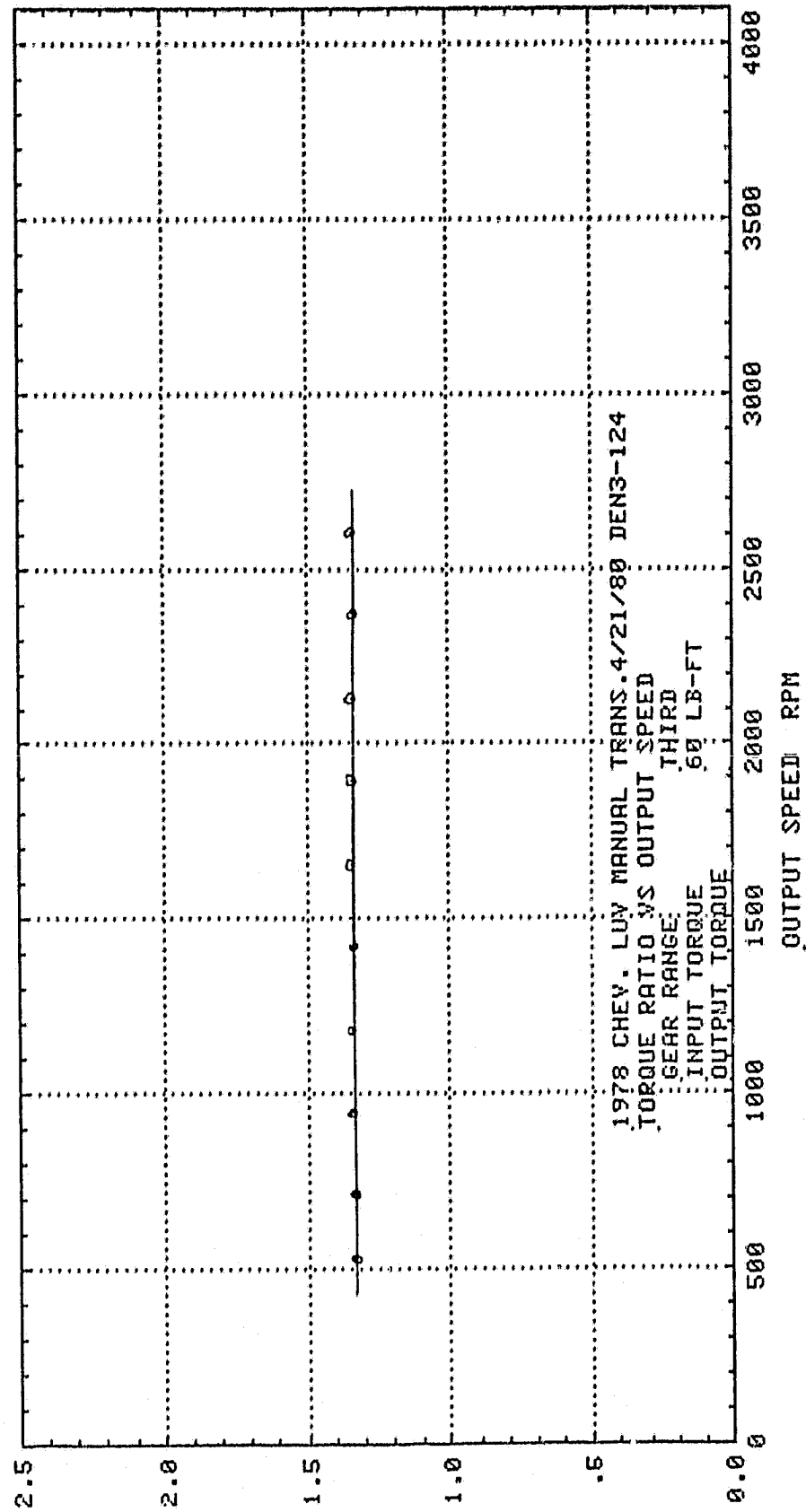

TORQUE RATIO $\frac{T_o}{T_i}$

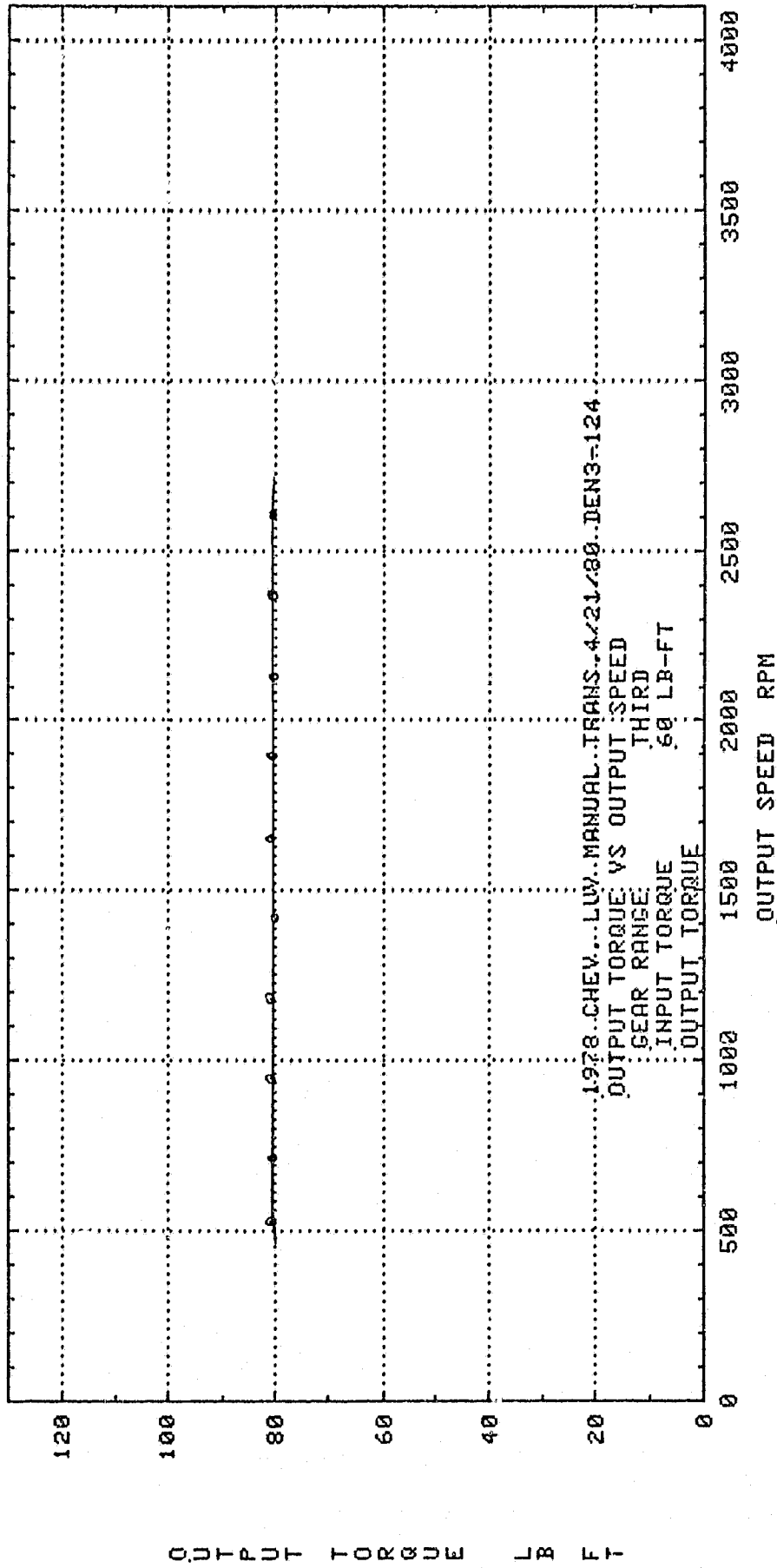

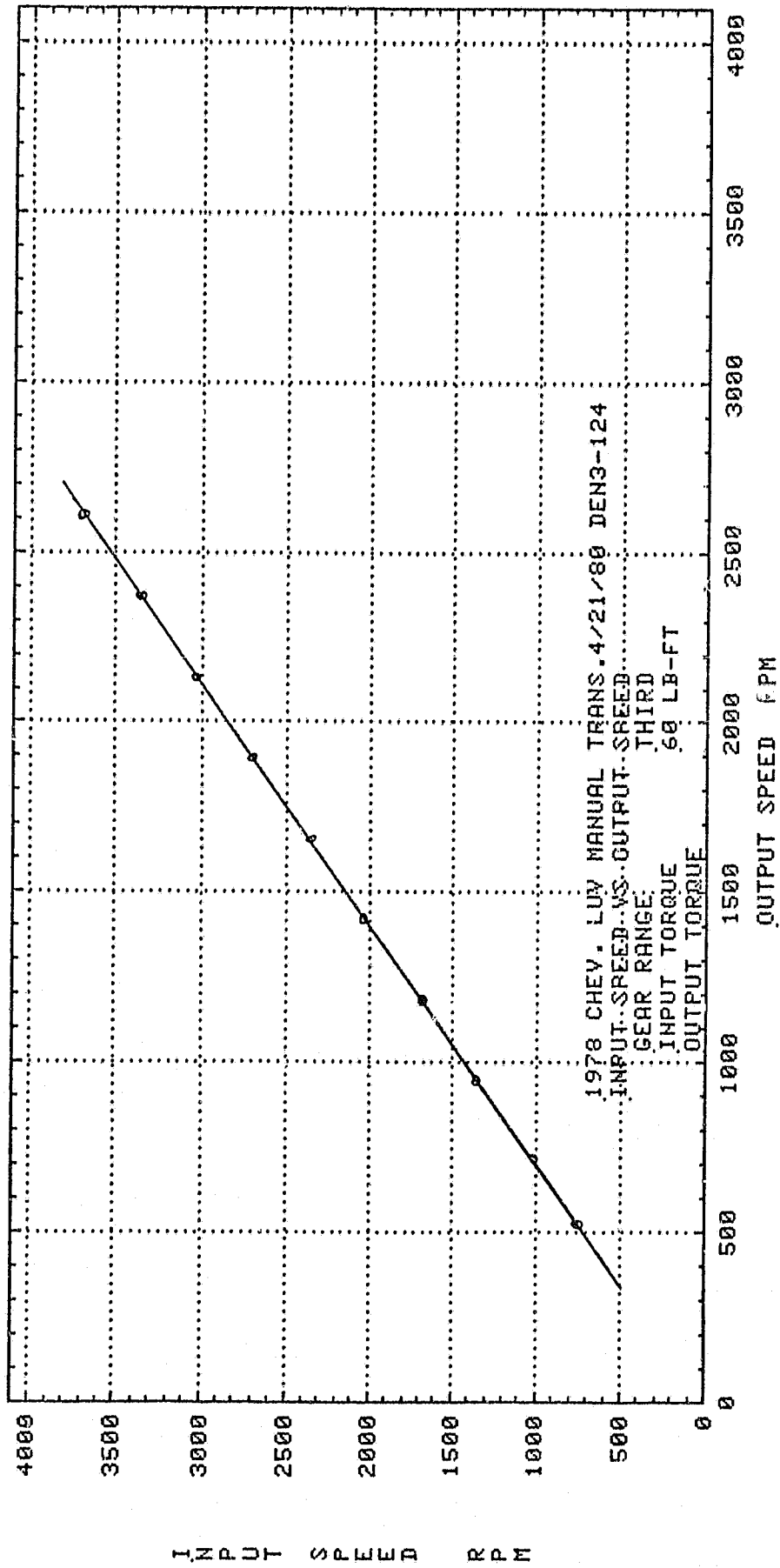

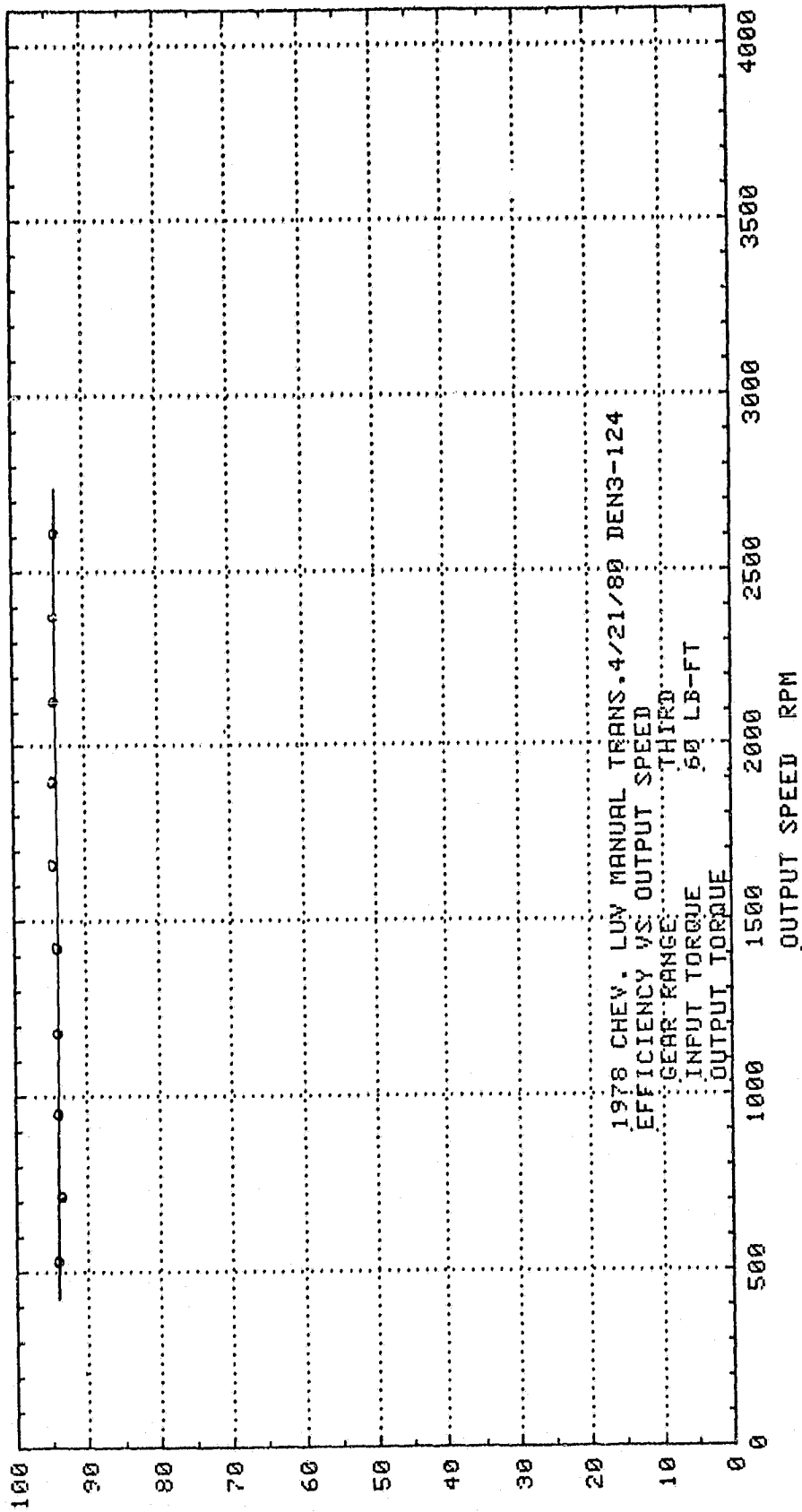

EFFICIENCY %

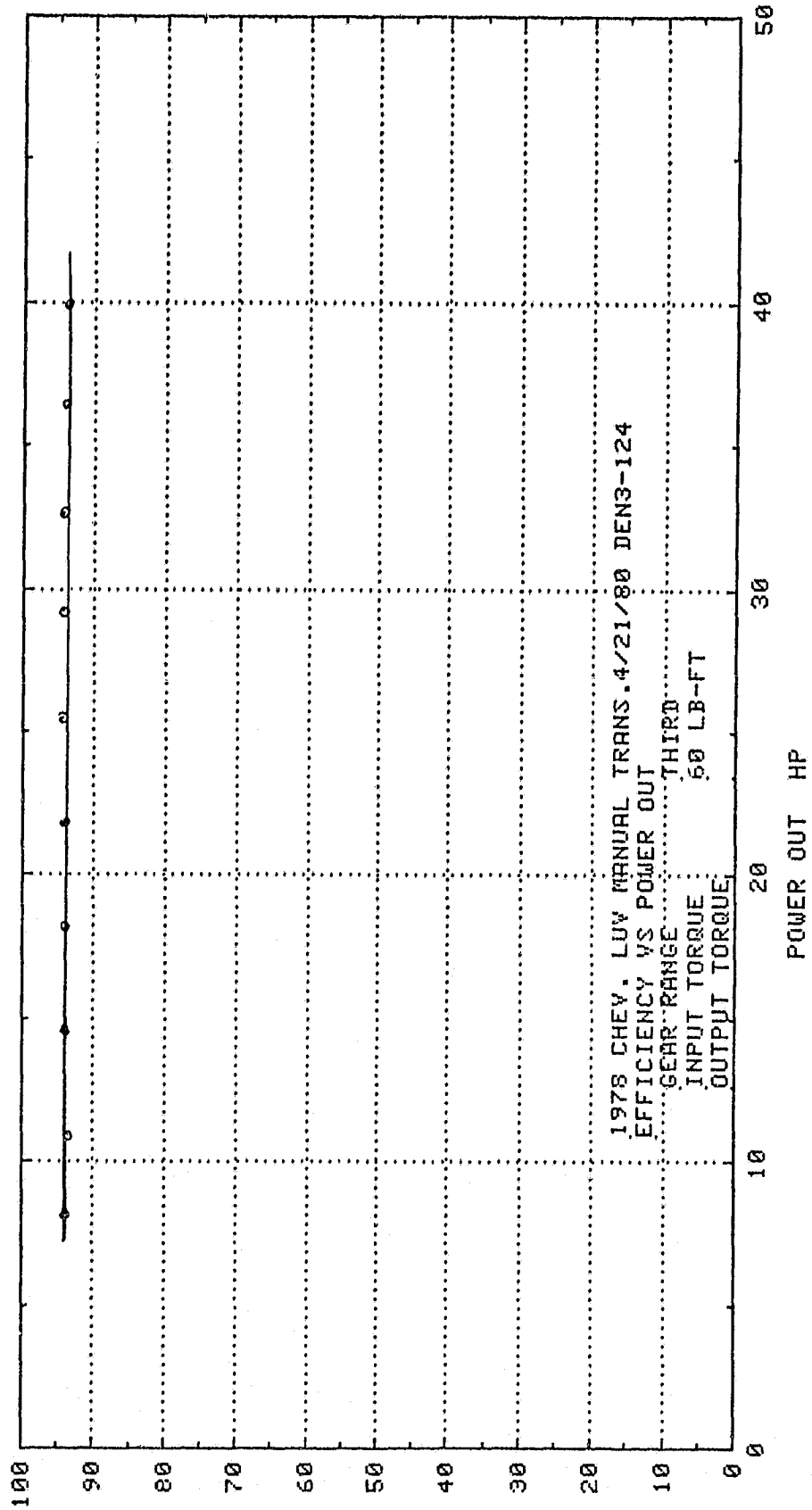

EFFICIENCY %

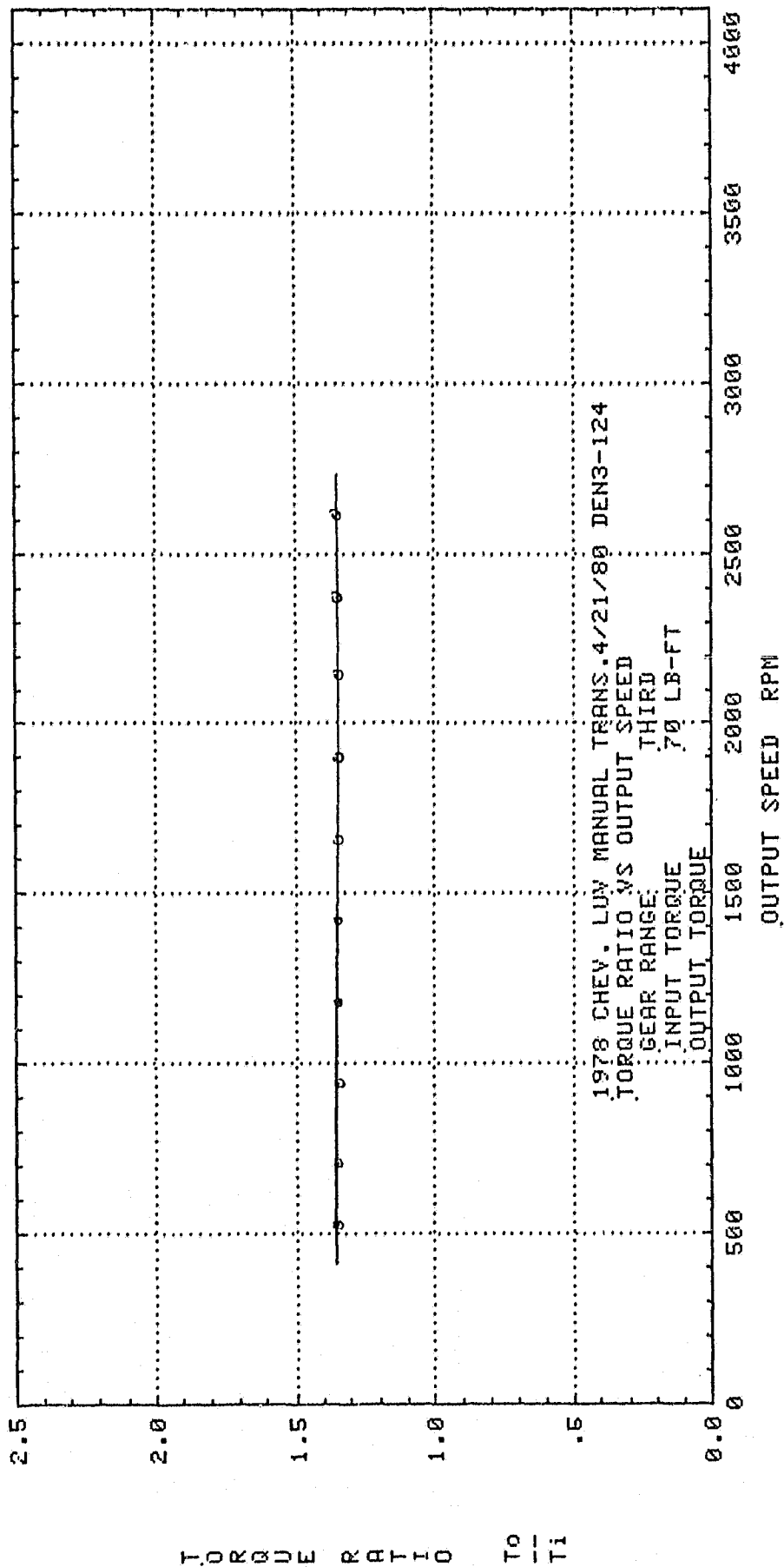

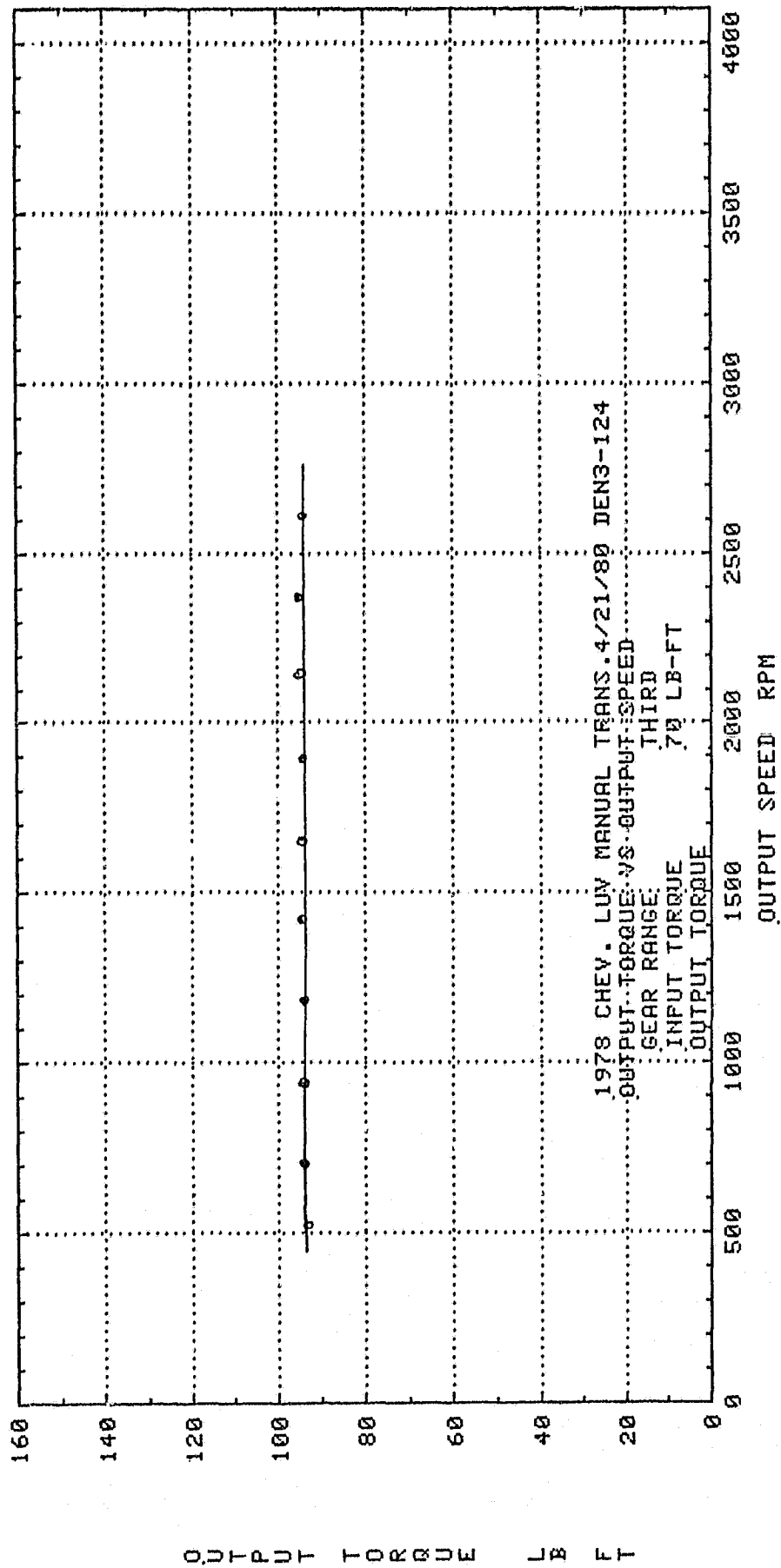

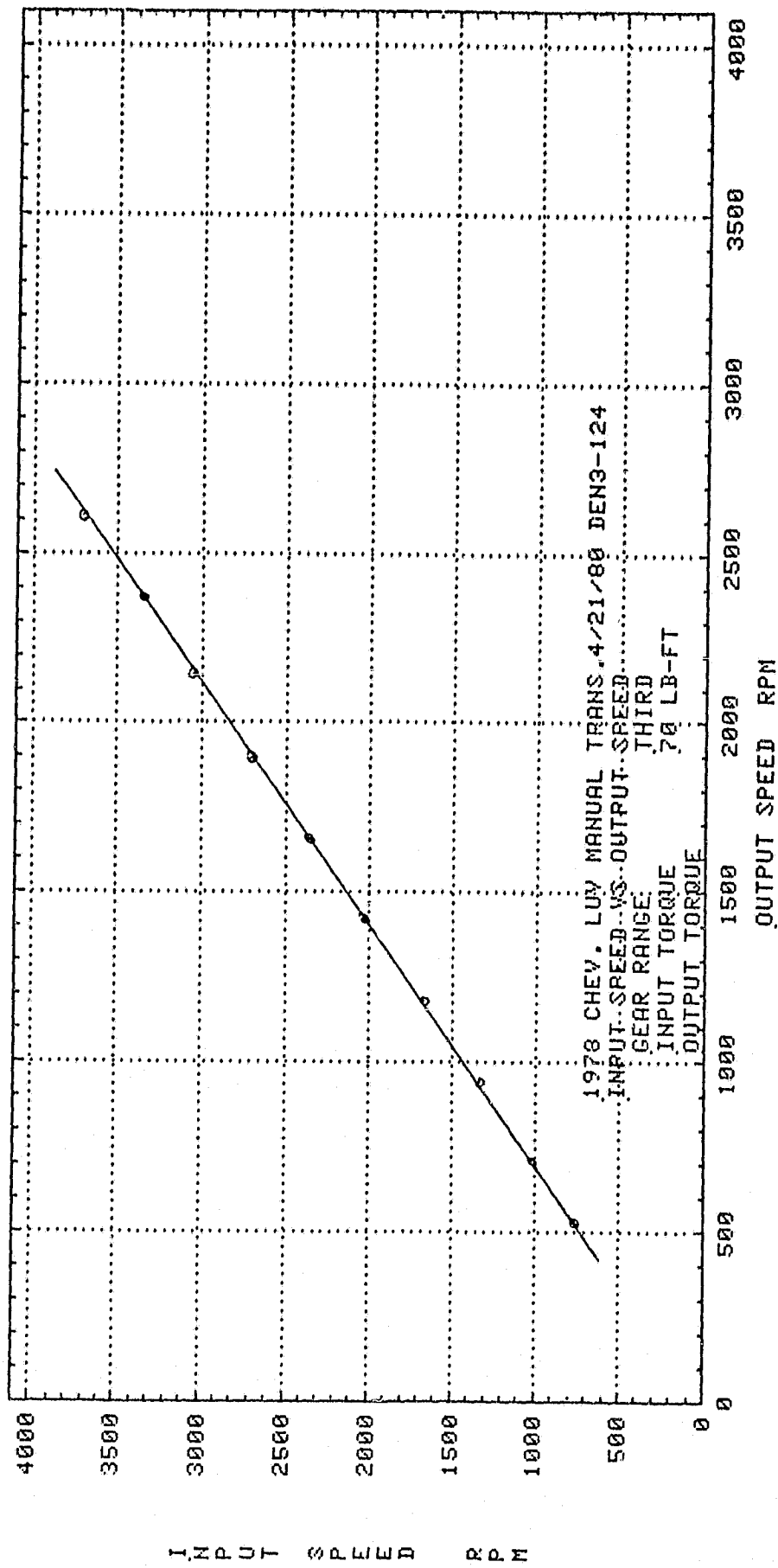

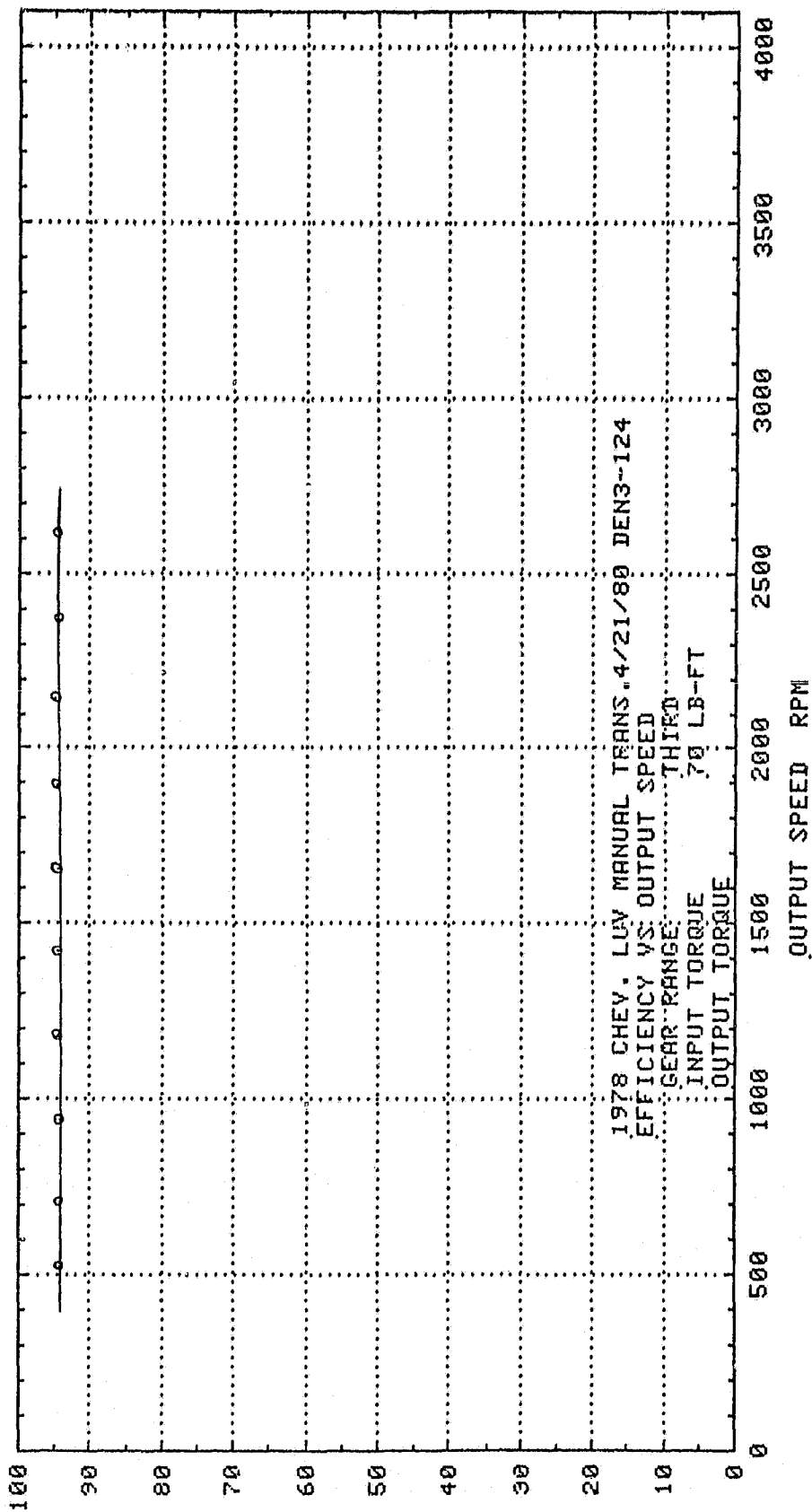

EFFICIENCY %

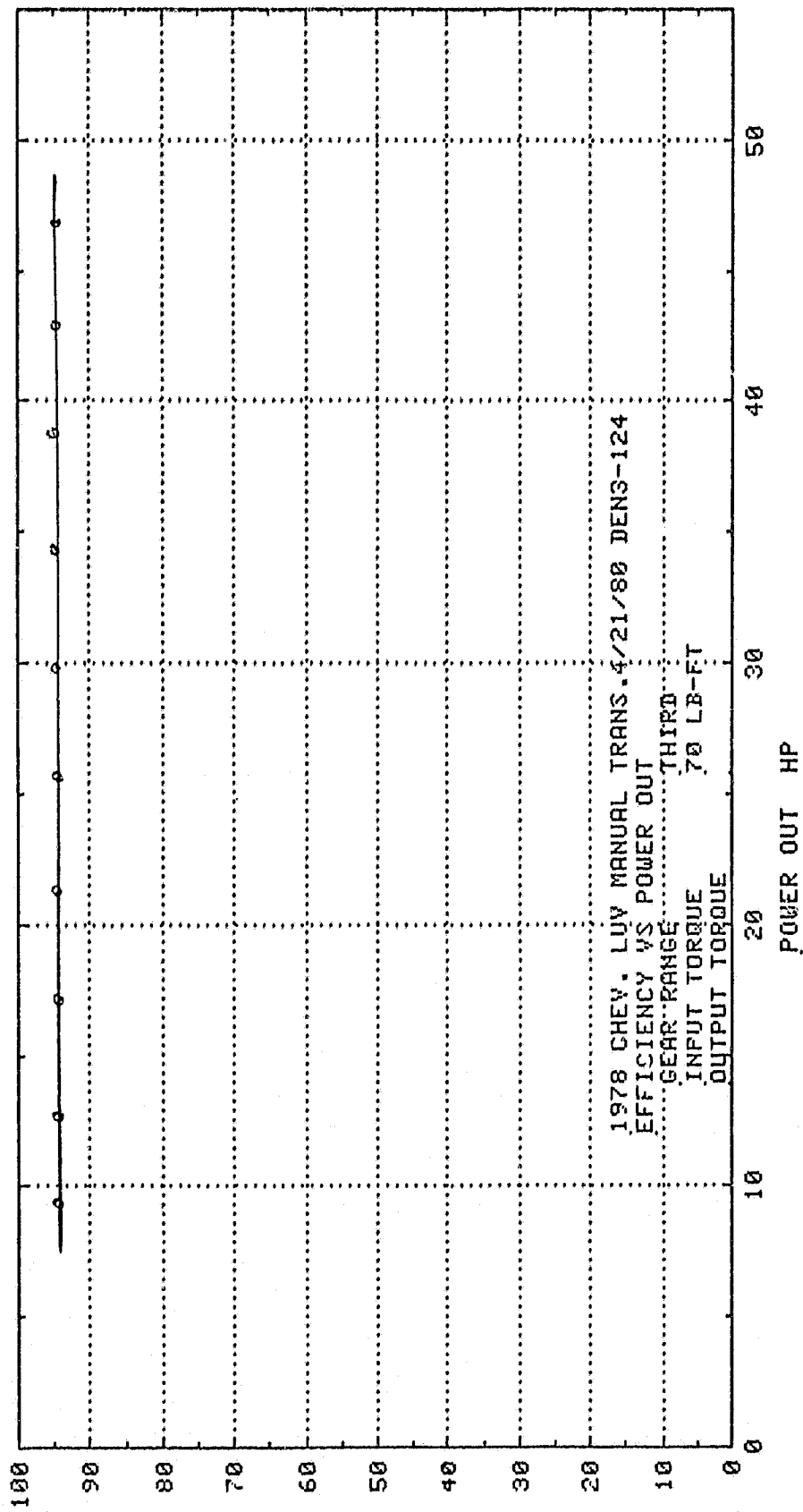

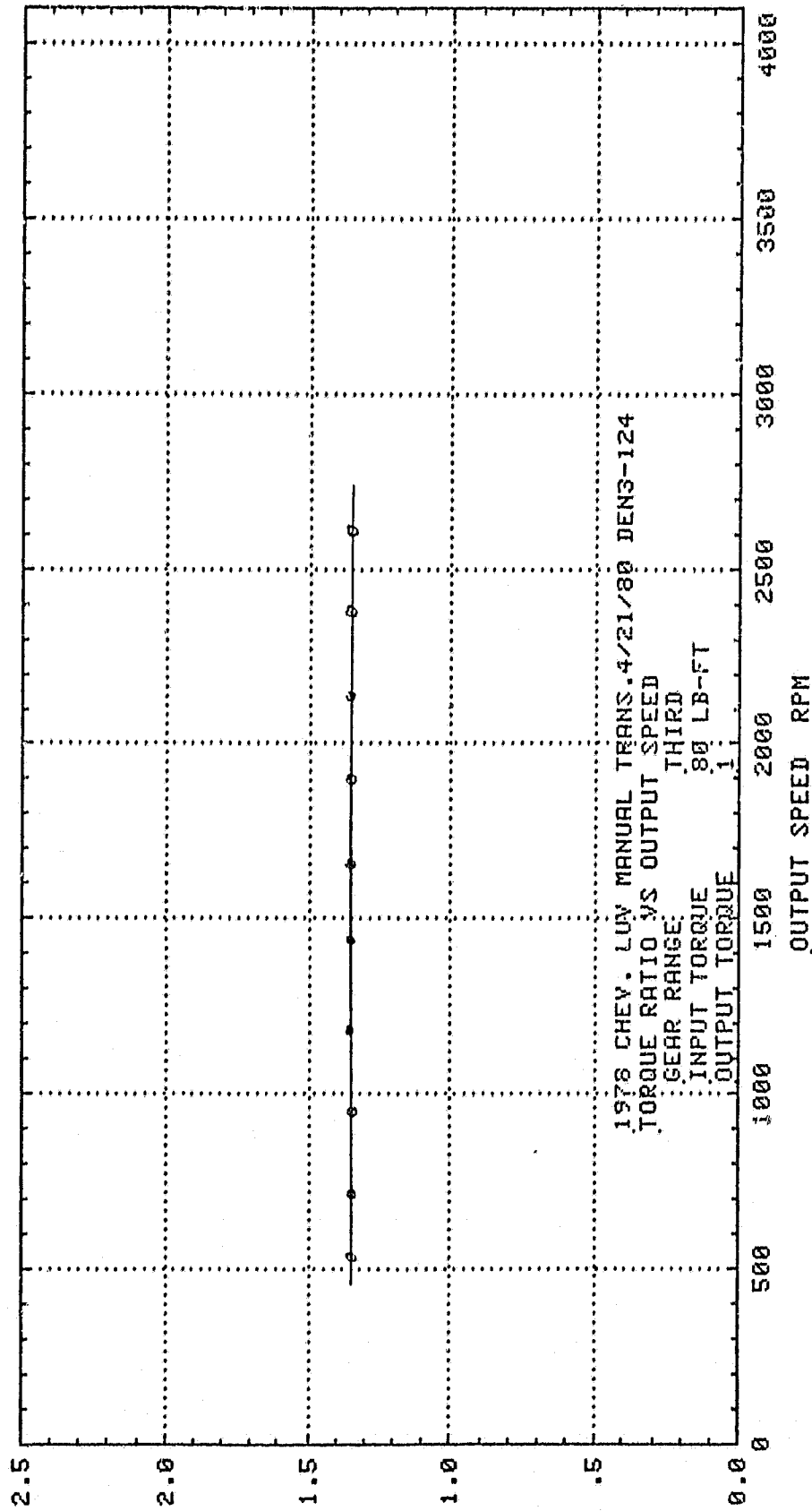

TORQUE RATIO $\frac{T_o}{T_i}$

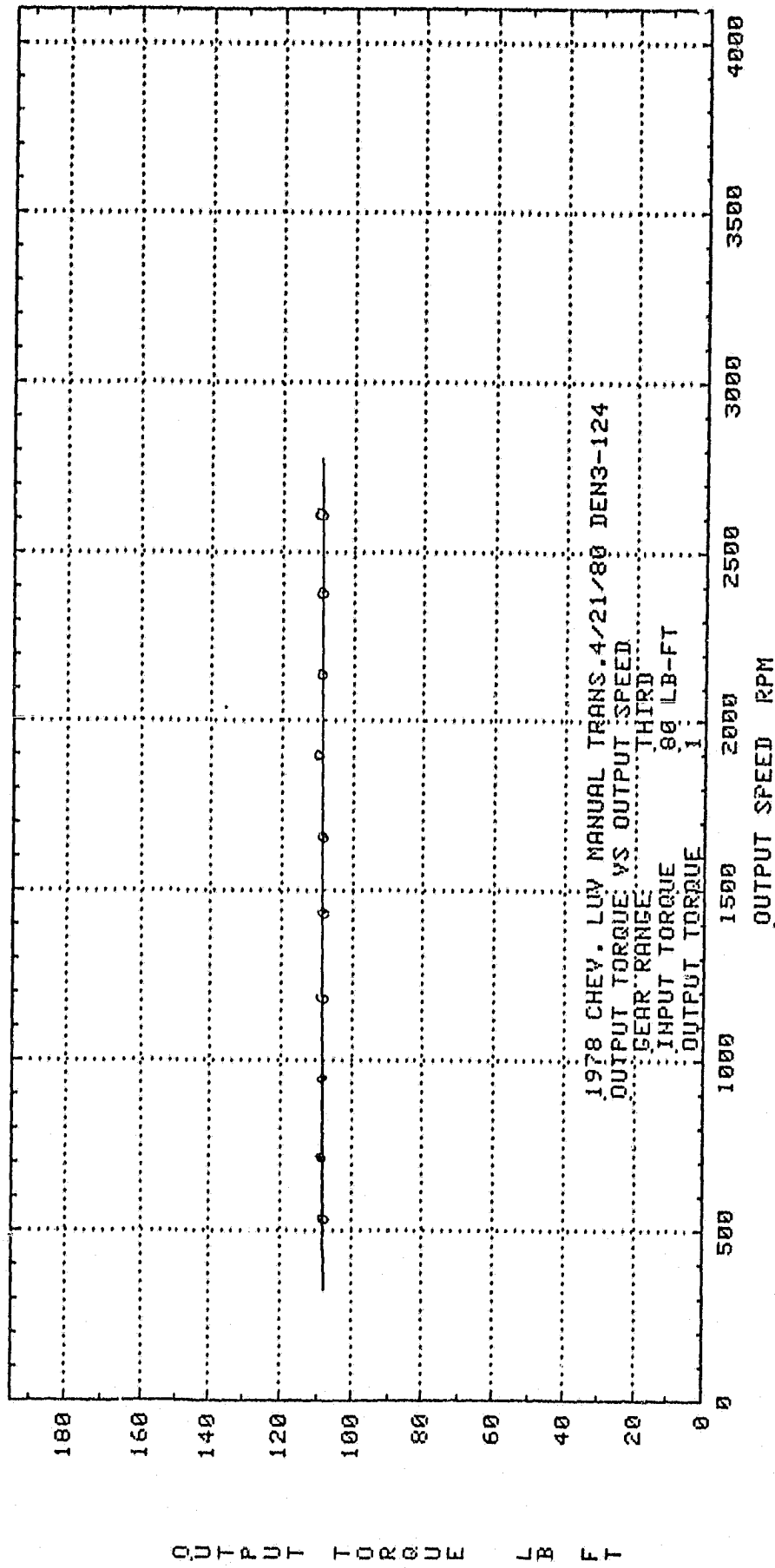

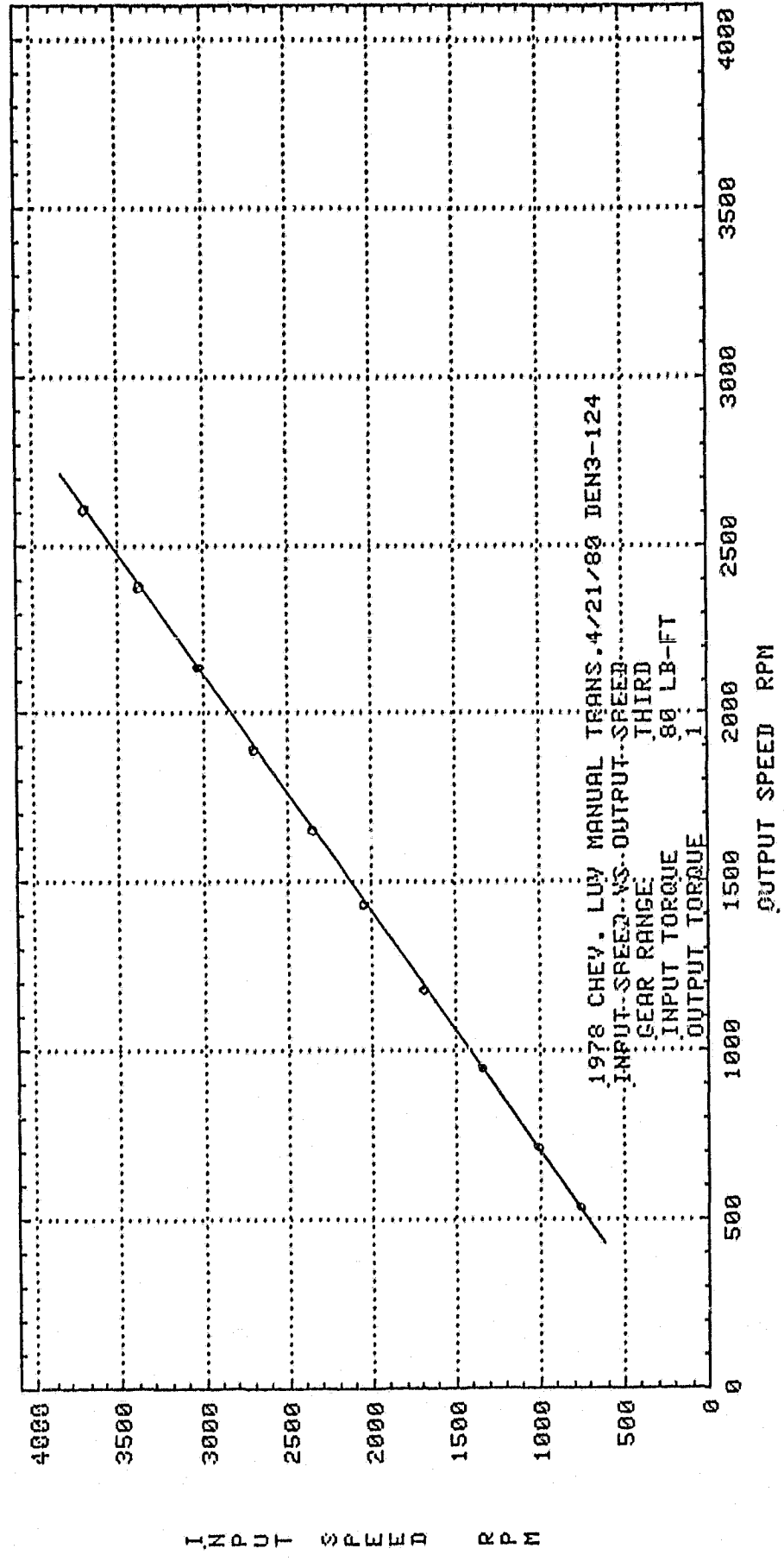

INPUT SPEED RPM

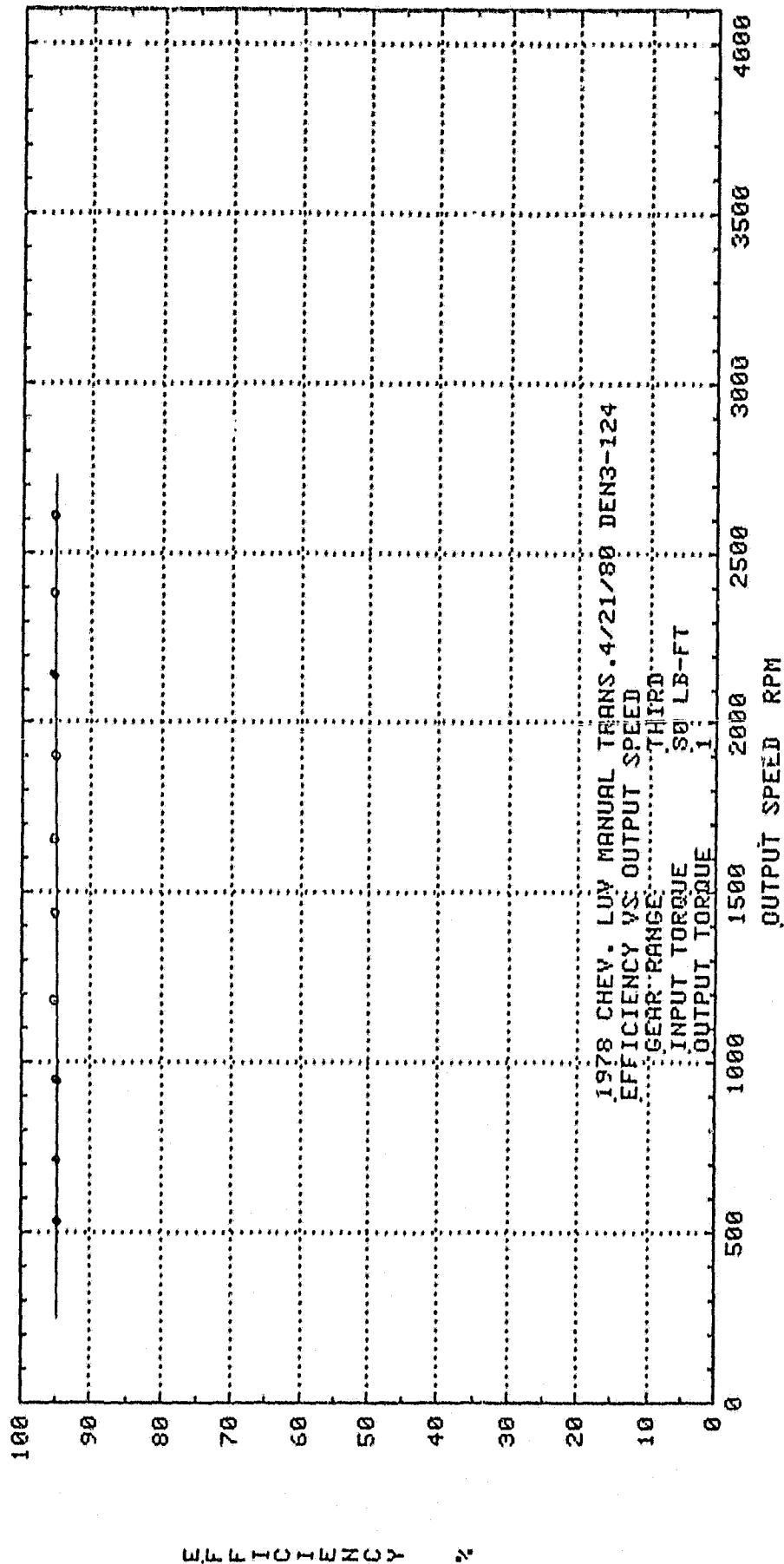

EFFICIENCY %

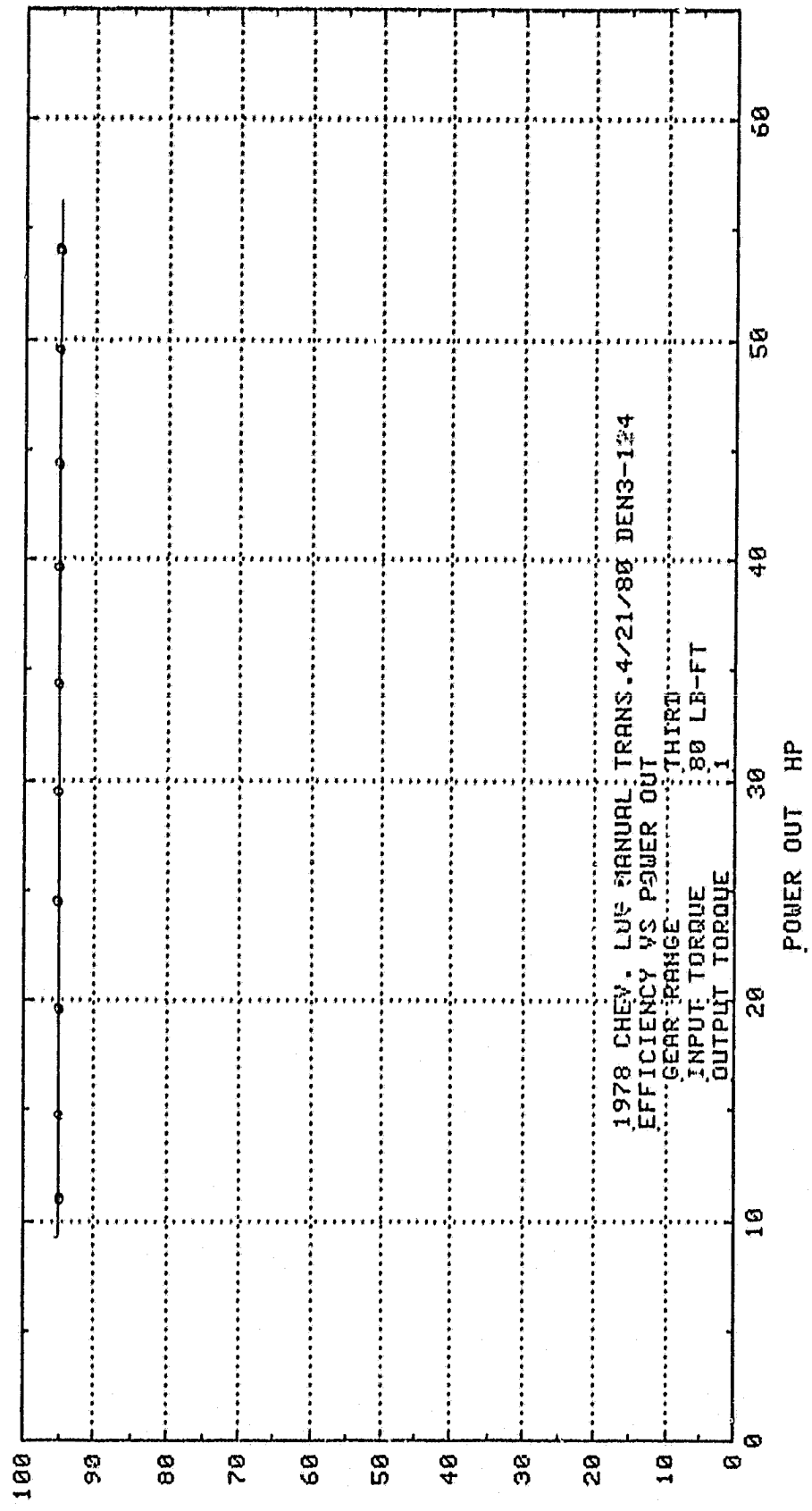

EFFICIENCY %

TORQUE RATIO $\frac{T_o}{T_i}$

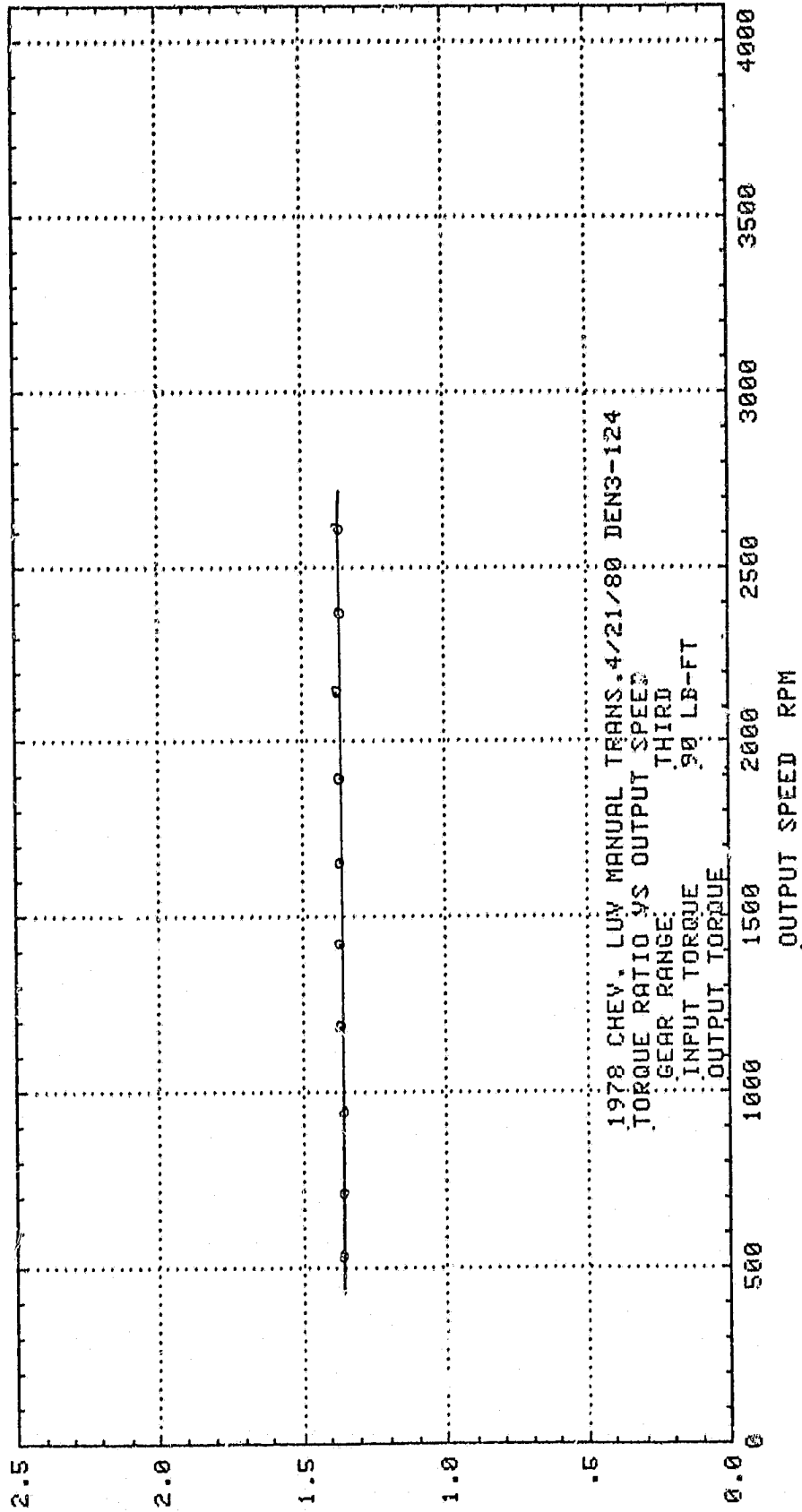

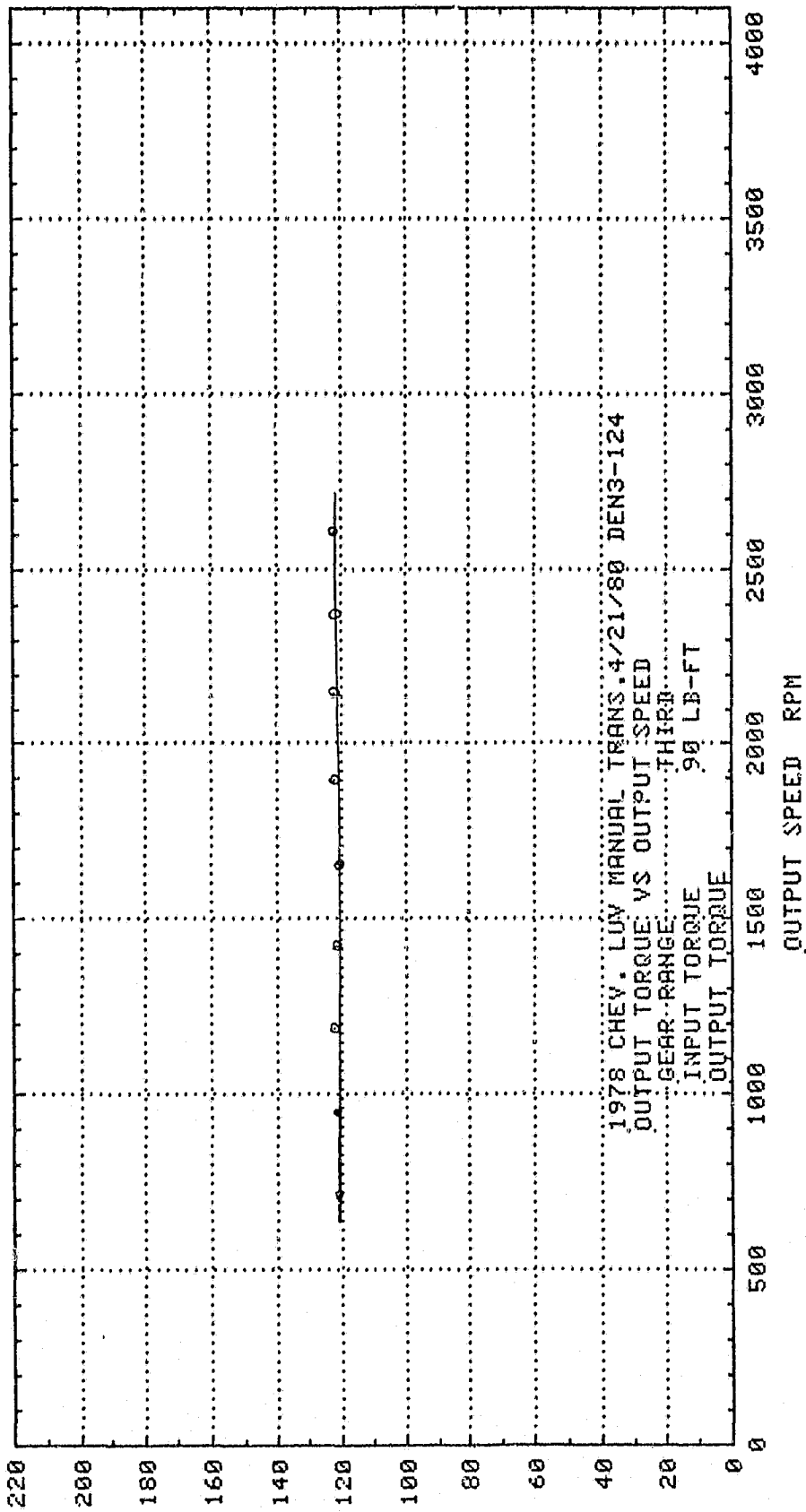

OUTPUT TORQUE LB FT

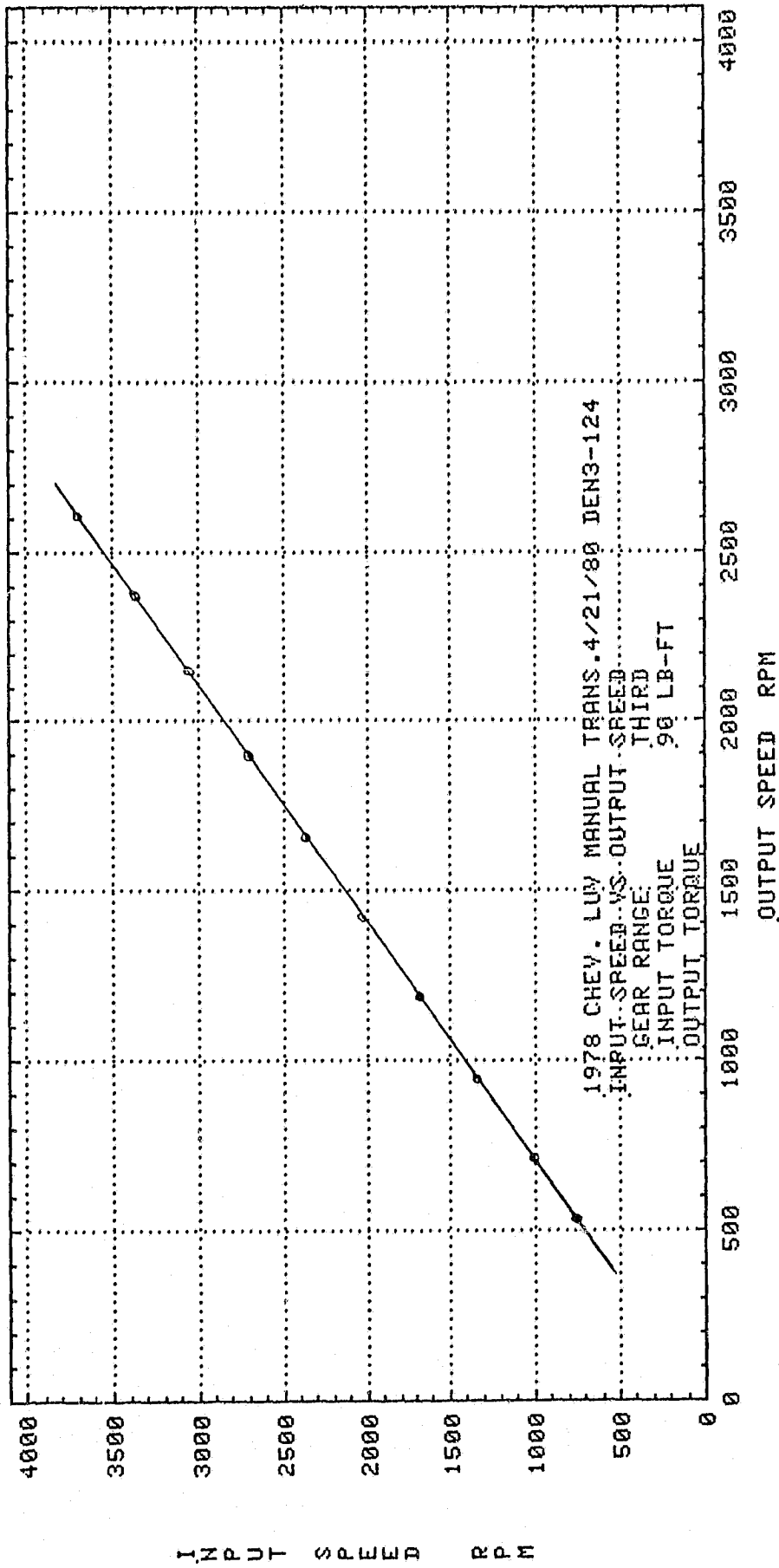

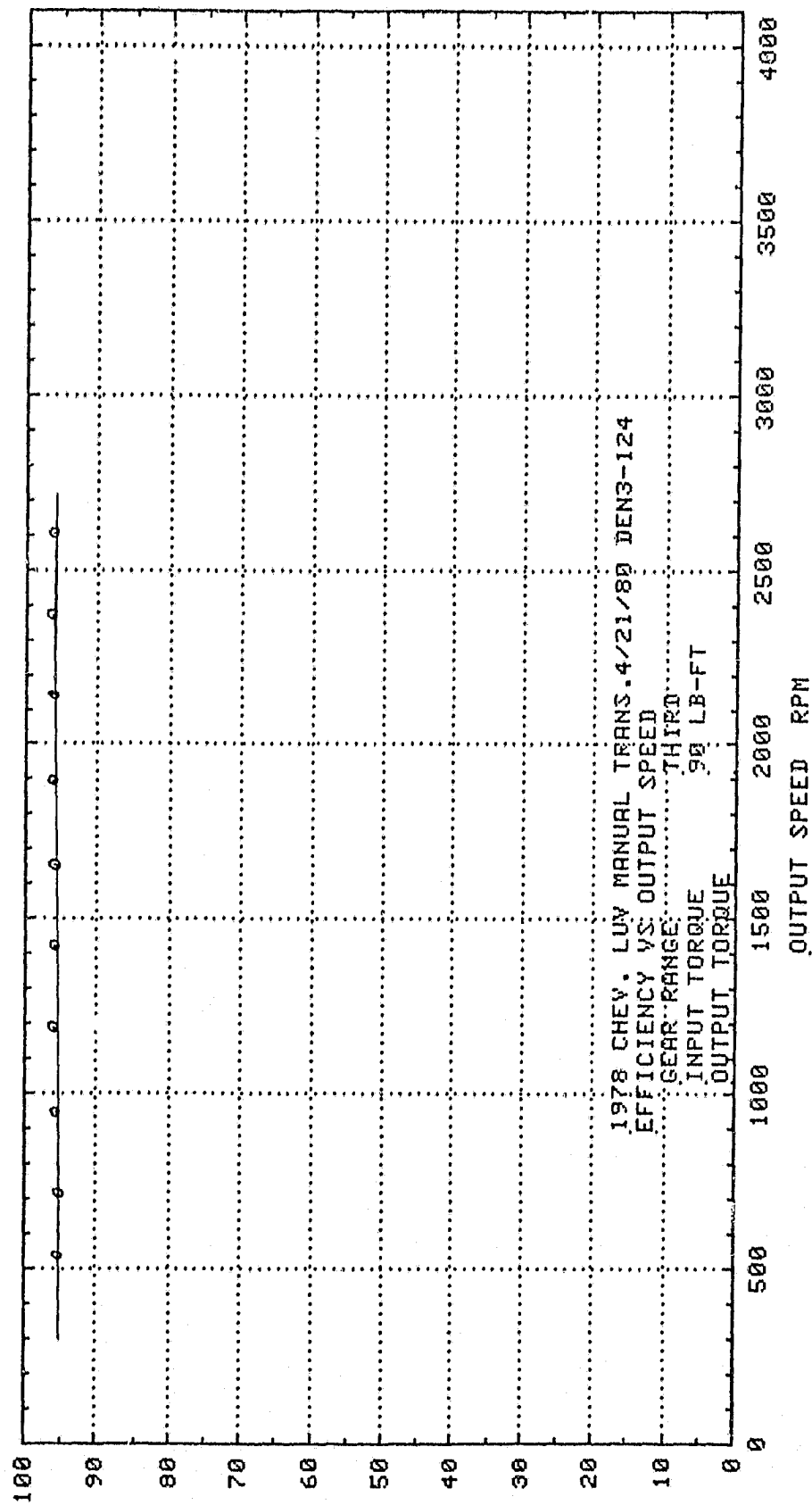

EFFICIENCY %

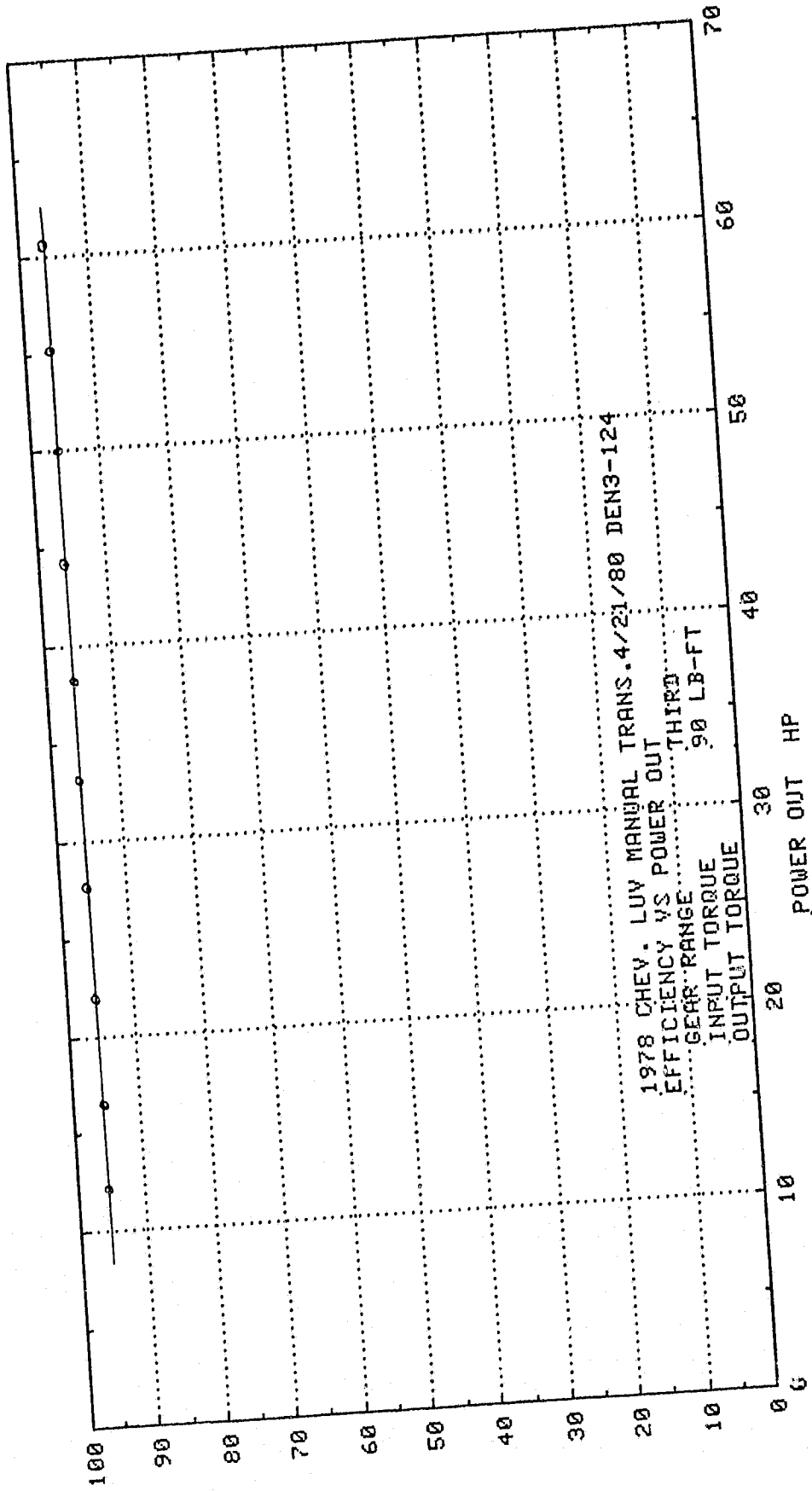

EFFICIENCY %

DRIVE PERFORMANCE

4TH GEAR

Graphs Contained in This Section

- Torque Ratio -vs- Output Speed
- Output Torque -vs- Output Speed
- Input Speed -vs- Output Speed
- Efficiency -vs- Output Speed
- Efficiency -vs- Power Out

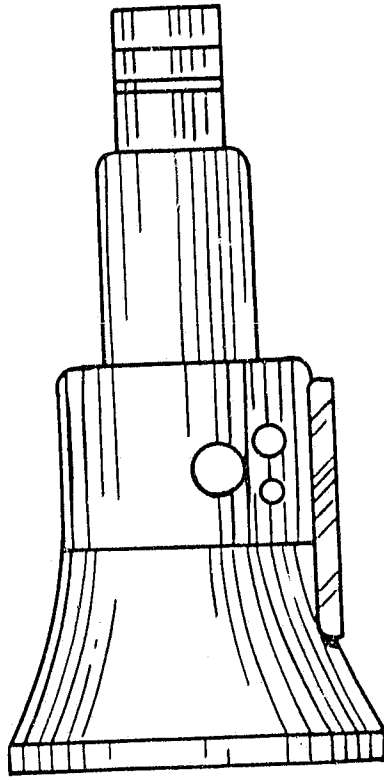

Torque In
Speed In

Torque Out
Speed Out

Drive Performance Tests

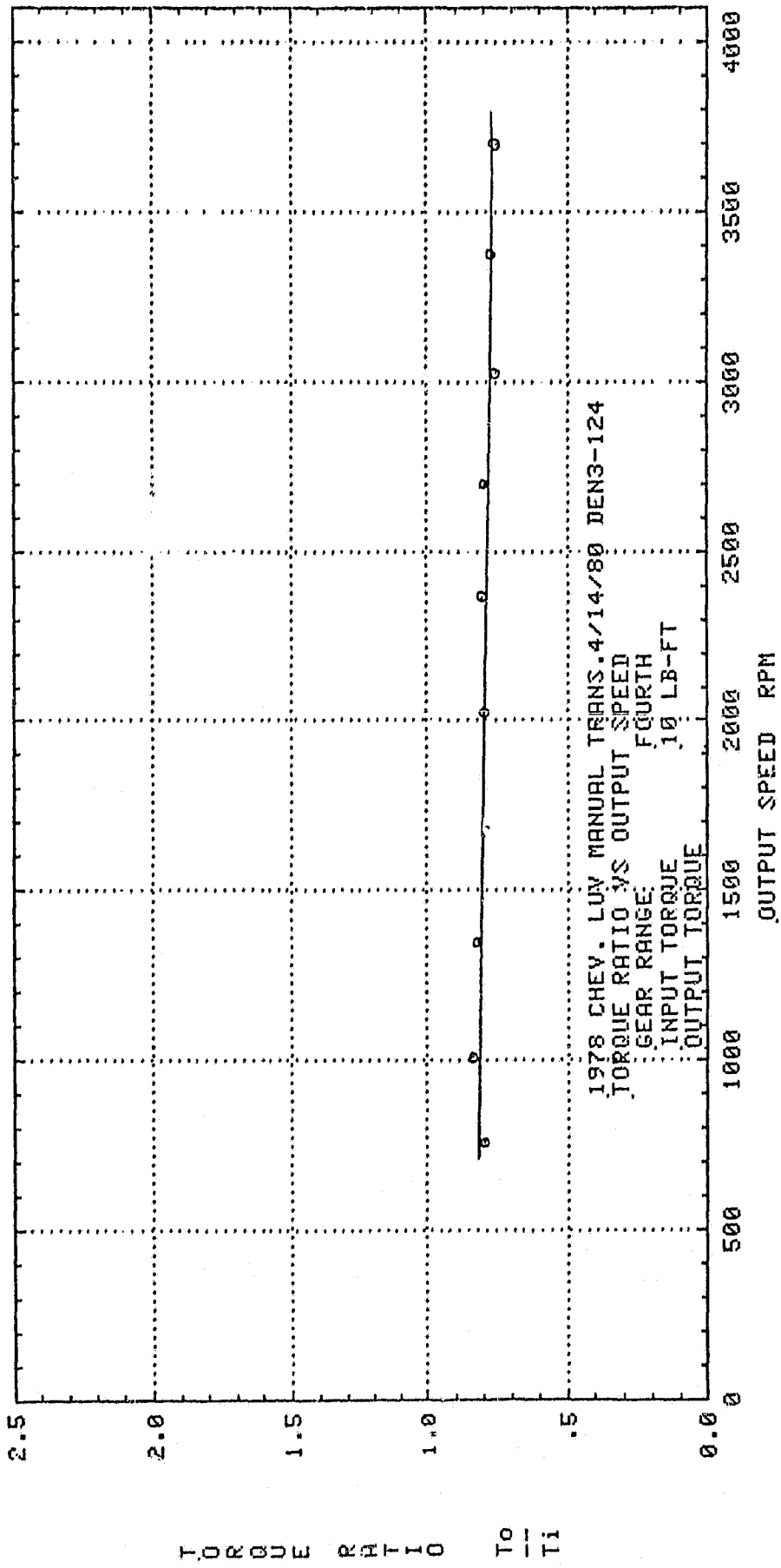

OUTPUT TORQUE LB FT

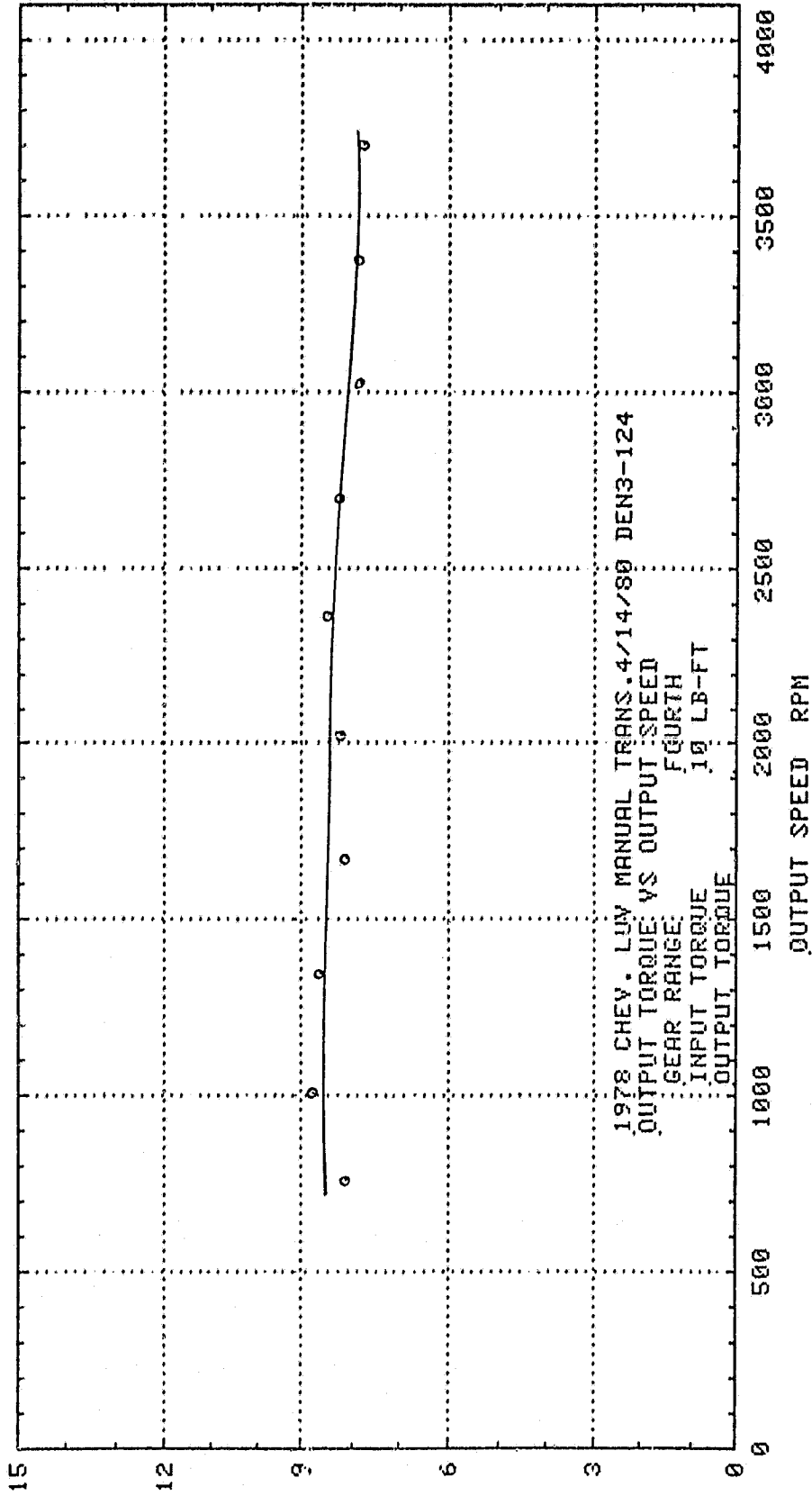

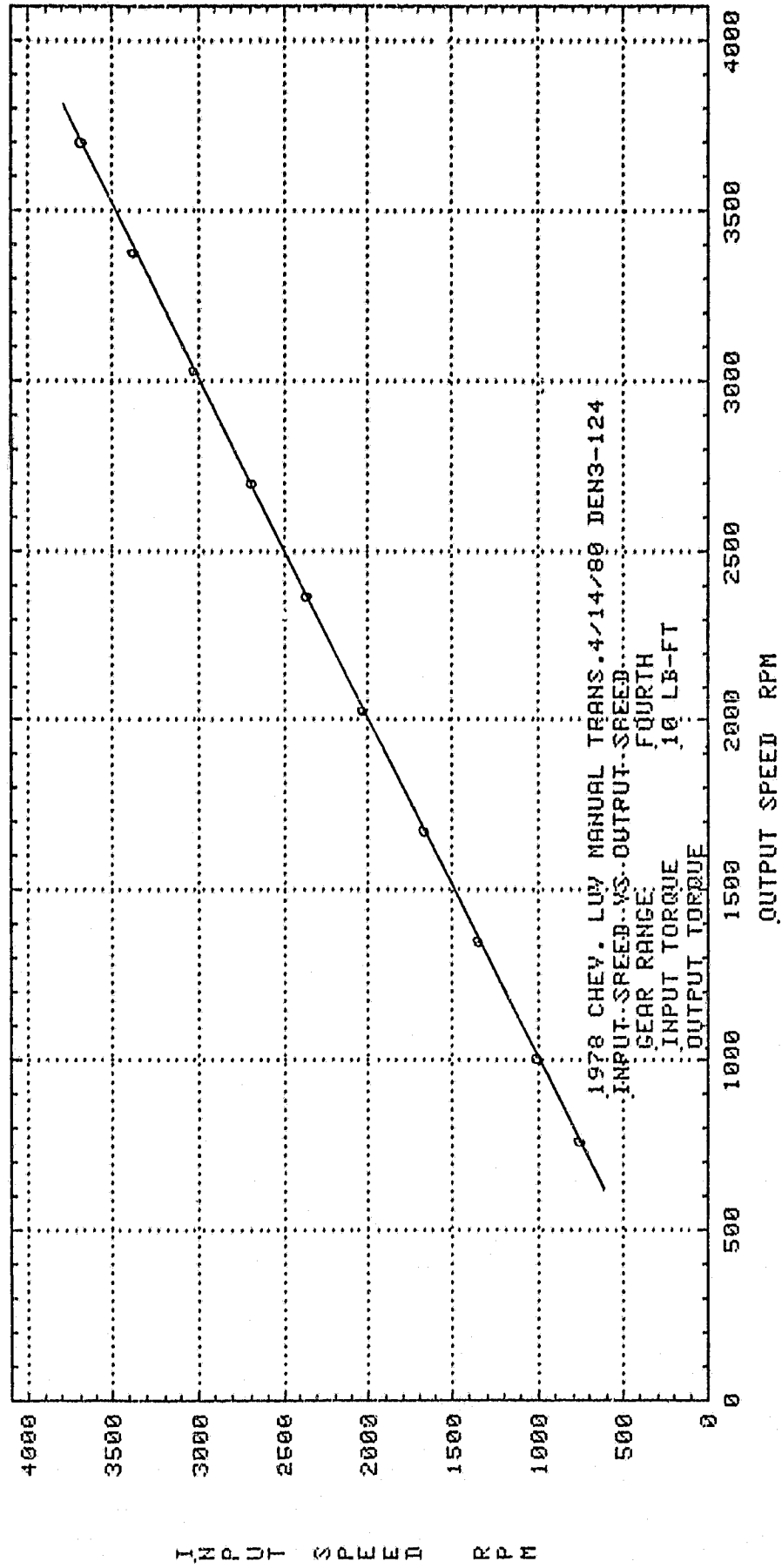

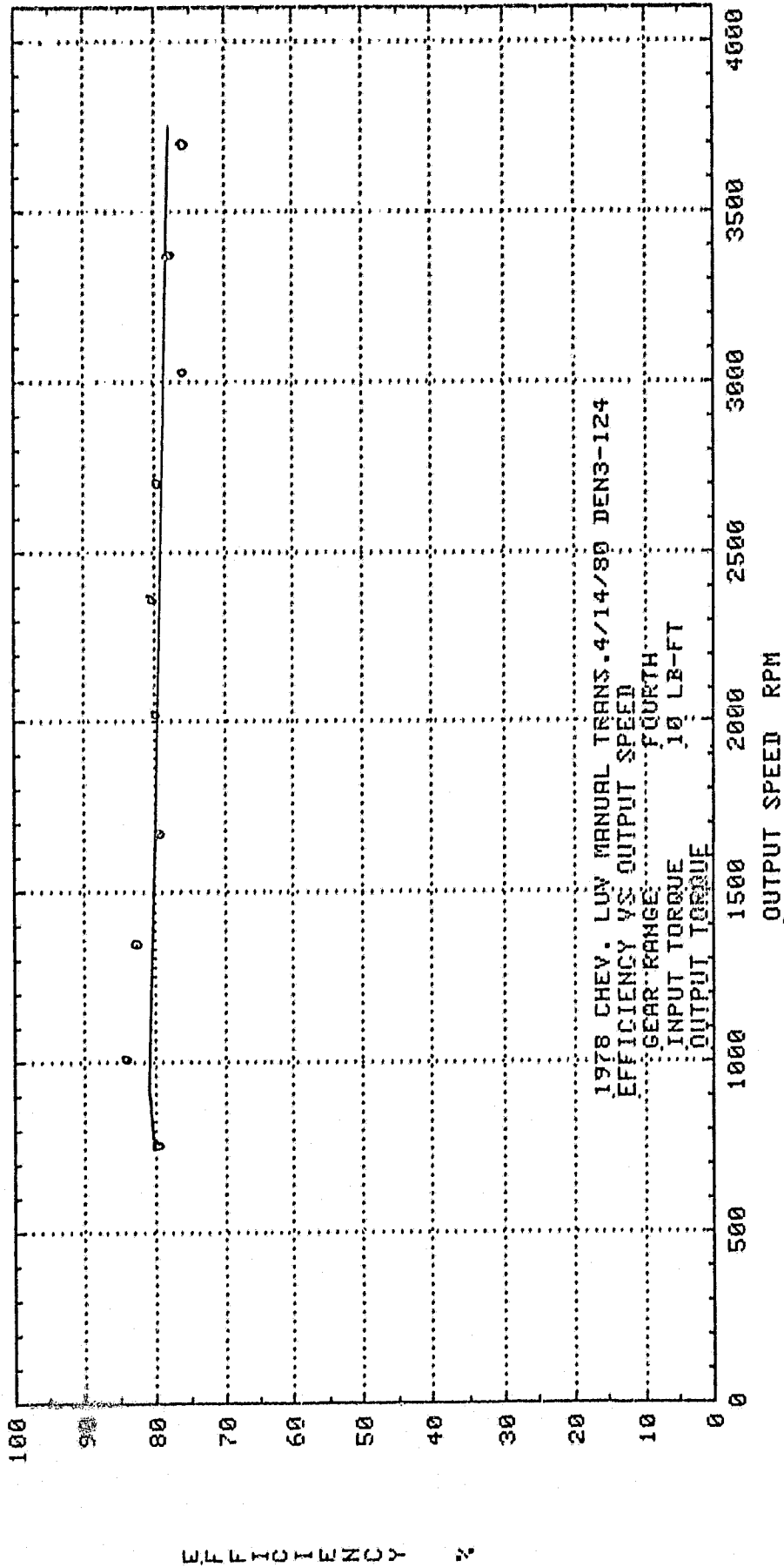

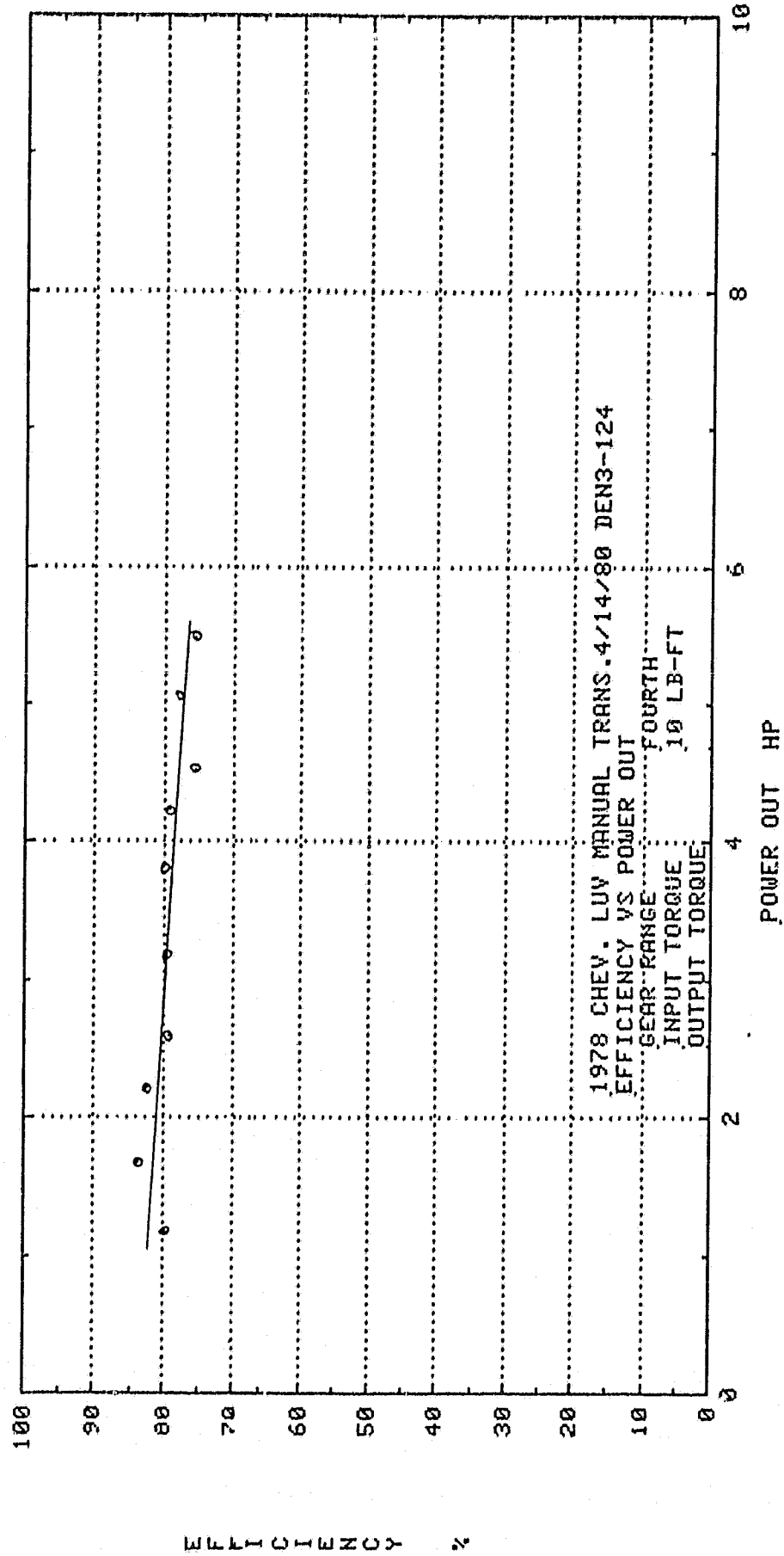

EFFICIENCY %

TORQUE RATIO $\frac{T_o}{T_i}$

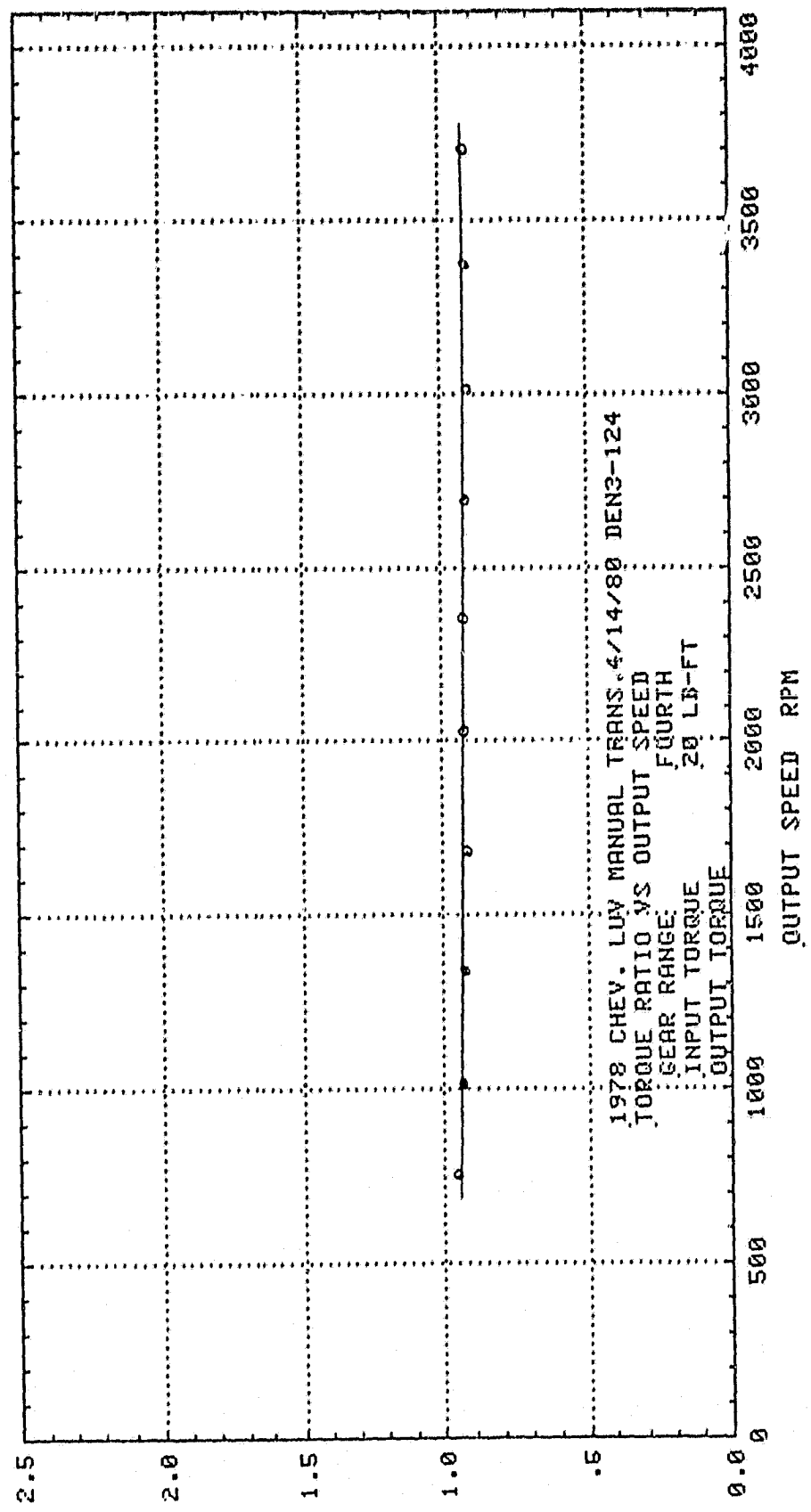

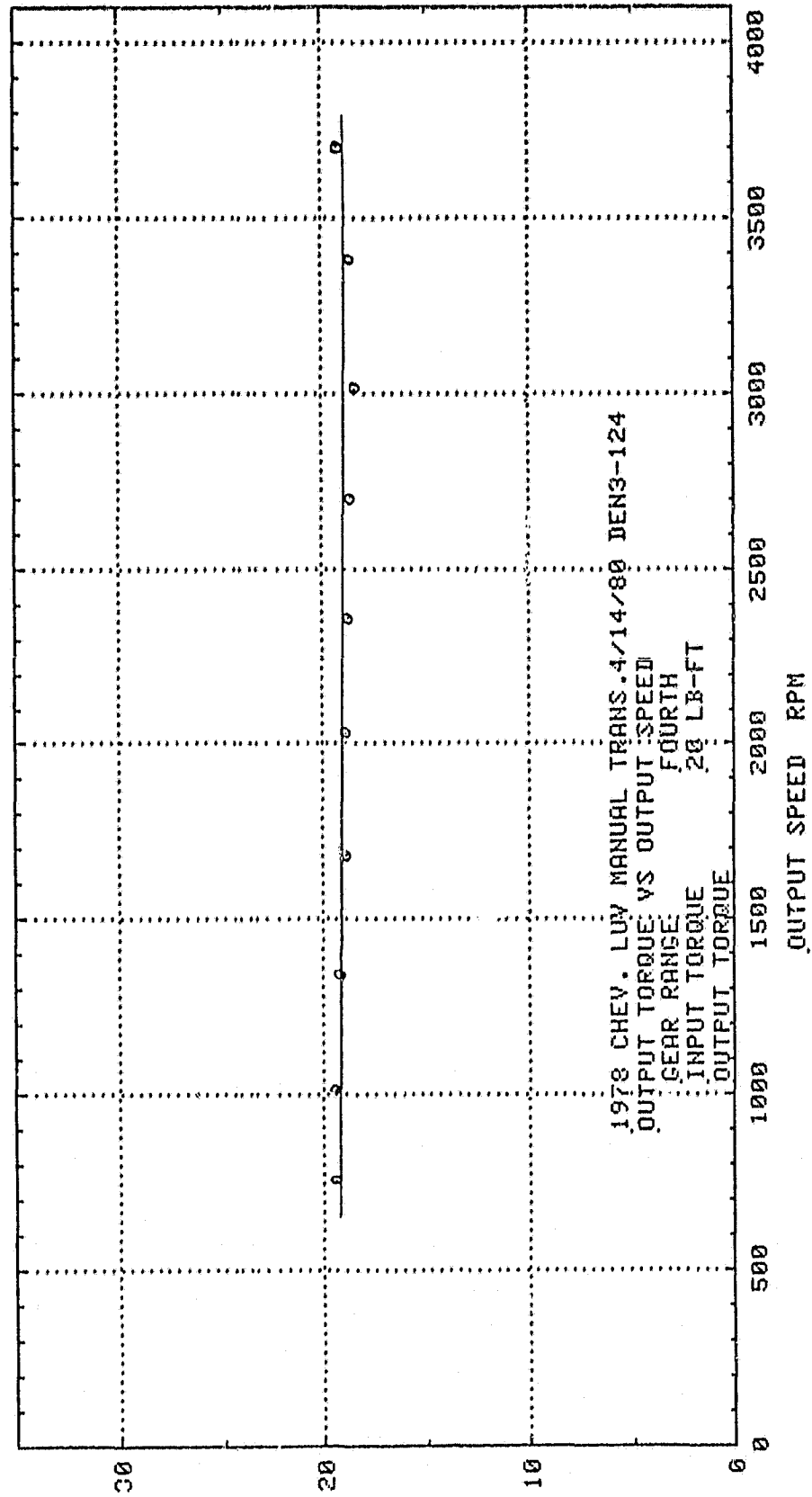

OUTPUT TORQUE LB FT

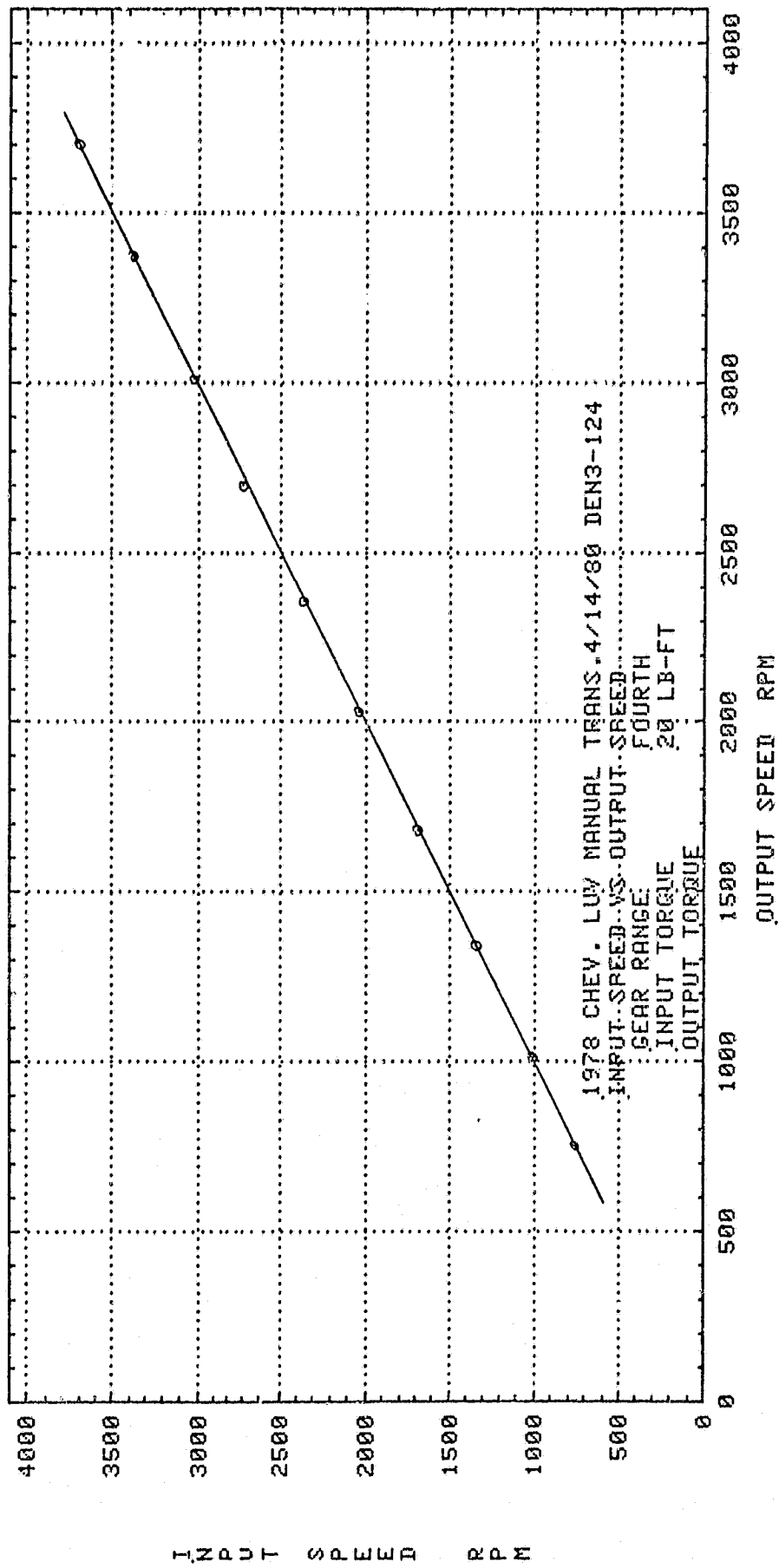

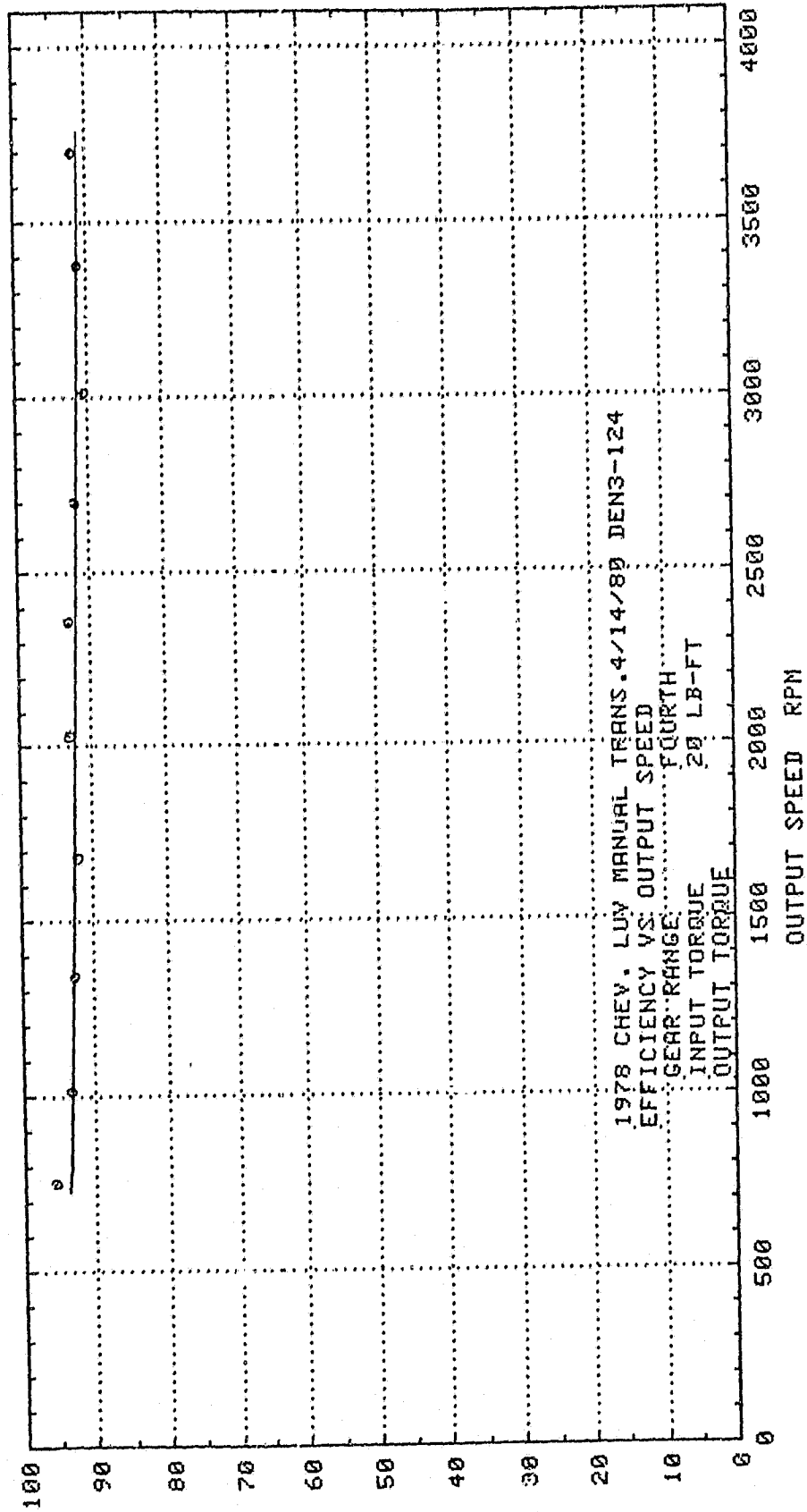

EFFICIENCY %

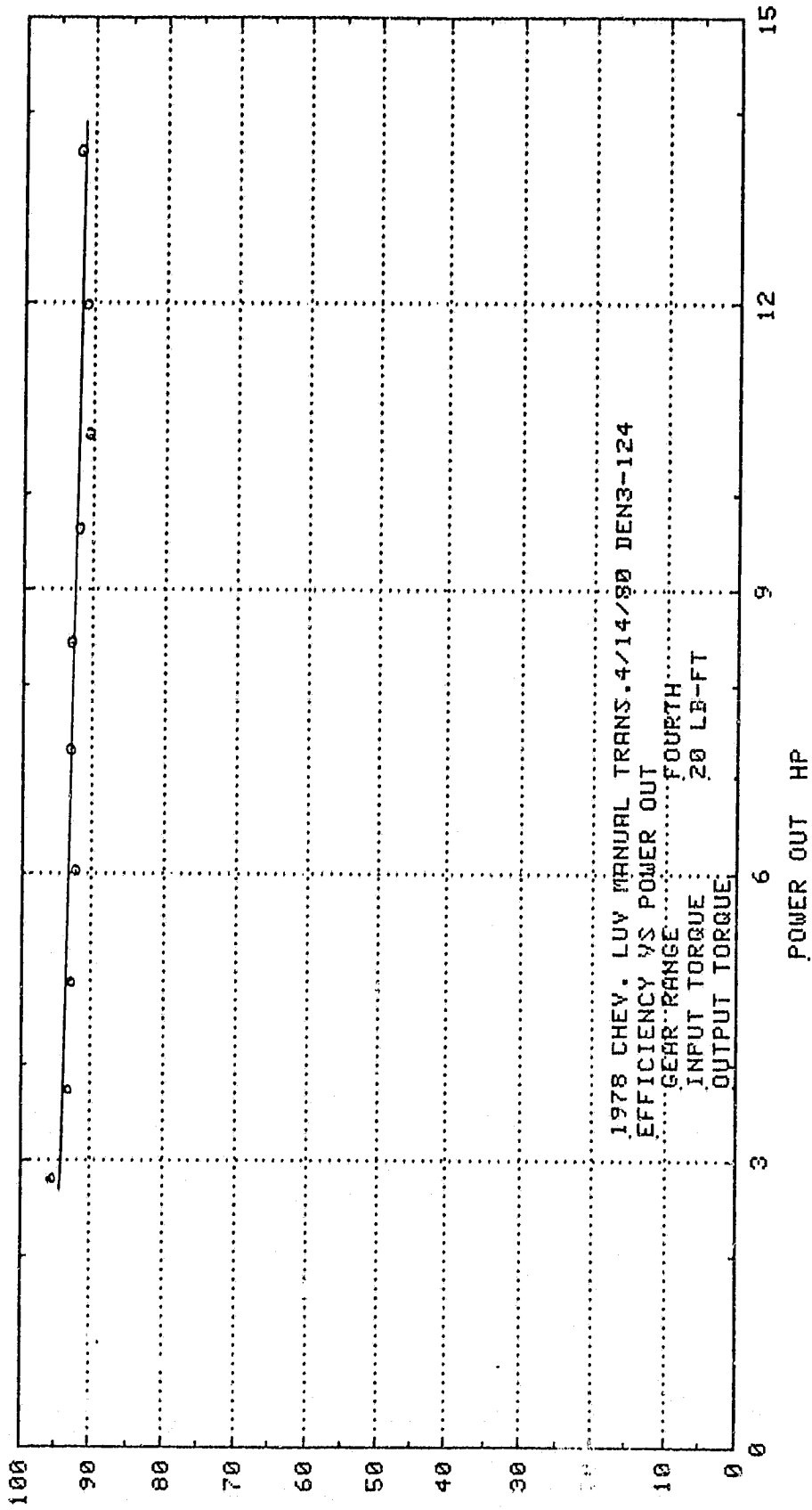

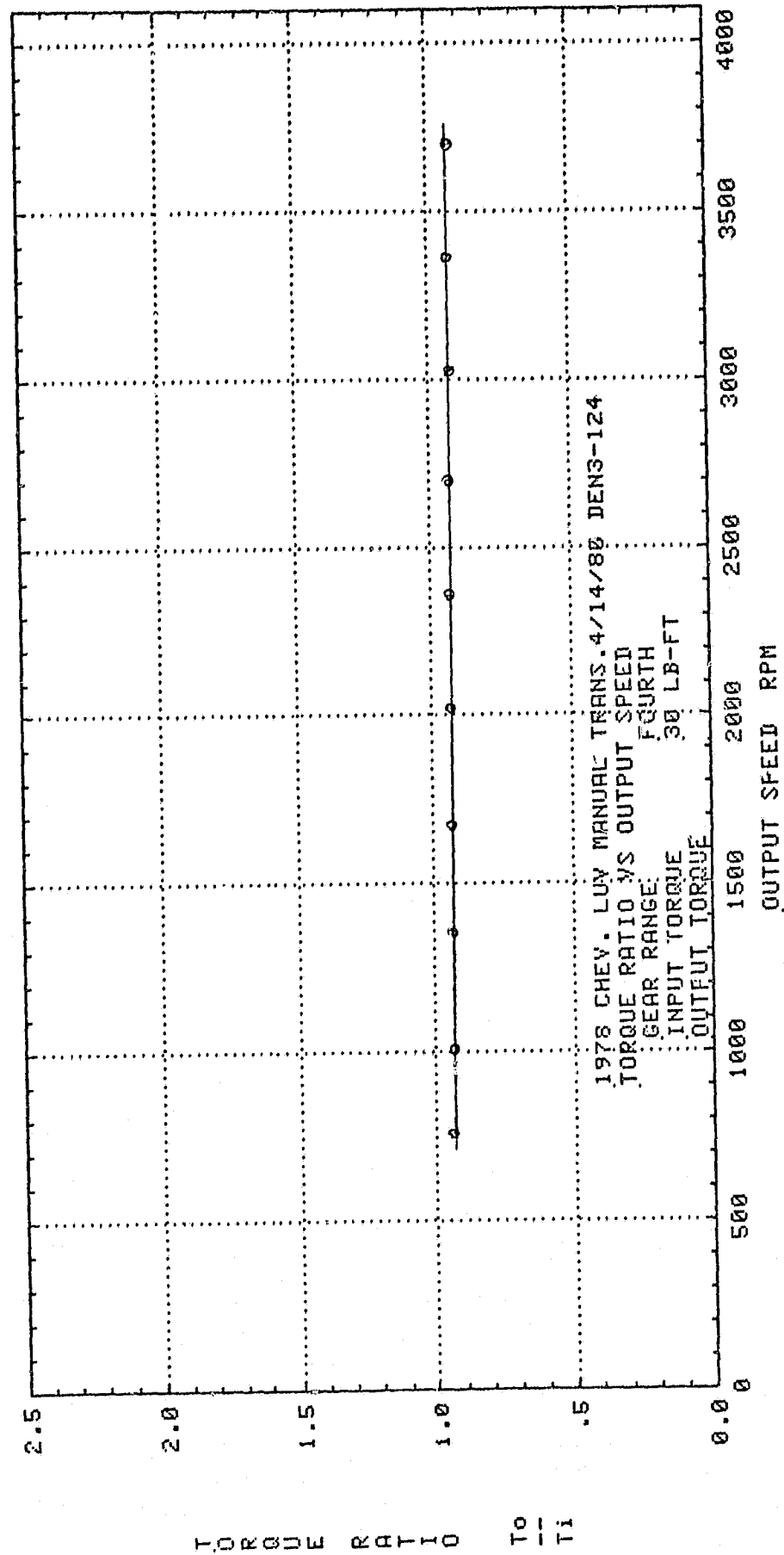

TORQUE RATIO $\frac{T_o}{T_i}$

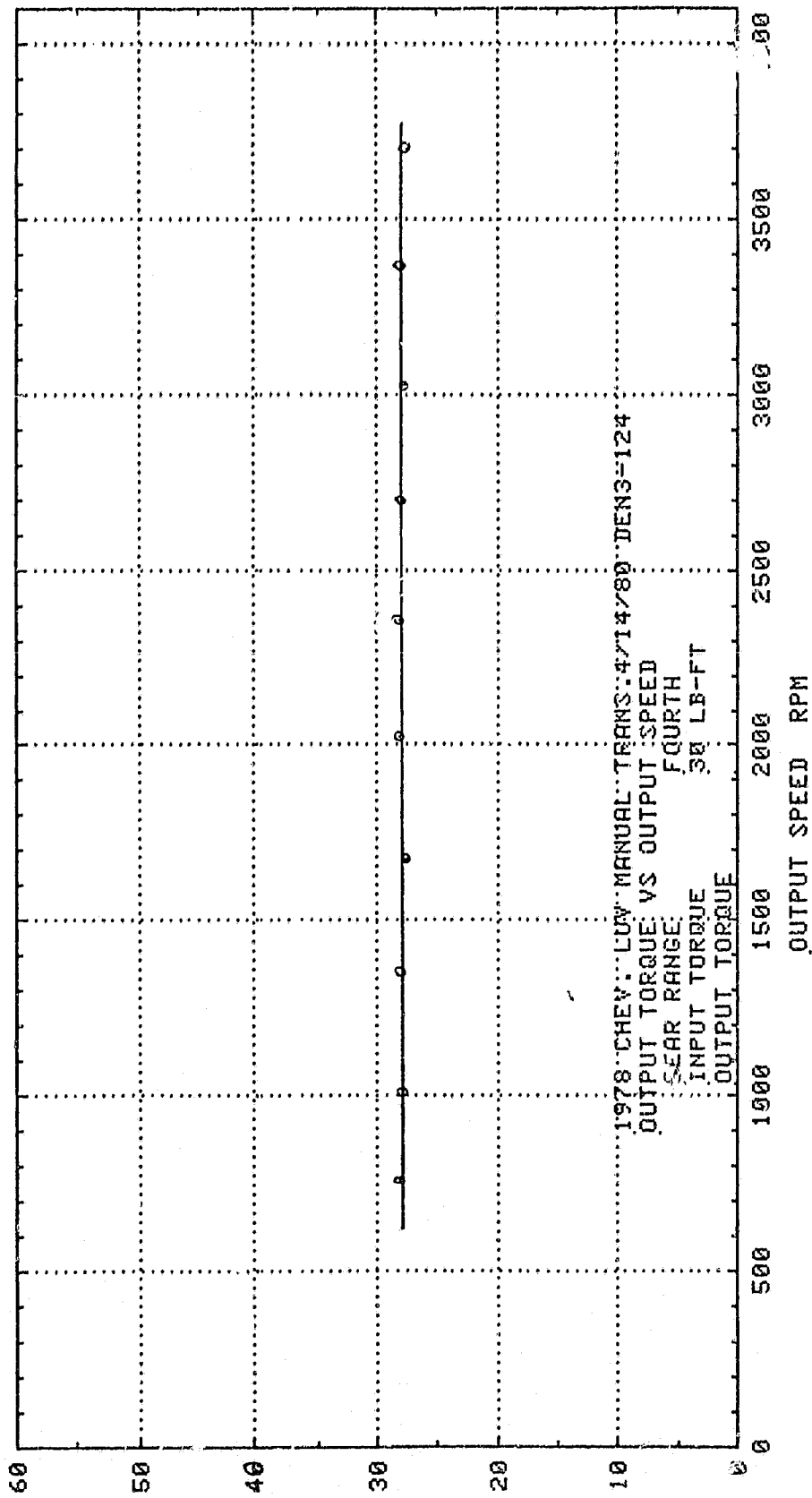

OUTPUT TORQUE LB FT

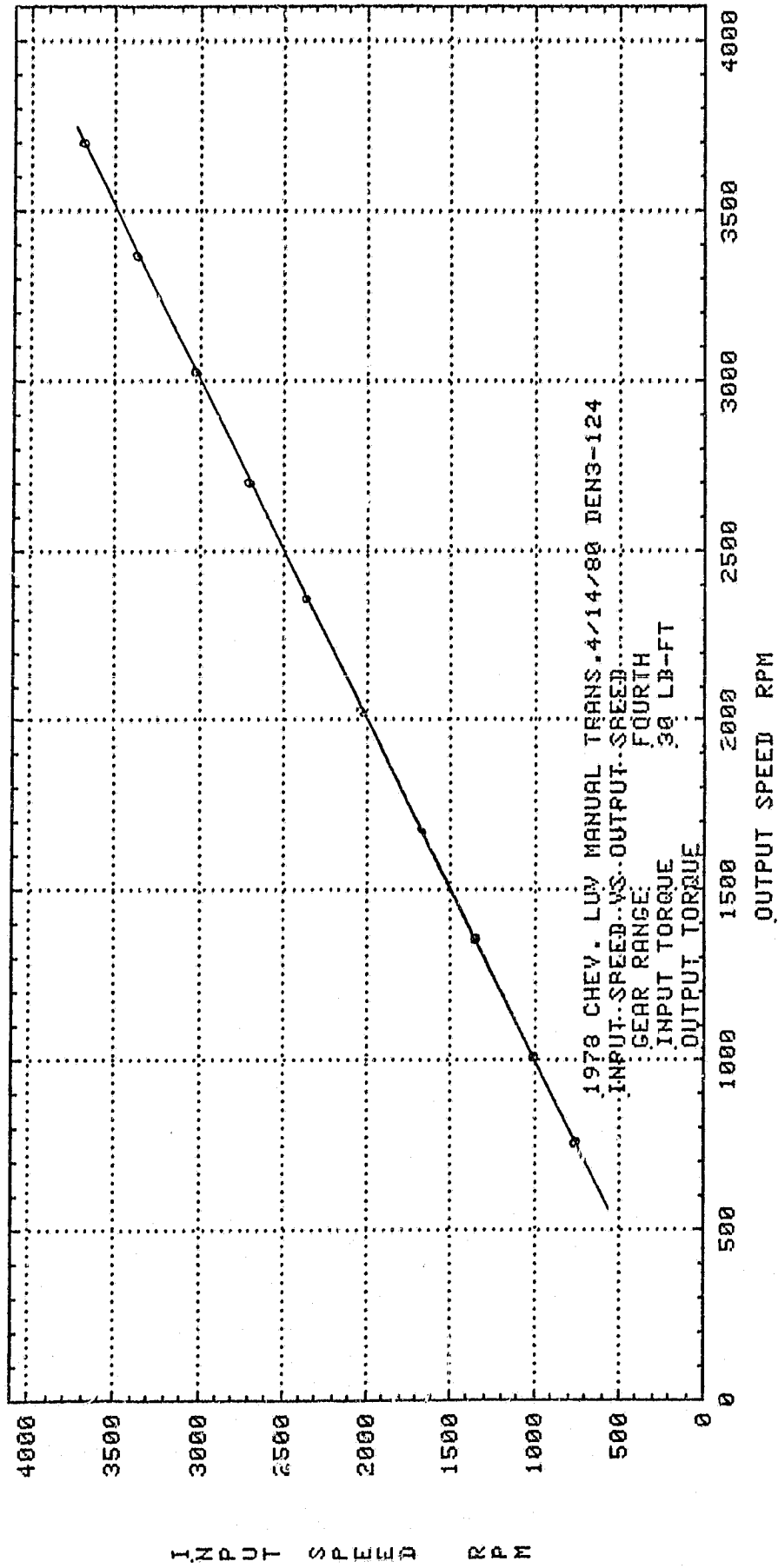

EFFICIENCY %

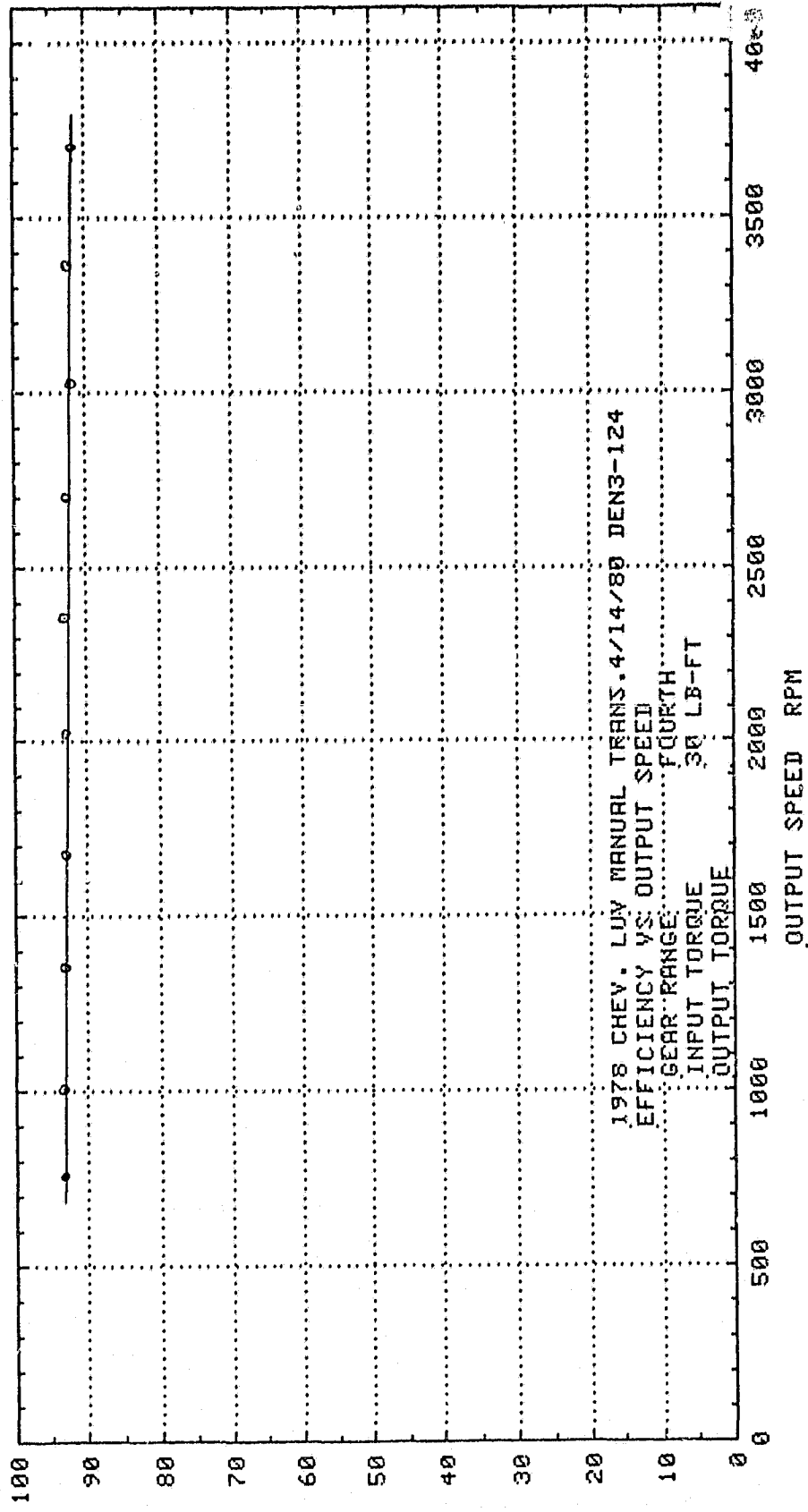

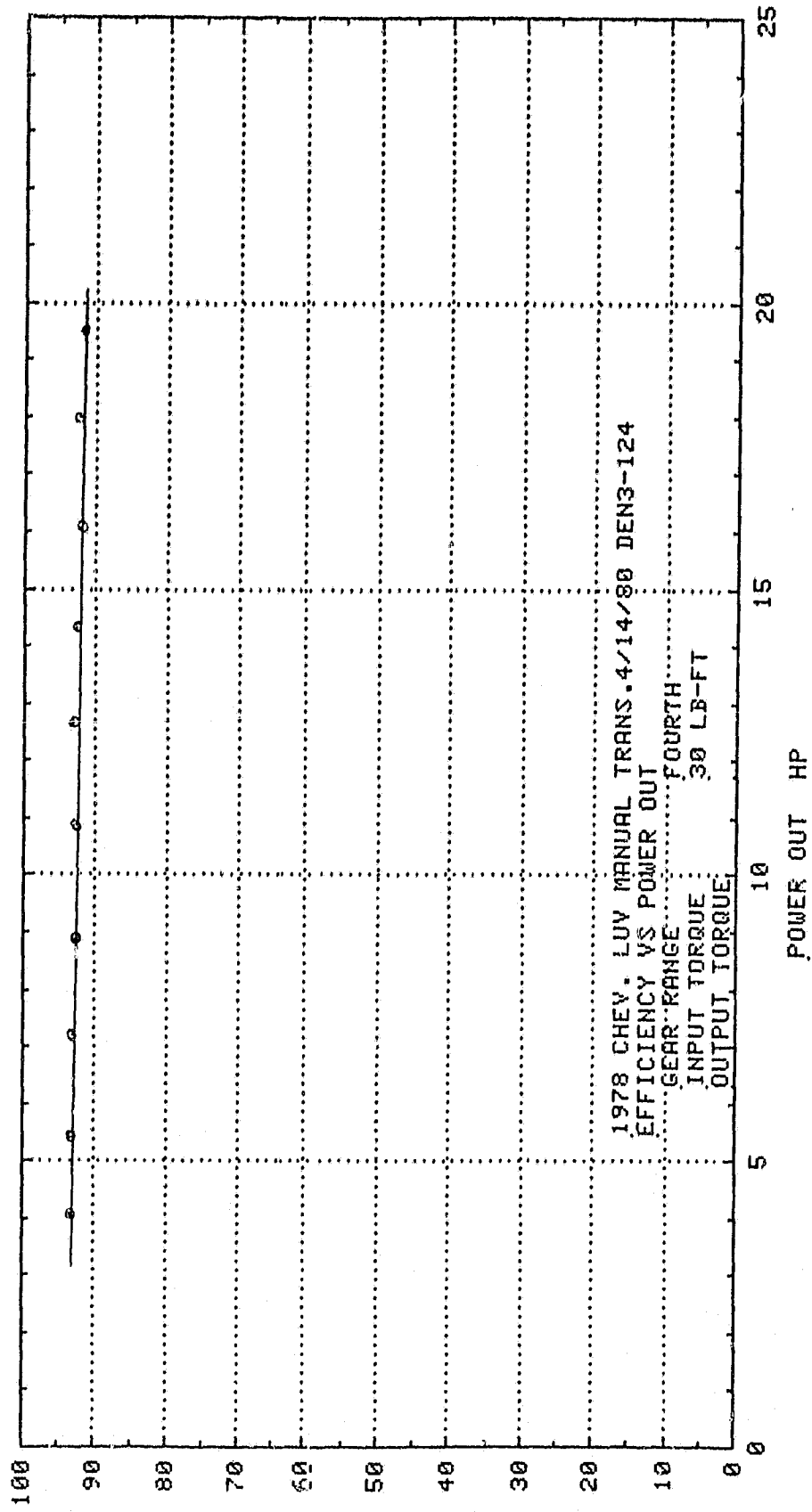

EFFICIENCY %

TORQUE RATIO $\frac{T_o}{T_i}$

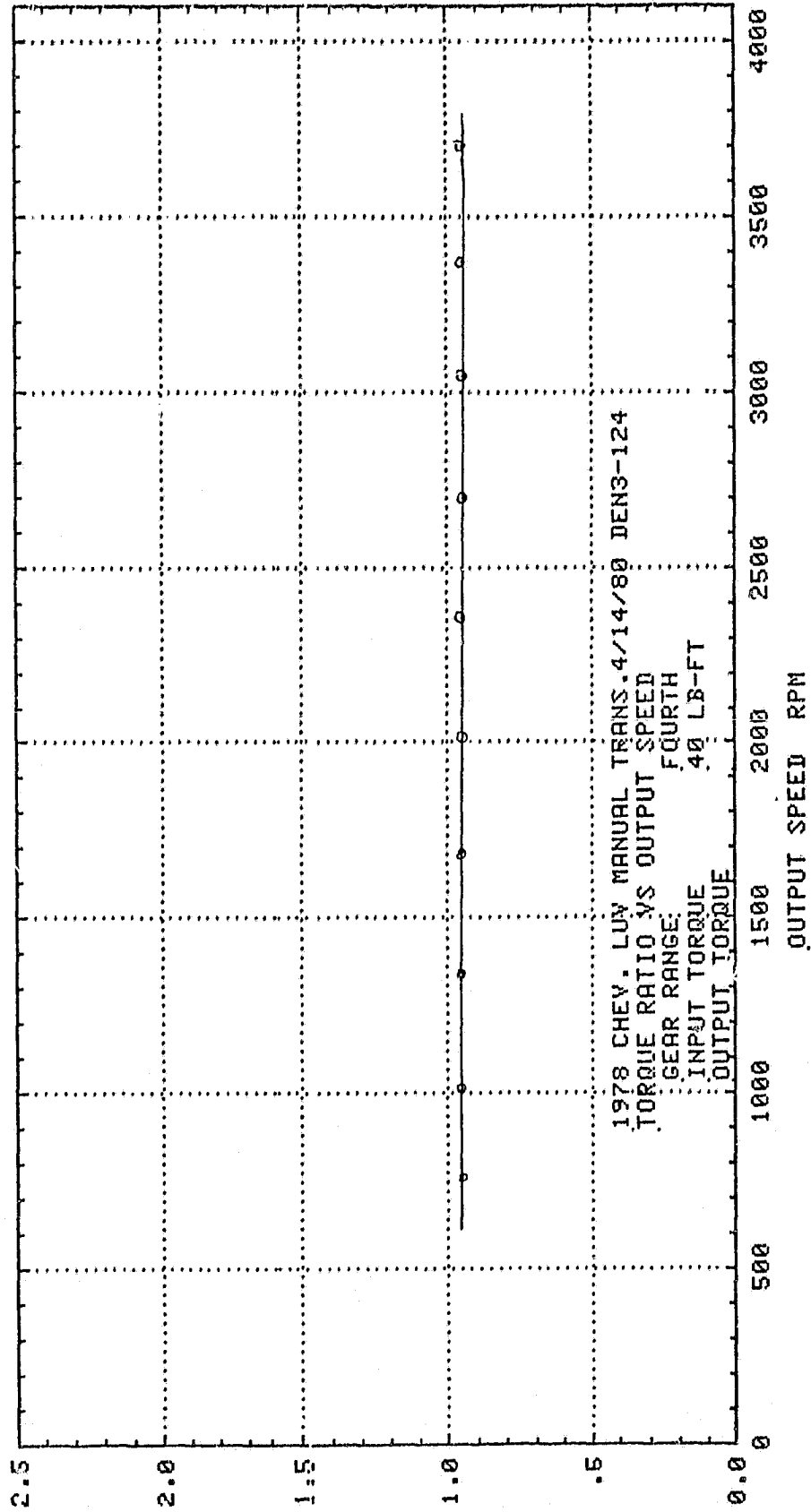

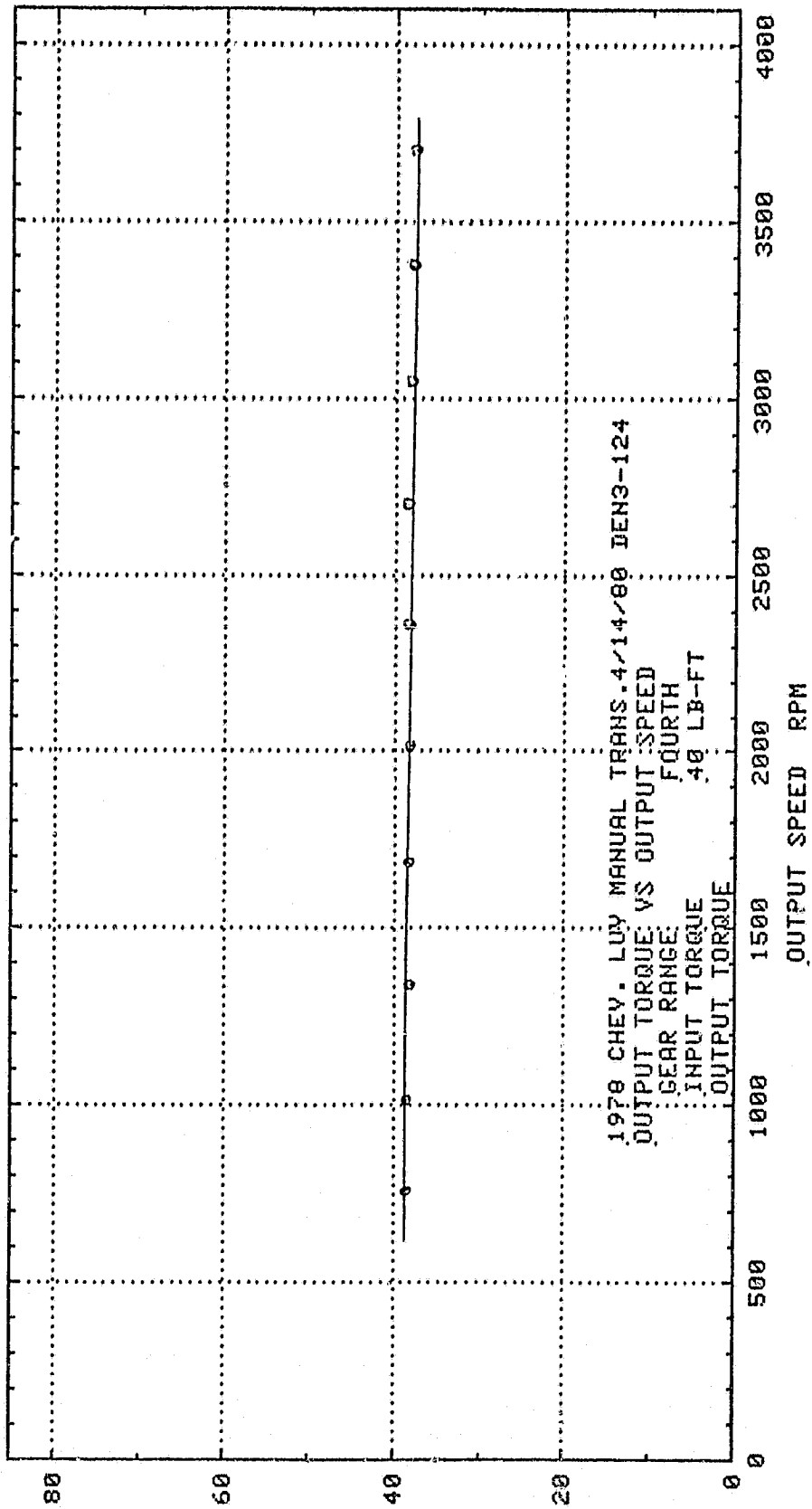

OUTPUT TORQUE LB FT

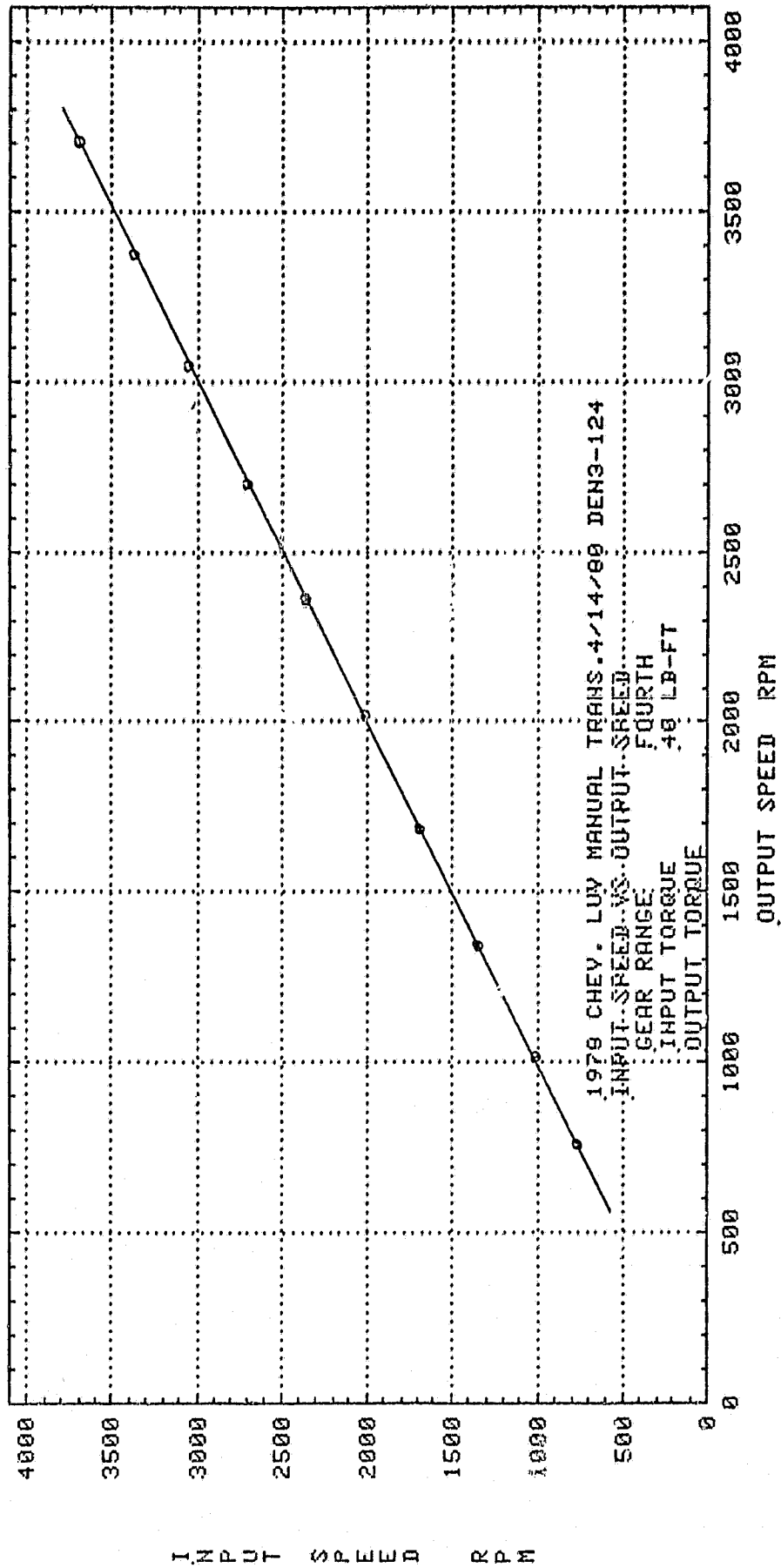

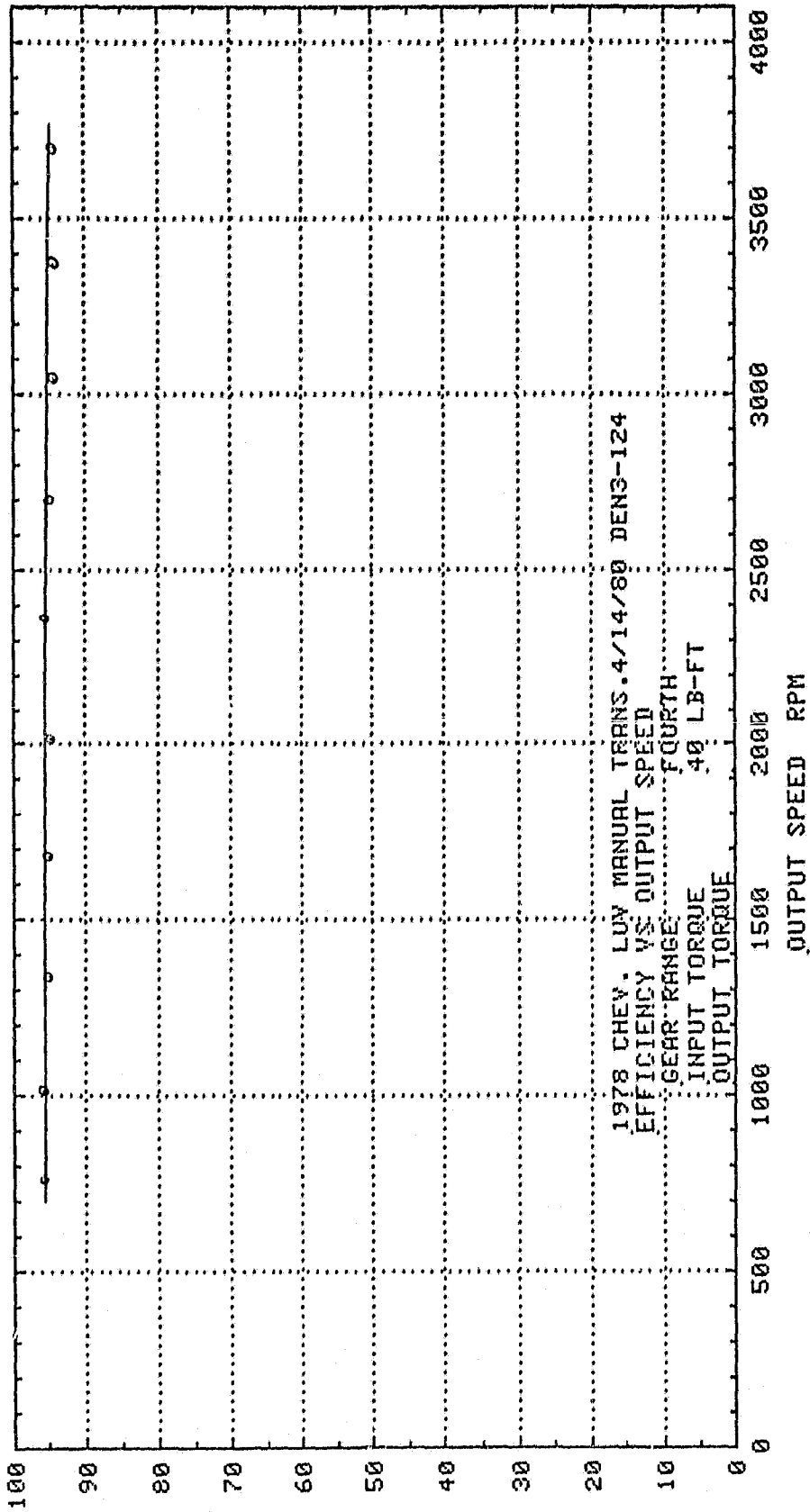

EFFICIENCY %

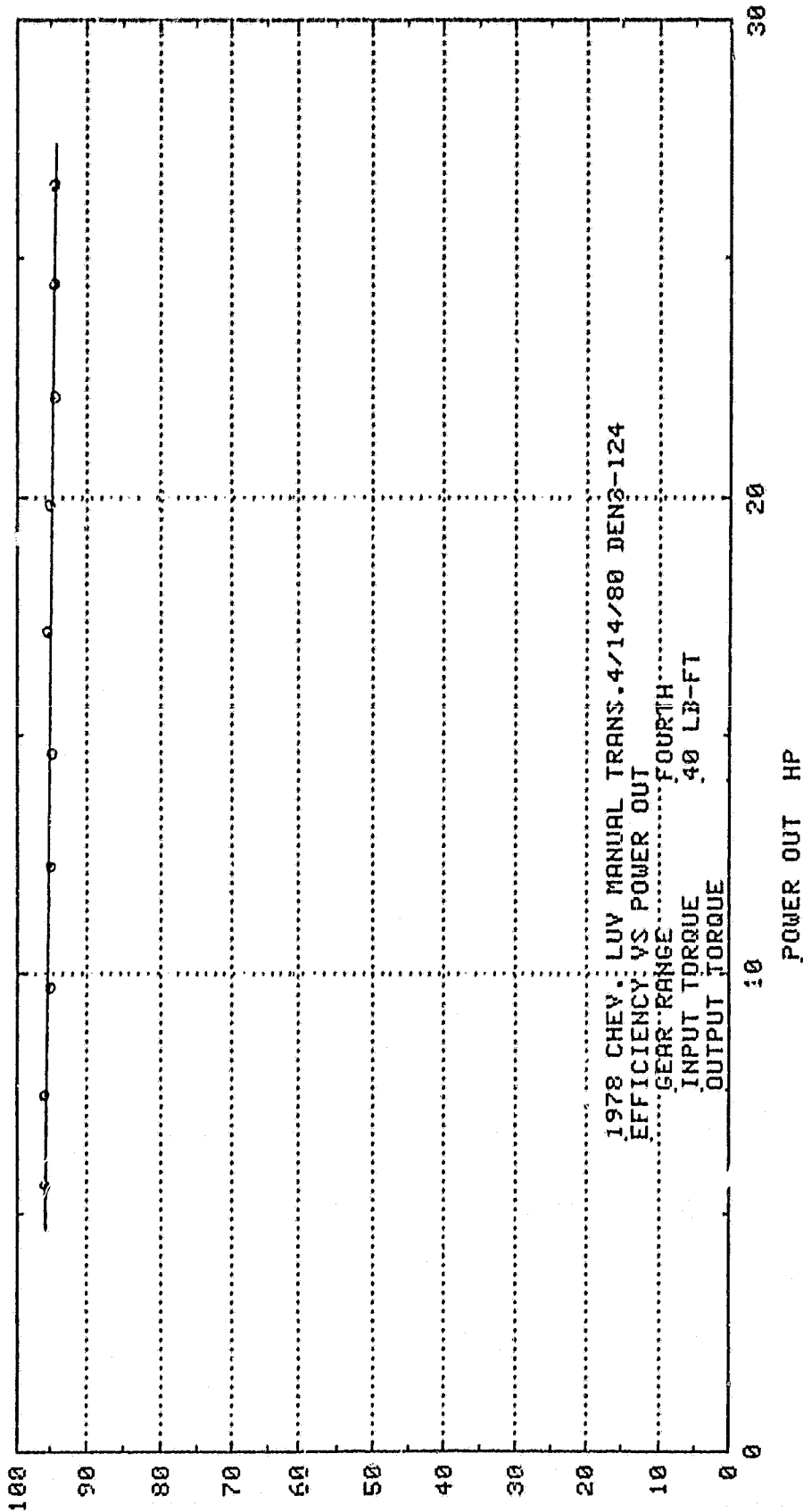

TORQUE RATIO $\frac{T_o}{T_i}$

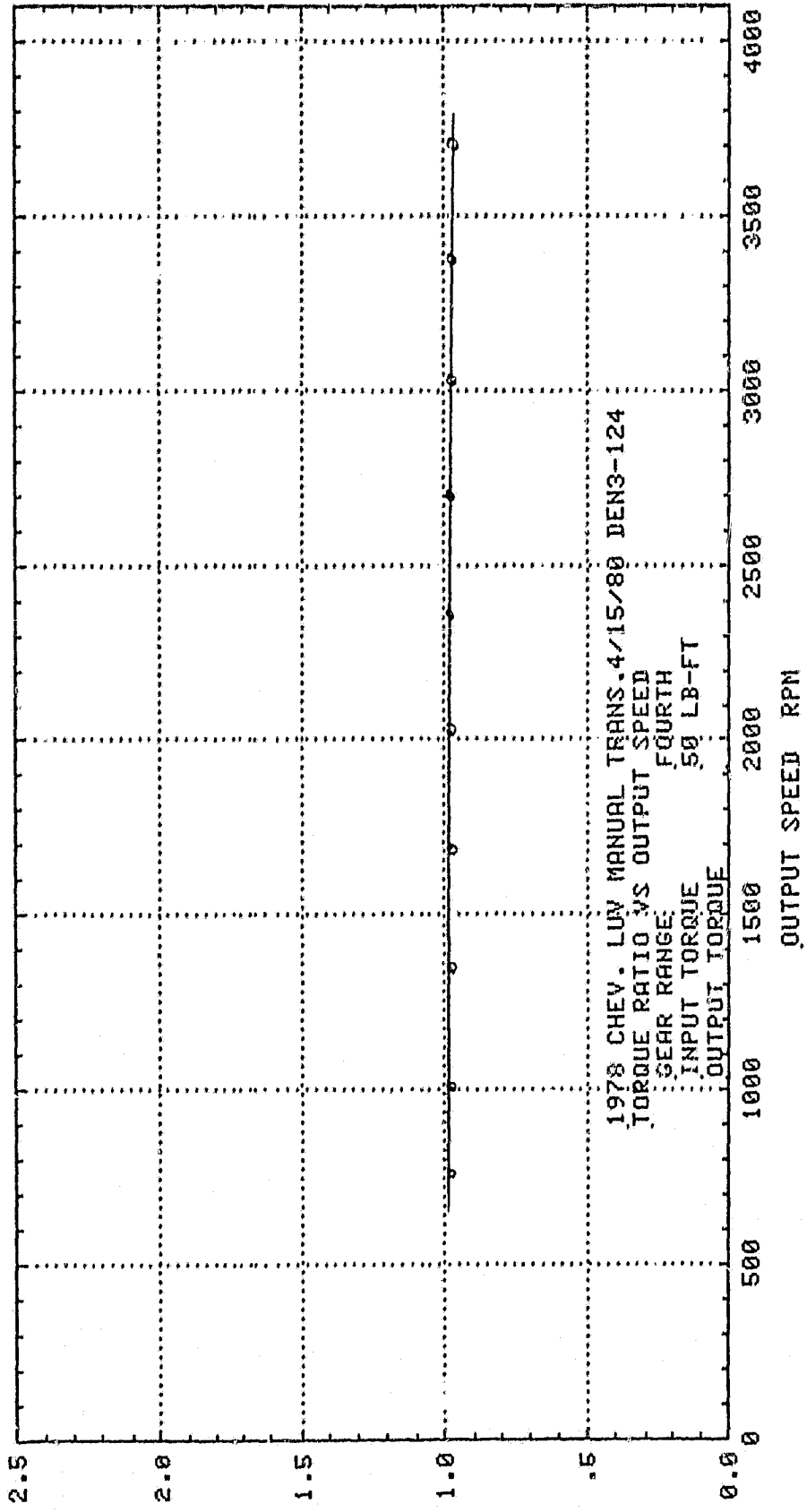

C-3

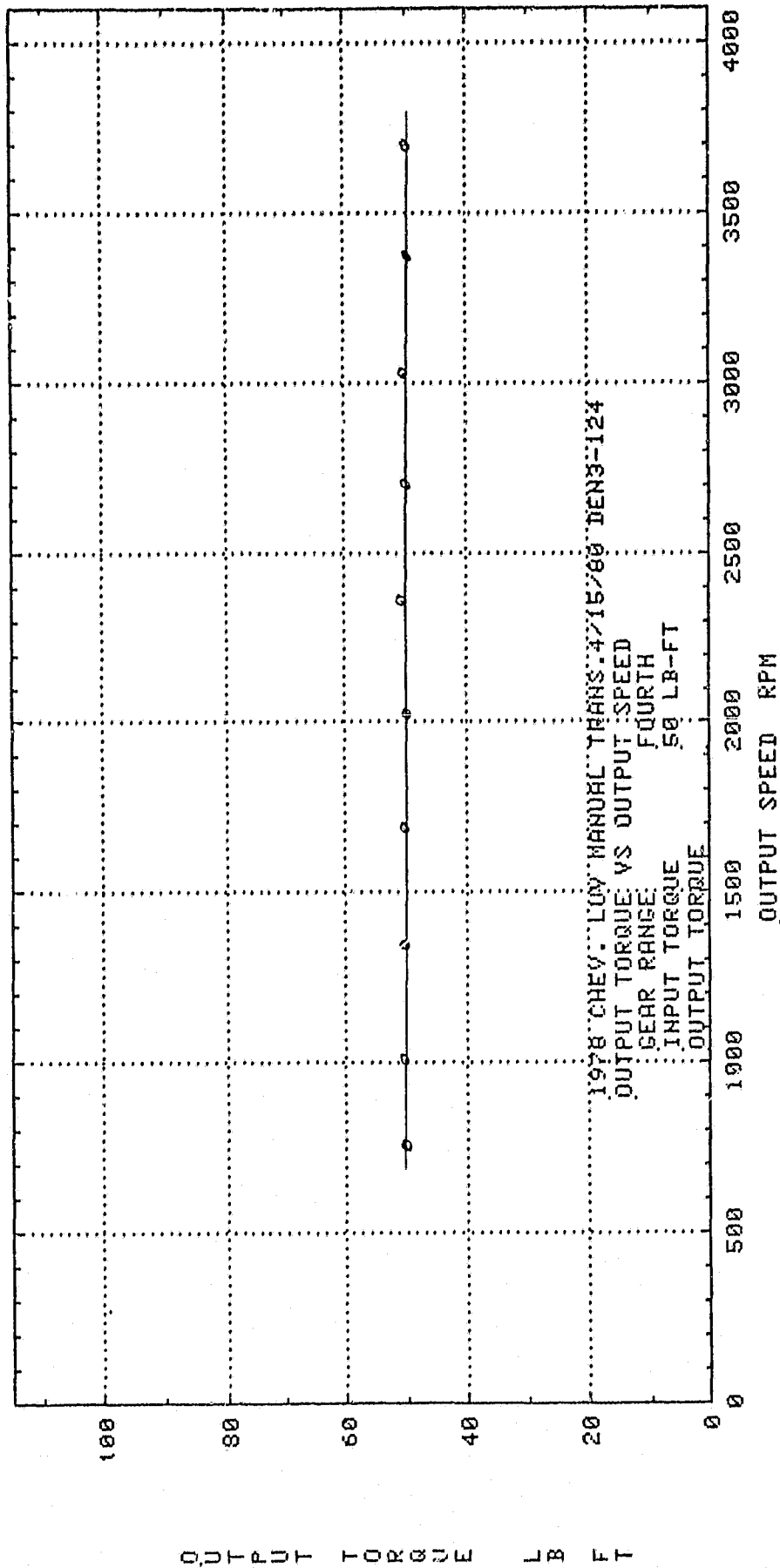

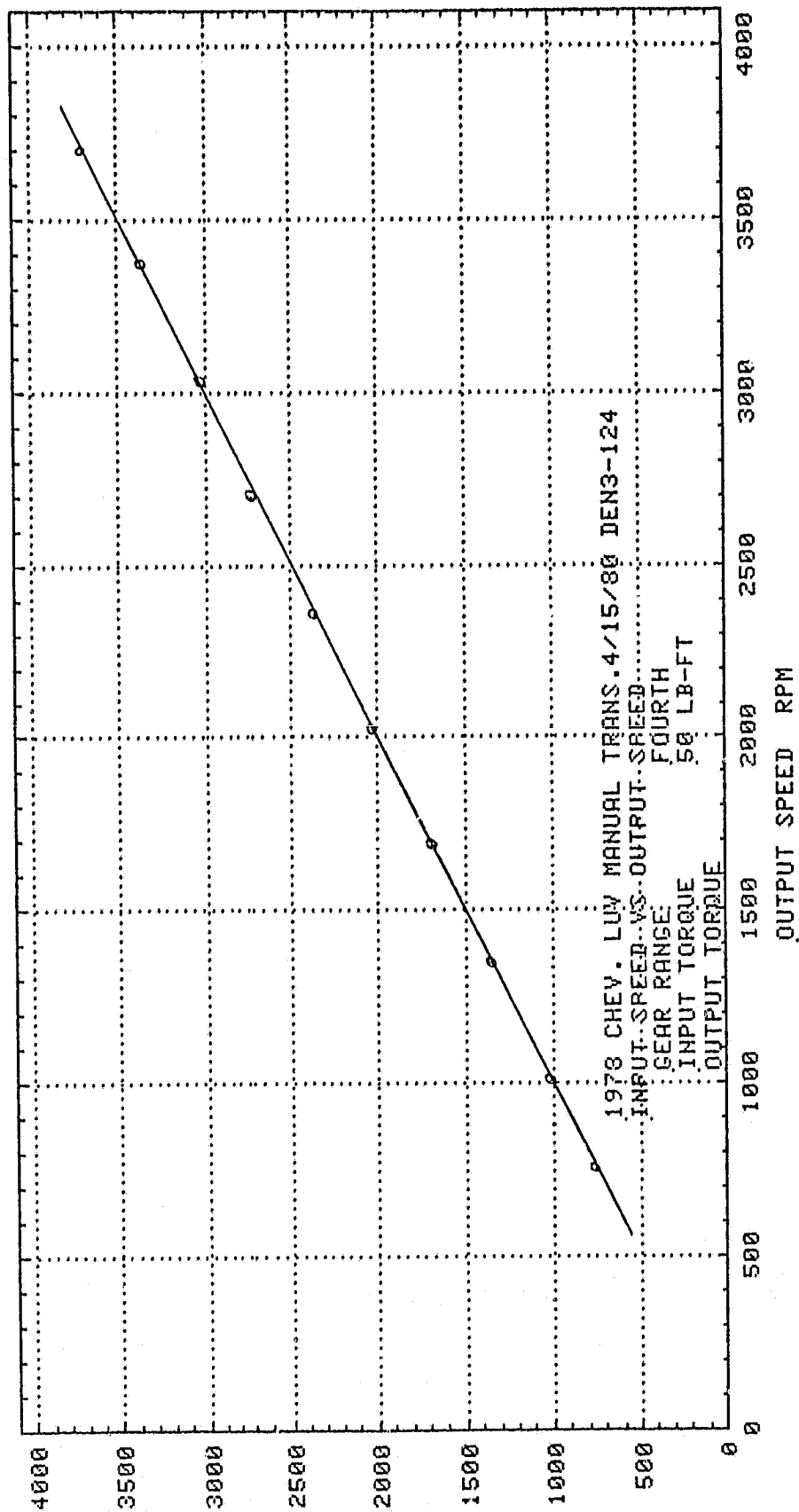

INPUT SPEED RPM

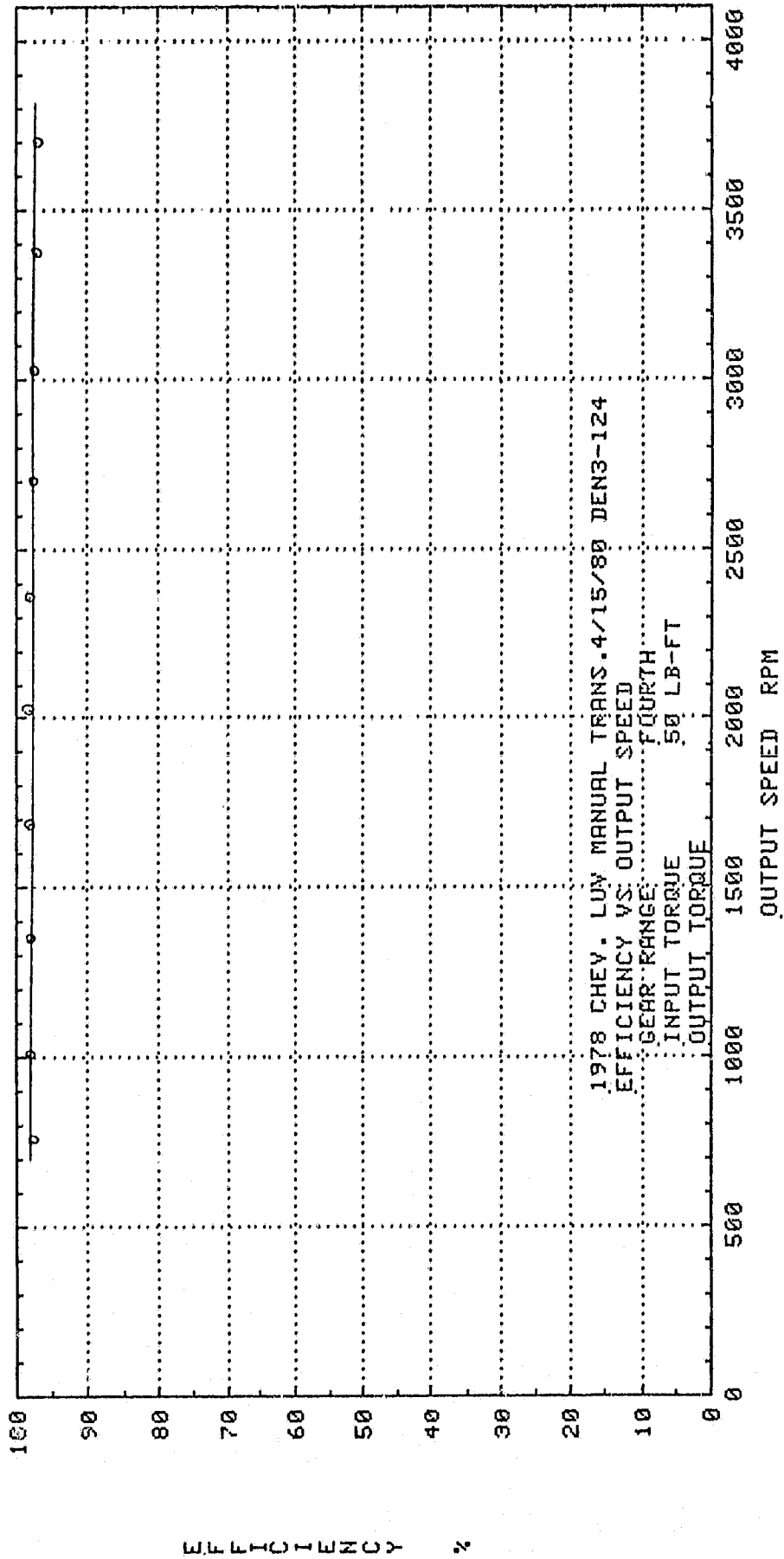

EFFICIENCY %

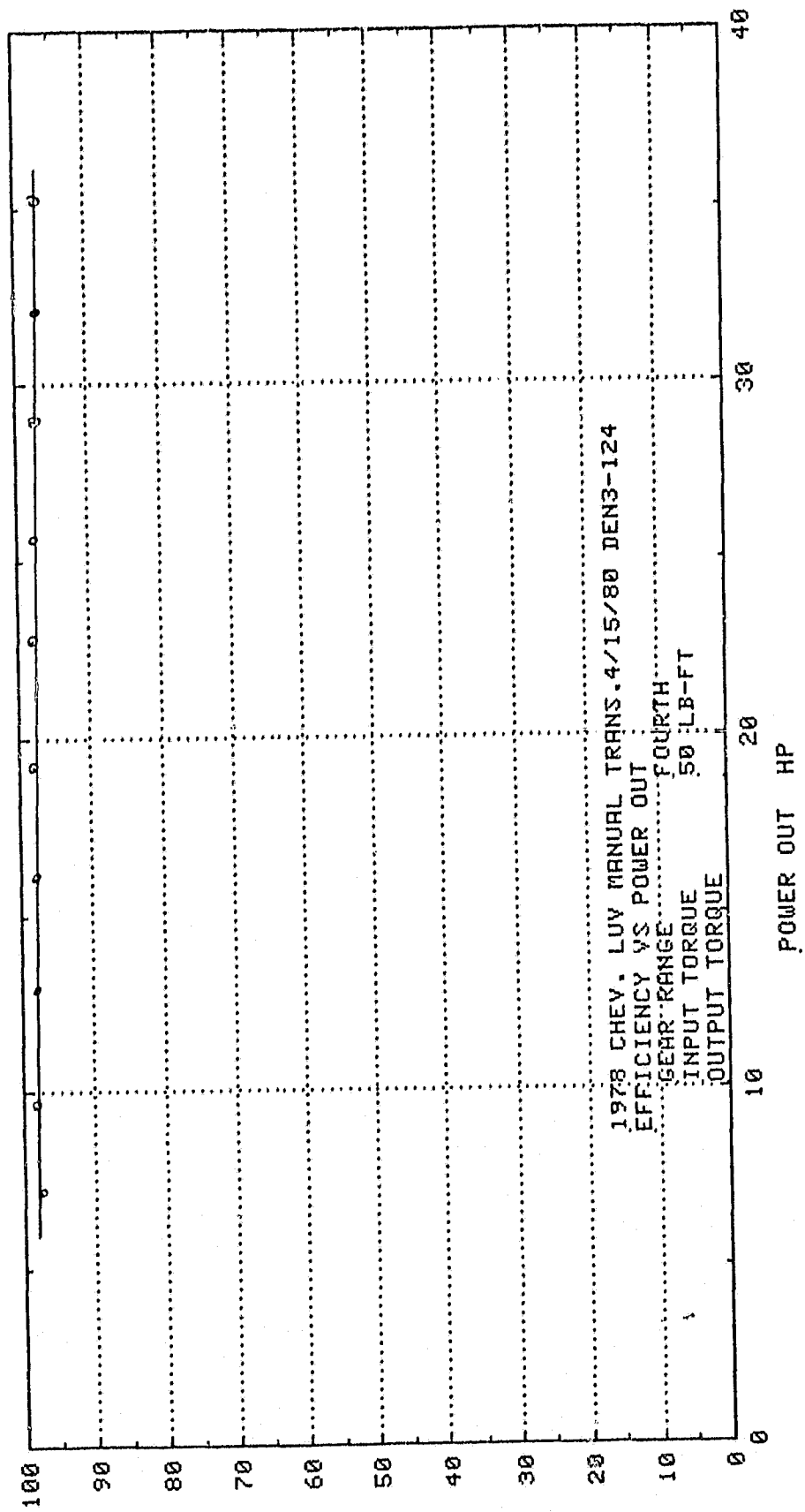

EFFICIENCY %

TORQUE RATIO $\frac{T_o}{T_i}$

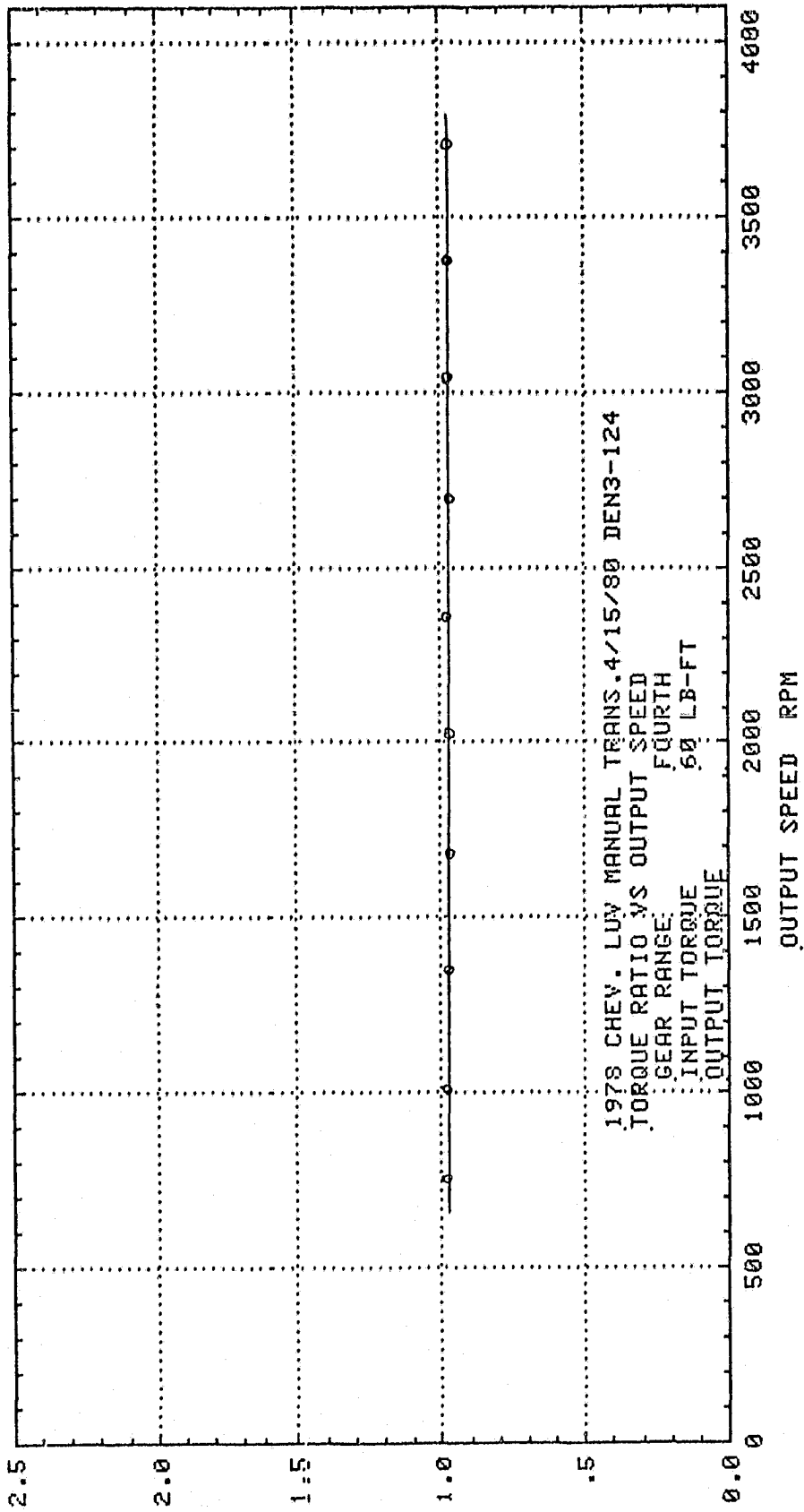

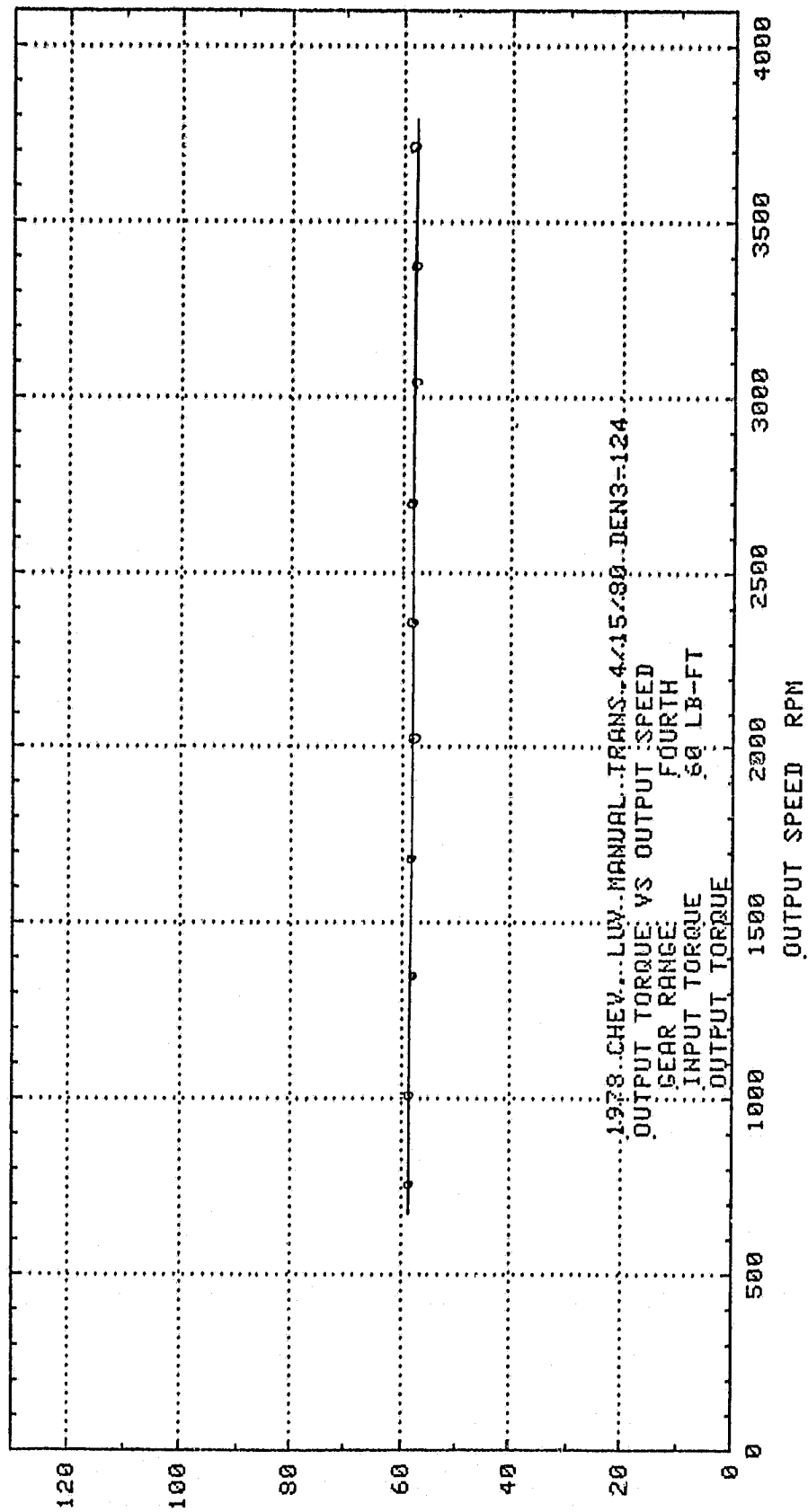

OUTPUT TORQUE LB FT

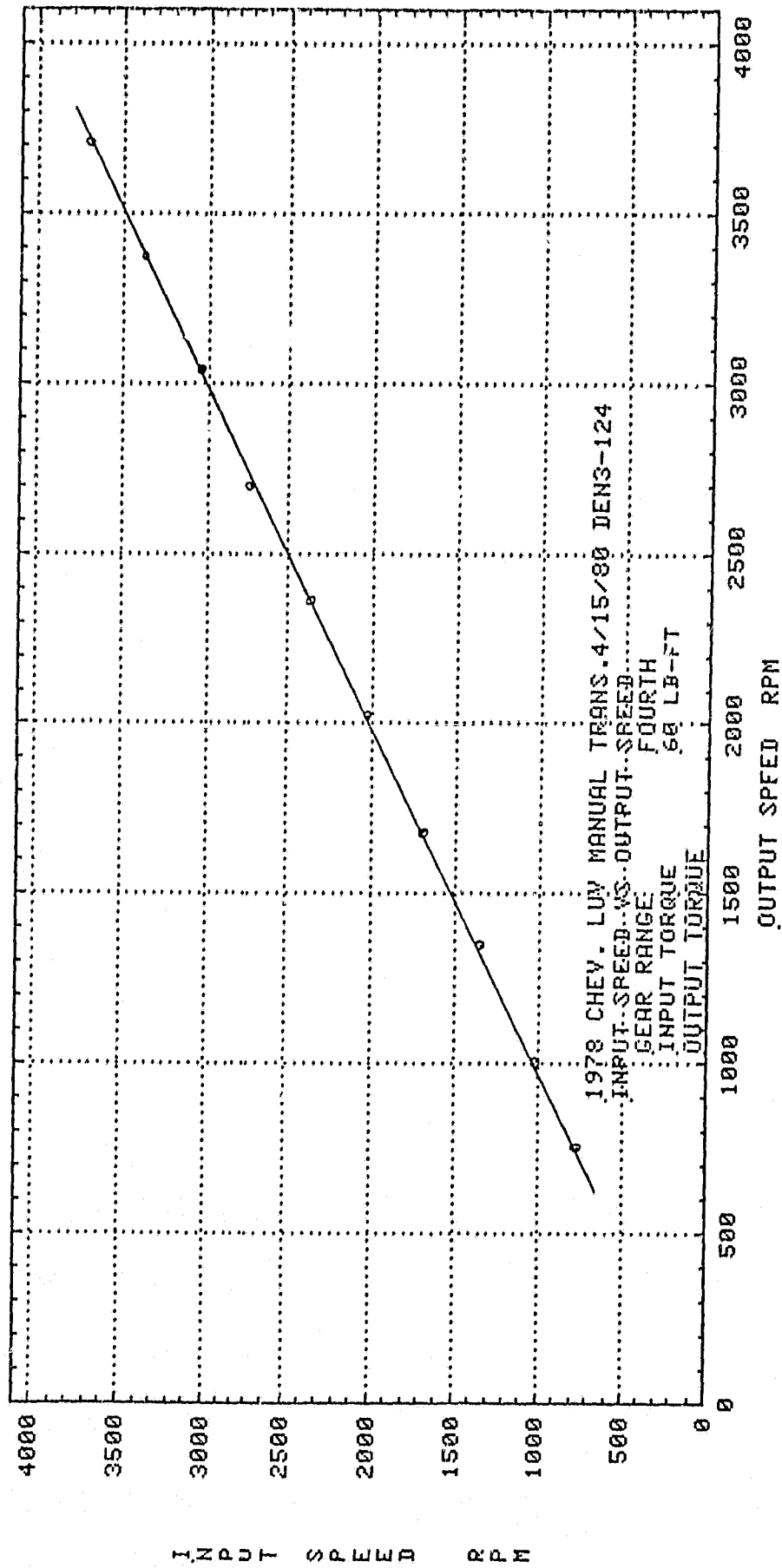

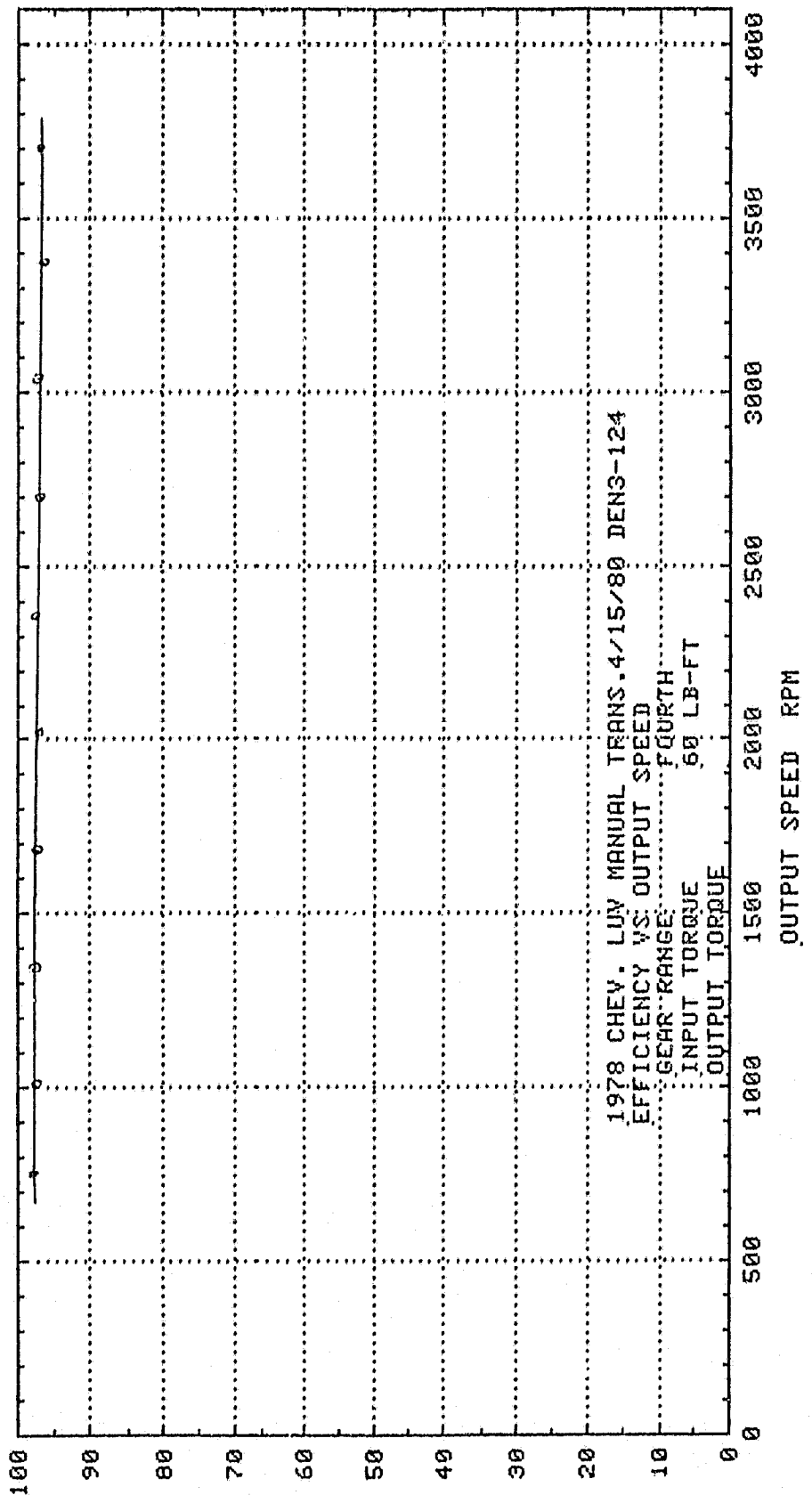

EFFICIENCY %

E F F I C I E N C Y %

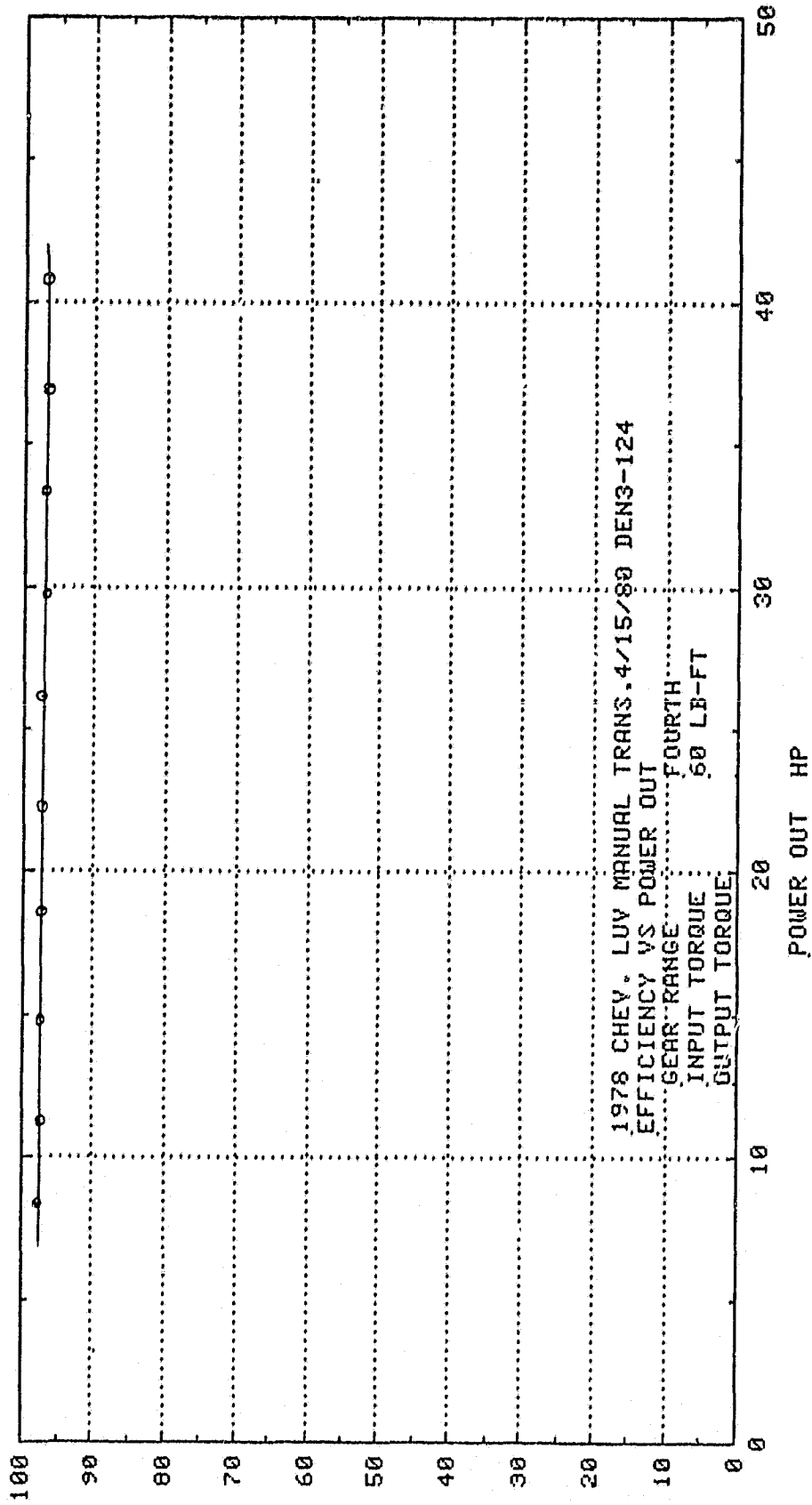

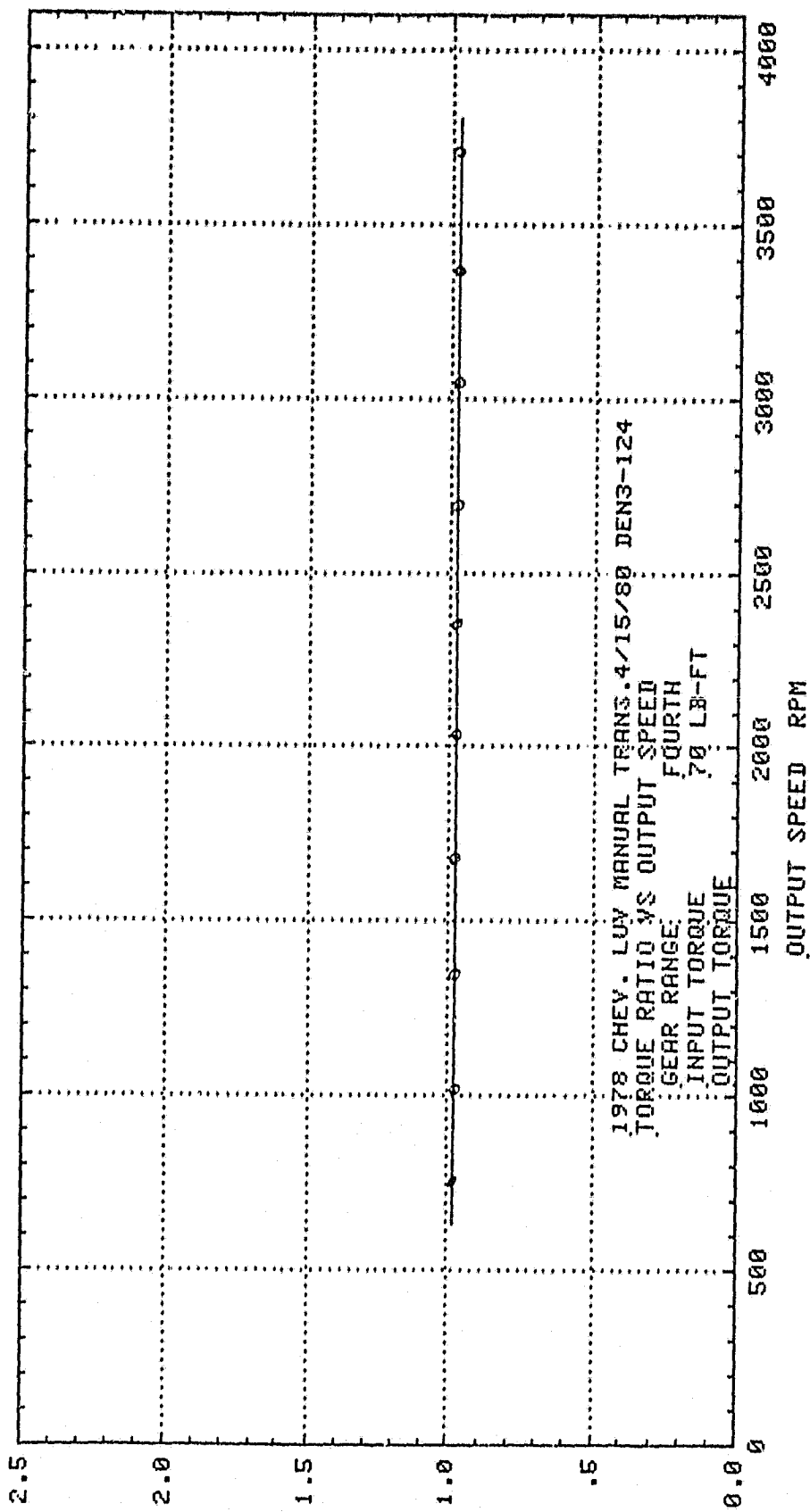

TORQUE RATIO $\frac{T_o}{T_i}$

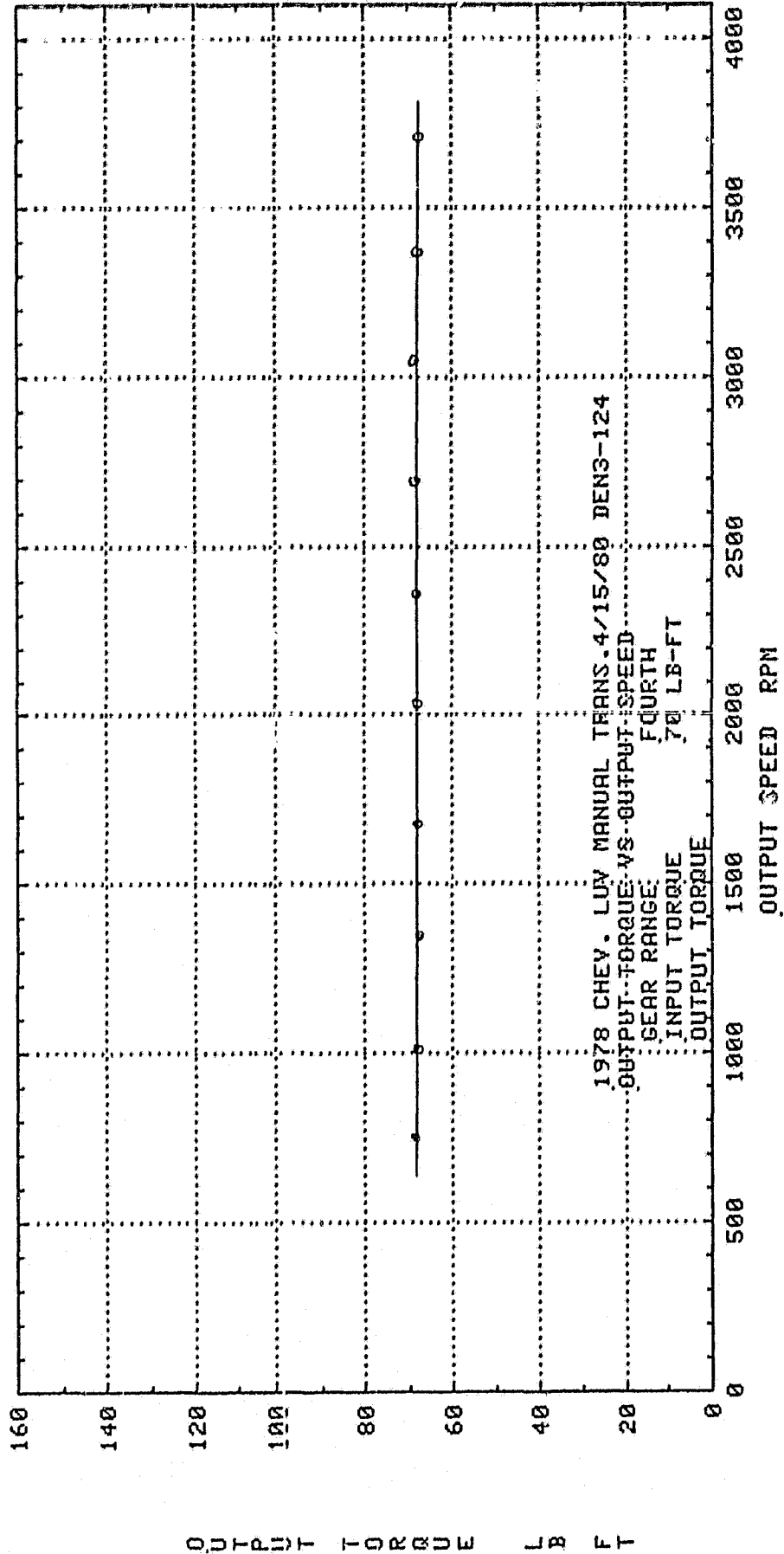

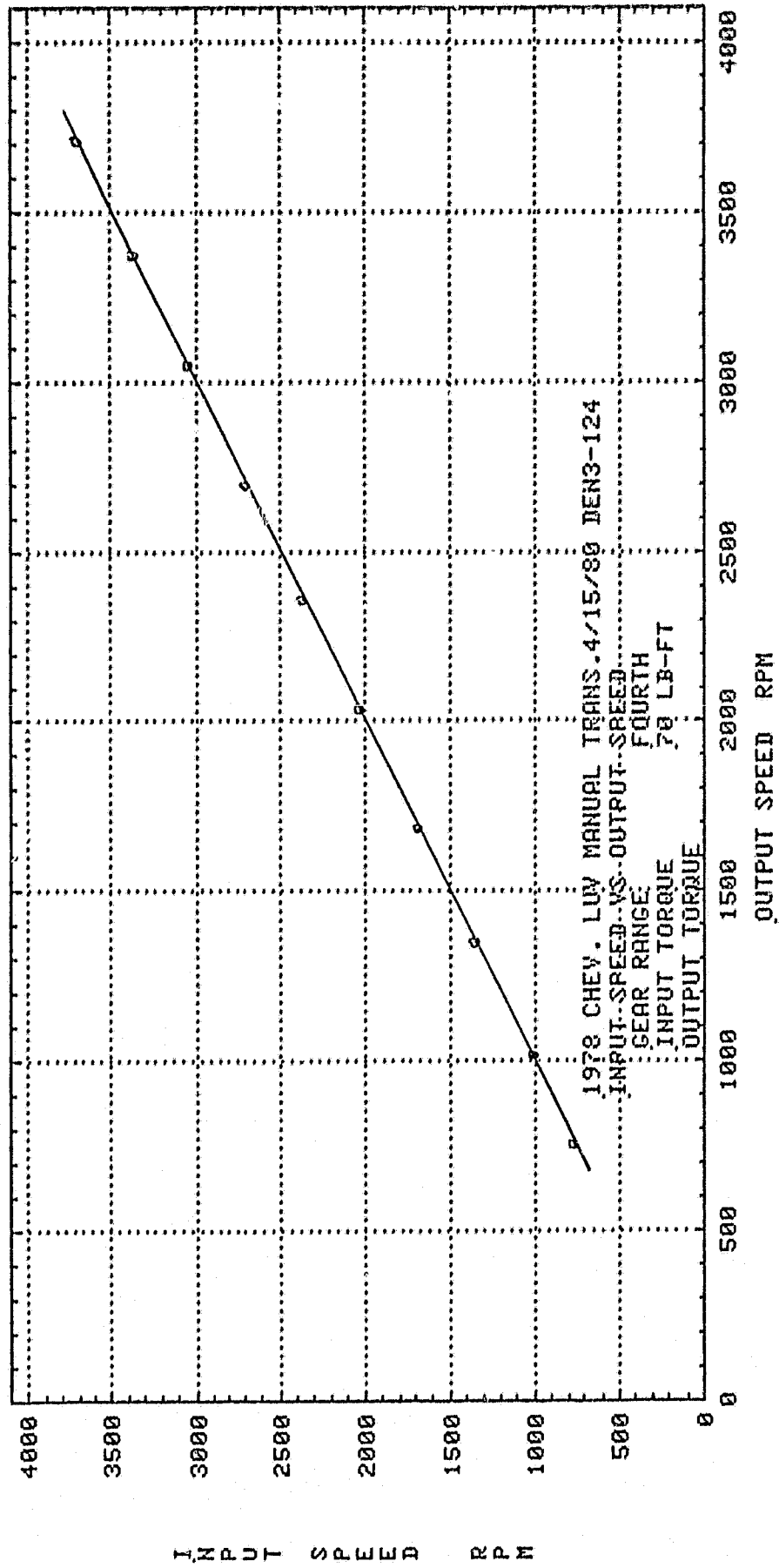

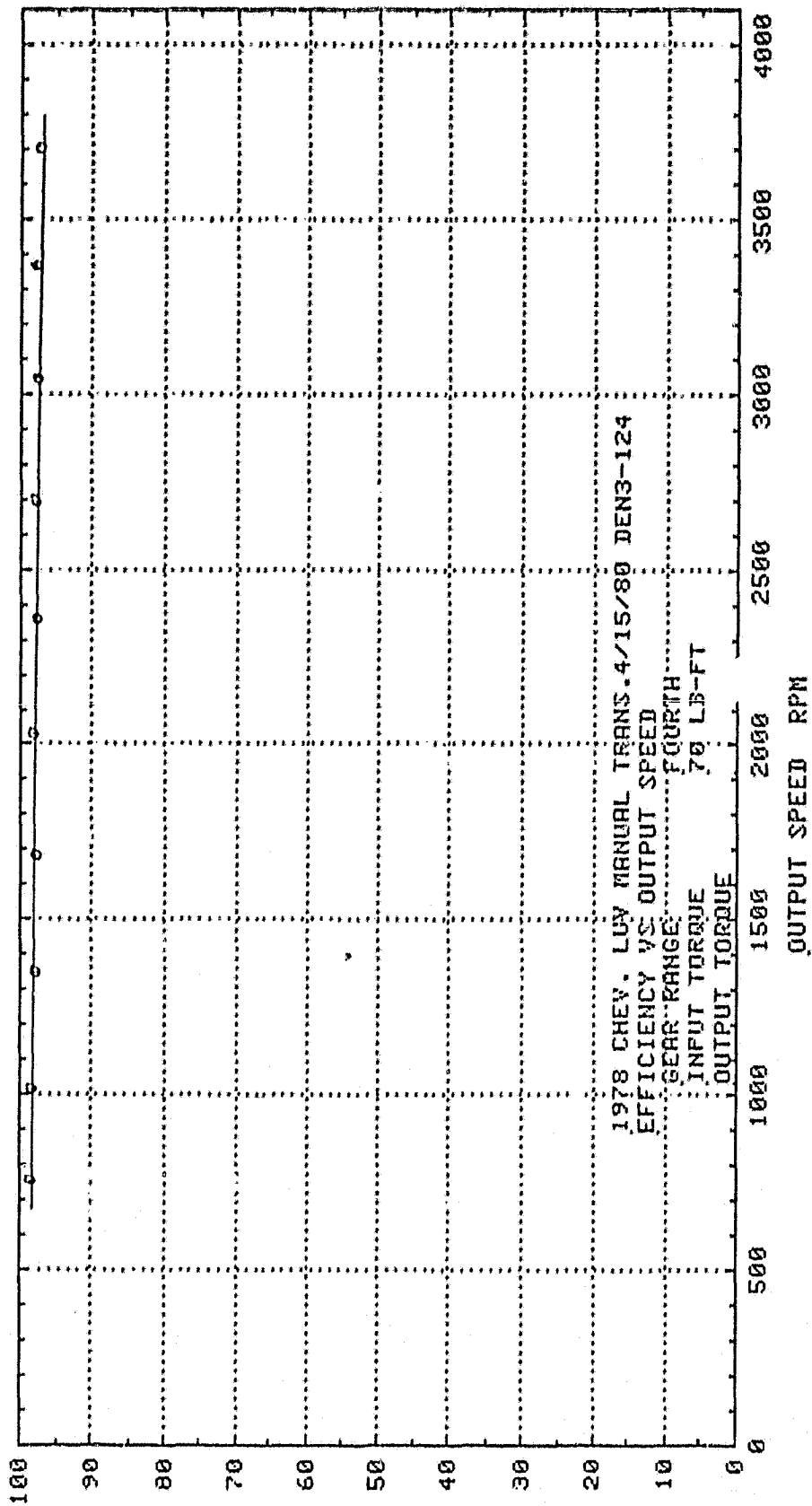

EFFICIENCY %

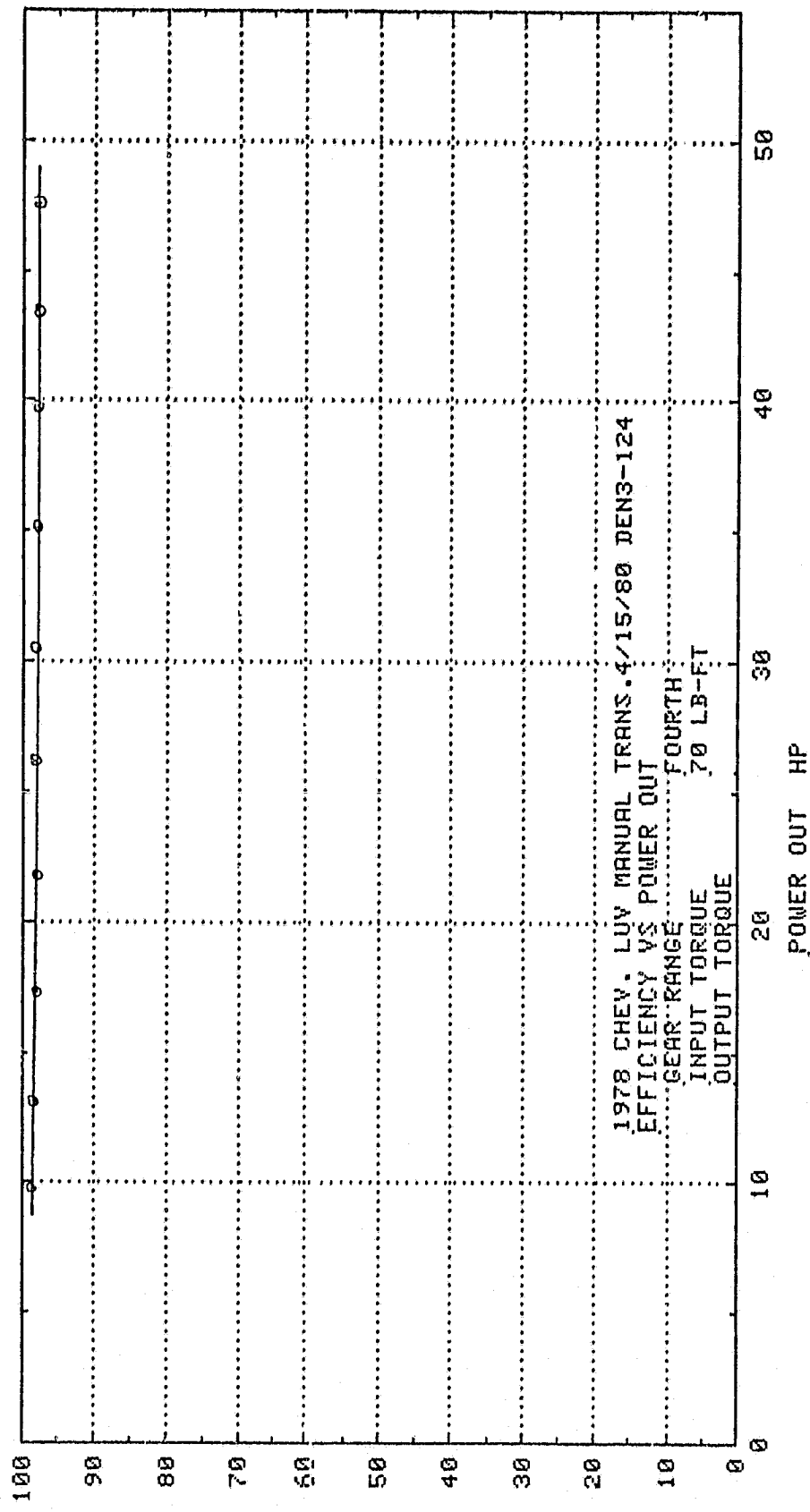

EFFICIENCY %

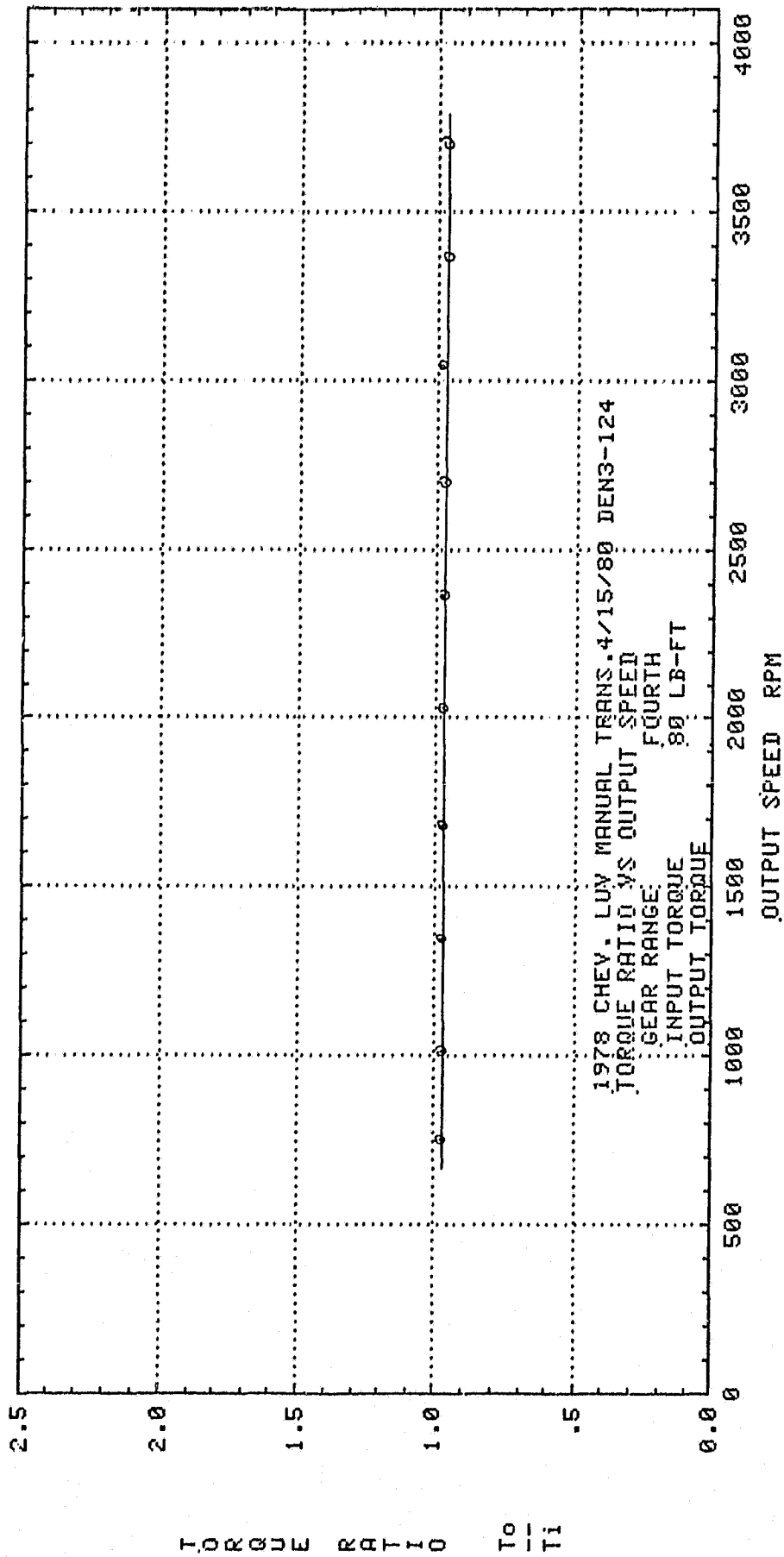

TORQUE RATIO $\frac{T_o}{T_i}$

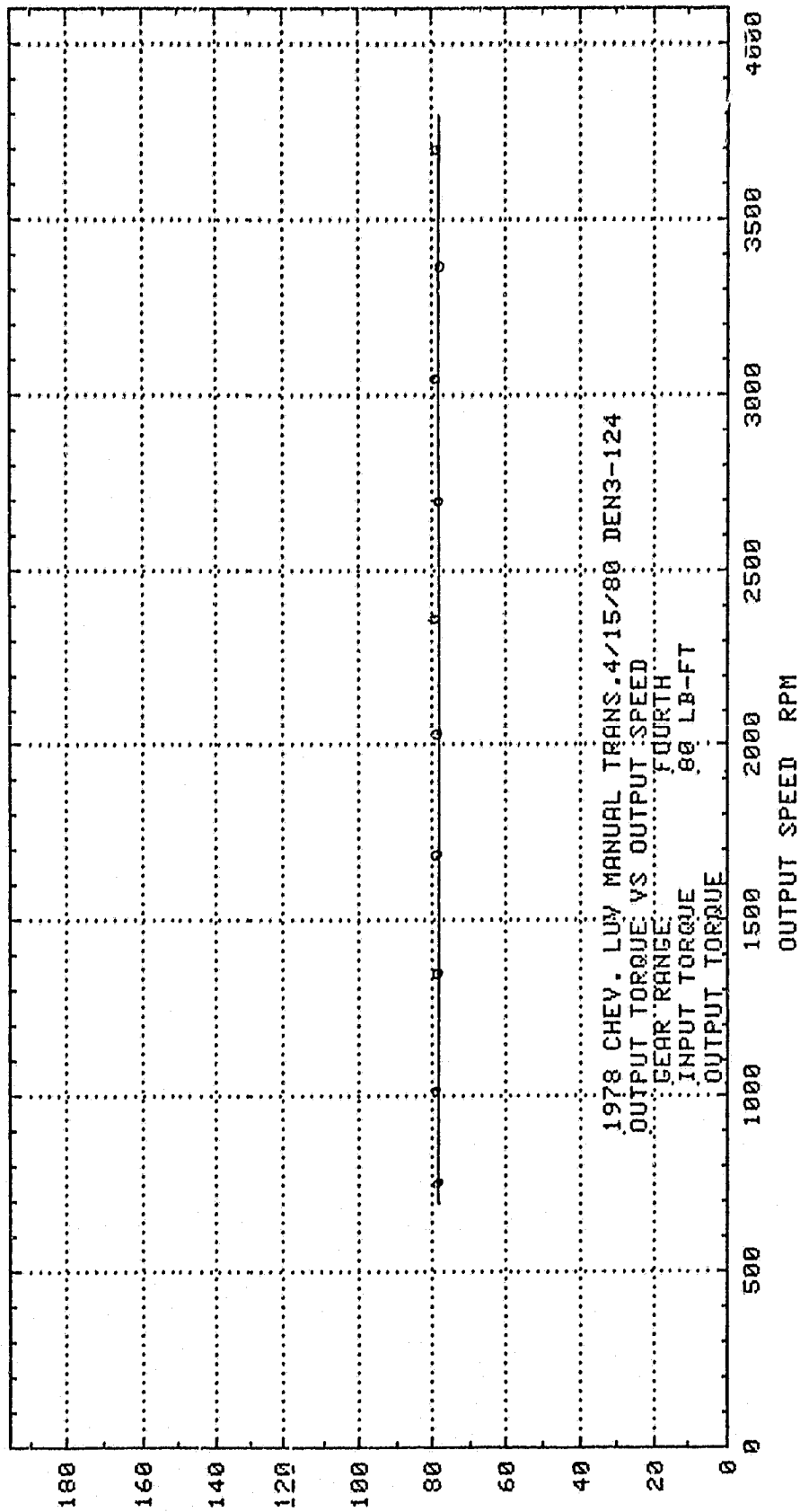

OUTPUT TORQUE LB FT

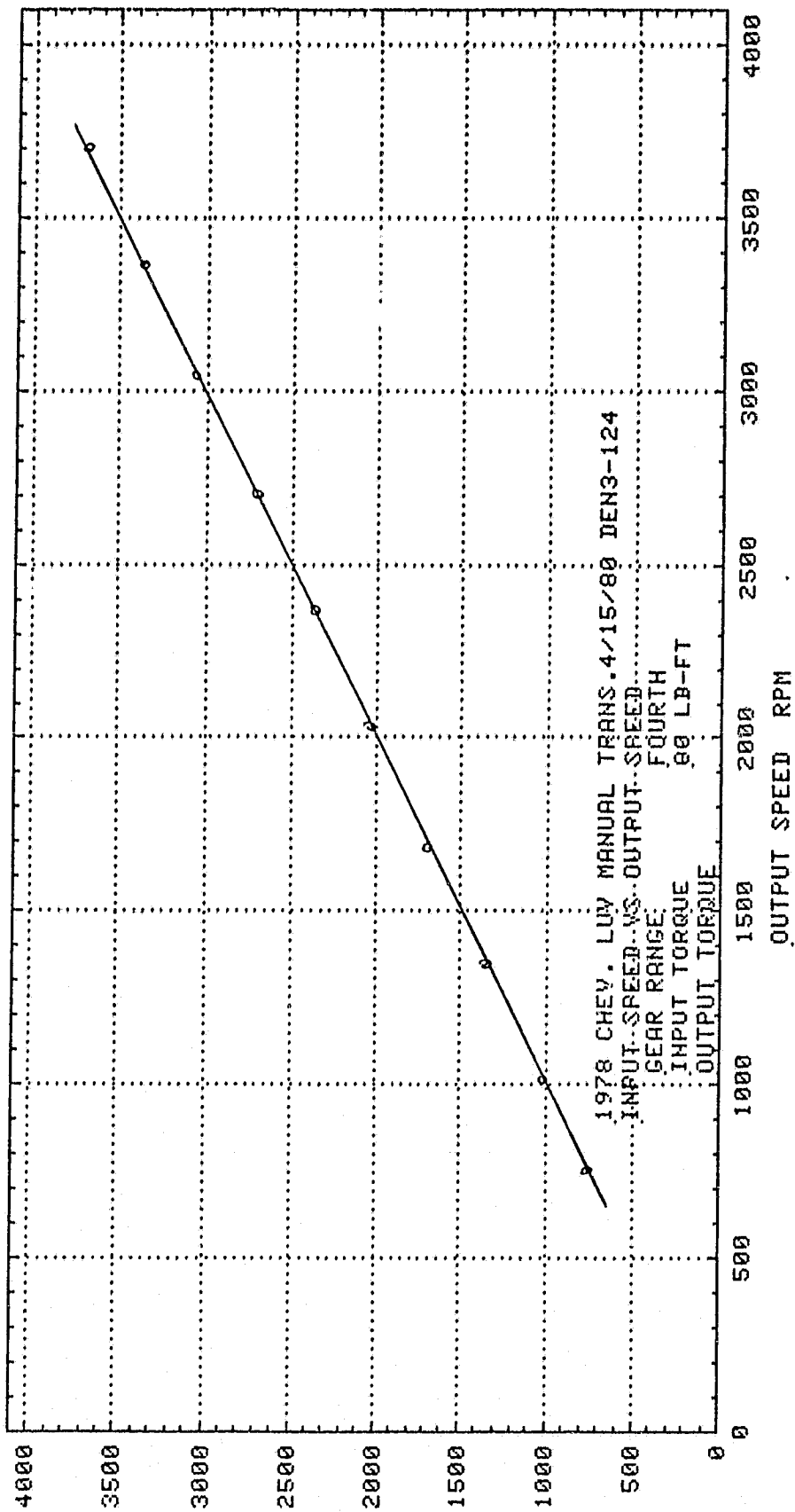

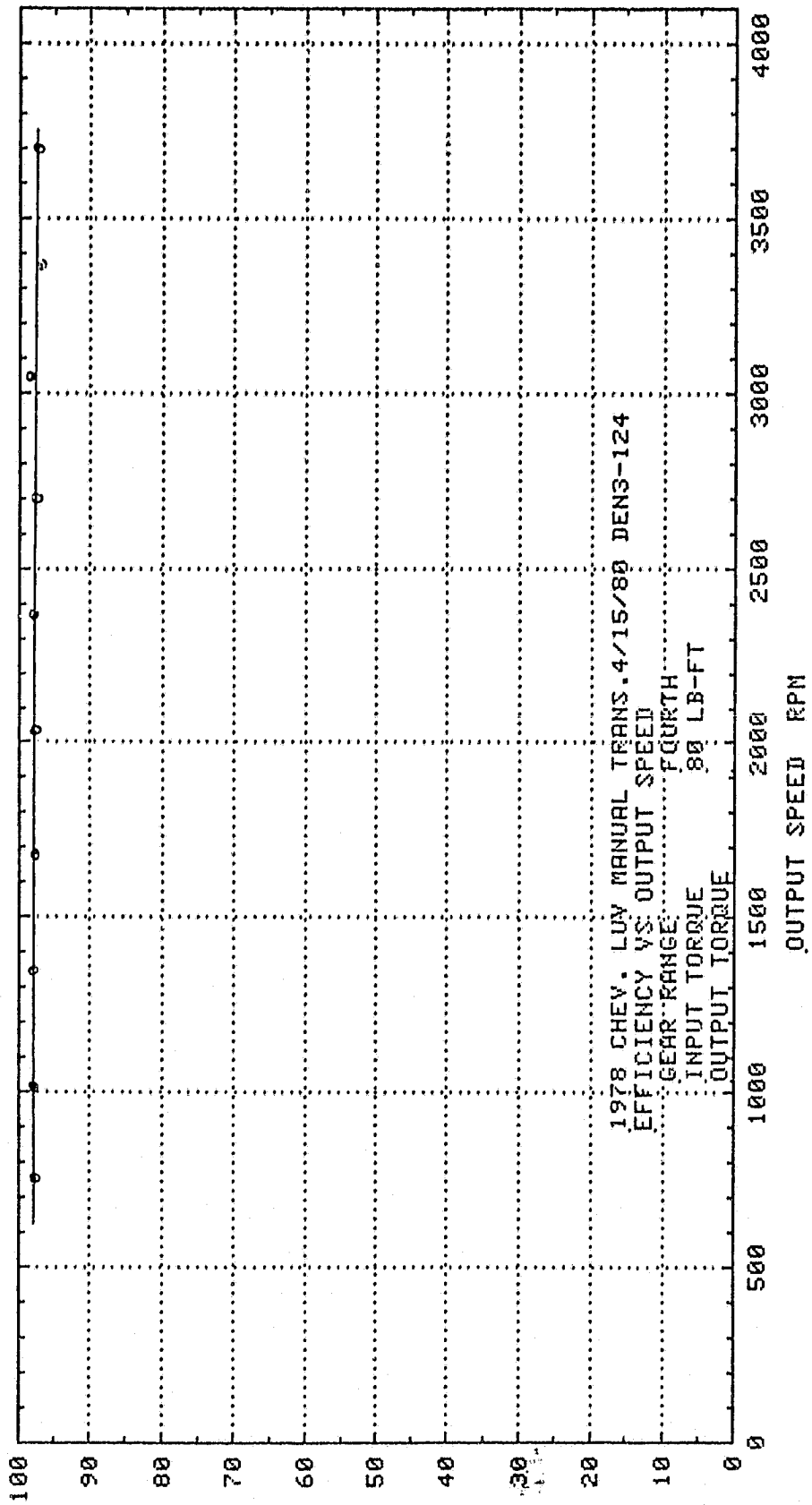

EFFICIENCY %

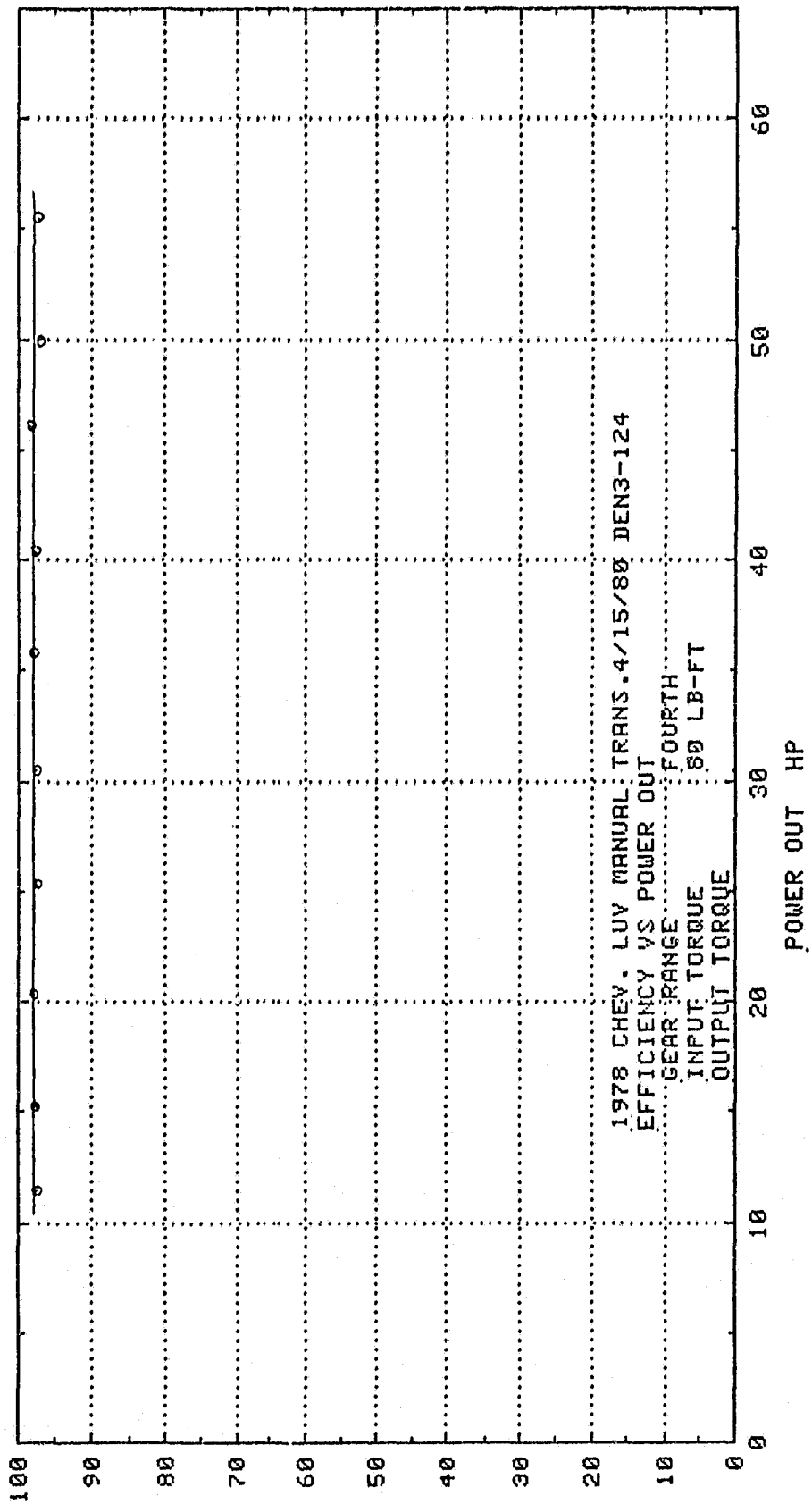

EFFICIENCY %

POWER OUT HP

TORQUE RATIO

$\frac{T_o}{T_i}$

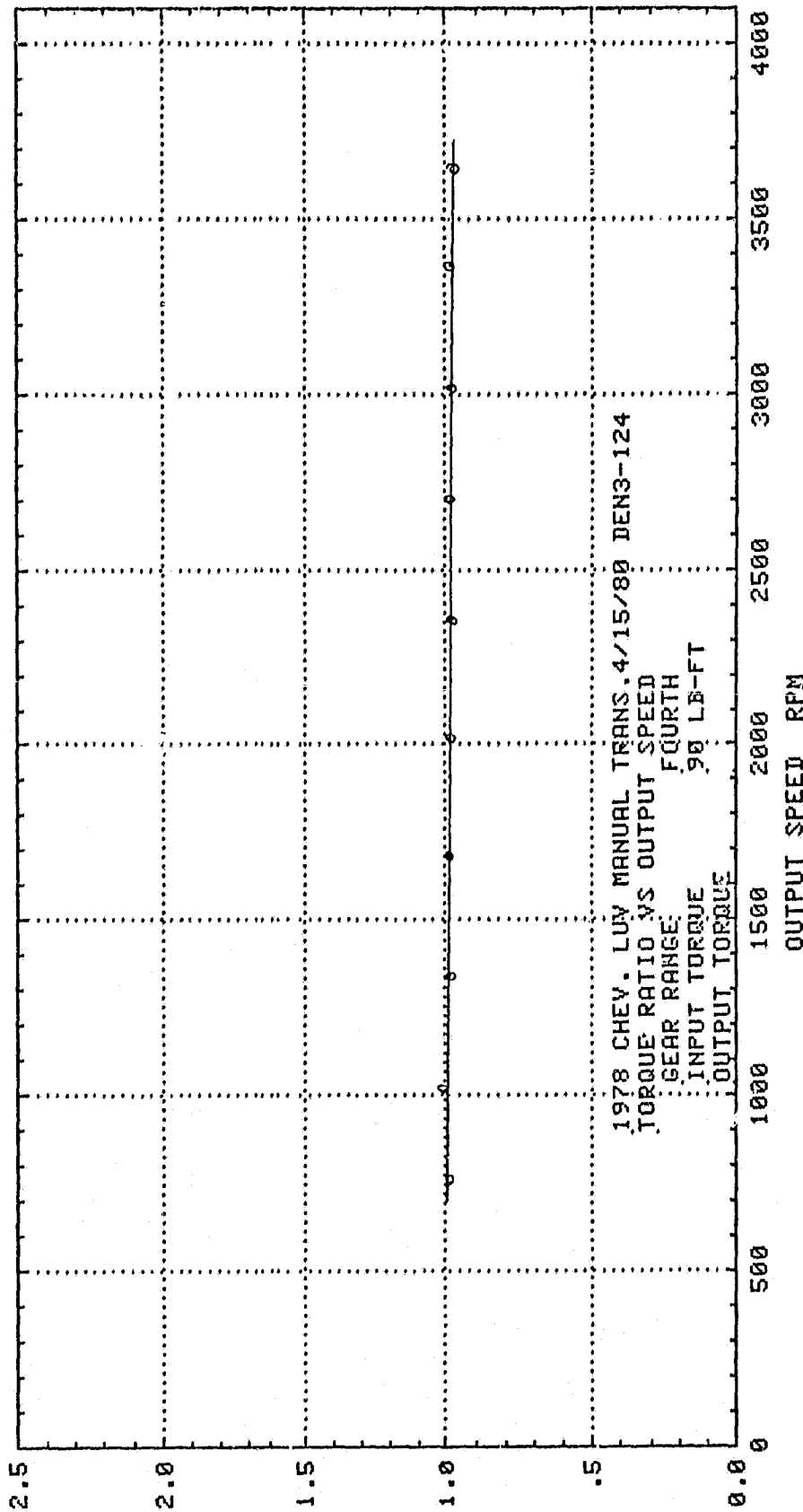

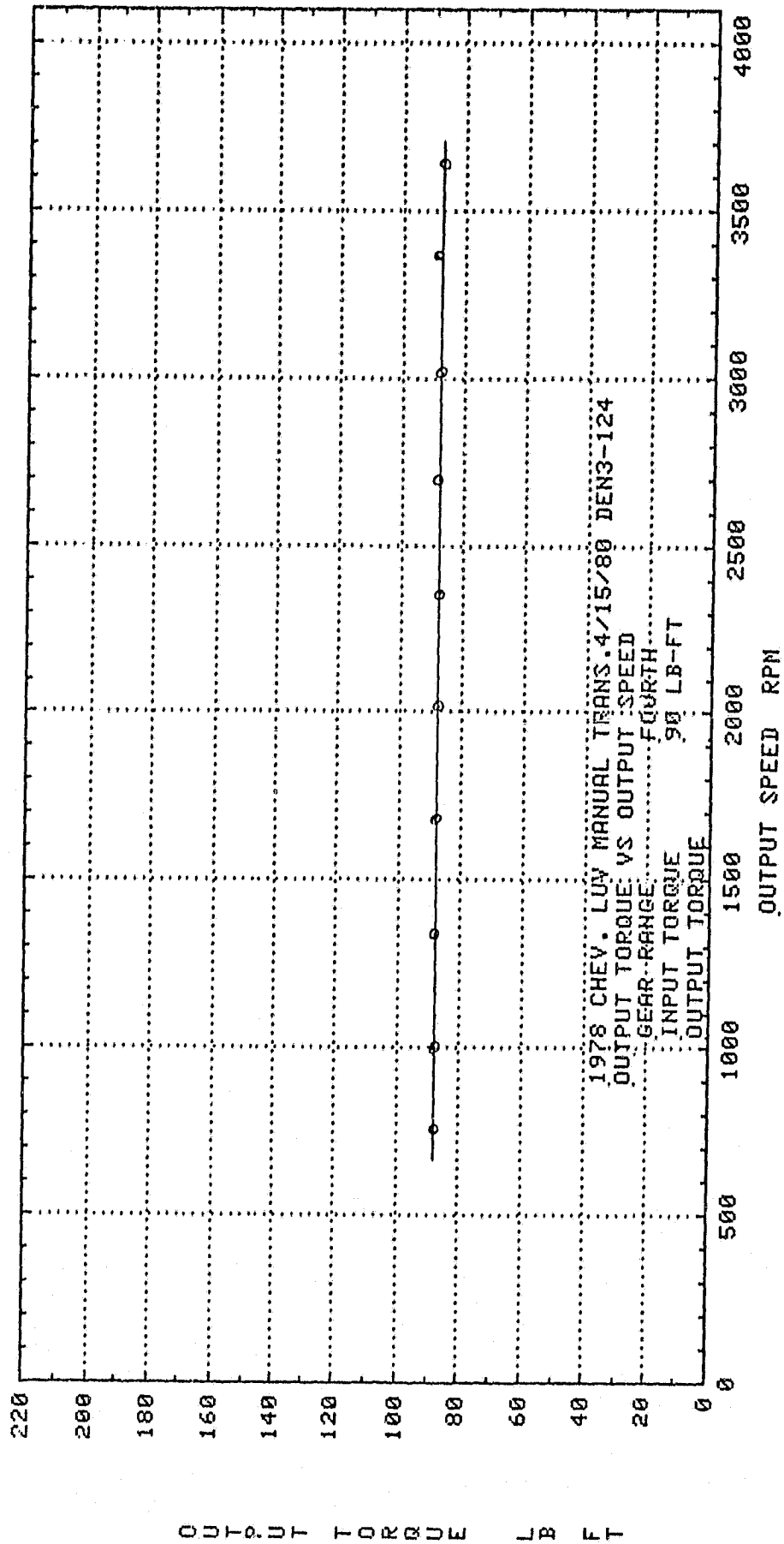

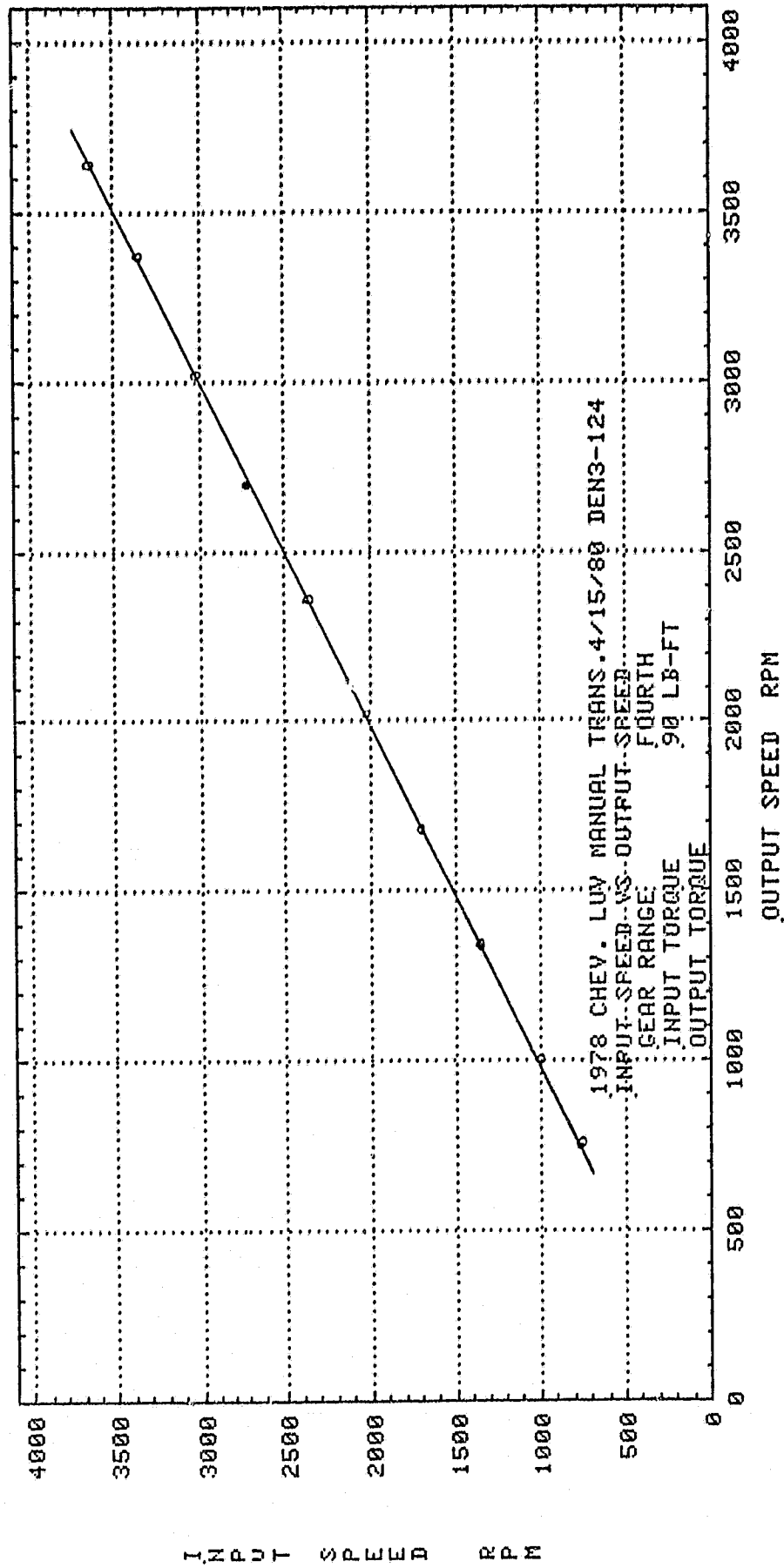

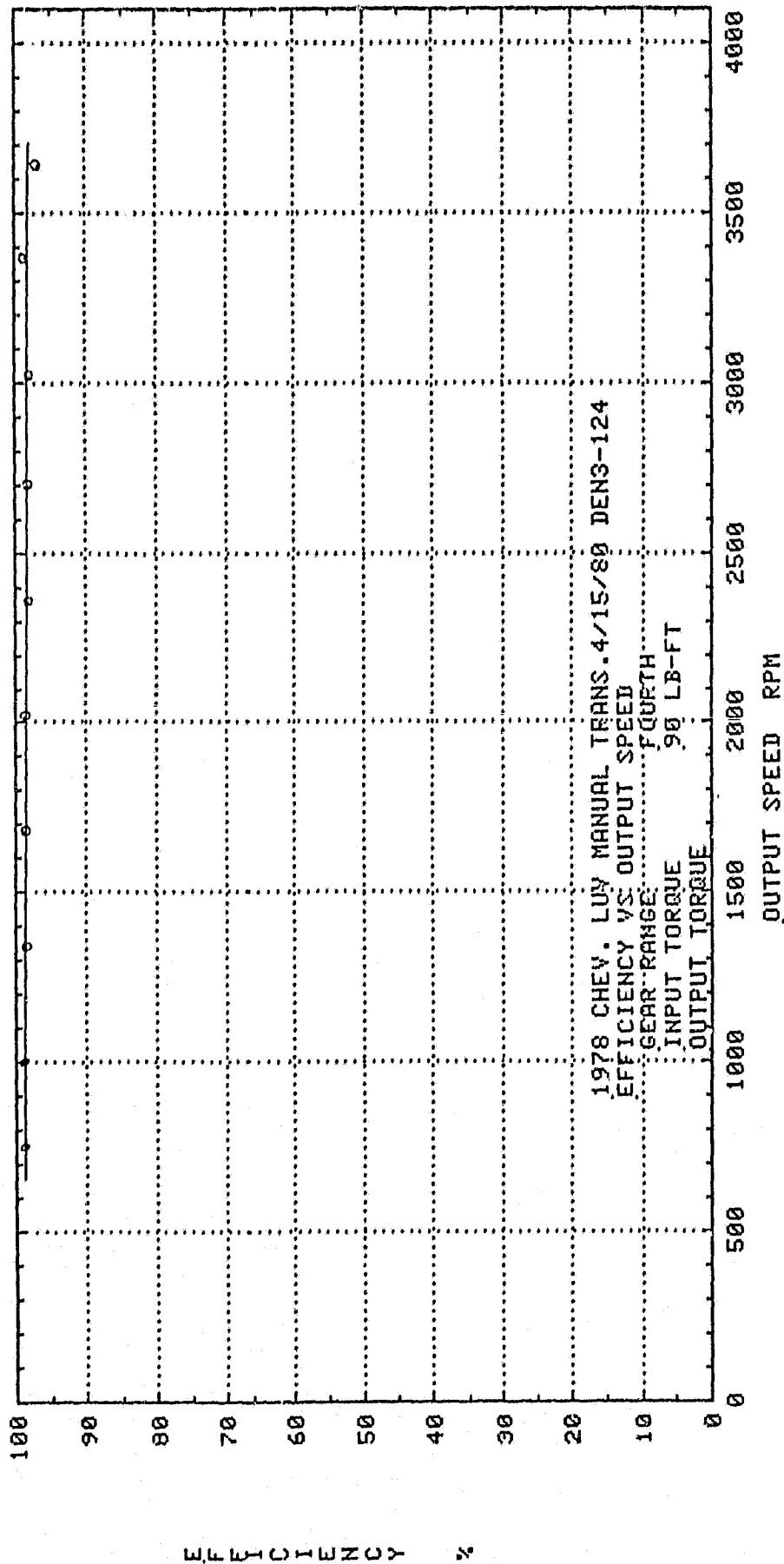

EFFICIENCY %

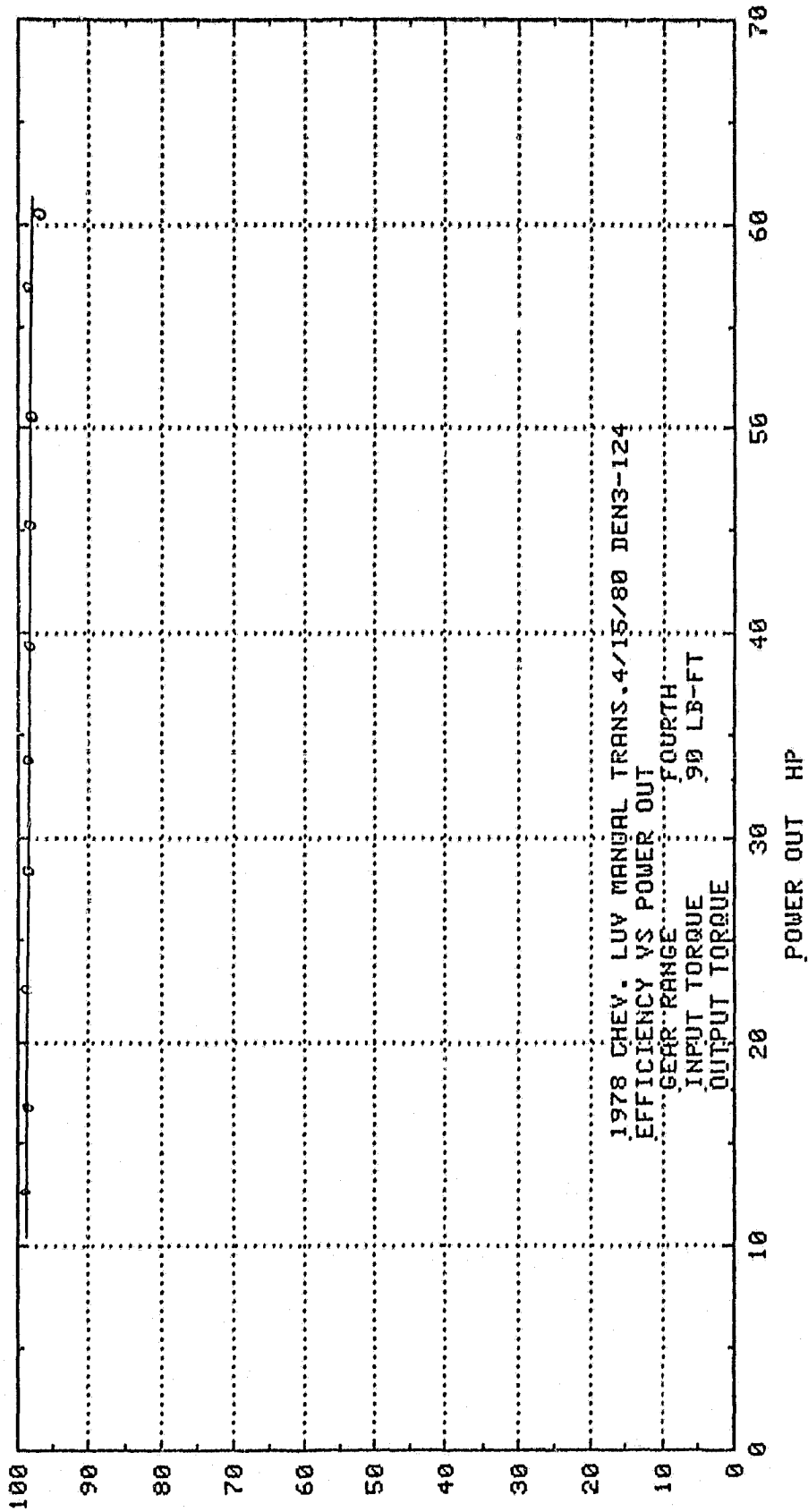

EFFICIENCY %

CROSS SECTIONAL
ROAD LOAD PERFORMANCE
4TH GEAR ONLY

Graphs Contained in This Section

Torque Ratio -vs- Output Speed

Output Torque -vs- Output Speed

Input Speed -vs- Output Speed

Efficiency -vs- Output Speed

Efficiency -vs- Power Out

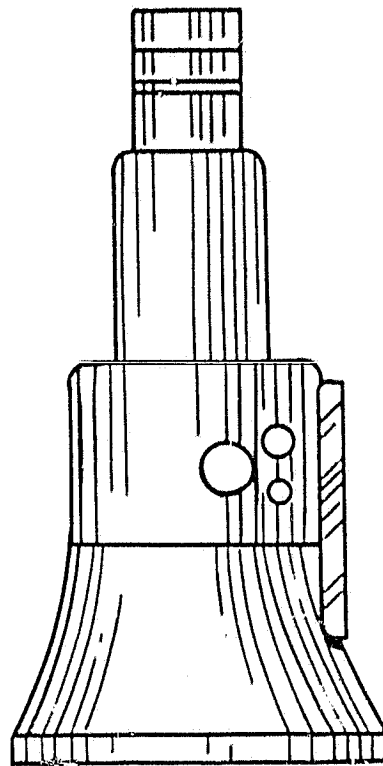

Torque In

Speed In

Torque Out

Speed Out

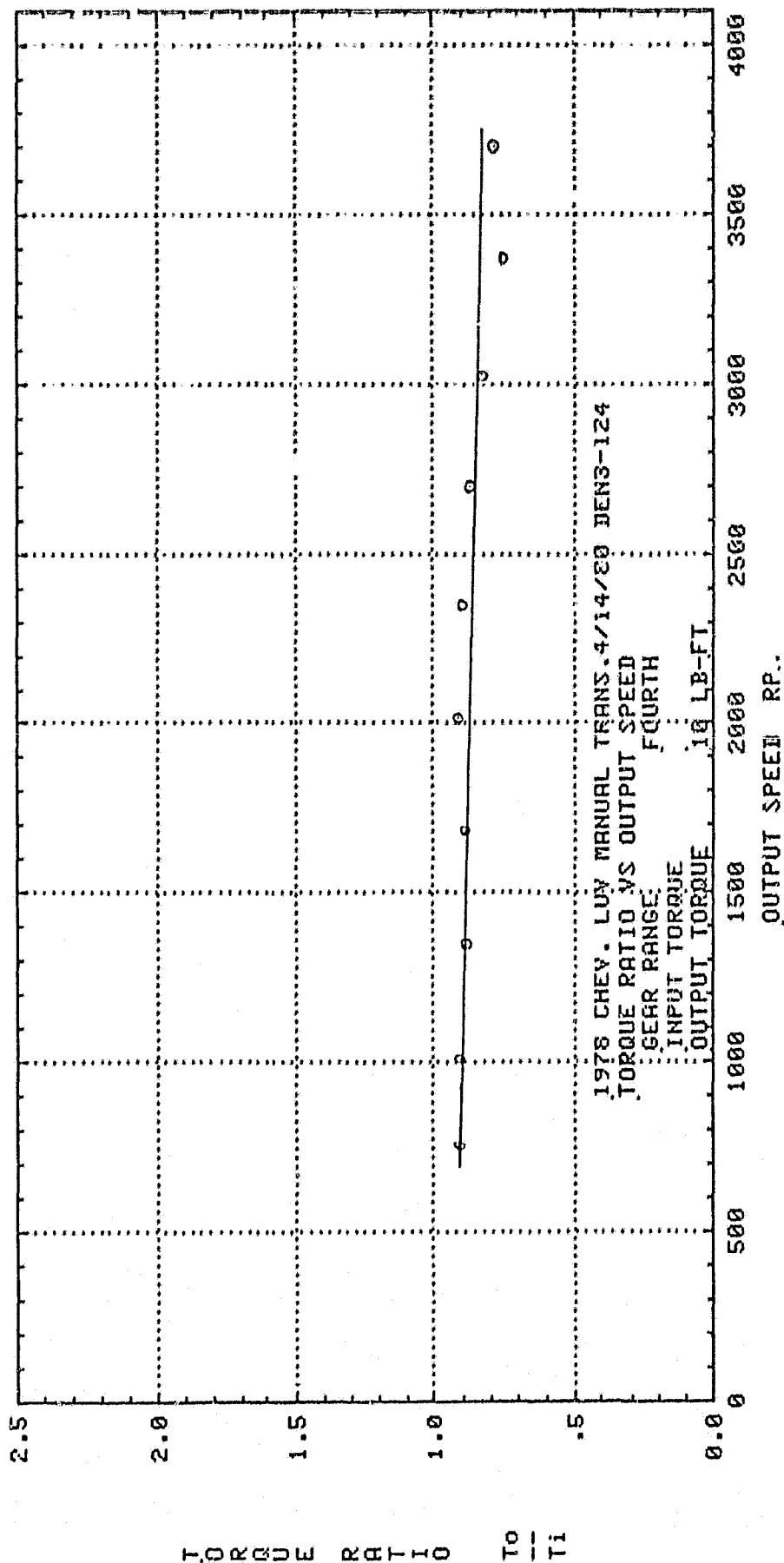

TORQUE RATIO $\frac{T_o}{T_i}$

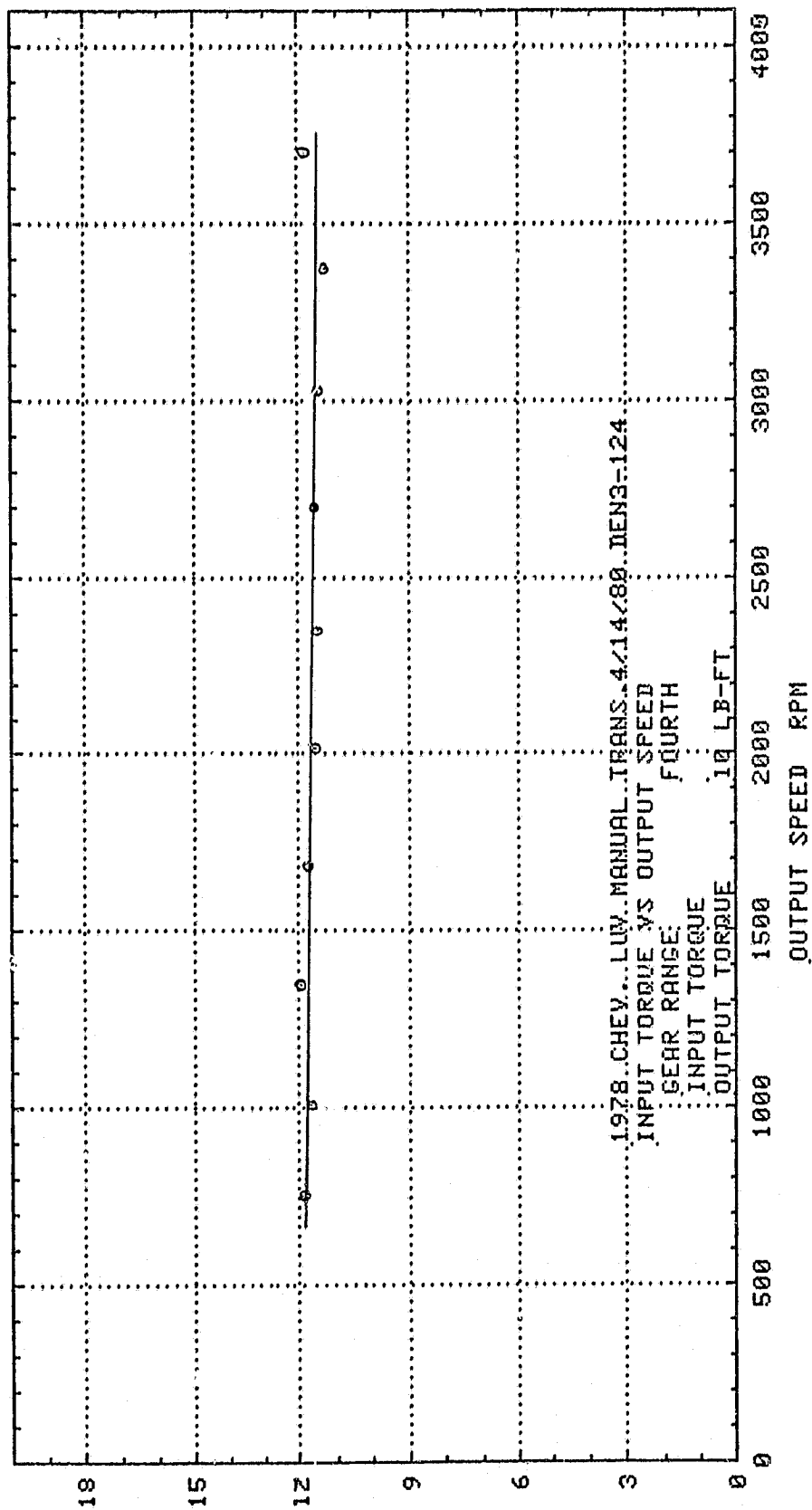

INPUT TORQUE LB FT

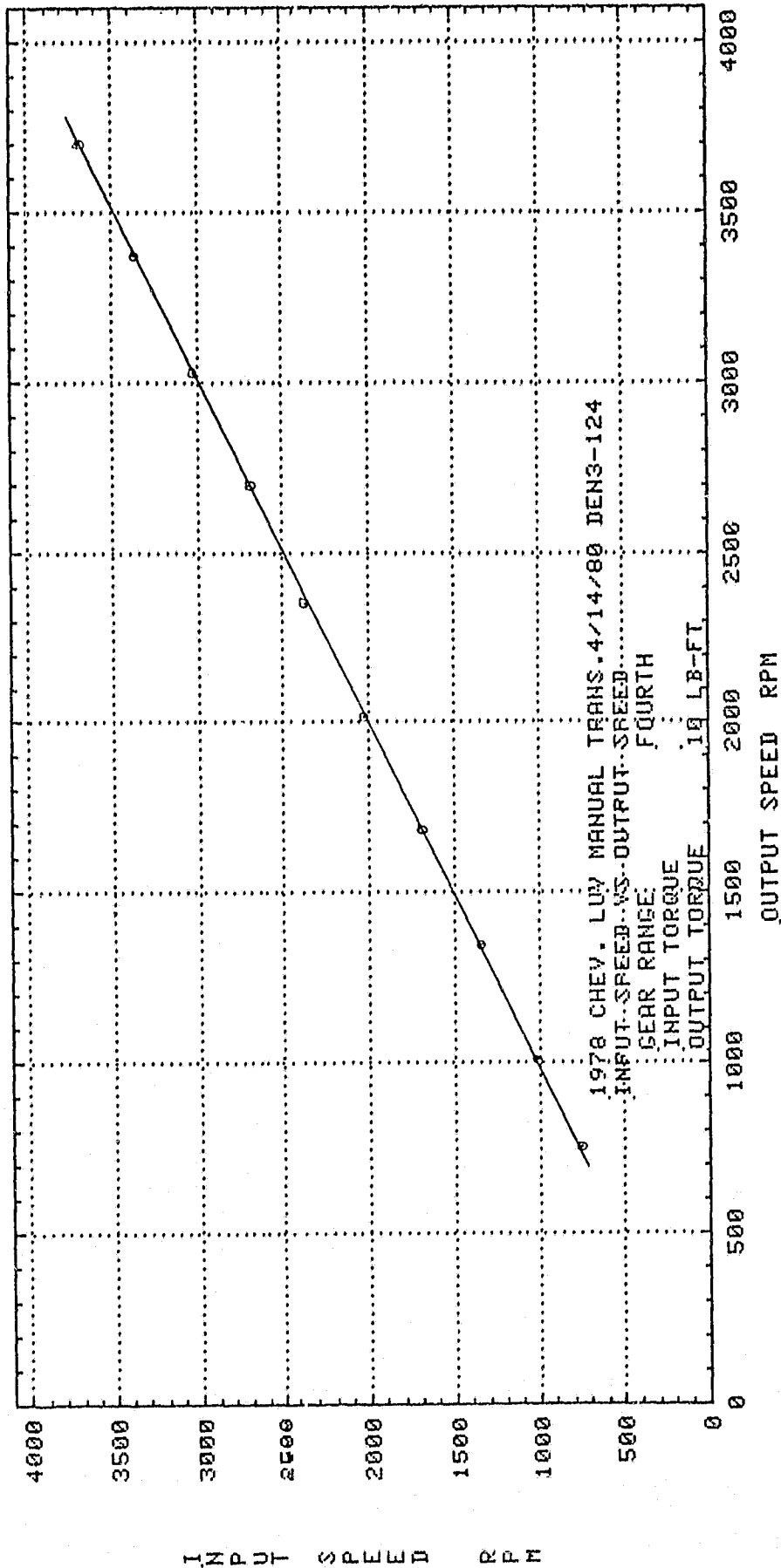

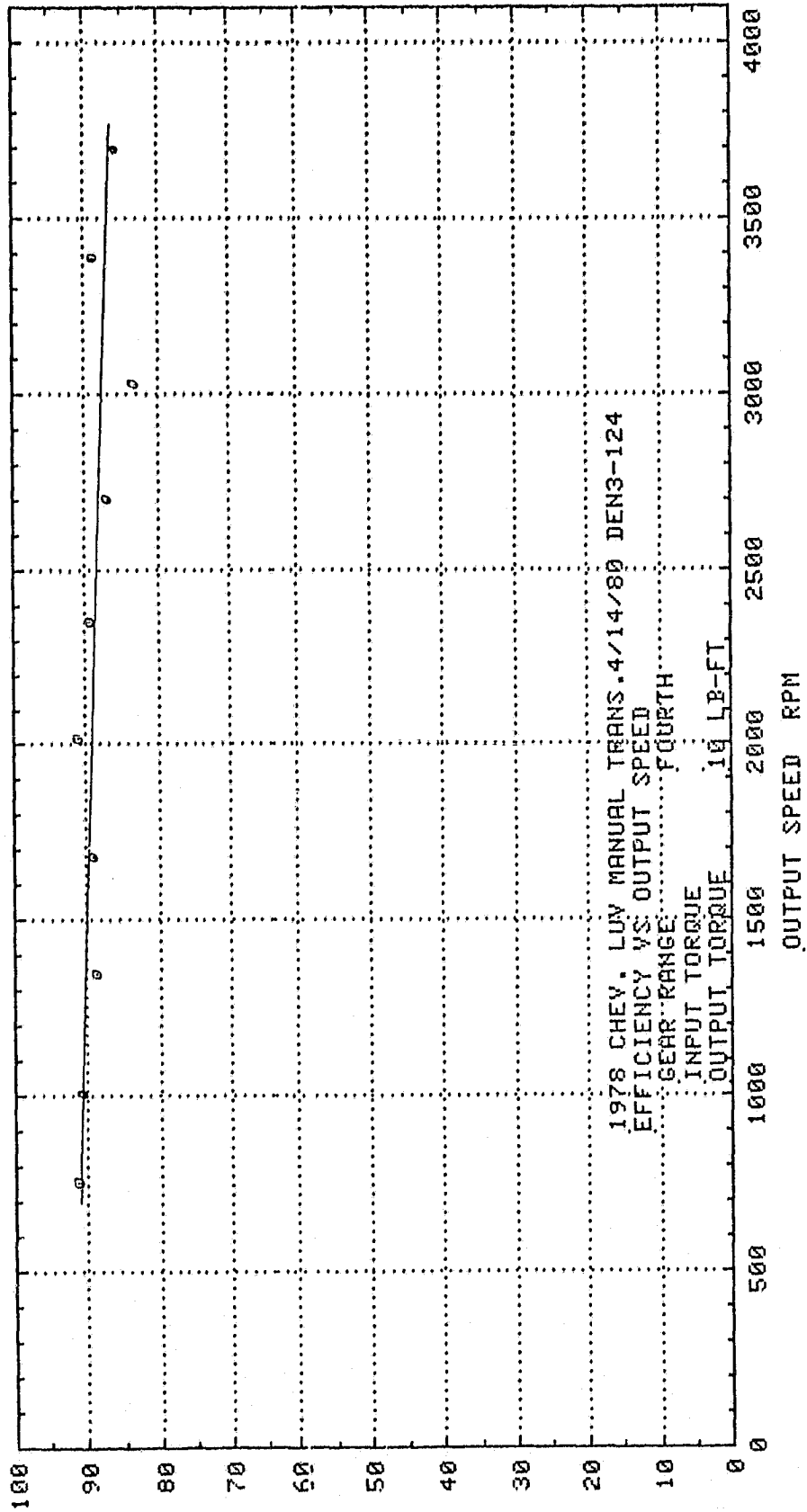

EFFICIENCY %

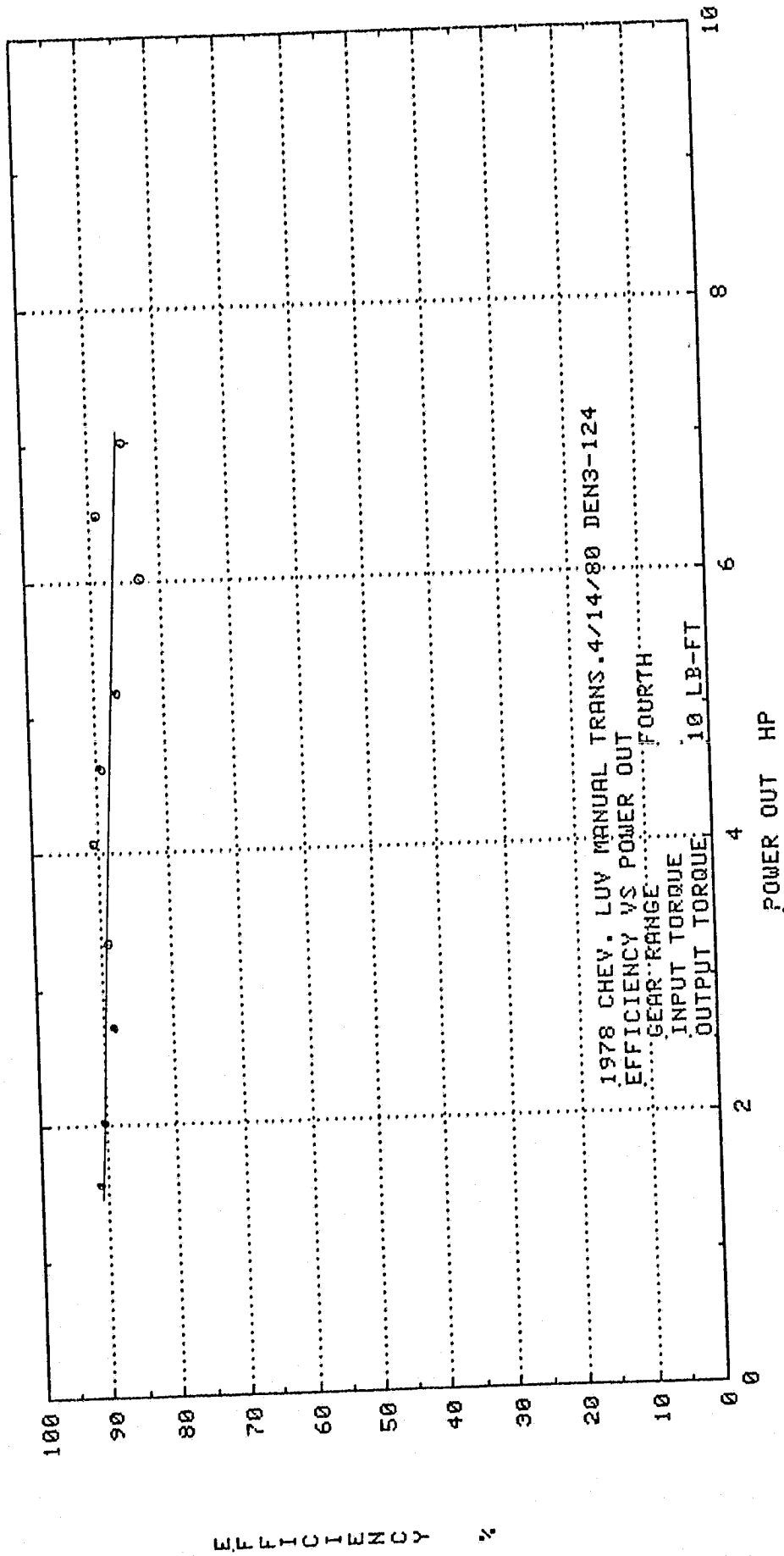

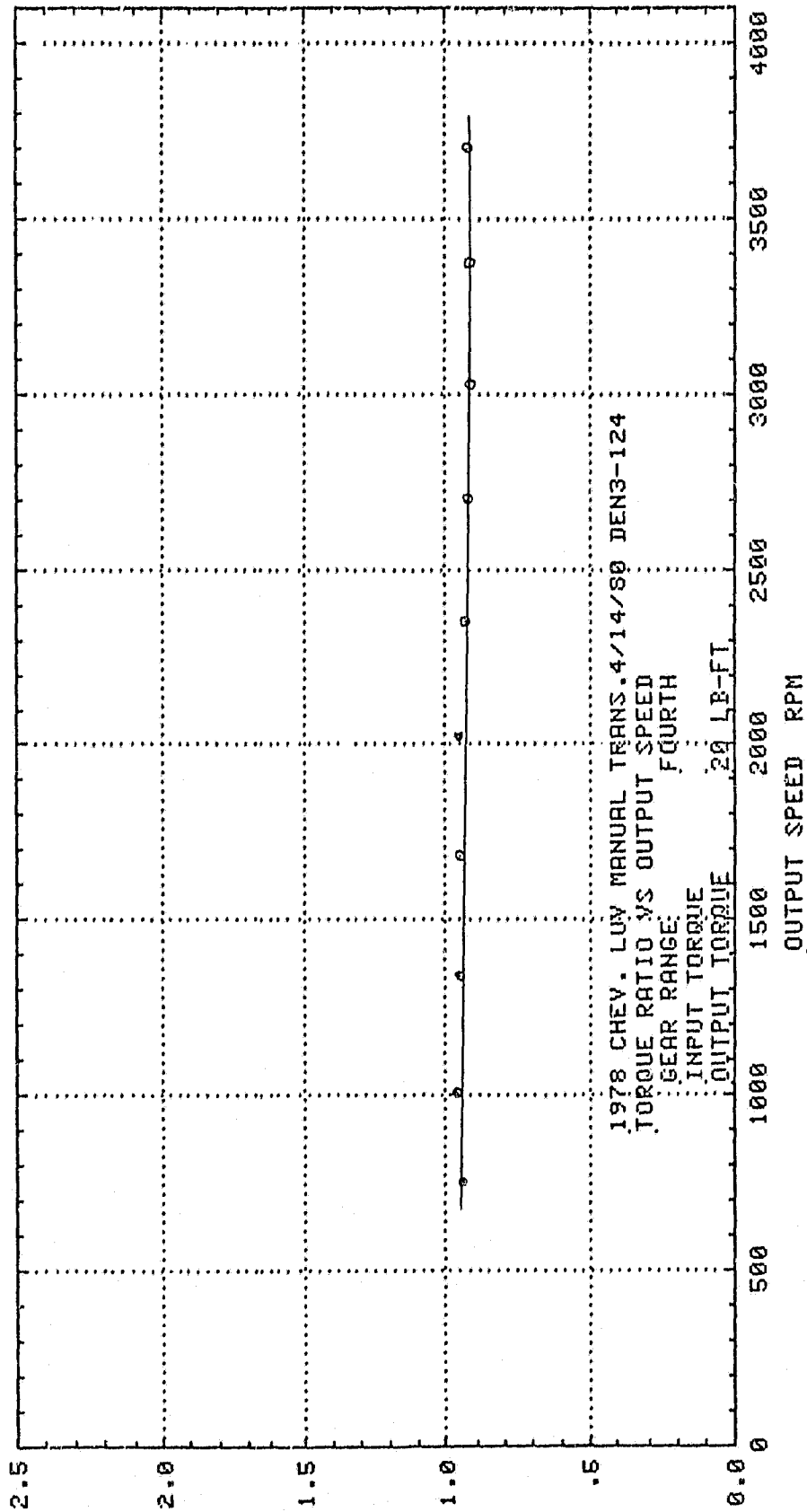

TORQUE RATIO $\frac{T_o}{T_i}$

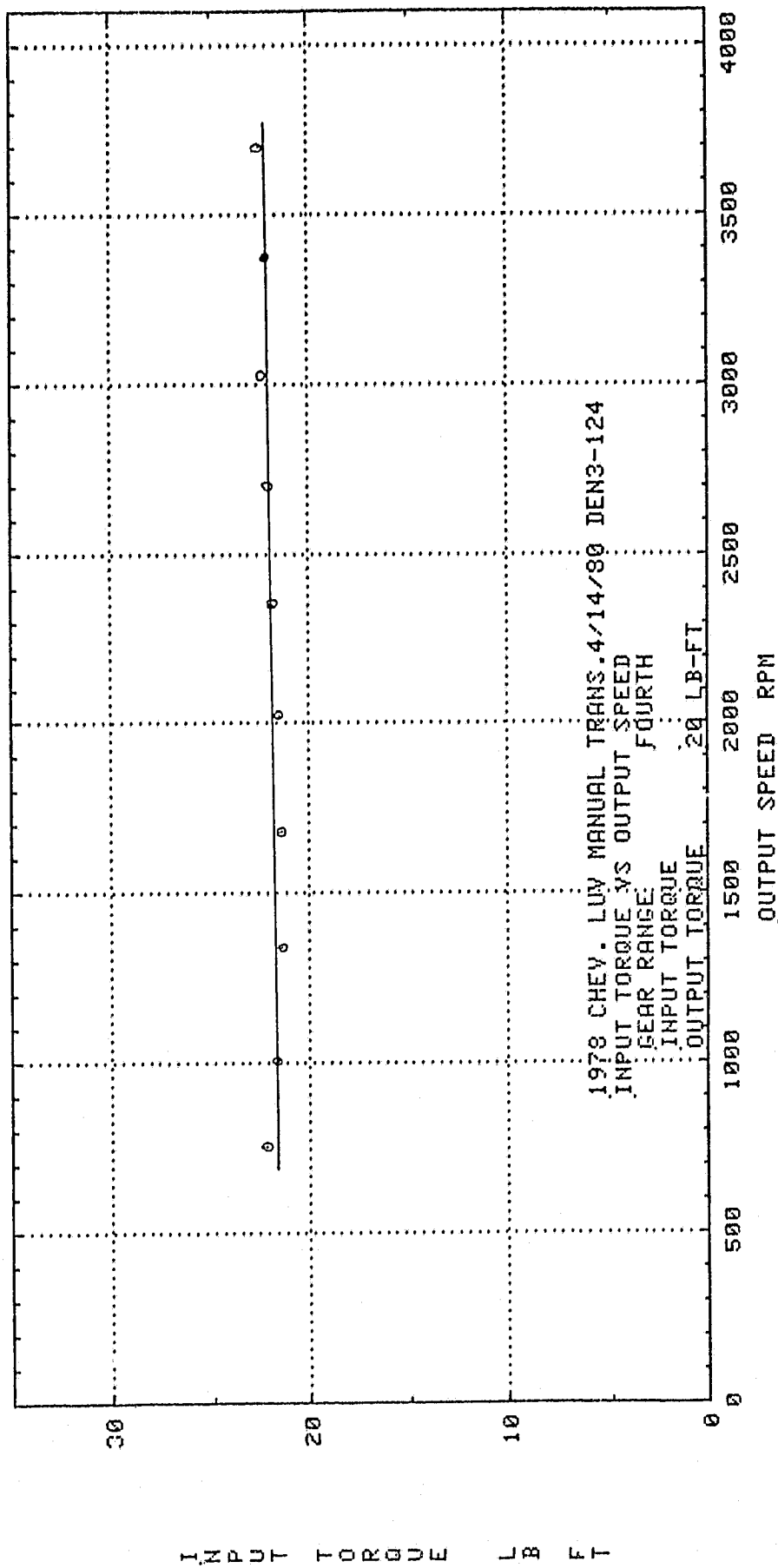

INPUT TORQUE LB FT

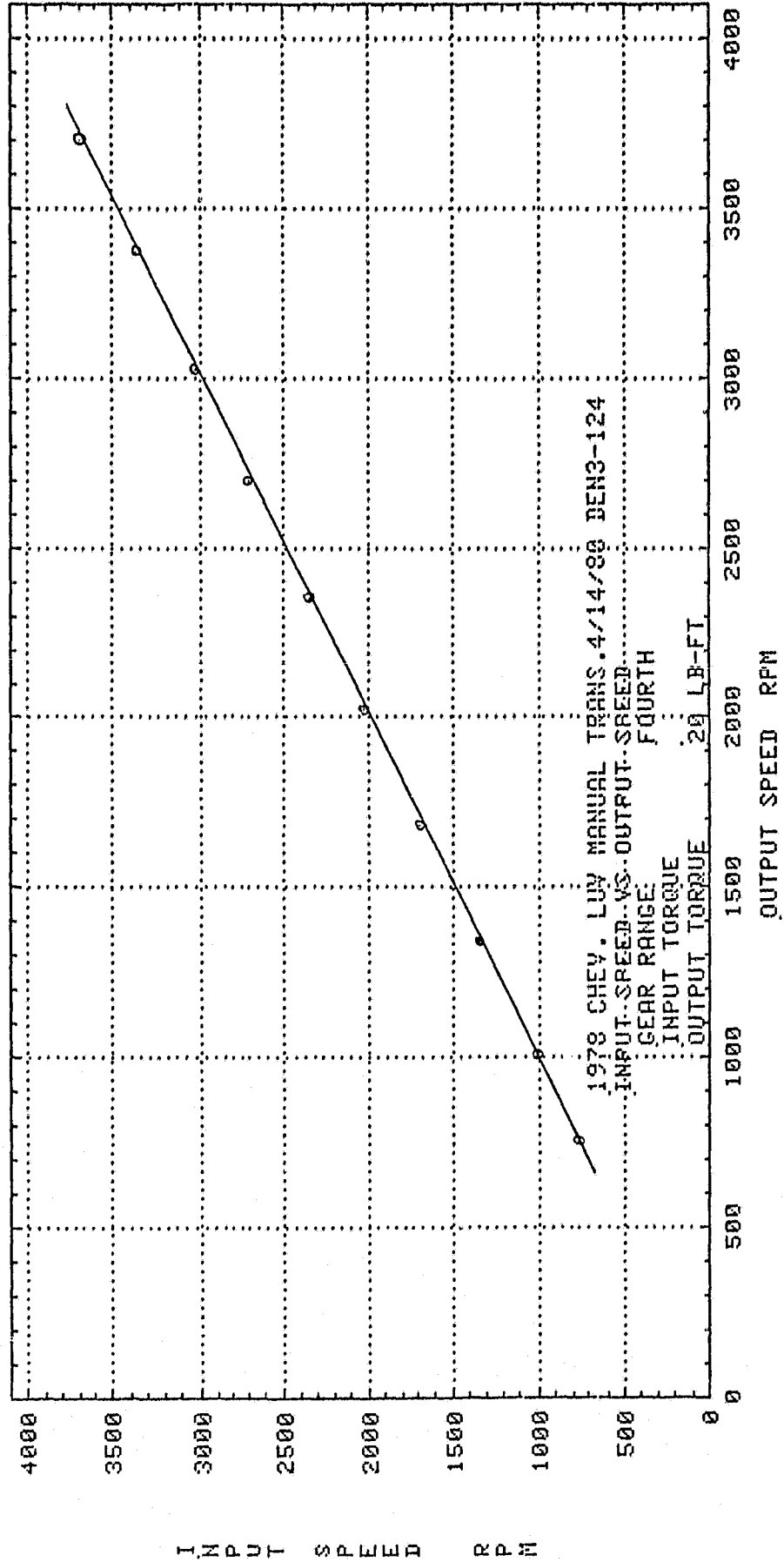

INPUT SPEED RPM

E F F I C I E N C Y %

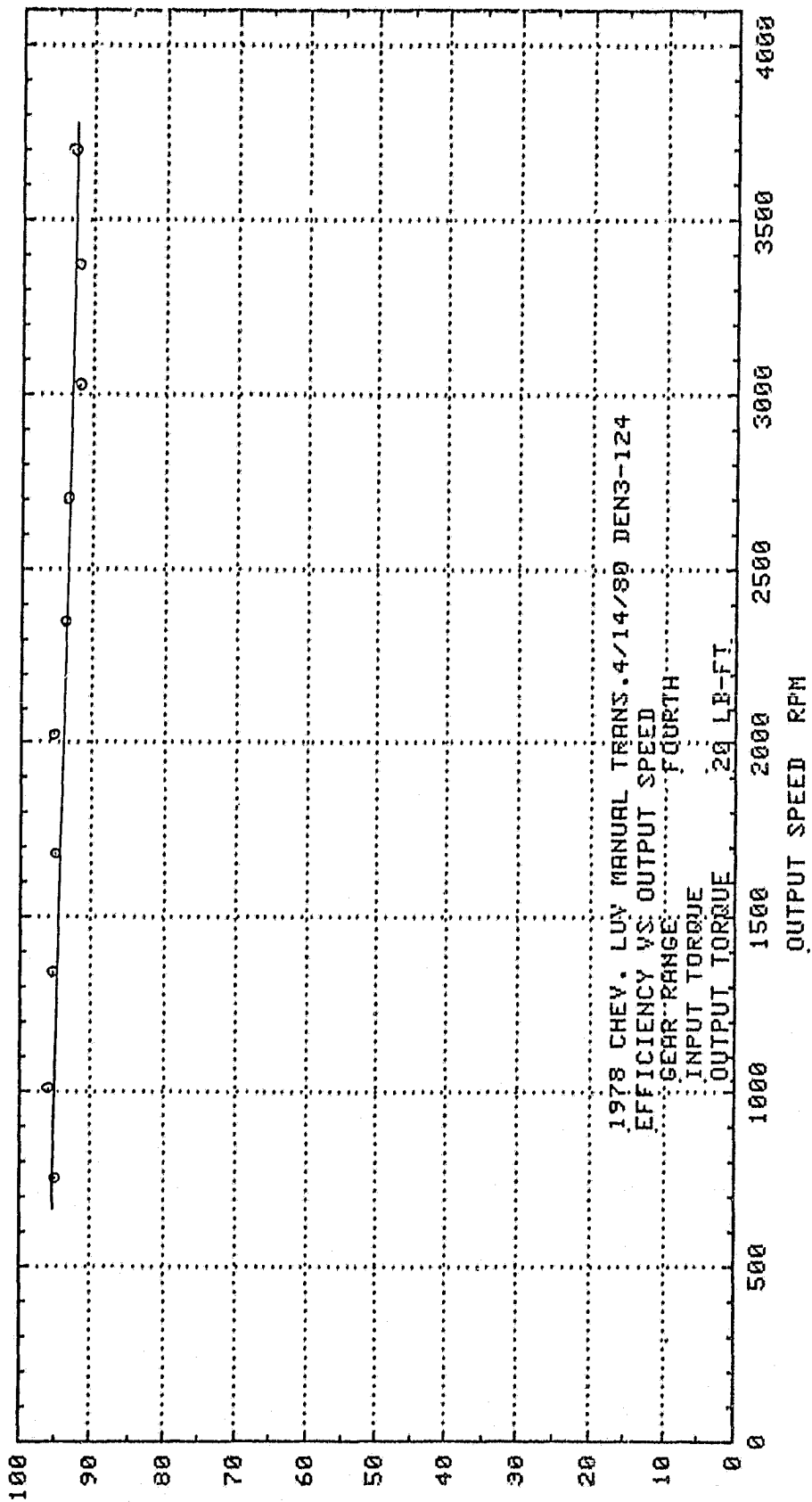

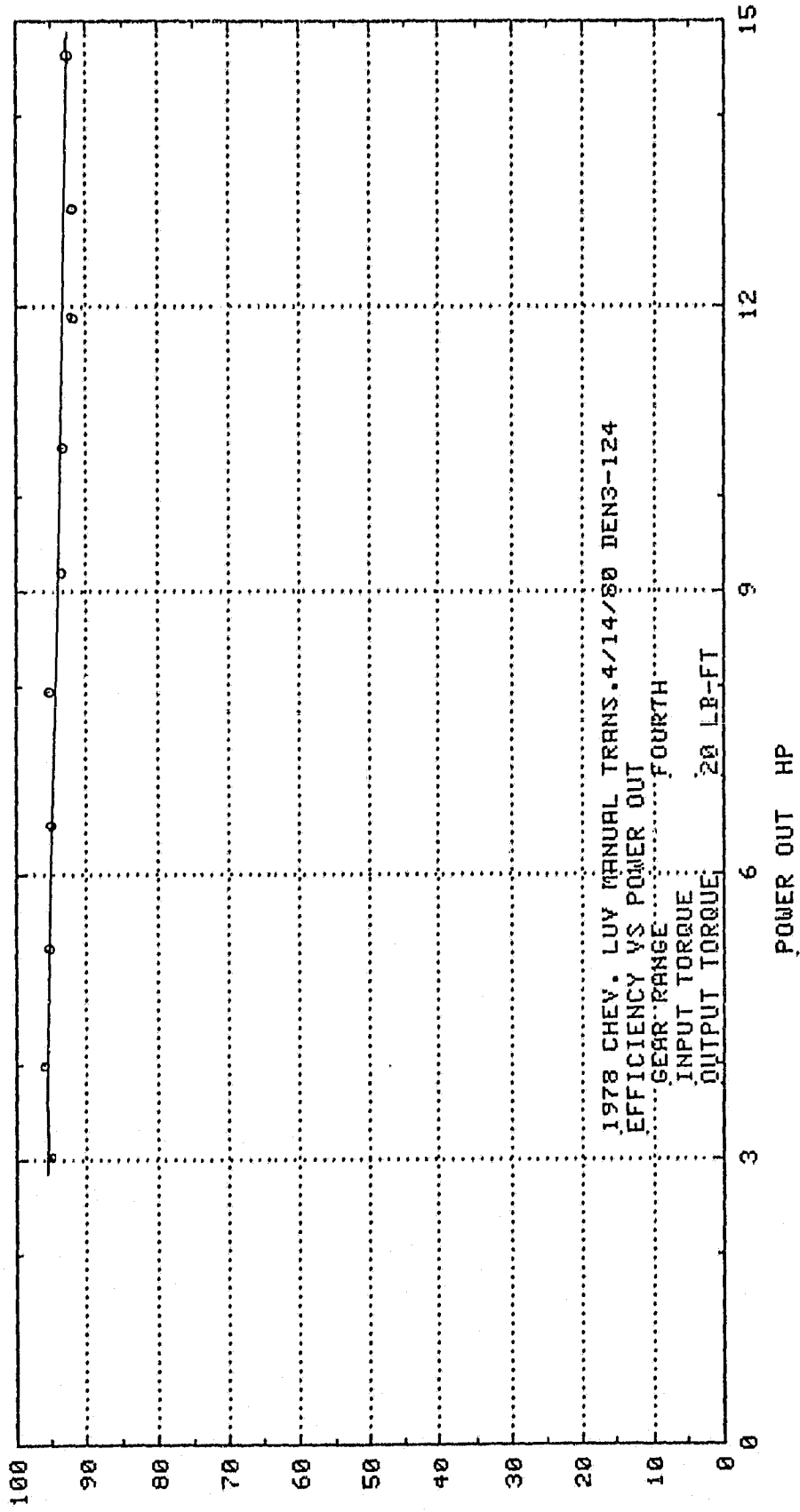

EFFICIENCY %

TORQUE RATIO $\frac{T_o}{T_i}$

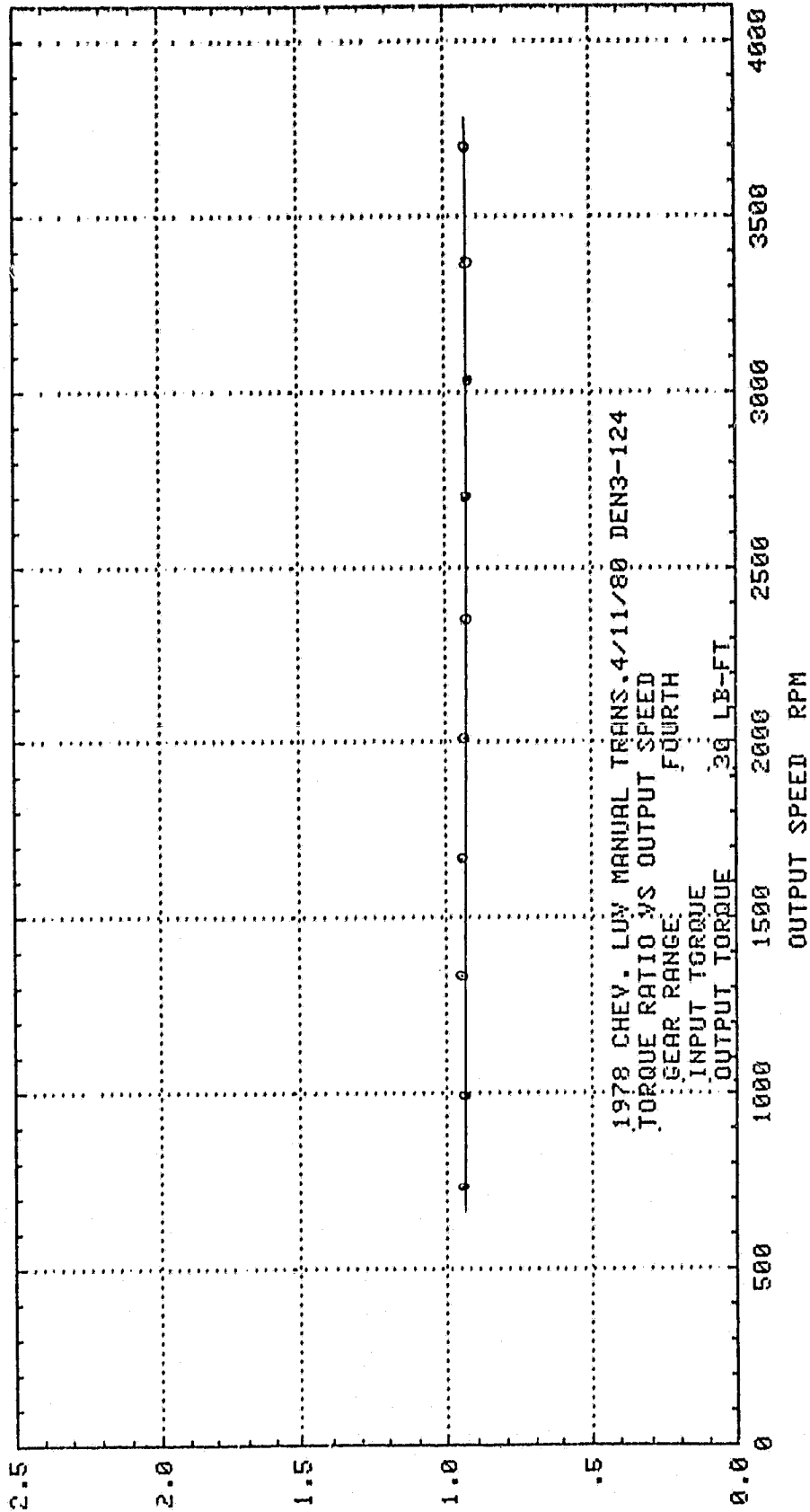

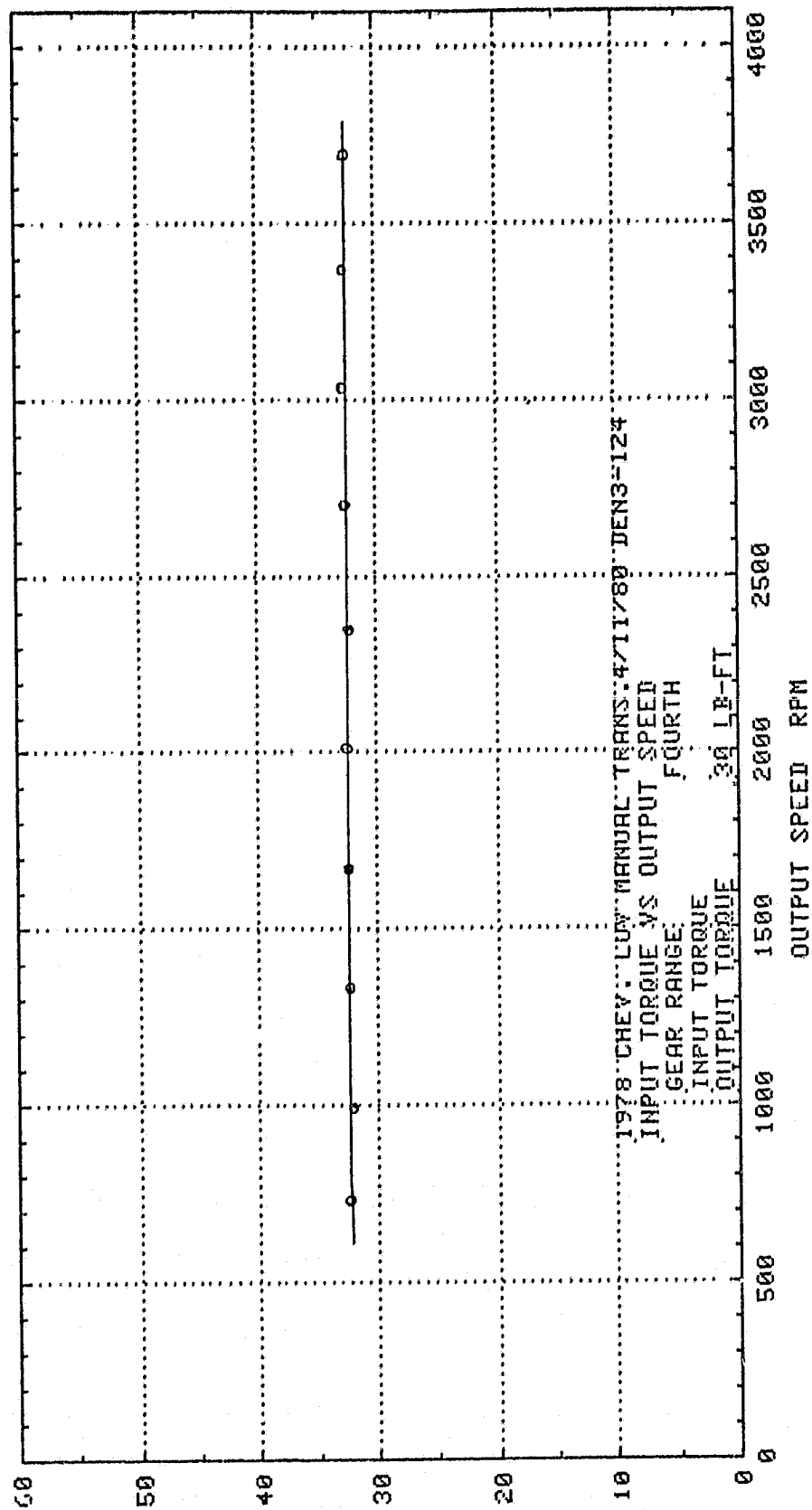

INPUT TORQUE LB FT

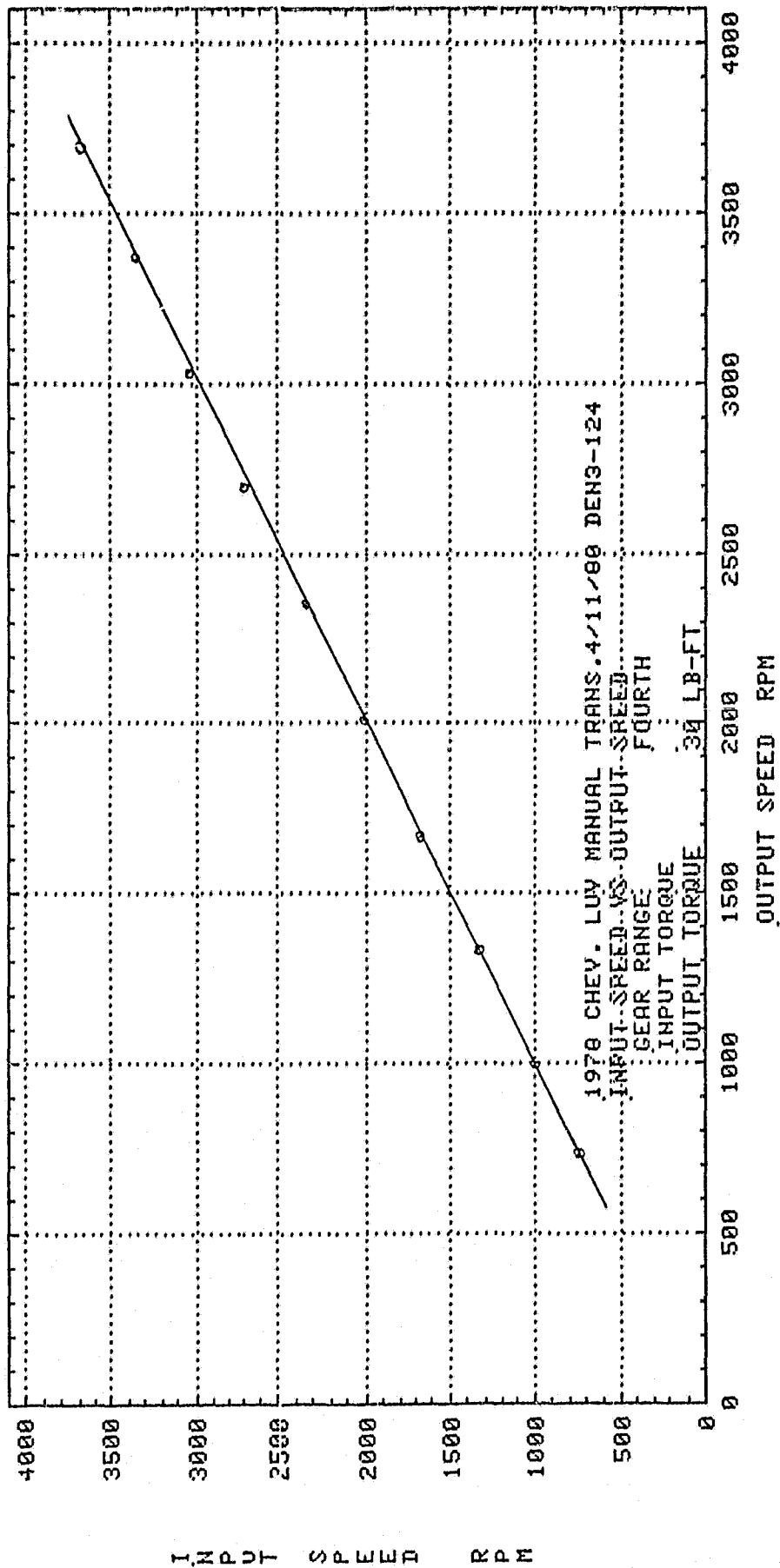

5Z

EFFICIENCY %

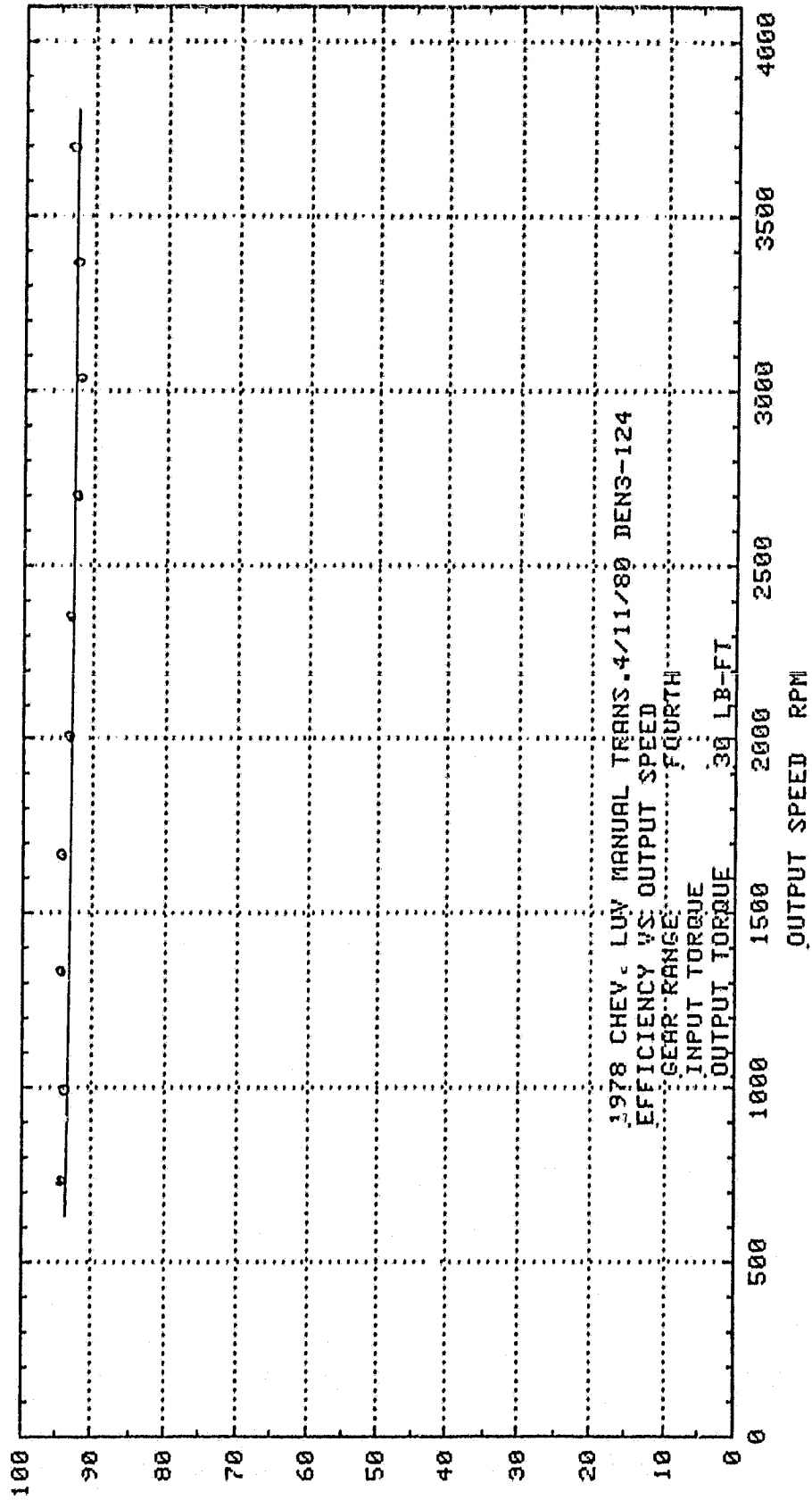

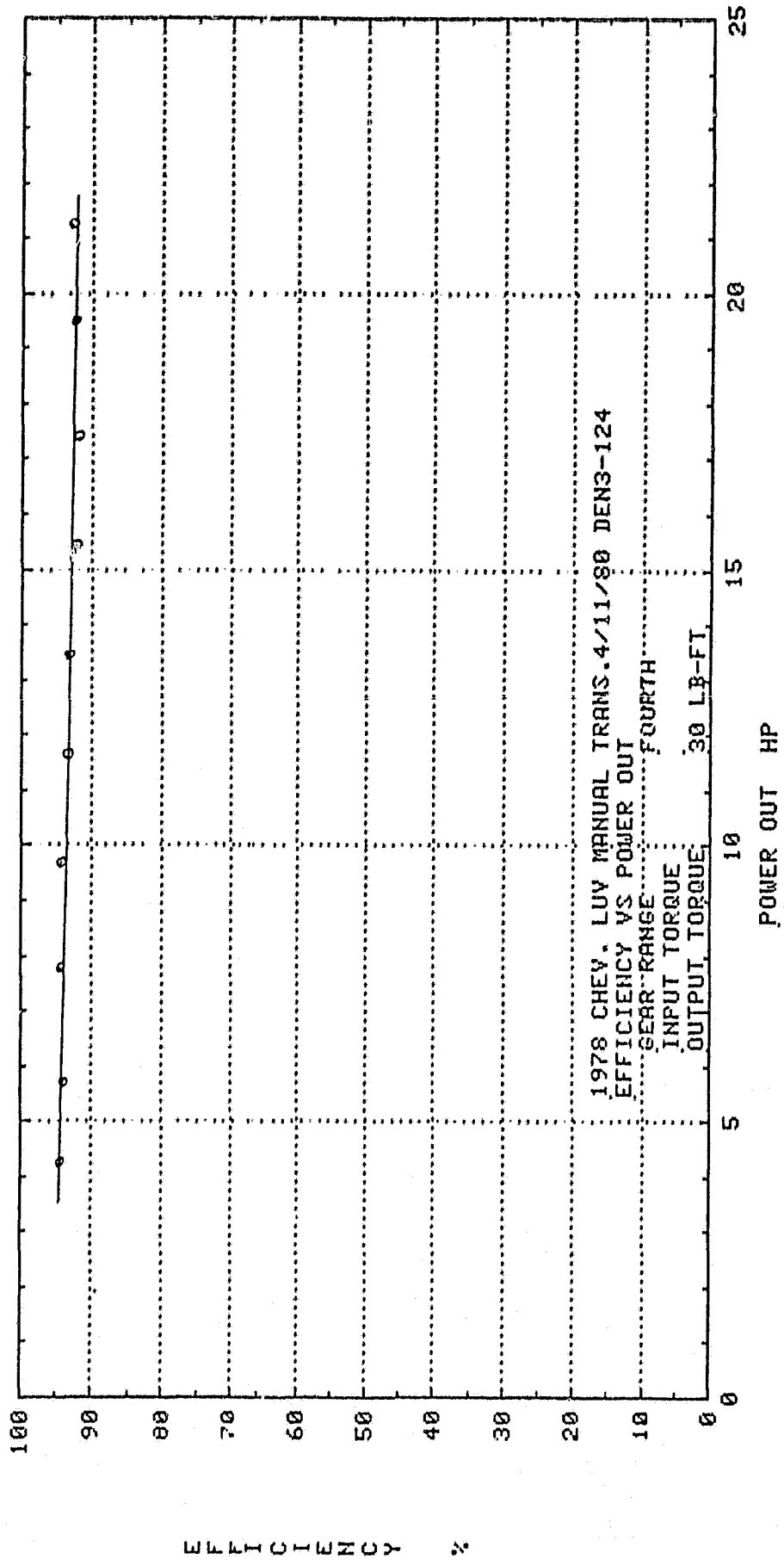

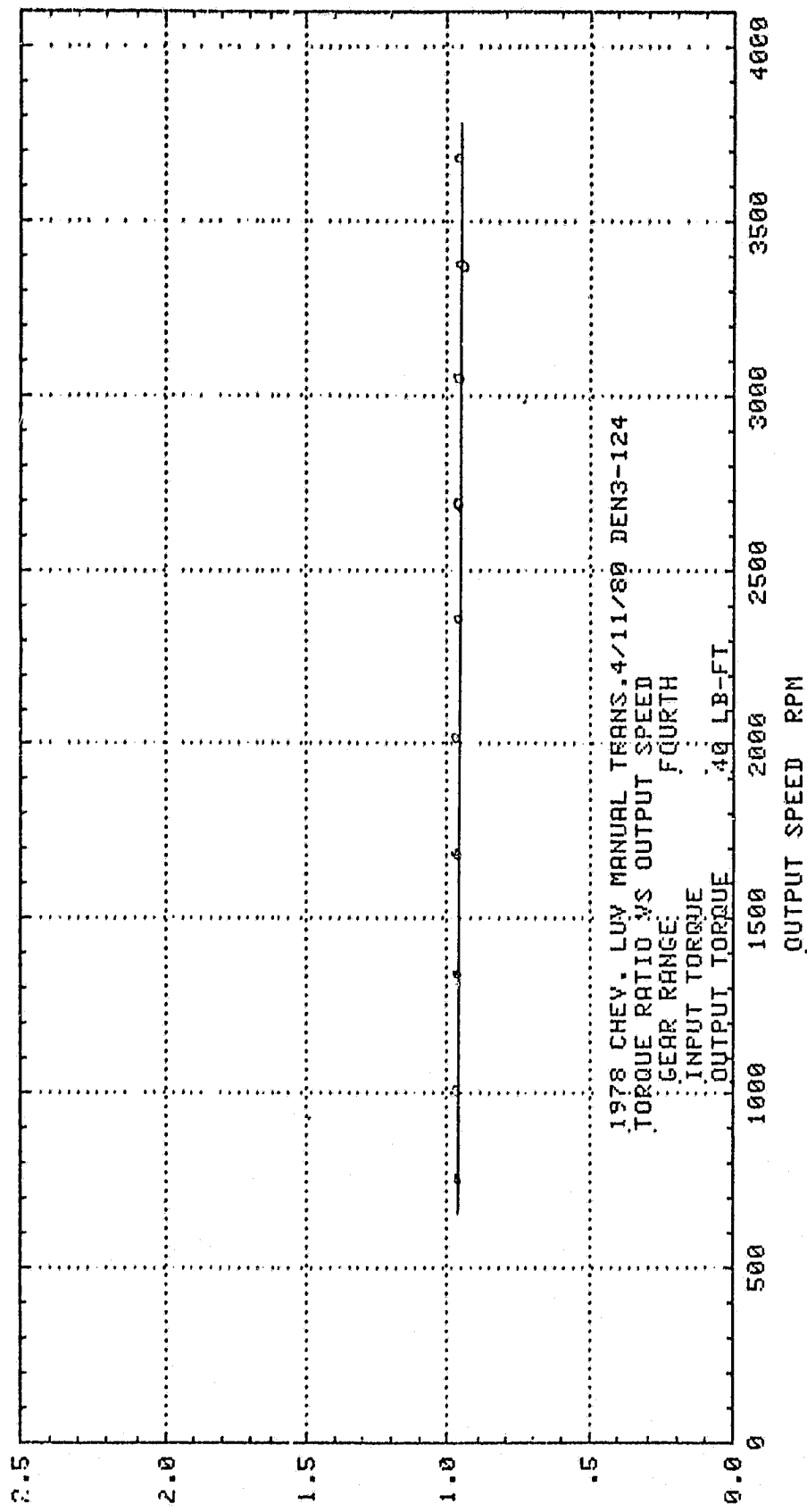

TORQUE RATIO $\frac{T_o}{T_i}$

INPUT TORQUE LB FT

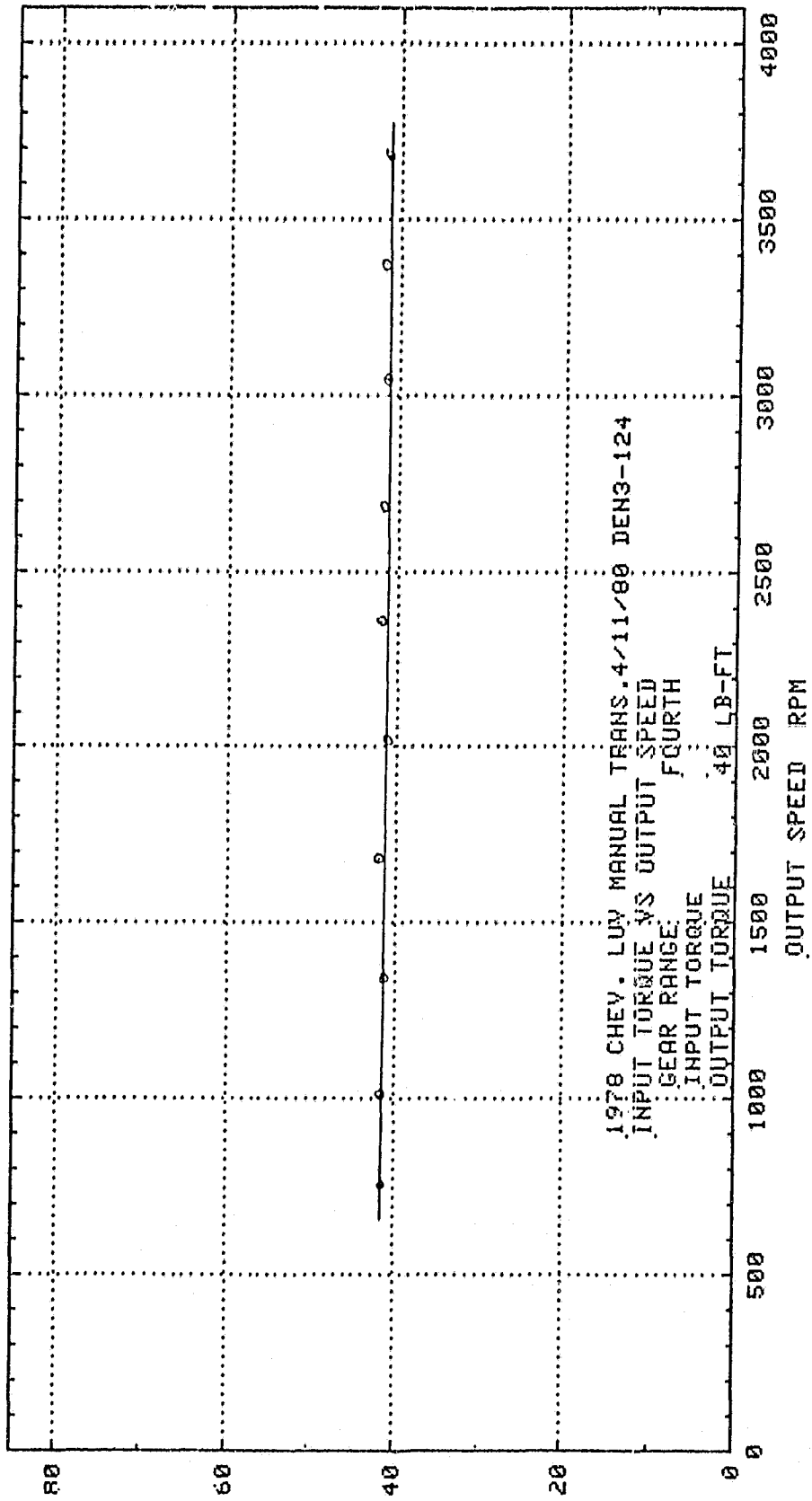

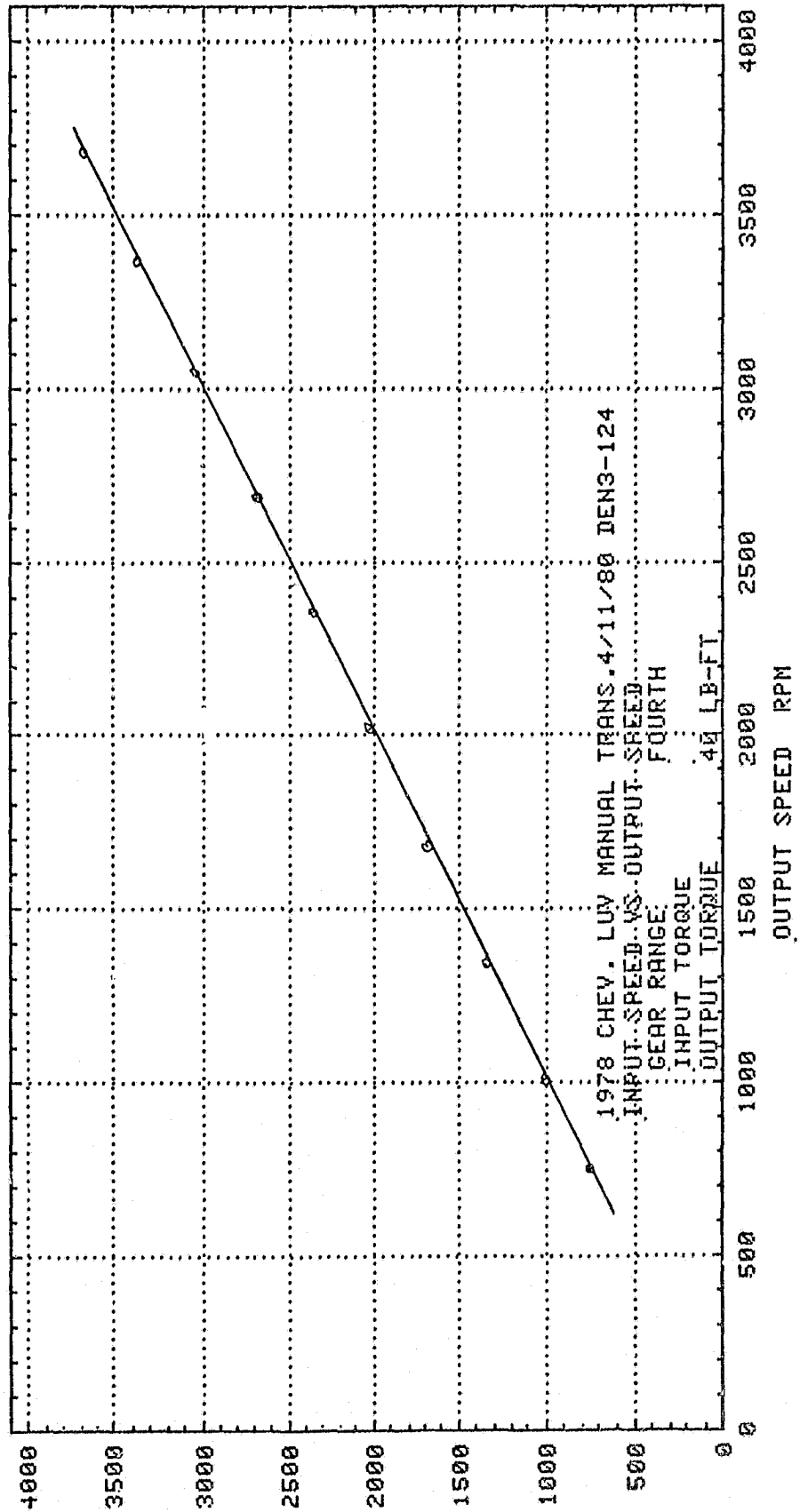

INPUT SPEED RPM

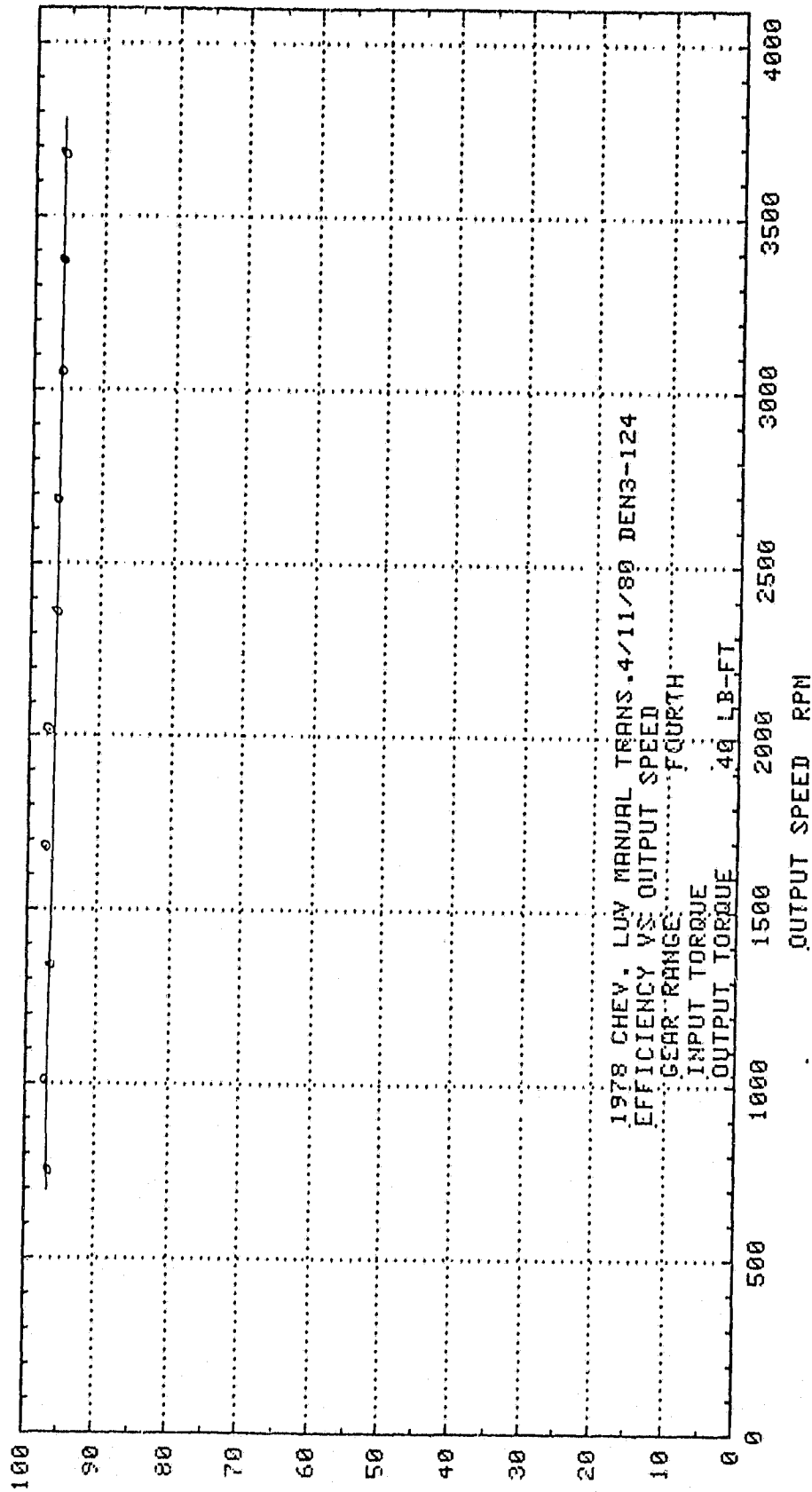

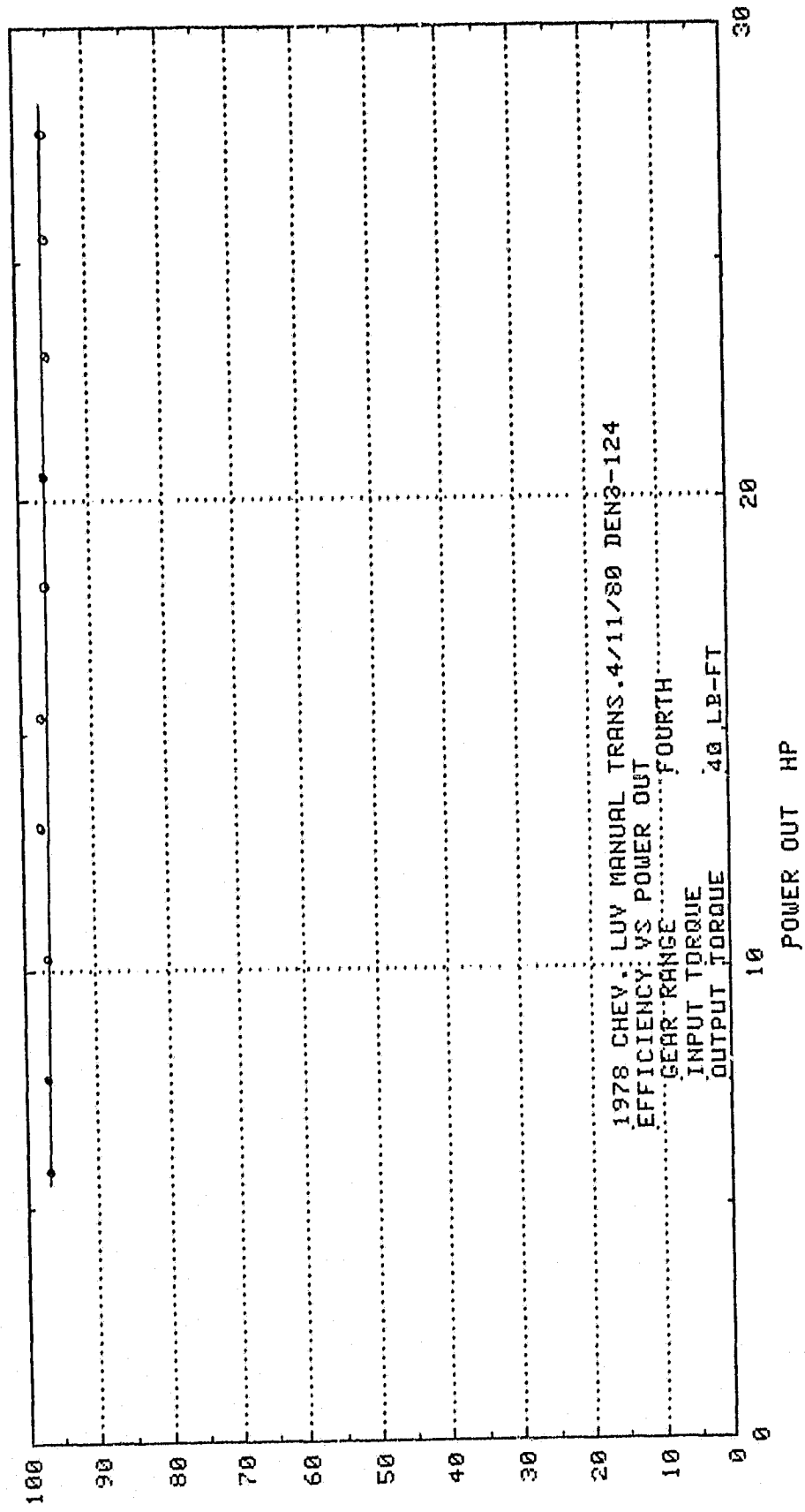

EFFICIENCY

TORQUE RATIO $\frac{T_o}{T_i}$

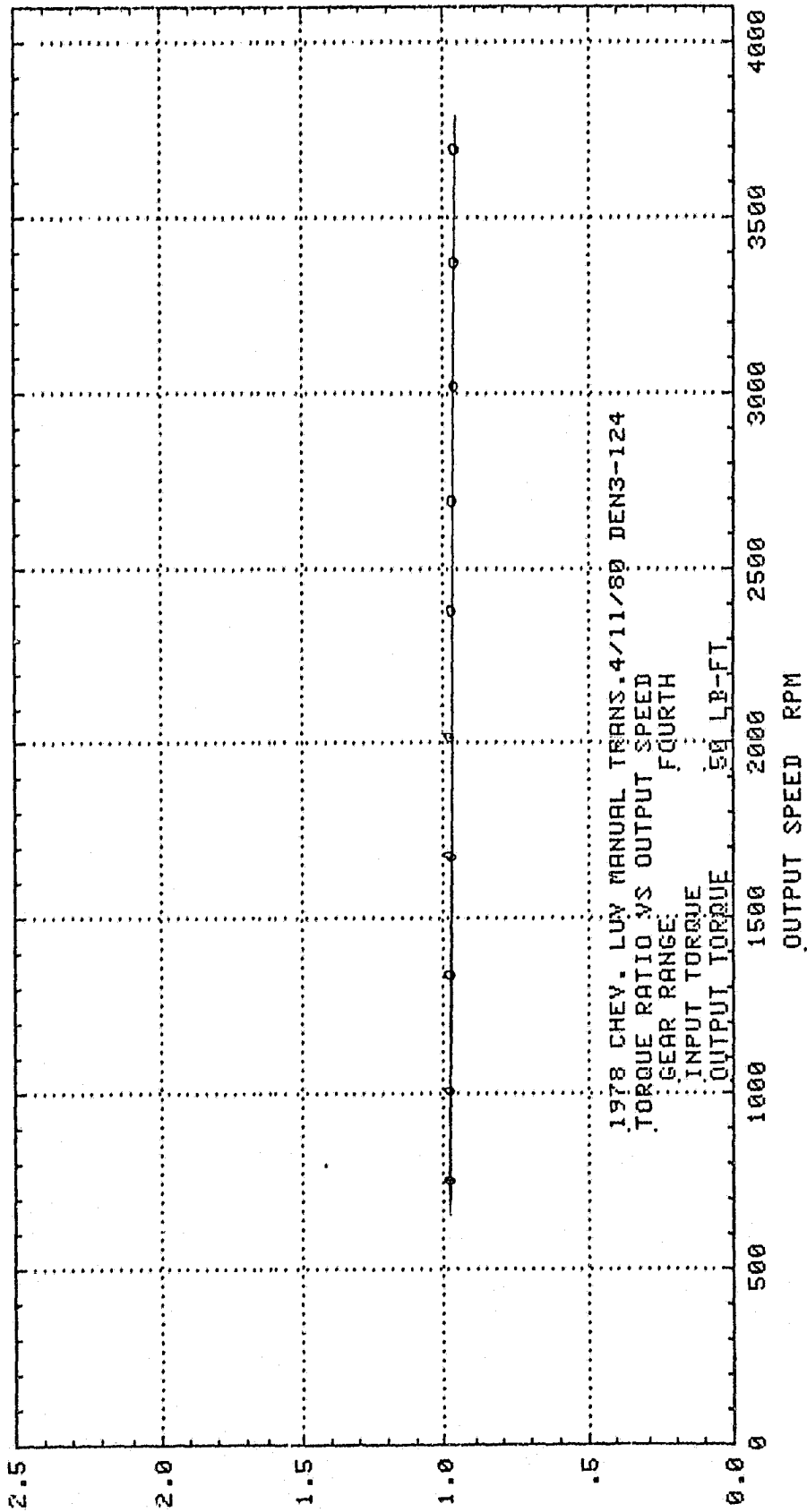

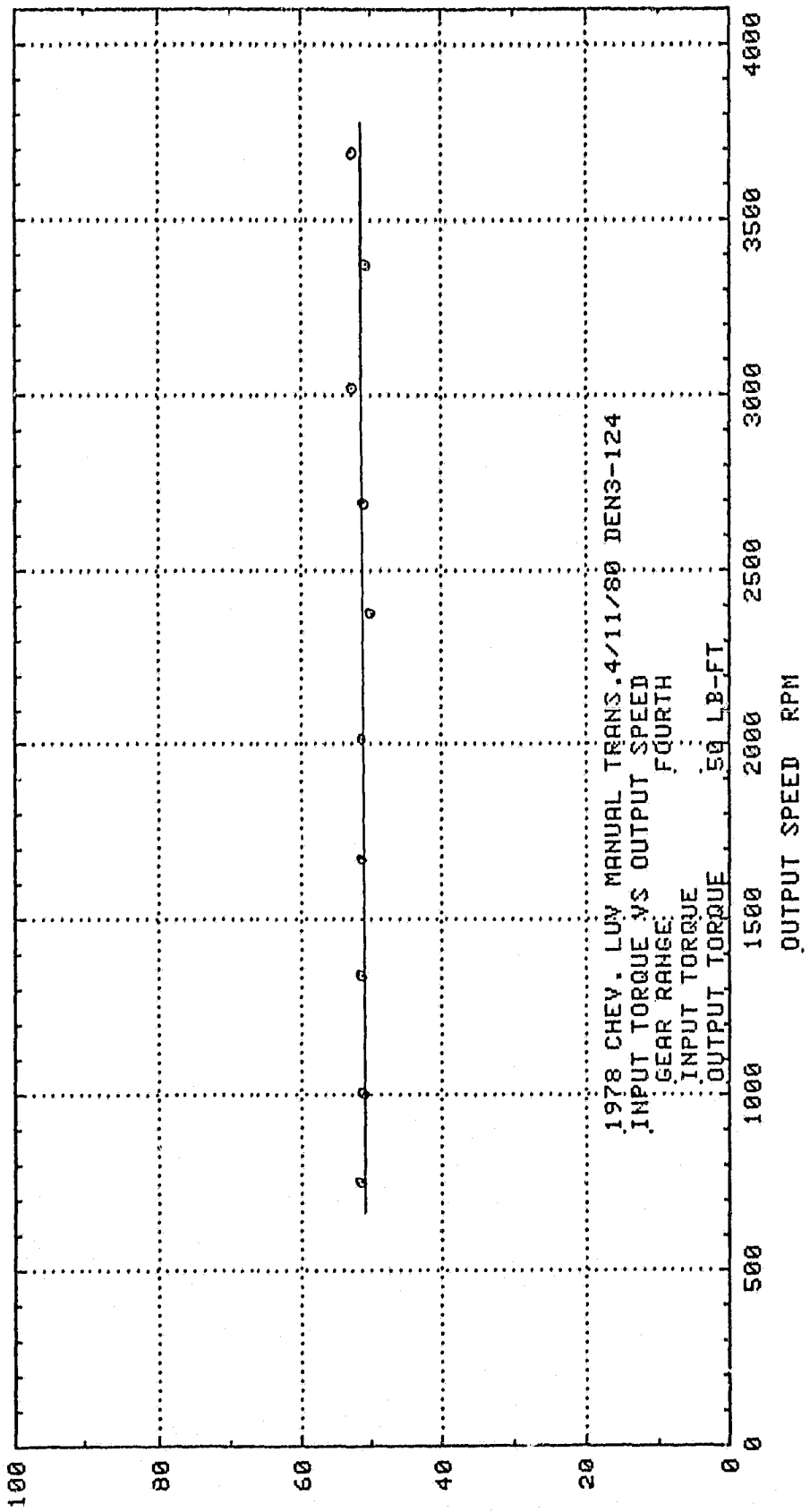

INPUT TORQUE LB FT

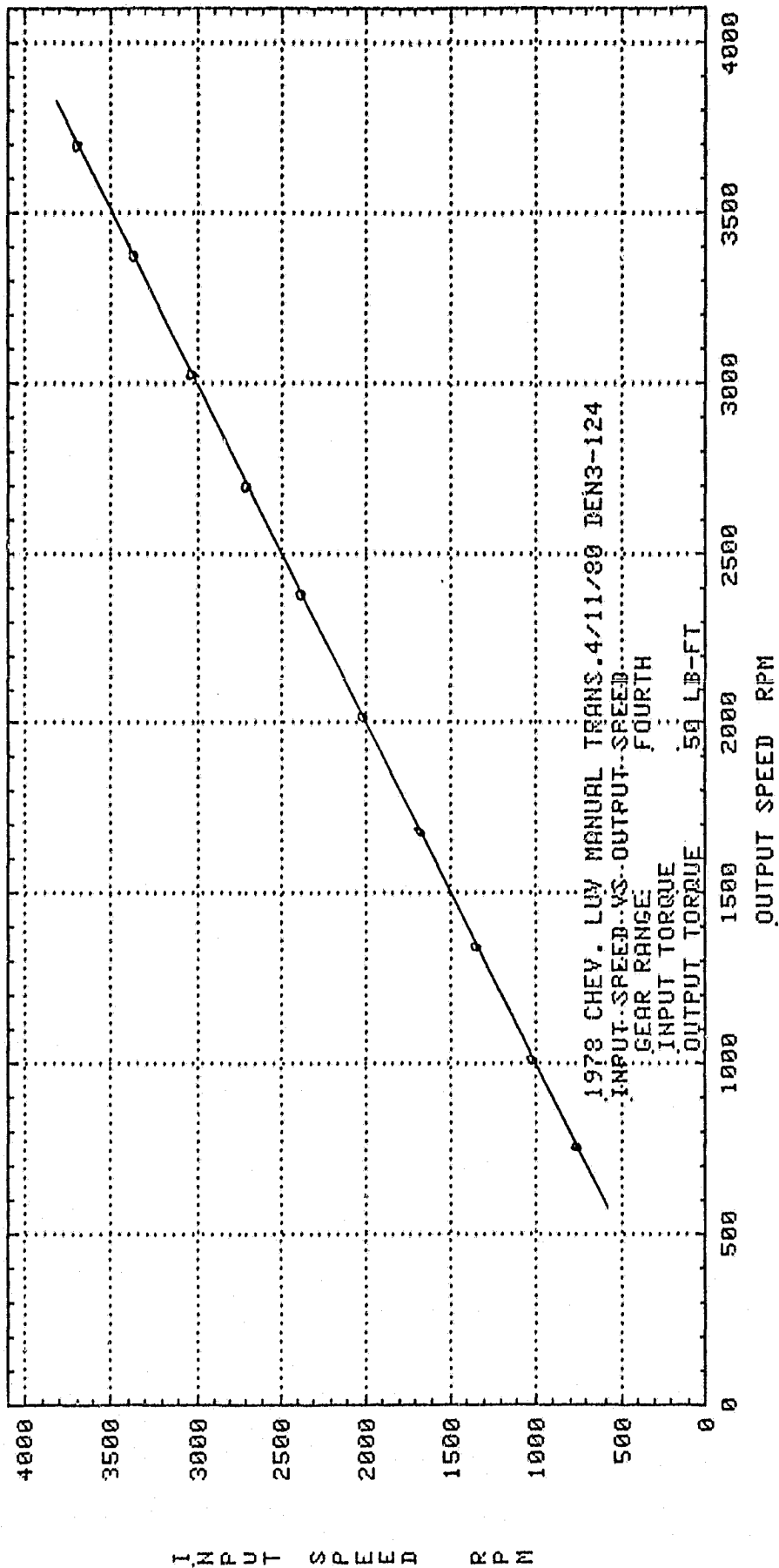

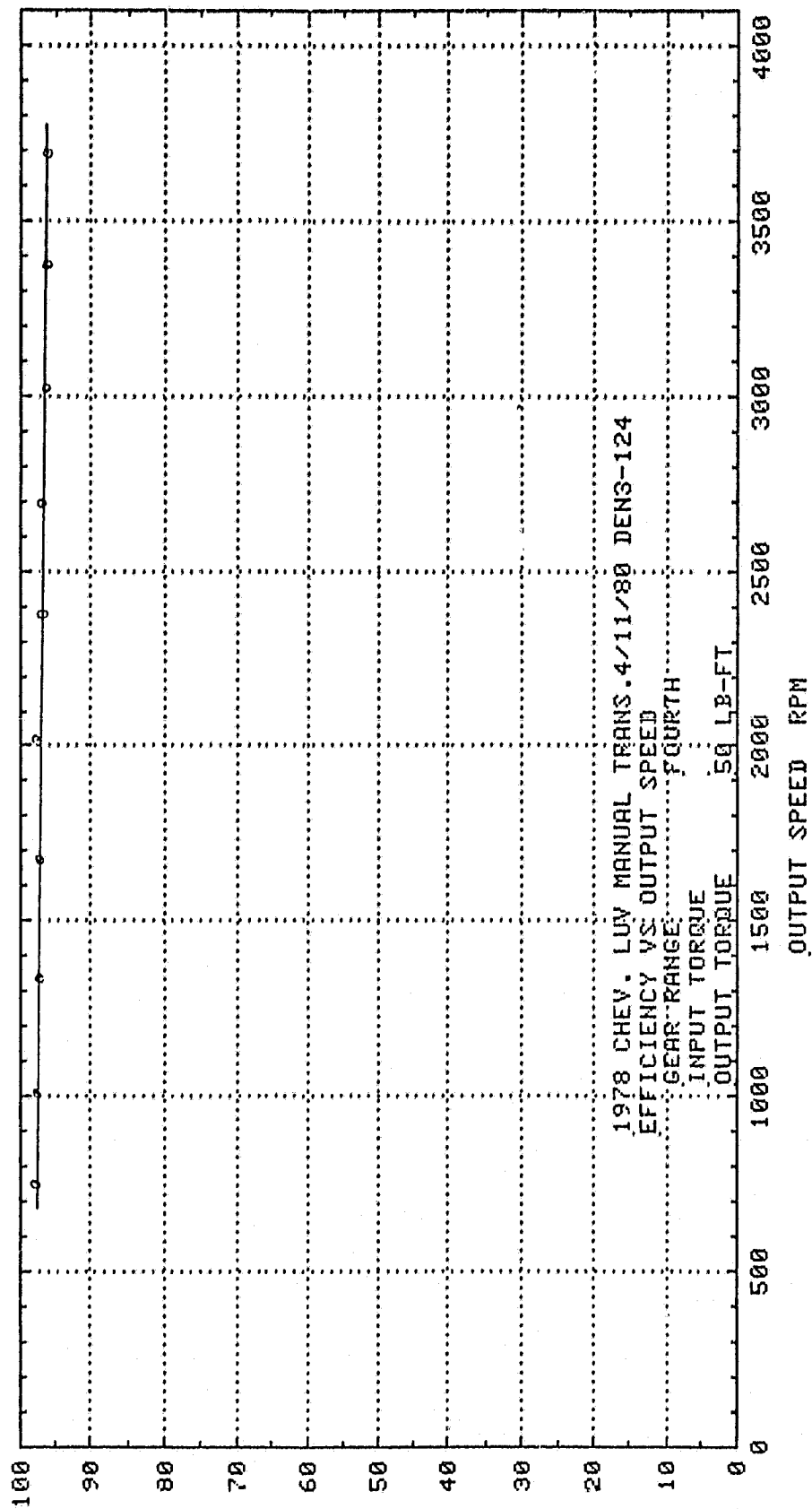

EFFICIENCY %

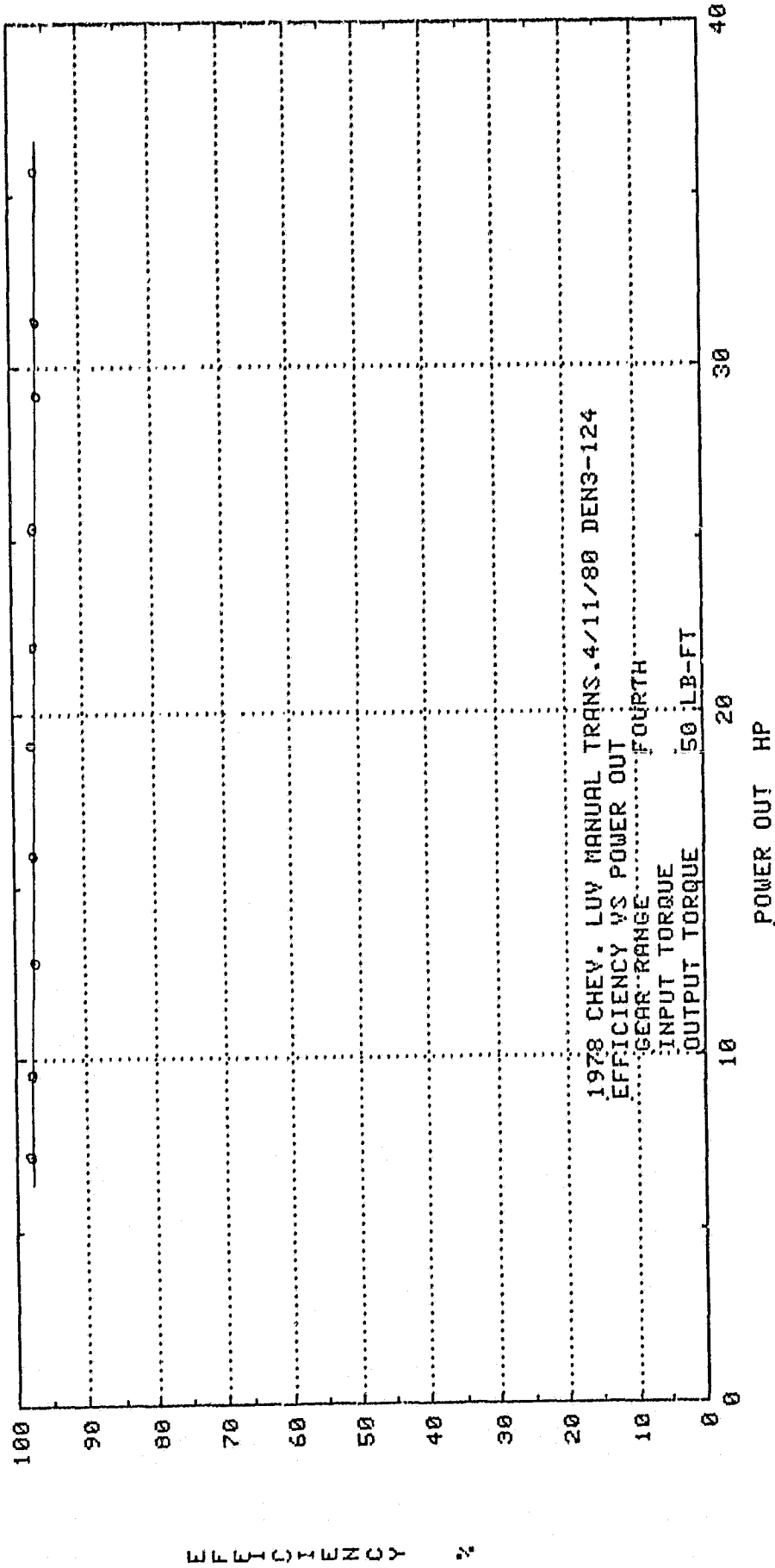

EFFICIENCY %

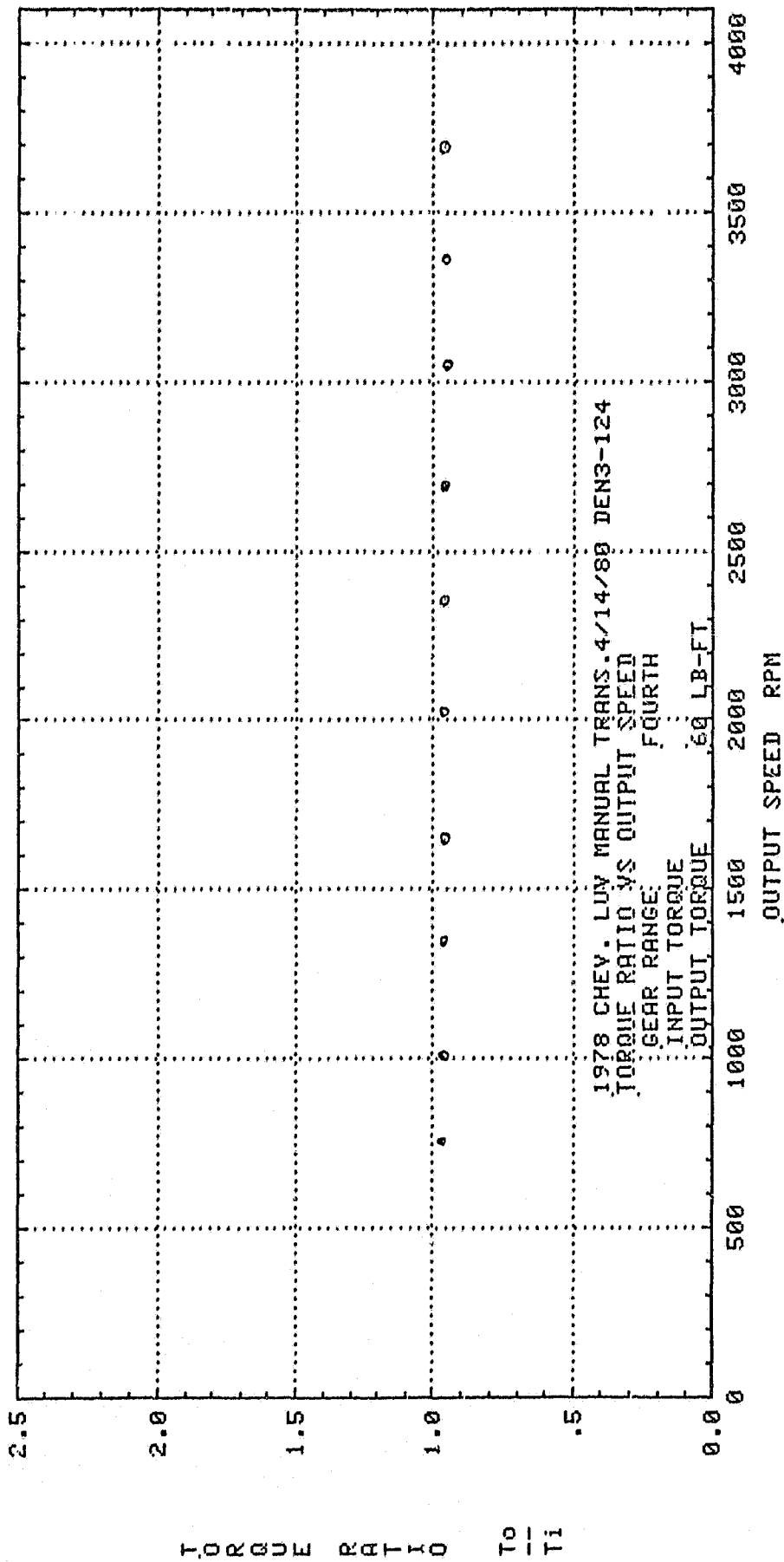

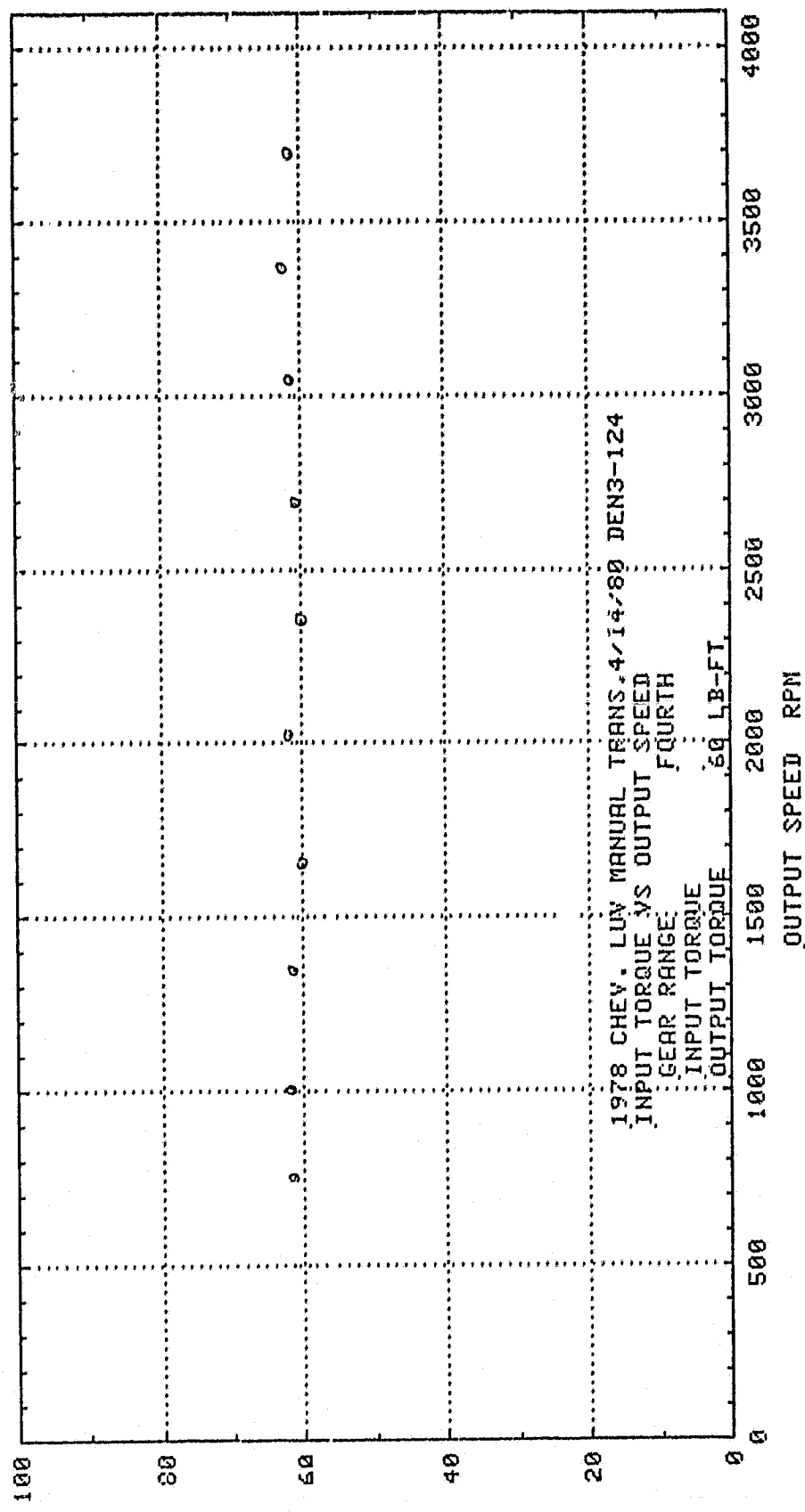

INPUT TORQUE LB FT

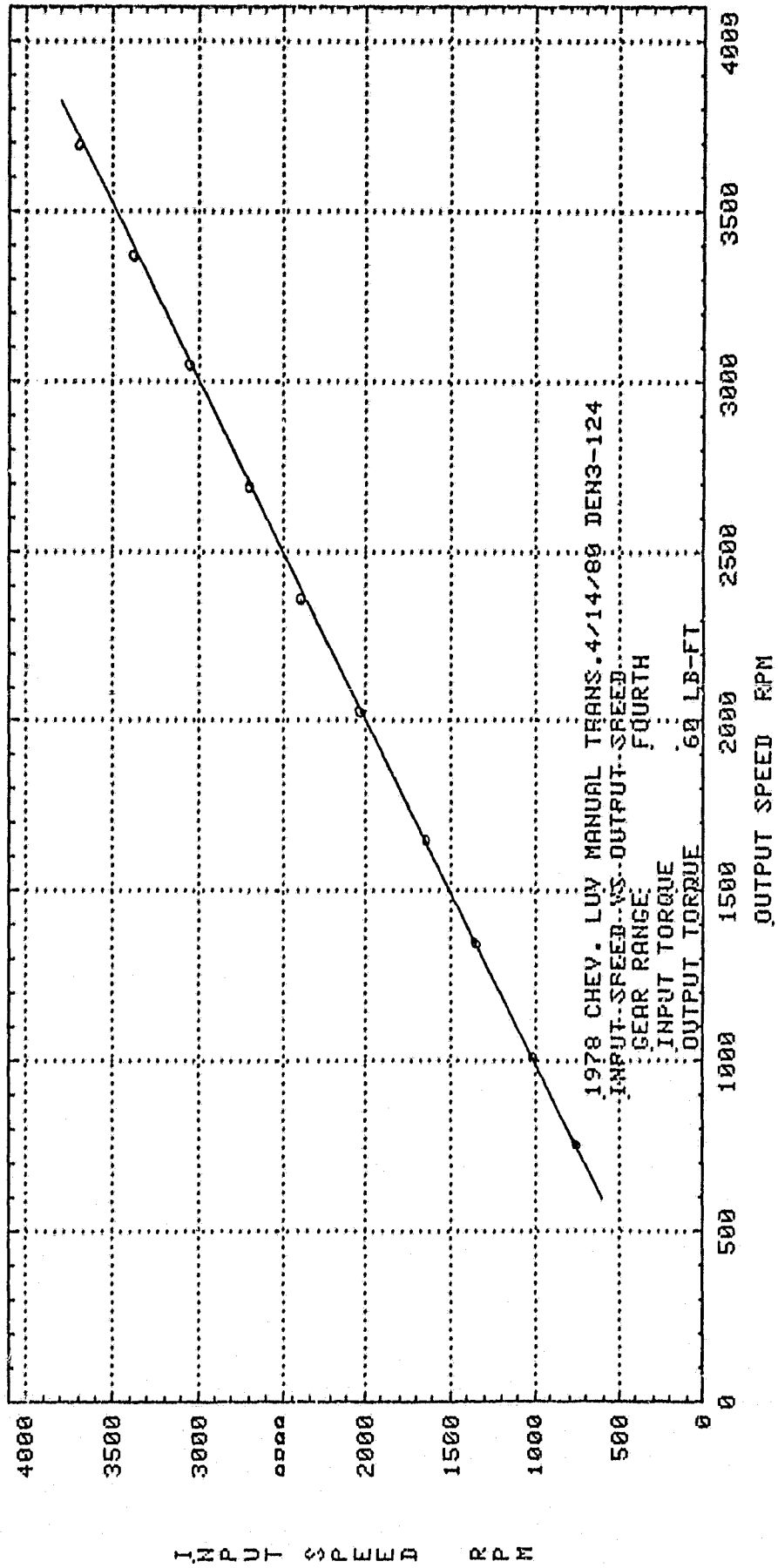

E F F I C I E N C Y %

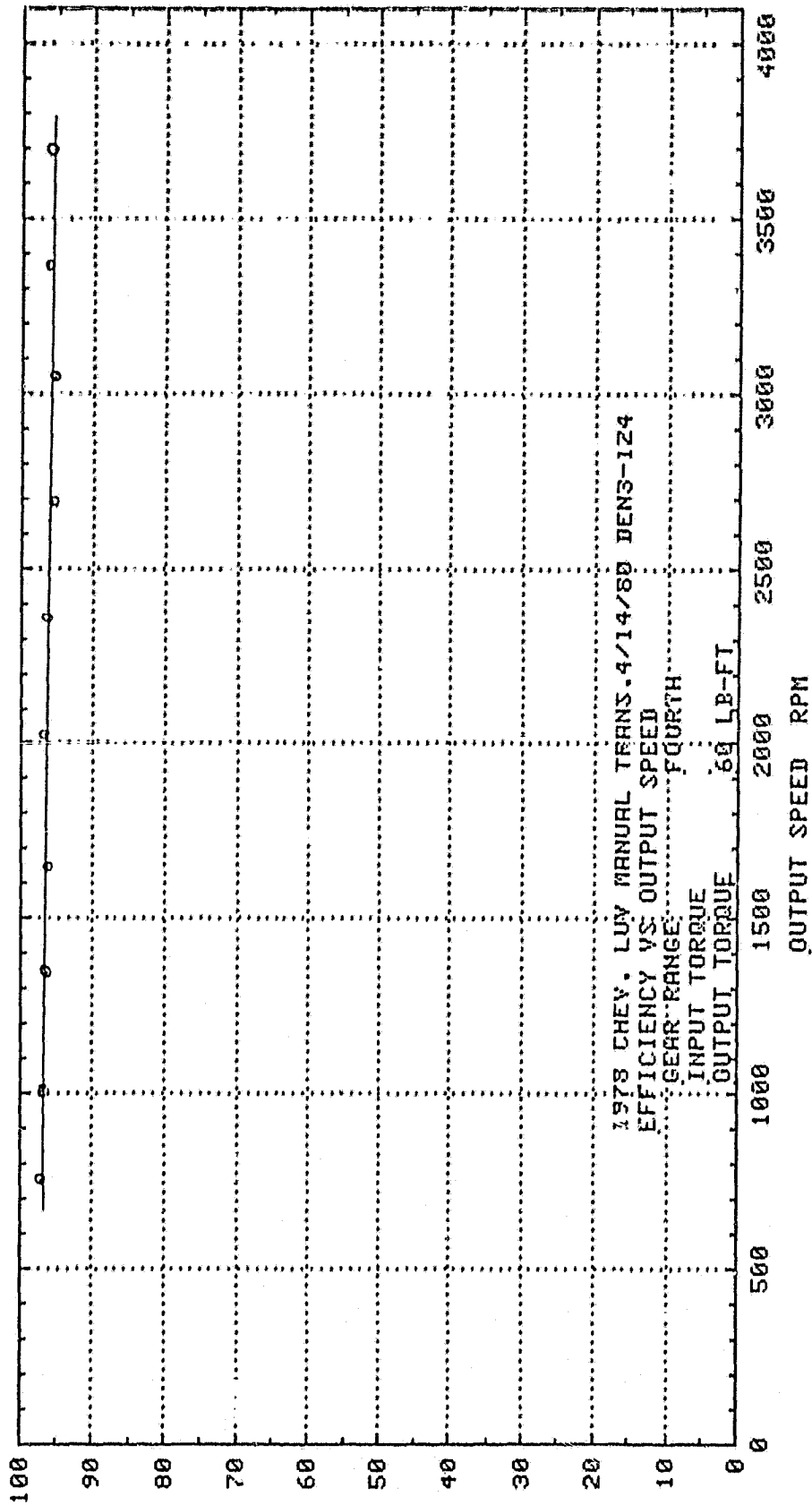

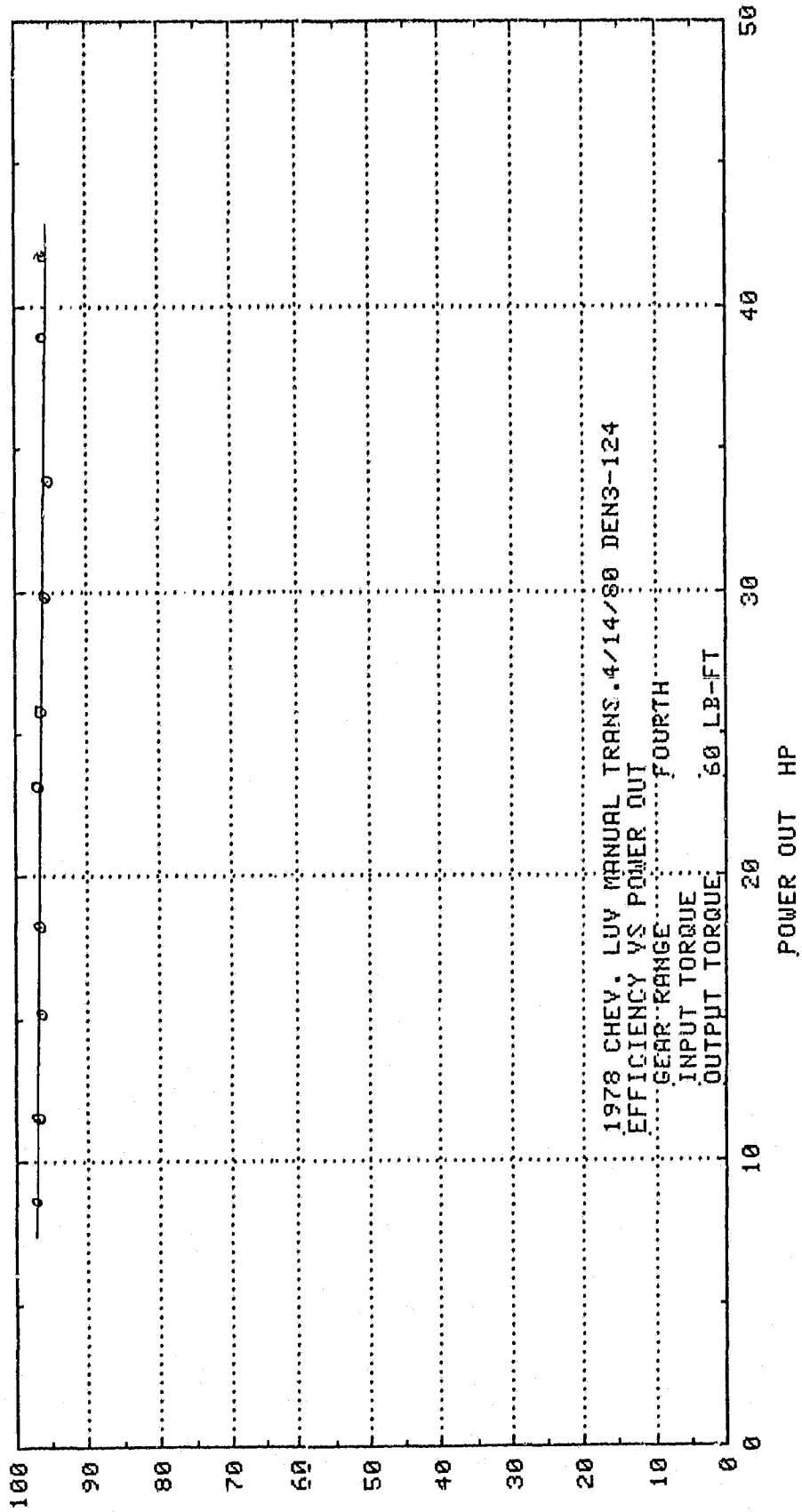

EFFICIENCY %

TORQUE RATIO $\frac{T_o}{T_i}$

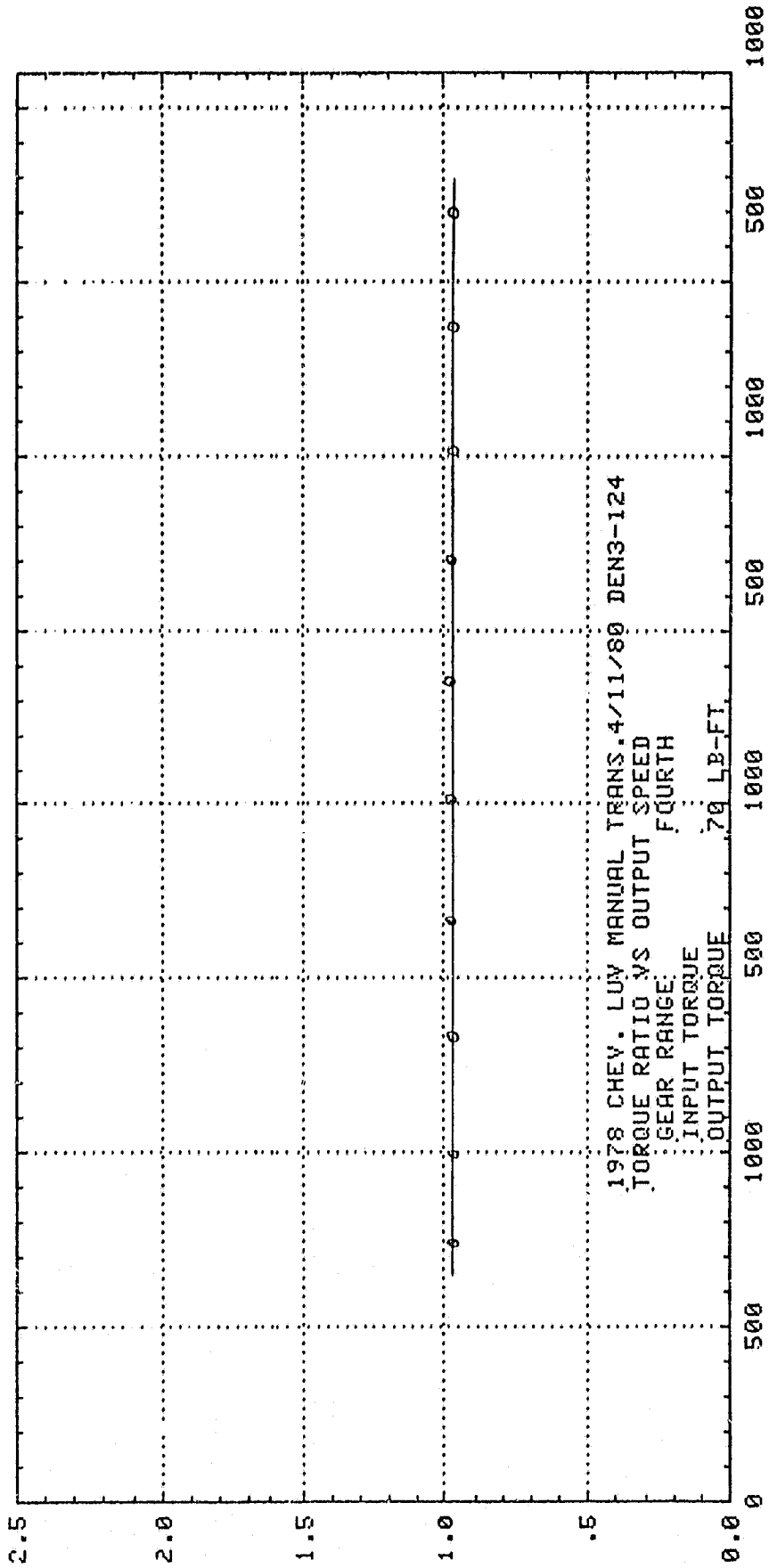

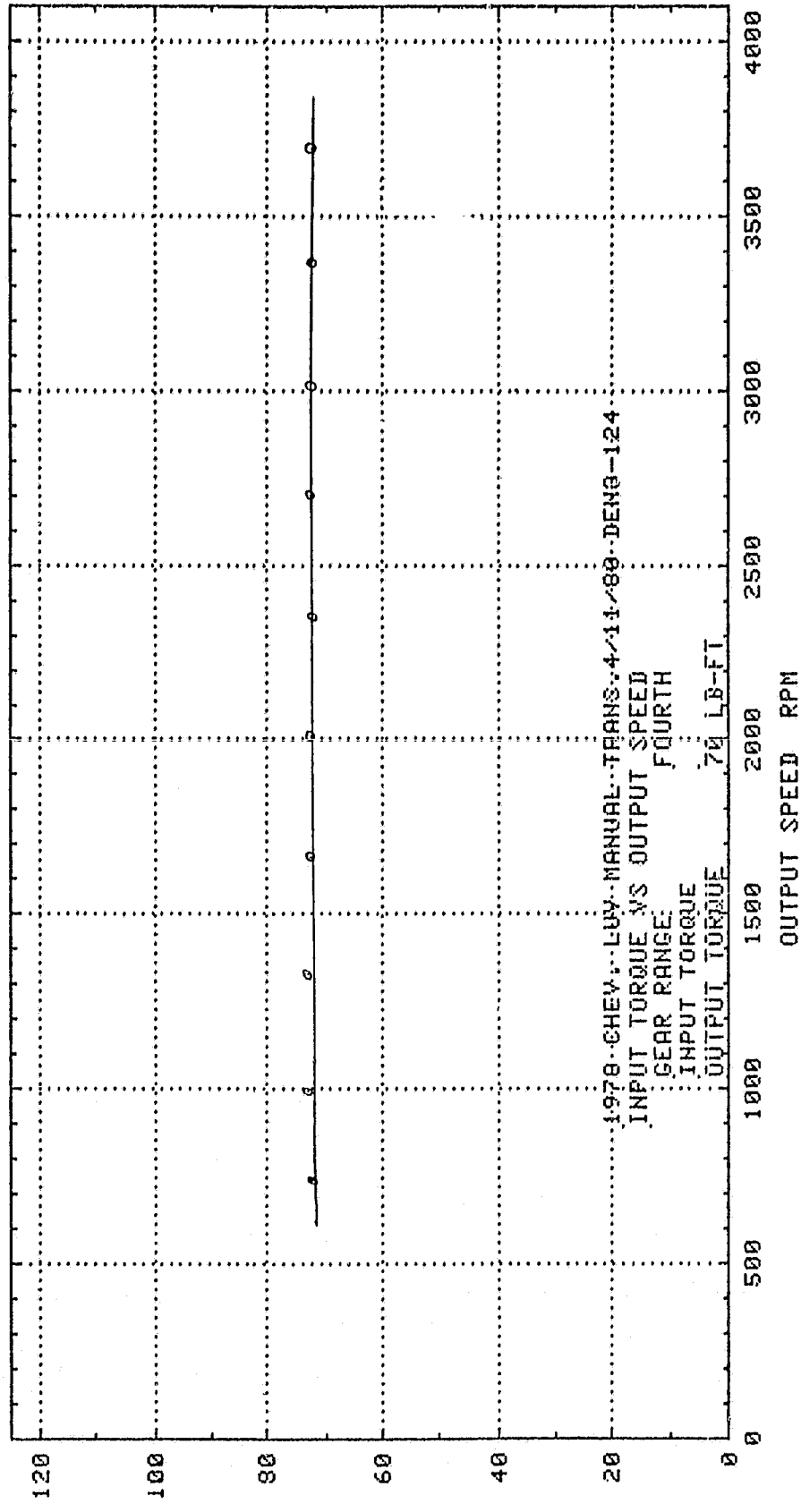

INPUT TORQUE LB FT

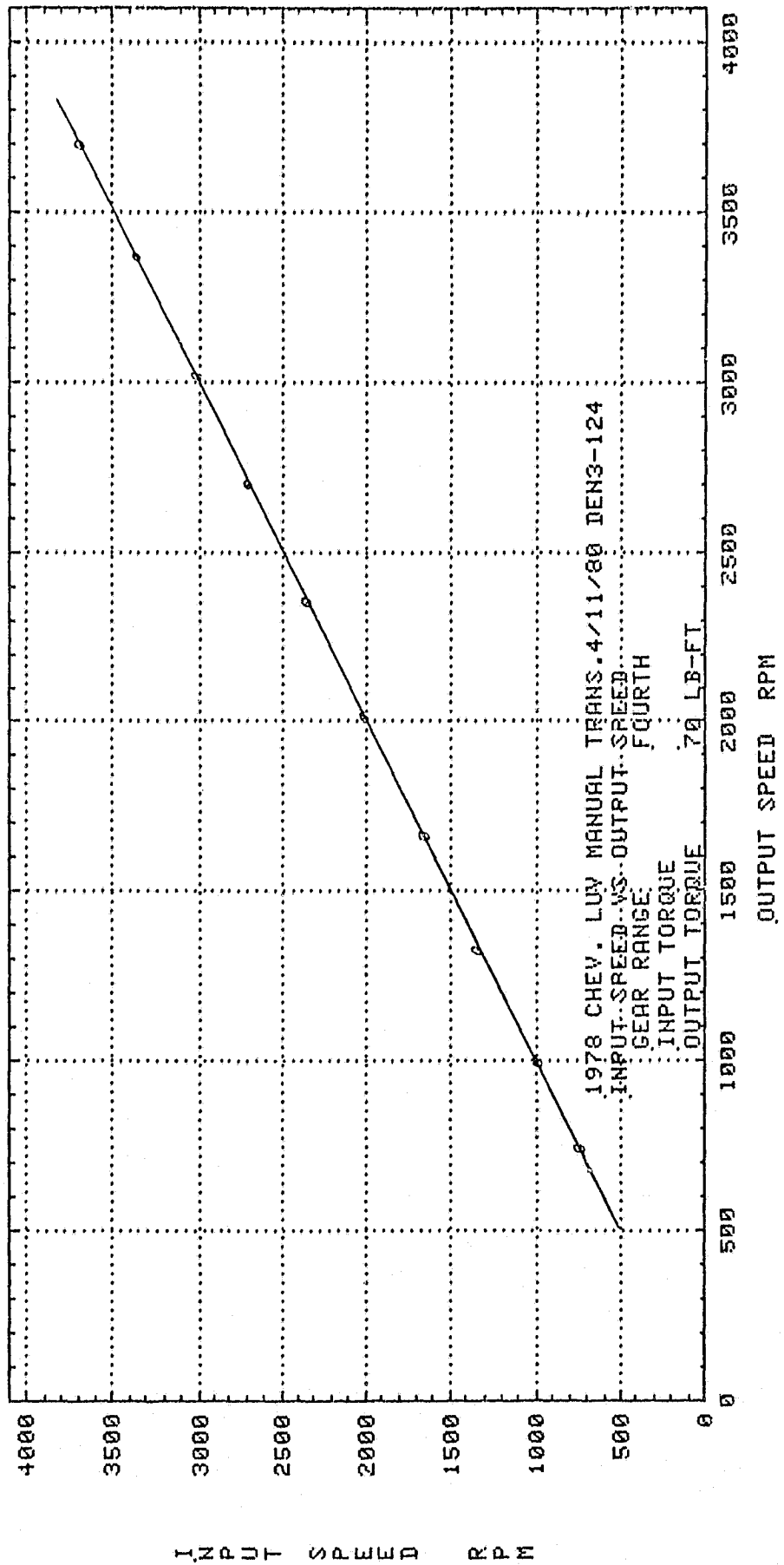

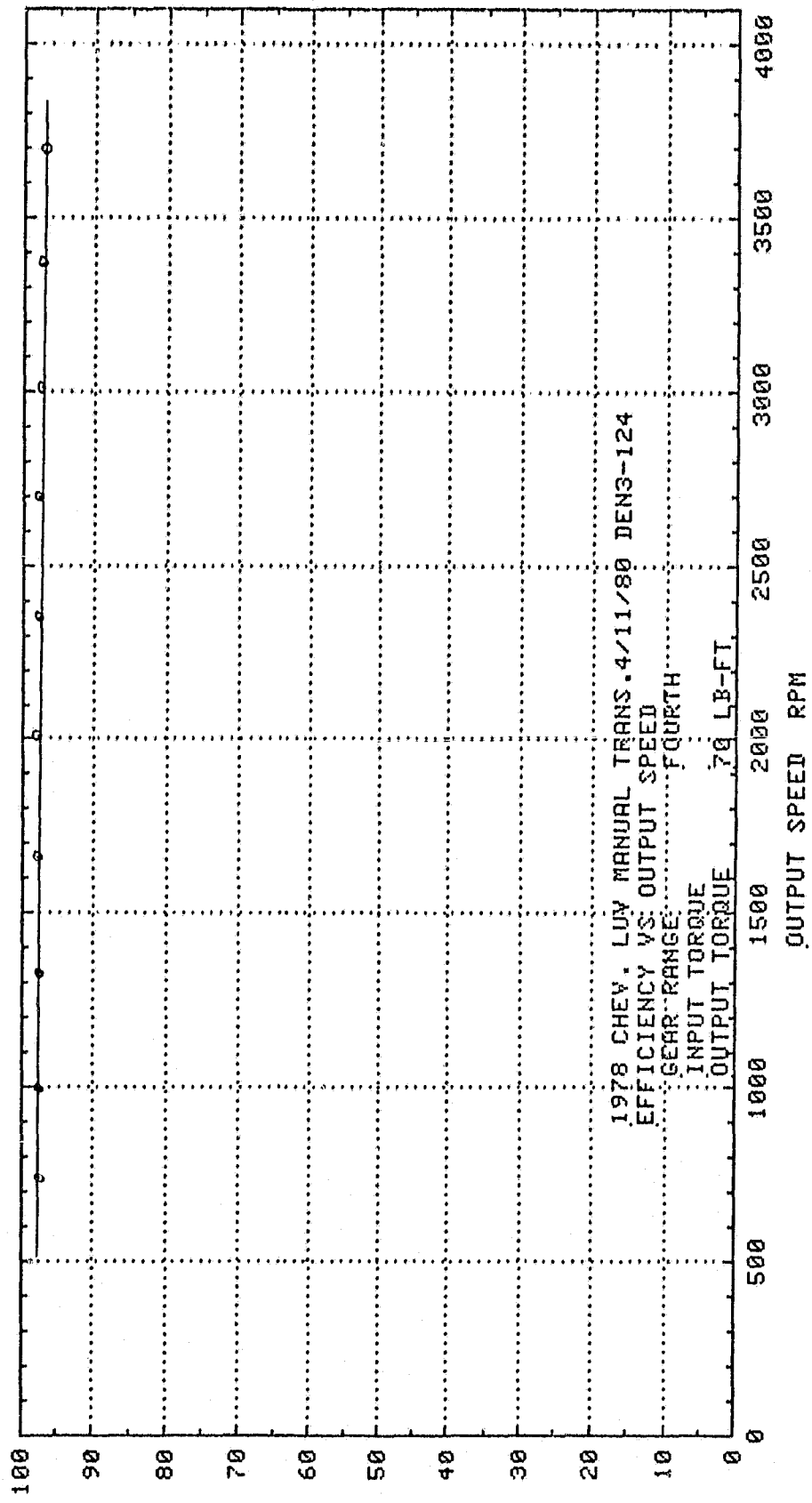

EFFICIENCY %

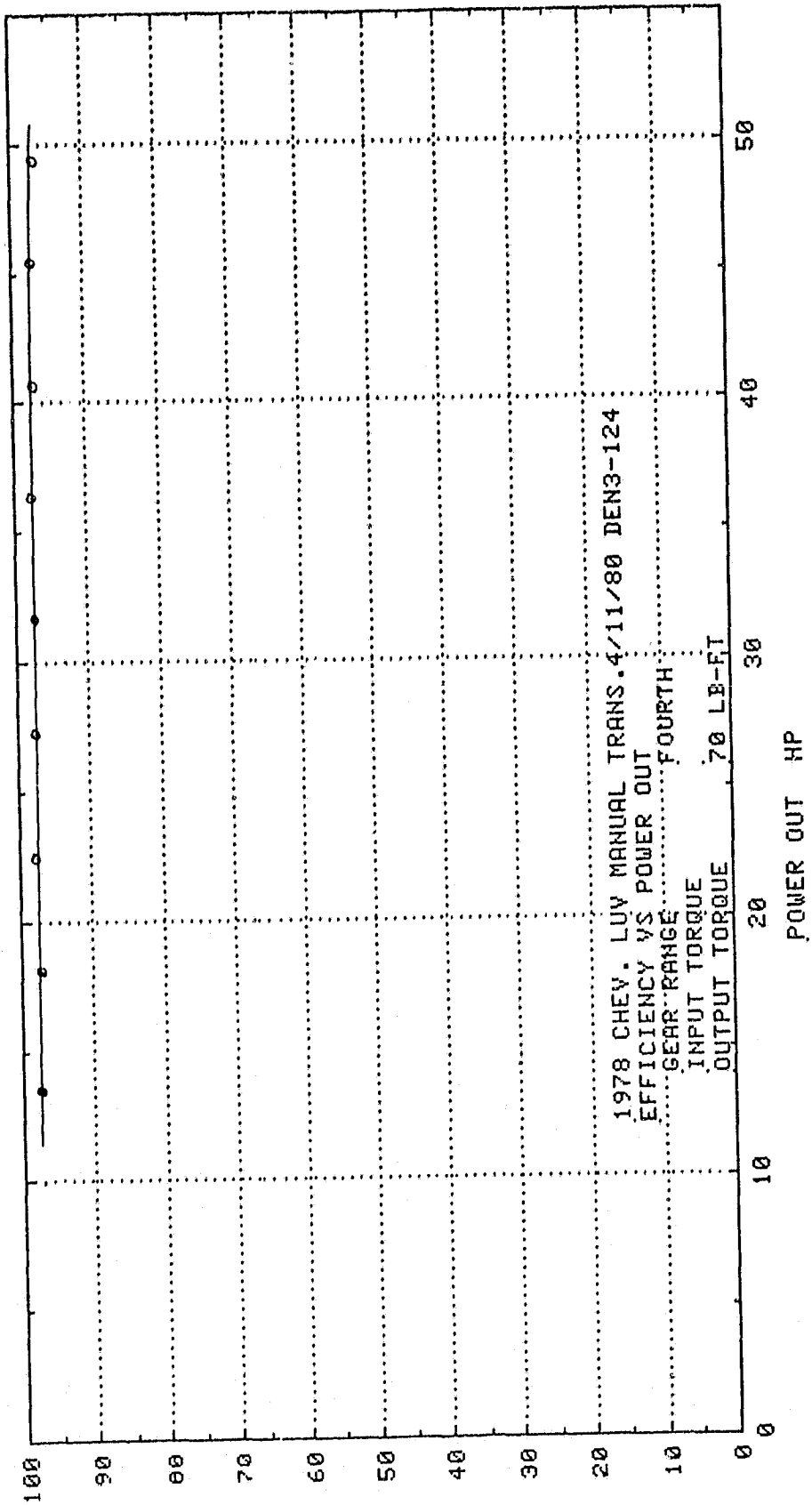

EFFICIENCY %

POWER OUT HP

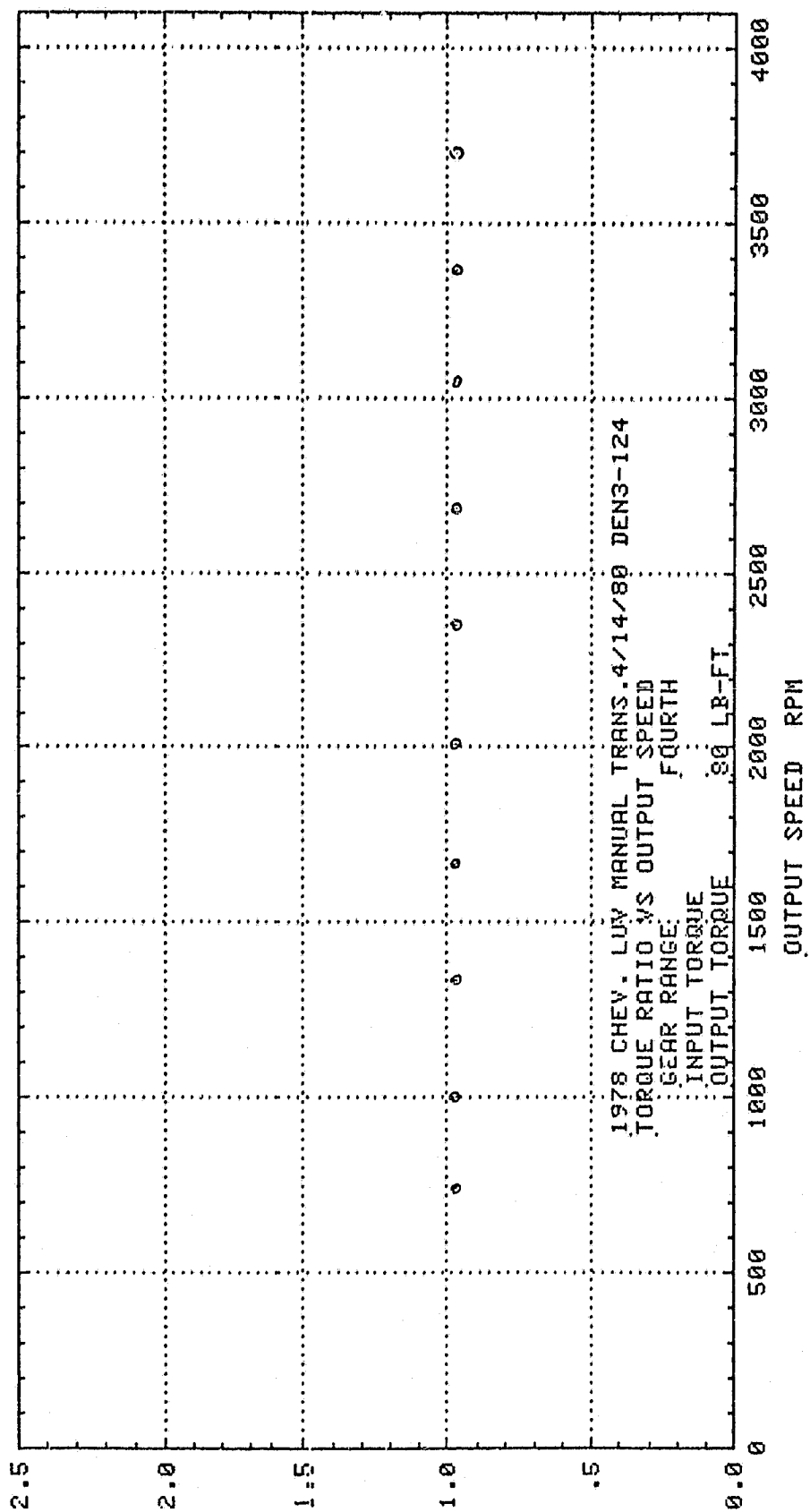

TORQUE RATIO $\frac{T_o}{T_i}$

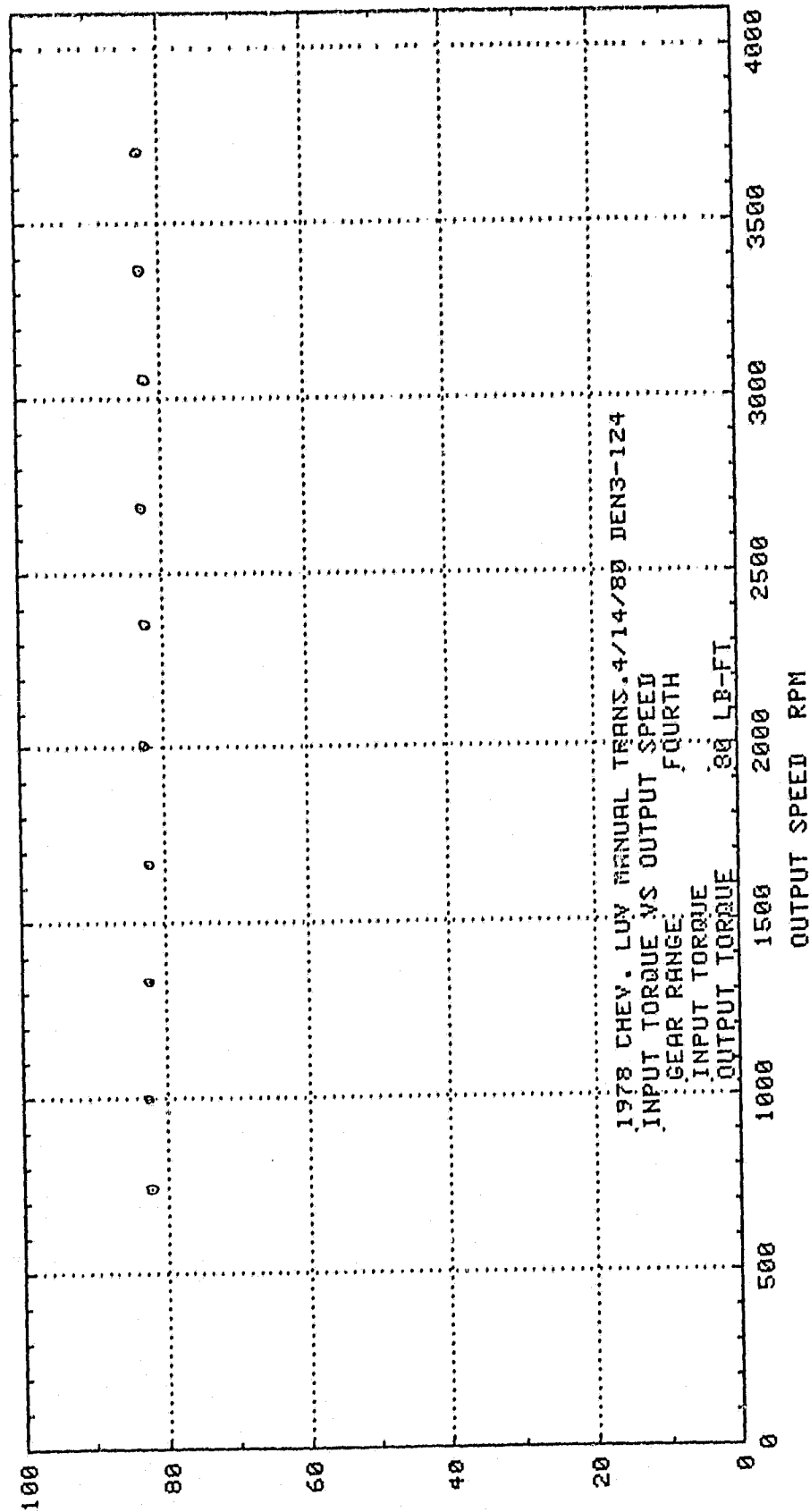

INPUT TORQUE LB FT

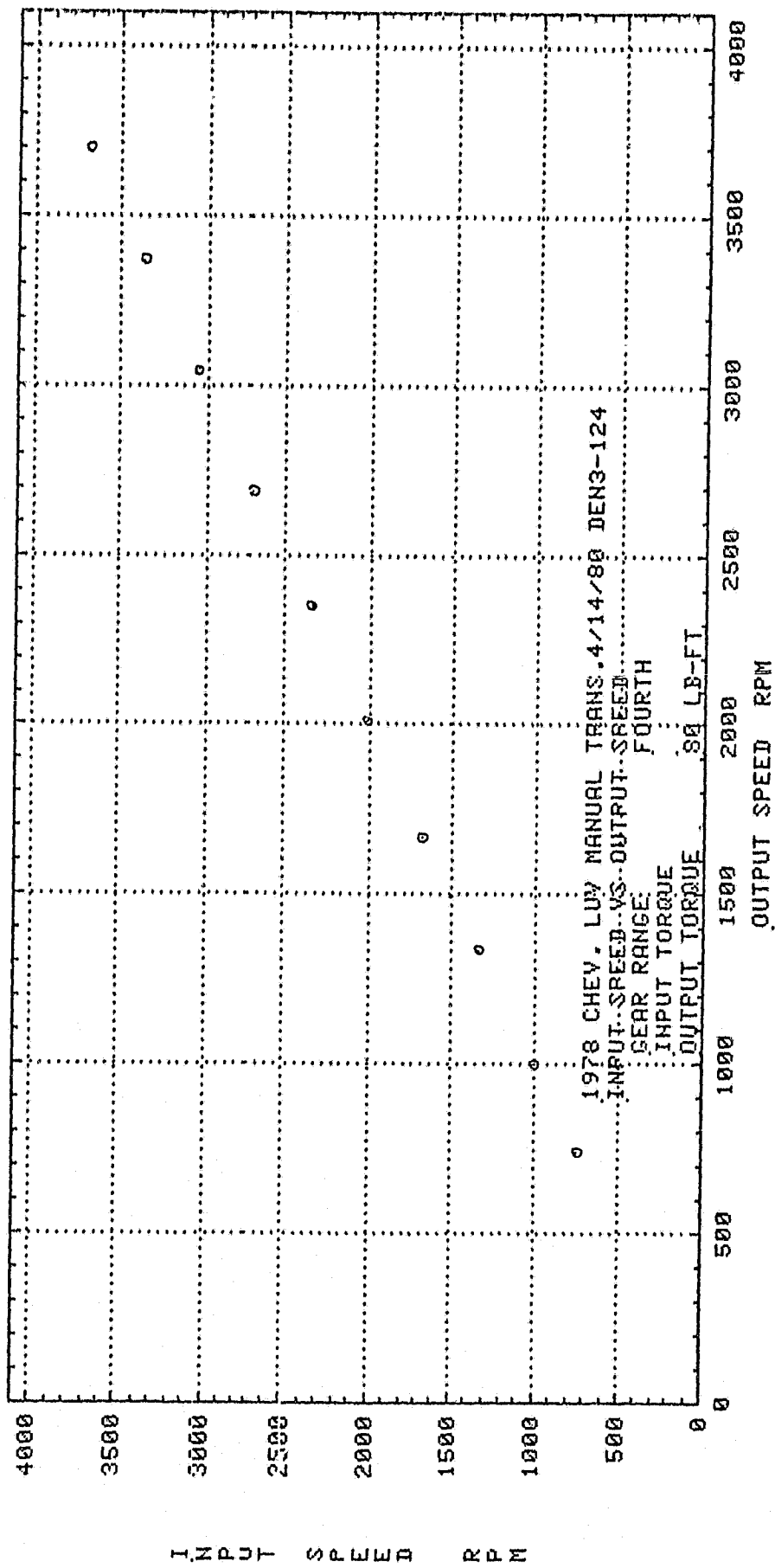

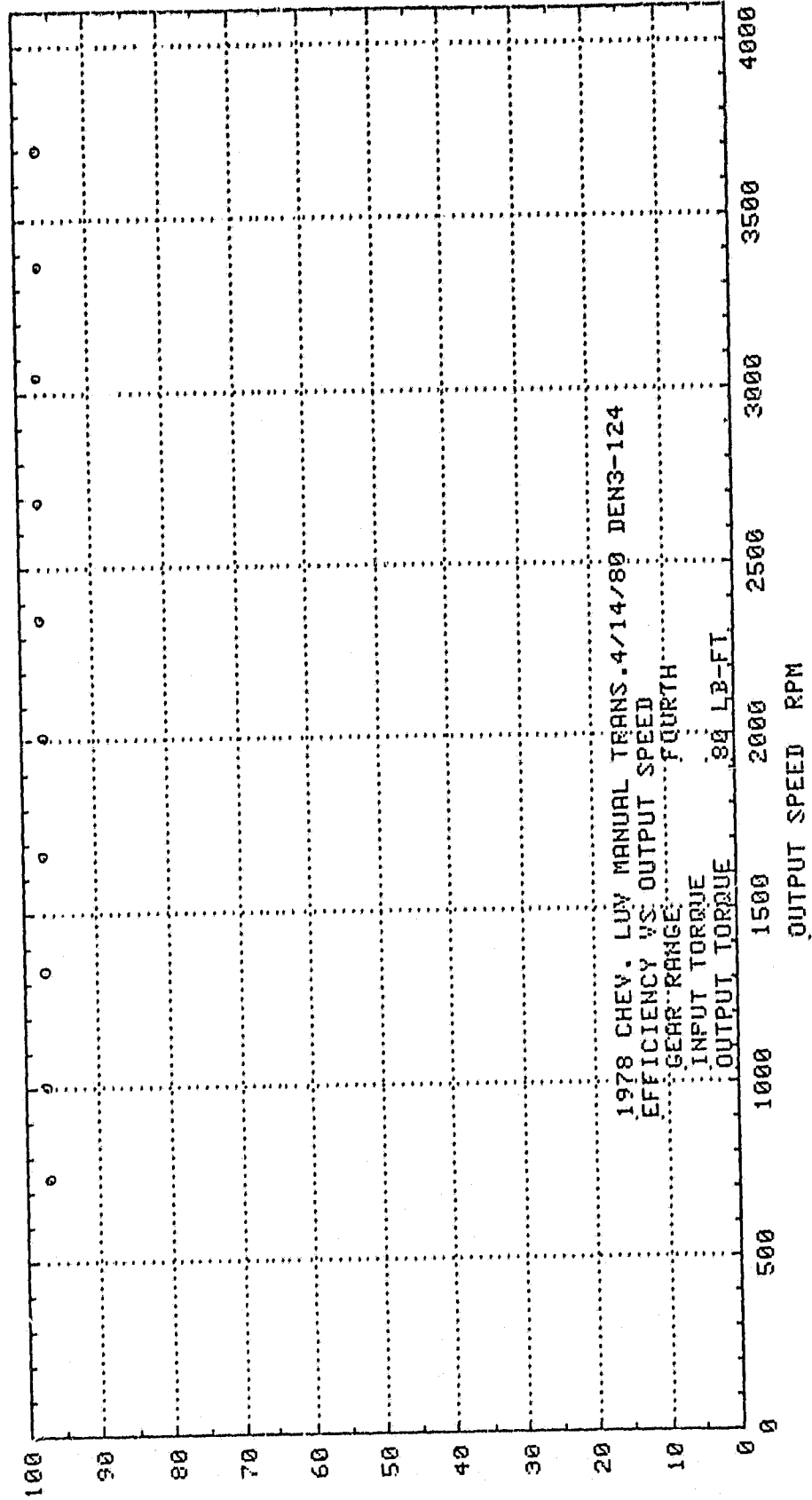

EFFICIENCY %

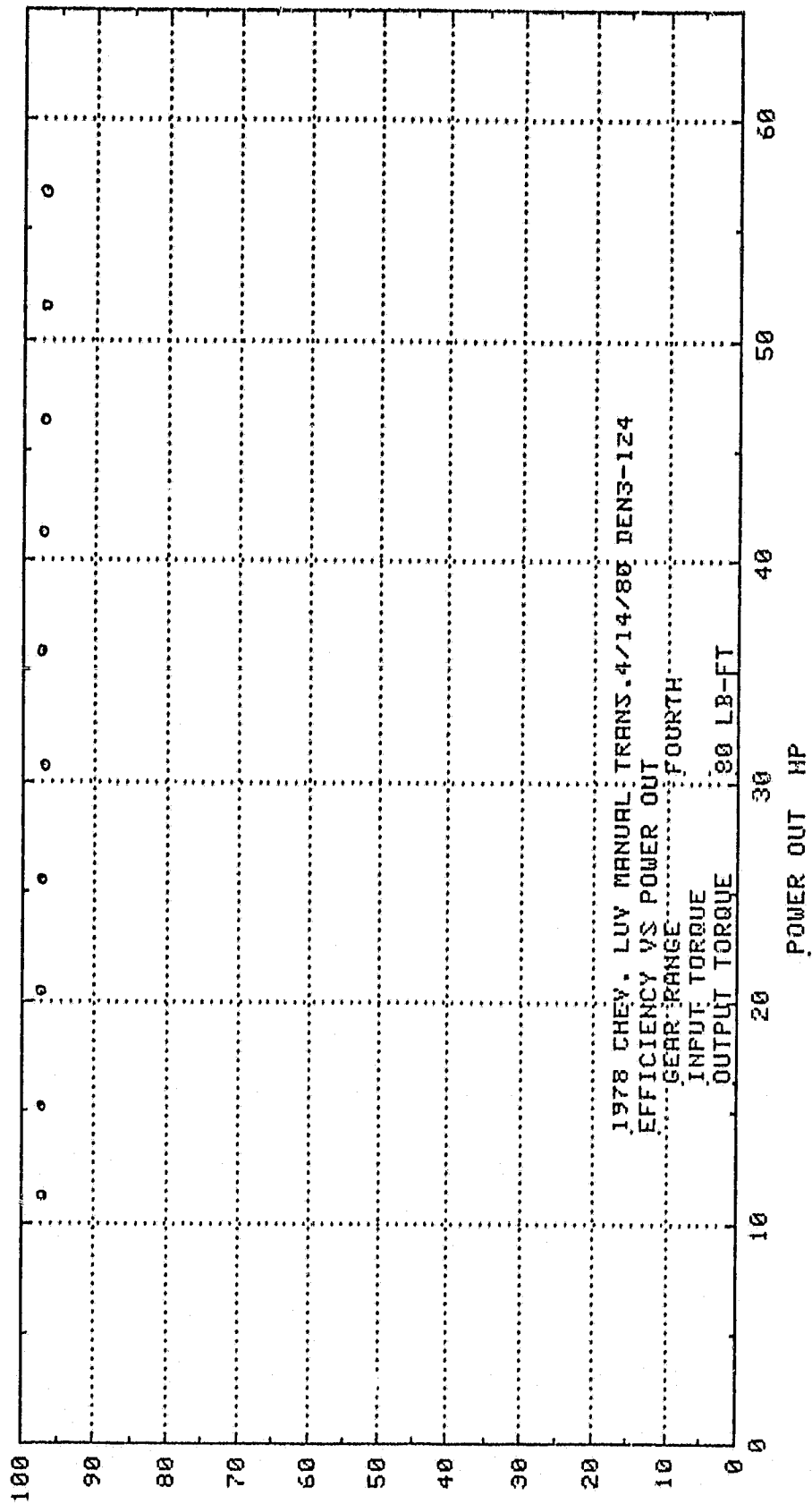

EFFICIENCY %

TORQUE RATIO $\frac{T_o}{T_i}$

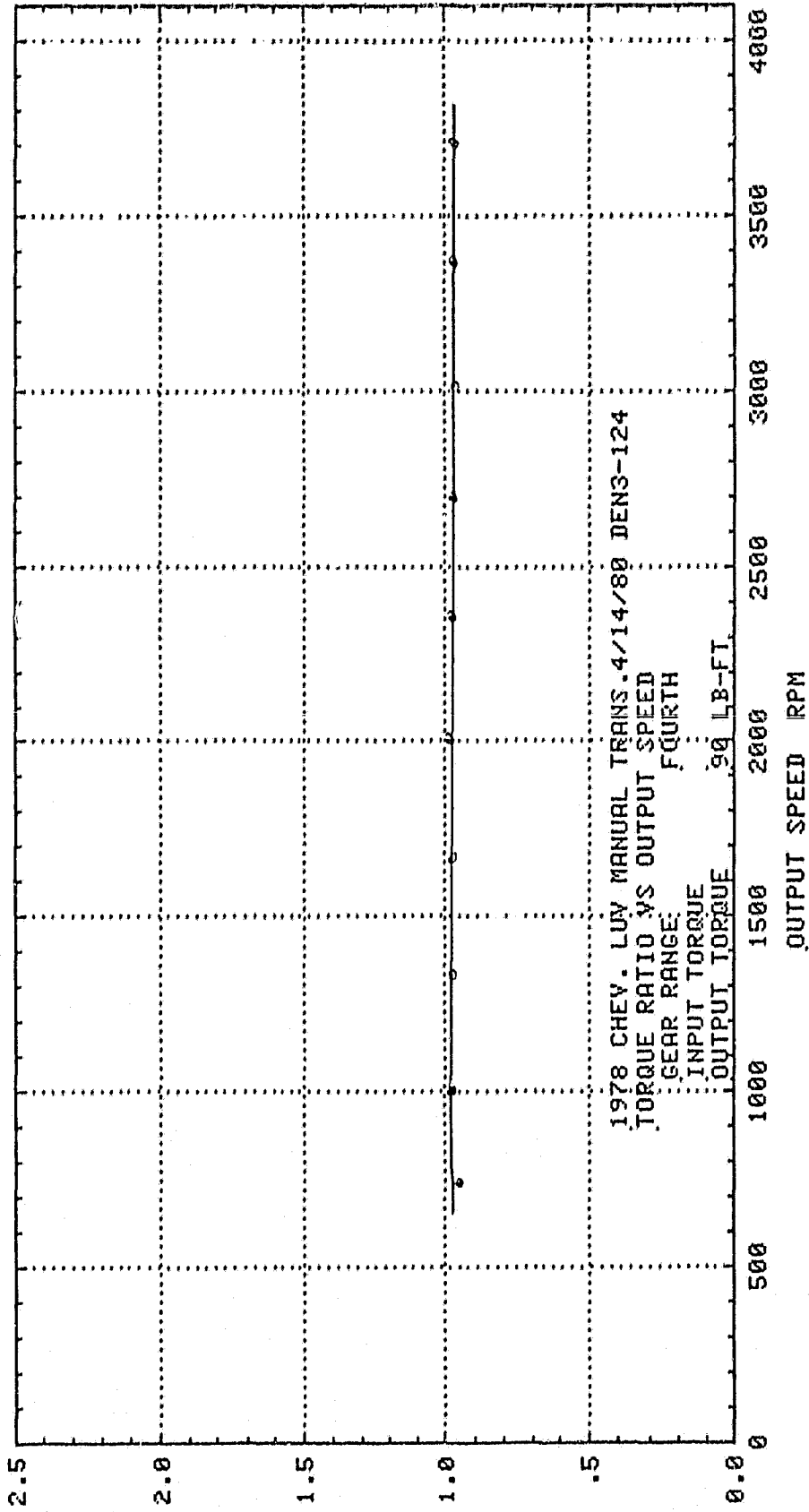

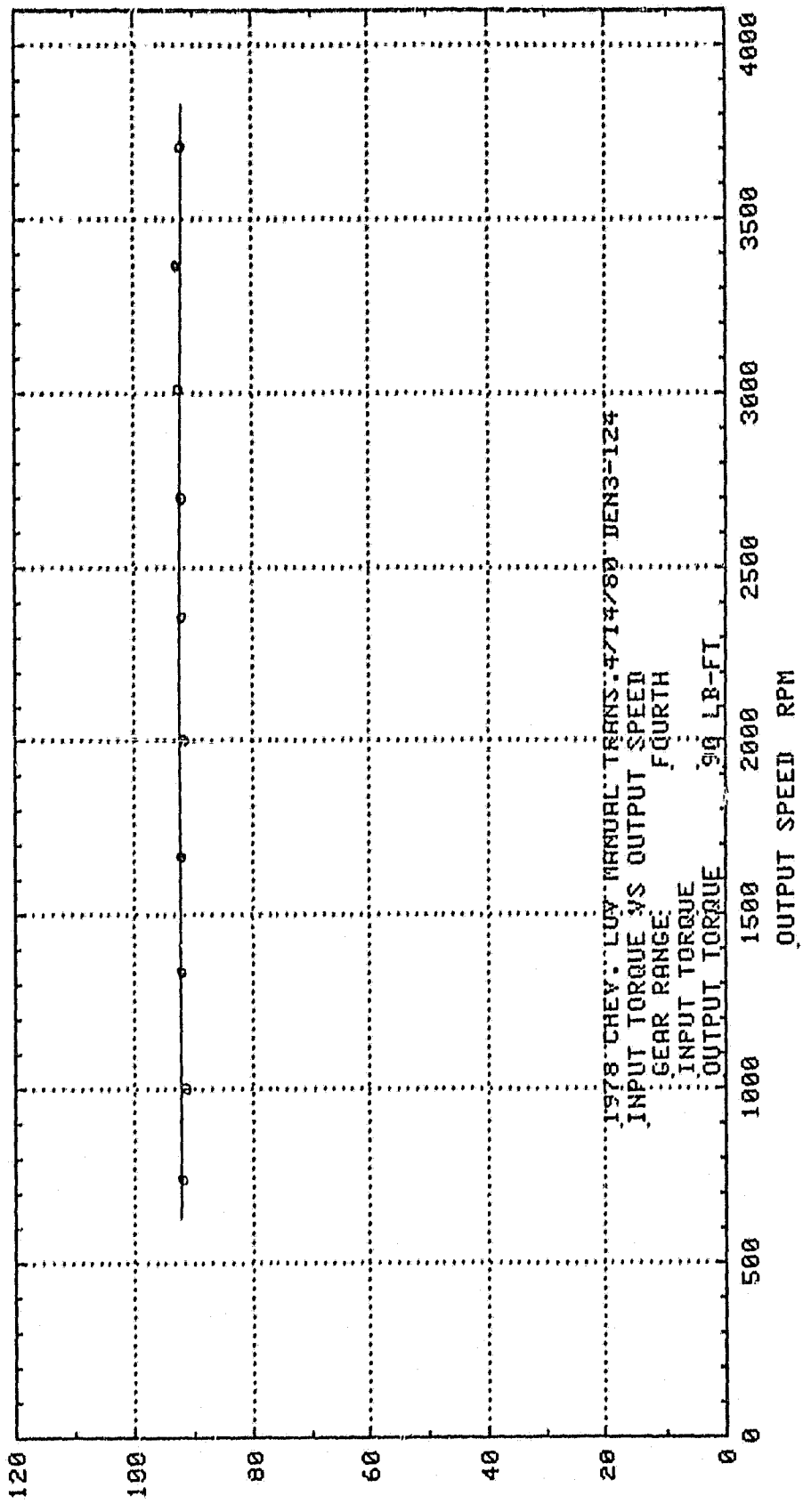

INPUT TORQUE LB FT

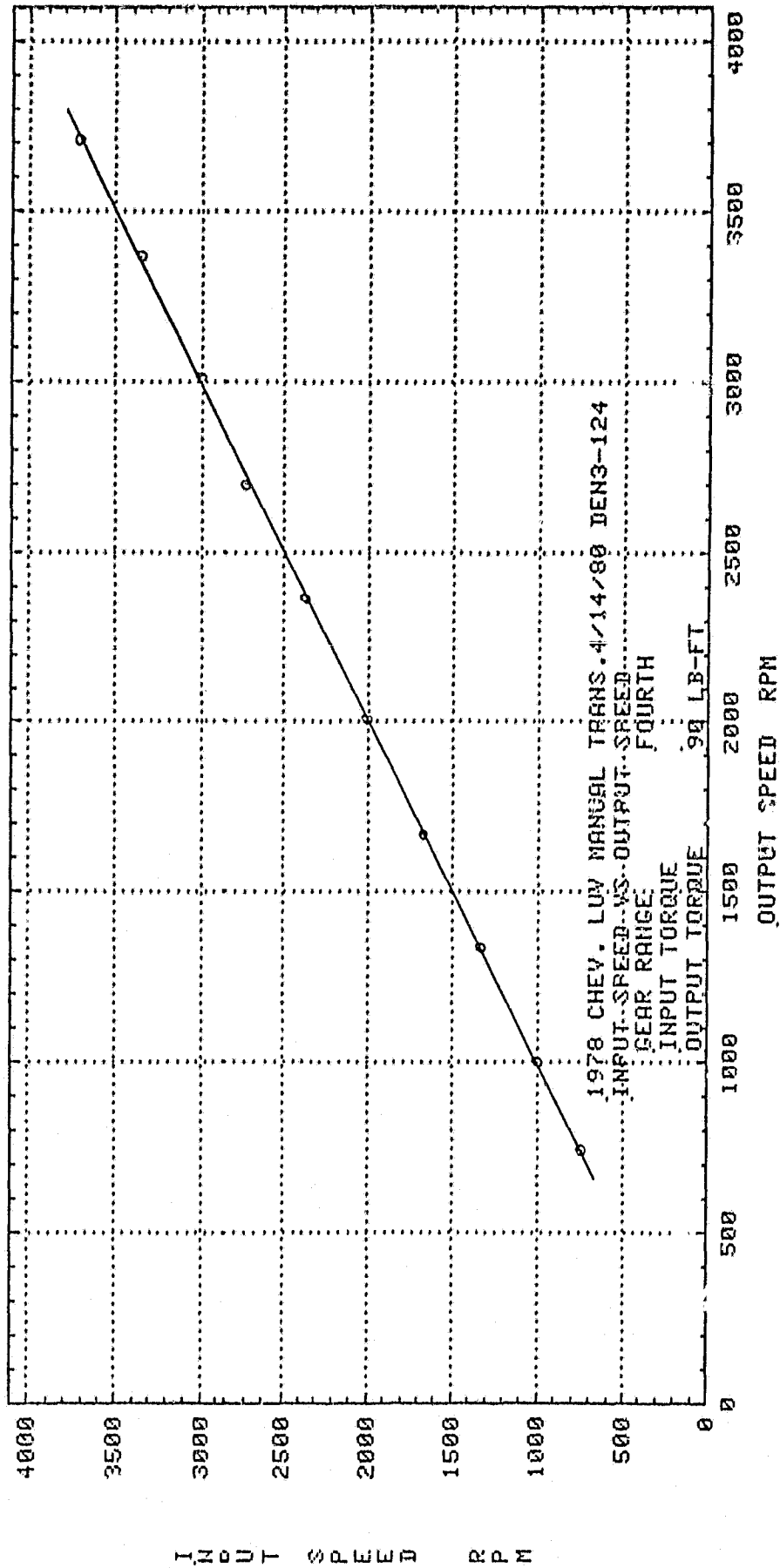

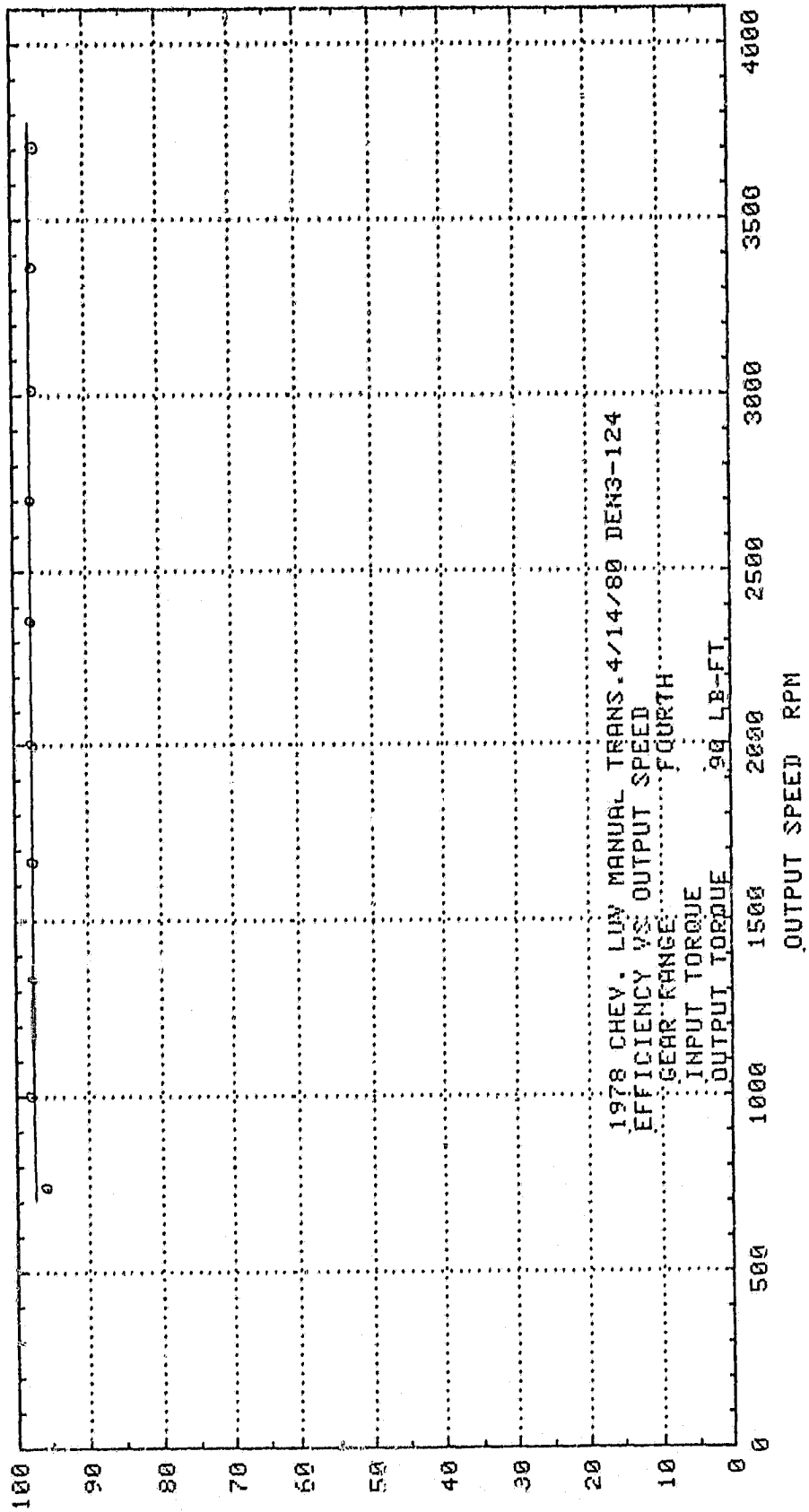

EFFICIENCY %

E F F I C I E N C Y %

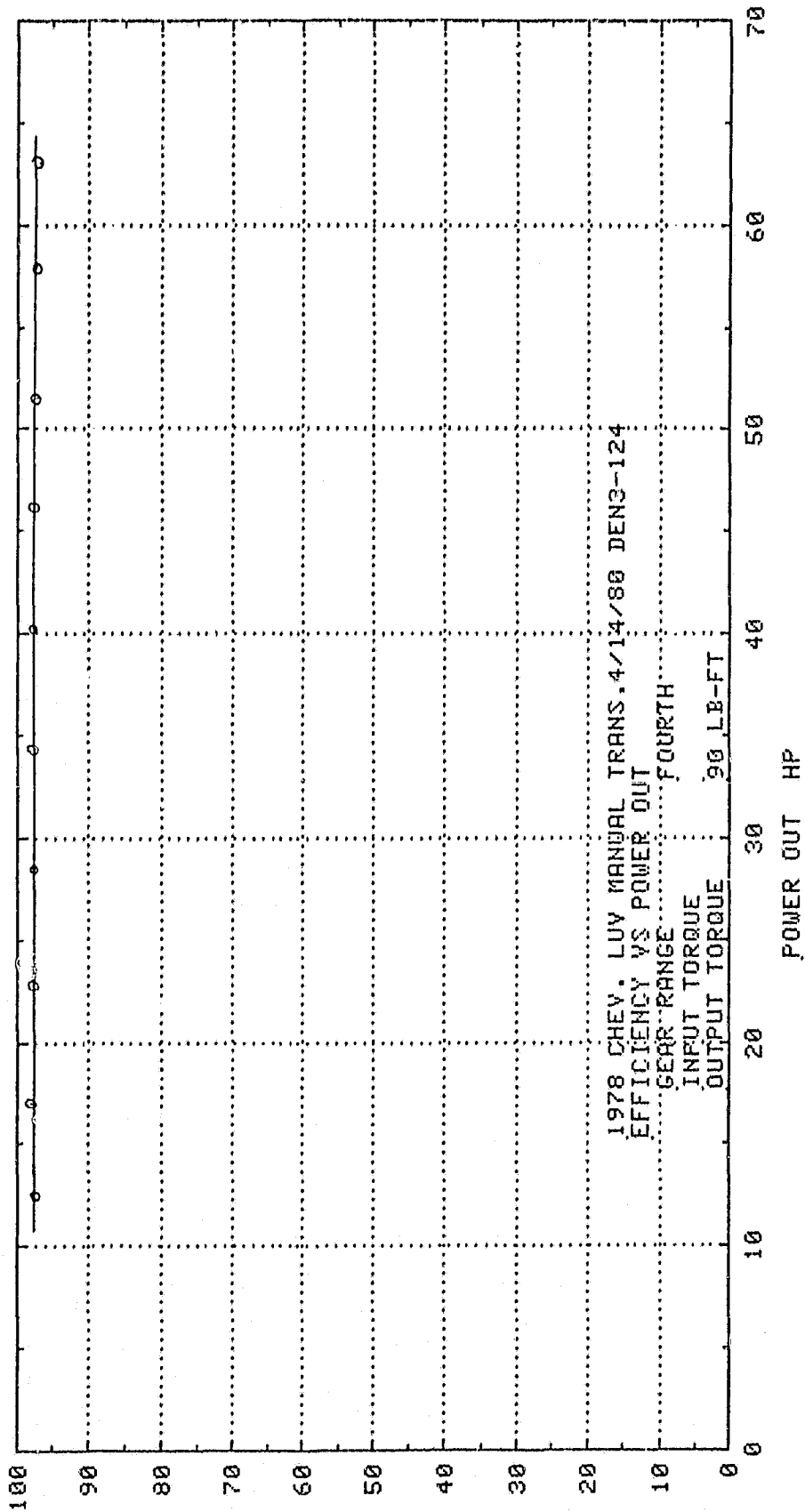

COAST PERFORMANCE

1ST GEAR

Graphs Contained in This Section

Torque Ratio -vs- Output Speed
Output Torque -vs- Output Speed
Input Speed -vs- Output Speed
Efficiency -vs- Output Speed
Efficiency -vs- Power Out

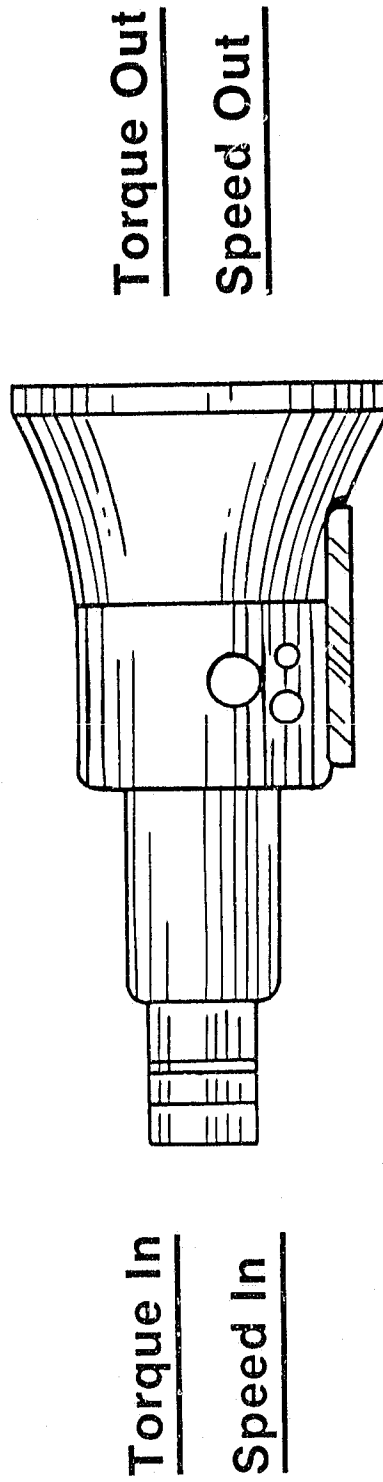

Coast Performance Tests

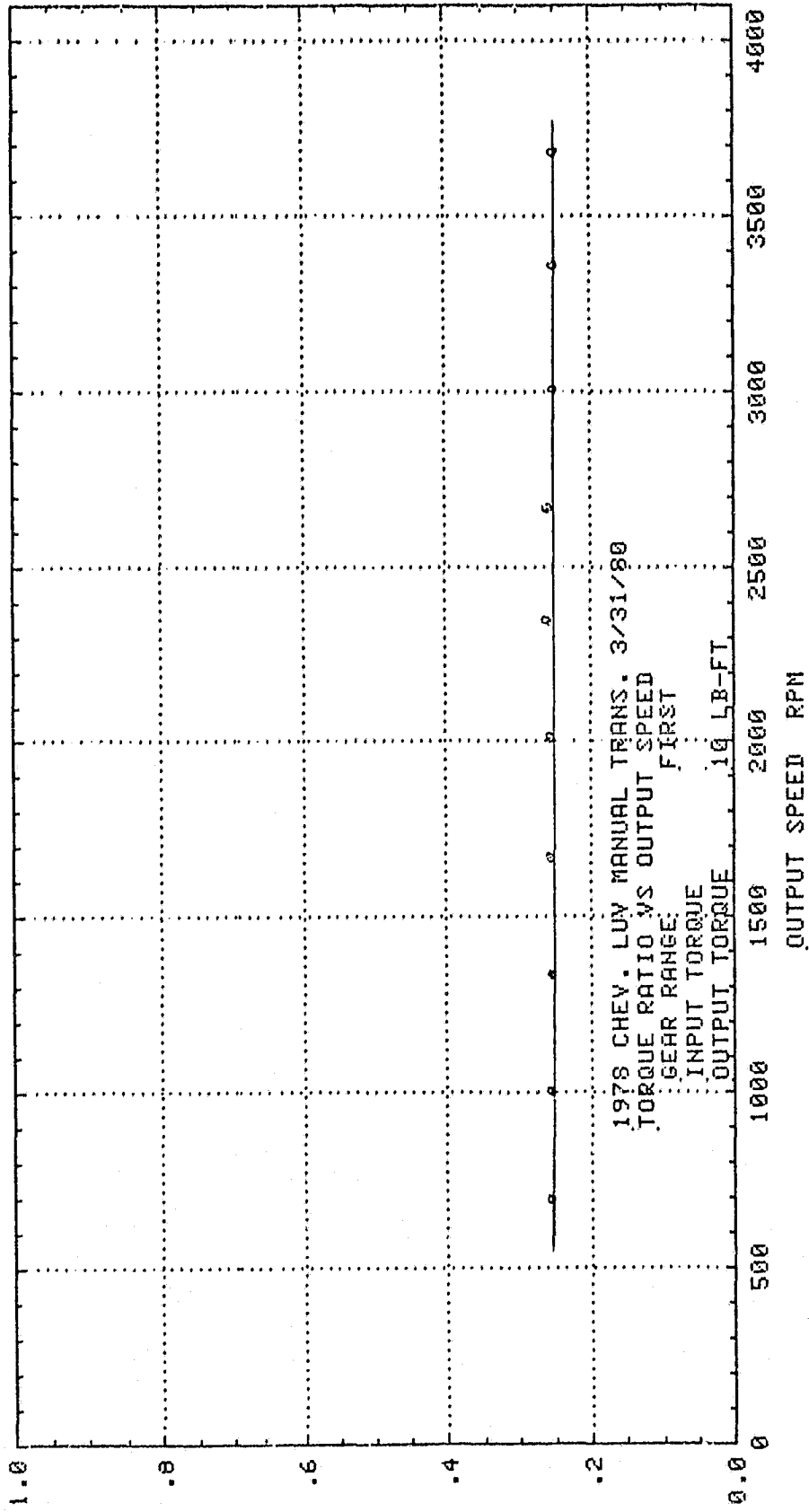

T O R Q U E R A T I O $\frac{T_o}{T_i}$

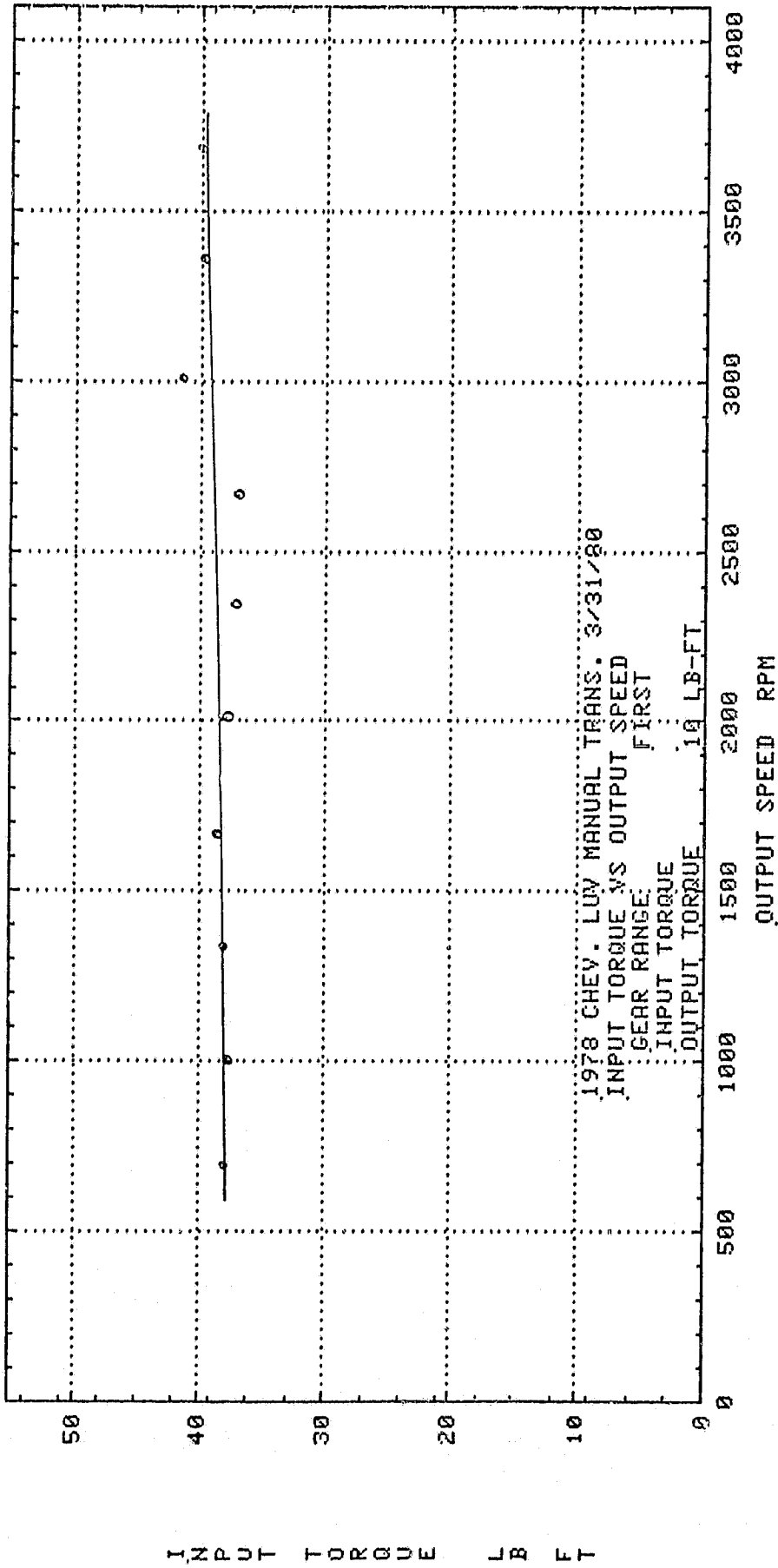

INPUT TORQUE LB FT

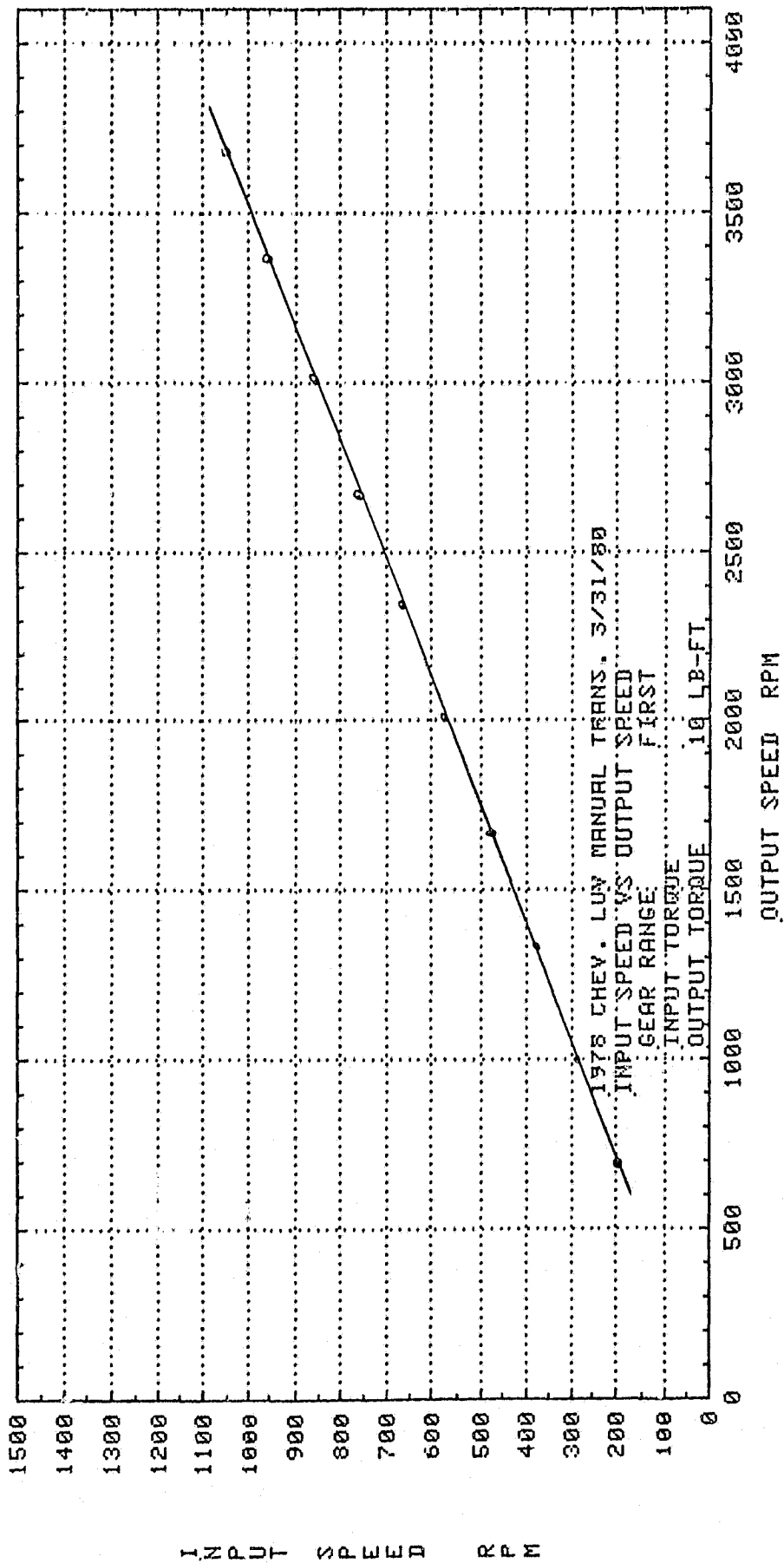

EFFICIENCY %

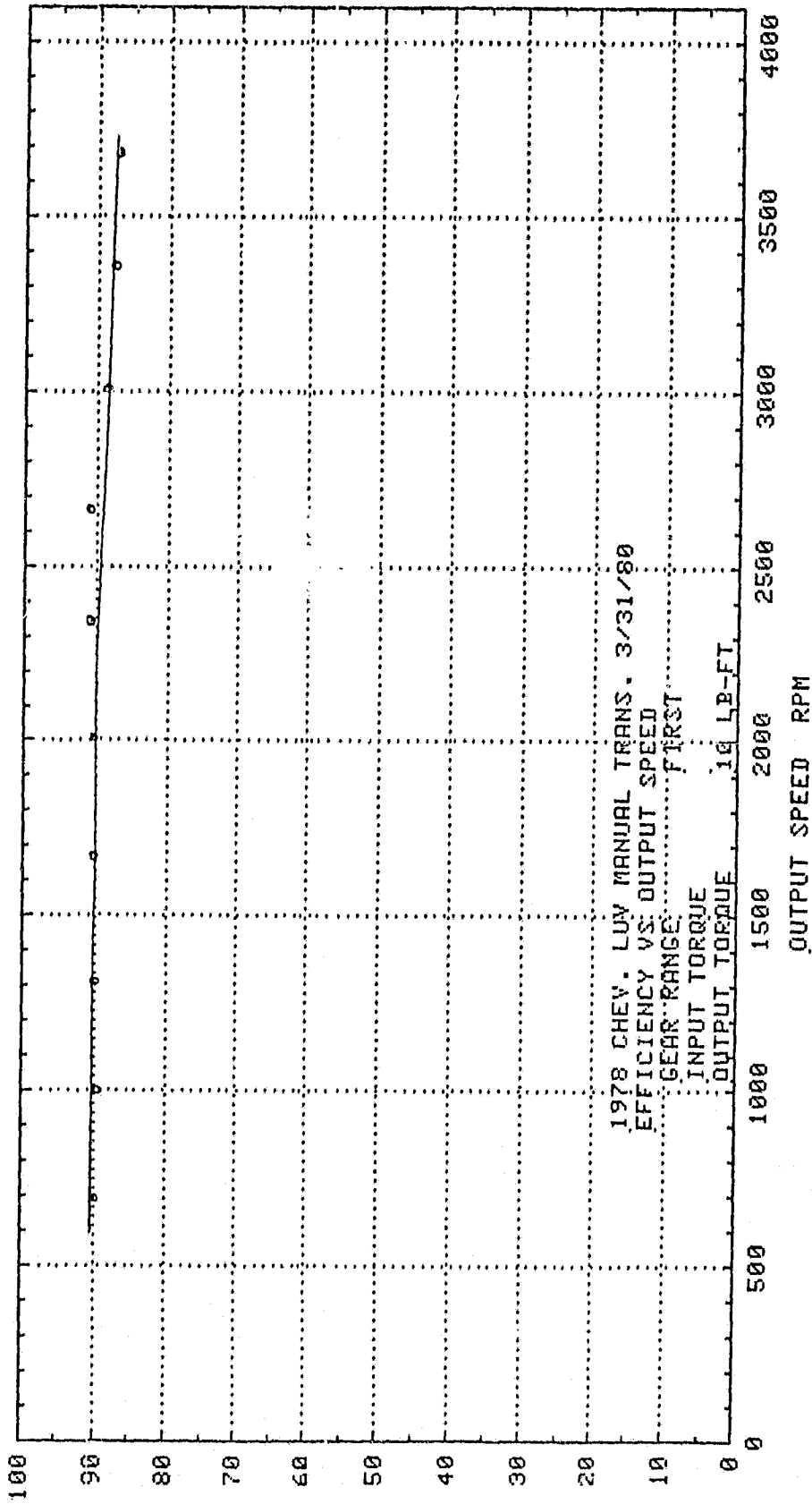

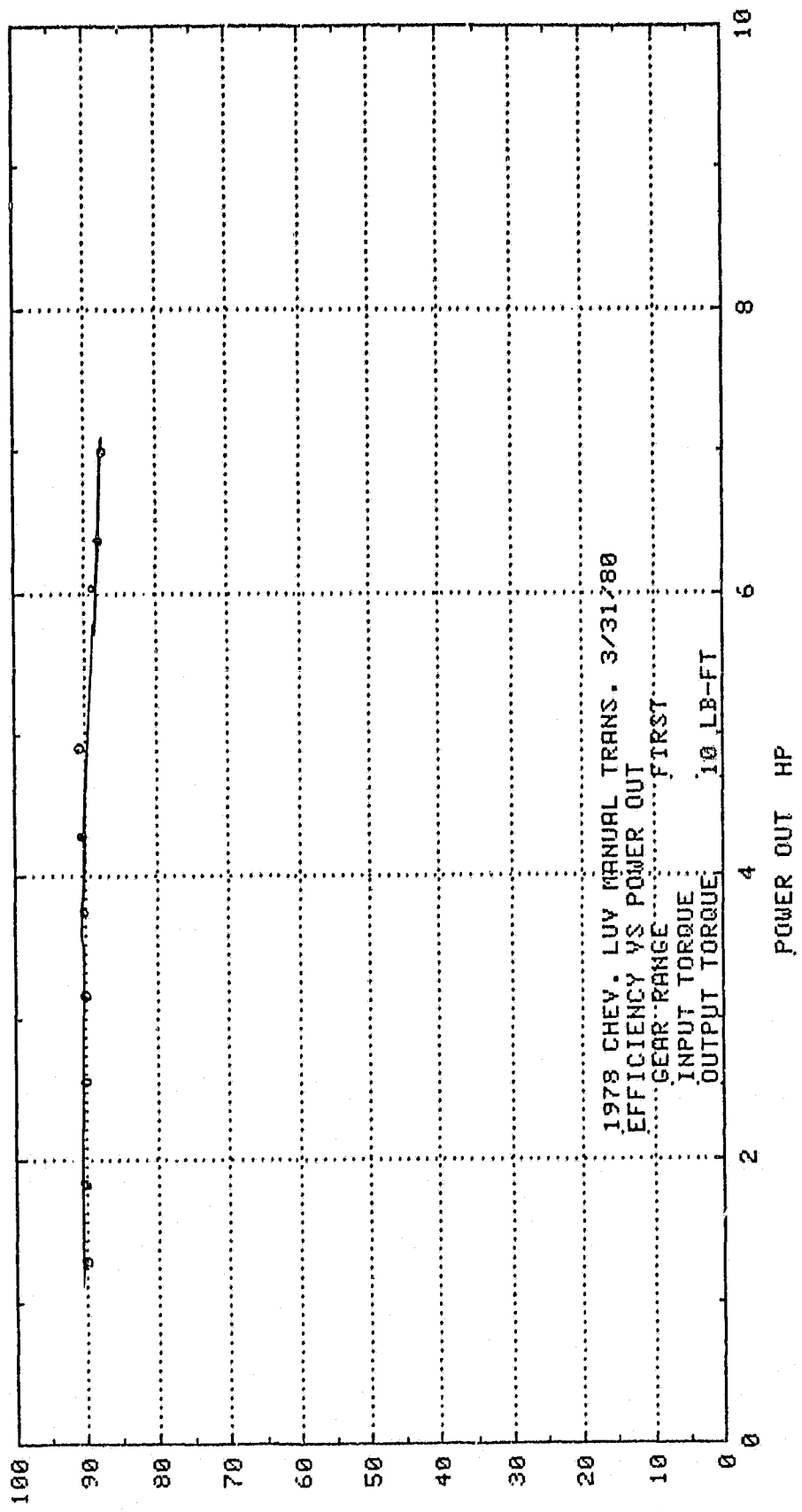

EFFICIENCY %

TORQUE RATIO

$$\frac{T_o}{T_i}$$

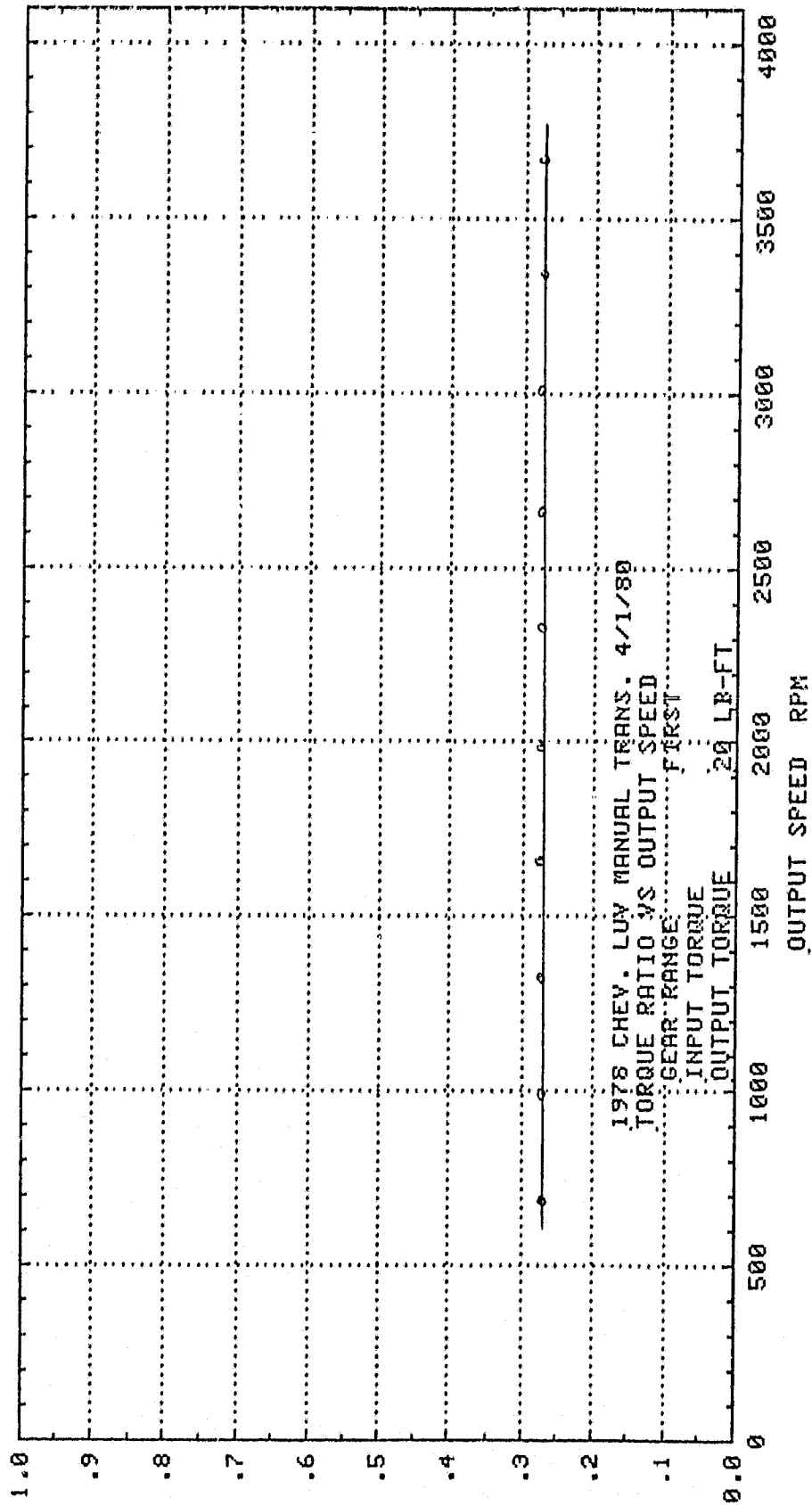

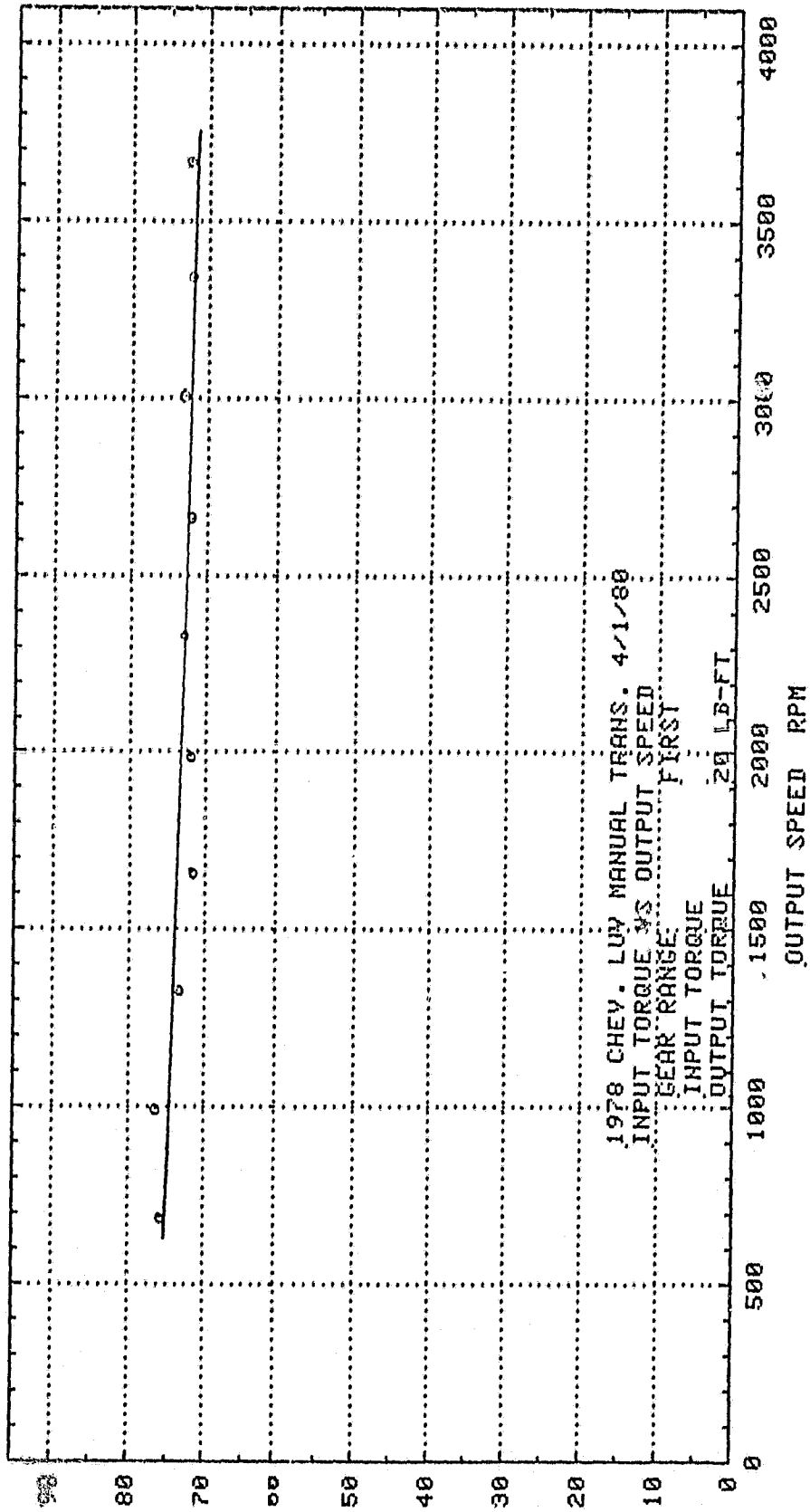

INPUT TORQUE LB FT

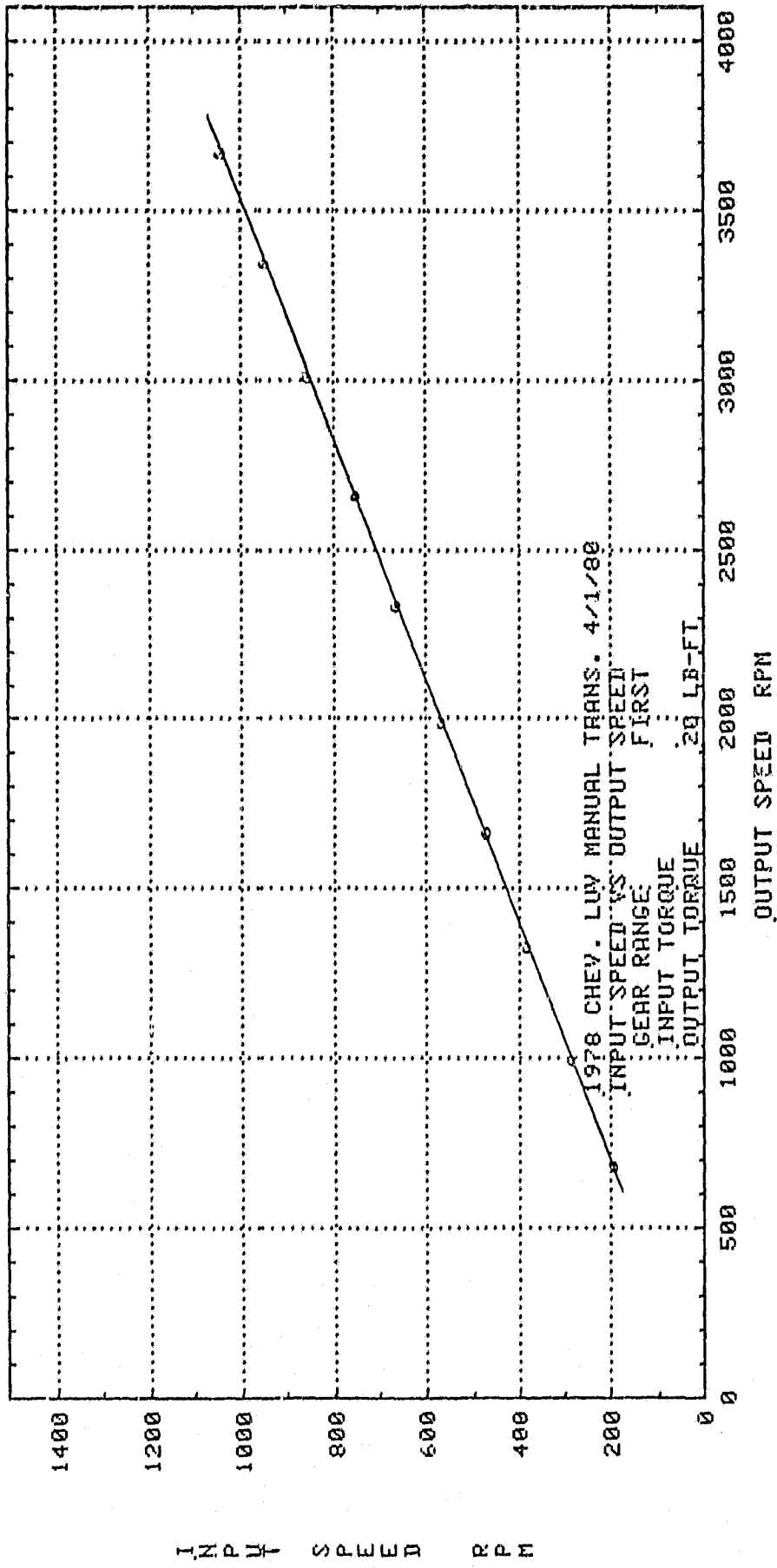

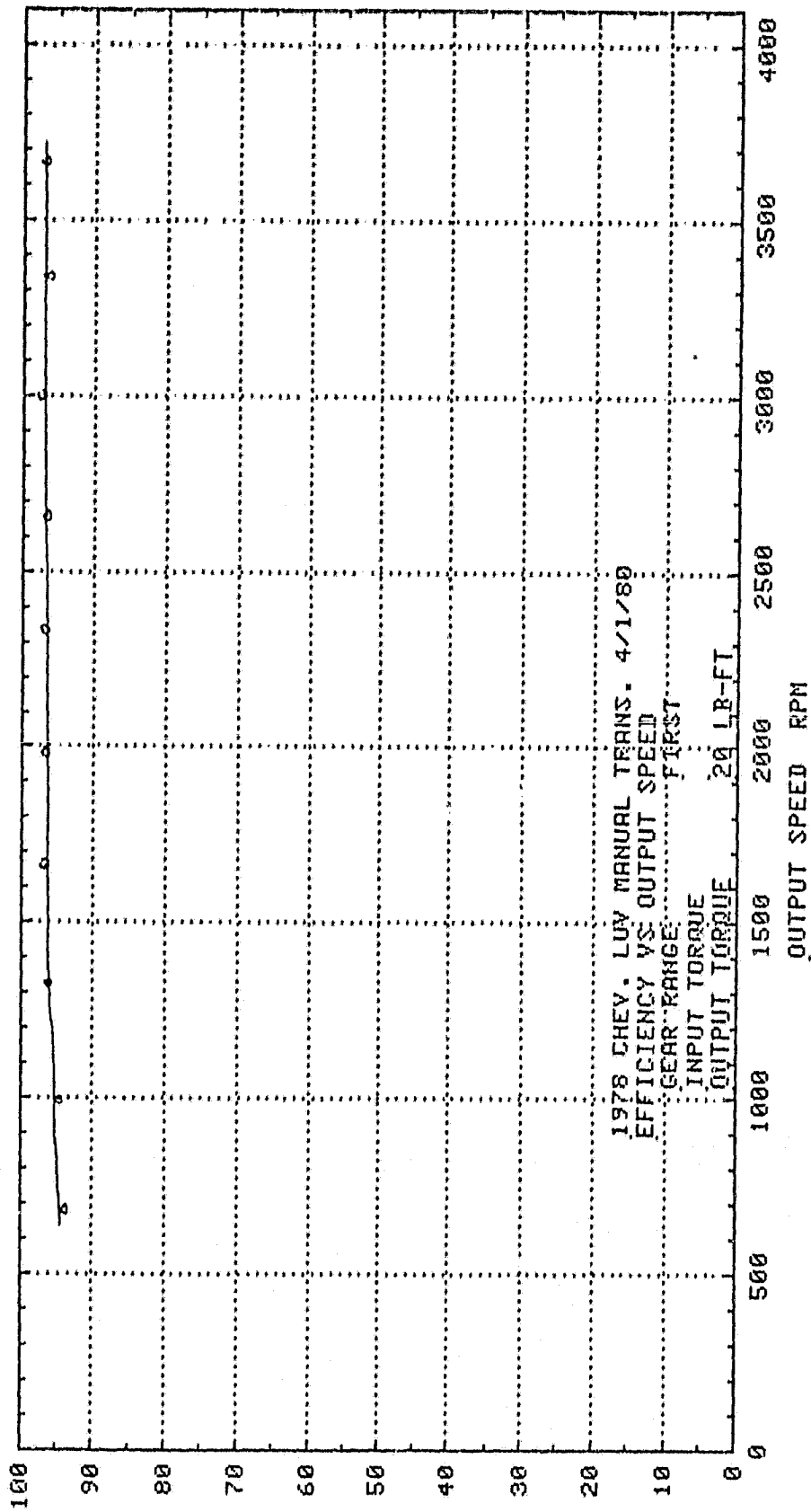

EFFICIENCY %

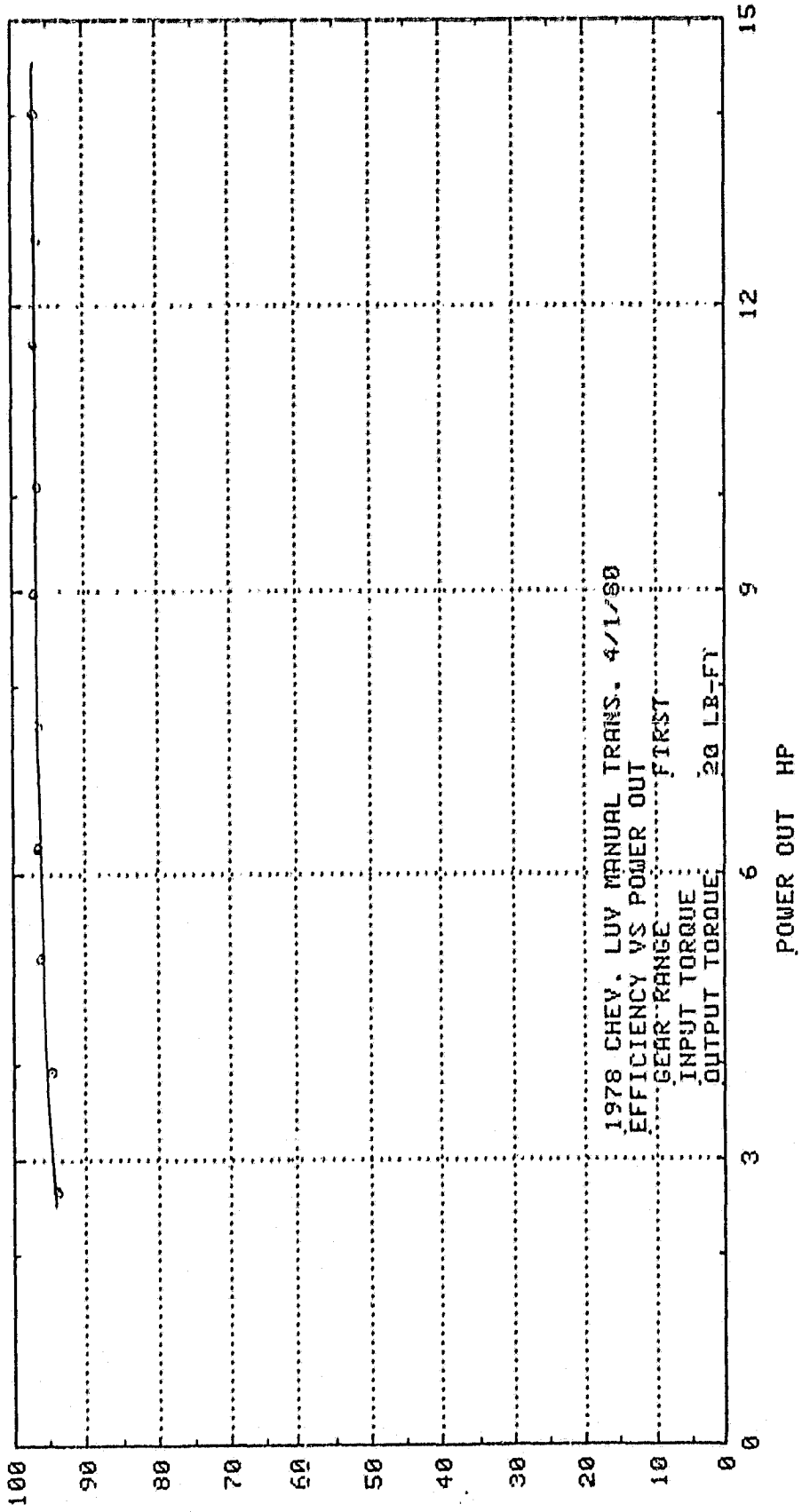

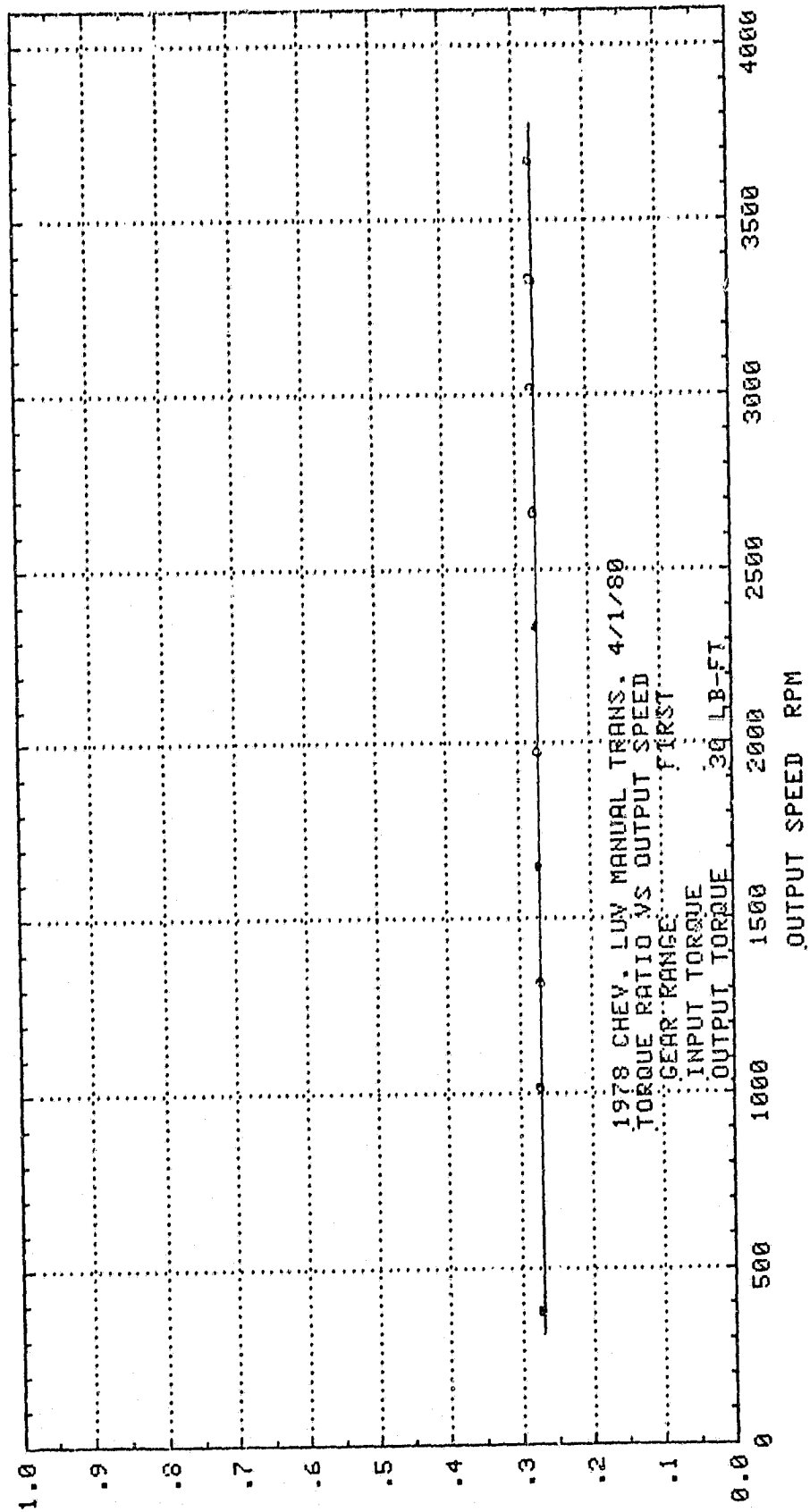

TORQUE RATIO $\frac{T_o}{T_i}$

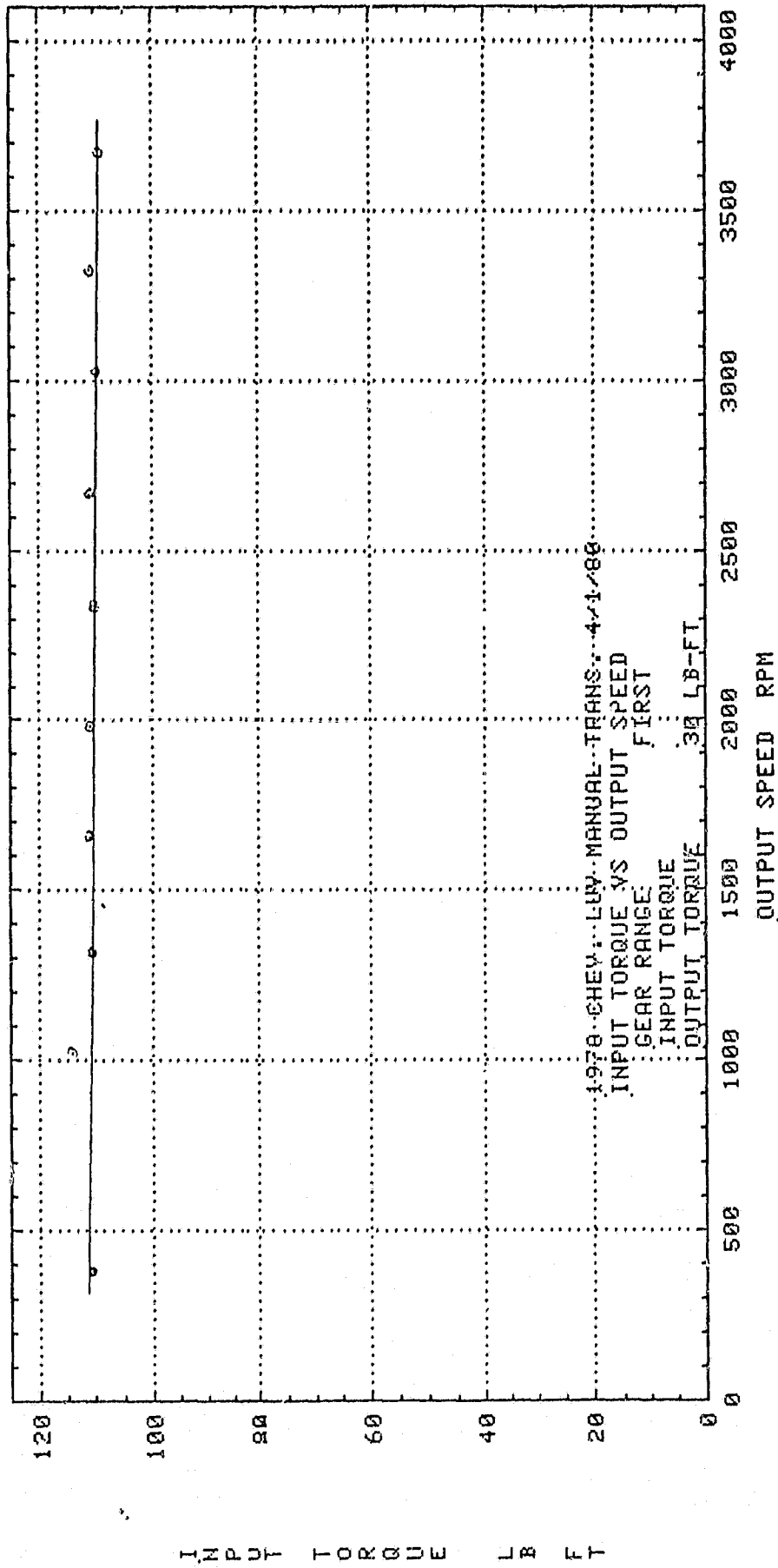

INPUT TORQUE LB FT

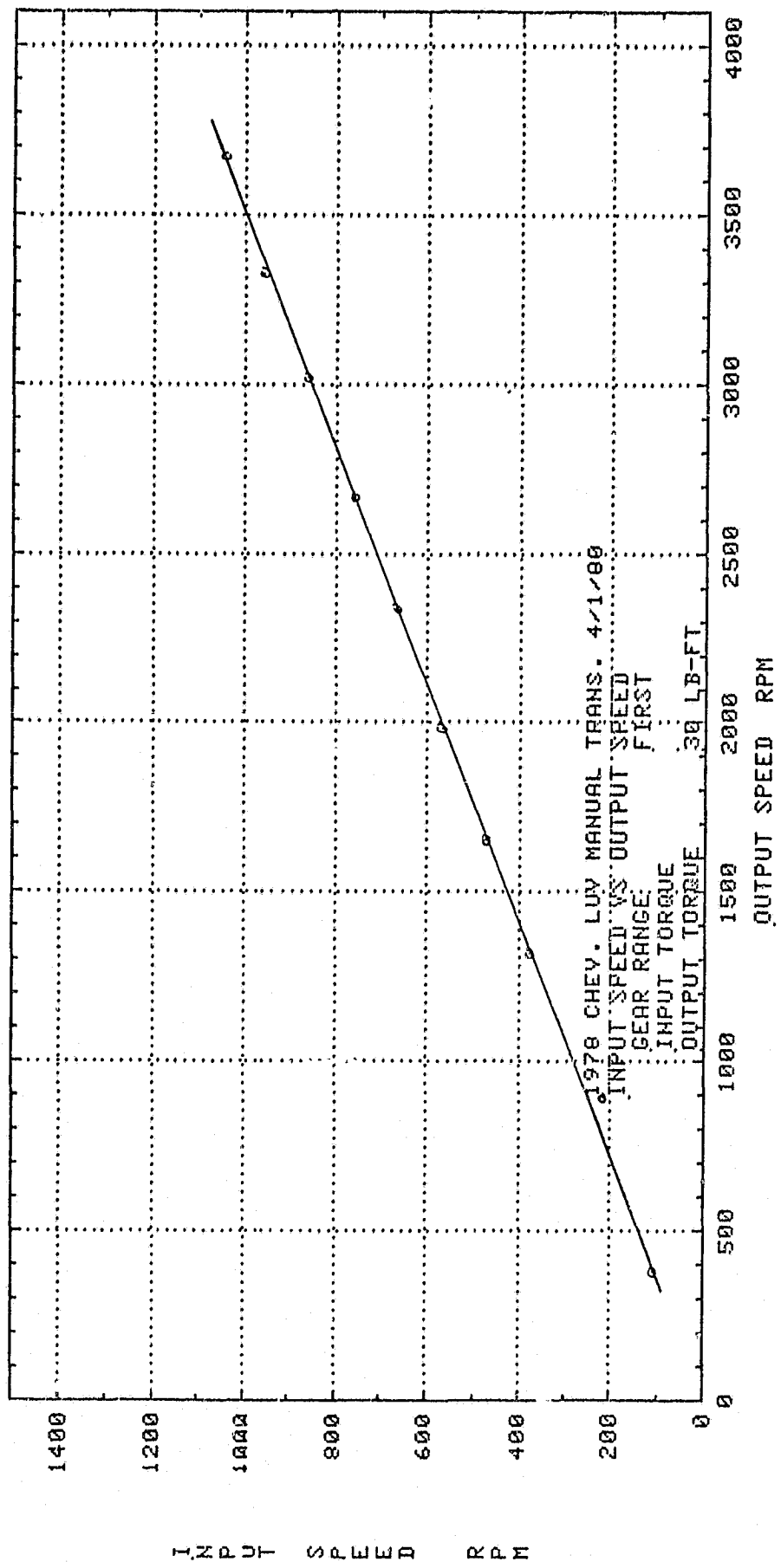

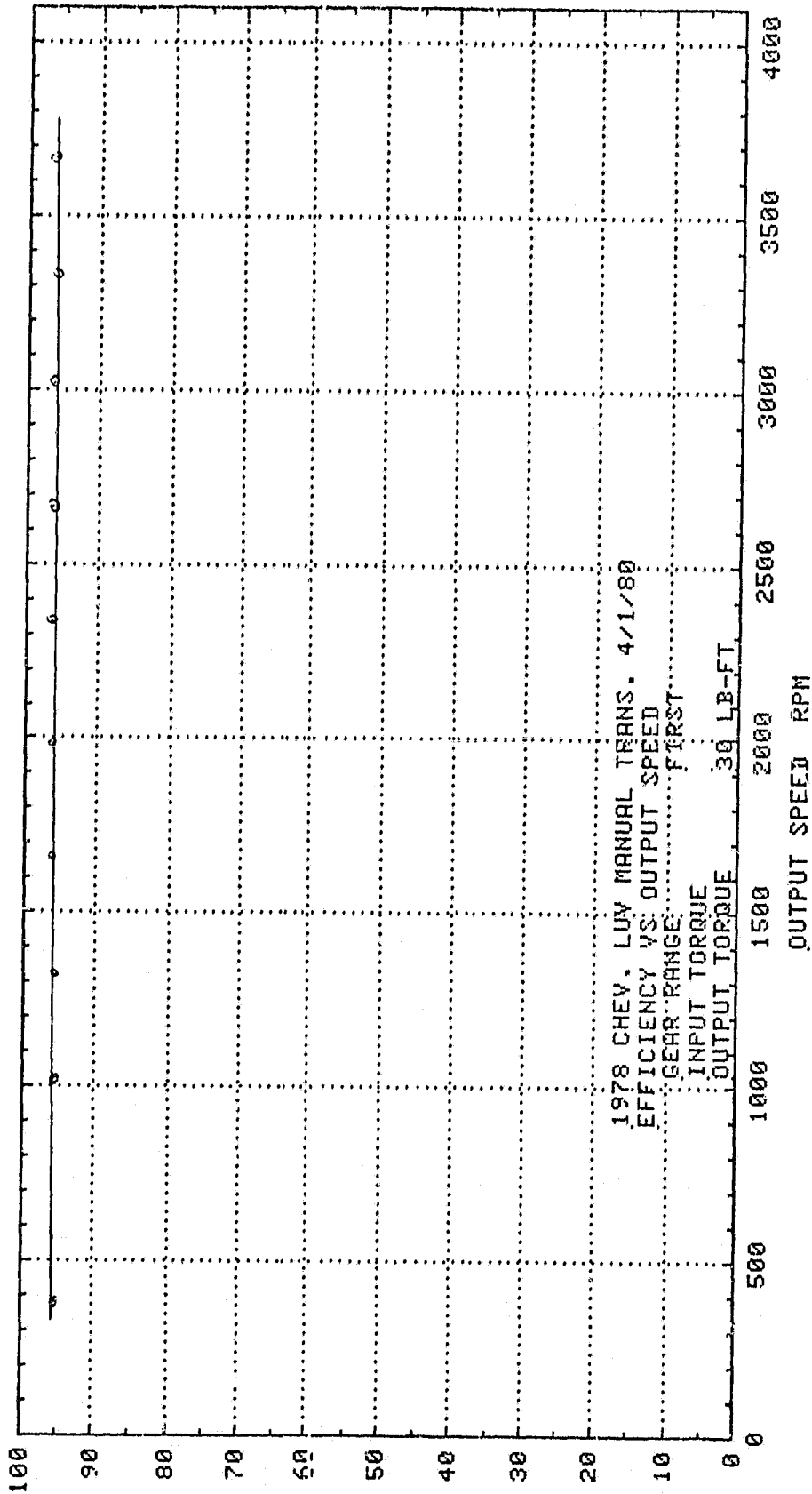

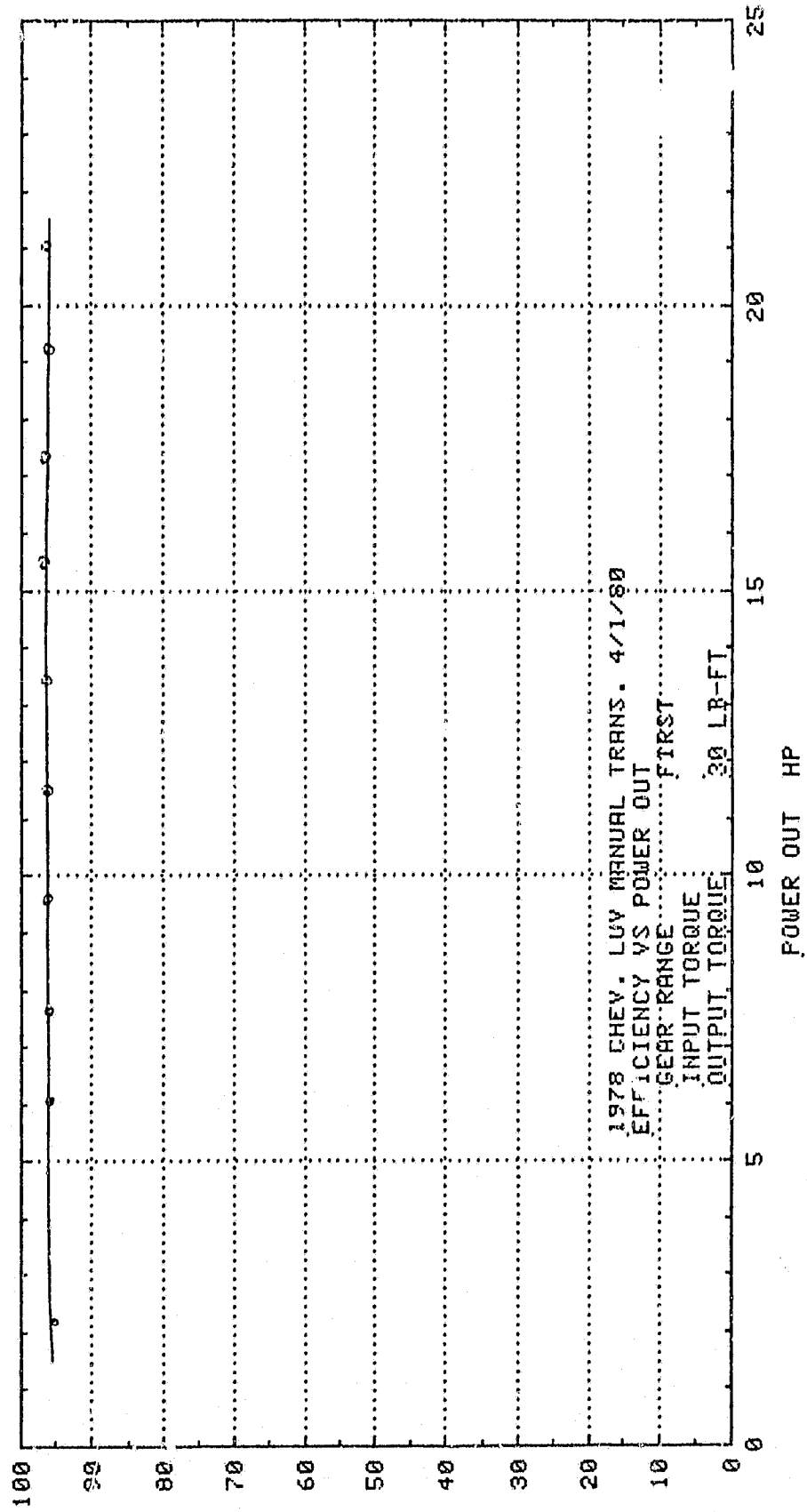

EFFICIENCY %

TORQUE RATIO $\frac{T_o}{T_i}$

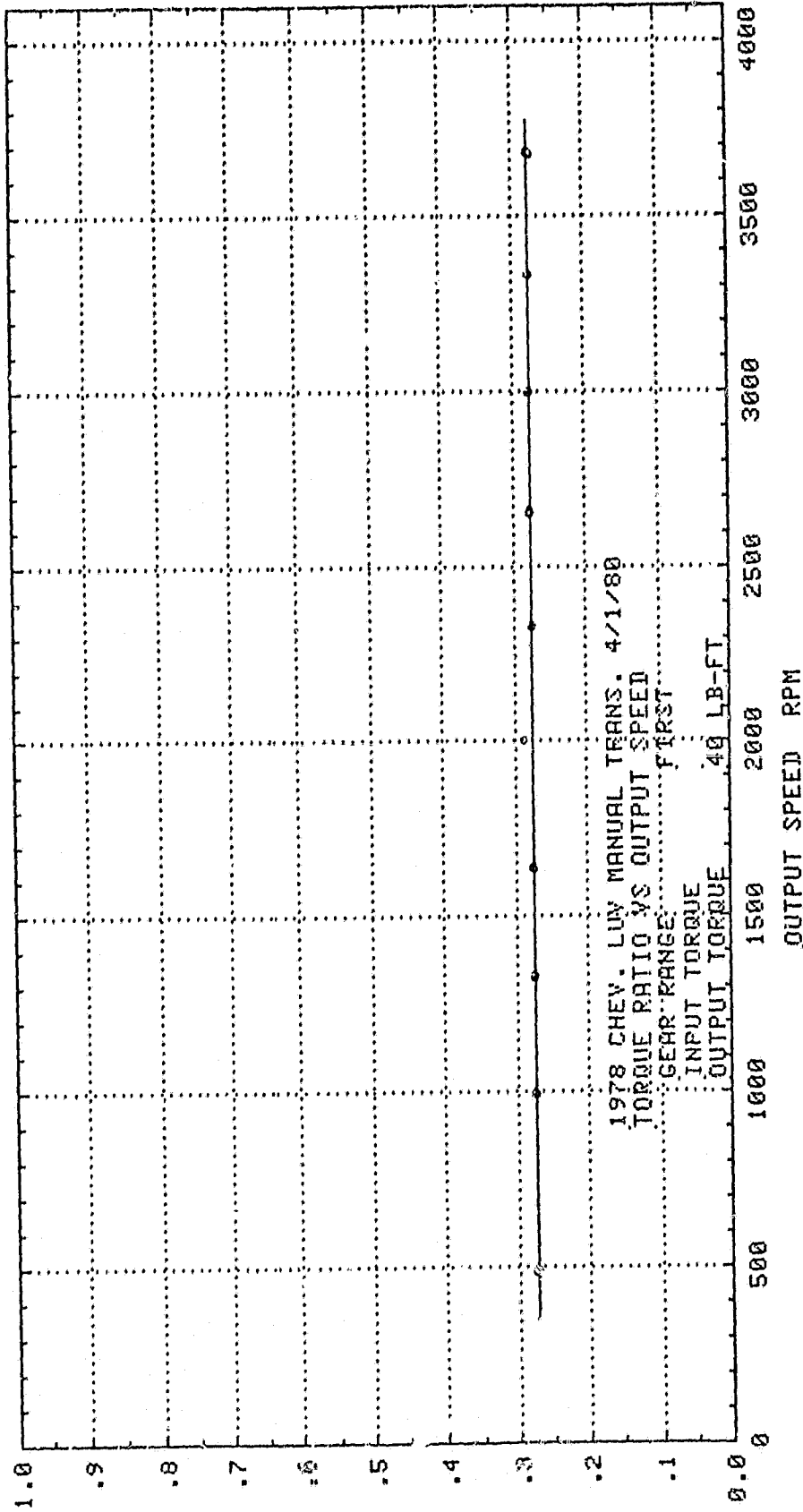

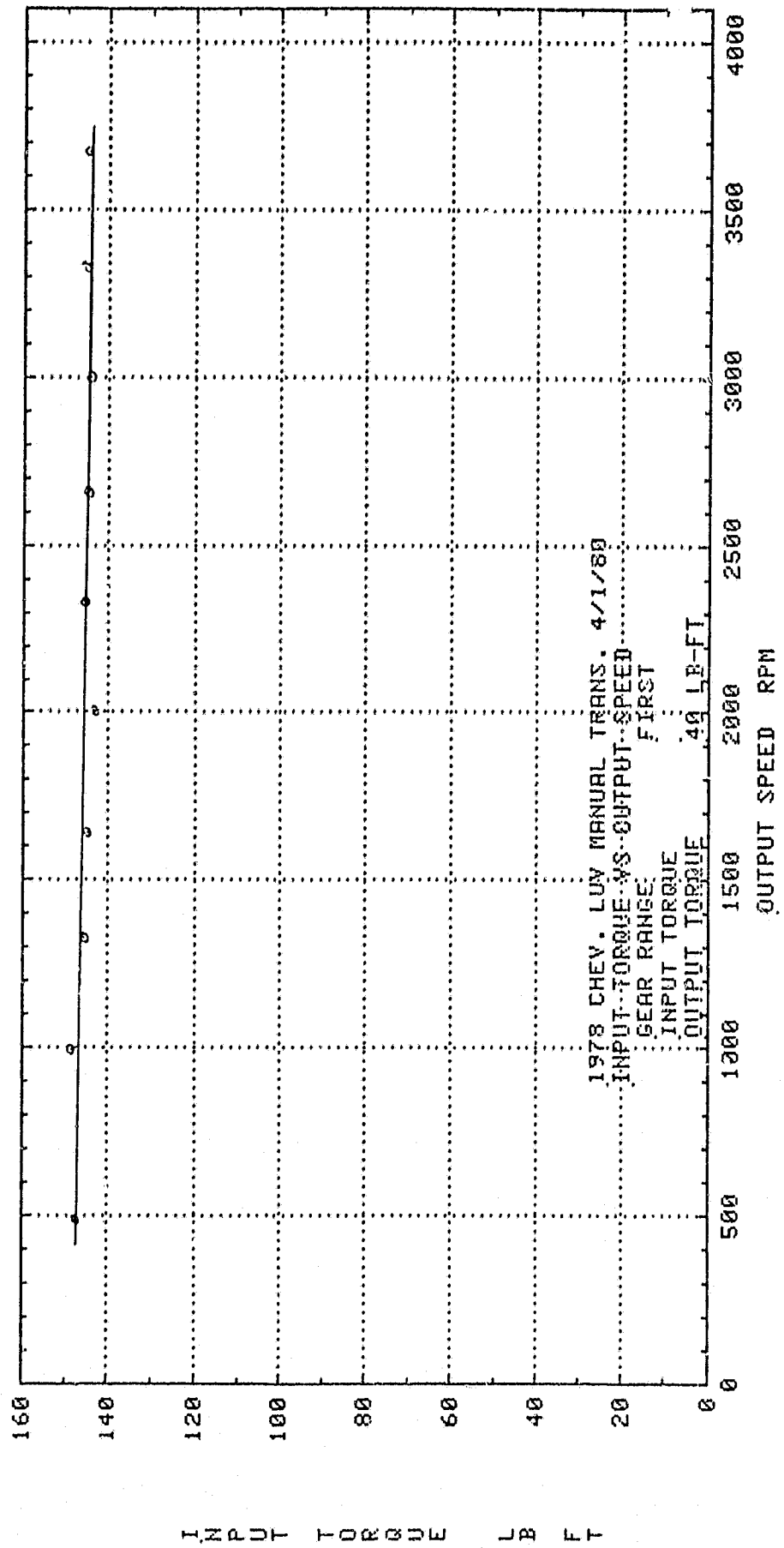

INPUT TORQUE LB FT

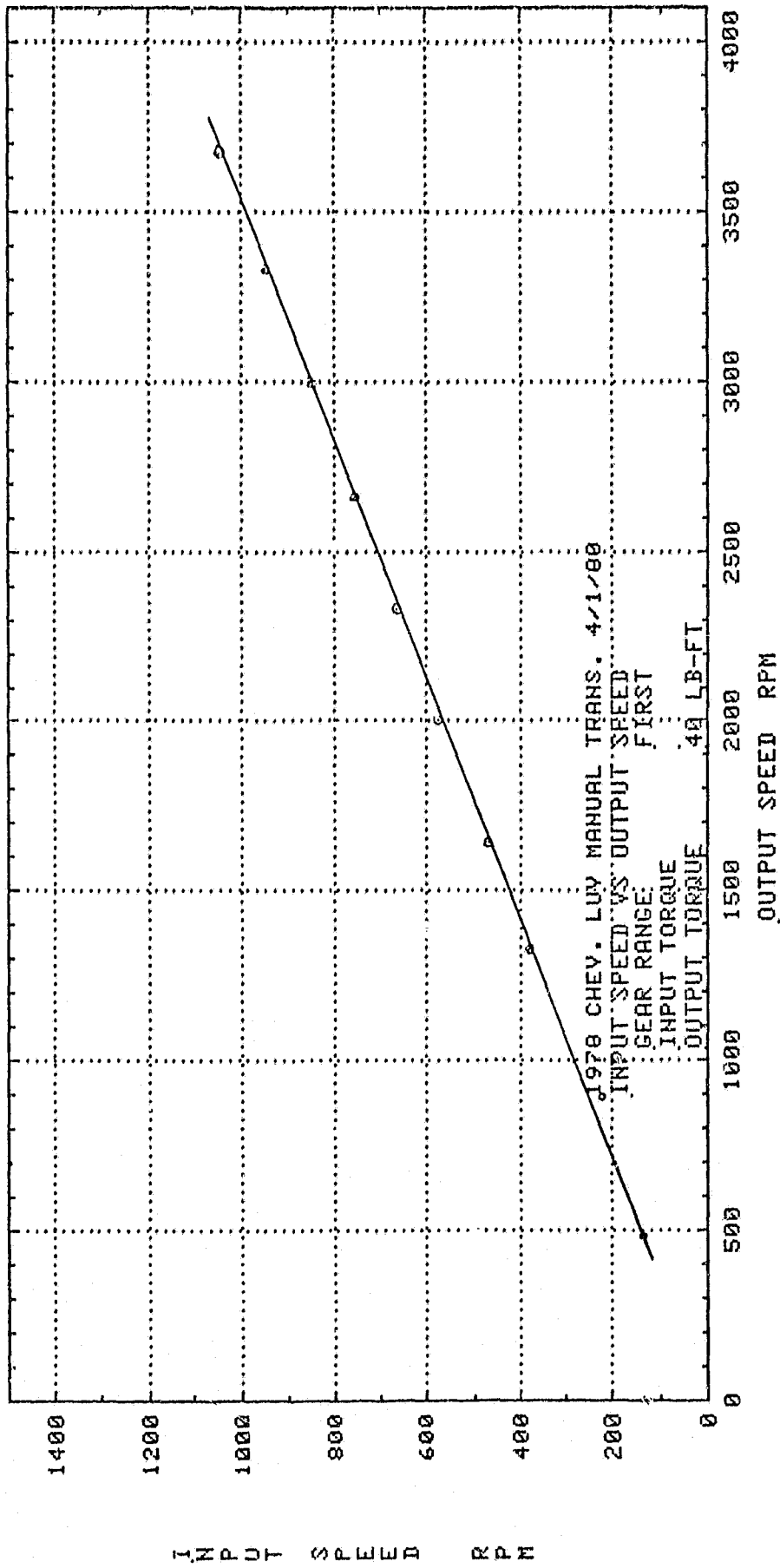

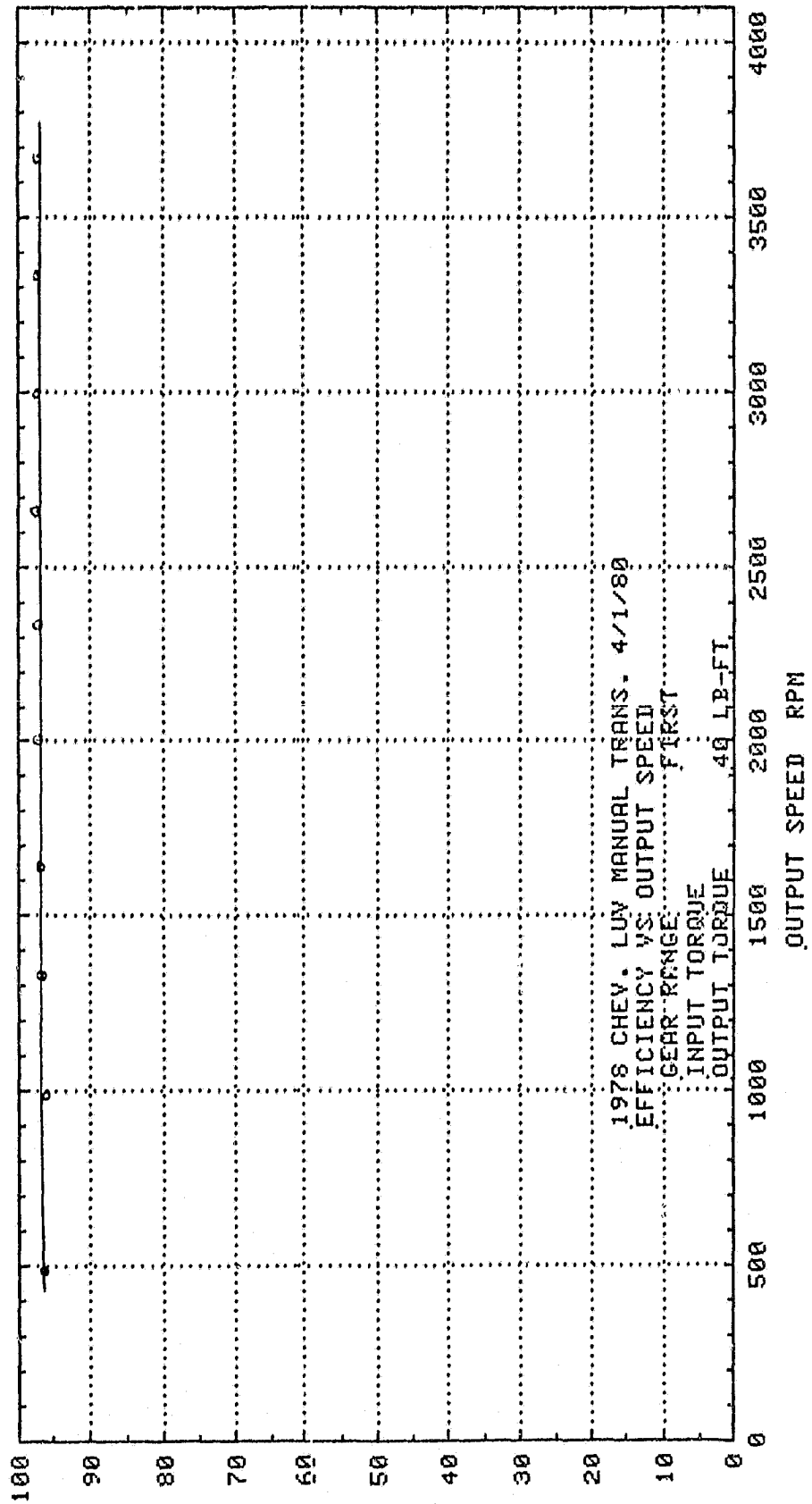

EFFICIENCY %

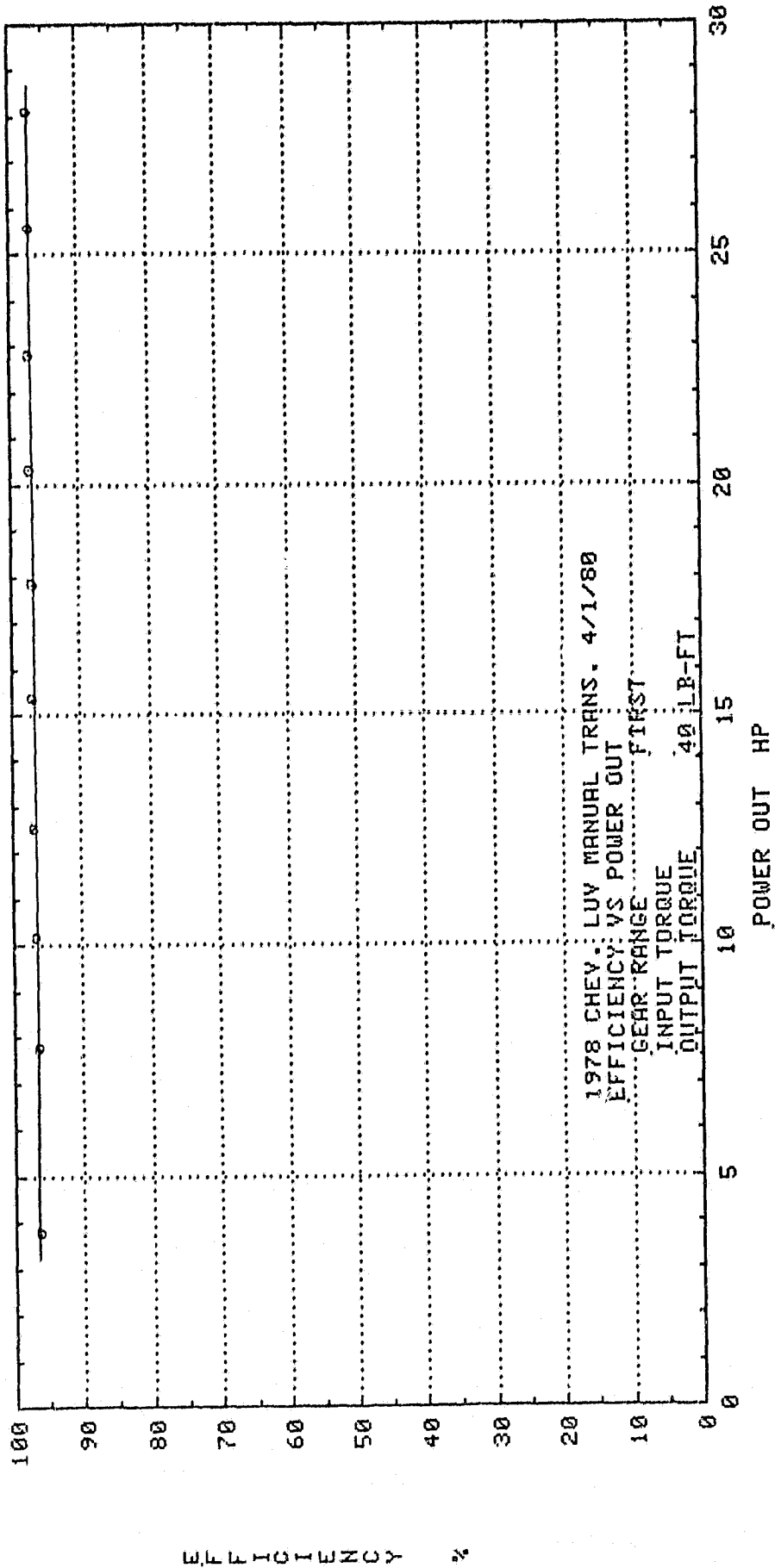

COAST PERFORMANCE

2ND GEAR

Graphs Contained in This Section

- Torque Ratio -vs- Output Speed
- Output Torque -vs- Output Speed
- Input Speed -vs- Output Speed
- Efficiency -vs- Output Speed
- Efficiency -vs- Power Out

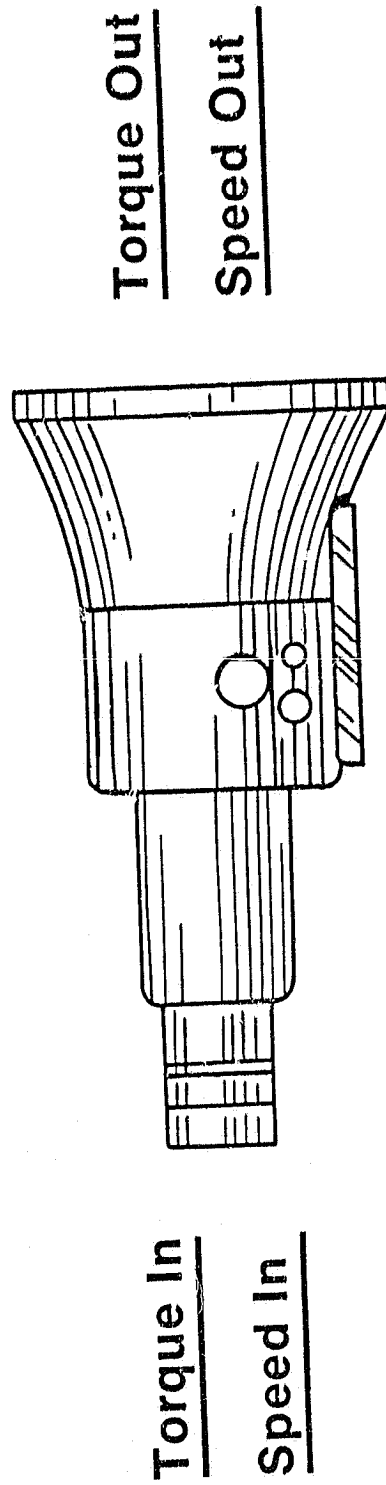

Coast Performance Tests

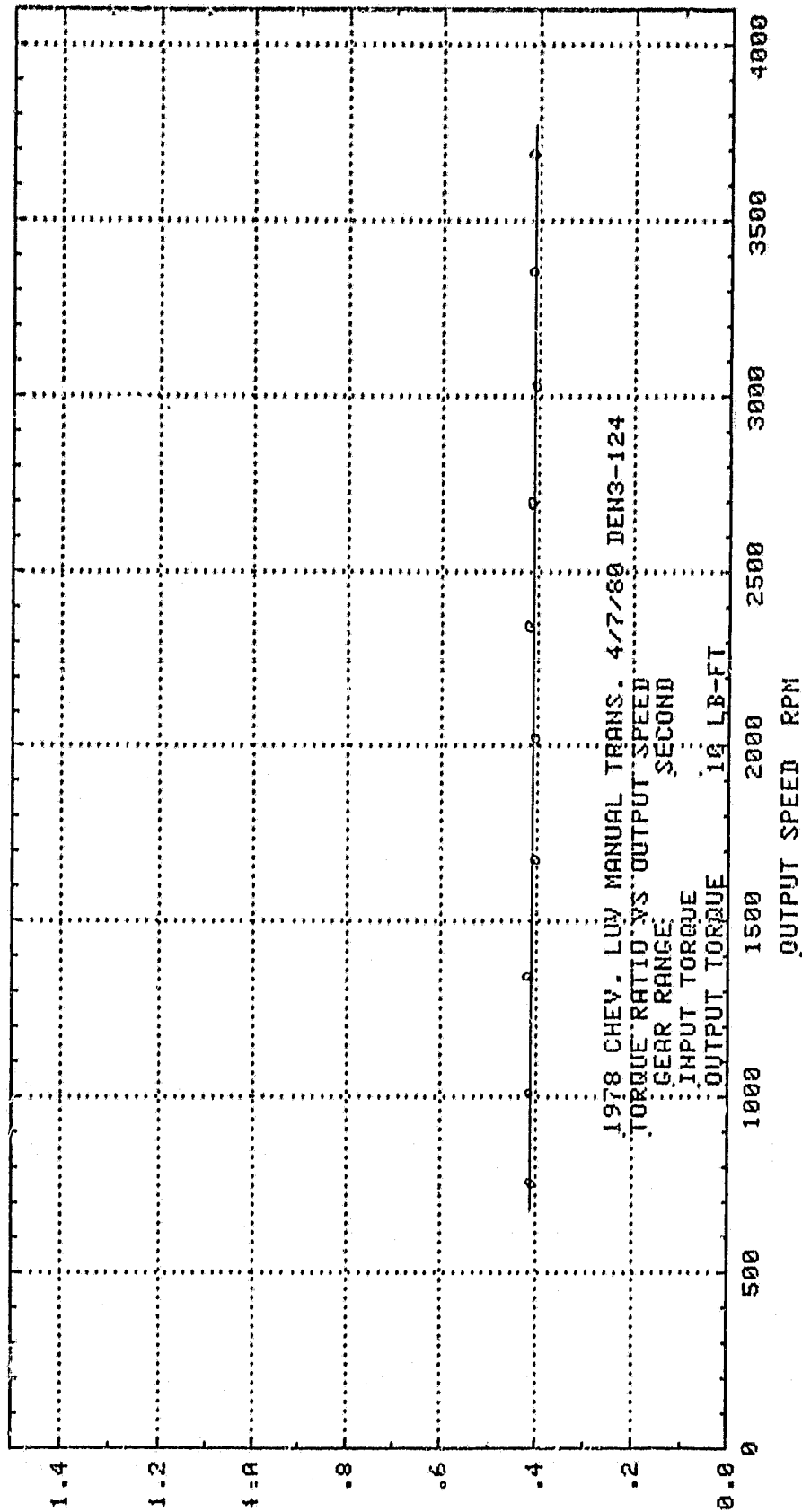

TORQUE RATIO $\frac{T_o}{T_i}$

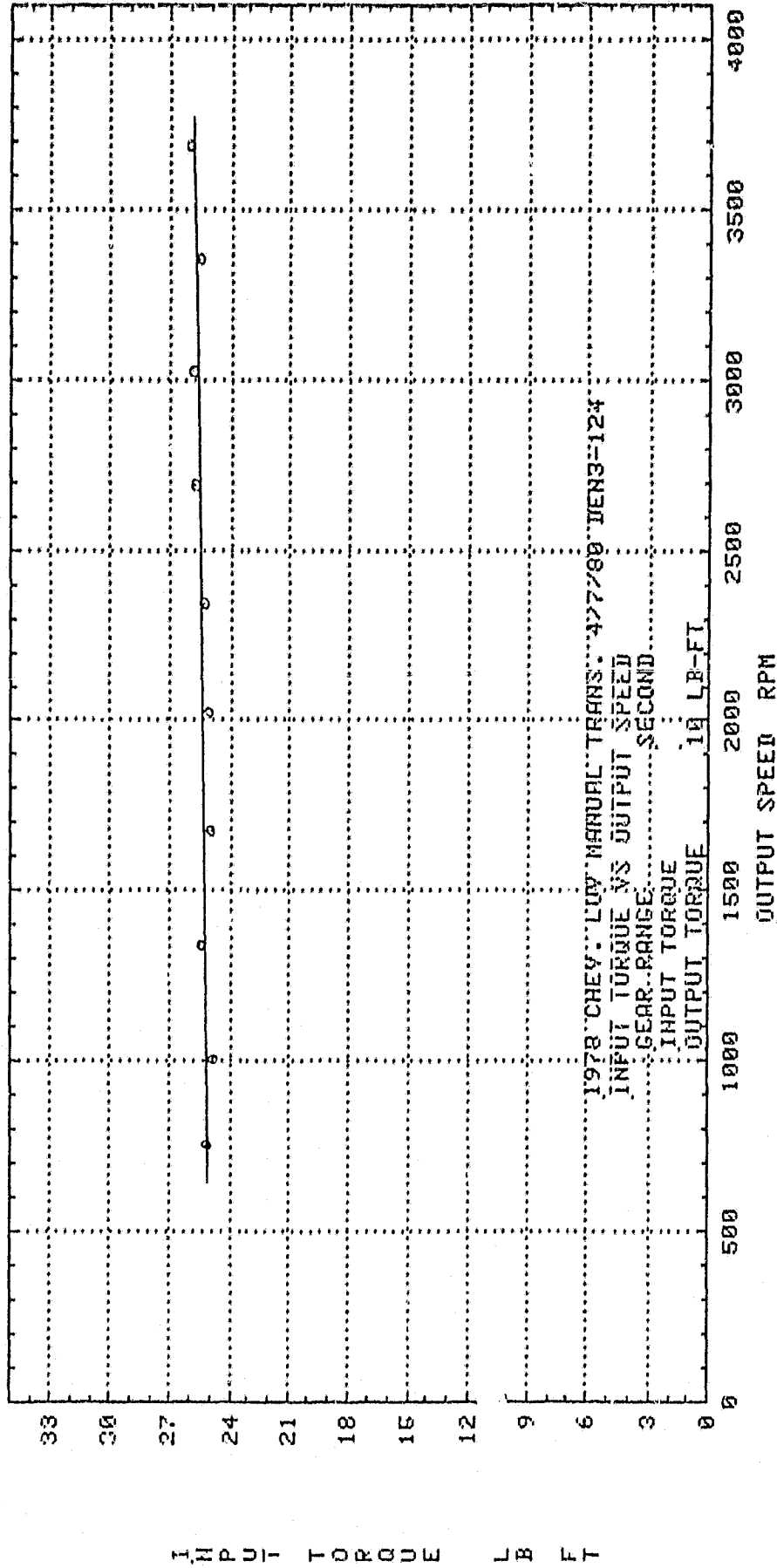

C-2

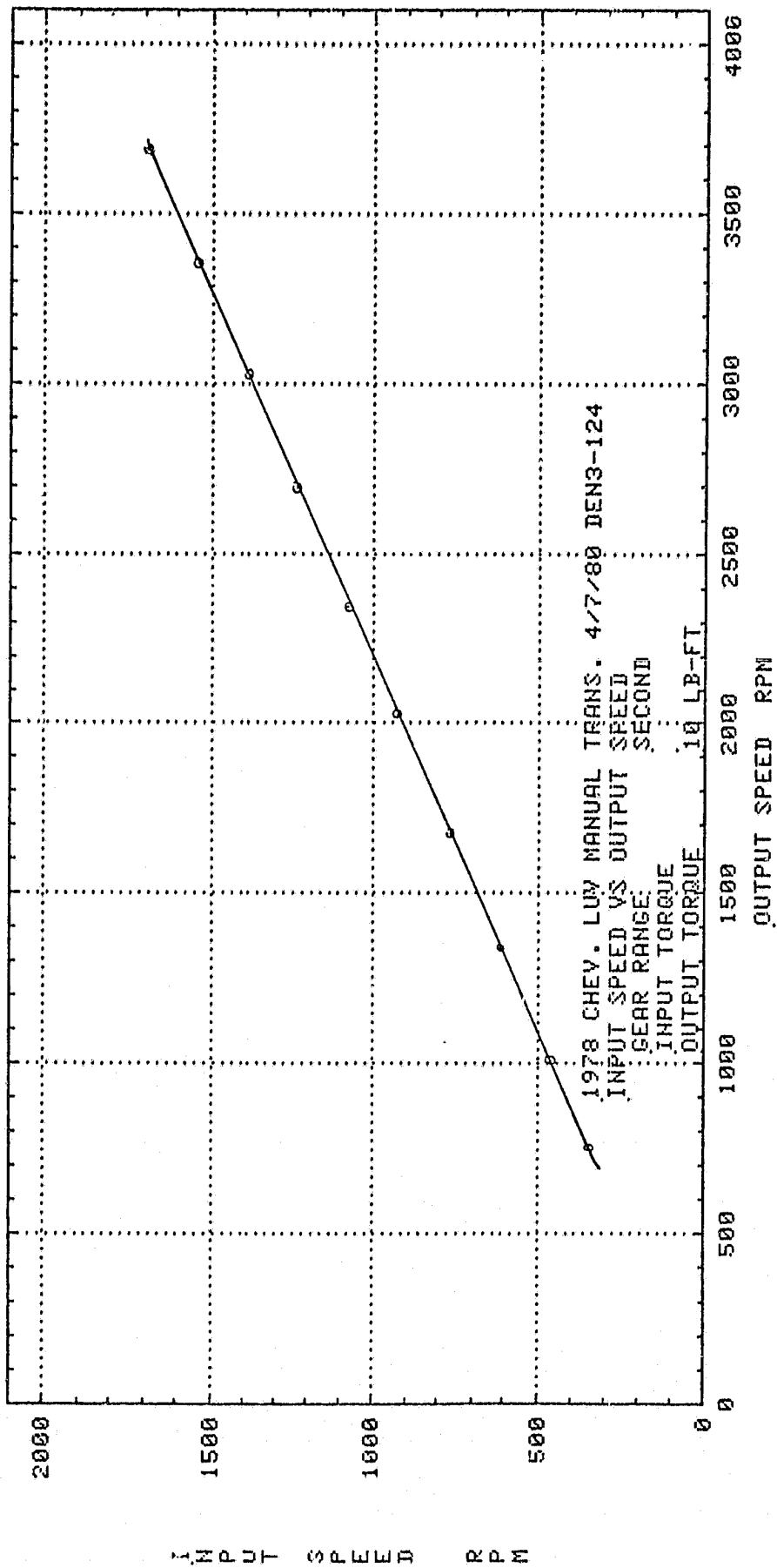

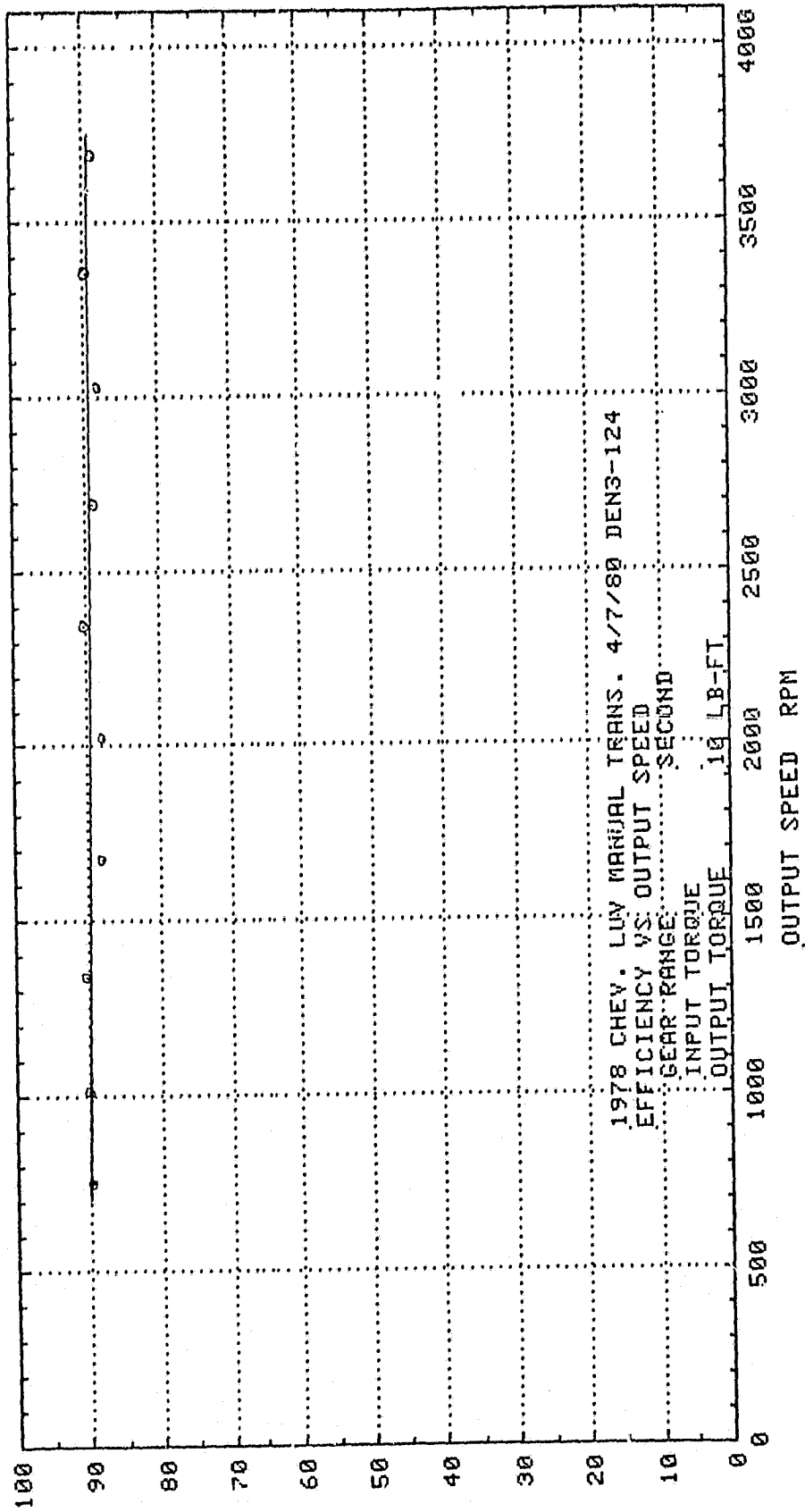

EFFICIENCY %

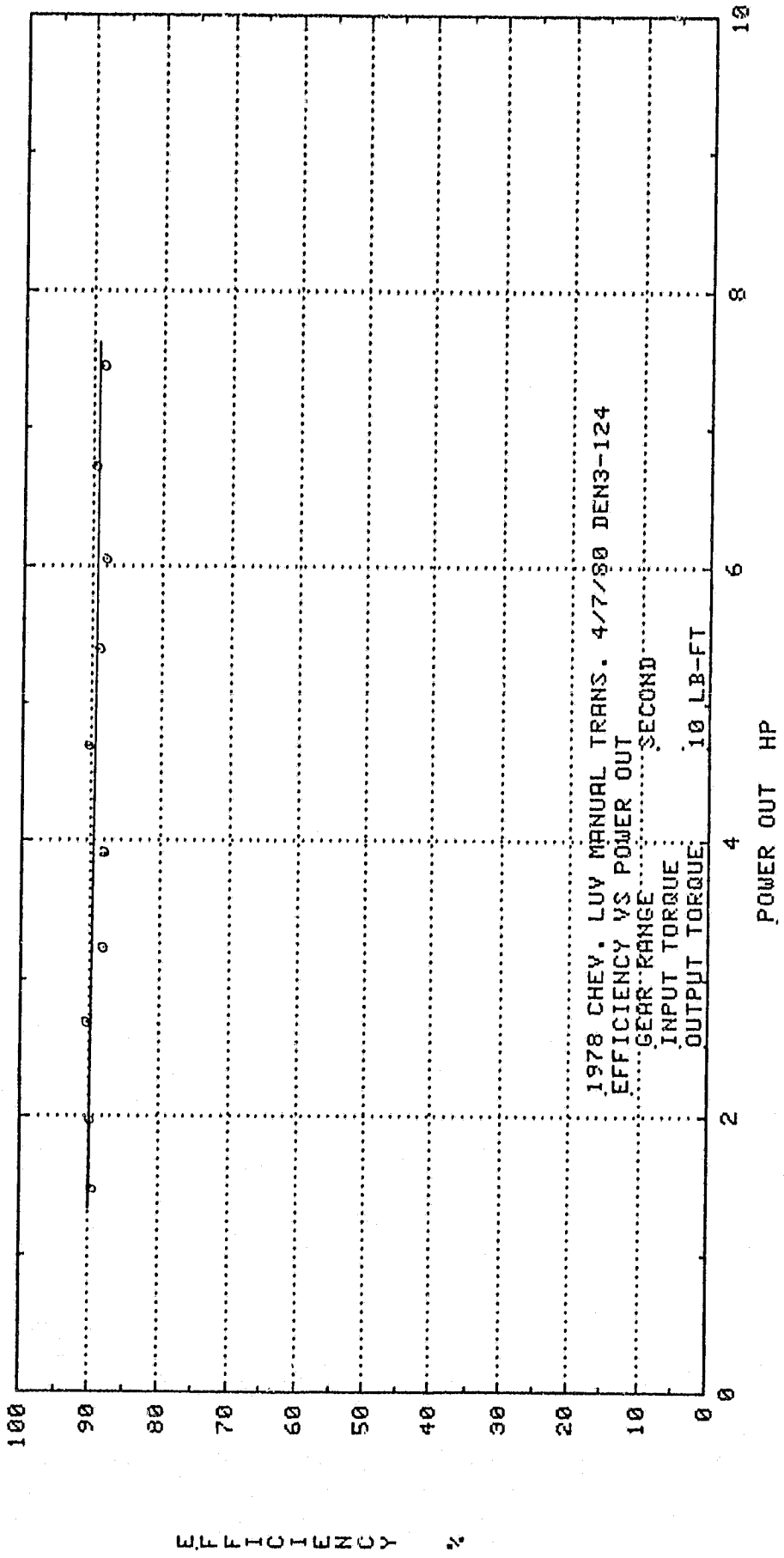

EFFICIENCY %

TORQUE RATIO $\frac{T_o}{T_i}$

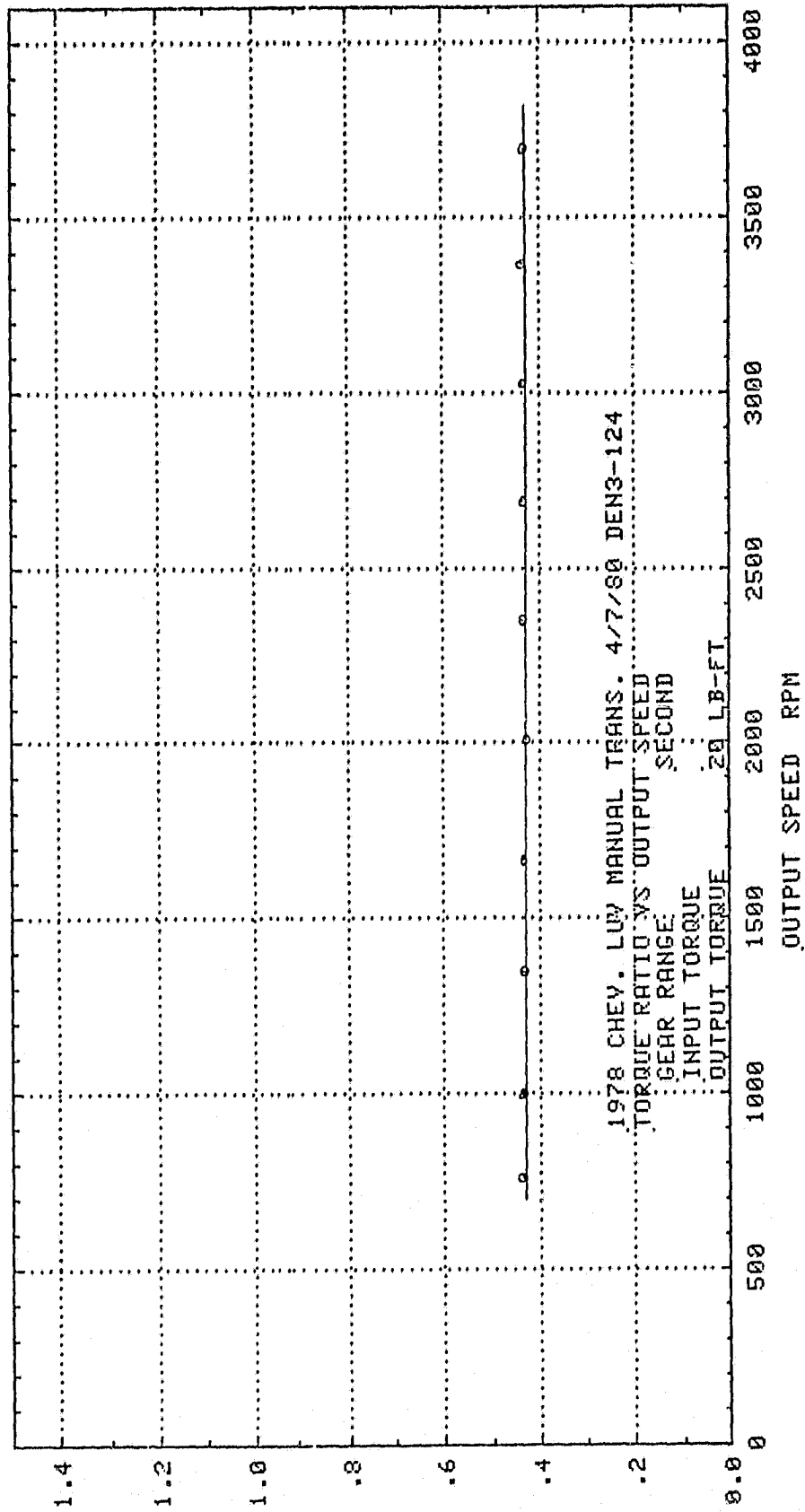

INPUT TORQUE LB FT

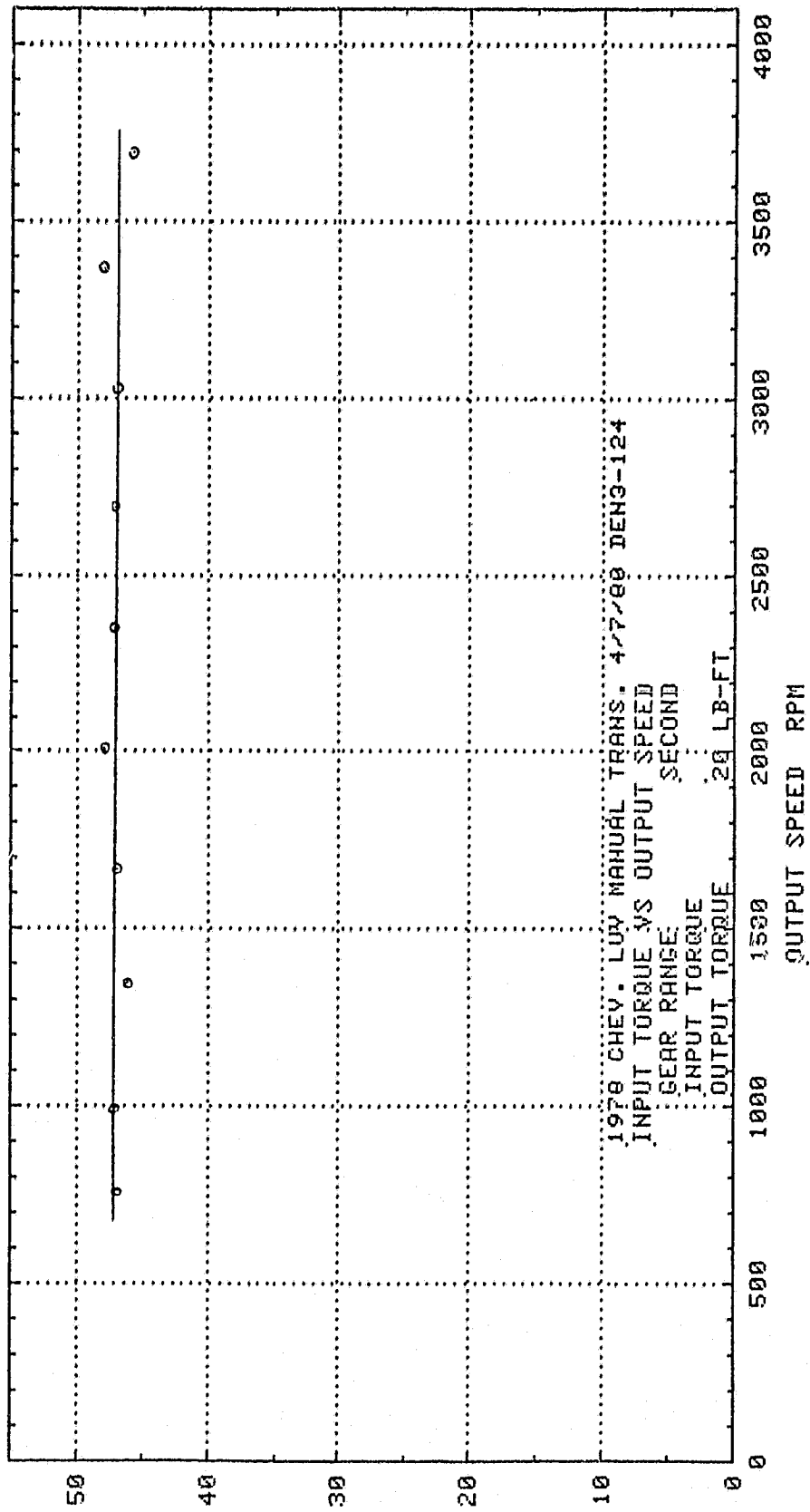

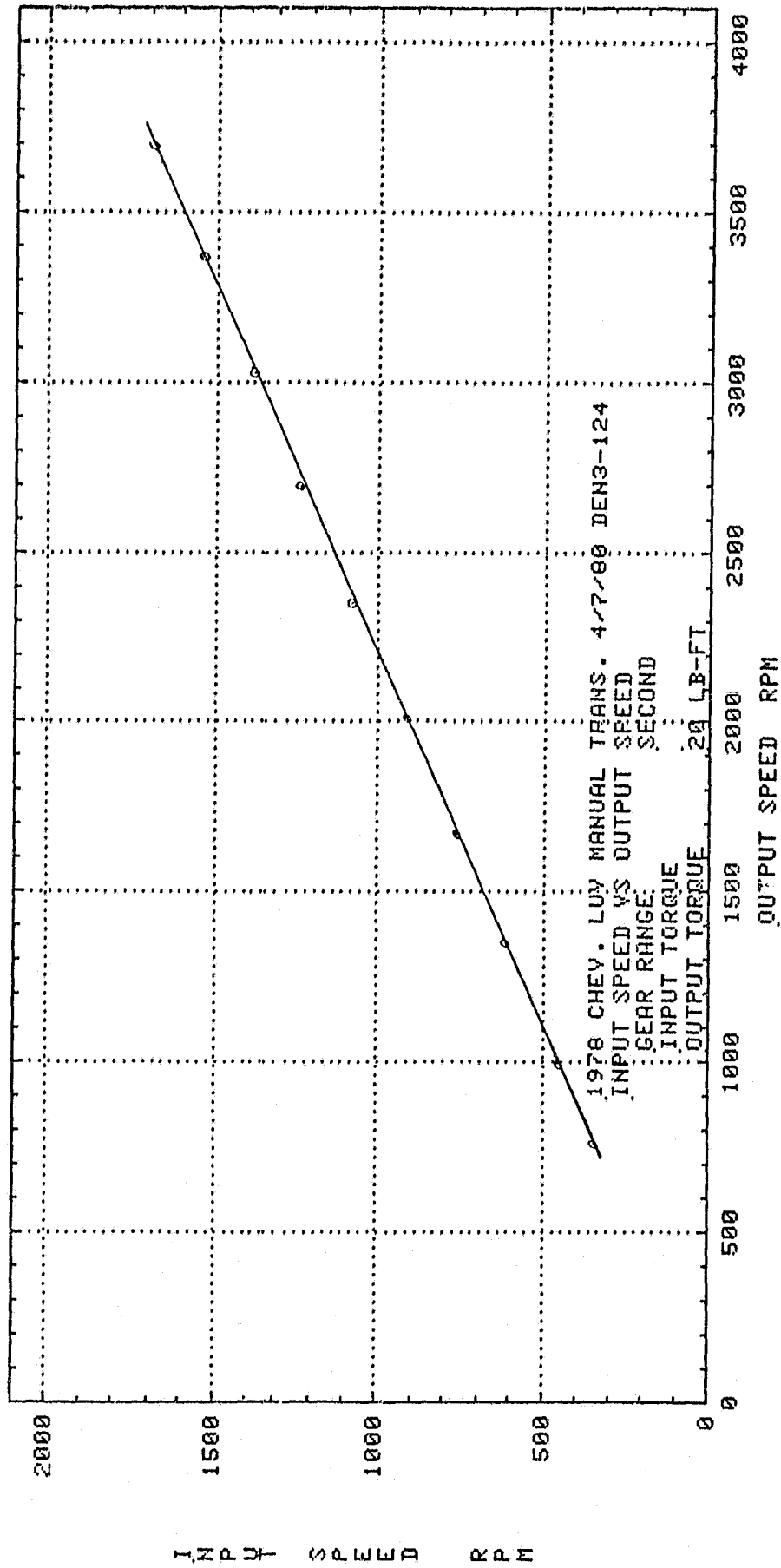

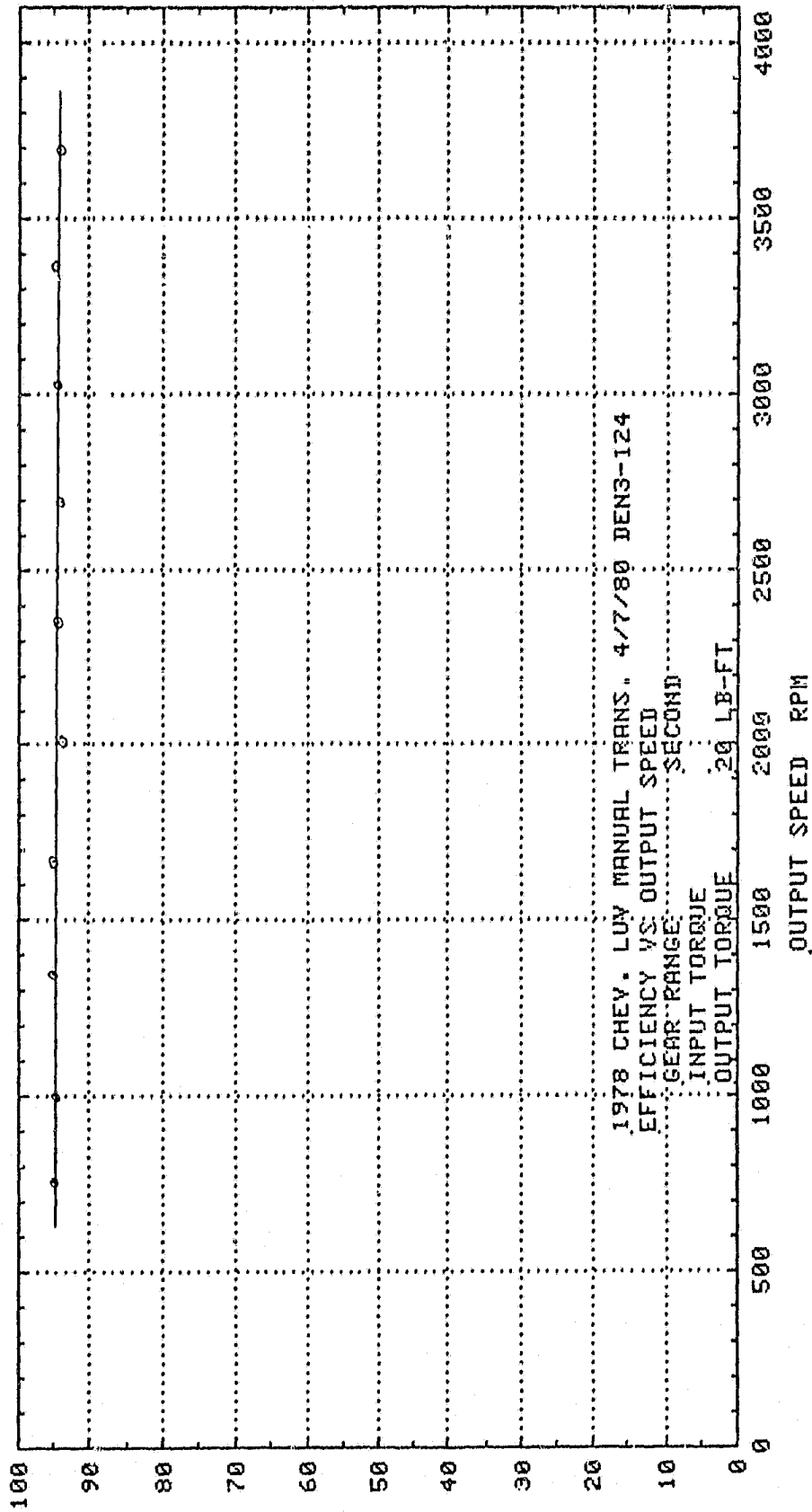

EFFICIENCY %

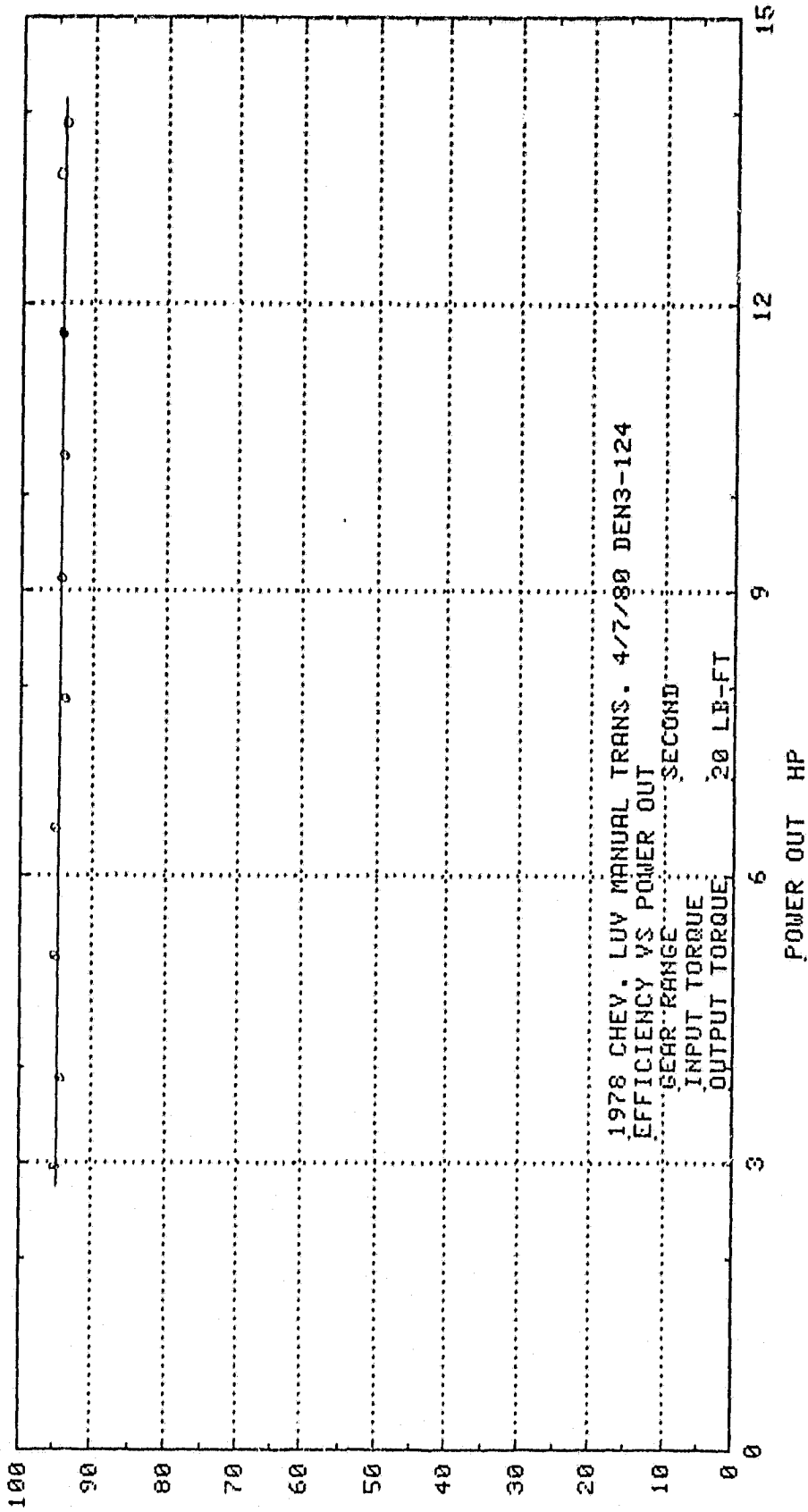

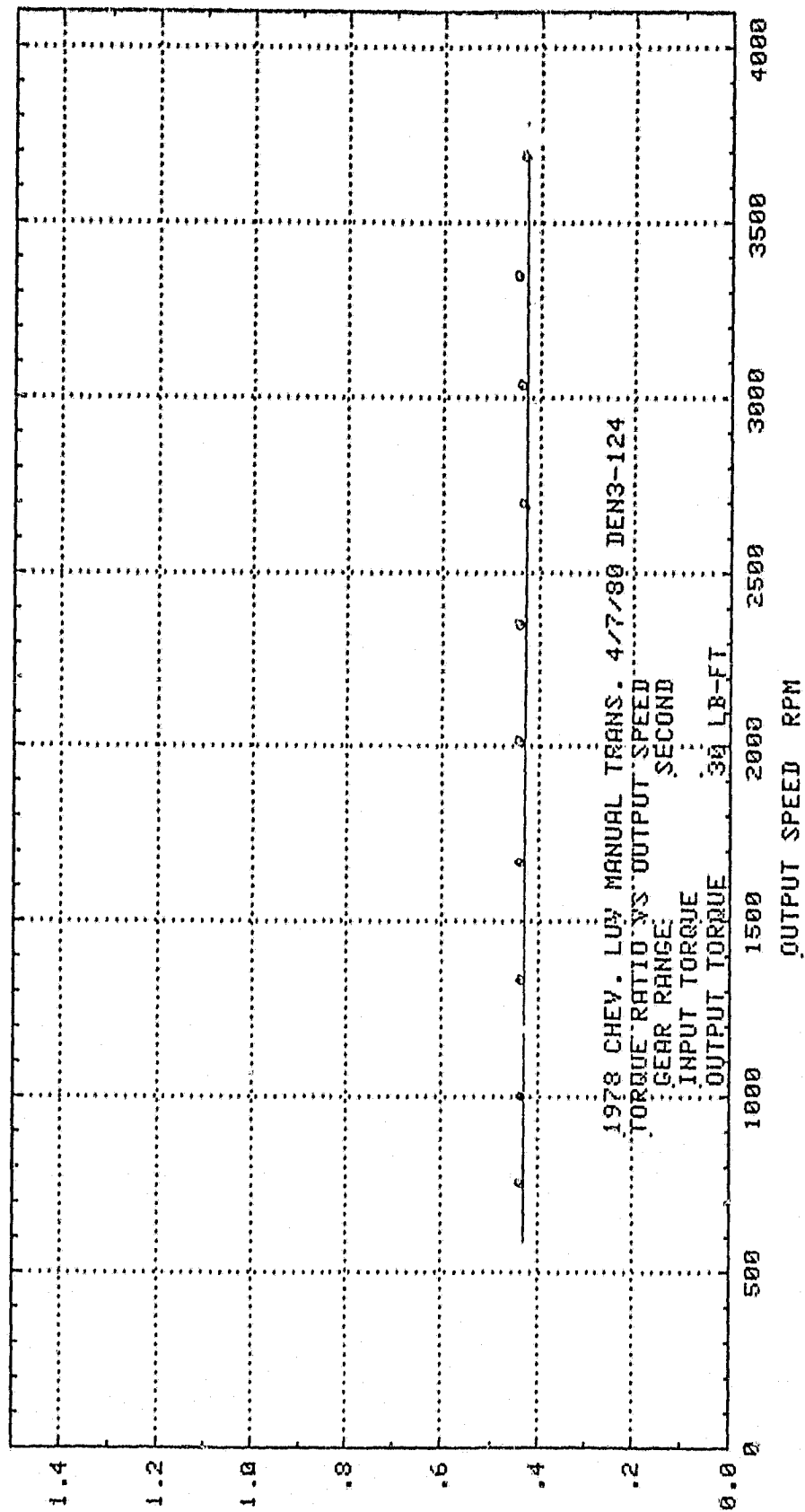

T O R Q U E R A T I O $\frac{T_o}{T_i}$

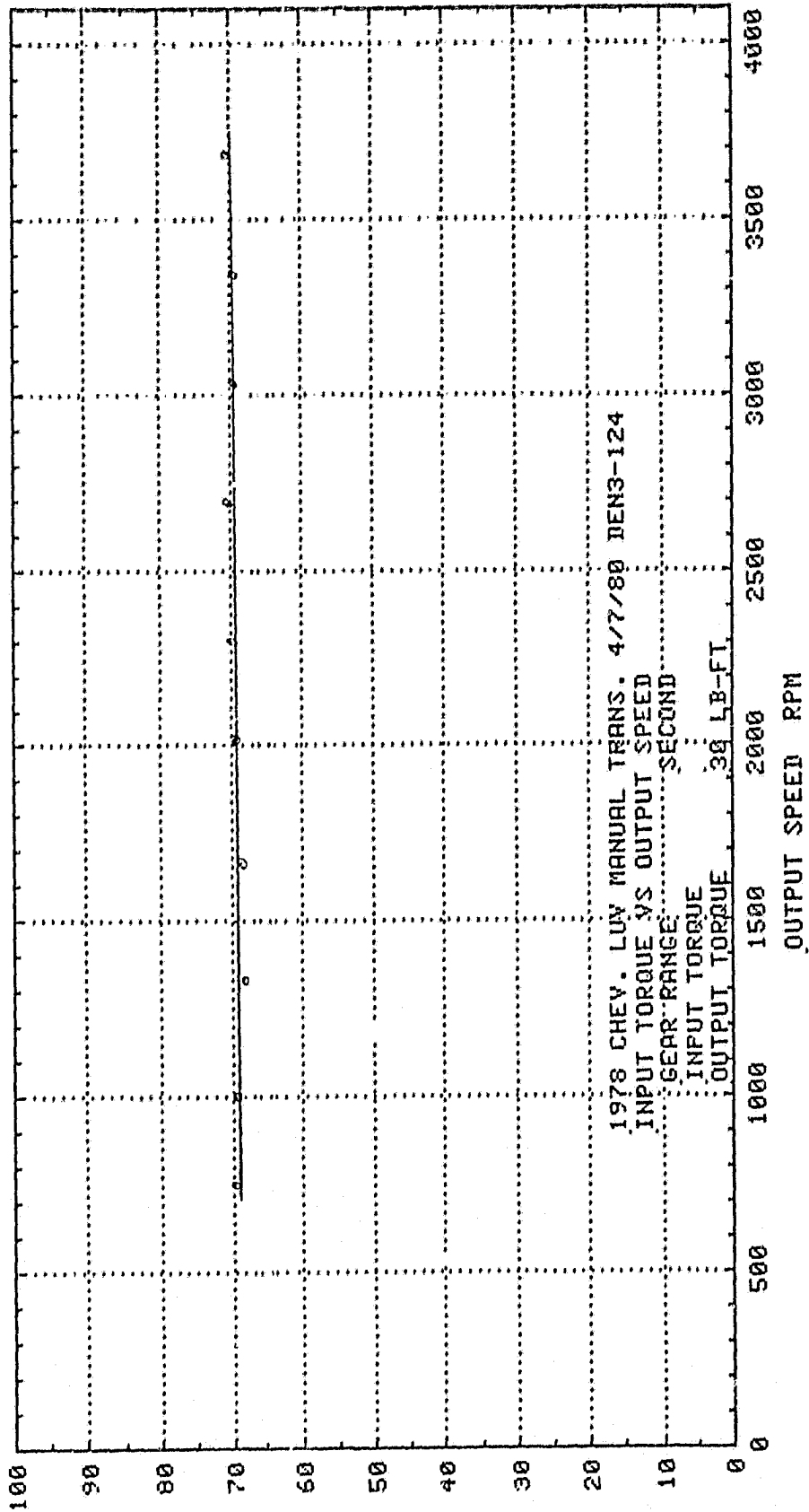

INPUT TORQUE LB FT

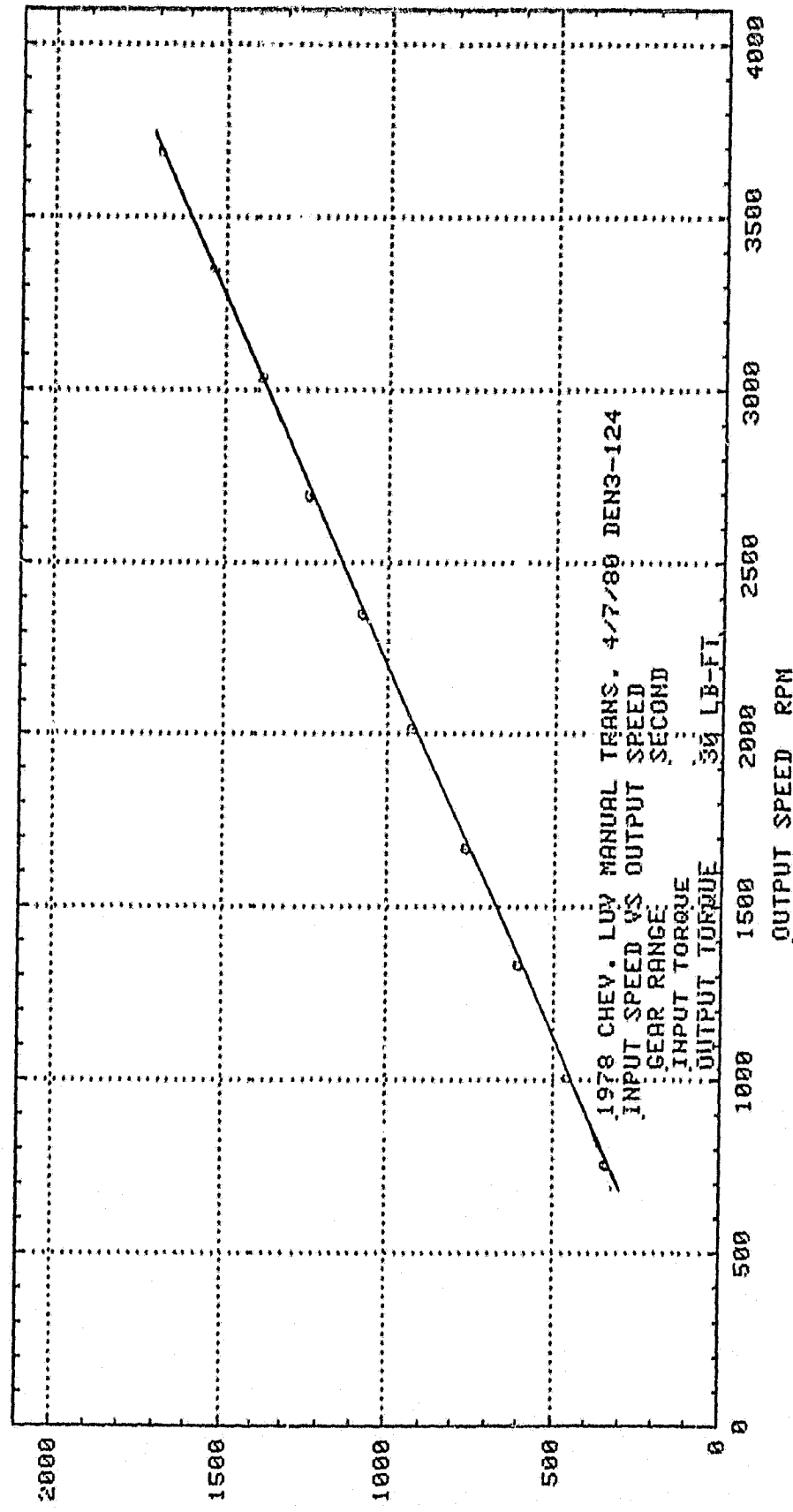

INPUT SPEED RPM

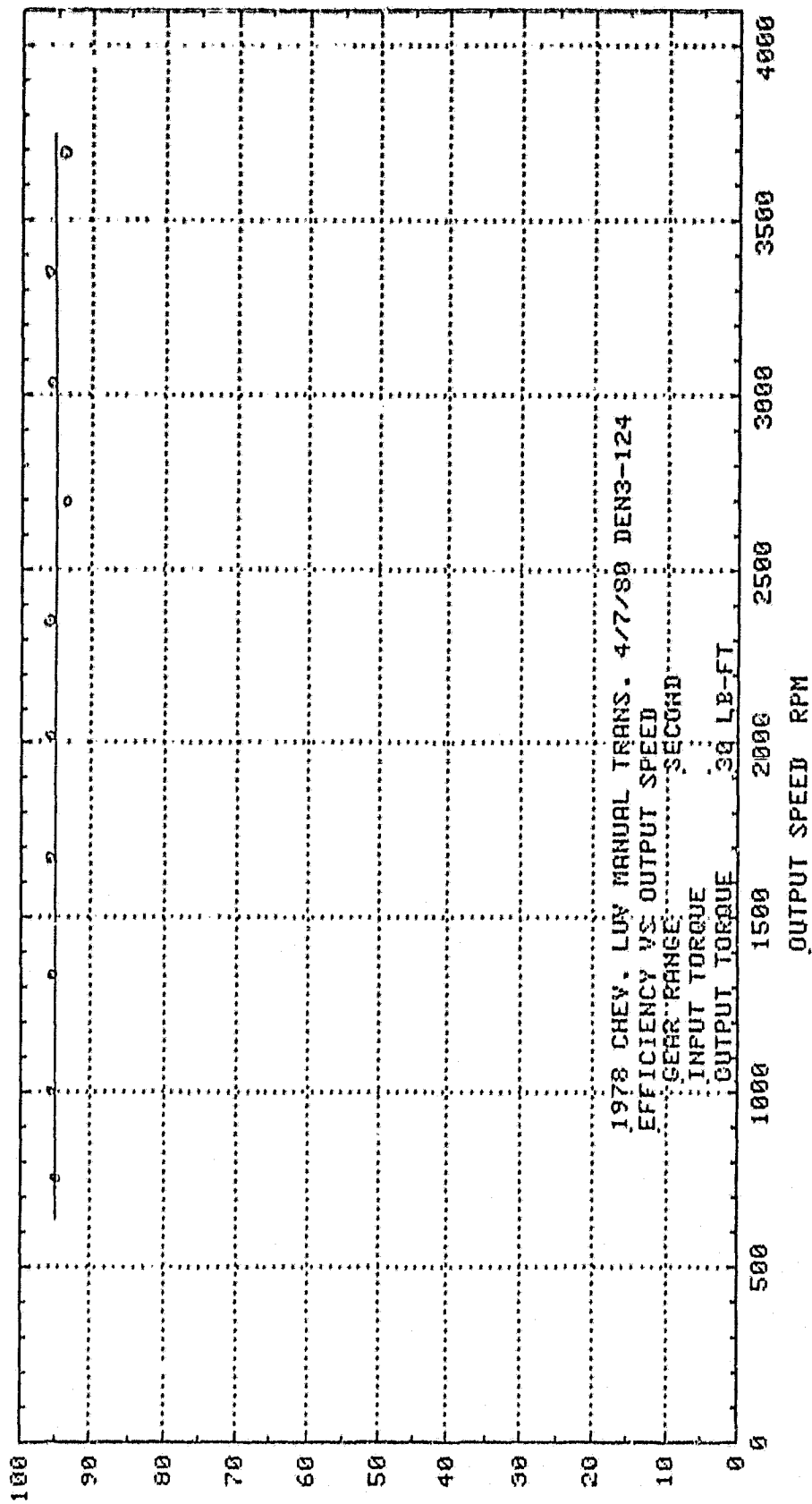

EFFICIENCY %

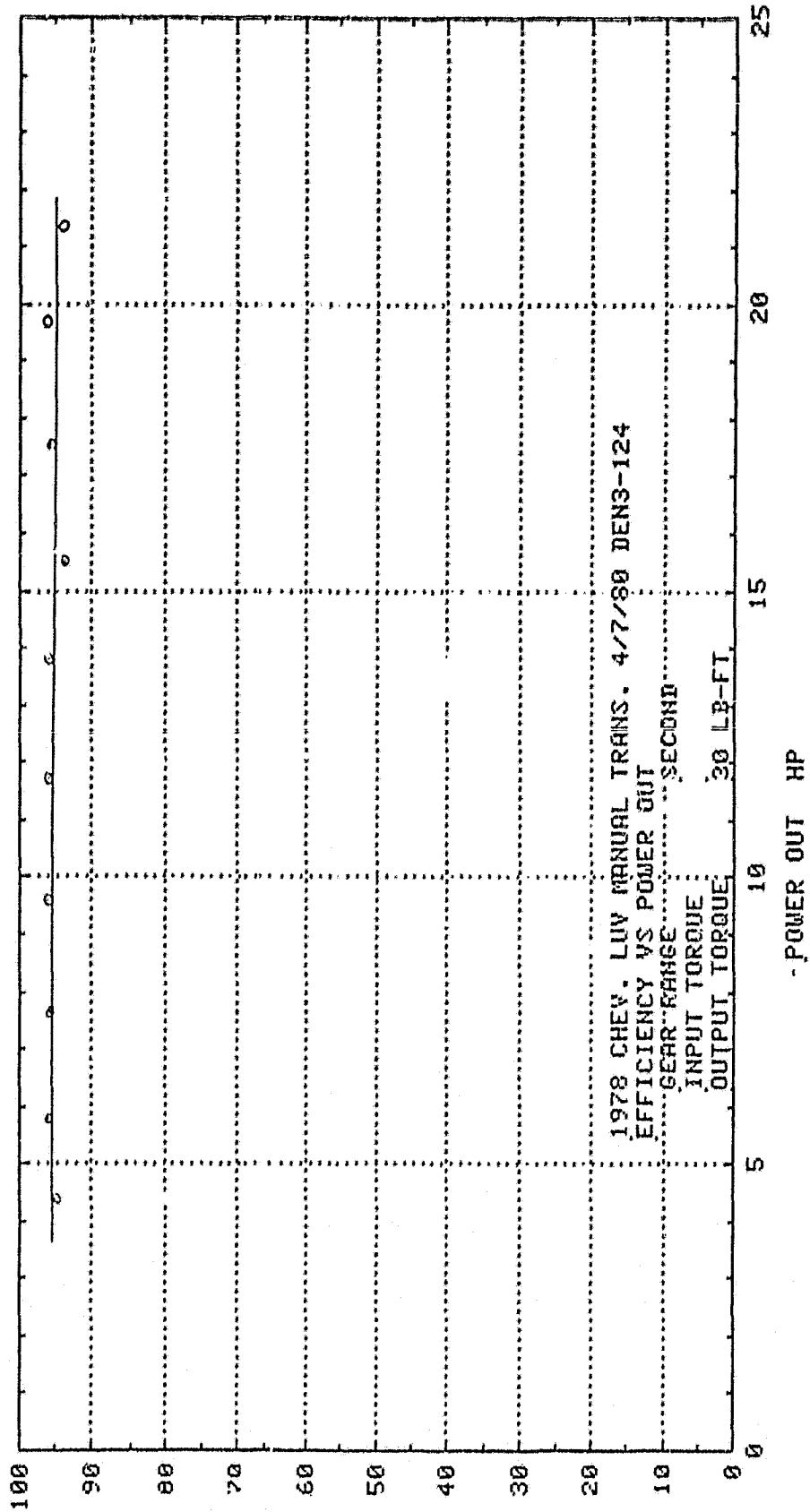

EFFICIENCY %

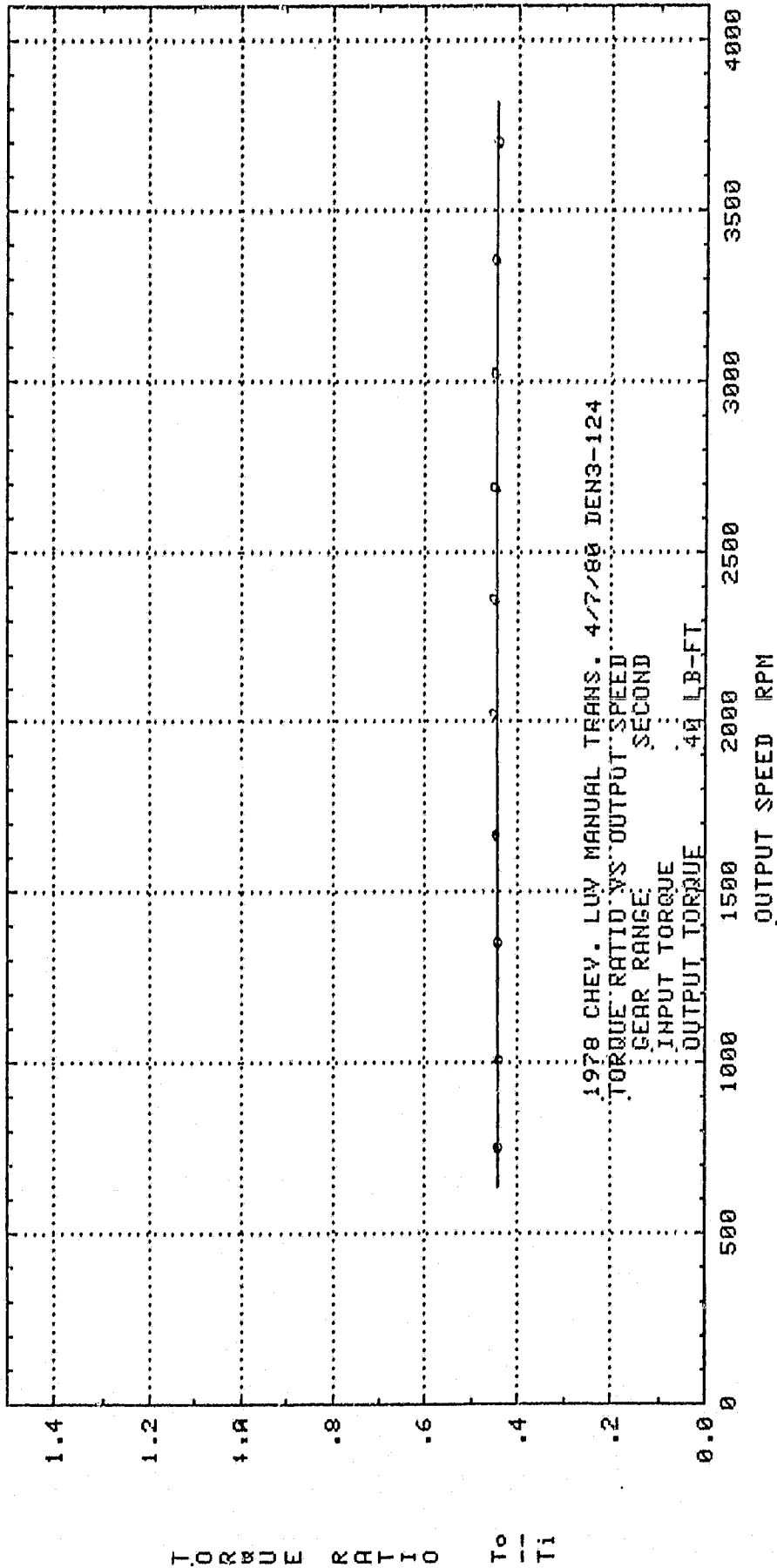

TORQUE RATIO

$$\frac{T_o}{T_i}$$

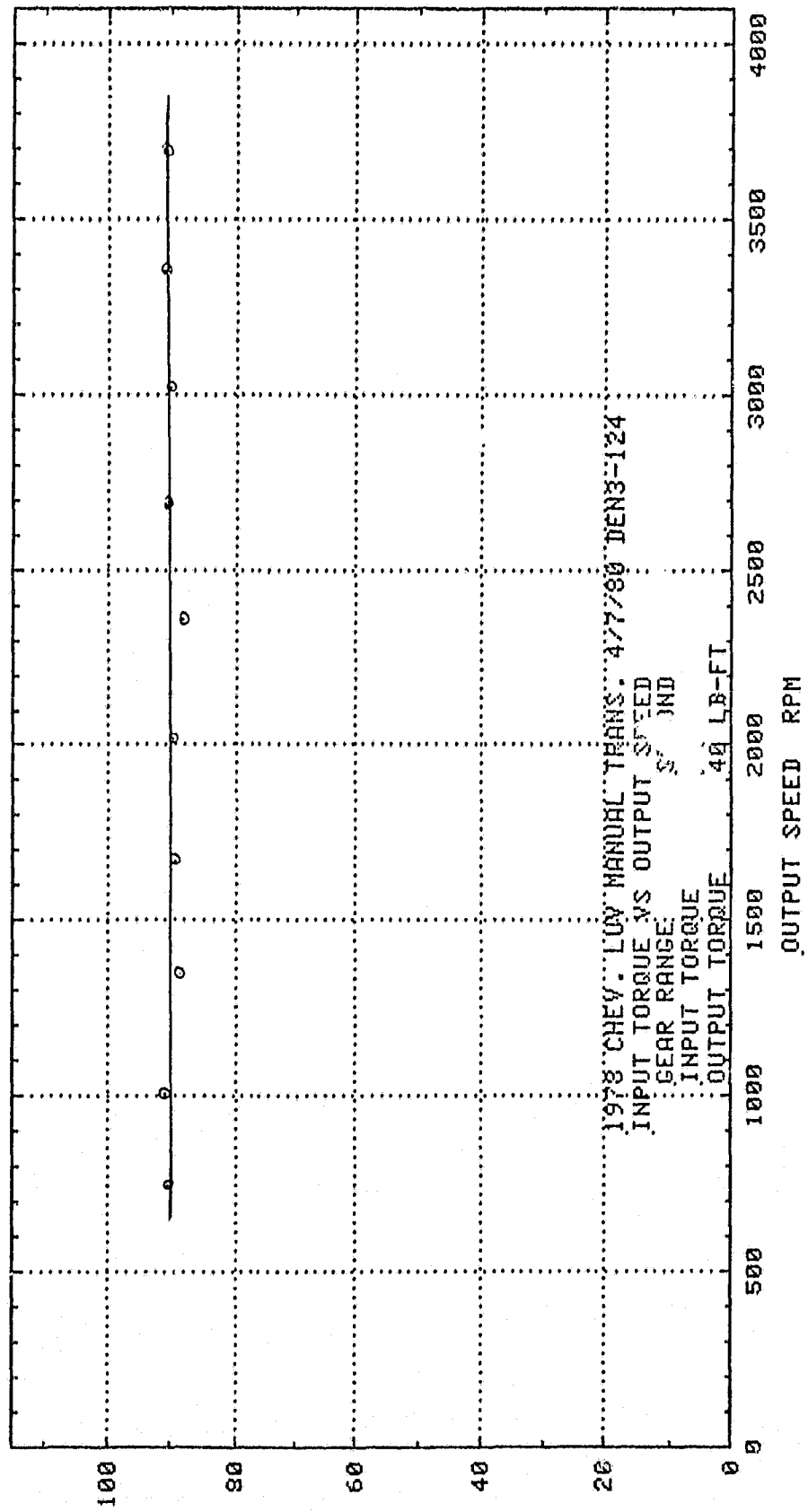

INPUT TORQUE LB FT

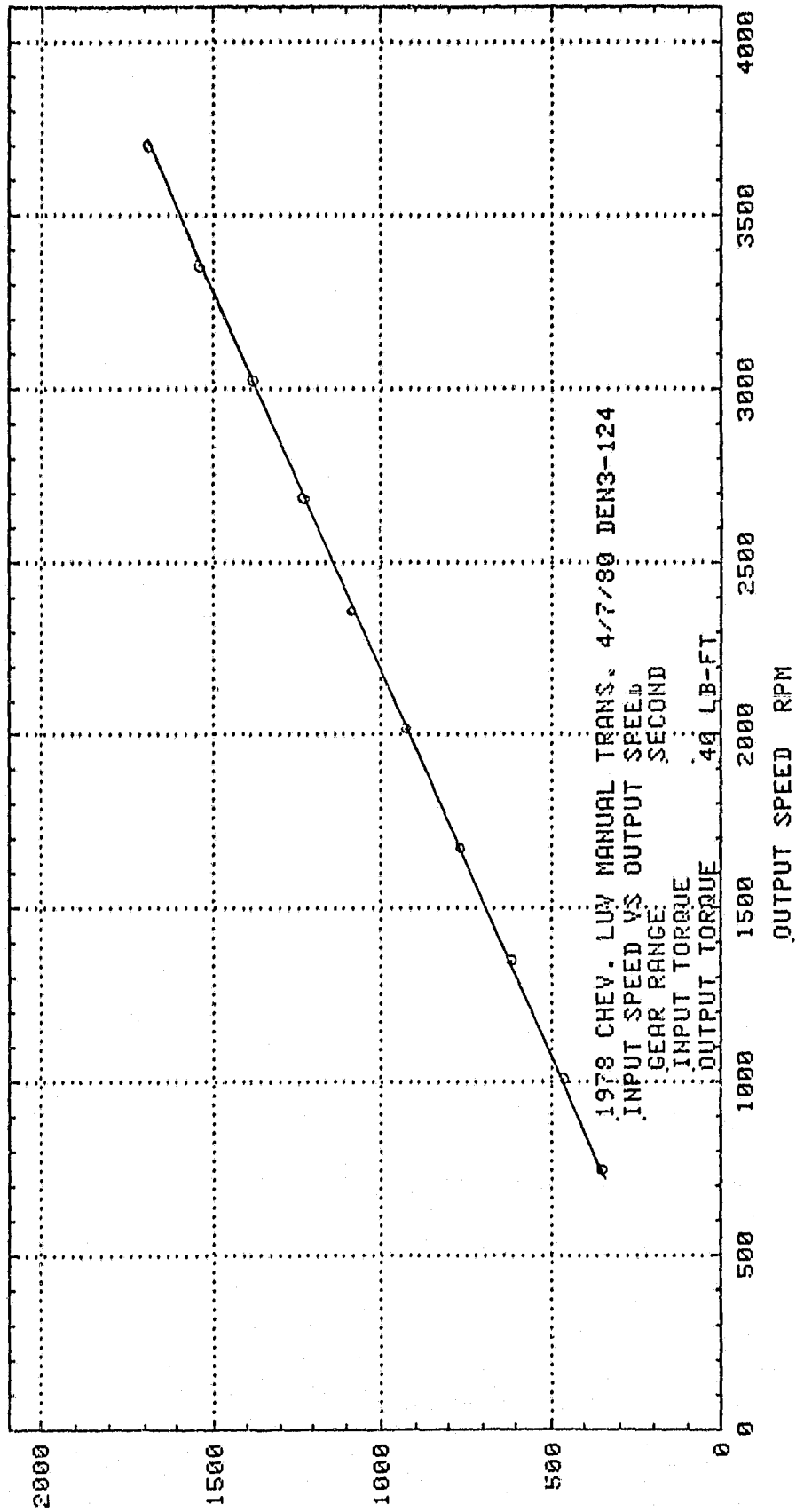

INPUT SPEED RPM

OUTPUT SPEED RPM

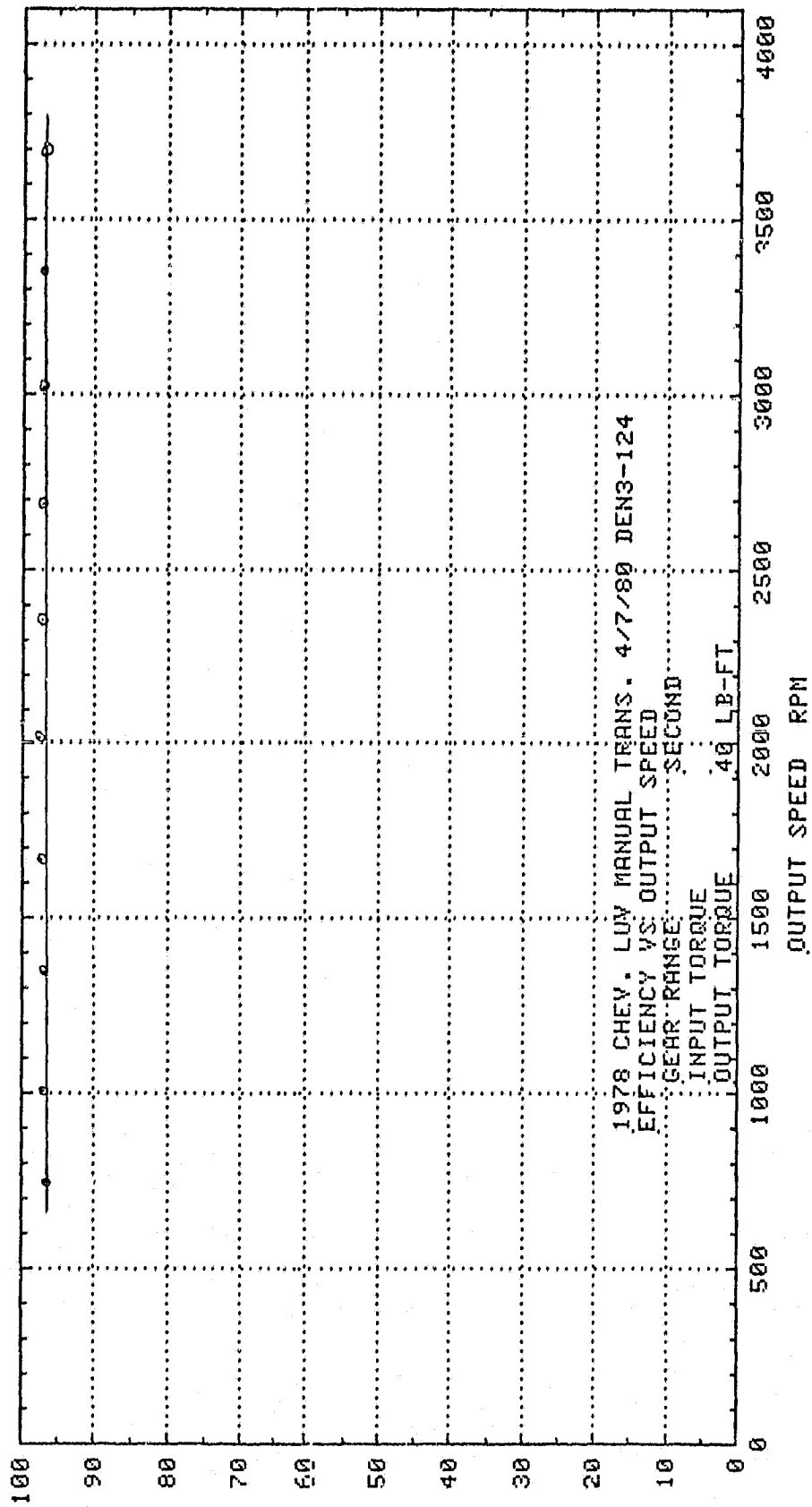

EFFICIENCY %

EFFICIENCY %

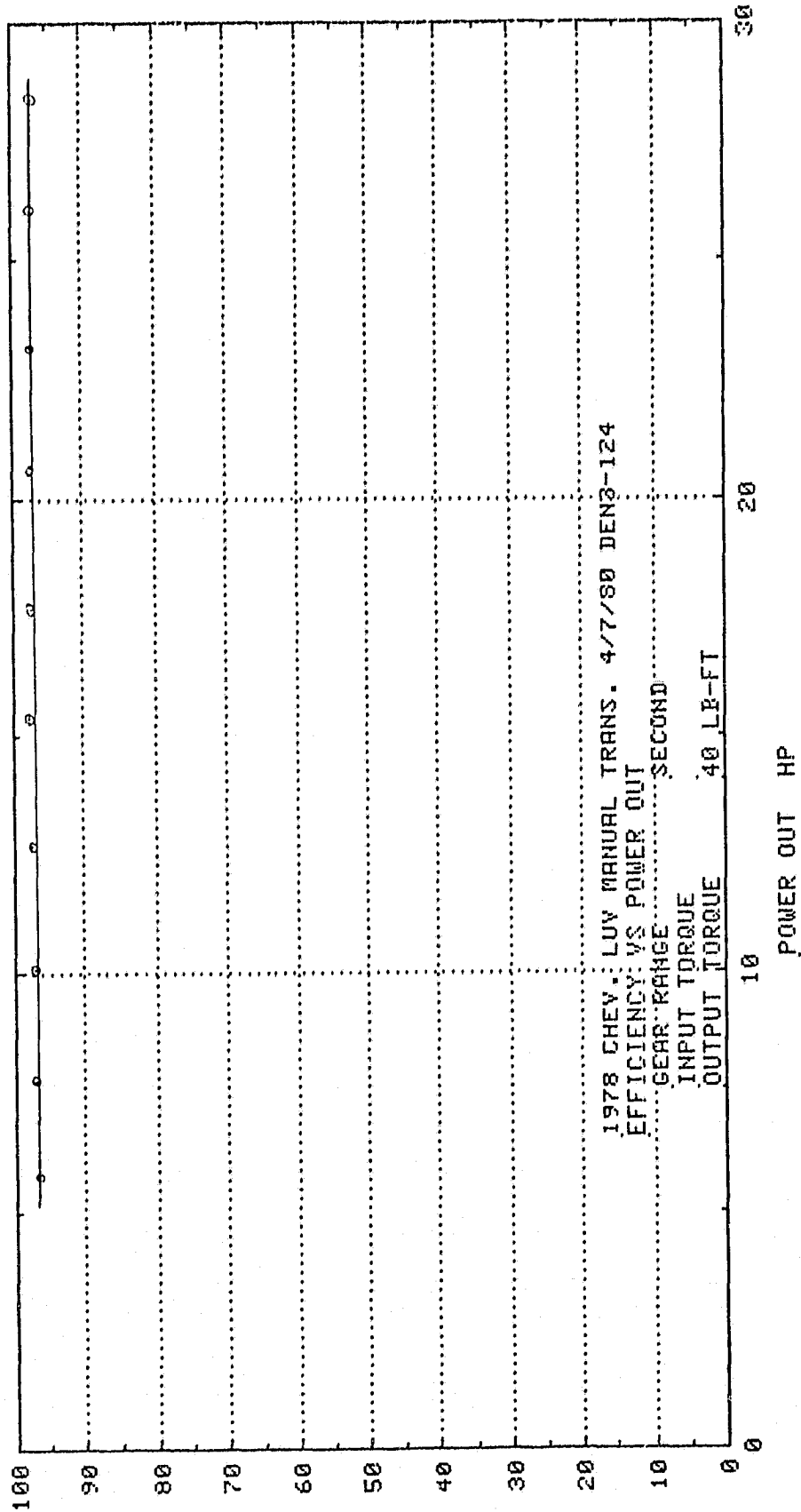

T O R Q U E R A T I O $\frac{T_o}{T_i}$

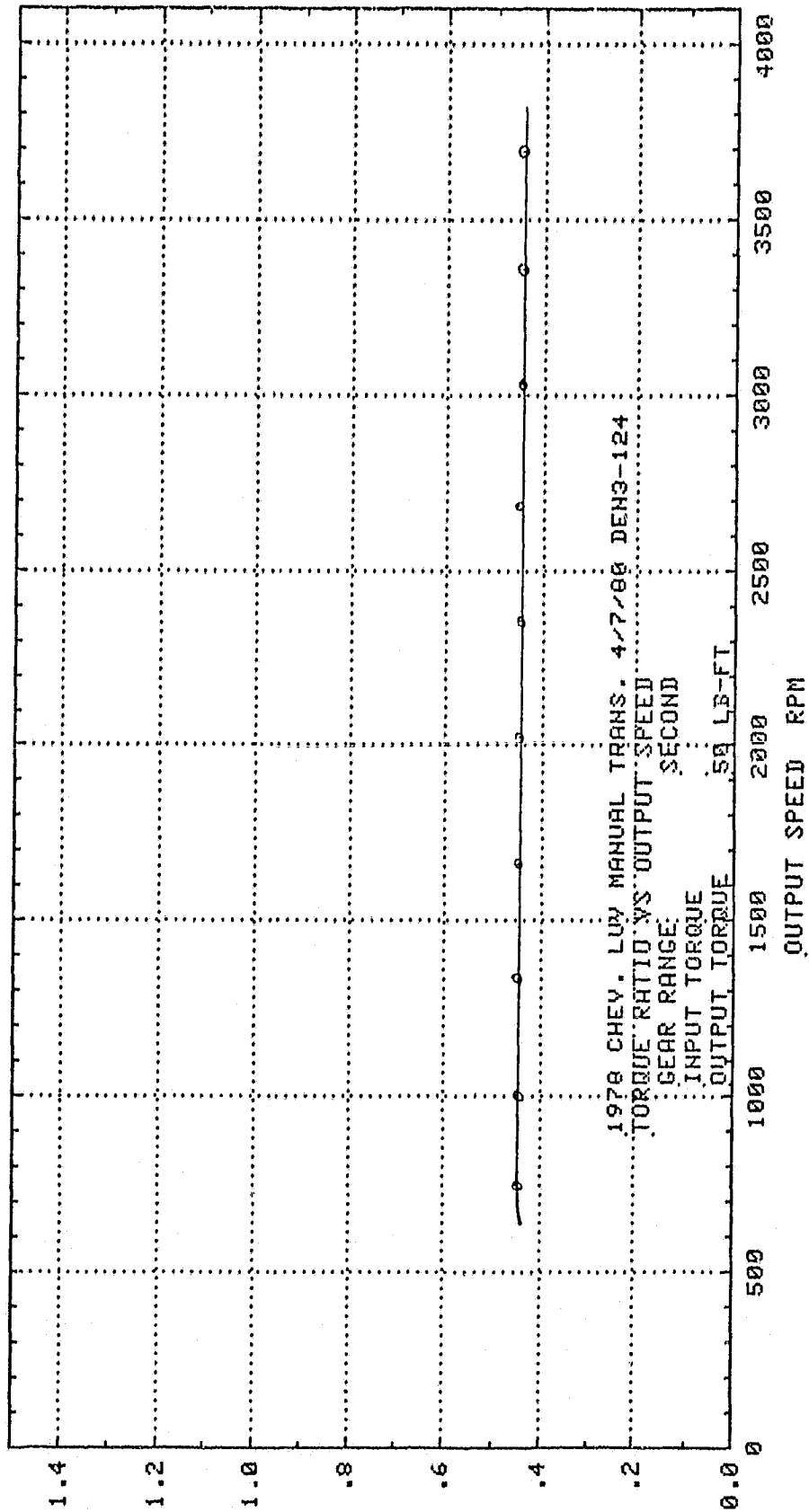

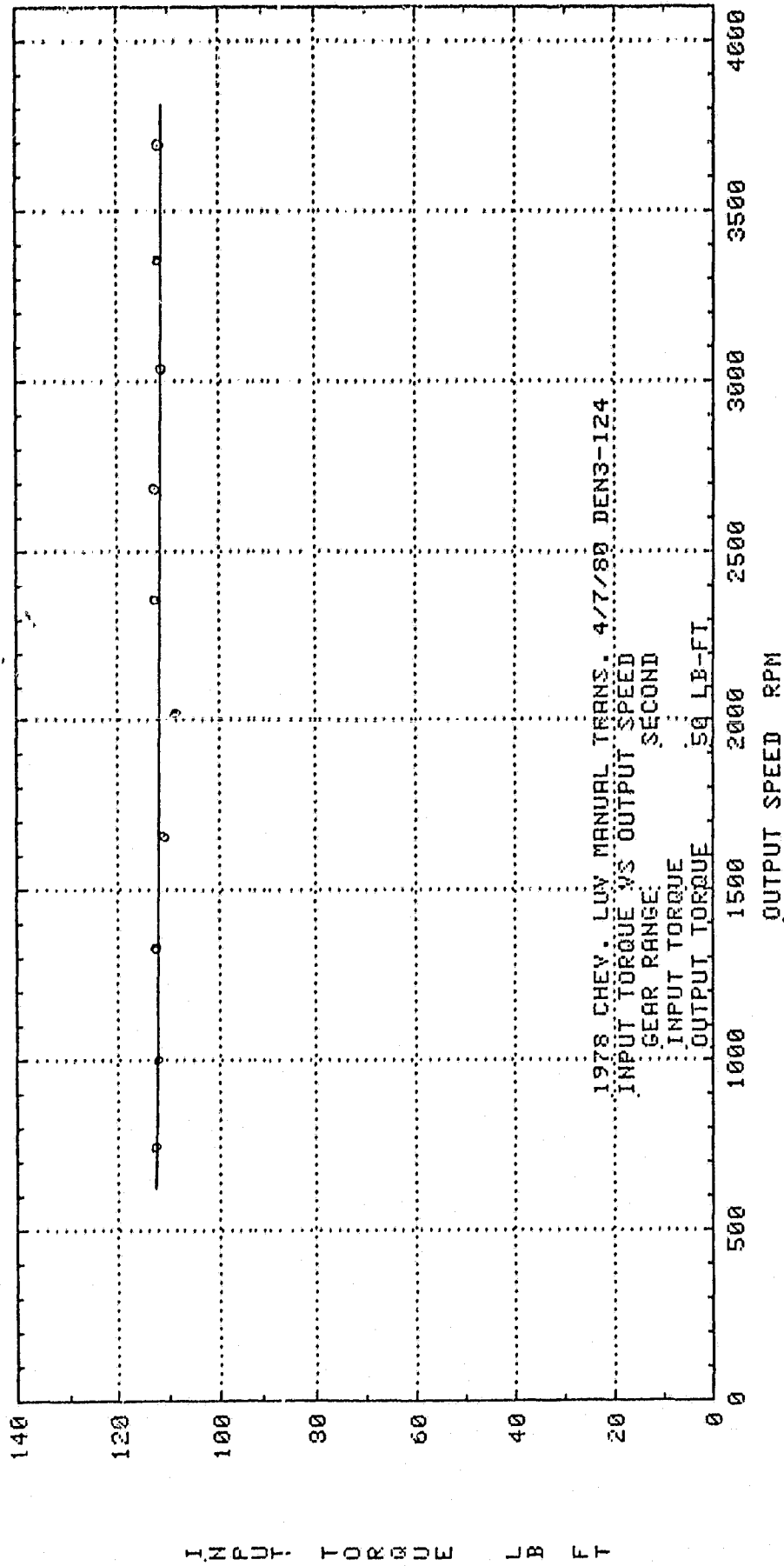

INPUT TORQUE LB FT

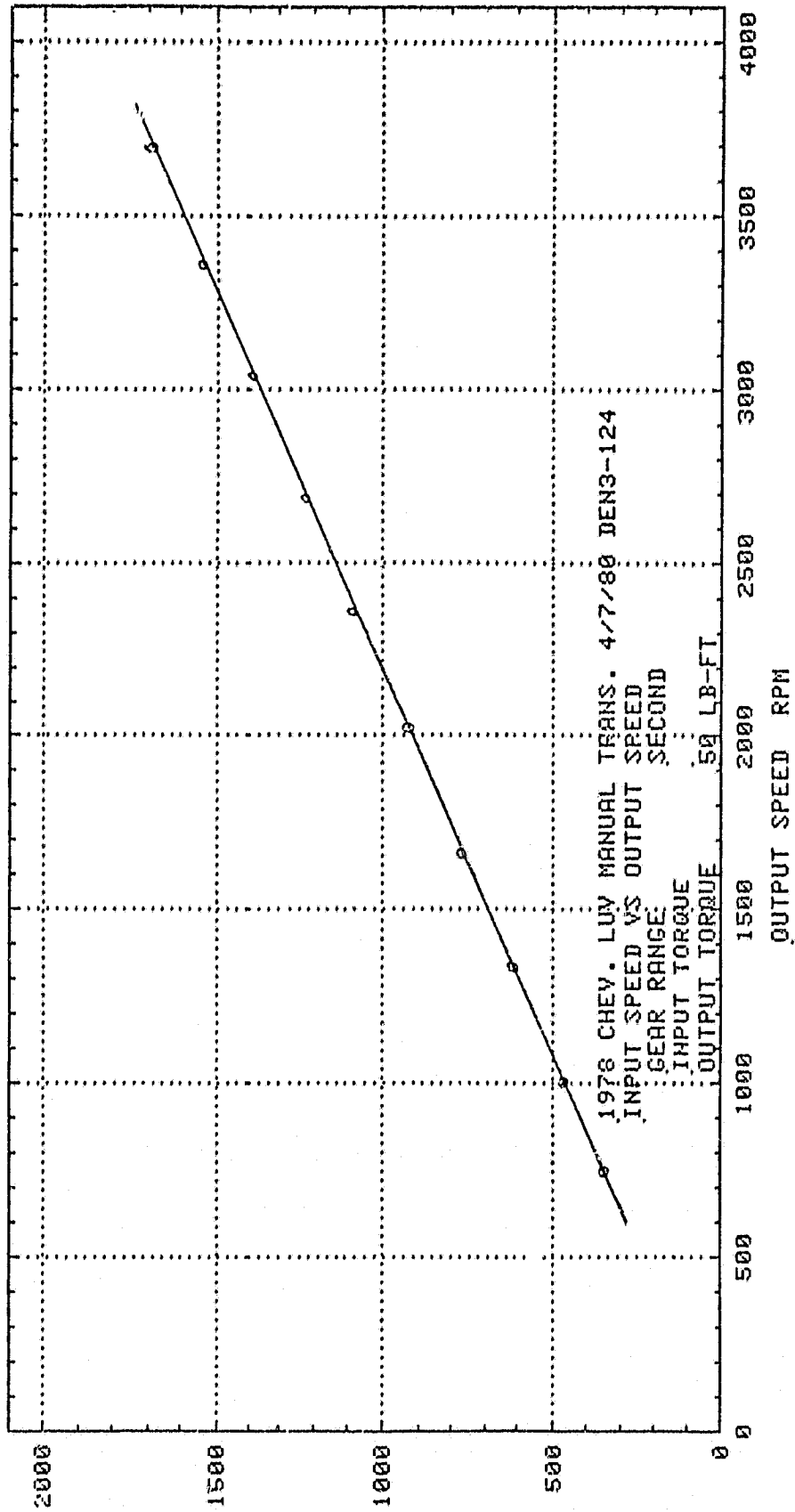

INPUT SPEED RPM

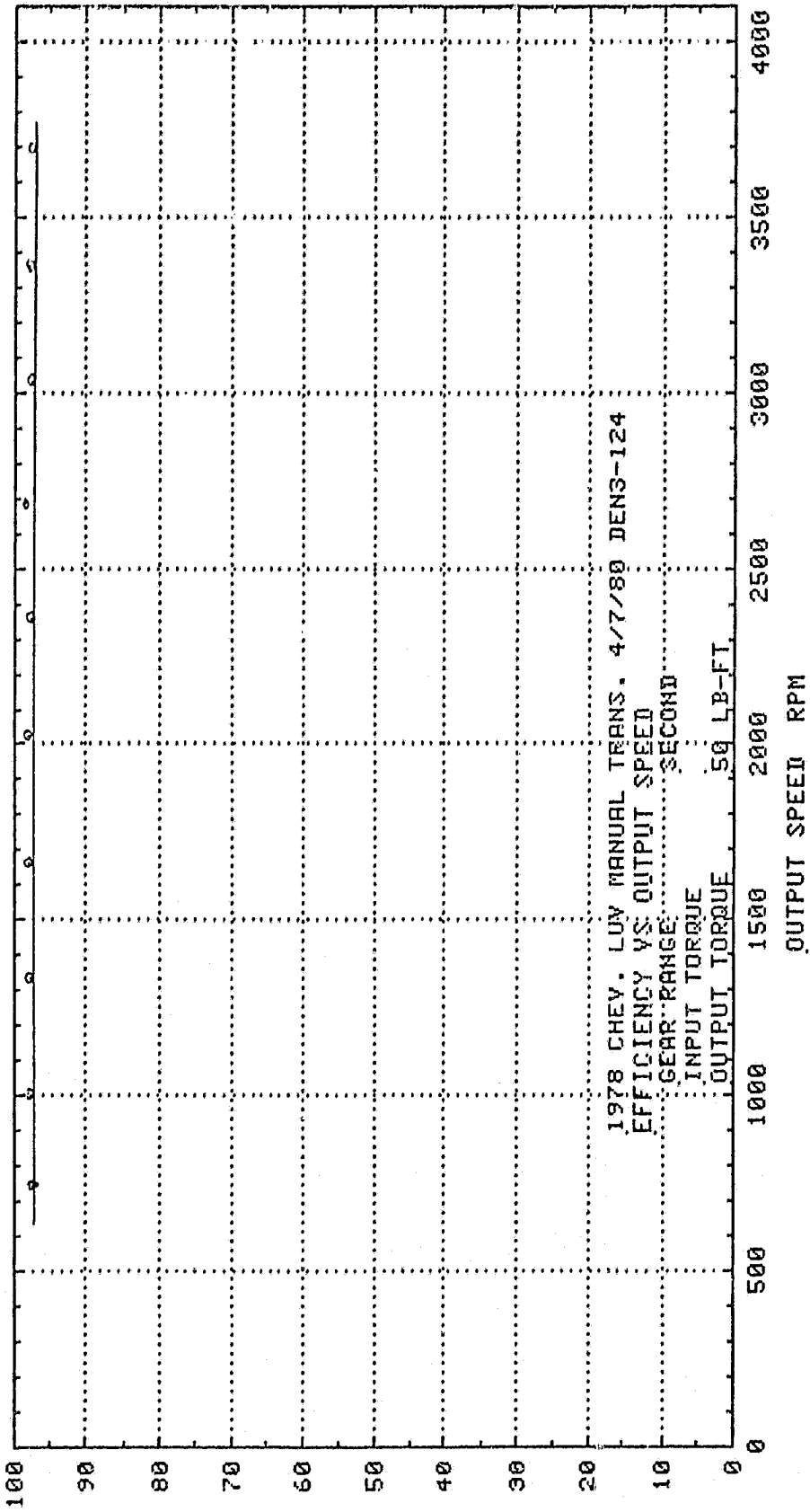

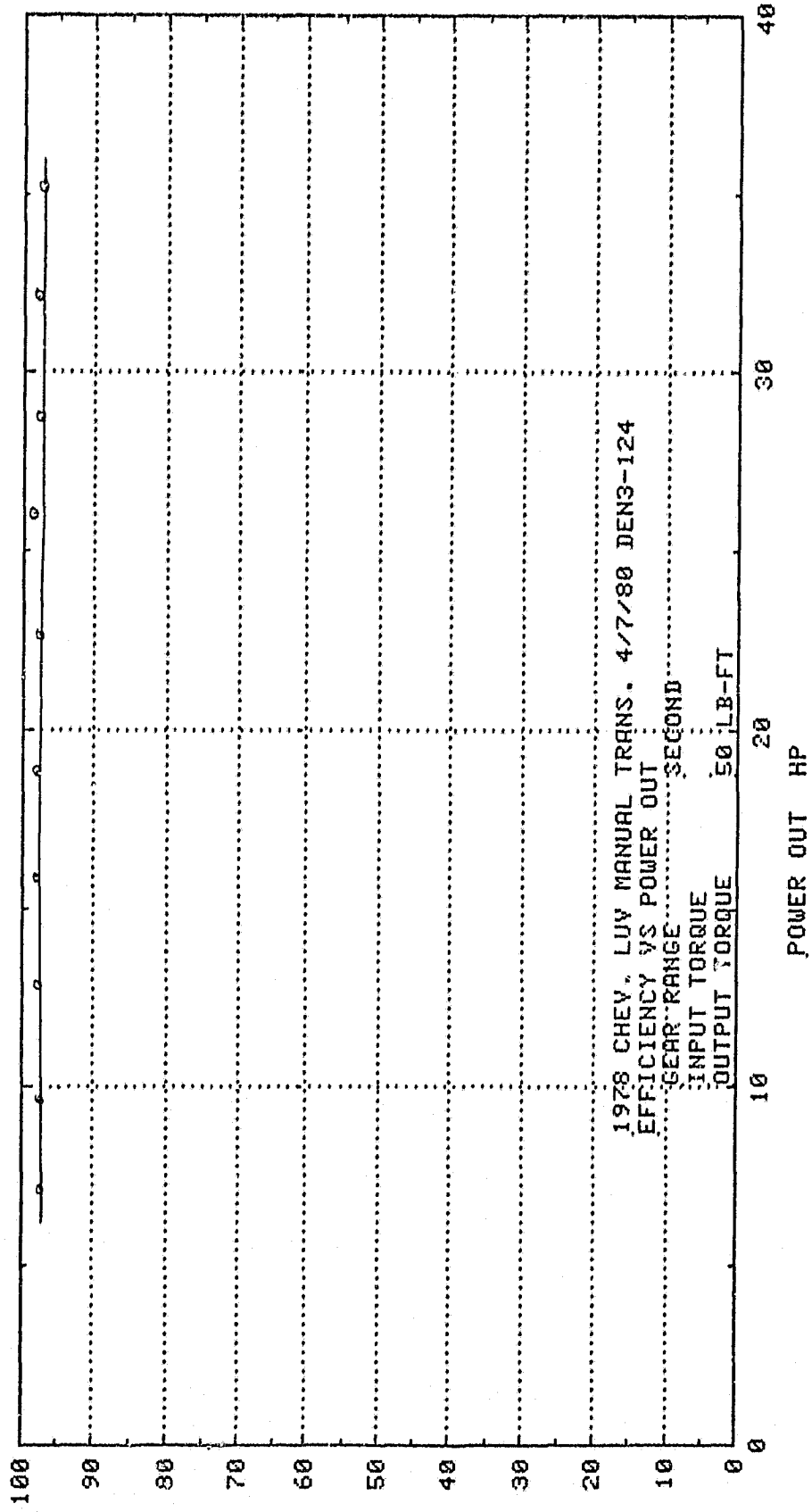

EFFICIENCY %

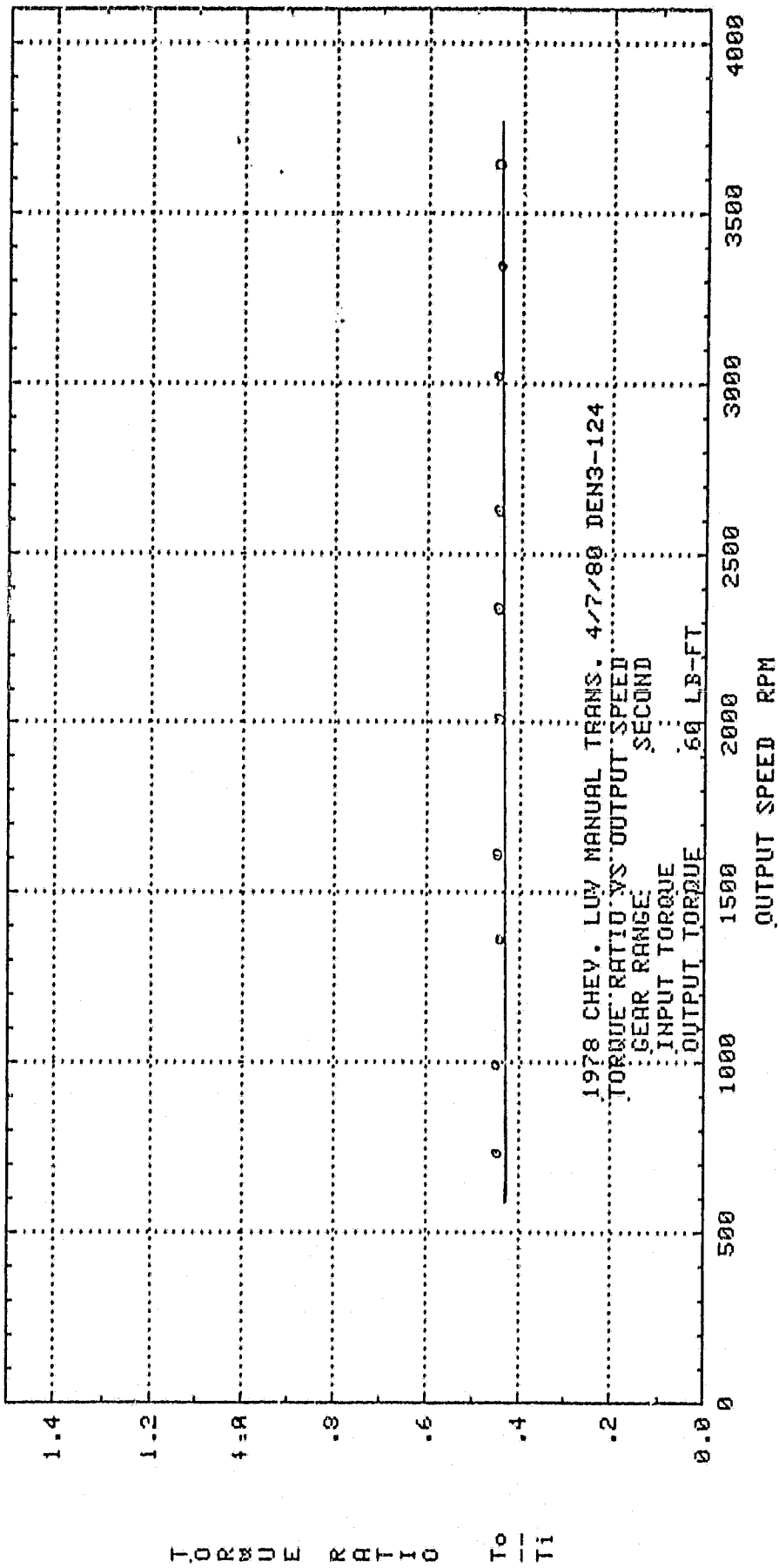

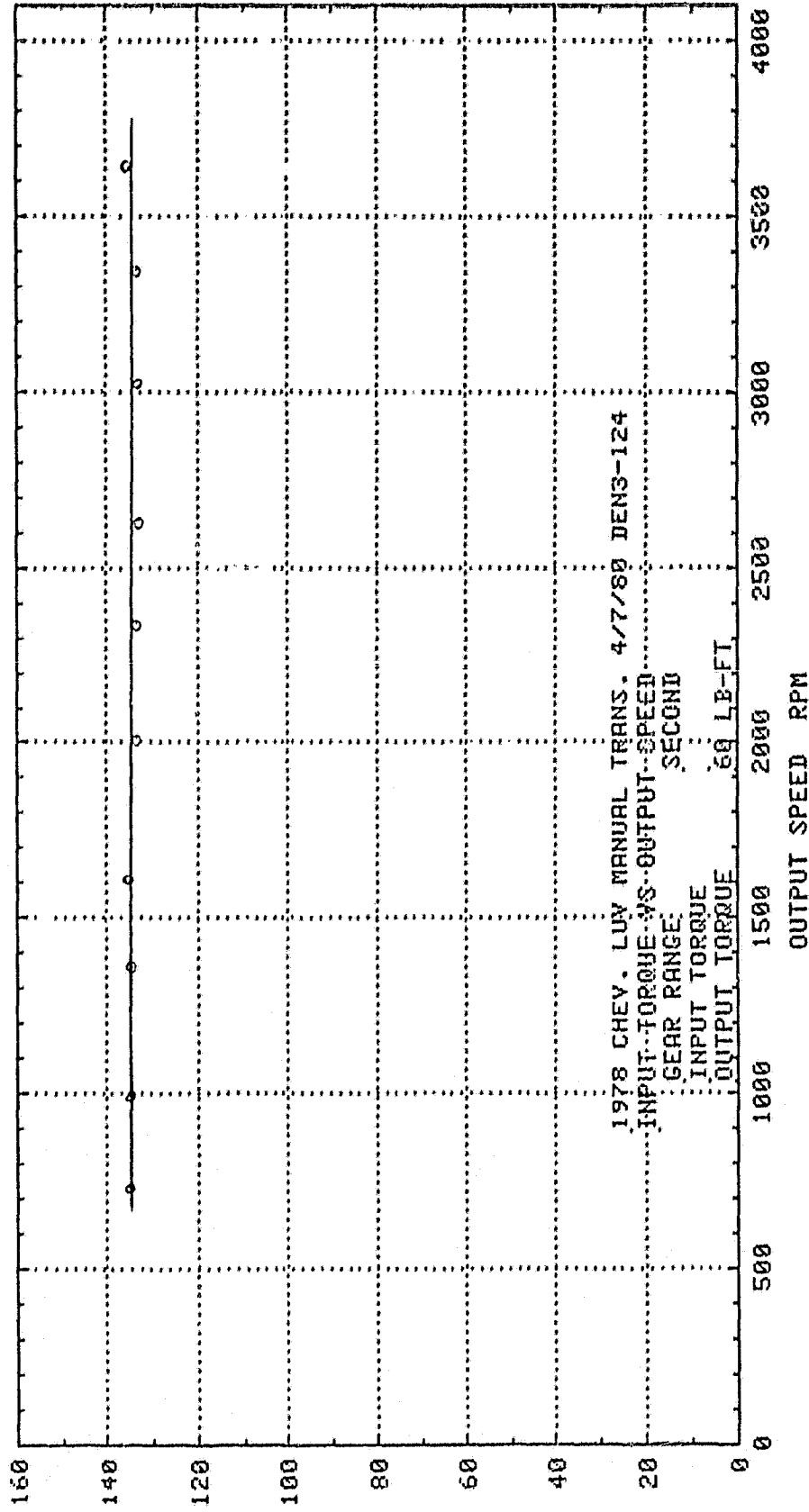

INPUT TORQUE LB FT

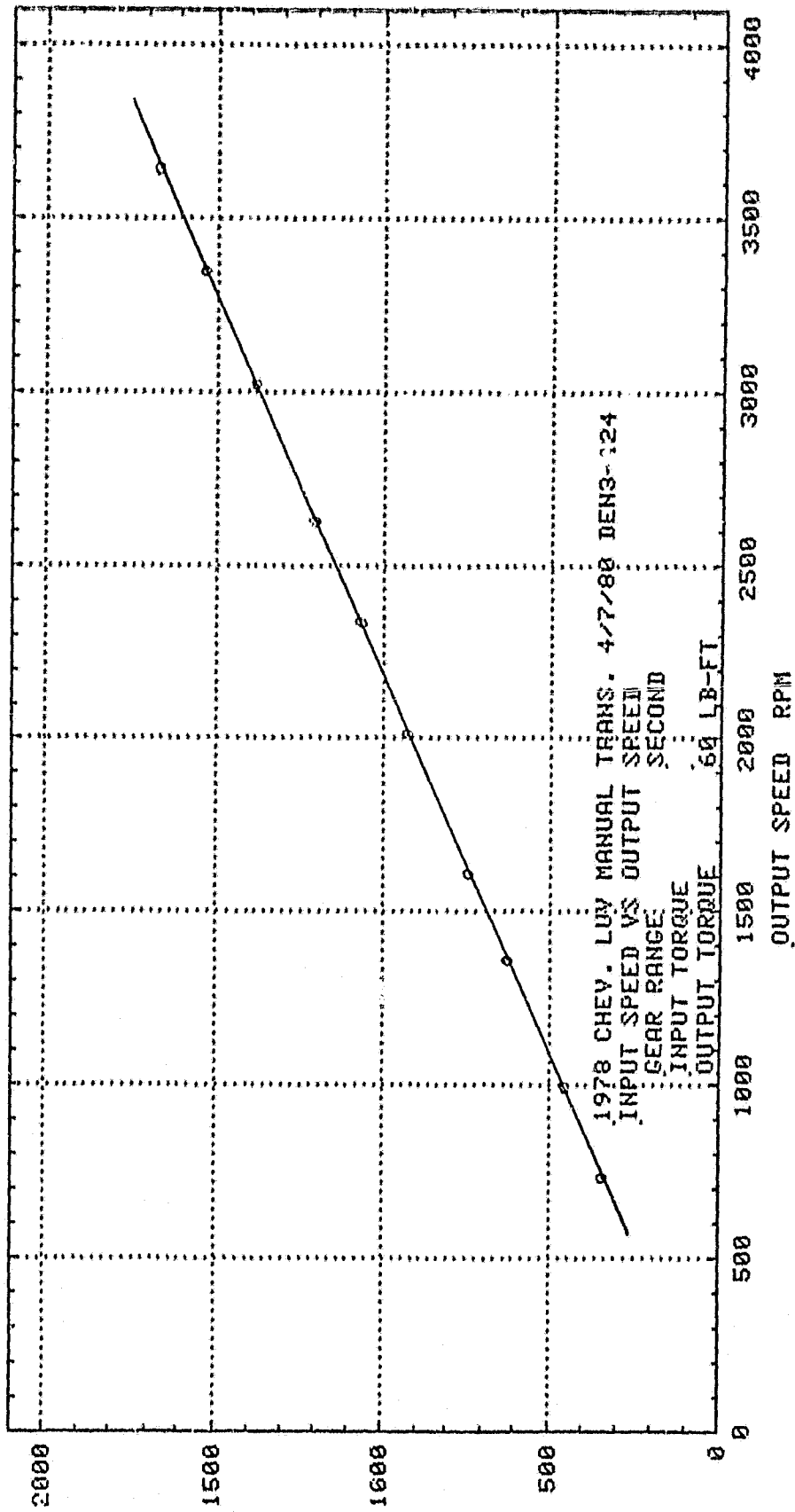

INPUT SPEED RPM

OUTPUT SPEED RPM

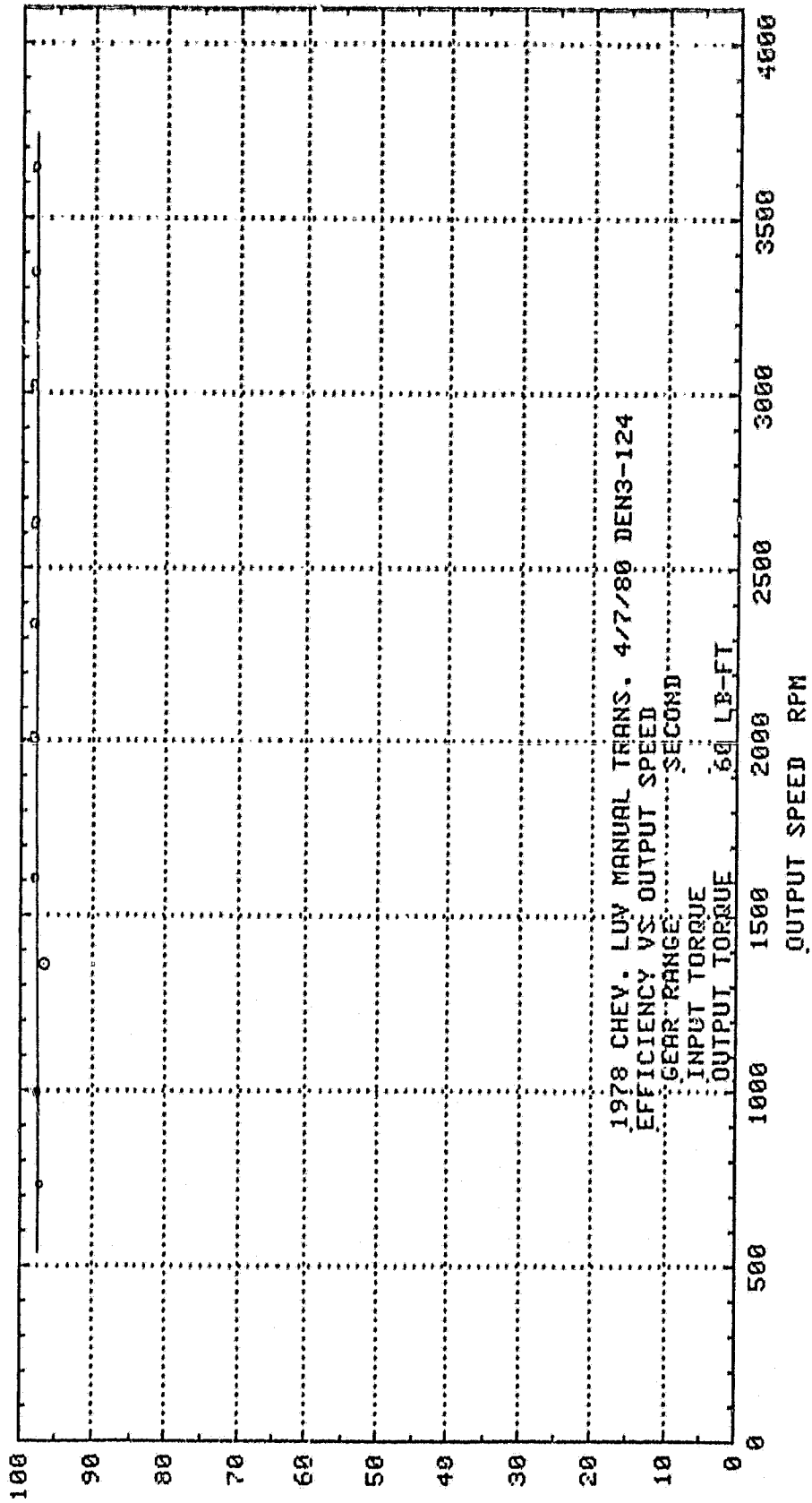

EFFICIENCY %

EFFICIENCY %

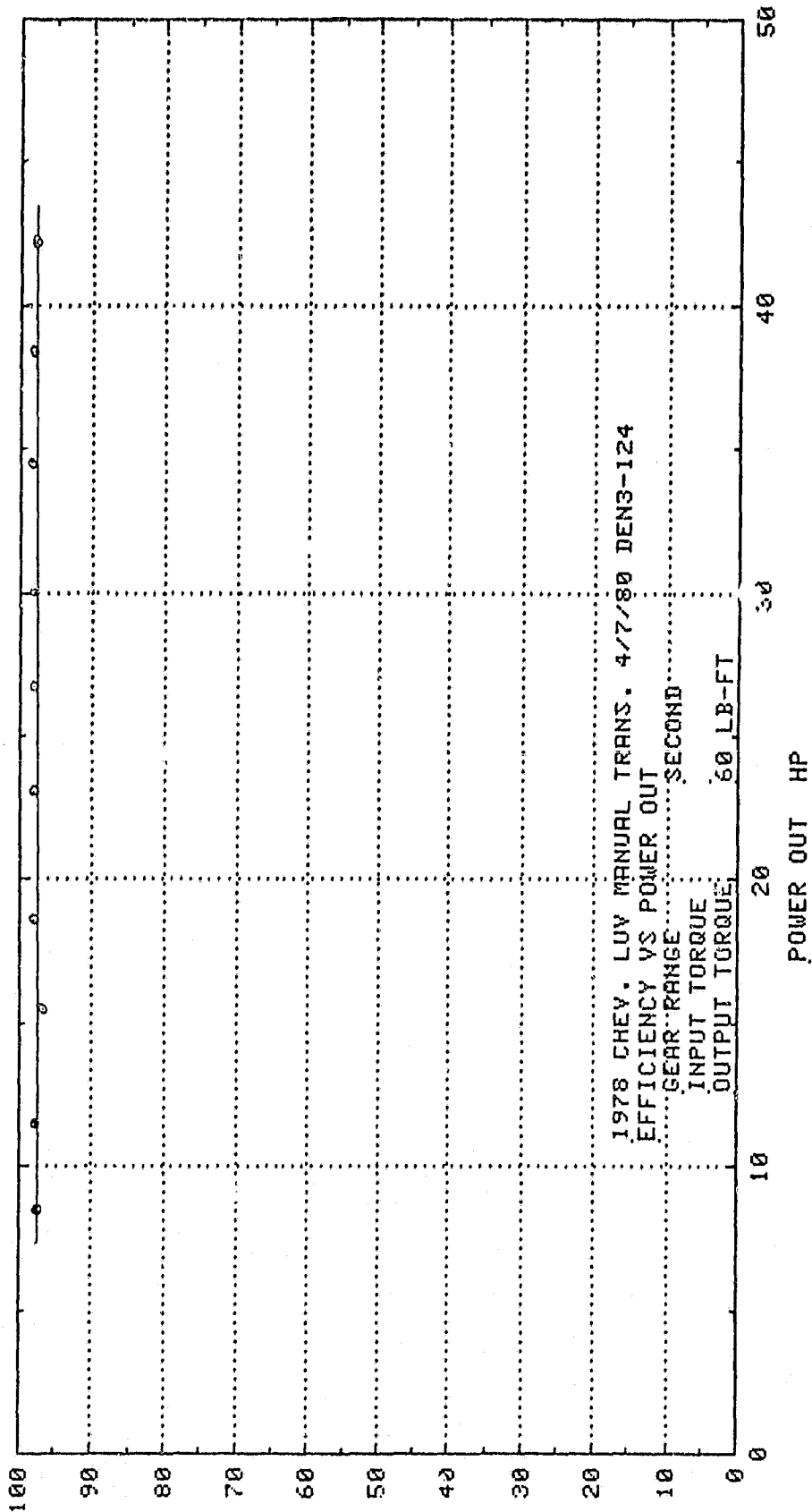

COAST PERFORMANCE

3RD GEAR

Graphs Contained in This Section

- Torque Ratio -vs- Output Speed
- Output Torque -vs- Output Speed
- Input Speed -vs- Output Speed
- Efficiency -vs- Output Speed
- Efficiency -vs- Power Out

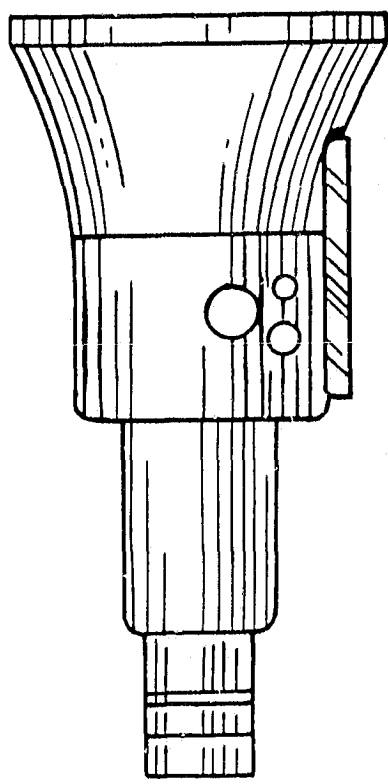

Torque In
Speed In

Torque Out
Speed Out

Coast Performance Tests

TORQUE RATIO

$$\frac{T_o}{T_i}$$

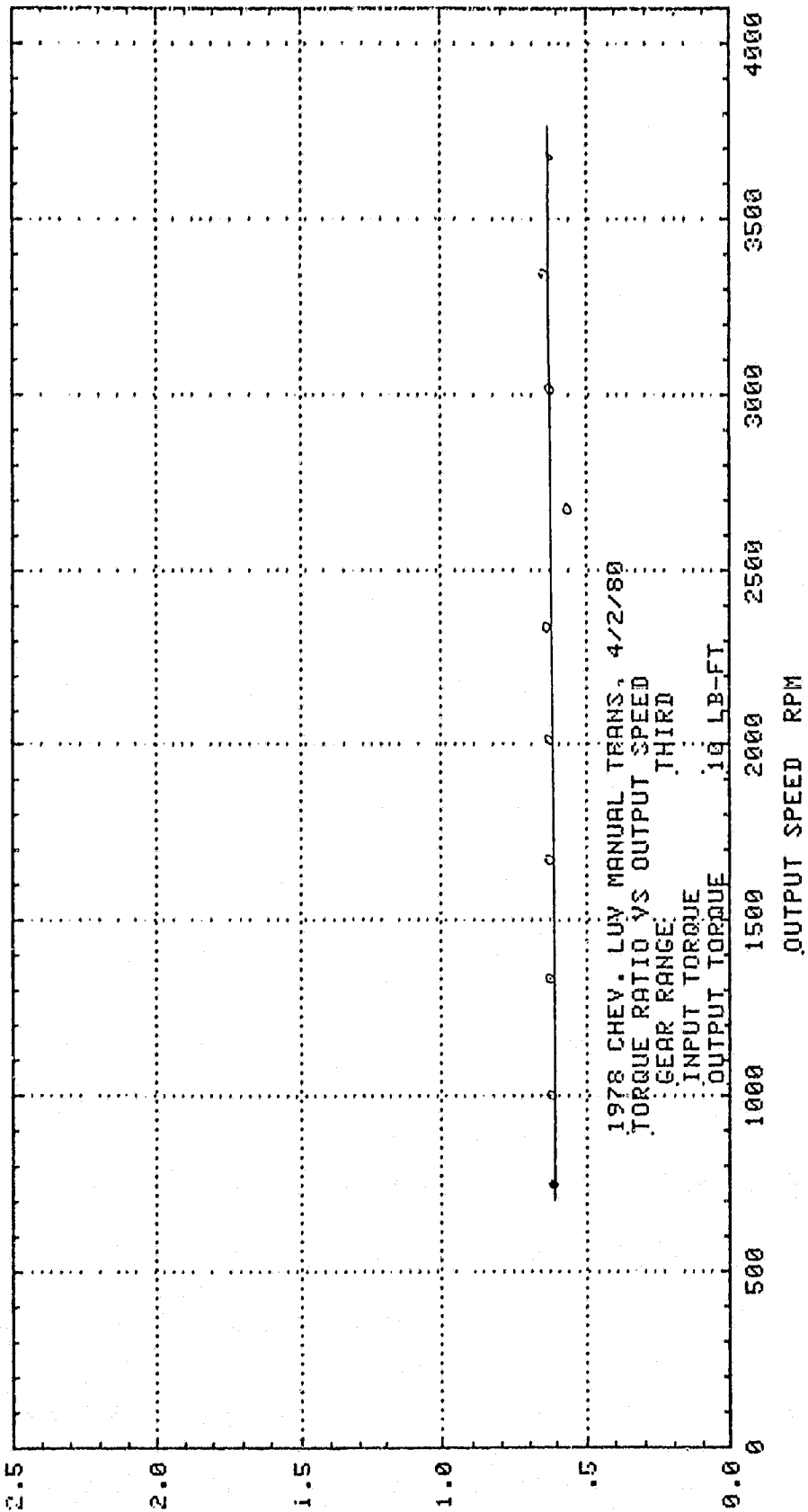

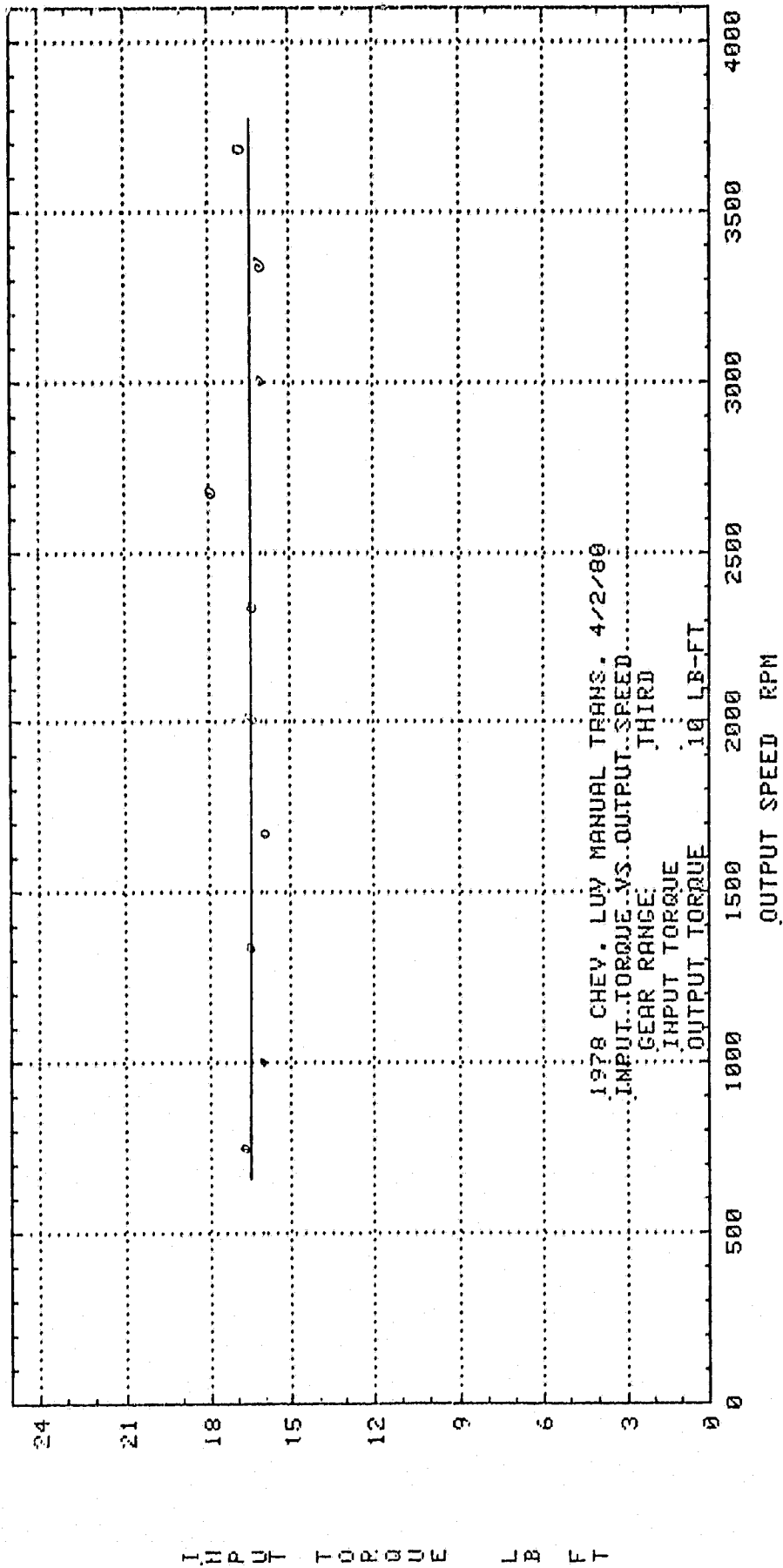

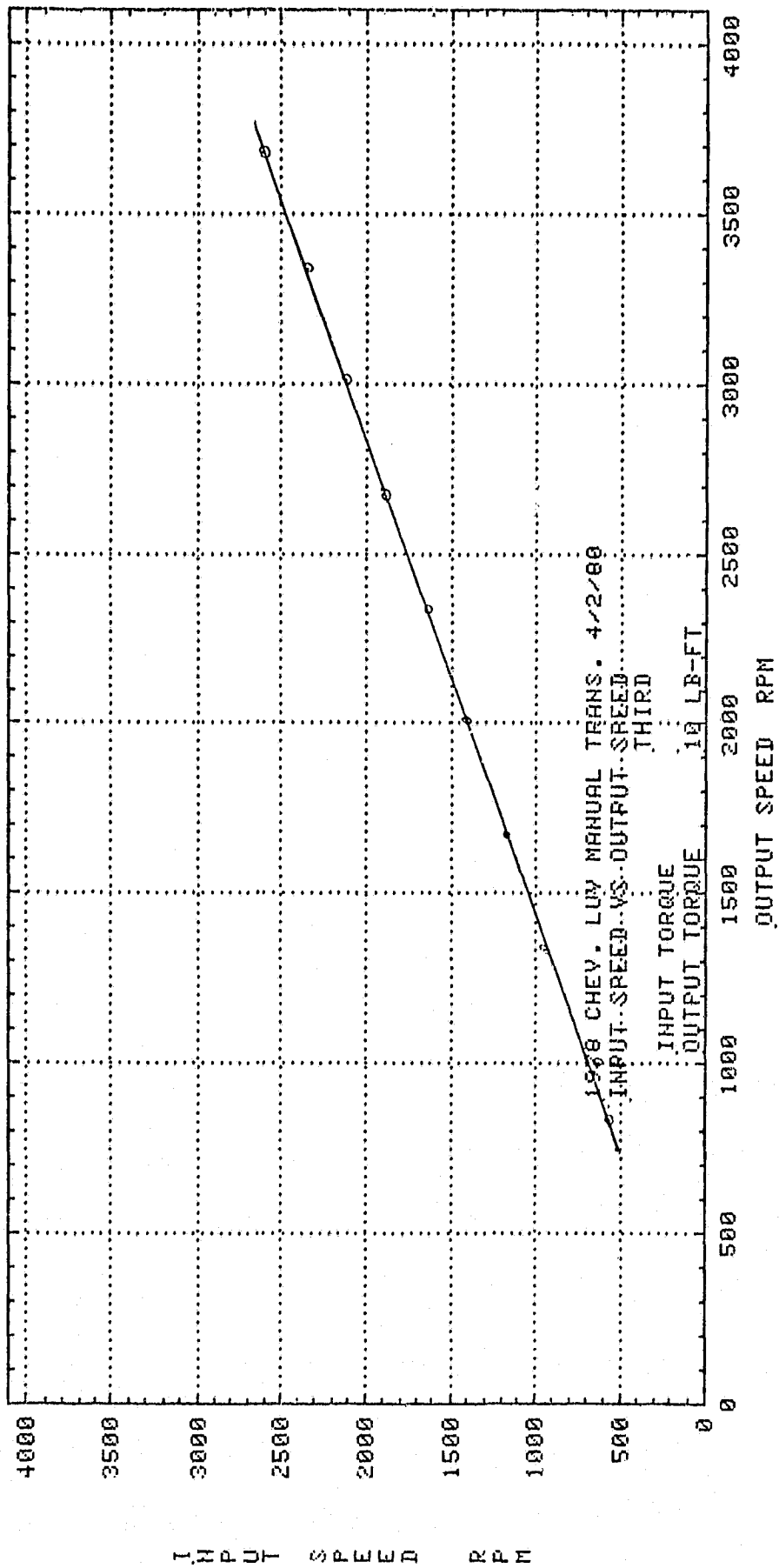

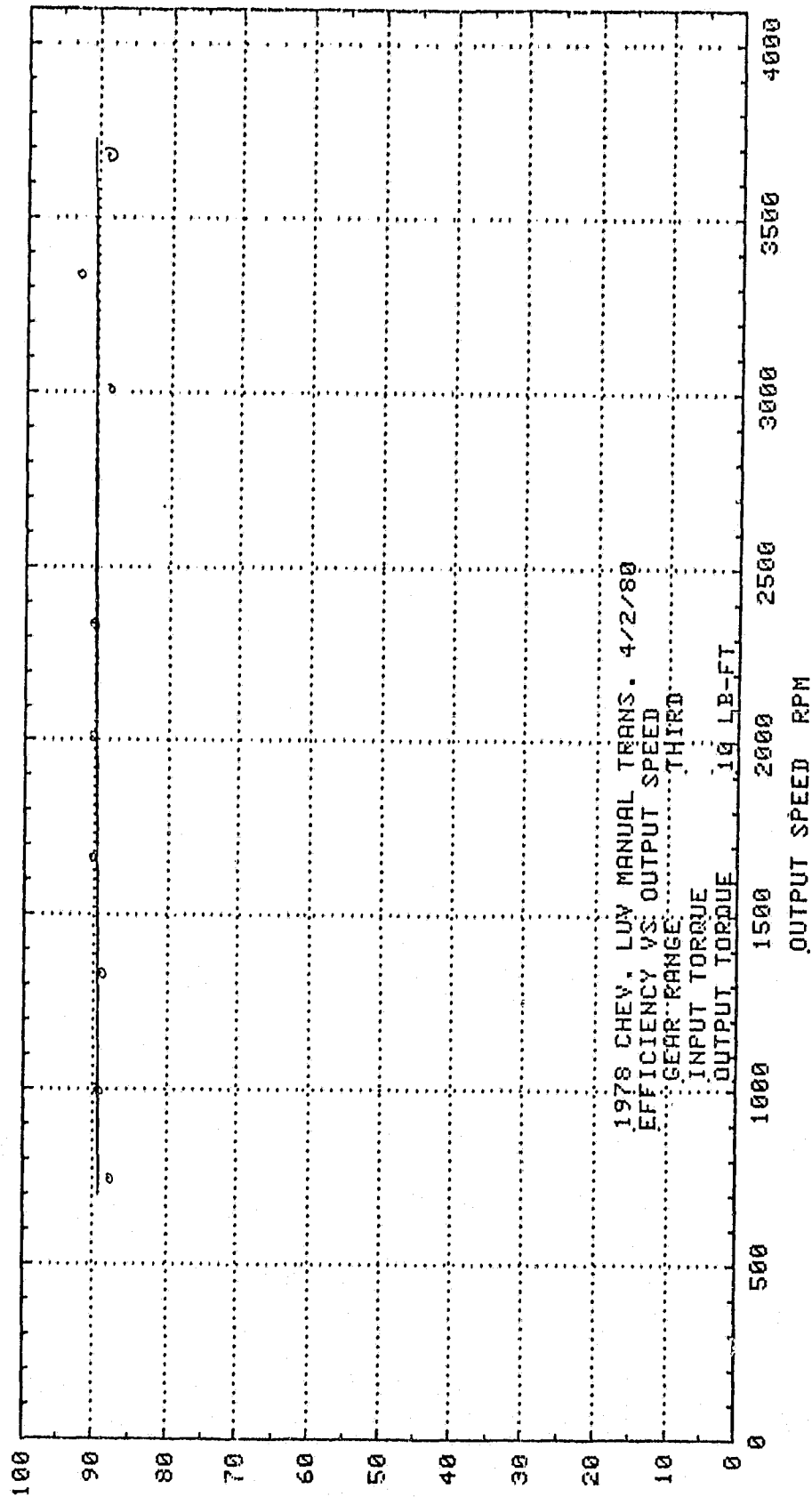

EFFICIENCY %

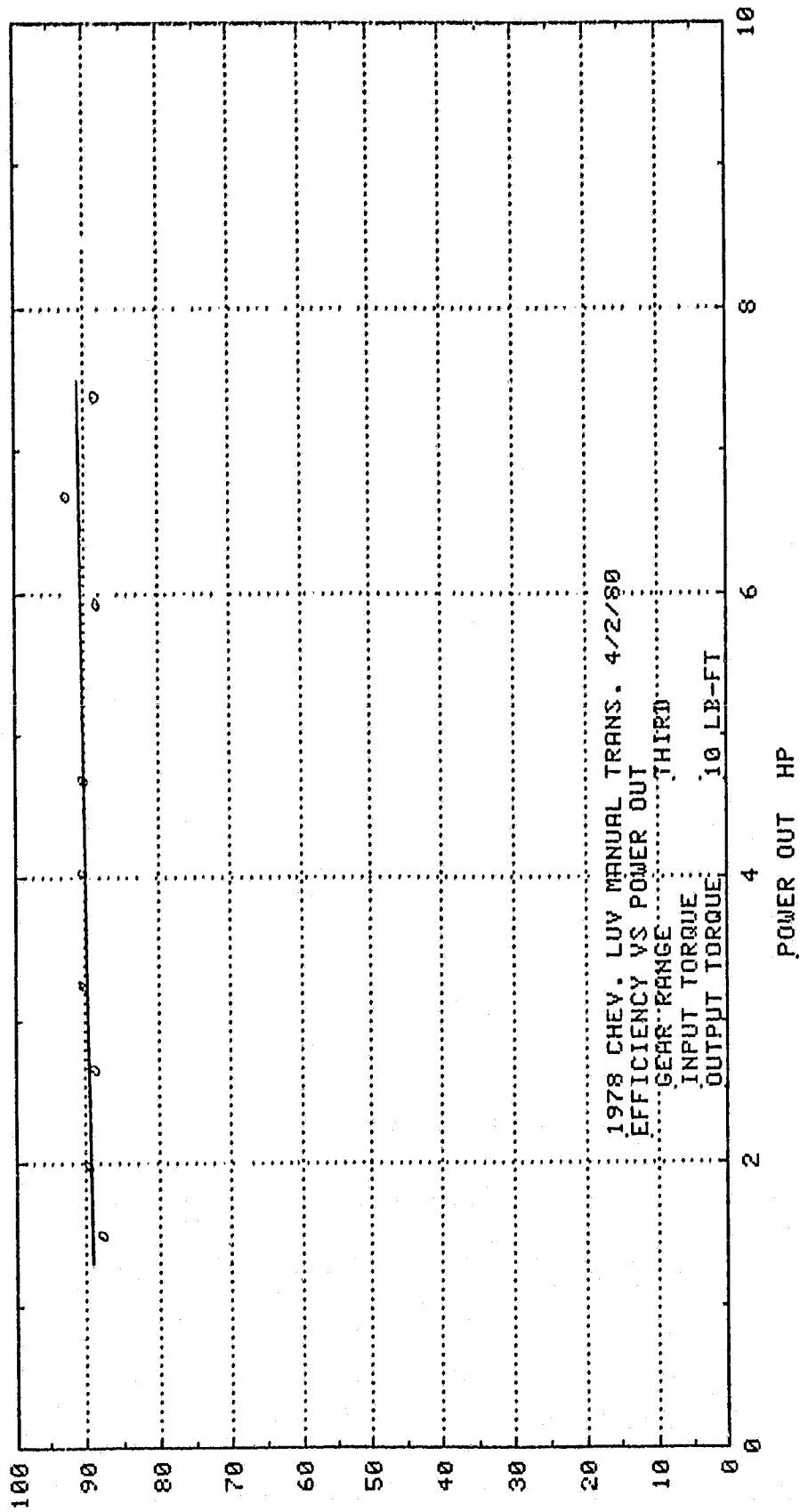

EFFICIENCY %

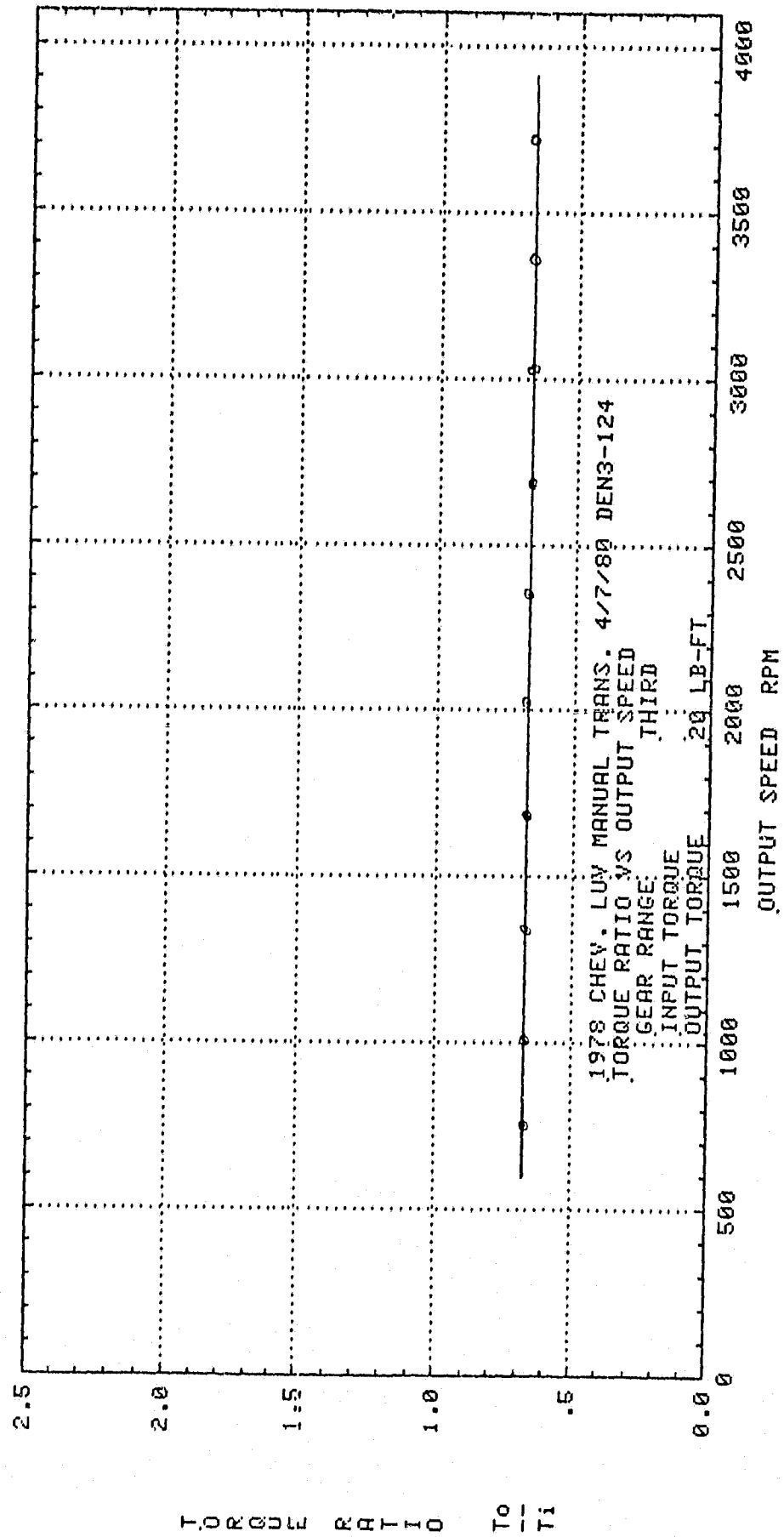

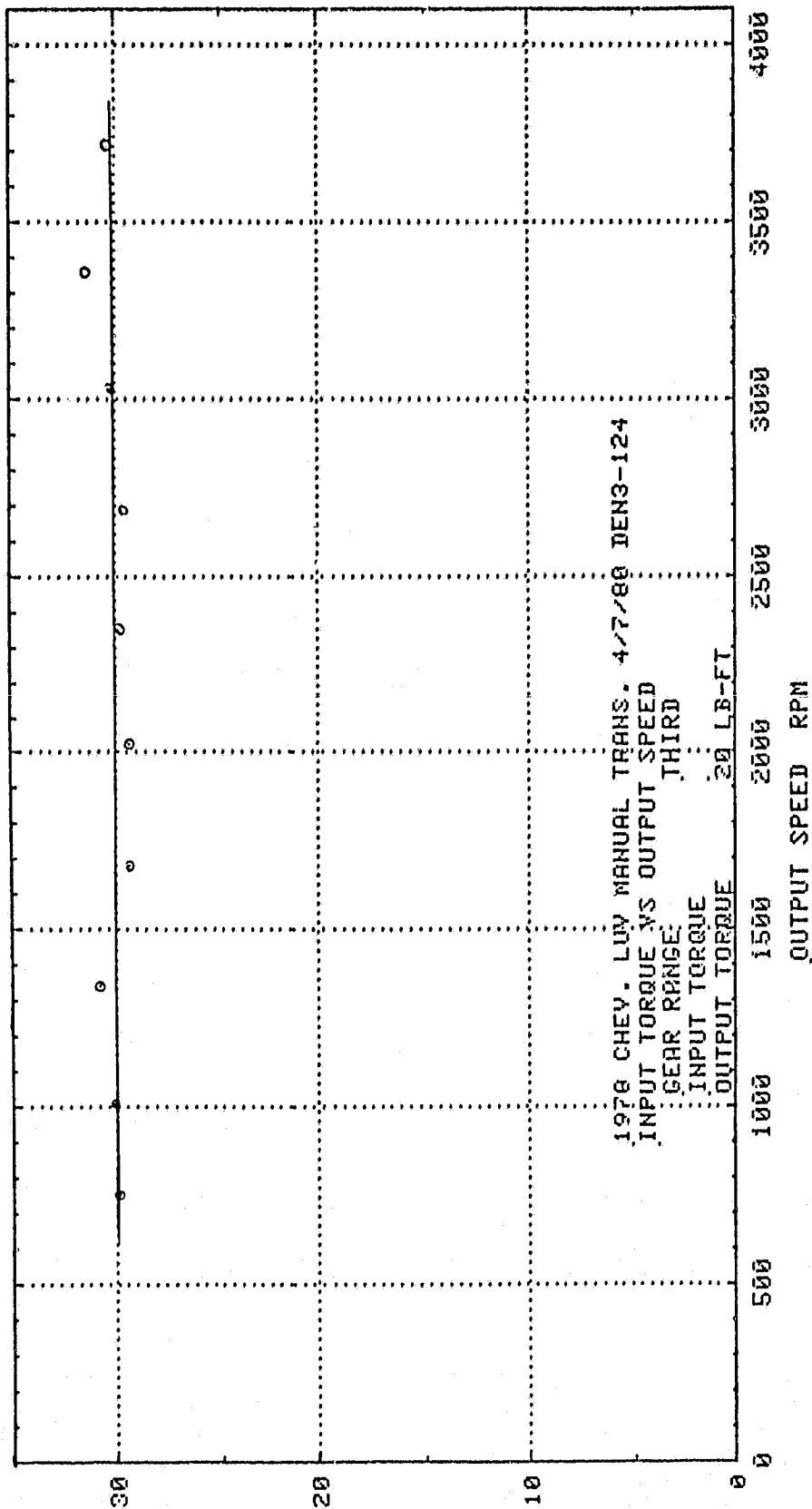

INPUT TORQUE LB FT

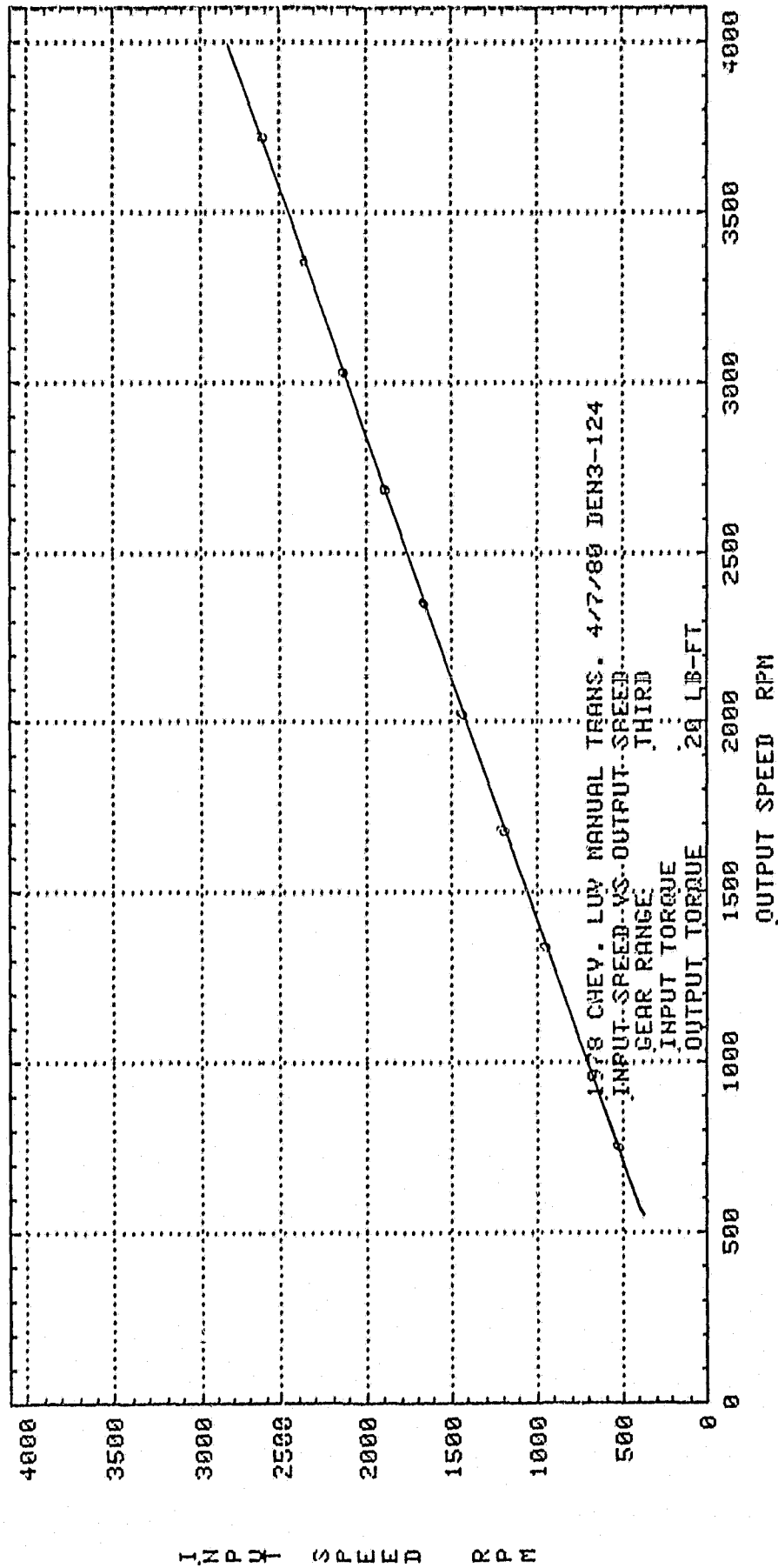

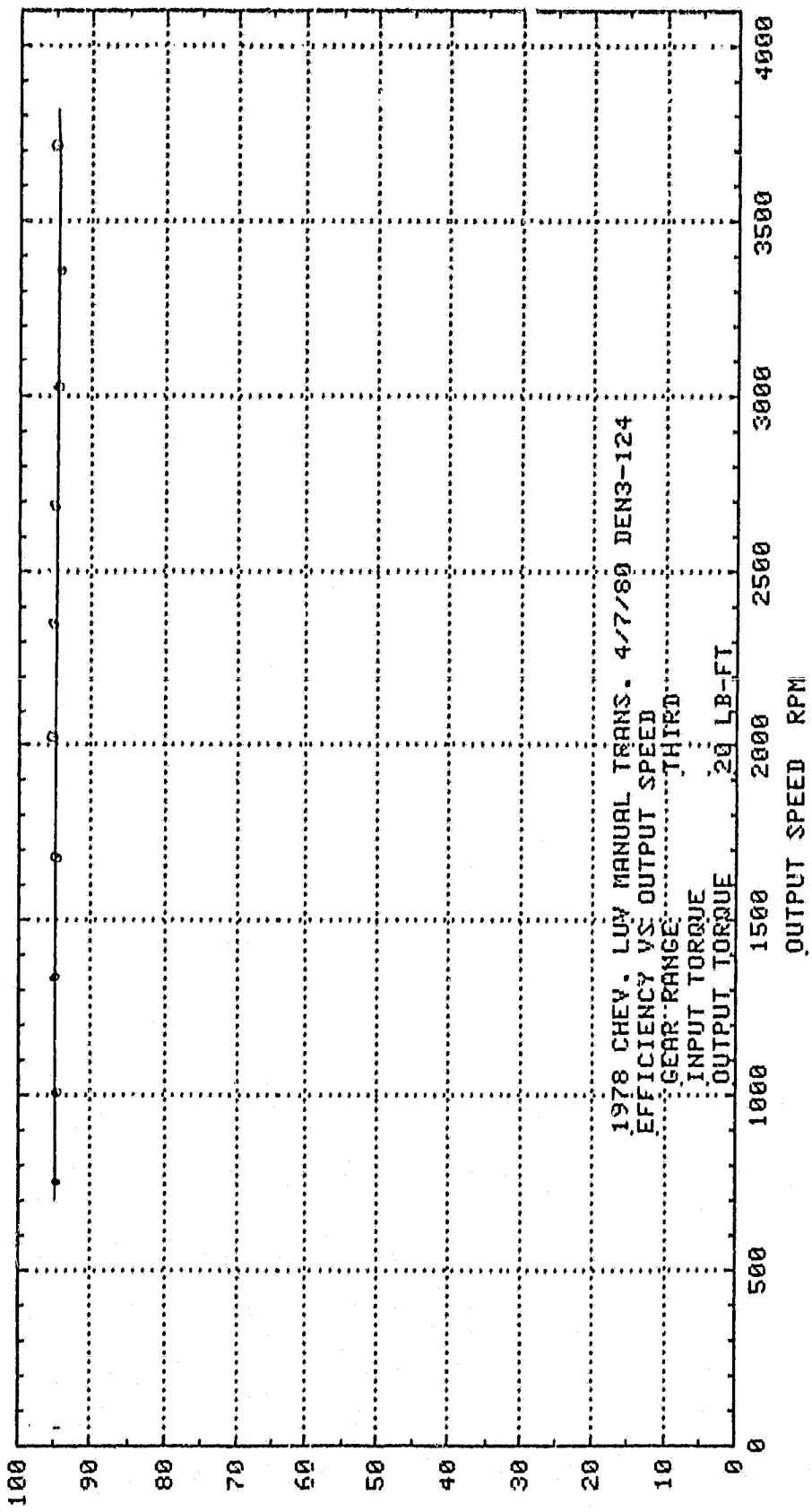

EFFICIENCY %

EFFICIENCY %

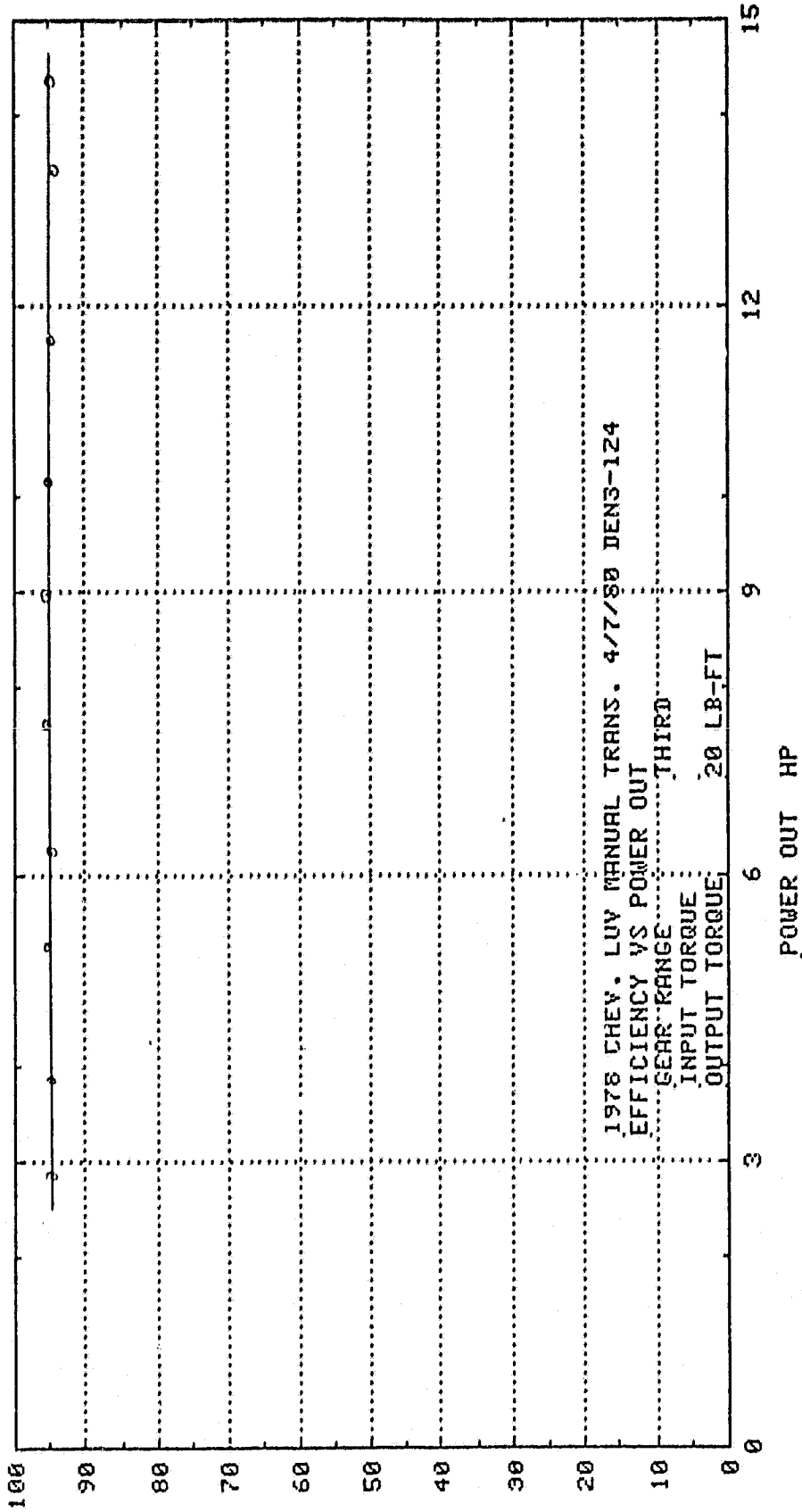

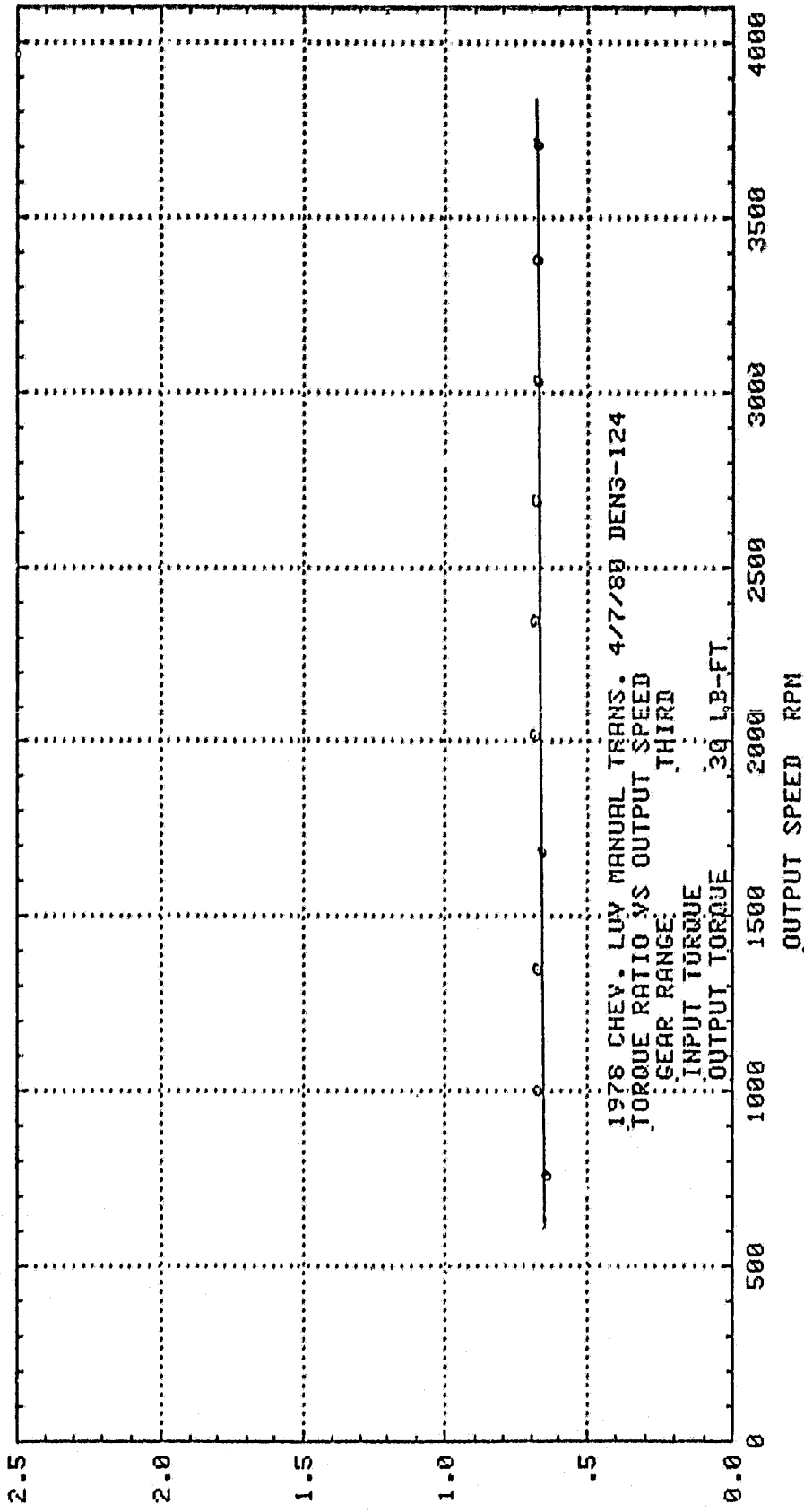

TORQUE RATIO $\frac{T_o}{T_i}$

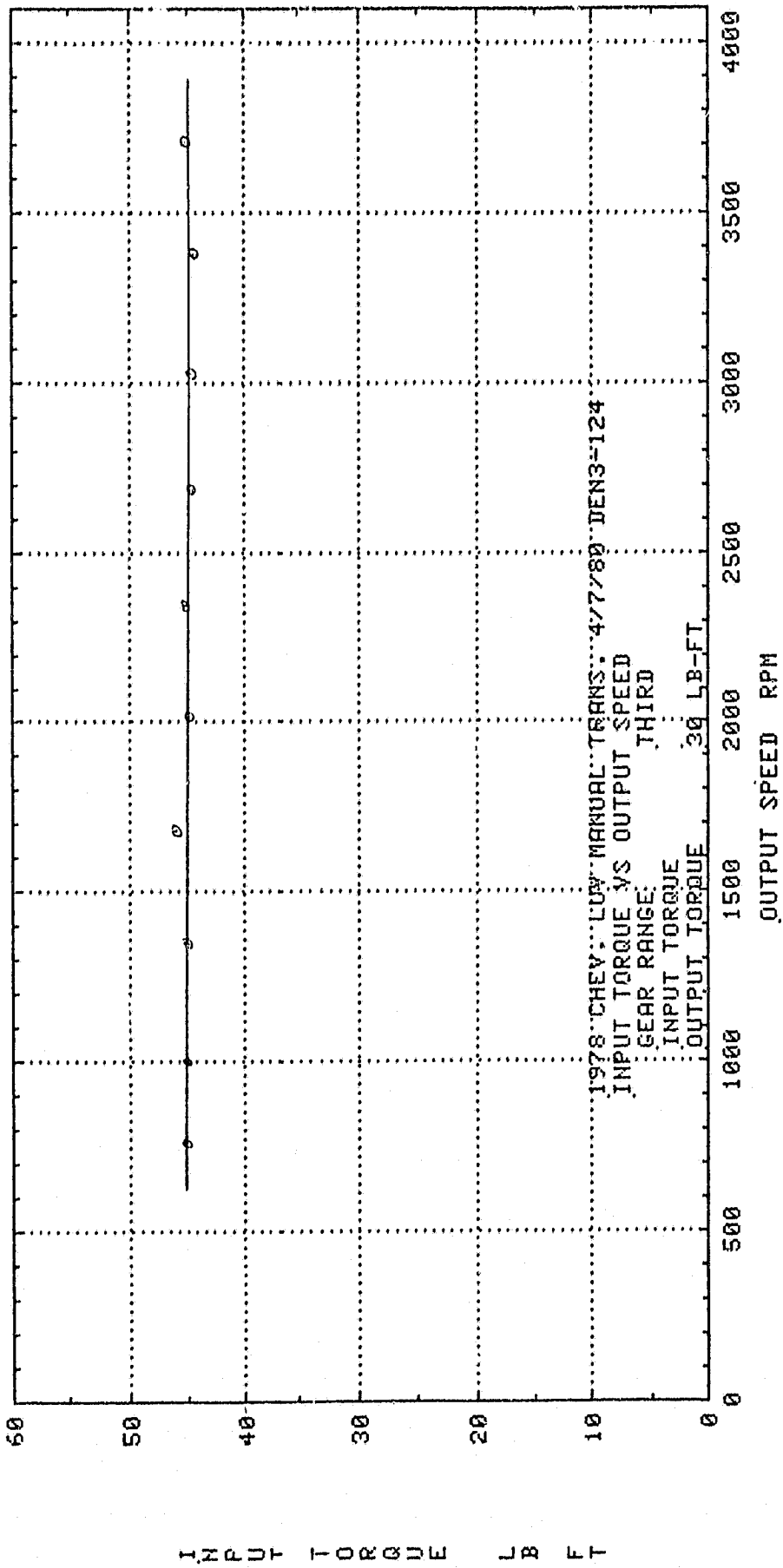

INPUT TORQUE LB FT

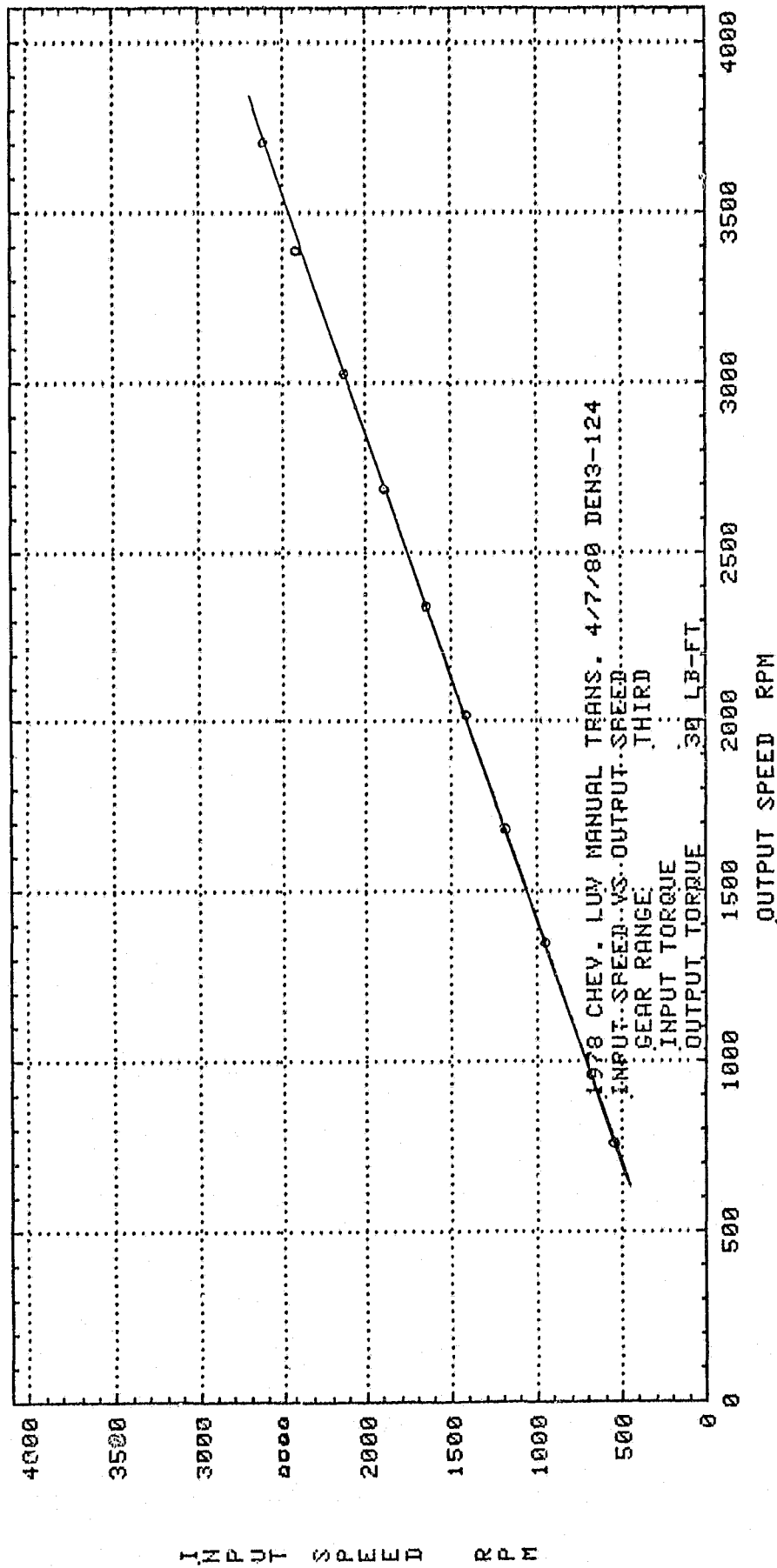

EFFICIENCY %

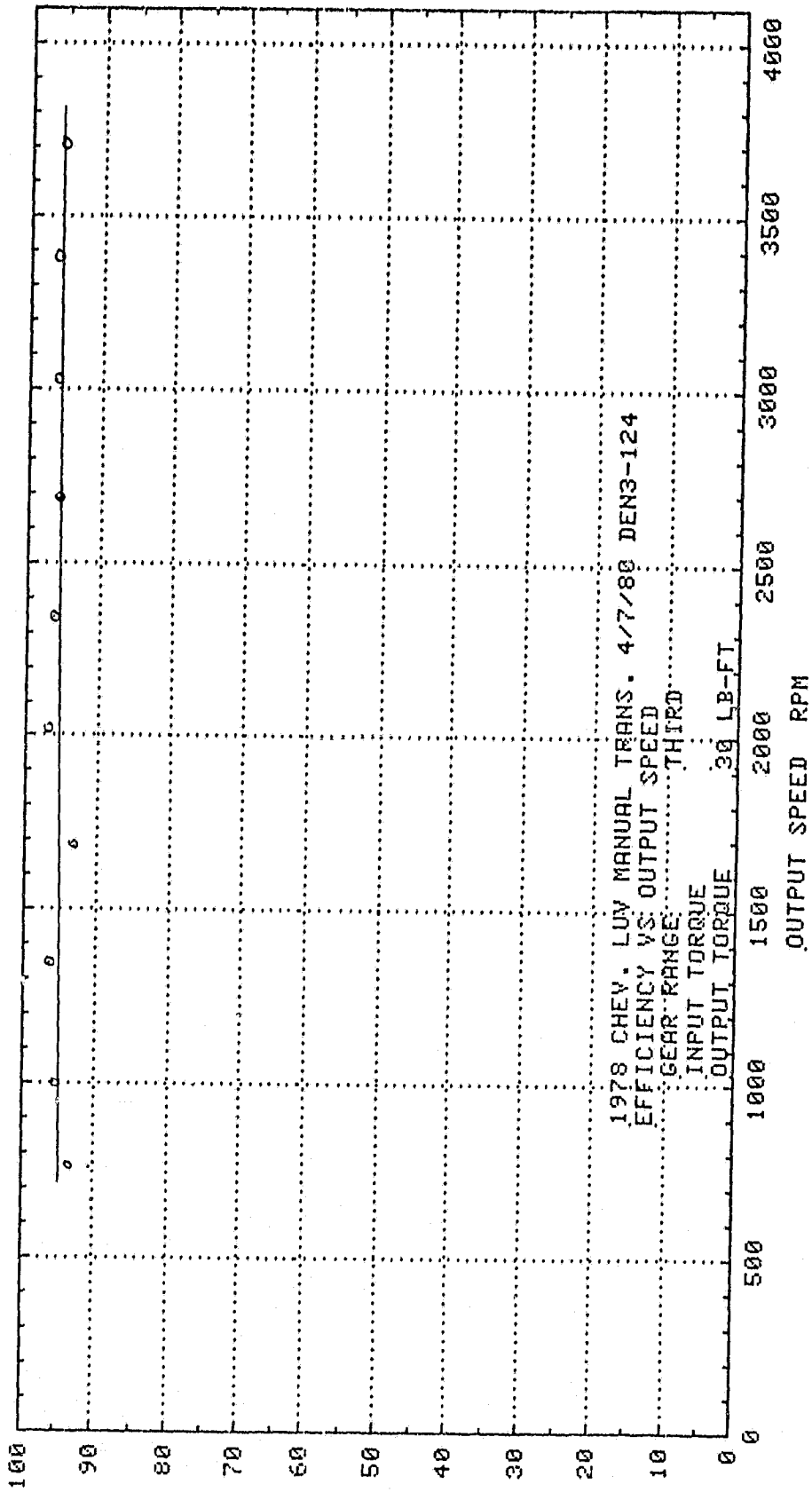

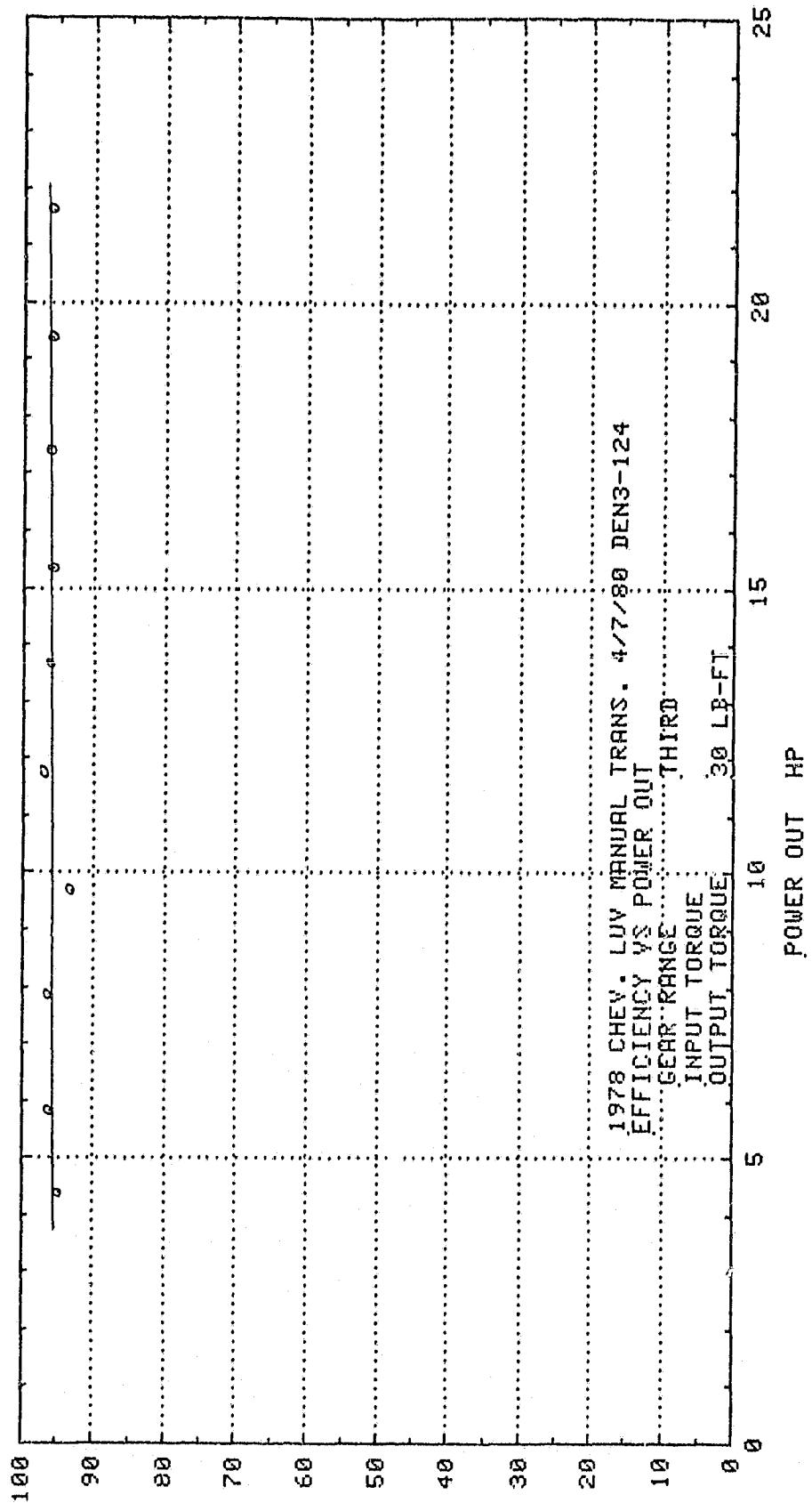

EFFICIENCY %

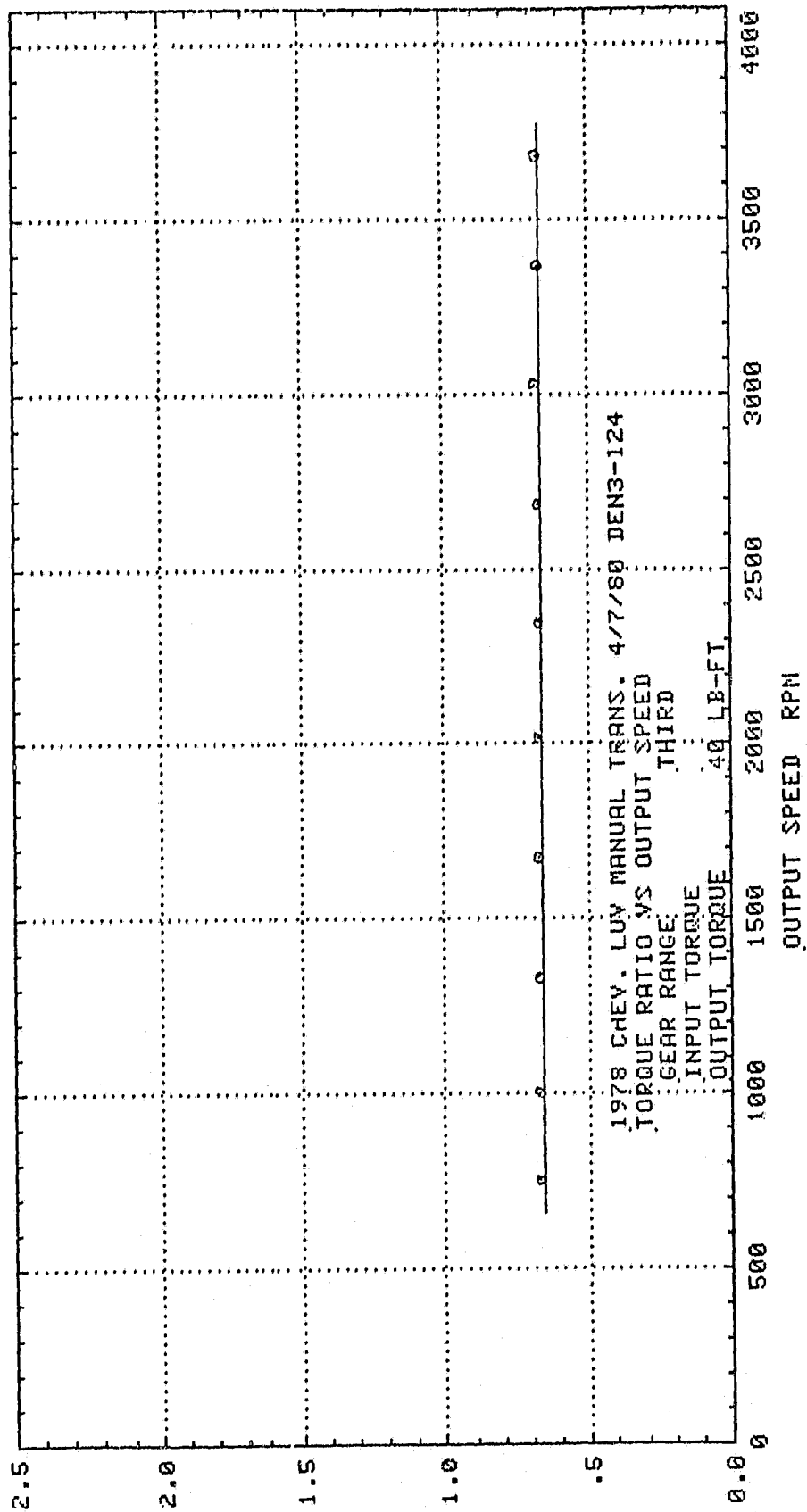

TORQUE RATIO $\frac{T_o}{T_i}$

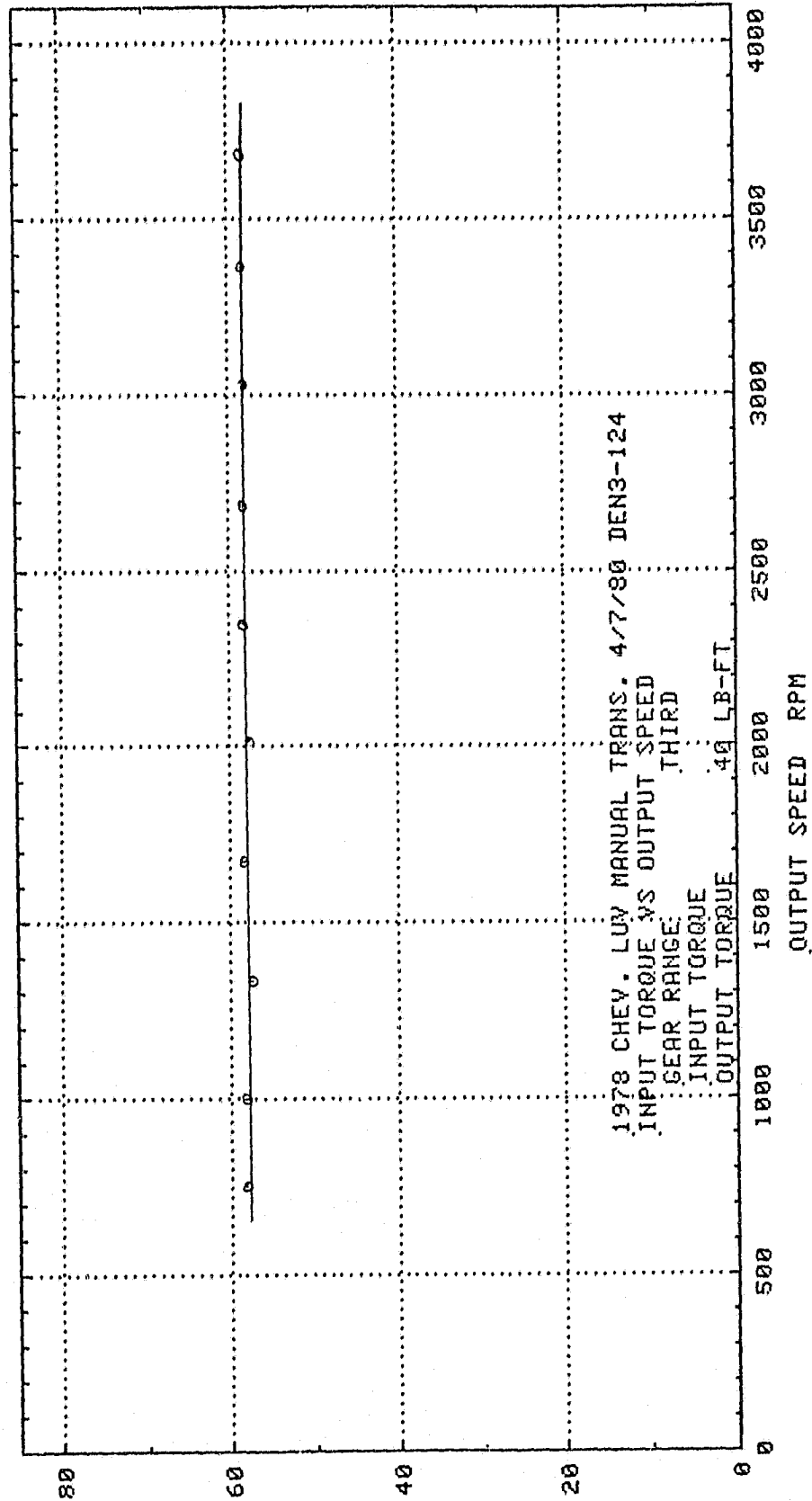

INPUT TORQUE LB FT

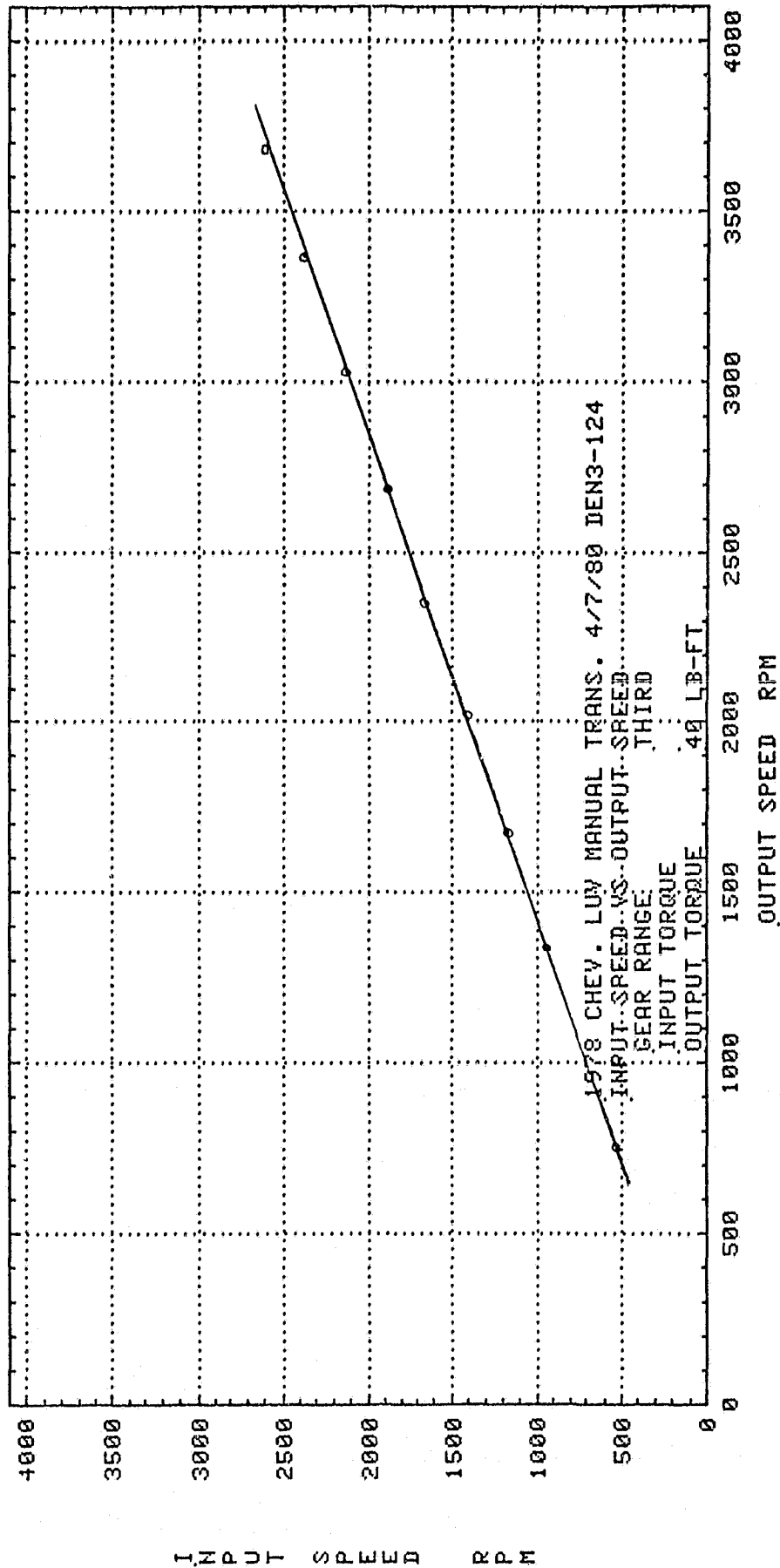

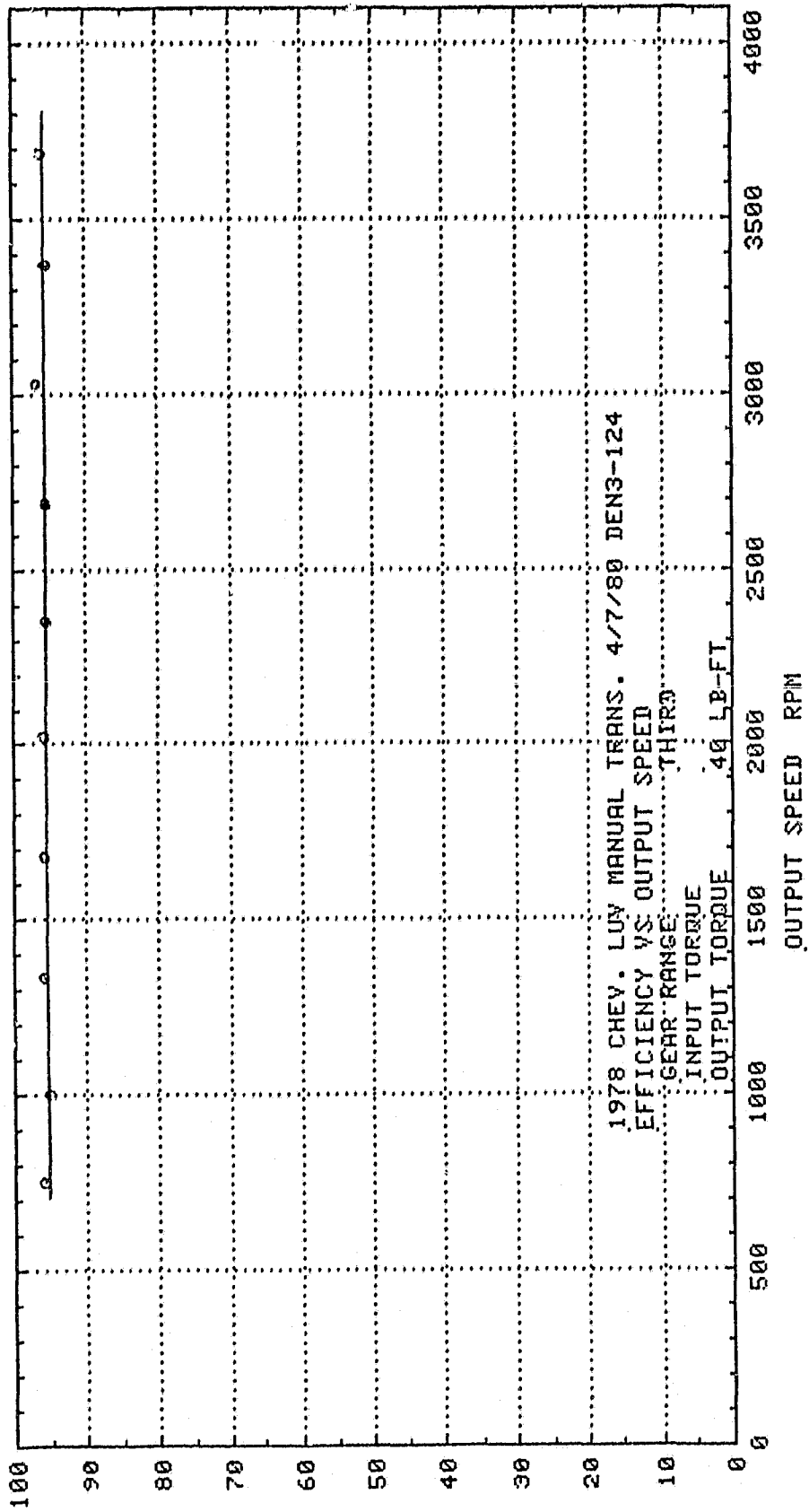

EFFICIENCY %

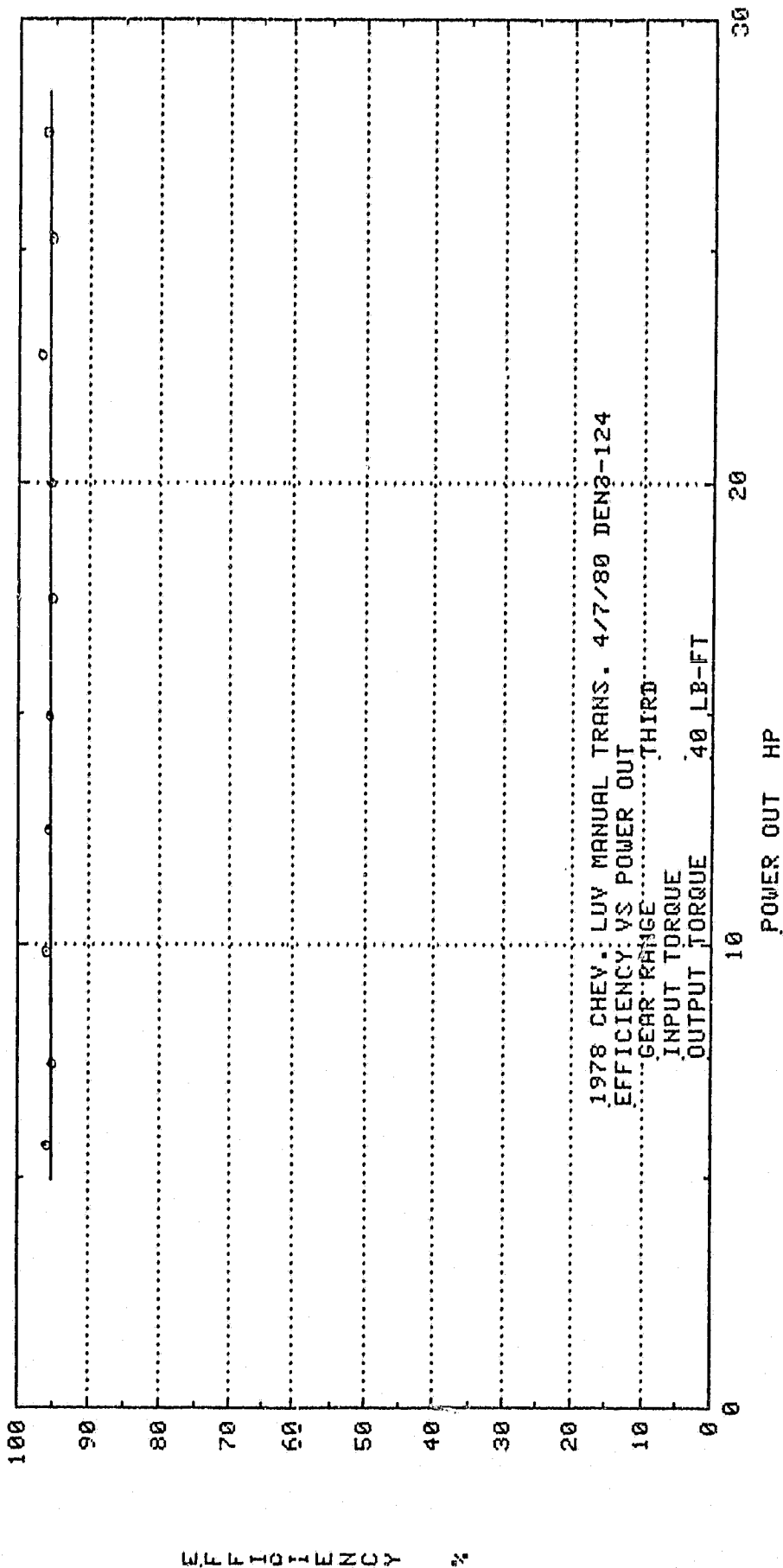

EFFICIENCY %

POWER OUT HP

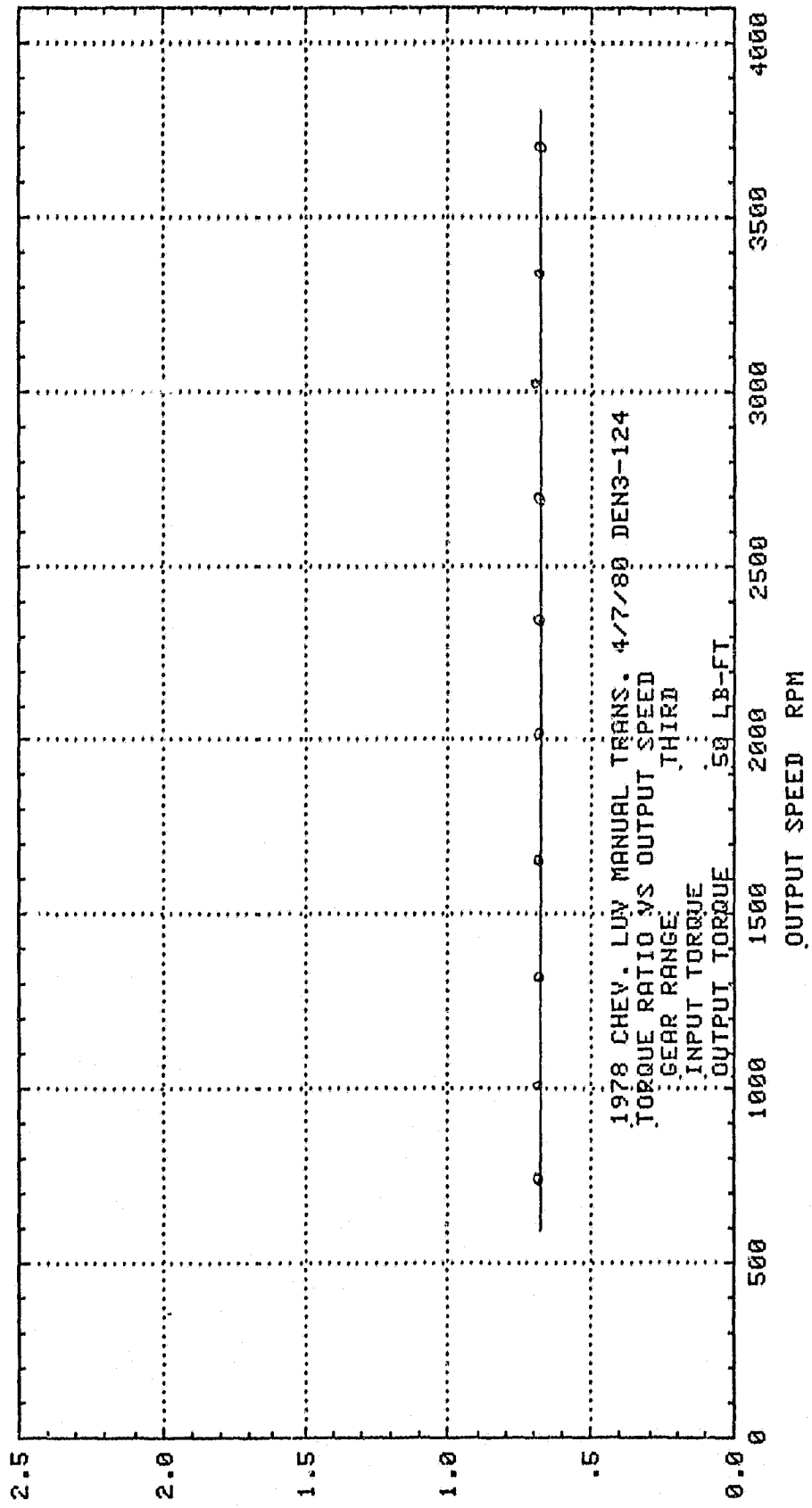

TORQUE RATIO

$$\frac{T_o}{T_i}$$

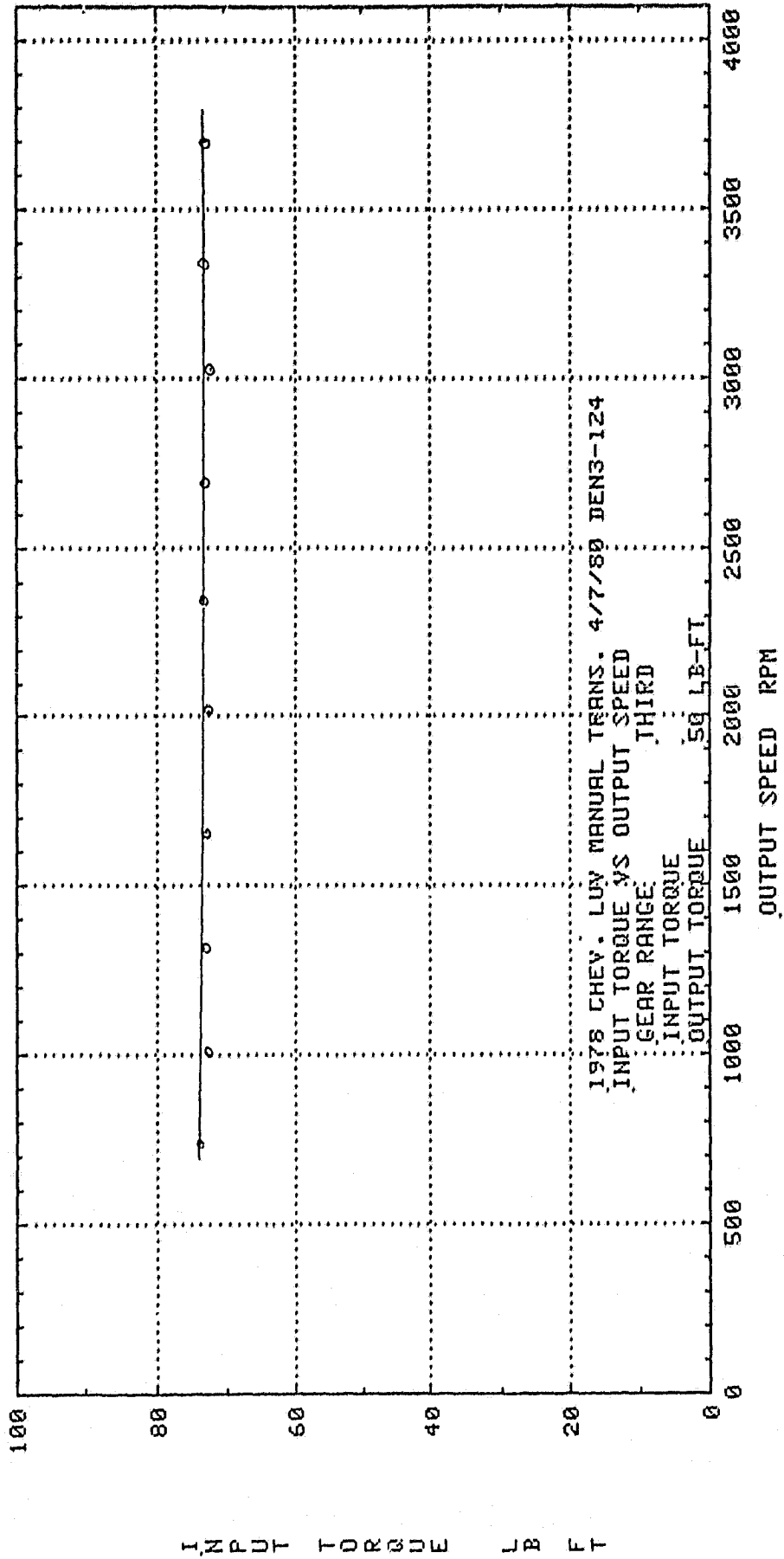

INPUT TORQUE LB FT

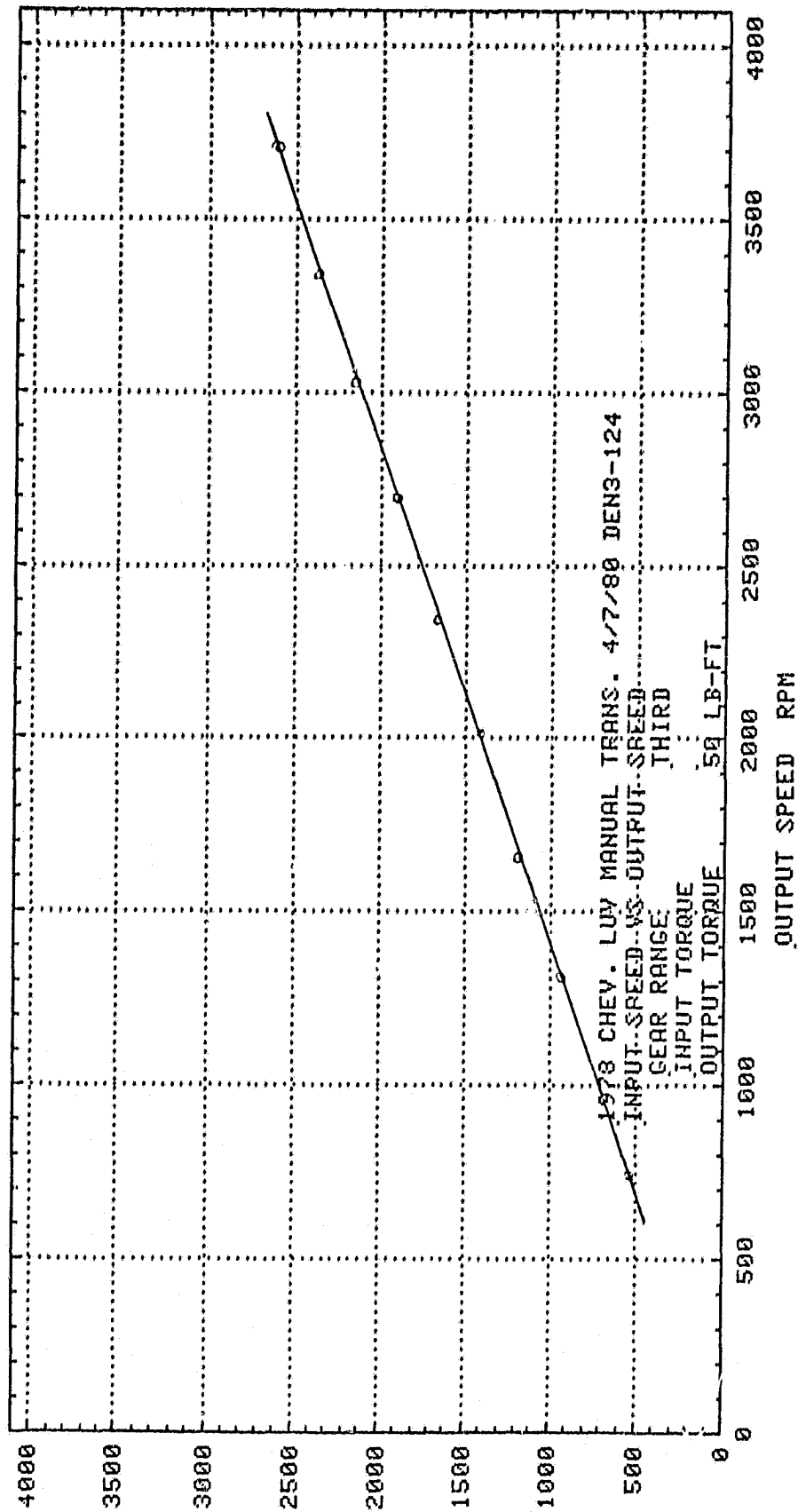

INPUT SPEED RPM

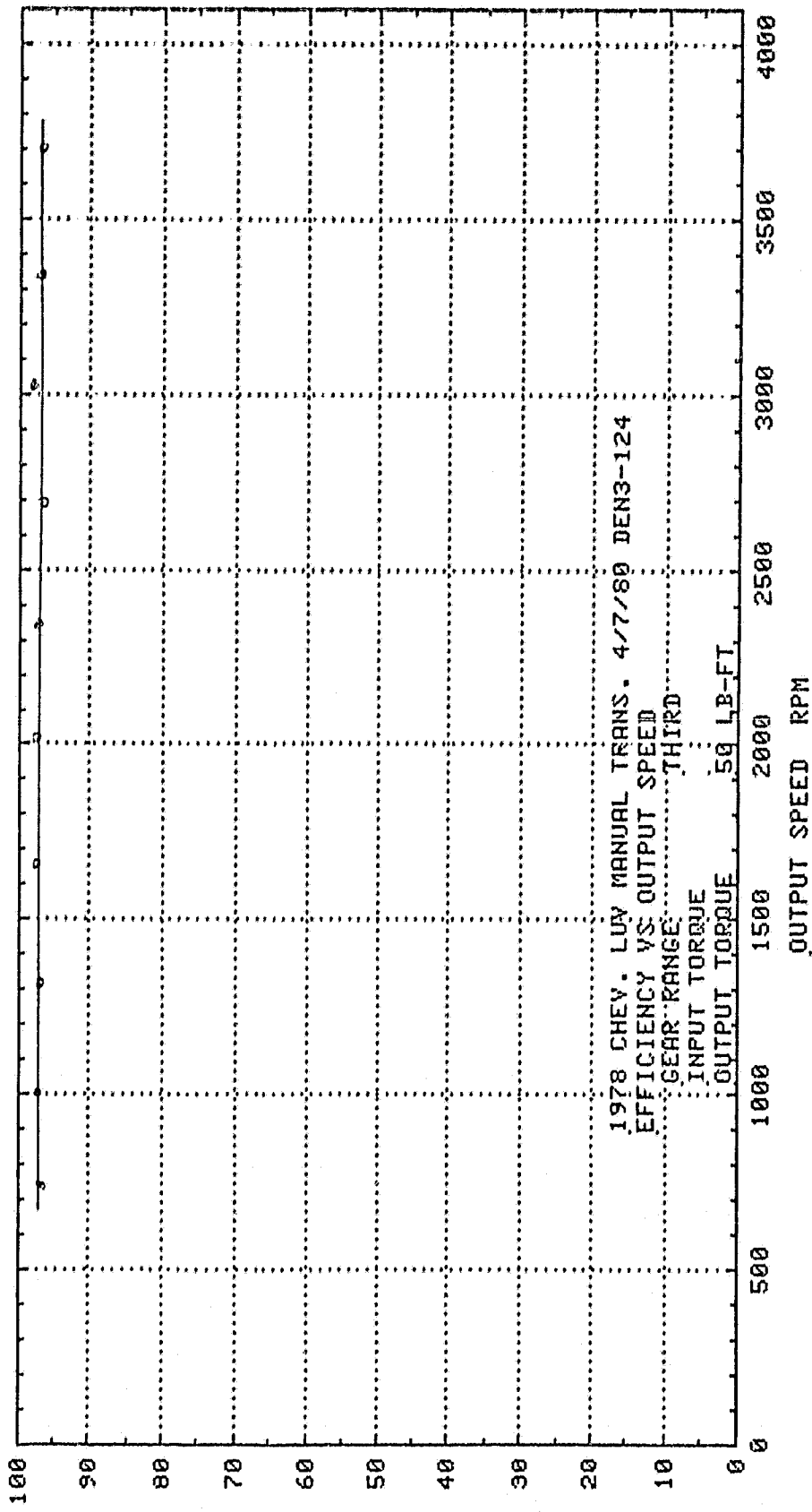

EFFICIENCY %

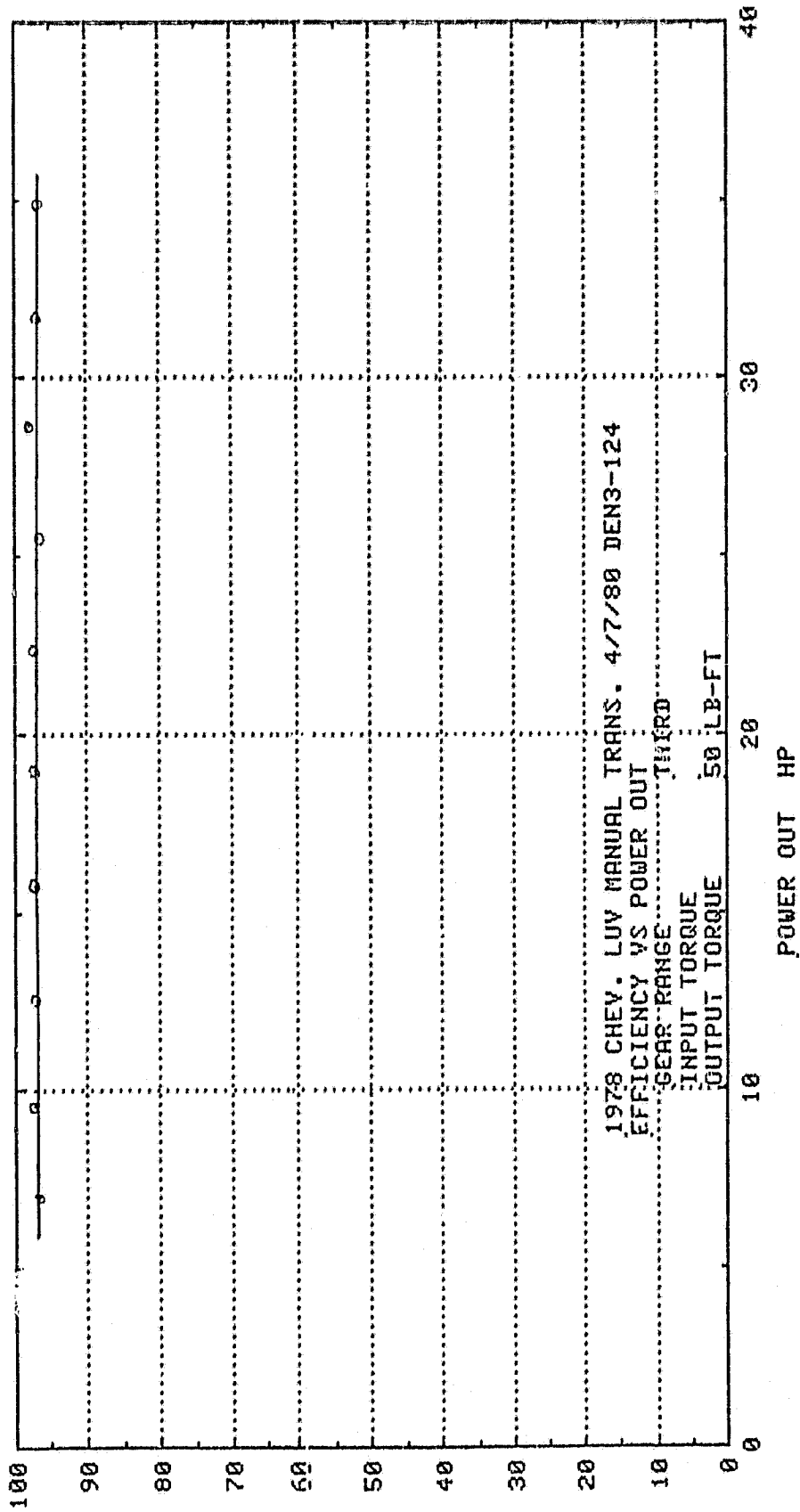

EFFICIENCY %

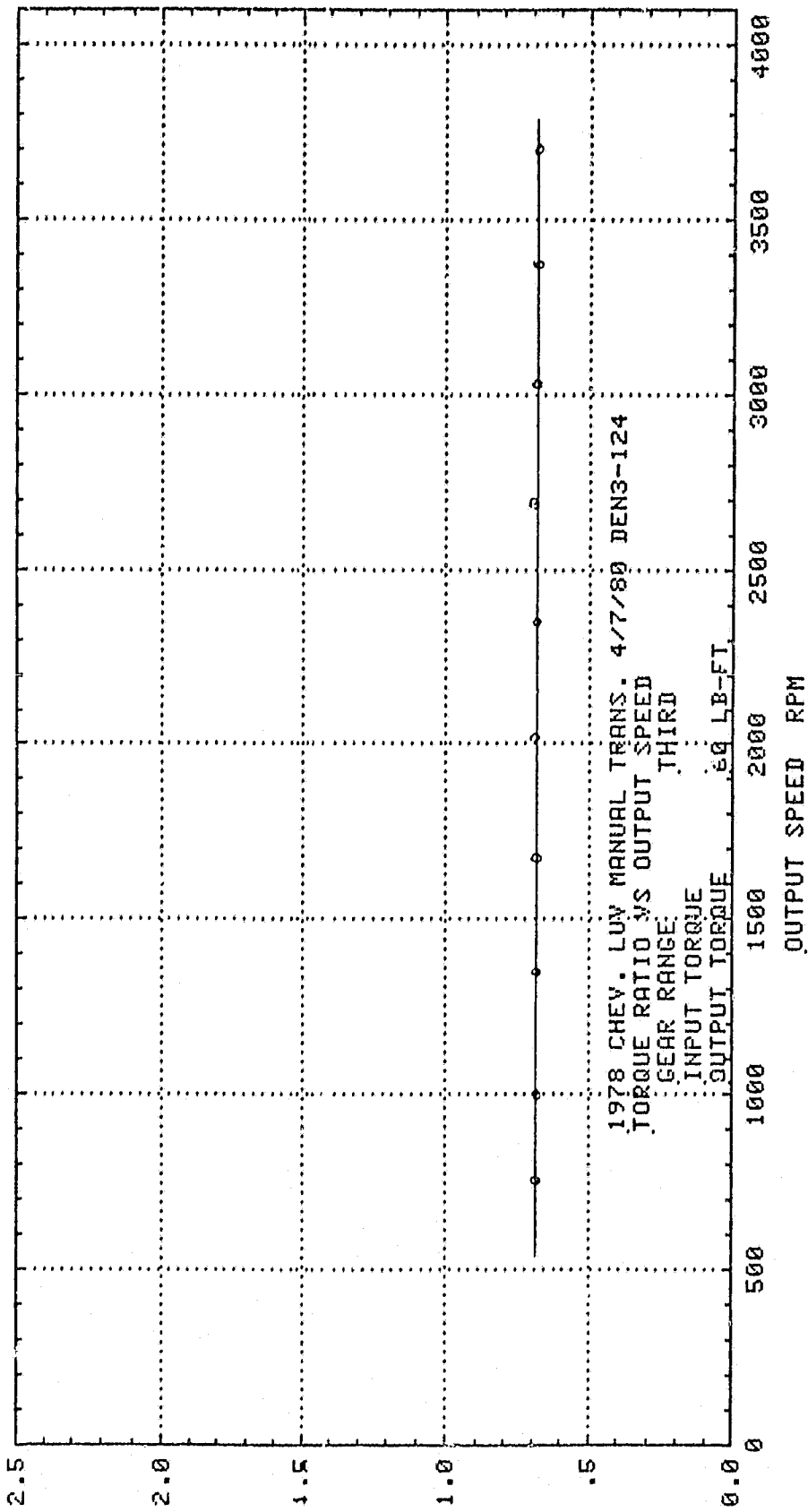

TORQUE RATIO $\frac{T_o}{T_i}$

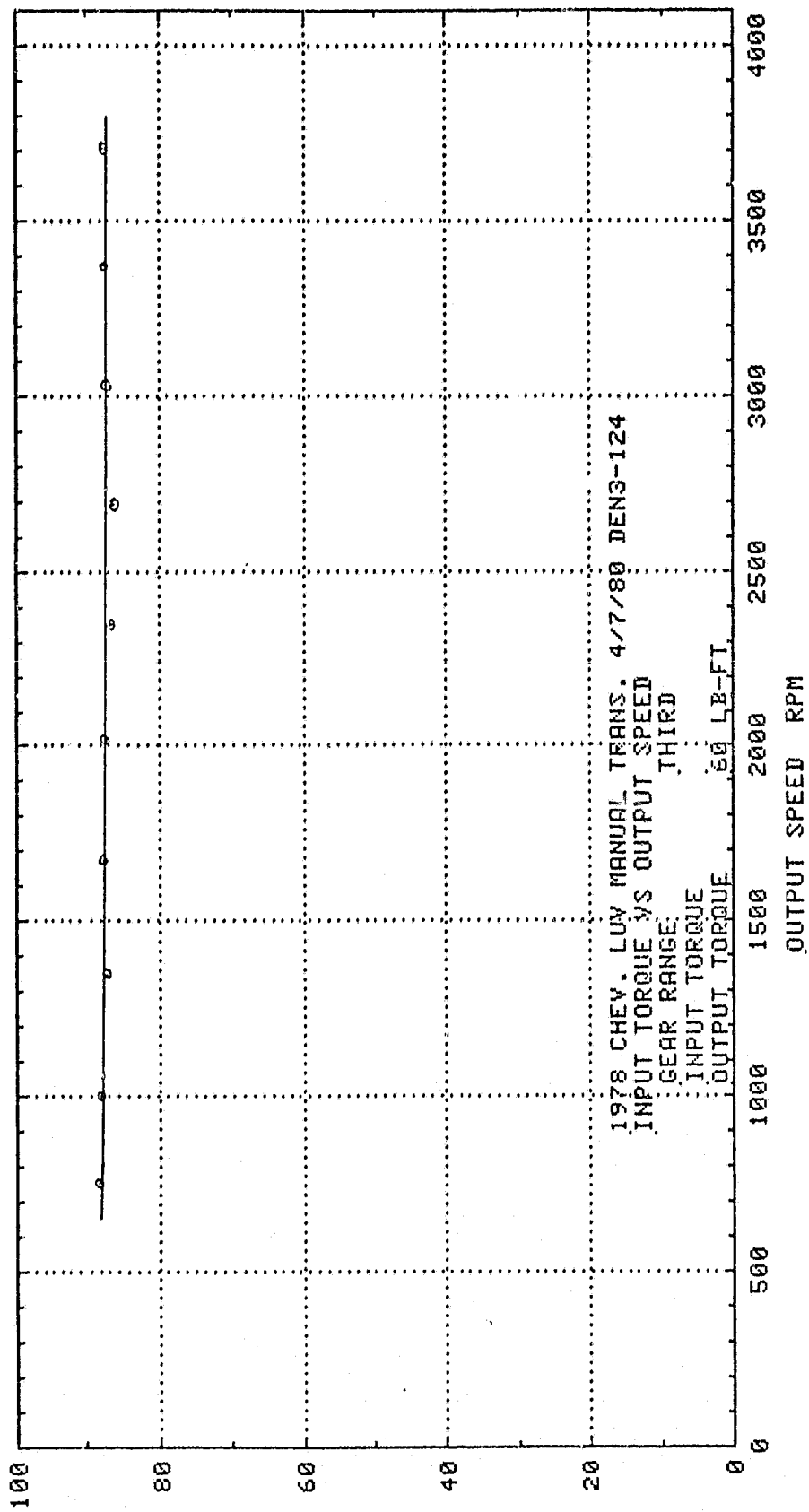

INPUT TORQUE LB FT

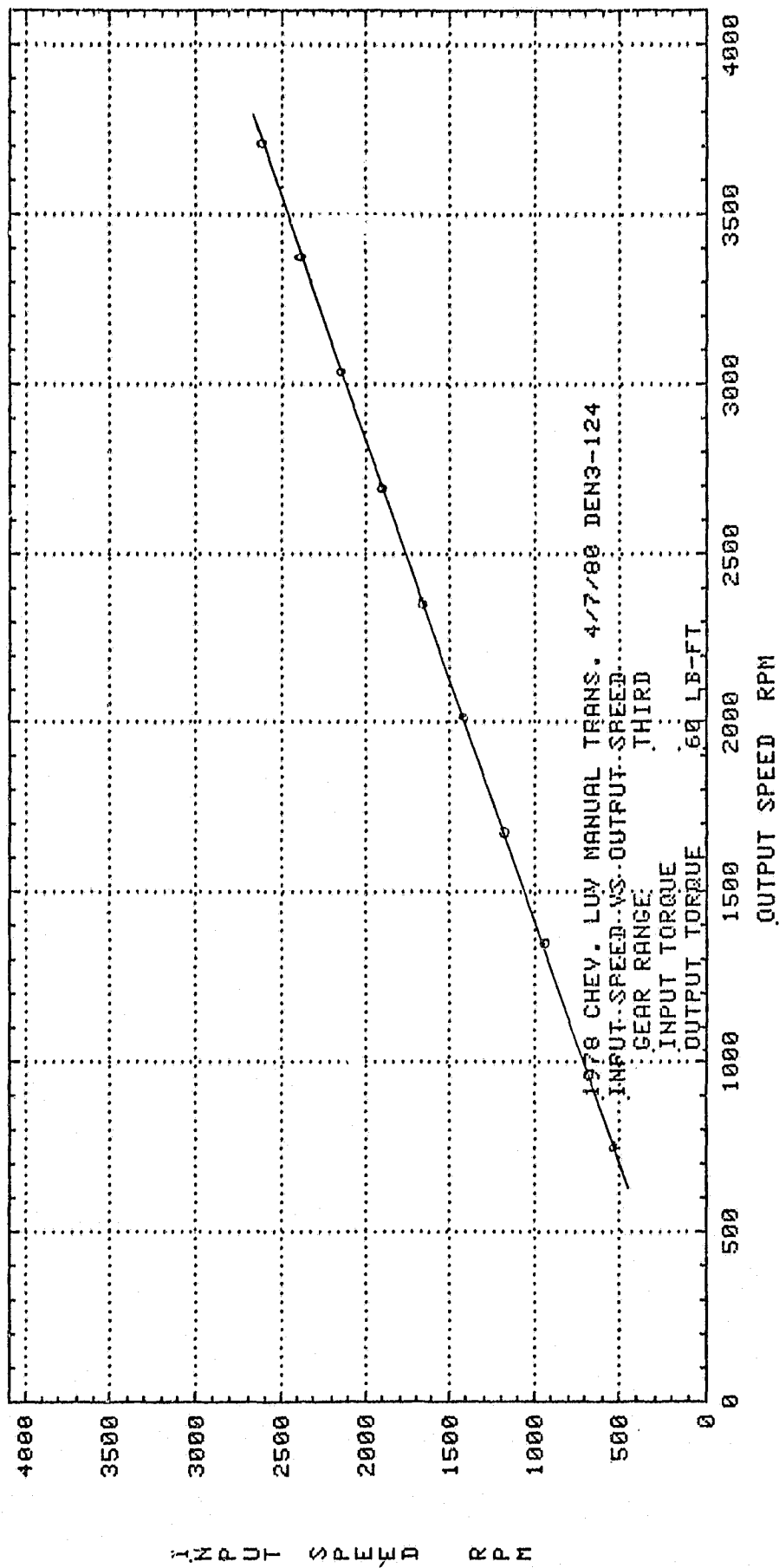

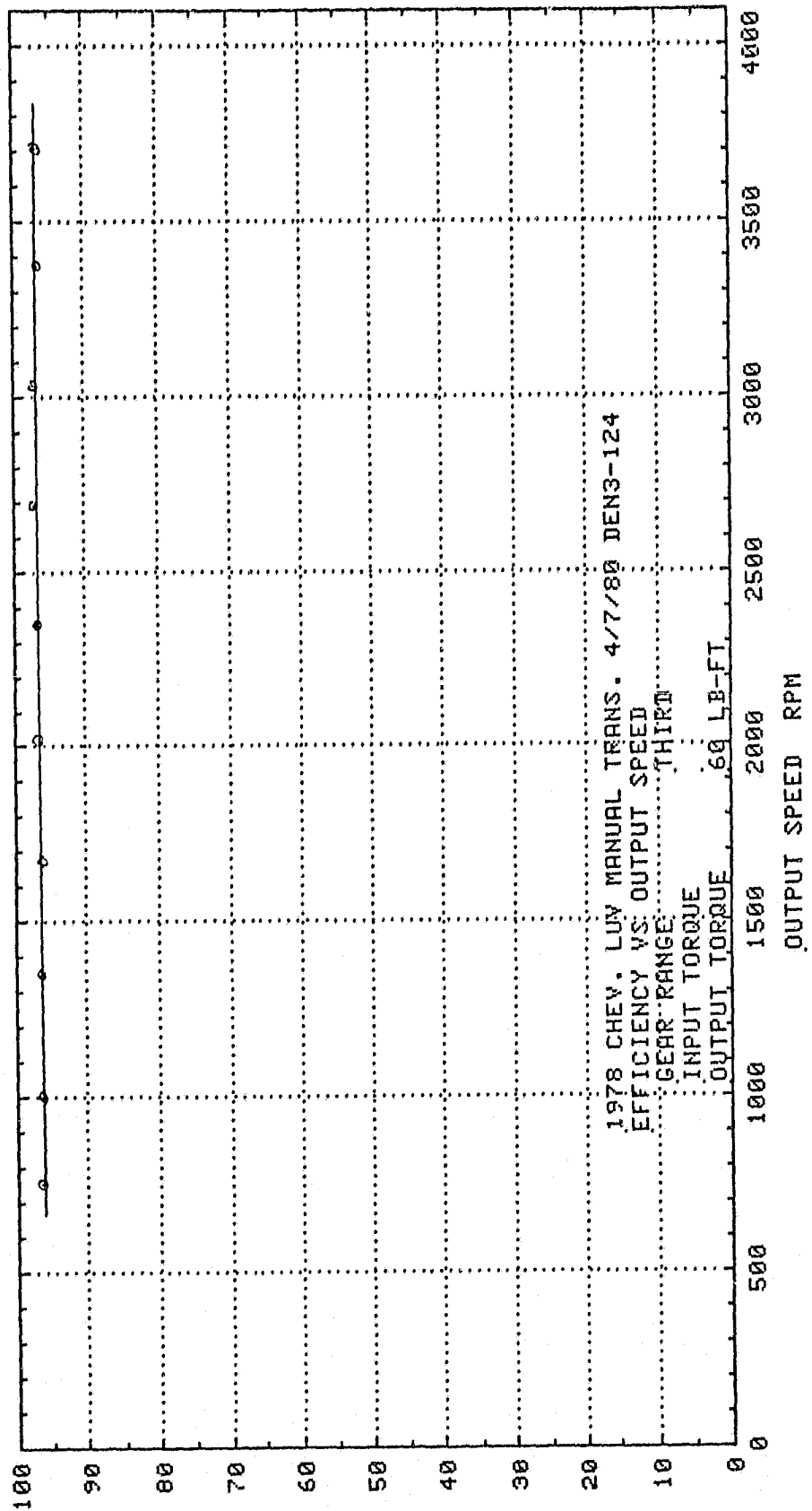

EFFICIENCY %

EFFICIENCY %

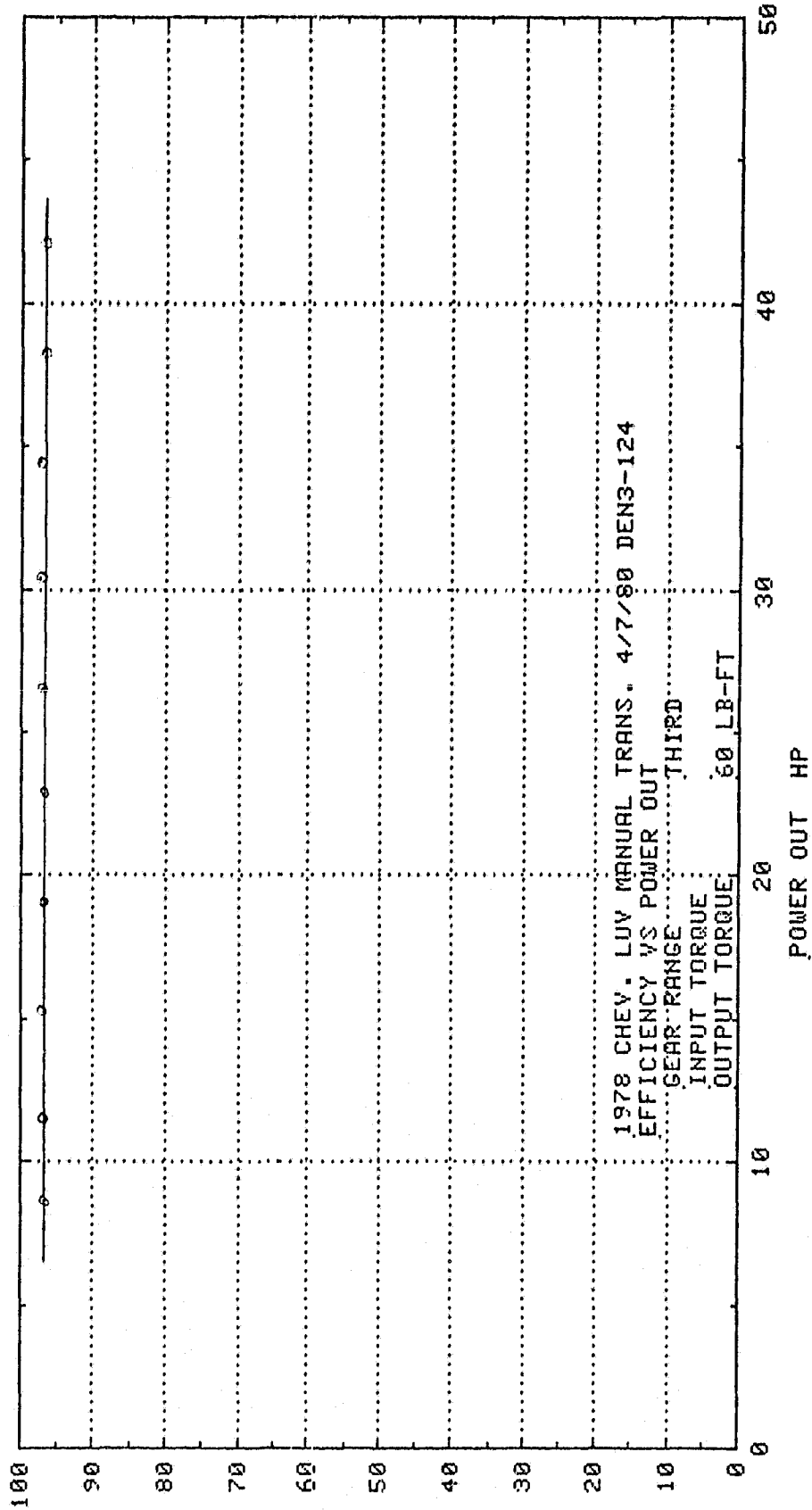

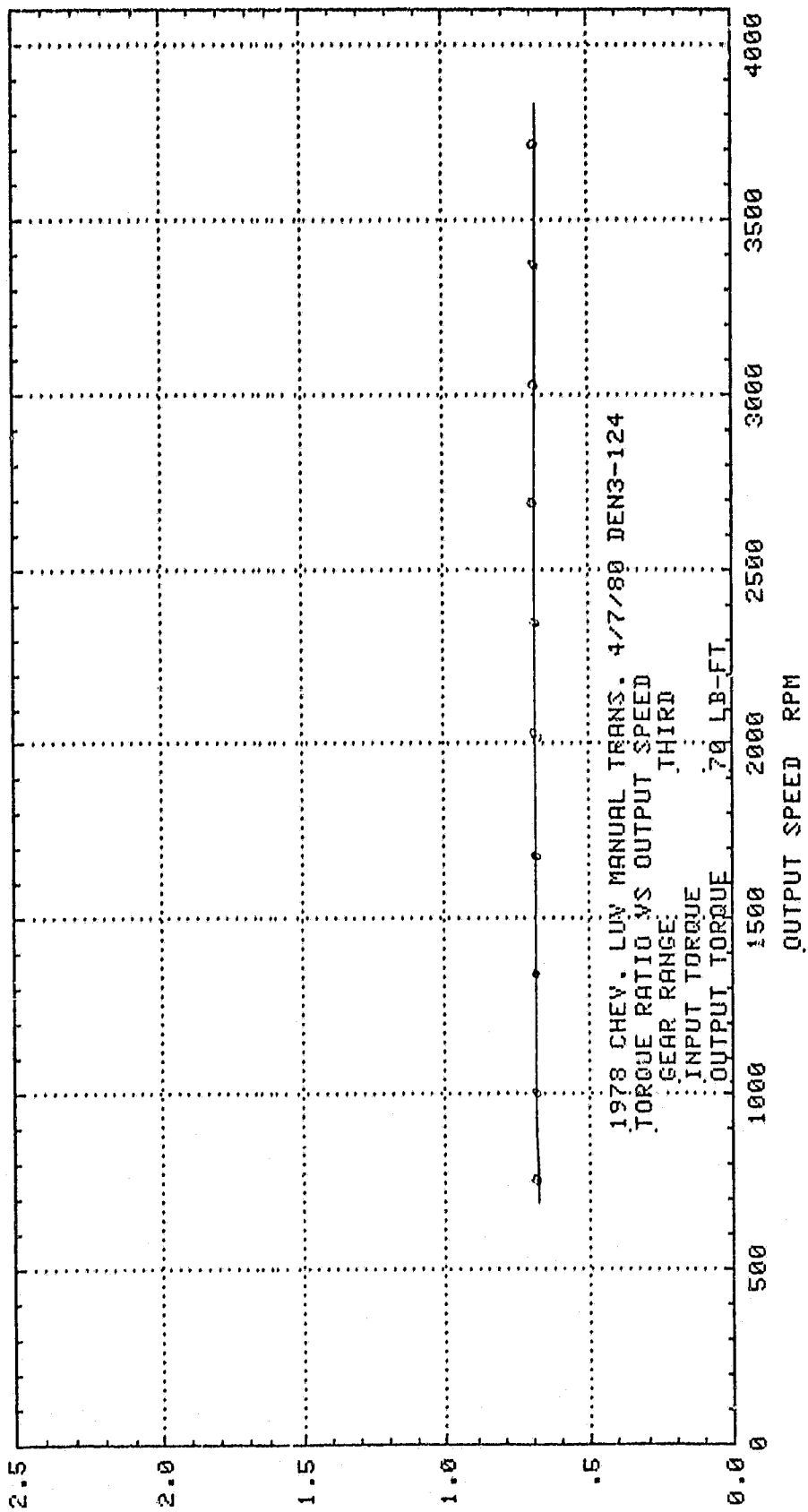

TORQUE RATIO $\frac{T_o}{T_i}$

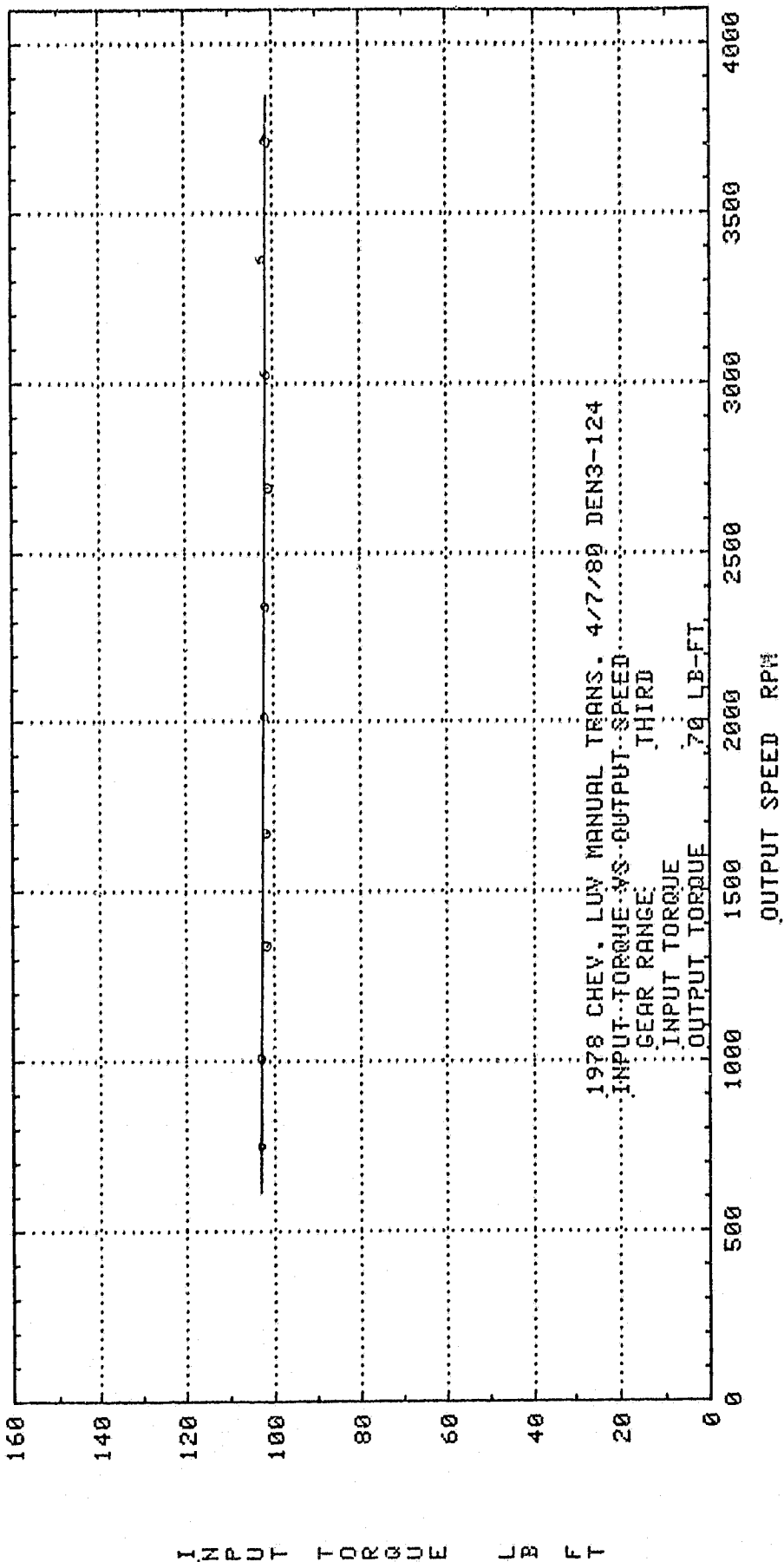

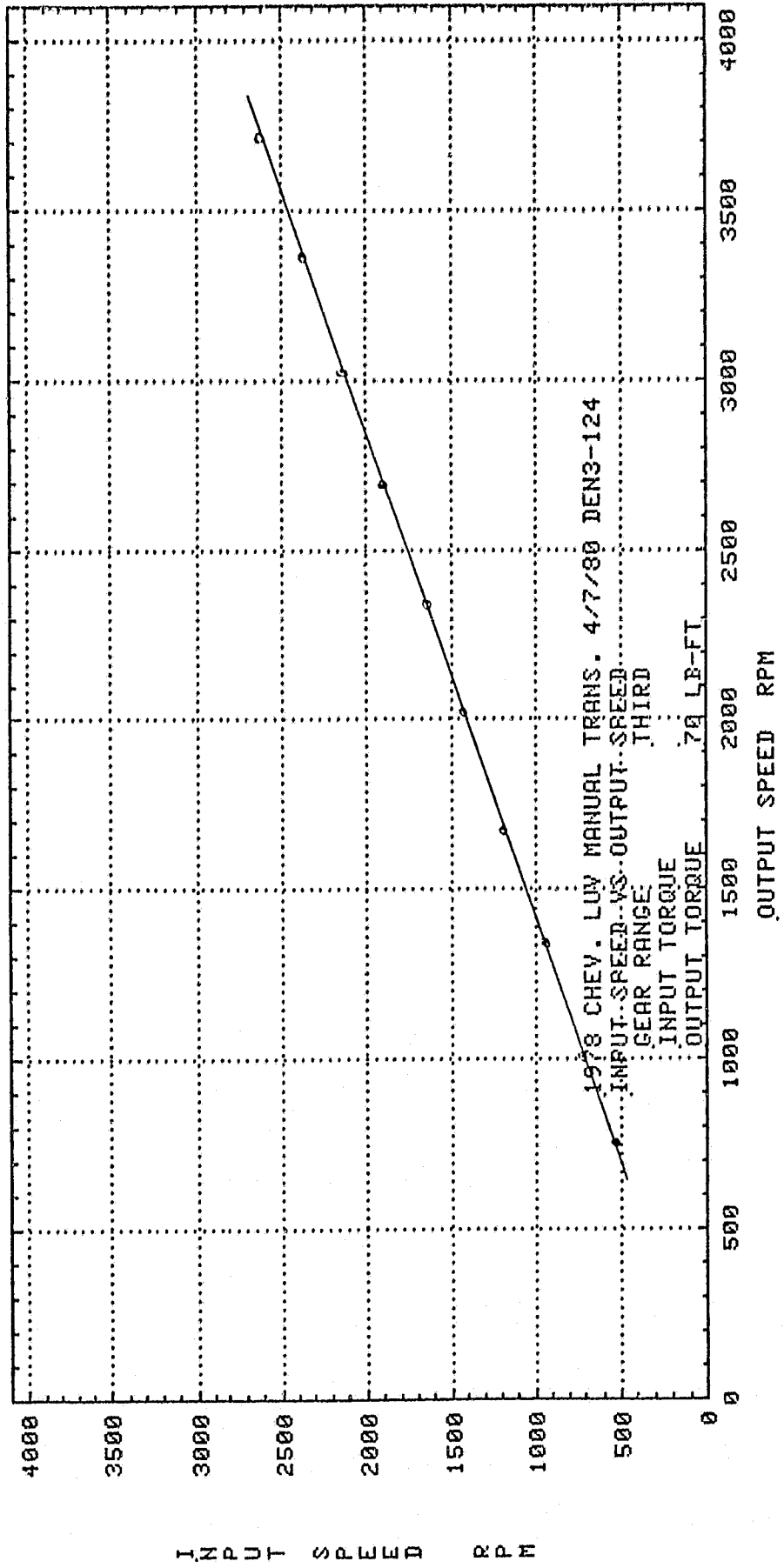

EFFICIENCY %

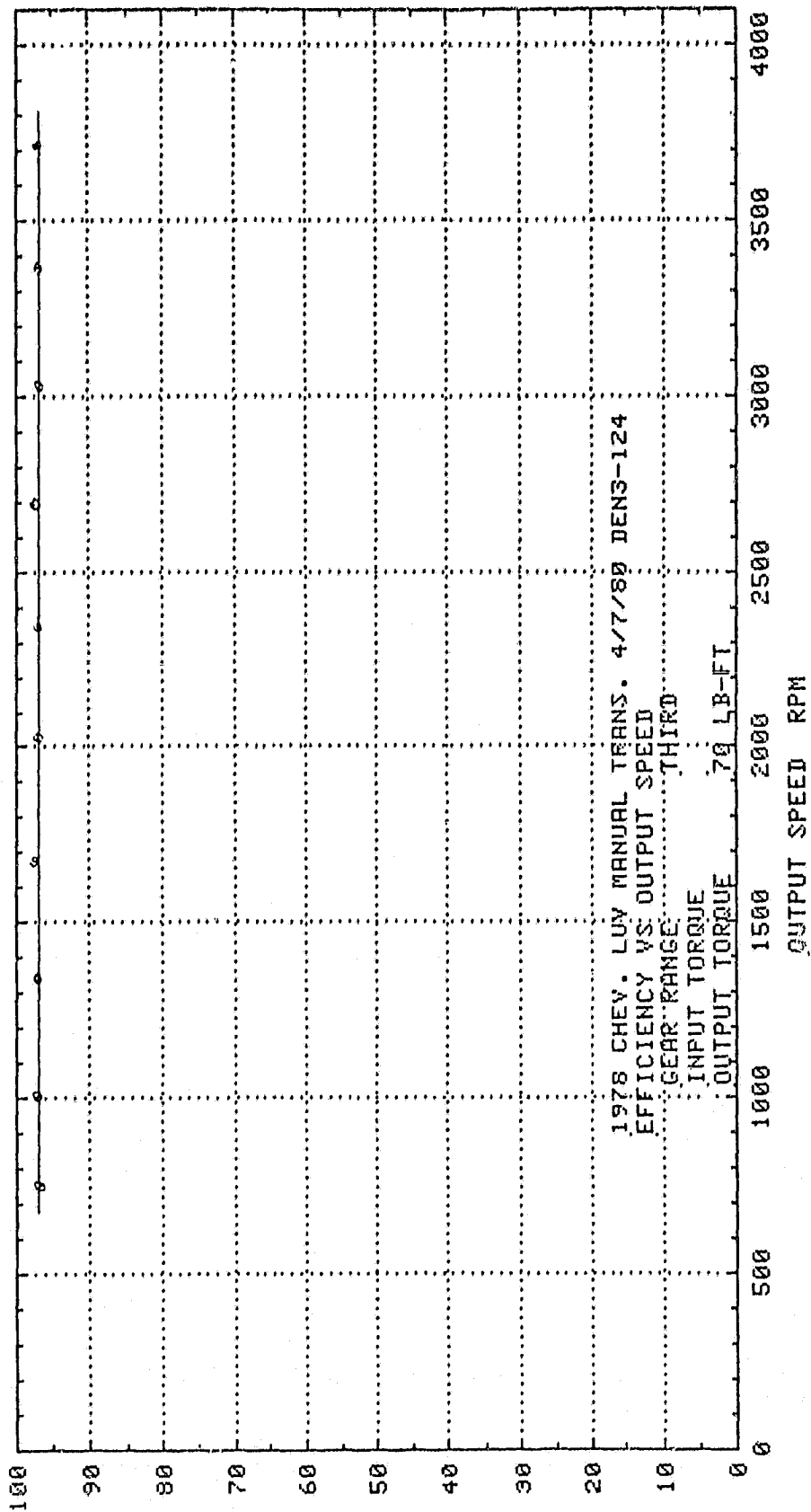

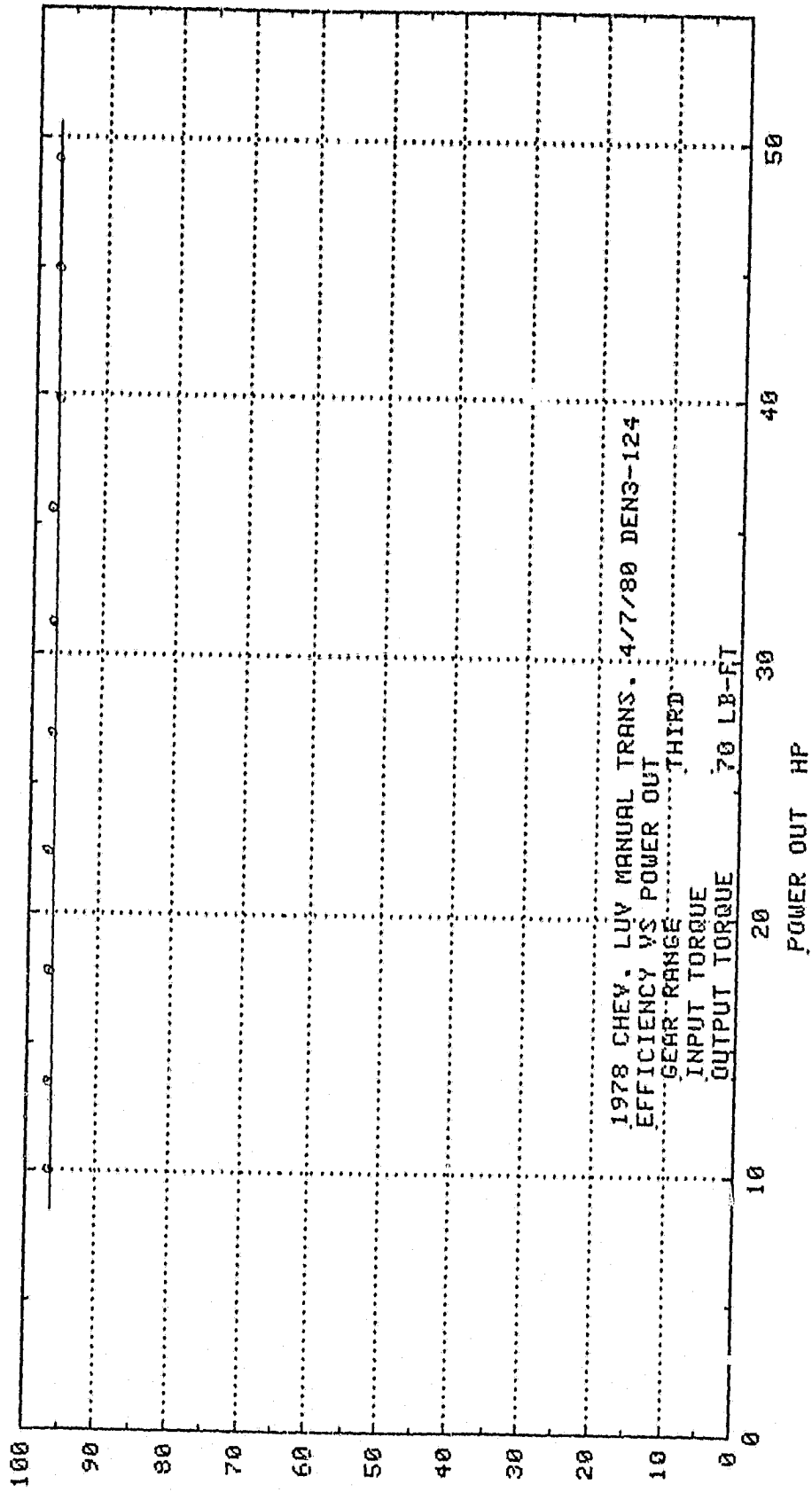

EFFICIENCY %

TORQUE RATIO $\frac{T_o}{T_i}$

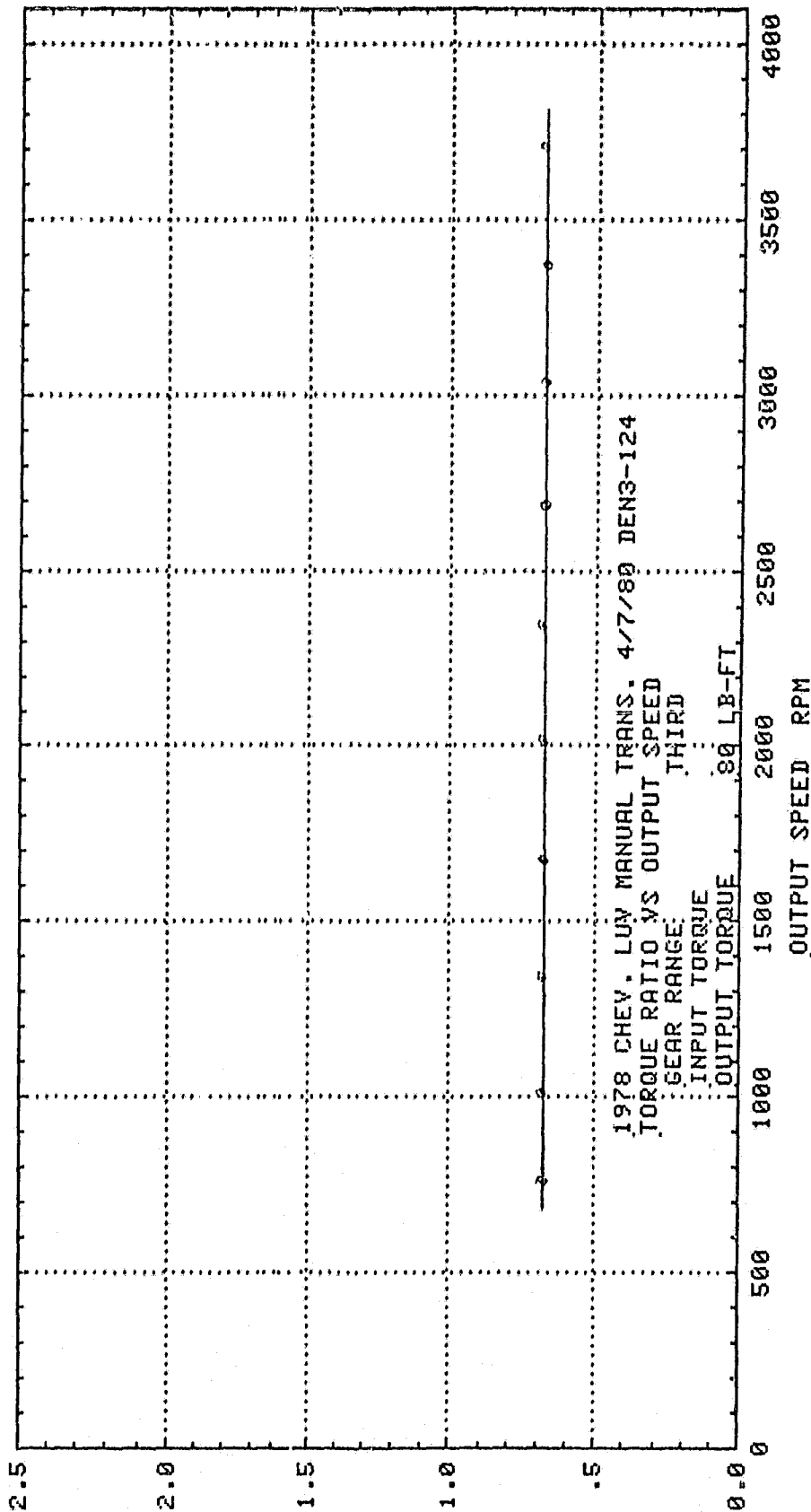

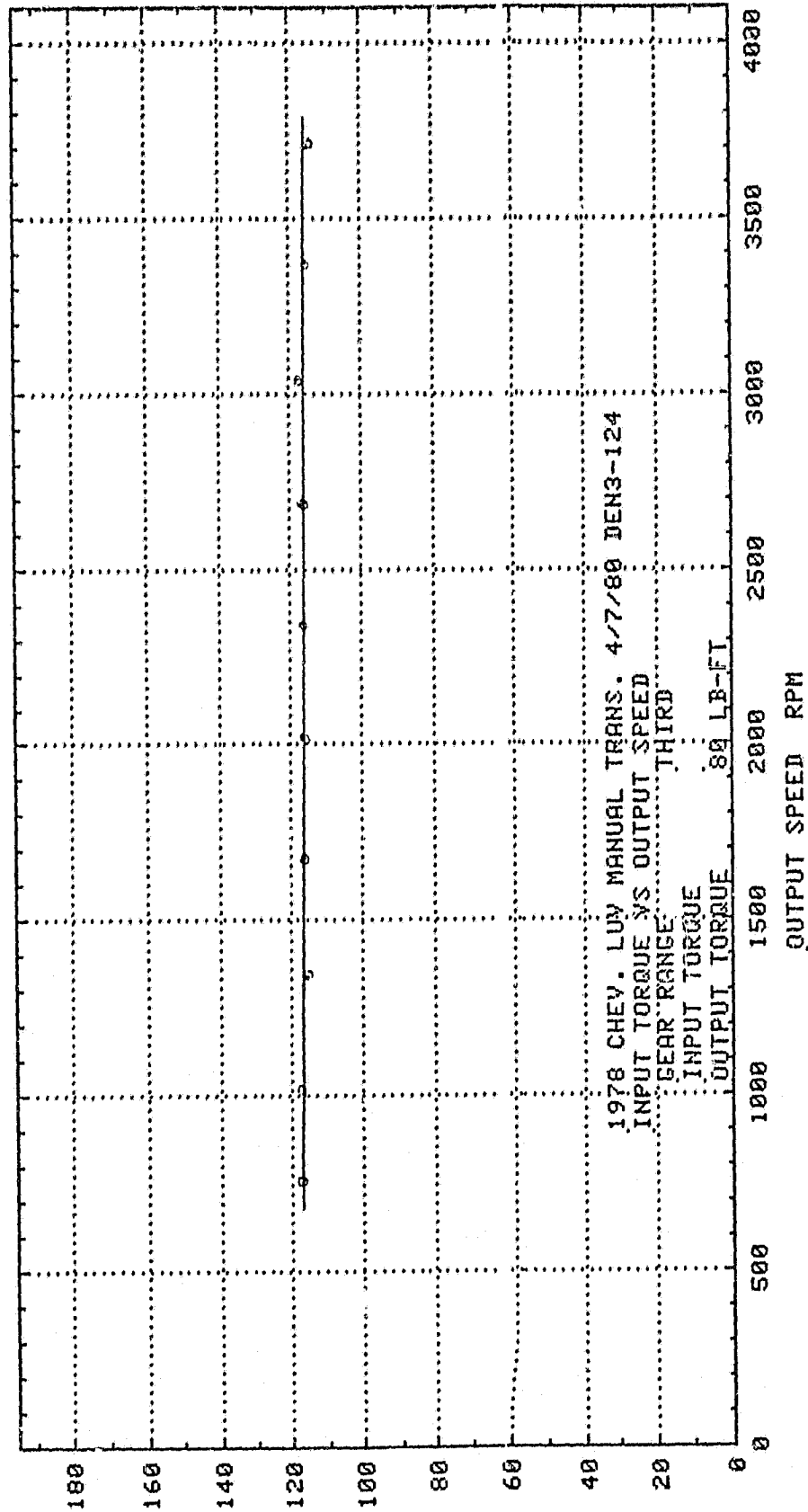

INPUT TORQUE LB FT

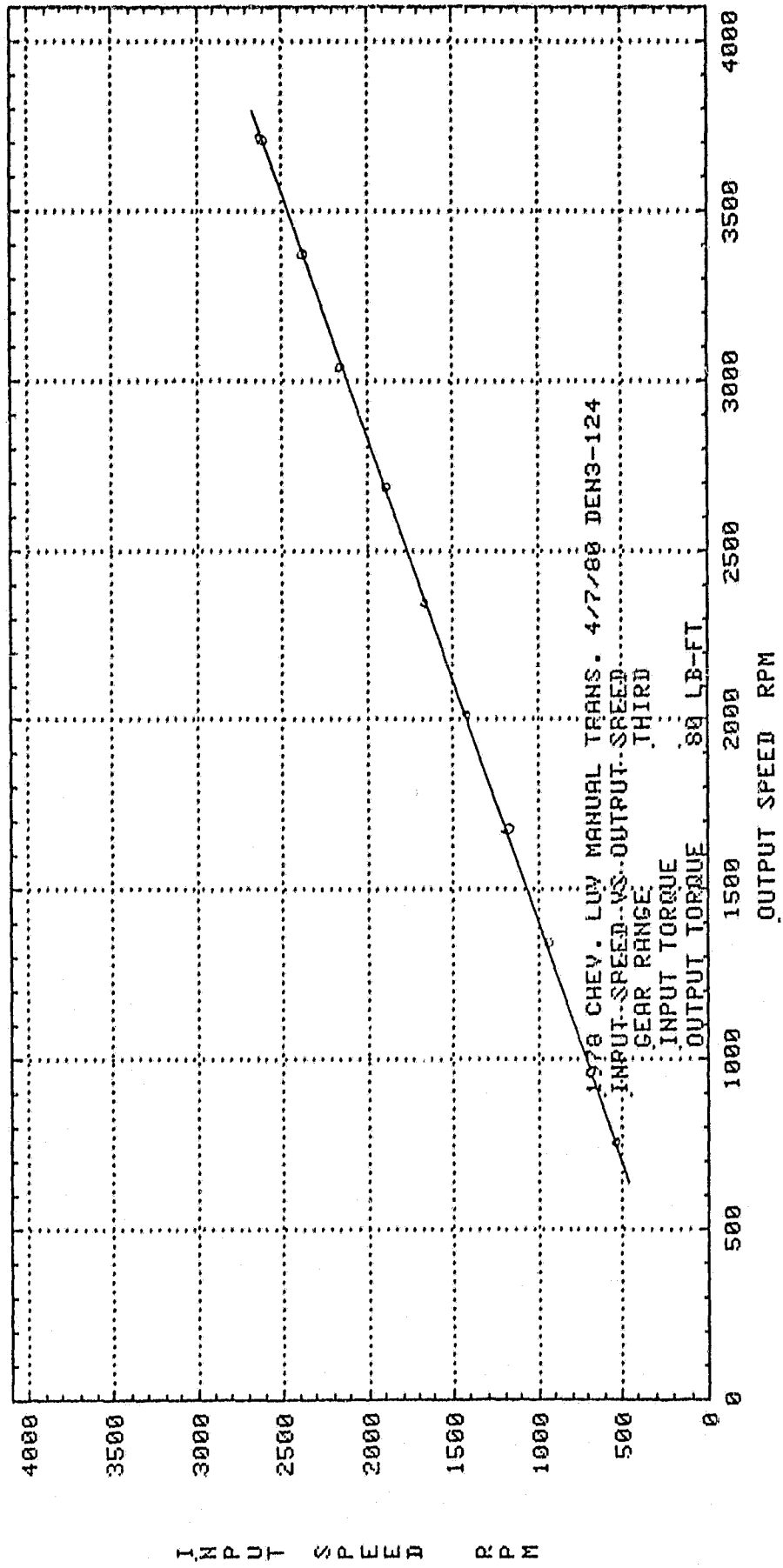

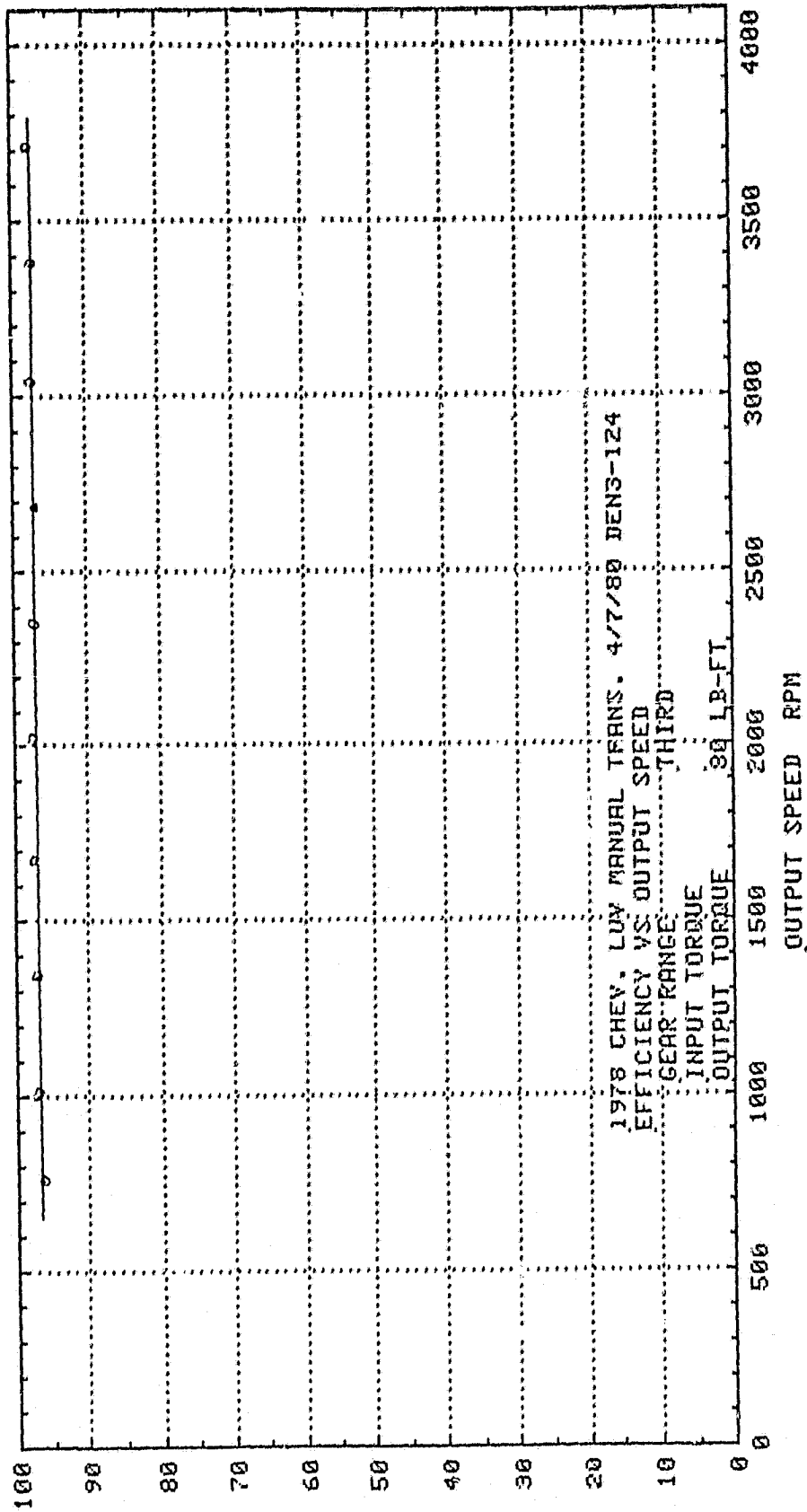

EFFICIENCY %

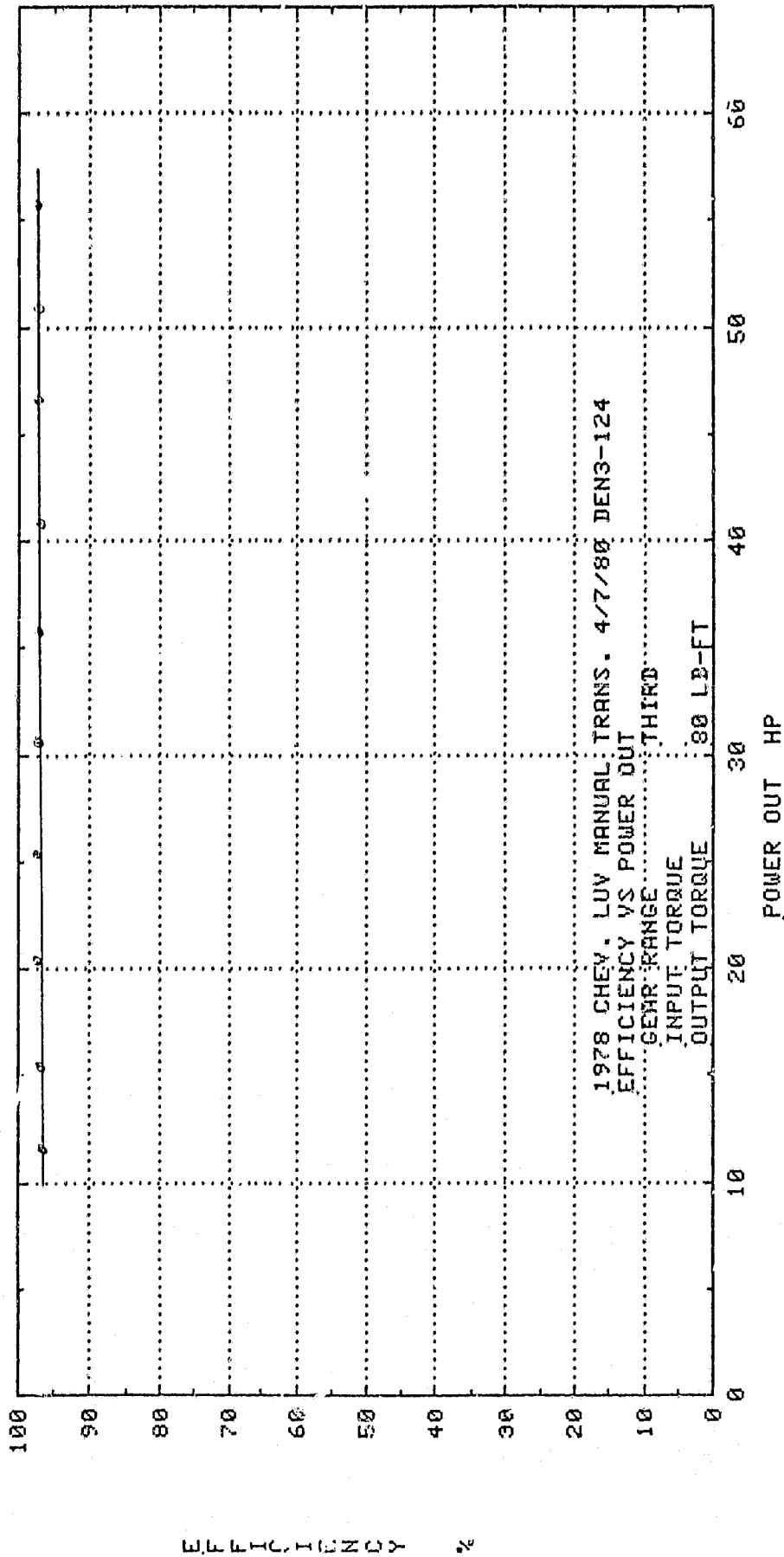

COAST PERFORMANCE

4TH GEAR

Graphs Contained in This Section

- Torque Ratio -vs- Output Speed
- Output Torque -vs- Output Speed
- Input Speed -vs- Output Speed
- Efficiency -vs- Output Speed
- Efficiency -vs- Power Out

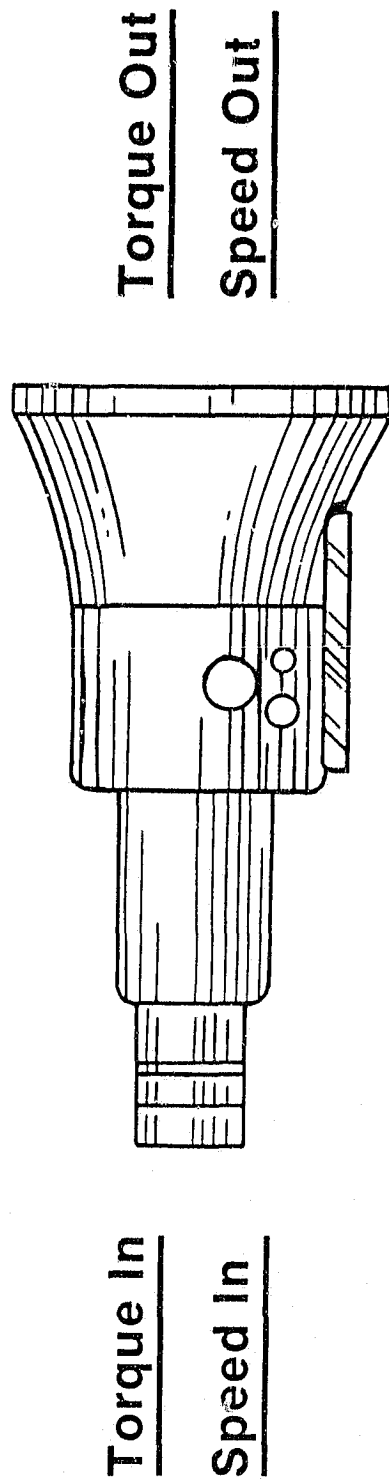

Coast Performance Tests

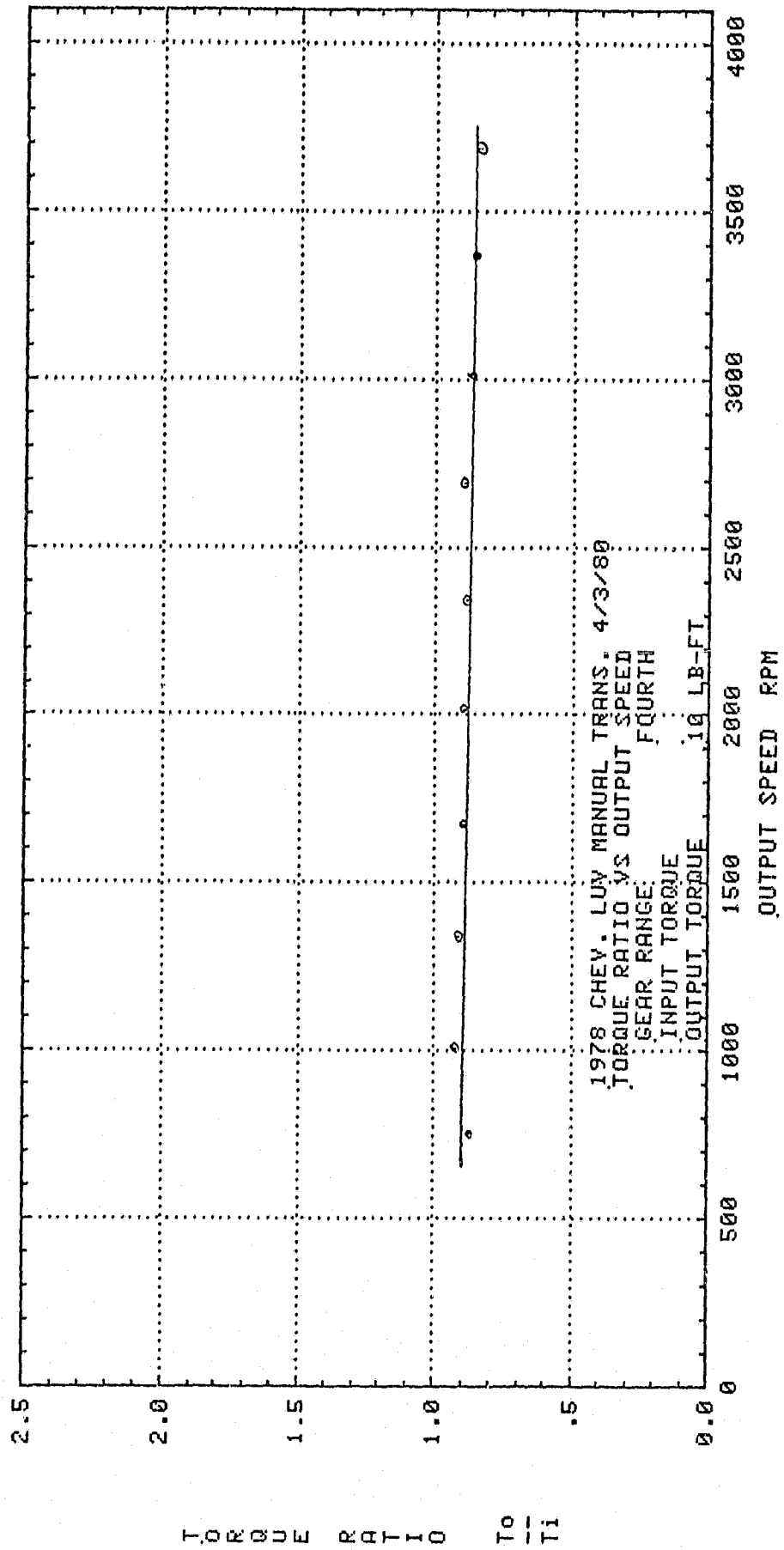

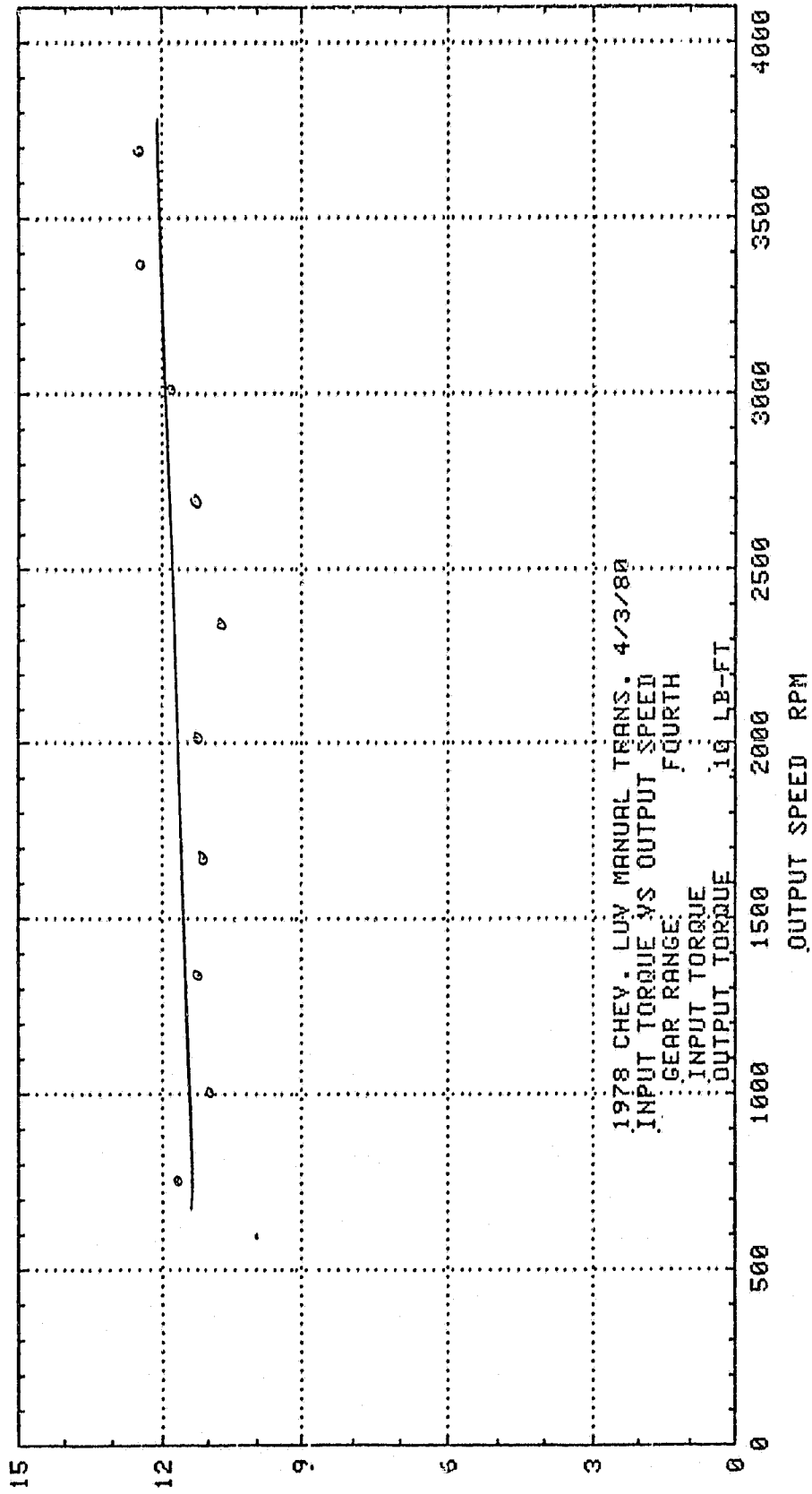

INPUT TORQUE LB FT

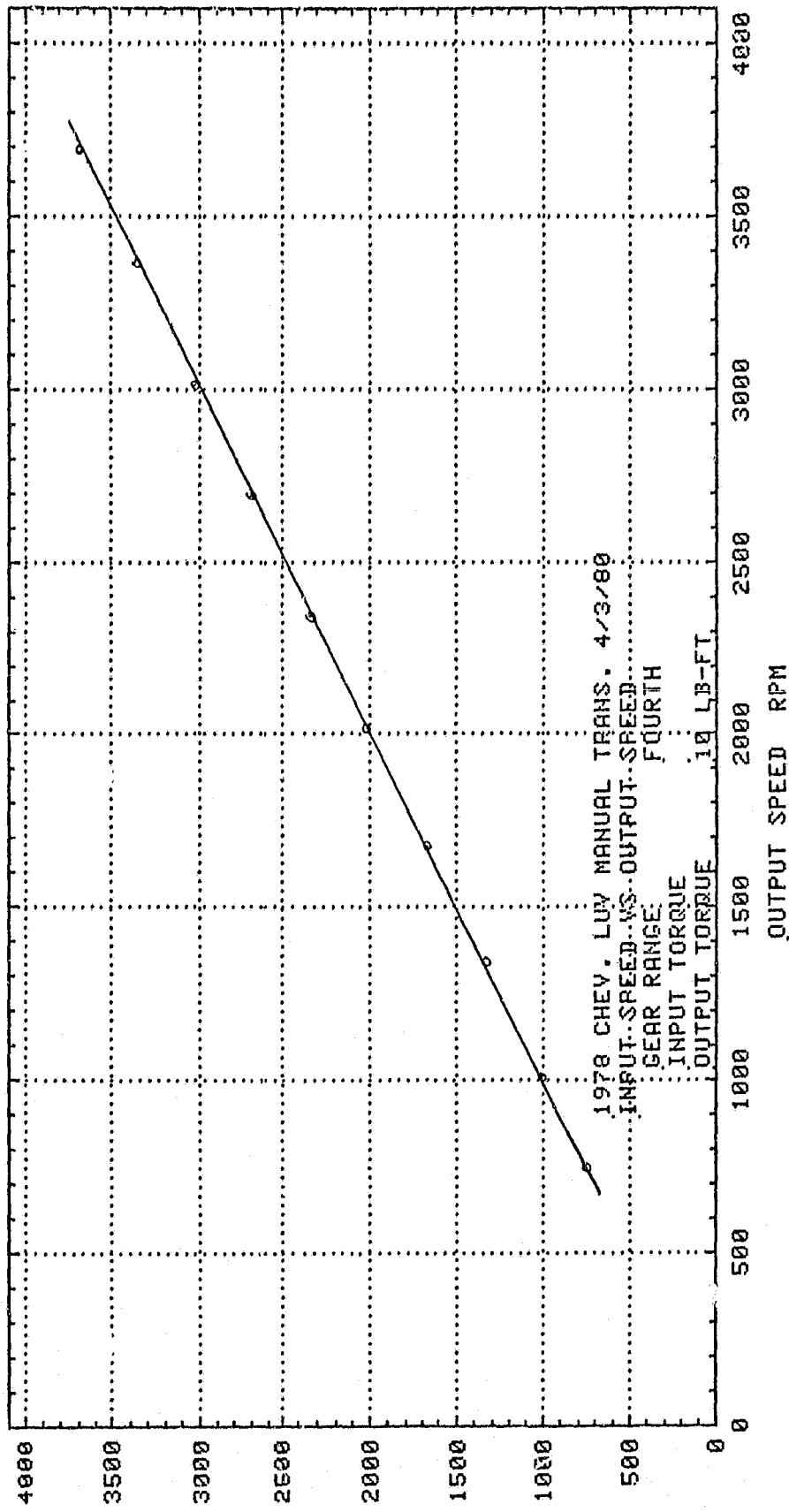

INPUT SPEED RPM

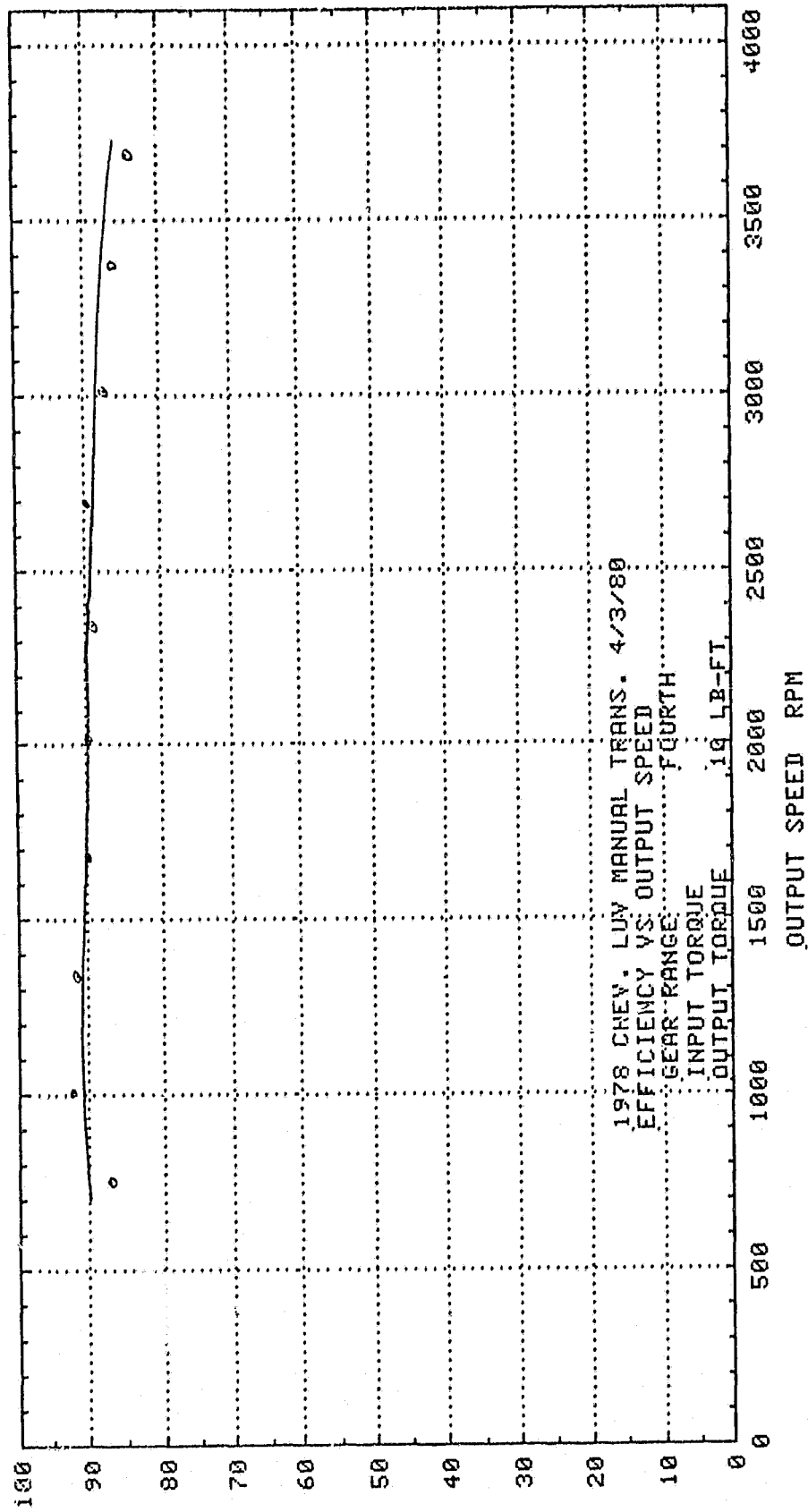

EFFICIENCY %

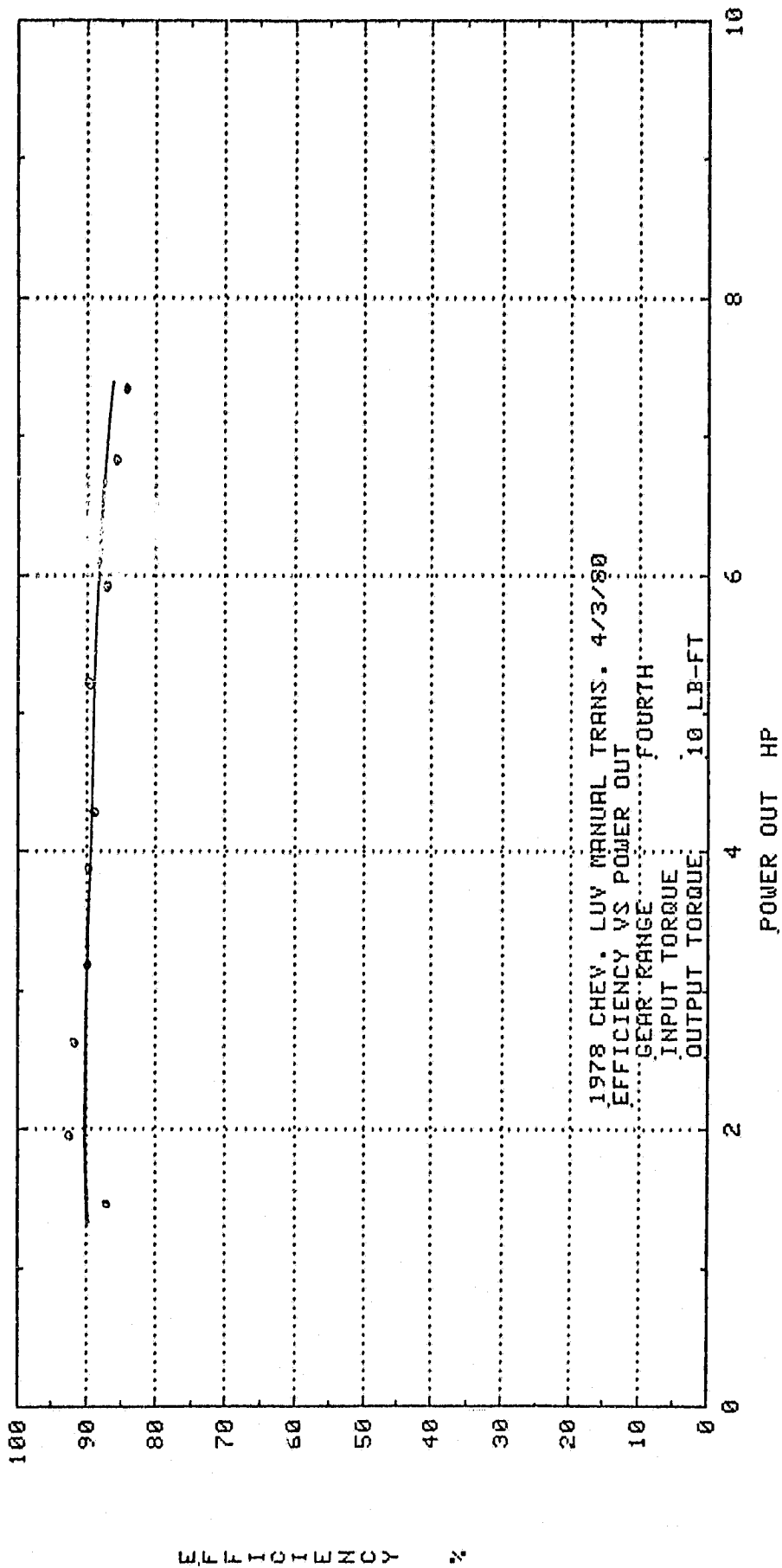

EFFICIENCY %

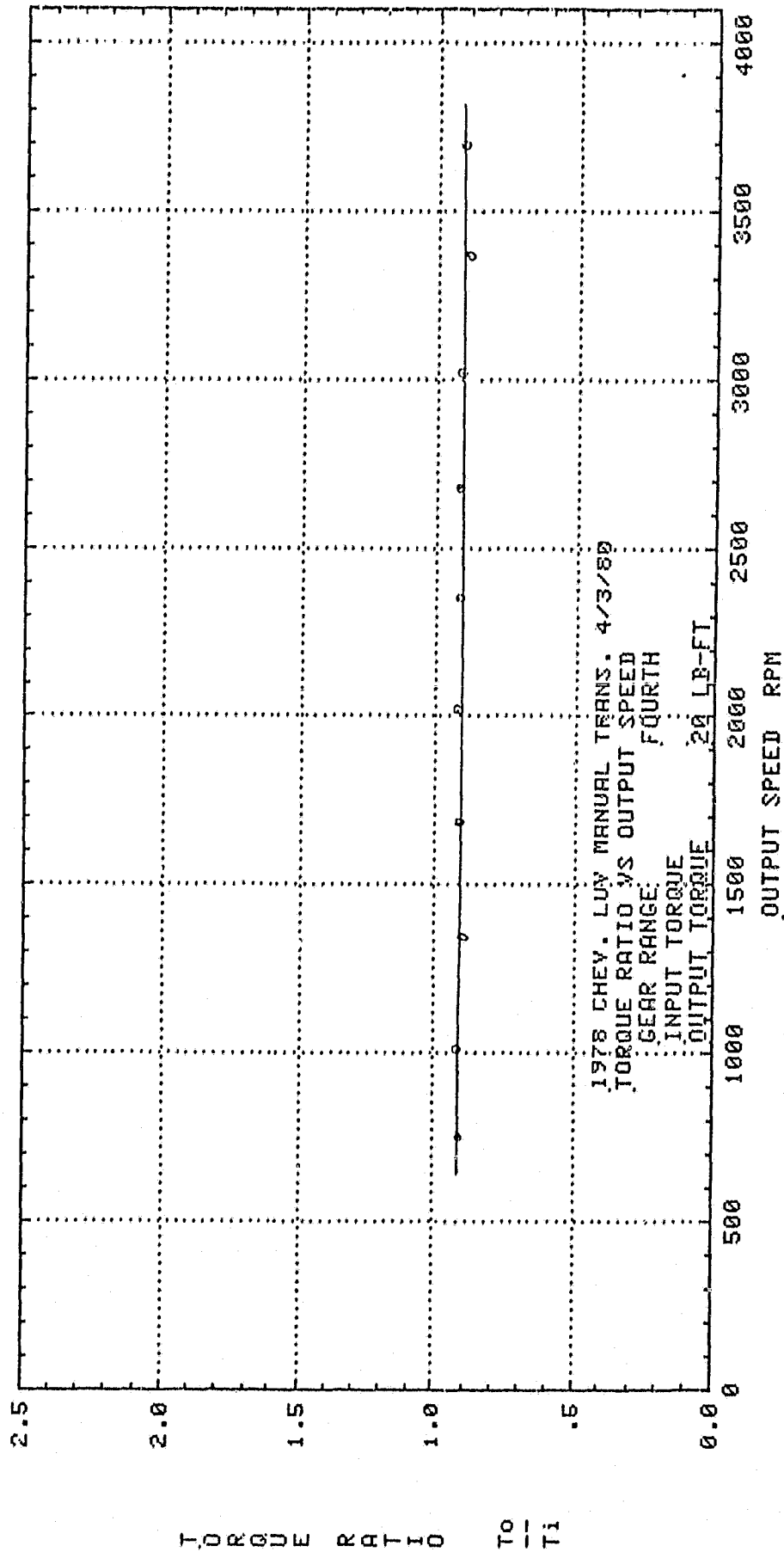

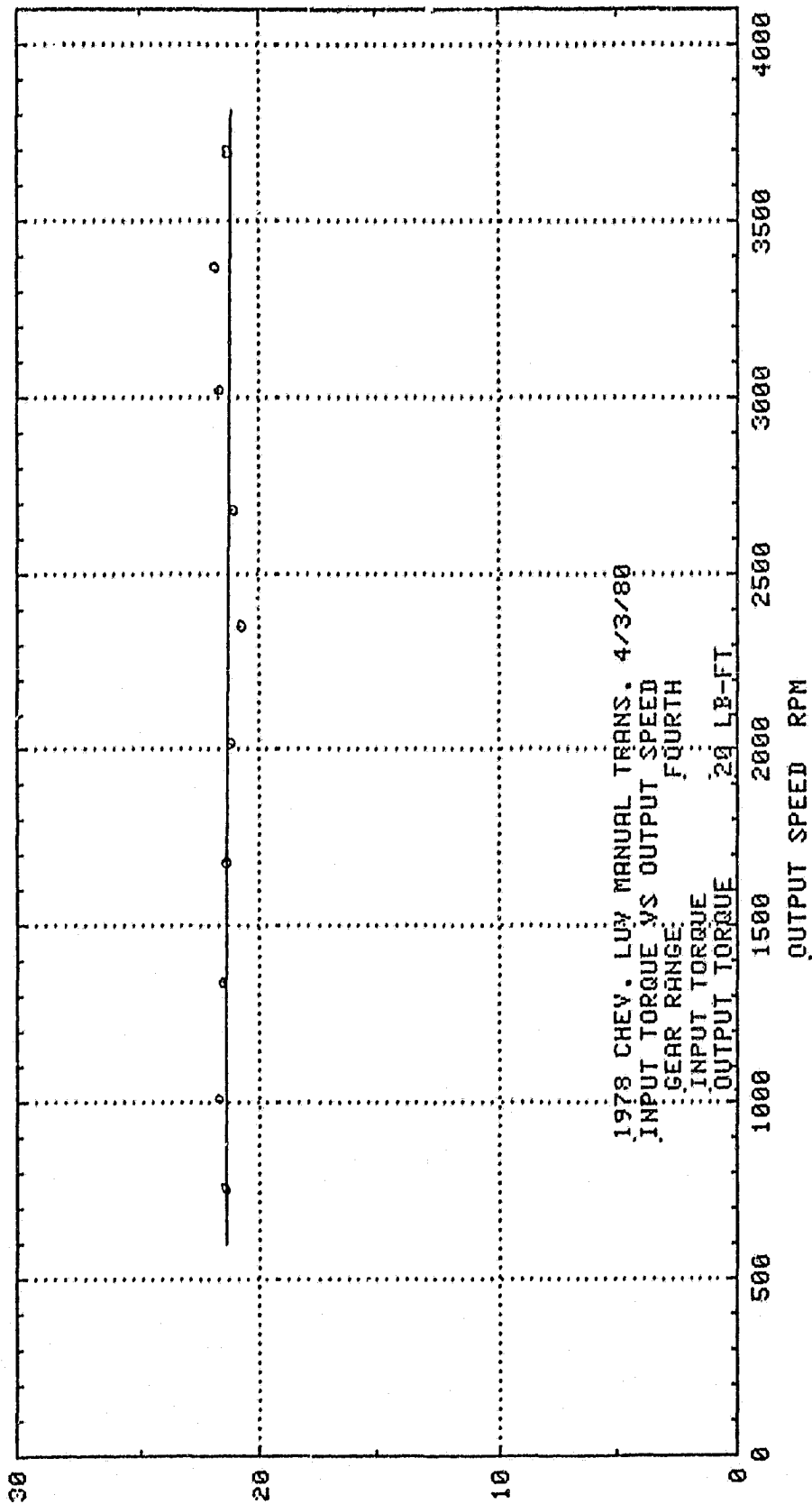

INPUT TORQUE LB FT

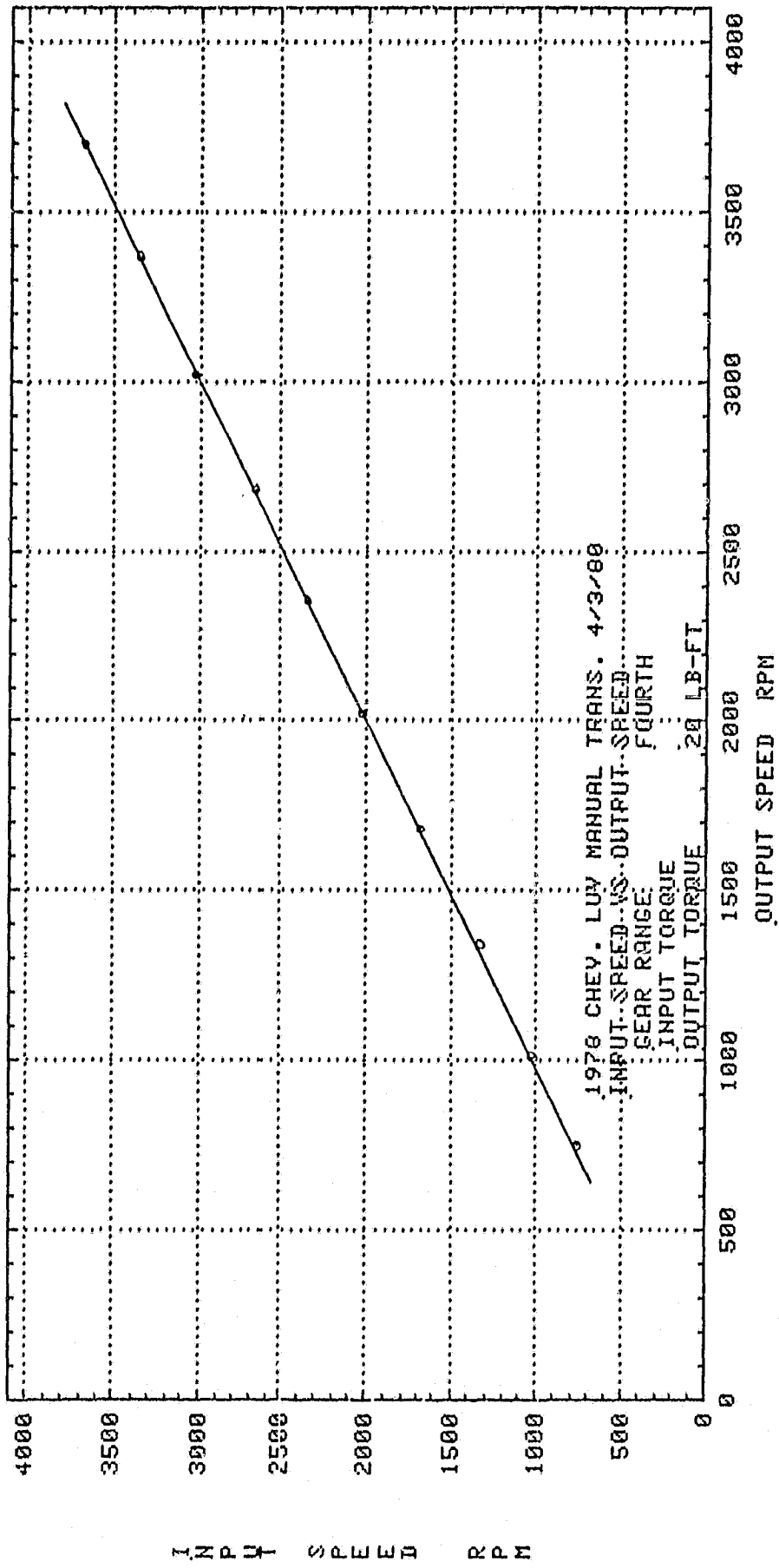

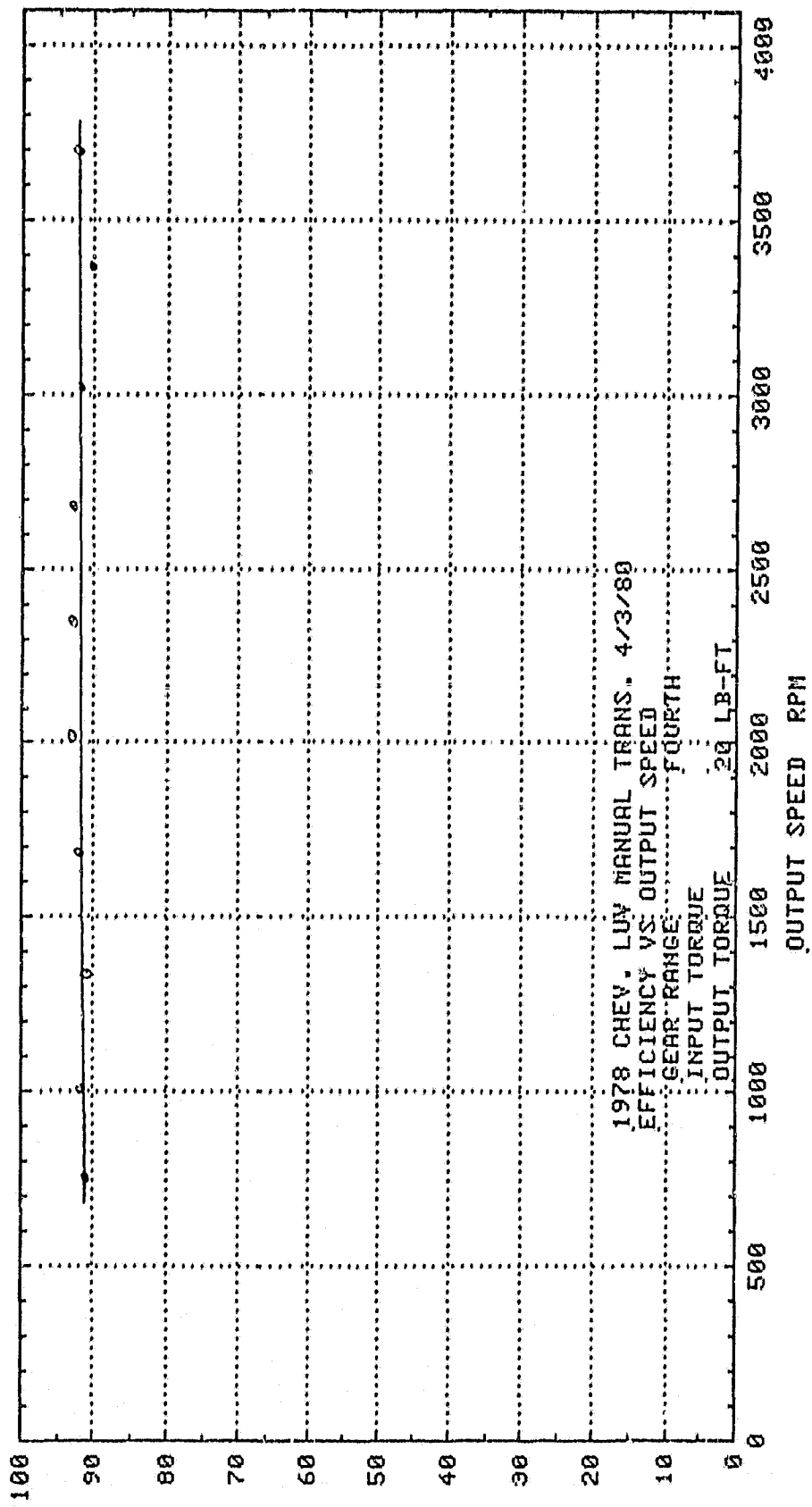

EFFICIENCY %

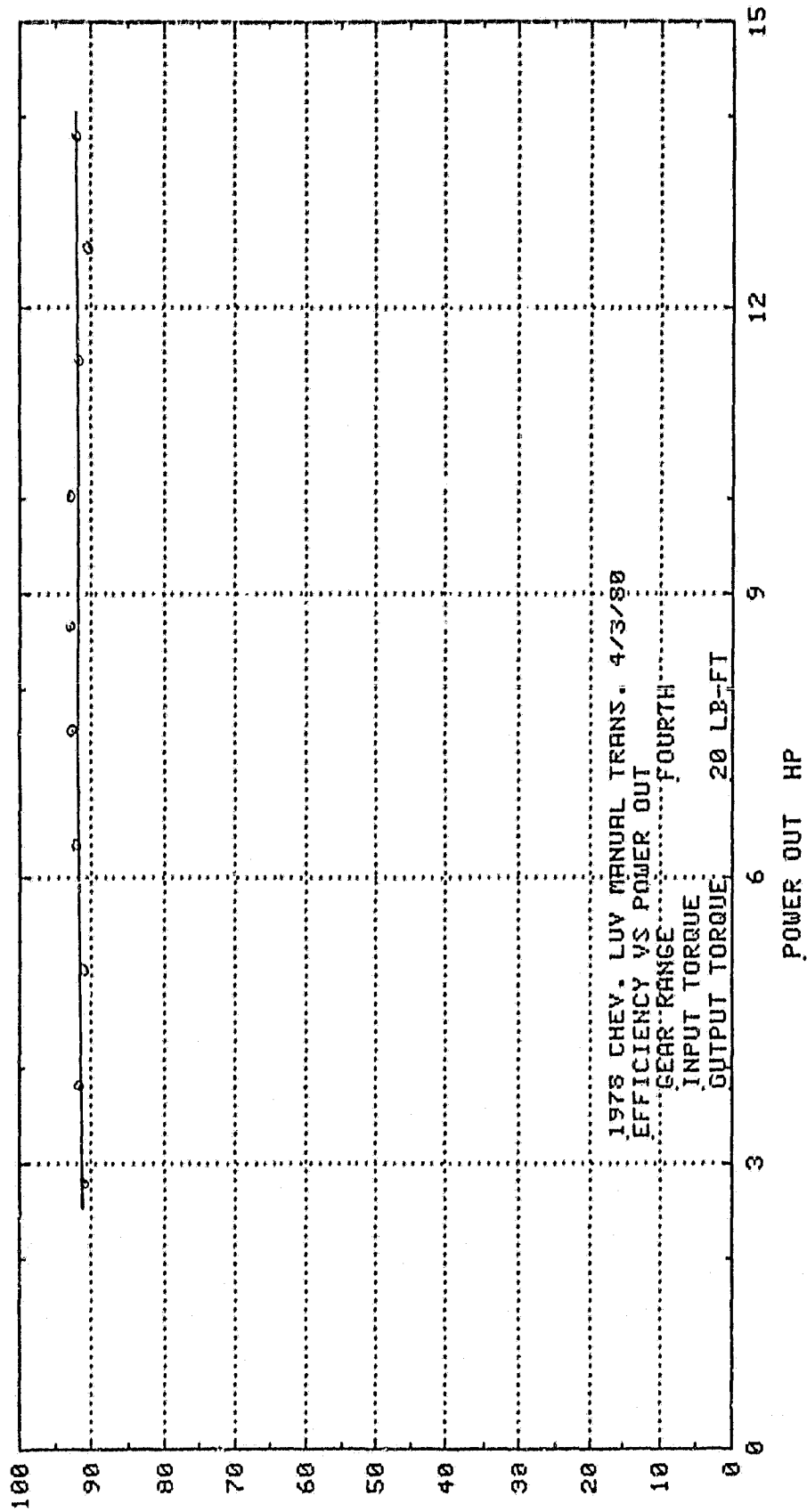

EFFICIENCY %

POWER OUT HP

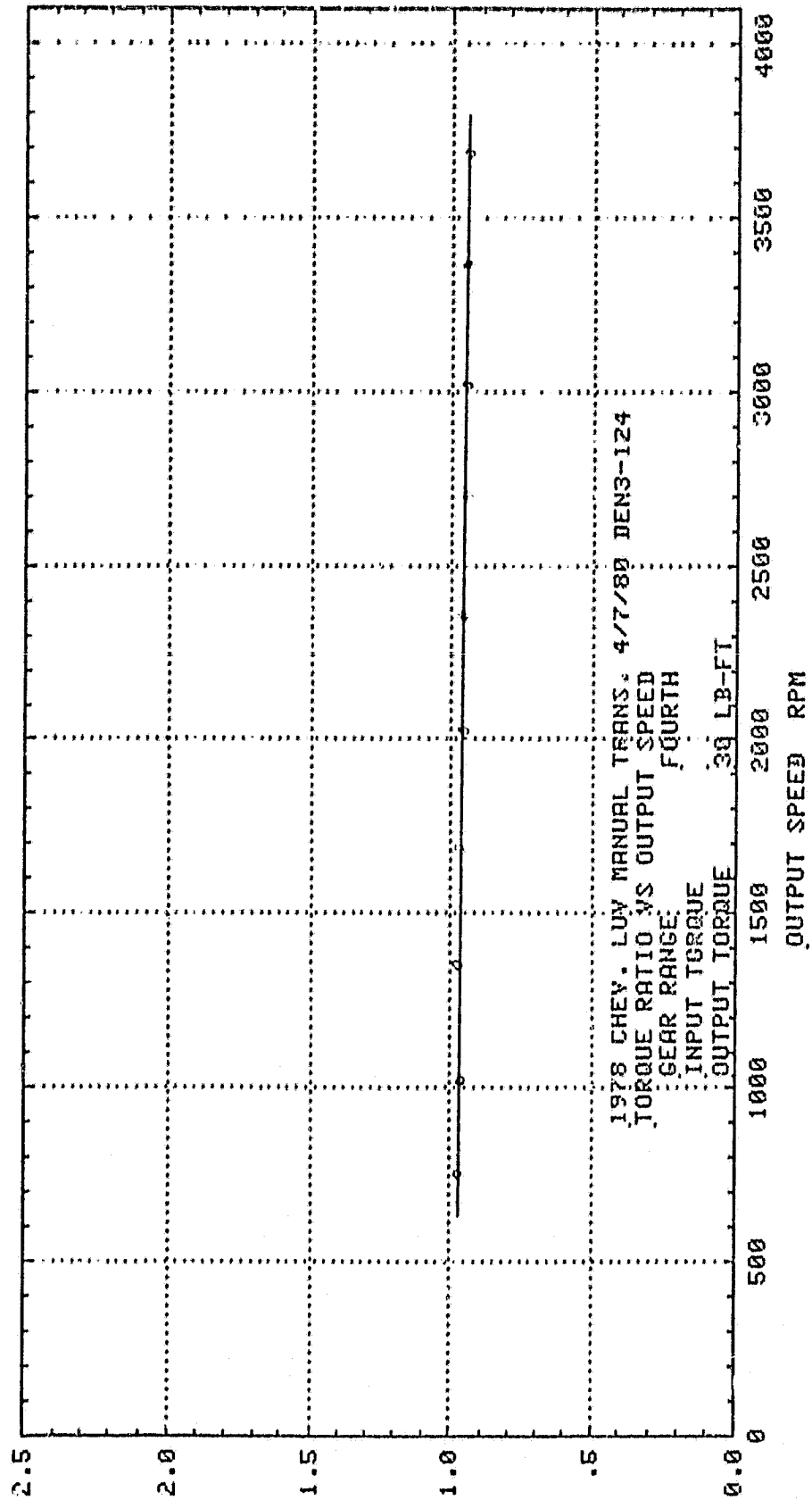

TORQUE RATIO $\frac{T_0}{T_1}$

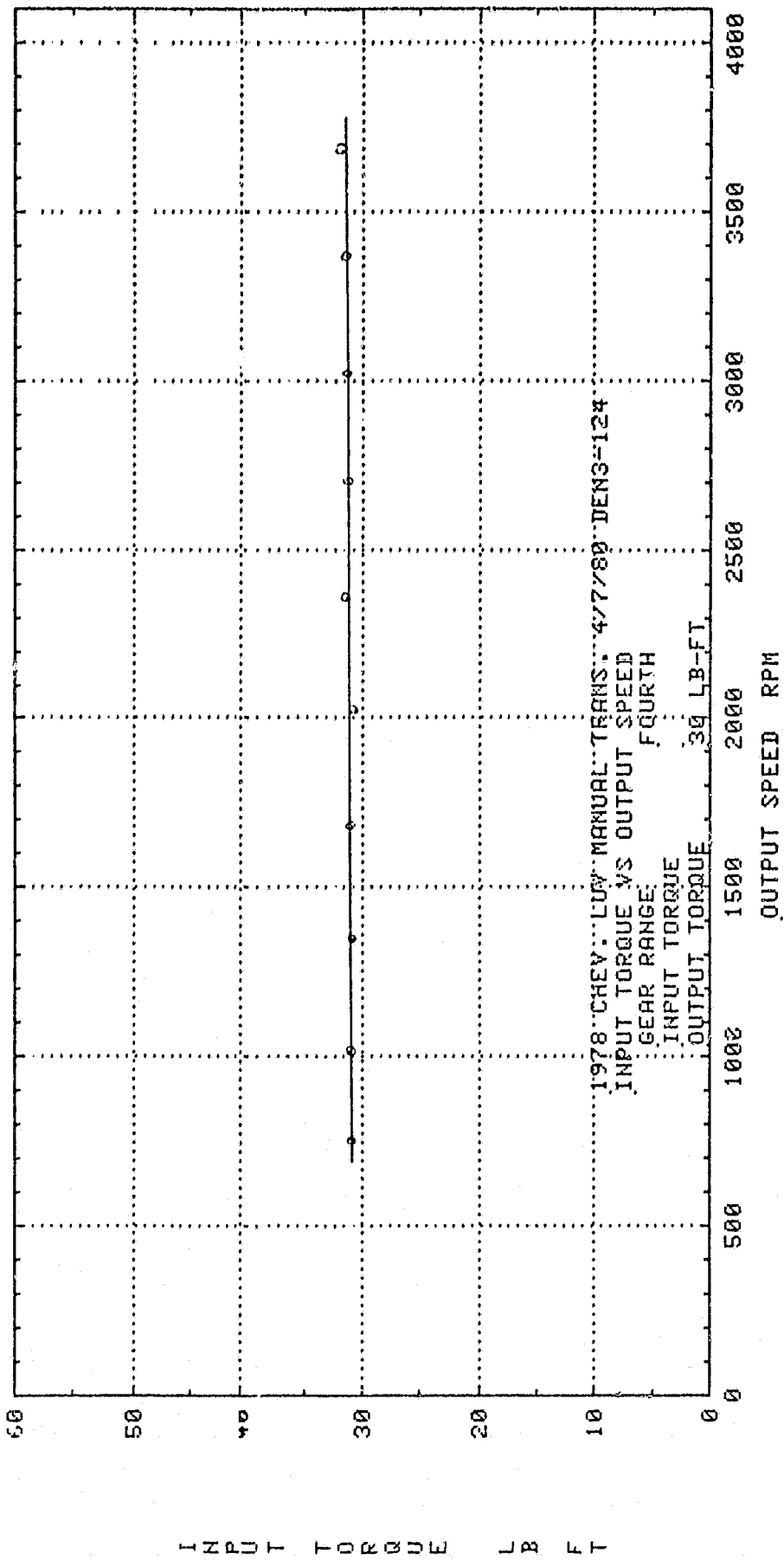

INPUT TORQUE LB FT

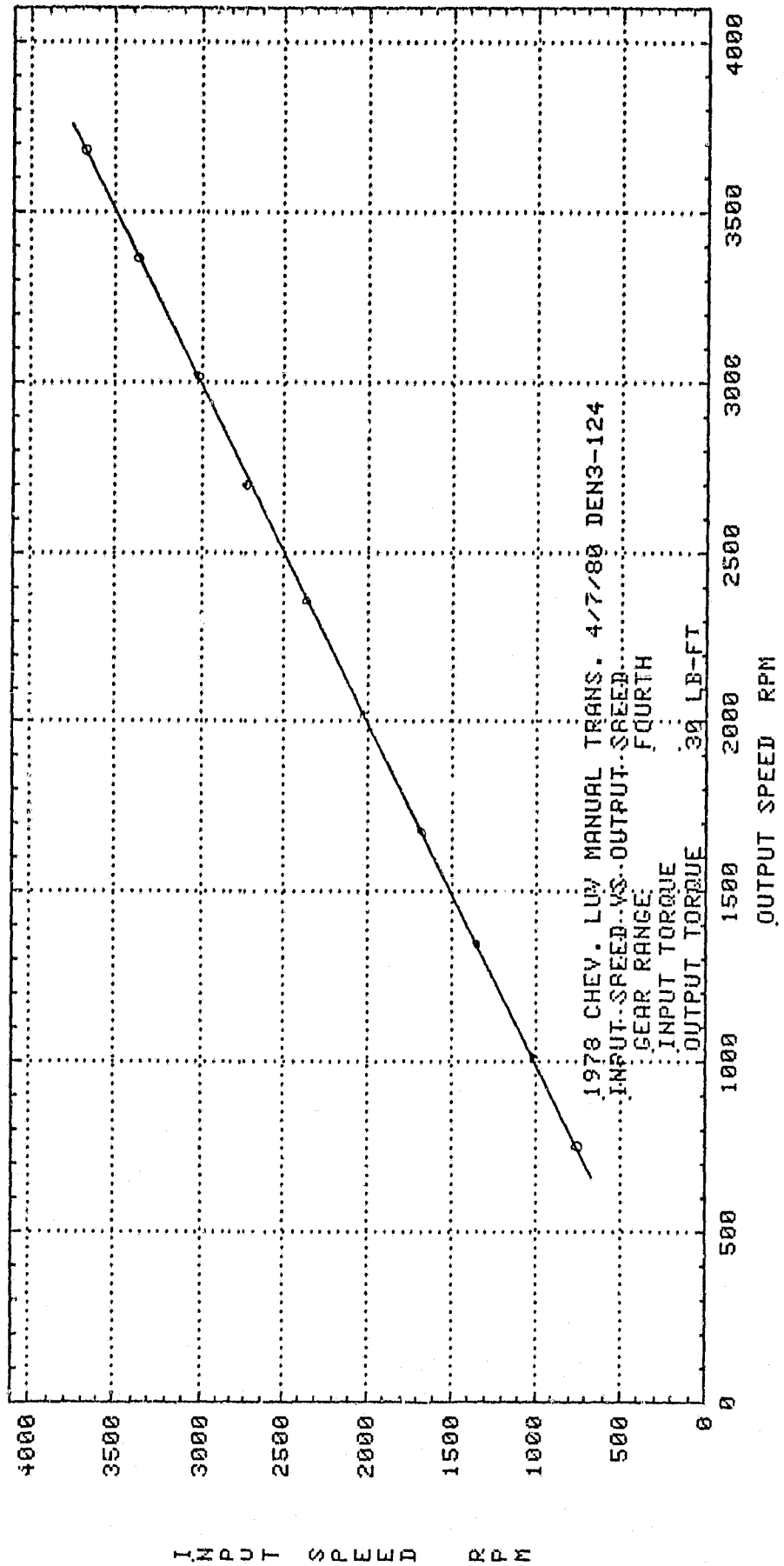

E F F I C I E N C Y %

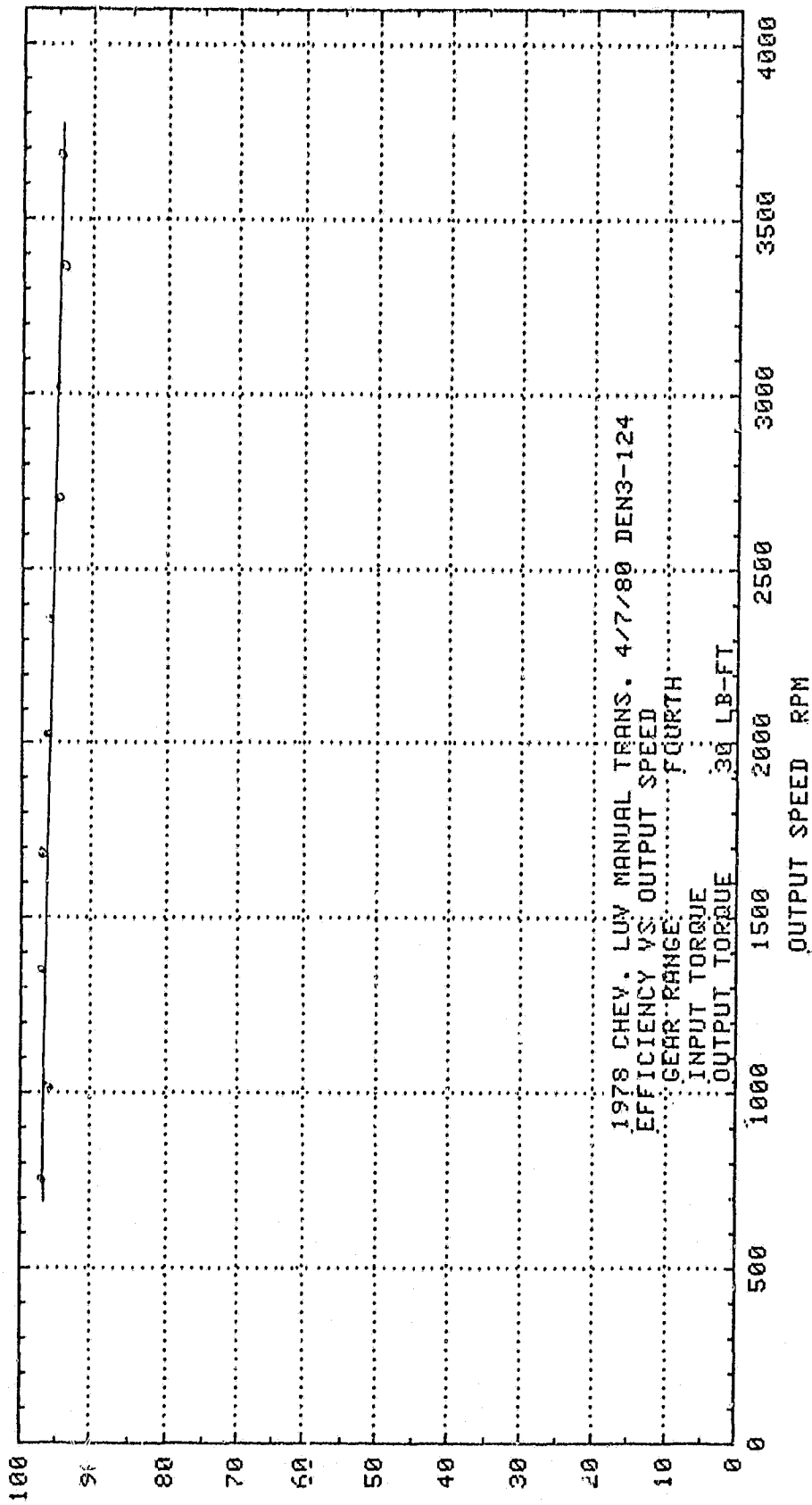

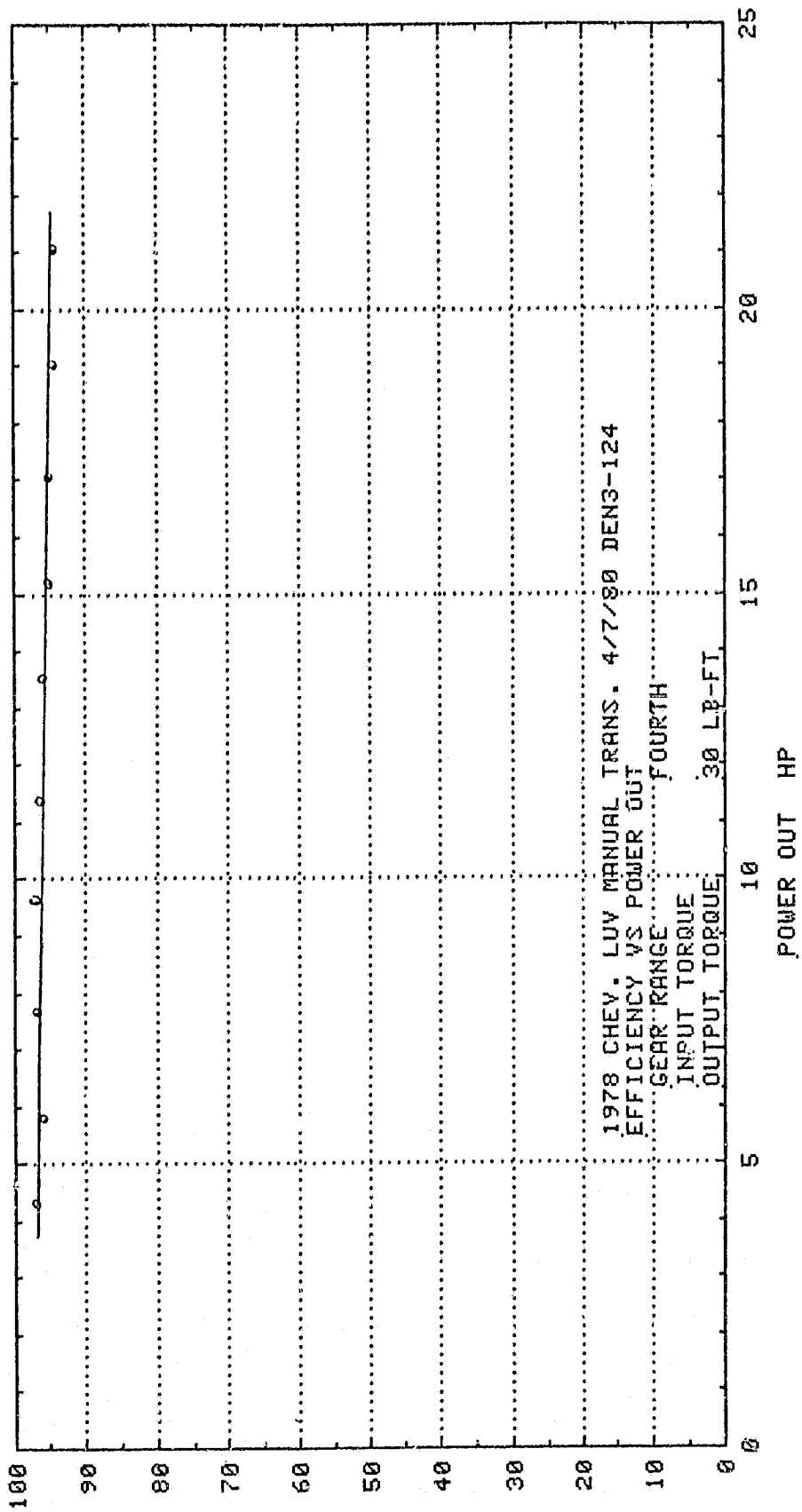

EFFICIENCY %

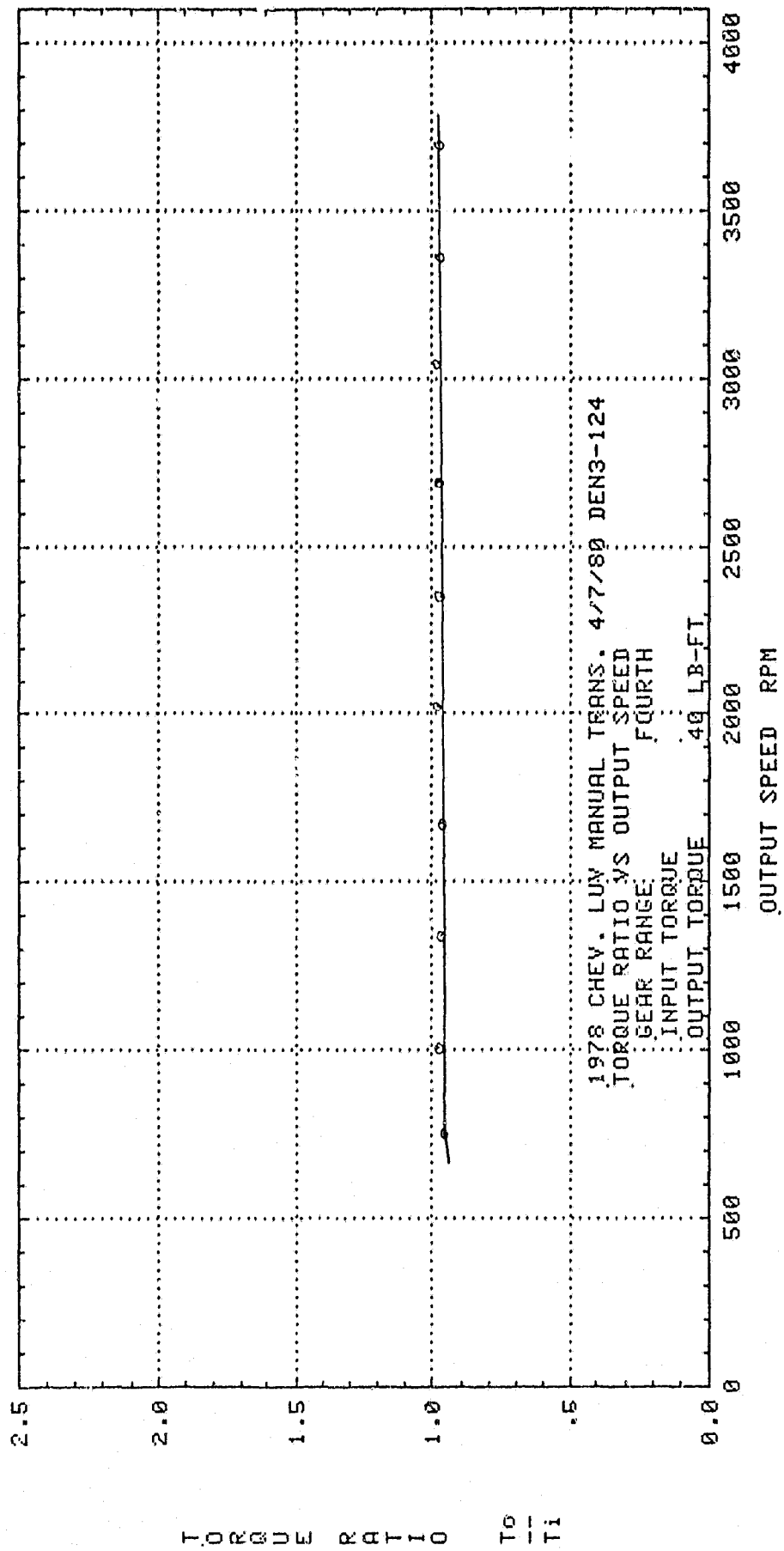

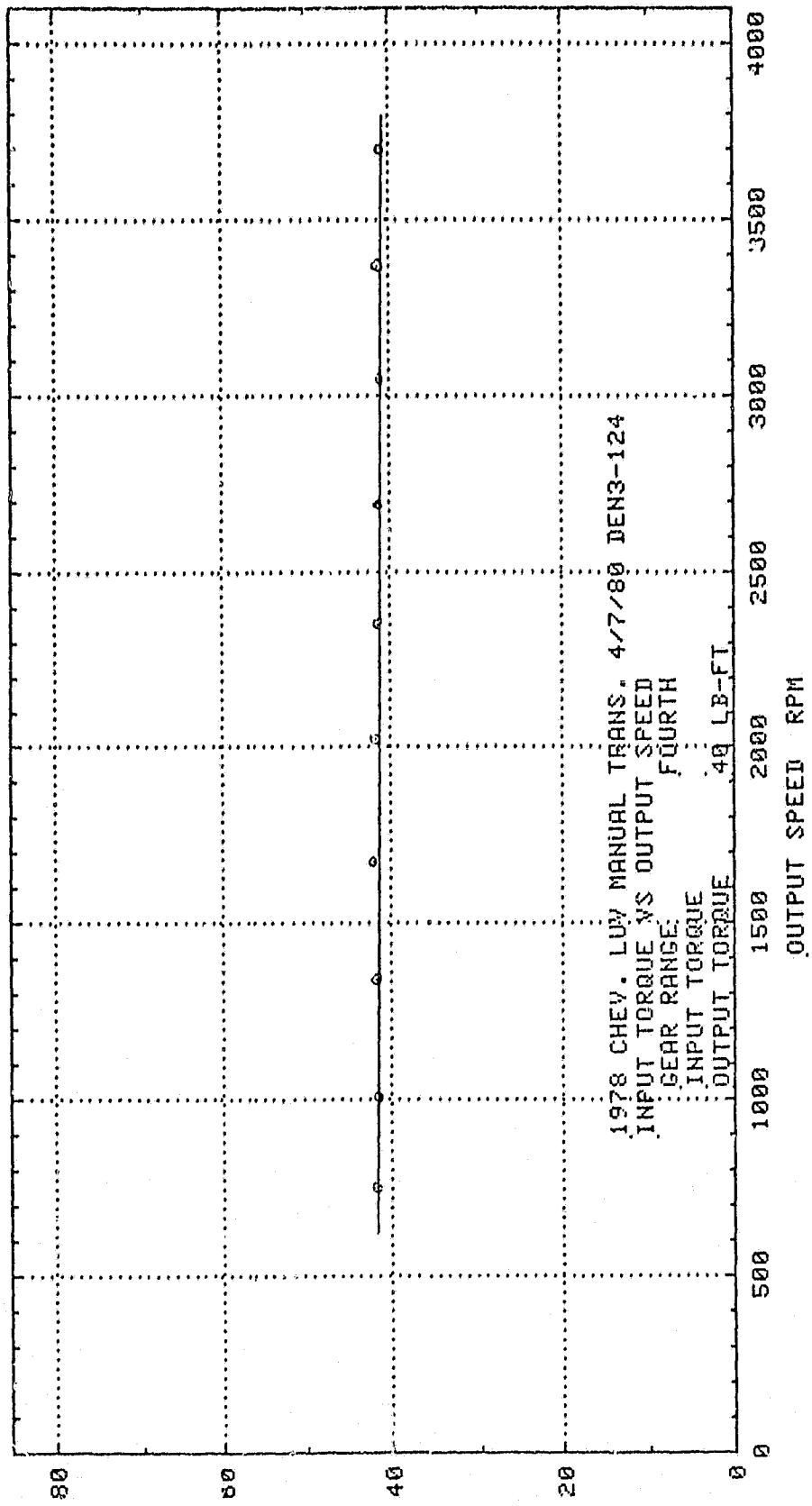

INPUT TORQUE LB FT

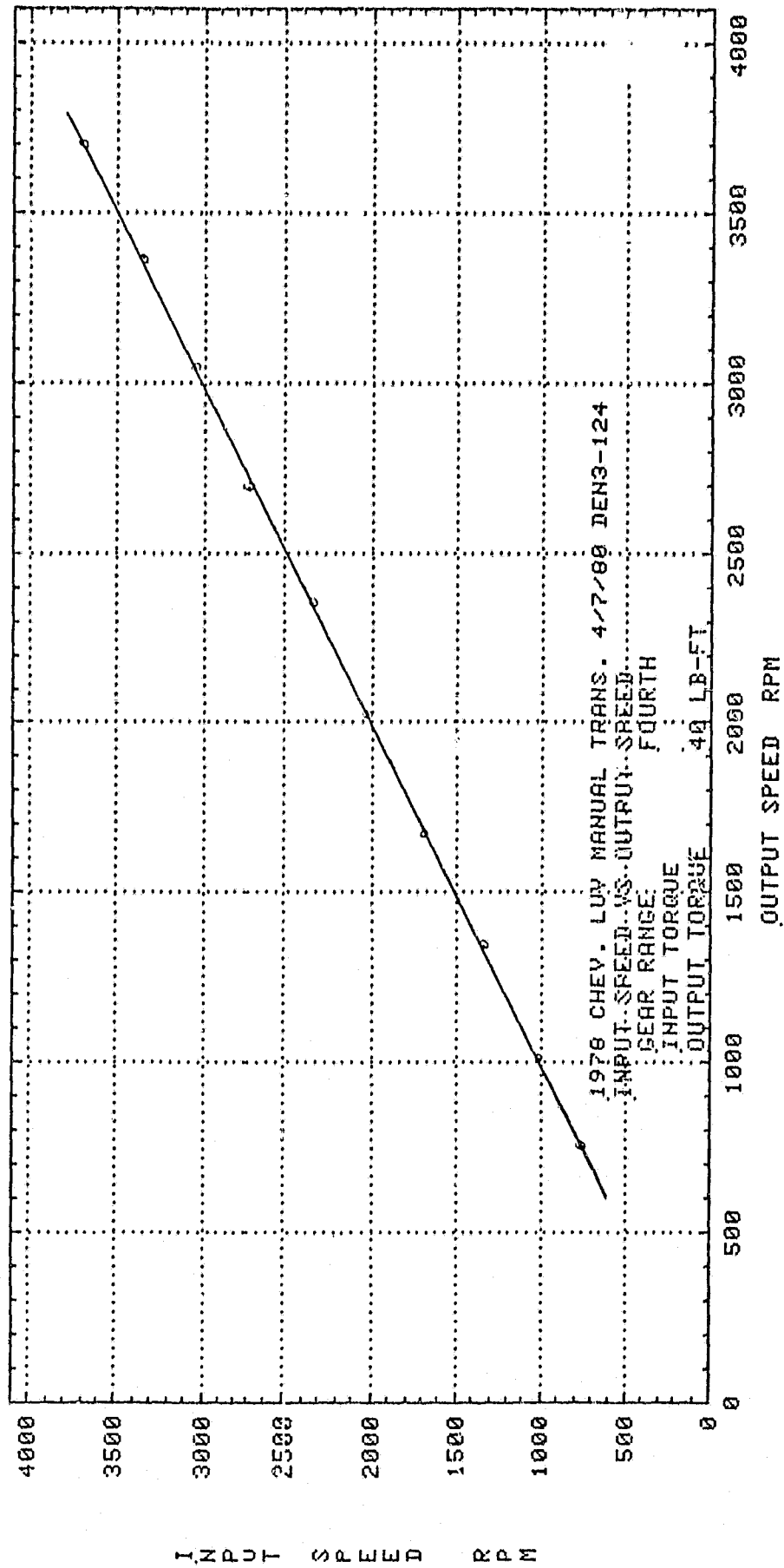

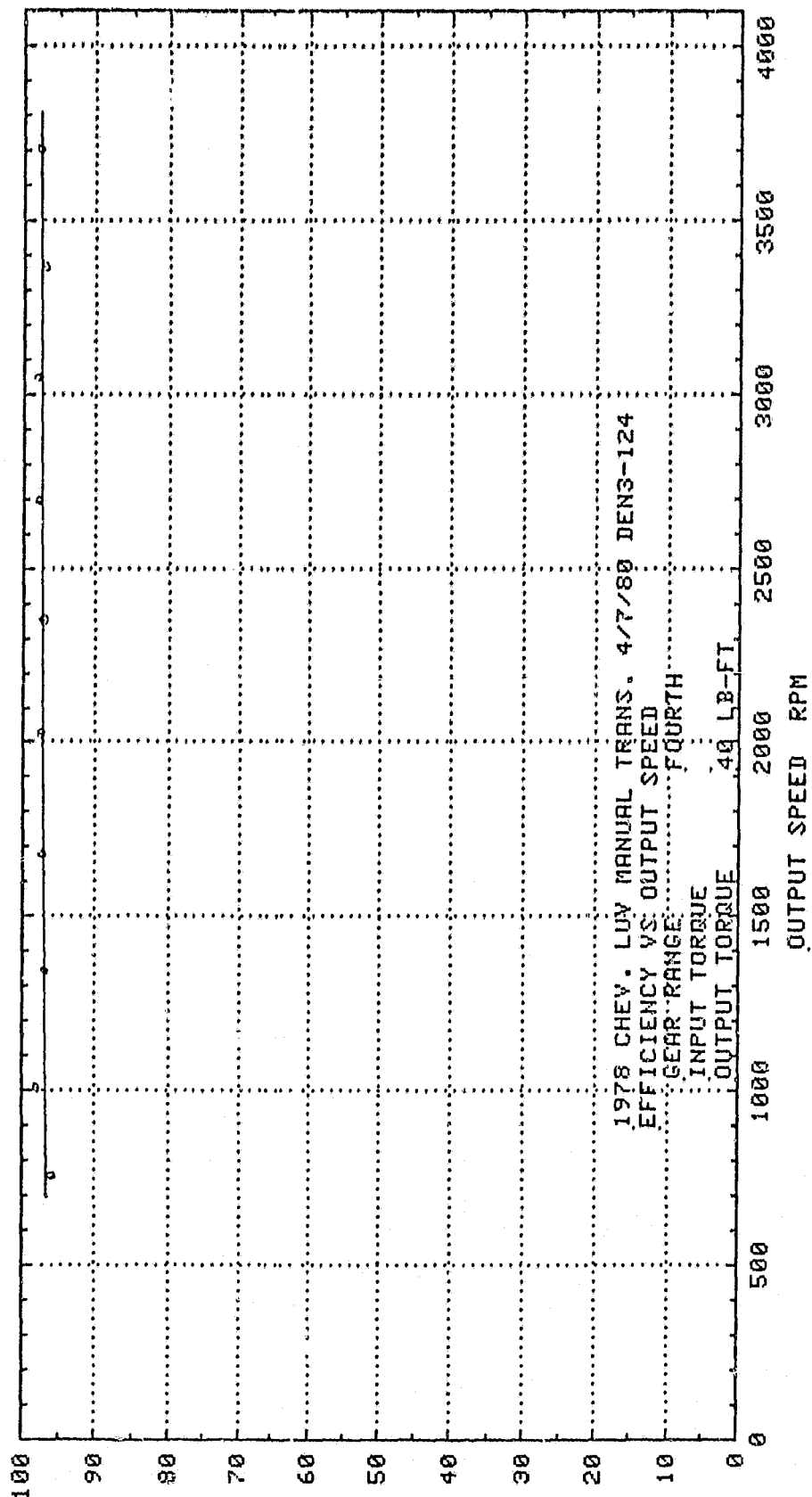

EFFICIENCY %

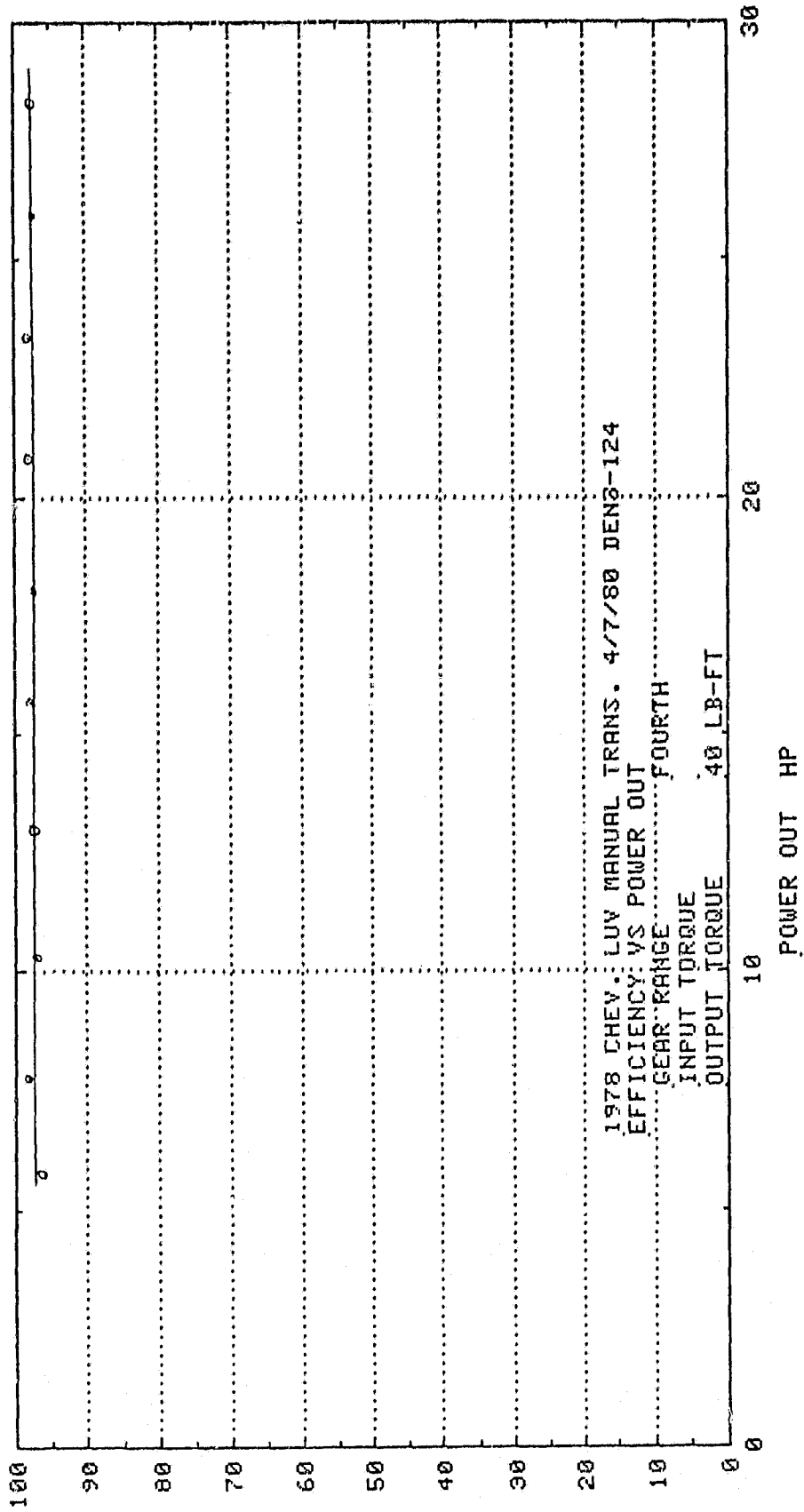

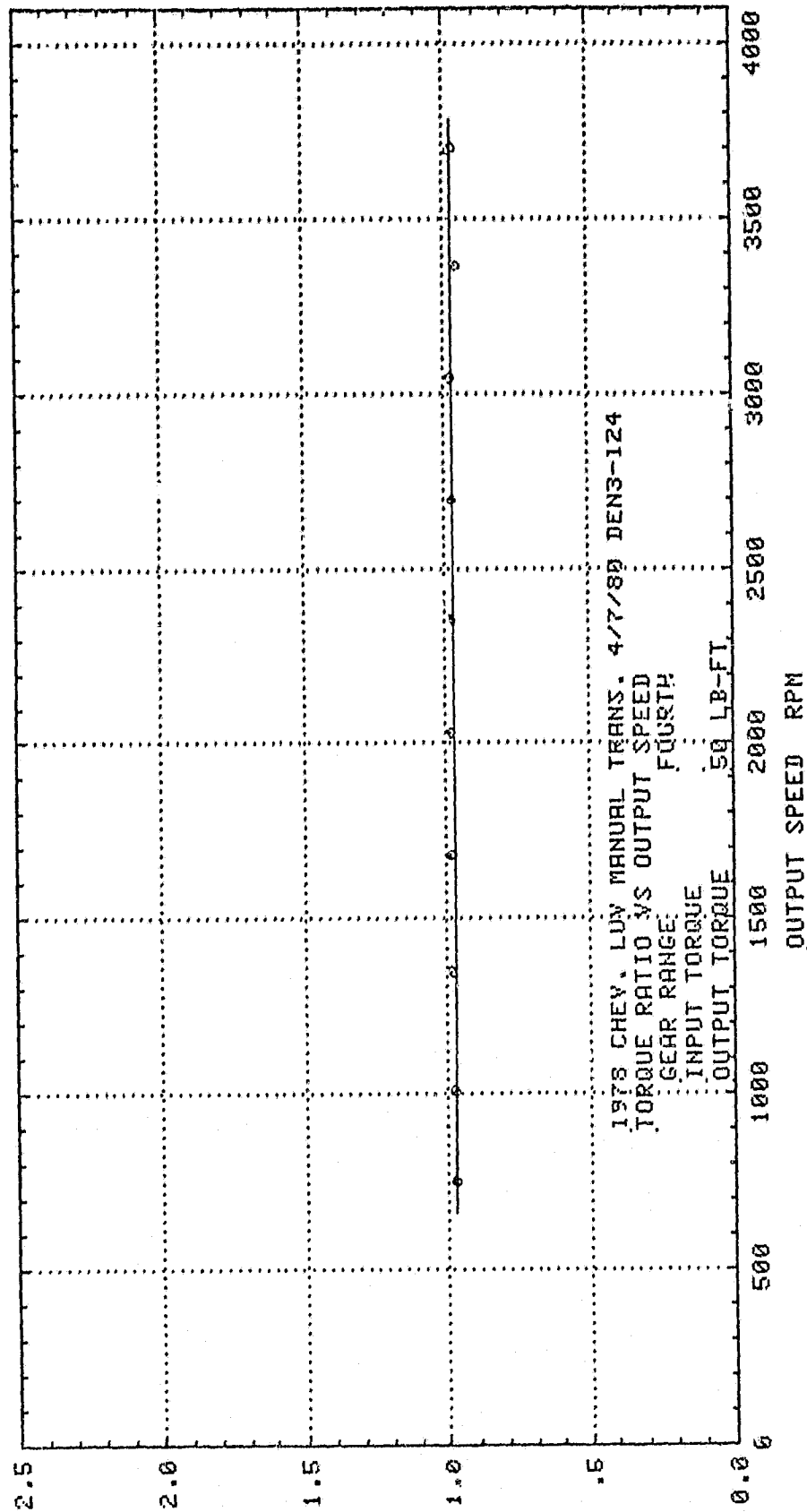

TORQUE RATIO $\frac{T_o}{T_i}$

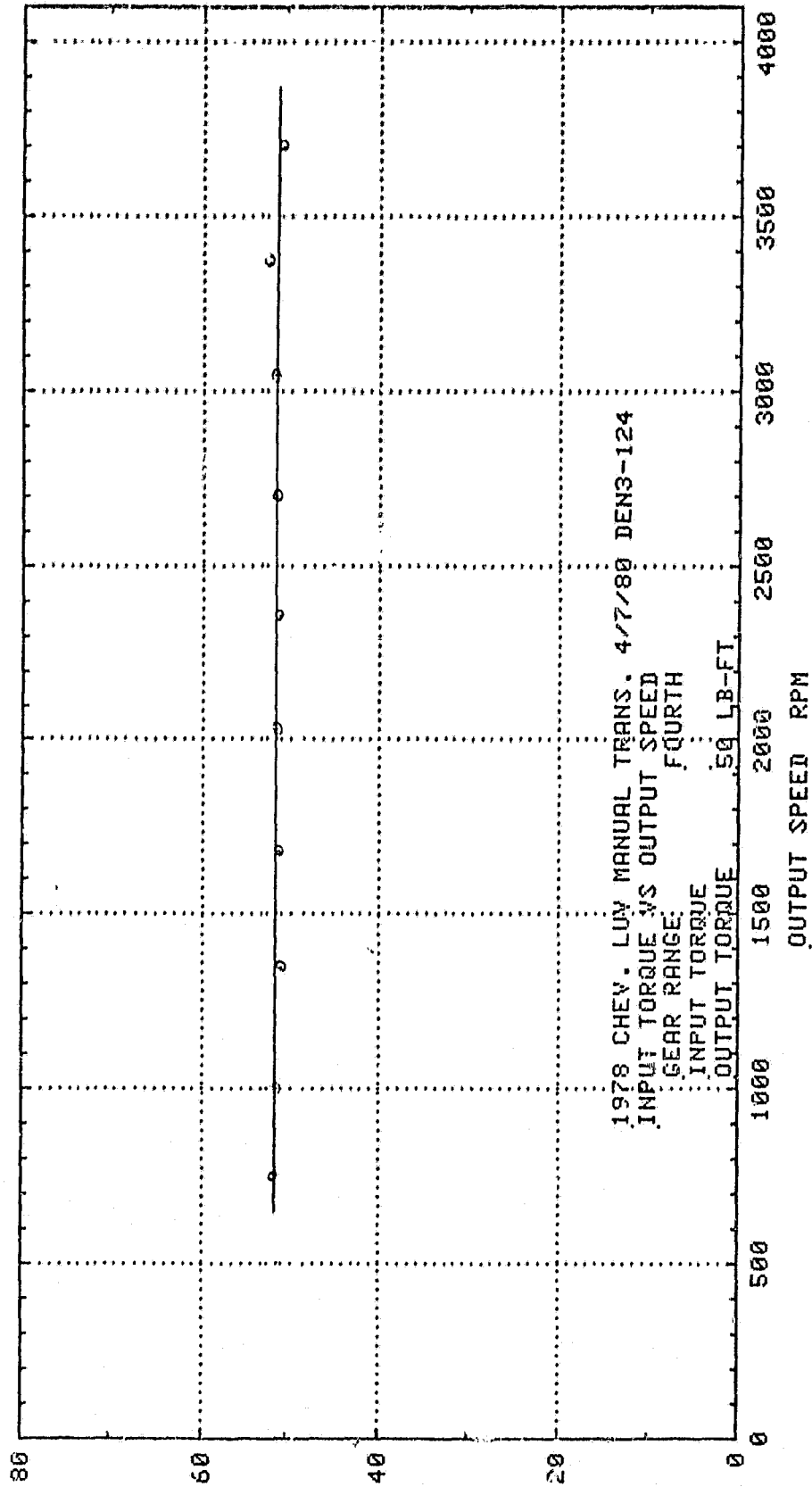

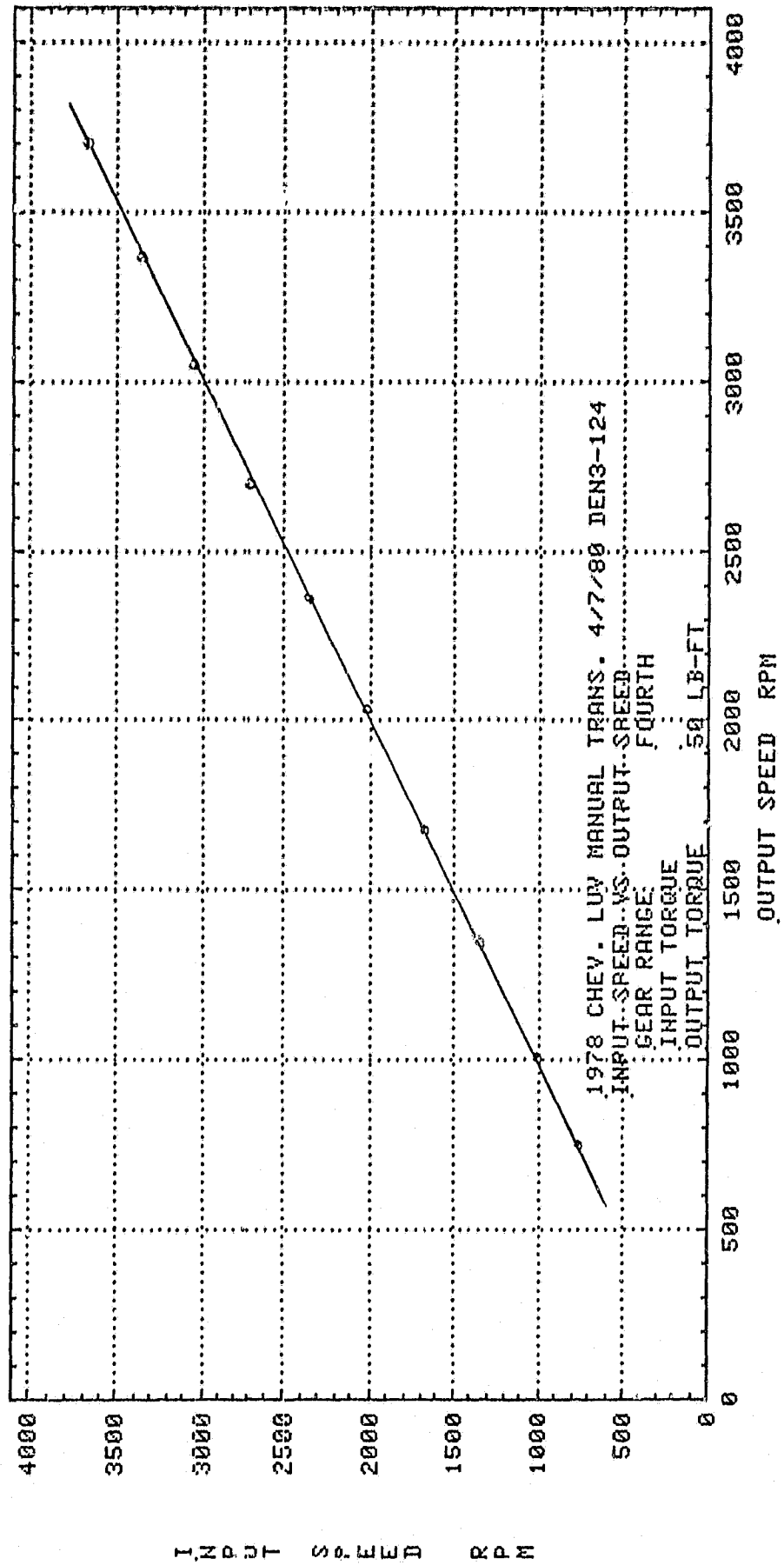

INPUT SPEED RPM

EFFICIENCY %

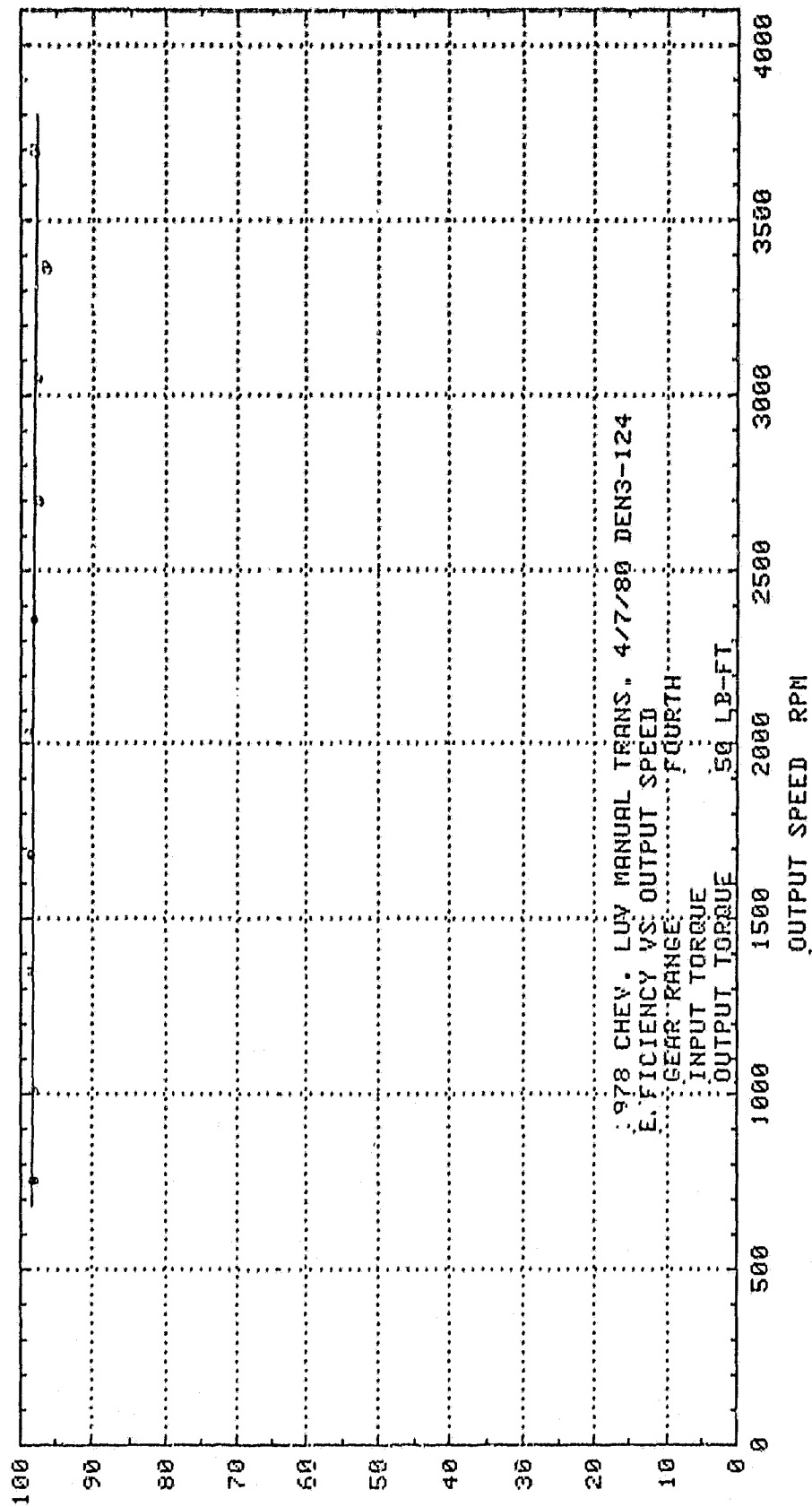

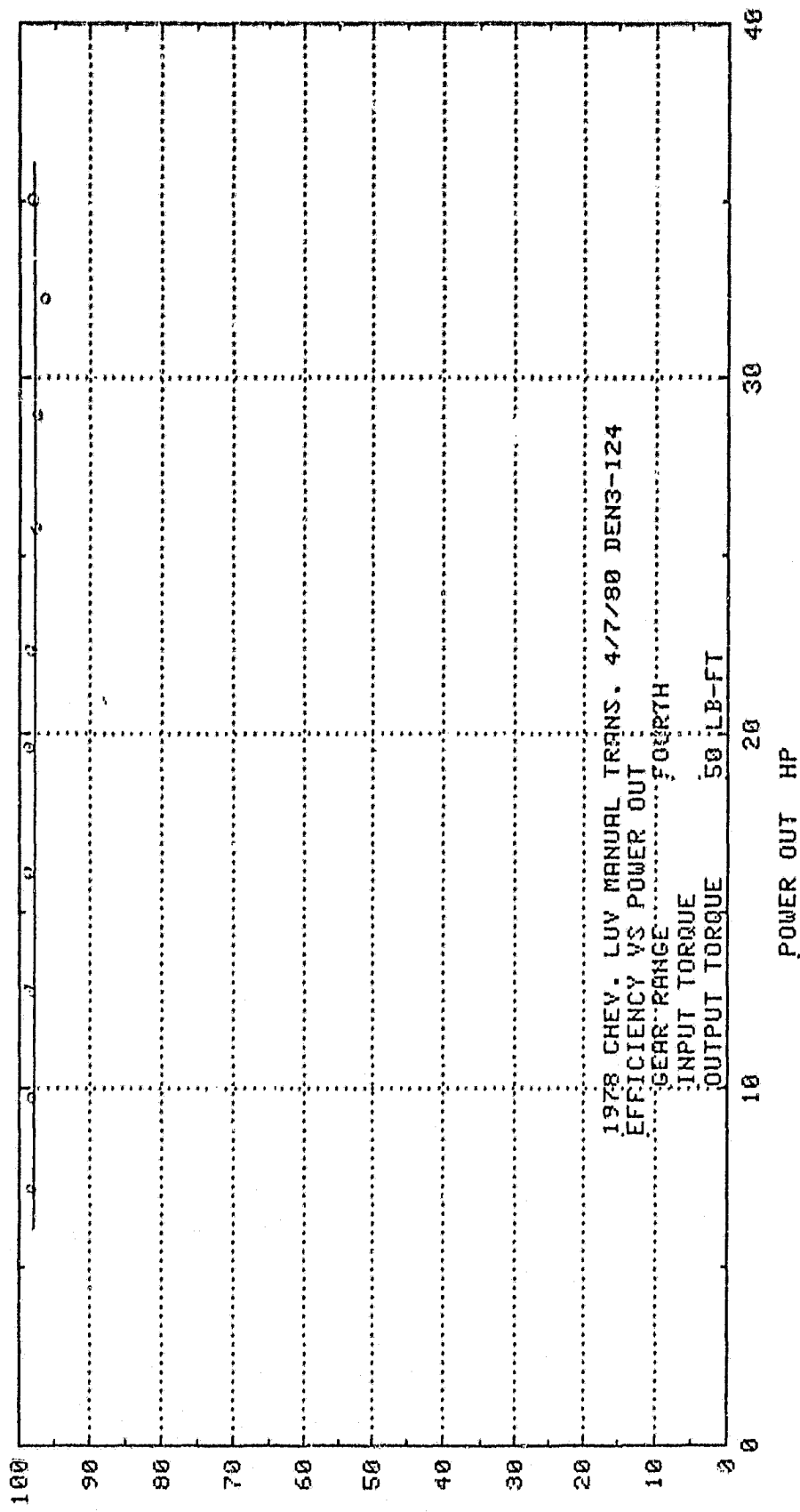

EFFICIENCY %

CB

TORQUE RATIO $\frac{T_o}{T_i}$

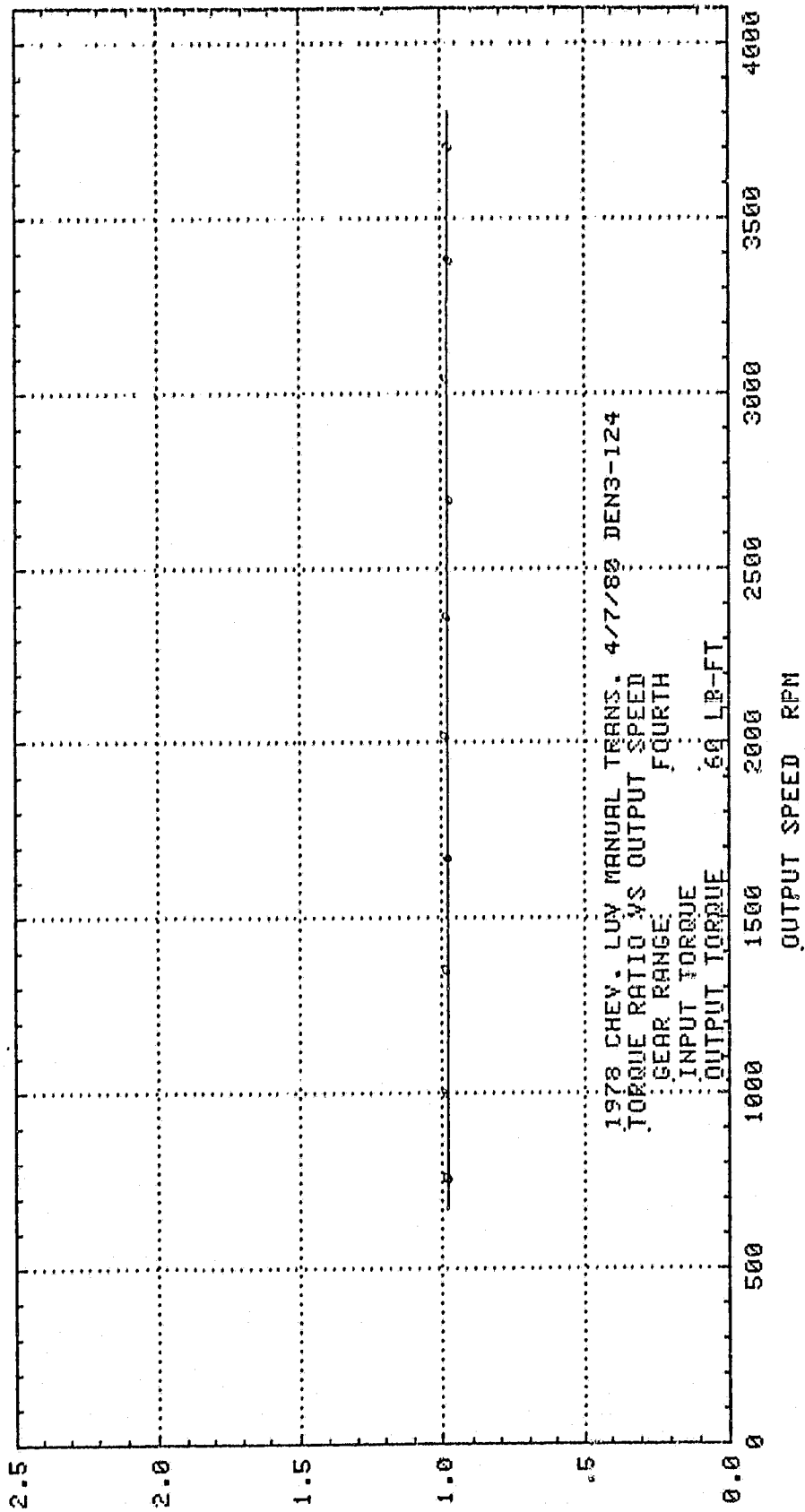

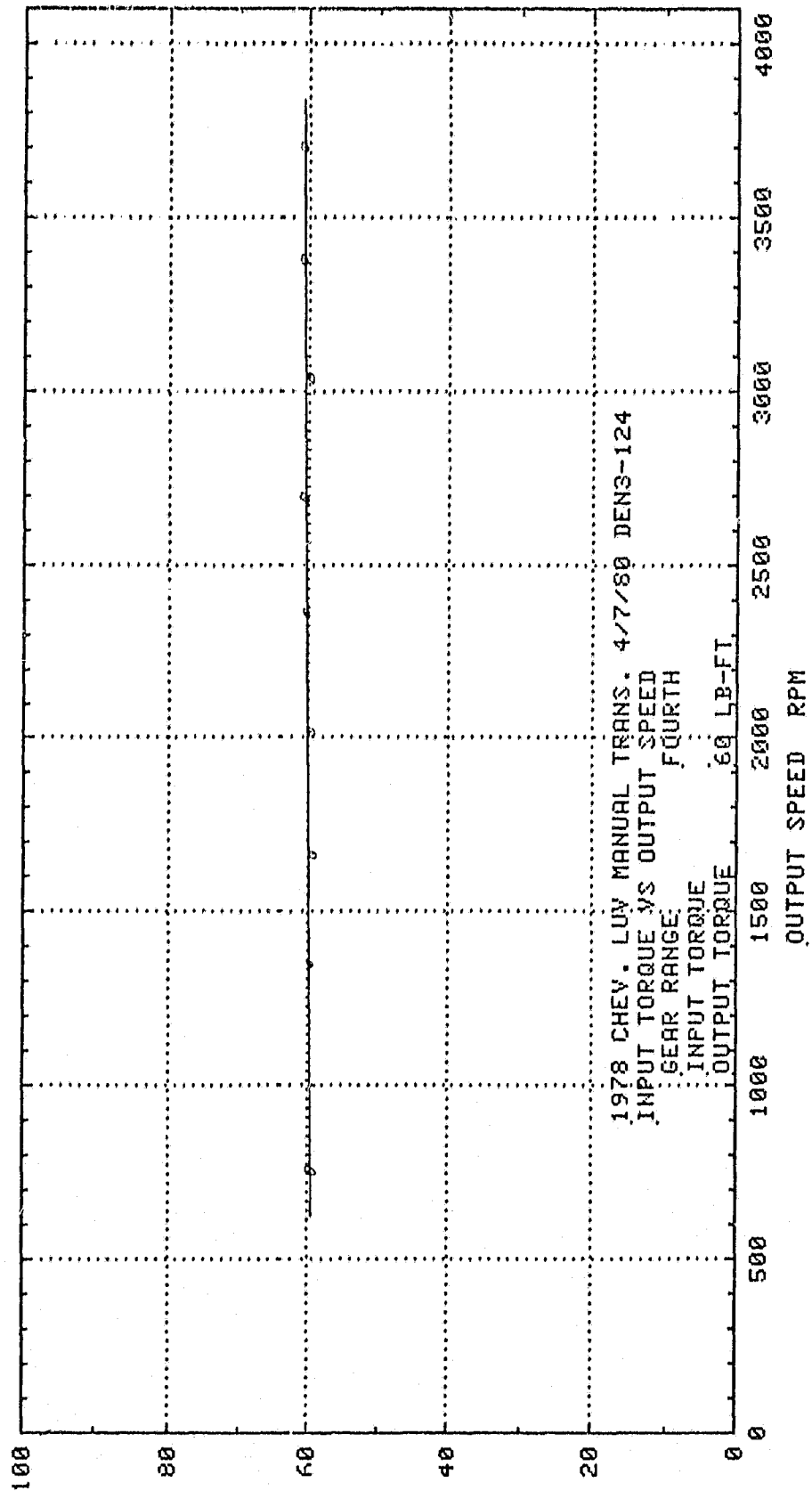

INPUT TORQUE LB FT

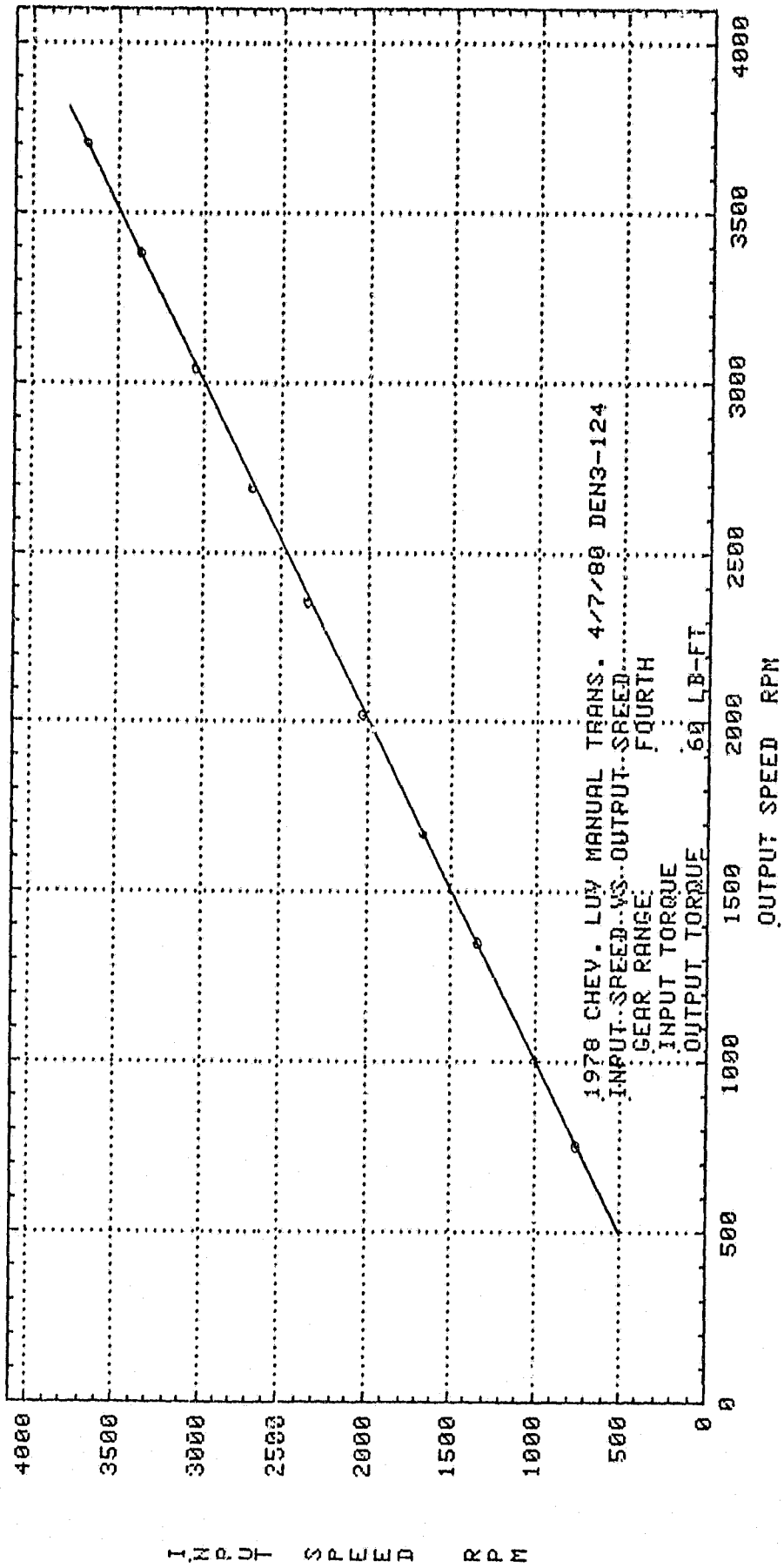

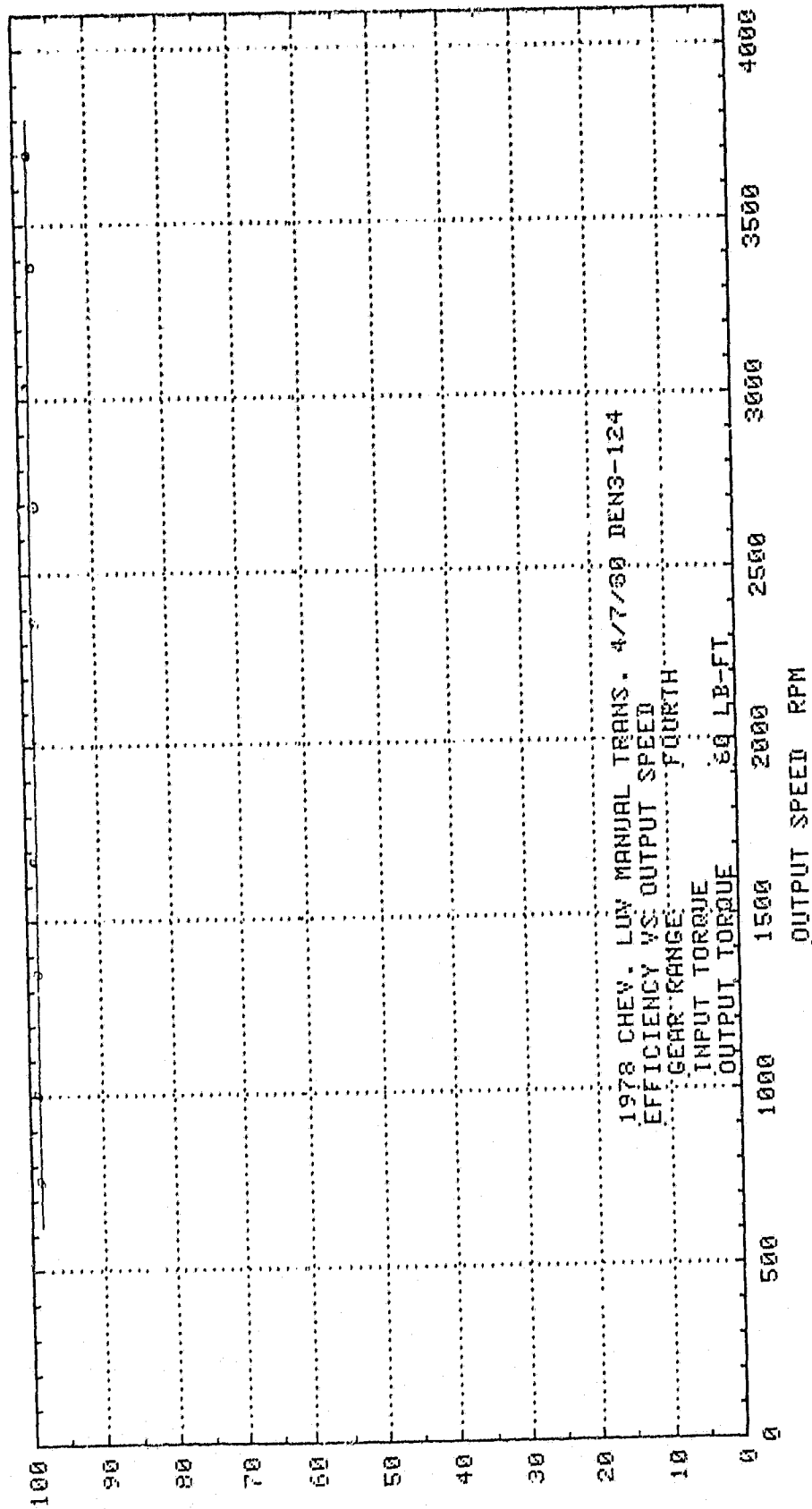

EFFICIENCY %

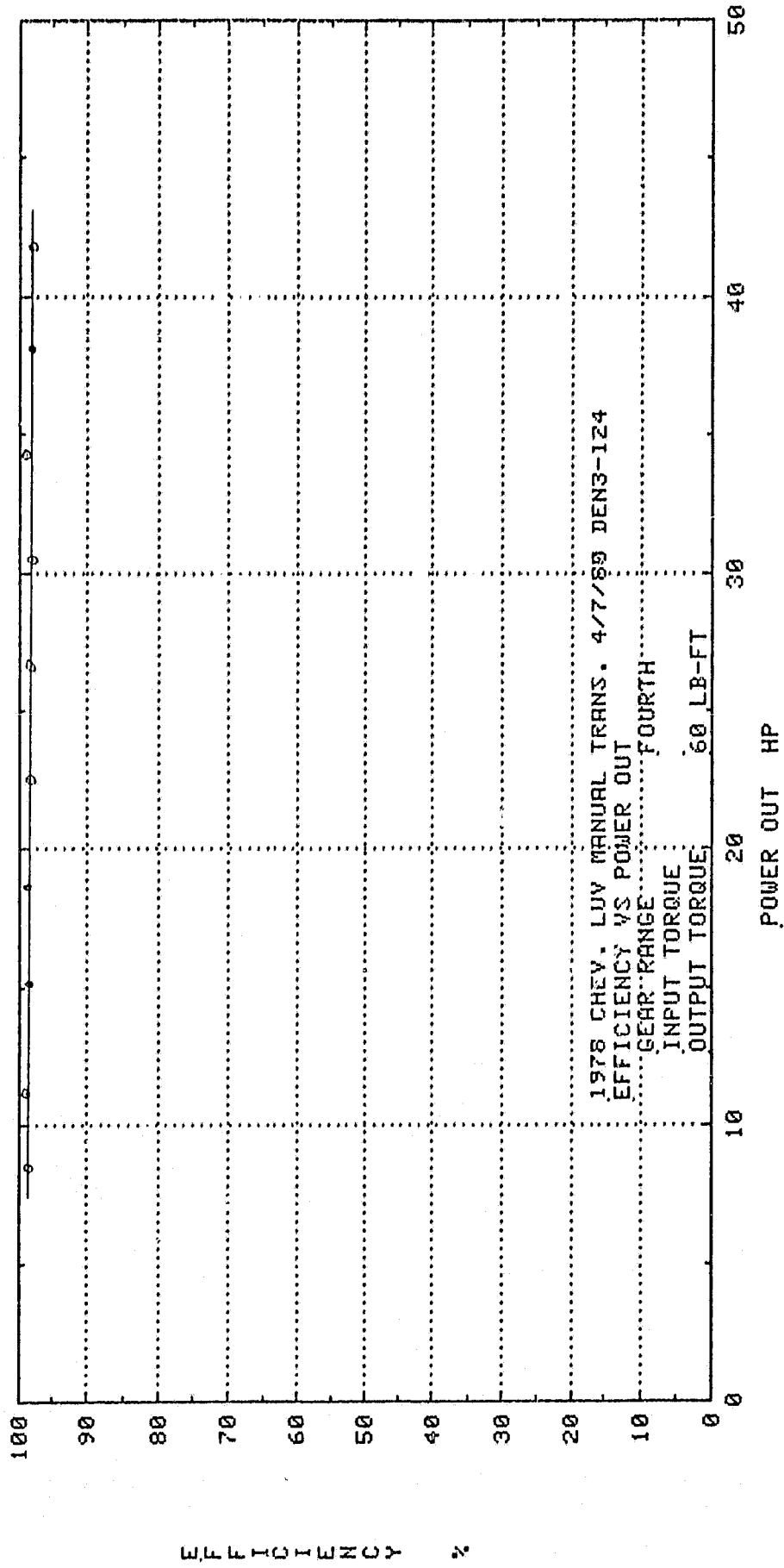

EFFICIENCY %

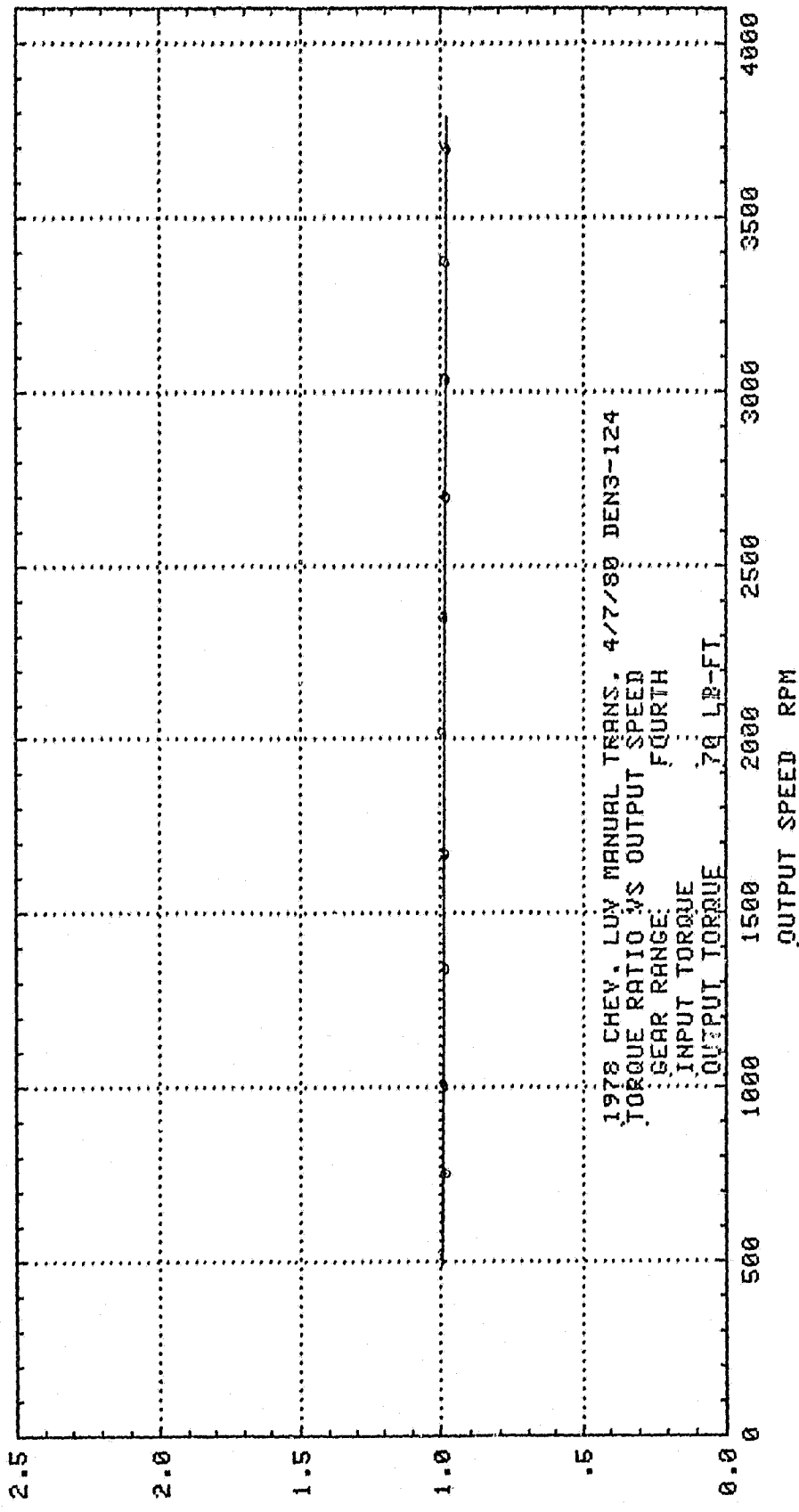

TORQUE RATIO TO TI

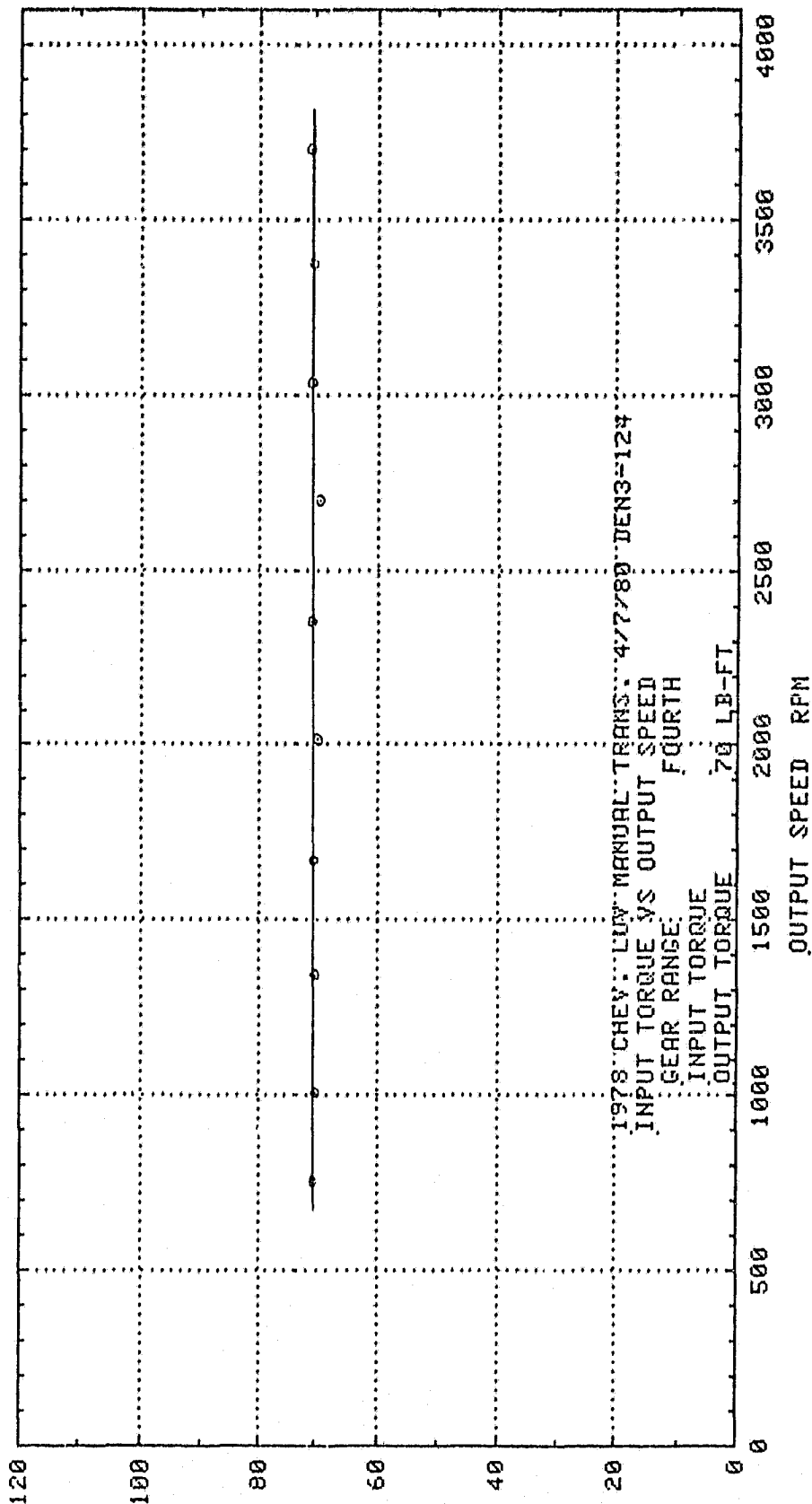

INPUT TORQUE LB FT

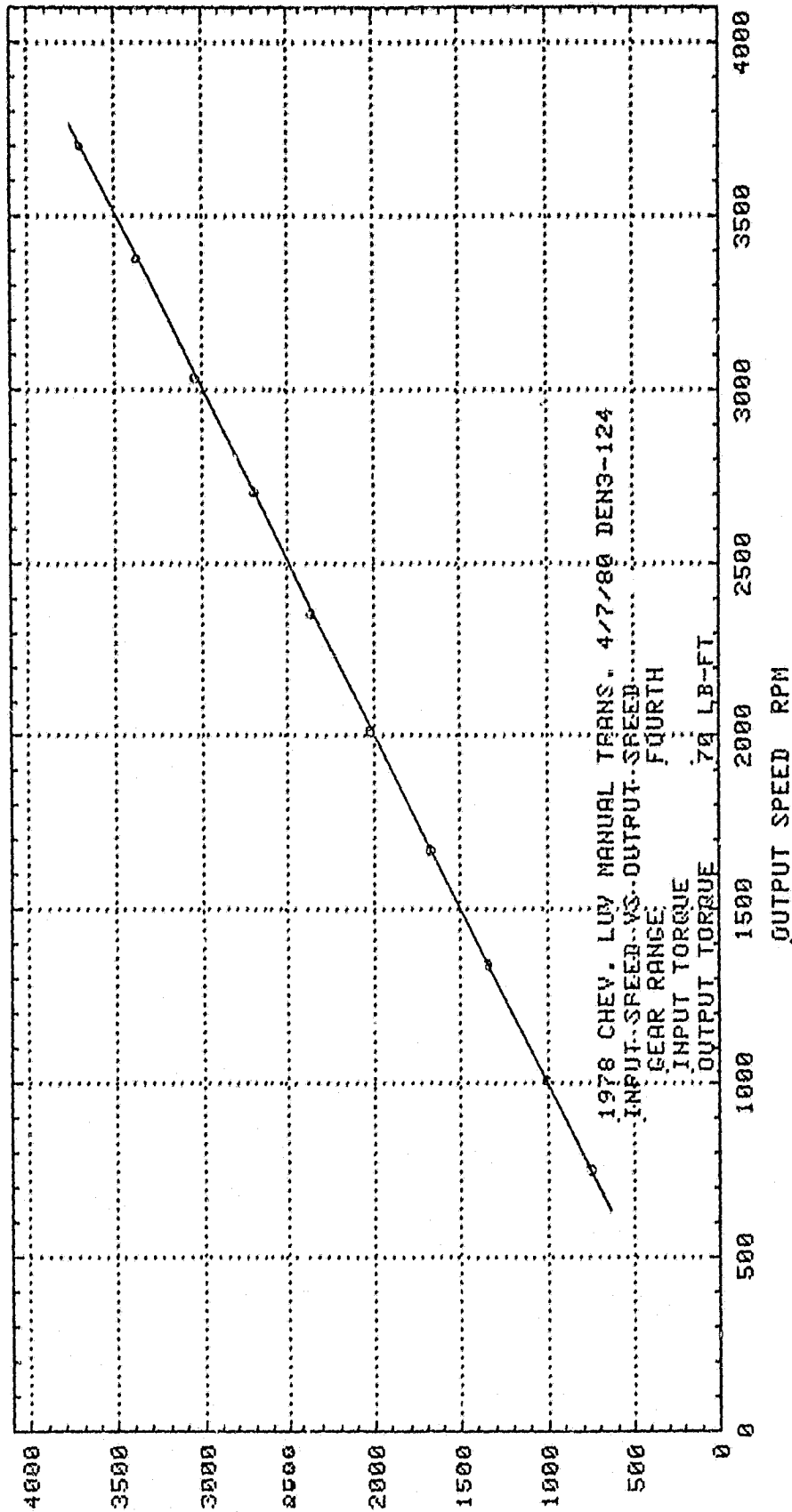

INPUT SPEED RPM

EFFICIENCY %

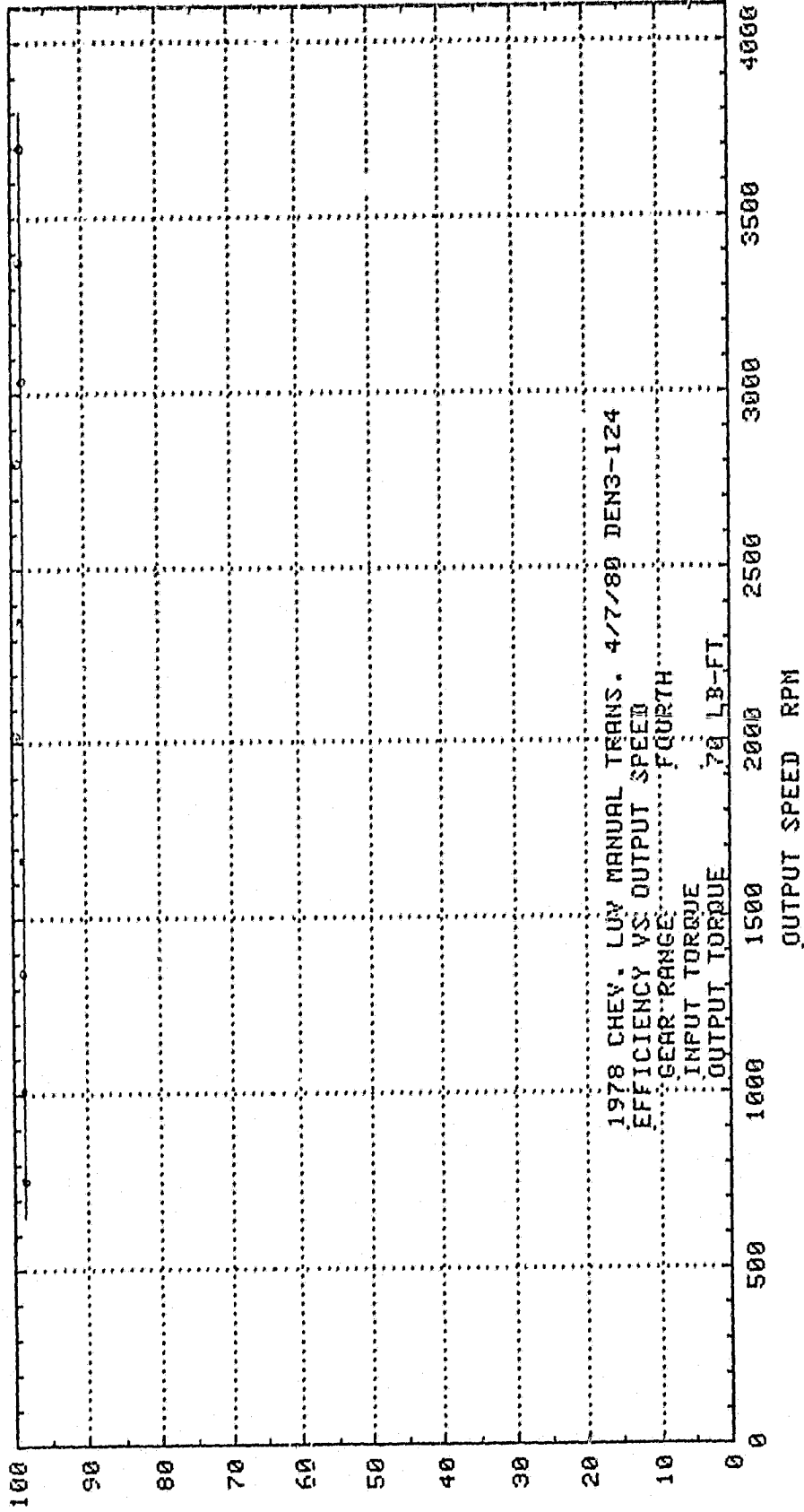

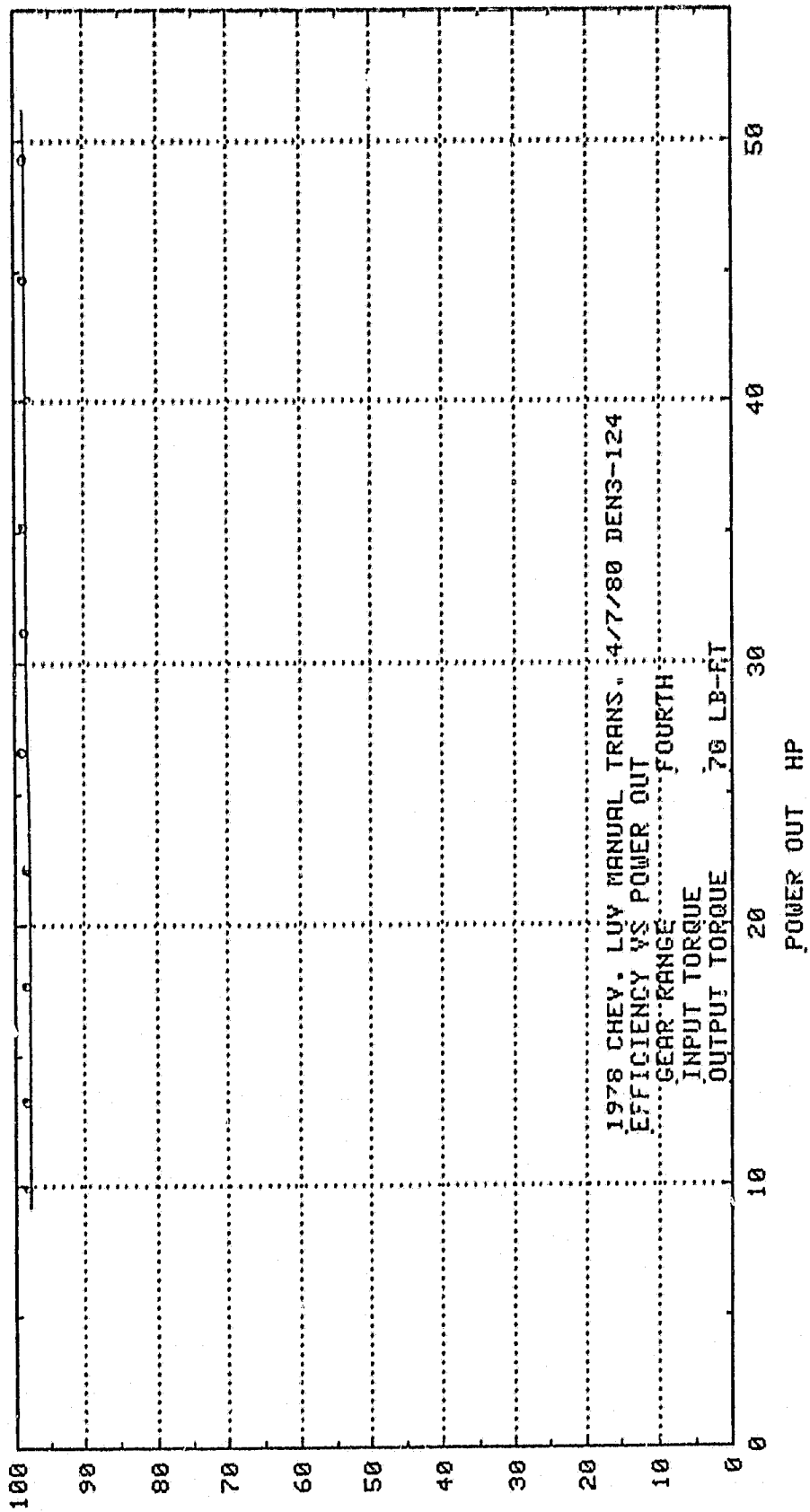

EFFICIENCY %

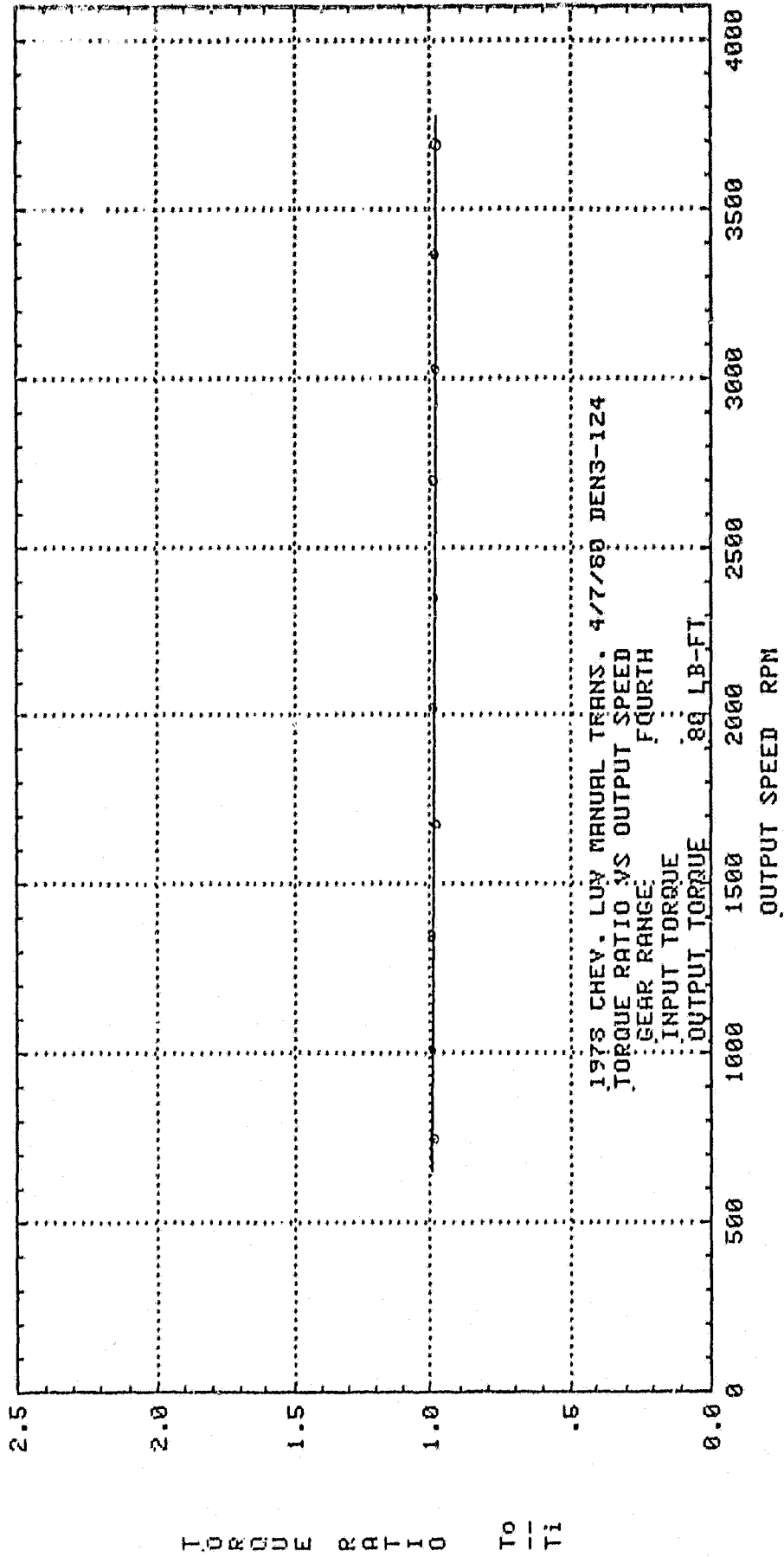

TORQUE RATIO $\frac{T_o}{T_i}$

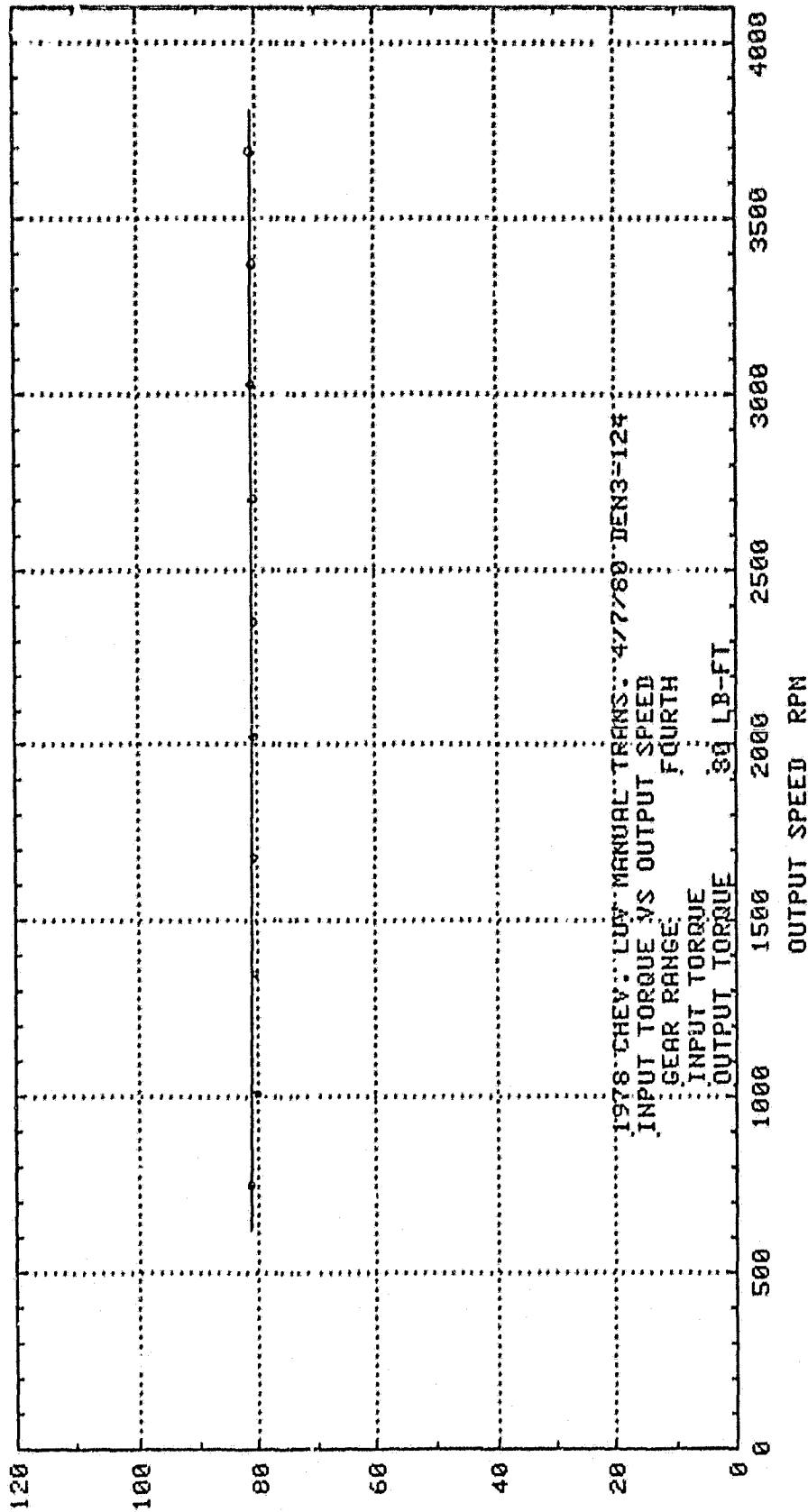

INPUT TORQUE LB FT

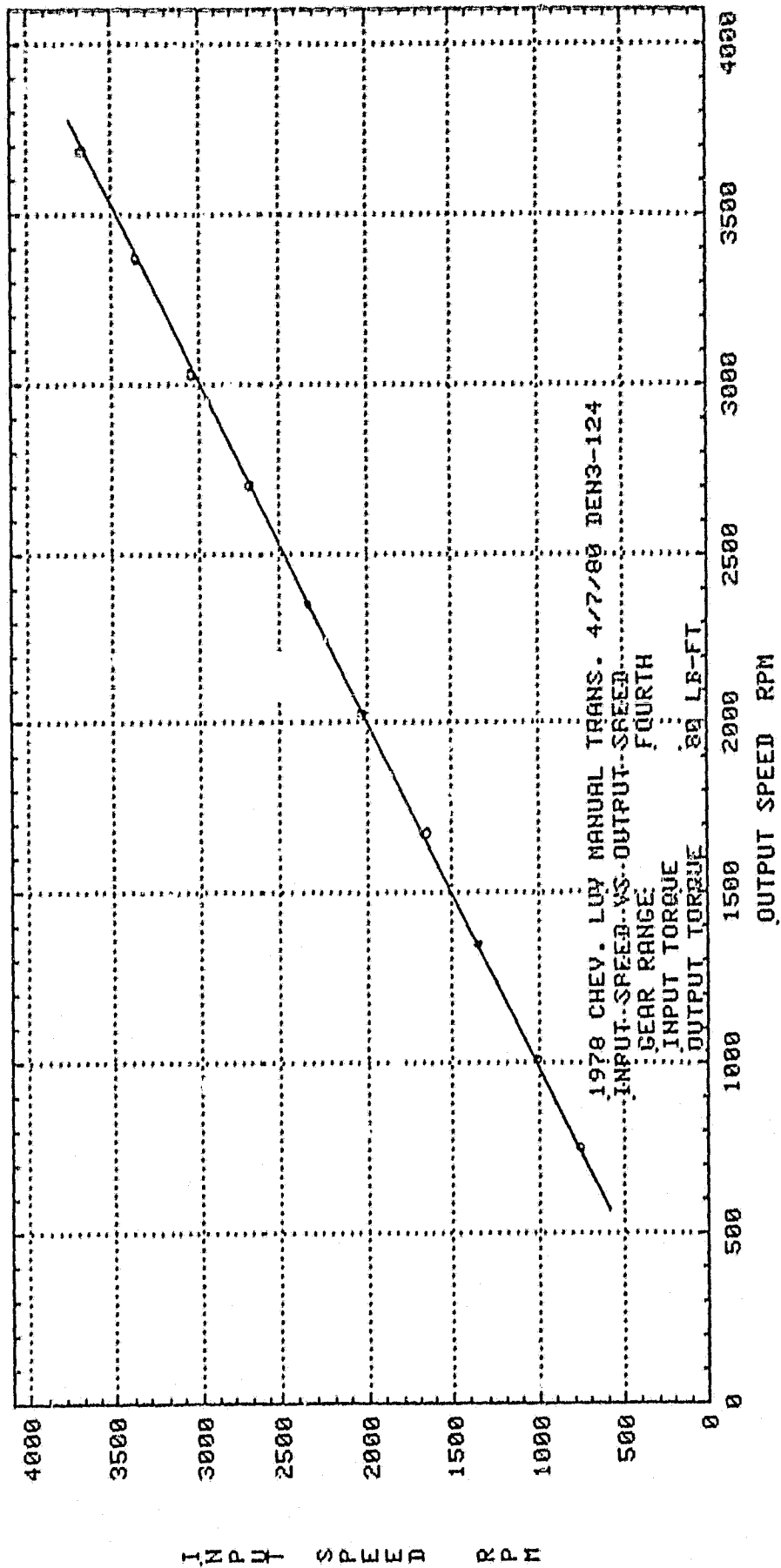

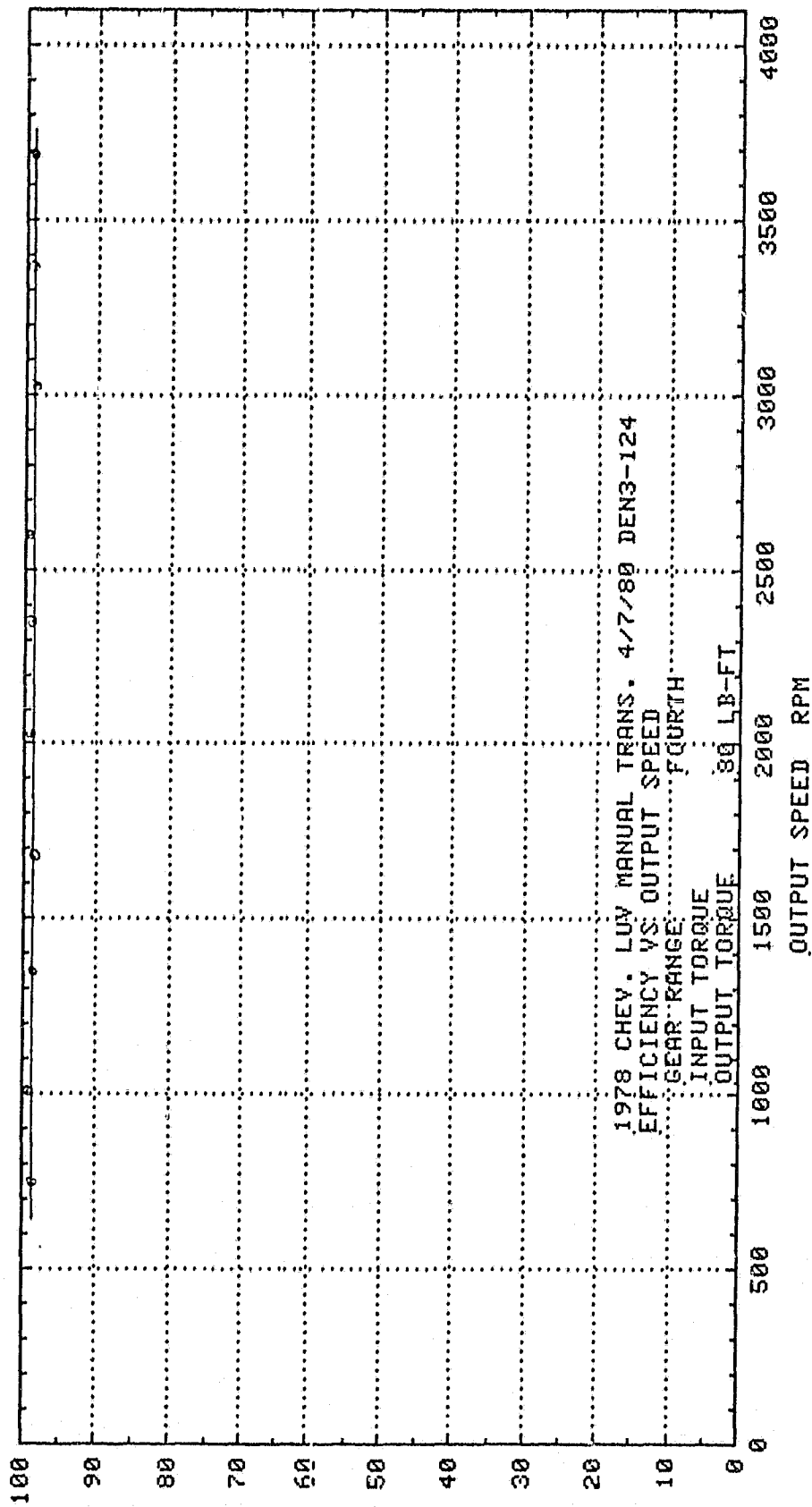

EFFICIENCY %

E F F I C I E N C Y %

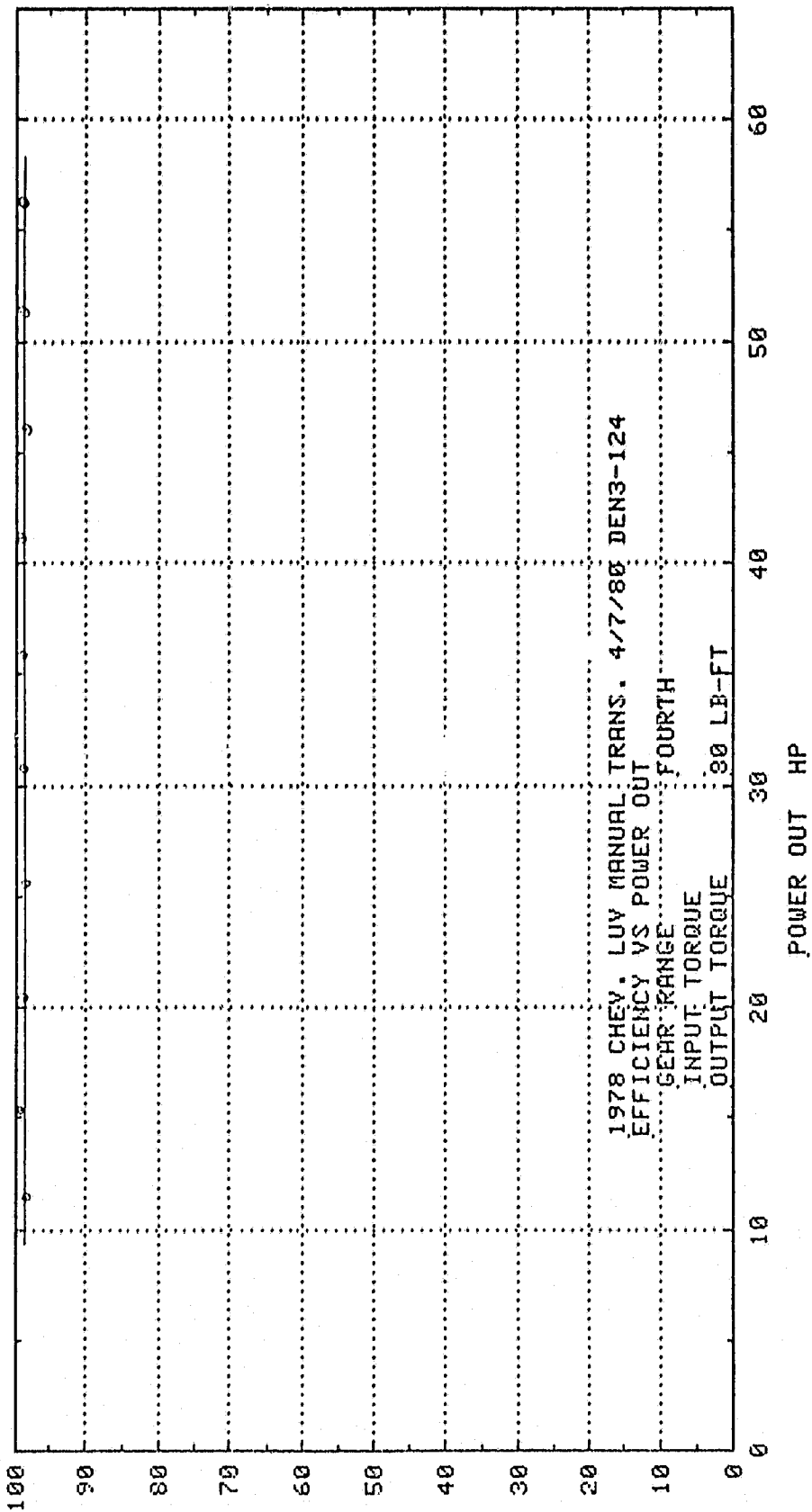

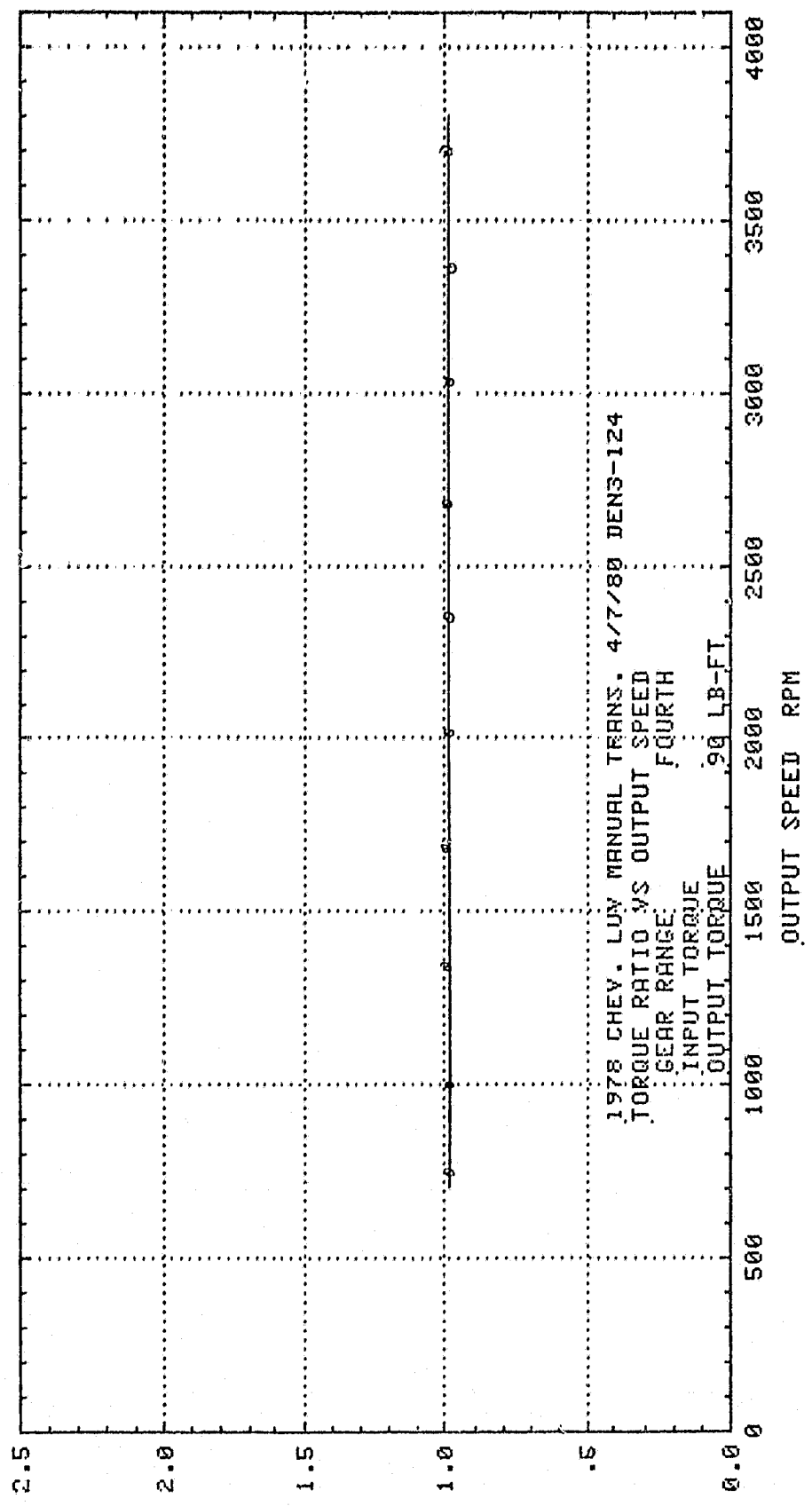

TORQUE RATIO $\frac{T_0}{T_1}$

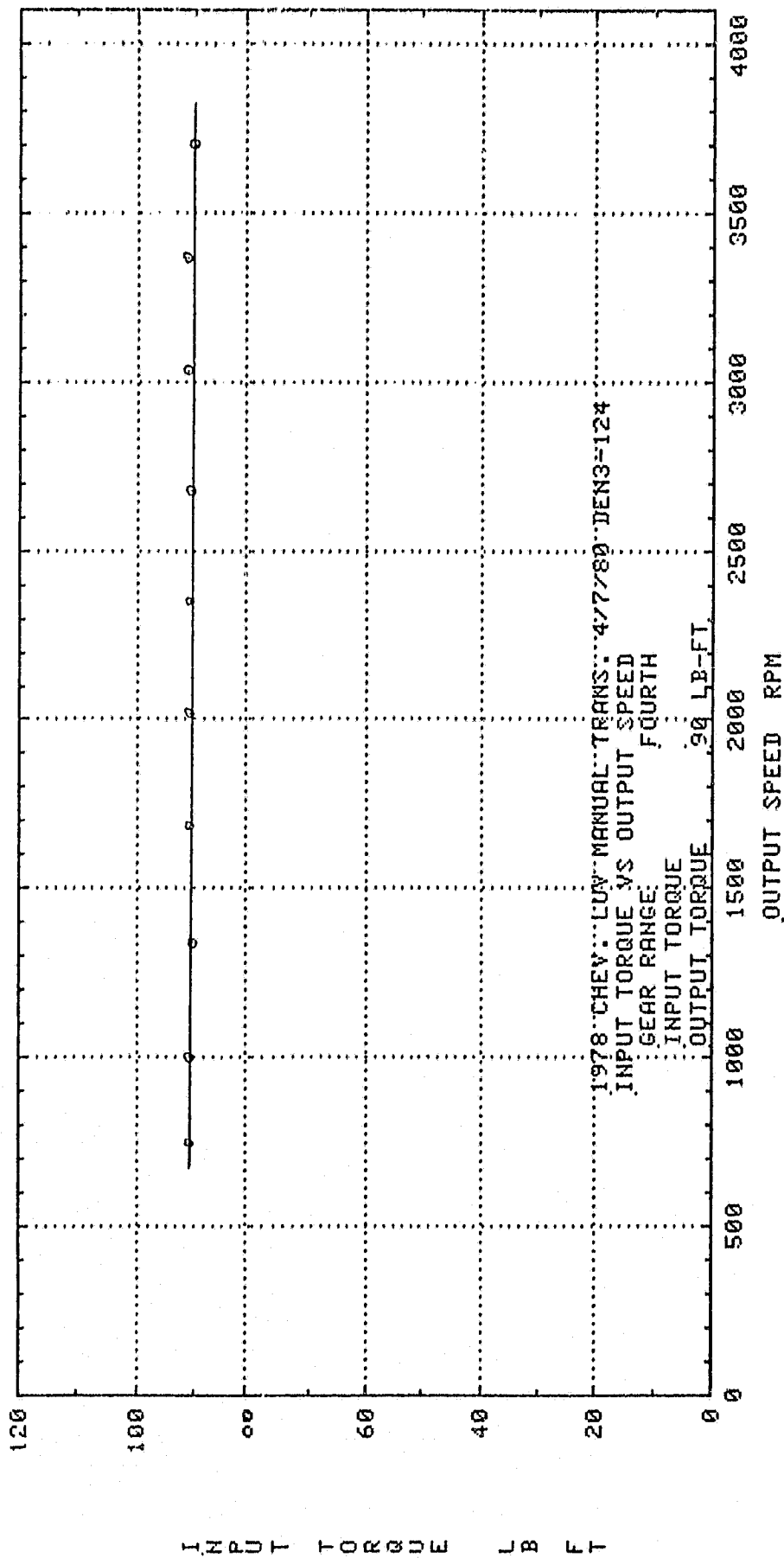

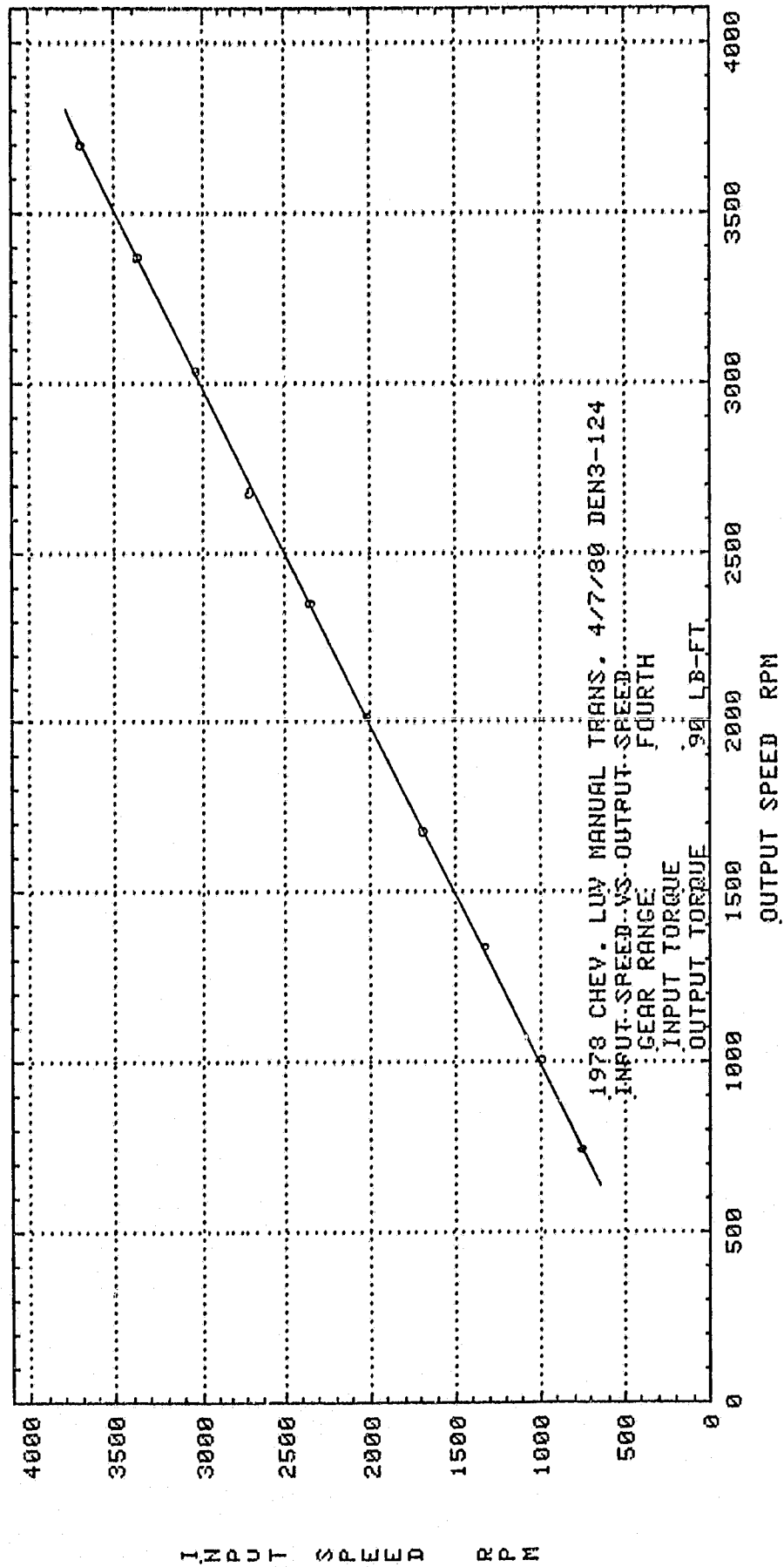

EFFICIENCY %

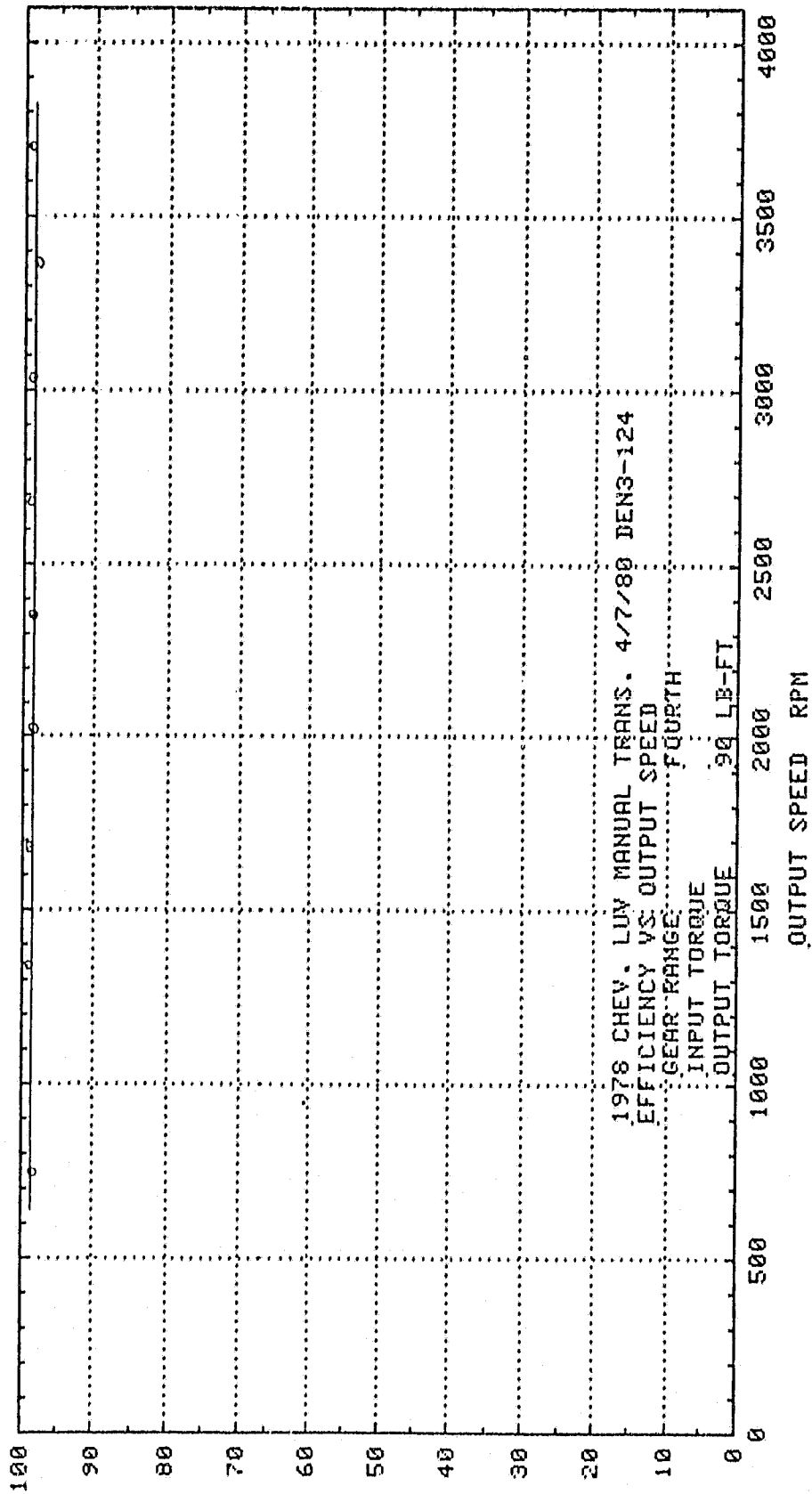

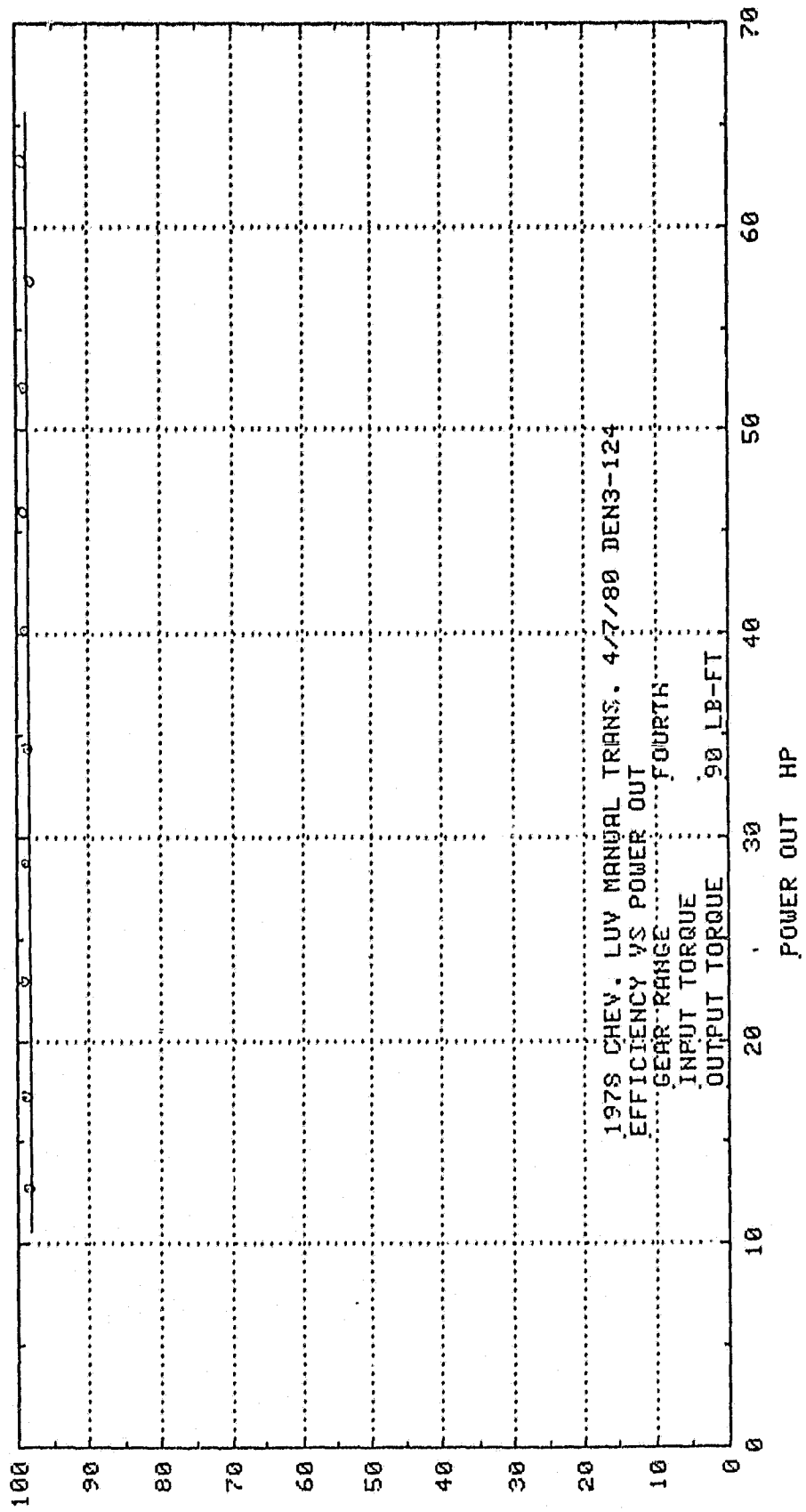

EFFICIENCY %

Graphs Contained in This Section

Torque Loss -vs- Input Speed

Torque In

Speed In

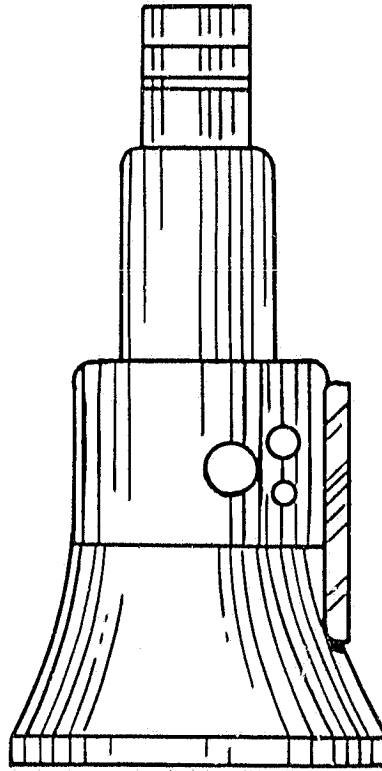

No Load Losses

NO LOAD LOSSES
1ST GEAR

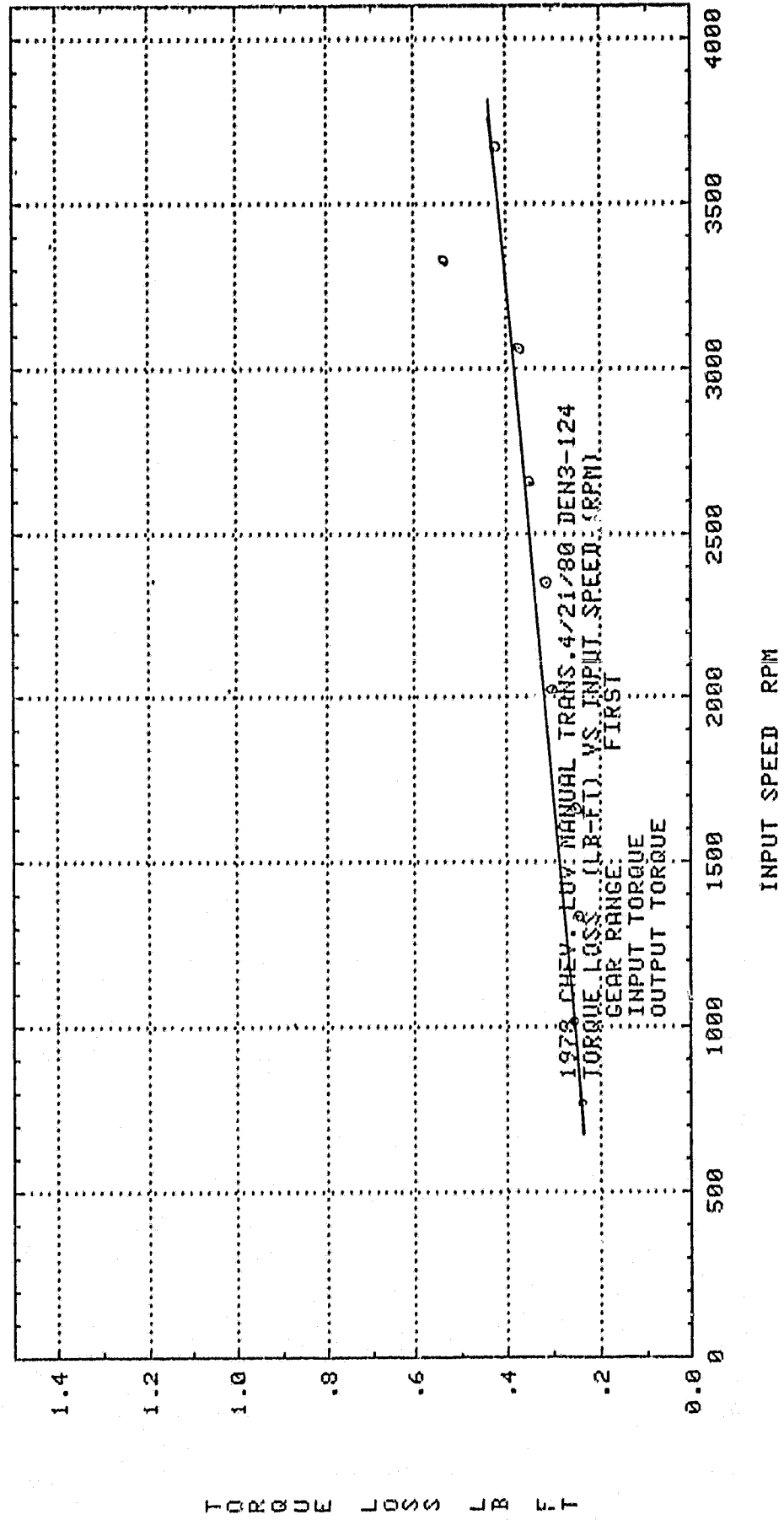

NO LOAD LOSSES
2ND GEAR

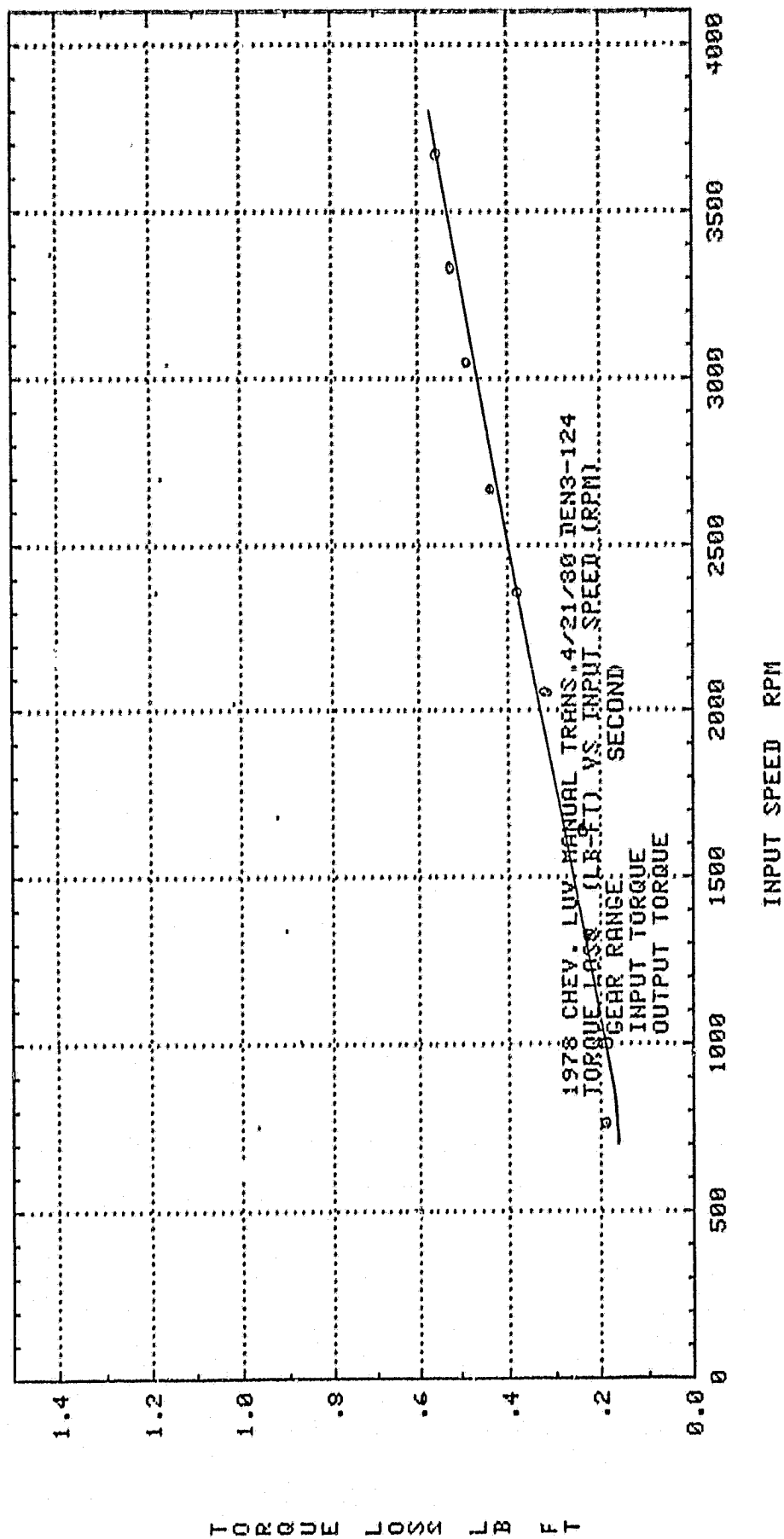

TORQUE LOSS LB FT

INPUT SPEED RPM

NO LOAD LOSSES
3RD GEAR

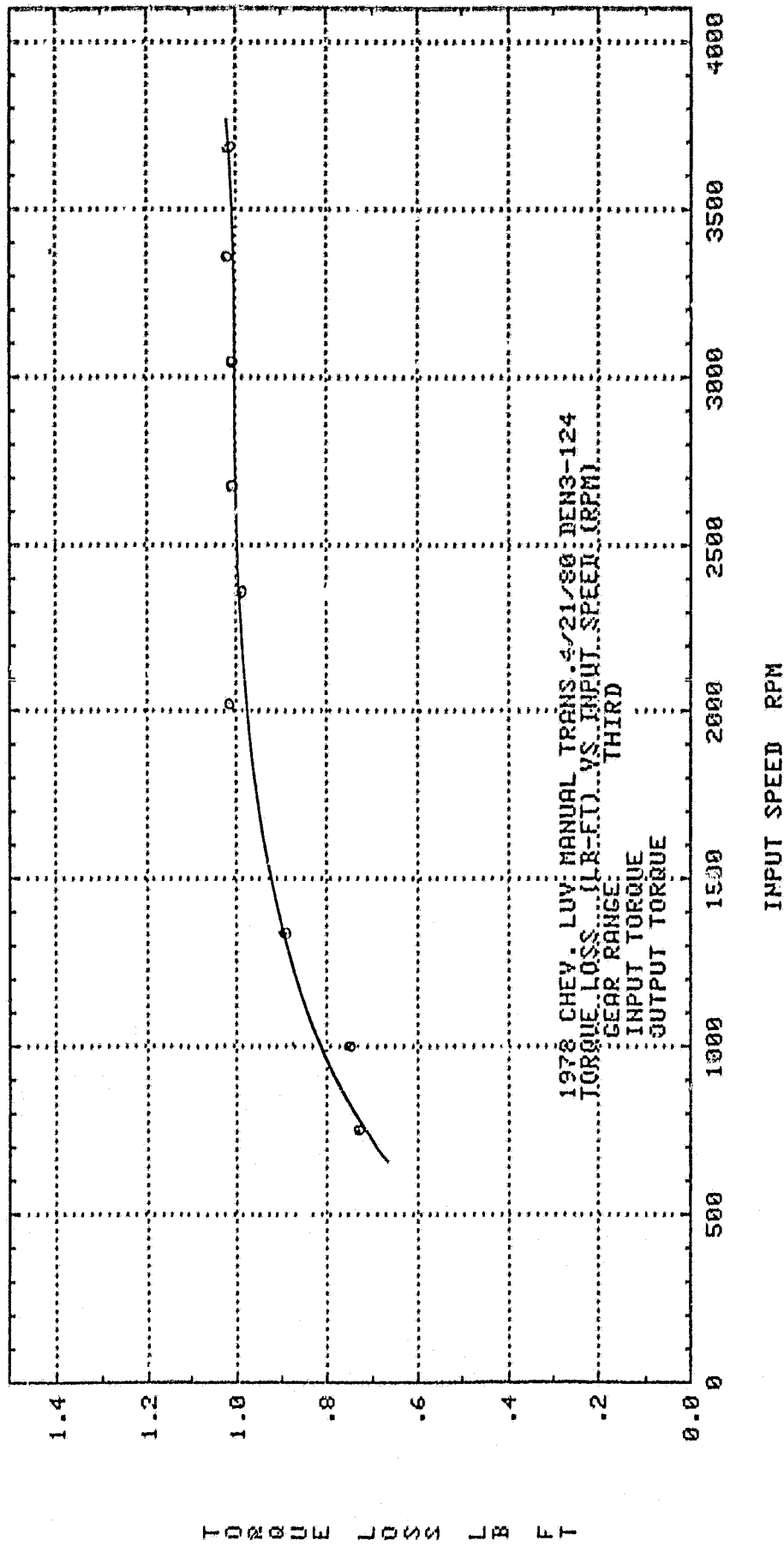

NO LOAD LOSSES
4TH GEAR

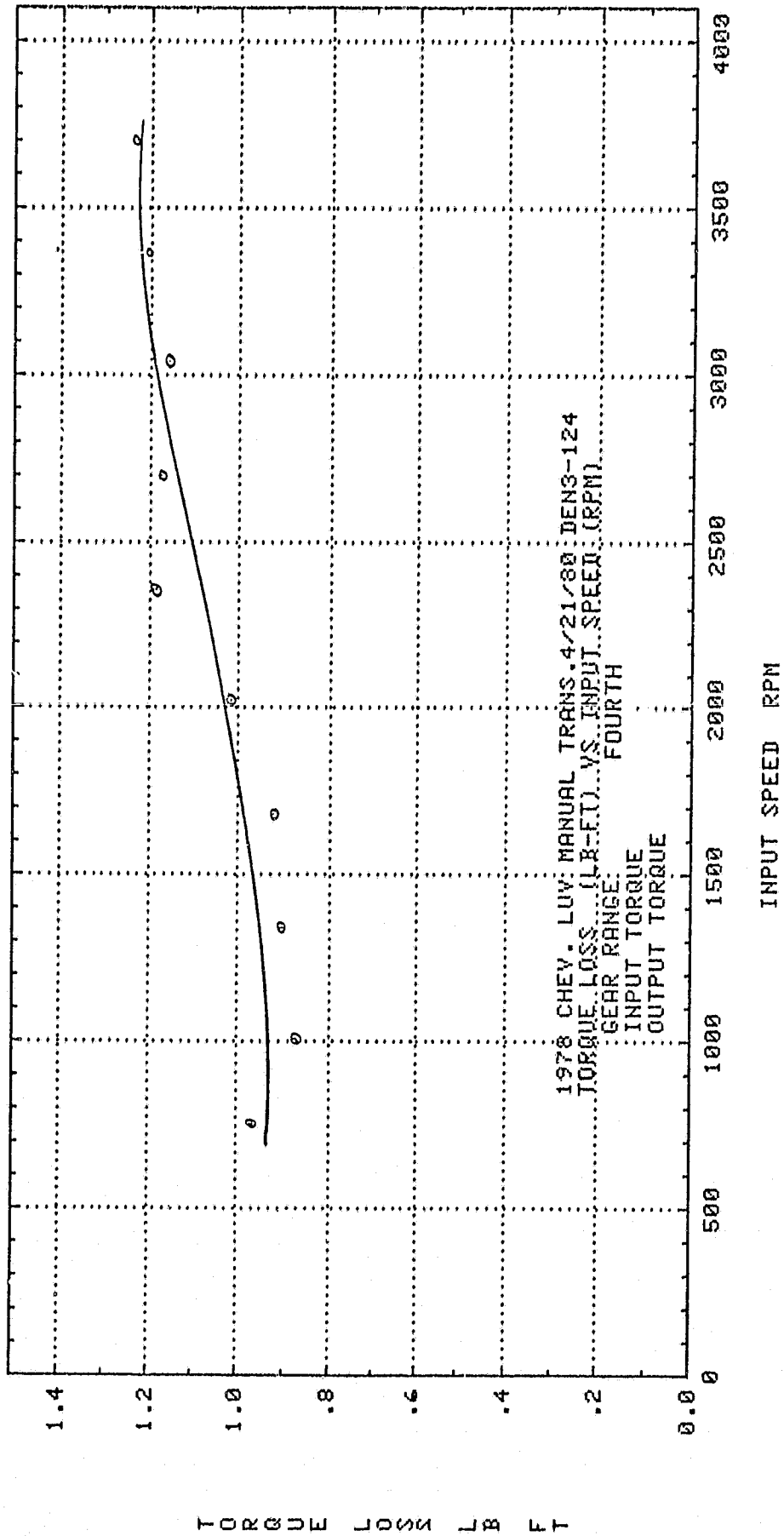

TORQUE LOSS LB FT

APPENDIX A
CALCULATION OF ERROR

ROOT MEAN SQUARE METHOD

$$\begin{aligned} \text{TORQUE ERROR (HIMMELSTEIN)} &= \sqrt{(\text{TORQUE TRANS. ERROR})^2 + (\text{TAPE RECORDER ERROR})^2 + (\text{ANALYZER ERROR})^2} \\ &= \sqrt{(0.21)^2 + (0.05)^2 + (0.048)^2} = \pm 0.221\% \text{ of Full Scale} \end{aligned}$$

$$\begin{aligned} \text{TORQUE ERROR (LEBOW)} &= \sqrt{(\text{TORQUE TRANS. ERROR})^2 + (\text{TAPE RECORDER ERROR})^2 + (\text{ANALYZER ERROR})^2} \\ &= \sqrt{(0.05)^2 + (0.05)^2 + (0.048)^2} = \pm 0.08\% \text{ of Full Scale} \end{aligned}$$

$$\begin{aligned} \text{SPEED ERROR} &= \sqrt{(\text{SPEED SENSOR})^2 + (\text{SPEED CONDITIONER})^2 + (\text{TAPE RECORDER ERROR})^2 + (\text{ANALYZER ERROR})^2} \\ &= \sqrt{(0.025)^2 + (0.10)^2 + (0.05)^2 + (0.048)^2} = \pm 0.124\% \text{ of Full Scale} \end{aligned}$$

$$\begin{aligned} \text{POWER OUT ERROR} &= \sqrt{(\text{TORQUE ERROR (LEBOW)})^2 + (\text{SPEED ERROR})^2 + (\text{COMPUTER CALCULATION ERROR})^2} \\ &= \sqrt{(0.08)^2 + (0.124)^2 + (0.5)^2} = \pm 0.5\% \text{ of Full Scale} \end{aligned}$$

$$\begin{aligned} \text{EFFICIENCY ERROR} &= \sqrt{(\text{TORQUE ERROR (LEBOW)})^2 + (\text{SPEED ERROR})^2 + (\text{TORQUE ERROR (HIMM)})^2 + (\text{SPEED ERROR})^2} \\ &\quad + (\text{COMPUTER CALCULATION ERROR})^2} \\ &= \sqrt{(0.08)^2 + (0.124)^2 + (0.221)^2 + (0.124)^2 + (0.5)^2} = \pm 0.579\% \text{ of Full Scale} \end{aligned}$$

SUM OF ERROR METHOD

$$\begin{aligned} \text{TORQUE ERROR HIMMELSTEIN} &= (\text{TORQUE TRANSDUCER ERROR}) + (\text{TAPE RECORDER ERROR}) + (\text{ANALYZER ERROR}) \\ &= (0.21) + (0.05) + (0.048) = \pm 0.308\% \text{ of Full Scale} \end{aligned}$$

$$\begin{aligned} \text{TORQUE ERROR (LEBOW)} &= (\text{TORQUE TRANS. ERROR}) + (\text{TAPE RECORDER ERROR}) + (\text{ANALYZER ERROR}) \\ &= (0.05) + (0.05) + (0.048) = \pm 0.148\% \text{ of Full Scale} \end{aligned}$$

$$\begin{aligned} \text{SPEED ERROR} &= (\text{SPEED SENSOR}) + (\text{SPEED CONDITIONER}) + (\text{TAPE RECORDER ERROR}) + (\text{ANALYZER ERROR}) \\ &= (0.025) + (0.1) + (0.05) + (0.048) = \pm 0.223\% \text{ of Full Scale (1 Volt = 4000 RPM)} \end{aligned}$$

$$\begin{aligned} \text{POWER OUT ERROR} &= (\text{TORQUE ERROR (LEBOW)}) + (\text{SPEED ERROR}) + (\text{COMPUTER CALCULATION ERROR}) \\ &= (0.08) + (0.124) + (0.5) = \pm 0.704\% \text{ of Full Scale} \end{aligned}$$

$$\begin{aligned} \text{EFFICIENCY ERROR} &= (\text{TORQUE ERROR (LEBOW)}) + (\text{SPEED ERROR}) + (\text{TORQUE ERROR (HIMM)}) + (\text{SPEED ERROR}) \\ &\quad + (\text{COMPUTER CALCULATION ERROR}) \\ &= (0.08) + (0.124) + (0.221) + (0.124) + (0.5) = \pm 0.1049\% \text{ of Full Scale} \end{aligned}$$

The inter number computer calculation error was determined by taking a set of sample calculations and comparing the accurate multiplication to the computer multiplication. A sample comparison is given below.

DATA DRIVE
PERFORMANCE
2ND GEAR

$T_i=40$ lb/ft

ACCURATE CALCULATION COMPUTER CALCULATION

$T_i=39.500$, $T_o=116.3369$

$T_o/T_i=2.9452$

$T_o/T_i=2.9367$

Comparison = $(2.9452 - 2.9367)/2.9452 \times 100 = 0.288\%$

Since every calculation was not checked in this manner, a factor of safety was added to 0.288%, and 0.5% was used as the inter number computer calculation error.

OTHER MANUALS

To locate specific manuals in the documentation shipped with the system, refer to the System Configuration Notice for the contents of each binder.

SYSTEM SPECIFICATIONS & CHARACTERISTICS

The specifications in Table 1-1 describe the system's warranted performance. Those items under the heading of "Characteristics" go beyond the guaranteed specifications and give typical performance for some additional parameters and operations. These are included only to give you information which may be useful in applying the system.

Table 1-1. System Specifications and Characteristics

SPECIFICATIONS (Specifications describe the standard system's warranted performance.)	
ANALOG-TO-DIGITAL CONVERTER Input Voltage Range: $\pm 0.125V$ to $\pm 8V$ peak in steps of 2. Input Coupling: dc or ac. Input Channels: 2 channels wired for 4 standard, 4 channels optional with plug-in cards. Resolution: 12 bits including sign. Input Frequency Range: dc to 50 kHz, 5 Hz to 50 kHz, ac coupled (100 kHz optional). Sample Rate: Internal: 100 kHz max. (1, 2, 3, or 4 channels simultaneously), 200 kHz optional on 1, 2, 3, or 4 channels, 150 kHz max. (3 or 4 channels simultaneously).† External: An external time base may be used to allow external control of the sampling rate up to 100 kHz (200 kHz optional). One sample can be taken for each clock pulse (TTL level). Internal Clock Accuracy: $\pm 0.01\%$.	EXECUTION TIMES* Fourier Transform: <55 ms Stable Power Spectrum Average: <80 ms Stable Tri-Spectrum Average: <220 ms REAL TIME BANDWIDTHS* Fourier Transform: >7.5 kHz Stable Power Spectrum Average: 5.4 kHz Stable Tri-Spectrum Average: 1.9 kHz MASS STORAGE SOFTWARE MAXIMUM REAL TIME DATA ACQUISITION RATE (Single Channel): BS 256: 10 kHz BS 1024: 39 kHz (25 kHz)† BS 4096: 80 kHz (30 kHz)†
DISPLAY UNIT Vertical Scale Calibration: Data in memory is automatically scaled to give a maximum on-screen calibrated display. The scale factor is given in volts/division, volts ² /division, or in dB offset. Log Display Range: 80 dB with a scale factor ranging from 0 to +998 dB. Offset selectable in 4 dB steps. Linear Display Range: ± 4 divisions with scale factor ranging from 1×10^{-512} to 5×10^{512} in steps of 1, 2, and 5. Digital UP/DOWN Scale: Allows 8 up-scale and 2 down-scale steps (calibrated continuous scale factor). Horizontal Scale Calibration: Linear Sweep Length: 10, 10.24 or 12.8 divisions. Log Horizontal: 0.5 decades/division. Markers: Intensity markers every 8th or every 32nd point.	OFF-LINE BSFA SOFTWARE Center Frequency Range: dc to one-half the Real Time Data Acquisition Rate. Center Frequency Resolution: Continuous resolution to the limit of the frequency accuracy for center frequencies >0.02% of the sampling frequency. Frequency Accuracy: $\pm 0.01\%$ Bandwidth Selection: In steps of $f/5n$ where $n = 2, 3, 4$, etc. Max. Resolution Enhancement: >400 Dynamic Range:** 90 dB from peak out-of-band spectral component to the peak level of the passband noise. 80 dB from peak in-band spectral component to the peak level of the passband noise. Out-of-Band Rejection: >90 dB Passband Flatness of the Digital Filter: ± 0.01 dB
BASE SOFTWARE Transform Accuracy: The expected rms value of computational error introduced in either the forward or inverse FFT will not exceed 0.1% of the rms value of the transform result. Dynamic Range: >75 dB for a minimum detectable spectral component in the presence of one full scale spectral component after twenty ensemble averages for a block size of 1024.	ENVIRONMENTAL CONDITIONS Temperature Range: 0°C to 40°C (104°F). <small>*For band limited random noise type signals at block size 1024, no display, no Hanning. **After eight ensemble averages of a power spectrum at block size 1024. Reduced by 10 dB at the exact center of the band. †These rates apply to systems with modules 5466B and 54451A, B having a serial prefix lower than 1842.</small>

FM RECORD/REPRODUCE SPECIFICATIONS

Input Sensitivity:	0.1 to 2.5 volts rms; adjustable with input attenuator for $\pm 40\%$ deviation. Can be extended to 10 volts.
Nominal Input Level:	± 1.4 volts peak.
Nominal Input Impedance:	100 K ohms resistive, shunted by less than 100 pf, unbalanced to ground.
Frequency Response:	
Flat Amplitude Filter	DC to 20 KHz, at 60 ips, ± 0.5 db; ± 40 deviation.
Linear Phase Filter	DC to 12 KHz, at 60 ips, ± 0.5 db; $\pm 40\%$ deviation.
	DC to 20 KHz at 60 ips, ± 0.5 , -3 db; $\pm 40\%$ deviation.
Frequency Responses (Optional):	DC to 80 KHz at 120 ips using $\pm 40\%$ deviation with IRIG intermediate band center frequency of 432 KHz. Upper frequency limit and center frequencies are proportionately lower at lower speeds, to 3-3/4 ips. DC to 10 KHz at 60 ips using $\pm 40\%$ deviation with IRIG low band frequency of 54 KHz for improved S/N ratios. Upper frequency limit and center frequencies are proportionately lower at lower speeds.
DC Drift (Oscillator and Discriminator):	Less than $\pm 0.5\%$ of peak-to-peak deviation per 10° F after 20 minute warm-up.
Signal/Noise Ratio	46 db at 60 ips.

DC Linearity:	Less than $\pm 0.5\%$ of peak-to-peak deviation reference to best straight line through zero.
AC Distortion:	Less than 1.5% total harmonic distortion at all speeds.
Transient Response (60 ips):	
Flat Amplitude Filter ($\pm 1/2$ db)	Rise Time (10% to 90% points) - 22 microseconds. Overshoot - less than 15%.
Linear Phase Filter (+1/2, -3 db)	Rise Time (10% to 90% points) - 18 microseconds. Overshoot - less than 2.5%.
Output Level ($\pm 40\%$ deviation):	± 1.4 volts peak, into 1000 ohms, with short circuit protection (SCP).
Output Current ($\pm 40\%$ deviation):	± 3 milliamperes peak with SCP.
Output Impedance:	Less than 50 ohms, unbalanced to ground, with SCP.

GENERAL

Configuration:	One standard 19 inch wide equipment enclosure for 14 channel FM or Direct Record/Reproduce System. For 28-32 vdc operation. Additional enclosure furnished for operation from other power supplies. Optional Rack Mounting Kit available.
Recorder Size (28-32 v):	26-1/8 inches high by 19 inches wide by 12 inches deep for a 7 channel-6 speed record/reproduce system or a 14 channel-6 speed record, 2 speed reproduce system. Additional enclosure (7-1/2 inches height) which attaches to portable

Rotating Shaft Torque Sensors

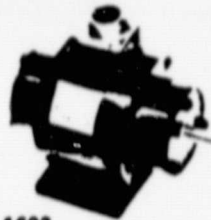

Model 1602
Low capacity torque sensors.

Capacity (Lb. In.)	Max. Speed (RPM)	Model	Protected for Overloads to (Oz. In.)	Torsional Stiffness (Lb. In./Rad.)	Rotating Inertia (Lb.-In. ²)	Weight (Lbs.)
50	20,000	1602-50	150	400	.35	3¼
100	20,000	-100	300	1,000	.35	3¼
200	20,000	-200	600	2,500	.35	3¼
500	20,000	-500	1,500	5,500	.35	3¼
1,000	20,000	-1K	1,500	8,000	.35	3¼

Models 1604, 1605 & 1607

Utility rotating shaft torque sensor recommended for general application.

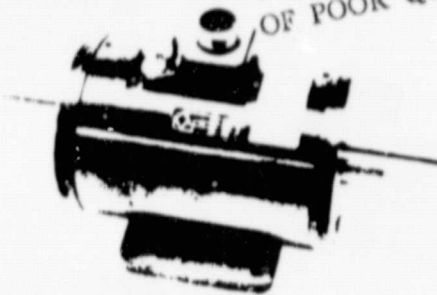

ORIGINAL PAGE IS
OF POOR QUALITY

Capacity (Lb. In.)	Max. Speed (RPM)	Model	Protected for Overloads to (Lb. In.)	Torsional Stiffness (Lb. In./Rad.)	Rotating Inertia (Lb.-In. ²)	Weight (Lbs.)
50	15,000	1604-50	150	5,000	1.0	18
100	15,000	-100	300	13,500	1.0	18
200	15,000	-200	600	33,000	1.0	18
500	15,000	-500	1,500	85,000	1.0	18
1,000	15,000	-1K	3,000	150,000	1.0	18
2,000	15,000	-2K	6,000	225,000	1.0	18
2,000	15,000	1605-2K	6,000	700,000	3.25	28
5,000	15,000	-5K	15,000	950,000	3.25	28
10,000	15,000	-10K	20,000	1,000,000	3.25	28
20,000	4,000	1607-20K	60,000	6,800,000	52.0	75
50,000	4,000	-50K	150,000	11,800,000	57.0	75
100,000	4,000	-100K	150,000	19,950,000	180.0	75

Model 1615

Standard flange housing mount with AND pads to match Army-Navy mountings standard.

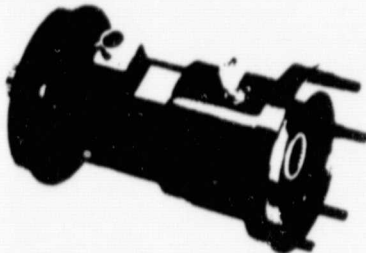

Capacity (Lb. In.)	Max. Speed (RPM)	Model	Protected for Overloads to (Lb. In.)	Torsional Stiffness (Lb. In./Rad.)	Rotating Inertia (Lb.-In. ²)	Weight (Lbs.)
50	15,000	1615A-50	150	1,500	1.0	24
100	15,000	-100	300	4,000	1.1	24
200	15,000	-200	600	10,000	1.2	24
500	15,000	-500	1,500	20,000	1.3	24
1K	15,000	-1K	1,500	25,000	1.4	24
50	15,000	1615K-50	75	1,620	1.04	25
100	15,000	-100	150	4,570	1.05	25
200	15,000	-200	300	12,900	1.06	25
500	15,000	-500	750	940,000	1.97	25
1,000	15,000	-1K	1,500	204,000	2.00	25
2,000	15,000	-2K	3,000	347,000	2.08	26
5,000	15,000	-5K	7,500	500,000	2.38	26
10,000	15,000	-10K	15,000	5,400,000	2.76	26

Model 1648

Flange drive units recommended for use when short length is mandatory.

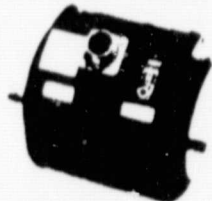

Capacity (Lb. In.)	Max. Speed (RPM)	Model	Protected for Overloads to (Lb. In.)	Torsional Stiffness (Lb. In./Rad.)	Rotating Inertia (Lb.-In. ²)	Weight (Lbs.)
2,000	5,000	1648-2K	3,000	742,000	23.0	23
5,000	5,000	-5K	7,500	1,811,000	23.0	23
10,000	5,000	-10K	15,000	2,248,000	23.0	23
20,000	5,000	-20K	30,000	3,507,000	23.5	23

GENERAL SPECIFICATIONS: (All Models)

SENSOR: Four arm bonded foil strain gage bridge
BRIDGE RESISTANCE: 350 ohms nominal
BRIDGE VOLTAGE: 20 volts maximum, 3 KHz
OUTPUT: 2 to 2.5 millivolt/volt nominal
LINEARITY: 0.1% of full scale

COMPENSATED TEMPERATURE RANGE: 30°F to 150°F
USEABLE TEMPERATURE RANGE: 0°F to 200°F
EFFECT OF TEMPERATURE ON ZERO: .002% of full scale/°F
EFFECT OF TEMPERATURE ON OUTPUT: .002% of reading/°F

TECHNICAL SPECIFICATION

MCRT®6-02T Non-Contact Torquemeter

MAX. TORQUE - 15,000 lb.-in.
SPEED - 0 - 7,500 rpm

GENERAL DESCRIPTION

The MCRT®6-02T is a compact, high accuracy, flanged torquemeter well adapted for vehicle drive-line measurements and continuous monitoring and feedback applications. It uses a rotating strain gage torque bridge, temperature compensated for drift and modulus. The bridge is connected to a stationary electronic readout via integral, non-contact rotary transformers.

The torquemeter is immune to water, lubricants, coolants, vibration, etc. The elimination of slip-rings permits high accuracy low level measurements with long, maintenance-free life. Thrust and bending loads are inherently cancelled by the transducer design. An optional, integral non-contact speed pickup may be specified when ordering.

Linearity: 0.1%

Temperature Effects: From 75 to 175° F maximum drift is 0.2% of full scale and maximum error due to modulus change is 0.2% of reading.

Maximum Operating Temperature: 220° F, assuming permanent lubrication. Above 175° F, the maximum shaft speed may have to be de-rated.

Readout: Any carrier amplifier suitable for strain gage service may be used.

Excitation Voltage: 10 volts rms, maximum.

Nominal Output: 0.75 millivolts/volt (open circuit)

Standard Ratings:

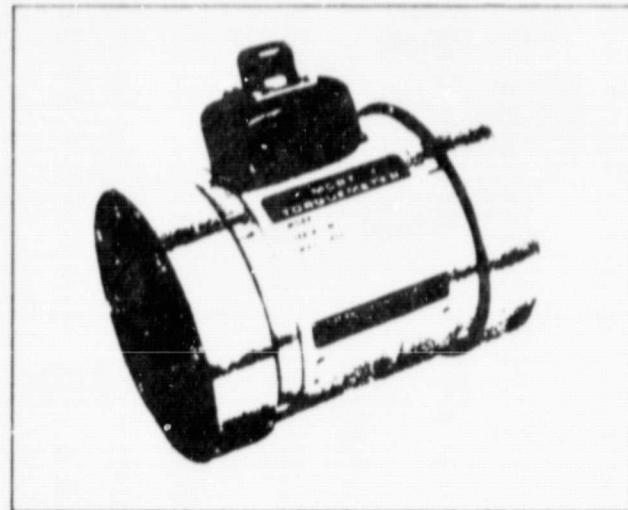

MODEL	FULL SCALE TORQUE (lb. - in.)	TORSIONAL STIFFNESS (lb. - in./rad.)	MAXIMUM BENDING MOMENT (lb. - in.)	MAXIMUM ROTATING INERTIA (in. - oz. sec. ²)	MAXIMUM WEIGHT (lbs.)
MCRT®6-02T					
-(1-3)	1,000	602,000	500	0.60	13.8
-(2-3)	2,000	1,375,000	1,000	0.60	13.8
-(4-3)	4,000	2,640,000	2,000	0.60	13.8
-(6-3)	6,000	2,430,000	3,000	0.90	17.0
-(10-3)	10,000	2,930,000	5,000	0.90	17.0
-(15-3)	15,000	3,530,000	5,500	0.90	17.0

Overload Capacity: 2 times full scale rating.

Shaft Speed: 0 to 7,500 rpm, bi-directional. Optional speed pickup produces 60 pulses per shaft revolution.

Construction: Load carrying members (flanges, shaft) are 17-4 PH high strength stainless steel.

NOTES:

- [1] Maximum speed rating assumes permanent lubrication. Consult factory for higher speed operation.
- [2] When combined axial and bending loads are present, the bending capacity must be de-rated. Consult factory.
- [3] Stator should be compliantly restrained from rotating.

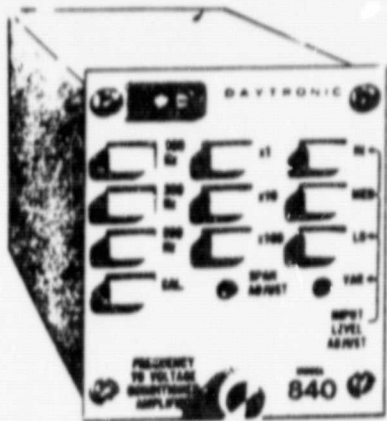

MODEL
840

**FREQUENCY-TO-VOLTAGE
CONVERTER**

The Model 840 Frequency-to-Voltage Converter is a conditioner-amplifier module that accepts input signals in a wide range of frequencies, wave shapes, and voltage levels and produces standard system output voltages precisely proportional to the frequency or repetition rate of the input signal. It is intended for use in "800" systems for measurement of flow, rpm, and similar phenomena that can be derived from magnetic pickups, turbine flowmeters, or other frequency-producing sources.

Nine selectable frequency ranges accommodate virtually all mechanical measurement requirements. An internal crystal oscillator reference and adjustable output span allow precise calibration of the indicating device in terms of frequency, rpm, or any other chosen units appropriate to the particular measurement. In flow measurement, for example, the Model 840 can be used with the Model 890 Digital Indicator and calibrated, using the front panel controls, so as to indicate directly in gallons per minute or gallons per hour, provided only that the flowmeter K Factor (cycles per gallon) is known.*

The Model 840 is also used in conjunction with the Model 862 Multiplier Module in an instrument that can display torque, rpm, and shaft horsepower in digital engineering units. Additional information on this and other instrument combinations is contained under the Model 862 description.

* If fluid specific gravity is also known, calibration can be made in units of mass flow, such as Pounds per Hour. For applications where specific gravity is subject to change, corrections can be entered manually on a calibrated dial (see Model 868, p 46) or applied automatically by a temperature sensing channel (see Model 862, page 42).

ORIGINAL PAGE IS
OF POOR QUALITY

SPECIFICATIONS

Input:

- Type any AC signal, grounded or floating, irrespective of waveform.
- Sensitivity: . . . Three ranges (Lo, Med, & Hi), plus vernier, allow adjustment of threshold level from 5 mv to 50 volts (peak). Maximum continuous input voltage is 25 v, 100 v, & 250 v (RMS), respectively. Input is undamaged by momentary peak voltage of 500 volts on any range. Differential input impedance is 20K ohms, 400K ohms, and 8 Megohms, respectively.
- Common mode rejection . . . greater than 60 dB to 2 kHz and greater than 30 dB to 100 kHz.
- Frequency ranges: 100 Hz, 200 Hz, and 500 Hz; with multipliers of X1, X10, and X100; each with 100% overrange.

Output:

- Standard One Volt Data Signal: (see Table One, page 7)
- Standard Ten Volt Output Signal: (see Table One, page 7)
- Step function response (to 99% of final value): 800 ms for X1 multiplier, 80 ms for X10 and X100 multipliers
- Step-function response (to 99.9% of final value): 2.5 sec for X1 multiplier, 250 ms for X10 and X100 multipliers
- Ripple and noise (max.): less than 0.2% of full scale from 10% to 100% of scale.
- Accuracy: 0.05% of scale (based on average value of DC output).
- Housing: standard full width module.
- Operating temperature range: +50 to +120 degrees F.
- Power requirements: 105-130 volts, 50-400 Hz.

PRICE: Model 840 Frequency-to-Voltage Converter \$495.00

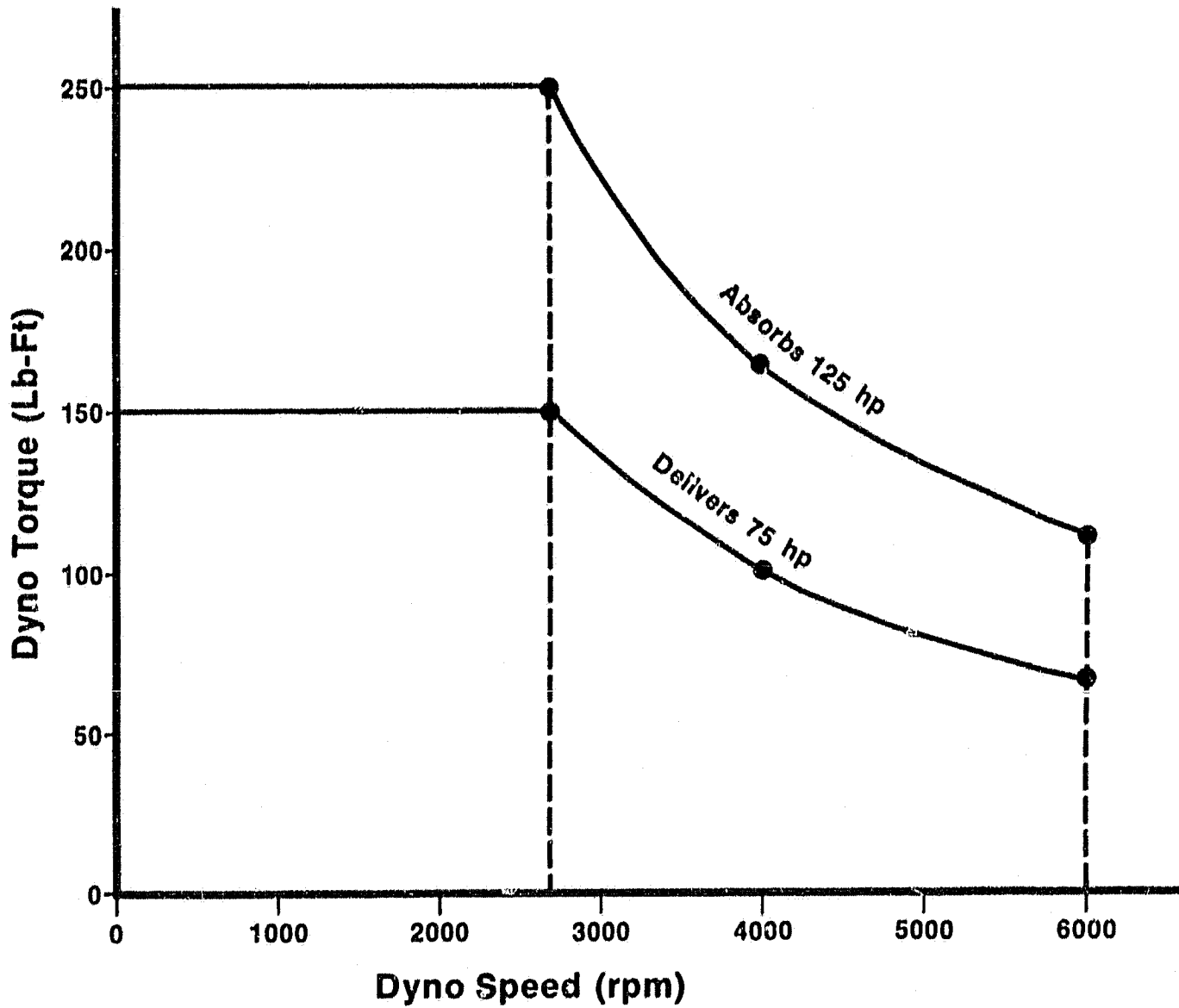

Dynamometer Characteristics

General Electric

**No 1739498
Amperes 360
Absorbs 125 hp
Speeds 2700/6000
Torque Arm 15.756**

**Type TCL-20
Volts 250
Delivers 75 hp
Insts. GE I-7360-B**

Class 4-125-2700

Absorption Model 1014WIG • Speed-Torque Curve

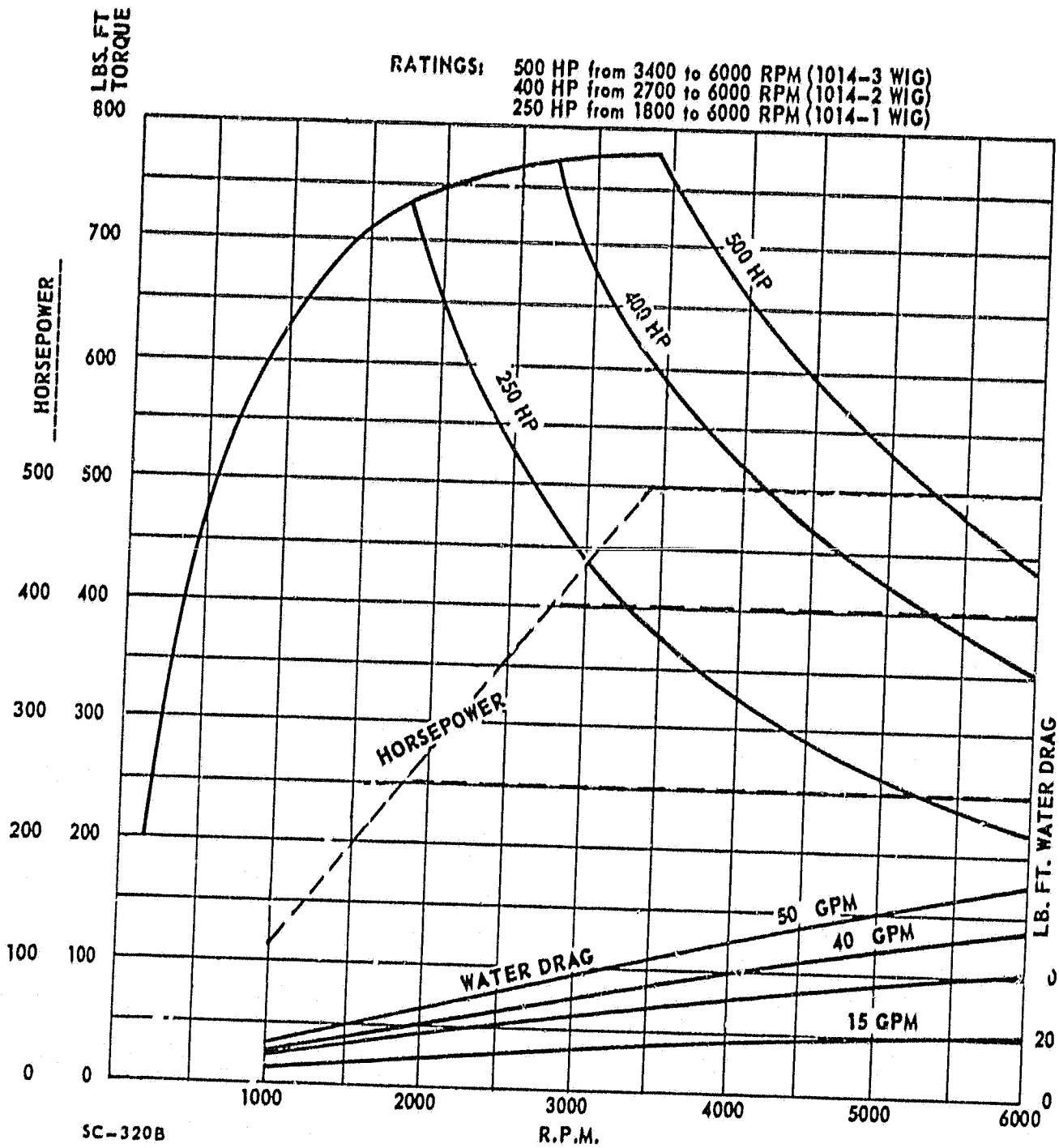

1. Report No NASA CR-159882		2. Government Accession No.		3. Recipient's Catalog No.	
4. Title and Subtitle SMALL PASSENGER CAR TRANSMISSION TEST - CHEVROLET LUV TRANSMISSION				5. Report Date June 1980	
				6. Performing Organization Code	
7. Author(s) M. P. Bujold				8. Performing Organization Report No. ERC LIB, 80121	
9. Performing Organization Name and Address Eaton Corporation Engineering & Research Center 26201 Northwestern Highway Southfield, MI 48037				10. Work Unit No.	
				11. Contract or Grant No. DEN 3-124	
				13. Type of Report and Period Covered Contractor Report	
12. Sponsoring Agency Name and Address U.S. Department of Energy Office of Transportation Programs Washington, DC 20585				14. Sponsoring Agency Code Report No. DOE/NASA/0124-3	
15. Supplementary Notes Final Report. Prepared under Interagency Agreement EC-77-A-31-1044, Project Manager, Henry B. Tryon, Transportation Propulsion Division, NASA Lewis Research Center, Cleveland, Ohio 44135.					
16. Abstract The small passenger car transmission test was initiated to supply electric vehicle manufacturers with technical information regarding the performance of commercially available transmissions. This information would enable EV manufacturers to design a more energy efficient vehicle. With this information the manufacturers would be able to estimate vehicle driving range as well as speed and torque requirements for specific road load performance characteristics. This report covers the testing of a 1978 Chevrolet LUV manual transmission. This transmission was tested per the applicable portions of a passenger car automatic transmission test code (SAE J651b) which required drive performance, coast performance, and no load test conditions. Under these test conditions, the transmission attained maximum efficiencies in the upper ninety percent range for both drive performance tests and coast performance tests. The major results of this test are the torque, speed and efficiency curves which are located in the data section of this report. These graphs map the complete performance characteristics for the Chevrolet LUV transmission.					
17. Key Words (Suggested by Author(s)) Electric vehicles Transmissions			18. Distribution Statement Unclassified - unlimited STAR Category 37 DOE Category UC-96		
19. Security Classif. (of this report) Unclassified		20. Security Classif. (of this page) Unclassified		21. No. of Pages 377	22. Price* A17

* For sale by the National Technical Information Service, Springfield, Virginia 22161