

# NASA Contractor Report 3201

NASA-CR-3201  
19800023828

FOR REFERENCE

DO NOT REMOVE FROM THIS ROOM

## Rotary Balance Data for a Typical Single-Engine General Aviation Design for an Angle-of-Attack Range of 8° to 90° II - High-Wing Model C

Randy S. Hultberg, Julio Chu,  
and Waldo L. Dickens

CONTRACT NAS1-14849  
OCTOBER 1980

LIBRARY COPY

OCT 23 1980

LANGLEY RESEARCH CENTER  
LIBRARY, NASA  
HAMPTON, VIRGINIA





NASA Contractor Report 3201

Rotary Balance Data for a Typical  
Single-Engine General Aviation  
Design for an Angle-of-Attack  
Range of  $8^{\circ}$  to  $90^{\circ}$   
II - High-Wing Model C

Randy S. Hultberg, Julio Chu,  
and Waldo L. Dickens  
*Bihrl Applied Research, Inc.*  
*Jericho, New York*

Prepared for  
Langley Research Center  
under Contract NAS1-14849



National Aeronautics  
and Space Administration

Scientific and Technical  
Information Branch

1980

---





## SUMMARY

Aerodynamic characteristics obtained in a helical flow environment utilizing a rotary balance located in the Langley spin tunnel are presented in plotted form for a 1/6-scale, single-engine, high-wing, general aviation model (model C). The configurations tested included the basic airplane and control deflections, wing leading edge devices, tail designs and airplane components. Data are presented without analysis for an angle-of-attack range of  $8^{\circ}$  to  $90^{\circ}$  and clockwise and counter-clockwise rotations covering an  $\frac{\Omega b}{2V}$  range from 0 to .9.

## INTRODUCTION

The NASA Langley Research Center has a broad general aviation stall/spin research program underway which includes spin-tunnel and free-flight radio control model tests, as well as full-scale flight tests for a number of configurations typical of light, general aviation airplanes. To support this effort, rotary balance wind tunnel force tests covering these same configurations have been conducted to establish a data base for analysis of model and full-scale flight results, and to develop design charts for desirable stall/spin characteristics.

A 1/6-scale, single-engine, general aviation model, referred to as model C, having a high-wing location, was tested in a helical flow environment utilizing a rotary balance located in the Langley spin tunnel. This report presents the data obtained for the basic configuration and control settings, various wing leading-edge modifications, tail designs and airplane components. Data for model C having a low-wing location are presented in reference 1.

## SYMBOLS

The units for physical quantities used herein are presented in the International System of Units (SI) and U.S. Customary Units. The measurements were made in the U.S. Customary Units; equivalent dimensions were determined by using the conversion factors given in reference 2.

b	wing span, m (ft)
$\bar{c}$	mean aerodynamic chord, cm (in.)
$C_N$	normal-force coefficient, $\frac{\text{Normal force}}{qS}$
$C_A$	axial-force coefficient, $\frac{\text{Axial force}}{qS}$
$C_Y$	side-force coefficient, $\frac{\text{Side force}}{qS}$
$C_l$	rolling-moment coefficient, $\frac{\text{Rolling moment}}{qSb}$
$C_m$	pitching-moment coefficient, $\frac{\text{Pitching moment}}{qS\bar{c}}$
$C_n$	yawing-moment coefficient, $\frac{\text{Yawing moment}}{qSb}$
q	free-stream dynamic pressure, N/m <sup>2</sup> (lb/ft <sup>2</sup> )
S	wing area, m <sup>2</sup> (ft <sup>2</sup> )
V	free-stream velocity, m/sec (ft/sec)
$\alpha$	angle of attack, deg
$\beta$	angle of sideslip, deg
$\Omega$	angular velocity about spin axis, rad/sec
$\frac{\Omega b}{2V}$	spin coefficient, positive for clockwise spin
$\delta_a$	aileron deflection, positive when right aileron is down ( $\delta_{a_{\text{right}}} - \delta_{a_{\text{left}}}$ )/2, deg
$\delta_e$	all movable horizontal tail deflection, positive when trailing edge is down, deg
$\delta_r$	rudder deflection, positive when trailing edge is to left, deg

Abbreviations:

cg center of gravity  
LE leading edge  
SR spin radius  
TE trailing edge

TEST EQUIPMENT

A rotary balance measures the forces and moments acting on an airplane while subjected to rotational flow conditions; the background for this apparatus is discussed in reference 3. A photograph and sketch of the rotary balance apparatus installed in the Langley spin tunnel are shown in figures 1 and 2, respectively. The rotating portion of the balance system, mounted on a horizontal supporting boom which is hinged at the wall, is moved from the wall to the center of the tunnel by cables. The rotary arm of the balance system, which rotates about a vertical axis, is attached to the outer end of the horizontal supporting boom and is driven by a drive shaft through couplings and gears.

A test model is mounted on a strain gauge balance which is affixed to the bottom of the rotary balance apparatus. Controls located outside the tunnel are used to activate motors on the rig which position the model to the desired attitude. The angle-of-attack range of the rig is 8 to 90 degrees and the sideslip angle range is  $\pm 15$  degrees. The spin radius and the lateral displacement motors allow the operator to position the moment center of the balance longitudinally and laterally relative to the spin axis. This is done for each combination of angle of attack and sideslip angle. The general practice is to mount the moment center of the balance at the cg location about which the aerodynamic moments are desired. Electrical current from the balance, and to the motors on the rig, is conducted through the slip-rings located at the rig head. Examples

of how the rig is positioned for different angle of attack and sideslip angle are shown in figures 2a and 2b, respectively.

The model can be rotated up to 90 rpm in either direction. By using different rotational speeds and a specific airflow in the tunnel, the motions of a steady spinning airplane can be simulated. The aerodynamic forces and moments can then be measured for values of  $\frac{\Omega b}{2V}$ , including the case of  $\frac{\Omega b}{2V} = 0$ , where static aerodynamic forces and moments can be obtained.

A NASA six-component strain gauge balance is mounted inside the model and measures the normal, lateral and longitudinal forces and the yawing, rolling and pitching moments acting about the model body axis. The interactions that exist between the six components are available from balance calibration tests and are accounted for after the balance voltages are converted to forces and moments.

The data acquisition, reduction and presentation system for the rotary balance system is composed of a 12-channel scanner/voltmeter, a mini-computer, and a plotter. With this equipment, on-line digital print-out and/or graphical plots of data are possible.

#### TEST PROCEDURES

Rotary aerodynamic data are obtained in two steps. The first step is to record the inertial forces and moments (tares) acting on the model at different attitudes and rotational speeds. To accomplish this, a covered bird-cage like structure is mounted to the upper rig which encloses the model without touching it. In this manner, the air immediately surrounding the model is rotated with it. As the rig is rotated at the desired attitude and rate, the inertial forces and moments generated by the model are measured and stored on magnetic tape for later use.

The second step in the data-gathering process is to measure aerodynamic and inertial forces at different attitudes and rotational speeds for a selected tunnel velocity with, of course, the cage structure removed. The tares are subtracted from these values, and the remaining aerodynamic forces and moments are then converted to coefficient form and stored on magnetic tape.

#### MODEL

A 1/6-scale high-wing, single-engine, light general aviation model was constructed of fiberglass-epoxy, wood and aluminum. A three-view drawing of this model is shown in figure 3, dimensional characteristics of the basic model are listed in Table I, and a photograph of the model installed on the rotary balance located in the Langley spin tunnel is presented in figure 1.

The various airplane components were removable for component build-up tests, the testing of wing leading edge devices and tail configurations. The three tail configurations tested involved different vertical and horizontal locations of the horizontal tail as shown in figure 4. The wing leading edge modifications include a full-span leading edge droop of large nose radius and an outboard drooped section of large nose radius (figures 5 and 6).

The model control surfaces could be set at any position prior to the test. The maximum deflections for the control surfaces were:

Rudder, deg	25 right, 25 left
All movable horizontal tail, deg	15 up, 2 down
Aileron, deg	20 up, 10 down

## TEST CONDITIONS

The tests were conducted in the spin tunnel at an airstream velocity of 7.62 m/sec (25 ft/sec) which corresponds to a Reynolds number of approximately 119,000 based on model wing chord. Unless noted otherwise in Table II, all the configurations were tested through an angle-of-attack range of 8 to 90° at a zero sideslip angle, with the spin axis passing through the full-scale airplane cg location for angles of attack above 30°. For angles of attack below 35°, the spin axis was set 182.9 cm (72 in.) forward of the cg location. Consequently, data was obtained for both 0 and 182.9 cm (72 in.) spin radius at angles of attack of 30 and 35°. For each angle of attack, data were obtained for nominal  $\frac{\Omega b}{2V}$  values of .1, .2, .3, .4, .5, .6, .7, .8, and .9 in both clockwise and counter clockwise directions, as well as for  $\frac{\Omega b}{2V} = 0$  (static value).

## DATA PRESENTATION

Table II identifies the configurations tested and the corresponding appendix figure numbers which present the aerodynamic data. The aerodynamic coefficients vs.  $\frac{\Omega b}{2V}$  are presented for each configuration in six sequentially numbered figures in the following order:  $C_n$ ,  $C_l$ ,  $C_m$ ,  $C_N$ ,  $C_Y$ ,  $C_A$ . Each figure in turn consists of four (seven for the basic configuration) pages which present the subject aerodynamic coefficient vs.  $\frac{\Omega b}{2V}$  for the following angles of attack and spin radii, unless noted otherwise in Table II:

- a)  $\alpha = 8, 10, 12, 14, 16$  deg      SR = 182.9 cm (72 in.)
- b)  $\alpha = 18, 20, 25, 30, 35$  deg      SR = 182.9 cm (72 in.)
- c)  $\alpha = 30, 35, 40, 45, 50$  deg      SR = 0
- d)  $\alpha = 55, 60, 70, 80, 90$  deg      SR = 0

All the moment data are presented for a cg position of  $.21\bar{c}$ .

Lift coefficient vs, angle of attack for zero rotation rate is presented at the end of the Appendix for several configurations cited in Table II.

## REFERENCES

1. Mulcay, William J.; Rose, Robert A.: Rotary Balance Data for a Typical Single-Engine General Aviation Design for an Angle-of-Attack Range of  $8^{\circ}$  to  $90^{\circ}$ . I - Low-Wing Model C. NASA CR-3200, 1980.
2. Mechtly, E.A.: The International System of Units - Physical Constants and Conversion Factors. NASA SP-7012, 1973.
3. Bihrlle, William, Jr.; Hultberg, Randy S.; and Mulcay, William: Rotary Balance Data for a Typical Single-Engine Low-Wing General Aviation Design for an Angle-of-Attack Range of  $30^{\circ}$  to  $90^{\circ}$ . NASA CR-2972, 1978.



TABLE I.- DIMENSIONAL CHARACTERISTICS OF THE BASIC MODEL

Overall length, m (ft) . . . . .	1.31 (4.29)
Wing:	
Span, m (ft) . . . . .	1.66 (5.46)
Area, m <sup>2</sup> (ft <sup>2</sup> ) . . . . .	.38 (4.06)
Root chord, cm (in.) . . . . .	22.32 (8.79)
Tip chord, cm (in.) . . . . .	22.32 (8.79)
Mean aerodynamic chord, cm (in.) . . . . .	22.32 (8.79)
Leading edge of $\bar{c}$ , distance rearward of leading	
edge of root chord, cm (in.) . . . . .	0.0 (0.0)
Aspect ratio . . . . .	7.4
Dihedral, deg . . . . .	1.5
Incidence:	
Root, deg . . . . .	+3.257
Tip, deg . . . . .	+1.0
Airfoil section	NACA 63 <sub>2</sub> A415
Horizontal tail:	
Span, m (ft) . . . . .	0.54 (1.78)
Incidence, deg . . . . .	0.0
Airfoil section . . . . .	NACA 63A <sub>1</sub> 012(modified)
Vertical tail:	
Airfoil section . . . . .	NACA 63A <sub>1</sub> 012
Sweep @ LE, deg . . . . .	41.0

TABLE II.- CONFIGURATIONS TESTED AND FIGURE INDEX  
 (Unless noted otherwise, all configurations tested through  $\alpha=8$  to  $90^\circ$  at  $\beta=0^\circ$ .)

FIGURE NO.	CONFIGURATION	$\delta_e$ deg	$\delta_a$ deg	$\delta_r$ deg	REMARKS
<sup>a</sup> A1-A6	Basic	0	0	0	also $\alpha=8-60^\circ$ , SR=6" $\beta=10^\circ$
A7-A12	↓	↓	↓	↓	
A13-A18	↓	-15	+20up +10down	-25	
A19-A24	↓	↓		↓	
A25-A30	T tail	0	0	0	
A31-A36	↓	-15	↓	-25	
A37-A42	#1 Horiz. tail	0		0	
A43-A48	↓	-15		-25	
A49-A54	Horiz. tail off	off		0	
A55-A60	Vert. tail off	0		off	
A61-A66	Horiz. and vert. tail off	off		↓	
<sup>a</sup> A67-A72	Full-span LE wing droop w/large nose radius	0		0	
<sup>a</sup> A73-A78	Outboard LE wing droop w/large nose radius	↓	↓	↓	

<sup>a</sup>  $C_L$  vs.  $\alpha$  presented in figure A79.

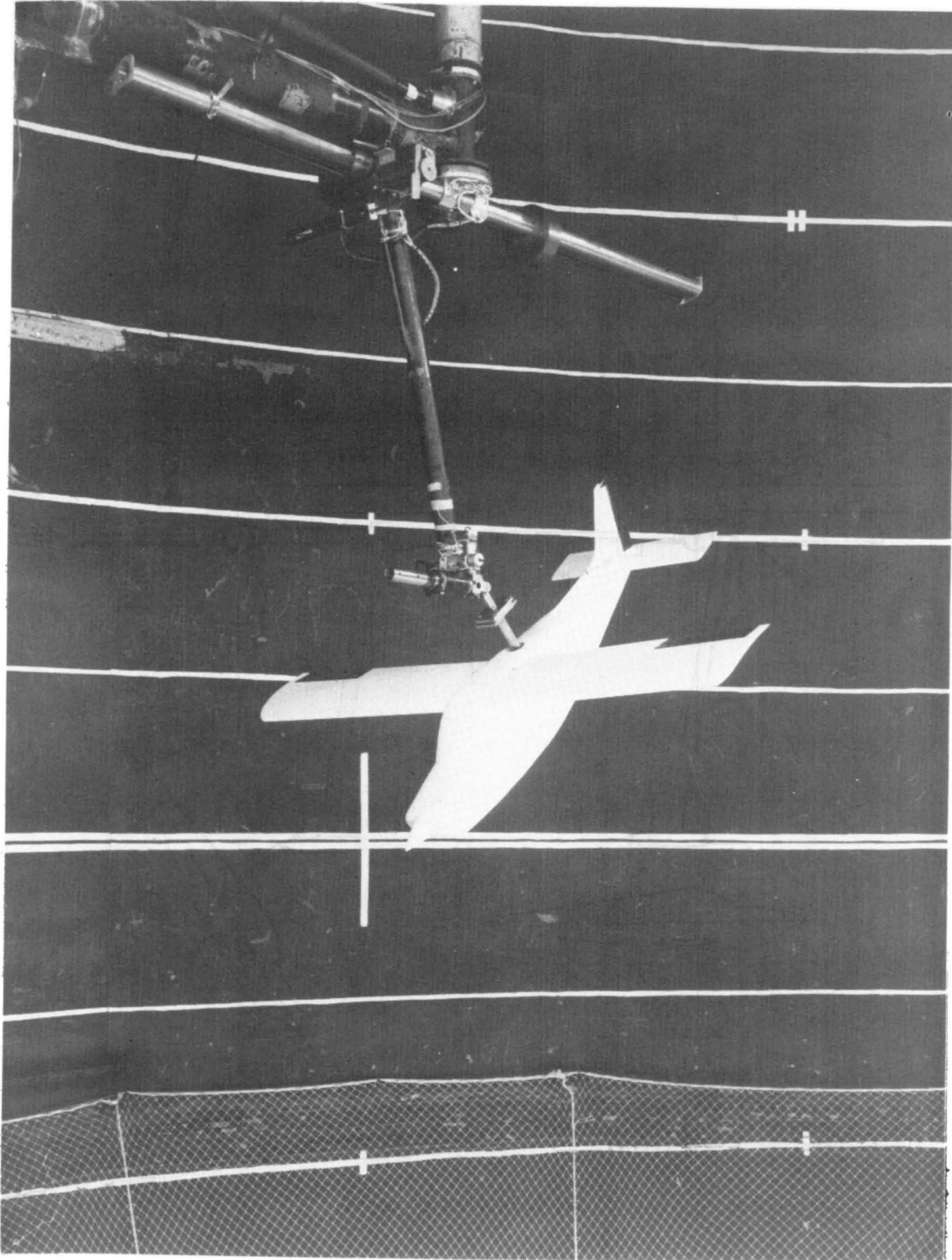
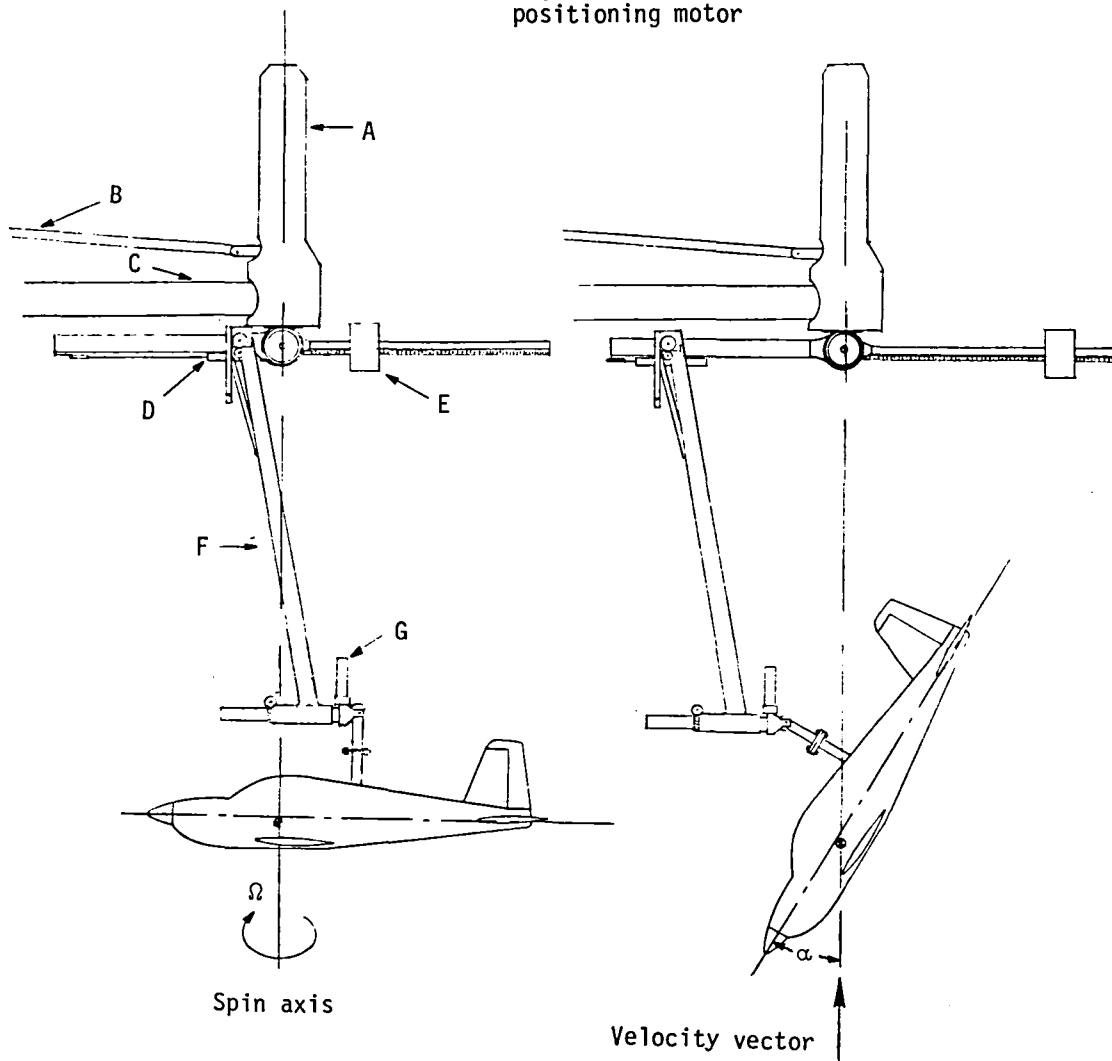

Figure 1. - Photograph of 1/6-scale model installed on rotary balance apparatus.

- A Slip ring housing
- B Drive shaft
- C Support boom
- D Spin radius offset potentiometer
- E Counterweight
- F Strut
- G Angle of attack positioning motor



(a) Side view of model.

Figure 2.- Sketch of rotary balance apparatus.

- A Slip ring housing
- B Spin radius offset potentiometer
- C Lateral offset drive gears
- D Lateral offset potentiometer
- E Strut
- F Sideslip angle potentiometer
- G Sideslip angle positioning motor

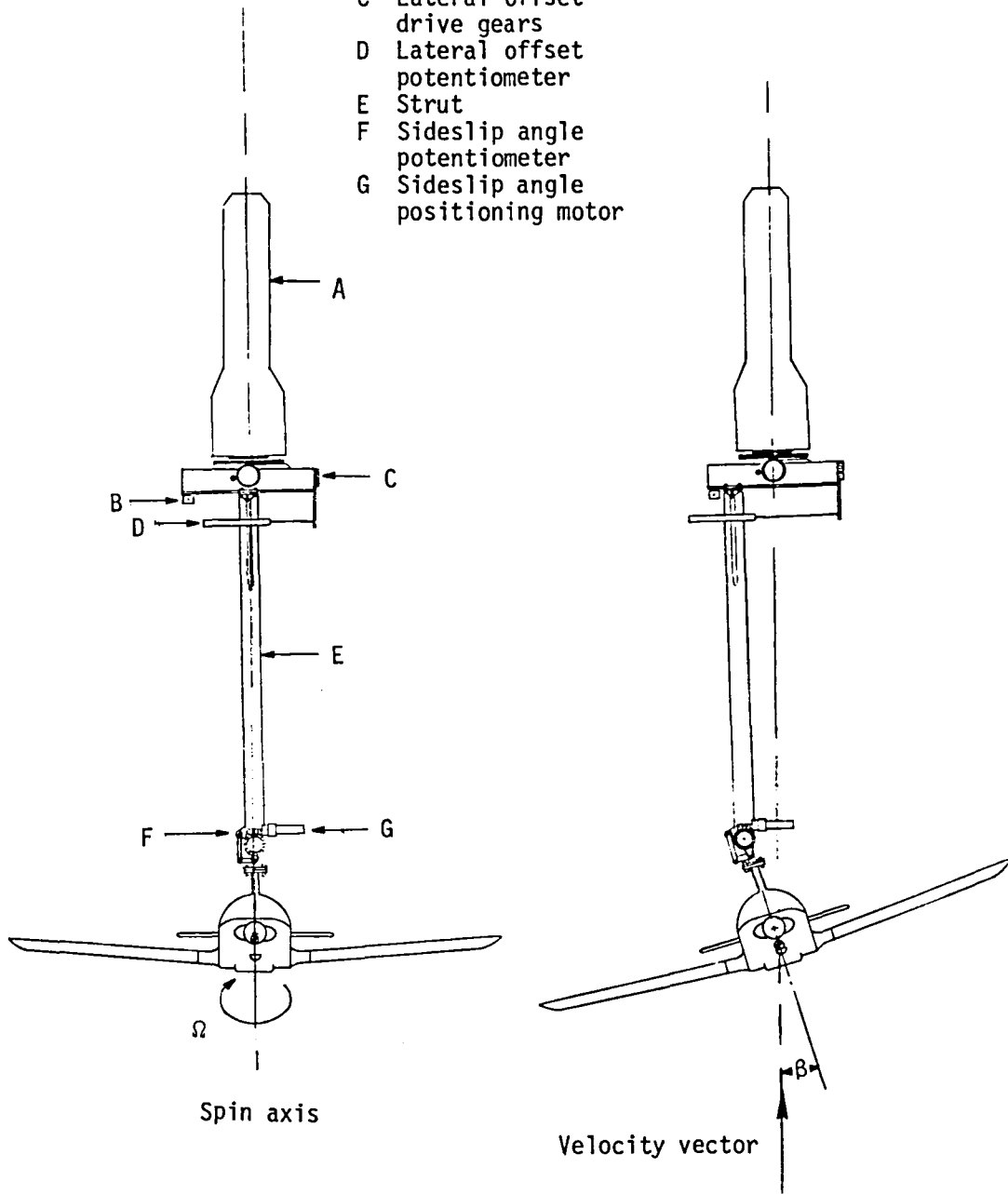

(b) Front view of model.

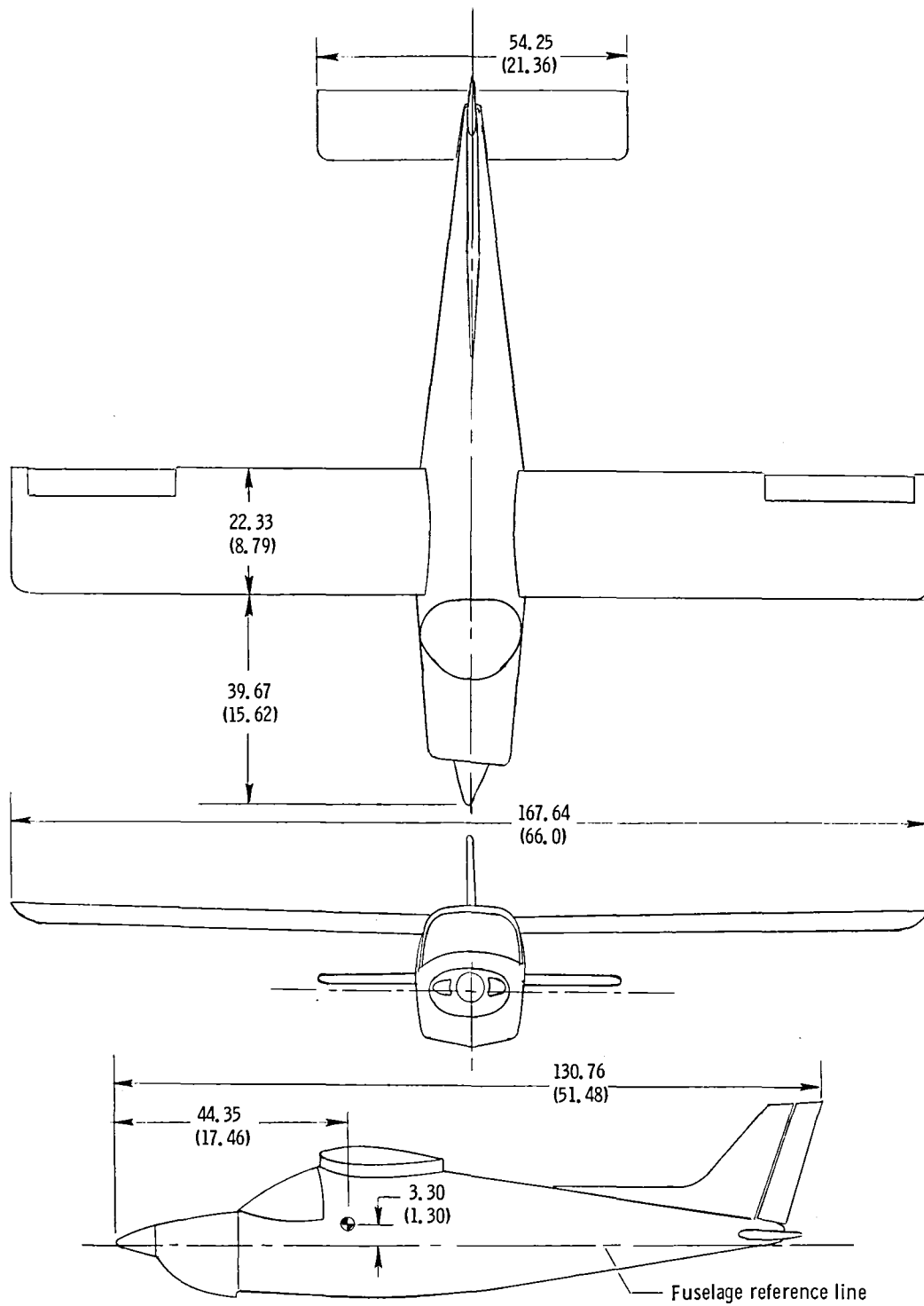

Figure 3. - Three-view drawing of 1/6-scale high-wing general aviation model C. Center-of-gravity positioned at 0.21  $\bar{c}$ . Dimensions are given in centimeters(inches), model scale.

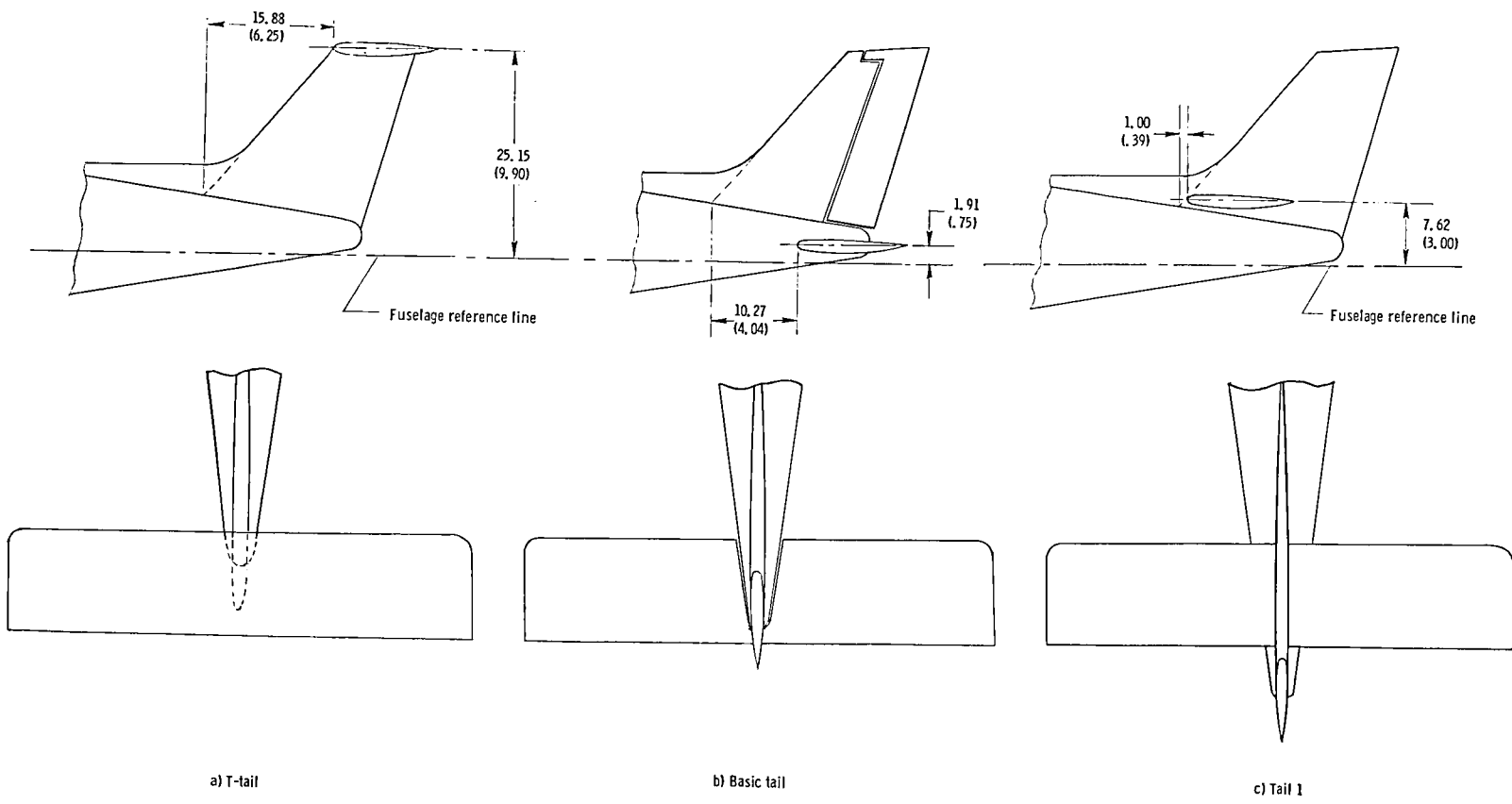

Figure 4. - Tail configurations tested on the model. Dimensions are given in centimeters(inches), model scale.

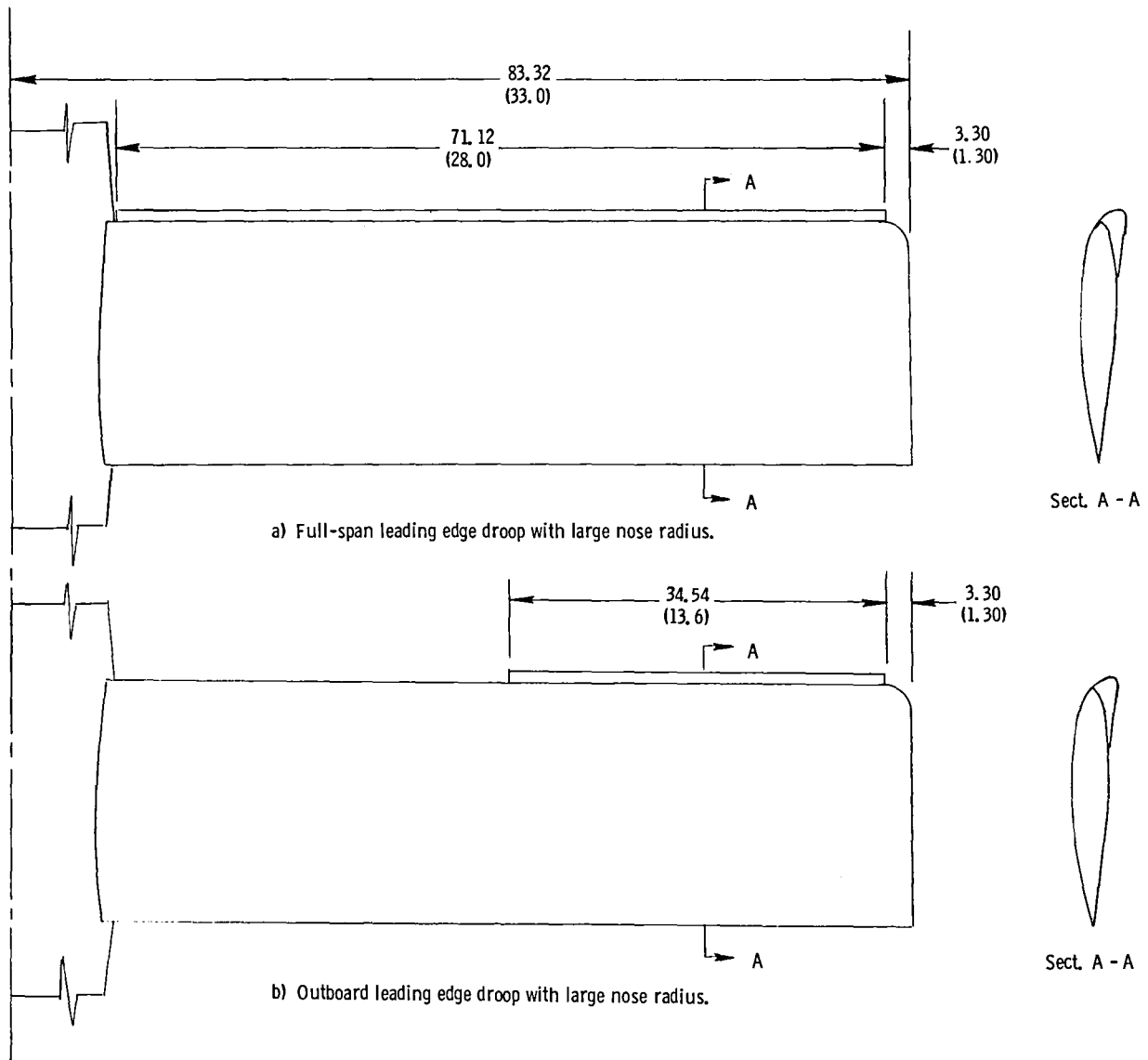
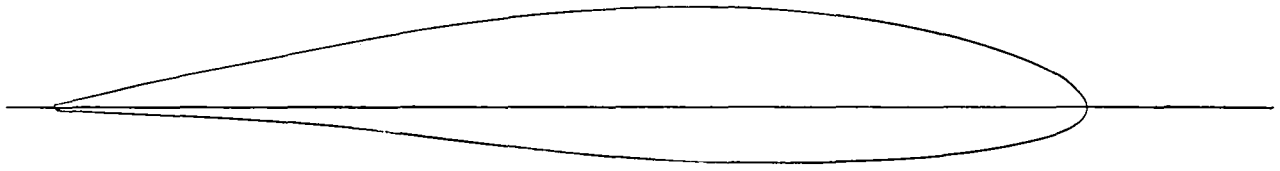
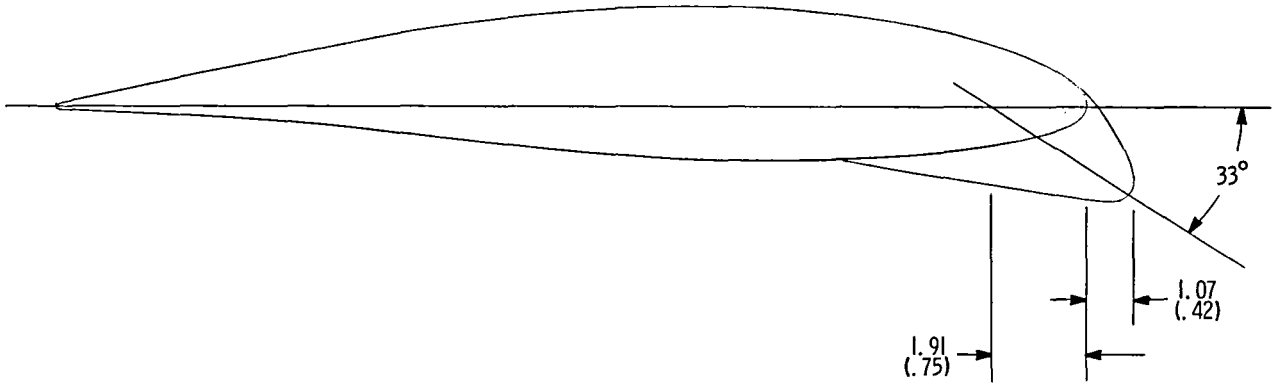

Figure 5. - Wing leading edge modifications tested on the model. Dimensions are given in centimeters(inches), model scale.





a) Basic airfoil.



b) Basic airfoil with large nose radius.

Figure 6. - Airfoil sections tested on model. Dimensions are given in centimeters (inches) model scale.



APPENDIX

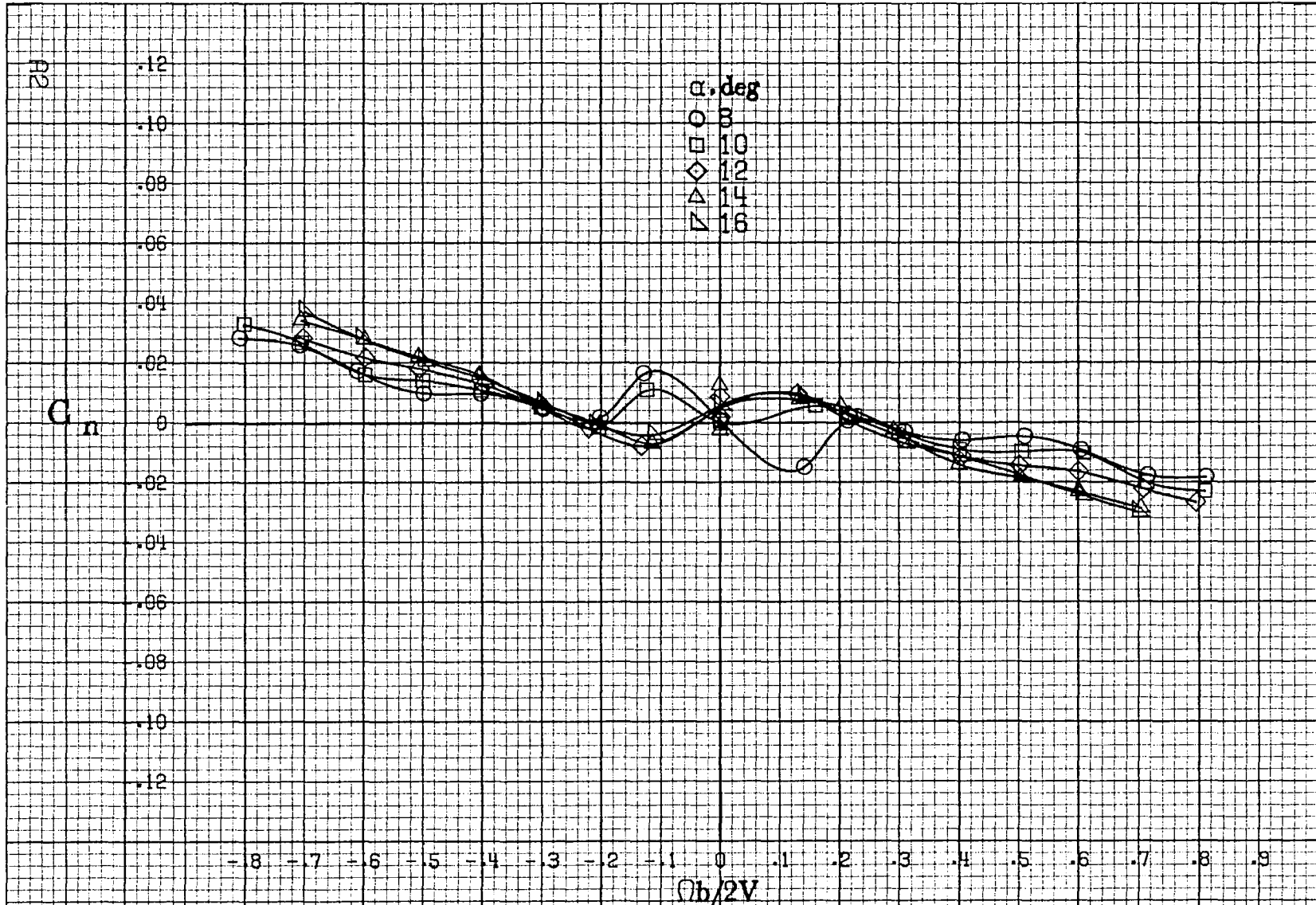

(a)  $\alpha = 8$  to  $16$  deg,  $SR = 182.9$  cm (72 in).

Figure A1-Effect of rotation rate and angle of attack on yawing-moment coefficient for basic configuration.  $\delta_e = 0^\circ$ ,  $\delta_a = 0^\circ$ ,  $\delta_r = 0^\circ$ ,  $B = 0^\circ$ .

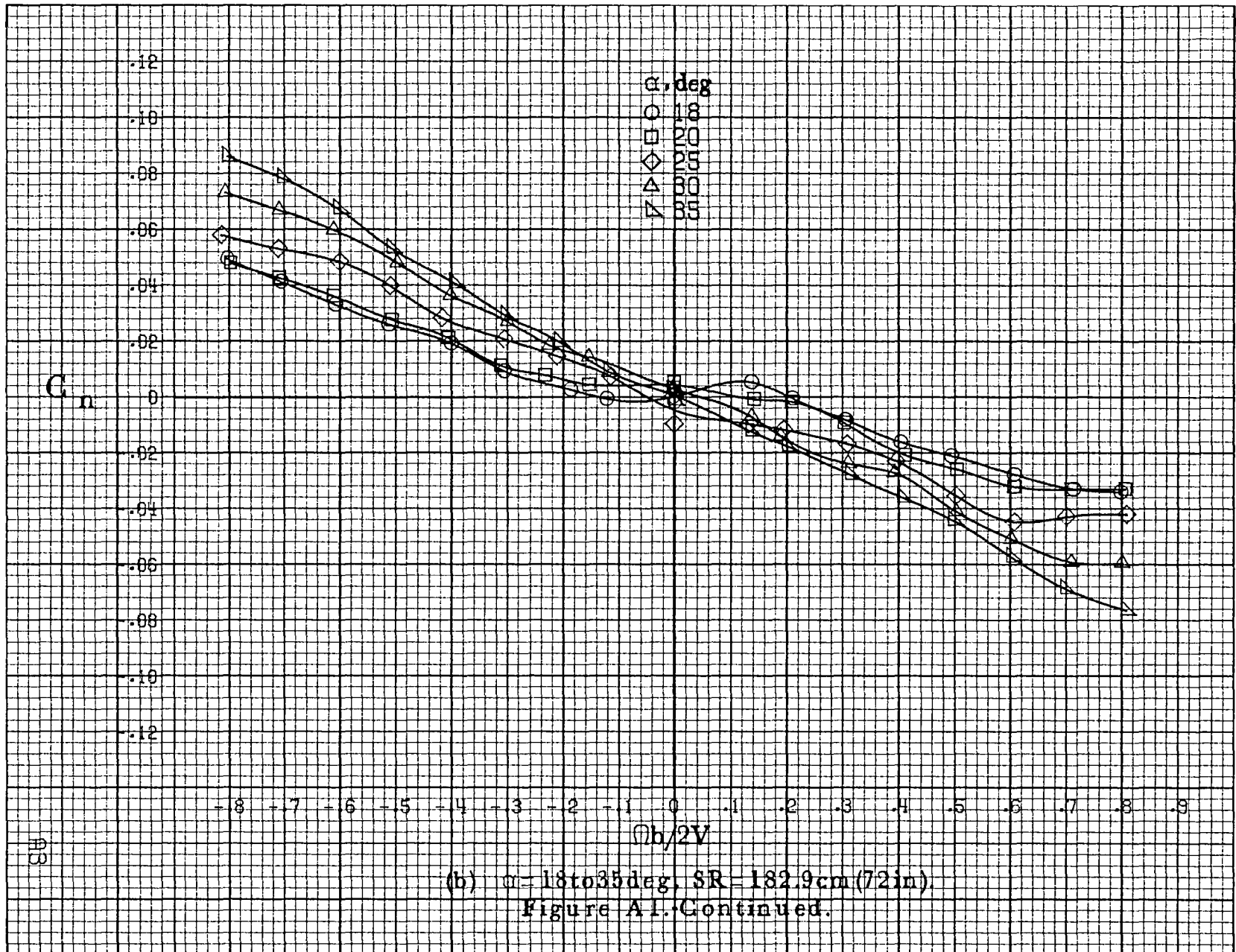

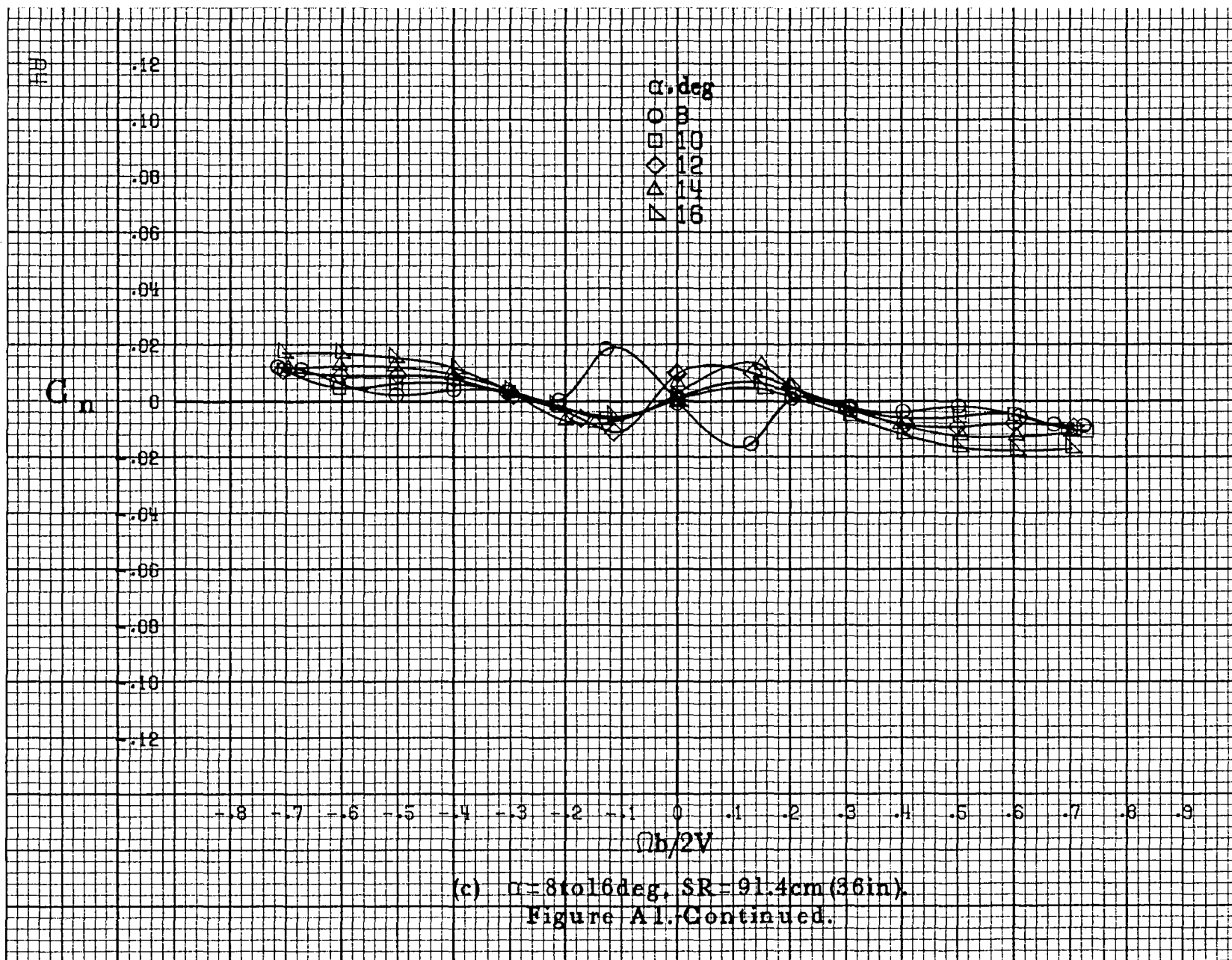

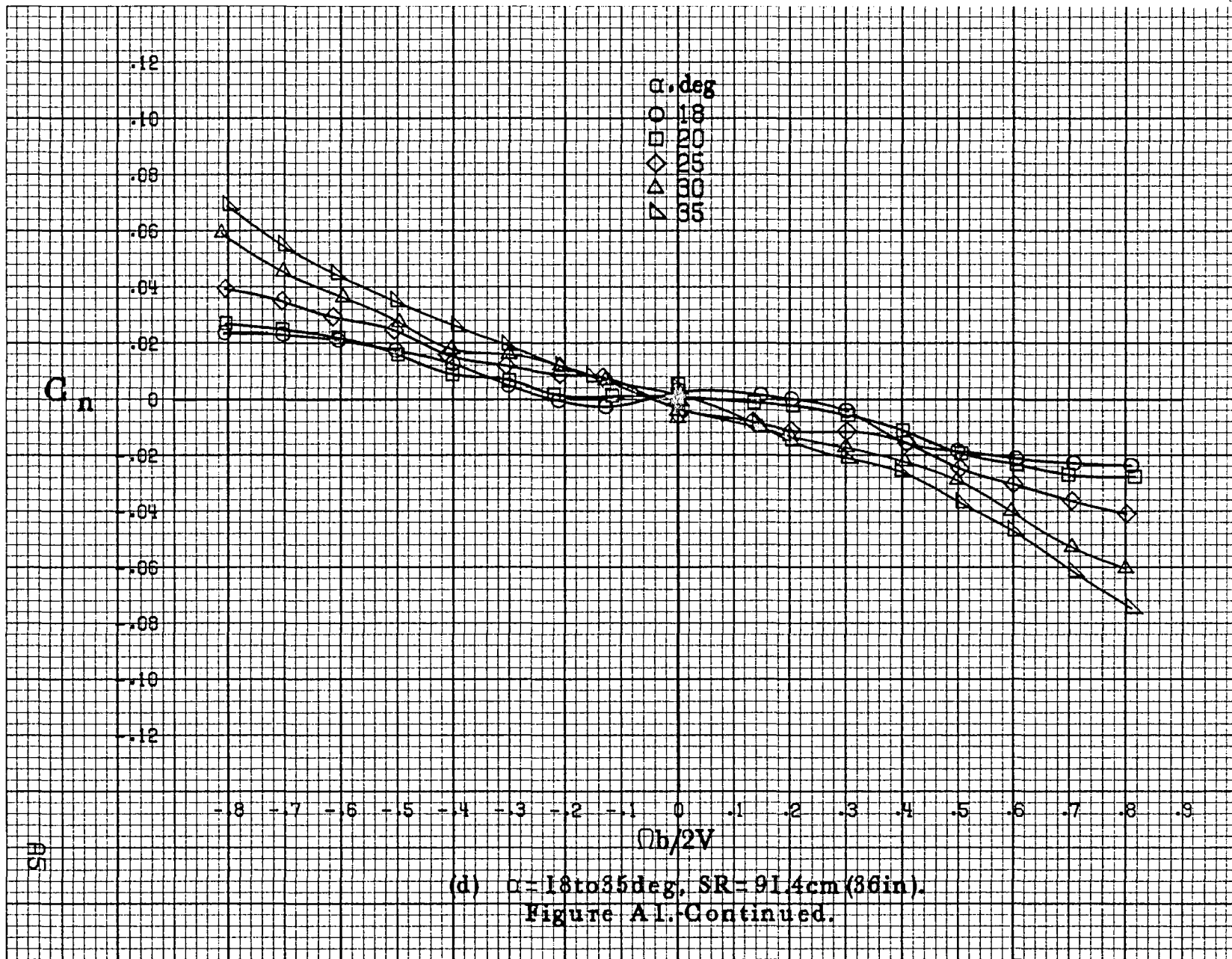

(d)  $\alpha = 18$  to  $85$  deg, SR = 91.4 cm (36 in).  
 Figure A1. Continued.

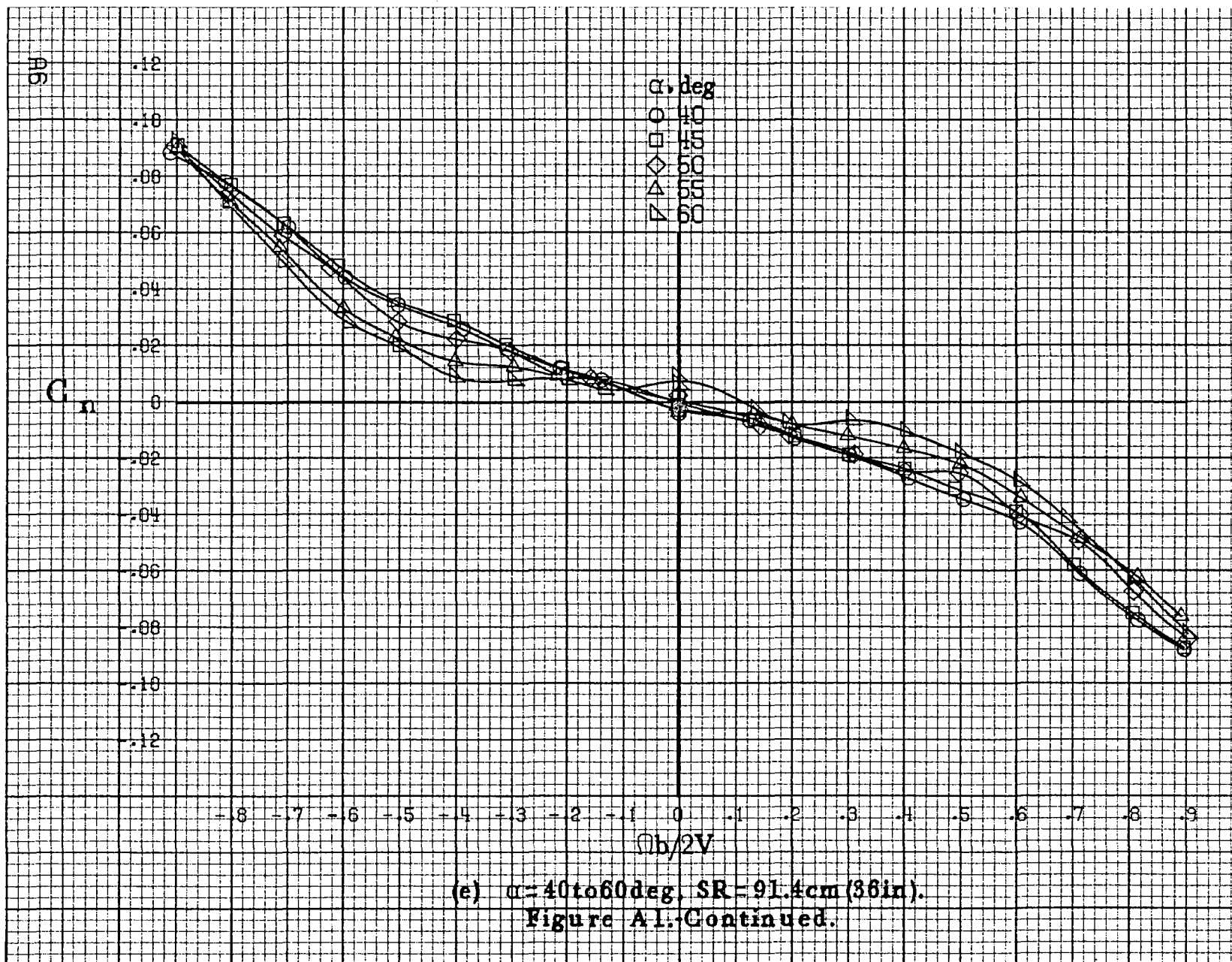



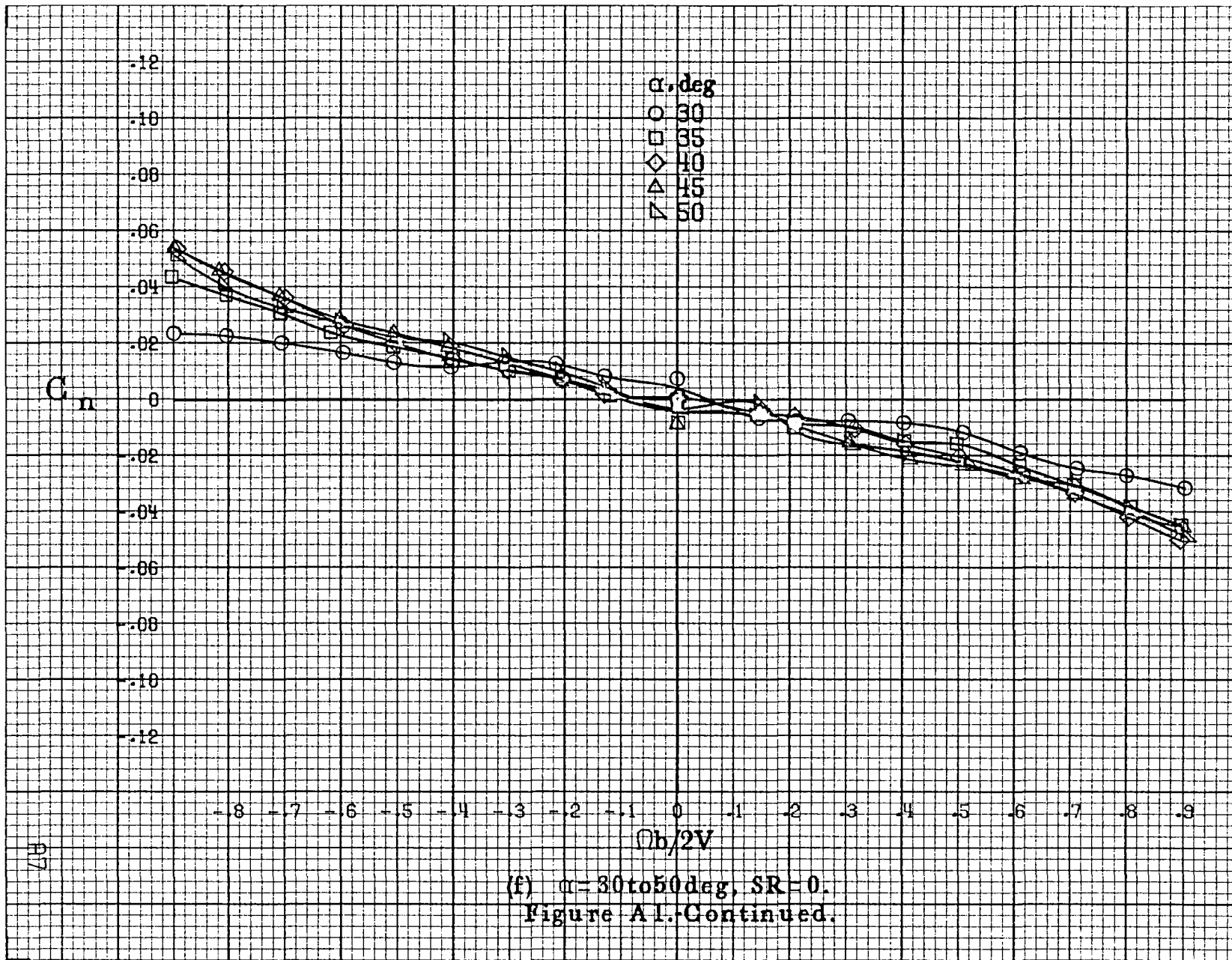

R7

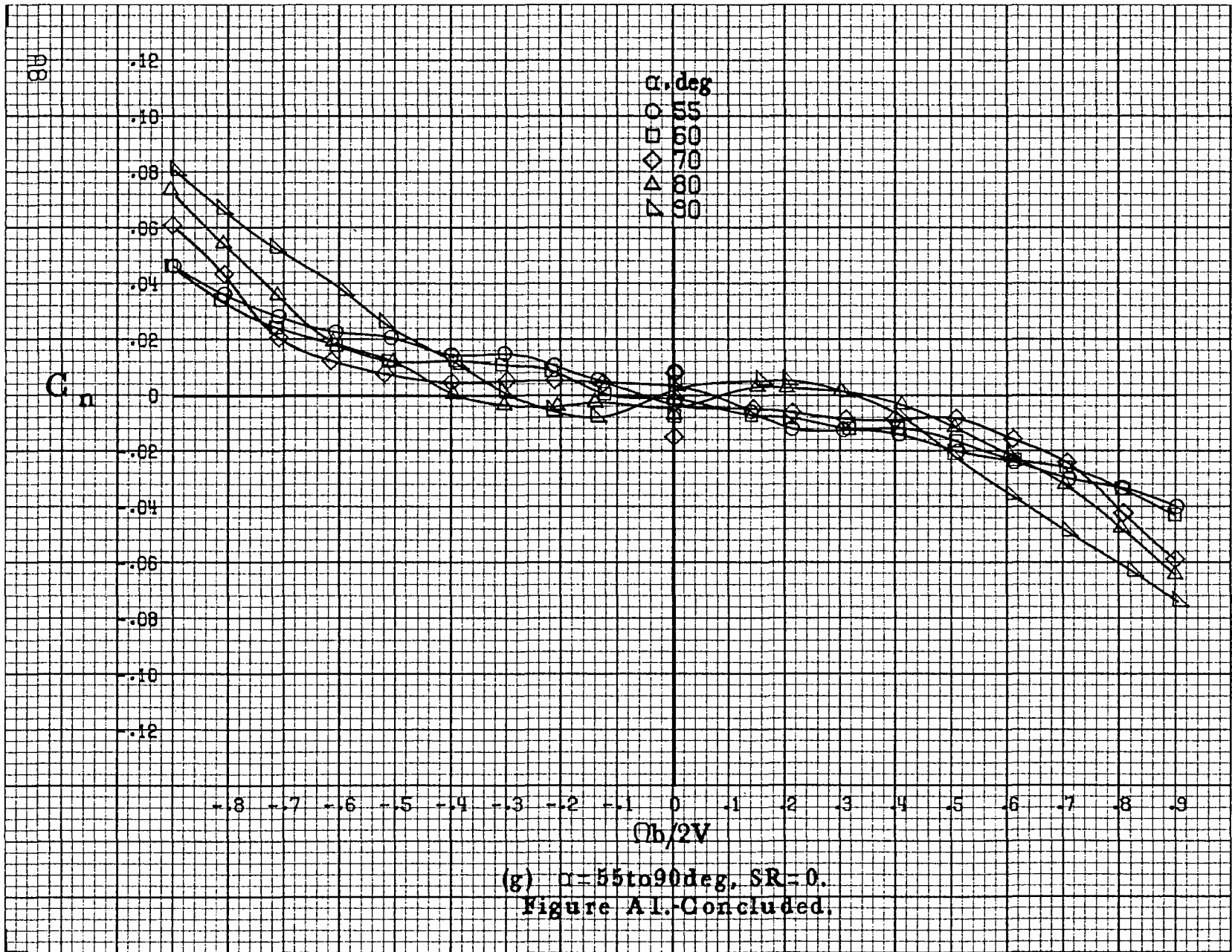

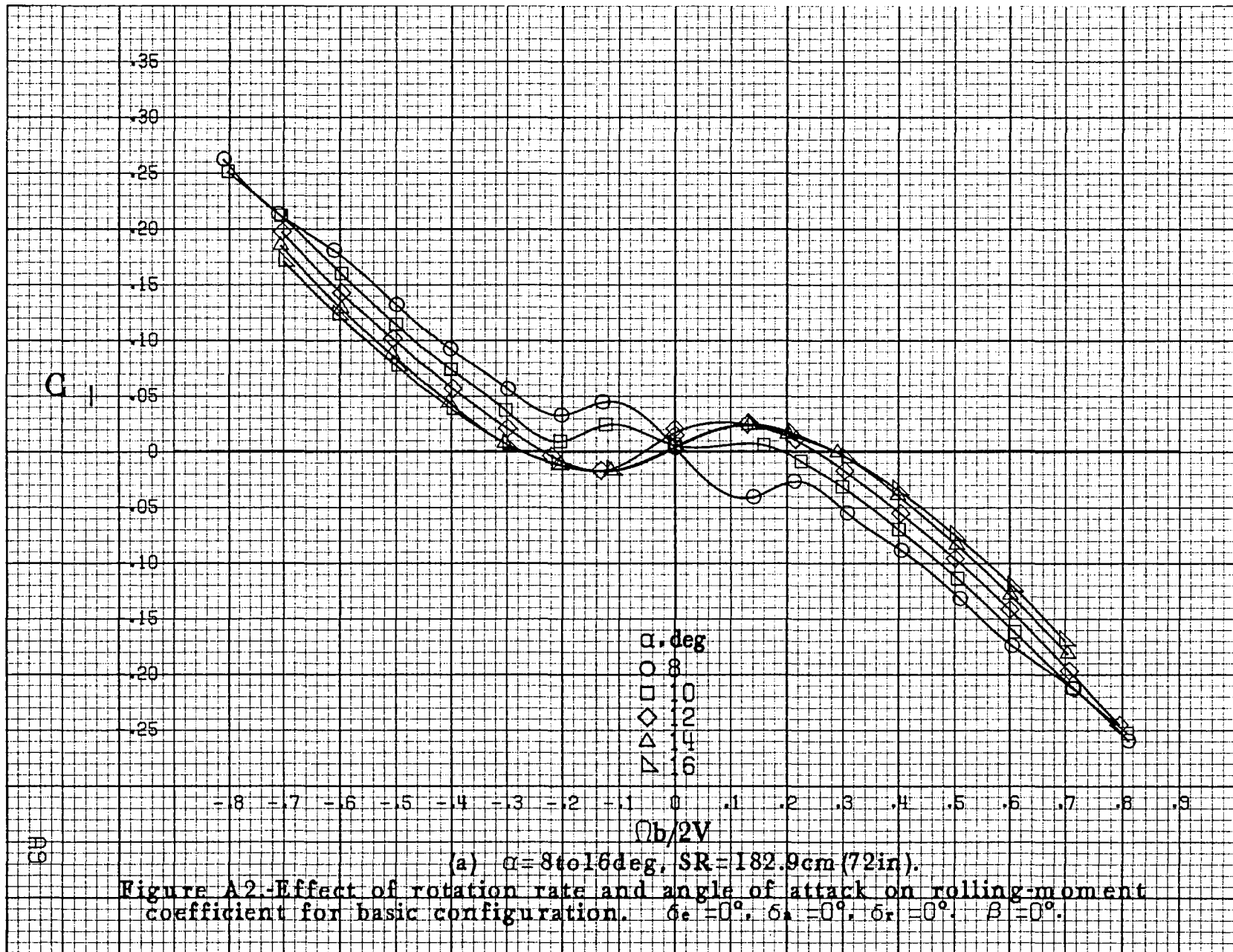

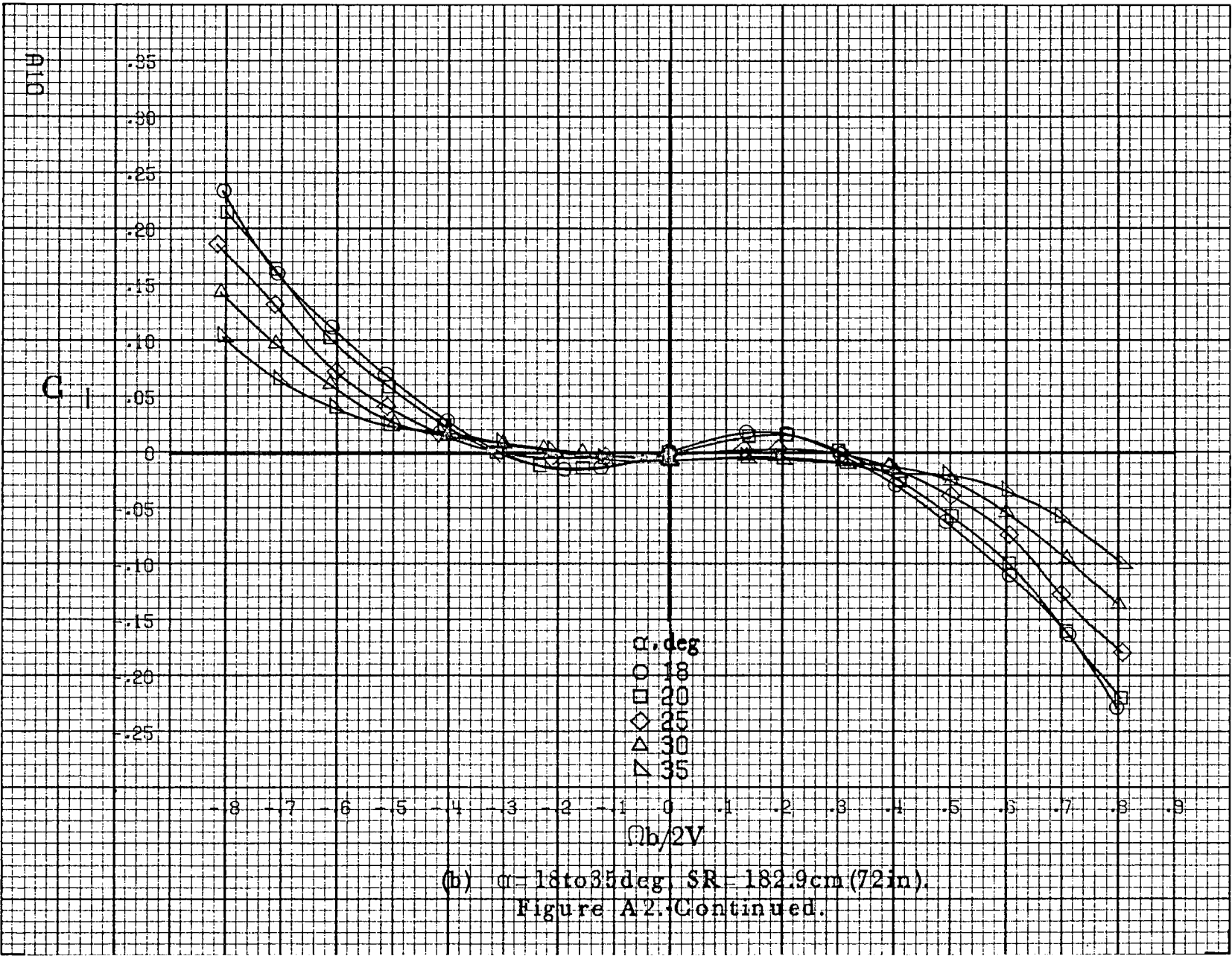

(b)  $\alpha = 18$  to  $35$  deg. SR = 182.9 cm (72 in).

Figure A2. Continued.

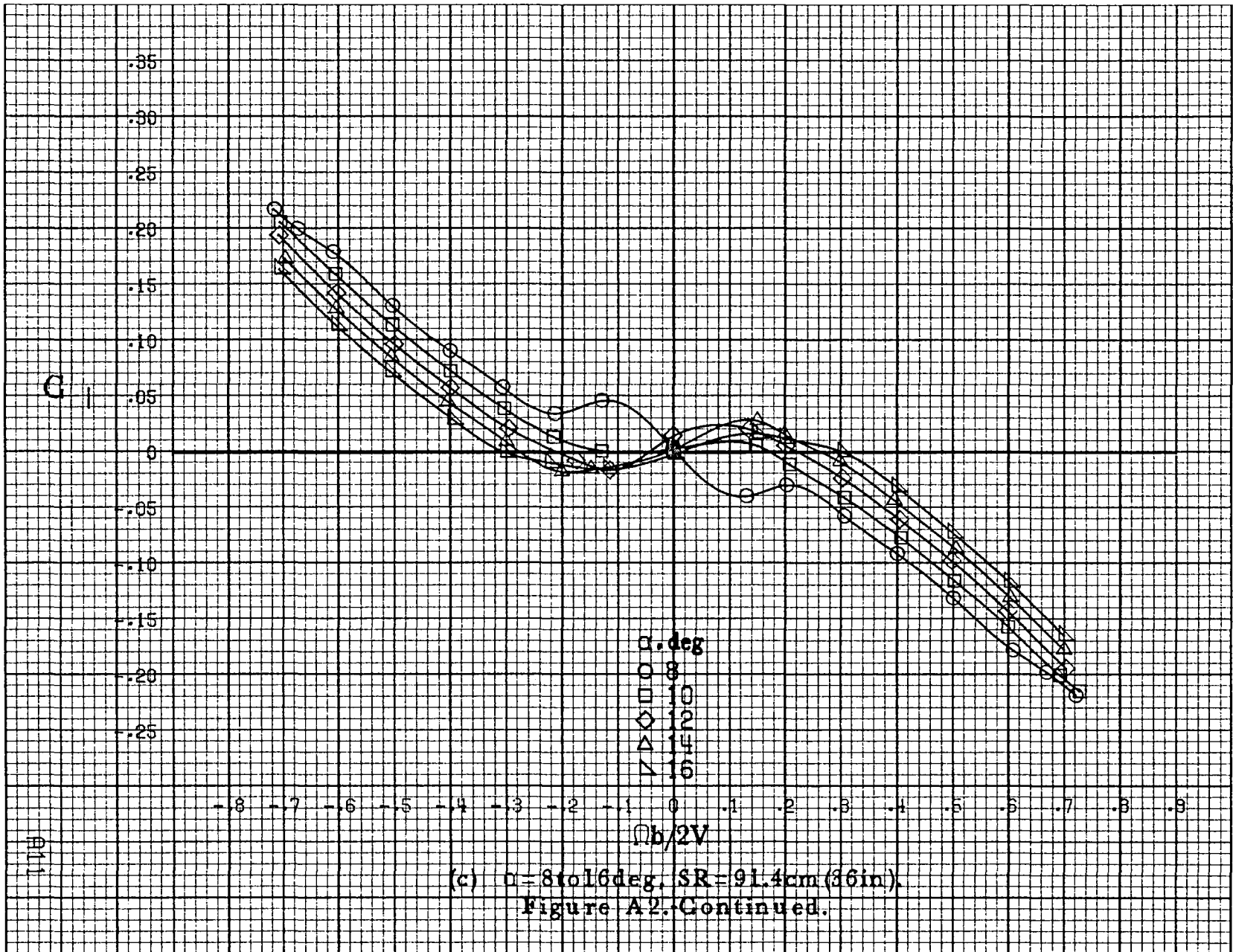

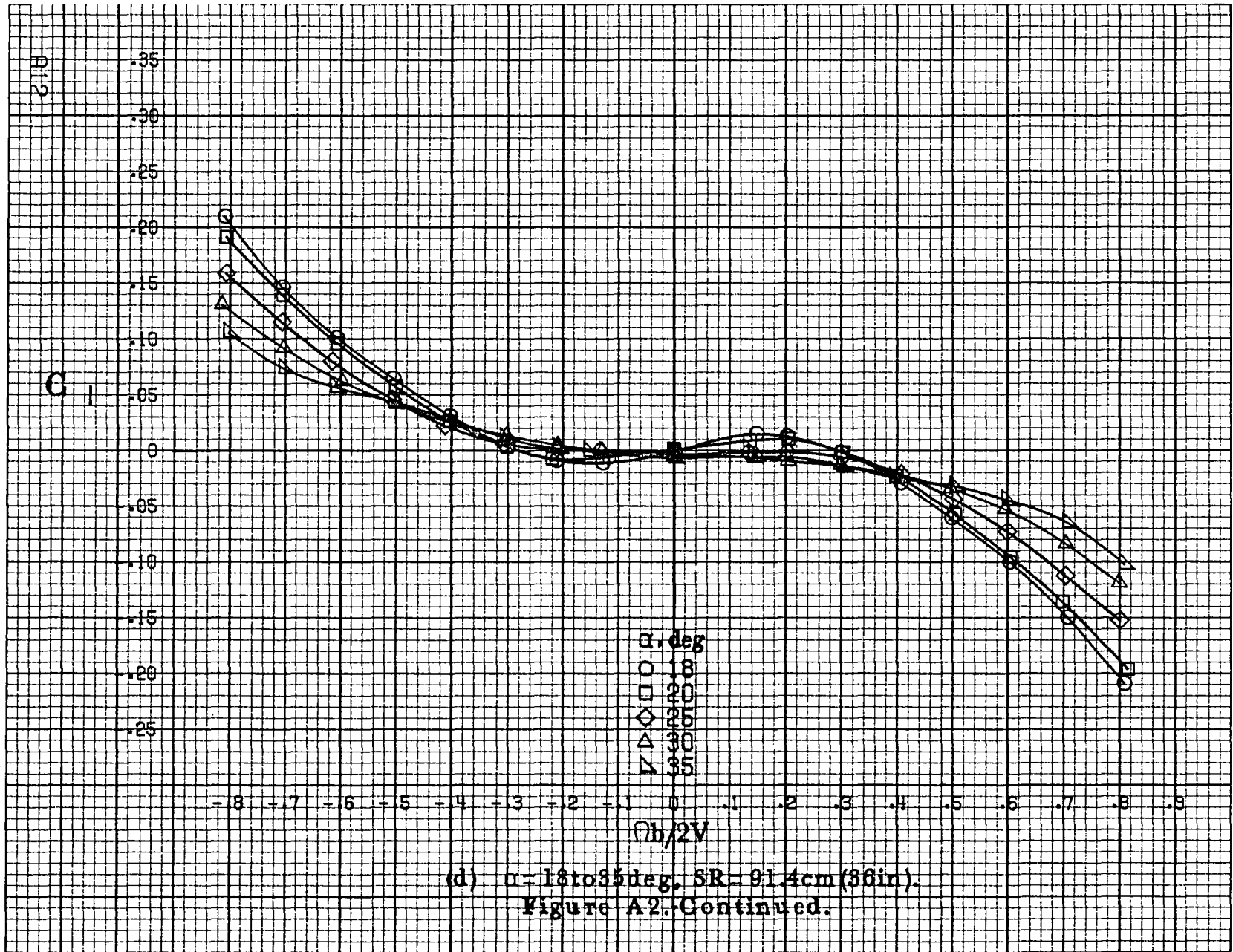

(d)  $\alpha = 18$  to  $35$  deg,  $SR = 91.4$  cm (36 in).  
 Figure A2. Continued.

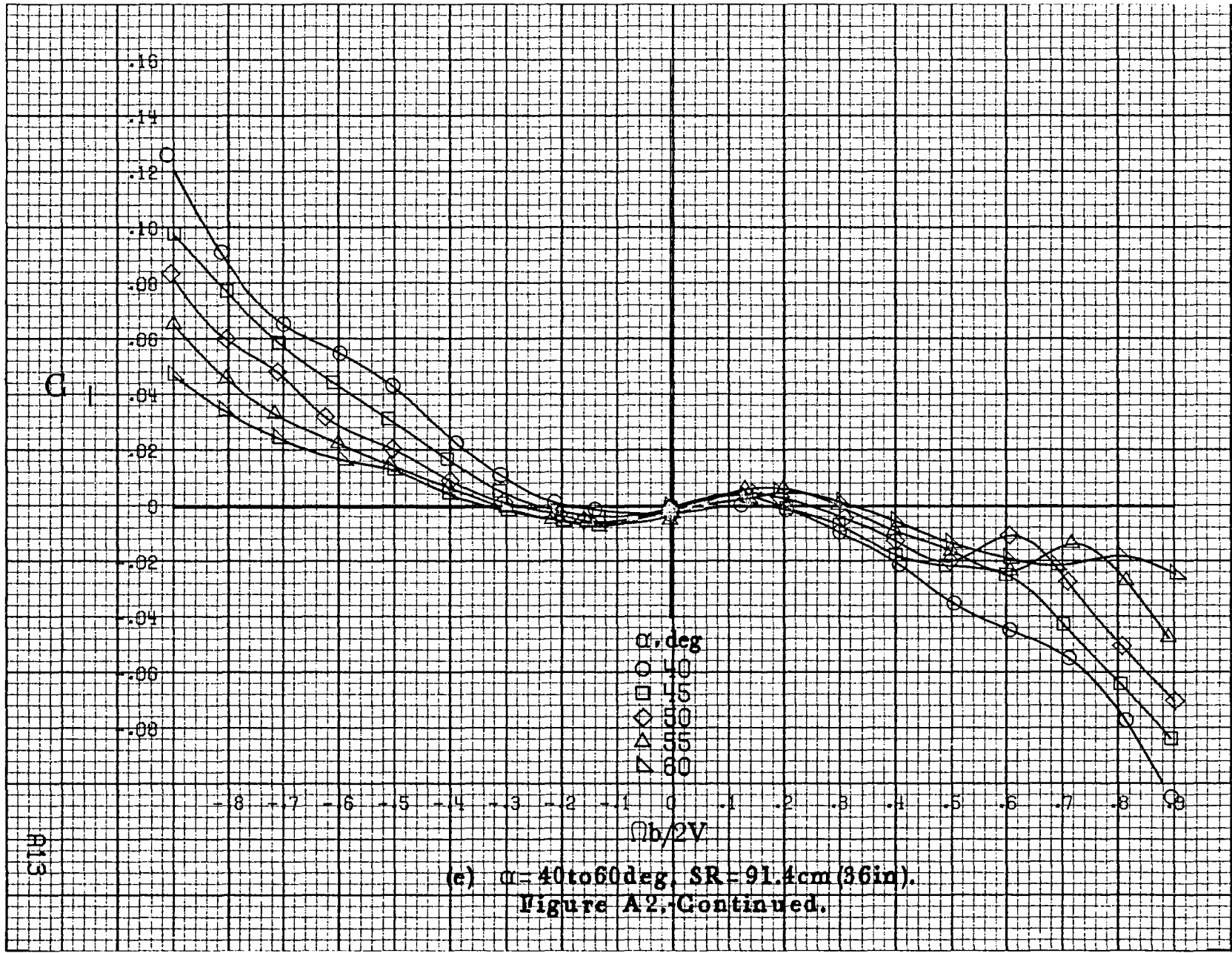



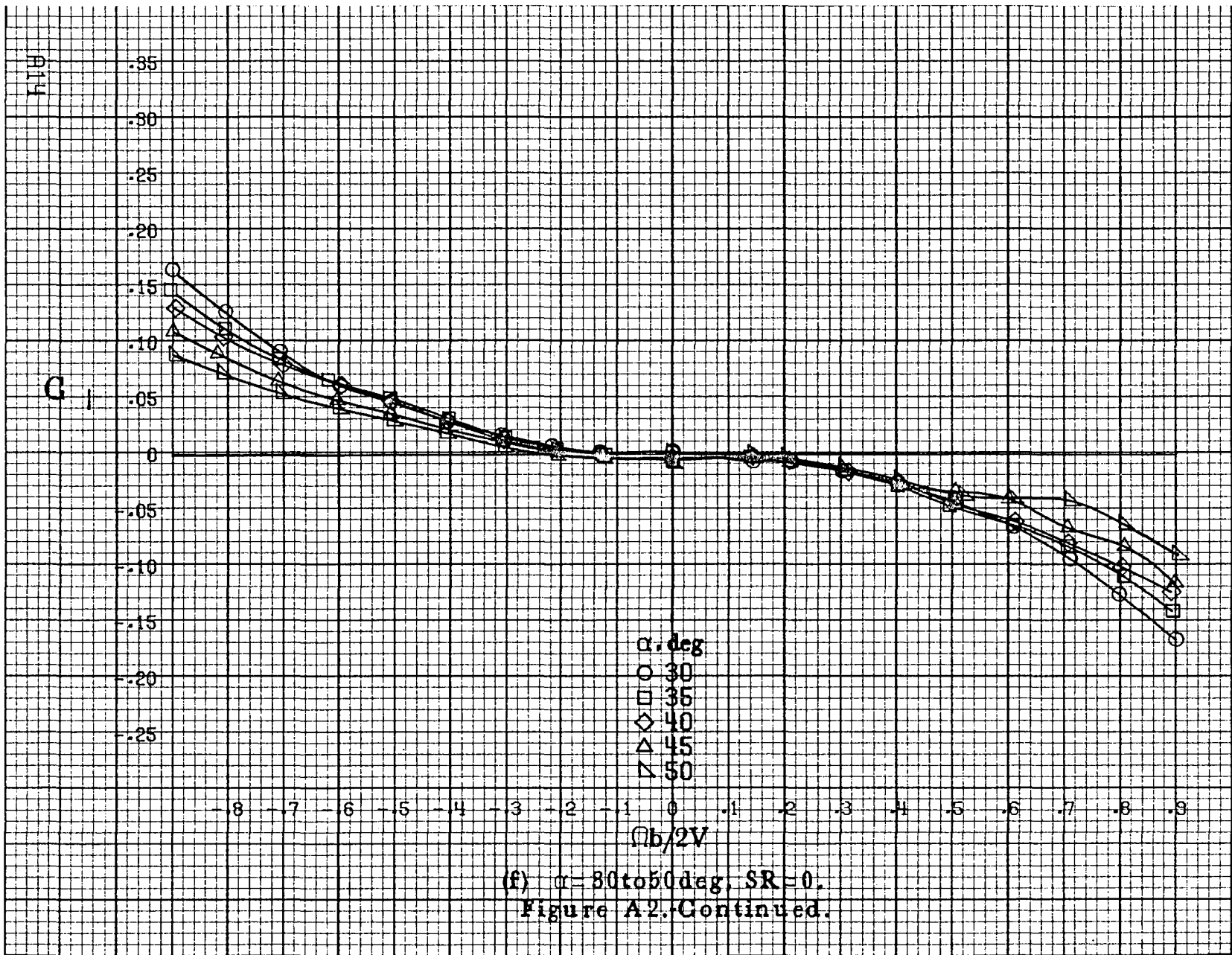

(f)  $\alpha = 30$  to  $50$  deg,  $SR = 0$ .  
 Figure A2. Continued.



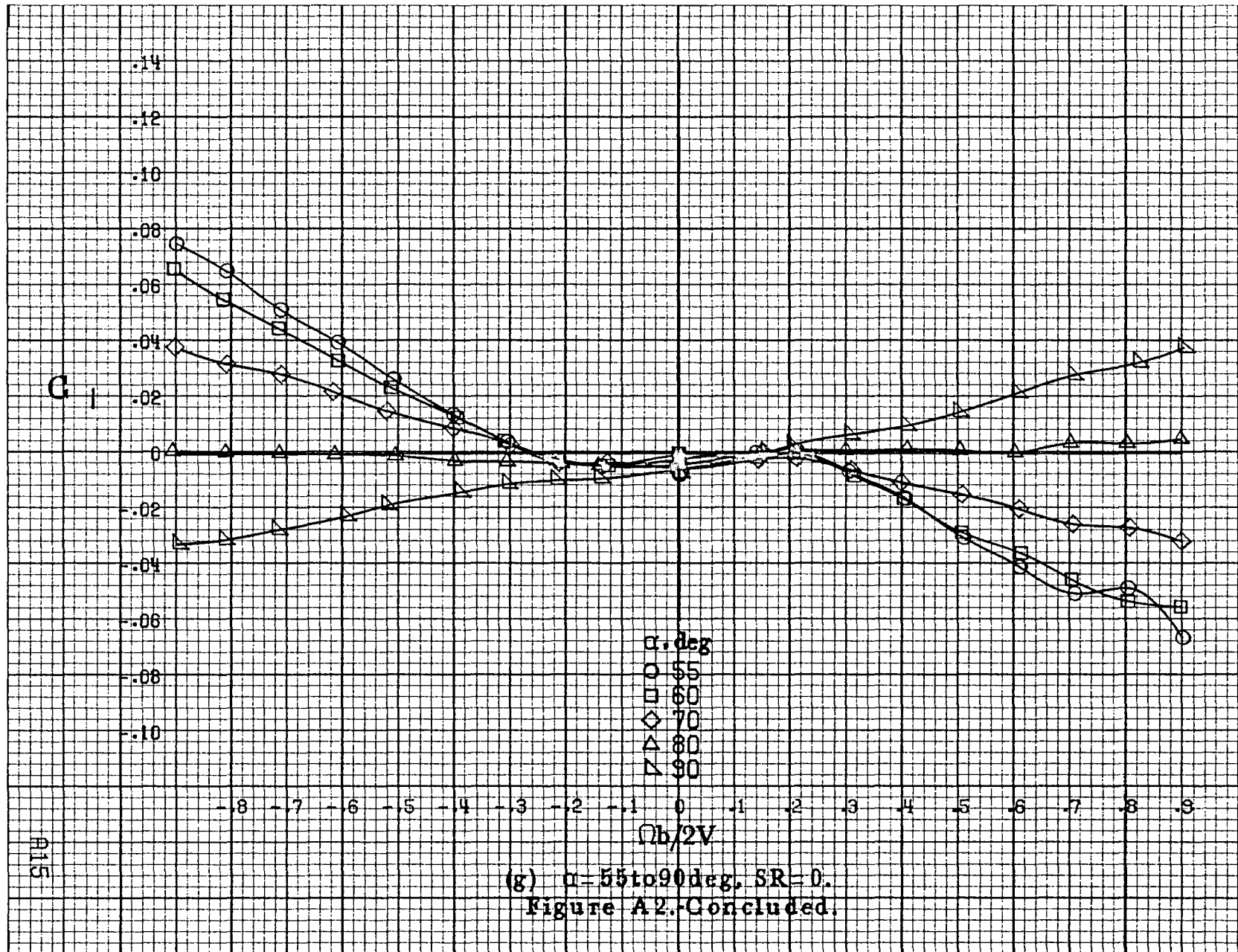

R16

$C_m$

0.2  
0.1  
0  
-0.1  
-0.2  
-0.3  
-0.4  
-0.5  
-0.6  
-0.7  
-0.8  
-0.9  
-1.0

-0.8 -0.7 -0.6 -0.5 -0.4 -0.3 -0.2 -0.1 0 0.1 0.2 0.3 0.4 0.5 0.6 0.7 0.8 0.9  
 $\Omega b/2V$

$\alpha$ , deg  
○ 8  
□ 10  
◇ 12  
△ 14  
▽ 16

(a)  $\alpha = 8$  to  $16$  deg,  $SR = 182.9$  cm (72 in).  
Figure A3.-Effect of rotation rate and angle of attack on pitching-moment coefficient for basic configuration.  $\delta_c = 0^\circ$ ,  $\delta_A = 0^\circ$ ,  $\delta_r = 0^\circ$ .  $\beta = 0^\circ$ .

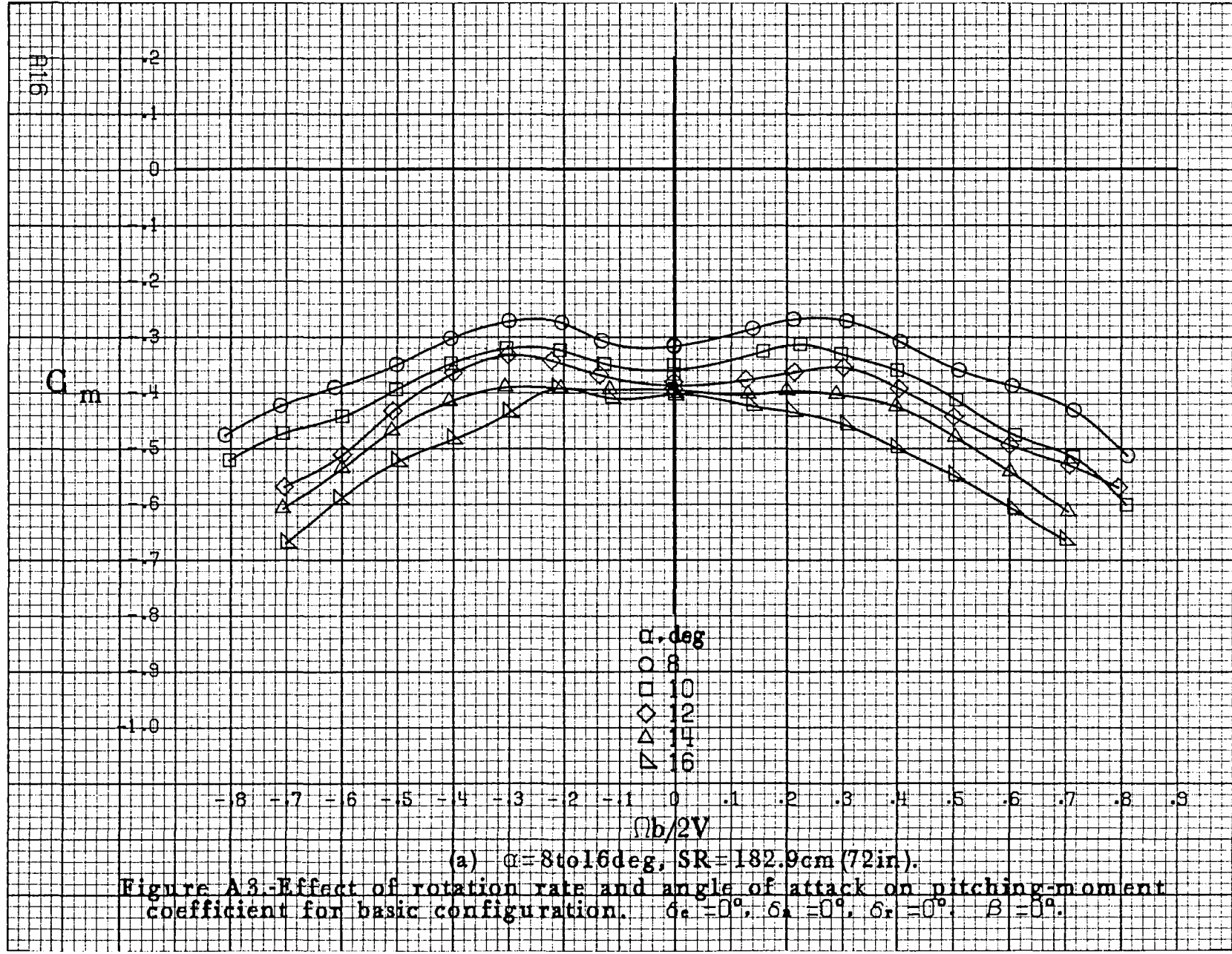

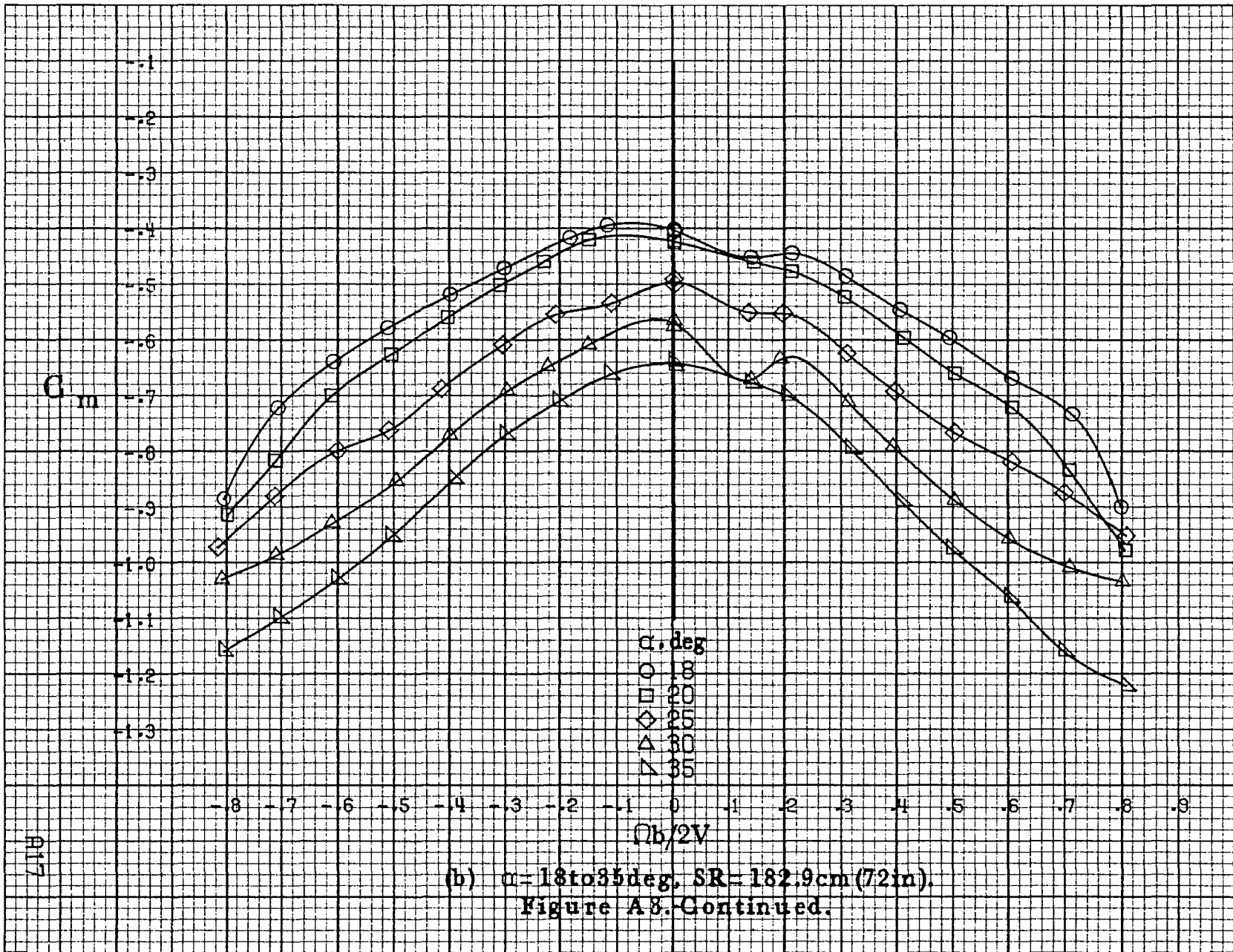

A117

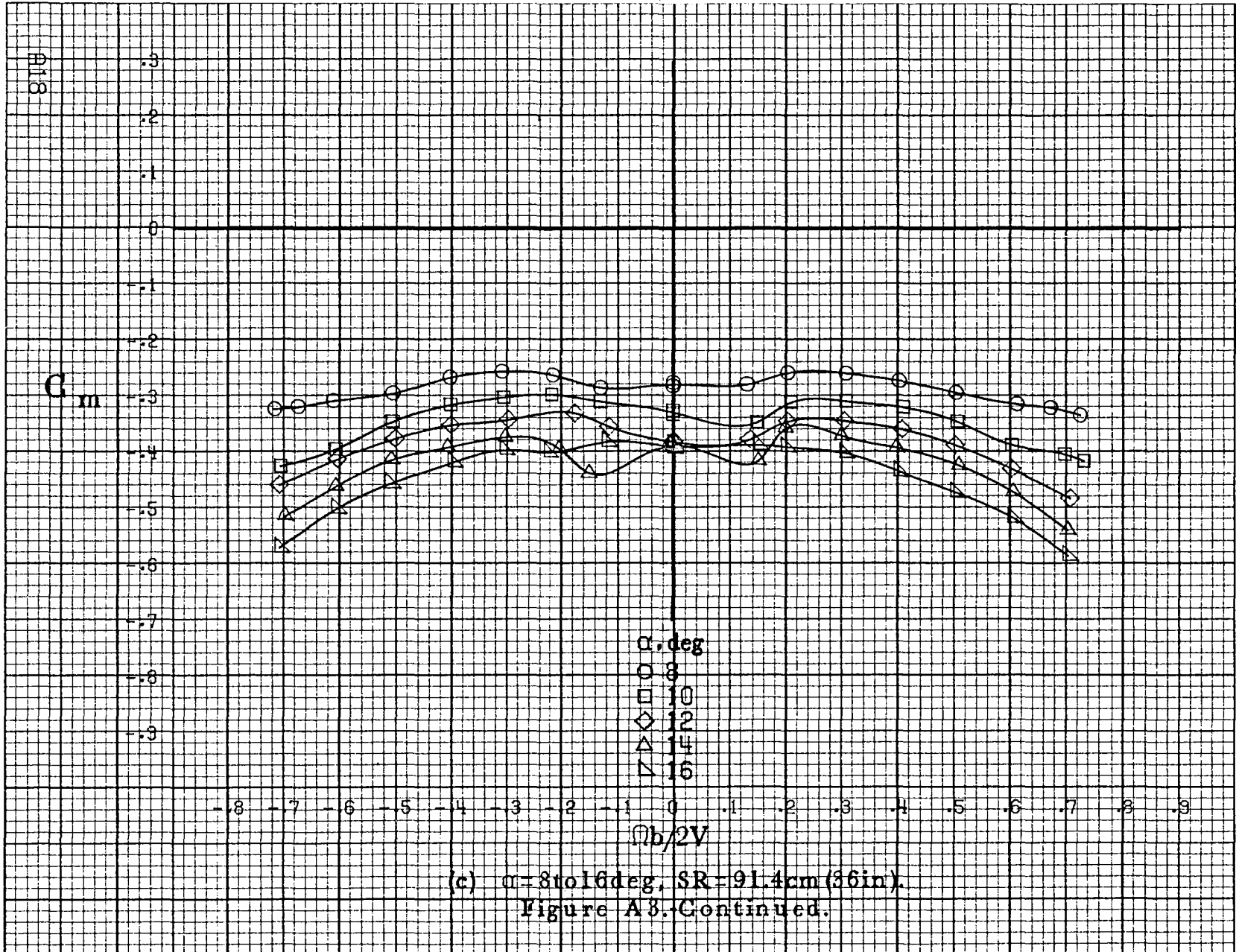

(c)  $\alpha=8$  to  $16$  deg,  $SR=91.4$  cm (36 in).  
 Figure A3. Continued.

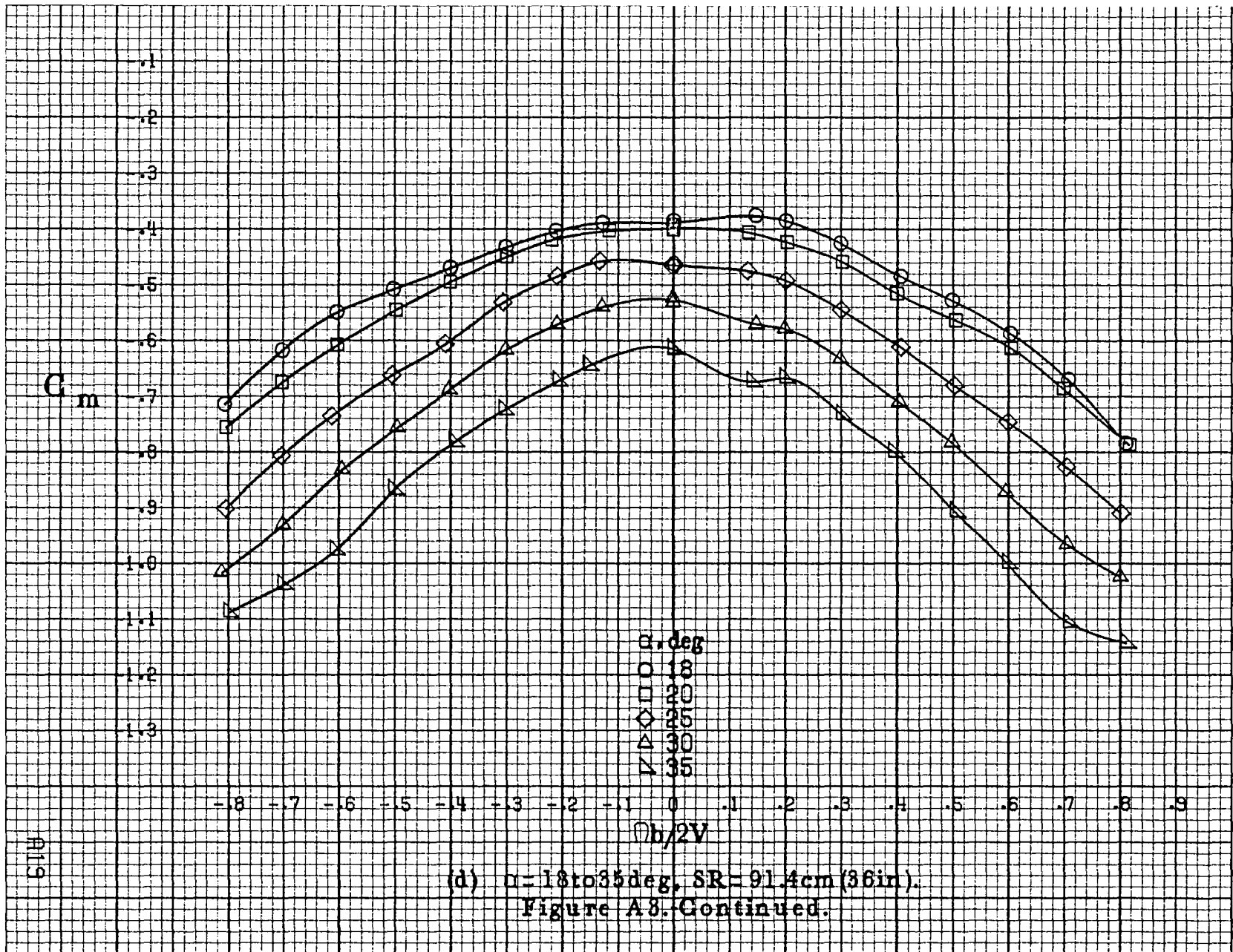

R19

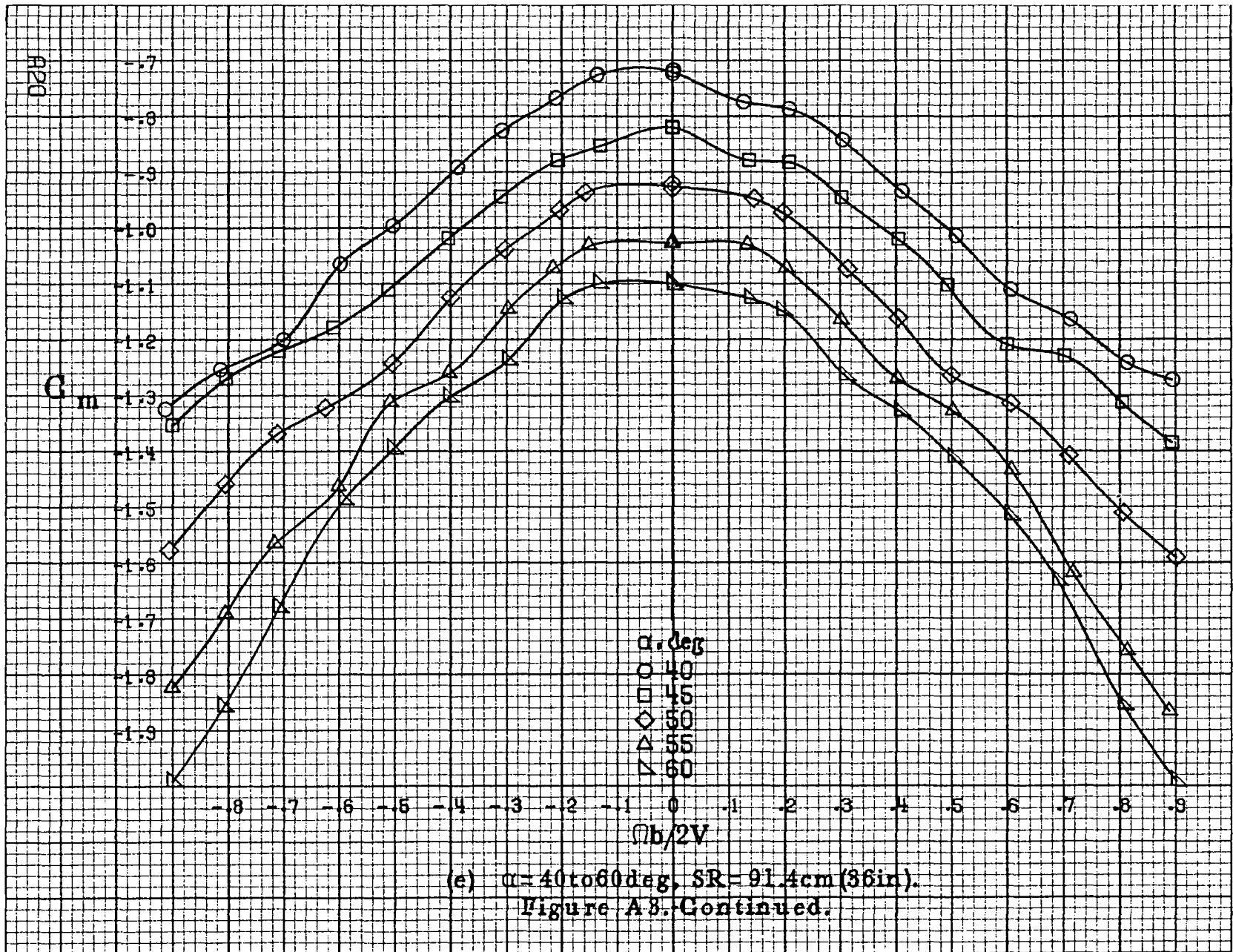



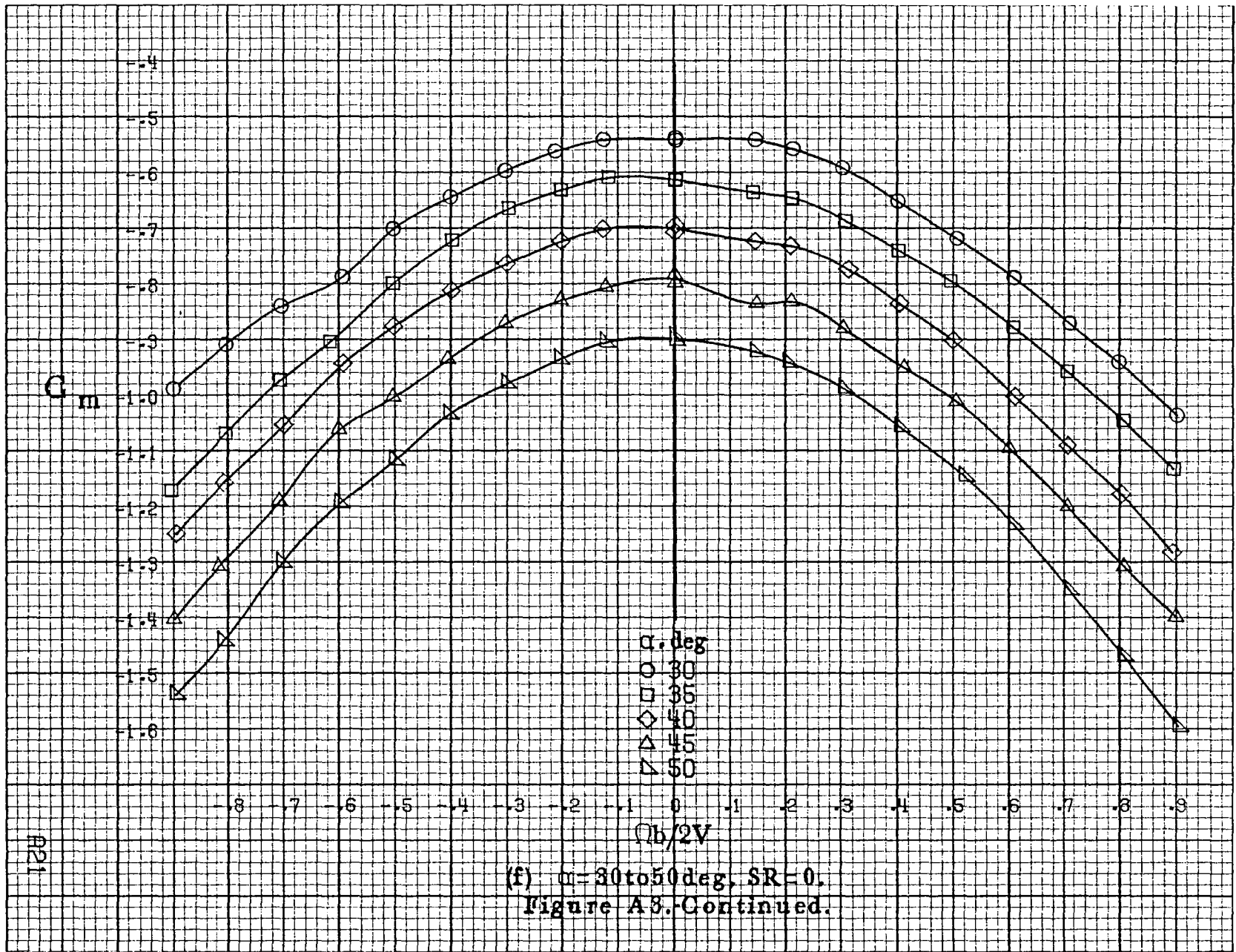

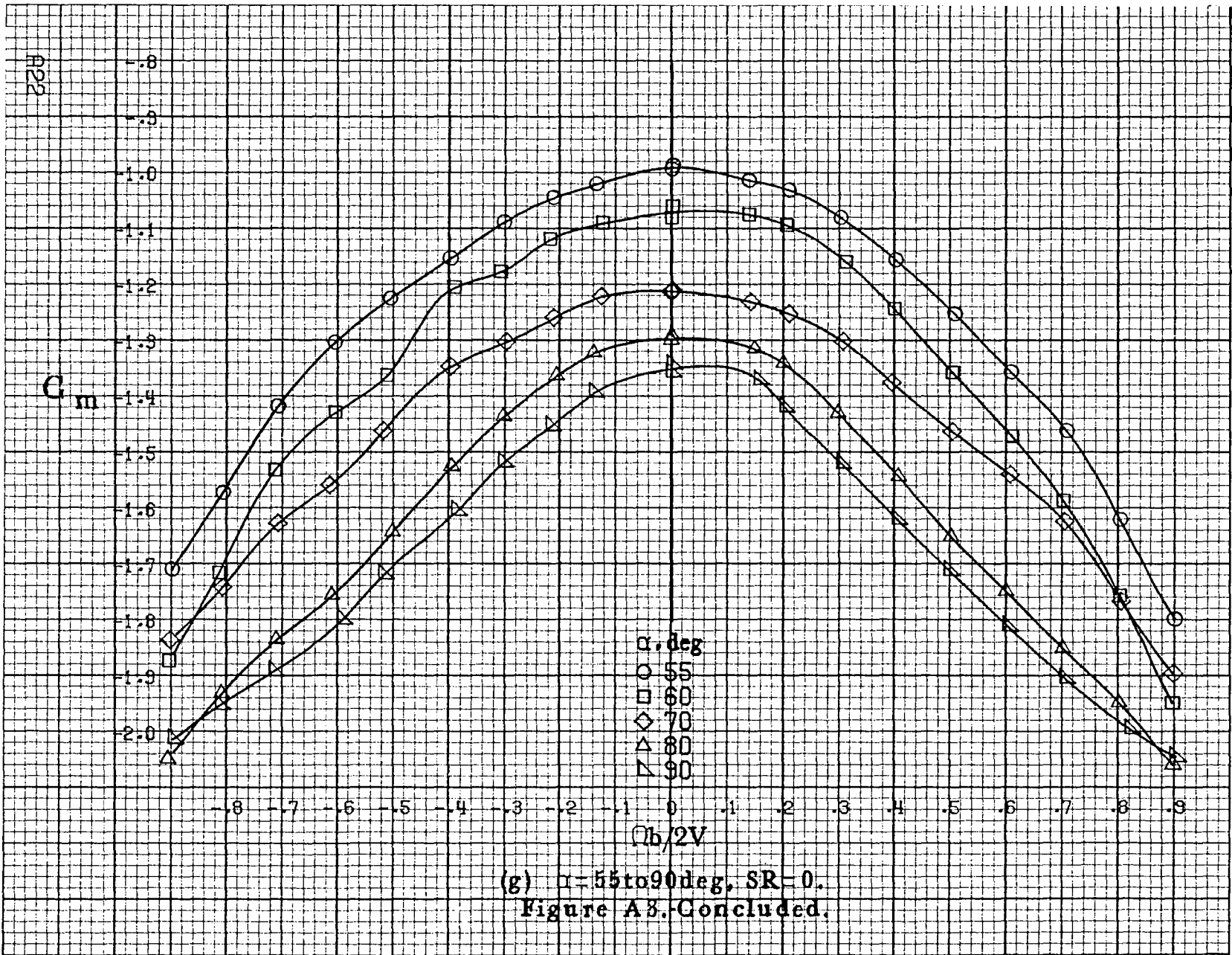



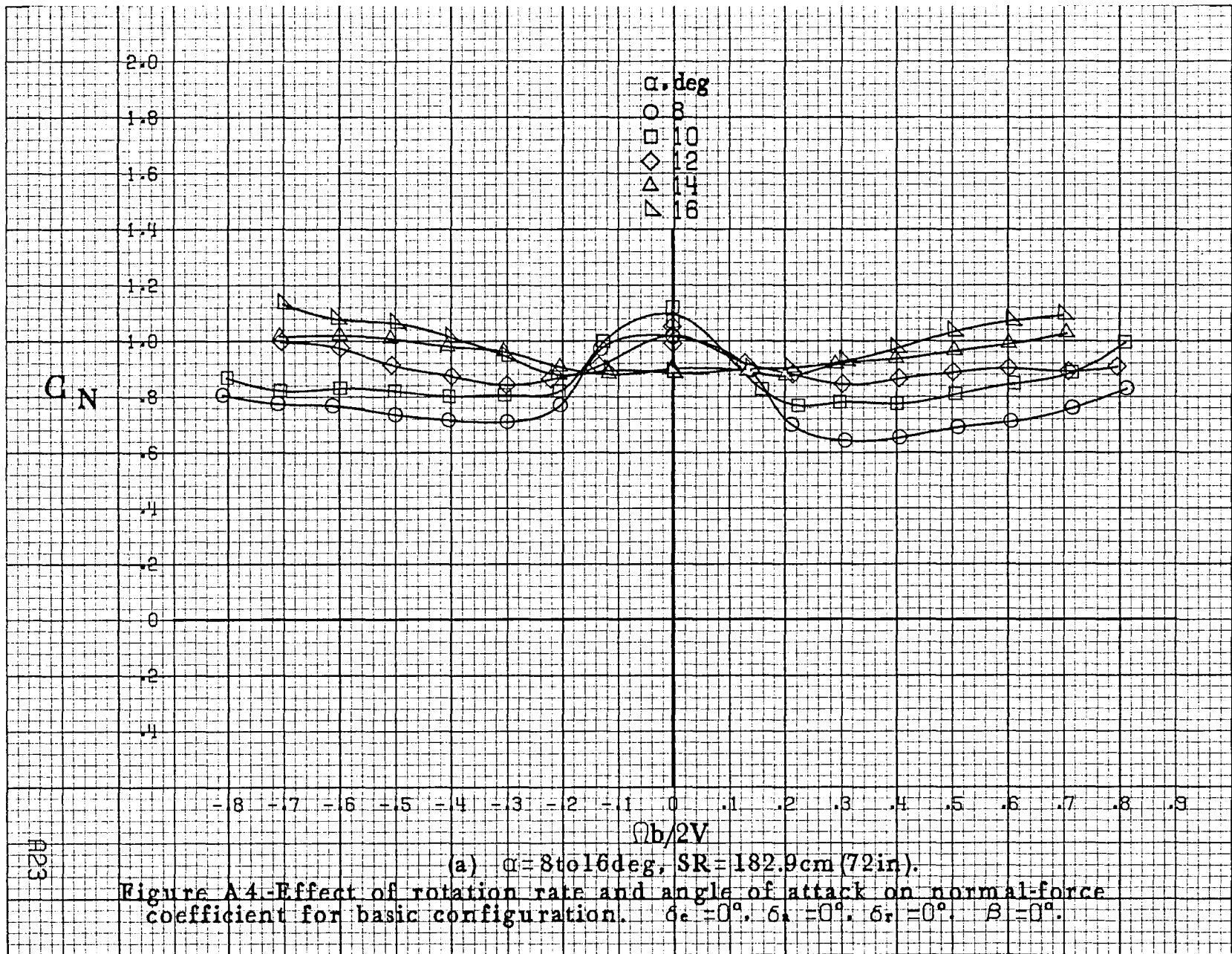

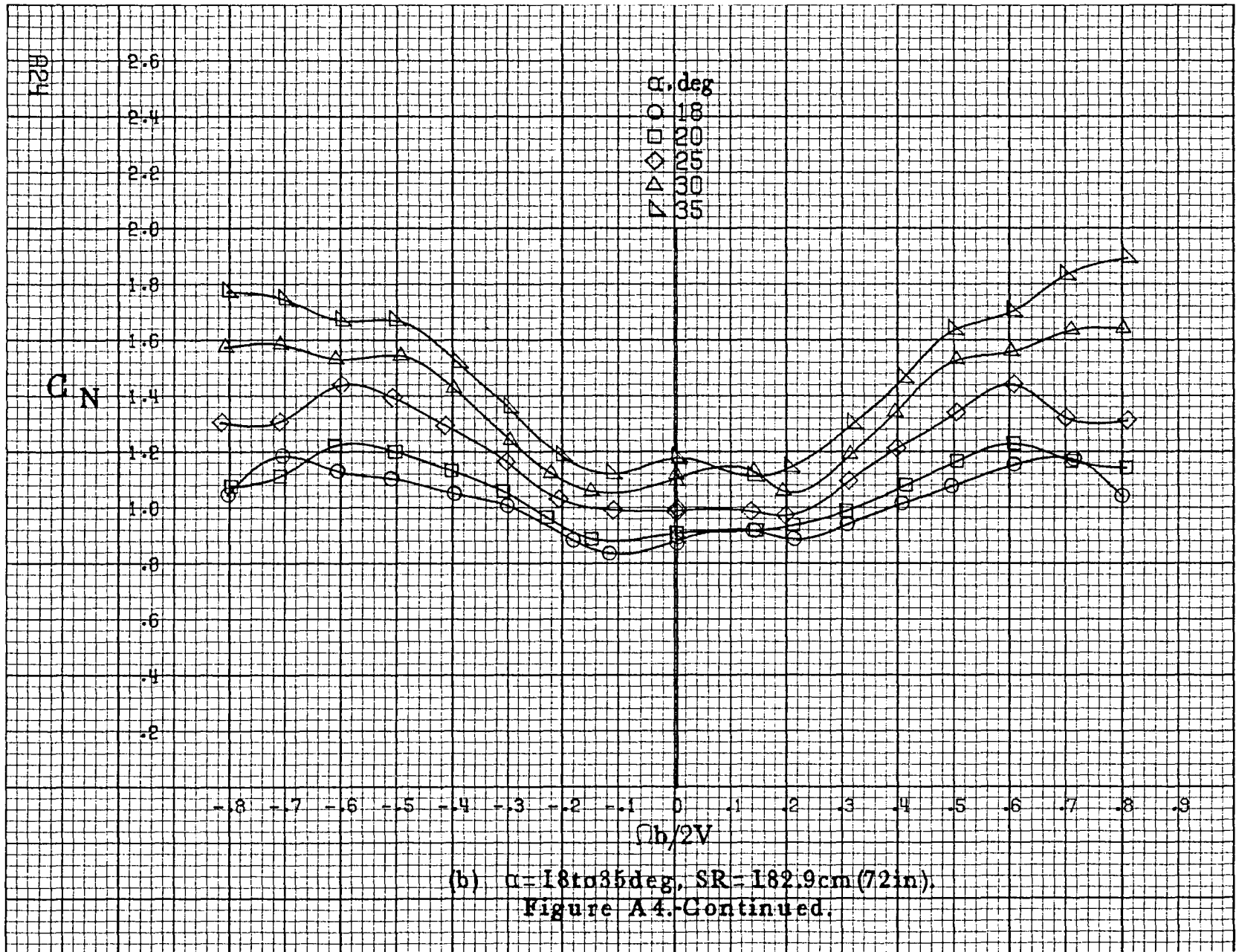

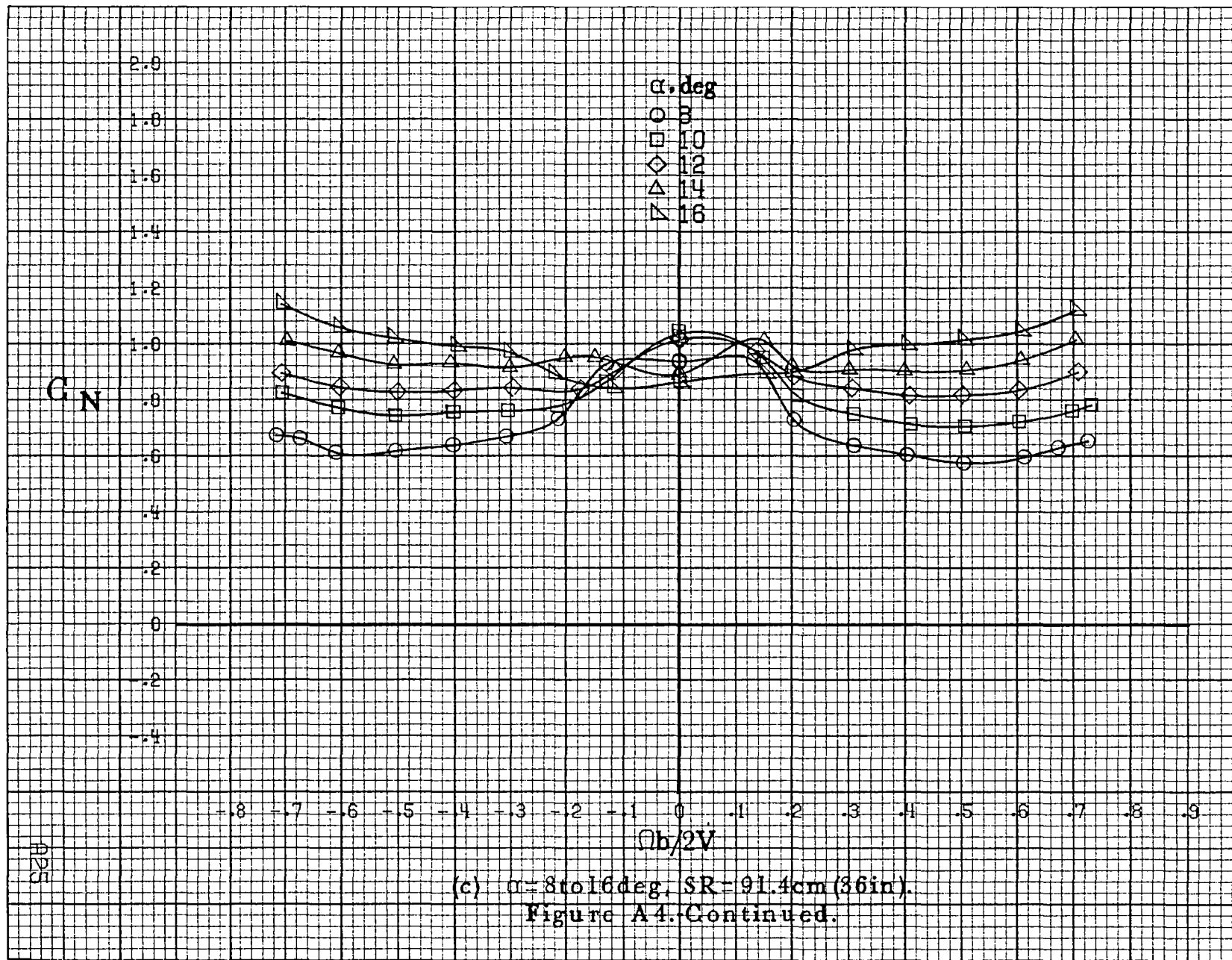

A26

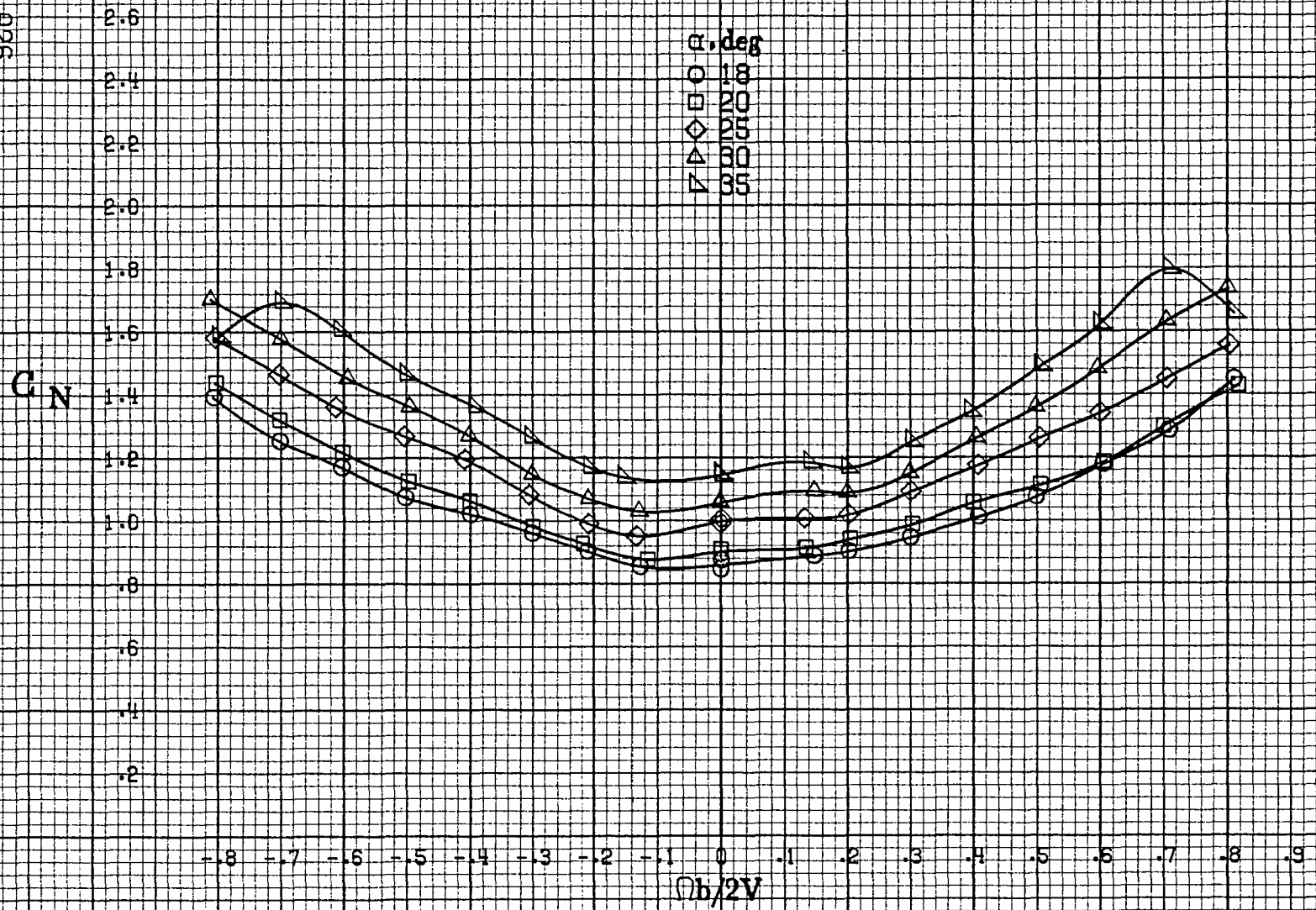

(d)  $\alpha = 18$  to  $35$  deg,  $SR = 91.4$  cm (36 in).  
Figure A4. Continued.

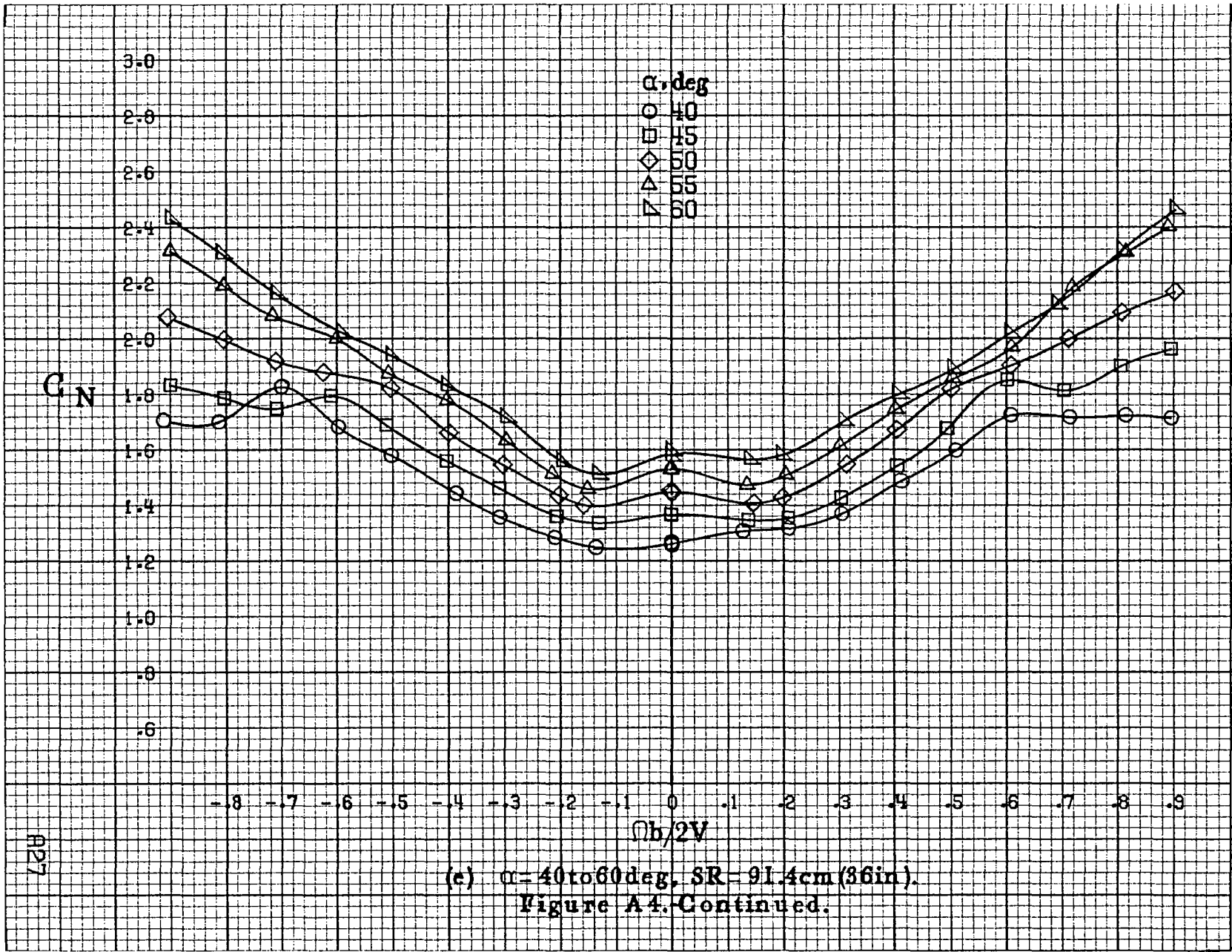

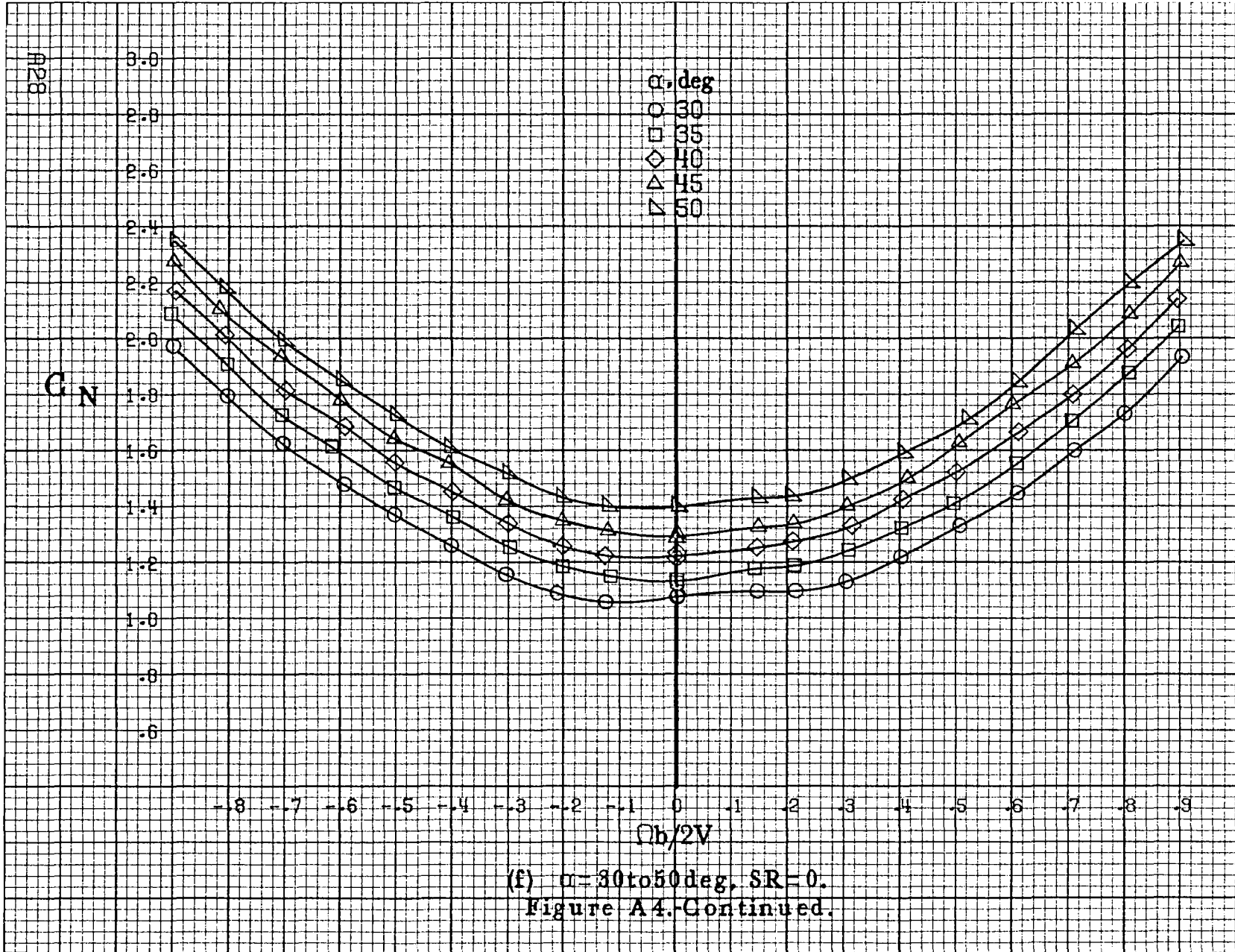



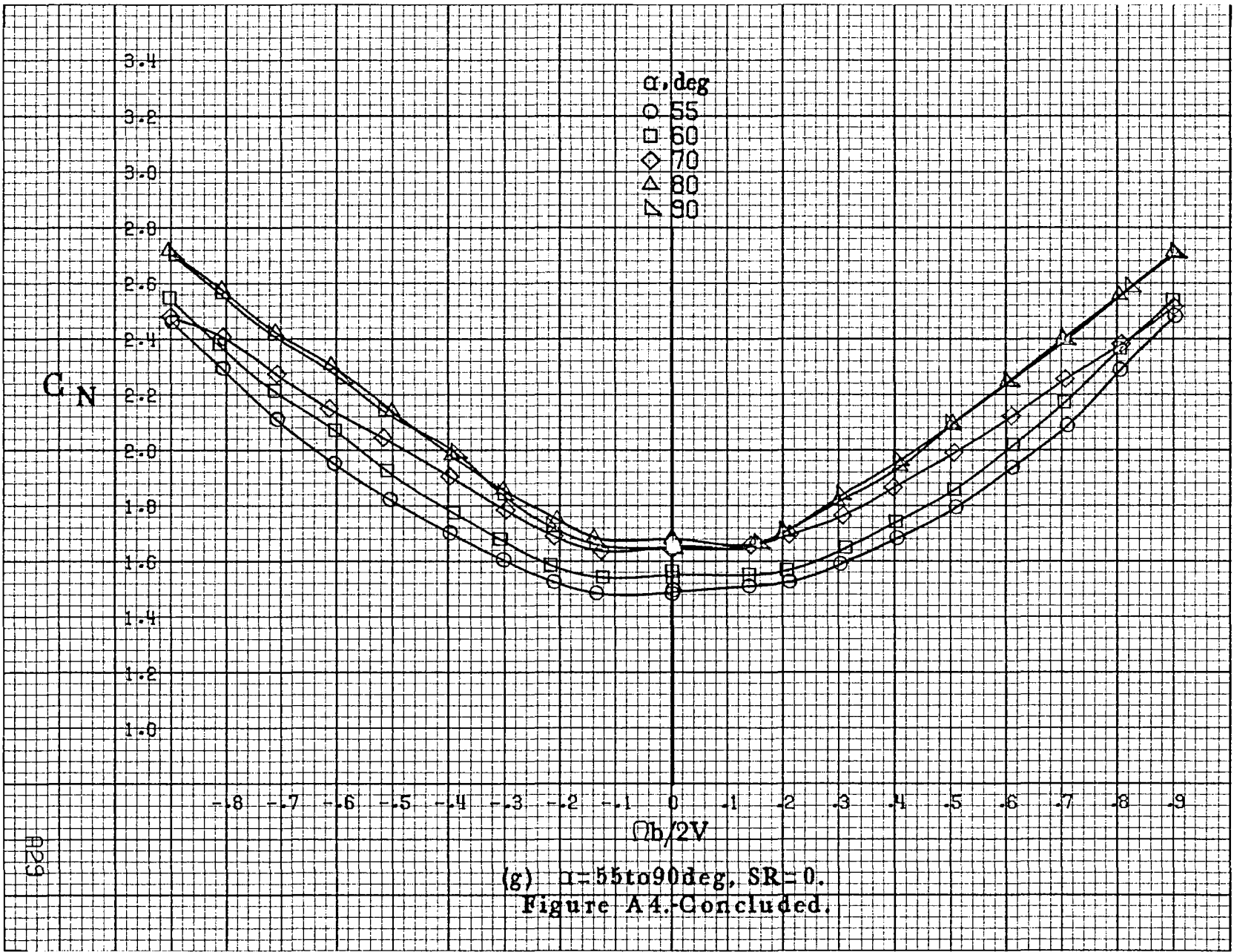

A29

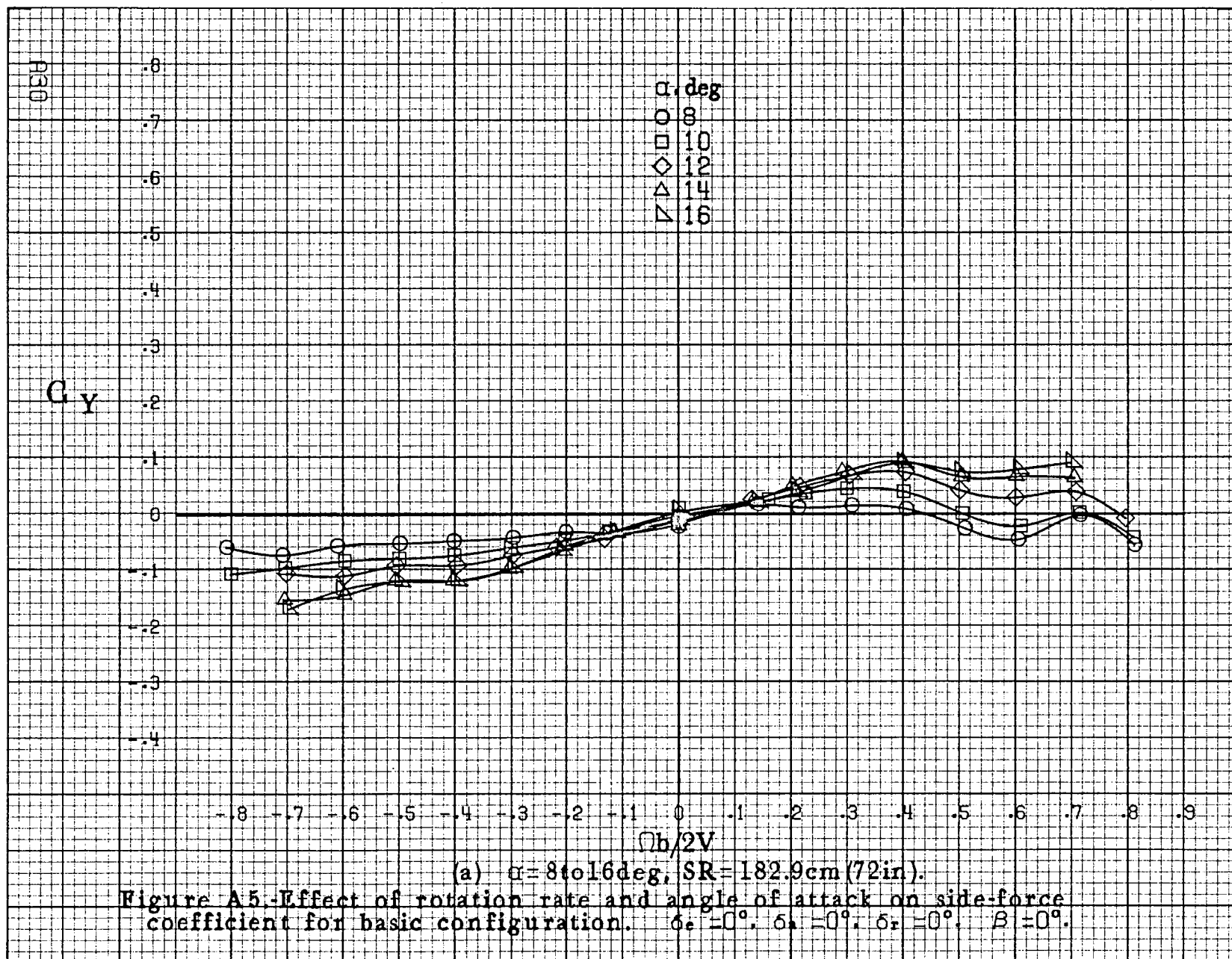



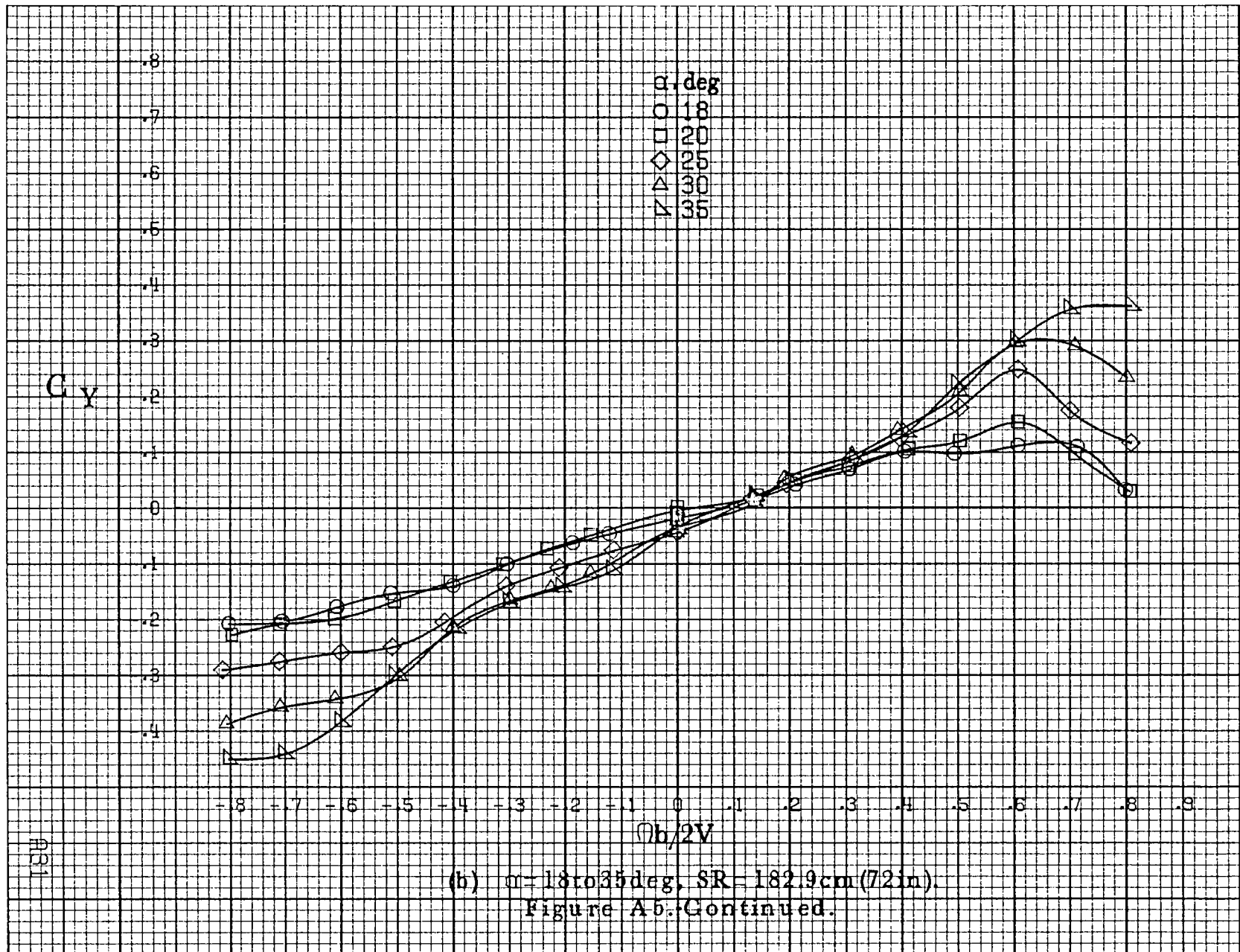

A32

$C_y$

$\alpha$ , deg  
○ 8  
□ 10  
◇ 12  
△ 14  
▽ 16

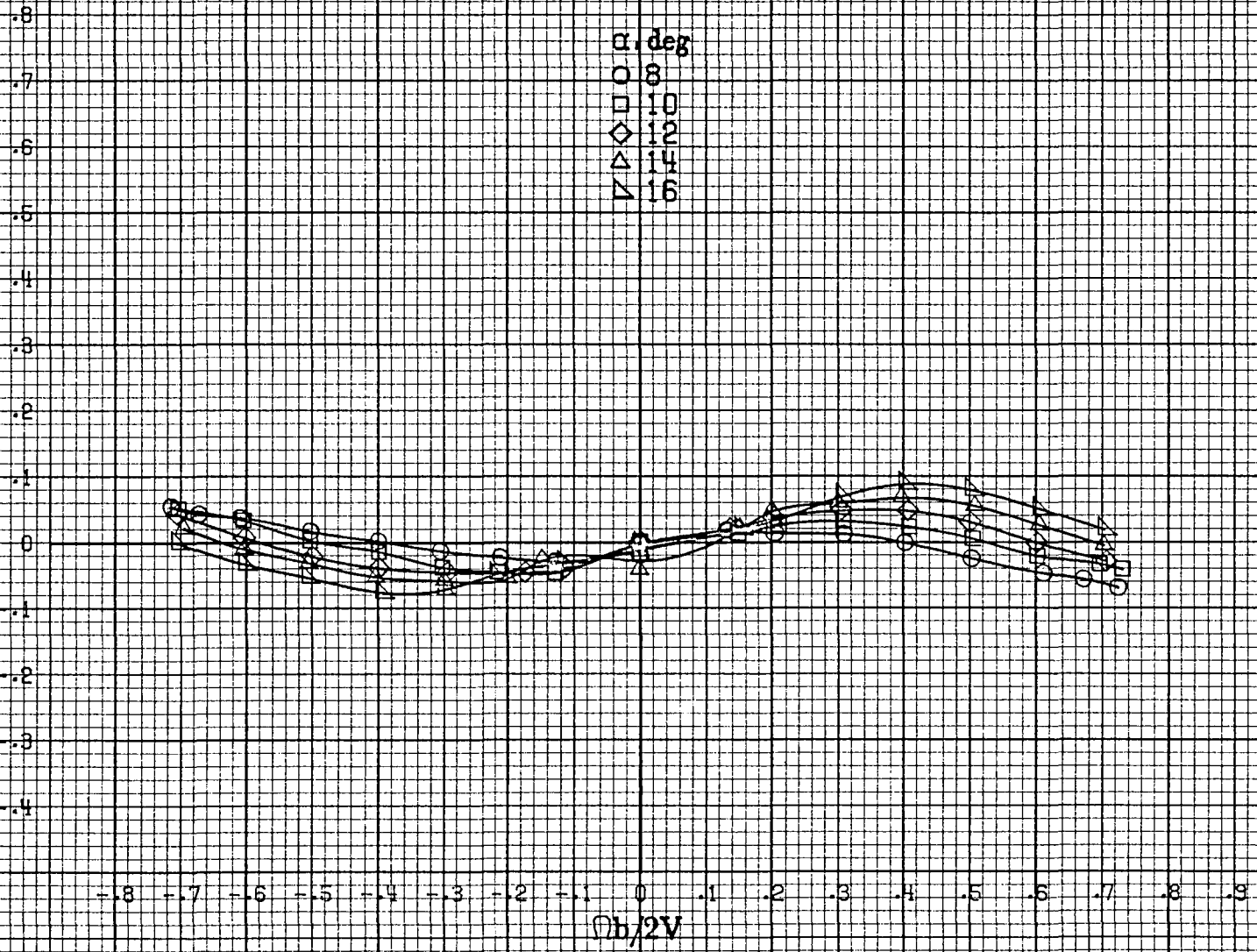

(c)  $\alpha=8$  to  $16$  deg,  $SR=91.4$  cm (36 in).  
Figure A5. Continued.

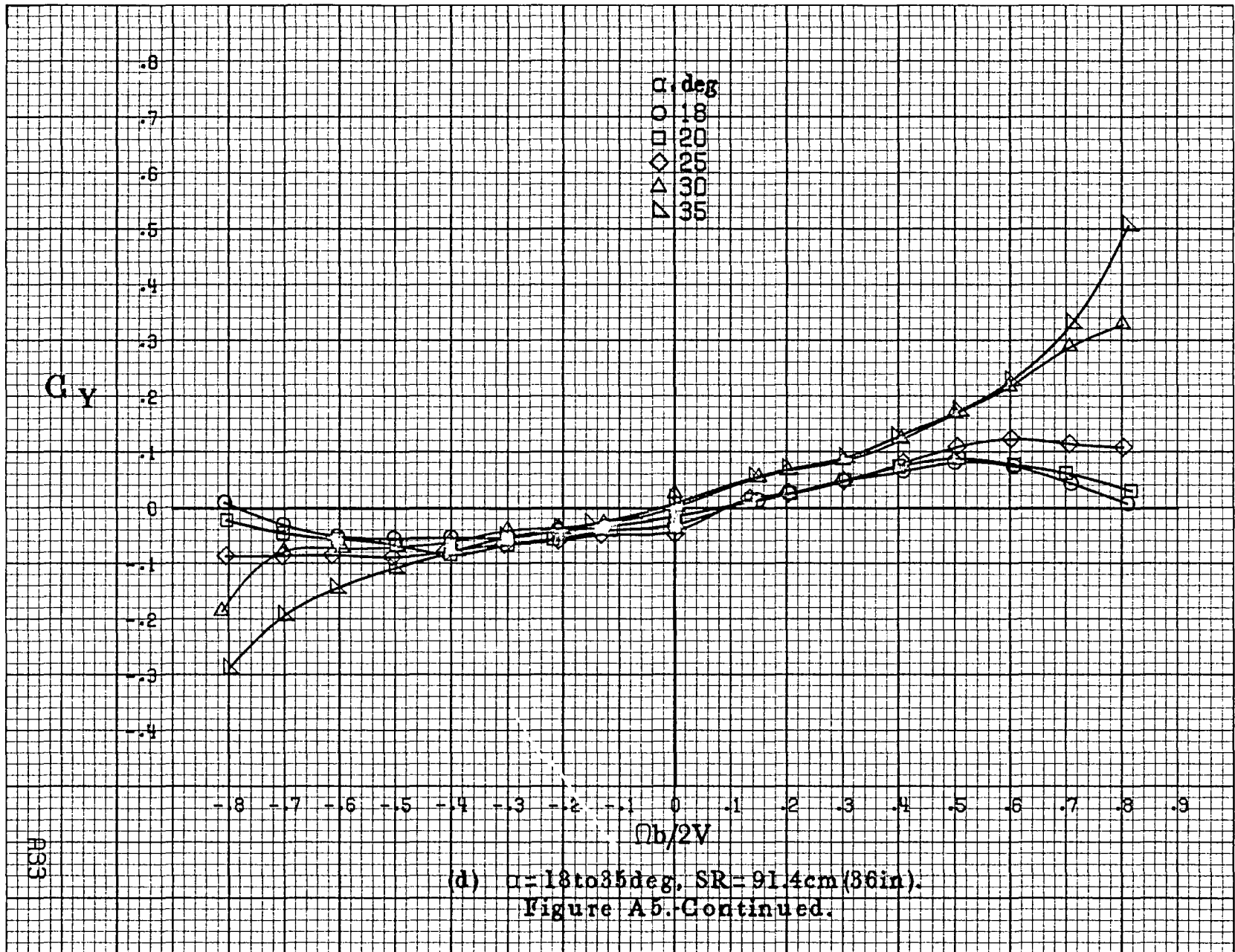

(d)  $\alpha = 18$  to  $35$  deg. SR = 91.4 cm (36 in).  
 Figure A5. Continued.

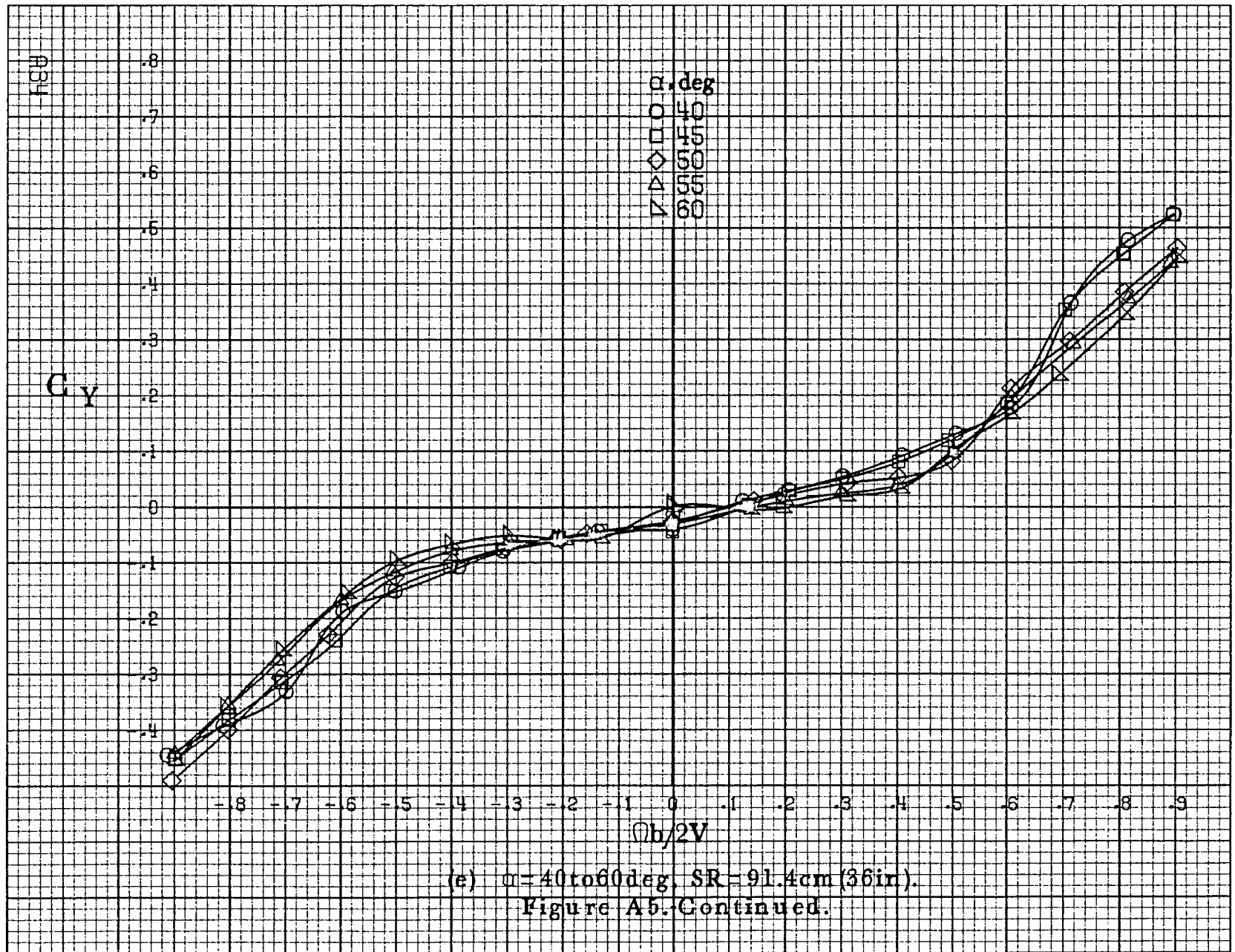

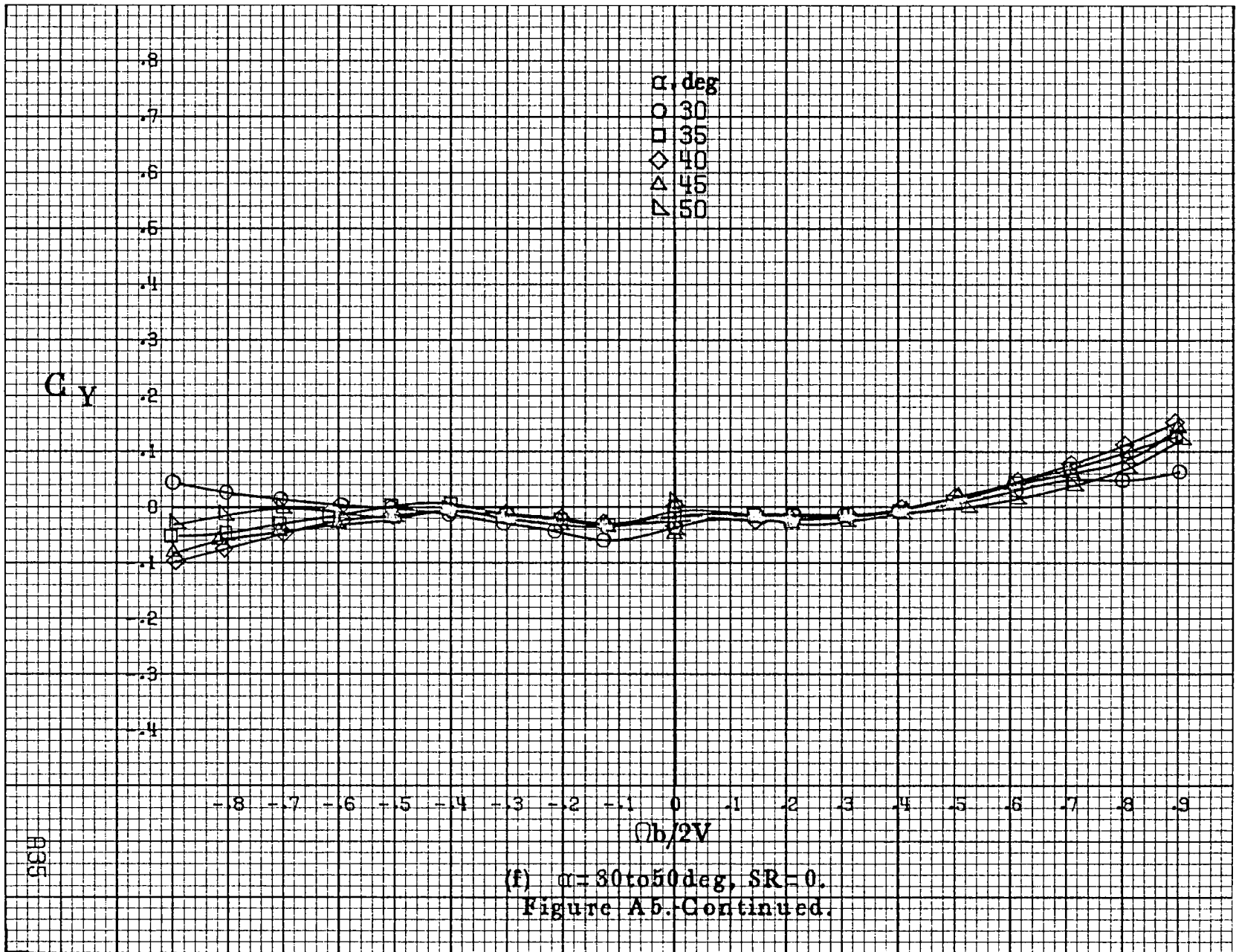

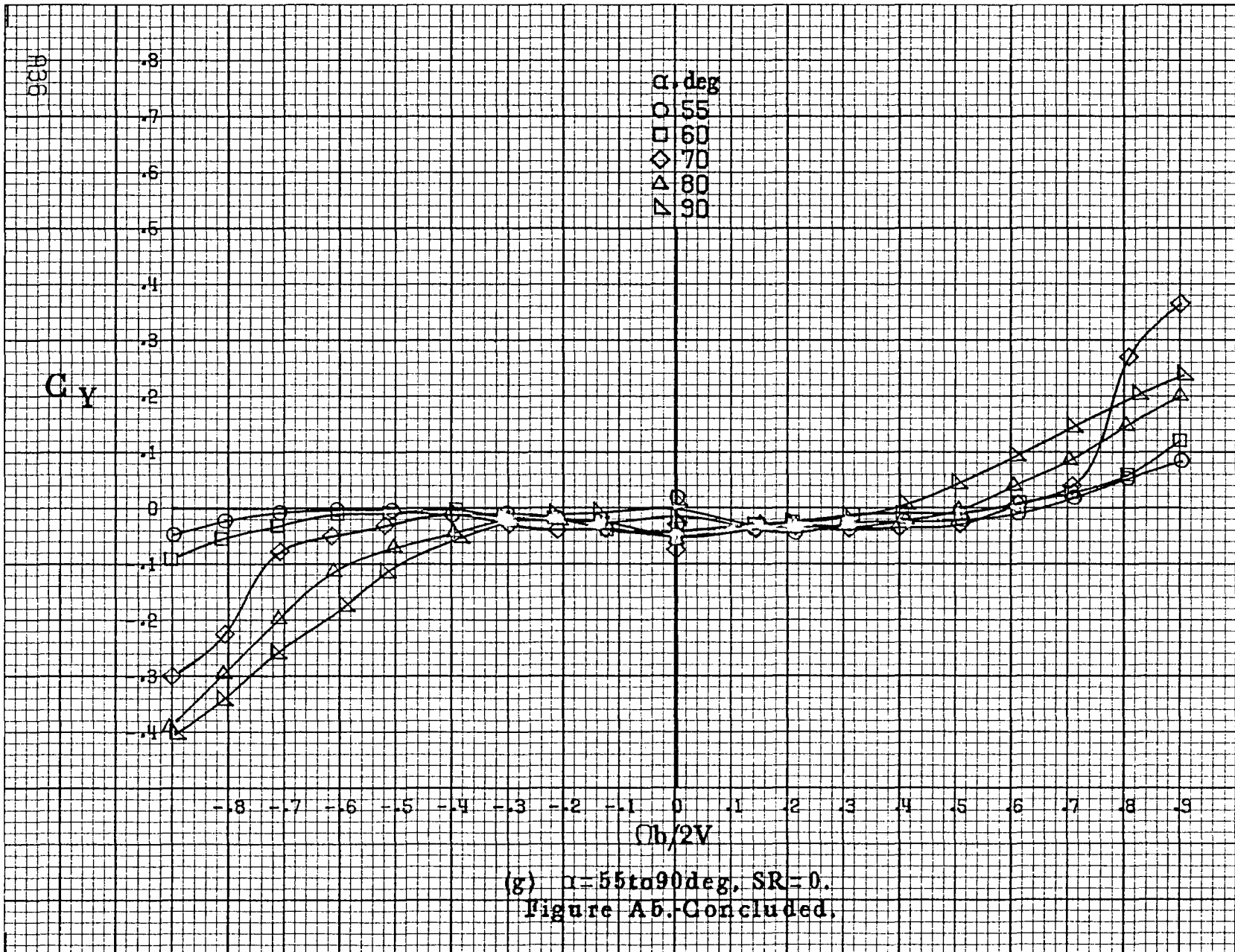

(g)  $\alpha=55$  to  $90$  deg,  $SR=0$ .  
 Figure A6. Concluded.

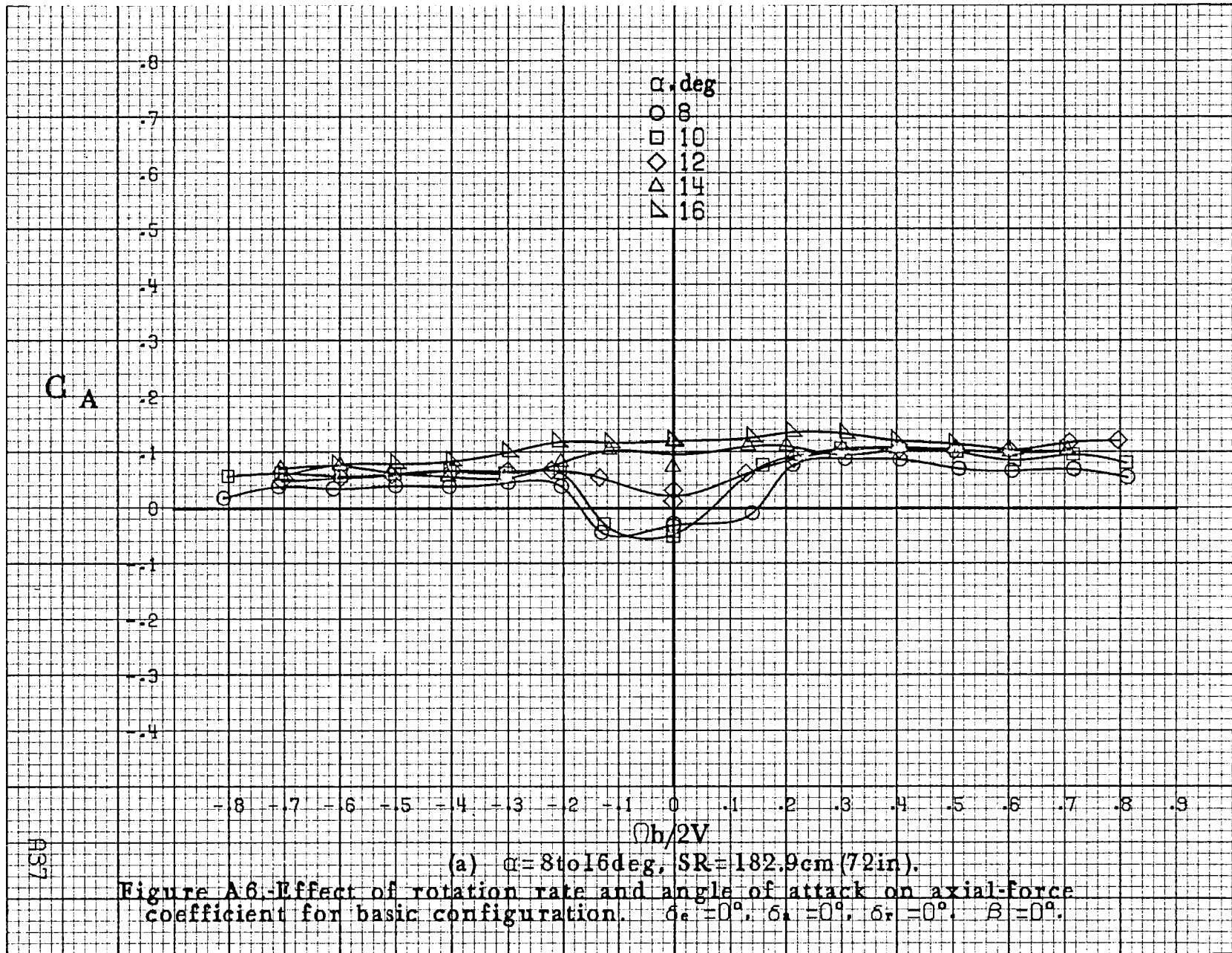



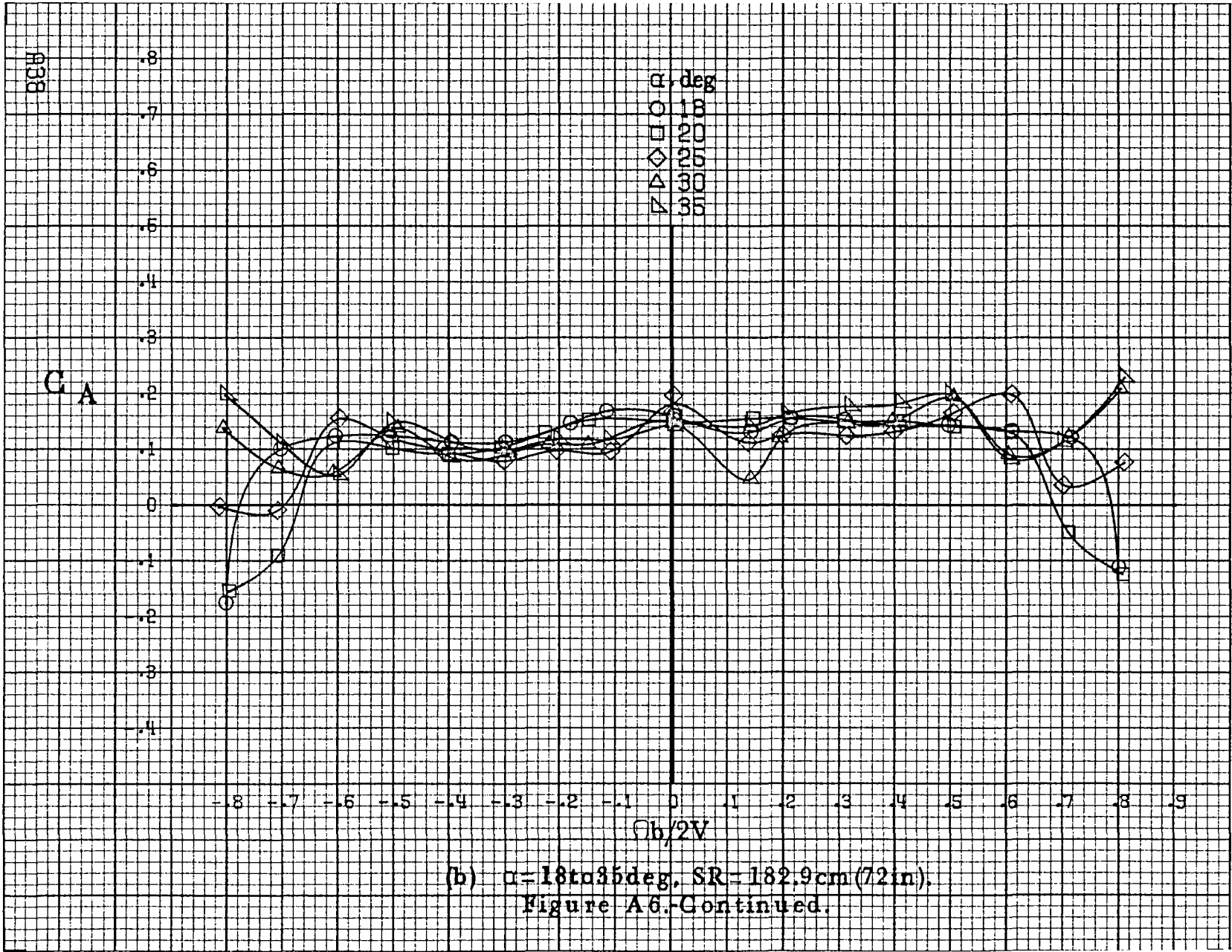



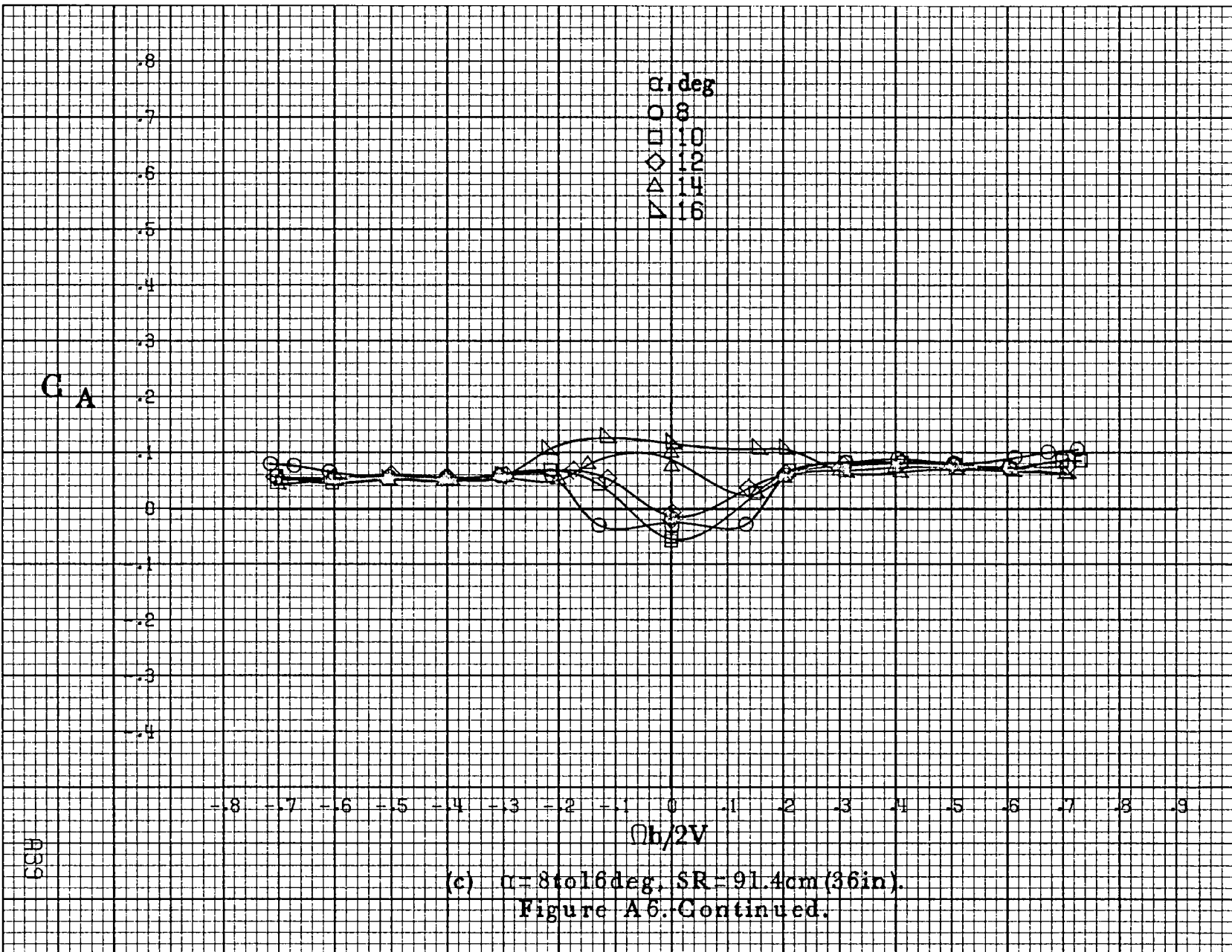

839

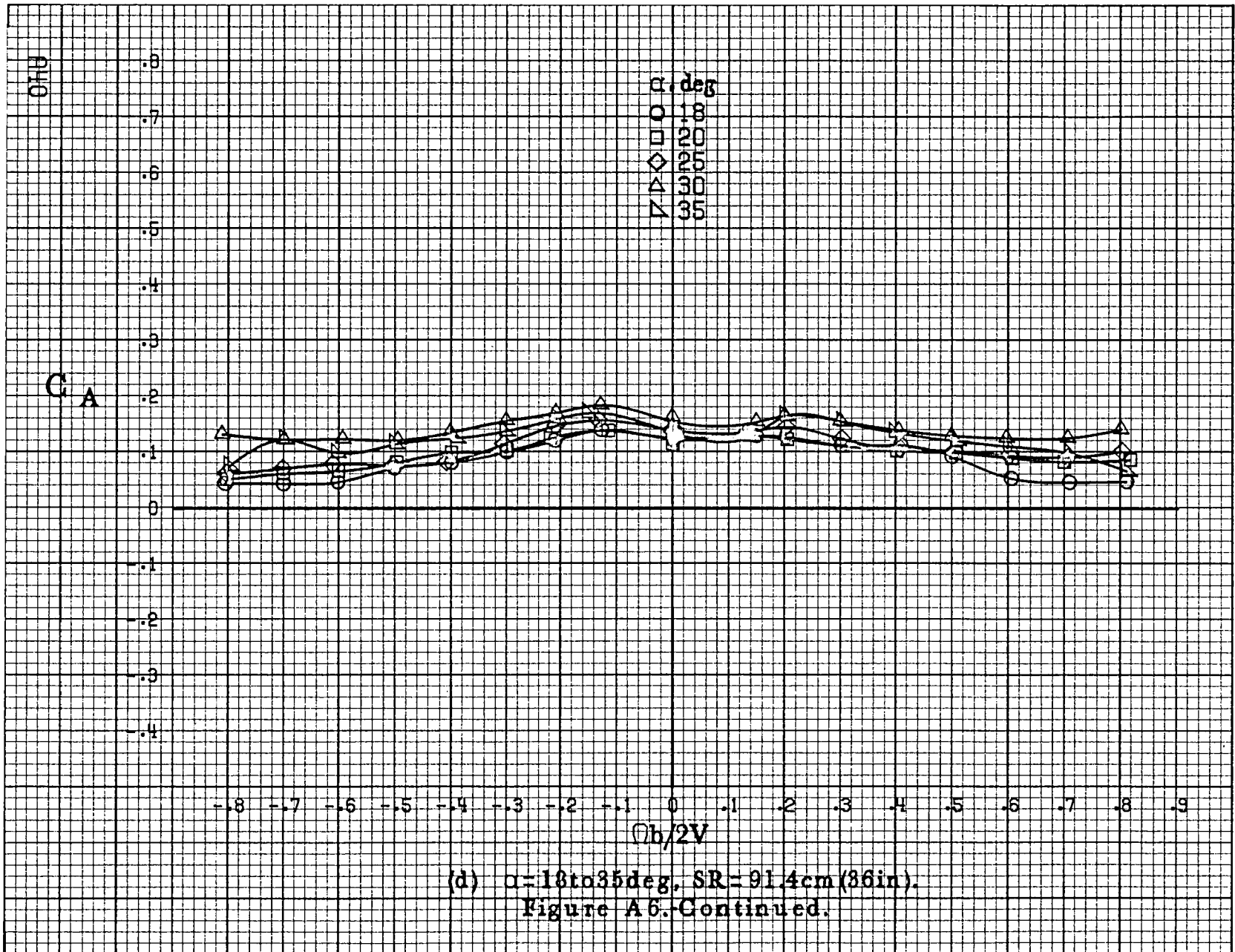

(d)  $\alpha = 18$  to  $35$  deg,  $SR = 91.4$  cm (36 in).  
 Figure A6-Continued.

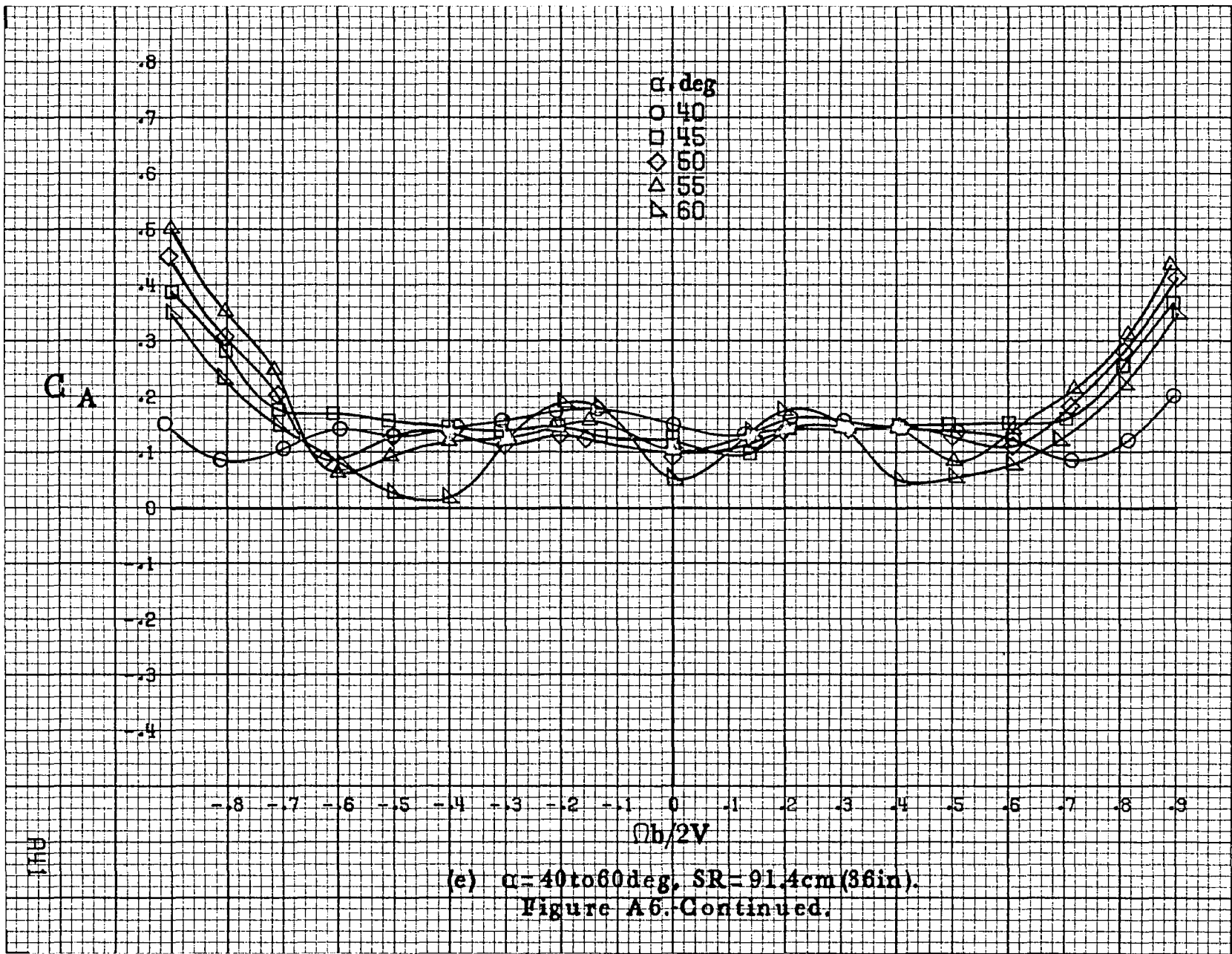

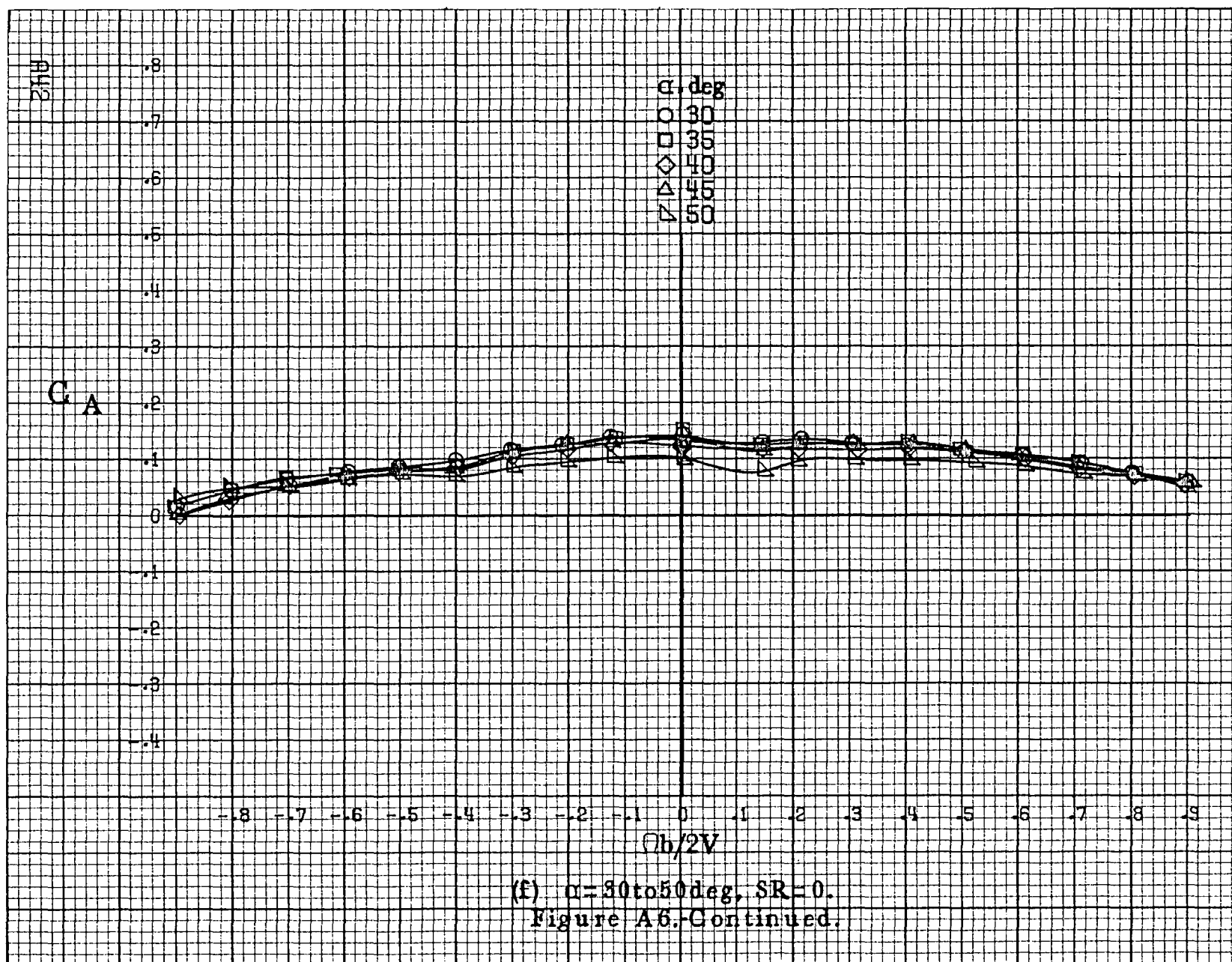

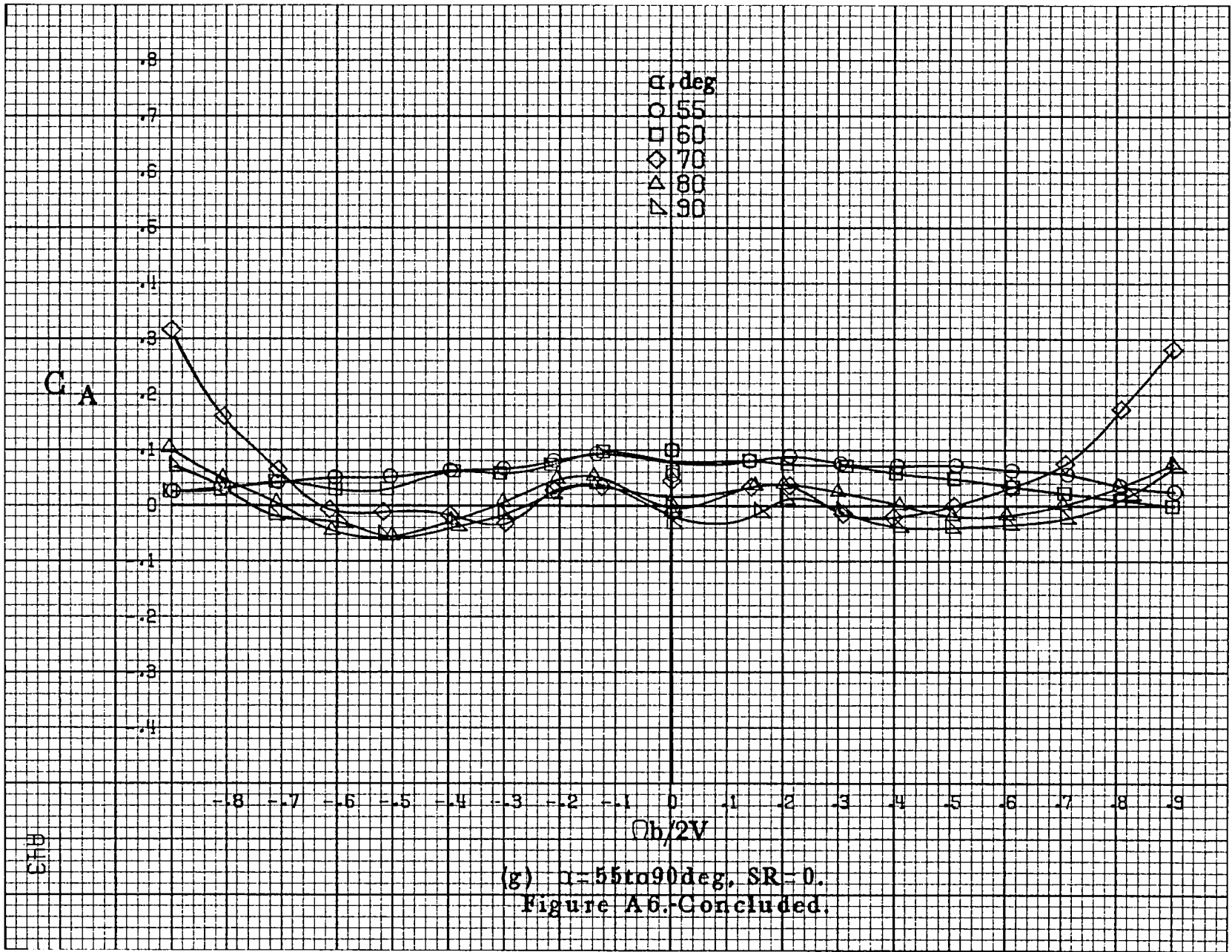

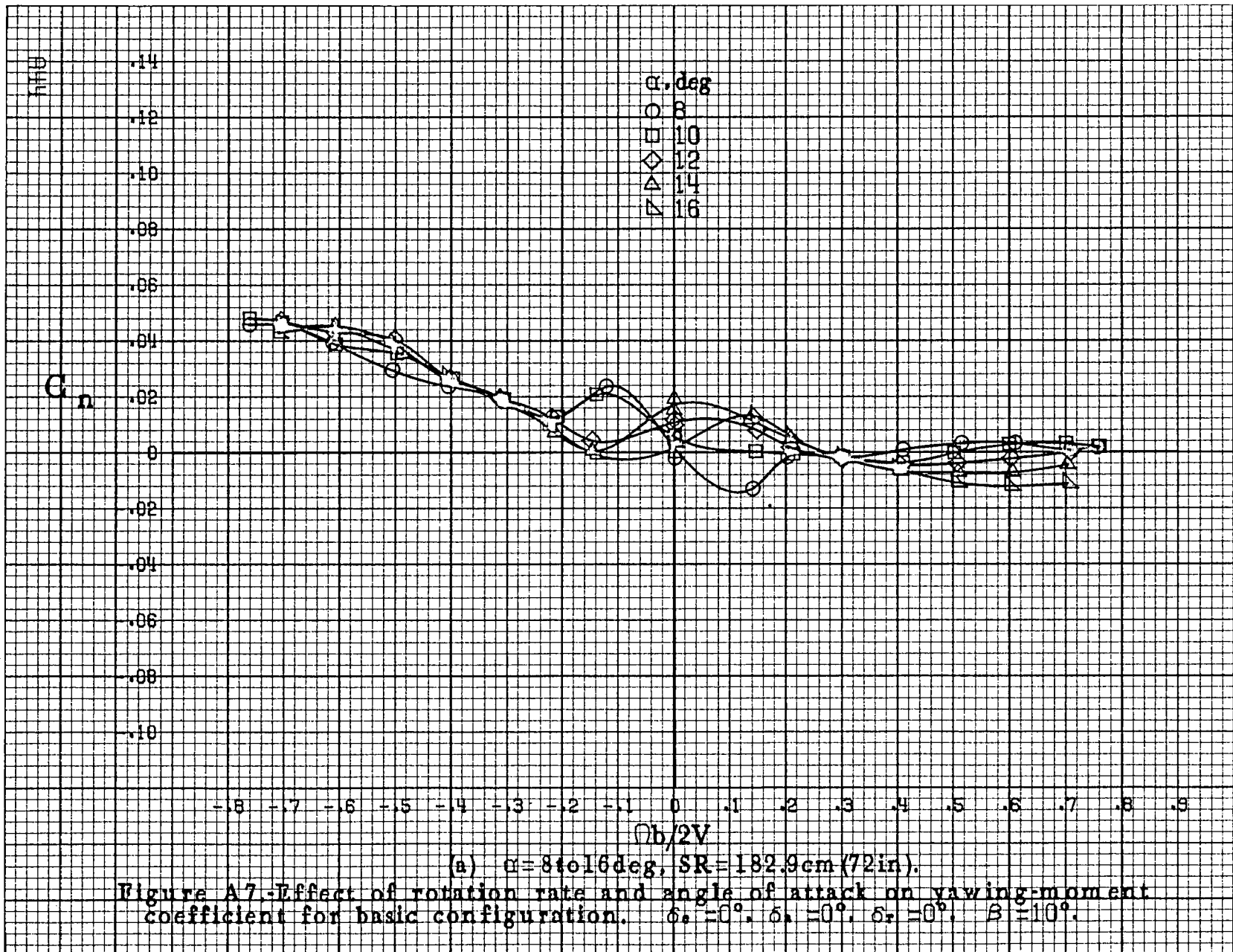

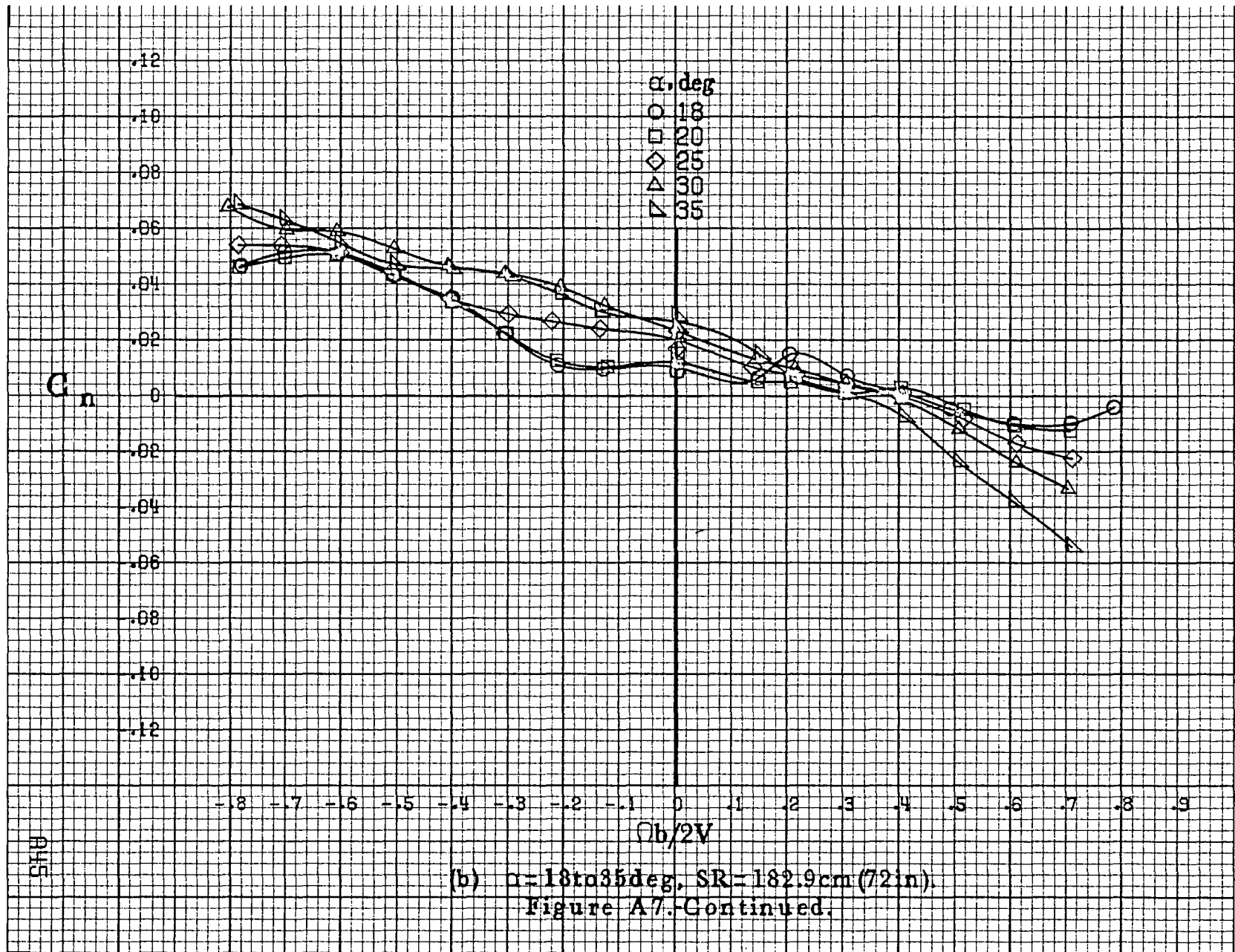



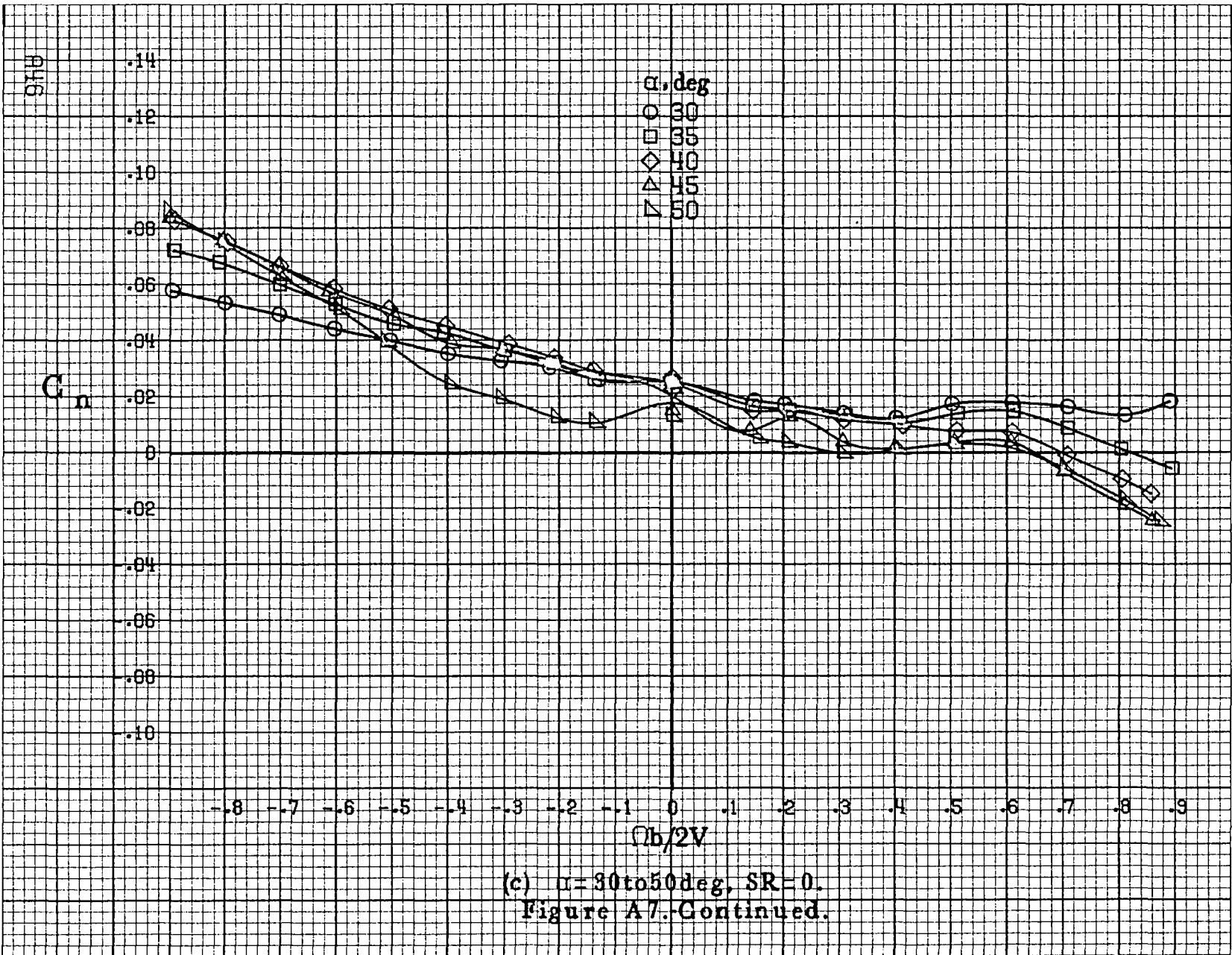



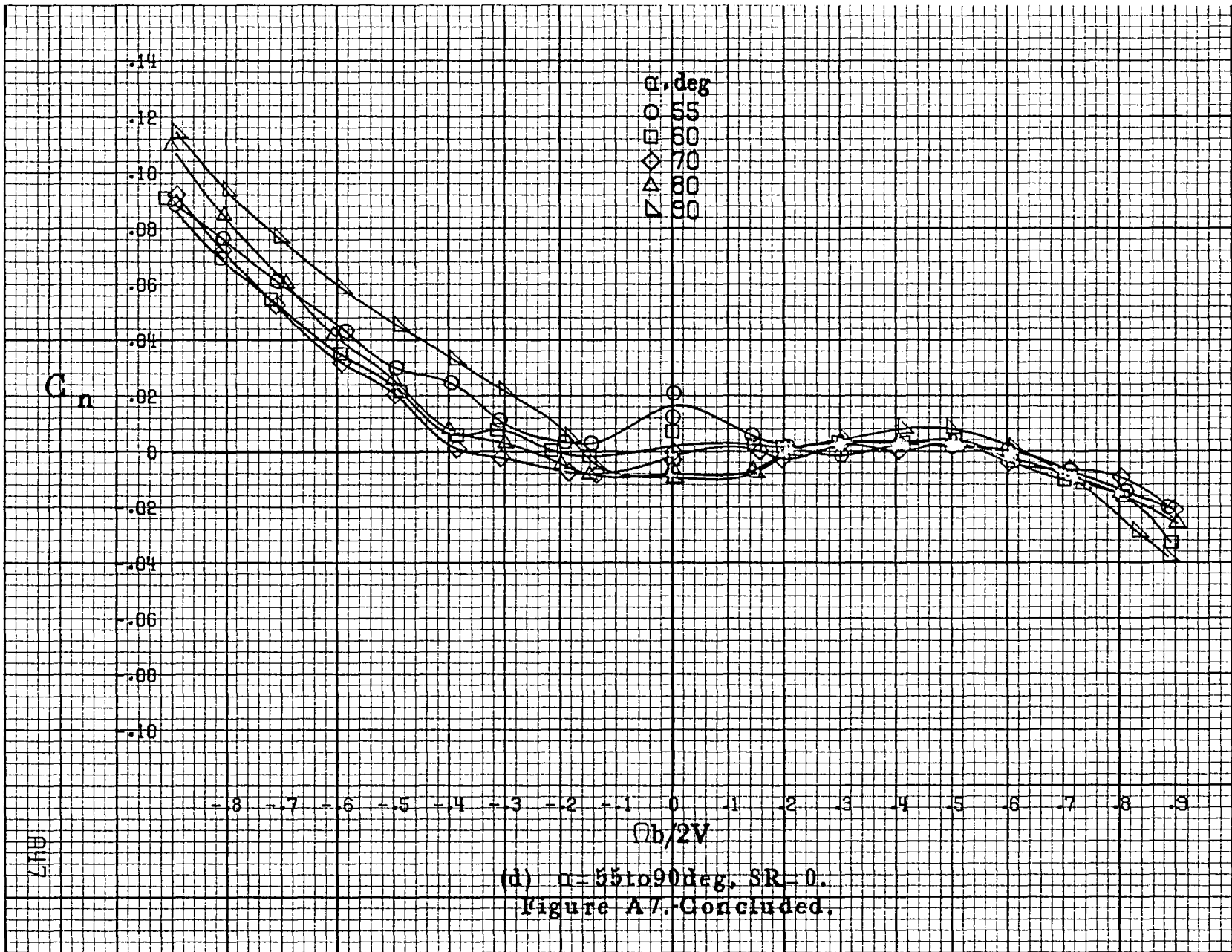

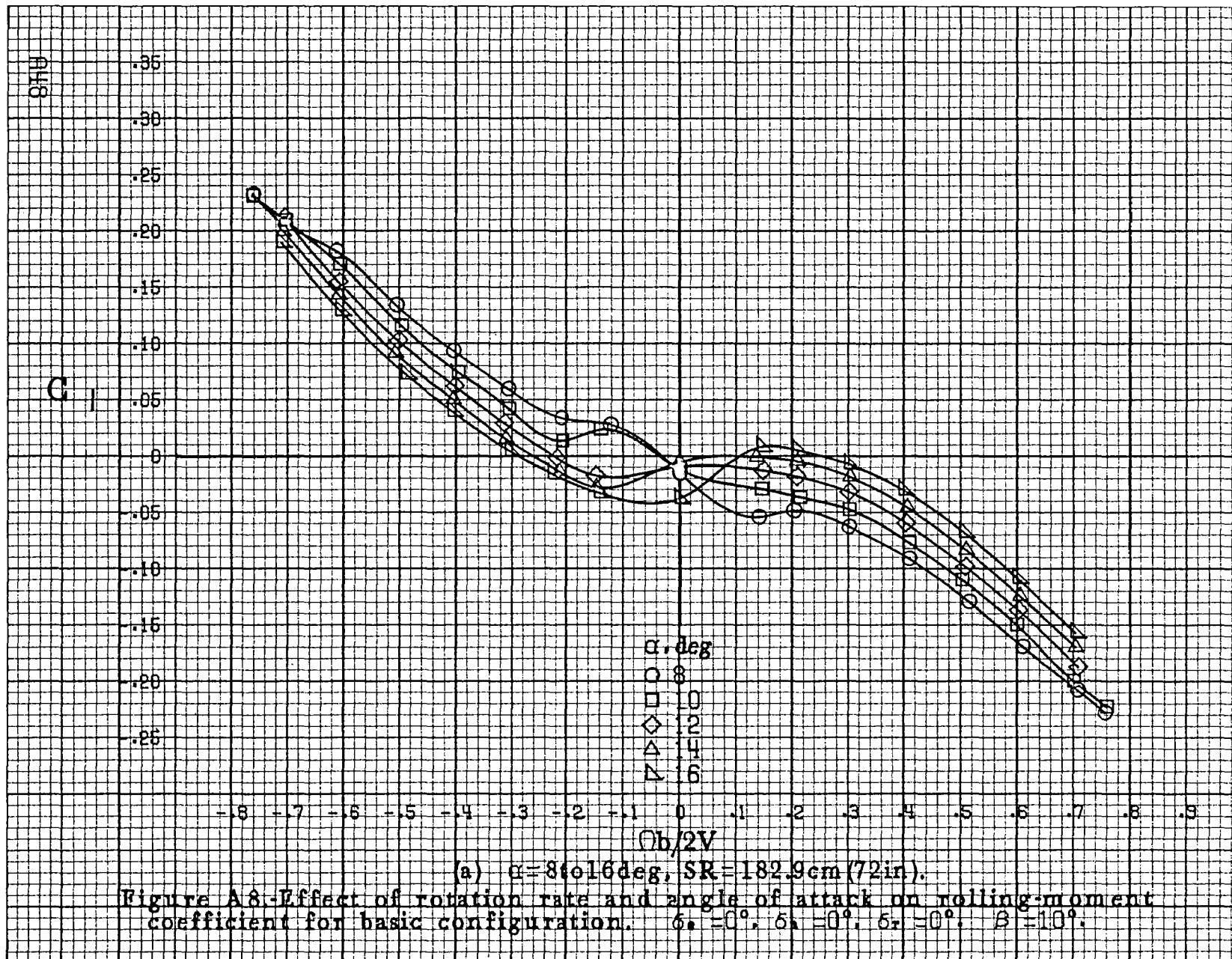

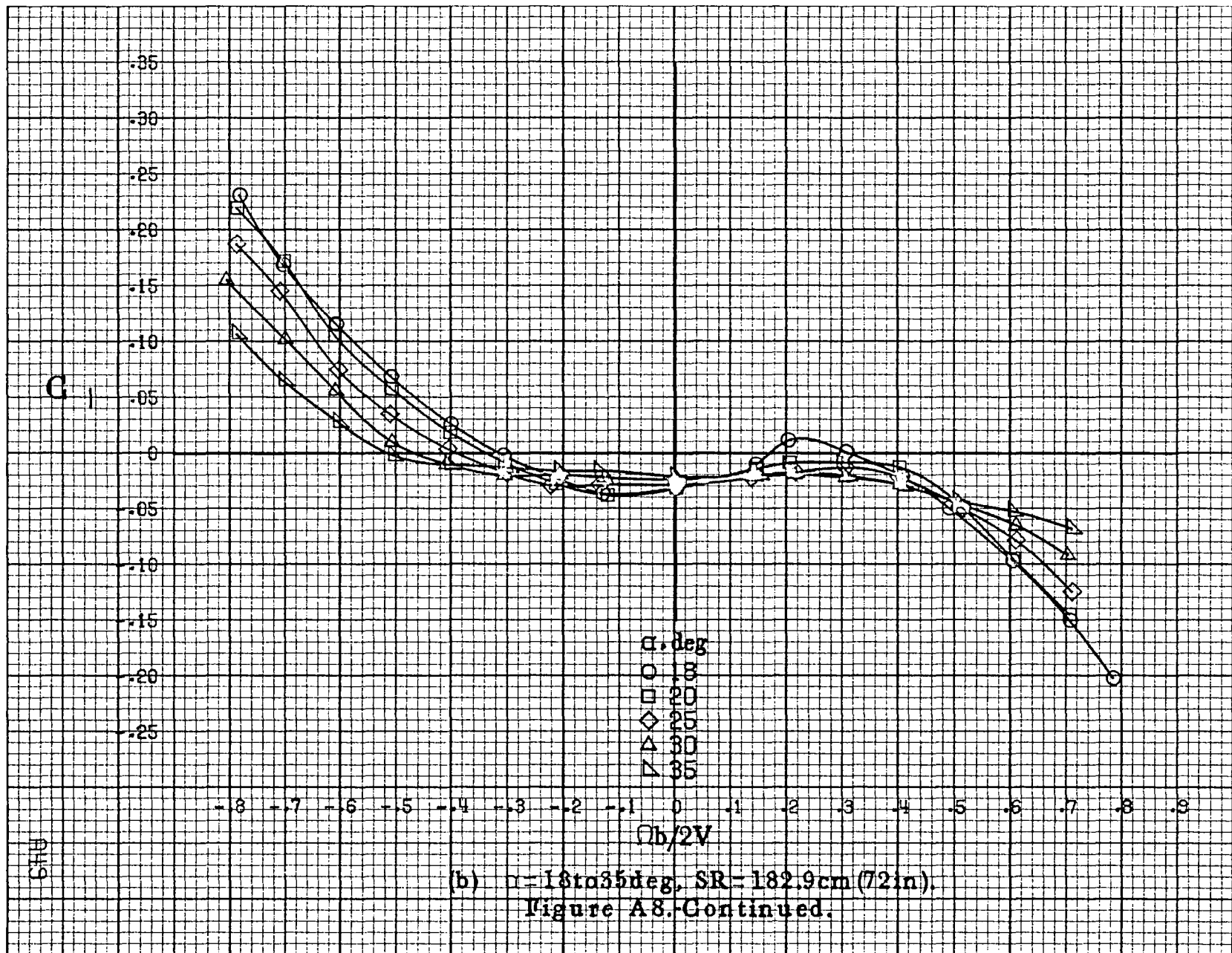

1919

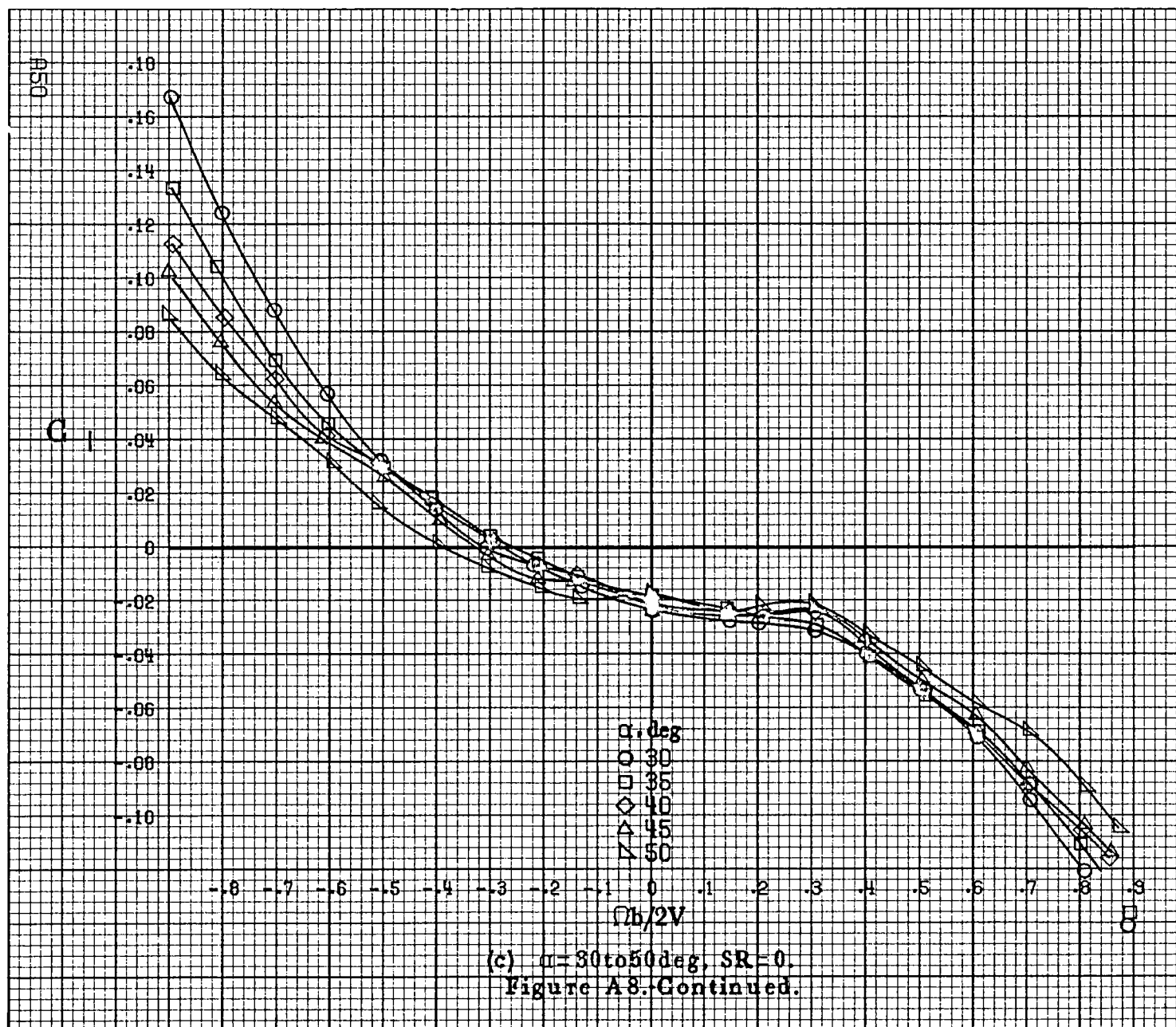

(c)  $\alpha = 30$  to  $50$  deg,  $SR = 0$ .  
 Figure A8. Continued.

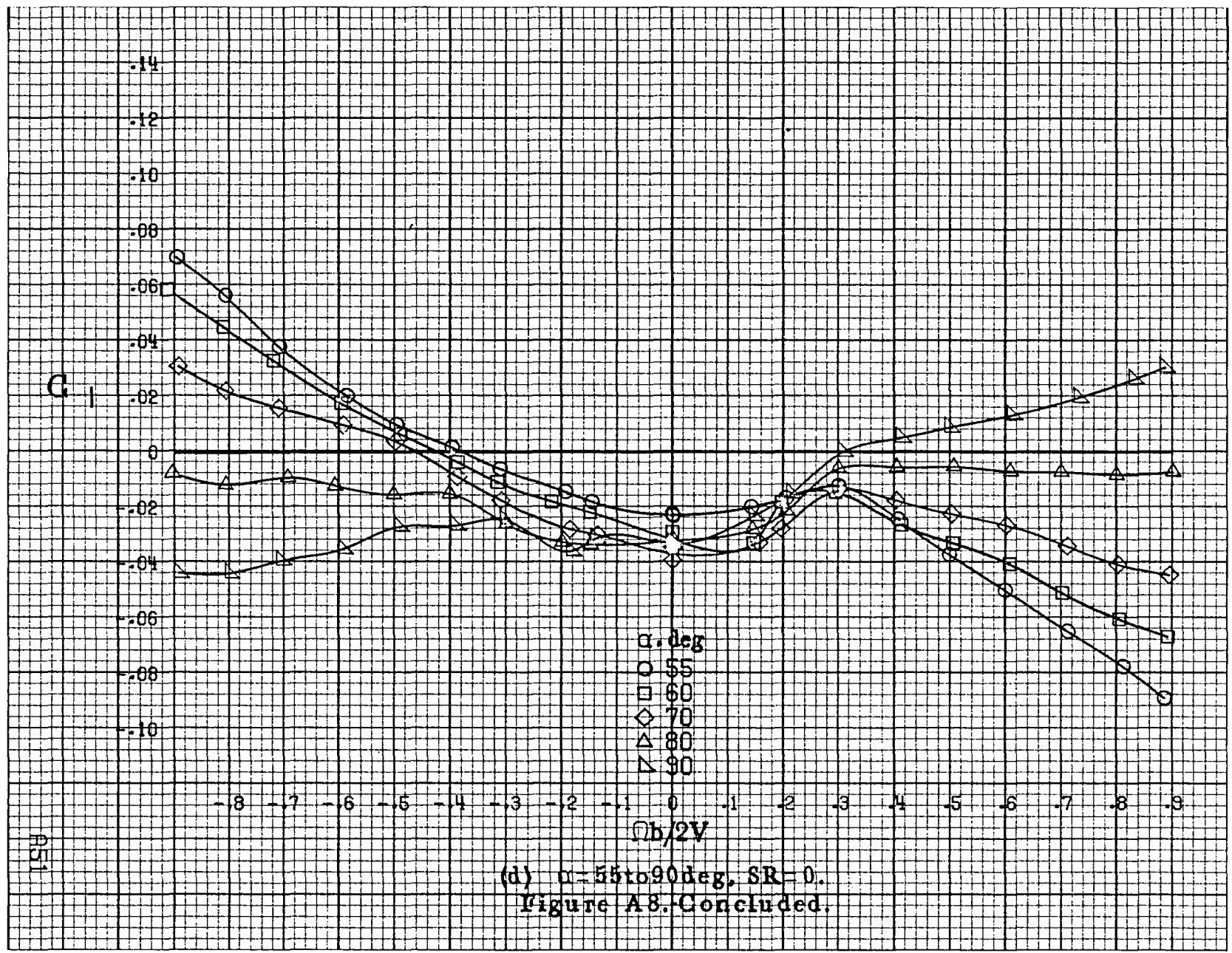

RS1

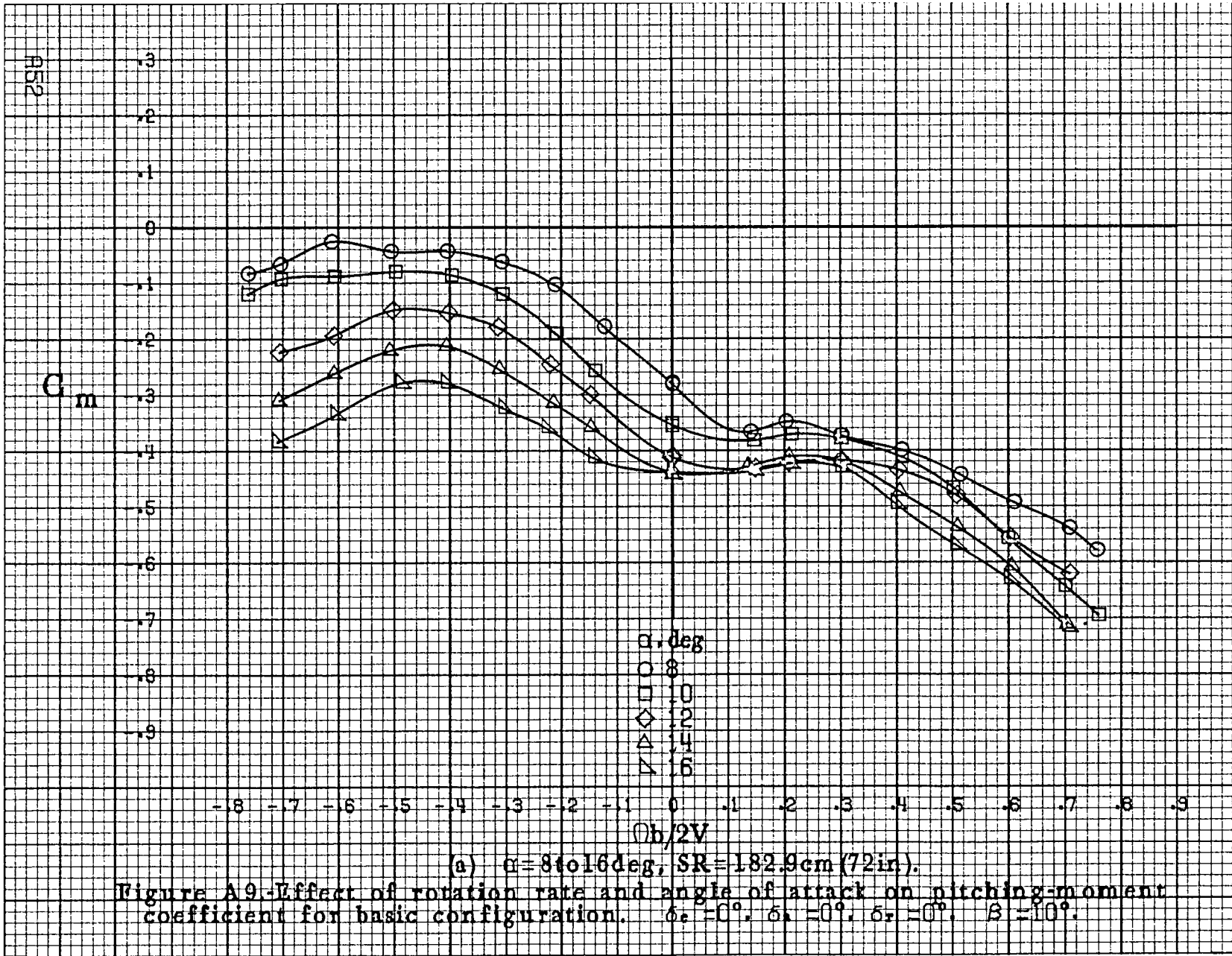

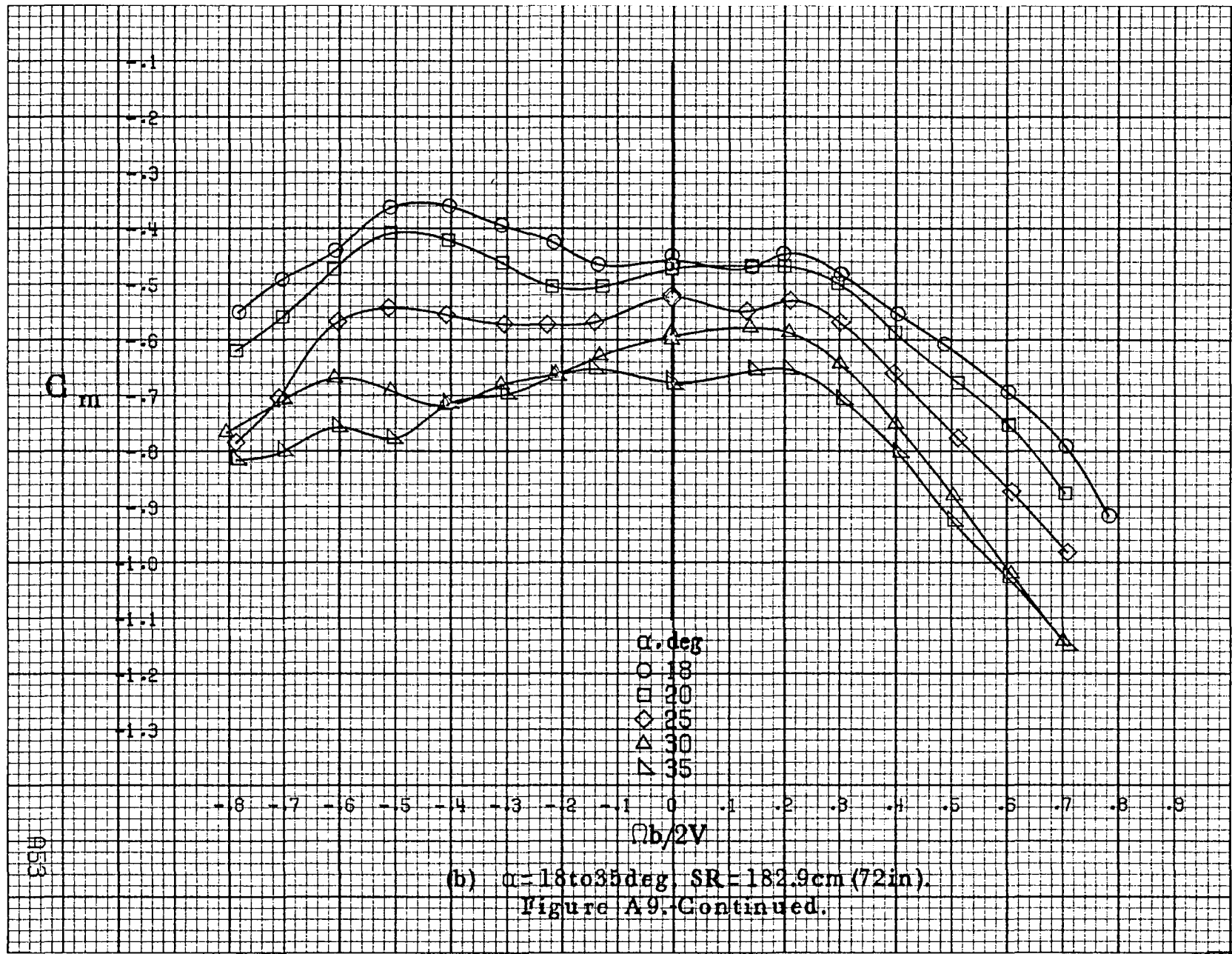



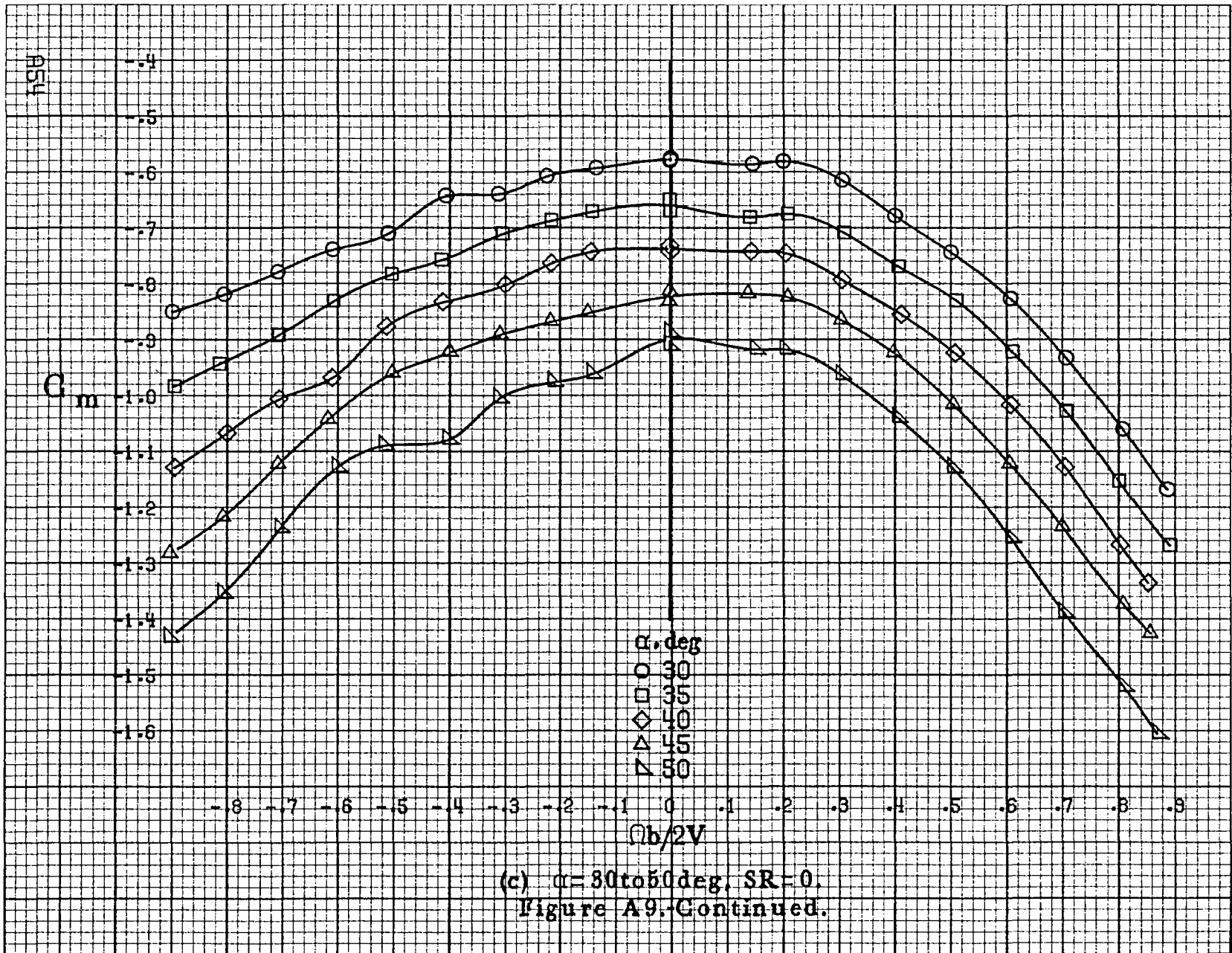



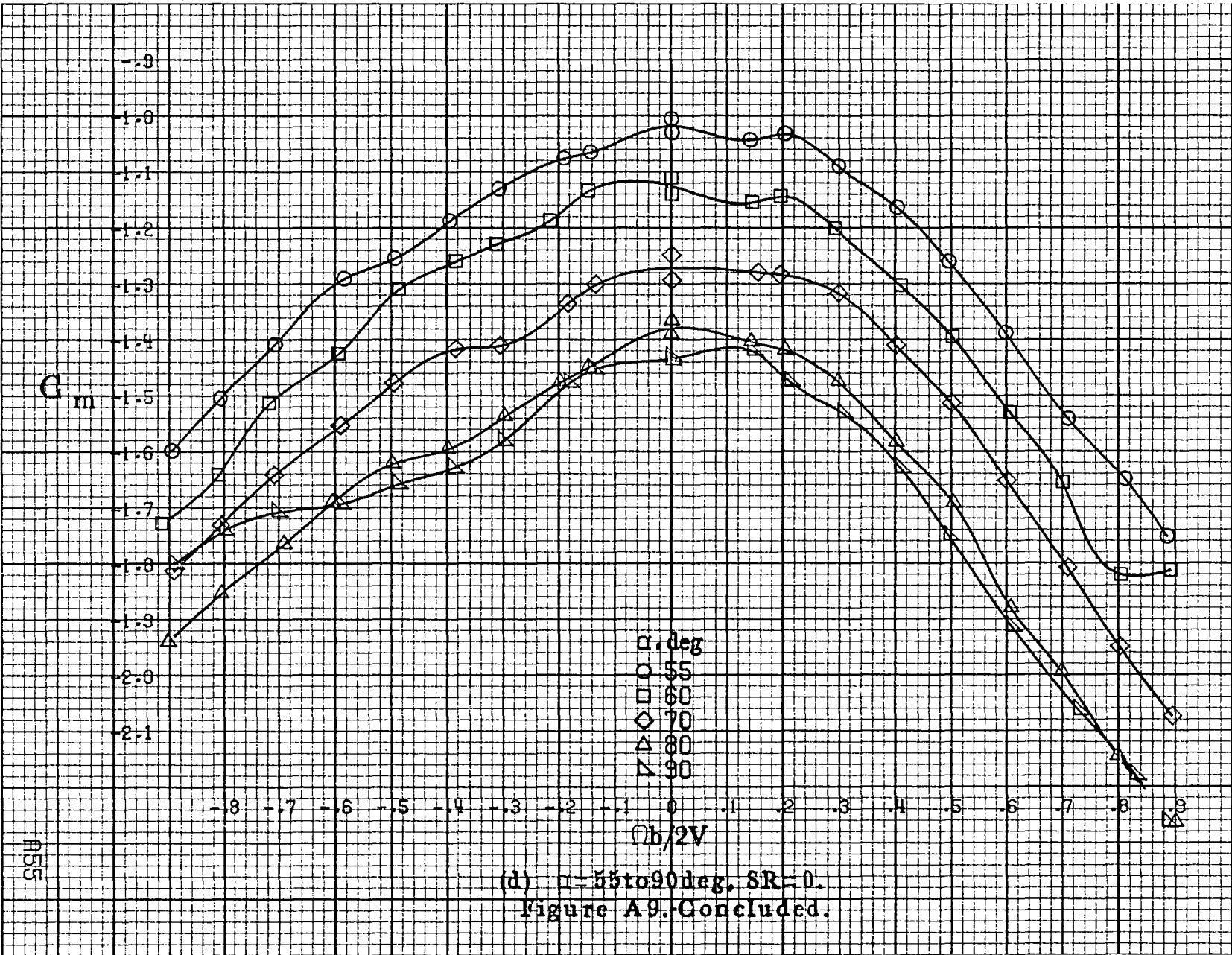

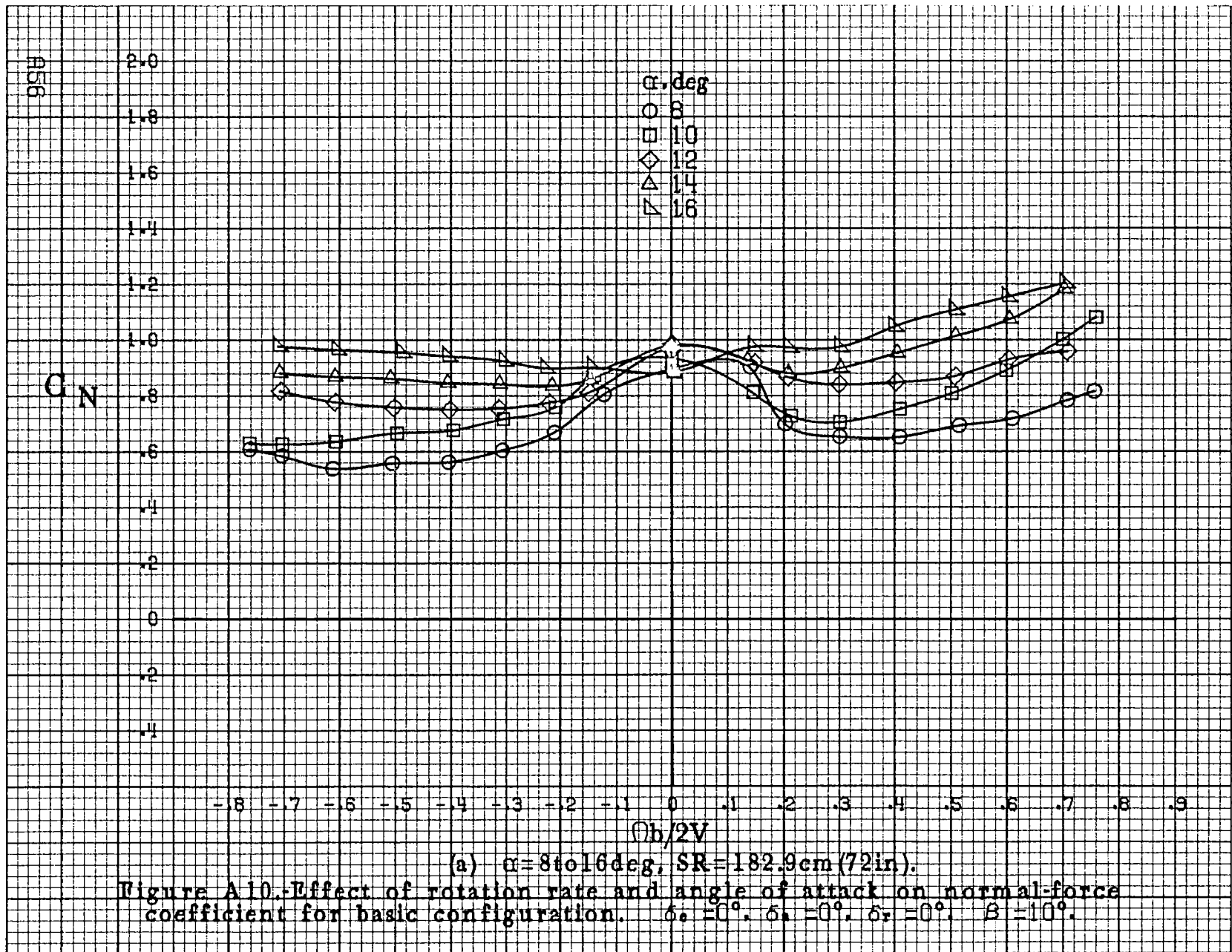

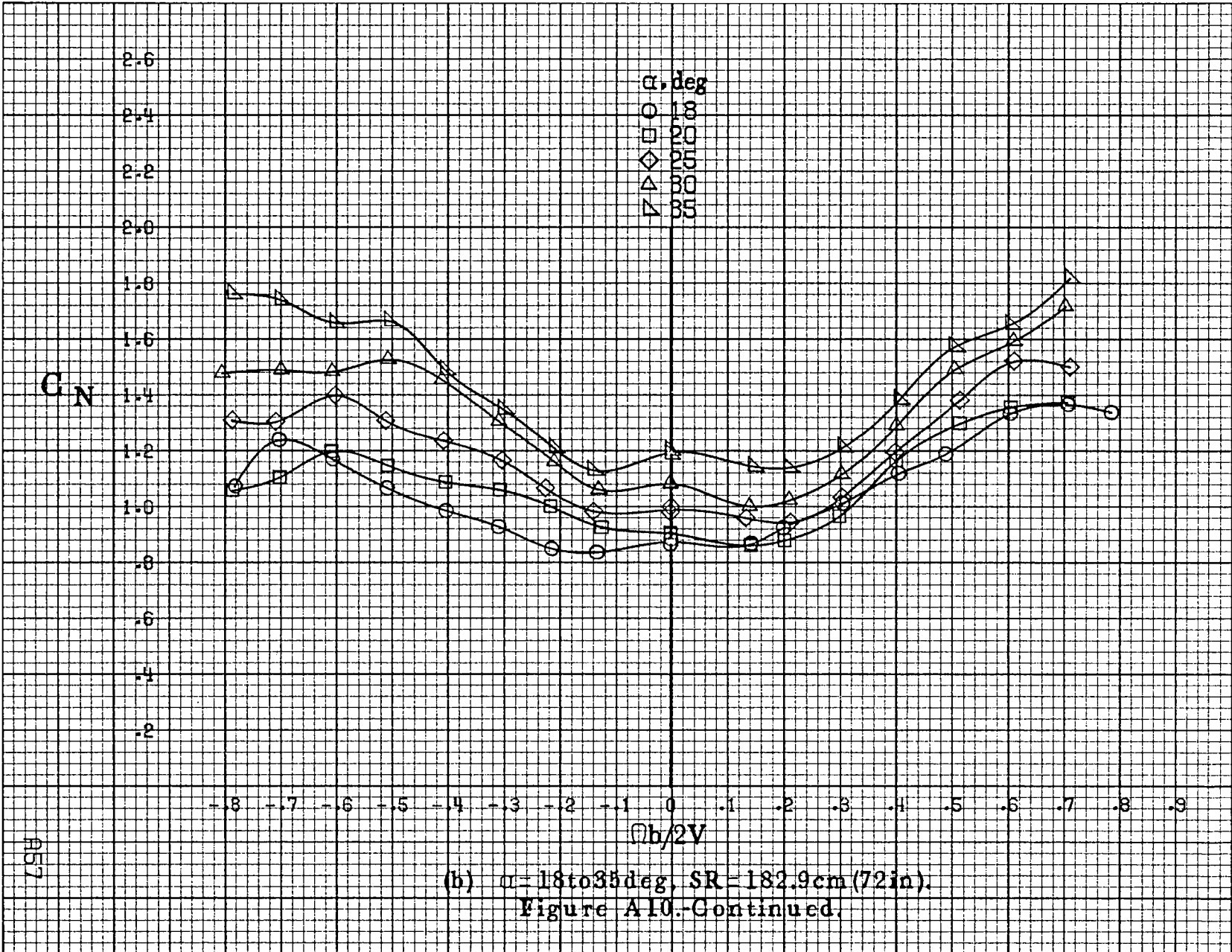

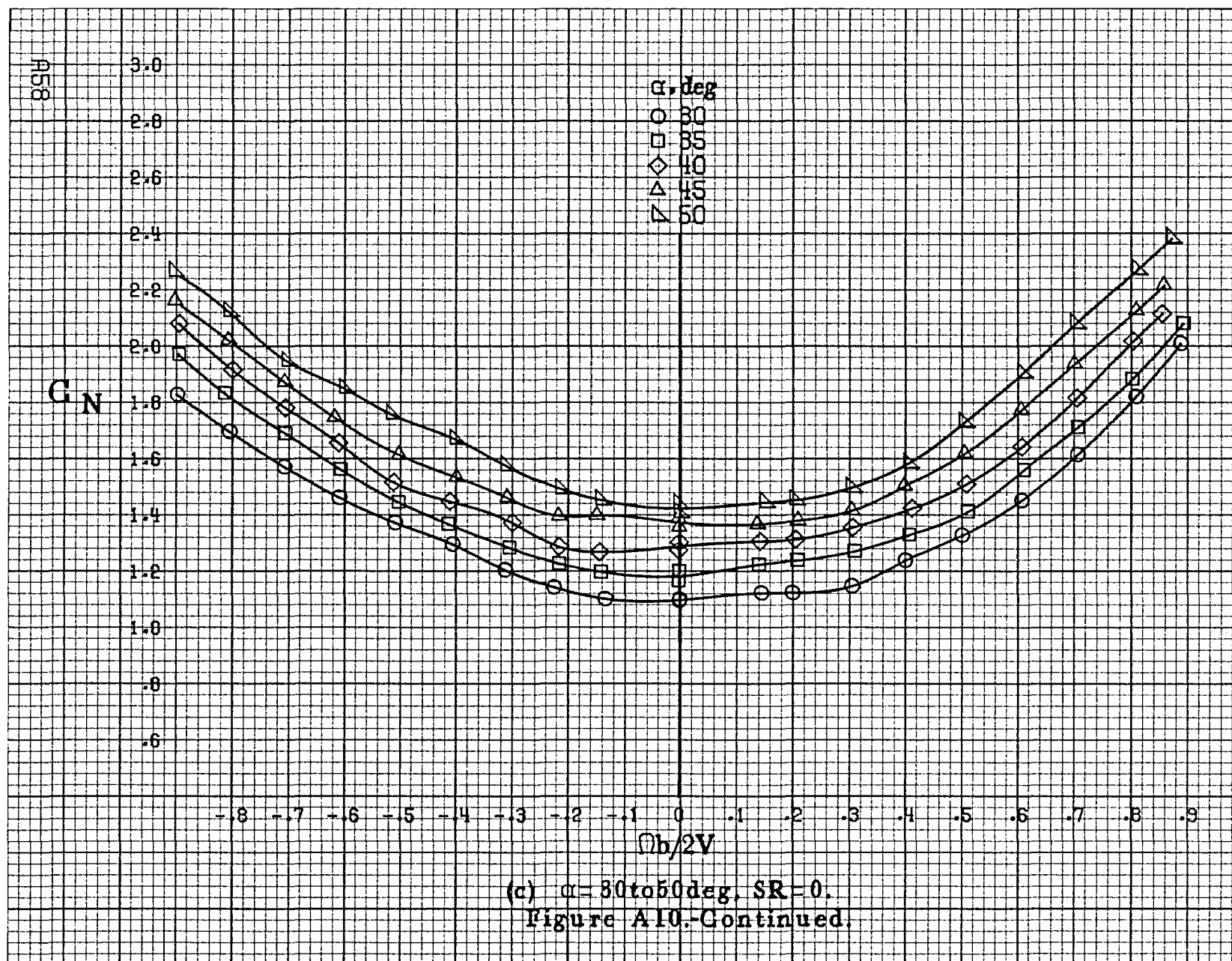

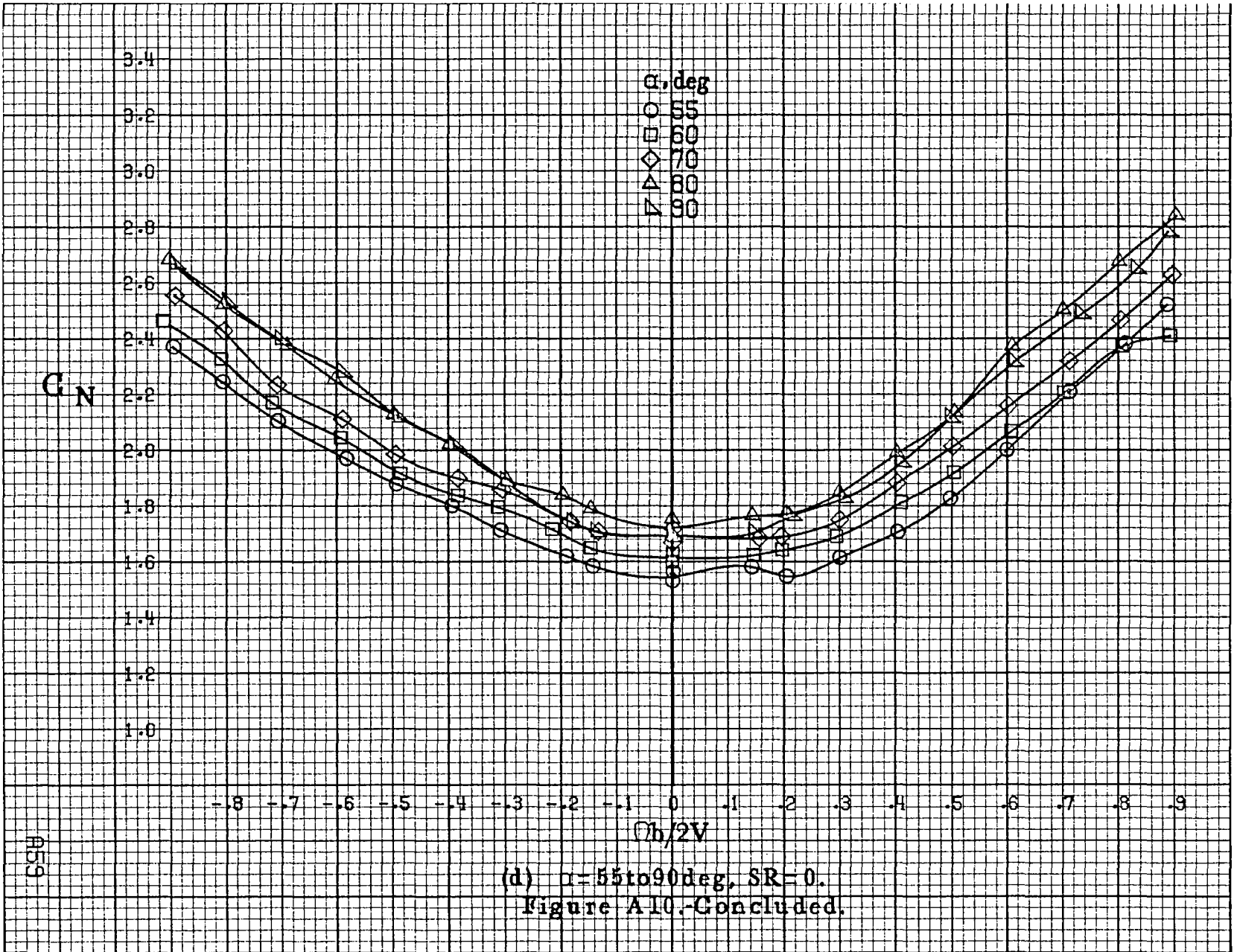

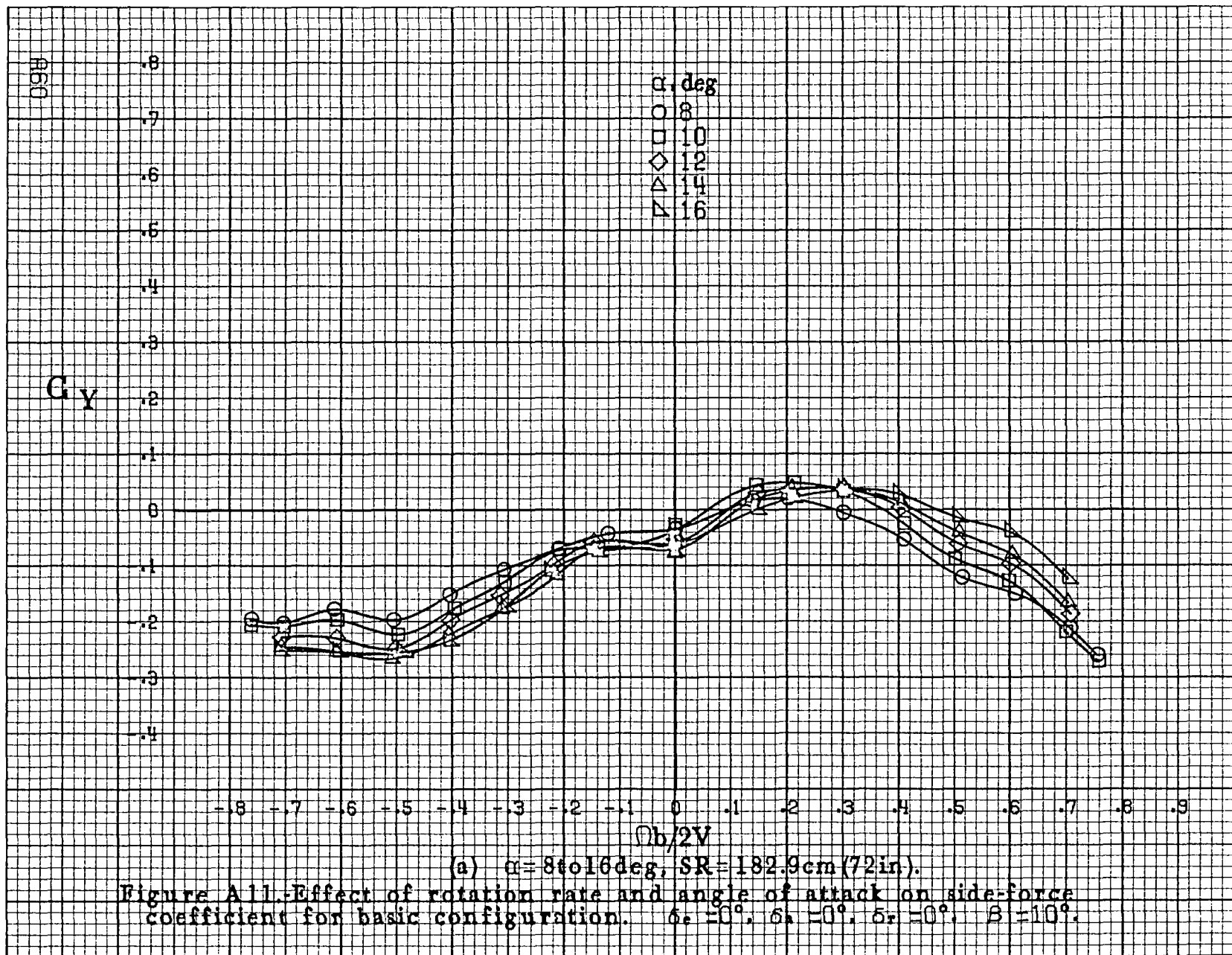

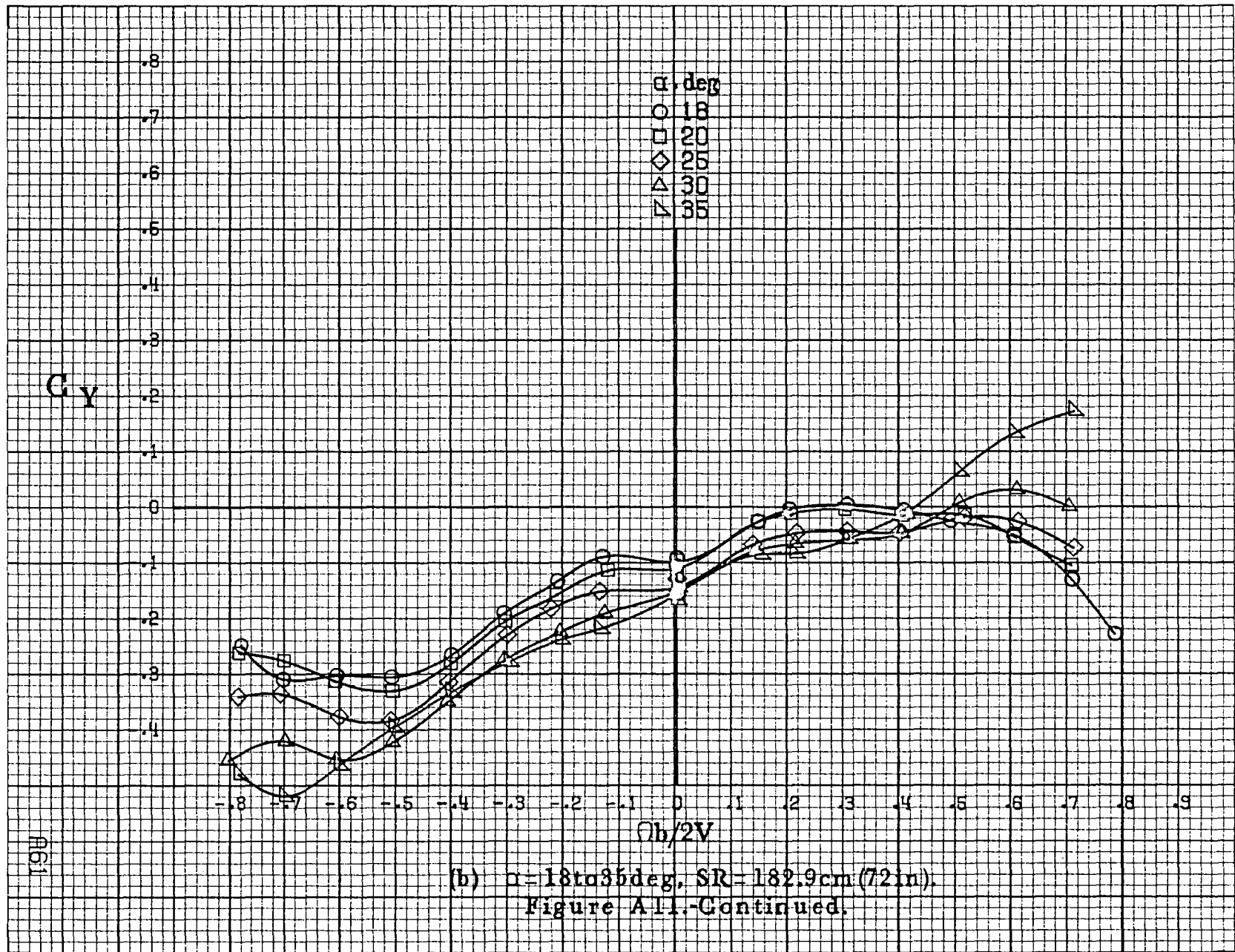



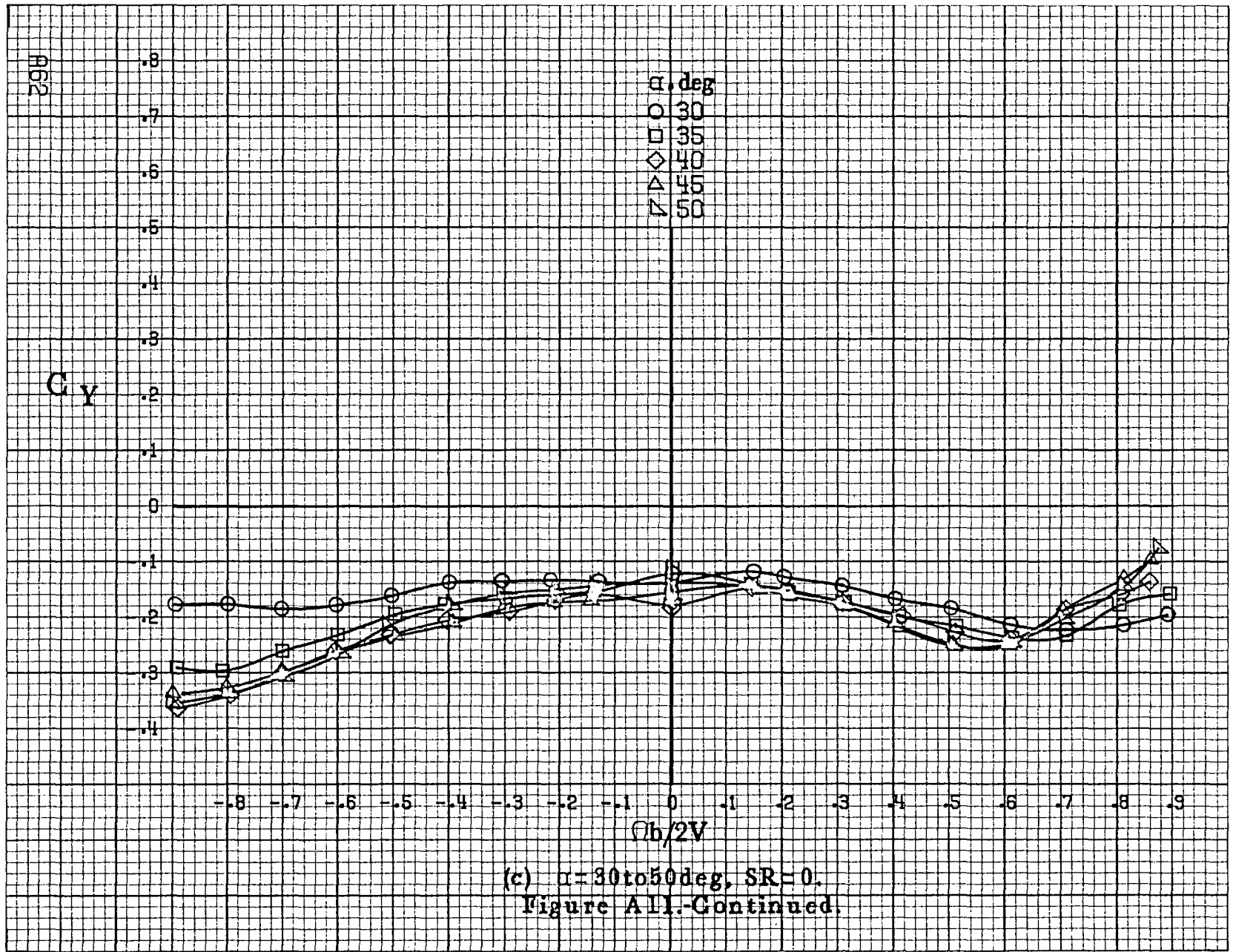

(c)  $\alpha = 30$  to  $50$  deg,  $SR = 0$ .  
 Figure A11-Continued.



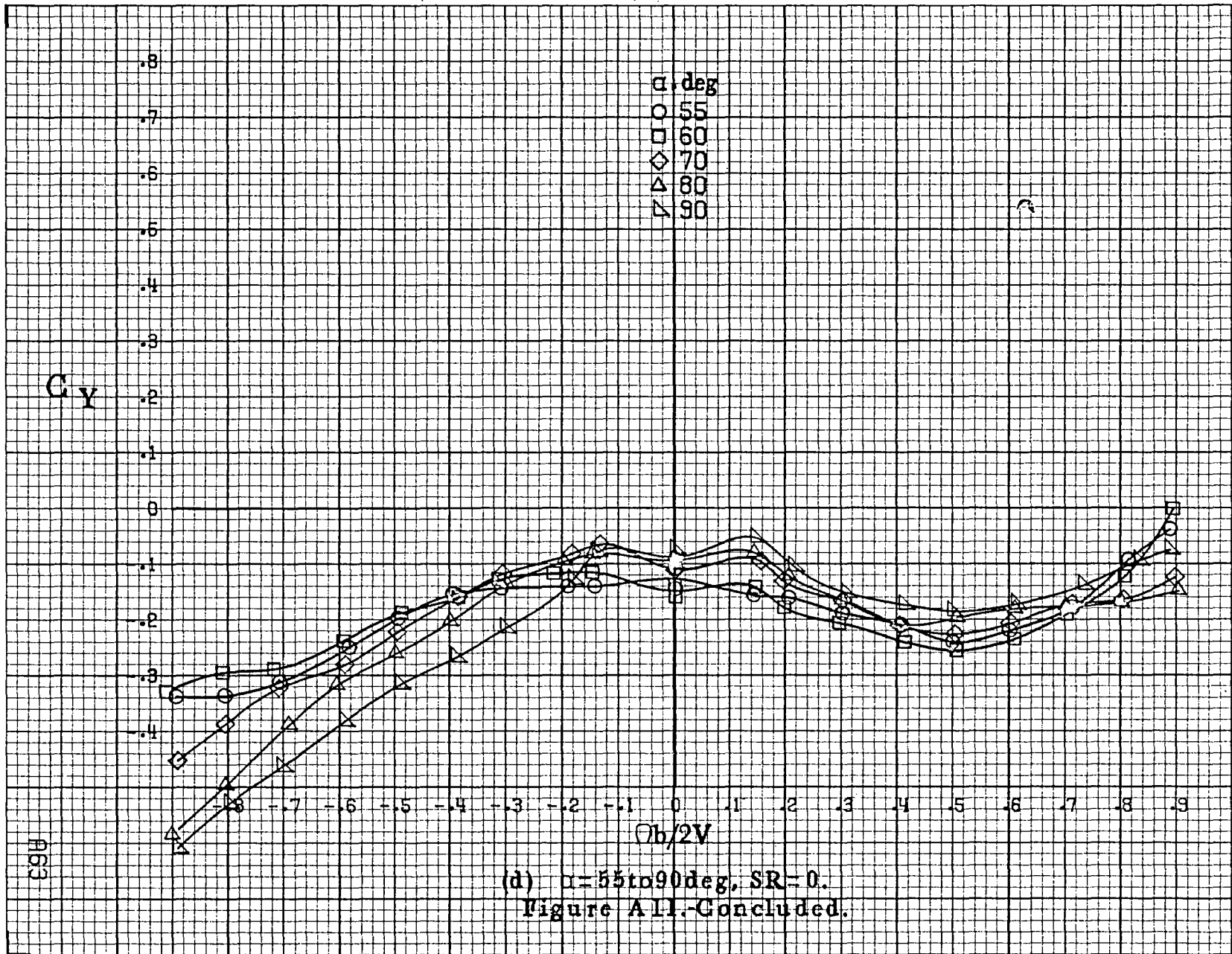

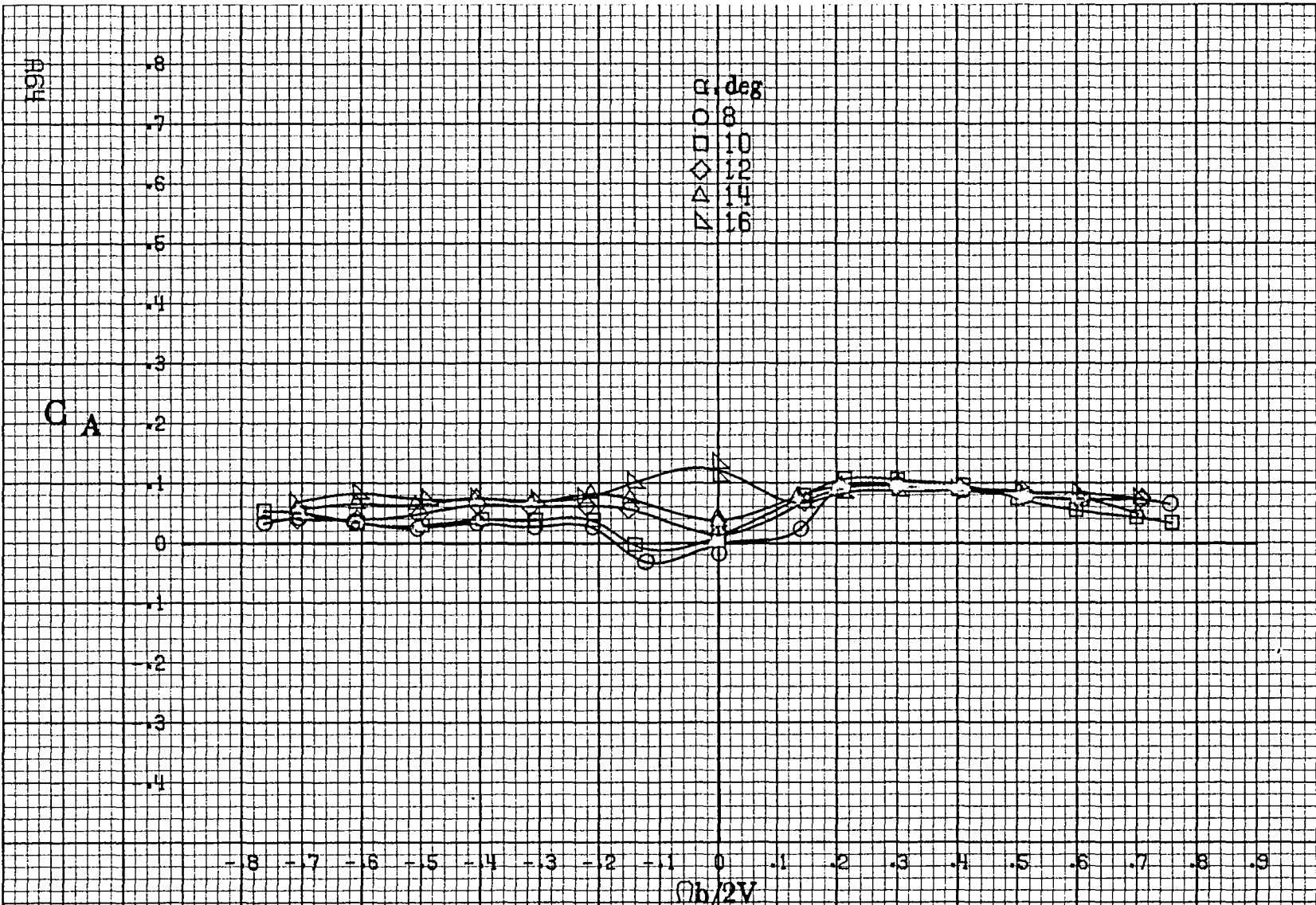

(a)  $\alpha = 8$  to  $16$  deg,  $SR = 182.9$  cm (72 in).

Figure A 12.-Effect of rotation rate and angle of attack on axial-force coefficient for basic configuration.  $\delta_s = 0^\circ$ ,  $\delta_h = 0^\circ$ ,  $\delta_r = 0^\circ$ ,  $B = 10^\circ$ .

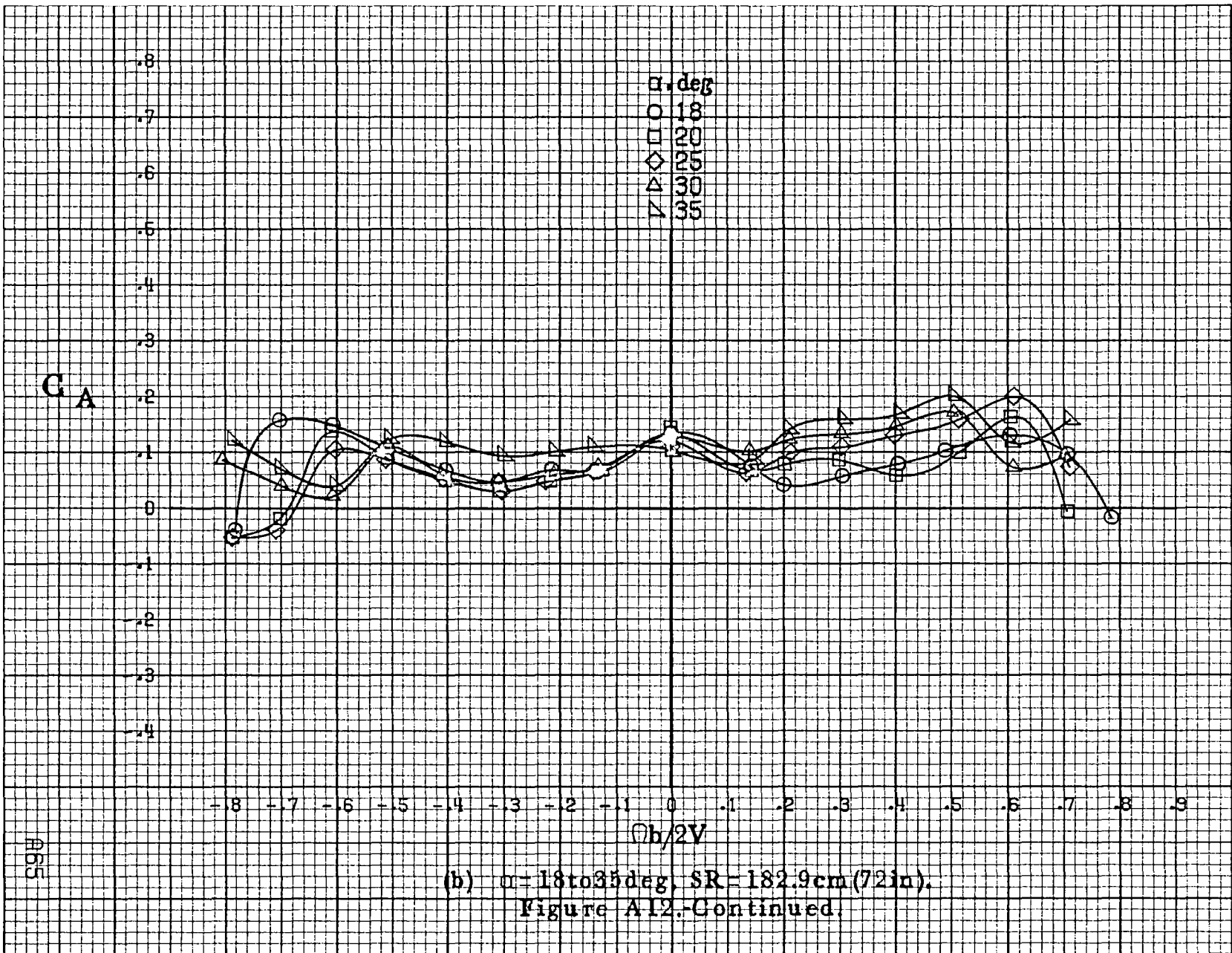

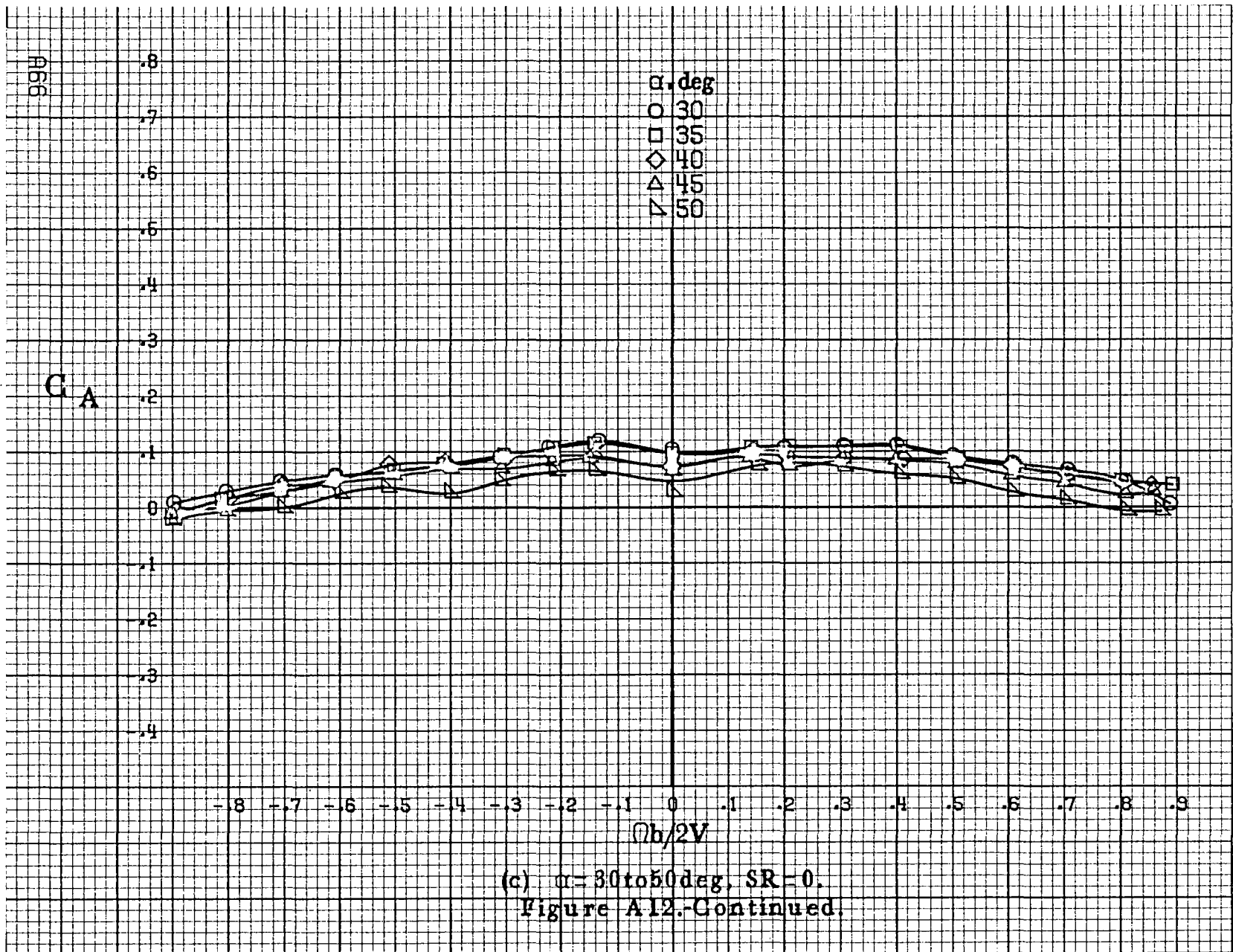

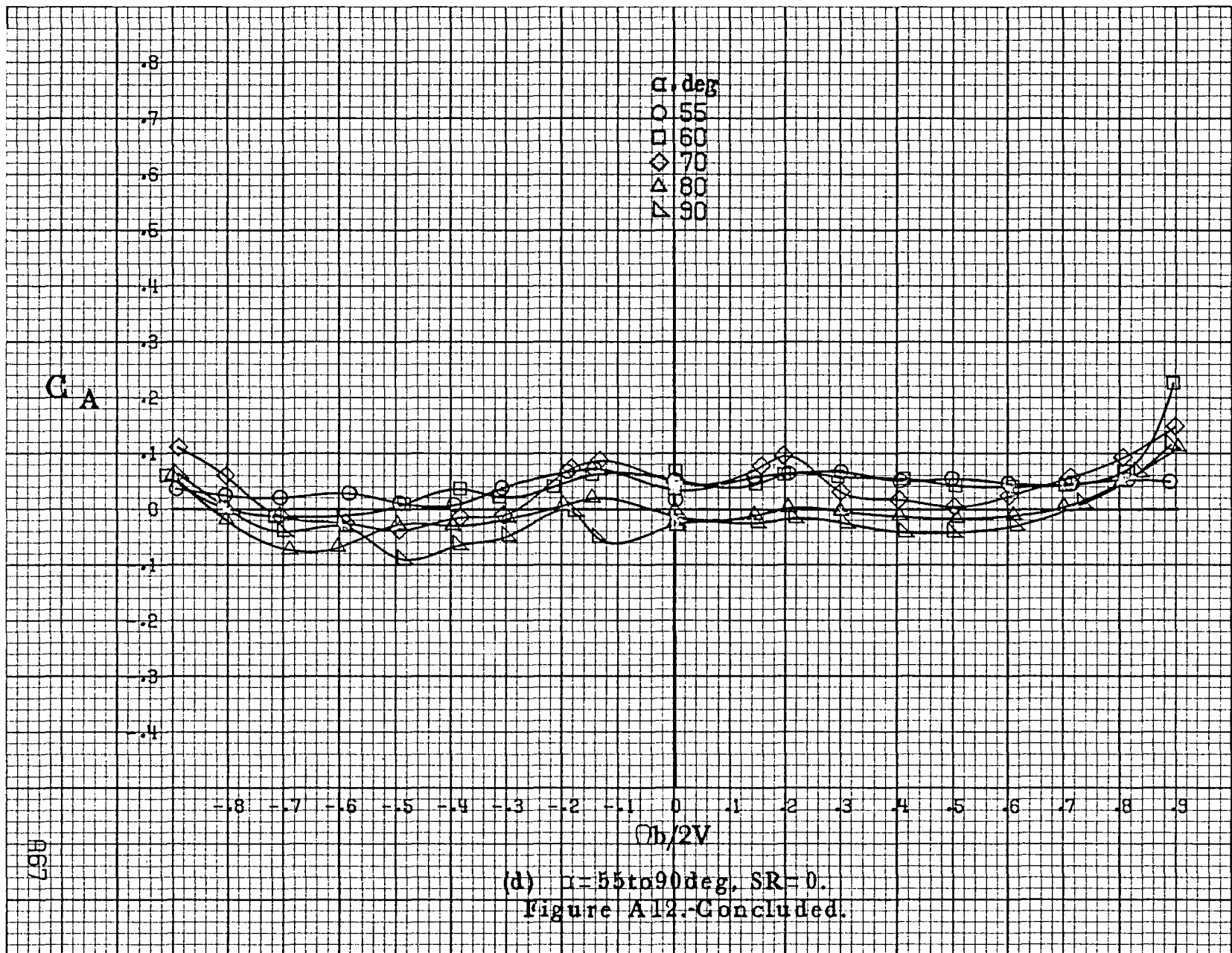

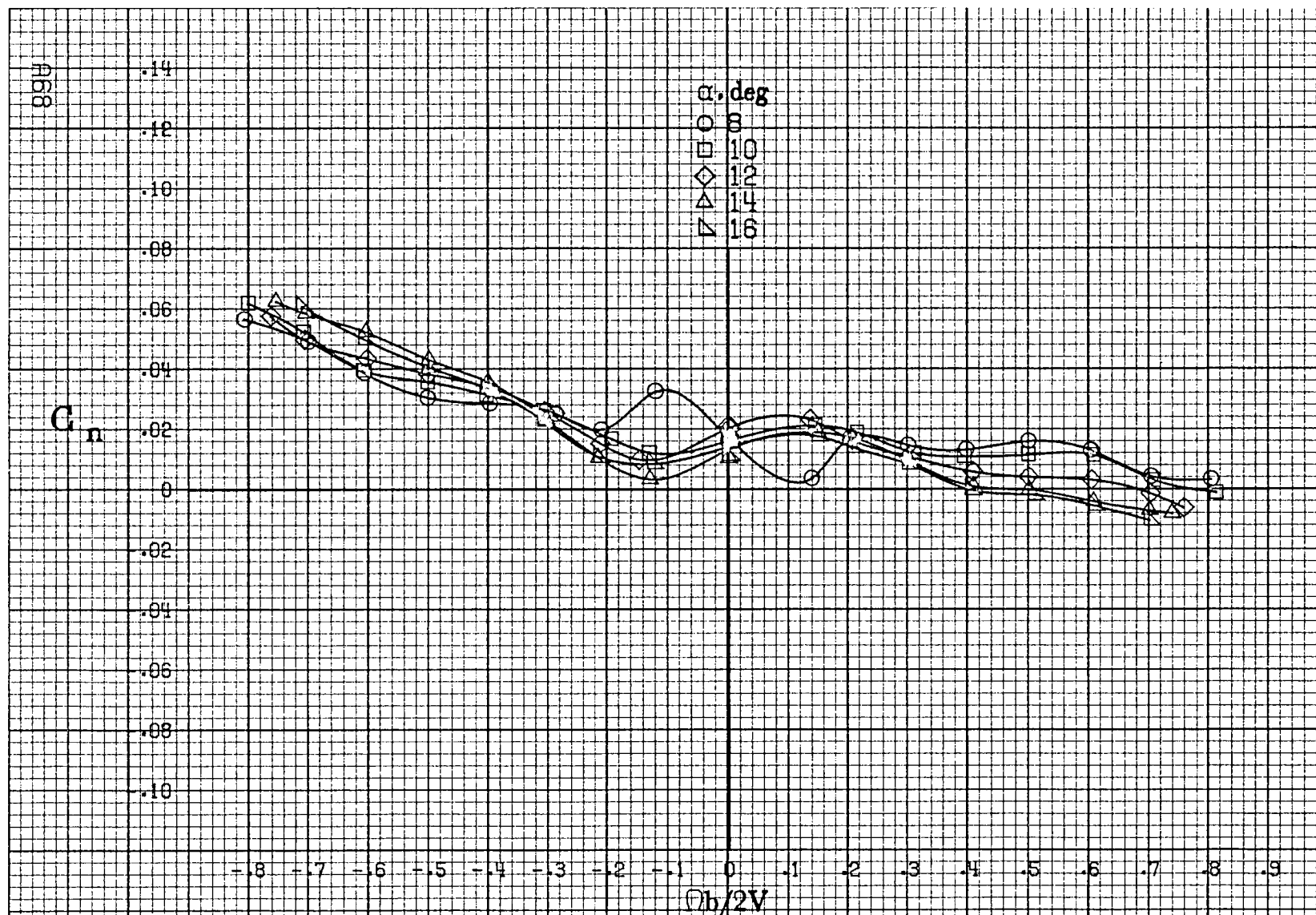

(a)  $\alpha = 8$  to  $16$  deg, SR = 182.9 cm (72 in).

Figure A13 - Effect of rotation rate and angle of attack on yawing-moment coefficient for basic configuration.  $\delta_e = -15^\circ$ ,  $\delta_r = 0^\circ$ ,  $\delta_a = -25^\circ$ ,  $\beta = 0^\circ$ .

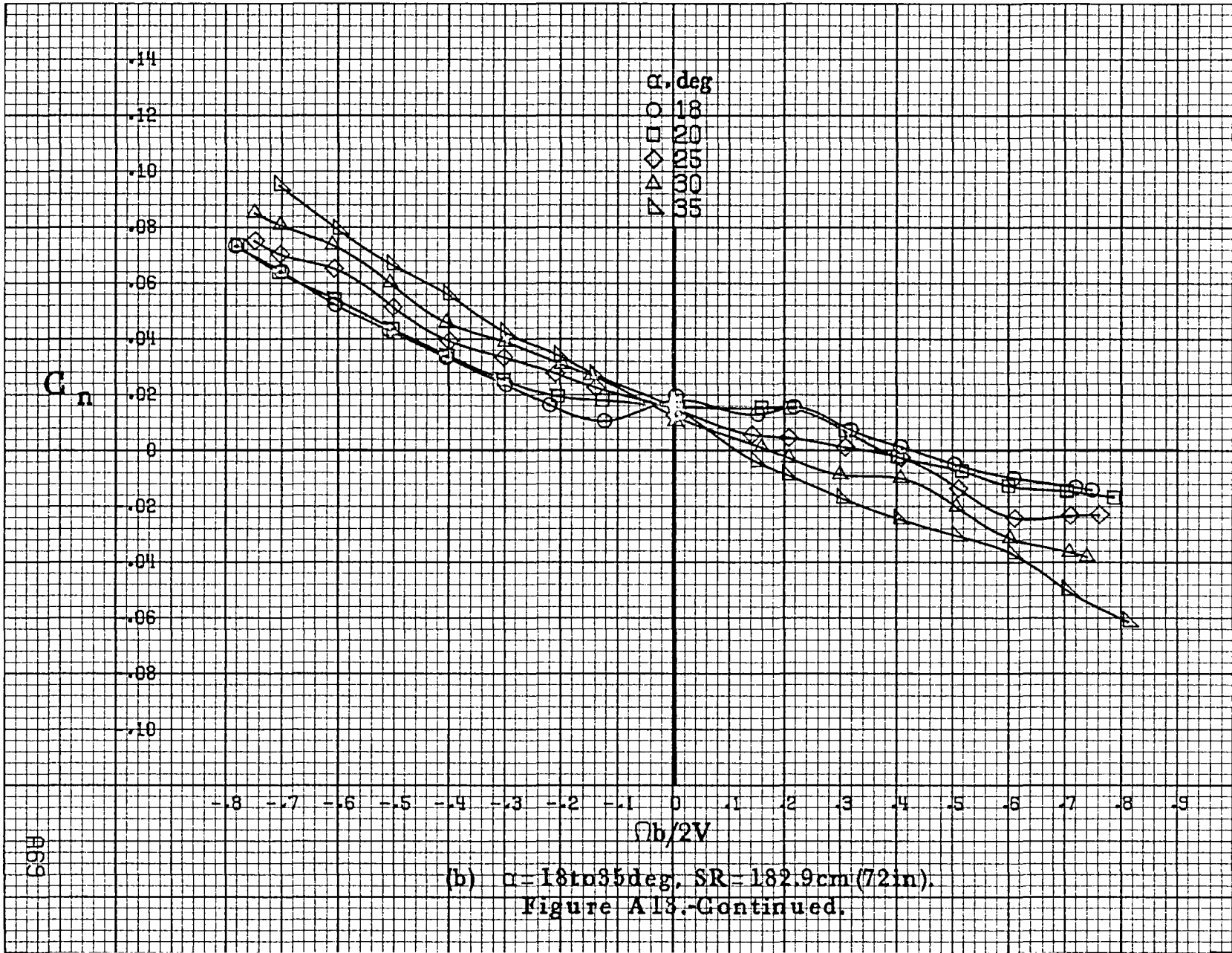

(b)  $\alpha = 18$  to  $35$  deg,  $SR = 182.9$  cm (72 in).  
 Figure A13. Continued.

A69



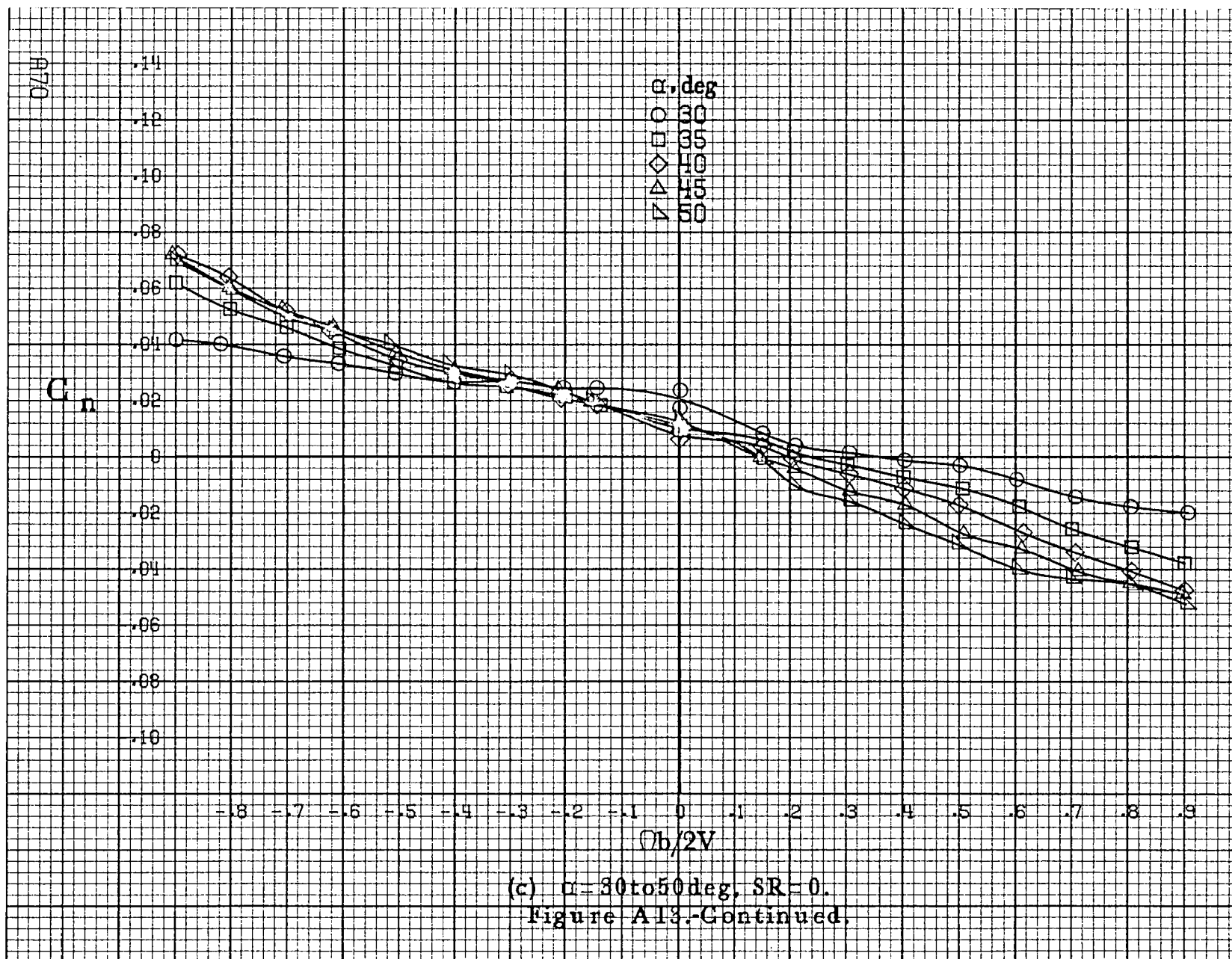



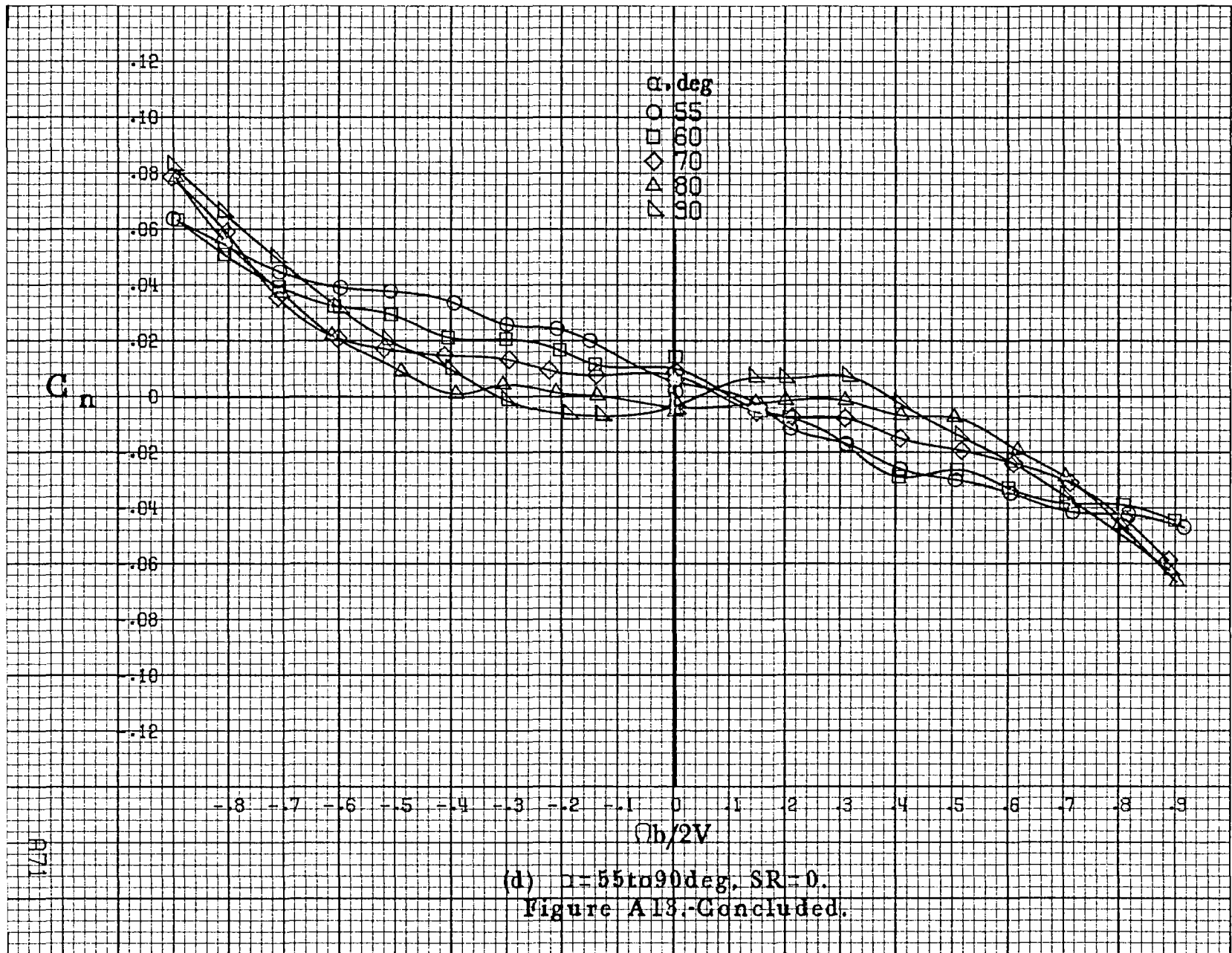

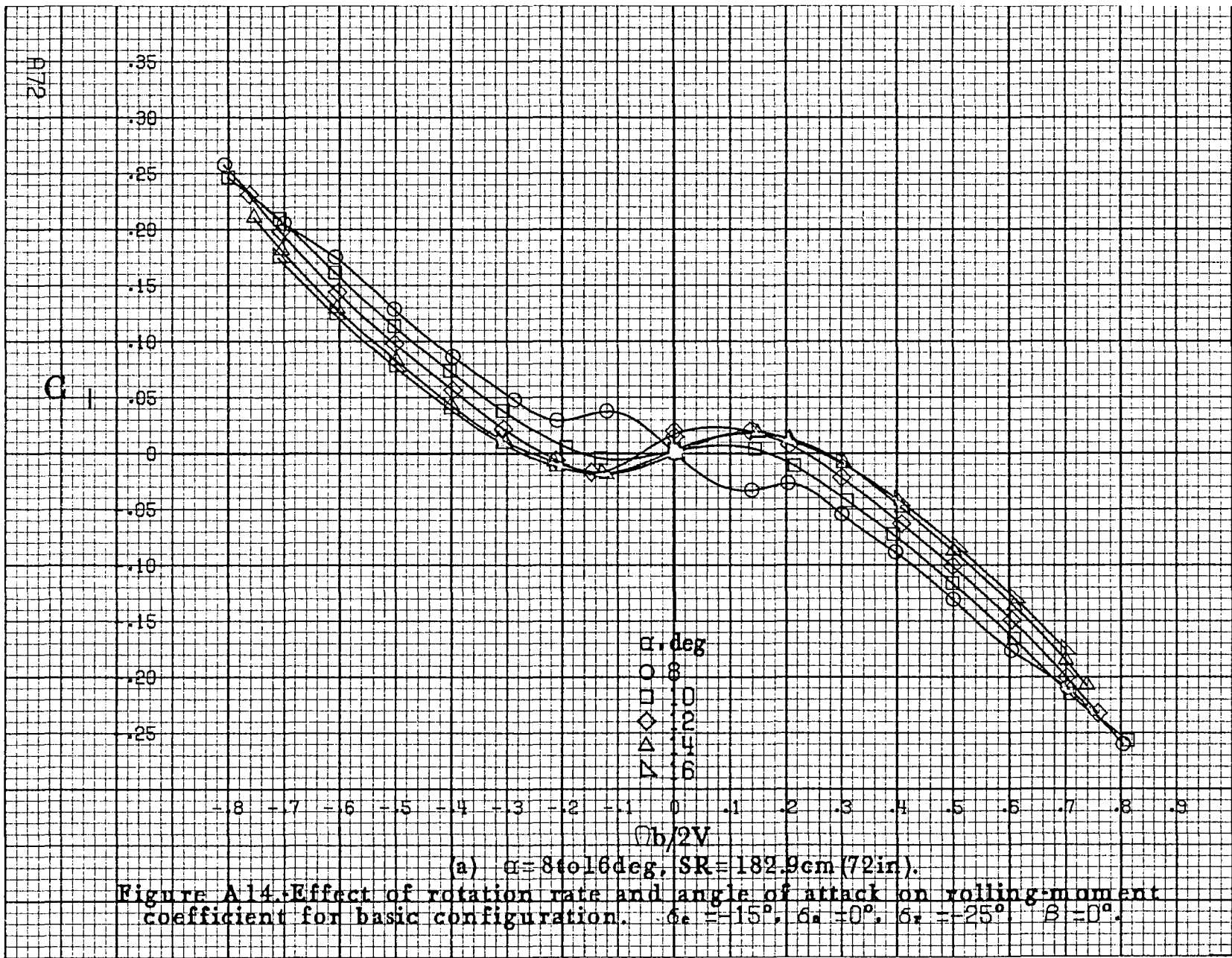

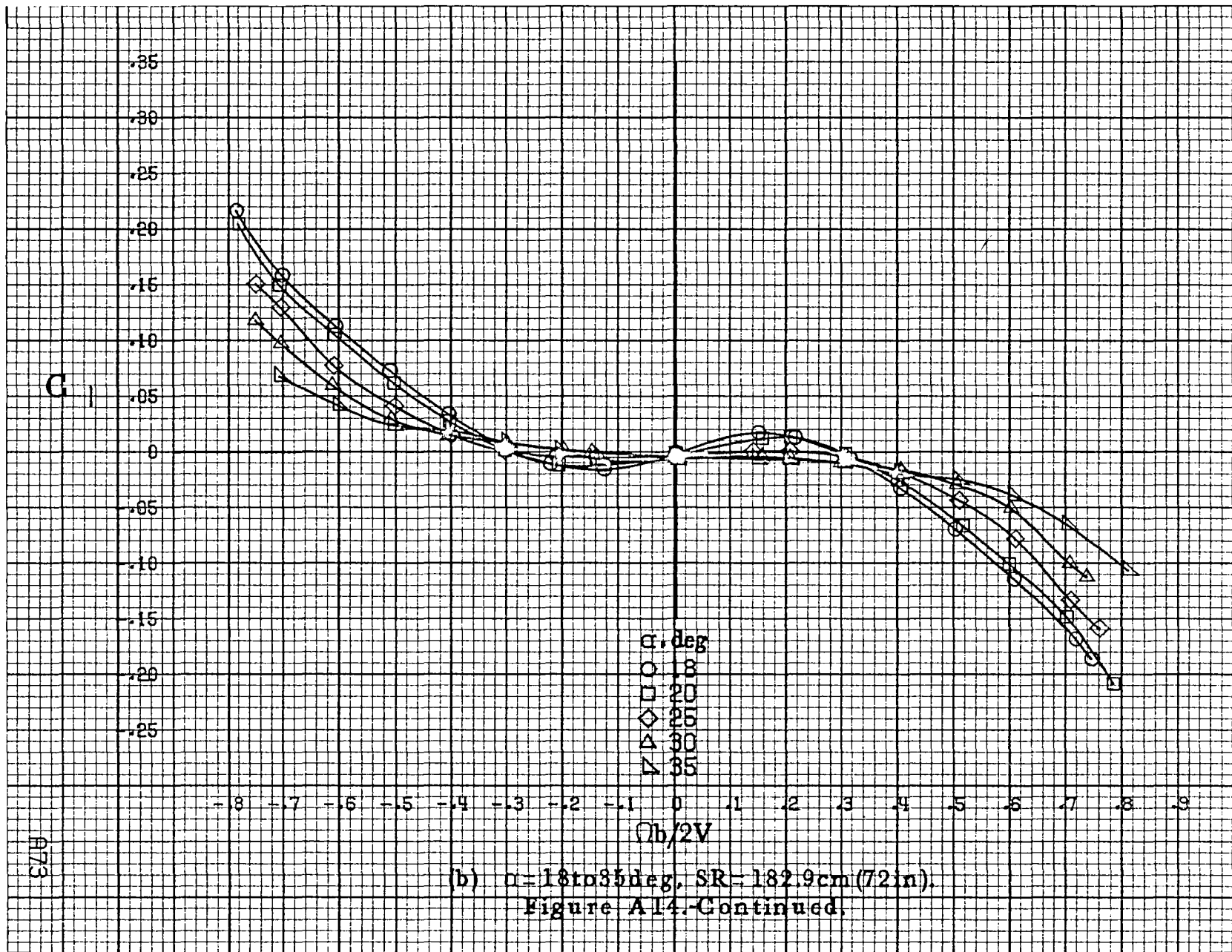

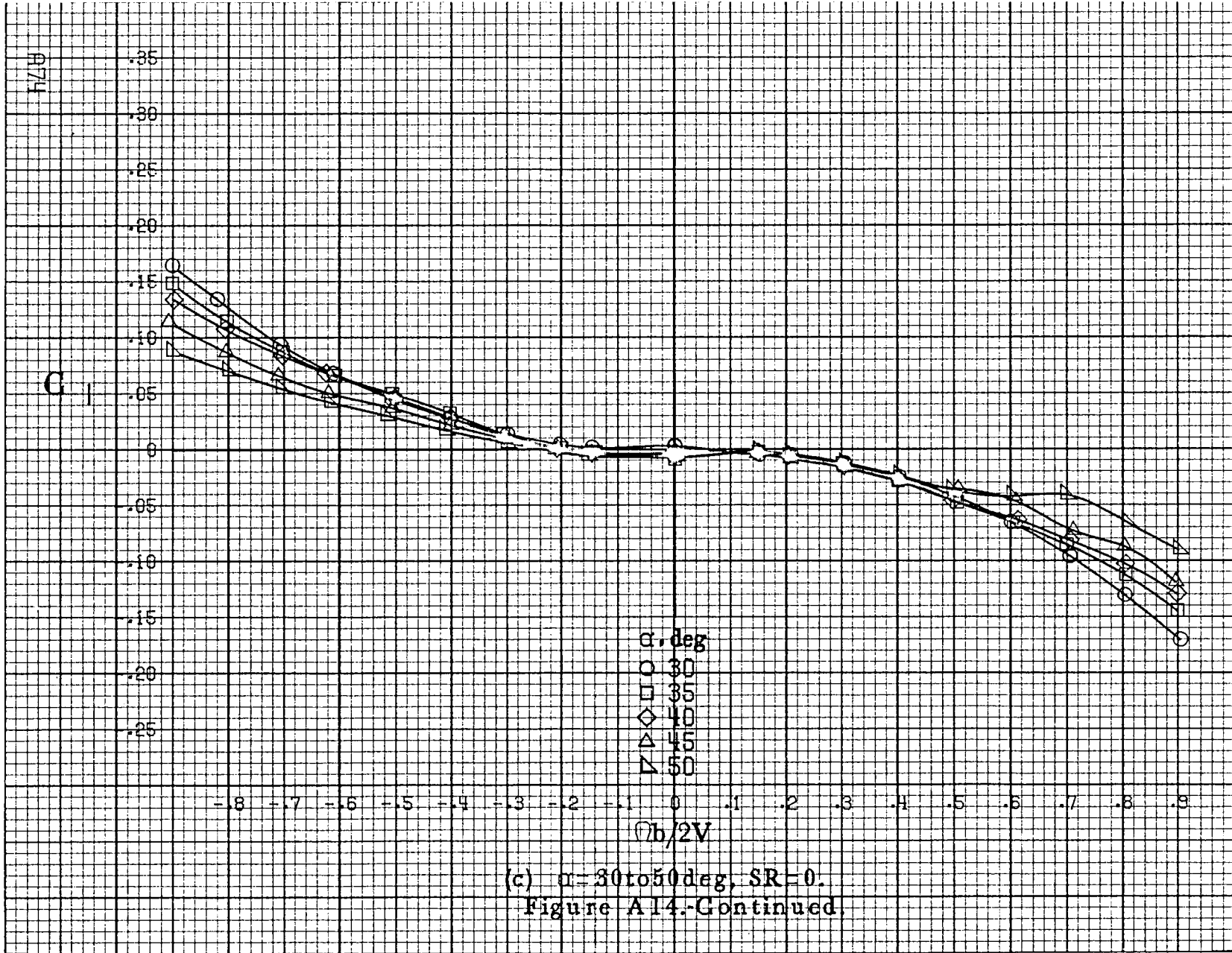

(c)  $\alpha=30$  to  $50$  deg,  $SR=0$ .  
 Figure A14-Continued.

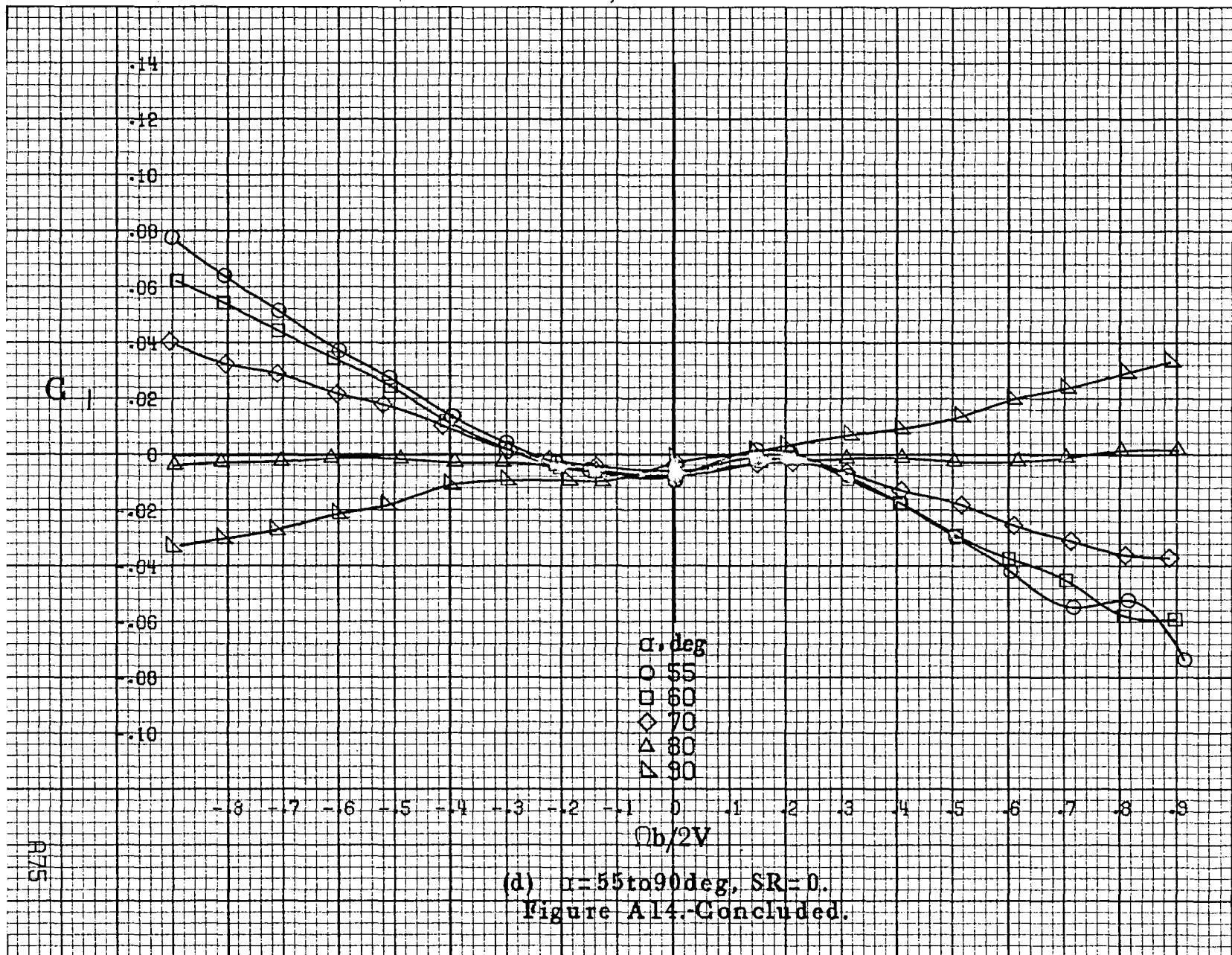

A75

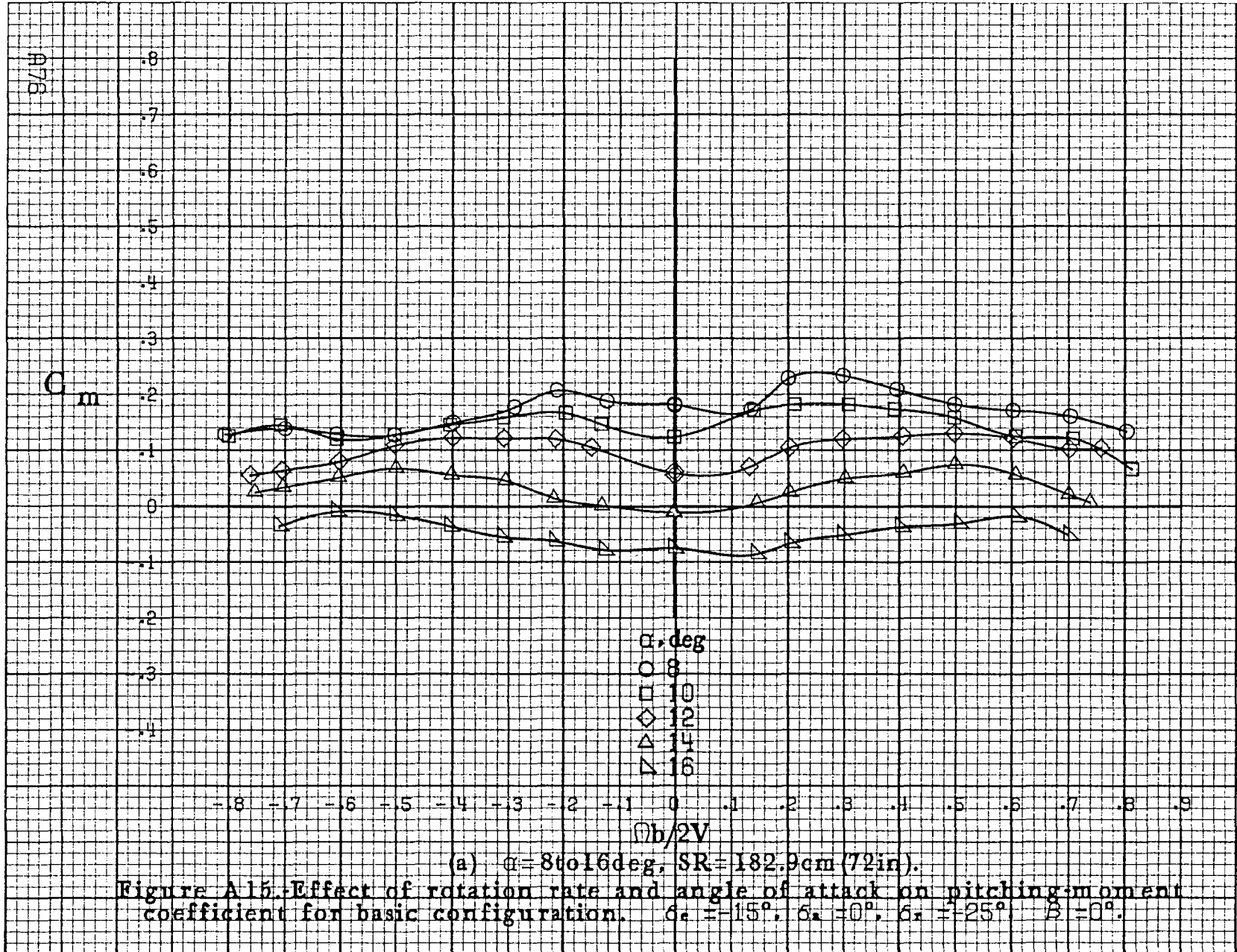

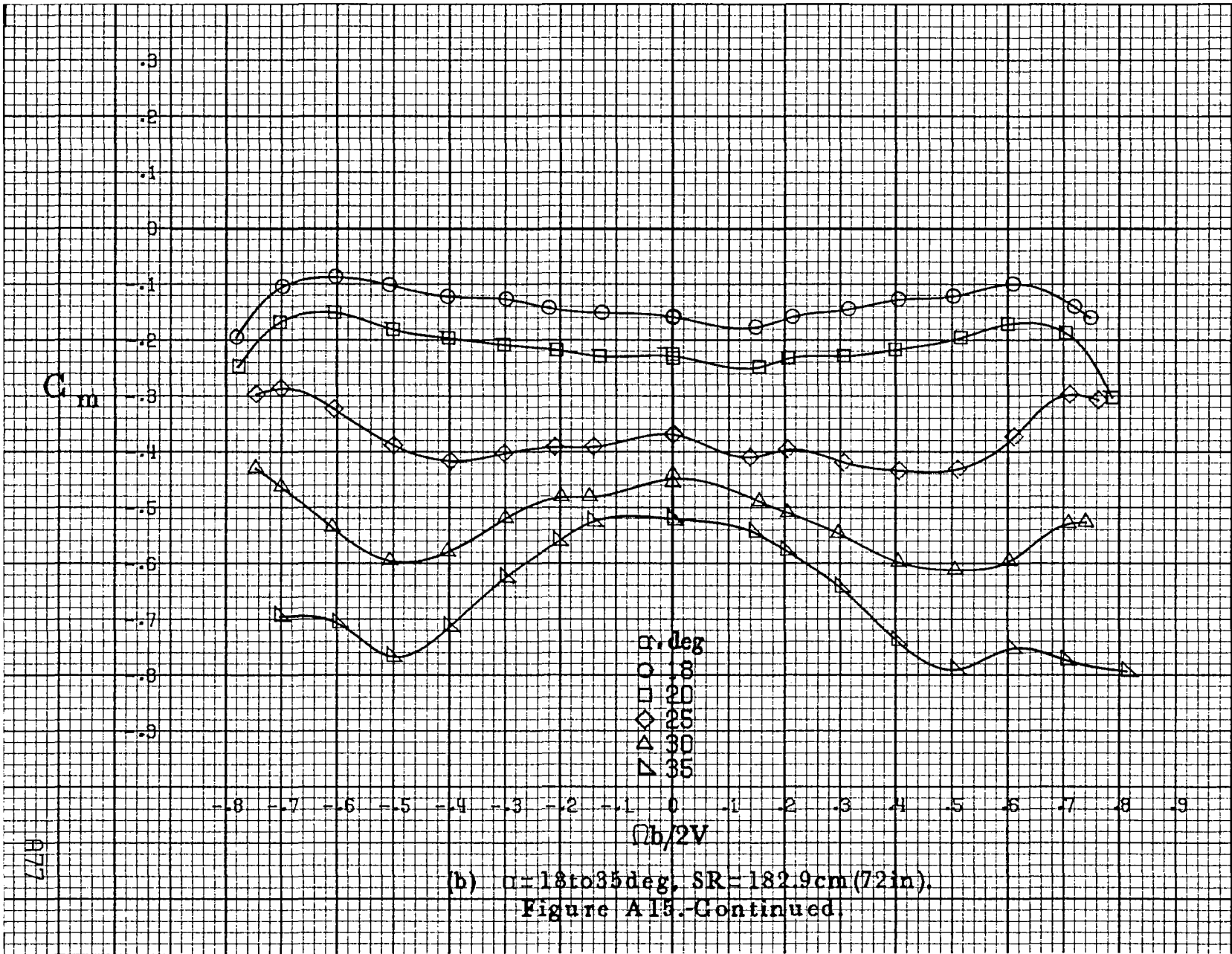

A77



$C_m$

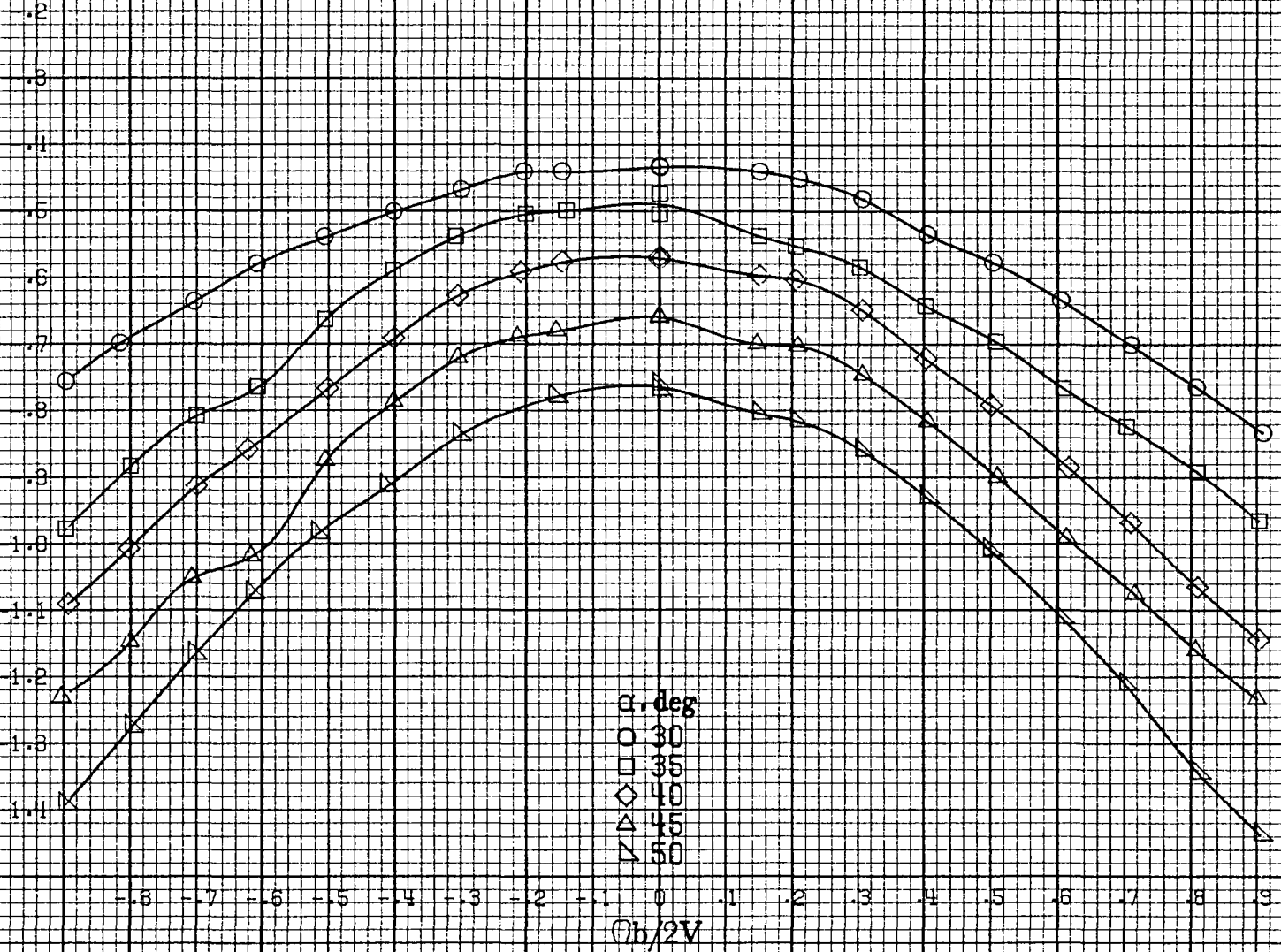

(c)  $\alpha = 30$  to  $50$  deg,  $SR = 0$ .  
Figure A15.-Continued.



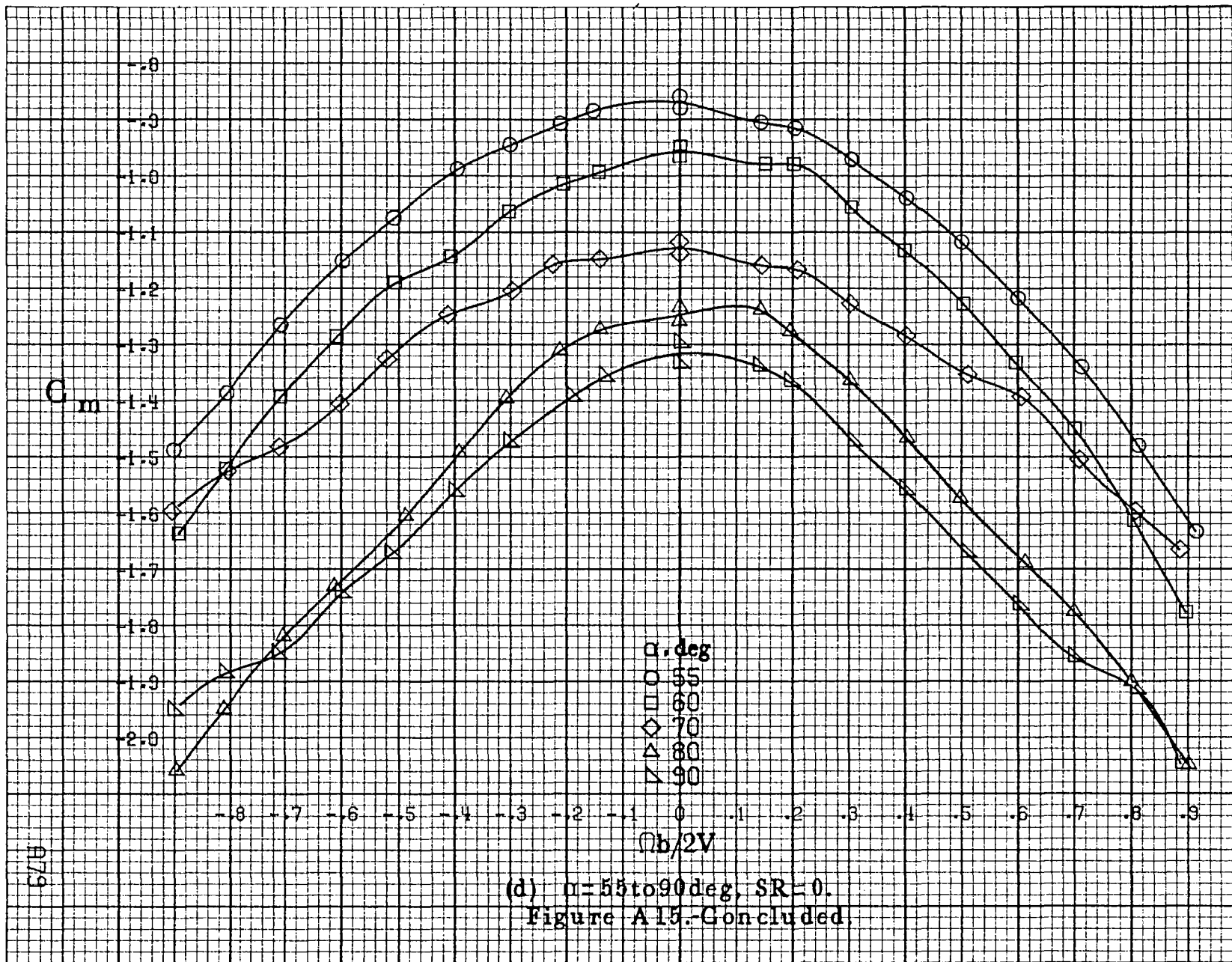

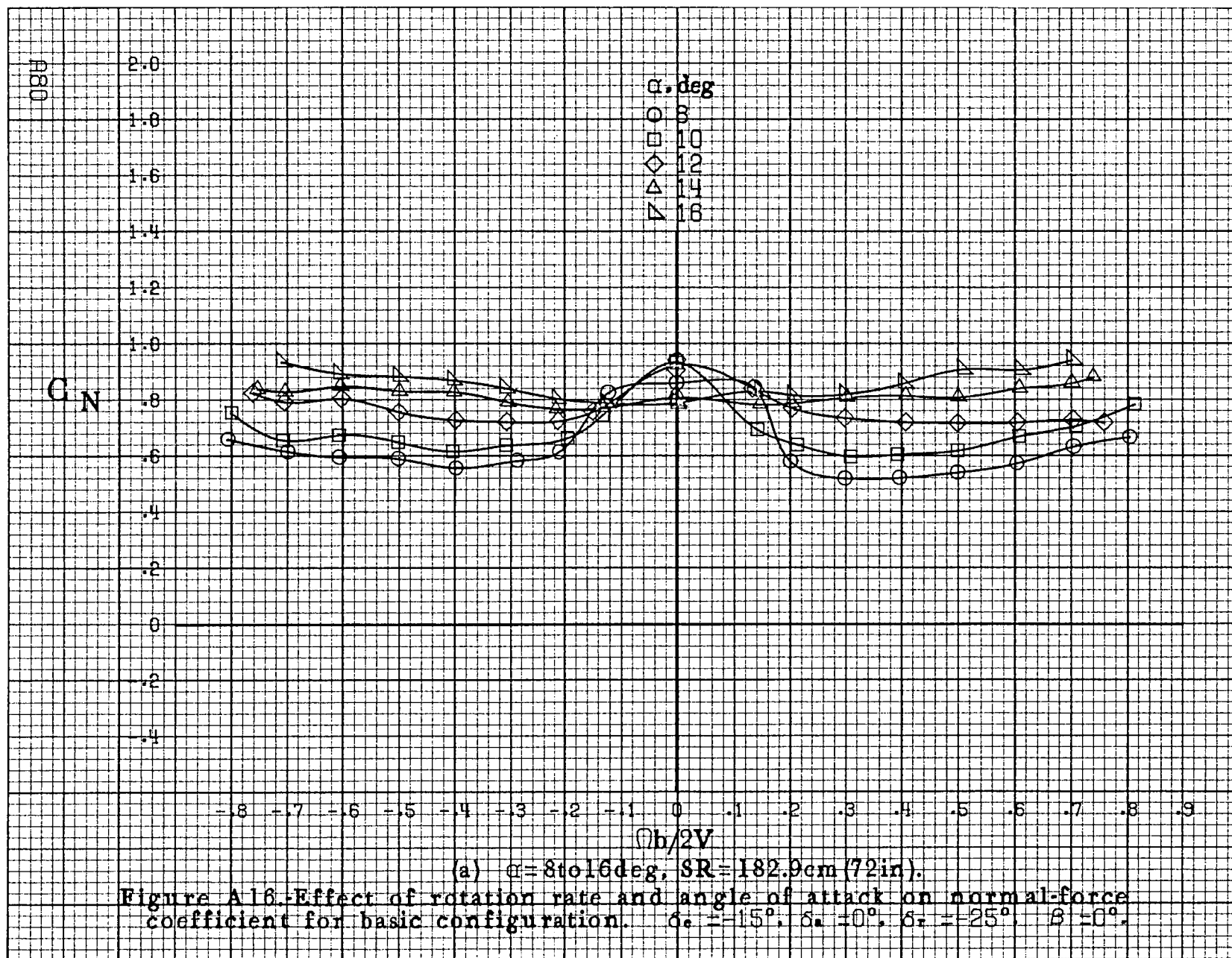

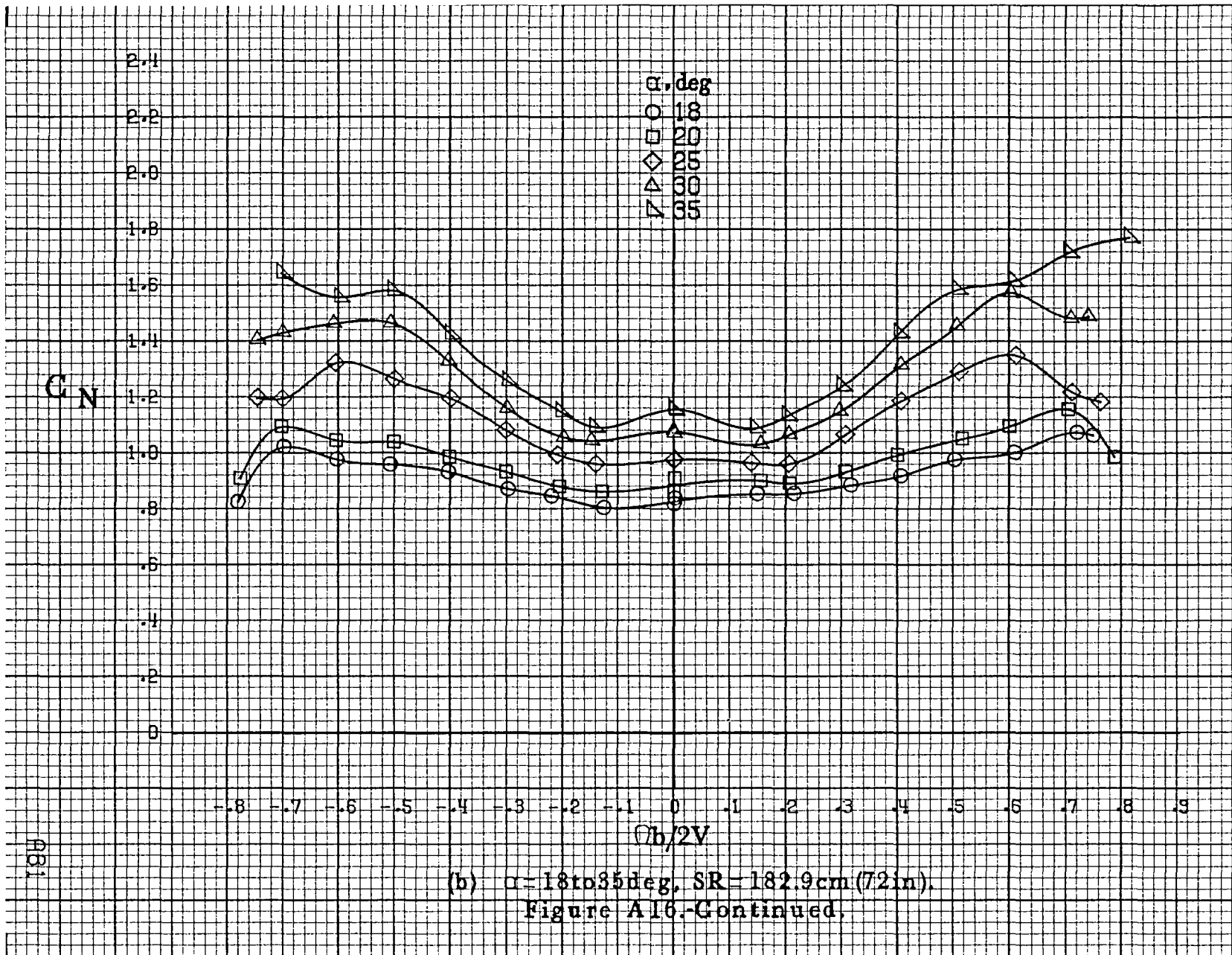

(b)  $\alpha = 18$  to  $35$  deg,  $SR = 182.9$  cm (72 in).  
 Figure A16.-Continued.

RB1

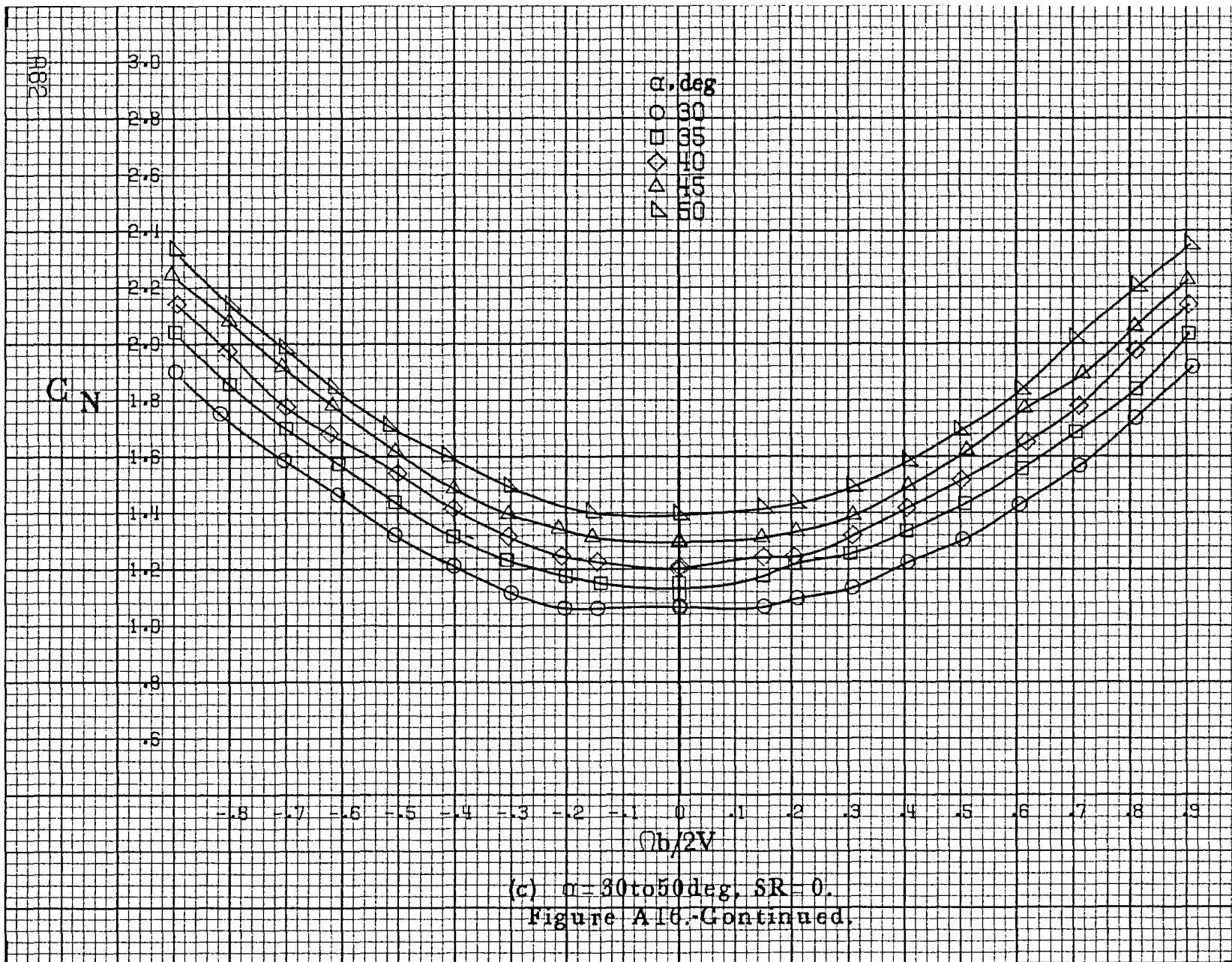

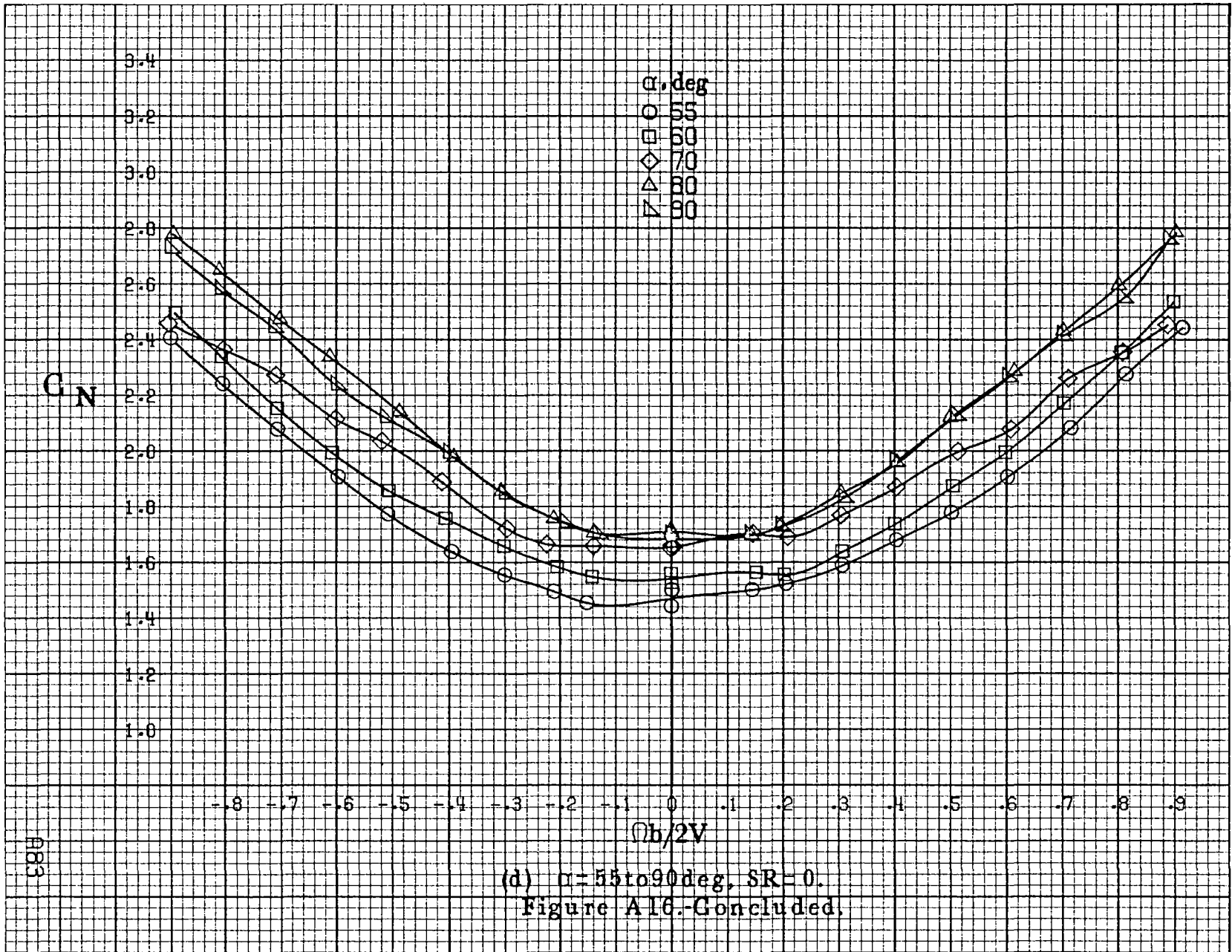

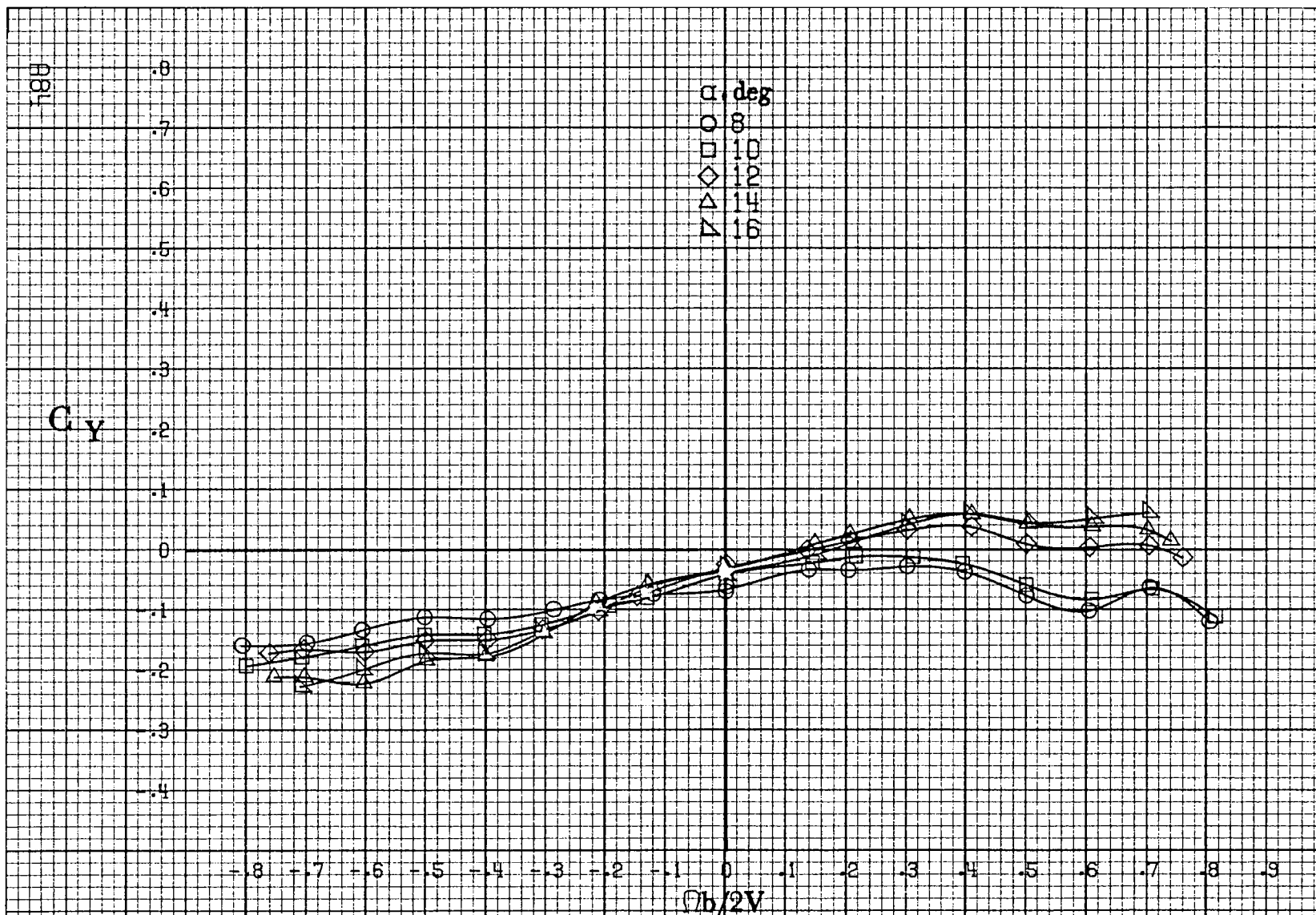

(a)  $\alpha = 8$  to  $16$  deg;  $SR = 182.9$  cm (72 in).

Figure A17.-Effect of rotation rate and angle of attack on side-force coefficient for basic configuration.  $\delta_e = -15^\circ$ ,  $\delta_a = 0^\circ$ ,  $\delta_r = -25^\circ$ ,  $\beta = 0^\circ$ .

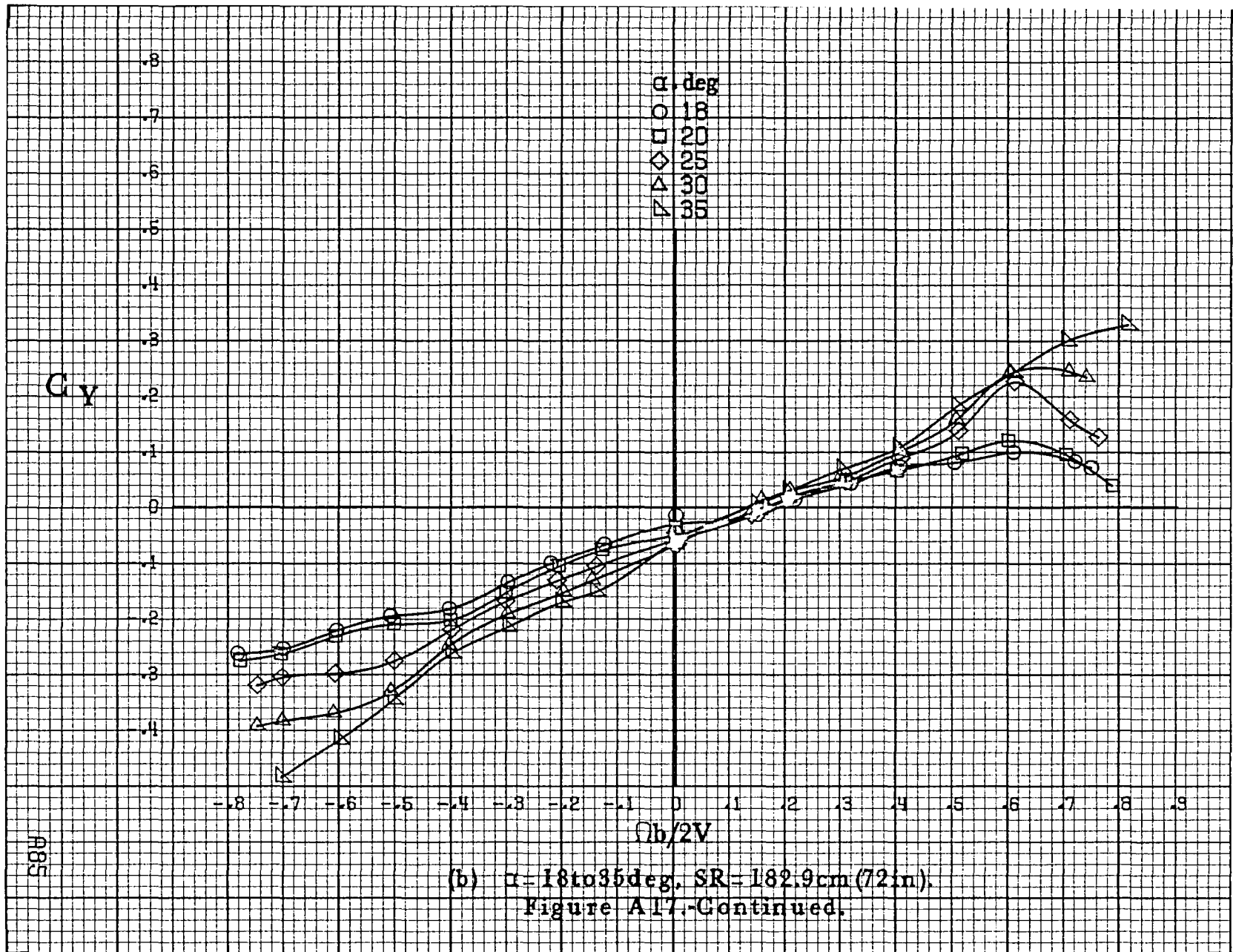



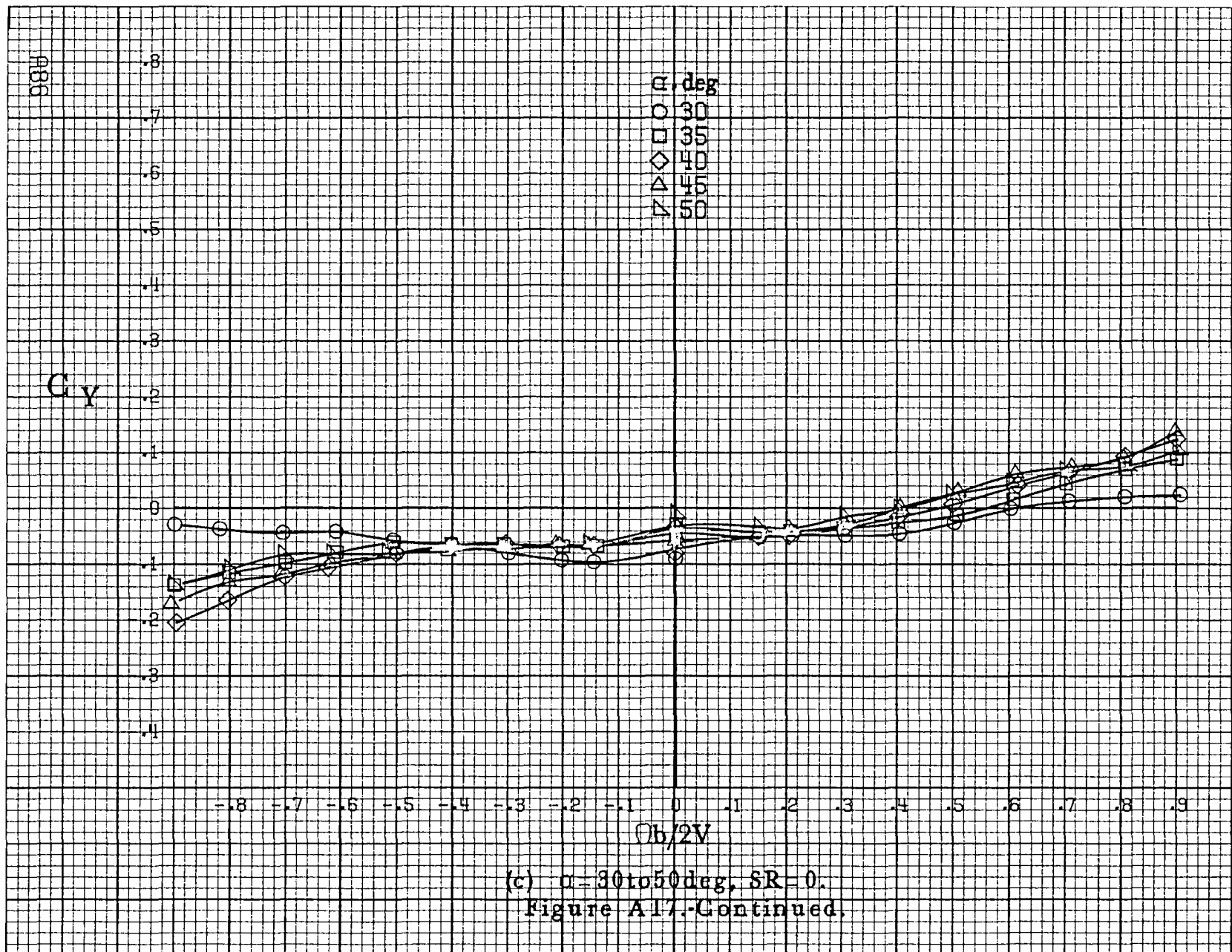



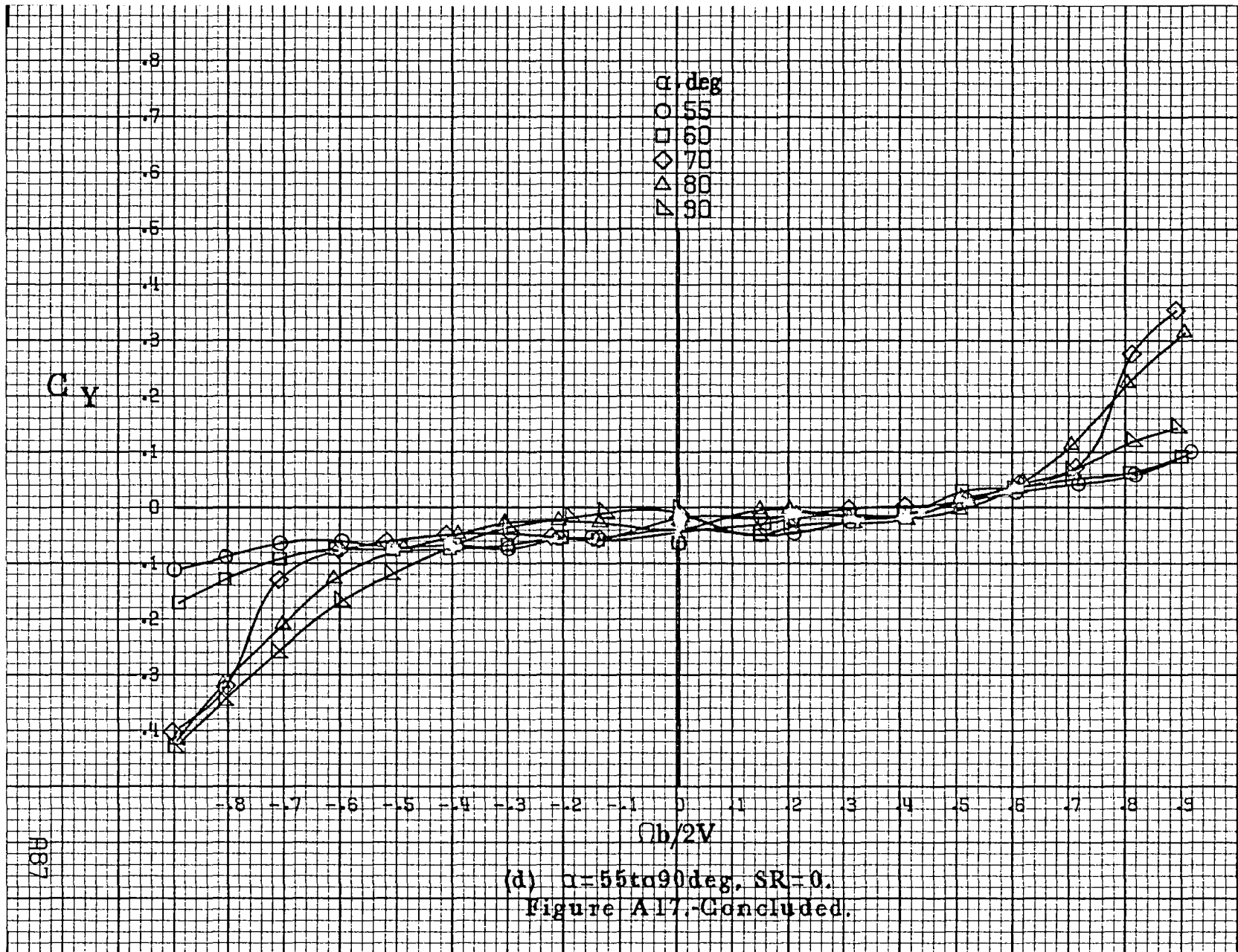

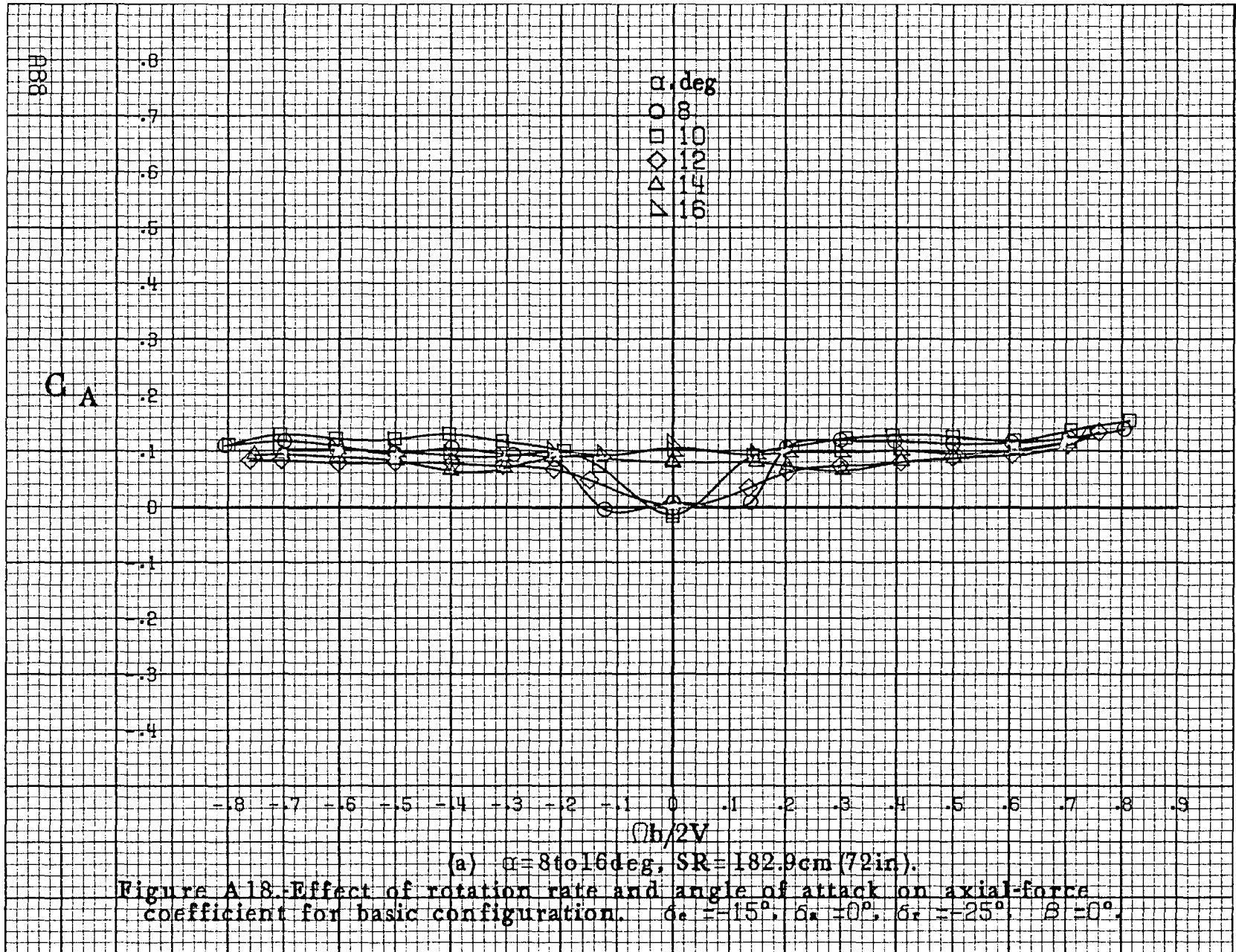

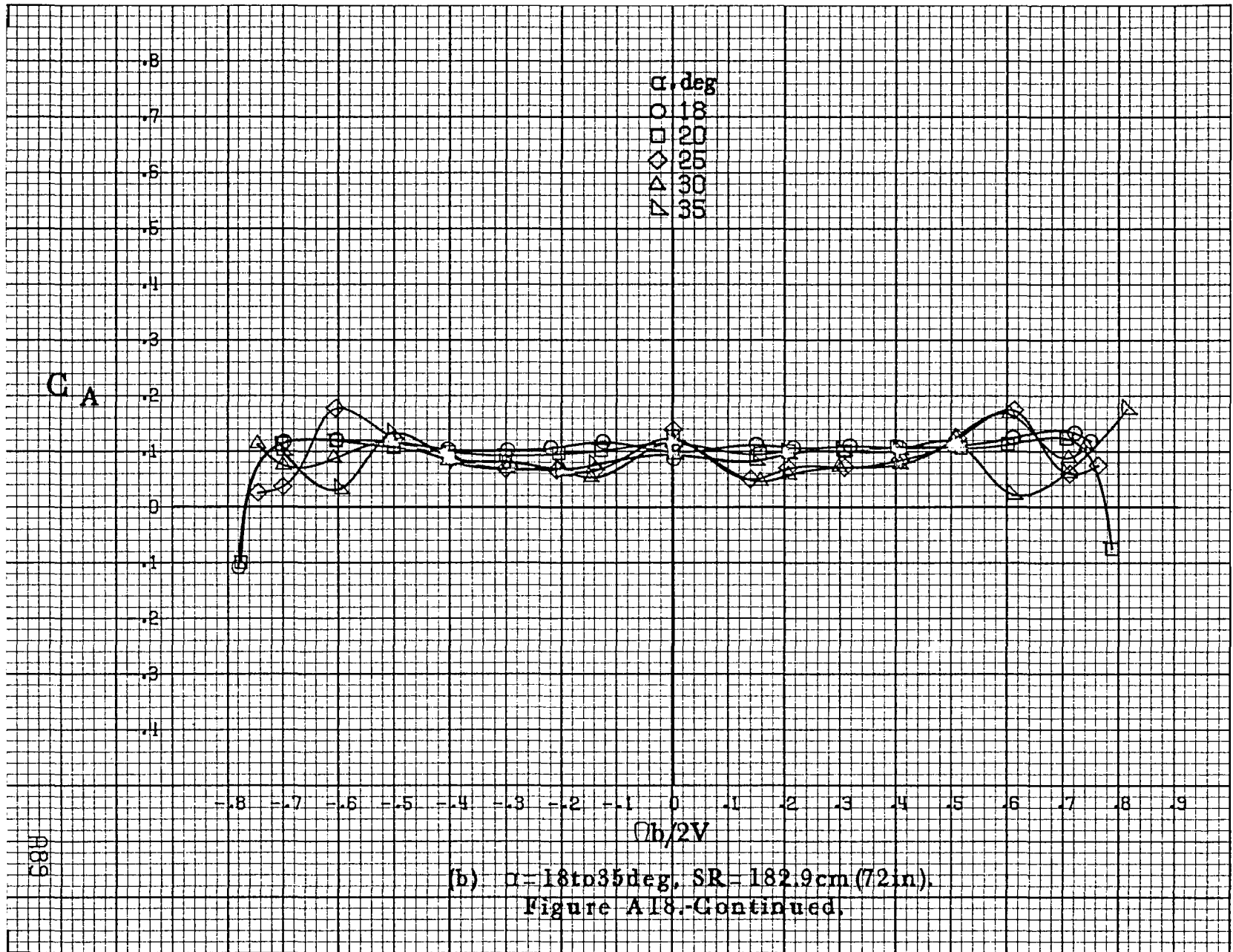

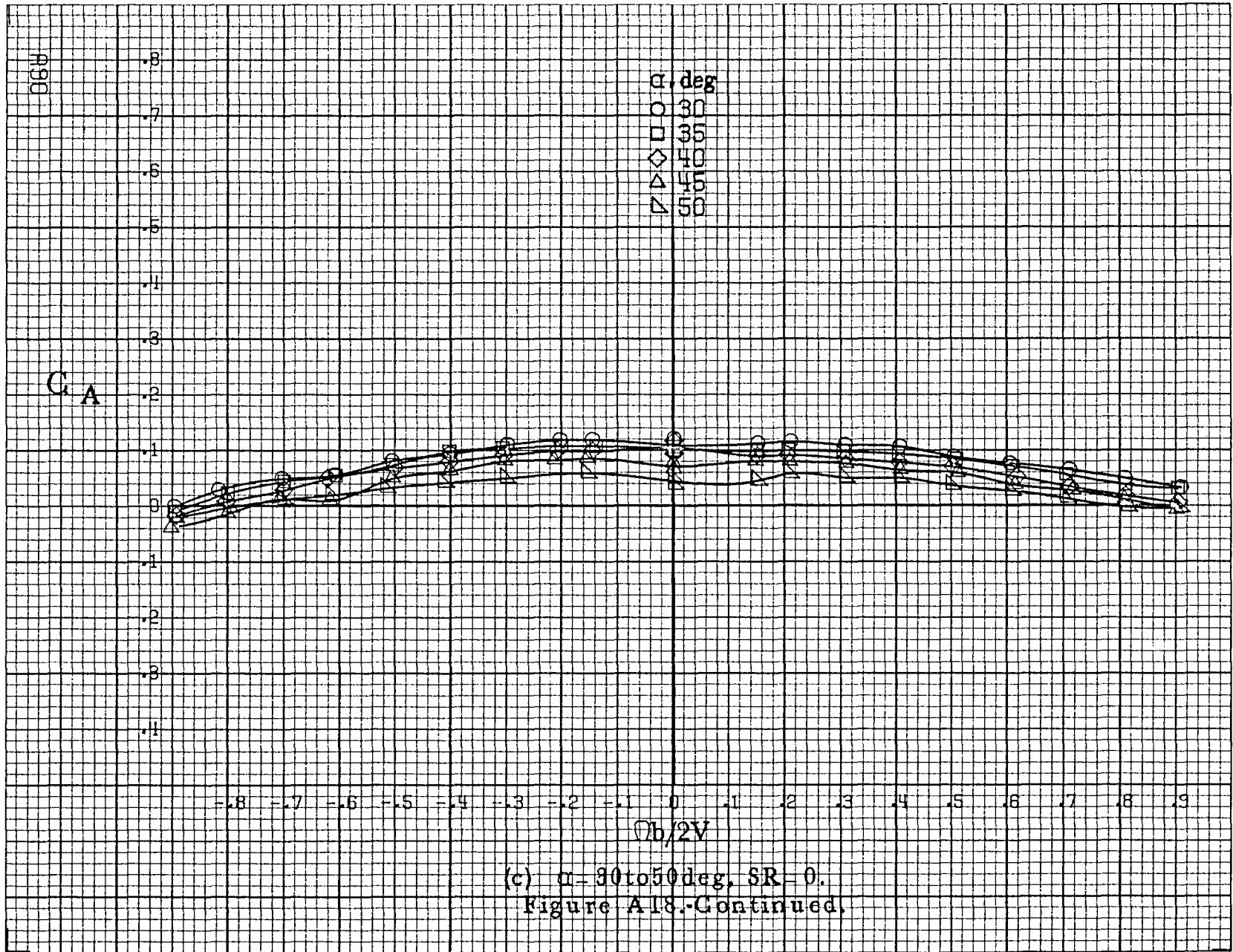

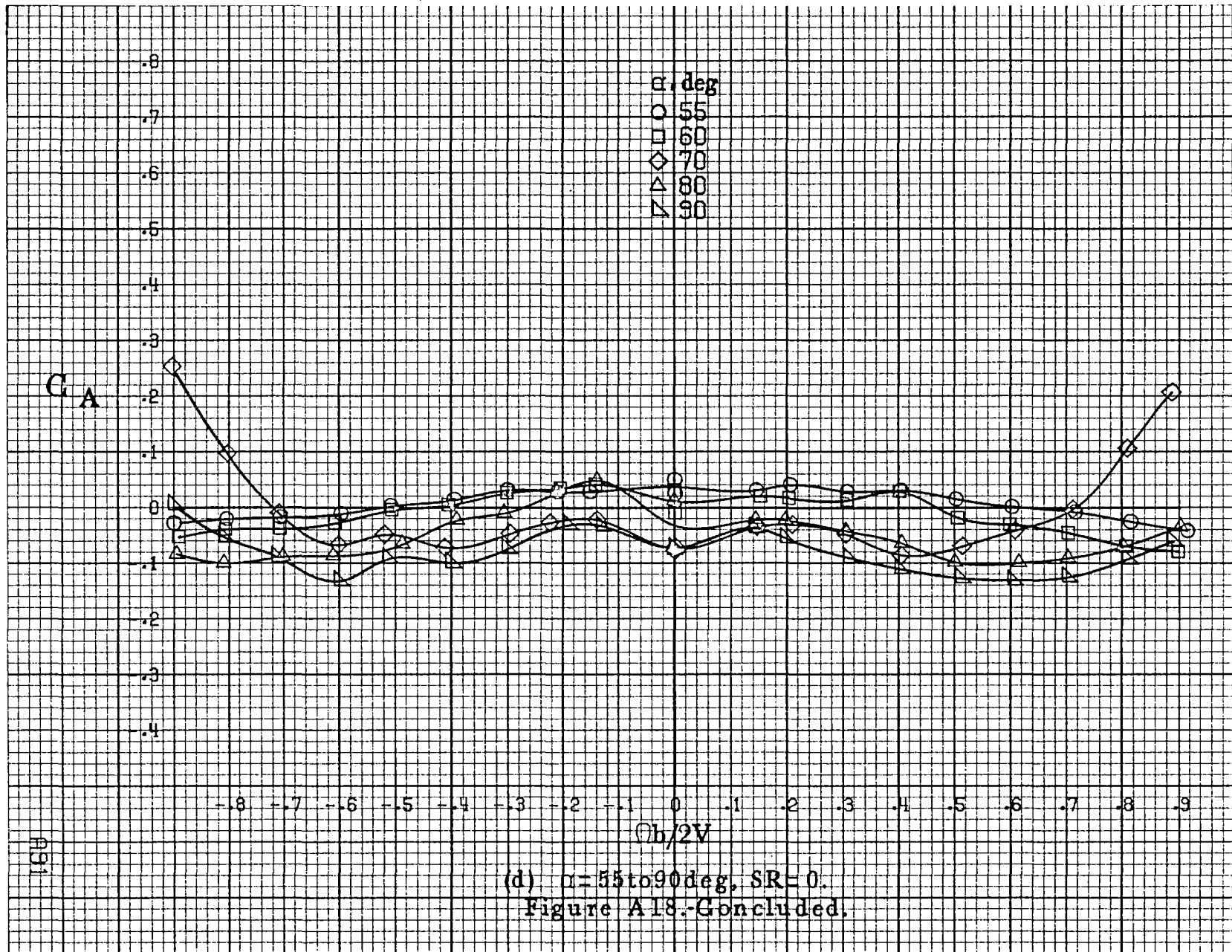

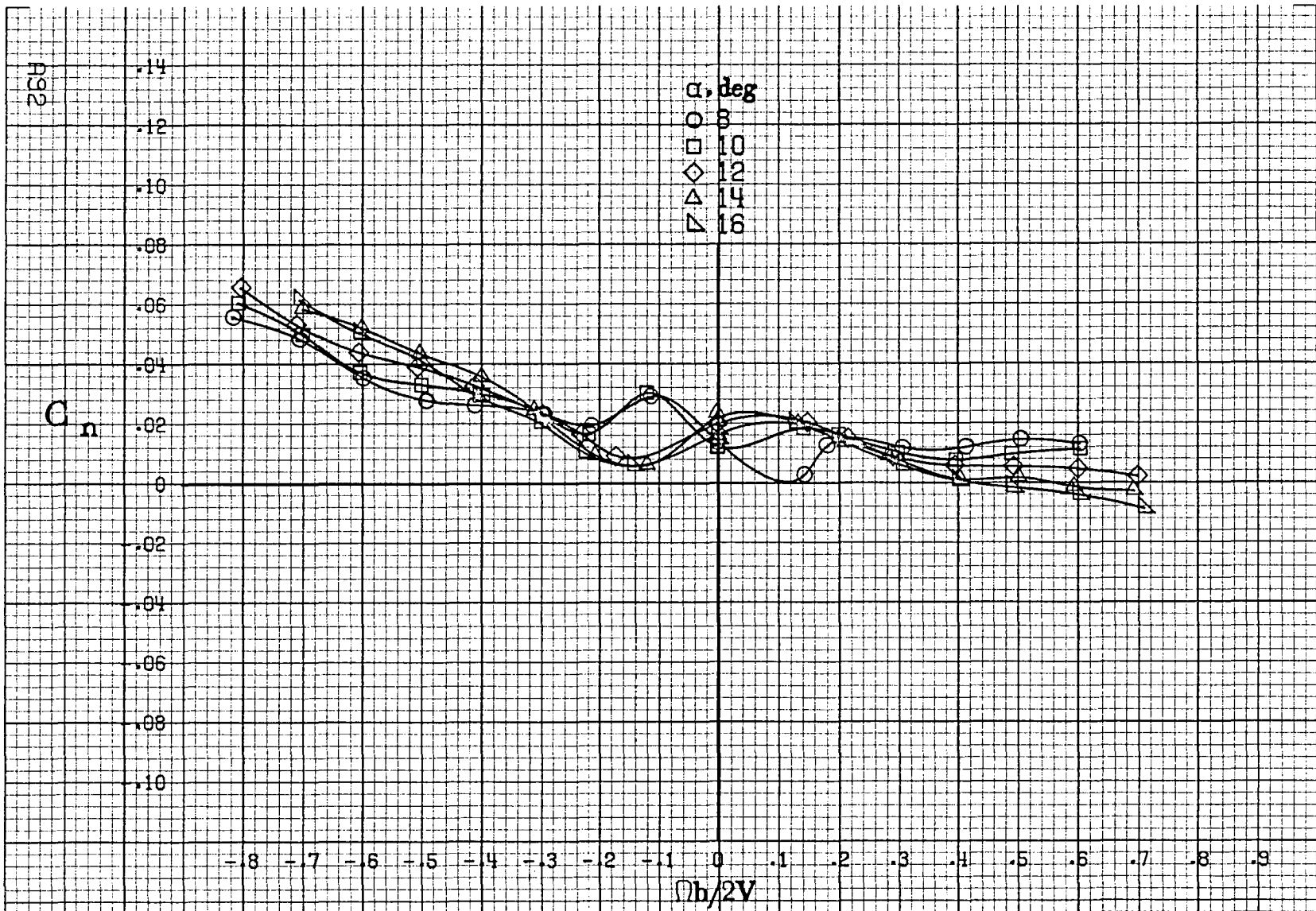

(a)  $\alpha = 8$  to  $16$  deg,  $SR = 182.9$  cm (72 in).  
 Figure A19.-Effect of rotation rate and angle of attack on yawing-moment coefficient for basic configuration.  $\delta_e = -15^\circ$ ,  $\delta_a = 15.0^\circ$ ,  $\delta_r = -25^\circ$ ,  $\beta = 0^\circ$ .

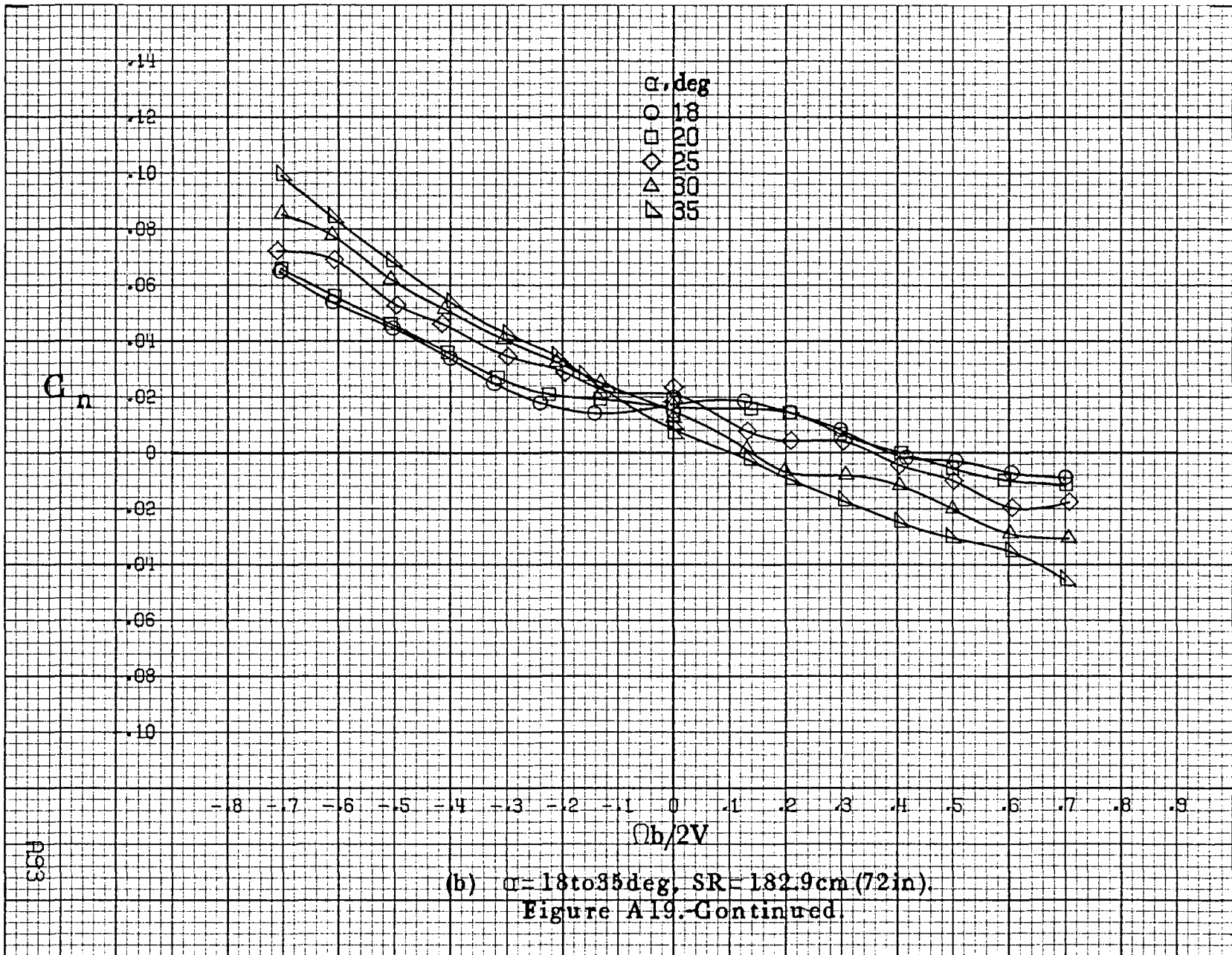



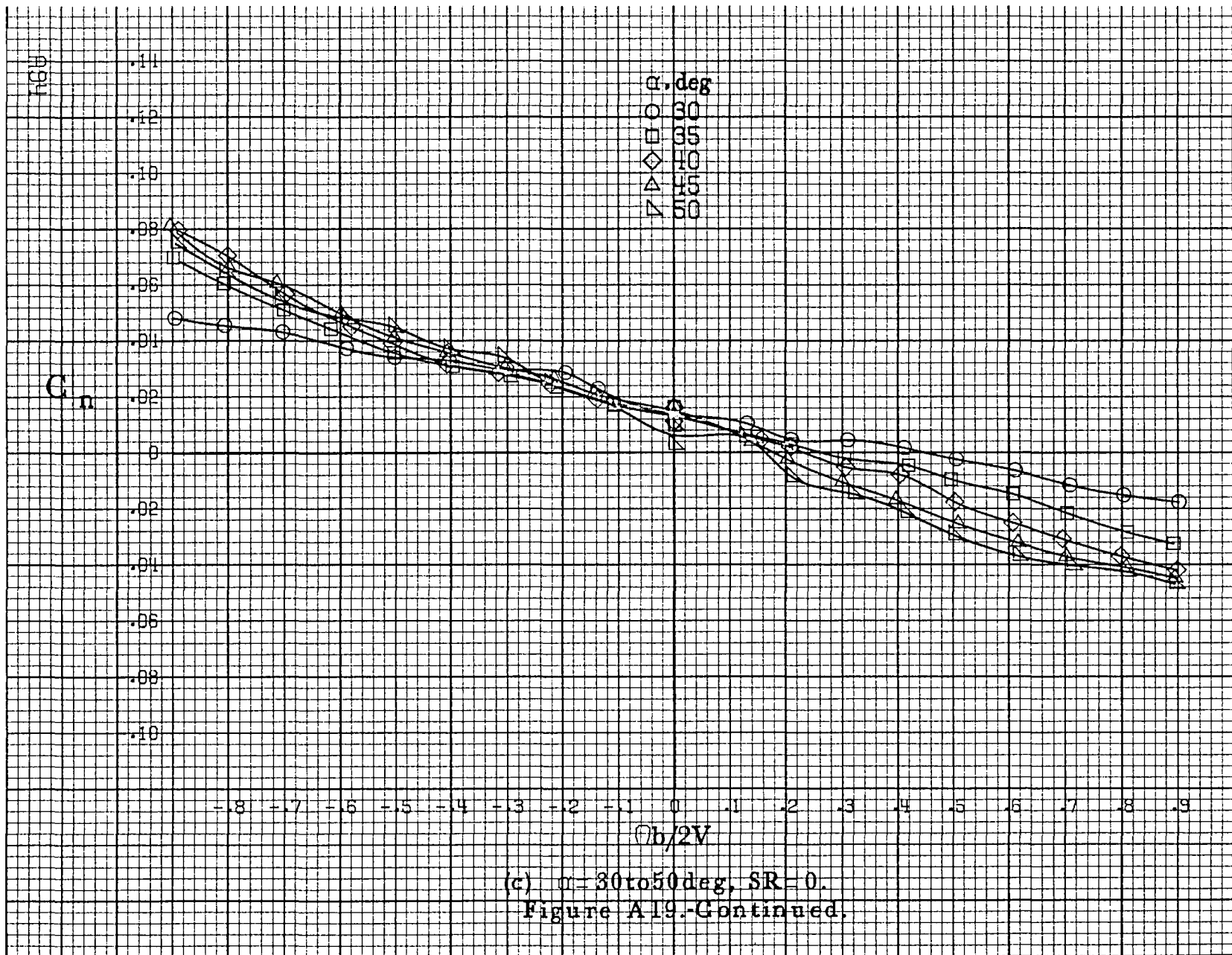



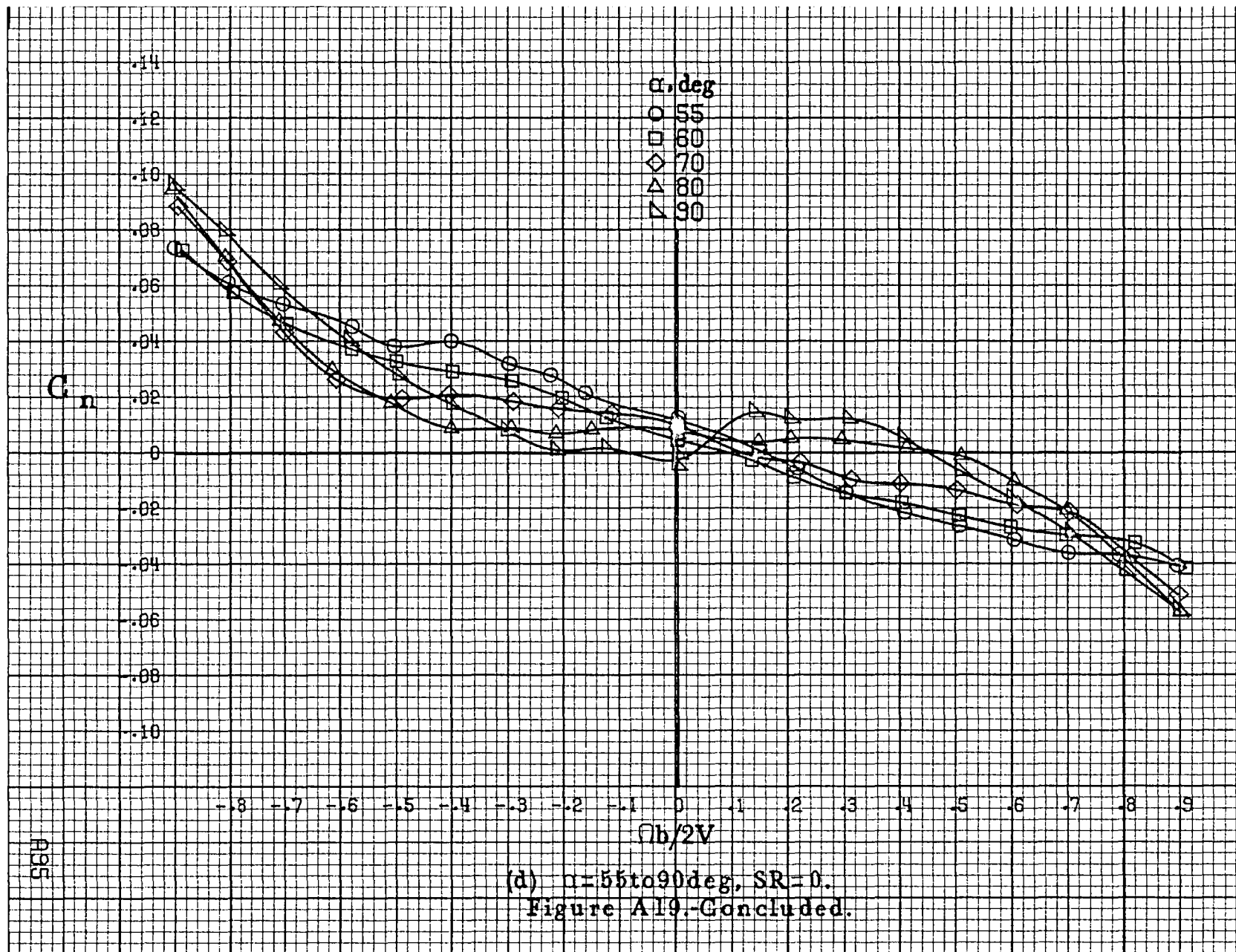

(d)  $\alpha = 55$  to  $90$  deg,  $SR = 0$ .  
 Figure A19.-Concluded.

A95

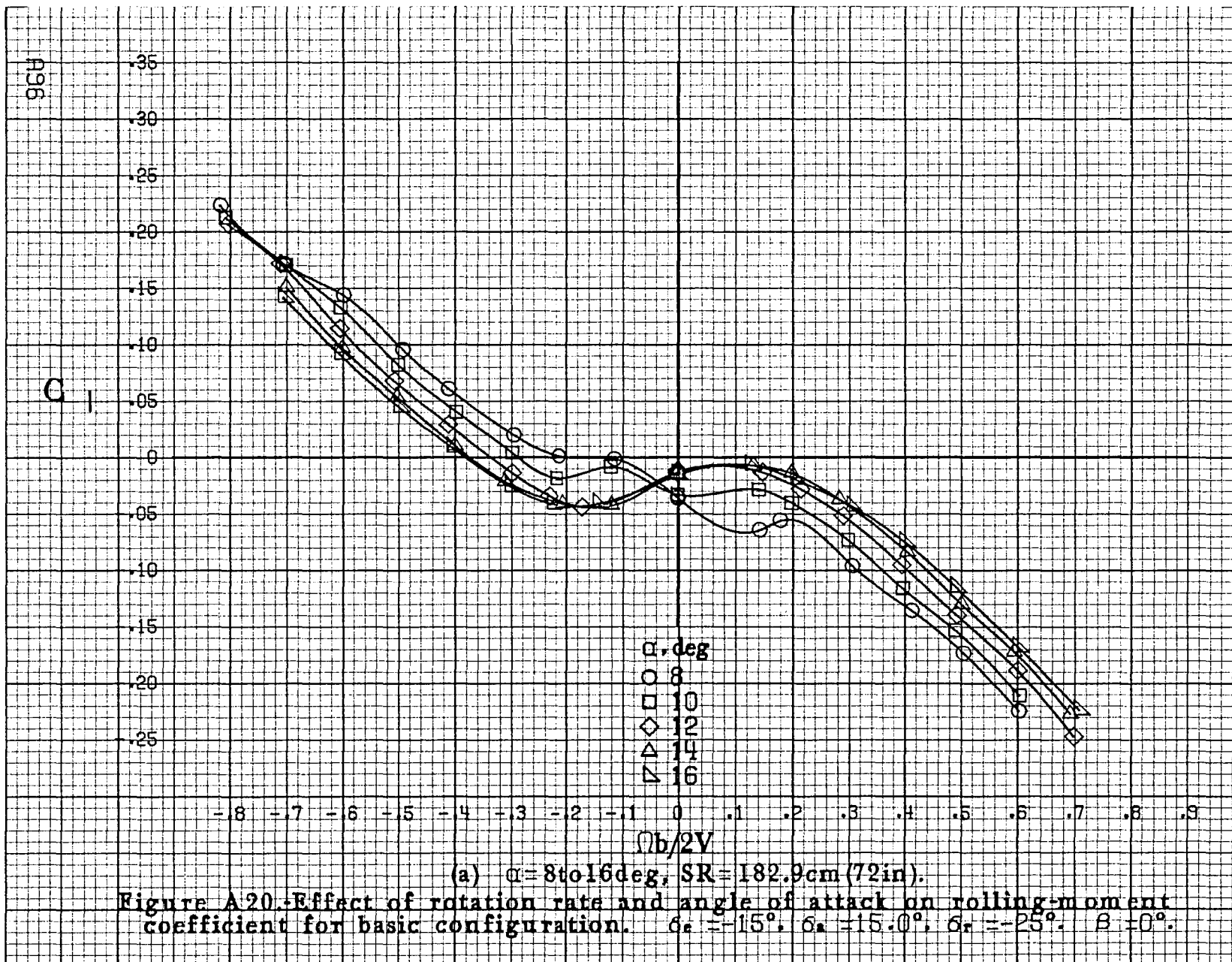

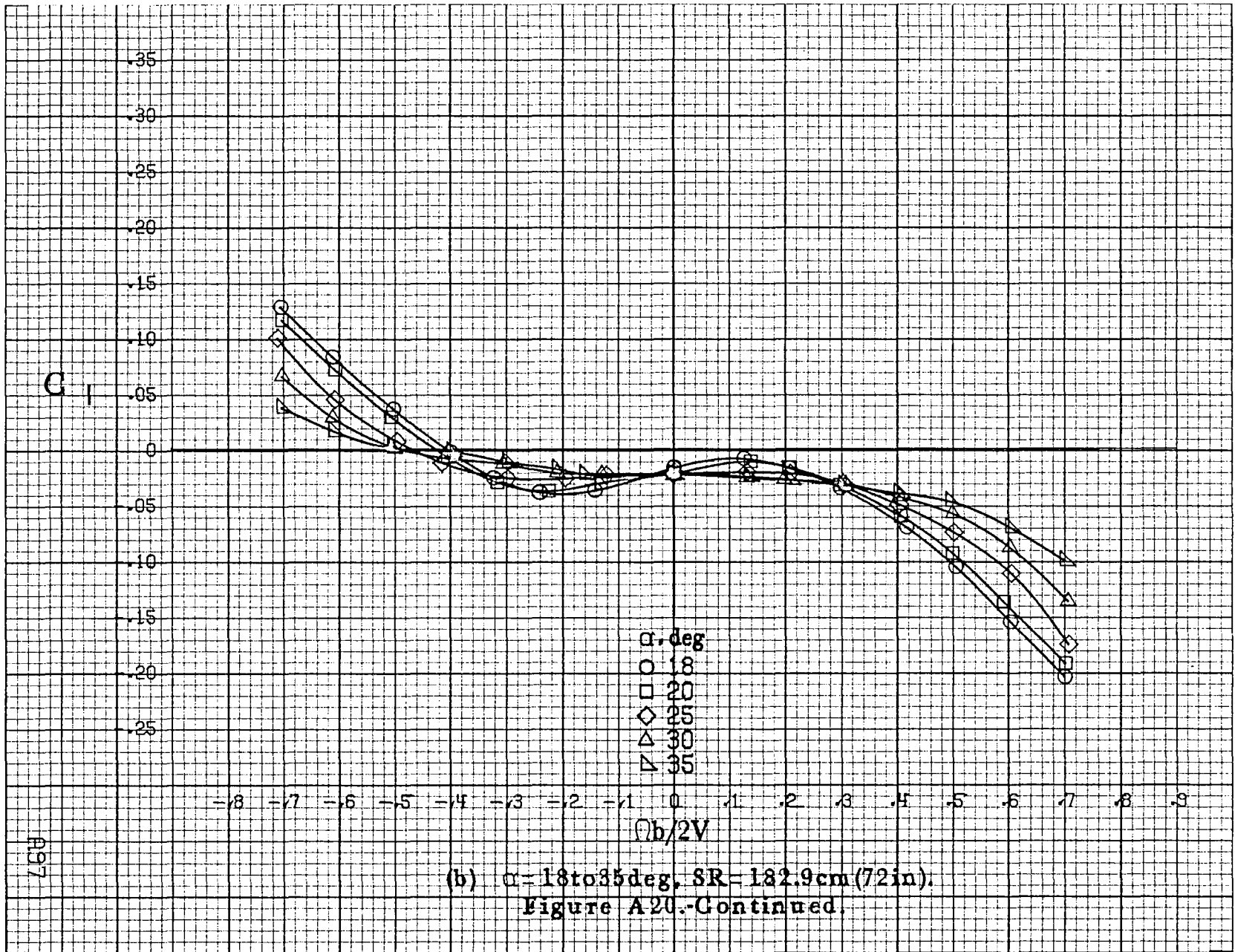

(b)  $\alpha = 18$  to  $35$  deg,  $SR = 182.9$  cm (72 in).  
Figure A20.-Continued.

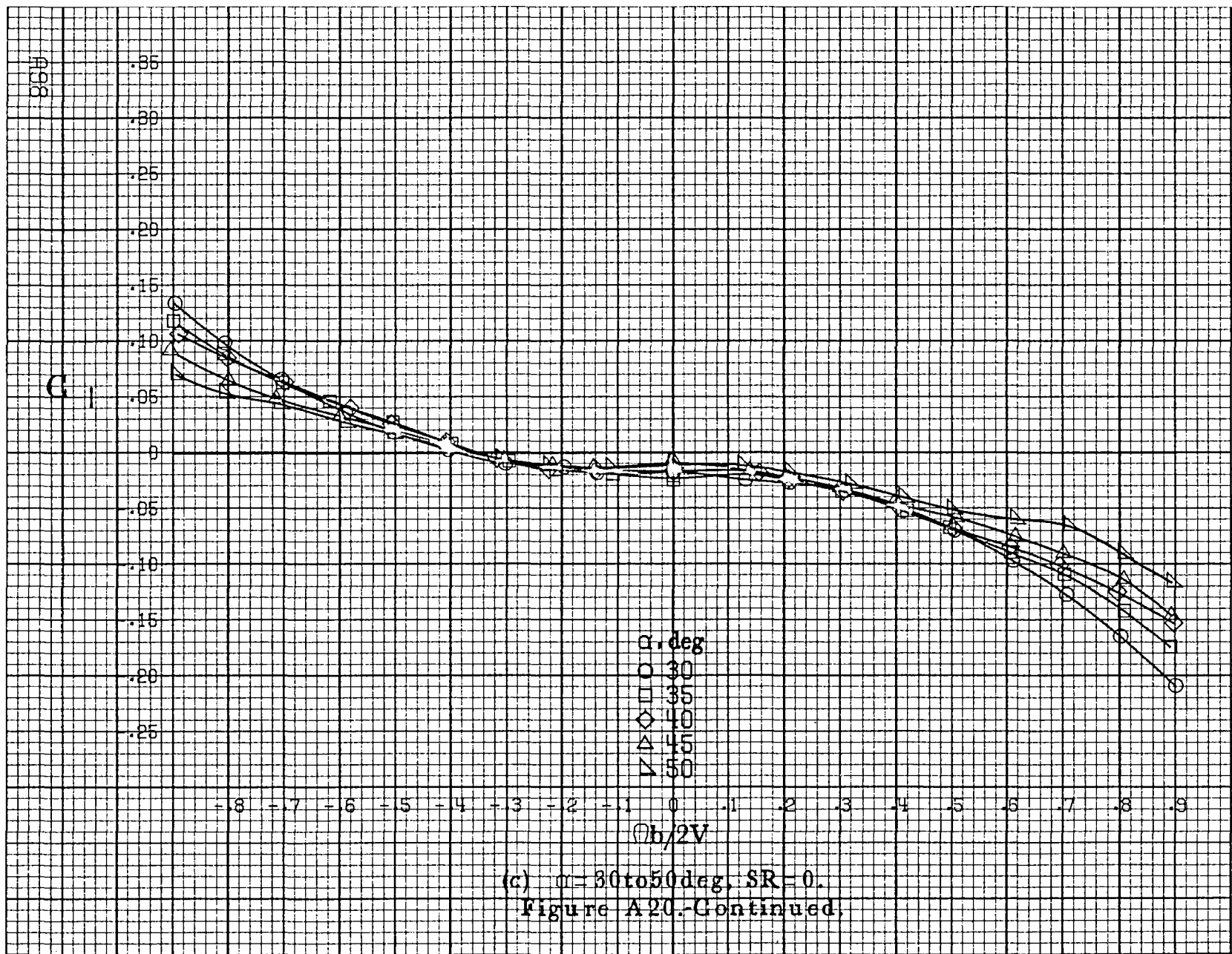

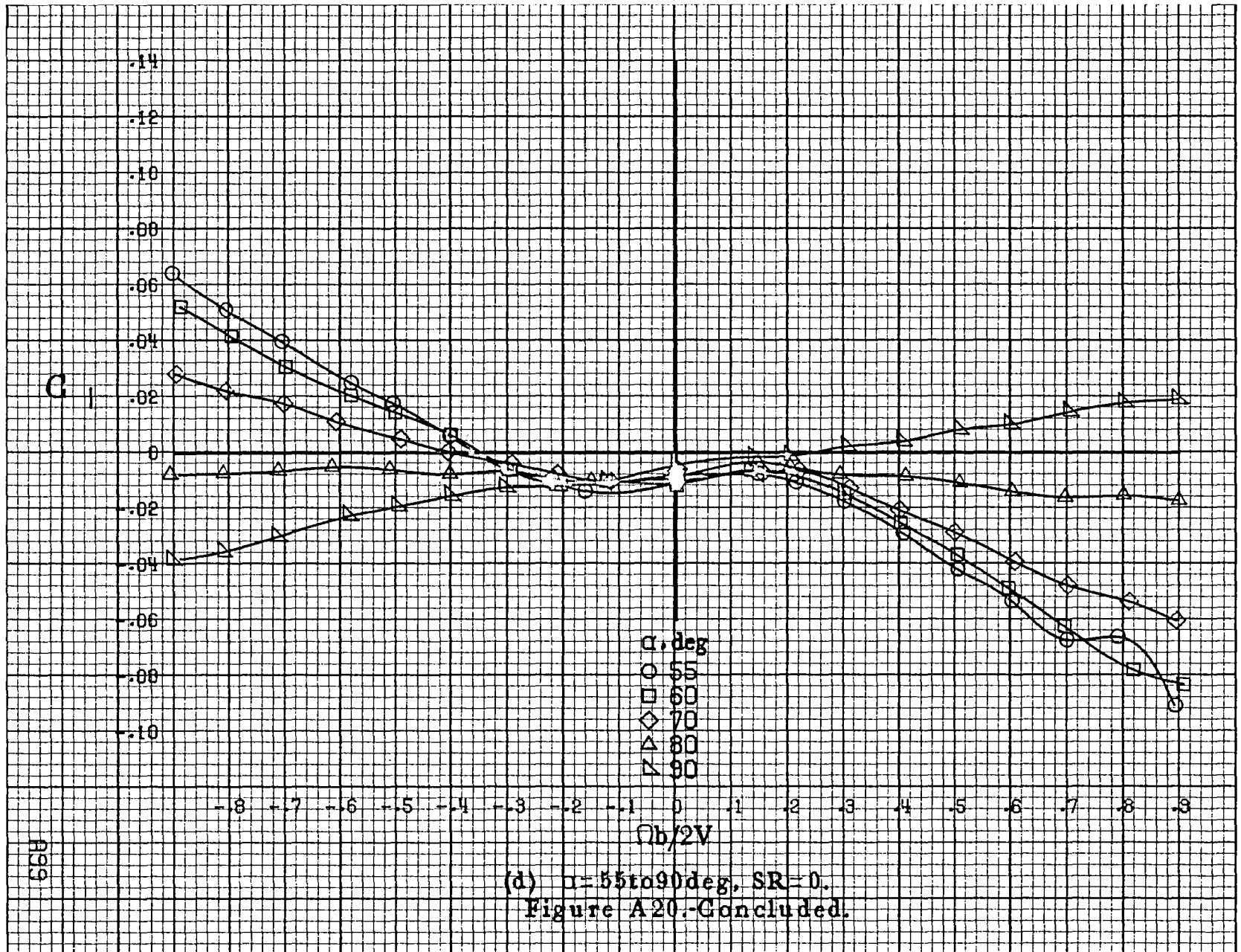

899

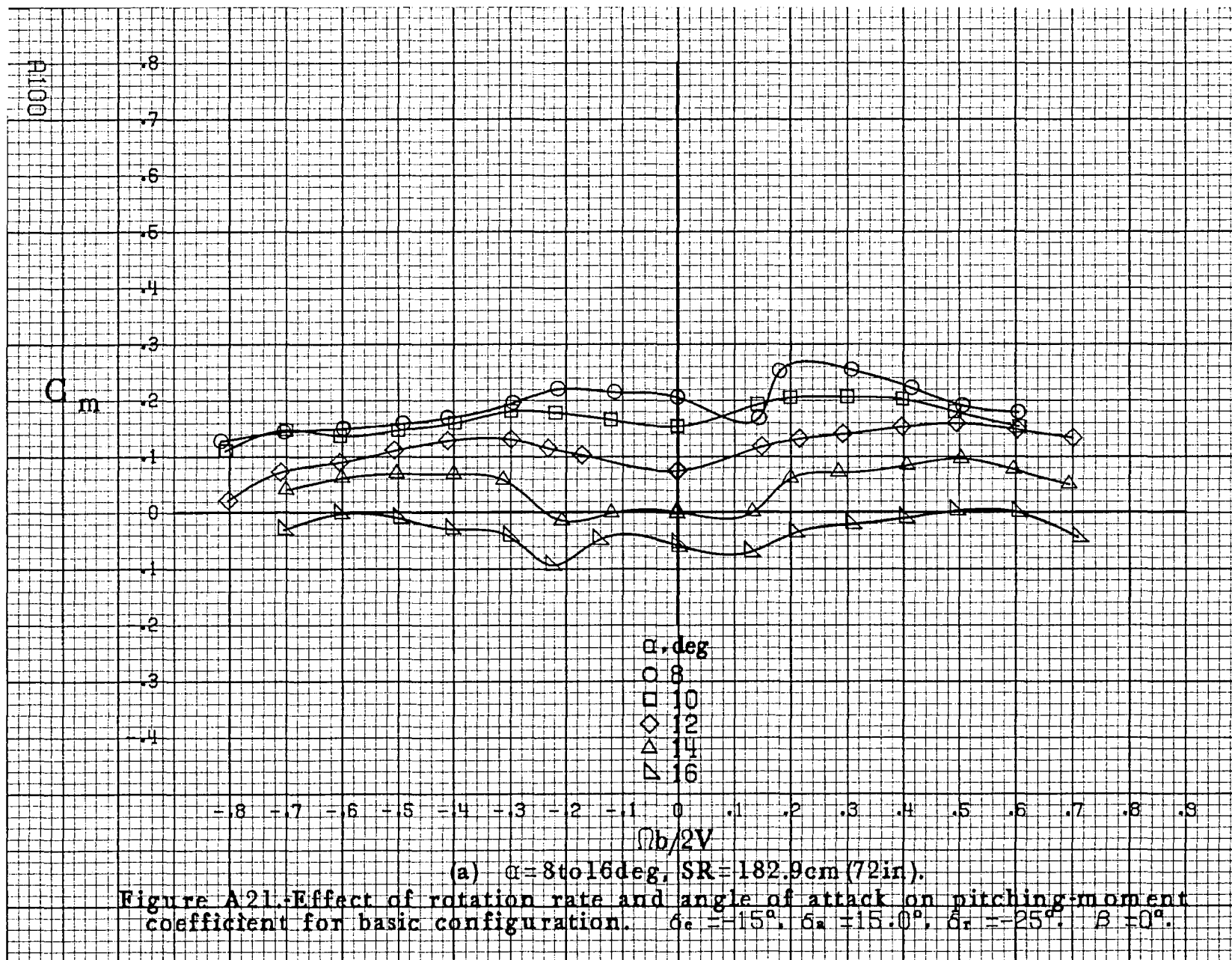

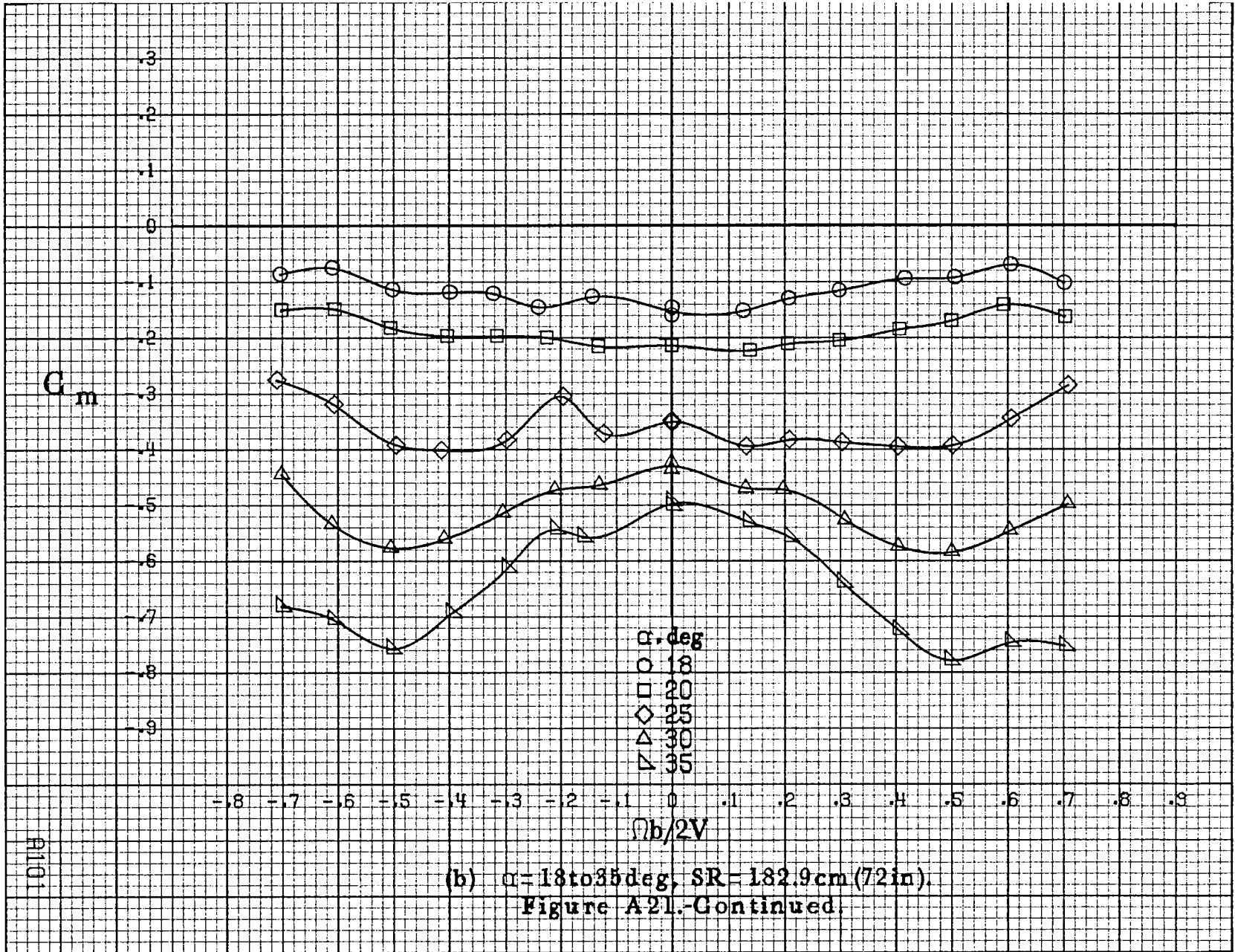

(b)  $\alpha = 18$  to  $35$  deg,  $SR = 182.9$  cm (72 in).  
 Figure A21.-Continued.

A101



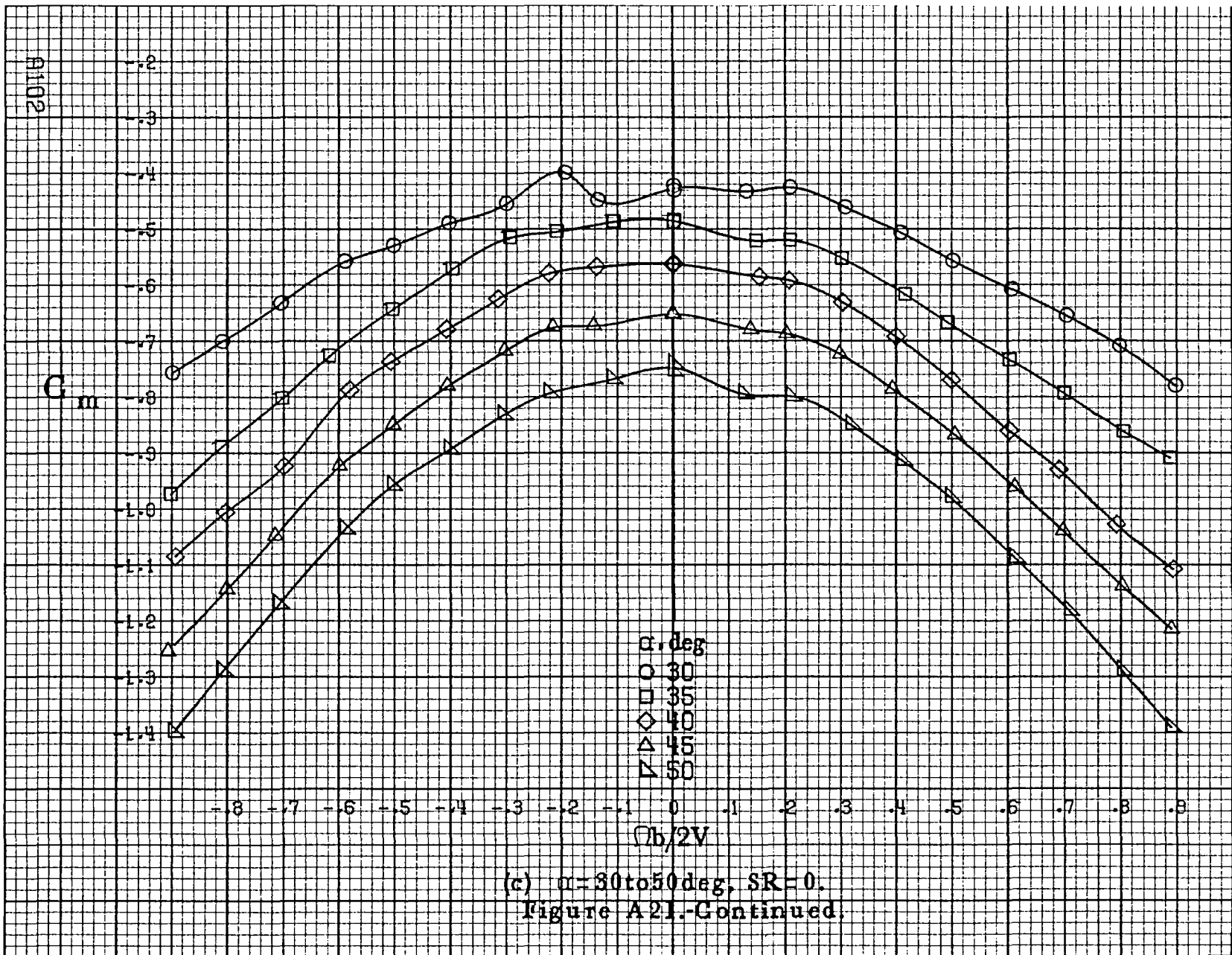



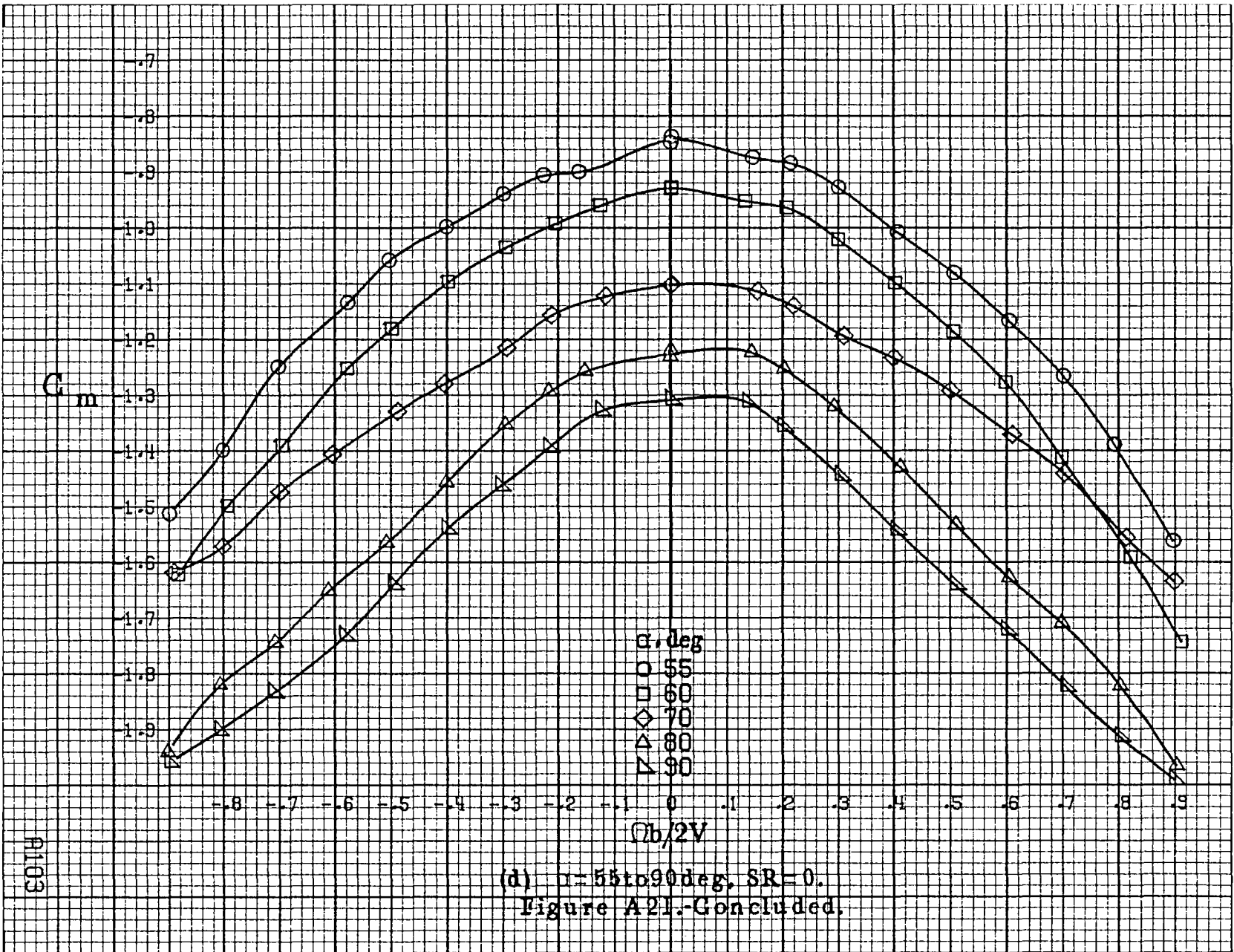

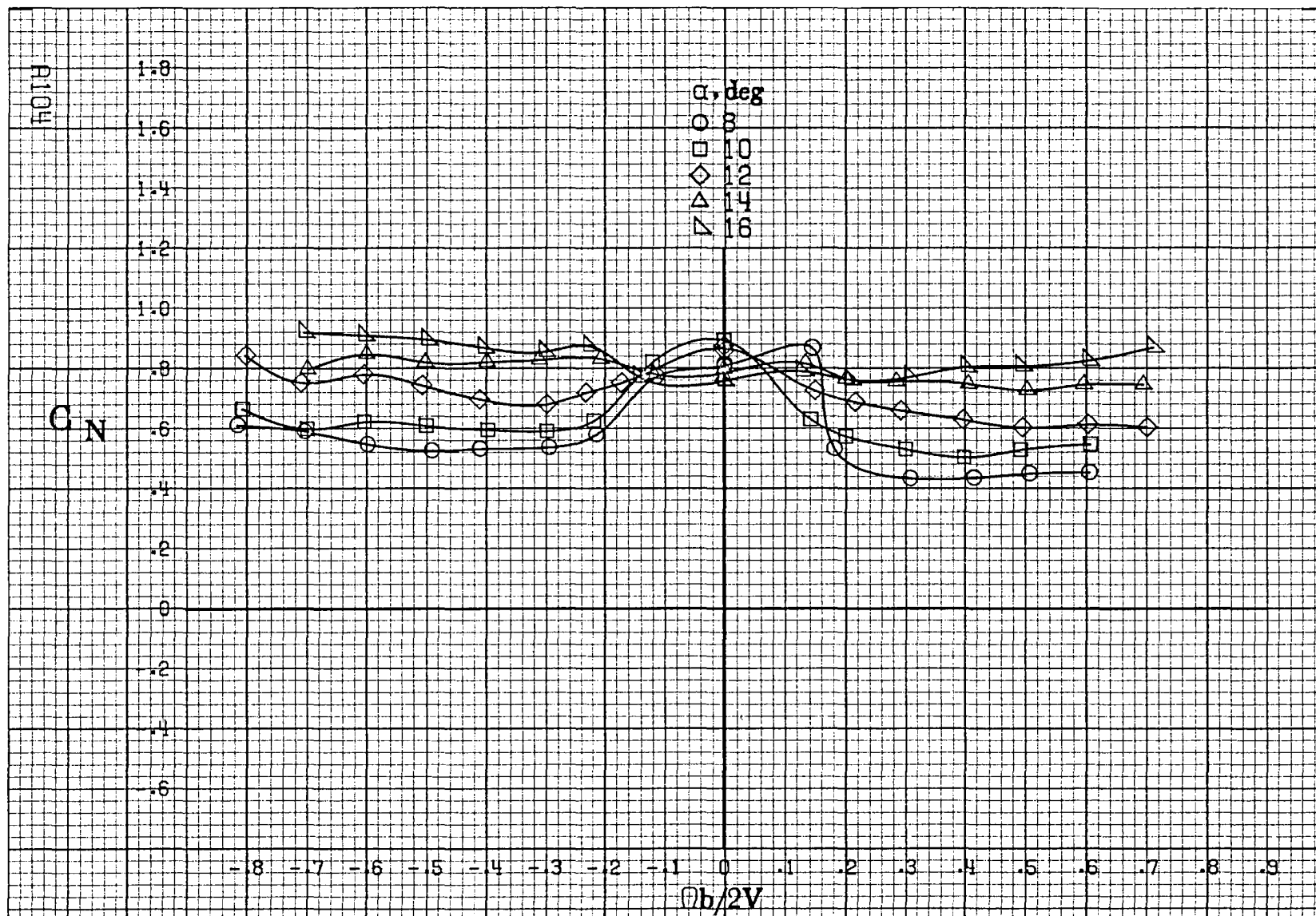

(a)  $\alpha = 8$  to  $16$  deg,  $SR = 182.9$  cm (72 in).

Figure A22.-Effect of rotation rate and angle of attack on normal-force coefficient for basic configuration.  $\delta_e = 15^\circ$ ,  $\delta_a = 15.0^\circ$ ,  $\delta_r = 25^\circ$ ,  $\beta = 0^\circ$ .

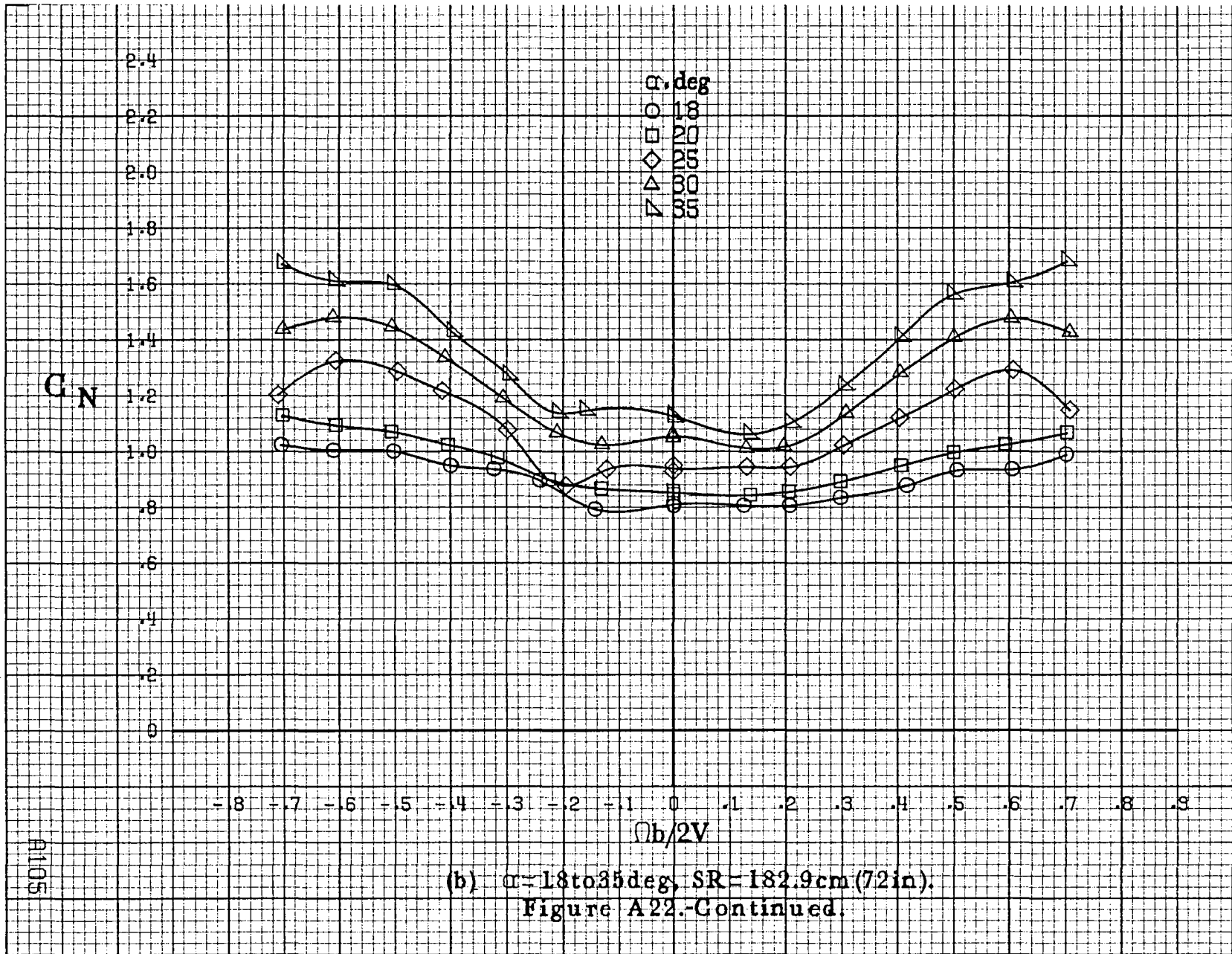

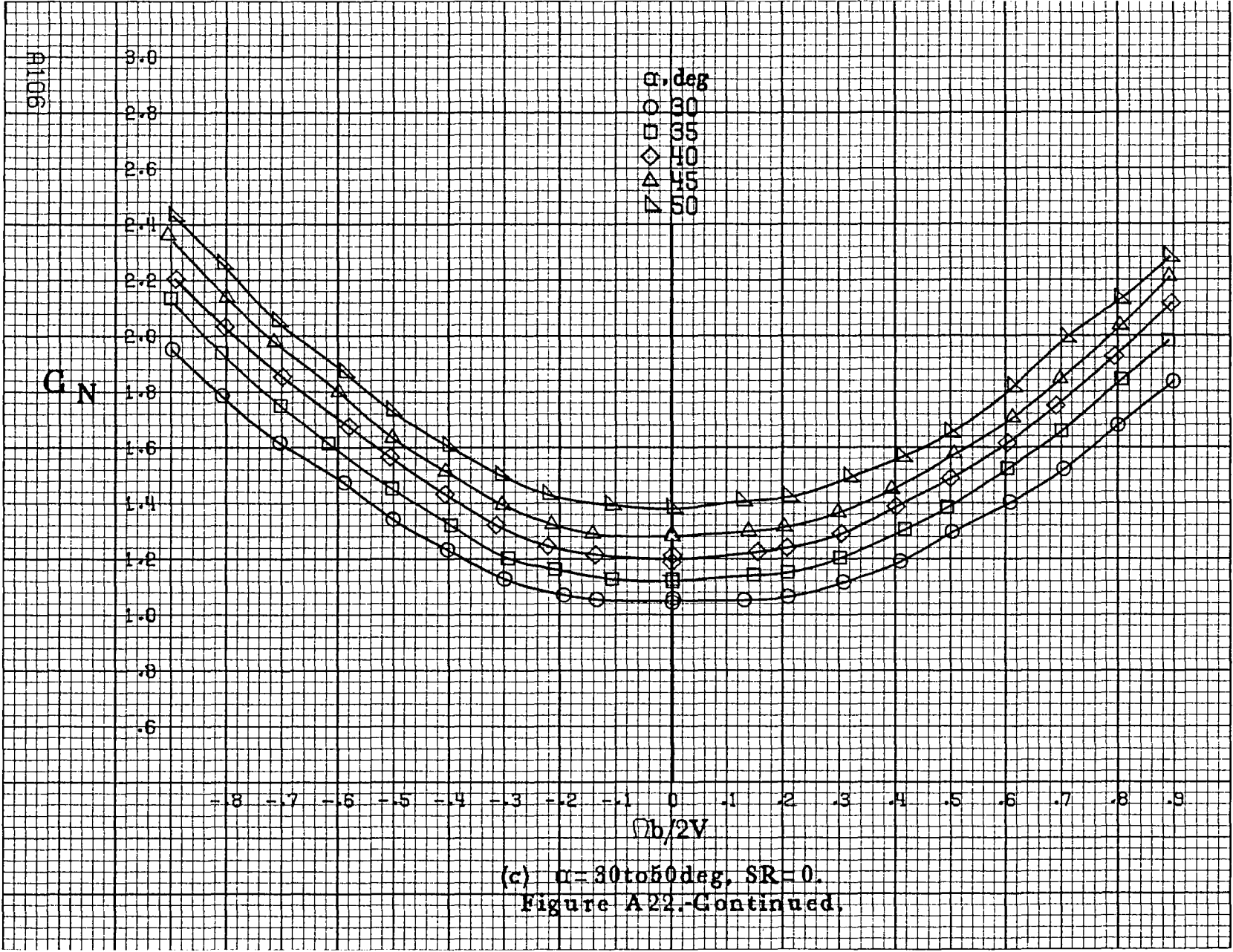

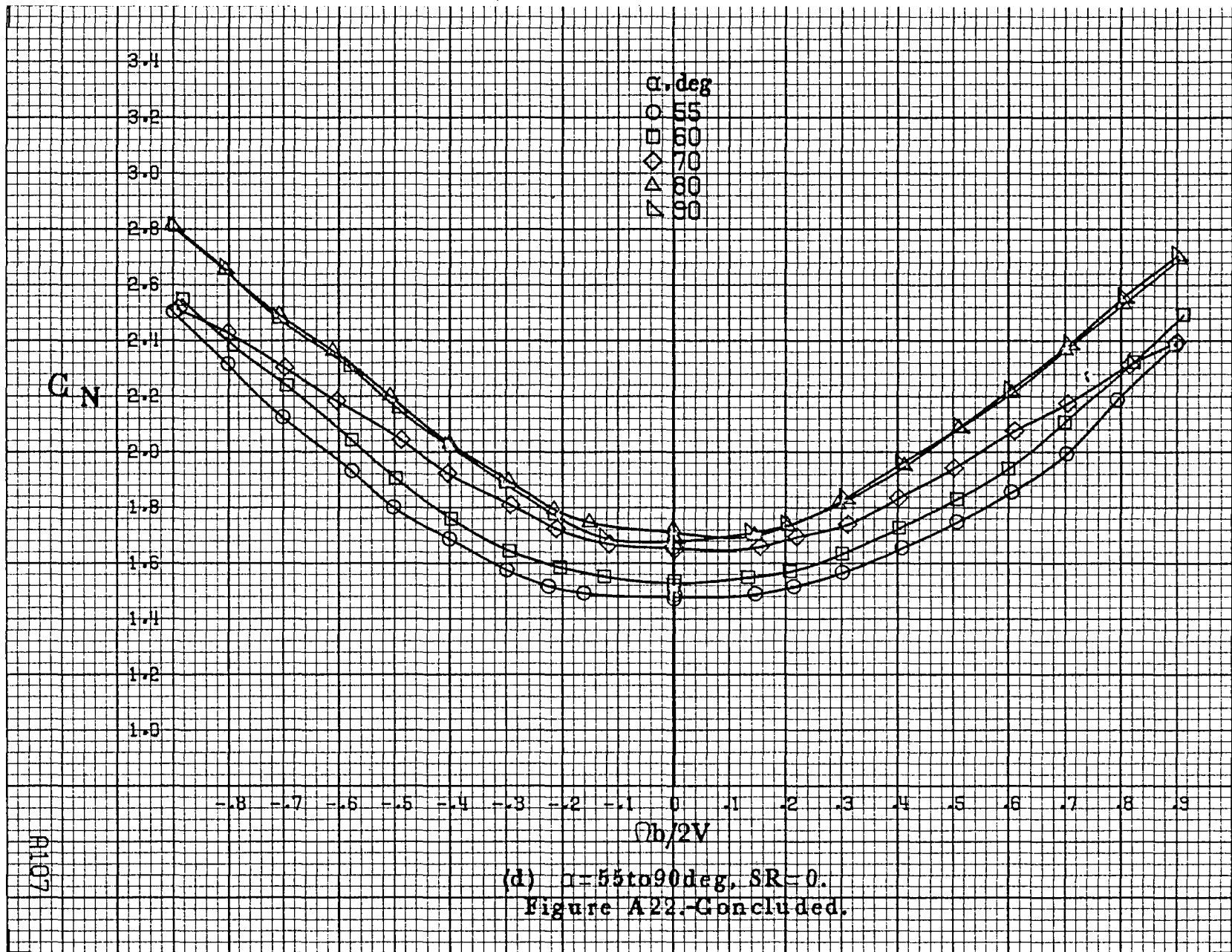

R107

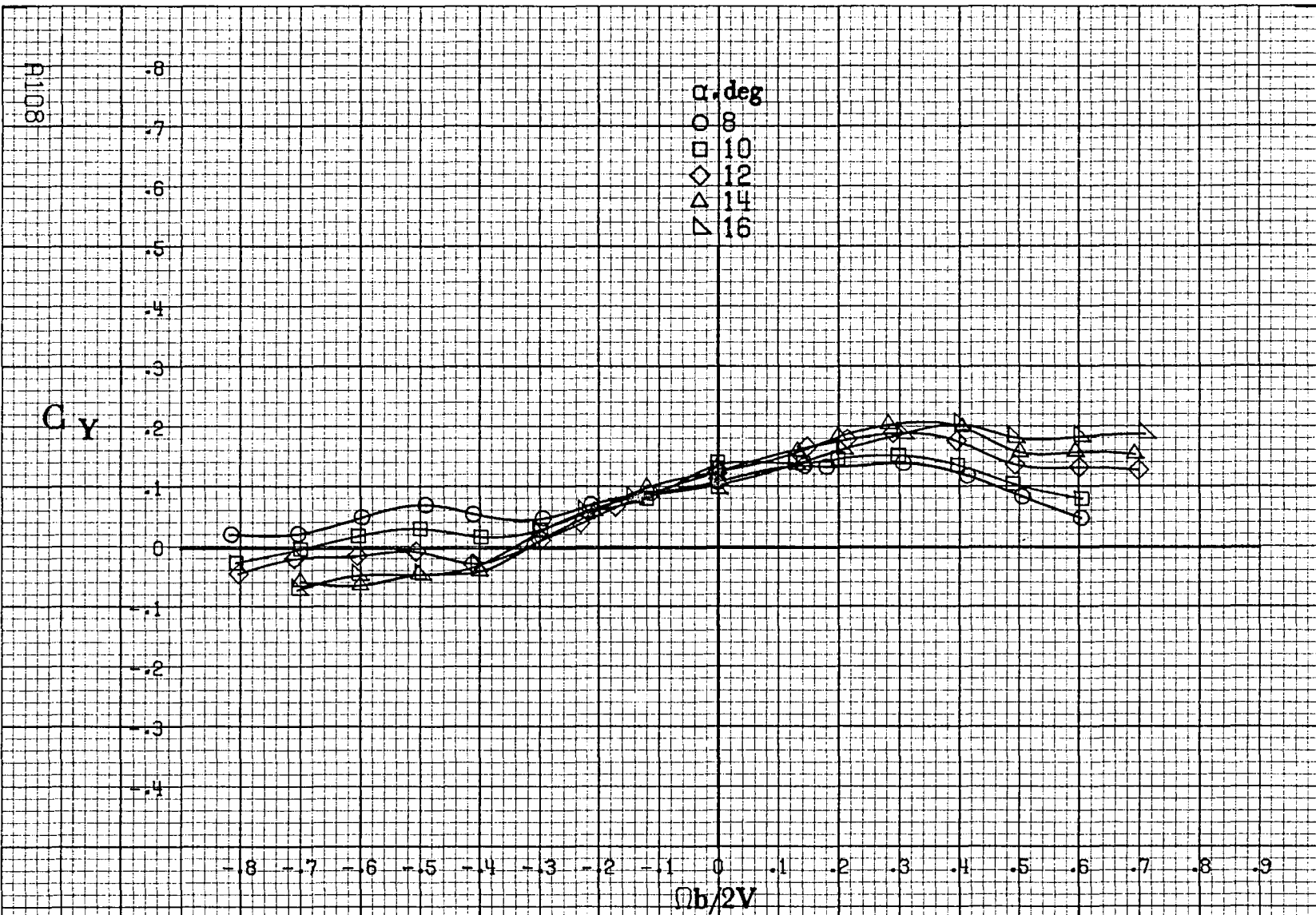

(a)  $\alpha = 8$  to  $16$  deg,  $SR = 182.9$  cm (72 in).  
 Figure A28. Effect of rotation rate and angle of attack on side-force coefficient for basic configuration.  $\delta_e = -15^\circ$ ,  $\delta_a = 15.0^\circ$ ,  $\delta_r = -25^\circ$ ,  $B = 0^\circ$ .

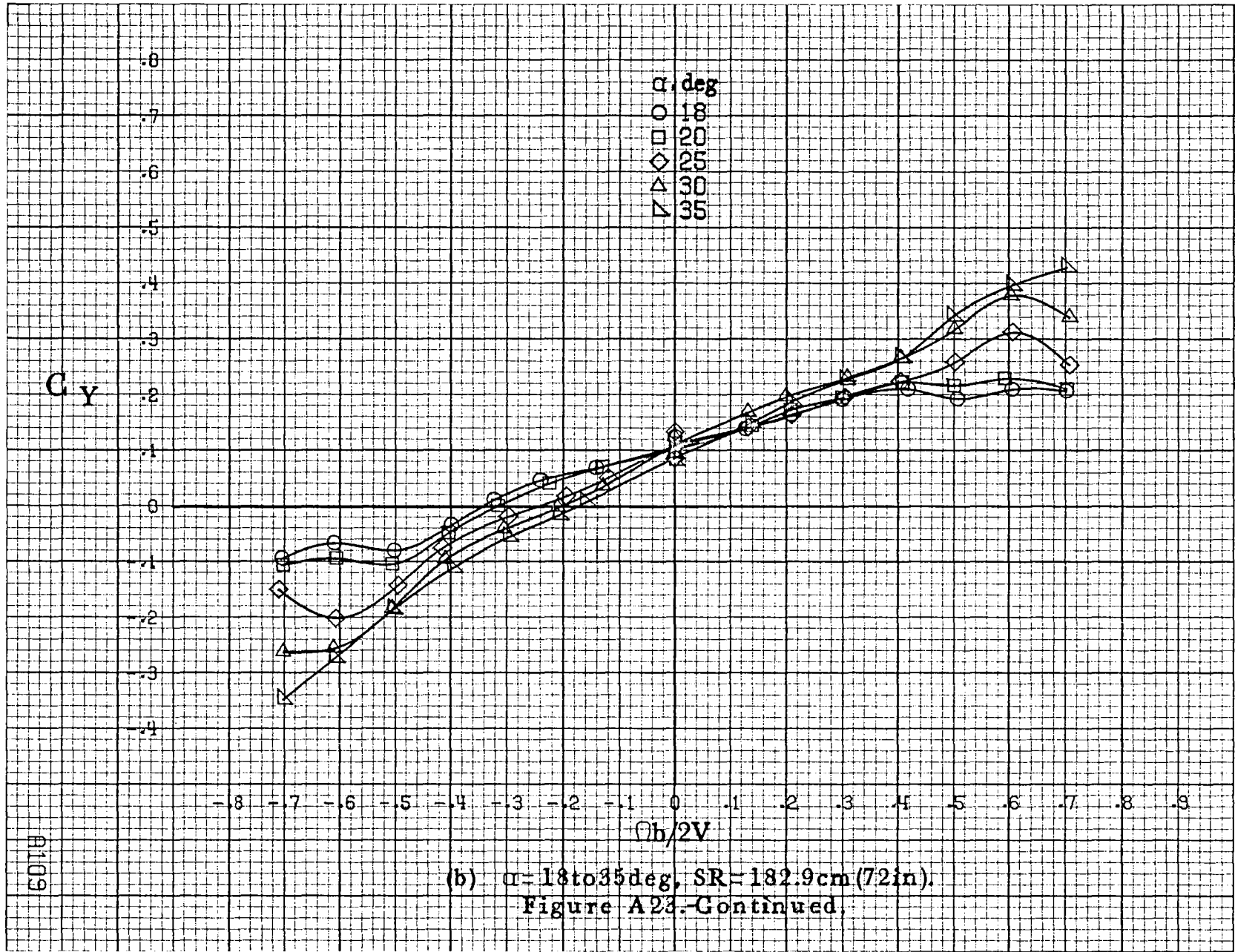



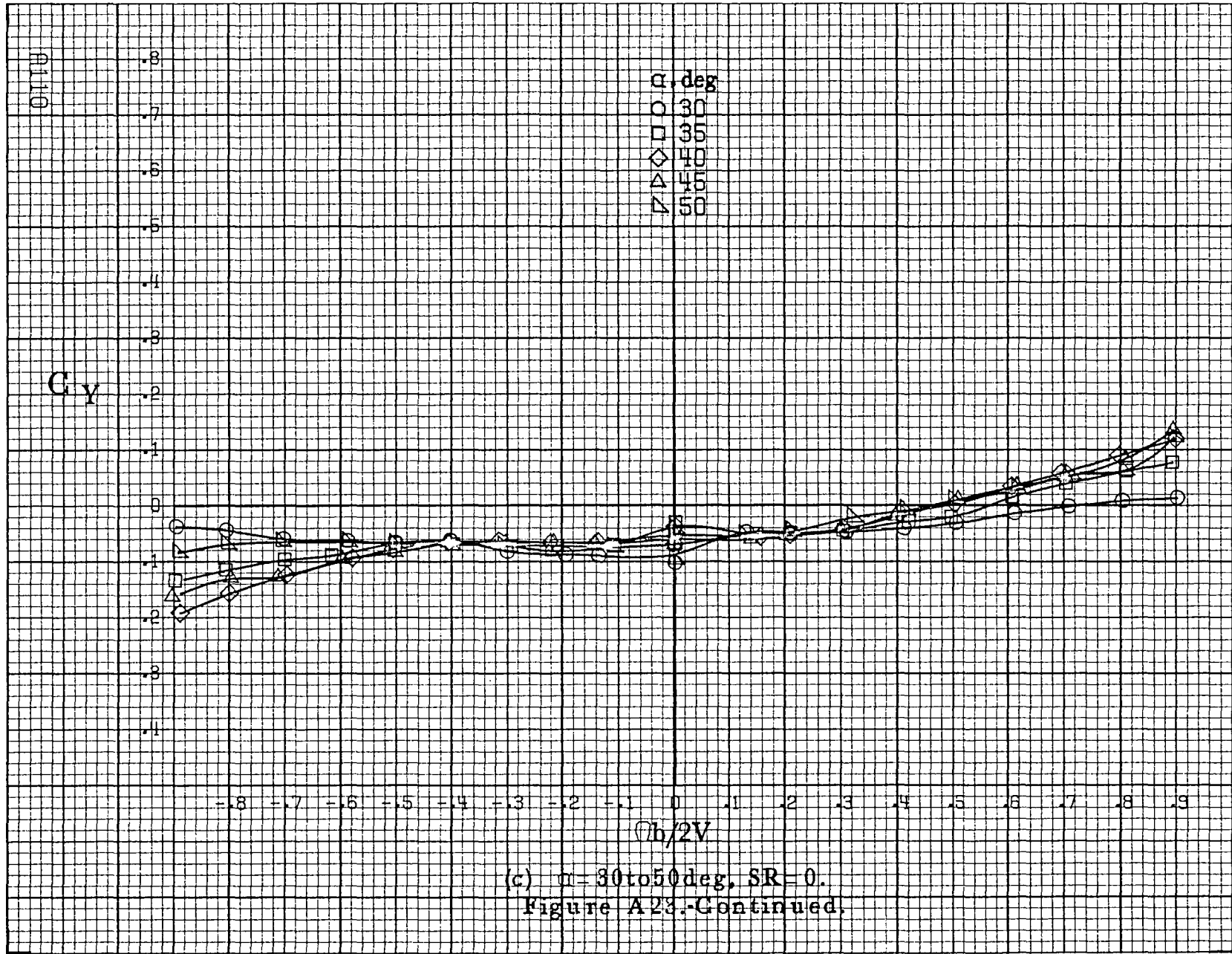



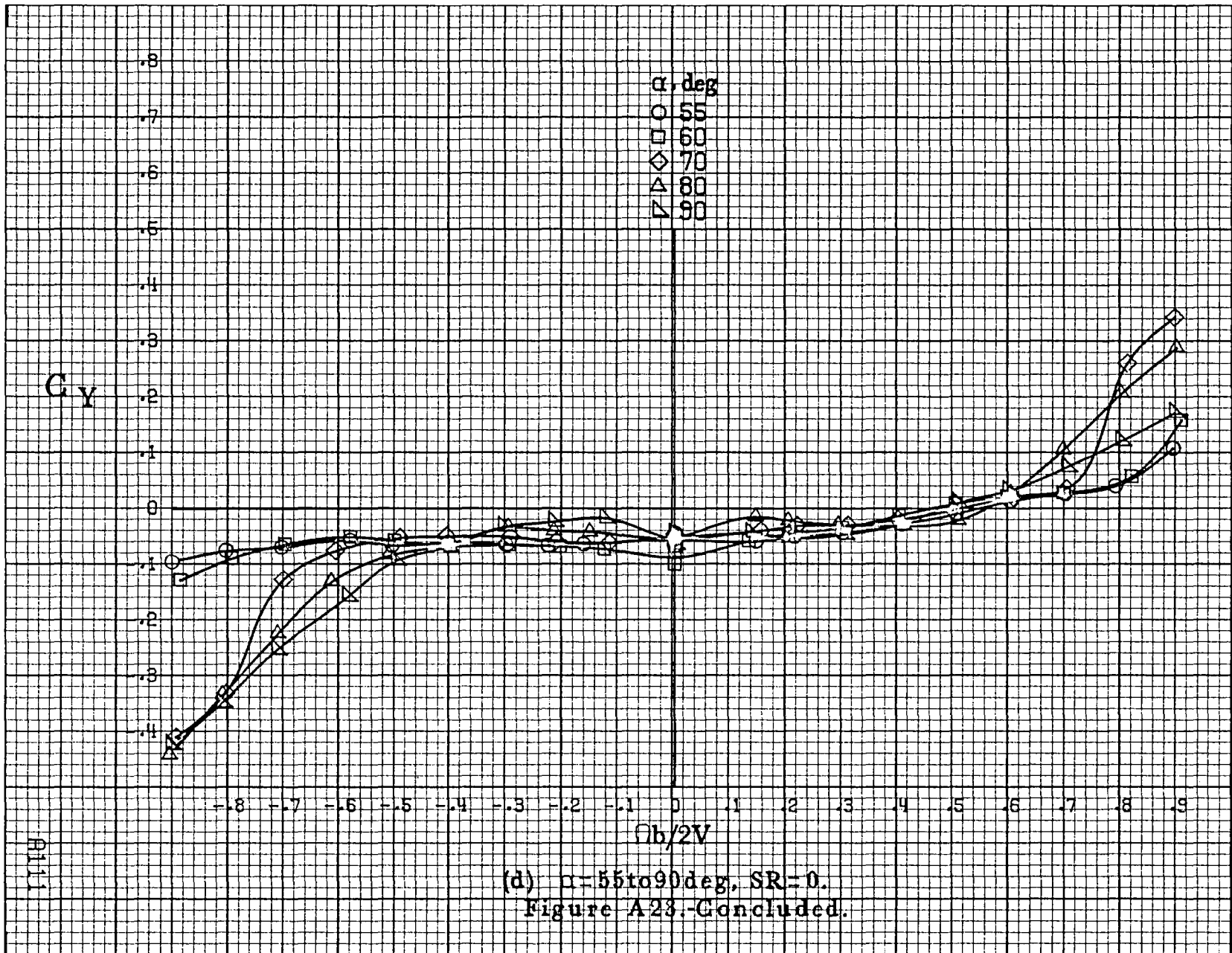

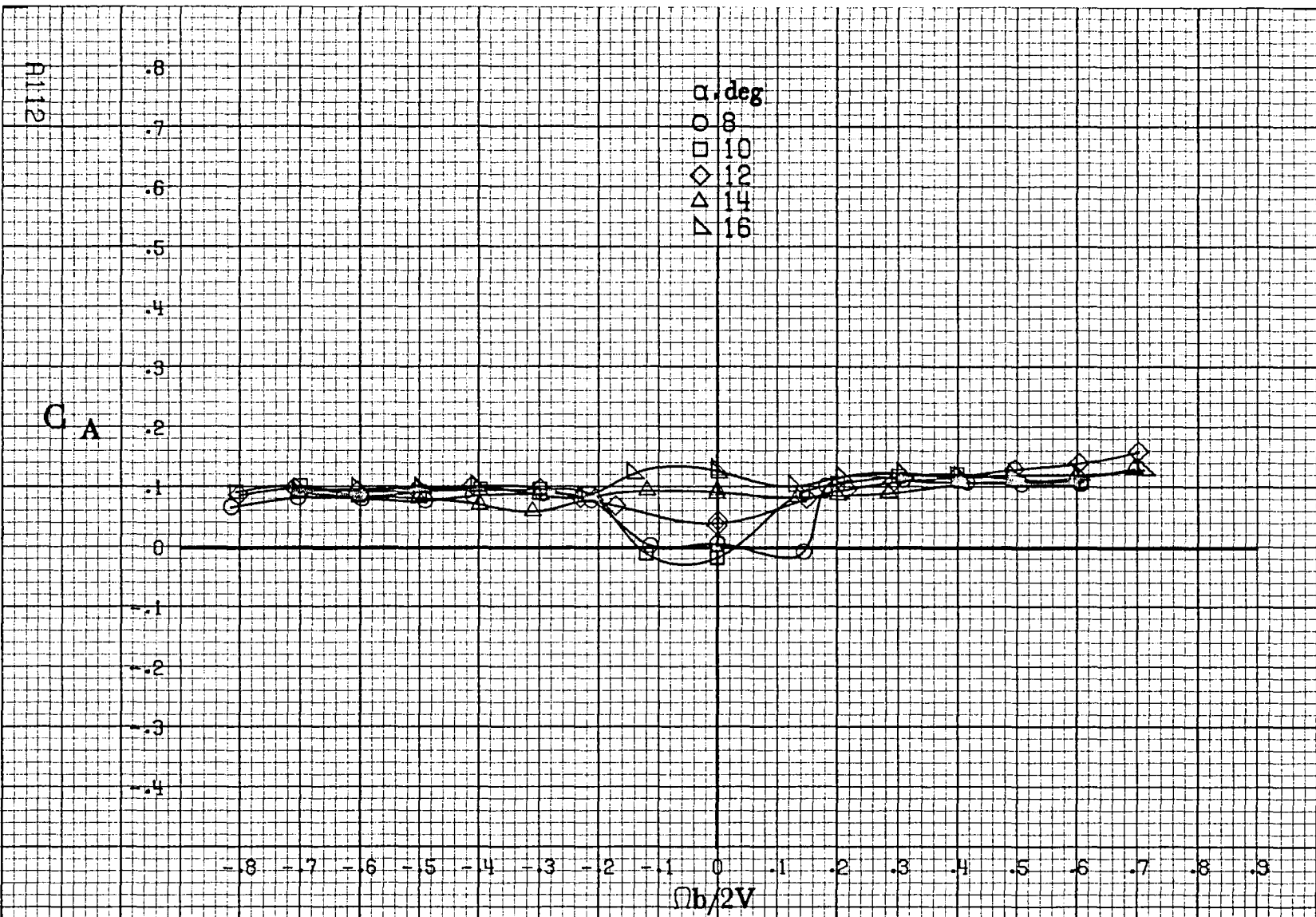

(a)  $\alpha = 8$  to  $16$  deg,  $SR = 182.9$  cm (72 in).

Figure A24. Effect of rotation rate and angle of attack on axial-force coefficient for basic configuration.  $\delta_e = -15^\circ$ ,  $\delta_n = 15.0^\circ$ ,  $\delta_r = -25^\circ$ .  $\beta = 0^\circ$ .

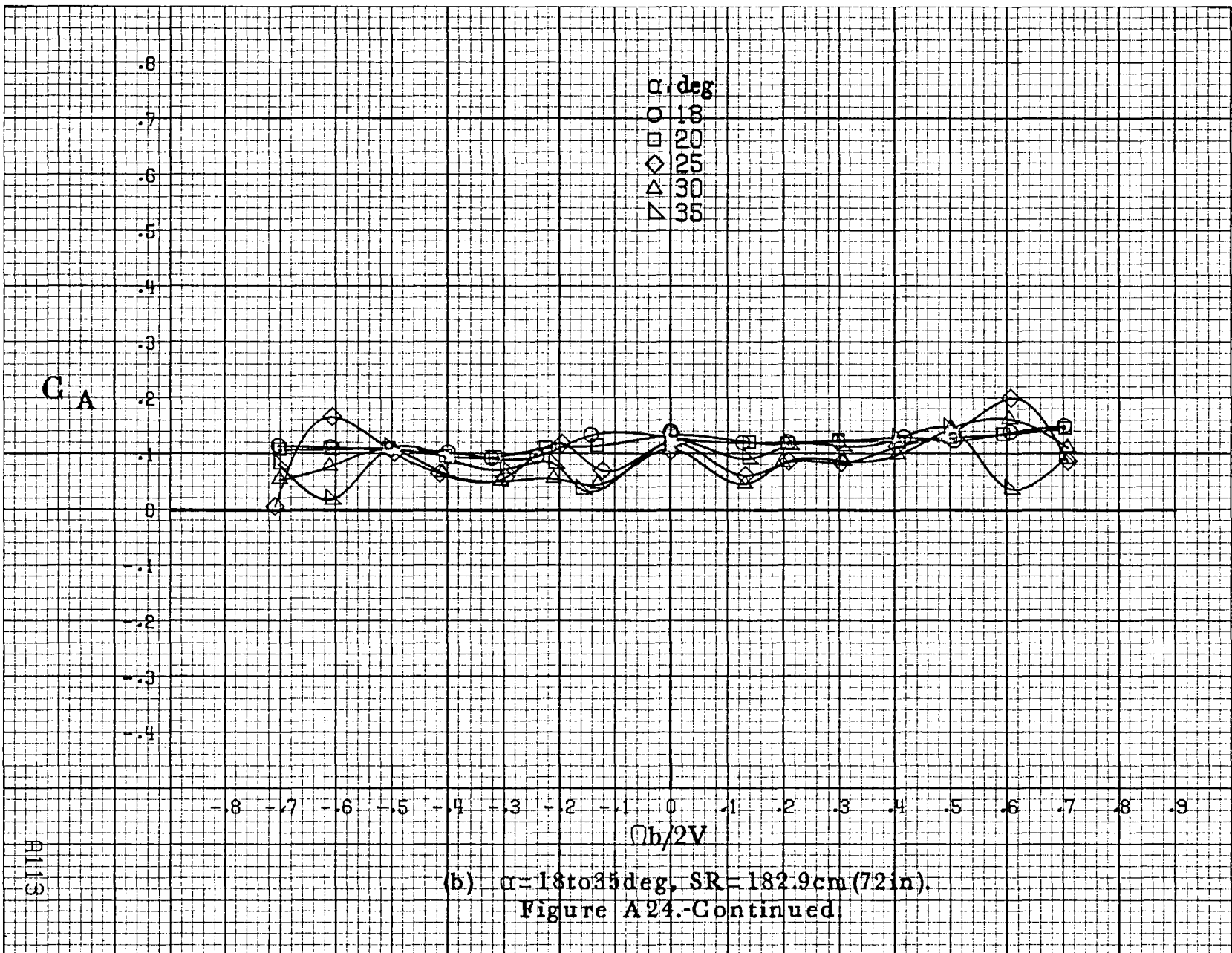

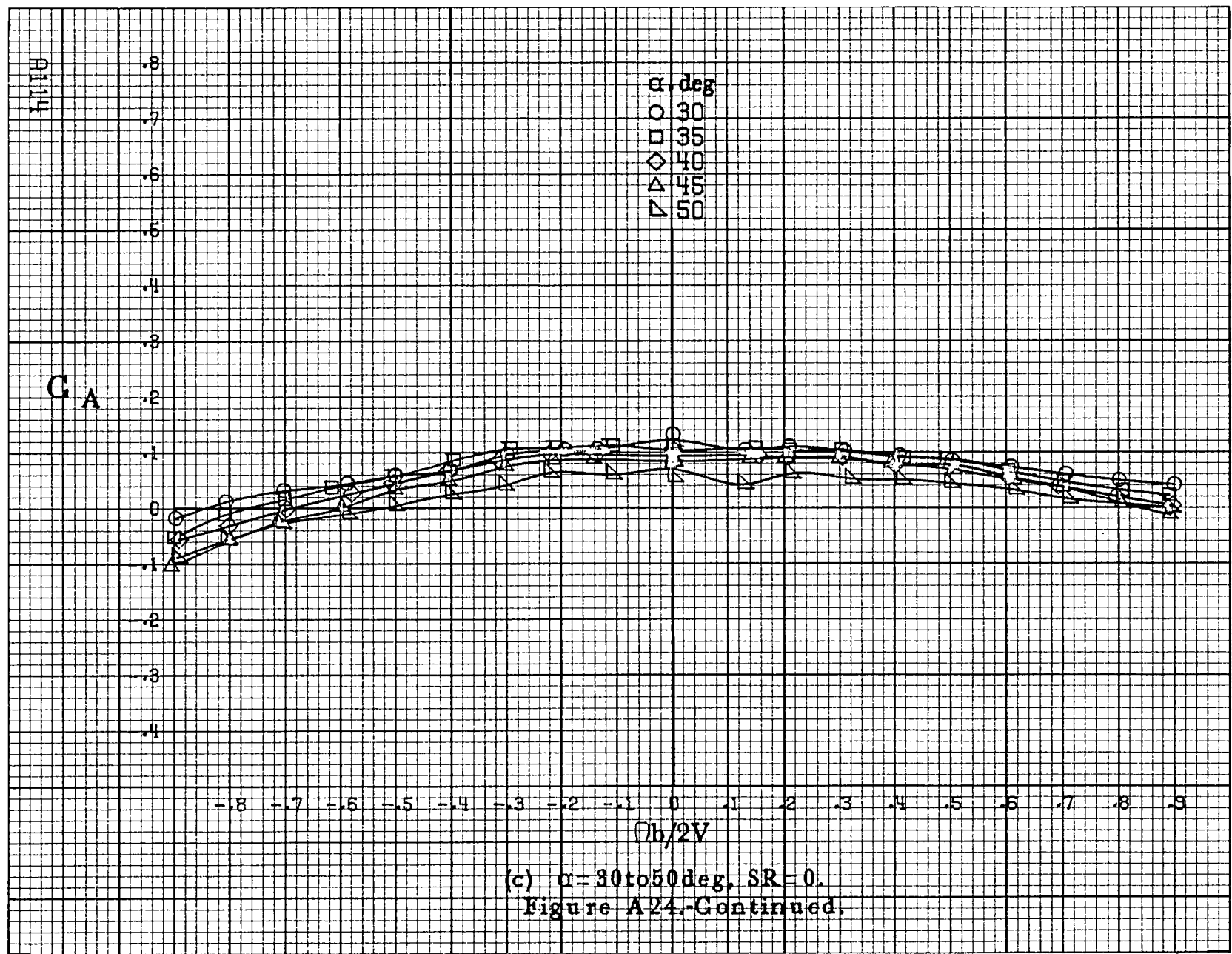

(c)  $\alpha = 30$  to  $50$  deg,  $SR = 0$ .  
 Figure A24-Continued.

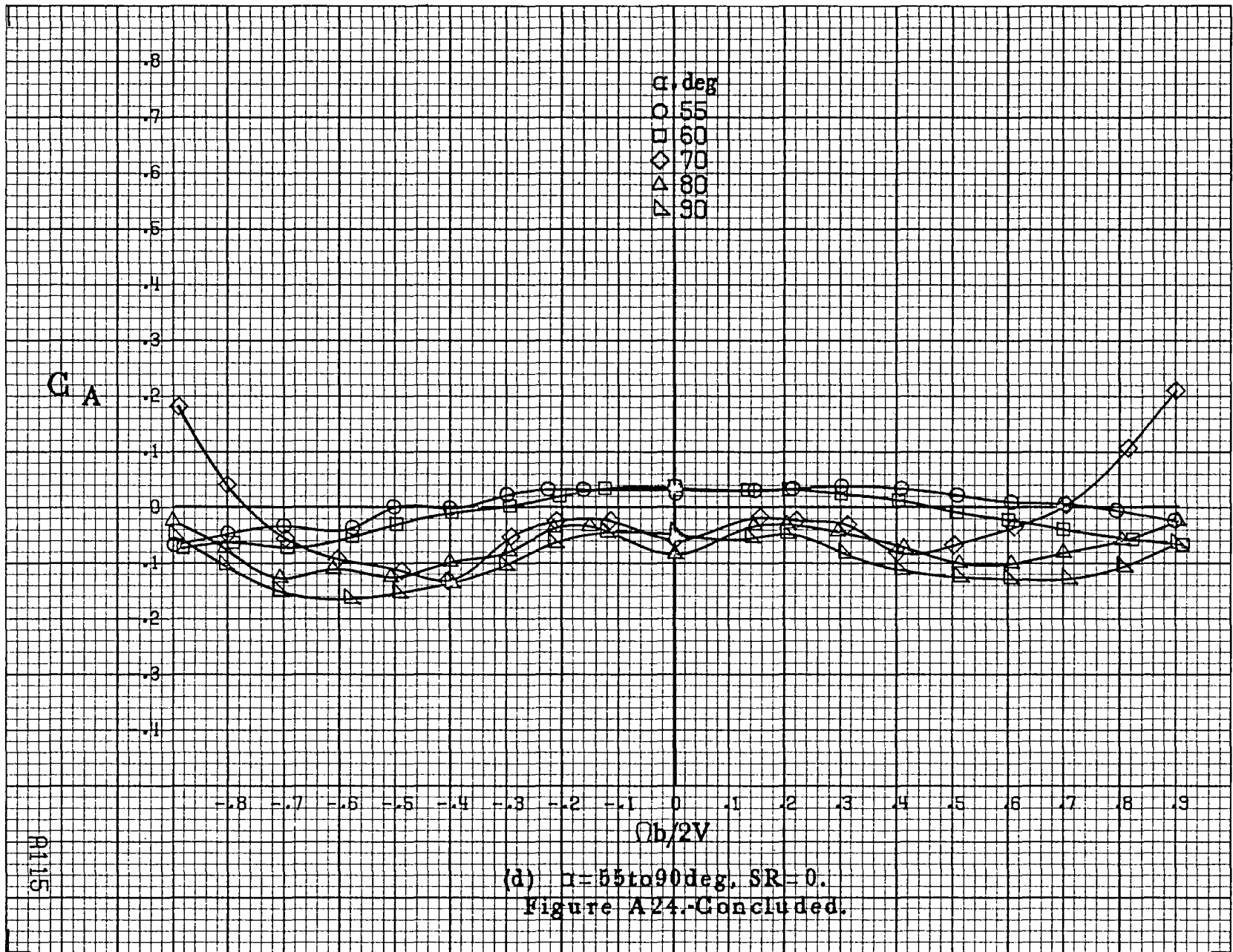

(d)  $\alpha = 55$  to  $90$  deg,  $SR = 0$ .  
 Figure A24.-Concluded.

R115

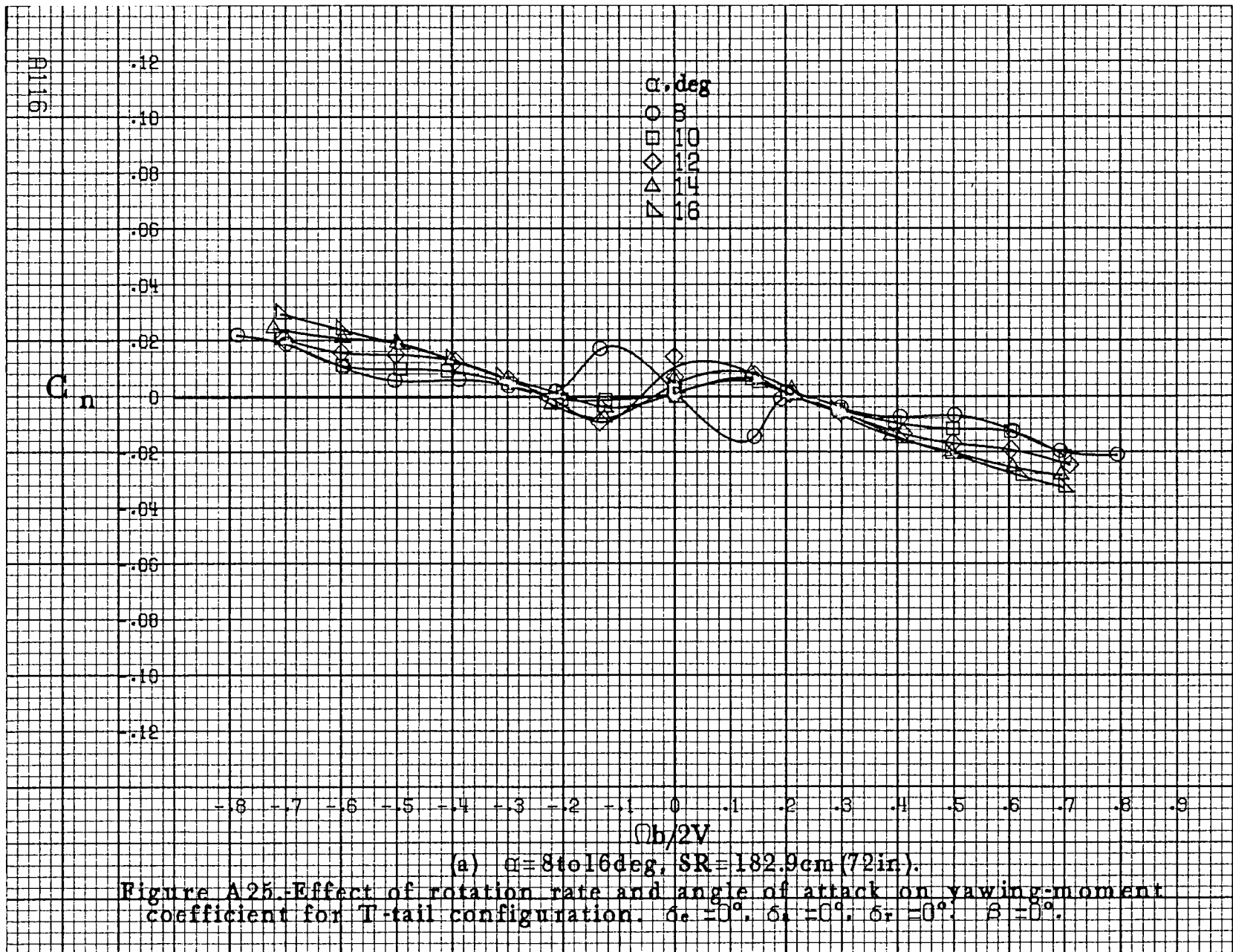

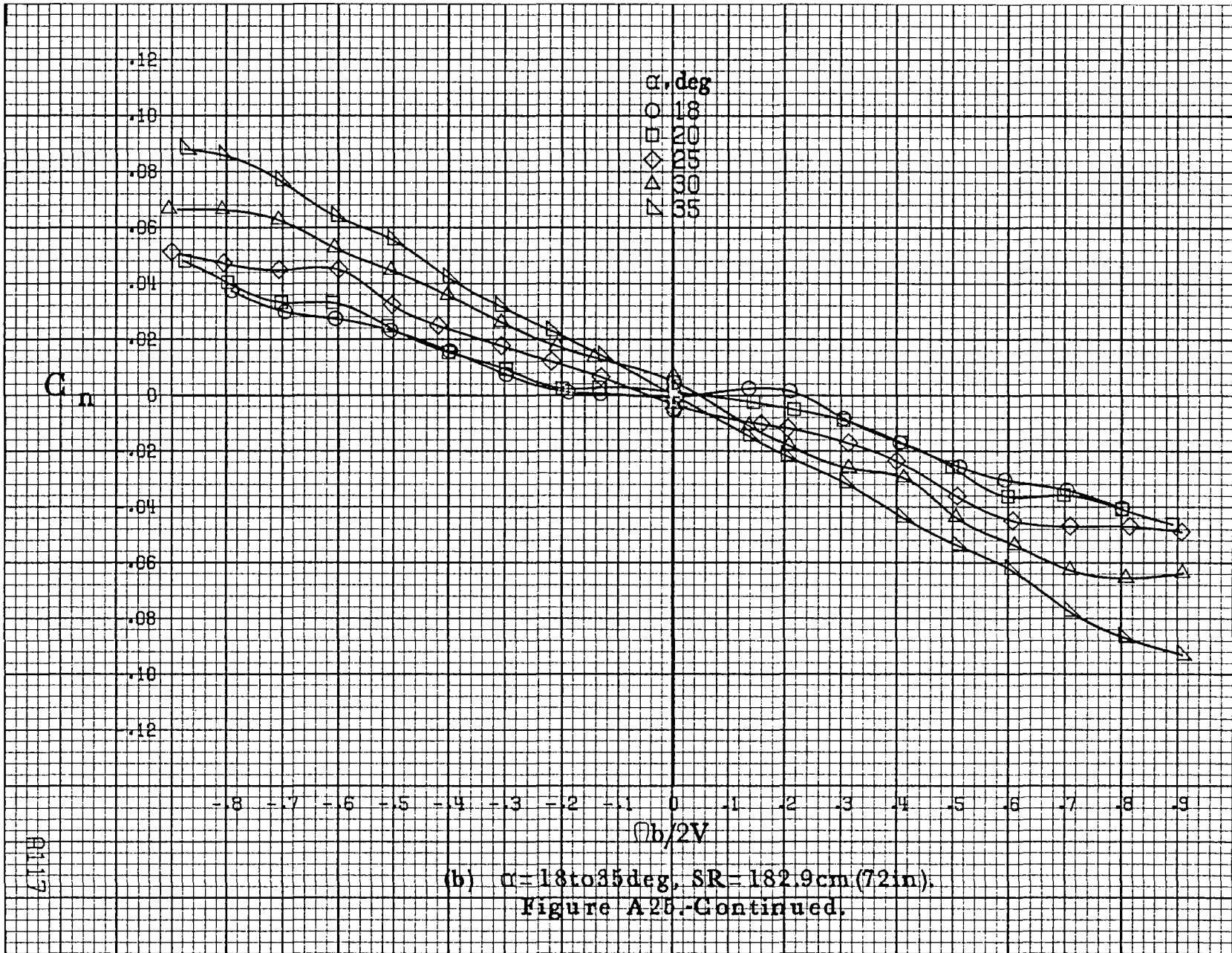

(b)  $\alpha = 18$  to  $35$  deg, SR = 182.9 cm (72 in).  
 Figure A25.-Continued.

A117



R1118

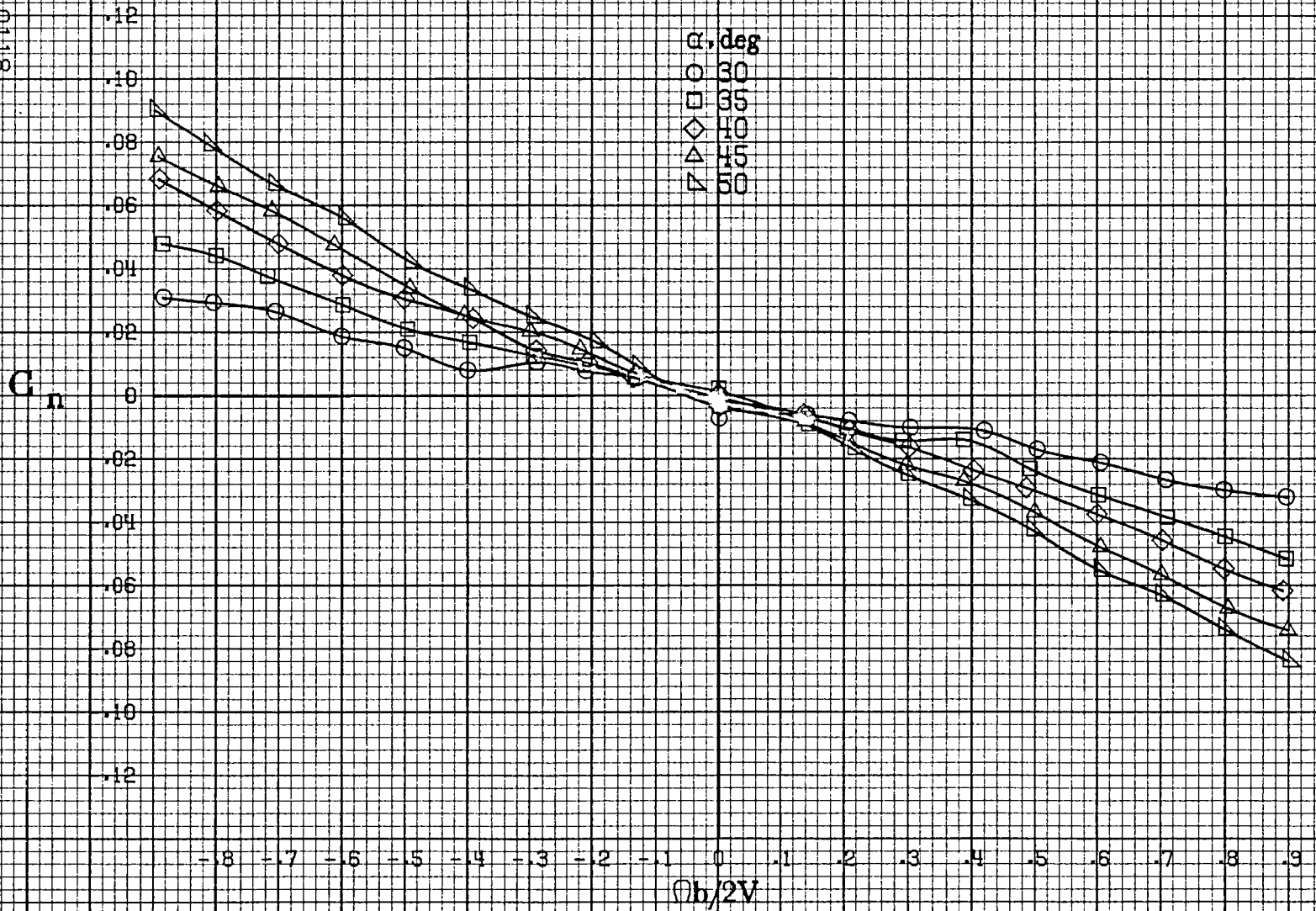

(c)  $\alpha = 30$  to  $50$  deg,  $SR = 0$ .  
Figure A25.-Continued.



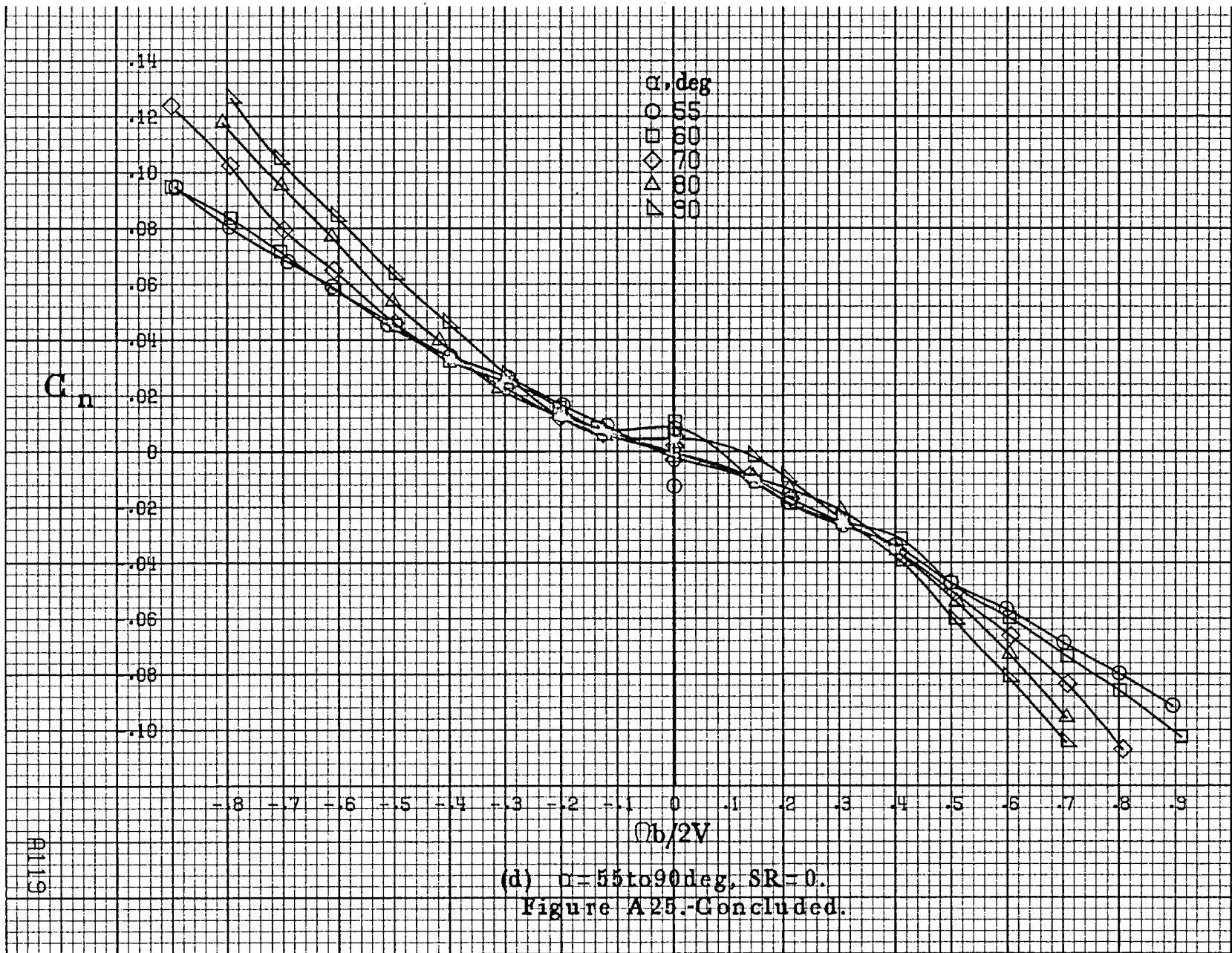

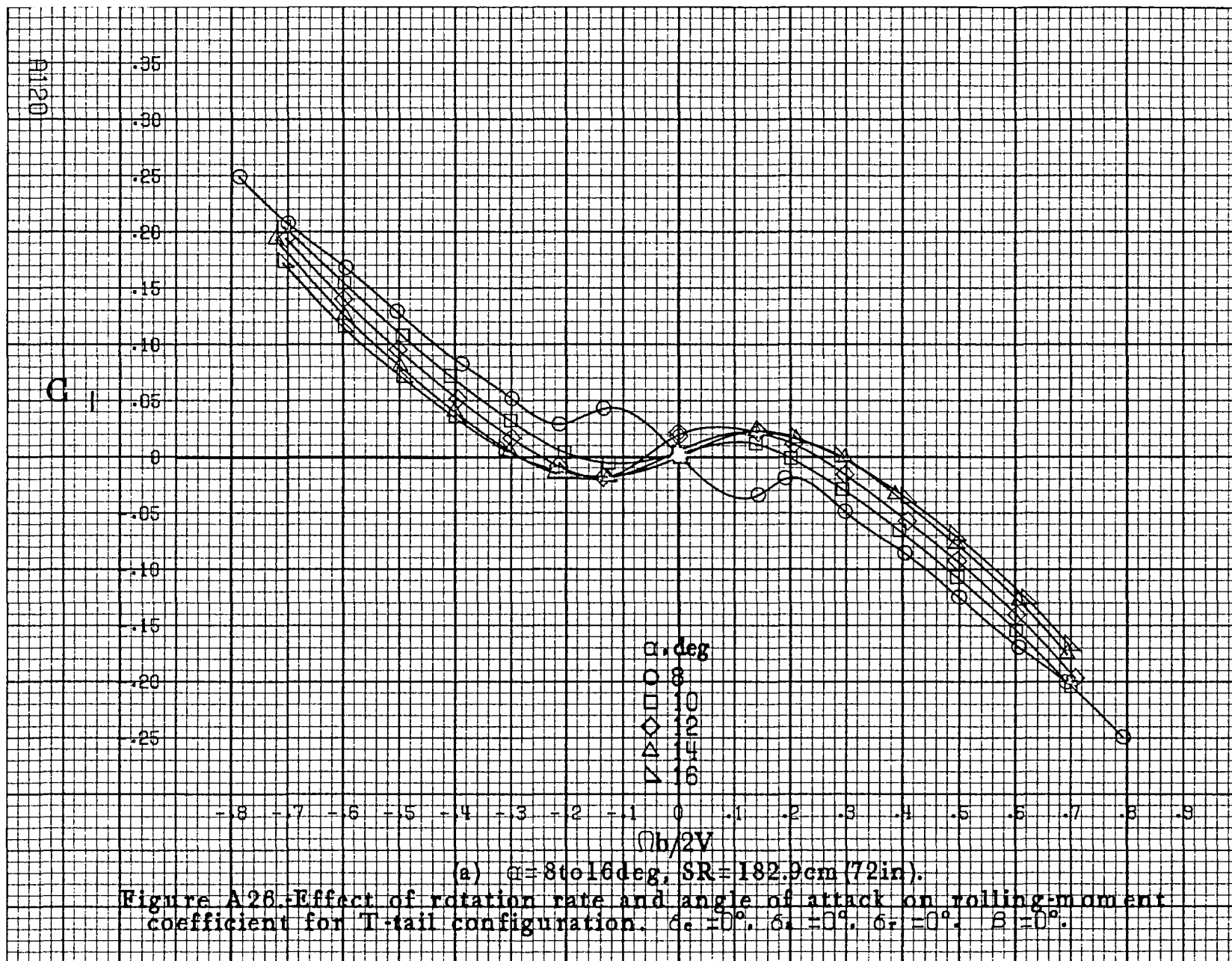

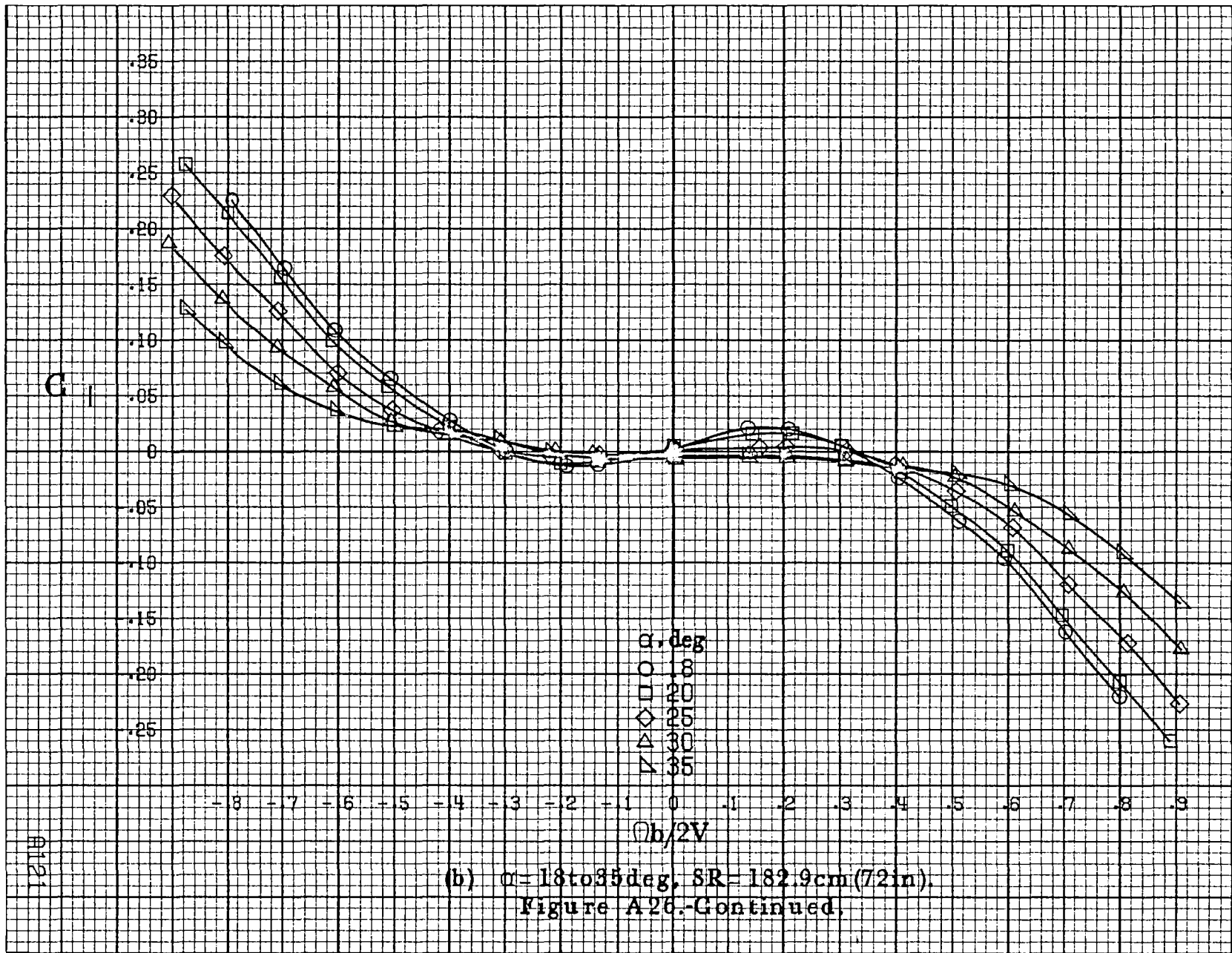

A121

0122

G

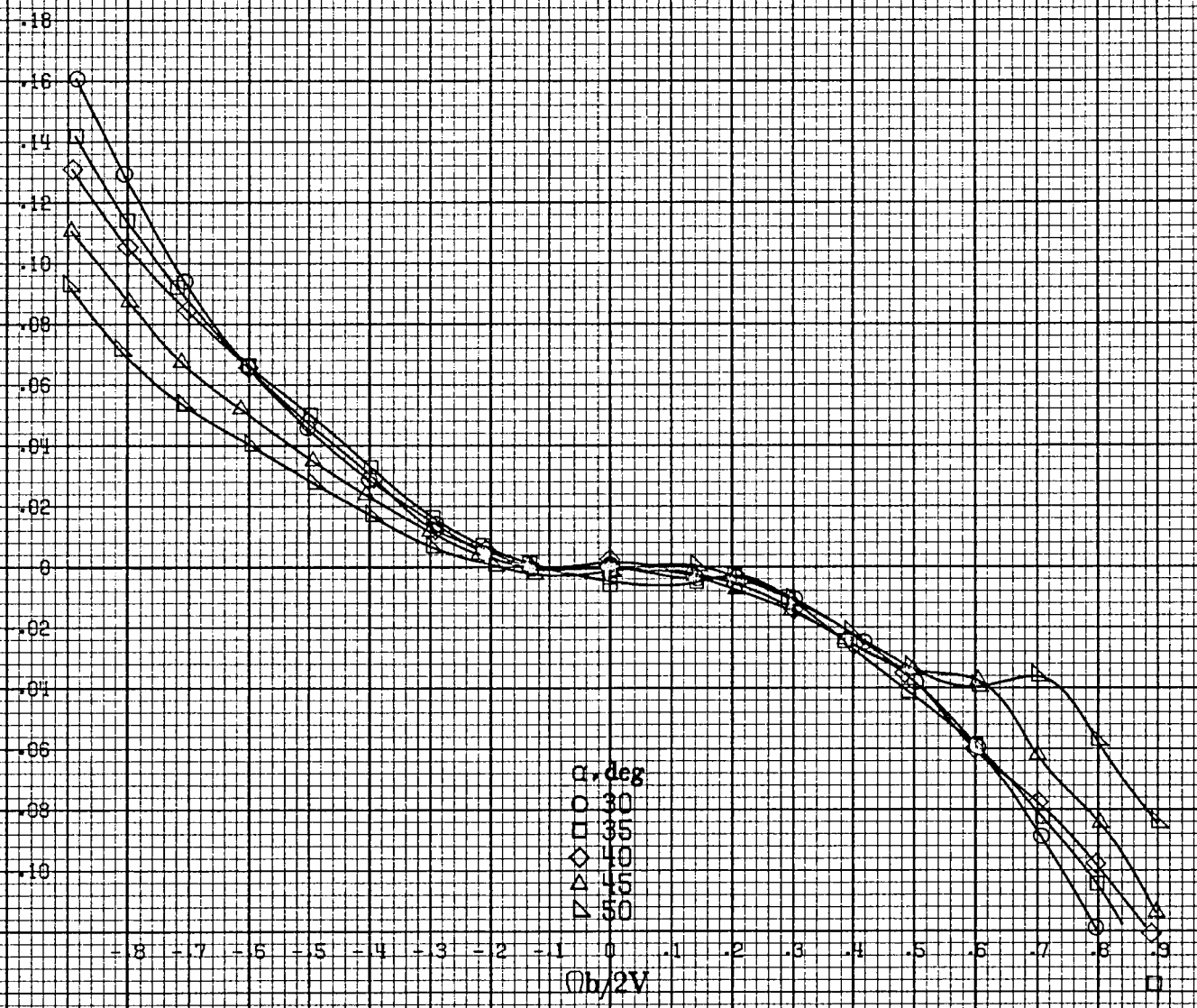

(c)  $\alpha = 30$  to  $50$  deg,  $SR = 0$ .  
Figure A 26.-Continued.

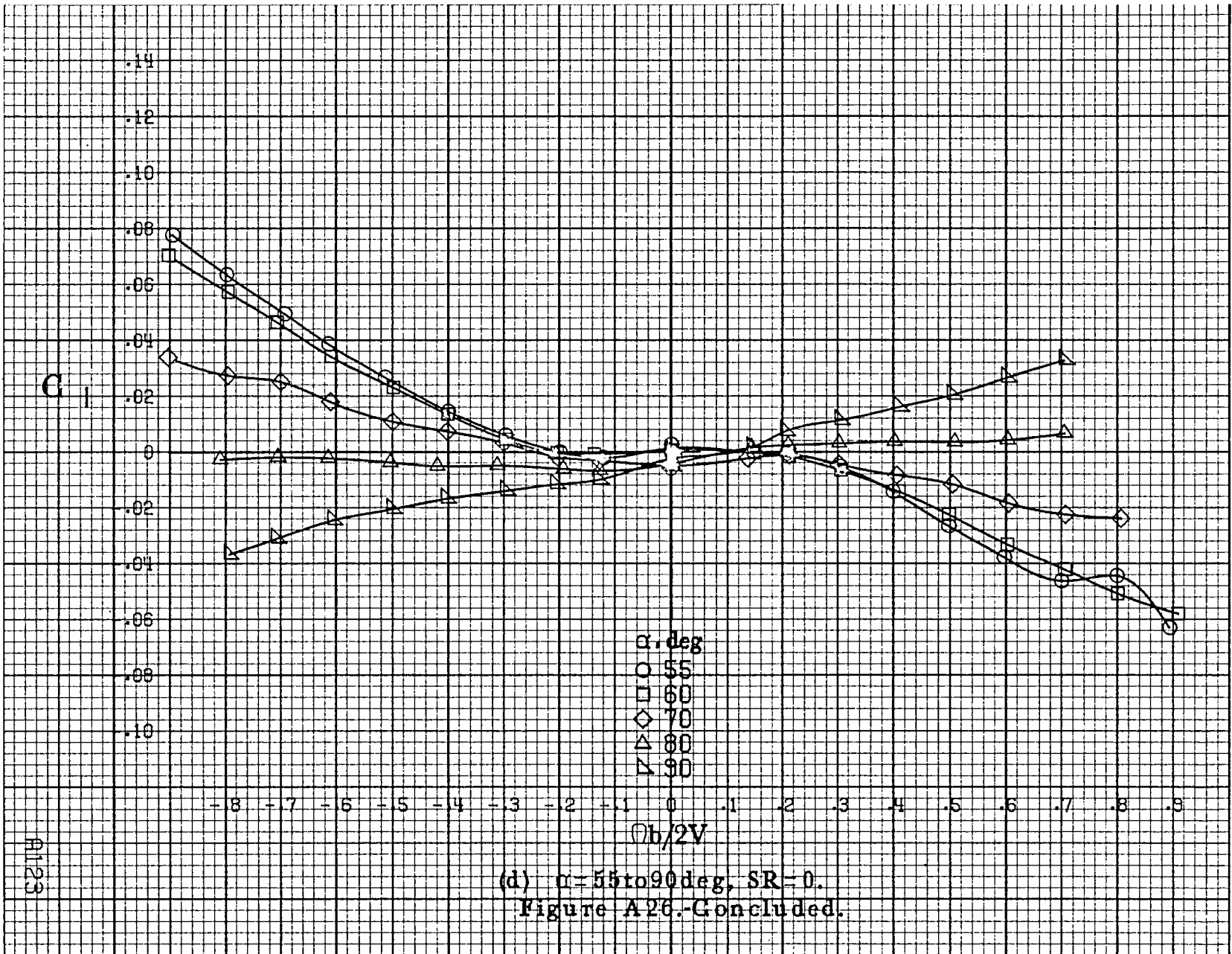

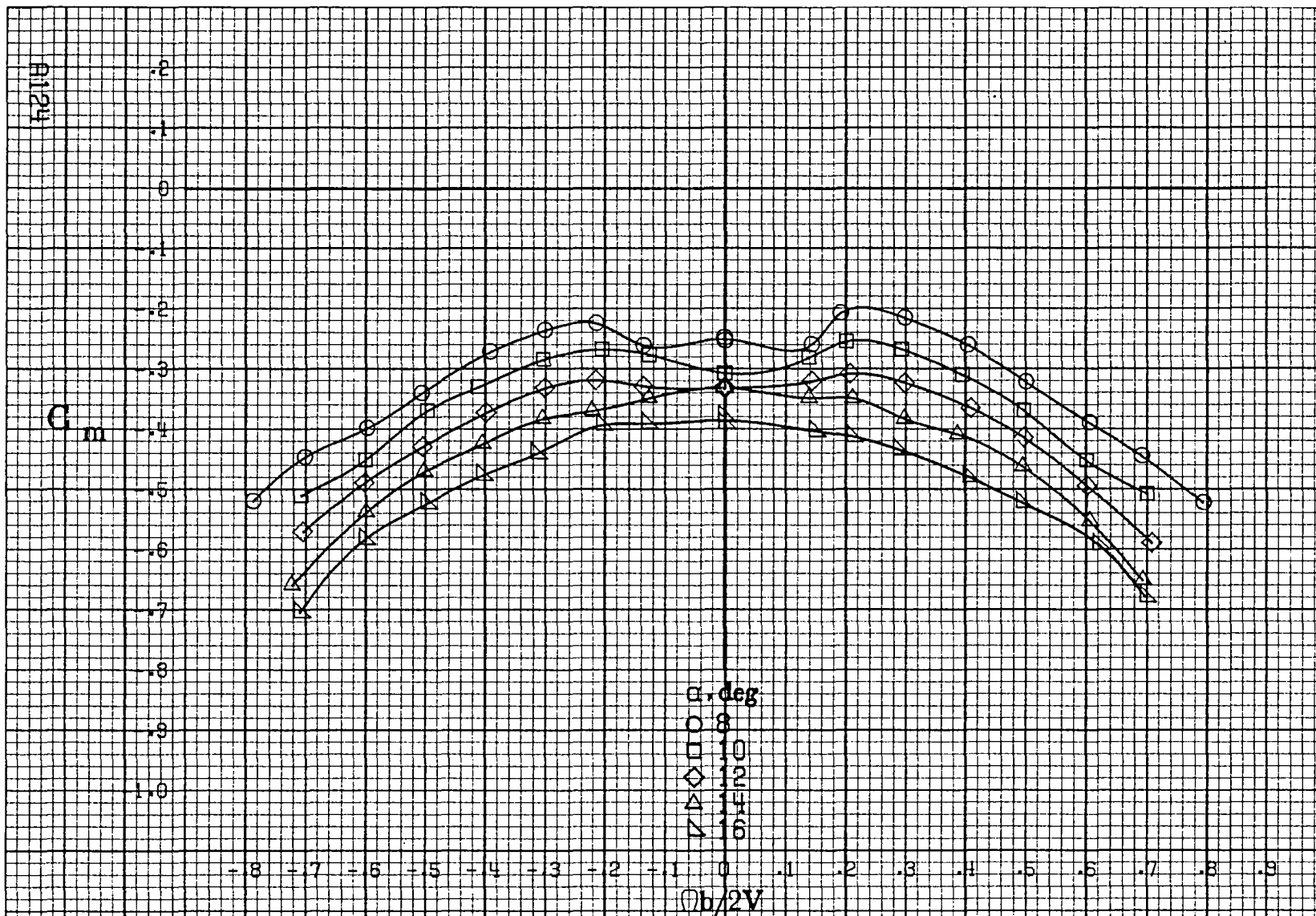

(a)  $\alpha = 8$  to  $16$  deg,  $SR = 182.9$  cm (72 in).

Figure A27. Effect of rotation rate and angle of attack on pitching-moment coefficient for T-tail configuration.  $\delta_e = 0^\circ$ ,  $\delta_a = 0^\circ$ ,  $\delta_r = 0^\circ$ ,  $\beta = 0^\circ$ .

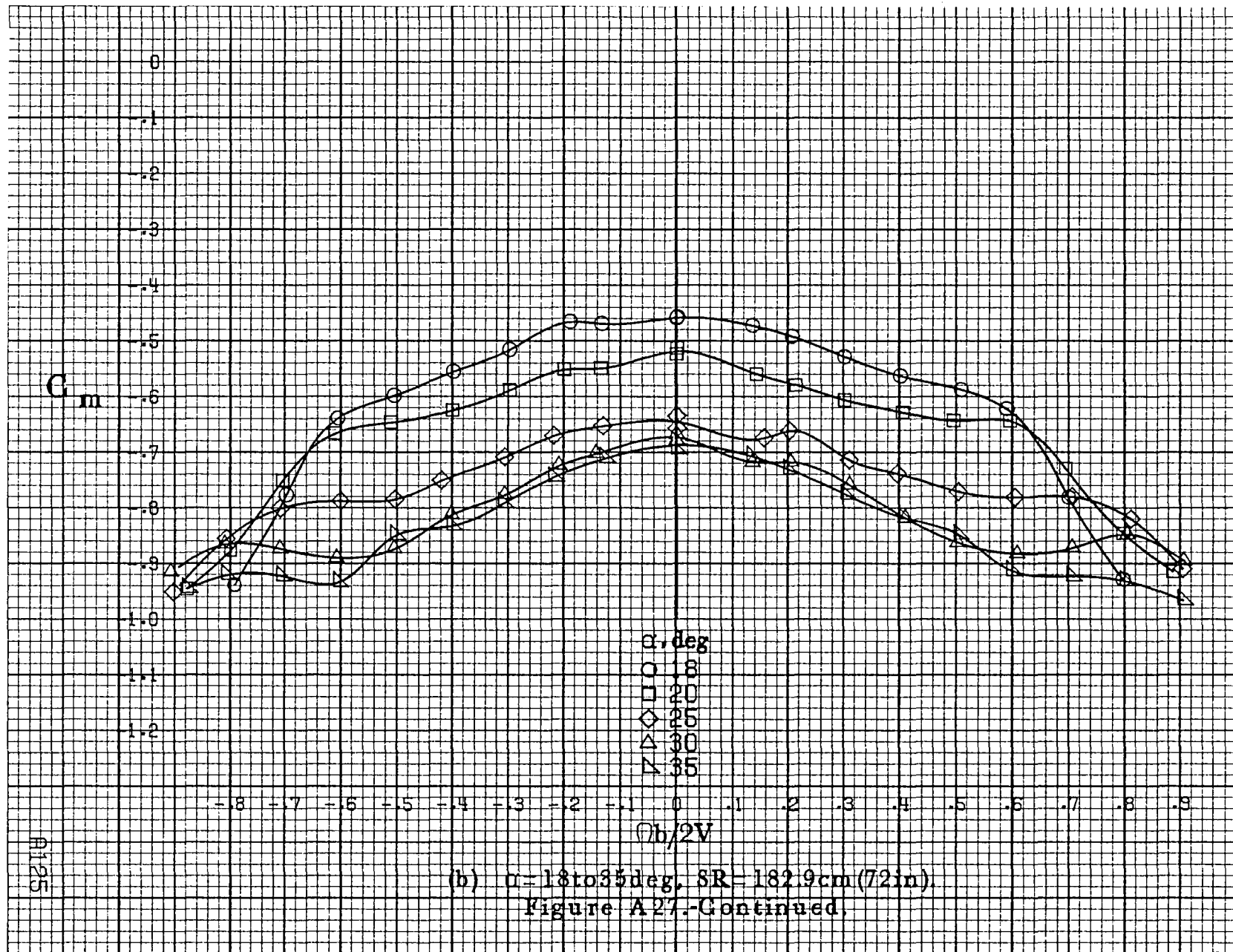

A125

(b)  $\alpha = 18$  to  $35$  deg,  $SR = 182.9$  cm (72 in).  
Figure A27.-Continued.



R1126

$C_m$

-.2  
-.3  
-.4  
-.5  
-.6  
-.7  
-.8  
-.9  
-1.0  
-1.1  
-1.2  
-1.3  
-1.4

-8 -7 -6 -5 -4 -3 -2 -1 0 .1 .2 .3 .4 .5 .6 .7 .8 .9

$\alpha, \text{deg}$   
 ○ 30  
 □ 35  
 ◇ 40  
 △ 45  
 ▽ 50

$b/2V$

(c)  $\alpha = 30 \text{ to } 50 \text{ deg}, SR = 0.$   
 Figure A27.-Continued.

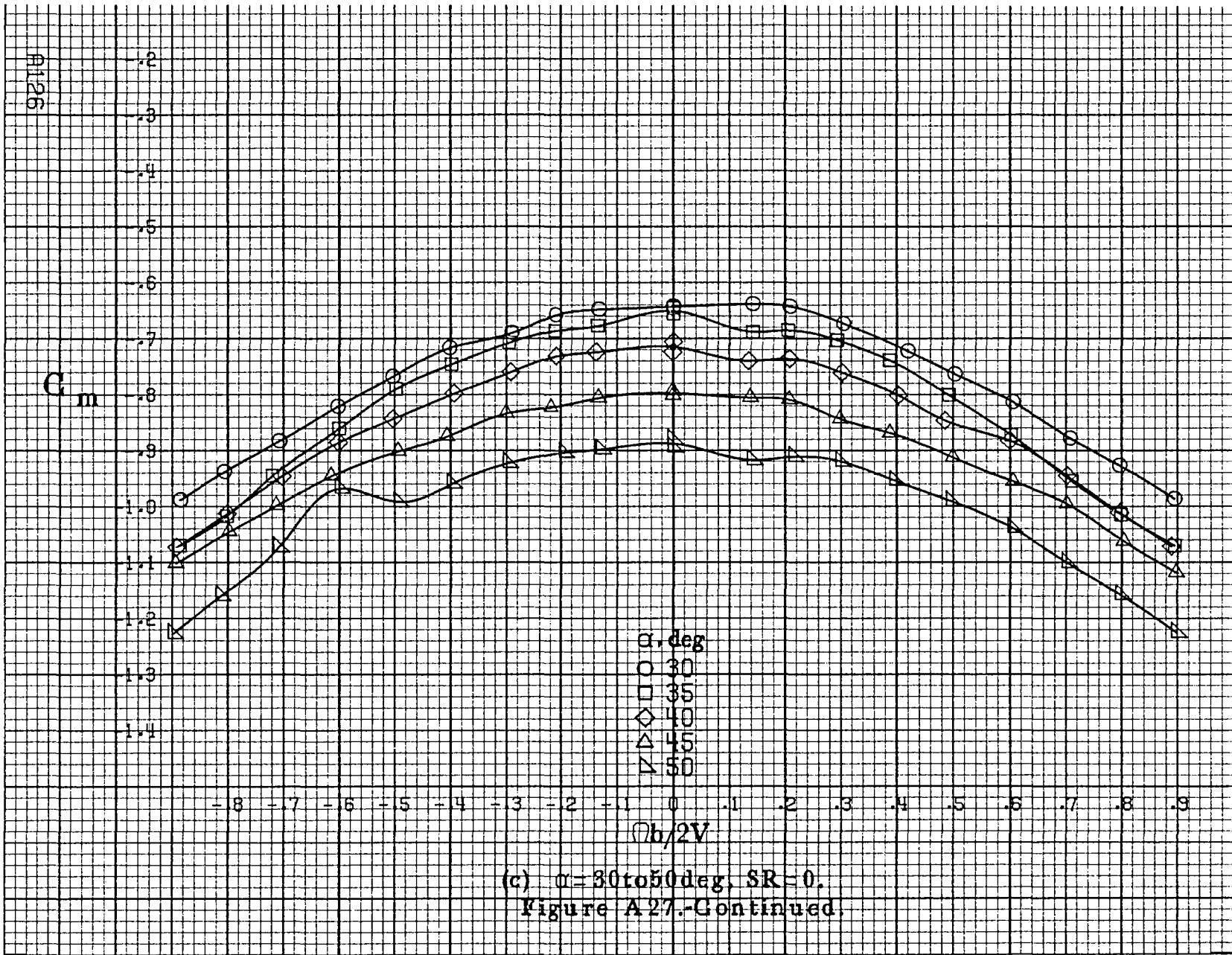



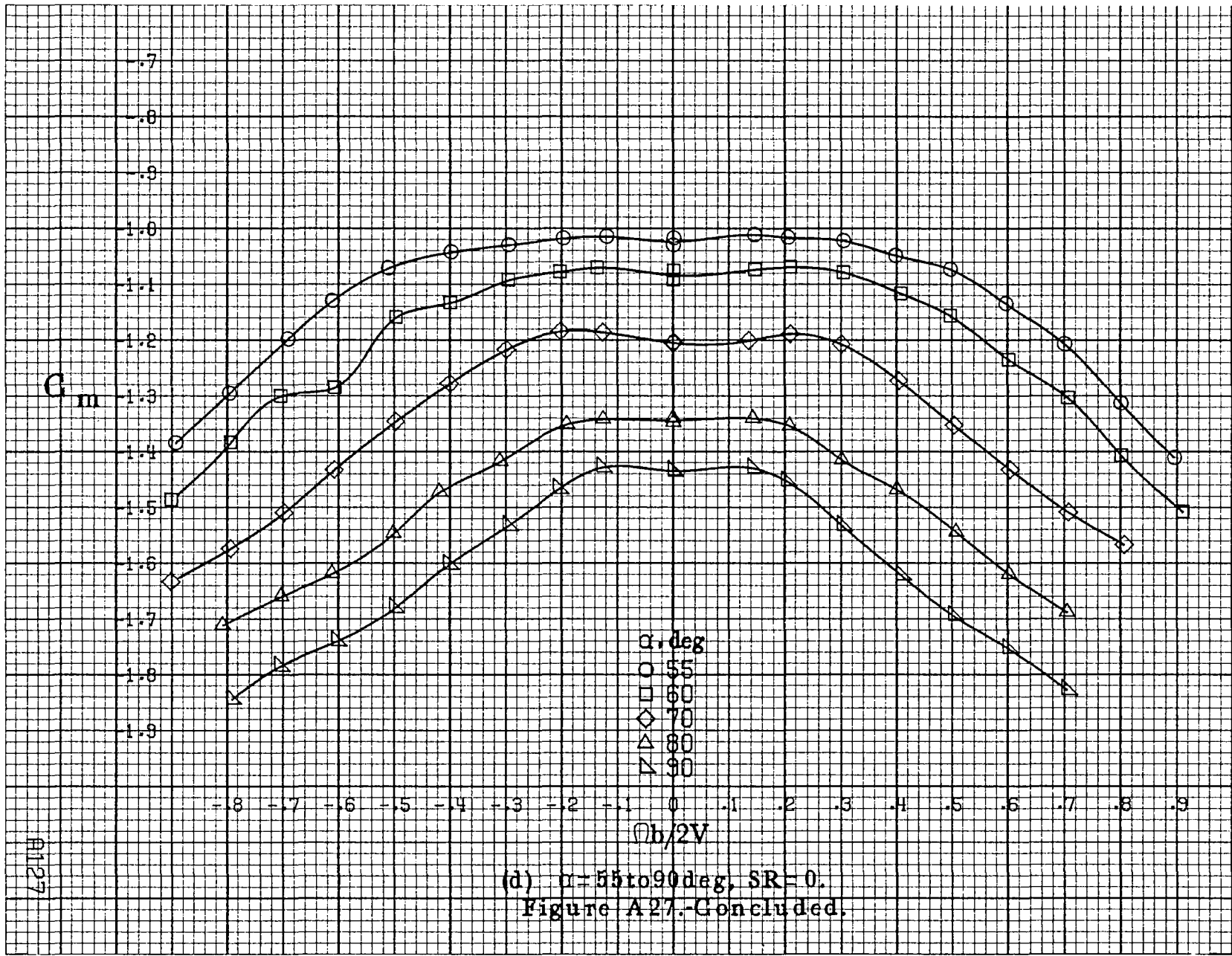

R128

$C_N$

2.2  
2.0  
1.8  
1.6  
1.4  
1.2  
1.0  
.8  
.6  
.4  
.2  
0  
.2

$\alpha$ , deg  
○ 8  
□ 10  
◇ 12  
△ 14  
▽ 16

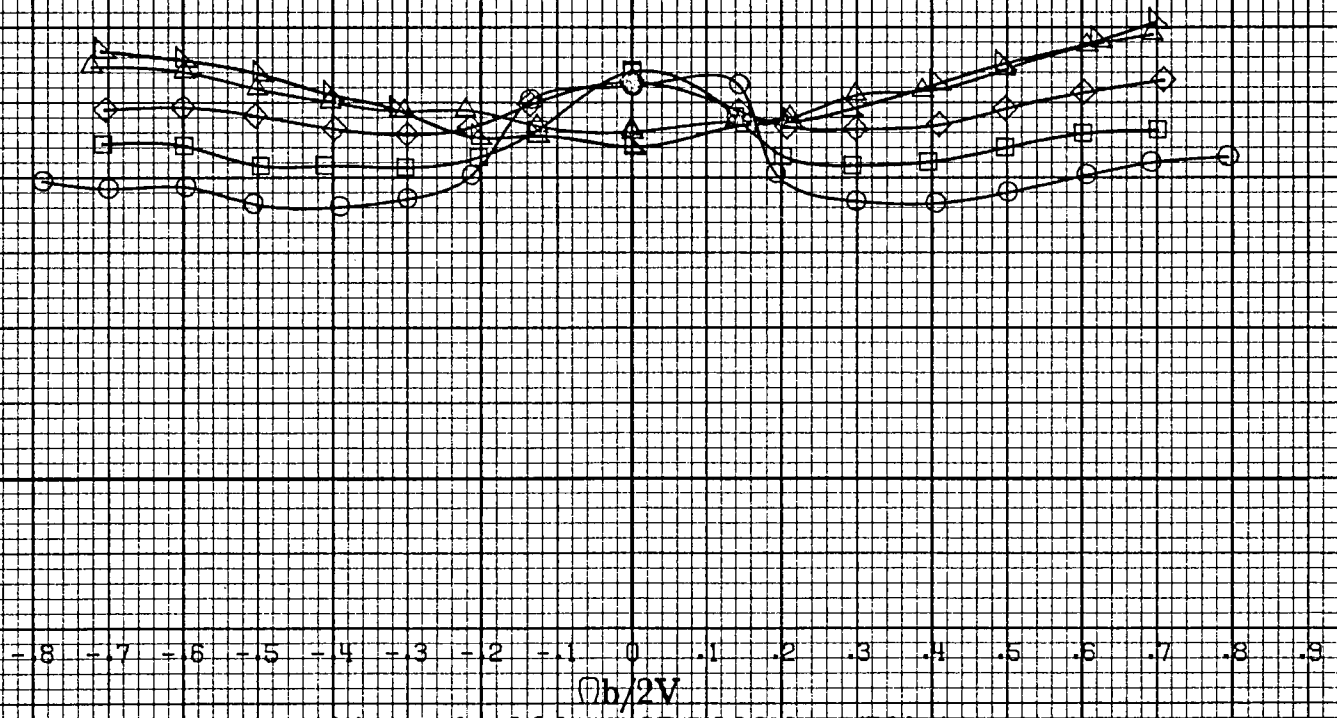

(a)  $\alpha = 8$  to  $16$  deg,  $SR = 182.9$  cm (72 in).

Figure A28. Effect of rotation rate and angle of attack on normal-force coefficient for T-tail configuration.  $\delta_r = 0^\circ$ ,  $\delta_a = 0^\circ$ ,  $\delta_z = 0^\circ$ ,  $\beta = 0^\circ$ .

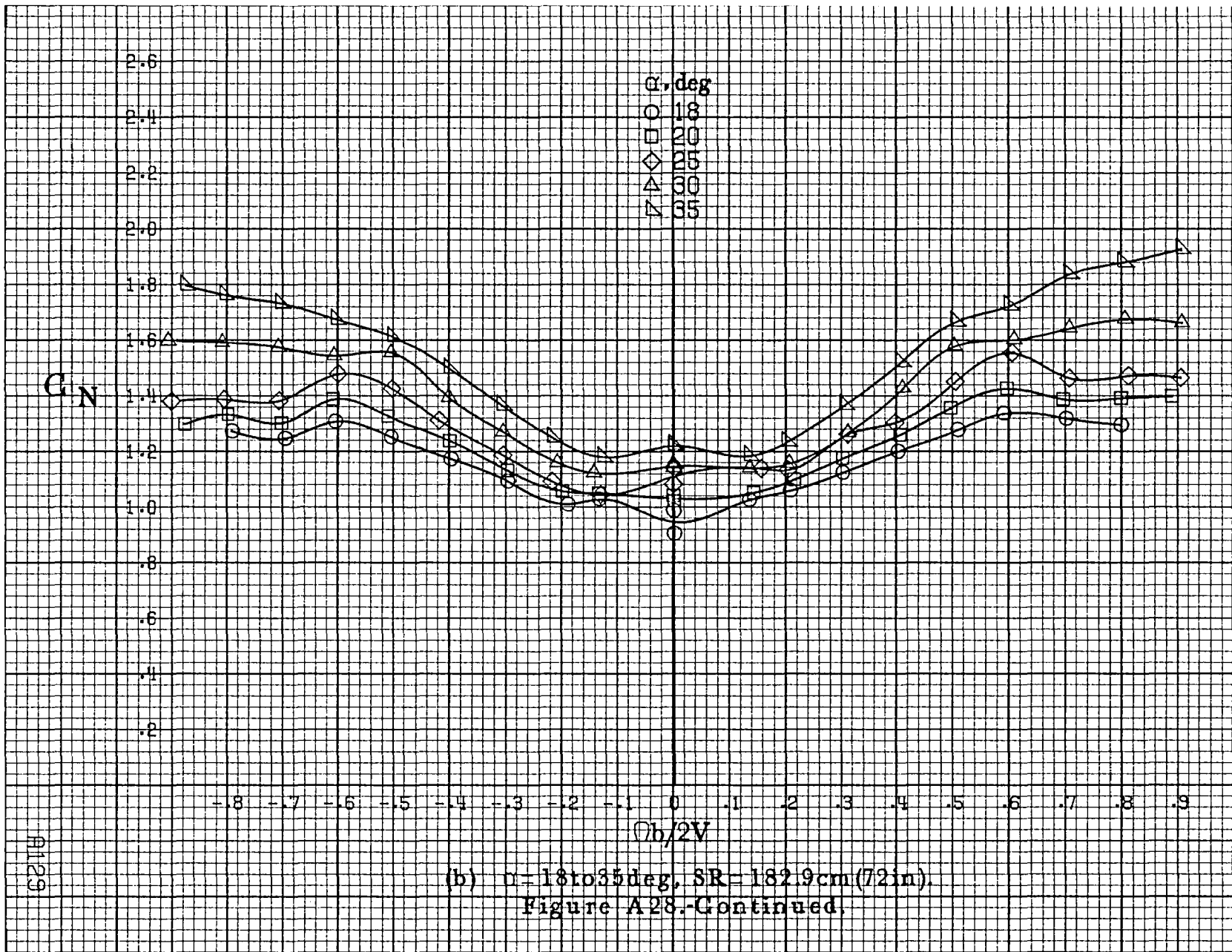

(b)  $\alpha = 18$  to  $35$  deg,  $SR = 182.9$  cm (72 in).  
 Figure A28.-Continued.

R129

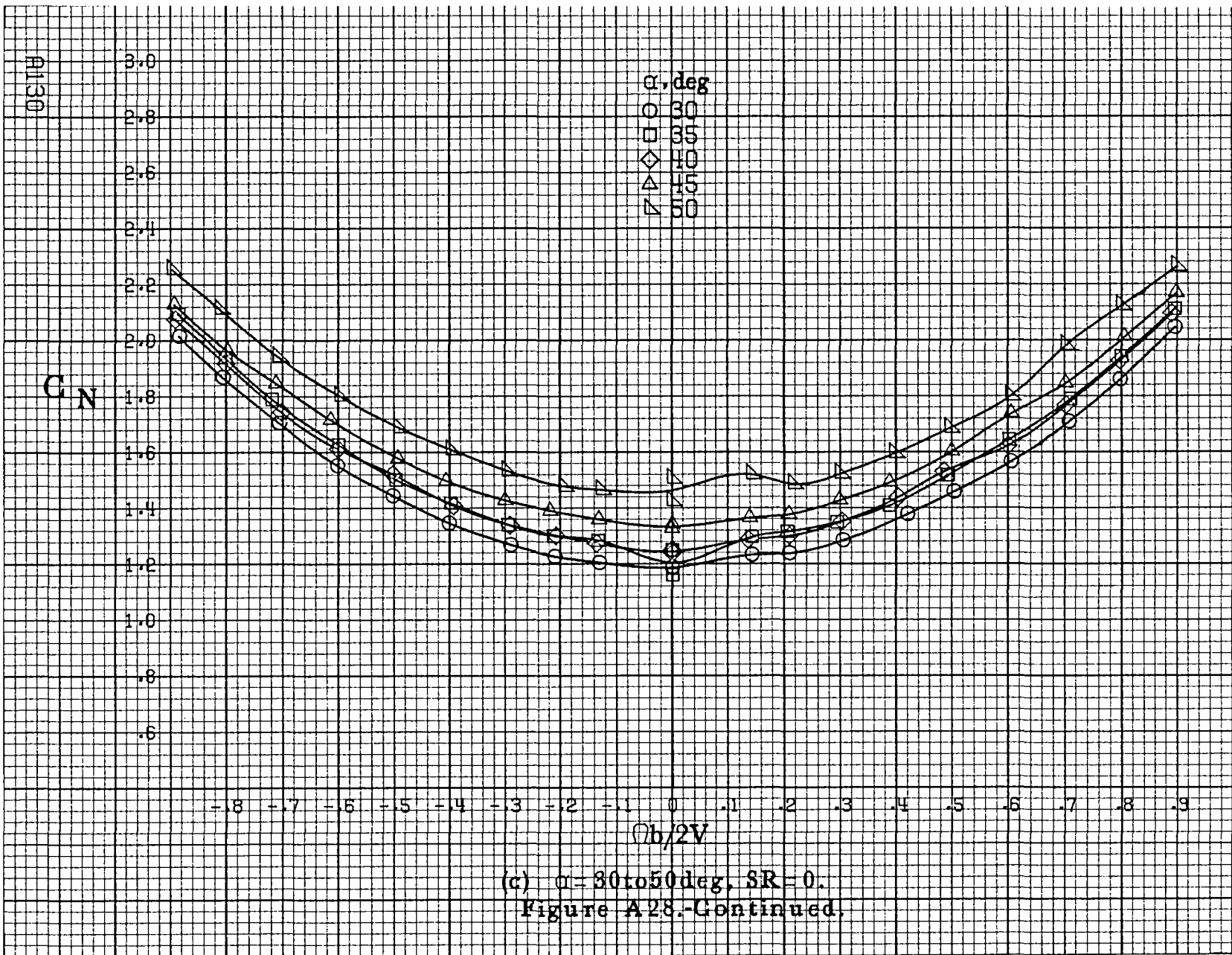

(c)  $\alpha=30$  to  $50$  deg,  $SR=0$ .  
 Figure A28.-Continued.



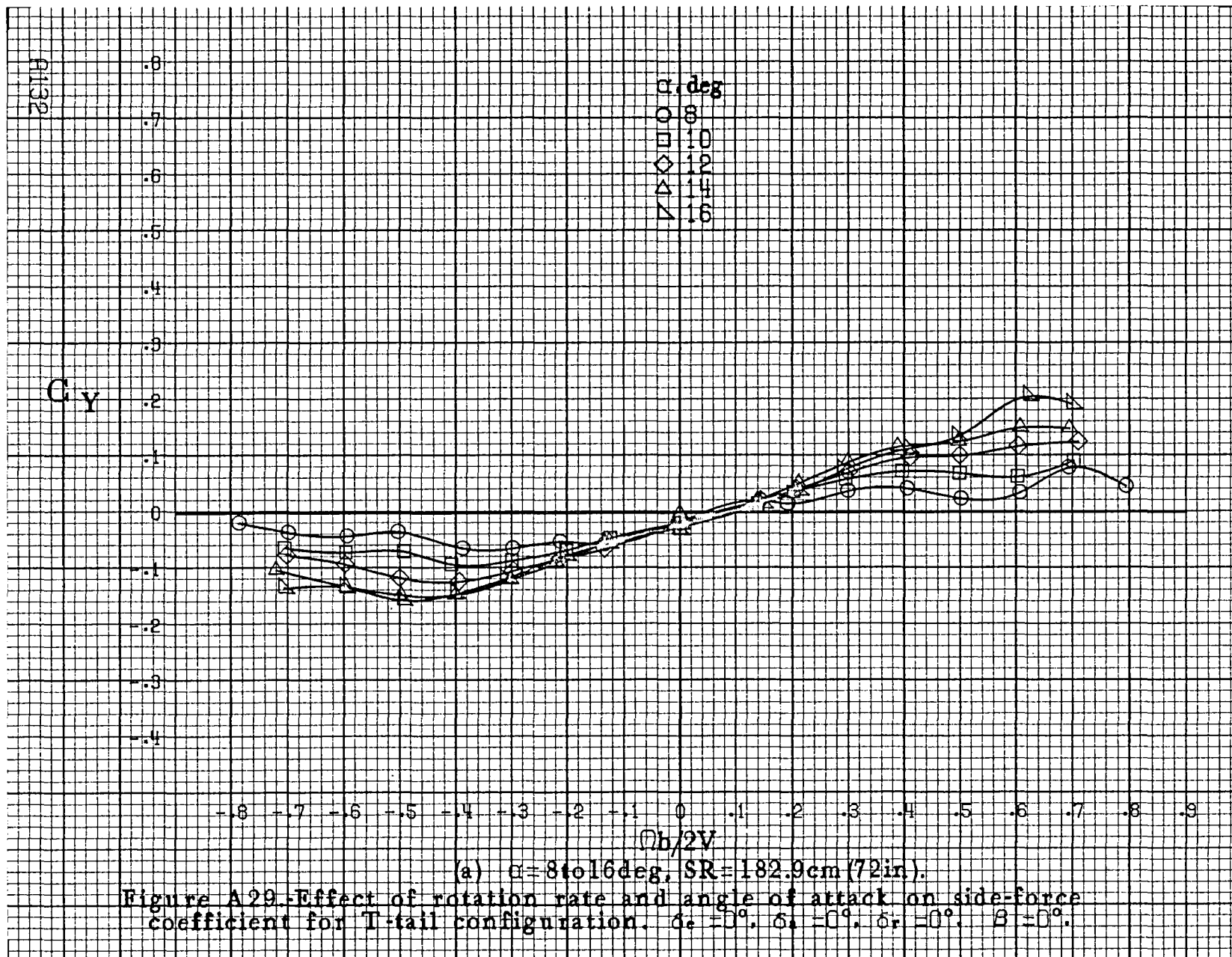

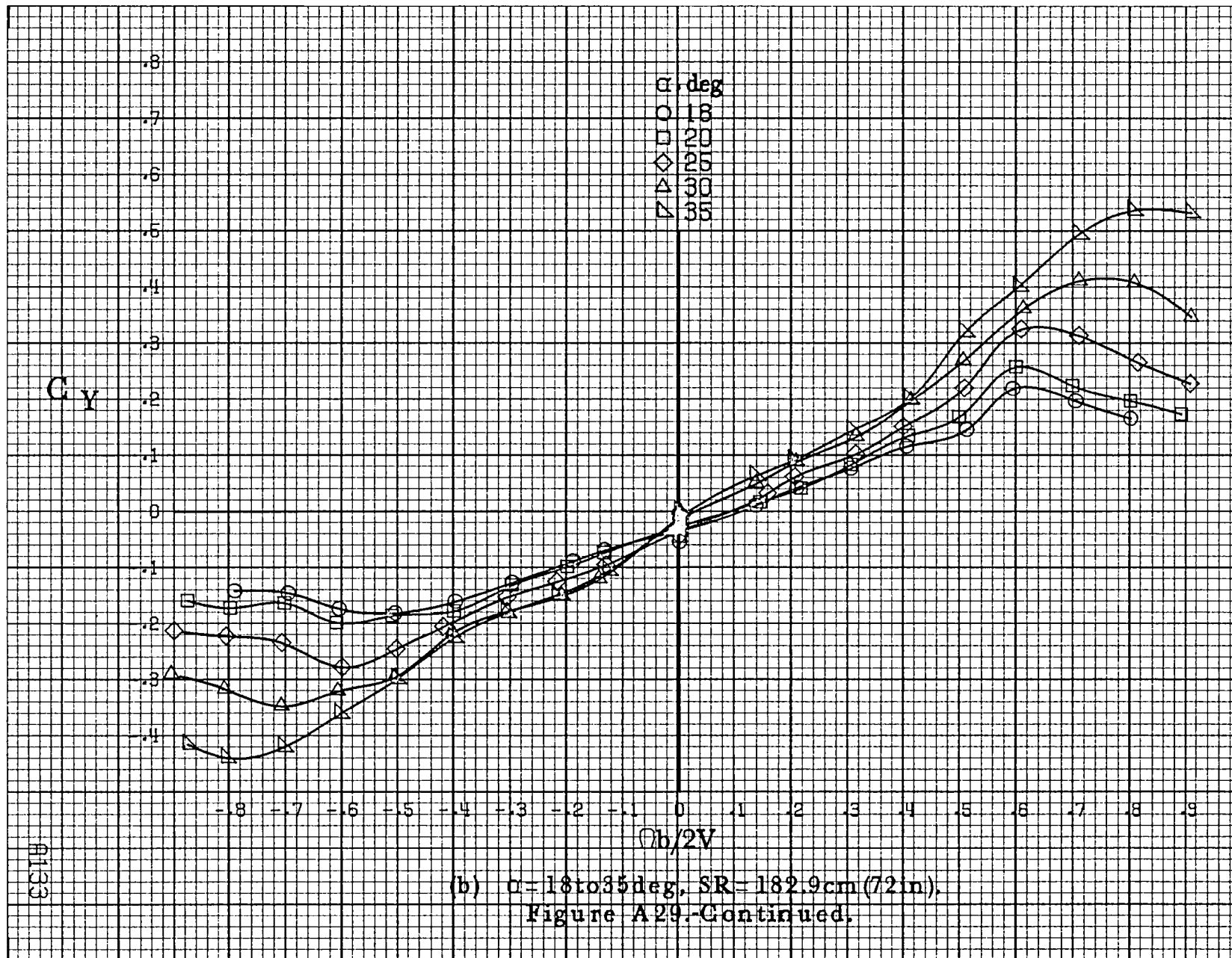

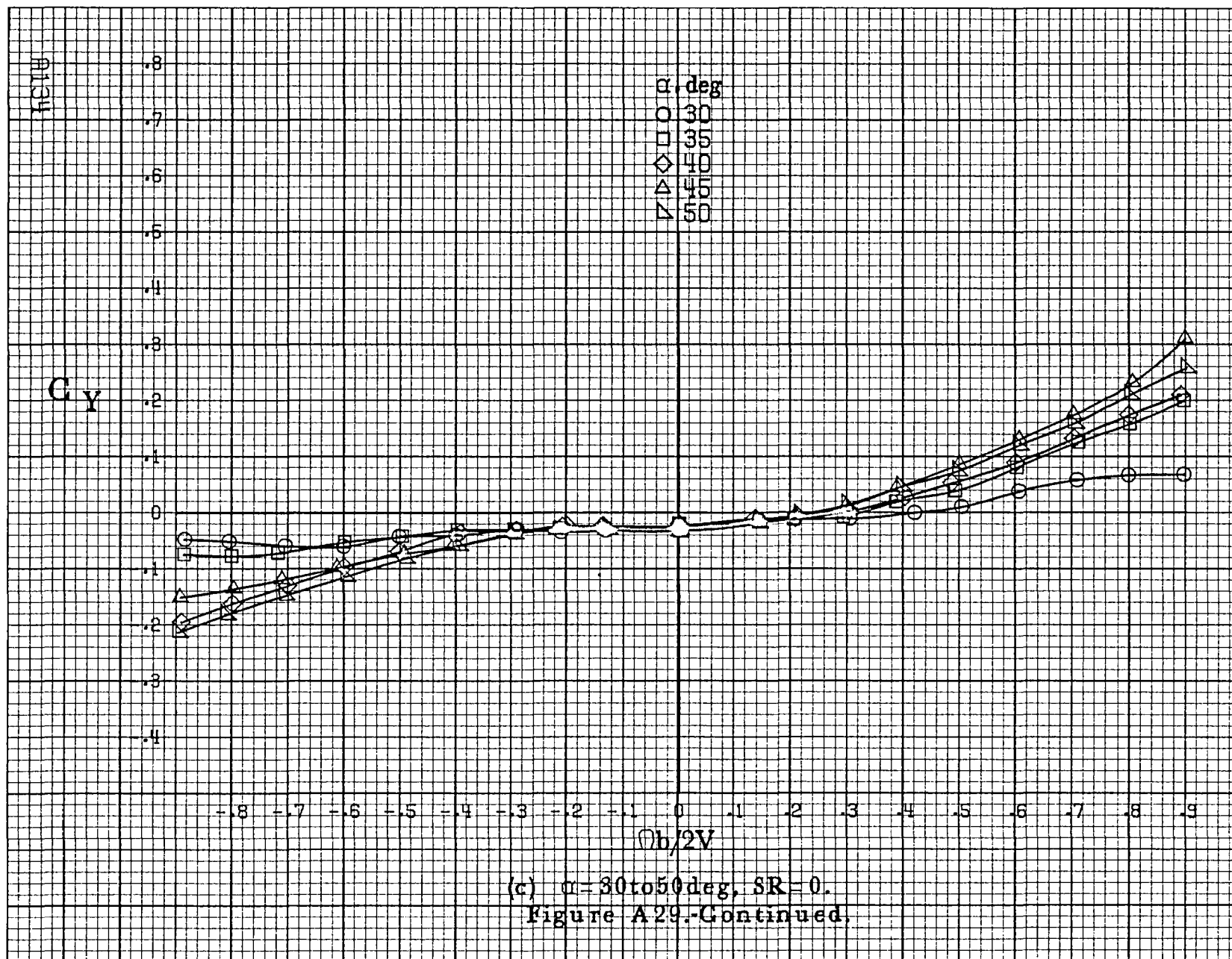



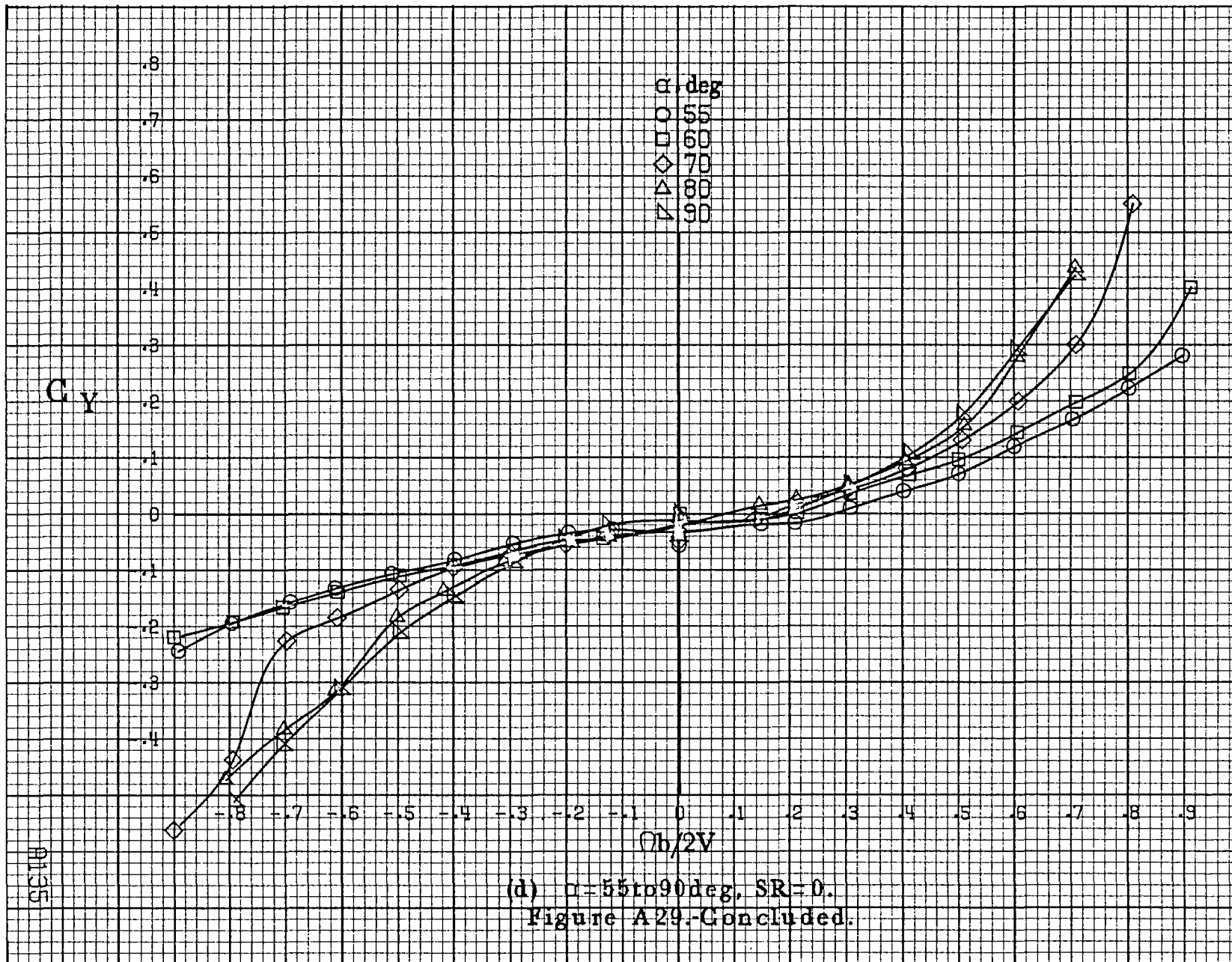

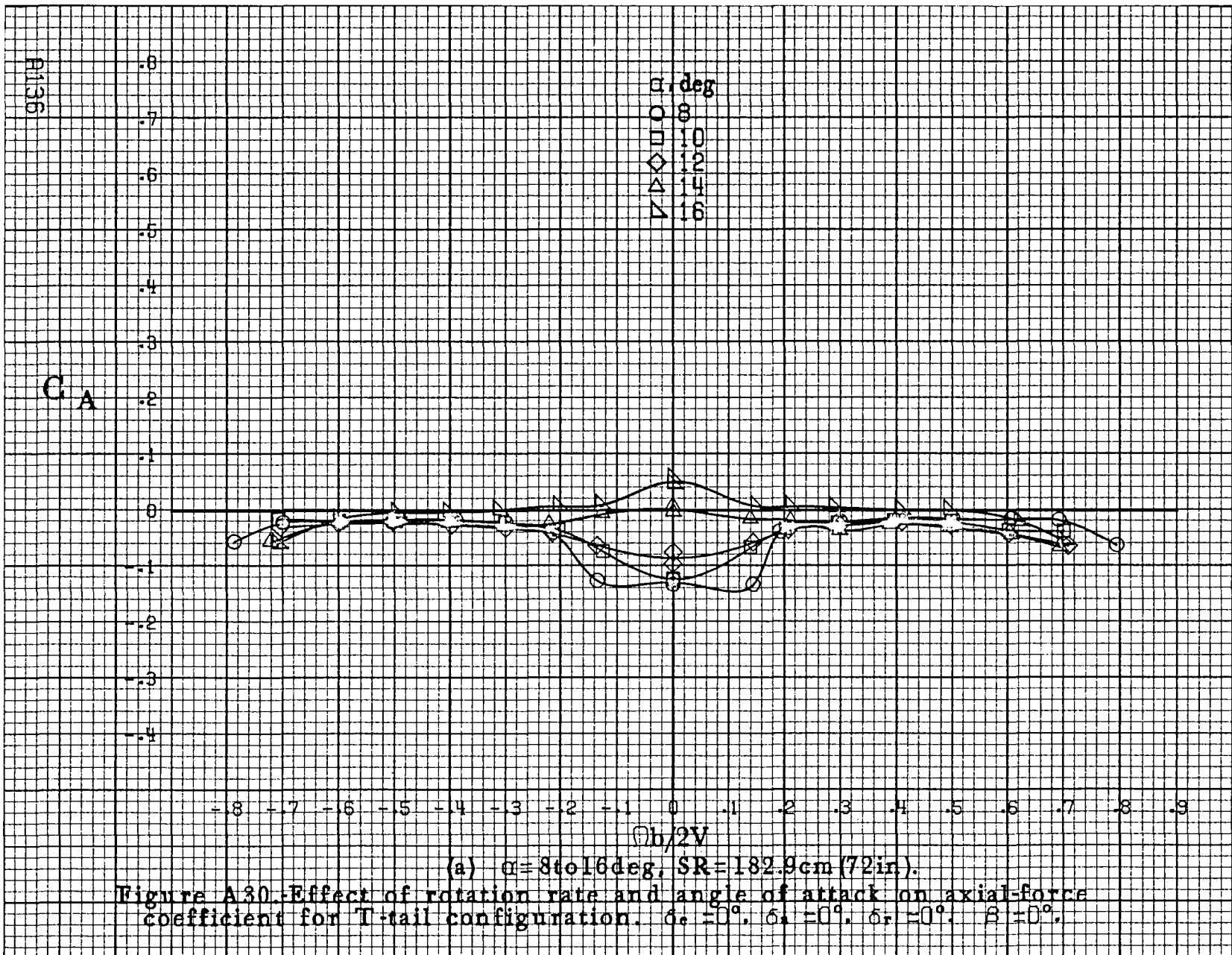

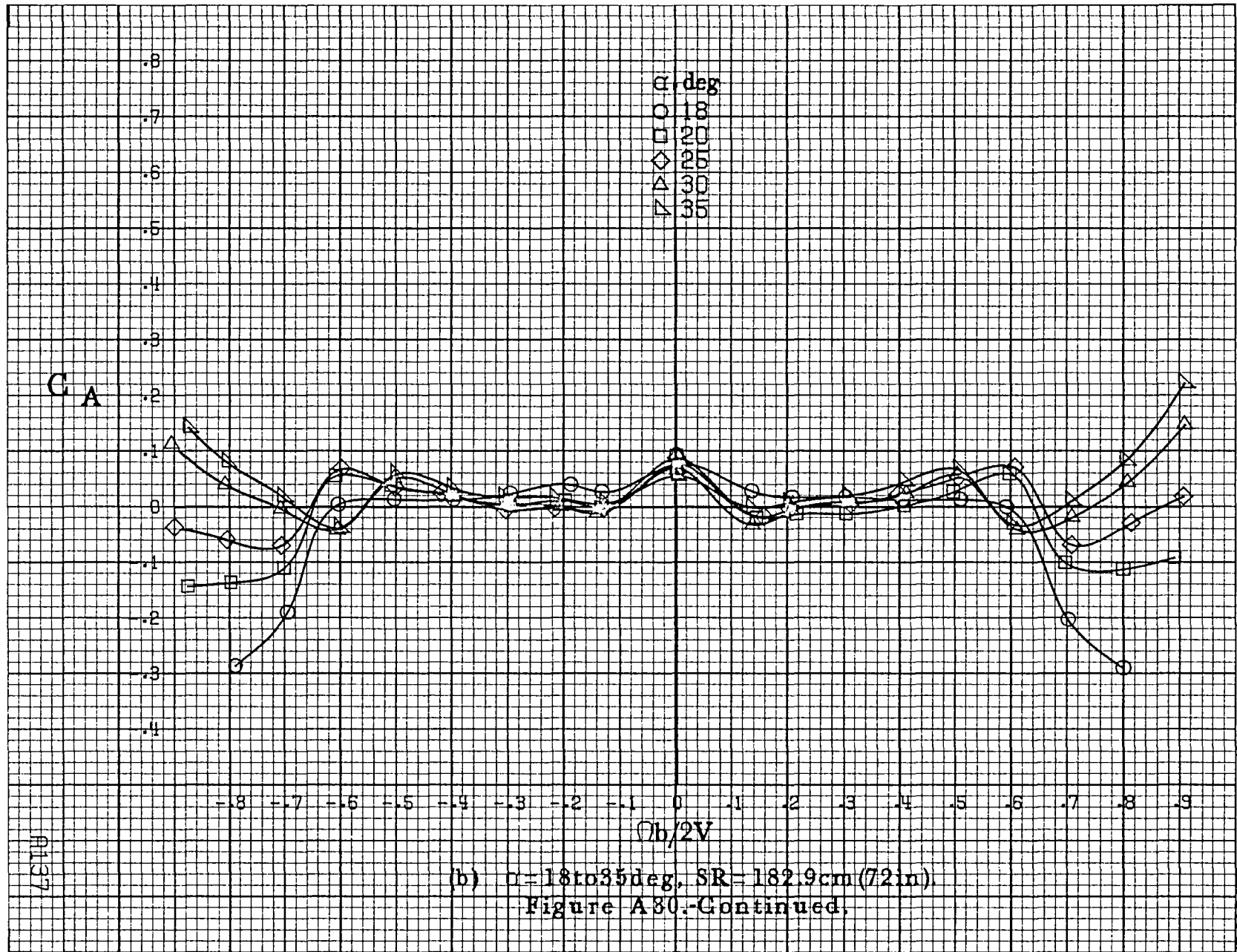

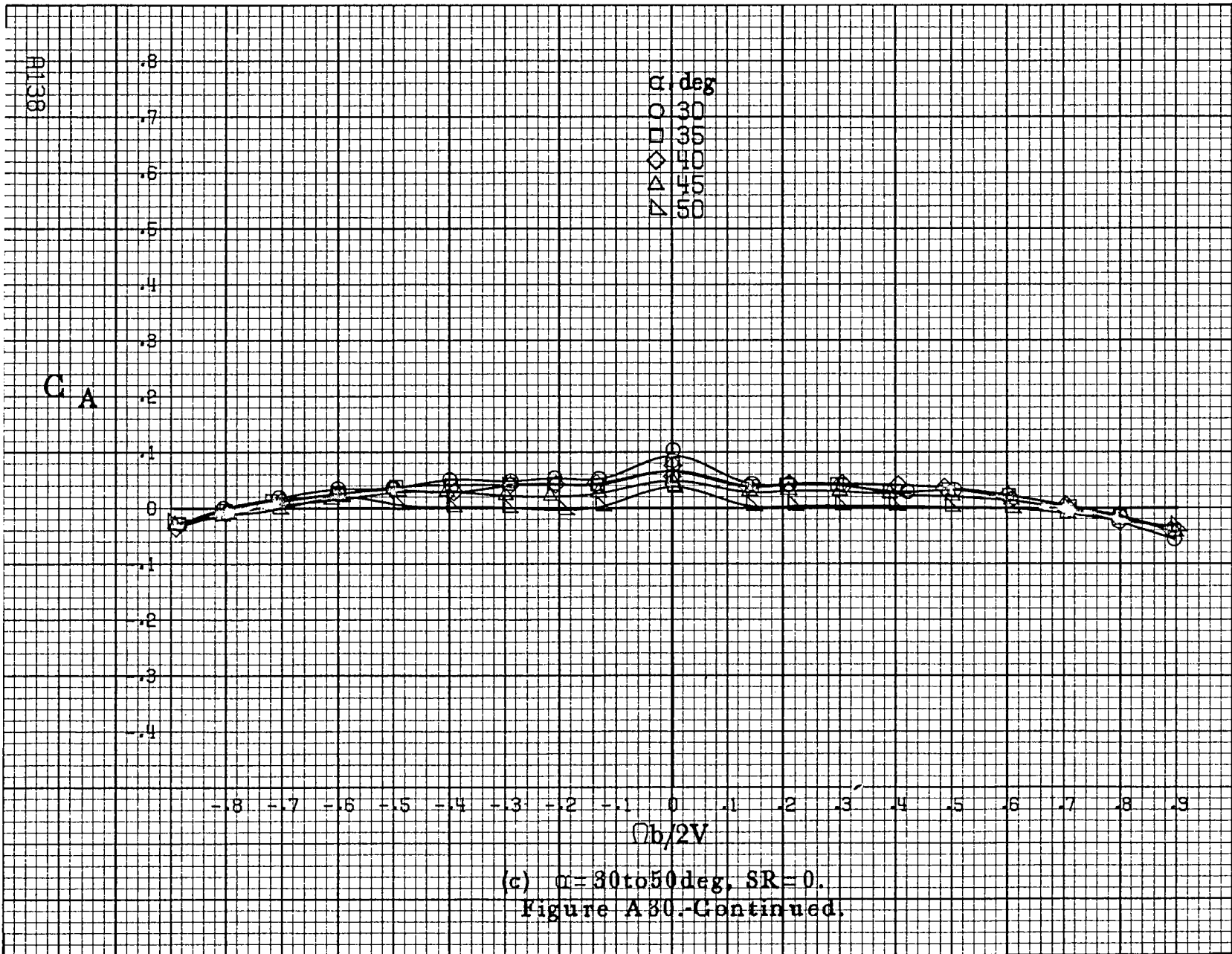

(c)  $\alpha=30$  to  $50$  deg,  $SR=0$ .  
 Figure A 30.-Continued.

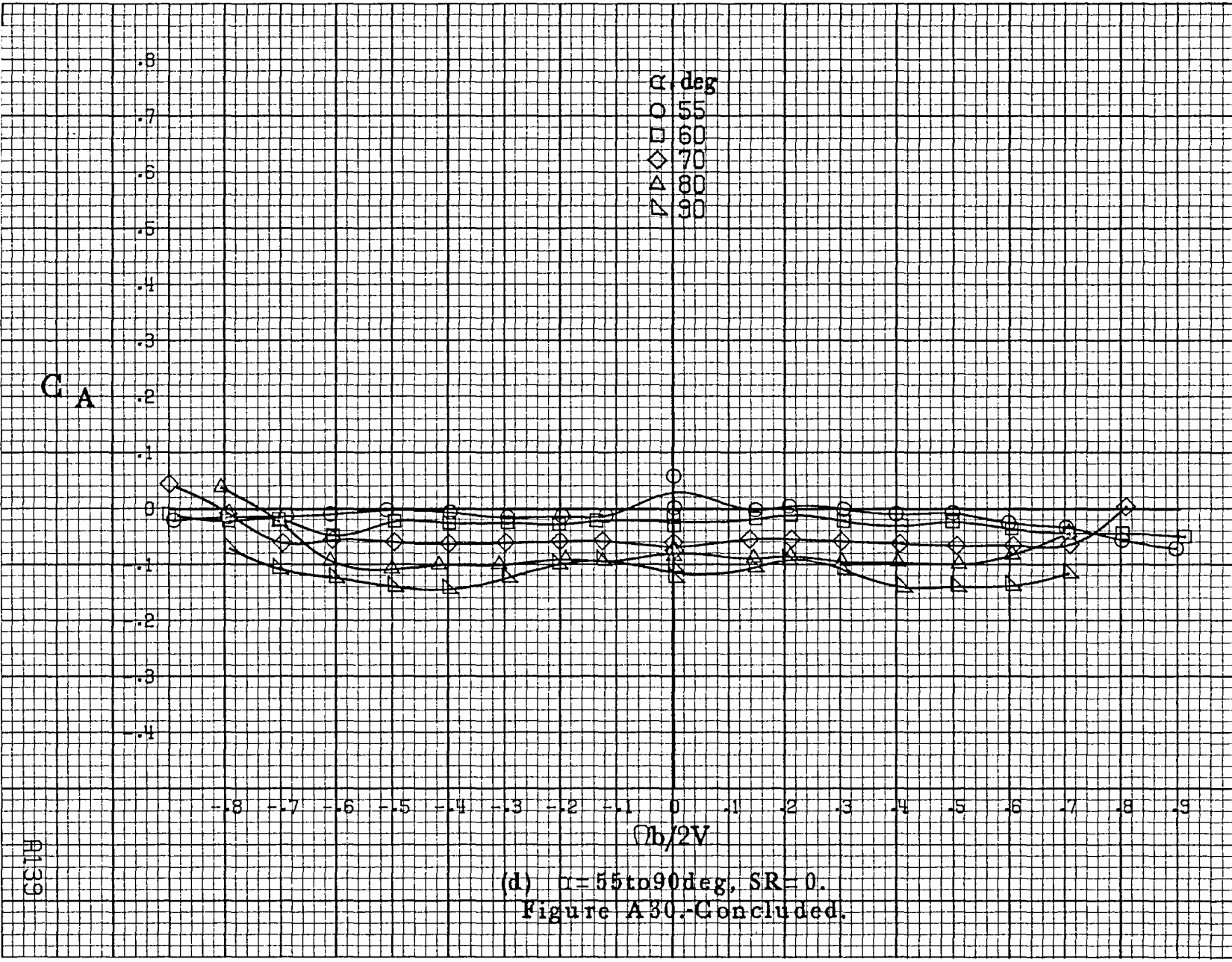

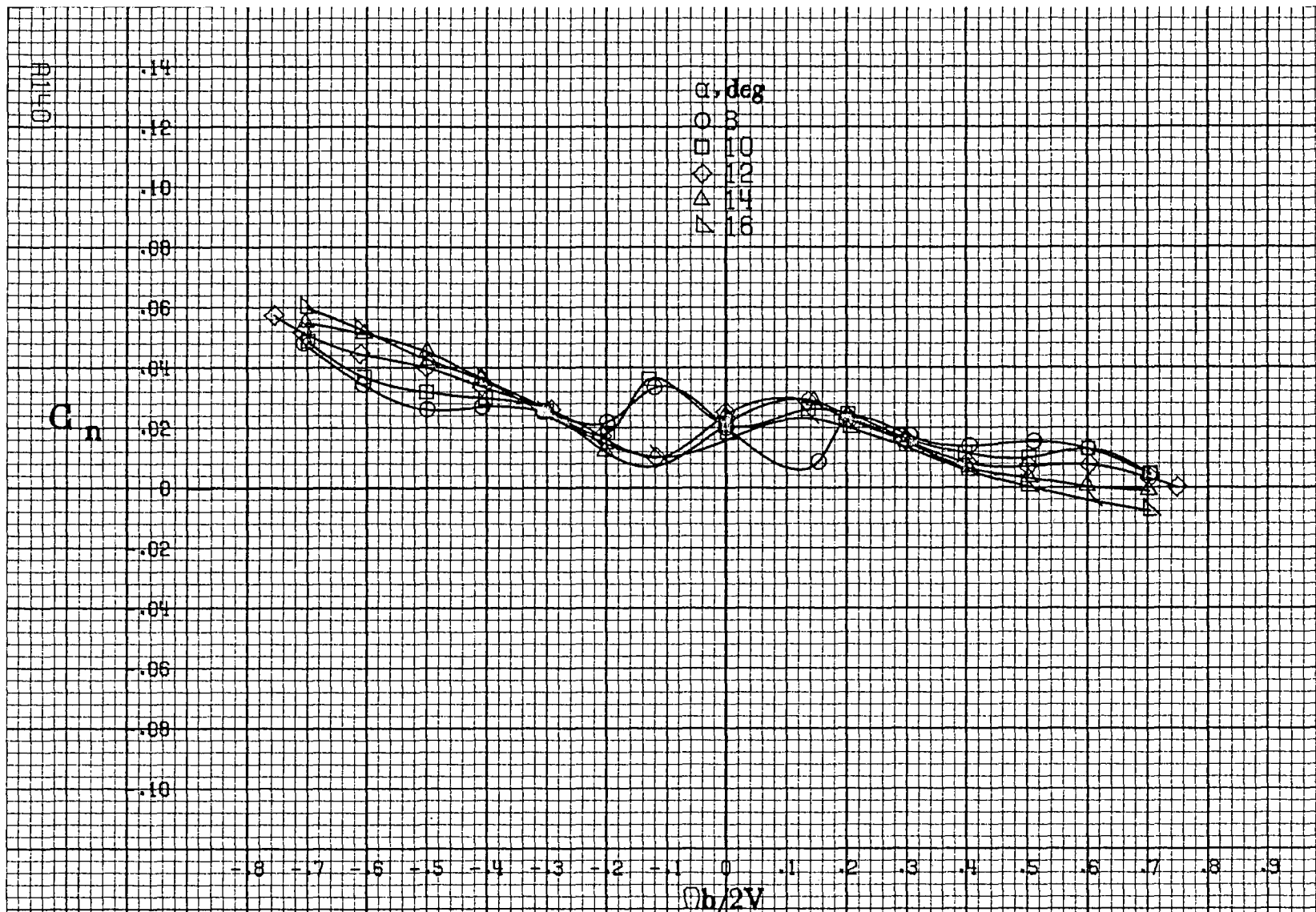

(a)  $\alpha = 8$  to  $16$  deg,  $SR = 182.9$  cm (72 in).

Figure A31.-Effect of rotation rate and angle of attack on yawing-moment coefficient for T-tail configuration.  $\delta_e = -15^\circ$ ,  $\delta_n = 0^\circ$ ,  $\delta_r = -25^\circ$ ,  $\beta = 0^\circ$ .

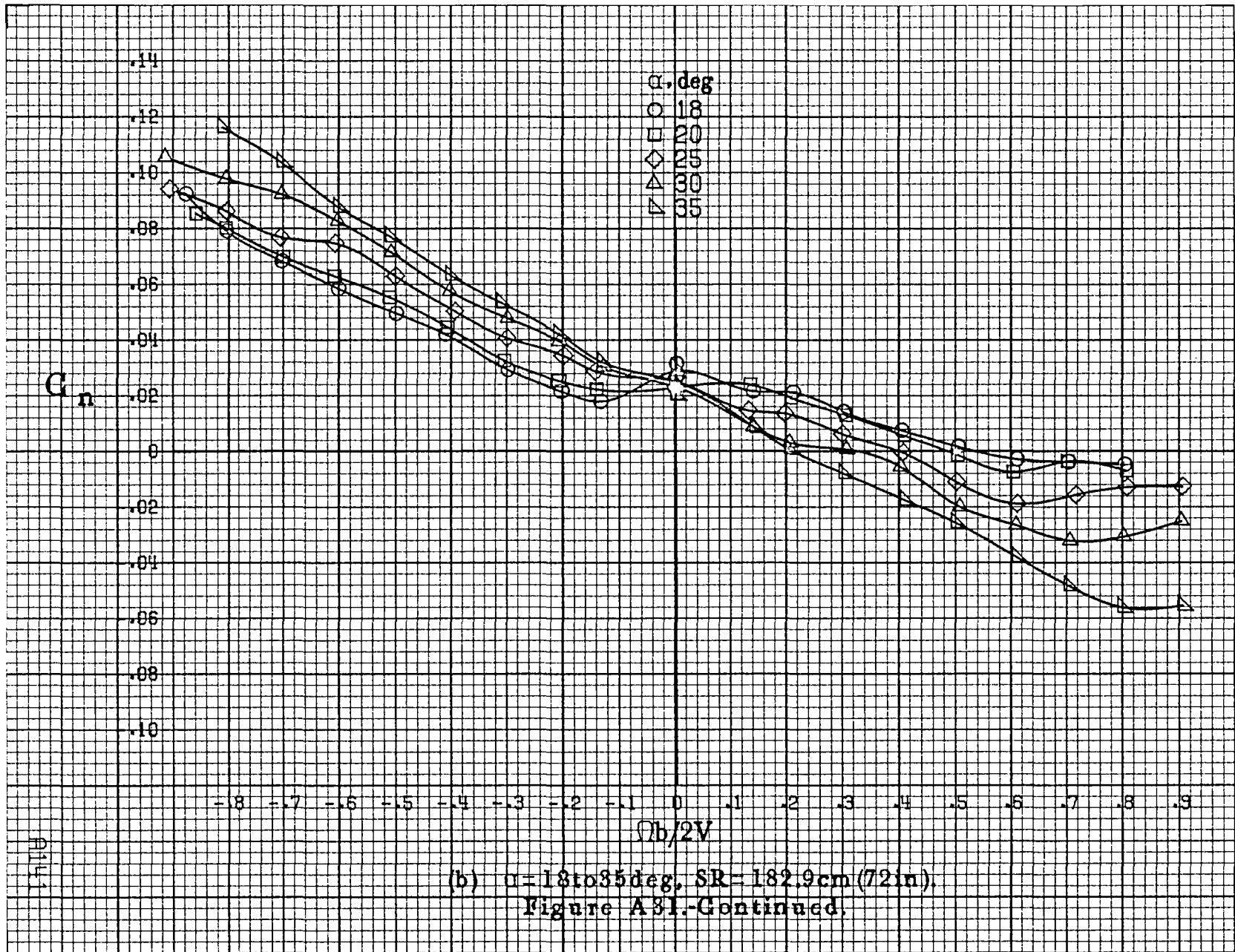

(b)  $\alpha = 18$  to  $35$  deg,  $SR = 182.9$  cm (72 in).  
 Figure A31-Continued.

A1147

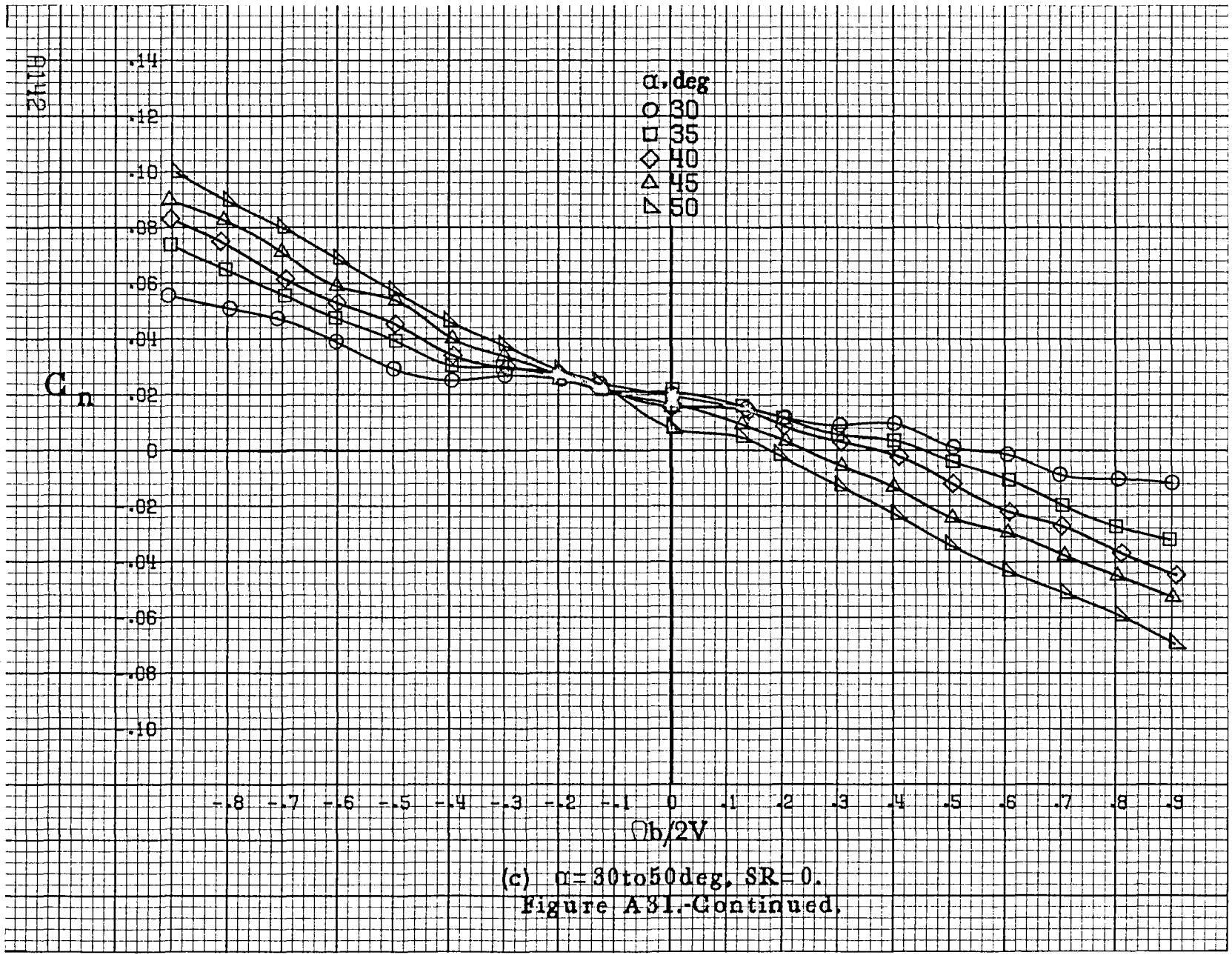

(c)  $\alpha = 30$  to  $50$  deg,  $SR = 0$ .  
 Figure A31.-Continued.



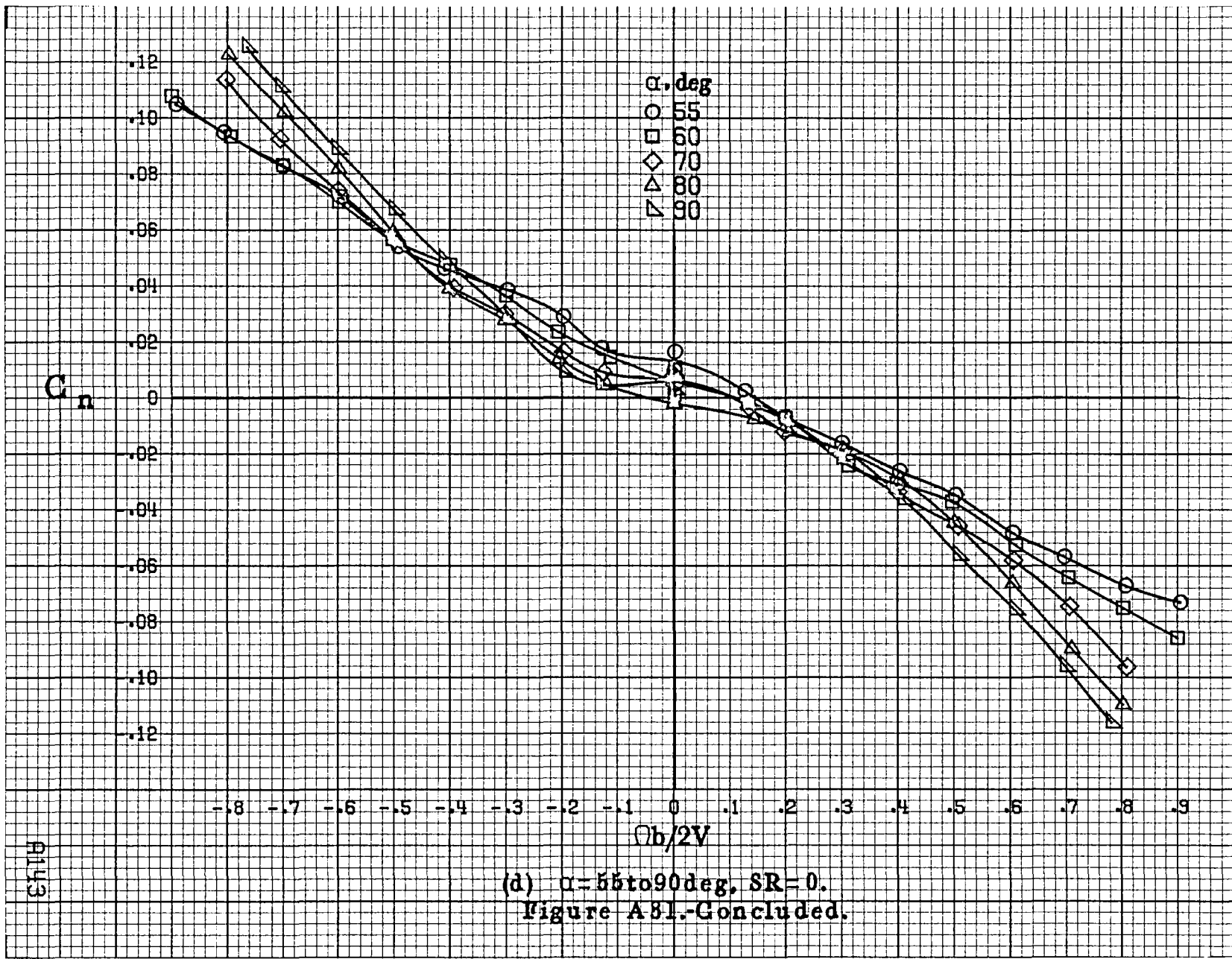

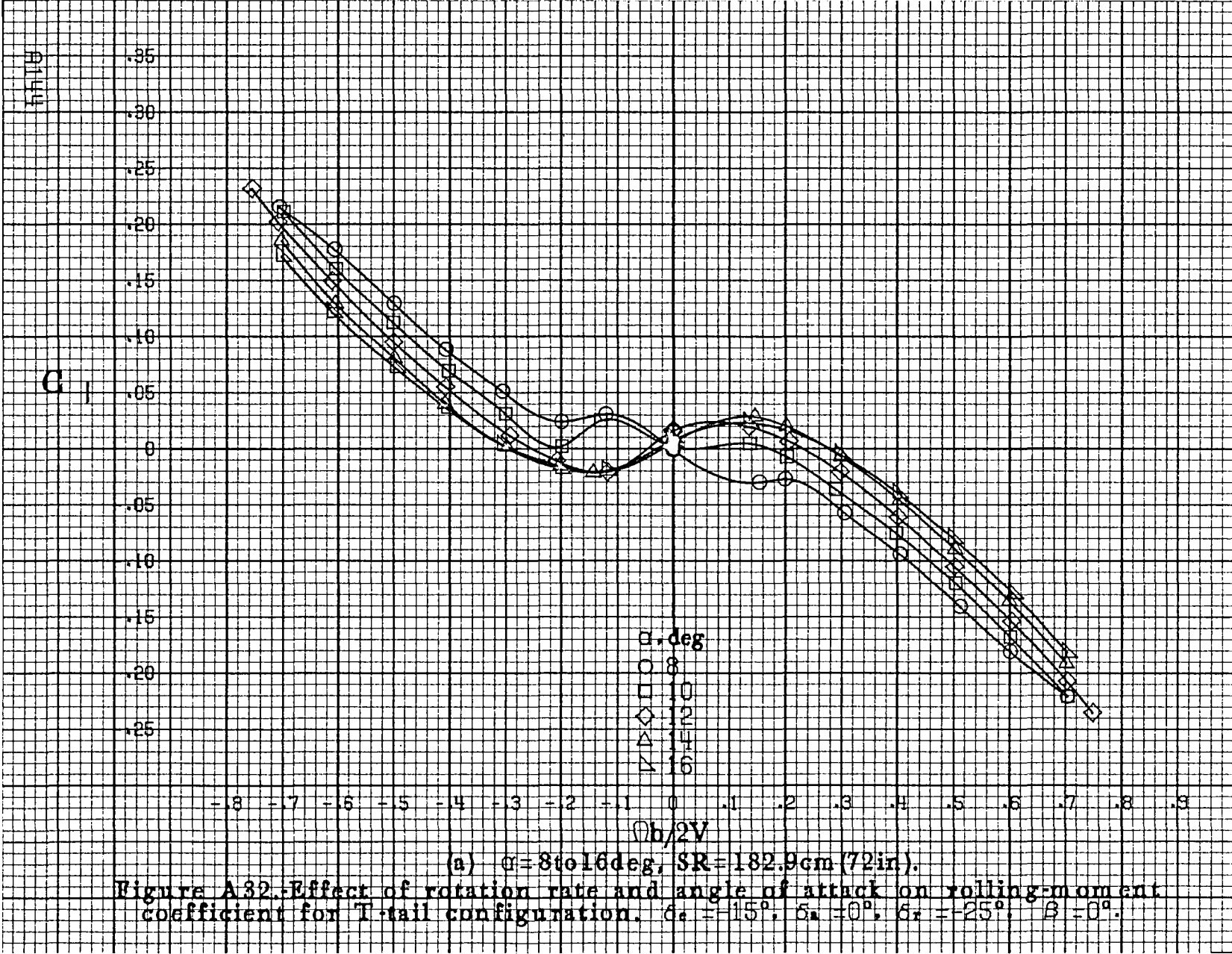

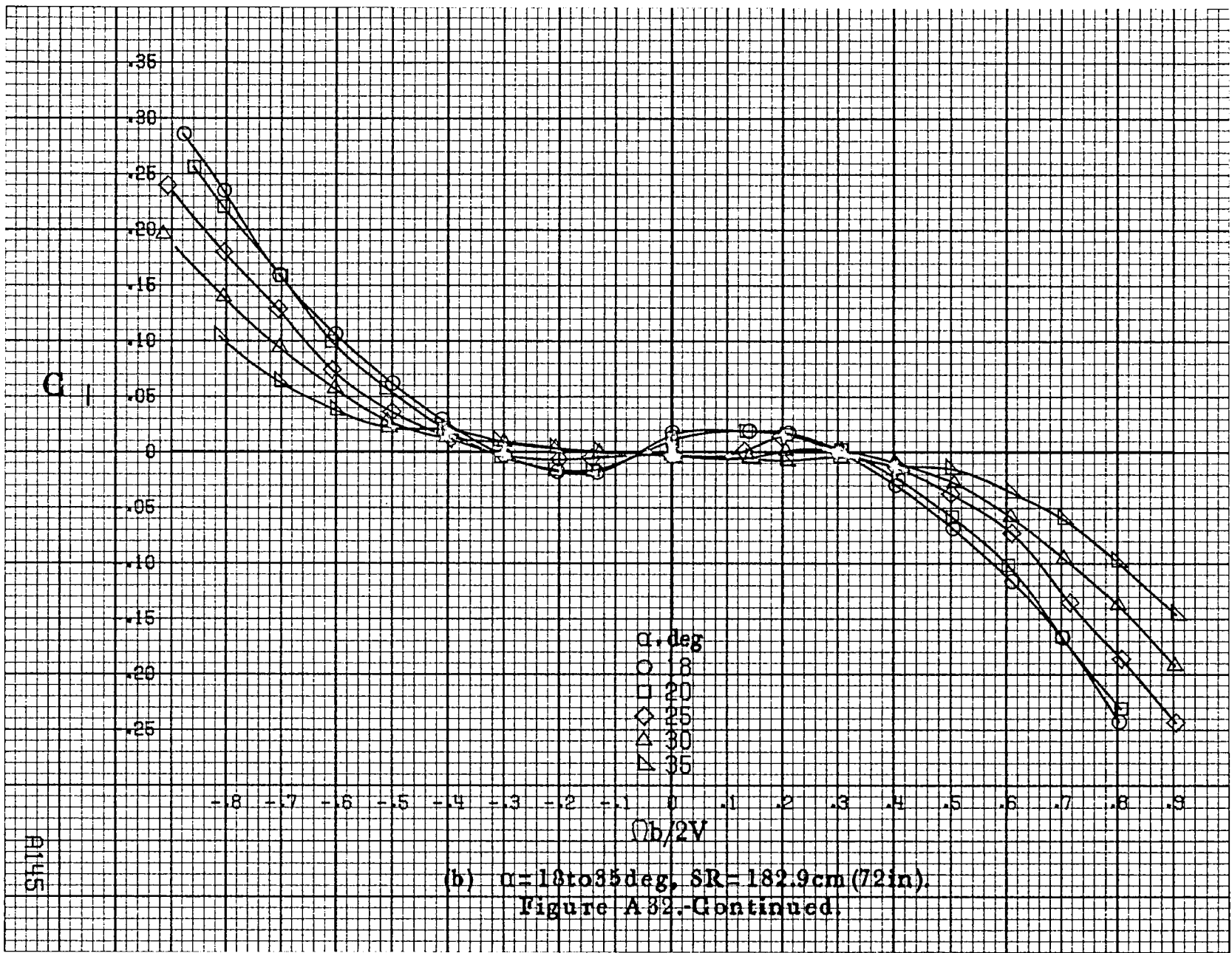

(b)  $\alpha = 18$  to  $35$  deg,  $SR = 182.9$  cm (72 in).  
 Figure A 82.-Continued.

ATLAS

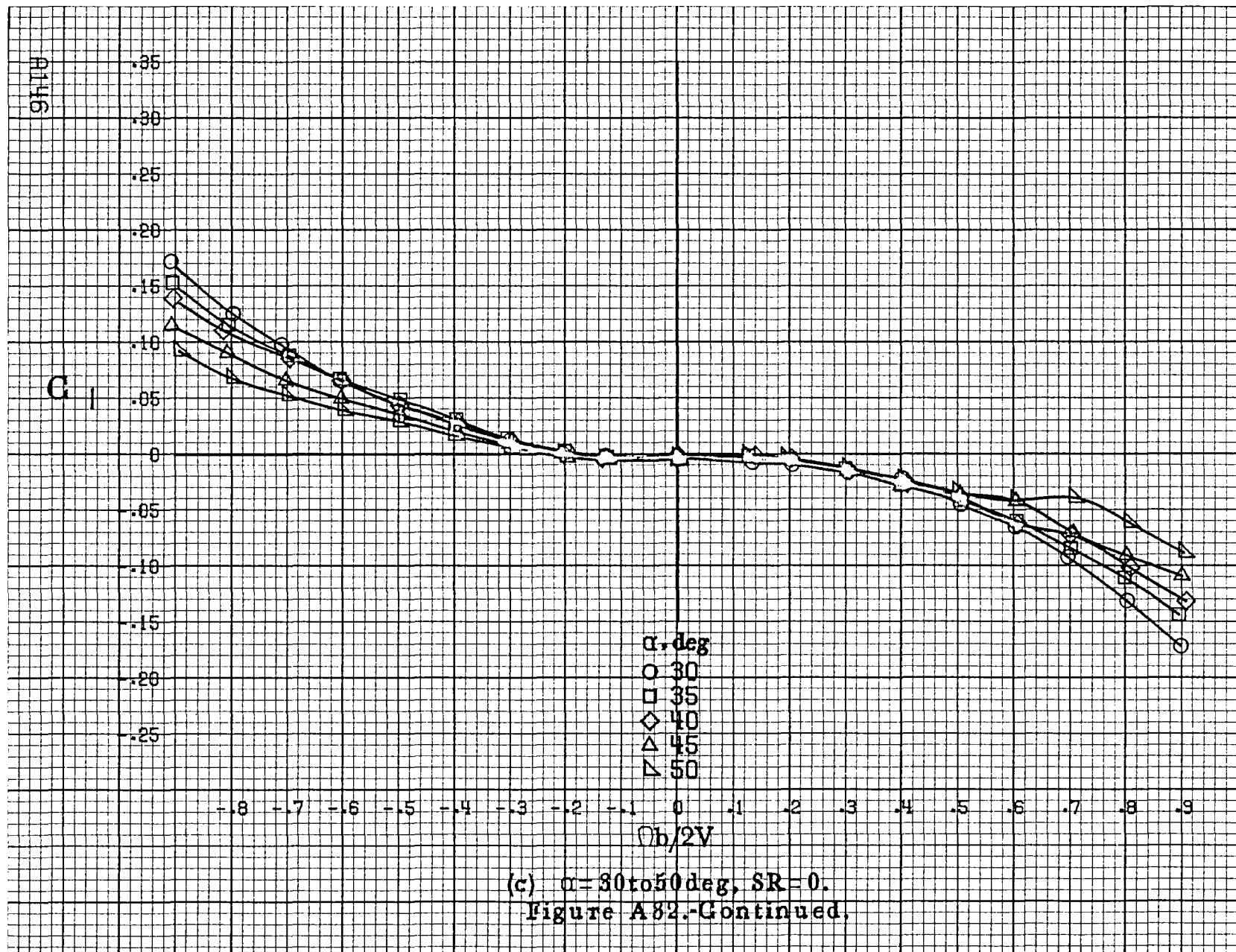

(c)  $\alpha = 30$  to  $50$  deg,  $SR = 0$ .  
 Figure A82.-Continued.

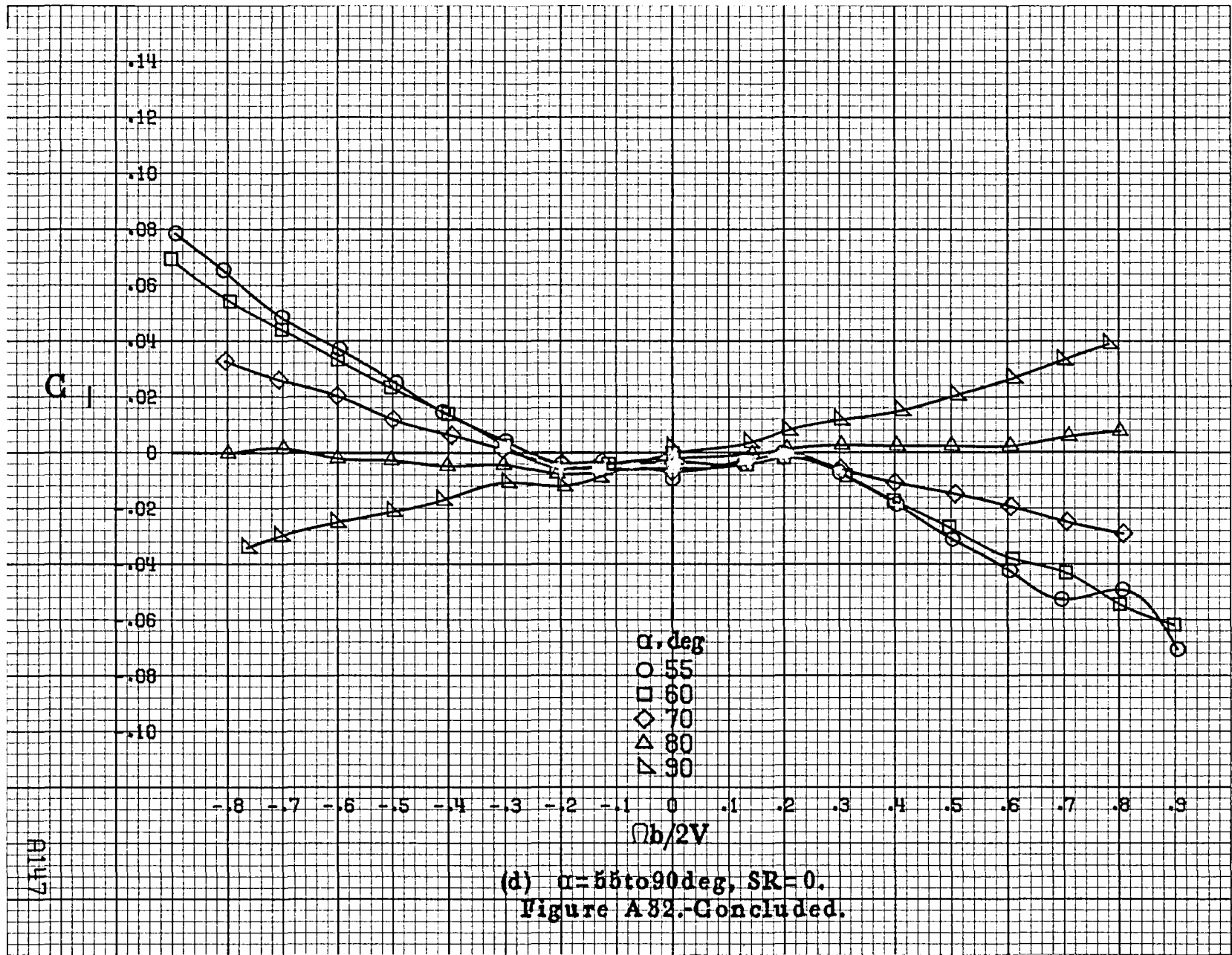

A147

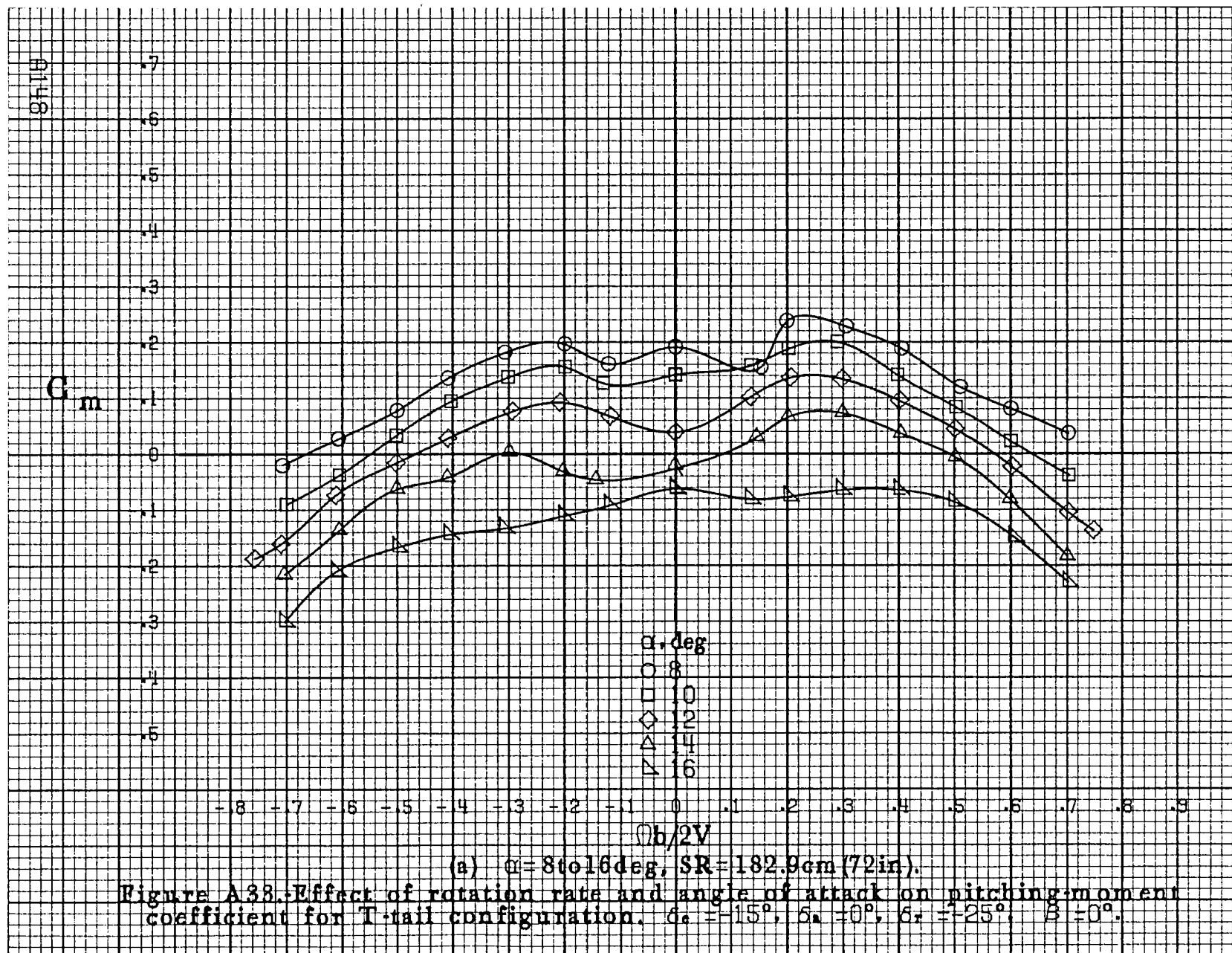

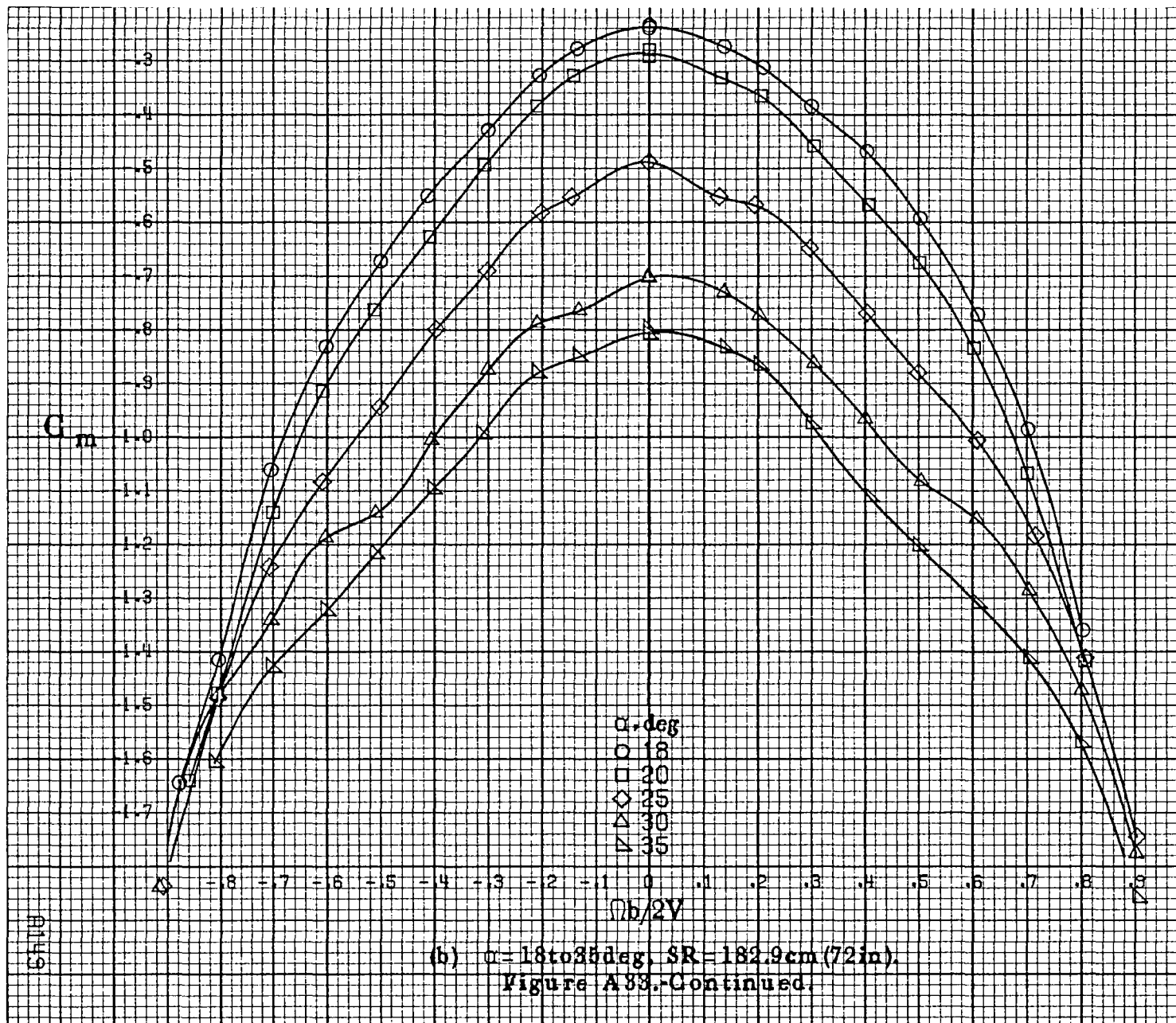



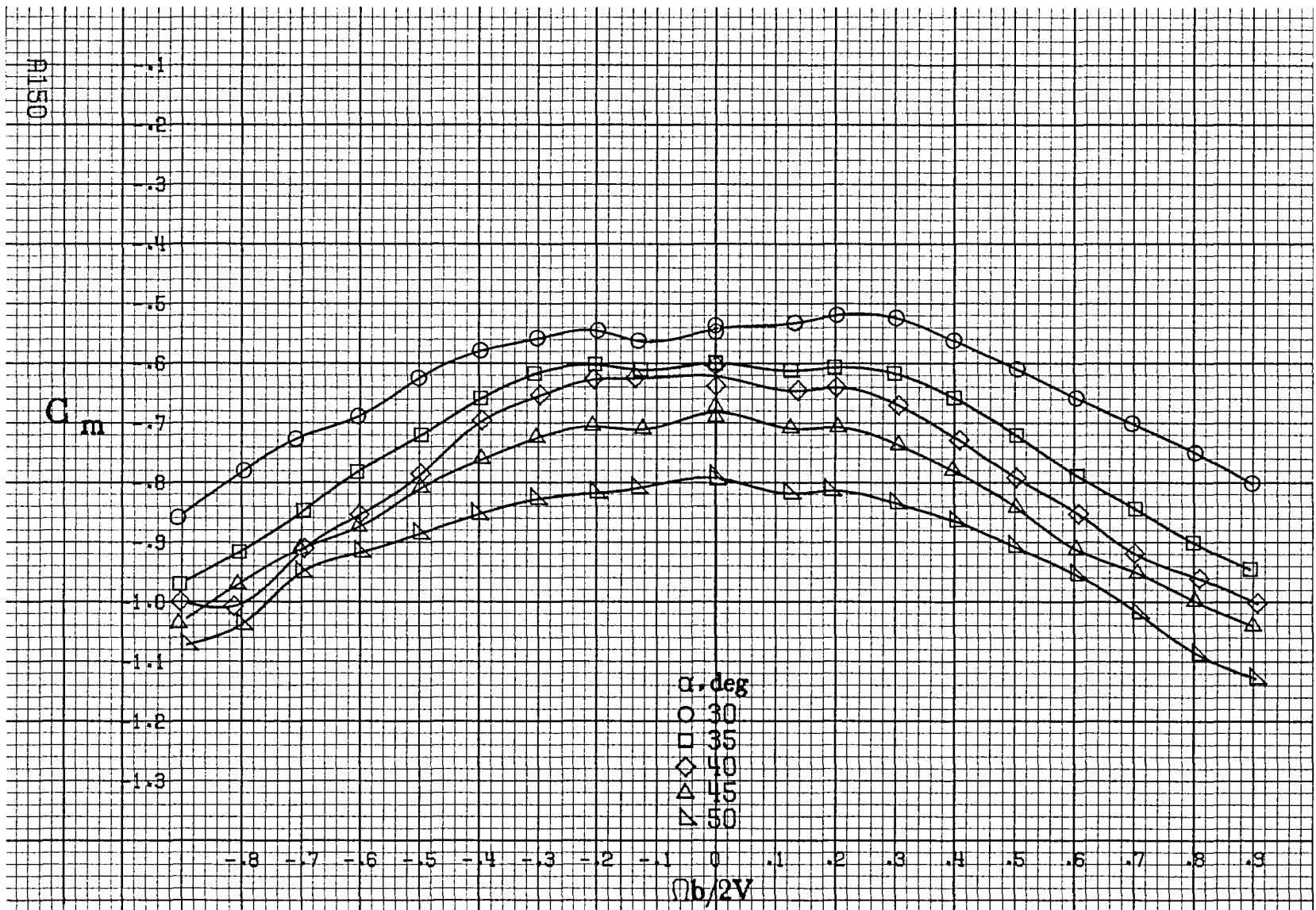

(c)  $\alpha = 30$  to  $50$  deg,  $SR = 0$ .  
 Figure A88.-Continued.



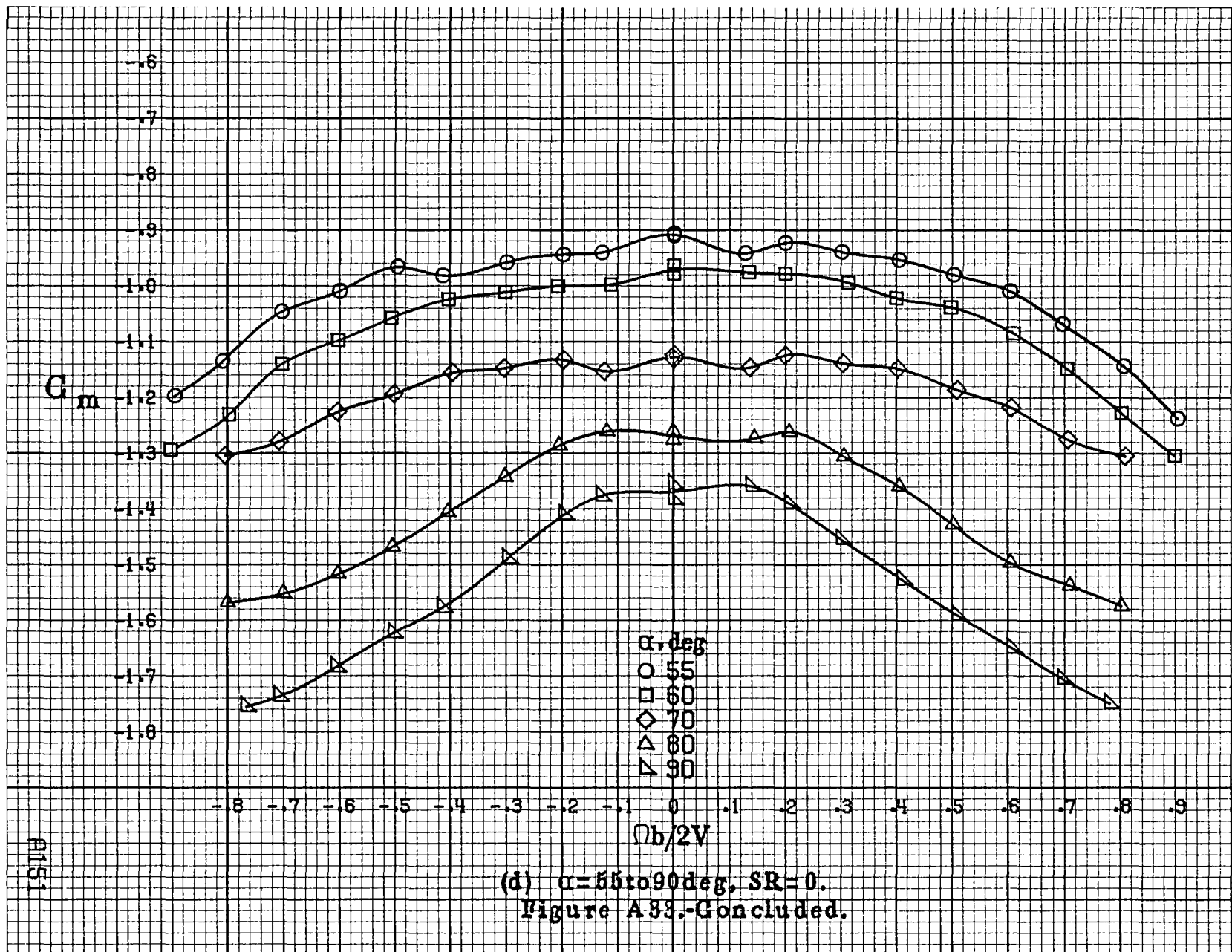

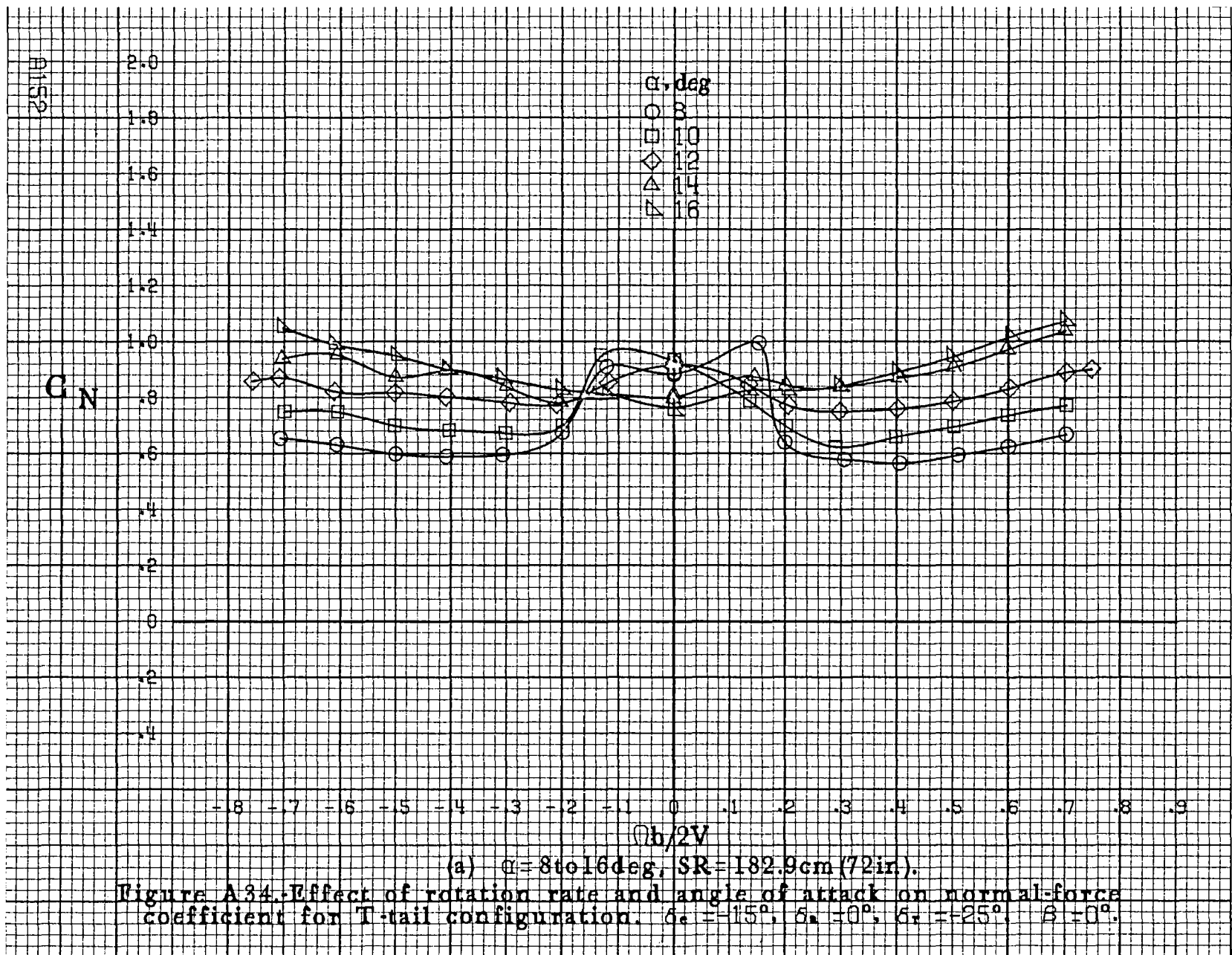

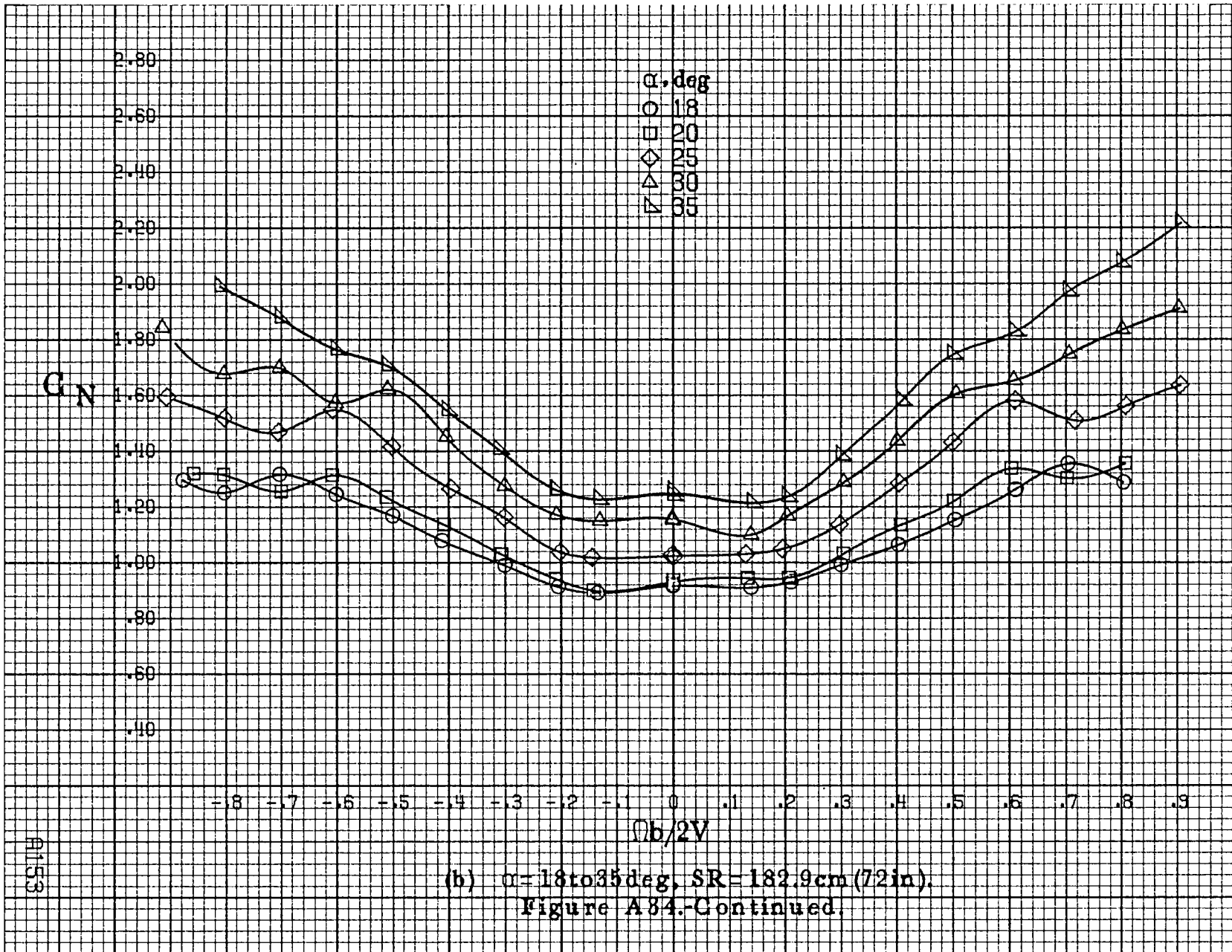

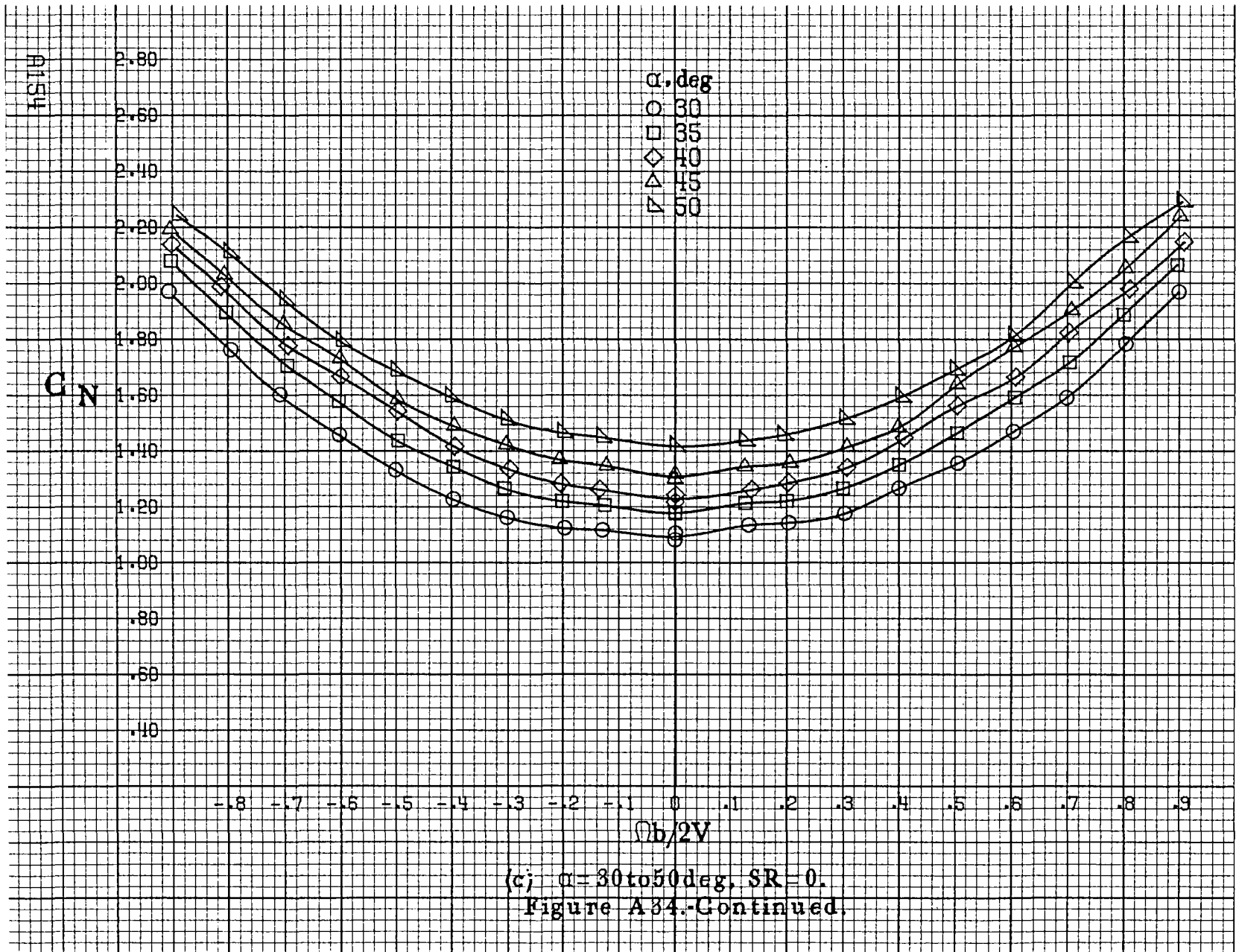

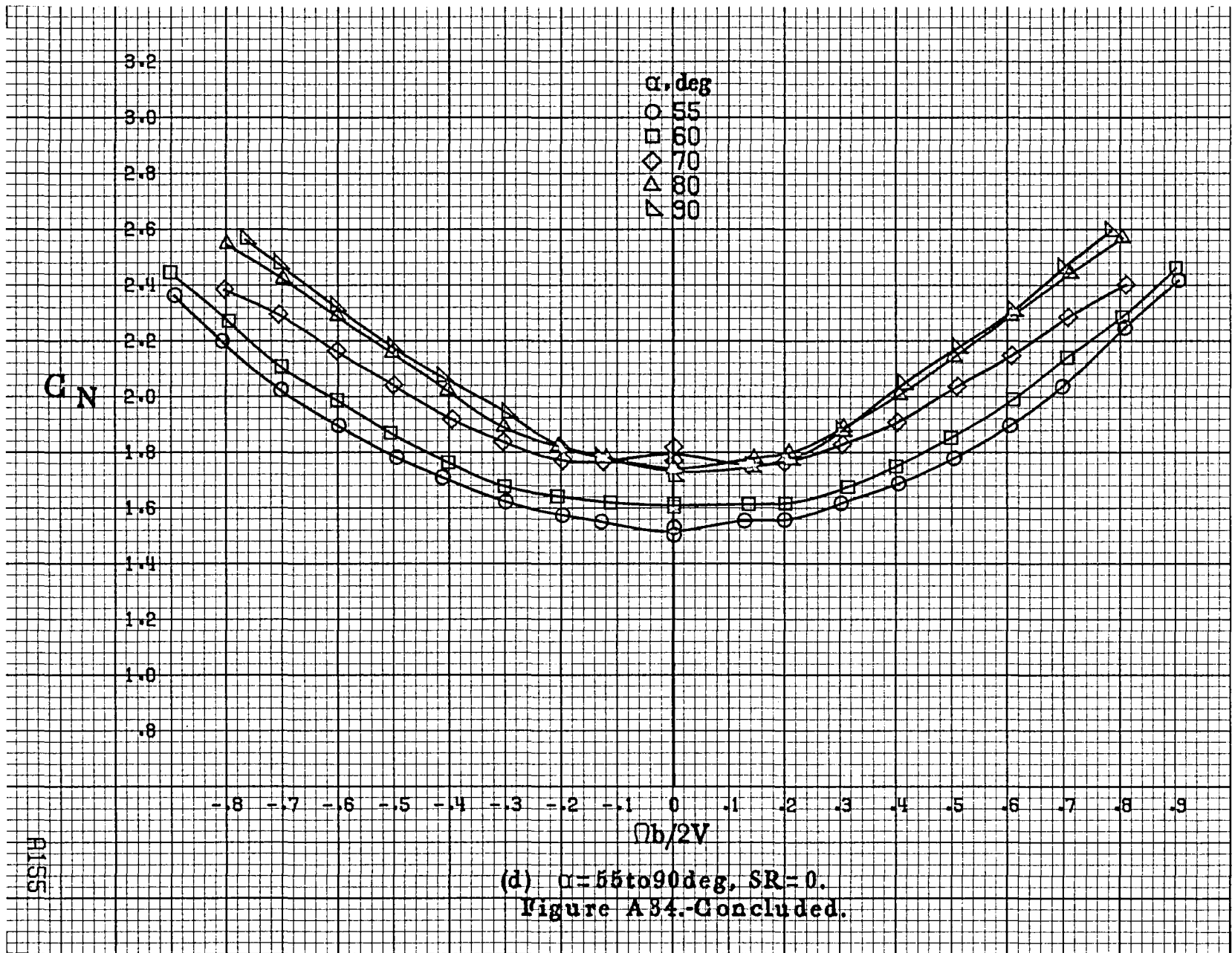

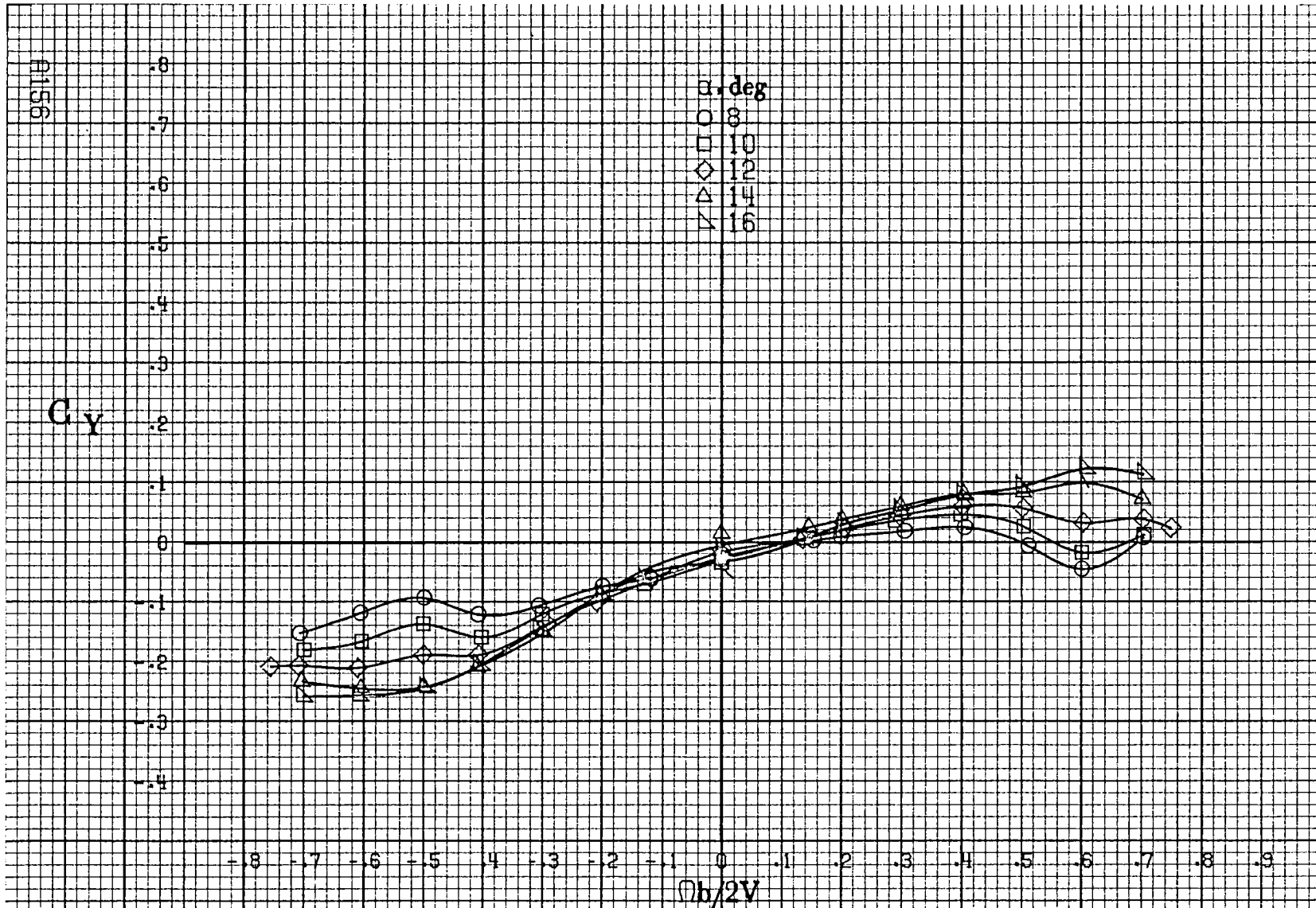

(a)  $\alpha = 8$  to  $16$  deg,  $SR = 182.9$  cm (72 in).

Figure A35. Effect of rotation rate and angle of attack on side-force coefficient for T-tail configuration.  $\delta_c = 15^\circ$ ,  $\delta_a = 0^\circ$ ,  $\delta_r = 25^\circ$ ,  $\beta = 0^\circ$ .

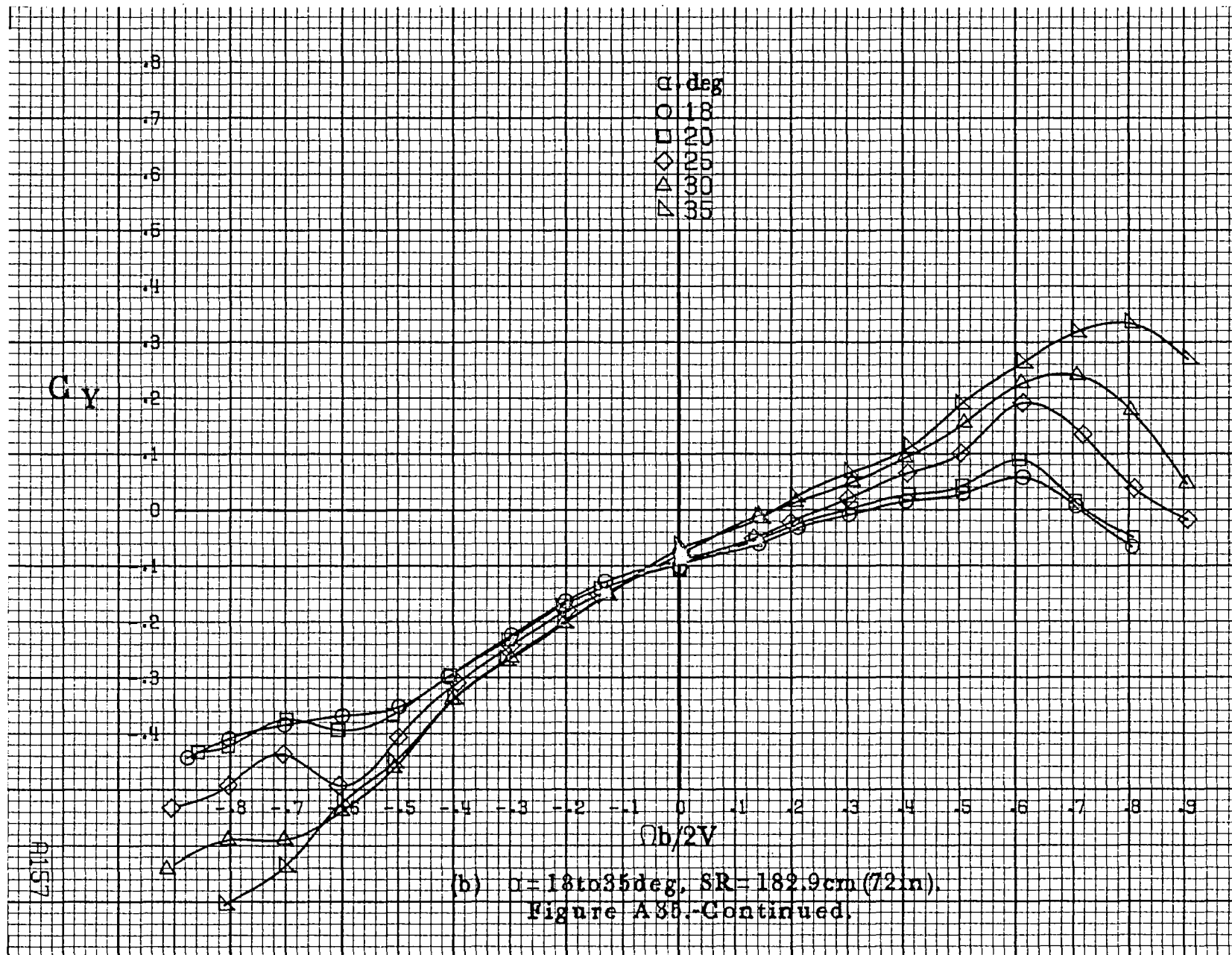

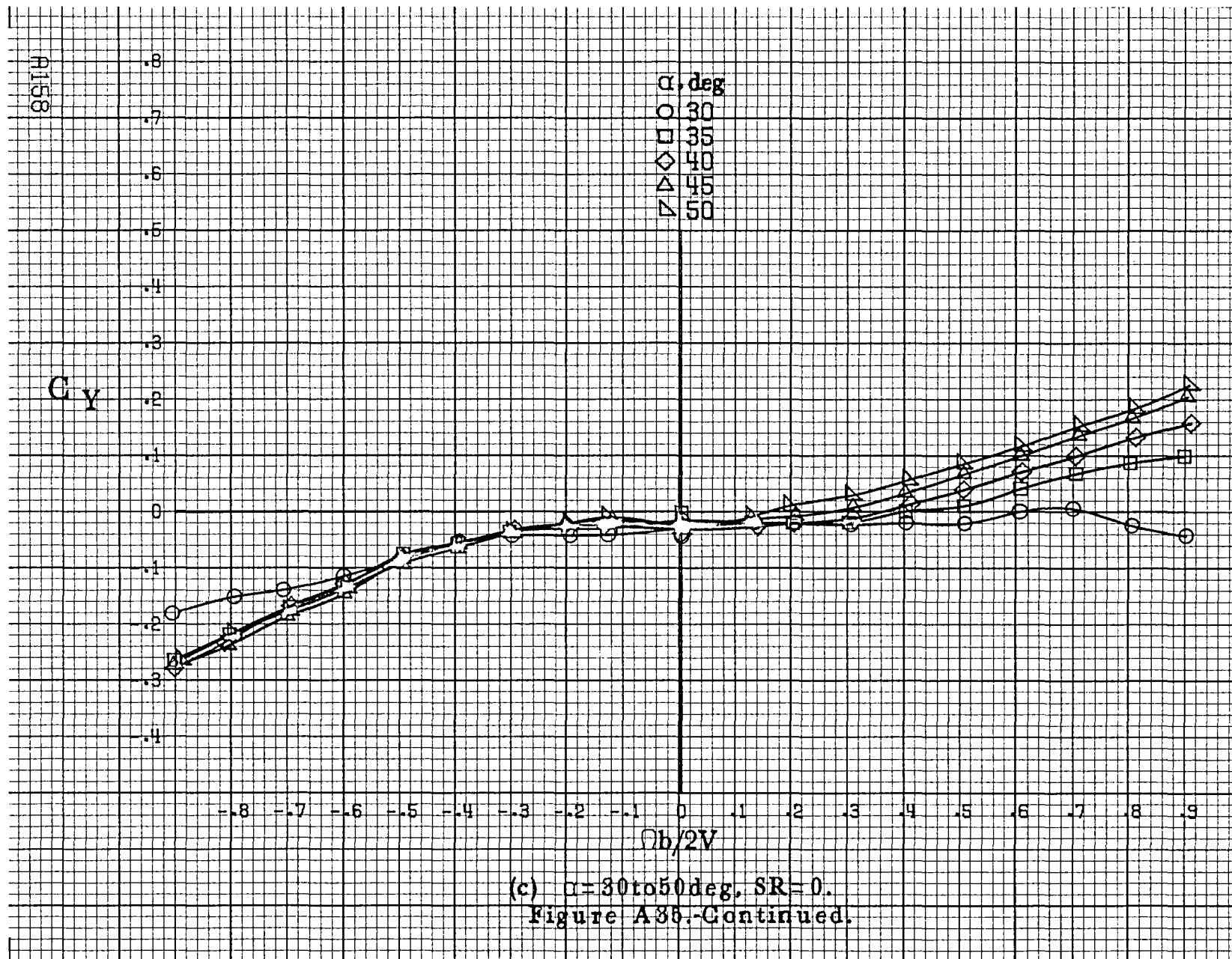



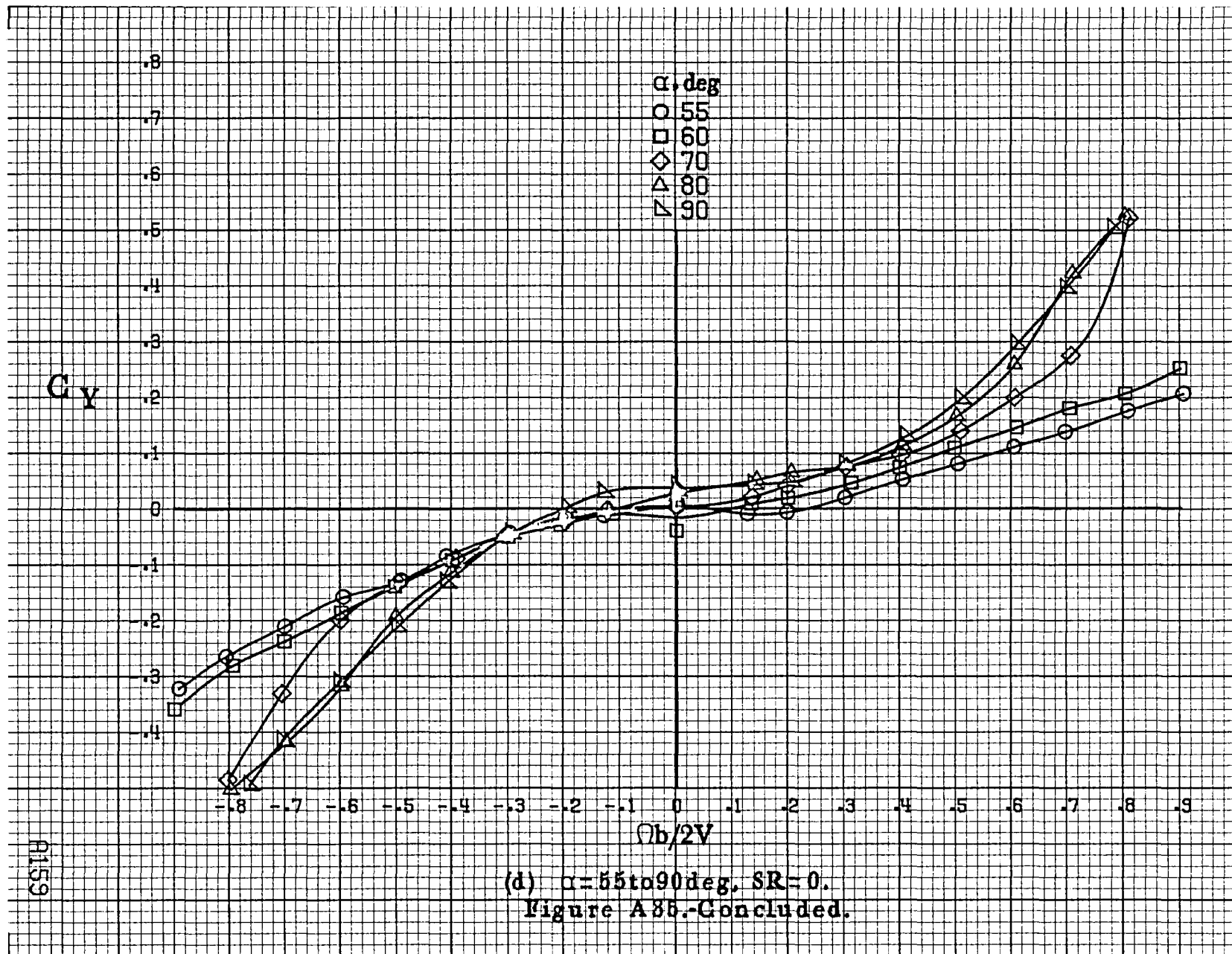

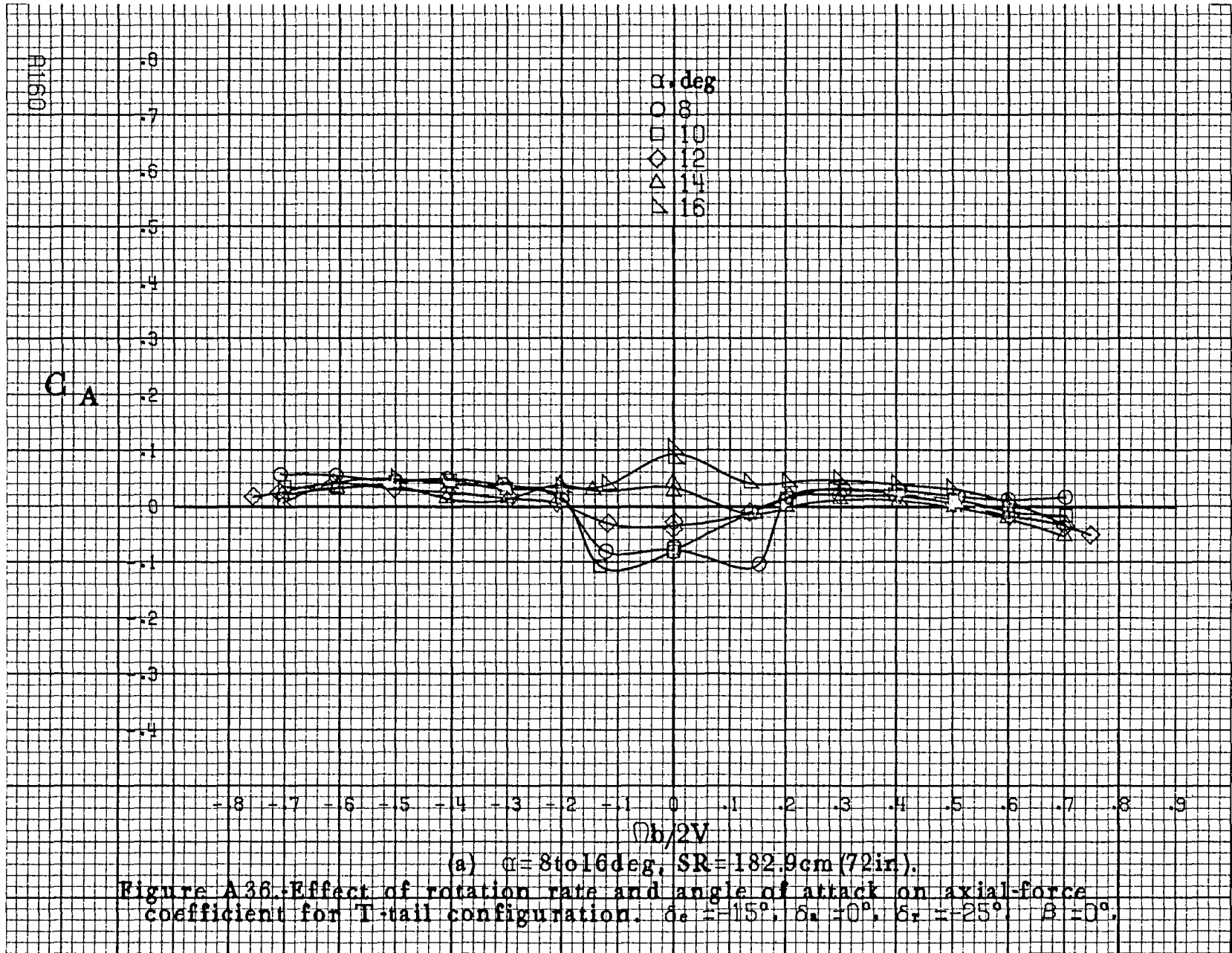

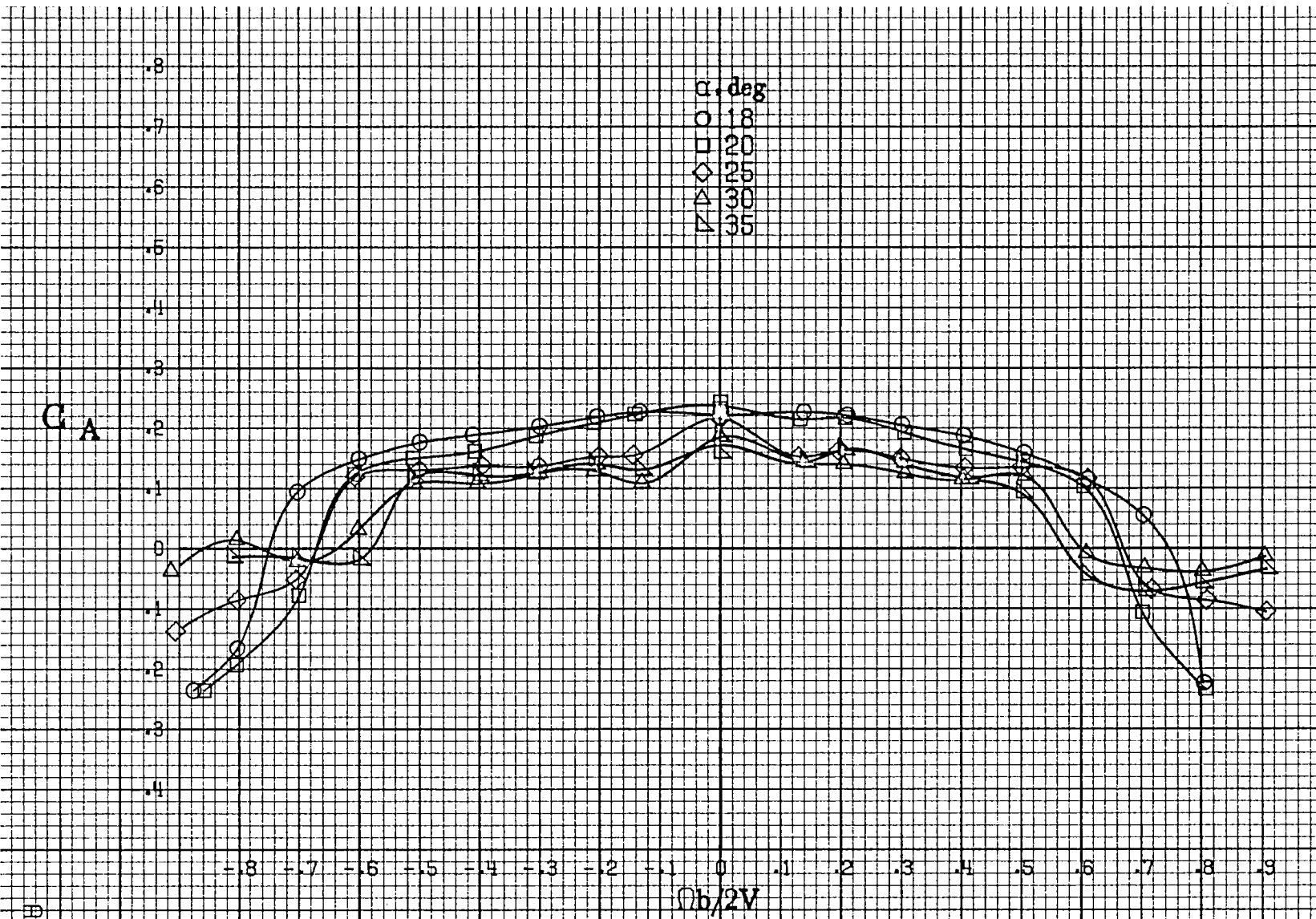

A161

(b)  $\alpha = 18$  to  $35$  deg,  $SR = 182.9$  cm (72 in).  
 Figure A36.-Continued.

A162

$G_A$

$\alpha$ , deg  
○ 30  
□ 35  
◇ 40  
△ 45  
▽ 50

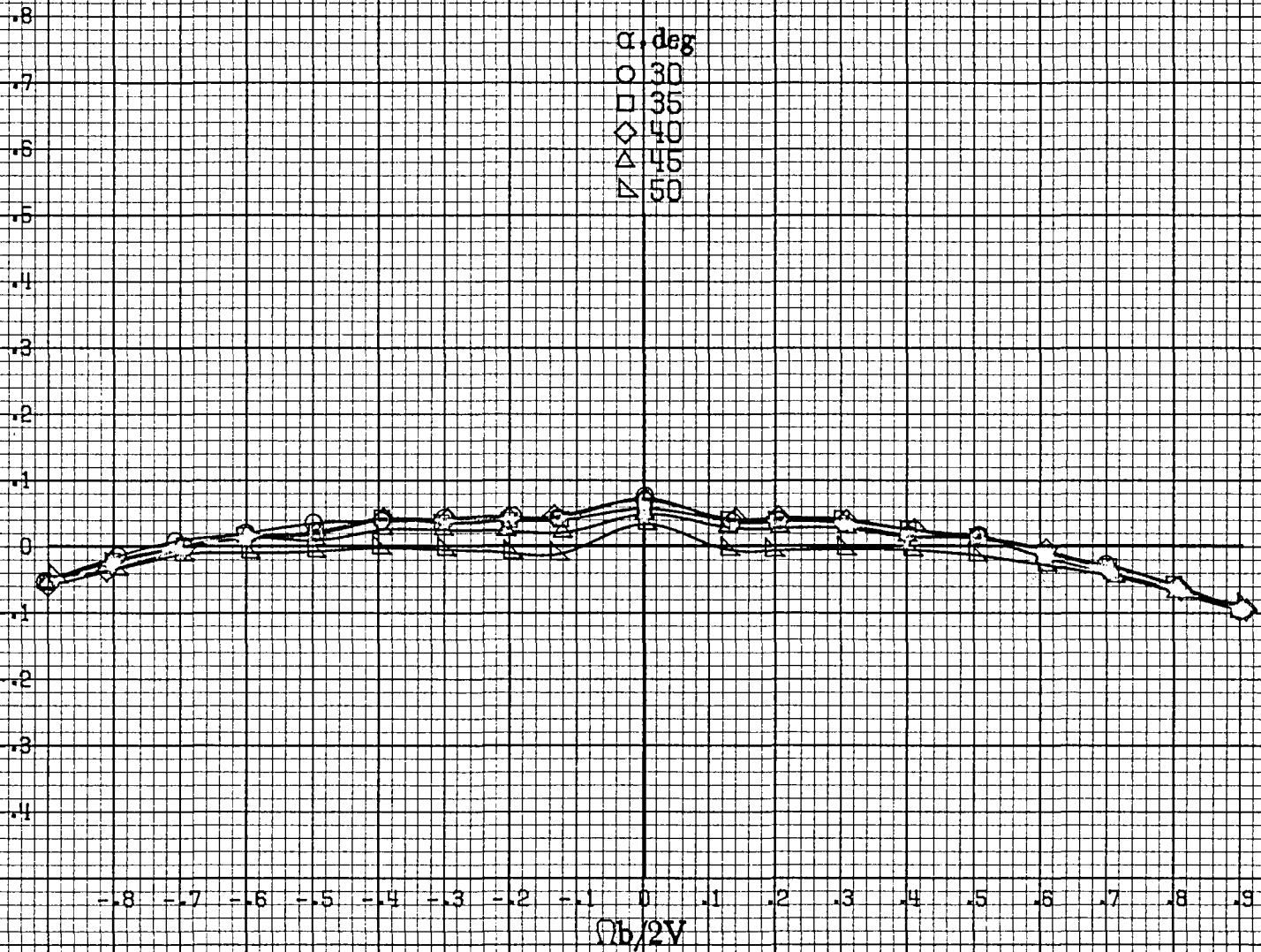

(c)  $\alpha=30$  to  $50$  deg,  $SR=0$ .  
Figure A 36.-Continued.

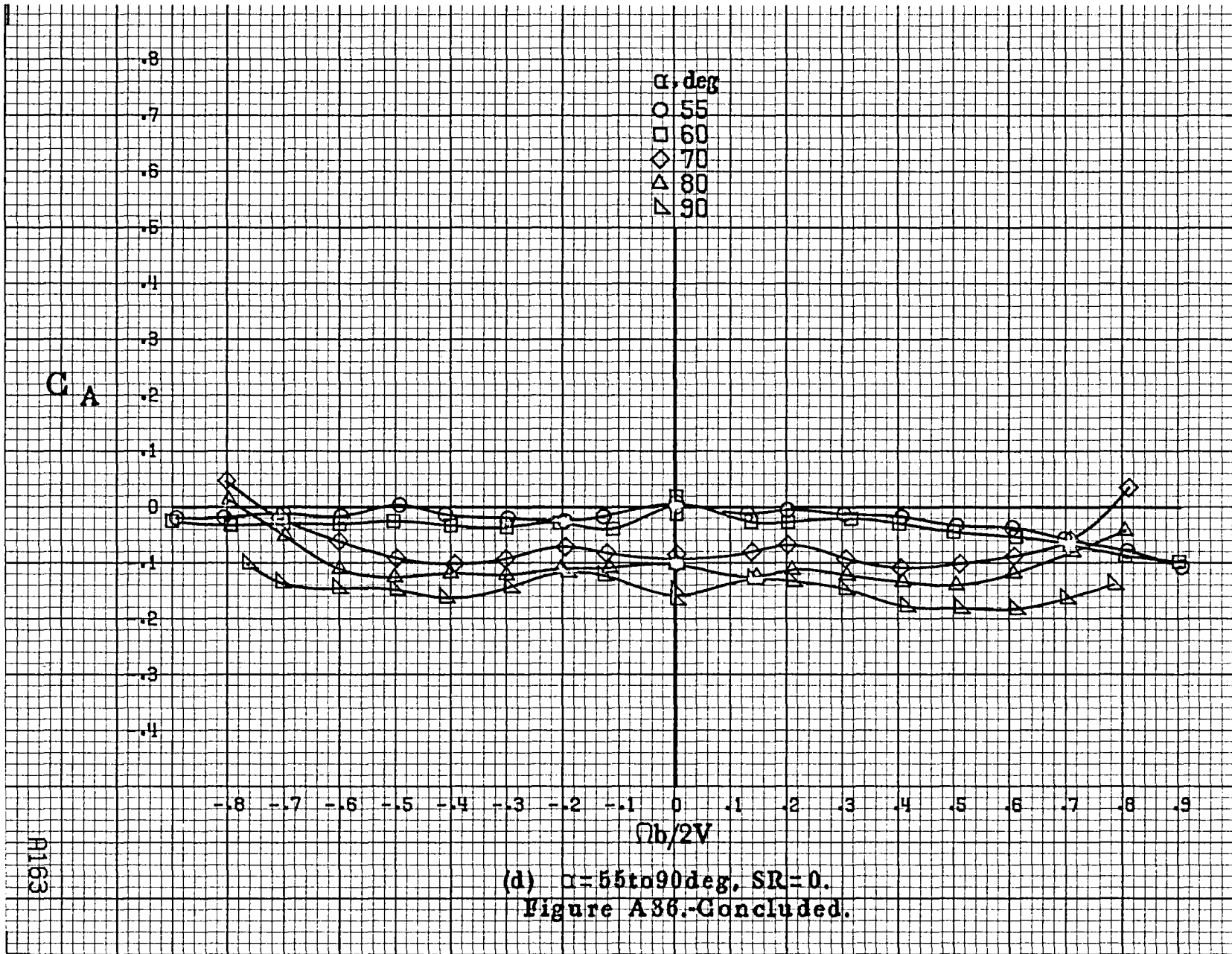

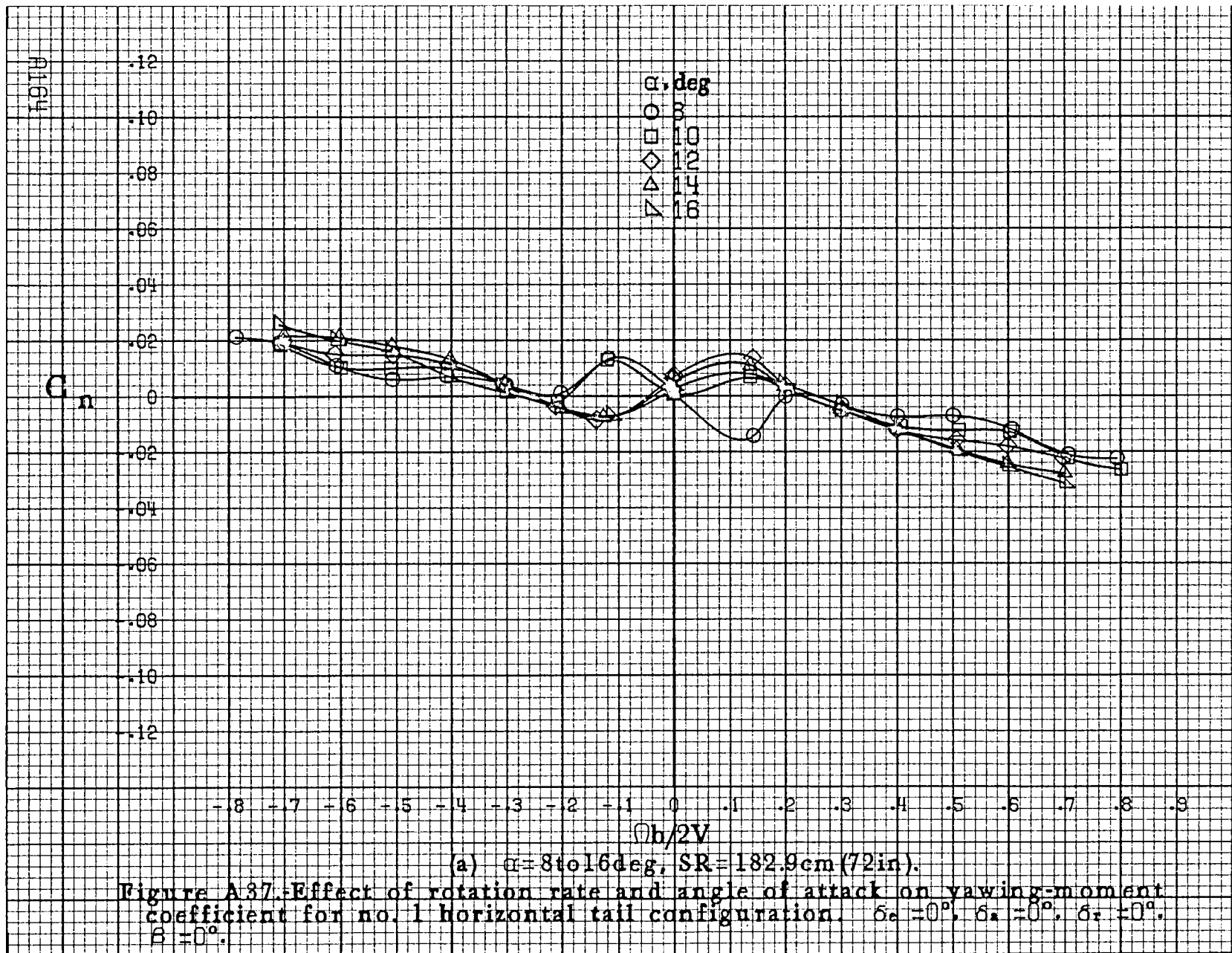

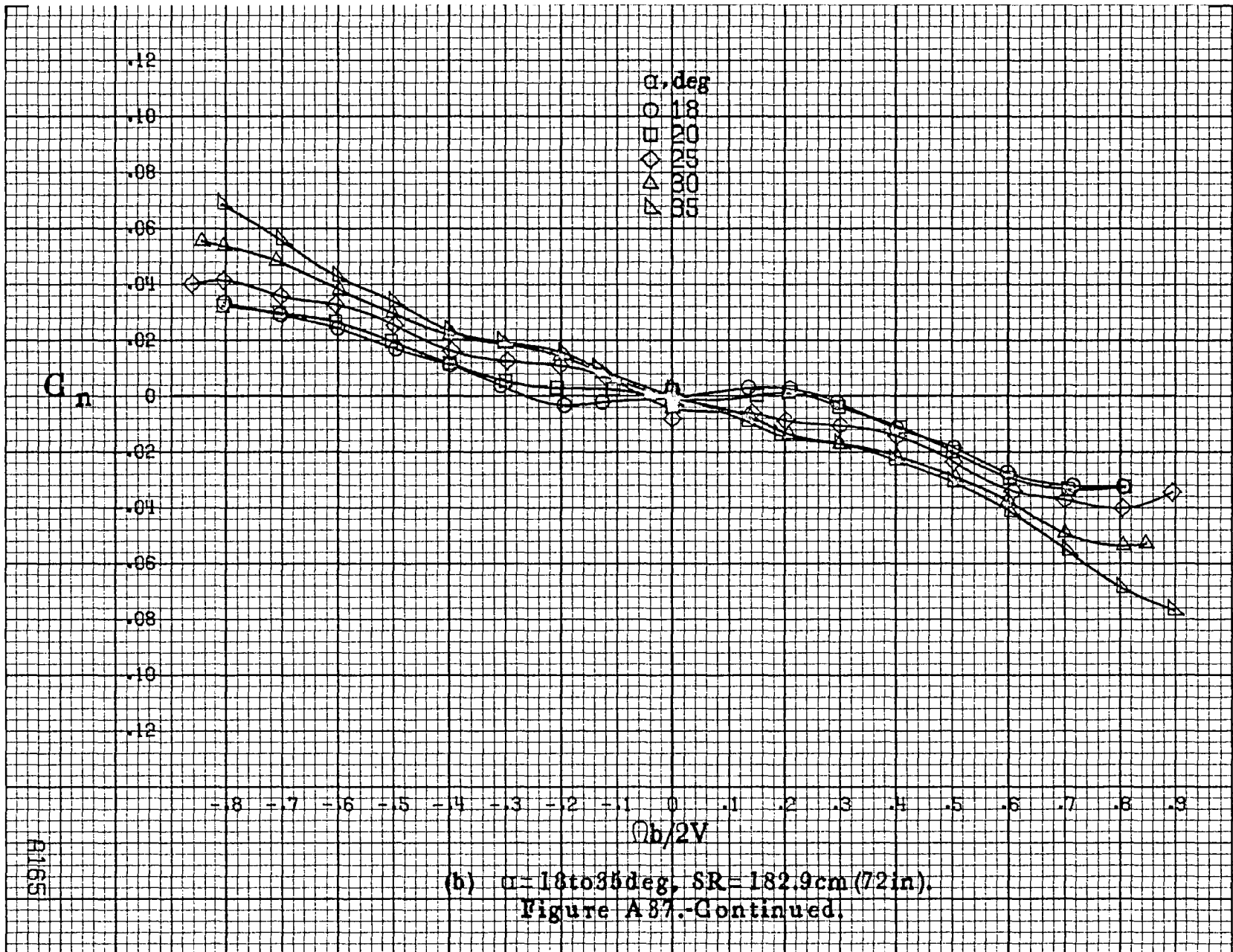

(b)  $\alpha = 18$  to  $35$  deg, SR = 182.9 cm (72 in).  
 Figure A 87.-Continued.

A165



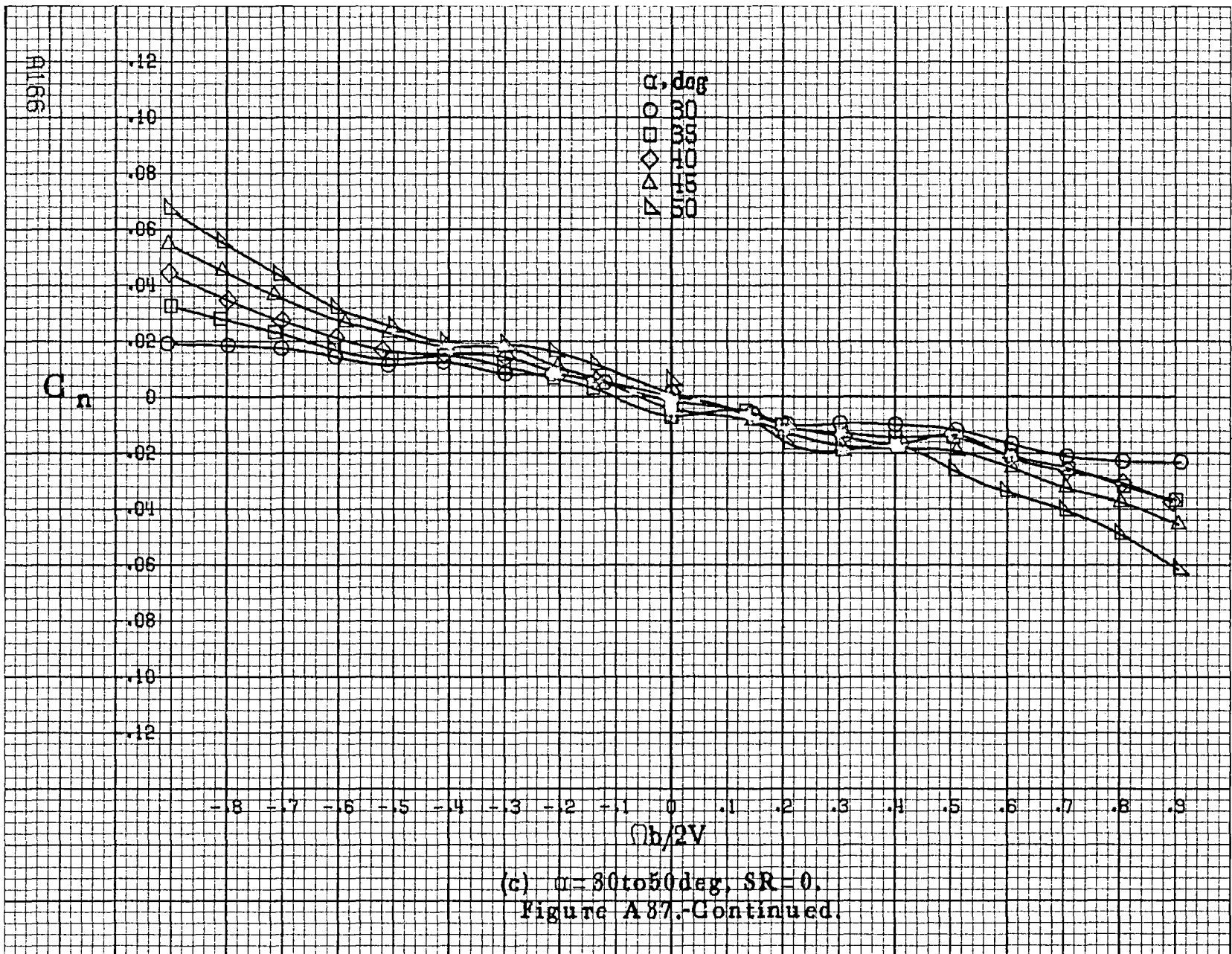

(c)  $\alpha = 30$  to  $50$  deg,  $SR = 0$ .  
 Figure A87.-Continued.



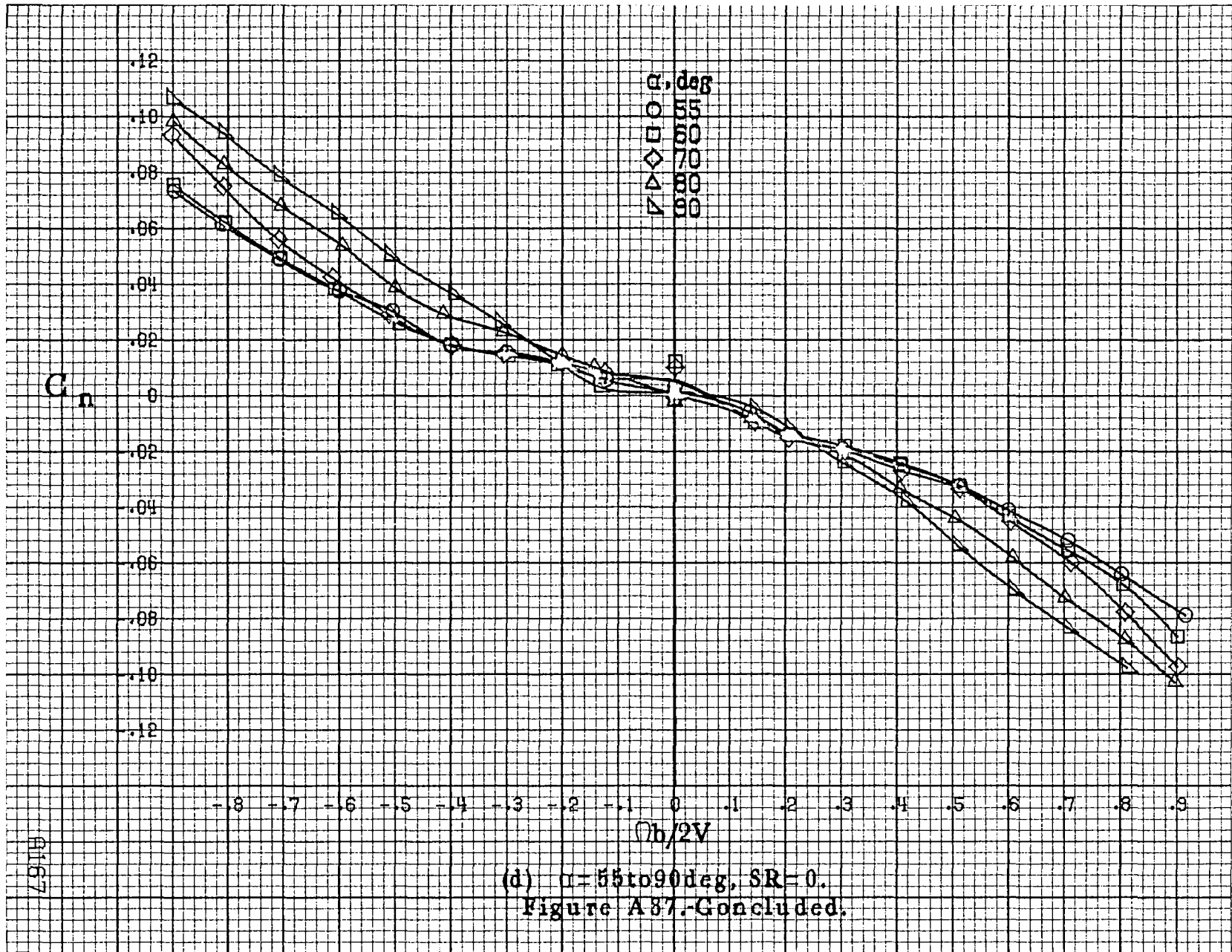

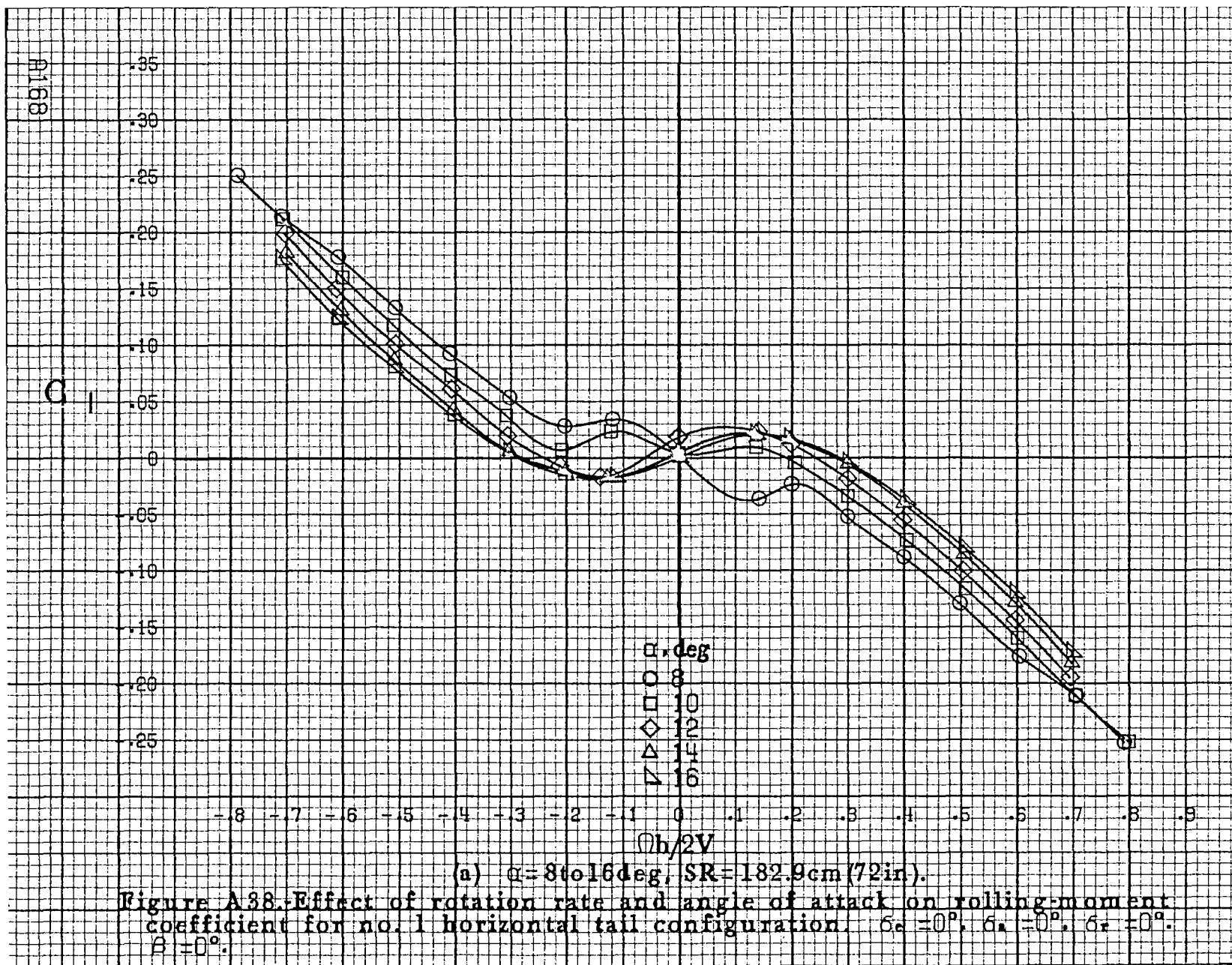

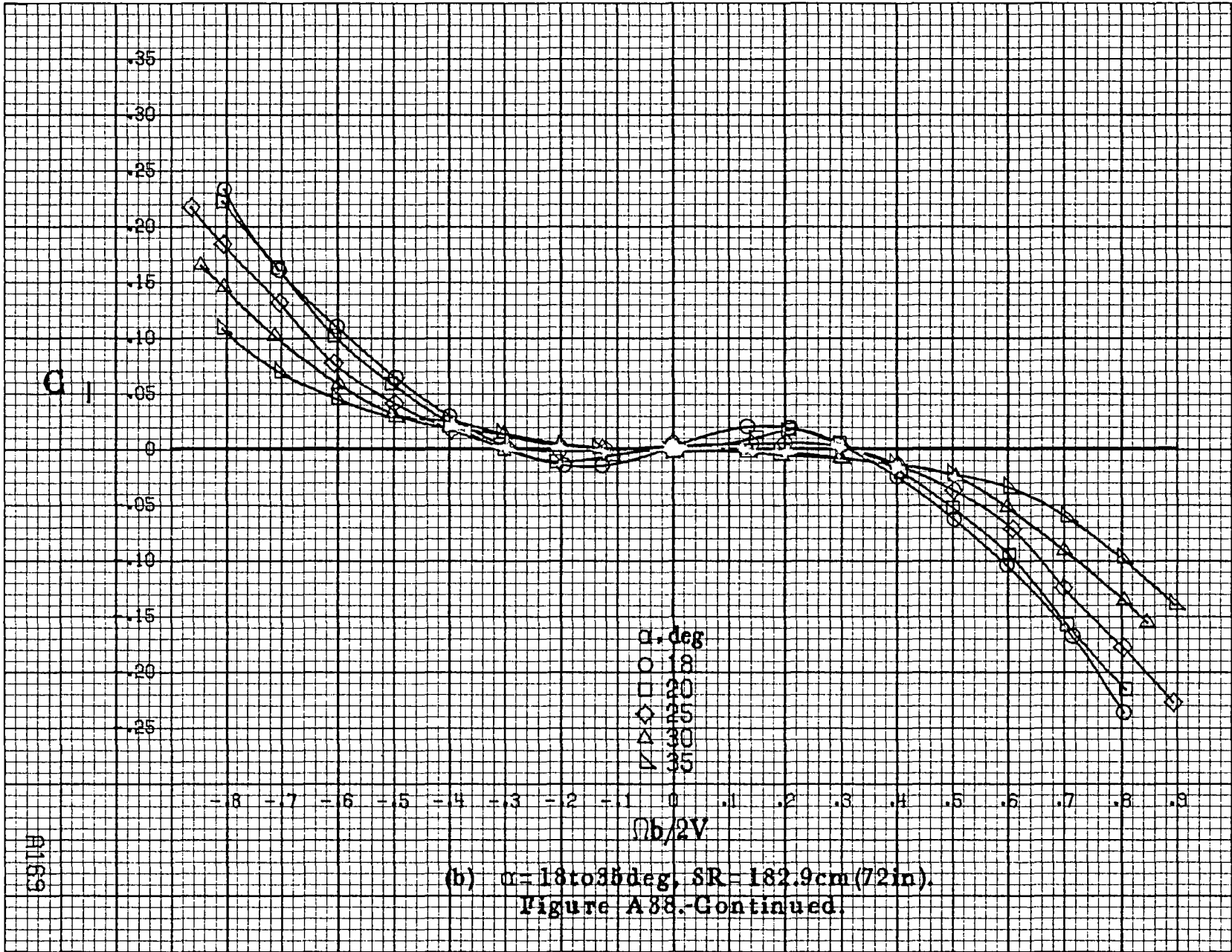

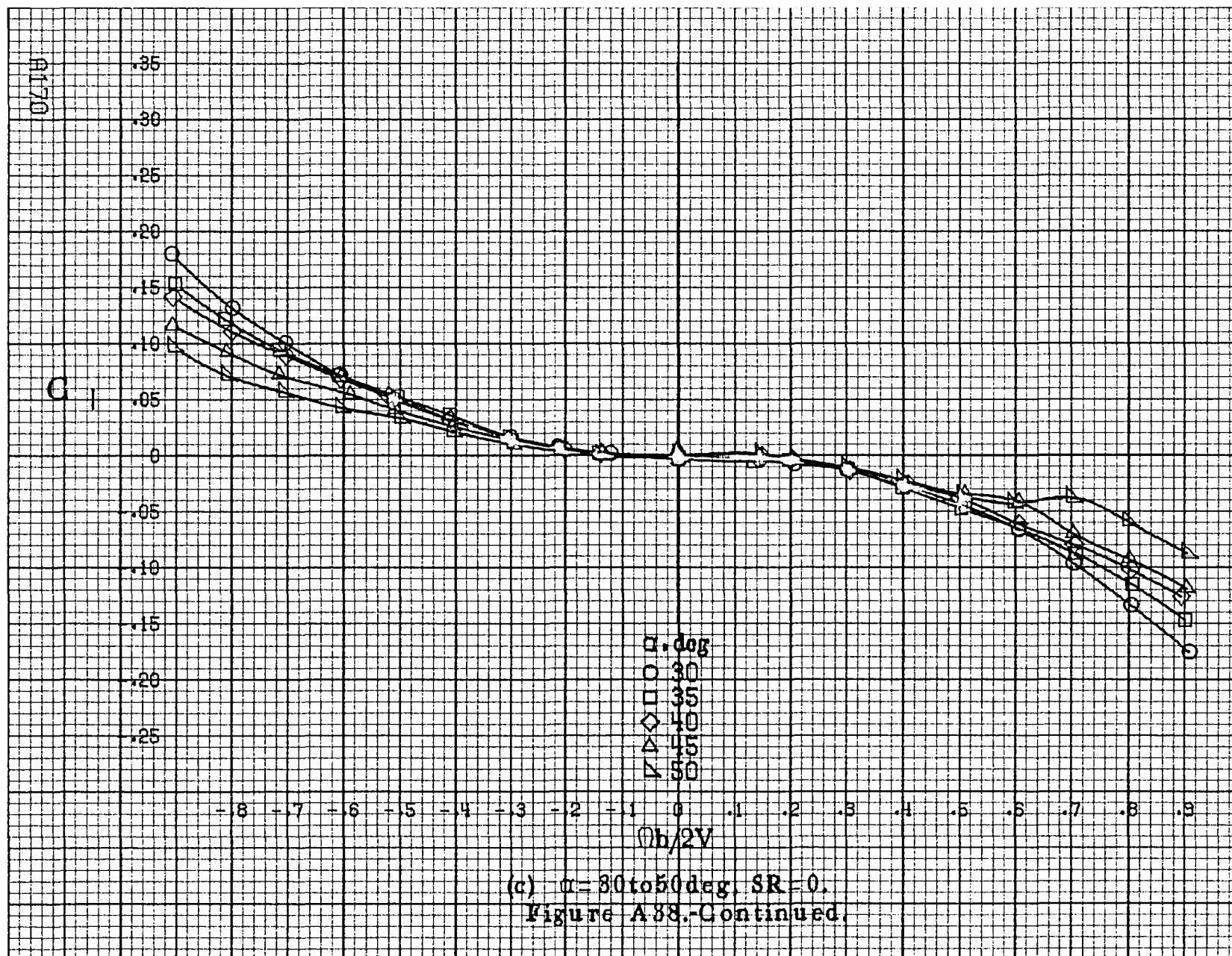

(c)  $\alpha = 30$  to  $50$  deg.  $SR = 0$ .  
 Figure A88.-Continued.

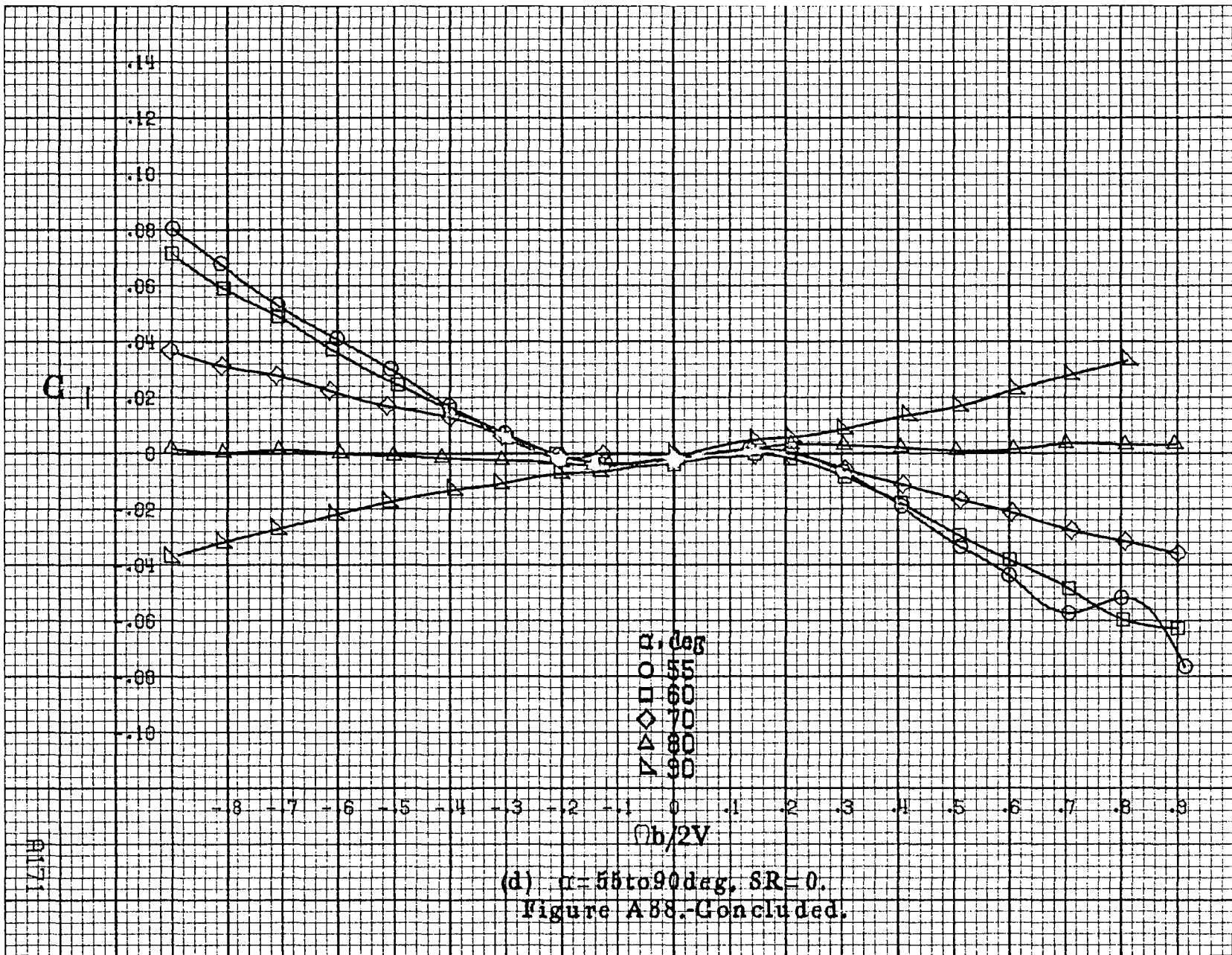

(d)  $\alpha = 55$  to  $90$  deg,  $SR = 0$ .  
 Figure A88.-Concluded.

A171

P172

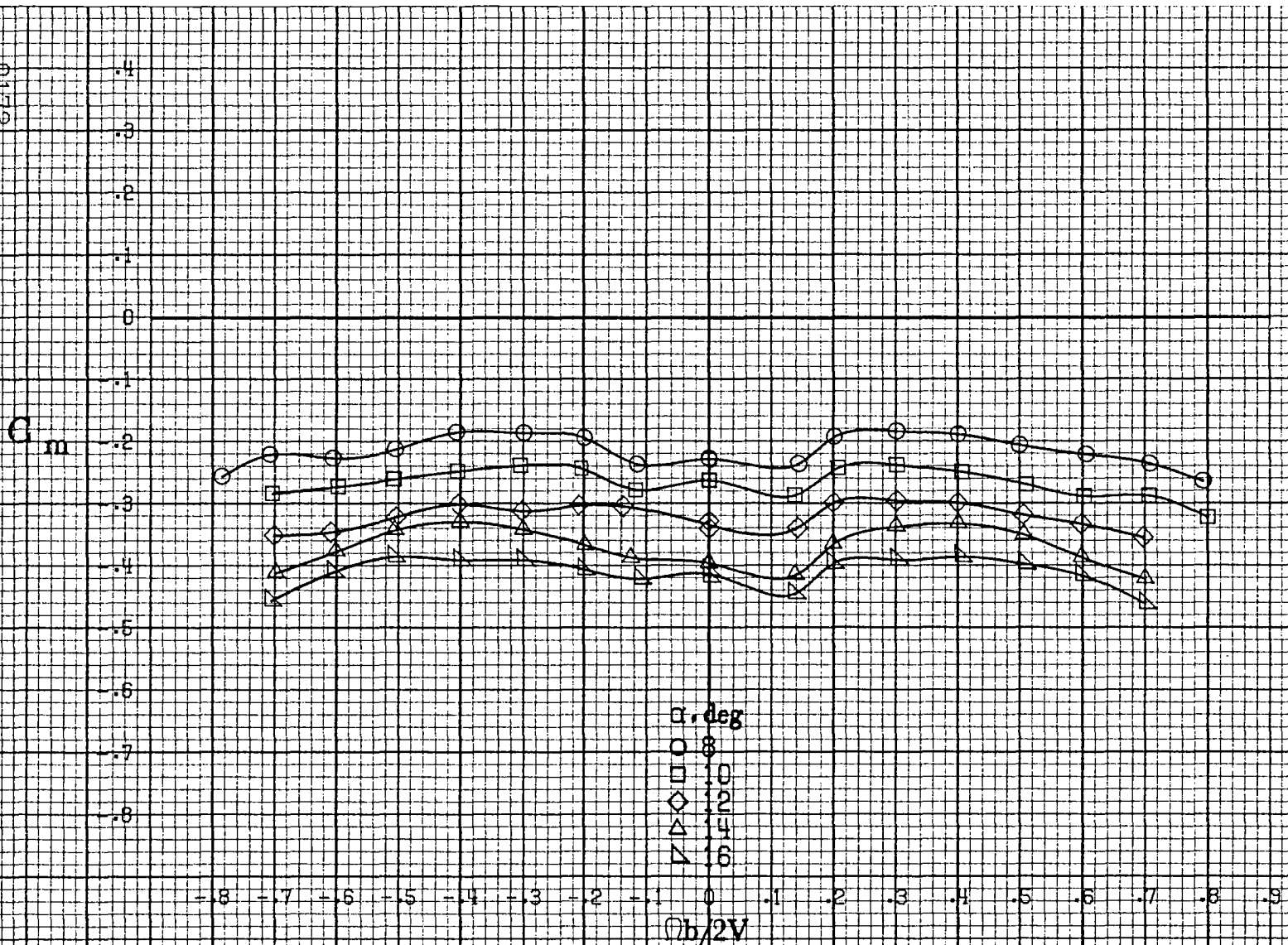

(a)  $\alpha = 8$  to  $16$  deg,  $SR = 182.9$  cm (72 in).

Figure A39. Effect of rotation rate and angle of attack on pitching moment coefficient for no. 1 horizontal tail configuration.  $\delta_a = 0^\circ$ ,  $\delta_s = 0^\circ$ ,  $\delta_z = 0^\circ$ ,  $\beta = 0^\circ$ .

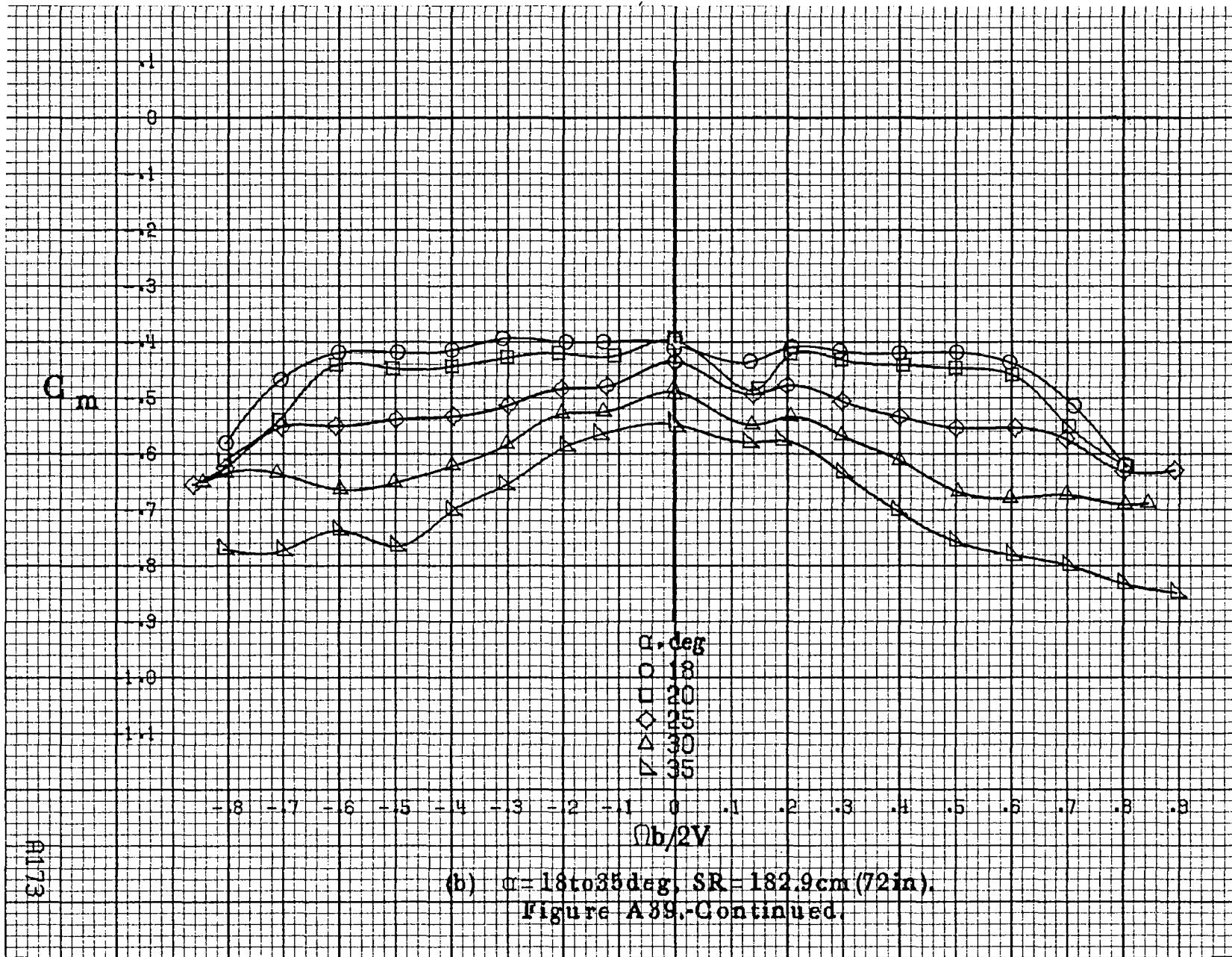

A173

(b)  $\alpha = 18$  to  $35$  deg,  $SR = 182.9$  cm (72 in).  
Figure A89.-Continued.



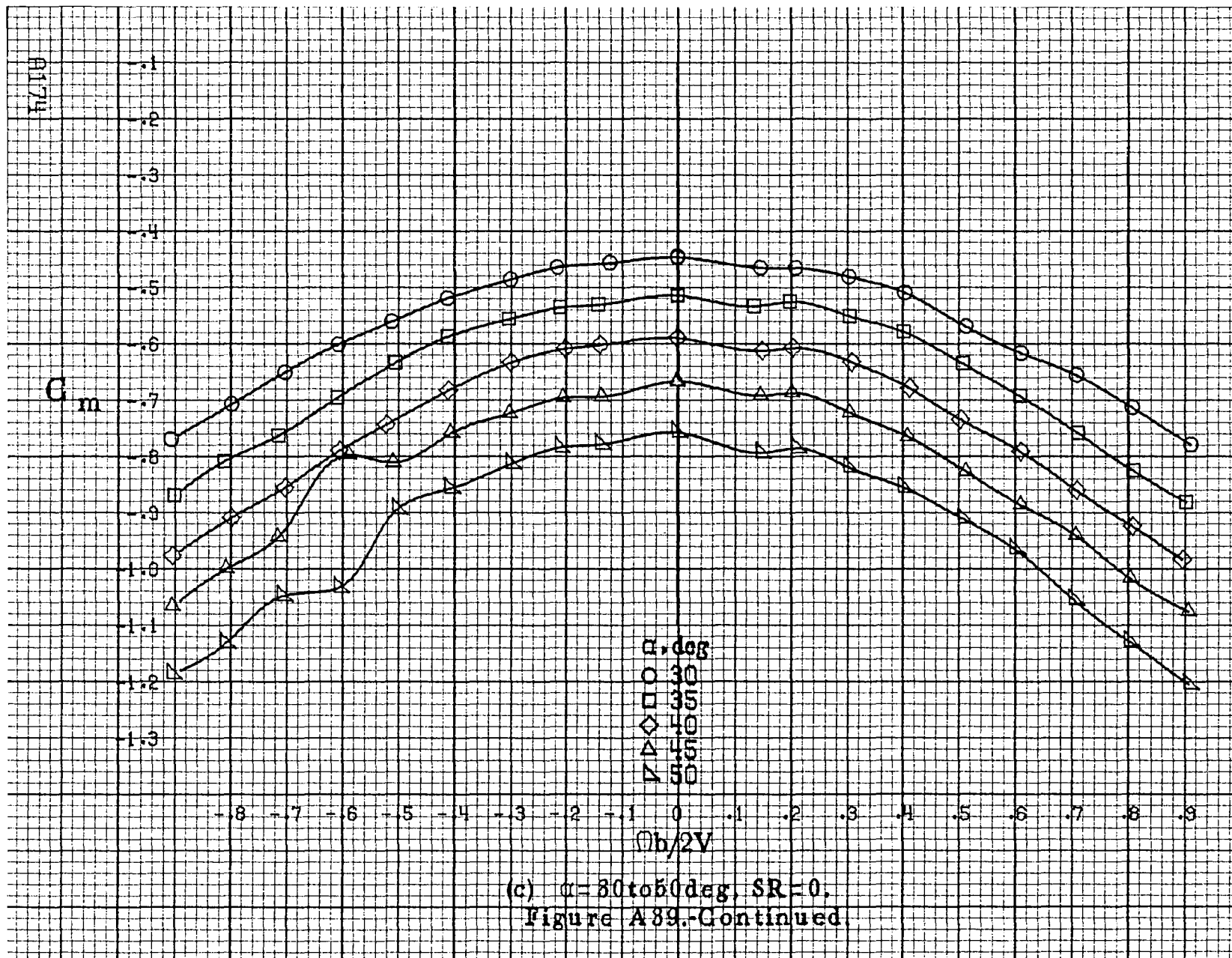

(c)  $\alpha = 30$  to  $50$  deg,  $SR = 0$ .  
 Figure A89.-Continued.



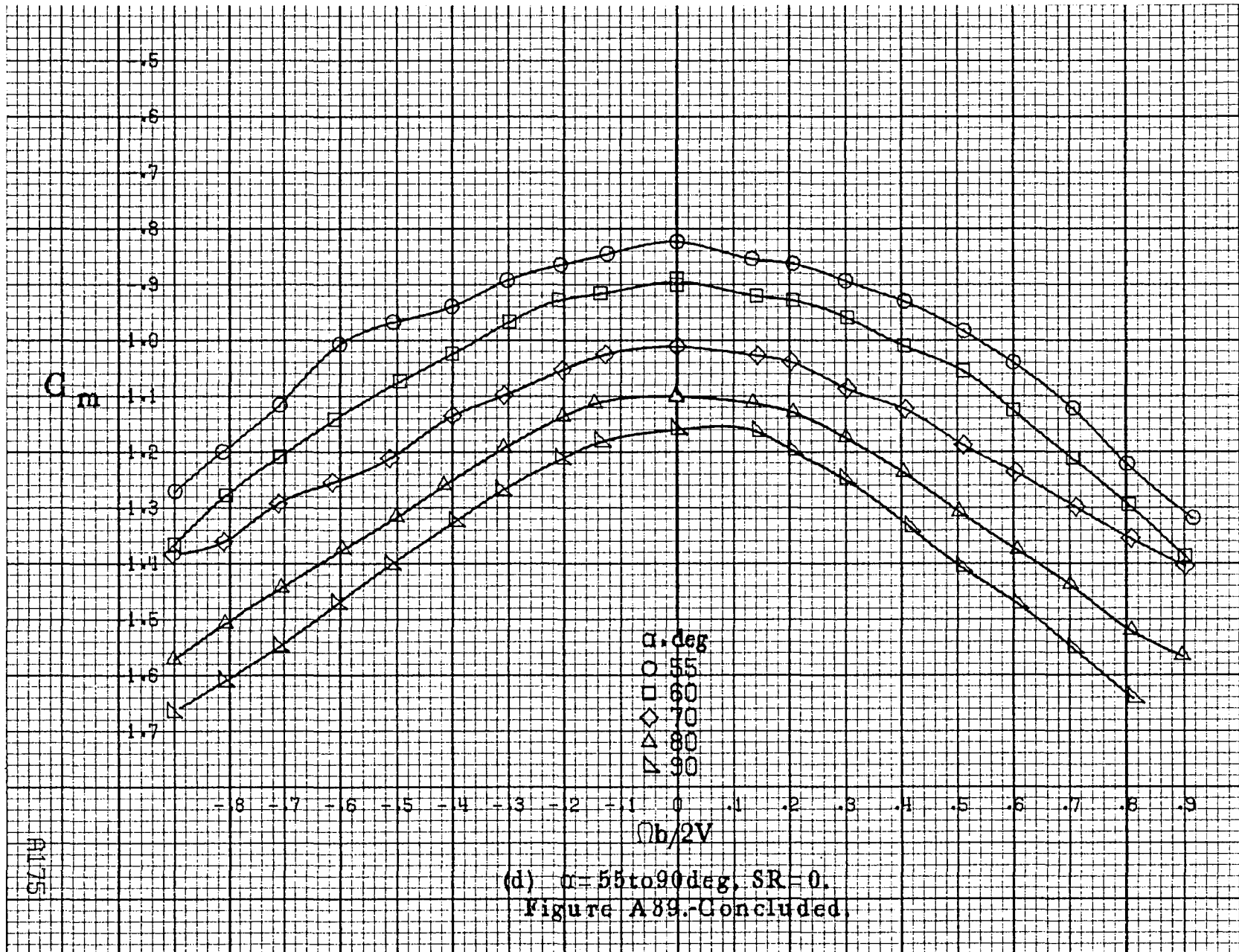

R1175

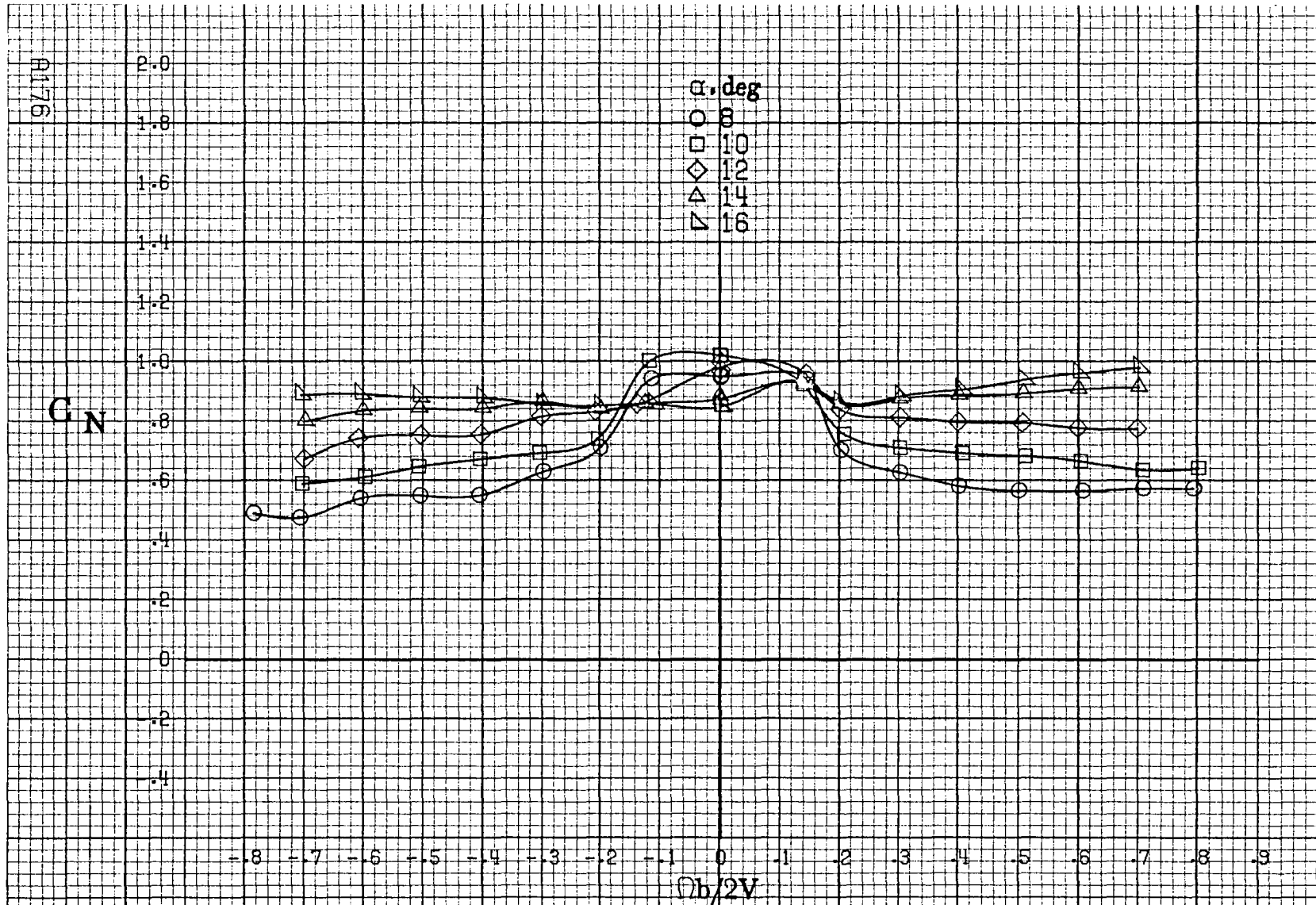

(a)  $\alpha = 8$  to  $16$  deg,  $SR = 182.9$  cm (72 in).

Figure A40. Effect of rotation rate and angle of attack on normal-force coefficient for no. 1 horizontal tail configuration.  $\delta_e = 0^\circ$ ,  $\delta_z = 0^\circ$ ,  $\delta_r = 0^\circ$ .  $\beta = 0^\circ$ .

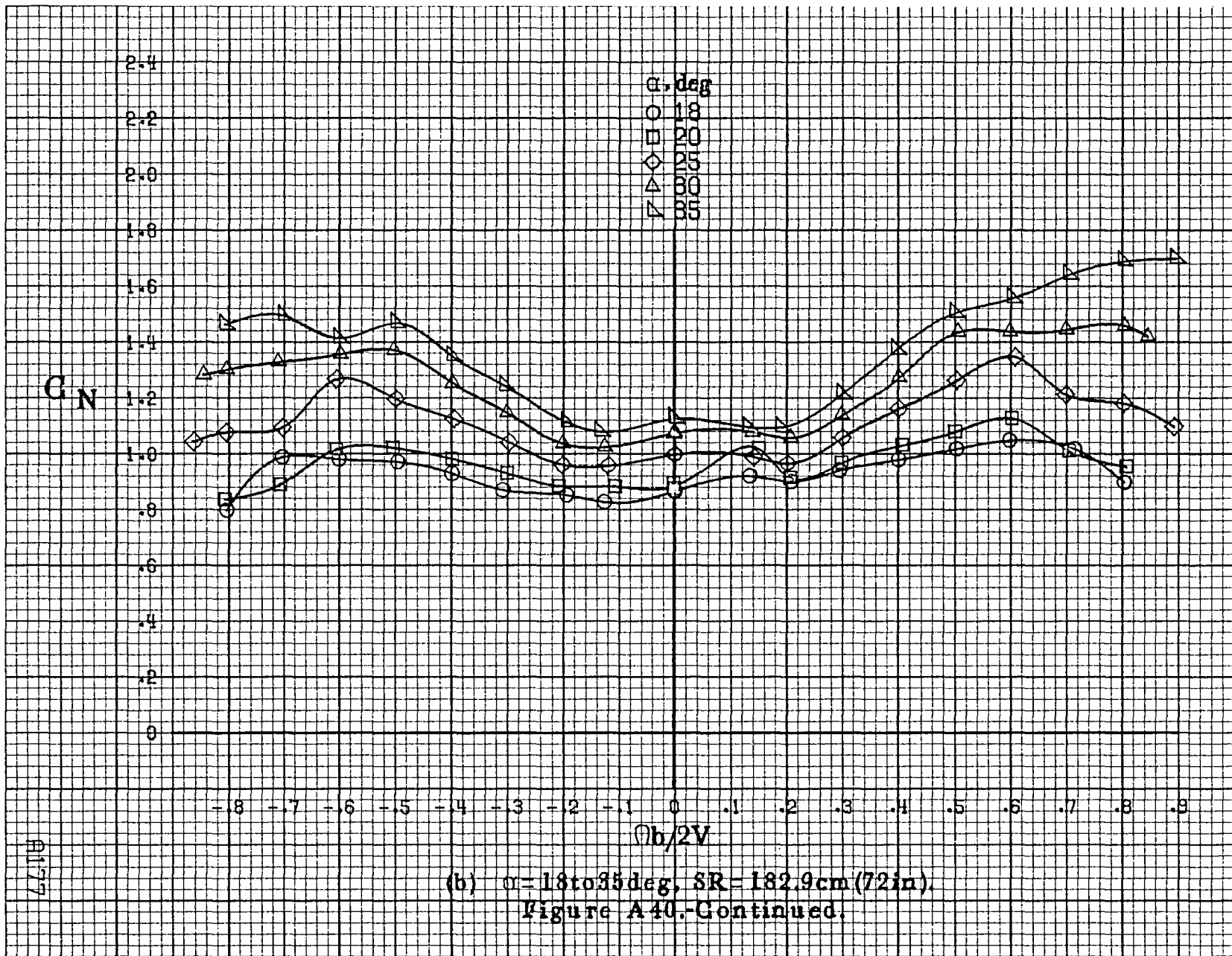

A177

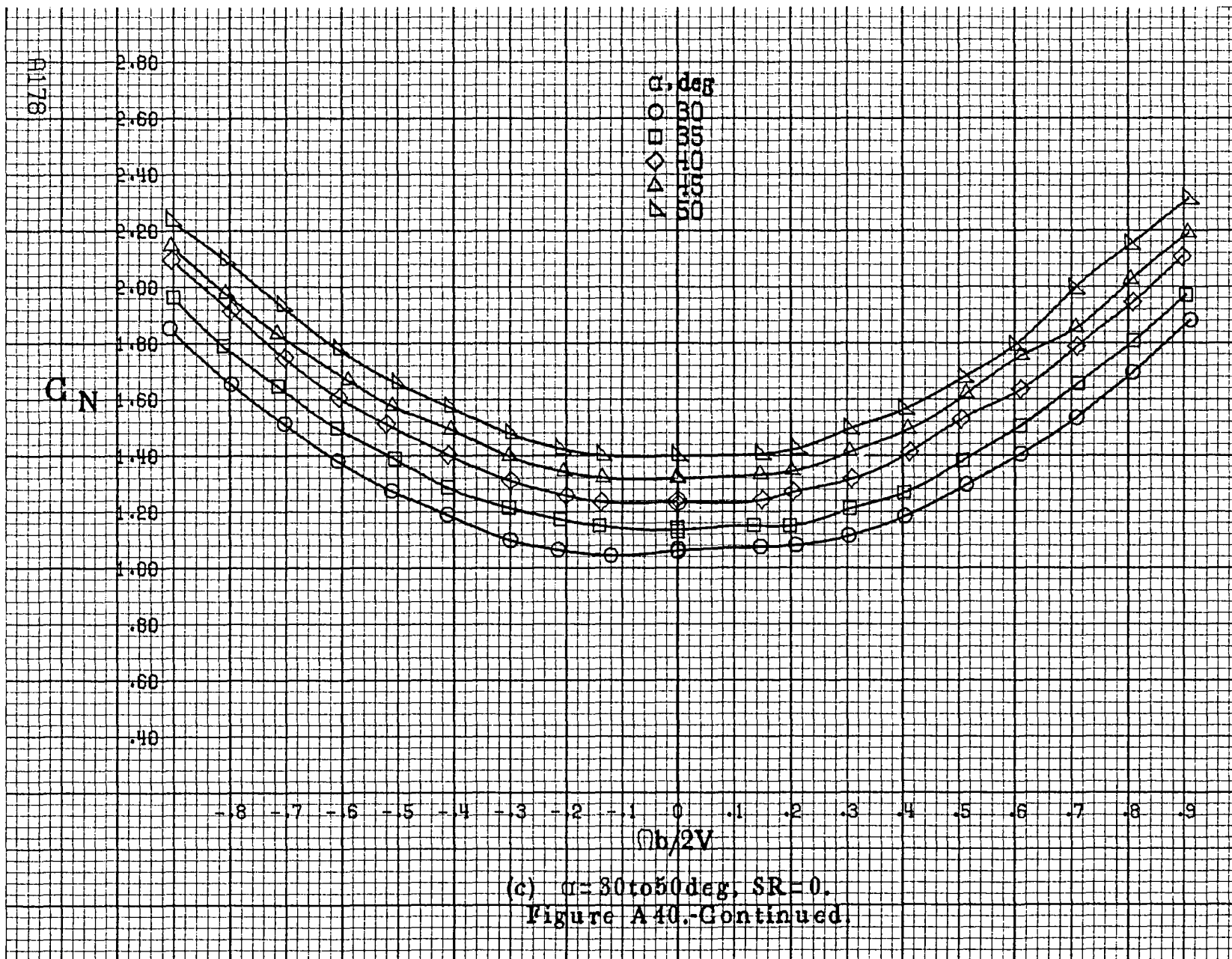

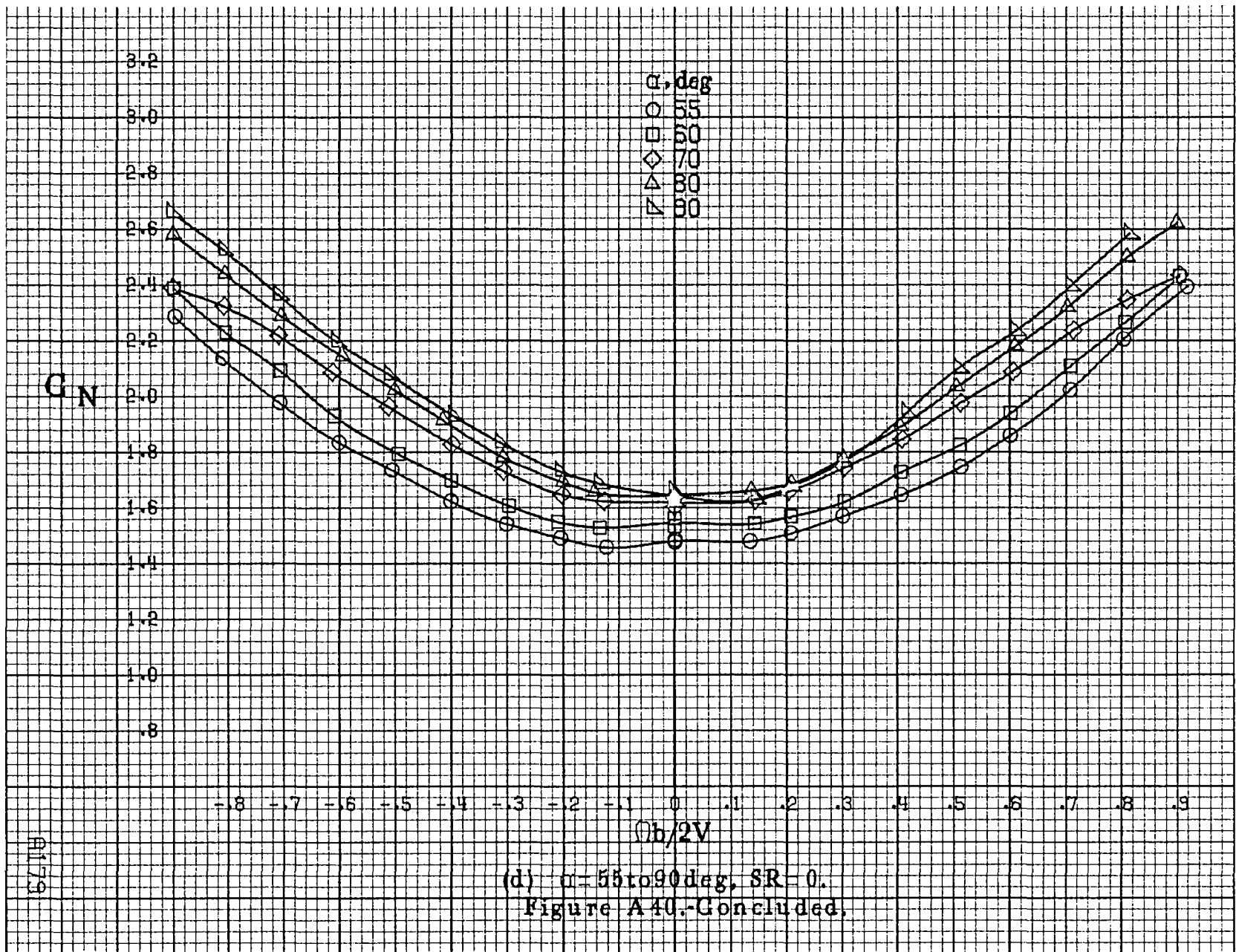

A179

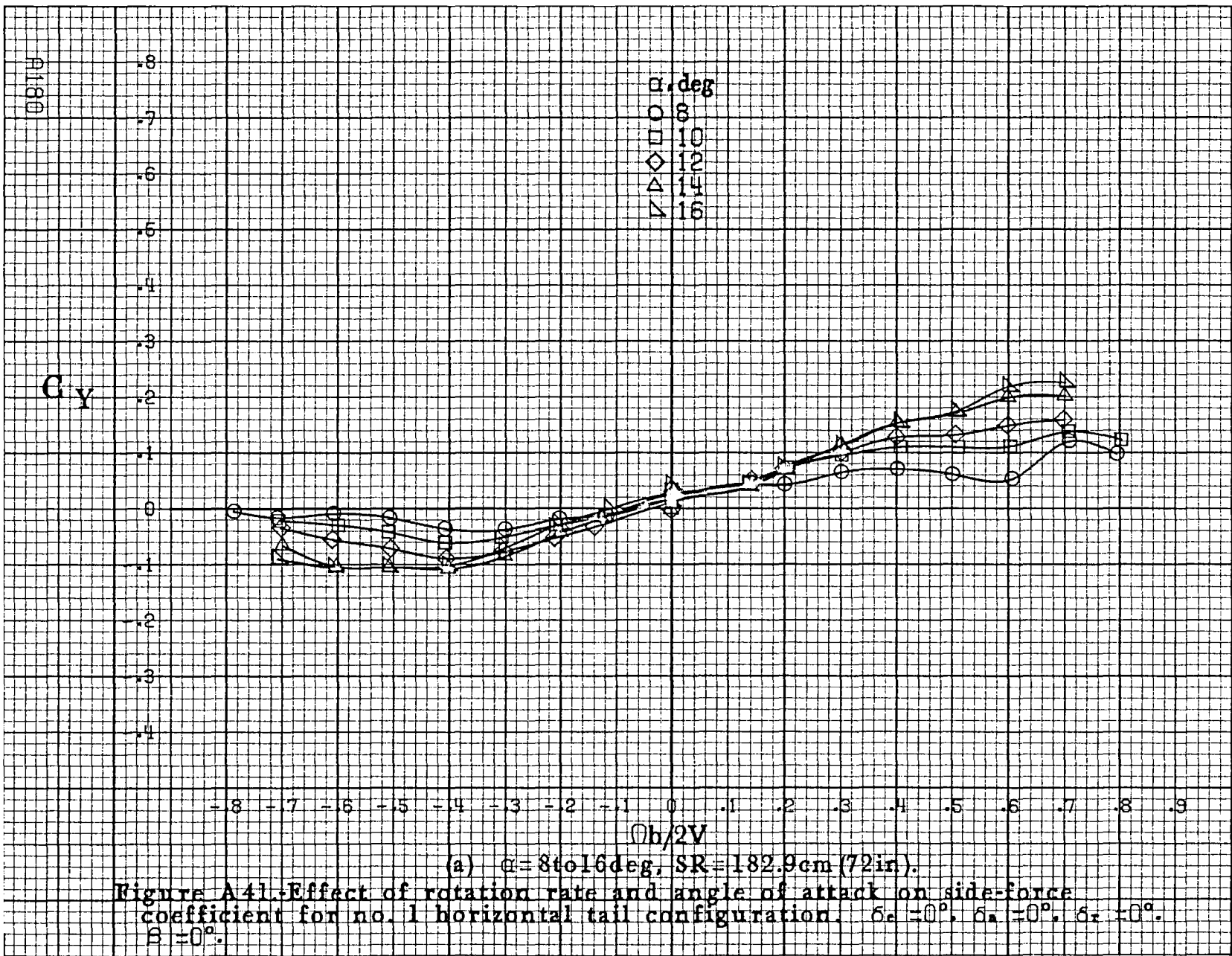

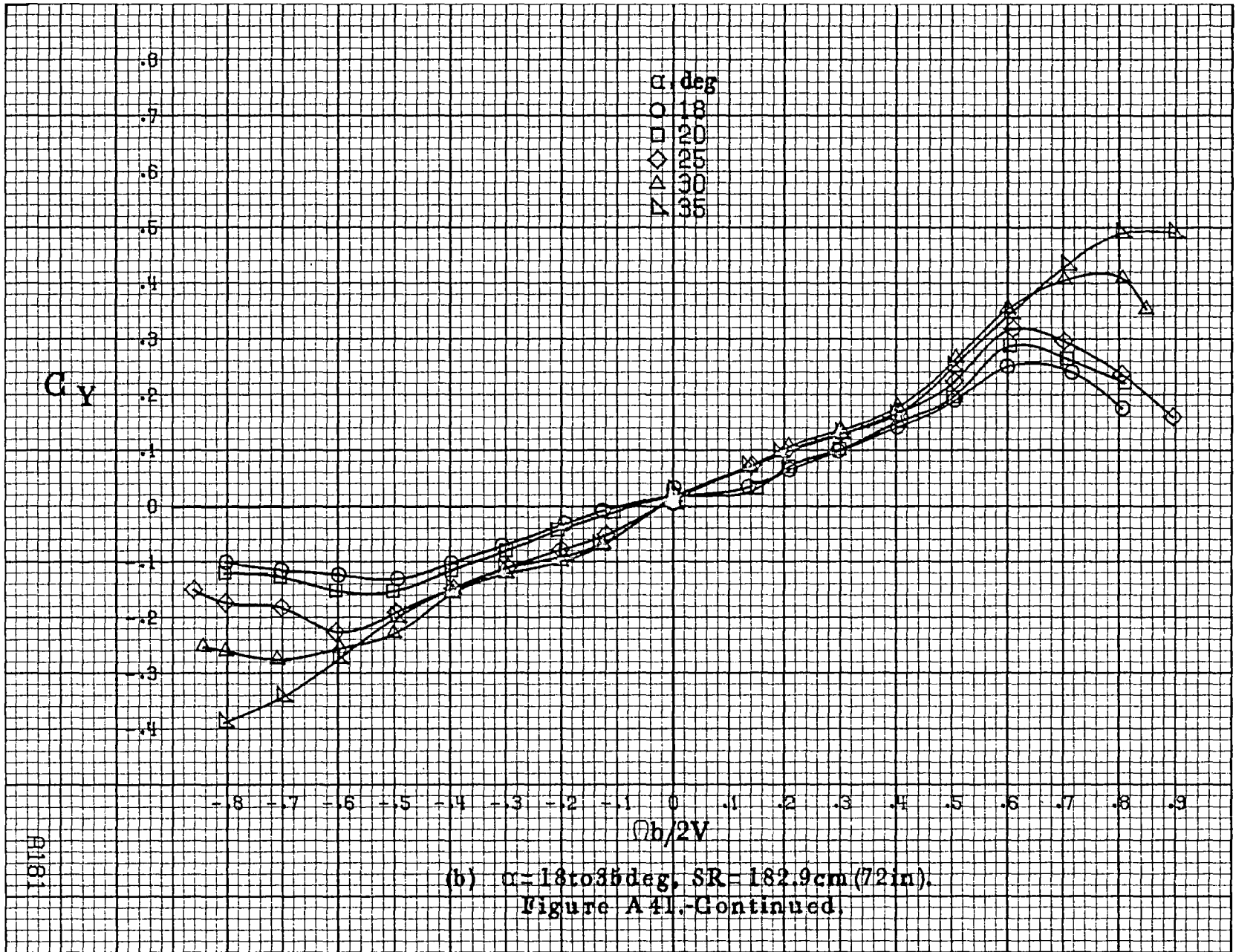



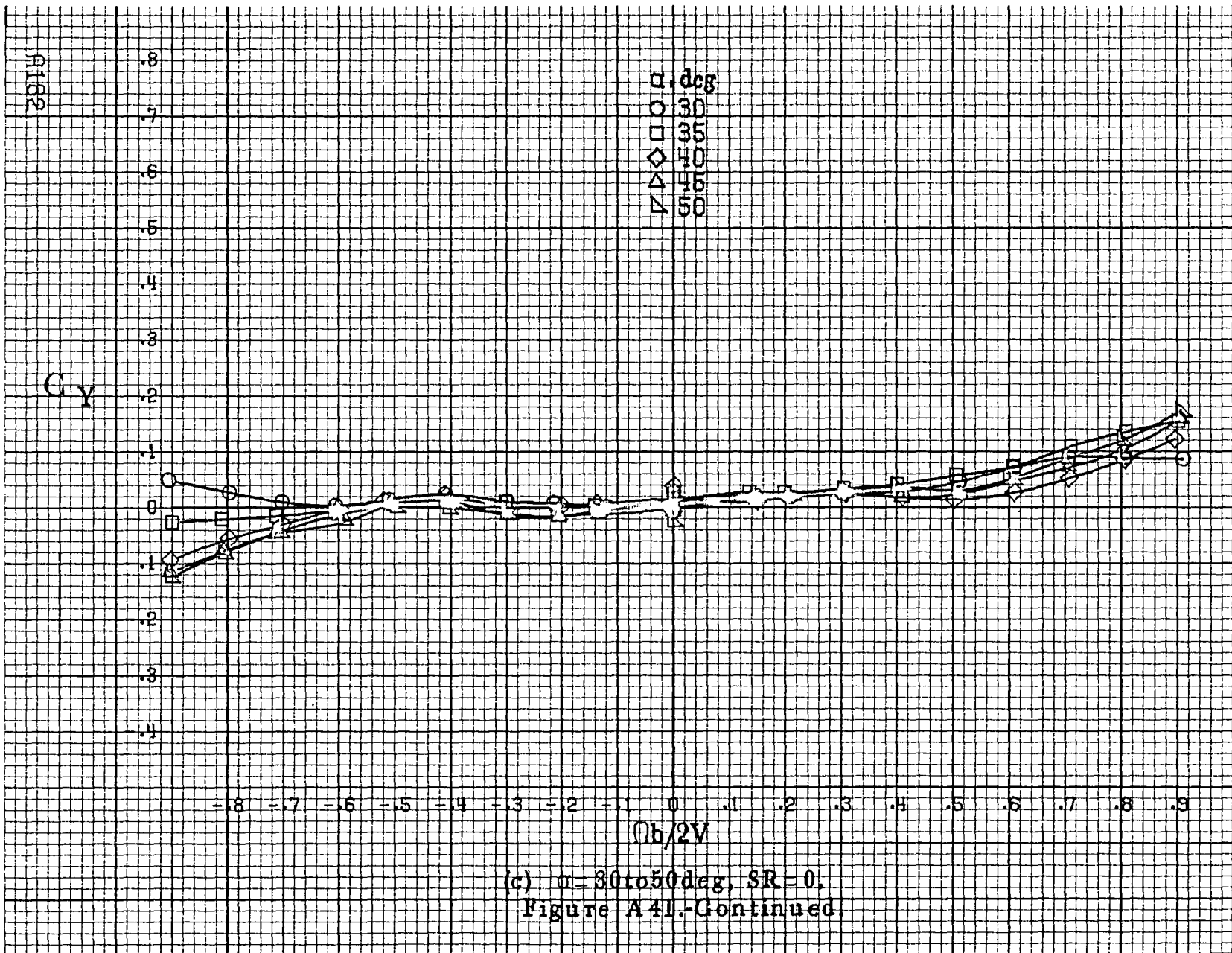



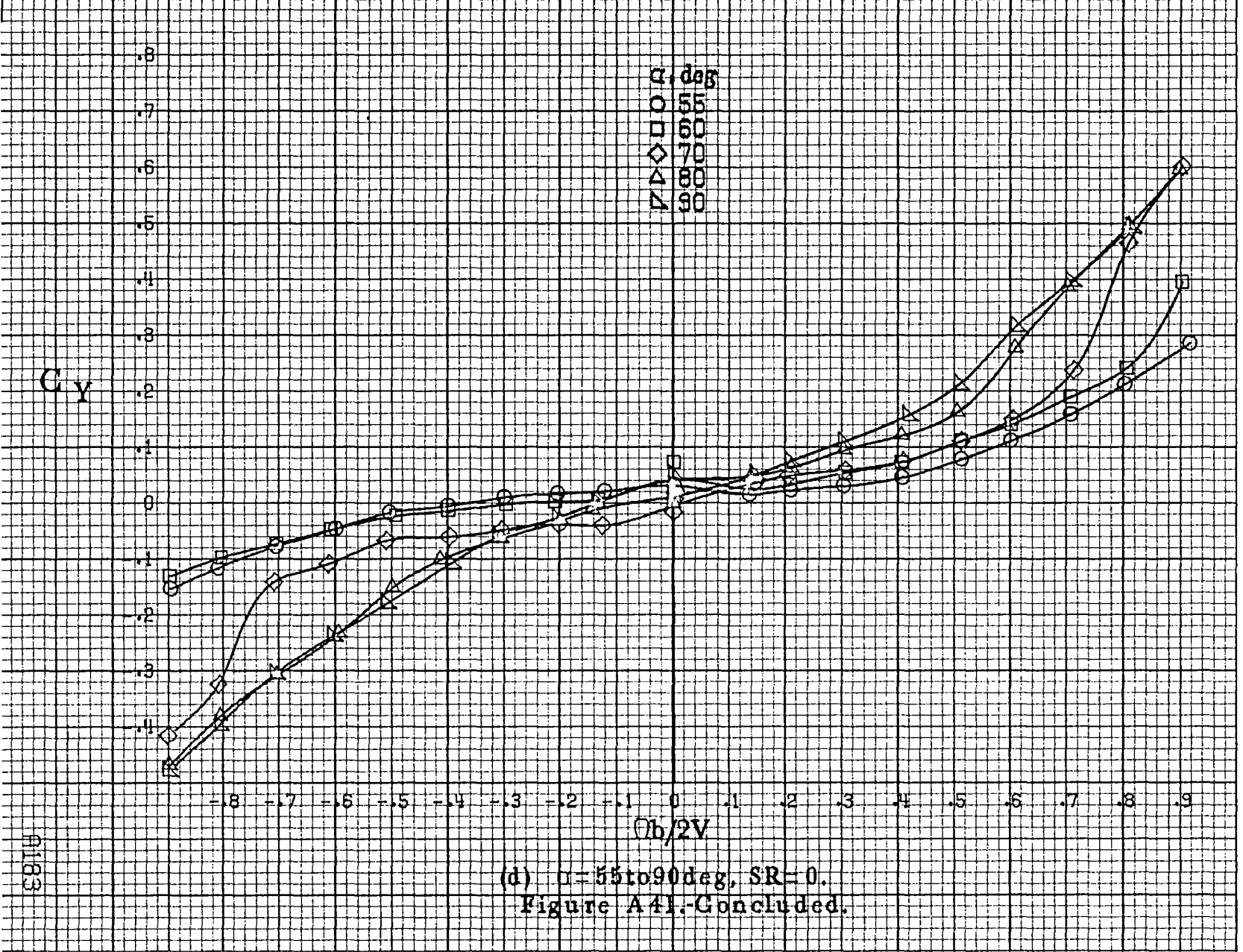

(d)  $\alpha = 55$  to  $90$  deg,  $SR = 0$ .  
 Figure A41.-Concluded.

P183

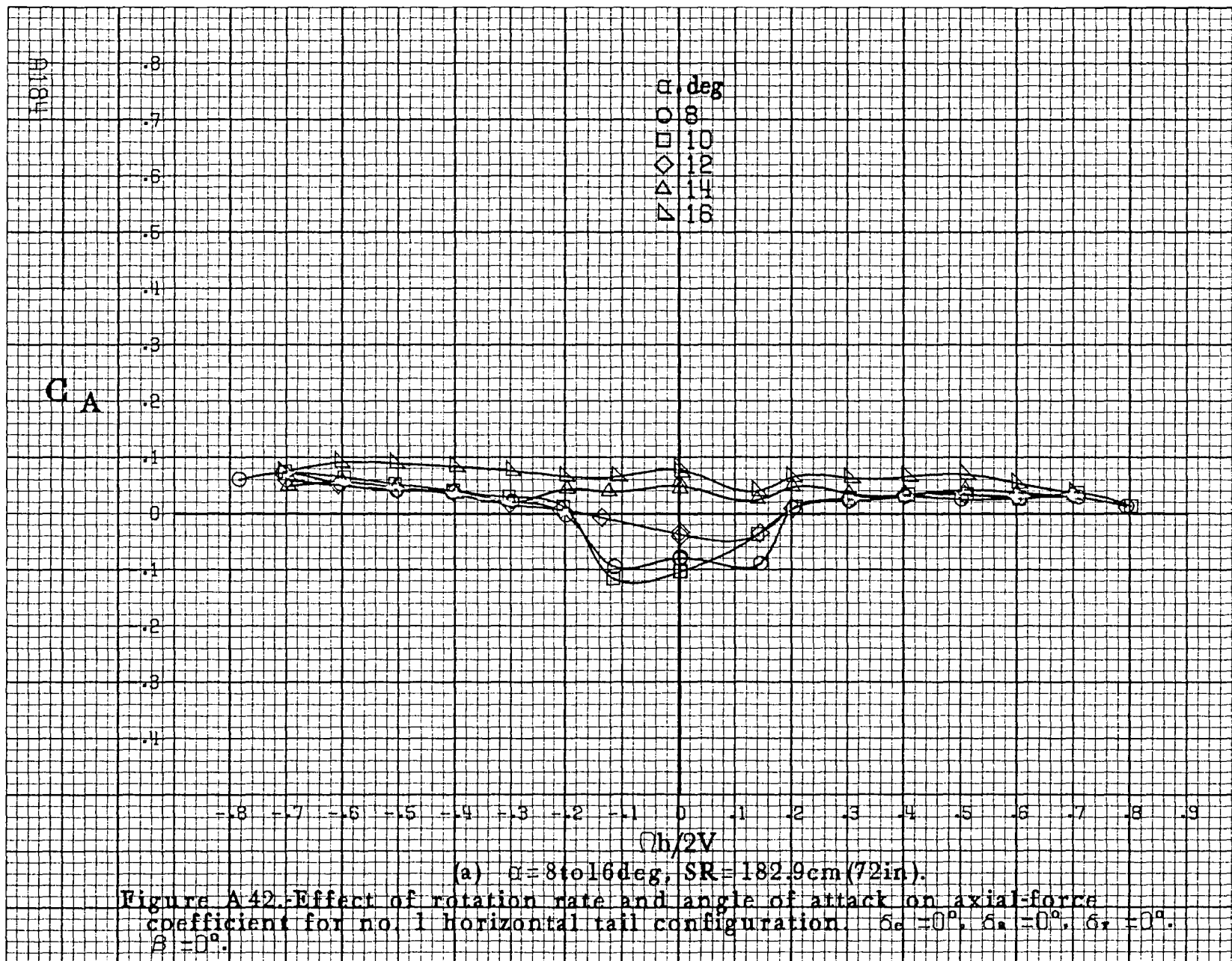

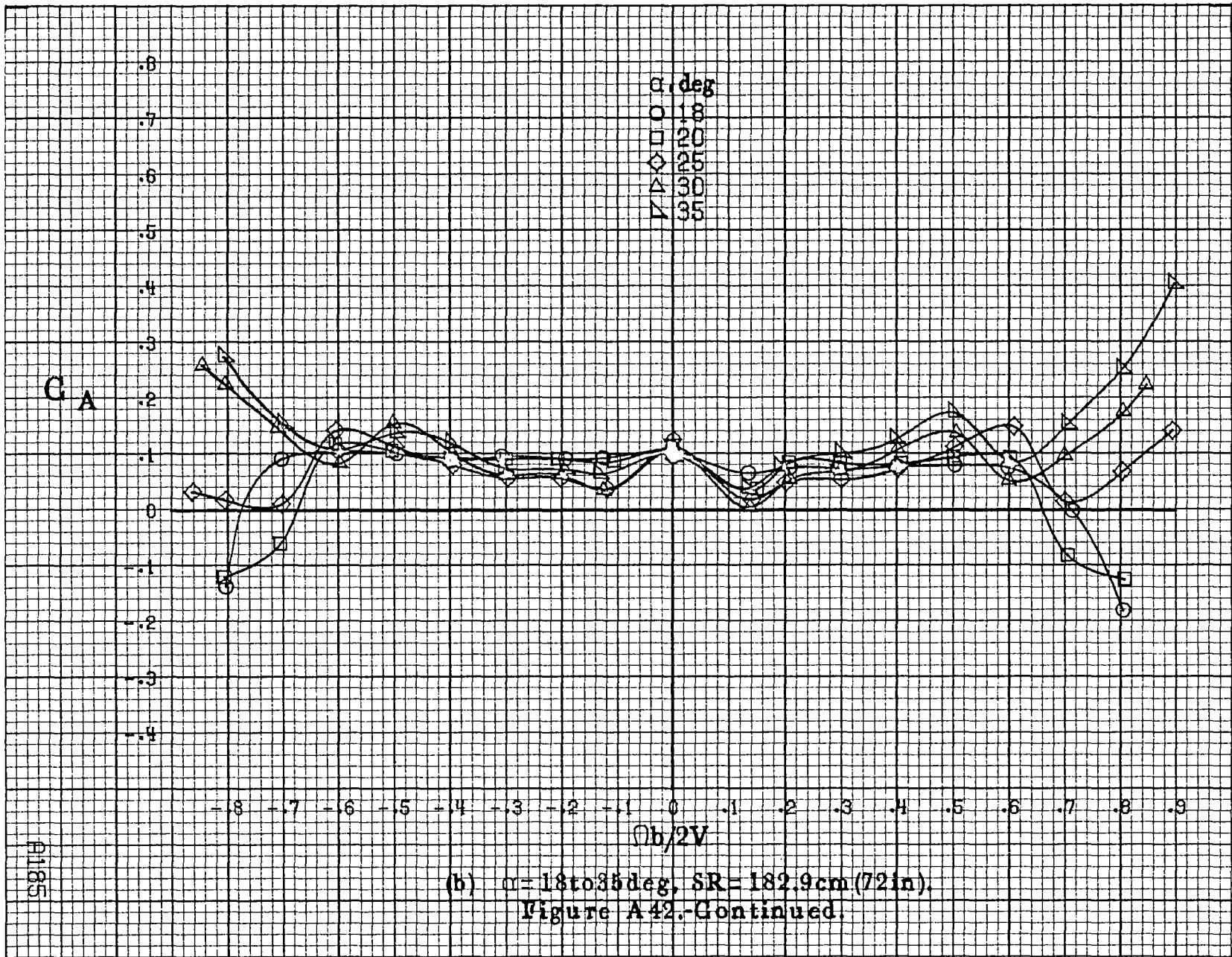

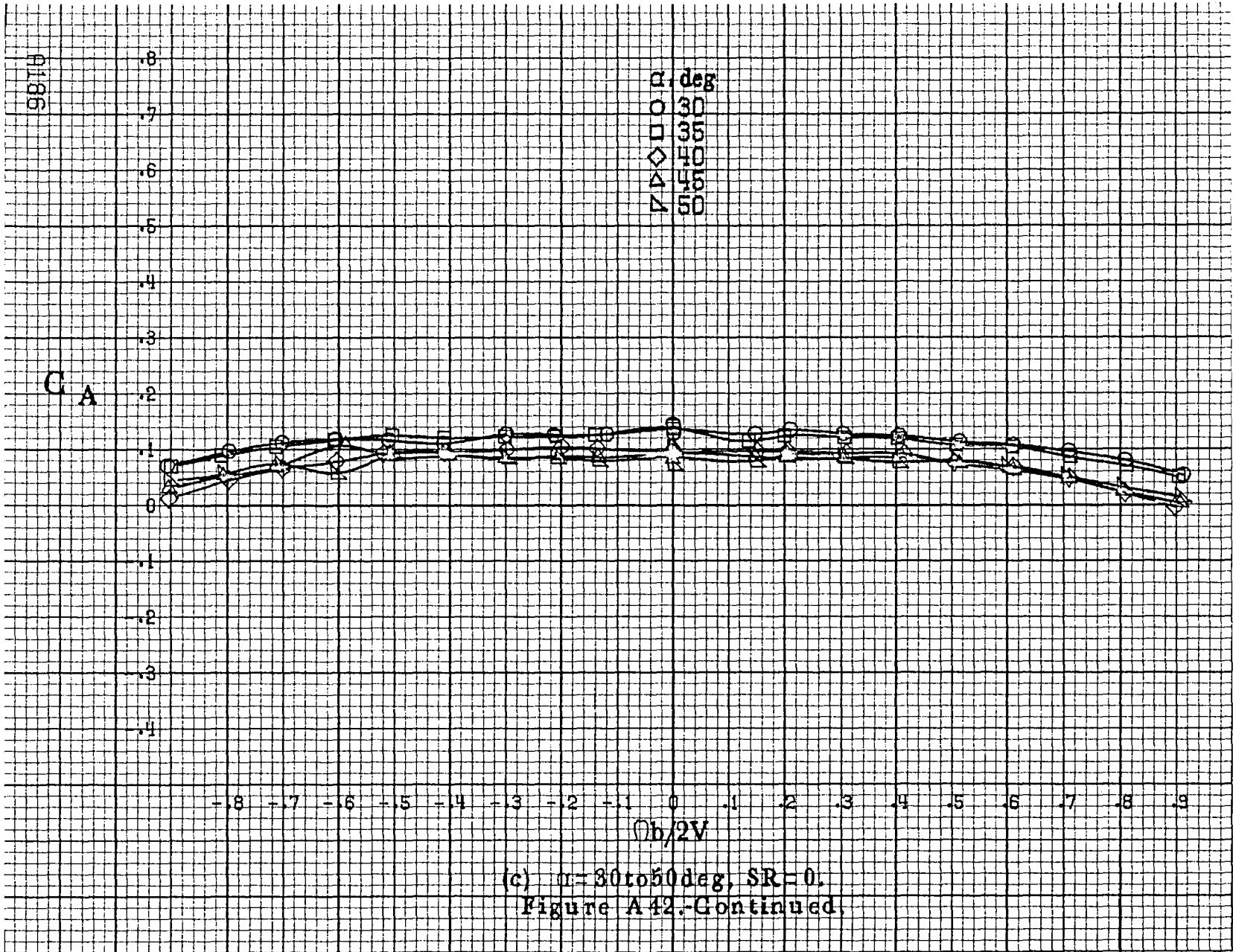

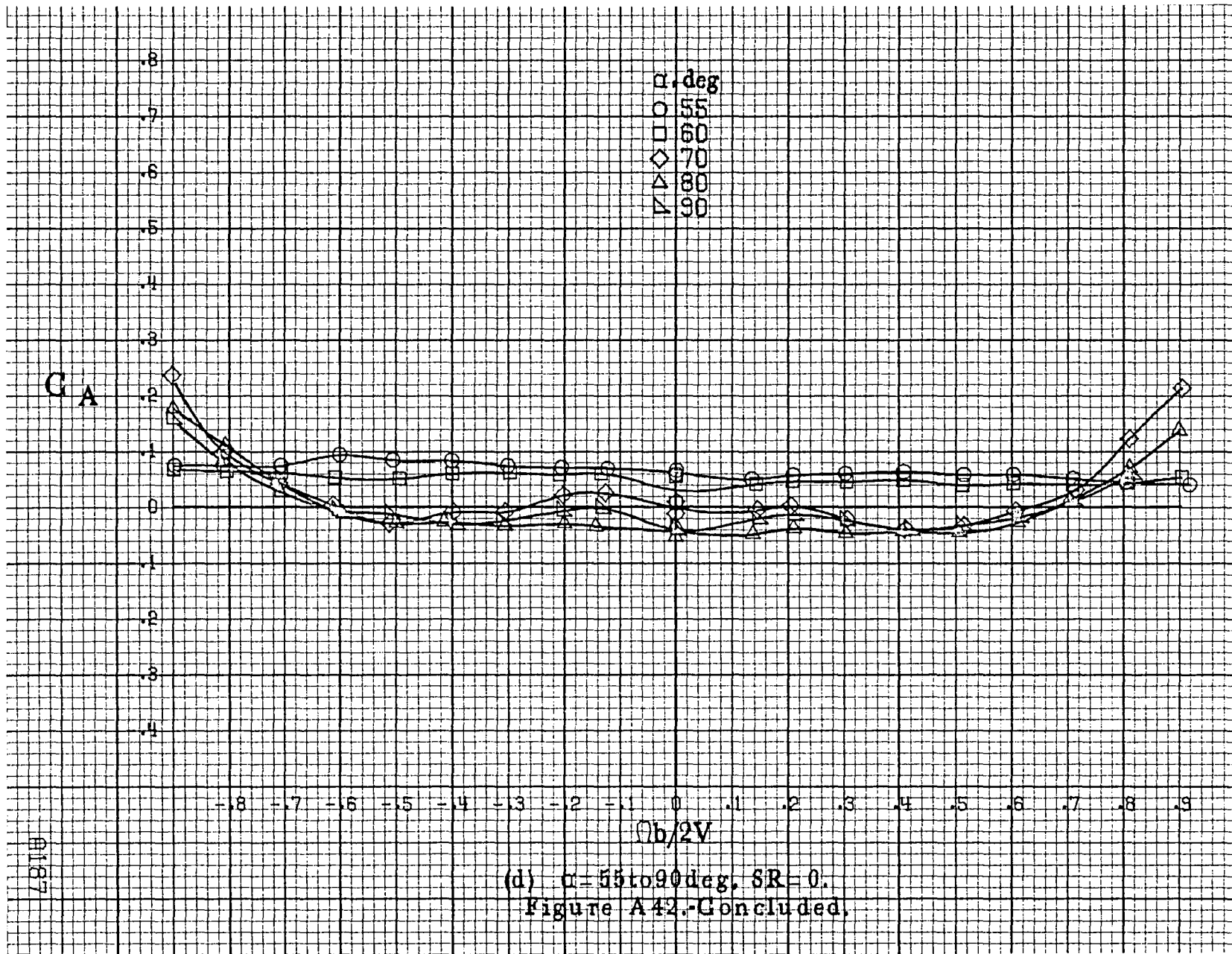

(d)  $\alpha = 55$  to  $90$  deg,  $SR = 0$ .  
 Figure A42.-Concluded.

0187

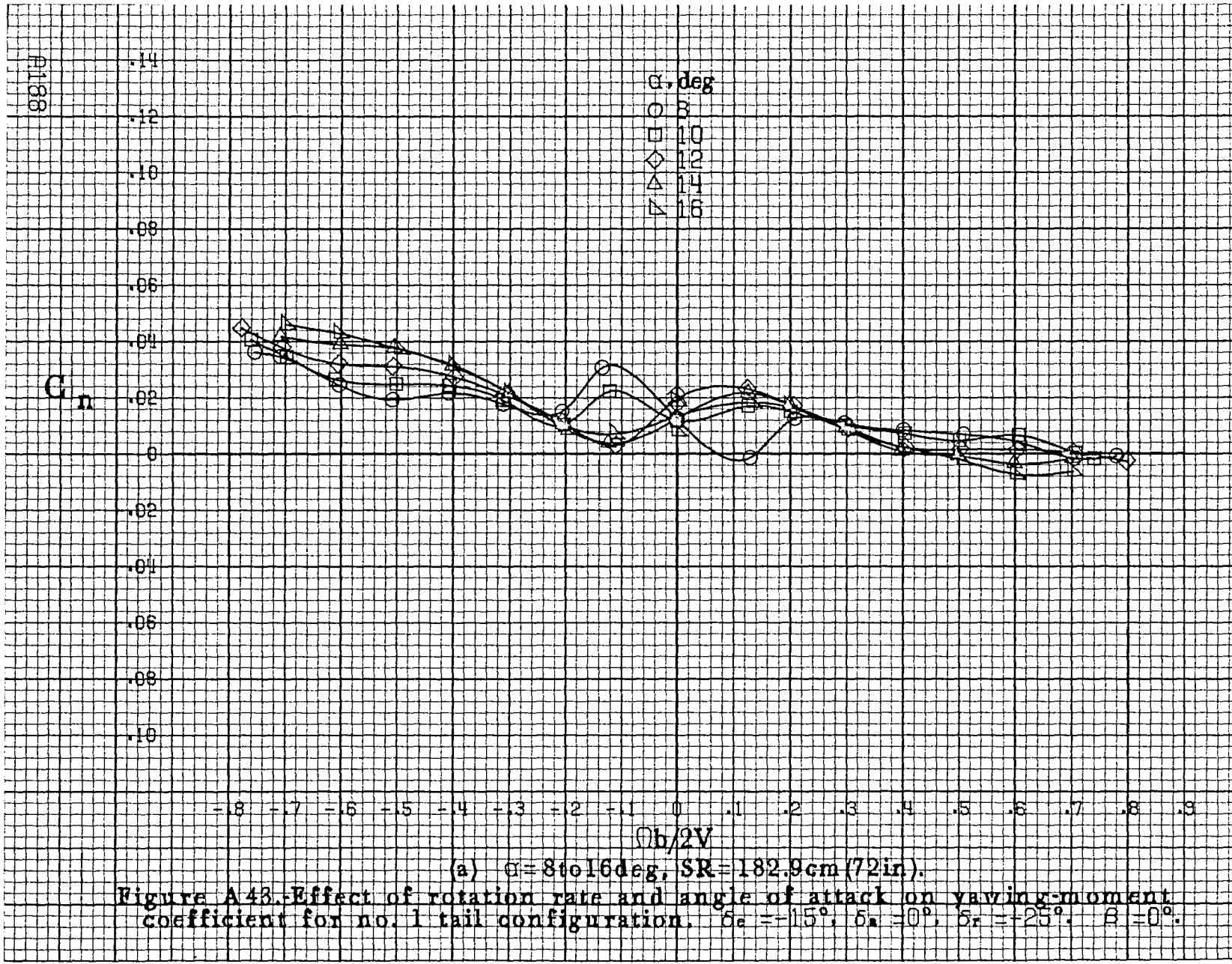

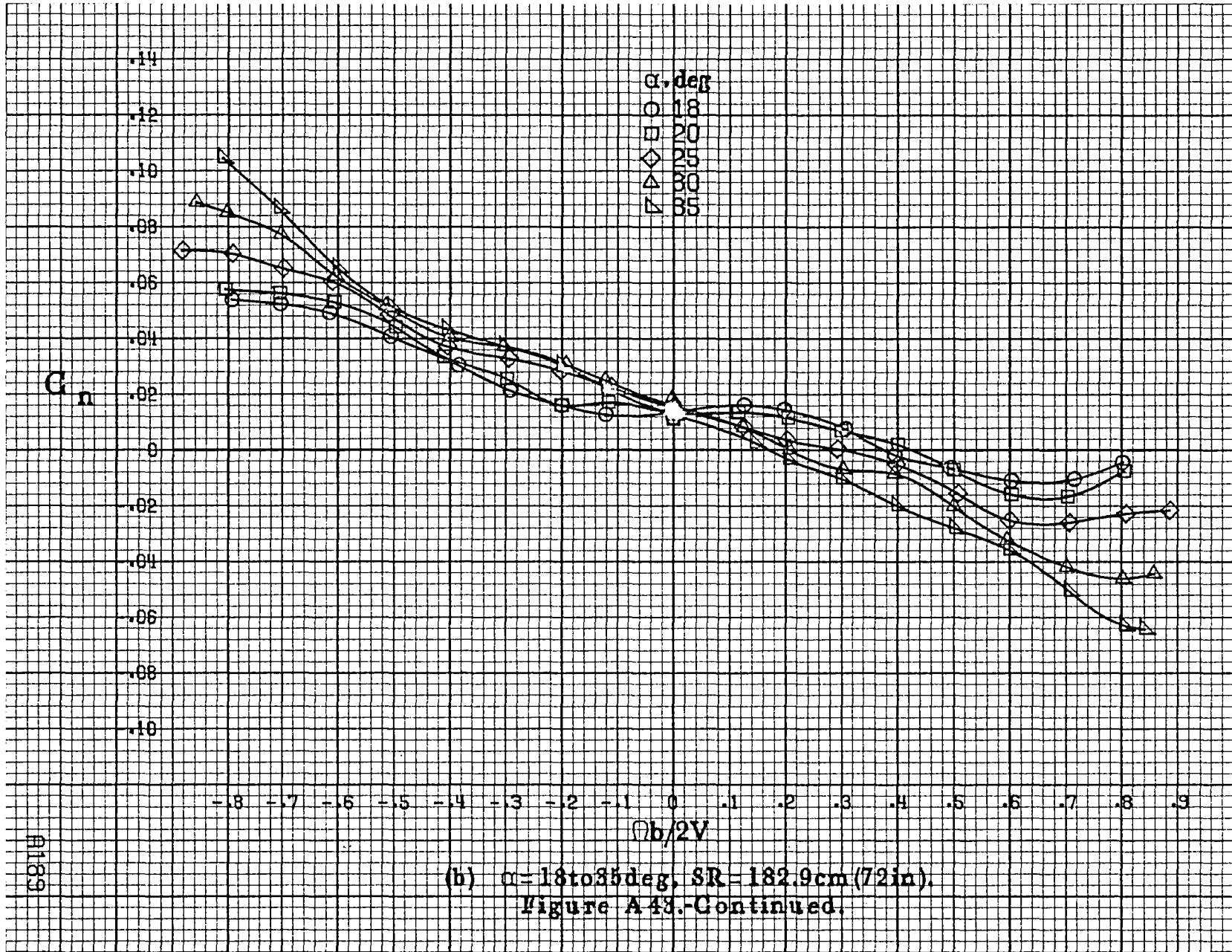

A189



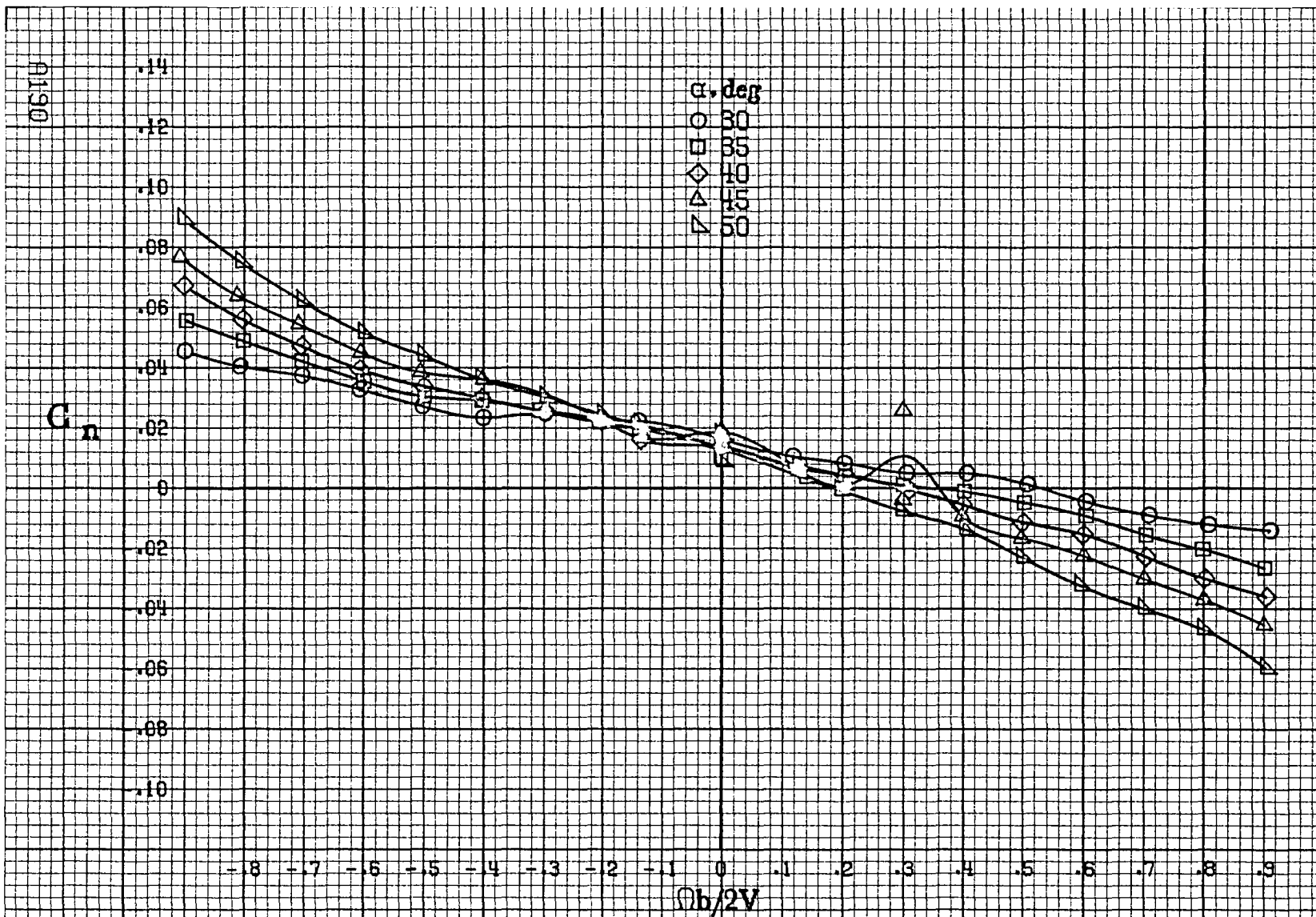

(c)  $\alpha = 30$  to  $50$  deg,  $SR = 0$ .  
 Figure A48.-Continued.



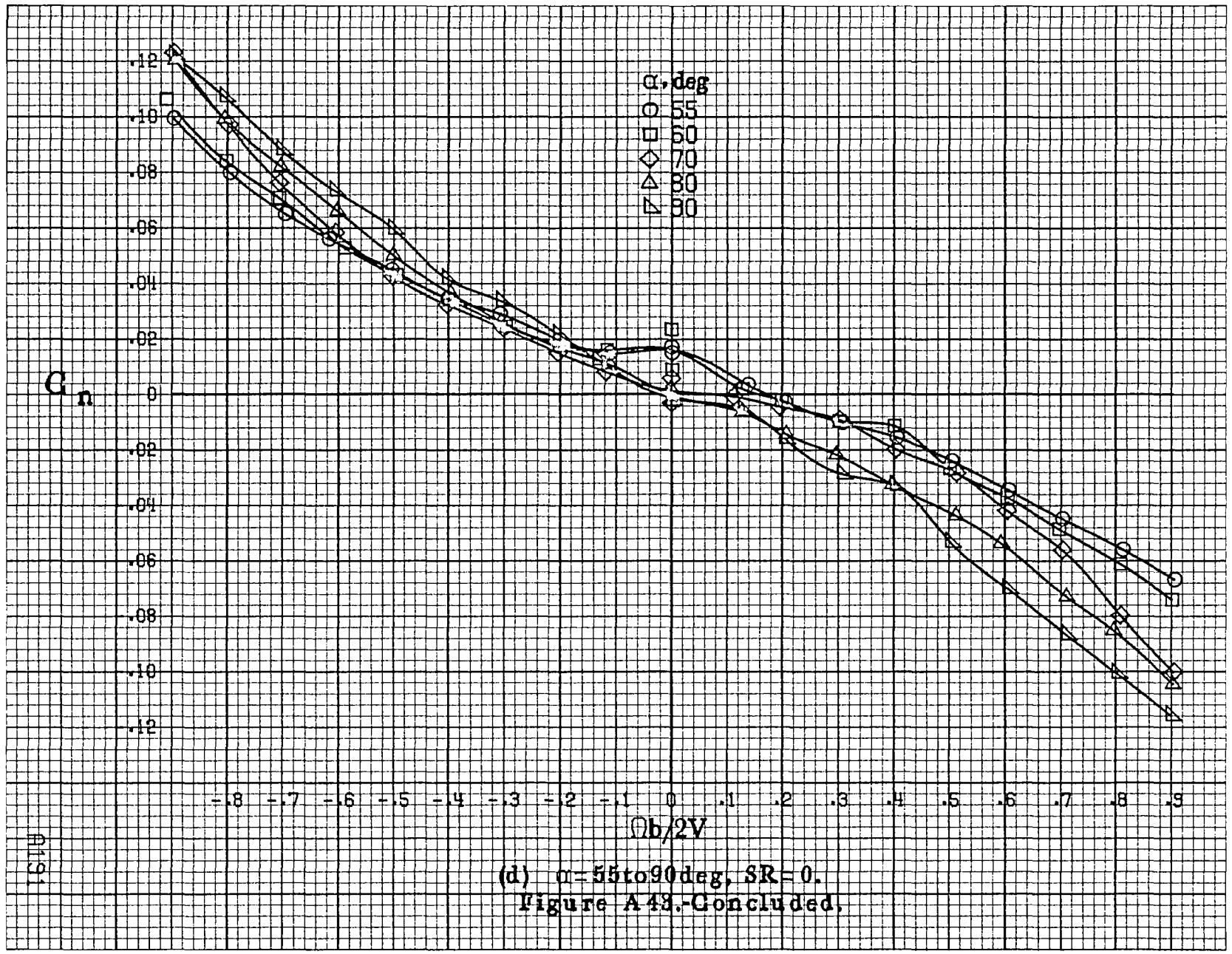

(d)  $\alpha = 55$  to  $90$  deg,  $SR = 0$ .  
 Figure A48.-Concluded.

A191

A192

$C_l$

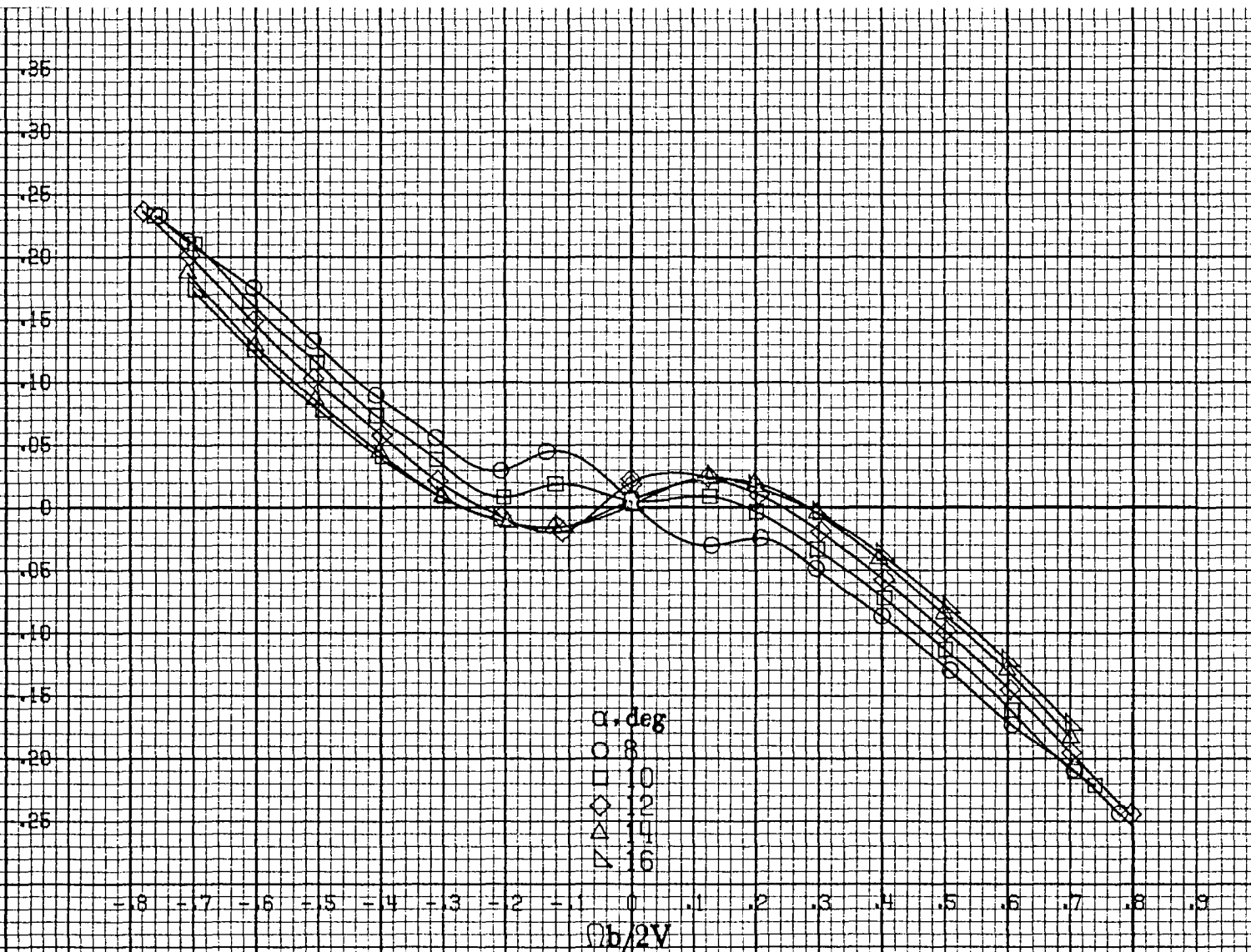

(a)  $\alpha = 8$  to  $16$  deg,  $SR = 182.9$  cm (72 in).

Figure A44.-Effect of rotation rate and angle of attack on rolling-moment coefficient for no. 1 tail configuration.  $\delta_e = -15^\circ$ ;  $\delta_a = 0^\circ$ ;  $\delta_r = -25^\circ$ ;  $\beta = 0^\circ$ .

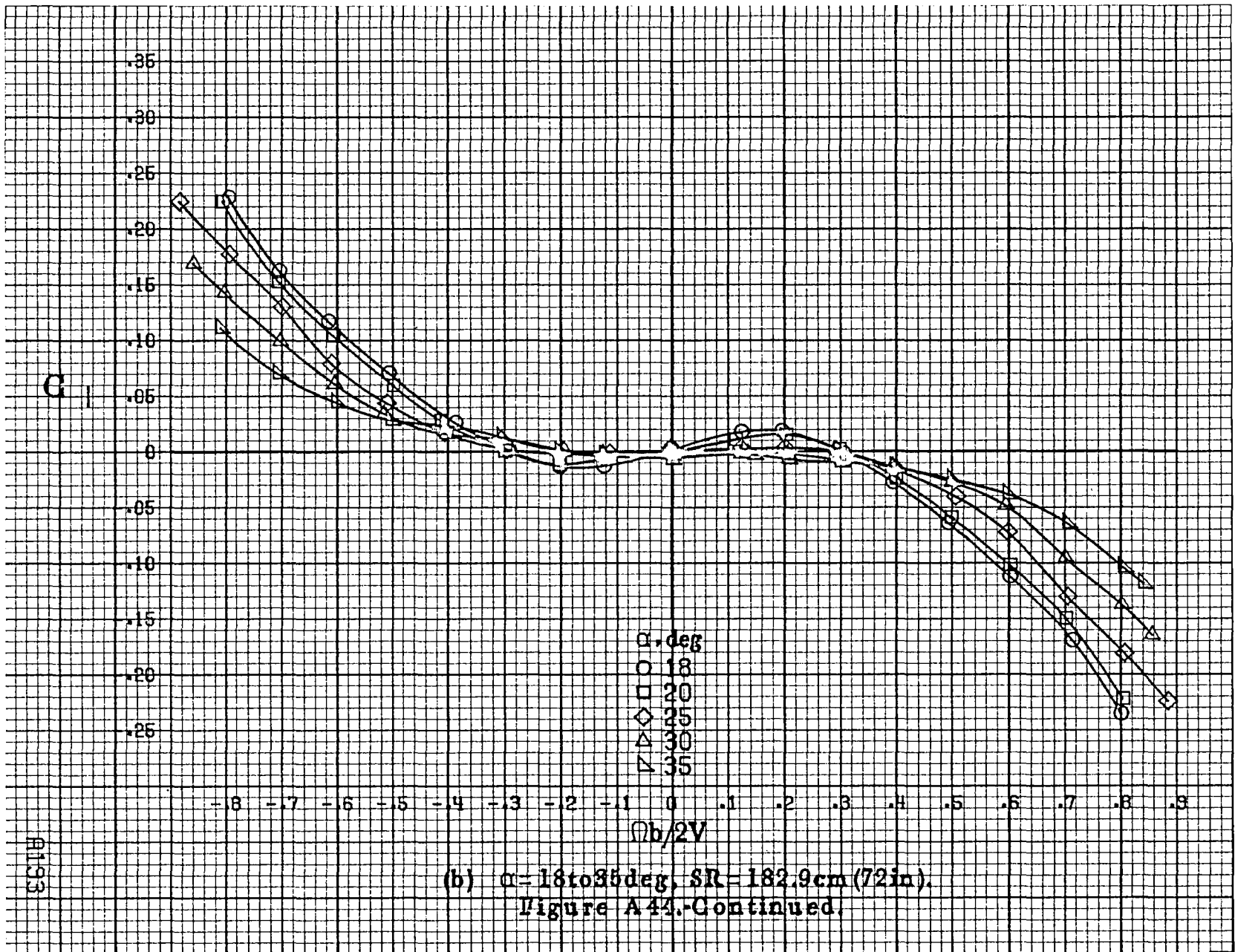

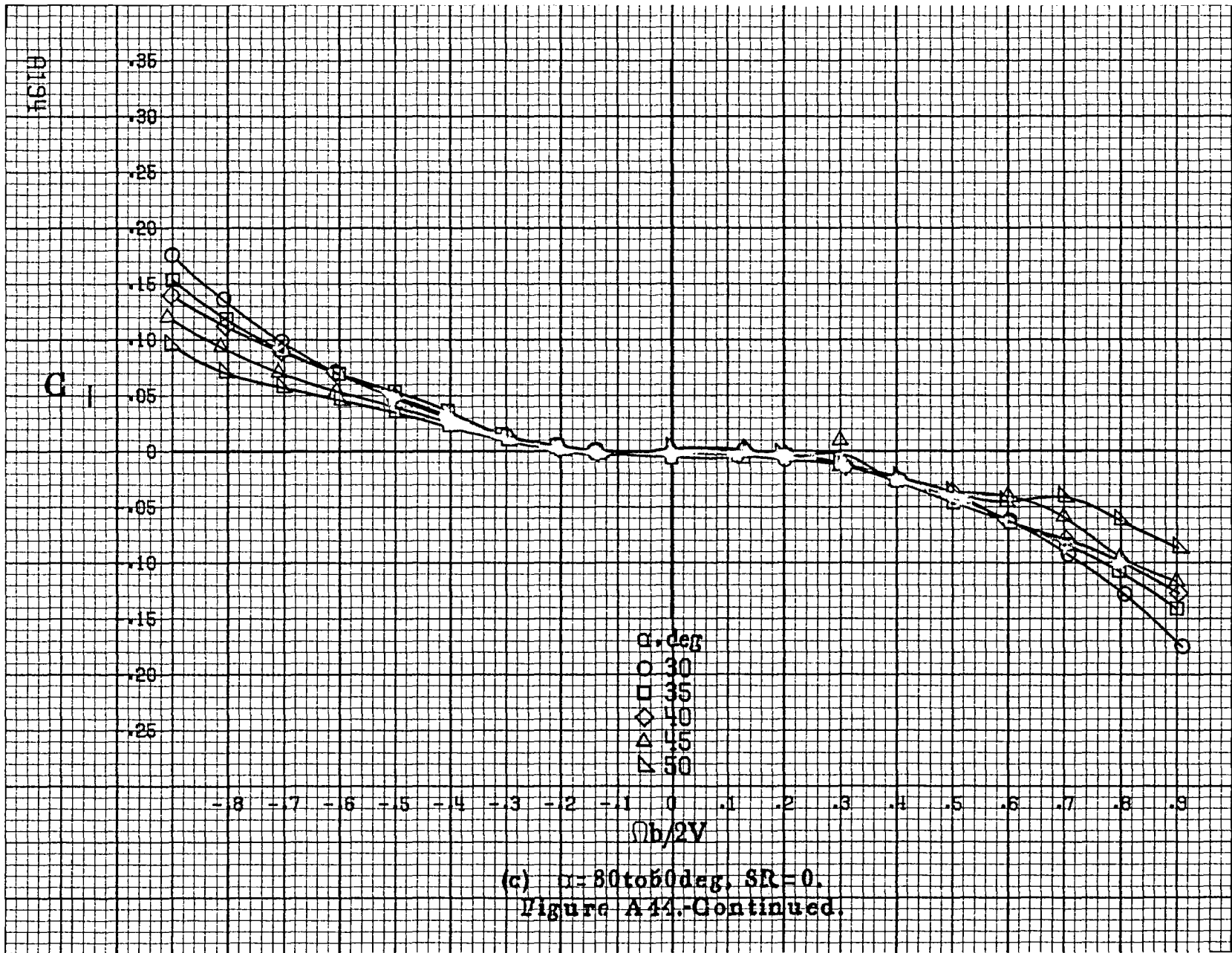

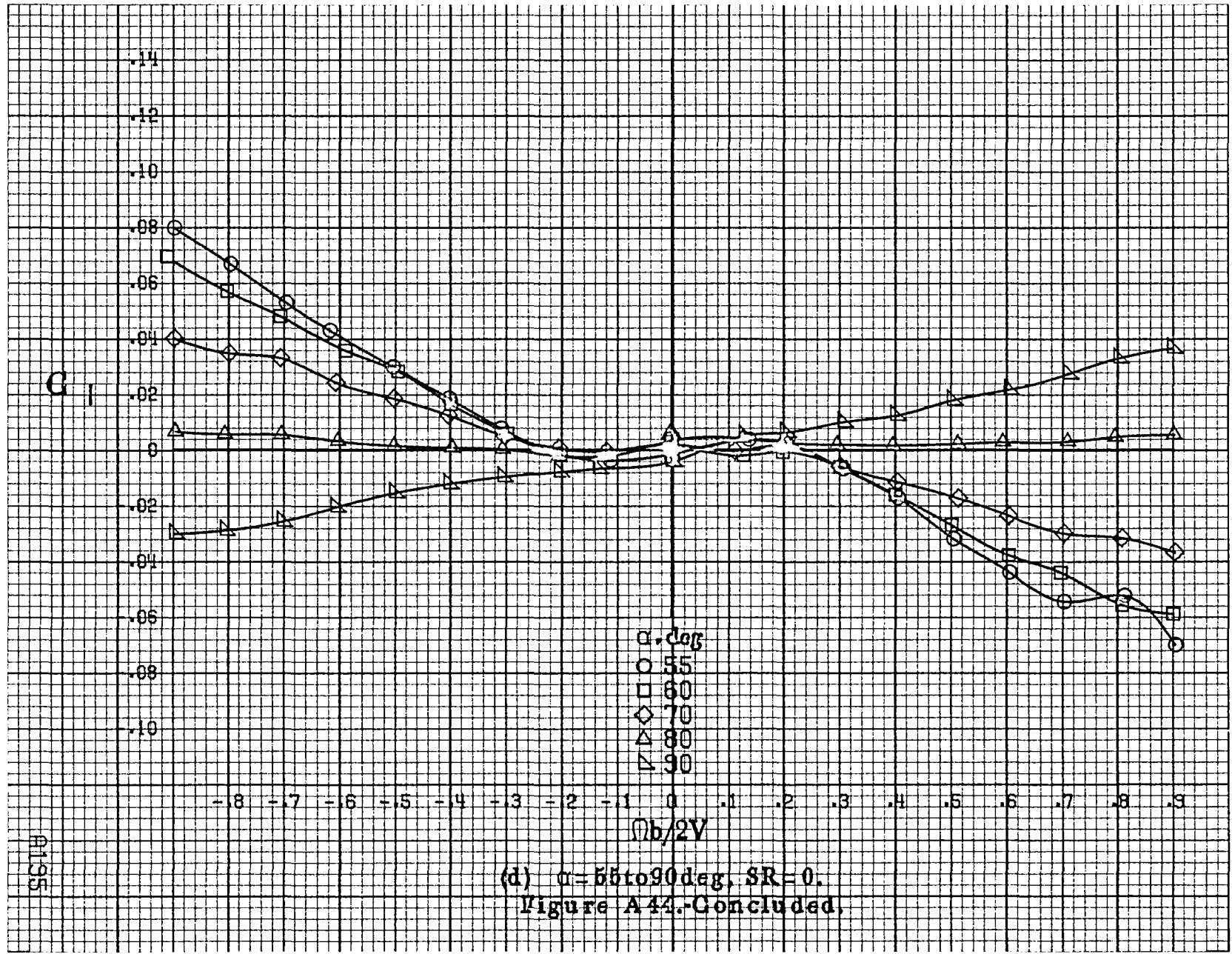

A135

(d)  $\alpha = 55$  to  $90$  deg,  $SR = 0$ .  
 Figure A44.-Concluded.

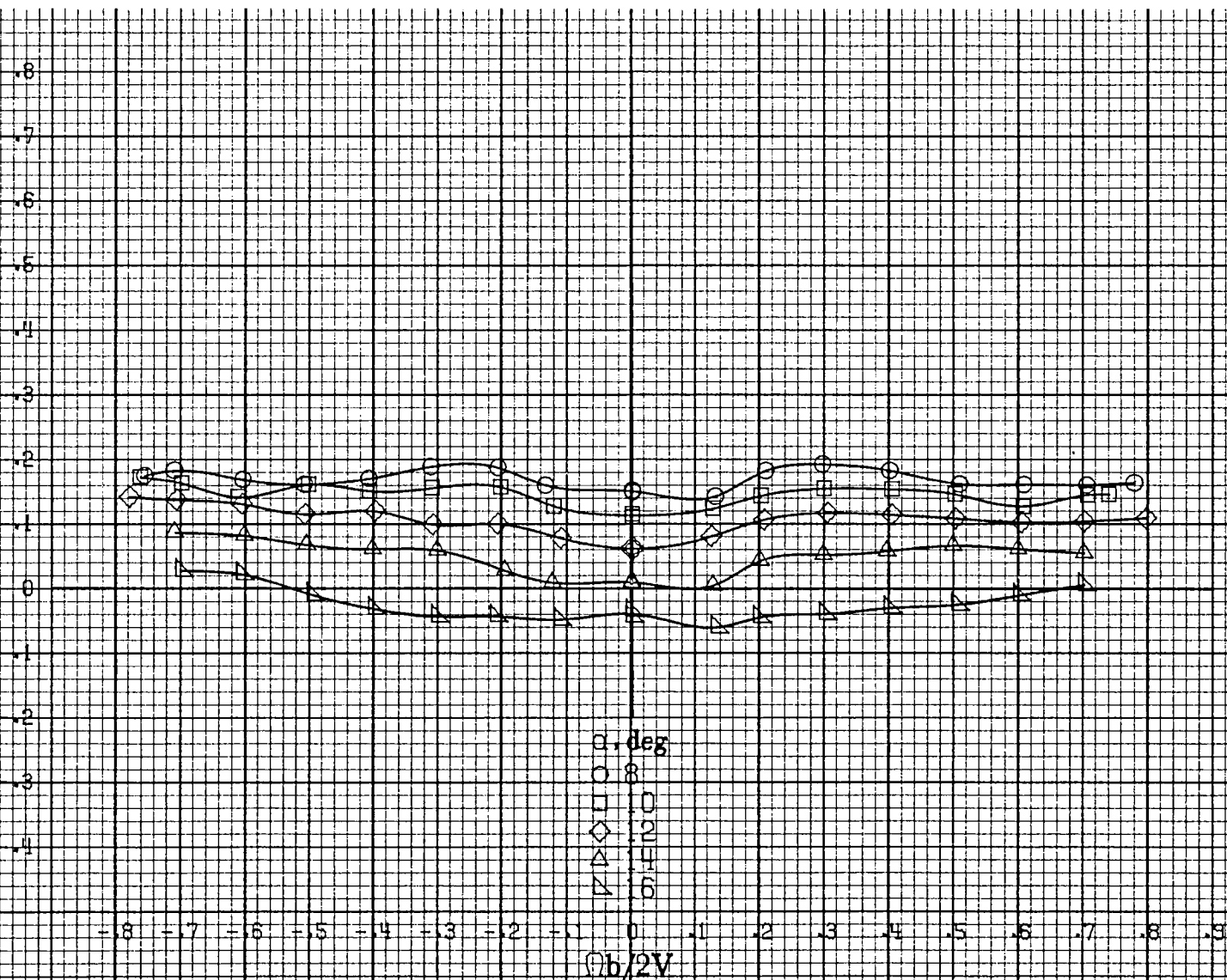
$C_m$ 

(a)  $\alpha = 8$  to  $16$  deg,  $SR = 182.9$  cm (72 in).

Figure A45. Effect of rotation rate and angle of attack on pitching moment coefficient for no. 1 tail configuration.  $\delta_a = 15^\circ$ ,  $\delta_n = 10^\circ$ ,  $\delta_r = 25^\circ$ ,  $\beta = 0^\circ$ .

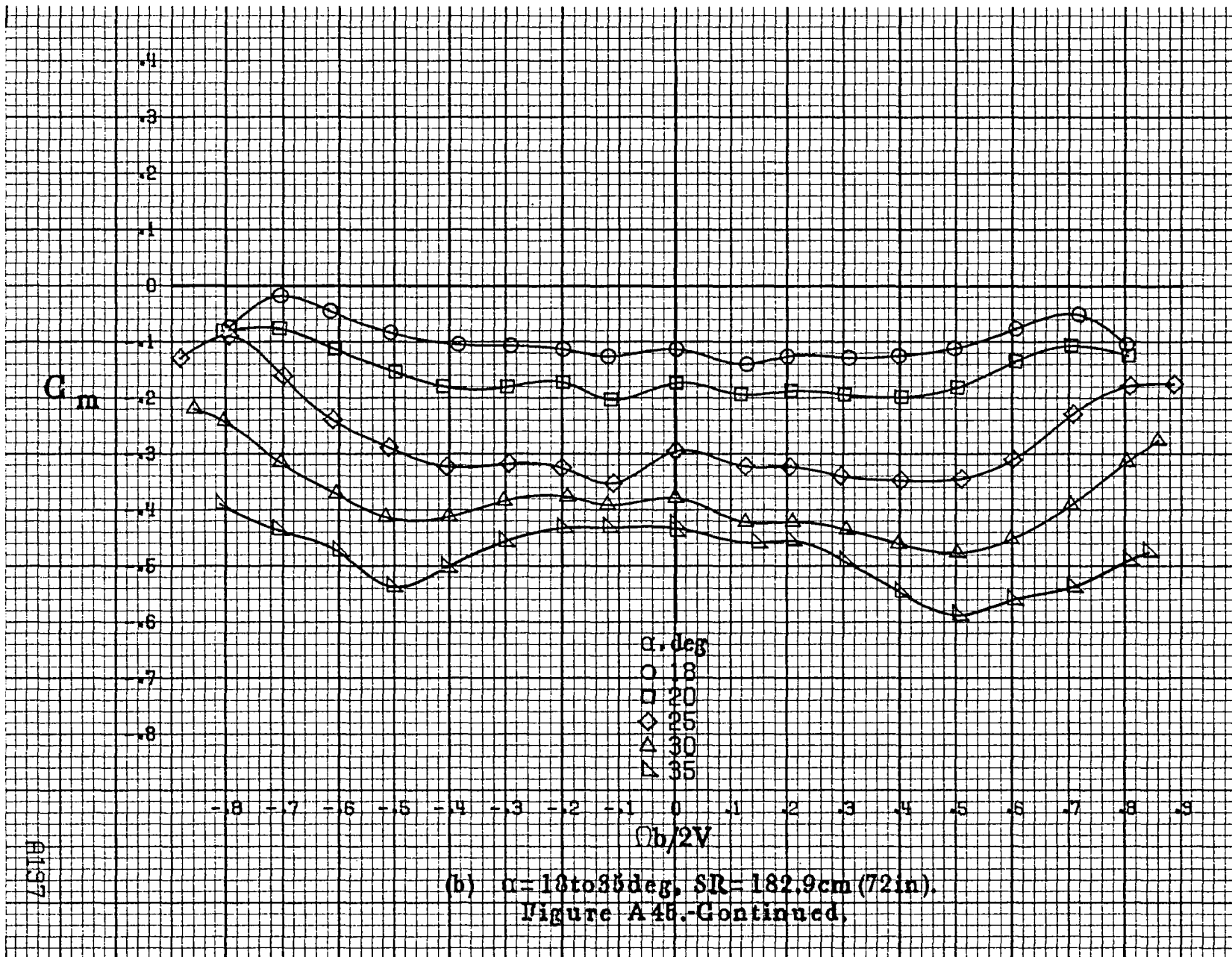



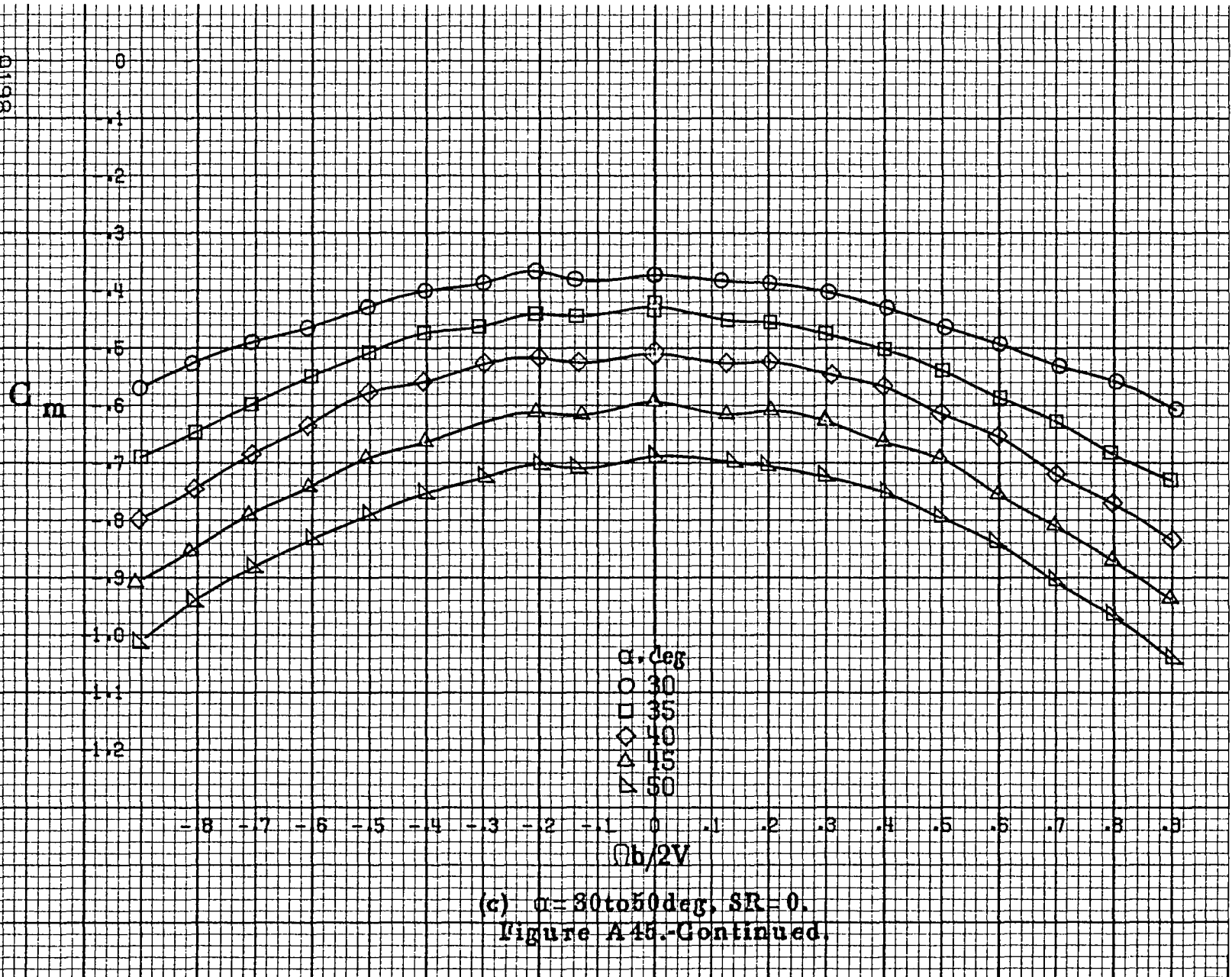

(c)  $\alpha = 30$  to  $50$  deg,  $SR = 0$ .  
 Figure A 45. Continued.



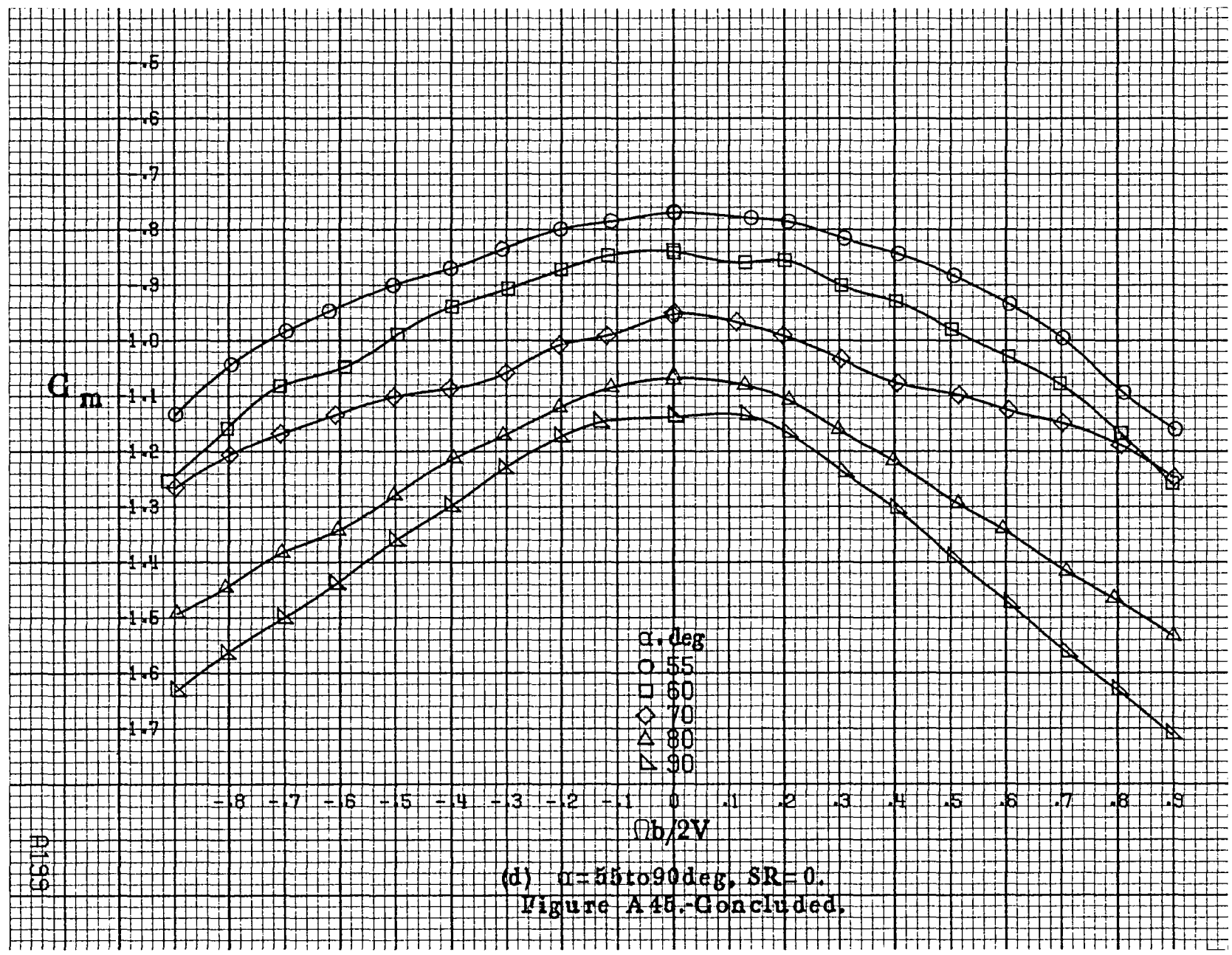

(d)  $\alpha = 55$  to  $90$  deg,  $SR = 0$ .  
Figure A45 - Concluded.

R1139

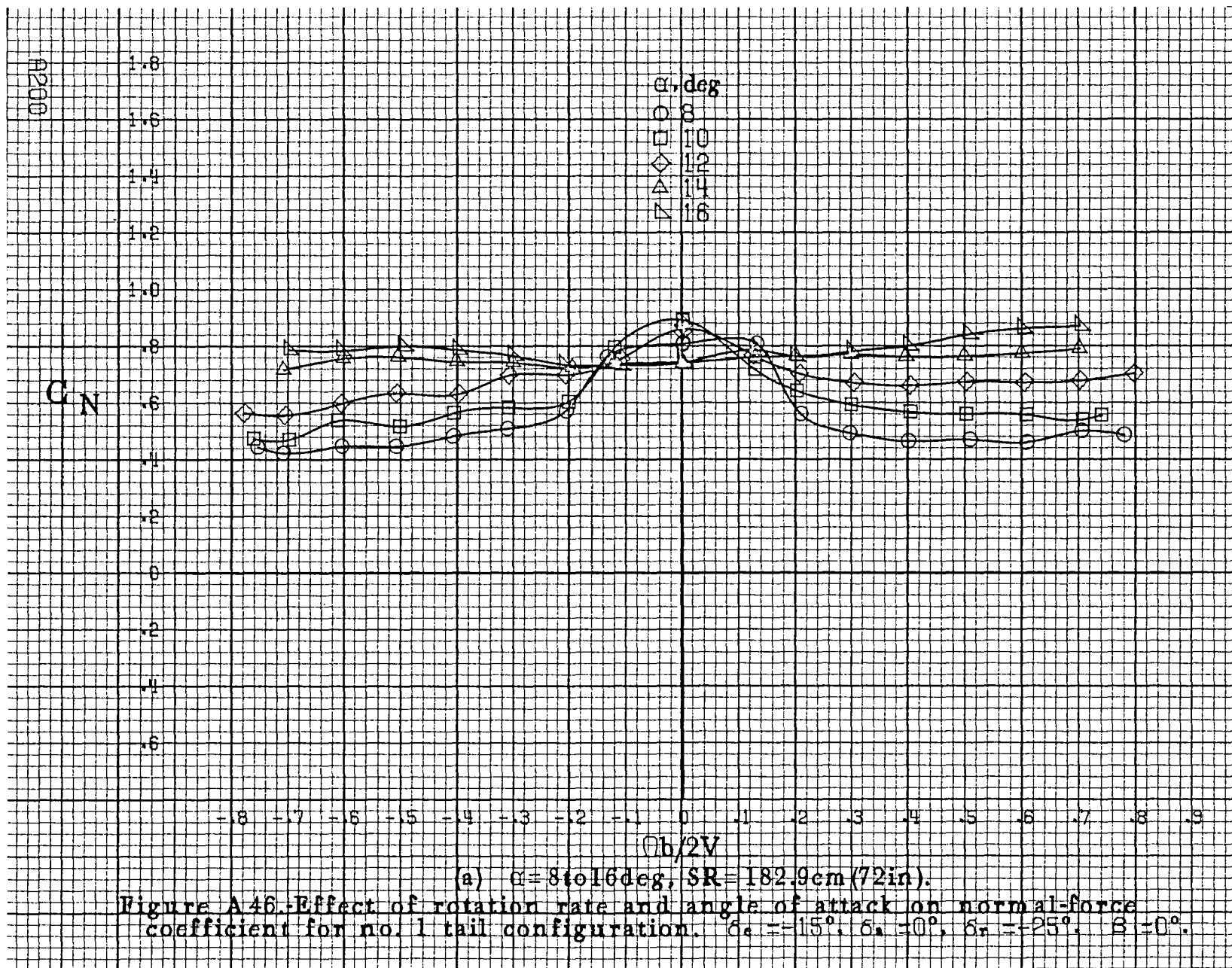

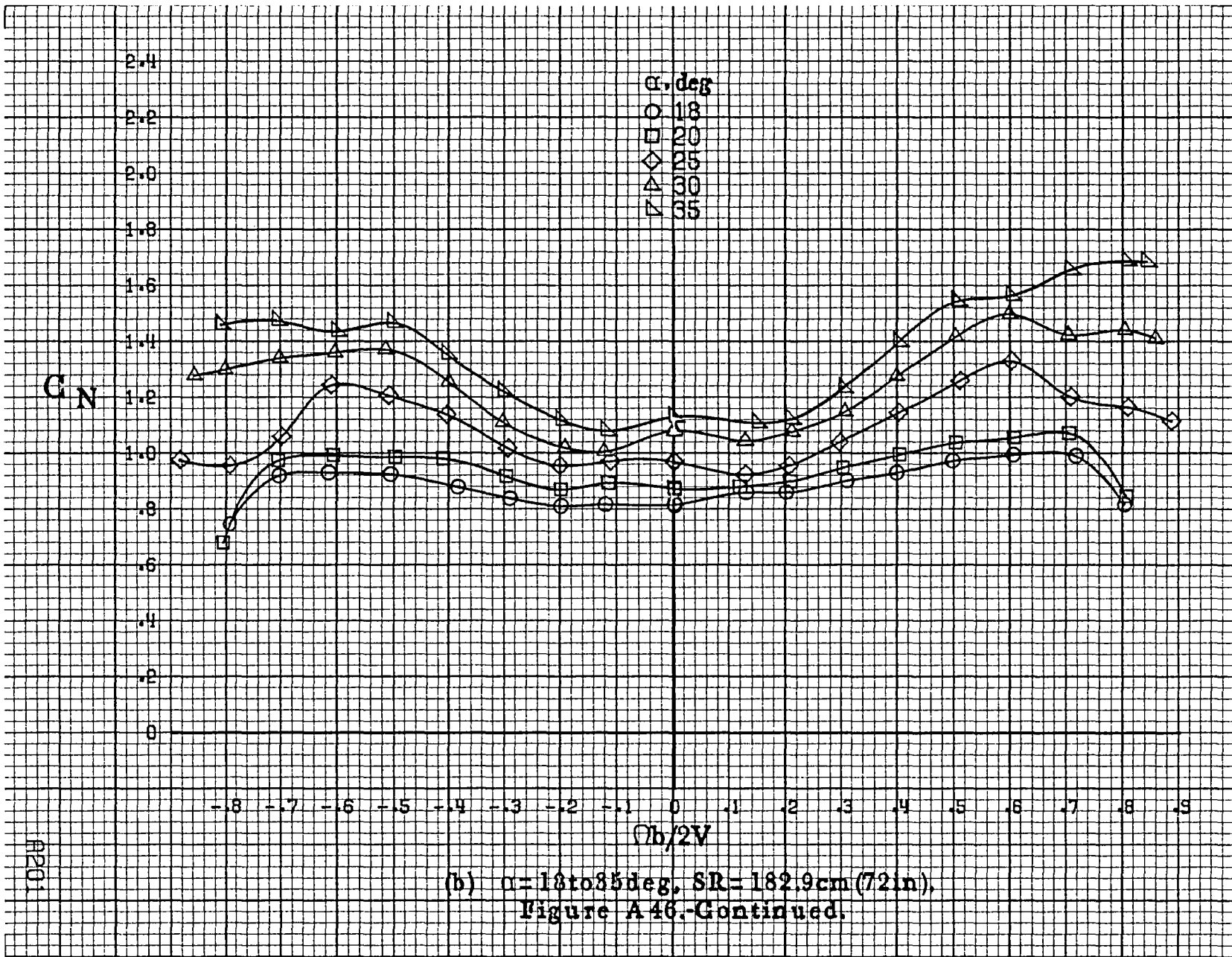

$C_N$

$\Omega_b/2V$

R201

(b)  $\alpha=18$  to  $35$  deg,  $SR=182.9$  cm (72 in),  
Figure A46.-Continued.

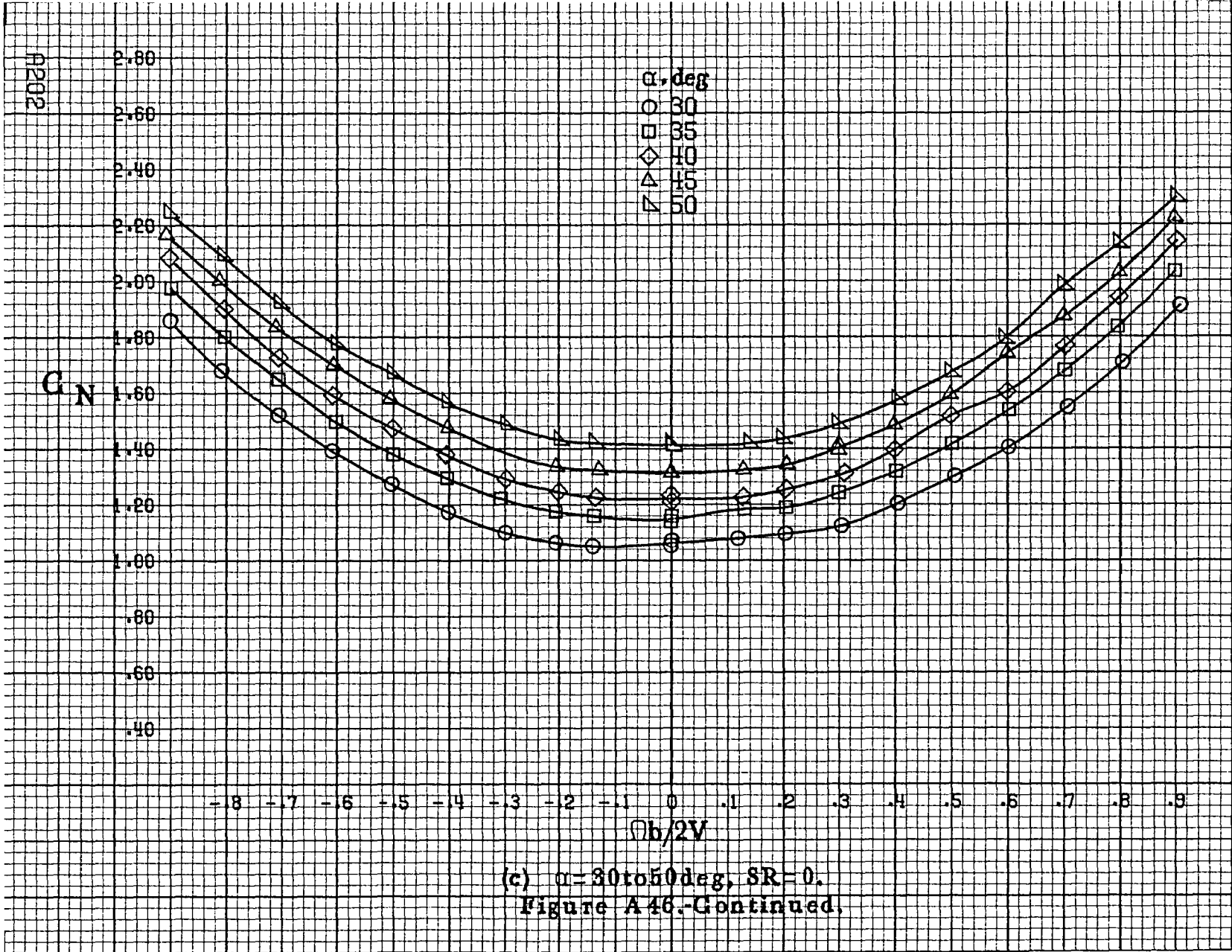

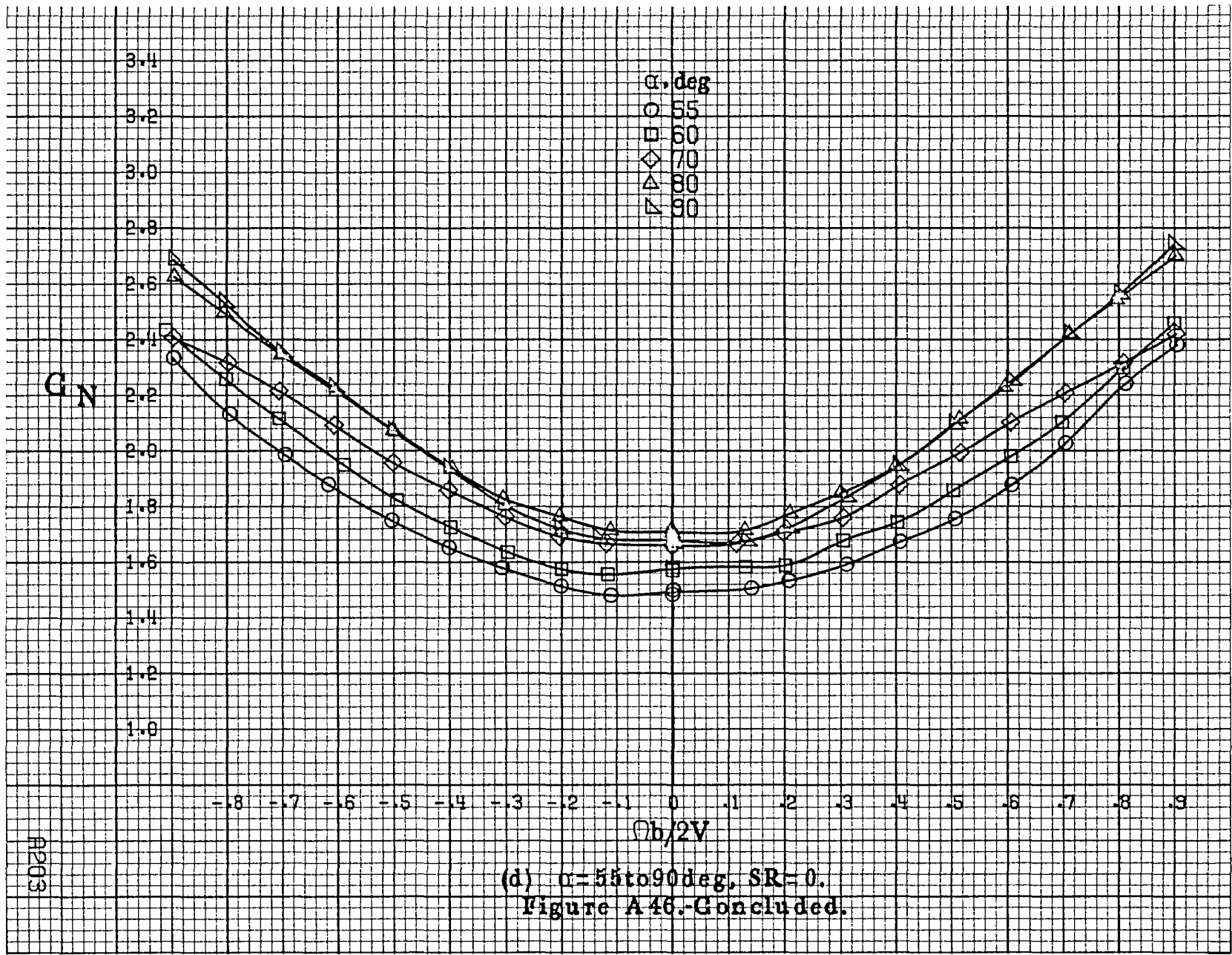

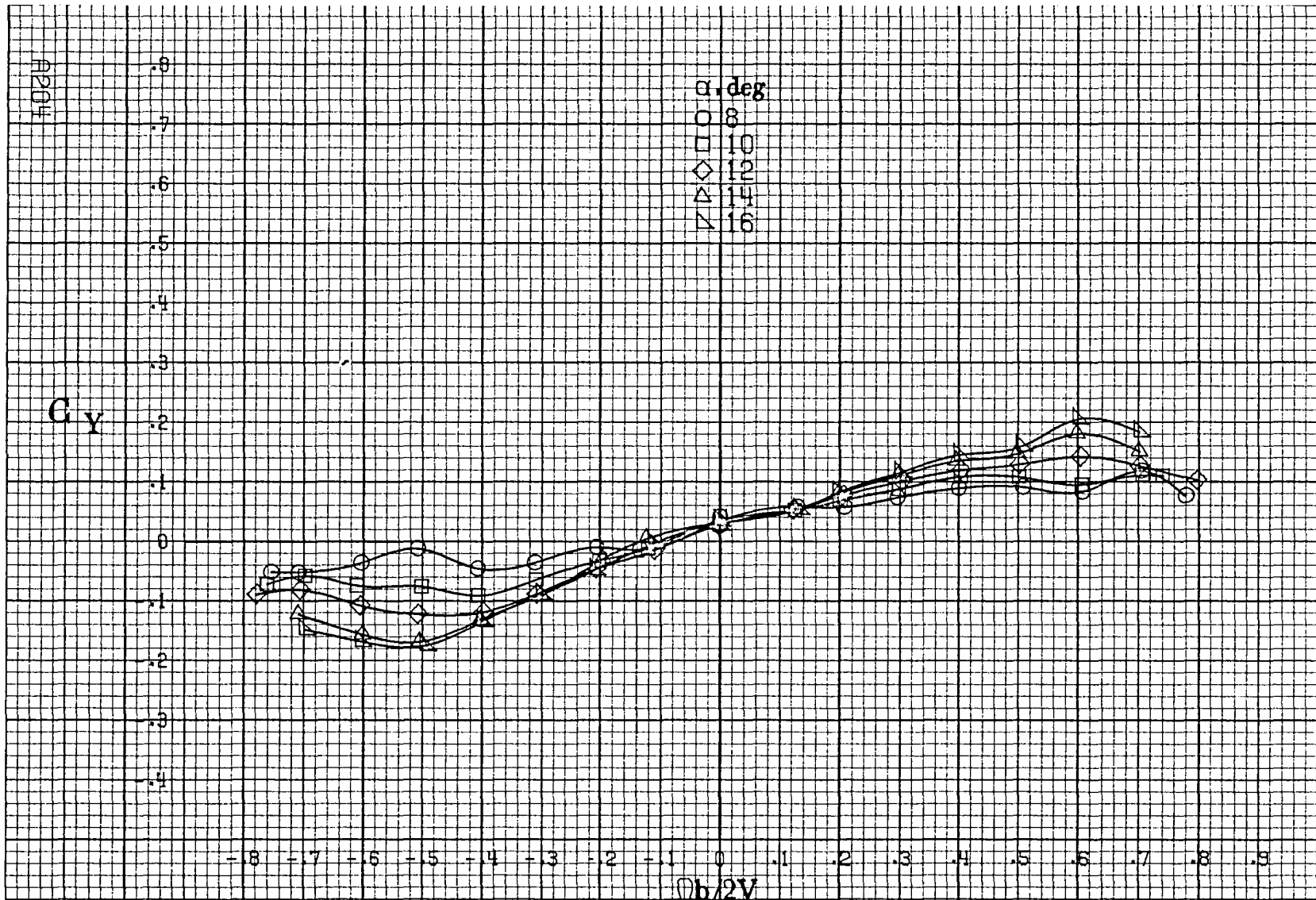

(a)  $\alpha = 8$  to  $16$  deg,  $SR = 182.9$  cm (72 in).

Figure A47. Effect of rotation rate and angle of attack on side-force coefficient for no. 1 tail configuration.  $\delta_a = -15^\circ$ ,  $\delta_a = 0^\circ$ ,  $\delta_r = +25^\circ$ ,  $\beta = 0^\circ$ .

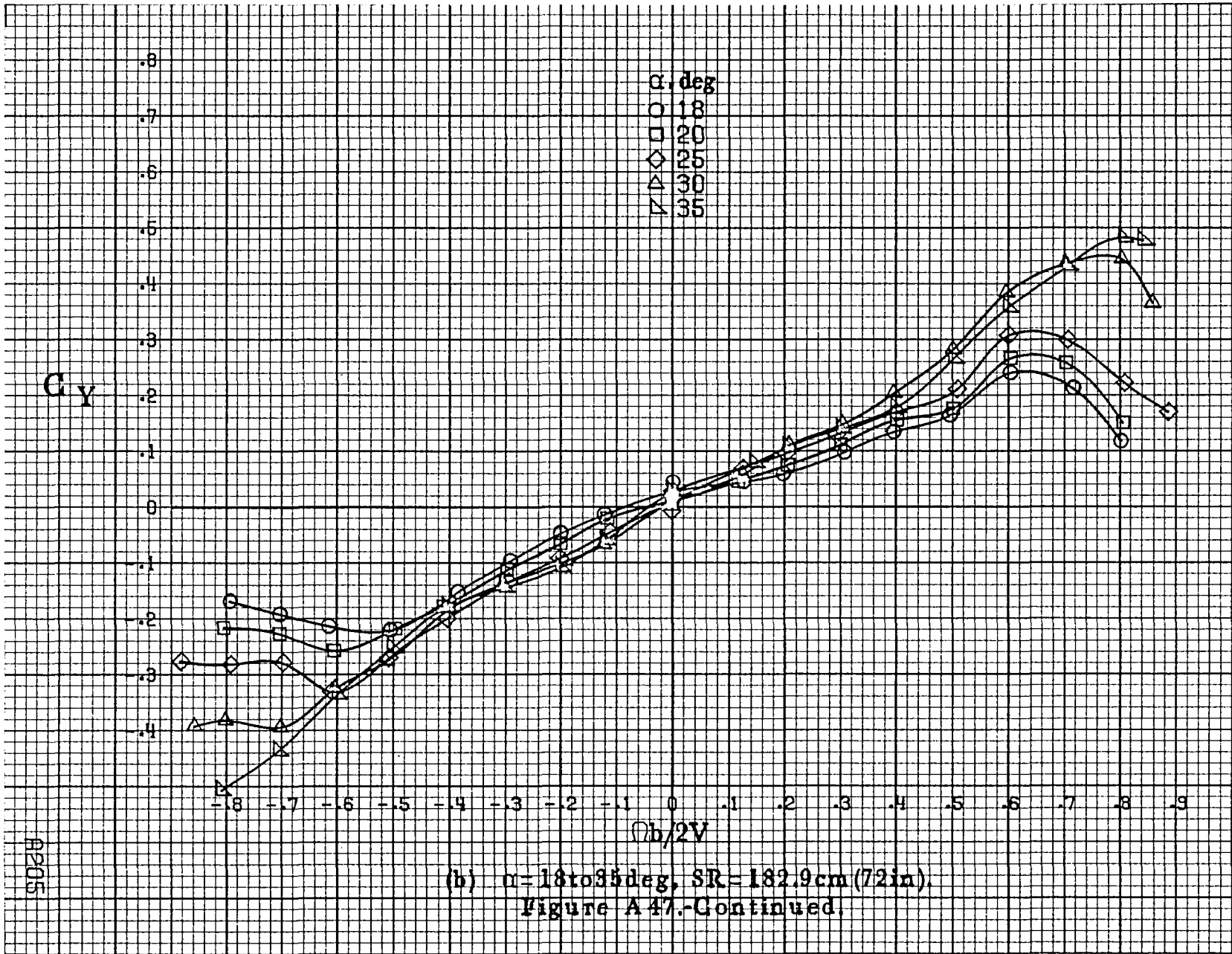



A206

$C_y$

.8  
.7  
.6  
.5  
.4  
.3  
.2  
.1  
0  
-.1  
-.2  
-.3  
-.4

$\alpha$ , deg  
○ 30  
□ 35  
◇ 40  
△ 45  
▽ 50

-.8 -.7 -.6 -.5 -.4 -.3 -.2 -.1 0 .1 .2 .3 .4 .5 .6 .7 .8 .9  
 $b/2V$

(c)  $\alpha=30$  to  $50$  deg,  $SR=0$ .  
Figure A 47.-Continued.

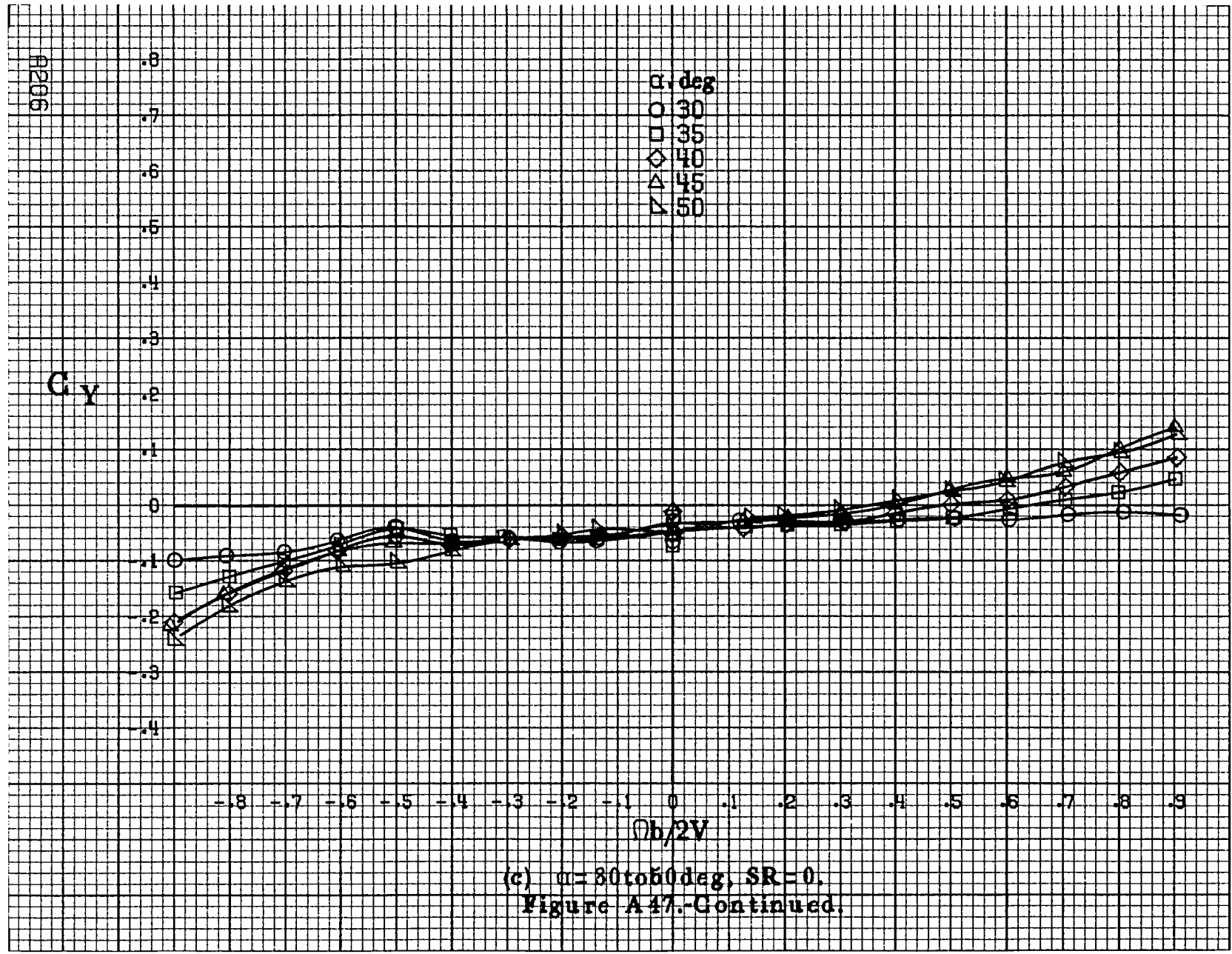



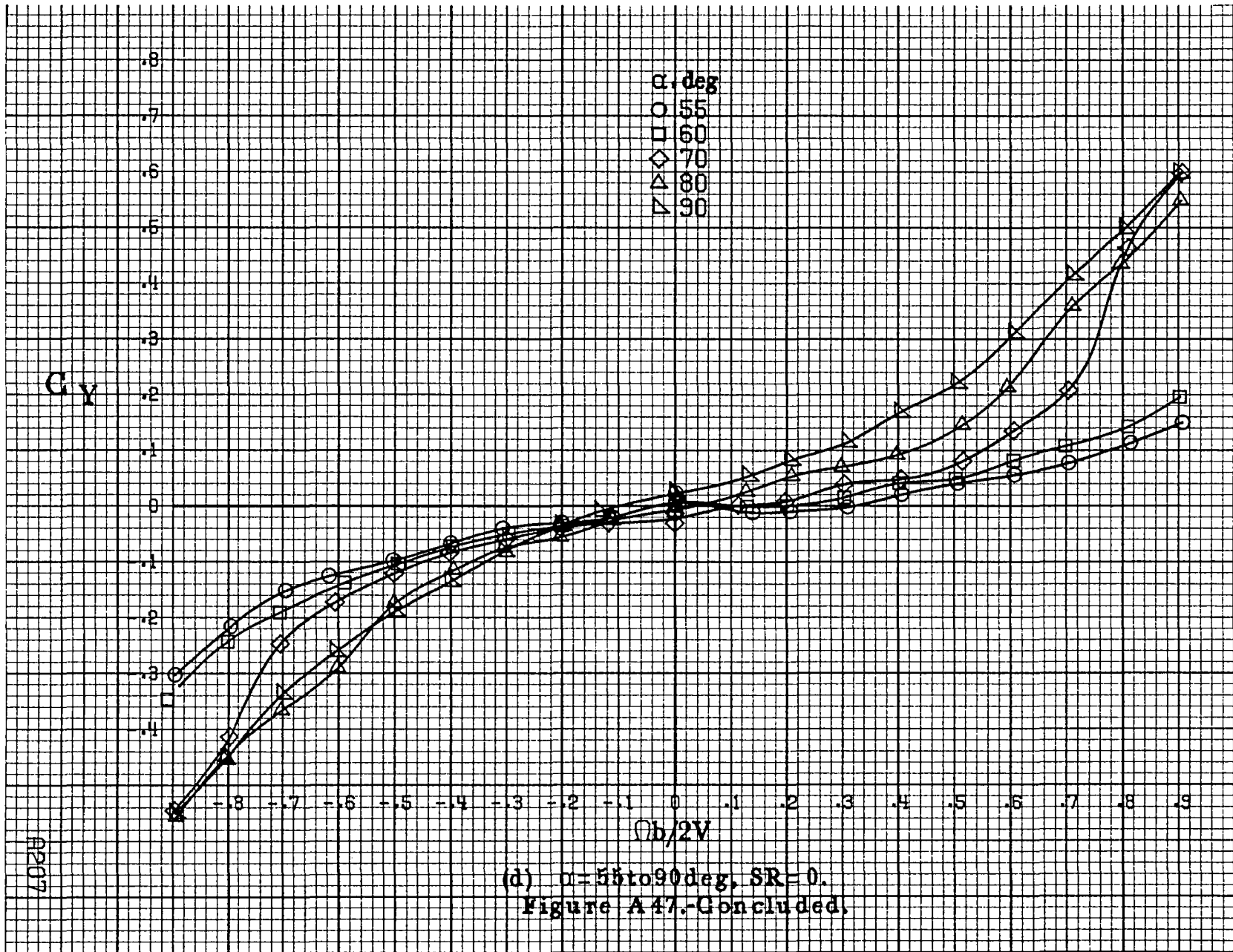

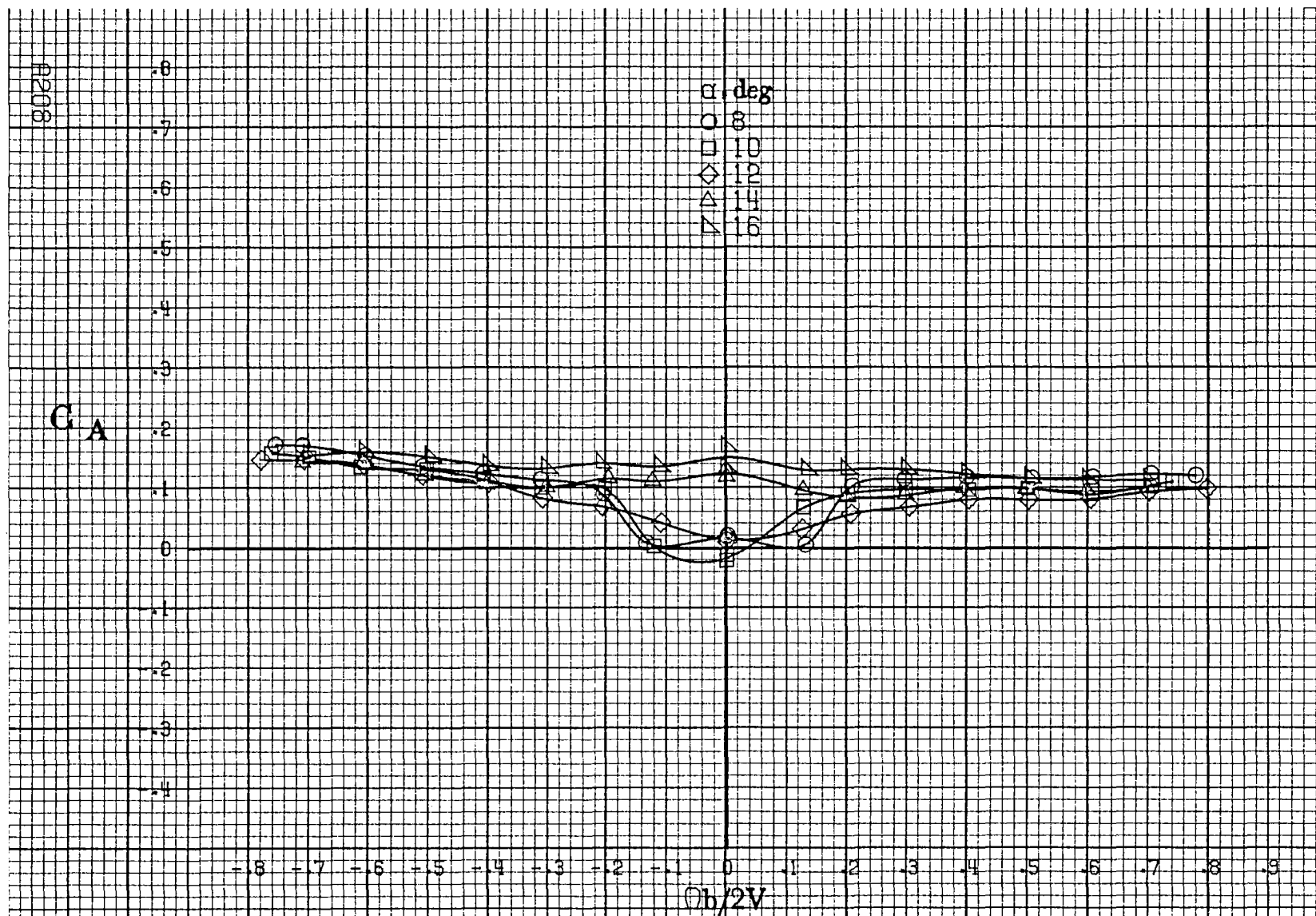

(a)  $\alpha = 8$  to  $16$  deg,  $SR = 182.9$  cm (72 in).  
 Figure A48. Effect of rotation rate and angle of attack on axial force coefficient for no. 1 tail configuration.  $\delta_c = -15^\circ$ ,  $\delta_n = 0^\circ$ ,  $\delta_r = -25^\circ$ ,  $\beta = 0^\circ$ .

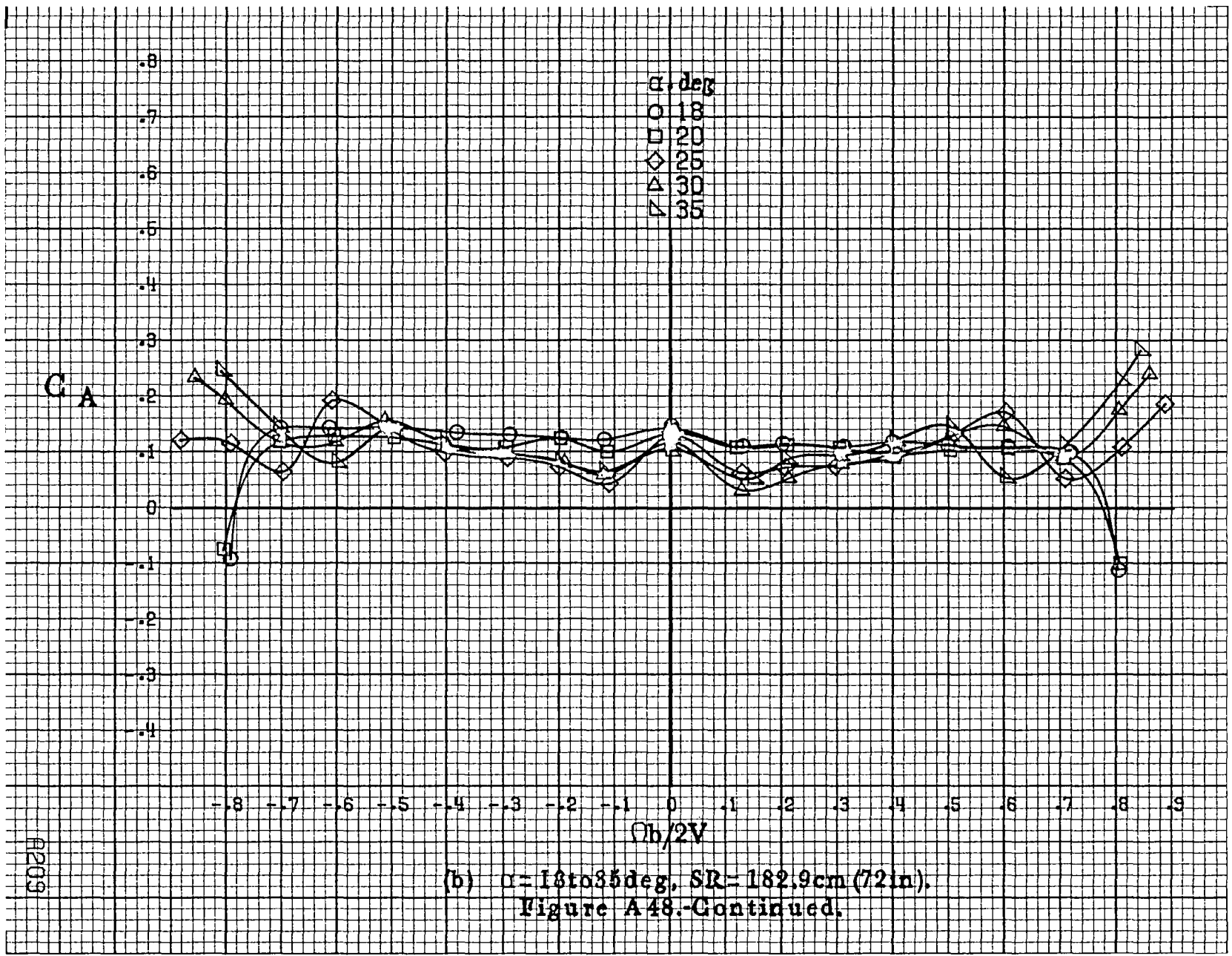

(b)  $\alpha = 18$  to  $35$  deg, SR = 182.9 cm (72 in).  
 Figure A48.-Continued.

A209

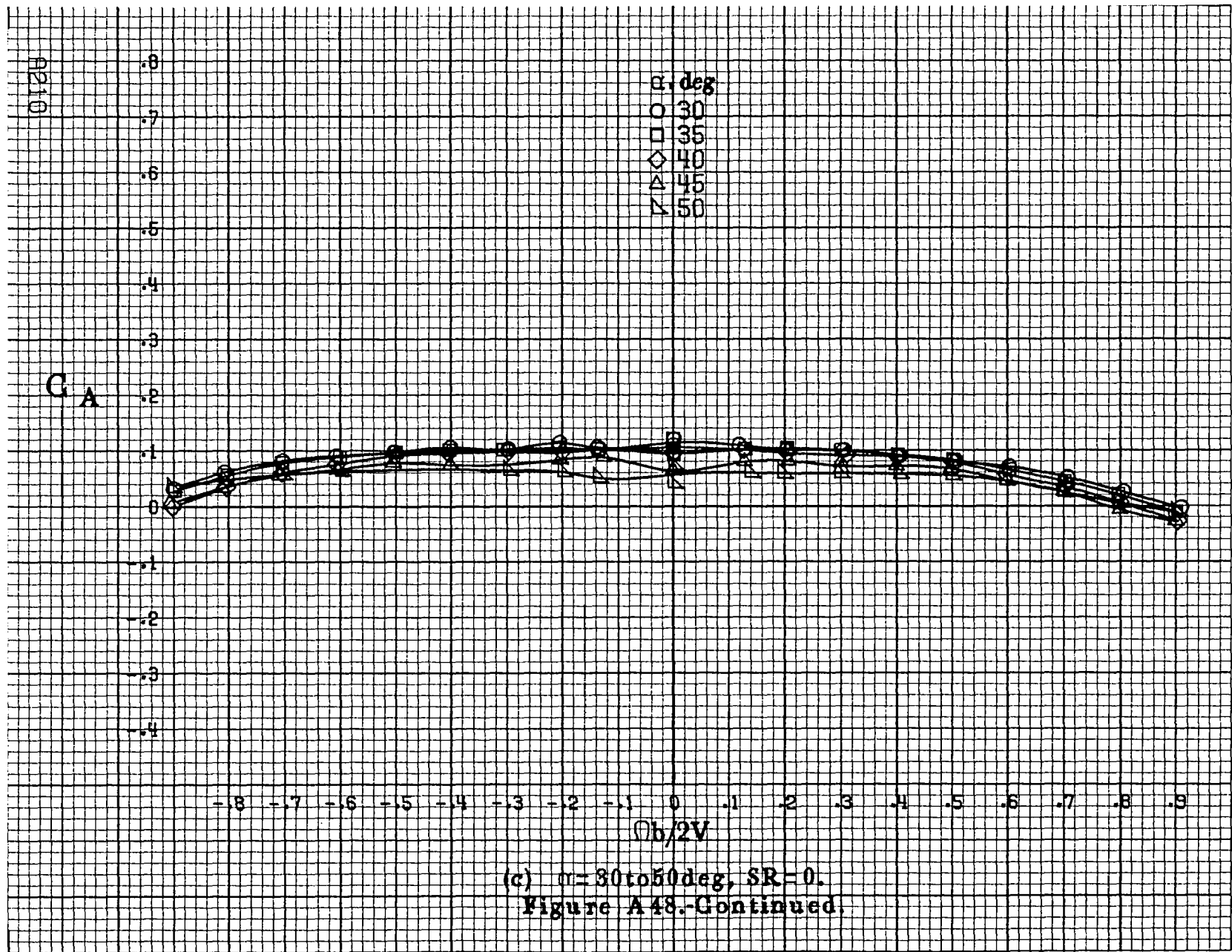

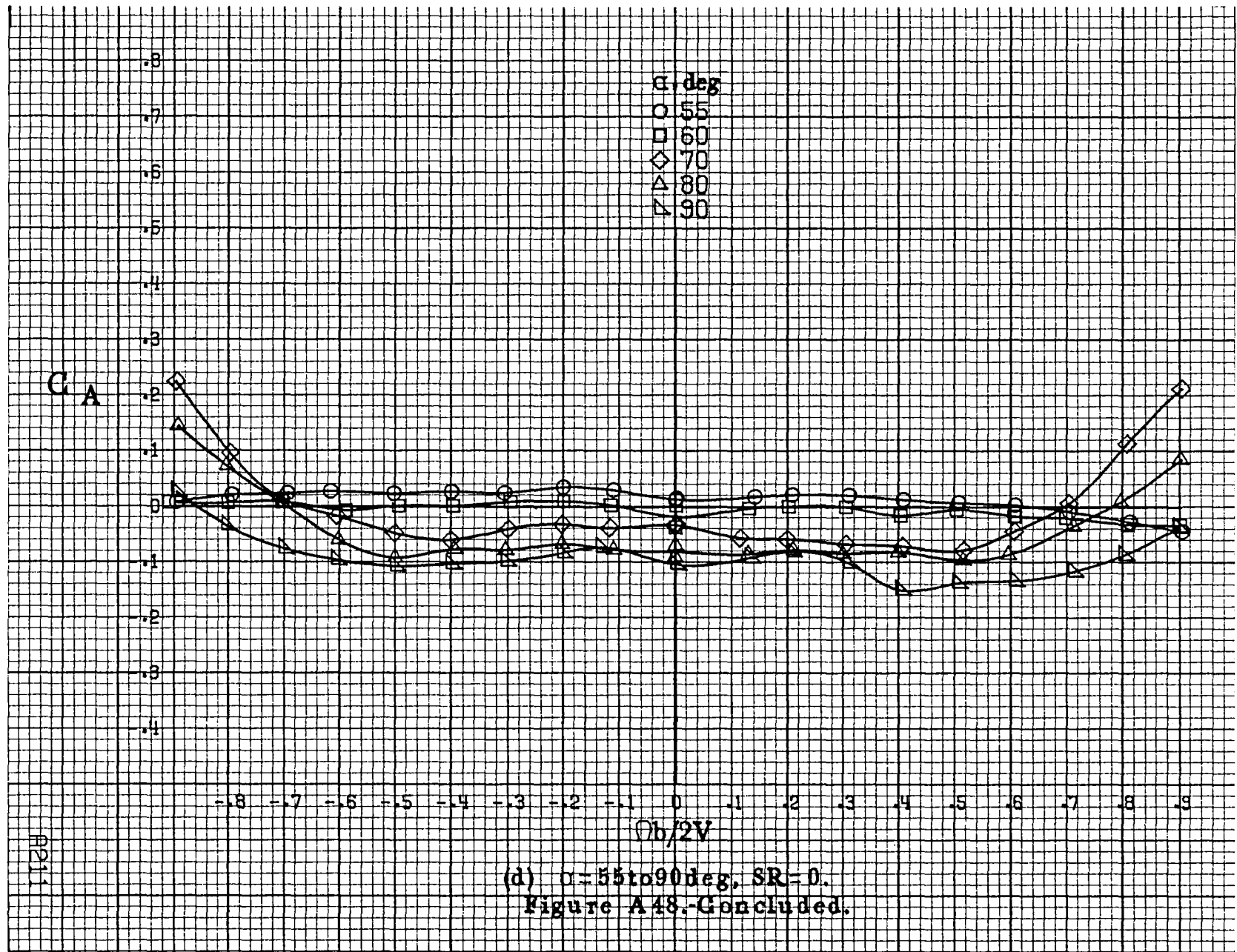

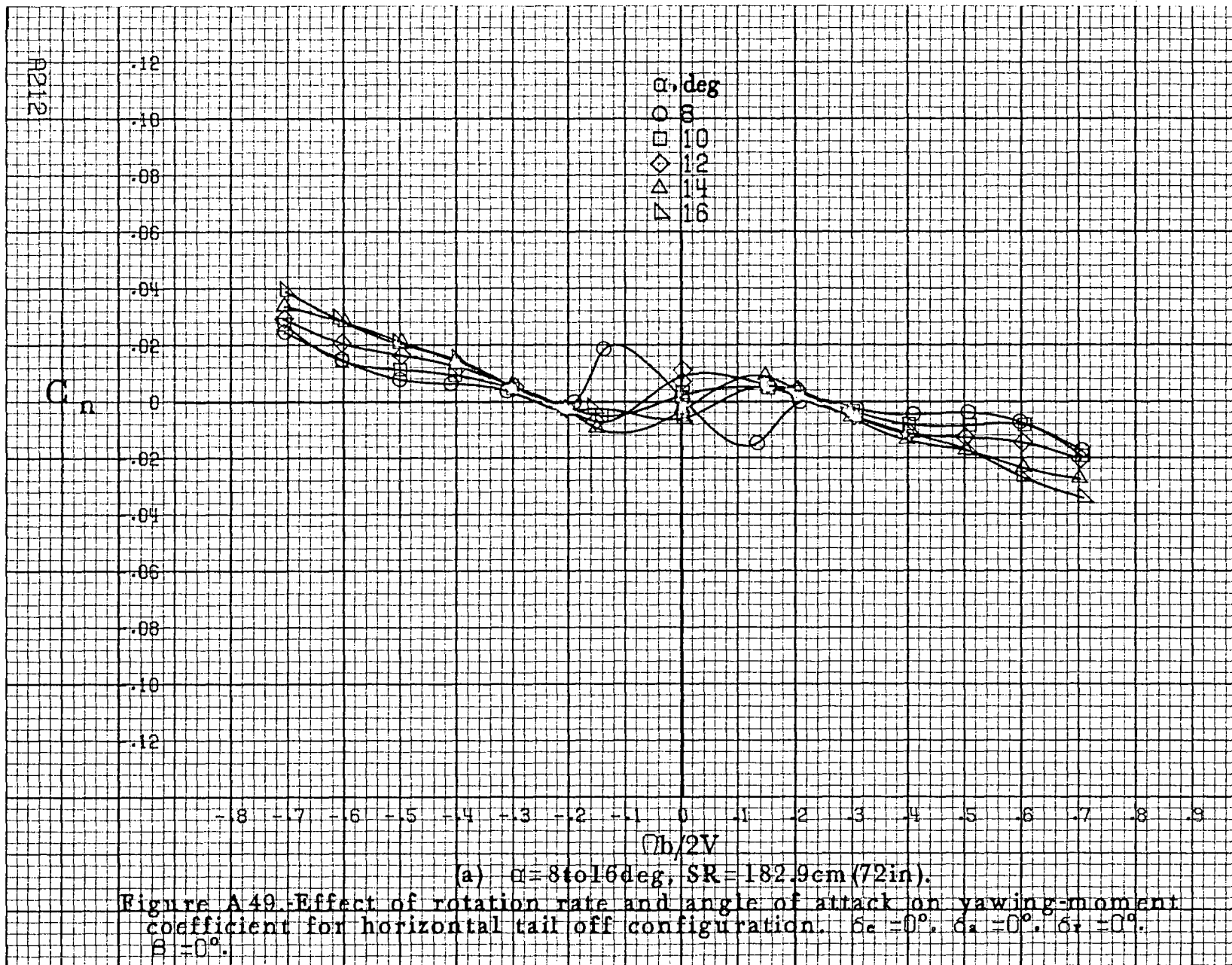

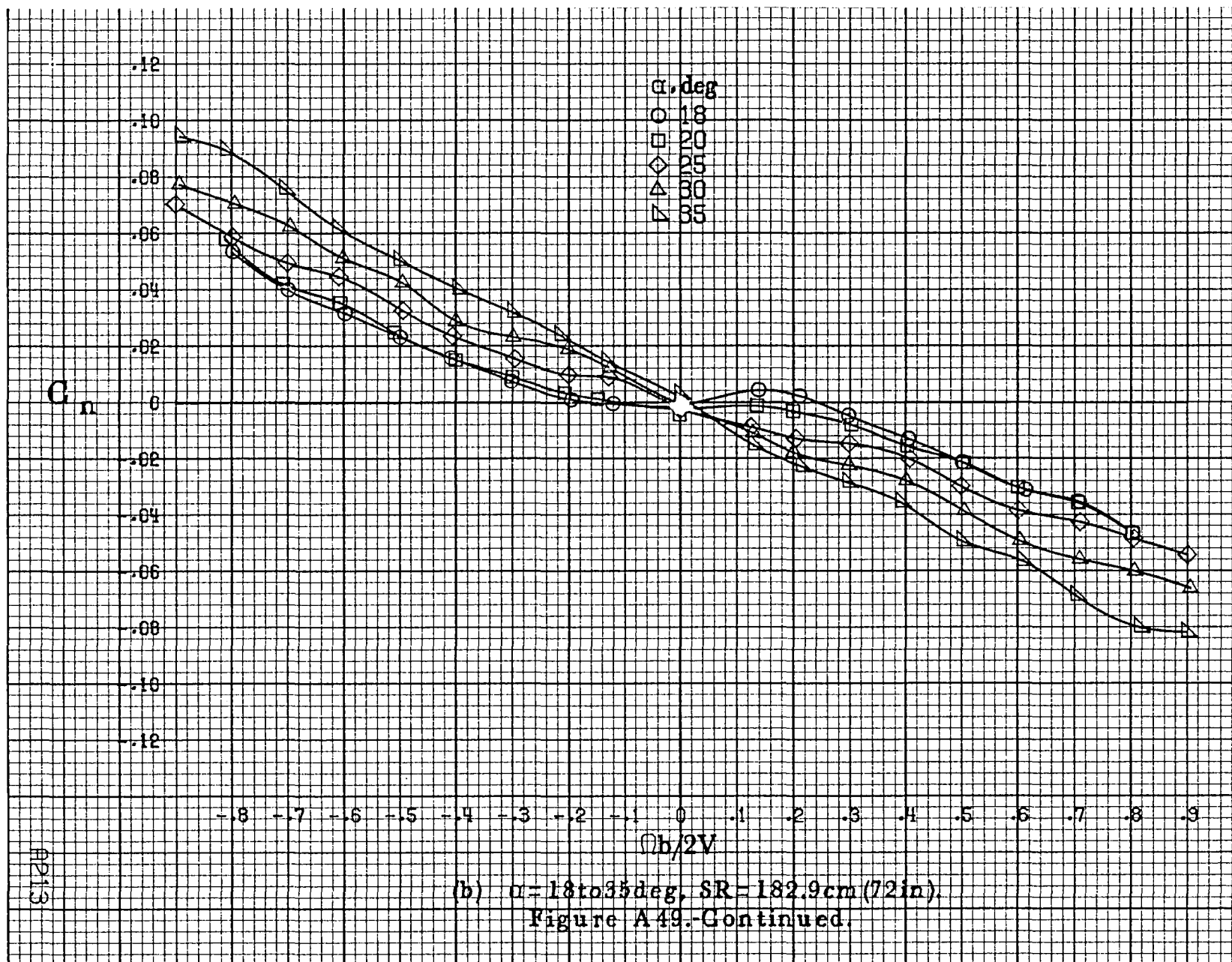



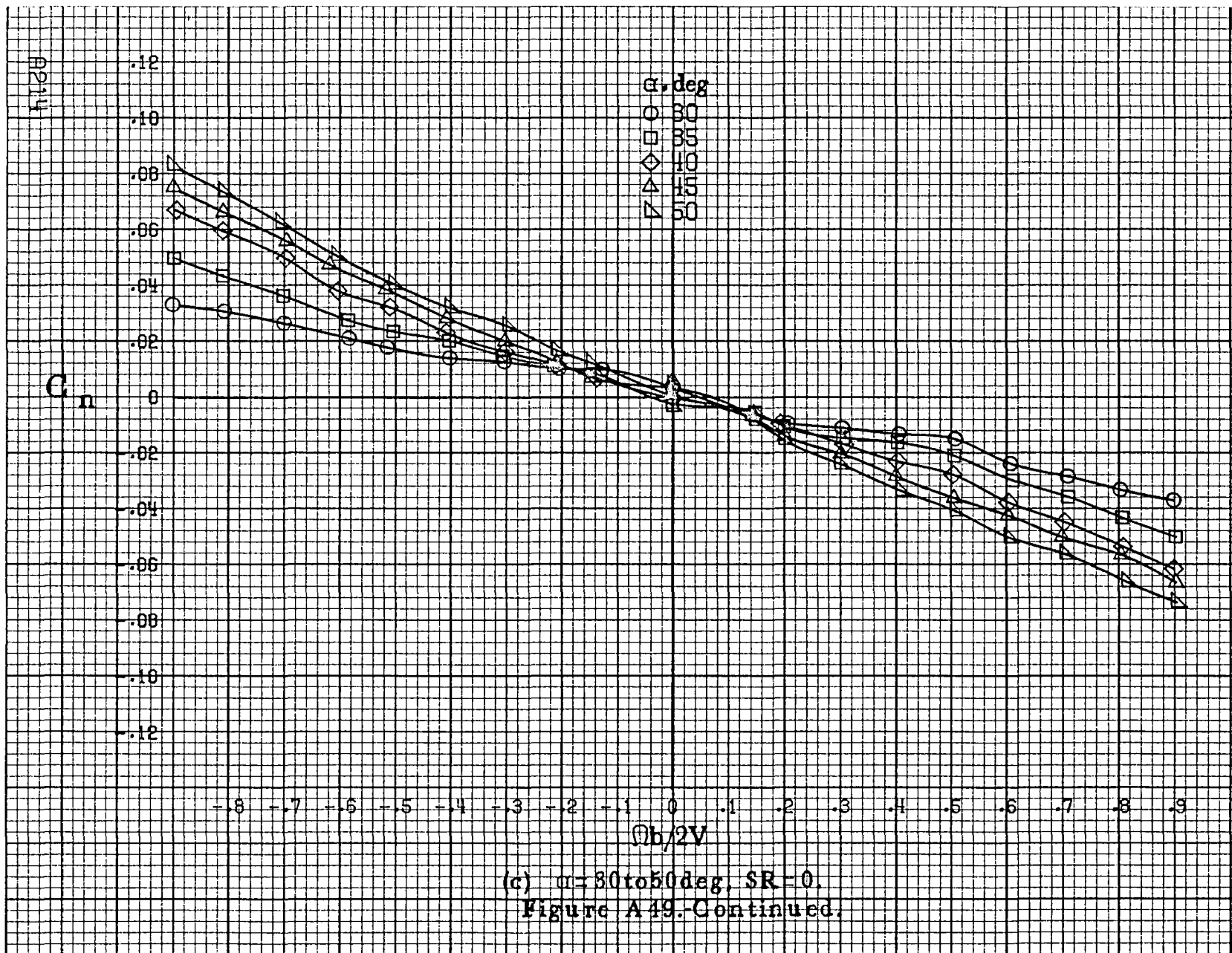



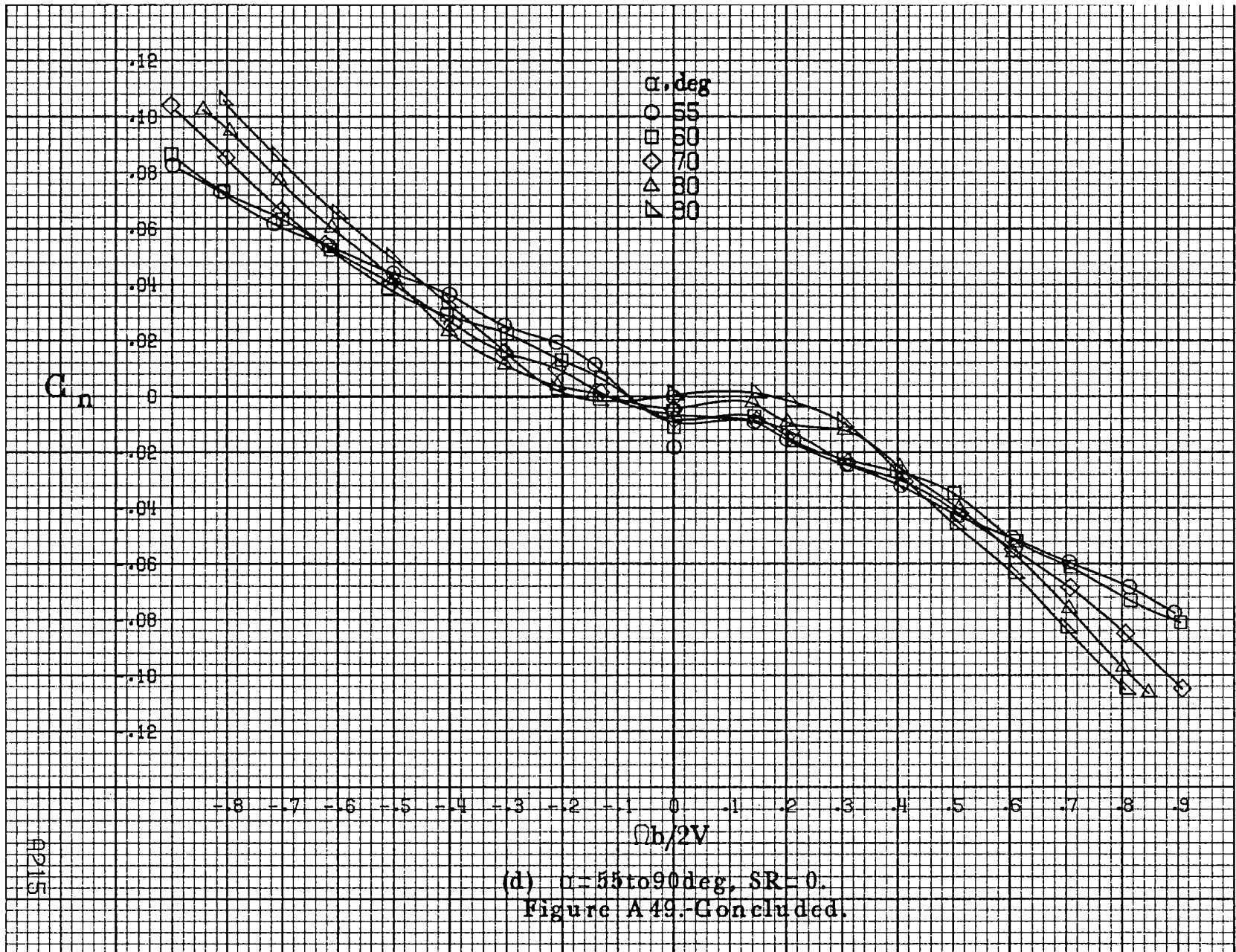

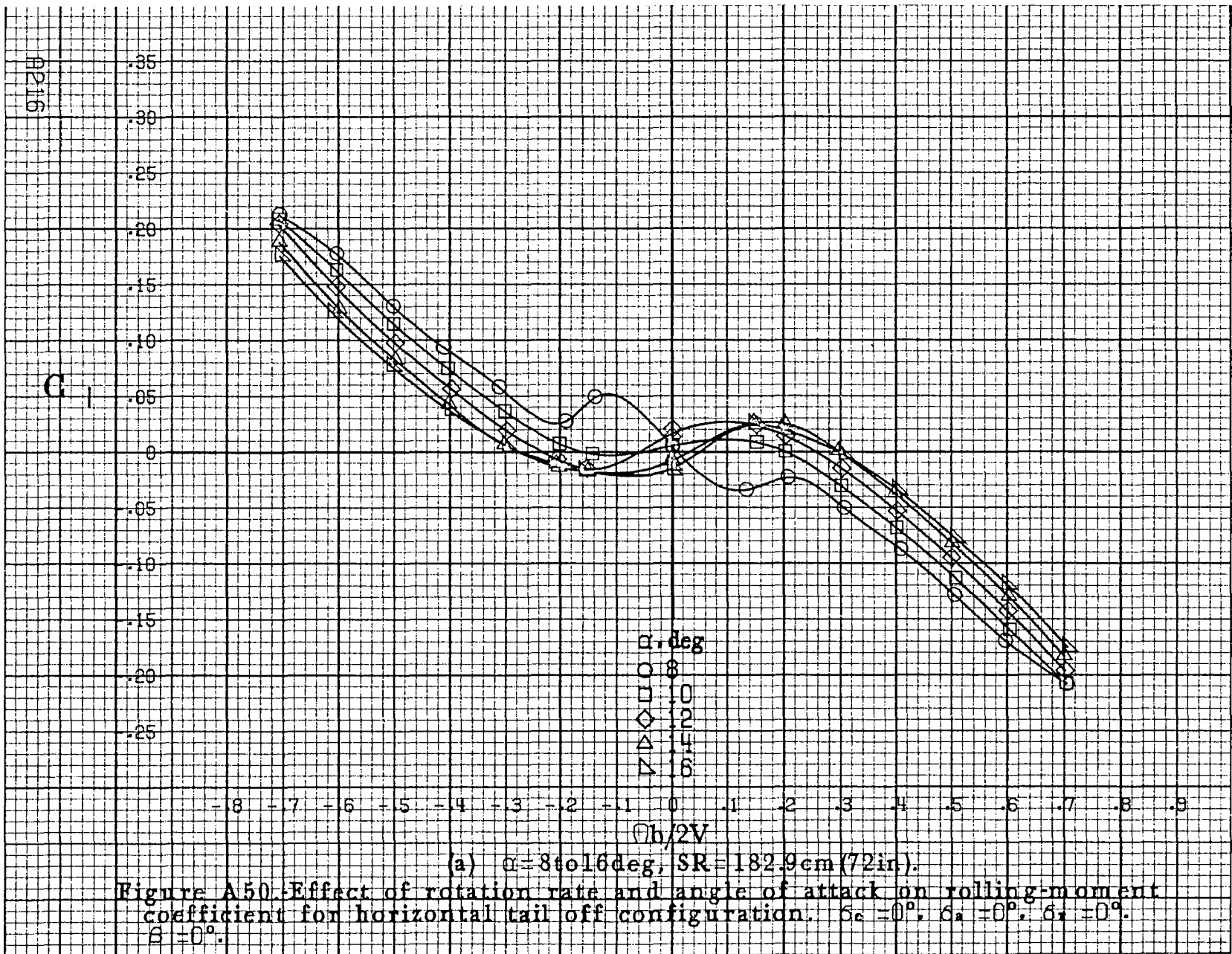

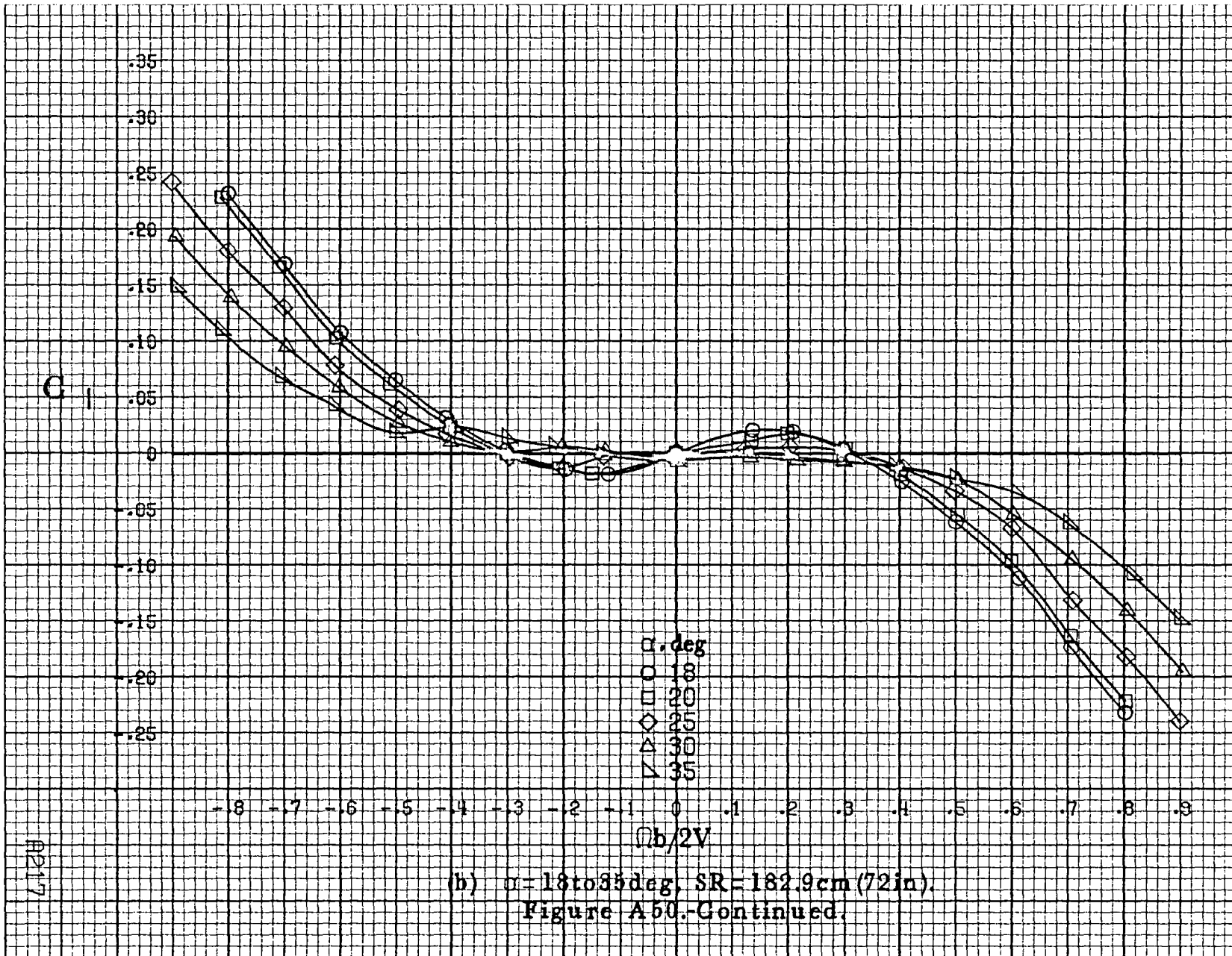

AP218

C<sub>1</sub>

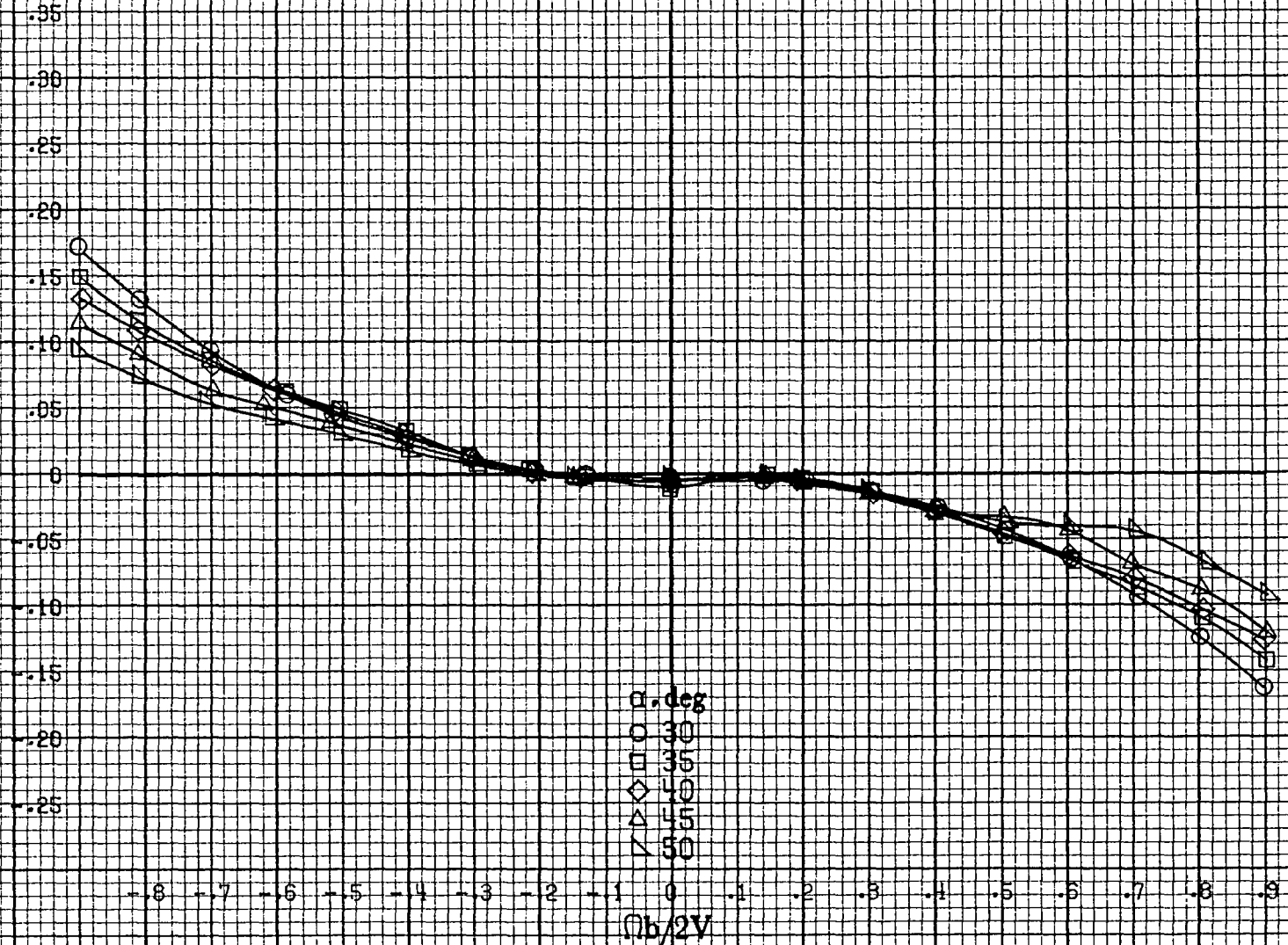

(c)  $\alpha = 30$  to  $50$  deg,  $SR = 0$ .  
Figure A50. Continued.

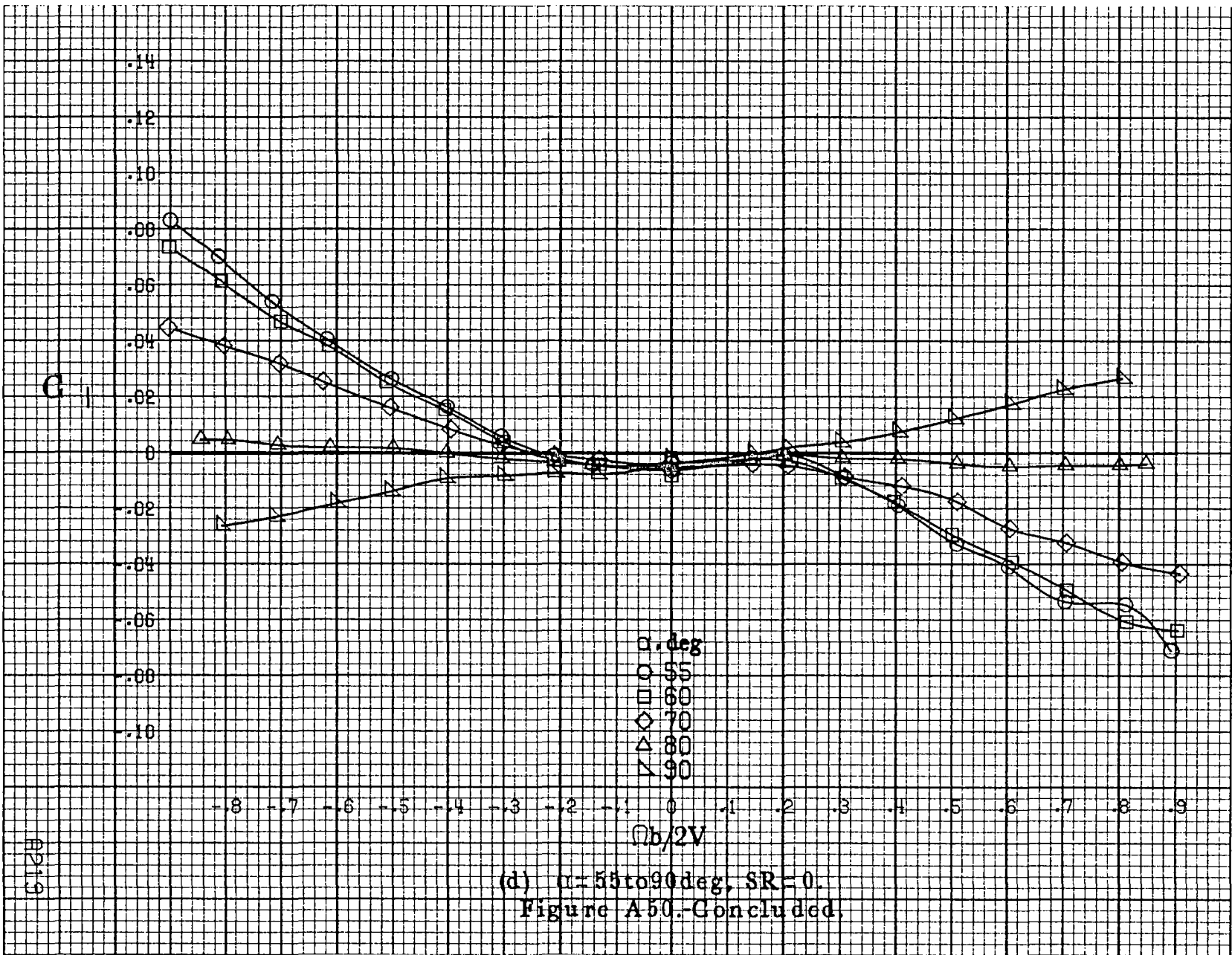

(d)  $\alpha = 55$  to  $90$  deg,  $SR = 0$ .  
 Figure A50. Concluded.

A219

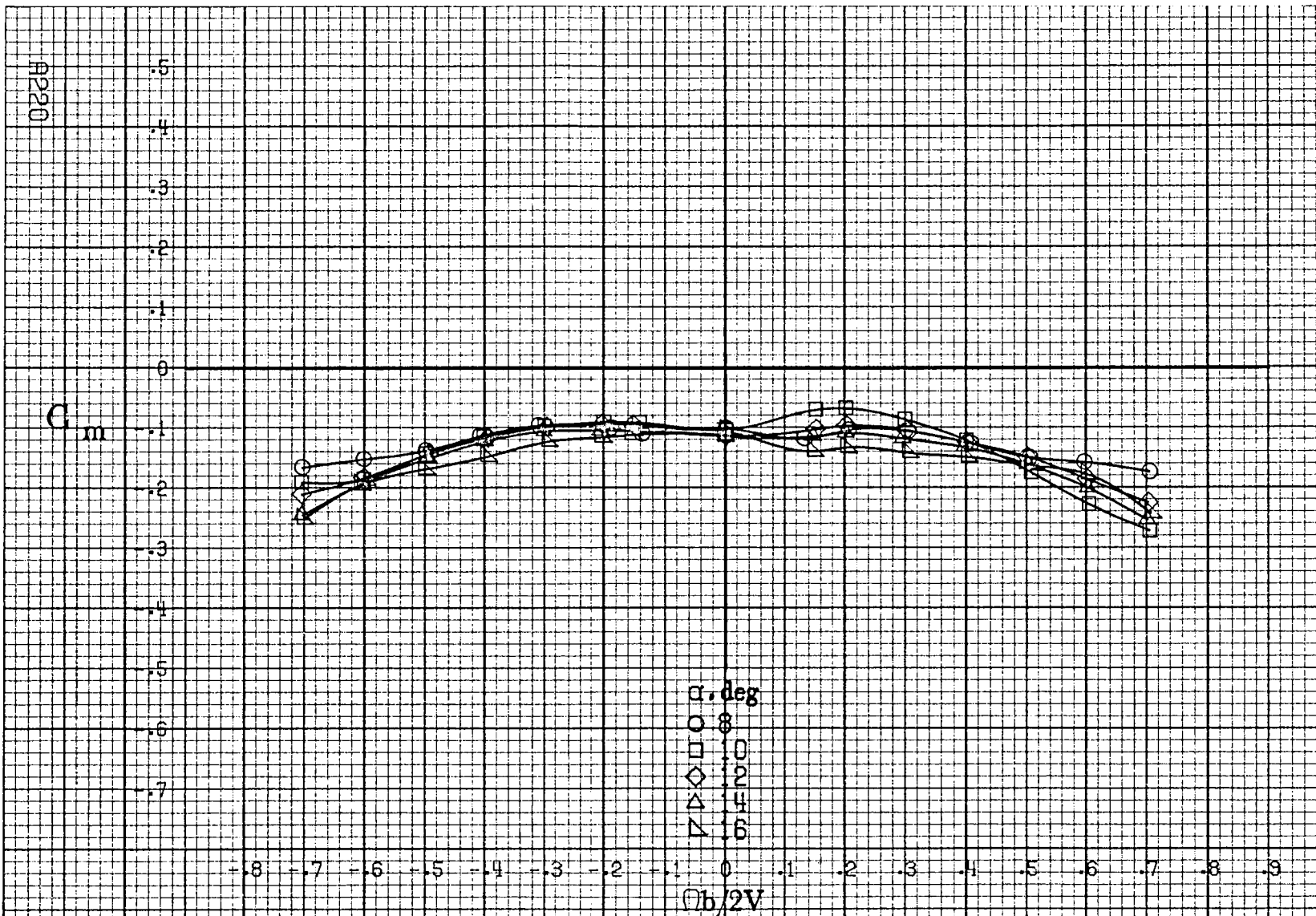

(a)  $\alpha = 8$  to  $16$  deg,  $SR = 182.9$  cm (72 in).

Figure A51.-Effect of rotation rate and angle of attack on pitching-moment coefficient for horizontal tail off configuration.  $\delta_e = 0^\circ$ ,  $\delta_r = 0^\circ$ ,  $\delta_z = 0^\circ$ ,  $\beta = 0^\circ$ .

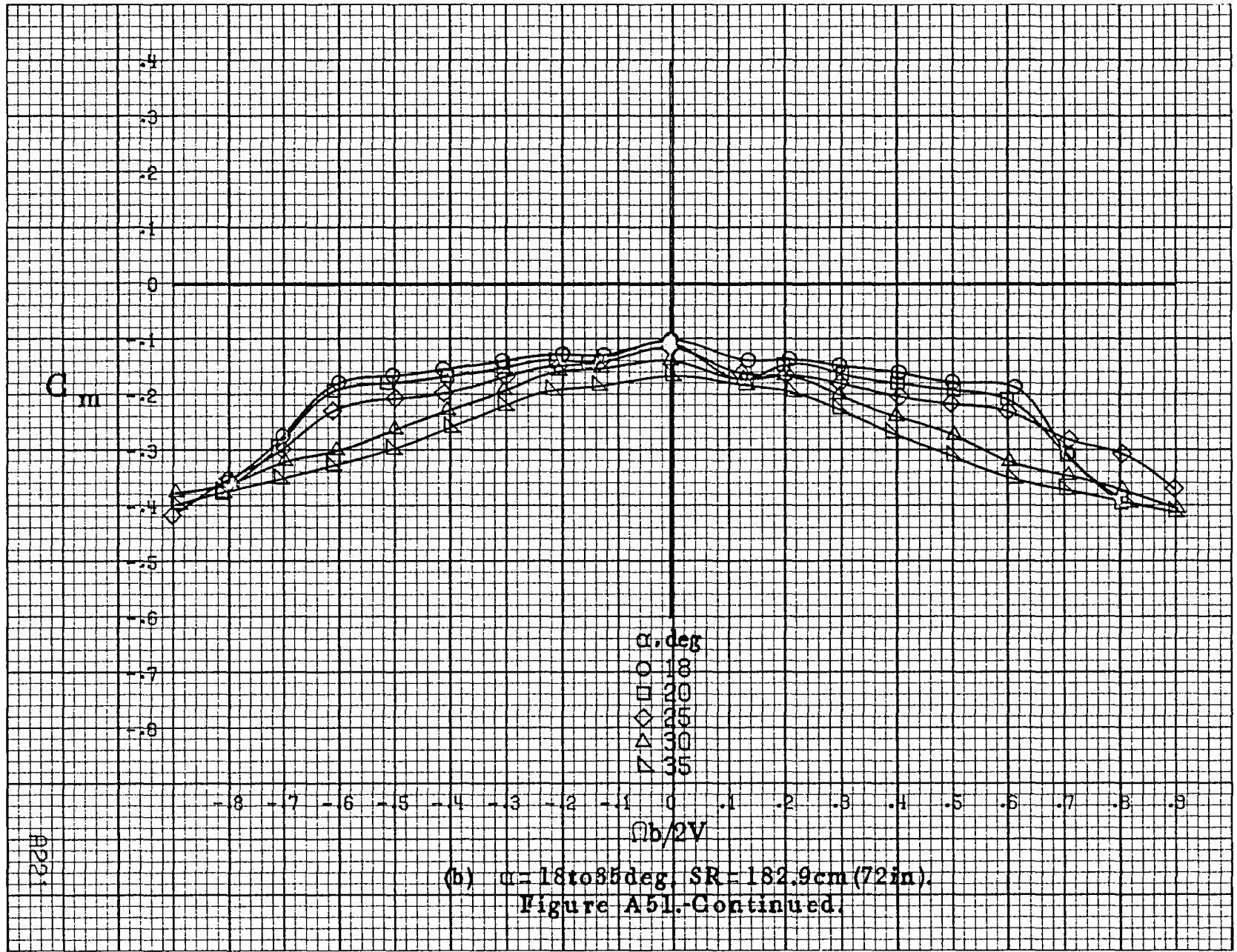

(b)  $\alpha = 18$  to  $35$  deg.  $SR = 182.9$  cm (72 in).  
 Figure A51. Continued.

A221



A222

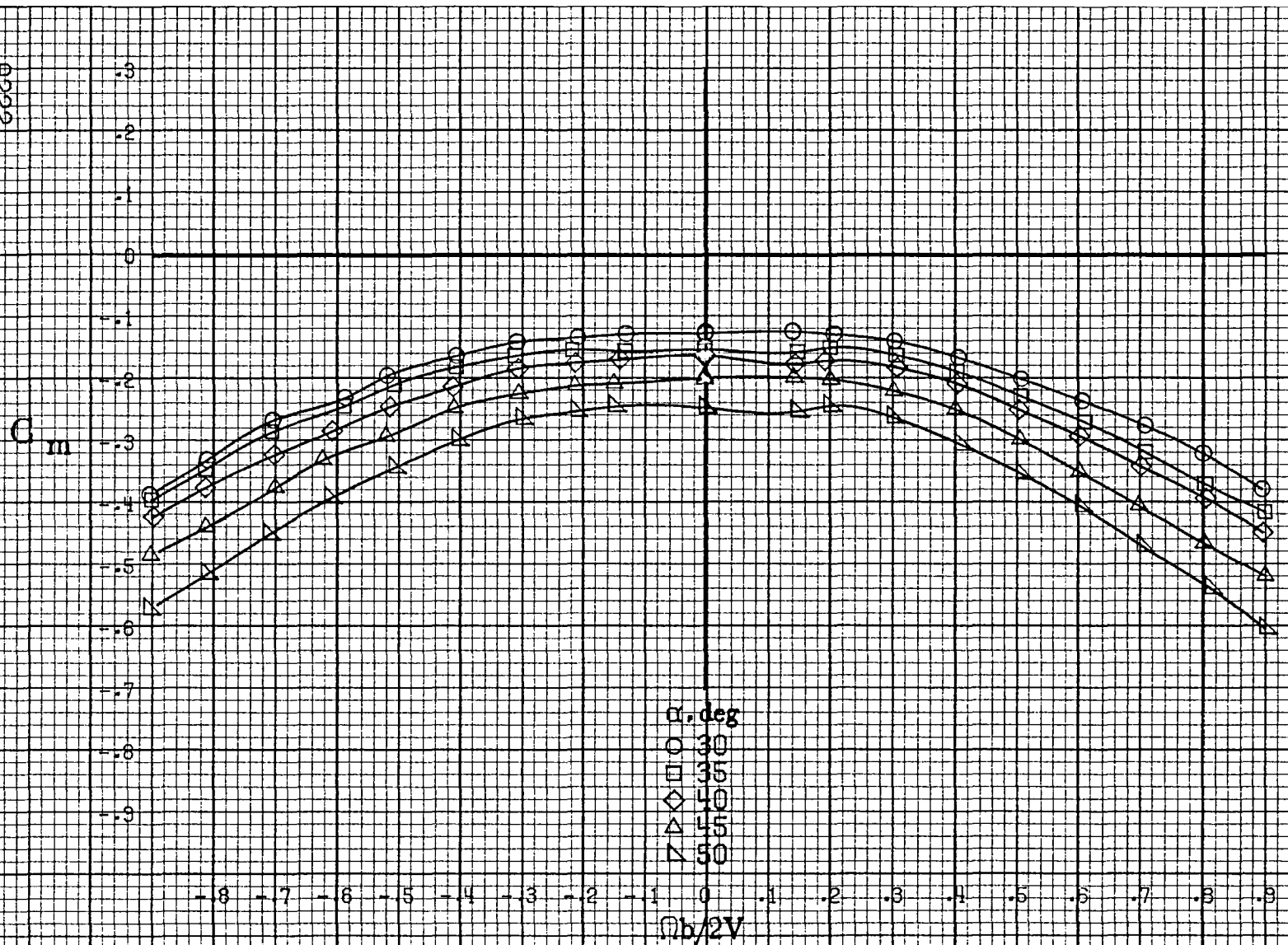

(c)  $\alpha = 30$  to  $50$  deg,  $SR = 0$ .  
Figure A51.-Continued.



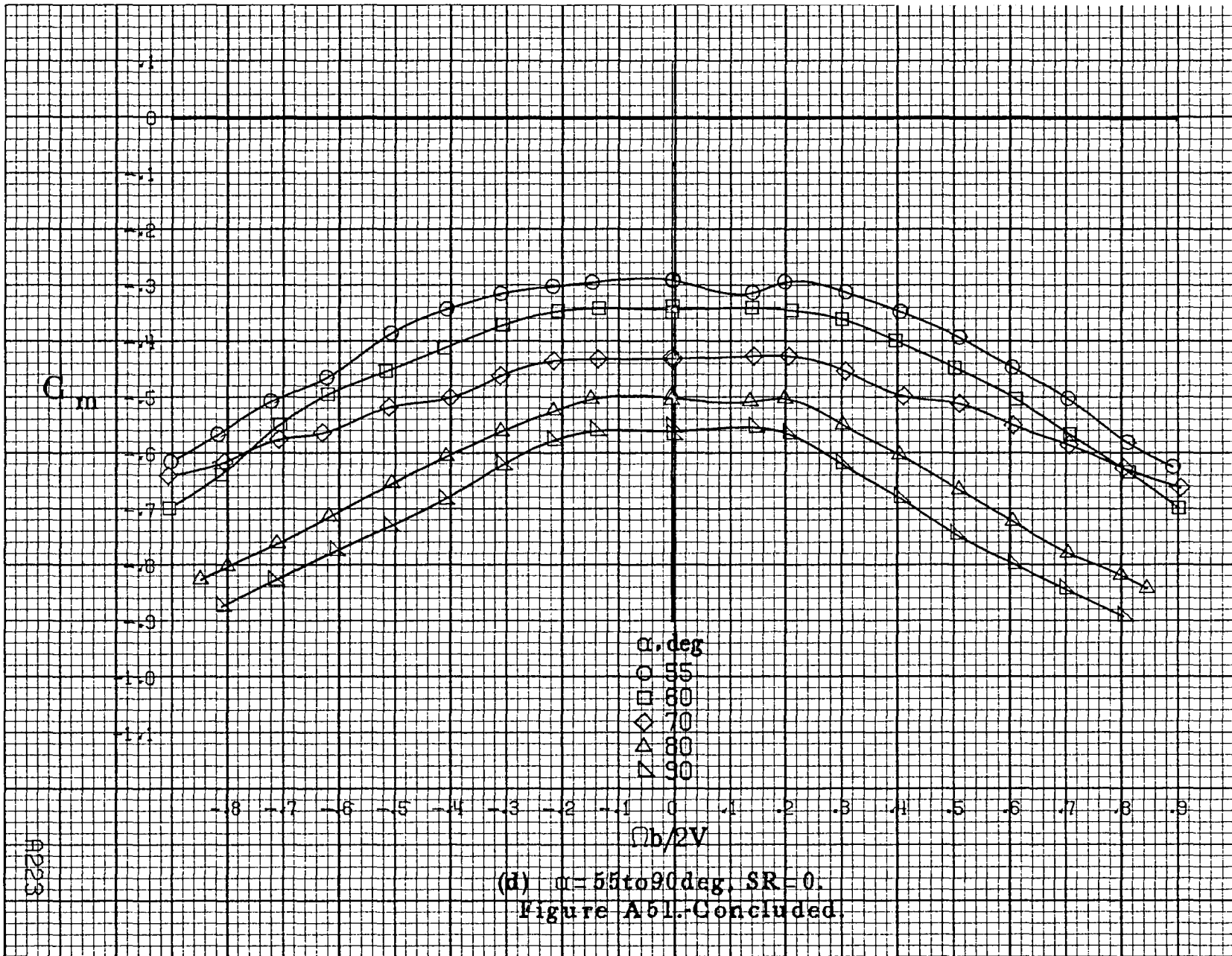

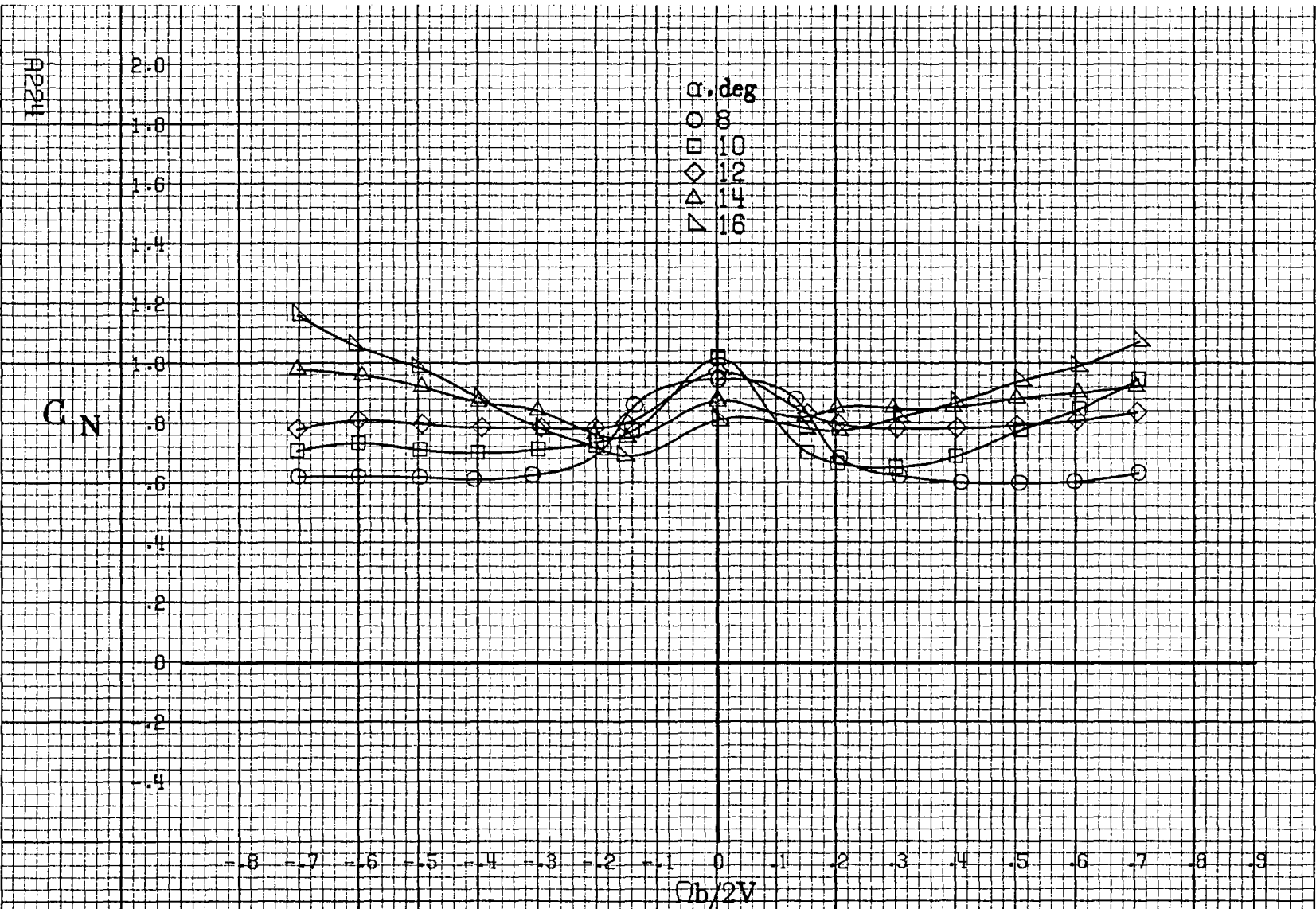

(a)  $\alpha = 8$  to  $16$  deg,  $SR = 182.9$  cm (72 in).

Figure A52.-Effect of rotation rate and angle of attack on normal-force coefficient for horizontal tail off configuration.  $\delta_e = 0^\circ$ ,  $\delta_a = 0^\circ$ ,  $\delta_r = 0^\circ$ ,  $\beta = 0^\circ$ .

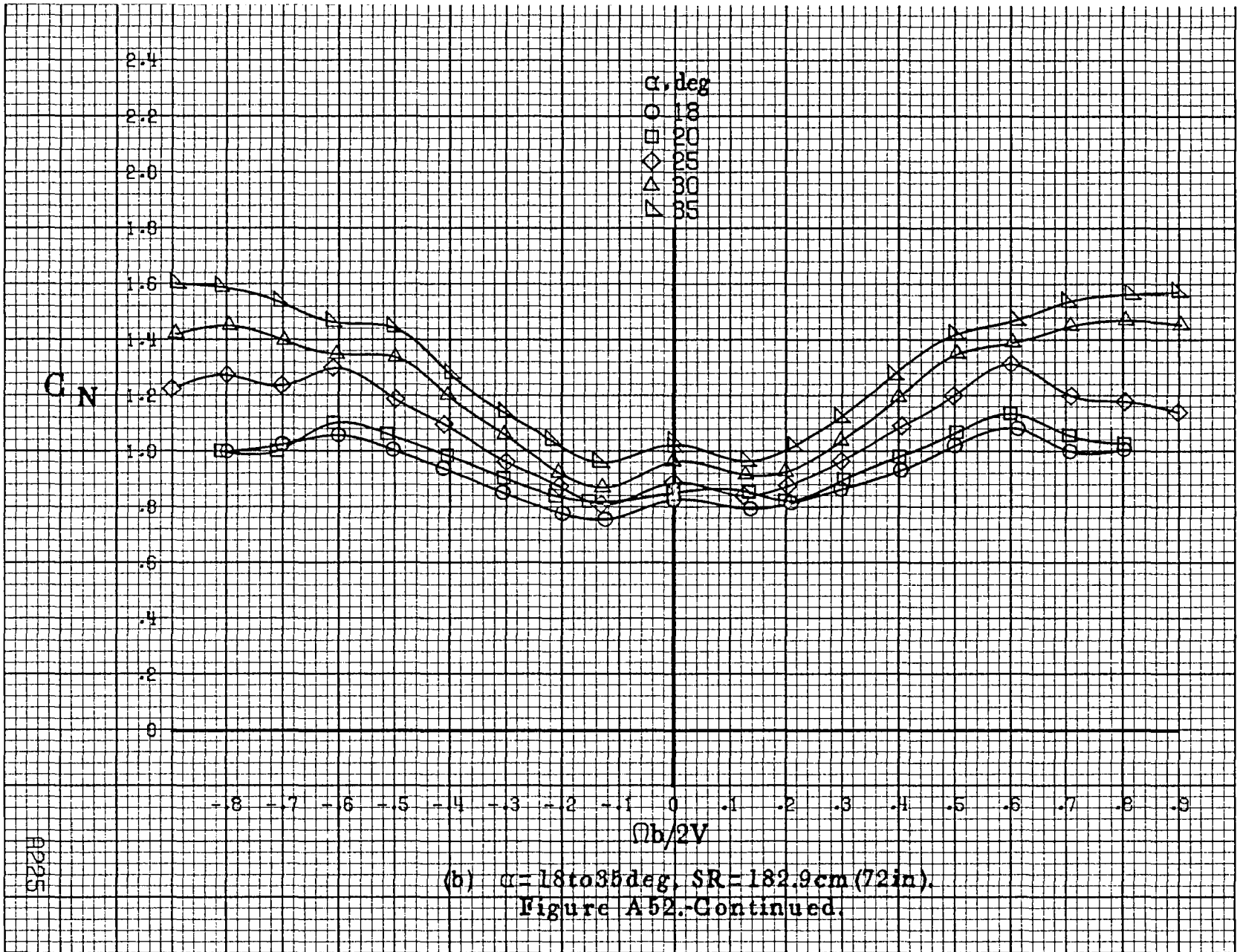

A9225



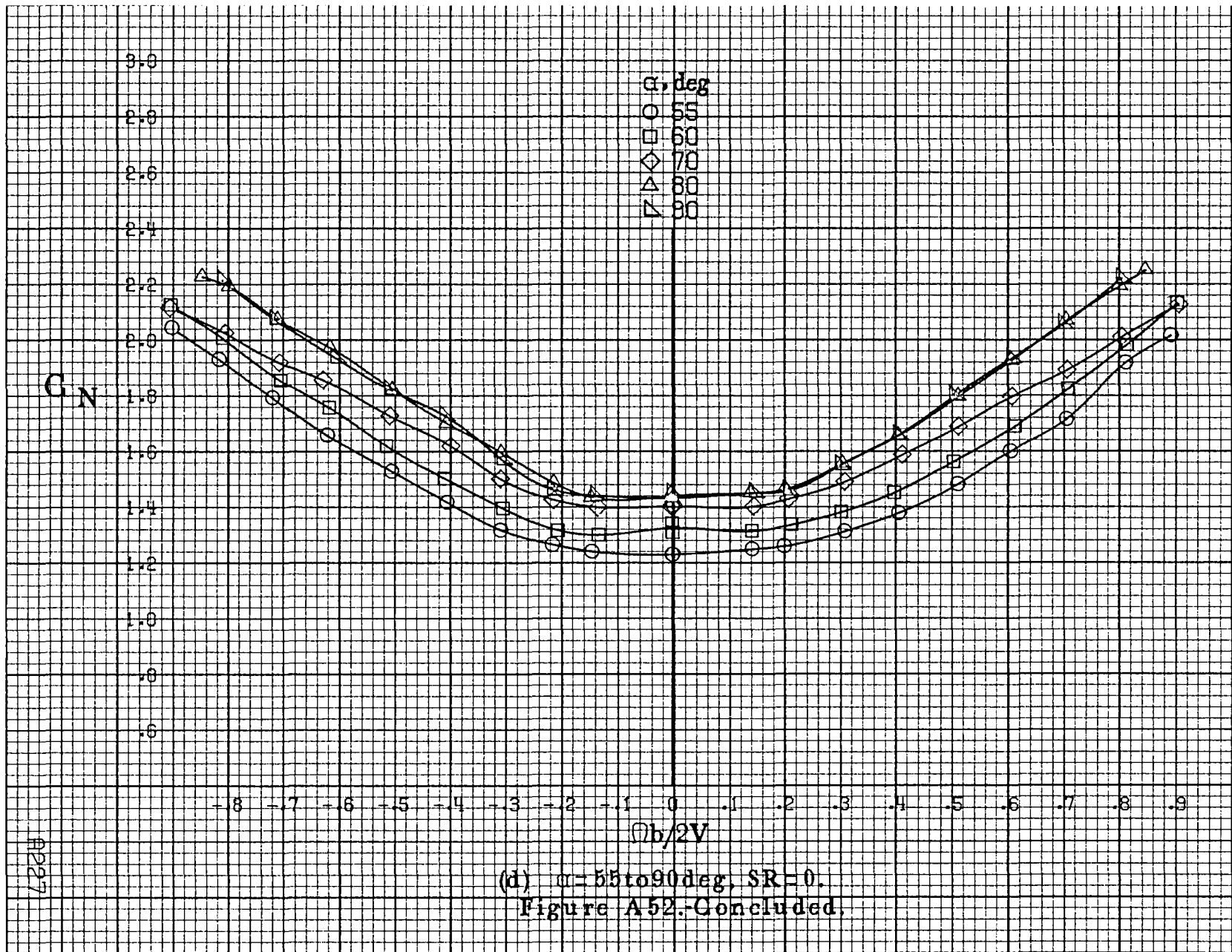

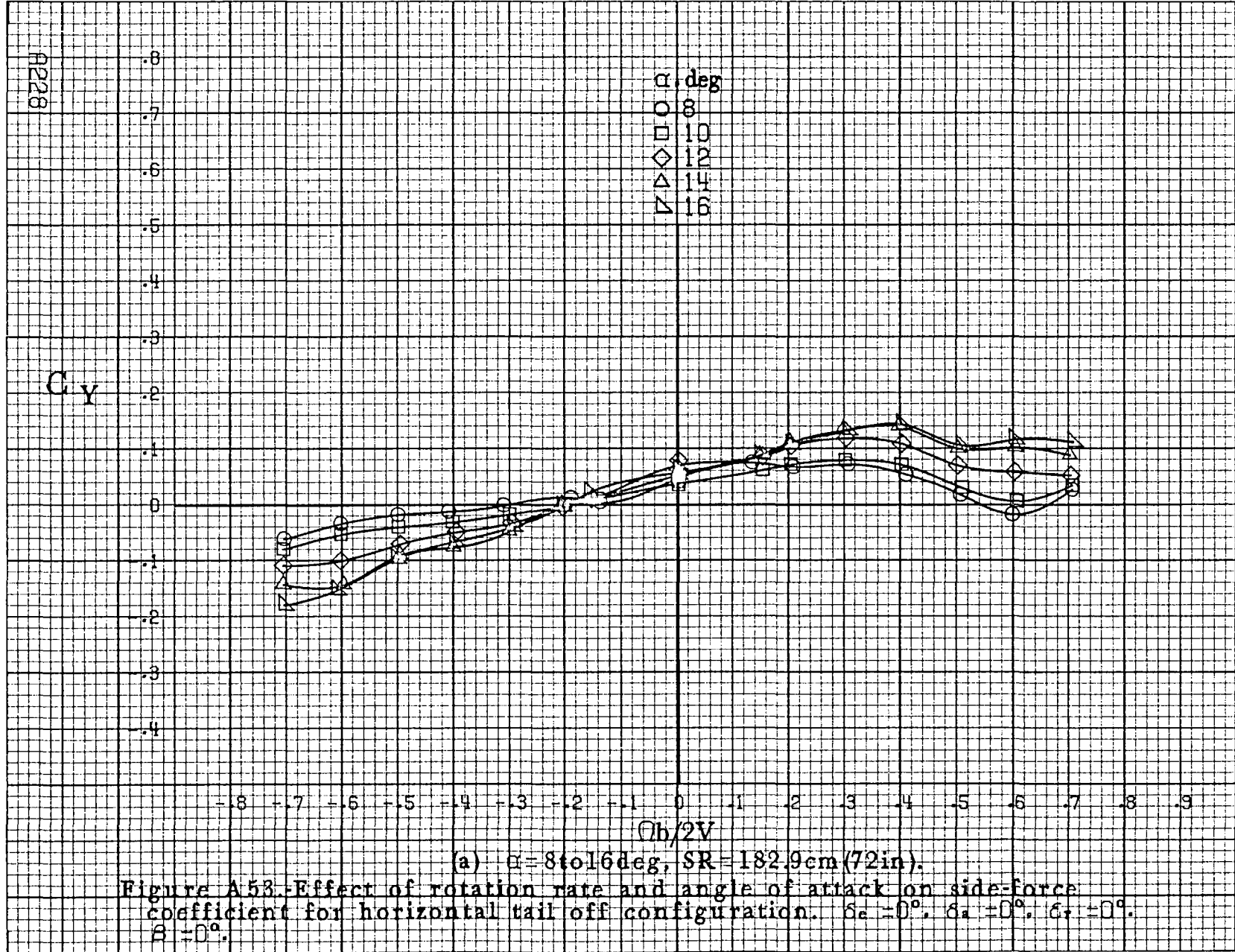

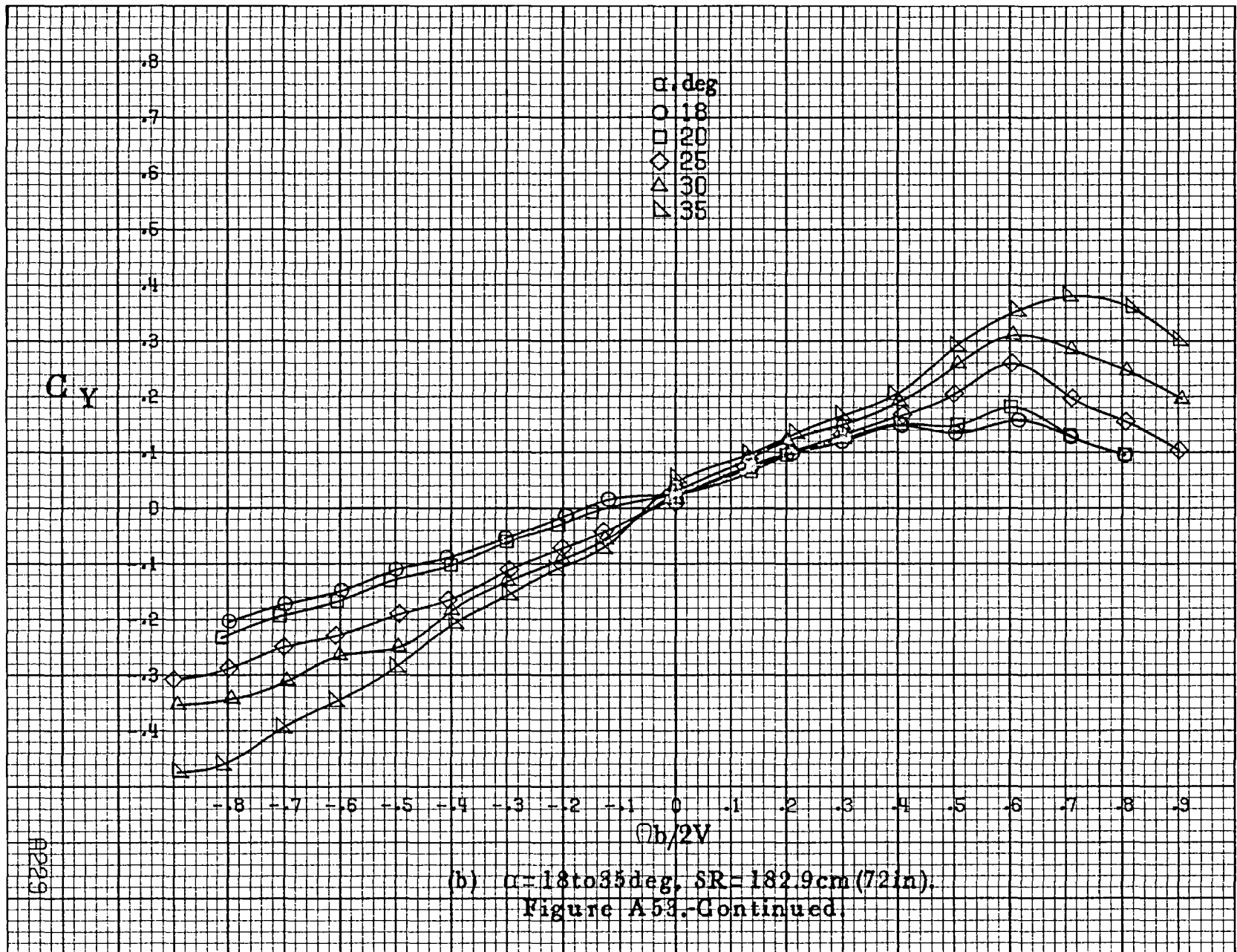



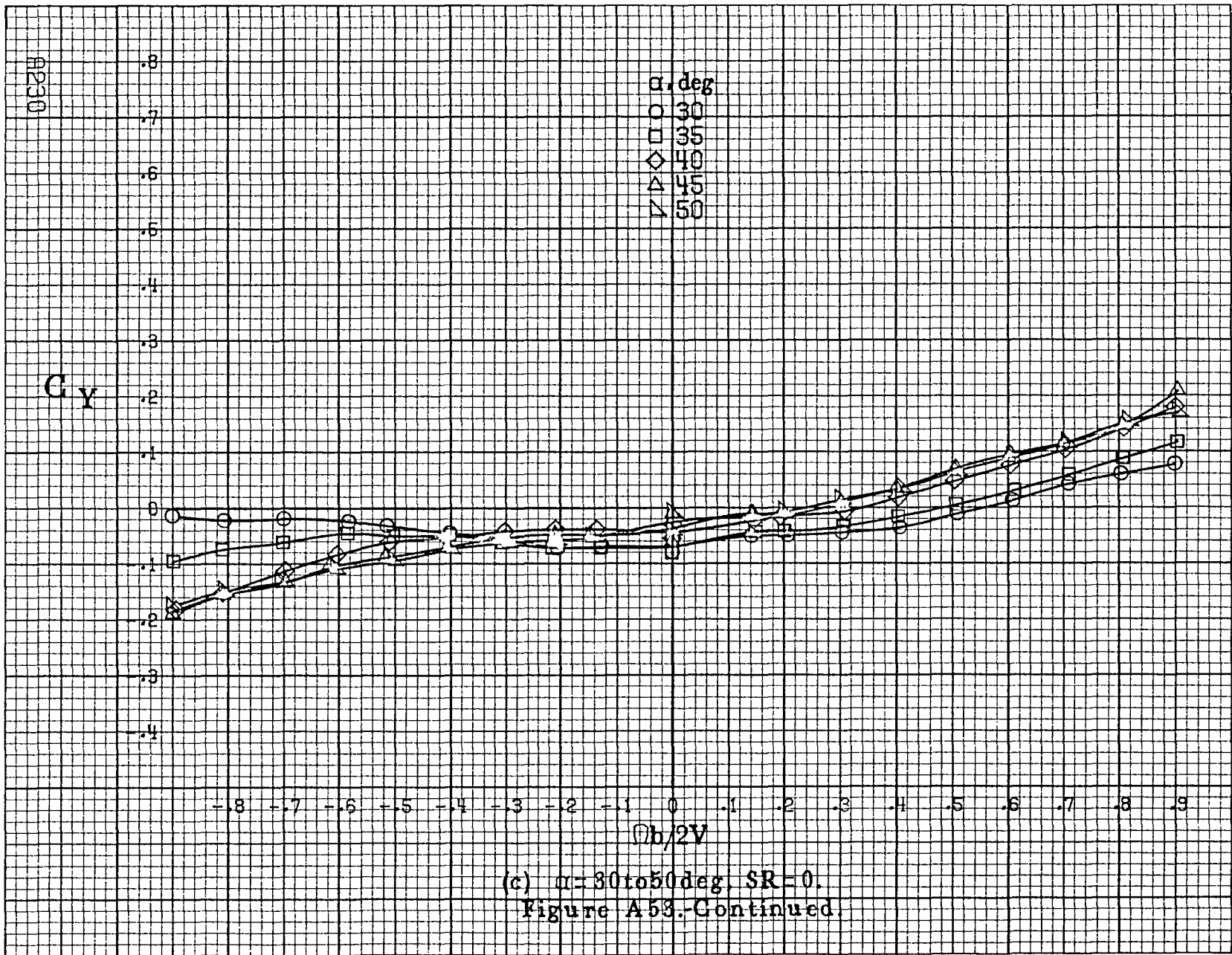



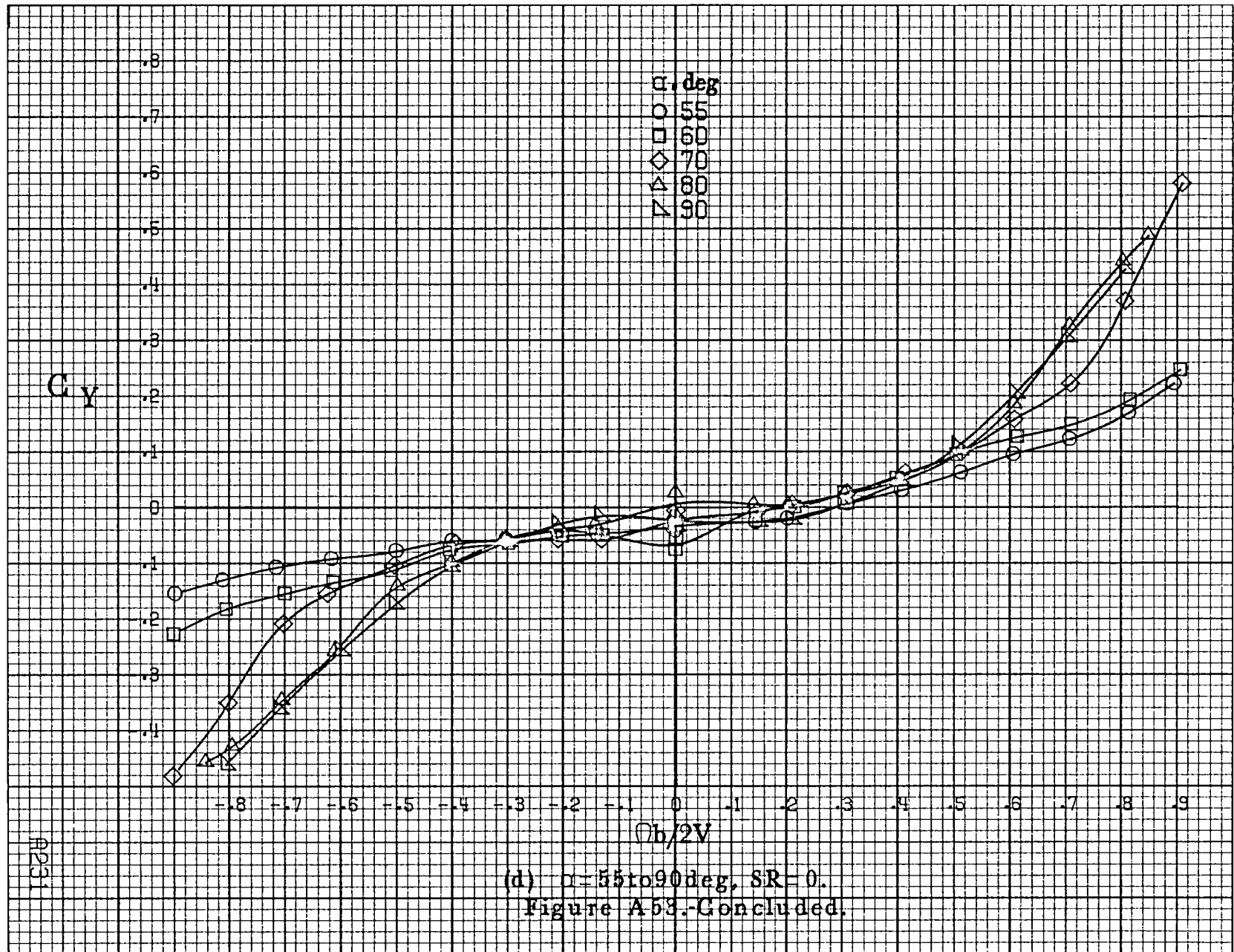

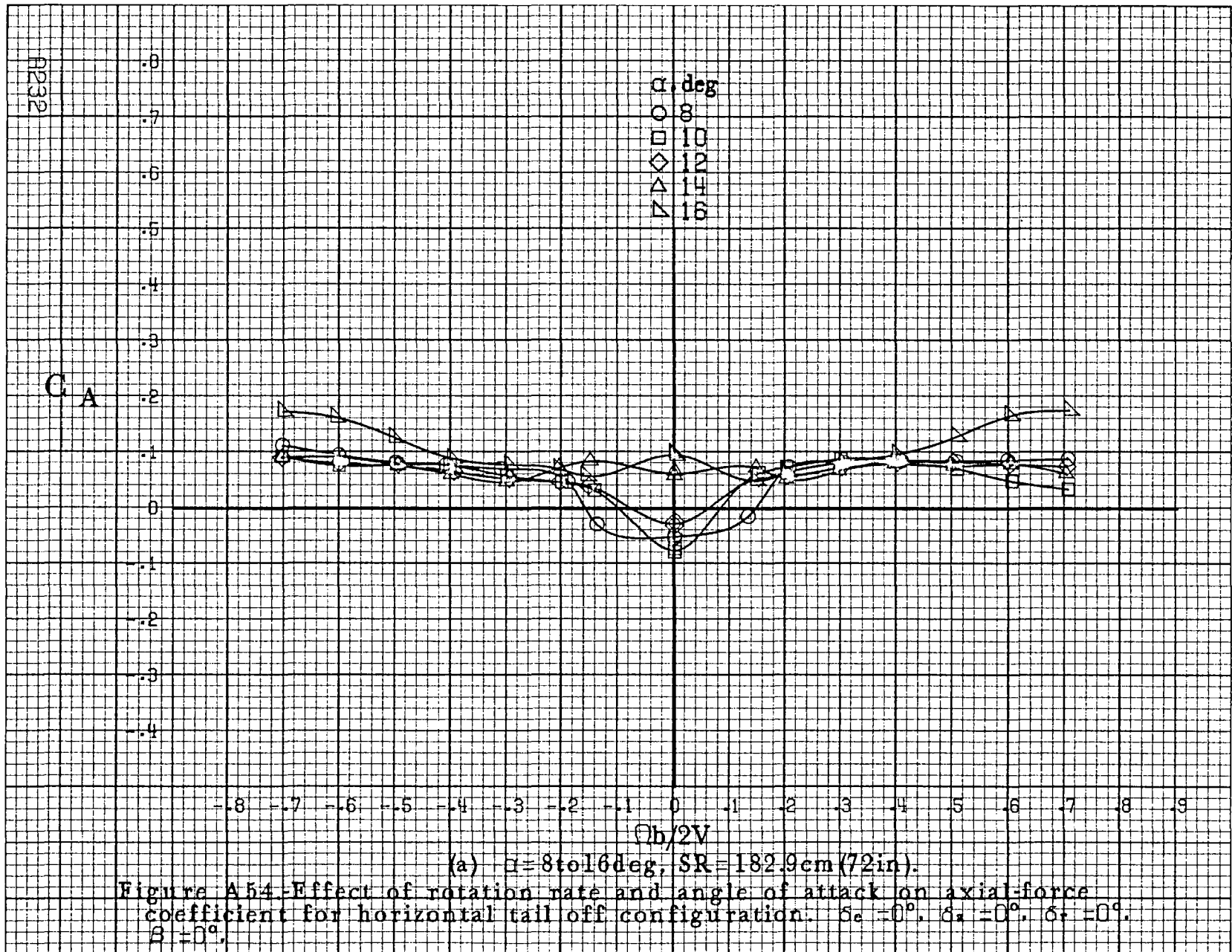

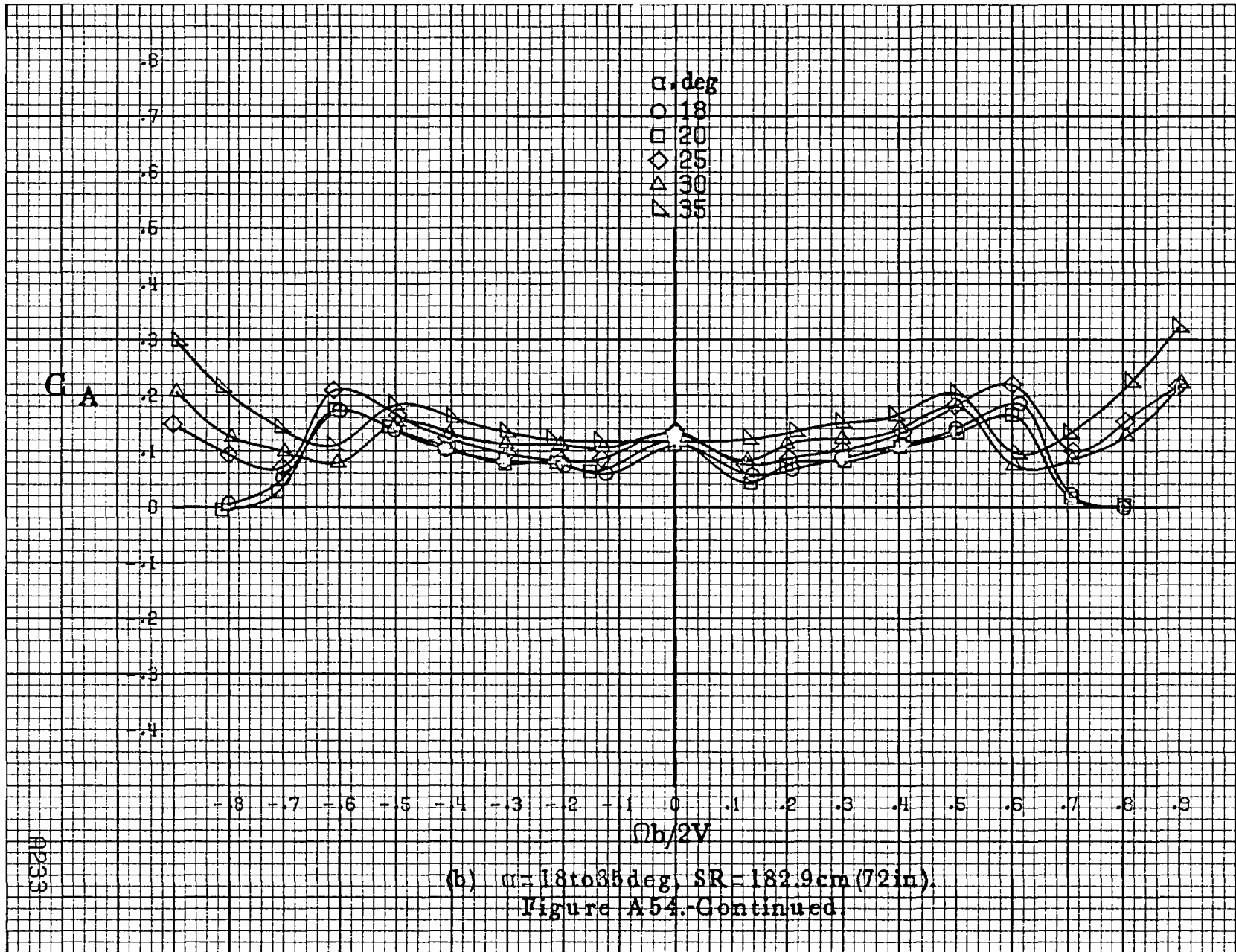

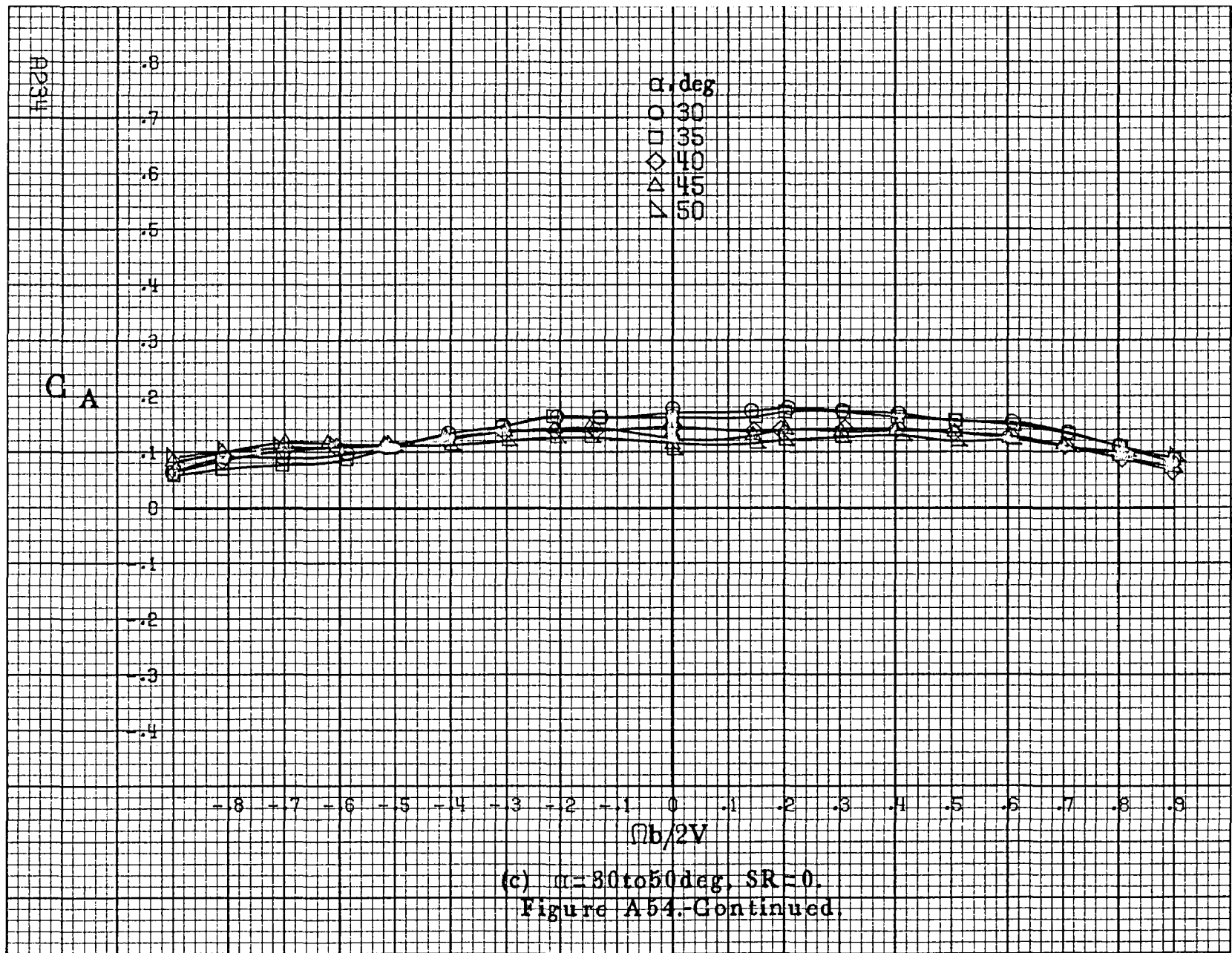

(c)  $\alpha=30$  to  $50$  deg, SR=0.  
 Figure A54.-Continued.

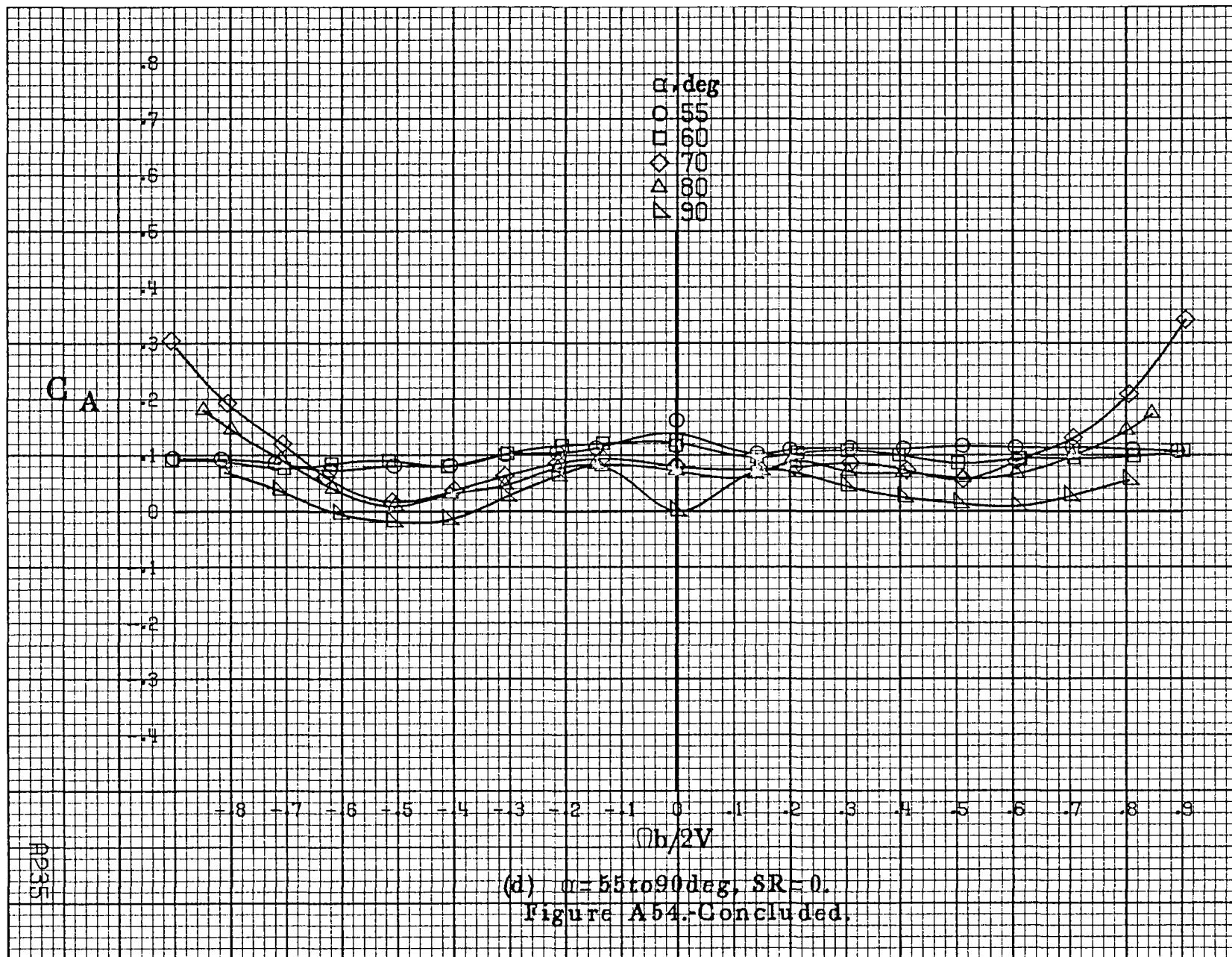

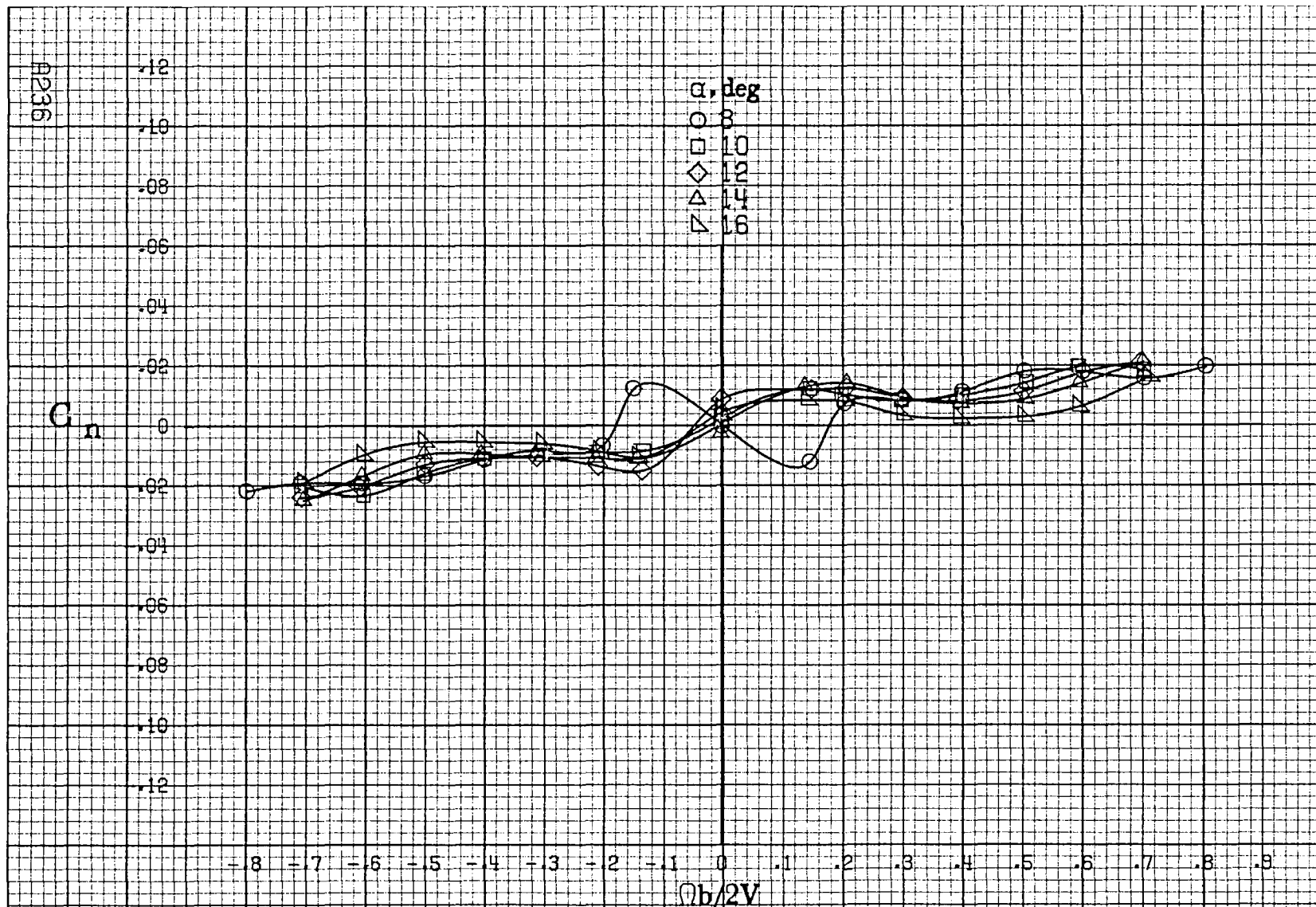

(a)  $\alpha = 8$  to  $16$  deg,  $SR = 182.9$  cm (72 in.).  
 Figure A55. Effect of rotation rate and angle of attack on yawing-moment coefficient for outboard LE wing droop with large nose radius.  $\delta_a = 0^\circ$ ,  $\delta_r = 0^\circ$ ,  $\beta = 0^\circ$ .

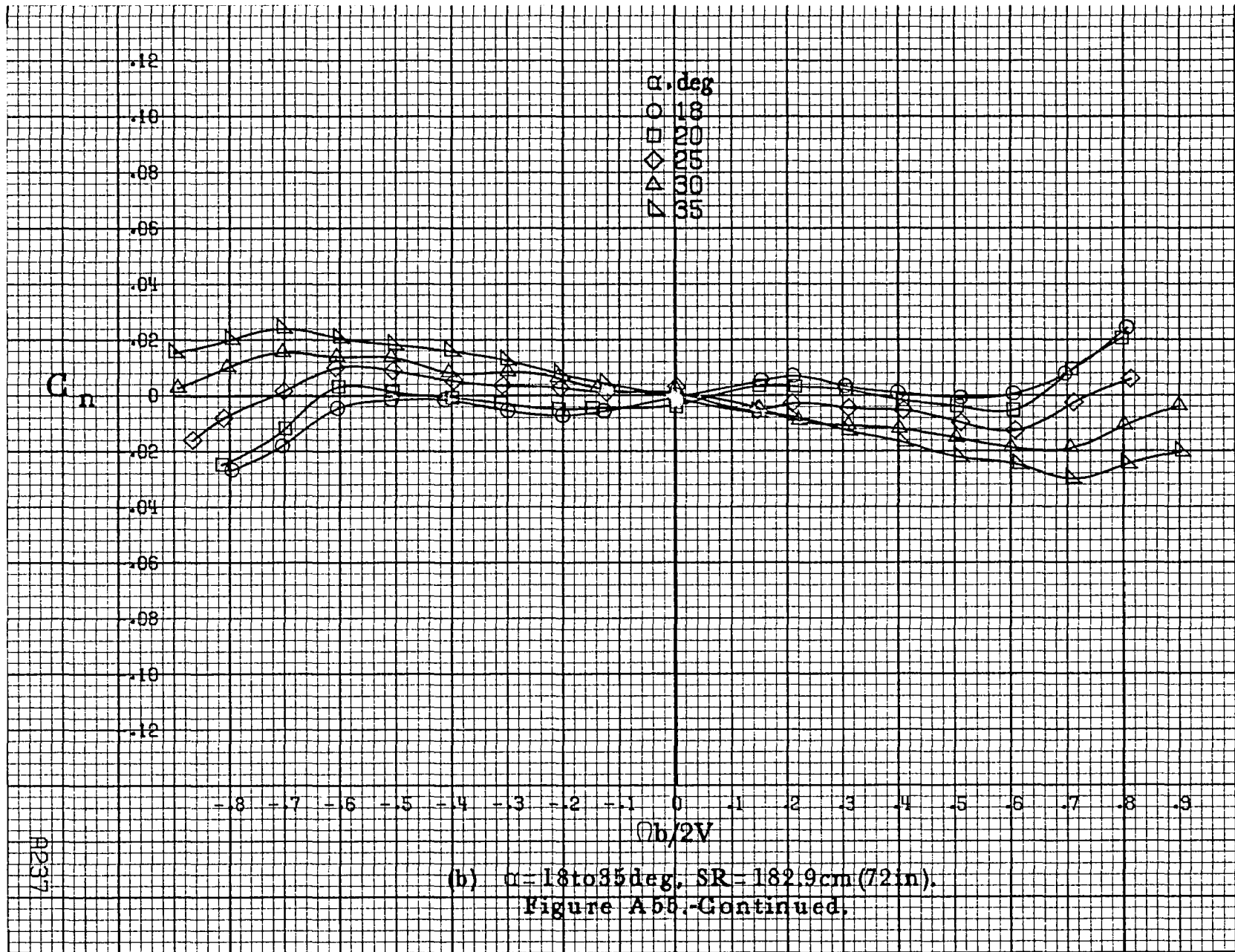



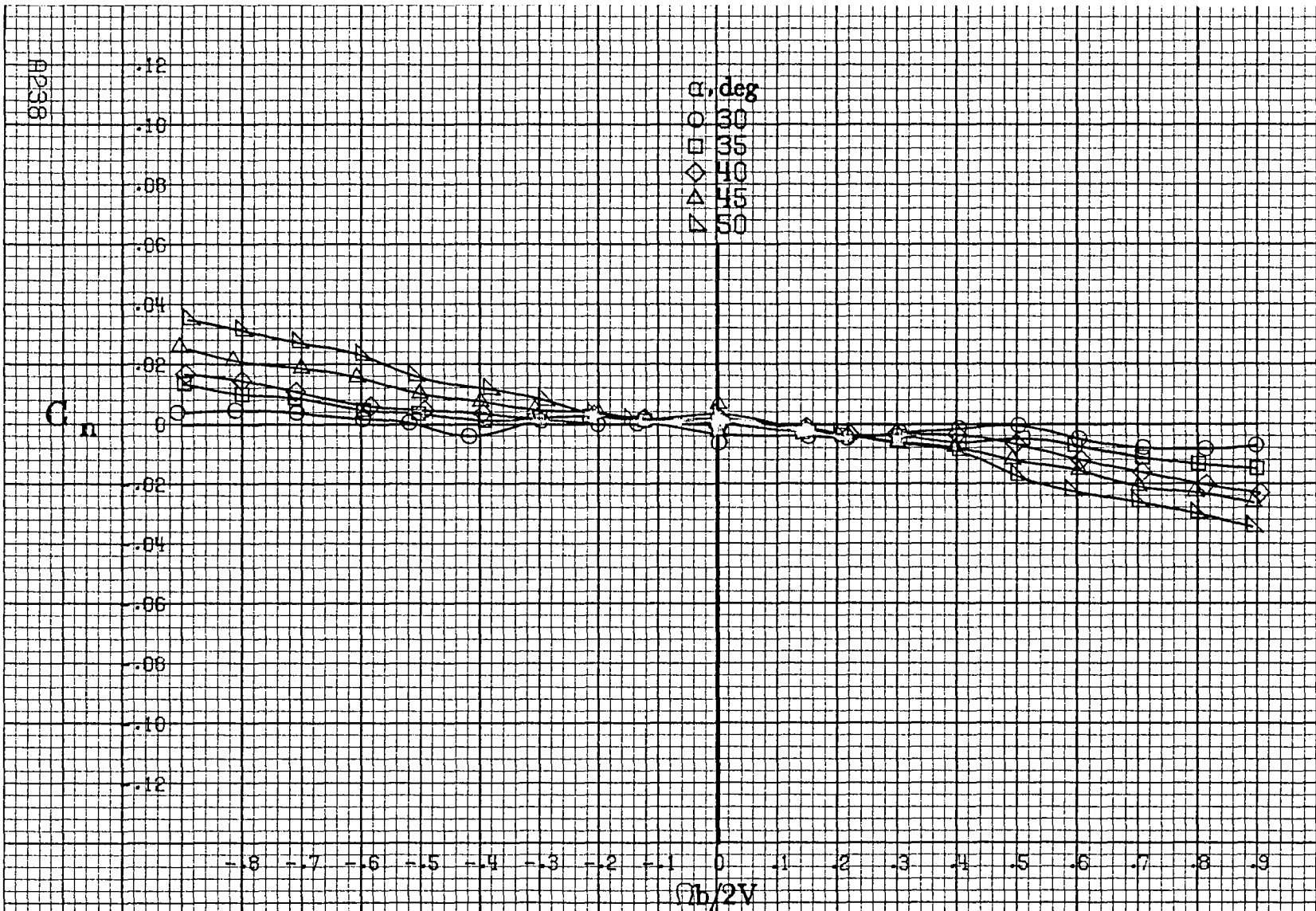

(c)  $\alpha=30$  to  $50$  deg,  $SR=0$ .  
 Figure A55. Continued.



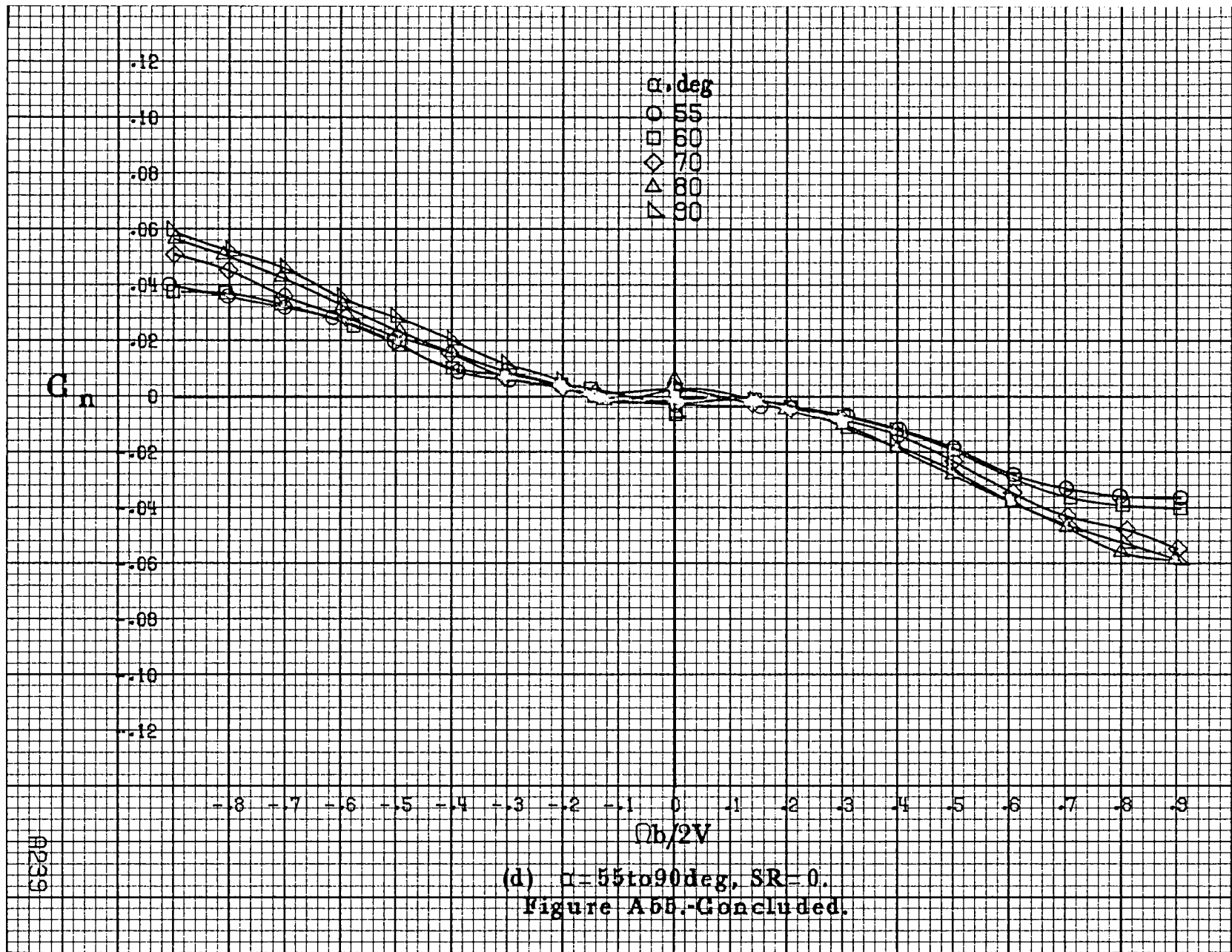

(d)  $\alpha = 55$  to  $90$  deg,  $SR = 0$ .  
 Figure A55.-Concluded.

A9239

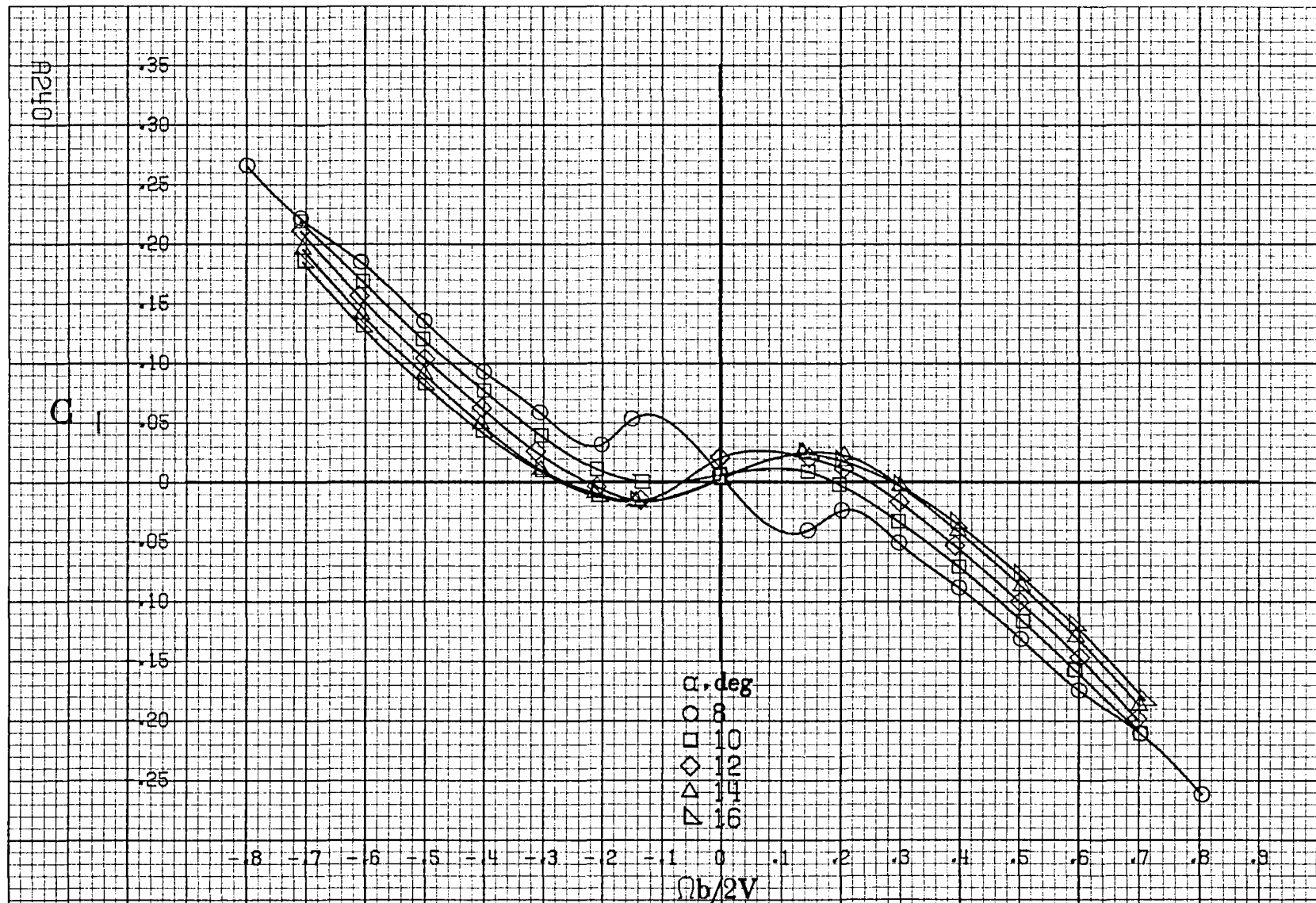

(a)  $\alpha = 8$  to  $16$  deg,  $SR = 182.9$  cm (72 in).

Figure A56. Effect of rotation rate and angle of attack on rolling-moment coefficient for outboard LE wing droop with large nose radius.  $\delta_e = 0^\circ$ ,  $\delta_a = 0^\circ$ ,  $\delta_r = 0^\circ$ .  $\beta = 0^\circ$ .

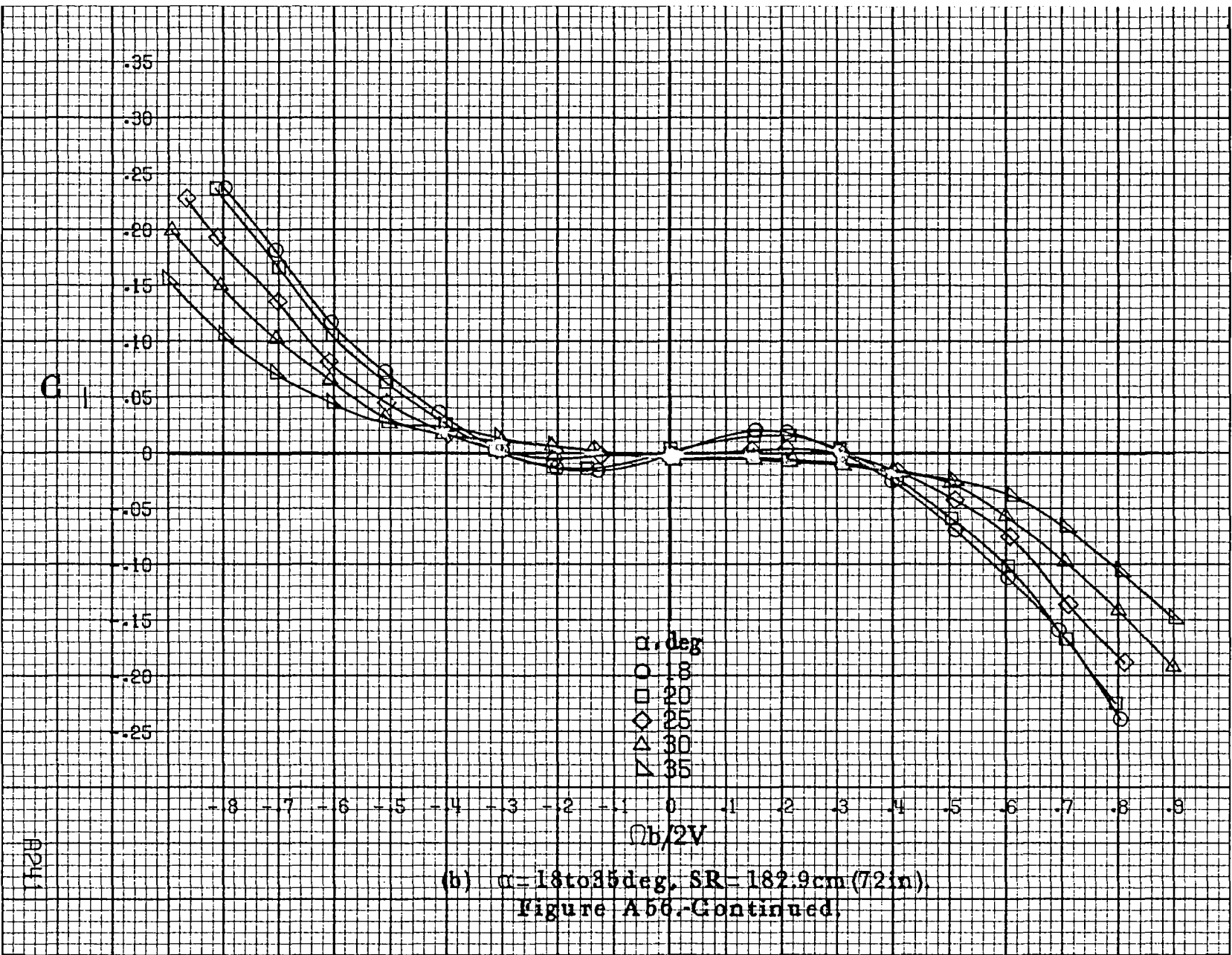

(b)  $\alpha=18$  to  $35$  deg,  $SR=182.9$  cm (72 in).  
Figure A56-Continued.

A241

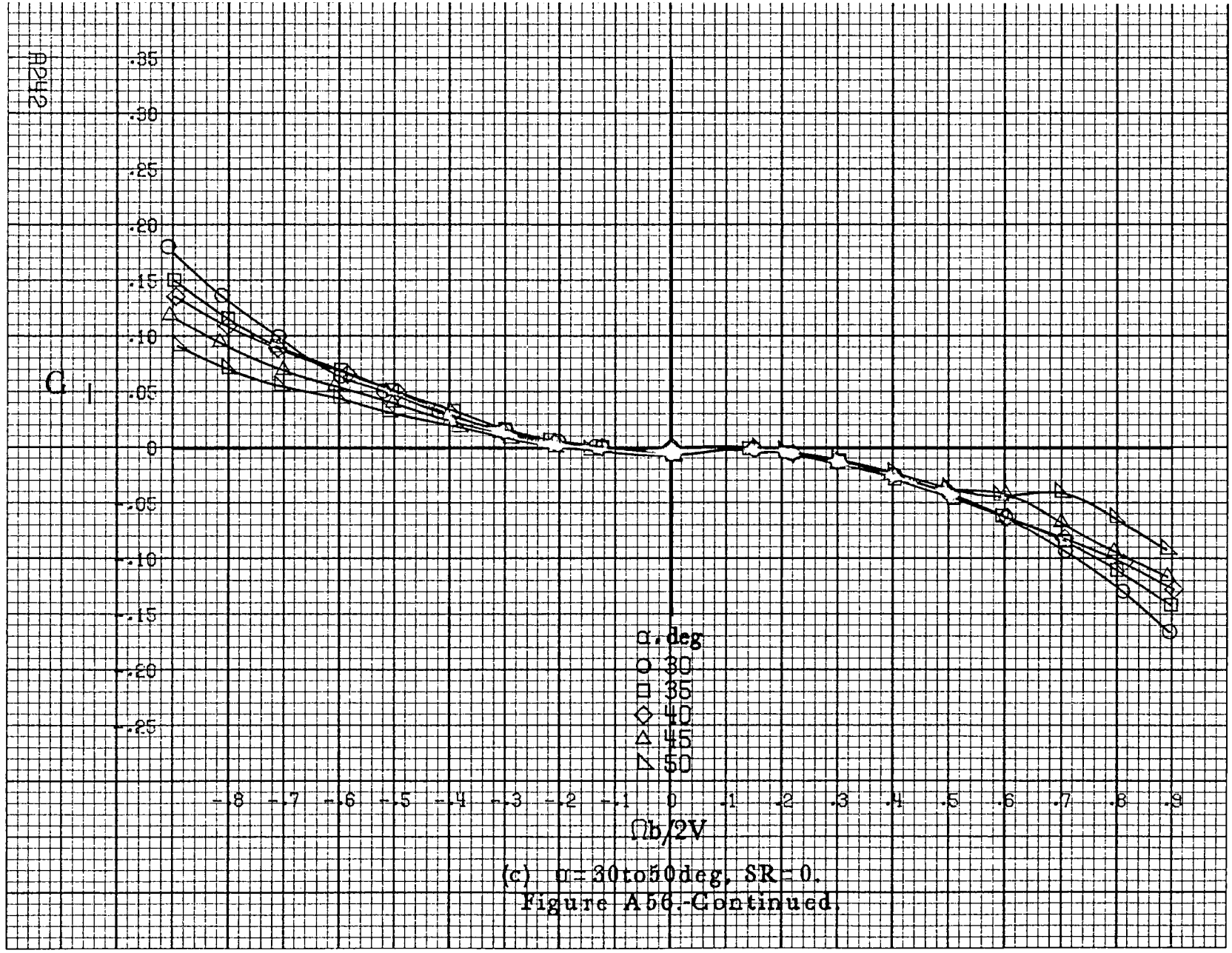

(c)  $\alpha = 30$  to  $50$  deg,  $SR = 0$ .  
 Figure A56-Continued.

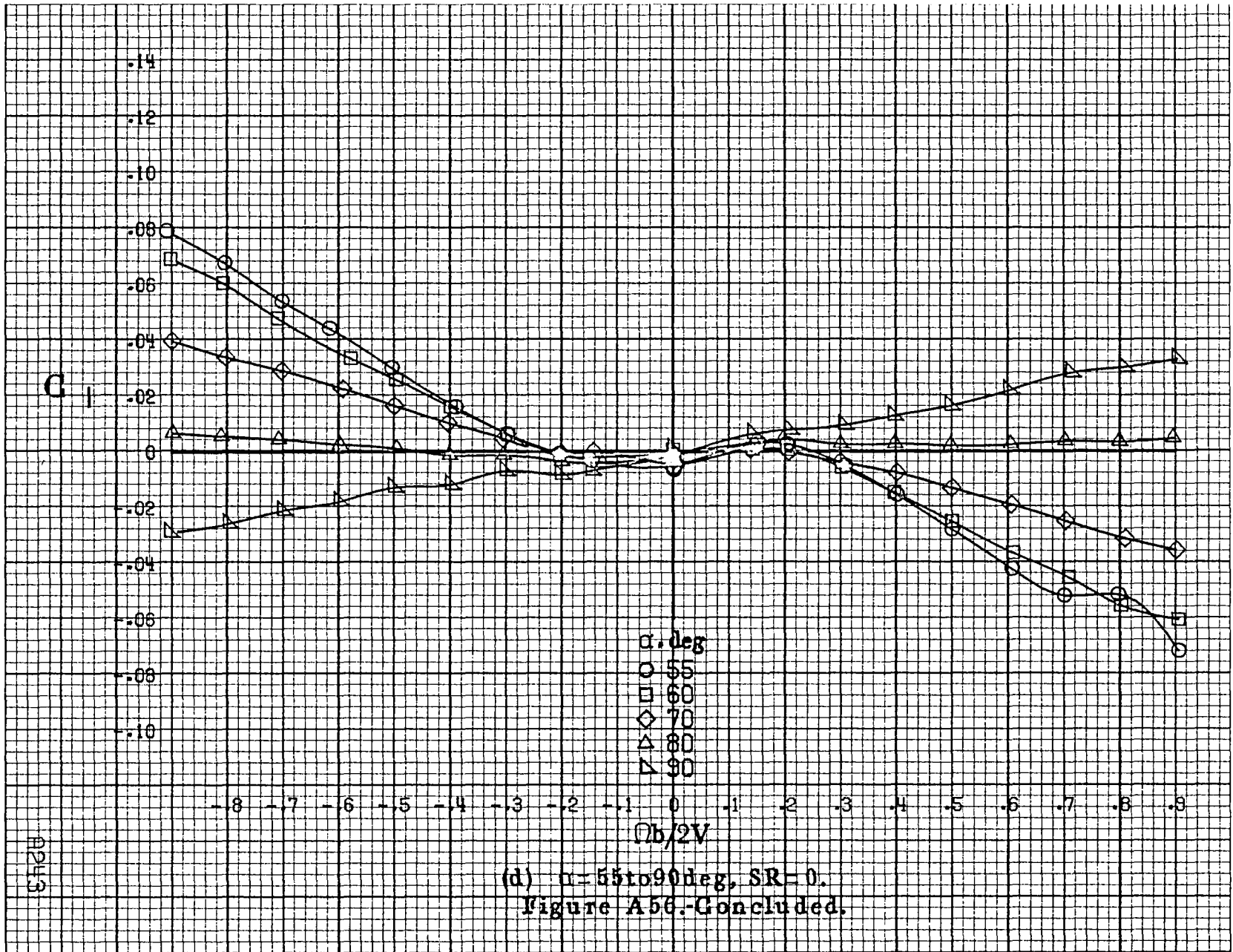

(d)  $\alpha = 55$  to  $90$  deg,  $SR = 0$ .  
 Figure A56.-Concluded.

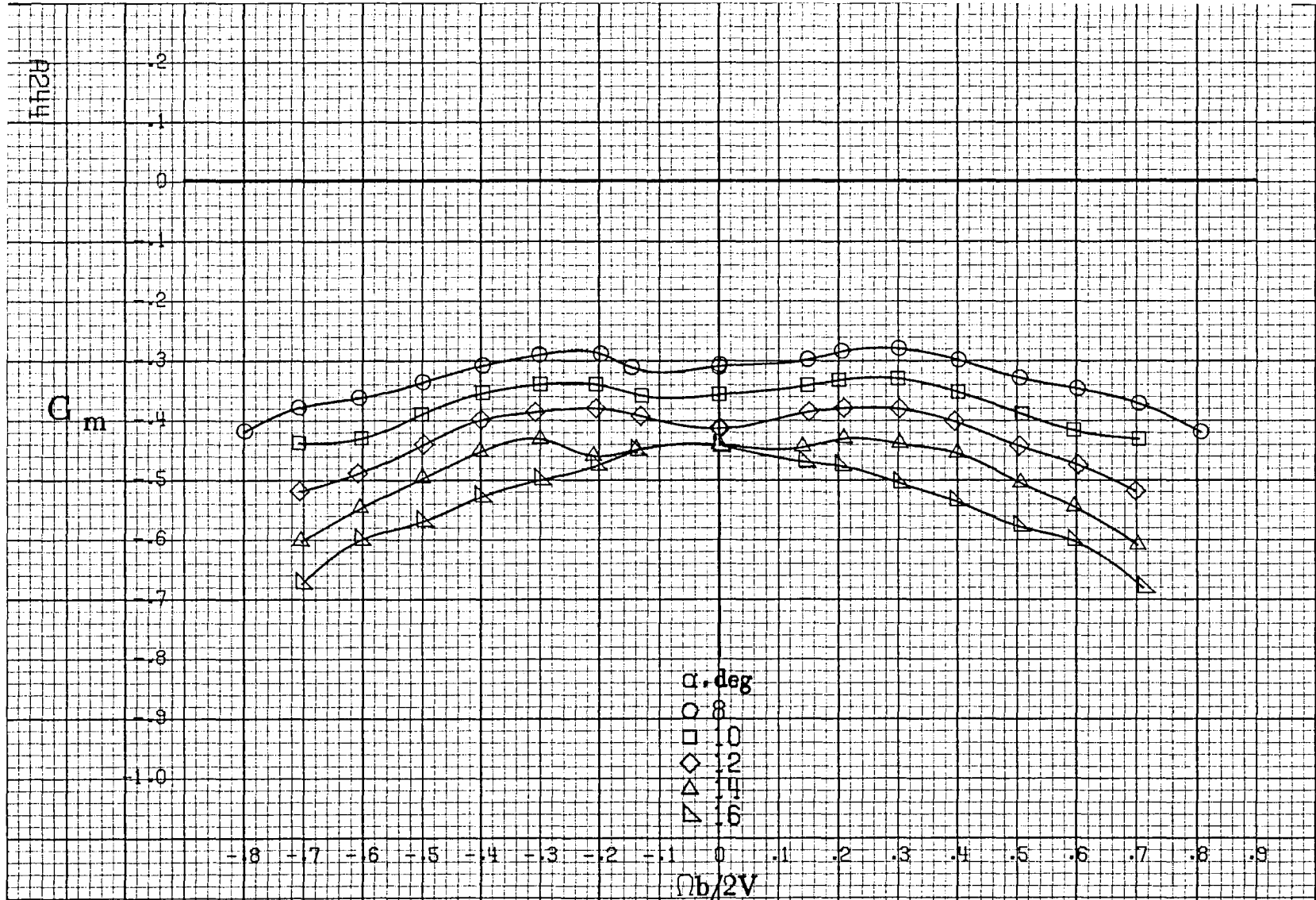

(a)  $\alpha = 8$  to  $16$  deg,  $SR = 182.9 \text{ cm (72 in)}$ .

Figure A57. Effect of rotation rate and angle of attack on pitching-moment coefficient for outboard LE wing droop with large nose radius.  $\delta_e = 0^\circ$ ,  $\delta_a = 0^\circ$ ,  $\delta_r = 0^\circ$ ,  $\beta = 0^\circ$ .

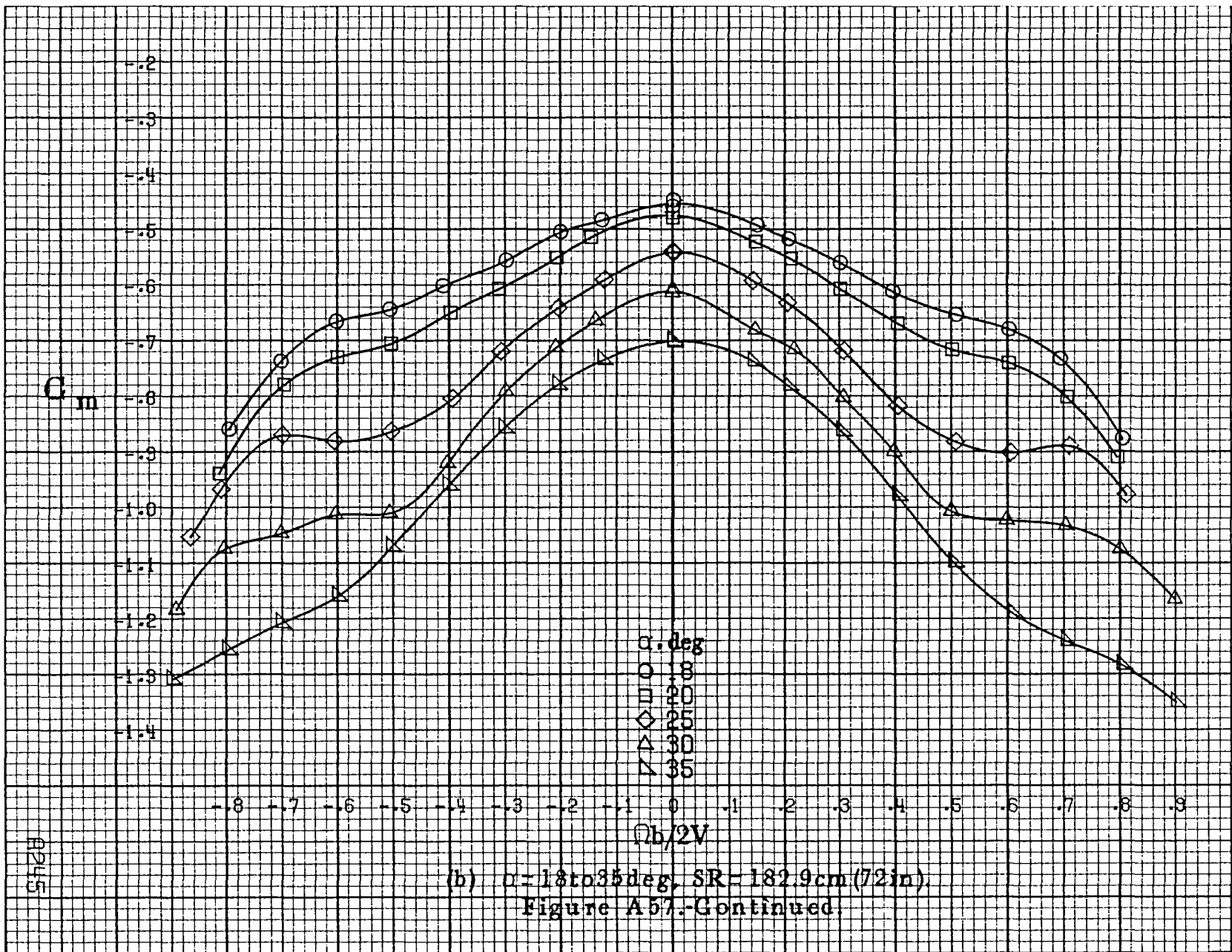

(b)  $\alpha = 18$  to  $35$  deg,  $SR = 182.9$  cm (72 in).  
 Figure A57.-Continued.

A2415



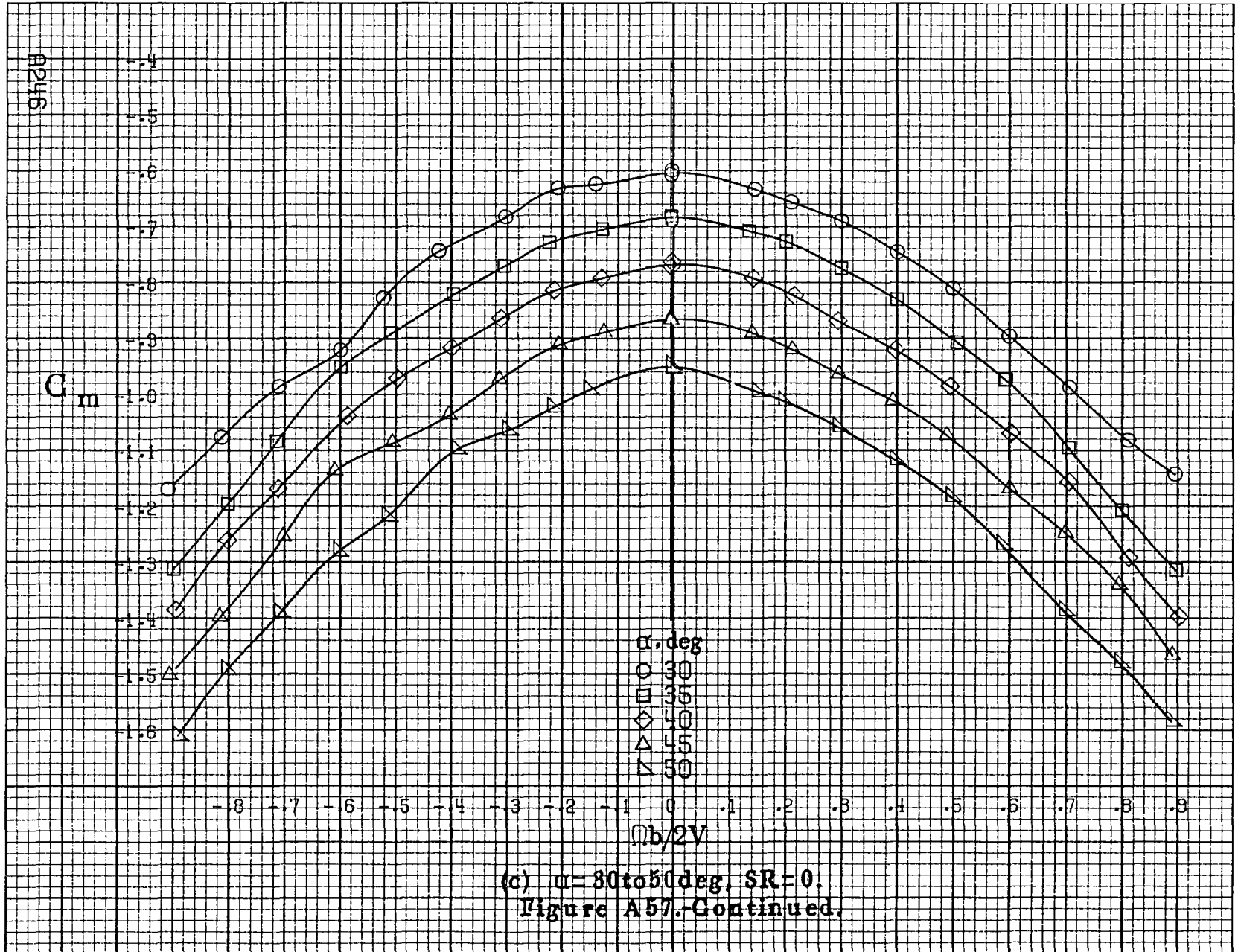



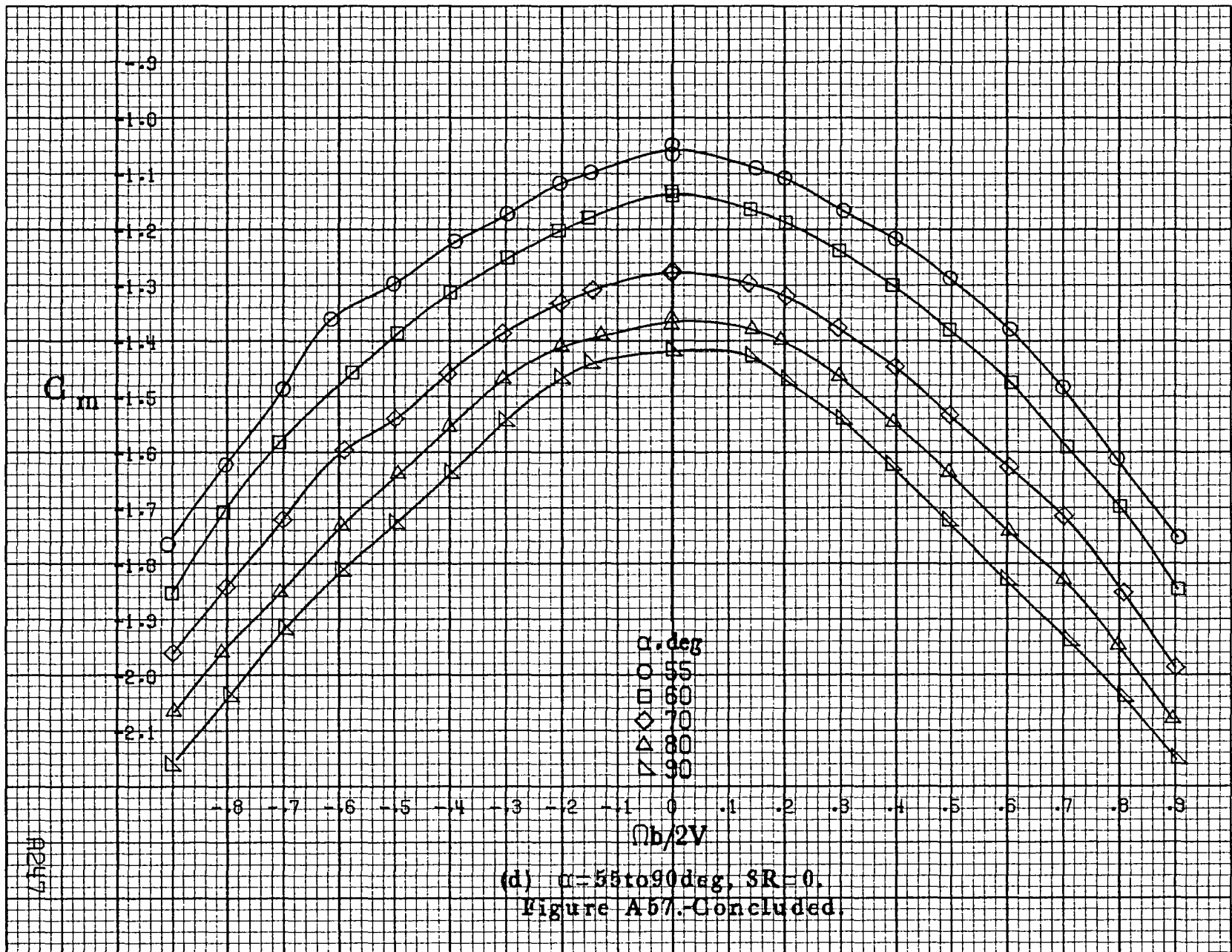

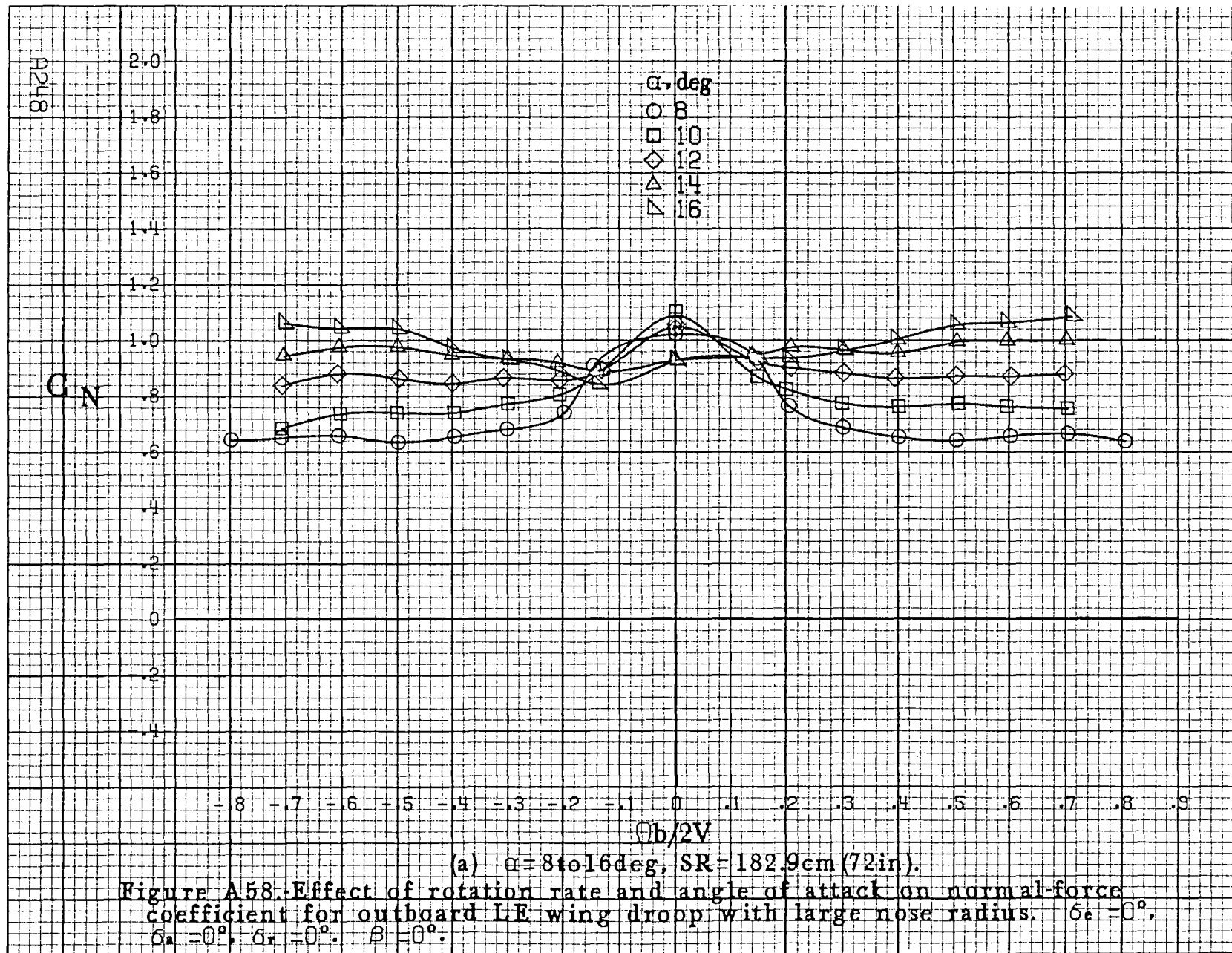

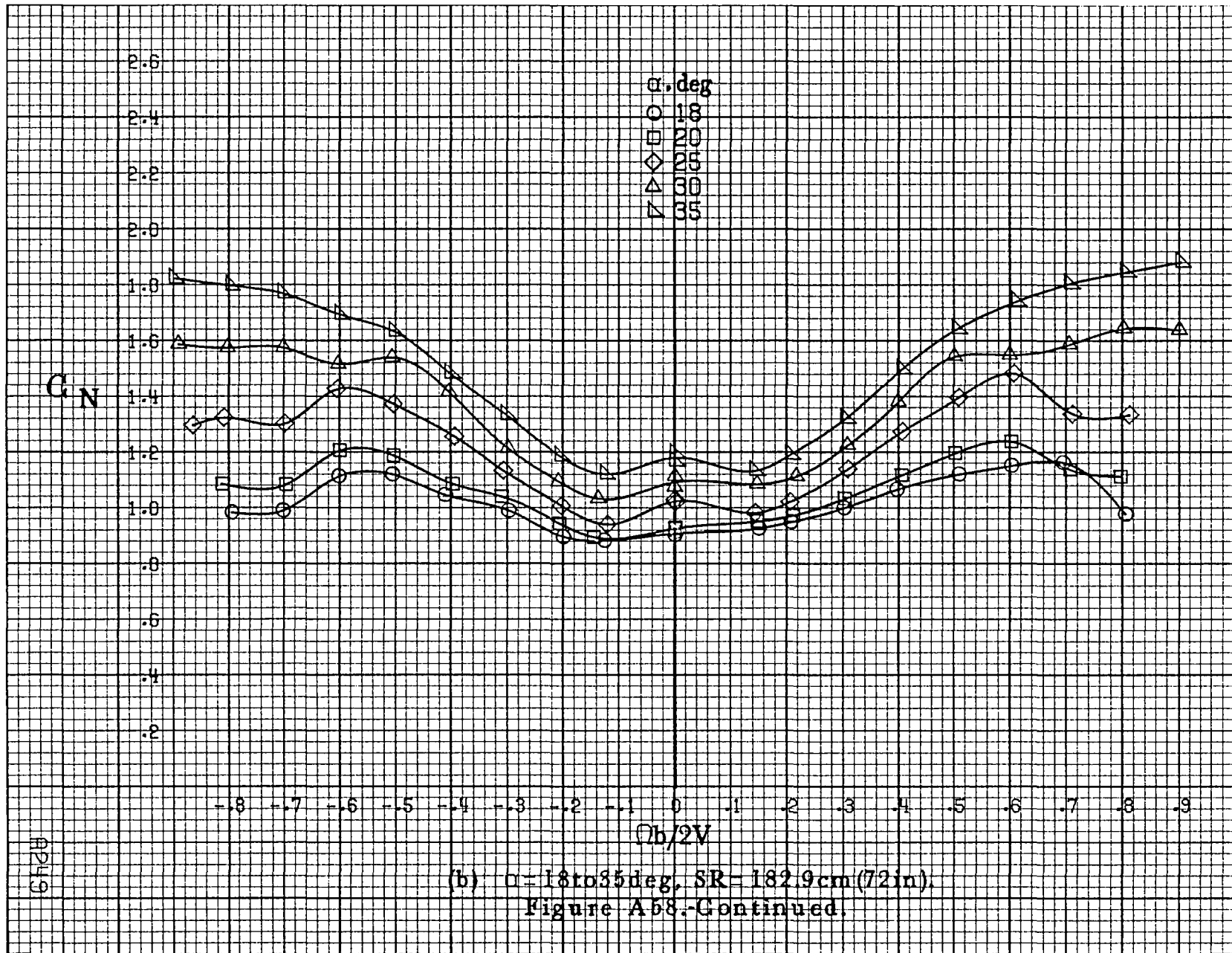

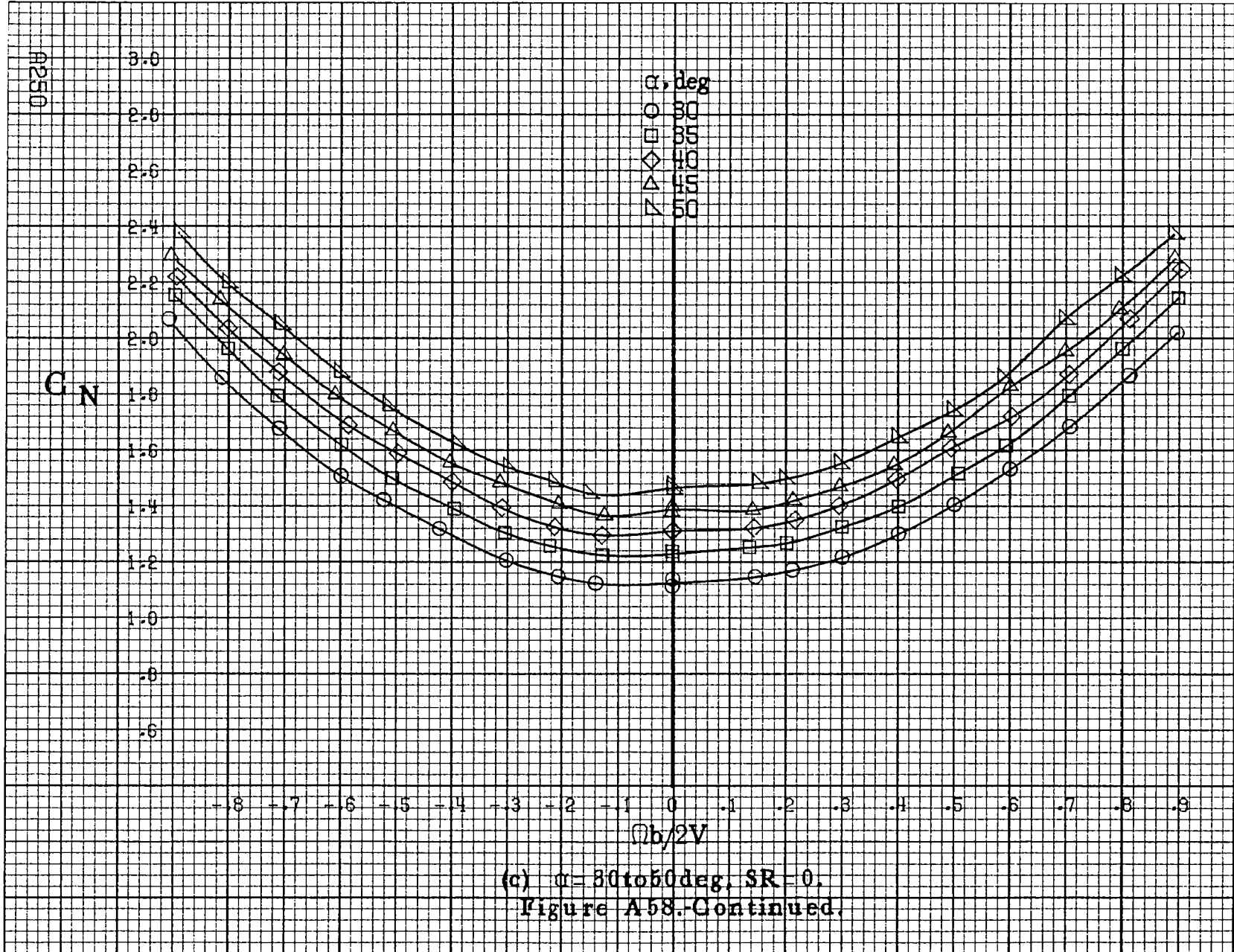

(c)  $\alpha = 30$  to  $60$  deg.  $SR = 0$ .  
 Figure A58-Continued.



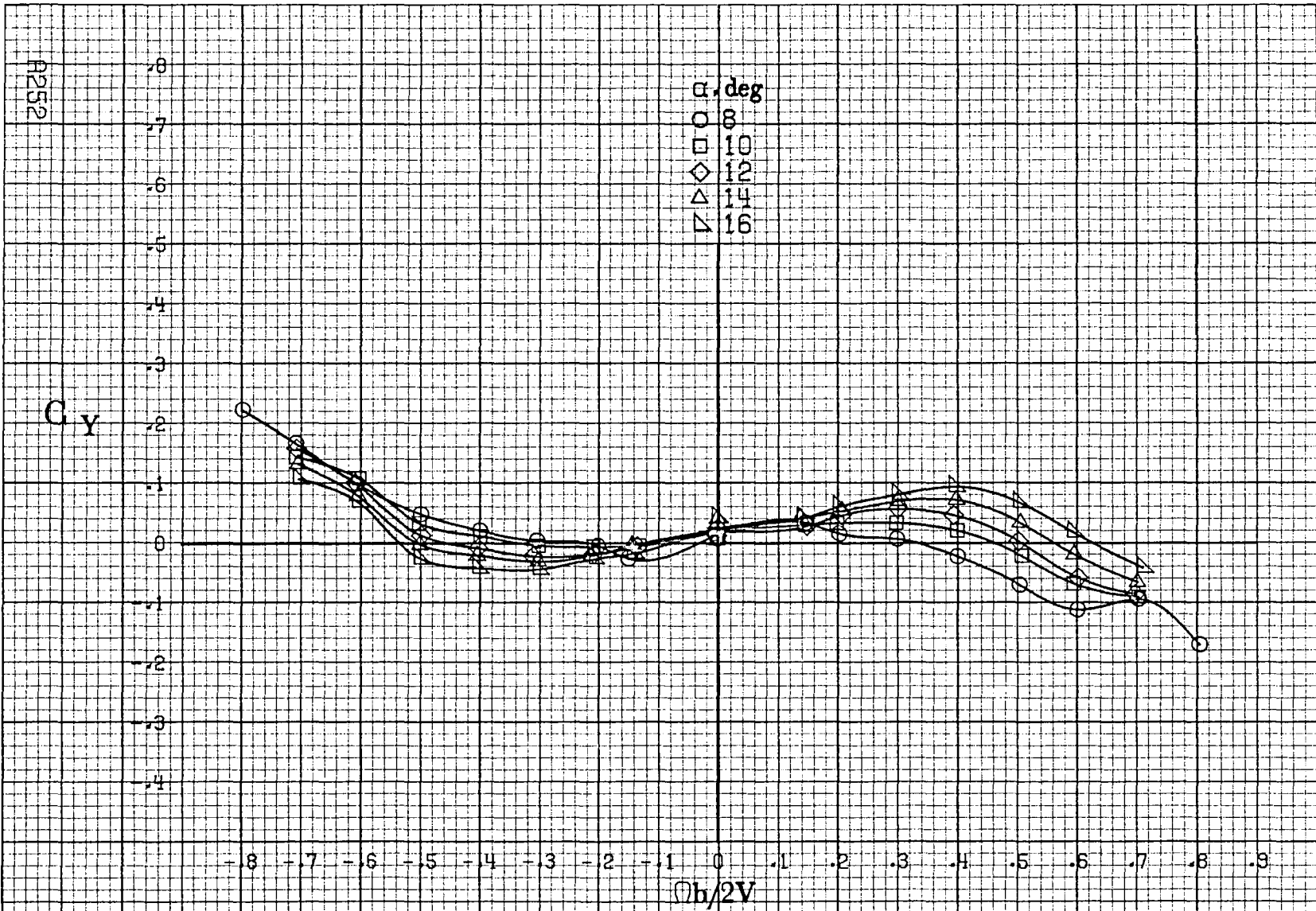

(a)  $\alpha = 8$  to  $16$  deg,  $SR = 182.9$  cm (72 in).

Figure A59. Effect of rotation rate and angle of attack on side-force coefficient for outboard LE wing droop with large nose radius.  $\delta_e = 0^\circ$ ,  $\delta_a = 0^\circ$ ,  $\delta_r = 0^\circ$ ,  $\beta = 0^\circ$ .

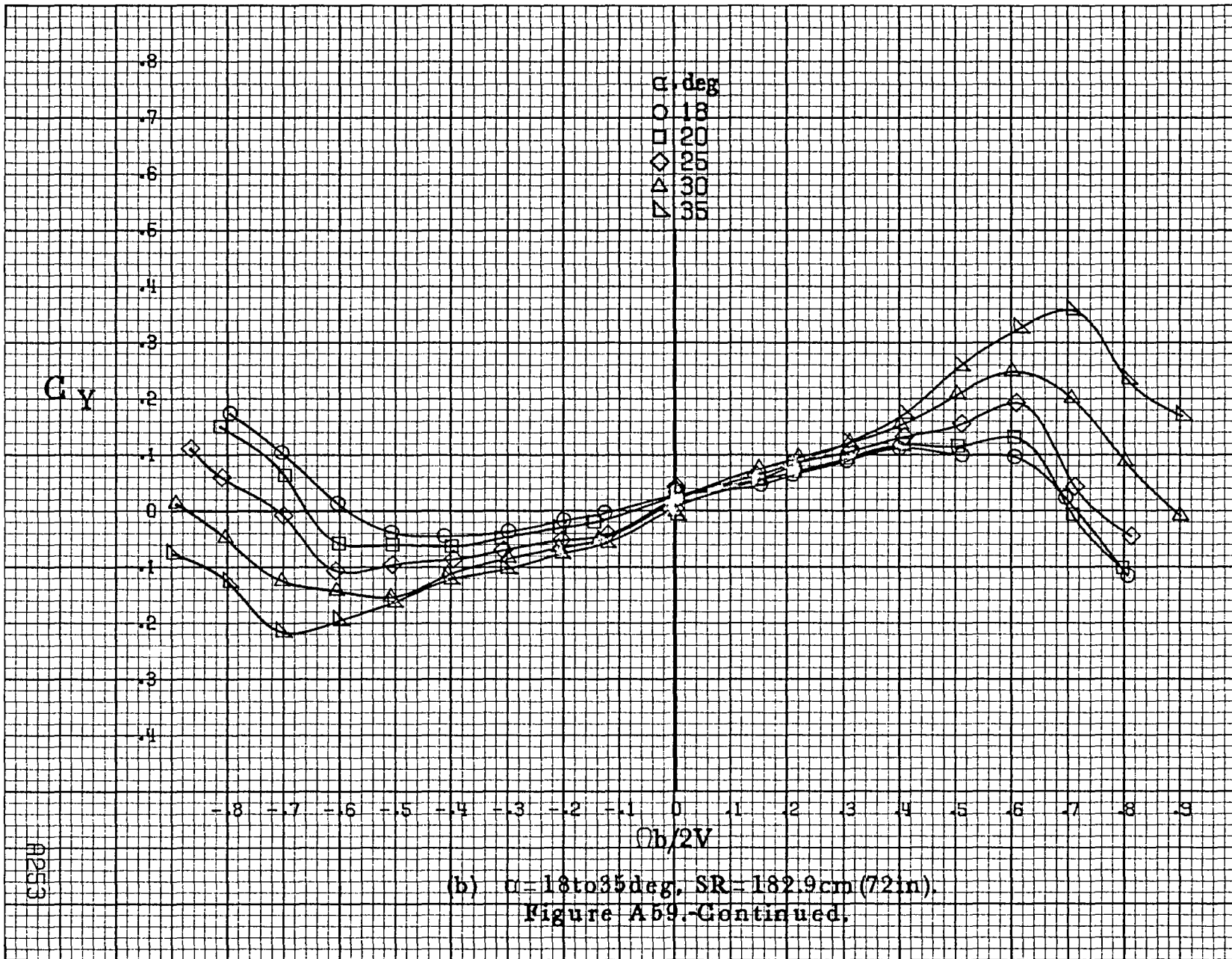



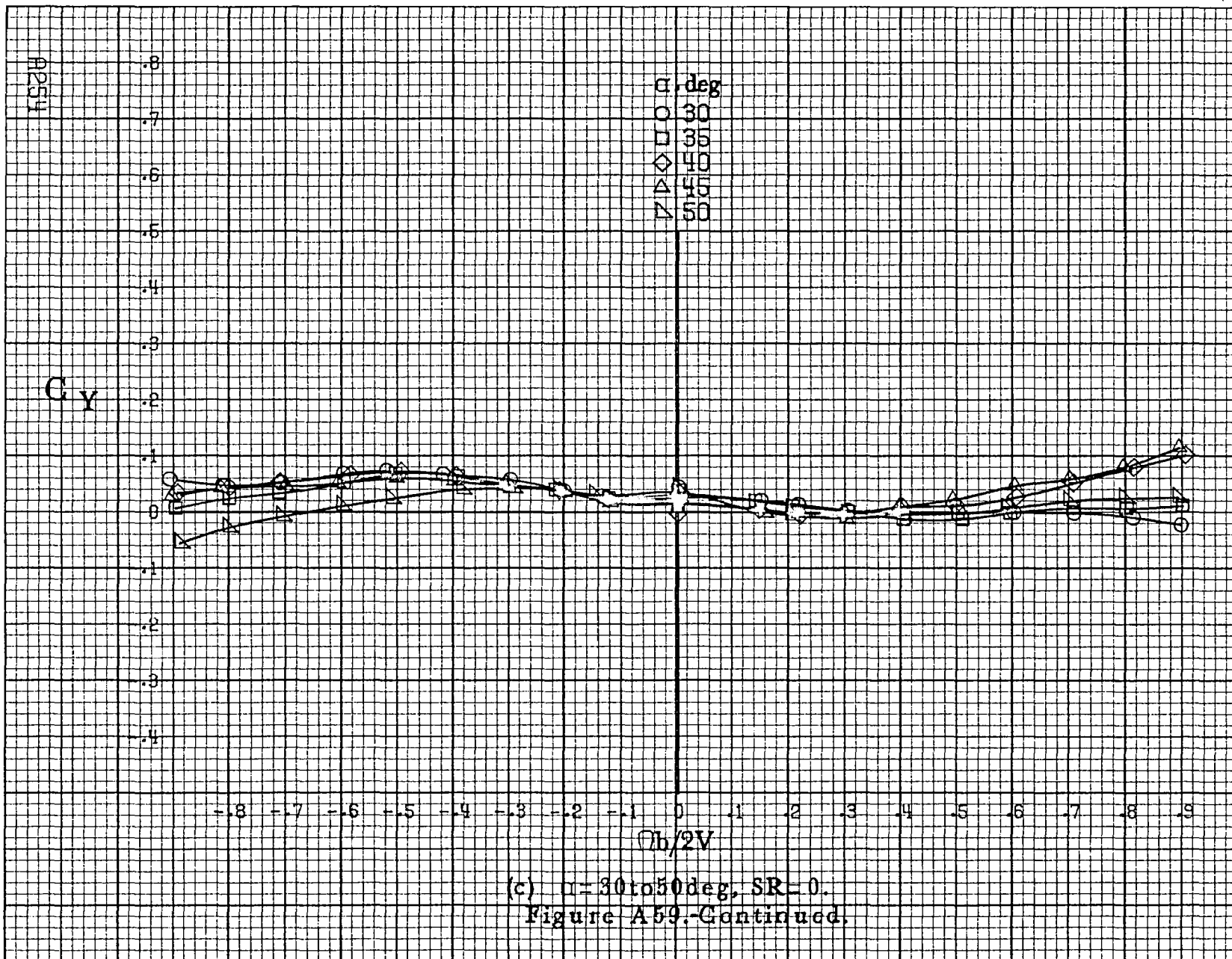



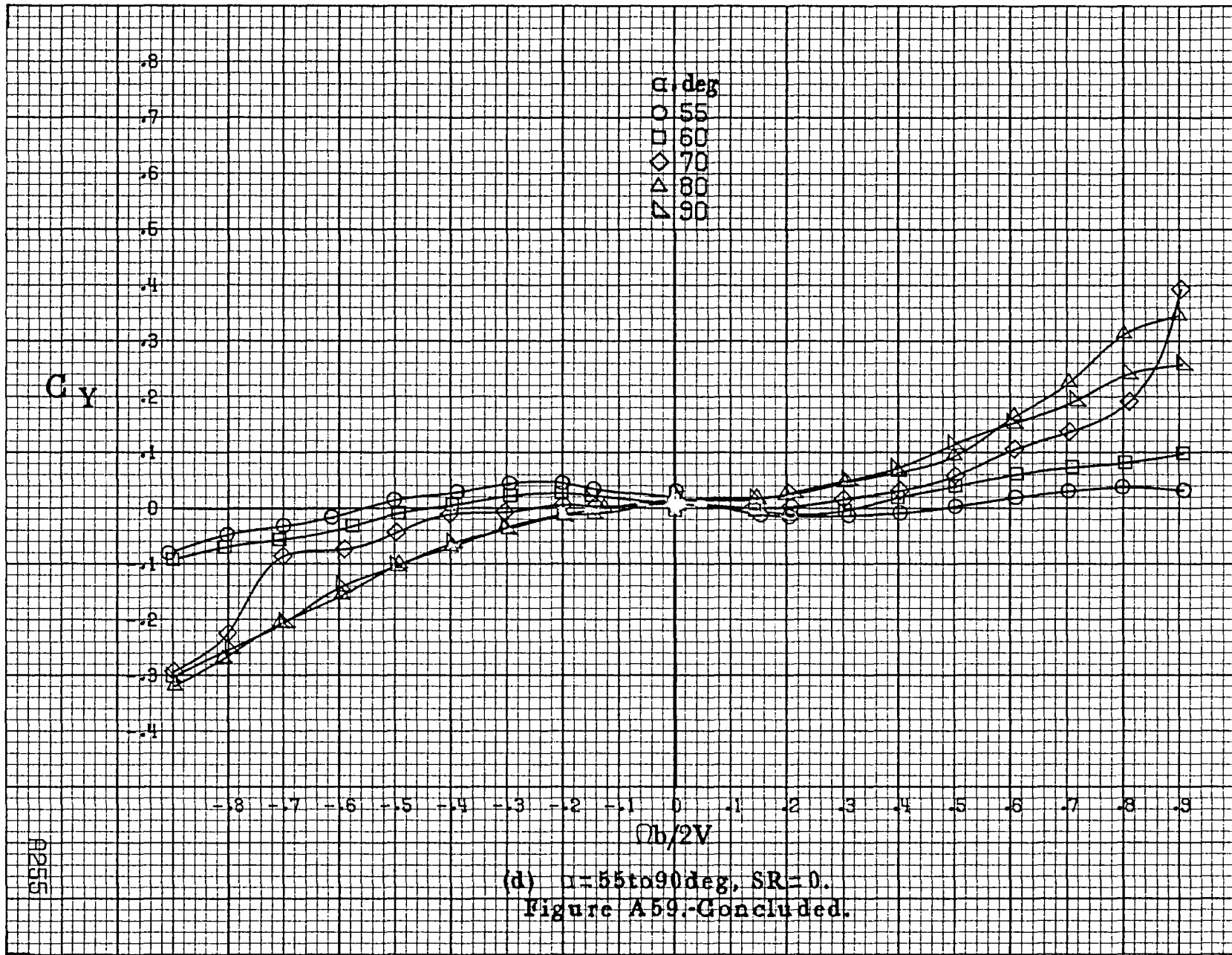

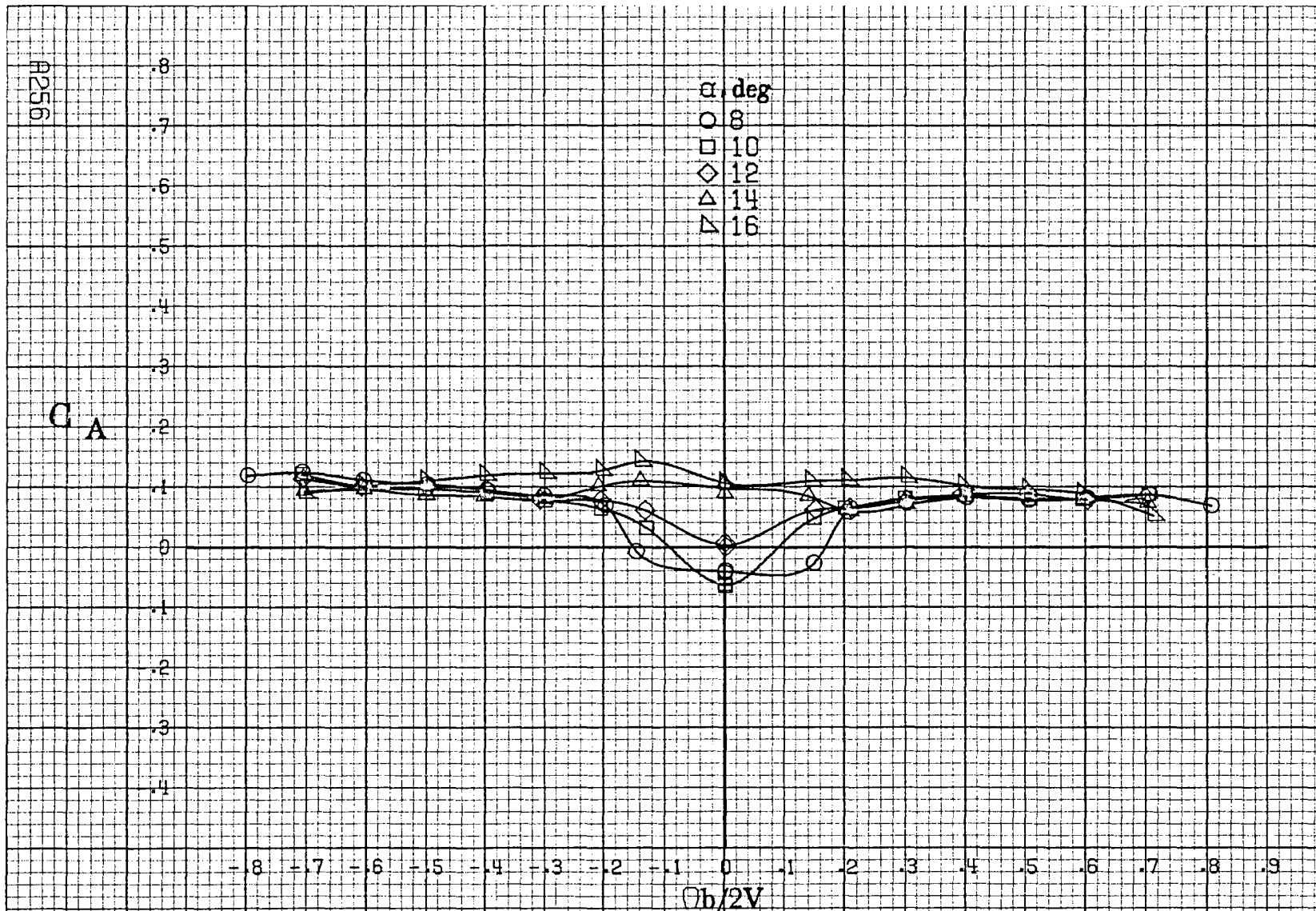

(a)  $\alpha = 8$  to  $16$  deg,  $SR = 182.9$  cm (72 in).

Figure A60.-Effect of rotation rate and angle of attack on axial-force coefficient for outboard LE wing droop with large nose radius.  $\delta_a = 0^\circ$ ,  $\delta_r = 0^\circ$ ,  $\beta = 0^\circ$ .

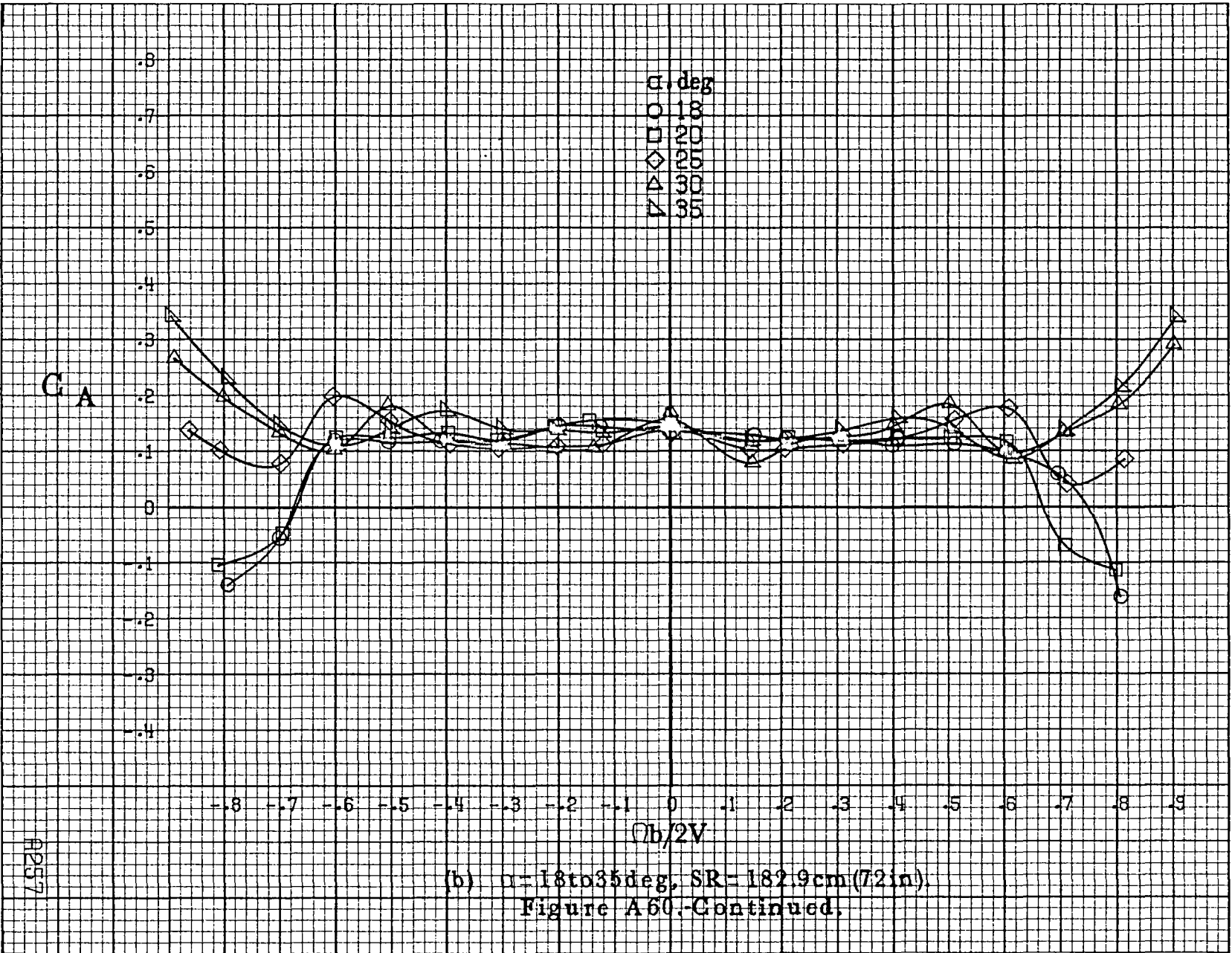

(b)  $\alpha = 18$  to  $35$  deg, SR = 182.9 cm (72 in).  
 Figure A 60.-Continued.

A257

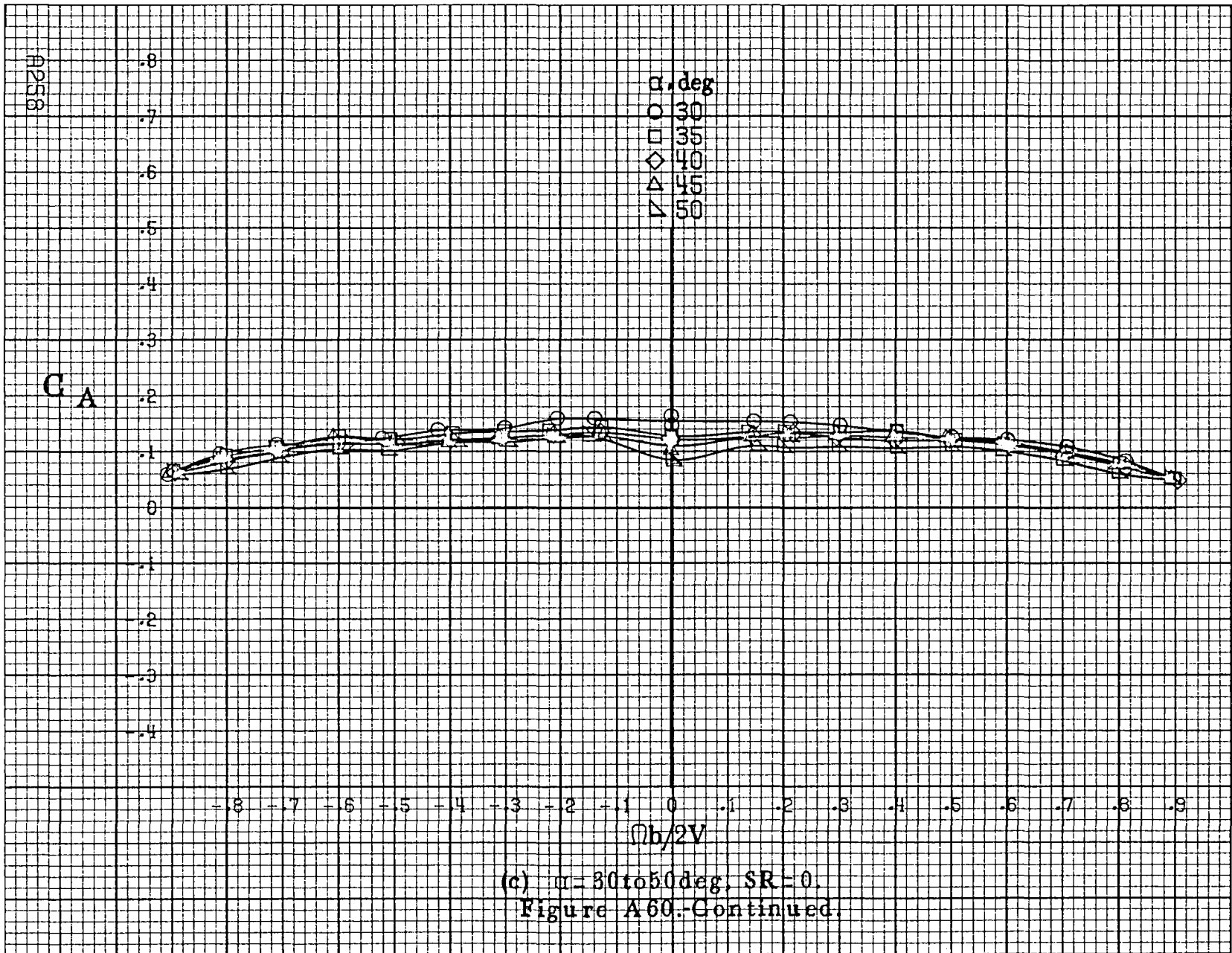

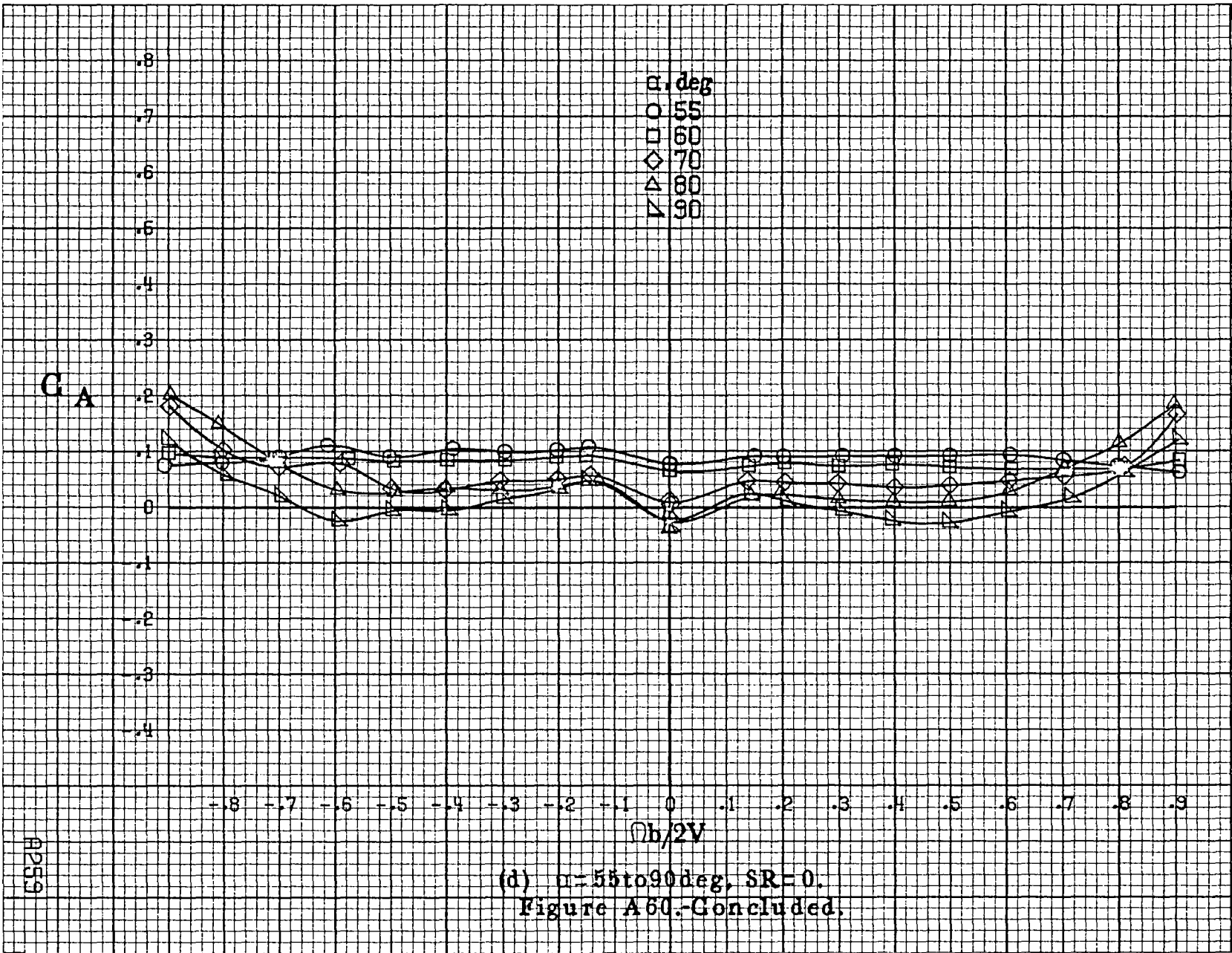

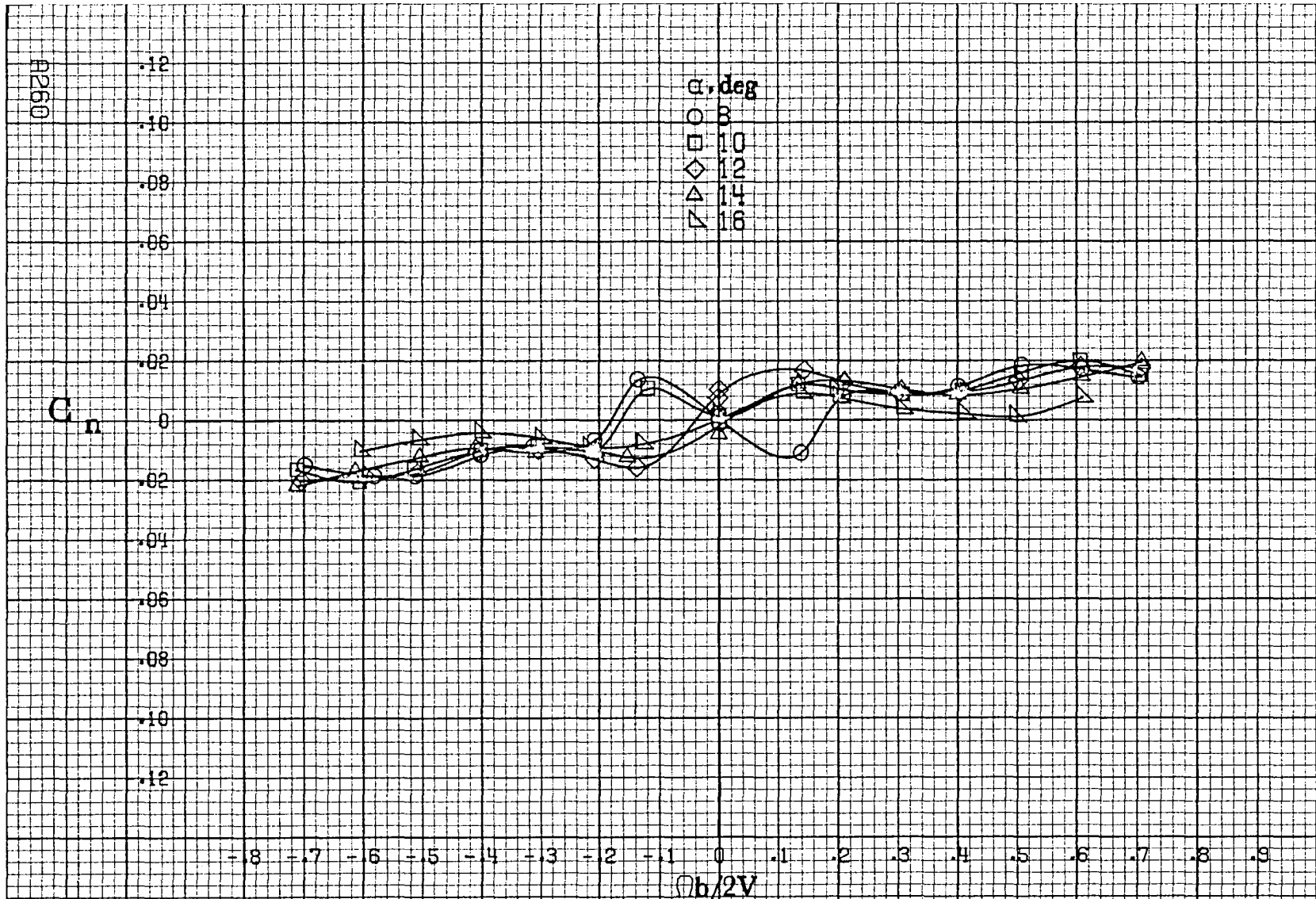

(a)  $\alpha = 8$  to  $16$  deg,  $SR = 182.9$  cm (72 in).

Figure A61.-Effect of rotation rate and angle of attack on yawing-moment coefficient for horizontal and vertical tail off configuration.  $\delta_r = 0^\circ$ ,  $\delta_a = 0^\circ$ ,  $\delta_c = 0^\circ$ ,  $\beta = 0^\circ$ .

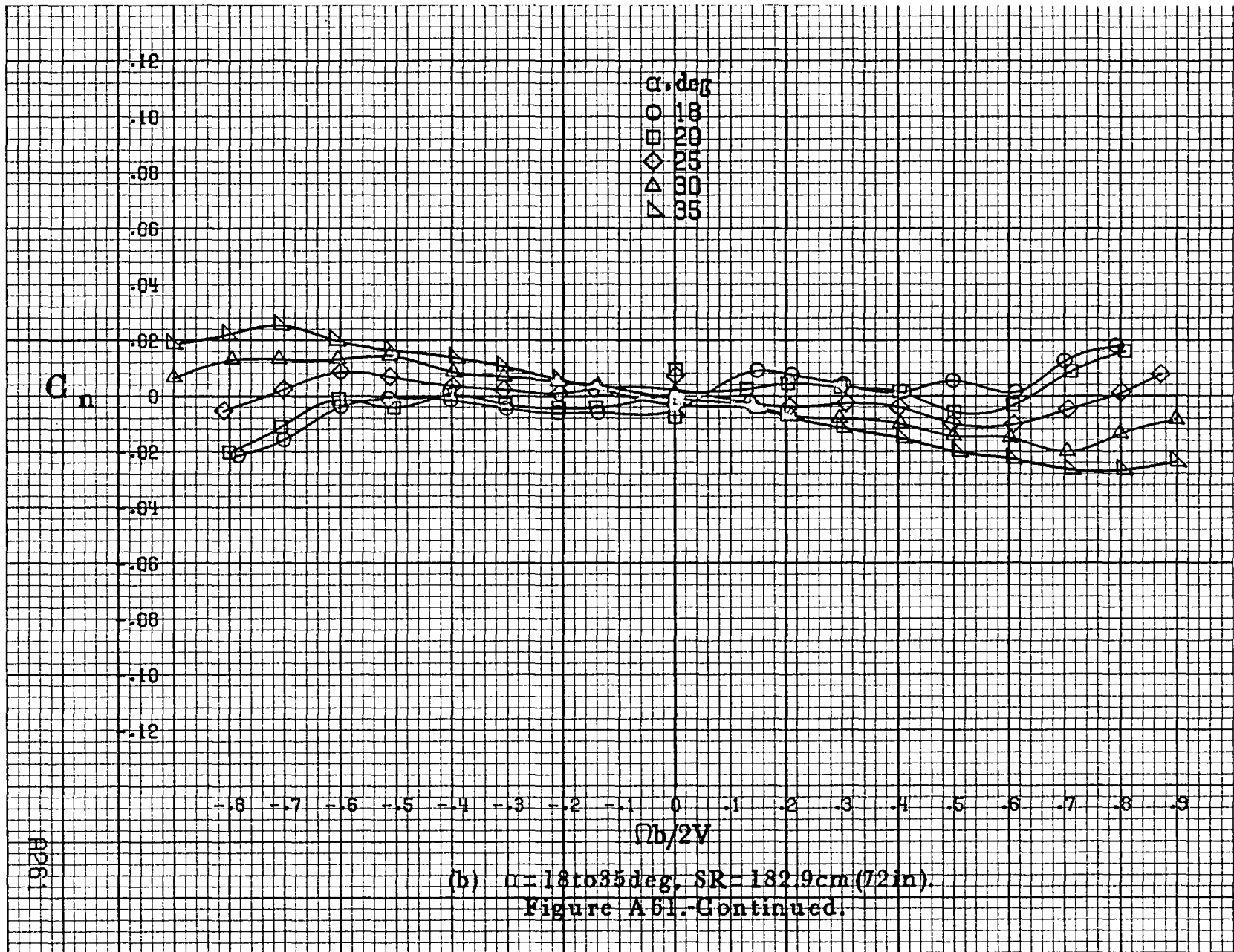



A282

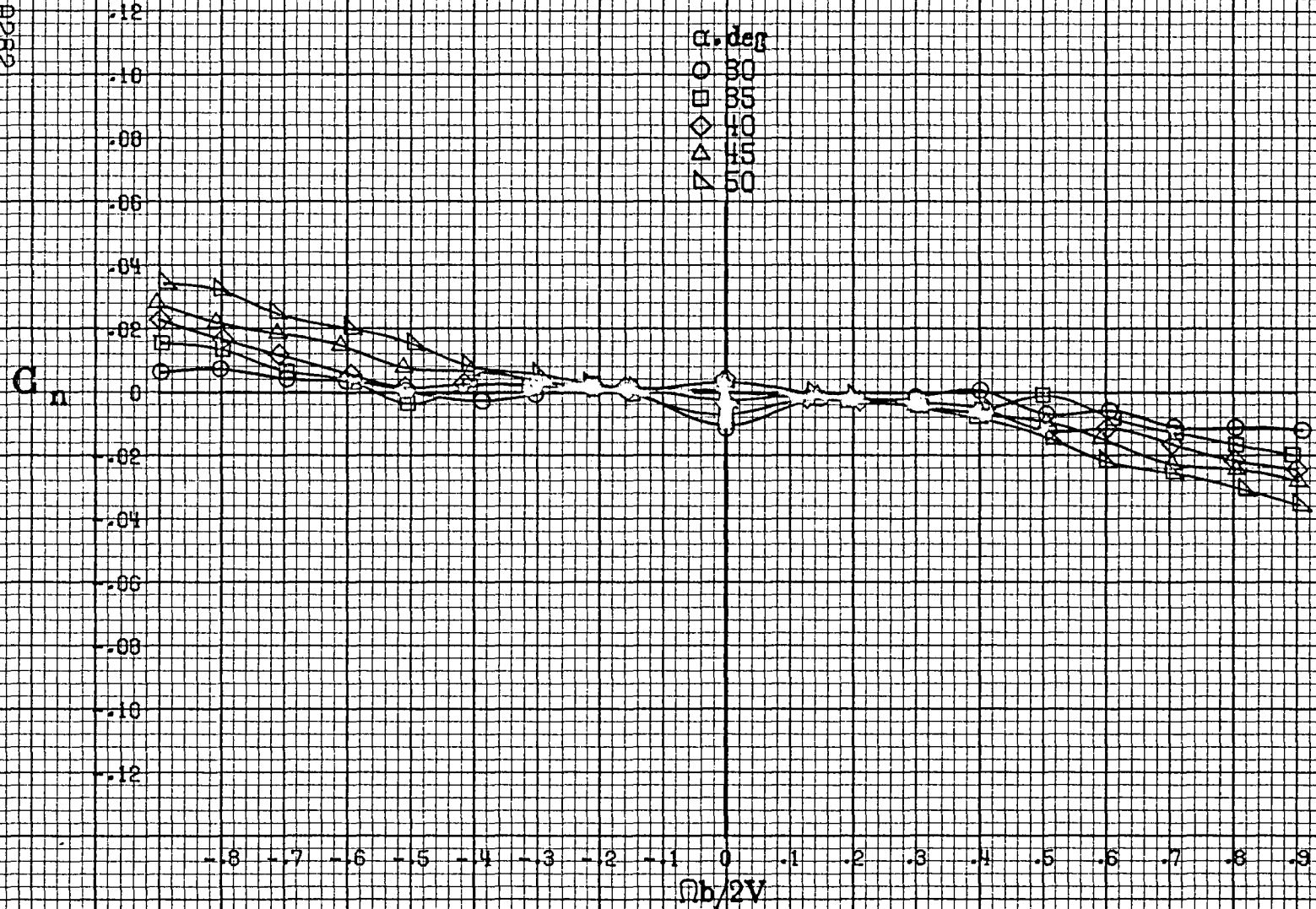

(c)  $\alpha = 30$  to  $50$  deg.  $SR = 0$ .  
Figure A61. Continued.



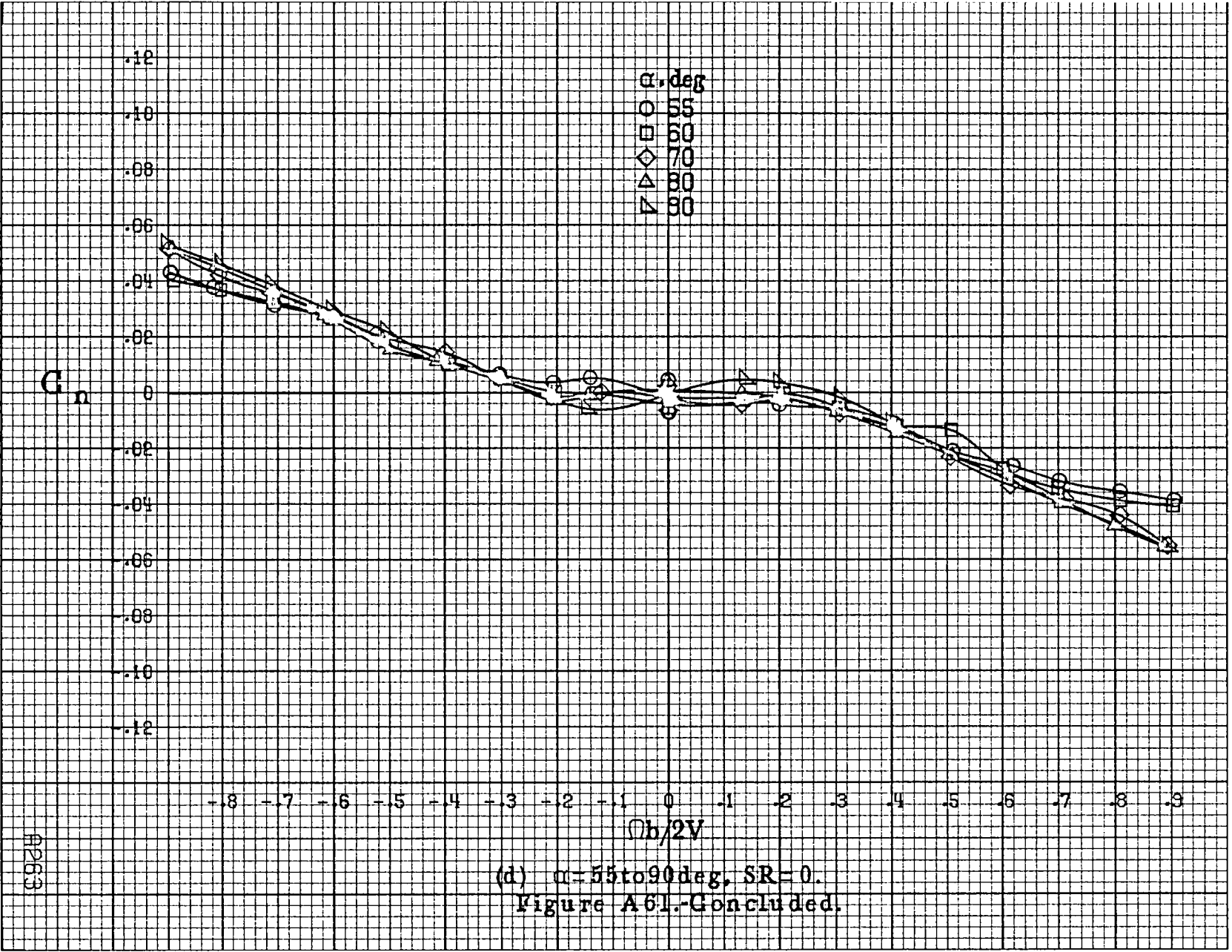

(d)  $\alpha = 55$  to  $90$  deg,  $SR = 0$ .  
 Figure A61.-Concluded.

A2653

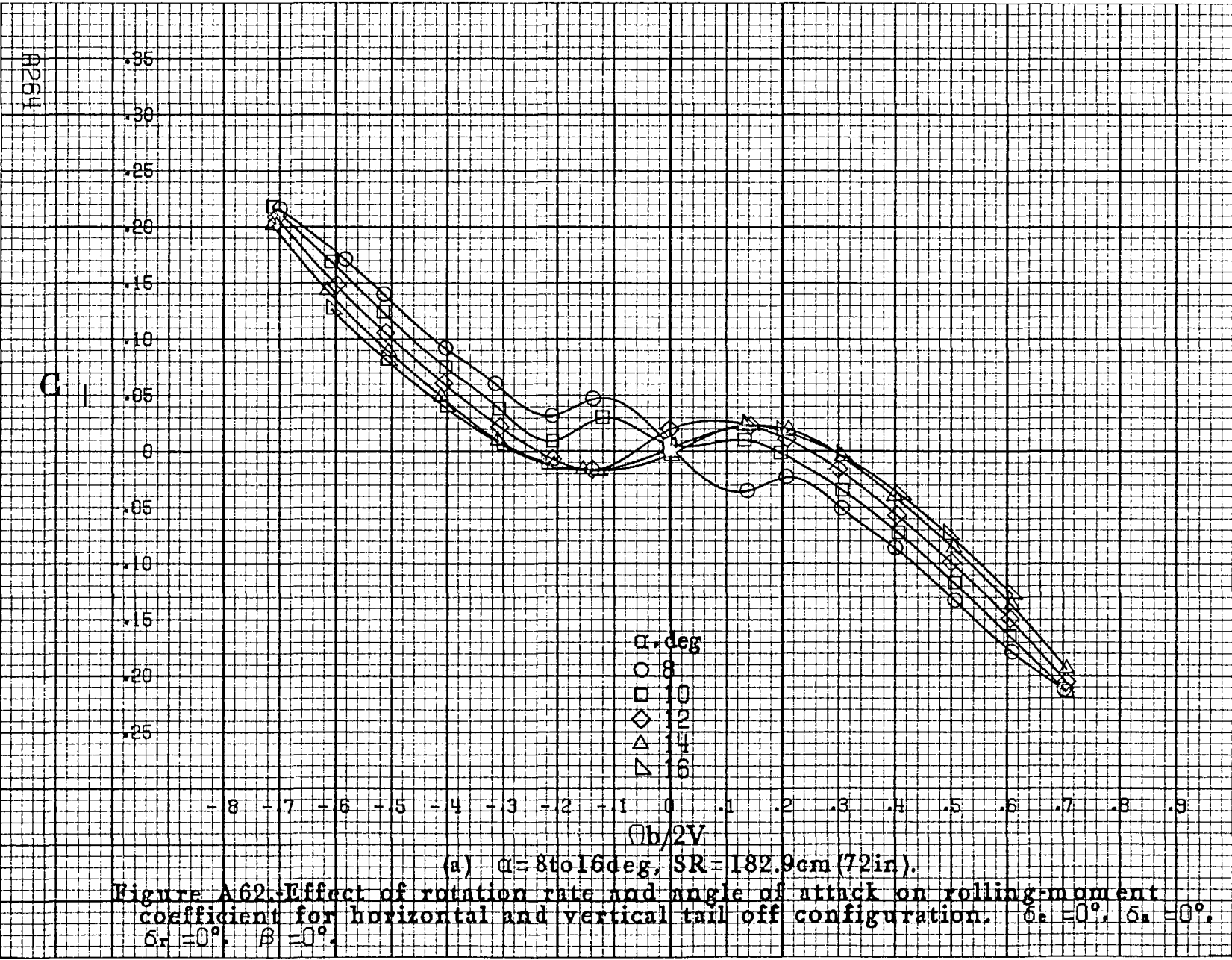

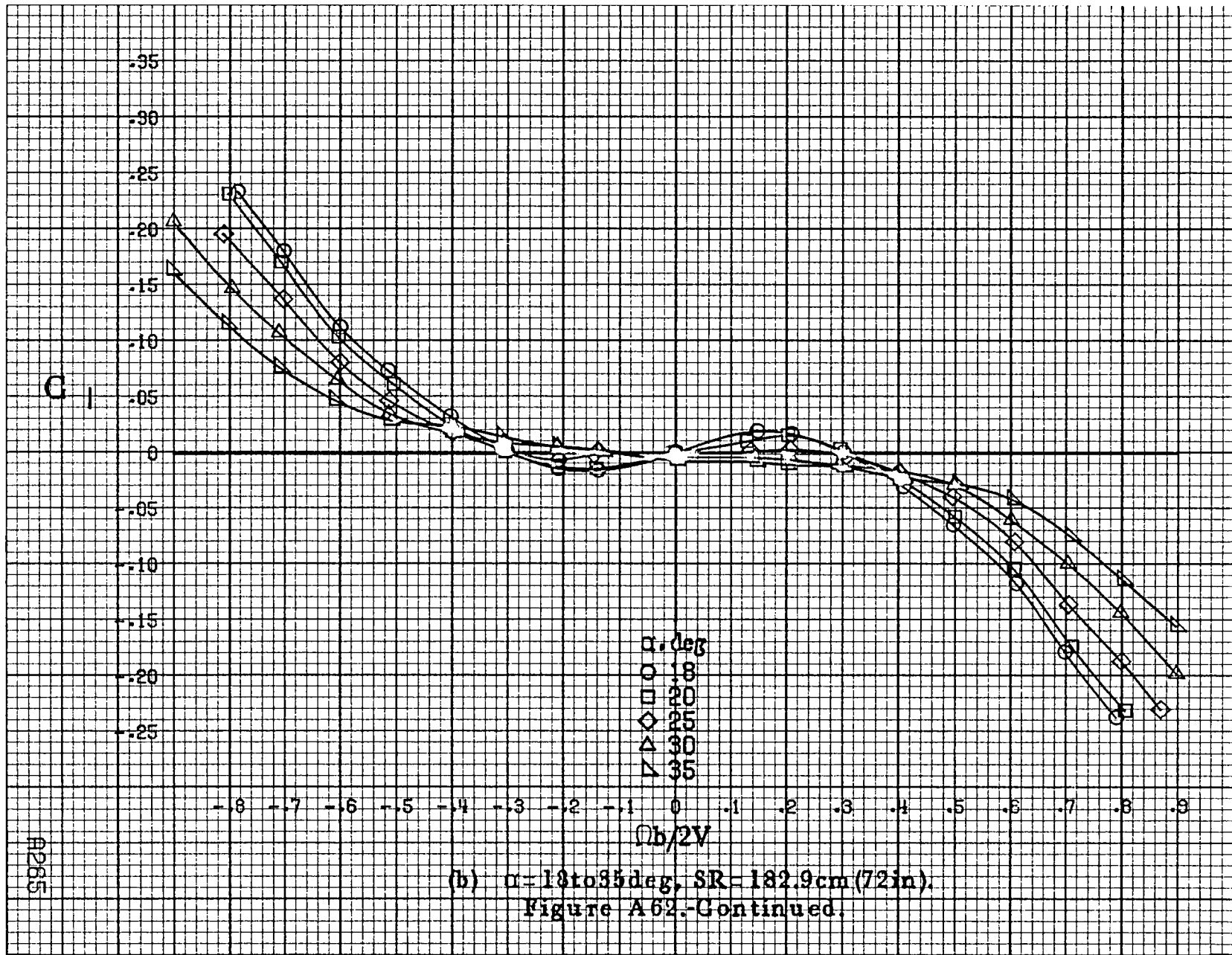

A265

(b)  $\alpha = 18$  to  $35$  deg,  $SR = 182.9$  cm (72 in).  
Figure A62.-Continued.

A266

C I

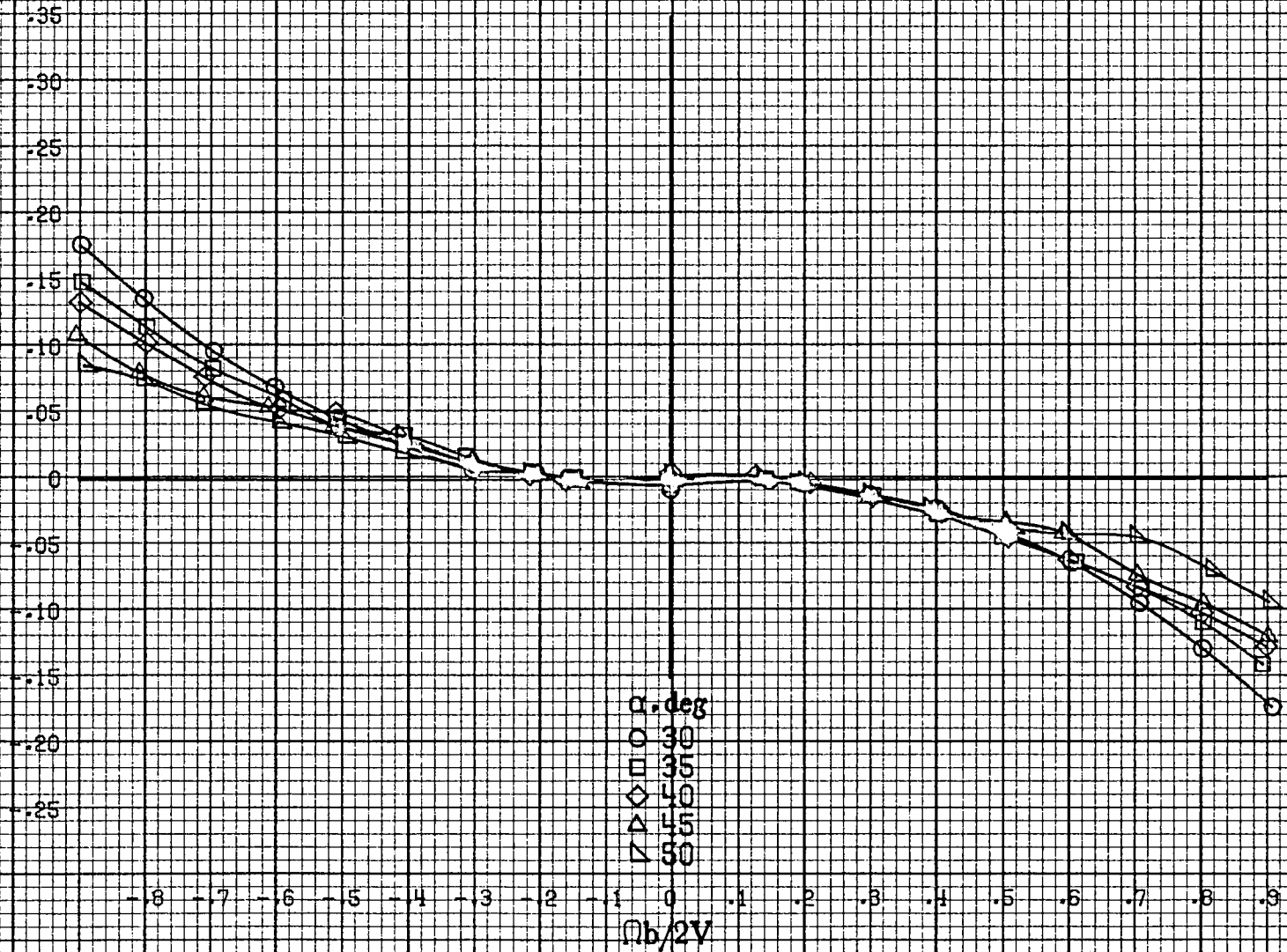

(c)  $\alpha = 30$  to  $50$  deg,  $SR = 0$ .  
Figure A62.-Continued.

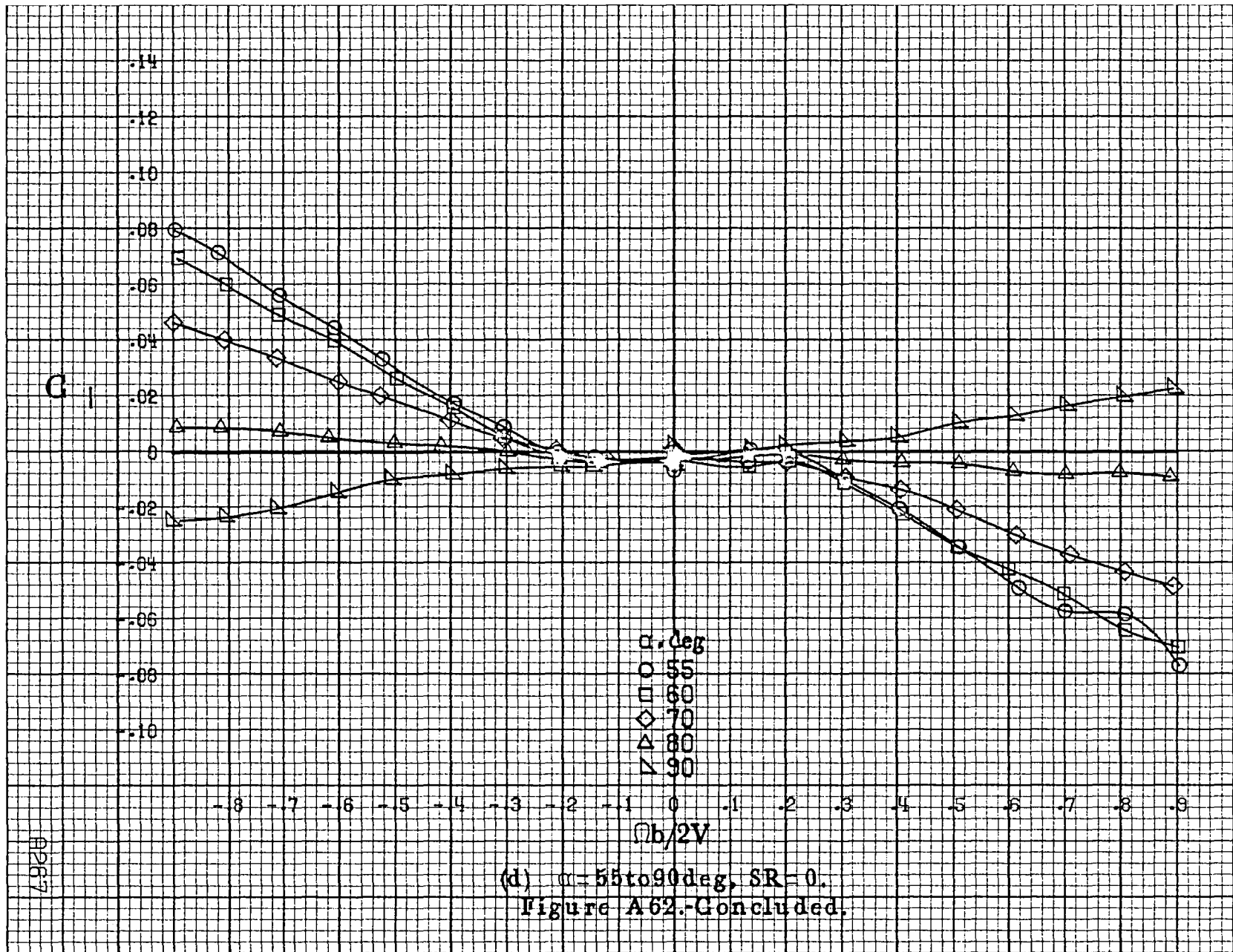

R268

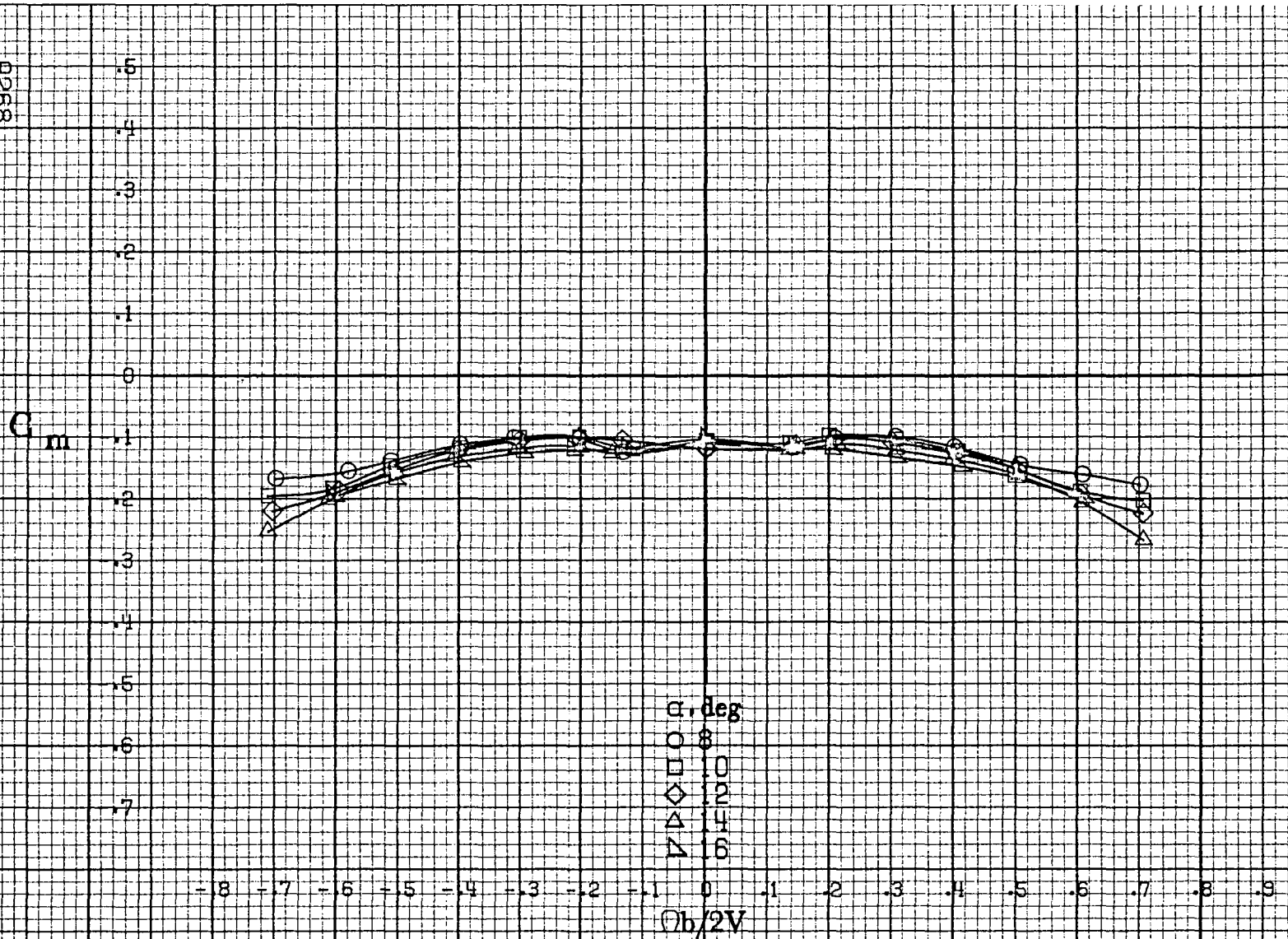

(a)  $\alpha = 8$  to  $16$  deg,  $SR = 182.9$  cm (72 in).

Figure A68. Effect of rotation rate and angle of attack on pitching moment coefficient for horizontal and vertical tail off configuration.  $\delta_e = 0^\circ$ ,  $\delta_a = 0^\circ$ ,  $\delta_r = 0^\circ$ ,  $\beta = 0^\circ$ .

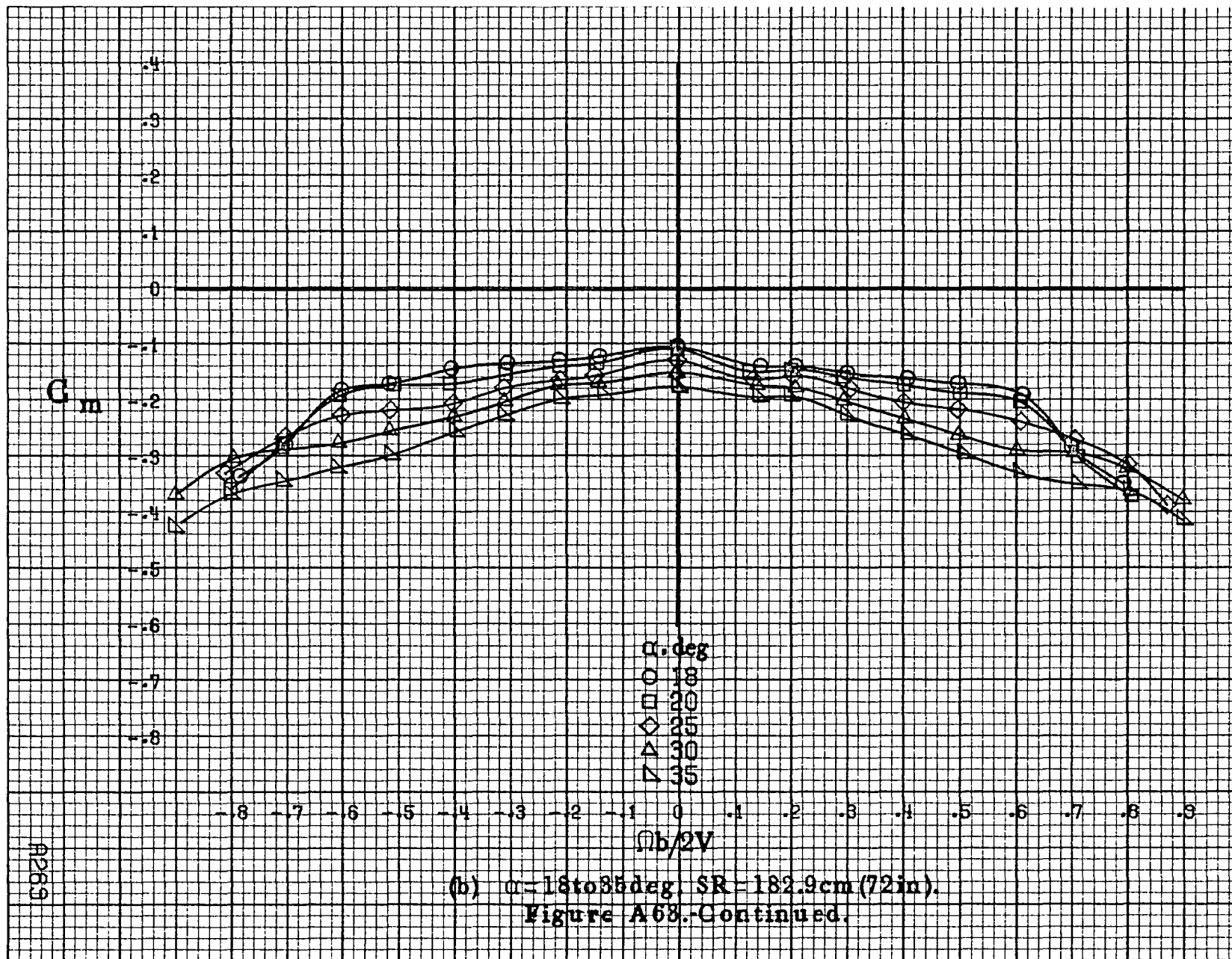



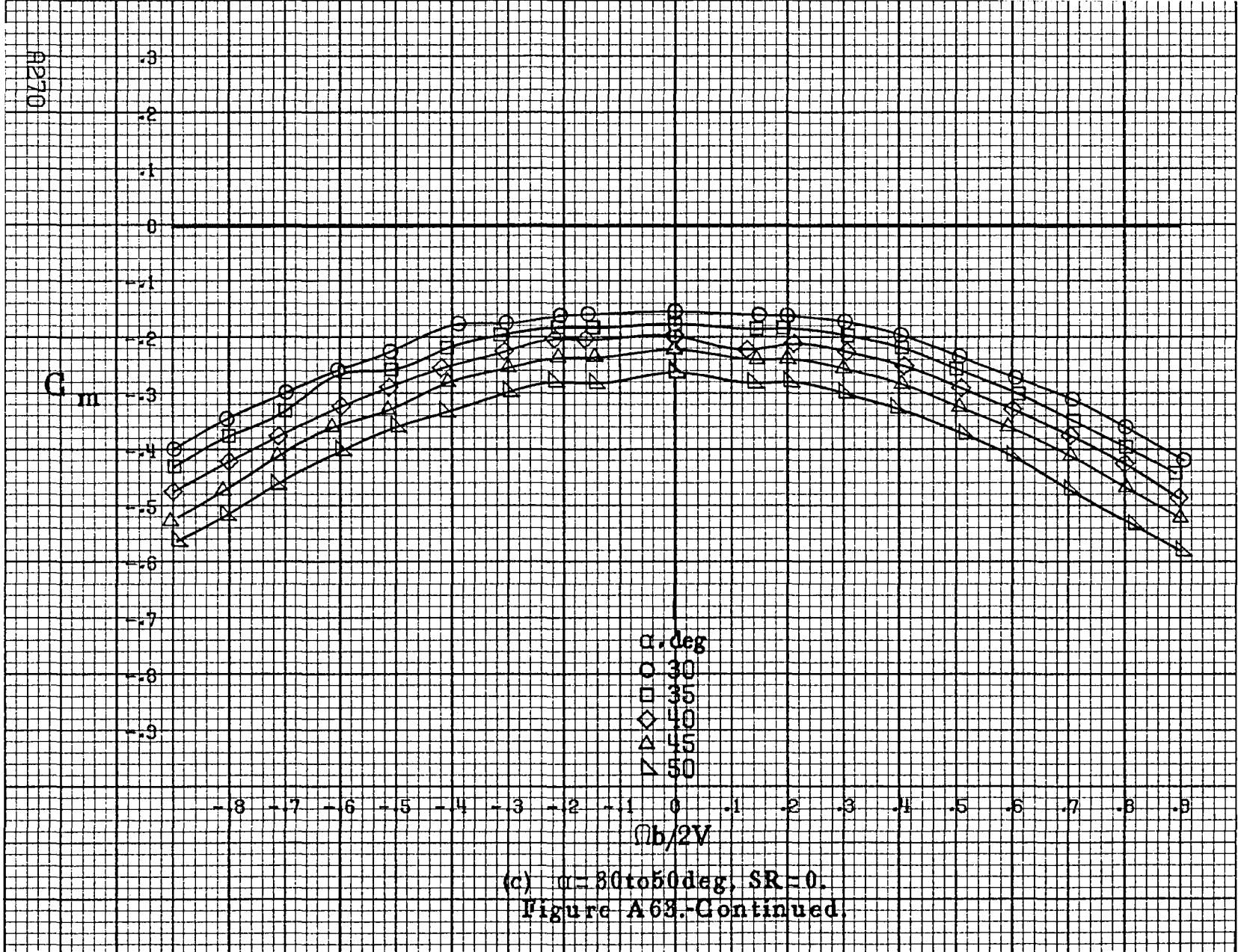

(c)  $\mu = 30$  to  $50$  deg,  $SR = 0$ .  
 Figure A63.-Continued.



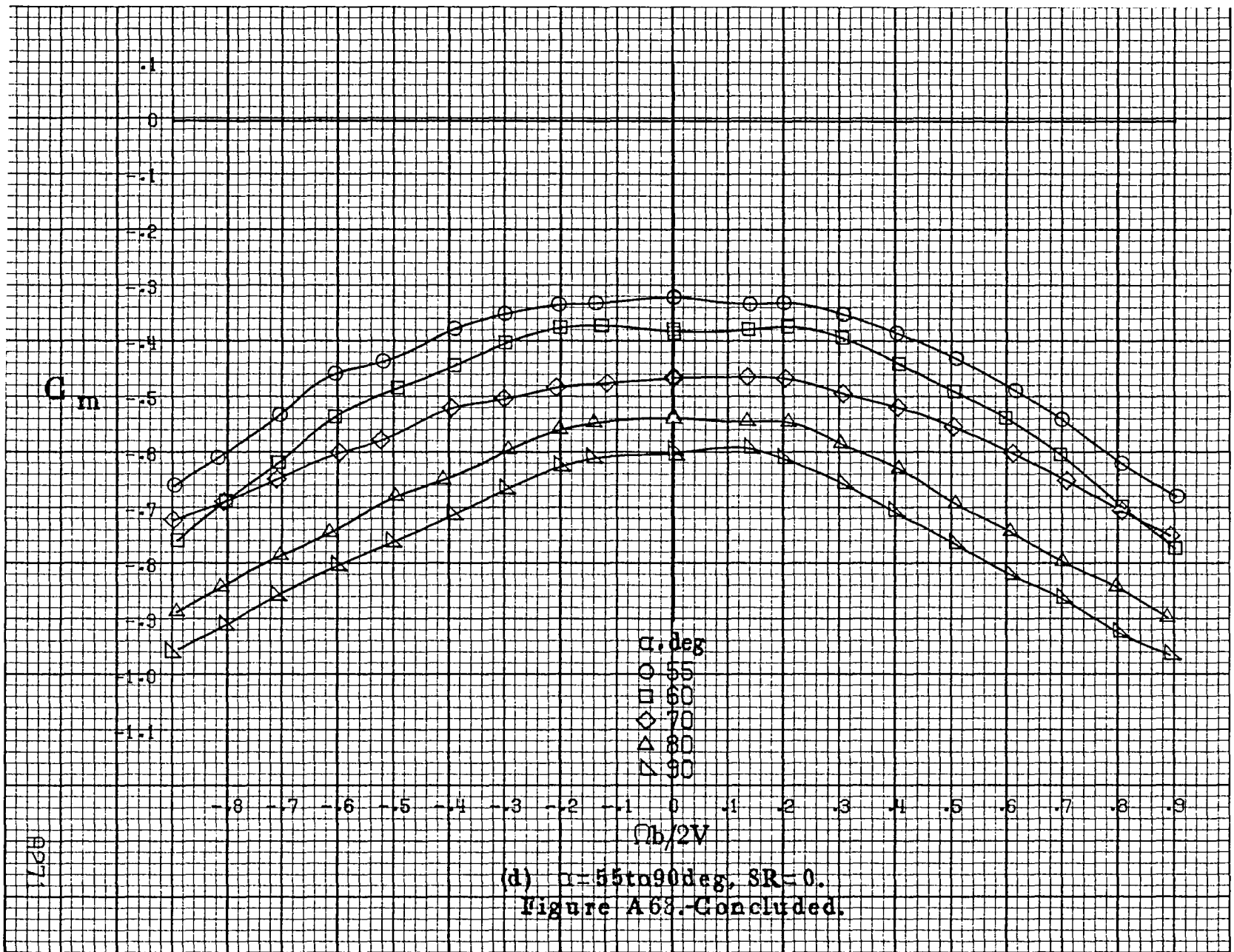

(d)  $\alpha = 55$  to  $90$  deg,  $SR = 0$ .  
 Figure A68.-Concluded.

RP71

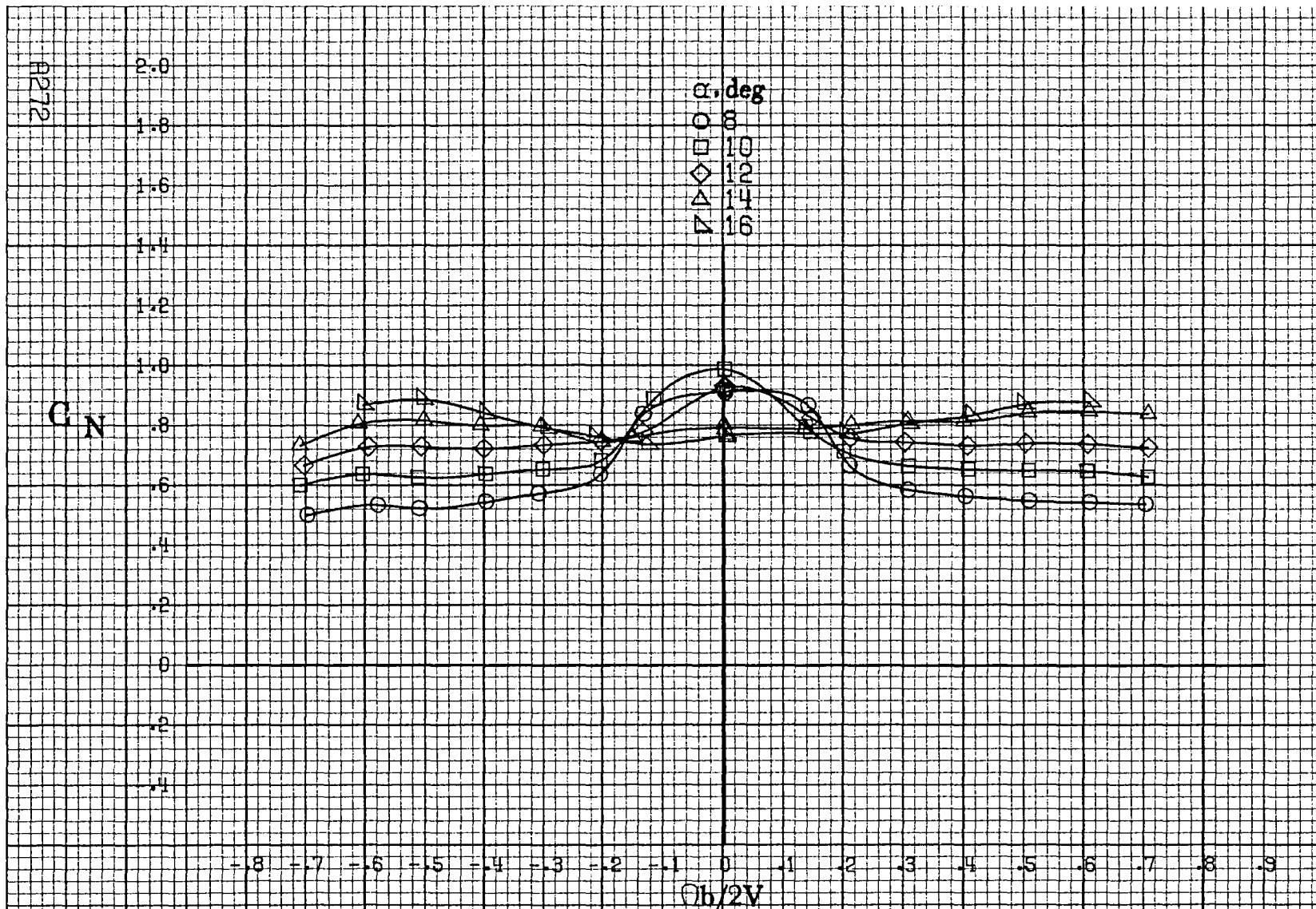

(a)  $\alpha = 8$  to  $16$  deg,  $SR = 182.9$  cm (72 in).

Figure A64.-Effect of rotation rate and angle of attack on normal-force coefficient for horizontal and vertical tail off configuration.  $\delta_r = 0^\circ$ ,  $\delta_a = 0^\circ$ ,  $\delta_r = 0^\circ$ ,  $\beta = 0^\circ$ .

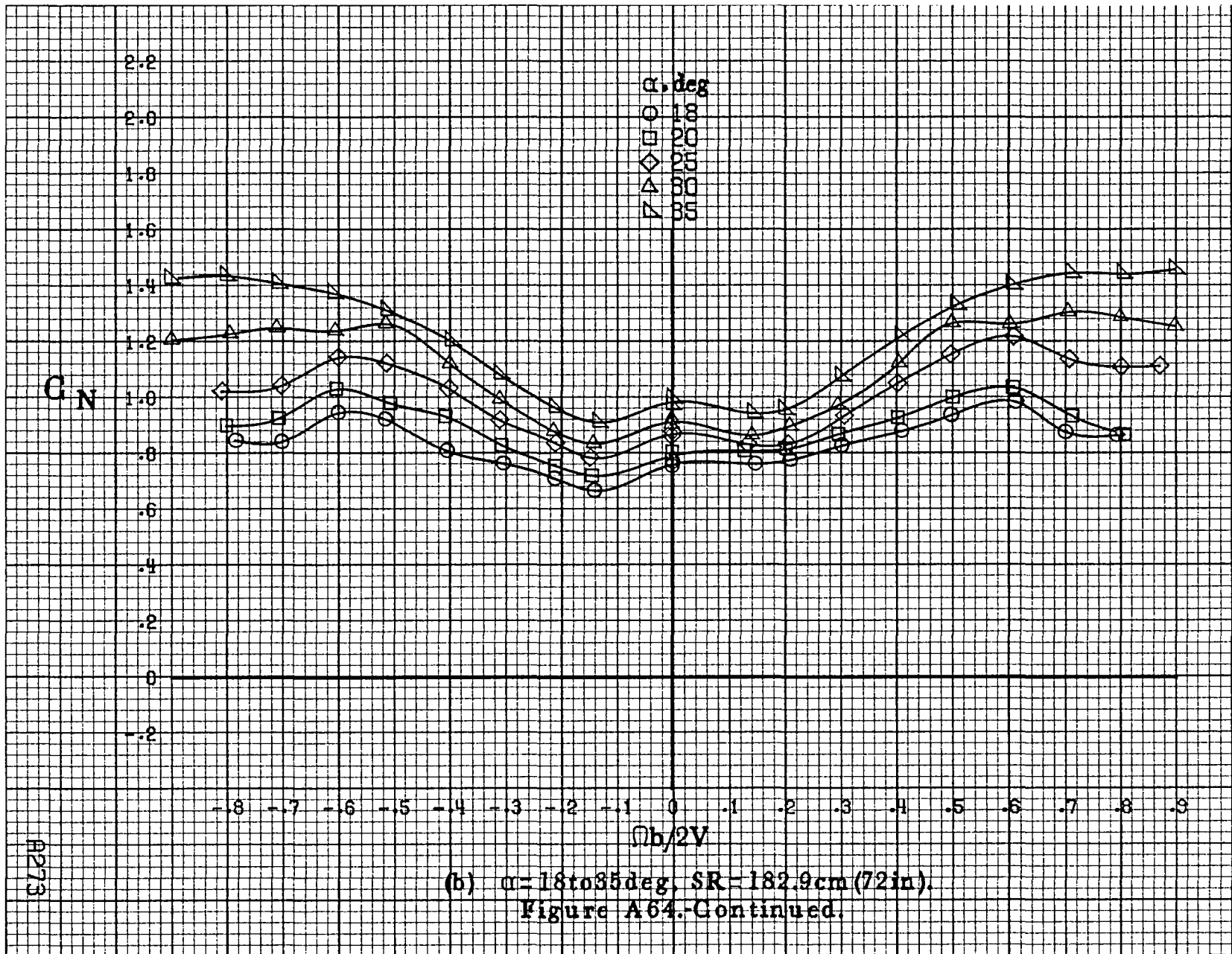

(b)  $\alpha = 18$  to  $35$  deg,  $SR = 182.9$  cm (72 in).  
 Figure A64.-Continued.

A273

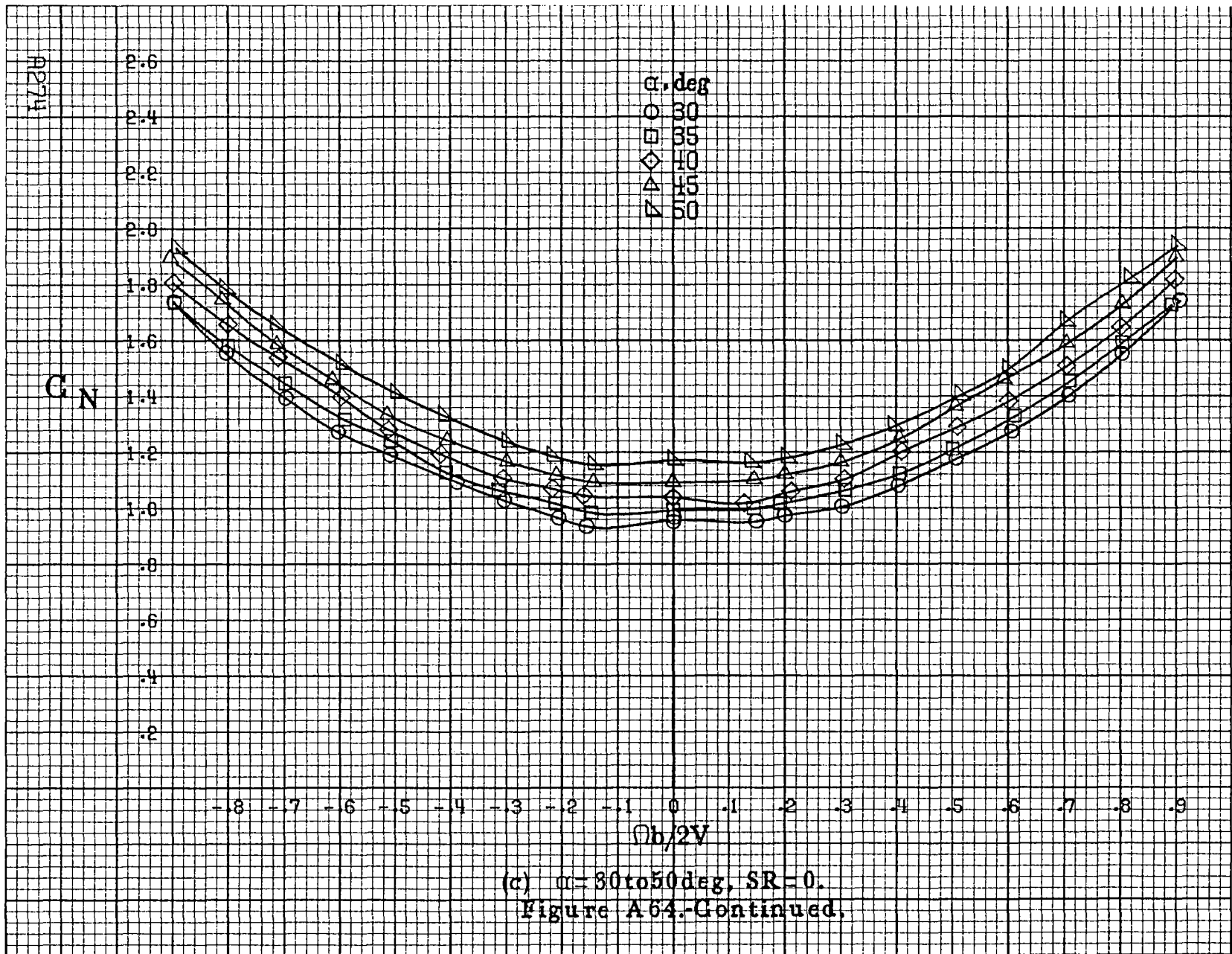

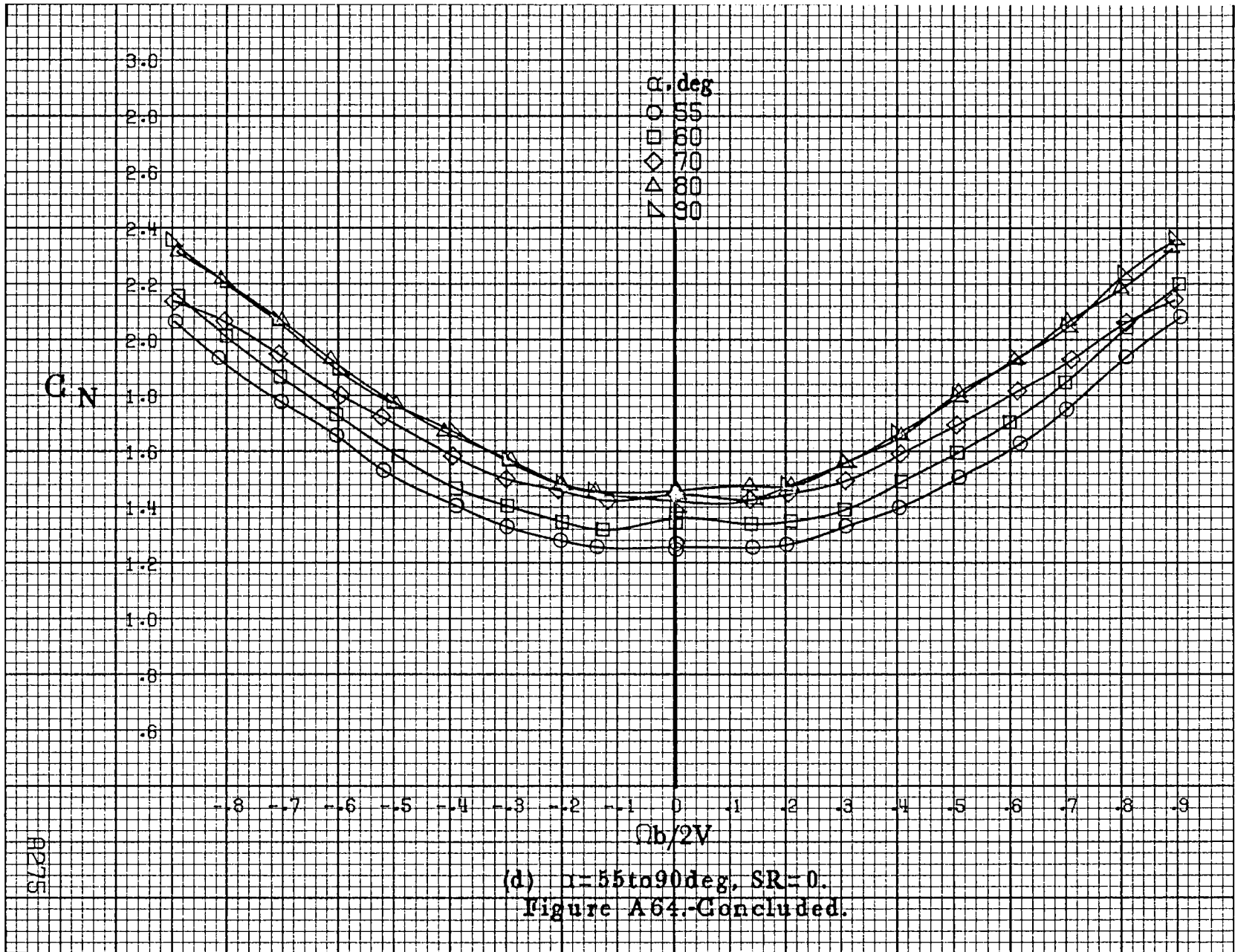

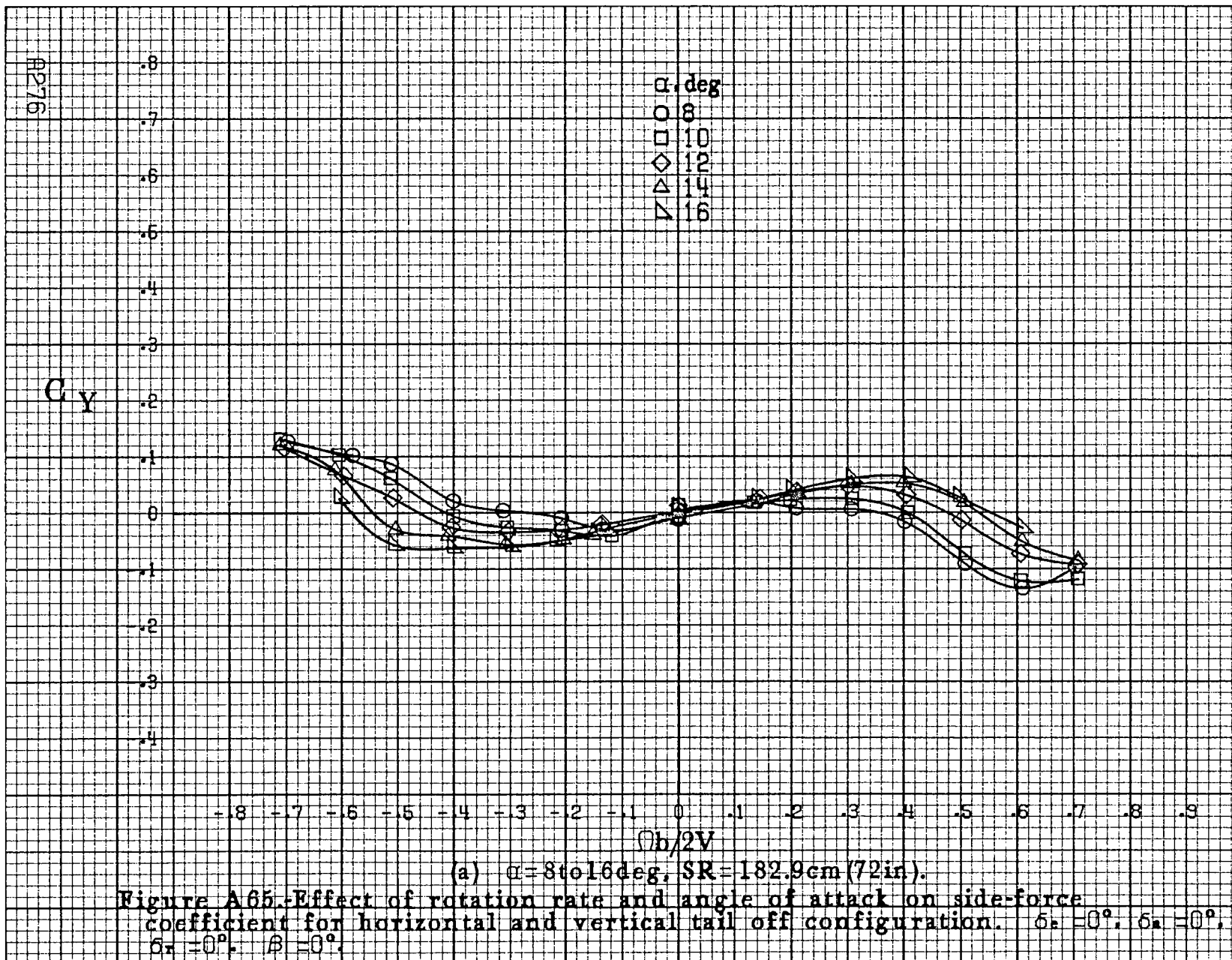

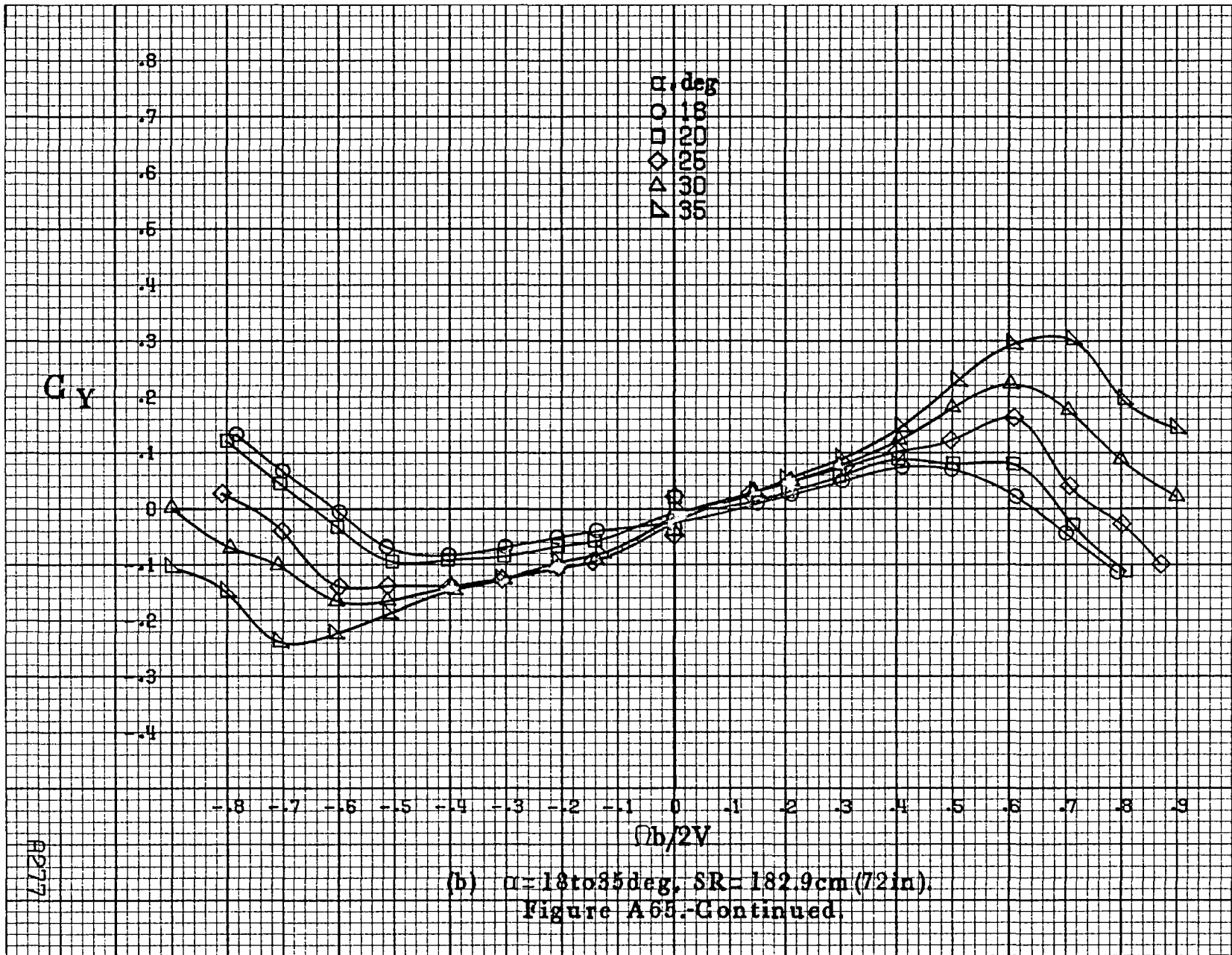



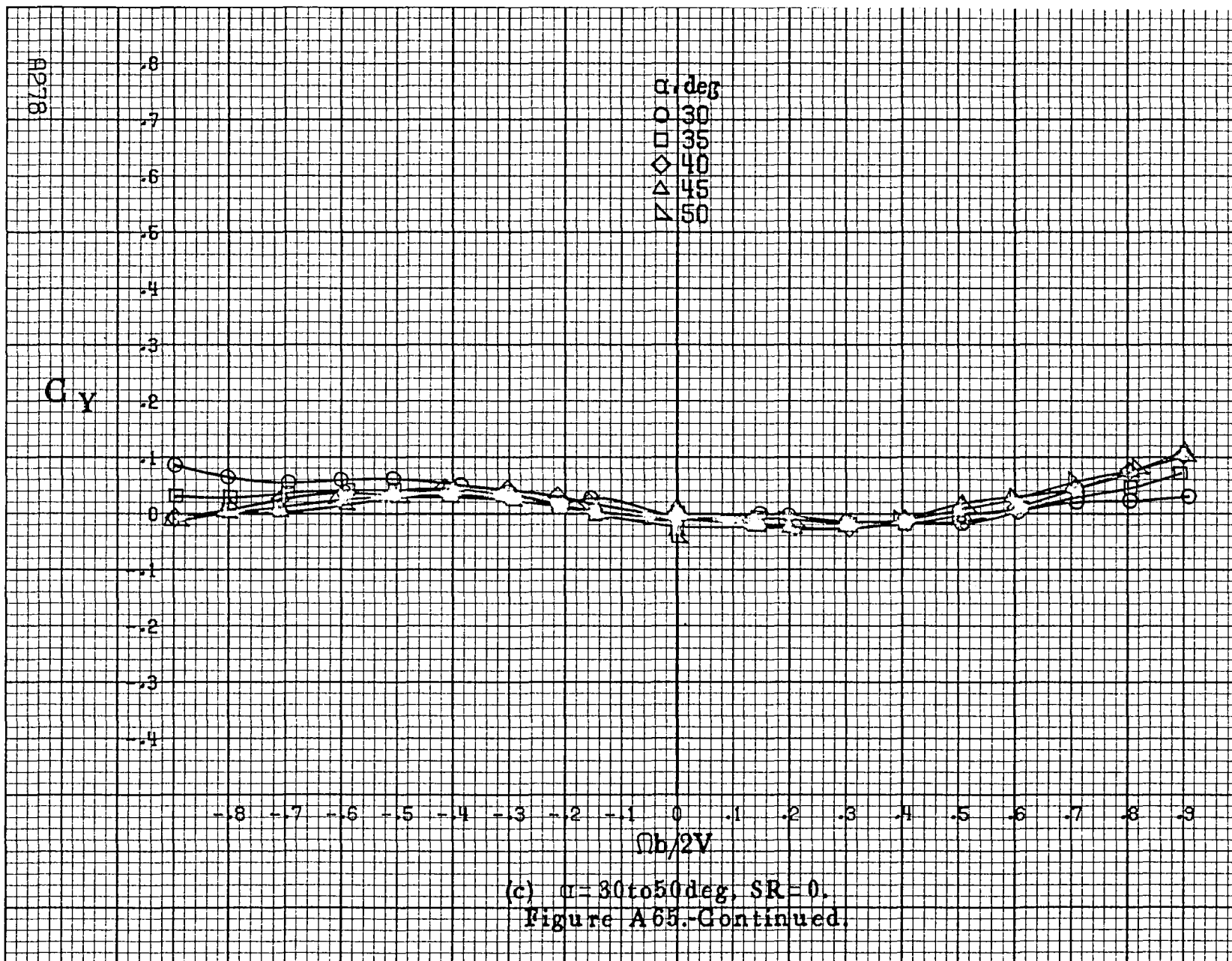



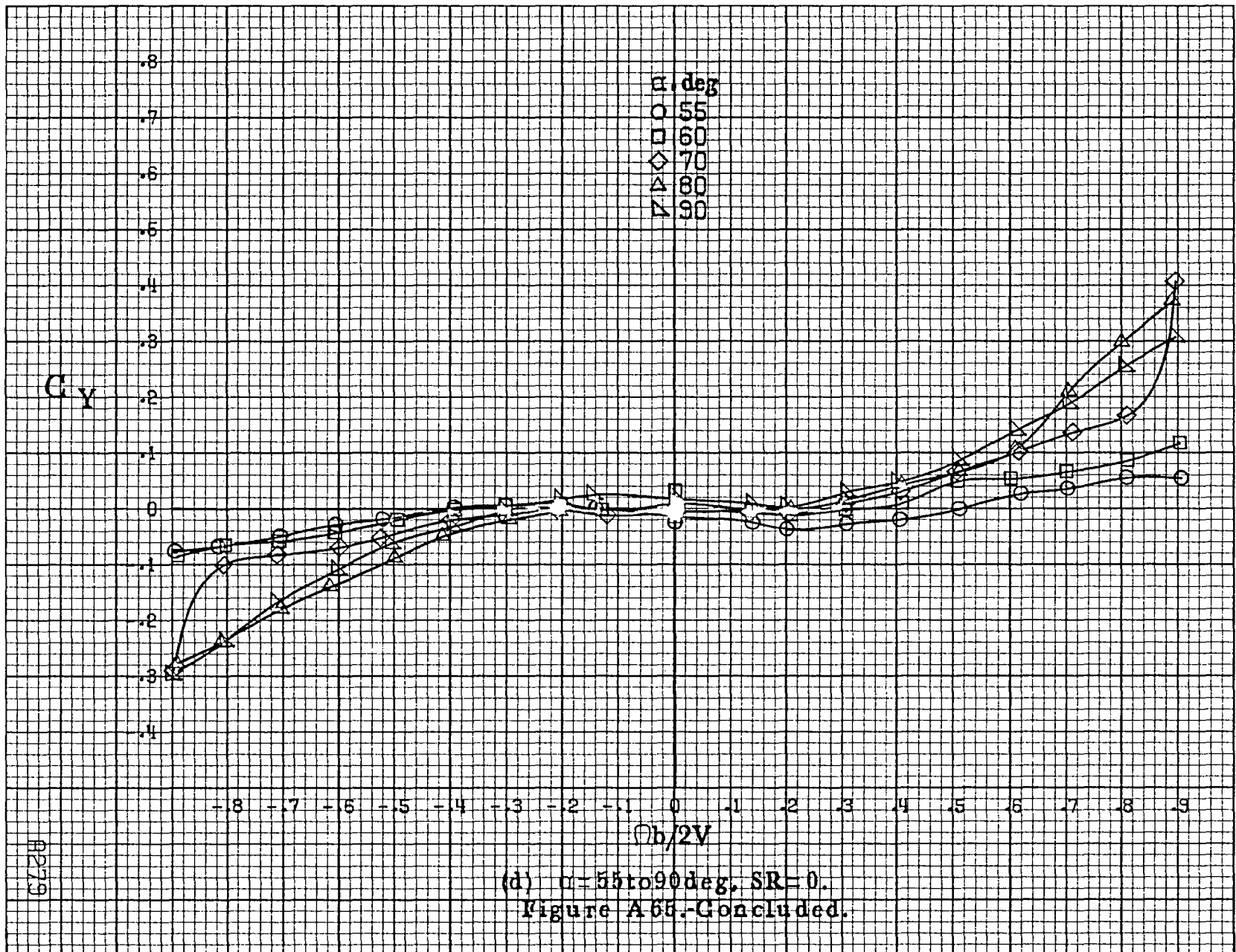

R279

(d)  $\alpha = 55$  to  $90$  deg,  $SR = 0$ .  
 Figure A65.-Concluded.

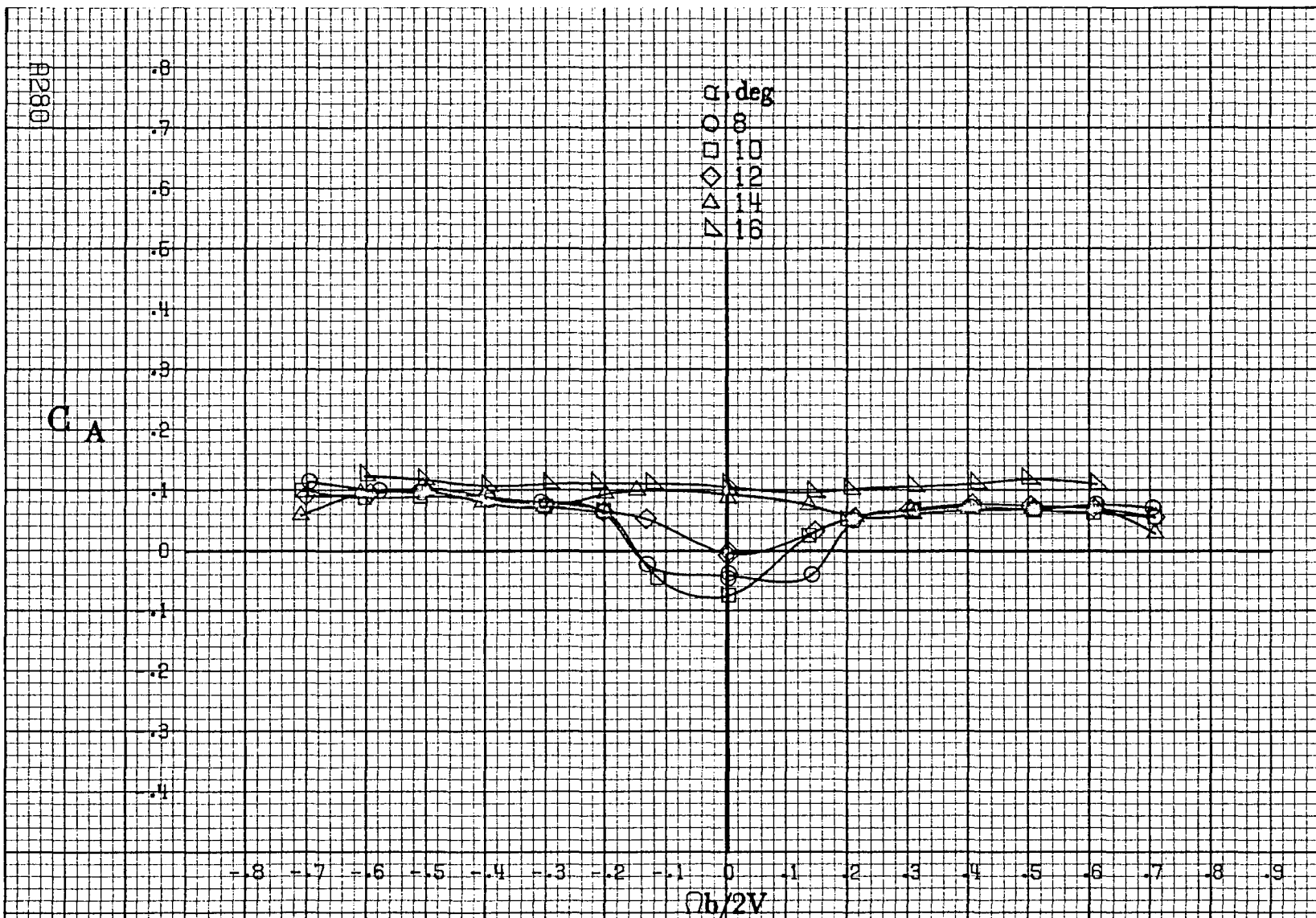

(a)  $\alpha = 8$  to  $16$  deg,  $SR = 182.9$  cm (72 in).  
 Figure A 66.-Effect of rotation rate and angle of attack on axial-force coefficient for horizontal and vertical tail off configuration.  $\delta_r = 0^\circ$ ,  $\delta_a = 0^\circ$ ,  $\delta_r = 0^\circ$ ,  $\beta = 0^\circ$ .

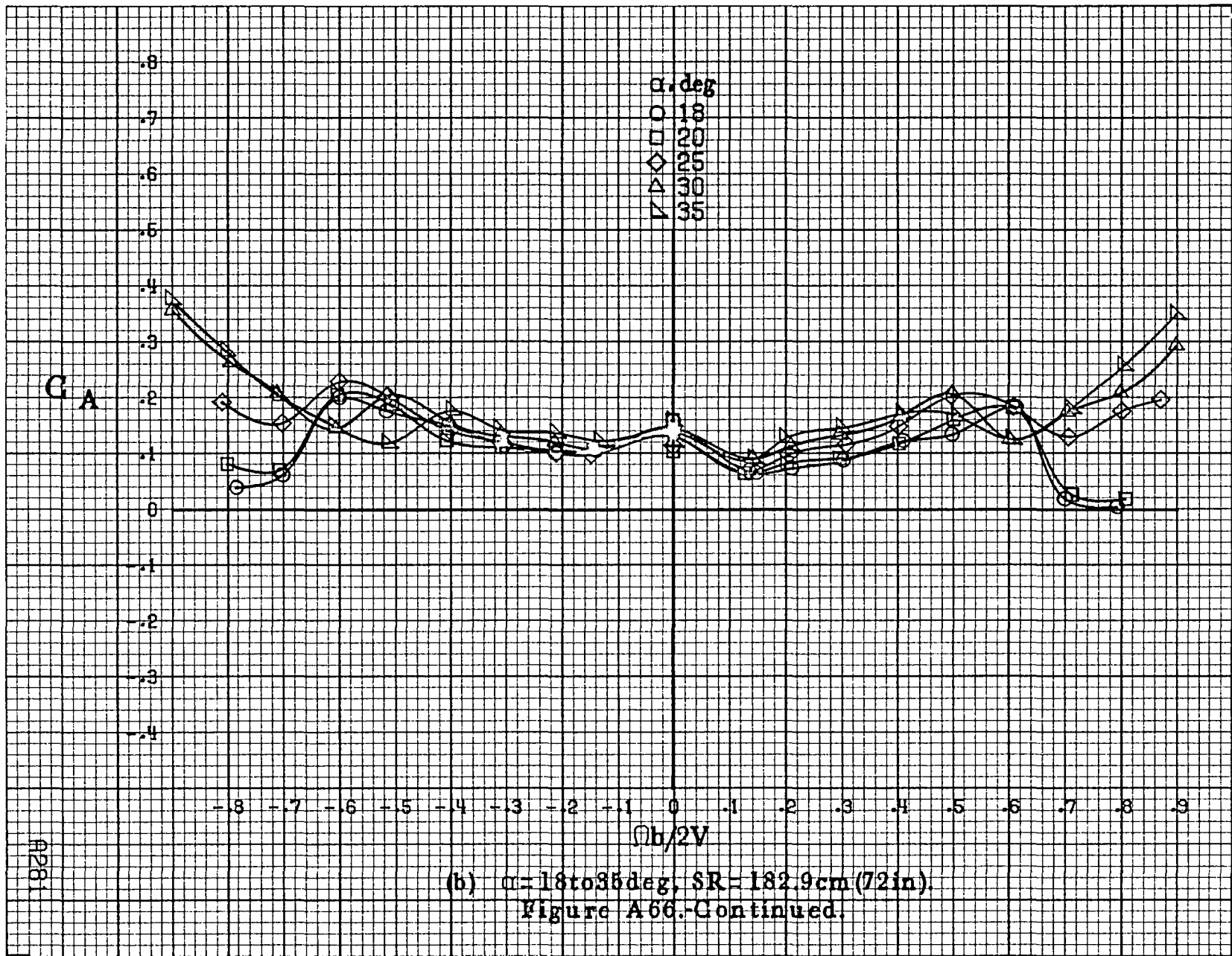

AP282

C A

- 30
- 35
- ◇ 40
- △ 45
- ▽ 50

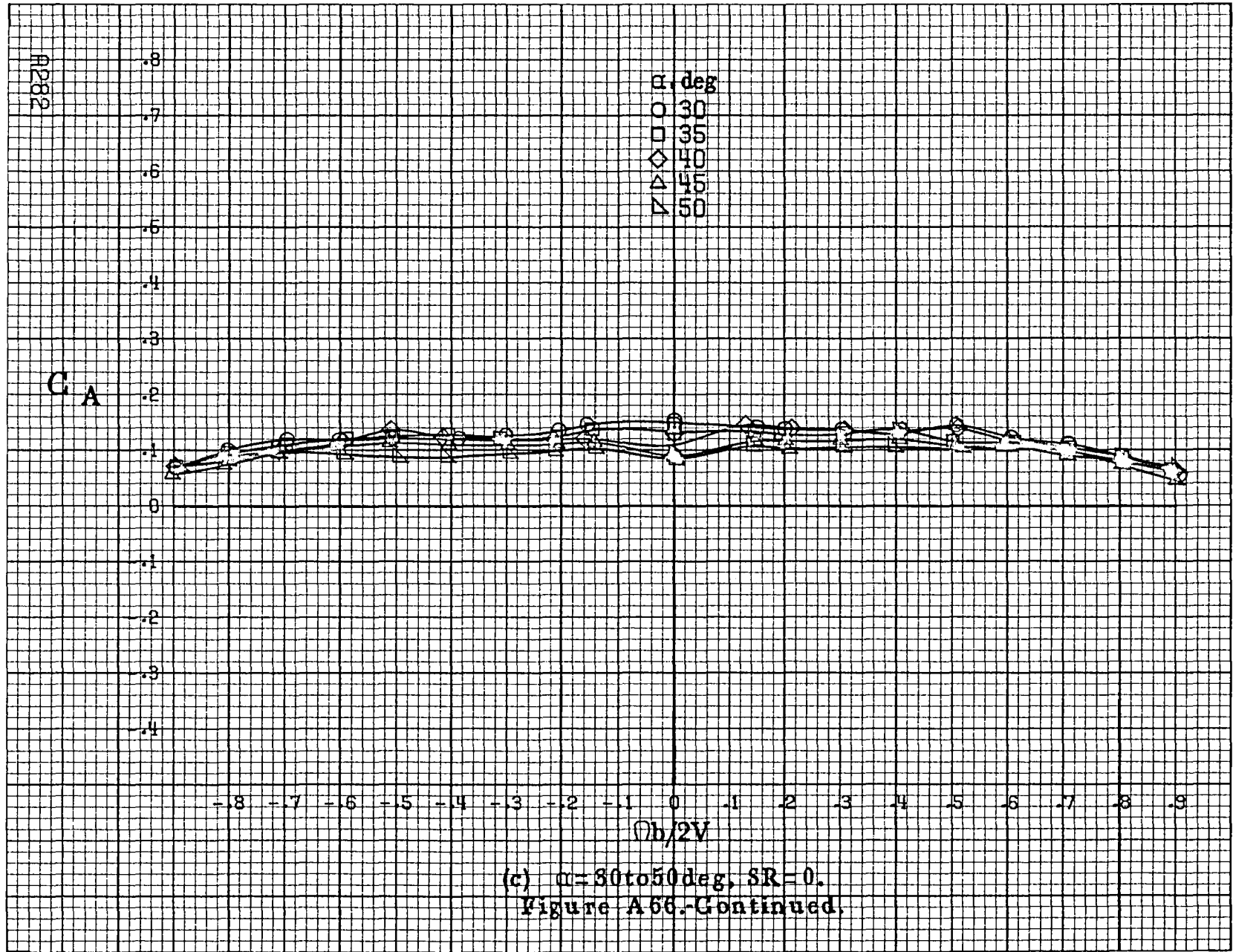

(c)  $\alpha = 30$  to  $50$  deg,  $SR = 0$ .  
Figure A66-Continued.

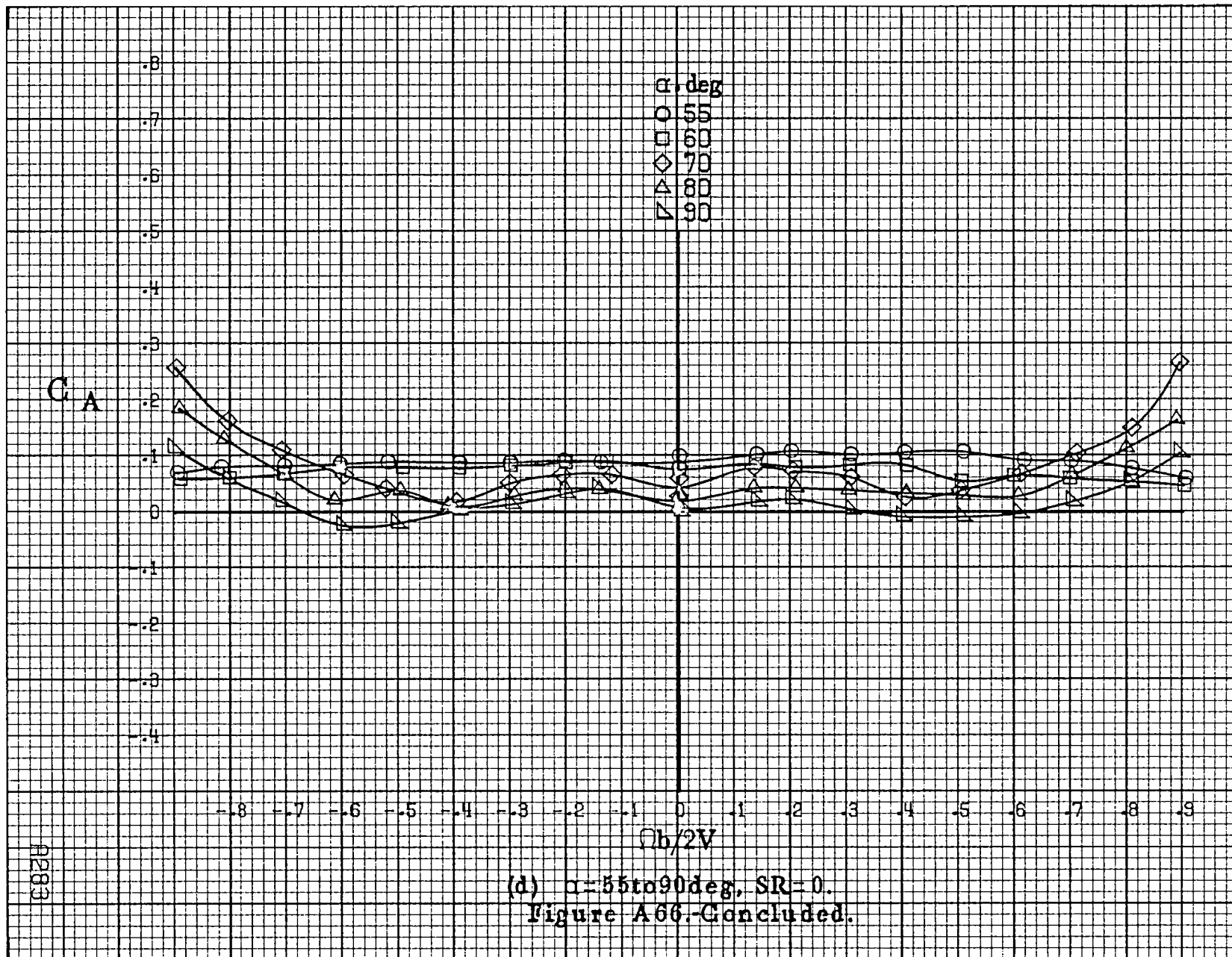

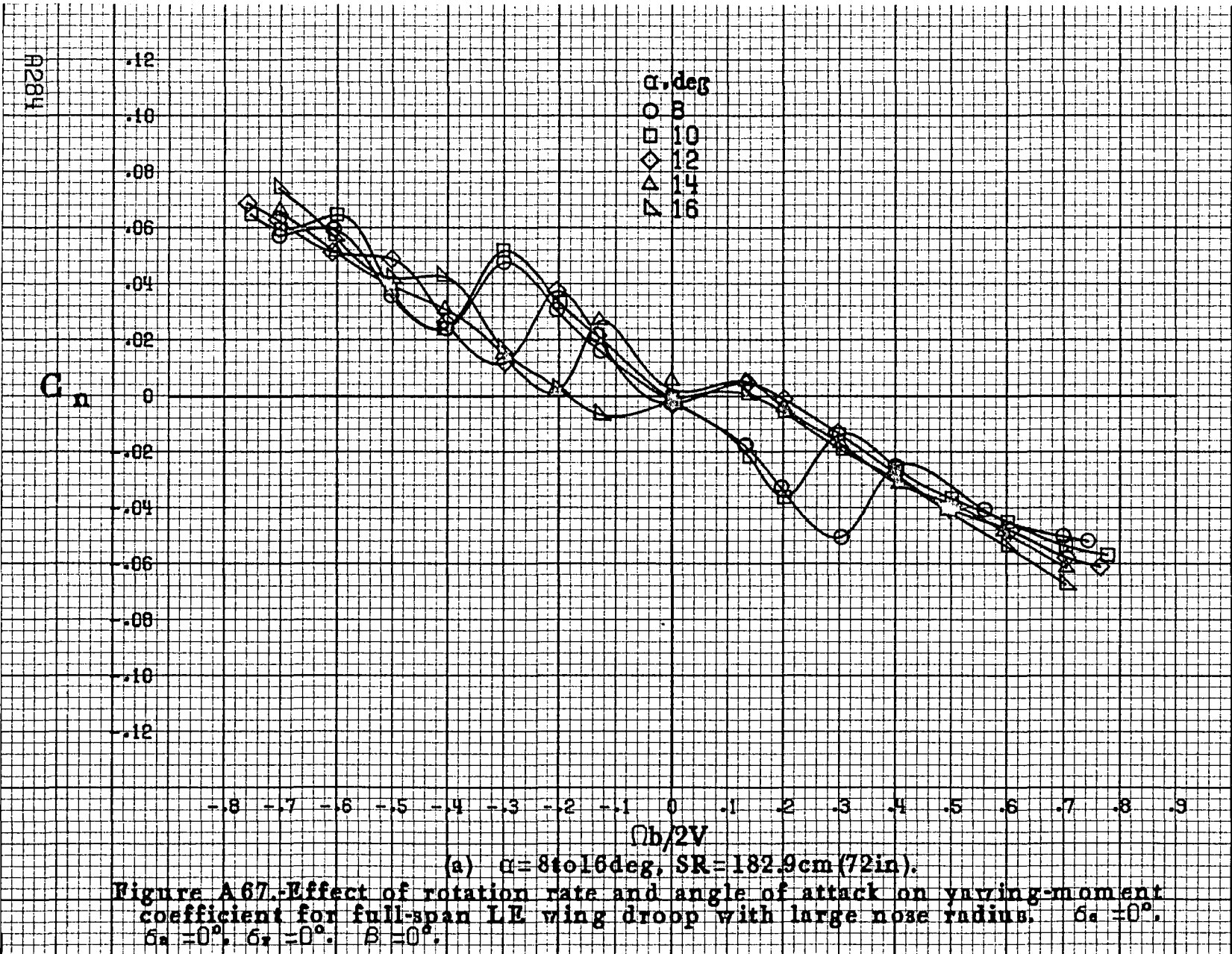

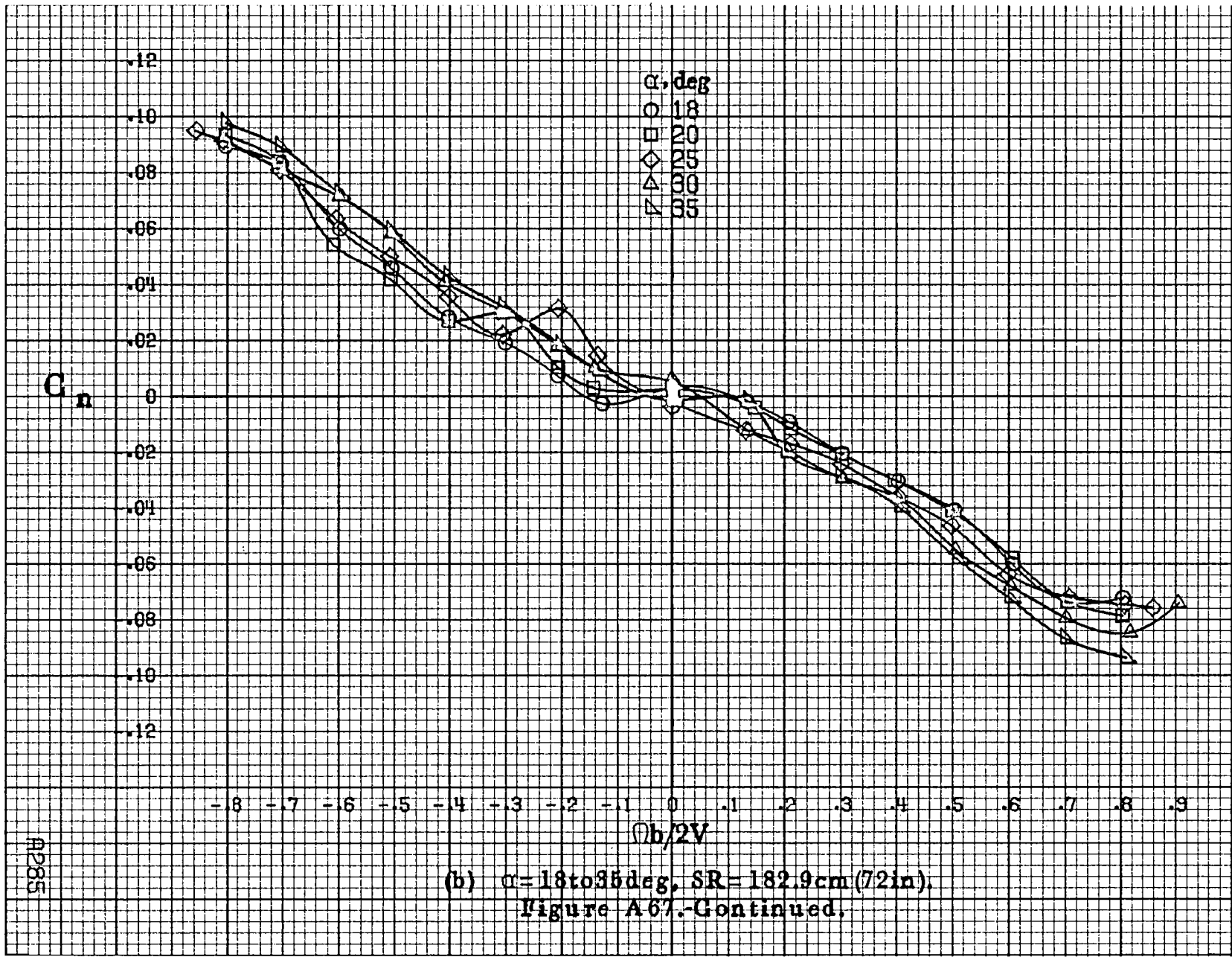



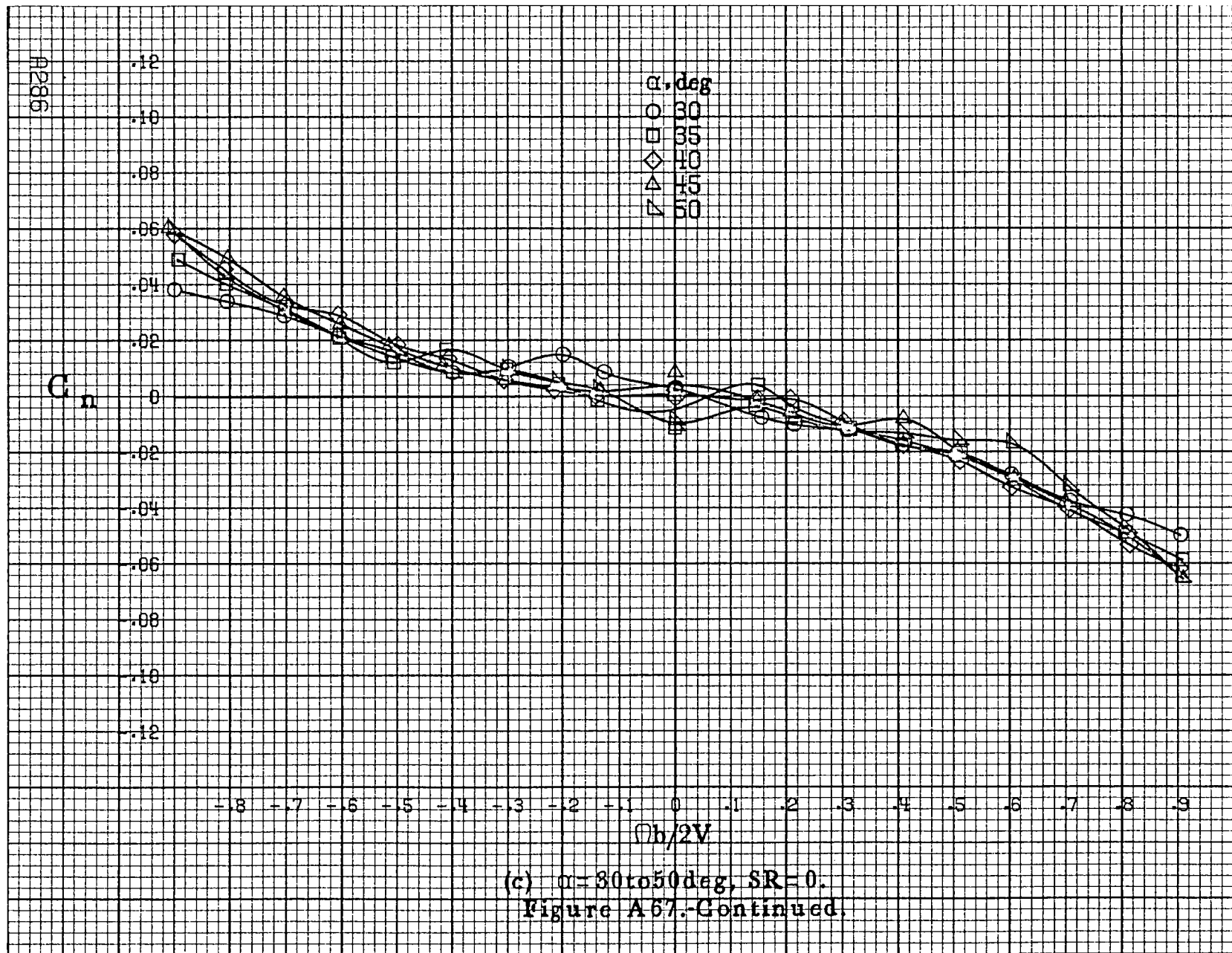

(c)  $\alpha = 30$  to  $50$  deg,  $SR = 0$ .  
 Figure A67.-Continued.



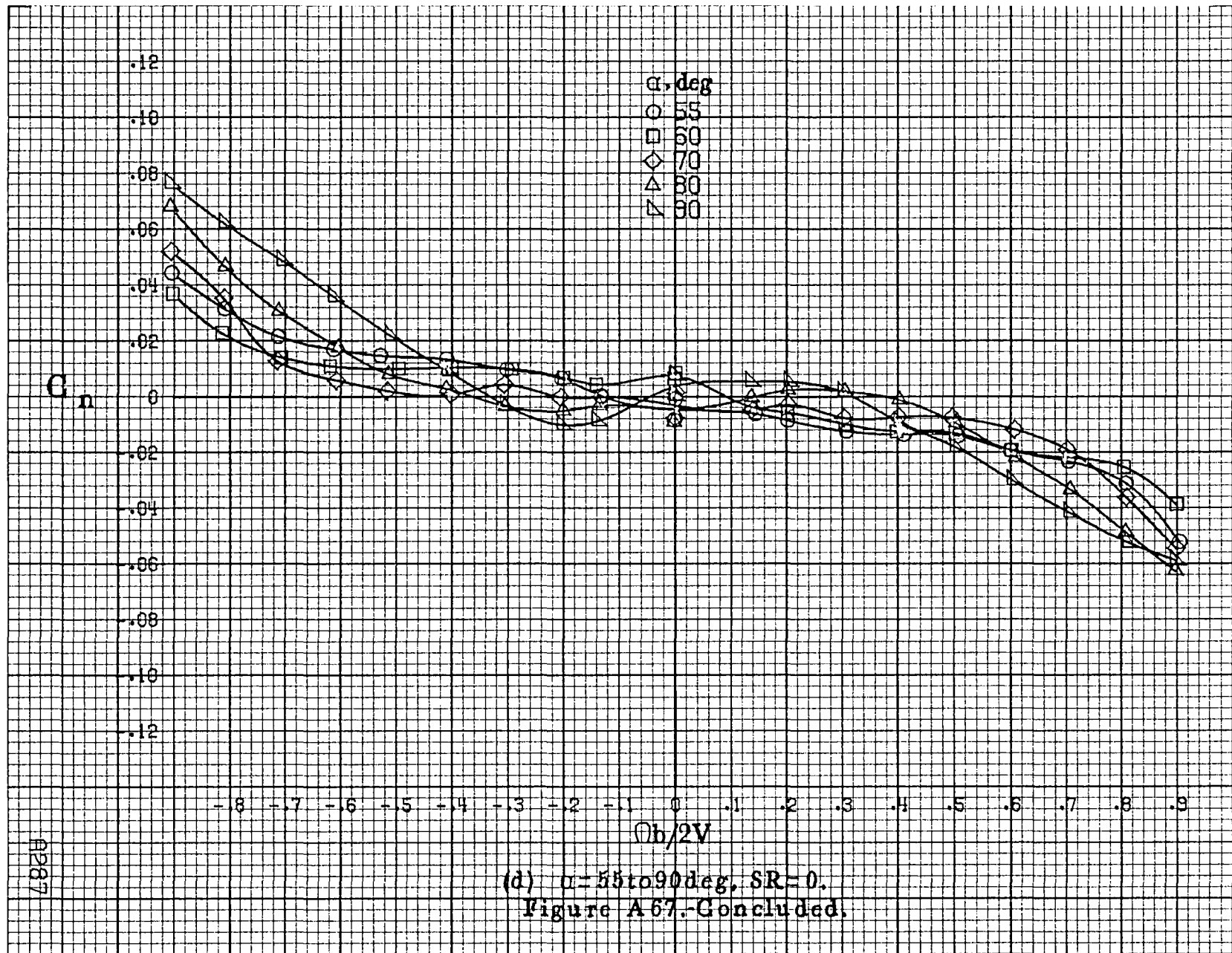

(d)  $\alpha = 55$  to  $90$  deg,  $SR = 0$ .  
 Figure A 67. Concluded.

A987

A288

$C_l$



(a)  $\alpha = 8$  to  $16$  deg,  $SR = 182.9$  cm (72 in).

Figure A68. Effect of rotation rate and angle of attack on rolling-moment coefficient for full-span LE wing droop with large nose radius.  $\delta_a = 0^\circ$ ,  $\delta_r = 0^\circ$ ,  $\beta = 0^\circ$ .



(b)  $\alpha = 18$  to  $35$  deg,  $SR = 182.9$  cm (72 in).  
Figure A 68.-Continued.

A289

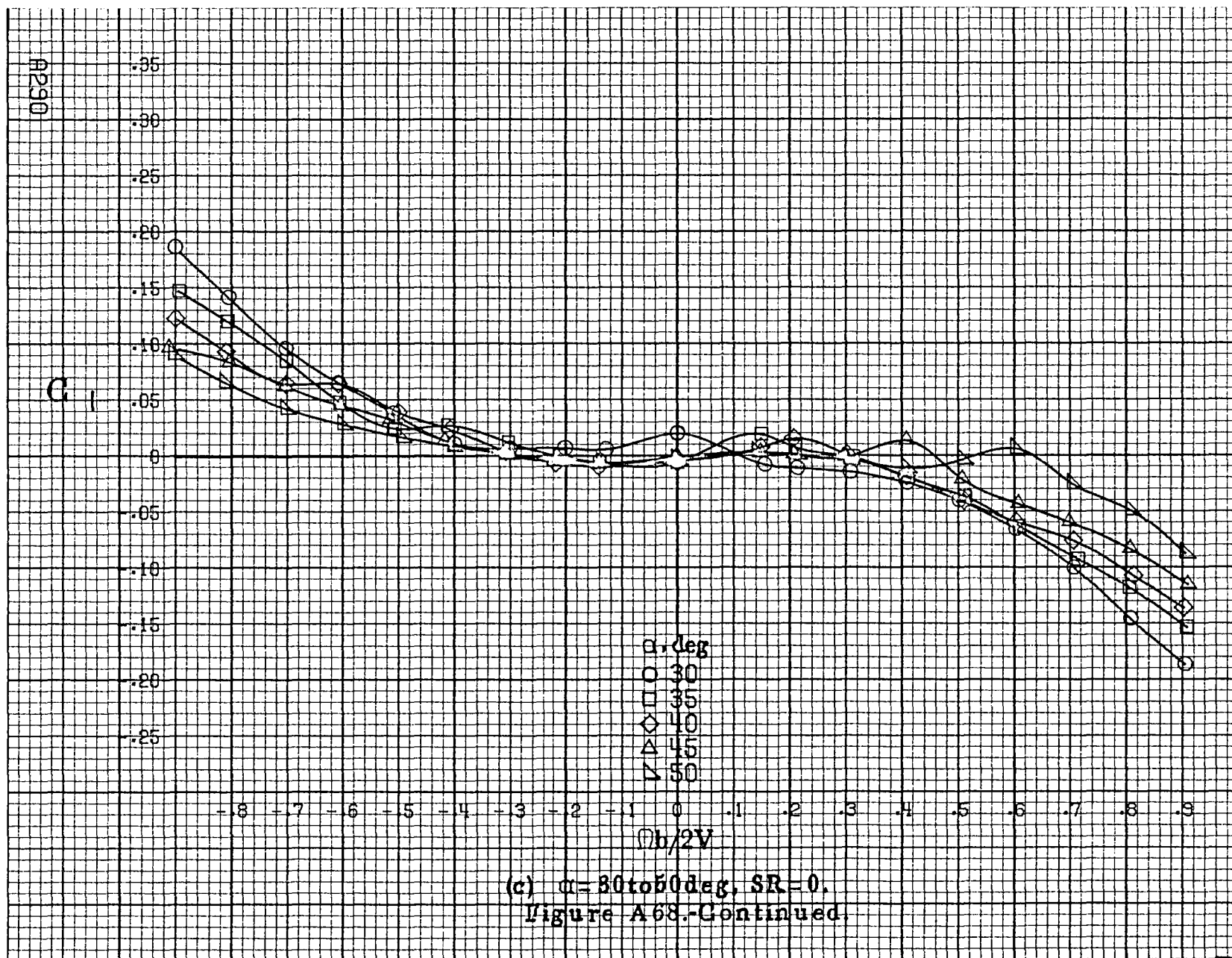

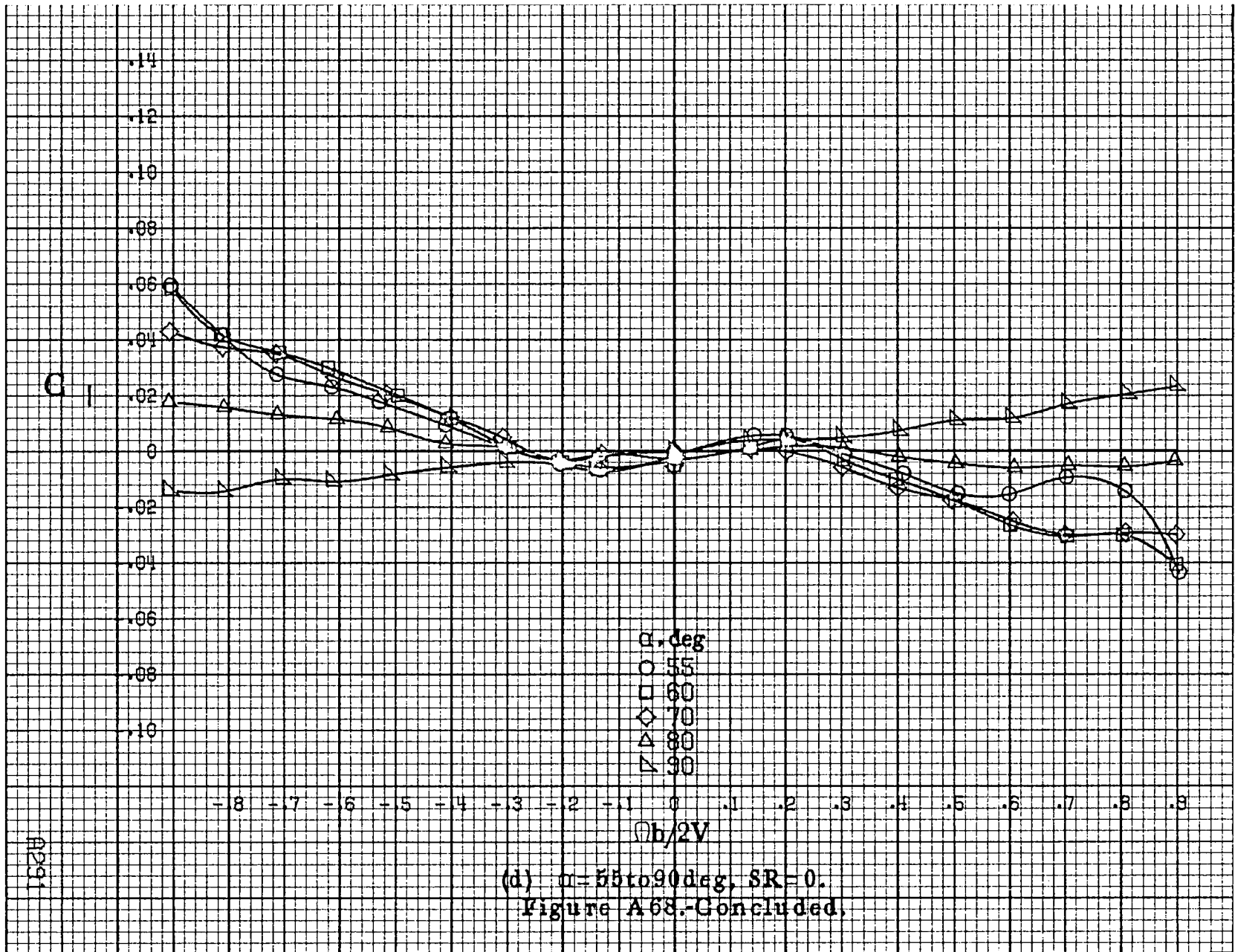

AP291

A292

$C_m$

.2  
.1  
0  
-.1  
-.2  
-.3  
-.4  
-.5  
-.6  
-.7  
-.8  
-.9  
-1.0

-8 -7 -6 -5 -4 -3 -2 -1 0 .1 .2 .3 .4 .5 .6 .7 .8 .9  
 $\Omega b/2V$

$\alpha$ , deg  
○ 8  
□ 10  
◇ 12  
△ 14  
▽ 16

(a)  $\alpha = 8$  to  $16$  deg,  $SR = 182.9$  cm (72 in).

Figure A69. Effect of rotation rate and angle of attack on pitching-moment coefficient for full-span LL wing droop with large nose radius.  $\delta_e = 0^\circ$ ,  $\delta_r = 0^\circ$ ,  $\beta = 0^\circ$ .

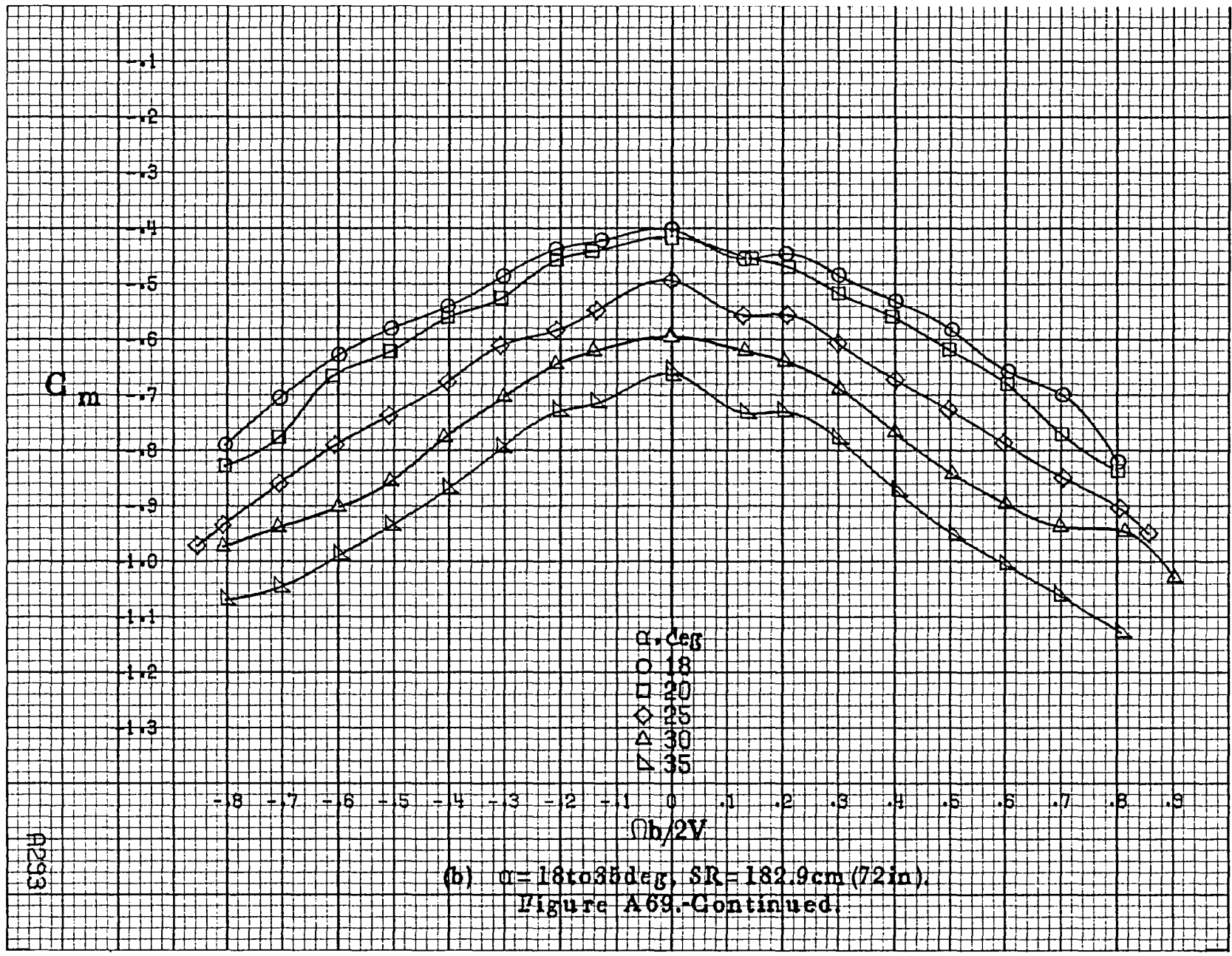

A2933

(b)  $\alpha = 18 \text{ to } 35 \text{ deg}$ ,  $SR = 182.9 \text{ cm (72 in)}$ .  
 Figure A69.-Continued.



R294

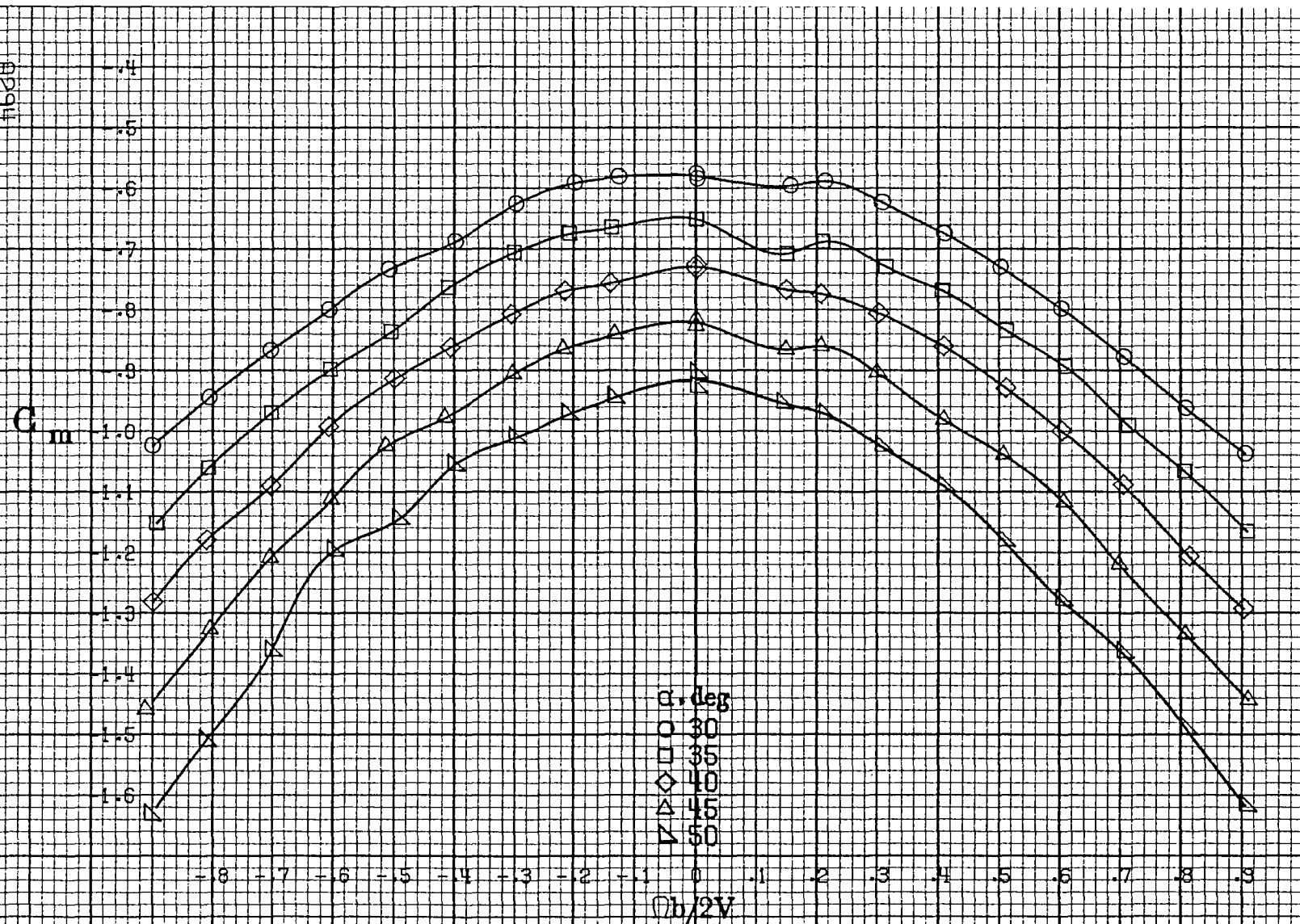

(c)  $\alpha = 30$  to  $50$  deg,  $SR = 0$ .  
Figure A69.-Continued.

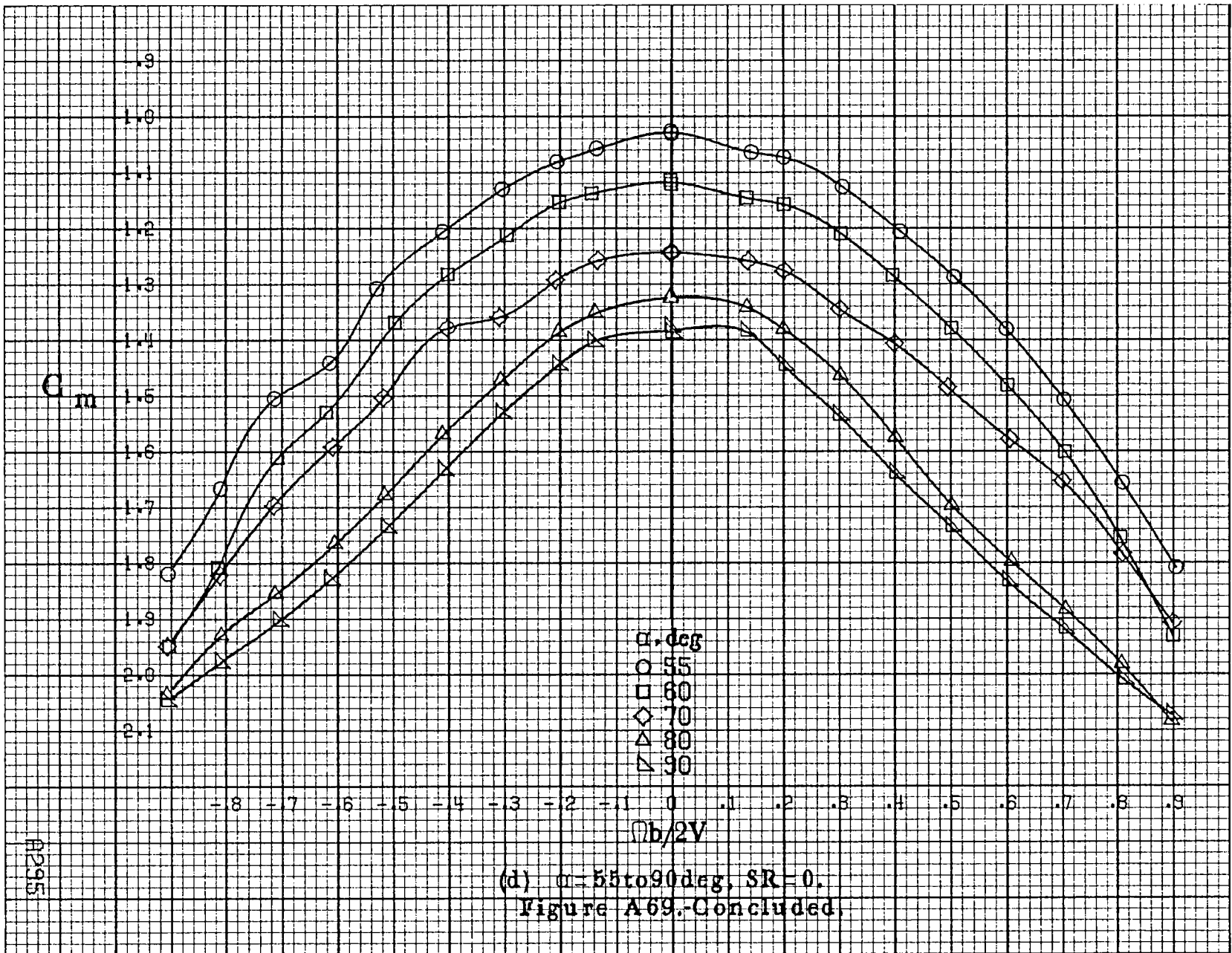

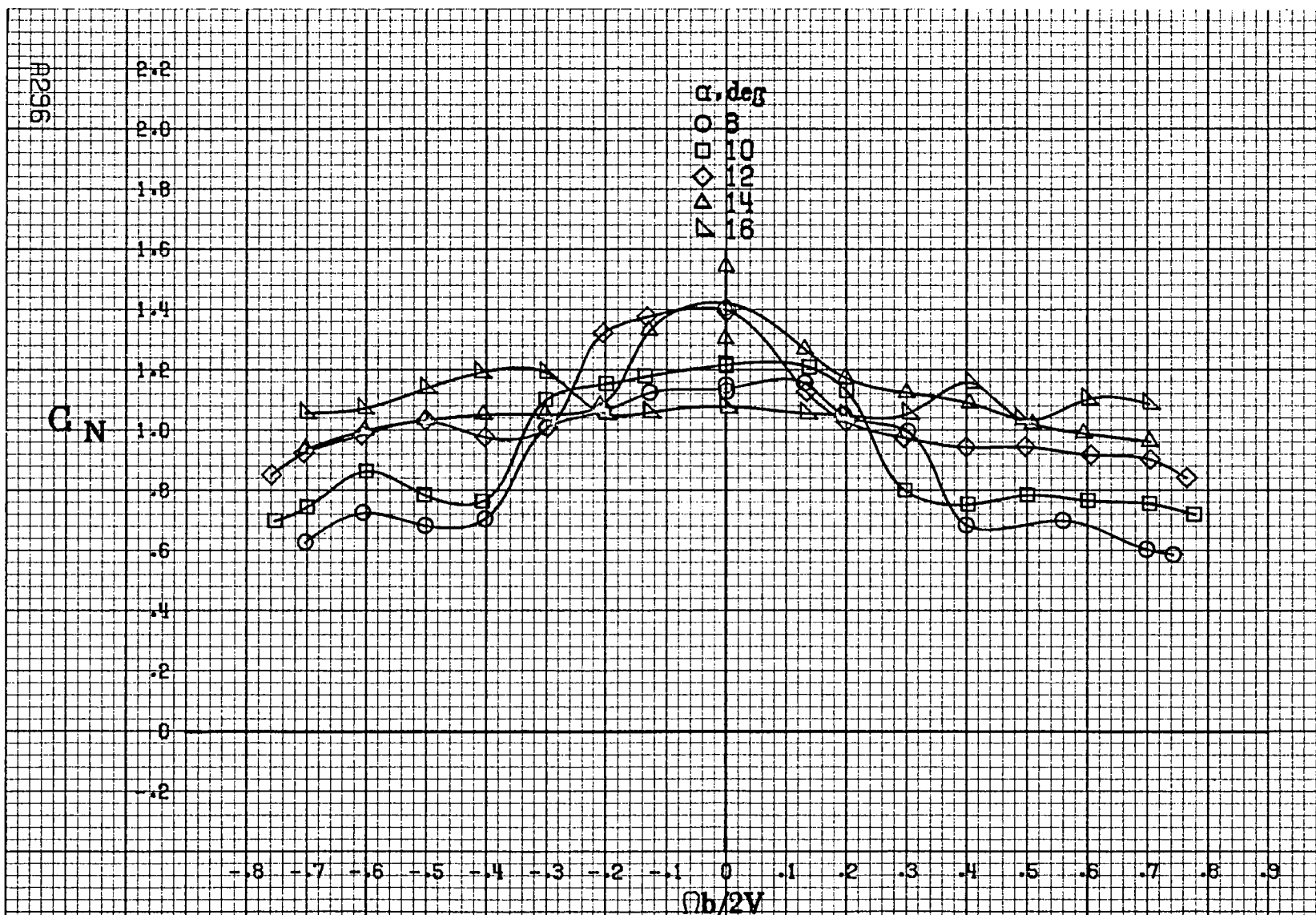

(a)  $\alpha = 8$  to  $16$  deg,  $SR = 182.9$  cm (72 in).

Figure A70.-Effect of rotation rate and angle of attack on normal-force coefficient for full-span LE wing droop with large nose radius.  $\delta_c = 0^\circ$ ,  $\delta_s = 0^\circ$ ,  $\delta_r = 0^\circ$ ,  $\beta = 0^\circ$ .

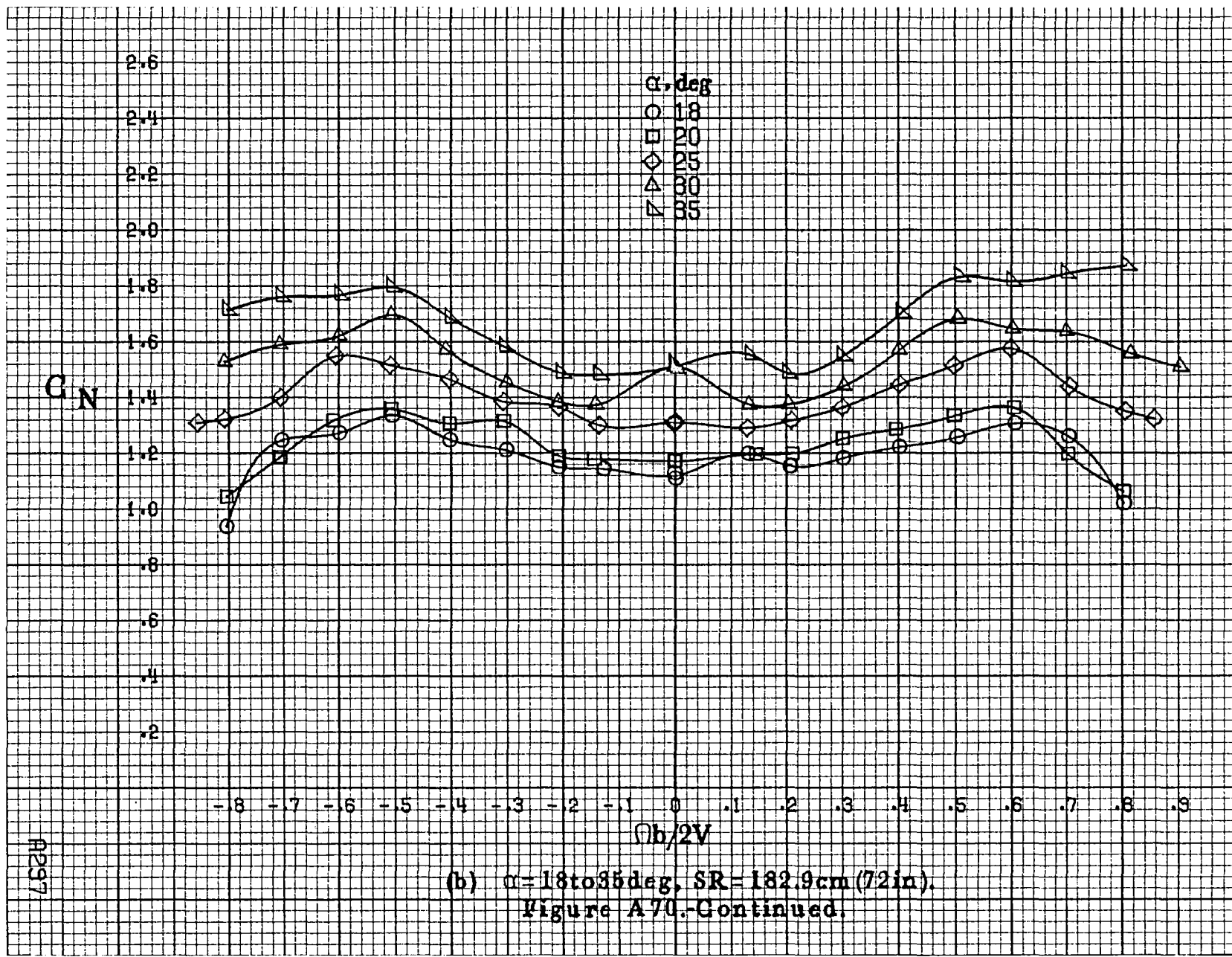

A297

(b)  $\alpha = 18$  to  $35$  deg, SR = 182.9 cm (72 in).  
Figure A70.-Continued.

AP298

$C_N$

3.2  
3.0  
2.8  
2.6  
2.4  
2.2  
2.0  
1.8  
1.6  
1.4  
1.2  
1.0  
.8

$\alpha$ , deg  
○ 30  
□ 35  
◇ 40  
△ 45  
▽ 50

-8 -7 -6 -5 -4 -3 -2 -1 0 .1 .2 .3 .4 .5 .6 .7 .8 .9  
 $\Omega b/2V$

(c)  $\alpha=30$  to  $50$  deg,  $SR=0$ .  
Figure A70.-Continued.

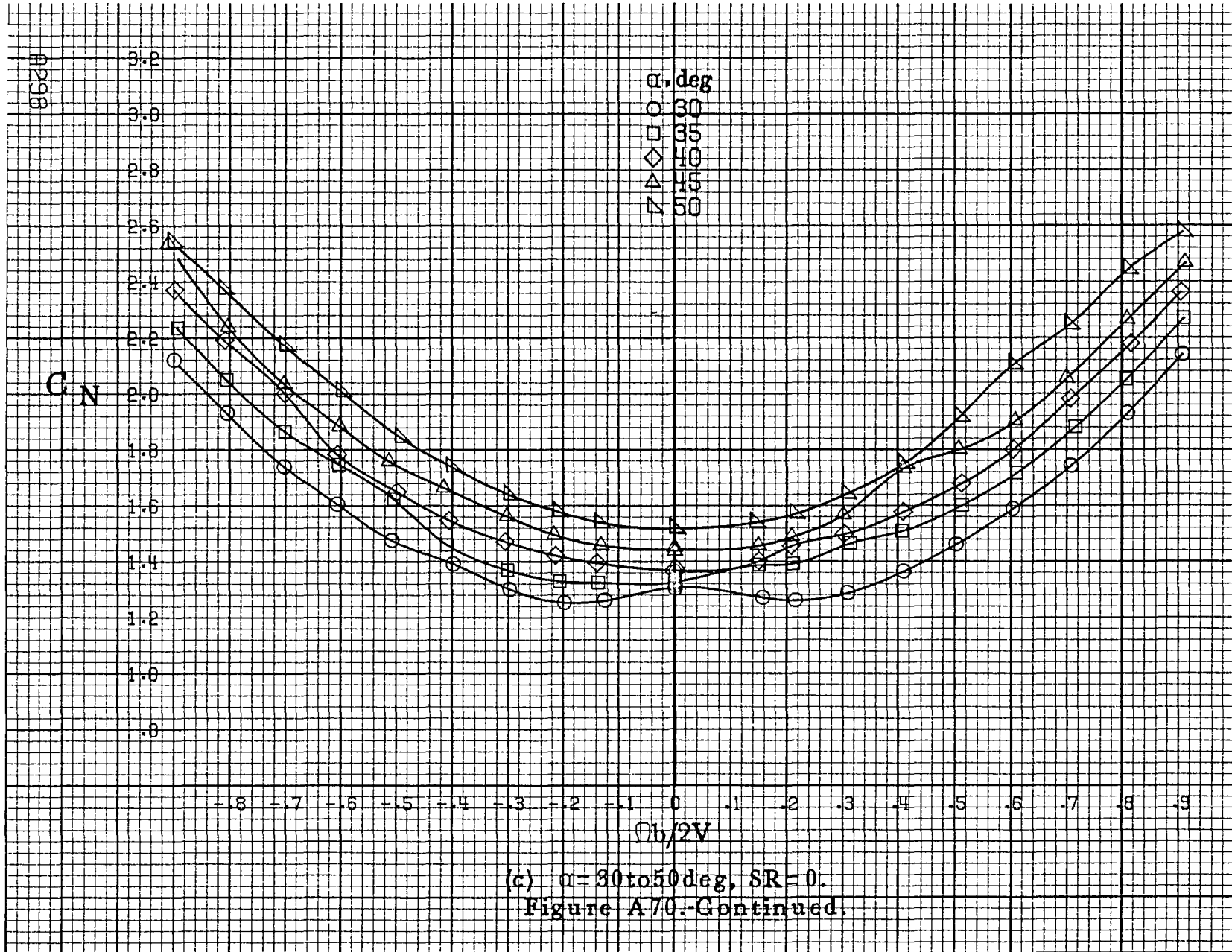

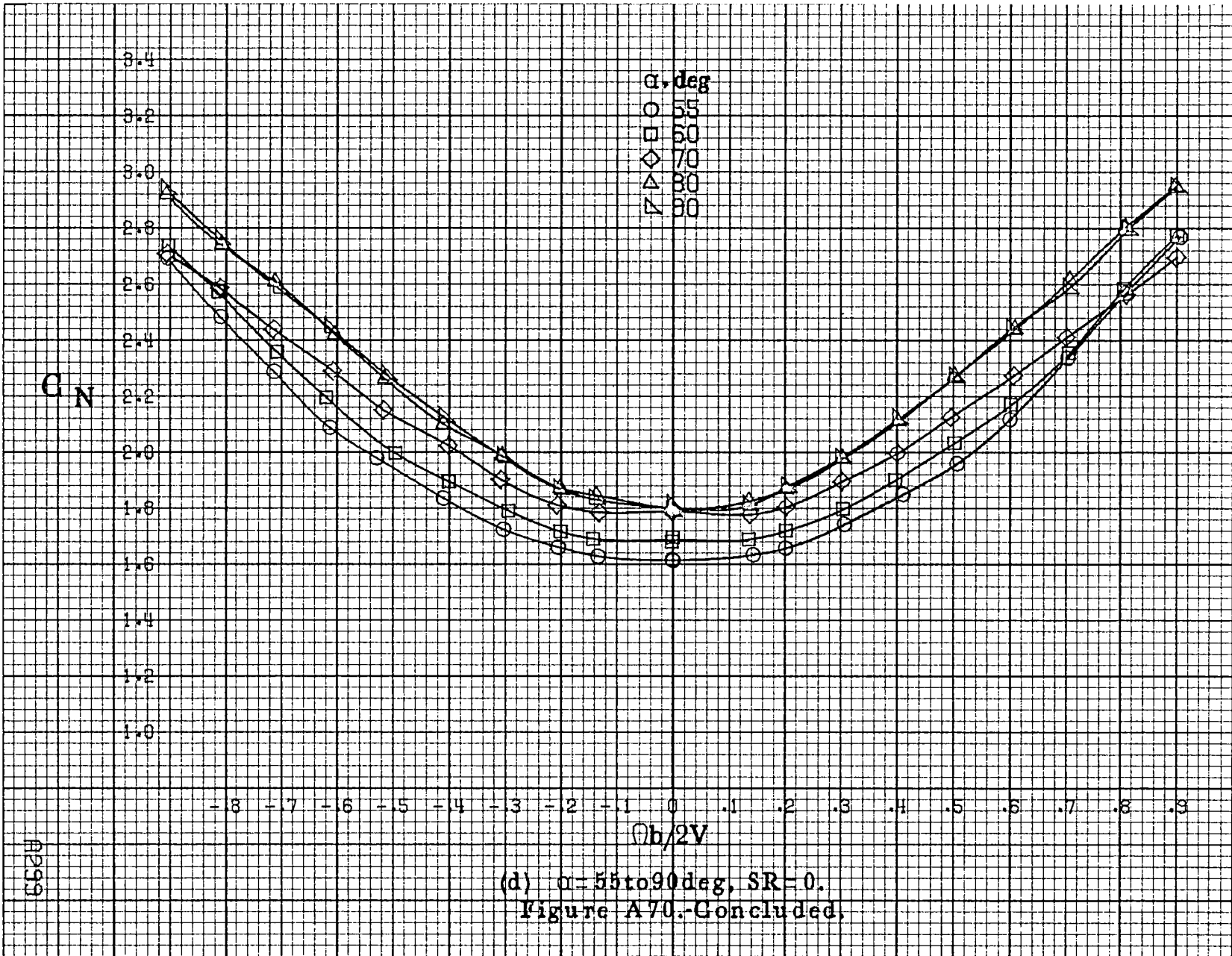

$C_N$

$Ob/2V$

A299

(d)  $\alpha=55$  to  $90$  deg,  $SR=0$ .  
Figure A70. Concluded.

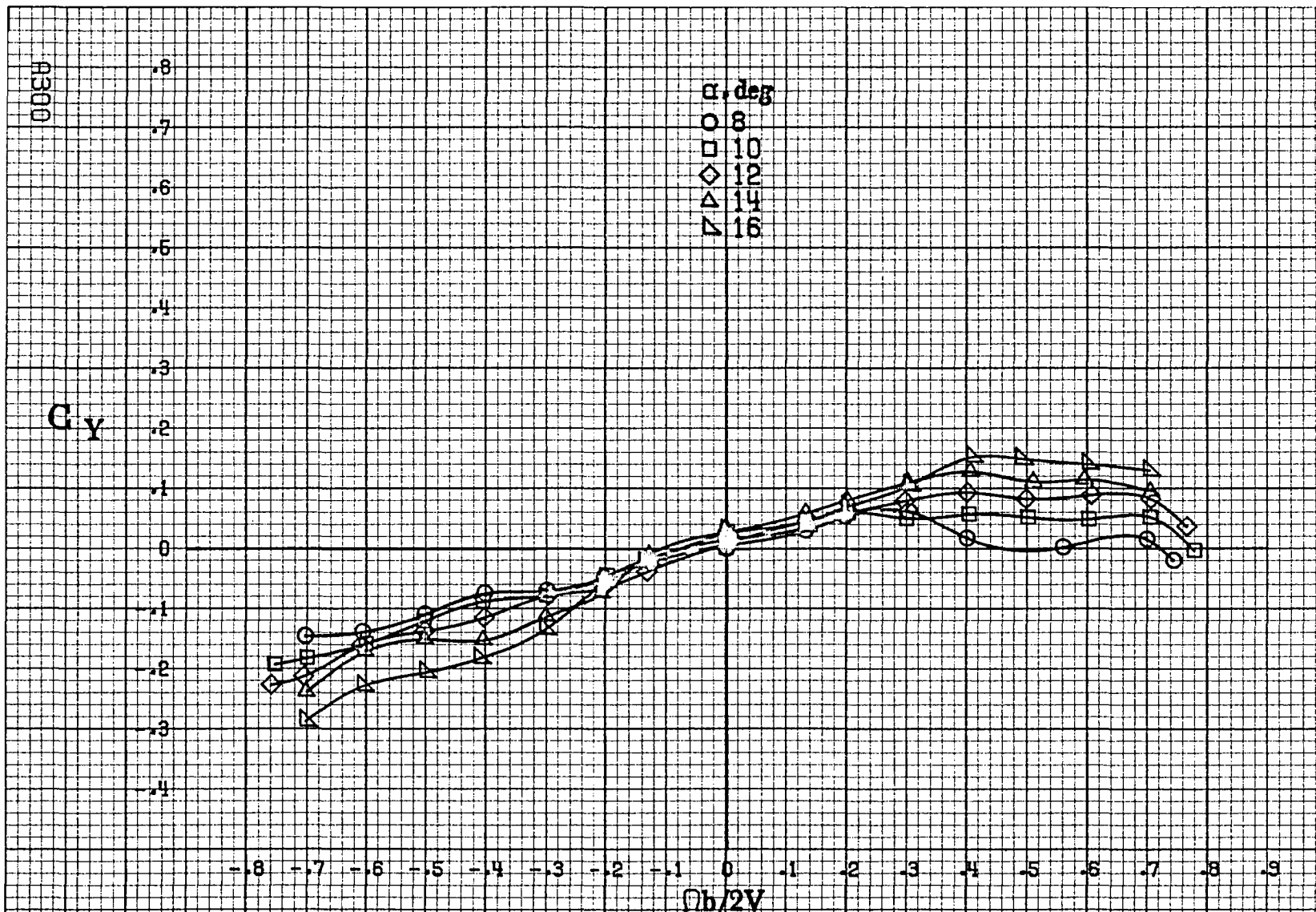

(a)  $\alpha = 8$  to  $16$  deg,  $SR = 182.9$  cm (72 in).

Figure A71. Effect of rotation rate and angle of attack on side-force coefficient for full-span LR wing droop with large nose radius.  $\delta_a = 0^\circ$ ,  $\delta_r = 0^\circ$ ,  $\beta = 0^\circ$ .



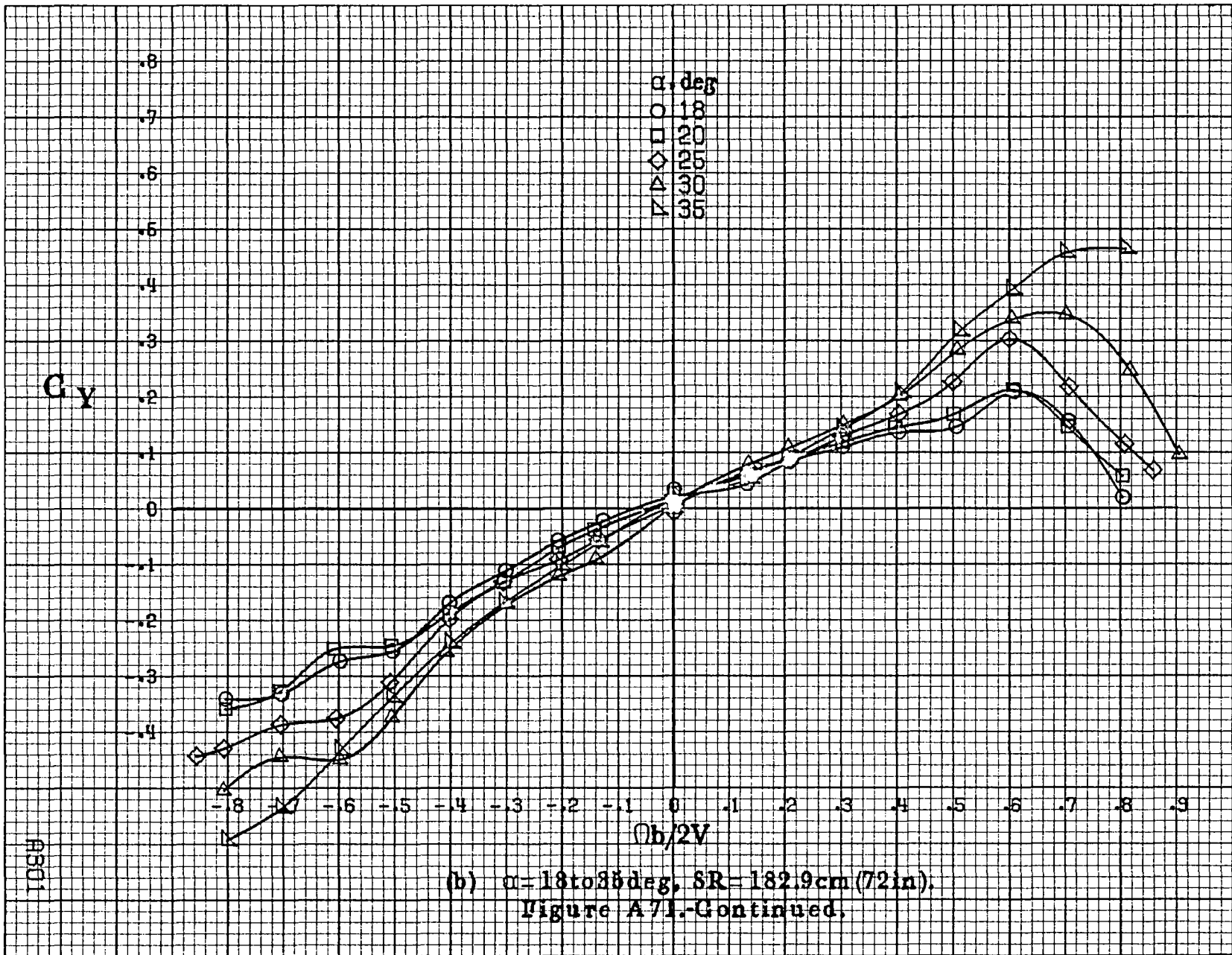

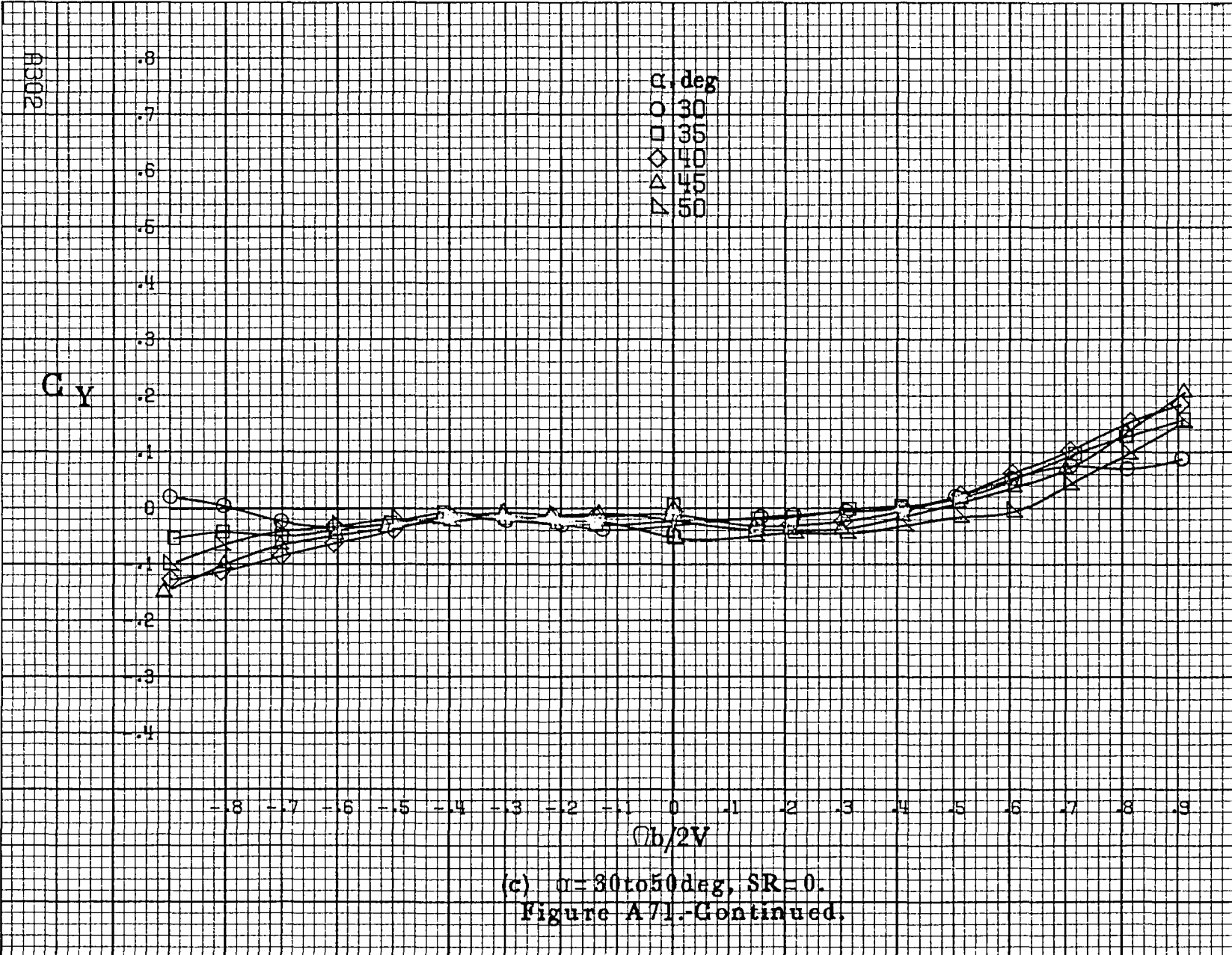

(c)  $\alpha = 30$  to  $50$  deg,  $SR = 0$ .  
 Figure A71-Continued.

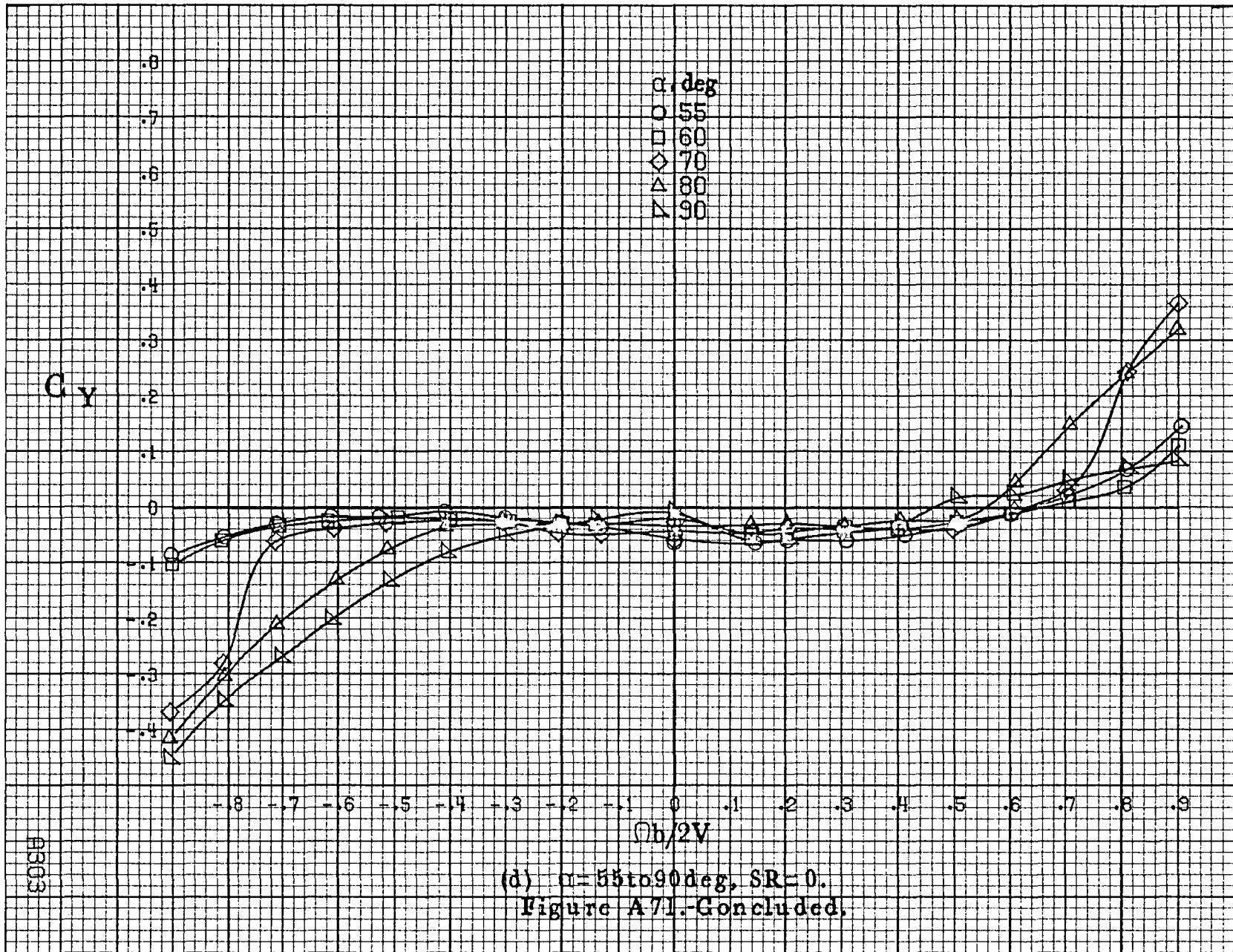

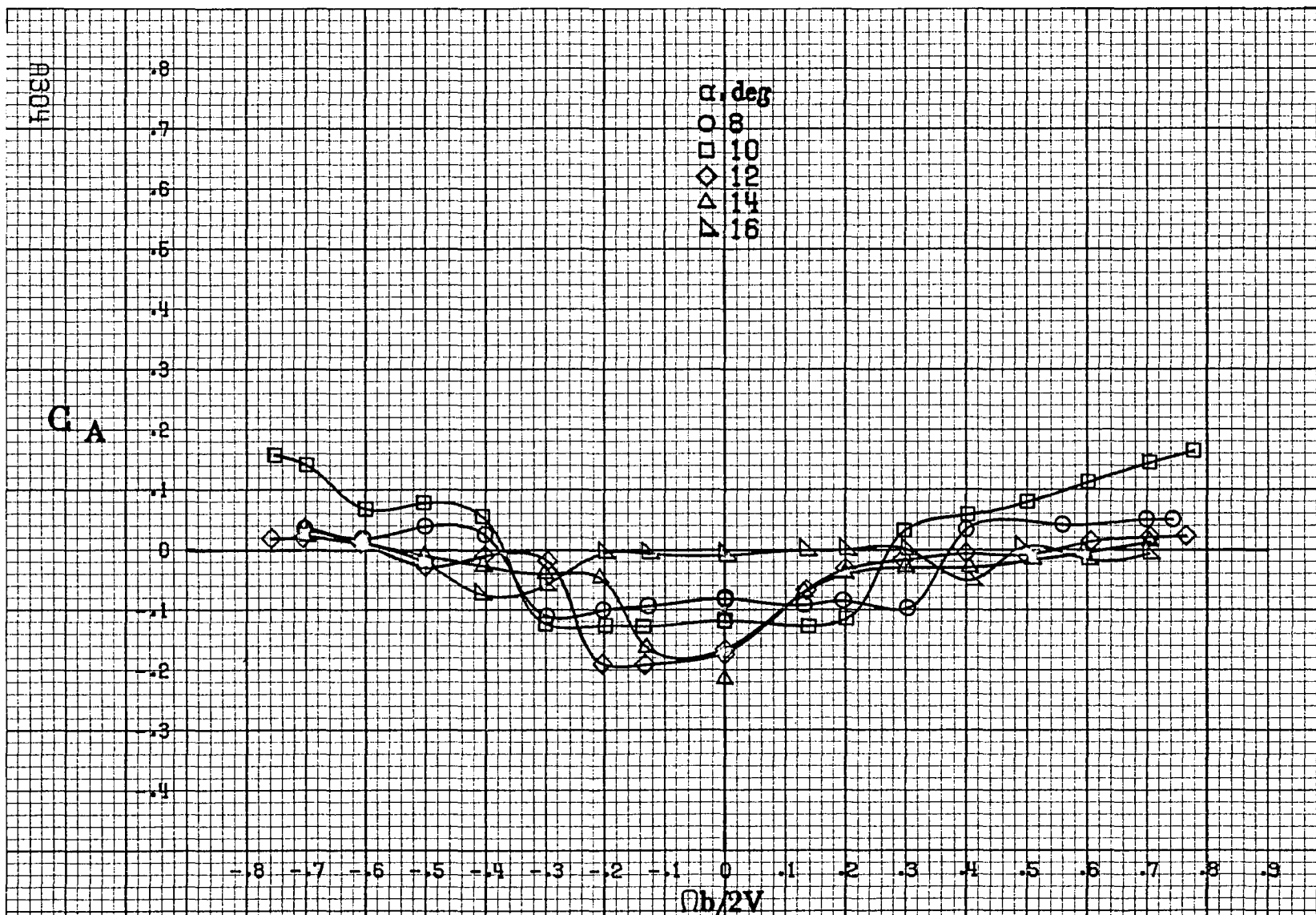

(a)  $\alpha = 8$  to  $16$  deg,  $SR = 182.9$  cm (72 in).

Figure A72. Effect of rotation rate and angle of attack on axial force coefficient for full-span LE wing droop with large nose radius.  $\delta_a = 0^\circ$ ,  $\delta_r = 0^\circ$ ,  $\beta = 0^\circ$ .

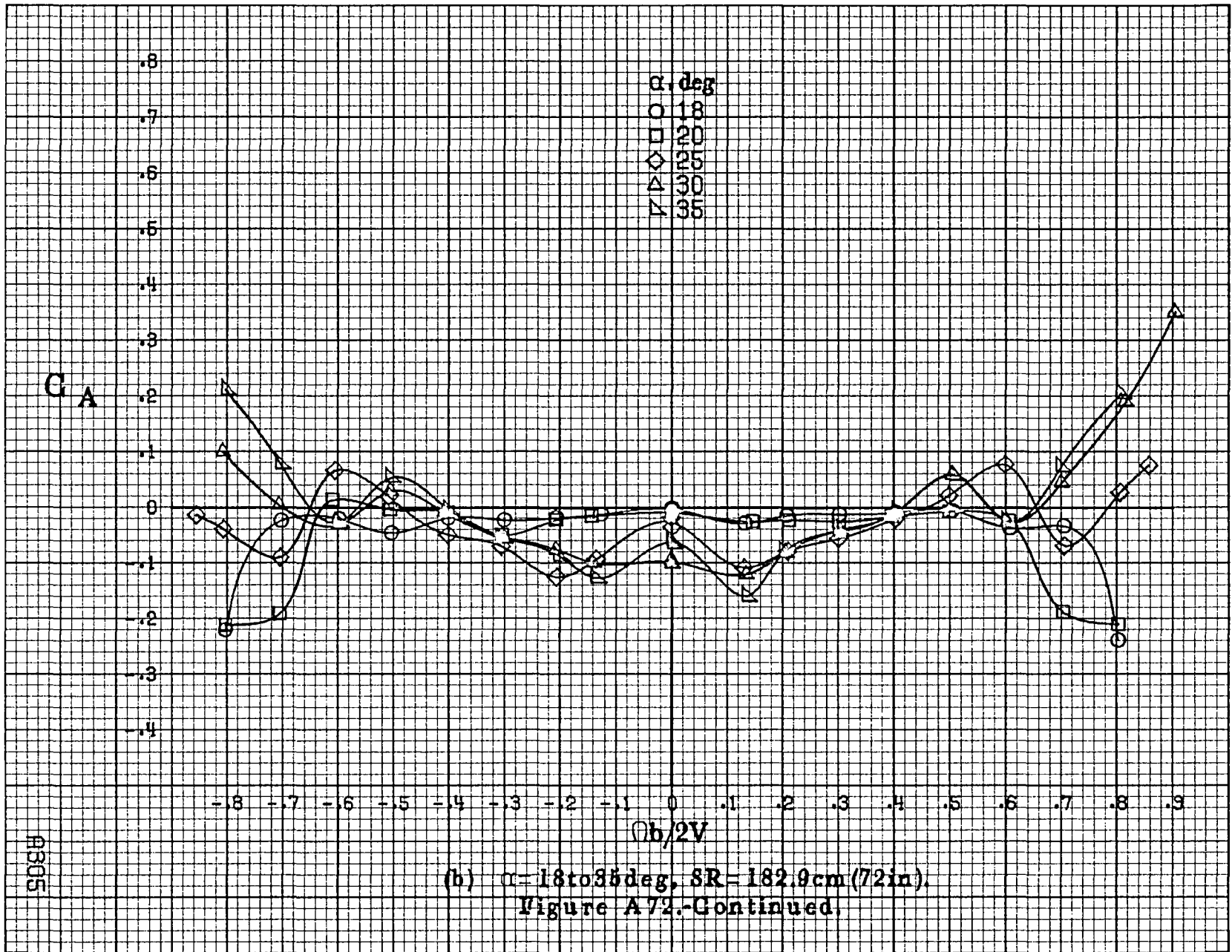

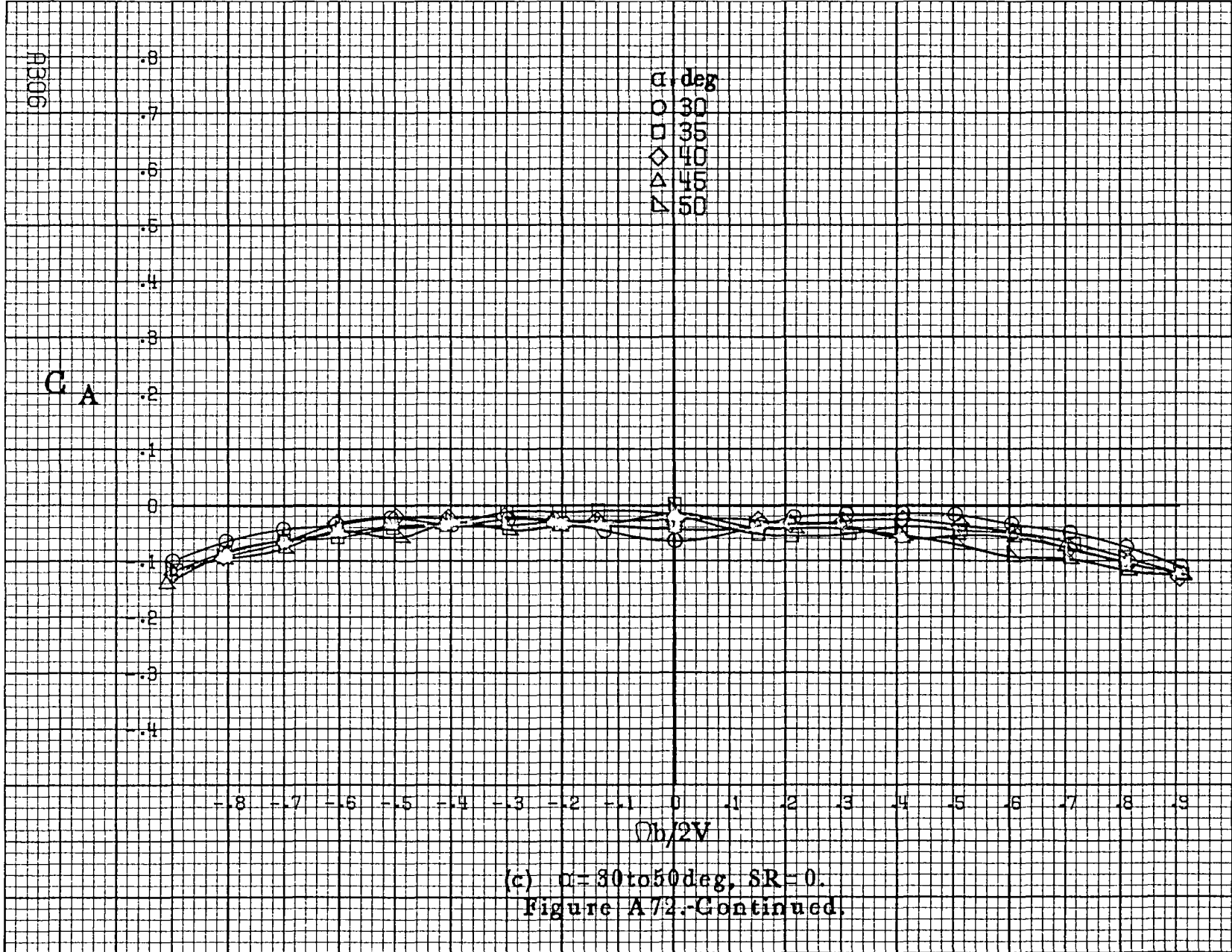

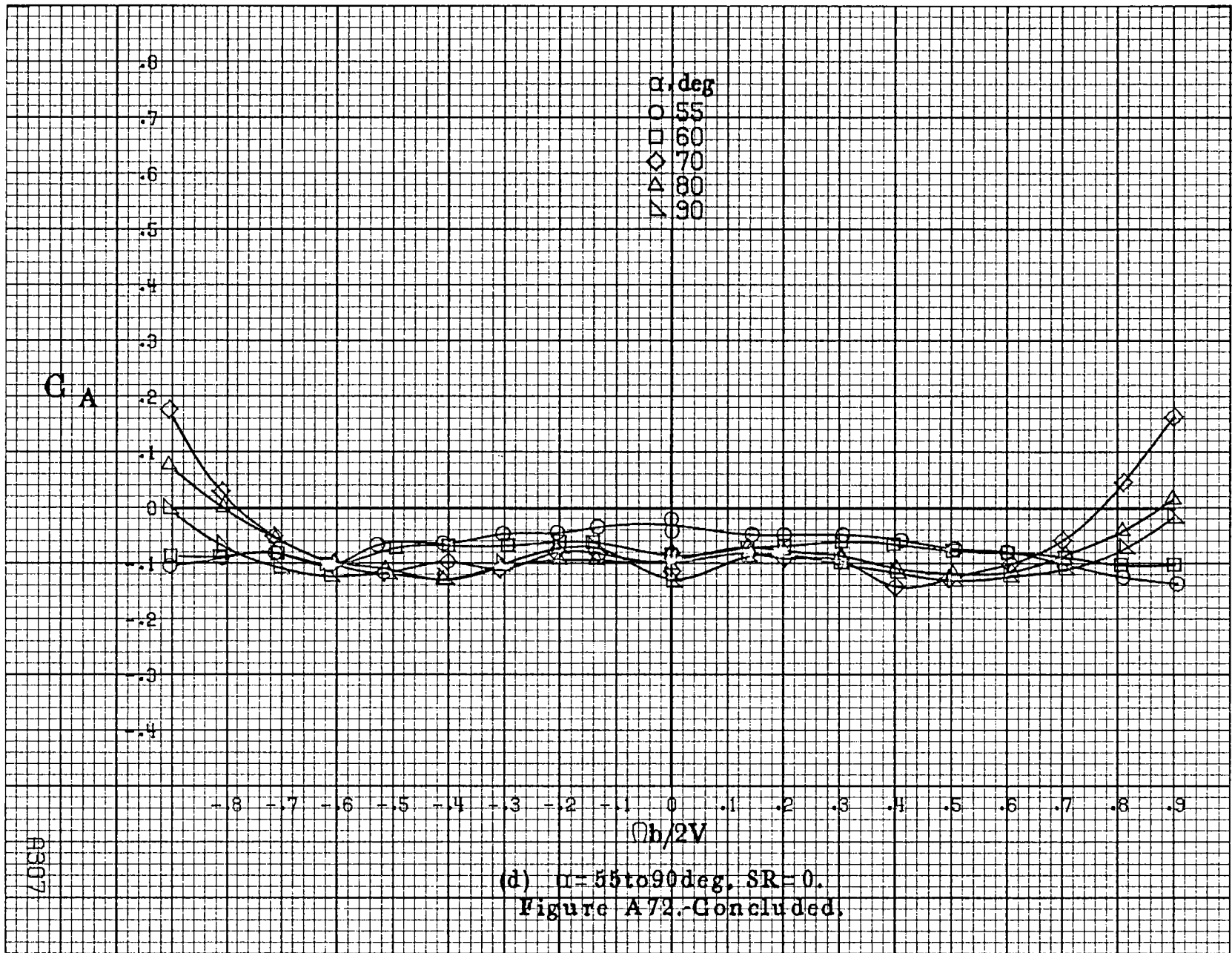



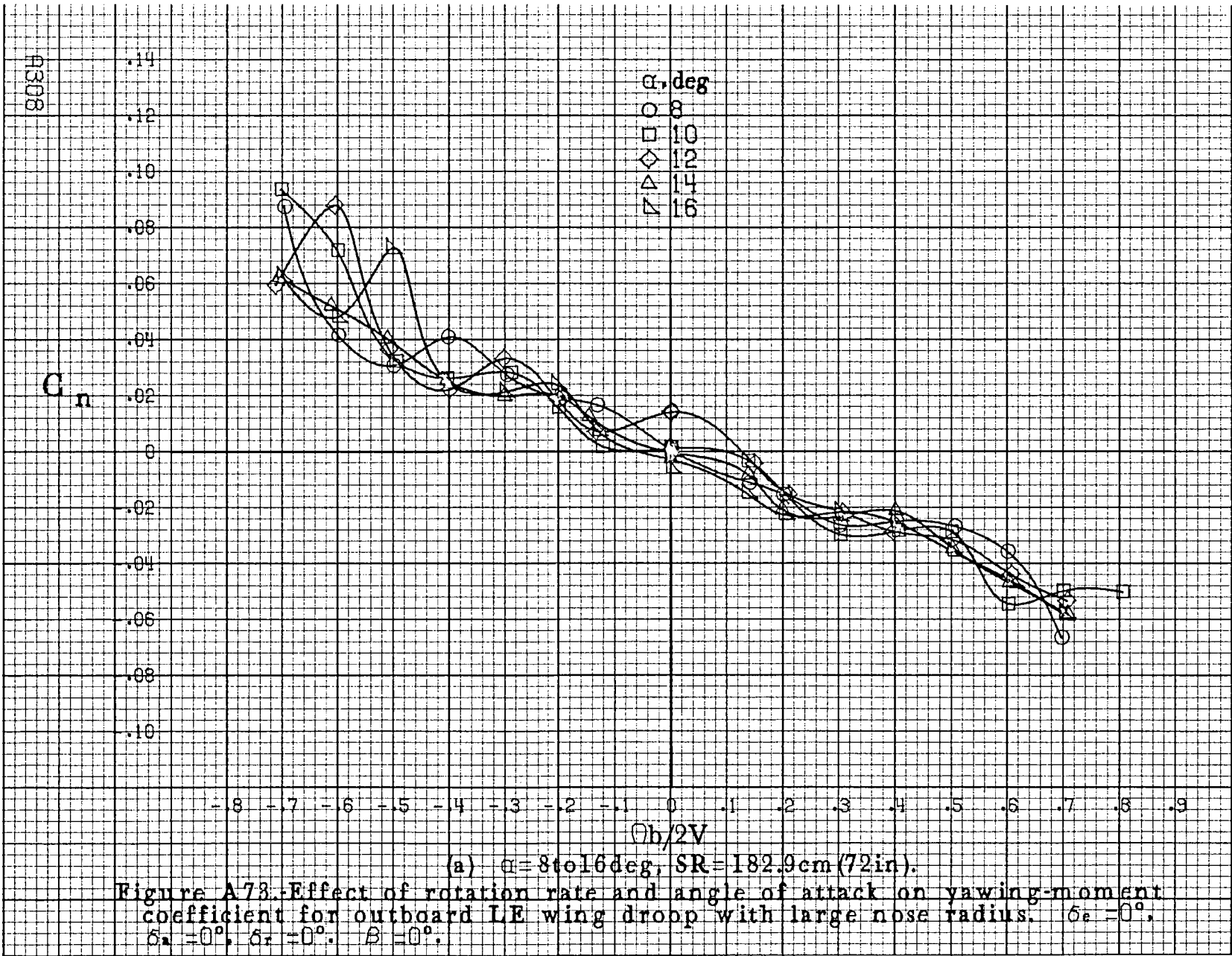

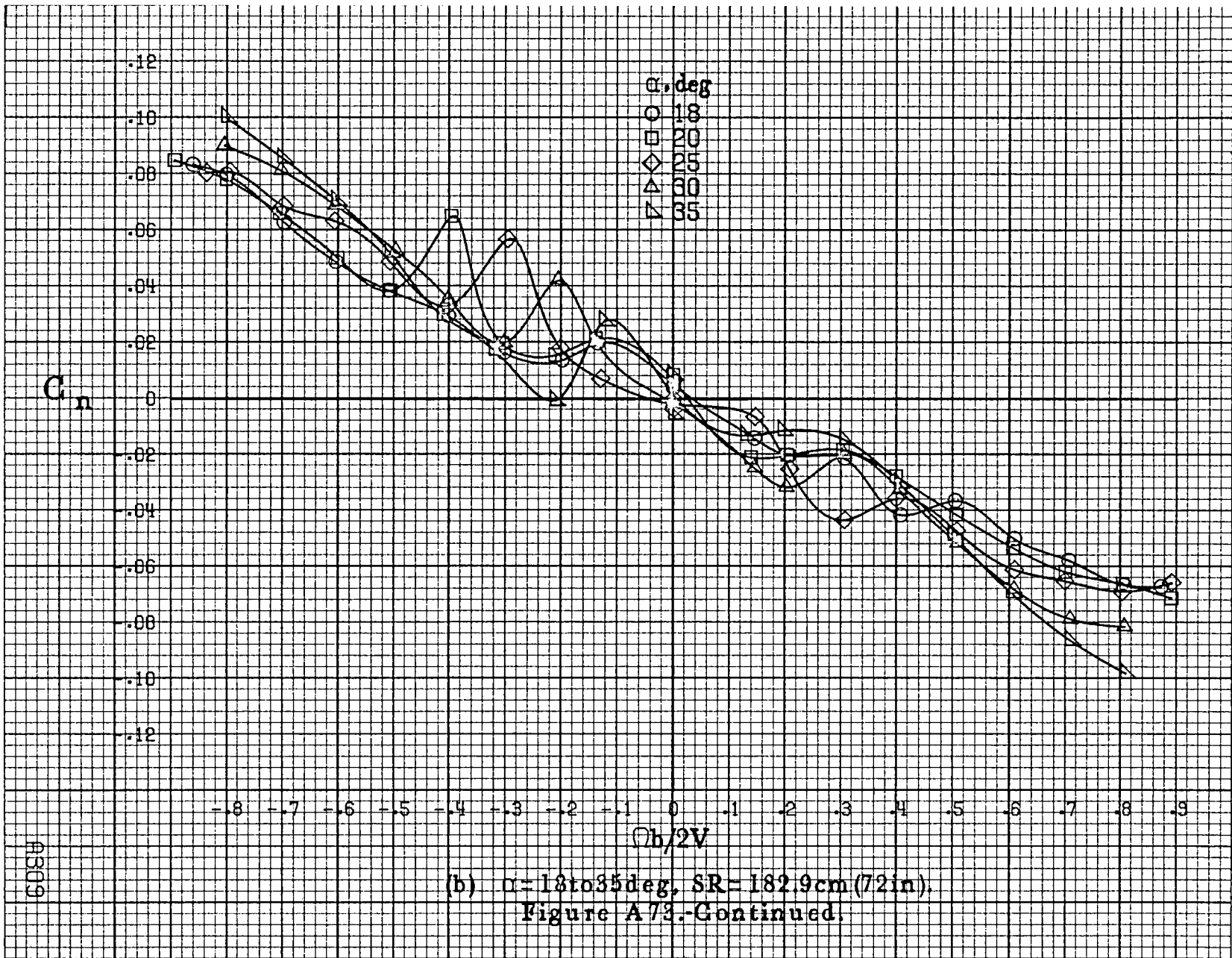

(b)  $\alpha = 18$  to  $35$  deg, SR = 182.9 cm (72 in).  
Figure A73.-Continued.

A309

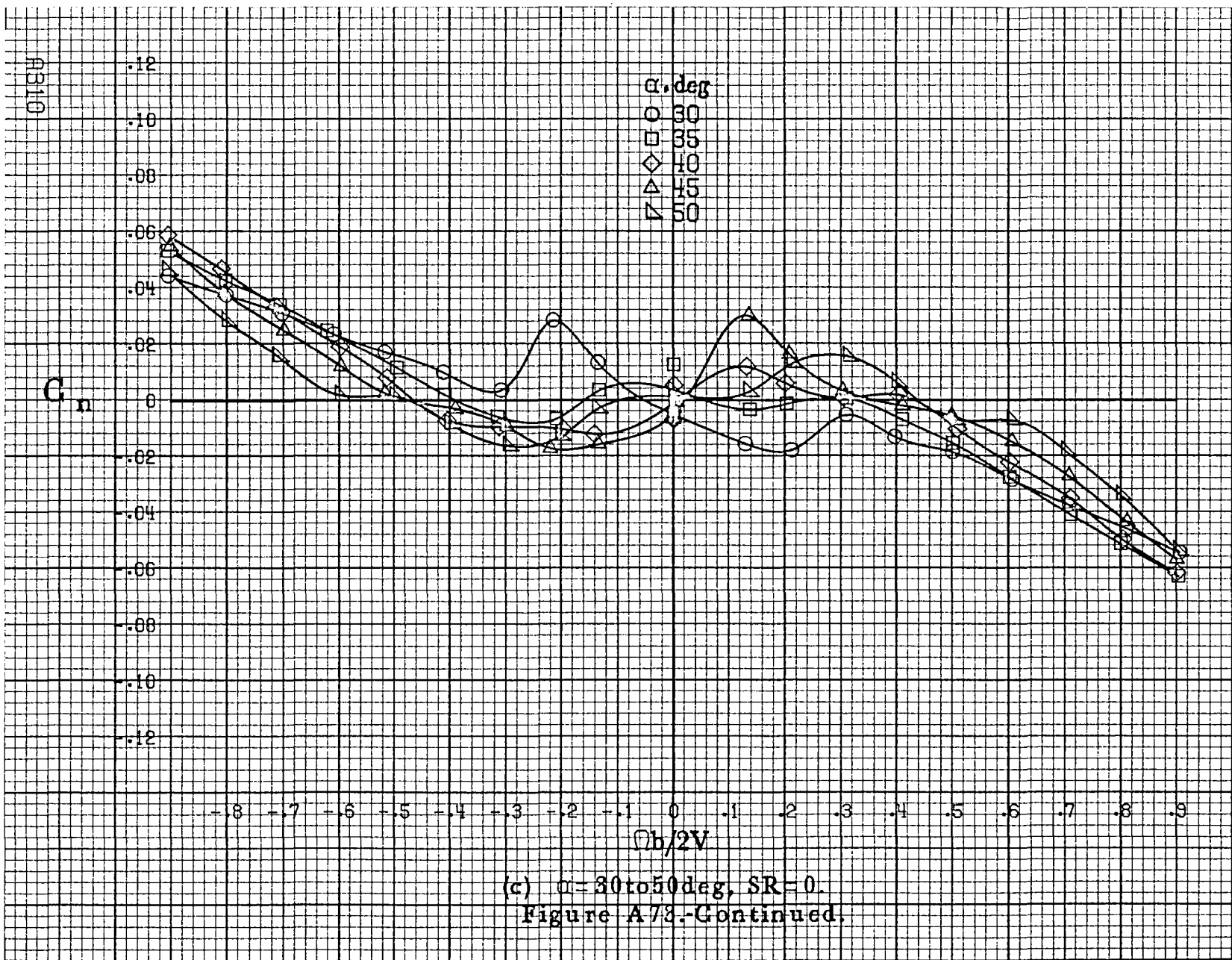

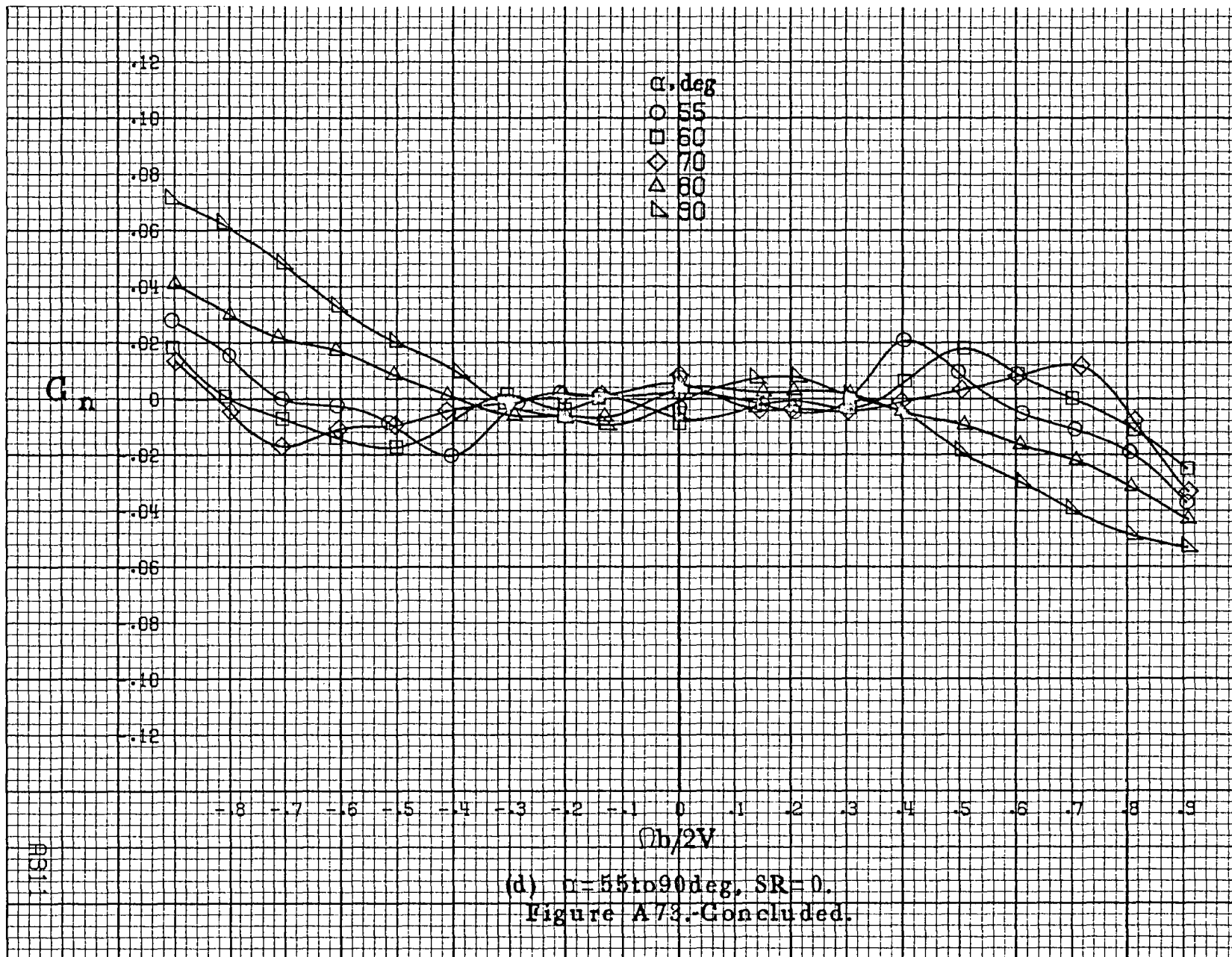

(d)  $\alpha = 55$  to  $90$  deg,  $SR = 0$ .  
 Figure A-73. Concluded.

4911

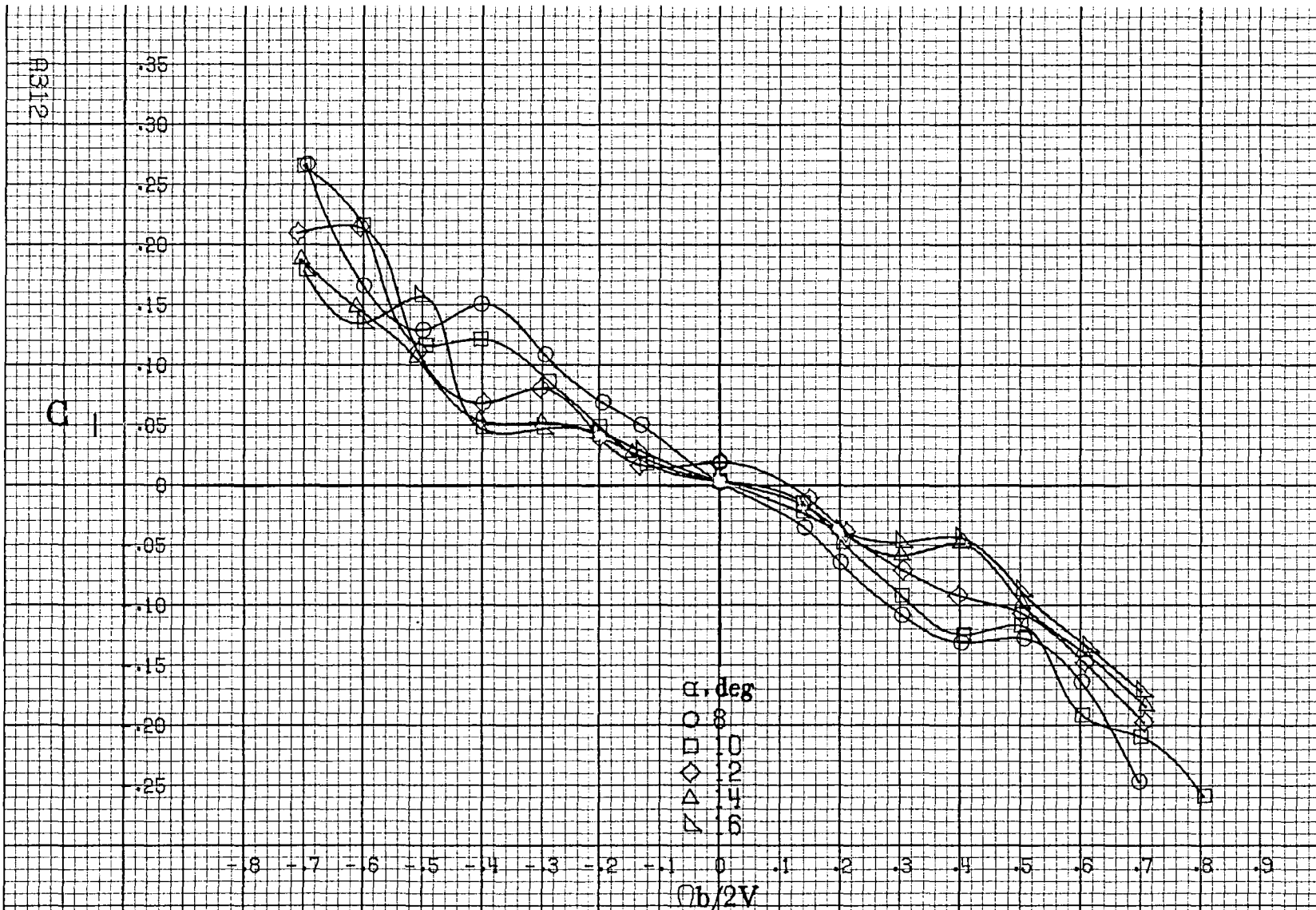

(a)  $\alpha = 8$  to  $16$  deg,  $SR = 182.9 \text{ cm (72 in)}$ .

Figure A74. Effect of rotation rate and angle of attack on rolling-moment coefficient for outboard LE wing droop with large nose radius.  $\delta_a = 0^\circ$ ,  $\delta_r = 0^\circ$ ,  $\beta = 0^\circ$ .

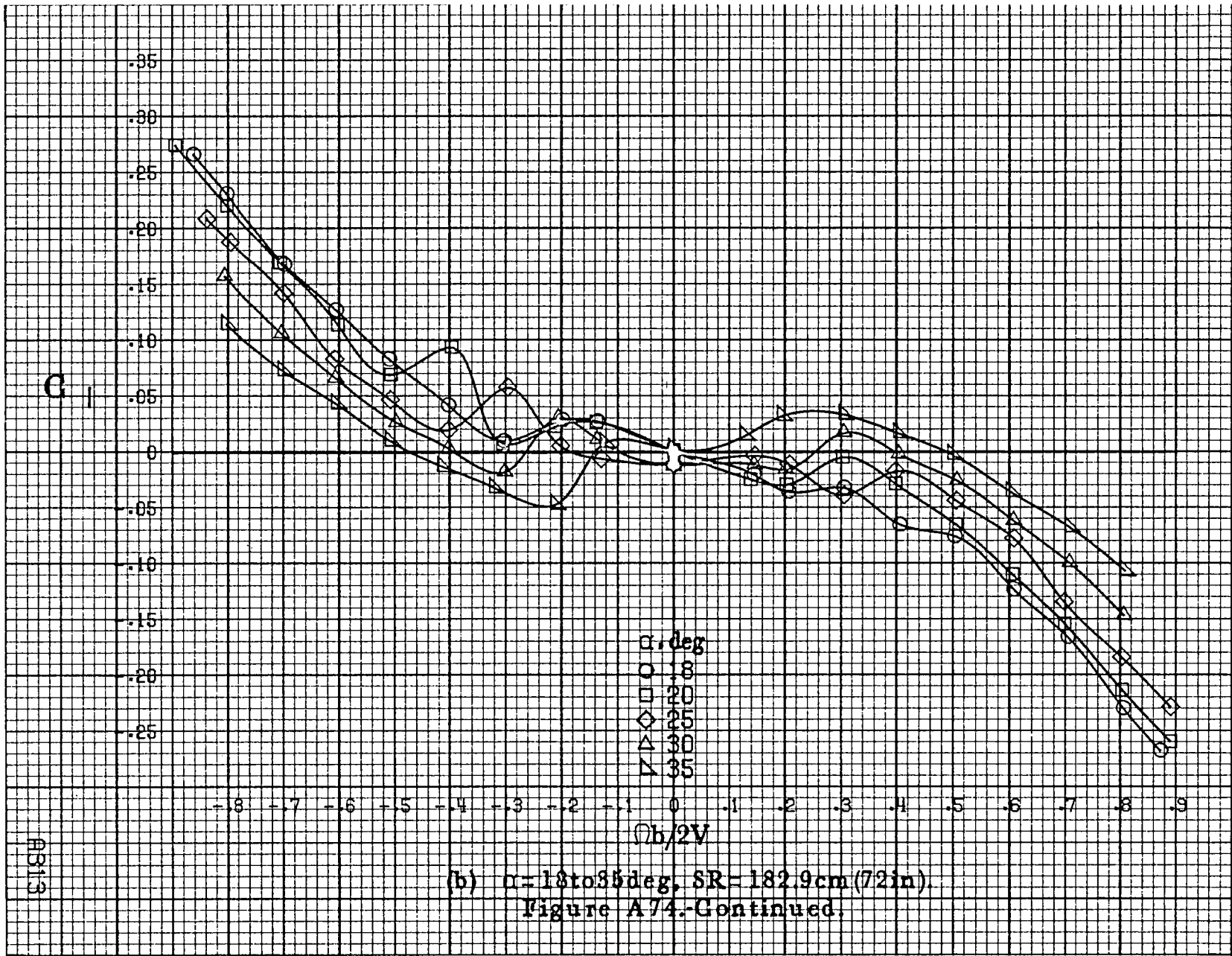

A313

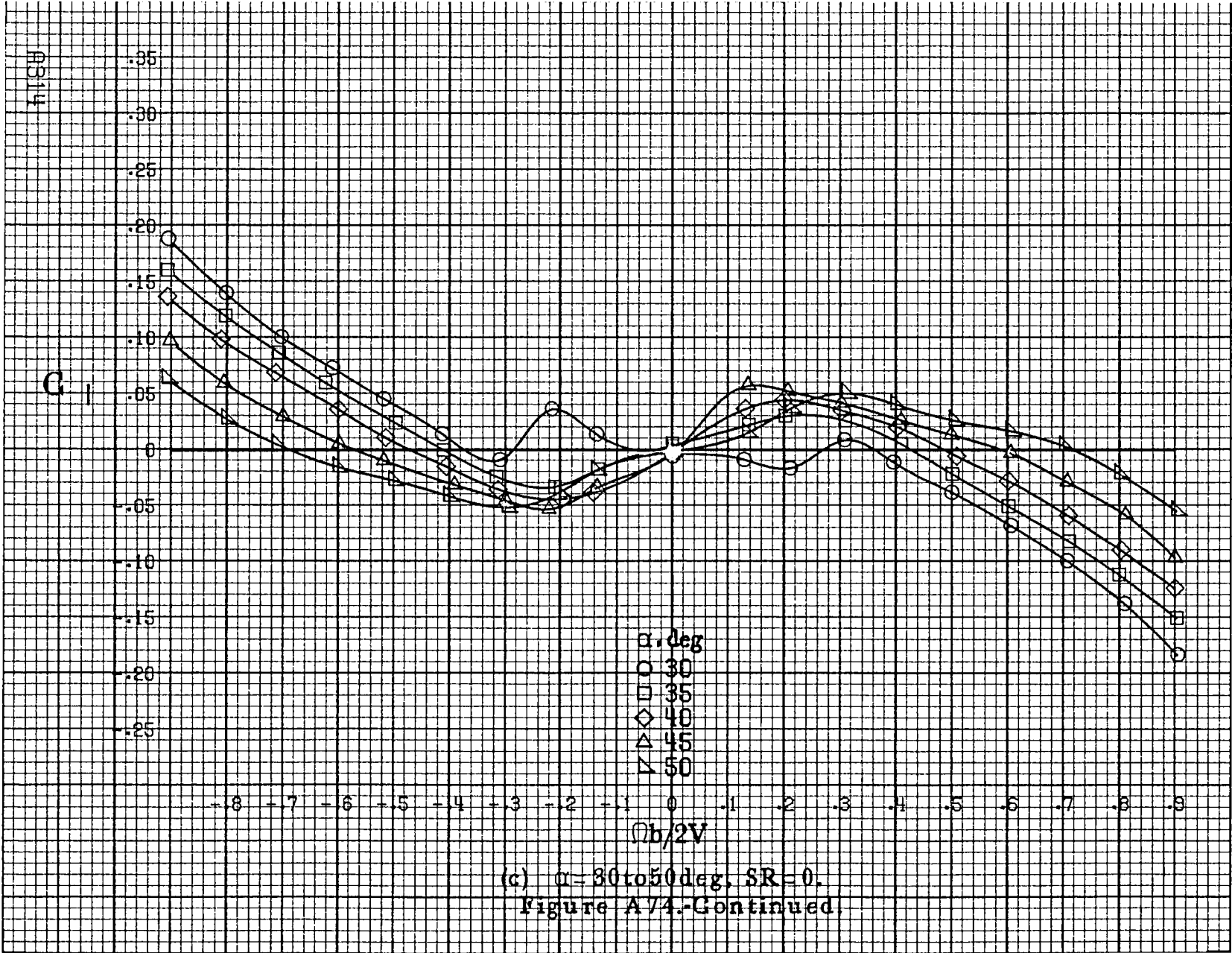

(a)  $\alpha = 30$  to  $50$  deg;  $SR = 0$ .  
 Figure A74.-Continued.



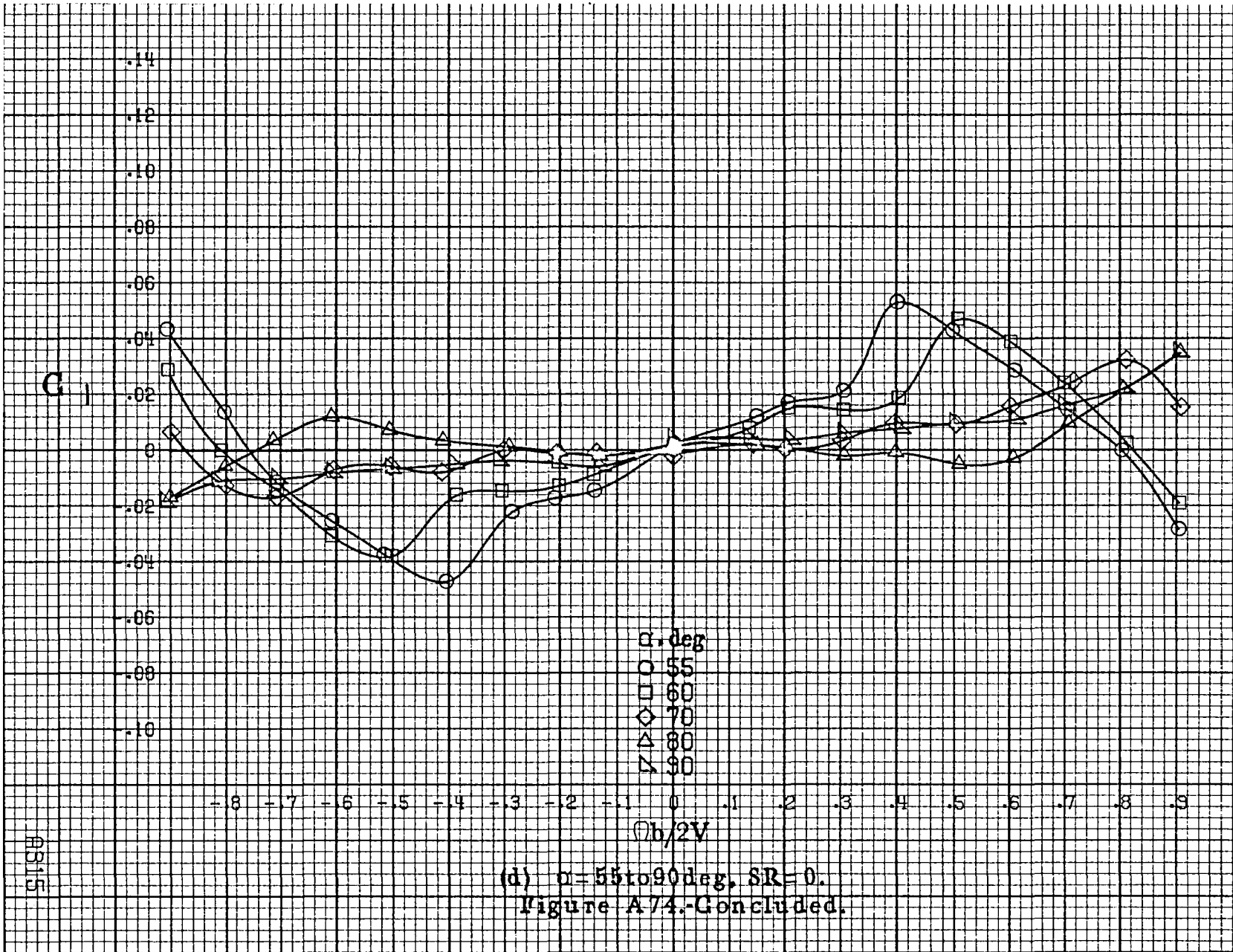

AB16

$C_m$

1.2  
1.1  
1.0  
0.9  
0.8  
0.7  
0.6  
0.5  
0.4  
0.3  
0.2  
0.1  
0  
-0.1  
-0.2  
-0.3  
-0.4  
-0.5  
-0.6  
-0.7  
-0.8  
-0.9  
-1.0

-0.8 -0.7 -0.6 -0.5 -0.4 -0.3 -0.2 -0.1 0 0.1 0.2 0.3 0.4 0.5 0.6 0.7 0.8 0.9

$\alpha$ , deg  
 ○ 8  
 □ 10  
 ◇ 12  
 △ 14  
 ▽ 16

$\Omega b/2V$

(a)  $\alpha = 8$  to  $16$  deg,  $SR = 182.9$  cm (72 in).

Figure A75. Effect of rotation rate and angle of attack on pitching-moment coefficient for outboard LE wing droop with large nose radius.  $\phi_e = 0^\circ$ ,  $\phi_r = 0^\circ$ ,  $\beta = 0^\circ$ .

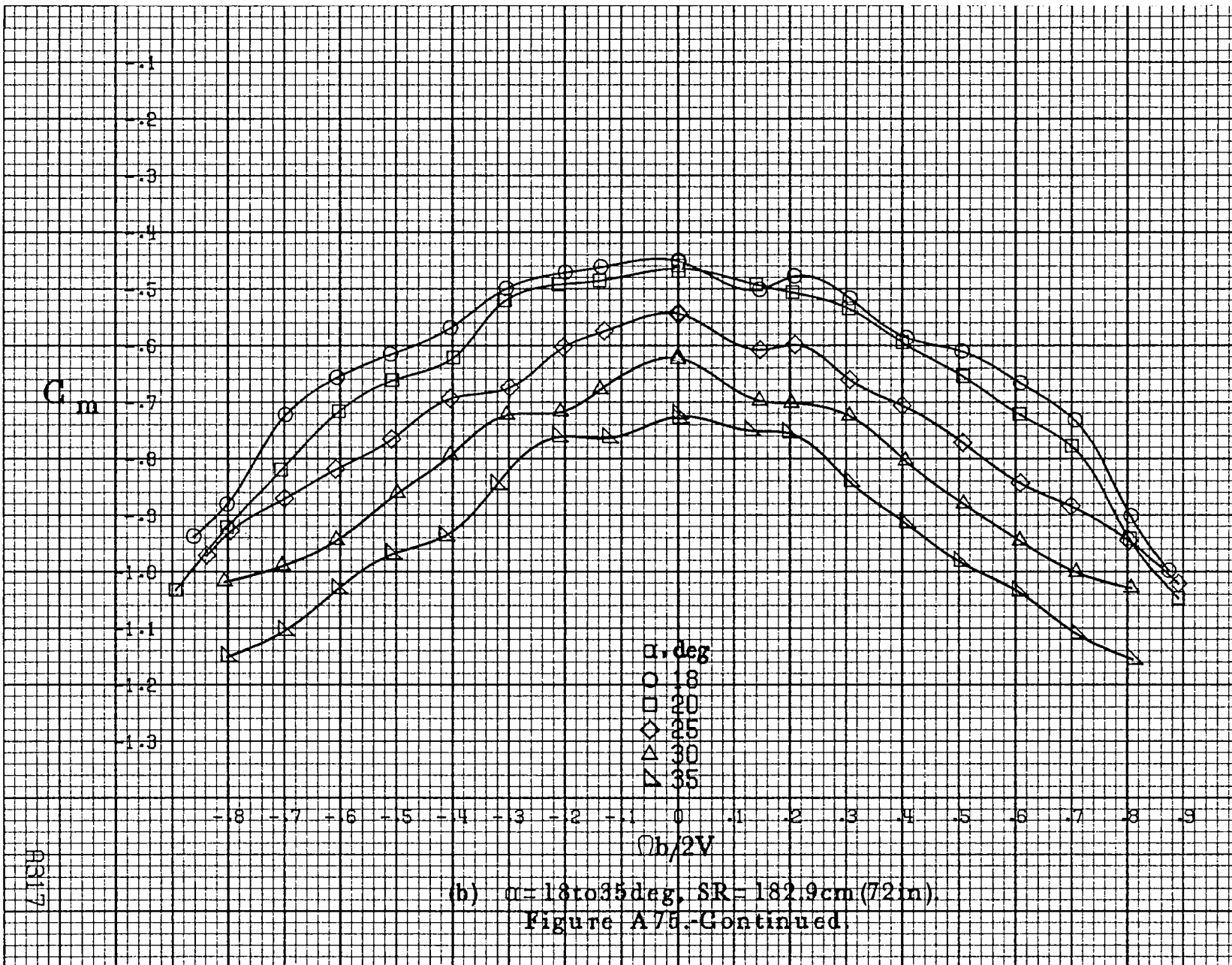

A317

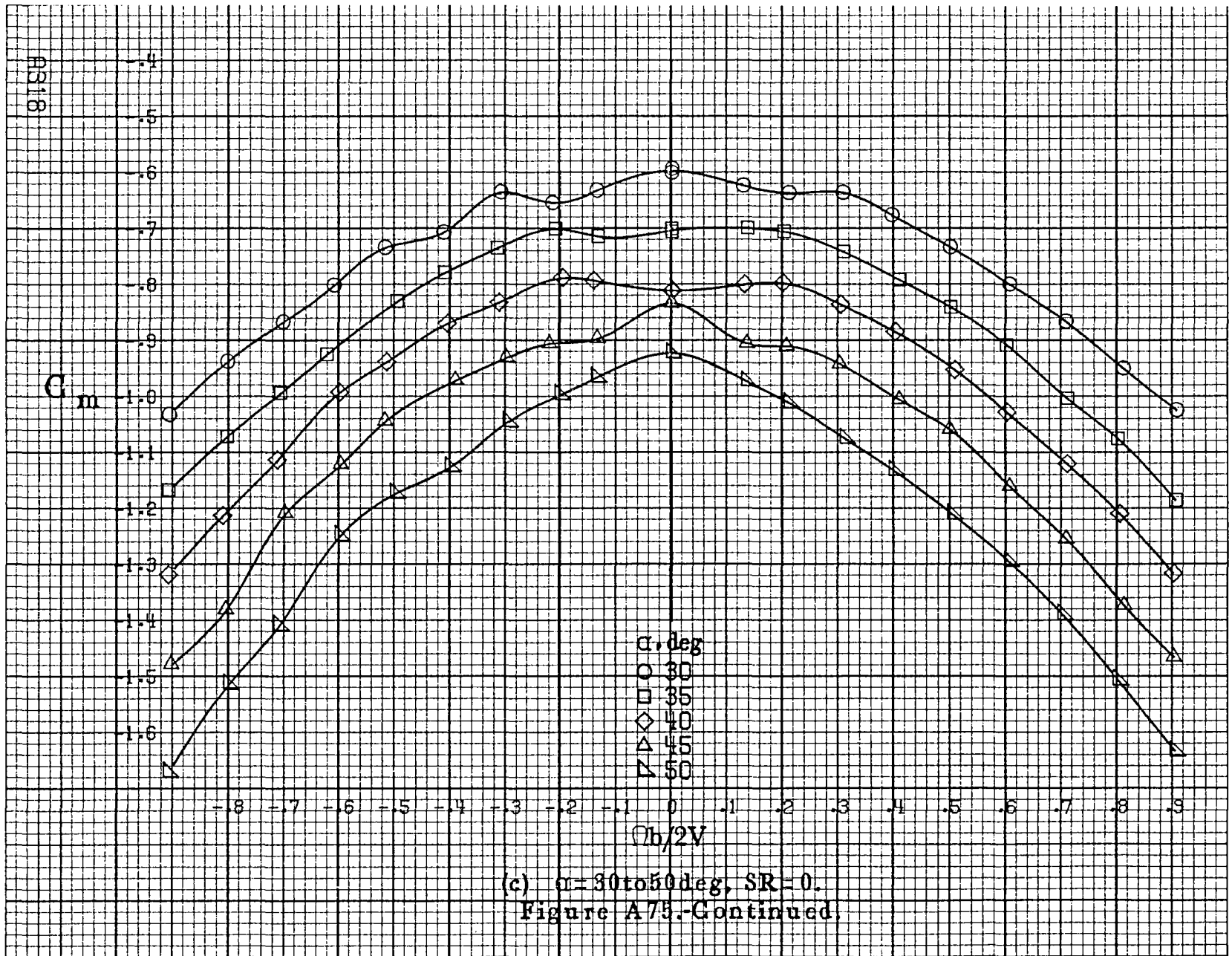

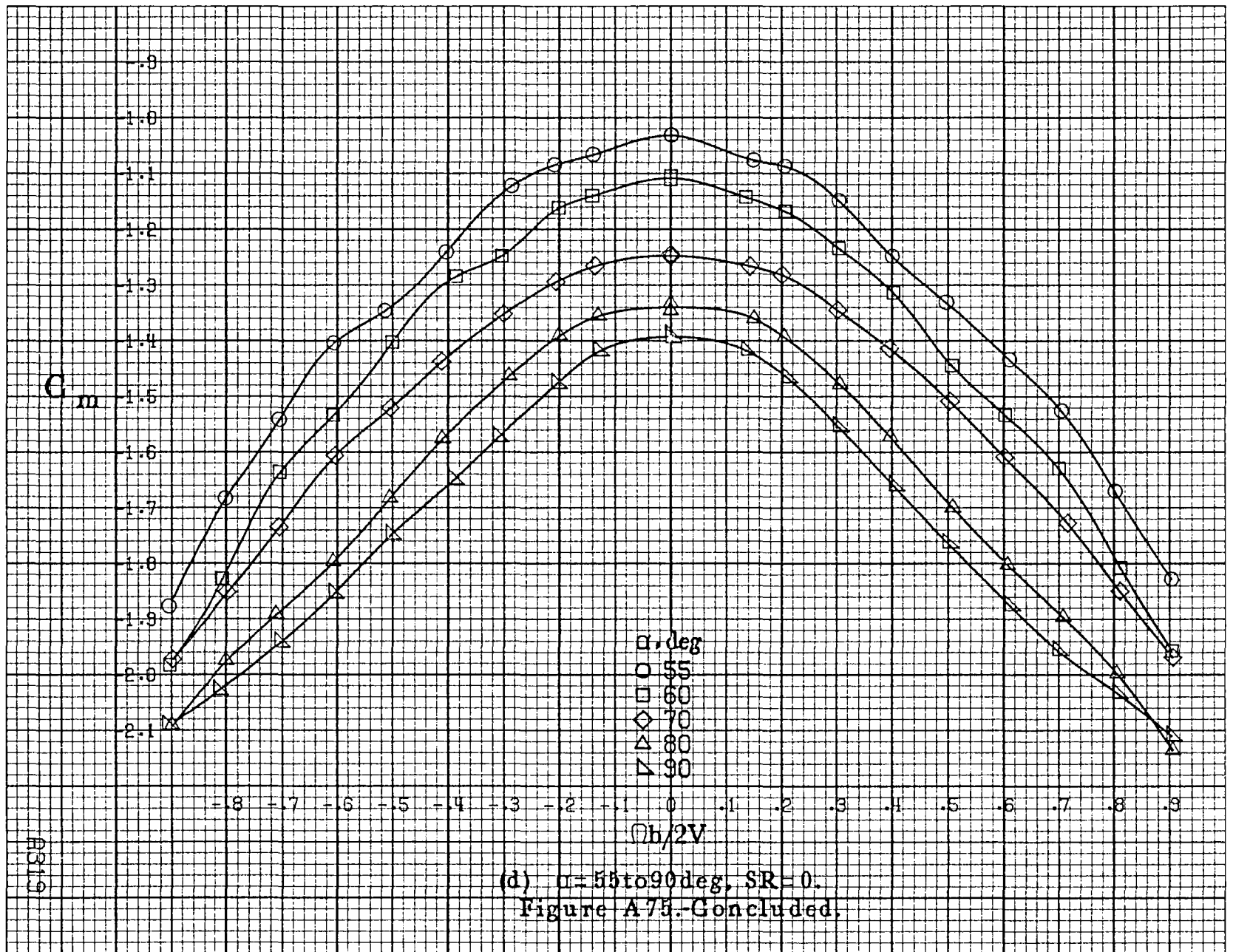

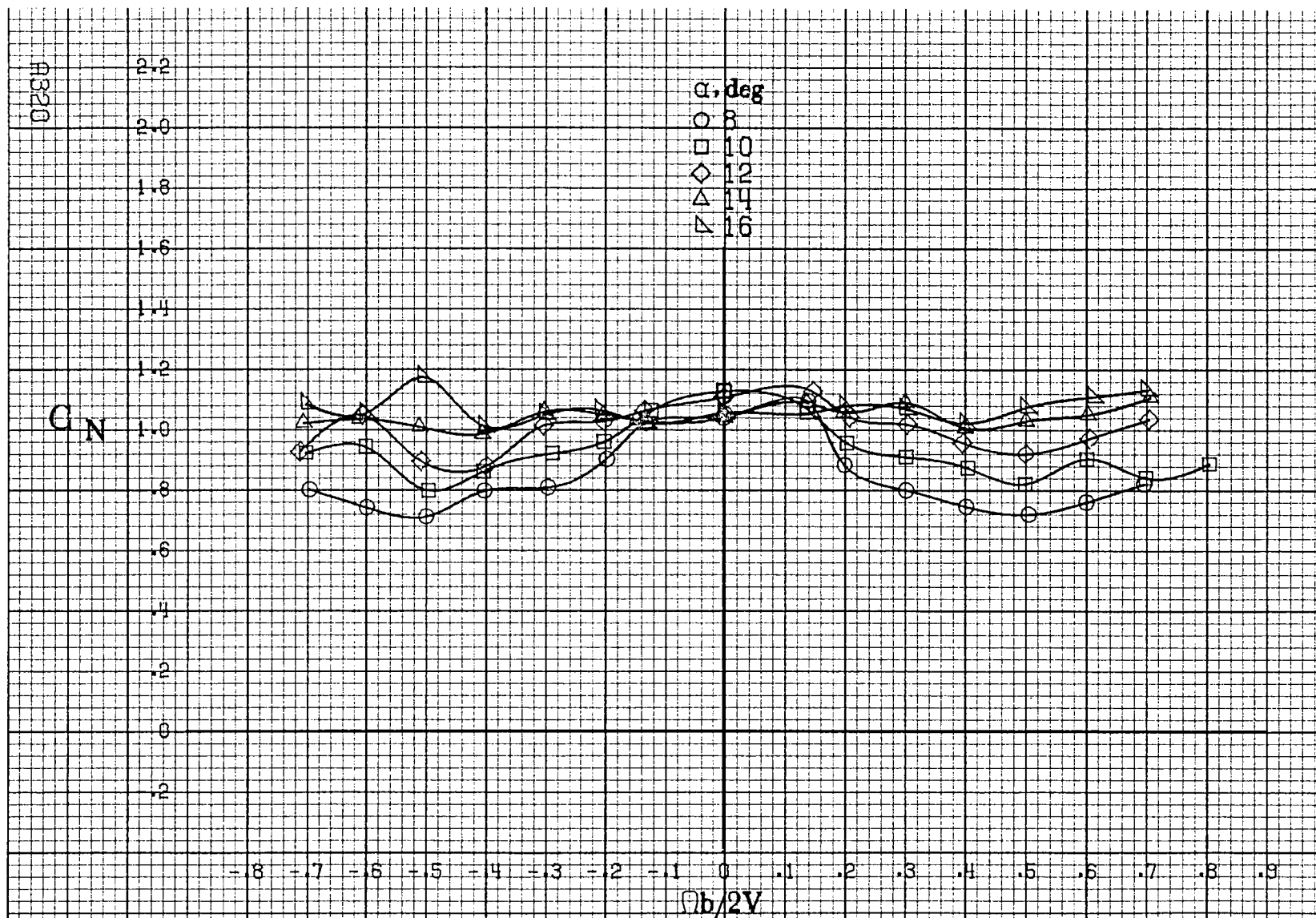

(a)  $\alpha = 8$  to  $16$  deg,  $SR = 182.9$  cm (72 in).

Figure A76.-Effect of rotation rate and angle of attack on normal-force coefficient for outboard LE wing droop with large nose radius.  $\delta_a = 0^\circ$ ,  $\delta_r = 0^\circ$ ,  $\beta = 0^\circ$ .

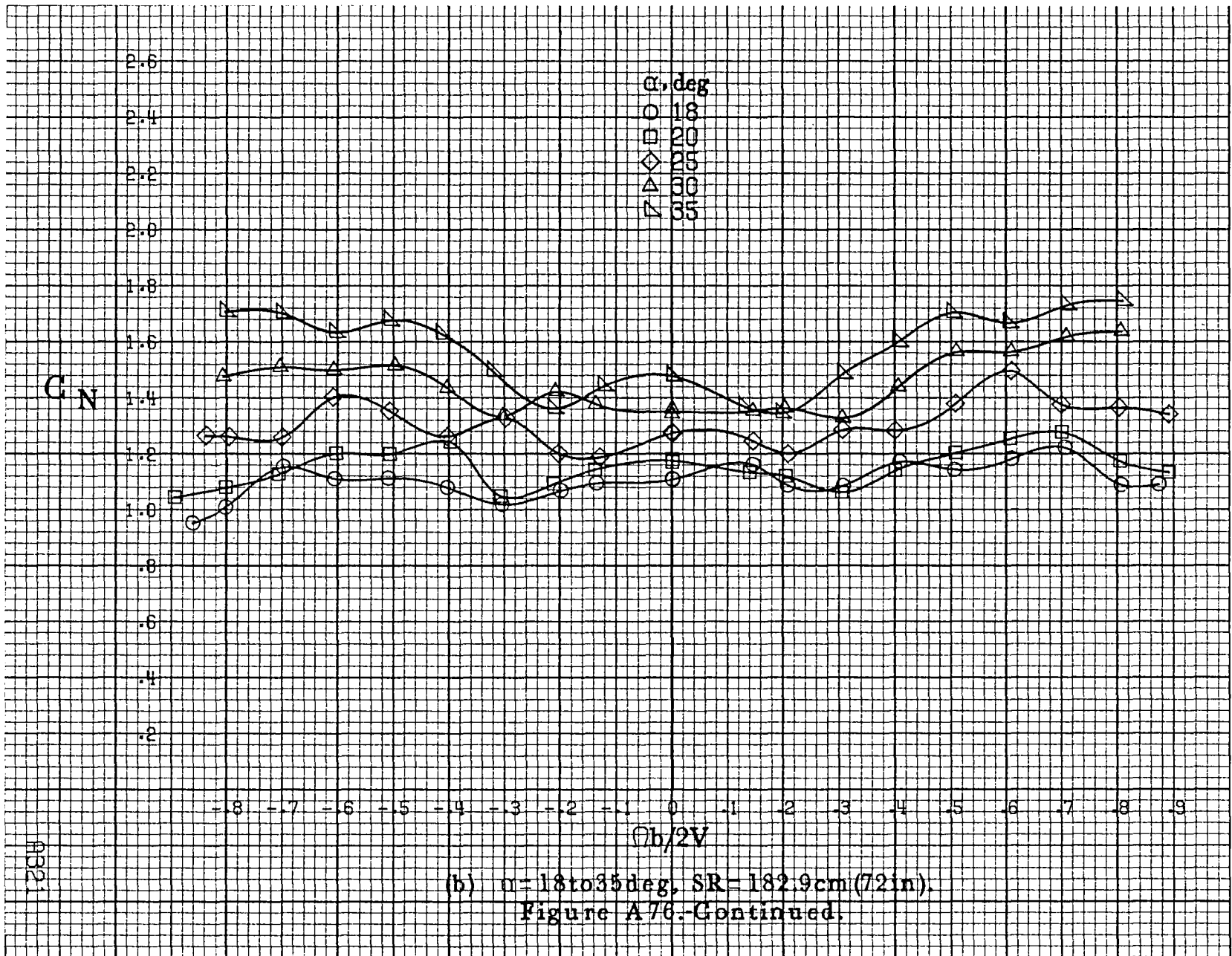

AB21



RB22

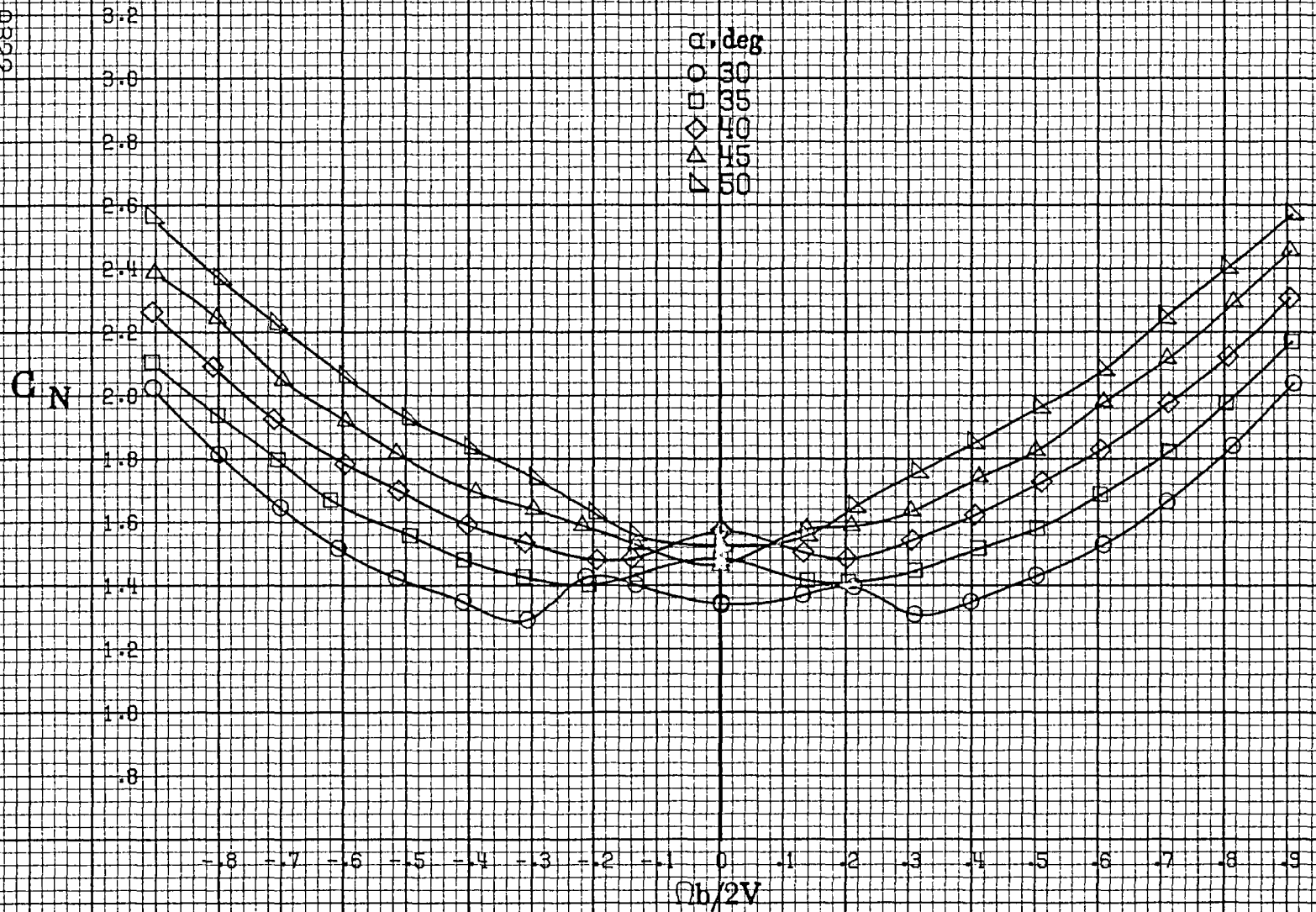

(c)  $\alpha=30$  to  $50$  deg,  $SR=0$ .  
Figure A76.-Continued.

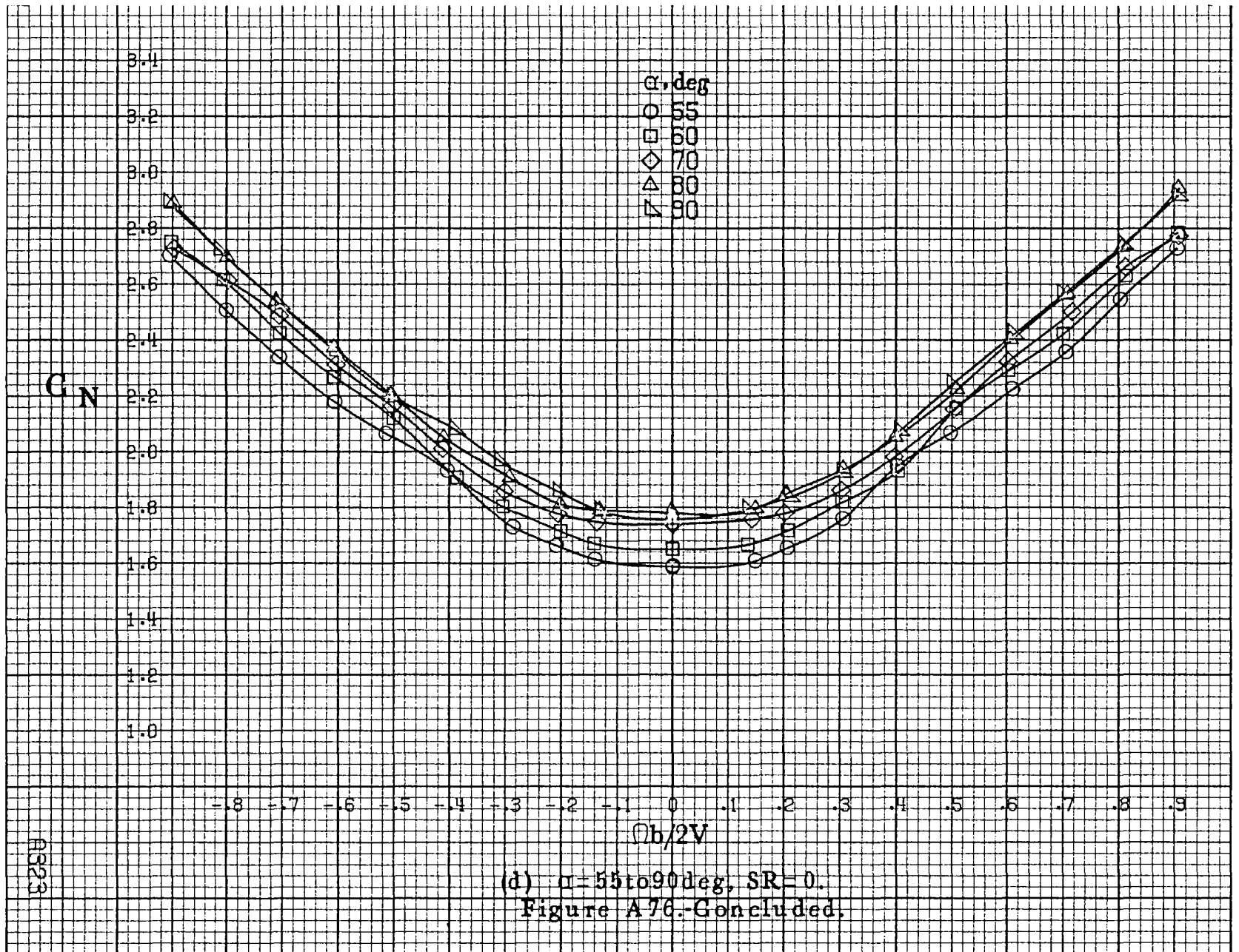

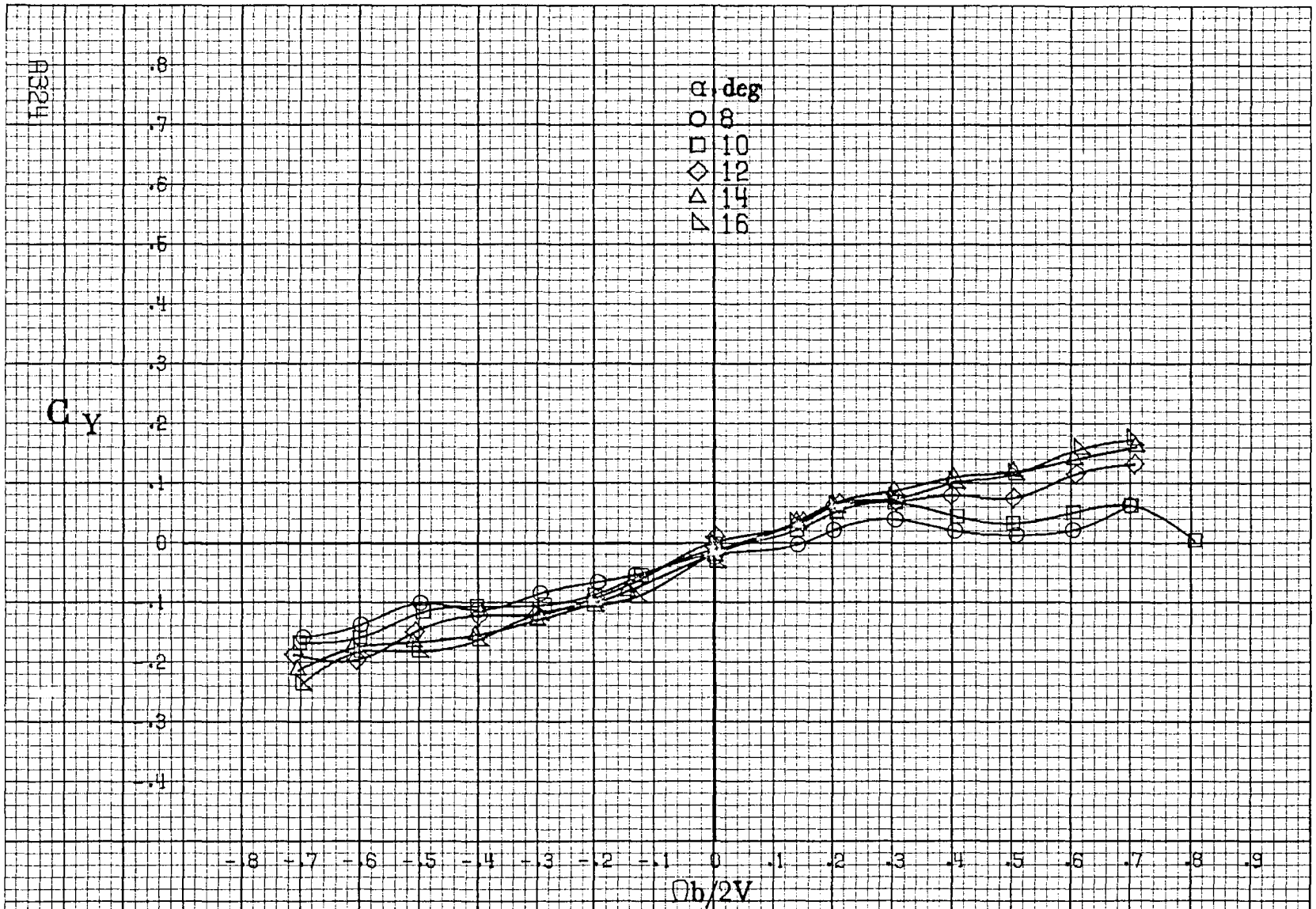

(a)  $\alpha = 8$  to  $16$  deg,  $SR = 182.9$  cm (72 in).

Figure A77. Effect of rotation rate and angle of attack on side-force coefficient for outboard LE wing droop with large nose radius.  $\delta_e = 0^\circ$ ,  $\delta_a = 0^\circ$ ,  $\delta_r = 0^\circ$ ,  $\beta = 0^\circ$ .

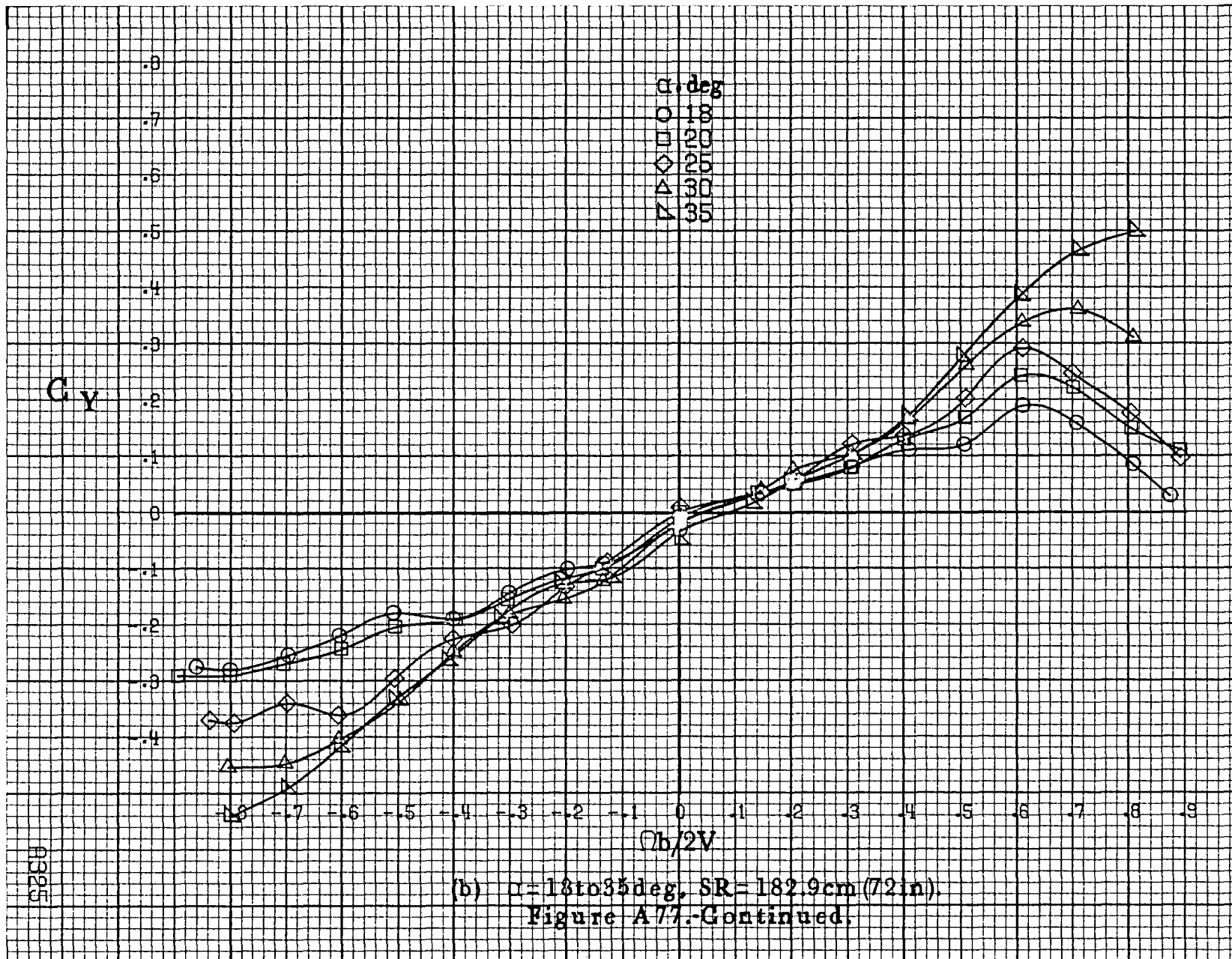

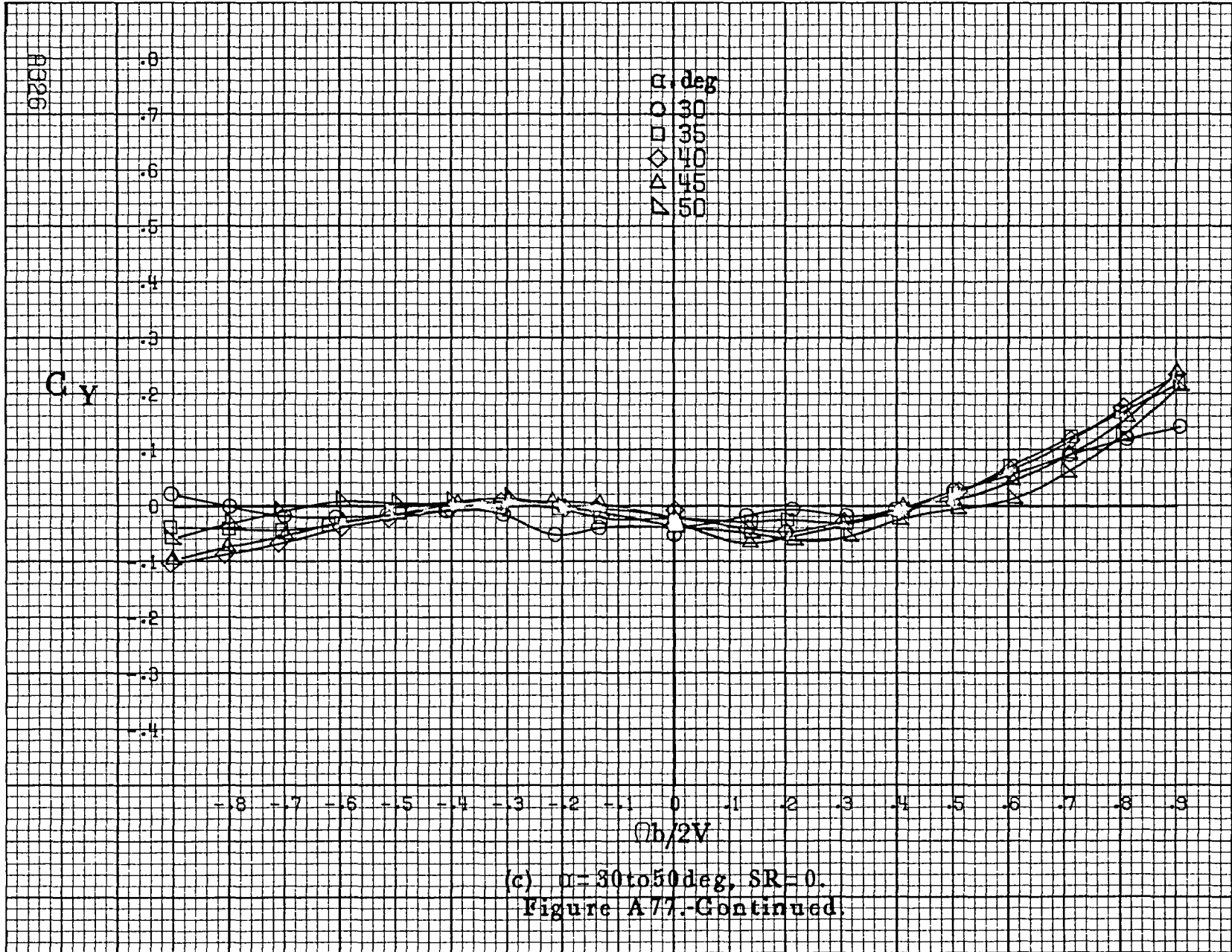

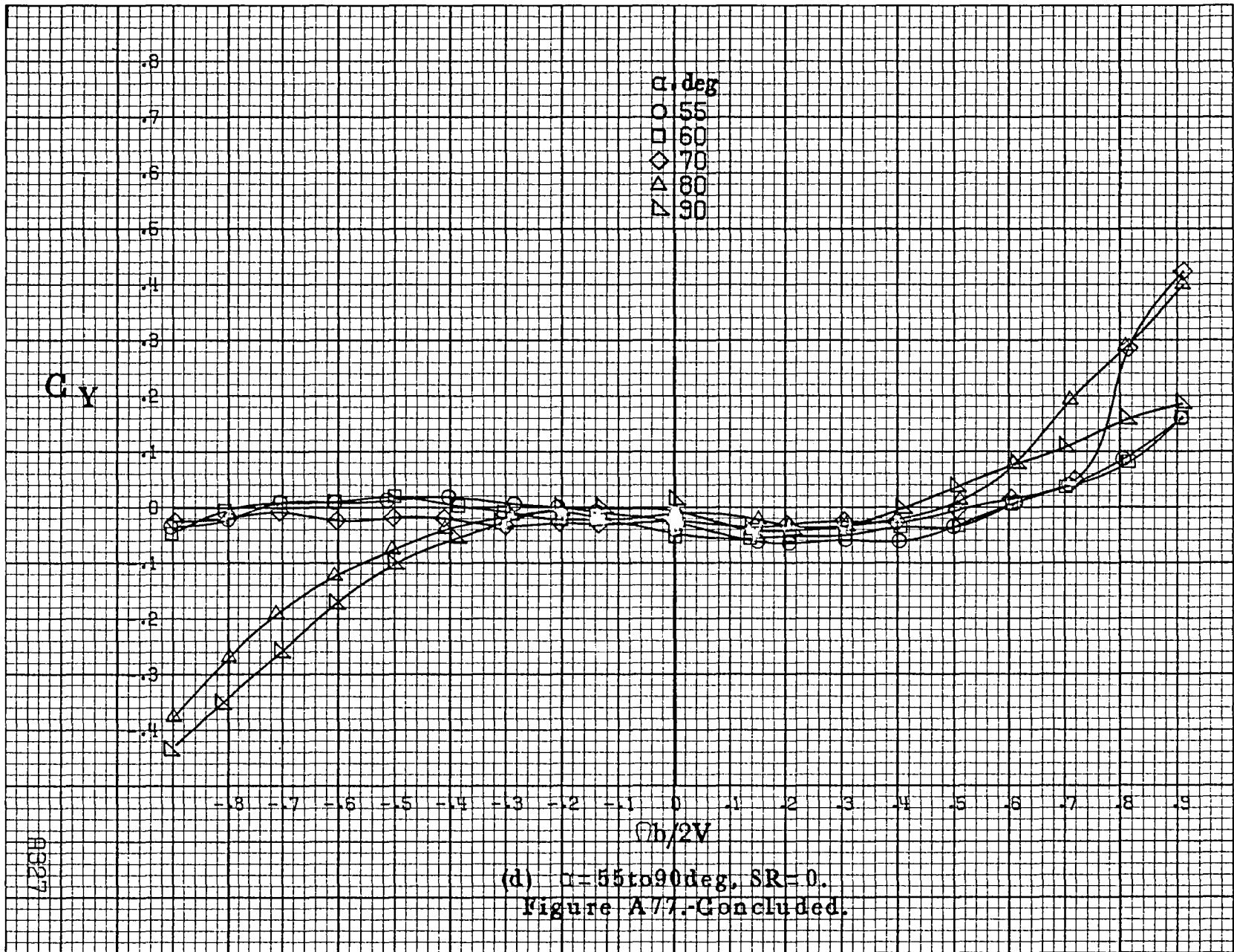

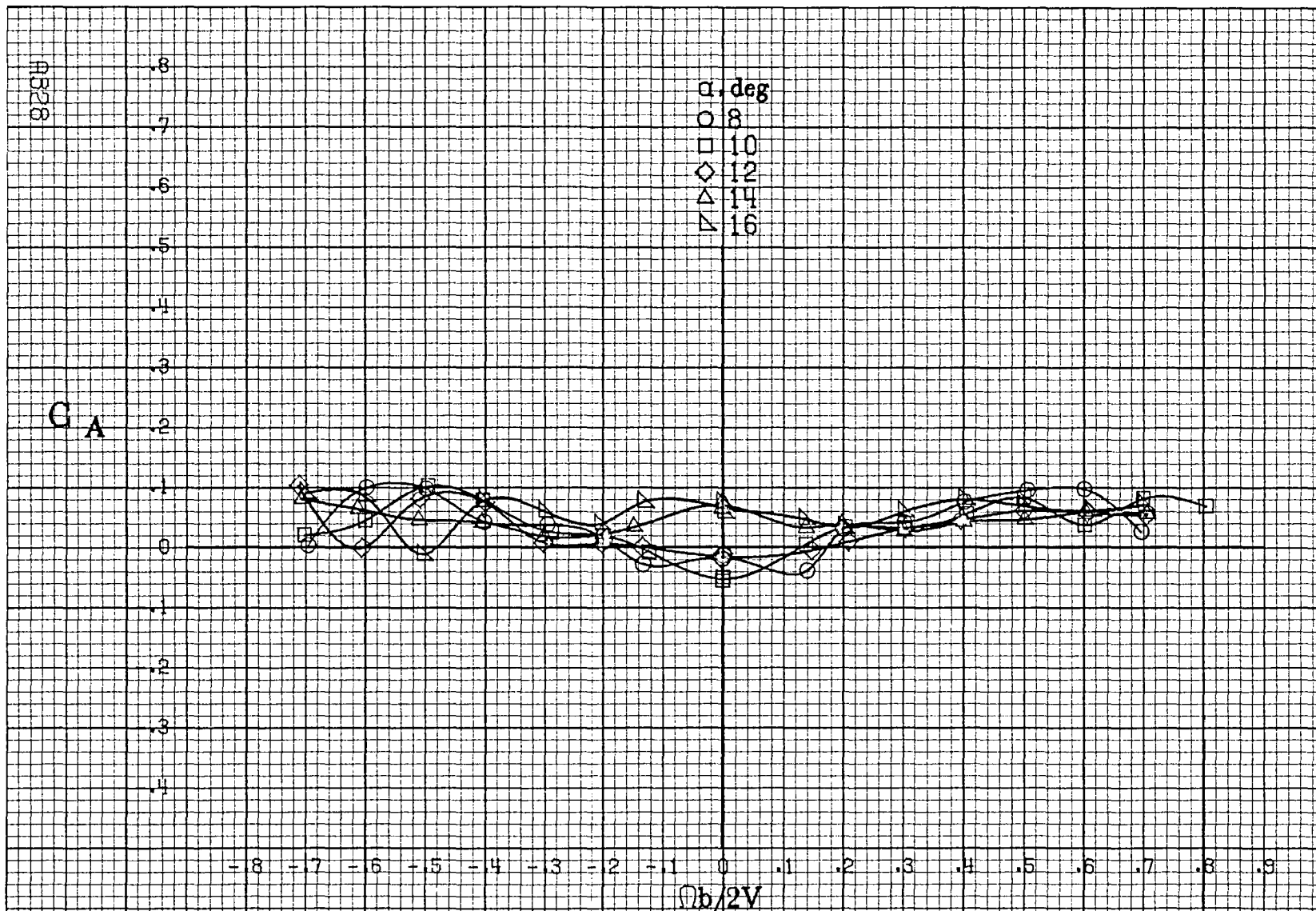

(a)  $\alpha = 8$  to  $16$  deg,  $SR = 182.9$  cm (72 in.).

Figure A78. Effect of rotation rate and angle of attack on axial-force coefficient for outboard LE wing droop with large nose radius.  $\delta_e = 0^\circ$ ,  $\delta_s = 0^\circ$ ,  $\delta_r = 0^\circ$ .  $\beta = 0^\circ$ .



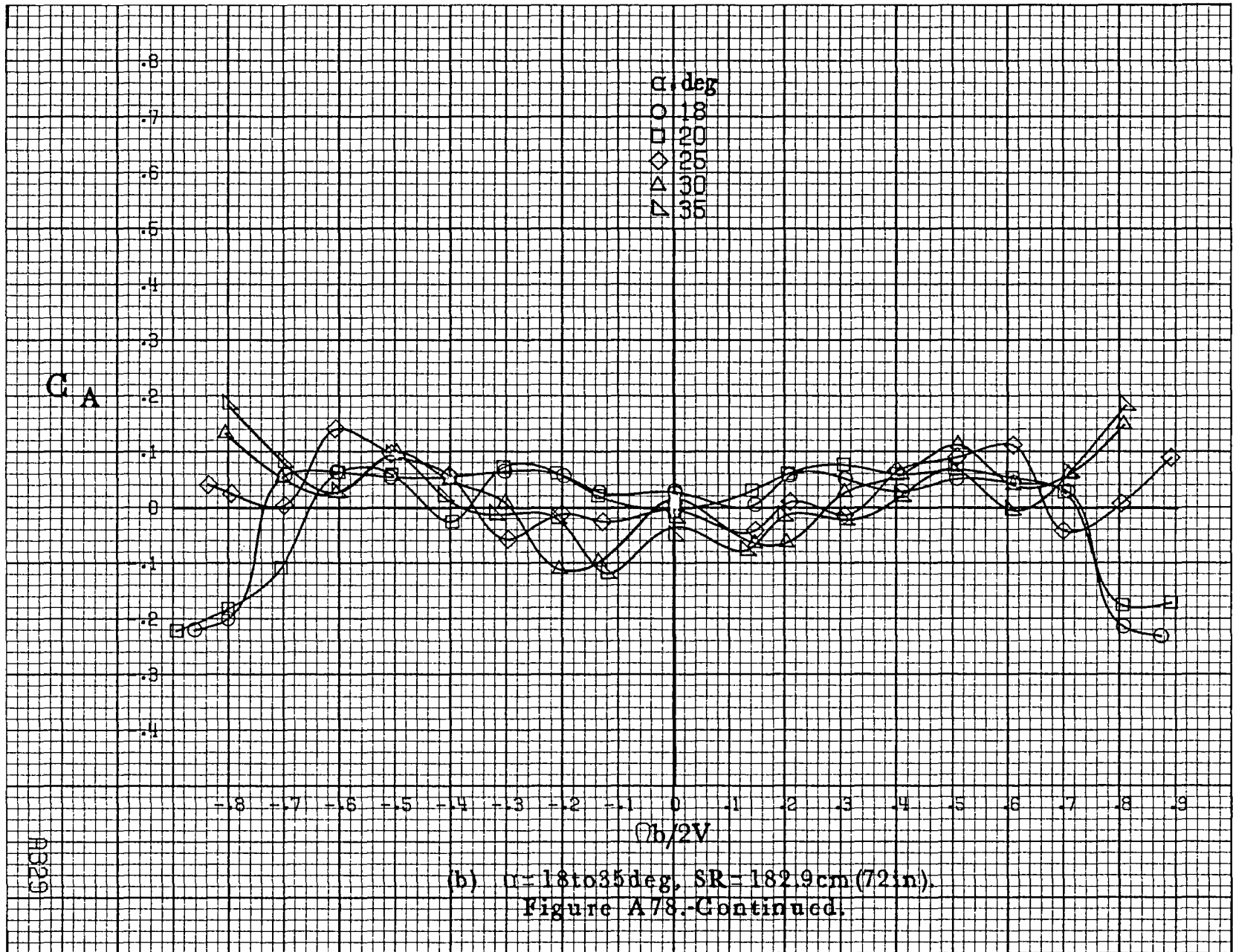

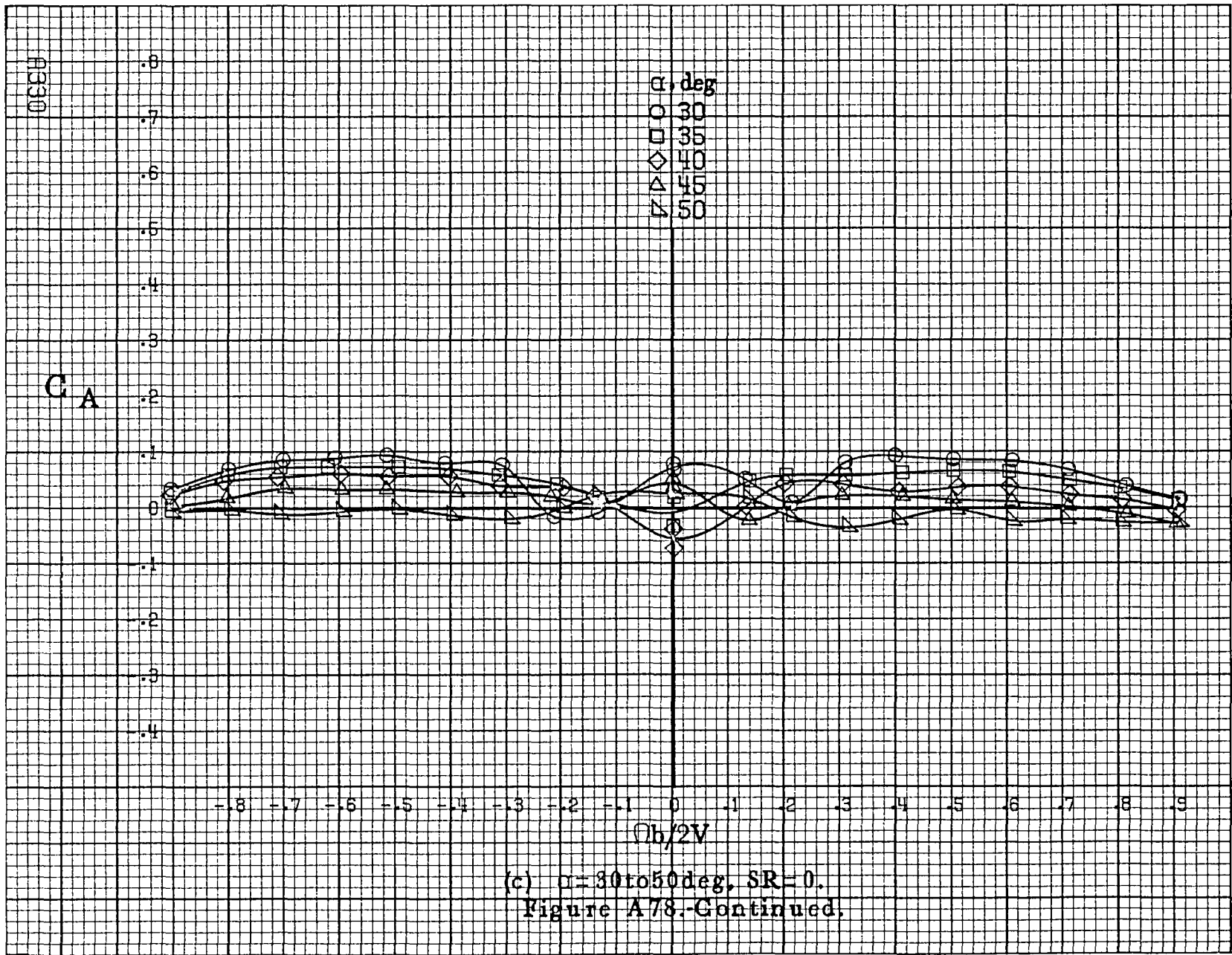

(c)  $\alpha = 30$  to  $50$  deg,  $SR = 0$ .  
 Figure A78-Continued.

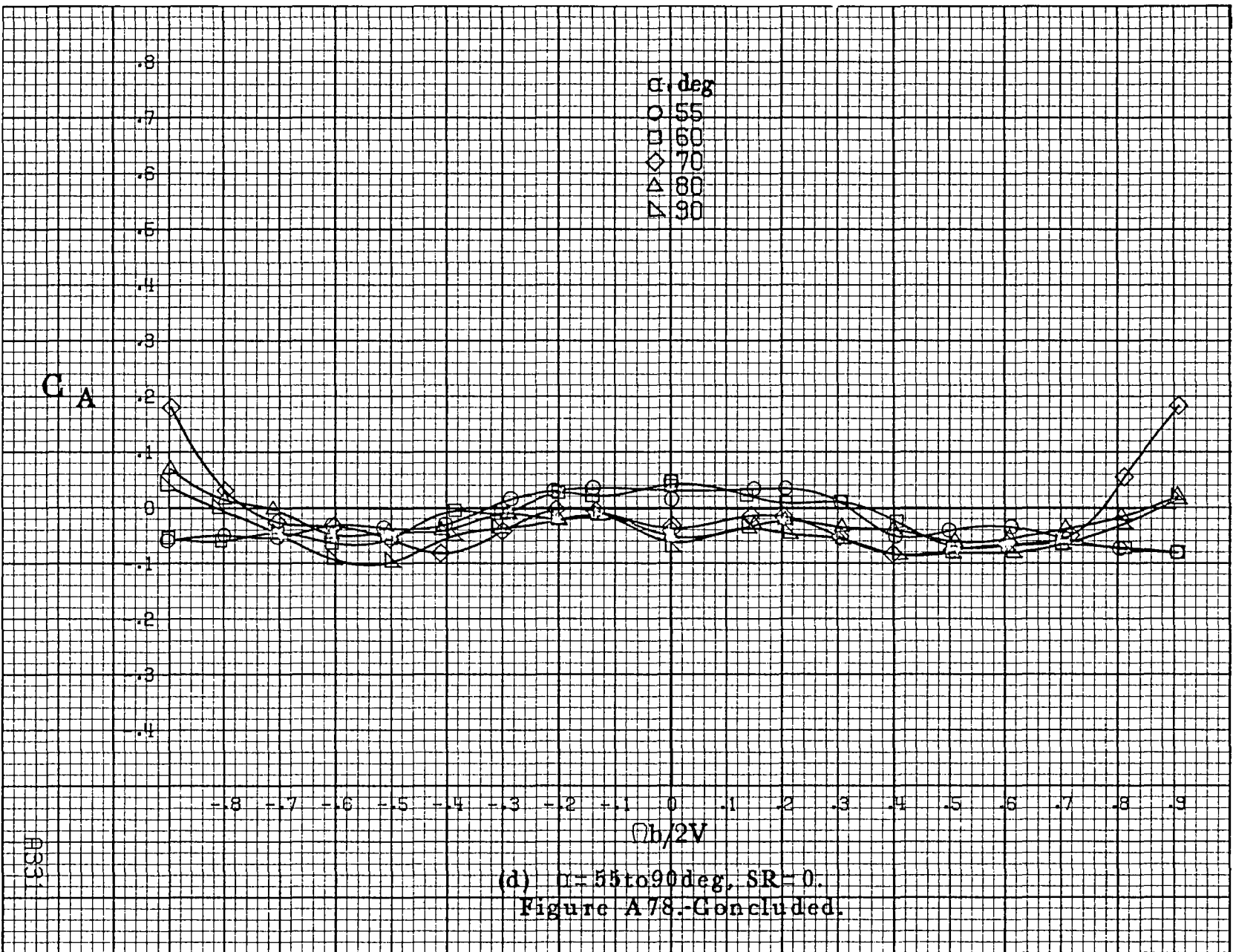

A331

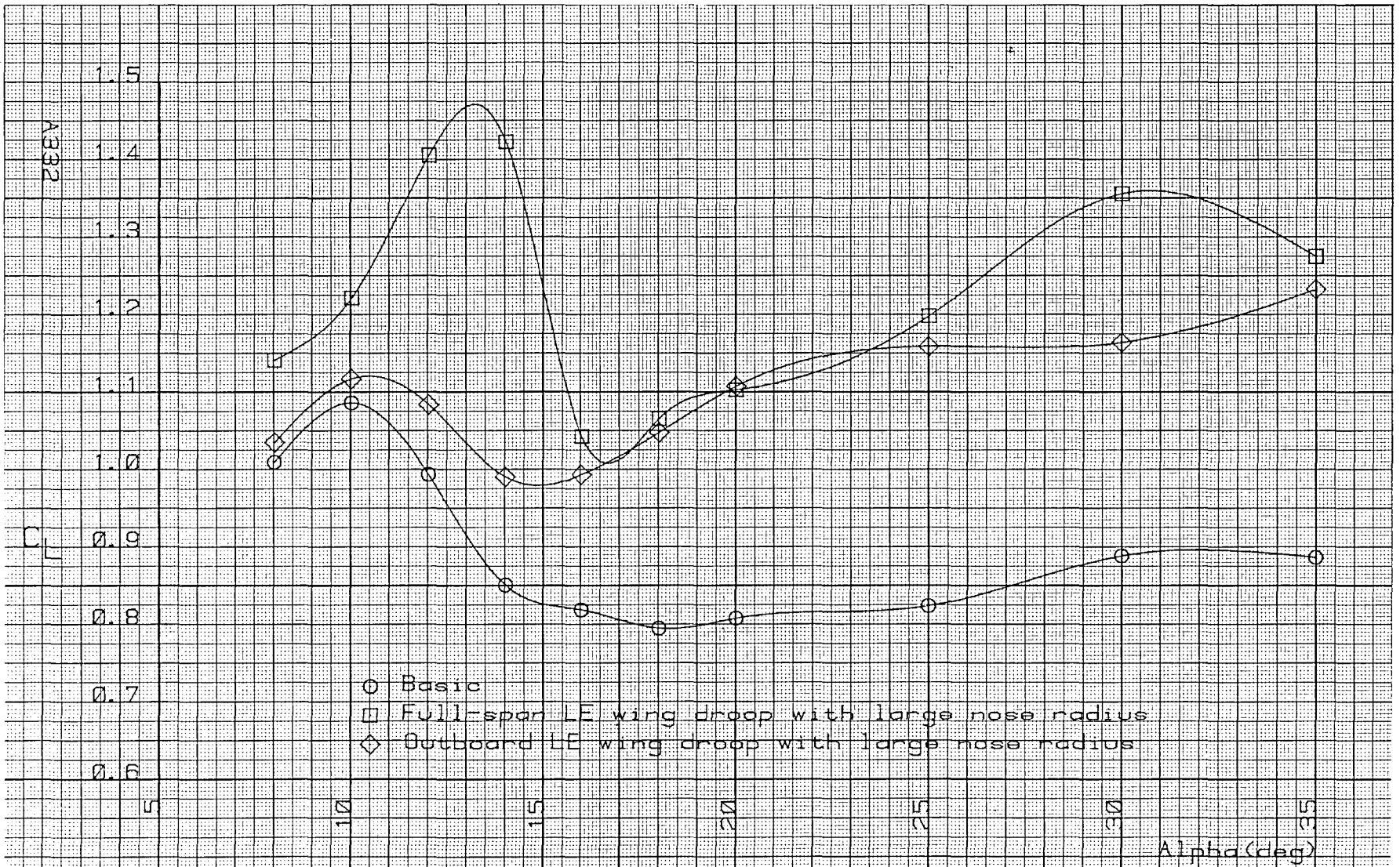
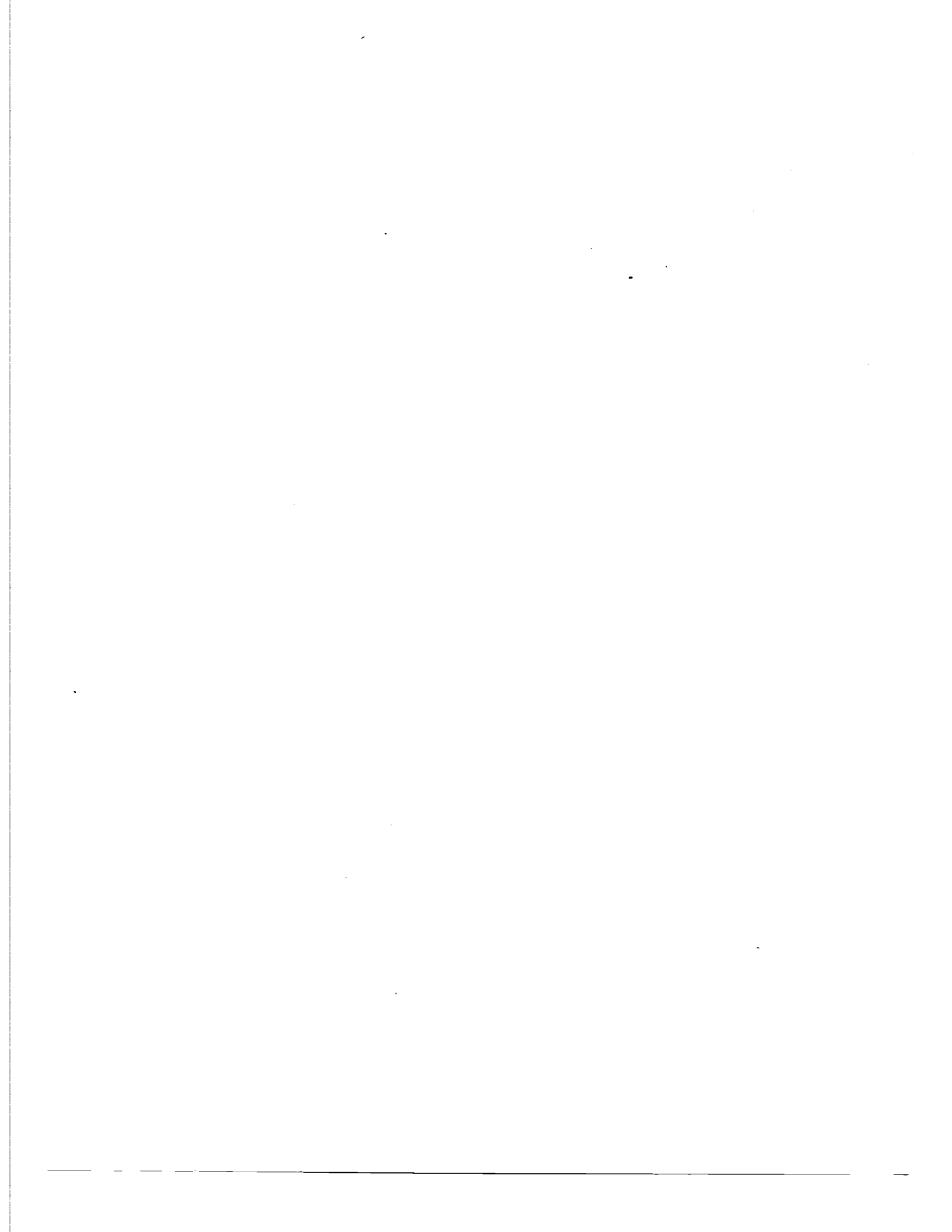
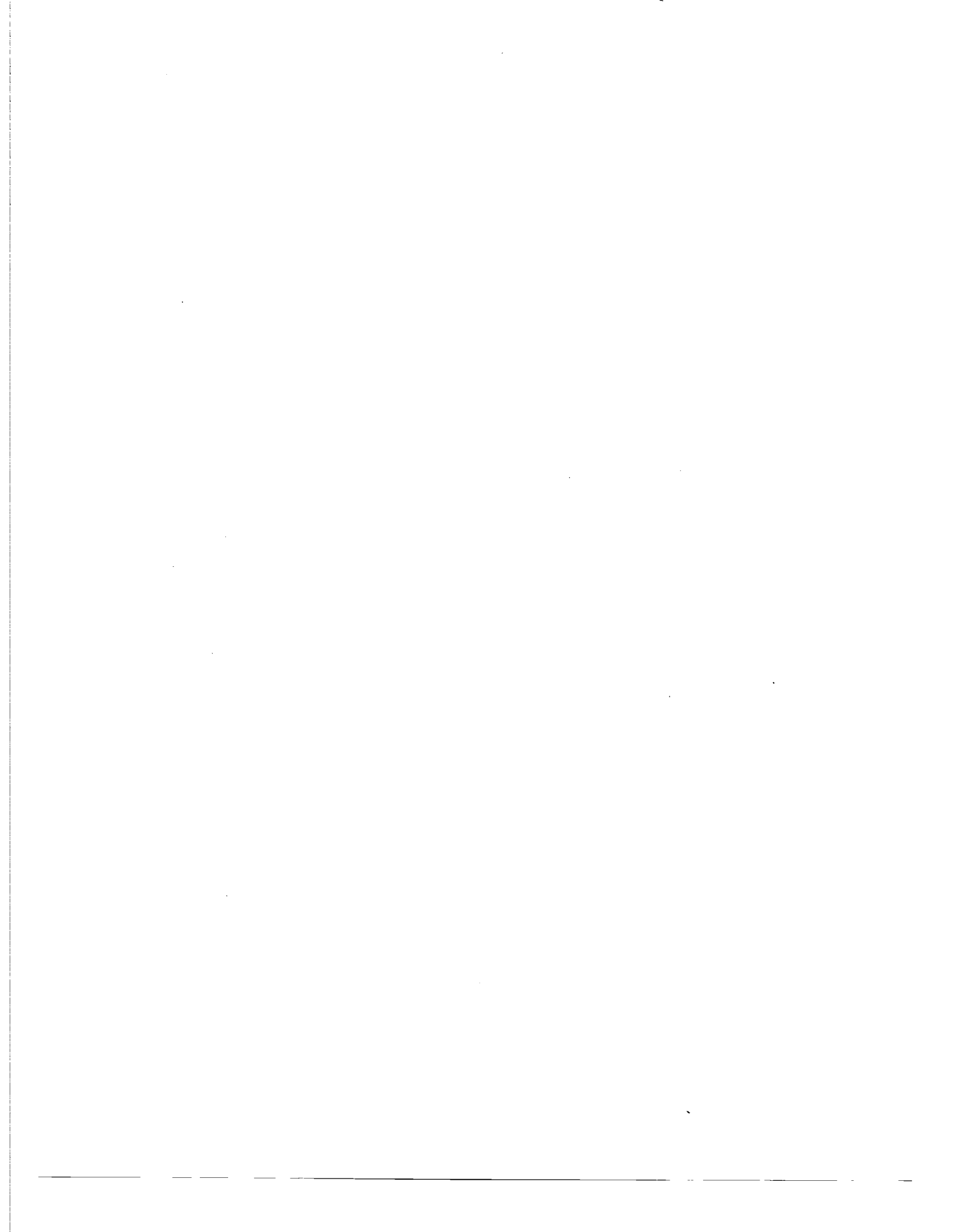

Figure A79. -Lift coefficient as a function of angle of attack for various wing LE devices.











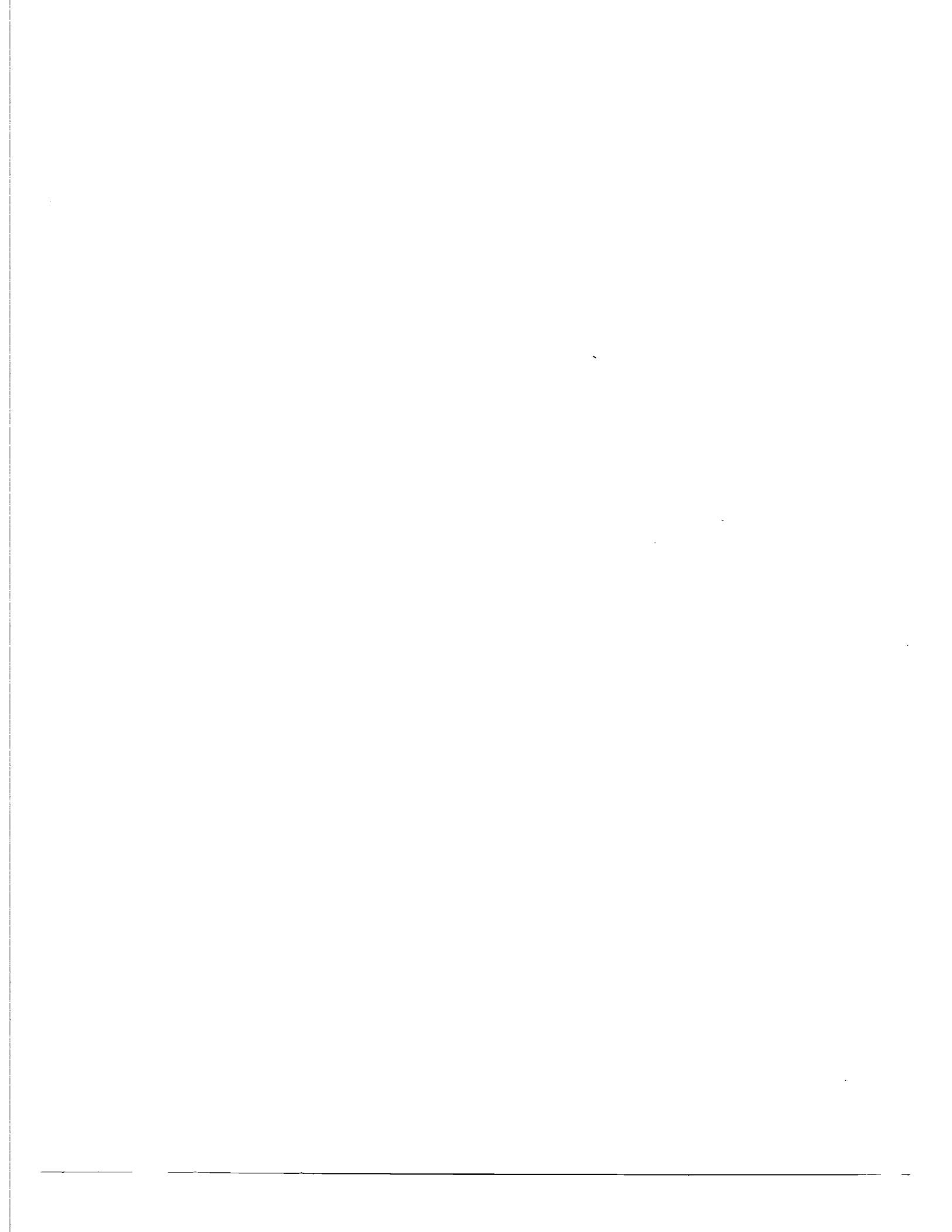





1. Report No. NASA CR-3201		2. Government Accession No.		3. Recipient's Catalog No.	
4. Title and Subtitle Rotary Balance Data for a Typical Single-Engine General Aviation Design for an Angle-of-Attack Range of 8° to 90°. II - High-Wing Model C.				5. Report Date October 1980	
				6. Performing Organization Code	
7. Author(s) Randy S. Hultberg Julio Chu Waldo L. Dickens				8. Performing Organization Report No.	
9. Performing Organization Name and Address Bihrl Applied Research, Inc. 400 Jericho Turnpike Jericho, New York 11753				10. Work Unit No. 505-10-13-06	
				11. Contract or Grant No. NAS1-14849, Task 35	
12. Sponsoring Agency Name and Address National Aeronautics and Space Administration Washington, DC 20546				13. Type of Report and Period Covered Contractor Report	
				14. Sponsoring Agency Code	
15. Supplementary Notes Langley Technical Monitor: James S. Bowman, Jr.  Topical report					
16. Abstract Aerodynamic characteristics obtained in a helical flow environment utilizing a rotary balance located in the Langley spin tunnel are presented in plotted form for a 1/6-scale, single-engine, high-wing, general aviation model (model C). The configurations tested included the basic airplane and control deflections, wing leading edge devices, tail designs, and airplane components. Data are presented without analysis for an angle-of-attack range of 8° to 90° and clockwise and counter-clockwise rotations covering an $\frac{\Omega b}{2V}$ range from 0 to .9.					
17. Key Words (Suggested by Author(s)) General Aviation Spinning Rotary Balance High angle-of-attack wind tunnel data			18. Distribution Statement  Unclassified - Unlimited  Subject Category 02		
19. Security Classif. (of this report) Unclassified		20. Security Classif. (of this page) Unclassified		21. No. of Pages 349	22. Price A15

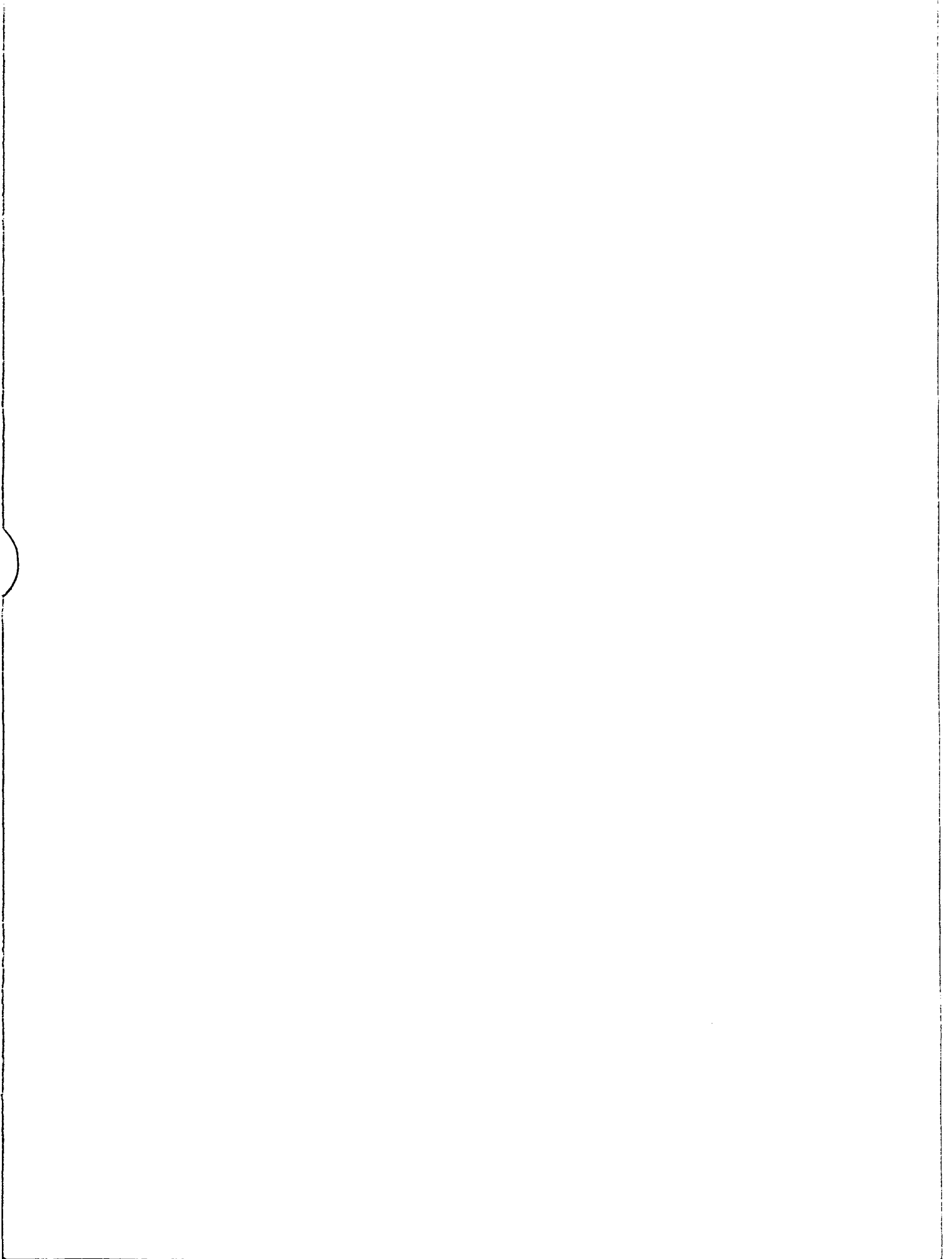

National Aeronautics and  
Space Administration

Washington, D.C.  
20546

Official Business  
Penalty for Private Use, \$300

SPECIAL FOURTH CLASS MAIL  
BOOK

Postage and Fees Paid  
National Aeronautics and  
Space Administration  
NASA-451



**NASA**

POSTMASTER: If Undeliverable (Section 158  
Postal Manual) Do Not Return

---