

DOE/NASA/23139-1
NASA TM-81502

DO NOT DESTROY
RETURN TO LIBRARY

LARGE WIND TURBINES— A UTILITY OPTION FOR THE GENERATION OF ELECTRICITY

W. H. Robbins, R. L. Thomas, and D. H. Baldwin
National Aeronautics and Space Administration
Lewis Research Center

Work performed for
U.S. DEPARTMENT OF ENERGY
Energy Technology
Distributed Solar Technology Division

Prepared for
American Power Conference sponsored by
Illinois Institute of Technology
Chicago, Illinois, April 21-23, 1980
and Annual Solar Energy Program Review sponsored by
Electric Power Research Institute
Rockport, Maine, August 26-28, 1980

30 SEP 1980
MCDONNELL DOUGLAS
RESEARCH & ENGINEERING LIBRARY
ST. LOUIS

M80-16184

NOTICE

This report was prepared to document work sponsored by the United States Government. Neither the United States nor its agent, the United States Department of Energy, nor any Federal employees, nor any of their contractors, subcontractors or their employees, makes any warranty, express or implied, or assumes any legal liability or responsibility for the accuracy, completeness, or usefulness of any information, apparatus, product or process disclosed, or represents that its use would not infringe privately owned rights.

LARGE WIND TURBINES— A UTILITY OPTION FOR THE GENERATION OF ELECTRICITY

W. H. Robbins, R. L. Thomas, and D. H. Baldwin
National Aeronautics and Space Administration
Lewis Research Center
Cleveland, Ohio 44135

Work performed for
U.S. DEPARTMENT OF ENERGY
Energy Technology
Distributed Solar Technology Division
Washington, D.C. 20545
Under Interagency Agreement DE-AI01-79ET-23139

American Power Conference sponsored by
Illinois Institute of Technology
Chicago, Illinois, April 21-23, 1980
and Annual Solar Energy Program Review sponsored by
Electric Power Research Institute
Rockport, Maine, August 26-28, 1980

Large Wind Turbines: A Utility Option for the Generation of Electricity*

William H. Robbins, Ronald L. Thomas, and Darrell H. Baldwin
National Aeronautics and Space Administration
Lewis Research Center
Cleveland, Ohio

For the past several years the Federal Government has sponsored an expanding research and development program to make renewable energy sources for the generation of electricity a viable technological alternative to conventional generating capacity. One renewable energy source, wind energy, appears to be a particularly attractive candidate in the near term.

The Federal Wind Energy program, under the sponsorship of the Department of Energy (DOE), is directed toward the development of safe, reliable, cost-effective, and environmentally acceptable machines that will generate significant amounts of electricity. The largest element of the Federal program, large wind turbine development, is managed by the NASA Lewis Research Center. There are several ongoing wind system development projects oriented primarily toward utility application within this program element (ref. 1).

First-generation-technology large wind turbines (Mod-0A and Mod-1) have been designed and are in operation at selected utility sites. Second-generation machines (Mod-2) are scheduled to begin operation on utility sites in 1981. These second-generation machines are predicted to generate electricity at less than 4¢ per kilowatt hour (in 1977 dollars) when manufactured at modest production rates. However, to make a significant energy impact, costs of 2¢ to 3¢ per kilowatt hour (in 1977 dollars) must be achieved. When these cost goals are achieved, the major use of wind turbines by utilities will be as fuel savers. The Federal program will continue to fund the development, by industry, of wind turbines that can meet the cost goals of 2¢ to 3¢ per kilowatt hour.

Lower costs will be achieved by incorporating new technology and innovative system designs that reduce weight, increase reliability, and increase energy capture. The National challenge, however, is the acceptance by the utilities of wind turbines as part of their energy-generating capability and the creation of a competitive industry to produce wind turbines efficiently. The principals—Government, industry, and the utilities—are currently involved in meeting this challenge.

This paper provides an overview of the potential of wind energy in the United States, as well as an assessment of wind turbine operational experience, the current economic status, the environmental posture, and the status of the technology.

Wind Turbine Description

NASA now has six large wind turbines in operation, with four more scheduled to be placed in operation within the next year. Several of these wind turbines are pictured in figure 1. Of the total of 10 prototype wind turbines, five are Mod-0/Mod-0A machines, one is a Mod-1 machine, and four are Mod-2 machines. The Mod-0 and Mod-0A wind turbines have rotor diameters of 125 feet and rated electric power outputs of 100 and 200 kilowatts, respectively. The Mod-1 is a larger machine,

*Also presented at Impact for the 80's, NASA Lewis Research Center, Cleveland, Ohio, May 14-15, 1980.

WIND TURBINE TECHNOLOGY

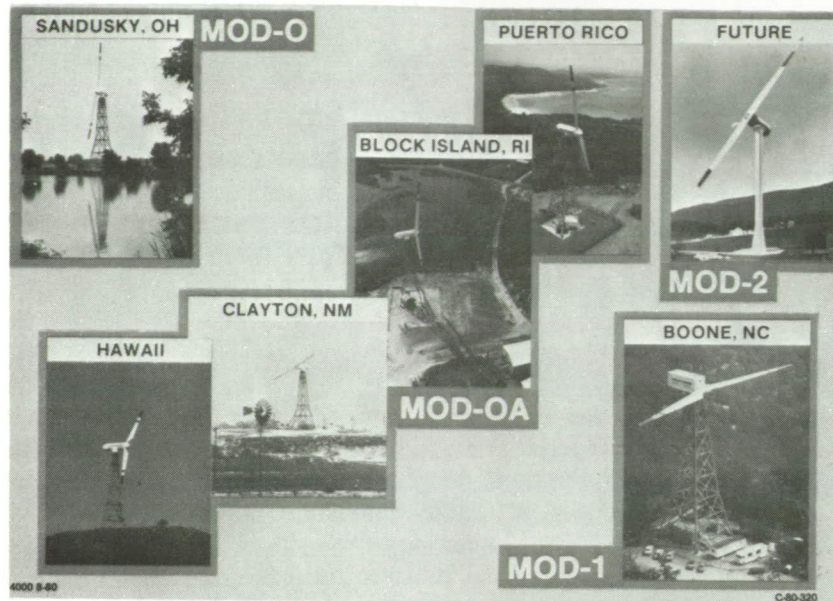

Figure 1

with a 200-foot rotor and 2000 kilowatts of rated power output. The Mod-2 will have a 300-foot rotor and 2500 kilowatts of rated power output. The rotor and the machinery pod (or nacelle) containing the drive train and other equipment are mounted on a tower 100 feet high for the Mod-0A's, and 200 feet high for the Mod-2. The Mod-0, Mod-0A, and Mod-1 wind turbines are first-generation machines that rely on high natural frequencies ("stiff" design) in the tower and rotor to avoid rotational frequency resonance. As shown in figure 2, these first-generation machines are typified by the truss tower and rigid rotor (no hinge motion between the rotor and the main shaft). In contrast the Mod-2 is a second-generation "soft" design. The lower frequency tube tower and the teeter-hinged rotor contribute to the marked difference in the appearance of the Mod-2 from the earlier designs.

The axis of rotation of the rotor is parallel (or horizontal) to the ground—thus the name horizontal-axis wind turbine. The propeller-like rotors have two blades and operate at low rotational speeds of about 20 to 40 rpm. A sketch of the interior of a 200-kilowatt wind turbine nacelle is shown in figure 3. The gearbox increases the rotor rotational speed to drive a standard synchronous generator at its design rpm. The generator output is connected to a utility network. There are two orientation control systems. The yaw control, consisting of an electric motor, a pinion shaft, and a bull gear, orients the nacelle in the direction of the wind. The pitch control system feathers the blades to control power, to start up, and to shut down. The pitch control is similar to that of an aircraft propeller.

All the wind turbines in operation or under development are automatically (microprocessor) controlled. Their operating map is shown in figure 4. The units start when the wind speed reaches about 10 mph (at a 30-ft height). As the wind speed increases, the power output also increases until rated power is attained. The power is then held constant (by feathering the blades) at the rated value until the cutout wind speed of approximately 35 mph (at 30 ft) is reached. At wind speeds exceeding this cutout speed, the wind turbine is shut down. It will not usually be cost effective to design the machines for operation at higher wind speeds. The annual energy content of the wind is small at high speeds because the wind does not reach these wind speeds often enough at most locations.

TECHNOLOGY ADVANCEMENT

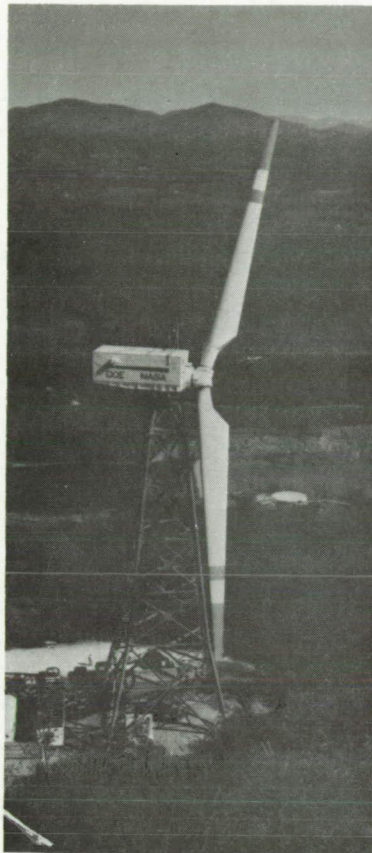

FIRST GENERATION
(MOD-0A AND MOD-1)



SECOND GENERATION
(MOD-2)

Figure 2

Assessment of Wind Energy Potential

The general land areas in the continental United States with high wind energy potential are shown in figure 5. These areas were identified in the investigations performed in reference 2. In general the Rocky Mountains block the prevailing west-to-east flow of air and the high wind potential areas are thus either through the great pass regions or around the southern end of the Rockies. Thus Wyoming and the Texas Panhandle have large areas of excellent wind potential. Other good areas are in the pass regions of Oregon, Washington, and California and in the Northeast as a result of off-shore air mass movement. A land-use survey was also conducted in reference 2. The results of that survey are summarized in figure 6, which shows the land available for wind turbines categorized into moderate, good, and excellent. Such land totals some 1.5 million square miles, with some 470 000 square miles shown as good or excellent. Included are mountain ridges and tops, rivers, tall-tree forests, and urban areas, which are not suitable for wind turbines. When such areas are removed, a total usable area of 214 000 square miles exists in the moderate-to-excellent category.

Aerodynamic interference of one turbine on others downwind is minimized when such turbines are spaced at least 15 diameters apart. Experiments now under way (the Mod-2 wind turbines will be

MOD-0A 200 kW WIND TURBINE

SCHEMATIC OF NACELLE INTERIOR

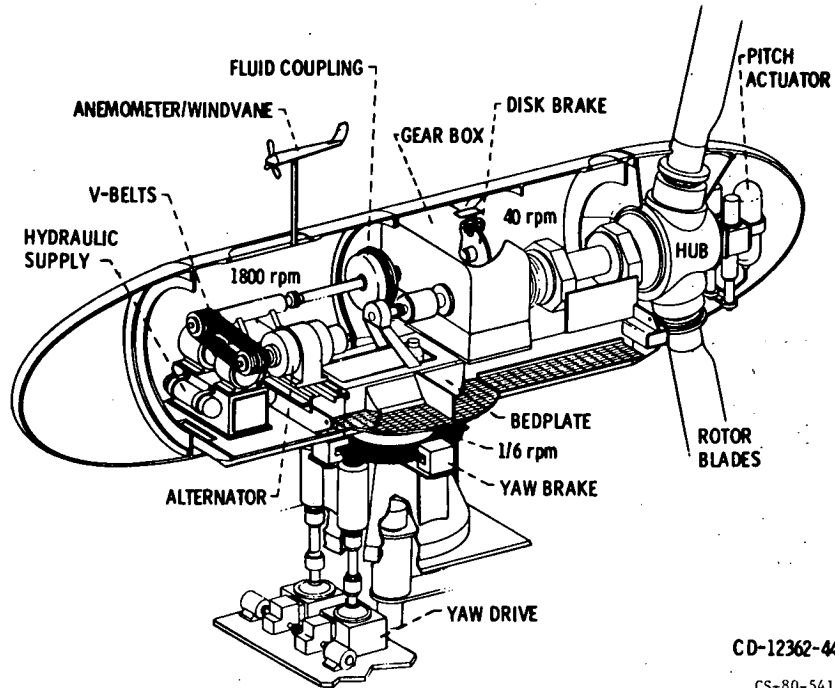

CD-12362-44

CS-80-541

Figure 3

WIND TURBINE OPERATING RANGE

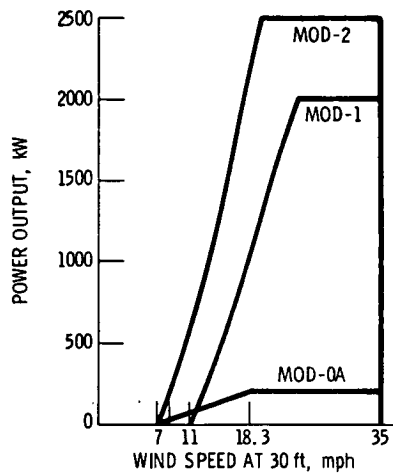

Figure 4

WIND ENERGY IN UNITED STATES

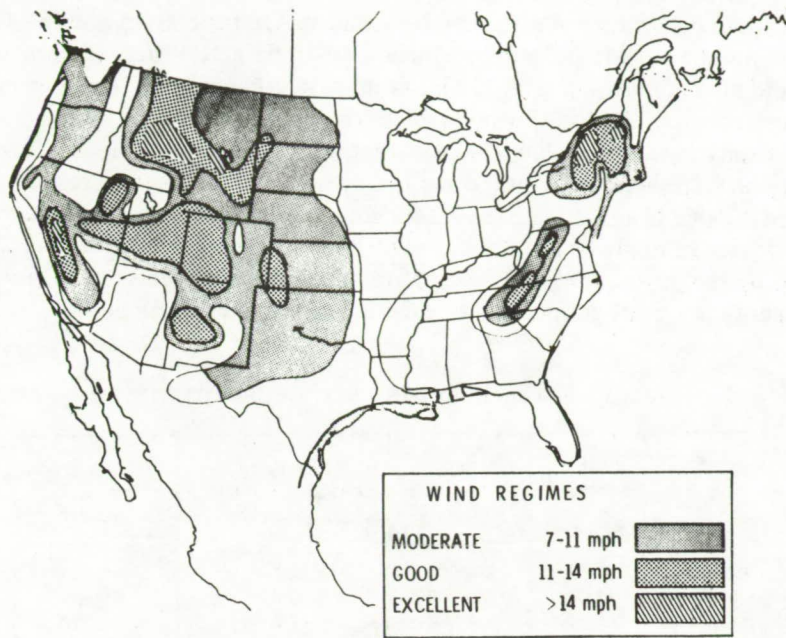

Figure 5

LAND AVAILABLE FOR WIND TURBINES

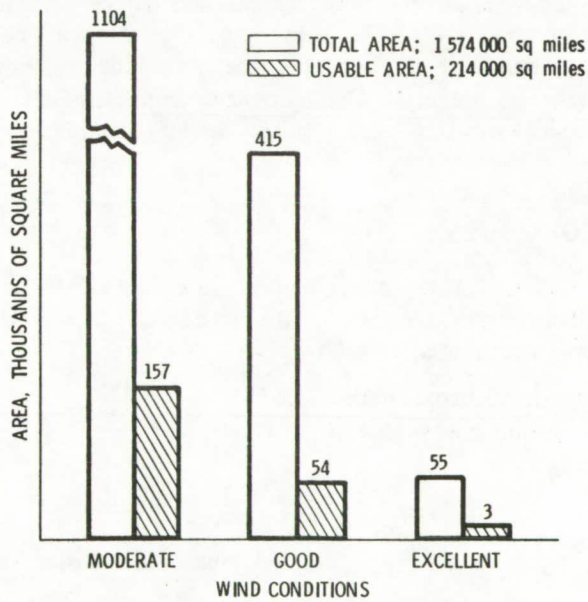

Figure 6

grouped with separations of 5, 7 and 10 diameters at Goldendale, Washington) may show that this spacing can be reduced to 10 diameters or less, especially in regions that have strong prevailing wind directions. If 10-diameter spacings are practical, the number of Mod-2's that can be installed is 2 1/4 times that which could be installed at a 15-diameter spacing. On the conservative basis of a spacing of 15 diameters, the number of Mod-2 wind turbines (300-ft diameter) that could be installed in each type of usable land area is shown in table I. This table shows that enough land area exists for 340 000 large Mod-2 wind turbines. (A Mod-2 wind turbine requires about 1 acre of ground after installation (4 acres during installation).) Thus, only 500 square miles of land out of the 214 000 square miles of wind turbine territory are actually required for the operational turbines (access roads and right of ways not included). Table I shows that the 340 000 Mod-2 wind turbines will produce on the order of 4.9 quads of electricity annually (where 1 quad = 300 billion kWh of electricity, or 172 million barrels of oil). Considering the powerplant efficiency of oil-fired utility systems, such generation will save 14.7 quads of energy per year, equivalent to some 2.5 billion barrels of oil.

TABLE I.—MAXIMUM WIND RESOURCE POTENTIAL

	Usable area, sq mi	Number of Mod-2's	Electricity produced per year, quads ^a	Energy saved per year, quads ^a
Moderate	157 000	250 000	2.7	8.1
Good	54 000	86 000	2.0	6.0
Excellent	3 000	4 800	.2	.6
Total	214 000	340 000	4.9	14.7

^a 1 Quad = 10¹⁵ Btu (300 billion kWh of electricity)
= 172 million bbl oil.

Many of the moderate wind sites will be marginal producers of cost-effective electricity, but even if they are eliminated, there is still the potential of 6 to 7 quads saved per year. This places wind energy generation in an attractive position as a potential producer of a large amount of energy. This is more fully dramatized by noting that in 1977 (fig. 7) gas and oil electric generators consumed 7.4 quads—an amount just about equal to the amount of fuel that can be saved by wind turbine generators if only the usable areas with good and excellent winds are employed. In summary, the wind energy resource has great potential. Deployment of approximately 90 000 Mod-2 size wind turbines at good and excellent wind sites can result in the large savings of 6 to 7 quads of fuel.

Wind Turbine Economics

The cost of electricity (COE) for a wind turbine is a measure of the value of the system and is reported by Ramler and Donovan in reference 3. The cost of electricity for wind turbines employed in a utility electrical network is computed as follows:

$$\text{COE, } \text{¢/kWh} = \frac{(\text{Capital costs, \$})(\text{Fixed charge rate, \%})}{\text{Annual energy, kWh}} + \frac{(\text{Annual O\&M Costs, \$})(\text{Levelized factor})(\times 100)}{\text{Annual energy, kWh}}$$

ENERGY USE IN U.S. IN 1977

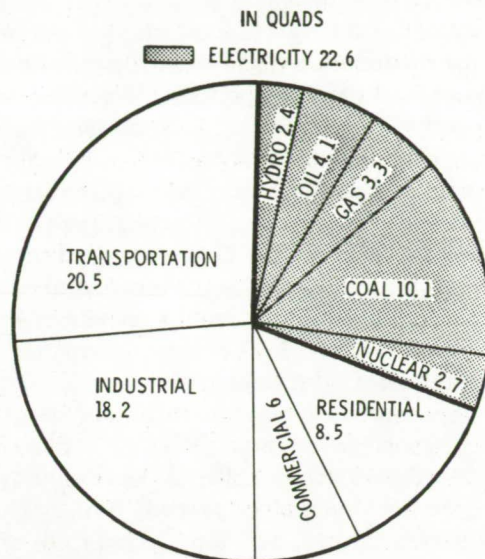

Figure 7

In most applications for the near future wind turbines will be used as fuel savers. The electric energy produced by a wind turbine in a utility system will enable the utility to reduce or shut down the generation from conventional, fuel-burning powerplants that would otherwise be required. The fuel thus saved can be credited to the wind turbine. In this mode wind turbine power would be used whenever it is generated.

The ability of wind turbines to save fuel will, in part, depend on how readily a utility's conventional powerplants can respond to changes in the wind power being produced. For modest amounts of wind power the wind power variations are expected to be of the same order as normal load variations and will appear to be a negative load to the rest of the system. At some level of wind power contribution (perhaps greater than 10 percent of system peak load), the wind variability may adversely affect system stability in the absence of short-term storage. This level must be determined by each individual utility because it depends on the conventional mix, the characteristics of the load, the variability of the wind at the wind turbine site, etc.

Most utilities use economic dispatch. Units with the lowest operational cost are dispatched first and those with the highest operational cost are dispatched last. With this strategy wind turbines will tend to save the most costly fuel being burned at any particular instant of time. At times the fuel saved will be relatively expensive gas turbine fuel (oil or gas), but at other times it will be relatively inexpensive baseload coal. (It is assumed that nuclear plants will not be throttled to save nuclear fuel.) Thus the first increment of wind turbine power added by a utility will be the most attractive. As more wind turbines are added to a system, they will tend to save less costly fuel as they meet more of the system load. Here again, each utility's fuel saving per kilowatt hour of wind turbine energy produced will be different depending on its generation mix, its cost of fuels, etc. Ultimately fuel savings attributable to wind turbines must be determined on an individual utility basis. The Department of Energy has supported a number of studies aimed at developing generic analytical techniques and approaches that can be used by utilities in this determination.

To obtain some overall feel for the COE requirements of wind turbines, one can examine the price of fuels paid by utilities. As noted, the first increment of wind turbine power added by a utility will tend to save the most expensive fuel being used at any instant of time when the wind turbine produces power. Successive additions will save fuels that are decreasingly costly. Thus for modest amounts of wind turbine power the average price of fossil fuels paid by a utility affords a conservative measure of

the COE that wind turbines must achieve to be generally attractive to a utility. This is a conservative approach in that the average price of fossil fuels for most utilities will be heavily weighted to their baseload fuel prices because of the predominance of baseload generation.

The estimated average price range for fossil fuels paid by 310 utilities in 1977 is shown in figure 8. The utilities included represent nearly 98 percent of all U.S. power generation by fossil fuels. Also shown is a projected cost range for 1977 to 2007 based on fuel costs escalating at the same rate as the inflation rate. Recent experience with fuel escalation has shown this to be a conservative assumption. For wind turbines to be an attractive investment as fuel savers, the projected COE must compare favorably with this projected fuel cost range. If the COE of a wind turbine is below about 6¢ per kilowatt hour, some utilities will become interested. On the other hand, if a wind turbine's projected COE is near 2¢ per kilowatt hour nearly all utilities would become interested. Therefore the wind energy cost goal of 2¢ to 4¢ per kilowatt hour (in 1977 dollars) shown on the chart is considered to be the range that will result in a substantial wind turbine market.

The position of DOE/NASA-sponsored large wind turbine systems in the utility market is summarized in figure 9. The first-generation system (Mod-1) is not competitive. However, the second-generation system (Mod-2) will produce electricity at less than 4¢ per kilowatt hour (in 1977 dollars) and therefore will penetrate the "substantial market" range. The third-generation system (Mod-5) will penetrate the market even further, with a projected COE of less than 3¢ per kilowatt hour (in 1977 dollars).

Environmental Considerations

Among the attractions of wind turbine system technologies is the fact that they are for the most part environmentally benign. They certainly can be expected to have relatively little effect on air and water quality, on ecological systems, or on solid-waste disposal requirements. Nevertheless, it has

FOSSIL FUEL COST TO UTILITIES
 EQUAL PAYMENTS FOR 30 yr - 6% INFLATION,
 FUEL INFLATION AND GENERAL INFLATION ARE THE SAME.

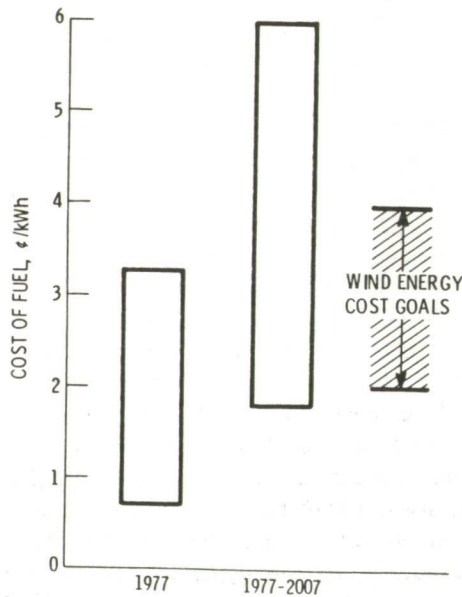

Figure 8

COST TRENDS OF LARGE WIND SYSTEMS

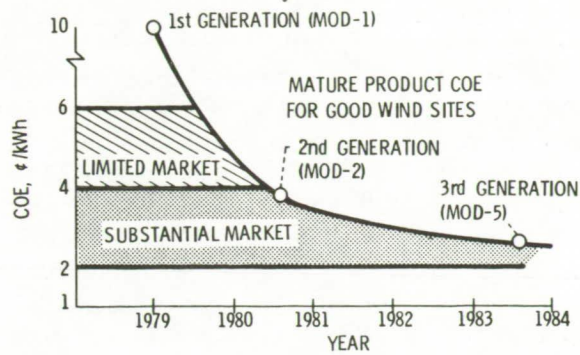

Figure 9

been important during the developmental stages to examine all possible environmental ramifications. Although a few aspects of environmental impact result in important siting considerations, no serious issues have been identified that would impede the development of wind turbine systems technologies.

All large wind turbine systems developed by DOE and NASA are designed with safety of the environment as a primary consideration (ref. 4). Foremost in this consideration is the safety of the public and of the construction and maintenance personnel. An example of such considerations is the development of an ice detection system that automatically shuts down a wind turbine generator during icing conditions to avoid the hazards to personnel and property of ice being thrown from the blades.

Three effects on the environment have been identified as possibly important considerations in the siting of wind turbine generators. The first of these, television interference, has been found to occur if large wind turbine generators are placed in areas where antenna reception is predominant. A definite zone of interference is being defined in order to identify acceptable sites (ref. 5). Tests are under way on types of television antennas that will not be affected by wind turbine operation. Obviously, homes supplied by cable television are not affected by the wind turbine. Another environmental impact important to siting is the noise associated with the motion of the blades (ref. 6). This noise, although modest in most cases, can have an adverse effect on the public. For example the Mod-1 experience at Boone, North Carolina, has shown that intermittent pressure waves (very low-frequency noise) have caused disturbing sounds in homes located close to the turbine. This is an annoyance, and NASA is conducting investigations to determine the cause and to arrive at a proper solution. The third possible environmental effect is land use and the associated potential visual pollution that may become an issue when large numbers of machines are deployed in an area. As a result, aesthetics and limited land intrusion are considerations in the wind turbine design efforts.

Early Operational Experience

At present the greater portion of wind turbine operational experience is being produced by the four operational Mod-0A machines located at Clayton, New Mexico; Culebra, Puerto Rico; Block Island, Rhode Island; and Oahu, Hawaii. The majority of operating experience and data to date has come from the Clayton machine. This machine's operation is reported in reference 7. The chronology as of July 1980 is as follows:

First rotation	November 1977
Utility turnover	March 1978
Operating time, hr	7300
Energy output, kWh650
Average percentage of Clayton power, percent	2 1/2

The system design and utility-wind turbine compatibility have been validated. Component problems in blades, controls, and electronics were identified early in the operations. However, the annual energy output has been below predictions because of losses in the start-stop cycle and yaw error.

The Clayton, New Mexico, site was an excellent choice for the first utility-operated wind turbine. The machine has been well received by the residents of the community, and its proximity to the municipal powerplant has made it convenient for service personnel when on-site presence is required. The size of the utility is such that the wind turbine can make a small but measurable contribution to the power output of the municipal system. During the period of its operation the wind turbine has produced 2 1/2 percent of the total energy used by the community and has, on occasion, during early morning hours produced over 20 percent of the total power requirements of the community. This machine has proven to be a good neighbor with low noise characteristics.

Major system design components that have been validated are the mechanical system, the control system (pitch, yaw, and microprocessor), the safety system, and the remote control and monitoring system. Compatibility with the Clayton diesel generator system has been demonstrated and is reported by Reddoch and Klein (ref. 8). The Clayton system frequency has a characteristic natural mode of oscillation of 3 hertz and a predominant mode of 1.33 hertz. The 1.33 hertz is due to the blades' rotational speed, the wind shear, and the tower shadow. There was some concern that the wind turbine might excite the utility system frequency, but it clearly does not. The operation of the wind turbine with the utility has been very satisfactory. This is partly due to the high per-unit resistance of the distribution line connecting the wind turbine to the central station. This line appears to attenuate any wind turbine oscillations to the point that they are not sensed by the diesel generators. In summary, there has been no problem in maintaining synchronism. Operation and routine maintenance have been handled by the Clayton utility operations personnel.

The major component problems that were identified early in the program were blade fatigue, control system mechanical and electronic component failures, and drive system components such as generator bearings.

Blade problems have arisen as a result of early design deficiencies and higher-than-expected loads. The blade design in the area of the root did not provide adequate strength at the joint between the wing-like structure and the steel root shank. Stress concentrations and wear in this area caused fatigue cracks after only 1000 hours of service. Also, blade loads higher than predicted were encountered in service at Clayton. These high loads occurred (1) at wind speeds near the cutout wind speed of 17.9 meters per second during the safety system shutdowns, where a high feather rate is used to stop the rotor, and (2) in some periods when the yaw brake did not supply normal restraint during yaw corrections.

Adjustments have been made to eliminate these problems in the future. The blade root area has been redesigned to provide the additional strength and better load paths for load transfer to the root fittings; a blade load monitor has been added to the safety system that will shut the machine down if high loads are encountered; and the high feather rate used in safety system shutdowns was reduced.

The control system has encountered the usual control system hardware and software problems and logic changes that are associated with early operation of any new system. No fundamental problems have been observed. Typical of the character of the issues, the Clayton wind turbine experienced electrical noise and heat buildup in the microprocessor and a number of false safety system shutdowns before proper adjustments and settings were determined.

A summary of the Clayton machine performance is shown in table II. Over the past year the wind turbine has produced 57 percent of the energy expected. The reduced energy production was primarily caused by mechanical and electrical problems that decreased the expected operating time. However, in recent months, as typified by August 1979 (table II), the power production has dramatically increased and is approaching the expected energy production. The reduced annual energy production in August 1979 was caused primarily by three factors: excessive start-stop time, yaw error, and a low power setpoint. Design modifications were then made to correct the blade structural and electronic problems. The start-stop time was also decreased by 50 percent, the yaw

TABLE II.—PERFORMANCE OF MOD-0A (200 kW) CLAYTON WIND TURBINE

Time	Predicted	Actual	Synchronous time wind available	Comments
	Energy output, kWh			
August 1978 to October 1979	500 800	292 000	0.57	Energy output below expected (0.9) because of structural and electronic problems
August 1979	38 500	31 170	.83	Energy output only slightly below predicted because of start-stop time, yaw error, and low power setpoint

error deadband was decreased from ± 25 degrees to ± 7 degrees, and the power setpoint was adjusted to produce 200 kilowatts.

The original startup control system varied the blade pitch during the starting sequence at a rate from 0.1 to 0.5 degree per second and then approached synchronism by varying the pitch rate such that rpm slowly approached the synchronization rpm of 40. This procedure consumed an average of 4 minutes, as shown in figure 10(a). A new control sequence wherein the blade pitch rate during starting is increased to 1 degree per second and synchronized by slowly oscillating the blade pitch near 40 rpm reduced the startup time to 2 minutes, as shown in figure 10(b).

MOD-0A STARTUP

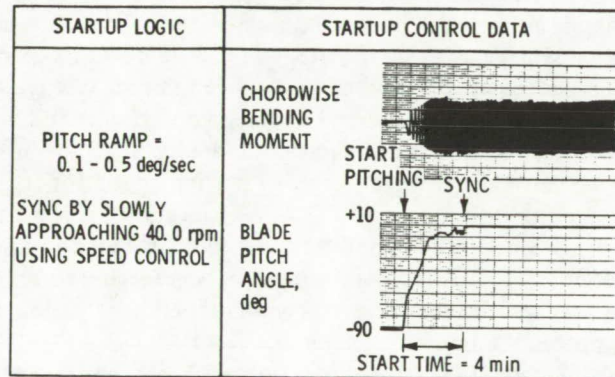

(a) ORIGINAL STARTUP CONTROL SYSTEM.

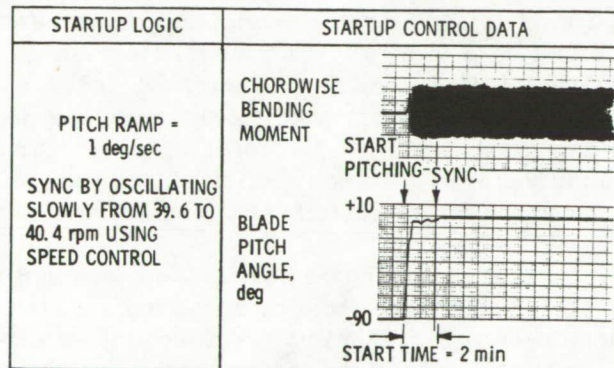

(b) IMPROVED STARTUP.

Figure 10

IMPROVED YAW ERROR CONTROL MOD-0A WIND TURBINES

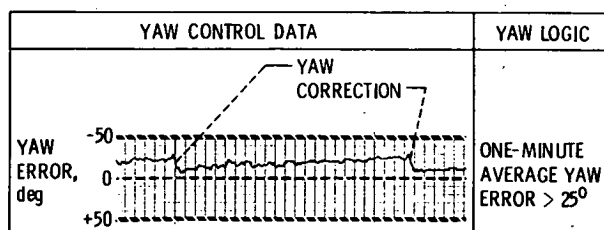

(a) ORIGINAL ANALOG YAW SYSTEM.

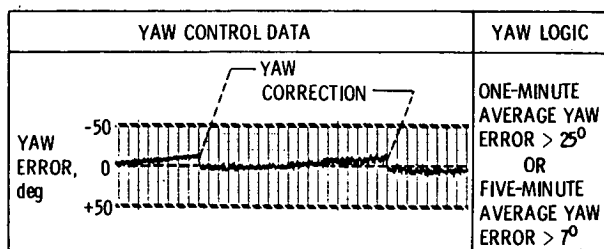

(b) MICROPROCESSOR DIGITAL YAW SYSTEM.

Figure 11

The original yaw control system was set up such that the wind direction could be misaligned up to 25° with no correction being initiated by the yaw control system. This allowed long periods during which considerable energy was lost, as shown by the trace in figure 11(a). A recent modification to the yaw system was made whereby if the wind error is more than an average of 7° for more than 5 minutes, a yaw correction is initiated. This system has given good results and holds the yaw error and thus energy losses due to yaw error to a minimum, as shown by the trace in figure 11(b).

The 1/2-hour averages of power output variation with wind speed for the Clayton machine are shown in figure 12. The general trend of measured power output agreed with the predicted output except for wind speeds near the rated wind speed. As a result of such measurements, it was concluded that the rated power setpoint of the power control system was set at 180 kilowatts rather than the current value of 200 kilowatts. Adjustments have been made, and the preliminary results show that correcting the power setpoint has solved this problem.

Preliminary results have indicated that these three control system improvements have increased the energy output.

The DOE/NASA Mod-1 wind turbine generator installed on Howard's Knob near Boone, North Carolina, was dedicated on July 11, 1979. With a rated power of 2 megawatts and a rotor diameter of 200 feet, the Mod-1 is the largest wind turbine ever constructed. Initial operation has produced preliminary test data on output power versus wind speed, rotor blade loads, system dynamic behavior, and start-stop characteristics. Figure 13 shows the power output versus wind speed measured at the present time and as of October 1979 (ref. 9). Although this is very early in the operation of this large machine, the data do show that the Mod-1 is generating the power that was expected.

A key element of the Mod-1 program that is being watched with interest is rotor blade structural performance. The largest Mod-1 blade loads, both by calculation and observation, occur during rapid feathering of the blades and stopping of the rotor from its overspeed limit of 38 revolutions per minute. Figure 14 shows a comparison between design loads for this condition and measured loads at three stations along the blades. The measured loads are the maximums of flatwise bending moments measured with strain gages while the blades were being feathered at a variety of rates. In the inboard

POWER VS WIND SPEED FOR MOD-0A WIND TURBINE
DATA FOR AUG. 1979

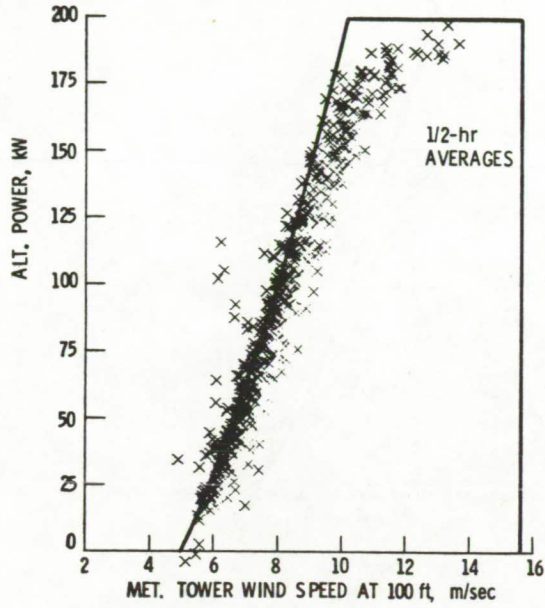

Figure 12

MEASURED AND DESIGN POWER OUTPUT FOR MOD-1 WIND TURBINE

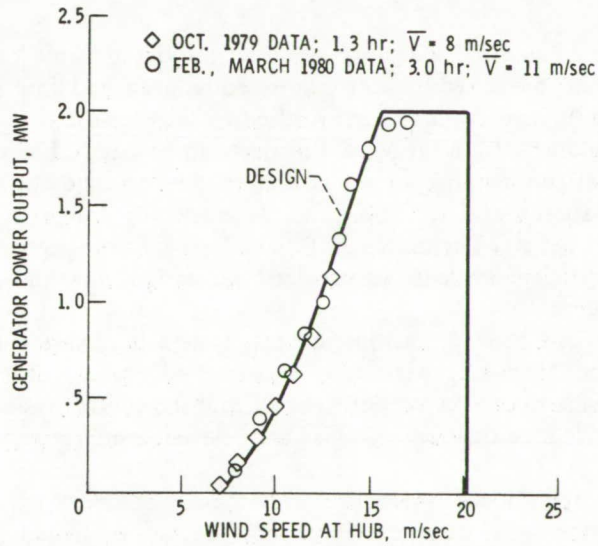

Figure 13

MEASURED AND DESIGN FLATWISE BENDING LOADS FOR MOD-1 WIND TURBINE

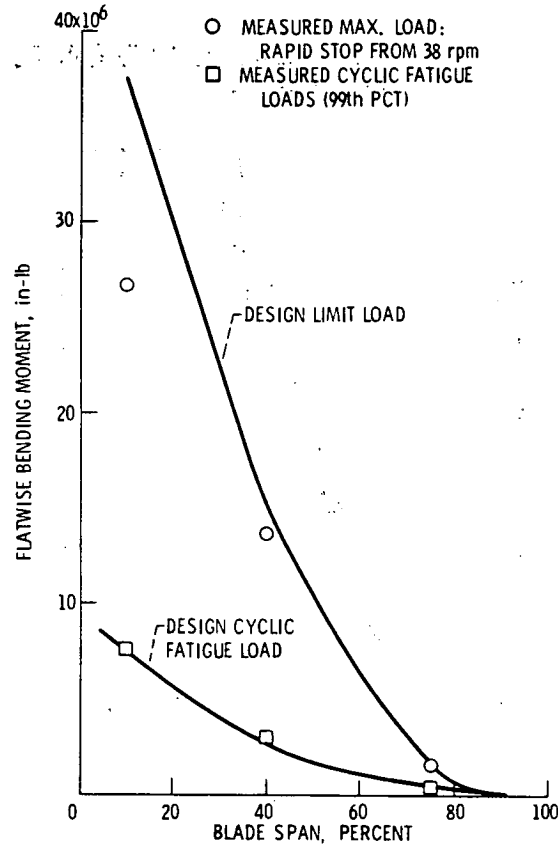

Figure 14

half of the blade the largest measured loads are less than the design limit loads. In the outboard regions of the blade, however, measured loads appear to equal predicted limit loads. In general, the procedures for establishing limit loads have been verified by these test data.

The fatigue design procedures used in the Mod-1 project can be assessed by using the summary of the blade flatwise cyclic fatigue bending moments accumulated to date shown in figure 14. The moments cover all wind speeds and directions in the operating range, starting and stopping transients, gustiness conditions, etc. The measured fatigue load spectrum agrees well with the design spectrum. Thus there is sufficient evidence to predict both design limit and cyclic loads on wind turbine blades with confidence.

In the early operation of the Mod-1 machine, control system hardware and software problems (similar to those with the Mod-0A) were also encountered. Minor software and hardware modifications have been made to correct the deficiencies, and the control system is now performing satisfactorily. Comprehensive investigations of noise and television interference are currently under way.

In summary, our early operational experience with these machines indicates that the design approach is correct, and the wind turbine/utility interface has presented no major problems. Additional operational experience is, however, required to evaluate long-term reliability, but no technological "breakthrough" is needed to make wind energy a viable energy alternative to other more conventional forms of energy.

References

1. Robbins, W. H.; and Thomas, R. L.: Large Horizontal Axis Wind Turbine Development. NASA TM-79174, 1979.
2. Wind Energy Mission Analyses. General Electric Co. for ERDA, Report COO/2578-1/3, February 1977.
3. Ramler, J. R.; and Donovan, R. M.: Wind Turbines for Electric Utilities: Development Status and Economics. NASA TM-79170, 1979.
4. Reilly, D. H.: Safety Considerations in the Design and Operation of Large Wind Turbines. NASA TM-79193, 1979.
5. Sengupta, D. L.; and Senior, T. B. A.: Electromagnetic Interference by Wind Turbine Generators. DOE Report TDI-28828, March 1978.
6. Keast, D. N.; and Potter, R. C.: Audible Noise of Constant-Speed, Wind Turbine Generators: A Preliminary Analysis. Bolt Beranek and Neuman Inc. for DOE, Report No. 4281, January 1980.
7. Glasgow, J. C.; and Robbins, W. H.: Utility Operational Experience on the NASA/DOE Mod-0A 200 kW Wind Turbine NASA TM-79084, 1979.
8. Reddoch, T. W.; and Klein, J. W.: No Illwinds for New Mexico Utility. IEEE Spectrum, vol. 16, no. 57, March 1979.
9. Spera, D. A.; Viterna, L. A.; Richards, T. R.; and Neustadter, H. E.: Preliminary Analysis of Performance and Loads Data from the 2-Megawatt Mod-1 Wind Turbine Generator. NASA-81408, 1979.

1. Report No. NASA TM-81502		2. Government Accession No.		3. Recipient's Catalog No.	
4. Title and Subtitle LARGE WIND TURBINES - A UTILITY OPTION FOR THE GENERATION OF ELECTRICITY				5. Report Date	
				6. Performing Organization Code	
7. Author(s) W. H. Robbins, R. L. Thomas, and D. H. Baldwin				8. Performing Organization Report No. E-440	
				10. Work Unit No.	
9. Performing Organization Name and Address National Aeronautics and Space Administration Lewis Research Center Cleveland, Ohio 44135				11. Contract or Grant No.	
				13. Type of Report and Period Covered	
				14. Sponsoring Agency Code Report No. DOE/NASA/23139-1	
12. Sponsoring Agency Name and Address U.S. Department of Energy Distributed Solar Technology Division Washington, D.C. 20545					
15. Supplementary Notes Prepared under Interagency Agreement DE-AI01-79ET-23139. Prepared for American Power Conference sponsored by Illinois Institute of Technology, Chicago, Illinois, April 21-23, 1980, and Annual Solar Energy Program Review sponsored by Electric Power Research Institute, Rockport, Maine, August 26-28, 1980.					
16. Abstract The wind resource is such that wind energy generation has the potential to save 6-7 quads of energy nationally. Thus, the Federal Government is sponsoring and encouraging the development of cost effective and reliable wind turbines. One element of the Federal Wind Energy Programs, Large Horizontal Axis Wind Turbine Development, is managed by the NASA Lewis Research Center for the Department of Energy. There are several ongoing wind system development projects oriented primarily toward utility application within this program element. In addition, a comprehensive technology program supporting the wind turbine development projects is being conducted. This paper presents an overview of the NASA activities with emphasis on application of large wind turbines for generation of electricity by utility systems.					
17. Key Words (Suggested by Author(s)) Wind turbines; Windmills; Wind energy conversion systems; Electric power generator				18. Distribution Statement Unclassified - unlimited STAR Category 44 DOE Category UC-60	
19. Security Classif. (of this report) Unclassified		20. Security Classif. (of this page) Unclassified		21. No. of Pages	22. Price*

~~24 NOV 80 C Pat Fisher 347/334N/21133 2 DEC 80 C~~

~~29 DEC 80 MA Mark F. Cassey E455-1106/E3/28000 6 JAN 81 MA~~

MACONNELL DOUGLAS
RESEARCH CORPORATION
1980

11 00 29 SEP RECD