

1

DEPT. OF AERONAUTICS
RESEARCH REPORT

A Reproduced Copy

OF

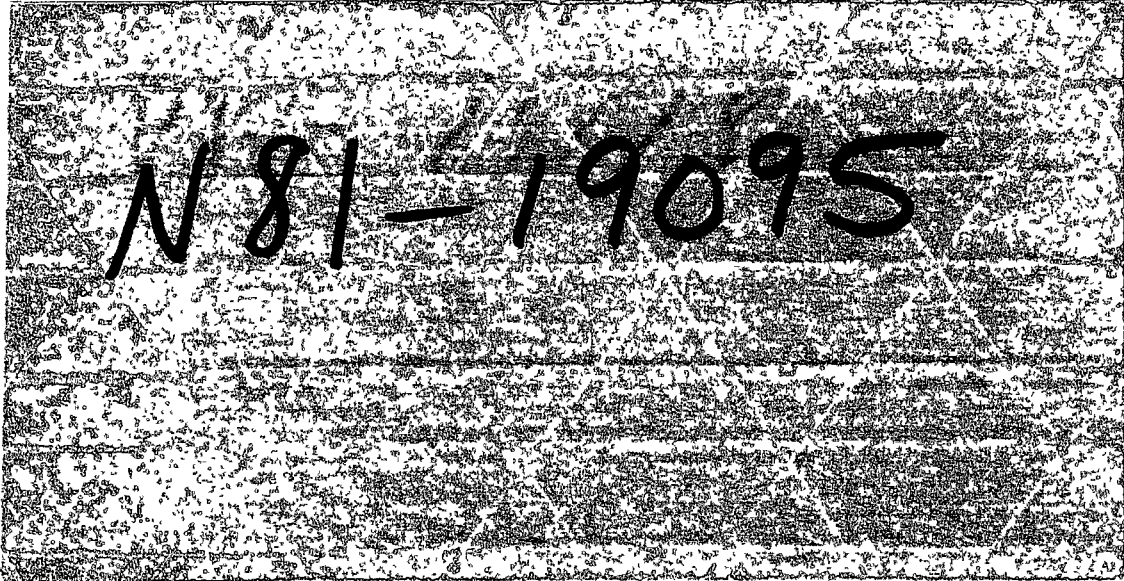

1981-19095-1

Reproduced for NASA

by the

NASA Scientific and Technical Information Facility

1 Report No NASA CR 152 321		2 Government Accession No		3 Recipient's Catalog No	
4 Title and Subtitle VIOL IN GROUND EFFECT FLOWS FOR CLOSELY SPACED JETS				5 Report Date December 1979 /	
				6 Performing Organization Code	
7 Author(s) David Migdal, William G. Hill, Jr. Richard C. Jenkins and Michael I. Siclari				8 Performing Organization Report No	
				10 Work Unit No	
9 Performing Organization Name and Address Grumman Aerospace Corporation Bethpage, New York 11714				11 Contract or Grant No NAS 2-10097	
				13 Type of Report and Period Covered Contractor Final Report	
12 Sponsoring Agency Name and Address National Aeronautics and Space Administration Washington, D.C. 20546				14 Army Project No	
15 Supplementary Notes Final Report. Technical Monitor, David Koenig, Flight Systems Research Division, NASA Ames Research Center, Moffett Field, California					
16 Abstract Results of a series of in-ground-effect twin jet tests are presented along with flow models for closely spaced jets to help predict pressures and upwash forces on simulated aircraft surfaces. The experimental data used to develop the models consist of the effect of jet spacing and height above ground on the ground and upwash pressures, oil flow visualization pictures, and the jet induced forces on a series of two and three dimensional bodies. The isolated twin jet tests revealed unstable fountains (or upwash flow) over a range of spacings and jet heights, regions of below ambient pressure on the ground, and negative pressure differential in the upwash flow field. With the simulated fuselage surfaces placed between the jets, significant positive lift forces in-ground-effect were found to result from the addition of strakes and squaring the fuselage lower contour. A separate computer code was developed for vertically oriented, incompressible jets which includes a jet impingement zone wall jet transition model. The model more accurately reflects fountain behavior without fully formed wall jets, as in the case of close jet spacing, and adequately predicts ground isobars, upwash dynamic pressure decay and fountain lift force variation with height above ground.					
17 Key words (Indexed by Author) V/STOL Wall Jet In-Ground-Effect Fountain Jet Recirculation Ground Footprint			18 Distribution Statement		
19 Security Classification Unclassified		20 Security Classification Unclassified		21 No of Pages 22	22 Price None*

CONTENTS

	Page
1 SUMMARY	1-1
2 INTRODUCTION	2-1
3 SYMBOLS	3-1
4 MODELS AND APPARATUS	4-1
5 JET PROPERTIES	5-1
6 GROUND PLANE PROPERTIES	6-1
Ground Plane Pressures	6-2
Summary Data of Maximum Ground Pressures	6-3
7 UPWASH PROPERTIES	7-1
Oil Flow Results	7-1
Summary of Upwash Pressures	7-2
Effect of Bodies on Upwash	7-5
Effect of Adding a Third Jet	7-5
8 JET INDUCED FORCES	8-1
9 THE DEVELOPMENT OF A THEORETICAL MODEL	9-1
10 CONCLUSIONS AND RECOMMENDATIONS, ...	10-1
11 APPENDIX A-Computer Program Description	11-1
12 REFERENCES	12-1

PRECEDING PAGE BLANK NOT FILED

LIST OF ILLUSTRATIONS

Fig.		Page
2-1	Modular Elements of Modeling Concept	2-2
2-2	Basic Two-Jet Interaction Flow Field	2-3
4-1	Facility 1 Flow Path	4-4
4-2	Photograph of Facility 1	4-4
4-3	Facility 2 Flow Path	4-5
4-4	Photograph of Facility 2	4-5
4-5	Segmented Diffuser	4-6
4-6	Eccentric Nozzle Mounting	4-6
4-7	Two-Fan Aircraft Configuration	4-7
4-8	Cylindrical Bodies with Different Corner Radii	4-7
4-9	Rectangular Body with Strakes	4-8
1-10	Dimensional Data for Bodies Placed in Upwash Flowfield	4-8
1-11	Model Coordinates and Nomenclature	4-9
5-1	Free Jet Profiles, $S/D = 2$	5-3
5-2	Free Jet Profiles, $S/D = 4$	5-3
5-3	Effect of Ground Plane on Nozzle Exit Pressure	5-4
6-1	Ground Plane Oil Flow Pattern for $S/D = 2.0$	6-7
6-2	Details of Ground Plane Impingement and Upwash	6-8
6-3	Ground Plane Pressure	6-9
6-4	Effect of Jet Spacing on Maximum Stagnation Line Ground Pressure	6-12
6-5	Maximum Ground Pressure on Center of Stagnation Line	6-13
6-6	Variation of Maximum Ground Pressure Along Stagnation Line	6-14
6-7	Maximum Ground Pressure Variation Along Stagnation Line	6-14
6-8	Ground Pressure Variation Across Center of Stagnation Line	6-15
6-9	Variation of Ground Stagnation Line Characteristics with H/D	6-16
6-10	Integrated Ground Pressure Force	6-16

LIST OF ILLUSTRATIONS (CONT)

Fig.		Page
7-1	Upwash Oil Flow Photographs	7-7
7-2	Pressure Profiles Across Upwash Centerline	7-10
7-3	Dynamic Pressure Profiles Across Upwash	7-11
7-4	Dynamic Pressure Decay Along Upwash Centerline	7-11
7-5	Variation of Dynamic Pressure Along Upwash (X).	7-12
7-6	Upwash Properties at Nozzle Exit Plane	7-13
7-7	Maximum Dynamic Pressure in Upwash at Nozzle Exit Height	7-14
7-8	Effect of Three Classes of Bodies on Upwash Properties	7-14
7-9	Effect of Aircraft on Upwash Development	7-15
7-10	Effect of Third Jet on Maximum Dynamic Pressure Along Two Jet Upwash	7-16
7-11	Effect of Third Jet on Maximum Dynamic Pressure Along Two Jet Upwash	7-16
7-12	Comparison of Fountain and Upwash Properties	7-17
7-13	Path of Maximum Fountain Dynamic Pressure	7-18
8-1	Effect of Jet Spacing on Aircraft Forces	8-5
8-2	Strakes Used on the Aircraft Model	8-6
8-3	Effect of Strakes on Jet Induced Forces	8-6
8-4	Flow Visualization of Upwash on Fuselage	8-8
8-5	Effect of Corner Radius on Fuselage Forces	8-8
8-6	Body Pressure Distribution	8-9
8-7	Effect of Strake Depth on Fuselage Forces	8-9
8-8	Effect of Body Width on Interference Force	8-10
8-9	Interference Forces on Rectangular Body	8-11
8-10	Strake Height Effect on Rectangular Body	8-11
8-11	Strake Location Effect on Rectangular Body	8-12
8-12	Suckdown Results With Large Flat Plate	8-12
9 1	Jet Impingement Region	9-44
9-2	Two-Jet Interacting Flows-Negligible Deflection Zone Interaction	9-44

LIST OF ILLUSTRATIONS (CONT)

Fig.		Page
9-3	Two-Jet Interacting Flow with Deflection Zone Interaction	9-45
9-4	Flow Behavior Just Prior To Coalescence	9-46
9-5	Jet Half-Velocity Width Model	9-47
9-6	Jet Decay Model	9-47
9-7	Definition of Scaling Parameters for Jet Impingement and Wall Jet Regions	9-48
9-8	Jet Impingement Region-Ground Plane Pressure Distribution	9-49
9-9	Wall Half-Velocity and Boundary Layer Thickness Models	9-49
9-10	Wall Jet Profile Models	9-50
9-11	Comparison of Initial Profile and Exact Solution	9-50
9-12	Wall Jet Model of Boundary Layer to Shear Layer Thickness	9-51
9-13	Typical Variation of Wall Jet Profile as a Function of Radial Distance	9-51
9-14	Turbulent Wall Jet Transition Model	9-52
9-15	Wall Jet Transition Model Maximum Velocity	9-52
9-16	Two-Jet Impingement Without Deflection Zone Interaction	9-53
9-17	Upwash Maximum Ground Pressure	9-54
9-18	Maximum Ground Pressure Distribution Along Upwash Stagnation Line	9-54
9-19	Upwash Momentum Model	9-55
9-20	Schematic Representation of Two-Jet Impingement Problem with Deflection Zone Interaction	9-55
9-21	Ground Plane Pressure Distributions ($X = 0$)	9-56
9-22	Ground Plane Pressure Distribution	9-56
9-23	Ground Plane Pressure Distribution ($S/D = 2.0$)	9-57
9-24	Computed Ground Isobars	9-58
9-25	Ground Isobars	9-59
9-26	Comparison of Measured Ground Pressures with Prediction	9-60
9-27	Characteristic Scaling Parameters for Upwash Model	9-61
9-28	Upwash Centerline ($X = 0$) Characteristics	9-62
9-29	Upwash Dynamic Pressures ($W/D = 4.0$)	9-63

LIST OF ILLUSTRATIONS (CONT)

Fig.		Page
9-30	Upwash Dynamic Pressures ($h/d = 3.0$)	9-63
9-31	Upwash Dynamic Pressures at Nozzle Height	9-64
9-32	Upwash Dynamic Pressures ($h/d = 6.0$)	9-64
9-33	Upwash Dynamic Pressures	9-65
9-34	Upwash Total Pressure	9-65
9-35	Upwash Dynamic Pressures at Centerline ($x = 0$)	9-66
9-36	Schematic of Momentum Capture Model	9-66
9-37	Typical Results Using Momentum Capture Model	9-67
9-38	Sketch of Upwash Force Prediction Parameters	9-68
9-39	Approximate Drag Models	9-69
9-40	Flat Bottom or Rectangular Cross Section Drag Coefficient	9-69
9-41	Circular Cross Section Drag Model	9-70
9-42	Upwash Force on Cylindrical (2D) Bodies	9-71
9-43	Upwash Force on Flat-Bottom Cylindrical (2D) Body	9-71
9-44	Effect of Body Longitudinal Shape on Upwash Force	9-72

VTOL IN GROUND EFFECT FLOWS FOR CLOSELY SPACED JETS

David Migdal, William G. Hill, Jr., Richard C. Jenkins
and Michael J. Siclari

Grumman Aerospace Corporation
Bethpage, New York

1. SUMMARY

The primary purpose of this study was to obtain detailed pressure and velocity field data for twin jet configurations in-ground-effect and to develop flow models to aid in predicting pressures and upwash forces on aircraft surfaces. For the basic experiments 50.8 mm (2 in) diameter jets were used, oriented normal to a simulated ground plane, with pressurized air providing a jet velocity up to 90 m/sec. The experimental data consisted of (1) the effect of jet spacing and height, on the ground and upwash pressures (2) oil flow visualization photographs to identify streamline directions (3) the effect of simulated aircraft surfaces on the isolated flow field (4) the effects of adding a third jet on the two-jet upwash properties and (5) the jet induced forces on a series of two and three dimensional bodies with strakes and variations in fuselage cross section.

The isolated twin jet tests revealed regions where the fountain flow was unstable, below ambient pressure regions in the upwash, and the formation of ground stagnation lines (and upwash flow) even when the outer boundaries of the free jets have merged. With the simulated fuselage surfaces placed between the jets significant lift forces were obtained in-ground-effect with the addition of strakes and squaring the lower fuselage contour. Similar effects were not obtained with flat plate models.

A new flow model was developed for vertically oriented twin jets which accounts for the non-fully formed wall jets at close spacing. It includes a jet impingement zone wall jet transition model, the effects of fuselage cross section on fountain induced lift forces, and adequately predicts the effects of spacing and height above ground on flow field pressures and upwash forces.

It is concluded that (1) flow field instabilities can be present at low heights above ground; (2) in a twin jet configuration the onset of jet boundary merging does not

preclude the formation of fountains; (3) values over 20% lift/jet thrust can be obtained in-ground-effect due to fountains impinging on the underside of a simulated fuselage for a twin jet configuration, depending on the shape of the fuselage and dimensions of horizontal strakes and; (4) the use of a modified wall jet transition model adequately predicts the trends with height above ground and jet spacing on the ground and upwash pressures.

2. INTRODUCTION

Lift and control for V/STOL aircraft operating in-ground-effect presents a critical condition in sizing the propulsion system. Ground proximity effects can result in large jet induced lift losses, or produce positive fountain lift, depending on the aircraft configuration. The complexity of the resulting flow field and the sensitivity to many design parameters gives rise to a large body of experimental data (Reference 1) which model various aspects of the flow field. References 2 to 6 describe the development of one technique to predict the pressure distributions and aerodynamic characteristics based on a modular approach to the various flow regions shown in Figure 2-1. The four major subregions consist of a free jet, impingement zone, wall jet and upwash flow. As shown in Figure 2-2, all of these major elements are present in the two jet ground impingement problem and the basic two-jet situation can thus be used as a building block for multi-jet configurations.

The simplified modular approach utilizes basic mass, momentum and energy conservation principles along with empirical data describing entrainment of ambient air (e.g. maximum velocity decay and velocity profiles as described in References 2 to 4). A review of the basic experimental data regarding two-jet behavior indicates several limitations when the jet spacing is decreased. As reported in Reference 8, instabilities in the upwash flow were noted for some combinations of spacing and height. Also, as the jets are brought closer an upwash is formed prior to the establishment of a fully developed wall jet. For even closer spacings, the upwash can completely disappear when the two free jets merge as they grow in size due to entrainment of ambient air. The object of this study was to explore in more detail, the two-jet close spacing problems experimentally to help establish a more accurate model of the resulting flow field.

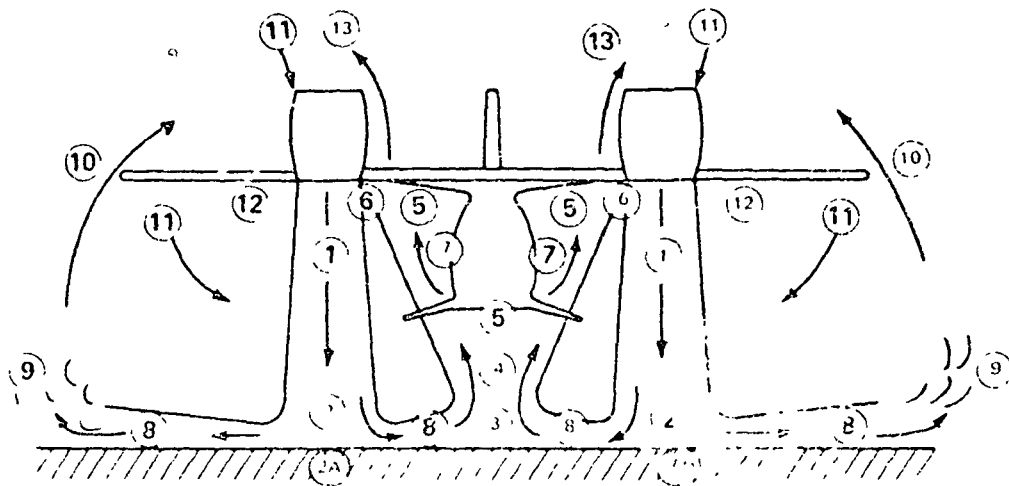

- 1 Jet Mixing and Mutual Interference
- 2 Jet Ground Impingement & Spreading
- 2A Deck Ejection
- 3 Fountain Formation
- 4 Fountain Flow and Mixing
- 5 Fountain Impingement on Aircraft
- 6 Spreading Fountain Effect on Base Jets
- 7 Fountain Flow Around Aircraft
- 8 Spreading Ground Jet After Impingement
- 9 Outer Separation of Spreading Jet
- 10 Rear Flow of Exhaust
- 11 Inflow Due to Interference and Recirculation
- 12 Pressures and Forces on Lower Surfaces of aircraft Due to Inflow
- 13 Fountain Exhaust Products Sucked Into Jets

98-0010

Figure 2-1. Modular elements of modeling concept.

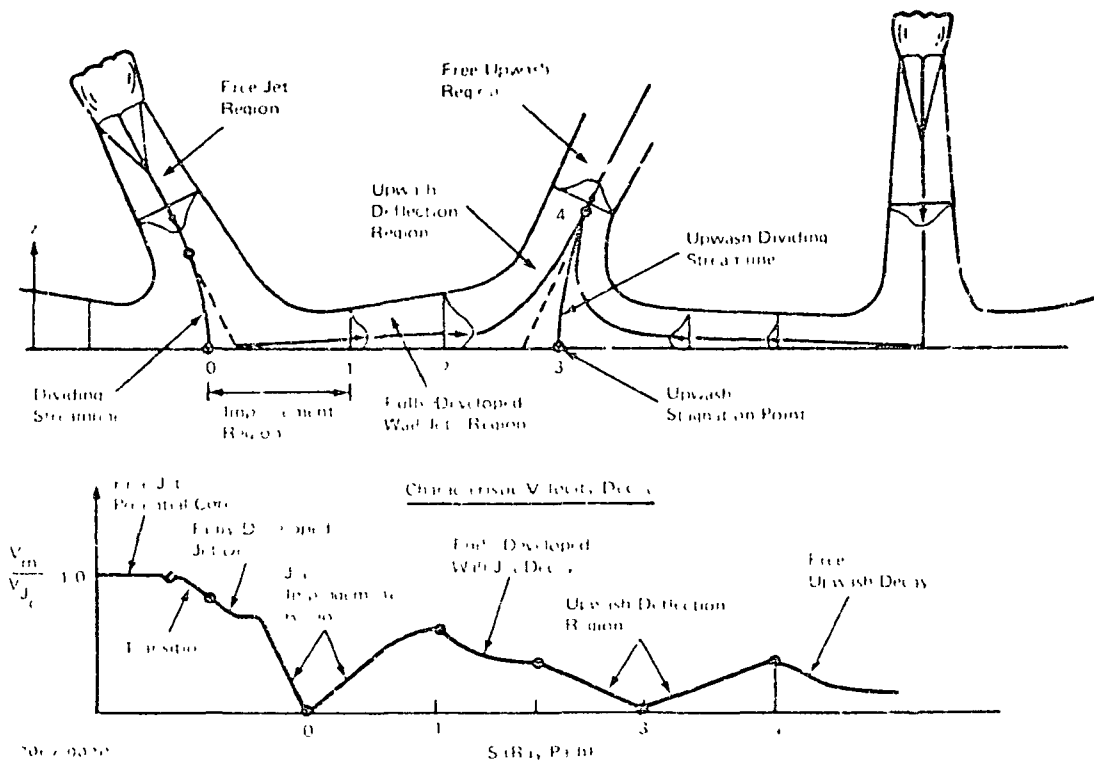

Figure 2-2. - Basic two-jet interaction flow field.

3. SYMBOLS

b	=	Boundary radius
ΔB	=	Body depth from nozzle exit
d, D	=	Nozzle diameter
δ (delta)	=	Boundary layer height
ΔF	=	Interference Force
h, H	=	Jet height above ground
L	=	Body length
M, \dot{M}	=	momentum
P_t	=	Total pressure
Δp	=	$p - p_a$
p	=	Static pressure
$\frac{\Delta p}{P_j}$	=	$\frac{p - p_a}{P_j - p_a}$
Q, q	=	Dynamic pressure
ρ (rho)	=	Density
r	=	Radius
S	=	Spacing between jet centerlines
σ	=	Strake depth
T	=	Jet thrust
V	=	Velocity
V_j	=	Jet exit velocity
W	=	Body width
W_c	=	Distance between strakes
X	=	Distance perpendicular to line joining jet centers
Y	=	Distance along line joining jet centers
Z	=	Probe height above ground
Z'	=	Distance from jet exit

SUBSCRIPTS

a	=	ambient
cs	=	stagnation line center conditions
g	=	ground plane
j, J	=	jet exit conditions
JH	=	jet half-width
m	=	maximum
n	=	nozzle
PC	=	potential core
s	=	static
0 (zero)	=	initial wall jet radius
.5	=	dimension at 1/2 maximum pressure
.25	=	dimension at 1/4 maximum pressure (1/2 maximum velocity)

4. MODELS AND APPARATUS

The experimental portions of this study were performed in the Grumman Research Department. Two similar air flow facilities were used, one for flow surveys (designated Facility 2) the other for vehicle force and pressure measurements (Facility 1). Sketches and photographs of these two facilities are shown in Figures 4-1 through 4-8. These facilities utilize centrifugal fans which are belt driven by 220 V/3 phase 1/2 HP motors. The flow rate and hence total pressure in the settling chamber is controlled by throttling the inlet to the fan. Experiments are usually conducted with a total pressure minus atmospheric pressure of 5004 \pm 1 (20.1 inches of water) resulting in an exit velocity of 91 m/sec (300 ft/sec).

The flow from the fan into the settling chamber is non-uniform with higher velocities towards the outside of the fan (top). This flow is passed through a short constant area section where vanes redirect the flow for a more uniform distribution. The fan is connected to this section with a flexible material to avoid transmission of vibration from the fan to the settling chamber. The air then flows through a diffuser into the large settling chamber. To bring the length of the facility within the available space, large-angle segmented diffusers are used. These diffusers are an extension to the two dimensional work reported by Kline (Ref. 7). The diffuser of Facility 1 is approximately a 33° square pyramid filled for 2/3 of its length with 7° paper cones. The flow at its exit is almost completely attached and uniform.

The diffuser of Facility 2 is a 66° pyramid and filled with pyramidal sections of plexiglass (see Fig. 4-5) of approximately 7° angle. Flow into the settling chamber is then conditioned by honeycomb and screens and passes into the settling chamber. For the pairs of 50.8 mm (2 inch) diameter jets in most of the current experiments, a 610 mm (2 foot) square cross section leads to an area ratio of 92 (Facility 1) while Facility 2 has an area ratio of 26. This produces a very uniform flow of low turbulence level (less than 1/2% RMS).

To facilitate changing the nozzle spacing, a pair of nozzles is mounted eccentrically on a pair of discs, which are clamped to the front face (Figure 4-6), providing continuous variation of nozzle spacing. The nozzles are spun aluminum with an entrance contour identical to an ASME long radius flow metering nozzle, but followed by a constant area section 5.5 diameters long. Alignment of nozzles in horizontal direction is done with reference to gravity by drop line and bubble level, and with reference

to other apparatus (traverse equipment primarily) by cross hair sightings. A check on the alignment is performed by traversing the free jets and tracking centerline (maximum q) locations using an electrically powered variable speed traversing mechanism.

Models

The models used for the upwash body impingement experiments include several classes. The initial experiments on the effect of jet spacing were conducted using the two-jet configuration shown in Figure 4-7. Cylindrical fuselage models (Figure 4-8) with a range of corner radii were used for the effect of body shape. These bodies were also instrumented for pressure distributions and were tested for various strake heights, in addition to the basic tests. The strakes are shown on a rectangular body (Figure 4-9) where the nozzles were contained within the planform. A third class of body is a large (12D x 12D) flat plate. Dimensional data for the various bodies are contained in Figure 4-10.

Instrumentation

The coordinate system for locating nozzles and probes is shown in Figure 4-11. The position of the ground plane and of the probes are measured by the voltage output of a 10-turn potentiometer for most data in this report (unless otherwise noted). For measurement of small dimensions, such as the boundary layer thickness, measurements were made with a linear potentiometer or a vernier caliper. For the traverse units, with screw thread drive or rack and pinion drive, (all probe movements and the ground plane motion on Facility 1) a rotary pot is used to measure cable motion connected to the moving apparatus. For the ground plane of Facility 2, a rotary pot was attached to a sprocket at one end of the chain loop. Since some hysteresis occurs for any of these systems, traverses were taken only in one direction, and a voltmeter was used to check an initial output at a starting location and periodically to check calibration.

The purpose of providing an electrical output for position is to produce a continuous curve of the parameter being measured (vehicle forces, pressures, hot wire velocities, etc.) versus position, and to plot that curve on an X-Y Recorder. A real-time analog data reduction technique was used to protect against missing unusual behavior of the data or the development of problems during a test.

Pressures were measured with differential pressure transducers. For the pitot-static probe, the total and static pressure tubes were each connected to separate transducer referenced to the atmosphere (an undisturbed area of the room). Each of these pressure tubes also contained a "T", and a third transducer was connected to both pressures, thereby directly reading $P_t - P_s$ or q (another analog data reduction technique). The pressure transducers were calibrated and periodically checked by use of an oil manometer; vertical or inclined, depending on the transducer range.

Vehicle force measurements were made using a five-component strain gage balance, while force measurement on the ground plane utilized three separate force elements, spaced at a distance from the force center. Calibration of the force balance was achieved by placing weights from a laboratory scale, set on a special graduated body, and spot checks were done periodically on the model being tested.

During efforts to identify the cause of the measured large negative static pressure differentials, velocities were measured with a hot film system. This system is essentially the same as a hot wire system; our measurements involved a constant temperature anemometer, a signal linearizer, and a true RMS time-averaging voltmeter. Output from the traverses was plotted on the X-Y recorder.

Oil flows were used for both ground plane indications of the end of upwash formation with increasing jet interference and for qualitative flow description with a splitter plate. The oil base was 10W-30 motor oil and it was colored for identification and thickened by artist oil colors.

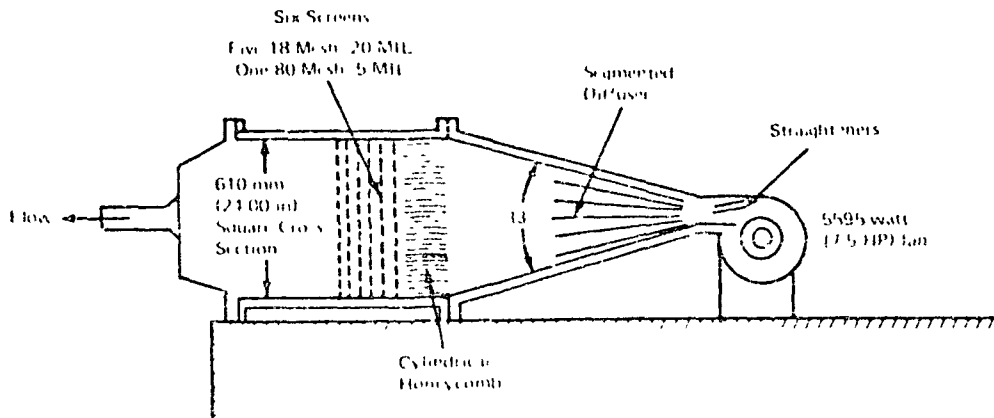

7067 001 P

Figure 1-1. - Facility 1 flow path.



Figure 1-2. Prototype of facility 1.

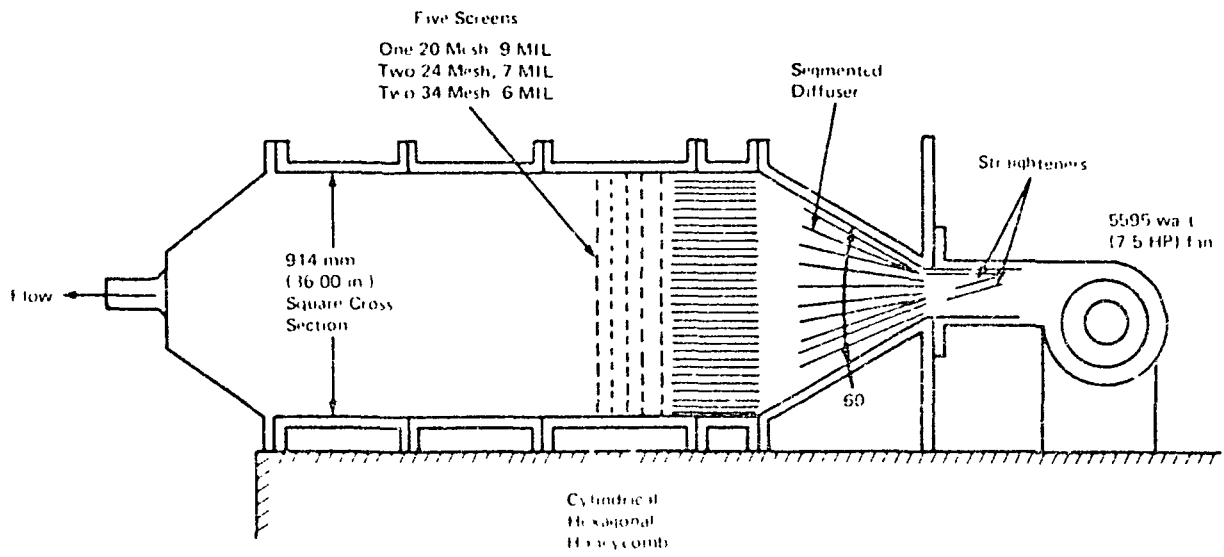

1000 0050

Figure 1-3. - Facility 2 flow path.

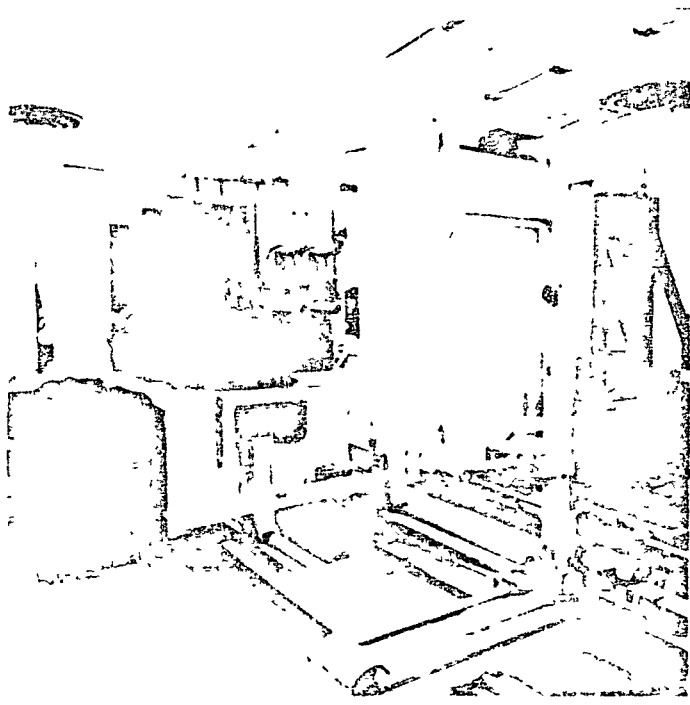
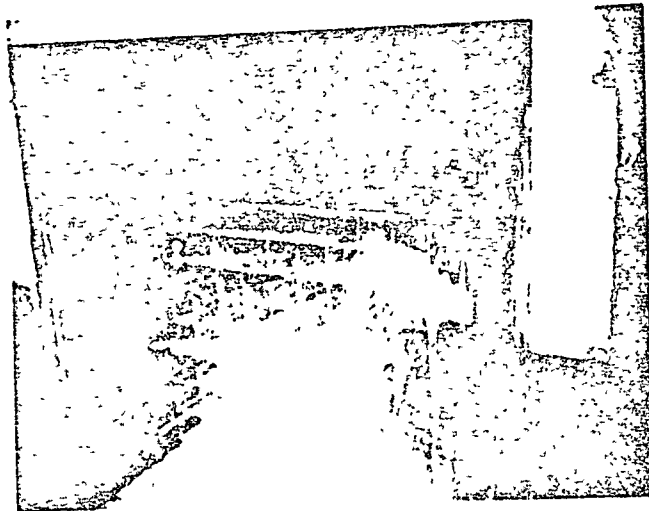

Figure 1-4 - Photograph of facility 2.

ORIGINAL PAGE IS
 OF POOR QUALITY



2067 007

Figure 1-5. segmented diffuser.



2067 008

Figure 1-6. Eccentric nozzle mounting.

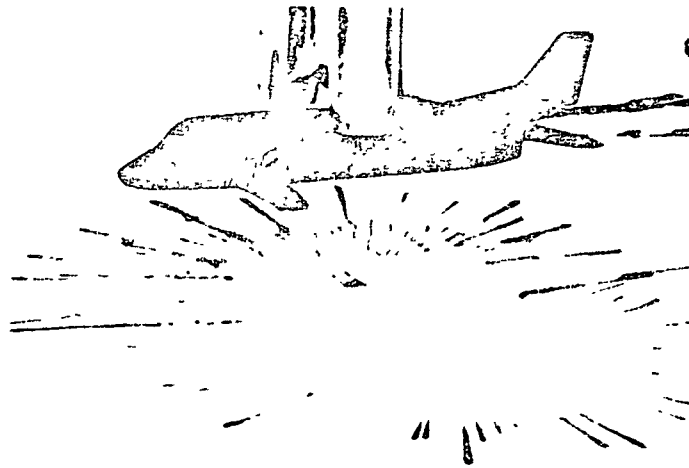

2067 009

Figure 4-7. Two-jet aircraft configuration (Ref. 5 & 6).

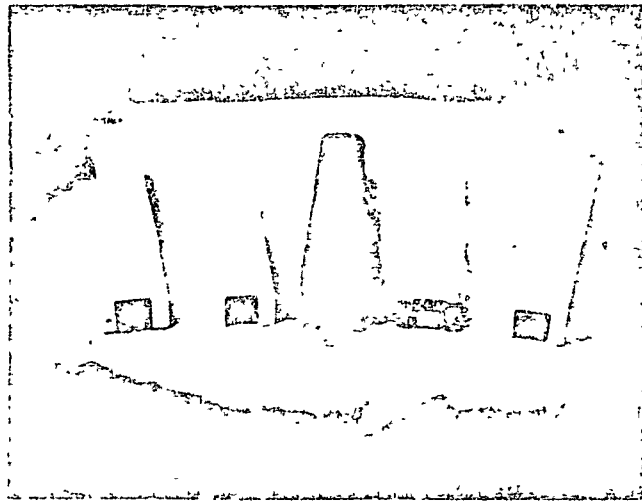

2067 010

Figure 4-8. Cylindrical bodies with different corner radii.

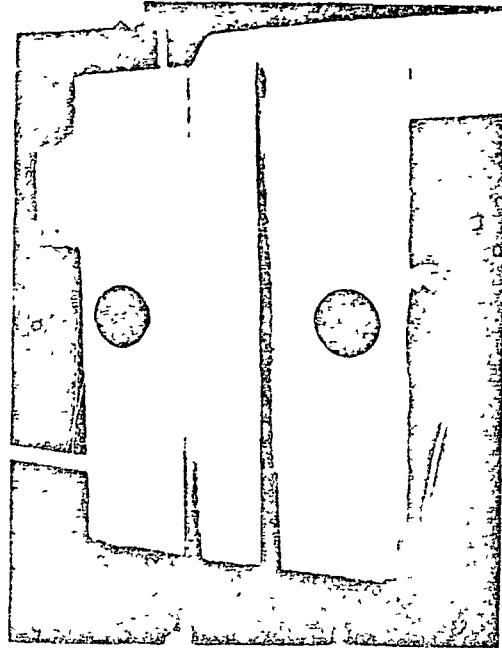

7067 0...

Figure 1-9. Rectangular body with strakes.

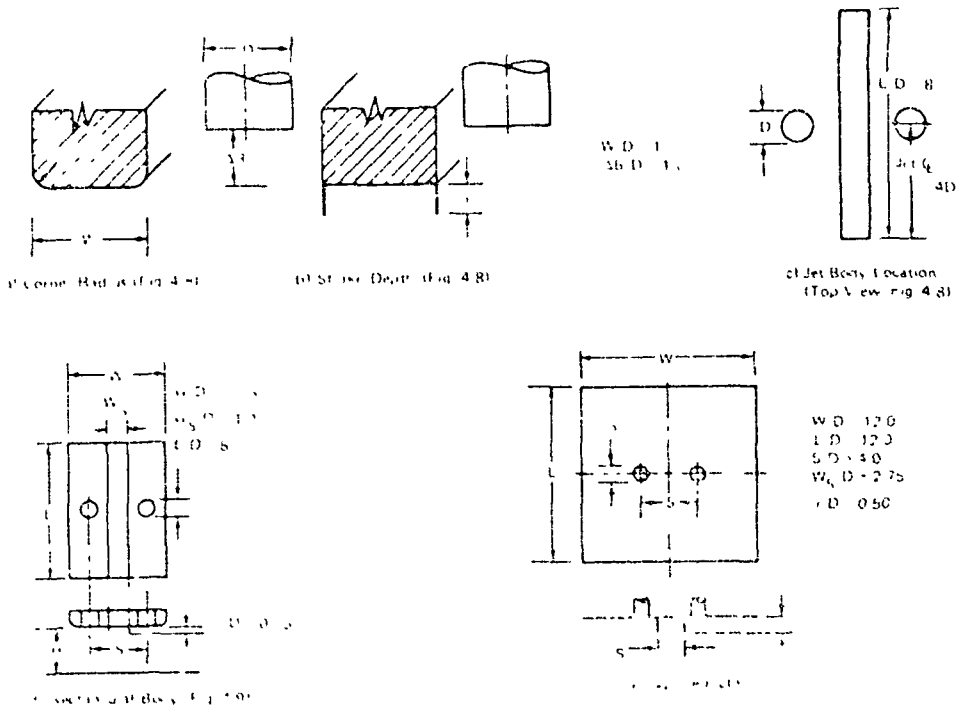
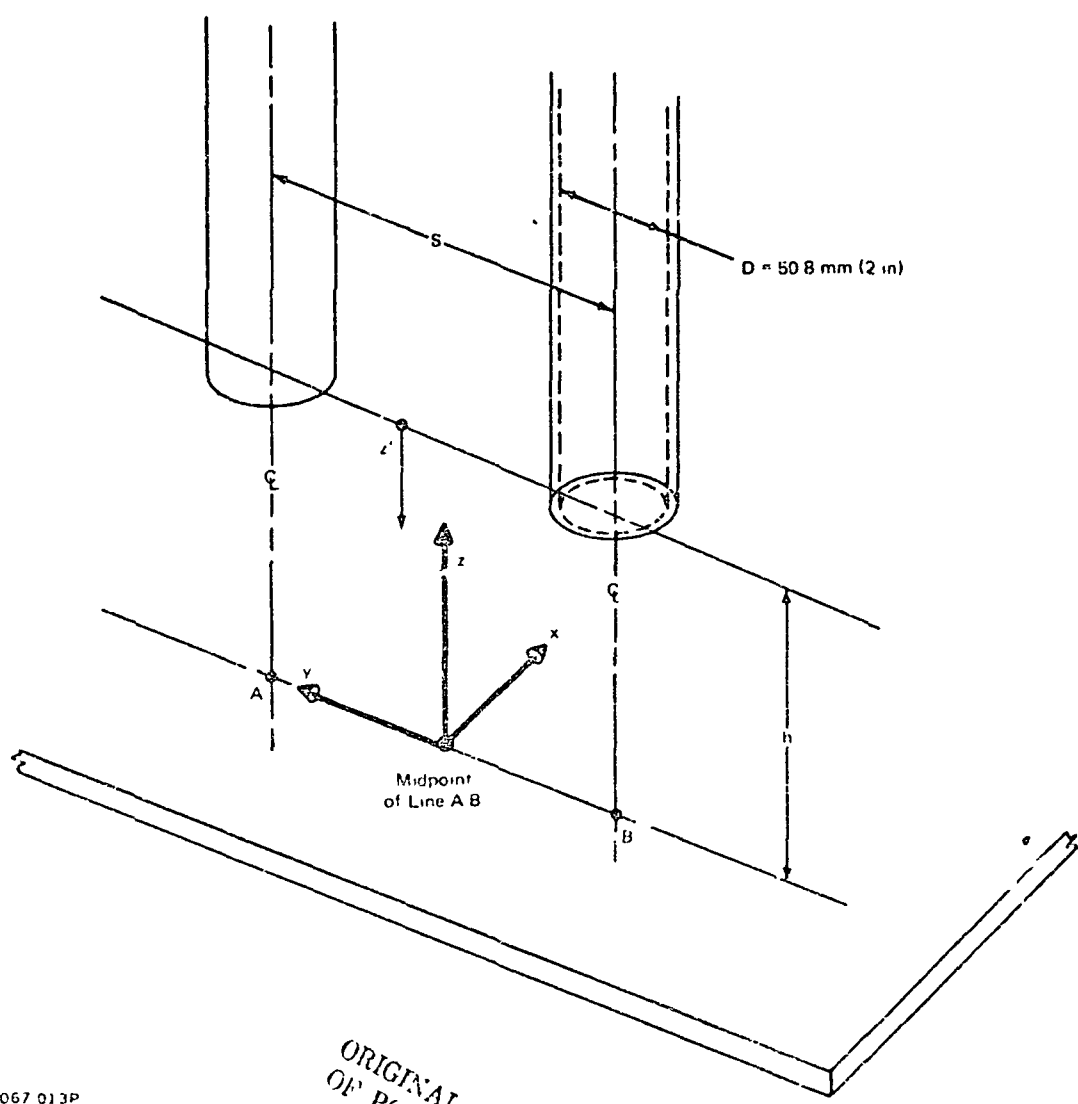

Figure 1-10. - Dimensional data and nomenclature for bodies placed in upwash flow field.



2067 013P

ORIGINAL PAGE IS
OF POOR QUALITY

Figure 4-11. - Model coordinates and nomenclature.

5. JET PROPERTIES

Figures 5-1 and 5-2 contain the results of traversing the jet plumes with pitot pressure probes at various distances (Z') downstream of the nozzle exit plane, in the absence of a ground plane. The characteristics of the initial jet can be inferred from the data very close to the nozzle exit ($Z'/D = 1/16$). As shown in Figures 5-1 and 5-2, a relatively uniform (top hat) profile is available at the jet exit with the eccentric jet spacing mechanism and tapered settling chamber. The Figure 5-1 data indicates that for $S/D = 2$ the jets start to merge 4 diameters from the nozzle exit and that the merging is nearly complete at 20 diameters. Merging is considered to be complete when there are no distinct peaks in the profiles. These peaks distinguish the central region for each free jet. Thus while the jet outer boundaries spread at an equivalent angle B [$\tan B = (S/D - 1) / (2Z'/D)$], and for $S/D = 2$, $Z'/D = 4$, B is approximately 7° , the inner core region for each jet persists for a considerable distance downstream.

Static Pressure Inside Nozzle Near Exit

Static Pressures were measured inside of a nozzle at $Z'/D = -1/16$ (upstream of the exit) to investigate the effect of the upwash on nozzle exit conditions. Two pressure taps were used, located on opposite sides of the nozzle. The static pressure differential was less than $2\% q_J$ for all cases.

Figure 5-3(a) shows the variation of nozzle exit pressure as the ground plane height was changed. The smooth curve shows the variation with ground height for single jet impingement, illustrating the influence of ground blockage when $h/d \leq 1.5$. The other two curves for dual jet impingement show that the effect of the presence of the ground plane on the nozzle exit flow are noticeable for $h/d < 4.5$. Data taken on the inner (towards the upwash) side of the nozzle illustrates an increasing pressure as the ground plane gets closer, which appears to be caused by interference between the incident flow and the upwash. The pressure rise with decreasing h/d is much less for slightly larger spacing (Figure 5-3(b)) and disappears for wide spacing (Figure 5-3(c)).

For a given nozzle spacing, decreasing h/d will decrease interference between upwash and incident flow, and at some value of h/d such interference should

disappear. Static pressure surveys showed that, in the absence of interference between upwash and incident flow, the static pressure on the upwash (inner) side of the nozzle should be slightly more negative than on the opposite side. Figure 5-3(a) shows that the inner tap pressure drops below outer tap pressure when $h/d = 1.75$, which should represent the ground height below which no interference between upwash and incident flow exists. Figures 5-3(b) and (c) show this value of h/d to be 3 for $S/d = 3$, and 4 for $S/d = 5, 6$.

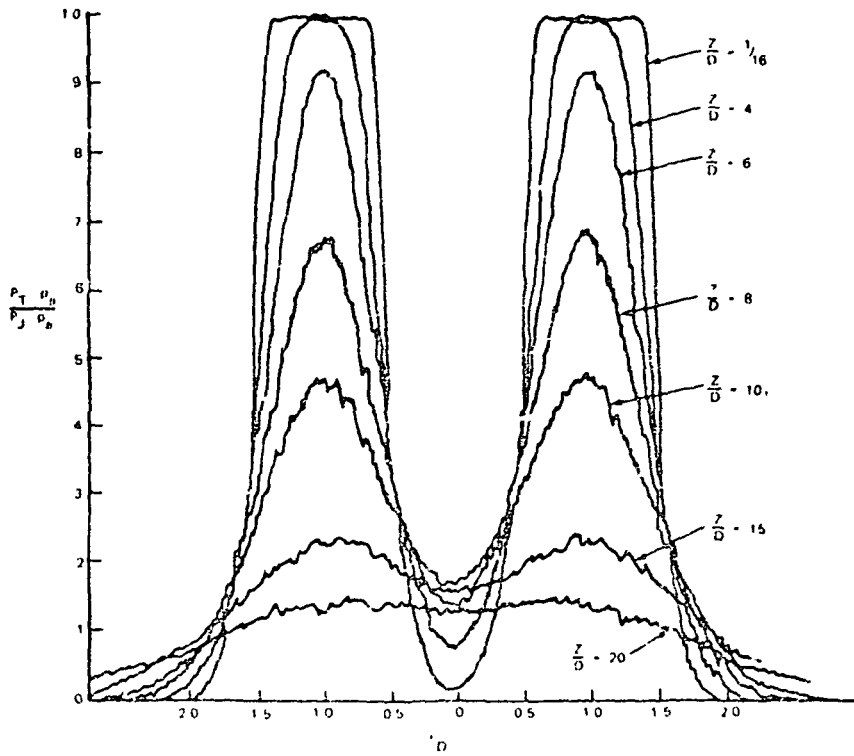

2067 014P

Figure 5-1. - Free jet profiles - $S/D = 2.0$.

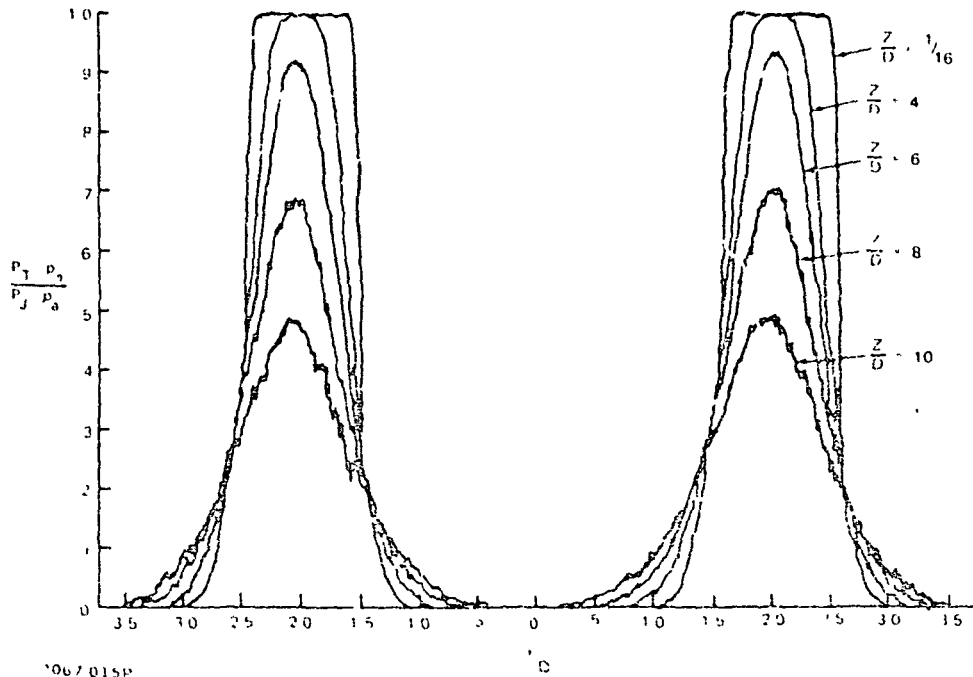

2067 015P

Figure 5-2. - Free-jet profiles - $S/D = 1$.

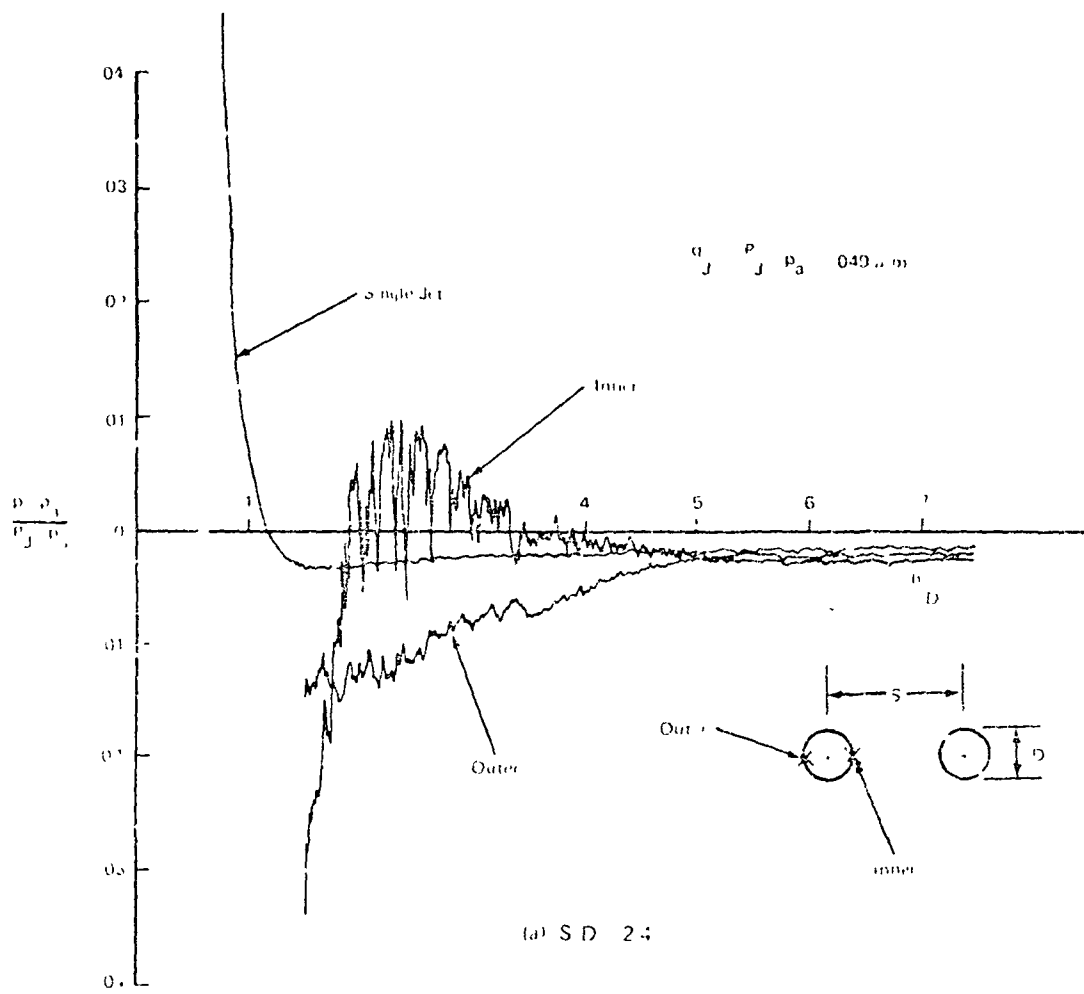

Figure 5-3. - Effect of ground plane on nozzle exit pressures.

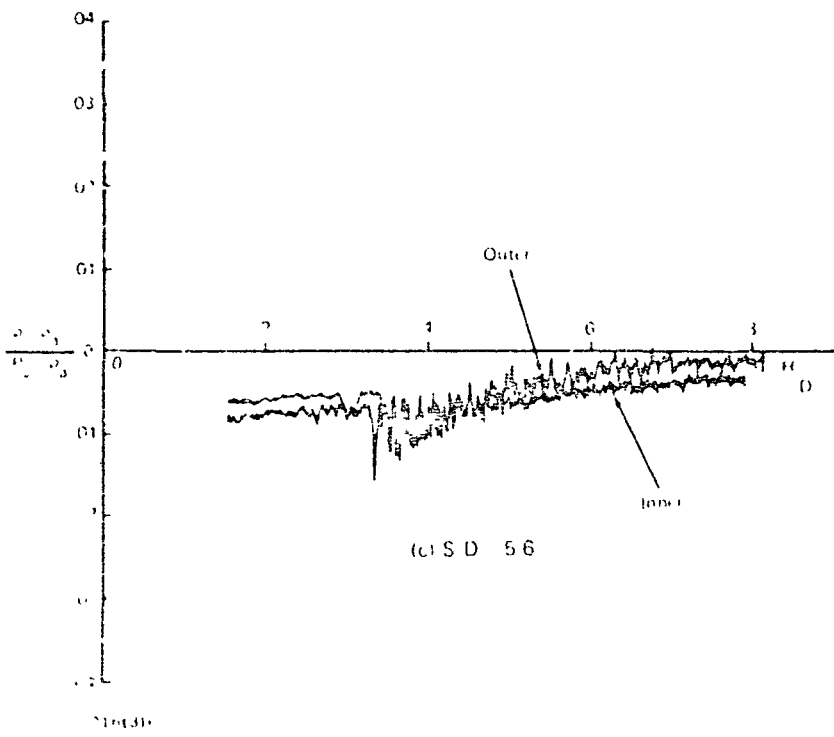
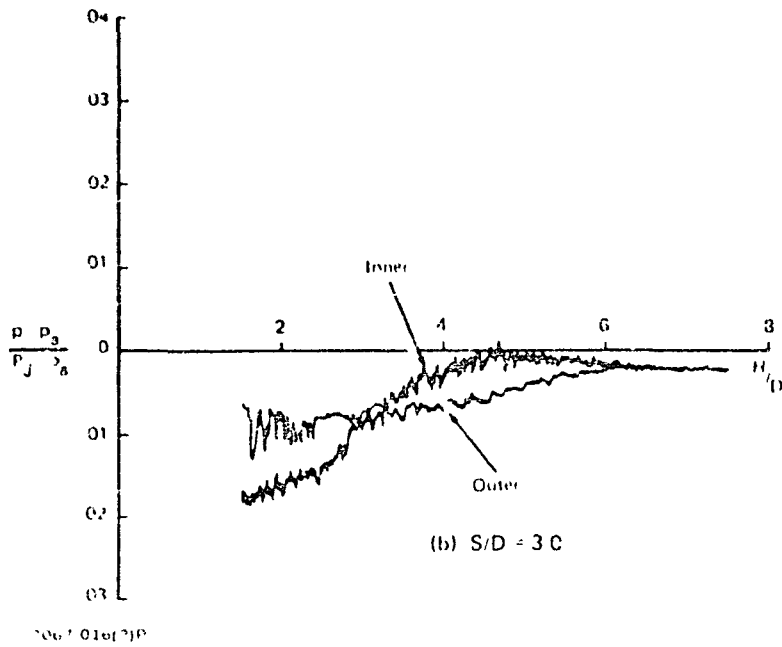

Figure 5-3, - Concluded.

6. GROUND PLANE PROPERTIES

The upwash formation region on the ground was investigated with oil flow patterns to aid in the identification of conditions where the upwash would no longer form because of jet/upwash interference. Several concentric rings of oil dots were placed around each jet impingement point and the flow was allowed to run for several minutes to develop a stable pattern. Figure 6-1(a) shows a typical radial flow from the jet impingement points meeting to form a straight stagnation line. For many cases, a double line was found. Further study showed this to be caused by a separation point. Oil drops placed within this bubble ran outwards along the outer line and towards the two oil lines (Figure 6-1(b)). Insufficient data exists at this time to determine the flow conditions that govern the formation of this separation bubble.

Figure 6-1 shows a series of oil flows for a spacing of $S/D = 2.0$ (closest available from eccentric nozzles). Starting at a height above ground of $H/D = 1.5$, a pattern of two separate radial spreading regions with a central stagnation region occurs until an H/D of about 20. This is generally above the region of interest for affecting airplane interference effects. Note that the separation region disappears at about $H/d = 10$ (Figure 6-1(d)).

Stream surveys without the ground plane, taken by traversing a pitot probe across both jet centerlines, showed that the two jets had partially merged 10 diameters from the exit. Ground plane pressure profiles at $H/D = 10$ indicated a pressure rise corresponding to the stagnation line.

For $H/D = 15$, where the free stream survey showed two peaks, the ground oil flow pattern showed two distinct jet impingement points and a stagnation line also. At $H/D = 20$, where the free stream pitot survey showed no distinct peaks, the ground oil pattern also indicated that the two jets had merged.

It therefore seems reasonable to use the rule of thumb that: if separate peaks exist in the pitot pressure profiles of the free jets without a ground plane, separate impingement and stagnation line/upwash formation will occur on the ground plane.

Ground Plane Pressures

Ground pressures were obtained with a line of pressure taps perpendicular to the line connecting the jets and spaced one-half a jet diameter apart (along the x axis of Figures 4-11 and 6-2). The ground plane was moved slowly in a direction perpendicular to the line of taps and to the nozzle axis producing a continuous display of ground pressures. The ground coordinates x and y are oriented parallel to and perpendicular to the stagnation line, with the origin at the upwash center. Figure 6-3 contains a complete set of ground pressure data obtained with various jet spacings and heights above ground. Figure 6-3(a) contains the ground pressures for both the single and dual jets at $S/D = 2$, $h/D = 3$ and demonstrates that an upwash is formed (peak pressure at $Y/D = 0$) prior to the end of the impingement zone. The data implies an inboard shift of pressure peak and a distortion from axial symmetry when the second jet is turned on.

Figure 6-3(b) contains a complete data set for the closest spacing ($S/D = 2$) and varying nozzle height above ground. The general trend is that the peak values under the jet and at the stagnation point ($Y/D = 0$) decreases with increasing h/D while the profile broadens. Note that under the jet ($Y/D = 1$, Figure 6-3(b)) the impingement pressure is within 2% of the jet stagnation pressure for values of h/D up to 1. As h/D increases the jet impingement pressure decays in a manner similar to the free jet decay in maximum pressure (Figure 5-1). In general, the maximum wall pressure is higher than the corresponding value for the free jet at the same distance from the nozzle exit. Figure 6-3(c) contains the ground plane pressures for $S/D = 2.5$ and a range of nozzle h/D from 1.5 to 15. In this, as well as other cases to follow, sufficient data is provided to determine the maximum pressure on the center of the stagnation line P_{CS} (Figure 6-2). Note that P_{CS} increases with decreasing h/D until an h/D of 3.0. The data in Figure 6-3(a) is similar in that the value of P_{CS} does not continually increase with decreasing h/D . In addition at $h/D = 2$ (Figure 6-3(d)) it was not possible to obtain a stable profile and two peak values were exhibited. This instability was not observed at other spacings. At $S/D = 3$ and $h/D = 1.5$ to 2.0 the upwash would change from one side to the other with no apparent disturbance up to about 20 seconds. It could be switched from one side to the other with a temporary blockage near the nozzle exit plane.

This unstable behaviour at $S/D = 3.0$ is shown in Figure 6-3(d) with the actual pressure trace at $h/D = 2.0$. The large oscillations help to explain why in this case there is a drop in the maximum stagnation line pressure. Since the probe is reading a time-averaged value, and for a portion of the time there is not jet flow over the probe, the time-averaged value is lower.

Figures 6-3(e), (f) and (g) show the ground pressure variation with increased spacing. Note that as the spacing is increased (e. g., Figure 6-3(f) for $S/D = 4.0$) there is less effect of the fountain upwash (at $Y/D = 0$) on the impingement zone pressure distribution.

Summary Data of Maximum Ground Pressures

Figure 6-2 illustrates the ground pressure profile along a line passing through the two jet impact points and the center line of the upwash. The maximum pressure in the jet impingement region was always greater than the maximum pressure on the center of the stagnation line (P_{CS}). The dimension $y_{.5}$ represents the half width of the pressure profile at half the maximum stagnation line pressure. Along the stagnation line the maximum ground pressure (P_m) decreases with distance (λ) from the centerline.

Figure 6-4 shows the variation of centerline stagnation pressure with nozzle spacing for a nozzle height of three diameters above ground. The curve shown for comparison was predicted by assuming that the ground pressure on the center of the stagnation line is equal to the maximum pressure that would exist in a wall jet profile at the same radial location from one of the jets if the opposite jet were turned off. The predicted curve is given by the relation

$$\frac{P_{CS} - P_a}{P_j - P_a} = 13.78(S/D)^{-2.4} \quad (1)$$

where P_j is the stagnation pressure at the nozzle exit and P_a is ambient pressure. The constants in this equation were derived from pitot probe measurements taken in the wall jet formed by impingement of a single 4 inch diameter jet. Figure 6-4 shows that this analysis provides an adequate prediction of the centerline ground pressure for jet spacings of about 4 diameters or greater. At closer nozzle spacings the measured values fall below the predicted curve. This deviation should be expected because

at $S/D = 4$ the stagnation line is two diameters from each jet impingement point, and this radial distance from a single impinging jet represents the beginning of the fully formed wall jet region. Hence the measured and predicted values begin to diverge, because at close jet spacings the ground flow approaching the stagnation line is not a fully formed wall jet. A modified wall jet analysis is needed to provide a better match.

For a given nozzle spacing, the ground pressure on the center of the stagnation line ($P_{cs} - P_a$) varied with nozzle height above ground as shown in Figure 6-5. For a nozzle spacing of 6 diameters above ground, increasing nozzle height above ground brought about a gradual decrease in ($P_{cs} - P_a$) that appears to be caused by interference between the edges of the upwash and the shear layers surrounding the incident jets close to the nozzle exit plane. At closer nozzle spacings, this variation of ($P_{cs} - P_a$) with height above ground was more extreme but followed the same trend. For nozzle spacings below 3 diameters, the effects of incident jet-upwash interference severely distorted the entire ground plane pressure profile at large H/D (see Figure 6-3(d)).

For each nozzle spacing the maximum value of ($P_{cs} - P_a$) occurred with H/D between 2 and 4. The decrease in ($P_{cs} - P_a$) at lower nozzle height appears to indicate the onset of instability conditions and may be caused by the presence of the ground affecting nozzle exit conditions. A severe instability was encountered at a nozzle spacing of 3 diameters for H/D less than 2-1/2. The ground pressure profile appeared to be temporarily stable in either of two unsymmetric shapes. This instability appeared to be peculiar to jet spacing of 3 diameters. For larger or smaller jet spacing, the ground plane pressure profile did not exhibit this bistable shape for nozzle heights down to 1-1/2 diameters.

The variation of maximum ground plane pressure ($P_m - P_a$) along the stagnation line is shown in Figure 6-6. Data taken at $H/D = 3$ at each jet spacing have been normalized by the corresponding centerline value and plotted versus X/D to illustrate the variation of this profile with jet spacing. When plotted versus X/S (Figure 6-7) the data for each nozzle spacing fall close to a profile which can be fitted by:

$$\frac{P_m - P_a}{P_{cs} - P_a} = \left[1 + \left(\frac{2X}{S} \right)^2 \right]^{-2.2} \quad (2)$$

Eq. (2) was derived by assuming that on the stagnation line only the components of wall jet velocity normal to the stagnation line contribute to the stagnation line pressure. The constants in Eq. (2) were obtained from wall jet measurements with a single impinging jet.

Figure 6-8 shows the shape of the ground pressure profiles taken across the center of the stagnation line for three nozzle heights above ground with a nozzle spacing of 4 diameters. For each ground height the pressures were normalized by the maximum value on the centerline and the distance y was normalized by the half-pressure dimension ($y_{.5}$). The data show that the profile shapes are essentially the same and can be represented by a Gaussian profile.

Integration of the ground pressure profile across the stagnation line provides a measure of the force exerted on the ground by the upwash, which can be related to the momentum flux of the upwash at ground level. Assume that the ground flow approaching the stagnation line from each of the impinging jets is an axisymmetric, radially expanding flow that exhibits constant momentum per radian in the wall jet. If flow momentum is conserved in the upwash formation region, the momentum flux per radian of the upwash flow normal to the ground at the stagnation line can be found by integrating the stagnation line pressure profile. Using a Gaussian equation to represent this profile, integration yields

$$\dot{M}_{\theta} = S/2 \sqrt{\frac{\pi}{0.6932}} (P_{CS} - P_a) y_{.5} \times \left[1 - \frac{y_{.5}}{S/2} \left(\frac{1}{\sqrt{0.6932\pi}} \right) \right] \quad (3)$$

Figure 6-9 shows the variation of maximum stagnation line pressure and half pressure width with nozzle height for $S/D = 4$. The maximum ground pressure decreases and the width increases as the ground height increases. This general trend appeared for all jet spacings. However, as seen in Figure 6-10, the centerline upwash momentum flux per radian computed from Eq. (3) using the data in Figure 6-9 is almost independent of nozzle height above ground. This result is important because it confirms one of the simplifying assumptions used in the prediction techniques.

The dashed line in Figure 6-10 represents twice the thrust per radian of one of the incident jets. Jet thrust was computed from velocity profiles that were taken at

the nozzle exit plane. We conclude that flow momentum is conserved in the upwash formation region, and that the upwash momentum at ground level can be computed from the nozzle exit conditions.

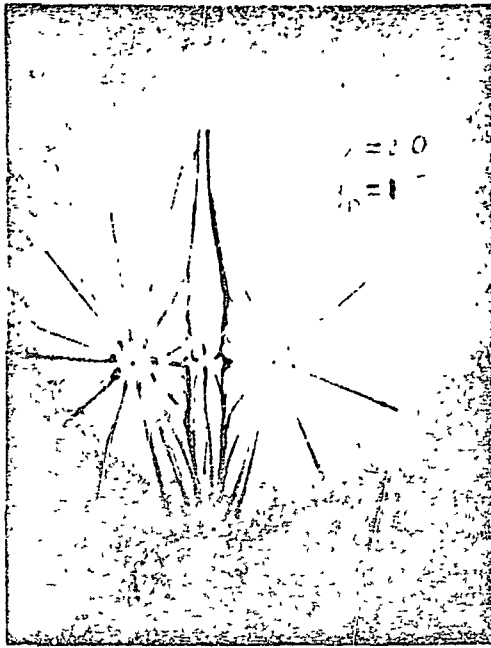

(a) $H/D = 15$

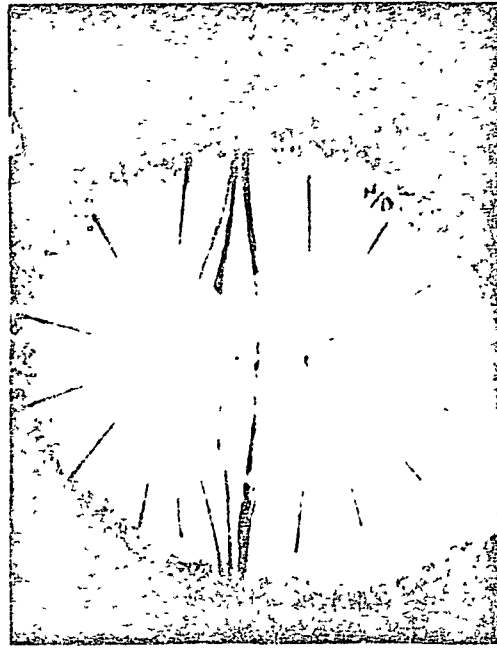

(b) $H/D = 20$

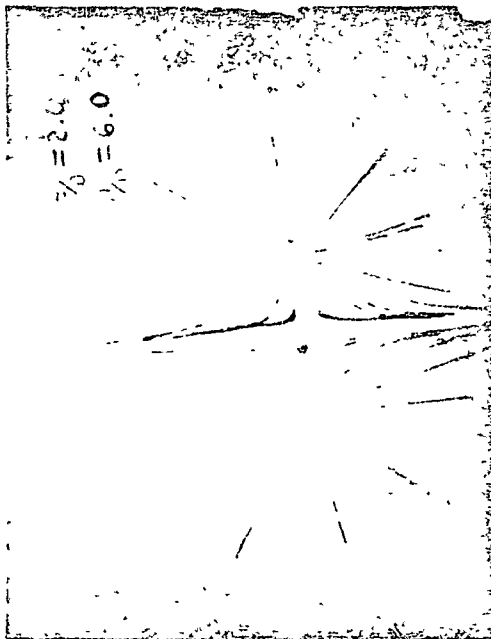

(c) $H/D = 50$



(d) $H/D = 10$

00707

Figure 6-1. Ground plane oil flow, $S/D = 2.0$.

ORIGINAL PAGE IS
OF FOUR (4) PAGES

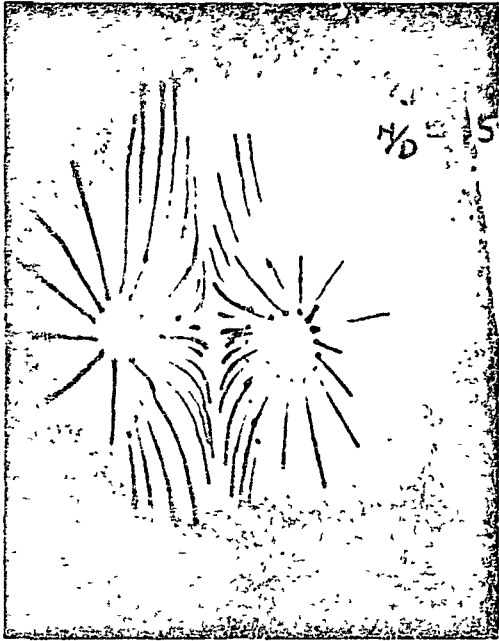

(e) H.D. 15

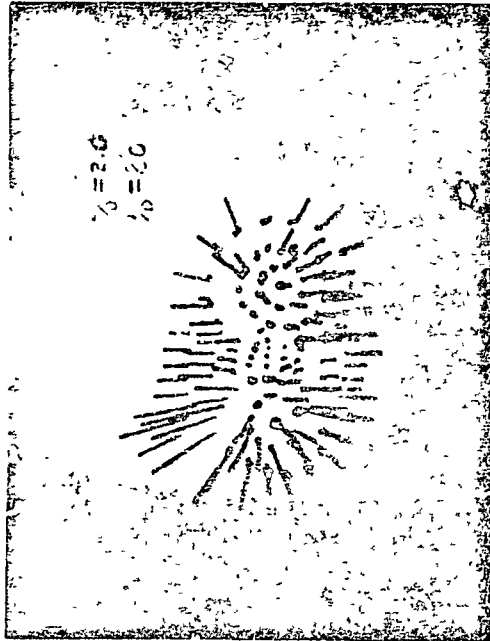

(f) H.D. 20

Figure 6-1. Concluded.

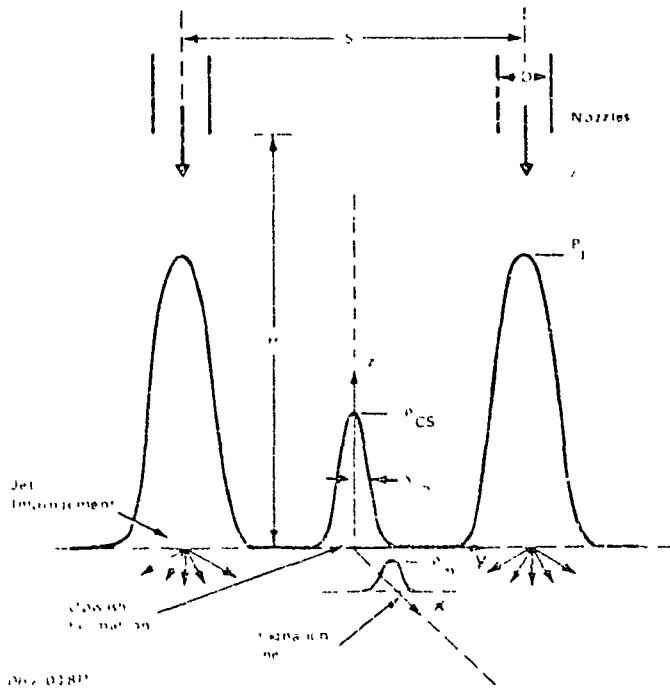

Figure 6-2. - Details of ground plane impingement and upwash.

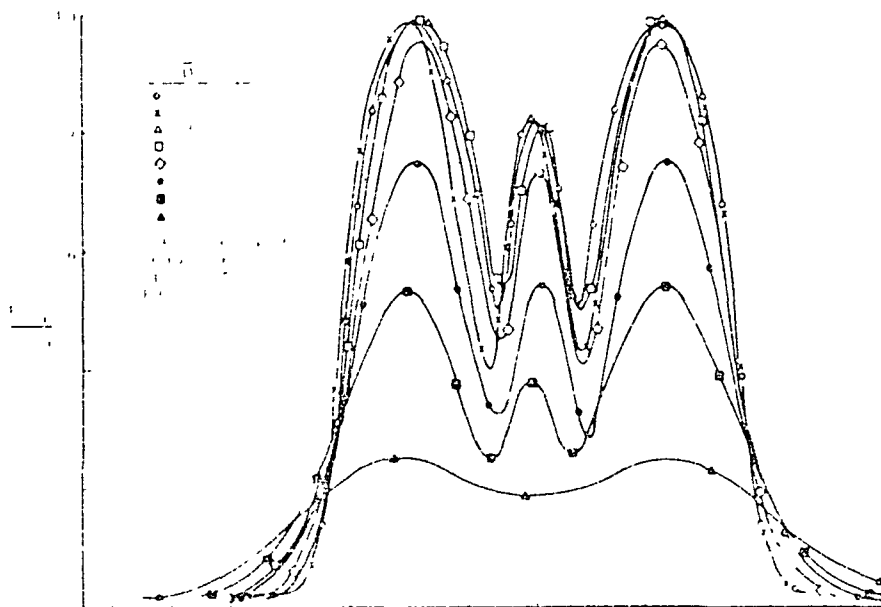
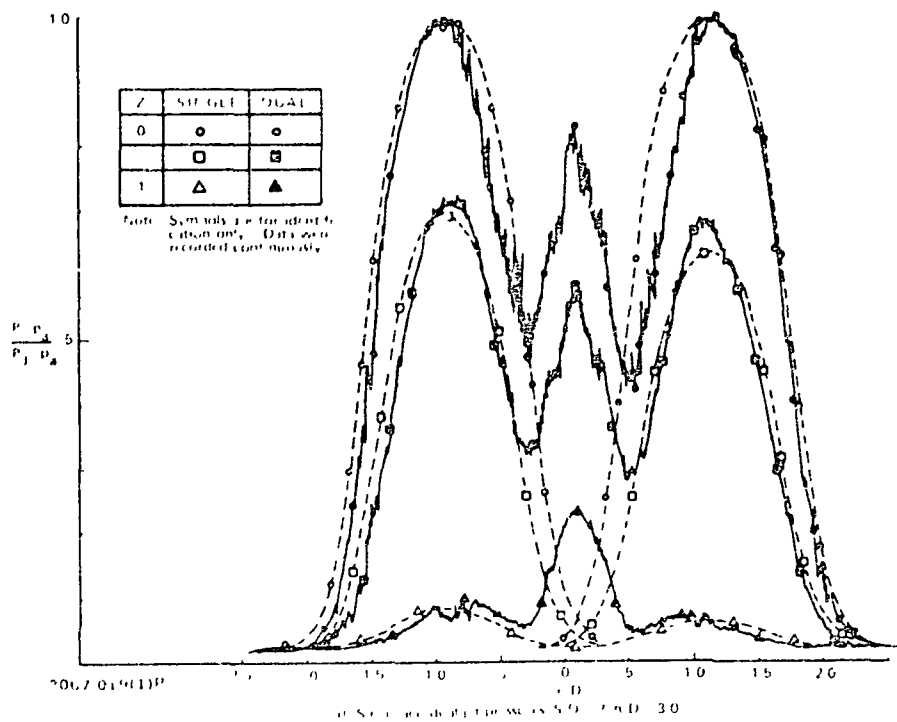

Figure 5-3. - Ground plane pressures.

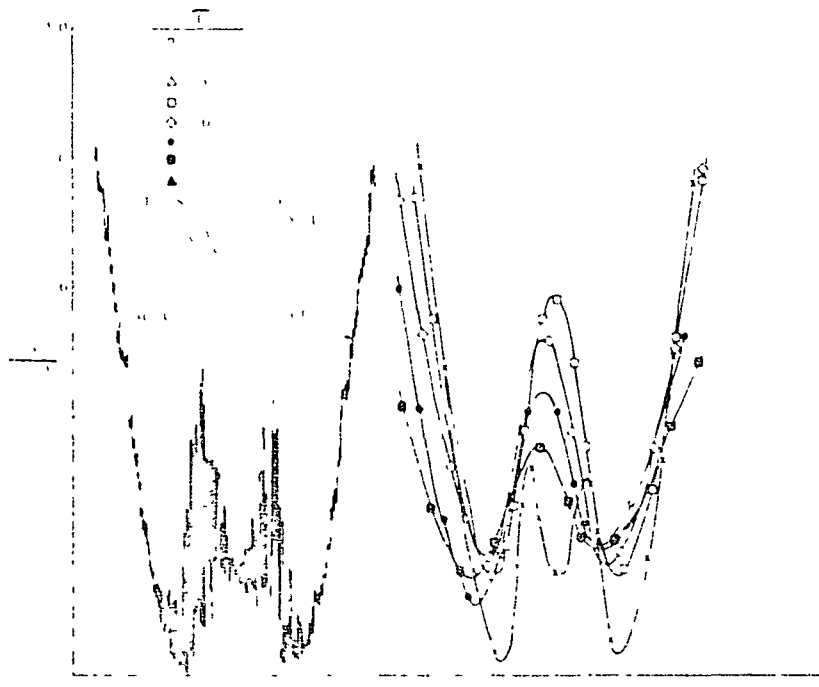
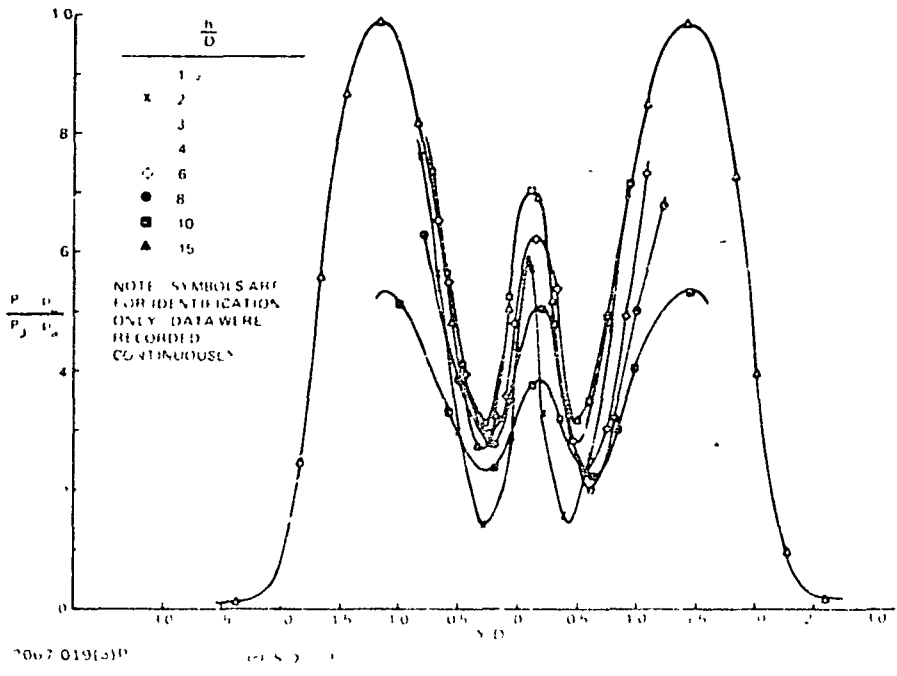

Figure 6-3 - Continued.

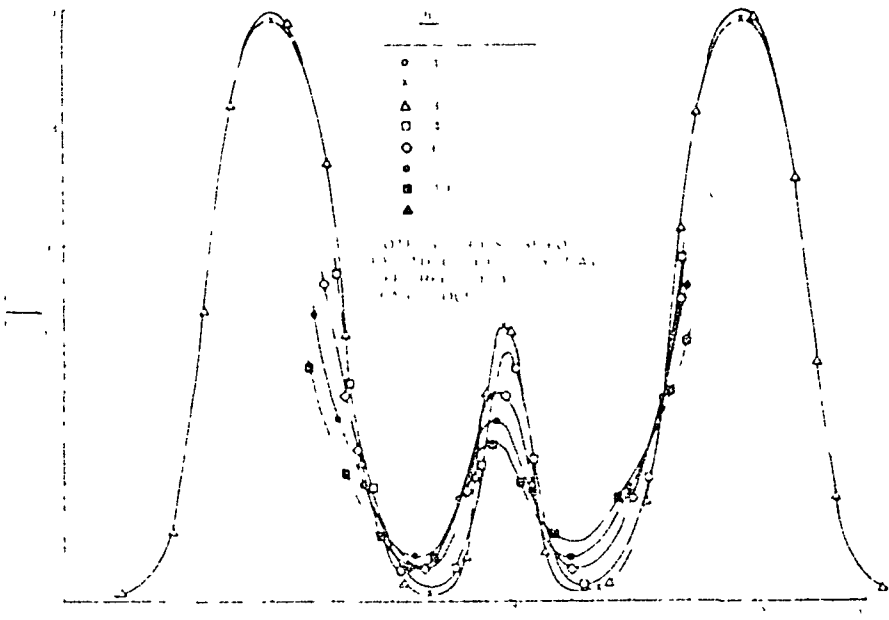
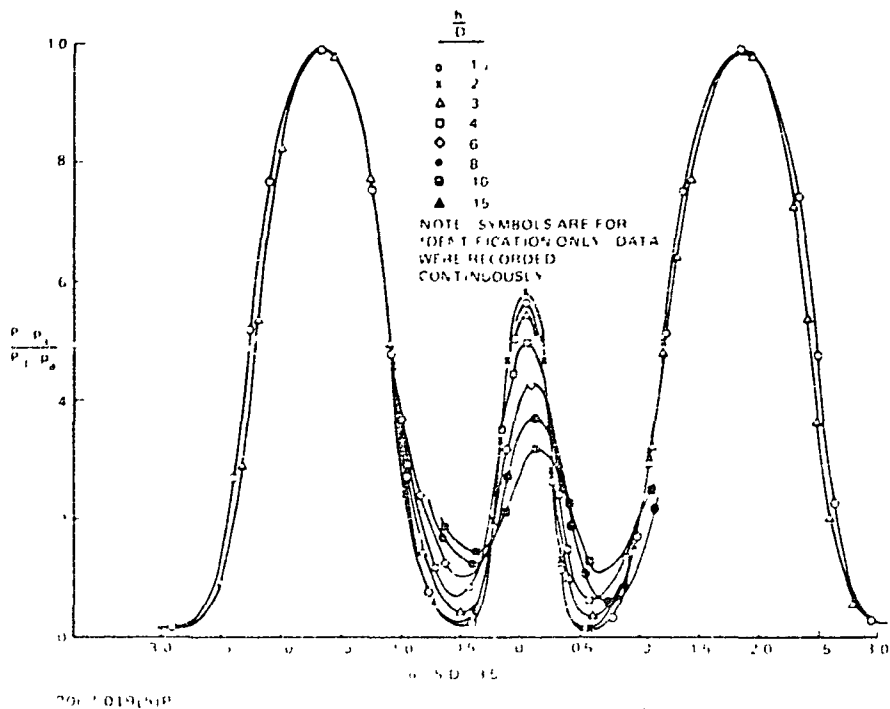

Figure 6-3. - Continued.

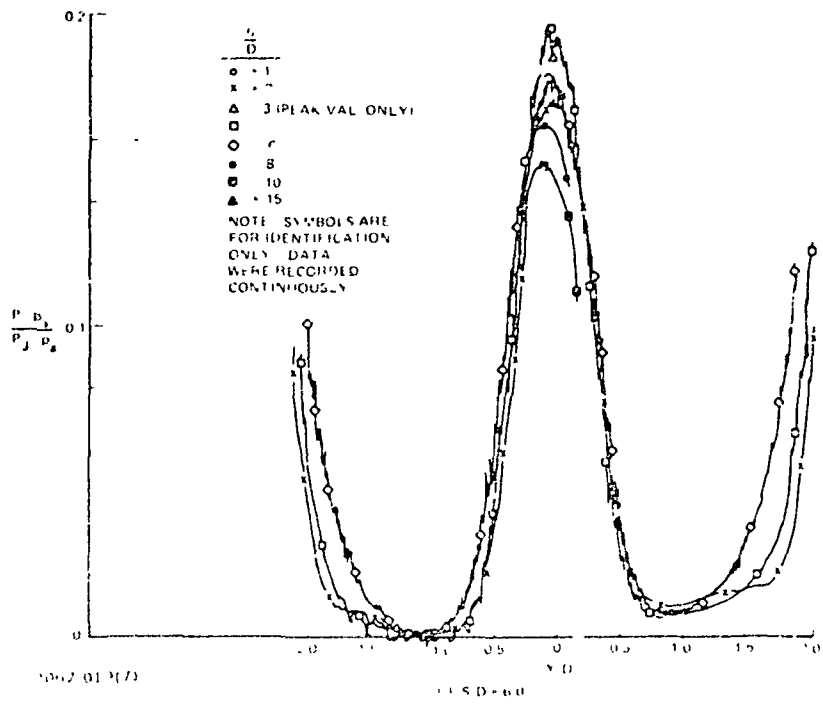

Figure 6-3. - Concluded.

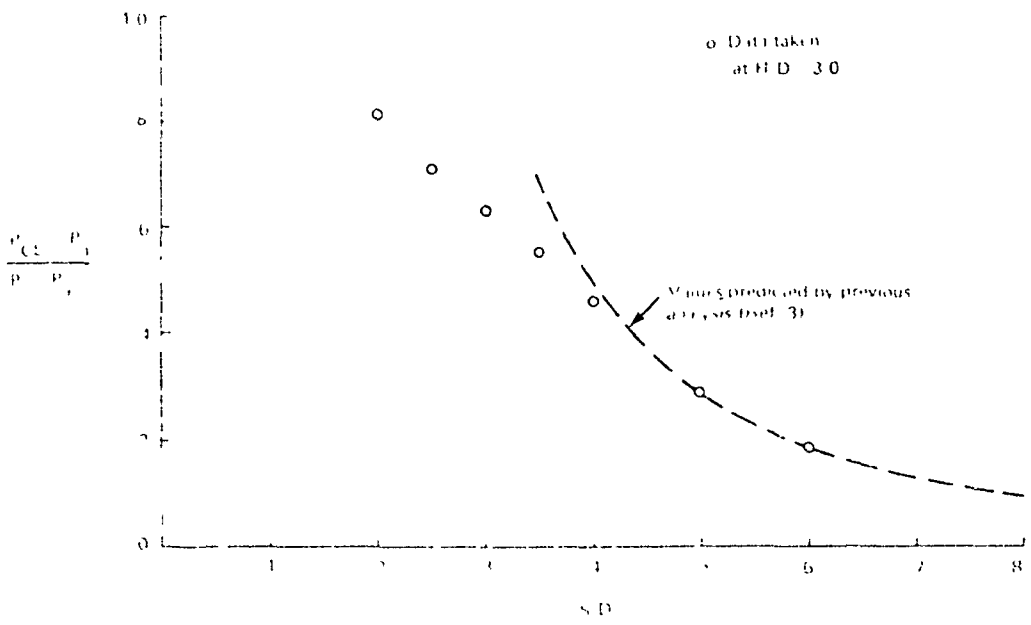
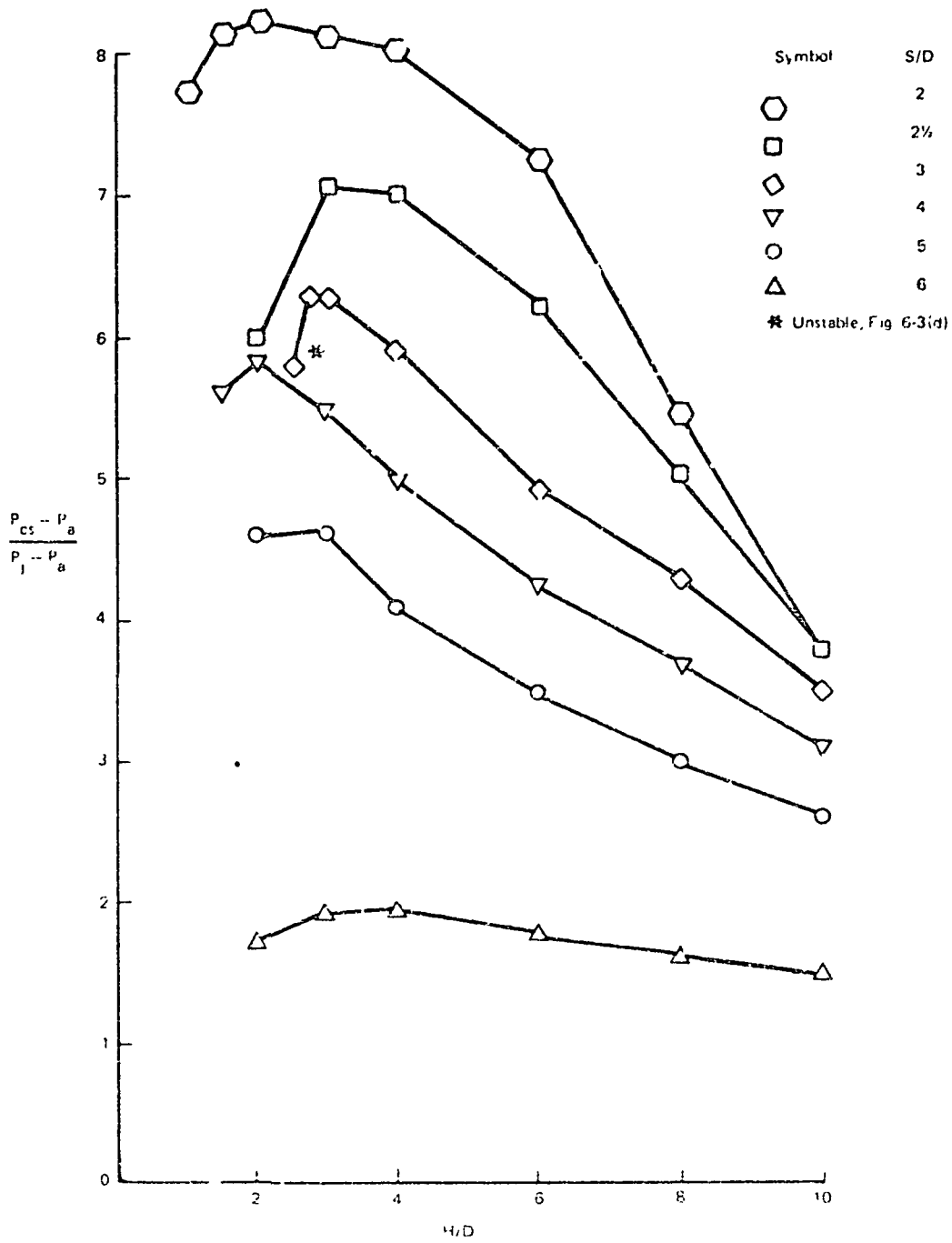

Figure 6-4. - Effect of jet spacing on maximum stagnation line ground pressure.



Doc 7 021P

Figure 6-5. - Maximum ground pressure on center of stagnation line.

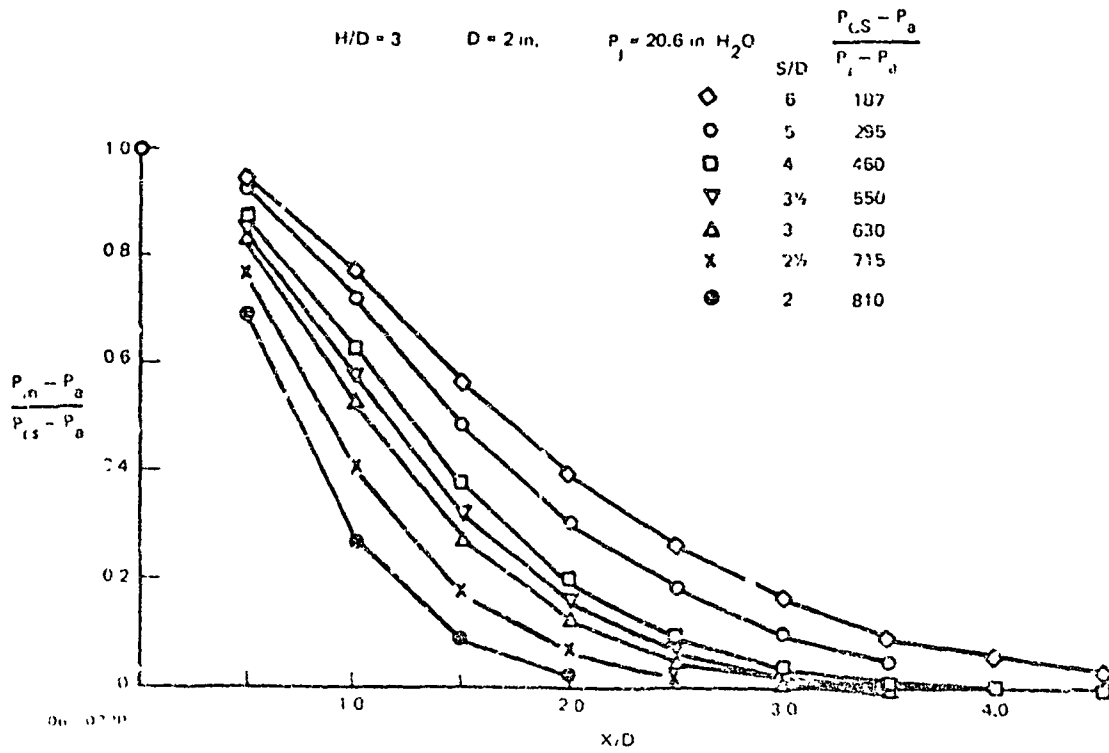

Figure 6-6. - Variation of maximum ground pressure along stagnation line.

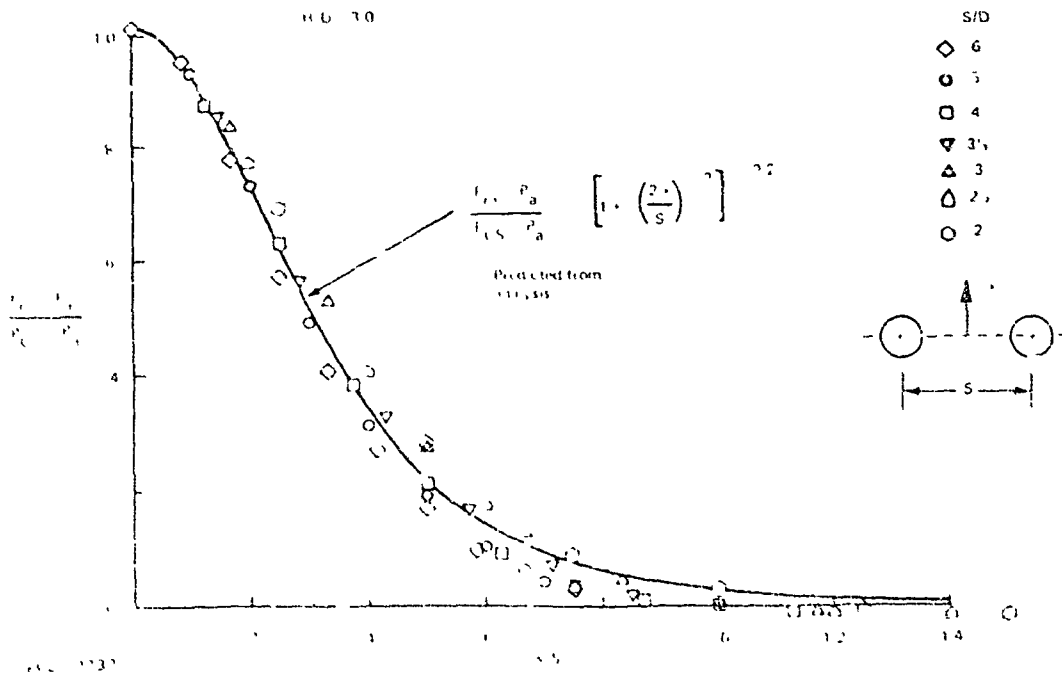
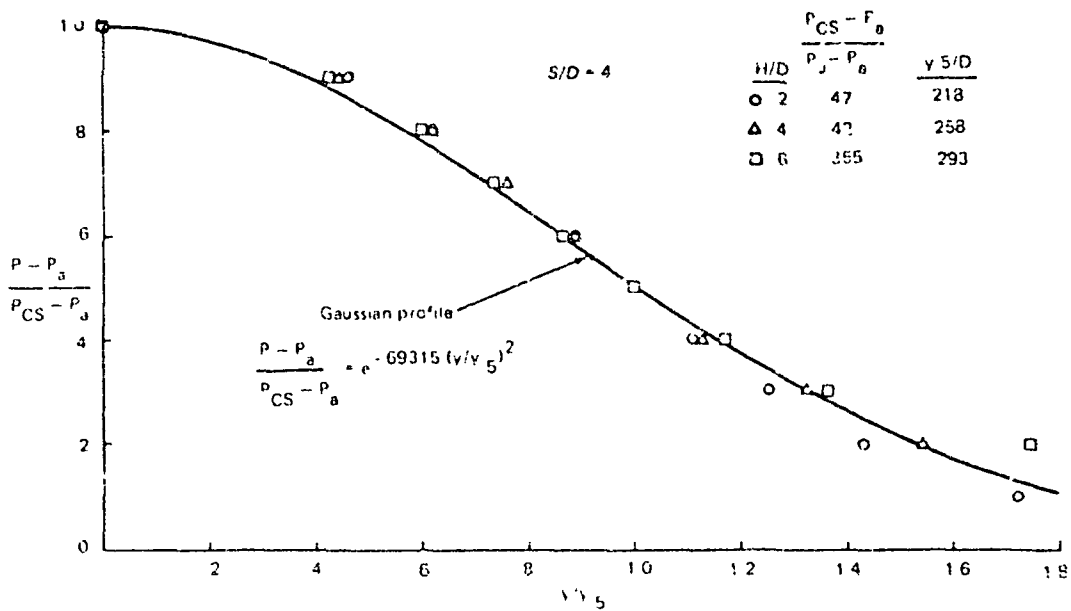
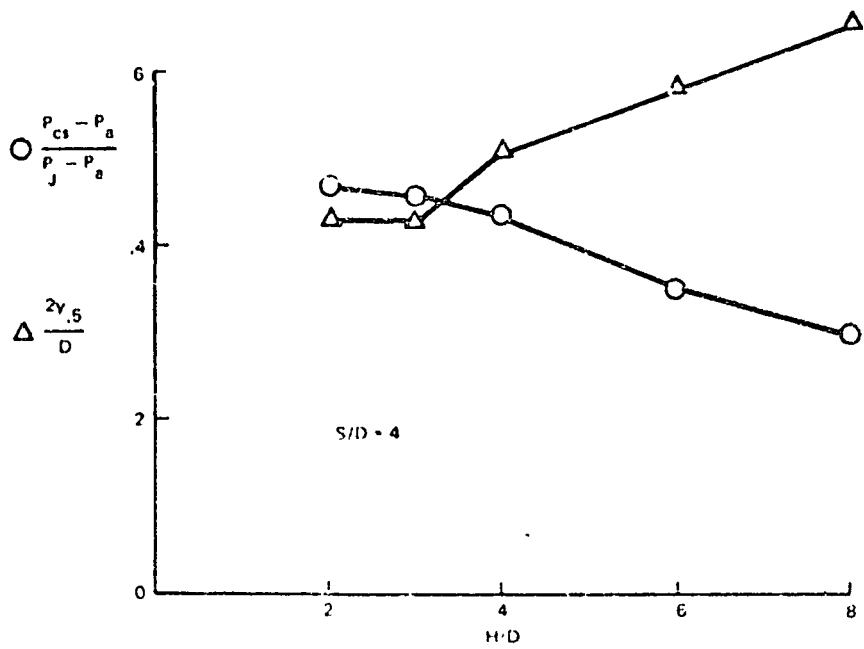

Figure 6-7. - Maximum ground pressure variation along stagnation line.



2007-0240

Figure 6-8. - Ground pressure variation across center of stagnation line.



2967-0750

Figure 6-9. - Variation of ground stagnation line characteristics with nozzle height.

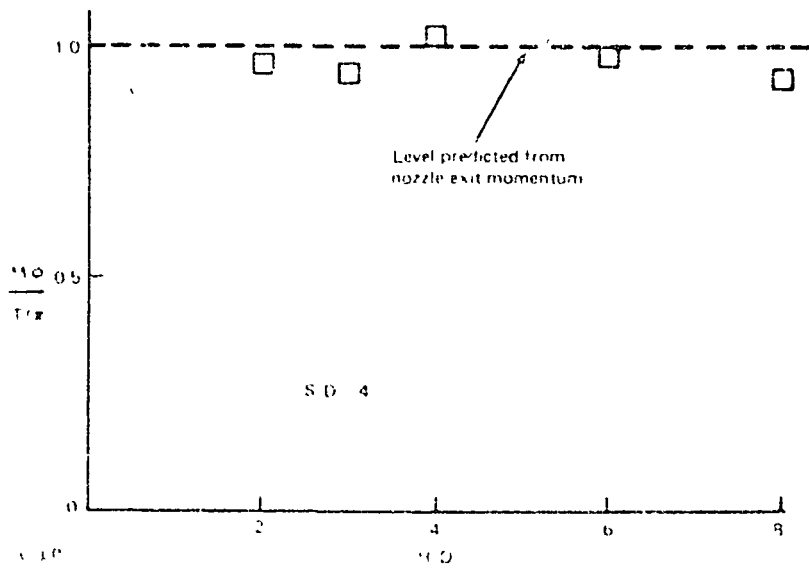

2967-0750

Figure 6-10. - Integrated ground pressure force.

7. UPWASH PROPERTIES

Oil flow techniques were used to qualitatively assess upwash flow behavior. A series of "splitter plates", (thin sheets of metal at right angles to the ground plane that split, or divide the flow) were used. In one series, the splitter plates were placed between the two jets along the centerline of the upwash (in the X-Z plane) looking at the radial spreading characteristics of the flow. In the second series, the splitter plate was placed along the line connecting the two nozzle centerlines (Y-Z plane) splitting each nozzle flow in half.

Oil Flow Results

The presence of the splitter plate will affect the upwash changing the flow both by damping the turbulent fluctuations normal to the flow direction and by developing a boundary layer of lower energy flow which can interfere when pressure gradients are encountered. We therefore sought primarily to look for the regions of jet/upwash interference with detailed probe surveys to follow.

For the splitter plate placed between the jets (X-Z plane), and a wide spacing ($S/D = 6$), a uniform spreading flow was found at heights of $H/D = 2$ and 6 (Figure 7-1(b)). For much closer spacings, beginning with $S/D = 2$ we find a similar situation at low heights. At $H/D = 2$, (Figure 7-1(c)), the flow spreading agrees well with our radial flow model. At a height of $H/D = 6$, streamlines along the center appear to be drawn in as if by entrainment from the jet (Figure 7-1(d)). At $H/D = 8$, a definite divergence of the center streamline occurs (7-1(a)) and going a little higher ($H/D = 9$, Figure 7-1(f)) a definite stagnation region is found where the oil in the upper center region is flowing downward. With another increase in height ($H/D = 10$, Figure 7-1(g)), the location of this stagnation point appears to remain the same, but the extent of its effect on the upwash is broadened.

With the splitter plate/nozzle arrangement, we were able to go to a spacing of $S/D = 1$, i.e., nozzle edges touching. At this spacing, a similar effect is found at lower heights. At $H/D = 2$ (Figure 7-1(h)), a spreading in the upper-central region is noted and a clear stagnation region is seen at $H/D = 1$ (Figure 7-1(i)).

For the second set of splitter plate experiments (Plate in Y-Z plane), we again began at a wide spacing of $S/D = 6$. Results are shown in Figures 7-1 (j), (k), (l), beginning at an H/D of 2 and increasing to 6. At the height of $H/D = 6$, the dynamic pressure was so low that it was difficult to form the oil patterns. Note the large angle (about 30°) that appears to be the outer wall jet growth angle. We believe that this is due to the corner flow and is a warning on the qualitative accuracy of this method of visualization.

Another view of changes produced by the splitter plate is found in Figure 7-1(m) looking down on the ground plane. A conventional ground flow/stagnation line is formed, but the center of the jet stagnation region is displaced outward from the splitter plate. Again, this is believed to be due to the boundary layer formed between the jet plume and the plate.

Proceeding then to the closer spacing ($S/D = 2$) a similar series of heights was examined. At $H/D = 2$, a fairly clean jet plume and upwash picture was formed (Figure 7-1(n)). At an $H/D = 4$, the upwash curved into the jet on the right (Figure 7-1(o)). A slight movement of the splitter plate caused this to be reversed with the upwash veering to the left (Figure 7-1(p)). By careful movement of the splitter plate while observing the oil, it was possible to obtain an upwash flow up the center (Figure 7-1(q)). At larger H/D , Figures 7-1(r) and 7-1(s), this sensitivity did not appear to exist, but a stagnation region marked the end of the upwash.

Summary of Upwash Pressures

Flow properties in the upwash were found by traversing the Kiel and static probes in the y-direction at various heights (z) above ground. Figure 7-2 shows data obtained from a probe traverse across the upwash centerline. Note that the static pressure was below ambient throughout the upwash and beyond its edges. At the edges of the upwash (smallest value y for which dynamic pressure is zero) and outside the edges, the Kiel pressure and static pressure readings were equal, in spite of the different shapes and orientations of the pressure holes in the probes. Within the upwash the static pressure profile was only slightly dependent on the size of the static pressure probe. The static pressure was below ambient throughout the region between the nozzle exit plane and the ground except for a small zone less than 25 mm above the ground just above the stagnation line. This large region of low static pressure

appears to be a characteristic of multiple jet ground impingement flows, and was found at all values of H and S that were run.

The dynamic pressure profile showed a Gaussian shape except at jet spacings below $S/D = 3$ where it was distorted by a lack of symmetry. Figure 7-3 shows data obtained from probe traverses across the center of the upwash at various heights above ground for $H/D = 2$ and $S/D = 4$. For each height above ground (z) the profile was normalized by the maximum dynamic pressure on centerline (q_c), and the probe distance (y) relative to the centerline was normalized by $y_{.25}$. This plot shows that data taken at different heights above ground has the same profile shape, which closely matches the Gaussian profile

$$q/q_c = e^{-1.386(y/y_{.25})^2} \quad (4)$$

Profiles of this shape were found for nozzle separation distances down to $S/D = 3$ providing the nozzle height above ground was not large enough to provide a significant interaction between the incident jets and the upwash. When the dynamic pressure profile shape is independent of height above ground, at any value of z the upwash properties on the centerline can be specified by the values of q_c/q_j and $y_{.25}$.

Figure 7-4 shows the dynamic pressure decay along the upwash centerline for $H/D = 1$ at different nozzle spacings. For each spacing the values of q_c were normalized by the corresponding maximum ground pressure at the center of the stagnation line. The data are plotted versus $\frac{S/2 + z}{S/2}$ to account for changes in the radial flow pattern in the upwash at different values of S . The data for $S/D = 5$ and 6 fall along a straight line, indicating that the dynamic pressure variation along the upwash centerline can be represented by a power law decay. As the spacing is decreased the data deviates from a straight line because of interference between the upwash and the incident jet flow at this nozzle height above ground.

Our modeling of the flow direction in the upwash assumes that the radial pattern of the wall jet flow on the ground continues into the upwash after the collision of wall jets at the stagnation line. The variation of dynamic pressure along the upwash at constant height above ground can be found from:

$$\frac{q_m}{q_c} = \frac{1}{1 + \left(\frac{x}{S/2 + z}\right)^2} \quad (5)$$

If there is no interaction between upwash and impingement zone. Equation (5) is plotted in Figure 7-5 for $S/D = 4$ and $Z/D = 2$ for comparison with data taken at several different values of nozzle height above ground.

The variation of upwash properties on the centerline at the nozzle exit plane with jet spacing and jet height above ground is illustrated in Figure 7-6. Decreasing nozzle spacing increases the exit plane maximum dynamic pressure, with not much change in upwash width, until a maximum value is reached between 3 and 4 diameters. Further decreases in nozzle spacing results in a decrease in exit plane dynamic pressure.

At low ground heights we encountered instabilities in the upwash at a nozzle spacing of 3 diameters. Such instabilities appeared as abnormally large fluctuations in probe readings. K11 probe fluctuations in the upwash were generally found to be in the range of 10 to 20 percent. Unstable upwash conditions increased the magnitude to over 50 percent. Such conditions were encountered for $S/D = 3$ when H/D was decreased to less than 2-1/2. Corresponding fluctuations in ground plane pressure were noted under the same impingement conditions, indicating that the entire upwash flow was affected. Further decrease in jet spacing provided more stable upwash conditions at low ground heights, but the pressure profiles at the exit plane were somewhat unsymmetric.

The flow properties on the upwash centerline at the nozzle exit plane are illustrated in Figure 7-7, which shows curves of constant dynamic pressure on a plot of H/D versus S/D . The boundaries on the left side of this curve, labeled 7° and 10° represent the conditions where the incident jets overlap shear layers before impinging on the ground. The difference in these two boundaries is the spreading angle assumed for the free jet plumes. The lower boundary corresponds to a stability limit illustrated on a similar plot presented by Hall and Rogers (Reference 8). We found that stable impingement flows existed at lower values of H/D than they indicated, however, an unstable region does appear to exist around $S/D = 3$ as illustrated by the dashed region sketched in Figure 7-7.

At the closest nozzle spacing, $S/D = 2$, we found that the upwash was mildly unstable at $H/D = 2-1/2$ and 3, but not for lower or higher values of H/D . Such instabilities would disappear if the symmetry of the impingement flow was disturbed. Misalignment of the ground plane by a few degrees would smooth out the instability described above. In addition, excessive blockage by a probe support could stabilize this type of fluctuation.

Effect of Bodies on Upwash

Since the basic analytic procedures assume isolated upwash behavior, using the two-jets as a building block, a brief experimental study was undertaken to determine the effects of adding various surfaces. Figure 7-8 illustrates the effects of the presence of our aircraft model on flow properties in the upwash. The total and static pressure profiles along the upwash centerline are shown for $H/D = 6$ and $S/D = 5$ with and without the model in place. At this height above ground the change in centerline upwash profiles caused by the model is significant only at points closer than one nozzle diameter from the fuselage underside. The static pressures increased as the flow stagnated on the bottom of the model. Figure 7-9 shows the effect on the upwash of the models used in the force experiments at the exit plane for a lower height above ground ($H/D = 3$) and a closer nozzle spacing ($S/D = 4$). In this case the models altered the flow properties of the upwash by producing lowered static and total pressures. The greater the body area, the greater the effect, although it was not large for any cases. This effect does not appear to alter the general behavior of the flow but a correction for its effects on the general pressure level may be needed.

Effect of Adding a Third Jet

To determine the influence of a third jet on the properties of the upwash formed between two jets, probe surveys were taken across one of the upwash flows with and without the third jet in operation. The primary jet pair was spaced at $S/D = 4$. The third jet was located at either $S/D = 3.86$ and $S/D = 5.69$ with respect to the other two jets (3.3 and 5.3) with respect to the line connecting the first two jet centerlines (see sketch on Figure 7-10 and 7-11).

The impingement geometry is illustrated in Figure 7-10, which shows measurements for the closest spacing of the third jet. The maximum dynamic pressure in the fountain flow is quite close to the predicted fountain location. Note that the maximum

dynamic pressure in the upwash formed between the primary jets is lowered 10% by the presence of the third jet, even at points that are far from the fountain region. The direct influence of the fountain presence appears to extend into the upwash about .75D from the predicted location.

Figure 7-11 shows a similar plot of maximum dynamic pressure with the third jet located further from the primary pair, showing that the influence of the third jet on the primary upwash almost negligible. The direct fountain presence again appears to extend 1.75D. For this case, probe surveys were taken at several heights above ground to investigate the fountain flow. Figure 7-12 shows a comparison of the properties in the fountain with the properties on the centerline of a two jet upwash. The inclination of the location of maximum fountain dynamic pressure is illustrated in Figure 7-13.



(a) S/D 6 H/D 2



(b) S/D 6 H/D 6

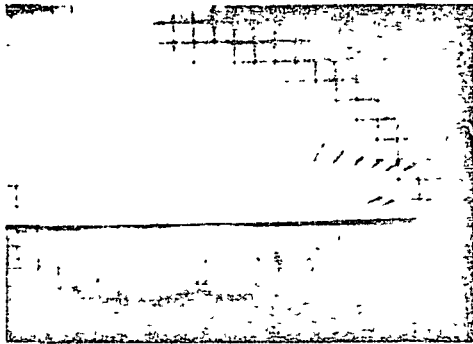

(c) S/D 2 H/D 2



(d) S/D 2 H/D 6

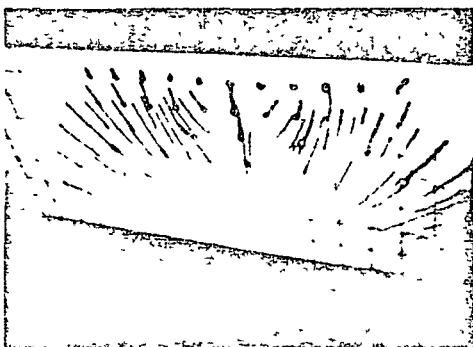

(e) S/D 5

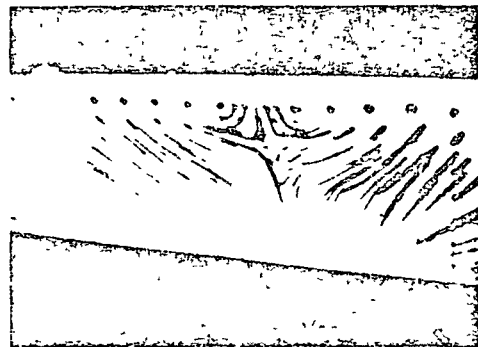

(f) S/D 9

FIGURE 7-1. UIC-151 Oil Flow Photographs.

ORIGINAL PAGE IS
OF POOR QUALITY

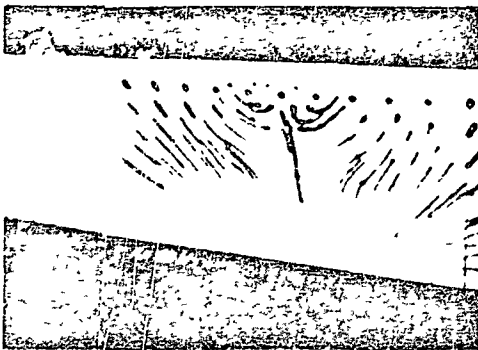

(g) S/D - 2 h/D - 10

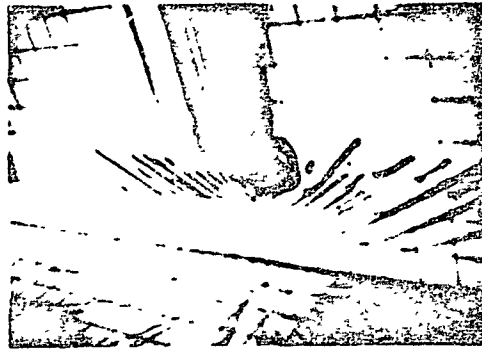

(h) S/D 11 h/D - 7

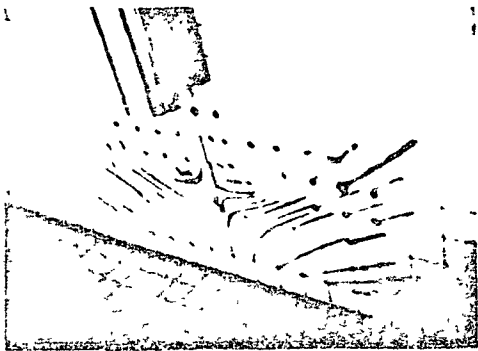

(i) S/D 1 h/D 4

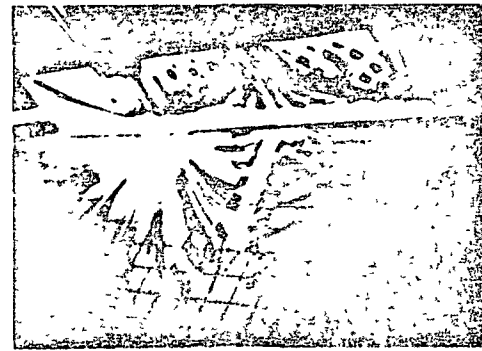

(j) S/D 6 h/D 2

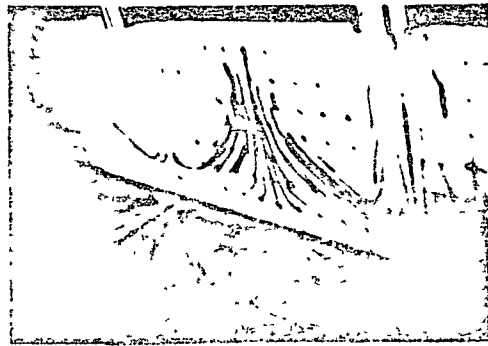

(k) S/D 6 h/D 1



(l) S/D 5 h/D 6

PHOTO 11

Figure 7-1 Continued

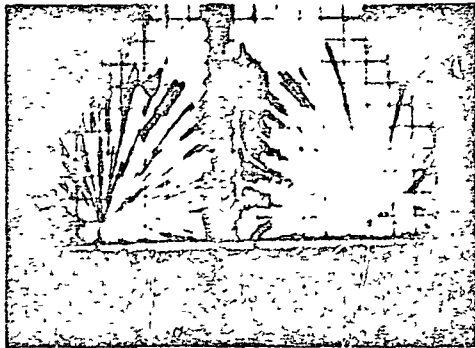

(m) VIEW LOOKING DOWN SPLITTER PLATE

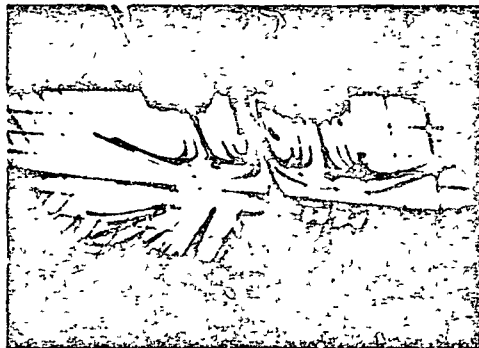

(n) S/D - 2 h/D - 2

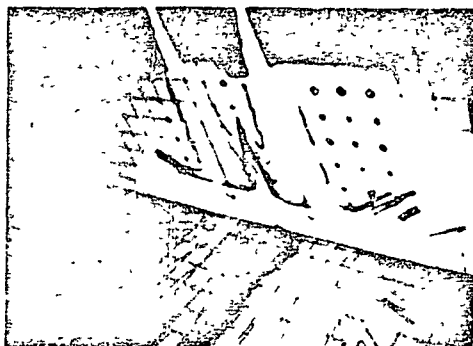

(o) S/D - 2 h/D - 4



(p) S/D - 2 h/D - 4

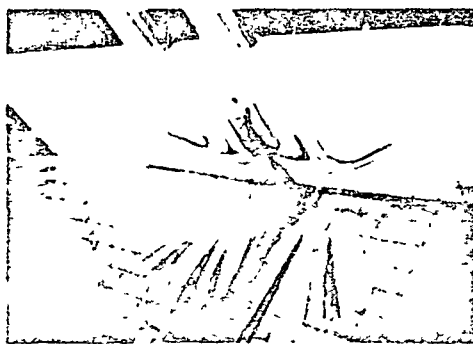

(q) S/D - 2 h/D - 4

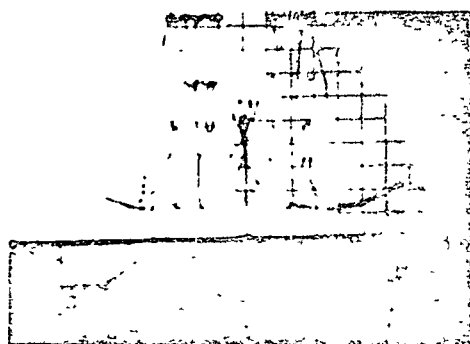

(r) S/D - 2 h/D - 6

7067027(3)

Figure 7-1 Continued.

ORIGINAL PAGE IS
OF POOR QUALITY

Handwritten text in the right margin, likely bleed-through from the reverse side of the page. The text is mostly illegible due to the quality of the scan and the angle of the page.

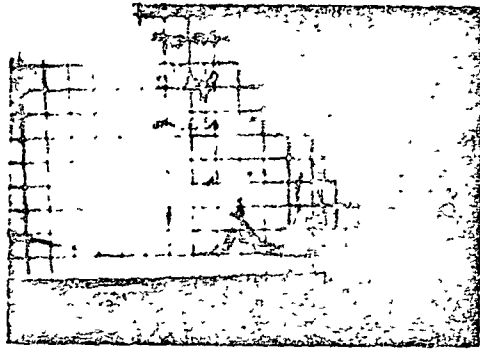

(s) $S/D = 2$ $h/D = 8$

02(7 02) (4)

Figure 7-1 Concluded.

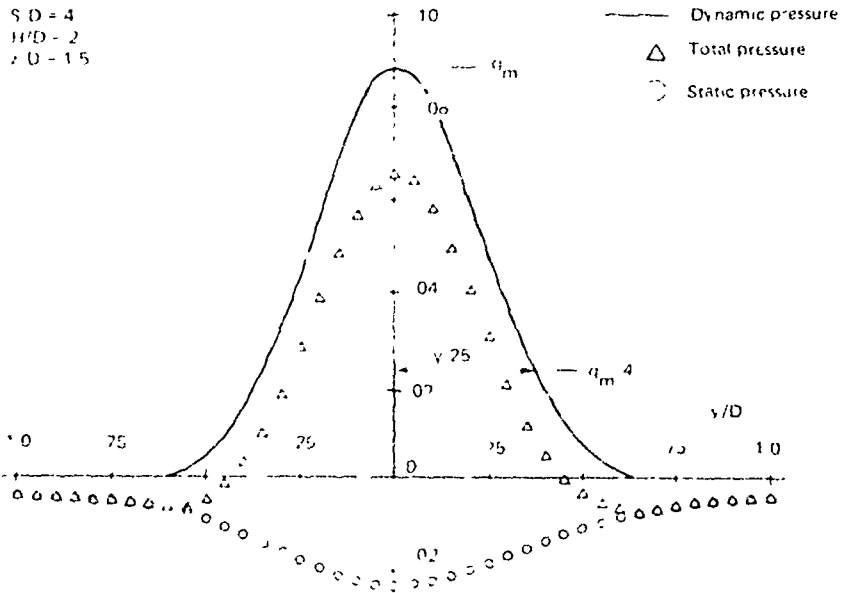

Figure 7-2. - Pressure profiles across flow with centerline.

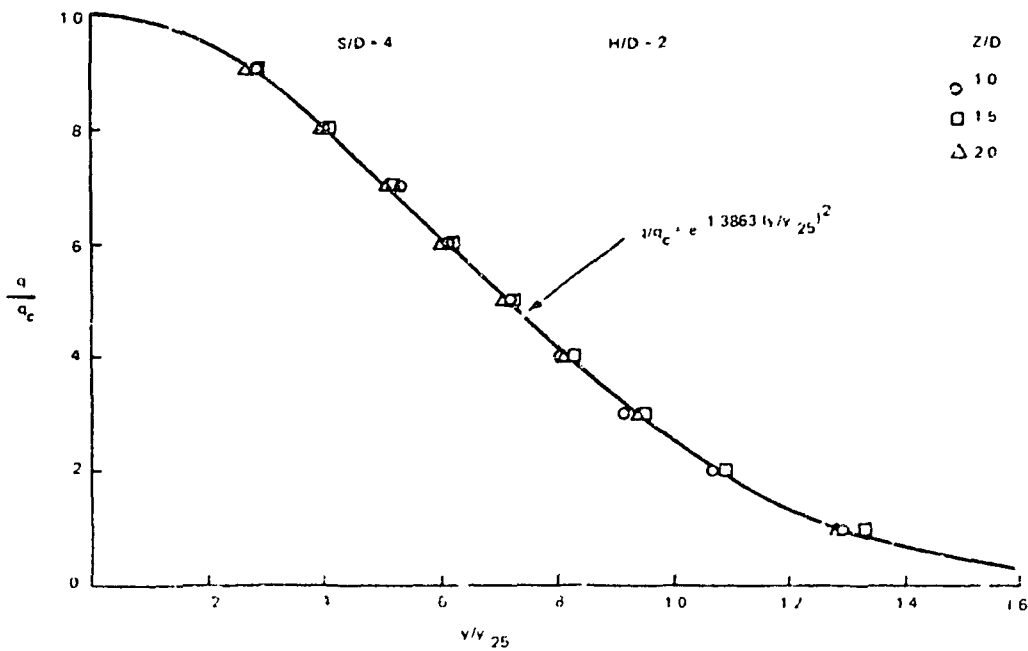

Figure 7-3. - Dynamic pressure profiles across upwash.

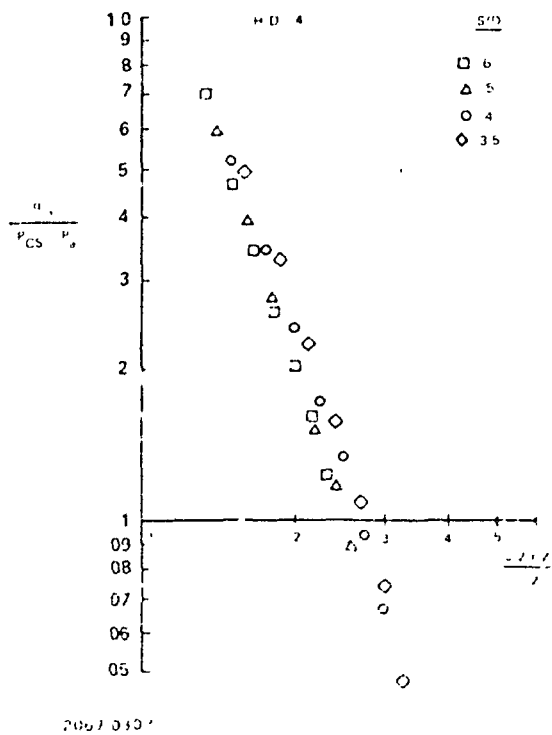
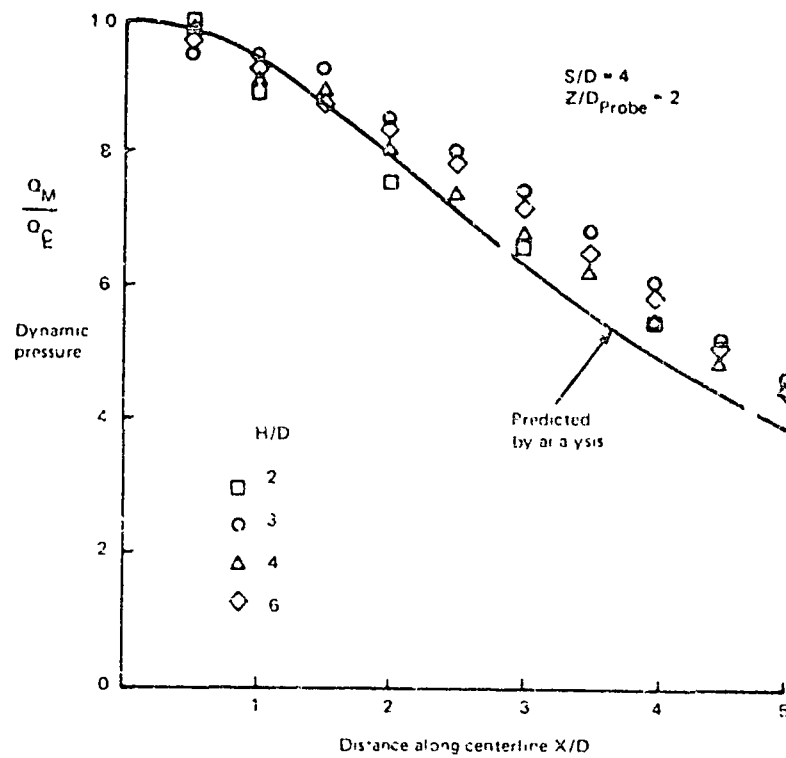

Figure 7-1. - Dynamic pressure decay along upwash centerline.



2007-031P

Figure 7-5. - Variation of dynamic pressure along upwash (X).

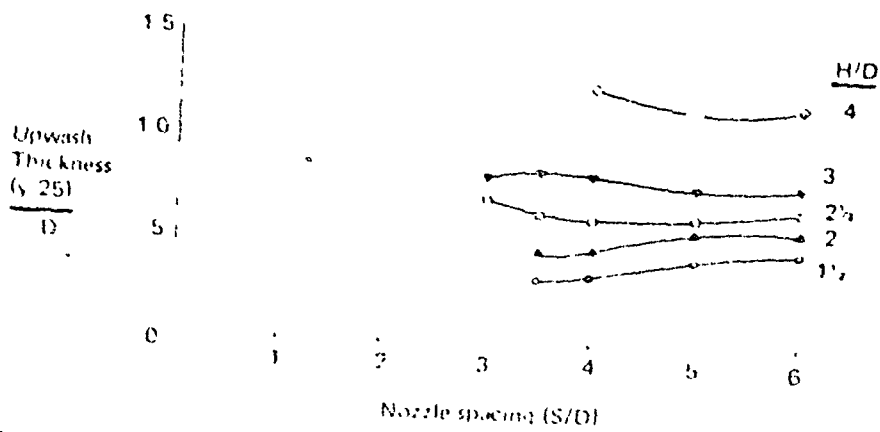
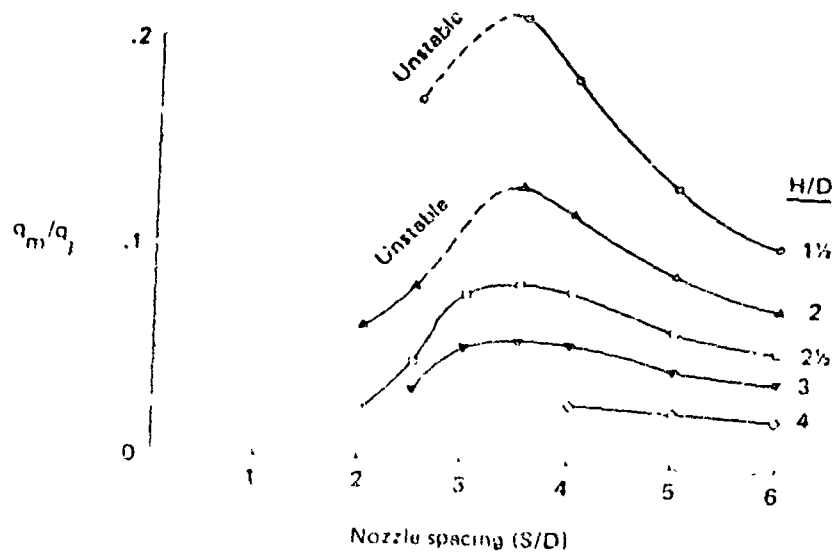

Figure 7. Upwash properties at nozzle exit plane.

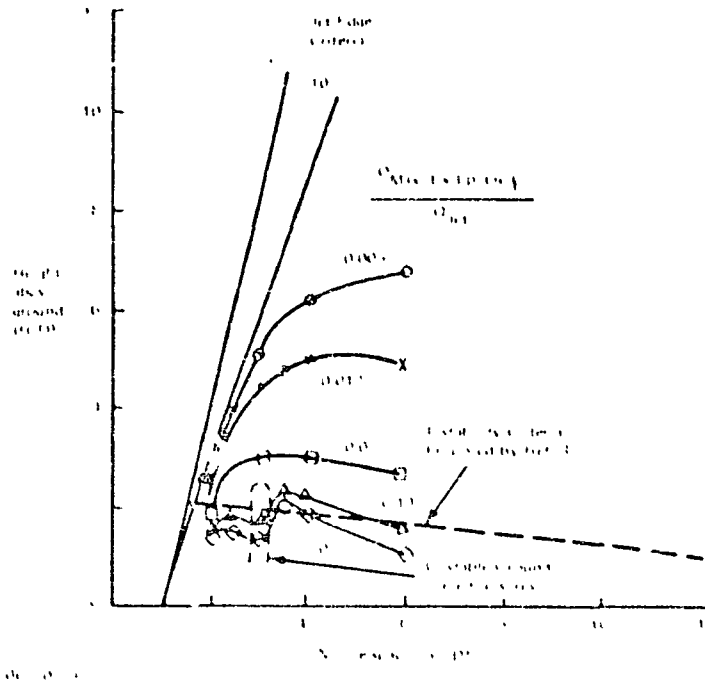

Figure 7-7. Maximum dynamic pressure in upwash at nozzle exit height.

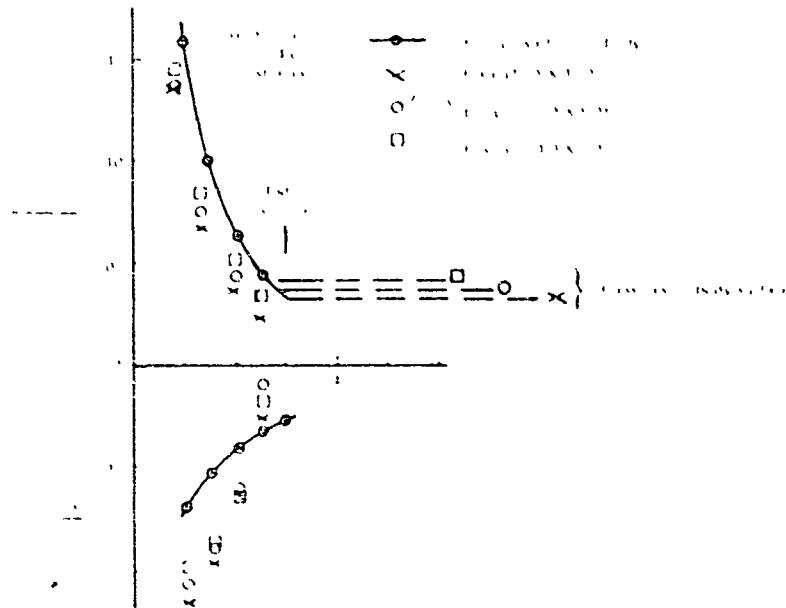

Figure 7-8. Effect of the three classes of bodies on the upwash properties.

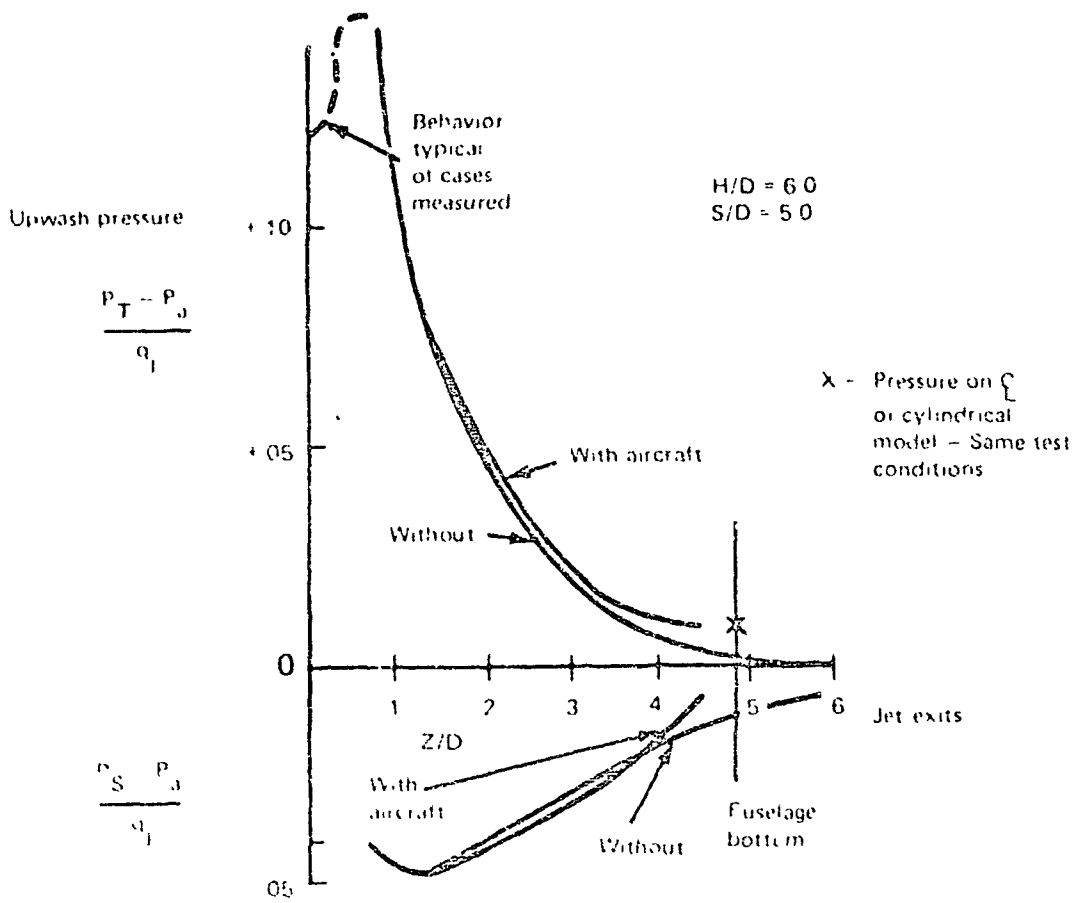

Figure 7-9. Effect of aircraft on upwash development.

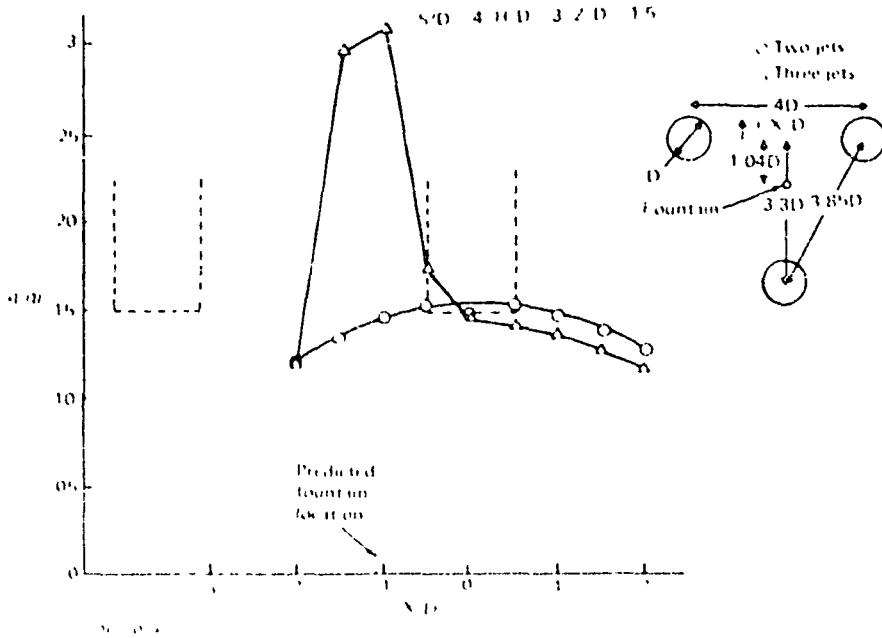

Figure 7-10. - Effect of third jet on maximum dynamic pressure along two-jet upwash. (Close spacing).

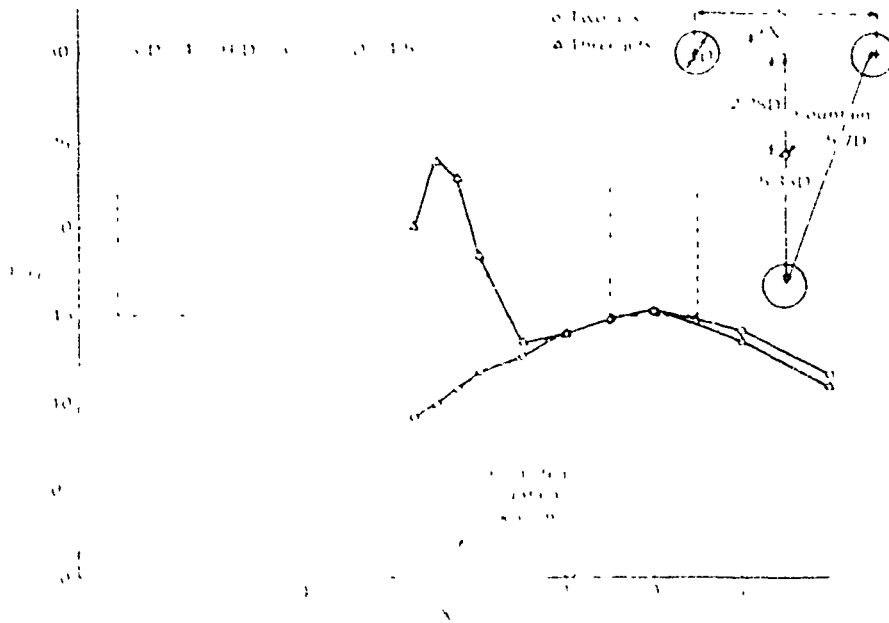
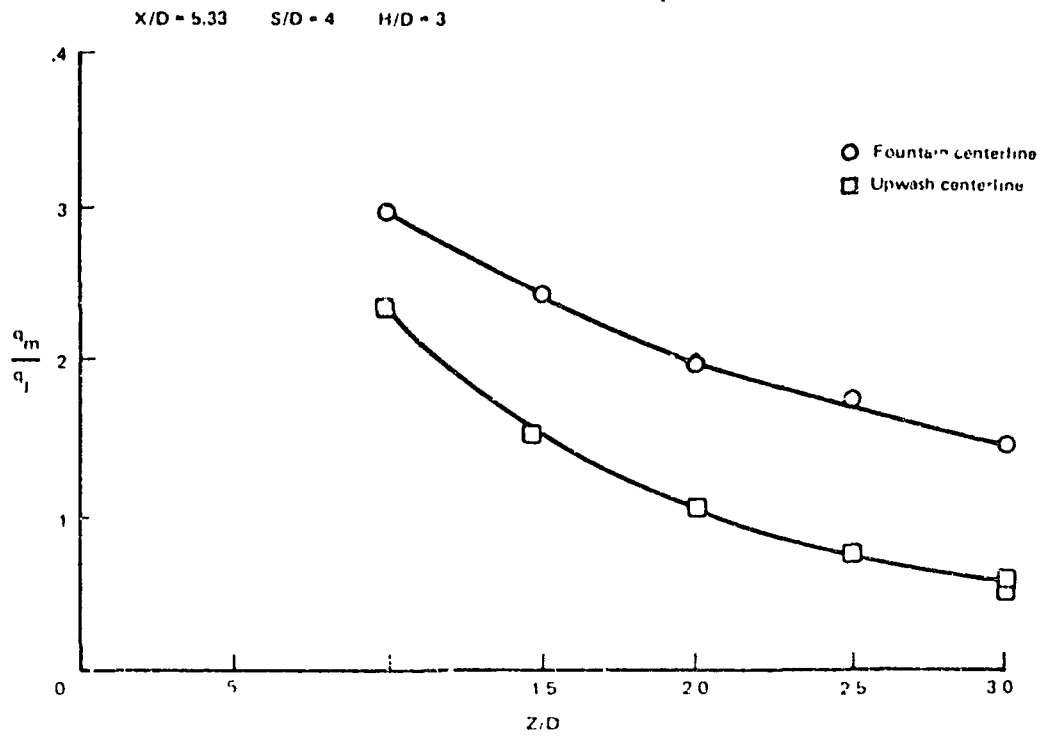
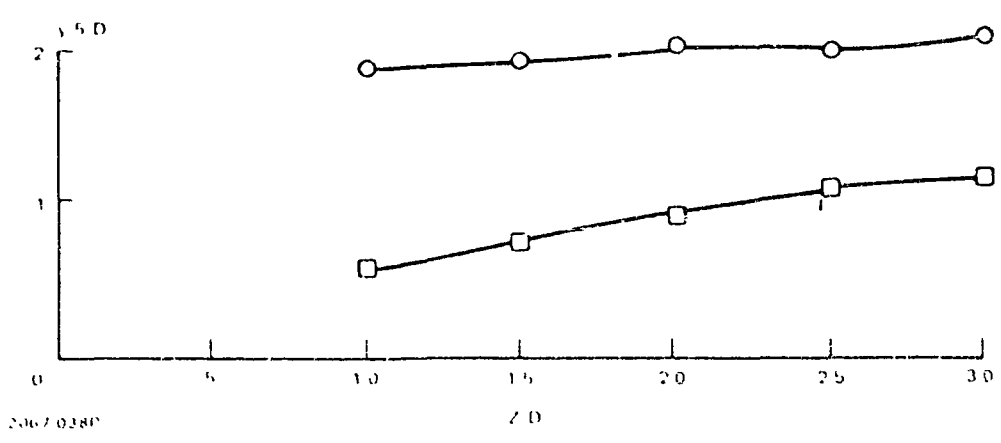

Figure 7-11. - Effect of third jet on maximum dynamic pressure along two-jet upwash. (Wide spacing).



(a) Maximum dynamic pressure



(b) Width at $q_{0,ax}$

Figure 7-12. - Comparison of fountain and upwash properties.

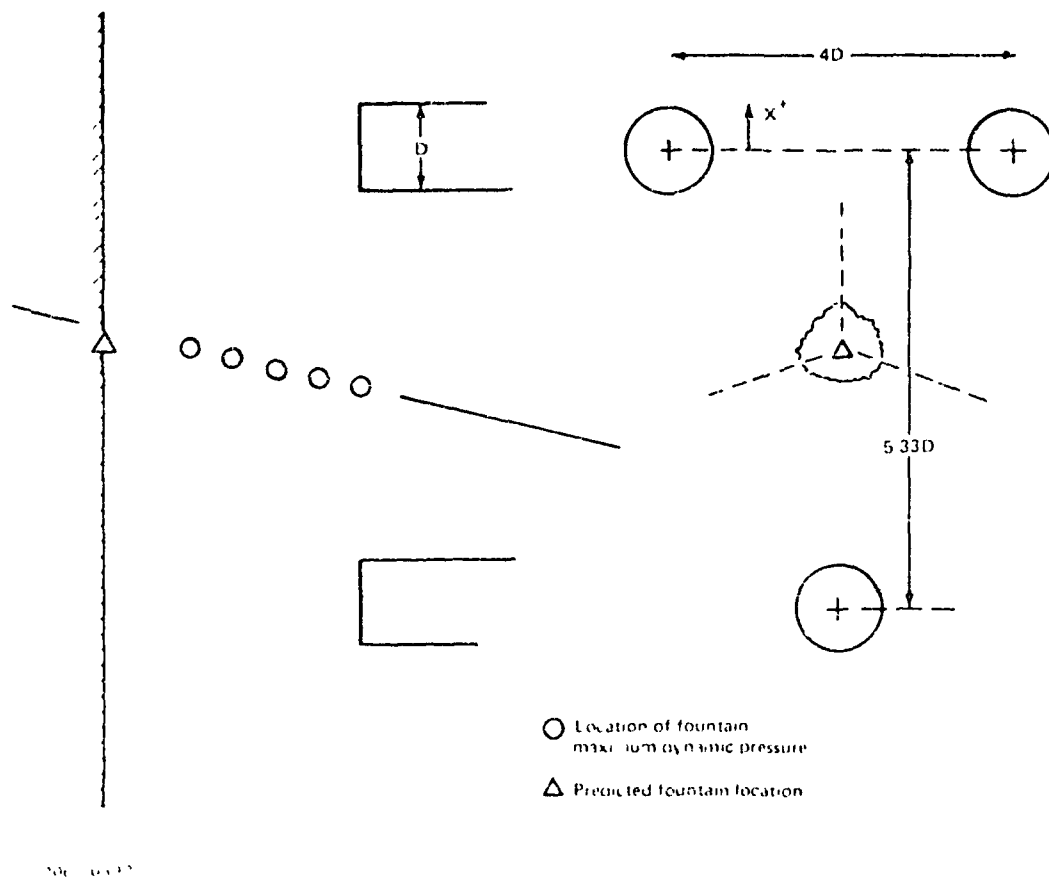

Figure 7-13. - Path of maximum fountain dynamic pressure.

8. JET INDUCED FORCES

Jet induced forces were obtained for two-jet configurations by using a strain gauge balance for the simulated aircraft surfaces (full aircraft model of Figure 4-1 and fuselages of Figure 4-8). For the flat plate (Figure 4-10) the force was measured with three separate strain gauge beams. In all cases, only the jet-induced forces were measured, and the jet thrust was not metric. Jet thrust was calculated from integrated total pressure profiles at the nozzle exit plane, including measurements through the boundary layer.

Forces on Aircraft Model

The aircraft design used in this study is shown in Figure 4-7. A series of experiments with the basic airplane (Figure 8-1) showed interference force levels becoming more negative as the jets were brought closer together, down to a nozzle spacing to diameter (S/D) ratio of 2.8. Below 2.8, down to 2.4 (the limit of our apparatus) the force curves stayed essentially constant. The only hint of any unusual behavior was the slightly more positive than expected force levels and the local positive deviation of the force curve for an S/D of 3.2 around a height of H/D = 1.6. (This curve is shown as a dashed line in Figure 8-1 for clarity.)

Strakes were then attached to the lower surface of the fuselage. These strake surfaces are shown in Figure 8-2. When strakes were added, a much more complicated situation developed. For aid in observing and understanding the behavior, these data are presented in a series of three graphs in Figure 8-3. Figure 8-3(a) shows that beginning at moderately wide spacings (S/D = 5.7) the interference forces ($\Delta F/P$) are positive over the range of H/D investigated. As the jet spacing is decreased, the forces become larger up to a spacing of S/D = 4, and then stay approximately constant to S/D = 3.2. Figure 8-3(b) (carrying over the curve for S/D = 3.2) indicates that at a spacing of S/D = 3.1 the flow became very unsteady for heights between approximately H/D = 1.8 and 2.4. The force levels varied over the range indicated in the shaded area of the figure. As the spacing decreased still further, this unsteady behavior disappeared, but a region near these same H/D's occurred where the force fell from the S/D = 3.2 value to a much lower value. The width (in H/D values) of this region of lowered forces grew wider as S/D was decreased until for spacings less than S/D = 2.8 the higher force

region did not occur at all. After this point the general force level again showed a slight increase with closer spacings down to $S/D = 2.4$. For these close spacings another much smaller unsteady transition area occurred near a height of $H/D = 5$. This was a transition between the forces with strakes and the lower force levels (negative) without strakes.

The changes in general level and shape of these interference forces with strakes were found to be a property of the upwash flow itself, rather than its interaction with the aircraft, as noted in Section 7.

The above experiments were conducted with one specific aircraft design. Earlier work indicated that details of the body geometry could strongly affect the interference forces also (Reference 6). An example of this is the effect of the fuselage corner radius. Making the fuselage corner radius sharper produces positive interference forces.

To conduct a systematic investigation of the effects of body geometry we used a series of simplified bodies, as well as extensive measurements and modeling of the basic jet/upwash flows.

Two-Dimensional Body Forces

The first series of experiments involved cylindrical bodies (shown in Figure 1-8), similar to the aircraft fuselage in the previous section, with varying lower surface contour. In addition to confirming that a fuselage-type surface can experience large positive forces in-ground-effect it was found that there was a change between attached flow around the body and separation at the lower corner as the corner radius was changed. Flow visualization photos using tufts show this behavior clearly (Figure 8-1). The switch between attached and separated flow was found at a corner radius to body width (r/w) of 0.188. At this radius both flows could exist, and could be switched by disturbances of the flow.

The effect of corner radius on the interference forces is shown in Figure 8-5. Beginning from a sharp corner which results in a large positive interference force, the force decreases as the corner radius is increased. When the flow switches from separation at the corners to attached flow ($r/w = 0.188$), the force jumps upward to a larger value. Further increase in the radius results in a return to the trend of decreasing force with increasing radius.

The occurrence of a larger upward force (body "drag" in the upwash flow) for attached flow than for separated flow is understandable with reference to the pressure distributions of Figure 8-6. The pressures on the lower surface and the upper surface are affected by the change from separated to attached flow. The pressure on the upper surface is very near ambient when the flow is separated. When the flow is attached the upwash above the body acts as an ejector and produces a larger negative pressure which, in this particular case, is a positive interference, or lift. The pressure distributions of Figure 8-6 also show the reason for the sensitivity of the forces to the body geometry. The integrated pressures (forces) involve two areas on the bottom surface, one positive, one negative. The resulting force is therefore the small difference between two large numbers, and very sensitive to shifts in the curve.

Another study area was the effect of the strake depth on interference forces. Figure 8-7 shows a continuing increase in upwards forces with increased depth. The curve for $r = 0$, no strakes is a reference line. This was the curve of greatest interference force in Figure 8-5. Note that also a body with a corner radius and fitted with strakes which are level with the fuselage bottom section produces a higher interference force than the flat bottomed body.

With a strake depth of $\sigma/D = 0.125$ a series of experiments was conducted with three different body widths, $W/D = 0.5, 1.0, \text{ and } 1.5$. Results of this series are shown in Figure 8-8. A progression of higher forces with greater body width is seen, but the thinnest body does not have as fast a drop off of force with height above ground as found for the other two. All three of these bodies are enveloped by the upwash for values of H/D down to 1.

Extending this investigation to other classes of bodies; a lower fineness ratio ($L/D = 2, 8 \text{ vice } 16$ for the fuselage type body) rectangular body was tested with and without strakes (Figure 4-9). Nozzle spacings between 2.4 and 1.0 result in nozzles contained within the plenum.

Interference forces on these bodies with strakes (Figure 8-9) have much larger negative values than those for the preceding cases. This results because of the larger area for the lower surface pressures to affect. We found no significant effect of the corner radius or the upper surface corner geometry for this body. The addition of strakes again produced a large positive increment in forces, and a region of

unsteady flow developed for $S/D = 3.0$ and height above ground between S/D of 1.5 and 2.5 (Figure 8-9).

A survey of the effects of strake height and strake spacing were conducted at a nozzle spacing (S/D) of 4.0 (Figures 8-10, 8-11). Variation of the strake spacing produced some changes in the force curves, with an optimum at some intermediate spacing. In all cases significant positive forces resulted. The positive force increment due to the strakes (Figure 8-10) increased with increasing strake height up to about $h/D = .25$. Doubling of that value produced very little change.

Also examined briefly was the flow with a very large plate at the nozzle exit plane, using a square plate $12D \times 12D$, with a nozzle spacing of $S/D = 4.0$. Large negative forces were found without strakes, but for this "vehicle" the large positive force increments with strakes did not occur (Figure 8-12). In fact, for some values of h/D the strakes resulted in more negative forces.

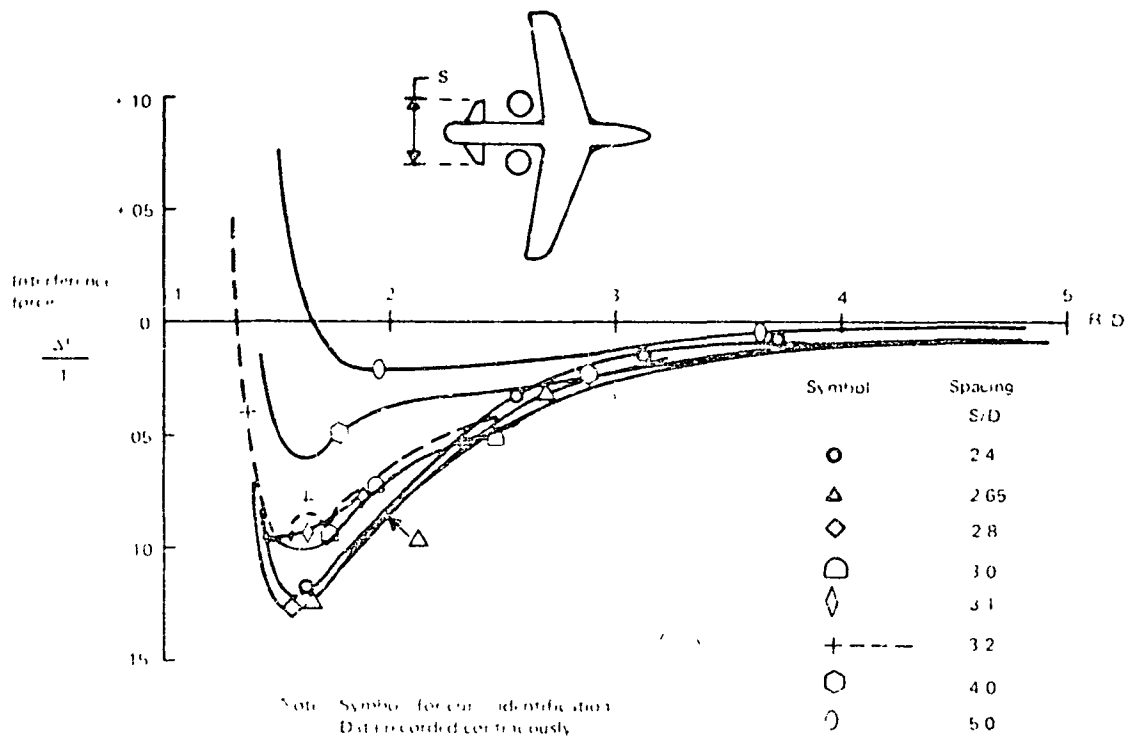

Figure S-1. - Effect of jet spacing on aircraft forces.

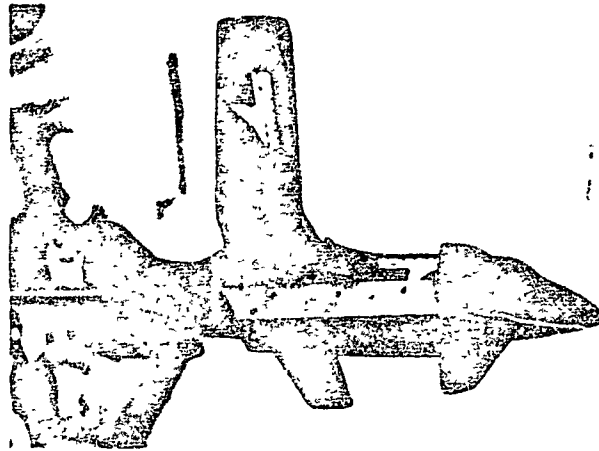

Figure S-2. Strake used on the aircraft model.

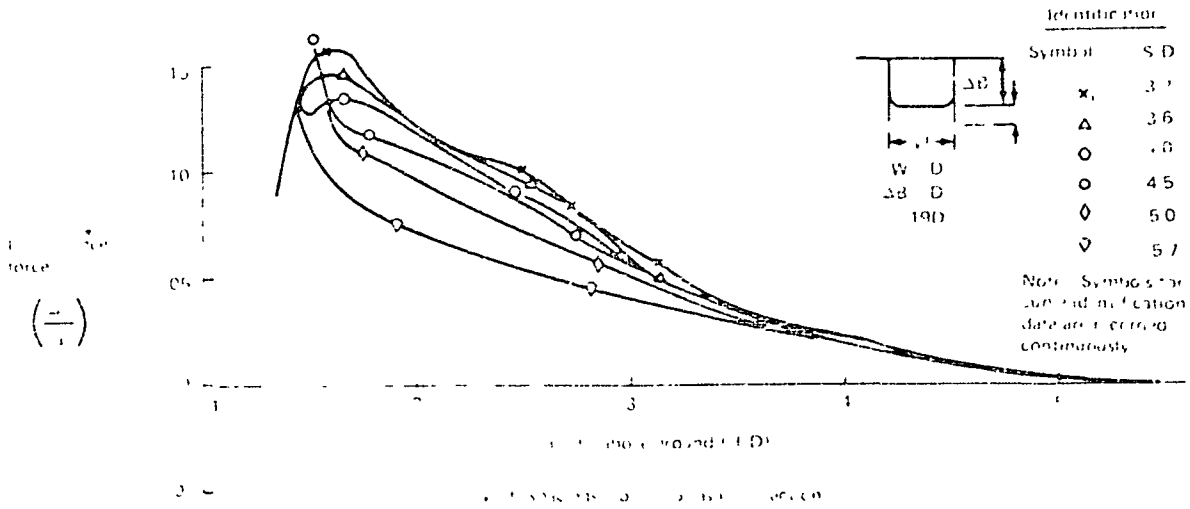
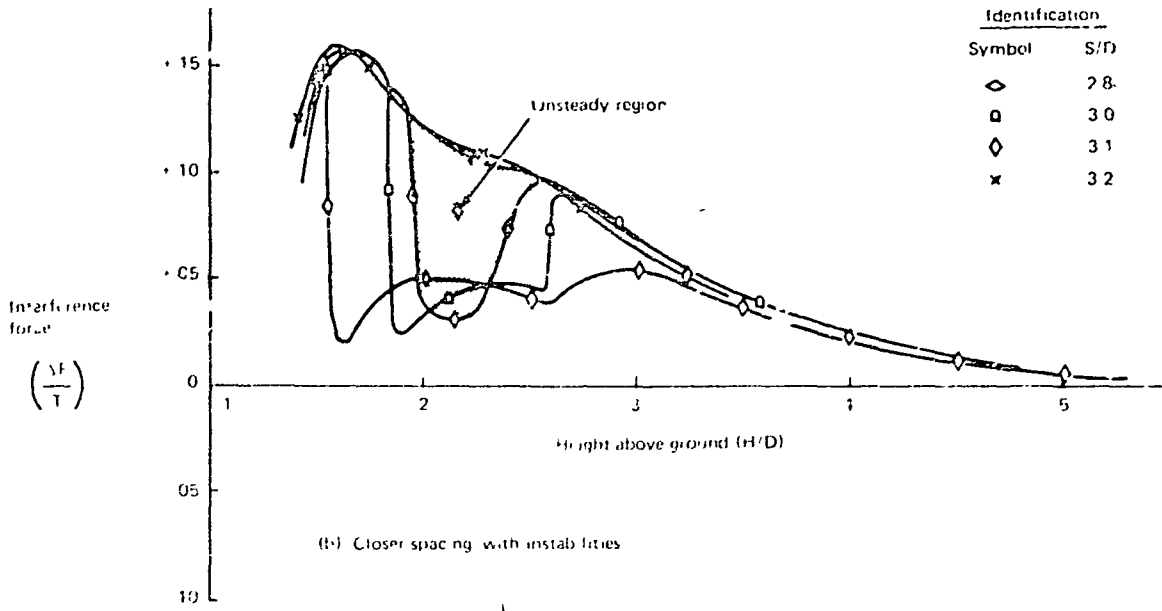

Figure S-3. Effect of strakes on jet-induced forces.



00701200

Figure 8-3. - Continued

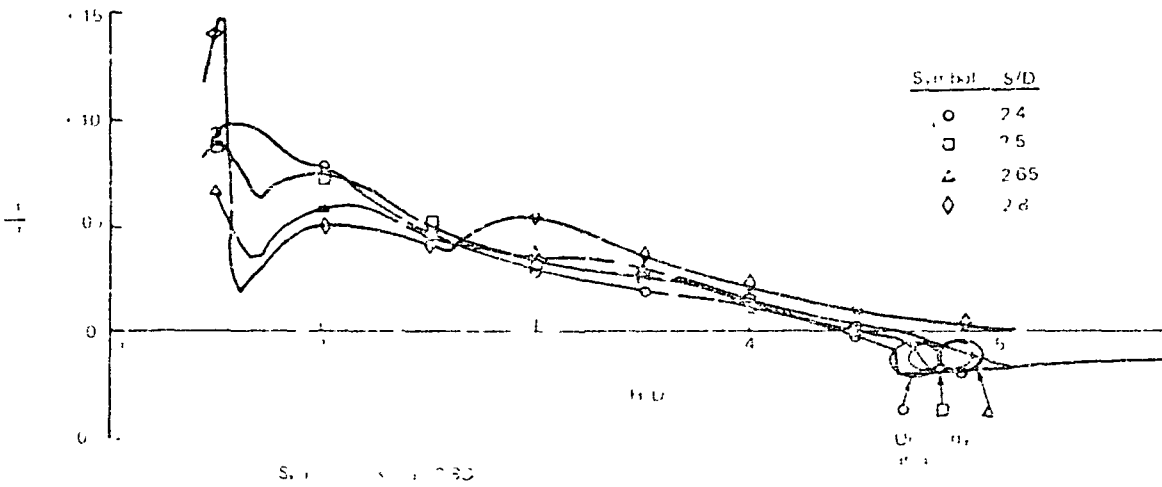
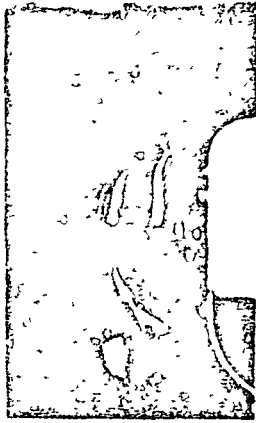

Figure 8-4. - Continued



(a) Flow spread



(b) Flow separated

Figure 5-1. Flow visualization of upwash on fuselage.

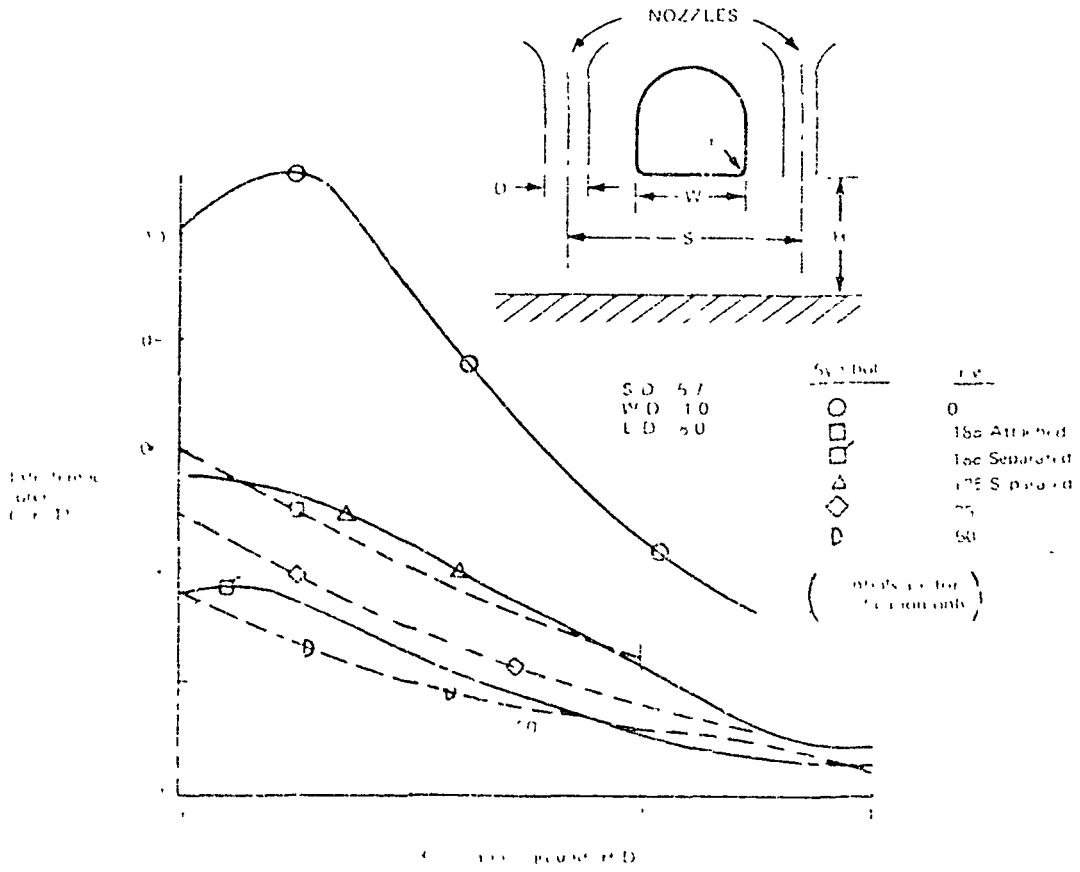

Figure 5. Effect of corner radius on lift (Fig. 5-1, c).

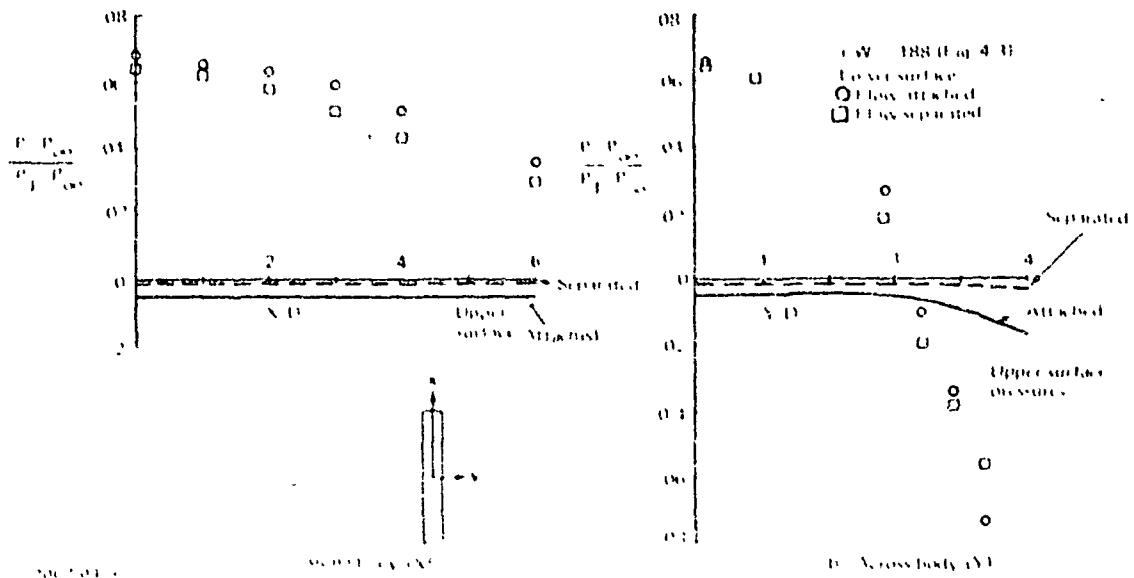

Figure 8.6. - Body pressure distribution.

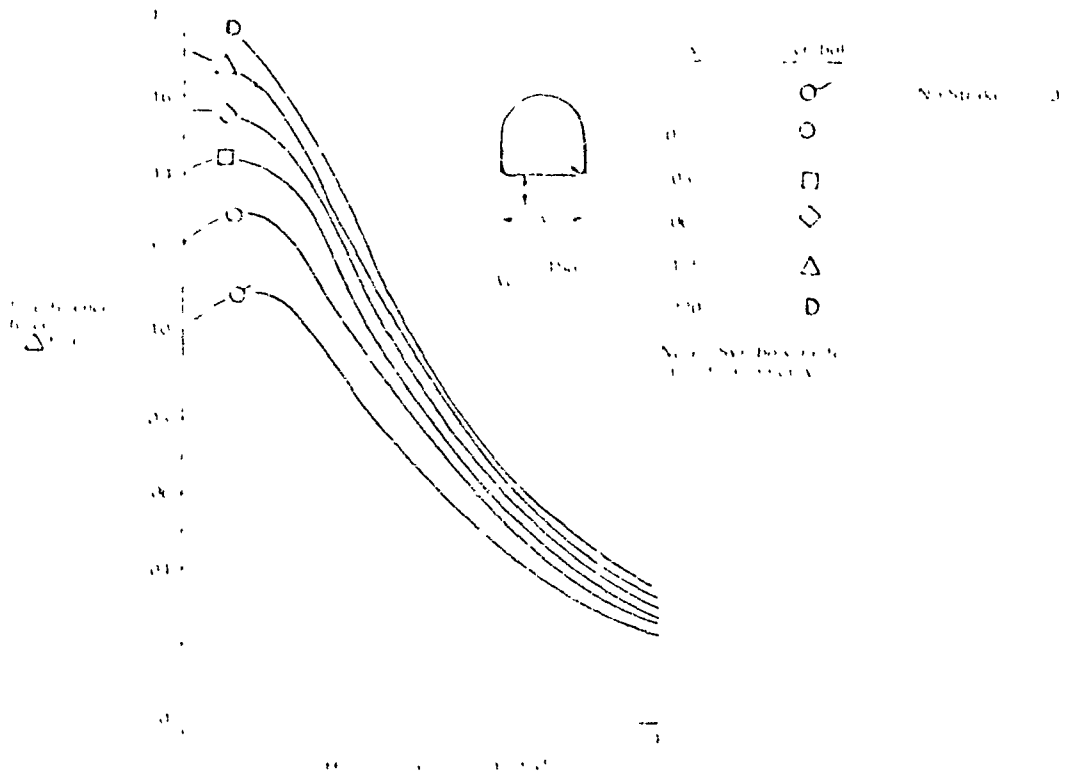

Figure 7. - Effect of rake depth on fuselage forces.

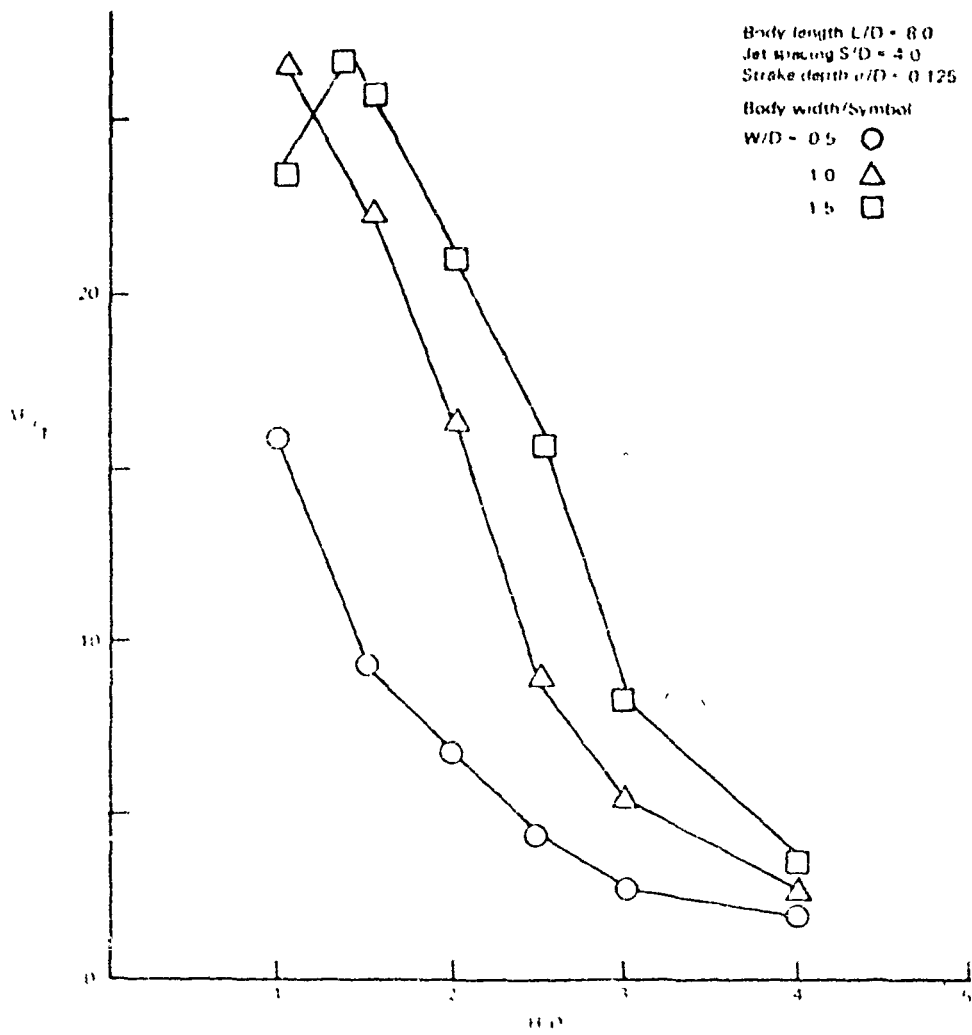

Figure 3-8. - Effect of body width on interference force.

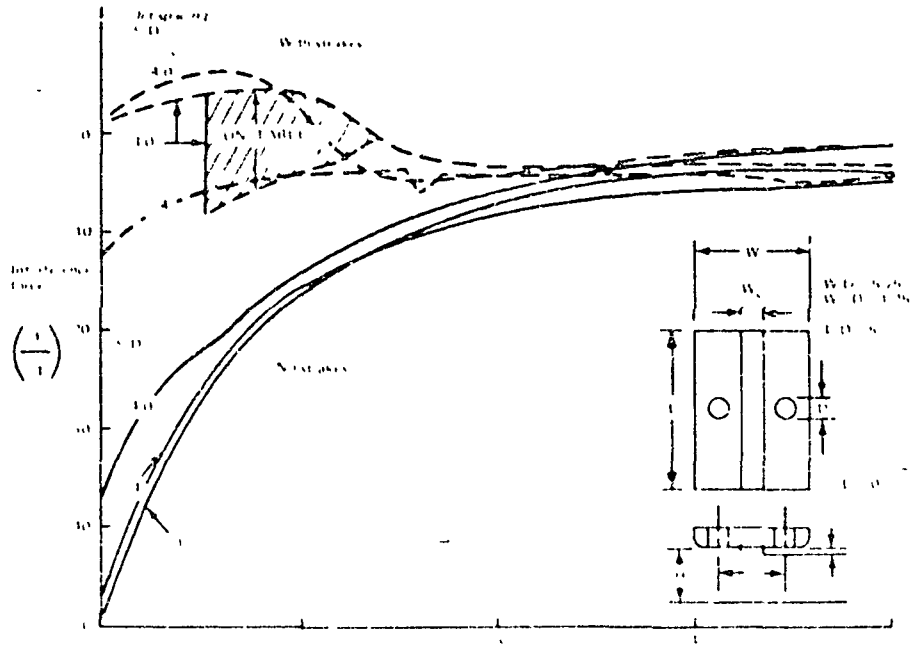

Figure 8-9. - Interference forces on rectangular body.

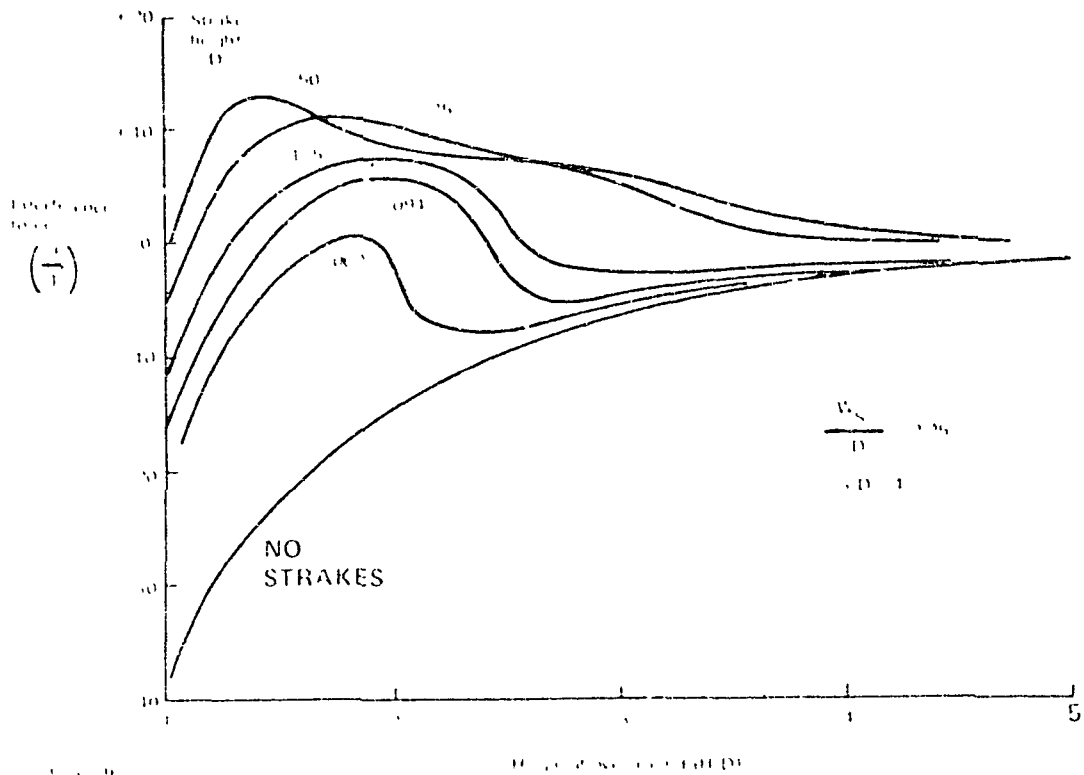

Figure 8-10. - Stroke height effect on rectangular body.

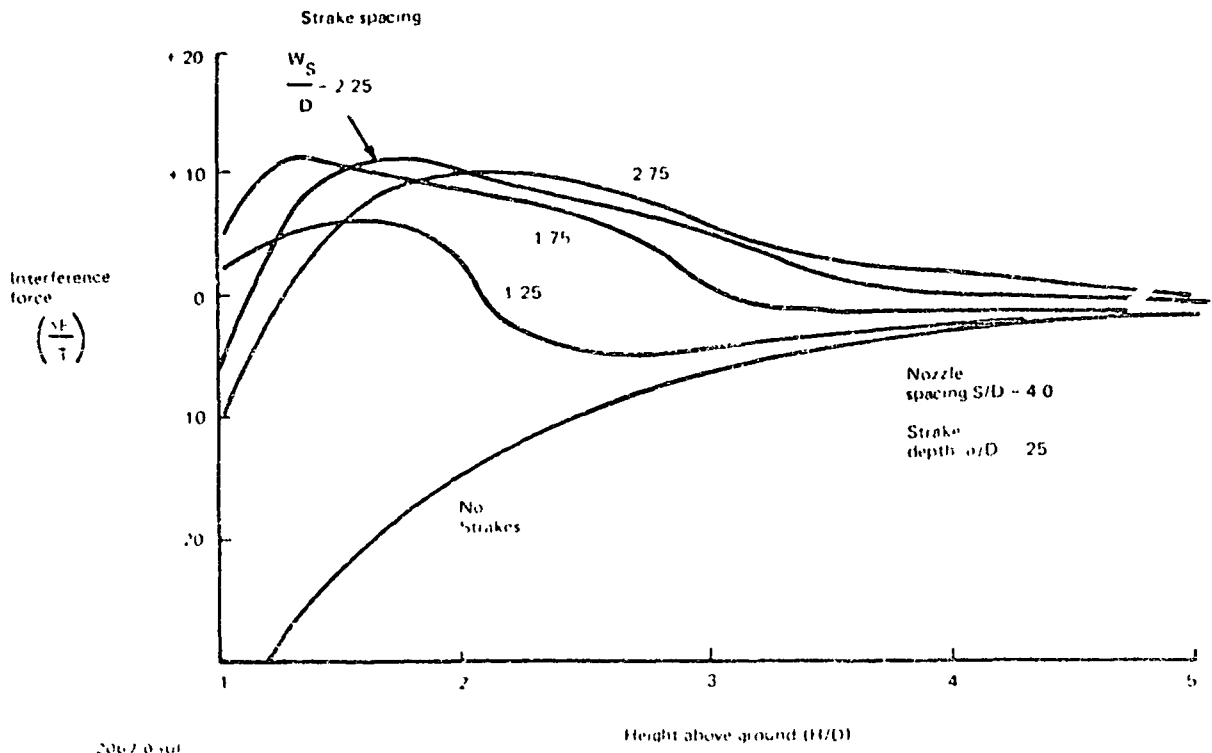

Figure 8-11. - Stroke Location effect on rectangular body

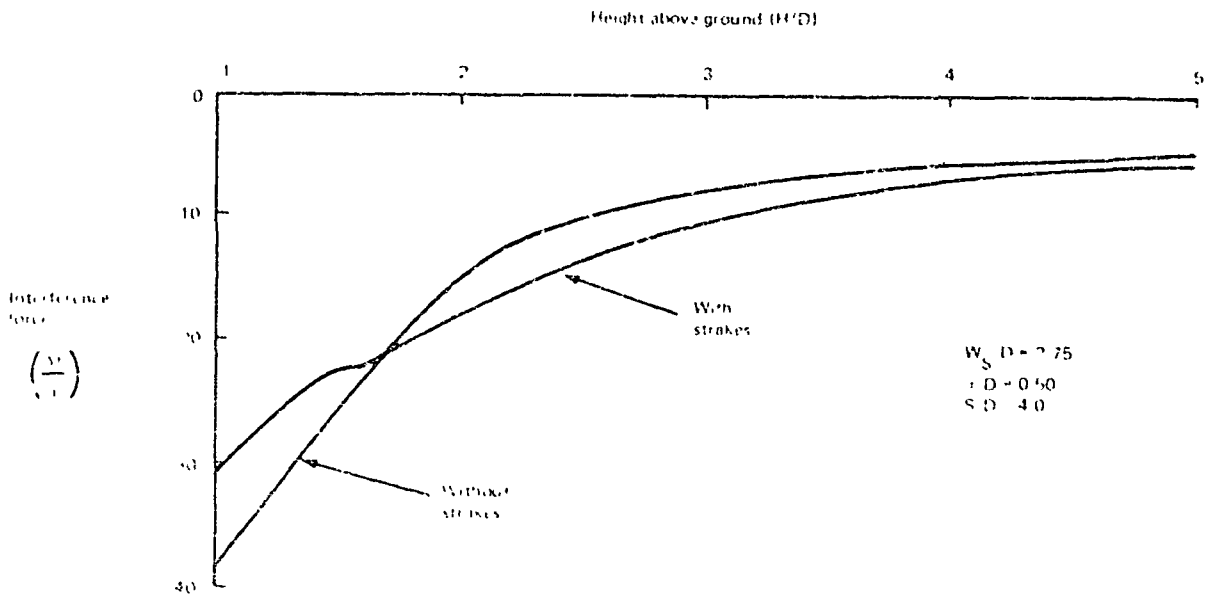

Figure 8-12. - Suckdown results with large flat plate.

9. THE DEVELOPMENT OF A THEORETICAL MODEL.

The problem of single vertical axially symmetric jet impingement has been studied both experimentally and theoretically by many investigators. A survey of some of the pertinent literature can be found in Ref. 9 with a sketch of the basic flow shown in Fig. 9-1. Downstream of the nozzle there is a velocity decay region due to turbulent mixing followed by a stagnation region on the ground plane and deflection parallel to the ground plane until the pressure returns to ambient. At that point the velocity is a maximum. Turbulent mixing will then govern the behavior of the radial wall jet.

The impingement region has been treated theoretically for an inviscid irrotational or uniform incident profile (e.g., Ref. 10, 11, 12). An analytic inviscid solution (i.e., Euler Eqs.) was generated for the impingement region due to a rotational or fully developed incident profile in Ref. 13. More recently, numerical solutions have been generated for the rotational inviscid impingement problem using a frozen vorticity concept (Ref. 14). These approaches, although theoretically sound, have deficiencies when compared to experimental data even when coupled with a boundary layer analysis. For example, any inviscid solution of the impingement region will yield a wall jet growth that is inversely proportional to the radial distance from the stagnation point and a maximum velocity along the wall equal to the maximum velocity of the incident profile. This behavior is never quite achieved in the physical flow. No adequate theoretical analysis is available that couples the jet decay, impingement region, and resultant turbulent wall jet.

In the present study semi-empirical models are formulated for each region and coupled together to simulate the physical flow. Momentum is conserved and the empirical input to each region is well defined and capable of experimental verification.

The establishment of a vertical jet impingement model is the basis for the behavior of two jets impinging on a ground plane. A sketch of the flow problem is shown in Figure 9-2. Figure 9-2(a) shows the vertical plane containing the jet stagnation points and the ground plane. Each jet impinges on the ground plane and deflects to form wall jets. The wall jets then interact and form an upwash deflection zone where the wall jets collide and are turned upward leaving the ground plane. The stagnation line lies on the ground in the vertical plane of symmetry between the two impinging jets. The

maximum upwash stagnation pressure occurs at the midpoint of the line connecting the two jet stagnation points on the ground. The ground pressure then drops off with lateral distance along the stagnation line. Figure 9-2(b) shows the radial streamline pattern that has been observed (Ref. 3) both in the ground plane and in the vertical plane of symmetry between the two jets. This flow situation only exists when the jets are spaced far enough apart so that the jet impingement zone does not interact or has a negligible effect on the upwash deflection zone.

Figure 9-3 shows a sketch of the flow pattern when the jets have a spacing such that the jet impingement pressure recovery is not achieved before the upwash deflection occurs. In this situation, some of the wall jet streamlines interact with the upwash deflection zone so that ambient pressure is not achieved along the entire upwash deflection line. Hence, a boundary of minimum pressure occurs between the jet impingement and upwash deflection zones (Figure 9-3). This boundary is a result of the matching of the pressures in these two regions.

In general, the flow in the upwash sheet behaves as a free shear flow in that it exhibits typical turbulent mixing behavior for the decay of total pressure and velocity. Figure 9-4 shows a sketch based upon empirical observations of what may happen when the two jets are very close or just prior to coalescence into a merged jet with no upwash flow. Upwash flow does not exist in the vertical plane containing the jet stagnation points but does occur laterally. The streamlines are diverted about a zone of no upwash flow near the center of the upwash sheet.

It is the intent of this study to model the behavior of two closely spaced jets interacting to form an upwash sheet. Few investigators have attempted to study this problem in any detail (Ref. 3, 4, 5, 16 and 17) and little was known about the behavior of closely spaced jets prior to this study.

Although some results for the two jet impingement problem have been obtained by numerical integration of the Navier-Stokes equations, (Ref. 15), this type of approach certainly is not a practical approach at the current time. Turbulence modeling, choice in length scales, and boundary conditions, aside from computational time, pose a formidable task in obtaining valid solutions of the Navier-Stokes equations. A Green-Swager semi-empirical component modeling approach was taken as described below.

Jet Impingement Models

The jet impingement problem is subdivided into three major regions:

- Free jet decay
- Impingement or deflection
- Wall jet

Each of these finite regions are further subdivided into minor regions where the flow transitions from inviscid to turbulent behavior. For simplicity, a power function of the form,

$$f(\eta) = (1 - \eta\alpha)^{\beta}$$

is used to simulate both pressure and velocity behavior. This functional form was first used by Abramovich (Ref. 18) for shear layers.

9.1 Free Jet Decay Model

Figure 9-5 shows a sketch of the basic jet decay model, subdivided into three regions:

- potential core
- transition
- fully turbulent

The half velocity boundary growth in each region can be determined largely from experimental data. The model assumes a simple linear boundary growth in each region.

$$\text{Region I: } \frac{b_{JII}}{r_N} = a_{J1} \left(\frac{z_J}{r_N} \right) + 1$$

$$\text{Region II: } \frac{b_{JII}}{r_N} = a_{J2} \left(\frac{z_J}{r_N} \right) + b_{J2}$$

$$\text{Region III: } \frac{b_{JII}}{r_N} = a_{J3} \left(\frac{z_J}{r_N} \right)$$

The constants governing the half velocity boundary growth in the transition and fully developed regions have been determined empirically. In addition, the potential core length and fully developed similarity exponent of the velocity profile must be specified.

The growth constant of the half-velocity boundary in the potential core region is determined by matching the boundaries at the end of the potential core.

$$a_{J_1} = \frac{(a_{J_2} - 1)}{(Z_{pc}/r_N)} + a_{J_2}$$

In addition, a linear decay in potential core radius, r_c , is assumed, or

$$\frac{r_c}{b_J} = 1 - \frac{Z_J}{Z_{pc}}$$

Further, the parameter Z_{JFD} is determined by matching the boundaries between the transition and fully developed regions.

$$\frac{Z_{JFD}}{r_N} = \frac{b_{J_2}}{(a_{J_3} - a_{J_2})}$$

The static pressure in the jet at the nozzle exit is assumed to be ambient. The momentum equation can then be written as,

$$M_J = \pi \rho V_N^2 r_N^2 = \rho \int_0^{h_J} \int_0^{2\pi} v^2 r dr d\omega = \text{CONSTANT} \quad (9-1)$$

$$\text{let } \frac{v(r, Z)}{V_m(Z)} = f(\eta_J) \quad \eta_J = \frac{r}{b_J(Z)}$$

Eq. 9-1 then reduces to:

$$M_J = \pi \left(\frac{V_m}{V_N} \right)^2 \left(\frac{b_J}{r_N} \right)^2 C_{SVJ} \quad (9-2)$$

where

$$C_{SVJ} = \int_0^1 f^2(\eta_J) \eta_J d\eta_J \quad (9-3)$$

C_{SVJ} is an integral of the profile function. In the fully developed region this integral is assumed to be a constant.

The general form of the velocity profile is chosen as, (after Ref. 18),

$$\frac{v}{v_m} = f(\eta) = \left\{ 1 - \left(\frac{\eta_J - \eta_{JC}}{1 - \eta_{JC}} \right)^{\alpha_J} \right\}^2 \quad (9-4)$$

where $\eta_{JC} = \frac{r_c}{b_J}$

Substituting into eq. 9-3 and integrating, yields

$$C_{SVJ}(\eta_{JC}, \alpha_J) = \frac{\eta_{JC}^2}{2} + (1 - \eta_{JC})^2 \left\{ \frac{1}{2} - \frac{4}{\alpha_J + 2} + \frac{3}{\alpha_J + 1} - \frac{4}{3\alpha_J + 2} + \frac{1}{4\alpha_J + 2} \right\} \\ + \eta_{JC}(1 - \eta_{JC}) \left\{ 1 - \frac{4}{\alpha_J + 1} + \frac{6}{2\alpha_J + 1} - \frac{4}{3\alpha_J + 1} + \frac{1}{4\alpha_J + 1} \right\} \quad (9-5)$$

which is a general expression for C_{SVJ} integral as a function of potential core radius and velocity exponent α_J .

The ratio of half velocity width to jet width can be determined from (9-4) as,

$$R_J = \frac{\eta_{JH}}{\alpha_J} = \eta_{JC} + (1 - \eta_{JC}) \left(\frac{2 - \sqrt{2}}{2} \right)^{\frac{1}{\alpha_J}} \quad (9-6)$$

9.1.1 Potential Core and Transition Region - The momentum equation 9-2, given that $v_m = v_N$, reduces to

$$\frac{R_J^2(\eta_{JH}, \alpha_J)}{2} \left(\frac{b_{JH}}{r_N} \right)^2 C_{SVJ}(\eta_{JC}, \alpha_J) \quad (9-7)$$

where $\eta_{JC} = 1 - \frac{r_c}{r_N}$

Thus, given η_{JC} and the half velocity boundary b_{JH} , the solution of equation (7) yields the exponent α_J governing the velocity profile in the potential core region.

The exponent α_{JPC} is known at $Z = Z_{pc}$. The fully developed exponent α_{JFD} is also given empirically for $Z \geq Z_{FD}$.

Thus, the velocity exponent α_{JT} must vary accordingly in this region. By prescribing the condition that the jet half radius (b_J) must vary continuously from the end of the potential core region to its known value in the fully developed region, the transition exponent α_{JT} can be computed as

$$\alpha_{JT} = \frac{\ln\left(\frac{2 - \sqrt{2}}{2}\right)}{\ln(b_{JH}/b_{JT})} \quad (9-8)$$

Thus, the momentum equation (9-7), given $\eta_{JC} = 0$, can be used to determine the maximum velocity:

$$\frac{v_m}{v_N} = \frac{1}{\sqrt{2}} \frac{R_J (\alpha_{JT}) C_{SV} (\alpha_{JT})}{(b_{JH}/1_N)} \quad (9-9)$$

9.1.2 Fully Developed Region - In this region similarity of the jet profile is assumed ($C_{JFD} = 1.5$) and, thus, the ratio of half velocity width to jet radius and the similarity integral are constants. The velocity, as determined from equation (9-9), decays inversely proportional to the half width or Z .

Figure 9-6 shows a typical result for maximum velocity decay and boundary growth in the free jet compared with some test data from Ref. 19.

9.2 Jet Deflection Region

Figure 9-7 shows a sketch of the scaling parameters for the jet impingement problem. At some height, Δ_J , the incident jet "feels" the effect of the ground plane and the centerline velocity decreases and finally stagnates at the ground. The jet mixing is inhibited somewhat in the deceleration region, although the stagnation pressure is observed to be lower than the total pressure of the jet at the ground cited height Δ_J , due to the effects of mixing in the deceleration region. The impingement half velocity radius and half width will be used to further scale the wall jet regions.

The ground effect height has been determined experimentally and is given from reference 11 as,

$$\frac{\Delta_J}{d_N} = 1.2 \quad \text{for} \quad \frac{h}{d_N} < 6.8$$

$$\frac{\Delta_J}{d_N} = 0.153 \left(1 + \frac{h}{d_N} \right) \quad \text{for} \quad \frac{h}{d_N} > 6.8$$

The stagnation pressure is also given in reference 11 as,

$$\frac{\Delta P_S}{\Delta P_J} = \left(\frac{V_G}{V_N} \right)^2$$

where $\frac{V_G}{V_N} = \left(1.001 - 0.003 \frac{h}{d_N} \right) \quad \text{for} \quad \frac{h}{d_N} \leq 5.5$

$$\frac{V_G}{V_N} = \left(1.35 - 0.066 \frac{h}{d_N} \right) \quad \text{for} \quad 5.5 \leq \frac{h}{d_N} \leq 10.0$$

and $\frac{V_G}{V_N} = \frac{7.37}{\left(0.67 + \frac{h}{d_N} \right)} \quad \text{for} \quad \frac{h}{d_N} > 10.0$

The jet impingement radius are determined from the jet decay model. The impingement or deflection radius on the ground, r_0 , is defined to be the location where the pressure in the ground plane reaches ambient conditions.

9.2.1 Ground Pressure Distribution. - The empirical input data requirements are,

$r_{JH1}, \Delta P_S, r_0$. The ground pressure recovery function is assumed to be of the form,

$$\frac{\Delta P}{\Delta P_S} = f_g(\eta) = \left(1 - (\eta_W)^{\alpha_g} \right)^4 \quad (9-10)$$

where

$$\eta_W = \frac{r}{r_0}$$

A momentum balance is performed with the integral of the ground pressure equal to the momentum or thrust of the incident jet.

$$\frac{M_J}{4} = \int_0^{r_0} \int_0^{\pi/2} \Delta P r dr d\varphi$$

or
$$1 \left(\frac{r_0}{r_N} \right)^2 \left(\frac{V_g}{V_N} \right)^2 \int_0^1 f_g(\eta_W) \eta_W d\eta_W$$

Let,
$$C_{SPg}(\alpha_g) = \int_0^1 f_g(\eta_W) \eta_W d\eta_W$$

where
$$C_{SPg}(\alpha_g) = \frac{1}{2} - \frac{1}{\alpha_g + 2} - \frac{3}{\alpha_g + 1} - \frac{4}{3\alpha_g + 2} + \frac{1}{4\alpha_g + 2}$$

$$C_{SPg}(\alpha_g) = \frac{1}{\left(\frac{r_0}{r_N} \right)^2 \left(\frac{V_g}{V_N} \right)^2} \tag{9-11}$$

This equation yields the exponent α_g of the pressure recovery function that satisfies the momentum condition.

The deflection radius r_0 is estimated empirically and in nondimensional form

$$2.9 \leq \frac{r_0}{r_{JH}} \leq 3.6 \quad \text{for} \quad 1.2 \leq \frac{h}{d_N} \leq 3.0$$

$$\frac{r_0}{r_{JH}} \leq 3.6 \quad \text{for} \quad \frac{h}{d_N} > 3.0$$

Figure 9-8 shows the kind of correlation achieved for the pressure distribution on the ground from this simple procedure. Unfortunately, the degree of success largely depends upon the chosen form of the pressure function, equation 9-10.

9.2.2 Wall Jet Transition Model. - The wall jet transition model consists of three subregions:

- i) Inviscid deflection region where the effects of viscosity are assumed to be negligible except in a region close to the wall and near the edge of the deflected flow. In this region, the inner boundary layer is established as governed by axially symmetric stagnation flow.
- ii) Transition region where the effects of viscosity are beginning to dominate and the inner boundary layer and outer shear flow transitions to the fully developed turbulent wall jet.
- iii) Fully developed flow where the effects of turbulent viscosity dominate and the static pressure through the wall layer is considered ambient, or fully recovered. In this region, the nearly similar wall jet develops.

The inviscid deflection region is assumed to occur under the half velocity width (r_{JH}) of the incident jet profile. The pressure distribution on the ground was determined in a previous section as

$$\Delta P = \Delta P_S f_g(\eta_W) = \Delta P_S \left[1 - (\eta_W)^{\frac{\alpha}{g}} \right]^{\frac{1}{g}}$$

The maximum velocity in this region can be predicted adequately from Bernoulli's equation as,

$$\frac{V_M}{V_g} = \sqrt{1 - \frac{1}{g} (\eta_W)^{\frac{\alpha}{g}}} \quad \text{where} \quad 0 \leq \eta_W \leq \frac{r_{JH}}{r_0} \quad (9-12)$$

The initial boundary layer thickness δ_s at the stagnation point is assumed to be both a function of nozzle height above ground and of Reynolds number. (Ref. 20). δ_s is assumed to be determined empirically. The determination of the maximum velocity variation is the only requirement of this region since the maximum total pressure is assumed constant.

A model must be established that matches the inviscid maximum velocity at the end of the inviscid region and transitions to a fully turbulent wall jet. Figure 9-9 shows a sketch of the wall jet transition boundary growth model. The model consists of two layers. The inner boundary layer flow and outer shear. The fully developed behavior of the boundary layer and half velocity width is assumed to be,

$$\frac{b_{WH}}{r_N} = a_{w_2} \left(\frac{r}{r_N} \right)^{\beta_S} \quad (9-13)$$

$$\text{and} \quad \frac{\delta_{bL}}{d_N} = a_{bL_2} \left(\frac{r}{d_N} - 1 \right)^{\beta_{bL}}$$

For simplicity, β_S and $\beta_{bL} \cong 1$.

The form of the boundary layer growth arises from experimental observation (Ref. 20). The thickness of the boundary layer appears to be relatively constant in the vicinity of the stagnation point or in the inviscid deflection region. The boundary layer grows relatively slowly until pressure recovery takes place and then the boundary layer grows with radial distance from the stagnation point. This delay in boundary layer growth is the reason for the choice of the above function which precludes the establishment of complete similarity in the wall jet profile.

The empirical constants for the fully developed wall layer growth are approximately, (Ref. 20)

$$a_{w_2} \cong .09$$

$$a_{bL_2} \cong .0175$$

Thus, the limit of the ratio of the boundary layer height to the half velocity point in the shear layer is,

$$\lim_{r \rightarrow \infty} K \frac{\delta_{bL}}{\delta_{WH}} = \frac{\delta_{bL}}{b_{WH}} = .1944$$

This value is in agreement with other investigators (Ref. 21).

The more ambiguous value of K_δ in the limit can be computed from,

$$K_\delta = \frac{\frac{1}{a_{WID}} K_{WH} \left(\frac{z - \sqrt{z^2 - 1}}{z} \right)}{1 + K_{WH} \left[\left(\frac{z - \sqrt{z^2 - 1}}{z} \right)^{a_{WID}} - 1 \right]} \quad \text{where } a_{WID} = .0962$$

which is slightly smaller than the often quoted value of 1/9 and may be the result of the finite form of the chosen profile.

9.2.3 Velocity and Static Pressure Profiles. - Figure 9-10 shows a sketch of the two layer model chosen to represent the velocity and static pressure profiles in the developing wall layer. The inner boundary layer velocity profile is approximated by the well known turbulent power law,

$$\frac{V(r, Z)}{V_m(r)} = \left(\frac{\xi}{k_\delta} \right)^{\frac{1}{N}} \quad \text{where} \quad \xi = \frac{Z}{b_W} \quad (9-14)$$

$$\text{and} \quad k_\delta = \frac{\delta}{b_W} \quad \text{for} \quad 0 \leq \xi \leq \frac{\delta}{b_W}$$

The static pressure across the boundary layer is assumed constant, or

$$\frac{\Delta P(r, Z)}{\Delta P_m(r)} = 1$$

The outer shear layer profiles are approximated by the functions,

$$\frac{V(r, Z)}{V_m(r)} = \left\{ 1 - \left(\frac{z - k_\delta \delta}{1 - k_\delta \delta} \right)^{\alpha_W} \right\}^2 \quad (9-15)$$

$$\text{and} \quad \frac{\Delta P(r, Z)}{\Delta P_m(r)} = \left\{ 1 - \left(\frac{z - k_\delta \delta}{1 - k_\delta \delta} \right)^{\alpha_W} \right\}^4$$

The ratio of the half velocity height to the wall layer height can be determined by,

$$R_W = \frac{b_{WH}}{b_W} = k_\delta (1 - k_\delta) \left(\frac{1 - \sqrt{2}}{2} \right)^{\frac{1}{\alpha_W}} \quad (9-16)$$

9.2.4 Radial Momentum Flux Equation. - The governing equation for the flow in the all jet is formulated as a radial momentum flux equation

In an inviscid flow solution of the exact rotational equations (Ref. 14) it can be shown, from the far field analytical solution, that the magnitude of the momentum

flux in any wall jet sector summed over 2π is exactly equal to the thrust of the incident jet. This is the basic principle used to construct the following equation where a pressure term has been added to account for the static pressure variation in the deflection region.

$$M_r = \frac{M_j}{2\pi} f_M(\eta_w) f_{MVIS}(r) = \int_0^{b_w} \{ \rho V^2(r, Z) + \Delta P(r, Z) \} r dZ \quad (9-17)$$

The above equation applies both to the transition region and fully developed wall jet. In the transition region, a static pressure variation exists in the wall layer due to the streamline deflection and hence the pressure term on the RHS of this equation. Because of the streamline deflection, the momentum flux in the radial direction does not achieve its constant optimum value until pressure recovery occurs. The function $f_M(\eta_w)$ on the LHS reflects the change of radial momentum in the deflection region.

Hence, the behavior of this function must be such that,

$$f_M(0) = 0$$

and
$$f_M(r) = 1 \quad \text{for } r \geq r_0$$

The second function f_{MVIS} on the LHS of this equation is a term reflecting the losses in momentum due to skin friction or shear at the wall. This term becomes important at large distances from the stagnation point. Its behavior can be approximated by,

$$f_{MVIS}(r) = \frac{1}{\left(\frac{r}{d_N}\right)^{\alpha_{VIS}}} \quad \text{where } \alpha_{VIS} \sim .15 - .25$$

In parametric form the radial momentum flux eq. (9-17) can be further expressed as,

$$f_M(\eta_w) f_{MVIS}(r) = \left(\frac{r}{r_N}\right) \left(\frac{r_w}{r_N}\right) \left(\frac{r_M}{r_N}\right)^2 \int_0^1 f_V(r, k_\delta, N, \sigma_w) dr$$

$$\frac{1}{2} \left(\frac{r_z}{r_N}\right)^2 f_z(\eta_w) \int_0^1 f_P(r, k_\delta, \sigma_w) dr \quad (9-18)$$

The integrals of the velocity squared and pressure profile functions vary with radial distance, or

$$C_{SWV}(r) = \int_0^1 F_V(\xi, k_\delta, N, \alpha_W) d\xi$$

$$C_{SWP}(r) = \int_0^1 F_P(\xi, k_\delta, \alpha_W) d\xi$$

Integration of the profile functions, 9-14 and 9-15 yield,

$$C_{SWV}(r) = \left(\frac{N}{2 + N} \right) k_\delta + (1 - k_\delta) I(\alpha_W) \tag{9-19}$$

$$C_{SWP}(r) = k_\delta + (1 - k_\delta) I(\alpha_W)$$

where

$$I(\alpha_W) = 1 - \frac{1}{\alpha_W + 1} + \frac{6}{2\alpha_W + 1} - \frac{4}{3\alpha_W + 1} + \frac{1}{4\alpha_W + 1}$$

In these equations α_W and k_δ are functions of r .

The momentum flux equation can then be rewritten as,

$$i_M(\eta_W) i_{MVIS}(r) = \left(\frac{2}{R_W} \right) \left(\frac{r}{r_N} \right) \left(\frac{b_{WH}}{r_N} \right) \left(\frac{V_m}{V_N} \right)^2 C_{SWV} + \frac{1}{2} \left(\frac{V_g}{V_N} \right)^2 i_g(\eta_W) C_{SWP} \tag{9-20}$$

As mentioned previously, the radial momentum function $i_M(\eta_W)$ is related to the pressure recovery in the deflection region. The approximation is now introduced that the radial momentum flux is related to the pressure recovery function $i_R(\eta_W)$ by,

$$i_M(\eta_W) = 1 - i_R(\eta_W) \tag{9-21}$$

The behavior of this function is such that when pressure recovery occurs at the wall all of the streamlines in the layer are assumed parallel to the wall.

The maximum velocity at the start of the wall jet at $r = r_{JH1}$ is given by the inviscid Bernoulli equation,

$$\left(\frac{V_m}{V_N}\right)_{INV}^2 = \left(\frac{V_g}{V_N}\right)^2 (1 - f_g(\eta_1)) \text{ where } \eta_1 = \frac{r_{JH1}}{r_0} \quad (9-22)$$

The initial boundary layer thickness δ_s is assumed constant throughout the inviscid region. The initial height of the wall layer is estimated to be the ground effect height Δ_J . Thus, K_{δ} has an initial value given by,

$$K_{\delta 1} = \frac{\delta_s}{\Delta_J} \quad \text{at } r = r_{JH1}$$

Given the inviscid starting maximum velocity, the momentum flux equation can be solved for the initial half velocity width b_{WH1} of the profile as

$$\frac{b_{WH1}}{r_N} = \frac{I_M(\eta_{w1}) R_w(\alpha_{w1})}{2 \left(\frac{r_{JH1}}{r_N}\right)^2 \left(\frac{V_m}{V_N}\right)_{INV}^2 \left\{ C_{SWA}(\alpha_{w1}) - \frac{1}{2} \left(\frac{V_g}{V_N}\right)^2 I_g(\eta_{w1}) C_{SWP}(\alpha_{w1}) \right\}} \quad (9-23)$$

where $\eta_{w1} = \frac{r_{JH1}}{r_0}$ and $I_{MVIS}(r_{JH1}) = 1$

The velocity profile expression also yields,

$$b_{WH1} = b_{w1} \left[1 + K_{\delta} (1 - K_{\delta}^2) \left(\frac{z - \sqrt{z^2}}{2} \right)^2 \right]^{\alpha_{w1}} \quad (9-24)$$

Given initial values α_{w1} , $K_{\delta 1}$, b_{w1} , δ_s , $7 \leq N_1 \leq 15$, and $\left(\frac{V_m}{V_N}\right)_{INV}$; the above

two equations have the two unknowns b_{WH1} and α_{w1} . The solution of eqs. 9-23 and 9-24 yields the initial starting profile for the wall layer.

Figure 9-11 shows a comparison between the initial profile predicted by this method and the exact solution for an inviscid rotational fully developed impinging jet at some distance beyond the deflection region as given in Ref. 11. This simple procedure yields an inviscid starting profile not unlike that of the exact inviscid solution.

To compute the maximum velocity variation and boundary along the wall, a fully developed value of the exponent c_w must be prescribed. This value is chosen to be $\alpha_{wfd} = 1.5$ after Abramovitch (Ref. 18). The turbulent wall exponent N must also be prescribed throughout the wall layer and has experimental values ranging from

$$7 \leq N \leq 15$$

The value of 7 is chosen to be the fully developed value at the end of the impingement region. The variation of the exponent α_w throughout the deflection region has to be prescribed with the boundary values given by,

$$\begin{aligned} \alpha_w &= \alpha_{wi} \text{ at } r = r_{JII} \\ \alpha_w &= \alpha_{FD} \text{ at } r \geq r_o \end{aligned}$$

Due to a lack of empirical or theoretical evidence in regard to the behavior of the profile in the deflection region, a simple linear variation of the exponent was assumed.

The half velocity height is determined for the initial profile and its behavior at the end of the deflection region is also known. Hence, the half velocity behavior assumes a simple linear variation matched to the fully developed height at the end of the deflection region.

The maximum velocity in the deflection region can then be computed as,

$$\frac{V_m}{V_\infty} = \frac{1}{C_{SWP}} \left(\frac{R_w^{(1-1/2)(\eta_w)+1} \text{MAIS}(r)}{2 \left(\frac{1}{r_\infty} \right) \left(\frac{r_{WII}}{r_\infty} \right)} - \frac{1}{2} \left(\frac{V_\infty}{V_\infty} \right)^2 \cdot \frac{1}{2} \eta_w \right) C_{SWP}^{1/2} \quad (9-25)$$

$$\text{for } r_{JII} \leq r \leq r_o$$

In the fully developed wall layer, this expression reduces to,

$$\frac{V_m}{V_N} = \frac{1}{\sqrt{C_{SWV}}} \left(\frac{R_W f_{MVIS}(r)}{2 \left(\frac{r}{r_N} \right) \left(\frac{b_{WH}}{r_N} \right)} \right)^{1/2} \quad \text{for } r > r_0 \quad (9-26)$$

Figure 9-12 shows a typical numerical result for the boundary layer thickness, as a ratio with respect to both the wall half-velocity thickness and layer height. Figure 9-13 shows a typical variation of the wall jet profile as a function of radial distance. The variation is relatively insignificant and becomes very nearly similar as the radial distance increases. Figure 9-14 shows a typical overall result from the wall jet transition model in terms of layer thicknesses, ground pressure, and maximum velocity along the wall. Figure 9-15 shows a comparison with the data of ref. 20 of the maximum velocity variation for different nozzle heights. Generally good agreement is achieved. In comparison, the level of maximum inviscid ground velocity at each nozzle height is also marked off.

9.3 Two-Jet Interaction Model

Figure 9-16 shows a sketch of the ground plane coordinate systems for the two jet impingement interaction problem. The jets stagnate on the ground, deflect into radial wall jets and collide along their plane of symmetry. The formation of an upwash stagnation zone is a result of the upward deflection of the wall jet flow. The point S_u , on the line joining the jet centers, is the only true stagnation point where the flow comes to rest and deflects vertically. At points off of the center, the flow is deflected at an angle such that the pressure is representative of the stagnation of the normal component of the maximum wall jet velocity. The flow continues radially after deflection into the upwash sheet as has been observed experimentally.

9.3.1 Maximum Pressure Distribution along the Upwash Stagnation Line. To estimate the upwash stagnation line ground pressure distribution the normal velocity at the stagnation line must be computed

$$V_{NORM} = V_{n,W} \cos \alpha \quad (9-26)$$

The pressure is then, simply,

$$\Delta P_{\text{umg}} = \frac{1}{2} \rho V_{\text{NORM}}^2 = \frac{1}{2} \rho V_{\text{mW}}^2 \cos^2 \phi_u \quad (9-27)$$

or

$$\frac{\Delta P_{\text{umg}}}{\Delta P_{\text{J}}} = \left(\frac{V_{\text{mW}}}{V_{\text{N}}} \right)^2 \cos^2 \phi_u - \left(\frac{V_{\text{mW}}}{V_{\text{N}}} \right)^2 \left[\frac{1}{1 + \left(\frac{X}{S_2} \right)^2} \right]$$

Figure 9-17 shows some typical results compared with test data, for the maximum stagnation point pressure on the ground (as computed from the wall jet transition model) as a function of jet spacing. Fairly good agreement is achieved down to a jet spacing of two diameters as a result of the transition model. For comparison, the fully developed wall jet decay is extrapolated back and yields much higher pressures than the test data indicate.

In general, the wall jet transition model must be used to compute the maximum velocity along the stagnation line for close jet spacing. For a jet spacing, s/d , large enough such that the wall jet is fully developed and the jet deflection regions do not interact with the upwash deflection zone, a simple expression can be derived to predict the maximum pressures along the stagnation line.

Under these conditions, the wall jet maximum velocity can be written as,

$$\left(\frac{V_{\text{mW}}}{V_{\text{N}}} \right)^2 = \frac{d_{\text{WFD}}^3}{\left(\frac{r}{r_{\text{N}}} \right)^2 (2 + \alpha_{\text{VIS}})}$$

where

$$d_{\text{WFD}} = \frac{R_{\text{W}} \alpha_{\text{VIS}}}{2 S_{\text{W}} + W_2}$$

(9-28)

or

$$\left(\frac{V_{\text{mW}}}{V_{\text{N}}} \right)^2 = \frac{d_{\text{WFD}}^3}{\left(\frac{S_2}{r_{\text{N}}} \right)^2 (2 + \alpha_{\text{VIS}})} [\cos \phi_u]^2 (2 + \alpha_{\text{VIS}})$$

Thus,
$$\frac{\Delta P_{umg}}{\Delta P_J} = \frac{a_{WFD}}{\left(\frac{S_2}{r_N}\right)^{2 + \alpha_{VIS}}} [\cos \varphi_u]^{(1 + \alpha_{VIS})}$$

or

where $\alpha_{vis} \approx .24$

$$\frac{\Delta P_{umg}}{\Delta P_J} = \frac{a_{WFD}}{\left(\frac{S_2}{r_N}\right)^{2 + \alpha_{VIS}}} \frac{1}{\left[1 + \left(\frac{X}{S_2}\right)^2\right] \left(2 + \frac{\alpha_{VIS}}{2}\right)} \quad (9-29)$$

If this expression is further nondimensionalized by the stagnation point pressure at $x = 0$,

$$\frac{\Delta P_{umg}}{\Delta P_{umg}(X=0)} = \frac{1}{\left[1 + \left(\frac{X}{S_2}\right)^2\right] \left(2 + \frac{\alpha_{VIS}}{2}\right)} \quad (9-30)$$

or, since $S_2 = \frac{S}{2}$,

$$\frac{\Delta P_{umg}}{\Delta P_{umg}(X=0)} = \frac{1}{\left[1 + \left(\frac{X}{S}\right)^2\right] \left(2 + \frac{\alpha_{VIS}}{2}\right)} \quad (9-31)$$

Figure 9-18 shows the computed results in comparison with test data for several jet spacings. The above expressions correspond to the larger jet spacings. For the closer jet spacings, equation (9-27) is modified slightly to account for the static pressure variation in the deflection region, or,

$$\frac{\Delta P_{umg}}{\Delta P_{S1}} = \frac{1}{2} (\eta_{WS}) \left(\frac{V_{mW}}{V_N}\right)^2 \cos^2 \varphi_u \quad (9-32)$$

where

$$\eta_{WS} = \frac{\sqrt{X^2 + S_2^2}}{r_u}$$

or, if $\eta_{WS} \geq 1$, the above expression reduces to the original equation (9-27).

The correlation is very good for spacings above 3.5. For closer jet spacings, the model yields slightly higher pressures along the stagnation line.

9.3.2 Model of Upwash Deflection Zone Without Jet Deflection Zone Interaction. -

In this section, a model for the ground pressure distribution of the upwash deflection zone is developed for the problem of large jet spacings. When the jet spacing is large enough, such that the jets deflect into radial wall jets prior to interaction, an upwash deflection zone of high pressures develop. This zone is demarcated by a line of ambient pressures. External to this line ambient pressures exist in the wall jet and internal to this line ($y < y_u$) the wall jet begins to deflect upward and, hence, develops the upwash deflection zone.

The ground pressures in the upwash deflection zone exert a force on the ground plane equal to the normal momentum of the entire upwash sheet. The normal momentum of the upwash sheet, assuming a radial streamline pattern emanating from the jet stagnation point, can be computed simply as

$$\frac{M_{UN}}{4} = \int_0^{\pi/2} \frac{M_J}{2\pi} \cos\psi_u d\psi_u = \frac{M_J}{2\pi} \quad (9-33)$$

for one quadrant of the upwash sheet. In this expression, the momentum of the incident jet is divided evenly per unit radian into the wall jet and finally into the upwash sheet. The normal momentum of the entire upwash sheet is then equal to $\frac{2M_J}{\pi}$

or, roughly, 64% of the momentum of one of the jets.

Equating the normal momentum of the upwash sheet to the upwash zone pressure distribution, yields the following expression:

$$M_{UN} = \frac{M_J}{2\pi} \int_0^{y_u} \int_0^{\infty} \Delta P_{u,z} dv dv \quad (9-34)$$

Relating this expression to the cylindrical ground coordinate system of an incident jet (see fig. 9-16), and noting that

$$x = S_2 \tan \phi_u$$

$$dx = S_2 \sec^2 \phi_u d\phi_u$$

the above expression becomes,

$$\frac{M_J}{2\pi} = S_2 \int_0^{y_{u\infty}} \int_0^{\pi/2} \Delta P_{ug} \sec^2 \phi_u d\phi_u dy \quad (9-35)$$

or,

$$1 = \frac{S_2}{r_\lambda^2} \int_0^{y_{u\infty}} \int_0^{\pi/2} \left(\frac{\Delta P_{ug}}{\Delta P_{SJ}} \right) \sec^2 \phi_u d\phi_u dy$$

To develop this expression further, a pressure function must be assumed across the upwash zone at any location λ or angle ϕ_u .

$$\frac{\Delta P_{ug}}{\Delta P_{SJ}} = \frac{\Delta P_{umg}}{\Delta P_{SJ}} f(\eta_{ug}) \quad (9-36)$$

where $f(\eta_{ug}) = \left[1 - (\eta_{ug})^{\alpha_{ug}} \right]^{\beta}$ and $\eta_{ug} = \frac{v}{v_u(\phi_u)}$

The expression for ΔP_{umg} along the stagnation line was developed previously, eq. 9-28. Substituting all this into eq. (9-35), and noting that

$$dy = \frac{v_u(\phi_u)}{v} d\eta_{ug}, \text{ yields,}$$

$$1 = \left(\frac{v_u}{r_\lambda} \right) \frac{W(1)}{(2 - \alpha_{v1S})} \int_0^{\pi/2} \int_0^1 \left[\cos \phi_u \right]^{(2 - \alpha_{v1S})} \frac{v_u(\phi_u)}{r_\lambda} f(\eta_{ug}) d\eta_{ug} d\phi_u \quad (9-37)$$

let $C_{\text{sug}} = \int_0^1 f(\eta_{\text{ug}}) d\eta_{\text{ug}}$ be the profile integral for the ground pressure distribution.

Now,

$$1 = \left(\frac{S_2}{r_N}\right) \frac{a_{\text{WFD}} C_{\text{sug}}}{\left(\frac{S_2}{r_N}\right) (2 + \alpha_{\text{VIS}})} \int_0^{\pi/2} [\cos \phi_u]^{(2 + \alpha_{\text{VIS}})} \frac{y_u(\phi_u)}{r_N} d\phi_u \quad (9-38)$$

An hypothesis about the behavior of the upwash zone must now be introduced into eq. (9-38). as,

$$\frac{y_u(\phi_u)}{r_N} = \frac{C_u \left(\frac{S_2}{r_N}\right)}{\cos \phi_u} \quad (9-39)$$

This expression says that the upwash zone becomes infinite in width and the radial distance to the stagnation line also becomes infinite as $\phi_u \rightarrow \pi/2$. Hence, the mass in the wall jet also approaches infinity. At the same time, the stagnation line pressure approaches zero. Substituting eq. (9-39) into the integral expression eq. (9-38) yields a finite integral.

$$1 = \left(\frac{S_2}{r_N}\right)^2 \frac{a_{\text{WFD}} C_u C_{\text{sug}}}{\left(\frac{S_2}{r_N}\right) (2 + \alpha_{\text{VIS}})} \int_0^{\pi/2} [\cos \phi_u]^{(1 + \alpha_{\text{VIS}})} d\phi_u \quad (9-40)$$

To derive a simple expression for the upwash zone, using eq. (9-10), and making the further assumption that there are no momentum losses in the wall jet, or

$$\alpha_{\text{VIS}} = 0$$

the following expression can be used to estimate the width of the upwash zone,

$$C_u = \frac{1}{a_{\text{WFD}} C_{\text{sug}}} \frac{2 C_{\text{SMA}}^2 W_2}{R_W C_{\text{sug}}} \quad (9-11)$$

Thus, the initial upwash width is proportional to the jet spacing and depends on the similarity constants for the velocity squared wall jet profile and upwash ground pressure profile as well as the slope of the wall jet half velocity growth. If it is further assumed that the exponent α_{ug} of the ground pressure profile is 1.5, an estimate can be made of the initial width of the upwash zone. Assuming a fully developed and nearly similar wall jet flow, or $K_{\delta} = .0962$, $\alpha_{WFD} = 1.5$, and $N = 7$,

$$C_{swv} = .36$$

$$a_{w2} = .09$$

$$R_w = .49481$$

$$C_{sug} = .3156$$

Hence, $C_u \cong .415$ and

$$\frac{y_u(\varphi)}{r_N} \sim 0.415 \left(\frac{S_2}{r_N} \right) \frac{1}{\cos \varphi_u} \quad (9-42)$$

For example, at a spacing $S/d_N = 6$, the entire width of the upwash deflection zone along the line connecting the jet stagnation points is approximately 2.4 nozzle diameters. A more realistic or representative boundary for the upwash deflection zone might be the half pressure boundary which can be easily computed as,

$$\frac{y_{uHP}(\varphi)}{r_N} \sim \frac{0.122}{\cos \varphi_u} \left(\frac{S_2}{r_N} \right) \quad (9-43)$$

9.3.3 Upwash Momentum Models for Close - Jet Interaction. - To further estimate the behavior of the upwash zone on the ground and upwash sheet for closer jet spacings, a model for the behavior of the momentum in the upwash sheet must be hypothesized. As the jets are spaced closer, their boundaries begin to merge, and a redistribution of momentum in the upwash sheet occurs until the jets coalesce. At this point, the upwash sheet ceases to exist. Hence, the normal or vertical momentum in the upwash is no longer M_j and a model must be provided

2

The condition for no upwash flow, in the vertical plane of symmetry containing the jet stagnation points, is presumed to be the nozzle height above ground where the jet boundaries touch at the ground effect height Δ_J . It is assumed that the momentum per unit angle in the upwash sheet has a parametric form:

$$M_u(\varphi_u) = \frac{M_J}{2\pi} f_{Mu}(\varphi_u, h/d_N, S/d_N) \quad (9-44)$$

In the limit as $s/d \rightarrow \infty$, $f_{Mu} \rightarrow 1$. It is also assumed, that until the jets begin to coalesce, the momentum per unit angle in the upwash sheet is conserved, or equal to the jet momentum and for any quadrant of the upwash sheet,

$$\frac{M_{uT}}{4} = \int_0^{\pi/2} M_u(\varphi_u) d\varphi_u = \frac{M_J}{4}$$

A function that satisfies all of the above conditions can be derived as,

$$f_{Mu} = a_u + 2(1 - a_u) \sin^2 \varphi_u \quad (9-45)$$

where

$$a_u = 1 - \left[\frac{r_{J1}(h/d_N)}{S_2} \right]^2$$

Thus, when the impingement radius of the jet equals the half spacing of the two jets, the above equation yields a zero momentum flux along the $\varphi_u = 0$ streamline.

Figure 9-19 shows the variation in f_{Mu} given by this model as a function of angle and the parameter a_u . Thus, this model indicates that as the spacing gets smaller or the nozzle height gets larger the momentum in the upwash sheet is redistributed away from the centerpoint between the two jets. The above expression can be further integrated to yield the normal momentum in the upwash sheet assuming that the upwash streamlines remain approximately radial.

$$\frac{M_{uN}}{4} = \frac{M_J}{2\pi} \int_0^{\pi/2} [a_u + 2(1 - a_u) \sin^2 \varphi_u] \cos \varphi_u d\varphi_u$$

$$\frac{M_{uN}}{4} = \frac{M_J}{2\pi} \left[a_u + \frac{2}{3} (1 - a_u) \right] \quad (9-16)$$

The model then predicts that the normal momentum in the entire upwash sheet decreases from a value of $\frac{2 M_J}{\pi}$ to $\frac{4}{3} \frac{M_J}{\pi}$.

At nozzle heights where the jets begin to merge, or their boundaries begin to overlap, another model must be hypothesized. In this situation, it is assumed that there is a region between the jets where no upwash flow exists. It is no longer assumed that the momentum in the entire upwash sheet equals the momentum in one of the jets. Hence, for $r_{J1} > S$, a function of the following form is assumed:

$$M_u(\varphi_u) = \frac{M_J}{\pi \sin^2\left(\frac{\pi}{2} - \varphi_{u0}\right)} \sin^2(\varphi_u - \varphi_{u0}) \quad \text{for } \varphi_u \geq \varphi_{u0}$$

$$\text{and } M_u(\varphi_u) = 0 \quad \text{for } \varphi_u < \varphi_{u0}$$

The value of 2 at $\varphi_u = \pi/2$ has been held fixed and the angle φ_{u0} denotes the angle at which upwash flow exists. This angle is estimated from whatever little empirical evidence that is available as,

$$a_c = \frac{S_2}{r_{J1}}$$

$$\varphi_{u0} = \cos^{-1}(a_c)^{\alpha_c} \quad \text{where } \alpha_c \sim .30$$

and is a function of the degree of overlap of the jet boundaries at the ground effect height as reflected in the coalescence parameter a_c . In the limit, when $r_{J1} \gg S_2$, the angle $\varphi_{u0} \rightarrow \pi/2$. The normal, or vertical upwash momentum, in general is

$$\frac{M_{uN}}{4} = \frac{M_J}{3\pi \sin^2\left(\frac{\pi}{2} - \varphi_{u0}\right)} \{1 + \sin\varphi_{u0} (\sin\varphi_{u0} - 2)\} \quad (9-17)$$

Thus, the vertical momentum in the upwash sheet vanishes rapidly as the jet boundaries overlap or as the jets coalesce as demonstrated in figure 9-19. This behavior is a result of the diverting of momentum flux into streamlines that become more parallel to the ground. In the limit as $\alpha_u \rightarrow \pi/2$, the amount of momentum in the upwash streamline does not have any effect on the vertical upwash momentum because this streamline lies parallel to the ground.

Further improvement in these simple models entails further empirical study. Unfortunately, it is extremely difficult, if not impossible, to measure the upwash momentum. Hence, the best evidence for such models comes by way of correlation between ground upwash pressures and total pressure in the upwash sheet.

9.3.4 General Approach to the Prediction of Two - Jet Ground Pressure Distributions for Close - Jet Spacing. - Figure 9-20 shows a schematic of the ground pressure phenomena that occurs for close jet spacing where the jet impingement and upwash deflection zone interact. The upwash deflection zone now includes a portion where the upwash pressures are equal to the jet impingement zone pressures. Along this portion of the upwash boundary the jet impingement pressures do not fully recover. Hence, the impinging flow does not become entirely parallel to the ground before it begins to deflect upward and stagnate in the upwash zone.

To estimate the behavior of such a flow, it is assumed that the jet impingement or deflection region is perturbed due to the closeness of the two jets. The ambient pressure boundary is assumed to have the form:

$$r_p(\varphi) = r_0 \cdot \epsilon(1 + \cos\varphi) \quad (9-48)$$

The upwash boundary is assumed to keep the same form except for the perturbation parameter σ , or

$$v_u(\varphi) = \frac{\sigma C S_u}{\cos\varphi} \quad (9-49)$$

Referring to figure 9-20, it can be seen that the pressure at the mutual boundary between the upwash zone and impingement zone is above ambient until the intersection of the two boundaries where the pressure returns to ambient. The jet impingement radius to the upwash boundary is given by,

$$r_u(\varphi) = \sqrt{X^2(\varphi_u) + [S_2 - y_u(\varphi_u)]^2} \quad (9-50)$$

The relationship between the two angles φ and φ_u is such that,

$$\tan \varphi = \frac{X(\varphi_u)}{S_2 - y(\varphi_u)}$$

and

$$\tan \varphi_u = \frac{X}{S_2}$$

Hence, given, φ_u ,

$$\varphi = \tan^{-1} \left[\frac{S_2 \tan \varphi_u}{S_2 - y(\varphi_u)} \right]$$

For a given ϵ and σ , the intersection of the two boundaries can be found from the solution of the following equations:

$$\begin{aligned} X^2(\varphi_{u0}) + [S_2 - y_u(\varphi_{u0})]^2 &= r_0^2 + 2\epsilon r_0(1 + \cos \varphi_0) + \epsilon^2(1 + \cos \varphi_0)^2 \\ \tan \varphi_0 &= \frac{X(\varphi_{u0})}{S_2 - y(\varphi_{u0})} \end{aligned} \quad (9-51)$$

This gives the two angles φ_{u0} and φ_0 which completely define the intersection of the two boundaries.

9.3.4.1 Jet Deflection Region. - To develop the analysis, it is assumed that the integral of the pressure in the jet impingement zone is still equal to the jet thrust, or

$$\frac{M_j}{2} = \int_0^{\varphi_0} \int_0^{r_u(\varphi_0)} \Delta P_I r dr d\varphi + \int_{\varphi_0}^{\sigma} \int_0^{r_p(\varphi)} \Delta P_I r dr d\varphi \quad (9-52)$$

The pressure integral is divided into two parts. The first integral represents the pressure in the region of interaction between the two deflection zones where

a minimum pressure boundary exists.

$$\Delta P_1(\varphi) = \Delta P_{JS} f(\eta_w)$$

$$\eta_w = \frac{r}{r_p(\varphi)}$$

Substituting into eq. 9-52,

$$\begin{aligned} \frac{M_J}{2} = \Delta P_{JS} \left\{ \int_0^{\varphi_0} \int_0^{\eta_{\min}(\varphi)} r_p^2(\varphi) f_g(\eta_w) \eta_w d\eta_w d\varphi \right. \\ \left. + \int_{\varphi_0}^{\pi} \int_0^1 r_p^2(\varphi) f_g(\eta_w) \eta_w d\eta_w d\varphi \right\} \end{aligned} \quad (9-53)$$

Let $G_{\min}(\varphi) = \int_0^{\eta_{\min}(\varphi)} f_g(\eta_w) \eta_w d\eta_w$ where $\eta_{\min}(\varphi) = \frac{r_u(\varphi)}{r_p(\varphi)}$

and $I_g = \int_0^1 f_g(\eta_w) \eta_w d\eta_w = C_{sp}(\alpha_g)$

Then the above expression reduces to, upon non dimensionalization,

$$\pi = \left(\frac{V_g}{V_N} \right)^2 \left\{ \int_0^{\varphi_0} r_p^2(\varphi) G_{\min}(\varphi) d\varphi + I_g \int_{\varphi_0}^{\pi} r_p^2(\varphi) d\varphi \right\} \quad (9-54)$$

where

$$I_g = \frac{1}{2} - \frac{4}{\alpha_g + 2} + \frac{3}{\alpha_g + 1} - \frac{4}{3\alpha_g + 2} + \frac{1}{\alpha_g + 2} \quad (9-55)$$

and
$$G_{\min}(\varphi) = \frac{\eta_{\min}^2}{2} - \frac{4\eta_{\min}^{u_g+2}}{\alpha_g+2} + \frac{3\eta_{\min}^{2\alpha_g+2}}{\alpha_g+1} - \frac{4\eta_{\min}^{3\alpha_g+2}}{3\alpha_g+2} + \frac{\eta_{\min}^{4\alpha_g+2}}{4\alpha_g+2}$$

Unfortunately, the first part of this integral does not lend itself to analytical integration. Aside from its complexity, the implicit nature of $r_u(\varphi)$ with respect to φ_u makes numerical integration a necessity.

The second integral in eq. 9-54 can be carried out and is equal to:

$$\int_{\varphi_0}^{\pi} r_p^2(\varphi) d\varphi = (\pi - \varphi_0) \left[r_0 (r_0 + 2\epsilon) + \frac{3}{2} \epsilon^2 \right] - 2\epsilon(r_0 + \epsilon) \sin \varphi_0 - \frac{\epsilon^2}{4} \sin^2 \varphi_0$$

9.3.4.2 Upwash Deflection Zone. - In the upwash deflection zone, the normal component or vertical momentum in the upwash sheet is assumed given by the momentum models described in section 9.3.3.

Hence, for a quadrant of the upwash zone,

$$\frac{M_{uZ}}{4} = S_2 \int_0^{\pi/2} \int_0^{y_u} \Delta P_u \sec^2 \varphi_u d\varphi_u dy$$

This integral is also divided into two parts, being

$$\frac{M_{uZ}}{4} = S_2 \int_0^{\varphi_{u0}} \int_0^{y_u} \Delta P_u \sec^2 \varphi_u d\varphi_u dy + S_2 \int_{\varphi_{u0}}^{\pi/2} \int_0^{y_u} \Delta P_u \sec^2 \varphi_u d\varphi_u dy \quad (9-56)$$

In the interaction region of the upwash zone, the upwash pressures are assumed given by,

$$\Delta P_u(\varphi_u) = \Delta P_{u\text{ming}}(\varphi_u) \cdot [\Delta P_{u\text{mg}}(\varphi_u) - \Delta P_{u\text{ming}}(\varphi_u)] [1 - \eta_u^{\alpha_u \varphi_u}]^4$$

for $0 < \varphi_u < \varphi_{u0}$

(9-57)

and for $\varphi_u > \varphi_{u0}$,

$$\Delta P_u(\varphi_u) = \Delta P_{umg}(\varphi_u) [1 - \eta_u^{\alpha_{ug}}]^4 \quad (9-58)$$

where
$$\eta_u = \frac{y}{y_u(\varphi_u)}$$

Substituting into eq. (9.56),

$$\begin{aligned} \frac{M_{uZ}}{4} = S_2 \int_0^{\varphi_{u0}} y_u [\Delta P_{uming} + (\Delta P_{umg} - \Delta P_{uming}) C_{sug}] \sec^2 \varphi_u d\varphi_u \\ + S_2 C_{sug} \int_{\varphi_{u0}}^{\pi/2} y_u \Delta P_{umg} \sec^2 \varphi_u d\varphi_u \end{aligned} \quad (9-59)$$

where
$$C_{sug} = \int_0^1 f(\eta_u) d\eta_u$$

Now, letting

$$\frac{\Delta P_{umg}}{\Delta P_J} = \Delta P_{wall}(\varphi_u)$$

Eq. (9-59) becomes,

$$\begin{aligned} \lambda_{uZ} = 0 C_u \left(\frac{S_2}{r_N} \right)^2 \left\{ \int_0^{\varphi_{u0}} \frac{1}{\cos^3 \varphi_u} \left[\left(\frac{V_g}{V_N} \right)^2 f_g(\eta_{min}) \right. \right. \\ \left. \left. + \left[\Delta P_{wall}(\varphi_u) - \left(\frac{V_g}{V_N} \right)^2 f_g(\eta_{min}) \right] C_{sug} \right] d\varphi_u \right. \\ \left. + C_{sug} \int_{\varphi_{u0}}^{\pi/2} \frac{1}{\cos^3 \varphi_u} \Delta P_{wall}(\varphi_u) d\varphi_u \right\} \end{aligned} \quad (9-60)$$

where
$$\frac{M_{uZ}}{t} = \lambda_{uZ} \left(\frac{M_J}{2\pi} \right)$$

Unfortunately, these integrals also do not lend themselves to analytical integration and must be numerically evaluated.

9.3.4.3 Overall Solution. - To obtain the solution for the ground pressure pattern for a given spacing and nozzle height, the following two simultaneous equations are solved iteratively for ϵ and σ ,

$$F_{J_i}(\epsilon, \sigma) = \pi - I_{J_1} - I_{J_2} = 0 \quad (9-61)$$

and
$$F_{u_i}(\epsilon, \sigma) = \lambda_Z - I_{u_1} - I_{u_2} = 0$$

where I_{J_1} and I_{J_2} are the two integral expressions for the jet impingement region and I_{u_1} and I_{u_2} correspond to the integrals for the upwash zone.

The Newton iterative scheme consists of,

$$\Delta\epsilon = \frac{1}{D} \left\{ F_{J_i}(\epsilon_0, \sigma_0) \frac{\partial F_{u_i}}{\partial \sigma} - F_{u_i}(\epsilon_0, \sigma_0) \frac{\partial F_{J_i}}{\partial \sigma} \right\} \quad (9-62)$$

and
$$\Delta\sigma = \frac{1}{D} \left\{ F_{u_i}(\epsilon_0, \sigma_0) \frac{\partial F_{J_i}}{\partial \epsilon} - F_{J_i}(\epsilon_0, \sigma_0) \frac{\partial F_{u_i}}{\partial \epsilon} \right\}$$

where
$$D = \frac{\partial F_{u_i}}{\partial \epsilon} \frac{\partial F_{J_i}}{\partial \sigma} - \frac{\partial F_{J_i}}{\partial \epsilon} \frac{\partial F_{u_i}}{\partial \sigma}$$

and the function and its partial derivatives are evaluated at the value ϵ_0, σ_0 which may be an initial guess. Further iterates are defined as

$$\begin{aligned} \epsilon_{1+1} &= \epsilon_1 + F_R \Delta\epsilon \\ \sigma_{1+1} &= \sigma_1 + F_R \Delta\sigma \end{aligned} \quad (9-63)$$

where a relaxation factor F_R may be necessary to speed up convergence.

Figures 9-21 and 9-22 show a comparison with test data of the computed ground pressure distribution along the line of the jet stagnation points ($X = 0$) for various jet spacings and a nozzle height of $3 d_N$. Reasonable good agreement is

achieved down to a spacing of two diameters. The assumed form of the jet deflection zone pressure function seems to differ somewhat from the test data but the maximum upwash pressures and widths seem to be in good agreement.

In addition, the predicted minimum pressures between the jet and upwash zone are in good agreement. Figure 9-23 shows some extreme situations for a close jet spacing of $2d_n$ and nozzle heights up to $10d_N$. At approximately $8d_N$ the upwash momentum model predicts no upwash between the jets. As the nozzle height is increased, the upwash width decreases significantly at this spacing. The test data is in fair agreement with the predicted pressures.

In general, the exponent α_{ug} of the upwash ground pressure function is assumed to be

$$\alpha_{ug} > \alpha_{ugFD} \quad \text{for} \quad \varphi_u < \varphi_{u0}$$

$$\text{and} \quad \alpha_{ug} = \alpha_{ugFD} \quad \text{for} \quad \varphi_u \geq \varphi_{u0}$$

Further, the exponent α_{ug} is assumed to be a function of the minimum pressure in the deflection zone for $\varphi_u < \varphi_{u0}$. To determine α_{ug} for $P_{min} > 0$, an equivalent profile for the upwash pressure function is assumed to exist whose integral force per unit length is equal to the partial integral or partial force of the fully developed pressure function ($\alpha_{ugFD} = 1.5$)

$$\text{Let, } \bar{P}_{min} = \frac{P_{min}}{P_{max}}$$

$$I(\alpha_{ugFD}, \eta_{min}(\bar{P}_{min})) = \int_0^{\eta_{min}} (1 - \eta^{\alpha_{ugFD}})^4 d\eta$$

$$\text{and} \quad I(\alpha_{ug}) = \int_0^1 (1 - \eta'^{\alpha_{ug}})^4 d\eta'$$

$$\text{where} \quad \eta_{min} = (1 - \bar{P}_{min}^{\frac{1}{4}})^{\frac{1}{\alpha_{ugFD}}}$$

Then,

$$\bar{P}_{min} = (1 - \bar{P}_{min}^{\frac{1}{4}})^{\frac{1}{\alpha_{ug}}} = I(\alpha_{ugFD}, \eta_{min}) \quad (9-61)$$

Given any \bar{P}_{\min} value along the upwash, equation 9-64 can be solved to find the exponent α_{ug} . When $P_{\min} = 0$ at $\varphi_u = \varphi_{u0}$, or at the intersection of the impingement and upwash deflection zone, equation (9-64) reduces to an identity and, hence, $\alpha_{ug} = \alpha_{ugFD}$.

It can be seen both in the test data and in the predicted pressures that negligible interaction between the deflection zones occurs at spacings greater than 6 dN. Significant interaction does not take place until a spacing of 3dN for this nozzle height as is reflected by the minimum upwash pressure level.

Figures 9-24 and 9-25 show a sample of the entire ground isobar pattern for a range of spacings and nozzle heights. Figure 9-26 shows the kind of correlation achieved for one case.

9.3.5 Upwash Decay Model. - Figure 9-27 shows a schematic of the upwash sheet model and the characteristic scaling parameters. The upwash sheet is assumed to be a reflection of the wall jet flow into the vertical plane of symmetry lying between the jets. The radial streamline pattern of the wall layer is assumed to continue into the upwash sheet and to a first approximation unperturbed by the turning region. The wall jet flow is assumed to enter the upwash deflection region with a characteristic profile, half velocity width and maximum velocity or total pressure. The characteristic length scale in the upwash sheet is the half velocity width of the incident wall jet layer estimated at the wall location. The pressure recovery region in the upwash sheet is assumed to be approximately 3 times the half velocity width of the incident wall jet profile. The magnitude of the momentum flux in the resulting upwash streamline is assumed equal to that of the incident wall jet. Hence, the upwash sheet is treated in a similar fashion as the wall jet with a few exceptions.

Due to the high turbulence levels typically measured in the upwash sheet the flow is considered to be fully turbulent and similar. The upwash velocity profile is taken to be that of a free shear profile with no internal momentum defect due to the wall layer. The upwash sheet growth rate is assumed to be constant without any initial transition phase. It is also assumed that the magnitude of the momentum flux distribution in the upwash sheet is given by the previously discussed momentum models. An expression analogous to that derived for the wall jet can now be derived for the upwash sheet:

$$f_{Mu}(\varphi_u) [1 - f_{Pu}(\xi)] = 2 \left(\frac{r_w(\varphi_u) + Z_S}{r_N} \right) \left(\frac{R_u b_{uH}(Z, \varphi_u)}{r_N} \right) C_{Su} \cdot \left\{ \left(\frac{V_{mu}}{V_N} \right)^2 + \frac{1}{2} \left(\frac{\Delta P_{wall}(\varphi_u)}{\Delta P_J} \right)^2 f_{Pu}(\xi) \right\} \quad (9-65)$$

where $\xi = \frac{Z_S}{Z_{Sou}}$, $R_u = \frac{b_{uH}}{b_u}$, and $f_{Pu} = [1 - \xi^{1.5}]^4$

$$R_u = .441 \text{ for } \alpha_u = 1.5$$

The velocity squared profile is assumed to be identical in shape to the static pressure profile and as a result only one similarity constant is required:

$$C_{Su} = \int_0^1 (1 - \eta_u^{\alpha_u})^4 d\eta_u = .31558 \text{ for } \alpha_u = 1.5 \text{ where } \eta_u = \frac{y}{b_u}$$

The procedure for starting the upwash flow is similar to that of the wall jet where an initial upwash half width (b_{uH0}) is determined from eq. 9-64 given an inviscid starting maximum velocity. A model for the upwash sheet growth must then be provided based upon empirical observation.

$$b_{uH}(\varphi_u, Z) = b_{uH0}(\varphi_u) + a_{bu}(Z_S - b_{WH}(r_w))(\cos \varphi_u)^{\alpha_{bu}} \quad (9-66)$$

where

$$a_{bu} \sim .30 \text{ and } Z_S = \frac{Z}{\cos \varphi_u}$$

$$\alpha_{bu} \sim .50$$

The value of $a_{bu} = .30$ is consistent with empirical observations that the upwash flow decays at a rate approximately three times that of a free jet.

An approximate expression can be derived for the upwash decay. Assume that the region of interest is beyond the turning region of the upwash sheet such that $f_{pu} = 0$. Then eq. 9-65 reduces to,

$$f_{Mu}(\varphi_u) = 2 \left(\frac{r_w(\varphi_u) + Z_S}{r_N} \right) (R_u C_{Su}) \left(\frac{b_{uH}}{r_N} \right) \left(\frac{V_{mu}}{V_N} \right)^2$$

Hence, the maximum velocity squared is equal to

$$\left(\frac{v_{mu}}{v_N}\right)^2 = \frac{f_{Mu}(\varphi_u)}{2\left(\frac{r_w + Z_s}{v_N}\right)\left(\frac{b_{uH}}{r_N}\right)R_u C_{su}} \quad (9-67)$$

Now, if the approximation that

$$b_{uH} \sim \frac{a_{bu} \bar{Z}}{(\cos \varphi)} a_{bu} \quad \text{is introduced}$$

Noting that

$$r_w + Z_s = \sqrt{X_u^2 + (S_2 + Z_u)^2}$$

$$\sin \varphi_u = \frac{X_u}{\sqrt{X_u^2 + (S_2 + Z_u)^2}}$$

$$\cos \varphi_u = \frac{S_2 + Z_u}{\sqrt{X_u^2 + (S_2 + Z_u)^2}}$$

and

$$f_{Mu}(\varphi_u) = a_u + 2(1 - a_u) \sin^2 \varphi_u \quad \text{for } a_u > 0$$

Then,

$$\left(\frac{v_{mu}}{v_N}\right)^2 = \frac{[a_u + 2(1 - a_u) \sin^2 \varphi_u] [\cos \varphi_u]^{(1 + a_{bu})}}{2a_{bu} R_u C_{su} Z_u (S_2 + Z_u)} \quad (9-68)$$

or, equivalently,

$$\left(\frac{v_{mu}}{v_N}\right)^2 = \frac{(S_2 + Z_u)^{(1 + a_{bu})}}{[X_u^2 + (S_2 + Z_u)^2]^{\frac{1 + a_{bu}}{2}}} \left[\frac{2(1 - a_u) X_u^2}{a_u + X_u^2 + (S_2 + Z_u)^2} \right] \quad (9-69)$$

Nondimensionalizing both of these expressions by the value at $\varphi_u = 0$ or $X_u = 0$:

$$\left(\frac{v_{mu}}{v_{mu_0}}\right)^2 = \frac{\left(\frac{v_{mu}}{V_N}\right)^2}{\left(\frac{v_{mu}}{V_N}\right)^2_{\varphi_u=0}} = \left[1 + \frac{2}{a_u} (1 - a_u) \sin^2 \varphi_u\right] [\cos \varphi_u]^{(1 + \alpha_{bu})} \quad (9-70)$$

or

$$\left(\frac{v_{mu}}{v_{mu_0}}\right)^2 = \left[1 + \frac{2(1 - a_u) X_u^2}{a_u [X_u^2 + (S_2 + Z_u)^2]}\right] \frac{1}{\left[1 + \frac{X_u^2}{(S_2 + Z_u)^2}\right]^{\frac{1 + \alpha_{bu}}{2}}} \quad (9-71)$$

where $a_u > 0$

The more general procedure was used to generate comparisons with test data. Figure 9-28 shows the upwash centerline ($X_u = 0$) decay and half velocity boundary growth characteristics in comparison with some test data. The model predicts higher initial total pressures for the closer jet spacings along with a smaller turning region. The decay curves tend to merge with increasing height above ground. The model half velocity boundary growth starts off at a smaller value closer to the ground for closer spacings and then grows at the same rate.

Figure 9-29 shows the predicted lateral variation in the upwash pressures for $H/d_N = 4.0$, $S/d_N = 6.0$ for several heights in the upwash sheet. The total pressure in the upwash sheet drops off more rapidly compared to the centerline value for greater heights due to the radial spreading of the upwash streamlines. Figure 9-30 shows a comparison of the lateral total pressure decay with some test data at $h/d_N = 3$, $S/d_N = 4$. Figure 9-31 demonstrates the small influence that nozzle height above ground has on the lateral characteristics of the upwash sheet in a fixed Z_u plane. Figure 9-32 shows the lateral decay characteristics for a close jet spacing of $2d_N$ just prior to significant coalescence effects. At greater heights above

ground significant upwash flow does not exist along the centerline between the jets. Figure 9-33 demonstrates this effect where the upwash total pressure now has to be nondimensionalized by the jet stagnation point pressure. Figure 9-34 shows an even more extreme condition with some test data plotted for comparison.

9.4 Model for the Prediction of Upwash Forces on Slender Bodies

It is a well known fact that when an upwash flow field impacts on the underside of an aircraft an upward lift force can be generated on the aircraft. This upwash lift force is sometimes negated at heights close to the ground by negative interference forces (suckdown) caused by the secondary induced flow field generated by the entrainment action of the primary jet and wall jet flows. It is the intent of this section to develop a method for the prediction of the upwash lift on a slender fuselage where the suckdown force has a minor effect in comparison to the upwash force.

9.4.1 Upper Limit of Upwash Forces from a Momentum Capture Model. Figure 9-36 shows a sketch of the flow model to be used for momentum capture:

The height above ground of the fuselage and nozzles are assumed equal. It will be assumed that the entire vertical momentum included in the upwash sheet by the length of the fuselage can be converted into a lift force. Accordingly, this lift force can be computed as:

$$\frac{L_u}{2\Gamma_J} = \frac{1}{\pi} \int_0^{\varphi_f} [a_u + 2(1-a_u)\sin^2\varphi_u] \cos\varphi_u d\varphi_u$$

$$\frac{L_u}{2\Gamma_J} = \frac{1}{\pi} \left[a_u \sin\varphi_f + \frac{2}{3} (1-a_u) \sin^3\varphi_f \right] \quad (9-72)$$

where $a_u = 1 - \left(\frac{r_{J1}}{S_2} \right)^2$ $\varphi_f = \tan^{-1} \left(\frac{r}{S_2 + h} \right)$

In the above expression, the lift force has been nondimensionalized by the thrust of the two jets. Hence, the maximum lift force attainable for an infinite length body with $a_u = 1$ is

$$\frac{L_u}{2T_J} = \frac{1}{\pi}$$

This expression, in the limit as $l \rightarrow \infty$, $\phi \rightarrow \frac{\pi}{2}$ tells us that only 31.8% of the thrust can be achieved as the optimum ideal lift force neglecting jet coalescence effects. In reality, for a finite length body, the lift force will be markedly less than this optimum value. Eq. (9-72) is plotted versus nozzle height for several jet spacings in figure 9-37 for a typical Type A fan jet V/STOL fuselage length of $8 d_N$. The jets are also placed at the midpoint of the fuselage. The figure shows that the maximum upwash force on this finite length body is about $.25 T_J$. The upwash force also drops off rapidly for a closely spaced jet configuration due to the rapid coalescence of the jets. The momentum capture model neglects any finite width or fuselage shape effects.

This type of calculation is most representative of a fuselage fitted with strakes which is capable of approaching the force as predicted by a momentum capture model.

9.4.2 General Approach to the Prediction of Upwash Force on Arbitrary Slender Bodies. In general, the finite width of a fuselage will have a marked effect on the amount of momentum transferred to the body as a lift force. In addition, the shape of the fuselage cross section will determine the local pressure distribution around the body and thus also effect the drag or upwash force. A general approach to a prediction model for the upwash force on slender bodies is developed in this section.

9.4.2.1 Maximum Stagnation Pressure Distribution Along Centerline of Fuselage Underbody. Figure 9-38 shows a schematic of the fuselage, the pertinent coordinate systems, and geometrical parameters. The centerpoint or centerline of the body is located at an arbitrary height Z_B relative to the ground and the nozzles are located at a height h above the ground. The fuselage depth is given by the equation

$$Z_B = f(X_B)$$

The fuselage half width is also defined as

$$W_{B_2} = g(X_B)$$

The nozzles are placed at the midpoint of the body. The angle in the upwash sheet included by the half length of the fuselage is then given by

$$\varphi_\ell = \tan^{-1} \left(\frac{\ell_2}{S_2 + Z_p - Z_B(\ell_2)} \right)$$

The underside fuselage centerline coordinate relative to the upwash sheet at any position X_B is given by

$$Z_u = S_2 + Z_p - Z_B(X_B)$$

To determine the maximum pressure distribution on the underside of the body, it is assumed that the local stagnation pressure on the body is representative of the stagnation of the cross flow component of the upwash velocity. The cross flow upwash velocity is just the normal component of the upwash relative to the underside of the body.

$$V_N = V_{mu}(\varphi_{uB}, Z_B) \cos(\varphi_{uB} + \theta_B)$$

where

$$\theta_B = \tan^{-1} \left(\frac{dZ_B}{dX_B} \right)$$

and

$$\varphi_{uB} = \tan^{-1} \left(\frac{X_B}{S_2 + Z_p - Z_B(X_B)} \right)$$

Hence

$$\frac{\Delta P_{usB}}{\Delta P_J} = \left(\frac{V_{mu}}{V_N} \right)^2 \cos^2(\varphi_{uB} + \theta_B) \quad (9-73)$$

9.4.2.2 General Force Integral. If $F_u(X)$ is defined to be the upwash force per unit length of the body, then the entire force on the body can be defined as

$$F_T = 2 \int_0^{\ell_2} F_u(X_B) dX_B \quad (9-74)$$

Converting this integral to the upwash coordinate system entails,

$$\tan \varphi_{uB} = \frac{X_B}{S_2 + Z_p - Z_B (X_B)}$$

Thus,

$$dX_B = \frac{(S_2 + Z_p - Z_B)^2}{(S_2 + Z_p - Z_B - X_B Z'_B)} \sec^2 \varphi_{uB} d\varphi_{uB}$$

where

$$Z'_B = \frac{dZ_B}{dX_B}$$

Hence, the integral eq. (9-74) for the total force becomes,

$$F_1 = 2 \int_0^{\varphi_1} \frac{(S_2 + Z_p - Z_B)^2}{(S_2 + Z_p - Z_B - X_B Z'_B)} F_u(\varphi_{uB}) \sec^2 \varphi_{uB} d\varphi_{uB} \quad (9-75)$$

Now, it is assumed that the force on any cross section is proportional to the local cross flow stagnation pressure, or

$$F_u(\varphi_{uB}) = 2 \Delta P_{uS}(\varphi_{uB}) \int_0^{y = W_{B_2}(\varphi_{uB})} G_p(y) dy \quad (9-76)$$

where $G_p(y)$ is the pressure function representing the local flow around the cross section.

Upon substitution of this expression into eq. (9-75) and using eq. (9-73) for the stagnation pressure, eq. (9-75) becomes,

$$F_1 = 2 \int_0^{\varphi_1} \frac{(S_2 + Z_p - Z_B)^2}{(S_2 + Z_p - Z_B - X_B Z'_B)} \left\{ \frac{\rho V^2 \cos^2(\varphi_{uB} + \theta_B)}{\cos^2 \varphi_{uB}} \int_0^{y = W_{B_2}(\varphi_{uB})} G_p(y) dy \right\} d\varphi_{uB} \quad (9-77)$$

If the integral over the body width is identified as the drag, and a sectional drag coefficient C_{DP} is introduced as,

$$C_{DP}(\varphi_{uB}) \equiv \frac{D_{rag}}{W_{B_2}(\varphi_{uB})} = \frac{1}{W_{B_2}(\varphi_{uB})} \int_0^{y = W_{B_2}(\varphi_{uB})} G_P(y) dy \quad (9-78)$$

and eq. (9-77) is nondimensionalized by the thrust of the two jets, the final expression for the total force becomes,

$$\begin{aligned} \frac{F_{uT}}{2T_J} &= \left(\frac{1}{\pi} \right) \int_0^{\varphi_l} \frac{(S_2 + Z_P - Z_B)^2}{(S_2 + Z_P - Z_B - X_B Z'_B)} \\ &\times W_{B_2} C_{DP} \left(\frac{V_{mu}}{V_N} \right)^2 \frac{\cos^2(\varphi_{uB} + \theta_B)}{\cos^2(\varphi_{uB})} d\varphi_{uB} \quad (9-79) \end{aligned}$$

where the above lengths are nondimensional.

For a cylindrical body (i.e., constant width and depth) whose underside is located at the nozzle height, or

$$Z_P - Z_B = h$$

the above expression reduces to,

$$\frac{F_{uT}}{2T_J} = \frac{(S_2 + h)}{\pi} W_{B_2} C_{DP} \int_0^{\varphi_l} \left(\frac{V_{mu}}{V_N} \right)^2 d\varphi_{uB} \quad (9-80)$$

9.1.2.3 Estimation of the Drag For Different Cross Sectional Shapes. Figure 9-39 shows approximate drag models corresponding to a circular and rectangular shaped cross section body. The models for the drag for the upwash problem are markedly different than conventional aerodynamics. A cylinder immersed in an infinite stream will exhibit zero drag if the flow is attached and inviscid. The viscous flow,

on the other hand, will separate at some point and a base pressure will result causing a drag on the cylinder. In the upwash problem, the viscous flow will impact the body, flow around it and also separate at some point. The difference being that the pressures aft of the separate point will be the result of secondary induced flow. Hence, resulting in base pressures much closer to ambient as compared to the body immersed in an already energized infinite stream. These considerations were the basis for the drag models. This is also the primary reason for consideration of slender bodies because these small secondary induced pressures acting over a large area will result in a significant suckdown force. For the present time they are neglected.

Figure 9-39 b shows the model for a flat bottom body. In this model, a finite width upwash flow impinges on the underside of the fuselage. The model assumes that the flow separates at the bottom corner of the fuselage and continues without curvature away from the body. In reality, the flow would have a tendency to follow the body after separation. The force can then be easily estimated as the portion of the force that would be exerted on an infinite flat plate but taking into account the finite width of the underbody.

If the pressure recovery zone for the stagnating flow is estimated to be approximately,

$$y_0 = a_0 b_{UH} \text{ where } a_0 \sim 3.6$$

in terms of the half velocity width of the incident upwash stream.

$$\text{Now, let } G_{P_{FLAT}}(\eta) = [1 - \eta^\alpha]^4$$

$$\text{where } \eta = \frac{y}{y_0} = \frac{y}{a_0 b_{UH}} \text{ and } \alpha \sim 1.5.$$

Substituting these expressions into eq. (9-77) yields for the cross-sectional drag function,

$$D_T = a_0 b_{UH} \int_0^{\frac{W_{B_2}}{a_0 b_{UH}}} G_{PF}(\eta) d\eta$$

$$\text{or } C_{D_{PF}} = \frac{D_F}{W_{B_2}} = 1 - \frac{4\eta_B \alpha}{\alpha + 1} + \frac{6\eta_B^{2\alpha}}{2\alpha + 1} - \frac{4\eta_B^{3\alpha}}{3\alpha + 1} + \frac{\eta_B^{4\alpha}}{4\alpha + 1}$$

(9-81)

where $\eta_B \leq 1$.

The drag coefficient for the flat bottom fuselage is thus totally dependent upon the relative size of the incident upwash flow and body width. In the limit of $b_{u_H} \rightarrow \infty$ or $\eta_B \rightarrow 0$, the maximum drag coefficient is 1. This can be interpreted as in the limit the stagnation pressure acts over the entire width of the body (analogous to a pitot tube). On the other hand, the minimum drag coefficient will be obtained when $\eta_B = 1$ and yields a value of .3156. The drag coefficient behavior versus the parameter η_B is shown in figure 9-40.

For the circular cross section, the potential flow solution for the pressure distribution around the cylinder immersed in an infinite stream is used. The flow is assumed to separate at some body angle θ_s and the base pressures are taken to be ambient. Thus, for the circular cylinder,

$$C_{P_c}(\theta_c) = (1 - 4\sin^2\theta_c) \cos\theta_c \quad (9-82)$$

and

$$C_{D_{FC}} = \frac{D_C}{W_{B_2}} = \sin\theta_s \left(1 - \frac{4}{3} \sin^2\theta_s \right) \quad (9-83)$$

It is assumed that the flow separates anywhere between 120° and 160°. The drag coefficient as a function of separation angle is shown in figure 9-41. The maximum value of the drag coefficient for a circular cross section occurs when the flow separates at $\theta_s = 150^\circ$ and is $C_{D_{FC}} = .333$.

To see how well these models work, some correlation with test data was carried out for cylindrical bodies whose underbody was placed at the nozzle height. Figure 9-42 shows the correlation achieved for two such bodies for circular and rectangular shapes and a cross sectional width equal to one diameter or half width of one nozzle radius. For the simple models used, the correlation achieved is quite remarkable especially since the suckdown effect was neglected. The test data drops

off at a slightly higher rate than that predicted probably because of the suckdown effect. Thus, the mysterious sensitivity to body curvative observed in past experiments can now be logically explained.

Figure 9-43 shows some parametric curves generated for the flat bottom cylindrical body as a function of body width. As expected, the predicted force increases proportionately to the width. Unfortunately, this trend is an ideal one and at some body width the suckdown forces will predominate. Figure 9-44 further shows the predicted trend for a parabolic body of maximum cross section equal to that of a cylindrical flat bottom body. As expected, the force on the parabolic body is somewhat less than that on the cylindrical body.

These models could further be improved by including the suckdown effect and also extending the estimate of the drag coefficient to arbitrary cross sectional shapes.

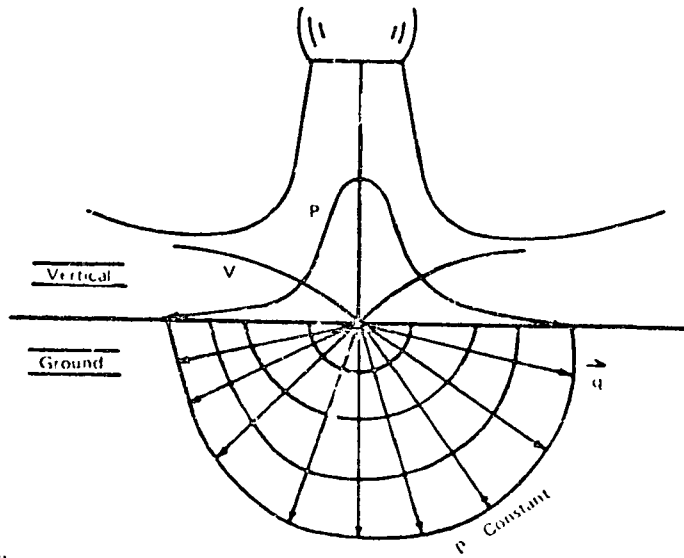

2067 05 10

Figure 9-1. - Jet impingement region.

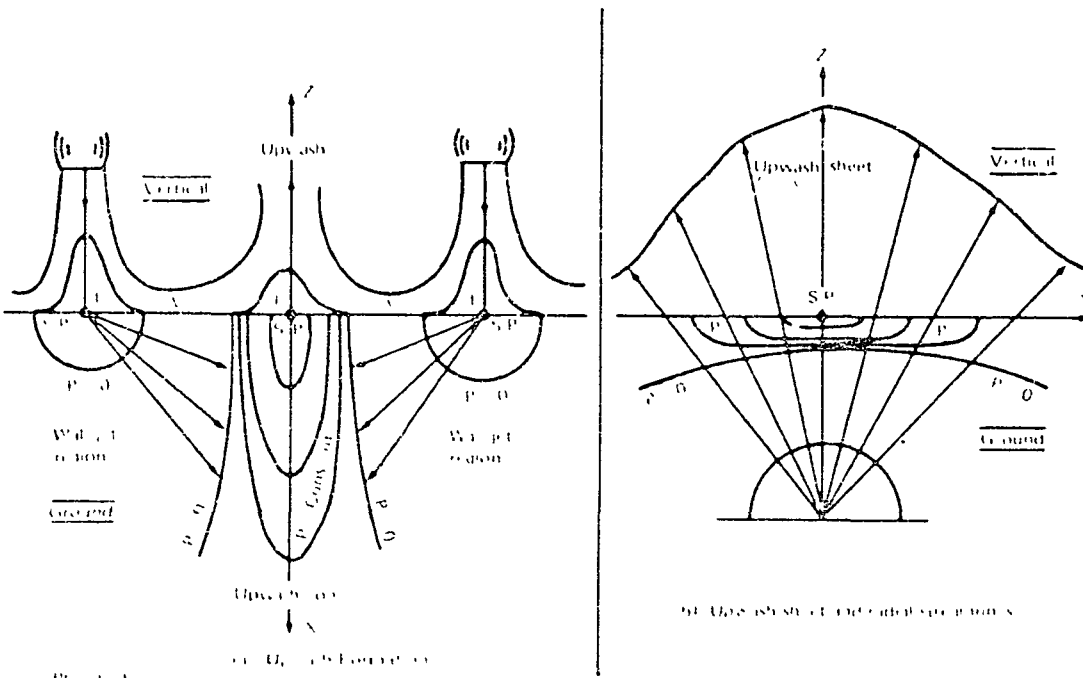
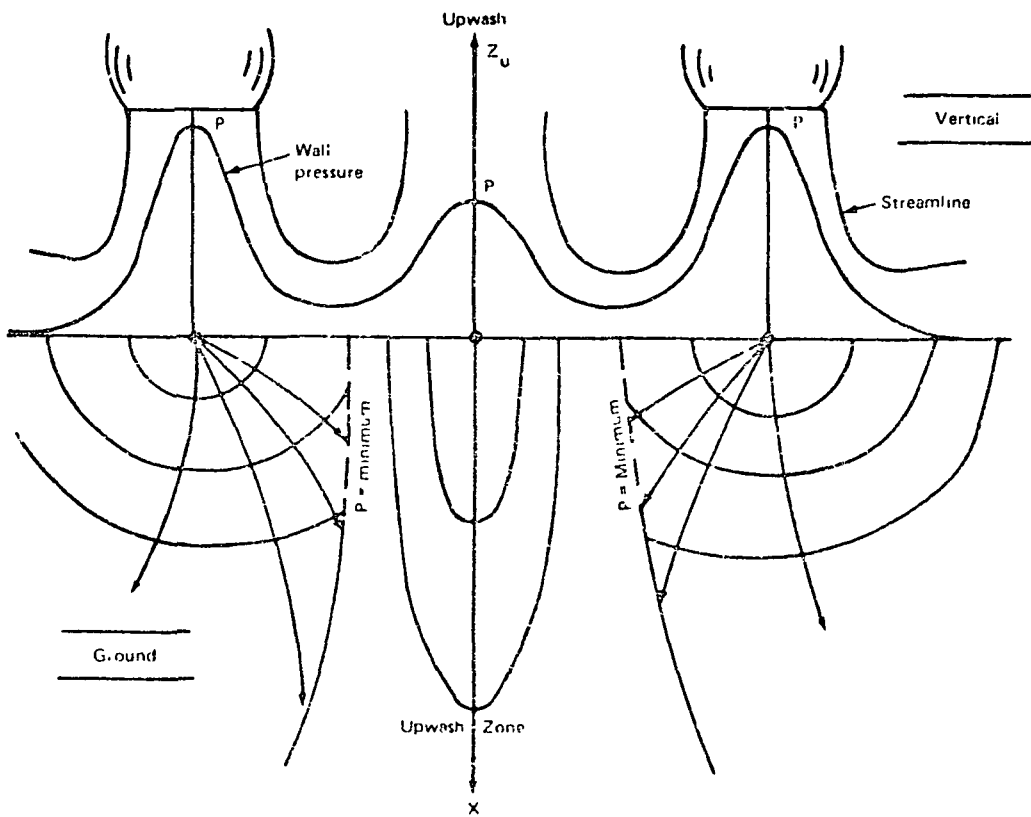
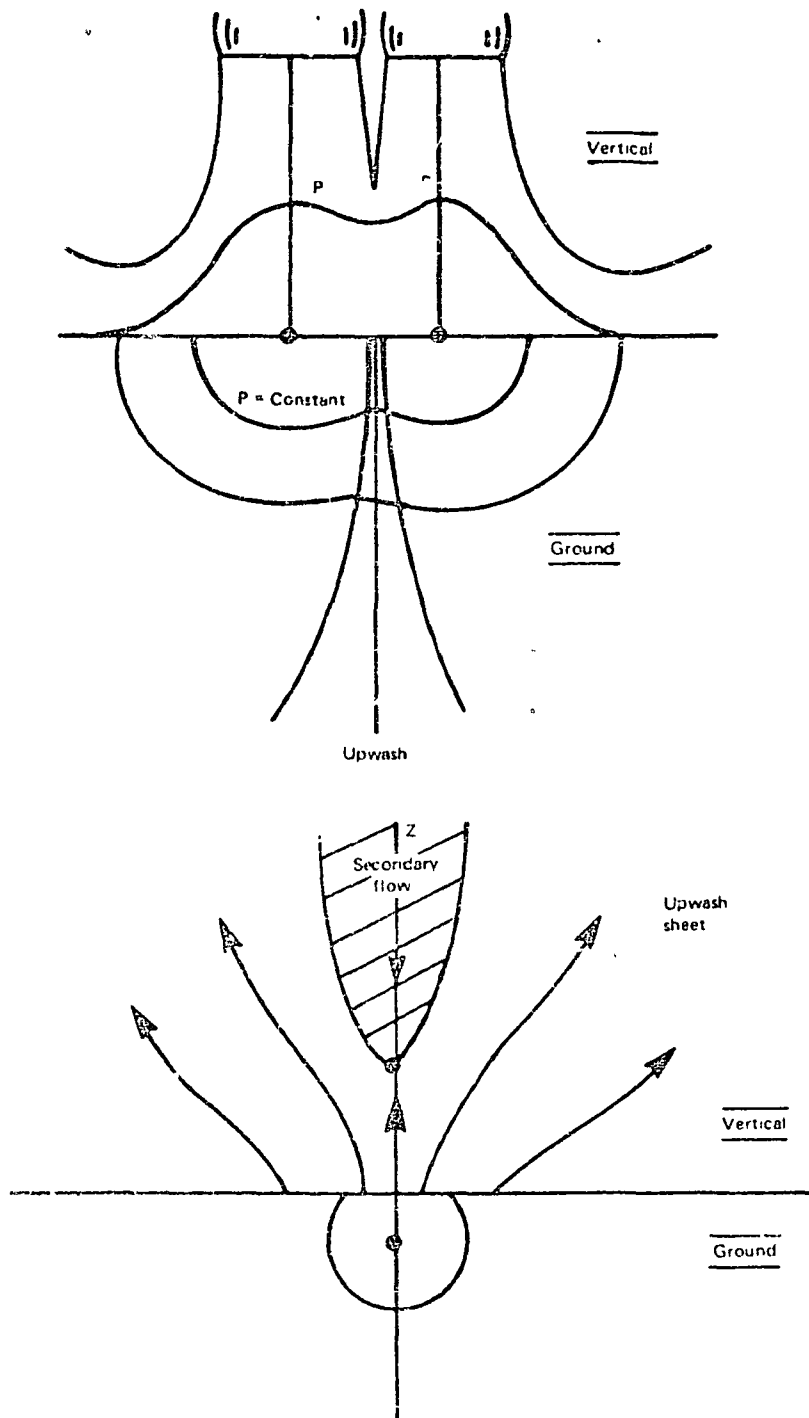

Figure 9-2. Two-jet interacting flows - negligible deflection zone interaction.



2067 0551'

Figure 9-3. - Two-jet interacting flow with deflection zone interaction.



2067 0561'

Figure 9-4. - Flow behavior just prior to coalescence.

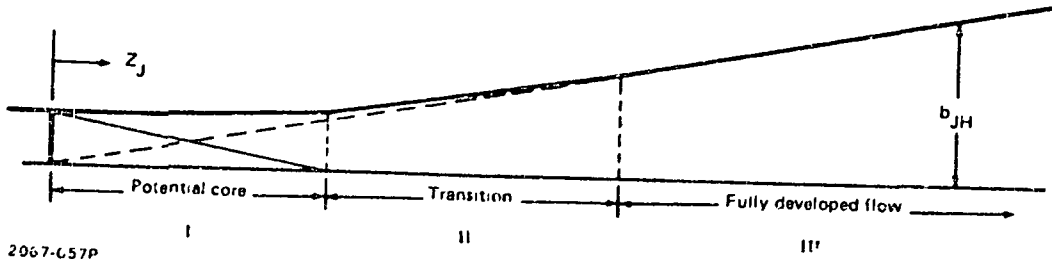

2067-C57P

Figure 9-5. - Jet half-velocity width model

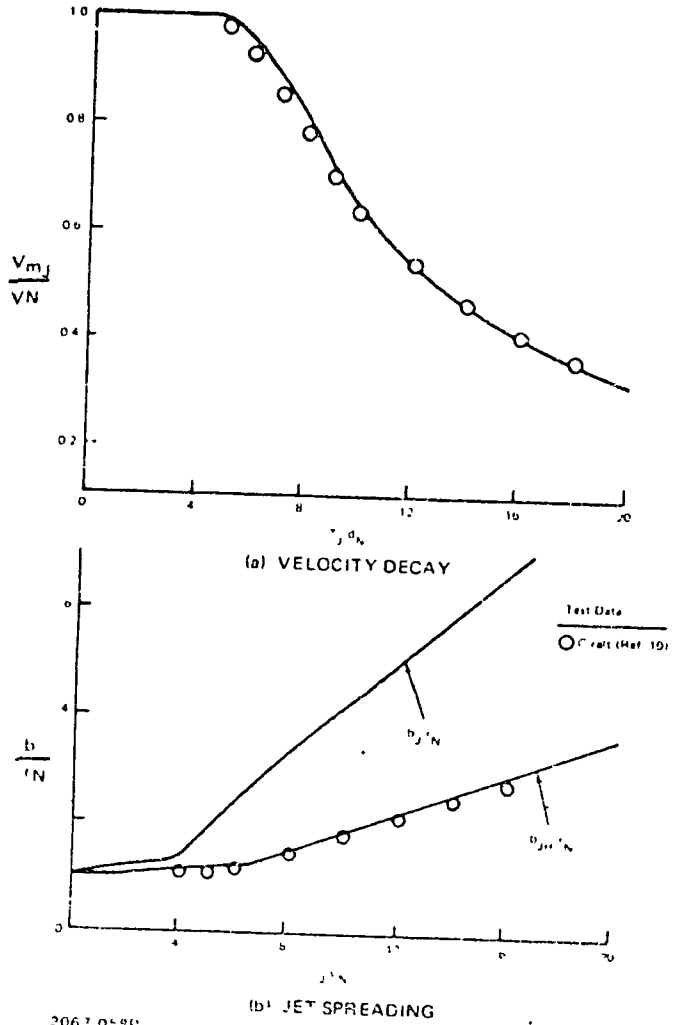

2067 0:31

Figure 9-6. - Jet decay model,

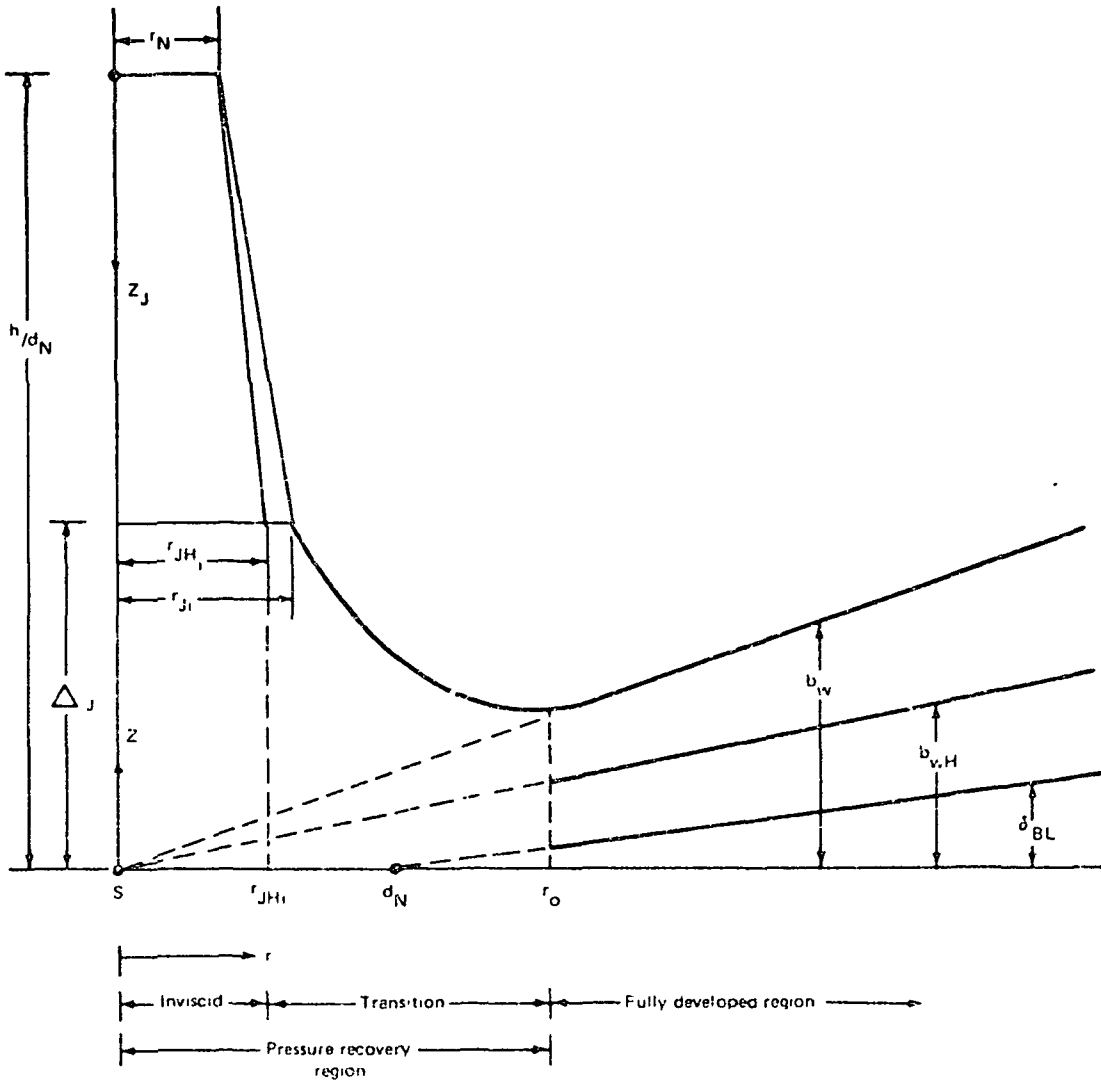

20c7 054P

Figure 9-7. - Definition of scaling parameters for jet impingement and wall jet regions.

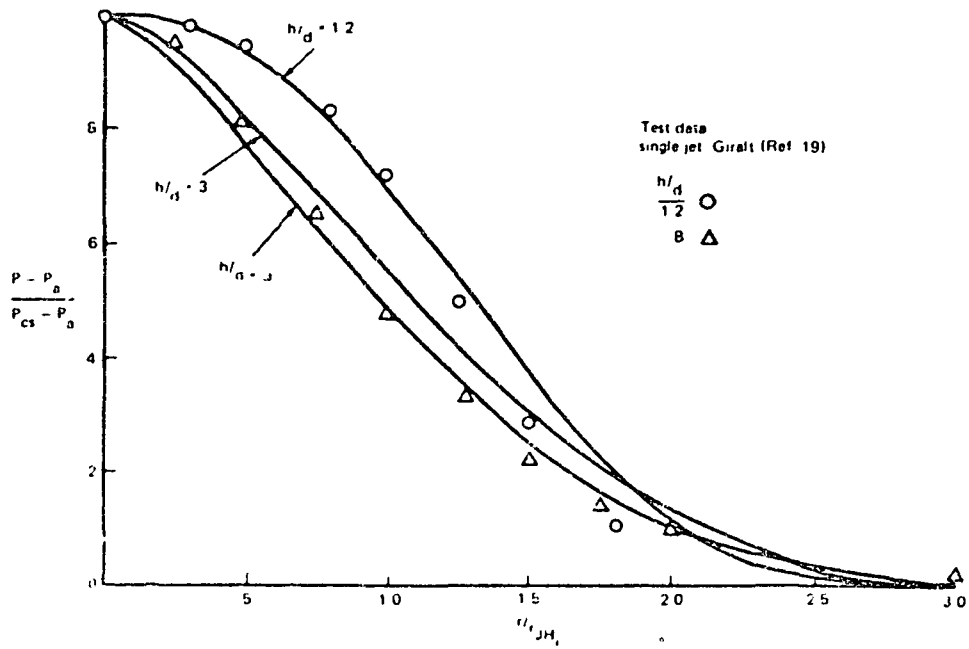

Figure 9-8. - Jet impingement region - ground plane pressure distribution.

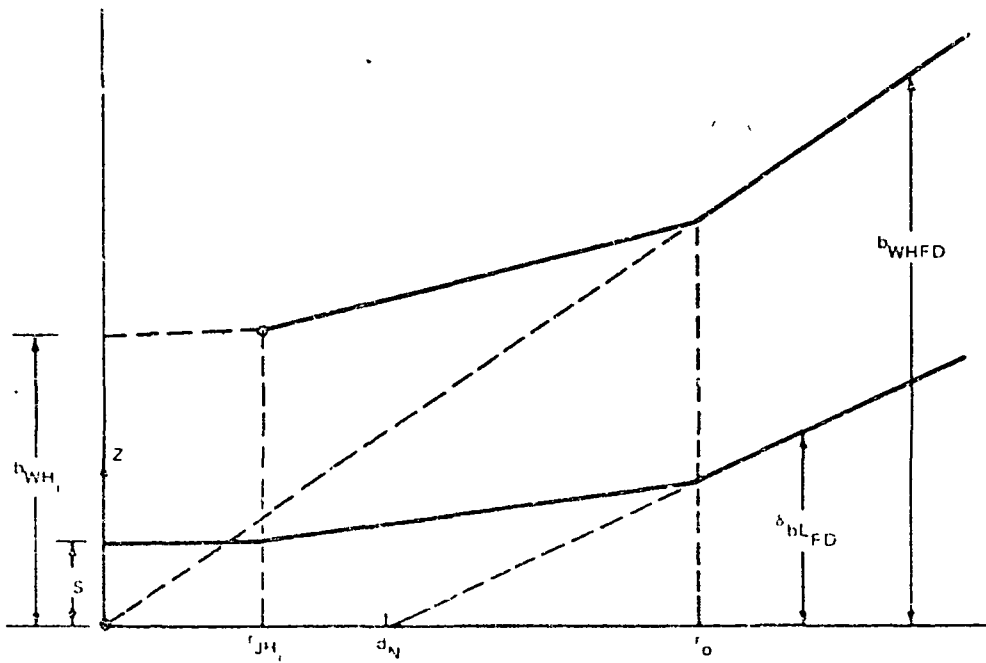
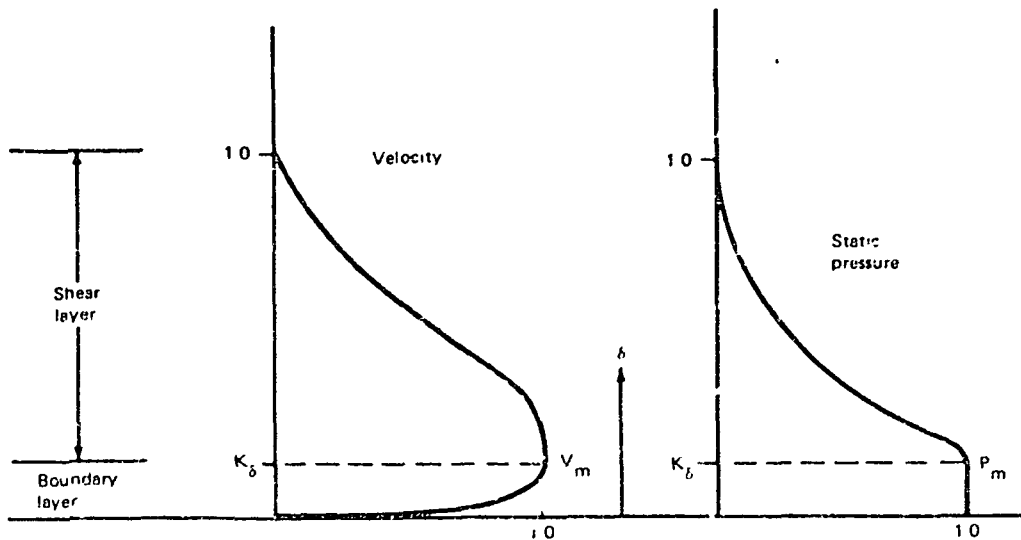
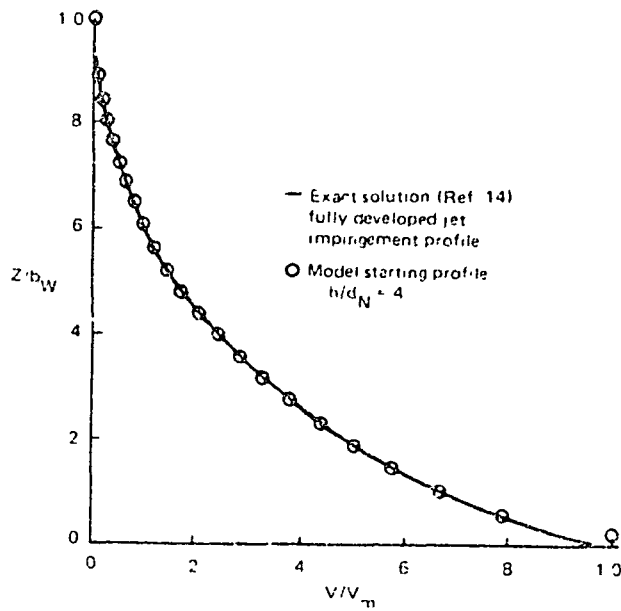

Figure 9-9. - Wall half-velocity and boundary layer thickness models.



2067 062P

Figure 9-10. - Wall jet profile models.



2067 063P

Figure 9-11. - Comparison of a typical inviscid starting profile with an exact inviscid rotational solution (Ref. 14).

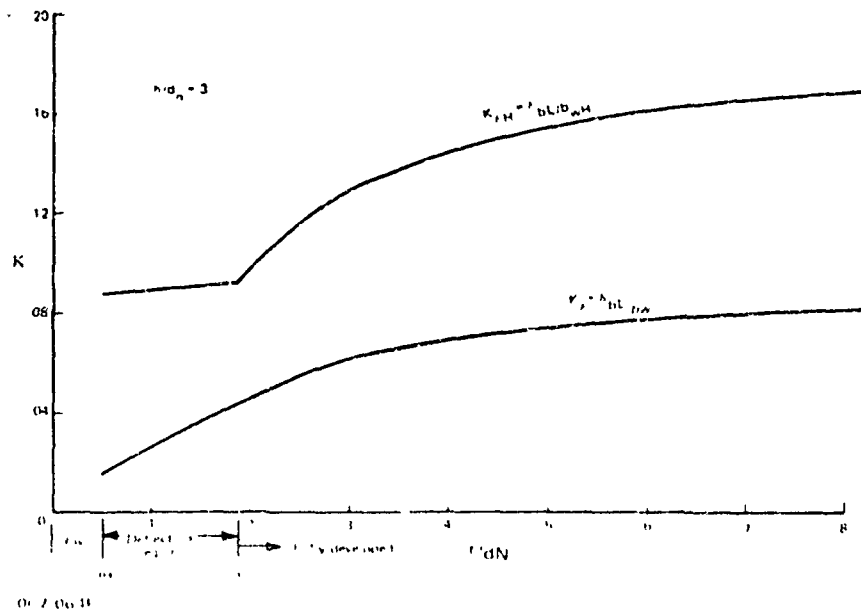

Figure 9-12. - Typical Behavior of wall jet model of boundary layer to shear layer thickness

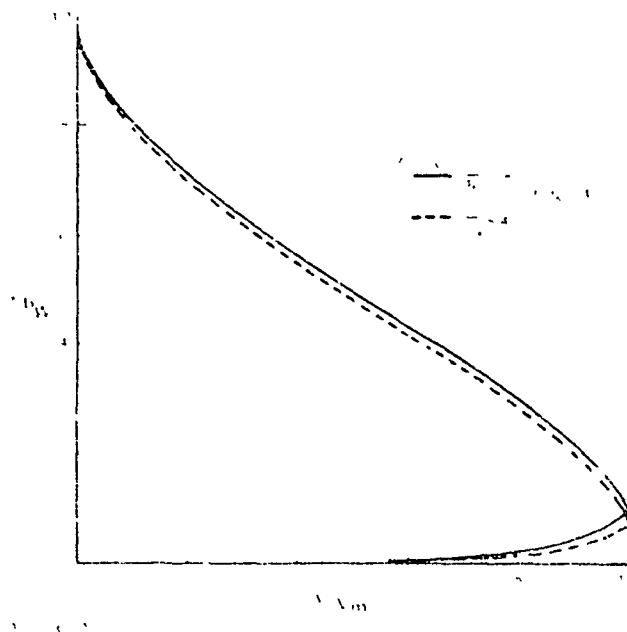

Figure 9-13. - Variation of wall layer profile with distance from stagnation point.

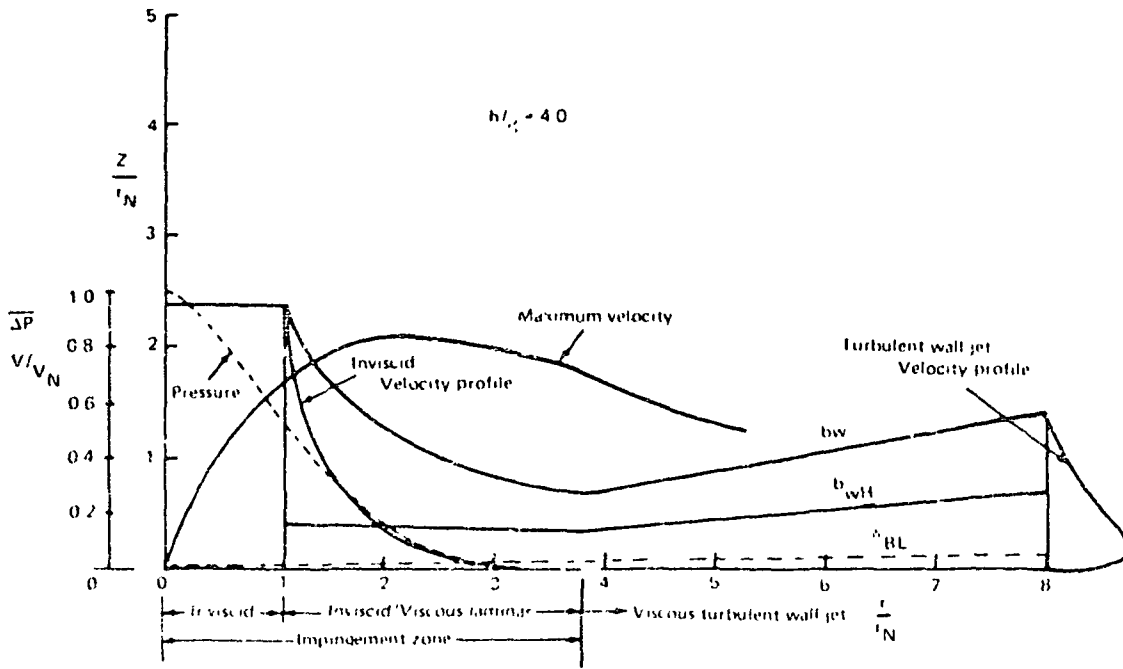

Figure 9-14. - Turbulent wall jet transition model.

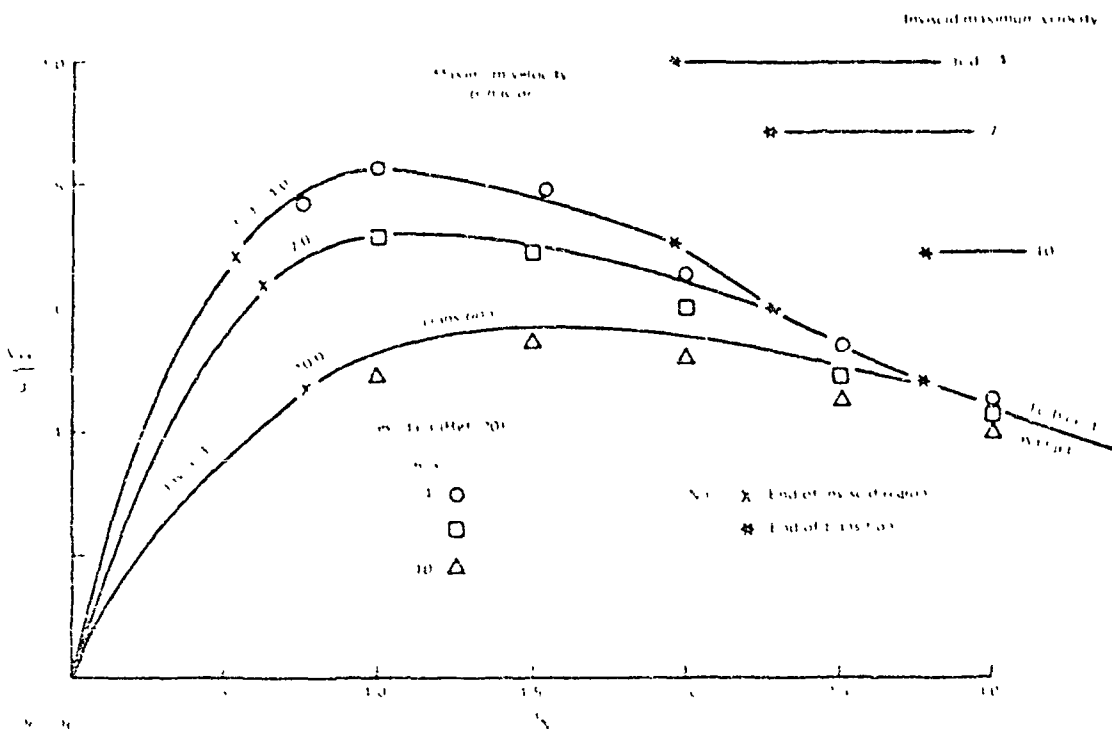

Figure 9-15. Wall jet transition model maximum velocity.

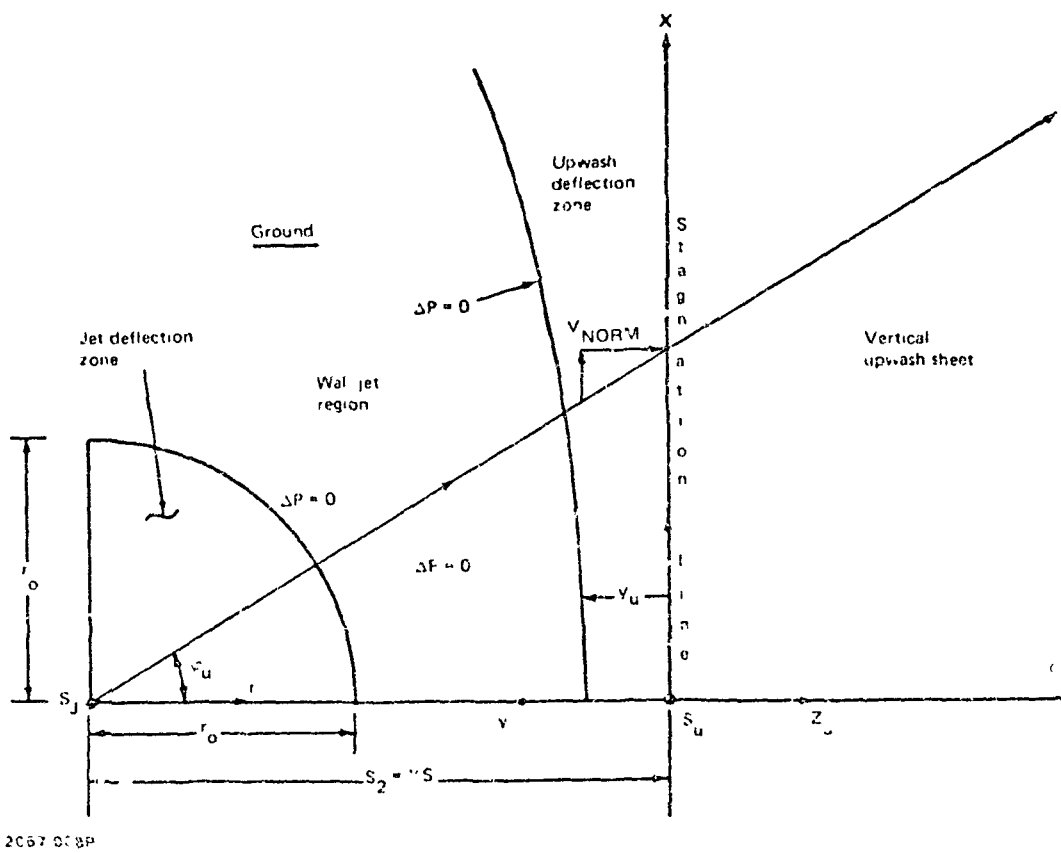

Figure 9-16. - Two-jet impingement without deflection zone interaction.

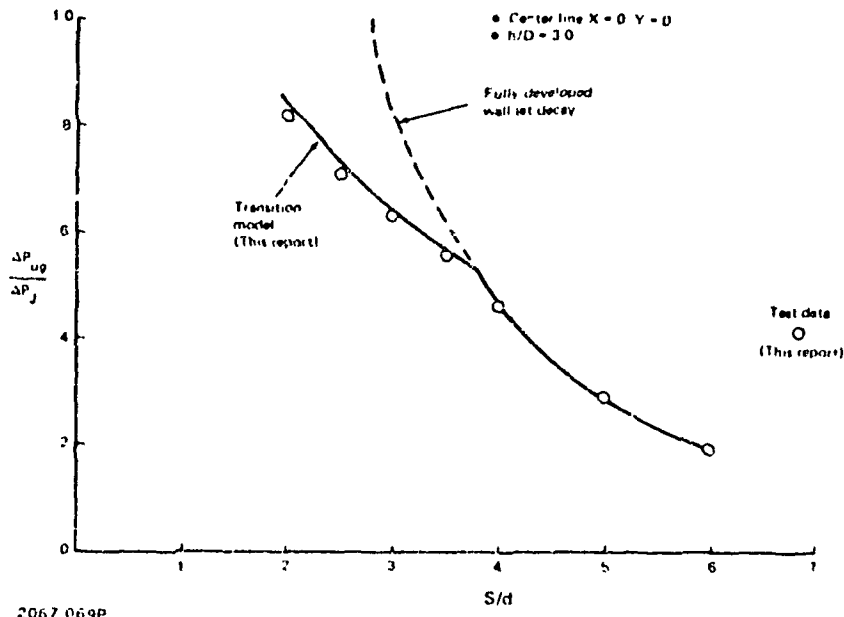

Figure 9-17. - Upwash maximum ground pressure.

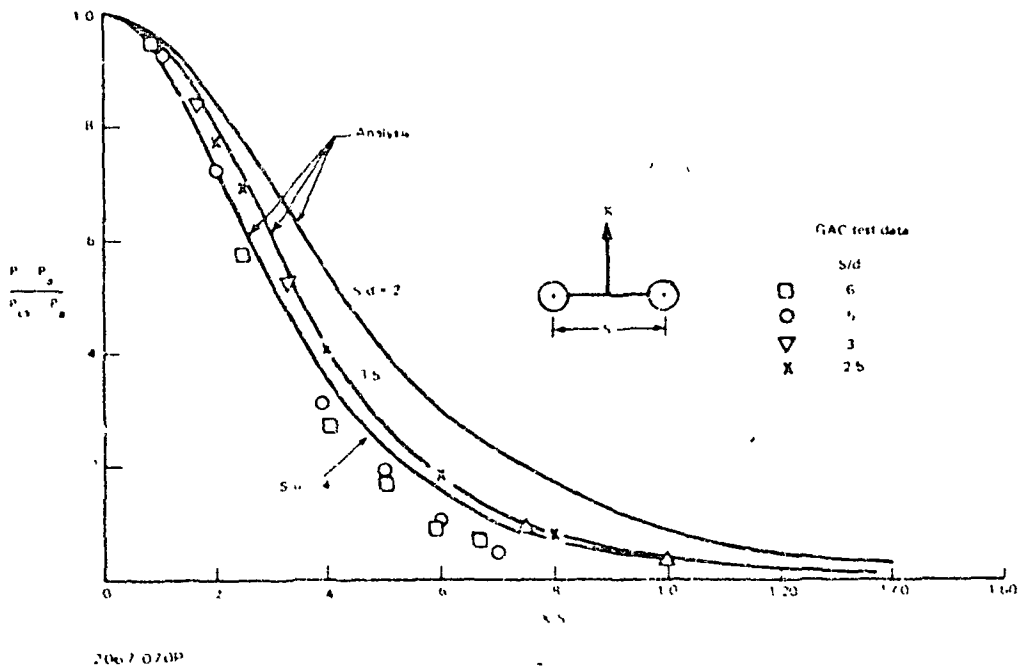

Figure 9-18. - Maximum ground pressure distribution along upwash stagnation line.

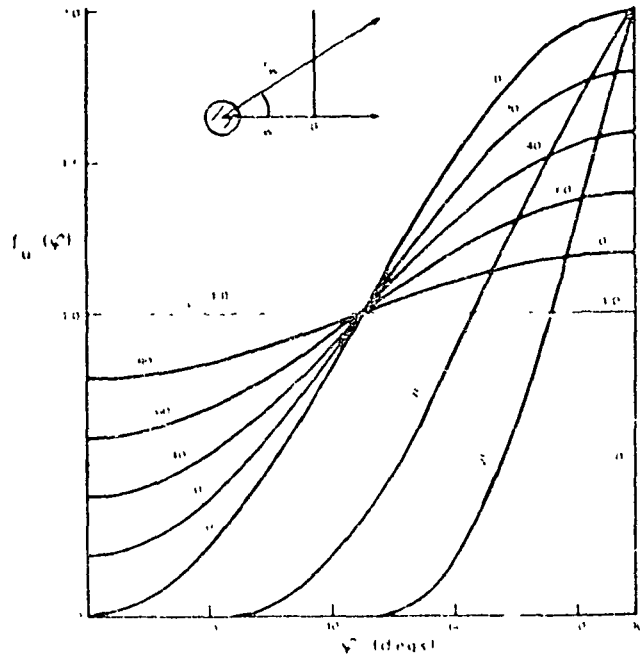

Figure 9-19. - Upwash momentum model.

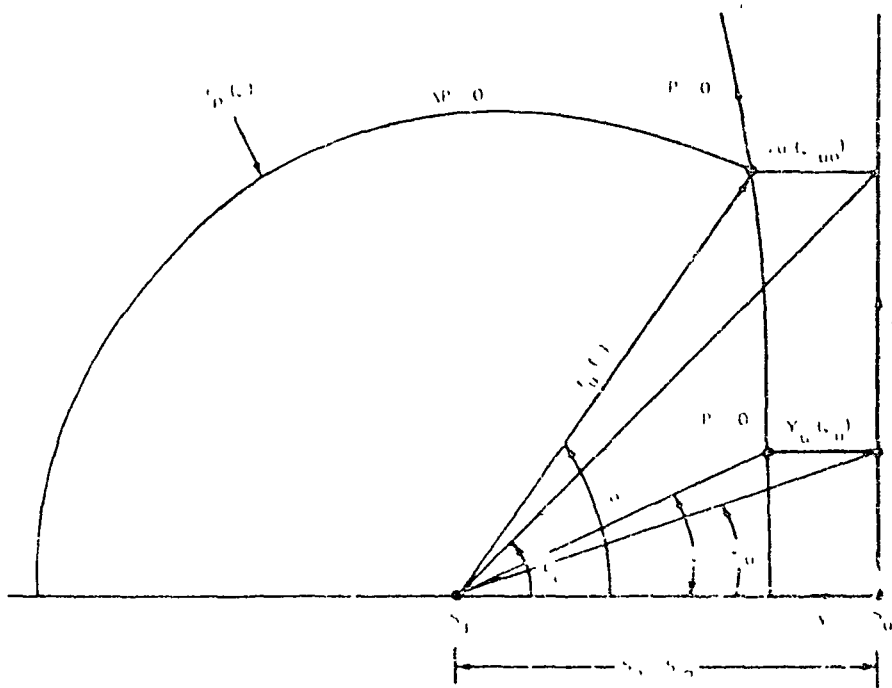

Figure 9-20. - Schematic representation of two-set impingement problem with deflection zone interaction.

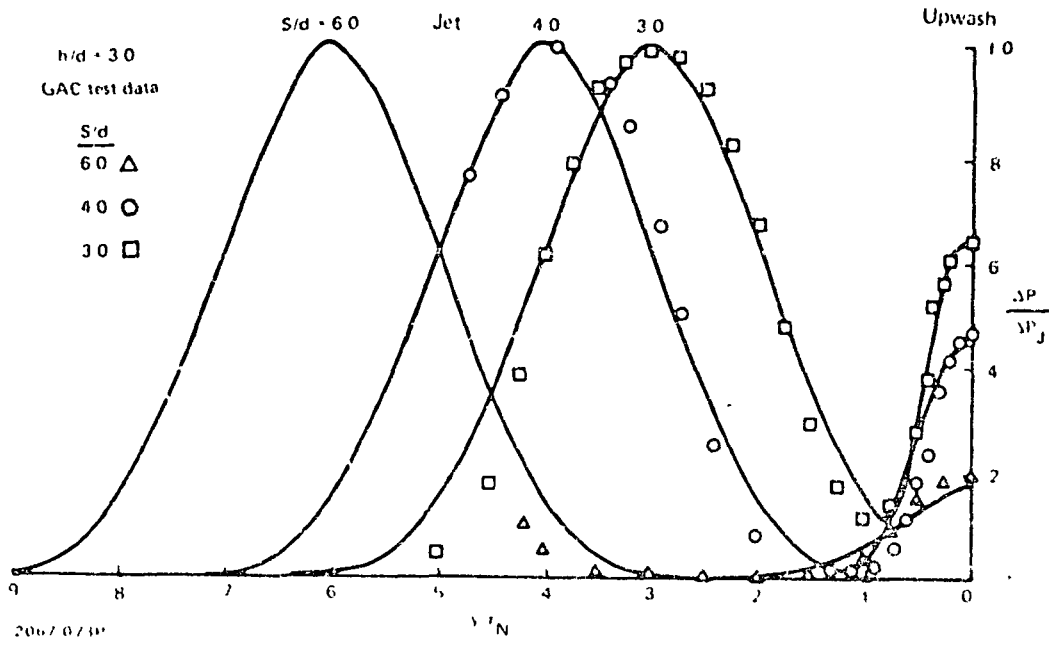

Figure 9-21. - Ground plane pressure distributions ($X = 0$).

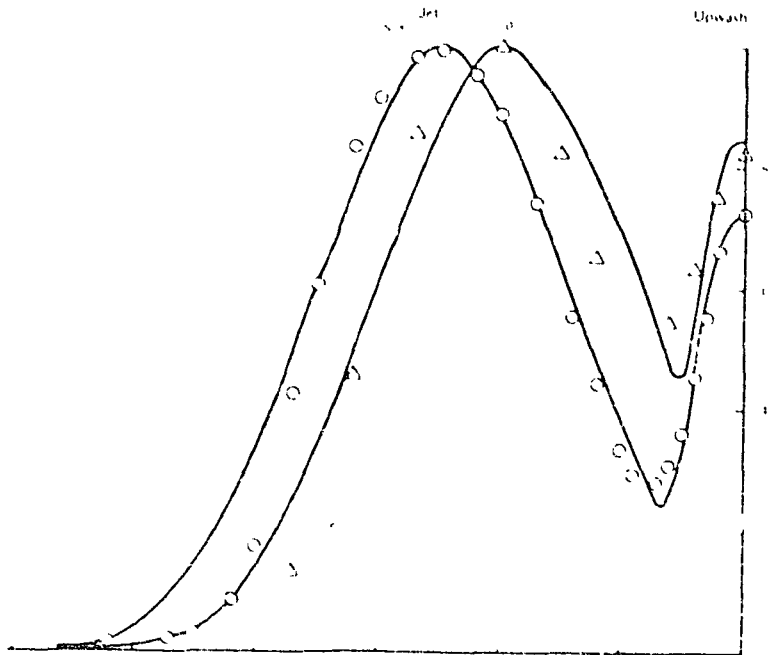

Figure 9-22. - Ground plane pressure distribution.

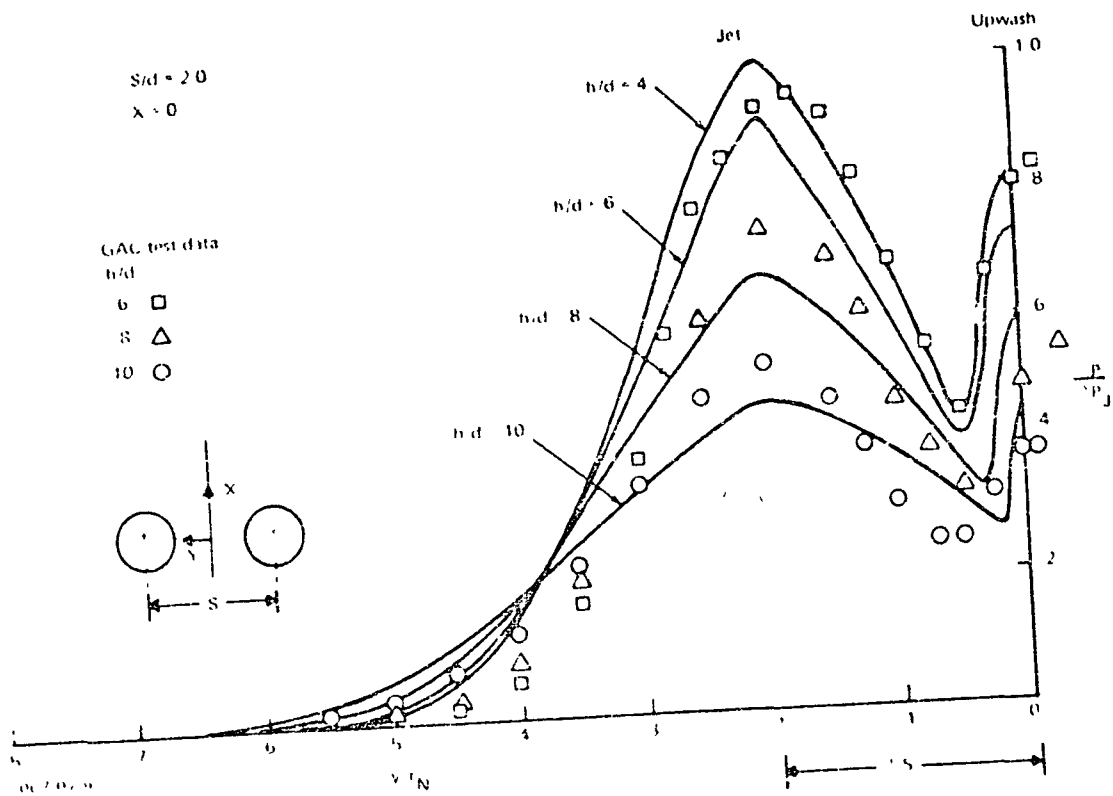
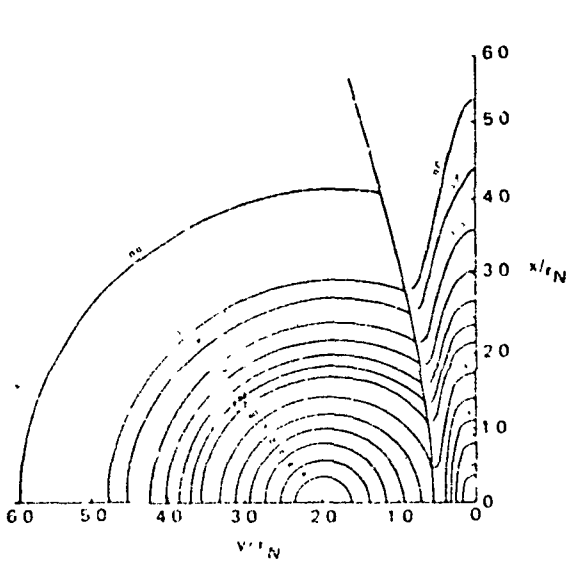
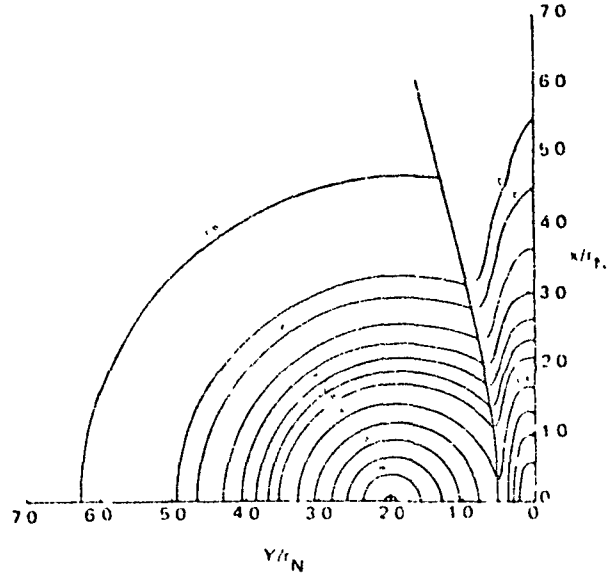

Figure 9-23. - Ground plane pressure distribution.



(a) H/D = 4.00 S/D = 2.00



(b) H/D = 6.0 S/D = 2.0

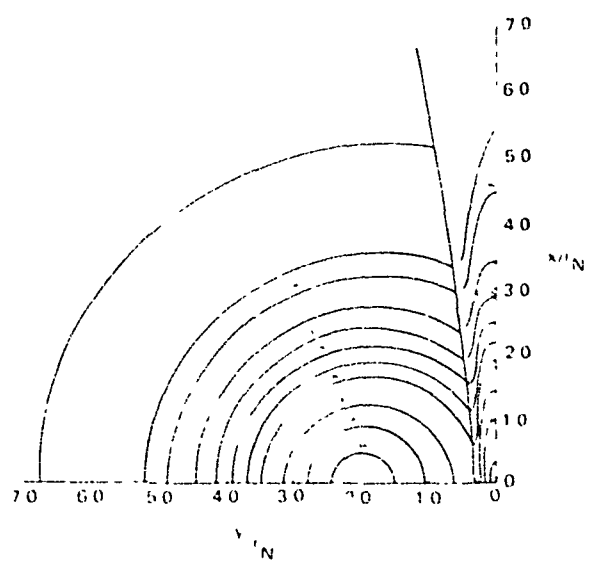

(c) H/D = 8.00 S/D = 2.00

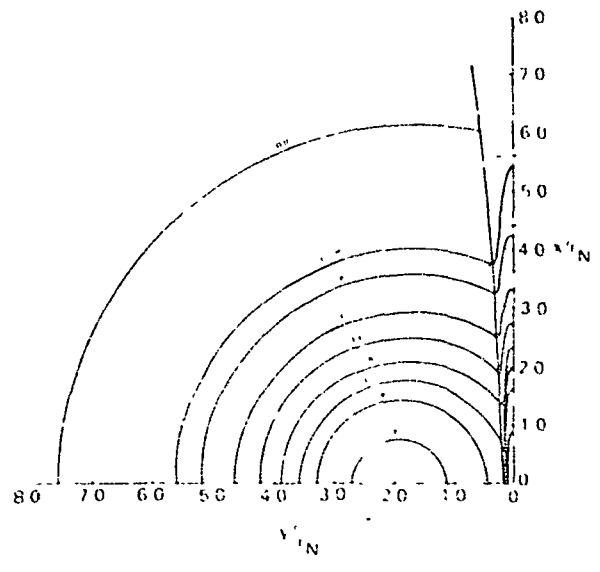

(d) H/D = 10.0 S/D = 2.0

Figure 9-21. - Computed ground isobars.

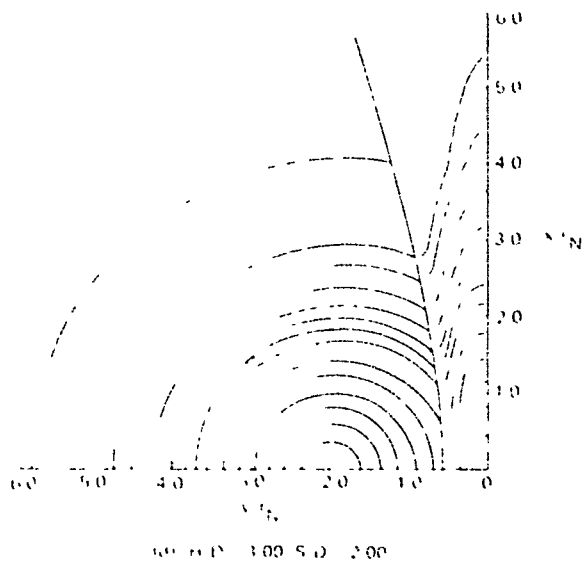
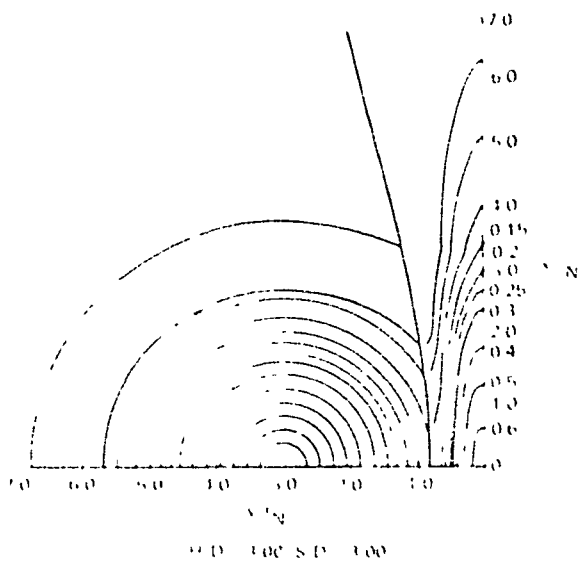
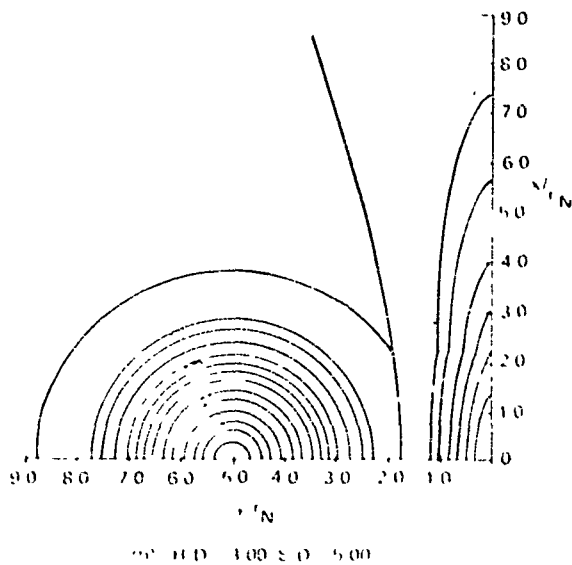
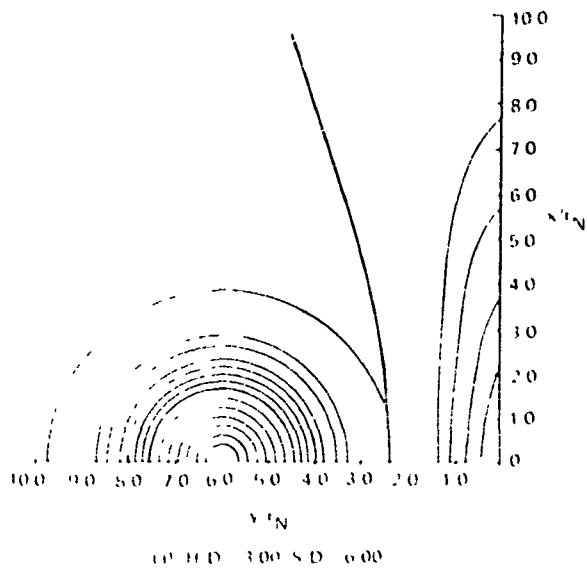
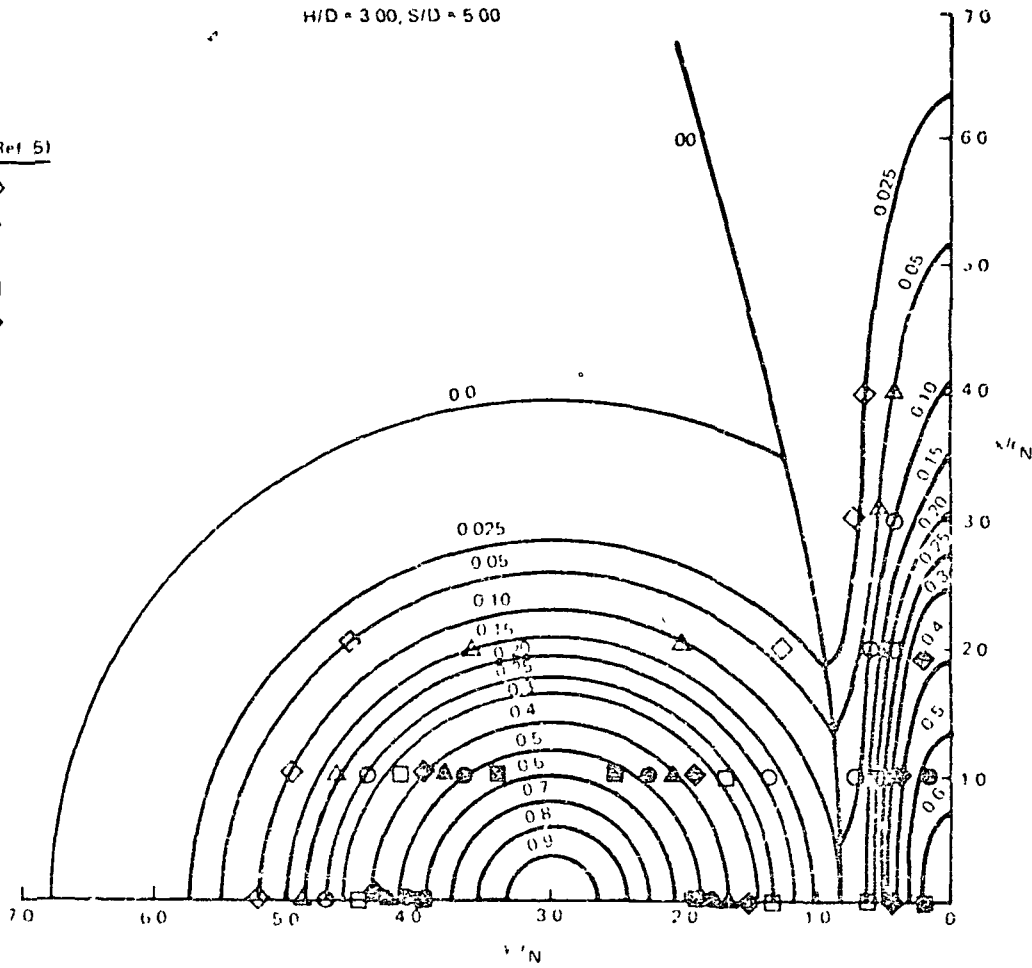

Figure 9-25. - Ground isobars (S.P. = 6.00).

H/D = 3.00, S/D = 5.00

Test Data (Ref. 5)

- 0.025 \diamond
- 0.05 \triangle
- 0.10 \circ
- 0.20 \square
- 0.30 \blacklozenge
- 0.40 \blacktriangle
- 0.50 \oplus
- 0.60 \boxplus



0.0 0.5

Figure 9-20. - Comparison of measured ground pressures with predictions.

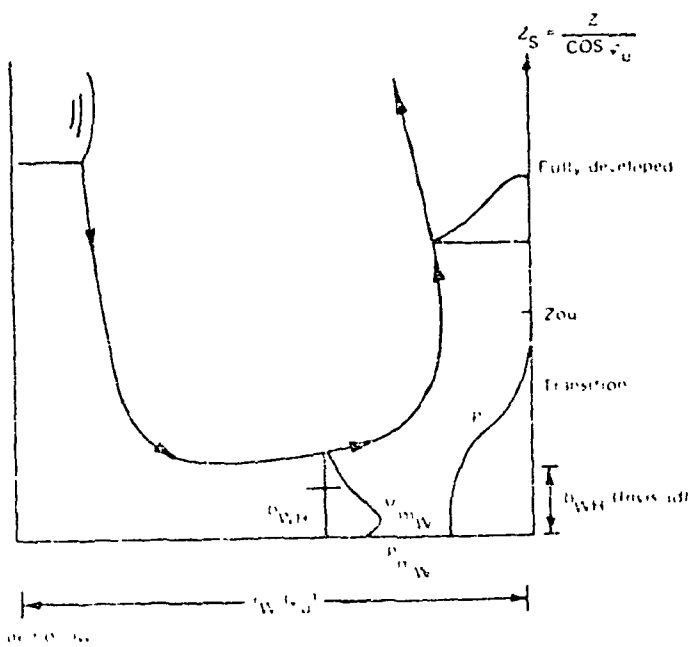

Figure 9-27. - Characteristic scaling parameters for upwash model.

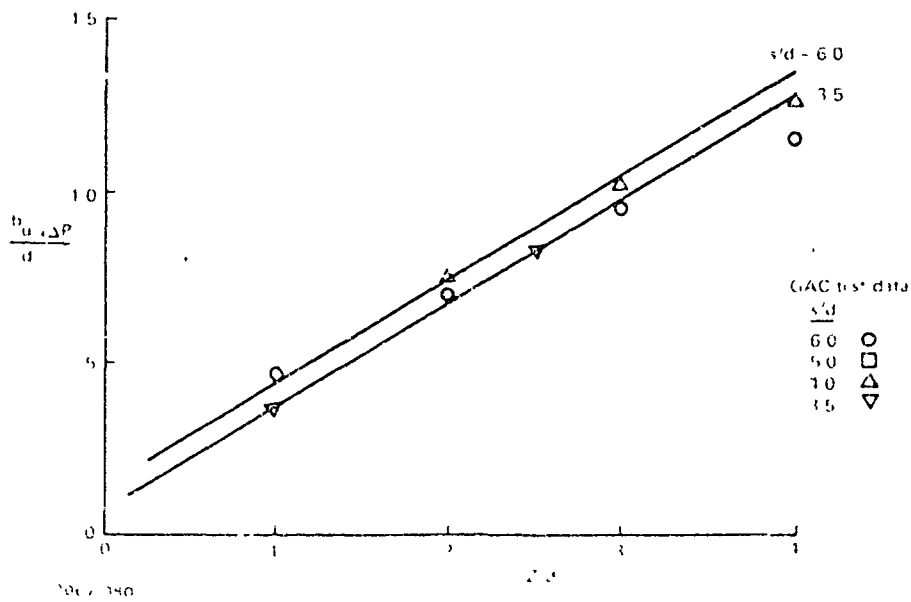
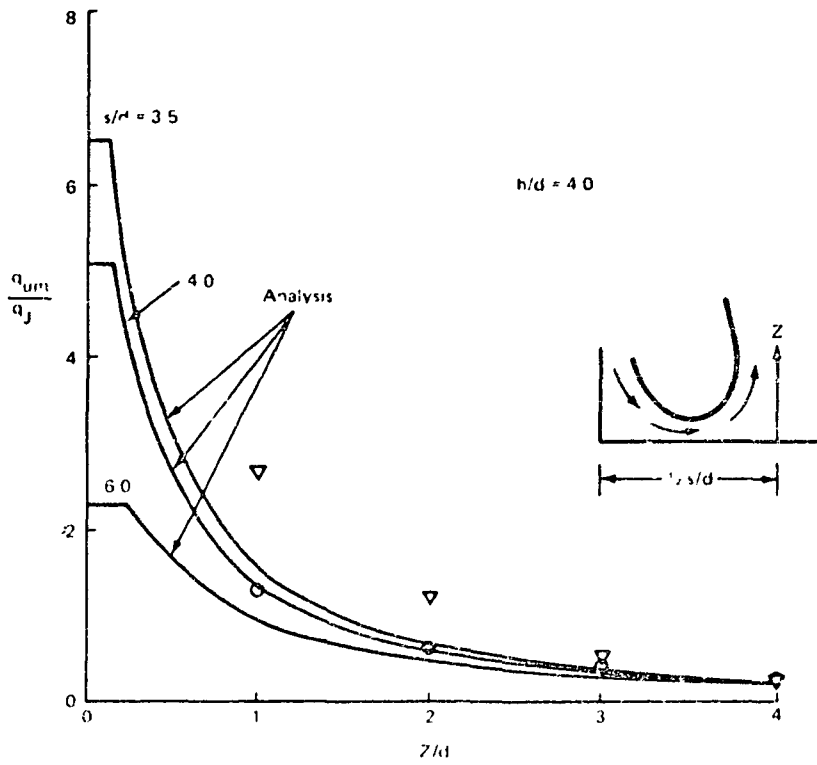

Figure 9-28. - Upwash centrifuge (X - O) characteristics.

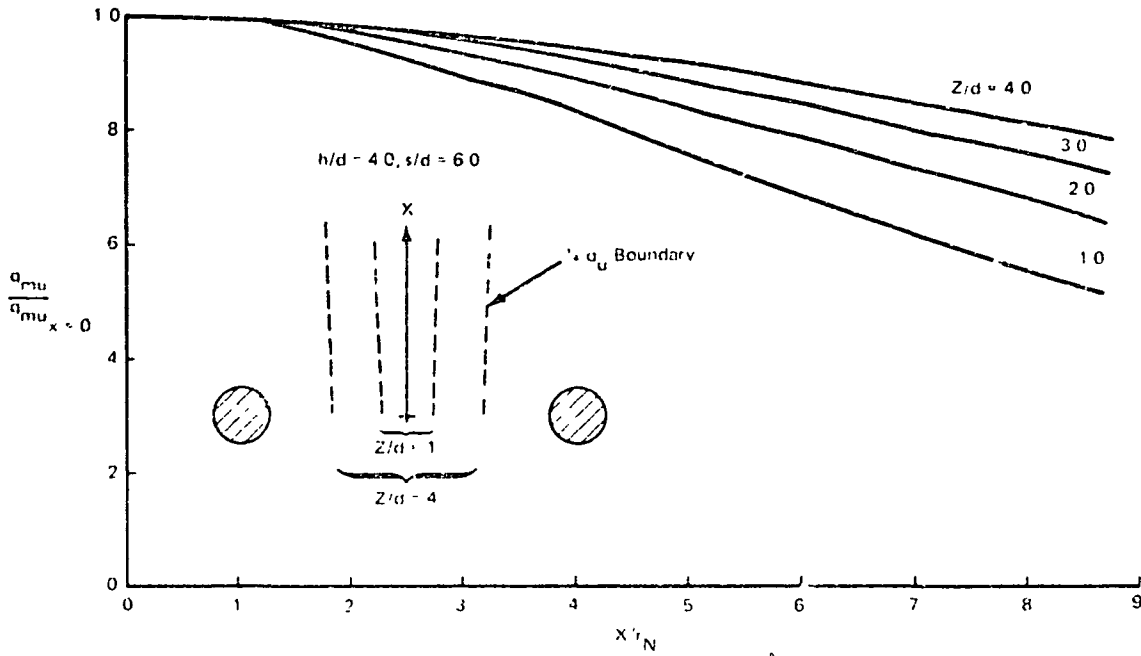

Figure 9-29. - Upwash dynamic pressures.

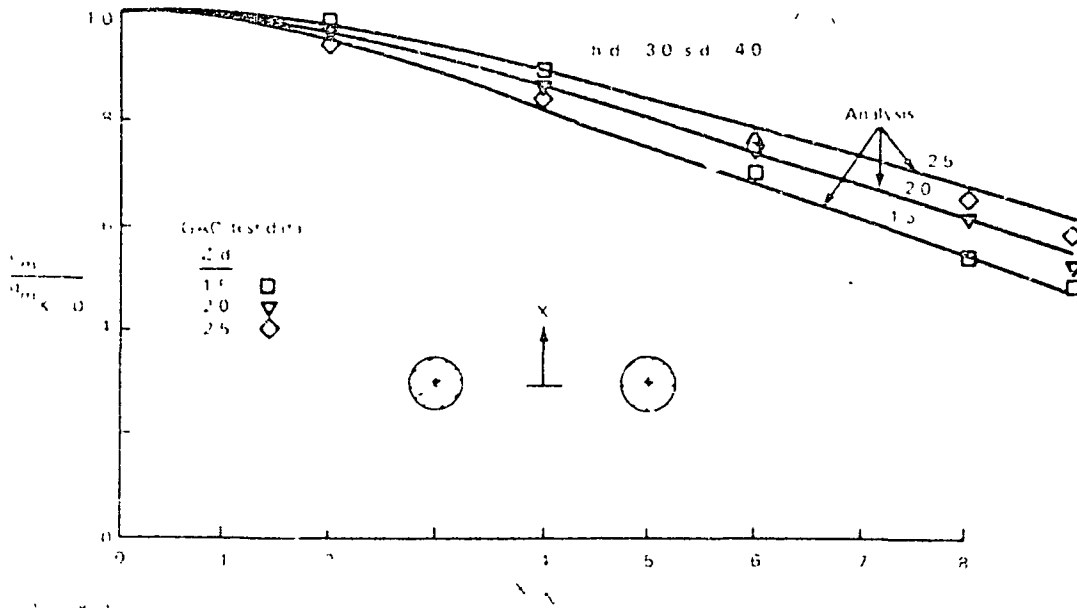

Figure 9-30. - Upwash dynamic pressures.

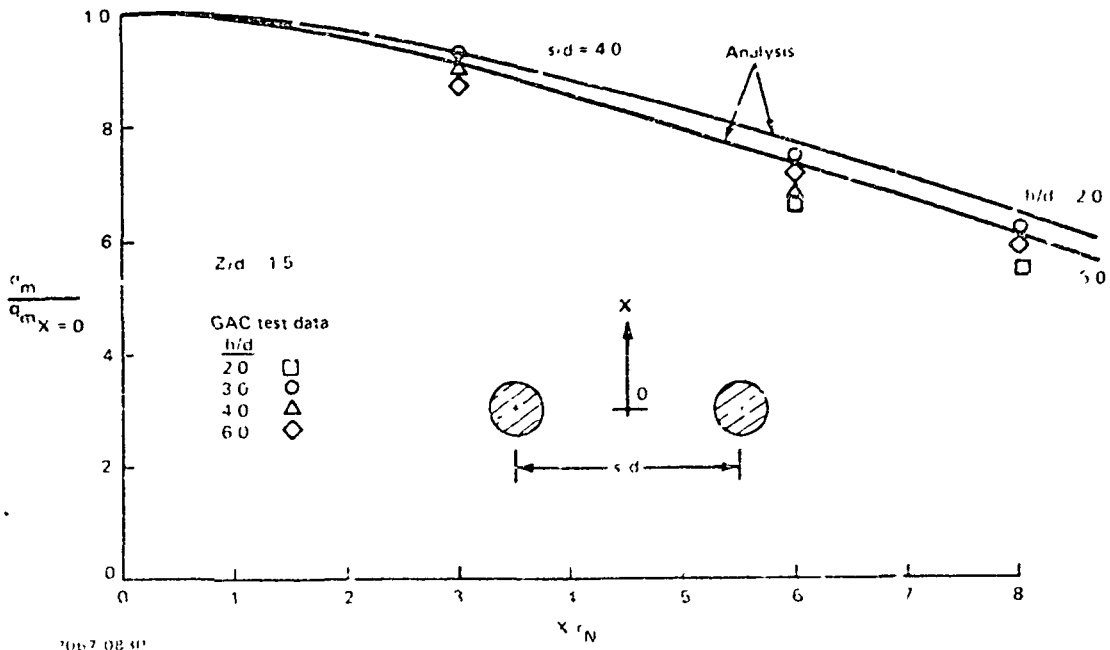

Figure 9-31. - Upwash dynamic pressures at nozzle height.

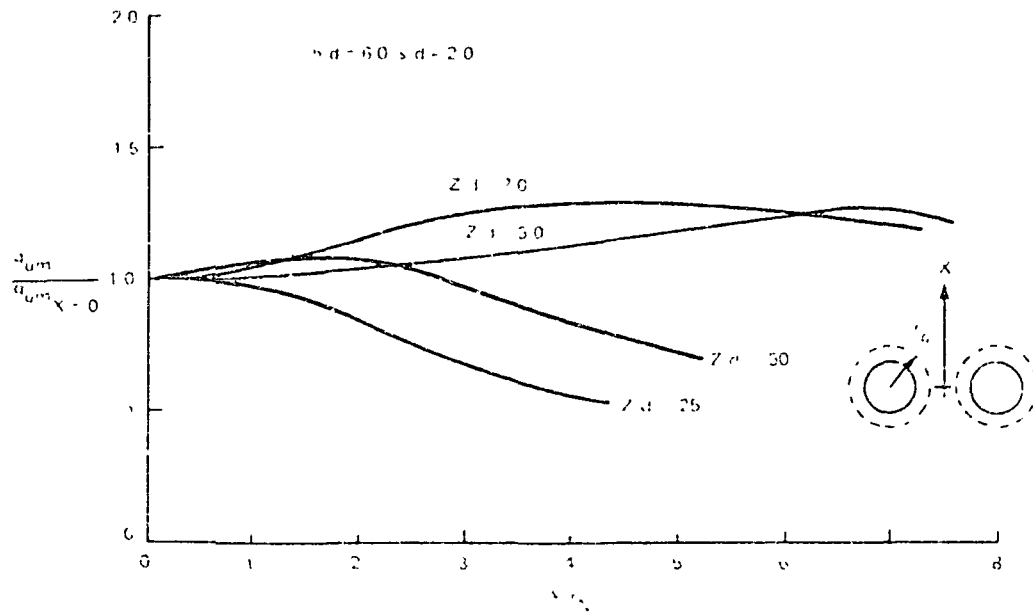

Figure 9-32. - Upwash dynamic pressure.

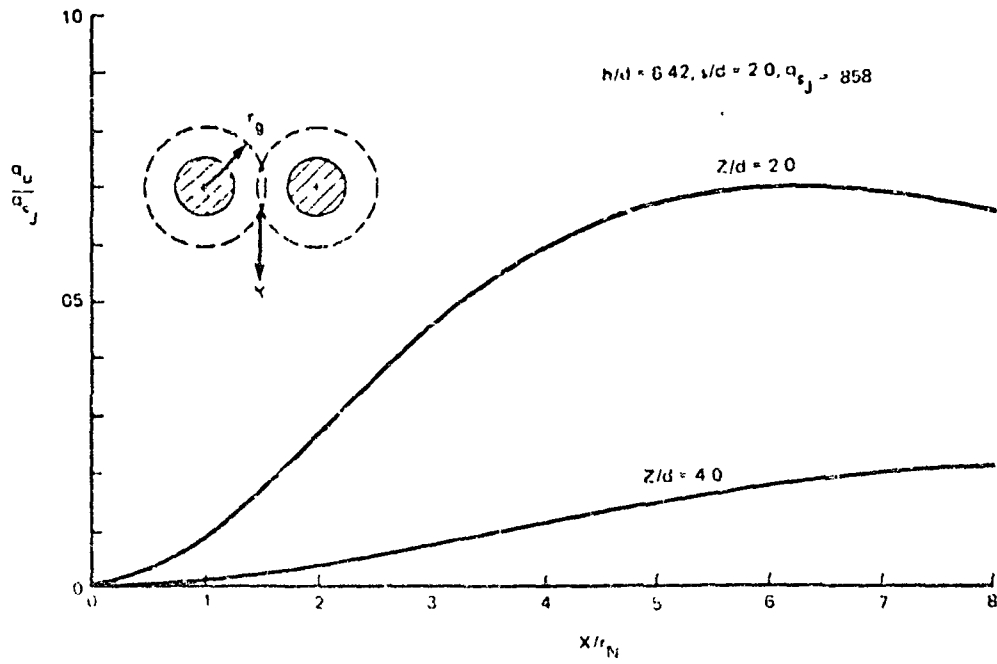

Figure 9-33. - Upwash dynamic pressures.

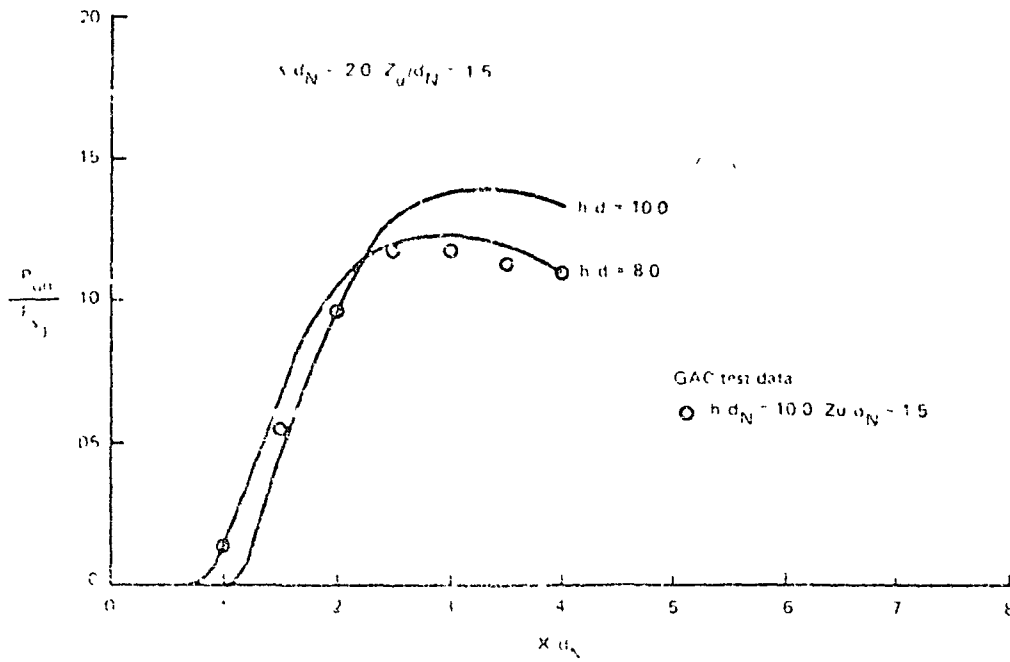

Figure 9-34. - Upwash total pressure.

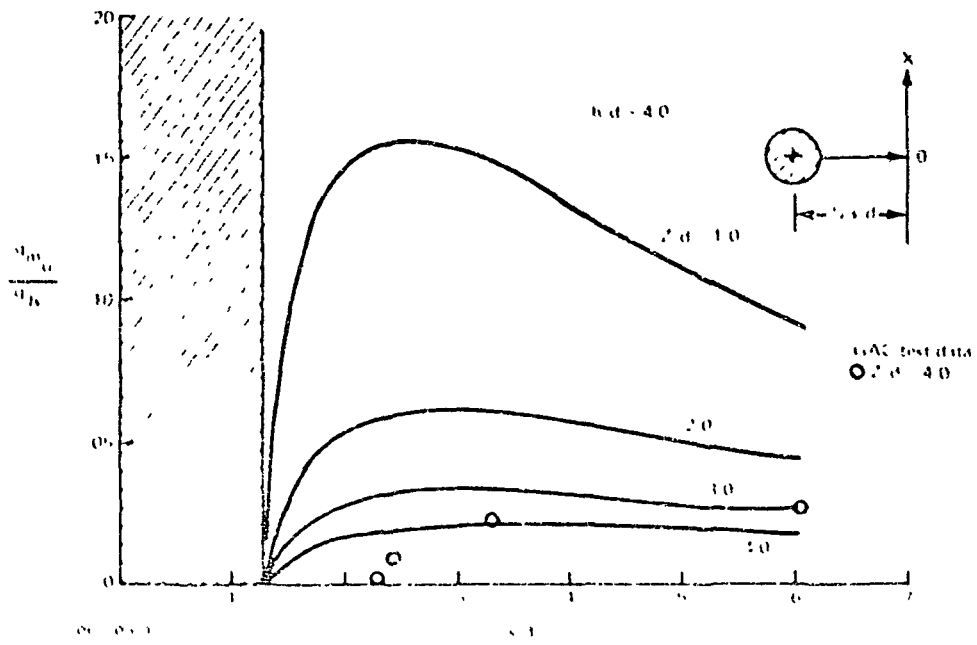

Figure 9-35. - Upwash dynamic pressures at centerline $X = 0$.

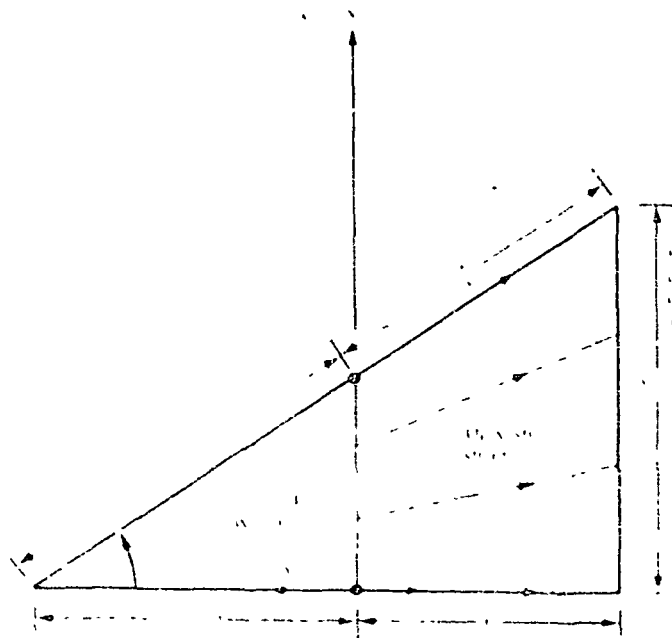

Figure 9-36. - Schematic of momentum capture model.

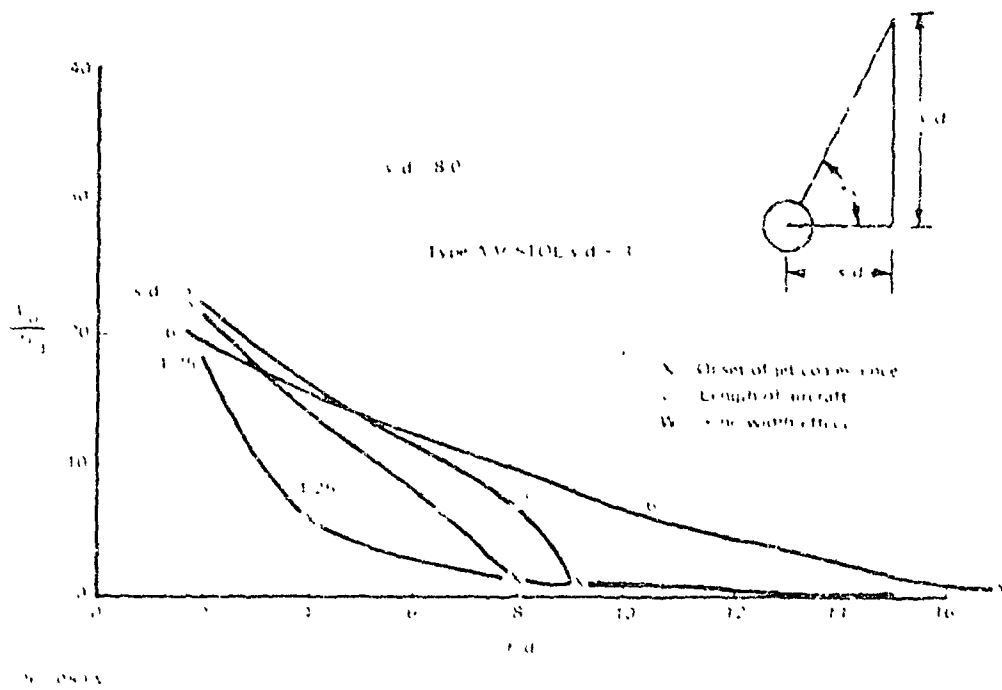

Figure 9-17. - Type d Results using momentum capture model.

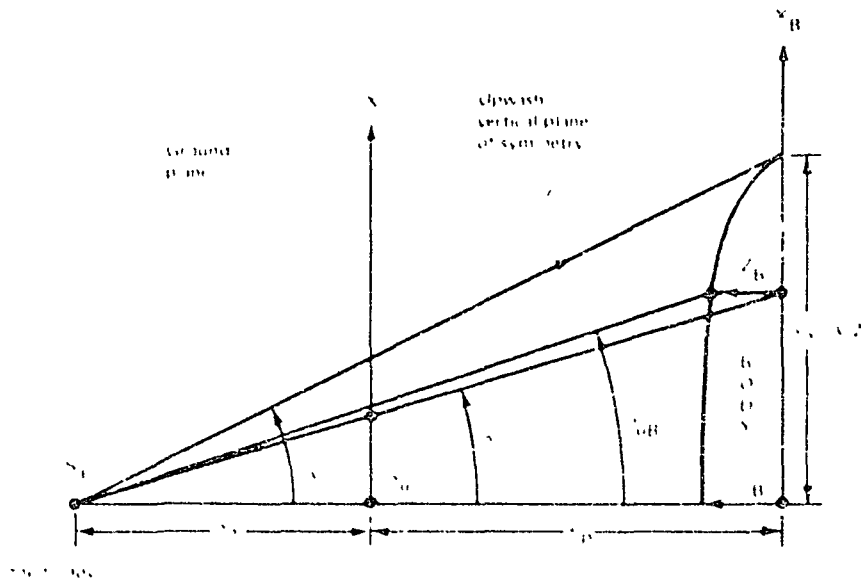
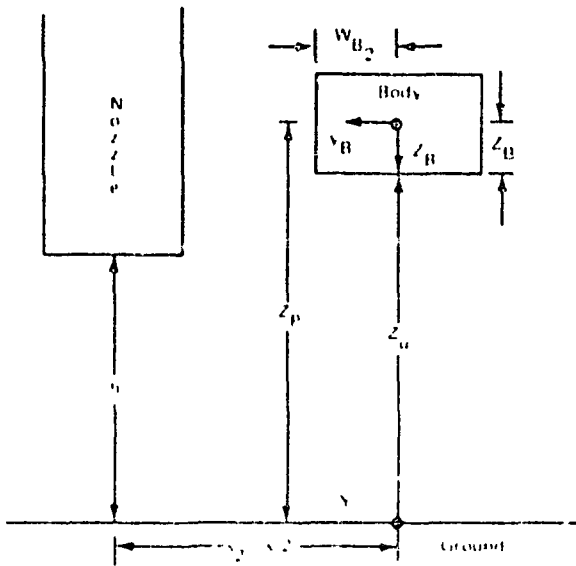
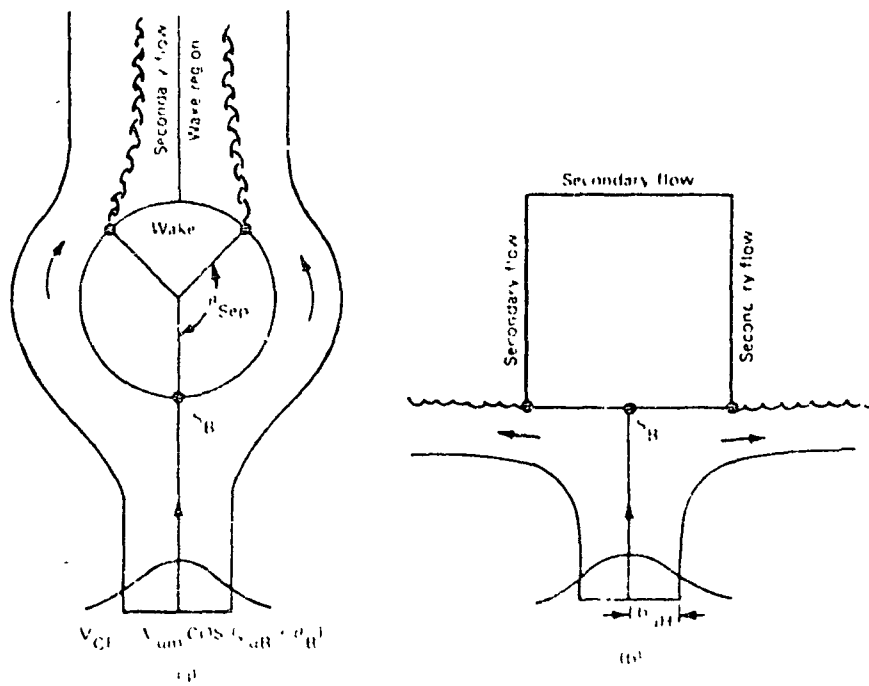
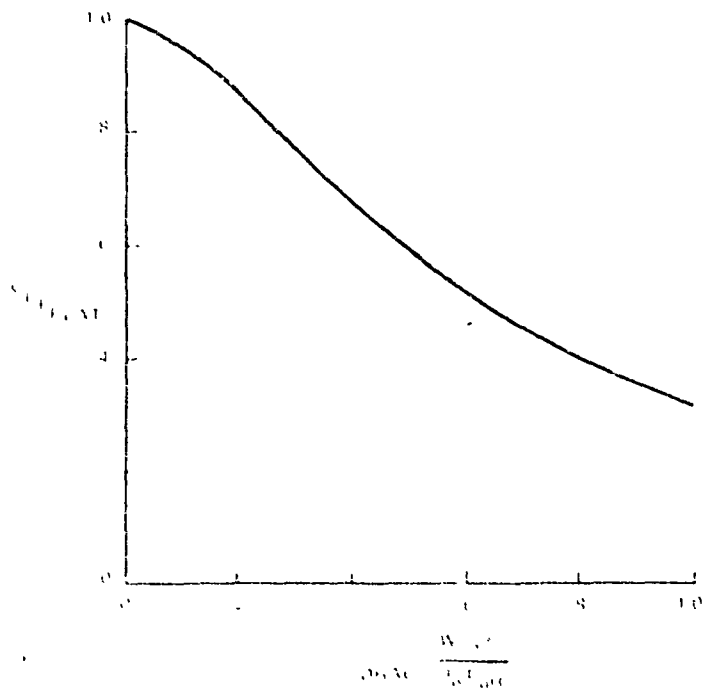

Figure 9-48. - Sketch of upwash force prediction parameters.



9-39

Figure 9-39. - Approximate drag models: a) circular, b) rectangular cross sectional shape.



9-40

Figure 9-40. - Lift bottom of rectangular cross section drag coefficient.

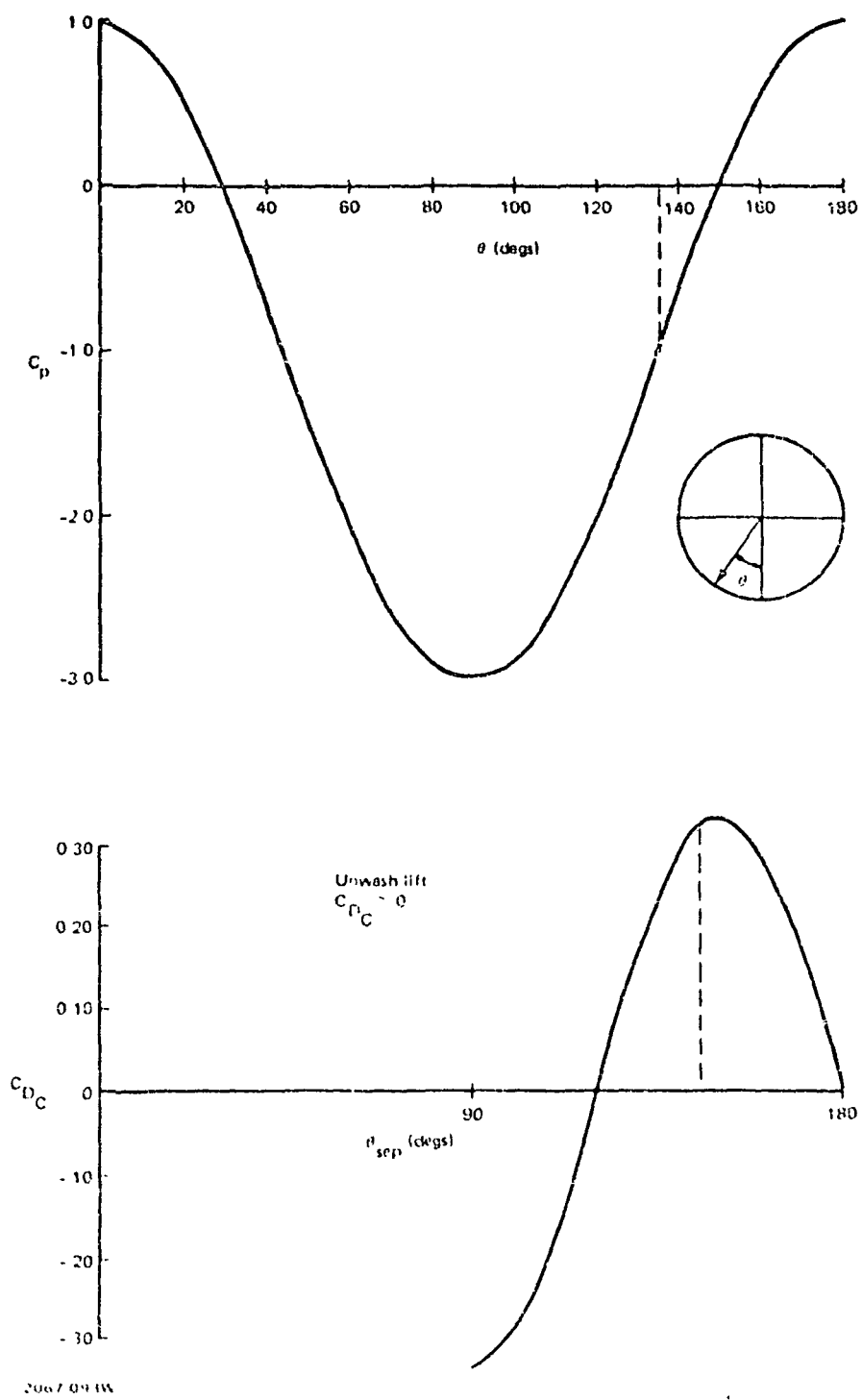

Figure 9-41. - Circular cross section drag model.

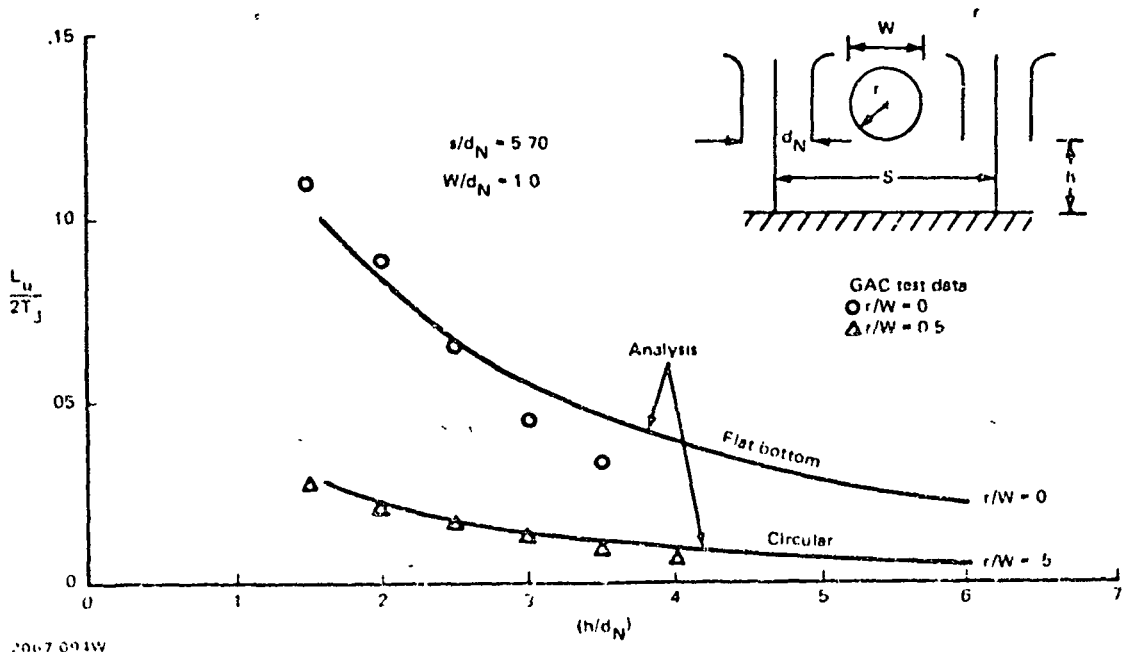

Figure 9-12. - Upwash force on cylindrical (2D) bodies.

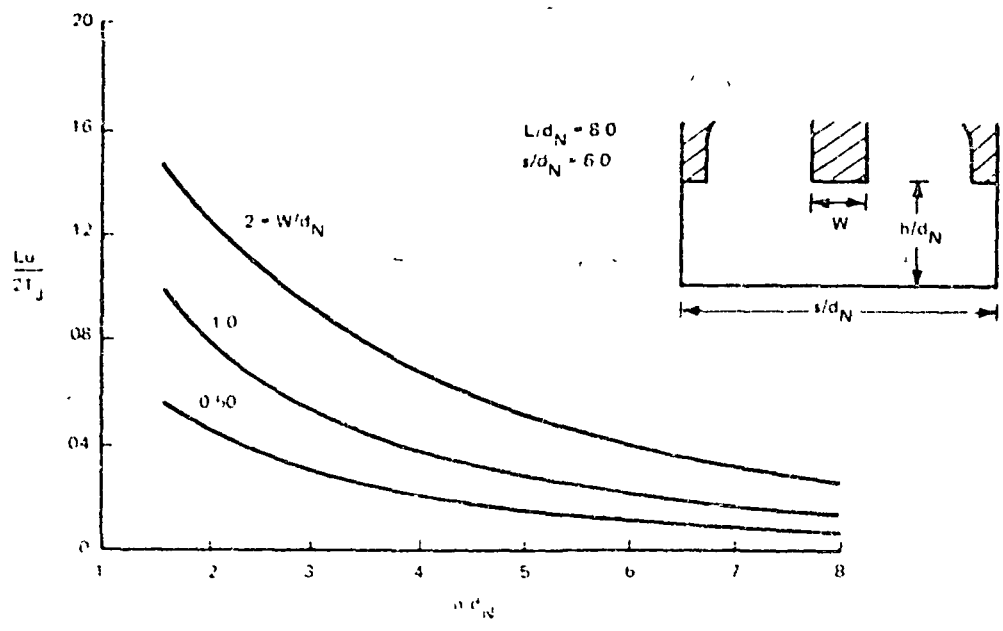
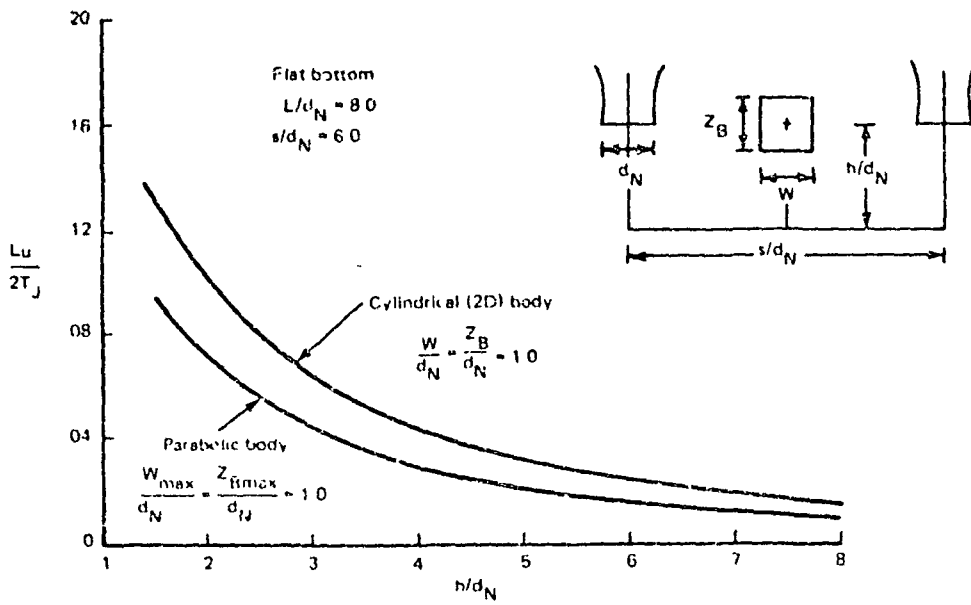

Figure 9-13. - Upwash force on flat bottom cylindrical (2D) body.



2067 096W

Figure 9-11. - Effect of body longitudinal shape on upwash force.

10. CONCLUSIONS

In ground effect twin jet tests were conducted to determine the general features of the resulting flow field and to ascertain whether such flows are amenable to a mathematical model. Some of the general features looked for were instabilities, basic flow structure as the jet spacing was decreased or height increased (causing jet merging), types of measurements, the deflection zone which results from the collision of wall jets and the resulting upwash sheet, and the effects of bodies placed in the upwash sheet.

The isolated twin jet tests revealed unstable upwash flow over a narrow range of jet spacing in the vicinity of three jet diameters and jet heights around $1\frac{1}{2}$ to 3 diameters. Instabilities were observed in pressure measurements on the ground plane in upwash pressures, and in force measurements on bodies placed in this flow field.

Regions of below ambient pressure were noted in many areas of the isolated two jet flow field. These included both static pressure measurements made by traversing probes across the upwash sheet and measuring surface pressures from the stagnation line on the ground plane. The low pressures in the upwash sheet appear to be a characteristic of the two jet ground impingement flow and were obtained for all values of height and spacing that were tested (from 2-6 diameters). The lowest static pressures occur in the center of the upwash sheet and not at the edges.

Three types of bodies placed in the resulting two jet upwash sheets as well as a 1/10th scale aircraft model with strakes of various depth produced markedly different jet induced forces. Net lift forces over 20% of the jet thrust were measured due to the upwash sheet impinging on fuselage-type surfaces. Strakes were beneficial on simulated fuselage surfaces but not on large flat plate surfaces.

A thorough investigation was made of the flow field that results when the jets are closely spaced and merging of the outer boundaries occurs prior to impingement on the ground plane. It was concluded that the upwash sheet continues to be formed even at close spacings and that if separate peaks appear in the free jet pressure profiles without a ground plane, separate impingement and upwash formation will occur with a ground plane.

A new flow model was developed for close jet spacings which accounts for non fully formed wall jets prior to the development of an upwash sheet. It includes a jet impingement zone wall-jet transition region which adequately predicts the effects of jet spacing and height above ground on the flow field pressures and upwash flow field. Integration of the upwash sheet pressures were used to compare with the test data on fountain lift. Good correlation was obtained with simple two-dimensional bodies of varying cross section.

11. APPENDIX

Appendix A

Computer Program Description

Program

Name: GRUMJET2

Purpose: VTOL Two - Jet Impingement Interaction Problem

The program is designed to estimate the flow characteristics associated with two vertically impinging and equal strength incompressible jets. This program is specifically oriented towards the closely spaced jet interaction problem where the deflection regions interact until eventually jet coalescence occurs.

Aside from the basic flow characteristics, the program assumes the symmetrical placement of a slender fuselage in the upwash flow. The upwash lift force is then computed for a cylindrical fuselage of constant cross-sectional shape. The body parameters, in terms of width and depth, do not vary longitudinally. The program estimates the force based on a rectangular and circular cross section. Two planes of symmetry are assumed and all output applies to one quadrant of the flow field (ie. equal jets and nozzles located at the midpoint of the fuselage). Jet entrainment effects may be significant but are neglected in this program. Hence, the force is only that due to upwash impingement. Some residual programming exists in the code for a parabolic body of revolution. These cards have been commented out but may be used if desired.

Input Description

Note: All input parameters are in terms of nozzle diameters.

<u>Card No.</u>	<u>Code Names</u>	<u>Format</u>
1	HD, SD, ZPLD, DZPL, ZFINAL	5F10.5

<u>Name</u>	<u>Definition</u>
HD	Nozzle height above ground
SD	Nozzle spacing

Note The program will compute one or several positions of the fuselage relative to the ground for a fixed nozzle height above ground.

ZPLD Initial fuselage height above ground
 DZPL Increment in fuselage ΔZ above ground
 ZFINAL Final Z coordinate of fuselage height relative to ground plane.

<u>Card No.</u>	<u>Code Names</u>	<u>Format</u>
2	XL2, WCON, ZCON	3F10.5

<u>Names</u>	<u>Definition</u>
XL2	Fuselage Length
WCON	Fuselage Width
ZCON	Fuselage Depth

Note: ZCON determines position of fuselage underside relative to its ZPLD location. Bottom of fuselage will be located at ZPLD-ZCON at first computed location. The upwash sheet properties are also computed at this Z location.

<u>Card No.</u>	<u>Code Names</u>	<u>Format</u>
3	IPBAR	11

<u>Name</u>	<u>Definition</u>
IPBAR	Integer controlling the output of ground pressure pattern. IPBAR = 0, no pressure pattern output IPBAR = 1, pressure pattern output is desired

Note: Card No. 4 is not required if IPBAR = 0.

<u>Card No.</u>	<u>Code Name</u>	<u>Format</u>
4	NU	12

<u>Name</u>	<u>Definition</u>
NU	Number of pressure values to be input for computation of ground isobar pattern NU < 25

Note: Card No. 5 is repeated NU times.

<u>Card No.</u>	<u>Code Name</u>	<u>Format</u>
5	PU	F10.5

<u>Name</u>	<u>Definition</u>
PU	Nondimensional pressure for isobar pattern $0.0 \leq PU < 1.0$

Figure A-1 shows a typical input set.

Printed Output Description

Figure A-2 shows a typical computer printout. Most of the geometrical output quantities are nondimensionalized by the nozzle radius. All velocities and pressure are initially nondimensionalized by the nozzle exit velocity and stagnation pressure. All pressures are relative to ambient conditions.

Note: RN and D refer to nozzle exit radius and diameter. VN refers to nozzle exit velocity.

Input Parameters

The first set of output echoes the input parameters.

<u>Output Titles</u>	<u>Definitions</u>
H/D	Nozzle height above ground
S/D	Nozzle spacing distance between jet centerlines
Z/D	Initial fuselage height
DZ/D	Increment in fuselage position
ZFINAL/D	Final location of fuselage
L/D	Body length
W/D	Body width
ZB/D	Location of underside of body relative to specified fuselage location

Note: If ZB = 0, underside location is coincident with specified fuselage position.

Jet Decay Region .

<u>Output Titles</u>	<u>Definitions</u>
DELG/D	Jet ground effect height relative to ground plane
ZPC/RN	Length of potential core
ZFD/RN	Length of potential core and transition regions
Z/RN	Jet axial location measured from nozzle exit
RJH/RN	Half-velocity radius of jet measured from jet centerline
RJ/RN	Half width of jet
ALP	Exponent of velocity profile
CV2	Momentum flux integral
VJ/VN	Centerline velocity
RCORE/RN	Potential core radius

Jet Deflection Region

Single jet impingement characteristics are printed.

<u>Output Titles</u>	<u>Definitions</u>
RGH/RN	Half velocity radius of jet at ground effect height
RG/RN	Jet half width at ground effect height
RO/RN	Deflection zone or pressure recovery radius
VG/VN	Square root of jet ground stagnation pressure
DPS/DPTJ	Jet ground stagnation pressure nondimensionalized by nozzle stagnation pressure
ATPG	Exponent of ground pressure distribution
R/RGH	Radial location in deflection region relative to ground stagnation point. Nondimensionalized by ground effect half velocity radius of jet
DPS/DPTG	Ground pressure nondimensionalized by ground stagnation pressure

Output Titles

Definitions

R/RN	Radial location in deflection region nondimensionalized by nozzle radius
DPS/DPTJ	Ground pressure nondimensionalized by nozzle stagnation pressure

Wall Jet Region

Isolated wall jet properties are printed in this set of output.

Output Titles

Definitions

DELS/RN	Boundary layer thickness at stagnation point
VM/VG	Inviscid maximum velocity at jet half width (RGH) radial location or start of transition to turbulent wall jet
ALPWO	Exponent of velocity profile at start of wall jet
BWOH/RN	Half velocity thickness at start of wall jet
BWO/RN	Initial thickness of wall layer
R/RN	Radial location on wall jet measured from ground stagnation point
VM/VG	Maximum velocity in wall layer nondimensionalized by square root of ground stagnation pressure
VM/VN	Maximum velocity in wall layer referenced to nozzle exit velocity
BWH/RN	Half velocity thickness of wall layer
BW/RN	Thickness of wall layer
DELBL/RN	Boundary layer thickness
DHLPJ	Maximum stagnation pressure in wall layer
KDLE	Ratio of boundary layer to total wall layer thickness
NPOWER	Exponent of boundary layer profile

Two Jet Impingement Interaction Output

Maximum Ground Pressures along Upwash Ground Stagnation Line

<u>Output Titles</u>	<u>Definitions</u>
XW/RN XW/S	Coordinate along stagnation line measured from upwash stagnation point
PMAX/PJ	Stagnation line pressure nondimensionalized by nozzle stagnation pressure
PMAX/PMAXO	Stagnation line pressure nondimensionalized by upwash stagnation point pressure

Upwash Momentum Function

<u>Output Titles</u>	<u>Definitions</u>
RG/RN	Radius of jet at ground effect height
ACON	Constant in momentum function
XMOMZ	Total vertical momentum in upwash sheet nondimensionalized by the optimum value of $M_j/2\pi$.
PHIO	Coalescence angle used in upwash momentum model If PHIO = 0 jets are not coalesced If PHIO > 0 jets have begun to coalesce

Note: Depending on the value of PHIO (i.e. zero or non-zero) the constant RCON applies to the appropriate upwash momentum model.

CU Nondimensional upwash deflection region width constant

Note: There are two possible outputs that can occur at this point. If the jets are spaced far enough apart the comment:

JET AND UPWASH DEFLECTION REGIONS DO NOT
INTERACT, CU ESTIMATE IS CORRECT

In this case the value of CU is correct and the jet impingement and upwash deflection regions are independent. The perturbation parameters are then defined as:

EPS = 0.0

SIG = 1.0

PHIUO = 0.0

PHIO = 0.0

PMIN = 0.0 along upwash line

ALPUG = 1.50

If the nozzle spacing and height above ground are such that the deflection regions interact, the subroutine INTERG will be called and

CALL INTERG

will be displayed. The following output will be printed.

<u>Output Titles</u>	<u>Definitions</u>
Iteration cycle	Number of iterations required to find solution using Newton's method
LPS or EPI	Perturbation parameter for jet impingement pressure distribution
SIGMA or SIG	Perturbation parameter for upwash deflection region pressure distribution
CU or CUI	Upwash width estimate prior to iterative solution
PHIUO	Angles defining the intersection of jet and upwash
PHIO	deflection regions
<u>Note</u>	The following values apply along the line connecting the jet stagnation points on the ground (i.e. $x = 0$).
DELPWO	Pressure at upwash stagnation point nondimensionalized by nozzle stagnation pressure
PMIN	Minimum pressure between jet and upwash deflection regions nondimensionalized by nozzle stagnation pressure
ALPUG	Exponent of upwash ground pressure distribution function
(CU) x (SIGMA)	Final value of upwash thickness constant

Note: If IPBAR \neq 0, the following output will occur.

Computation of Two - Jet Ground Isobar Pattern

<u>Output Titles</u>	<u>Definitions</u>
PBAR	Input values of pressure, nondimensionalized by nozzle stagnation pressures, will be echoed.

Note: The following will be repeated NU times.

<u>Output Titles</u>	<u>Definitions</u>
IJET	Number of points on jet impingement region isobar
IU	Number of points on upwash deflection region isobar

If IJET = 0 or IU = 0, the specified value of PBAR was not found in ground pressure distribution

Note: The following coordinates are referenced to the jet stagnation point on the ground.

XISOJ	X coordinate of jet isobar
YISOJ	Y coordinate of jet isobar
XISOU	X coordinate upwash region isobar
YISOU	Y coordinate of upwash region isobar

The final set of output in this section is the upwash deflection zone line. If the deflection zones do not interact, ambient conditions exist along this line.

XUP	X coordinate of upwash line
YUP	Y coordinate of upwash line

Computation of Upwash Flow Field

Upwash Streamline Properties

Note: Two streamlines are printed

<u>Output Titles</u>	<u>Definitions</u>
PHID	Azimuthal angle of upwash streamline referenced to jet ground coordinate system
INV. VTL	Inviscid turning region maximum velocity

DELPWJ	Maximum pressure on upwash stagnation line on the ground where upwash streamline originated
BWGH/RN	Half velocity width of incident wall jet streamline
ZOU/RN	Upwash turning region height above ground
BUO/RN	Initial upwash width
BUOHN/RN	Initial upwash half velocity width

Upwash Streamline Decay Properties

Z/RN	Upwash streamline coordinate (ZS)
VMU/VN	Upwash maximum or centerline velocity
BUH/RN	Half velocity width
BU/RN	Half-width
DELPU/DELPJ	Upwash centerline or maximum total pressure nondimensionalized by nozzle stagnation pressure

Upwash Properties Computed At Z Location of Underside of Body

If ZB = 0, the output will yield the upwash properties at Z = constant plane above ground.

<u>Output Titles</u>	<u>Definitions</u>
ZU/RN	Upwash coordinate measured from ground plane
RW/RN	Radial coordinate from jet ground stagnation point to upwash stagnation line
PHIB	Azimuthal location of upwash streamline referenced to jet coordinate system
X/RN	X coordinate in upwash sheet or X coordinate on fuselage
VMU/VN	Maximum or centerline upwash velocity
PU/PN	Maximum or centerline upwash total pressure nondimensionalized by nozzle stagnation pressure
BUH/RN	Half-velocity width of upwash

PU/PUO	Upwash total pressure nondimensionalized by total pressure on streamline originating from upwash stagnation point ($X = 0, Y = 0$)
PU/PJS	Upwash total pressure nondimensionalized by jet ground stagnation pressure
PBS/PN	Stagnation pressure on underside of fuselage placed in upwash sheet

Upwash Lift Force

Two values are printed:

FLAT BOTTOM VEHICLE WITH SHARP CORNERS

BODY WITH CIRCULAR CROSS SECTION

Output Title

Definition

LU/2TJ	Upwash lift force nondimensionalized by the total thrust of the two jets
--------	--

Computer Program Listing

Figure A-3 shows a fortran listing of the computer program.

4.00	4.00	2.00	-1.00	4.00
8.00	1.00	0.0		
1				
4				
.60				
.3				
.2				
.05				

Figure A-1. Sample Input Data Set

DMSI 107401 EXECUTION BEGINS...

*** INPUT PARAMETERS ***

H/D= 4.00000 S/D= 4.00000 Z/D= 1.00000
 Z/H= 2.00000 DZ/D= 1.00000 ZFINAL/E= 4.00000
 BODY LENGTH L/D= 0.00000 WIDTH W/D= 1.00000 DEPTH ZB/D= 0.0

***** REFLECTION REGION *****

REFLECTION HEIGHT DZ/D = 1.19340
 REF KN= 1.00000 ZFD KN= 15.20913

REF	KJH KN	KJ KN	ALF	CV2	VJ/VN	RECON/KN
0.0	1.00000	1.00000	0.0	0.50000	1.00000	1.00000
0.2369	1.00935	1.03047	4.07761	0.47096	1.00000	0.95013
1.24733	1.01871	1.04045	4.11106	0.44462	1.00000	0.89510
1.87107	1.02807	1.09022	4.39514	0.42027	1.00000	0.84523
2.44475	1.03742	1.11988	4.55906	0.39838	1.00000	0.77065
3.11344	1.04678	1.11953	4.71406	0.37818	1.00000	0.70144
3.74133	1.05613	1.17927	4.87081	0.35953	1.00000	0.67765
4.36782	1.06549	1.170917	5.00033	0.34197	1.00000	0.54929
4.99951	1.07484	1.13929	5.13302	0.32551	1.00000	0.44636
5.61170	1.08420	1.26970	5.25945	0.31011	1.00000	0.37882

***** REFLECTION REGION *****

REF KN= 1.00470 KJH KN= 1.26770 KJ KN= 1.90311 VJ/VN= 1.00000
 TAGNATION PRESSURE DEF/DZ = 1.00000
 P = 1.4870

SINGLE REFLECTION PRESSURES

REF	CV2	KJ/KN	DEF (FT)
0.0	1.00000	0.0	1.00000
0.2369	0.47096	0.97763	0.93763
1.24733	0.44462	0.15931	0.86549
1.87107	0.42027	0.23997	0.93036
2.44475	0.39838	0.31862	0.90678
3.11344	0.37818	0.39820	0.97132
3.74133	0.35953	0.47793	0.83406
4.36782	0.34197	0.55759	0.79498
4.99951	0.32551	0.63714	0.75464
5.61170	0.31011	0.71590	0.71349
		0.79545	0.67190
		0.87621	0.63024
		0.95806	0.59881
		1.04117	0.54787
		1.12517	0.50769
		1.21483	0.46845
		1.27448	0.43037
		1.37414	0.39360

Figure A-2. Sample Computer Printout

1.32245	0.35827	1.43370	0.35827
1.32592	0.32457	1.51345	0.32452
1.46737	0.29244	1.59310	0.29244
1.54886	0.26109	1.67276	0.26109
1.61632	0.23355	1.75241	0.23355
1.68979	0.20686	1.83207	0.20686
1.76326	0.18207	1.91172	0.18207
1.83673	0.15906	1.99138	0.15906
1.91020	0.13796	2.07103	0.13796
1.98367	0.11869	2.15069	0.11869
2.05714	0.10174	2.23034	0.10173
2.13061	0.08551	2.31000	0.08551
2.20408	0.07118	2.38965	0.07149
2.27755	0.05907	2.46931	0.05907
2.35102	0.04870	2.54896	0.04820
2.42449	0.03877	2.62862	0.03977
2.49795	0.03038	2.70827	0.03060
2.57142	0.02385	2.78793	0.02385
2.64489	0.01816	2.86758	0.01816
2.71836	0.01349	2.94724	0.01347
2.79183	0.00975	3.02689	0.00975
2.86530	0.00688	3.10655	0.00688
2.93877	0.00457	3.18620	0.00457
3.01224	0.00272	3.26586	0.00272
3.08571	0.00175	3.34551	0.00175
3.15918	0.00096	3.42517	0.00096
3.23265	0.00047	3.50482	0.00047
3.30612	0.00020	3.58448	0.00020
3.37959	0.00006	3.66413	0.00006
3.45305	0.00001	3.74379	0.00001
3.52652	0.00000	3.82345	0.00000
3.59999	0.00000	3.90310	0.00000

***** WALL JET REGION *****

TRANSITION POINT BOUNDARY LAYER THICKNESS DELS R/E = 0.03735
 HEIGHT AT START OF TURBULENT WALL HT. U/W/C = 0.69070
 START OF WALL JET REGION. U/W/C = 0.6177 RWJH/RN 0.41473 RWJH/RN 2.38637

WALL JET PROPERTIES

R/RN	U/W/C	U/W/C	R/RN	R/RN	DELS/RN	DELS	R/DEI	NFLOWER
0.0	0.0	0.0	0.41473	0.74632	0.03734	1.00000	0.01565	14.00000
0.137	0.18859	0.18859	0.41473	0.38637	0.03734	1.00000	0.01565	14.00100
0.274	0.31151	0.31151	0.41473	0.19632	0.03734	1.00000	0.01565	14.00200
0.411	0.41473	0.41473	0.41473	0.09637	0.03734	1.00000	0.01565	14.00300
0.548	0.51473	0.51473	0.41473	0.04637	0.03734	1.00000	0.01565	14.00400
0.685	0.58176	0.58176	0.41473	0.03863	0.03734	1.00000	0.01565	14.00500
0.822	0.64507	0.64507	0.41473	0.03863	0.03734	1.00000	0.01565	14.00600
0.959	0.70888	0.70888	0.41347	2.23378	0.03734	0.99576	0.01639	13.95433
1.096	0.75097	0.75097	0.40723	0.019	0.03734	0.97955	0.01847	13.44891
1.233	0.77221	0.77221	0.40206	1.30277	0.03734	0.9495	0.02047	13.01749
1.370	0.78411	0.78411	0.40210	1.13463	0.03654	0.92445	0.02215	12.64896
1.507	0.78742	0.78742	0.39793	0.49743	0.03574	0.89271	0.02426	12.33644
1.644	0.78271	0.78271	0.39534	1.68272	0.03509	0.85574	0.02610	12.07771
1.781	0.77014	0.77014	0.39316	1.28170	0.03456	0.81511	0.02769	11.82179
1.918	0.74953	0.74953	0.39229	0.10261	0.03411	0.77386	0.02941	11.57536
2.055	0.721	0.721	0.39411	1.71	0.03375	0.73410	0.03110	11.34074

Figure A-2. Continued

2.61224	0.81647	0.81647	0.18034	1.05774	0.03516	0.70721	0.03194	10.70551
2.77551	0.80572	0.80572	0.17756	1.01224	0.03492	0.67403	0.03450	9.80009
2.53677	0.79314	0.79314	0.17729	0.96289	0.03469	0.61301	0.03603	9.39466
3.10 04	0.77633	0.77943	0.17971	0.91870	0.03445	0.61431	0.03750	8.94924
3.26530	0.76487	0.76487	0.16524	0.87616	0.03427	0.58795	0.03894	8.58382
3.47857	0.75019	0.75029	0.16196	0.84272	0.03399	0.56387	0.04033	8.17839
3.59184	0.73605	0.73505	0.15329	0.80778	0.03375	0.54194	0.04168	7.77297
3.75510	0.72249	0.72249	0.15461	0.77958	0.03352	0.52220	0.04299	7.36754
3.91837	0.70819	0.70819	0.15265	0.75705	0.03357	0.50153	0.04434	7.00000
4.08163	0.697810	0.697810	0.16735	0.76675	0.03643	0.45981	0.04630	7.00000
4.24490	0.64885	0.64885	0.18104	0.61645	0.035 9	0.47101	0.04812	7.00000
4.40816	0.62191	0.62191	0.19673	0.84614	0.04214	0.39677	0.04981	7.00000
4.57143	0.59700	0.59700	0.41141	0.87984	0.04700	0.37641	0.05138	7.00000
4.73469	0.57392	0.57392	0.42612	0.90553	0.04765	0.32939	0.05285	7.00000
4.89796	0.55247	0.55247	0.44082	0.935 3	0.05071	0.30573	0.054 3	7.00000
5.06122	0.53249	0.53249	0.45551	0.95492	0.05357	0.28355	0.05552	7.00000
5.22449	0.51384	0.51384	0.47020	0.99462	0.05643	0.26403	0.05674	7.00000
5.38775	0.49538	0.49538	0.48490	1.07431	0.05929	0.24640	0.05788	7.00000
5.55102	0.48007	0.48007	0.49959	1.05401	0.06 14	0.23047	0.05894	7.00000
5.71428	0.46484	0.46484	0.51429	1.08371	0.06500	0.21539	0.05998	7.00000
5.87755	0.45017	0.45017	0.52898	1.11340	0.06786	0.20266	0.06095	7.00000
6.04081	0.43654	0.43654	0.54367	1.14310	0.07071	0.19056	0.06186	7.00000
6.20406	0.42326	0.42326	0.55837	1.17279	0.07357	0.17949	0.06273	7.00000
6.36733	0.41140	0.41140	0.57306	1.20249	0.07643	0.16932	0.06356	7.00000
6.53059	0.39995	0.39995	0.58775	1.23218	0.07929	0.16076	0.06435	7.00000
6.69386	0.38900	0.38900	0.60245	1.26188	0.08214	0.15374	0.06510	7.00000
6.85713	0.37864	0.37864	0.61714	1.29157	0.08500	0.14817	0.06581	7.00000
7.02039	0.36887	0.36887	0.63184	1.32127	0.08786	0.14359	0.06649	7.00000
7.18366	0.35936	0.35936	0.64653	1.35097	0.09071	0.12915	0.06715	7.00000
7.34692	0.35042	0.35042	0.66122	1.38066	0.09357	0.12280	0.06777	7.00000
7.51019	0.34187	0.34187	0.67592	1.41035	0.09643	0.11849	0.06837	7.00000
7.67345	0.33372	0.33372	0.69061	1.44004	0.09929	0.11138	0.06895	7.00000
7.83672	0.32594	0.32594	0.70531	1.46973	0.10214	0.106 4	0.06950	7.00000
8.00000	0.31849	0.31849	0.72000	1.49942	0.10500	0.10133	0.07005	7.00000

***** TWO SET INTERACTION TABLE *****

MAXIMUM POINT ESTIMATE APPROXIMATE STANDARD DEVIATION LINE

LINE NO.	LINE	ESTIMATE	STANDARD DEVIATION
1	1	46118	0.0000
2	2	0.477	0.07782
3	3	0.374	0.08159
4	4	0.3732	0.07704
5	5	0.4744	0.07040
6	6	0.4791	0.06515
7	7	0.3744	0.06779
8	8	0.3747	0.06977
9	9	0.37945	0.07015
10	10	0.37119	0.06280
11	11	0.3745	0.06004
12	12	0.3782	0.05197
13	13	0.3711	0.05172
14	14	0.3740	0.05944
15	15	0.37358	0.05168
16	16	0.37388	0.05192

Figure A-2. Continued

6.08169	0.76021	0.03786	0.07868
6.97818	0.06602	0.02534	0.05270
7.96461	0.99558	0.01603	0.03332
9.77298	1.15912	0.00943	0.01961
10.98930	1.37372	0.00506	0.01052
13.36074	1.67009	0.00210	0.00498
16.87698	2.10962	0.00095	0.00198
22.66445	2.67554	0.00029	0.00059

UFWASH MOMENTUM FUNCTION: JET RADIUS, INTERACTION CONSTANT, VERTICAL UFWASH SHEET MOMENTUM,
AND COALESCENCE ANGLE

KG/RN= 1.26970 ACON= 0.89924 XNUM/= 0.96641 FHD(DEGS)= 0.0
UFWASH WIDTH CONSTANT ESTIMATE, CU= 0.79401

*** CALC INTERG ***

SOLUTION OF GROUND PRESSURE DISTRIBUTION HAS BEEN FOUND
ITERATION CYCLE= 12 FFS= 0.00346 SIGMA 0.99063
EFI= 0.00346 CUI= 0.29803 FHIID= 36.70523 FHIU= 49.27178 DEGREES
FHI=0.0, DELFW= 0.48118
FHI=0.0, FHIW= 0.02186
FHI=0.0, AIFU= 2.76955
UFWASH THICKNESS CONSTANT, (CU) X (SIGMA)= 0.29522

*** COMPUTATION OF TWO-JET GROUND ISOBAR PATTERN ***

4 VALUES OF PRESSURE SPECIFIED FOR PATTERN

PRK= 0.60000 0.30000 0.20000 0.05000

GROUND PATTERN IN JET CENTERED COORDINATE SYSTEM

PRK= 0.60000

JET IMPINGEMENT REGION, IJET= 58

UFWASH DEFLICTION REGION, IUD= 0

XISUJ	YISUJ	XISOU	YISOU
0.93593	0.0		
0.83743	0.01038		
0.63395	0.06071		
0.43149	0.17095		
0.2400	0.12106		
0.92366	0.15100		
0.71130	0.18077		
0.51000	0.21018		
0.30418	0.23934		
0.19665	0.26816		

Figure A-2. Continued

0.88764	0.29662
0.87776	0.32486
0.86704	0.35226
0.85551	0.37938
0.84319	0.40600
0.83011	0.43209
0.81640	0.45761
0.80177	0.48256
0.78761	0.50690
0.77080	0.53062
0.75437	0.55370
0.73737	0.57612
0.71983	0.59787
0.70177	0.61894
0.68323	0.63937
0.66424	0.65901
0.64484	0.67798
0.62505	0.69625
0.60499	0.71380
0.60469	0.71380
0.54497	0.76048
0.48145	0.80213
0.414 9	0.83849
0.34537	0.86931
0.27370	0.89440
0.20023	0.91359
0.12545	0.92666
0.04983	0.93381
0.07605	0.93471
0.10178	0.92945
0.17607	0.91807
0.25069	0.90064
0.32490	0.87727
0.39797	0.84813
0.46945	0.81341
0.52498	0.77333
0.57581	0.72816
0.62197	0.67810
0.66521	0.62378
0.70408	0.56527
0.73744	0.50301
0.76565	0.43747
0.78837	0.36904
0.80545	0.29819
0.81670	0.22538
0.82198	0.15109
0.82119	0.07580
0.81427	0.00001

Total = 0.35000

MINIMUM REFLECTION REGION, TIME = 22

1500	1600	1700	1800
0.51971	0.0	0.51971	0.0
0.07053	0.07053	0.07053	0.07053
0.18112	0.18112	0.18112	0.18112
0.27499	0.27499	0.27499	0.27499
0.36106	0.36106	0.36106	0.36106

Figure A-2. Continued

1.55606	0.25438	3.55292	0.41960
1.54703	0.30415	3.55097	0.55258
1.53642	0.35400	3.54621	0.64616
1.52476	0.40321	3.53905	0.74043
1.51056	0.45177	3.53031	0.83551
1.49538	0.49970	3.52012	0.93149
1.47874	0.54694	3.50821	1.02837
1.46068	0.59344	3.49477	1.12667
1.44125	0.63913	3.47982	1.22611
1.42050	0.68398	3.46328	1.32695
1.39847	0.72792	3.44520	1.42933
1.37520	0.77093	3.42567	1.53342
1.35076	0.81296	3.40460	1.63932
1.32519	0.85396	3.38204	1.74724
1.29854	0.89392	3.35806	1.85719
1.27087	0.93280	3.33269	1.96981
1.24223	0.97058	3.30600	2.08644
1.21267	1.00722		
1.18225	1.04272		
1.15102	1.07705		
1.11903	1.11021		
1.08634	1.14218		
1.05300	1.17295		
1.01905	1.20253		
0.98465	1.23093		
0.94989	1.25815		
0.91469	1.28420		
0.87906	1.30907		
0.84300	1.33277		
0.80651	1.35530		
0.76959	1.37667		
0.73225	1.39688		
0.69449	1.41593		
0.65631	1.43383		
0.61771	1.45057		
0.57870	1.46615		
0.53928	1.48057		
0.50045	1.49384		
0.46121	1.50596		
0.42256	1.51693		
0.38350	1.52675		
0.34403	1.53542		
0.30515	1.54294		
0.26586	1.54931		
0.22716	1.55453		
0.18805	1.55860		
0.14953	1.56152		
0.11160	1.56329		
0.07426	1.56391		
0.03751	1.56338		
0.00135	1.56170		
	1.55887		
	1.55489		
	1.54976		
	1.54348		
	1.53605		
	1.52747		
	1.51774		
	1.50696		
	1.49513		
	1.48225		
	1.46831		
	1.45331		
	1.43725		
	1.42013		
	1.40205		
	1.38299		
	1.36296		
	1.34195		
	1.32005		
	1.29725		
	1.27355		
	1.24895		
	1.22345		
	1.19705		
	1.16975		
	1.14205		
	1.11395		
	1.08545		
	1.05655		
	1.02725		
	0.99755		
	0.96745		
	0.93695		
	0.90605		
	0.87475		
	0.84305		
	0.81095		
	0.77845		
	0.74555		
	0.71225		
	0.67855		
	0.64445		
	0.60995		
	0.57505		
	0.53975		
	0.50405		
	0.46795		
	0.43145		
	0.39455		
	0.35725		
	0.31955		
	0.28145		
	0.24295		
	0.20405		
	0.16475		
	0.12505		
	0.08495		
	0.04445		
	0.00355		

FEAF = 0.0000

REFLECTIVE REGION: I= 50 REFLECTIVE REGION: I= 20

* 500 * 1000 * 500 * 1000

Figure A-2. Continued

1.85678	0.0	1.40526	0.0
1.85678	0.06026	3.40557	0.09113
1.85205	0.12044	3.40687	0.18116
1.84797	0.18043	3.40934	0.27499
1.84115	0.24017	3.41075	0.36710
1.83242	0.29956	3.41396	0.45960
1.82179	0.35852	3.41791	0.55258
1.80930	0.41657	3.42267	0.64616
1.79497	0.47482	3.42834	0.74043
1.77884	0.53291	3.43494	0.83551
1.75076	0.59015	3.44257	0.93149
1.72135	0.64408	3.45133	1.02851
1.72010	0.69883	3.46132	1.12667
1.69772	0.75264	3.47268	1.22611
1.67276	0.80545	3.48550	1.32695
1.64684	0.85700	3.50019	1.42913
1.61944	0.90785	3.51672	1.53341
1.59057	0.95714	3.53545	1.63937
1.55954	1.00521	3.55684	1.74724
1.52916	1.05168	3.58065	1.85734
1.49653	1.09847	3.60709	1.96981
1.46115	1.14295	3.63680	2.08484
1.42804	1.19611	3.67097	2.20264
1.39227	1.24791	3.71141	2.32345
1.35544	1.30834	3.75913	2.44752
1.31778	1.36738	3.81522	2.57511
1.27928	1.43502	3.87990	2.70652
1.24001	1.50127	3.95936	2.84206
1.20003	1.56610	4.05000	2.98185
1.20003	1.61810		
1.20003	1.67029		
1.20003	1.72267		
0.80000	1.77524		
0.80000	1.82799		
0.80000	1.88092		
0.80000	1.93402		
0.80000	1.98729		
0.80000	2.04072		
0.80000	2.09432		
0.80000	2.14808		
0.80000	2.20199		
0.80000	2.25606		
0.80000	2.31029		
0.80000	2.36468		
0.80000	2.41922		
0.80000	2.47392		
0.80000	2.52877		
0.80000	2.58377		
0.80000	2.63892		
0.80000	2.69422		
0.80000	2.74967		
0.80000	2.80527		
0.80000	2.86102		
0.80000	2.91692		
0.80000	2.97297		
0.80000	3.02917		
0.80000	3.08552		
0.80000	3.14202		
0.80000	3.19867		
0.80000	3.25547		
0.80000	3.31242		
0.80000	3.36952		
0.80000	3.42677		
0.80000	3.48417		
0.80000	3.54172		
0.80000	3.59942		
0.80000	3.65727		
0.80000	3.71527		
0.80000	3.77342		
0.80000	3.83172		
0.80000	3.89017		
0.80000	3.94877		
0.80000	4.00752		
0.80000	4.06642		
0.80000	4.12547		
0.80000	4.18467		
0.80000	4.24402		
0.80000	4.30352		
0.80000	4.36317		
0.80000	4.42297		
0.80000	4.48292		
0.80000	4.54302		
0.80000	4.60327		
0.80000	4.66367		
0.80000	4.72422		
0.80000	4.78492		
0.80000	4.84577		
0.80000	4.90677		
0.80000	4.96792		
0.80000	5.02922		
0.80000	5.09067		
0.80000	5.15227		
0.80000	5.21402		
0.80000	5.27592		
0.80000	5.33797		
0.80000	5.39917		
0.80000	5.46052		
0.80000	5.52202		
0.80000	5.58367		
0.80000	5.64547		
0.80000	5.70742		
0.80000	5.76952		
0.80000	5.83177		
0.80000	5.89417		
0.80000	5.95672		
0.80000	6.01942		
0.80000	6.08227		
0.80000	6.14527		
0.80000	6.20842		
0.80000	6.27172		
0.80000	6.33517		
0.80000	6.39877		
0.80000	6.46252		
0.80000	6.52642		
0.80000	6.59047		
0.80000	6.65467		
0.80000	6.71902		
0.80000	6.78352		
0.80000	6.84817		
0.80000	6.91297		
0.80000	6.97792		
0.80000	7.04302		
0.80000	7.10827		
0.80000	7.17367		
0.80000	7.23922		
0.80000	7.30492		
0.80000	7.37077		
0.80000	7.43677		
0.80000	7.50292		
0.80000	7.56922		
0.80000	7.63567		
0.80000	7.70227		
0.80000	7.76902		
0.80000	7.83592		
0.80000	7.90297		
0.80000	7.97017		
0.80000	8.03752		
0.80000	8.10502		
0.80000	8.17267		
0.80000	8.24047		
0.80000	8.30842		
0.80000	8.37652		
0.80000	8.44477		
0.80000	8.51317		
0.80000	8.58172		
0.80000	8.65042		
0.80000	8.71927		
0.80000	8.78827		
0.80000	8.85742		
0.80000	8.92672		
0.80000	9.00000		

ORIGINAL PAGE IS
OF POOR QUALITY

8888 2 05000

Figure A-2, Continued

1150J	1150J	1150U	1150U
2.51941	0.0	4.17002	0.0
2.53113	0.00242	3.12876	0.09153
2.53411	0.12472	3.17900	0.18116
2.52744	0.24688	3.13022	0.27499
2.51811	0.32040	3.13190	0.35710
2.50617	0.40970	3.13404	0.45960
2.49161	0.49034	3.13662	0.55258
2.47475	0.57020	3.13961	0.64616
2.45495	0.64946	3.14301	0.74043
2.43289	0.72762	3.14680	0.83551
2.40844	0.80481	3.15099	0.93149
2.38164	0.88090	3.15557	1.02851
2.35256	0.95578	3.16056	1.12667
2.32127	1.02940	3.16599	1.22611
2.28784	1.10160	3.17189	1.32695
2.25236	1.17240	3.17830	1.42933
2.21489	1.24165	3.18530	1.53341
2.17552	1.30934	3.19297	1.63937
2.13433	1.37540	3.20140	1.74724
2.09141	1.43974	3.21071	1.85714
2.04685	1.50236	3.22089	1.96901
2.00077	1.56320	3.23196	2.08288
1.95311	1.62227	3.24396	2.20064
1.90411	1.67954	3.25684	2.32134
1.85381	1.73501	3.27069	2.44492
1.80230	1.78869	3.28551	2.57141
1.74965	1.84058	3.29120	2.70082
1.69585	1.89068	3.29787	2.84206
1.64107	1.93897	3.30549	2.98508
1.58531	1.98547	3.31407	3.13000
1.52854	2.03016	3.32362	3.27686
1.47074	2.07307	3.33416	3.42569
0.93710	2.11421	3.34569	3.57651
0.71761	2.15357	3.35821	3.72934
0.50115	2.19116	3.37173	3.88419
0.28740	2.22699	3.38625	4.04106
0.07619	2.26107	3.40177	4.20096
0.00000	2.29341	3.41829	4.36389
0.00000	2.32401	3.43581	4.52986
0.00000	2.35287	3.45433	4.69887
0.00000	2.38000	3.47385	4.87092
0.00000	2.40541	3.49437	5.04601
0.00000	2.42911	3.51589	5.22414
0.00000	2.45111	3.53841	5.40531
0.00000	2.47141	3.56193	5.58954
0.00000	2.49001	3.58645	5.77681
0.00000	2.50691	3.61197	5.96714
0.00000	2.52211	3.63849	6.16051
0.00000	2.53561	3.66501	6.35694
0.00000	2.54741	3.69253	6.55641
0.00000	2.55751	3.72105	6.75894
0.00000	2.56601	3.75057	6.96451
0.00000	2.57291	3.78109	7.17314
0.00000	2.57831	3.81261	7.38481
0.00000	2.58221	3.84513	7.59954
0.00000	2.58461	3.87865	7.81741
0.00000	2.58551	3.91317	8.03844
0.00000	2.58491	3.94869	8.26261
0.00000	2.58281	3.98521	8.49094
0.00000	2.57921	4.02273	8.72341
0.00000	2.57411	4.06125	8.96094
0.00000	2.56751	4.10077	9.20351
0.00000	2.55941	4.14129	9.45114
0.00000	2.54981	4.18281	9.70381
0.00000	2.53871	4.22533	9.96144
0.00000	2.52611	4.26885	10.22411
0.00000	2.51211	4.31337	10.49184
0.00000	2.49671	4.35889	10.76451
0.00000	2.47991	4.40541	11.04214
0.00000	2.46171	4.45293	11.32481
0.00000	2.44211	4.50145	11.61244
0.00000	2.42111	4.55097	11.90511
0.00000	2.39871	4.60149	12.20274
0.00000	2.37491	4.65301	12.50541
0.00000	2.34971	4.70553	12.81304
0.00000	2.32311	4.75905	13.12571
0.00000	2.29511	4.81357	13.44334
0.00000	2.26571	4.86909	13.76601
0.00000	2.23491	4.92561	14.09364
0.00000	2.20271	4.98313	14.42631
0.00000	2.16911	5.04165	14.76494
0.00000	2.13411	5.10117	15.10951
0.00000	2.09771	5.16169	15.46004
0.00000	2.06001	5.22321	15.81651
0.00000	2.02111	5.28573	16.17904
0.00000	1.98001	5.34925	16.54761
0.00000	1.93671	5.41377	16.92214
0.00000	1.89121	5.47929	17.29271
0.00000	1.84351	5.54581	17.66934
0.00000	1.79371	5.61333	18.05201
0.00000	1.74181	5.68185	18.44064
0.00000	1.68781	5.75137	18.83521
0.00000	1.63171	5.82189	19.23574
0.00000	1.57351	5.89341	19.64231
0.00000	1.51321	5.96593	20.05494
0.00000	1.45081	6.03945	20.47351
0.00000	1.38631	6.11397	20.89804
0.00000	1.31971	6.18949	21.32861
0.00000	1.25101	6.26601	21.76524
0.00000	1.18021	6.34353	22.20791
0.00000	1.10731	6.42205	22.65654
0.00000	1.03231	6.50157	23.11111
0.00000	0.95521	6.58209	23.57164
0.00000	0.87601	6.66361	24.03821
0.00000	0.79471	6.74613	24.51084
0.00000	0.71131	6.82965	24.98941
0.00000	0.62581	6.91417	25.47404
0.00000	0.53821	6.99969	25.96471
0.00000	0.44851	7.08621	26.46144
0.00000	0.35671	7.17373	26.96421
0.00000	0.26291	7.26225	27.47304
0.00000	0.16711	7.35177	27.98791
0.00000	0.06931	7.44229	28.50884
0.00000	0.00000	7.53381	29.03581

Figure A-2. Continued

UFWASH DEFLECTION ZONE LIMITS FROM 0 OUTSIDE INTERACTION REGION

XUF	YUF
2.81913	0.0
2.81727	0.22464
2.81166	0.45068
2.80220	0.67963
2.78876	0.91797
2.77116	1.15230
2.74892	1.39966
2.72183	1.65685
2.68933	1.92630
2.65078	2.21072
2.60536	2.51336
2.55707	2.83815
2.40761	3.18919
2.47630	3.57461
2.33000	4.00000
2.2784	4.4599
2.10603	5.01503
1.97914	5.6146
1.76045	6.26594
1.55877	7.03741

***** COMPUTATION OF UFWASH FLOW FIELD *****

COMPUTATION OF UFWASH STREAMLINE PROPERTIES

TABLE 1.0. B165

TR0 UELLA 0.5258 DEFLEN 0.48118 PWCH ENP 0.32000
 TR0/KN 1.08100 R0/KN 1.47570 R0/KN/ENP 0.71920

Z KN	TR0/KN	R0/KN	RU KN	SELF/EFLEJ
0.32000	0.42917	0.71867	0.429170	0.46118
0.45633	0.60746	0.76411	1.59985	0.45633
0.67963	0.82151	0.80962	0. 0703	0.4 111
0.91797	1.07910	0. 5512	0. 60520	0. 15269
1.15230	1.3 158	0.4007	0. 67814	0.31575
1.39966	1.547	0.4481	1.01153	0. 7518
1.65685	1.844	0.4716	1. 74 0	0.24253
1.92630	2.1951	0. 71 12	1. 7 96	0. 757
2.21072	2.5190	1.10267	1. 3 17	0.19151
2.51336	2.8102	0.8 12	1.4420	0.17474
2.83815	3.1841	0.6 362	1.52 36	0.15073
3.18919	3.5719	0.71911	1.51557	0.14495
3.57461	3.9865	0.6497	1. 53 7	0.1329
4.00000	4.4300	0. 617	1. 23885	0. 1250
4.4599	4.9075	0.5512	1.54001	0. 11727
4.9599	5.4111	0. 711	0.41.7	0. 1072
5.51503	5.9414	0. 47	1.4. 57	0. 11
6.1146	6.4917	0. 421	1. 21.27	0. 09779
6.76594	7.0719	0. 47	1. 17. 9	0. 08541
7.43741	7.6814	0. 511	4. 7. 75	0. 07111

Figure A-2. Continued

3.39733	0.27441	1.12062	2.55902	0.07570
3.54500	0.26633	1.17412	2.66219	0.07093
3.69667	0.25822	1.21962	2.76516	0.06694
3.84833	0.25156	1.26512	2.86852	0.06320
4.00000	0.24480	1.31062	2.97169	0.05993

PHIP= 40.0000 BEGS

I P/VFL= 0.24143 DELFUJ= 0.10143 RWGH/PH= 0.17000
 ZOU/KR= 1.16000 RWJ/RH= 1.37333 RWOHY/KR= 0.60769

Z/KN	VMU/VN	BUH/RN	RU/RN	DELFU/BFLPJ
0.27000	0.24145	0.60569	1.37335	0.10143
1.02333	0.29300	0.67004	1.51925	0.10682
1.77665	0.30741	0.71419	1.66515	0.10107
1.63000	0.30555	0.79071	1.81104	0.09479
1.93333	0.29246	0.86108	1.95694	0.08559
2.23666	0.27805	0.92743	2.10284	0.07731
2.53999	0.26498	0.99177	2.24874	0.07021
2.84333	0.25316	1.05612	2.39464	0.06409
3.14666	0.24242	1.12047	2.54054	0.05877
3.44999	0.23180	1.18481	2.68644	0.05410
3.75332	0.22129	1.24916	2.83234	0.04997
4.05666	0.21528	1.31351	2.97823	0.04615
4.35999	0.20780	1.37785	3.12414	0.04310
4.66332	0.20047	1.44220	3.27003	0.04019
4.96665	0.19383	1.50655	3.41593	0.03757
5.26999	0.18764	1.57089	3.56183	0.03521
5.57332	0.18185	1.63524	3.70773	0.03307
5.87665	0.17641	1.69958	3.85363	0.03112
6.17998	0.17130	1.76393	3.99953	0.02934
6.48331	0.16649	1.82828	4.14543	0.02772
6.78665	0.16195	1.89262	4.29132	0.02623
7.08998	0.15765	1.95697	4.43722	0.02485
7.39331	0.15357	2.02132	4.58312	0.02359
7.69664	0.14973	2.08566	4.72902	0.02242
7.99998	0.14607	2.15001	4.87492	0.02134

UPWASH PROPERTIES COMPUTED AT 2 LOCATION OF UNDESIRABLE OF BODY

BODY CENTERLINE ELEVATION AT 1 KN= 4.00000

U KN	KW/KN	FIB	X RN	VMU/VN	FU/FN	FUR/RN	FU/FUD	FU/FJS	FBS/FN
4.00000	4.00000	0.0	0.0	0.24480	0.05993	1.31062	1.00000	0.05993	0.05993
4.00000	4.00000	1.16914	0.16333	0.24477	0.05991	1.31081	0.99974	0.05991	0.05986
4.00000	4.00000	1.33731	0.12653	0.24468	0.05987	1.31139	0.99896	0.05987	0.05977
4.00000	4.00000	1.50548	0.08980	0.24451	0.05979	1.31197	0.99768	0.05979	0.05957
4.00000	4.00000	1.67365	0.05305	0.24430	0.05968	1.31267	0.99585	0.05968	0.05925
4.00000	4.00000	1.84182	0.01633	0.24401	0.05954	1.31341	0.99353	0.05954	0.05893
4.00000	4.00000	2.01000	0.00000	0.24366	0.05937	1.31420	0.99071	0.05937	0.05849
4.00000	4.00000	2.17817	0.00000	0.24326	0.05917	1.31504	0.98749	0.05917	0.05799
4.00000	4.00000	2.34634	0.00000	0.24279	0.05895	1.31593	0.98379	0.05895	0.05741

Figure A-2, Continued

4.00000	4.06691	10.40770	1.46939	0.24225	0.05864	1.32592	0.97931	0.07864	0.05677
4.00000	4.08745	11.53461	1.63125	0.24167	0.05840	1.32946	0.97457	0.07840	0.05607
4.00000	4.09955	12.65774	1.79197	0.24103	0.05809	1.33336	0.96919	0.07809	0.05531
4.00000	4.11120	13.76078	1.95018	0.24033	0.05776	1.33760	0.96377	0.07776	0.05449
1.00000	4.13038	14.85660	2.12745	0.23978	0.05740	1.34218	0.95774	0.05740	0.05362
4.00000	4.16006	15.94538	2.38571	0.23877	0.05701	1.34710	0.95131	0.05701	0.05271
4.00000	4.18127	17.02051	2.64798	0.23791	0.05660	1.35235	0.94449	0.05660	0.05175
4.00000	4.20784	18.08344	2.91224	0.23701	0.05617	1.35792	0.93730	0.05617	0.05078
4.00000	4.23184	19.13362	2.77551	0.23605	0.05577	1.36381	0.92977	0.05577	0.04973
4.00000	4.26134	20.17064	2.93877	0.23505	0.05525	1.37000	0.92191	0.05525	0.04868
4.00000	4.29618	21.20505	3.10104	0.23401	0.05476	1.37644	0.91375	0.05476	0.04760
4.00000	4.33936	22.23346	3.26330	0.23292	0.05425	1.38327	0.90529	0.05425	0.04651
4.00000	4.38187	23.25958	3.42557	0.23180	0.05373	1.39034	0.89658	0.05373	0.04539
4.00000	4.40467	24.27909	3.58784	0.23064	0.05319	1.39768	0.88761	0.05319	0.04427
4.00000	4.41671	25.28476	3.75011	0.22944	0.05264	1.40534	0.87841	0.05264	0.04314
4.00000	4.42805	26.27741	3.91237	0.22821	0.05208	1.41316	0.86901	0.05208	0.04200
4.00000	4.43954	27.25884	4.07464	0.22695	0.05150	1.42128	0.85943	0.05150	0.04085
4.00000	4.45119	28.22994	4.23690	0.22565	0.05092	1.42965	0.84967	0.05092	0.03974
4.00000	4.46295	29.19164	4.40016	0.22434	0.05033	1.43829	0.83977	0.05033	0.03861
4.00000	4.47480	30.14486	4.56343	0.22299	0.04973	1.44720	0.82975	0.04973	0.03749
4.00000	4.48675	31.08958	4.72669	0.22164	0.04911	1.45631	0.81961	0.04911	0.03638
4.00000	4.49881	32.02581	4.89096	0.22024	0.04835	1.46564	0.80938	0.04835	0.03528
4.00000	4.51099	32.95360	5.05523	0.21884	0.04759	1.47529	0.79907	0.04759	0.03418
4.00000	4.52328	33.87304	5.21950	0.21741	0.04677	1.48524	0.78861	0.04677	0.03311
4.00000	4.53568	34.78414	5.38377	0.21597	0.04584	1.49540	0.77800	0.04584	0.03200
4.00000	4.54819	35.68689	5.54804	0.21454	0.04490	1.50577	0.76729	0.04490	0.03086
4.00000	4.56081	36.58126	5.71231	0.21310	0.04395	1.51634	0.75649	0.04395	0.02974
4.00000	4.57354	37.46726	5.87658	0.21167	0.04300	1.52711	0.74561	0.04300	0.02861
4.00000	4.58638	38.34489	6.04085	0.21024	0.04205	1.53808	0.73467	0.04205	0.02749
4.00000	4.59933	39.21416	6.20512	0.20881	0.04110	1.54924	0.72369	0.04110	0.02638
4.00000	4.61239	40.07509	6.36939	0.20738	0.04015	1.56059	0.71267	0.04015	0.02528
4.00000	4.62556	40.92768	6.53366	0.20595	0.03920	1.57214	0.70161	0.03920	0.02418
4.00000	4.63884	41.77193	6.69793	0.20452	0.03825	1.58389	0.69051	0.03825	0.02308
4.00000	4.65223	42.60784	6.86220	0.20309	0.03730	1.59584	0.67937	0.03730	0.02198
4.00000	4.66573	43.43541	7.02647	0.20166	0.03635	1.60799	0.66821	0.03635	0.02088
4.00000	4.67934	44.25464	7.19074	0.20023	0.03540	1.62034	0.65701	0.03540	0.01978
4.00000	4.69306	45.06561	7.35501	0.19880	0.03445	1.63289	0.64577	0.03445	0.01868
4.00000	4.70689	45.86832	7.51928	0.19737	0.03350	1.64564	0.63451	0.03350	0.01758
4.00000	4.72083	46.66279	7.68355	0.19594	0.03255	1.65859	0.62321	0.03255	0.01648
4.00000	4.73488	47.44892	7.84782	0.19451	0.03160	1.67174	0.61187	0.03160	0.01538
4.00000	4.74904	48.22671	8.01209	0.19308	0.03065	1.68509	0.60051	0.03065	0.01428
4.00000	4.76331	49.00616	8.17636	0.19165	0.02970	1.69864	0.58911	0.02970	0.01318
4.00000	4.77769	49.77727	8.34063	0.19022	0.02875	1.71239	0.57767	0.02875	0.01208
4.00000	4.79218	50.54004	8.50490	0.18879	0.02780	1.72634	0.56621	0.02780	0.01098
4.00000	4.80678	51.29447	8.66917	0.18736	0.02685	1.74049	0.55471	0.02685	0.00988
4.00000	4.82149	52.04056	8.83344	0.18593	0.02590	1.75484	0.54317	0.02590	0.00878
4.00000	4.83631	52.77831	8.99771	0.18450	0.02495	1.76939	0.53161	0.02495	0.00768
4.00000	4.85124	53.50772	9.16198	0.18307	0.02400	1.78414	0.52001	0.02400	0.00658
4.00000	4.86628	54.22879	9.32625	0.18164	0.02305	1.79909	0.50841	0.02305	0.00548
4.00000	4.88143	54.94152	9.49052	0.18021	0.02210	1.81424	0.49681	0.02210	0.00438
4.00000	4.89669	55.64591	9.65479	0.17878	0.02115	1.82959	0.48521	0.02115	0.00328
4.00000	4.91206	56.34196	9.81906	0.17735	0.02020	1.84514	0.47361	0.02020	0.00218
4.00000	4.92754	57.02967	9.98333	0.17592	0.01925	1.86089	0.46201	0.01925	0.00108
4.00000	4.94313	57.70904	10.14760	0.17449	0.01830	1.87684	0.45041	0.01830	0.00000

FLAT BOTTOM VEHICLE WITH SHARP CORNERS

WEIGHT (LBS) 10000 H (IN) 0.090

BODY WITH FLARE CROSS SECTION

WEIGHT (LBS) 10000 H (IN) 0.460

WEIGHT (LBS) 10000 H (IN) 0.090

FLAT BOTTOM VEHICLE WITH SHARP CORNERS

Figure A-2. Continued

U/RN	AW/RN	THIS	V/RN	VNU/VN	PU/PN	BUH/RN	PU FUD	PU/F IN	EDG/EN
6.00000	4.00000	0.0	0.0	0.18135	0.03289	1.91062	1.00000	0.03209	0.03289
6.00000	4.00053	0.93536	0.16477	0.18131	0.03288	1.91078	0.99944	0.03288	0.03287
6.00000	4.00113	1.87022	0.32653	0.18129	0.03287	1.91126	0.99937	0.03287	0.03283
6.00000	4.00479	2.80408	0.48980	0.18122	0.03284	1.91207	0.99858	0.03284	0.03276
6.00000	4.00852	3.73645	0.65306	0.18112	0.03280	1.91321	0.99747	0.03280	0.03266
6.00000	4.01130	4.66666	0.81633	0.18099	0.03276	1.91466	0.99605	0.03276	0.03254
6.00000	4.01915	5.59479	0.97959	0.18083	0.03270	1.91643	0.99431	0.03270	0.03239
6.00000	4.02604	6.51580	1.14286	0.18065	0.03263	1.91851	0.99210	0.03263	0.03221
6.00000	4.03197	7.44140	1.30612	0.18044	0.03256	1.92094	0.98996	0.03256	0.03201
6.00000	4.04295	8.35915	1.46935	0.18020	0.03247	1.92366	0.98777	0.03247	0.03178
6.00000	4.05296	9.27259	1.63245	0.17993	0.03237	1.92669	0.98440	0.03237	0.03154
6.00000	4.06199	10.18131	1.79492	0.17963	0.03227	1.93003	0.98118	0.03227	0.03126
6.00000	4.07004	11.08488	1.95918	0.17931	0.03215	1.93368	0.97747	0.03215	0.03096
6.00000	4.08910	11.98190	2.12245	0.17897	0.03204	1.93762	0.97389	0.03204	0.03065
6.00000	4.10316	12.87499	2.28571	0.17859	0.03190	1.94107	0.96984	0.03190	0.03031
6.00000	4.11820	13.76070	2.44898	0.17820	0.03175	1.94440	0.96553	0.03175	0.02996
6.00000	4.13417	14.63990	2.61224	0.17777	0.03160	1.94813	0.96096	0.03160	0.02958
6.00000	4.15111	15.51204	2.77551	0.17733	0.03144	1.95213	0.95614	0.03144	0.02920
6.00000	4.16815	16.37665	2.93877	0.17686	0.03128	1.95617	0.95108	0.03128	0.02879
6.00000	4.18530	17.23400	3.10204	0.17637	0.03110	1.96018	0.94579	0.03110	0.02837
6.00000	4.20254	18.08344	3.26530	0.17585	0.03092	1.96417	0.94028	0.03092	0.02794
6.00000	4.22087	18.92482	3.42857	0.17531	0.03073	1.96811	0.93444	0.03073	0.02750
6.00000	4.23920	19.75745	3.59184	0.17476	0.03054	1.97200	0.92816	0.03054	0.02707
6.00000	4.25753	20.58165	3.75510	0.17418	0.03034	1.97584	0.92148	0.03034	0.02665
6.00000	4.27586	21.40702	3.91837	0.17358	0.03013	1.97963	0.91516	0.03013	0.02621
6.00000	4.29419	22.22346	4.08163	0.17296	0.02991	1.98337	0.90826	0.02991	0.02576
6.00000	4.31252	23.03100	4.24490	0.17233	0.02970	1.98706	0.90080	0.02970	0.02531
6.00000	4.33085	23.82985	4.40816	0.17168	0.02949	1.99070	0.89289	0.02949	0.02486
6.00000	4.34918	24.61900	4.57143	0.17101	0.02928	1.99429	0.88452	0.02928	0.02441
6.00000	4.36751	25.39841	4.73469	0.17032	0.02907	1.99783	0.87570	0.02907	0.02396
6.00000	4.38584	26.16802	4.89795	0.16961	0.02885	2.00132	0.86643	0.02885	0.02351
6.00000	4.40417	26.92782	5.06121	0.16888	0.02863	2.00476	0.85671	0.02863	0.02306
6.00000	4.42250	27.67781	5.22447	0.16814	0.02841	2.00815	0.84654	0.02841	0.02261
6.00000	4.44083	28.41798	5.38773	0.16738	0.02818	2.01149	0.83592	0.02818	0.02216
6.00000	4.45916	29.14832	5.55099	0.16660	0.02795	2.01478	0.82485	0.02795	0.02171
6.00000	4.47749	29.86883	5.71425	0.16581	0.02772	2.01802	0.81333	0.02772	0.02126
6.00000	4.49582	30.57940	5.87751	0.16500	0.02749	2.02121	0.80136	0.02749	0.02081
6.00000	4.51415	31.28003	6.04077	0.16418	0.02726	2.02435	0.78894	0.02726	0.02036
6.00000	4.53248	31.97072	6.20403	0.16334	0.02703	2.02744	0.77607	0.02703	0.01991
6.00000	4.55081	32.65147	6.36729	0.16249	0.02680	2.03048	0.76275	0.02680	0.01946
6.00000	4.56914	33.32228	6.53055	0.16162	0.02657	2.03347	0.74898	0.02657	0.01901
6.00000	4.58747	33.98315	6.69381	0.16074	0.02634	2.03641	0.73476	0.02634	0.01856
6.00000	4.60580	34.63408	6.85707	0.15985	0.02611	2.03930	0.72009	0.02611	0.01811
6.00000	4.62413	35.27507	7.02033	0.15894	0.02588	2.04214	0.70497	0.02588	0.01766
6.00000	4.64246	35.90612	7.18359	0.15802	0.02565	2.04493	0.68940	0.02565	0.01721
6.00000	4.66079	36.52723	7.34685	0.15708	0.02542	2.04767	0.67338	0.02542	0.01676
6.00000	4.67912	37.13840	7.51011	0.15613	0.02519	2.05036	0.65691	0.02519	0.01631
6.00000	4.69745	37.73963	7.67337	0.15516	0.02496	2.05300	0.64000	0.02496	0.01586
6.00000	4.71578	38.33092	7.83663	0.15418	0.02473	2.05559	0.62265	0.02473	0.01541
6.00000	4.73411	38.91227	8.00010	0.15318	0.02450	2.05813	0.60496	0.02450	0.01496
6.00000	4.75244	39.48368	8.16357	0.15216	0.02427	2.06062	0.58693	0.02427	0.01451
6.00000	4.77077	40.04515	8.32704	0.15113	0.02404	2.06306	0.56846	0.02404	0.01406
6.00000	4.78910	40.59668	8.49051	0.15008	0.02381	2.06545	0.54955	0.02381	0.01361
6.00000	4.80743	41.13827	8.65398	0.14901	0.02358	2.06779	0.53020	0.02358	0.01316
6.00000	4.82576	41.66992	8.81745	0.14793	0.02335	2.07008	0.51051	0.02335	0.01271
6.00000	4.84409	42.19163	8.98092	0.14684	0.02312	2.07232	0.49048	0.02312	0.01226
6.00000	4.86242	42.70340	9.14439	0.14573	0.02289	2.07451	0.47001	0.02289	0.01181
6.00000	4.88075	43.20523	9.30786	0.14460	0.02266	2.07665	0.44910	0.02266	0.01136
6.00000	4.89908	43.69712	9.47133	0.14346	0.02243	2.07874	0.42775	0.02243	0.01091
6.00000	4.91741	44.17907	9.63480	0.14230	0.02220	2.08078	0.40606	0.02220	0.01046
6.00000	4.93574	44.65108	9.79827	0.14113	0.02197	2.08277	0.38403	0.02197	0.01001
6.00000	4.95407	45.11315	9.96174	0.14000	0.02174	2.08471	0.36166	0.02174	0.00956
6.00000	4.97240	45.56528	10.12521	0.13884	0.02151	2.08661	0.33895	0.02151	0.00911
6.00000	4.99073	46.00747	10.28868	0.13766	0.02128	2.08846	0.31590	0.02128	0.00866
6.00000	5.00906	46.43972	10.45215	0.13647	0.02105	2.09026	0.29251	0.02105	0.00821
6.00000	5.02739	46.86203	10.61562	0.13527	0.02082	2.09201	0.26878	0.02082	0.00776
6.00000	5.04572	47.27440	10.77909	0.13406	0.02059	2.09371	0.24471	0.02059	0.00731
6.00000	5.06405	47.67683	10.94256	0.13283	0.02036	2.09536	0.22030	0.02036	0.00686
6.00000	5.08238	48.06932	11.10603	0.13159	0.02013	2.09696	0.19555	0.02013	0.00641
6.00000	5.10071	48.45187	11.26950	0.13034	0.01990	2.09851	0.17046	0.01990	0.00596
6.00000	5.11904	48.82448	11.43297	0.12908	0.01967	2.10001	0.14503	0.01967	0.00551
6.00000	5.13737	49.18715	11.59644	0.12781	0.01944	2.10146	0.11926	0.01944	0.00506
6.00000	5.15570	49.53988	11.75991	0.12653	0.01921	2.10286	0.09315	0.01921	0.00461
6.00000	5.17403	49.89267	11.92338	0.12524	0.01898	2.10421	0.06670	0.01898	0.00416
6.00000	5.19236	50.23552	12.08685	0.12394	0.01875	2.10551	0.04001	0.01875	0.00371
6.00000	5.21069	50.56843	12.25032	0.12263	0.01852	2.10676	0.01308	0.01852	0.00326
6.00000	5.22902	50.89140	12.41379	0.12131	0.01829	2.10796	0.00000	0.01829	0.00281
6.00000	5.24735	51.20443	12.57726	0.12000	0.01806	2.10911	0.00000	0.01806	0.00236
6.00000	5.26568	51.50752	12.74073	0.11868	0.01783	2.11021	0.00000	0.01783	0.00191
6.00000	5.28401	51.80067	12.90420	0.11735	0.01760	2.11126	0.00000	0.01760	0.00146
6.00000	5.30234	52.08388	13.06767	0.11602	0.01737	2.11226	0.00000	0.01737	0.00101
6.00000	5.32067	52.35715	13.23114	0.11468	0.01714	2.11321	0.00000	0.01714	0.00056
6.00000	5.33900	52.62048	13.39461	0.11334	0.01691	2.11411	0.00000	0.01691	0.00011
6.00000	5.35733	52.87387	13.55808	0.11200	0.01668	2.11496	0.00000	0.01668	0.00000
6.00000	5.37566	53.12732	13.72155	0.11065	0.01645	2.11576	0.00000	0.01645	0.00000
6.00000	5.39399	53.37083	13.88502	0.10930	0.01622	2.11651	0.00000	0.01622	0.00000
6.00000	5.41232	53.60440	14.04849	0.10795	0.01600	2.11721	0.00000	0.01600	0.00000
6.00000	5.43065	53.82803	14.21196	0.10660	0.01577	2.11786	0.00000	0.01577	0.00000
6.00000	5.44898	54.04172	14.37543	0.10525	0.01555	2.11846	0.00000	0.01555	0.00000
6.00000	5.46731	54.24547	14.53890	0.10390	0.01532	2.11901	0.00000	0.01532	0.00000
6.00000	5.48564	54.43928	14.70237	0.10255	0.01510	2.11951	0.00000	0.01510	0.00000
6.00000	5.50397	54.62315	14.86584	0.10120	0.01487	2.12001	0.00000	0.01487	0.00000
6.00000	5.52230	54.79708	15.02931	0.09985	0.01465	2.12046	0.00000	0.01465	0.00000
6.00000	5.54063	54.96107	15.19278	0.09850	0.01442	2.12086	0.00000	0.01442	0.00000
6.00000	5.55896	55.11512	15.35625	0.09715	0.01420	2.12121	0.00000	0.01420	0.00000
6.00000	5.57729	55.26923	15.51972	0.09580	0.01397	2.12151	0.00000	0.01397	0.00000
6.00000	5.59562	55.41340	15.68319	0.09445	0.01375	2.12176	0.00000	0.01375	0.00000

UPWASH LIFT FORCE LU/2TJ= 0.01512

UPWASH LOAD EFFETS COMPUTED AT Z LOCATION OF UNDERSIDE OF BODY

BODY CENTERLINE LOCATION AT Z/RN= 0.00000

Z/RN	RW/RN	THIB	X/RN	VMU/UN	FU/FN	BUH/RN	FU/UO	FU/FJS	FBS/FN
0.00000	4.00000	0.0	0.0	0.14447	0.02096	2.51062	1.00000	0.07086	0.02086
0.00000	4.00017	0.77949	0.16327	0.14441	0.02085	2.51074	0.99989	0.07085	0.02085
0.00000	4.00148	1.55828	0.33653	0.14439	0.02085	2.51118	0.99957	0.07085	0.02083
0.00000	4.00333	2.33733	0.48980	0.14435	0.02084	2.51168	0.99904	0.07084	0.02080
0.00000	4.00592	3.11504	0.65306	0.14429	0.02082	2.51288	0.99877	0.07084	0.02076
0.00000	4.00924	3.89187	0.81633	0.14423	0.02080	2.51412	0.99773	0.07080	0.02071
0.00000	4.01330	4.66886	0.97959	0.14414	0.02078	2.51546	0.99616	0.07078	0.02064
0.00000	4.01810	5.44611	1.14286	0.14404	0.02075	2.51749	0.99476	0.07075	0.02056
0.00000	4.02362	6.22381	1.30612	0.14393	0.02071	2.51957	0.99319	0.07071	0.02047
0.00000	4.02988	6.99109	1.46939	0.14380	0.02068	2.52193	0.99141	0.07068	0.02037
0.00000	4.03685	7.74776	1.63265	0.14365	0.02064	2.52458	0.98941	0.07064	0.02026
0.00000	4.04455	8.51277	1.79592	0.14349	0.02059	2.52748	0.98771	0.07059	0.02014
0.00000	4.05296	9.27259	1.95918	0.14332	0.02054	2.53065	0.98482	0.07054	0.02001
0.00000	4.06208	10.03020	2.12245	0.14313	0.02049	2.53409	0.98273	0.07049	0.01986
0.00000	4.07193	10.78427	2.28571	0.14293	0.02043	2.53780	0.97994	0.07044	0.01971
0.00000	4.08245	11.53351	2.44898	0.14271	0.02037	2.54176	0.97647	0.07037	0.01955
0.00000	4.09366	12.28004	2.61224	0.14248	0.02030	2.54594	0.97331	0.07030	0.01938
0.00000	4.10547	13.02307	2.77551	0.14223	0.02023	2.55042	0.96977	0.07023	0.01920
0.00000	4.11787	13.76278	2.93877	0.14197	0.02016	2.55520	0.96645	0.07016	0.01902
0.00000	4.13087	14.49786	3.10204	0.14170	0.02009	2.56019	0.96276	0.07009	0.01882
0.00000	4.14444	15.22812	3.26530	0.14142	0.02000	2.56541	0.95889	0.07000	0.01862
0.00000	4.15857	15.95338	3.42857	0.14112	0.01991	2.57088	0.95481	0.06991	0.01841
0.00000	4.17324	16.67434	3.59184	0.14081	0.01983	2.57659	0.95068	0.06983	0.01820
0.00000	4.18845	17.39169	3.75510	0.14049	0.01974	2.58253	0.94634	0.06974	0.01798
0.00000	4.20420	18.10534	3.91837	0.14015	0.01964	2.58871	0.94183	0.06964	0.01775
0.00000	4.22049	18.81530	4.08163	0.13981	0.01954	2.59511	0.93719	0.06954	0.01757
0.00000	4.23732	19.52157	4.24490	0.13945	0.01945	2.60172	0.93241	0.06945	0.01738
0.00000	4.25469	20.22424	4.40816	0.13908	0.01934	2.60858	0.92749	0.06934	0.01719
0.00000	4.27260	20.92333	4.57143	0.13870	0.01924	2.61564	0.92244	0.06924	0.01700
0.00000	4.29105	21.61884	4.73470	0.13831	0.01913	2.62293	0.91722	0.06913	0.01680
0.00000	4.31004	22.31087	4.89796	0.13791	0.01902	2.63040	0.91197	0.06902	0.01660
0.00000	4.32957	22.99942	5.06123	0.13750	0.01891	2.63809	0.90655	0.06891	0.01640
0.00000	4.34964	23.68459	5.22450	0.13709	0.01879	2.64597	0.90103	0.06879	0.01620
0.00000	4.37025	24.36637	5.38776	0.13668	0.01868	2.65405	0.89541	0.06868	0.01604
0.00000	4.39140	25.04474	5.55103	0.13627	0.01856	2.66233	0.88969	0.06856	0.01588
0.00000	4.41309	25.71971	5.71430	0.13585	0.01844	2.67081	0.88387	0.06844	0.01573
0.00000	4.43532	26.39128	5.87757	0.13543	0.01833	2.67948	0.87797	0.06833	0.01557
0.00000	4.45809	27.05945	6.04084	0.13501	0.01821	2.68836	0.87198	0.06821	0.01541
0.00000	4.48140	27.72422	6.20411	0.13459	0.01809	2.69745	0.86592	0.06809	0.01525
0.00000	4.50525	28.38559	6.36738	0.13417	0.01797	2.70674	0.85978	0.06797	0.01509
0.00000	4.52964	29.04356	6.53065	0.13375	0.01785	2.71624	0.85357	0.06785	0.01493
0.00000	4.55457	29.69813	6.69392	0.13333	0.01773	2.72594	0.84729	0.06773	0.01477
0.00000	4.58004	30.34930	6.85719	0.13291	0.01761	2.73584	0.84094	0.06761	0.01461
0.00000	4.60605	30.99707	7.02046	0.13249	0.01749	2.74594	0.83451	0.06749	0.01445
0.00000	4.63260	31.64144	7.18373	0.13207	0.01737	2.75624	0.82799	0.06737	0.01429
0.00000	4.65969	32.28241	7.34700	0.13165	0.01725	2.76674	0.82139	0.06725	0.01413
0.00000	4.68732	32.92008	7.51027	0.13123	0.01713	2.77744	0.81471	0.06713	0.01397
0.00000	4.71549	33.55445	7.67354	0.13081	0.01701	2.78834	0.80795	0.06701	0.01381
0.00000	4.74420	34.18552	7.83681	0.13039	0.01689	2.79944	0.80111	0.06689	0.01365
0.00000	4.77345	34.81329	7.99998	0.13000	0.01677	2.81074	0.79419	0.06677	0.01349
0.00000	4.80324	35.43776	8.16325	0.12961	0.01665	2.82224	0.78719	0.06665	0.01333
0.00000	4.83357	36.05893	8.32652	0.12923	0.01653	2.83394	0.78011	0.06653	0.01317
0.00000	4.86444	36.67680	8.48979	0.12885	0.01641	2.84584	0.77295	0.06641	0.01301
0.00000	4.89585	37.29137	8.65306	0.12847	0.01629	2.85794	0.76571	0.06629	0.01285
0.00000	4.92780	37.90264	8.81633	0.12809	0.01617	2.87024	0.75839	0.06617	0.01269
0.00000	4.96029	38.51061	8.97960	0.12771	0.01605	2.88274	0.75101	0.06605	0.01253
0.00000	4.99332	39.11528	9.14287	0.12733	0.01593	2.89544	0.74357	0.06593	0.01237
0.00000	5.02689	39.71665	9.30614	0.12695	0.01581	2.90834	0.73607	0.06581	0.01221
0.00000	5.06092	40.31472	9.46941	0.12657	0.01569	2.92144	0.72851	0.06569	0.01205
0.00000	5.09549	40.90949	9.63268	0.12619	0.01557	2.93474	0.72089	0.06557	0.01189
0.00000	5.13060	41.50096	9.79595	0.12581	0.01545	2.94824	0.71321	0.06545	0.01173
0.00000	5.16625	42.08913	9.95922	0.12543	0.01533	2.96194	0.70547	0.06533	0.01157
0.00000	5.20244	42.67390	10.12249	0.12505	0.01521	2.97584	0.69767	0.06521	0.01141
0.00000	5.23917	43.25527	10.28576	0.12467	0.01509	2.99004	0.68981	0.06509	0.01125
0.00000	5.27644	43.83324	10.44903	0.12429	0.01497	3.00444	0.68189	0.06497	0.01109
0.00000	5.31425	44.40781	10.61230	0.12391	0.01485	3.01904	0.67391	0.06485	0.01093
0.00000	5.35260	44.97898	10.77557	0.12353	0.01473	3.03384	0.66587	0.06473	0.01077
0.00000	5.39149	45.54675	10.93884	0.12315	0.01461	3.04884	0.65777	0.06461	0.01061
0.00000	5.43092	46.11112	11.10211	0.12277	0.01449	3.06404	0.64961	0.06449	0.01045
0.00000	5.47089	46.67209	11.26538	0.12239	0.01437	3.07944	0.64139	0.06437	0.01029
0.00000	5.51140	47.22976	11.42865	0.12201	0.01425	3.09504	0.63311	0.06425	0.01013
0.00000	5.55245	47.78413	11.59192	0.12163	0.01413	3.11084	0.62477	0.06413	0.00997
0.00000	5.59404	48.33520	11.75519	0.12125	0.01401	3.12684	0.61637	0.06401	0.00981
0.00000	5.63617	48.88307	11.91846	0.12087	0.01389	3.14304	0.60791	0.06389	0.00965
0.00000	5.67884	49.42774	12.08173	0.12049	0.01377	3.15944	0.59939	0.06377	0.00949
0.00000	5.72205	49.96921	12.24500	0.12011	0.01365	3.17604	0.59081	0.06365	0.00933
0.00000	5.76580	50.50738	12.40827	0.11973	0.01353	3.19284	0.58217	0.06353	0.00917
0.00000	5.81009	51.04225	12.57154	0.11935	0.01341	3.20984	0.57347	0.06341	0.00901
0.00000	5.85492	51.57382	12.73481	0.11897	0.01329	3.22704	0.56471	0.06329	0.00885
0.00000	5.90029	52.10219	12.89808	0.11859	0.01317	3.24444	0.55589	0.06317	0.00869
0.00000	5.94620	52.62736	13.06135	0.11821	0.01305	3.26204	0.54701	0.06305	0.00853
0.00000	5.99265	53.14943	13.22462	0.11783	0.01293	3.27984	0.53807	0.06293	0.00837
0.00000	6.03964	53.66840	13.38789	0.11745	0.01281	3.29784	0.52907	0.06281	0.00821
0.00000	6.08717	54.18427	13.55116	0.11707	0.01269	3.31604	0.52001	0.06269	0.00805
0.00000	6.13524	54.69704	13.71443	0.11669	0.01257	3.33444	0.51089	0.06257	0.00789
0.00000	6.18385	55.20681	13.87770	0.11631	0.01245	3.35304	0.50171	0.06245	0.00773
0.00000	6.23290	55.71358	14.04097	0.11593	0.01233	3.37184	0.49247	0.06233	0.00757
0.00000	6.28249	56.21735	14.20424	0.11555	0.01221	3.39084	0.48317	0.06221	0.00741
0.00000	6.33262	56.71812	14.36751	0.11517	0.01209	3.41004	0.47381	0.06209	0.00725
0.00000	6.38329	57.21589	14.53078	0.11479	0.01197	3.42944	0.46439	0.06197	0.00709
0.00000	6.43450	57.71066	14.69405	0.11441	0.01185	3.44904	0.45491	0.06185	0.00693
0.00000	6.48625	58.20243	14.85732	0.11403	0.01173	3.46884	0.44537	0.06173	0.00677
0.00000	6.53854	58.69120	15.02059	0.11365	0.01161	3.48884	0.43577	0.06161	0.00661
0.00000	6.59137	59.17697	15.18386	0.11327	0.01149	3.50904	0.42611	0.06149	0.00645
0.00000	6.64474	59.65974	15.34713	0.11289	0.01137	3.52944	0.41639	0.06137	0.00629
0.00000	6.69865	60.13951	15.51040	0.11251	0.01125	3.55004	0.406		

8.00000	4.74782	12.59209	7.67347	0.12938	0.01687	2.78545	0.80274	0.01487	1.01197
8.00000	4.77744	13.14697	7.83673	0.17935	0.01673	2.79598	0.80219	0.01673	0.01173
8.00000	4.80740	14.69003	8.00000	0.12882	0.01657	2.90664	0.79561	0.01659	0.01149

FLAT BOTTOM VEHICLE WITH SHARP CORNERS

UPWASH LIFT FORCE 10/211# 0.04130

BODY WITH CIRCULAR CROSS SECTION

UPWASH LIFT FORCE 10/211# 0.01029

Figure A-2, Concluded

```

C*****GRU00010
C      VTOL TWO-JET IMPINGEMENT INTERACTION COMPUTER PROGRAM      GRU00020
C      FOR CLOSELY SPACED JETS                                     GRU00030
C      BY M.J.SICLARI                                             GRU00040
C      516 575-2207                                              GRU00050
C      GRUMMAN AEROSPACE CORPORATION                             GRU00060
C      BETHPAGE, NEW YORK 11714                                  GRU00070
C      GRU00080
C      GRU00090
C*****GRU00100
C      PROGRAM GRUMJET2                                          GRU00110
C      REAL KDELFD,KDFLO,NFD,NO,N,NDEL                            GRU00120
C      COMMON/MALL/DELFS,NO,NDFLO,ALFG,ALFWD,ALFWD,RO,RGH,VG,BWHD GRU00130
C      COMMON/DELTD,SD,KGU                                        GRU00140
C      COMMON/HEIGHT/HD,IPBAR                                    GRU00150
C      F(LAMB(ETA,A))=TA-(4./(A+1.))*ETA**(A+1.)*(6./(2.*A+1.))*ETA**(2.*GRU00160
C      I(A+1.)*(4./(3.*A+1.))*ETA**(3.*A+1.)*(1./(4.*A+1.))*ETA**(4.*A+1.) GRU00170
C      GRU00180
C      BODY SHAPE FUNCTIONS FOR FORCE PREDICTION                 GRU00190
C      W2...HALF WIDTH IN NOZZLE RADIUS                          GRU00200
C      ZBODY...NOSE DEPTH IN NOZZLE RADIUS                       GRU00210
C      DZDX...AXIAL SLOPES                                       GRU00220
C      THNOSE...NOSE ANGLE OF PARABOLIC BODY                     GRU00230
C      GRU00240
C      GRU00250
C      GRU00260
C      GRU00270
C      GRU00280
C      GRU00290
C      GRU00300
C      GRU00310
C      GRU00320
C      GRU00330
C      GRU00340
C      GRU00350
C      GRU00360
C      GRU00370
C      GRU00380
C      GRU00390
C      GRU00400
C      GRU00410
C      GRU00420
C      GRU00430
C      GRU00440
C      GRU00450
C      GRU00460
C      GRU00470
C      GRU00480
C      GRU00490
C      GRU00500
C      GRU00510
C      GRU00520
C      GRU00530
C      GRU00540
C      GRU00550
C      GRU00560
C      GRU00570
C      GRU00580
C      GRU00590
C      GRU00600
C      GRU00610
C      GRU00620
C      GRU00630
C      GRU00640

```

Figure A-3. Computer Listing

```

C COMPUTE JET STANDOFF DISTANCE AND EFFECTIVE JET DECAY HEIGHT
C (GIRALT ET AL)
C
  IF (HD.11.6.8) DELG=0.153*7.8
  IF (HD.61.6.8) DELG=0.153*(1.+HD)
  ZEND=(HD-DLLB)*2.
  WRITE (6,22)
22 FORMAT (///30X,'***** JET DECAY REGION *****//')
  WRITE (6,7) DELG
  7 FORMAT (10X,'JET DEFLECTION HEIGHT DELG/D =',F10.5)
C
C COMPUTE JET DECAY
C
C ALL DIMENSIONS NONDIMENSIONALIZED BY NOZZLE RADIUS
C
C SET EMPIRICAL CONSTANTS FOR HALF-WIDTH BEHAVIOR AND LENGTH OF
C POTENTIAL CORE (HRYCAN, ET AL)
C
  A2=.04
  B2=.800
  A3=.0926
  B3=0.
  ZFC=H.
  A1=A2*(B2-1.)/ZFC
  ZFD=B2/(A3-A2)
  ALI=1.5
  WRITE (6,23) ZFC,ZFD
23 FORMAT (10X,'ZFC/RN=',F10.5,2X,'ZFD/RN=',F10.5)
  WRITE (6,12)
12 FORMAT (16X,'Z/RN',6X,'RJH/RN',6X,'RJ/RN',7X,'ALP',9X,'CV2',8X,'UJGRU00940
  1/UN',6X,'RCURK/RN'//)
C
C REGION 1...POTENTIAL CORE REGION OF JET..
C
  NBJC=10
  DNFC=NBJC-1
  IF (.FND.GE.ZFC) DZFC=ZFC/DNFC
  IF (ZEND.LT.ZFC) DZFC=ZEND/DNFC
  Z=0.
  DO 100 I=1,NBJC
  IF (I.EQ.1) GO TO 102
  GO TO 103
102 VJ=1.
  KJI=1.
  KI=1.
  ALFC=0.
  CV2=.5
  KJFC=1.
  KC=1.
  GO TO 104
103 ETAC=1./Z/ZFC
  KJI=AI*Z*E.
  CALL ALFC (ETAC,RJH,ALFC,K,CV2)
  KJ=KJI/K
  KJFC=KJ
  KJFC=(KJFC-KJFC0)/DZFC
  VJ=1.
  KI=ETAC*KJ
104 WRITE (6,11) Z,KJI,KJ,ALFC,CV2,UJ,KC
  11 FORMAT (11X,'Z(F10.5,2X)
  Z ZFC(F10.5)
  KJI KJFC
100 CONTINUE
C
C TRANSITION REGION II AND FULLY DEVELOPED REGION OF JET
C

```

Figure A-3. Continued

```

IF (ZEND.LE.ZPC) GO TO 998
NJFD=50
DNFD=NJFD-1
CALL SIM(O.,ALFZD,RFD,DUM)
RZFD=A3/RFD
RJFD=(A3*ZFD+B3)/RFD
DZ=(ZEND-ZPC)/DNFD
Z=ZPC+DZ
DO 200 I=2,NJFD
IF (Z.LT.ZFD) RJ=AAJ*(Z-ZPC)**3+BBJ*(Z-ZPC)**2+CCJ*(Z-ZFC)+DDJ
KCON=(Z.-SQRT(Z.))/Z.
DZCF=ZFD-ZPC
CCJ=RJZPC
DDJ=RJPC
AAJ=(2.*DDJ+CCJ*DZPCF+RZFD)*DZPCF-2.*RJFD)/DZPCF**3
BBJ=.5*(RZFD-C-3.*AAJ*DZCF**2)/DZCF**2
IF (Z.LT.ZFD) RJ=RJCF+(RJFD-RJPC)/(ZFD-ZPC)*(Z-ZPC)
IF (Z.GE.ZFD) ALFT=ALFFD
IF (Z.LE.ZFD) RJJ=A2*Z+D2
IF (Z.GT.ZFD) RJJ=A3*Z+B3
IF (Z.LT.ZFD) R=RJJ/KJ
IF (Z.LT.ZFD) ALFT=ALOG(KCON)/ALOG(K)
CALL SIM(O.,ALFT,R,CV2)
VJ=R/(RJJ*SQRT(2.*CV2))
RJR=R/KJ
WRITE (6,11) Z,RJJ,RJ,ALFT,CV2,VJ
7 71DZ
200 CONTINUE
C
C JET DEFLECTION REGION
C JET IMPINGEMENT PRESSURES
C
998 ACCON=-.032026
FCON=.3354248
GCON=.748
IF (HD.GT.3.) AD=5.6
AUGLH=(3.6-2.5)/(3.1-2.)
IF (HD.LE.3.) AD=2.9+AD*H*(HD-1.)
WRITE (6,29)
29 FORMAT (//30X, '***** JET DEFLECTION REGION *****')
DO FORMAT (10X,'KGR/RN=',F10.5,'X', 'RGR/RN=',F10.5,'X', 'KOR/RN=',F10.5,'X', 'GGR/RN=',F10.5,'X')
11 90ZVN=(F10.5//)
C
C SLT CHARACTERISTIC SCALE LENGTHS FOR IMPINGEMENT REGION
C
RGR RJJ
KGR R
KOR=KGR/KJ
ETAWG=RGR/KJ
VG=1.
IF (Z.HND.LE.ZFC) GO TO 454
C
C DETERMINE STAGNATION POINT PRESSURE
C
IF (Z.HND.LE.ZFD) KHH=AD*2.*HND*B2
IF (Z.HND.GT.ZFD) KHH=1.*HND*B3+B5
ZL=HND-.2*KHH
IF (Z.LT.ZFD) ALFT=ALFFD+(ALFFD-ALFL)/(ZFD-ZPC)*(Z-ZFD)
IF (Z.GE.ZFD) ALFT=ALFFD
CALL SIM(O.,ALFT,R,CV2)
VG=RZCF/KJ*SQRT(2.*CV2)
IF (HD.LE.3.) VG=1.004+.003*HD
IF (HD.LE.10.) VG=1.004+HD*(.0015-0.0001*HD)
IF (HD.GT.10.) VG=1.004+HD*(.0015-0.0001*HD)
11 90ZVN=(F10.5//)

```

```

GRU01310
GRU01320
GRU01330
GRU01340
GRU01350
GRU01360
GRU01370
GRU01380
GRU01390
GRU01400
GRU01410
GRU01420
GRU01430
GRU01440
GRU01450
GRU01460
GRU01470
GRU01480
GRU01490
GRU01500
GRU01510
GRU01520
GRU01530
GRU01540
GRU01550
GRU01560
GRU01570
GRU01580
GRU01590
GRU01600
GRU01610
GRU01620
GRU01630
GRU01640
GRU01650
GRU01660
GRU01670
GRU01680
GRU01690
GRU01700
GRU01710
GRU01720
GRU01730
GRU01740
GRU01750
GRU01760
GRU01770
GRU01780
GRU01790
GRU01800
GRU01810
GRU01810
GRU01810
GRU01840
GRU01840
GRU01870
GRU01870
GRU01870
GRU01890
GRU01900
GRU01910
GRU01920
GRU01930
GRU01940
GRU01950
GRU01960

```

Figure A-3. Continued

```

C STAGNATION PRESSED NONDIMENSIONALIZED BY JET TOTAL PRESSED
C
  RCU=RG
  DELFS=UG**2
  WRITE (6,B1) DELFS
B1 FORMAT (10X,'STAGNATION PRESSED, DPS/DFTJ=',F10.5)
  CALL GPNFS(RD,UG,ALFG,R,CV2)
  WRITE (6,B2) ALPG
B2 FORMAT (10X,'ALPG=',F10.5)
  NG=50
  RNDH=NG-1
  DR=RD/(RNGM*RGN)
  DELTA=1./RNGM
  ETA=0.
  R=0.
  WRITE (6,B3)
B3 FORMAT (30X,'SINGLE JET GROUND PRESSED //25X,'R/RGN',6X,'DPS/DFTGRU01970
  10 ,2X,'R/RN',2X,'DPS/DFTJ // GRU01980
  DO 300 I=1,NG GRU01990
  DFTG=(1.-ETA**ALFG)**4 GRU02000
  DFTJ=DFTG*DELF5 GRU02010
  RKN=R*FGR GRU02020
  WRITE (7,B4) R,DFTG,RKN,DFTJ GRU02030
B4 FORMAT (20X,4(F10.5,5X)) GRU02040
  R=K*DR GRU02050
  ETA=ETA+DELTA GRU02060
300 CONTINUE GRU02070
C GRU02080
C INITIALIZE WALL JET REGION GRU02090
C
  AW3=.09 GRU02100
  ALFW=1.-AW3 GRU02110
  KDEL=1.0942 GRU02120
  ALUG=1.5 GRU02130
  NCR=2. GRU02140
  CALL SIMW(KDEL,ALFW,ALFW,ALFW,ALFW,ALFW,ALFW,ALFW) GRU02150
  CALL SIMUG(ALUG,ALUG,ALUG,ALUG,ALUG,ALUG,ALUG,ALUG) GRU02160
  CU=1.5*AW3*ALUG/ALFW GRU02170
  AS1=.015434 GRU02180
  AS2=.128055 GRU02190
  DELS=2.*AS1*(1+AW3)**AS2 GRU02200
  WRITE (6,B5) GRU02210
B5 FORMAT (77X, '***** WALL JET REGION *****') GRU02220
  WRITE (6,B6) DELS GRU02230
B6 FORMAT (5X,'STAGNATION POINT BOUNDARY LAYER THICKNESS, DELS/RN=', GRU02240
  IF10.5) GRU02250
  NU=14 GRU02260
  KDEL=DELS/(2.*ALFG) GRU02270
  CALL GPNCH(RGN,UG,ALFG,KDEL,NO,ETAW,DELS,ALFW,R) GRU02280
  CALL SIMW(KDEL,NO,ALFW,R,CV2,C1) GRU02290
  KATW=R GRU02300
  FETAG=(1.-ETAW**ALFG)**4 GRU02310
  DEN=(RGN*UG**2)**(2.*FUG2*(1.-FETAG)+C1*FETAG) GRU02320
  BWD=(1.-FETAG)*DEN GRU02330
  BWN=R*BWD GRU02340
  DELM=BWD*KDEL GRU02350
  XIAM=(1.-FETAG) GRU02360
  UMG1=C1*F(XIAM) GRU02370
  WRITE (6,B7) UMG1 GRU02380
B7 FORMAT (5X,'VELOCITY AT START OF TURBULENT WALL JET, UM,UG=',F10.5) GRU02390
  1) GRU02400
  WRITE (6,B8) ALFW,BWN,BWD GRU02410
B8 FORMAT (10X,'START OF WALL JET REGION, ALFW=',F10.5,2X,'BWN/RN= GRU02420
  1,F10.5,2X,'BWD/RN=',F10.5) GRU02430
C GRU02440
C MAXIMUM VELOCITY DISTRIBUTION IN DEFLECTION REGION GRU02450

```

```

C
NWFT=50
XNWFT=NWFT 1
KEND=2.*SD
DR=KEND/XNWFT
BW3HO=AW3*KO
DELBRH=(BW3HO-BWH)/(RO-RGH)
DELNR=(NFID-NO)/(RO-RGH)
DELAR=(ALFJFD-ALFW)/(RO-RGH)
ADELRT=.0175
ADELRL=(ADELRT*(RO-2.)) DELS)/(RO-RGH)
R=0.
WRITE (6,107)
107 FORMAT (//45X, 'WALL JET PROPERTIES'//)
WRITE (6,97)
97 FORMAT (//15X, 'K/KN', 6X, 'UM/UG', 6X, 'UH/UN', 6X, 'BWH/RN', 6X,
1 'BW/RN', 6X, 'DEL BL/RN', 6X, 'DEL T', 6X, 'NDEL', 6X, 'NPOWER'//)
DO 400 I=1,NWFT
IF (K.LE.KO) FETA=(1.-(E/RO)**ALF)*R
IF (K.GT.KO) FETA=0.0
IF (K.LE.RGH) VMG=VORT(1.-FETA)
IF (K.LE.RGH) VHN=VMG*VU
IF (K.LE.RGH) DELT=DELTS
IF (K.LE.RGH) DELTA=NDELO*BWO
IF (K.LE.RGH) N=14
IF (K.LE.RGH) NDEL=NDELO
IF (K.LE.RGH) BW=BWO
IF (K.LE.RGH) BWH=KATW*BWC
IF (K.LE.RGH) GO TO 301
IF (K.LE.FG) BWH=BWH0+DELEBN*(K-RGH)
IF (K.GE.KO) BWH=AW3*K
IF (K.LE.KO) ALF=ALF0+DELAR*(K-RGH)
IF (K.LE.KO) DELR=DELSTADELH*(K-RGH)
IF (K.GE.KO) DELR=ADELRT*(K-2.)
IF (K.LE.KO) N=NO+DELNR*(K-RGH)
IF (K.GE.KO) N=N0
IF (K.GE.KO) ALF=ALF0+DELAR*(K-RGH)
KDEL=DELRL*(DELRL*(BWH-DELRL)/ALF)
LDEL=SIMCO DELN/ALF+KAT*CO*(1)
IF (K.LE.4.) VISMUM=1.0
IF (K.GE.4.) VISMUM=1./(K/4.)**24
F1=VISMUM*KAT*(1.-FETA)/(K*BWH)
F2=DELSTADELH**2
VMG=VORT(1.-F1)/(2.*CO2)
VHN=VMG/VU
DELT=DELTS+LDEL*VISMUM**2
PW=BWH/KAT
DELTA=NDEL*BW
301 WRITE (6,97) F,VMG,VHN,BW,BWH,DELTA,DELT,DELR,
K,RDE
99 FORMAT (10X,9(10.4,2X))
400 CONTINUE
C
DEWASH GROUND MAXIMUM PRESSURE DISTRIBUTION
WRITE (6,104)
104 FORMAT (//30X, '**** TWO JET INTERACTION PROBLEM ****'//)
WRITE (6,100)
100 FORMAT (//30X, '**** GROUND STAGNATION PRESSURE DISTRIBUTION ****'//)
111 FORMAT (//30X, 'MAXIMUM GROUND PRESSURES ALONG DEWASH GROUND STAGNATION'//)
112 FORMAT (//30X, 'MAXIMUM GROUND PRESSURES ALONG DEWASH GROUND STAGNATION'//)
113 FORMAT (//30X, 'MAXIMUM GROUND PRESSURES ALONG DEWASH GROUND STAGNATION'//)
114 FORMAT (//30X, 'MAXIMUM GROUND PRESSURES ALONG DEWASH GROUND STAGNATION'//)
115 FORMAT (//30X, 'MAXIMUM GROUND PRESSURES ALONG DEWASH GROUND STAGNATION'//)
116 FORMAT (//30X, 'MAXIMUM GROUND PRESSURES ALONG DEWASH GROUND STAGNATION'//)
117 FORMAT (//30X, 'MAXIMUM GROUND PRESSURES ALONG DEWASH GROUND STAGNATION'//)
118 FORMAT (//30X, 'MAXIMUM GROUND PRESSURES ALONG DEWASH GROUND STAGNATION'//)
119 FORMAT (//30X, 'MAXIMUM GROUND PRESSURES ALONG DEWASH GROUND STAGNATION'//)
120 FORMAT (//30X, 'MAXIMUM GROUND PRESSURES ALONG DEWASH GROUND STAGNATION'//)
121 FORMAT (//30X, 'MAXIMUM GROUND PRESSURES ALONG DEWASH GROUND STAGNATION'//)
122 FORMAT (//30X, 'MAXIMUM GROUND PRESSURES ALONG DEWASH GROUND STAGNATION'//)
123 FORMAT (//30X, 'MAXIMUM GROUND PRESSURES ALONG DEWASH GROUND STAGNATION'//)
124 FORMAT (//30X, 'MAXIMUM GROUND PRESSURES ALONG DEWASH GROUND STAGNATION'//)
125 FORMAT (//30X, 'MAXIMUM GROUND PRESSURES ALONG DEWASH GROUND STAGNATION'//)
126 FORMAT (//30X, 'MAXIMUM GROUND PRESSURES ALONG DEWASH GROUND STAGNATION'//)
127 FORMAT (//30X, 'MAXIMUM GROUND PRESSURES ALONG DEWASH GROUND STAGNATION'//)
128 FORMAT (//30X, 'MAXIMUM GROUND PRESSURES ALONG DEWASH GROUND STAGNATION'//)
129 FORMAT (//30X, 'MAXIMUM GROUND PRESSURES ALONG DEWASH GROUND STAGNATION'//)
130 FORMAT (//30X, 'MAXIMUM GROUND PRESSURES ALONG DEWASH GROUND STAGNATION'//)
131 FORMAT (//30X, 'MAXIMUM GROUND PRESSURES ALONG DEWASH GROUND STAGNATION'//)
132 FORMAT (//30X, 'MAXIMUM GROUND PRESSURES ALONG DEWASH GROUND STAGNATION'//)
133 FORMAT (//30X, 'MAXIMUM GROUND PRESSURES ALONG DEWASH GROUND STAGNATION'//)
134 FORMAT (//30X, 'MAXIMUM GROUND PRESSURES ALONG DEWASH GROUND STAGNATION'//)
135 FORMAT (//30X, 'MAXIMUM GROUND PRESSURES ALONG DEWASH GROUND STAGNATION'//)
136 FORMAT (//30X, 'MAXIMUM GROUND PRESSURES ALONG DEWASH GROUND STAGNATION'//)
137 FORMAT (//30X, 'MAXIMUM GROUND PRESSURES ALONG DEWASH GROUND STAGNATION'//)
138 FORMAT (//30X, 'MAXIMUM GROUND PRESSURES ALONG DEWASH GROUND STAGNATION'//)
139 FORMAT (//30X, 'MAXIMUM GROUND PRESSURES ALONG DEWASH GROUND STAGNATION'//)
140 FORMAT (//30X, 'MAXIMUM GROUND PRESSURES ALONG DEWASH GROUND STAGNATION'//)
141 FORMAT (//30X, 'MAXIMUM GROUND PRESSURES ALONG DEWASH GROUND STAGNATION'//)
142 FORMAT (//30X, 'MAXIMUM GROUND PRESSURES ALONG DEWASH GROUND STAGNATION'//)
143 FORMAT (//30X, 'MAXIMUM GROUND PRESSURES ALONG DEWASH GROUND STAGNATION'//)
144 FORMAT (//30X, 'MAXIMUM GROUND PRESSURES ALONG DEWASH GROUND STAGNATION'//)
145 FORMAT (//30X, 'MAXIMUM GROUND PRESSURES ALONG DEWASH GROUND STAGNATION'//)
146 FORMAT (//30X, 'MAXIMUM GROUND PRESSURES ALONG DEWASH GROUND STAGNATION'//)
147 FORMAT (//30X, 'MAXIMUM GROUND PRESSURES ALONG DEWASH GROUND STAGNATION'//)
148 FORMAT (//30X, 'MAXIMUM GROUND PRESSURES ALONG DEWASH GROUND STAGNATION'//)
149 FORMAT (//30X, 'MAXIMUM GROUND PRESSURES ALONG DEWASH GROUND STAGNATION'//)
150 FORMAT (//30X, 'MAXIMUM GROUND PRESSURES ALONG DEWASH GROUND STAGNATION'//)

```

Figure A-3. Continued

```

DPHI=PHIM/24. GRU03290
DO 450 IL=1,25 GRU03300
XW=SD*TAN(PHI) GRU03310
RW=SQRT(XW**2+SD**2) GRU03320
XWS=XW/(2.*SD) GRU03330
CALL WALLJ (RW,VMN,DUM2,DUM3,DUM4,DELFW) GRU03340
IF (IL,EQ,1) DELFW=DELFW GRU03350
PMAXG=DELFW-VMN**2+(VMN*COS(PHI))**2 GRU03360
PMAXND=PMAXG/DELFW GRU03370
WRITE (6,455) XW,XWS,PMAXG,PMAXND GRU03380
455 FORMAT (10X,4(F10.5,2X)) GRU03390
PHI=PHI+DPHI GRU03400
450 CONTINUE GRU03410
ACON=1.-(RG/SD)**2 GRU03420
PHID=0.0 GRU03430
IF (ACON.GE.0.) PHID=0.0 GRU03440
IF (ACON.GE.0.) GO TO 667 GRU03450
PHID=ARCCOS((SD/RG)**.20) GRU03460
PHID=PHID*180./PI GRU03470
ACON=2./(SIN(.5*PI-PHID)**2) GRU03480
XMMZ=ACON*(1.0+SIN(PHID))*(SIN(PHID)-2.0)/3. GRU03490
GO TO 668 GRU03500
667 XMMZ=ACON*2.*(1.-ACON)/3. GRU03510
668 WRITE (6,553) GRU03520
553 FORMAT (/5X,'UPWASH MOMENTUM FUNCTION: JET RADIUS, INTERACTION GRU03530
CONSTANT, VERTICAL UPWASH SHEET MOMENTUM, AND COALESCENCE ANGLE') GRU03540
WRITE (6,551) RG,ACON,XMMZ,PHID GRU03550
551 FORMAT (15X,'RG/KN=',F10.5,2X,'ACON=',F10.5,2X,'XMMZ=',F10.5,2X, GRU03560
1FHID(DEGS)=',F10.5/) GRU03570
CALL WALLJ(SD,DUM1,DUM2,DUM3,DUM4,DELFW) GRU03580
CALL FGMAT(CU,DEFS,DELFW,RO,SD,ALFG,ALFUG) GRU03590
CALL SIMW(KDELFD,NFD,ALFWD,RATW,CSUW,CPU) GRU03600
CALL SIMUG(ALFUG,RATUG,CPU) GRU03610
CU=2.*AW*SL*VW/(RATW*CSUG) GRU03620
WRITE (6,557) CU GRU03630
557 FORMAT (25X,'UPWASH WIDTH CONSTANT ESTIMATE , CU=',F10.5) GRU03640
READ (5,661) IFRK GRU03650
661 FORMAT (11) GRU03660
C GRU03670
C TEST FOR INTERACTION OF DEFLECTION REGIONS GRU03680
C IF (CU*SD*RO.LE.SD) GO TO 222 GRU03690
C GRU03700
C COMPUTATION OF DEFLECTION REGION INTERACTION GRU03710
C CALL INTERG(XMMZ,DEFS,SD,RO,ALFG,EF5,CU,SIG) GRU03720
C GRU03730
C GO TO 223 GRU03740
222 EPS=0.0 GRU03750
SIG=1.0 GRU03760
PHID=0. GRU03770
PHID=0.0 GRU03780
WRITE (6,28) EF5,SIG,PHID,PHID GRU03790
28 FORMAT (1,20X,'JET AND UPWASH DEFLECTION REGIONS DO NOT INTERACT. GRU03800
1 CU ESTIMATE IS CORRECT / GRU03810
1/35X, F10.5,2X, SIG= ',F10.5,2X,'PHID=',F10.5,2X,'PHID= ',F10.5) GRU03820
1) GRU03830
WRITE (6,29) ALFG GRU03840
29 FORMAT (30X,'PHID=0.0 ALONG UPWASH LINE. ALFG=',F8.4,1X,' IN UPWASH GRU03850
WASH DEFLECTION REGION /) GRU03860
IF (IFRK.NE.0) CALL GLOT (ALFG,DEFS,SD,RO,EF5,CU,SIG,PHID,PHID) GRU03870
1) GRU03880
C GRU03890
C GRU03900
223 WRITE (6,111) GRU03910
111 FORMAT (1,20X,'***** COMPUTATION OF UPWASH FLOW FIELD *****' GRU03920

```

FIGURE 1-3. (Continued)

```

1*///
WRITE (6,112)
112 FORMAT (//35X,'COMPUTATION OF UPWASH STREAMLINE PROPERTIES')
PHI=60.0/180.
PHI=0.
114 FORMAT (//30X,'PHI=',FB.4,' DEGS')
DO 600 I=1,2
PHI=PHI+180./PI
WRITE (6,114) PHI
ZEND=ZFLANL/COS(PHI)
Y=5D*TAN(PHI)
RW=SQRT(5D**2+Y**2)
IF (RW.EQ.0) BWH=BWHD+DLBRN*/RW-RGH)
IF (RW.GT.0) BWH=BW3RW
CALL WALLJ(RW,VJGN,BWHG,BWG,CWVG,DELPWS)
IWR=1
CALL UPWASH(KO,RW,PHI,ZEND,BWHG,BWG,VJGN,DELPWS,CWVG,ALPG,DELF5,
1VUN,DELFUJ,RH,DOUG,IWR)
PHI=PHI+DEHL
600 CONTINUE
NUFT=50
XNUFT=XNUFT-1
ALFU=1.5
1
C CIRCULAR CYLINDER DRAG FUNCTION
C
DRAG=1/(1+0.5*(1-(4./3.)*(SIN(PHISL)**2)))
DO 700 I=1,25
SUMI=0.0
SUMIC=0.0
XI=0.
DADR=PI/25/XNUFT
WRITE (6,116)
116 FORMAT (//30X,'UPWASH PROPERTIES COMPUTED AT Z LOCATION OF UNDE
15) BODY BODY')
WRITE (6,118) ZFLANL
118 FORMAT (//30X,'BODY CENTERLINE LOCATION AT Z/RN=',F10.5)
WRITE (6,120)
20 FORMAT (//30X,'Z/RN=',F7.4,'X/ZEN=',F7.4,'X/RN=',F7.4,'X/ZEN',
16X,'LUNZEN=',F7.4,'LUNZRN=',F7.4,'LUNZRN',F7.4,'LUNZRN',F7.4,
1WR=0
DO 500 I=1,NUFT
FACT=1.0
IF (I.EQ.1) FACT=1.0
IF (I.EQ.NUFT) FACT=1
ZB=ZBODY(I)
PHI=ATAN(CWB/COS(ZFLANL-ZB))
RW=SQRT(CWB**2+ZB**2)
CALL WALLJ(RW,VJGN,BWHG,BWG,CWVG,DELPWS)
PHI=PHI+DEHL
CALL UPWASH(KO,RW,PHI,ZEND,BWHG,BWG,VJGN,DELPWS,CWVG,ALPG,DELF5,
1VUN,DELFUJ,RH,DOUG,IWR)
PHI=PHI+DEHL
ETAW=2*(1+ZB**2)/RW
IF (I.EQ.1) ETAW=1.
C=CUBIC(TAWB**3)
DELF=1.5*(1+DELF)
DELF=1.5*(1+DELF)
SUMI=CUBIC(ETAW)*FACT*DELF*(CUN**2)*(COS(PHISL)*DELF)**2)
SUMIC=CUBIC(ETAW)*DELF*FACT*DELF*(CUN**2)*(COS(PHISL)*DELF)**2)
DELF=1.5*(1+DELF)
PHI=PHI+DEHL
IF (I.EQ.1) PHI=180.
IF (I.EQ.1) PHI=180.
DELF=1.5*(1+DELF)

```

```

GRU03950
GRU03960
GRU03970
GRU03980
GRU03990
GRU04000
GRU04010
GRU04020
GRU04030
GRU04040
GRU04050
GRU04060
GRU04070
GRU04080
GRU04090
GRU04100
GRU04110
GRU04120
GRU04130
GRU04140
GRU04150
GRU04160
GRU04170
GRU04180
GRU04190
GRU04200
GRU04210
GRU04220
GRU04230
GRU04240
GRU04250
GRU04260
GRU04270
GRU04280
GRU04290
GRU04300
GRU04310
GRU04320
GRU04330
GRU04340
GRU04350
GRU04360
GRU04370
GRU04380
GRU04390
GRU04400
GRU04410
GRU04420
GRU04430
GRU04440
GRU04450
GRU04460
GRU04470
GRU04480
GRU04490
GRU04500
GRU04510
GRU04520
GRU04530
GRU04540
GRU04550
GRU04560
GRU04570
GRU04580
GRU04590
GRU04600

```

Figure A-8. Continued

```

      IF (DELFM.EQ.0.) DELFM=DELFUJ
      DELFUS=DELFUJ*DELFM
      FRS=(VUN*LOS(FHIB)*THETA)**2
      WRITE (6,77) ZU,RW,FHIB,XB,VUN,DELFUJ,BWH,DELFM,DELFUS,FRS
77  FORMAT (1X,9(F10.5,2X),F8.5)
      XB=XBIDXB
500  CONTINUE
C
C  FLAT BOTTOM LIFT FORCE
C
      XLUT=(1./PI)**SUMF
      WRITE (6,77B)
77B  FORMAT (//30X,'FLAT BOTTOM VEHICLE WITH SHARP CORNERS')
      WRITE (6,771) XLUT
771  FORMAT (35X,'UPWASH LIFT FORCE',5X,'(L/2T)**',F10.5//)
C
C  UPWASH LIFT FORCE FOR CIRCULAR CROSS SECTION
C
      XLUT=(1./PI)**SUMFL
      WRITE (6,773)
773  FORMAT (//30X,'BODY WITH CIRCULAR CROSS SECTION')
      WRITE (6,771) XLUT
      ZPLANE=ZPLANE+2.*ZFL
      IF (ZPLANE.GT.2.*ZFINAL) STOP
700  CONTINUE
      END

```

```

GRU04610
GRU04620
GRU04630
GRU04640
GRU04650
GRU04660
GRU04670
GRU04680
GRU04690
GRU04700
GRU04710
GRU04720
GRU04730
GRU04740
GRU04750
GRU04760
GRU04770
GRU04780
GRU04790
GRU04800
GRU04810
GRU04820
GRU04830
GRU04840
GRU04850
GRU04860

```

```

      SUBROUTINE WALLJ(R,VUN,BWH,RW,CU2,DELFM)
      REAL KDEL,NO,KDELF,NO,NO,N,KDEL
C
C  THIS COMPUTES THE WALL JET PROPERTIES GIVEN A WALL RADIUS
C
C  (COMMON/WALL/ DELS,NO,KDEL,ALFD,ALFWD,ALFWD,RO,RGH,UG,BWH)
C
C  MAXIMUM VELOCITY DISTRIBUTION IN DEFLECTION REGION
C
      AM3=.09
      NI D=2.
      KDELF=1./9.
      RW3HO=AM3*RO
      DELBRH=(RW3HO-BWH)/(RO-RGH)
      ALFWD=1.5
      DELAR=(ALFWD-ALFWD)/(RO-RGH)
      DELNR=(NI D*NO)/(RO-RGH)
      ABELBT=.0175
      ABELBL=(ABELBT*(RO-2.)-DELS)/(RO-RGH)
      DKDELK=(KDELF-KDEL)/(RO-RGH)
      IF (R.LE.KO) FETA=(1.-(R/RO)**ALFG)**4
      IF (R.GT.KO) FETA=0.0
      IF (R.LE.RGH) VHG=SQRT(1.-FETA)
      IF (R.LE.RGH) VUN=VHG*UG
      IF (R.LE.RGH) GO TO 401
      IF (R.LE.KO) BWH=BWH+DELBRH*(R-RGH)
      IF (R.GT.KO) BWH=AM3*RO
      IF (R.LE.KO) ALFW=ALFWD+DELAR*(R-RGH)
      IF (R.GT.KO) ALFW=ALFWD
      IF (R.LE.KO) N=NO+DELNR*(R-RGH)
      IF (R.GT.KO) N=NO
      IF (R.LE.KO) DELBL=DELS+ABELBL*(R-RGH)
      IF (R.GT.KO) DELBL=ABELBT*(R-2.)
      ALAM=(2.-SQRT(2.))/2.*(1./ALFB)
      KDEL=DELFM/(DELFM+BWH-DELFM)/ALAM
      C.LL 51FW(KDEL,N,ALFW,FAT,CU2,LP)
      (C.LL.4.) VJDELH=1.0

```

```

WAL00010
WAL00020
WAL00030
WAL00040
WAL00050
WAL00060
WAL00070
WAL00080
WAL00090
WAL00100
WAL00110
WAL00120
WAL00130
WAL00140
WAL00150
WAL00160
WAL00170
WAL00180
WAL00190
WAL00200
WAL00210
WAL00220
WAL00230
WAL00240
WAL00250
WAL00260
WAL00270
WAL00280
WAL00290
WAL00300
WAL00310
WAL00320
WAL00330
WAL00340
WAL00350
WAL00360
WAL00370

```

Figure A-5. Continued

```

IF (R.GT.4.) VISION=1./R/4.**.24
F1=VISION*ARAT*(1.-FETA)/(R*BW)
F2=CF*FETA*VG**2
VMN=SDRT*((F1-F2)/(2.*FV2))
VMG=VMN/UG
DELPW=FETA*VG**2+VMN**2
RW=BMH/RAT
DELTA=KEL*RW
401 CONTINUE
IF (K.LT.RGH) DELP=VG**2
IF (K.LT.RGH) RW=BMH
RETURN
END
MAL00380
MAL00390
MAL00400
MAL00410
MAL00420
MAL00430
MAL00440
MAL00450
MAL00460
MAL00470
MAL00480
MAL00490
MAL00500

SUBROUTINE DUMASH (K0,KWALL,PHI,ZEND,BWGH,BWG,VMGN,DEL,MS+CPWG,
1ALFG,DELT,VMN,DELP,ROH,ZOU,TWR)
COMMON /AT/ MS+KGH
REAL RUMU
UP000010
UP000020
UP000030
UP000040
UP000050
UP000060
UP000070
UP000080
UP000090
UP000100
UP000110
UP000120
UP000130
UP000140
UP000150
UP000160
UP000170
UP000180
UP000190
UP000200
UP000210
UP000220
UP000230
UP000240
UP000250
UP000260
UP000270
UP000280
UP000290
UP000300
UP000310
UP000320
UP000330
UP000340
UP000350
UP000360
UP000370
UP000380
UP000390
UP000400
UP000410
UP000420
UP000430
UP000440
UP000450
UP000460
UP000470
UP000480
UP000490
UP000500

C THIS ROUTINE COMPUTES THE DUMASH STEADY STATE PROPERTIES
C
ADD=5.
F1=5.14159265
ALUM=1.7
ALUM1=1.7
ALON=1.-(K0/MS)**2
IF (ALON.GE.0.) GO TO 20
FHD=ABS((ALON/MS)**2)
ALON=1.-(K0/MS)**2
FHD=1-FHD
IF (FHD.GE.0.) MOVE ALON=SIGN(FHD,FHD)**2
IF (FHD.LT.0.) MOVE ALON=SIGN(FHD,FHD)**2
IF (FHD.LT.0.)
17 MOVE=ABS(FHD)
20 CONTINUE
25 F1=K0*(1.+ALON)/(F10.5)*K*MOVE/(F10.5)
ADD=5.
ALUM=1.7
ALUM1=1.7
ALUM2=1.7
ALUM3=1.7
ALUM4=1.7
ALUM5=1.7
ALUM6=1.7
ALUM7=1.7
ALUM8=1.7
ALUM9=1.7
ALUM10=1.7
ALUM11=1.7
ALUM12=1.7
ALUM13=1.7
ALUM14=1.7
ALUM15=1.7
ALUM16=1.7
ALUM17=1.7
ALUM18=1.7
ALUM19=1.7
ALUM20=1.7
ALUM21=1.7
ALUM22=1.7
ALUM23=1.7
ALUM24=1.7
ALUM25=1.7
ALUM26=1.7
ALUM27=1.7
ALUM28=1.7
ALUM29=1.7
ALUM30=1.7
ALUM31=1.7
ALUM32=1.7
ALUM33=1.7
ALUM34=1.7
ALUM35=1.7
ALUM36=1.7
ALUM37=1.7
ALUM38=1.7
ALUM39=1.7
ALUM40=1.7
ALUM41=1.7
ALUM42=1.7
ALUM43=1.7
ALUM44=1.7
ALUM45=1.7
ALUM46=1.7
ALUM47=1.7
ALUM48=1.7
ALUM49=1.7
ALUM50=1.7

C DETERMINE DELTA FROM INFLUID DEFLECTION
C DETERMINE INITIAL DUMASH WIDTH
C
DELP=VMN**2
DELP=DELP*F1
DELP=DELP*F2
DELP=DELP*F3
DELP=DELP*F4
DELP=DELP*F5
DELP=DELP*F6
DELP=DELP*F7
DELP=DELP*F8
DELP=DELP*F9
DELP=DELP*F10
DELP=DELP*F11
DELP=DELP*F12
DELP=DELP*F13
DELP=DELP*F14
DELP=DELP*F15
DELP=DELP*F16
DELP=DELP*F17
DELP=DELP*F18
DELP=DELP*F19
DELP=DELP*F20
DELP=DELP*F21
DELP=DELP*F22
DELP=DELP*F23
DELP=DELP*F24
DELP=DELP*F25
DELP=DELP*F26
DELP=DELP*F27
DELP=DELP*F28
DELP=DELP*F29
DELP=DELP*F30
DELP=DELP*F31
DELP=DELP*F32
DELP=DELP*F33
DELP=DELP*F34
DELP=DELP*F35
DELP=DELP*F36
DELP=DELP*F37
DELP=DELP*F38
DELP=DELP*F39
DELP=DELP*F40
DELP=DELP*F41
DELP=DELP*F42
DELP=DELP*F43
DELP=DELP*F44
DELP=DELP*F45
DELP=DELP*F46
DELP=DELP*F47
DELP=DELP*F48
DELP=DELP*F49
DELP=DELP*F50

```

Figure A-3. Continued

```

1.2X,'BUOHN/RN=',(10.5/,)
NUPT=25
XNUPT=NUPT-1
DZ=(ZEND-PWGH)/XNUPT
Z=BWGH
IF (IWR.NE.0) WRITE (6,12)
12 FORMAT (16X,'Z/RN',6X,'VMU/UN',6X,'BUH/RN',6X,'BU/RN',6X,
1'DELPU/DELPJ'/)
DO 100 I=1,NUPT
BUH=BUOHN/AU3*(Z-BWGH)*(COS(PHI)**ALU1)
BU=BUH/RAT
ZETA=Z/ZOU
IF (Z.GE.ZOU) ZETA=1.
FETA=(1.-ZETA**ALPU1)**4
FETAH=(1.-ZETA**ALPHU)**4
F1=.5*VMU*(1.-FETAH)/(BU*(HWALL+Z)*CV2U)
F2=.5*DELFUJ*FETA
IF (F1.LT.F2) VMUN=0.
IF (F1.LT.F2) GO TO 905
VMUN=SQRT(F1-F2)
905 DELFUJ=VMUN**2*DELFUJ*FETA
IF (IWR.EQ.0) DELPUJ=DELFUJ/DELS
IF (IWR.NE.0) WRITE (6,11) Z,VMUN,BUH,BU,DELPJ
11 FORMAT (10X,'',(F10.5,2X))
Z=Z+DZ
100 CONTINUE
RETURN
END

```

```

UPW00510
UPW00520
UPW00530
UPW00540
UPW00550
UPW00560
UPW00570
UPW00580
UPW00590
UPW00600
UPW00610
UPW00620
UPW00630
UPW00640
UPW00650
UPW00660
UPW00670
UPW00680
UPW00690
UPW00700
UPW00710
UPW00720
UPW00730
UPW00740
UPW00750
UPW00760
UPW00770
UPW00780

```

Figure A-3, Continued

```

XPTS=NUPTS-1.
DFHIU=FHIU0/XPTS
FHIU(1)=0.
SUM1=0.
DO 200 IJ=1,NUPTS
FACT=2.0
IF (IJ.EQ.1) FACT=1.0
IF (I.IE.NUPTS) FACT=1.0
RW=SD/COS(FHIU(IJ))
CALL WAI LJ (RW,VMN,DUM2,DUM3,DUM4,DELFW)
IF (I.IE.1.AND.IFLAG.EQ.1) WRITE (6,111) DELFW
111 FORMAT (3X, F10.0, DELFW, F10.5)
YU=FHI*SIGI*SD/COS(FHIU(IJ))
XU=SD*ATAN(FHIU(IJ))
PHI(IJ)=ATAN2(XU,SD-YU)
RU=(SD-YU)/COS(FHIU(IJ))
ROF=ROFF I*(1.-COS(PHI(IJ)))
ETAM=RO/ROF
IF (ETAM.GT.1.) ETAG=0.0
IF (ETAM.GT.1.) GO TO 1011
ETAG=ETAC(ETAM,ALPG)
1011 FMIN=DELFS*ETAG
IF (I.IE.1.AND.IFLAG.EQ.1) WRITE (6,775) FMIN
775 FORMAT (3X, F10.0, FMIN, F10.5)
PMAX=DELFW*VMN**2*(VMN*COS(FHIU(IJ)))**2
CALL FBATCH (FMIN,PMAX,ALPG)
IF (I.IE.1.AND.IFLAG.EQ.1) WRITE (6,1075) ALPG
1075 FORMAT (3X, F10.0, ALPG, F10.5)
CALL SIMCO,ALPG,KATU,CSEBU)
PMAX=DELFW*VMN**2*(VMN*COS(FHIU(IJ)))**2
FU=DELFS*ETAG*SD*ROF*(MAX(DELFS*ETAG)
FU=SIGI*RU/COS(FHIU(IJ))**2)
SUM1=SUM1+.5*DFHIU*FACT*FU
IF (ETAM.GT.1.) ETAM=1.0
CSEBU(1)=SEI(ETAM,ALPG)
FHIU(IJ)=FHIU(IJ)+DFHIU
200 CONTINUE
X110G=(U1)*SUM1**0.5
SUM1=0.
NPTS=NPTS-1
DO 300 IJ=1,NPTS
ROFF=ROFF I*(1.-COS(FHIU(IJ)))
ROFSD=ROFF**2
ROFM=ROFF I*(1.-COS(FHIU(IJ)))
ROFMSD=ROF**2
FM=ROFMSD*CSEBU(1)
FF=ROFMSD*CSEBU(1)
DFHI=FHIU(IJ)-FHIU(IJ)
SUM1=SUM1+.5*DFHI*(FM+FF)
300 CONTINUE
X110G=DELFS*SUM1
CALL SIMCO,ALPG,KATU,CSEBU)
X110G=CSEBU(1)*DELFS*ROFF I*(K012,SEI(1)*1.5*ETI**2)
X110G=X110G*X110G
FHIU(IJ)=X110G
DFHI=CSEBU(1)*DFHI*(X110G)
SUM1=0.0
DFHIU=DFHIU
X110G=X110G*(1.-SIN(FHIU(IJ)))
FHIU(IJ)=X110G*X110G*VMN
IF (I.EQ.1) GO TO 502
FHIU(IJ)=DFHIU
502 CONTINUE
DO 11 IJ=1,NUPTS
DELFS=VMN
END

```

```

INT00630
INT00640
INT00650
INT00660
INT00670
INT00680
INT00690
INT00700
INT00710
INT00720
INT00730
INT00740
INT00750
INT00760
INT00770
INT00780
INT00790
INT00800
INT00810
INT00820
INT00830
INT00840
INT00850
INT00860
INT00870
INT00880
INT00890
INT00900
INT00910
INT00920
INT00930
INT00940
INT00950
INT00960
INT00970
INT00980
INT00990
INT01000
INT01010
INT01020
INT01030
INT01040
INT01050
INT01060
INT01070
INT01080
INT01090
INT01100
INT01110
INT01120
INT01130
INT01140
INT01150
INT01160
INT01170
INT01180
INT01190
INT01200
INT01210
INT01220
INT01230
INT01240
INT01250
INT01260
INT01270
INT01280

```

Figure A-3. Continued

```

IF (ITR.EQ.2) FUIE=(FUI(ITR)-FUI(ITR-1))/DEFI      INTO1290
IF (ITR.EQ.4) FUII=(FUI(ITR)-FUI(ITR-1))/DCUI      INTO1300
IF (ITR.EQ.2) FJIE=(FJI(ITR)-FJI(ITR-1))/DEFI      INTO1310
IF (ITR.EQ.4) FJII=(FJI(ITR)-FJI(ITR-1))/DCFI      INTO1320
1000 CONTINUE
DET=FUIE*FJIE-FJIE*FUII
DELE=(FJI(1)*FUII-FUI(1)*FJII)/DET                INTO1330
DELC=(FUI(1)*FJII-FJI(1)*FUII)/DET                INTO1340
EP(J+1)=EP(1)+RELAX*DELE                          INTO1350
C(J+1)=C(1)+RELAX*DELC                            INTO1360
900 FORMAT (15X,' ITERATION CYCLE=',I3,2X,'EFS=',F10.5,2X,'SIGMA=',F10.5,INTO1370
15)
IF (ABS(DELE).LT.1.E-5.AND.ABS(DELC).LT.1.E-5) IFLAG=1  INTO1400
IF (IFLAG.EQ.1) WRITE (6,909)                      INTO1410
909 FORMAT (20X,' SOLUTION OF GROUND PRESSURE DISTRIBUTION HAS BEEN FOUND',INTO1430
1ND')
IF (IFLAG.EQ.1) WRITE (6,905) J,EP(J+1),C(J+1)      INTO1440
900 CONTINUE                                       INTO1450
STOP                                             INTO1460
907 SIG=C(J)                                       INTO1470
EFS=EP(J)                                         INTO1480
CUI=SIG*CUI                                       INTO1490
WRITE (6,13) CUI                                  INTO1500
13 FORMAT (20X,' WASH THICKNESS CONSTANT, (CUI) X (SIGMA)=',F10.5) INTO1510
IF (IPBAR.NE.0) CALL GPHD(CALF,DEFS,SD,RO,LPS,CUI),SIG,PHUD,PHIG,INTO1530
1)                                                 INTO1540
RETURN                                           INTO1550
END                                             INTO1560

```

Figure A-3. Continued

```

SURROUTINE GPLOT (ALPG,DELPS,SD,RO,EPS,CUT,SIGI,FHUB,PHIO)      GPL00010
DIMENSION PU(25),RWALL(102),ERR(102),XPLOTU(202),YPLDTU(      GPL00020
1202),XPLDTJ(202),YPLDTJ(202),XAXIS(30),YAXIS(30),XDATA(10),YDATA(10)      GPL00030
20)      GPL00040
COMMON /HEIGHT/ HD,IPBAR      GPL00050
THIS ROUTINE COMPUTES THE GROUND ISOBAR PATTERN FOR THE TWO-JET      GPL00070
IMPINGEMENT FLOW FIELD      GPL00080
      GPL00090
      FETA(ETA,A)=(1.-ETA**A)**4      GPL00100
INPUT NUMBER OF ISOBAR VALUES      GPL00110
      GPL00120
      READ(5,51) NU      GPL00130
51 FORMAT (12)      GPL00140
      WRITE (6,53) NU      GPL00150
53 FORMAT (1,'//30X,*** COMPUTATION OF TWO-JET GROUND ISOBAR PATTERN'      GPL00170
1RN ***'//32X,12,' VALUES OF PRESSURE SPECIFIED FOR PATTERN'      GPL00180
2//)      GPL00190
INPUT NU ISOBAR VALUES FOR GROUND PATTERN      GPL00200
      GPL00210
      READ(5,1) (I(1),I=1,NU)      GPL00220
1 FORMAT (F10.5)      GPL00230
      WRITE (6,112) (I(1),I=1,NU)      GPL00240
112 FORMAT (10X,'FRAN=',0(F10.5,2X))      GPL00250
      WRITE (6,121)      GPL00270
121 FORMAT (//25X,'GROUND PATTERN IN JET (CENTERED COORDINATE SYSTEM'//      GPL00280
1)      GPL00290
      NU IS=29      GPL00300
      CALL PLOT(6,0,-3)      GPL00310
      XLMAX=KDFD      GPL00320
      XSC=XLMAX/B      GPL00330
      XSC=1.0      GPL00340
      XMIN=0.      GPL00350
      DXMIN= 1.      GPL00360
      DO B01 IP=1,100      GPL00370
      IF (XMIN,11, K0) GO TO B02      GPL00380
      XMIN=XMIN+DXMIN      GPL00390
B01 CONTINUE      GPL00400
B02 XMAX=XD      GPL00410
      DXAXIS=XD-XMIN      GPL00420
      NAPIS=DXAXIS/11      GPL00430
      XAXIS(1)=XMIN,XSC      GPL00440
      YAXIS(1)=0.      GPL00450
      DO B03 IF=2,NAPIS      GPL00460
      XAXIS(IF)=XAXIS(1)+11./XSC      GPL00470
      YAXIS(IF)=YAXIS(1)+1      GPL00480
B03 CONTINUE      GPL00490
      DYAX=1./XSC      GPL00500
      XAXIS(NAPIS+1)=SD/XSC      GPL00510
      YAXIS(NAPIS+1)=0.      GPL00520
      DO B04 IF=2,NAPIS      GPL00530
      XAXIS(NAPIS+1)+SD/XSC      GPL00540
      YAXIS(NAPIS+1)=YAXIS(NAPIS+1)+1/DYAX      GPL00550
B04 CONTINUE      GPL00560
      NE(1)=NAPIS      GPL00570
      CALL LINE (XAXIS,YAXIS,NE(1),1,1, 3,1,1)      GPL00580
      CALL SYMBOL (3,0,1,2, HD,0-14 0, 5/2=2.00 *0.1B)      GPL00590
      I=3,11,2,5      GPL00600
      X1=NU+1      GPL00610
      KLEAS=      GPL00620

```

Figure A-3, Continued

```

DO 500 I=1,NU
WRITE (6,66) PU(I)
66 FORMAT (///45X,'PBAR=',F10.5)
IFLAG=1
XPUF=0.
IJET=1
IU=1
RW=SD
ALPUG=1.5
CALL WALLJ (RW,VMN,DUM2,DUM3,DUM4,DELFW)
PMAX=DELFW
IF (FMXG.LT.FU(I)) IFLAG=0
RW=SD/COS (PHIU)
CALL WALL (RW,VMN,DUM2,DUM3,DUM4,DELFW)
PMAF=DELFW-VMN**2+(VMN*LOS(PHIU))**2
IF (IFLAG.EQ.0) GO TO 502
RWALL(1)=SD
RWALL(2)=SD*.1
DO 400 K=1,100
CALL WALLJ(RWALL(K),VMN,DUM2,DUM3,DUM4,DELFW)
XU=SQRT(RWALL(K)**2-SD**2)
PHIU=ATAN2(XU,SD)
PMAF=DELFW-VMN**2+(VMN*LOS(PHIU))**2
ERR(K)=FU(I)-PMAF
IF (K.EQ.1) GO TO 400
IF (ABS(ERR(K)).LT.1.E-5) GO TO 501
DRDE=(RWALL(K)-RWALL(K-1))/(ERR(K)-ERR(K-1))
RWALL(K+1)=RWALL(K)-RELAX*DRDE*ERR(K)
400 CONTINUE
STOP
501 RW=RWALL(K)
XPUF=SQRT(RW**2-SD**2)
PUF=ATAN2(XPUF,SD)
YUF=CUI*SIGI*SD/COS(PUF)
FUI=FU(I)*180./PI
502 DEHIU=PHIU/XFIS
IF (PHIU.EQ.0.) GO TO 201
PHIU=0.
DO 200 I=1,NUMPTS
RW=SD/COS(PHIU)
CALL WALLJ (RW,VMN,DUM2,DUM3,DUM4,DELFW)
YU=CUI*SIGI*SD/COS(PHIU)
XU=SD*ATAN(PHIU)
PHI=ATAN2(XU,SD-YU)
KU=(SD-YU)/COS(PHI)
KUI=KUI*SIGI*1./COS(PHI)
ETAM=KUI/KUI
IF (ETAM.GT.1.) FETAG=0.0
IF (ETAM.GT.1.) GO TO 1011
FETAG=FETAG*ALFEG)
1011 FMIN=DELFW-VMN**2+(VMN*LOS(PHIU))**2
CALL FMATCH (FMIN,FMAX,ALFEG)
FBAK=CUI(I)*FMIN)/(FMAX-FMIN)
IF (FMIN.GE.FUCI) GO TO 509
FBAK=FUCI)/DELFW
IF (FBAK.GE.1.) GO TO 509
FETAG=CUI*FBAK**2)*ALFEG)
ALFEG=CUI(I)*KUI*ETA*LOS(PHI)
FETAG=CUI(I)*KUI*ETA*LOS(PHI)
ALFEG=CUI(I)*FETAG*FETAG**2)*ALFEG)
FETAG=CUI(I)*FETAG*FETAG**2)*ALFEG)
FETAG=CUI(I)
509 IF (FBAK.GE.1.05) FBAK=FETAG GO TO 506
FETAG=CUI*FBAK**2)*ALFEG)
FETAG=CUI(I)*FETAG
FETAG=CUI(I)*FETAG

```

```

GPL00630
GPL00640
GPL00650
GPL00660
GPL00670
GPL00680
GPL00690
GPL00700
GPL00710
GPL00720
GPL00730
GPL00740
GPL00750
GPL00760
GPL00770
GPL00780
GPL00790
GPL00800
GPL00810
GPL00820
GPL00830
GPL00840
GPL00850
GPL00860
GPL00870
GPL00880
GPL00890
GPL00900
GPL00910
GPL00920
GPL00930
GPL00940
GPL00950
GPL00960
GPL00970
GPL00980
GPL00990
GPL01000
GPL01010
GPL01020
GPL01030
GPL01040
GPL01050
GPL01060
GPL01070
GPL01080
GPL01090
GPL01100
GPL01110
GPL01120
GPL01130
GPL01140
GPL01150
GPL01160
GPL01170
GPL01180
GPL01190
GPL01200
GPL01210
GPL01220
GPL01230
GPL01240
GPL01250
GPL01260
GPL01270
GPL01280

```

Figure A-3. Continued

YFLOTU(IU)=XU	GFLO1290
XFLOTU(IU)=XFLOTU(IU)/XSC	GFLO1300
YPLOTU(IU)=YFLOTU(IU)/XSC	GFLO1310
IU=IU+1	GFLO1320
506 PHIU=PHIU+DPHIU	GFLO1330
200 CONTINUE	GFLO1340
201 IF HI=(PI-FHI0)/XFITS	GFLO1350
FHI=FHI0	GFLO1360
DO 600 IN=1,NUFITS	GFLO1370
FRARJ=FU(I)/DELS	GFLO1380
IF (FRARJ.GT.1.) GO TO 600	GFLO1390
ETAJ=(1.-FRARJ**.25)**(1./ALPG)	GFLO1400
ROP=RO+ELCS*(1.+COS(PHI))	GFLO1410
XFLOTJ(IJET)=ROF*ETAJ*COS(PHI)	GFLO1420
YFLOTJ(IJET)=ROP*ETAJ*SIN(PHI)	GFLO1430
XFLOT(IJET)=XFLOTJ(IJET)/XSC	GFLO1440
YFLOT(IJET)=YFLOTJ(IJET)/XSC	GFLO1450
IJET=IJET+1	GFLO1460
FHI=FHI+DPHI	GFLO1470
600 CONTINUE	GFLO1480
IF (IFLAG.EQ.0) GO TO 513	GFLO1490
IF (FU(I).EQ.0.) GO TO 513	GFLO1500
IF (FUF.LT.FHI00) GO TO 510	GFLO1510
GO TO 511	GFLO1520
510 XFLOTH(IU)=SF	GFLO1530
XFLOTU(IU)=XFUF	GFLO1540
XPLOTU(IU)=XFLOTU(IU)/XSC	GFLO1550
YPLOTU(IU)=YFLOTU(IU)/XSC	GFLO1560
GO TO 800	GFLO1570
511 PHIU=(FUF-FHI00)/XFITS	GFLO1580
FHIU=FHI00	GFLO1590
DO 700 IJ=1,NUFITS	GFLO1600
YU=CU1*SIG1*SD/COS(PHIU)	GFLO1610
XU=SD*TAN(PHIU)	GFLO1620
KW=SD*COS(PHIU)	GFLO1630
(ALL WALL JCRW,VMN,DUM2,DUM3,DUM4,DELFW)	GFLO1640
FMAX=DELFW-VMN**2*(VMN*COS(PHIU))**2	GFLO1650
FBAK=FU(I)/FMAX	GFLO1660
ETAU=(1.-FBAK**.5)**(1./ALPUG)	GFLO1670
XFLOTU(IU)=SD-YU*ETAU	GFLO1680
YFLOTU(IU)=XU	GFLO1690
XFLOTU(IU)=XFLOTU(IU)/XSC	GFLO1700
YFLOTU(IU)=YFLOTU(IU)/XSC	GFLO1710
IU=IU+1	GFLO1720
PHIU=PHIU+DPHIU	GFLO1730
700 CONTINUE	GFLO1740
513 IU=IU-1	GFLO1750
800 IJET=IJET-1	GFLO1760
WRITE (6,11) IJET,IU	GFLO1770
11 FORMAT ('//1X, IJET= ',I4,3X, 'UFWASH DEFL',G10.5,2X)	GFLO1780
12 IJETION REGION, IU = ',I4//)	GFLO1790
IF (IJET.GE.0.OR.IU.GE.0) WRITE (6,552)	GFLO1800
552 FORMAT ('//3X, X150J ,6X, Y150J ,8X, X150U ,8X, Y150U //')	GFLO1810
IMIN=IU	GFLO1820
IMAX=IJET	GFLO1830
IF (IU.GE.1.IJET) IMAX=IU	GFLO1840
IF (IU.GE.1.IJET) IMIN=IJET	GFLO1850
DO 103 IM=1,IMAX	GFLO1860
IF (IM.LE.IMIN) WRITE (6,12) XFLOT(IM),YFLOTJ(IM),XFLOTU(IM),YFLOTG101870	GFLO1870
103 IM)	GFLO1880
12 FORMAT ('50X,4(F10.5,2X)')	GFLO1890
IF (IM.GE.IMIN.AND.IMIN.EQ.IU) WRITE (6,15) XFLOTJ(IM),YFLOTJ(IM)	GFLO1900
15 FORMAT ('50X,2(F10.5,2X)')	GFLO1910
IF (IW.GE.IMIN.AND.IMIN.EQ.IJET) WRITE (6,16) XFLOTU(IM),YFLOTU(IM)	GFLO1920
16	GFLO1930
15 FORMAT ('54X,2(F10.5,2X)')	GFLO1940

Figure A-3. Continued

```

803 CONTINUE                                GFLO1950
C CALL LINE (XFLOTU,YFLOTU,IU,1,1,1,1)     GFLO1960
C CALL LINE (XFLOTJ,YFLOTJ,IJET,1,1,1,1)   GFLO1970
700 CONTINUE                                GFLO1980
DEHIU=.5#I/XPTS                             GFLO1990
PHIU=0.                                       GFLO2000
DO 900 I=1,NPTS                               GFLO2010
YU=CUI#SIGI#SD/COS(PHIU)                     GFLO2020
XD=SD#TAN(PHIU)                               GFLO2030
IF (ABS(UT,XLMAX) GO TO 901                   GFLO2040
XFLOTU(I)-SD*YU                               GFLO2050
YFLOTU(I)-XU                                  GFLO2060
XFLOTU(I)-XFLOTU(IJ)/XSC                     GFLO2070
YFLOTU(I)-YFLOTU(IJ)/XSC                     GFLO2080
FHU=FHIU+DEHIU                               GFLO2090
900 CONTINUE                                GFLO2100
901 I=I+1                                     GFLO2110
WRITE (6,107)                                GFLO2120
807 FORMAT (//15X, 'WASH DEFLECTION ZONE LINE, PPAR=0 OUTSIDE INTERA',GFLO2130
ACTION REGION //)                            GFLO2140
WRITE (6,108)                                GFLO2150
808 FORMAT ('X',XUP,'BX',/UP//)             GFLO2160
DO 813 IM=1,IU                               GFLO2170
WRITE (6,811) XFLOTU(IM),YFLOTU(IM)         GFLO2180
813 CONTINUE                                GFLO2190
811 FORMAT ('OX',2(F10.5,2X))               GFLO2200
C CALL LINE (XFLOTU,YFLOTU,IU,1,1,1,1)     GFLO2210
C CALL DRAW                                  GFLO2220
C CALL PLOT (-99.,99.,-1)                   GFLO2230
C READ (5,101) FAUSE                          GFLO2240
101 FORMAT (1X,F10.5)                        GFLO2250
RETURN                                       GFLO2260
END                                           GFLO2270

SUBROUTINE JETIC (LTAU,KJH,ALFC,K,CV2)       JE100010
DIMENSION ALP(100),ERR(100)                JE100020
THE ROUTINE COMPUTES THE EXPONENT OF THE JET VELOCITY PROFILE
IN THE POTENTIAL CURVE REGION              JE100030
JE100040
JE100050
JE100060
ALP(1)=1.0                                  JE100070
ALP(2)=10.                                  JE100080
DO 100 I=1,99                               JE100090
CALL SIM(LTAU,ALP(I),K,CV2)                 JE100100
ERR(I)=CV2*.25*(K-K0)**2                    JE100110
JE (1,6E-2) ALP(I+1)=ALP(I) ((ALP(I)-ALP(I-1))/(ERR(I)-ERR(I-1)))# JE100120
ERR(I)                                       JE100130
ALP(I)=ALP(I)                               JE100140
IF (ABS(ERR(I)).LT 1.E-5) GO TO 101         JE100150
100 CONTINUE                                JE100160
C END                                         JE100170
101 RETURN                                   JE100180
END                                           JE100190

SUBROUTINE SIM(LTAU,ALP,K,CV2)              SIM00010
INTEGRAL OF JET VELOCITY PROFILE FUNCTION CV2
K RATIO OF 0.00 TO 1.0                     SIM00020
SIM00030
SIM00040
SIM00050
ALP(1)=ALP(1) CALL F1(X) CALL F2(X) CALL F3(X) CALL F4(X) CALL F5(X) SIM00060
ALP(2)=ALP(2) CALL F1(X) CALL F2(X) CALL F3(X) CALL F4(X) CALL F5(X) SIM00070
C CALL F1(X) CALL F2(X) CALL F3(X) CALL F4(X) CALL F5(X) SIM00080

```

Figure A-2. Continued

```

R=ETAC*(1.-ETAC)*((2.-SQRT(2.))/2.)**(1./ALF)
RETURN
END
SIM00090
SIM00100
SIM00110

SUBROUTINE GPRES (FO,UG,ALPG,R,CV2)
DIMENSION ALF(100),ERR(100)
GFR00010
GFR00020
GFR00030
GFR00040
GFR00050
GFR00060
GFR00070
GFR00080
GFR00090
GFR00100
GFR00110
GFR00120
GFR00130
GFR00140
GFR00150
GFR00160
GFR00170
GFR00180
GFR00190

C THIS ROUTINE SOLVES GROUND PRESSURE INTEGRAL FOR GROUND PRESSURE
C EXPONENT
C
ALP(1)=1.5
ALP(2)=5.
DO 100 I=1,99
CALL SIM(0.0,ALP(I),R,CV2)
ERR(I)=R0-1./(UG*SQRT(CV2))
IF (I.GE.2) ALP(I+1)=ALP(I)-((ALP(I)-ALP(I-1)))/(ERR(I)-ERR(I-1))
1ERR(I)
ALPG=ALP(I)
IF (ABS(ERR(I)).LT.1.E-5) GO TO 101
100 CONTINUE
STOP
-101 RETURN
END

SUBROUTINE SIMW(KDEL,N,ALFW,R,CV2,CP)
SIM00010
SIM00020
SIM00030
SIM00040
SIM00050
SIM00060
SIM00070
SIM00080
SIM00090
SIM00100
SIM00110
SIM00120
SIM00130
SIM00140
SIM00150
SIM00160
SIM00170
SIM00180
SIM00190

C THIS ROUTINE COMPUTES THE INTEGRAL OF THE VELOCITY SQUARED PROFILE
C AND STATIC PRESSURE PROFILE FOR WALL JET FUNCTIONS
C CV2=VELOCITY SQUARED INTEGRAL
C CP=STATIC PRESSURE INTEGRAL
C R=RATIO OF BWH TO BW
C
REAL KDEL,N
XN=N
XI1=1.-4./(ALFW+1.)+6./(2.*ALFW+1.)-4./(3.*ALFW+1.)+1./(4.*ALFW+1.)
CV2=(XN/(2.*XN))*KDEL*(1.-KDEL)*XI1
CP=KDEL*(1.-KDEL)*XI1
F=((2.-SQRT(2.))/2.)**(1./ALFW)
R=KDEL*(1.-KDEL)*F
RETURN
END

SUBROUTINE SIMUG(ALFU,R,CV2U)
SIM00010
SIM00020
SIM00030
SIM00040
SIM00050
SIM00060
SIM00070
SIM00080
SIM00090
SIM00100

C THIS ROUTINE COMPUTES VELOCITY SQUARED INTEGRAL FOR WASH
C
CV2U=1.-4./(ALFU+1.)+6./(2.*ALFU+1.)-4./(3.*ALFU+1.)+1./(4.*ALFU+1.)
F=(SQRT(2.)-1.)/SQRT(2.)
R=F**2./ALFU
RETURN
END

SUBROUTINE GMATCH (RG,UG,ALPG,KDEL,N,ETAWG,DELS,ALFW,R)
GMA00010
GMA00020
GMA00030

C THIS ROUTINE IS USED FOR INITIATING WALL JET REGION

```

Figure A-3. Continued

```

C      COMPUTES THE INTIAL INVISCID EXPONENT FOR WALL JET PROFILE
C
REAL KDEL,N
DIMENSION ALF(100),ERR(100)
ALF(1)=.1
RELAX=.5
ALP(2)=1.5
DO 100 I=1,100
CALL SIMW(KDEL,N,ALF(I),R,CV2,CP)
FETAG=(1.-ETAG**ALPG)**4
DEN=(RG*VG**2)*(2.*CV2*(1.-FETAG)+CP*FETAG)
RWD=(1.-FETAG)/DEN
RWOH=R*RWD
DELDM=RWO*KDEL
ERR(I)=DELDM DELS
IF (ABS(ERR(I)).LT.1.E-5) GO TO 101
IF (1.GE.2) ALF(I+1)=ALF(I)-((ALF(I)-ALF(I-1)))/(ERR(I)-ERR(I-1))*RELAX
100 CONTINUE
STOP
101 ALF=N-ALF(I)
RETURN
END
GHA00040
GHA00050
GHA00060
GHA00070
GHA00080
GHA00090
GHA00100
GHA00110
GHA00120
GHA00130
GHA00140
GHA00150
GHA00160
GHA00170
GHA00180
GHA00190
GHA00200
GHA00210
GHA00220
GHA00230
GHA00240
GHA00250
GHA00260

SUBROUTINE SIMU(ALFU,R,CV2U)
CV2U=1.4/(ALFU+1.)+6./(2.*ALFU+1.)-4./(3.*ALFU+1.)+1./(4.*ALFU+1.)
1.)
F=(SQRT(2.)-1.)/SQRT(2.)
K=F*(1./ALFU)
RETURN
END
SIM00010
SIM00020
SIM00030
SIM00040
SIM00050
SIM00060
SIM00070

SUBROUTINE FGMAT(CUFD,DELS,DELF,RO,SD,ALPG,ALFUG)
DIMENSION ERR(101),SIG(101)
C
C THIS ROUTINE COMPUTES EXPONENT OF UFWASH GROUND PRESSURE PROFILE
C
SIG(1)=.10
SIG(2)=1.0
ALFU=.15
DO 100 I=1,100
FR=(DELS/DELF)**(.25)
ETAG=RO*(1.-SIG(I))/RO
ETAU=SIG(I)/CUFD
F1=FR*(1.-ETAG**ALPG)
F2=1.-ETAU**ALFUG
ERR(I)=F1-F2
IF (1.EQ.1) GO TO 100
S=(SIG(I)-SIG(I-1))/(ABS(ERR(I)-ERR(I-1)))
IF (ABS(ERR(I)).LT.1.E-5) GO TO 101
SIG(I+1)=SIG(I)-S*ERR(I)
100 CONTINUE
STOP
101 SIG=N-SIG(I)
RETURN
END
FGU00010
FGU00020
FGU00030
FGU00040
FGU00050
FGU00060
FGU00070
FGU00080
FGU00090
FGU00100
FGU00110
FGU00120
FGU00130
FGU00140
FGU00150
FGU00160
FGU00170
FGU00180
FGU00190
FGU00200
FGU00210
FGU00220
FGU00230
FGU00240
FGU00250
FGU00260

```

Figure A-3. Continued

```
SUBROUTINE PMATCH (PMIN,PMAX,ALPUG)
DIMENSION ERR(101),AL(101)
```

THIS ROUTINE COMPUTES THE EXPONENT OF THE PRESSURE PROFILE FOR THE UPWASH DEFLECTION ZONE

```
ALPUFD=1.5
PB=PMIN/PMAX
ETAM=(1.-PB**25)**(1./ALPUFD)
CALL SIMUF(ALPUFD,ETAM,CSPUFD)
AL(1)=1.5
AL(2)=3.0
DO 100 I=1,100
CALL SIMUF(AL(I),1.0,CSPU)
X1=ETAM*(PB+(1.-PB)*CSPU)
X2=CSPUFD
ERR(I)=X1-X2
IF (ABS(ERR(I)).LT.1.E-5) GO TO 101
IF (I.EQ.1) GO TO 100
S=(AL(I)-AL(I-1))/(ERR(I)-ERR(I-1))
AL(I+1)=AL(I)-S*ERR(I)
100 CONTINUE
STOP
101 ALPUG=AL(I)
RETURN
END
```

```
FMA00010
FMA00020
FMA00030
FMA00040
FMA00050
FMA00060
FMA00070
FMA00080
FMA00090
FMA00100
FMA00110
FMA00120
FMA00130
FMA00140
FMA00150
FMA00160
FMA00170
FMA00180
FMA00190
FMA00200
FMA00210
FMA00220
FMA00230
FMA00240
FMA00250
FMA00260
```

Figure A-3. Concluded

12. References

1. Platzer, M.F. and Margason, R.J., "Prediction Methods for Jet V/STOL Propulsion Aerodynamics", *Jr. of Aircraft*, Vol. 15, No. 2, pp. 69-77, Feb. 1978.
2. Siciari, M.J., Migdal, D., and Palcza, J.L., "The Development of Theoretical Models for Jet-Induced Effects on V/STOL Aircraft", AIAA Paper No. 75-1216, AIAA/SAE 11th Propulsion Conference, Anaheim, Cal. Sept. 29 - Oct. 1, 1975.
3. Siciari, M.J., Hill, W.G., Jr., and Jenkins, R.C., "Investigation of Stagnation Line and Upwash Formation", AIAA Paper No. 77-615, AIAA/NASA, Ames V/STOL Conference, June 1977.
4. Siciari, M.J., Aklonis, P., Wohllobe, F., and Palcza, J.L., "Development of Prediction Techniques for Multi-Jet Thermal Ground Flow Fields and Fountain Formation", AIAA Paper No. 77-616, AIAA/NASA AMES V/STOL Conference, Palo Alto, Calif. June 6-8, 1977.
5. Hill, W.G., Jr. and Jenkins, R.C., "Effect of Nozzle Spacing on Ground Interference Forces for a Two-Jet V/STOL Aircraft" AIAA Paper No. 79-1856, AIAA Aircraft Systems and Technology Conference, New York City, N.Y., Aug. 20-22 1979.
6. Wohllobe, F.A. and Migdal, D. "Some Basic Test Results of V/STOL Jet-Induced Lift Effects in Hover", AIAA Paper No. 79-9339, Jan. 1979.
7. Kline, S.J., "On The Nature of Stall", *Trans. ASME, Series D, Journal of Engineering*, Vol. 81, pp. 305-320, 1959.
8. Hall, G.R. and Rogers, K.H., "Recirculation Effects Produced by a Pair of Heated Jets Impinging on a Ground Plane", NASA CR 1307, May 1969.
9. Gauntner, J.W., Livingood, J.N.B., and Hrycek, P., "Survey of Literature on Flow Characteristics of a Single Turbulent Jet Impinging on a Flat Plate", NASA TN D-5642, Feb. 1970.
10. Strand, T., "On the The Theory of Normal Ground Impingement of Axisymmetric Jets in Inviscid Incompressible Flow", AIAA Paper No. 64-424, 1964.

11. Schach, W., "Umlenkung eines Kreisförmigen Flüssigkeitsstrales an einer ebenen Platte senkrecht zur Strömungsrichtung," Ingenieur Archiv, p. 51, Vol. 6, 1935.
12. Shen, Y.C., "Theoretical Analysis of Jet-Ground Plane Interaction", IAS Paper No. 62-144, June 1962.
13. Barnes, D.A., and Sullivan, R.D., "Rotational Solutions of the Euler Equations", ARAP Report No. 79., AFOSR Scientific Report No. AFOSR 65-2656.
14. Rubel, A., "Computations of Jet Impingement on a Flat Surface", AIAAJ., Vol. 18, No. 2, 1980 (to be published) or AIAA Paper No. 73-207.
15. Bower, W.W., Agarwal, R.K., and Peters, G.R., "A Theoretical Study of Two and Three Dimensional Impinging Jets", Presented at Navy Workshop on V/STOL Aerodynamics, Monterey, Calif., May 1979.
16. Kotansky, D.R., Duranio, N.A., Bristow, D.R., and Saundres, P.W., "Multi-Jet Induced Forces and Moments on VTOL Aircraft Hovering In and Out of Ground Effect", Naval Air Development Center, Report No. NADC-77-229-30, June 1977.
17. Karemaa, A., Smith, C.W., Weber, H.A., and Garner, J.E., "The Aerodynamic and Thermodynamic Characteristics of Fountains and Some Far-Field Temperature Distributions", Office of Naval Research Report No. ONR-CR212-237-1F.
18. Abramovich, G.N., "The Theory of Turbulent Jets", MIT Press, 1963.
19. Giralt, F.G., Chia, C-J., and Trass, O., "Characterization of the Impingement Region in an Axisymmetric Turbulent Jet", Ind. Eng. Chem., Fundam., Vol. 16, No. 1, 1977.
20. Hrycak, P., Lee, D.T., Gauntner, J.W., and Livingood, J.N.B., "Experimental Flow Characteristics of a Single Turbulent Jet Impinging on a Flat Plate", NASA TN-D 5690, March 1970.
21. Glauert, M.B., "The Wall Jet", J. Fluid Mech, Vol. 1, (1956) 625-643.