

NASA
TP
1837
c. 1

NASA Technical Paper 1837

LOAN COPY: R
APWL TECHNIC
KIRTLAND AFB



TECH LIBRARY KAFB, NM

A Computer Technique for Detailed Analysis of Mission Radius and Maneuverability Characteristics of Fighter Aircraft

Willard E. Foss, Jr.

MARCH 1981





NASA Technical Paper 1837

A Computer Technique for Detailed
Analysis of Mission Radius and
Maneuverability Characteristics
of Fighter Aircraft

Willard E. Foss, Jr.
*Langley Research Center
Hampton, Virginia*

NASA

National Aeronautics
and Space Administration

**Scientific and Technical
Information Branch**

1981

SUMMARY

A computer technique to determine the mission radius and maneuverability characteristics of combat aircraft has been developed. The technique has been used at the Langley Research Center to determine critical operational requirements and the areas in which research programs would be expected to yield the most beneficial results. In turn, the results of research efforts have been evaluated in terms of aircraft performance on selected mission segments and for complete mission profiles. The aircraft characteristics and flight constraints are represented in sufficient detail to permit realistic sensitivity studies in terms of either configuration modifications or changes in operational procedures. Sample calculations are provided to illustrate the wide variety of military mission profiles that may be represented. Extensive use of the technique in evaluation studies indicates that the calculated performance is essentially the same as that obtained by the proprietary programs in use throughout the aircraft industry.

INTRODUCTION

A computer technique to determine the mission radius and maneuverability characteristics of combat aircraft for a variety of military profiles has been developed. The technique has been used at the Langley Research Center to determine critical operational requirements and the areas in which research programs would be expected to yield the most beneficial results. In turn, the results of research efforts have been evaluated in terms of aircraft performance on selected mission segments and for complete mission profiles. The aircraft characteristics and flight constraints are represented in sufficient detail to permit realistic sensitivity studies of configuration modifications and changes in operational procedures. The technique has also been utilized in cooperative efforts with the Department of Defense to evaluate the performance capabilities of a proposed military aircraft and of configuration concepts developed at Langley Research Center. In a preliminary phase of the former effort, the performance for several mission profiles was determined by using the present technique, and the results were compared with similar calculations by the contractor for the purpose of calibrating any differences in calculation technique. The results were in excellent agreement both in terms of overall mission capability and detailed mission segment performance.

The main text of this paper is a description of the features and assumptions of the technique and of the associated numerical computer program. The mission profiles are described, and then the representation of each mission segment is discussed in detail. As each item is described, examples are included to illustrate aircraft performance. Appendix A contains a description of the input data required to define the aircraft as well as the input data concerned with profile selection and flight-path control. Appendix B contains descriptions of the output data. Options to control both the amount and form of the output results are described, and sample output listings are included

to illustrate the effect of these options. The output parameters are also defined in appendix B.

The program requires 105 000₈ words of central core memory to run on the Control Data CYBER 175 computer system operating under NOS 1.3 at the Langley computer complex. The run time for a single mission profile is about four seconds; about 12 seconds are required for a series of five different profiles.

SYMBOLS

The units used for the physical quantities in the figures and discussion in this paper are given in the International System of Units (SI) and parenthetically in the U.S. Customary Units. The tabulated output data are in SI units. Calculations were made in U.S. Customary Units. Conversion factors relating the two systems are presented in reference 1.

D	aircraft drag
D _r	engine ram drag
ESF	engine sizing factor
E _s	aircraft specific energy
g	gravitational acceleration
h	altitude
L	aircraft lift
L/D	aircraft lift-drag ratio
M	Mach number
n	load factor
OWE	aircraft operating weight empty
P _s	aircraft specific power
R	range
SFC	engine specific fuel consumption
SLS	sea-level-static conditions
T _g	engine gross thrust
TOGW	aircraft take-off gross weight
T/W	aircraft thrust-weight ratio (thrust loading), installed SLS

V	true velocity
W	weight
W_f	engine-fuel weight
W/S	wing loading, gross weight over wing reference area
x	horizontal distance
α	angle of attack
γ	flight-path angle
δ	thrust inclination angle, positive nozzle down

A dot over a symbol denotes its time derivative.

RESULTS AND DISCUSSION

GENERAL DESCRIPTION OF PROGRAM

In the development of the program a modular concept was selected as the most logical approach to a multimission program. The present program is a combination of five mission modules which represent mission profiles currently of interest. The mission modules are listed by number identification in table 1 with brief descriptions to indicate the profile variety that is available. Each mission module is designed to determine the combat radius or range capability for a specific military mission with its associated ground rules and profile definitions. Several of these mission modules contain optional profile segments which may be deleted to represent alternate missions. The module concept permits the addition of new modules, or the modification of existing modules, to represent new or unusual mission profile specifications.

Although the mission modules have been used in vehicle sizing studies, the program is not designed to internally synthesize configurations or to generate aerodynamic, propulsion, or structural characteristics. The characteristics of these vehicles are predetermined by specialists in each discipline, and they are input to the program as a data base for all calculations. The representation of the aircraft data (appendix A) is extensive and includes realistic limits on engine and aircraft operational boundaries and on maximum attainable lift coefficients.

Each mission module controls the calculation of the mission-segment data (take-off, climb, cruise, combat, etc.) required by the profile definition and utilizes appropriate segment modules. The profile logic within the mission module is then used to calculate the overall range or radius capability with balanced outbound and inbound radii and with the required combat fuel allowance. If a low-level penetration, or dash, is included in the profile definition, the outbound and inbound dash radii may also be balanced. Performance for missions with alternate radii and combat fuel allowances are also calculated for use in

trade-off studies. For each mission profile, an iterative procedure is used to balance the radii. Initially, the outbound performance is calculated to a desired mission radius. Then the fuel allowances at the combat station are determined. Finally, the remaining fuel is consumed to determine the inbound (return) radius. Based on the difference in outbound and inbound radii, an estimate of the outbound radius is made, and the calculations are repeated until the radii are equal. During each iteration some outbound segments, and all inbound segments, must be recalculated because of the sensitivity of segment performance to vehicle weight. Although most mission profiles are balanced in several iterations, this process could involve a large number of calculations, particularly if the inbound profile includes a climb to a return cruise condition.

MISSION SEGMENT MODULES

The present program was developed with the assumption that great emphasis would be placed on balanced-radius profiles, and that alternate radius missions would be of interest as trade-off information. A technique was therefore developed that would produce accurate performance results for all mission segments and would minimize the repetitive calculations normally required to balance radii and develop radius trades. When a segment module is first utilized to compute performance for a particular mode of flight (for example, climb to cruise altitude) which is known to be sensitive to vehicle weight, the segment performance is automatically computed for a series of four initial weights. The results, in terms of quantities appropriate to the particular segment, are retained in data arrays as functions of the four initial weights. These data arrays are referred to as mission-segment data. The four initial weights are selected (internally) to cover the range of actual weights that would be expected to occur throughout the mission. Specific details of the segment data are presented as each segment module is described in a subsequent section.

After the mission-segment data has been calculated for all segments in the mission definition, the mission-module logic can determine the balanced radii and alternate radii missions very efficiently by interpolating the segment data for required parameters at the appropriate segment weight.

After the performance has been determined for a given aircraft take-off gross weight (TOGW) and associated operating weight empty (OWE), additional missions may be calculated for four other combinations of TOGW and OWE. The results of these optional missions indicate the performance sensitivity to variations in fuel load or to overall aircraft weight, depending on the relationship of the two input weights. More specifically, an increase in TOGW with no increase in OWE would represent an increase in fuel load; an equal increase in both input weights would represent an increase in the vehicle OWE with the same fuel load; and an increase in OWE with no increase in TOGW would represent an increase in the vehicle OWE with an equal reduction in the fuel load. These sensitivities are of great interest in the early development stage of an aircraft concept. They are available for all mission modules as an optional output and require very little computer effort because they utilize the mission-segment data that was calculated for the original aircraft TOGW.

APPLICATION TO VEHICLE SIZING

The program may be operated in a preliminary sizing mode, that is, to provide an indication of which combinations of TOGW, wing-loading W/S, and thrust-loading T/W would provide the best performance for a given mission requirement. For this mode of operation, the OWE should be input as a function of TOGW, W/S, and T/W to represent realistic weight variations with the size of the aircraft, the wing area, and the engines. The segment data for each input TOGW is recomputed for each combination of W/S and T/W that results in a new wing area, or engine sizing factor (ESF), so that the segment performance reflects these changes. The propulsion data are scaled to correspond to the desired engine size, and the aerodynamic lift and drag are scaled to the desired wing area, but the basic aerodynamic characteristics are not internally modified to reflect the actual wing or engine configuration changes. Caution must be used if T/W and W/S are varied far from the original input concept. The results of such a sizing study serve as useful guidelines for resizing the aircraft by configuration specialists. The aerodynamic characteristics of the resized configuration are then estimated and are resubmitted to the program to evaluate the results in terms of mission performance. This process has been used successfully for several aircraft concepts studied at the Langley Research Center.

DESCRIPTION OF SEGMENT MODULES

The subsequent sections describe (in chronological order for a typical mission profile) how each mission segment is calculated. The descriptions include the techniques and assumptions employed and present sample results. The sample cases represent an aircraft concept developed at the Langley Research Center. It is representative of an advanced fighter-type aircraft with supersonic cruise capability. The concept is powered by two advanced turbofan engines. For the purposes of the present paper, the aircraft is sized with a basic TOGW of 196 kN (44 000 lbf), a W/S of 2.93 kPa (61.2 lb/ft²), and a T/W of 1.04. For mission profiles which specify external fuel tanks, the aircraft carries an additional weight of 23.5 (5290 lbf), with a resulting TOGW of 219 kN (49 290 lbf).

Take-off Segment

The take-off segment of the mission is considered only to the extent that it affects the mission performance. No estimate of take-off distance is made, but increments of range and time to the initial climb point may be determined externally and input to the program. The primary output of this module is a fuel allowance to simulate the take-off. There are two input options available for the fuel allowance. The first is either a fixed weight of fuel or a fixed percentage of the aircraft TOGW. The second option is the fuel required for the combination of a number of minutes of engine operation at normal rated thrust plus a number of minutes at maximum thrust. For this option, the total fuel allowance is calculated at sea-level-static (SLS) conditions for the appropriate number and size of engines. For the sample aircraft, one minute at normal rated thrust plus one-half minute at maximum power consumes 498 kg (1097 lbm) of fuel.

Climb and Acceleration Segment

Climb Profile

In the climb and acceleration segment, the performance is computed along any desired climb profile described in terms of Mach number and altitude. Either of two engine power settings may be selected at each point along the profile. The climb profile and engine power setting may be selected by the user in an effort to maximize the performance within any operational constraints peculiar to the vehicle, the flight envelope restrictions, or the mission-profile ground rules. Accessory programs that determine minimum-time-to-climb or minimum-fuel profiles based on specific energy techniques may be used to select the climb profile. An excellent discussion of the energy approach to aircraft performance problems can be found in reference 2. An alternate approach is to select a nominal climb profile and then compute a series of missions, each with the nominal profile perturbed slightly. The climb profile used for the sample aircraft is shown in figure 1.

Method of Calculations

The performance along the climb profile is determined by a numerical integration of the following equations of motion:

$$\dot{V} = \frac{g}{W} [T_g \cos (\alpha + \delta) - D - D_f - W \sin \gamma]$$

$$\dot{\gamma} = \frac{g}{VW} [T_g \sin (\alpha + \delta) + L - W \cos \gamma]$$

$$\dot{h} = V \sin \gamma$$

$$\dot{x} = V \cos \gamma$$

$$\dot{W} = -\dot{W}_f$$

The first input Mach number and altitude of the profile are assumed to be the conditions that exist after the take-off segment and are the initial conditions for the climb. An iterative procedure is utilized to determine the fuel, range, and time increments from point to point along the climb profile. For each step, a weight change is assumed, and the equations of motion are utilized to determine the instantaneous rates of climb, acceleration, and fuel flow at the end point. The initial and end-point rates for each step are averaged and then used to compute the time interval and actual fuel usage for the step. This process

is continued until the assumed weight change for the step equals the calculated fuel consumption. The step range is then computed, and the initial point values of all variables (weight, range, time, etc.) are incremented by the computed step changes. This procedure is repeated from point to point along the climb profile until the desired cruise Mach number is reached. In the event a specified rate-of-climb limit is reached during the climb and acceleration before the cruise Mach number is reached, an estimate is made of the climb ceiling for the aircraft and the mission calculations are terminated. When the cruise Mach number is reached, the same stepwise technique is used to climb at the cruise Mach number, but additional calculations described in the next section are made after the climb performance to each altitude has been determined.

Termination of Climb

The climb at cruise Mach number continues until one of the following conditions is met: (1) If the last input profile altitude is reached, the cruise segment is begun at that altitude. (2) If the rate of climb at any altitude falls below the specified level, an iterative technique is utilized to determine the altitude ceiling (to within 15 m (50 ft)) at which the minimum rate of climb can be met, and the cruise segment is begun at that altitude. (3) If neither of these events occurs, the climb continues until the altitude for most efficient cruise is located.

Determination of Start of Cruise

The range during cruise is determined by using the Breguet range equation. The equation, which is developed in reference 3, is as follows:

$$R = \left(V \frac{L}{D} \frac{1}{SFC} \right) \ln \left(\frac{W_{\text{initial}}}{W_{\text{final}}} \right)$$

When the first term in parentheses (referred to as the Breguet factor) is maximized, the range for a given cruise weight ratio is also maximized. The values of L/D and SFC are determined, for a given Mach number and altitude, by the solution of the equations of motion for the lift coefficient and the engine thrust setting required to sustain steady level flight. The start-of-cruise altitude is selected, not on the basis of the best Breguet factor at the initial cruise condition, but on the basis of the lowest total fuel consumed from the start of climb to end of a cruise to a desired range. The selection is made by computing, at each climb altitude, a single-step Breguet cruise segment to the desired outbound cruise range, and then choosing the altitude resulting in the heaviest aircraft weight at the end of cruise. For long-range missions, where the cruise segment consumes a major portion of the mission fuel, the altitude selected for the beginning of the cruise by this procedure is also the altitude which develops the best cruise Breguet factor. For short-range missions, typical of fighter aircraft, using the present procedure results in a cruise segment at altitudes lower than would be indicated by the initial Breguet

factor. Short-range missions do not expend the additional climb fuel that would be required to reach higher altitudes in order to attain the best cruise efficiency. The initial climb steps at the cruise Mach number are normally in intervals of 610 m (2000 ft), and an iteration procedure in the search-for-cruise-altitude logic determines the start-of-cruise altitude to within 15 m (50 ft) of the optimum.

Sample Initial Climb Calculation

The climb performance to the start of cruise, calculated along the profile of figure 1 and utilizing maximum engine thrust, is presented in figure 2 for the sample aircraft with an initial climb weight of 214 kN (48 193 lbf). This weight corresponds to a take-off weight with external tanks of 219 kN (49 290 lbf) less the take-off fuel allowance. Climb to the start-of-cruise altitude consumes 1.70 Mg (3747 lbm) of fuel and attains a range of 78.5 km (42.4 n. mi.) in only 3.5 minutes. As would be expected with the high T/W (0.93), no rate-of-climb limits are encountered, and the cruise altitude of 15.4 km (50 650 ft) is determined on the basis of optimum cruise performance. The cruise Breguet factor is 72.7 km-N/g (4005 n. mi.) for the aircraft with the external fuel tanks and weapons aboard. The cruise efficiency for other store combinations is discussed in a subsequent section.

Effect of Initial Climb Weight

The variation of the final values of the major climb performance parameters with initial climb weight is presented in figure 3. These are the climb-segment parameters used by the mission modules to determine the start-of-cruise weight, range, and altitude for any initial climb weight. The values at the heaviest initial weight are the same performance data shown in figure 2. All the data shown in figure 3 are for the same aircraft size (that is, the wing area and the engine size are fixed); therefore, the data represent performance variations as weight is reduced (fuel is expended). As mentioned previously, the initial weights are selected to cover the range of weights that are likely to occur throughout the mission profile.

Inbound Climb

If the inbound (return) climb of a particular mission profile does not begin at the same Mach and altitude conditions as the outbound climb, the segment data for the outbound climb cannot be used directly to represent the return-climb performance. As the climb calculations are made for each initial aircraft weight, increments in the weight, range, and time required to climb to an energy level representing the return start-of-climb conditions are retained as part of the segment data. By subtracting these increments from the appropriate initial-climb-segment quantity, a second set of climb data is developed, which represents the performance from the return start-of-climb conditions to the return start-of-cruise conditions.

Assumptions

There are two assumptions inherent in the use of the climb-segment data. The first assumption is that the climb Mach-number—altitude profile and the cruise Mach number must be the same for the outbound and inbound mission segments. This is not considered to be a significant assumption, because most military profiles are defined in this manner. The second assumption is that the aircraft external configuration is the same for the outbound and inbound climbs. This is not the case for many mission definitions in which external fuel tanks are dropped when empty, or in which large external weapons are dropped at the combat (or radius) station. The effect of the second assumption on overall mission performance is described in detail in the discussion of the air superiority mission profile. Sample calculations show the effect to be small, and a procedure to evaluate this assumption is built into the program.

Cruise Segment

The aircraft weight and altitude and the associated Breguet cruise factor are determined during the climb calculations previously discussed. The cruise-segment data represent the variation of the Breguet factor with aircraft weight. The cruise segments of all mission profiles are calculated as single-step Breguet cruises. For profiles which have relatively short-range cruise requirements, the Breguet factor at the start-of-cruise weight is used to compute the performance. For the long-range cruise of module 5, an average of the initial and final Breguet factors is used to calculate the range.

Loiter Segment

The loiter or holding operation is a steady (nonaccelerating) flight condition at a fixed altitude for a given period of time. The performance parameter of primary interest is the fuel flow rate. For a given Mach number and altitude, an iterative procedure is used to solve the equations of motion for the lift coefficient and engine throttle setting required to sustain steady level flight. The fuel flow rate associated with the throttle setting is the required loiter fuel flow. These calculations are made at three Mach numbers, and the lowest fuel flow is used. Figure 4 presents the results of the loiter calculations for four values of aircraft weight. Note that the loiter fuel flow is sensitive to aircraft weight. When the mission-module logic interpolates these data, the average of the actual mission weights before and after loiter is used to determine the mission loiter fuel flow.

Dash Segment

The dash or low-level penetration is essentially a cruise at a constant altitude. The mission specifications usually define both the flight altitude

and the Mach number. For this mode of flight, the performance parameter of interest is the specific-range factor, which is defined as the aircraft velocity divided by the fuel-flow rate. The specific-range factor is an instantaneous cruise efficiency, as it is a measure of the distance that can be traveled for a given amount of fuel. An iterative solution of the equations of motion is employed to obtain the required fuel-flow rate. The results of the dash-segment calculations are presented in figure 5 for four values of aircraft weight. Performance is shown for the aircraft with and without external weapons. As was the case with the loiter-segment data, the specific-range factor is a strong function of aircraft weight. When these data are interpolated by the mission module, an average dash-segment weight is used for the independent variable.

Combat Segment

Combat Weight Specifications

This segment calculates the fuel allowance required to perform the combat operations specified in each mission definition. Because of the wide variety of combat definitions, this segment module contains a number of optional calculations that may be selected to represent many fuel-allowance specifications. The reference aircraft weight (combat weight) at which the combat fuel allowances are to be calculated is an important consideration. Some mission specifications identify the combat weight in terms of a percent of the fuel capacity of the aircraft (e.g., weight with 50 percent of internal fuel). Other missions specify that the combat weight be the actual weight of the aircraft when it reaches the combat station (overall mission radius). The former specification results in combat fuel allowances that are independent of the other segments of the mission definition (i.e., the calculated combat fuel allowance is the same for all mission radius trade-offs). The later combat weight definition results in a variable combat fuel allowance with changes in mission radius.

The options available within the program for the reference combat weight are the aircraft OWE with a fraction of the internal fuel remaining, the aircraft TOGW with a fraction of the total fuel (internal plus external) removed, or the actual weight of the aircraft at the combat radius. The third combat weight option is a calculation of the combat fuel allowance for a series of four weights. Thus, the combat fuel for the actual aircraft weight can be interpolated during the mission-balancing logic.

Combat Fuel-Allowance Options

At the present time there are four combat fuel-allowance specifications available in the combat-segment module. Additional requirements may be inserted as desired to represent new specifications.

Specific power.- The first combat fuel-allowance option is specified as the fuel required to increase the specific-energy level of the aircraft. The specific energy E_g is the total energy of the aircraft per unit of aircraft weight. The time required to accomplish the increase in E_g is determined by the energy rate, or specific power at a given flight condition. The fuel allow-

ance is the product of the fuel flow at the flight condition and the resulting time interval. Specific power P_S is the instantaneous excess power per unit of aircraft weight and is expressed in m/s (ft/sec) as

$$P_S = [T_G \cos (\alpha + \delta) - D_r - D]V/W$$

Specific power is calculated for a specified Mach number, altitude, load factor, and throttle setting. The aircraft drag D in the preceding equation is associated with the lift and angle of attack that are obtained from an iterative solution of the expression for load factor, which is

$$n = [L + T_G \sin (\alpha + \delta)]/W$$

Figure 6 presents, as a function of aircraft weight, the specific power and combat fuel allowance based on a specific energy increase of 43.9 km (144 000 ft) and typical combat specifications.

Specified Mach number, altitude, and throttle setting.- The second combat fuel-allowance option is calculated as the fuel required to fight for a given time interval at a specified Mach number, altitude, and throttle setting. The fuel required is independent of aircraft weight and aerodynamic characteristics. It is calculated as the product of the time interval and the engine fuel flow for the given flight conditions. For the sample aircraft, combat for 2 minutes at $M = 1.2$ and $h = 9144$ m (30 000 ft) at maximum augmented throttle would require 973 kg (2144 lbm) of fuel.

Acceleration to combat.- The third combat fuel-allowance option is similar to the previous option except that it requires a constant altitude acceleration before combat begins. The acceleration is calculated in a stepwise fashion similar to that described for the climb segment. The fuel expended during the acceleration is a function of both the weight and the aerodynamic characteristics of the aircraft, so these calculations are repeated for four representative combat weights. The individual fuel requirements for acceleration and combat are shown in figure 7 for a typical set of combat specifications.

Accelerate and maneuver.- The fourth combat fuel-allowance option is specified as the sum of three fuel requirements. The first requirement is an acceleration at constant altitude, which is calculated as described in the third option. After the acceleration, two sets of sustained turn maneuvers are required. Each maneuver is calculated at a given Mach number, altitude, and throttle setting for a given number of turns, and at the maximum load factor for sustained flight. This load factor is found by a technique which involves calculation of the variation of P_S with load factor to determine the load factor for which P_S is zero. The variation of P_S with load factor is shown in figure 8 for a typical set of combat specifications and a combat weight of 160 kN (36 000 lbf). The maximum sustained load factor is 3.09 at $M = 0.90$ and 4.47 at $M = 1.20$. Turns at load factors less than the maximum sustained load factor

(with positive P_S) would gain altitude or speed; turns at higher load factors (with negative P_S) would lose altitude or speed.

The fuel required for each turn maneuver is the product of the number of turns specified, the time required for each turn, and the fuel-flow rate. The relationship of turn rate (in degrees per second) to the load factor is given by

$$\text{TURN RATE} = \frac{180g \sqrt{n^2 - 1}}{V}$$

The individual fuel requirements for the acceleration and the two sets of sustained turns are presented in figure 9 as a function of aircraft weight. The fuel required for the turn maneuvers is for a single 360° turn and is based on the instantaneous turn rate calculated for the weight at the beginning of the turn. When this combat-segment data is utilized in the mission module to calculate the total fuel allowance for the acceleration and the specified number of turns, two optional summing techniques are available. All the individual combat components can be determined on the basis of a single fixed (i.e., the combat weight), or the component fuels can be assembled on the basis of the actual chronological weight that exists at the start of each maneuver. For the latter option, an iterative procedure is used to account for the weight of fuel burned during each set of turn maneuvers.

All calculations of combat fuel allowances assume that the external tanks, if carried during the outbound segments of the mission profile, have been dropped; thus, the tank drag-coefficient increments are not included in the aircraft drag. In addition, with the exception of the sustained turn maneuvers of the last combat option, calculations of P_S do not include the drag-coefficient increments for the external weapons. The values of P_S represent the energy-maneuverability characteristics of a "clean" aircraft configuration. If any mission-profile specification requires that the store-drag increments be included in the P_S calculations, this can be accomplished easily for selected profiles.

Descent Segment

The descent and deceleration segments of most military profiles are specified as "non-segments" with no credit for range gained or fuel expended. The present program represents the final descent with increments in range, time, and fuel burned. The increments must be estimated externally. The fuel-burned increment may be input as a percentage of the weight at the end of the descent, so that it increases proportionally with increases in the landing weight of the aircraft. In the mission modules, any descents other than the final descent are non-segments with no range, time, or fuel credits. An exception is the pre-target descent in mission module 4. The outbound descent increments of fuel and range are scaled from the final descent increments, based on a ratio of the aircraft weights.

Reserve Segment

The reserve fuel allowance for a military mission is generally specified in terms of a percentage of fuel capacity, or a given number of minutes of engine operation at sea-level-static fuel flow, or some combination of these or similar modes. Because of the variety of reserve fuel definitions among the military services and the missions, the reserve-segment module contains six optional calculations which may be selected to represent many fuel specifications. The options may be selected individually or in combination in any sequence. The operational reserve modes are listed in table 2. They vary in complexity from a simple fuel-weight increment to the calculation of the fuel required to hold or loiter for a given period of time. The reserve descriptions of table 2 are self explanatory with the exception of mode 5. If desired, the hold calculations of mode 5 may be performed at five Mach numbers, and the Mach number with the lowest fuel flow would be selected. The fuel flow is determined from the engine throttle setting required to maintain a steady level flight condition at each particular Mach number at a given altitude. The weight basis for these calculations is the landing weight of the aircraft for the particular mission. The aircraft drag is calculated for the existing external store configuration at the end of the mission. For the sample aircraft, with a weight of 107 kN (24 000 lbf), a 10-minute hold at an altitude of 1.52 km (5000 ft), conducted at a Mach number of 0.40, requires 401 kg (883 lbf) of reserve fuel. Since the reserve fuel allowance is not affected by the mission-radius trades, the reserves are calculated only once for each mission. If additional calculations are desired, either for a change in aircraft OWE or for a change in sizing (T/W or W/S) of the aircraft, the reserve fuel is recalculated as required for each mission.

Configuration Changes

Types of Changes

Configuration changes occur when any externally mounted store is expended during the mission. Each mission definition specifies the stores (fuel tanks and weapons) to be carried and whether they are to be retained or dropped during the mission. Each external store is represented as an incremental weight and an incremental drag coefficient as a function of Mach number. Internal weapons may be represented by a weight increment and a drag coefficient of zero. If the user wishes to retain the external tanks for a mission module that is designed to drop the tanks, there is sufficient input flexibility to represent retention of the tanks. In general, all mission profiles have the capability to retain or to drop the external weapons at the combat (or radius) station. As indicated in table 1, three of the five profiles have external-tank capability, but the logic for retaining or dropping these stores varies with each profile. These details are presented in the subsequent discussions of the individual missions modules.

Acceleration and Climb

In the acceleration-and-climb-segment module, the performance is calculated on the assumption that the external stores are to be retained until the end-of-climb (start-of-cruise) point is reached. This is a reasonable assumption because the external fuel load is usually selected to accomplish both the climb and a portion (sometimes all) of the outbound cruise segment. For profiles which specify that the stores be dropped during the mission, the inbound (return) climb performance is conservative because it is interpolated from the climb-segment data, which include the effect of the store-drag increments. The amount of conservatism depends on many factors, such as the aircraft sizing (excess thrust capability), the climb profile, and, of course, the magnitude of the combined store-drag increments with respect to the drag of the clean aircraft. The overall effect in terms of mission radius is discussed for the sample aircraft in a subsequent section.

Cruise

The search for the best start-of-cruise altitude is also based on the aircraft with the store-drag increments included. If the profile definition specifies that either the fuel tanks or the weapons are to be dropped, the calculations for the cruise Breguet factor are repeated for the appropriate aircraft-store configurations. The Breguet factors for these alternate configurations are retained as part of the segment data for use in determining the cruise performance after the stores are expended. The variation of the Breguet factor with aircraft weight for the sample aircraft, with and without external stores, is presented in figure 10 for a cruise Mach number of 1.60. The lower curve of figure 10, for the aircraft with external tanks and weapons, would be used in the mission module for the outbound cruise. Mission definitions which permit the tanks to be dropped when they are empty would use the middle curve (which excludes the tank-drag increment) to continue the outbound cruise after the tanks are dropped. The upper curve, which represents the clean aircraft, would be used for the return (inbound) cruise if the weapons are expended at the combat station.

It should be noted that the two upper curves are calculated at the altitudes which were selected for cruise with the external stores. As an indication of the effect of this assumption, the cruise Breguet factors for a clean aircraft have been calculated, and the results are shown as symbols in figure 10. These latter calculations were made at the altitudes for the best cruise performance of the aircraft with no external stores. The upper curve is in good agreement with the actual clean-aircraft efficiency. The present procedure is about 2 percent conservative at lower aircraft weights, which are representative of the return cruise conditions.

Loiter

The loiter fuel-flow calculations are made for the aircraft with the external weapons aboard. At the present time, no other aircraft configurations are

included in the calculations, because no mission definitions with other store specifications have been encountered.

Dash

The dash specific range factors are calculated on the assumption that the external fuel tanks are dropped before the dash segment begins; therefore, the external tank-drag increments are not considered. If the mission specifies that the weapons are to be expended, the dash calculations are made with and without the weapon-drag increments. Both sets of range factors are retained as segment data for use in determining the outbound and inbound dash performance.

Reserves

As mentioned previously, the reserve fuel allowance for holding is calculated for the external-store configuration that exists at the end of the mission.

MISSION-PROFILE MODULES

General Considerations

As discussed briefly in preceding sections of this paper, there are five mission modules in the program (table 1). Each of these modules is designed to determine the performance for a specific military mission with its associated ground rules and profile definitions. The mission module controls the calculation of the required mission-segment performance with appropriate store configurations. The segment data is then utilized to calculate the overall mission performance with balanced outbound and inbound radii and with the specified combat fuel allowance. Alternate mission profiles, with different radii and combat fuel allowances, are also calculated using the segment data. Subsequent sections of this paper describe each mission profile and present examples of performance results appropriate to each. For the sample cases, the aircraft sizing and store combinations, as well as the choice of flight conditions for cruise, dash, and holding operations, are not intended to represent best or optimum conditions. They are selected solely to illustrate the available features of each module. Special features or options peculiar to each mission profile are described and, in most cases, illustrated with typical results.

Mission Profile 1 - Air Superiority

Mission Description

The first mission module represents an air-superiority profile with a low-level penetration to the combat. The Hi-Lo-Lo-Hi profile is shown schematically in table 3 with a general description of each mission segment. The items listed as inputs for each segment are the major inputs which are used to define

the mission in greater detail. The word "options" appears for mission segments which have two or more optional calculations, and represents the segment with a fuel allowance. These segments are the take-off, combat, and reserve fuel allowances. The inputs for each option are described in the individual segment discussions. The climb Mach-number—altitude schedule and the cruise Mach number define the climb and the outbound cruise segments which are initially calculated for the desired cruise radius. The dash segments are defined by a dash Mach number, a dash altitude, and a desired dash radius. The inbound dash is assumed to be equal to the outbound dash radius, unless the inbound dash radius is specifically input as a zero distance. For such a case, the return climb to profile point 13 would begin immediately after the combat with no return dash, and the result would be a Hi-Lo-Hi profile. The weapon is retained to the end of the mission if the weapon weight is input with a positive sign. A negative sign causes the weapon weight to drop before the combat.

External tanks

If external tanks are carried, they are dropped when empty during the outbound cruise, as indicated in table 3. Two restrictions are imposed on this logic; first, if the tanks are emptied during the climb to the start of cruise, they are dropped at profile point 3; secondly, tanks are not carried beyond profile point 6. Even if they contain fuel, the tanks and any remaining external fuel are dropped when the aircraft reaches the cruise radius (point 6). In an early definition of the air-superiority mission, the tanks were always retained to profile point 6 and then dropped just as the descent began. This tank logic is still available, and when it is selected it overrides all other tank-drop logic.

Sample Calculations

Results of calculations for mission profile 1 are presented in figure 11 for the aircraft with external tanks and a TOGW of 219 kN (49 290 lbf). The resulting take-off T/W is 0.93 and W/S is 3.28 kPa (68.5 lb/ft²). The aircraft weight and flight altitude are shown as functions of the mission radius. Straight lines are used to connect the actual profile-point data. The following specific ground rules were used to define the mission: The take-off fuel allowance selected is the option which involves engine operation. This option consumes 498 kg (1097 lbf) of fuel. The climb is calculated along the schedule shown in figure 1 using maximum power. For this mission option, the external fuel is burned during the take-off and climb segments, and the tanks are dropped at the end of the climb. The high-altitude cruise is at a Mach number of 1.60 with a desired cruise range of 1111 km (600 n. mi.). The low-level penetration is conducted at a Mach number of 0.80 at an altitude of 610 m (2000 ft), with a desired radius of 185 km (100 n. mi.). The combat fuel allowance selected is the option requiring an increase in the specific-energy E_s level of the aircraft. The available specific power P_s is calculated, for a fixed reference weight, at a Mach number of 1.20 and an altitude of 1524 m (5000 ft). For $E_s = 43.9$ km (144 000 ft), the fuel allowance required for combat is 1571 kg (3463 lbf). The reserve fuel allowance is calculated as the fuel required to loiter at an altitude of 1524 m (5000 ft) for 10 minutes. The

loiter is conducted at a Mach number of 0.40 and requires 401 kg (883 lbm) of fuel. The primary mission results shown in figure 11 indicate that with the desired cruise radius of 1111 km (600 n. mi.) and with the specified combat allowance, the dash-radius capability is 298 km (161 n. mi.).

Sample Alternate Mission Calculations

Two additional mission options are calculated for this profile, with alternate radii. With one option, a desired 1111 km (600 n. mi.) cruise radius and a 185 km (100 n. mi.) dash radius is assumed, and the fuel available for combat is calculated to be 72 percent greater than the specified allowance. With the other option, the desired-radius and the specified combat allowance are assumed, and a cruise radius of 1496 km (808 n. mi.) is calculated. These three sets of mission results are calculated each time this mission module is selected. A sample of the summary output listing for this module is presented in table 4. (Definitions of the output parameters are given in appendix B). These three missions are referred to as options 1, 2, and 3, respectively. The weight, range and altitude are listed for each profile point. Note that the combat fuel allowance is the same for options 1 and 3 because the selected combat option is independent of the actual combat weight.

Additional Performance Quantities

Two additional performance quantities are computed using this mission module. The first is a level acceleration for a given Mach number schedule. The second is concerned with the energy-maneuverability characteristics of the aircraft. The calculations are independent of the mission-profile results, except that they are based on the initial combat weight of the option-1 mission. For the sample aircraft, an acceleration from Mach = 0.80 to Mach = 1.30 at an altitude of 10.7 km (35 000 ft) requires 35 seconds. The acceleration performance is computed without the external tanks. The second calculation determines the instantaneous specific power and turn-rate capability for 12 preselected flight conditions. The specified conditions are Mach number, altitude, load factor, and engine power setting. Results of these calculations may be compared with results previously determined for alternate aircraft sizes or with a set of energy-maneuverability requirements which might represent an enemy aircraft. The performance is computed for the clean-aircraft configuration with no external stores. These calculations are performed without the mission-profile calculations if the outbound cruise radius is input as zero.

Effect of Store-Drag Assumptions

This mission profile is used to indicate the effect of the assumption that, even though the external tanks and weapons are dropped before the return climb begins, the external store-drag increments may be included in the return climb performance. Two steps are required to determine the effect of the store drag on the return climb. The first step is a separate run, without the store-drag increments, to generate the climb-segment data for the clean aircraft. The second step is to recalculate the mission with the external stores, but with the

new clean-segment data superimposed in the mission-module logic for the return-climb and cruise segments. The results of the second step represent the exact mission performance, and the profile points that are affected are plotted with square symbols in figure 11. The overall mission radius is 1420 km (767 n. mi.), with a dash radius of 309 km (167 n. mi.). The effect of the store-drag assumption on dash radius in the original calculations is short (conservative) by 11 km (6 n. mi.). The range decrement is believed to be typical for a mission of this type and could be considered as a tolerance on supersonic cruise missions employing relatively large external stores which are dropped during the mission. The decrement would be less for a mission with a subsonic cruise segment, and is, of course, dependent on aircraft configuration, the relative magnitude of the store drag, and the specific mission profile. The radius increments that might be calculated for variations in aircraft TOGW or OWE would be realistic sensitivities, even though the absolute radii would be slightly underestimated. For mission profiles which do not involve store configuration changes, or which do not have a return-climb-segment, the performance results are not affected by the present assumption.

As an aid to the user who wishes to determine the exact performance capability of a particular aircraft and mission-profile combination (which would be affected by the return-climb decrement), an optional mode of calculation is available. It would be used to determine the exact range capability for a mission profile with a return climb and involving a configuration change. The optional mode logic correctly accounts for the configuration change in the calculation of the return-climb performance; thus, the mission results are exact. As computed using the two-step procedure, the optional mode for the example aircraft and mission profile mentioned previously results in a dash radius of 309 km (167 n. mi.). The optional mode can be used for only one combination of TOGW and OWE at a time. The sensitivity of radius to variations of these two weights would have to be calculated with a series of input cases. The option would not be used (or required) in initial exploratory runs to size a new configuration or to determine, for example, the best cruise and dash Mach numbers.

Second Sample Calculation

As an indication of the flexibility of this module in the representation of other profiles, a second example is presented for the same aircraft configuration. The mission is a Hi-Lo-Hi profile with a penetration to the combat station, but without a return dash. The following specific ground rules define the mission. The take-off and reserve fuel allowances are the same as in the first sample calculations. The outbound cruise is conducted at a Mach number of 1.60, as in the previous example, with a desired range of 1111 km (600 n. mi.). The penetration is at a Mach number of 0.90 and an altitude of 9144 m (30 000 ft). The combat fuel allowance is the option which requires an acceleration and two sets of sustained turn maneuvers. The acceleration is from Mach 0.90 to 1.20, and is followed by three sustained turns at Mach 0.90 and one turn at Mach 1.20. All combat maneuvers are calculated at an altitude of 9144 m (30 000 ft) and are based on a fixed combat weight. The total combat fuel allowance is the sum of the individual components at the actual mission combat weight. The inbound dash-radius requirement is input as zero, so the return climb begins immediately after combat.

The primary mission results shown in figure 12 indicate that, with the desired cruise radius of 1111 km (600 n. mi.) and the specified combat allowance, the dash capability is 912 km (493 n. mi.) for a total mission radius of 2024 km (1093 n. mi.). The total combat fuel allowance is 1552 kg (3422 lbm) and is the direct sum of the components shown in figure 9 for a combat weight of 153 kN (34 304 lbf). The output listing for this mission profile is presented in table 5. Two additional missions are calculated for this profile. For the first additional mission (option 2 in table 5(b)), the desired cruise and dash radii are assumed, and it is calculated that the fuel available for combat would be 142 percent greater than the specified allowance. For the second additional mission (option 3 in table 5(b)) the desired dash radius and the specified combat are assumed, and it is calculated that the outbound cruise radius is 2045 km (1104 n. mi.). Note that the combat fuel allowance for option 3 is greater than that of option 1. This is because the allowance is based on the actual weight at the start of the combat, which is greater in option 3.

Mission Profile 2 - Fighter Escort

Mission Description

The second mission module represents a fighter-escort profile. The Hi-Lo-Hi profile is shown schematically in table 6 along with a general description of each mission segment. The climb and cruise segments of the profile are defined with the same inputs as for mission profile 1. There are no low-level dash segments in this mission. The descent is made to the altitude specified in the particular combat option selected. As with all profiles, the weapon is retained to the end of the mission if the weapon weight is input with a positive sign. A negative sign causes the weapon to be dropped before the combat. The mission logic contains no provision for dropping the tanks. If tanks are installed at take-off, they are retained throughout the mission.

Sample Calculations

Results of calculations for mission profile 2 are presented in figure 13 for the sample aircraft with and without external tanks. The circular symbols represent the aircraft without external tanks with TOGW = 196 kN (44 000 lbf). The square symbols represent the aircraft with tanks and TOGW = 219 kN (49 290 lbf). The following specific ground rules were used to define the mission. The take-off fuel allowance selected is the option involving engine operation and consumes 498 kg (1097 lbm) of fuel. The cruise is at a Mach number of 0.85 and the climb schedule of figure 1 is used until the cruise speed is reached. The desired cruise radius is 1111 km (600 n. mi.) without external tanks and is 1296 km (700 n. mi.) with the external fuel. The combat fuel allowance selected is the option requiring 2 minutes of combat at full power at a Mach number of 1.0 and an altitude of 3048 m (10 000 ft). This option is independent of the aircraft weight and aerodynamic efficiency and requires 1662 kg (3664 lbm) of fuel. The reserve fuel allowance selected is the same as for the previous mission with a fuel requirement of 393 kg (866 lbm) for the clean aircraft and 402 kg (887 lbm) for the aircraft with the external tanks.

The mission results indicate that with the full specified combat allowance, the radius without tanks is 1165 km (629 n. mi.), and it can be increased to 1406 km (759 n. mi.) when tanks are carried. The alternate mission for this profile is to cruise to the desired radius and calculate the available combat allowance. With a design radius of 1111 km (600 n. mi.), the basic aircraft without tanks can fight for 2.3 minutes or 114 percent of the specification combat time. At a radius of 1296 km (700 n. mi.), the aircraft with tanks can combat for 2.7 minutes or 133 percent of the required combat time.

This mission module also determines the time and fuel required for an acceleration from Mach = 0.80 to Mach 1.00 at an altitude of 3048 (10 000 ft). The acceleration is independent of the mission profile and is calculated with the tank drag excluded, even if the mission specifies external tanks. For a weight of 160 kN (36 000 lbf), the acceleration is completed in 7 seconds and consumes 86 kg (190 lbm) of fuel. A sample of the summary output listing for this mission is presented in table 7 for the mission with external tanks.

Mission Profile 3 - Combat Air Patrol

Mission Description

The third mission module represents a Combat-Air-Patrol profile. The Hi-Hi profile is shown schematically in table 8 along with the segment descriptions. The distinguishing segment of this mission is the loiter at the combat station. Typically, a loiter time is required and the Mach number and altitude are defined. This profile specifies that the external tanks, if carried, are dropped at the end of cruise, even if the external fuel is completely burned at a shorter radius. A special feature regarding the tank drop is that, if any external fuel is in the tanks at the end of cruise, it is retained. In this event, the mission summary indicates that this has occurred by listing the amount of external fuel that is retained.

Sample Calculations

Results of calculated performance for mission profile 3 are presented in figure 14 for the sample aircraft with and without external tanks. The aircraft is the same as that described in the previous mission profiles. The same mission specifications were also used for this profile, but with the following modifications: The desired cruise radius is 556 km (300 n. mi.) for the clean aircraft and 741 km (400 n. mi.) for the aircraft with external tanks. The required loiter time at the combat radius station is 2 hours at a Mach number of 0.70 and an altitude of 9144 m (30 000 ft). The combat fuel allowance selected is the option requiring a level acceleration at 9144 m (30 000 ft) altitude from the loiter Mach number to a Mach number of 1.0. Two minutes of combat at full power at the final Mach number and altitude are also required. The acceleration portion of this combat option is dependent on the aircraft weight and the aerodynamic efficiency, but the final combat for 2 minutes is only a function of the fuel-flow rate at the specified conditions. When calculated on the basis of a fixed combat weight of 133 kN (30 000 lbf), the required acceleration fuel is 106 kg (233 lbm) without tanks and 124 kg

(273 lbm), with tanks. The two-minute combat allowance is the same for both configurations and requires 798 kg (1759 lbm) of fuel.

The mission performance shown in figure 14 indicates that, with the full two-hour loiter at the combat station, the radius achieved without tanks is 468 km (253 n. mi.). This radius can be increased to 796 km (430 n. mi.) when external fuel is carried. The alternate mission for this profile is to cruise to the desired radius and determine the loiter time with the full combat fuel allowance. With no external fuel the aircraft can loiter for 1.8 hours at a radius of 556 km (300 n. mi.). The aircraft with external fuel can loiter at a radius of 741 km (400 n. mi.) for 2.1 hours. A sample of the summary output listing for this module is presented in table 9 for the mission with external tanks. Note that the retained external fuel is listed as zero, which indicates that no tank fuel remained aboard when the tanks were dropped.

Mission Profile 4 - Long-Range Penetration

Mission Description

The fourth mission module represents a long-range-penetration profile. The Hi-Lo-Lo-Hi profile is shown schematically in table 10 along with the segment descriptions. Although a radius-type mission can be represented by this module, the profile is depicted as a long-range mission composed of four range increments (A to D), each of which may have a specified value. The outbound (pre-target) penetration and the inbound (post-target) dash may be conducted at different speeds and altitudes. The outbound descent increments of fuel and range are scaled from the final descent increments based on a ratio of the aircraft weights. The module does not contain the logic to drop external fuel tanks; therefore, if they are carried, they are retained throughout the profile. The weapon is dropped at the end of the outbound penetration if given a negative sign.

Air-to-Air Refueling

The aircraft can be refueled during the outbound cruise if the cruise speed is compatible with the tanker capability. The optimum fuel-transfer range is determined by internal logic, so that the receiver aircraft can be "topped off" to a specified gross weight at the maximum possible range. This technique is illustrated in figure 15 for a refueling Mach number of 0.75. The tanker capability is represented by the change, with range, of the weight of fuel available for transfer. The available fuel is dependent upon the ground rules that may be specified for the tanker, such as the point of origin of the tanker and whether it must return to the same or an alternate base after the refueling operation. This curve must be developed externally, for the specific tanker rules, and it is input to the present program. For convenience, the range scale is referenced to the receiver aircraft, and it is in terms of the range at the conclusion of the refueling operation. The curve for the receiver aircraft represents the weight of fuel to top off to a given gross weight as a function of range at the end of refueling. This curve is calculated internally and considers the climb-and-cruise fuel plus the fuel burned during "hook-up" and refueling operations.

The fuel flow for the receiver aircraft during refueling is based on cruise at the appropriate Mach number and altitude and the average refueling weight. No consideration is given to possible interference due to the proximity of the tanker (or other aircraft in the case of a multi-aircraft refueling).

The intersection of the two curves in figure 15 represents the point where, at the end of refueling, the receiver aircraft is at the desired gross weight. The tanker must have sufficient fuel remaining to return to its specified base. The range of the receiver at this point is the maximum that can be attained with the specified tanker rules.

Sample Calculations

Results of calculations for mission profile 4 are presented in figure 16 for the sample aircraft with a TOGW of 198 kN (44 600 lbf). The following specific rules were used to define the mission. The take-off fuel allowance, the descent increments, and the reserve allowance are the same as for mission profile 3. Cruise is at a Mach number of 0.75 and the climb schedule of figure 1 is used until the cruise speed is reached. Pre-target penetration is conducted at a Mach number of 0.80 and an altitude of 152 m (500 ft) for a range of 370 m (200 n. mi.). The weapon weight of 4.5 kN (1000 lbf) is dropped at the target station. The post-target dash is for 185 km (100 n. mi.) at a Mach number of 0.55 and an altitude of 152 m (500 ft). The desired range for the return climb, cruise, and the descent is 926 km (500 n. mi.). Figure 16 indicates that the outbound cruise radius is 1.99 Mm (1076 n. mi.) with an overall mission range of 3.53 Mm (1907 n. mi.). The aircraft was refueled to the original TOGW at a range of 1.16 Mm (625 n. mi.). A sample summary output listing of this mission is presented in table 11. The refueling details for this mission are those indicated in figure 15, which describe the refueling logic. No optional missions are calculated for this profile.

The mission performance without refueling is also shown in figure 16. The overall range is 2.04 Mm (1102 n. mi.), and the effect of refueling is to increase the range by 1.49 Mm (805 n. mi.).

Mission Profile 5 - Long-Range Cruise

Mission Description

The fifth mission module represents the long-range-cruise (ferry-mission) profile. The profile is shown schematically in table 12 along with a general description of each mission segment. The segments are the same as in previous missions. If external tanks are carried, they are dropped during cruise when they are empty.

Sample Calculations

Results of calculations for mission profile 5 are presented in figure 17 for the sample aircraft with external tanks and a TOGW of 219 kN (49 290 lbf).

The fuel-allowance specifications for the take-off, descent, and reserves are the same as for mission profile 4. The cruise Mach number is 0.85, and the range is 3.87 Mm (2089 n. mi.). The flight time for a long-range mission is important from the standpoint of crew fatigue. For this profile, the total mission time is 4.4 hours.

Optional Calculations

An optional calculation for this module can be used to determine the radius capability with a given number of sustained turns at the midrange station. The turns are calculated at cruise conditions (Mach number, altitude, and weight) that exist at the radius (midrange) station. The weapon may be expended before the turns are initiated, and, if this occurs, the turn-rate calculations are based on the clean configuration. For the present example, the weapon is retained, so that the turn performance includes the effect of the external-store drag. The sustained turn rate is calculated to be 4.9 deg/sec and a half-turn (180°) requires 171 kg (377 lbm) of fuel. The mission radius, which does not include the radius of the turn maneuver, is 1.9 Mm (1025 n. mi.). The summary output listing for this mission is presented in table 13.

The climb performance for this mission was calculated by using the maximum thrust of the engines, which is the standard operating procedure for most military profiles. On the other hand, the ferry mission is not concerned primarily with rapid climb times; thus, the performance has also been determined by using a reduced level of thrust. The resulting range is 4.0 Mm (2169 n. mi.) with an overall time of 4.6 hours. At the reduced thrust level, the climb to start of cruise takes more time and distance, but the reduced fuel-flow rates result in a reduction in the total fuel required for climb. The fuel saved during the climb is available for a more efficient cruise, thus increasing range. An additional fuel savings is possible in that, since it is not employed during this modified mission, the take-off allowance (which also simulates the engine warm-up) would not have to include operation at full power.

SUMMARY OF SAMPLE MISSION PERFORMANCE

The primary performance for the five mission profiles is summarized in table 14. Specific details for these, and the alternate missions, may be found in the tables for each profile. As discussed in previous sections, the missions vary in complexity from a long-range cruise mission to a multisegmented combat-radius mission. The specific cruise and dash Mach numbers and the combat fuel allowances selected for the sample cases illustrate the flexibility of the program in the representation of a wide variety of military mission profiles.

CONCLUDING REMARKS

A computer technique to determine the mission radius and maneuverability characteristics of combat aircraft has been developed. The aircraft characteristics and flight constraints are represented in sufficient detail to permit

realistic sensitivity studies in terms of either configuration modifications or changes in operational procedures. Sample performance results are provided to illustrate the wide variety of military mission profiles that may be represented. Extensive use of the technique in evaluation studies indicates that the calculated performance is essentially the same as that obtained by the proprietary programs in use throughout the aircraft industry.

Langley Research Center
National Aeronautics and Space Administration
Hampton, VA 23665
February 6, 1981

APPENDIX A

DESCRIPTION OF PROGRAM INPUTS

This appendix contains descriptions of the input data required to define the aircraft configuration and the mission requirements. The aircraft descriptions are presented to give the reader a feel for the degree of detail available to define a specific aircraft design. The inputs related to mission specifications illustrate that a wide variety of mission profiles and combat fuel requirements may be represented.

AIRCRAFT INPUTS

The description of the aircraft inputs is divided into three major sets. The first and largest set deals with the characteristics of the propulsion system. The second set defines the aerodynamic characteristics of the aircraft and of any external stores that may be carried. The third set deals primarily with the weight and size of the vehicle and its components.

The propulsion characteristics are precomputed, usually from data supplied by an engine manufacturer. All engine characteristics are given for a single, full-size engine. These values are multiplied within the program by the number of engines on the aircraft and are scaled (sized) to the proper thrust level as required by the vehicle inputs. The propulsion data are considered to be installed in that they include the effects of inlet pressure recovery, horsepower and bleed-air extraction, and nozzle velocity coefficient. The data also include all engine-related drags (inlet bleed, bypass, spillage, and boattail) except the nacelle external skin-friction drag. The latter drag is included in the aerodynamic data, and the change in external nacelle drag with engine size is represented by an incremental drag input. The engine characteristics required for performance calculations are the gross thrust, ram drag, and fuel flow. These data are input in two groups. The first group is for climb operations at either of two fixed throttle settings. For each throttle setting, the data are input as a function of flight Mach number and altitude. The program can accept data for as many as 15 altitudes at each of 15 Mach numbers. The second group is for cruise and loiter operations at reduced engine throttle settings. The ram-drag and fuel-flow parameters are input as functions of the thrust level for up to ten selected Mach-number--altitude combinations. The program can accept data for as many as 15 throttle settings at each flight condition. These two data groups can be interpolated to determine the engine characteristics at any Mach number, altitude, and throttle-setting combination. Independent multipliers for each parameter are available which can be used to simulate another engine type or to represent, for example, an improvement in specific fuel consumption for a sensitivity study.

The aerodynamic characteristics of a given configuration are represented in terms of lift and drag coefficients as functions of aircraft angle of attack and flight Mach number. The data are input for full-scale trimmed conditions for a clean configuration (retracted gear, no external stores). The data are based on a given reference wing area. The program can accept as many as 15 angles of

APPENDIX A

attack of each of 15 Mach numbers. At each Mach number, the friction drag contribution to the total aircraft drag is based on a reference flight altitude. The reference altitude is usually coincident with the nominal climb schedule, but can be any altitude. When calculations are made for the aircraft drag at other altitudes, the change in the friction drag contribution (due to Reynolds number effects) can be accounted for. If this option is used, the rate of change of the friction drag coefficient with altitude must be predetermined at each Mach number and input along with the basic aerodynamic characteristics.

Three separate arrays of drag-coefficient increments are available to modify the basic drag data at any Mach number. The first is a general-purpose increment that may be used to represent any drag increments not in the basic drag data. This increment is useful for drag sensitivity studies or to represent store racks that are retained when the stores are dropped. The other two arrays are utilized specifically to define the drag-coefficient increments of external weapons and external fuel tanks. The application of these two increments is controlled by individual mission-module logic so that they are not included in calculations of performance in mission segments occurring after the individual stores have been dropped.

The size of the aircraft is defined in terms of the wing area, the size and number of engines, and the take-off gross weight. The wing area and engine size may be defined alternately in terms of wing loading and thrust loading. Additional weight items are required to define the aircraft. They are the operating weight empty OWE and the weight of external stores. If external fuel is to be carried, the weight of both the fuel and the tanks must be defined. The OWE can be input in several ways. For preliminary performance studies, the OWE is input either as a constant or as a tabular function of the aircraft TOGW. It may be expressed in absolute units or as a percentage of the TOGW. In more detailed studies, particularly those involving size changes of the aircraft wing and engines, OWE can be considered as the sum of three items. The first item is the weight of the aircraft minus the wing and propulsion-system weights. The other two items would be the wing and engine weights with appropriate scaling factors applied. This method does not recognize the interface between the components. For example, it could not represent the possible reduction in wing weight as the engines (if wing mounted) were reduced in size. A third method of representing OWE is to input the variation of OWE as a three-dimensional function of three major components; TOGW, wing area, and engine size. Data in this form, which would be calculated externally, would include the integrated effects on all components as each individual component was changed. The effort required to calculate the required matrix of data for this method of representing OWE is considered excessive, but in principle, the resulting OWE would correctly reflect the configuration changes. A more direct approach would be to incorporate the weight equations in the program as a module. A compromise would be to calculate the OWE for selected combinations of the three components and to input the results using the first option described in this paragraph.

A caution previously noted is repeated here. In aircraft sizing studies, the weight and propulsion characteristics can be appropriately modified internally as changes in both wing area and engine size occur, but the basic aerodynamic characteristics are not altered by the program to reflect such configuration modifications. Therefore, caution must be used if the T/W and

APPENDIX A

W/S are varied far from the original input concept. The repetitive technique described in the section entitled "Application to Vehicle Sizing" is recommended as a practical approach to large excursions from the original aircraft concept.

MISSION INPUTS

The major mission inputs are described in detail in the main text and are briefly reviewed in this section. The desired mission profile is selected by the mission module from table 1. The schedule of climb altitude versus Mach number must be developed with consideration of all operational constraints of the vehicle and the specific mission ground rules. The desired ranges for the mission segments must be input along with the definition of the required Mach number and altitude for any dash or loiter segment. The fuel allowance options for the take-off, combat maneuvers, and the reserve segments are selected by input controls, and the associated Mach number, altitude, and time specifications required by each selected option must be input. For a given set of input data the program can be used to calculate the mission results along with the optional radius trade-off data for each value of TOGW that is input up to five values. As described in the main text, these results would indicate the performance sensitivity to the variations input for the TOGW and the OWE.

The additional results described in some of the mission modules, such as the accelerating performance and energy-maneuverability characteristics, may be calculated without the mission-profile performance by inputting the desired cruise range as a zero.

The following optional features are available and can be incorporated in the performance calculations with control inputs. They are briefly described in order of their significance to the mission performance results. The atmospheric model utilized was the U.S. Standard Atmosphere of 1962. (See ref. 4.) An atmospheric model with a nonstandard temperature can be represented by inputting the desired temperature increment (which is the same for all altitudes). The propulsion data must be based on the same atmospheric model for a proper representation of the hot-day effects on mission performance. The thrust-inclination terms in the equations of motion can be eliminated; however, these terms result in beneficial effects on performance, particularly at the high angles of attack encountered during combat maneuvers. The engine nozzle may be inclined to increase the benefit, and the input angle can be used to simulate thrust vectoring. It should also be noted that it is the gross thrust that is being inclined, not the net thrust. This is significant because the magnitude of the gross thrust is two or more times that of the net thrust. Gravitational acceleration can be held constant (usually at the sea level value) or, more realistically, can be allowed to vary with altitude using the inverse-square variation. The effects of centrifugal force due to flight-path curvature and of the contribution of the Earth's rotational velocity are also available but are insignificant for the missions being considered. Indeed, the latter effect is canceled on a radius-type mission.

APPENDIX B

DESCRIPTION OF PROGRAM OUTPUTS

This appendix contains descriptions of the output options and the specific output parameters. Sample tabulations are presented which illustrate both the minimum summary output and the extensive detail of the point-by-point output.

OUTPUT OPTIONS

The amount of tabulated output resulting from a given set of calculations is controlled by inputs. The minimum output from the calculations for a particular profile is illustrated for each profile. A typical example is shown in table 4 for profile 1. (Definitions of output parameters are given at the end of this appendix.) The tabulated output for a given profile can be progressively increased until each calculated flight point during the climb is represented. A sample of such a flight-point tabulation is presented in table 15. This flight point is at the end of the climb for the aircraft used to describe mission 1. The tabulation includes 18 state variables and acceleration rates. An additional option is available which controls the printout of interim results during the iterations required to balance the equations of motion at each point along the climb profile. Such a listing is useful in the analysis of problems that may develop in some extreme cases.

The performance for many individual aircraft or mission-profile combinations may be calculated in series (upper limit of 50). For this type of production running, it is convenient to request the minimum mission-profile printout and to have the results summarized as indicated in table 16. The calculations of a particular profile are represented by a single line containing selected parameters which identify the mission and the aircraft and show key results. This form of output can be used to scan the results of many calculations in order to observe significant trends. The eleven cases shown in table 16 are for the sample missions described in this report and are in the same order as the results of table 14, with the exception of the second case. The dash radius of the second case is the exact performance capability for mission profile 1 as referred to in the main text and illustrated in figure 11.

DEFINITIONS OF OUTPUT PARAMETERS

The following is a list of the abbreviations, and their definitions, for the parameters used in the tabular outputs. The parameters as indicated on the tables, may be in either the SI or foot-pound-second system of units.

<u>PARAMETER</u>	<u>DEFINITION</u>
ACC FUEL	Acceleration fuel weight
ALPHA	Aircraft angle of attack

APPENDIX B

<u>PARAMETER</u>	<u>DEFINITION</u>
AVCRH	Average cruise altitude
AVGAM	Average flight-path angle
AVG COMBAT PS	Average combat specific power
AVG TR	Average turn rate
AVG TRAD	Average turn radius
AV STTR1	Average sustained turn rate, first requirement
AV STTR2	Average sustained turn rate, second requirement
BF	Breguet cruise factor
CD	Aircraft drag coefficient
CL	Aircraft lift coefficient
COMFUEL	Combat fuel-allowance weight
CRM	Flight cruise Mach number
CR RD	Cruise radius
DASH RD	Dash radius
DW1	Take-off fuel weight
ES	Aircraft specific energy
ESF	Engine sizing factor
FEXT	External fuel weight
FFML	Fuel flow at military power
FFMX	Fuel flow at maximum power
FINT	Internal fuel weight
H	Flight altitude
H1-H16	Altitude at profile points 1-16
LOD	Aircraft lift-drag ratio
M	Flight Mach number

APPENDIX B

<u>PARAMETER</u>	<u>DEFINITION</u>
MID CR WT	Aircraft weight at midrange
MISS	Mission-profile identification number
OWE	Aircraft operating weight empty
PER COMBAT	Percent of specified combat fuel weight
PER LOITER	Percent of specified loiter time
Q	Flight dynamic pressure
RES	Reserve-fuel weight
RETFEXT	Retained external fuel weight
RNG/KG	Range loss per unit fuel mass
ROC	Rate of climb
R1-R16	Radius for profile points 1-16
S	Aircraft wing area
T	Aircraft thrust
TFF	Total fuel flow, all engines
TMD	Thrust minus drag
TM1-TM16	Time at profile points 1-16
TOGW	Aircraft take-off gross weight
TOW	Aircraft thrust-weight ratio
TTNET	Total engine net thrust, all engines
TURN FUEL	Turn fuel weight
V	Flight velocity
W	Weight
WOS	Wing loading, weight per area
WTANKS	Weight of external tanks
WT1-WT16	Weight at profile points 1-16

REFERENCES

1. Standard for Metric Practice. E 380-79, American Soc. Testing & Mater., c.1980.
2. Rutowski, Edward S.: Energy Approach to the General Aircraft Performance Problem. J. Aeronaut. Sci., vol. 21, no. 3, Mar. 1954, pp. 187-195.
3. Perkins, Courtland D.; and Hage, Robert E.: Airplane Performance Stability and Control. John Wiley & Sons, Inc., c.1949, pp. 185-186.
4. U.S. Standard Atmosphere, 1962. NASA, U.S. Air Force, and U.S. Weather Bur., Dec. 1962.

TABLE 1.- MISSION MODULES

Module	Type	Profile description	Tank-drop logic
1	Radius	Hi-Lo-Lo-Hi; Air superiority	Yes
2	Radius	Hi-Lo-Hi; Fighter escort	No
3	Radius	Hi-Hi; Combat air patrol	Yes
4	Range	Hi-Lo-Lo-Hi; Long-range penetration	No
5	Range	Hi; Long-range cruise	Yes

TABLE 2.- RESERVE-FUEL MODES

Mode	Description
1	Fixed fuel weight
2	Fraction of internal fuel
3	Fraction of total fuel
4	Fraction of take-off gross weight
5	Loiter at a given altitude for time interval
6	Time interval at military-power fuel flow plus time interval at maximum-power fuel flow

TABLE 3.- MISSION PROFILE 1: AIR SUPERIORITY; HI-LO-LO-HI

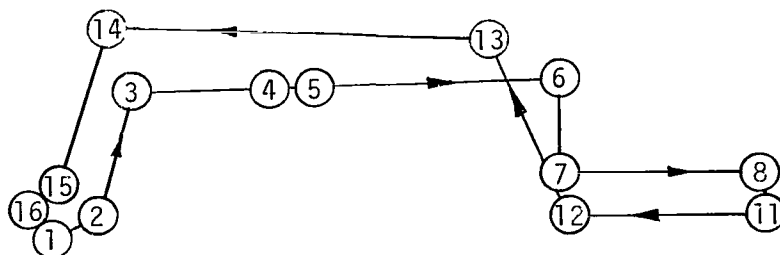

Profile points	Description	Inputs
1 - 2	Take-off fuel allowance	Options
2 - 3	Accelerate and climb to start of cruise	Climb schedule
3 - 4	Outbound cruise (with tanks, if carried)	Cruise Mach number
4 - 5	Drop tanks (if carried) ¹	Tank weight
5 - 6	Outbound cruise (without tanks)	Cruise radius
6 - 7	Descend, no range or fuel	-----
7 - 8	Outbound dash	Mach number, altitude, radius
8 - 10	Weapon expended	Weapon weight
10 - 11	Combat fuel allowance	Options
11 - 12	Inbound dash	Dash radius
12 - 13	Accelerate and climb to cruise altitude	-----
13 - 14	Inbound cruise	-----
14 - 15	Descend	Increment weight, range, time
15 - 16	Reserve-fuel allowance	Options

¹Optional tank drop logic described in main text.

TABLE 4.- MISSION DETAILS FOR PROFILE 1

(a) Primary mission

*** CASE= 1.00 2001 MISSION SUMMARY TOGW= 219.25 OWE= 106.76 S= 66.61 ESF= 1.0000
 PAYLOAD= -1.78 FINT= 87.19 FEXT= 21.40 WTANKS= 2.14

**** UNITS FOR OUTPUT DATA ****

SYSTEM	ALTITUDE	DISTANCE	FORCE	TIME	ANGLE	PRESSURE	VELOCITY	FUEL FLOW
SI	M	KM	KN	MIN	DEG	KPA	M/S	KG/S
FPS	FT	N MI	LBF	MIN	DEG	PSF	FPS	LRM/H

***** FOR TOGW= 219.25 T/W= .930 W/S= 3.28 *****

*** TAKEOFF FUEL= 4.88 ***

*** TOTAL RESERVES= 3.93 ***

● OPTION 1 CRUISE RADIUS=1111.2 AT MACH=1.60 DASH RADIUS= 298.9 AT MACH= .40
 COMBAT FUEL WT.= 15.40 AVG COMBAT PS= 553.95

WT1 = 219.25 WT2= 214.37 WT3= 197.71 WT4= 197.71 WT5= 195.57 WT6= 177.00
 WT7 = 177.00 WT8= 161.93 WT9= 161.93 WT10= 160.15 WT11= 144.75 WT12= 130.78
 WT13= 121.94 WT14= 111.13 WT15= 110.68 WT16= 106.76

R1 = 0.00 R2 = 18.52 R3 = 78.59 R4 = 78.59 R5 = 78.59 R6 =1111.18
 R7 =1111.18 R8 =1410.03 R9 =1410.03 R10=1410.03 R11=1410.03 R12=1111.18
 R13=1071.08 R14= 37.04 R15= 0.00 R16= 0.00

H1 = 0. H2 = 15. H3 = 15453. H4 = 15453. H5 = 15453. H6 = 16153.
 H7 = 610. H8 = 610. H9 = 1524. H10= 1524. H11= 610. H12= 610.
 H13= 18511. H14= 19022. H15= 15. H16= 0.

TABLE 4.- Concluded

(b) Alternate missions

● OPTION 2 CRUISE RADIUS=1111.2
DASH RADIUS= 185.2 COMBAT FUEL= 26.43 PER COMBAT=171.59

WT1 = 219.25	WT2= 214.37	WT3= 197.71	WT4= 197.71	WT5= 195.57	WT6= 177.00
WT7 = 177.00	WT8= 167.65	WT9= 167.65	WT10= 165.87	WT11= 139.44	WT12= 130.78
WT13= 121.94	WT14= 111.13	WT15= 110.68	WT16= 106.76		
R1 = 0.00	R2 = 18.52	R3 = 78.59	R4 = 78.59	R5 = 78.59	R6 =1111.18
R7 =1111.18	R8 =1296.38	R9 =1296.38	R10=1296.38	R11=1296.38	R12=1111.18
R13=1071.08	R14= 37.04	R15= 0.00	R16= 0.00		
H1 = 0.	H2 = 15.	H3 = 15453.	H4 = 15453.	H5 = 15453.	H6 = 16153.
H7 = 610.	H8 = 610.	H9 = 1524.	H10= 1524.	H11= 610.	H12= 610.
H13= 18511.	H14= 19022.	H15= 15.	H16= 0.		

● OPTION 3 DASH RADIUS= 185.2
CRUISE RADIUS=1497.0 COMBAT FUEL= 15.40

WT1 = 219.25	WT2= 214.37	WT3= 197.71	WT4= 197.71	WT5= 195.57	WT6= 170.52
WT7 = 170.52	WT8= 161.20	WT9= 161.20	WT10= 159.42	WT11= 144.02	WT12= 135.36
WT13= 126.24	WT14= 111.13	WT15= 110.68	WT16= 106.76		
R1 = 0.00	R2 = 18.52	R3 = 78.59	R4 = 78.59	R5 = 78.59	R6 =1497.02
R7 =1497.02	R8 =1682.21	R9 =1682.21	R10=1682.21	R11=1682.10	R12=1497.91
R13=1456.84	R14= 37.04	R15= 0.00	R16= 0.00		
H1 = 0.	H2 = 15.	H3 = 15453.	H4 = 15453.	H5 = 15453.	H6 = 16395.
H7 = 610.	H8 = 610.	H9 = 1524.	H10= 1524.	H11= 610.	H12= 610.
H13= 18308.	H14= 19022.	H15= 15.	H16= 0.		

TABLE 5.- MISSION DETAILS FOR PROFILE 1 WITH NO RETURN DASH

(a) Primary mission

*** CASE= 3.00 2001 MISSION SUMMARY TOGW= 219.25 OWE= 106.76 S= 66.81 ESF= 1.0000
 PAYLOAD= -1.78 FINT= 87.19 FEXT= 21.40 WTANKS= 2.14

**** UNITS FOR OUTPUT DATA ****

SYSTEM	ALTITUDE	DISTANCE	FORCE	TIME	ANGLE	PRESSURE	VELOCITY	FUEL FLOW
SI	M	KM	KN	MIN	DEG	KPA	M/S	KG/S
FPS	FT	N MI	LBF	MIN	DEG	PSF	FPS	LRM/H

***** FOR TOGW= 219.25 T/W= .930 W/S= 3.24 *****

***** FOLLOWING MISSIONS HAVE NO RETURN DASH *****

*** TAKEOFF FUEL= 4.88 ***

*** TOTAL RESERVES= 3.93 ***

* OPTION 1 CRUISE RADIUS=1111.2 AT MACH=1.60 DASH RADIUS= 912.0 AT MACH= .90
 COMBAT FUEL WT.= 15.24 AV STR1= 6.81 AV STR2= 7.56

WT1 = 219.25 WT2= 214.37 WT3= 197.71 WT4= 197.71 WT5= 195.57 WT6= 177.00
 WT7 = 177.00 WT8= 154.38 WT9= 154.38 WT10= 152.61 WT11= 137.37 WT12= 137.37
 WT13= 132.45 WT14= 111.13 WT15= 110.66 WT16= 106.70

R1 = 0.00 R2 = 19.52 R3 = 78.59 R4 = 78.59 R5 = 78.59 R6 =1111.18
 R7 =1111.18 R8 =2023.21 R9 =2023.21 R10=2023.21 R11=2023.21 R12=2023.22
 R13=1990.58 R14= 37.04 R15= 0.00 R16= 0.00

H1 = 0. H2 = 15. H3 = 15453. H4 = 15453. H5 = 15453. H6 = 16153.
 H7 = 9144. H8 = 9144. H9 = 9144. H10= 9144. H11= 9144. H12= 9144.
 H13= 18015. H14= 19022. H15= 15. H16= 0.

TABLE 5.- Concluded

(b) Alternate missions

* OPTION 2 CRUISE RADIUS=1111.2
 DASH RADIUS= 185.2 COMBAT FUEL= 41.70 PER COMBAT=242.18

WT1 = 214.25 WT2= 214.37 WT3= 197.71 WT4= 197.71 WT5= 195.57 WT6= 177.00
 WT7 = 177.00 WT8= 172.25 WT9= 172.25 WT10= 170.49 WT11= 128.78 WT12= 128.78
 WT13= 124.07 WT14= 111.13 WT15= 110.54 WT16= 106.76

R1 = 0.00 R2 = 18.52 R3 = 78.59 R4 = 78.59 R5 = 78.59 R6 =1111.18
 R7 =1111.18 R8 =1296.38 R9 =1296.38 R10=1296.38 R11=1296.38 R12=2023.22
 R13=1263.99 R14= 37.04 R15= 0.00 R16= 0.00

H1 = 0. H2 = 15. H3 = 15453. H4 = 15453. H5 = 15453. H6 = 16153.
 H7 = 9144. H8 = 9144. H9 = 9144. H10= 9144. H11= 9144. H12= 9144.
 H13= 18411. H14= 19022. H15= 15. H16= 0.

* OPTION 3 DASH RADIUS= 185.2
 CRUISE RADIUS=2044.7 COMBAT FUEL= 15.54

WT1 = 214.25 WT2= 214.37 WT3= 197.71 WT4= 197.71 WT5= 195.57 WT6= 161.73
 WT7 = 161.73 WT8= 157.24 WT9= 157.24 WT10= 155.46 WT11= 139.92 WT12= 139.92
 WT13= 134.93 WT14= 111.13 WT15= 110.54 WT16= 106.76

R1 = 0.00 R2 = 18.52 R3 = 78.59 R4 = 78.59 R5 = 78.59 R6 =2044.74
 R7 =2044.74 R8 =2229.94 R9 =2229.94 R10=2229.94 R11=2229.94 R12=2229.69
 R13=2196.81 R14= 37.04 R15= 0.00 R16= 0.00

H1 = 0. H2 = 15. H3 = 15453. H4 = 15453. H5 = 15453. H6 = 16741.
 H7 = 9144. H8 = 9144. H9 = 9144. H10= 9144. H11= 9144. H12= 9144.
 H13= 17898. H14= 19022. H15= 15. H16= 0.

TABLE 6.- MISSION PROFILE 2: FIGHTER ESCORT; HI-LO-HI

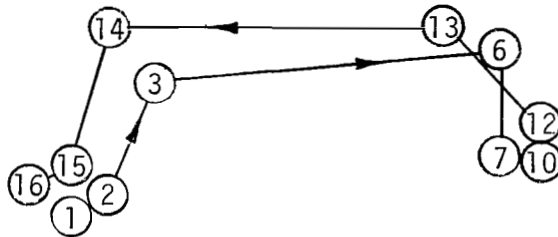

Profile points	Description	Inputs
1 - 2	Take-off fuel allowance	Options
2 - 3	Accelerate and climb to start of cruise	Climb schedule
3 - 6	Outbound cruise ¹	Cruise Mach number and radius
6 - 7	Descend, no range or fuel	-----
7 - 10	Weapon expended	Weapon weight
10 - 12	Combat fuel allowance	Options
12 - 13	Accelerate and climb to cruise altitude	-----
13 - 14	Inbound cruise	-----
14 - 15	Descend	Increment weight, range, time
15 - 16	Reserve-fuel allowance	Options

¹Tanks, if carried, are retained throughout mission.

TABLE 7.- MISSION DETAILS FOR PROFILE 2

*** CASE= 5.00 2002 MISSION SUMMARY TOGW= 219.25 OWE= 106.76 S= 66.81 ESF= 1.0000
 PAYLOAD= -1.78 FINT= 87.19 FEXT= 21.40 WTANKS= 2.14

**** UNITS FOR OUTPUT DATA ****

SYSTEM	ALTITUDE	DISTANCE	FORCE	TIME	ANGLE	PRESSURE	VELOCITY	FUEL FLOW
SI	M	KM	KN	MIN	DEG	KPA	M/S	KG/S
FPS	FT	N MI	LBF	MIN	DEG	PSF	FPS	LBM/H

**IN TOFUEL, SLSFFML= 0.0000 SLSFFMX= 0.0000 DWI= 4.88

*** TOTAL RESERVES= 3.95 ***

* OPTION 1 MISSION RADIUS=1406.0 AT MACH= .85
 COMBAT FUEL WT= 16.30

WT1 = 219.25 WT2= 214.37 WT3= 205.23 WT4= 163.70 WT5= 163.70 WT6= 163.70
 WT7 = 163.70 WT8= 163.70 WT9= 163.70 WT10= 161.92 WT11= 145.62 WT12= 145.62
 WT13= 140.90 WT14= 113.28 WT15= 112.84 WT16= 108.99

R1 = 0.00 R2 = 18.52 R3 = 35.90 R4 =1405.97 R5 =1405.97 R6 =1405.97
 R7 =1405.97 R8 =1405.97 R9 =1405.78 R10=1405.78 R11=1405.78 R12=1405.78
 R13=1393.43 R14= 37.04 R15= 0.00 R16= 0.00

H1 = 0. H2 = 15. H3 = 8184. H4 = 9982. H5 = 9982. H6 = 9982.
 H7 = 3048. H8 = 3048. H9 = 3048. H10 = 3048. H11 = 3048. H12 = 3048.
 H13 = 11115. H14 = 12602. H15 = 15. H16 = 0.

* OPTION 2 MISSION RADIUS=1296.4 COMBAT FUEL= 21.76 PER COMBAT= 1.33

WT1 = 219.25 WT2= 214.37 WT3= 205.23 WT4= 166.69 WT5= 166.69 WT6= 166.69
 WT7 = 166.69 WT8= 166.69 WT9= 166.69 WT10= 164.91 WT11= 143.15 WT12= 143.15
 WT13= 138.46 WT14= 113.28 WT15= 112.84 WT16= 108.89

R1 = 0.00 R2 = 18.52 R3 = 35.90 R4 =1296.38 R5 =1296.38 R6 =1296.38
 R7 =1296.38 R8 =1296.38 R9 =1296.38 R10=1296.38 R11=1296.38 R12=1296.38
 R13=1284.08 R14= 37.04 R15= 0.00 R16= 0.00

H1 = 0. H2 = 15. H3 = 8184. H4 = 9847. H5 = 9847. H6 = 9847.
 H7 = 3048. H8 = 3048. H9 = 3048. H10 = 3048. H11 = 3048. H12 = 3048.
 H13 = 11246. H14 = 12602. H15 = 15. H16 = 0.

TABLE 8.- MISSION PROFILE 3: COMBAT AIR PATROL; HI-HI

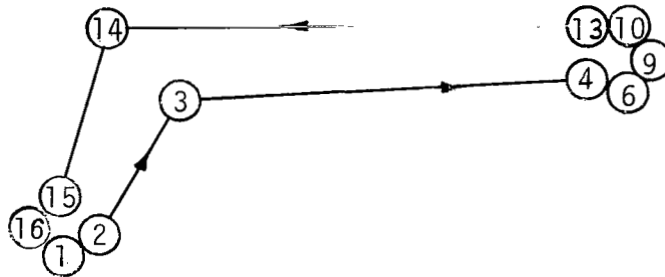

Profile points	Description	Inputs
1 - 2	Take-off fuel allowance	Options
2 - 3	Accelerate and climb to start of cruise	Climb schedule
3 - 4	Outbound cruise (with tanks, if carried)	Cruise Mach number and radius
4 - 6	Drop tanks (if carried) ¹	Tank weight
6 - 9	Loiter for given time	Mach number, altitude
9 - 10	Weapon expended	Weapon weight
10 - 13	Combat fuel allowance	-----
13 - 14	Inbound cruise	-----
14 - 15	Descend	Increment weight, range, time
15 - 16	Reserve-fuel allowance	Options

¹Tanks dropped at end of cruise.

TABLE 9.- MISSION DETAILS FOR PROFILE 3

*** CASE= 7.00 2003 MISSION SUMMARY TOGW= 219.25 OWE= 106.76 S= 66.81 ESF= 1.0000
 PAYLOAD= -1.78 FINI= 87.19 FEXT= 21.40 WTANKS= 2.14

**** UNITS FOR OUTPUT DATA ****

SYSTEM	ALTITUDE	DISTANCE	FORCE	TIME	ANGLE	PRESSURE	VELOCITY	FUEL FLOW
SI	M	KM	KN	MIN	DEG	KPA	M/S	KG/S
FPS	FT	N MI	LBF	MIN	DEG	PSF	FPS	LRM/H

**IN TOFUEL, SLSFFML= 0.0000 SLSFFMX= 0.0000 Dw1= 4.88

*** TOTAL RESERVES= 3.93 ***

* OPTION 1 MISSION RADIUS= 796.5 AT MACH= .85
 LOITER FUEL WT= 43.47 LOITER HR= 2.00

WT1 = 219.25 WT2= 214.37 WT3= 205.89 WT4= 180.86 WT5= 178.72 WT6= 178.72
 WT7 = 135.25 WT8= 134.05 WT9= 126.22 WT10= 124.45 WT11= 124.45 WT12= 124.45
 WT13= 124.45 WT14= 111.13 WT15= 110.68 WT16= 106.76

R1 = 0.00 R2 = 18.52 R3 = 33.59 R4 = 796.45 R5 = 796.45 R6 = 796.45
 R7 = 796.45 R8 = 796.45 R9 = 796.45 R10= 796.08 R11= 796.08 R12= 796.08
 R13= 796.08 R14= 37.04 R15= 0.00 R16= 0.00

H1 = 0. H2 = 15. H3 = 7163. H4 = 8792. H5 = 8792. H6 = 8792.
 H7 = 9144. H8 = 9144. H9 = 9144. H10= 9144. H11= 9144. H12= 9144.
 H13= 11948. H14= 12854. H15= 15. H16= 0.

ACC. FUEL= 1.20 TOT. COMBAT FUEL= 9.03 RETFEXT= 0.00

* OPTION 2 MISSION RADIUS= 740.8 LOITER FUEL= 46.20 LOITER HR= 2.12

WT1 = 219.25 WT2= 214.37 WT3= 205.89 WT4= 182.58 WT5= 180.44 WT6= 180.44
 WT7 = 134.24 WT8= 133.03 WT9= 125.21 WT10= 123.43 WT11= 123.43 WT12= 123.43
 WT13= 123.43 WT14= 111.13 WT15= 110.68 WT16= 106.76

R1 = 0.00 R2 = 18.52 R3 = 33.59 R4 = 740.79 R5 = 740.79 R6 = 740.79
 R7 = 740.79 R8 = 740.79 R9 = 740.79 R10= 740.79 R11= 740.79 R12= 740.79
 R13= 740.79 R14= 37.04 R15= 0.00 R16= 0.00

H1 = 0. H2 = 15. H3 = 7163. H4 = 8792. H5 = 8792. H6 = 8792.
 H7 = 9144. H8 = 9144. H9 = 9144. H10= 9144. H11= 9144. H12= 9144.
 H13= 12017. H14= 12854. H15= 15. H16= 0.

PER LOITER=106.06 RETFEXT= 0.00

TABLE 10.- MISSION PROFILE 4: LONG-RANGE PENETRATION; HI-LO-LO-HI

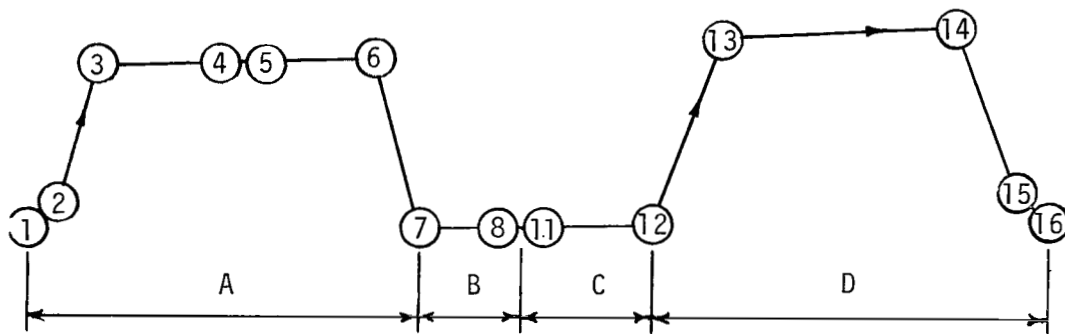

Profile points	Description	Inputs
1 - 2	Take-off fuel allowance	Options
2 - 3	Accelerate and climb to start of cruise	Climb schedule
3 - 4	Outbound cruise ¹	Cruise Mach number
4 - 5	Refuel	Tanker data
5 - 6	Outbound cruise	Cruise range ²
6 - 7	Descend	Scaled increments
7 - 8	Outbound dash	Mach number, altitude, range
8 - 11	Weapon expended	Weapon weight
11 - 12	Inbound dash	Mach number, altitude, range
12 - 13	Accelerate and climb to cruise	-----
13 - 14	Inbound cruise	Range
14 - 15	Descend	Increments
15 - 16	Reserve-fuel allowance	Options

¹Outbound refers to pre-target events, inbound refers to post-target events.

²A, B, C, and D are desired range increments.

TABLE 11.- MISSION DETAILS FOR PROFILE 4

*** CASE= 9.00 2004 MISSION SUMMARY TOGW= 198.39 OWE= 106.76 S= 66.81 ESF= 1.0000
 PAYLOAD= -4.45 FINT= 63.65 FEXT= 21.40 WTANKS= 2.14

*** UNITS FOR OUTPUT DATA ***

SYSTEM	ALTITUDE	DISTANCE	FORCE	TIME	ANGLE	PRESSURE	VELOCITY	FUEL FLOW
SI	M	KM	KN	MIN	DEG	KPA	M/S	KG/S
FPS	FT	N MI	LRF	MIN	DEG	PSF	FPS	LRM/H

*** TAKEOFF FUEL= 4.88 ***

*** TOTAL RESERVES= 3.93 ***

** REFUEL TO WT= 198.39 COMPLETED AT R= 1156.87

* OPTION 1 MISSION RANGE=3532.0 CRUISE AT MACH= .75
 TRANSFER FUEL WT= 47.19

WT1 = 198.39	WT2= 193.51	WT3= 186.01	WT4= 152.43	WT5= 198.39	WT6= 170.82
WT7 = 170.14	WT8= 150.33	WT9= 150.33	WT10= 145.49	WT11= 145.89	WT12= 136.88
WT13= 129.56	WT14= 111.13	WT15= 110.68	WT16= 106.76		

R1 = 0.00	R2 = 18.52	R3 = 31.28	R4 = 1132.71	R5 = 1156.87	R6 = 1993.51
R7 = 2070.45	R8 = 2420.84	R9 = 2420.84	R10= 2420.44	R11= 2420.84	R12= 2606.04
R13= 2634.75	R14= 3494.98	R15= 3532.02	R16= 3532.02		

H1 = 0.	H2 = 15.	H3 = 7620.	H4 = 8900.	H5 = 7620.	H6 = 8107.
H7 = 152.	H8 = 152.	H9 = 152.	H10= 152.	H11= 152.	H12= 152.
H13= 10301.	H14= 11759.	H15= 15.	H16= 0.		

TABLE 12.- MISSION PROFILE 5: LONG-RANGE CRUISE

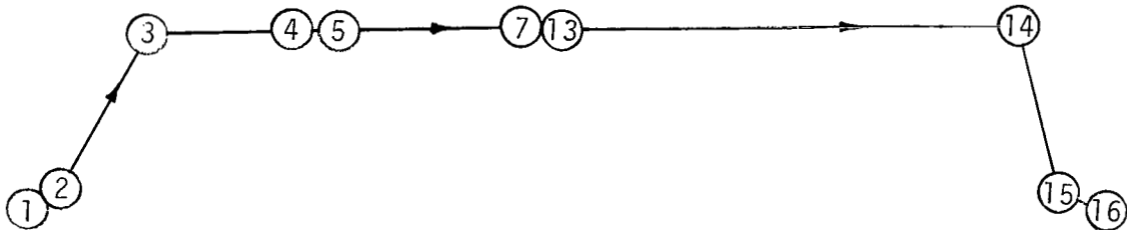

Profile points	Description	Inputs
1 - 2	Take-off fuel allowance	Options
2 - 3	Accelerate and climb to start of cruise	Climb schedule
3 - 4	Outbound cruise (with tanks, if carried)	Cruise Mach number
4 - 5	Drop tanks (if carried) ¹	Tank weight
5 - 7	Outbound cruise (without tanks)	-----
7 - 13	Midrange station	-----
13 - 14	Continued cruise	Cruise range
14 - 15	Descend	Increment weight, range, time
15 - 16	Reserve-fuel allowance	Options

¹Tanks dropped when empty.

TABLE 13.- MISSION DETAILS FOR PROFILE 5

*** CASE=10.00 2005 MISSION SUMMARY TOGW= 219.25 OWE= 106.76 S= 66.81 ESF= 1.0000
 PAYLOAD= 1.78 FINT= 87.19 FEFT= 21.40 WTANKS= 2.14

**** UNITS FOR OUTPUT DATA ****

SYSTEM	ALTITUDE	DISTANCE	FORCE	TIME	ANGLE	PRESSURE	VELOCITY	FUEL FLOW
SI	M	KM	KN	MIN	DEG	KPA	M/S	KG/S
FPS	FT	N MI	LBF	MIN	DEG	PSF	FPS	LBM/H

***** FOR TOGW= 219.25 T/W= .930 W/S= 3.28 *****

*** TAKEOFF FUEL= 4.88 ***

*** TOTAL RESERVES= 4.01 ***

* OPTION 1 FERRY MISSION RANGE= 3867.3 CRM= .85

WT1 = 219.25 WT2= 214.37 WT3= 205.07 WT4= 197.86 WT5= 195.72 WT6= 195.72
 WT7 = 151.20 WT8= 151.20 WT9= 151.20 WT10= 151.20 WT11= 151.20 WT12= 151.20
 WT13= 151.20 WT14= 112.99 WT15= 112.54 WT16= 108.44

R1 = 0.00 R2 = 18.52 R3 = 36.51 R4 = 253.48 R5 = 253.48 R6 = 253.48
 R7 = 1933.63 R8 = 1933.63 R9 = 1933.63 R10= 1933.63 R11= 1933.63 R12= 1933.63
 R13= 1933.63 R14= 3830.22 R15= 3867.26 R16= 3867.26

H1 = 0. H2 = 15. H3 = 8428. H4 = 8687. H5 = 8687. H6 = 8687.
 H7 = 10630. H8 = 10630. H9 = 10630. H10= 10630. H11= 10630. H12= 10630.
 H13= 10630. H14= 12953. H15= 15. H16= 0.

TM3= 1.6 TM4= 15.5 TM15= 262.5 AVCRH= 10820.

* OPTION 2 MISSION RADIUS WITH .50 TURNS AT MID POINT.

MID.CR.WT= 151.20 BF= 6384.28 RNG/KG= .422
 AVG. TR= 4.90 AVG. TRAD.= 2.94 TURN FUEL= 2.

MISSION RADIUS= 1897.54

TABLE 14.- SUMMARY OF MISSION PROFILE RESULTS

See tables 1 to 13 for alternate profiles and details

Mission profile	Cruise Mach number	TOGW kN (lbf)	External fuel weight, kN (lbf)	Combat fuel weight, kN (lbf)	Mission distance ¹ km (n. mi.)	Table
1 - Air superiority	1.60	219 (49 290)	21.40 (4810)	15.40 (3463)	1410 (761)	4
				15.24 (3422)	² 2023 (1093)	5
2 - Fighter escort	0.85	196 (44 000)	0	16.30 (3664)	1165 (629)	---
		219 (49 290)	21.40 (4810)	16.31 (3664)	1406 (759)	7
3 - Combat air patrol	0.85	196 (44 000)	0	8.86 (1991)	468 (253)	---
		219 (49 290)	21.40 (4810)	9.03 (2029)	796 (430)	9
4 - Long-range penetration	0.75	198 (44 600)	0	0	2041 (1102)	---
					³ 3532 (1907)	11
5 - Long-range cruise	0.85	219 (49 290)	21.40 (4810)	0	3837 (2088)	13
					⁴ 4017 (2169)	---

¹Radius or range, see profile.

²No return dash.

³With refuel.

⁴Climb at reduced power.

TABLE 15.- SAMPLE OF TABULATED RESULTS FOR EACH FLIGHT POINT

*** UNITS FOR OUTPUT DATA ***

SYSTEM	ALTITUDE	DISTANCE	FORCE	TIME	ANGLE	PRESSURE	VELOCITY	FUEL FLOW
SI	M	KM	KN	MIN	DEG	KPA	M/S	KG/S
FPS	FT	N MI	LBF	MIN	DEG	PSF	FPS	LBM/H

M= 1.60 H= 15453. W= 197.71 RANGE= 78.59 TIME= 3.45 LOD= 5.76 ES= 26R18.
 Q= 20.2 CL= .1439 CD= .0250 DRAG= 33.73 TTNET= 76.30 TFF= 4.82
 V= 472.1 ALPHA= 1.289 ROC= 6150.63 TMD= 42.57 AVGAM=12.46

TABLE 16.- SUMMARY LISTING OF PRIMARY MISSION RESULTS

SUMMARY OF PRIMARY MISSION RESULTS FOR 11 CASES. (DETAILS AND TRADES IN CASE LISTINGS)

CASE	MISS	TOWW KN	WOS KPA	TOW	OwE KN	PAYLOAD KN	FINT KN	FEXT KN	RES KN	CR RD KM	DASH RD KM	COMFUEL KN
1.00	2001.	219.3	3.28	.93	106.76	-1.74	87.19	21.40	3.93	1111.2	298.9	15.40
2.00	2001.	219.3	3.28	.93	106.76	-1.74	87.19	21.40	3.93	1111.2	308.5	15.40
3.00	2001.	219.3	3.28	.93	106.76	-1.74	87.19	21.40	3.93	1111.2	912.0	15.24
4.00	2002.	195.7	2.93	1.04	106.76	-1.74	87.19	0.00	3.85	1164.6	0.0	16.30
5.00	2002.	219.3	3.28	.93	106.76	-1.74	87.19	21.40	3.95	1406.0	0.0	16.30
6.00	2003.	195.7	2.93	1.04	106.76	-1.74	87.19	0.00	3.85	467.8	0.0	9.46
7.00	2003.	219.3	3.28	.93	106.76	-1.74	87.19	21.40	3.93	796.5	0.0	9.03
8.00	2004.	198.4	2.97	1.03	106.76	-4.45	63.65	21.40	3.93	2040.9	370.4	0.00
9.00	2004.	198.4	2.97	1.03	106.76	-4.45	63.65	21.40	3.93	3532.0	370.4	0.00
10.00	2005.	219.3	3.28	.93	106.76	1.74	87.19	21.40	4.01	3867.3	0.0	0.00
11.00	2005.	219.3	3.28	.93	106.76	1.74	87.19	21.40	4.01	4017.4	0.0	0.00

■ TOTAL RANGE FOR MISSION PROFILE 4 AND 5.

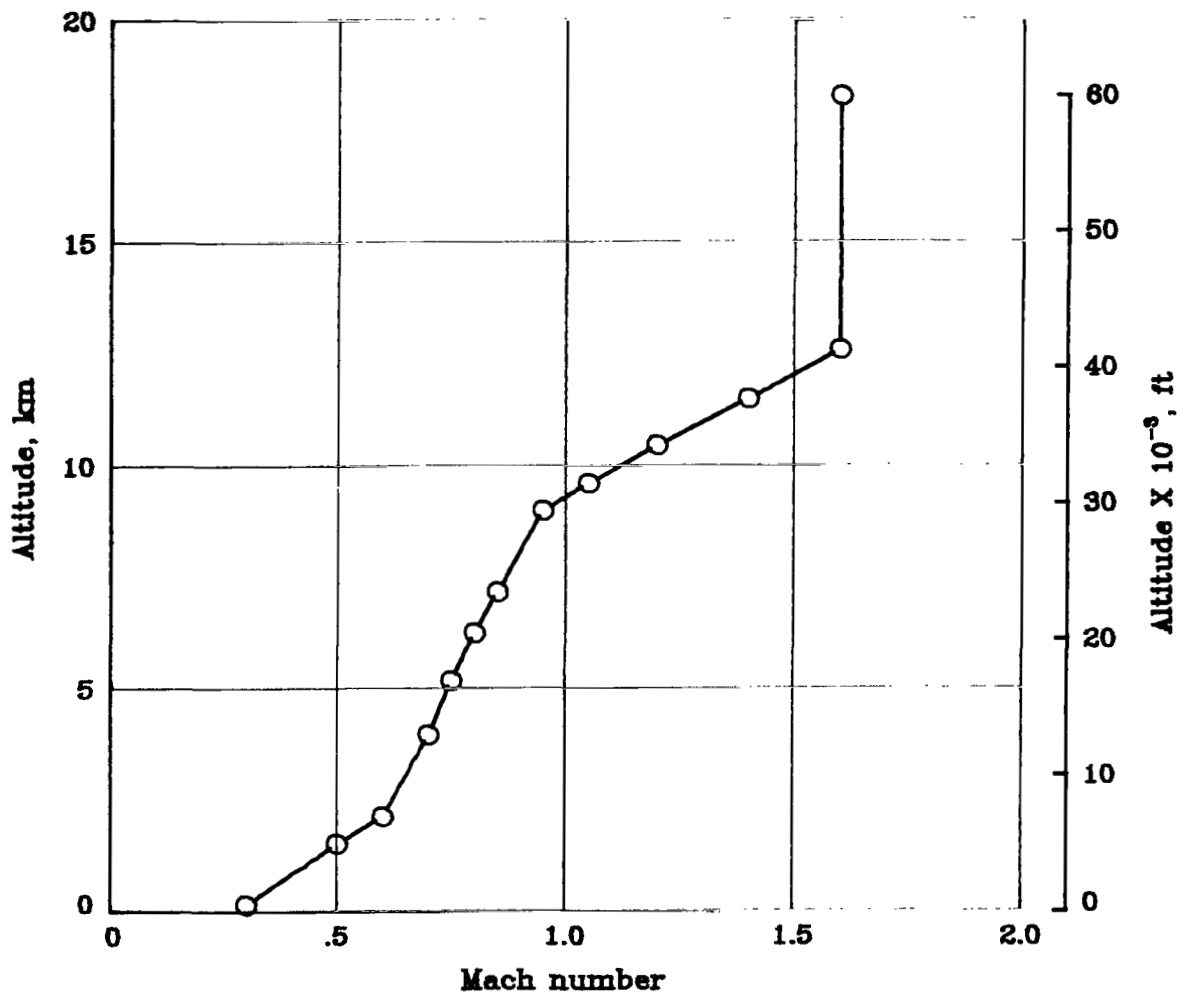

Figure 1.- Climb Mach-number—altitude profile for sample mission performance.

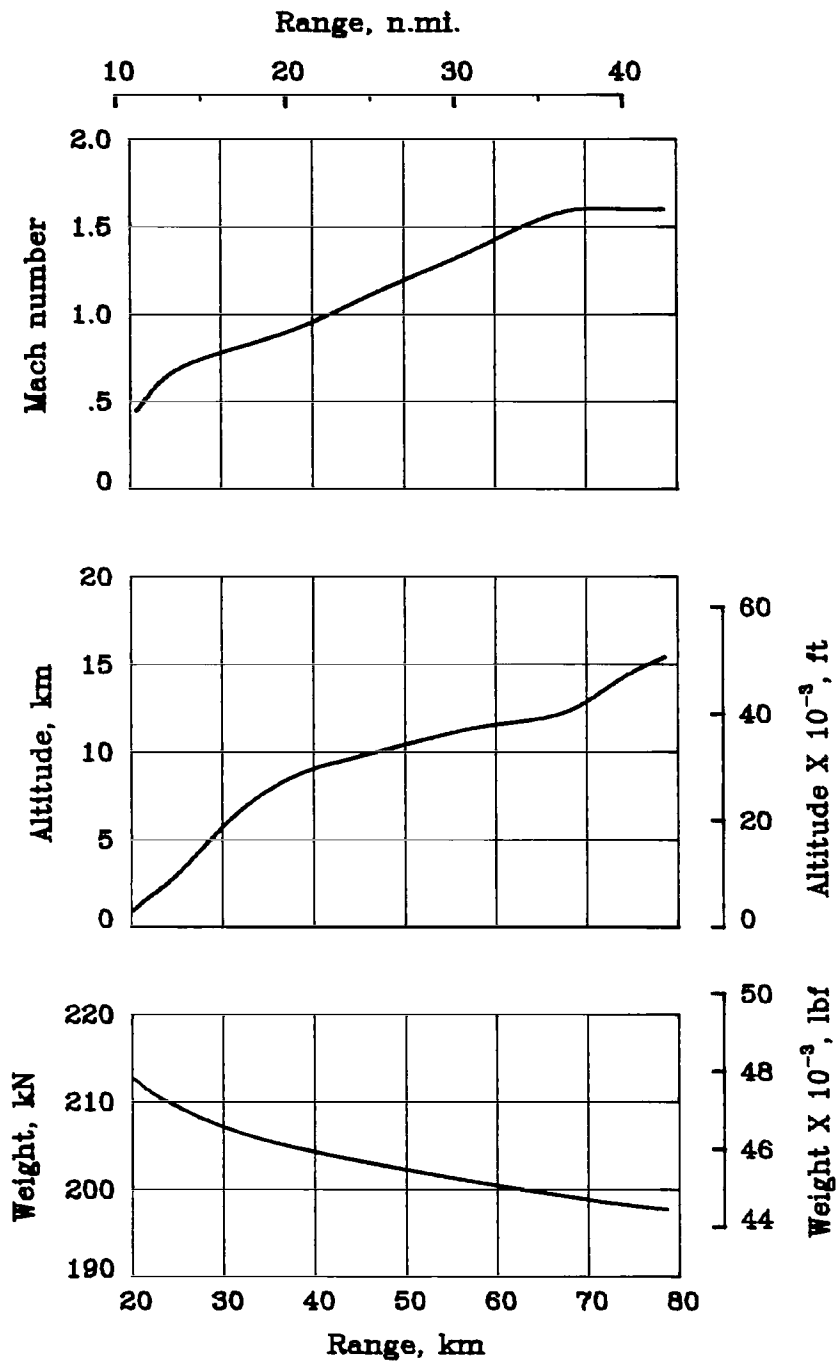

Figure 2.- Climb performance to start of cruise.
Initial weight = 214 kN (48 193 lbf).

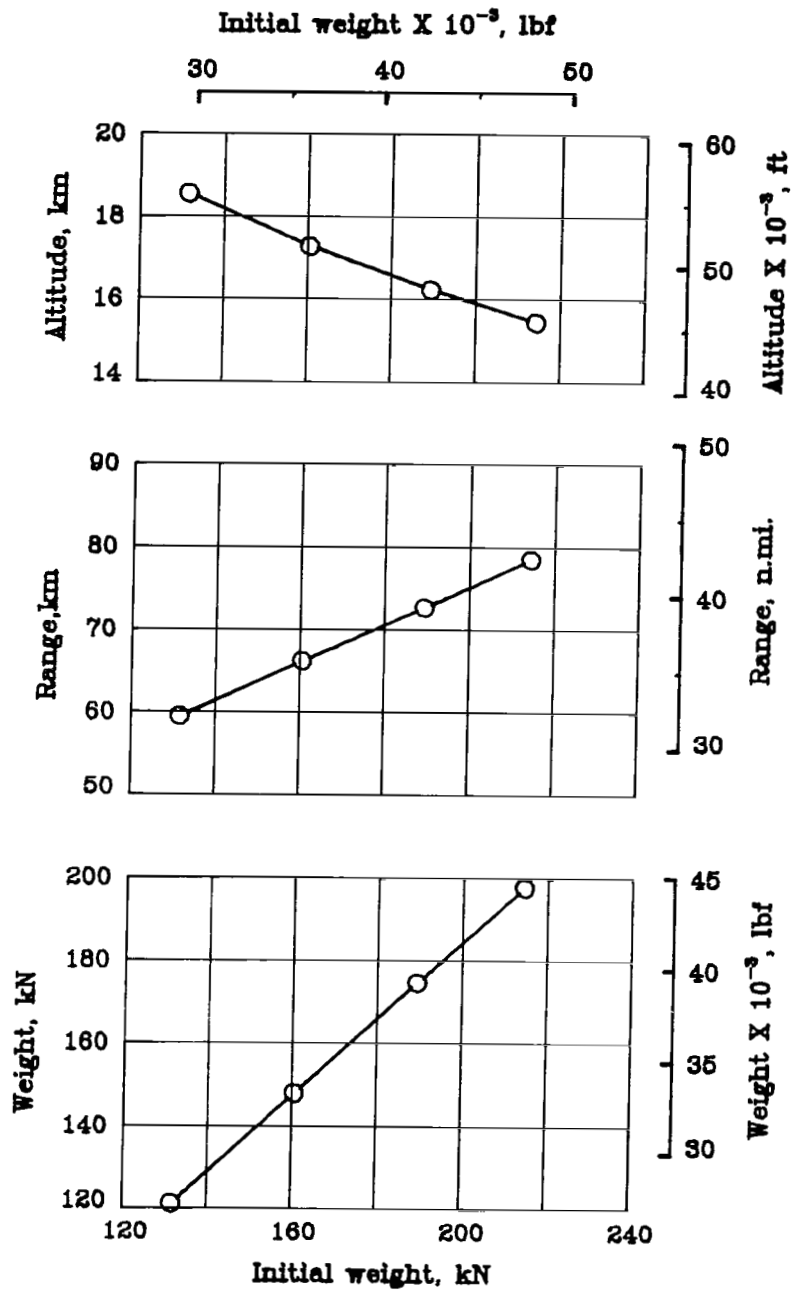

Figure 3.- Climb-segment data. Variation of start-of-cruise conditions with initial climb weight.

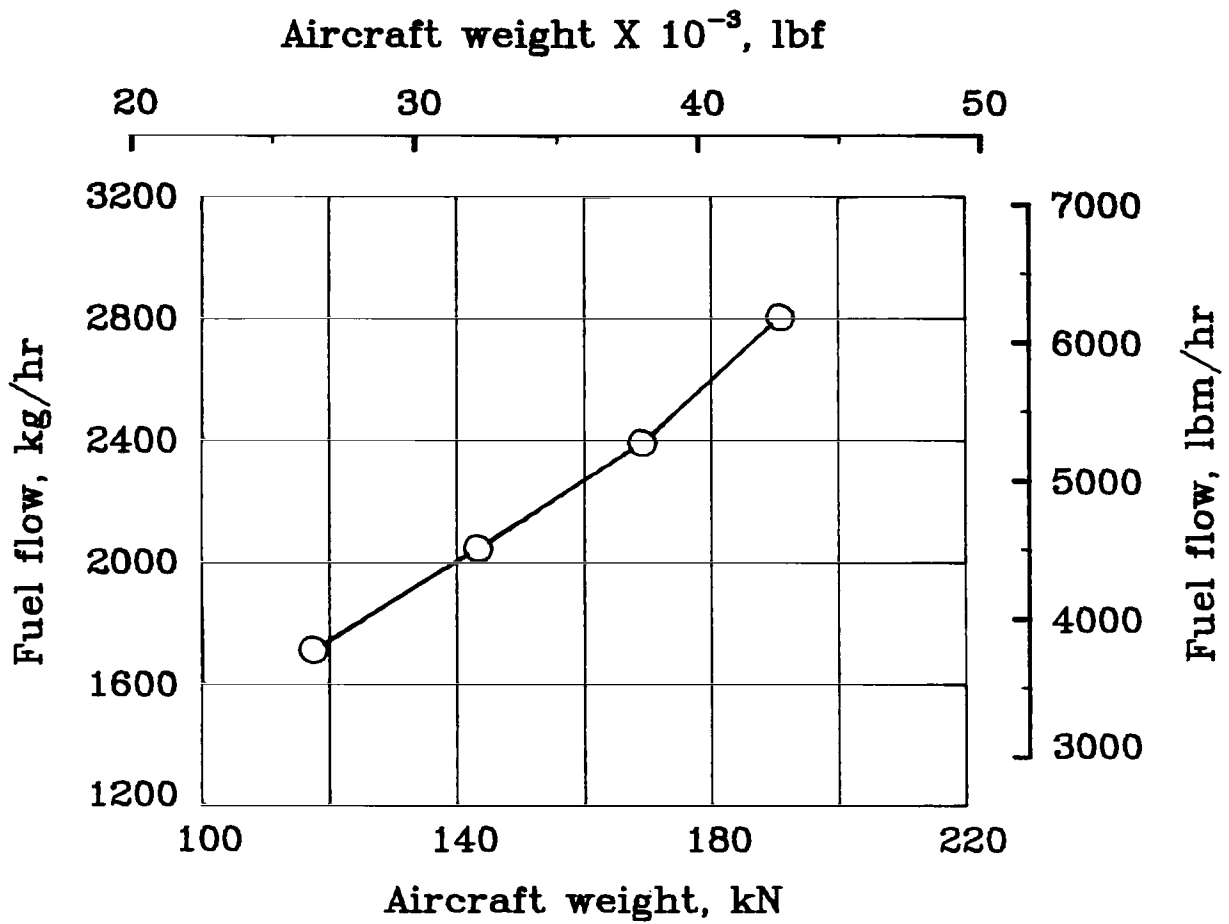

Figure 4.- Loiter-segment data. $M = 0.70$; Altitude = 9144 m (30 000 ft).

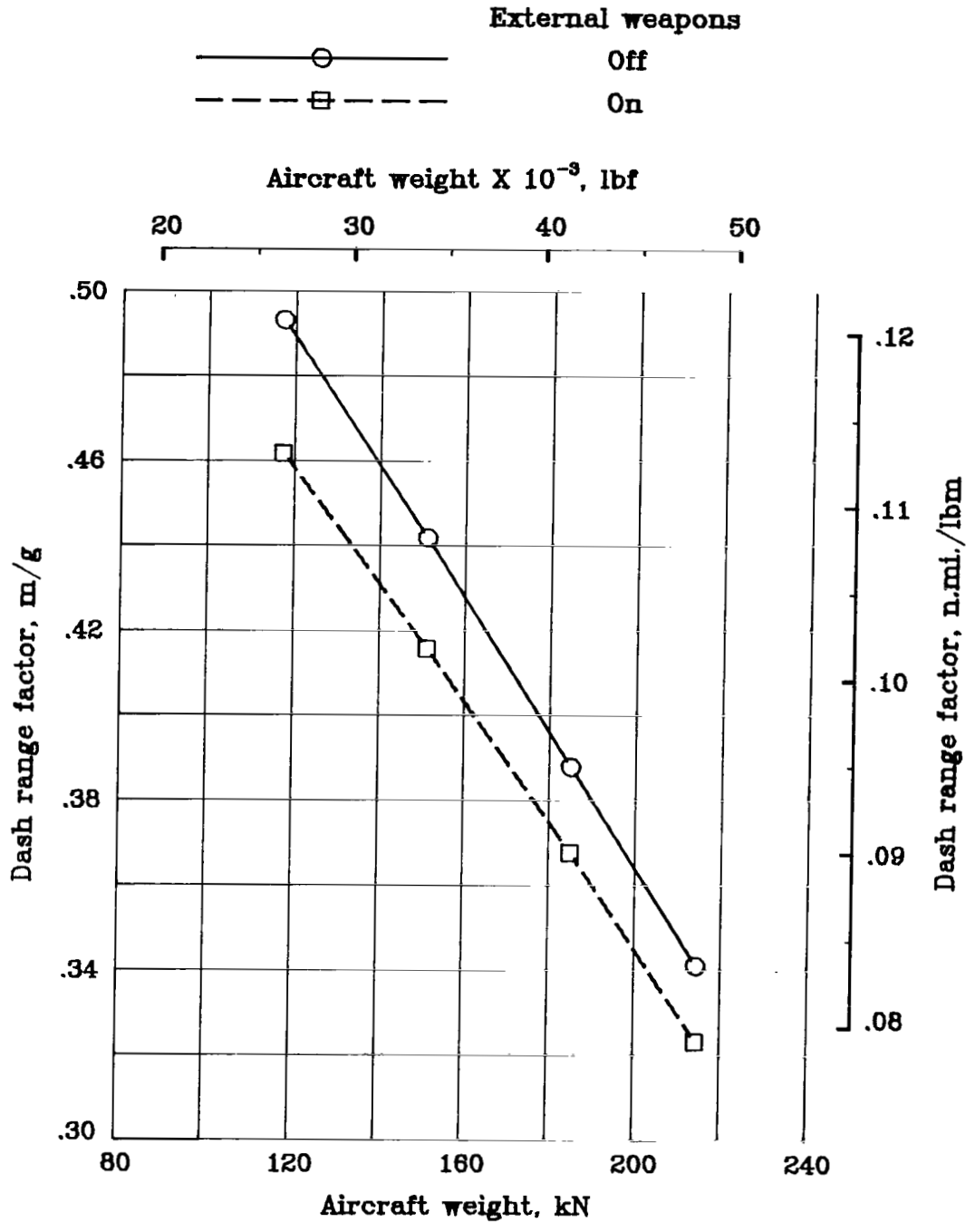

Figure 5.- Dash-segment data. M = 0.90; Altitude = 9144 m (30 000 ft).

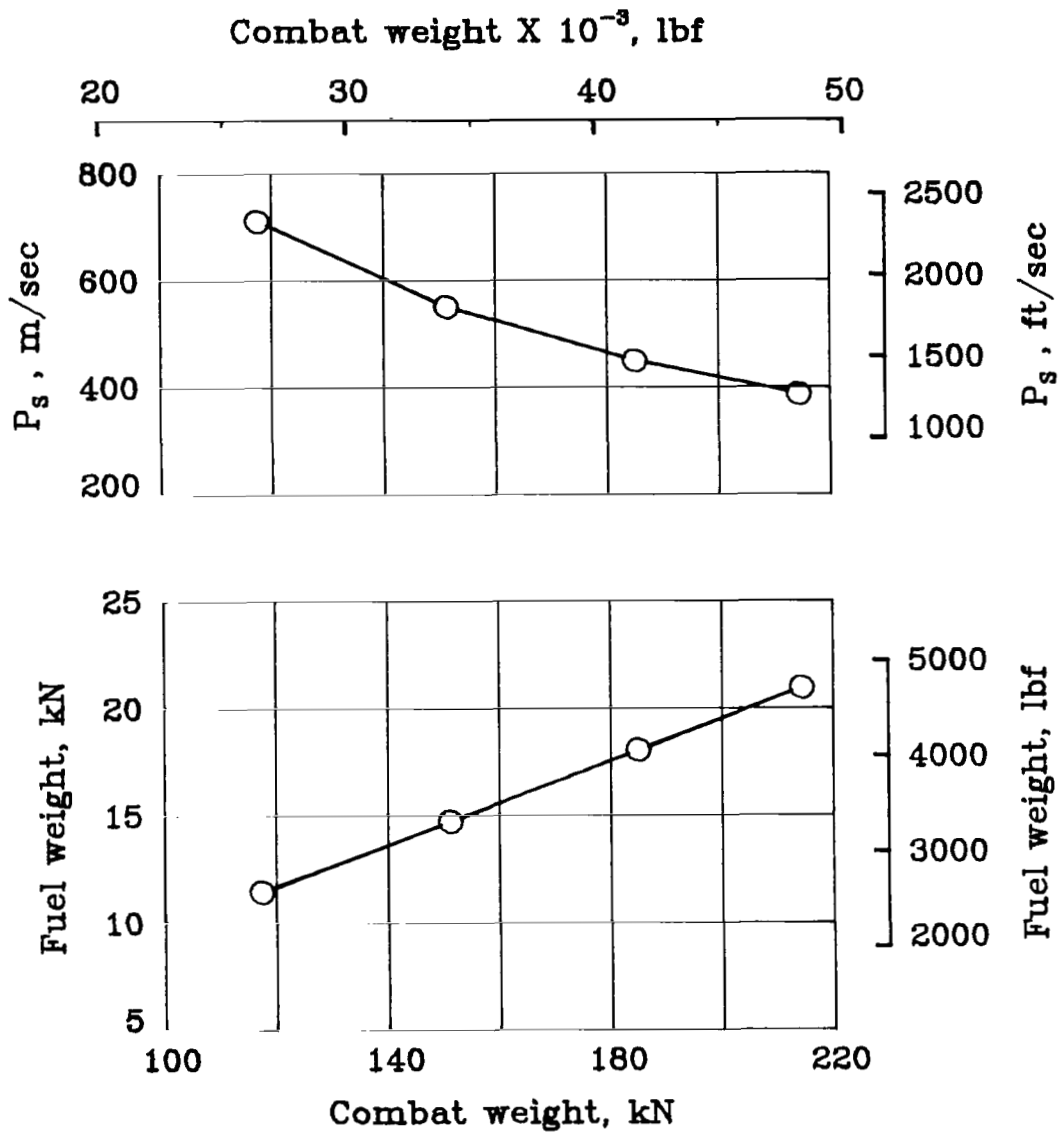

Figure 6.- Combat segment data, option 1. A change in specific energy of 43.9 km (144×10^3 ft), at $M = 1.2$ and Altitude = 1524 m (5000 ft).

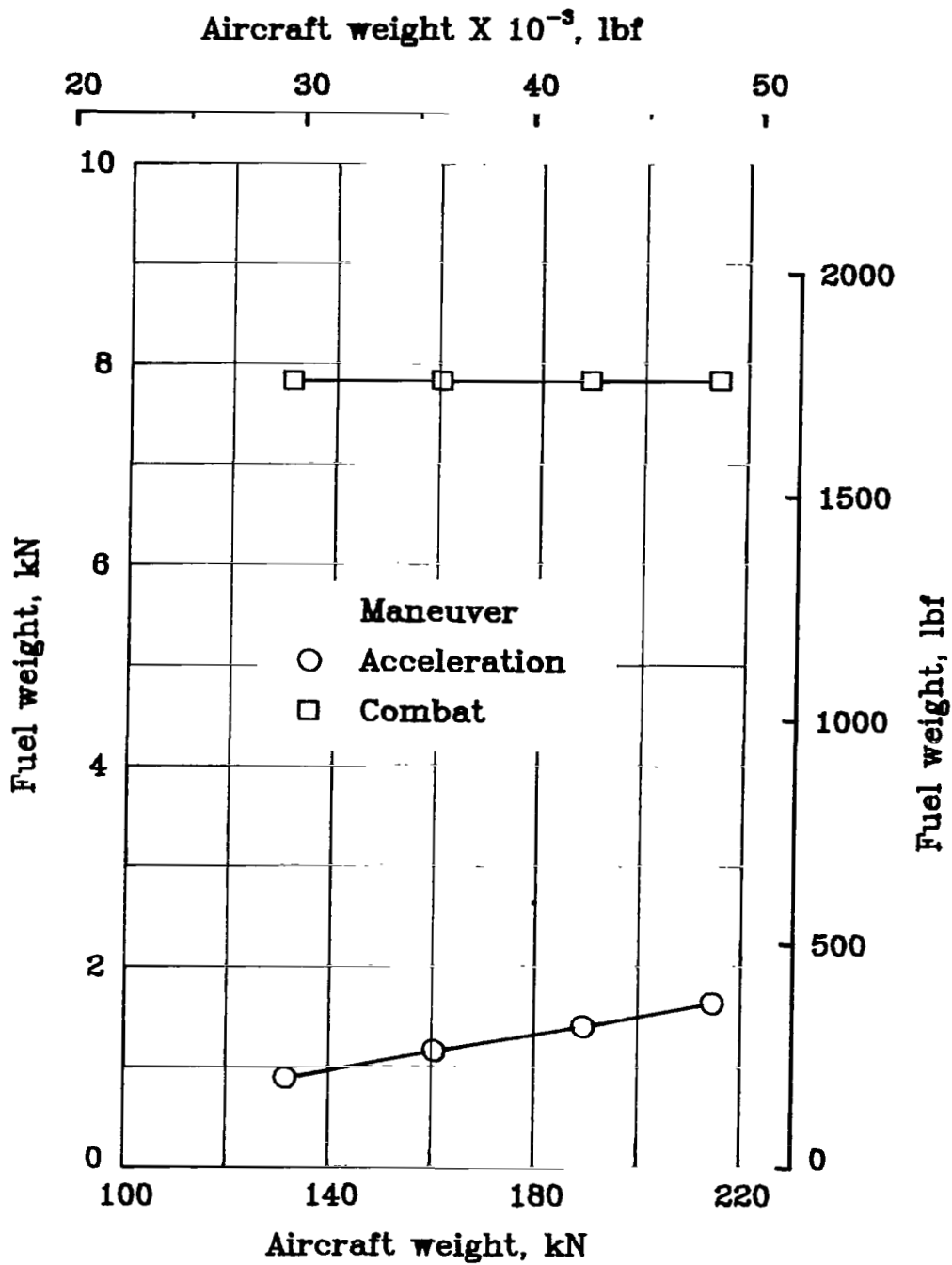

Figure 7.- Combat segment data, option 3. An acceleration from $M = 0.75$ to 1.00 and a 2-minute combat at $M = 1.0$, both at an altitude of 9144 m (30 000 ft).

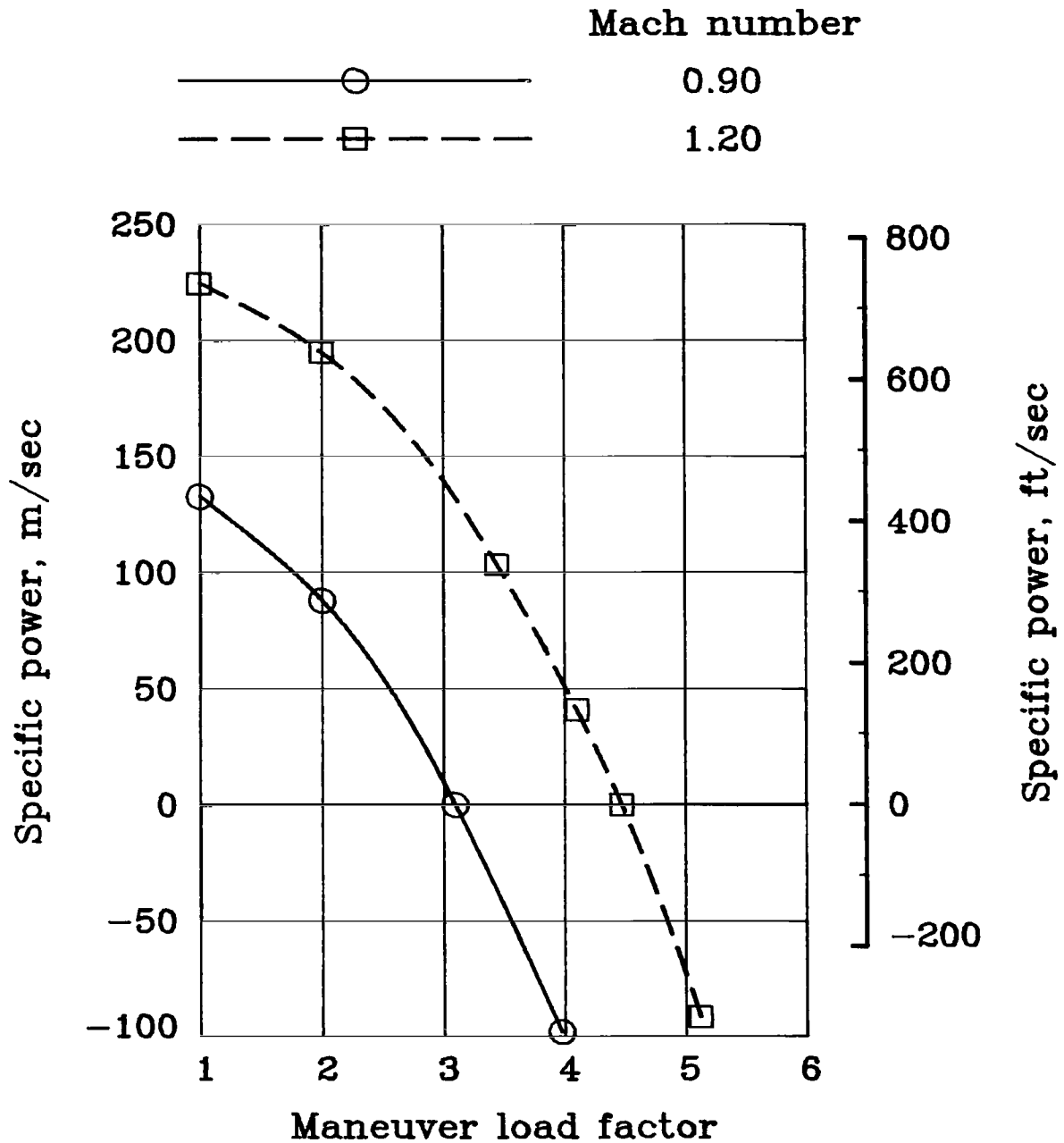

Figure 8.- Determination of sustained maneuver load factors for two Mach numbers at an altitude of 9144 m (30 000 ft). Aircraft weight is 160 kN (36 000 lbf).

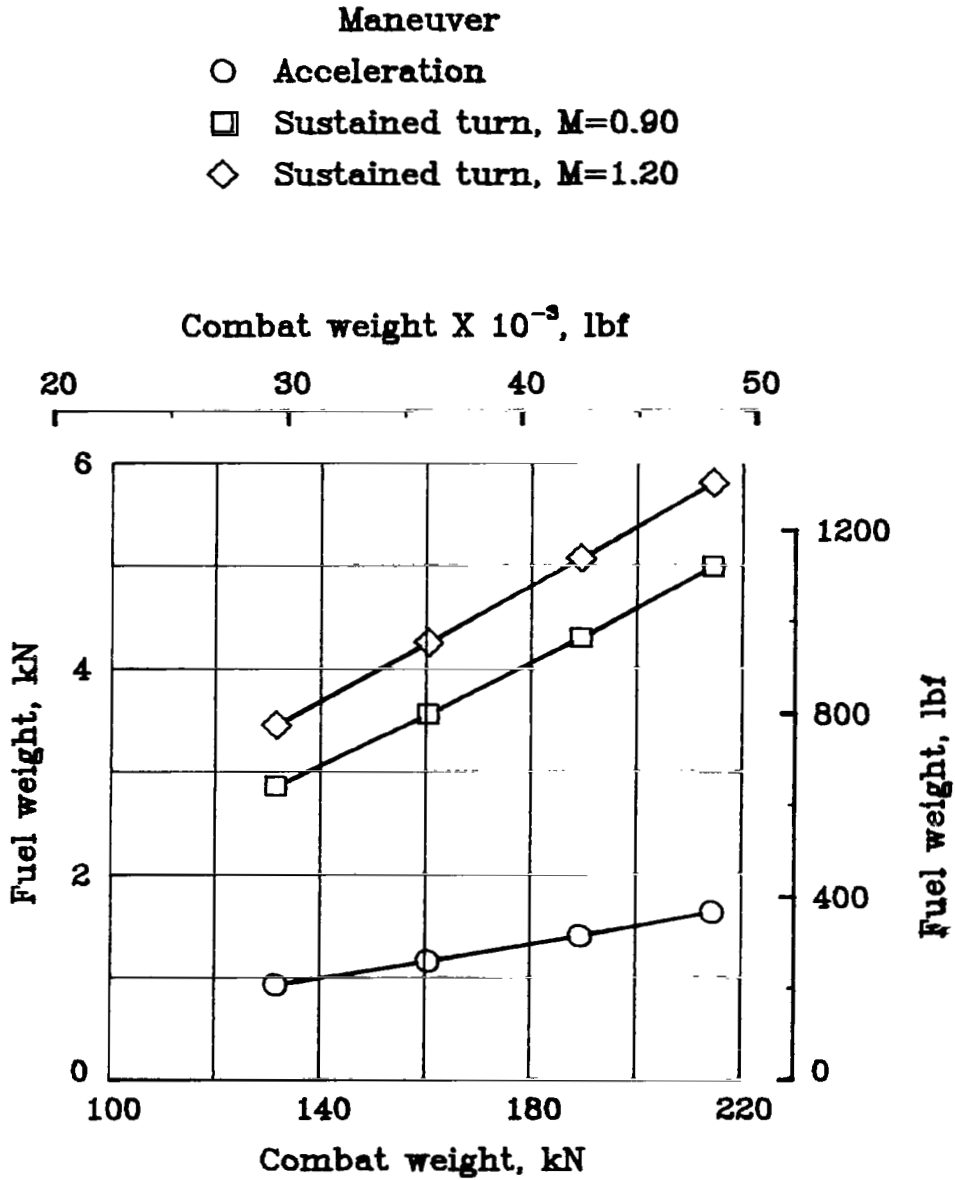

Figure 9.- Combat-segment data, option 4. An acceleration followed by sustained turns at two Mach numbers, all at an altitude of 9144 m (30 000 ft).

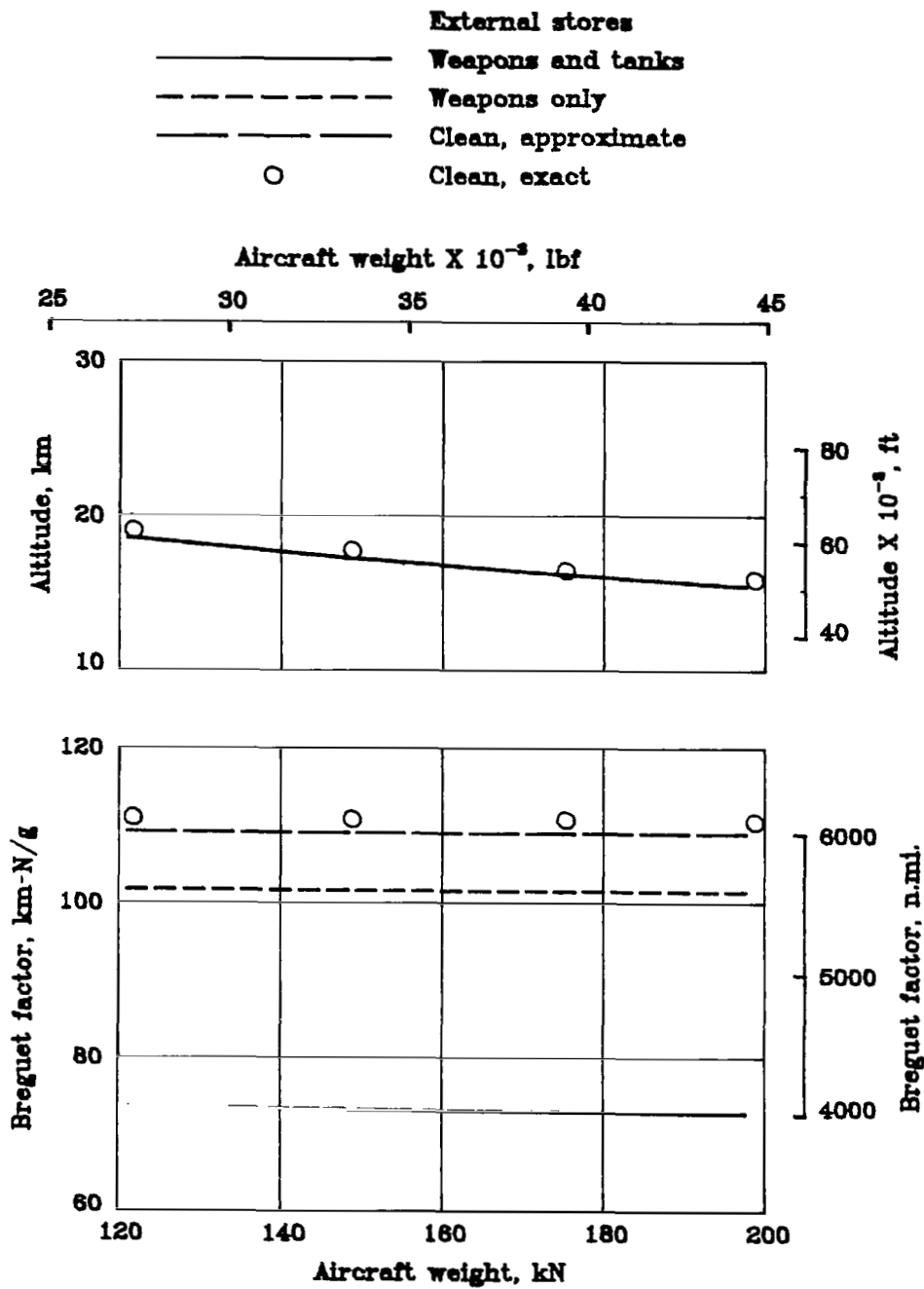

Figure 10.- Variation of cruise Breguet factor and altitude with aircraft weight for aircraft with and without external stores. $M = 1.60$.

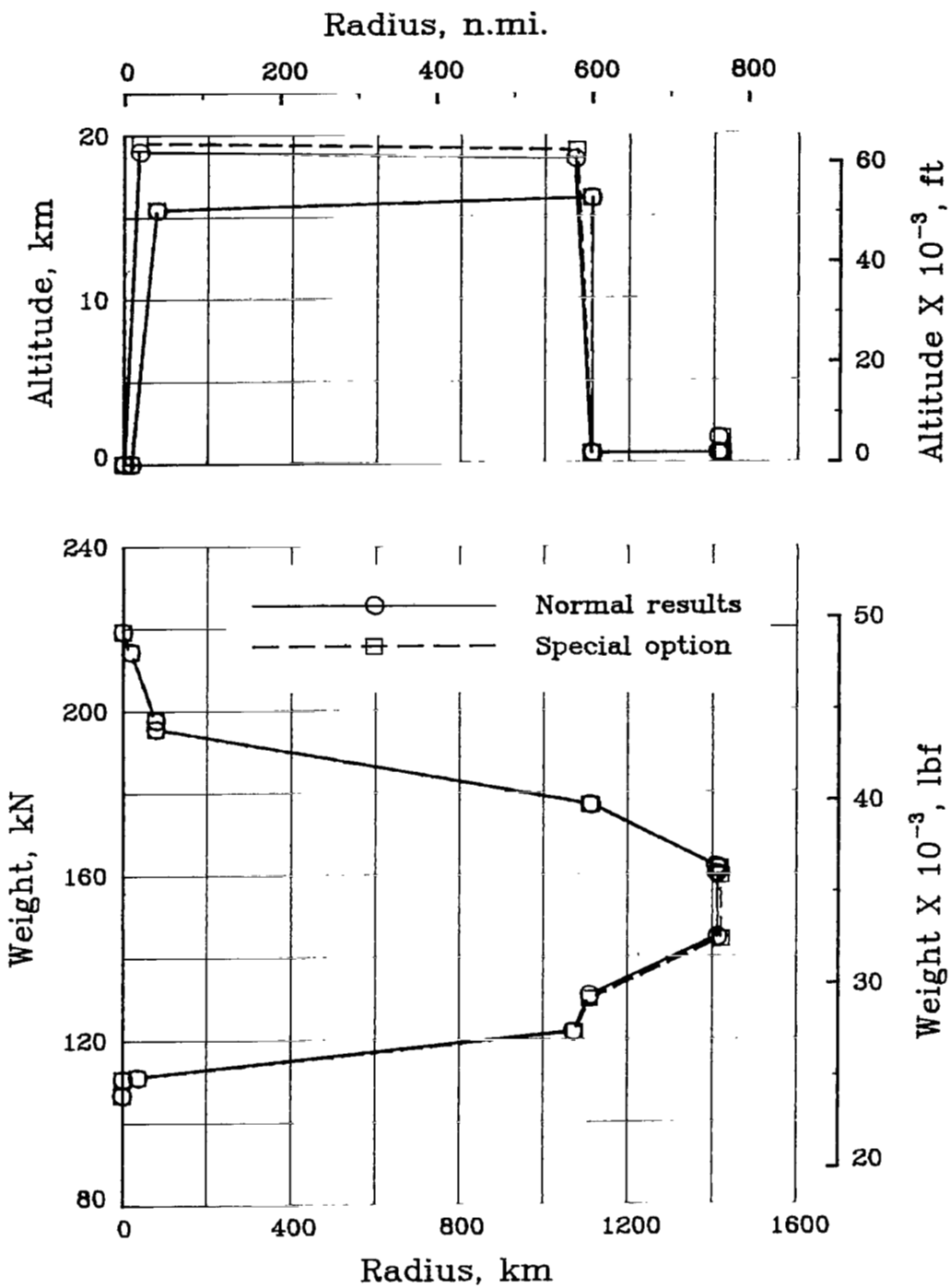

Figure 11.- Results for mission profile 1 with external tanks. Cruise at $M = 1.60$; dash at $M = 0.80$; special option calculates exact radius.

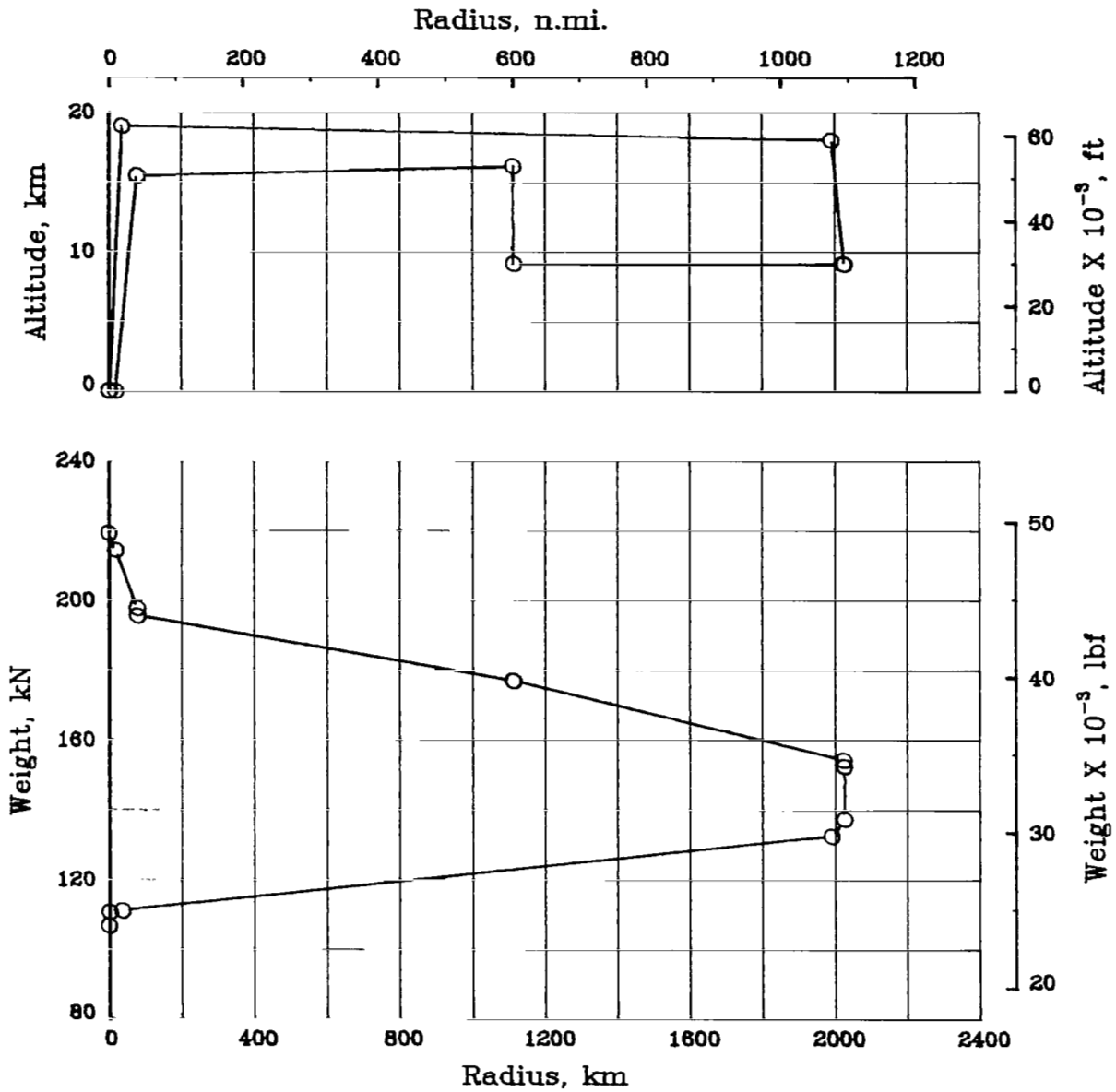

Figure 12.- Results for mission profile 1 with no return dash. Aircraft with external tanks; cruise at $M = 1.60$; dash at $M = 0.90$ at Altitude = 9144 m (30 000 ft).

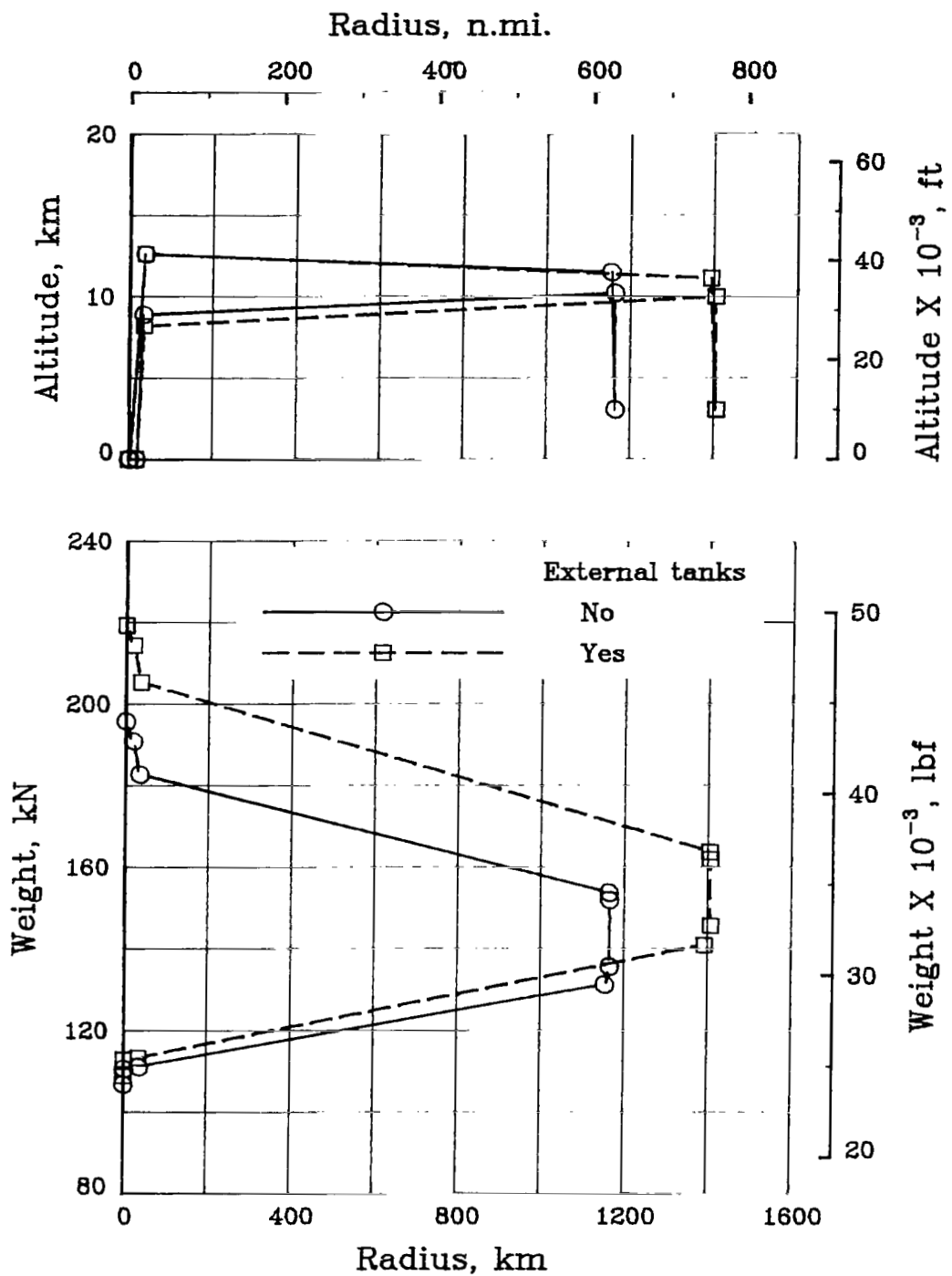

Figure 13.- Results for mission profile 2 with and without external tanks. Cruise at M = 0.85.

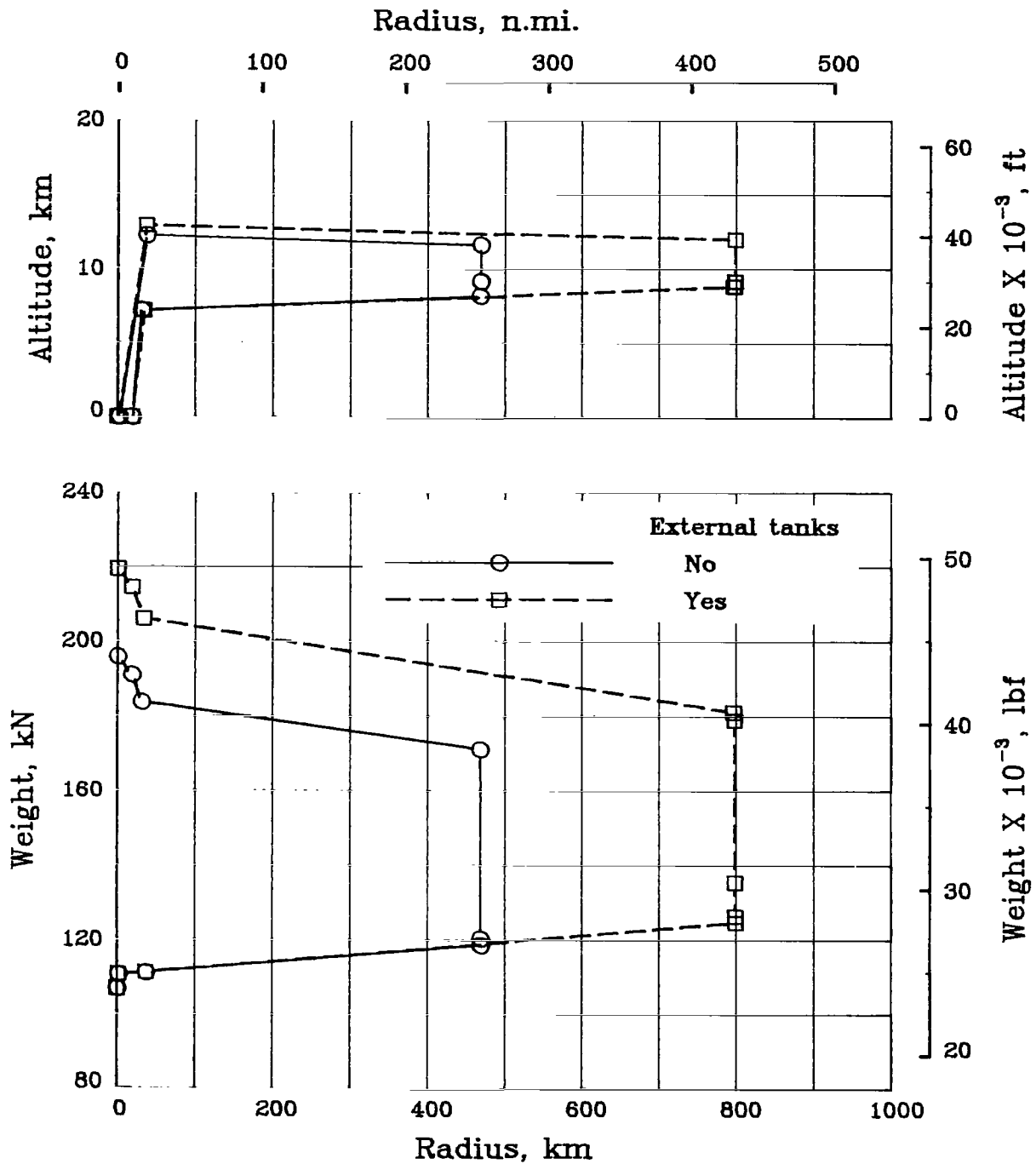

Figure 14.- Results for mission profile 3 with and without external tanks.
Cruise at $M = 0.85$; 2-hour loiter at combat station.

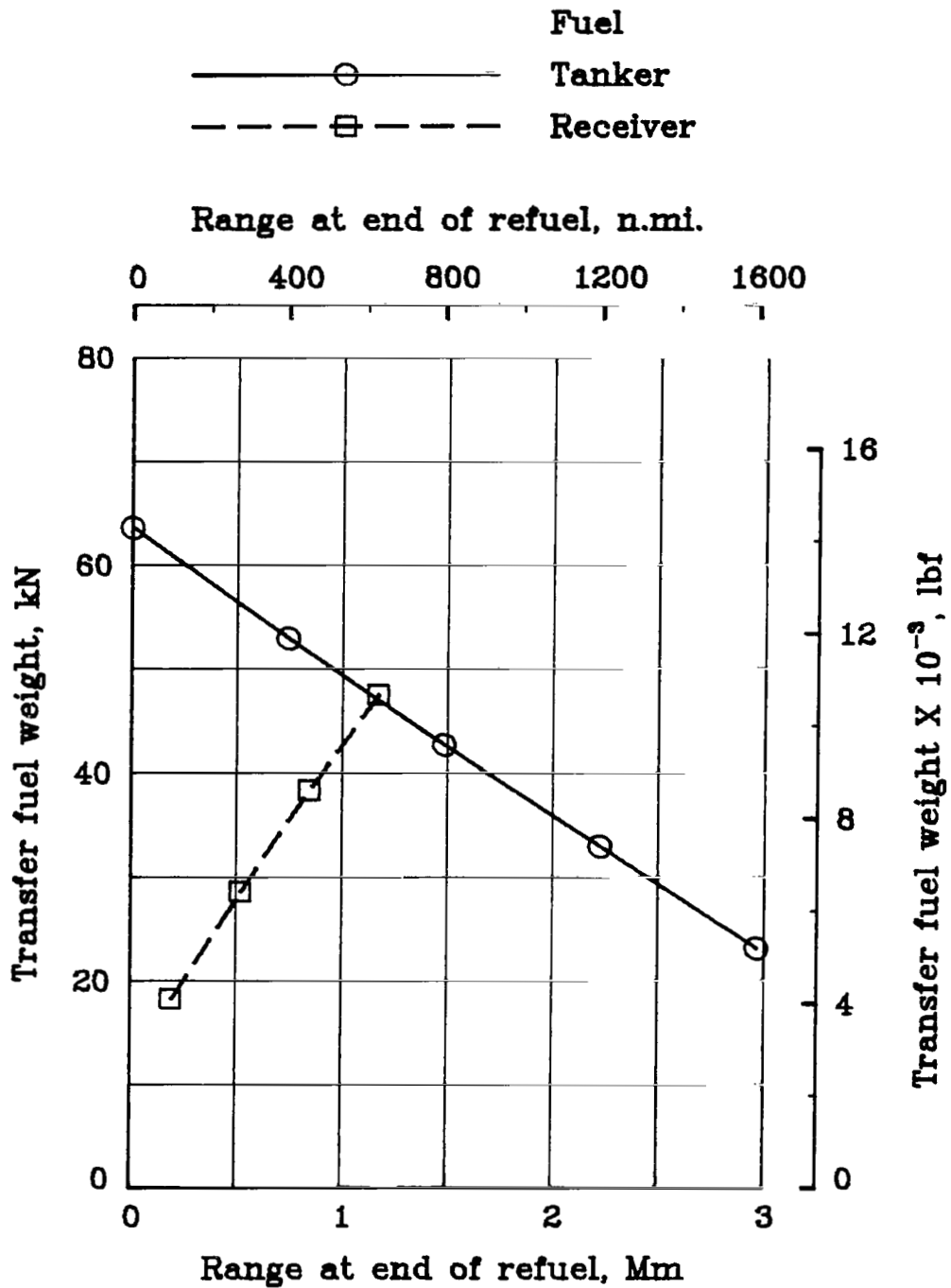

Figure 15.- Determination of optimum fuel-transfer range. Refuel at $M = 0.75$ at an altitude of 7620 m (25 000 ft).

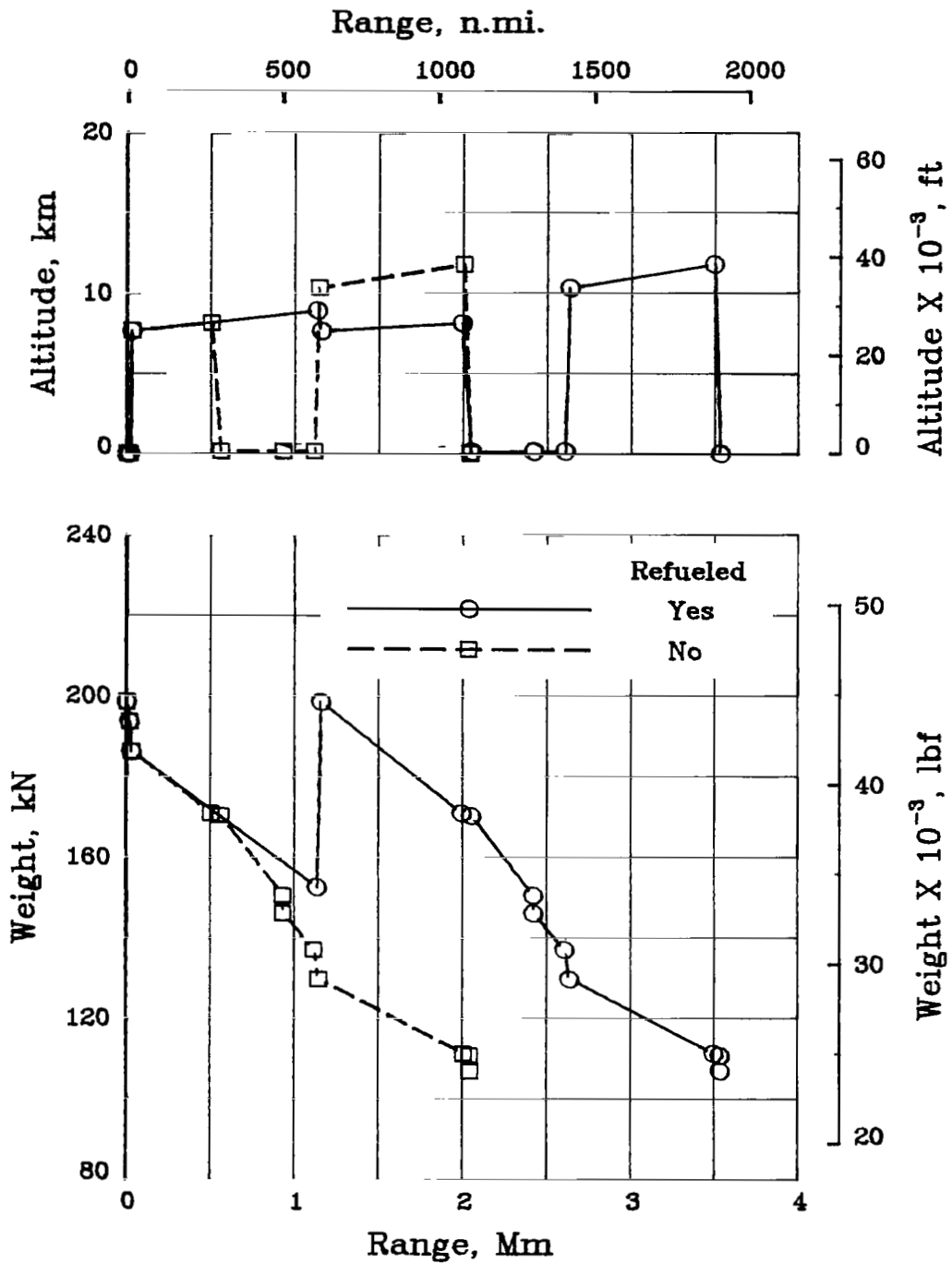

Figure 16.- Results for mission profile 4 with and without refueling. Cruise and refuel at $M = 0.75$.

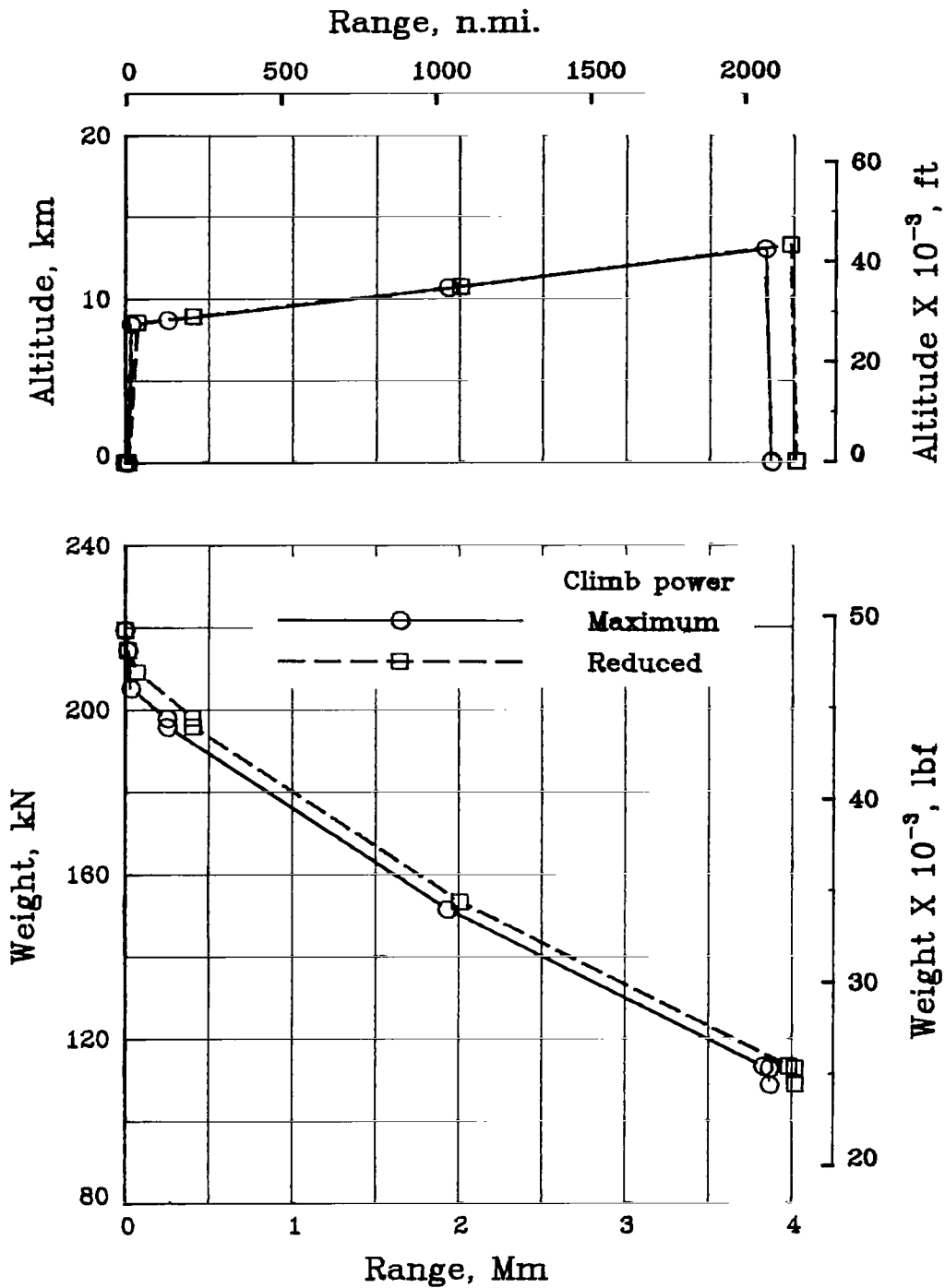

Figure 17.- Results for mission profile 5 with external tanks. Cruise at $M = 0.85$.

1. Report No. NASA TP-1837		2. Government Accession No.		3. Recipient's Catalog No.	
4. Title and Subtitle A COMPUTER TECHNIQUE FOR DETAILED ANALYSIS OF MISSION RADIUS AND MANEUVERABILITY CHARACTERISTICS OF FIGHTER AIRCRAFT				5. Report Date March 1981	
				6. Performing Organization Code 530-03-13-02	
7. Author(s) Willard E. Foss, Jr.				8. Performing Organization Report No. L-14213	
9. Performing Organization Name and Address NASA Langley Research Center Hampton, VA 23665				10. Work Unit No.	
				11. Contract or Grant No.	
12. Sponsoring Agency Name and Address National Aeronautics and Space Administration Washington, DC 20546				13. Type of Report and Period Covered Technical Paper	
				14. Sponsoring Agency Code	
15. Supplementary Notes					
16. Abstract A computer technique to determine the mission radius and maneuverability characteristics of combat aircraft has been developed. The technique has been used at the Langley Research Center to determine critical operational requirements and the areas in which research programs would be expected to yield the most beneficial results. In turn, the results of research efforts have been evaluated in terms of aircraft performance on selected mission segments and for complete mission profiles. Extensive use of the technique in evaluation studies indicates that the calculated performance is essentially the same as that obtained by the proprietary programs in use throughout the aircraft industry.					
17. Key Words (Suggested by Author(s)) Aerodynamics Mission performance Aircraft combat Maneuverability			18. Distribution Statement Unclassified - Unlimited Subject Category 02		
19. Security Classif. (of this report) Unclassified		20. Security Classif. (of this page) Unclassified		21. No. of Pages 64	22. Price A04

For sale by the National Technical Information Service, Springfield, Virginia 22161

National Aeronautics and
Space Administration

THIRD-CLASS BULK RATE

Postage and Fees Paid
National Aeronautics and
Space Administration
NASA-451



Washington, D.C.
20546

Official Business

Penalty for Private Use, \$300

8 1 1U,A, 030981 S00903DS
DEPT OF THE AIR FORCE
AF WEAPONS LABORATORY
ATTN: TECHNICAL LIBRARY (SUL)
KIRTLAND AFB NM 87117

NASA

POSTER:

If Undeliverable (Section 158
Postal Manual) Do Not Return