

D/CT
1/16/81

Start first line of text

**SATELLITE-AIDED MOBILE COMMUNICATIONS
LIMITED OPERATIONAL TEST
IN THE TRUCKING INDUSTRY**

Roy E. Anderson
Richard L. Frey
James R. Lewis
General Electric Company
Corporate Research and Development
Schenectady, New York 12301

July 1980
Final Report for Period November 1977 - July 1980

Prepared for
NATIONAL AERONAUTICS AND SPACE ADMINISTRATION
Goddard Space Flight Center
Greenbelt, Maryland 20771
Contract Technical Officer - Dr. James P. Brown

1. Report No.	2. Government Accession No.	3. Recipient's Catalog No.	
4. Title and Subtitle SATELLITE-AIDED MOBILE COMMUNICATIONS LIMITED OPERATIONAL TEST IN THE TRUCKING INDUSTRY FINAL REPORT		5. Report Date July 1980	
		6. Performing Organization Code	
7. Author(s) Roy E. Anderson, Richard L. Frey, James R. Lewis		8. Performing Organization Report No. SRD-81-005/005	
9. Performing Organization Name and Address General Electric Company Corporate Research and Development Post Office Box 43 Schenectady, New York 12301		10. Work Unit No.	
		11. Contract or Grant No. NAS5-24365	
		13. Type of Report and Period Covered Final Report November 1977 - July 1980	
12. Sponsoring Agency Name and Address National Aeronautics and Space Administration Goddard Space Flight Center Greenbelt, Maryland James P. Brown, Technical Monitor		14. Sponsoring Agency Code	
15. Supplementary Notes			
<p>16. Abstract</p> <p>An experiment with NASA's ATS-6 satellite demonstrated that satellite-aided land mobile communications are convenient and practical over continental distances. Satellite communications equipment for the experiment was designed so that it would be no more expensive, when mass produced, than conventional two-way mobile radio equipment. It embodied the operational features and convenience of present day mobile radios.</p> <p>Vehicle antennas 75 cm tall and 2 cm in diameter provided good commercial quality signals to and from trucks and jeeps. Operational applicability and usage data were gathered by installing the radio equipment in five long-haul tractor-trailer trucks of Smith's Transfer Corporation and later in two Air Force search and rescue jeeps. Although the truck drivers found the radios quite useful, the management of the regulated trucking company found little value in communicating with their trucks enroute, but volunteered that nonregulated carriers might find the communications valuable. Channel occupancy rates are reported. Air Force personnel found the satellite radio system extremely valuable in their search and rescue mission during maneuvers and actual rescue operations in Wichita Falls, Texas following a tornado.</p> <p>Propagation data is subjectively analyzed and over 4 hours of random data is categorized and graded as to signal quality on a second by second basis. Trends in different topographic regions are reported. An overall communications reliability of 93% was observed despite low satellite elevation angles ranging from 9 to 24 degrees.</p>			
17. Key Words (Selected by Author(s)) Satellite Mobile Communications Truck Communications Emergency Communications Long-Range Communications Safety and Distress Communications ATS-6		18. Distribution Statement	
19. Security Classif. (of this report) Unclassified	20. Security Classif. (of this page) Unclassified	21. No. of Pages 145	22. Price

PREFACE

The General Electric Company arranged an experiment with Smith Transfer, a large trucking company with headquarters at Staunton, Virginia, to test the use of satellite-aided communications in the long-haul trucking industry. Five trucks in service throughout most of the eastern United States were equipped with commercial mobile radios built for the 806-890 MHz mobile band. The radios were modified by the addition of varactor frequency doublers to transmit on 1651 MHz and with frequency down converters to receive on 1551 MHz. The antennas were of the Wheeler type, 80 cm tall, 2 cm in diameter consisting of seven half wave sections in a vertical line with phasing between sections to provide a radiation pattern that was omnidirectional in azimuth with a vertical pattern that included all elevation angles to the ATS-6 satellite as seen from the eastern half of the contiguous states. The linearly polarized antennas had an effective gain of 4.3 dB when operating with the circularly polarized satellite. Transmitter power into the antenna was 12-15 watts. The receiver noise figure was 2.6 dB.

A base station with characteristics like the truck equipments was installed at the central dispatch offices at Staunton, Virginia. A four foot diameter parabolic antenna was used instead of the Wheeler type.

The trucks and base station were equipped with subaudible squelch circuits and Touch-Tone[®] signalling to permit selective calling to individual trucks.

General Electric's Earth Station Laboratory near Schenectady, New York served as the central coordination point for the experiment. All communications between the trucks and the dispatcher passed through the Laboratory. Signals from trucks were relayed by ATS-6, received at the Laboratory and simultaneously relayed back through ATS-6 on a different channel to the base station. Signals from the base station returned over the same links. The two hop, one-half second, delay was not troublesome because the communications were in the simplex mode. All of the communications were recorded at the Laboratory for later evaluation and analysis.

In addition to obtaining some initial data on the uses and value of satellite communications in trucking, and demonstrations that the

Preface (cont'd)

communications could be provided with vehicle equipment comparable in complexity and cost with terrestrial mobile radio equipment, the experiment produced data on the signalling characteristics of satellite-aided mobile communications. The long distance operations of the trucks exposed them to terrain features including the midwestern prairies, the Appalachian mountains and the eastern coastal region.

The geostationary ATS-6 satellite was over the Pacific Ocean; farther west than an operational mobile satellite for the contiguous states would be placed, so that its elevation angle was considerably lower than optimum. There was more blockage by terrain features and trees than would be experienced with a satellite at higher elevation. The reliability of the communications was 93% overall when the trucks were within the 3 dB contour of the satellite footprint, despite the low angle to the satellite. The result adds further confirmation to the feasibility of satellite mobile communications.

The results show that satellite-aided mobile communications operate satisfactorily with much smaller fading margins than terrestrially based mobile radio because ground reflection and obstruction multipath effects are smaller. Signal blockage due to trees, hills and structures is more severe for the satellite signals because there are fewer reflected signals to fill the "shadows" behind the objects. The truck drivers soon observed that if there is no impediment visible in the direction of the satellite they could communicate reliably, and the geostationary placement of the satellite makes it easy to determine the direction to the satellite.

The management of the trucking company, Smith Transfer, found the satellite-aided communications of little value in their operations. While communications are exceedingly important to them, they are accomplished over telephone lines between their terminals in 118 cities and their central dispatch headquarters at Staunton, Virginia. Records of every departure and arrival throughout their 28 state service area are transmitted immediately to Staunton. As a regulated carrier on fixed routes, they believe that direct vehicle-to-dispatcher communications would not significantly improve efficiency. Their evaluation of the communications that

Preface (cont'd)

took place during two weekends in December 1978 shows an estimate of three hours saved as a result of the satellite communications for 409 truck hours; i.e., the number of satellite hours available multiplied by the number of satellite communication equipped trucks that were in operation during the measurement time.

The management volunteered that the satellite communications could be valuable to independent truckers if it is used in a cargo brokering service. A data bank in each city would keep records of loads and destinations. As an independent trucker is en route to the city he would contact the brokerage service and learn where he could pick up a load for his next destination.

The truck drivers found the satellite communications useful and were impressed by their quality and reliability. The satellite was used in several breakdown situations, for routing around a flooded area, for contacting the central dispatcher to identify loads to be picked up at distant terminals late at night when the terminals were unmanned, and for a variety of other purposes.

In a later phase of the experiment, two of the units were removed from the trucks and installed in communication jeeps of the United States Air Force in support of an experiment by the National Association for Search and Rescue in cooperation with the Air Force. The jeeps are equipped with a wide assortment of terrestrial communications gear, including high-frequency (2-30 MHz) for long distance communications by ionospheric reflection, very high frequency and ultra high frequency equipments for line-of-sight communications including coordination with public safety, aircraft and other services. The jeeps are flown to disaster areas for use in emergency communications. While the satellite equipment was installed, one of them was deployed at the Wichita Falls, Texas, tornado site and later in Panama during a political crisis in another Central American country.

A base station was installed at the Rescue Coordination Center, RCC, Scott Air Force Base, in Illinois. The 1.5 degree wide beam of ATS-6 could illuminate approximately one-fourth of the contiguous United States.

Preface (cont'd)

When the beam could be directed to include the jeep, the RCC and the General Electric Earth Station Laboratory, ESL, in Schenectady, New York communications between the jeep and the RCC were possible via automatic relay through the ESL. If the jeep was far removed from the ESL or the RCC, the satellite beam was pointed directly at the jeep. The ESL could then communicate with the jeeps through a side lobe of the ATS-6 antenna pattern by using the 9-meter diameter antenna at the ESL. A telephone patch from the Laboratory to the RCC completed the link.

An experiment was conducted in Yosemite National Park. One jeep was located on a mountain, the other in the valley below. The intervening terrain was such that direct communications between the jeeps was impossible on all of the terrestrial frequencies available to them. Both could communicate via the satellite to the RCC, and also with each other.

A special test was conducted with an attache size radio transmitter/receiver furnished by Dr. James P. Brown, NASA-GSFC, the technical monitor of the experiment. The unit was carried in a helicopter to nine locations in Yosemite where terrestrial communications to base stations have been extremely difficult or impossible. Communications via the satellite were achieved at all nine places. The unit was used while the helicopter was in flight. To our knowledge, it was the first satellite communications from a flying helicopter. The blade interrupted the transceiver-satellite link as it rotated, but did not destroy the intelligibility of the communications. They sounded like a person talking with a helicopter operating nearby.

All major objectives of the experiment were achieved. Results indicate that satellites can perform needed mobile communications functions that cannot be performed as well by other known means. The likelihood that satellites can fulfill the needs in a cost effective way justifies further study and test of their potential.

ACKNOWLEDGMENTS

The authors wish to acknowledge the support and cooperation of Smith's Transfer Corporation in making available their offices and five of their long-haul tractors for the experiment described in this report. Individuals and organizations contributing to the experiment include the following:

<u>INDIVIDUAL</u>	<u>AFFILIATION</u>	<u>CONTRIBUTION</u>
Roy E. Anderson	General Electric Company	Principal Investigator; Data Analysis; Laboratory Operations
Ben G. Bemis	Westinghouse Electric Company	Equipment Installation A. F. Jeeps and RCC; ATSOCC Operations
James P. Brown	NASA Goddard Space Flight Center	NASA Contract Technical Officer
Ahmet Ergene	General Electric Company	R.F. Equipment Design, Performance Evaluation
Richard L. Frey	General Electric Company	Project Engineer; Vehicle and Laboratory Radio Frequency Systems and Equipment; Laboratory Operations
Major Charles Hagerhjelm	United States Air Force	Coordinated Experimental Radio System with the AF Rescue Coordination Center, Scott AF Base
MSGT William E. Kratch	United States Air Force	Equipment Installation in AF Jeeps and RCC; Test Operations
Howard L. Lester	General Electric Company	R.F. Propagation Analysis
James R. Lewis	General Electric Company	Vehicle and Laboratory Signaling Systems; Data Management Software; Laboratory Operations
James R. Murray	General Electric Company	Vehicle and Laboratory Equipment Construction, Data Reduction
Charles K. Welliver	Smith's Transfer Corporation	Coordinated Equipment Installation and Maintenance

PARTICIPATING ORGANIZATIONS

National Aeronautics and Space Administration

Smith Transfer, Staunton, Virginia

Air Force Rescue Coordination Center

303 ARRS March AFB, California

305 ARRS Selfridge, ANGB, Selfridge, Michigan

NASA-ATSOCC Applications Technology Satellite
Operation Control Center

National Association for Search and Rescue
San Diego, California

TABLE OF CONTENTS

Start first line of typing

	<u>PAGE</u>
1.0 INTRODUCTION	1
2.0 OBJECTIVES	3
3.0 COMMUNICATION SYSTEM CHARACTERISTICS	5
3.1 ATS-6 Spacecraft L-Band Transceiver	5
3.2 Spacecraft Antenna Beam and Pointing	10
3.3 System Power Budgets	15
4.0 EXPERIMENTAL EQUIPMENT DESCRIPTION	31
4.1 Equipment Design Considerations	31
4.2 Mobile Transmitter	34
4.2.1 Transmitter Specifications	34
4.2.2 Transmitter Design Alternatives	37
4.3 Mobile Receiver	40
4.3.1 Receiver Specifications	40
4.3.2 Receiver Design	40
4.3.2.1 Preselector Filter	43
4.3.2.2 Preamplifier	43
4.3.2.3 R.F. Filter, First Mixer and First IF Board	44
4.3.2.4 Low Level Doubler and Injection Filter	45
4.3.2.5 First IF Band Pass Filter	46
4.3.2.6 Oscillator-Multiplier Board	46
4.4 Mobile Antenna Selection and Design	46
4.4.1 Biconical Horn Antenna	47
4.4.2 Microstrip Patch Antenna	47
4.4.3 Quadrifilar Helix and Conical Spiral	49
4.4.4 Transposed Coaxial Segment (Wheeler) Antenna	50
4.4.4.1 Antenna Specifications	53
4.4.4.2 Antenna Construction	53
4.4.4.3 Antenna Test Results	59

Start first line of typing

	<u>PAGE</u>
5.0 TRUCKING INDUSTRY TEST RESULTS	67
5.1 Tape Recorded Usage Data	67
5.2 Management Commentary	77
5.3 Management Evaluation of Selected Business Communication	81
5.4 Driver Evaluation	90
6.0 EMERGENCY RESPONSE TESTS AND OPERATIONS	98
6.1 Yosemite Valley Tests	98
6.2 Air Force Evaluation	105
7.0 PROPAGATION	110
7.1 Communication Performance Evaluation	111
7.1.1 Digital Tone Encoded Communications	111
7.1.2 Voice Communications	113
7.2 Comparison With Propagation in Terrestrial Land Mobile Service	123
7.3 Helicopter Communications	124
7.4 Tabulation of Propagation Results	128
8.0 CONCLUSIONS	129
9.0 RECOMMENDATIONS	131
10.0 REFERENCES	132

LIST OF TABLES

Start first line of typing

	<u>PAGE</u>	
3.1	ATS-6 Spacecraft Performance L-Band Frequency Translation Mode Pencil Beam Configuration	9
3.2	ATS-6 Spacecraft Performance L-Band Frequency Translation Mode Fan Beam Configuration	11
3.3	Elevation Angle of ATS-6 at 140° West Longitude from Various US Cities	13
3.4	Satellite-Aided Mobile Radio Transceiver Specifications	
	Part 1 - Transmitter	16
	Part 2 - Receiver	17
	Part 3 - Antenna System	18
3.5	ATS-6 Uplink Power Budget Truck to ATS-6 Best Peak Conditions	20
3.6	ATS-6 Uplink Power Budget Truck to ATS-6 Worst Case Conditions	21
3.7	Best Peak Beam Case, ATS-6 "Double Hop" Power Budget	
	Part 1 - Uplink	26
	Part 2 - Downlink	27
3.8	Worst Case ATS-6 "Double Hop" Power Budget	
	Part 1 - Uplink	28
	Part 2 - Downlink	29
4.1	Satellite Mobile Radio Transmitter Specifications	35
4.2	Satellite Mobile Radio Receiver Specifications	42
4.3	Land Mobile Satellite Antenna System	54
4.4	Transposed Coaxial Segment Antenna Mechanical Analysis	60
4.5	Transposed Coaxial Antenna Gains Computed from Analysis and from Patterns	65

Start first line of typing

	<u>PAGE</u>	
5.1	ATS-6 Satellite Schedule	69
5.2	Summary of Truck Hours In Service of Files Analyzed in Detail	71
5.3	Satellite Communication Channel Occupancy Summary	73
5.4	Business Conversation Channel Occupancy	75
5.5	Cassette Tape No. 1 (Business Conversation Contents)	83
5.6	Cassette Tape No. 2, Side 1 (Business Conversation Contents)	84
5.7	Cassette Tape No. 2, Side 2 (Business Conversation Contents)	85
5.8	Cassette Tape No. 3 (Business Conversation Contents)	86
5.9	Cassette Tape No. 4 (Business Conversation Contents)	87
5.10	Dispatcher Questionnaire Responses	88
6.1	Summary of ATS-6 Transceiver Questionnaire	109
7.1	Success in Decoding DTMF Automatic Transmitter Identification from Vehicle	112
7.2	Voice Communications Signal Quality with Satellite Pointed to 38.5°N, 85.0°W	114
7.3	Q-Signal Definitions	115
7.4	Voice Communications Signal Reliability with Satellite Pointed to 38.5°N, 85.0°W	117
7.5	Voice Communications Signal Quality Auxiliary Data	121
7.6	Voice Communications Signal Reliability Auxiliary Data	122

LIST OF FIGURES

<u>FIGURE NUMBER</u>		<u>PAGE</u>
3.1	ATS-6 Spacecraft	6
3.2	ATS-6 Communications Transponder L-Band Frequency Translation Mode	8
3.3	ATS-6 Pencil Beam Footprint	14
3.4	"Double Hop" System Configuration	23
4.1	800 MHz Mastr [®] Executive II Mobile Radio Set	33
4.2	Transmitter Design Options	38
4.3	Satellite-Aided Land Mobile Radio Transceiver	41
4.4	Transposed Coaxial Antenna Mounted for Use	52
4.5	Smith's Transfer Corporation Route Map	55
4.6	Complete Transposed Coaxial Segment Antenna	56
4.7	Transposed Coaxial Segment Antenna Internal Assembly	58
4.8	Transposed Coax Antenna Mounted for Pattern Test	61
4.9	Transposed Coaxial Segment Array Elevation Pattern at 1550 MHz Receive Frequency	62
4.10	Transposed Coaxial Segment Array Elevation Pattern at 1650 MHz Transmit Frequency	63
5.1	Business Conversation Management Questionnaire Form	82
7.1	Comparison of Satellite Relayed Signals and 150 MHz Terrestrial Land Mobile Signals	125

Start first line on page

<u>FIGURE NUMBER</u>		<u>PAGE</u>
7.2	Photograph of Helicopter Used for In-Flight Satellite Communications	126
7.3	Signals from Helicopter in Flight via ATS-6 Spacecraft	127

1.0 INTRODUCTION

Mobile communications within urban areas are essential to efficient commercial operations as well as for public safety. It is reasonable to conjecture that mobile communications would be useful for vehicles that travel between cities as well as for those that travel within them. With few exceptions, present-day mobile communications are limited to line-of-sight distances because the radio waves do not follow the curvature of the earth. Vehicles that must communicate with distant base stations must relay their communications through repeaters. Most long distance communications are not by radio but are accomplished by stopping the vehicle and making a long distance phone call.

Efficiency would be increased and costs might be lowered if satellites are used as repeaters to provide direct and immediate communications between vehicles and their base stations. Previous experiments [1,2] demonstrated that the communications are feasible with vehicle equipment that is potentially no more complex or costly than mobile radios for direct line-of-sight communications.

The trucking industry is one commercial enterprise that relies on mobile radio communications to facilitate its operations in urban areas. Its long distance and intercity operations do not benefit from the communications because there is no present way for a truck to communicate with a company office while the truck is on the road. Truck drivers use citizens band radio for short range vehicle-to-vehicle communications, but that service is not useful for business operations of the trucking companies.

Recognition that satellite communications may have potential value to the trucking industry and accomplished demonstrations of their feasibility suggested that a limited test should be performed to evaluate the communications in the operations of a major trucking company. The availability of the L-band transponder of NASA Application Technology Satellite, ATS-6, enabled the experiment to be performed with equipment that had the appearance and operating characteristics of commercial mobile radio equipment like that used in urban trucking operations, so that it was familiar to its users.

The experiment produced limited operational data on the use of satellite communications in the trucking industry, demonstrated that the

communications are feasible with equipment comparable in cost and complexity with present-day commercial mobile radio equipment, and yielded data on satellite-mobile propagation characteristics for a wide variety of terrain conditions at all times of the day.

Continued consideration of satellite-aided mobile communication is warranted by the results of this experiment together with previous experimental results and expressions of interest by potential users in the public service, public safety, commercial and industrial services. A parallel study [3] to define a concept for an operational system concludes that the best implementation would be a satellite-aided mobile radio telephone system designed to augment the new cellular type terrestrial mobile telephone systems that are now being developed. The terrestrial cellular systems will provide large capacity, high quality radio telephone service to millions of subscribers in metropolitan areas. The terrestrial systems will be cost effective in densely populated areas, but will not be cost effective in thinly populated areas. A satellite may be cost effective in thinly populated areas. A satellite-aided cellular type system would require a large satellite antenna with many independent beams that in their totality cover the entire nation. There would be many two-way channels in each beam. Signalling parameters and operating protocols would be fully compatible with the terrestrial systems so that the same vehicle equipment would operate through terrestrial systems when the vehicle is inside an urban area. Together the satellite-aided and terrestrial systems would provide an ubiquitous telephone service.

2.0 OBJECTIVES

Overall objectives as initially stated were to give hands-on experience with satellite-aided communications to the trucking industry, its drivers and unions; to provide useful systems planning and design data for NASA and other system designers; and to provide some meaningful data for market estimates by common carriers and equipment suppliers.

Specific objectives were:

- A. Equip five trucks with equipment for two-way communications at L-band through the ATS-6 satellite. The equipment will be operated in the simple manner anticipated for eventual operating systems.
- B. Equip a terminal with a base station for communications with vehicles through the satellite.
- C. Employ the satellite-aided communications in routine operations of a trucking company.
- D. Identify uses of satellite-aided communications including dispatching, emergency and driver assistance.
- E. Obtain union reaction to concept.
- F. Measure channel occupancy per vehicle, determine ratio of satellite usage to direct communication usage as a basis for estimating potential market, requirement for satellite channel assignments.
- G. Measure quality and reliability of satellite communications including multipath, signal blocking, environmental noise and interference.
- H. Equip other potential users of direct satellite-mobile communications mutually agreed upon by the NASA technical monitor and the GE program manager to determine the applicability of satellite-aided mobile communication in a manner consistent with the objectives listed above.
- I. Prepare and publish a comprehensive report.

All objectives were met, although to varying degrees. Hands-on experience was provided to management and drivers, but there was no specific interaction with a union except to the extent the drivers represented their union. While the hands-on experience was sufficient to be meaningful, it was a miniscule sampling and exposure in comparison to the size of the trucking industry or even to Smith Transfer, that has more than one thousand over-the-road trucks.

Technical objectives, including demonstration of practical designs for vehicle equipments were adequately met, as were the measurements of signal quality and reliability.

While the experiment provided a sampling that was too small for a meaningful market estimate, it helped to clarify the application of satellites to land mobile in the parallel "Satellite-Aided Mobile Radio Concepts Study." That study concluded satellites will serve a large market drawn from the general public as well as public service and business and industrial users if the satellites are used to augment the planned terrestrial cellular type mobile telephone systems.

3.0 COMMUNICATION SYSTEM CHARACTERISTICS

3.1 ATS-6 SPACECRAFT L-BAND TRANSCEIVER

Experiments in satellite-aided communications with land mobile vehicles were made possible by the successful deployment of NASA's ATS-6 spacecraft. [4] (Figure 3.1) The satellite radiated high power densities on the earth with its 30' diameter parabolic antenna. Future operational land mobile communications satellites would require antennas as large or larger so that land mobile vehicles could use relatively small, low gain antennas.

The communications subsystem aboard ATS-6 utilizes a 30' diameter parabolic antenna fed by a multifrequency prime focus feed for frequencies at VHF, UHF, L-band, S-band and C-band. The C-band transmitters and receivers may also be switched on command to earth coverage horn antennas. A ground station can communicate through ATS-6 using the C-band earth coverage horns even when the main antenna beam of the spacecraft is pointed in another direction.

In the stowed configuration during launch the parabolic reflector formed an annulus 0.8' high with an inside diameter of 4.8' and an outside diameter of 6.6'. When deployed, the reflector was formed from a copper coated dacron mesh supported by 48 radial thin-gage ribs hinged from an aluminum annulus. The deployed parabolic reflector had a focal distance to diameter ratio (f/D) of 0.44. The focal point of the parabolic reflector fell on the prime focus feeds mounted in the center top of the earth viewing module (EVM). The EVM contained three subsections. The top section was the communications module containing the transponder and the prime focus feeds for the high gain parabolic reflector antenna. The middle section of the EVM, called the service module, contained components of the electrical power subsystem, the telemetry and command subsystem, and the attitude control subsystem. The lower subsection, designated the experiment module, contained most of the experiments, and all of the earth viewing sensors including the C-band earth coverage horn antenna.

The communications transponder of the ATS-6 spacecraft were functionally divided into four major areas: the receivers, the IF amplifier

PHOTOGRAPH NOT AVAILABLE

FIGURE 3.1
ATS-6 SPACECRAFT

assembly, the frequency synthesizer and the transmitters. The transponder received signals on VHF, L-band, S-band and C-band, and transmitted on VHF, UHF, L-band, S-band and C-band. In general, the signal received on any band could be routed through one of three IF amplifiers, and then retransmitted on any frequency band.

During the experiment described in this report, the transponder was configured in the L-band, narrowband frequency translation mode, as illustrated by Figure 3.2. Signals received by the pencil beam antenna feed element on approximately 1650 MHz were routed through the antenna switch and the diplexer, through the preselector filter, into the L-band preamplifier. After this initial stage of amplification, the received signals were down-converted to 150 MHz in the mixer preamplifier. The synthesizer module of the communications transponder provided the necessary local oscillator frequency of 1500 MHz for the down conversion. The received signal, now at 150 MHz, passed through the IF distribution matrix switch to one of the three intermediate frequency amplifiers in the spacecraft.

Signals received on other bands could be routed simultaneously through the IF distribution matrix switch to any intermediate frequency amplifier not in use. The three identical IF amplifiers have commandable bandwidths of 40 MHz or 12 MHz. The narrower 12 MHz bandwidth was used during this experiment. After passing through the IF amplifier, the 150 MHz signal was routed through the second IF distribution matrix switch and applied to the transmitting L-band isolator mixer and filter. The 1400 MHz signal from the synthesizer was also applied to this block. The 1550 MHz sum output of the mixer passed through a bandpass filter and then into the L-band power amplifier.

The power amplifier block contained two redundant drivers and power amplifiers. The input signal was divided equally between the two L-band driver amplifiers but only one driver amplifier pair had DC power applied to it. A radio-frequency switch connected the output from the selected L-band power amplifier through a bandpass filter to the antenna switch and diplexer. The transmitter was thus connected to the same antenna element that was used to receive the uplink signal.

Table 3.1 summarizes ATS-6 performance in the L-band, narrowband frequency translation mode using the pencil beam antenna configuration.

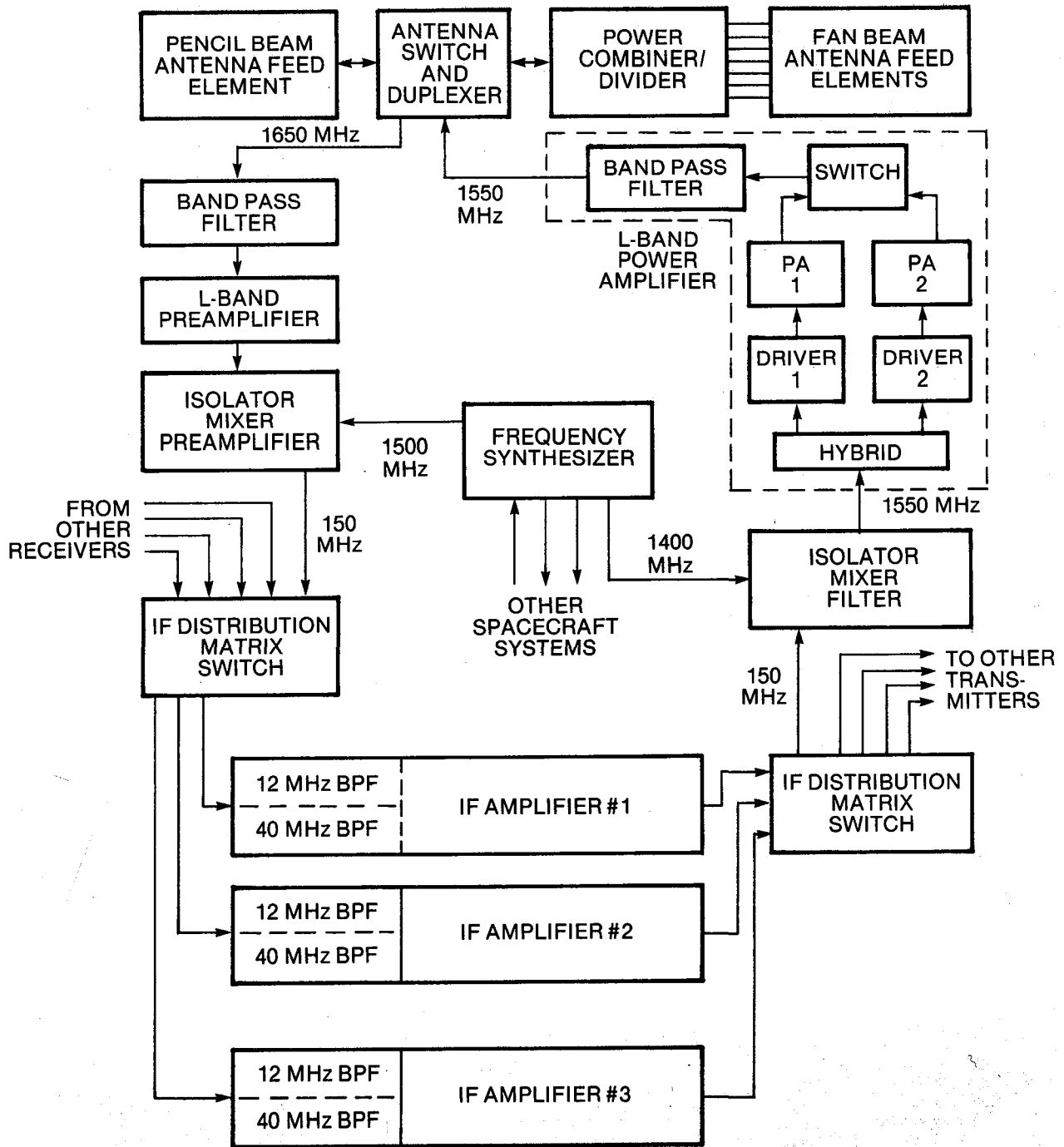

FIGURE 3.2
 ATS-6 COMMUNICATIONS TRANSPONDER
 L-BAND FREQUENCY TRANSLATION MODE

TABLE 3.1
 ATS-6 SPACECRAFT PERFORMANCE
 L-BAND FREQUENCY TRANSLATION MODE

Pencil Beam Configuration

RECEIVE

Receiver Noise Figure (dB)	6.5
Equivalent Receiver Noise Temperature (°K)	1005
Antenna Temperature Pointed at Earth (°K)	290
Receive System Temperature (°K)	1295
Antenna Gain, peak (dB)	38.4
Spacecraft G/T, peak (dB/°K)	7.3
Half Power Beamwidth (degrees)	1.3
Gain over Field of View (dB)	35.4
Spacecraft G/T over Field of View (dB/°K)	4.3

TRANSMIT

Transmit Power (dBW)	15.3
Antenna Gain, peak (dB)	37.7
Effective Radiated Power, peak (dBW)	53.0
Half Power Beamwidth (degrees)	1.4
Gain over Field of View (dB)	34.8
Effective Radiated Power over Field of View (dBW)	50.1

ATS-6 was configured in this way for most of this experiment. Occasionally ATS-6 was configured in the fan beam mode for special tests with search and rescue vehicles conducted during the later parts of this experiment. Table 3.2 summarizes spacecraft performance when the fan beam was used.

3.2 SPACECRAFT ANTENNA BEAM AND POINTING

The ATS-6 ground control station selected the shape and size of the satellite antenna beam by commanding the spacecraft to connect the appropriate antenna feed elements to the transmitter and receiver. For L-band, the ground controller could select a 7-element array of cavity-backed crossed dipoles which produced a fan-shaped beam in the east-west direction. This beam was approximately 7° east west by 1° north-south at its half-power contour, and covered the United States in the east-west direction. It also covered a large part of the United States in the north-south direction. Spacecraft antenna gain in the fan beam mode was too small for adequate signal level margins in this experiment with mobile vehicles.

The ground station controller could select a single cavity-backed dipole feed element that produced a circular pencil beam with a half-power beamwidth of 1.3° . The pencil beam mode had 6 dB more gain than the fan beam mode and provided adequate signal margin for the low power mobile units with small antennas. Each of the L-band feeds received at 1650 MHz and transmitted at 1550 MHz simultaneously with the aid of bandpass filters configured as a diplexer. Both beams were right hand circularly polarized.

The beam of the spacecraft was pointed at the desired area on earth by maneuvering the entire body of the spacecraft including the integral 30' parabolic reflector antenna. The spacecraft was then kept in the desired position by an automatic 3-axis stabilization system. ATS-6 was usually maneuvered by accelerating or decelerating the three momentum wheels within the spacecraft. One momentum wheel was used for each orthogonal axes of rotational motion. When a momentum wheel speed became excessive due to a continuing correction against uneven solar "wind" pressure, a pair of attitude control jets were fired, forcing the control system to decelerate the wheel as it maintained spacecraft attitude.

TABLE 3.2

ATS-6 SPACECRAFT PERFORMANCE
L-BAND FREQUENCY TRANSLATION MODE

Fan Beam Configuration

RECEIVE

Receiver Noise Figure (dB)	6.5
Equivalent Receiver Noise Temperature (°K)	1005
Antenna Temperature, pointed at Earth (°K)	290
Receive System Temperature (°K)	1295
Antenna Gain, peak (dB)	30.8
Spacecraft G/T peak (dB/°K)	- 0.3
Half Power Beamwidth - see Figure 3.2	
*Gain over Field of View (dB)	27.8
Spacecraft G/T over Field of View	- 3.3

TRANSMIT

Transmit Power (dBW)	15.3
Antenna Gain, peak (dB)	31.8
Effective Radiated Power, peak (dBW)	47.1
Half Power Beamwidth - see Figure 3.2	
*Gain over Field of View (dB)	28.8
Effective Radiated Power over Field of View (dBW)	44.1

* The Field of View is taken as the Half Power Beamwidth.

Before each of the weekend test periods of the experiment, NASA controllers configured the ATS-6 spacecraft for the L-band, narrowband, pencil beam mode. This configuration formed a beam approximately 1.3° wide at the half-power points.

Several factors limited where the ATS-6 L-band pencil beam could be pointed during this experiment. First, the satellite beam had to include the General Electric Earth Station Laboratory (ESL) located near Schenectady, New York, as it was an essential part of the experimental network. This factor dictated that the experiment operational arena be generally in the eastern United States. Second, a high elevation angle from the experimental vehicle to the spacecraft should be used to avoid signal path blockage by surrounding objects.

An operational land mobile communications spacecraft would probably be centrally located south of the United States at approximately 95° west longitude over the equator. Elevation angles to that synchronous orbit location range from 30° in the states of Maine and Washington to 56° in the southern part of Texas. The high elevation angles typical of a future operation system such as this could not be tested during this experiment because the ATS-6 spacecraft was located far west of the Earth Station Laboratory. In order to maximize the elevation angle to the spacecraft, its beam was pointed as far west and south as possible and yet include the Earth Station Laboratory. The coverage area of the 1.3° beam was an ellipse that included the northeastern and central eastern United States. Satellite elevation angles from various cities within the coverage area are shown in Table 3.3.

During the early part of the experiment General Electric requested that NASA point the ATS-6 L-band pencil beam at 40° N latitude and 85° W longitude. The dashed curve of Figure 3.3 represents the 3 dB contour of the ATS-6 pencil beam at this pointing. At this pointing, signals received from near Atlanta, Georgia, were at least 6 dB weaker than signals received from trucks in areas near the center of the satellite beam. Signals from trucks near Atlanta were thus much weaker due to the off-beam loss of the satellite antenna. The southern edge of the ATS-6 beam was located too far north for this experiment. On 29 December 1978 General Electric requested that NASA point the ATS-6 L-band pencil beam further south at 38.5° N latitude and 85° W longitude. That pointing, illustrated by the solid curve

TABLE 3.3

ELEVATION ANGLE OF ATS-6 AT 140° WEST
 LONGITUDE FROM VARIOUS U. S. CITIES

<u>CITY AND STATE</u>	<u>CITY LATITUDE (°N)</u>	<u>CITY LONGITUDE (°W)</u>	<u>ATS-6 ELEVATION (Degrees)</u>
New York, New York	40	74	9
Washington, D. C.	39	77	13
Cleveland, Ohio	42	82	15
Cincinnati, Ohio	39	85	18
Chicago, Illinois	42	88	19
Des Moines, Iowa	42	94	23
St. Louis, Missouri	39	90	22
Memphis, Tennessee	35	90	24
Atlanta, Georgia	34	84	19
Charlotte, North Carolina	35	81	17
Staunton, Virginia	38	79	14
Schenectady, New York	43	74	9

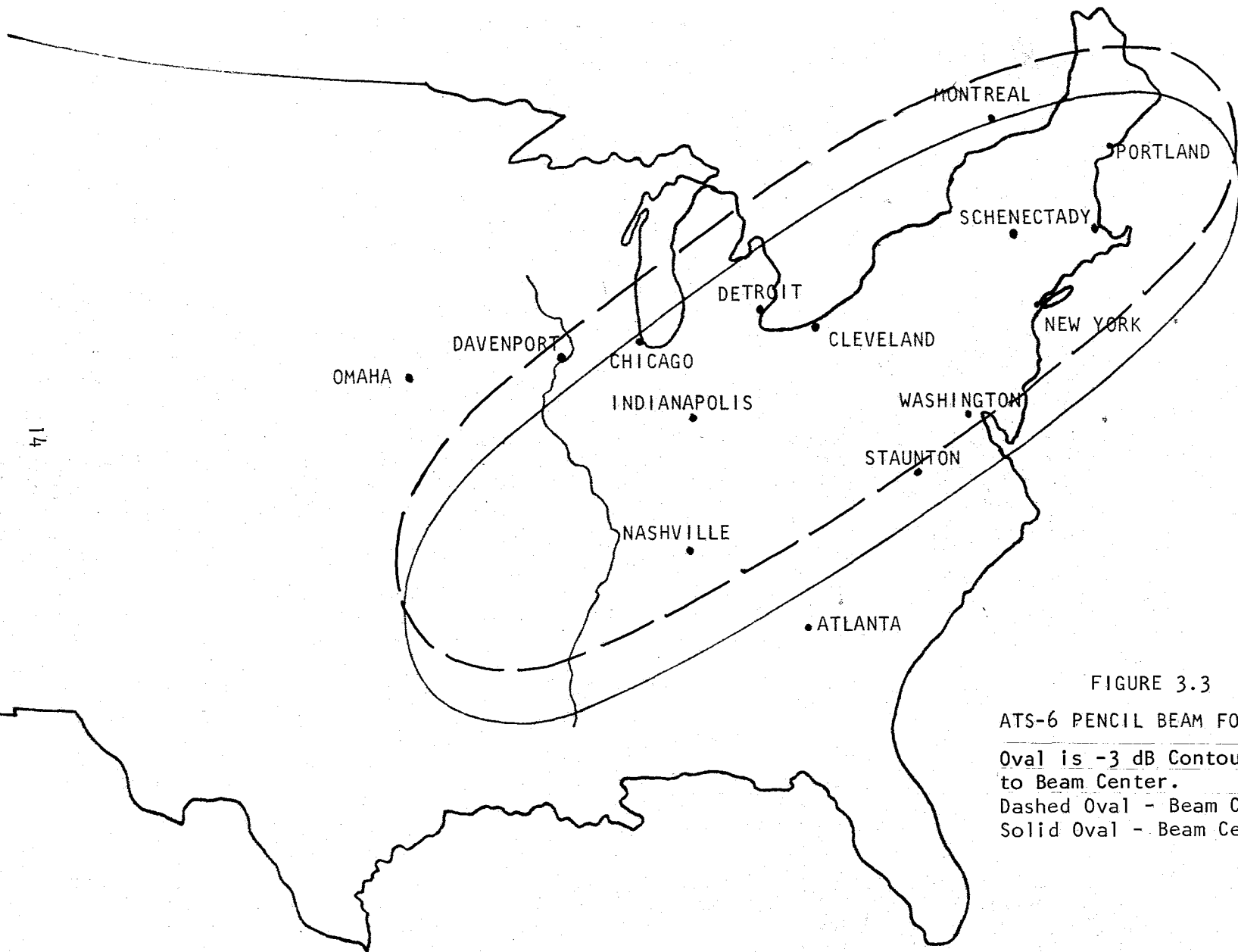

FIGURE 3.3

ATS-6 PENCIL BEAM FOOTPRINT

- Oval is -3 dB Contour Relative to Beam Center.
- Dashed Oval - Beam Centered at 85°W 40°N
- Solid Oval - Beam Centered at 85°W 38.5°N

in Figure 3.3, was used for the experiment during the months of January and February, 1979. The signals received from trucks travelling in open areas near Atlanta, Georgia, were then fully readable, indicating at least a 3 dB improvement in their signal level.

Another characteristic of ATS-6 that affected the experiment was the possibility of self-desensitization of the satellite's receiver. Like all hard limiting transponders, ATS-6 transmitted its own receiver front end noise at full power when there was no uplink signal. The front end random noise was evenly distributed across the intermediate frequency amplifier passband. This situation is expected and normally causes no difficulty, but when the ATS-6 L-band transmitter operated in this noise-saturated condition, it generated enough broadband noise at the L-band receive frequency to override weak received signals. If the transmitted noise was suppressed with at least one saturating carrier, receiver desensitization was prevented. When ATS-6 was designed, plans for all experiments included at least one saturating uplink carrier when the L-band frequency translation mode was used. L-band transponder performance was therefore deemed adequate though there was a possibility of desensitization. A strong uplink carrier was transmitted at all times during the truck communications experiment to prevent spacecraft receiver noise desensitization.

3.3 SYSTEM POWER BUDGETS

One purpose of this experiment was to demonstrate a direct satellite-land mobile radio communications system that resembled an operational system as closely as possible. To accomplish this goal, a mobile radio set was designed to the specifications of Table 3.4. These specifications represent only a moderate extension of the present state-of-the-art in mobile radio transceivers. The transmitted power specification was limited to that of a varactor doubler connected to the output of a medium power 800 MHz mobile radio transmitter. Approximately the same amount of power can be generated in a single transistor package without the aid of splitters and combiners. The noise figure specified in Table 3.4 is somewhat lower than can be obtained with inexpensive plastic case transistors, but only by approximately 1 dB. A \$15 device was used as the first RF amplifier in the experimental satellite transceiver, but devices having the specified noise figure will soon be available for less than \$5.00. Construction methods used in the mobile transceivers can be easily adapted to mass production.

TABLE 3.4

Part 1

SATELLITE-AIDED MOBILE RADIO
TRANSCEIVER SPECIFICATIONS

Transmitter

Frequency	1655.050 MHz
Power Output	16 watts nominal 12 watts minimum
Frequency Stability	$\pm 0.0002\%$ (-30° to $+60^\circ$)
Modulation	16 F ₃ Adjustable from 0 to ± 5 kHz swing FM with instantaneous modulation limiting
Audio Frequency Response	Within +1 dB and -3 dB of a 6 dB/octave pre-emphasis from 300 - 3000 Hz per EIA standards
Duty Cycle	EIA 20% intermittent
Maximum Frequency Spread	± 6 MHz with center tuning
RF Output Impedance	50 ohms

TABLE 3.4

Part 2

SATELLITE-AIDED MOBILE RADIO
TRANSCEIVER SPECIFICATIONS

Receiver

Frequency	1552.000 MHz
Frequency Stability	$\pm 0.0002\%$ (-30° to +60°C)
Noise Figure	2.6 dB referenced to transceiver antenna jack
Equivalent Receiver Noise Temperature	238° Kelvin
Selectivity	-75 dB by EIA Two-Signal Method
Audio Output	5 watts at less than 5% distortion
Frequency Response	Within +1 and -8 dB of a standard 6 dB per octave de-emphasis curve from 300 - 3000 Hz
Modulation Acceptance	± 7 kHz
RF Input Impedance	50 ohms

TABLE 3.4

Part 3

SATELLITE-AIDED MOBILE RADIO
TRANSCEIVER SPECIFICATIONSAntenna System

Antenna Type	"Wheeler" transposed coaxial segment array
Polarization	Linear (vertical)
Gain	7.3 dBi (peak)
Vertical Pattern (all angles with reference to the horizon = 0°)	At 1550 MHz Receive
	Beam peak + 11° -3 dB Points + 4° and + 19°
	At 1650 MHz Transmit
	Beam Peak + 18° -3 dB Points + 11° and + 28°
Horizontal Pattern	Omnidirectional (< <u>±</u> 1 dB)
Feed Line Loss	1.8 dB (15 ft. of RG-214)
Receive System Noise Figure Referenced to Antenna Terminals	4.4 dB, including feedline loss (509°K equivalent temperature)
Estimated Antenna Background Temperature	290°K
Total Receive System Equivalent Noise Temperature	799°K

The base station equipment deployed at the trucking company central dispatch facility had essentially the same specifications as the mobile radio equipment. A larger antenna was chosen for the base station to insure that the base station could transmit a signal strong enough to capture any truck signal and retain control of the communications network.

Although several alternate antenna designs were considered for the mobile radio transceiver, the primary antenna requirement was relatively small size and convenient installation. The antenna required an omnidirectional azimuth pattern so the truck could travel in any direction without requiring the driver to point the antenna. For a number of reasons outlined later in this report, a transposed coaxial antenna, have a net gain of 4.3 dB, was chosen for the truck. A more-than-adequate 1.3 meter dish was chosen for the base station located at the central dispatching facility because it was available.

The equipment at the General Electric Earth Station Laboratory could be configured in a variety of ways to complete the experimental communications system. A fixed 2 meter parabolic dish, as well as a fully steerable 10 meter dish, were in place. The L-band power amplifiers could generate as much as 300 watts. Assorted low noise amplifiers, duplexers, down converters, local oscillators, tape recorders, transmitting exciters, as well as a PDP-11 computer were available. Various equipment was selected from the inventory to meet the specifications required of the Laboratory in this experimental system.

Tables 3.5 and 3.6 show the limiting best case and worst case power budgets describing the truck to ATS-6 spacecraft uplink performance. Even in the best of circumstances, the truck signal level in the spacecraft IF is 8 dB less than the total random noise power in the IF passband. Only a small part of the spacecraft transmitter power would be devoted to retransmitting a truck signal. The output power from the hard limiting spacecraft transponder is divided among the input signals (including receiver random noise) according to their power level, hence the spacecraft could have accommodated a number of trucks all transmitting at the same time. With only one truck signal, most of the transmitter power would be used to retransmit random receiver noise distributed across the entire 12 MHz bandwidth of the spacecraft IF amplifier. The truck signal retransmitted by

TABLE 3.5

ATS-6 UPLINK POWER BUDGET
TRUCK TO ATS-6

Best Peak Conditions

GROUND STATION

Transmitter Power, 16 Watts (dBW)	12.0
Antenna Gain (dB)	7.3
Pointing Loss (dB)	0
Polarization Loss (dB)	- 3.0
Feedline Loss, 15 ft. RG-214 (dB)	<u>- 1.8</u>
Ground Station EIRP (dBW)	14.5
Space Loss at 1650 MHz (dB)	-188.4
Spacecraft G/T, at beam peak (dB/°K)	<u>8.1</u>
Spacecraft Received Signal (dBW/°K)	-165.8
Boltzmann's Constant (dBW/°K Hz)	-228.6
Received Signal-to-Noise Power Density (dB-Hz)	62.8
Satellite Noise Bandwidth, 12 MHz (dB over 1 Hz)	70.8
S/N in Spacecraft 12 MHz IF (dB)	- 8.0
S/N in 15 kHz Communications BW (dB)	+ 21.0

TABLE 3.6

ATS-6 UPLINK POWER BUDGET
TRUCK TO ATS-6

Worst Case Conditions

GROUND STATION

Transmitter Power, 12 Watts (dBW)	10.8
Antenna Gain (dB)	7
Max Pointing Loss (dB)	- 1
Polarization Loss (dB)	- 3
Feedline Loss (dB)	<u>- 1.8</u>
EIRP (dBW)	12.0
Space Loss at 1650 MHz (dB)	-188.4
Spacecraft G/T over Field of View (dB/°K)	<u>4.3</u>
Spacecraft Received Signal (dBW/°K)	-172.1
Boltzmann's Constant (dBW/°K Hz)	-228.6
Received Signal-to-Noise Power Density (dB-Hz)	56.5
Satellite Noise Bandwidth, 12 MHz (dB over 1 Hz)	70.8
S/N in Spacecraft IF (dB)	- 14.3
S/N in 15 kHz Communications BW (dB)	+ 14.7

ATS-6 in this simple configuration would be too weak to hear at another small station. This effect, known as noise power sharing, can only be reduced by using a smaller IF bandwidth in the spacecraft transponder. The 12 MHz bandwidth selected for these experiments is the smallest available on ATS-6.

The "double hop" system configuration illustrated in Figure 3.4 was suggested by Dr. James Brown of NASA-Goddard to overcome noise power sharing and the spacecraft transmitter noise desensitization effect described above. In this configuration the Earth Station Laboratory continuously transmitted a carrier through ATS-6 to prevent transmitter noise desensitization of the spacecraft receiver. When no truck or base station was using the system, the ESL transmitted an "idle carrier" through ATS-6 on a frequency that could not be heard by the trucks or the base station. The carrier quieted the spacecraft transmitter noise when the system was not in use. When a truck or base station made a transmission, the spacecraft retransmitted the signal. Very little satellite transmitter power was devoted to retransmitting the truck or base station signal because it was very much weaker than the ESL carrier, but the ESL received the weak truck or base station signal clearly with its large receiving antenna.

Upon receiving a truck or base station, the ESL transmitter immediately and automatically changed its frequency to the one the trucks and base station could hear, thus any message transmitted by the truck or base station was relayed to all other stations in the network. Only one station in the network could transmit at any given time. Although Figure 3.4 shows the truck near the base station, the truck could operate anywhere within the beam of ATS-6 (see Figure 3.3). A message originated by one station passed through the spacecraft was detected and repeated by the ESL and then retransmitted through the spacecraft a second time, hence the designation: "double hop configuration."

The transmit power of the ESL was adjusted to nearly saturate the spacecraft transponder, thereby capturing most of its transmitter power. The trucks could then receive satellite signals with small antennas. If the ESL transmitted more than just enough power to saturate the spacecraft transponder, less power would have remained for the weak truck transmissions

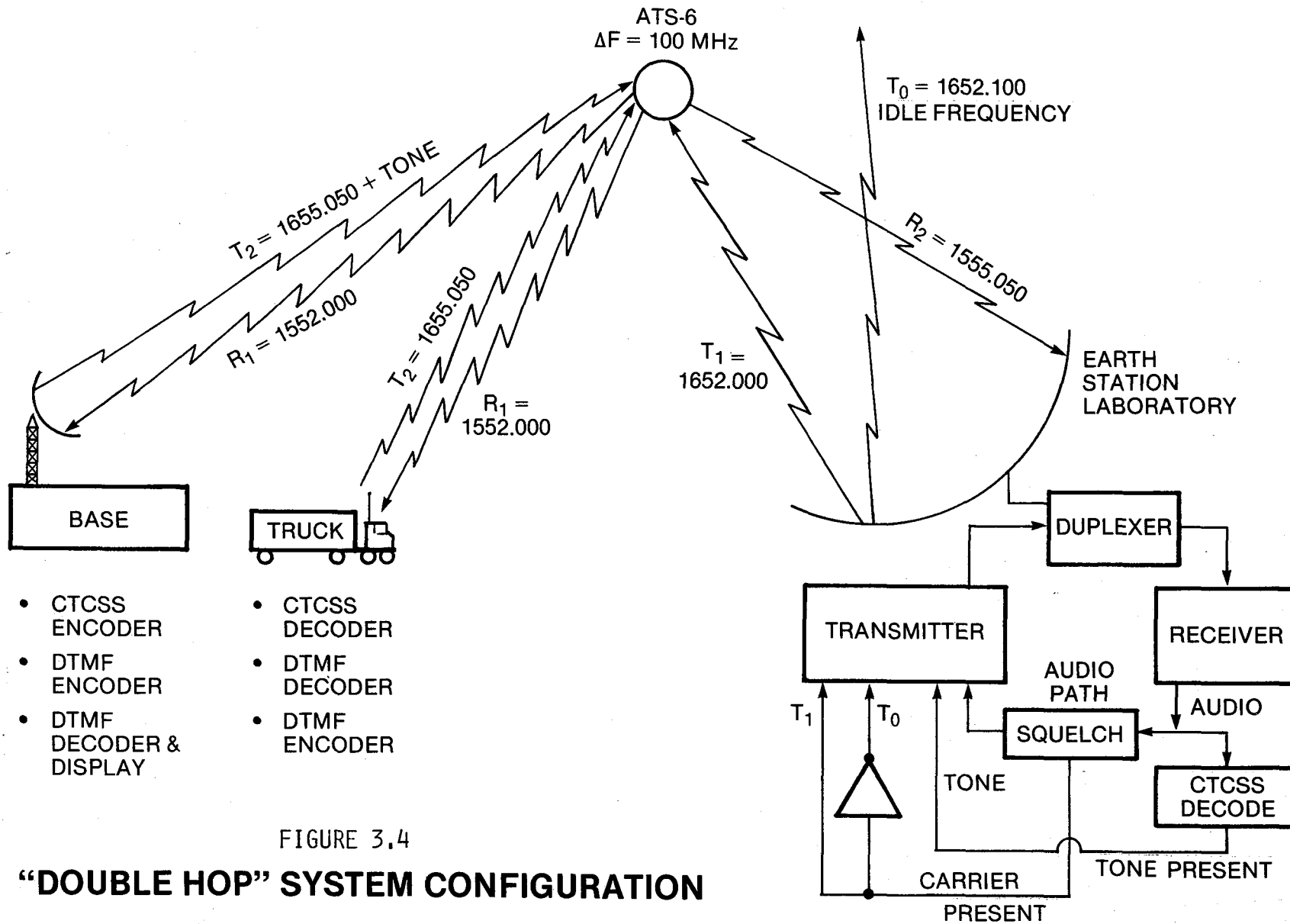

making them more difficult to receive at the ESL. It should also be noted that the ESL equipment functioned in the full duplex mode. The filter duplexer mounted at the Earth Station Laboratory antenna permitted the simultaneous transmission and reception of ATS-6 signals.

Two types of selective tone signalling were employed in the experimental system. The base station transmitted a low frequency continuous tone-coded squelch system (CTCSS) tone to distinguish its transmissions from those made by the trucks. If the Earth Station Laboratory receiver detected the CTCSS tone, the low frequency tone encoder in the laboratory transmitter was automatically enabled. It was necessary to decode and regenerate the CTCSS tone because the voice audio circuits in the Earth Station Laboratory receiver and transmitter will not pass the low frequency tones. All base station messages repeated by the Earth Station Laboratory contained the CTCSS tone. Each of the trucks contained a CTCSS tone decoder in order to receive messages from the base station.

Although the satellite transceivers installed in the trucks could receive only CTCSS tone coded signals, they did not transmit a sub-audible tone. The Earth Station Laboratory repeated truck signals that did not contain a sub-audible tone as it received them - without a tone. Therefore, trucks could normally hear only those messages transmitted from the base station which contained tones but could not hear radio transmissions made from any other truck. The base station could hear all transmissions repeated by the Earth Station Laboratory as it contained an ordinary carrier squelch receiver.

Although the trucks were normally prevented from communicating with each other as described above, the tone was sometimes transmitted continuously from the Earth Station Laboratory in order to accumulate propagation data as the truck drivers spoke to one another.

The experimental system also included a Dual Tone Multiple Frequency (DTMF) selective signalling system which permitted automatic vehicle identification as well as individual and group selective calling. Encoding and decoding equipments manufactured by Speedcall Corporation were added to the radio equipment at the base station and in the trucks. The selective signalling

equipment used a standard two of 7 Touch-tone[®] format as used in the telephone system. An individually addressable DTMF decoder was added to the satellite transceiver in each truck. The decoder contained both visual and audible alarms which actuated when the satellite transceiver received the individual address code. The decoder was placed in series with the radio transceiver speaker, enabling the speaker only on receipt of the correct address code. The radio set therefore remained silent except when it was addressed. In order to call a specific truck, the dispatch operator at the base station entered the address code of the desired truck through the keyboard on the DTMF encoder. The dispatcher then depressed a key, sending the address code to the truck via the voice communications link. The decoder alarm in the truck sounded to alert the driver. When the driver finished the conversation he pressed the reset button, silencing his radio until the next call.

Each truck also included a DTMF encoder which automatically transmitted a short sequence of touch-tone digits at the beginning of each radio transmission. The number sequence automatically identified each truck transmission on a decoder and display at the base station. The identification sequence did not interrupt conversation as it lasted only a fraction of a second.

All voice conversations and selective signalling tones were recorded at the Earth Station Laboratory for later analysis. The ESL also contained DTMF encoders and decoders equivalent to those at the base station for system test and control.

The power budgets in Table 3.7 and 3.8 summarize the performance of the experimental satellite land mobile communications system. The Tables detail the link calculation in the forward direction from the ESL through ATS-6 to the trucks as well as transmissions from the trucks through ATS-6 to the ESL (the return link). The links must be calculated simultaneously as the ESL continuously retransmitted everything it received to all other stations in the network.

Even in worst case conditions, the ESL forward link carrier was 5.5 dB stronger than the total noise power in the spacecraft 12 MHz IF.

[®] Touch-tone - Registered trademark of American Telephone and Telegraph Co.

TABLE 3.7

Part 1

BEST PEAK BEAM CASE
ATS-6 "DOUBLE HOP" POWER BUDGET

	UPLINK CARRIERS AT 1650 MHz	
	Forward Link ESL-ATS-6	Return Link Truck-ATS-6
<u>GROUND STATION</u>		
Transmitter Power (dBW)	11.0	12.0
Antenna Gain (dBi)	27.5	7.3
Pointing Loss (dB)	0	0
Polarization Loss (dB)	- 3.0	- 3.0
Feedline Loss (dB)	- 1.7	- 1.8
Effective Isotropic Radiated Power (dBW)	33.8	14.5
Space Loss at 1650 MHz (dB)	-188.4	-188.4
Spacecraft G/T at Beam Peak (dB/°K) ⁽¹⁾	<u>8.1</u>	<u>8.1</u>
Spacecraft Received Signal (dBW/°K)	-146.5	-165.8
Boltzmann's Constant (dBW°K/Hz)	-228.6	-228.6
Received Signal-to-Noise Power Density (dB-Hz)	82.1	62.8
Satellite Noise Bandwidth, 12 MHz ⁽¹⁾ (dB) (relative to 1 Hz)	70.8	70.8
Pre-Limiter C/N in Spacecraft IF (dB)	11.3	- 8.0
Pre-Limiter C/N in 15 kHz Communications Bandwidth (dB)	40.3	21.0
Post-Limiter C/N in Spacecraft IF (dB)	14.3	- 11.0
Post-Limited C/N in 15 kHz Communications Bandwidth (dB)	43.3	+ 18.0
Power Sharing Factor (dB)	- 0.2	- 25.5

(1) Spacecraft configured in the L-band narrowband frequency translation mode using the pencil beam.

TABLE 3.7

Part 2

BEST PEAK BEAM CASE
ATS-6 "DOUBLE HOP" POWER BUDGET

	DOWNLINK CARRIERS AT 1550 MHz	
	Forward Link ATS-6-Truck	Return Link ATS-6-ESL
<u>SPACECRAFT TRANSMITTER</u> ⁽¹⁾		
Transmitter Power (dBW)	15.3	15.3
Antenna Gain, Peak (dBi)	37.7	37.7
Antenna Pointing Loss (dB)	0	0
Power Sharing Factor (dB)	<u>- 0.2</u>	<u>- 25.5</u>
Spacecraft EIRP (dBW)	52.8	27.5
Ground Antenna Gain (dBi)	7.3	26.9
Pointing Loss (dB)	0	0
Circuit Losses (dB)	Included in system temperature	
Polarization Loss (dB)	- 3.0	- 3.0
Space Loss at 1550 MHz (dB)	<u>-187.8</u>	<u>-187.8</u>
Power at Ground Receiver (dBW)	-130.7	-136.4
Total Receive System Noise Temperature (°K)	799	600
Boltzmann's Constant (dBW/Hz/°K)	-228.6	-228.6
Receiver Noise Power Density (dBW/Hz)	-199.6	-200.8
15 kHz Communications Bandwidth, referenced to 1 Hz (dB)	41.8	41.8
Downlink C/N in Communications BW (dB)	27.1	22.6
Uplink C/N in Communications Bandwidth (dB) (From Part 1, Table 3.7)	43.3	18.0
System C/N in Communications BW (dB)	27.0	16.7

(1) Spacecraft configured on the L-band narrow band frequency translation mode using the pencil beam.

TABLE 3.8

Part 1

WORST CASE

ATS-6 "DOUBLE HOP" POWER BUDGET

	UPLINK CARRIERS AT 1650 MHz	
	Forward Link ESL-ATS-6	Return Link Truck-ATS-6
<u>GROUND STATION</u>		
Transmitter Power (dBW)	11.0	10.8
Antenna Gain (dBi)	27.5	7.0
Pointing Loss (dB)	- 2.0	- 1.0
Polarization Loss (dB)	- 3.0	- 3.0
Circuit Loss (dB)	- <u>1.7</u>	- <u>1.8</u>
Effective Isotropic Radiated Power (dBW)	31.8	12.0
Space Loss at 1650 MHz (dB)	-188.4	-188.4
Spacecraft G/T, over field of view (dB/°K) (1)	<u>4.3</u>	<u>4.3</u>
Spacecraft Received Signal (dBW/°K)	-152.3	-172.1
Boltzmann's Constant (dBW/°K/Hz)	-228.6	-228.6
Received Signal-to-Noise Power Density (dB-Hz)	76.3	56.5
Satellite 12 MHz (1) Noise Bandwidth, Referenced to 1 Hz (dB)	70.8	70.8
Pre-Limiter C/N in Spacecraft IF (dB)	+ 5.5	- 14.3
Pre-Limiter C/N in a 15 kHz Communication Bandwidth (dB)	+ 34.5	+ 14.7
Post-Limiter C/N in Spacecraft IF (dB)	+ 8.5	- 17.3
Post-Limiter C/N in 15 kHz Communications Bandwidth (dB)	+ 37.5	+ 11.7
Power Sharing Factor (dB)	- 0.6	- 26.4

(1) Spacecraft configured in the L-band narrowband frequency translation mode using the pencil beam.

TABLE 3.8

Part 2

WORST CASE

ATS-6 "DOUBLE HOP" POWER BUDGET

	UPLINK CARRIERS AT 1550 MHz	
	<u>Forward Link</u> <u>Truck-ATS-6</u>	<u>Return Link</u> <u>ATS-6-ESL</u>
<u>SPACECRAFT TRANSMITTER</u> ⁽¹⁾		
Transmitter Power (dBW)	15.3	15.3
Antenna Gain (dBi)	37.7	37.7
Antenna Pointing Loss (dB)	- 3.0	- 3.0
Power Sharing Factor (dB)	<u>- 0.6</u>	<u>- 26.4</u>
Spacecraft EIRP (dBW)	49.4	23.6
Ground Antenna Gain (dBi)	7.0	26.9
Pointing Loss (dB)	- 1.0	- 2.0
Circuit Losses (dB)	Included in System Temperatures	
Polarization Loss (dB)	- 3.0	- 3.0
Space Loss at 1550 MHz (dB)	<u>-187.8</u>	<u>-187.8</u>
Power at Ground Receiver (dBW)	-135.4	-142.3
Total Receive System Noise Temperature (°K)	799	600
Boltzmann's Constant (dBW/°K/Hz)	-228.6	-228.6
Receiver Noise Power Density (dBW/Hz)	-199.6	-200.8
15 kHz Communications Bandwidth, Referenced to 1 Hz (dB)	41.8	41.8
Downlink C/N in Communications BW (dB)	22.4	16.7
Uplink C/N in Communications Bandwidth (dB) (from Table 3.8, Part 1)	+ 37.5	+ 11.7
System C/N in Communications BW (dB)	22.3	10.5

(1) Spacecraft configured in the L-band narrow band frequency translation mode using the pencil beam.

The saturating forward link carrier thus captured almost all of the satellite transmitter power as it retransmitted to the trucks. The saturating forward link carrier also depressed the broad band noise transmitted by the satellite by at least 5.5 dB, an amount found sufficient to prevent desensitization of the spacecraft receiver.

Downlink calculations show that the forward link signal had a signal-to-noise ratio of approximately 22 dB in the mobile transceiver even under worst case conditions. The signal received in the truck is degraded only by thermal noise inherent to the mobile receiver itself. The high power ESL to ATS-6 uplink makes no substantial noise contribution to the forward link.

In the case of the relatively weak return link transmissions from the trucks, both the uplink and downlink added noise to the signal received at the ESL. In all cases, the uplink portion of the return link contributed more noise to the truck signal than the downlink between ATS-6 and the Earth Station Laboratory. In fact, measurements at the ESL showed the spacecraft receiver noise power retransmitted by ATS-6 on the truck frequency increased the total ESL receiver noise by at least 6 dB.

This would require the noise received from the spacecraft to be at least 4.7 dB stronger than the inherent receiver noise. The value predicted by the power budgets is 4.5 dB and 5.0 dB for the best and worst cases respectively.

The performance of the experimental system was also checked using the 10 meter dish for receive at the ESL rather than duplexing through the 2 meter antenna. Although all the signals received from ATS-6 were much stronger with the 10 meter antenna, no change could be measured in the signal-to-noise ratio of even weak signals from the trucks. These two tests confirmed that the links from ATS-6 to the trucks limited the performance of the experimental system. The 10 meter dish was not used for much of the experiment as an operator had to repoint its narrow beam at the satellite at least twice a day to insure adequate systems performance.

4.0 EXPERIMENTAL EQUIPMENT DESCRIPTION

4.1 EQUIPMENT DESIGN CONSIDERATIONS

One major objective of the experiment was to demonstrate that a practical satellite-aided land mobile radio set can be manufactured using current mass production technology. To meet this goal, the experimental equipment was designed as nearly like current land mobile equipment as possible. Standard mobile radio equipment was modified to implement the design but several parts of the experimental radio set were specially designed.

The radio set was packaged like a standard mobile radio set so that it would be familiar to the users. The packaging assured mechanical integrity in rough field tests encountered in long-haul tractor trailer trucks. As is typical in mobile radio installations, the controls of the radio set were mounted separately from the main chassis of the radio to conserve space near the dashboard of the truck. A multi-conductor cable connected the control head with the main chassis of the radio set.

The experimental satellite mobile radio set was patterned after the 806-870 MHz MASTR[®] EXECUTIVE II General Electric two-way FM mobile radio combination, as many of the circuits of this standard product could be used without modification in the experimental equipment. The 800 MHz band is the highest frequency band currently assigned for land mobile use and closest to the ATS-6 spacecraft frequencies (1550 MHz/1650 MHz). The equipment currently manufactured for the 800 MHz band can also serve as models for equipment that would be required for future operational satellite-aided land mobile radio systems in the 500 to 2000 MHz region of the spectrum.

The 800 MHz radio has the best frequency stability of any standard mobile radio equipment and requires only one stable crystal oscillator for both transmit and receive. Particular attention must be paid to the frequency stability of radio equipment using narrow bandwidths at high carrier frequencies. The standard commercial narrow band (± 5 kHz) frequency modulation used in this experiment occupies only 16 kHz of bandwidth. For best signal-to-noise ratio, receiver IF filters as narrow as 12 kHz can be used without excessively distorting the received signal provided the transmitter and receiver have sufficient frequency stability.

If the receiver operates on a frequency different from the transmitter, the received signal modulation will be distorted as it passes through the selective channel filter asymmetrically. A broader filter will reduce the distortion but the received signal-to-noise ratio will suffer. Current 800 MHz mobile radio equipment has a stability of ± 2 parts per million (ppm) and fixed repeater station equipment in the same service must drift less than ± 1.5 parts per million. Stable crystal oscillators meeting these specifications over the full -30 to $+60^{\circ}\text{C}$ commercial radio temperature range contribute substantially to the final radio set cost especially in multichannel sets. Frequency synthesizers can be used to reduce the cost of radio sets having a large number of channels but add complexity and cost to the radio set. With current technology, radio sets requiring more than 4 or 5 channels can be built less expensively with a synthesizer, than by using separate crystal oscillators for each frequency.

Most radio transceivers use one stable crystal oscillator in the transmitter and another in the receiver local oscillator, but the low power stages of the transmitter can serve as the receiver first local oscillator if the corresponding receive frequency always differs from the transmit frequency by a constant equal to the first intermediate frequency of the superhetrodyne receiver. This technique, illustrated in Figure 4.1, uses only one expensive stable crystal oscillator per channel.

The transmitter crystal oscillator and the multiplier exciter operate continuously whenever the radio set is turned on. In the receive mode the microphone preamplifier and the audio processor are disabled to prevent incidental noise reaching the microphone from modulating the signal generated by the crystal oscillator. In the receive mode, the injection switch connects the output from the multiplier-exciter (typically on 806 MHz) through an attenuator and the injection filter to the first mixer of the receiver. Received signals pass from the antenna through the antenna switch and the pre-selector to the first mixer. The preselector filter passes only signals approximately 45 MHz above the 806 MHz first mixer injection frequency. The first mixer then converts the signal received at exactly 851 MHz to

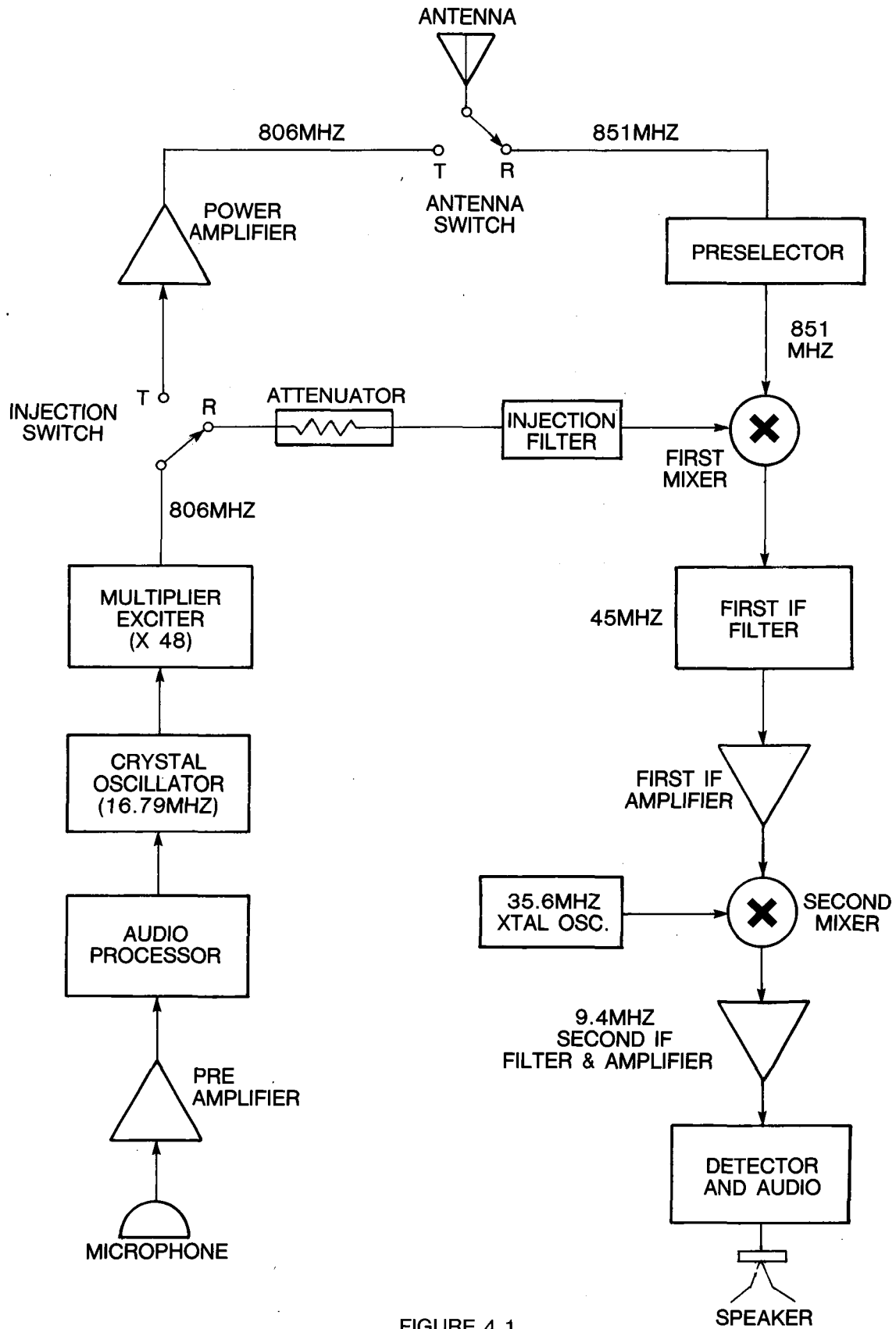

FIGURE 4.1
800 MHz MASTR® EXECUTIVE II
MOBILE RADIO SET

exactly 45 MHz. Only this signal can pass through the first IF crystal filter tuned to 45 MHz. The 45 MHz signal then passes through the remainder of the receiver in a conventional manner.

For each transmitter channel frequency near 806 MHz, the radio set will receive a corresponding signal exactly 45 MHz higher in frequency. The radio set requires only one high stability crystal oscillator for each corresponding transmit-receive frequency pair. This technique is particularly applicable to the 800 MHz radio band where channels are always assigned by the FCC in pairs separated by a constant (45 MHz) frequency. Tower mounted base stations and repeater stations complete the 800 MHz radio system by operating with the same constant 45 MHz transmit receiver spacing, but with the transmitter and receiver frequencies interchanged.

The radio equipment for this experiment was designed with the single oscillator per channel technique described above.

4.2 MOBILE TRANSMITTER

Power budget calculations shown in Table 3.7 and 3.8 indicate that a practical satellite-aided land mobile communications experiment can be conducted using the NASA ATS-6 spacecraft with an effective radiated power of 20 watts from the vehicle.

4.2.1 Transmitter Specifications

The required ERP of 20 watts may be radiated from a vehicle with an omnidirectional antenna with as little as 12 watts of transmitter power even in worst case conditions of vehicle and spacecraft antenna misalignment. Tables 3.4 and 4.1 present a set of practical specifications for the transmitters used in the trucks.

Frequency modulation with a peak deviation of ± 5 kHz was selected primarily because most standard mobile radio equipment is currently manufactured for that modulation index, and thus receiver intermediate frequency circuit boards including crystal filters, could be selected from currently produced models. The standard General Electric Mastr[®] Executive II 800 MHz transmitter exciter could also serve as the first part of a 1650 MHz satellite radio transmitter provided the deviation of the exciter was adjusted to ± 2.5 kHz and 825 kHz. The output of the exciter or the transmitter final amplifier could then be doubled to the 1650 MHz satellite uplink frequency resulting in a transmitted signal having ± 5 kHz deviation.

TABLE 4.1

ATS-6 POWER BUDGET

Satellite Mobile Radio
Transmitter Specifications

Frequency	1655.050 MHz
Power Output	16 watts nominal 12 watts minimum
Frequency Stability	$\pm 0.0002\%$ (-30° to $+60^{\circ}\text{C}$)
Modulation	16 F ₃ Adjustable from 0 to ± 5 kHz swing FM with in- stantaneous modulation limiting
Audio Frequency Response	Within +1 dB and -3 dB of a 6 dB/octave pre-emphasis from 300 - 3000 Hz per EIA standards
Duty Cycle	EIA 20% Intermittent
Maximum Frequency Spread	± 6 MHz with center tuning
RF Output Impedance	50 ohms

The overall frequency stability of the radio set remained a serious concern. In theory, a 1650 MHz transmitter requires twice the frequency stability of an 825 MHz transmitter if the communications bandwidth (deviation index) remains constant. For ± 5 kHz deviation, the satellite mobile radio would therefore require a frequency stability of $\pm 0.0001\%$ or 1 part per million (ppm) as 2 ppm stabilities suffice for current 800 MHz, 5 kHz deviation systems.

For purposes of this experiment, a 2 ppm transmitter was sufficiently stable for two special reasons. First, the complete satellite mobile radio equipment was mounted in the heated driver compartment (cab) of a tractor trailer truck. To insure their own comfort, the truck drivers keep the cab temperature within a rather small temperature range probably between 50° and 90°F and usually between 60° and 80°F. A standard 2 ppm 800 MHz transmitter remains well within the desirable 1 ppm over such limited temperature excursions.

Secondly, the truck always received signals from, and transmitted signals to, the Earth Station Laboratory. All the frequency sensitive satellite communications equipment was installed in the heated radio room at the laboratory where the temperature remained stable within a few degrees Fahrenheit. The transmitter and receiver frequencies were compared with the ESL high stability crystal oscillator standard which was maintained within 1×10^{-9} of the 60 kHz frequency standard transmitted by the National Bureau of Standards via WWVB. The transmitters and receivers were manually adjusted as required to remain within approximately 0.3 ppm of the correct frequency. As a result, the ESL contributed little to the relative frequency drift between the vehicle radio and the laboratory equipment.

Normally, the frequency drift at each end of a communications link must be considered. A future operational satellite-aided land mobile system would require equipment with frequency stabilities on the order of 1 ppm if ± 5 kHz deviation frequency modulation is used. Alternatively, peak FM deviations on the order of ± 10 kHz or larger would relax stability requirement to 2 ppm or more at 1600 MHz carrier frequencies. Although such systems would require more spectrum space, they would also benefit from greater noise improvement ratios inherent to wider bandwidth frequency modulation. In any case, multichannel radio equipment for a future satellite-aided system would undoubtedly require

only one stable reference oscillator from which all the required frequencies would be digitally synthesized.

The remaining transmitter specifications presented in Table 4.1 represent limitations inherent in the design of the 800 MHz standard mobile radio exciter which served as the first part of the 1650 MHz transmitter for this experiment.

4.2.2 Transmitter Design Alternatives

Three distinct transmitter designs were considered during the initial construction phase of this experiment. One approach would pattern the transmitter after the NASA/Westinghouse briefcase transceiver illustrated schematically in Figure 4.2A. The briefcase transceiver uses the transmitter section of an Amateur Radio FM Transceiver on 440 MHz as a frequency modulated exciter. The output of the transmitter is attenuated to approximately 1 mw to properly drive an L-Band up-converting mixer. A stable temperature compensated crystal oscillator-multiplier assembly included in the briefcase served as the local oscillator for the mixer. The mixer converts the output from the Exciter to the final operating frequency, 1650 MHz. The output from the mixer then passes through a power amplifier emerging at the final power level of 12 to 20 watts.

The mixer-amplifier approach also requires a second stable crystal oscillator-frequency multiplier assembly to provide local oscillator injection to the first receive mixer that converts the 1550 MHz satellite downlink signal to the input frequency of the FM transceiver. Each custom-made stable local oscillator assembly was nearly as expensive as a complete mobile radio set mass produced for the land mobile market. The cost of the power amplifier made the mixer-amplifier approach nearly twice as expensive as its nearest alternative.

Figure 4.2B illustrates a second approach considered for the design of the transmitter. The approach uses an 825 MHz exciter which normally drives a power amplifier in 800 MHz land mobile radio equipment. The output from the exciter passes through a low-level frequency doubler which drives a power amplifier to develop the required 12-15 watts of output at 1650 MHz. In the receive mode, the output of the low-level frequency doubler passes through a relay to serve as the local oscillator injection for the first receive mixer as described in Section 4.1.

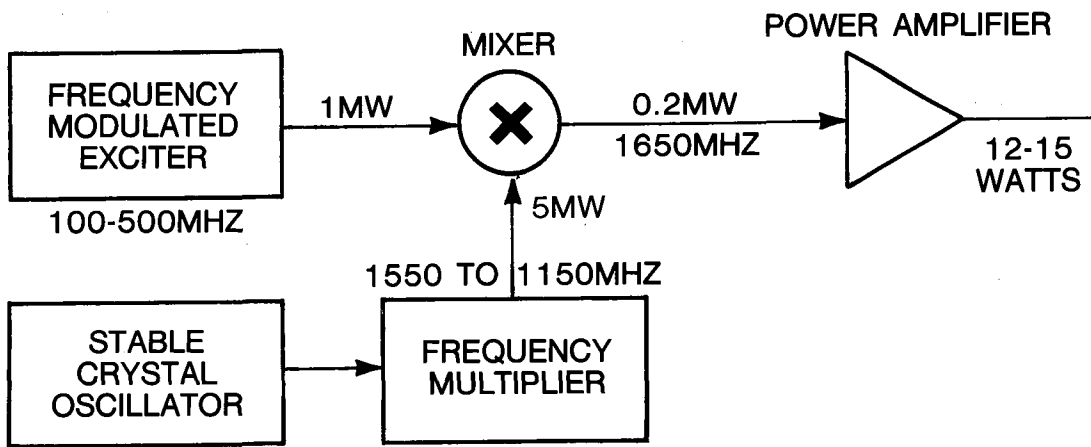

A. MIXER-AMPLIFIER

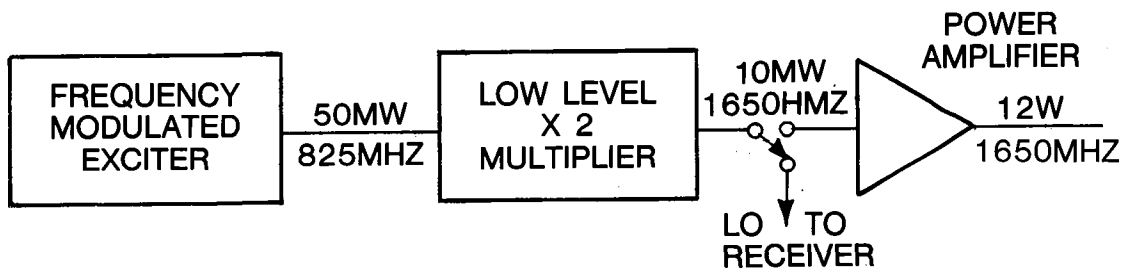

B. LOW LEVEL MULTIPLIER-AMPLIFIER

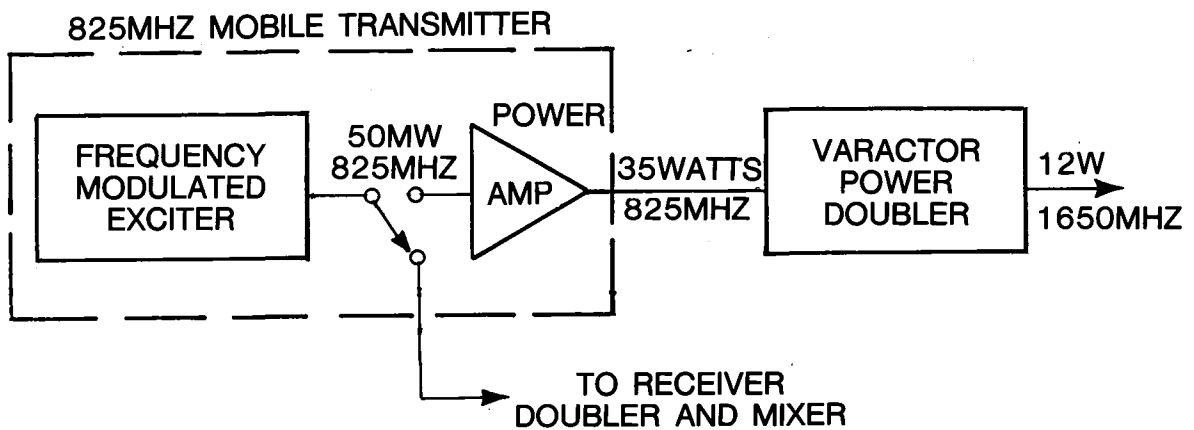

C. HIGH LEVEL POWER DOUBLES

FIGURE 4.2
TRANSMITTER DESIGN OPTIONS

This approach requires no separate stable crystal oscillator in the receiver, but does require an additional low level power doubler and the exchange of a 1650 MHz power amplifier for the 800 MHz power amplifier in a standard land mobile radio set. Unfortunately, no cost savings could be realized by deleting the power amplifier from the mass-produced 800 MHz radio. The cost of special instructions and test procedures required to delete the amplifier during mass production exceeded the value of the amplifier itself.

The cost of a 1650 MHz, 12 watt, power amplifier was then directly compared with the cost of a high-power passive varactor frequency doubler that would deliver at least 12 watts of output at 1650 MHz from 35 watts of drive at 825 MHz. The High Level Power Doubler alternative shown in Figure 4.2C was selected for this experiment because it proved least expensive. It is probable, however, that the low-level multiplier-amplifier alternative would be the least expensive if the entire radio set were mass produced. A 15 watt 1650 MHz power amplifier would cost almost the same as a 35 watt, 825 MHz power amplifier. One added stage of low level multiplication would not raise the cost of the exciter substantially.

It is also probable that a 15 watt power amplifier for 1650 MHz could be manufactured by the same mass production techniques as are currently used to manufacture amplifiers for the 800 MHz land mobile band. The "teflon-glass" composite substrate material used for current 800 MHz power amplifier printed circuit boards has sufficiently low dielectric losses to serve well in power amplifiers to at least 2 GHz. Although the only power transistors currently available for 1.6 GHz operate from a 24 volt power supply, manufacturers would soon develop parts that operate directly from 12 volt vehicle electrical systems to meet a volume market.

In conclusion, the transmitting equipment needed for a satellite-aided land mobile radio system could be mass produced at costs comparable to current 800 MHz land mobile transmitters with only slight extensions of current designs and manufacturing techniques.

4.3 MOBILE RECEIVER

The receiver for the experimental satellite radio used the transmitter exciter to provide injection to the first receiving mixer. This technique reduces cost and simplifies the design as discussed in Section 4.1. Figure 4.3 presents a block diagram of the complete ATS-6 satellite-aided land mobile radio transceiver.

4.3.1 Receiver Specifications

The specifications of the receiver portion of the transceiver appear in Table 4.2. The receiver has the frequency stability of the transmitter because the transmitter exciter provides the injection to the first receiver mixer as outlined above. The discussion of frequency stability presented in Section 4.2.1 applies to the receiver as well as the transmitter. Although the transmitter and receiver are specified to drift less than 0.0002% over a range of -30° to $+60^{\circ}\text{C}$, the equipment actually drifted less than 0.0001% over the limited temperature range encountered during this experiment.

The power budget calculations shown in Table 3.7 and 3.8 indicate that a 1550 MHz receiver having a 2.6 dB noise figure would provide excellent reception of signals transmitted directly to a test vehicle from the NASA ATS-6 spacecraft. In fact, the test vehicle receives the signal transmitted by the Earth Station Laboratory at least 8 dB better than the Laboratory receives the signal from the vehicle. A less sensitive receiver would have provided an adequate signal-to-noise ratio in the vehicle, but the receiver was made as sensitive as possible to determine if inexpensive mass-producible techniques could provide receiver noise figures under 3 dB.

The remaining receiver specifications in Table 4.2 require little discussion as they represent specifications typical of current state-of-the-art two way mobile radio equipment manufactured for the 800 MHz radio band. Equipment meeting these specifications would most probably perform adequately in any future satellite-aided land mobile radio system, although these specifications would undoubtedly be adjusted in accordance with specific spacecraft designs.

4.3.2 Receiver Design

Although an unmodified 800 MHz mobile radio transmitter could serve as a driver for the 1650 MHz varactor power doubles in the satellite

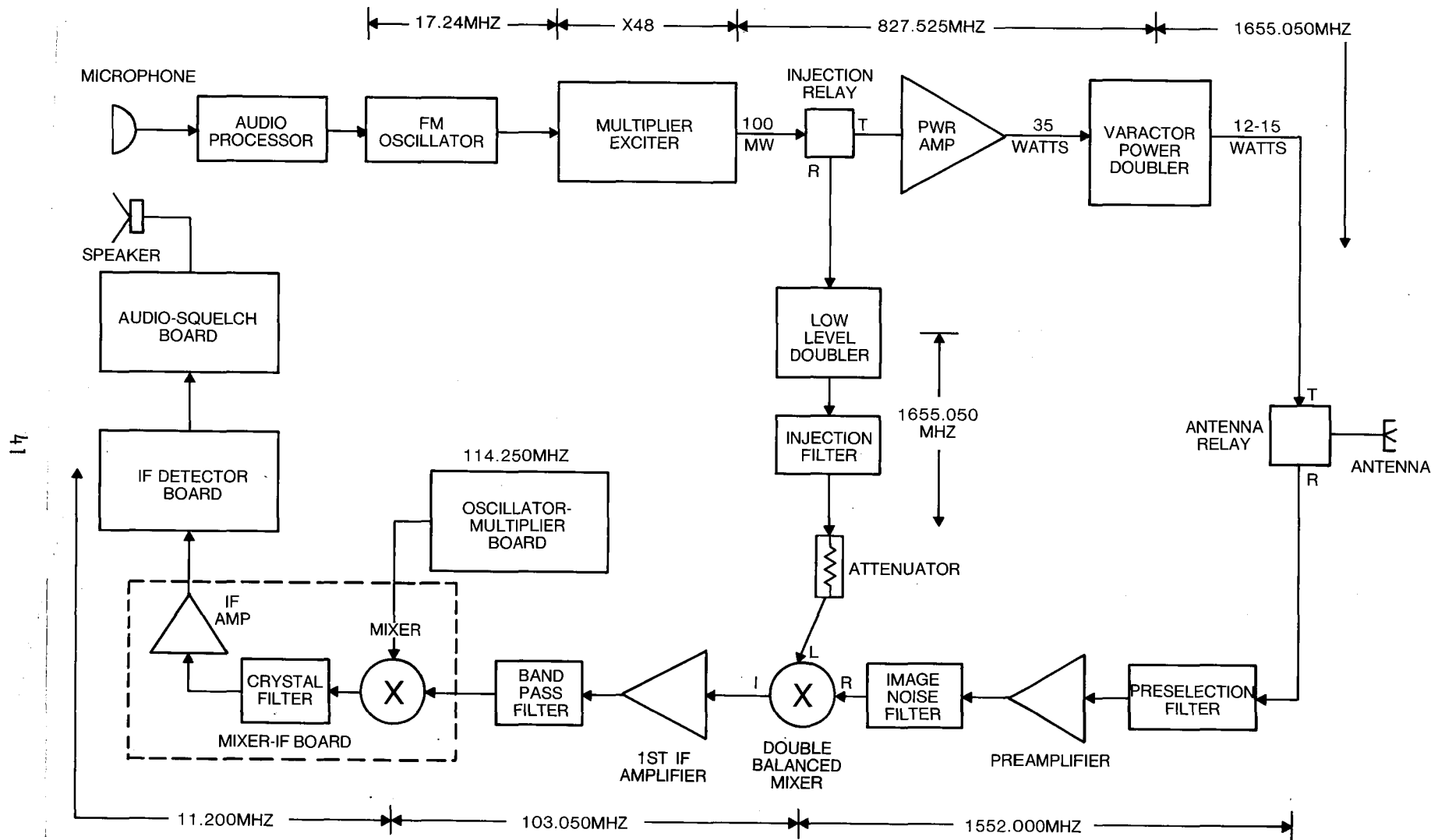

FIGURE 4.3
SATELLITE-AIDED LAND
MOBILE RADIO TRANSCEIVER

TABLE 4.2

Satellite Mobile Radio
Receiver Specifications

Frequency	1552.000 MHz
Frequency Stability	$\pm 0.0002\%$ (-30° to +60°C)
Noise Figure	2.6 dB referenced to transceiver antenna jack
Equivalent Receiver Noise Temperature	238° Kelvin
Selectivity	-75 dB by EIA Two-Signal Method
Audio Output	5 watts at less than 5% distortion
Frequency Response	Within ± 1 and -8 dB of a standard 6 dB per octave de-emphasis curve from 300 - 3000 Hz
Modulation Acceptance	± 7 kHz
RF Input Impedance	50 ohms

transceiver, little of the standard 850 MHz receiver could be redesigned for 1550 MHz. Only the audio and squelch circuit board could be saved.

As discussed in Section 4.1, a transceiver using a single stable crystal oscillator must have a receiver first intermediate frequency equal to the difference between its transmit and receive frequencies. The Mastr[®] Executive receiver design for 138 to 155 MHz was selected as a standard product that could be readily modified to receive the 103.050 MHz first IF signal in the satellite receiver. The receiver RF and IF sections of the 800 MHz radio set were completely replaced by corresponding sections of a 138 MHz receiver from the same Mastr[®] Executive product line. Corresponding circuit boards and assemblies within the same product line are mechanically and electrically interchangeable so the mechanical integrity of the mobile radio set was maintained. The remaining assemblies required to complete the satellite receiver were mounted in various free spaces within the 138 MHz receiver RF casting and within the original radio case.

4.3.2.1 Preselector Filter

The preselector filter used to protect the RF preamplifier of the satellite receiver represents no substantial new technology beyond the techniques currently applied to land mobile receivers. Filters purchased from a custom filter house for the satellite receiver use loaded quarter wave resonators identical to those currently used in 800 MHz land mobile radio equipment. No substantial differences in cost should be expected for preselector filters specifically manufactured for a new satellite-aided land mobile service in the 500 to 2000 MHz frequency range.

4.3.2.2 Preamplifier

During the construction phases of this experiment a substantial effort was devoted toward constructing a very low noise preamplifier using inexpensive mass producible techniques. Although circuits in the 1550 MHz region are often constructed using high-quality "teflon-glass" or ceramic substrate microstrip techniques, ordinary "G-10" glass-epoxy circuit board can be used with excellent results at least for receiving preamplifiers. The two-stage preamplifier designed for these receivers provides approximately 24 dB of gain over a broad frequency band limited by the bandpass characteristic of the preselector filter.

In the first stage, a low-noise, high gain bipolar transistor manufactured by Nippon Electric Company provides an optimum noise figure of 1.4 dB with an associated gain of 13 dB. Although this device represents a substantial expense (~ \$13 each) at this time, it was used primarily to determine if very low noise preamplifiers could be constructed using inexpensive circuit board material. The second stage of the preamplifier provided at least an additional 10 dB of gain with a device costing less than \$2. The 3 dB typical noise figure of the second stage degrades the overall performance only slightly.

A total of six preamplifiers were constructed during this experiment. Each provided a measured noise figure between 1.7 and 1.9 dB and a gain of at least 23 dB. The final design was also unconditionally stable with any source or load impedance.

The preamplifier design includes only one adjustable piston trimmer capacitor in the output circuit of the second stage. No other adjustment or microstrip trimming was required to optimize various units of the final design.

The consistent unit to unit performance of this preamplifier design confirms that even very low noise preamplifiers can be mass produced on inexpensive circuit board materials at frequencies as high as 1550 MHz. Certain high power transmitter stages may require special low loss circuit board to prevent power dissipated in the board dielectric from excessively heating the board.

This design has also shown that modern very low noise preamplifiers require little special attention during manufacture.

4.3.2.3 RF Filter, First Mixer and First IF Board

All the components associated with the first frequency down converter of the 1550 MHz receiver were assembled on a common circuit board mounted in a free space within the modified 138 MHz receiver casting. Ordinary "G-10" glass epoxy circuit board exhibited sufficiently low loss to provide good performance in this design at 1550 MHz.

The image noise RF bandpass filter is the most critical circuit etched on this circuit board. This filter centered at 1550 MHz prevents broadband noise generated within the preamplifier from reaching the first mixer at the first mixer image frequency. If noise at the 1750 MHz first mixer image frequency were not filtered, the receiver sensitivity could suffer by as much as 3 dB. The image noise filter should provide at least

20 dB of rejection. The three-pole bandpass filter etched on this circuit board utilizes a coupled microstrip technique to provide an image rejection of more than 35 dB with an insertion loss of 1.25 dB in the passband at 1550 MHz. The output of the filter feeds the RF port of the first mixer.

The first mixer is a double-balanced mixer housed in a hermetically sealed PC mounted module. The manufacturer specifies a 6 dB conversion loss and 40 dB of isolation between ports. The mixer requires the standard level of +7 dBm of local oscillator injection at 1655 MHz. The output of the mixer is fed into the input of the first IF amplifier.

The first IF amplifier uses a single bipolar transistor that provides 18 dB of gain with a noise figure under 2 dB. The low noise IF preamplifier makes up for losses in the 103 MHz bandpass filter that follows it to assure good overall receiver sensitivity. The circuit incorporates a second transistor in an active bias network to stabilize the DC operating point of the low noise transistor.

Finally, the circuit board includes an attenuator for the local oscillator signal provided from the low level doubler. Three 1/8 watt metal film resistors arranged in a π configuration provide approximately 10 dB of attenuation to reduce the +17 dBm doubler output to +7 dBm required by the first mixer.

4.3.2.4 Low Level Doubler and Injection Filter

In the receive mode, the low level doubler multiplies the frequency of the signal from multiplier exciter to the final 1655.050 transmit frequency but at a much lower power level than the Varactor Power Doubler used in the transmit mode. The multiplier exciter provides as much as 100 mW of drive to the low level doubler at approximately 827 MHz. Two bipolar transistors configured in a push-push circuit deliver more than 40 mW of output at 1655 MHz from 60 mW or more drive power at 825 MHz. As was the case with the pre-amplifier and the first mixer board, the low level doubler is constructed on G-10 glass epoxy circuit board and was successfully duplicated in small quantities. The low level doubler circuit board was mounted directly beneath the first mixer circuit board in a free space within the modified 138 MHz receiver casting.

The 1655 MHz output from the low level doubler circuit board was fed directly to the injection filter to strip unwanted harmonics from the signal applied to the first mixer. The 138 MHz Mastr[®] Executive receiver normally uses a 5 section helical resonator as a preselector. The 138 MHz receiver casting was modified for this application by redesigning two of the helical resonator cavities as coupled, loaded quarter-wave resonators for the 1655 MHz injection frequency. After the injection signal passes through this filter, all unwanted spectrum lines are at least 60 dB below the desired injection signal.

4.3.2.5 First IF Band Pass Filter

The remaining three helical resonator cavities of the 138 MHz receiver casting continue to serve as a preselector filter for the following mixer. The output from the low noise first IF amplifier was fed through coaxial cable to the third helical resonator cavity instead of the first cavity (now converted to 1650 MHz). In addition, the helical resonators required larger tuning capacitors to permit the 138 MHz filter to tune to the 103.050 MHz first IF frequency of the satellite receiver. With larger tuning discs installed, the resonators performed properly at the lower frequency.

4.3.2.6 Oscillator-Multiplier Board

The Oscillator-Multiplier board of the 138 MHz receiver required minor modification to make the entire 138 MHz receiver operate at 103.050 MHz. Two small additional capacitors were required to tune the circuit board output down to 114.250 MHz as required for the L-Band receiver.

All remaining portions of the 138 MHz receiver required no modification.

4.4 MOBILE ANTENNA SELECTION AND DESIGN

The specifications of the truck antenna were determined primarily by the low elevation angle to the ATS-6 spacecraft from the area where the trucks operated. The elevation angle to ATS-6 varied from 9° to 24° above the horizon over the area of operation as shown in Table 3.3. At least 4 dB net gain was desired from the antenna at the elevation angles mentioned above for the experimental system to perform as described in Section 3. An omnidirectional azimuth pattern

was required to allow the truck to travel in any direction. The antenna also had to be relatively small, unobtrusive and convenient to install as well as waterproof, corrosion resistant, and resistant to vibration encountered on long haul trailer-towing tractors.

Four antenna designs were studied for this unique application before implementing a final design. The options studied included a Biconical Horn, a Cylindrical Microstrip Patch antenna, a Quadrifilar Conical Spiral antenna and a Transposed Coaxial Segment design. Each choice had advantages and disadvantages discussed in the following subsections.

4.4.1 Biconical Horn Antenna

A biconical horn antenna consists of a half wave excitation dipole in the center of one or several flat, cone-shaped parasitic surfaces that direct the maximum beam to the desired elevation angle. The entire structure, approximately four feet in diameter and 1 foot tall, would mount to the flat surface of the tractor cab roof.

Advantages of the biconical horn include low cost as well as noncritical design. The antenna has a relatively broad bandwidth as only a single resonant element is actively fed and the beam is formed by the parasitic surfaces. The conical design of the parasitic surfaces enhance the frequency independent nature of the antenna.

The primary disadvantage of this antenna is its large size. With a diameter of four feet, it would occupy most of the cab roof top, requiring removal of the air conditioner mounted on some trucks. The entire antenna would also require a protective radome to exclude ice, snow, salt spray and water from the interior. The structure would add wind resistance and mounting would be difficult.

On balance, the size and structure of the biconical horn prevented its use on a mobile vehicle at this frequency. The antenna may be more practical at higher carrier frequencies.

4.4.2 Microstrip Patch Antenna

A second design considered for use as a truck antenna in the experiment was a microstrip patch antenna. [5,6]

Elements of this antenna would be constructed by etching patterns on one side of a thin substrate material initially covered on both sides with a conducting foil such as a double-sided copper-clad

circuit board. The elements etched on one side of the substrate would form radiating resonant microstrip circuit elements over the continuous unetched copper foil remaining on the reverse side. A single element microstrip patch antenna may be constructed to transmit and receive linearly or circularly polarized signals and has a broad, roughly hemispherical radiation pattern. An array of patch elements may be phased to form a highly directive antenna beam. Microstrip patch antennas can also be constructed on preformed or flexible substrate materials to conform to any required shape.

To construct a horizontally omnidirectional vehicle antenna for the experiment, several microstrip patch antenna elements would be mounted to a vertical cylindrical structural member approximately 4 inches in diameter and 18 to 24 inches high. The structural member would not affect the electrical performance of the antenna as the ground plane side of the antenna substrate faces inward toward the cylinder. Individual elements of the cylindrical array would be constructed to transmit and receive circularly polarized signals resulting in at least 3 dB more effective gain to the circularly polarized ATS-6 spacecraft than a linearly polarized antenna of the same height and pattern directivity.

Although inherently narrow band, the microstrip patch antenna would be constructed of separate element arrays for the transmit and receive frequencies. Each array would have an omnidirectional pattern in the horizontal plane and a vertical pattern with a beam peak at the elevation angle of the ATS-6 satellite. The antenna would have separate transmit and receive beam peaks as well as provide better cancellation of ground reflections. The antenna would provide nearly identical performance at the transmit and receive frequency bands.

A cylindrical structure 24 inches high by 4 inches in diameter could not be considered unobtrusive. The antenna could be securely fastened to a tractor cab with relatively little difficulty. The antenna would offer negligible additional wind resistance compared to the wind resistance already offered by the tractor. An antenna only six times higher than its diameter would also resist damage from the severe vibration encountered on an over-the-road trailer towing tractor.

Aside from its relatively large diameter, the only disadvantage of the microstrip patch antenna was its cost. Preliminary cost estimates made during the antenna selection process indicated the microstrip patch antenna would cost three times more than the biconical horn or the transposed coaxial segment array; and almost twice as much as the Quadrifilar conical spiral. The Microstrip Patch design was rejected for this experiment because its larger cost could not be justified even though the design offered better performance than other alternatives.

4.4.3 Quadrifilar Helix and Quadrifilar Conical Spiral

Each of these antenna structures consists of four electrical conductors wound in a spiral along the surface of a conic section. In the case of a quadrifilar helix, the four conductors are wound about a cylinder and in the case of the conical spiral, the conductors are wound about a cone. Either antenna will radiate a circularly polarized signal approximately perpendicular to the surface of the conic section provided alternating conductors of the antenna are fed in and out of phase in sequence. The precise beam elevation and vertical pattern of either antenna may be adjusted by varying the spiral pitch and, in the case of the conical spiral, the cone angle.

The quadrifilar helix differs from the conical spiral primarily in bandwidth. For impedance matching reasons, two separate quadrifilar helix antennas would be desirable to span the 1550 to 1650 MHz transmit-to-receive spacing required by ATS-6 while the conical spiral design is nearly independent of frequency with practical models showing more than a 4 to 1 operating bandwidth. In the technical literature of 1961 [7], J. D. Dyson and P. E. Mays described a four conductor conical spiral having the appearance of a large dunce cap or a traffic cone at ATS-6 frequencies. Although broadband, the conical spiral occupies three or more times as much volume than a quadrifilar helix having the same gain.

During the experiment, a prototype quadrifilar conical spiral was constructed and compared with the transposed coaxial segment array described in the next section. The prototype antenna was wound on a traffic cone 1 foot in diameter and nearly three feet high. Although theory predicted the conical spiral should perform 3 dB better than the transposed coaxial segment array, very little difference could be observed during the comparison tests. The tests were conducted once a day on approximately five

successive days by measuring the signal strength received in a moving vehicle from the ATS-6 spacecraft.

Although the tests provided no conclusive evidence, the Quadrifilar Conical Spiral may have performed poorly due to large dielectric losses in the traffic cone used for the form. The conical spiral design was rejected because it appeared to offer little advantage over the smaller transposed coaxial segment array. The size and appearance of the conical spiral was deemed much more objectionable than either the cylindrical microstrip patch antenna vs. the transposed coaxial segment antenna.

During the course of the experiment NASA provided a pair of Quadrifilar helix antennas designed for the ATS-6 transmit and receive frequencies. Each antenna measured approximately 1-1/2 inches in diameter by 10 inches tall. These two antennas were installed on a moving vehicle for comparison with the transposed coaxial segment array described in the next section. As in the case of the conical spiral, the transposed coaxial segment array performed about as well as the two quadrifilar helices, perhaps just a bit better (perhaps 1 dB on the average). The transposed coaxial antenna was finally selected as least expensive and easiest to mount of the various alternatives studied.

4.4.4 Transposed Coaxial Segment (Wheeler) Antenna

The Transposed Coaxial Segment Antenna first described by Wheeler [8] consists of a series of coaxial feedline sections each approximately one-half wavelength long connected end to end. At each joint, the inner and outer conductor of the coaxial cable segments are cross connected. The coaxial segments thus form an end-fed linear array of elements.

Although the current along a simple end-fed wire antenna would reverse phase at each half wavelength along the length of the antenna, the cross-connected joints between the segments of this antenna introduce an additional phase inversion causing each segment of this antenna to radiate a signal in phase with all other segments forming a beam in the plane perpendicular to the line of the elements.

If a Transposed Coaxial Segment array is mounted vertically, it forms a radiation pattern omnidirectional in the horizontal plane but flattened much like a pancake in the elevation plane with the maximum energy directed toward the horizon. The maximum of the elevation pattern can be directed upward by increasing the length of each coaxial segment beyond its nominal half wavelength. The progressive phase shift

introduced along the array tips the elevation pattern upward as required for this satellite communication application.

Transposed Coaxial Segment antennas have been used extensively as base station antennas in the mobile radio industry at 150 MHz and 450 MHz. At 150 MHz, an antenna having 5.8 dB of gain (over a dipole) has the appearance of a thick fishing rod approximately 20 feet long tapering from two inches in diameter at the base to approximately one inch in diameter at the top. Solid shield coaxial cable segments are assembled to each other and then inserted into a tapered fiber glass tube that provides strength and protection for the completed antenna.

An antenna constructed in a similar fashion for 1600 MHz is approximately 30 inches long and 1 inch in diameter for 7.3 dBi gain. Such an antenna is linearly polarized in the vertical plane incurring a 3 dB loss of signal when used with the circularly polarized ATS-6 spacecraft.

Another disadvantage of the Transposed Coaxial Segment array results from its performance at frequencies separated from the design center frequency. As discussed above, the segment length may be altered to adjust the elevation angle of the beam peak but a change in operating frequency has the same electrical effect on segment length. As the operating frequency increases, the elevation pattern of the Coaxial Segment Array also rises further above the horizon as each segment represents a larger progressive phase delay. The design of a practical antenna represents a compromise of the performance required over the frequency band of interest. The gain (and therefore the length) of the Transposed Coaxial Antenna is limited by the frequency bandwidth as well as the elevation beam width required by the application.

The Transposed Coaxial Segment array was selected for this experiment primarily for its low cost. Five antennas were designed, constructed and tested at a cost substantially less than estimates for any alternate designs. The antenna also met requirements for simple mounting and sturdy construction. Its 1 inch by 30 inch "stick" shape also represented a relatively unobtrusive addition to the cab of a tractor-trailer truck as can be seen in Figure 4.4. The antenna was mounted in the center of the cab roof as far forward as possible, directly over the windshield for the clearest view toward the satellite.



FIGURE 4.4
TRANSPosed COAXIAL ANTENNA
MOUNTED FOR USE

4.4.4.1 Antenna Specifications

Table 4.3 details the electrical specification of the 30" long Transposed Coaxial Antenna used in the experiment. Antenna range measurements showed the vertically polarized main lobe of the antenna had a peak gain of 7.3 dB compared to an isotropic reference antenna. The table also shows the vertical pattern of the antenna differs substantially at the transmit and receive frequencies. If the antenna had been designed for more gain, the transmit and receive patterns would have overlapped even less than shown in the table. The truck may have received strong signals, but may not have been heard in some locations. In other locations, the opposite may have occurred.

Table 3.3 of the previous section, shows that the elevation angle to ATS-6 ranges from 9° to 24° over the area where the trucks were driven. Except for the extreme Northeast, an area seldom visited by the trucks during this experiment, all of the operating area has an elevation angle to ATS-6 that falls within the half power beam width of the antenna at the transmit frequency. Some cities in the southern and western portions of the Smith's Transfer service area (Figure 4.5) had high elevation angles to ATS-6 that fell outside the half power beam width of the antenna on the receive frequency. This design compromise was accepted as power budget calculations showed the forward link signal received in the truck was 6 to 8 dB stronger than the signal transmitted by the truck. High angle signals were also less likely to suffer attenuation due to tree foilage absorption than low angle signals.

4.4.4.2 Antenna Construction

During the construction phase of the experiment five Transposed Coaxial Segment Antennas were completed under the direction of W. T. Whistler by the Antenna Equipment Engineering Group of the General Electric Company Space Division. The first of the five antennas was constructed and then fully pattern tested and impedance tested. Data from those tests appear in this section. The remaining four antennas were impedance tested only.

Figure 4.6 is a photograph of a completed Transposed Coaxial Antenna. The design is similar to a Harold Wheeler design except for a

TABLE 4.3

Land Mobile Satellite Antenna System

Antenna Type	"Wheeler" transposed coaxial segment array
Polarization	Linear (vertical)
Gain	7.3 dBi (peak)
Vertical Pattern (all angles with reference to the horizon = 0)	At 1550 MHz Receive Beam Peak + 11° -3 dB Points + 4° and + 19° At 1650 MHz Transmit Beam Peak + 18° -3 dB Points + 11° and + 28°
Horizontal Pattern	Omnidirectional (± 1 dB)
Feed Line Loss	1.8 dB (15 ft. of RG - 214)
Receive System Noise Figure Referenced to Antenna Terminals	4.4 dB, including feedline loss (509°K equivalent temperature)
Estimated Antenna Background Temperature	290°K
Total Receive System Equivalent Noise Temperature	799°K



**ST SMITH'S
TRANSFER CORP.**

HAULMARK OF SERVICE General Office: P. O. Box 1000 Staunton, Virginia 24401 Area Code 703 886-8231

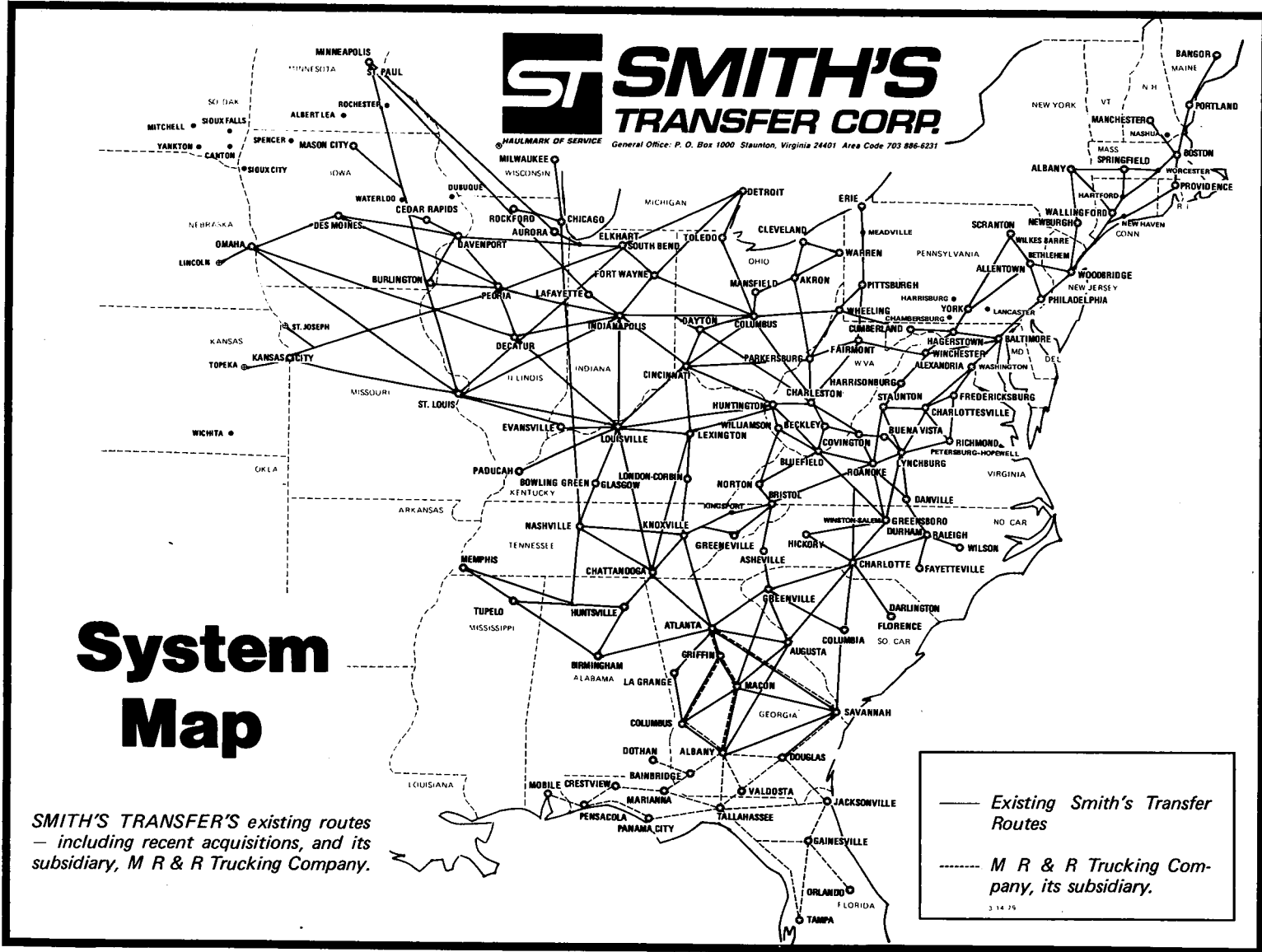

System Map

SMITH'S TRANSFER'S existing routes — including recent acquisitions, and its subsidiary, M R & R Trucking Company.

— Existing Smith's Transfer Routes
 - - - M R & R Trucking Company, its subsidiary.

3 14 75

FIGURE 4.5

55

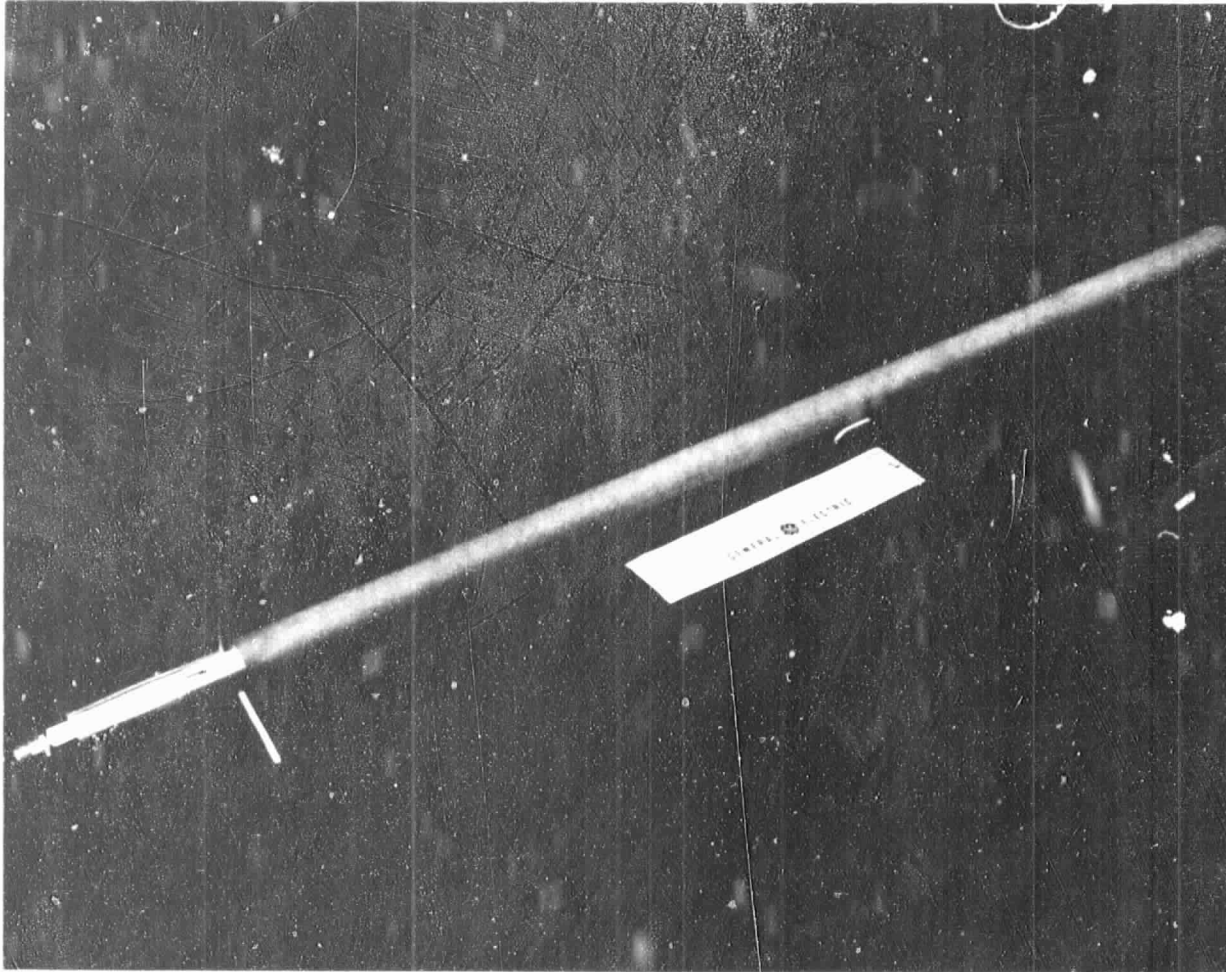

FIGURE 4.6
COMPLETE TRANSPOSED COAXIAL SEGMENT ANTENNA

lengthening of each section to achieve the required 14° upward beam tilt. Figure 4.7 is a photograph of the internal antenna assembly before insertion into the protective outer tube. Individual elements of the antenna, each slightly longer than one-half wavelength are assembled to a fiber glass center board with the center conductor of one section soldered to the outer sheath of the next section and conversely. Sections of the antenna were cut from $1/4''$ solid copper shield semiflexible coaxial cable with teflon[®] dielectric.

A preliminary model was constructed according to the Wheeler paper with sections $3.07''$ long and evaluated. The beam tilt was much too large; 32° at 1.6 GHz rather than the 14° desired, because the electrical length of the cross over connections was neglected. A computer program was used to evaluate electrical effect of the cross over length. By comparing analytic and experimental results, a new value for section length of $2.60''$ resulted. Antenna #1 was built from the revised dimensions and produced the desired 14° beam tilt.

Figure 4.7 shows internal fabrication details of the Transposed Coaxial Segment Antenna. Seven equal length segments are fastened alternately to both sides of a $0.031''$ thick fiber glass center board with the shield and center conductor cross connected at each segment joint. The top section has an external length of one-half wavelength in air but contains a short circuit connection from the center conductor to the sheath at the quarter wave point to provide a resonant termination to the antenna array.

The bottom section of the antenna also serves as the feedline input to the completed antenna. A convenient length of $1/4''$ semiflexible coaxial cable was inserted through an offset hole in the cylindrical brass base of the antenna to extend $1/4''$ wavelength (in air) above the three ground plane radials. The cable was then soldered into the base, attached to the center board assembly, and cross connected to the next higher antenna element on the center board. The antenna was fed through a connector assembled to the portion of the cable extending from the bottom of the base.



FIGURE 4.7
TRANPOSED COAXIAL SEGMENT ANTENNA
INTERNAL ASSEMBLY

Antenna
Internal Assembly

With the antenna now functional, only a matching adjustment remained before final assembly. Each antenna was individually tuned by capacitive tabs added to the first and second section joints. Adjustment was accomplished by trimming copper foil tabs with a razor blade as required. A VSWR of less than 2:1 was obtained on all models by this empirical method.

The fiber glass center board was designed just narrow enough to fit snugly within the protective outer tube, so that the internal parts would not fail from excessive vibration. In the final assembly step, the fiber glass outer tube slides over the center board and tightly overlaps a 3/4 inch turned-down length of the machined brass base.

A final tubing wall thickness of 0.062" was selected after the mechanical analysis outlined in Table 4.4. The tubing first selected had only a 0.031" wall thickness which analysis showed would be stressed to 25% of its breaking strength but stresses would be increased further at the base of the tube by the drilling of holes through the fiberglass for the ground plane stubs. The thickness was increased to .062" for this reason, and 3/4" ID x 7/8" OD tube was chosen for immediate availability at the distributor's plant.

The assembled antenna was held together by the three threaded ground plane rods screwed through a brass clamping sleeve and the fiberglass tube into the base. The three ground plane rods also serve to choke off currents flowing in the antenna elements from continuing along the support structure and disturbing the antenna pattern.

4.4.4.3 Antenna Test Results

Antenna patterns were measured in an 8' x 30' indoor antenna range. Patterns were taken with the antenna mounted as in the photo of Figure 4.8. Absorber was placed between antenna and pedestal as shown, and care was taken to place the antenna phase center (its midpoint tip-to-ground plane stubs) on the pedestal rotation center. The antenna was tested at 14.125' range, 0.5' beyond $2D^2/\lambda$ limit of the antenna far field.

TABLE 4.4

Transposed Coaxial Segment
Antenna Mechanical Analysis

Round Tubing 24.6" Long

<u>O.D.</u>	x <u>Wall t</u>	<u>l</u>	$S = \frac{l}{P_{max}}$	Force <u>W</u> lbs	Max Moment $\frac{WL}{2}$ (in-lb)	δ Defl. In.	Stress PSC	Resonant Freq. Hz
3/4"	x .031	.005		5.67	69.71	.703	5809	3.73
13/16"	x .062	.0104	.026	6.14	75.52	.365	2943	5.176
7/8"	x .062	.0132	.0302	6.61	81.3	.310	2692	5.62
1"	x .062	.020	.041	7.556	92.94	.234	2267	6.46

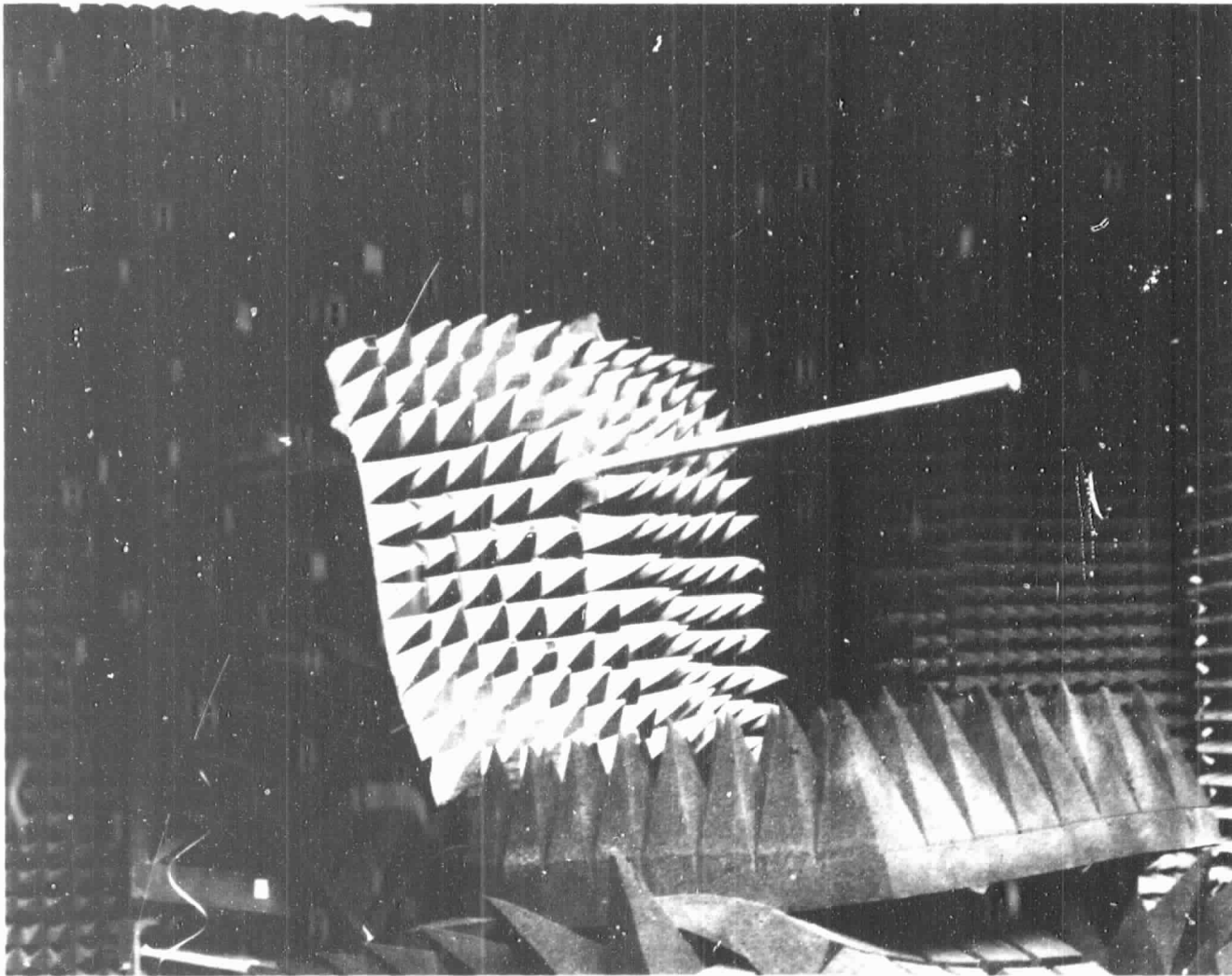

FIGURE 4.8
TRANSPOSED COAXIAL ANTENNA MOUNTED FOR PATTERN TEST

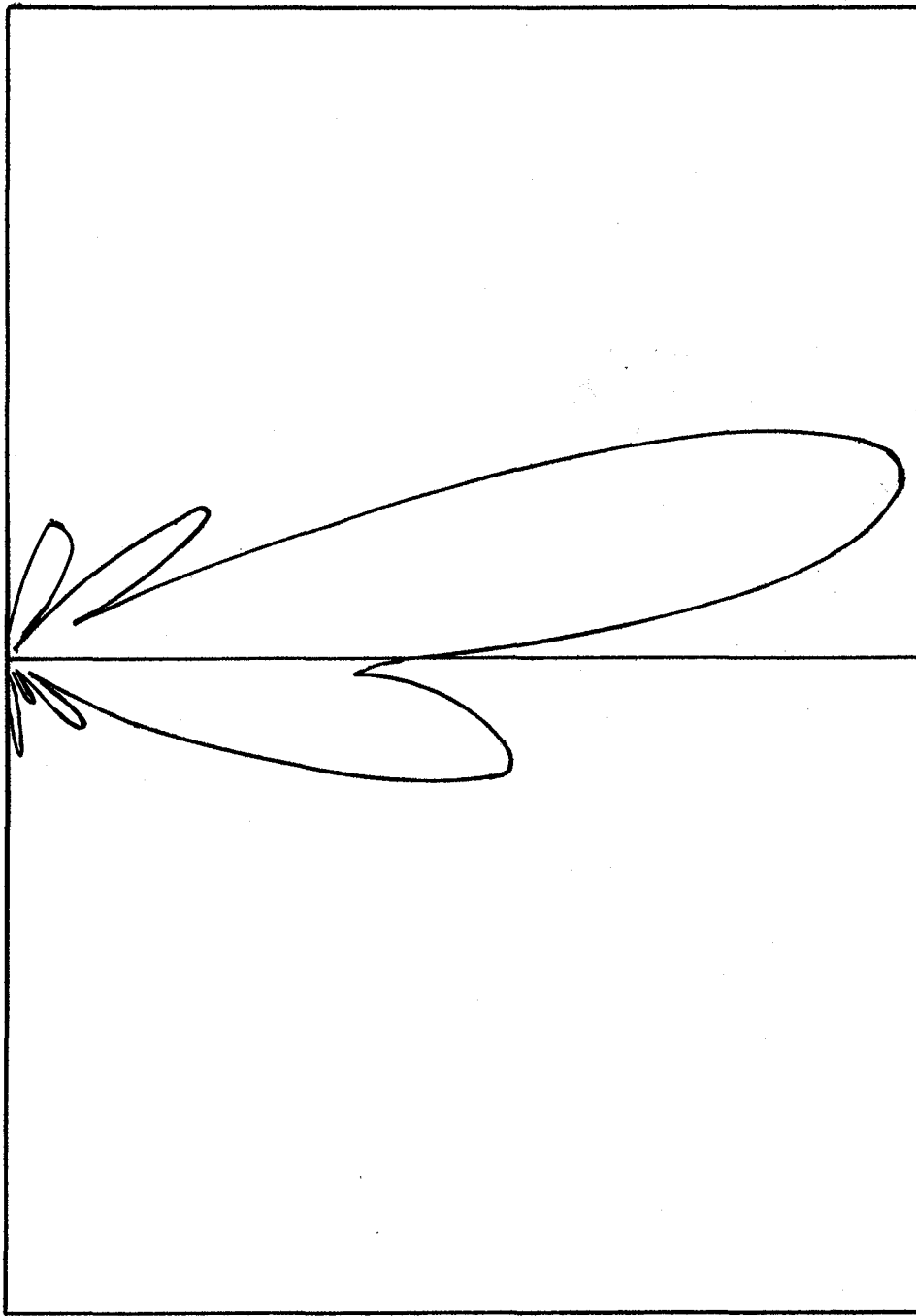

FIGURE 4.9
TRANSPosed COAXIAL SEGMENT ARRAY
ELEVATION PATTERN AT 1550 MHz RECEIVE FREQUENCY
RELATIVE ELECTRIC FIELD vs. ANGLE

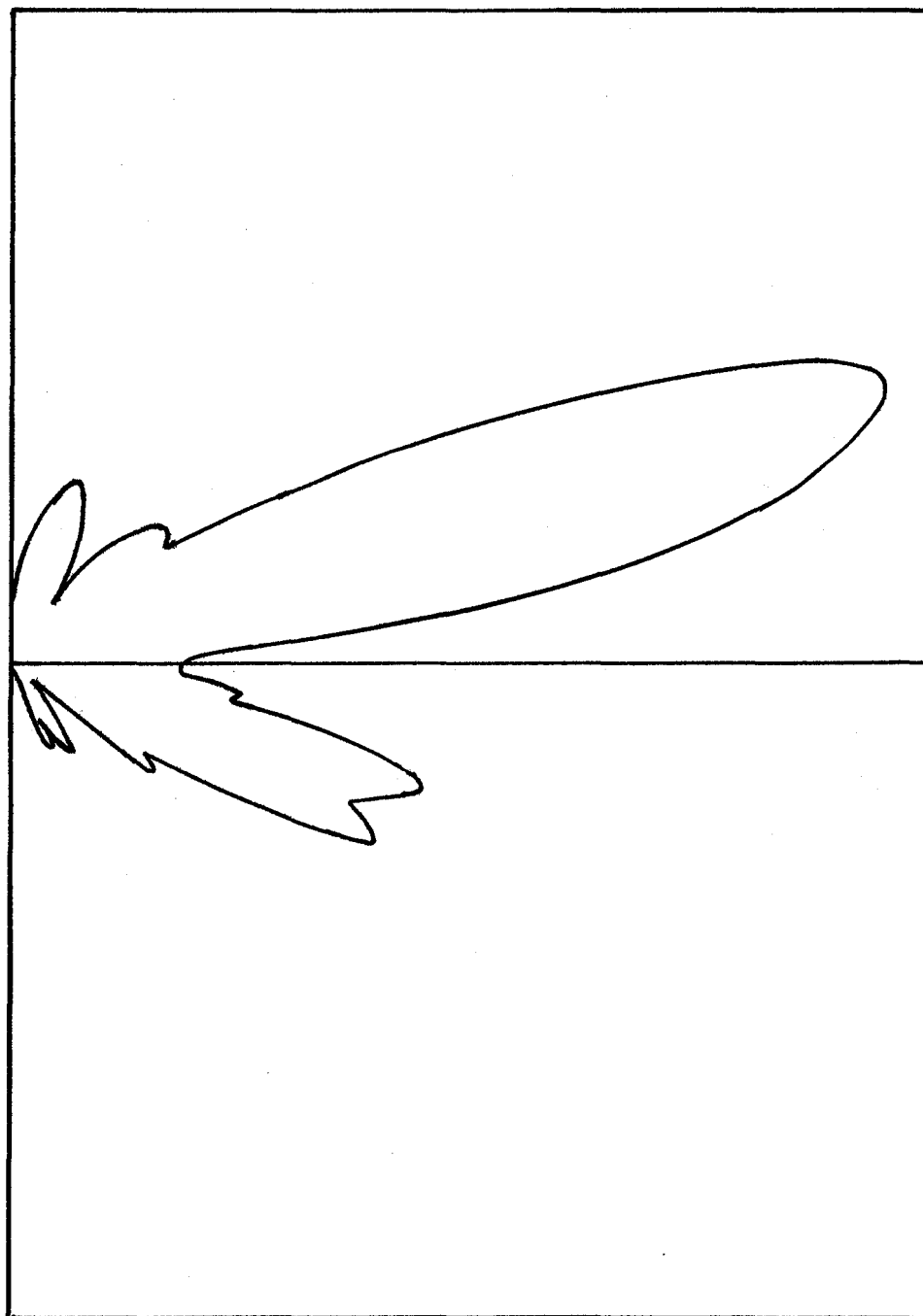

FIGURE 4.10
TRANSPPOSED COAXIAL SEGMENT ARRAY
ELEVATION PATTERN AT 1650 MHz TRANSMIT FREQUENCY
RELATIVE ELECTRIC FIELD vs. ANGLE

72-383

Pattern rotational symmetry was checked by taking four patterns with 90 steps in ϕ angle, and also by taking cuts at elevation angles $+9^\circ$, beam peak and $+19^\circ$. The azimuth pattern shows an .8 dB total magnitude change with ϕ at 1.55 GHz and a lower value of .2 dB variation at 1.65 GHz.

The typical elevation patterns shown in Figures 4.9 and 4.10 indicate that the below horizon lobes at angles -9° to -19° , the included angles of ground reflected energy, are roughly 5 to 7 dB below the desired beam peak. This high level was not seen in breadboard antenna patterns having the same beam tilt. It is not explained by the analysis, which predicted -12 dB lobes, or by the presence of the fiber-glass cover, since the same pattern lobe was present in patterns with no cover. One possible source of error is the increase in gap size relative to the coax radiator length, shortened from 3.07" to 2.6" in the final model; another error source may be phase error over the antenna length. No attempt was made to find the discrepancy in theory because of time limitations.

Antenna gain computed by two methods is shown in Table 4.11. In one case, gain was computed from an analytic program (TRKSAT) based on Wheeler's paper. In the other, gain was computed from the measured antenna range patterns. Both used the same basic equation for gain found in Silver or Jasik:

$$G = \frac{4\pi R_{\max}^2}{\int_0^{2\pi} \int_0^{\pi} [E(\theta, \phi)]^2 \sin \theta d\theta d\phi}$$

For a pattern normalized to $E_{\max} = 1$, a uniform pattern in ϕ angle and the integral replaced by a summation to adapt for computer processing, the gain equation becomes:

TABLE 4.5

TRANSPOSED COAXIAL ANTENNA
Gains Computed from Analysis and from Patterns

<u>Frequency</u>	<u>Computed by the Analytic Program "TRKSAT"</u>			<u>Computed from Pattern</u>			
	GHz	G _{max} dB	9° dB	G19° dB	G _{max} dB	G9° dB	G19° dB
1.55		4.47	4.27	2.57	4.30	+3.9	+1.3
1.65		4.48	3.41	4.28	4.63	+ .9	+4.5

$$G = \frac{2}{60 \sum_{i=1} [P(\theta) \sin \theta \Delta \theta]}$$

For Pattern computation:
For 6° intervals.

$$\Delta \theta = \frac{\pi}{60} \text{ radians}$$

Direct summation of $P(\theta)\sin \theta$ was done in the analytic program, TRKSAT for the angular interval set in the program. The pattern computation was done on a programmable calculator using Simpson's rule.

Note all gains in Table 4.5 are computed gains. No comparison with a standard gain horn was made.

Minimum sector gain can be estimated from the lowest edge of sector gain, which is + .9 dB. Other factors in estimating minimum gain are: 1) one-half the total dB variation with angle, or .7 dB; 2) half of any variation of gain due to range effects, shown in Trace 19 as .5 dB. Thus, the minimum edge of sector gain is + .9 dB over a circularly polarized isotropic radiator (ICP), with a possible variation of ± 1.2 dB from range and rotational asymmetry effects.

In conclusion the transposed coax antenna produced a peak gain of greater than 4.3 dB ICP in the 1.55 - 1.65 GHz band and an edge of sector gain greater than .9 dB over the angles + 9° + 19° that view the ATS-6 satellite. The antenna is designed for a simple pipe clamp mount and is expected to withstand 60 mph winds while operating on a moving truck. The antenna is matched to less than 2:1 VSWR. An undesirable characteristic of a high secondary lobe 4 to 6 dB below desired peak may be caused by phase error along the antenna length.

5.0 TRUCKING INDUSTRY TEST RESULTS

One of the three major objectives of this experiment was to determine to what extent direct satellite to mobile vehicle communication would aid daily operations in the long-haul trucking industry. This section reports how the addition of immediate long-range satellite-aided communications affected the operation of 5 long-haul sleeper team tractors operated throughout the Eastern United States by the Smith's Transfer Company. Only operational data are presented including both management and driver opinions of the communications system. Technical propagation test results appear in Section 7.0.

Operational data were obtained from three sources; audio tape recordings, discussions with Smith's management, and questionnaires completed by Smith's management and drivers. Audio tape recordings made at the General Electric Earth Station Laboratory provided raw data for analysis. The tapes represent a complete record of all conversations that took place during the experiment. After the experiment was concluded, General Electric personnel met with Smith's management to obtain their detailed view of the experiment. At that time, GE requested Smith's management to evaluate 50 separate business conversations excerpted from the complete tape record as to their business value. Smith's also agreed to administer a driver questionnaire prepared by GE.

5.1 TAPE RECORDED USAGE DATA

Although all communications were tape recorded during the entire operational period of the experiment extending from mid-November 1978 through May 1979, the data were analyzed in detail for only the months of November, December and January. The data gathered during tests conducted with two Air Force emergency communications jeeps later in the experiment are presented in Section 6 of this report.

An important goal was to gather usage data from a satellite communications system that resembled a fully operational system of the future as closely as possible. The experiment was conducted during a series of weekends when the ATS-6 spacecraft could be scheduled for long uninterrupted periods of time so that the drivers and dispatchers could use the radio almost at will. On many weekends, the satellite was available nearly continuously.

Table 5.1 contains the ATS-6 satellite schedule for the first eleven weekends of the experiment. The table shows the spacecraft was available for at least 16 hours and more typically 20 to 24 hours on most weekend days. A continuous 24 hour schedule could be maintained only as long as the solar arrays on ATS-6 could generate more power than the spacecraft required in the L-Band Frequency Translation Mode. Through the cooperation of other experimenters, NASA scheduling personnel were able to free the majority of the weekend time on the spacecraft for this operational experiment, but a few users could conduct their experiments only at specific times during the weekend. Occasionally NASA controllers also interrupted the schedule to perform attitude maneuvers as required to maintain the spacecraft in the proper orbit. In general, the spacecraft schedule was interrupted only once each weekend day, usually for less than 4 hours. The spacecraft was sometimes available continuously for periods of 62 hours or longer when no other user required the satellite.

The Friday and Monday schedule periods permitted GE personnel to conduct various systems checks at the Earth Station Laboratory during normal working hours. The weekly checks included instruction of the dispatchers and drivers, recording their comments, schedule announcements, propagation tests, as well as occasional equipment debugging and repair. In one instance a Smith's driver repaired a defective microphone push button with only verbal instructions as his team partner drove their truck to its next destination. Another driver was able to repair a broken wire in the radio set cabling in similar fashion. The Earth Station Laboratory was completely unattended during the remainder of the weekends except for occasional announcements at the beginning and end of some satellite schedule periods.

The drivers and dispatchers were encouraged to use the satellite-aided communication system for any communication need that might arise. No specific plan or routine was suggested by the investigators. The drivers and dispatchers were completely free to use the satellite radio or other communications means at their disposal as they saw fit. The degree of satellite usage therefore reflected the individual user preferences and prejudices toward the new system.

Data from 10 files (weekends) of the first 2 1/2 months of this experiment have been analyzed in detail. During any weekend a given truck

Table 5.1

ATS-6 Satellite Schedule
Limited Operational Test in the Trucking Industry

Day	Date	Schedule Periods (Local Time)		Total Time Hours
Thursday	11/9/78	1030 - 1700		6.5
Friday	11/10/78	0830 - 1300	1700 - 2200	9.5
Saturday	11/11/78	0130 - 1500	1800 - 2400	19.5
Sunday	11/12/78	0000 - 1430	1800 - 2400	20.5
Monday	11/13/78	0000 - 1600		16.0
Friday	11/17/78	0830 - 1100	1700 - 2200	7.5
Saturday	11/18/78	0130 - 2400		
Sunday	11/19/78	0000 - 2400		
Monday	11/20/78	0000 - 1600		
Wednesday	11/22/78	1630 - 2300		6.5
Thursday	11/23/78	0130 - 2200		20.5
Friday	11/24/78	0130 - 2200		20.5
Saturday	11/25/78	0130 - 2400		22.5
Sunday	11/26/78	0000 - 2400		24.0
Monday	11/27/78	0000 - 1600		16.0
Friday	12/1/78	0830 - 1400	1830 - 2200	9.0
Saturday	12/2/78	0130 - 2400		22.5
Sunday	12/3/78	0000 - 2100	2330 - 2400	21.5
Monday	12/4/78	0000 - 1600		16.0
Friday	12/8/78	0830 - 1400	1830 - 2200	9.0
Saturday	12/9/78	0130 - 2400		22.5
Sunday	12/10/78	0000 - 2400		24.0
Monday	12/11/78	0000 - 1600		16.0
Saturday	12/16/78	0130 - 2400		22.5
Sunday	12/17/78	0000 - 1100	1400 - 2400	21.0
Monday	12/18/78	0000 - 1600		16.0
Friday	12/22/78	0830 - 1400		5.5
Friday	12/29/78	0830 - 2200		13.5
Saturday	12/30/78	0130 - 2400		22.5
Sunday	12/3/79	0000 - 2400		24.0
Monday	1/1/79	0000 - 1400		14.0
Sunday	1/7/79	1930 - 2400		4.5
Monday	1/8/79	0000 - 1500		15.0
Friday	1/12/79	1200 - 1530		3.5
Saturday	1/13/79	0130 - 1600	2230 - 2400	16.0
Sunday	1/14/79	0000 - 1130	1930 - 2400	16.0
Monday	1/15/79	0000 - 1500		15.0
Saturday	1/20/79	0130 - 1130	1430 - 1800	15.0
			2230 - 2400	
Sunday	1/21/79	0000 - 1100	2230 - 2400	12.5
Monday	1/22/79	0000 - 1200		12.0
Saturday	1/27/79	0130 - 0900	1230 - 1400	10.5
			2230 - 2400	
Sunday	1/28/79	0000 - 0500	0630 - 1400	14.8
Monday	1/29/79	0000 - 1500		
TOTAL				680.5

participating in the experiment was only in service for a portion of the total satellite schedule time. Table 5.2 presents the number of hours that each truck was in service during each file analyzed in detail. On the average the trucks were in service from 22 to 54 percent of the total time that the satellite was on.

Some trucks were in service much more than others as their operating schedules coincided more exactly with the satellite schedule. A truck was considered "in service" if it was enroute between terminals of the Smith's Transfer Company and the satellite radio equipment was functional. The drivers were instructed to leave the satellite transceiver on at all times except when leaving the truck for long periods of time, such as for 72 hours of rest after many days on the road.

Rest stops counted as time "in service" because the truck could be called with automatic selective signalling equipment even if both team drivers were out of the tractor. The Dual Tone Multiple Frequency, DTMF, (Touch-Tone[®]) selective signalling sequence actuated a red "call received" lamp so the drivers would know they had been called while away from the cab and question the dispatcher upon their return.

It was difficult to determine when trucks were out of service from the records available after the experiment, especially if a truck used the radio only occasionally. A truck was considered out-of-service if it was off the road for repair, routine maintenance, extended driver rest, or if the radio equipment had failed. Although the driver teams were normally assigned to specific trucks, the teams were sometimes assigned alternate tractors while their "usual" tractors were repaired. Dispatcher records then showed the driver team on the road when the radio equipped truck was actually in a garage. The dispatcher records did not show tractor numbers.

A search of maintenance records provided additional information about truck serviceability, but on-the-air comments of the drivers themselves provided the most complete record. Table 5.2 was compiled after reviewing all available data as well as listening to all the tapes of drivers comments during the time period shown. The service time recorded in each column represents time when the truck was definitely in service. The last line in the table contains the total time during which the truck may or may not have been in service. For example, Truck 1 was definitely in service for 134.5 hours but could possibly have been in service 41 additional hours for a

TABLE 5.2

SUMMARY OF TRUCK HOURS IN SERVICE
OF FILES ANALYZED IN DETAIL

File No.	Dates (1978-1979)	Hours in Service (by Truck Number)					Satellite on Time
		T1	T2	T3	T4	T5	
578	11/17-11/20	13	56	15.5	39	59	70
582	11/22-11/27	0	42	46.5	6.5	5.0	110
586	12/1-12/4	9	46.5	22.5	37.5	0	69
590	12/8-12/11	0	50.5	62.5	31.5	0	71.5
593	12/16-12/19	38.5	59.5	38.5	59.5	43.5	59.5
594A	12/29-1/1	24	14	36	52.5	0	74
595	1/7-1/8	4.5	15	15	0	0	19.5
597	1/12-1/15	19.5	16	34.5	19.5	0	50.5
598	1/20-1/22	12.0	24.5	15	0	27.5	39.5
599	1/27-1/29	14	0	25.5	33.5	31.5	39.5
TOTAL TIME		134.5	324	311.5	279.5	166.5	603
TOTAL TIME AS A % OF SATELLITE ON TIME		22	54	52	46	28	
TOTAL UNCERTAIN TIME		41	18	54	71	0	

total of 175.5 hours. The uncertainty of in-service operating time ranges from a maximum of 30% for Truck 1 to 0% for Truck 5 with a weighted average of 15%. The fractional usage data presented in the following paragraphs assume the total service times of Table 5.2.

A most important factor required for the design of any communication system is the channel loading fraction of the proportion of time that any customer actively uses the communications hardware compared to the total time the customer is "in-service" or has access to the communications system. Given this channel occupancy information, a system can be designed where a number of users can share a common channel or set of channels and yet receive a certain quality of service; that is have the ability to communicate as desired.

During the detailed analysis of data from the first 10 weekends of this experiment, all truck transmissions were timed with a stop watch as the audio record tape was played. The investigator then entered the total one-way truck transmission time on a working log sheet that contained a single line entry for each conversation. The investigator also recorded the conversation topics, truck location, direction of travel and various propagation data for each conversation recorded on the tape. The summary Table 5.3 was then prepared by summing all the truck-to-dispatcher one-way transmission times and multiplying the total by a factor of 2.2 to give an estimate of the total conversation length including dispatcher transmission time, truck transmission time and dead time between transmissions. For truck-to-truck conversations, the total contact time was taken as the simple sum of the transmissions made by each truck with no multiplying factor.

All truck conversations were divided into business and non-business categories. Any conversation between the truck and the central dispatcher that contained any information even vaguely useful to the trucking operations was classified as a business conversation. Non-business conversations included all contacts between the GE Earth Station Laboratory and the trucks for satellite schedule coordination, propagation tests, instruction purposes as well as incidental conversations between the trucks and GE or the Smith's Transfer central dispatcher. Truck-to-truck conversations appear separately in Table 5.3 and are generally of a non-business nature. Truck-to-truck contact contact time totals do not represent typical occupancy

TABLE 5.3

SATELLITE COMMUNICATION
CHANNEL OCCUPANCY SUMMARY

17 November 1978 - 29 January 1979

	Truck 1	Truck 2	Truck 3	Truck 4	Truck 5
Smith's Vehicle No.	6304	6300	6314	6320	9998
Satellite-On Time (Hrs.)	603	603	603	603	603
Total Time in Service (Hrs.)	134.5	324	311.5	279.5	165.5
Business Conversation(*) Contact Time (Sec.)	156	5577	5086	1454	3637
Non-Business, (*) Coordination and Propagation Contact Time (Sec.)	1595	5188	5449	1817	2006
Truck-to-Truck(#) Contact Time (Sec.)	98	0	1040	141	662
Total Contact Time (Sec.)	1849	10765	11575	3412	6305
Business Conversation Channel Occupancy %	0.03	0.48	0.45	0.14	0.61
Non-Business, Coordination and Propagation Channel Occupancy (%)	0.33	0.44	0.48	0.18	0.33
Truck-to-Truck Conversation Channel Occupancy (%)	0.02	0	0.09	0.01	0.11
Total Channel Occupancy (%)	0.38	0.92	1.03	0.34	1.05
Average Channel Occupancy All Trucks (% per Truck)			0.77%		

(*) For conversations between a truck and a fixed station, two-way contact times were estimated by multiplying the one-way truck transmission time by 2.2.

(#) Only the one-way truck transmission time is reported for each truck during truck-to-truck conversations.

rates because the Earth Station Laboratory equipment prevented truck-to-truck contact, except when specifically permitted. This measure was considered necessary to prevent overload of the system by incidental truck-to-truck conversation. The trucks were permitted to converse freely only during the last weekend of the first 2 1/2 months of the experiment.

Table 5.3 shows that most trucks spend roughly equal amounts of time on the air for business and non-business purposes. Truck 1 is the notable exception with only about 1/10 as much business conversation time as non-business, coordination and propagation time. The truck 1 driver team also had the smallest amount of time in service during the satellite schedule. Apparently the truck 1 team did not find the satellite radio as useful as the remaining teams. It should be noted that non-business occupancy does not accurately represent driver interest in the satellite radio system as most non-business conversations were prompted by General Electric personnel to coordinate schedules and conduct propagation studies.

The four trucks other than truck 1 occupied the radio channel for business purposes from 0.14% to 0.61% of the time. Truck 4 had an abnormally low occupancy rate of 0.14% compared with 0.45%, 0.48%, and 0.61% for trucks 3, 2, and 5 respectively. Truck 4 also had a correspondingly lower non-business occupancy rate. No specific reason is suggested by the data for this difference. Five trucks represent a relatively small statistical sample especially for a limited 10 weekend test.

The total channel occupancy for both business and non-business purposes was quite low for trucks 1 and 4 at 0.38% and 0.34% respectively. The remaining 3 trucks used the satellite system for approximately 1% of the time. The weighted average channel occupancy per truck was 0.77% of the total in-service time for all conversations and 0.36% for business conversations only.

These averages are somewhat smaller than would be expected in most land-mobile communications systems probably due to the very long distances and times between stops made by these over-the-road trucks. The averages may have been further decreased because freedom of choice was emphasized and the satellite communications system represented the new and unfamiliar choice.

Table 5.4 gives a breakdown of the business conversation channel occupancy data of each truck for each weekend for which data were analyzed

Table 5.4

Business Conversation Channel Occupancy

File Number	1979 Dates	Contact Time (Seconds)					Time in Service (Hours)					Channel Occupancy (Percent)				
		T1	T2	T3	T4	T5	T1	T2	T3	T4	T5	T1	T2	T3	T4	T5
578-579	11/17-11/20	0	2831	218	264	1518	13	56	15.5	39	59	0	1.4	0.39	0.19	0.71
582	11/22-11/27	-	1613	902	0	0	0	42	46.5	6.5	5.0	-	1.08	0.54	0	0
586	12/1-12/4	0	330	308	257	-	9	46.5	22.5	37.5	0	0	0.20	0.38	0.20	-
590	12/8-12/11	-	634	1432	476	-	0	50.5	62.5	31.5	0	-	0.35	0.64	0.42	-
593	12/16-12/18	0	145	288	301	504	38.5	59.5	38.5	59.5	43.5	0	0.07	0.21	0.14	0.32
594A	12/29-1/1	0	0	0	134	-	24	14	36	52.5	0	0	0	0	0.07	-
595	1/7-1/8	147	0	352	-	-	4.5	15	15	0	0	0.91	0	0.65	-	-
597	1/12 - 1/15	9	0	0	9	-	19.5	16	34.5	19.5	0	0.01	0	0	0.01	-
598	1/20 - 1/22	0	0	0	-	59	12.10	24.5	15	0	27.5	0	0	0	-	0.06
599	1/27 - 1/29	0	-	1586	13	1556	14	0	25.5	33.5	31.5	0	-	1.73	0.01	1.37
TOTALS		156	5577	5086	145.4	3637	134.5	324	311.5	279.5	166.5	0.03	0.48	0.45	0.14	0.61

AVERAGE BUSINESS CONVERSATION CHANNEL OCCUPANCY (% per TRUCK)

0.36%

in detail. As in the previous table, the contact time for each truck was estimated by multiplying the one-way transmission time of the truck by a factor of 2.2 to account for the other half of the conversation. All contact times are expressed in seconds. A dash entry in the table indicates the truck was not in service during the weekend in question so no channel occupancy data could be obtained.

The time in service columns in the second part of the table show that only truck 3 was in service for at least part of every weekend. Truck 5 was in service during only half the weekends analyzed. During the weekends of December 1 and December 8, 1978, Truck 5 was "out-of-service" due to a satellite antenna failure. Truck 5 then returned to service for the weekend of 16 December 1978 only to require major engine overhaul work the following three weekends.

Although the disposition of truck 4 could not be determined for the weekend of January 7, 1979, central dispatch records showed driver team 4 were taking extended rest during the January 20 weekend. Driver team 2 was similarly off duty during the weekend of January 27, 1979. Dispatch records also show driver team 1 off the road during the 1978 Thanksgiving weekend, November 22 through November 27, but all available records are silent as to why truck 1 was out of service for the weekend beginning December 8, 1978.

In summary, Smith's Transfer specifically selected the long haul tractor teams because they would be on the road most during the experiment test periods, but even these trucks were in service only about 50% of the time the satellite was available. More accurate service time data could have been obtained had the investigators established a strict call-in procedure, but such a procedure may have irritated the drivers and may have biased the channel occupancy data.

5.2 MANAGEMENT COMMENTARY

As a means for determining the opinion of Smith's Transfer Corporation with regard to the applicability of satellite communications to their trucking operations, the authors of this report met with the management of Smith's Transfer at their Staunton, Virginia headquarters on September 20, 1979 to discuss the outcome of the experiment. J. Kinder, Vice-President-Operations, C. W. Bowles, Director-Line Haul Operations, Darryl Chestnut, Manager-Line Haul Operations and Charles Welliver, Office Manager-Maintenance represented Smith's Transfer at the meeting.

Communications are vital to operations of Smith's Transfer Corporation. Data transmission from all of their terminals to the central dispatching headquarters at Staunton, Virginia are used to coordinate all freight movements and keep track of the shipments. Information in alphanumeric form is transmitted from the terminals to the dispatch headquarters where they are displayed on cathode ray tubes and also printed out. When a driver must report a delay or breakdown while he is enroute, he does so by telephone using an 800 number. Despite the importance of communications, the management of Smith's Transfer believes that immediate communications from the trucks to dispatch while the trucks are enroute would be of no value in their operations, and might even be counterproductive. They are of the opinion that the convenience of such communications would result in overloading their system with unnecessary information.

Smith's Transfer Corporation ranks eighth in size among the nation's longhaul motor transport carriers. It serves an area bounded by Tampa, Florida; Bangor, Maine; Minneapolis, Minnesota; Lincoln, Nebraska; Memphis, Tennessee, and Mobile, Alabama. Regulated by the Interstate Commerce Commission, it provides freight service to many cities within that area over specified routes. The Corporation's headquarters, maintenance shops and central dispatching are located at Staunton, Virginia. Its 1140 trucks operate from Staunton and from eight domicile terminals distributed throughout their system. A domicile terminal is the home base of truck drivers. No driver may be called upon to drive a distance more than 10 hours driving time from his domicile terminal except for the drivers of about 15 sleeper trucks that are in a specialized service serving specific customers. A sleeper truck has two drivers that may traverse the distance across the entire area served by the company, but only over certain routes. The

sleeper trucks will be phased out of the Corporation's operation. For purposes of testing the satellite-aided communications, the satellite communications, were installed on sleeper trucks. In addition to the domicile terminals, there are terminals in many other cities, each one under the supervision of a local supervisor. Loads may be delivered or picked up at any of the terminals at any hour of the day or night whether the supervisor is present at the terminal or not. Figure 4.5 is a system map of the Smith Transfer Corporation.

Smith's trucks drive a total of 2 1/2 to 3 million miles per week. The average load is 29,000 pounds.

A load picked up at one city may contain separate shipments to several other cities. The load is brought to a break bulk facility where the separate shipments are sorted and loaded on to other trucks destined for the various destinations. Each shipment is tracked through the system by information transmitted over the telephone lines to the central station at Staunton, Virginia. The time and completeness at each transfer of the shipment on its route is recorded at every waypoint, such as the break bulk terminal.

Smith's Transfer now has a central computer system at Staunton. It was not installed at the time of the experiment. The contents of every load from every terminal and its departure time from the terminal is transmitted to the central computer when the load leaves, together with its estimated time of arrival at its next terminal. In addition, the identification of the truck, its maintenance conditions, and the name of the driver is included in the information stored within the computer. In this way the real time status of all shipments, all over the road equipment, and all of the drivers is immediately available, except during the actual transit periods. Should the driver experience a delay or an equipment malfunction, he reports this as soon as he has access to a telephone, a state police officer, or by requesting another truck driver by CB radio to telephone the information to the Staunton headquarters. The delays experienced over these communications paths from drivers to Staunton are not considered of significance by the management of Smith Transfer, and there would be little value in real time direct truck-to-headquarters communications.

The only situation in which Smith's feels there might be some need for direct truck-to-headquarters communications would be to provide surveillance for ultra-high value loads. Smith's hauls only one or two such loads a week in their entire system so permanently installed radio equipment would not be cost effective. Management felt they might consider buying surveillance service for the few loads that would benefit from such service but expressed concern for the security of the satellite communications link. Effective voice scramblers would be required for such service.

No objection to the radio system was voiced by the union to Smith's Transfer management during the course of the experiment. The management also stated they would expect no objections if satellite radio equipment were installed in all of their road tractors. Smith's Transfer currently uses conventional two-way land mobile radio in trucks used for local delivery in many cities. Although Smith's Transfer believes these would be little value in real-time satellite-aided communications directly to trucks, they expressed a need for more reliable data communications between central dispatch and outlying terminals. The rented telephone lines that currently provide the data connection have failed often enough to have prompted management to specifically mention the problem during our meeting. The authors indicated that current satellite links could probably provide more reliable service but at relatively high cost. Smith's Transfer requires only low speed data communication on a single channel from each outlying terminal. Currently available domestic spacecraft require ground stations which provide much more service than Smith's could use. A future satellite system with small inexpensive narrow band ground stations would provide the service Smith's requires.

The management of the Smith's Transfer Corporation believes that their operations are representative of regulated carriers generally, and that their views would be held throughout the regulated trucking industry.

The management states that their comments with respect to the regulated industry may not apply to the unregulated independent truckers. Unregulated carriers often contract for their services on a load-by-load basis. They are not restricted on their routes and rates in the same way that the regulated carriers are controlled. Most perishable items and food stuffs and raw materials are carried by unregulated carriers. Smith's

Transfer often leases the services or contracts with unregulated independent carriers. An independent may contract to take a load from city A to city B sharing revenue with the agency, such as Smith's Transfer, that located the load for him. He may also have a contract to take a load from a city C distant from city B and so it is important for him to find a load at city B that is to be delivered near city C. When this situation occurs, Smith Transfer attempts to find such a load for the independent, but may not always be successful in doing so.

A centralized cargo brokering service would be of value to the independent carriers. The effectiveness and value of the service would be enhanced if convenient communications between independent drivers and the brokering service were in place. Suppose that a driver is carrying a load from city A to city B and has a contract to pick up another load as city C which distant from city B, but he has no contract for a load from B to C. As he approaches city B he could access the brokering service in the city stating his time of arrival and requesting a load from B to C. The brokering service would scan its stored information and advise the driver if there is a load to be delivered near city C and whereabouts in city B the load may be picked up. The efficiency and value of the brokering service would be enhanced by a long-range convenient communications between drivers and the brokering service for collecting information about incoming shipments and advising drivers on loads that are ready for departure.

5.3 MANAGEMENT EVALUATION OF SELECTED BUSINESS COMMUNICATIONS

To obtain some measure of the time saved as well as convenience value of the satellite communications during the experiment, General Electric excerpted from the complete audio tape made at the Earth Station Laboratory all conversations between the dispatcher and the trucks that had even marginal value to the day to day business of Smith's Transfer Company. The excerpted conversations were transcribed from the ESL reel-to-reel tape to several cassettes. The cassettes, together with listings of their contents and a tabular questionnaire, were given to the management of Smith's Transfer with the request that they evaluate each conversation by answering the multiple choice questions presented in the tabular questionnaire. Figure 5.1 shows a blank tabular questionnaire supplied.

A total of four cassette tapes were made of business conversations but Smith's Transfer could only analyze one complete cassette tape and part of another due to time constraints. Tables 5.5 through 5.9 show the complete contents of all four business conversation cassette recordings. The tables include brief descriptions of the typical business conversations. Smith's Transfer analyzed the contents of cassette tape 2 and cassette tape 3, side 1. The results of the Smith's Transfer analysis are presented in Table 5.10.

Three different individuals in Smith's Transfer management analyzed different parts of the cassette tapes. Respondent number 1 found that 4 of the 13 conversations he heard were desirable to business operations. He also found another 3 helpful. Of the 4 desirable conversations each conversation would have required 5-20 minutes of time before any alternate communications means could have been found. The satellite thus saved approximately 40 minutes in establishing these four communications. Of the four desirable conversations, 3 resulted in a delay of the truck (one seriously delayed the truck), but apparently the communications were still "desirable" to the business in spite of the delay. One of the conversations saved the truck "some time."

Respondent 2 found 8 of the 25 conversations that he analyzed were either "Essential" or "Desirable" to business. Four of the eight were essential and an additional 6 conversations were helpful. Of the 8 essential or desirable conversations an alternate communications means could have been

CASSETTE TAPE NO. 2 SIDE 1 ONLY

December 1 through December 8, 1978

QUESTION	ANSWER	CONVERSATION																											
		DATE TIME	D/1 016	D/1 060	D/1 093	D/3 143	D/3 190	D/3 239	D/3 277	D/3 314	D/3 360	D/3 397	D/8 413	D/8 431	D/8 454	D/8 499	D/8 545	D/8 599	D/8 615	D/8 659	D/8 692	D/8 739	D/8 763	D/8 783	D/8 828	D/8 867	D/8 888		
1 Please rate the quality of the radio transmissions made by the truck in this taped conversation.	A Excellent B Good C Fair D Poor E Not Understood																												
2 How important was the conversation you just heard to business operation?	A Essential B Desirable C Helpful D Unnecessary E Wasted Time																												
3 Whether this call had been made via satellite or conventional means, how did it effect the truck's schedule?	A Saved Much Time B Saved Some Time C Had Little Effect D Delayed Slightly E Seriously Delayed																												
4 For DRIVER initiated calls, what alternate conventional communications means might have been used for this conversation?	A Terminal Telephone B Roadside Payphone C CB D Via Police, Motorist E Would Not Have Occurred																												
5 For DISPATCHER calls, what alternate conventional communications means might have been used for this conversation?	A Telephone to Terminal B Teletype to Terminal C Telephone Outside Agency D None Available E Call Unnecessary																												
6 If no satellite had been available, how long would it have taken to FIND an alternate conventional communications means?	A Under 5 Minutes B 5-20 Minutes C 20 Min-1 Hour D Several Hours																												
7 Once the alternate communications means had been found, please estimate how long it would have taken to establish contact and send the message.	A Under 1 Minute B 1 to 5 Minutes C 5 to 20 Minutes D Over 20 Minutes																												
8 How did the speed of satellite communications in this conversation compare with alternate conventional communications means?	A Satellite Faster B Same C Conventional Faster D No Alternate to Compare																												
9 Why do you think the driver chose to use the satellite rather than alternate conventional communications means for this conversation?	A No Alternate B Alternate too Slow C Satellite Convenient D Followed Instructions																												

FIGURE 5.1

BUSINESS CONVERSATION MANAGEMENT QUESTIONNAIRE FORM

Start first line of page

TABLE 5.5
CASSETTE TAPE NO. 1
29 DECEMBER, 1978 - 29 JANUARY, 1979

<u>DATE</u>	<u>EST. TIME</u>	<u>TAPE INDEX</u>	<u>CALLING STATION</u>	<u>STATION CALLED</u>	<u>BRIEF DESCRIPTION OF CONVERSATION</u>
27 Jan. 79	----	----	-----	-----	Tape Announcement Start File 599
27 Jan. 79	0147	----	Dispatch	Truck 5	Location, Weather, Road Conditions
27 Jan. 79	0611	----	Dispatch	Truck 3	Location, Weather, Road Conditions
27 Jan. 79	0651	----	Truck 5	Dispatch	Road Conditions, Weather, Location
27 Jan. 79	0655	----	Dispatch	Truck 3	Location, Weather, Road Conditions
27 Jan. 79	0738	----	Truck 5	Dispatch	Ice On Windshield Delay, Location
27 Jan. 79	0814	----	Truck 5	Dispatch	Location, Weather, Road Conditions
27 Jan. 79	?	----	Truck 3	Dispatch	Reports Delay Due To Weather
27 Jan. 79	1245	----	Truck 3	Dispatch	Requests Information About Accident
27 Jan. 79	1310	----	Truck 5	Dispatch	Location, Fuel Filter, Maintenance
27 Jan. 79	2239	----	Truck 3	Dispatch	Lights On Trailer Have Failed
27 Jan. 79	2257	----	Dispatch	Truck 5	Weather, Location, Road Conditions, Route Change
27 Jan. 79	2311	----	Truck 3	Dispatch	Trailer Lights Hard To Repair; Please Keep Working-- Hot Load
28 Jan. 79	0207	----	Truck 3	Dispatch	Lights Working--- Repair Paperwork
28 Jan. 79	0434	----	Truck 5	Dispatch	Location--- Stopping To Eat
28 Jan. 79	0904	----	Truck 3	Dispatch	Weather, Road Conditions
28 Jan. 79	1238	----	Dispatch	Truck 3	Location, Weather
28 Jan. 79	2252	----	Truck 5	Dispatch	Location, Weather, Roads, Destination
29 Jan. 79	0125	----	Truck 3	Dispatch	Lynchburg Terminal Gate Lock Broken Please Call Terminal Manager; Next Load
29 Jan. 79	----	----	Truck 5	Dispatch	Destination, Next Load. Broken Lock
29 Jan. 79	----	----	Truck 3	Dispatch	Going Through Broken Lock Gate Now
29 Jan. 79	0250	----	Truck 3	Dispatch	Leaving Lynchburg Now
29 Jan. 79	----	----	-----	-----	End Of File 599 Announcement
20 Jan. 79	----	----	-----	-----	Begin File 598 Announcement
21 Jan. 79	1052	----	Truck 5	Dispatch	Destination, Next Load, "Bobtail"
22 Jan. 79	----	----	-----	-----	End File 598 Announcement
END OF CASSETTE NO. 1 SIDE 1. GO TO SIDE 2					
29 Dec. 78	----	----	-----	-----	Start File 594 Announcement
29 Dec. 78	0119	----	Truck 4	Dispatch	Weather, Road Conditions, Destination
1 Jan. 79	----	----	-----	-----	End File 594 Announcement

TABLE 5.6
 CASSETTE TAPE NO. 2 SIDE 1
 1 - 8 DECEMBER 1978

<u>DATE</u>	<u>EST. TIME</u>	<u>TAPE INDEX</u>	<u>CALLING STATION</u>	<u>STATION CALLED</u>	<u>BRIEF DESCRIPTION OF CONVERSATION</u>
1 Dec. 78	----	000	-----	-----	Start File 586 Announcement
1 Dec. 78	----	016	Dispatch	Truck 4	Location, Radio Check
1 Dec. 78	----	060	Truck 1	Dispatch	No Dispatch Reply
1 Dec. 78	----	093	Dispatch	Truck 3	Automatic Response Only
1 Dec. 78	----	Cont.	Truck 3	Dispatch	Reply To Above, Location, Destination
3 Dec. 78	----	143	Dispatch	Truck 4	Location, Weather, Future Weather
3 Dec. 78	----	190	Dispatch	Truck 3	Automatic Response Only
3 Dec. 78	----	---	Dispatch	Truck 2	Location, Destination
3 Dec. 78	----	239	Truck 3	Dispatch	Reply To Above, Location, Destination
3 Dec. 78	----	277	Truck 4	Dispatch	Next Load, Location, Weather
3 Dec. 78	----	314	Truck 2	Dispatch	Location, Weather, Next Load
3 Dec. 78	----	360	Dispatch	Truck 4	Location
4 Dec. 78	----	397	-----	-----	End Of File 583
8 Dec. 78	----	400	-----	-----	Start File 589 & 590
8 Dec. 78	----	413	Truck 4	Dispatch	Moving After Delay
		431	Truck 3	Dispatch	Location, Stop To Eat
		454	Truck 4	Dispatch	Location, Weather
		499	Truck 4	Dispatch	Trailer Wheel Bearing Bad
		545	Dispatch	Truck 4	Wheel Bearing Repair Discussed
		599	Truck 4	Dispatch	Will Go To Indianapolis To Repair
		615	Truck 3	Dispatch	Next Load, Location, Weather
		659	Truck 2	Dispatch	Location, Weather, Future Weather
		692	Truck 3	Dispatch	Weather, Road Conditions
		739	Truck 2	Dispatch	Location, Next Load
		763	Truck 3	Dispatch	Location, Next Load
		783	Dispatch	Truck 2	Location, Weather, Truck Re-Routed
		828	Dispatch	Truck 2	Location, Weather, Road Conditions
		867	Truck 2	Dispatch	Road Conditions, New Route ?
		888	Truck 2	Dispatch	Reports Other Truck Has No Heater
		935	-----	-----	End Cassette Tape 2 Side 1

TABLE 5.7

CASSETTE TAPE NO. 2 SIDE 2

<u>DATE</u>	<u>EST. TIME</u>	<u>TAPE INDEX</u>	<u>CALLING STATION</u>	<u>STATION CALLED</u>	<u>BRIEF DESCRIPTION OF CONVERSATION</u>
11 Dec. 78	----	000	-----	-----	Continue Files 589 & 590
11 Dec. 78	----	016	Truck 3	Dispatch	Flooded Road In Several Places
11 Dec. 78	1045	321	Truck 3	Dispatch	Flooded Road
11 Dec. 78	1055	359	Truck 3	Dispatch	Flooded Road
11 Dec. 78	----	516	Truck 5	Dispatch	Road Condition Report
11 Dec. 78		560	-----	-----	End Of File 590
14 Dec. 78		561	-----	-----	Begin File 592 Announcement
14 Dec. 78		571 T1	Dispatch	Truck 1	Location, Weather, Destination
14 Dec. 78		571 T2	Dispatch	Truck 2	Location, Weather, Destination
14 Dec. 78		571 T3	Dispatch	Truck 3	Location, Weather, Destination
14 Dec. 78		571 T4	Dispatch	Truck 4	Location, Weather, Destination
14 Dec. 78		571 T5	Dispatch	Truck 5	No Reply - Truck Not In Service
14 Dec. 78		733			End Of File 592
15 Dec. 78	----	735	-----	-----	Start Announcement File 593
15 Dec. 78		741	Truck 3	Dispatch	Location
15 Dec. 78		764	Truck 1	Dispatch	Accident But No Delay
15 Dec. 78		776	Dispatch	Truck 4	Location, Destination, Radio Check
15 Dec. 78		797	Truck 3	Dispatch	Location, Radio Check
15 Dec. 78		844	Truck 5	Dispatch	Location, Satellite Schedule Check
15 Dec. 78		868	Truck 5	Dispatch	Location, Drivers Short On Hours
15 Dec. 78		909 a	Truck 5	Dispatch	Another Truck Disabled On Exit
15 Dec. 78		909 b	Truck 5	Dispatch	Did You Send Replacement Tractor?

END CASSETTE NO. 2 SIDE 2, GO TO CASSETTE 3

TABLE 5.8

CASSETTE NO. 3 SIDE 1
15 - 18 DECEMBER 1978

<u>DATE</u>	<u>EST. TIME</u>	<u>TAPE INDEX</u>	<u>CALLING STATION</u>	<u>STATION CALLED</u>	<u>BRIEF DESCRIPTION OF CONVERSATION</u>
15 Dec. 78	----	000	-----	-----	Tape Announcement Con't File 593
		013	Dispatch	Truck 3	Destination, Location, Weather
		062	Truck 2	Dispatch	Next Load, Location, Weather
		140	Dispatch	Truck 5	Did You Call Us?
		242	Dispatch	Truck 3	Load? Truck Repaired, Location, Destination
		318	Truck 4	Dispatch	Out Of Fuel, Location, Delayed, Dispatch Mechanic, Fuel Here
		400	Truck 5	Dispatch	Location, Weather
		422	Truck 3	Dispatch	Location, Please Call Home For Transportation To Appointment
18 Dec. 78		475	-----	-----	End File 593

TABLE 5.9

CASSETTE NO. 4 SIDE 1 AND 2
17 - 27, NOVEMBER, 1978

<u>DATE</u>	<u>EST. TIME</u>	<u>TAPE INDEX</u>	<u>CALLING STATION</u>	<u>STATION CALLED</u>	<u>BRIEF DESCRIPTION OF CONVERSATION</u>
17 Nov. 78	----	000	-----	-----	Tape Announcement, Start File 579
17 Nov. 78	2100	010	Dispatch	Truck 5	Location, Weather
17 Nov. 78	2125	043	Dispatch	Truck 2	Location, Weather
18 Nov. 78	0630	093	Dispatch	Truck 5	Location, Weather At Destination, Come Home Or Stay "Wild"
17 Nov. 78	1545	165	Truck 2	Dispatch	Location, Next Load, Change Dispatch To High Value Load
18 Nov. 78	1745	260	Truck 5	Dispatch	Location, Destination, Next Load At Destination
18 Nov. 78	2245	286	Dispatch	Truck 2	Location
19 Nov. 78	0230	312	Dispatch	Truck 2	Location, Weather
19 Nov. 78	2340	432	Dispatch	Truck 5	Location, Destination, Weather
19 Nov. 78	?	479	Truck 2	Dispatch	Location, ETA Staunton, Va.
19 Nov. 78	1900	524	Truck 5	Dispatch	Location, ETA, Running "Wild"?, Next Load
19 Nov. 78	?	562	Truck 5	Dispatch	Can't Find Bills Of Lading, Macon Dispatcher Called To Get Them
19 Nov. 78	2325	620	Dispatch	Truck 4	Location, Weather
20 Nov. 78	0500	643	Dispatch	Truck 5	Location, Weather, Radio Check
20 Nov. 78	0530	663	Truck 4	Dispatch	Location, Weather, Destination, Radio Check
20 Nov. 78	1100	---	-----	-----	End Of File 579 Announcement
END OF CASSETTE NO. 4 SIDE 1 - CONTINUE WITH SIDE 2					
22 Nov. 78	1715	000	-----	-----	Tape Announcement Start File 582
23 Nov. 78	2311	013	Dispatch	Truck 2	Weather, Next Load, Then Return To Staunton "Bobtail," Present Location
24 Nov. 78	-----	123	Truck 2	Dispatch	Weather, Load Number, Load Weight, Location
24 Nov. 78	0950	178	Dispatch	Truck 2	Location, Weather, Road Conditions
26 Nov. 78	0520	241	Dispatch	Truck 3	Dispatch Wants Weather For Other Trucks
26 Nov. 78	1535	307	Truck 3	Dispatch	Stop For Food - Clean-Up, Location
26 Nov. 78	1955	329	Truck 3	Dispatch	Needs Gate Lock Combination
26 Nov. 78	2100	364	Truck 3	Dispatch	Can't Find Bills Of Lading
27 Nov. 78	1600	424	-----	-----	End Of File 582 Announcement

TABLE 5.10

DISPATCHER RESPONSES

		Number of Responses		
		Respondent		
Question	Answer	1	2	3
1 Please rate the quality of the radio transmissions made by the truck in this taped conversation.	A Excellent	-	-	-
	B Good	6	5	5
	C Fair	10	14	2
	D Poor	-	6	-
	E Not Understood	-	-	1
2 How important was the conversation you just heard to business operation?	A Essential	-	4	2
	B Desirable	4	4	1
	C Helpful	3	6	-
	D Unnecessary	9	9	2
	E Wasted Time	-	2	2
3 Whether this call had been made via satellite or conventional means, how did it effect the truck's schedule?	A Saved Much Time	-	-	2
	B Saved Some Time	1	5	3
	C Had Little Effect	11	4	2
	D Delayed Slightly	3	16	-
	E Seriously Delayed	1	-	-
4 For DRIVER initiated calls, what alternate conventional communications means might have been used for this conversation?	A Terminal Telephone	-	4	1
	B Roadside Payphone	9	9	1
	C CB	-	1	-
	D Via Police, Motorist	-	-	2
	E Would Not Have Occurred	3	3	3
5 For DISPATCHER calls, what alternate conventional communications means might have been used for this conversation?	A Telephone to Terminal	-	-	1
	B Teletype to Terminal	-	-	-
	C Telephone Outside Agency	-	-	-
	D None Available	-	6	2
	E Call Unnecessary	4	2	4
6 If no satellite had been available, how long would it have taken to FIND an alternate conventional communications means?	A Under 5 Minutes	-	6	1
	B 5-20 Minutes	16	13	4
	C 20 Min-1 Hour	-	6	2
	D Several Hours	-	-	-
7 Once the alternate communications means had been found, please estimate how long it would have taken to establish contact and send the message.	A Under 1 Minute	16	15	1
	B 1 to 5 Minutes	-	3	6
	C 5 to 20 Minutes	-	7	-
	D Over 20 Minutes	-	-	-
8 How did the speed of satellite communications in this conversation compare with alternate conventional communications means?	A Satellite Faster	16	25	1
	B Same	-	-	6
	C Conventional Faster	-	-	-
	D No Alternate to Compare	-	-	-
9 Why do you think the driver chose to use the satellite rather than alternate conventional communications means for this conversation?	A No Alternate	-	-	-
	B Alternate too Slow	-	-	2
	C Satellite Convenient	16	25	5
	D Followed Instructions	-	-	-

found in less than 5 minutes in 5 cases; in 5-20 minutes in 2 cases; and in one case it would have taken 20 minutes to an hour to find an alternate communications means. Savings in finding an alternate means totaled 70 minutes for these conversations. In the case of one conversation, establishing contact with the alternate means would have required about another 10 minutes. The truck mounted satellite communications equipment thus saved approximately 80 minutes during these essential or desirable communications. Respondent 2 also estimated that 5 of the conversations saved the truck "some time" two had little effect and 1 delayed the truck slightly.

The third respondent analyzed only 8 conversations one of which he could not understand. Of the remaining 7 conversations he found 2 essential and 1 desirable. Of these three conversations, the respondent said, that in one case an alternate communications means could be found almost immediately but in 2 cases, 20 minutes to 1 hour would have passed before an alternate communications means could have been found. Two conversations also resulted in the saving of "much time" in the truck's schedule.

In summary, Table 5.10 shows that many business conversations are really not particularly useful but that quite often the satellite radio saved a substantial amount of time in providing desirable and essential communications. In fact, 3 hours and 10 minutes of time was saved just in finding a communications means. Often the truck schedule benefited from the communications as well; although this time was not quantified.

The amount of truck service time recorded during the time frame from which these business conversations were excerpted totals 490.5 hours. Referring to Table 5.3 the typical channel occupancy for business conversations is about 0.4% or about 2 hours for 490.5 service hours. The data then implies that more than 3 hours can be saved for each 2 hours of radio contact time. These 3 hours still do not include the savings realized by improved truck schedules but only the time saved in communicating.

It should also be noted that no effort was made during the experiment by GE or Smith's Transfer to minimize the amount of relatively useless conversation or to encourage only valuable business conversations. Even a moderate effort to make conversations more efficient would probably double the amount of time saved for a given amount of radio contact time.

5.4 DRIVER EVALUATION

Start After the operational phase of the experiment had been concluded, General Electric requested Smith's Transfer management to administer the following questionnaire to the drivers to obtain their opinions and impressions of the satellite-aided land mobile radio system they had used in their truck. The questionnaire and replies are presented here with very little comment as the questionnaire is largely self-explanatory. Comments of all the drivers have been included in bold face type beneath the number of replies of each choice for each question.

In summary, the drivers found the radio system useful and desirable. It may also be helpful to note most drivers are experienced CB radio operators which may bias certain of their answers.

Dear Sir:

General Electric is interested in your opinion on the operation of their satellite communications system. Please complete the attached questionnaire to the best of your ability and return it to me in dispatch.

Thank you for your time and effort.

Ken McCoy
Dispatcher

ksw

DRIVER QUESTIONNAIRE

Please answer the following questions about the experimental satellite radio installed in your truck.

Please make any comments you like under the question, or on the back of the page.

1. Did the operation of the satellite radio set interfere with your driving at any time?

- 0 A. It interfered with driving quite often
- 1 B. It interfered with driving occasionally
- 2 C. It never interfered with driving

Driver 6. It didn't interfere with driving because we use (CB) radios all the time.

2. When the satellite was on, how often could you get through when you wanted to use the radio?

- 9 A. About 9 times out of 10
- 1 B. About 7 times out of 10
- 2 C. About half the time
- 0 D. About 8 times out of 10
- 0 E. Almost never got through

Driver 2. Radio never was on.

3. How often did you usually have to call before dispatch could answer?

- 4 A. Usually 1 time
- 5 B. Usually 2 or 3 times
- 2 C. Usually more than 3 times

Driver 2. Radio never was on.

Driver 4. (B) On 2nd shift first times and third shift (first times).

Driver 7. I never had to call dispatch.

4. Did the satellite radio save you time on the road during the experiment? Please tell us about how often.

- 5 * times it saved us more than an hour
- 3 times it saved us a few minutes
- 1 times it slowed us down a few minutes
- 0 times it slowed us down more than an hour

*Circled numbers represent numerals inserted in blank. Uncircled numerals indicate total number of checkmarks.

~~EO 12812~~ ~~Conf~~

Driver 1. It never saved any time or caused (us) to lose any.

Driver 2. Radio never was on.

Driver 4. When satellite was on it save(ed) many hrs on breakdown.

Driver 6. It saved us two or three times on breakdowns of more than 1 hour. It saved us considerable time in being dispatched.

Driver 8. Could have saved us more time if satellite were on weekends.

Driver 12. The satellite radio in my opinion is a very good thing to have in trucks. It saves a driver a lot of time in Foreign Terminal. He can call in ahead of time to get his new trailer number.

5. Thinking back on the big picture, for what kind of communications did the satellite work best? Please use the number 1 for the best use; 2 for the next best use, and so on.*

28 A. Trailer dispatching

25 B. Breakdowns on the road

42 C. Safety problems

28 D. Getting weather and road condition reports

48 E. Getting a message home

Add more choices if you want.

Driver 2. Never used radio.

Driver 8. Traveling west on interstate 74 between Woodhall, Ill. and Davenport, Iowa, (I met) another Smith's (driver) headed eastbound (who) needed another truck [due to breakdown]. He requested by CB radio for me to stop at Davenport and get them to send him another tractor. I told him I could talk to dispatch from my tractor. He couldn't believe I could so he came over to my tractor to see the radio. I broke for dispatch and told them the location, his name, his truck number and his problem. I then left and traveling less than forty miles I met a tractor going to help him and I feel he could have saved up to three hours in delayed time.

If it was possible if two trucks could stay in contact at all times it would be nicer for information on weather. For instance I was approaching DesMoines, Iowa at that time GE-1 gave me clearance to talk to tractor 3 going into Winchester, Va and by talking to Truck 3 I found the weather in Virginia was fine but the weather in DesMoines was miserable which I reported to him.

Note E — I understand from my partner that GE-1 hooked him up to his home phone and he got to talk to his wife because he was snowbound. I feel like it relieved her mind of worries when she heard from him.

Driver 12. The satellite works good in case a Driver has a High Value Load that is subject to being hijacked. He can call in and give his position on any highway or location in the country.

*Note numbers reported are the sum of the rankings.

02020023 p 1/10/94

6. Many times you have been near a telephone, but used the satellite radio in the truck. If you used the radio, why did you use it rather than the telephone?

- 8 A. Radio was more convenient
- 1 B. Someone was using the telephone
- 2 C. It took too long to place the call by telephone
- 0 D. We were told to use the radio
- 0 E. Please tell us any other reason

Driver 2. Never used radio

Driver 6. A, B, and C are the reasons we used the satellite radio.

Driver 9. None

Driver 12. It also saves time. The Driver can keep driving and talk on the radio at the same time.

Driver 13. Watts line busy at times ... only 1 Watts line for breakdown and dispatch system.

7. Did the radio set bother you in the truck?

- 1 A. Yes — It woke me up when I was sleeping
- 1 B. Yes — The boxes got in my way. It took too much space.
- 0 C. It bothered my driving.
- 1 D. I had to worry about the antenna too much.
- 1 E. Please tell us anything else that bothered you about the radio.

Driver 2. Radio was never on.

Driver 3. It did not bother me.

Driver 4. Should have better mount on antenna. Broke too many time(s) when bobtailing.

Driver 5. No, the radio did not bother me. I like the radio although there were many times the radio wasn't working properly in truck #524.

Driver 6. A few times the radio woke me up but that was because we had the volume turned up too loud.

Driver 8. It bothered me none whatsoever.

one was

Driver 10. It did not bother me in any way.

Driver 11. No

Driver 12. The radio did not bother me. It is a very good thing to have in a truck. It (could) save a company money and time on Dispatcher and Via's on the road for a driver.

Driver 13. No bother at all.

8. Did the radio ever give you the feeling that "big brother" was watching?

0 A. Yes. It bothered me a lot.

1 B. Sometimes

12 C. No. It didn't bother me.

Driver 6. I was aware of the possibility of being monitored by the use of the satellite radio. But it help(ed) me to perform my job better. If a man does a good job, he wants someone to watch.

9. Some people have suggested that the satellite radio in the truck should work like a regular telephone where you just dial up any number you want to talk to, and anyone can dial you. Do you agree?

3 Yes

8 No

Please tell us why you answered this way.

Driver 1. (Yes) It would be a lot easier, and if they needed you, they could get ahold of you faster.

Driver 2. Never used radio.

Driver 3. In some ways it may be good in that you could check on dispatches, etc. In other ways it would not work. It may be too much bother if "anyone" could call.

Driver 4. (No) Because it should be for company and home only, for quick Dispatch and Breakdown and safety condition(s).

Driver 5. (No) Because I think that the satellite radio should be used for business. The driver should be able to communicate with the dispatcher or other drivers.

Driver 6. (Yes) I think that it would be an exceptionally good communications system. The satellite radio would be a very good time saver, plus the fact is, it would not interrupt the daily operations of business. The satellite radio could be used for moment by moment change of conditions or operations. The telephone cannot be used this way. The satellite radio should not be abused.

Driver 7. (No) I believe it would cause too many unnecessary calls tying up the radio channel, and possibly causing an accident. I also feel some people would still like to have some privacy left.

Driver 8. (No) I feel like it would be used for pleasure purposes rather than emergency or trouble breakdown purposes.

Driver 10. (Yes) I would prefer to dial direct and not go through a third party.

Driver 12. (No) In the first place the satellite is not a telephone. It works better than a telephone. A Driver can call in without stopping to go to a pay phone.

Driver 13. (No) If like telephone, (there) would be too much traffic.

John D. ...

10. Were you bothered by signal drop-outs when you were talking through the satellite?

- 0 A. Yes — most conversations were hard to understand.
- 2 B. Some conversations were hard to understand.
- 3 C. Most conversations were easy to understand.
- 6 D. Almost all conversations were loud and clear.

Driver 2. Never used radio.

Driver 4. (D) Except south past Atlanta, Ga.

Driver 8. Almost all conversations were loud and clear due to the fact that I would wait until I knew I was in the beam of the satellite rather than in a blockage. (There) were times when GE-1 or any of the other radios would break that I would try (to make contact) under experimental conditions. For instance if I was sitting still and in the beam of the satellite, I might have to move the position of the truck (to establish contact).

Driver 13. (D) Except in mountains or wooded areas.

11. How would you rate the coverage area of the satellite radio system?

- 9 A. The radio could be used almost everywhere we went.
- 3 B. The radio could be used most places.
- 0 C. The radio worked in about half the places we went.
- 0 D. The radio worked in only a few places.

Please make any other comments you want to make on the blank pages that follow.

Driver 2. Never used radio.

Driver 4. I think (the) Co. should have radio in some units for safety and road condition (reports) and breakdown (reports). I think it would save time and cost. (a) number of time(s), Elliot and Thompson used the radio to call in breakdown(s) for other company driver(s). (They also reported) roadblock(s), weather condition(s) and High Value Load(s).

Driver 8. The only regret I have (is) the satellite couldn't be on twenty-four hours a day. I feel like it would be one of the greatest things that would happen to the trucking industry. The only time I was troubled by interference was around Davenport, Iowa and at that time I was talking to GE-1 for experimental purposes. I explained to GE-1 that the only thing I knew that would be interfering would be the airport and (a) radio speed check mounted on (an) overpass. After I passed the interference, on my return trip I made another check passing through the same area only eastbound and I never encountered any interference.

Driver 10. The hours for experimentation should have been longer but I liked using the radio. I feel all trucks should have one if possible. Emergency problems such as truck breakdowns and accidents could be reported a lot faster and we could get help quicker by using this radio instead of having to look for a telephone to report problems.

Driver 12. I personally would like to have a satellite (*radio*) in a tractor. They are good for weather reports, for safety en route, prevents hijacking except in unusual cases like being in a truck stop. It is very good for communication between the Driver and his home terminal or central Dispatch. The Driver can always give his exact location while on the road. That way the company can always know the exact time he arrives at a terminal.

6.0 EMERGENCY RESPONSE TESTS AND OPERATIONS

6.1 YOSEMITE VALLEY TESTS

The National Association for Search and Rescue, NASAR, organized an Applications Technology Satellite Integrated Experiment "...to demonstrate the application of satellite communications to search and rescue and emergency response operations." The objectives, as stated in the NASAR test plan, [9] were as follows:

- a. To assess the operational suitability of a centrally coordinated communications system for use in SAR missions where conventional communication systems are limited or nonexistent.
- b. To evaluate the functional reliability of the system during actual SAR missions and operational training exercises.
- c. To examine the effectiveness of space communications equipment during coordinated SAR missions.

Organizations involved in the test were:

- (1) General Electric Earth Station Laboratory.
- (2) ATSOCC (ATS Operations Control Center, NASA-GSFC)
- (3) HQ ARRS/AFRCC.
- (4) 403 RWRW (Res).
- (5) 303 ARRS (Res).
- (6) 305 ARRS (Res).
- (7) NASA Goddard Space Flight Center.
- (8) State of California.
- (9) National Association for Search and Rescue (NASAR).
- (10) National Park Service, Yosemite, California.

The role of General Electric during the test was:

- a. Act as net control for the ATS spacecraft.
- b. Provide the turn around function (Receive vehicle signals on one ATS-6 L-band channel, retransmit them back through ATS-6 on another L-band channel. See Section 3.0.).
- c. Provide the phone-patch function.
- d. Provide the interconnect for ATS-1, -3 and -6 where desirable and/or appropriate.
- e. Advise all users on radio.

- f. Coordinate schedules (with ATSOCC) for other experiments and users.

In preparation for the test, two L-band transceivers were removed from trucks of Smith Transfer and installed in communication jeeps of the Air Force. The jeeps carried a variety of communications equipments for use in emergency response operations including HF (2-30 MHz) for long distance communications and VHF and UHF equipments for short range communications and interaction with other emergency response services.

The jeeps are deployed, as required, aboard HC-130 aircraft.

Antennas for the jeeps were the linear Wheeler antennas used on the Smith Transfer trucks and also 6-turn helical antennas, 2-1/4 inches in diameter and 10 inches long, circularly polarized with 13 dB gain. The Wheeler antennas were omnidirectional in azimuth. The helical antennas had beamwidths of 46 degrees, requiring pointing in the direction of the satellite. Antenna choice was at the option of the operators.

An L-band transceiver, furnished by NASA, was installed at the Air Force Rescue Coordination Center (AFRCC), Scott Air Force Base, Illinois. The transceiver was augmented with a Dual Tone Multiple Frequency (Touch Tone[®]) encoder furnished by General Electric. A portable "briefcase" L-band transceiver was supplied by NASA-GSFC (Photo 6.1). The State of California had acquired portable equipment for communications through the VHF transponders of ATS-1 and ATS-3.

The jeeps were deployed to Yosemite National Park where the satellite communications were compared with conventional means. Transceiver operators attempted to establish alternate routes of communication between the field, California State Emergency Operations Center (EOC) Park Headquarters and AFRCC. Some alternate routes were telephone, ground-to-air relay, air-to-air relay, and phone patches through HF radio stations. Timeliness, clarity of transmissions, and ease of establishing contact were key factors evaluated.

The ATS-6 satellite was operated in the fan beam mode to include California, Illinois and New York within its radiation pattern. Gain of the satellite antenna was then 30 dBi.

Master Sergeant William E. Kratch operated the jeep of 303 ARRS. The jeep was designed "Rescue 621". Lt. Paul Villery, 303 ARRS, operated

the 305 ARRS jeep, designed "Rescue 624". Sgt. Kratch filed an "ATS-6 Transceiver Questionnaire" for each day of the test. The questionnaire form was prepared by NASAR. Table 6.1 summarizes his responses to the questionnaire. His responses and extracts from his remarks are presented with his permission.

REMARKS

14 May 1979

"At 0800 personnel of the 303rd, with both communications vehicles met again with Mr. John Dill, [Head of Search and Rescue Operations within the National Park and vicinity] . At this time both units were set up to make initial contact with ATS-6. Included in this initial contact was Goddard Mobile Three. Goddard Mobile Three is a suitcase transceiver. With little adjustment of the ATS-6 satellite, contact was made with outstanding reliability of signal. We then asked Mr. Dill for his "Inter Park High Band" VHF-FM frequencies. (For further references: Inter Park or car to car 171.800 MHz 172.650 repeats 172.775 - Park dispatcher Call Sign 719). We then asked Mr. Dill to continue his business for the next 30 minutes and we would, through the capabilities of Rescue 621 [303rd communications vehicle] and the ATS-6 Satellite demonstrate its abilities to communicate even through buildings. Mr. Dill did exactly what we requested. At this point, personnel of the 303rd connected their "aeropatch" equipment to the Satellite transceiver within Rescue 621 and the center working console. The center working console of Rescue 621 is a piece of equipment that is used for selecting receiving or transmitting normal communications to and from the vehicle. The "aeropatch" is a piece of equipment designed and developed by TSG John Irsik of the 303rd for a total cost of \$25.00. The aeropatch balances both incoming receiving signals as well as outgoing transmitting signals. The unit can "patch" through a balancing system any normal UHF-VHF, Lo-Band RF, High Band VHF-FM or high frequency (HF) through the Satellite.

This is both transmit and receive.

"As stated, Mr. Dill continued his normal duties around the camp area. The "aeropatch" was used to patch Mr. Dill's "handie Talkie" through the Satellite to the AFRCC at Scott. However, Mr. Dill did state the RCC was somewhat "scratchie." We feel this was due to the AFRCC transceiver being a little off frequency. Regardless, it appeared after Mr. Dill's return that he was very impressed with ATS-6 Satellite abilities.

"Further experiments with Rescue 624 (305th Communications Vehicle) and Goddard Mobile Three was conducted. At 1030L, Rescue 621 departed the Ranger Headquarters area to fully experiment with the abilities of ATS-6 within the more heavily forested area. This was to determine the ability of the Satellite in dense area. Rescue 624 remained at the Ranger's headquarters. This would provide a direct comparison of signals to GE-1 General Electric's Earth Station Laboratory near Schenectady, New York. Regardless of the type of deep overhead coverage of trees or the high terrain, communications, both transmit and receive, of ATS-6 was excellent.

"At the recommendation of Mr. Dill, both Rescue 621 and Rescue 624 drove around the park, becoming familiar with the terrain and roads. During this period both Rescue 621 and 624 experimented with transmission and reception abilities of the ATS-6 Satellite via the high band VHF-FM, inter Park Communications Net. Rescue 621 and 624 could find no place except under the Wawona Tunnel that we could not communicate with GE-1 via ATS-6. We did however find many places within the park area that we could not communicate with the Ranger dispatcher Call Sign 719 non-satellite VHF.

"At 1230L, communications with ATS-6 was completed. Both Rescue 621 and 624 at this time returned to the Ranger Headquarters for arrangements for a meeting to be held with all interested parties at 2100. This meeting was to discuss

the communication problems within the "back area" of the National Park area. Nine places out of 15 were covered during this meeting were to be experimented with the following day. The meeting was completed at 2300 hours.

15 May 1979

"Four completely different experiments were to be conducted on this date. Experiment 1 was to send Rescue 624 to the highest point possible overlooking the valley floor. Experiment 2 was to integrate ATS-3 with ATS-6. The California representative was to go to the same position as Rescue 624. Experiment 3 was to send Rescue 621 to Yosemite Village area on the floor of the valley. The 4th experiment was to test fly Goddard Mobile 3 in a Navy Lemoore U111-11 helicopter. After the test flight we would proceed to four different locations within the National Park area where known present day communications would not work.

"Rescue 624 departed the Group Camp Site at 0630L and arrived at Bagger Pass ski area. This is approximately 41 miles and 3000 feet above the valley floor. Arrival time: 0745L.

"Rescue 621 departed the Group Camp Site at 0645L and arrived at the Big Meadow area at 0810L, dropping off Goddard Mobile 3 and party. Rescue 621 then returned to the prearranged area.

"At 0835L, a ground communications check was accomplished with Goddard Mobile 3, against Rescue 624, Rescue 621 and GE-1. All systems functioned correctly. At 0842L, Goddard Mobile 3 was secured in Navy Lemoore helicopter. At 0864L, the Navy Lemoore started engines with all its avionics equipment functioning. Test transmissions were transmitted from Goddard Mobile 3. No crew member nor the transceiver operator of Goddard Mobile 3 could detect any problems with the aircraft avionics. The helicopter then lifted off to a height of 50 feet. Again transmission was made to locate any difficulties

with the aircraft, to avionic systems or with ATS-6 transceiver, Goddard Mobile 3. None could be indicated or located. The helicopter then, after carefully checking all systems, rose to a height of 4500 AGL or 500 feet above the Big Meadow area. A four minute hover was accomplished by the helicopter and voice and antenna patterns were recorded by GE-1. Voice contact was also established by the transceiver operator to Rescue 621 and 624 with excellent reception and transmission. At 0905L, the helicopter returned to Big Meadow for refueling and received a detailed briefing on the four most important areas. These areas are in areas of importance (1) Jack Main Canyon, (2) Benson Lake, (3) Pate Valley, and (4) Merced Lake.

"At 0920L, the Navy Lemoore helicopter departed. A test of transmission capability while in route was accomplished to the AFRCC at Scott. Also included were Rescue 621 and Rescue 624. At all test locations the Mobile ATS-6 transceiver worked well. One of the accompanying rangers also off loaded at these four locations and attempted his communications equipment. It did not work at all.

"The Navy Lemoore heliicopter returned with all parties safely aboard at 1200L at the Big Meadow area. This concluded all experiments at 1230L.

"The overall tests concluded that ATS-6 L-band Transmission, both transmit and receive are workable from aircraft, including helicopters. That areas that are considered dead by conventional means are workable by L-band communications and that even in heavy overhead foliage and in all kinds of terrain, this equipment works clearly and every time in temperatures of +5°F.

"Rescue 624 broke down on its return from his position. The alternator failed and there was no means of repair. Thanks to the US Forestry Service the batteries were charged to enable Rescue 621 and 624 to return to Castle AFB on 18 May 1979. Rescue 624 (305 Communications Vehicle) is in need of maintenance and care, this not only

includes the vehicle, but also includes the condition of the other communications equipment which includes power leads to the ATS-6 transceiver in this vehicle.

16 May 1979

"In accordance with objective 5c of the Operational Test Plan, the objective of today's plan was to attempt to establish alternate voice grade communications with the State of California Emergency Operations Center, Park Headquarters and the Air Force Rescue Coordination Center at Scott AFB 11. The attached log is a copy out of the Log Rescue 621 (303rd Communications Vehicle).

NOTE: The log records interconnection of the ATS-6 communications equipments with parties in San Diego, Long Beach, San Francisco, RCC, and Schenectady. Telephone interconnections were used to reach the final destinations. GE-1 interconnected ATS-6 and ATS-3 at the satellite fixed terminals, such as GE-1, so that signals from the jeeps via ATS-6 were retransmitted through ATS-3 to the VHF equipped terminals of the State of California.

17 May 1979

"This was the second in a series of tests IAW the operational Test Plan at Yosemite. With the loss of Rescue 624 (305th Communication Vehicle) only Rescue 621 (303rd Communications Vehicle), Goddard Mobile 3 (ATS-6 Satellite Suit Case Transceiver) and California Mobile (ATS-3 OES unit) participated.

"Rescue 621 departed the group campsite at 0700L and arrived at the Ranger Headquarters, 0715L, dropping off Lt. Paul Villery and Goddard Mobile 3 transceiver operator. The US Forestry personnel provided transportation to the Big Meadow area. At 0835L a ground test of Goddard Mobile 3 was conducted prior to its flight in the Navy Lemoore helicopter. In today's test were five different areas that were considered no communications capability areas by the

US Forestry Service. These locations by importance and by test are: (1) Lake Vernon, (2) Twin Lakes, (3) Ireland Lake, (4) Moraine Mountain, and (5) South Wawona. In all the areas noted the Goddard Mobile 3 worked in an outstanding manner."

6.2 AIR FORCE EVALUATION

The following items are quoted from the Air Force Military Airlift Command final report on the ATS-6 communications experiments. [10]

"Abstract

"The lack of responsive communications in remote areas or areas of degraded communications often causes unnecessary delays in providing relief to people in distress. A satellite communications system developed by NASA was evaluated to see if this void could be filled by using non-terrestrial systems. The basic objectives of the test were to see if a centrally coordinated communications system was suitable, reliable, and effective during SAR missions in areas of limited communications capability. Transceivers were installed in jeeps, stationed at 303 ARRS (R), March AFB CA, and at 305 ARRS (R), Selfridge ANGB MI, and in the AFRCC at Scott AFB IL. The jeeps were kept on alert for development aboard unit HC-130 aircraft.

"It was determined that this type system was very well suited to SAF missions because of its ability to operate independently of local weather, geographical or conventional communications conditions. The equipment was very reliable and always provided an effective line of communication between the AFRCC and on-scene operators.

"The test concluded that a centrally coordinated communications system is highly desirable; the equipment tested was very reliable; and, space communication systems give controlling agencies the ability to maintain direct contact with on-scene coordinators regardless of local conditions.

"Recommend MAC/ARRS continue to support satellite communications systems with characteristics similar to ATS-

6 for SAR applications.

"ATS-6 AID IN TEXAS TORNADO DISASTER

"A tornado in the Wichita Falls TX, area had caused tremendous damage to the city and had knocked out all but one commercial telephone line. This line was clogged with personal distress calls. The State Emergency Operations Center (EOC) in Austin TX, had no dependable communications with the disaster area. At the request of the Texas Department of Public Safety (DPS), one of the jeeps was placed at the EOC in Austin and the other was placed at the Wichita Falls Highway Patrol Office. The jeeps established the only continuous communication link between the state capital and the disaster scene. This link insured that needed materials and emergency services were expedited into the area.

"The Wichita Falls deployment identified the desire to be able to patch the satellite system into the other conventional communications equipment carried on in the jeeps. MSgt William Kratch, 303 ARRS (R), installed a small, low-cost patching system in the 303rd jeep. This system allowed any system carried on in the jeep (HF, UHF, VHF, FM) to be patched into the satellite with very good quality. This capability was used effectively during the Howard AB CZ, deployment.

"During the Canal Zone deployment, the 303 ARRS (R) jeep used its patching capability to connect arriving MAC airlift and ARRS aircraft to the MAC Operations Center (MAC/OC) and Rescue Operations Center (ROC) at Scott AFB IL. The MAC/OC and ROC were able to talk directly with the aircraft on a real-time basis. Unlike the deployed W-3 communication vehicles, the ARRS jeep was able to communicate via satellite, conventional, and patched satellite/conventional systems.

"FINDINGS:

"a. Objective a: To assess the operational suitability of a centrally coordinated communications system

for use in SAR missions where conventional communications systems are limited or nonexistent.

"FINDING: This type communications system is particularly well suited for use in SAR missions. It is independent of on-scene conditions. Varying climatic and geographical environments had little or no effect on the excellent quality of the transmissions. The only restriction encountered was when the antennas' view of the satellite was blocked by dense materials such as buildings, mountains, or large trees. The remedy was to simply move the jeep or portable antenna to allow an uncluttered line-of-sight view of the satellite. The jeeps were able to communicate while driving, and depending on their geographic location, required little or no setup time. They were ready to begin direct communications with the AFRCC as soon as they excited their transporting aircraft. This ability to quickly pass information at a high transmission quality reduces the possibility that the controlling agency will lose contact with, and control of a rapidly developing SAR mission.

"b. Objective b: To evaluate the functional reliability of the system during actual SAR mission and operation training exercises.

"FINDING: The ATS-6 equipment performed without problems during the test period. At no time did any of the components fail. Minor field tuning adjustments by the radio operators were made to insure that the high quality transmissions were kept at optimum levels. The battery packs for the portable briefcase unit encountered a minor difficulty which NASA technicians attributed to improper charging technique.

"c. Test Objective c: To examine the effectiveness of space communications equipment during coordinated SAR missions.

"FINDINGS:

"(1) During the test, the effectiveness of this system was compared to conventional long-range high freq-

uency (HF) communications by attempting to establish HF phone patches from the same areas the jeeps were in. In those cases where an HF patch was possible, the satellite system was far superior. The patches were characterized by normal HF noise and delays, and were often difficult to understand, particularly during periods of poor weather conditions. The satellite transmissions were always crisp and clear regardless of the weather. Everyone who heard the radio in operation was impressed with the transmission quality."

TABLE 6.1

SUMMARY OF ATS-6 TRANSCEIVER QUESTIONNAIRE

	<u>MAY 14</u>	<u>MAY 15</u>	<u>MAY 16</u>	<u>MAY 17</u>
Weather Conditions	Clear	Clear	Clear	Clear
Elevation	3966 to 8357	Variable (see Remarks Section)	3966	3966
Terrain	Heavy forest to clear	All kinds (see remarks)	Mountainous	Mountainous
Foliage	Heavy to light	Heavy to clear	Medium to light	All kinds
How do you rate the ease and simplicity of operating this system compared with other ground-to-air and air-to-air radios?	Easier	Easier	Easier	Easier
Do you anticipate any components of the system may require excessive maintenance?	None	None	None	None
How do you rate the reliability of the system under the climatic conditions experienced?	Very good	Very good	Very good	Very good
How did the system function in various geographical environments, e.g., mountains, desert, etc.	Excellent	Excellent	Excellent	Great
Describe any problem areas encountered and your recommended corrective actions.	None	None	None	None
How do you rate the effectiveness of the radio during operational use?	Out- standing	Very good	Very good	Very good
In your estimation, does it improve present systems enough to be considered for ARRS use?	Yes	No question about it - it works!	No question about it	Excellent coverage

7.0 PROPAGATION

This section presents an evaluation of the communications, a description of how the data were taken, a summary of communications effectiveness in terms of propagation variables, and a comparison of satellite and terrestrial propagation effects in land mobile radio communications.

Propagation factors for the satellite are much different than for terrestrial communications because the satellite repeater is located at high elevation angles and at a nearly uniform, very long distance from all mobiles. The high elevation angles permit the use of mobile antennas that discriminate against ground reflections and reduce the effects of multipath.

The experiment produced a set of propagation data that is significantly different from most satellite communication data because the ground stations were in motion, using short antennas and low power. It was made possible by the large antenna of the ATS-6 satellite plus an extension of the newly available 806 MHz land mobile equipment.

Table 5.2 shows a total of 603 hours of satellite time was used for the experiments conducted with the Smith Transfer trucks. Additional data were taken using two-way communications to the satellite from a flying helicopter and from a portable "briefcase" transceiver developed by Dr. James P. Brown of NASA-Goddard.

All transmission were recorded at General Electric's Earth Station Laboratory near Schenectady using a high quality open reel tape recorder. Signal strength of the received signals from the satellite transponder were recorded on a chart recorder that had a frequency response of approximately 100 hertz.

As described in section 3.0, Touch-Tone[®] signals were used to address the individual station being called. An Automatic Transmitter Identification System (ATIS) also used automatic Touch-Tone[®] signals with a burst automatically transmitted each time a microphone transmit button was pressed. The Touch-Tone[®] signals were also recorded on the data magnetic tape recorder. The received Touch-Tone[®] signals were displayed on a digital LED read-out. Digital time was added on a second track of the recording as generated by the Earth Station Laboratory PDP-11 computer corrected by a precision GOES satellite time receiver and clock.

A second by second playback of all communications was made by an observer using high quality earphones. For each transmission he recorded the

subjective data of signal quality on the standard Q1 to Q5 scale. Q4 to Q5 is considered to be commercial communications quality with lower quality being useful but not considered communications quality. In this playback the success of signaling a truck by means of the Touch-Tone[®] address sent by the dispatcher was noted. The correctness of the truck's response as a visually displayed vehicle identification number (ATIS) was recorded by the observer. Also recorded was the area of operation of the vehicle and the general terrain; that is, whether in mountains and hills or passing through underpasses. Other factors such as foliage and trees blocking the view toward satellite were noted.

Thus two types of data were taken:

- Touch-Tone[®] signaling accuracy - by determining correctness of the digital display.
- Subjective determination of signal quality - by listening to the recorded conversation.

At the beginning of the experiment, the center of the satellite beam was pointed at 85°W, longitude 40°N, latitude as discussed in section 3.2 and illustrated in figure 3.3. Between files 593 and 594 on approximately December 20, 1978, the pointing of the satellite was changed to 85°W, 38.3°N in order to achieve a beam footprint that more nearly matched the operations of Smith Transfer. Even at the revised pointing their operations in the southern Piedmont area of Georgia and South Carolina were on the edge of the beam footprint. This presented the additional opportunity to see the effect of signal dropoff at the edge of a beam footprint and the probable effectiveness of such isolation of footprints on a given frequency. For consistency only those data taken when the satellite beam was centered at 85°W, 38.5°N were used in the discussions of this section unless specifically stated to the contrary.

7.1 COMMUNICATIONS PERFORMANCE EVALUATION

7.1.1 Digital Tone Encoded Communications

The digital tone encoding sequence used dual tone multifrequency coding known more familiarly as Touch-Tone[®]. The Automatic Transmitter Identification System (ATIS) sent a sequence of four digits for vehicles and five digits for the dispatch station. Table 7.1 is a summary of the responses that were received and success in decoding the received transmissions correctly on the decoder as seen by the operator on the digital LED display.

TABLE 7.1

SUCCESS IN DECODING
DTMF AUTOMATIC TRANSMITTER
IDENTIFICATION FROM VEHICLE
With Satellite Pointed To
38.5°N, 85.0°W.

REGION	STATES	ATIS TRANSMISSIONS		ELEVATION
		Received & Decoded Correctly	Sent by Vehicle	Angle to Satellite
Open Plains	Ind., Ohio, Neb., Illinois, Iowa	283	284	17° - 26°
Western Appalachian Foothills	Ohio, Tennessee	53	55	15° - 19°
Appalachian Mountains	West Virginia	93	112	15° - 17°
Piedmont	Virginia	54	58	14° - 15°
Piedmont	Virginia, North Carolina	124	132	11° - 16°
South Piedmont	Georgia South Carolina	21	49	17° - 18°
TOTAL		628	690	

- Overall Success = 91% Received
- Without South Piedmont = 95% Received

The data are shown for five regions, with one region, the Piedmont, subdivided into the largest portion of the Virginia Piedmont, and that part that is in North Carolina and neighboring Virginia.

The elevation angle from the vehicle to the satellite varied across the footprint from a low of 11° in the Piedmont area of North Carolina to 22° on the western foothills of the Appalachians. The satellite elevation angle rose to a high of 26° in the mid-western plains states but few terrain features blocked the satellite signal path in these open areas. The southern Piedmont area of Georgia and South Carolina was on the edge of the satellite footprint. All other areas of the experiment were within the satellite footprint. (Figure 3.3)

There were a total of 690 ATIS transmissions sent by the vehicle through the satellite and received at the Schenectady Earth Station Laboratory. Six-Hundred Twenty-Eight (628) of these transmissions were received and decoded correctly, thus the overall success rate was 91%. As a result of the sharp dropoff of signals at the footprint edge in Georgia and South Carolina only 21 of 49 of the transmissions were received correctly for a 43% success rate. If data from that area is subtracted from the overall data, the remaining regions have a 95% record of correctly received Touch-Tone[®] messages.

7.1.2 Voice Communications

Table 7.2 is a summary of the voice communications quality achieved. Quality of the transmissions were subjectively judged from Q1 to Q5, Q1 being unintelligible and Q5 being completely intelligible or excellent. Q4 and Q5 are considered to be desirable commercial quality although lower quality such as Q3, could provide useful commercial communications. Table 7.3 more completely defines the subjective grading indexes Q1 - Q5. The authors have considered that Q1, Q2, and Q3 are less than desired commercial quality. On that basis, commercial communications quality was achieved on over 91% of the total communications. Exclusion of those communications which were out of the footprint or beyond the 3 dB contour of the ATS-6 antenna pattern in the Southern Piedmont region results in an overall commercial quality communication of voice for 93% of the time. These results agree closely with the more objective testing numbers for the Touch-Tone[®] signal decoding accuracy.

TABLE 7.2

VOICE COMMUNICATIONS SIGNAL QUALITY*

AREA	TRANSMISSION TIME (Seconds)	NO BLOCKAGE TIME (Seconds)		OVERPASSES (Momentary Dropouts)			MOUNTAINS AND HILLS			TREES			STRUCTURES		
		Q5	Q4	Q3	Q2	Q1	Q3	Q2	Q1	Q3	Q2	Q1	Q3	Q2	Q1
Open Plains	2481	2334	73	13	2	20	4	1	3	1	1	0	15	10	4
Western Foothills	344	311	2	0	0	0	6	12	13	0	0	0	0	0	0
Appalachian Mountains	1037	614	267	0	2	7	20	31	37	43	17	0	0	0	0
Piedmont	1219	482	625	4	1	4	25	16	10	5	15	19	8	4	1
Southern Piedmont	270	0	146	0	2	0	0	0	0	107	3	12	0	0	0
TOTAL TIME (Seconds)	5351	3741	1113	17	5	33	55	60	63	155	36	31	23	14	5
		4854													

114

* TOTAL TIMES IN SECONDS FOR EACH QUALITY OF RECEIVED SIGNALS

NOTE:

Q5 = Excellent

Q1 = Unintelligible

TABLE 7.3

Q - SIGNAL DEFINITIONS

- Q5 • readable with almost no difficulty
- Q4 • readable with little difficulty
(could understand all words)
- Q3 • readable with considerable difficulty
(occasionally lost words); repeats
sometimes required
- Q2 • poor readability (only occasional words
and phrases could be understood)
- Q1 • only signal presence could be discerned
(also included times when signal blocked
briefly by obstructions, such as under
an overpass)

Table 7.2 and 7.4 present the reasons why 7% of communications were not of commercial quality when the vehicle was in the footprint of the satellite. These data were assembled with the excellent gratifying cooperation and perception of the Smith's Transfer drivers. Table 7.4 expresses fraction of time that signals were disturbed as a percent of the total transmission time of the trucks in specific geographic areas.

For example, Table 7.2 shows that highway overpasses degraded the signal for a total of 35 seconds as the trucks transmitted for 2481 seconds in the open plains region of the midwestern United States. Table 7.2 also indicates that overpasses often completely blocked the signal from the truck as indicated by the Q1 signal time of 20 seconds as compared to the Q2 and Q3 time. This complete blockage might be expected as interstate highway overpasses are usually quite large and opaque to UHF radio signals. It should be noted however, that the truck signal did not always fall off and return in an absolutely sharp manner. The truck signal was often readable for some distance into the overpass although the quality degraded to Q3 or worse rather quickly. Truck signals were heard best beneath overpasses when the truck travelled directly toward or away from ATS-6, an effect probably due to the low elevation angle to the satellite. Overpasses interrupted the truck transmissions most abruptly and for the longest intervals when the truck travelled along a road perpendicular to the satellite azimuth direction.

Table 7.4 shows that overpasses interrupted the satellite signal path from the trucks more than any other reason in the Open Plains region. The total blockage time of 35 seconds represents 1.4% of the total truck transmission time in the Open Plains region.

The fraction of time that overpasses interrupted communications as determined from this data may actually exceed the true outage time by a substantial amount. One second was the smallest interval of time recorded for a signal interruption and small overpasses carrying a single road may have interrupted the beam for less than one second. If an error exists, the data presented are conservative showing more blockage than actually existed.

Structures such as buildings in larger towns were the only other significant factor affecting propagation in the open plains. Table 7.2

TABLE 7.4

VOICE COMMUNICATIONS SIGNAL RELIABILITY
WITH SATELLITE POINTED TO 38.5°N, 85.0°W

Start first line of table

<u>Geographic Area</u>	<u>Transmission Time (Seconds)</u>	<u>Percent of Time Path was Blocked</u>				
		<u>No Blockage</u>	<u>Overpasses</u>	<u>Mountains or Hills</u>	<u>Trees</u>	<u>Structures</u>
Open Plains	2481	97.0	1.4	0.3	-	1.2
Western Foothills	344	91.0	0	9.0	0	0
Appalachian Mountains	1037	85.0	0.9	8.5	5.7	0
Piedmont	1219	90.8	0.7	4.2	3.2	1.1
Subtotal In Beam	5081	92.7	1.0	3.5	1.9	0.9
Southern Piedmont (Beam Edge)	270	54.1	0.7	0	45.2	0
TOTAL	5351	90.7	1.0	3.3	4.2	0.8

shows such structures usually degraded the signal only to Q3 as the signal path just grazed to the top edge of the structure. The low elevation angle of ATS-6 in the area of operation caused results that were more pessimistic than a future operational satellite. The higher elevation angles 30° to 56° to an operational spacecraft optimally located south of the contiguous 48 states would mean only tall city buildings would block the satellite signal path.

As might be expected, the communications reliability from the truck was best in the midwestern open plains at an overall rate of 97%.

Although only 344 seconds of transmission data were available for the Western Foothills region, Table 7.4 shows a sharp increase in the fraction of time that the signal path was obstructed mountains or hills. The blockage rate increased from 0.3% in open plains to 9.0% in the western Appalachian foothills. From the large amount of Q1 vs. Q3 time shown in Table 7.2, it is evident that hills and mountains are very opaque to radio waves at L-Band frequencies. In fact, if a mountain completely blocks the truck-to-satellite path, no propagation can occur. The Q2 and Q3 marginal signal quality categories would only result when the satellite path just grazes a hilltop or passes through isolated tree branches at the top of nearby hills.

The radio signal propagation trends observed in the western foothills region continue in the Appalachian mountains proper. Mountains and Hills in this region interrupted communications more often than any other cause. The Appalachian mountain propagation data is more significant than the foothills data because nearly 3 times as much data is available.

The data also show that trees block the satellite signal nearly 6% of the time in the mountain region where trees do not even appear in the data in the foothills region. One explanation may be that the trucks used more narrow state roads in the Appalachian Mountain region than in the foothills, thereby coming closer to trees. Another reason may have been that tree blockage could not be distinguished from hill blockage on the audio tapes made of conversations in the foothills. Only the random comments of the truck drivers on the tape helped to distinguish these categories.

From Table 7.2 the distribution of Q3 time as compared to Q1 time for tree blockages in the Appalachian Mountains indicates that many times signals are interrupted only briefly or just decrease somewhat in strength.

This characteristic is consistent with a signal path rapidly passing through isolated tree branches or grazing the top of a grove or forest. Careful tests conducted in a vehicle near the Earth Station Laboratory at a 9° elevation angle to ATS-6, show that an L-Band signal passing through the center of single tree is attenuated more than 20 dB, a value of link margin that is probably not practical for satellite-aided mobile radio systems. Fortunately the higher elevation angle of an operational satellite will undoubtedly raise the unblocked time fraction in the Appalachian Mountains from 85% to more than 90%, a value currently accepted as adequate in the land mobile community.

Finally, the satellite signals were found to be more reliable in the Piedmont area of central and eastern Virginia and North Carolina than in the mountainous regions even though the elevation angle to ATS-6 was lower in the Piedmont area. As in the foothills and in the mountains, hills represent the most important cause of signal blockage followed closely by trees. Hills interrupted the signal path 4.2% of the time and trees intervened 3.2% of the time. Structures blocked the beam only 1.1% of the time and overpasses 0.7%. As in all other regions, the higher elevation angle expected to an operational satellite would improve signaling reliabilities.

The four regions discussed above have all been within the 3 dB beam width of the ATS-6 pencil beam. Line 5 of Table 7.4 shows a weighted average of the signal reliability for the total transmission time of the trucks in these four regions. Overall communication reliability was found to be approximately 93% within the ATS-6 beam.

Tables 7.2 and 7.4 show one remaining geographic area that must be discussed separately because it was outside the 3 dB contour of the ATS-6 pencil beam. Figure 3.3 shows that trucks on the road in most of Georgia and South Carolina were outside of the satellite beam. The propagation data strongly confirms this fact although the data sample for this region is rather small at 270 seconds. Of the 270 second total, no excellent signals were recorded and only 146 seconds of adequate Q4 signal strength were observed. Communications were affected a great deal by even the slightest amount of foliage as the link margin was considerably smaller in this area outside the beam. Communications were reliable for only 54% of the time in this out of beam region.

The rapid drop of signal levels outside the beam shows that frequencies could be reused in a multibeam satellite if the same frequencies were not

used in immediately adjacent cells.

Two auxiliary data tables have also been included in this subsection to report the remaining propagation data that was timed and analyzed during the experiment. Tables 7.5 and 7.6 contain propagation data gathered with the ATS-6 satellite pencil beam pointed too far north at 40°N latitude, 85°W longitude.

The general trends observed in table 7.2 and 7.4 are also seen in the auxiliary data with a few noteworthy exceptions. First, the "Other Causes" column in table 7.6 replaces the "Structures" column of table 7.4 primarily because of the Southern Piedmont entry in this column in table 7.6. With the satellite pointed further north, the primary cause for communications failure in the Southern Piedmont is simply insufficient signal strength due to improper satellite antenna beam pointing. Entries in the "Other Causes" column for the other regions reflect structure interference as well as other unidentifiable causes for poor signals. At least half of the time entered under "Other Causes" in the Open Plains and again in the Piedmont was caused by a radio microphone failure that was later repaired.

As mentioned in the description of the data gathered with the proper satellite pointing angle, the tape analyst found it quite difficult to distinguish path failure due to trees from path failure due to hills and mountains unless the truck drivers specifically stated the nature of their surroundings. For purposes of comparing data it becomes necessary to group the "Mountains and Hills" time with the "Tree" blockage time. If this grouping is done, the auxiliary data agrees fairly well with the data taken at the proper satellite pointing except, of course, in the out of beam Southern Piedmont.

TABLE 7.5

VOICE COMMUNICATIONS SIGNAL QUALITY*

Auxiliary Data
With Satellite Pointed Too Far North at 40°N, 85°W

Start First Line of W

Geographic Area	Transmission Time	No Blockage Time		Overpasses Momentary Dropouts			Mountains and Hills			Trees			Other Causes		
		Q5	Q4	Q3	Q2	Q1	Q3	Q2	Q1	Q1	Q2	Q1			
Open Plains	4699	4467	81	9	8	29	0	0	0	41	5	2	35	3	19
Western Foothills	1187	978	117	4	6	4	0	0	0	28	6	44	0	0	0
Appalachian Mountains	2811	2214	333	0	0	3	60	31	17	92	22	26	11	0	2
Piedmont	1055	774	207	0	0	1	1	0	0	17	14	19	5	0	17
Subtotal IN Beam	9752	8433	738	13	14	37	61	31	17	178	47	91	51	3	38
Southern Piedmont (Outside Beam)	909	108	247	0	0	5	0	0	0	33	4	6	493	0	13
TOTAL	10661	8541	985	13	14	42	61	31	17	211	51	97	544	3	51

* Total Times in Seconds
for Each Quality of Received Signals

TABLE 7.6

VOICE COMMUNICATIONS SIGNAL RELIABILITY

Auxiliary Data

With Satellite Pointed so Far North at 40°N, 85°W

Start first time of year

<u>Geographic Area</u>	<u>Transmission Time (Seconds)</u>	<u>Percent of Time Path Was Blocked</u>				
		<u>No Blockage</u>	<u>Overpasses</u>	<u>Mountains or Hills</u>	<u>Trees</u>	<u>Other Causes</u>
Open Plains	4699	96.8	1.0	0	1.0	1.2
Western Foothills	1187	92.2	1.2	0	6.6	0
Appalachian Mountains	2811	90.6	0.1	3.8	5.0	0.5
Piedmont	1055	93.0	0.1	0.1	4.7	2.1
Subtotal In Beam	9752	94.0	0.7	1.1	3.2	0.9
Southern Piedmont (Out of Beam)	909	39.1	0.6	0	4.7	55.7
TOTAL	10661	89.4	0.6	1.0	3.4	5.6

7.2 COMPARISON WITH PROPAGATION IN TERRESTRIAL LAND MOBILE SERVICE

Start The propagation characteristics for satellite land mobile service are much different than those of the terrestrial land mobile communications services. The differences result because the range from the satellite to the land mobile is essentially constant over the total land operating area of the vehicle, and because the geometry of reflections in the signal paths are markedly different. The satellite is at a long distance that is not much different in range from one edge of the footprint to the other. In a terrestrial situation the vehicle can drive within a few meters of a terrestrial base station or it can be at a distance equal to the extreme range to be served; a ratio that may exceed 100:1. Thus the amplitude difference of signals due to range differences is very much different for the two cases. In the terrestrial case, the angle of arrival from a terrestrial station may also range from 90° (vehicle passing in the street in front of building containing the base station) to the more usual case of nearly a zero degree arrival angle over most of the coverage area of the base station.

One of the most striking characteristics of satellite communications compared to terrestrial land mobile is the lack of fast flutter and fading that is characteristic of terrestrial VHF and UHF systems. A signal received by a land mobile from a terrestrial tower contains a combination of direct signals plus reflected rays from a large number of reflectors.

Signal fading characteristics of terrestrial mobile links are usually described by Rayleigh statistics. In most areas, especially urban, many reflectors in and near the path between the mobile and base station cause rapid, deep fading as the vehicle moves because there are rapid changes in the phasor sum of the received multipath signals. On open flat plains there may be few reflectors, the principle one being the ground surface. The fading may then be less random than Rayleigh but the fades can be very deep especially if the vehicle antenna radiates toward the ground and the ground reflectivity is high.

Signal fades on satellite links are very small if the vehicle antenna is designed to take advantage of the relatively high elevation angle of the satellite. The ground reflection component is then reduced to small significance. The high arrival angle of satellite signals also reduces the likelihood that objects will be near the path to block or reflect signals causing signal strength fluctuations. For those cases where the vehicle is not

in direct view but is blocked by a mountain, or momentarily by a tree, then the signal drops abruptly from full value to a very low value and returns to full value as the vehicle moves. Otherwise, steady signals are passed between the satellite and the land mobile vehicle.

Figure 7.1 is a direct copy of two signal recordings made of land mobile signals. The chart on the right is that of a vehicle traveling at normal highway speeds in the town of Schaghticoke, New York, 24 miles distant from the pickup point at the Schenectady Laboratory. The land mobile was operating in the terrestrial service at approximately 150 megahertz. The area around the vehicle was suburban to rural and is an area of rolling ground on the east side of the Hudson Valley. There were rapid signal variations of 20 to 30 dB. This recording shows a conventional land signal with typical Rayleigh fading statistics.

The chart on the left of Figure 7.1 illustrates typical signals being received through ATS-6 from a Smith Transfer truck. Notice that the signal varies slowly with a peak-to-peak fluctuation of two or three dB at most. This means that excellent commercial grade communication can be obtained with satellite links that have a much smaller fading margin than is needed for terrestrial links.

Space diversity reception using dual antennas helps to overcome Rayleigh fading in terrestrially based 900 MHz systems, but diversity reception offers little benefit for satellite-aided land mobile systems. Antennas used in diversity mode for land mobile terrestrial systems would also be satisfactory for satellite systems, however.

7.3 HELICOPTER COMMUNICATIONS

Tests were conducted from a helicopter with a suitcase carried transceiver developed by Dr. James P. Brown of NASA-Goddard. The helicopter is shown in the photo, Figure 7.2. The rotor blades interrupted the path between the satellite and helicopter antennas each time the blade passed between them. The helicopter rotor has two blades. It was estimated that the satellite signal path was interrupted by the rotor blade at a radius of about six feet. Since the rotor blade is approximately a foot in width it interrupted the path approximately 2.8% of the time.

Figure 7.3 is a recording of signals from the helicopter. The chart speed was 25 millimeters per second. It is obvious that the pen width of the chart could not resolve the interval that the signal dropped, but one

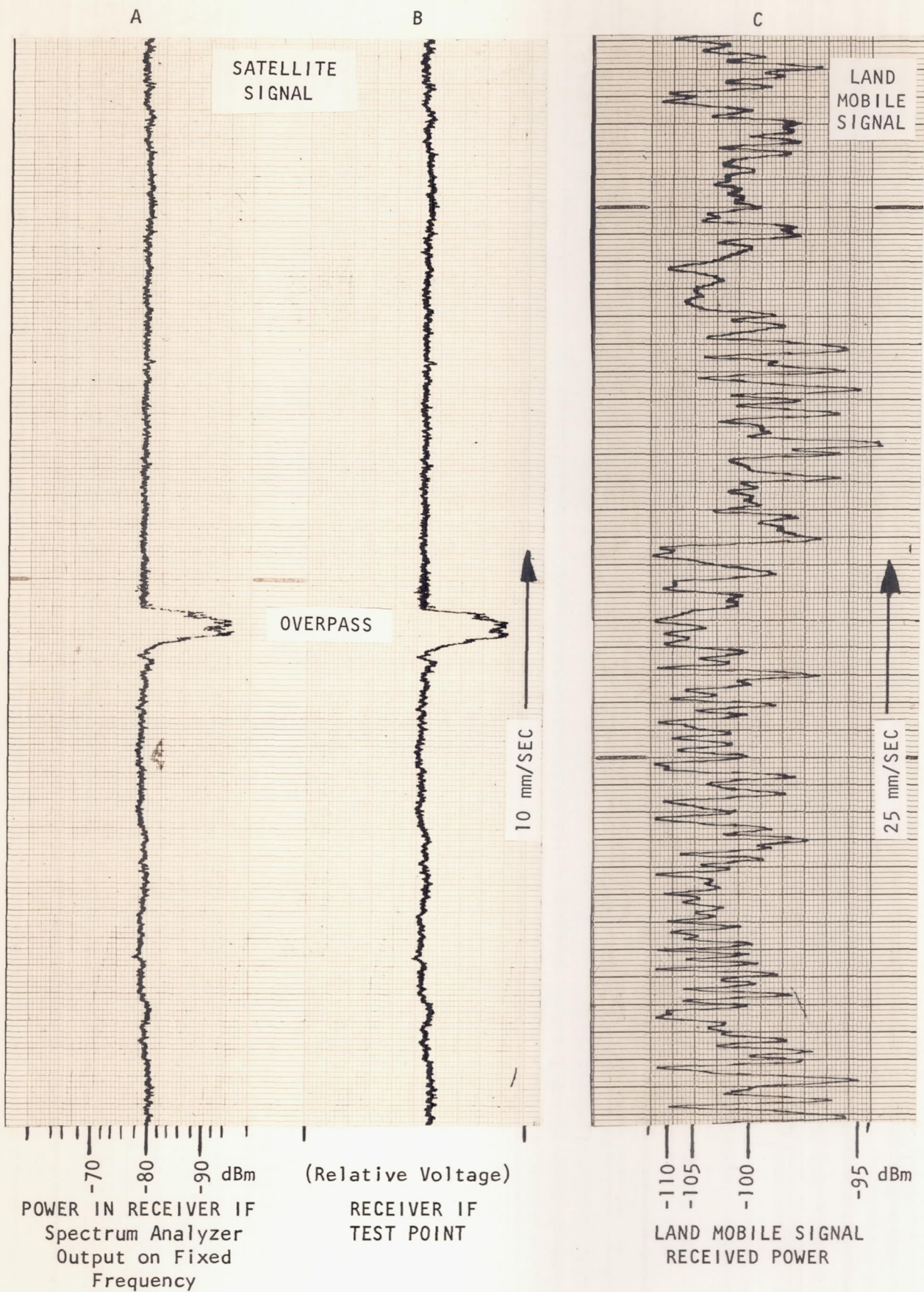

FIGURE 7.1
 COMPARISON OF SATELLITE RELAYED SIGNALS
 AND 150 MHz TERRESTRIAL LAND MOBILE SIGNALS



FIGURE 7.2
PHOTOGRAPH OF HELICOPTER USED FOR IN FLIGHT SATELLITE COMMUNICATIONS

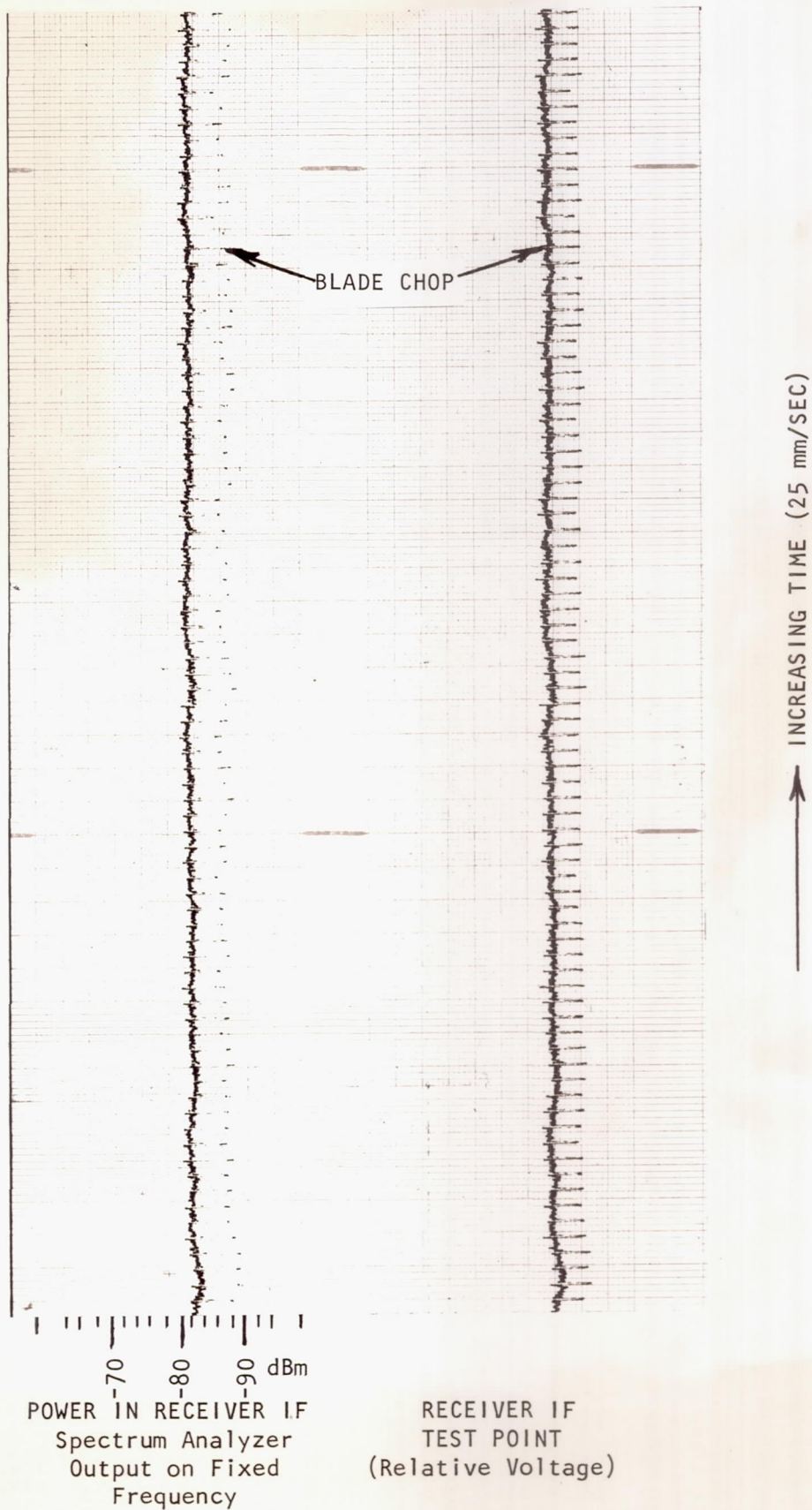

FIGURE 7.3
SIGNALS FROM HELICOPTER IN FLIGHT
VIA ATS-6 SPACECRAFT

can see the brief straight lines showing the rotor blade interference. Again, typical of satellite communications only the brief clean chop of the signal path is noted. Not knowing the rotor speed, it was deduced from the speed of the chart and the spacing of the twice per rotation line to be 320 rpm. The actual dropout time was then approximately 2.5 milliseconds. Based on other two-way FM systems, it is expected that if the rotor interrupt time caused the audio to be blanked for 2.5 milliseconds, it would be difficult for the ear to detect any rotor effects.

An observer listening to the signal coming through the satellite has the impression that he is listening to someone talking while near an operating helicopter rather than listening to a signal which is being chopped by the blades. Intelligibility was good.

7.4 TABULATION OF PROPAGATION RESULTS

The propagation characteristics for satellite land mobile communications that were studied during these experiments with ATS-6 at L-band lead to the following conclusions:

- Satellite land mobile communications worked well and predictably to vehicles in non-urban areas.
- Clutter fading is minor, but complete blockage occurs from large nearby buildings and highway underpasses.
- Trees cast a sharply defined shadow in a satellite L-band beam: individual trees cause brief dropouts in communications between vehicle and satellite.
- Satellite footprints can be used to define a coverage area and form the basis for development of a well-defined adjunct to a terrestrial cellular type system.
- Satellite communications to helicopters are practical.

CONCLUSIONS

1. It is practical to construct mobile radio communications equipment for communications through geostationary satellites that is no more complex or expensive than present-day land mobile equipment for terrestrial links.
2. Communication reliability exceeded 93% for vehicles traveling over routes in the midwestern prairies, the Appalachian mountains, and the eastern and southern piedmonts where the satellite elevation angles were between 9° and 24° . The angles were low in the mountainous regions. An operational system with higher elevation angles would provide higher reliability. The reliability estimate includes momentary dropouts as the vehicles drove under overpasses, which were about the only cause of dropouts on the midwestern highways.
3. Multipath reflection effects are much smaller in properly designed mobile satellite links than they are in terrestrial links so that fading margin allowance can be of the order of 20 dB less than the usual 20 to 30 dB required for terrestrial links.
4. Vegetation is a serious screen to the signals at L-band. Any object, including structures, hills or foliage in the direct path between the vehicle and satellite will reduce the signal by an amount that cannot be overcome by any reasonable allowance for fading margin in a satellite system design.
5. The blockage effects of objects in the signal path are sharply defined. If an operator can see a clear path in the direction of the satellite, the communications are reliable.
6. The management of Smith Transfer found little use for the satellite communications. While communications from their terminals to central dispatch are vital to their operation, direct communication from enroute trucks to dispatcher would contribute little to efficiency of their operations as a regulated carrier

on fixed routes. They volunteered that the communications might be valuable to independent truckers, especially to facilitate cargo brokering.

7. Smith Transfer management estimated that the satellite communications resulted in a saving of 3 hours in their operations during 409 truck-house of satellite availability (satellite time availability multiplied by satellite-equipped trucks in operation).
8. Driver reactions to the satellite communications were favorable. They found them convenient, reliable and useful in many situations. They were effective participants in signal reliability and propagation tests. They stated a preference for the dispatch mode of operation over a suggested radio telephone implementation.
9. Dispatchers generally found the experiment to be a distraction from their normal duties. They should have been provided with a conveniently located telephone style handset rather than a separate speaker and microphone installation.
10. Channel occupancy per truck for business purposes was 0.36 percent of the total time that the trucks were in service while the satellite was available.
11. The Air Force and National Association for Search and Rescue found the satellite-aided communications to be superior to any other means of long distance communications from disaster sites, remote areas, and in rugged terrain.

9.0 RECOMMENDATIONS

1. NASA should proceed with its narrowband communication program. The land mobile portion of the program should emphasize the use of satellites to augment the planned terrestrial cellular type mobile radio telephone systems. The next effort in the program should be a study to obtain realistic estimates of economic feasibility and the institutional, regulatory and technical problems including the problem of equipment compatibility between terrestrial and satellite services. A technology readiness program should be initiated, including the development of large aperture, multibeam spacecraft antennas.
2. NASA should continue to honor requests for the use of ATS-3 and ATS-1 in mobile communications demonstrations provided that the requested demonstrations are on behalf of a potential community of mobile satellite users and further provided that they understand an operational system will not be available soon and will operate much differently than the ATS demonstration.
3. An experiment should measure the reliability of vehicle-satellite signal paths as a function of satellite elevation in all types of terrain and regions of the country. The suggested experiment is conducted on cloudless days. A photocell exposed to the sun is mounted on top of a vehicle and is connected to a recorder in the vehicle. Time, date and location are recorded as the vehicle travels. The output of the photocell drops when the vehicle passes in the shadow of an object, just as the signal from a satellite would be blocked if the satellite were at the elevation of the sun. Time, date and location yield the elevation to the sun. The percentage of satellite outage time is the percentage of time the vehicle was in shadows. Duration of individual dropouts is the duration of individual shadows. Analysis of the data as a function of elevation angle will be very useful for evaluating the reliability of the satellite links.

10. REFERENCES

1. Final Report, "Application of Satellite Communication and Position Fixing Techniques to Land Mobile Systems," January-November 1976 Contract DEA-76-20, General Electric Report SRD-77-001.
2. Brisken, A. F. et al, "Land Mobile Communications and Position Fixing Using Satellites," IEEE Transactions on Vehicular Technology, Vol. VT-28, No. 3, August 1979, page 153.
3. "Satellite-Aided Mobile Radio Concepts Study," Final Report June 1979, Contract No. NAS5-25134, General Electric Document No. 79SDS4240.
4. "The ATS-F and -G Data Book," NASA-Goddard Space Flight Center, October 1971, Revised September 1972.
5. John Q. Howell, "Microstrip Antennas," IEEE Trans. on Antennas & Propagation, Vol. AP-23, January 1975, pp. 90-93.
6. Robert E. Munson, "Conformal Microstrip Antennas and Microstrip Phased Arrays," IEEE Trans. on Antennas & Propagation, Vol. AP-22, January 1974, pp. 74-78.
7. J. D. Dyson, P. E. Mayes, "New Circularly-Polarized Frequency-Independent Antennas with Conical Beam or Omnidirectional Patterns," IRE Trans. on Antennas and Propagation, Vol. AP-9, July 1961, pp. 334-342.
8. H. A. Wheeler, "A Vertical Antenna Made of Transposed Sections of Coaxial Cable," IRE Convention Record, 1956, pp. 160-164.
9. National Association for Search and Rescue, "Applications Technology Satellite Integrated Experiment Operational Test Plan 14, 15, 16, 17 May 1979," dated 2 May 1979, Lois Clark McCoy, Principal Investigator.
10. "Operational Test and Evaluation," MAG Final Report 24-8-78 Applications Technology Satellite Six Communication System, October 1979 Directorate of Operational Requirements DCS/Plans Hq. Military Airlift Command Scott AFB, IL. 62225.