

3 1176 00168 1239

DOE/NASA/1028-31
NASA TM-81744

NASA-TM-81744 19810013941

Comparison of Upwind and Downwind Rotor Operations of the DOE/NASA 100-kW Mod-0 Wind Turbine

FOR REFERENCE
[Handwritten signature]
NOT TO BE TAKEN FROM THIS BOOK

John C. Glasgow, Dean R. Miller, and Robert D. Corrigan
National Aeronautics and Space Administration
Lewis Research Center

LIBRARY COPY

JUN 2 1981

LIBRARY, NASA
CAMPBELL, MISSOURI

Work performed for
U.S. DEPARTMENT OF ENERGY
Conservation and Solar Energy
Division of Wind Energy Systems

Prepared for
Second DOE/NASA Wind Turbine Dynamics Workshop
Cleveland, Ohio, February 24-26, 1981

NOTICE

This report was prepared to document work sponsored by the United States Government. Neither the United States nor its agent, the United States Department of Energy, nor any Federal employees, nor any of their contractors, subcontractors or their employees, makes any warranty, express or implied, or assumes any legal liability or responsibility for the accuracy, completeness, or usefulness of any information, apparatus, product or process disclosed, or represents that its use would not infringe privately owned rights.

**Comparison of Upwind and Downwind
Rotor Operations of the DOE/NASA
100-kW Mod-0 Wind Turbine**

John C. Glasgow, Dean R. Miller, and Robert D. Corrigan
National Aeronautics and Space Administration
Lewis Research Center
Cleveland, Ohio 44135

Work performed for
U.S. DEPARTMENT OF ENERGY
Conservation and Solar Energy
Division of Wind Energy Systems
Washington, D.C. 20545
Under Interagency Agreement EX-76-I-01-1028

Prepared for
Second DOE/NASA Wind Turbine Dynamics Workshop
Cleveland, Ohio, February 24-26, 1981

1781-22472

COMPARISON OF UPWIND AND DOWNWIND ROTOR OPERATIONS OF THE DOE/NASA 100-kW MOD-0 WIND TURBINE

John C. Glasgow
Dean R. Miller
Robert D. Corrigan

National Aeronautics and Space Administration
Lewis Research Center
Cleveland, Ohio

ABSTRACT

Tests have been conducted on a 38m diameter horizontal axis wind turbine, which had first a rotor downwind of the supporting truss tower and then upwind of the tower. Aside from the placement of the rotor and the direction of rotation of the drive train, the wind turbine was identical for both tests. Three aspects of the test results are compared: rotor blade bending loads, rotor teeter response, and nacelle yaw moments. As a result of the tests, it is shown that while mean flatwise bending moments were unaffected by the placement of the rotor, cyclic flatwise bending tended to increase with wind speed for the downwind rotor while remaining somewhat uniform with wind speed for the upwind rotor, reflecting the effects of increased flow disturbance for a downwind rotor. Rotor teeter response was not significantly affected by the rotor location relative to the tower, but appears to reflect reduced teeter stability near rated wind speed for both configurations. Teeter stability appears to return above rated wind speed, however. Nacelle yaw moments are higher for the upwind rotor but do not indicate significant design problems for either configuration.

INTRODUCTION

The Mod-0 100-kW Experimental Wind Turbine located near Sandusky, Ohio, has served as the major test facility for the U. S. Large Horizontal Axis Wind Energy Program since initial operation of the machine in 1975. The machine was designed, fabricated, and has been operated by the NASA Lewis Research Center as a part of the research and technology program under the direction of the U. S. Department of Energy. Many concepts in current use or planned for future use on wind turbines have been first evaluated on the Mod-0 machine.

The subject of this report, a comparison of upwind and downwind rotor operating characteristics, is the result of tests to describe the loads and operating characteristics of the teetered tip-controlled rotor with the rotor in turn downwind and upwind of the tower. Preliminary results of the downwind rotor configuration were presented previously in reference 1, but this report presents some new information for the downwind configuration and makes specific comparisons with the upwind rotor configuration.

The wind turbine test configuration was the same for both tests, only the direction of rotation was reversed when the rotor was put upwind of the tower; otherwise, the wind turbine and rotor were identical. Tests were conducted to determine loads and operating characteristics of each configuration and comparisons will be made of the following items: blade bending loads, teeter motion, and nacelle yaw moments.

TEST CONFIGURATION

The upwind and downwind rotor tests were conducted on the Mod-0 100-kW Experimental Wind Turbine in the teetered, tip-controlled rotor configuration described previously (Refs. 1 and 2). Toward the end of the downwind rotor test program and throughout the upwind rotor program a hydraulic motor was used for the nacelle yaw drive, replacing

the electric motor drive and double reduction worm gears used previously for orienting the nacelle in yaw. This greatly simplified the yaw drive and provided an effective method of measuring nacelle yaw torque. Otherwise, the nacelle and rotor were unchanged from earlier tests. A schematic of the Mod-0 nacelle with the teetered rotor and hydraulic yaw drive is shown in Fig. 1. The rotor is either downwind or upwind of the tower and the nacelle is tilted $8-1/2^\circ$ to provide tower clearance for the uncoined rotor. Wind speed and nacelle yaw angle are measured on the anemometer/windvane mounted atop the nacelle as shown in Fig. 1.

Drive train slip was 4.66% for the downwind rotor tests and only 2.32% for the upwind rotor tests, which resulted in a 33.0 rpm rotor speed at 100 kW for the downwind tests and a 32.6 rpm rotor speed at 100 kW for the upwind rotor tests.

Tower

The wind turbine is mounted on the Mod-0 open-truss tower; however, an adjustable spring base has been added to provide capability for simulating various tower flexibilities (Ref. 3). The tower first cantilever bending frequency for this test configuration was measured to be 1.6 to 1.7 Hz or 2.9 to 3.1 times the rotor speed at 33 rpm. The flexible tower base adds 1m to the rotor axis height placing it 31.4m above the ground at the tower centerline. Fig. 3 shows the wind turbine on the tower and also presents parameter definitions and sign conventions pertinent to the upwind and downwind rotor configurations.

Rotor

The teetered, tip-controlled rotor is depicted in Fig. 3. The rotor is uncoined, the blades have a 23% root cutout, and the outer 30% of span is pitchable. The blade section is a NACA 23024 airfoil from root to tip, and speed and power control is achieved by pitching the blade tip about its 25% chord point. The tip is capable of pitch angle changes from $+10^\circ$ to the full feather

position at -90° . The tip is driven by a hydraulic actuator and the rotor is stopped by feathering the blade tip at a rate of 2° per second. Rotor and blade characteristics are presented in Table I.

Rotor Power

The upwind and downwind rotor tests did not provide adequate data for a comparison of the rotor performance for upwind and downwind rotors as would be indicated by power output as a function of wind speed. The variation in rotor power between an upwind and a downwind rotor turbine has been predicted to be less than 5%, and the anemometer used in the Mod-0 upwind and downwind rotor tests was not accurate enough to distinguish differences this small; therefore, a comparison is not presented. Rotor performance as a function of the wind speed measured on the nacelle was obtained, and indicated a rated wind speed (i.e., wind speed at which 100 kW of alternator power is produced) of 9.4 m/s for the upwind rotor and 7.3 m/s for the downwind rotor. The rated wind speed values are not corrected for local interference effects and differences in slip in the drive train; therefore the actual values are unimportant as a basis of comparison of the two configurations. However, the rated wind speeds are important in understanding the data presented in the following sections comparing the configurations. These data are shown as a function of nacelle wind speed and different behavior is noted as the control system becomes active to regulate power. This makes rated wind speed an important point. Unfortunately, a comparison of rotor performance must wait for a more accurate wind measuring system.

A new array of wind instrumentation has recently been installed at the Mod-0 wind turbine site and rotor performance tests are planned for early spring 1981. Once operational, this system will make it possible to accurately define rotor performance.

Table 1 - Rotor Characteristics

Rotor diameter, m (ft)	37.95 (124.5)
Root cutout, % span	23
Tip control, % span	30
Blade pitch, inb'd section, deg.	Zero
Airfoil (root to tip)	NACA 23024
Taper	Linear
Twist, deg	Zero
Solidity	0.033
Precone, deg	Zero
Max. teeter motion, deg	+6
Rotor speed @ 100 kW, rpm	33 (approx.)
Drive train slip @ 100 kW, percent	
Upwind Rotor	4.66
Downwind Rotor	2.32
Blade mass, kg (lb)	1815 (4000)
Blade Lock number	6.56
Blade first cantilever bending frequency	
Flapwise - Hz	1.76
Edgewise - Hz	1.90

The teetered hub is depicted in Fig. 3; it was designed to mate with the Mod-0 low speed shaft at the original hub-shaft interface. The teetered hub provides capability for approximately $\pm 6^\circ$ of teeter motion with initial contact with the stop occurring at approximately $\pm 5.8^\circ$. The stops were designed to be easily replaceable should they become damaged or worn during the test program; this feature has been used several times to date.

TEST RESULTS

Tests on the wind turbine in the upwind and downwind rotor configurations were designed to obtain loads and operating characteristics for each configuration and the items compared in this report include bending moments on the blades, rotor teeter response, and nacelle yaw moments. It was also desirable to define rotor aerodynamic performance but this was not possible using the nacelle wind speed measurement which was available for the tests.

Analysis of the test data makes use of the bins analysis techniques, (Ref. 4) that have been used extensively in the past in the evaluation of wind turbine operational data. The results presented in this paper will use terms that are common in this type of analysis and have been described in previous reports. These terms, such as mean and cyclic values and median value of a given "bin" of data, are described in Fig. 4 for the convenience of the reader. The test results are a statistical presentation of data that have been sorted into "bins" or specific intervals of an independent variable, such as nacelle wind speed or nacelle yaw angle. A single revolution of the rotor provides a data point, and typically anywhere from 2000 to 10,000 data points comprise a data set used in the bins analysis.

Blade Bending Moments

Flatwise rotor blade bending moments at blade station 13.21 for the downwind and the upwind rotor are shown in Fig. 5 and Fig. 6. Station 13.21 is on the pitchable tip near the 70% span point of the blade and the data shown represents bending parallel and perpendicular to the chordplane of the blade, but not always aligned with the rotor plane. Flatwise bending moments are loads which produce blade deflections which are generally perpendicular to the rotor plane; chordwise bending moments produce deflections which are generally in the plane of the rotor. Mean flatwise bending moments increase as wind speed increases until rated wind speed is attained. At this point the control system is active and the blades are pitched toward feather to maintain a power level of 100 kW. Above rated wind speed rotor thrust is decreased as the wind speed increases; this is reflected in reduced blade bending moments. The trend appears to be the same for both the downwind and the upwind rotor (Fig. 5a and Fig. 6a) though the data sample for the upwind rotor did not contain enough high wind speed data to define the upwind rotor response at higher wind speeds. Mean bending loads peak at the same value and drop off at rated wind speed, indicating that both configurations are experiencing approximately the same level of rotor thrust at rated condition.

The main difference between upwind and downwind blade loads appears in the cyclic component of the bending moment (Fig. 5b and Fig. 6b). While mean bending loads are related to rotor thrust and decrease at wind speeds above rated conditions, cyclic flatwise bending loads are related to flow disturbances that occur as the rotor blade completes each revolution. In the cyclic blade bending data (Fig. 5b), the downwind rotor shows a trend that increases with wind speed while the upwind rotor (Fig. 6b) does not appear to indicate this trend. The tendency of the downwind rotor loads to increase with wind speed is consistent with the effects of tower shadow, which become more pronounced as wind speed increases. The upwind rotor does not experience this disturbance, as demonstrated by the data in Fig. 6b.

Three stations along the rotor blade were instrumented for blade bending, but problems with the instrumentation unfortunately prevented obtaining reliable data from both configurations at other stations.

No differences were noted in blade chordwise bending and this data was not included in the paper.

Rotor Teeter Response

Rotor teeter response for downwind and upwind rotors are compared in Fig. 7 and Fig. 8. Cyclic teeter angles as a function of wind speed and yaw angle indicated on the nacelle are shown for both configurations.

The median values of teeter angle show no discernable trend with wind speed for either configuration (Fig. 7a and Fig. 8a), but the maximum values show a tendency to increase with wind speed until rated wind speed is reached, at which point the maximum values show a decreasing trend. We feel that this tendency of the rotor teeter response to peak at rated wind speed is associated with an approaching instability in the rotor as the blade stall margin decreases. Local stall occurs when the wind speed increases to the point that the local angle of attack on the blade exceeds the airfoil stall point. As the blade operates nearer the stall point, the rotor stall margin is reduced. At wind speeds above V-rated, the blade tips are pitched to reduce the blade angle of attack, which increases the stall margin of the tip of the blade and adds stability to the teetered rotor. We plan additional tests to verify this theory.

Teeter angle as a function of yaw angle, as indicated on the nacelle, is shown for the downwind rotor in Fig. 7b and for the upwind rotor in Fig. 8b. The downwind rotor case exhibits a slight tendency for teeter angle to increase as yaw angle increases, whereas the upwind rotor reaches a maximum value at a yaw angle of 10° and shows a second peak at 35° . The reason for this behavior around 10° of yaw angle is not understood, but the increase at 35° is consistent with similar behavior on the downwind rotor and appears to be connected with the rotor direction of rotation.

The rotor teeter response for the downwind rotor differs from that presented in an earlier report (Ref. 1). The teeter data shown in this report was taken from a data set which was tailored to resemble the data set which was yielded by the upwind rotor tests. The data set used in the earlier report contained more high wind data, and perhaps more importantly, data that were more turbulent in terms of wind speed and azimuthal variations and was not felt to be a proper basis for a comparison.

Nacelle Yaw Moment Tests

Tests were run on the wind turbine to determine the effect of yaw angle on nacelle yaw moment. To acquire the necessary data, the wind turbine was synchronized with the utility grid at 33 rpm with the yaw brake released, the machine was yawed out of the wind approximately 30° , the yaw motor was deactivated, and data were taken for a period of 30 minutes, allowing only the variation in wind direction to vary yaw angle. This process was repeated for a mean yaw angle of -30° , the data sets were combined, and bins analysis was performed to determine the effect of yaw angle on nacelle yaw moment. The tests were performed on both the upwind and the downwind rotor and the results are shown in Fig. 9 and Fig. 10. Yaw torque data were taken on the yaw shaft torque gage shown in Fig. 1, which have been converted to nacelle yaw moment for the convenience of the reader. Yaw angle was measured on the nacelle mounted wind vane.

Test results for the downwind rotor shown in Fig. 9 indicate that mean values of nacelle yaw moment remained relatively constant at -6900 N-m over the range of yaw angles from -30° to 40° . At -30° the yaw moment increases and passes through zero at -53° . The data point at $+45^\circ$ also indicates a trend toward zero yaw moment; however, the data set provided no information past this point. The point of zero yaw moment corresponds well with a "free yaw" equilibrium point of 50° , which was obtained in free yaw tests on this configuration of the wind turbine and adds to our confidence in the validity of the yaw moment data.

Cyclic yaw moments show no particular trend except for the slight decrease in the median value around a yaw angle of -50° , near the point of zero yaw moment. Both cyclic and mean yaw moments for the downwind rotor are very well behaved when compared with these terms for the upwind rotor, which tend to be more variable, i.e., have larger standard deviations in each of the bins.

For the upwind rotor, mean yaw moments (Fig. 10a), tend to increase with yaw angle and peak at a yaw angle of $+40^\circ$, where the trend appears to reverse with the yaw moments decreasing, as we approach the limits of the data set. The point of zero yaw moment occurs at a yaw angle of approximately -50° , very near the point of zero yaw moment indicated for the downwind rotor. However we can place no particular significance on this coincidence.

The cyclic component of the nacelle yaw moment for the upwind rotor (Fig. 10b) shows the same trend as the mean component, i.e., increasing with increasing yaw angle. The two components, mean and cyclic, showed similar trends for the downwind rotor also. However, as mentioned above, the magnitude and the variability of the cyclic component indicates that the upwind teetered rotor is less well behaved when compared with a downwind rotor.

The median of the mean component of yaw moment for the downwind rotor was measured to be -6900 N-m for yaw angles between -30° and $+40^{\circ}$. The yaw moment caused by the $8-1/2^{\circ}$ tilt of the nacelle while 100 kW is being produced by the rotor is -5350 N-m, which indicates that the major portion of the mean yaw moment measured on the downwind rotor machine was due to the tilt in the nacelle. These tests will be repeated later this year on a tubular tower with the rotor tilt removed, and the yaw moment and "free yaw" characteristics will again be evaluated.

The results of the yaw moment tests indicate that from the viewpoint of yaw forces, a downwind rotor is to be preferred over an upwind rotor. Both mean and cyclic yaw forces were higher for the upwind rotor, indicating the need for more power and damping in the yaw drive mechanism and the potential for increased fatigue. There was no indication that the upwind rotor presented particularly difficult design problems with respect to yaw loads, however.

CONCLUDING REMARKS

Tests have been conducted on a 100 kW horizontal axis wind turbine having first a rotor downwind of the supporting truss tower and then upwind of the tower. Aside from the placement of the rotor and the direction of rotation relative to the nacelle, the wind turbines tested were identical. Three aspects of the test results were compared: rotor blade bending loads, rotor teeter response, and nacelle yaw moments. Conclusions based on the comparisons are presented below:

1. Cyclic flatwise bending moments are higher for the downwind rotor and increase with wind speed, reflecting the flow disturbance created by the tower. Cyclic bending moments for the upwind rotor appear to be relatively unaffected by wind speed. Mean flatwise bending moments were the same for upwind and downwind rotors.

2. Rotor teeter response appears to indicate a tendency toward teeter instability near rated wind speed for both upwind and downwind rotors. Further testing is required to verify this conclusion. No significant differences were noted between upwind rotor and downwind rotor teeter response.

3. Nacelle yaw moments were smaller for the downwind rotor but the increased yaw loads on the upwind rotor do not indicate significant design problems.

REFERENCES

1. Glasgow, J. C.; and Miller, D. R.: Teetered, Tip-Controlled Rotor: Preliminary Test Results from Mod-0 100-kw Experimental Wind Turbine. DOE/NASA 1028-80/26, NASA TM-81445, 1980.
2. Glasgow, J. C.; and Birchenough, A. G.: Design and Operating Experience on the U. S. Department of Energy Experimental Mod-0 100-kw Wind Turbine. DOE/NASA 1028-78/18, NASA TM-78915, 1978.
3. Winemiller, J. R.; et. al.: Design, Fabrication and Initial Test of a Fixture for Reducing the Natural Frequency of the Mod-0 Wind Turbine Tower. DOE/NASA 1028-79/24, NASA TM-79200, 1979.
4. Richards, T. R., and Neustadter, H. E.: DOE/NASA Mod-0A Wind Turbine Performance. DOE/NASA 1004-78/13, NASA TM-78916, 1978.

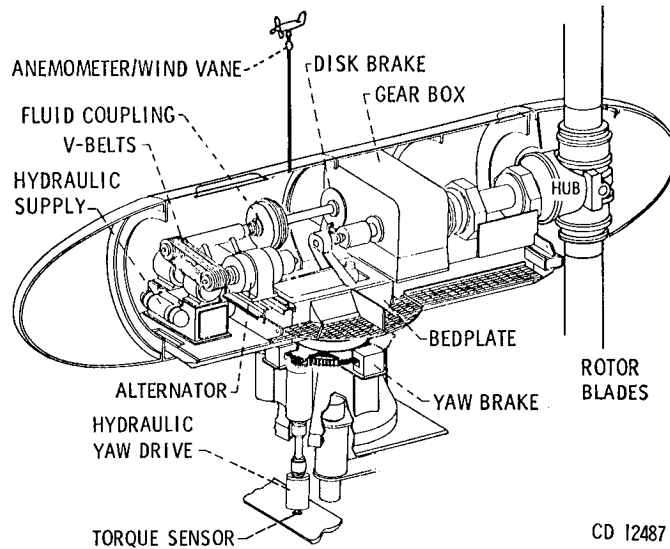

Figure 1. - Mod-0 100 kW experimental wind turbine nacelle interior.

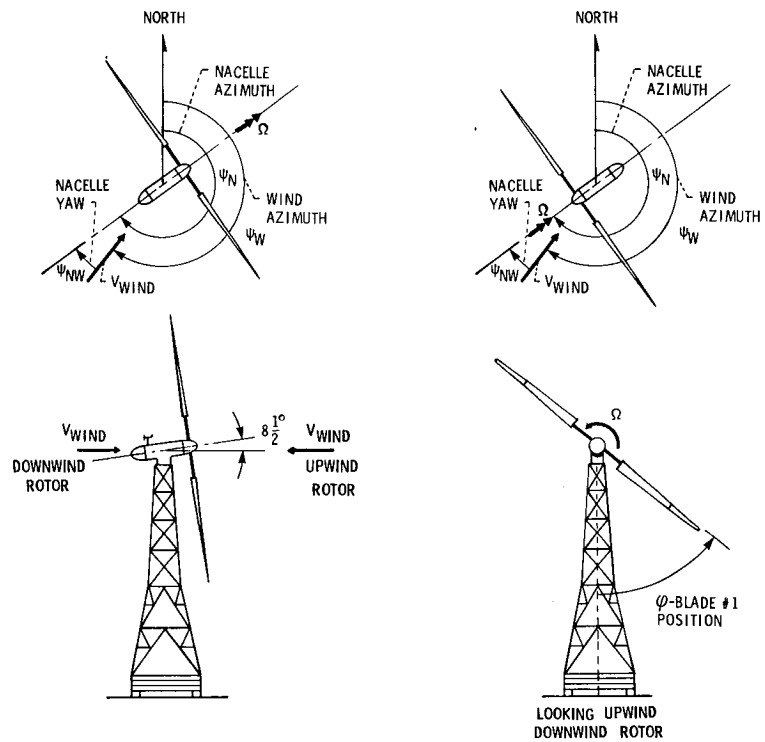
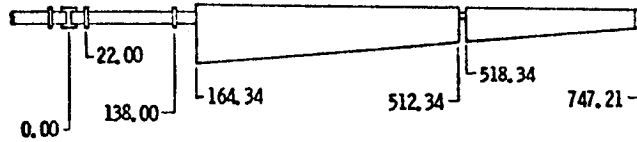
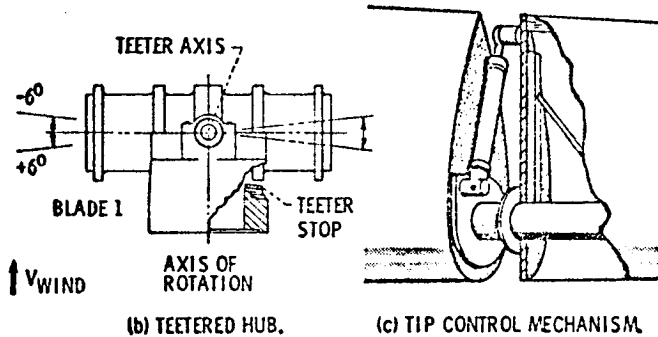

Figure 2. - Mod-0 100 kW wind turbine sign conventions for upwind and downwind rotors.

STATION	RADIUS, m	CHORD, m
164.34	4.174	1.964
512.34	13.013	1.171
518.34	13.166	1.154
747.21	18.979	.672



(a) BLADE PLANFORM.



(b) TEETERED HUB.

(c) TIP CONTROL MECHANISM.

Figure 3. - Mod-0 rotor details.

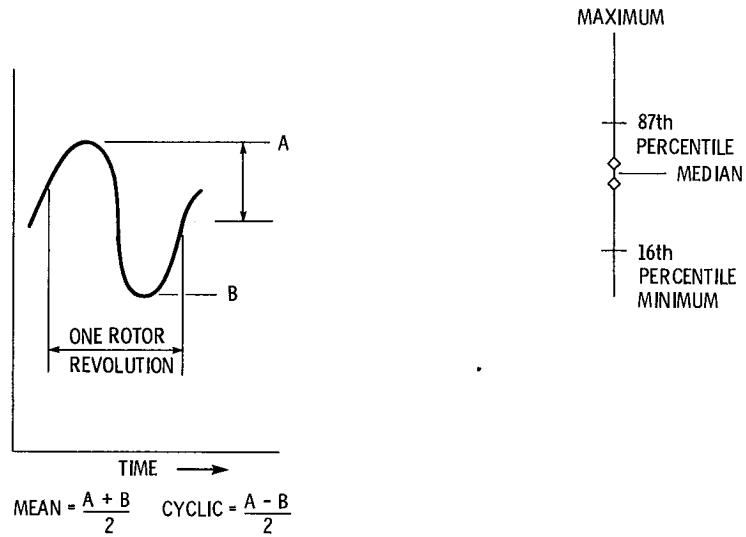
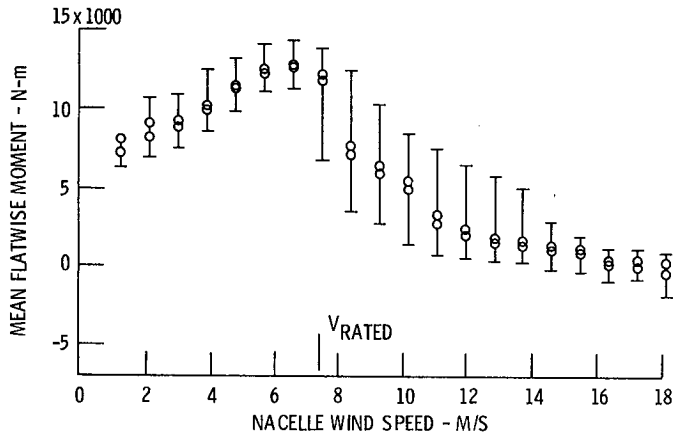
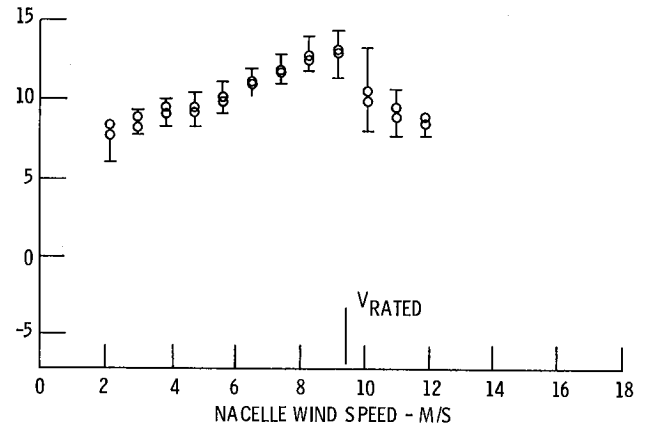

Figure 4. - Definition of terms used in bins analysis of wind turbine data.



(a) MEAN BENDING



(a) MEAN BENDING

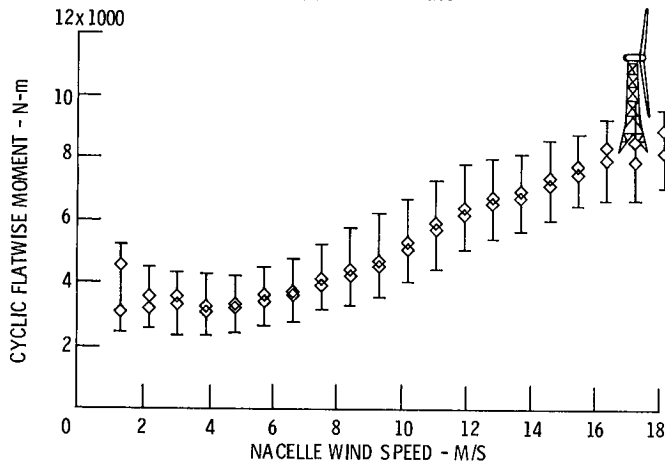

(b) CYCLIC BENDING

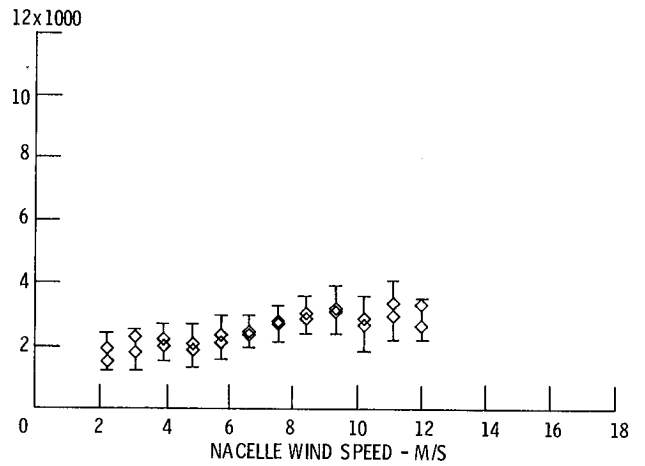

(b) CYCLIC BENDING

Figure 5. - Downwind rotor: Flatwise rotor blade bending moment at station 13.21; mean bending, (a), and cyclic bending, (b), vs. nacelle wind speed.

Figure 6. - Upwind rotor: Flatwise rotor blade bending moment at station 13.21; mean bending, (a), and cyclic bending, (b), vs. nacelle wind speed.

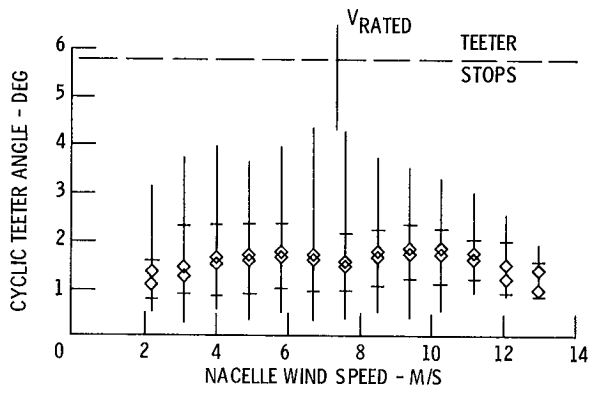

(a) VS. NACELLE WIND SPEED.

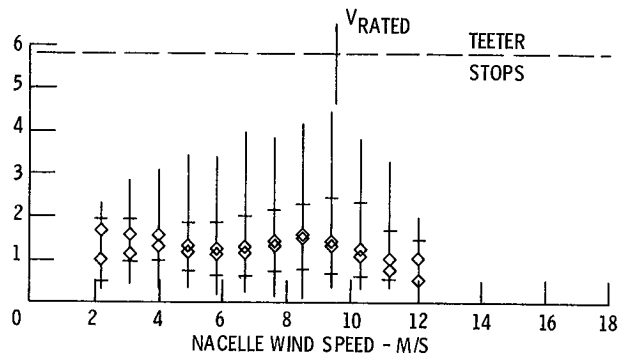

(a) VS. NACELLE WIND SPEED.

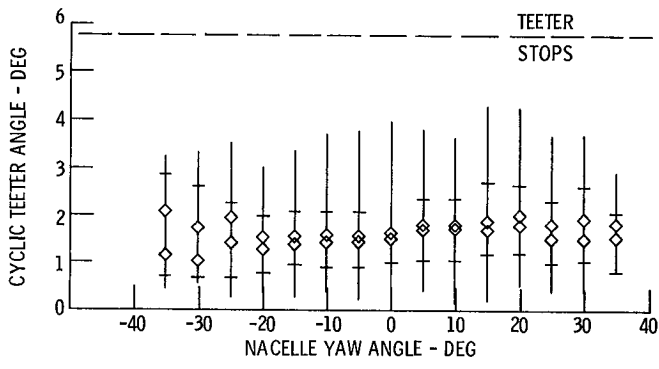

(b) VS. NACELLE YAW ANGLE.

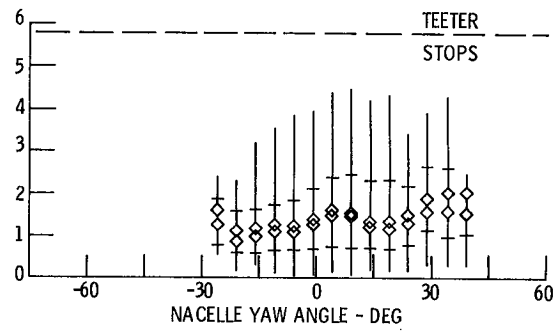

(b) VS. NACELLE YAW ANGLE.

Figure 7. - Downwind rotor: Cyclic teeter angle vs. nacelle wind speed, (a), and nacelle yaw angle, (b).

Figure 8. - Upwind rotor: Cyclic teeter angle vs. nacelle wind speed, (a), and nacelle yaw angle, (b).

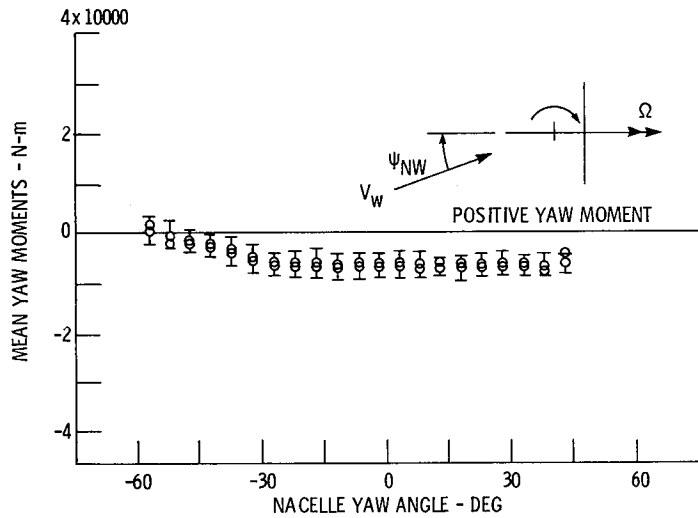

(a) MEAN YAW MOMENTS

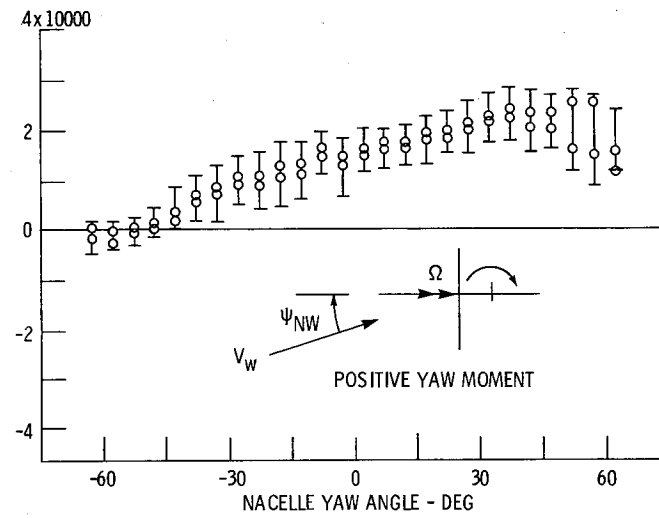

(a) MEAN YAW MOMENT

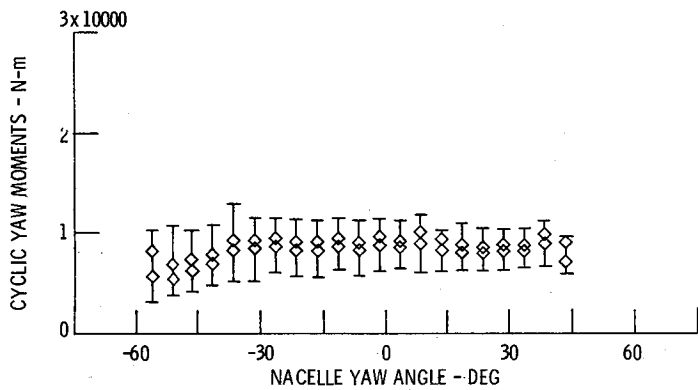

(b) CYCLIC YAW MOMENTS

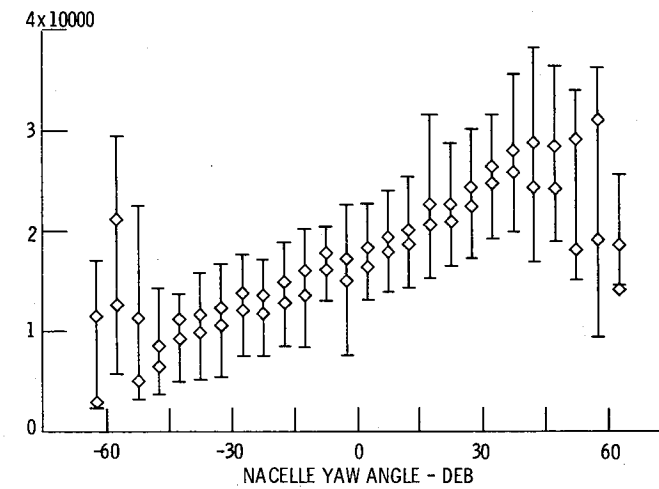

(b) CYCLIC YAW MOMENT

Figure 9. - Downwind rotor: Mean nacelle yaw moments, (a), and cyclic nacelle yaw moments, (b), vs. nacelle yaw angle.

Figure 10. - Upwind rotor: Mean nacelle yaw moments, (a), and cyclic nacelle yaw moments, (b), vs. nacelle yaw angle.

1. Report No. NASA TM-81744	2. Government Accession No.	3. Recipient's Catalog No.	
4. Title and Subtitle COMPARISON OF UPWIND AND DOWNWIND ROTOR OPERATIONS OF THE DOE/NASA 100-kW MOD-0 WIND TURBINE		5. Report Date	
		6. Performing Organization Code 776-31-41	
7. Author(s) John C. Glasgow, Dean R. Miller, and Robert D. Corrigan		8. Performing Organization Report No. E-798	
		10. Work Unit No.	
9. Performing Organization Name and Address National Aeronautics and Space Administration Lewis Research Center Cleveland, Ohio 44135		11. Contract or Grant No.	
		13. Type of Report and Period Covered Technical Memorandum	
12. Sponsoring Agency Name and Address U.S. Department of Energy Division of Wind Energy Systems Washington, D.C. 20545		14. Sponsoring Agency Code Report No. DOE/NASA/1028-31	
		15. Supplementary Notes Prepared under Interagency Agreement EX-76-I-01-1028. Prepared for Second DOE/NASA Wind Turbine Dynamics Workshop, Cleveland, Ohio, February 24-26, 1981.	
16. Abstract <p>Tests have been conducted on a 38 m diameter horizontal axis wind turbine, which had first a rotor downwind of the supporting truss tower and then upwind of the tower. Aside from the placement of the rotor and the direction of rotation of the drive train, the wind turbine was identical for both tests. Three aspects of the test results are compared: rotor blade bending loads, rotor teeter response, and nacelle yaw moments. As a result of the tests, it is shown that while mean flatwise bending moments were unaffected by the placement of the rotor, cyclic flatwise bending tended to increase with wind speed for the downwind rotor while remaining somewhat uniform with wind speed for the upwind rotor, reflecting the effects of increased flow disturbance for a downwind rotor. Rotor teeter response was not significantly affected by the rotor location relative to the tower, but appears to reflect reduced teeter stability near rated wind speed for both configurations. Teeter stability appears to return above wind speed, however. Nacelle yaw moments are higher for the upwind rotor but do not indicate significant design problems for either configuration.</p>			
17. Key Words (Suggested by Author(s)) Teetered rotor; Upwind and downwind; Yaw loads; Teeter response; Blade loads		18. Distribution Statement Unclassified - unlimited STAR Category 44 DOE Category UC-60	
19. Security Classif. (of this report) Unclassified	20. Security Classif. (of this page) Unclassified	21. No. of Pages	22. Price*



