

## NOTICE

THIS DOCUMENT HAS BEEN REPRODUCED FROM  
MICROFICHE. ALTHOUGH IT IS RECOGNIZED THAT  
CERTAIN PORTIONS ARE ILLEGIBLE, IT IS BEING RELEASED  
IN THE INTEREST OF MAKING AVAILABLE AS MUCH  
INFORMATION AS POSSIBLE



DEPARTMENT OF ELECTRICAL ENGINEERING  
SCHOOL OF ENGINEERING  
OLD DOMINION UNIVERSITY  
NORFOLK, VIRGINIA

**AIRBORNE ANTENNA PATTERN CALCULATIONS**

*By*

Timothy J. Knerr

*and*

Roland R. Mielke, Principal Investigator



Progress Report

For the period November 1, 1980 - April 30, 1981

*Prepared for the*  
National Aeronautics and Space Administration  
Langley Research Center  
Hampton, Virginia

*Under*  
Research Grant NSG 1655  
Melvin C. Gilreath, Technical Monitor  
Flight Electronics Division

(NASA-CR-164350) AIRBORNE ANTENNA PATTERN  
CALCULATIONS Progress Report, 1 Nov. 1980 -  
30 Apr. 1981 (Old Dominion Univ., Norfolk,  
Va.) 17 p HC A02/MF A01 CSCL 20N

N81-24321

Uncias  
G3/32 42429

May 1981

DEPARTMENT OF ELECTRICAL ENGINEERING  
SCHOOL OF ENGINEERING  
OLD DOMINION UNIVERSITY  
NORFOLK, VIRGINIA

## AIRBORNE ANTENNA PATTERN CALCULATIONS

*By*

Timothy J. Knerr

*and*

Roland R. Mielke, Principal Investigator

Progress Report

For the period November 1, 1980 - April 30, 1981

*Prepared for the*  
National Aeronautics and Space Administration  
Langley Research Center  
Hampton, Virginia 23665

*Under*  
Research Grant NSG 1655  
Melvin C. Gilreath, Technical Monitor  
Flight Electronics Division

*Submitted by the*  
Old Dominion University Research Foundation  
P.O. Box 6369  
Norfolk, Virginia 23508



May 1981

# AIRBORNE ANTENNA PATTERN CALCULATIONS

By

Timothy J. Knerr<sup>1</sup> and Roland R. Mielke<sup>2</sup>

## INTRODUCTION

This report summarizes the progress of applied work conducted during the period from November 1, 1980 to April 30, 1981 under NASA grant NSG-1655. Major objectives of this work include continued development of computer software for aircraft modeling and use of this software and program OSUVOL to calculate principal plane and volumetric radiation patterns. This study is important for the determination of proper placement of antennas on aircraft to meet the requirements of the Microwave Landing System.

The next section briefly discusses the work performed. This is followed by an example of a roll plane model for the Piper PA-31T Cheyenne aircraft and the resulting calculated roll plane radiation pattern.

## WORK PERFORMED

### Introduction

A new set of computer programs for the calculation of principal plane radiation patterns has been in use at NASA/Langley Research Center (LaRC) for the past 12 months. The computer code consists of programs NMOD, PFLT, NPLOT, and OSUVOL. The first three programs, developed by the authors, generate a mathematical model of an aircraft from three-view scale drawings. The last program, developed at Ohio State University, uses the aircraft model to calculate principal plane radiation patterns. During the past six months, work has been directed toward continuing development of the modeling software, testing the software against calculated data from

---

<sup>1</sup>Graduate Research Assistant, Department of Electrical Engineering, Old Dominion University, Norfolk, Virginia 23508.

<sup>2</sup>Associate Professor, Department of Electrical Engineering, Old Dominion University, Norfolk, Virginia 23508.

program VPAP and measured patterns, and calculating roll plane patterns for a number of general aviation aircraft.

### Program Development

The set of computer programs used to generate various volumetric pattern plots had not been used since the summer of 1979. This set of programs, including VOLPAT, DIRTVT, and VARPLOT, was reactivated and updated for changes in the network operating system. New volumetric pattern data for the Boeing 737 aircraft was then calculated and compared to previously obtained results to check for consistency. In addition, a new program segment was inserted in program NMOD to provide for automatic centering of side and top views of aircraft roll plane models.

### Software Testing

Verification of calculated patterns using the new set of programs was conducted. Elevation plane pattern data for the de Havilland Canada DHC-7 aircraft and the Rockwell Sabreliner 75A were calculated and compared to results obtained using program VPAP. Roll plane pattern data was then obtained for several antenna locations.

### Roll Plane Pattern Calculations

The older pattern calculation program, VPAP, did not have the capability to calculate roll plane patterns for small general aviation aircraft. A primary objective of work performed during this report period was to use the new computer code to calculate roll plane pattern data for general aviation aircraft for which elevation plane pattern data had previously been obtained. The aircraft modeled to date are presented in table 1, and sample roll plane calculations are presented in the next section.

### SAMPLE CALCULATIONS

In this section two examples of the roll plane models and resulting antenna patterns for the Piper PA-31T Cheyenne aircraft are presented. First, the three views of the actual aircraft are shown, with antenna locations 1 and 3 marked on the side and top views (figs. 1 to 3). Next,

the model for antenna location 1 is given in three views (figs. 4 to 6). This is followed by the calculated antenna pattern (fig. 7). Finally, the three views of the model for antenna location 3 and the resulting calculated antenna pattern are presented (figs. 8 to 11).

Table 1. Aircraft modeled to date.

---

<u>Aircraft</u>	<u>Antenna Locations</u>
Lockheed Jet Star II	7
Piper PA-31T Cheyenne	7
Beechcraft Duke B60	7
Piper PA-31-350 Navajo Chieftain	7
Rockwell Commander 700	7
Cessna Citation III	5
Rockwell Sabreliner 75A	6
Piper PA-31P Pressurized Navajo	5

---

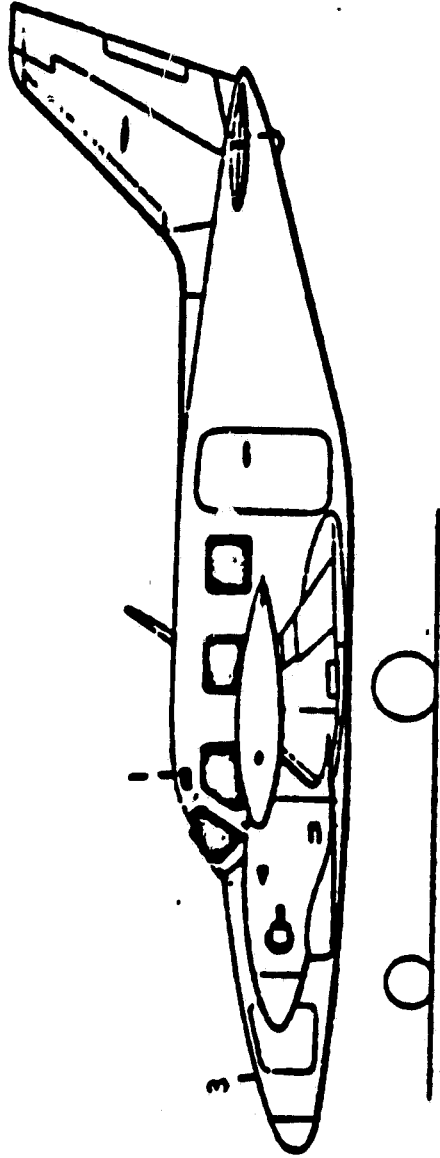

Figure 1. Piper PA-31T Cheyenne aircraft—side view.



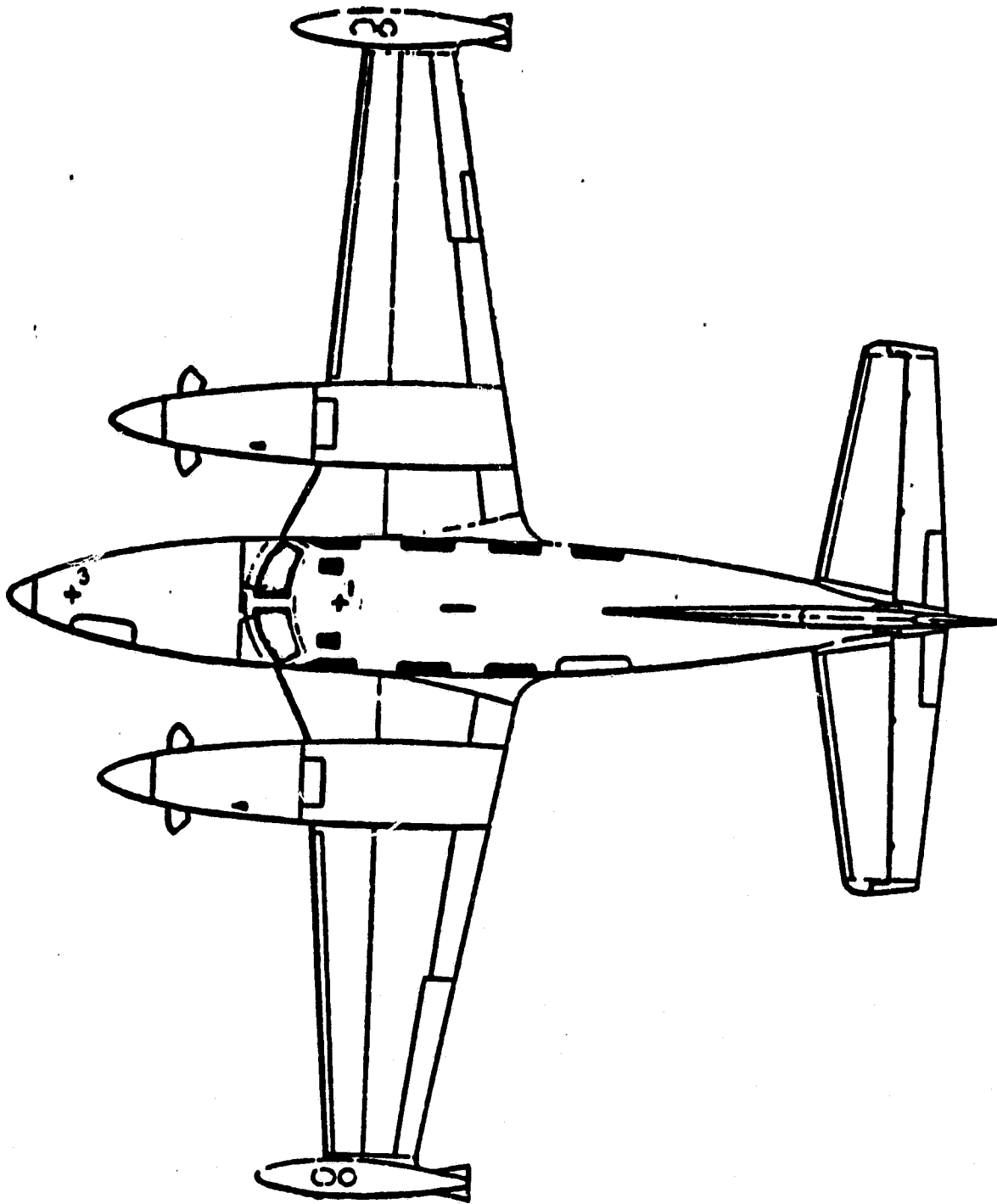

Figure 2. Piper PA-31T Cheyenne aircraft—top view.

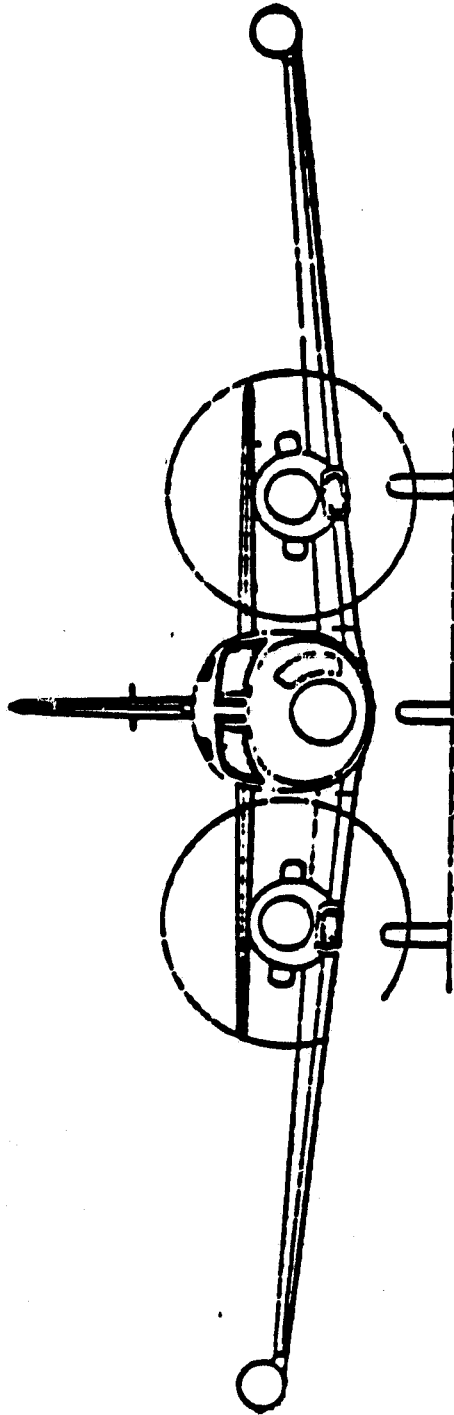

Figure 3. Piper PA-31T Cheyenne aircraft—front view.

**POINT  
FUELAISE PROFILE  
(ELEVATION PLANE)**



**S. F. = 136.000**

Figure 4. Aircraft model side view, antenna location 1.

PCW/  
HEADING PROFILE  
(AZIMUTH PLANE)

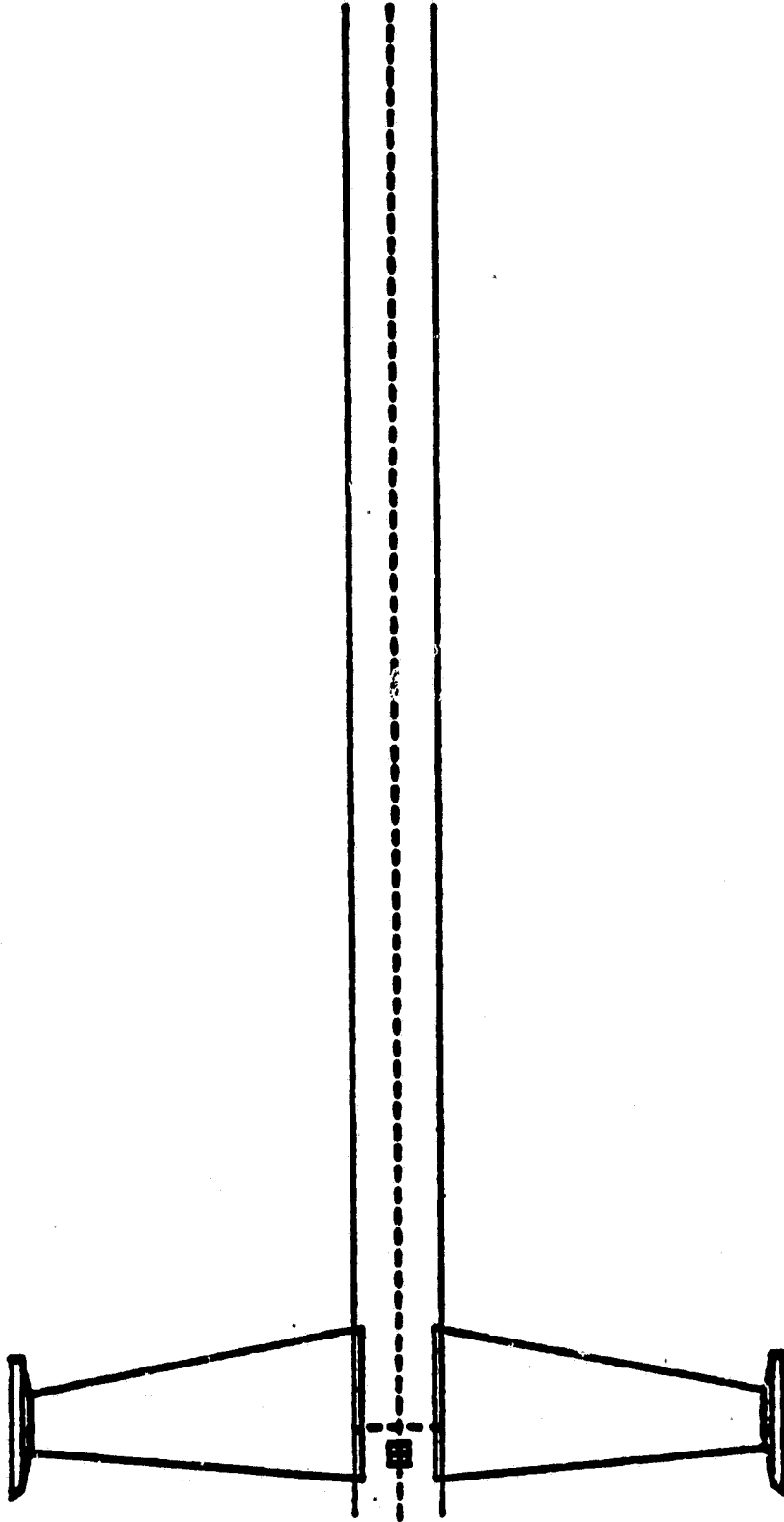

S. F. z 155-000

Figure 5. Aircraft model top view, antenna location 1.

**PCHV1  
CROSS SECTION  
(ROLL PLANE)**

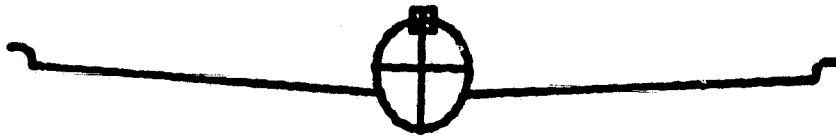

**S. F. = 196.000**

Figure 6. Aircraft model front view, antenna location 1.

E-PHI  
DB FLOT

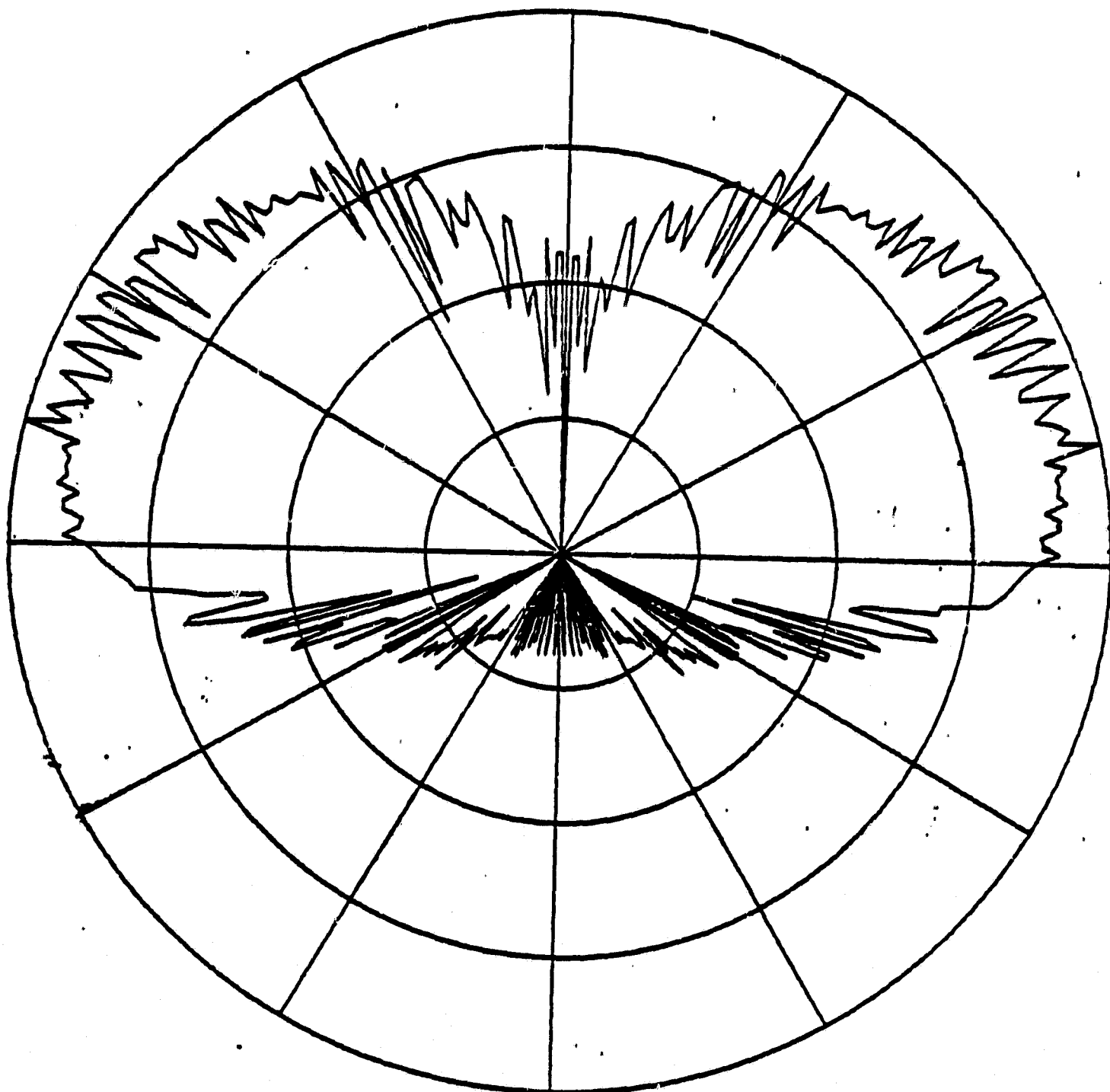
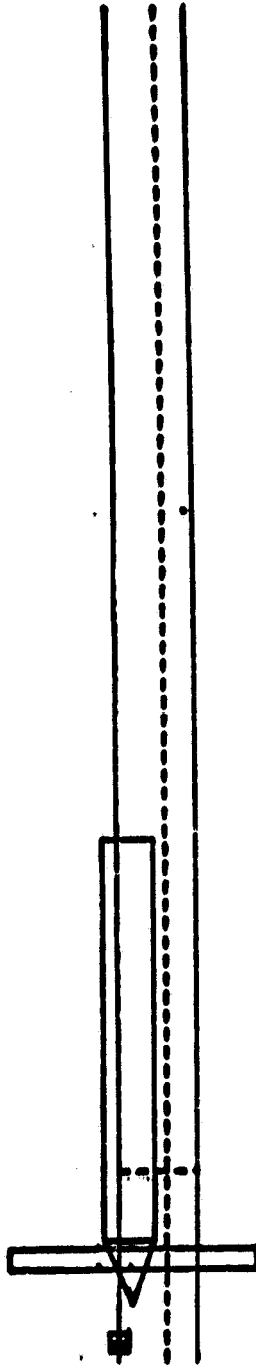

Figure 7. Roll plane pattern, antenna location 1.

**POW3  
FUSELAGE PROFILE  
(ELEVATION PLANE)**



**S. F. = 67.700**

Figure 8. Aircraft model side view, antenna location 3.

**POWERS  
HEADING PROFILE  
(AZIMUTH PLANE)**



**S. F. = 67.700**

Figure 9. Aircraft model top view, antenna location 3.



PHYS  
CROSS SECTION  
(ROLL PLANE)

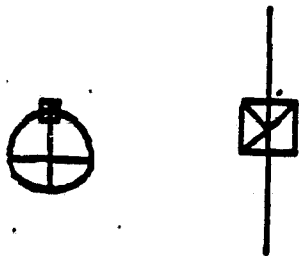

S. F. s 87.700

Figure 10. Aircraft model front view, antenna location 3.

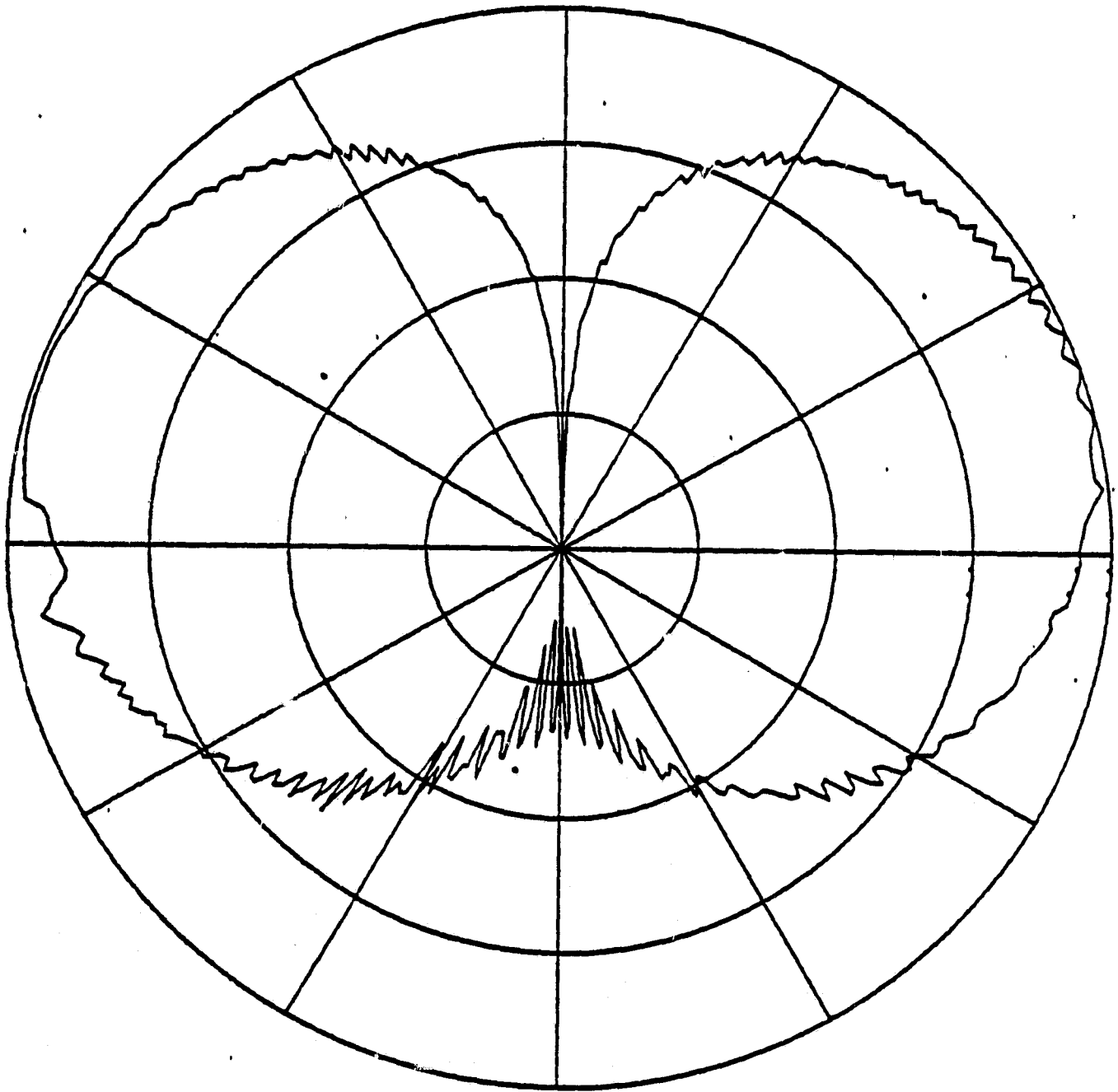

Figure 11. Roll plane pattern, antenna location 3.