

N O T I C E

THIS DOCUMENT HAS BEEN REPRODUCED FROM
MICROFICHE. ALTHOUGH IT IS RECOGNIZED THAT
CERTAIN PORTIONS ARE ILLEGIBLE, IT IS BEING RELEASED
IN THE INTEREST OF MAKING AVAILABLE AS MUCH
INFORMATION AS POSSIBLE

Effects of Ultra-Clean and Centrifugal Filtration on Rolling-Element Bearing Life

(NASA-TM-82660) EFFECTS OF ULTRA-CLEAN AND
CENTRIFUGAL FILTRATION ON ROLLING-ELEMENT
BEARING LIFE (NASA) 34 p HC A03/MF A01

N81-29440

CSCL 13I

Unclass

G3/37 27074

Stuart H. Loewenthal
Lewis Research Center
Cleveland, Ohio

and

Donald W. Moyer
Tribon Bearing Company
Cleveland, Ohio

and

William M. Needelman
Pall Corporation
Glen Cove, New York

Prepared for the
Joint Lubrication Conference
cosponsored by the American Society of Mechanical Engineers
and the American Society of Lubrication Engineers
New Orleans, Louisiana, October 5-7, 1981



EFFECTS OF ULTRA-CLEAN AND CENTRIFUGAL FILTRATION ON
ROLLING-ELEMENT BEARING LIFE

by Stuart H. Loewenthal*
National Aeronautics and Space Administration
Lewis Research Center
Cleveland, Ohio

Donald W. Moyer†
Tribon Bearing Company
Cleveland, Ohio

and

William M. Needelman
Pall Corporation
Glen Cove, New York

ABSTRACT

E-329

Fatigue tests were conducted on groups of 65-millimeter bore diameter deep-groove ball bearings in a MIL-L-23699 lubricant under two levels of filtration. In one test series, the oil cleanliness was maintained at an exceptionally high level (better than a class of "00" per NAS 1638) with a 3 micron absolute barrier filter. These tests were intended to determine the "upper limit" in bearing life under the strictest possible lubricant cleanliness conditions. In the tests using a centrifugal oil filter, contaminants of the type found in aircraft engine filters were injected into the filters' supply line at 125 milligrams per bearing-hour. "Ultra-clean" lubrication produced bearing fatigue lives that were approximately twice that obtained in previous tests with contaminated oil using 3 micron absolute filtration and approximately three times that obtained with 49 micron filtration. It was also observed that the centrifugal oil filter had approximately the same effectiveness as a 30 micron absolute filter in preventing bearing surface damage.

*Member ASME.
†Member ASLE.

INTRODUCTION

There is ample evidence in the literature that contaminants in lubrication systems significantly increases rolling-element bearing wear (1 to 5). There is also evidence that debris damage adversely effects bearing fatigue life but the proper life derating factor has not yet been conclusively established (5 to 9).

In aircraft propulsion systems, debris is a major factor in component failure (10). A survey of bearing rejection-causes for aircraft engine, transmission and accessory bearings (11) indicates that the indentations/contaminants grouping accounts for approximately 20 percent of all bearing rejections. Only the corrosion/pitting grouping account for more bearing rejections with a 30 percent share. Classical rolling-element fatigue was the least likely cause of bearing failure having only a 1 to 3 percent share. There is now a growing realization that fine filtration coupled with oil condition monitoring procedures can lead to significant reductions in aircraft engine and drive train maintenance costs.

In a previous study by the authors (9), tests were conducted on groups of 65-millimeter-bore ball bearings under four levels of filtration with and without a contaminated MIL-L-23699 lubricant. The test filters had absolute particle removal ratings of 3, 30, 49, and 105 microns (0.45, 10, 30, and 70 microns nominal), respectively. Running track condition and bearing life, to a lesser extent, generally improved with finer filtration. The 3 and 30 micron filter bearings in a contaminated lubricant had statistically equivalent lives, approaching those from the baseline tests with no contaminants using 49 micron filtration. The degree of surface distress, weight loss, and probable failure mode were found to be dependent on filtration level, with finer filtration being clearly beneficial (9).

In (9), an experimental bearing 10-percent life of 14 times the AFBMA predicted life was obtained with a 49 micron filter in oil that was not contaminated with debris. However, these tests did not conclusively establish that this bearing fatigue life represented the "upper limit" in terms of bearing life had even stricter lubricant cleanliness conditions been maintained. The research of (6,8) suggests that bearing B_{10} lives of 30 times AFBMA calculated B_{10} lives or greater are achievable with nearly ideal lubricant cleanliness. Also the test filters used in (9) included only static barrier types, excluding other potentially promising filter concepts (12), such as the centrifugal oil filter. It therefore became the objectives of this investigation to determine (1) the bearing life improvement potential of an ultra-clean lubrication system and (2) the relative effectiveness of a centrifugal oil filter in preventing bearing wear and failure.

To accomplish these objectives, two series of bearing fatigue tests were conducted with 65-millimeter-bore-diameter deep-groove ball bearings, lubricated with a MIL-L-23699, tetra ester oil. These tests were conducted on the same test rig used in (9) at the same bearing shaft speed of 15 000 rpm, radial load of 4580 newtons (1030 lb) and oil inlet temperature of 347 K (165⁰ F). In the ultra-clean lubricant test series, the test stand lubrication system was purged of contaminants by continuously cycling the oil through a 3 micron absolute filter. System lubricant cleanliness was maintained at an exceptionally high level, class 00 per NAS 1638.

In the centrifugal oil filter test series, contaminants of the type used in the previous investigation were injected in the filter supply line at a rate of 125 mg per bearing-hour. To assess the effectiveness of the ultra-clean lubrication system and the performance of the centrifugal oil

filter, the results of these bearing tests were compared to those obtained in (9).

TEST BEARINGS, LUBRICANT, FILTERS, AND CONTAMINANT

Test Bearings

The test bearings were ABEC-3 grade, deep groove ball bearings with a 65-millimeter-bore-diameter, a 90-millimeter outer diameter, a 13-millimeter width and contained 18 balls having a 7.94-millimeter (5/16-in) diameter. These bearings were from the same group as those tested in the previous investigation. The inner and outer races as well as the balls were manufactured from a single heat of carbon vacuum-degassed (CVD) AISI 52100 steel. The nominal hardness of the races and balls were Rockwell C 62 ± 1.0 . The ball retainer was a riveted, two-piece, machined, inner-land riding cage made from silicon-iron bronze. The raceways were ground to a nominal surface finish of 0.1 micron ($4\text{-}\mu\text{in}$) rms and the balls to a surface finish of 0.05 microns ($2\text{-}\mu\text{in}$) rms.

Test Lubricant

The lubricant utilized for this test program was a 5-centistoke at 372 K (210° F), neopentylpolyol (tetra) ester for which a substantial amount of test data is available. This oil is qualified for use in jet-engine lubrication systems under MIL-L-23699 specifications. The test oil was from the same batch as that used previously.

Test Filters

Two types of filters were used during the course of this study: a centrifugal type and a 3-micron absolute, barrier type having porous-depth media construction. Manufacturers specifications of these commercially available filters are presented in Table 1. Also included for comparison

are specifications for some of the other test filters used in the earlier study.

The barrier filters used in these tests were noncleanable, full flow type with outside to inside flow direction. The filter media consisted of multiple layers of sheet material utilizing mixtures of organic and inorganic fibers integrally bonded by an epoxy resin. This provided uniform pore openings and a high voids volume. The media, supported by wire mesh, is formed into a corrugated cylinder over a perforated metal support cylinder. These filters were standard commercial units.

The absolute removal ratings shown in Table 1 have been determined from traditional filter test methods per MIL-F-27656 where a known distribution of graduated glass beads are fed "once through" the test filter. The largest diameter of glass bead that passes through the filter on to a microscopic slide establishes its absolute removal rating. This rating method has limitations since it is not unusual to find irregularly shaped particles larger than the absolute rating downstream of a filter. Secondly, the time dependent performance of the filter in a recirculating lubrication system cannot be determined by this method.

A filter rating method which gives a more realistic assessment of a lubricant filter performance is known as the Multi-Pass Test Method, MPT (13,14). Briefly, a suspension of particles of known size and concentration is flowed into a filter at constant rated flow until a predetermined differential pressure is reached. Particle count analysis is performed on samples taken upstream and downstream of the filter during the test. The averaged ratio of upstream to downstream counts for particles greater than a given size (x) in micrometers is reported as the filtration ratio at x micrometers, or β_x . The spectrums of β_x values obtained for different fil-

ters have found widespread utility as guidelines, and in specifications, for filter performance. The contamination level that would be maintained downstream of a filter in a recirculating system is approximately an inverse function of β_x .

The efficiency of the 3 micron absolute filter used in this study as well as that for the 30 and 49 micron test filters from (9) was determined by the MPT method. The results of these measurements appear in Fig. 1. This procedure does not lend itself to filter efficiency measurements of extremely coarse filters, and so only limited data could be generated with the 49 micron filter and none with the 105 micron filter.

Efficiencies of an in-service filters can vary from those measured in laboratory MPT's. Operating conditions such as flow surges, temperature extremes, mechanical vibration and differing contaminants all affect filter efficiency. Thus the MPT results given for the three filters in Fig. 1 are for guidance in comparing the filters, rather than to describe their operation during the series of bearing tests or what could be expected in-service. Nevertheless, the dramatic differences in abilities to capture particles of various sizes is apparent. Also apparent from Fig. 1 is that some particles which are larger than the "absolute" rating of the filter can pass through the filter during actual operation in the MPT's recirculating lubrication system. Thus the absolute removal rating of a filter is an indication of its relative performance, since it is based on a static calibration with spherical glass beads rather than the operating conditions that might be found in actual service.

The centrifugal oil filter used in this investigation was a standard commercial unit. A centrifugal filter removes particulate matter from the fluid by centrifugal force as shown in Fig. 2. Entering fluid is acceler-

ated to high rotational speed within a canister. The centrifugal force created by such rotation drives the dense particles in the fluid to the outer diameter of the canister where they are caught and held.

The contaminated oil and entrained air enter the centrifuge shaft axially from the inlet cavity and begin to rotate in a cavity in the centrifuge shaft. A spinner (not shown) in the inlet aids in the separation of some of the entrained air, which passes axially through the bore in the shaft to the air outlet port in the cover. The oil collected at the periphery of the cavity in the centrifuge shaft is pumped from the shaft through a series of radial holes leading to the centrifuge canister. This pumping imparts a tangential velocity to the oil, which creates the centrifugal forces required to remove contaminants from the oil. As the oil passes through the annular passage in the canister, the dirt migrates from the oil into the dirt-retaining basket, where it collects and is retained. The cleaned oil, leaving the centrifuge basket, flows to a sump in the bottom of the centrifugal housing where it is pumped out by an integral gear pump.

The centrifugal filter used in these tests was driven by a 3550 rpm electric motor which resulted in a canister speed of 7100 rpm. This generated a separating force of 2885 g's at the inner diameter of the canister.

Test Contaminants

The contaminants used for the centrifugal oil filter tests consisted of a mixture of carbon dust, Arizona coarse dust, and stainless steel powder. The composition of this contaminant mixture, as listed in Table 2, was similar to the composition of particulate matter found in the lubricant filters of typical aircraft gas turbine engines, based on a field survey of 50 JT8D commercial engines. Analysis of debris from the engine lubrication system

showed that up to 90 percent of the particles were carbonaceous in composition with the remainder being primarily silaceous and metallic.

BEARING FATIGUE TESTER AND TEST CONDITIONS

Two identical bearing fatigue testers, as shown in Fig. 3, each containing four test bearings were operated concurrently. Each bearing tester is driven to a test speed of 15 000 rpm by a quill shaft system connected to the 37.3 kW (50 hp) variable speed drive system (not shown in the illustration). The bearings are loaded only in a radial direction to a radial load of 4580 N (1030 lb) by a hydraulic cylinder. The radial load is transmitted equally to the two center bearings through a wiffletree and is reacted by the two outboard bearings as shown. This radial load results in a calculated maximum Hertz stress of 2.4 GPa (350 000 psi) on the bearing inner race. Thermocouples were mounted to the outer race of each of the test bearings.

The lubrication supply system, delivers a total of 1090 kg/hr (2400 lb/hr) of oil through the test filter to the eight test bearings. The flow is equally divided among the test bearings by a calibrated orifice at an oil supply pressure of 0.28 MPa (40 psi). From the test bearings the oil gravity-drains into a collector pan from where it is returned to the oil supply tank by a scavenge pump. On this return line is an oil to water (shell and tube type) heat exchanger that regulates the oil in temperature to the bearings at the required 347 K (165⁰ F).

Based on the above operating conditions and average outer race temperature of 361 K (190⁰ F), the isothermal elastohydrodynamic film thickness at the inner race contact was 0.373 micron (14.7 μ in)(15). This resulted in

a minimum film thickness to composite roughness ratio of 3.3 which provides full film lubrication (16).

For the contaminated lubricant centrifugal filter tests, the test contaminant and replenishment oil are mixed together in the form of an oil slurry. This slurry was periodically (approximately every 10 min.) injected by a hydraulic piston into the test filter lubricant supply line in 12-milimeter quantities, containing approximately 170 milligrams of contaminant. This produced a contamination rate of 125 milligrams of contaminant per hour per bearing or roughly a level teaspoon of contaminant powder every 16 hours. The amount and concentration of contaminants actually reaching the test bearings were some function of the centrifugal filter's performance, generally being only a fraction of the ingestion rate as determined by particle counts taken without the filter in place.

The test stand instrumentation included an accelerometer system which detects bearing failures as well as the standard protective circuits which shutdown the drive system, if any of the test parameters deviate from the programmed conditions. Parameters monitored and recorded during the test were rig shaft speed (bearing inner race speed), oil flow to each tester, test bearing outer race temperature, lubricant supply and scavenge temperature, and rig vibration level.

RESULTS AND DISCUSSION

Ultra-clean Lubricant Tests

In this test series nine bearings were fatigue tested with an exceptionally clean lubrication system containing a 3 micron absolute barrier filter. An appreciation of the degree of lubricant cleanliness attained during these tests can be obtained from a comparison of the representative

particle counts listed in Table 3 with the fluid contamination standards appearing in Table 4. The particle count levels for the ultra-clean tests in Table 3 were consistently at the lower limits of contamination, class "00" level. This level is categorized as "rarely attained." As a point of comparison, a class 9 to 10 level would be representative of a typical industrial lubrication system.

Also appearing in Table 3 are the particle count readings for the bearing tests reported in (9) along with their nominal contamination class. These readings, unlike those for the ultraclean tests, were taken at a point downstream of the test bearings. Therefore these readings contain particles that not only passed through the filter but also particles generated by the test bearings and scavenge pump as well. The contamination class for the baseline bearings tested with 49 micron filtration (9) in oil not contaminated with external debris is nominally a class 8, "typical aerospace hydraulic system." The lubrication system for these baseline tests is relatively clean by industrial standards but Table 3 indicates that there are greater than 3 orders of magnitude more particles of a given size than those present in the ultra-clean lubricant in system tests. However this comparison is only on an approximate basis since the particle count readings for the baseline and other tests performed in (9) were taken downstream of the test bearings while those for the ultra-clean tests were taken just after the test filter. Nonetheless large differences can be observed in Table 3 between the debris levels with ultra-clean lubrication compared to those from the other test series.

The particle count readings for the ultra-clean lubrication system had so few particles that it was difficult getting an accurate count with the visual count method using a light microscope. The background count of the

clean, oil sample bottles themselves initially gave an oil contamination level of only class 6 or 7. To get valid readings, it was necessary to institute a thorough sample bottle cleaning procedure in which the bottles were repeatedly rinsed with filtered petroleum ether until a blank reading showed no particles greater than 100 microns in size and no more than one particle greater than 50 microns. Using this procedure it was possible to obtain consistent contamination level readings of class 00 or better with the bottle sampling method. These measurements were periodically verified by an inline electronic particle counter that was installed directly into the test bearing supply line.

Table 3 also contains particle count readings for two of the contaminated oil test series conducted in (9) where contaminants were injected into the oil line leading to the test filter. The contamination levels associated with the 3 micron filter, contaminated lubricant tests were slightly higher (class 8 to 9) than the clean lubricant, baseline tests. However significantly higher levels (class 10 to 11) were recorded for the 49 micron filter, contaminated lubricant tests.

In Table 3, all particle count readings remained relatively constant with time, indicating stable filter performance. Further more initial calibration tests of the contaminant injection system performed in (9) indicated that all test filters, except for the 105 micron absolute filter, prevented more than 99 percent of the incoming particles of 5 microns in size or larger from reaching the test bearings.

Fatigue Test Results

A summary of the fatigue lives of bearings tested with ultraclean lubrication along with those reported in (9) are listed according to lubricant contamination level in Table 5. These fatigue life results were statisti-

cally analyzed using the method of (17). Weibull failure distributions for the ultra-clean, baseline and 3-micron/contaminated oil test series appears in Fig. 4.

In the ultra-clean test series, five of the nine test bearings experienced fatigue failures. One of the remaining four bearings failed prematurely at 154 hours. This failure was thought to be rig related and was consequently treated as an early suspension in accordance with (17). The other three bearings were suspended from test unfailed.

The experimental 10-percent life of the test bearings from the ultra-clean oil tests was 1099 hours. This is approximately 23 times the AFBMA catalog life of 47 hours. Due to the operating conditions and quality of the bearing steel, a life improvement factor of 5.2 would normally be expected for these bearings according to (16). It is interesting to note that even the bearings tested in relatively dirty oil with 49 micron filtration yielded a bearing 10-percent life that is 8 times the AFBMA life.

Bearings tested in an ultra-clean lubrication system showed about a 64 percent life improvement at the 10-percent life level relative to the baseline tests with a laboratory clean lubrication system. However this relative life improvement is not statistically significant, since there is only a 76 percent probability (confidence number) that the bearings from the ultra-clean test series would be longer lived than those from the baseline tests. (A confidence number of 90 percent or greater is generally considered to be statistically significant while a confidence of number of 50 percent has no significance.) The differences in experimental fatigue life at the 50-percent life level for these two groups of bearings is also statistically insignificant.

Table 5 also shows that bearing fatigue lives generally deteriorated with coarser filtration in a contaminated oil. All experimental fatigue lives were statistically inferior to that obtained with the ultra-clean oil system. The 10-percent life obtained with 3 micron filtration in oil injected with significant amounts of contaminants was approximately half that obtained with the same pore size filter in oil not exposed to external contaminants (ultra-clean test series). This test result suggests that the use of a 3 micron absolute filter in an industrial or aircraft lubrication system would bring bearing lives within 50 percent of that attainable under nearly ideal lubricant cleanliness.

Comparing the life dispersion parameter or Weibull slope for the different test series in Table 5, a relatively large value of 4.09 was observed for the ultra-clean tests as shown in Fig. 4. As noted in (9), the tests conducted with contaminated lubricants generally have Weibull slopes which progressively increase with coarser filter pore size. This qualitatively agreed with the progressive damage theory advanced in (18). The reason for this change in trend is not clear. The high Weibull slope suggests that ultra-clean lubrication may help to eliminate early failures. However an undue amount of importance should not be placed on the exact value of Weibull slope for this test series. According to the statistical methods of (17), a failure distribution containing only five failures will have 52 percent variability in Weibull slope. This means that in 90 percent of all possible cases, the true slope will be within ± 52 percent of the observed slope of 4.09. Had 20 failures occurred, this variability factor would have diminished to ± 26 percent.

Centrifugal Filter Tests

The tests using the centrifugal oil filter with the contaminant injection system did not produce enough valid bearing fatigue failures to prepare a Weibull analysis. Two tests were terminated due to operational difficulties with the centrifugal filter and no valid failures were obtained. The third test run lasted 748 hours and two bearings sustained inner race spalls. The test was stopped at this time because the remaining six test bearings were running very roughly.

The oil cleanliness varied with time with centrifugal filtration. As the dirt holding basket started to become filled, more contaminant would pass through the filter. This was possibly caused by some of the lighter weight particles being reentrained into the oil while it was flowing over the basket. With the centrifugal oil filter there is no sure way to determine when the basket is full except to periodically monitor the oil cleanliness. Unless the basket is changed at regular short intervals, a high level of contamination could unexpectedly build up and cause accelerated bearing damage. To prevent this from occurring, the basket assembly was changed about every 250 hours during the third test run.

Test Bearing Condition

Post test examination of the raceways of the unfailed (suspended) test bearings from the ultra-clean and centrifugal oil filter tests showed large differences in the degree of surface distress. Fig. 5 shows representative macro and scanning electron microscope (SEM) photographs of the inner raceways of these bearings as well as those from tests in (9). The surface distress of the ultra-clean test bearings are comparable to that of the test bearings used in the clean, baseline tests. In both the ultra-clean and clean tests bearings, the original grinding marks are still present after

completing 1790 test hours and 1206 test hours, respectively. Bearings from both tests show some debris dents. Since in the case of ultra-clean test series the oil entering the bearing was in a state of extremely high cleanliness as indicated in Table 3, it is reasonable to conclude that these debris dents were generated from within the bearing assembly itself. The main source of internal particle generation is most likely the sharp edges on the cage. Thus debris denting caused by debris generated within the bearings assembly represents some inherent limit to the effectiveness of using finer filters to improve fatigue life. This is probably why no statistically significant life differences were observed between the bearings from ultra-clean and clean test series.

The bearings from the centrifugal oil filter test had much more surface distress than those from the ultra-clean test series being comparable to bearings from the tests in which a 30-micron absolute filter was used with contaminated oil. The grinding marks were completely worn away in both tests with only a mated surface remaining.

The progressive increase in surface distress with increased filter size as shown in Fig. 5 is mainly the result of debris particles interrupting the protective EHD film between the ball and raceway. In general, the size of the particles which penetrates the contact are on the order of the EHD film thickness which is 0.38 microns in this case. Even with 3 micron filtration, the filter efficiency curves in Fig. 1 indicate that relatively few of these fine particles, which are generally quite numerous, can be readily filtered out. However, occasionally larger particles are entrained and these would be more amenable to filtration. These larger debris particles, despite their fewer number, are expected to have the more dominant effect on

spall initiation (19). This is because the severity of the defect they produce, that is, the depth and size of the debris dent, is so much greater.

Bearing Wear Rates

Corroborating this apparent increase in bearing surface damage with filter pore size is the increase in bearing average weight loss of the suspended bearings as listed in Table 6. On the basis of grams of weight loss per 100 test hours the baseline suspended test bearings with clean oil and 49 micron absolute filtration had 3.9 times the weight loss of the bearings from the ultra-clean tests while the bearings from the centrifugal, 3, 30, 49, and 105 micron filter tests with contaminated oil had 6.6, 7.4, 12.5, 16.2, and 344.6 times the weight loss as the ultra-clean test bearings. It can be noted that the average weight loss of the failed bearings generally were 2 to 10 times higher than the weight loss for the unfailed bearings. This difference was used during the tests to determine which of the four bearings in a rig had failed after a bearing failure indication was given by an accelerometer.

Failure Modes

The fatigue failures examined from tests with the ultra-clean lubrication systems appear to be predominantly subsurface originated, although in some cases, extensive spall propagation made failure mode determination inconclusive. It is possible that some failures could have nucleated from debris dents, acting as stress raisers, since dents often quite large were occasionally found on unfailed bearings. Many of these debris dents were significantly larger than the "absolute" pore size of the filter, suggesting that debris particles can break loose from the line downstream of the filter and/or be generated with the bearing assembly itself. It is not uncommon to find debris dents which are larger than the filter's openings on the race-

ways of test bearings which have been protected by full flow filtration. The limiting life factor from surface defect related fatigue is therefore not the size of filter but rather the internal debris generation rate of the bearing itself.

Other Considerations

The advantages gained from using high efficiency filters are discussed elsewhere in this paper. However, in the past, using fine filtration has occasionally been associated with some liabilities, in particular additive removal and reduce filter life. These items are addressed here.

Additives - The mechanism of removal of particles from oils by barrier filters is essentially a sieving process (20). A particle continues to pass through a filter medium until a constriction is reached which stops motion. Materials can only be removed from an oil stream by barrier filters if they are present as rigid bodies with sizes that are retained by the filter. Most additives are present as dissolved species. The additive molecules are far too small to be mechanically sieved out of the host oil. Similarly, additives present as emulsions cannot be removed. The flexible walls of each droplet permit the emulsion to easily pass through barrier filters, carried along by the streaming host liquid. Precautions must only be exercised in those applications where additives are present as suspensions of solid particles. In these circumstances a balance must be struck between filter pore size, additive particle size, and the size and number of contaminant particles that can produce wear mechanical components.

Service life - The service life of a filter is defined as either a scheduled removal after a predefined interval of operation or an amount of system operation until the filter becomes "plugged," that is, reaches a predefined differential pressure drop requiring removal.

The pressure drop across a newly installed filter will start with an initially low (clean) value, which increases with service as the filter collects contaminants. For a given filter assembly size, the service life of a filter is dependent on filter construction and the contaminant loading of the system.

Advances in filter media now allow fine filters to be constructed of materials that have greater efficiency with lower clean pressure drop and even greater dirt capacity than earlier coarser filters of comparable size. This is because the fibers in the filter media can now be made so fine as to maximize the void space or number of pores for a given filter volume.

Furthermore, component wear is frequently a major source of contaminant loading in a system. By reducing component wear with finer filtration, the dirt loading of the oil is substantially reduced. Thus the fine filter has less material to collect, and may last as long or longer than a coarser filter in the same application. For these reasons, the use of an extremely fine filter should not be dismissed out of hand because of an assumed short service life.

SUMMARY AND CONCLUSIONS

Fatigue tests were conducted on groups of 65-millimeter-bore-diameter deep-groove ball bearings in a MIL-L-23699 oil under two levels of filtration. A 3 micron absolute filter was used to establish a lubrication system with nearly ideal cleanliness. The debris level, as determined by oil sample particle counts, was less than a class "00" per NAS 1638. In a second test series, a centrifugal oil filter was used. Contaminants of the type found in aircraft engine filters were injected into the centrifugal filter's supply line at a rate of 125 milligrams per bearing-hour. Bearing fatigue lives, surface distress and weight loss were compared to previous bearing

fatigue tests in contaminated and noncontaminated oil with filters having absolute removal ratings of 3, 30, 49, and 105 microns. Test conditions included a bearing shaft speed of 15 000 rpm, a radial load of 4580 newtons (1030 lb) producing a maximum Hertz stress of approximately 2410 MPa (350 000 psi) on the bearing inner race. The temperature of the lubricant into the test bearing and the sump temperature was maintained at 347 K (165⁰ F). The following results were obtained:

1. Using a lubrication system of nearly ideal cleanliness produce bearing fatigue lives that were approximately twice that obtained in contaminated oil with 3 micron filtration and three times that with 49 micron filtration. However, bearing fatigue life and surface appearance did not significantly improve relative to a clean lubrication system having 49 micron filtration and oil not contaminated with external debris.

2. The centrifugal oil filter had approximately the same effectiveness as a 30 micron absolute filter in preventing bearing surface damage.

3. Bearing surface damage and wear were more sensitive to changes in lubricant cleanliness than was bearing fatigue life, regardless of the type of filter used.

REFERENCES

1. Fitzsimmons, B. and Cave, B. J., "Lubricant Contaminants and Their Effects on Bearing Performance," SAE Paper No. 750583, 1975.
2. Fitzsimmons, B. and Clevenger, H. D., "Contaminated Lubricants and Tapered Roller Bearing Wear," ASLE Transactions, Vol. 20, No. 2, 1977, pp. 97-107.
3. Perrotto, J. A., "Effect of Abrasive Contaminants on Ball Bearing Performance," ASLE Journal of Lubrication Engineering, Vol. 35, No. 12, Dec. 1979, pp. 698-705.

4. Lynch, C. W. and Cooper, R. B., "The Development of a Three-Micron Absolute Main Oil Filter for the T53 Gas Turbine," ASME Journal of Lubrication Technology, Vol. 93, No. 3, 1971, pp. 430-436.
5. Dalal, H. and Senholzi, P., "Characteristics of Wear Particles Generated During Failure Progression of Rolling Bearings," ASLE Transactions, Vol. 20, No. 3, 1977, pp. 233-243.
6. Dalal, H., Cotellesse, G., Morrison, F., and Ninos, N., "Final Report on Progression of Surface Damage in Rolling Contact Fatigue," SKF-AL74T002, SKF Industries, Inc., King of Prussia, PA, Feb. 1974. (AD-780453.)
7. Okamoto, J., Fujita, K., and Toshioka, T., "Effects of Solid Particles in Oil on the Life of Ball Bearings," Journal of the Mechanical Engineering Laboratory (Tokyo), Vol. 26, No. 5, 1972, pp. 228-238, (NASA Technical Translation; NASA TT-F-15, 653, 1974).
8. Tallian, T. E., "Prediction of Rolling Contact Fatigue Life in Contaminated Lubricant: Part II-Experimental," ASME Journal of Lubrication Technology, Vol. 98, No. 3, July 1976, pp. 384-392.
9. Loewenthal, S. H. and Moyer, D. W., "Filtration Effects on Ball Bearing Life and Condition in a Contaminated Lubricant," ASME Journal of Lubrication Technology, Vol. 101, No. 2, Apr. 1979, pp. 171-179.
10. Wedeven, L. D., "Diagnostics of Wear in Aeronautical Systems," NASA TM-79185, 1979.
11. Cunningham, J. S., and Morgan, M. A., "Review of Aircraft Bearing Rejection Criteria and Causes," ASLE Lubrication Engineering, Vol. 35, No. 8, Aug., 1979, pp. 435-441.

12. Smith, R. L., McGrew, J. M., and Petersen, M. B., "A Comparison of Alternative Filter Concepts for Helicopter Transmissions," SRC 78-TR-38, Shaker Research Corp., Ballston Lake, NY, Jan., 1979.
13. Fitch, E. C., "The Multi-Pass Filter Test - Now A Viable Tool," 8th Annual Fluid Power Research Conference, Stillwater, Ok, 1974, Paper No. P74-39.
14. "Multi-Pass Method for Evaluating the Filtration Performance of a Fine Hydraulic Fluid Power Filter Element," ANSI B93.31-1973, American National Standards Institute, New York, 1973.
15. Cheng, H. S., "A Numerical Solution of the Elastohydrodynamic Film Thickness in an Elliptical Contact," ASME Journal of Lubrication Technology, Vol. 92, No. 1, Jan. 1970, pp. 155-162.
16. Bamberger, E. N., Harris, T. A., Kocmarsky, W. M., Moyer, C. A., Parker, R. J., Sherlock, J. J., and Zaretsky, E. V., Life Adjustment Factors for Ball and Roller Bearings - An Engineering Design Guide, American Society of Mechanical Engineers, New York, 1971.
17. Johnson, L. G., "The Statistical Treatment of Fatigue Experiments," GMR-202, General Motors Corp., 1956.
18. Tallian, T. E., "Prediction of Rolling Contact Fatigue Life in Contaminated Lubricant: Part I - Mathematical Model," ASME Journal of Lubrication Technology, Vol. 98, No. 2, Apr. 1976, pp. 251-257.
19. Authors' Closure to "Filtration Effects on Ball Bearing Life and Condition in a Contaminated Lubricant," ASME Journal of Lubrication Technology, Vol. 101, No. 2, Apr. 1979, pp. 178-179.
20. Needelman, W. M., "Filtration For Wear Control," Wear Control Handbook, M. B. Petersen and W. O. Winer, eds., American Society of Mechanical Engineers, New York, 1980, pp. 507-582.

Table 1 - Test filters specifications

Removal ratings, microns Nominal & Mean Absolute	Clean pressure drop at 19 liters/min (5 gal/min)		Dirt capacity ^c g	Filter media material
	kPa	psi		
0.45	0.9	3	290	Resin impregnated fiber
30	40	49	550	Resin impregnated fiber
10	20	30	570	Resin impregnated fiber
30	40	49	550	Resin impregnated fiber
70	(d)	105	22.5	Sintered square weave stainless wire cloth
(e)		(f)	945 (g)	Centrifugal oil filter

^aNominal removal rating based on MIL-F-5504.

^bAbsolute removal rating based on MIL-F-27656.

^cDirt capacity based on MIL-F-25682.

^dNot available.

^eNot applicable - removes particles by density difference.

^fCentrifugal oil filter has built-in pump and generates a pressure rise.

^gBased on a density of .069 lb/in³ for sand.

Table 2 - Composition of test contaminant

Constituent	Parts per mixture by weight	Particle distribution
Stainless-steel particles	1	100% less than 44 microns
Arizona coarse test dust	10	12% less than 5 microns 24% less than 10 microns 38% less than 20 microns 61% less than 40 microns 91% less than 80 microns 100% less than 200 microns
Carbon-graphite test dust	80	75% less than 10 microns 92% less than 20 microns 100% less than 40 microns
Total contaminant mixture	91	70% less than 10 microns 86% less than 20 microns 96% less than 40 microns 4% greater than 40 microns

Table 3 - Summary of Representative Particle Count Readings

Test Series Lubricant Cleanliness	Test Filter Absolute Rating, μm	Test Time, hr	Particle Count, Particles/100ml						Contamination Class per NAS 1638
			Micron Size Range						
			5-15	15-25	25-50	51-100	>100		
Ultra-Clean ^a	3	0	50	10	0	0	10	0	<0C
		307	40	20	0	0	0	0	<0C
		1022	60	20	10	0	0	0	<0C
		1409	70	20	10	0	0	0	<0C
		1607	30	20	0	0	0	0	<0C
		1761	30	10	0	0	0	0	<0C
Clean (baseline) ^b	49	139	5-15	16-30	31-50	51-100	>100		6
		417	25000	4600	1800	400	200	200	6
		1207	23800	7100	3000	500	200	200	6
Contaminated ^b	3	12	80000	11100	200	200	200	200	6
		785	129000	7000	700	300	200	200	6
		876	145000	9000	2700	500	300	300	9
Contaminated ^b	49	205	102000	6000	1900	400	300	300	9
		412	1732000	79000	3600	400	200	200	1C
		663	255000	19000	6800	1000	200	200	1C
			605000	38000	8800	1200	400	400	11

^a Samples taken downstream of test filter.

^b Samples taken downstream of test bearings from (9).

^c Minimal Contamination class from Table 4.

ORIGINAL PAGE IS
OF POOR QUALITY

Table 4 - Aerospace Industries Association of America, Inc,
 Cleanliness requirements of parts used in hydraulic
 systems in maximum number of particles per 100 ml..
 NAS 1638, Jan. 1964

SIZE RANGE MICRONS	Classes													
	00	0	1	2	3	4	5	6	7	8	9	10	11	12
5 - 15	125	250	500	1000	2000	4000	8000	16,000	32,000	64,000	128,000	256,000	512,000	1,024,000
15 - 25	22	44	89	178	356	712	1425	2,850	5,700	11,400	22,800	45,600	91,200	182,400
25 - 50	4	8	16	32	63	126	253	506	1,012	2,025	4,050	8,100	16,200	32,400
50 - 100	1	2	3	6	11	22	45	90	180	360	720	1,440	2,880	5,760
over 100	0	0	1	1	2	4	8	16	32	64	128	256	512	1024

Class 00-2	rarely attained	Class 9-10	typical industrial lube system
Class 3-5	good missile system	Class 11-12	poor lube system
Class 6-8	typical aerospace hydraulic system		

ORIGINAL PAGE IS
 OF POOR QUALITY

Table 5 - Comparison of ball bearing fatigue life results with an ultra clean lubricant and fatigue life with different levels of filtration in a contaminated lubricant from [9]

(Radial load, 4580 N (1030 lbf); speed, 15,000 rpm; temperature, 347 K (165°F); test lubricant, MIL-L-23699 type.)

Test series lubricant condition	Test filter absolute rating, microns	Experimental hours		Weibull slope	Failure index ^a	Confidence number, percent	
		10-percent life, L ₁₀	50-percent life, L ₅₀			10%	50%
Ultra-clean	3	1099	1741	4.09	5 out of 9	---	---
clean (baseline) ^c	49	672	2276	1.54	9 out of 32	76	---
Contaminated ^c	3	505	993	2.78	10 out of 16	93	99
Contaminated ^c	30	594	857	5.12	11 out of 16	96	99
Contaminated ^c	49	367	533	5.06	20 out of 32	99	99

^aNumber of fatigue failures out of number of bearings tested.

^bProbability (expressed as a percentage) that bearing fatigue life in a given test series will be inferior to the life obtained with ultra-clean lubrication. A 90 percent or greater confidence number is considered statistically significant.

^cTest data from [9]

Table 6 - Summary of test bearing average weight loss

Test series lubricant condition	Test filter absolute rating, microns	Suspended test bearings		Failed test bearings	
		g/bearing	g/100 hr	g/bearing	g/100 hr
Ultra-clean centrifugal oil filter	3	0.0143	0.0008	0.4045	0.0211
	---	.0395	.0053	----	----
Clean ^a (base-line)	49	.0412	.0031	.2775	.0311
contaminated ^a	3	.0548	.0059	.3157	.0390
contaminated ^a	30	.0806	.0100	.1679	.0214
contaminated ^a	49	.0809	.0130	.3288	.0713
contaminated ^{a,b}	105	1.0204	.2757	----	----

^a Test data from [9]

^b All bearings suspended due to heavy wear. No fatigue failures obtained.

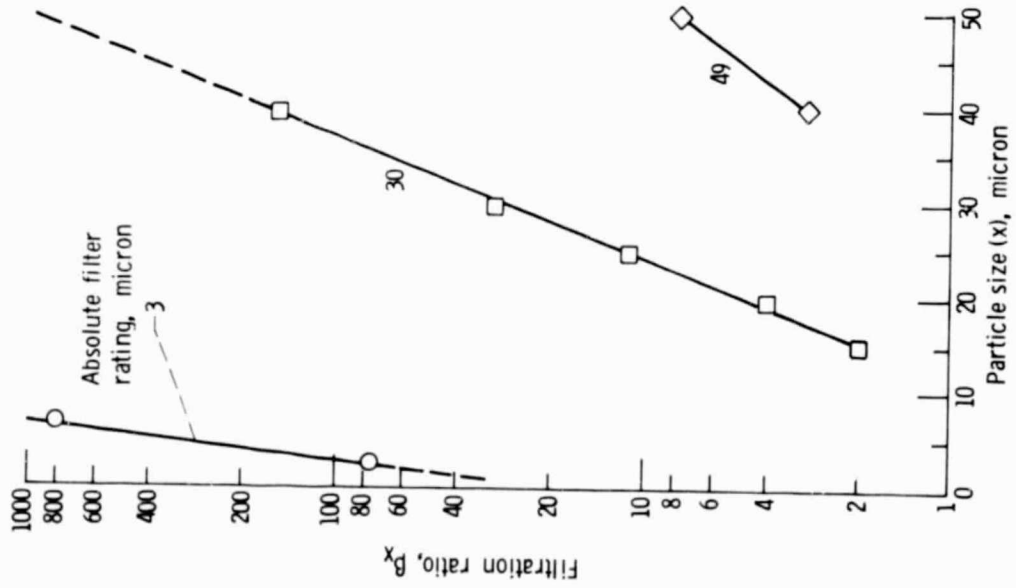

Figure 1. - Efficiency of test filters from multi-pass filter test.

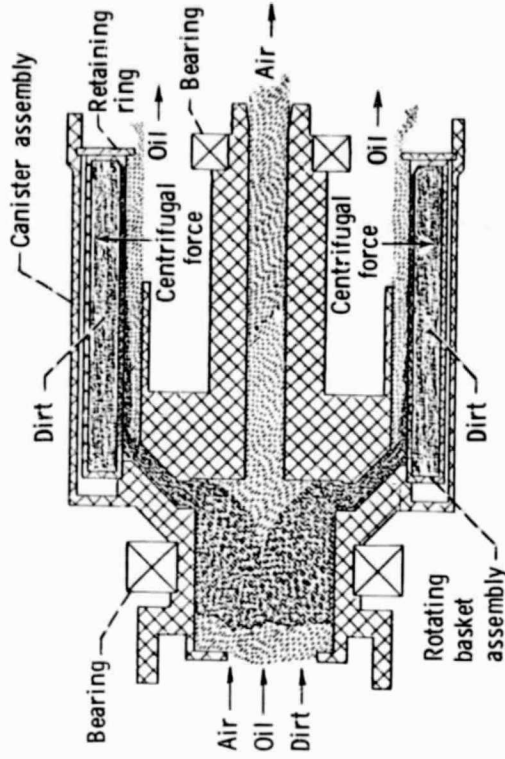

Figure 2. - Cross section of centrifugal oil filter.

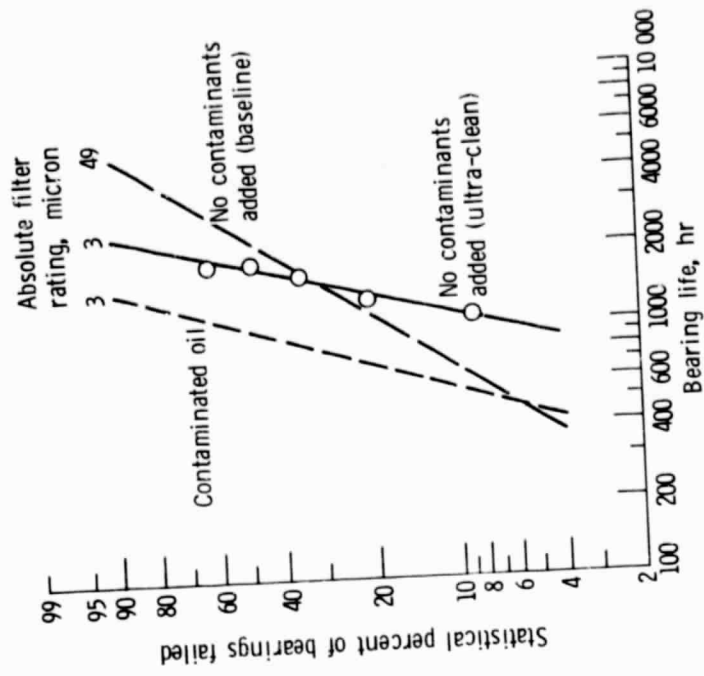

Figure 4. - Effect of ultra-clean lubrication on 65 mm bore, ball-bearing life. Speed, 15 000 rpm; lubricant, MIL-L-23699.

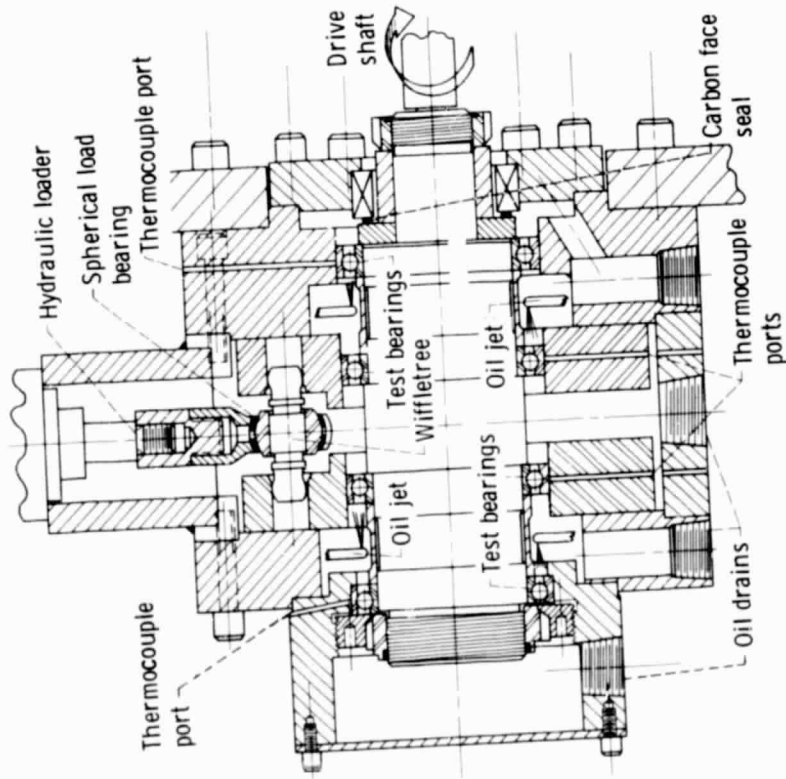
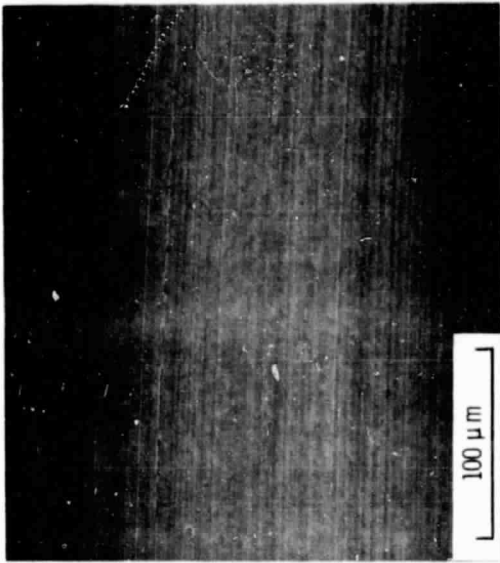
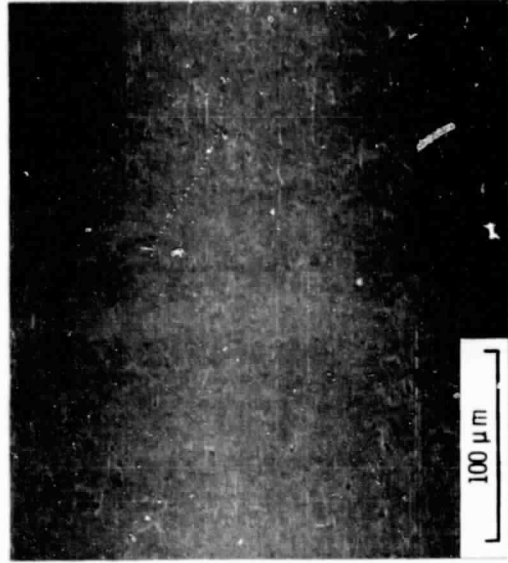

Figure 3. - Bearing fatigue tester.



TEST BEARING SUSPENDED AFTER 1790 hr FROM ULTRA-CLEAN TESTS WITH 3 micron ABSOLUTE FILTER



TEST BEARING SUSPENDED AFTER 748 hr FROM CENTRIFUGAL OIL FILTER TESTS



Figure 5. - A comparison of test bearing inner race surface damage as a function of contamination level.

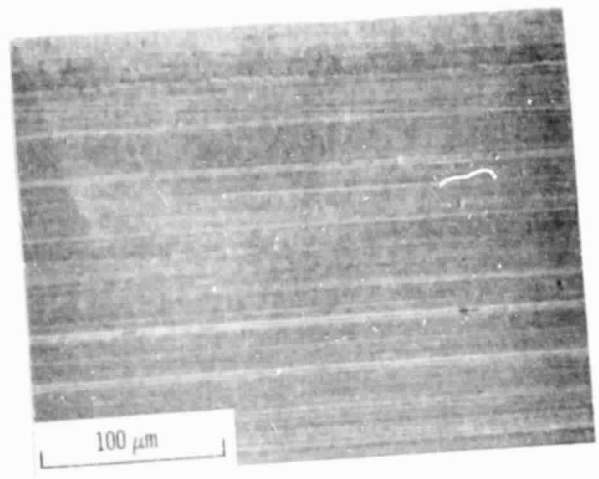
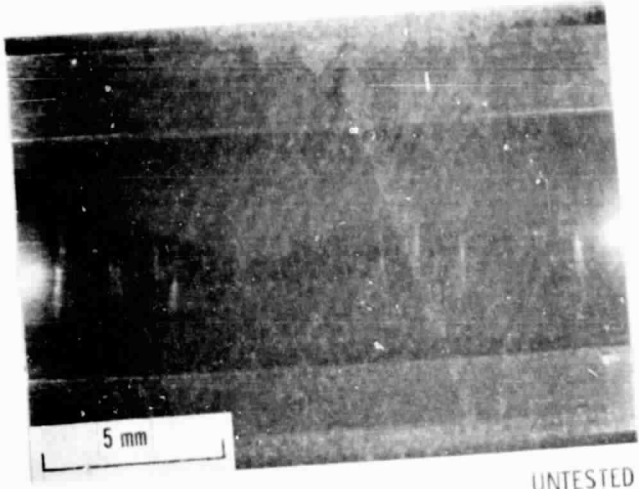

UNTESTED TEST BEARING

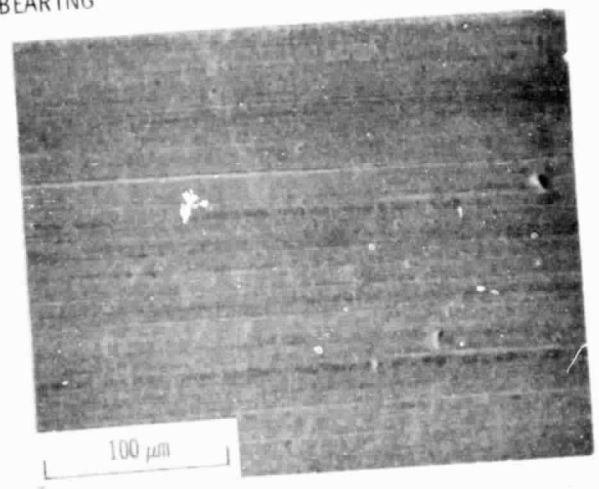
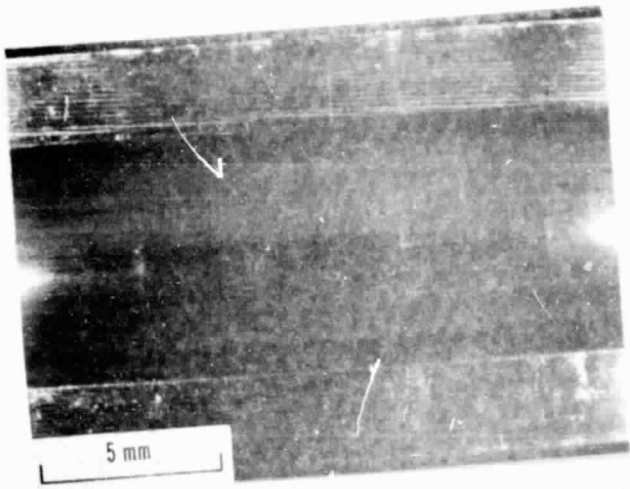

TEST BEARING SUSPENDED AFTER 1206 hr FROM 49-micron-ABSOLUTE FILTER TESTS WITH CLEAN LUBRICANT (9)

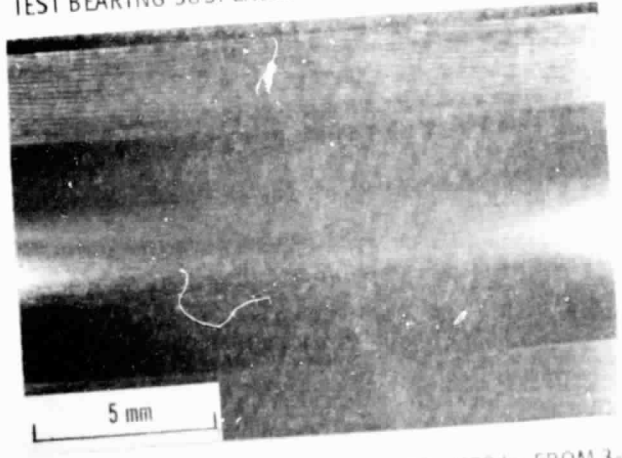

TEST BEARING SUSPENDED AFTER 1172 hr FROM 3-micron-ABSOLUTE FILTER TESTS WITH CONTAMINATED LUBRICANT (9)

Figure 5. - Continued.

**ORIGINAL PAGE IS
OF POOR QUALITY**

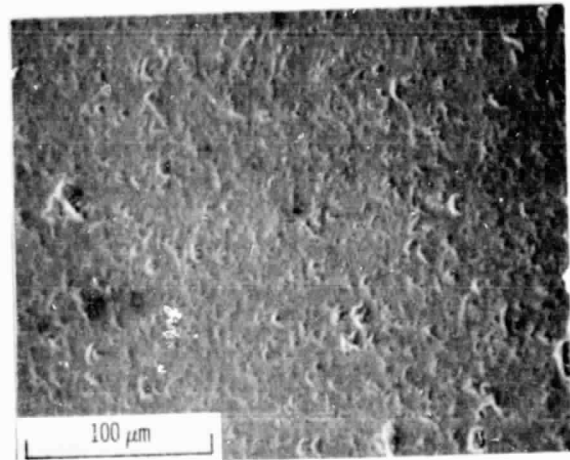
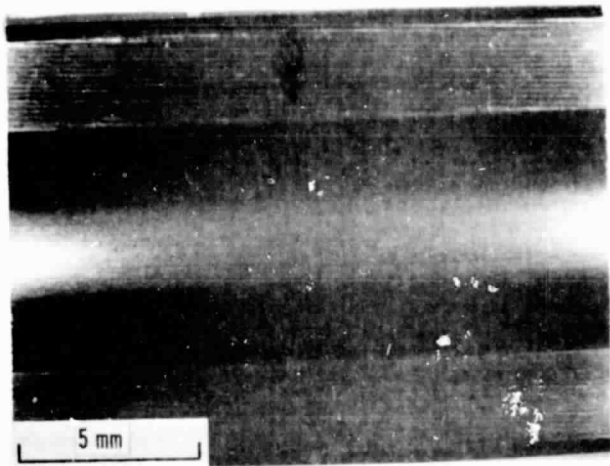

TEST BEARING SUSPENDED AFTER 987 hr FROM 30-micron-ABSOLUTE FILTER TESTS WITH CONTAMINATED LUBRICANT (9)

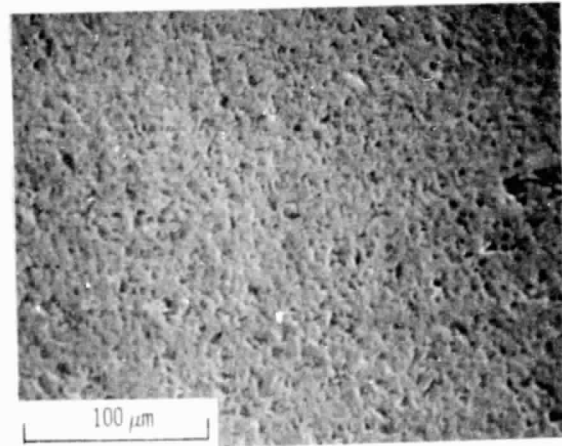
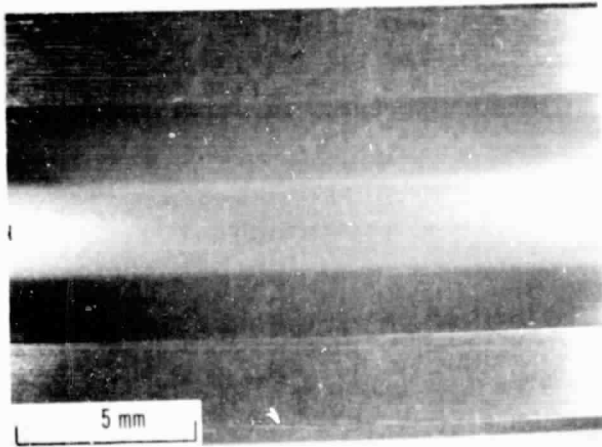

TEST BEARING SUSPENDED AFTER 663 hr FROM 49-micron-ABSOLUTE FILTER TESTS WITH CONTAMINATED LUBRICANT (9)

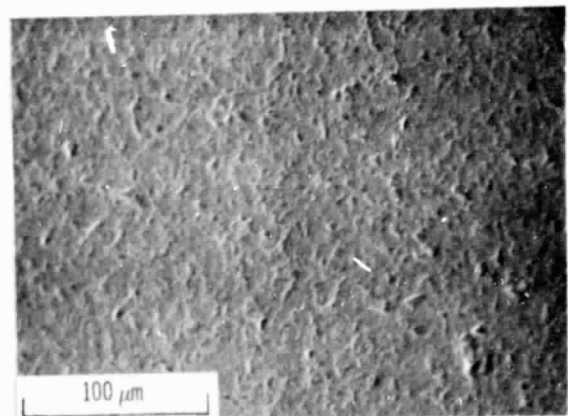
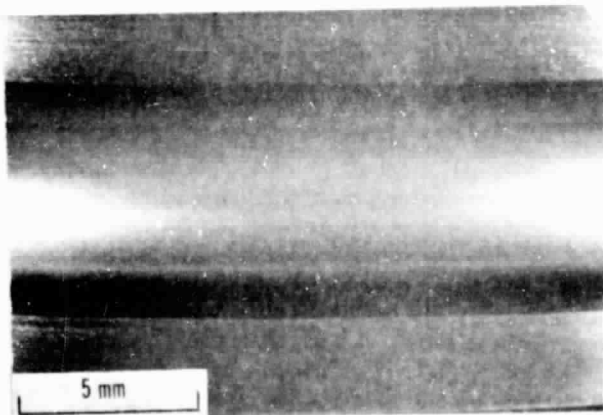

TEST BEARING SUSPENDED AFTER 449 hr FROM 105-micron-ABSOLUTE FILTER TESTS WITH CONTAMINATED LUBRICANT (9)

Figure 5. - Concluded.