

## N O T I C E

THIS DOCUMENT HAS BEEN REPRODUCED FROM  
MICROFICHE. ALTHOUGH IT IS RECOGNIZED THAT  
CERTAIN PORTIONS ARE ILLEGIBLE, IT IS BEING RELEASED  
IN THE INTEREST OF MAKING AVAILABLE AS MUCH  
INFORMATION AS POSSIBLE

(NASA-CR-165420-Vol-1) ELECTROCHEMICAL  
ENERGY STORAGE SUBSYSTEMS STUDY, VOLUME 1  
Final Contractor Report, Oct. 1979 - Sep.  
1981 (PRC Systems Sciences Co.) 341 p  
HC A15/MF A01

N81-31630

Unclas

CSSL 10C G3/44 27392

# Electrochemical Energy Storage Subsystems Study

## FINAL REPORT

Volume 1 of 2

Prepared For  
NASA LEWIS RESEARCH CENTER  
CLEVELAND, OHIO 44135  
CONTRACT NAS3-21962  
SEPTEMBER 1981

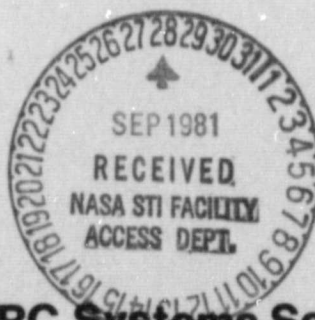

**prc**  
**PRC Systems Services Company**  
A DIVISION OF PLANNING RESEARCH CORPORATION

# **Electrochemical Energy Storage Subsystems Study**

**FINAL REPORT**

**Volume 1 of 2**

Prepared For  
NASA Lewis Research Center  
Cleveland, Ohio 44135  
Contract NAS3-21962  
September 11, 1981

**PRC Systems Services Company**

A DIVISION OF PLANNING RESEARCH CORPORATION

7911 Charlotte Drive

Huntsville, Alabama 35802

Telephone (205) 881-2260/883-2900

**prc**

September 11, 1981

NASA-Lewis Research Center  
21000 Brookpark Road  
Cleveland, OH 44135

Attention: Don F. Hoffman, Contract Specialist, MS500-305

Subject: Submission of Final Report

Reference: Contract Number NAS3-21962,  
Electrochemical Energy Storage Subsystems Study

Gentlemen:

In compliance with the referenced contract, the specified copies of the Electrochemical Energy Storage Subsystems Study Final Report are hereby submitted.

Should you have any questions, please contact the undersigned at (205) 883-2900.

Very truly yours,

PRC SYSTEMS SERVICES

*Fred Q. Miller*

Fred Q. Miller  
Project Manager

FQM/bjs

Enclosures: As stated

NASA CR-165420

Final Report

ELECTROCHEMICAL ENERGY STORAGE SUBSYSTEMS STUDY

by

Fred Q. Miller, Project Manager  
Peter W. Richardson, Deputy Director, Systems Engineering  
Charles L. Graff, Consultant  
Michael V. Jordan, Senior Associate  
Vickie L. Patterson, Research Associate

PRC SYSTEMS SERVICES

Prepared For

National Aeronautics and Space Administration  
NASA-Lewis Research Center  
Contract NAS3-21926

## TABLE OF CONTENTS

<u>Section</u>	<u>Title</u>	<u>Page</u>
	LIST OF EXHIBITS . . . . .	iii
	FOREWORD . . . . .	v
	EXECUTIVE SUMMARY . . . . .	vii
1.0	STUDY OVERVIEW . . . . .	1
	1.1 Background . . . . .	1
	1.2 Study Purpose . . . . .	2
	1.3 Study Methodology . . . . .	2
	1.3.1 Mission/System Subsystem Requirements . . . . .	5
	1.3.2 Performance and Cost Models . . . . .	5
	1.3.3 Baseline Subsystems . . . . .	11
	1.3.4 Results and Conclusions . . . . .	22
	1.3.5 Areas for Further Study . . . . .	22
2.0	ESS PERFORMANCE MODEL . . . . .	25
	2.1 General Methodology . . . . .	25
	2.1.1 ESS Battery Performance . . . . .	31
	2.1.2 ESS Fuel Cell Performance . . . . .	31
	2.2 ESS Performance Relationships . . . . .	33
	2.2.1 Battery Performance Relationships . . . . .	33
	2.2.2 Fuel Cell Performance Relationships . . . . .	38
	2.3 ESS Physical Characteristics . . . . .	41
	2.3.1 Battery Subsystem Physical Characteristics . . . . .	41
	2.3.2 Fuel Cell Subsystem Physical Characteristics . . . . .	41
	2.4 ESS Baseline Configurations . . . . .	47
	2.4.1 NiCd Baseline Configurations . . . . .	47
	2.4.2 NiH <sub>2</sub> Baseline Configurations . . . . .	49
	2.4.3 Fuel Cell Baseline Configurations . . . . .	49
	2.5 ESS Performance Comparisons . . . . .	49
3.0	TOTAL LIFE CYCLE COST MODEL (LCCM) . . . . .	55
	3.1 LCCM Ground Rules and Assumptions . . . . .	55
	3.2 Functional Flow Diagrams . . . . .	58
	3.3 DDT&E Phase of the LCCM . . . . .	58

TABLE OF CONTENTS (Cont'd.)

<u>Section</u>	<u>Title</u>	<u>Page</u>
3.4	Production Phase of the LCCM . . . . .	63
	3.4.1 Battery ESS Production Costs . . . . .	65
	3.4.2 Fuel Cell ESS Production Costs . . . . .	72
3.5	O&M Phase of the LCCM . . . . .	83
	3.5.1 Battery ESS O&M Costs . . . . .	84
	3.5.2 Fuel Cell ESS O&M Costs . . . . .	87
3.6	Interface Subsystem Costs . . . . .	93
3.7	Baseline ESS LCC and LCCM Relationships . . . . .	93
4.0	TECHNOLOGY VARIATIONS vs LIFE CYCLE COST . . . . .	99
4.1	General . . . . .	99
4.2	Methodology . . . . .	99
4.3	Technology Parameters to be Varied . . . . .	99
4.4	Major Technology Parameters . . . . .	100
	4.4.1 NiCd Battery Parameters . . . . .	101
	4.4.2 NiH <sub>2</sub> Battery Parameters . . . . .	101
	4.4.3 Discussion of Battery Parameters . . . . .	102
	4.4.4 Fuel Cell Parameters . . . . .	106
	4.4.5 Discussion of Fuel Cell Parameters . . . . .	106
5.0	CONCLUSIONS . . . . .	109
	5.1 Battery Conclusions . . . . .	109
	5.2 Fuel Cell Conclusions . . . . .	109
	5.3 Other Conclusions . . . . .	109
6.0	RECOMMENDATIONS . . . . .	113
7.0	BIBLIOGRAPHY . . . . .	117

LIST OF APPENDICES

A.	Baseline Energy Storage Subsystems Requirements . . .	A-1
B.	NiCd Battery Model Logic . . . . .	B-1
C.	NiH <sub>2</sub> Battery Model Logic . . . . .	C-1
D.	H <sub>2</sub> O <sub>2</sub> Fuel Cell Model Logic . . . . .	D-1
E.	Baseline Printouts (Performance and LCC) . . . . .	E-1
F.	Computer Program Listings (Volume 2) . . . . .	F-1
G.	Data for Technical Variations vs Life Cycle Cost . . . (Volume 2)	G-1

## LIST OF EXHIBITS

<u>Number</u>	<u>Title</u>	<u>Page</u>
1-1	Typical Missions for Different Power Levels . . . . .	3
1-2	LEO Platform . . . . .	4
1-3	GEO Platform . . . . .	4
1-4	Space Services Platform System (SSFS) . . . . .	6
1-5	Mission, System, Subsystems Requirements . . . . .	7
1-6	Battery Subsystems Performance/Cost Model Summary . . . . .	9
1-7	Fuel Cell/Electrolysis Cell Subsystems Performance/Cost Model Summary . . . . .	9
1-8	Life Characteristics Used in the Model . . . . .	10
1-9	Generalized Performance and Cost Model Parameters . . . . .	12
1-10	Battery Life Cycle Cost Model (LCCM) . . . . .	13
1-11	Fuel Cell Life Cycle Cost Model (LCCM) . . . . .	14
1-12	Performance Model Cells . . . . .	15
1-13	NiCd Hierarchy/Configuration . . . . .	17
1-14	NiH Hierarchy/Configuration . . . . .	18
1-15	Fuel Cell/Electrolysis Hierarchy/Configuration . . . . .	19
1-16	Baseline ESS Performance and Life Cycle Cost . . . . .	20
1-17a	EOL Maximum DOD (Capacity Variable) NiCd . . . . .	21
1-17b	EOL Maximum DOD (Capacity Variable) NiH <sub>2</sub> . . . . .	21
1-17c	FCU Current Density - Fuel Cell . . . . .	21
1-18	Conclusions . . . . .	23
1-19	Recommendations . . . . .	24
2-1	Battery ESS Performance Model Structure . . . . .	26
2-2	Fuel Cell ESS Performance Model Schematic . . . . .	27
2-3	Block Diagram of Battery ESS Performance Model . . . . .	28
2-4	Block Diagram of Fuel Cell ESS Performance Model . . . . .	29
2-5	Performance Model Cells . . . . .	32
2-6	NiCd Performance Curves . . . . .	34
2-7	Example of Three-Dimensional Performance Curves (NiCd Charge Voltage vs Charge Throughput, Charge Current and Temperature . . . . .	35
2-8	NiH <sub>2</sub> Performance Curves . . . . .	36



LIST OF EXHIBITS (Cont'd.)

<u>Number</u>	<u>Title</u>	<u>Page</u>
2-9	Fuel Cell - Life vs Performance . . . . .	39
2-10	ESS Battery WBS . . . . .	42
2-11	NiCd Hierarchy/Configuration . . . . .	43
2-12	NiH <sub>2</sub> Hierarchy/Configuration . . . . .	44
2-13	ESS Fuel Cell WBS . . . . .	45
2-14	Fuel Cell/Electrolysis Hierarchy/Configuration . . . . .	46
2-15	Baseline NiCd Battery ESS Parameters and Characteristics . . . . .	48
2-16	Baseline NiH <sub>2</sub> Battery ESS Parameters and Characteristics . . . . .	51
2-17	Baseline Fuel Cell ESS Parameters and Characteristics . . . . .	52
2-18	ESS Performance Comparisons . . . . .	53
3-1	Generalized Performance and Cost Model Parameters . . . . .	56
3-2	Top Level Elements of LCC . . . . .	57
3-3	DDT&E Functional Flow . . . . .	59
3-4	Battery ESS Production and Space Transportation/Assembly & Checkout Flow Diagram . . . . .	60
3-5	Fuel Cell ESS Production and Space Transportation/Assembly & Checkout Flow Diagram . . . . .	61
3-6	O&M Functional Flow . . . . .	62
3-7	Factors for Adjusting Basic CER Results . . . . .	64
3-8	Production Cost Development Procedure . . . . .	66
3-9	NiCd ESS Baseline LCC . . . . .	94
3-10	NiH <sub>2</sub> ESS Baseline LCC . . . . .	95
3-11	Fuel Cell Baseline LCC . . . . .	96
3-12	Baseline LCC . . . . .	97
5-1	Conclusions . . . . .	110
6-1	Recommendations . . . . .	114
7-1a	Bibliography-General . . . . .	118
7-1b	Bibliography-Batteries, General . . . . .	119
7-1c	Bibliography-NiCd Battery . . . . .	120
7-1d	Bibliography-NiH <sub>2</sub> Battery . . . . .	121
7-1e	Bibliography-Fuel Cell . . . . .	122

## FOREWORD

This document is the final report for the "Electrochemical Energy Storage Subsystems Study", performed by PRC/SSc under contract NAS3-21962 with NASA-Lewis Research Center. The effective date of the contract is September 26, 1979. The basic contract study encompassed the study of subsystems consisting of fuel cells/electrolysis cell and battery cell type subsystems at 25, 50, 100 and 250 kW in low earth orbit. A modification was made, dated September 30, 1980, which expanded the study scope to include the geosynchronous case at 25 kW power level, again using both types of energy storage devices.

## EXECUTIVE SUMMARY

### Purpose of the Study

To develop computer models which are used to establish quantitative relationships between the total life cycle cost and technical parameters of electrochemical energy storage subsystems for earth orbiting spacecraft.

### Background

Future NASA and USAF space programs will require significant increases in electrical power requirements from the 1980 average for existing programs of 1 kW. These requirements are projected to increase to approximately 500 kW by the year 2000.

Electrical energy storage systems appropriately sized for future requirements and configured with today's technology will prove inordinately expensive in terms of projected life cycle costs. These costs must be considered truly significant in that they will command a disproportionate share of available resources thereby constraining the numbers and types of future space programs.

Accordingly, it is imperative that new technologies be developed for the design of electrical energy storage systems. Implicit in the development of these technologies is the capability to analyze the impact on system life cycle costs resulting from varying design specifications. Every attempt must be made to maximize system performance and minimize life cycle costs. The models presented herein are the first step toward obtaining this critical capability.

### Methodology

A series of fifteen baseline electrical storage subsystems using today's technologies were specified and hypothetically subjected to either a low earth orbit (LEO) or geosynchronous earth orbit (GEO). The following matrix applies.

Electrical Energy Storage Subsystem	LEO				GEO
	25 kW	50 kW	100 kW	250 kW	25 kW
NiCd Battery	•	•	•	•	•
NiH <sub>2</sub> Battery	•	•	•	•	•
Fuel Cell	•	•	•	•	•

Algorithms representing life cycle costs were developed for each of the fifteen baseline subsystems in their designated orbit. Each subsystem was then subjected to changes in design specifications and the resulting changes in life cycle costs were computed. These iterations resulted in the development of a series of mathematically expressed relationships between individual system components/parameters and life cycle costs.

It should be noted that the model's effectiveness is somewhat limited at this time due to the absence of certain empirical data relating to performance, physical characteristics and costs. Such data are noticeably absent for  $\text{NiH}_2$  cells and the advanced light-weight fuel cell now being developed.

The model is however logically correct, internally consistent, and realistic. Its full effectiveness as a design and budgeting tool will be realized when the voids in empirical data are filled.

#### Results and Conclusions

The models provide an extensive and detailed series of mathematically expressed relationships between individual system components/parameters and life cycle costs. Graphic representations of these relationships are provided in Volume II (Appendix G).

The conclusions of the research are summarized in Section 5.0. Several of the more pertinent conclusions are as follows:

- Quantitative relationships and computer models were developed which enable examination of the effects on life cycle cost resulting from varying technical parameters of the subsystem.
- The life cycle costs of NiCd systems are approximately twice those of comparable  $\text{NiH}_2$  systems.
- The life cycle costs of  $\text{NiH}_2$  systems are comparable to those of comparable fuel cell systems.
- The driving parameters of battery systems have a greater impact on life cycle costs than do comparable parameters for fuel cell systems.

It should be emphasized again that there is a lack of accurate data with which to model battery and fuel cell performance, physical characteristics

and costs. In many cases, it was necessary to interpolate, extrapolate, and otherwise estimate relationships in order to complete the study. The model is, however, logically correct, internally consistent, and realistic and can be used effectively as a design and budgeting tool.

#### Areas for Further Study

Numerous areas for further study having high potential returns on investment are readily apparent. These are discussed in detail in Section 6.0.

Four of the more promising areas are:

- The conduct of life cycle cost sensitivity analyses on designated system parameters by varying only one designated parameter while holding all else constant.
- The conduct comparative life cycle cost analyses on the development of alternative component technologies and on the configuration of alternative system designs.
- The modification and use of the models, as guides, to plan and coordinate future component/system development and test programs, thereby maximizing the use of available resources.
- The modification and use of the models to optimize specified system performance parameters for given levels of life cycle funding.

## 1.0 STUDY OVERVIEW

### 1.1 Background

NASA and USAF proposed space programs for the period of the 1980s and 1990s indicate increases in space power requirements, from a 1980 average (existing programs) of about 1 kW to just under 500 kW in the year 2000. These power levels (which do not include the Solar Power Satellite power levels) present a technical and economic challenge to the NASA, USAF, and commercial/industrial sectors. As a result the projected costs of reliable, light-weight energy storage subsystems are considerable and will become serious constraints on the number and types of space programs which may be implemented over the next 20 to 30 years.

Based upon this study, space energy storage subsystems using NiCd cells weigh about 170 kg per kW. From this, the initial space transportation costs alone for a 25 kW NiCd energy storage subsystem for delivery to LEO by Shuttle are on the order of \$8M, and to GEO by Shuttle/IUS are \$36M. Using the newer technology NiH<sub>2</sub> cell, these costs can be reduced about \$4M to LEO and \$24M to GEO. If the advanced lightweight fuel cell technology is used, these transportation costs can be further reduced to about \$4M to LEO and \$11M to GEO.

The initial space transportation costs are but one element of the life cycle costs (LCC). Other costs which are important include unit costs, subsystem assembly costs, maintenance and spares costs, ancillary equipment costs, interfacing subsystems costs and mission user costs. (In some concepts, spares costs may be represented by such life-extending schemes as "switch-on" redundancy and low level operation.)

It is important, therefore, to examine and quantify the LCC benefits of various physical, performance and operational technologies applied to electrical power systems for high power early orbiting missions. These benefits provide the basis for research and technology development and ultimate cost savings and/or enlargement of our space programs.

## 1.2 Study Purpose

It was the purpose of this study to establish the cost-technology relationships of energy storage subsystems for four LEO missions (25, 50, 100 and 250 kW) and one GEO mission (25 kW). Two types of energy storage subsystems were examined for each of the LEO and GEO power levels: (1) subsystems using batteries and (2) subsystems using fuel cells/electrolysis cells. The study also identifies areas of new technology for each type of subsystem which, if the technology were incorporated, would reduce the cost of space power systems.

Stated another way, the study objective was to establish the relative sensitivity of energy storage subsystem life cycle costs (LCC) to variations in parameters such as battery depth of discharge, cell capacity, internal operating temperatures, current density, and weights and volumes. The cost of developing and/or implementing specific technology solutions is, however, not quantified. For example, the effect on LCC of depth of discharge (DOD) of a  $\text{NiH}_2$  battery subsystem is quite pronounced at about 60 percent DOD (\$10M per percent DOD at 70 percent DOD), indicating large potential cost reductions given the capability to operate  $\text{NiH}_2$  at a 70 percent DOD without a corresponding severe reduction in operating cycle life.

Typical missions for each of four power levels in LEO and one power level in GEO are shown in the table of Exhibit 1-1. Exhibit 1-2 depicts a high power multi-user Space Platform for LEO missions requiring a total of 250 kW, continuous power. Exhibit 1-3 depicts a 25 kW Space Platform for GEO missions requiring 25 kW, continuous power. These exemplify the types of missions which were analyzed in this study.

## 1.3 Study Methodology

The study methodology involved (1) development of mission, system/subsystem requirements for each subsystem power level and orbit, (2) development of performance and cost model structures and the required interrelated algorithms of physical, performance and cost parameters, (3) establishment of baseline subsystems, representative of existing technology, and (4) variation of the physical, performance and technology parameters and determination

POWER LEVEL (CONTINUOUS)	LEO TYPICAL MISSIONS	GEO TYPICAL MISSIONS
25 kW	PHYSICAL/CHEMICAL RESEARCH MATERIALS SCIENCE RESEARCH BIOLOGICAL MATERIALS RESEARCH COMMERCIAL PROCESSING DEVELOPMENT	ALL NATION HOTLINE WORLD-WIDE SEARCH & RESCUE ELECTRONIC MAIL 3-D TELECONFERENCING NUCLEAR FUEL LOCATOR
50 kW	SPACE RADAR POWER SPACELAB/SHUTTLE AUGMENTATION FREE-FLYER SERVICES	
100 kW	OVER THE HORIZON RADAR SYNTHETIC APERTURE MAPPERS RADIO TELESCOPES	
250 kW	MILITARY APPLICATIONS SPACE PROCESSING LONG DURATION LABORATORY	

*Exhibit 1-1. Typical Missions for Different Power Levels*



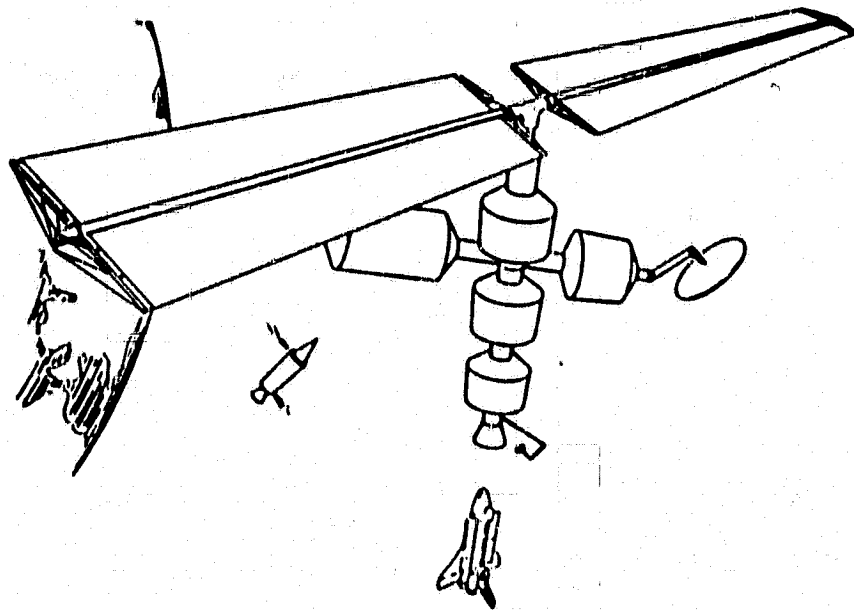

**Exhibit 1-2. LEO Platform**

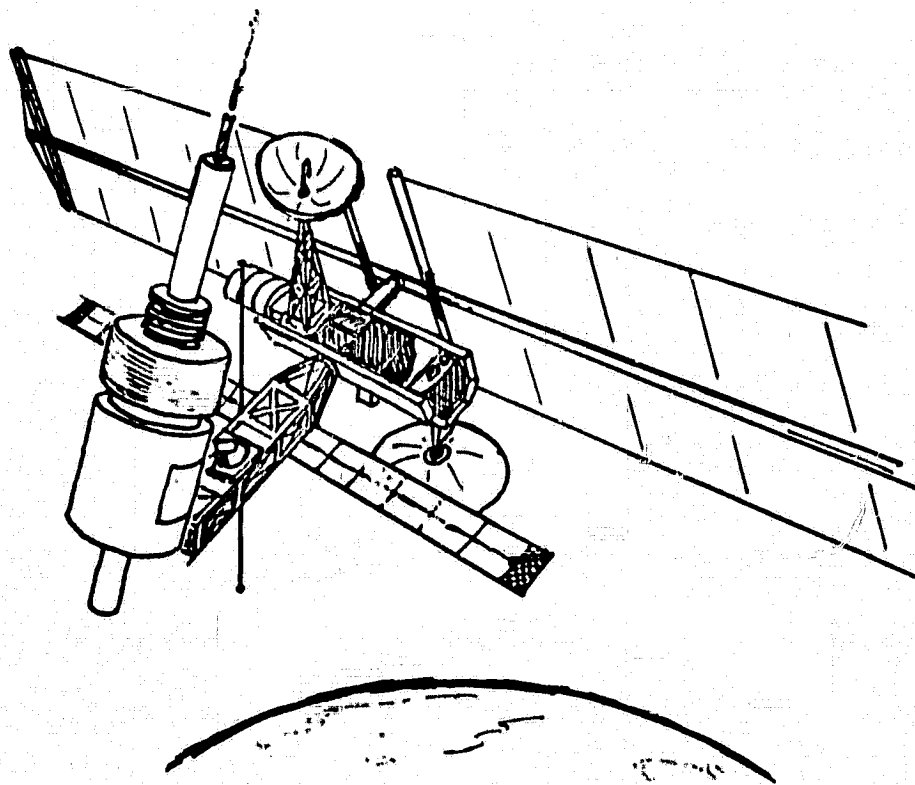

**Exhibit 1-3. GEO Platform**

of their effect on LCC. Each step in the methodology is described in the following sections.

### 1.3.1 Mission/System Subsystem Requirements

The purpose of this task was to establish reasonably representative mission scenarios and system and subsystem requirements which derive from the mission. This sets the stage and establishes the boundaries for the design of the baseline subsystems.

A review was made of current literature to determine reasonably typical scenarios for the LEO and GEO missions. Then, LEO and GEO Space Platform block diagrams were developed to identify subsystem functional interfaces requiring consideration in the LCC of the energy storage subsystem (ESS) (see Exhibit 1-4). The Thermal Control Subsystem (TCS) is a good example. In varying the operating temperatures of the fuel cells or batteries, the load on the TCS will vary, thus affecting the LCC. Another subsystem interface affected by the ESS design is the operations and maintenance (O&M) crew subsystem (OMCS), wherein the reliability and life capabilities of the ESS determine the unscheduled and scheduled maintenance man-hours (performed by astronauts/technicians). These interface elements are included in the Performance and Cost Models developed for the study.

The set of requirements which were developed, in specification format, are contained in Appendix A. Exhibit 1-5 is a summary of the specification.

### 1.3.2 Performance and Cost Models

Two sets of performance/cost models were generated, one for battery type subsystems and one for fuel cell/electrolysis cell type subsystems. Each model can be exercised at any desired subsystem power level in the selected LEO (444 km, 56° inclination) or GEO orbits, or with the appropriate manual inputs, earth orbits at any altitude. The purpose of the performance and cost models, which are the keys to the study, is to represent dynamically the design and design variations of the baseline subsystems, and their effects on life cycle costs (LCC).

- LEGEND:**
- SSPS SPACE SERVICES PLATFORM SYSTEM
  - ESS ENERGY STORAGE SUBSYSTEM
  - PMS POWER MANAGEMENT SUBSYSTEM
  - SAS SOLAR ARRAY SUBSYSTEMS
  - CDS COMMAND AND DATA SUBSYSTEM
  - SMS STRUCTURAL MECHANICAL SUBSYSTEM
  - PCS PROPULSION AND CONTROL SUBSYSTEM
  - OMCS OPERATIONS AND MAINTENANCE CREW SUBSYSTEM
  - TCS THERMAL CONTROL SUBSYSTEM

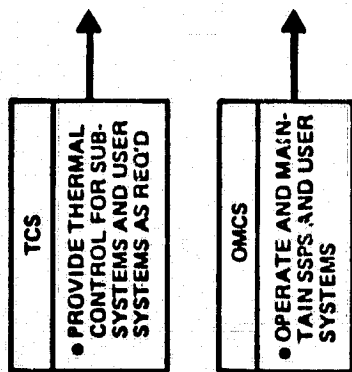

(LEO ONLY)

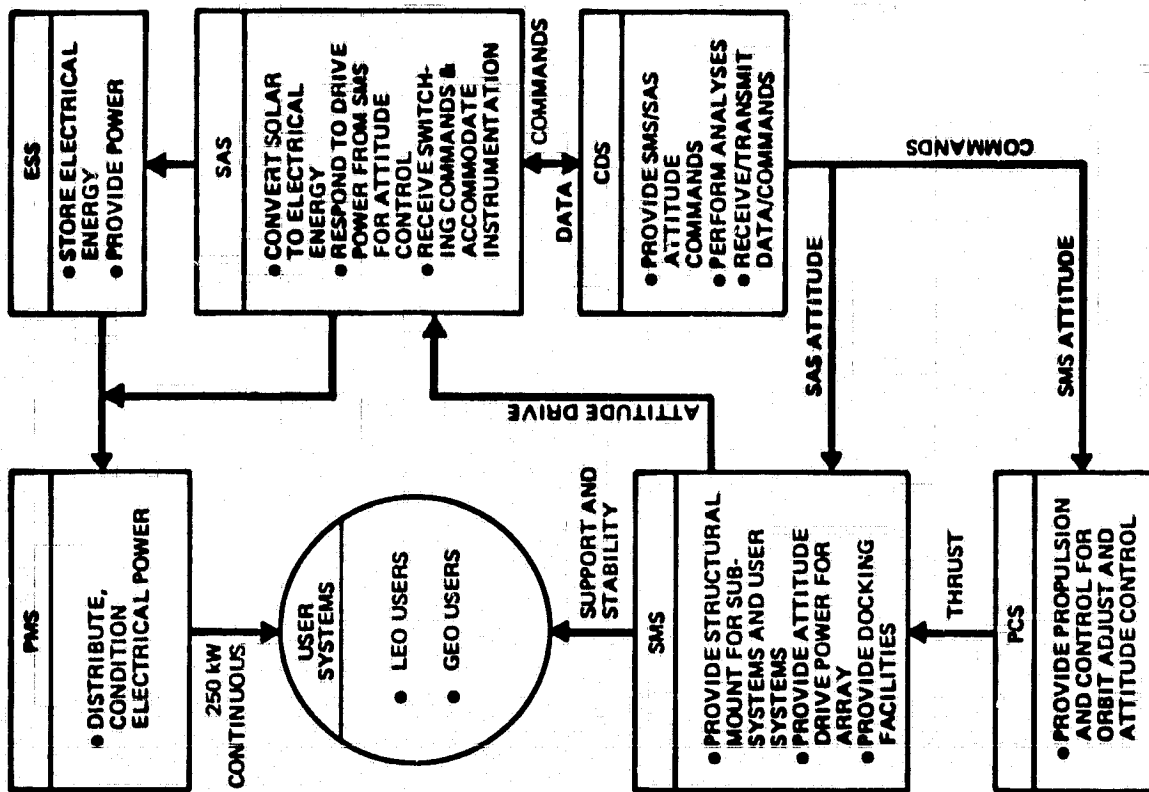

Exhibit 1-4. Space Services Platform System (SSPS)

- **Power output (4 LEO Missions, 1 GEO Mission)**
  - LEO Missions: 25, 50, 100, 250 kW Continuous, EOL
  - GEO Missions: 25 kW Continuous, EOL
- **Voltages (All Missions)**
  - Input to power distribution & control subsystem (PDCS) 128.8 VDC
  - To Users: 75% of power at 120 VDC
  - To Users: 25% of power at 30 VDC
- **LEO Orbit: 444 KM, 56° Inclination**
- **GEO Orbit: Equatorial Stationary (35,786 KM)**
- **System Operational 1985-1995**
- **State-of-Art Design for Baseline**
- **Transportation to LEO: Shuttle**
- **Transportation to GEO: Shuttle/IUS**
- **Astronaut Assisted Deployment & C/O for LEO Missions**
- **Autonomous Deployment for GEO Missions**
- **30 Year Life for LEO Subsystems with overhauls**
- **5 Year Life for GEO Subsystems**
- **LEO Reliability: Maximum replacement of 10% of battery cell or fuel cell or electrolysis cell or pressurizing pumps over 1 overhaul cycle**
- **GEO Reliability: No overhauls or replacement of hardware**
- **Structural Loads on ESS**
  - Operating: 0.01 G, All Axes
  - Stowed: Shuttle/IUS Payload Environment

***Exhibit 1-5. Mission, System, Subsystems Requirements***

With relative ease, the programs for the models can be modified to utilize any set of self-consistent relationships such as battery life versus depth-of-discharge (DOD) versus operating temperature, or fuel cell life versus current density of a fuel cell stack (FCS). The logic and relationships used in the performance/cost model are contained in Appendices B and C for the battery subsystems and Appendix D for the fuel cell subsystems.

Representative forms of the performance models are shown in Exhibits 1-6 and 1-7 for the battery and fuel cell subsystems respectively. In each case, the orbit determines the maximum eclipse time,  $T_1$ , and the minimum illumination time  $T_2$ . This, in turn, determines the discharge and charge rates, the numbers of modules, the size of modules, life requirements, efficiencies and reliability (all of which are variable). The selected values of these variables then determine, through the respective cost model, the LCC of any set of design parameters representing a particular subsystem and its interfacing subsystems (TCS, SAS or OMCS).

Exhibit 1-8 depicts the life characteristics of the NiCd, the NiH<sub>2</sub> and the light-weight fuel cell. These characteristics are used in the subsystem baseline designs described in the next section. These are typical of the relationships for which algorithms were developed for use in the models, all of which are provided in the appendices.

As stated previously, there is a lack of accurate and consistent data with which to model battery and fuel cell performance, physical characteristics and costs. This is especially true of NiH<sub>2</sub> cells and the advanced light-weight fuel cell presently in development. In many cases, it was necessary to interpolate, extrapolate, and otherwise estimate relationships in order to complete the study.

However, the model as it stands is realistic. Because the model is logically correct and consists of considerable detail, it has significant value as a design tool. One may hypothesize new sets of data, insert these in place of the existent sets and obtain the technological benefit in terms of LCC. In addition, the models may be used to establish developmental objectives and test requirements for new technology programs.

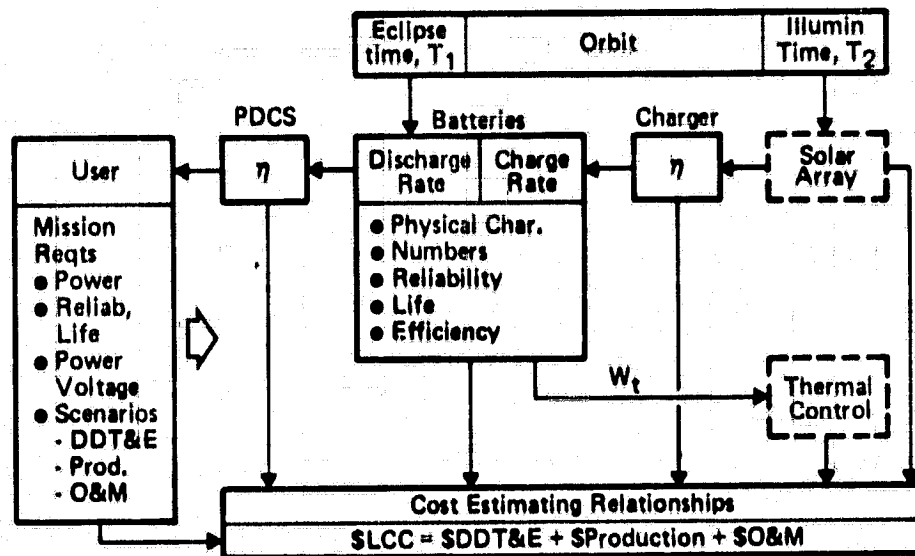

Exhibit 1-6. Battery Subsystems Performance/Cost Model Summary

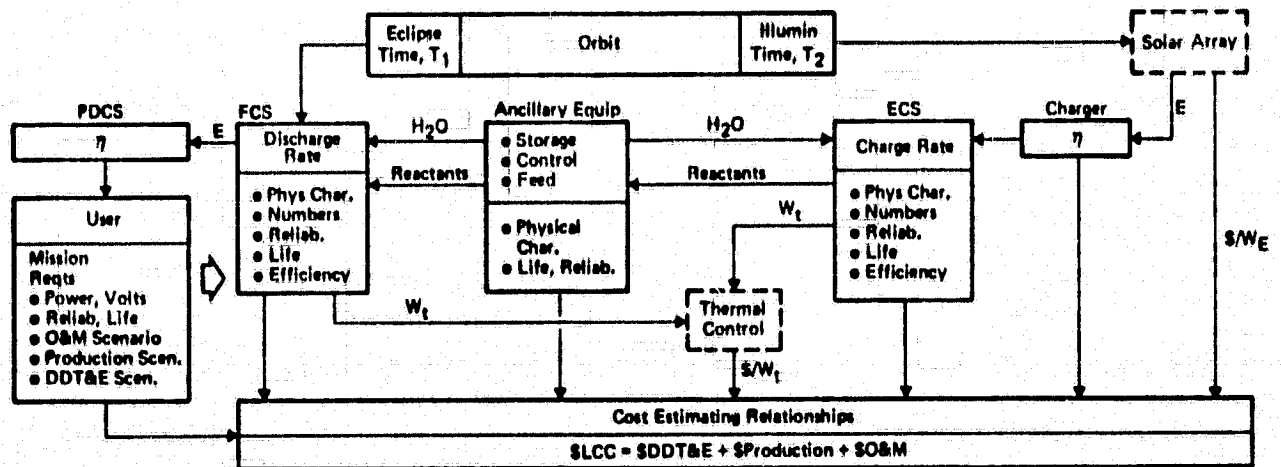

Exhibit 1-7. Fuel Cell/Electrolysis Cell Subsystems Performance/Cost Model Summary

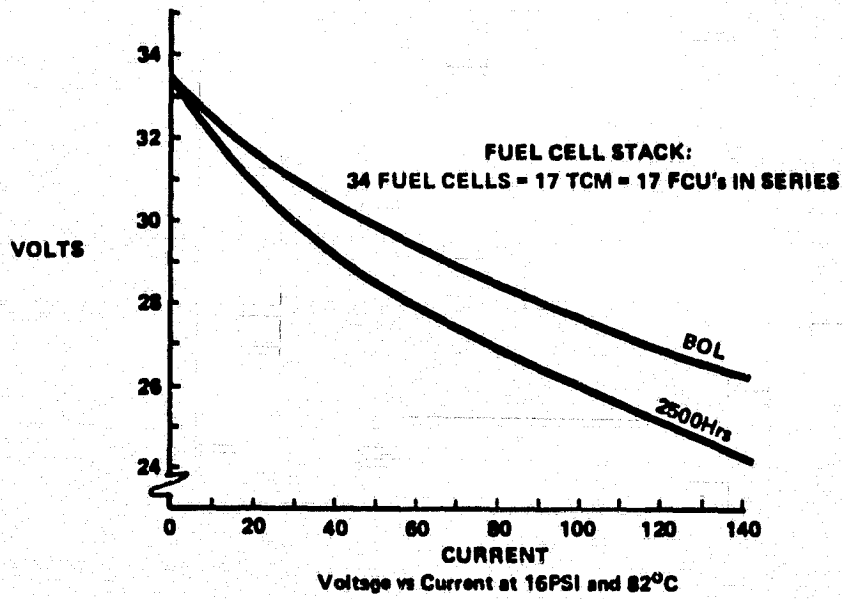
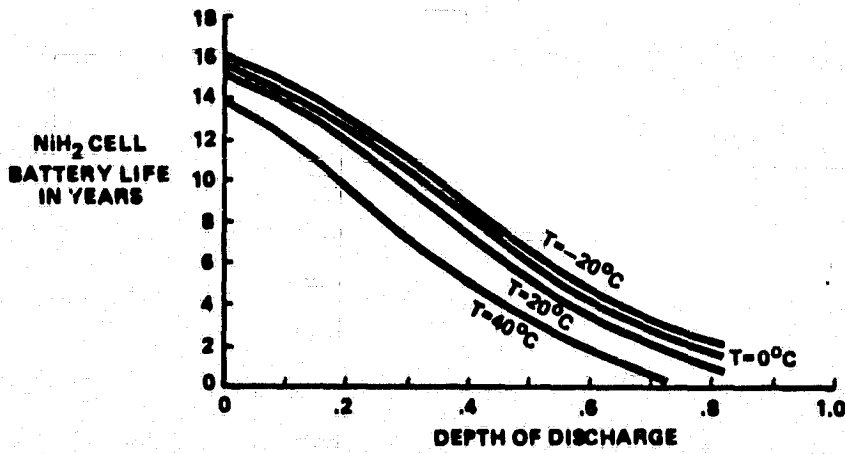
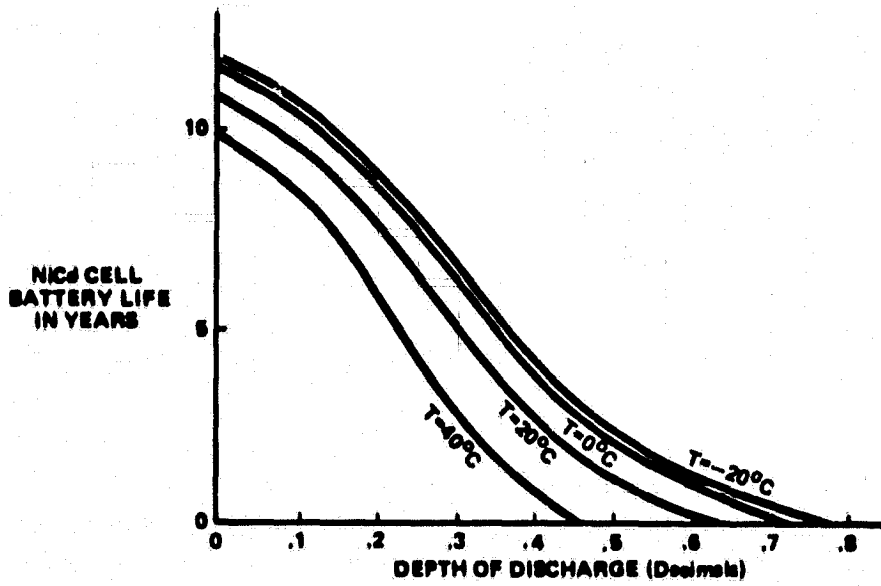

Exhibit 1-8. Life Characteristics Used in the Model

Exhibit 1-9 provides a summary of the parameters which are accessible and quantifiable in the performance/cost models and in the input requirements set. These and other parameters and their interrelationships are either inherent in and/or may be provided as inputs to the models. The arrows in the performance model identify the parameters which are the inputs to the cost model.

As stated earlier, Appendices B through D contain the detailed cost model logic and the cost relationships assumed for the battery and fuel cell subsystems. Exhibit 1-10 is a matrix representing the battery life cycle cost model (LCCM) and Exhibit 1-11, the fuel cell LCCM.

The cost models were constructed using (1) the work breakdown structure (WBS) presented in Section 2.0 and (2) the Life Cycle Cost flow diagrams presented in Section 3.0. Referring to Exhibit 1-11, the intersections of the matrix represent cost elements. Cost estimating relationships (CERs) were developed for each cost element. Generally, the production (in-plant) CERs consist of the costs of direct labor; materials and components; process equipment, and wraparound costs such as burdens, fringes, overhead, G&A, maintenance, and factory resources. Inputs consist of a number of cells, weights, volumes, and other cost sensitive parameters such as attrition and component rejection rate. The O&M CERs consist of astronaut man-hours; training (based on assumed attrition rates); spares (based on life and reliability), and space transportation (based on estimated dollars per unit weight (or volume) for Shuttle and Shuttle/IUS transportation.

### 1.3.3 Baseline Subsystems

#### Battery and Fuel Cell Characteristics

The battery performance and cost models were developed for the use of either NiCd or NiH<sub>2</sub> cells. The fuel cell performance and cost models were developed around the light weight fuel cell design presently being developed by UTC under contract NAS8-30637 with George C. Marshall Space Flight Center. The details for each type cell are summarized in Exhibit 1-12. These data represent the cells used in the baseline subsystems.



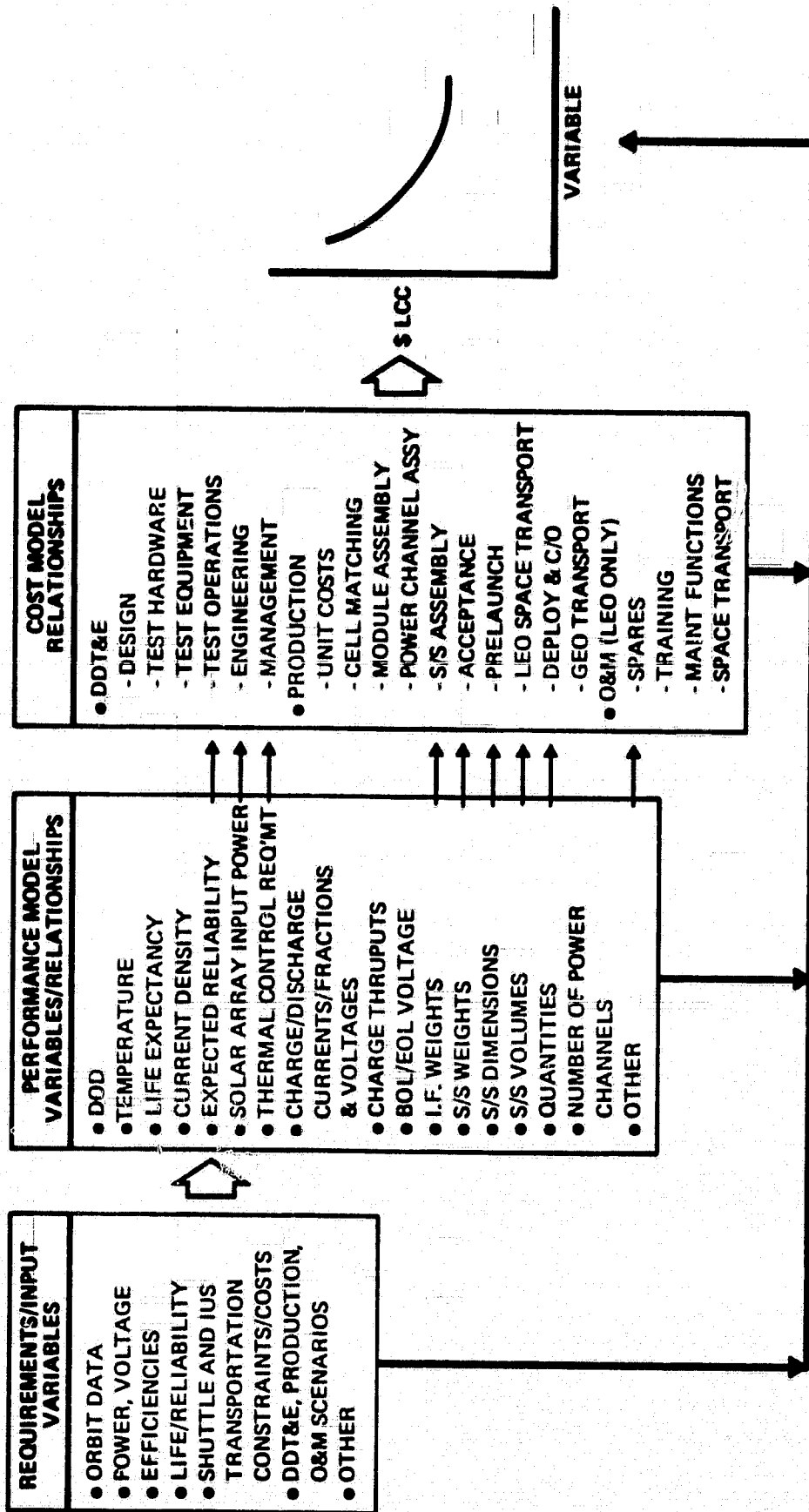

Exhibit 1-9. Generalized Performance and Cost Model Parameters

ESS BATTERY LCCM	DDT&E			PRODUCTION							O&M				S-SIMULATED		
	DESIGN	TEST HARDWARE	TEST OPERATIONS	SYSTEMS ENGR	MANAGEMENT	BATTERY MODULE ASSY	BATTERY ASSY	SUBSYSTEM ASSY	ACCEPTANCE OPERATIONS	PRELAUNCH	SPACE TRANSPORT	SPACE DEPLOYMENT	SPARES	TRAINING		MAINT. FUNCTIONS	SPACE TRANSPORT
BATTERY CELLS																	
BATTERY MODULE																	
INTERCONNECTS																	
HOUSING/STRUCTURE																	
BATTERY POWER CHANL																	
BRPC/INSTRU																	
P3																	
INTERCONNECTS																	
HOUSING/STRUCTURE																	
SUBSYSTEM																	
INTERCONNECTS																	
HOUSING/STRUCTURE																	
S/S INTERFACES																	
THERMAL CONTROL																	
SOLAR ARRAY																	
OMCS																	



Exhibit 1-10. Battery Life Cycle Cost Model (LCCM)

S-SIMULATED

ESS FUEL CELL LCCM	DOT&E			PRODUCTION										O&M								
	DESIGN	TEST HARDWARE	TEST OPERATIONS	SYSTEMS ENGR	MANAGEMENT	FUEL CELL UNIT	ELECTROLYSIS CELL UNIT	FUEL CELL STACK	ELECTROLYSIS CELL STACK	POWER MODULE ASSY	ANCILLARY EQUIP	S/S ASSY	ACCEPTANCE & XPORT	PRELAUNCH	SPACE TRANSPORT	SPACE DEPLOYMENT	SPARES	TRAINING	MAINT. FUNCTIONS	SPACE TRANSPORT		
FUEL CELL STACK																						
FUEL CELL UNIT (FCU)																						
INTERCONNECTS																						
HOUSING/STRUCTURE																						
ELECTROLYSIS CELL STACK (ECS)																						
ELECT. CELL UNIT (ECU)																						
INTERCONNECTS																						
HOUSING/STRUCTURE																						
POWER MODULE ASSY																						
P <sub>3</sub>																						
INTERCONNECTS																						
HOUSING/STRUCTURE																						
ANCILLARY EQUIPMENT																						
PUMPS																						
TANKS																						
COMPRESSORS																						
SEPARATOR/CONDENSER																						
MISC																						
SUBSYSTEM ASSY																						
INTERCONNECTS																						
HOUSING/STRUCTURE																						
S/S INTERFACES																						
THERMAL CONTROL																						
SOLAR ARRAY																						
OMCS																						



Exhibit 1-11. Fuel Cell Life Cycle Cost Model (LCCM)

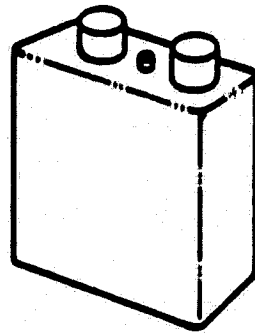

**NiCd CELL**

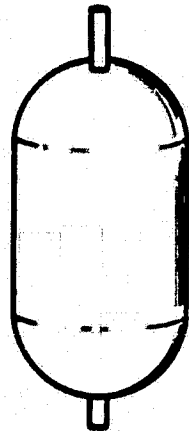

**NiH<sub>2</sub> CELL**

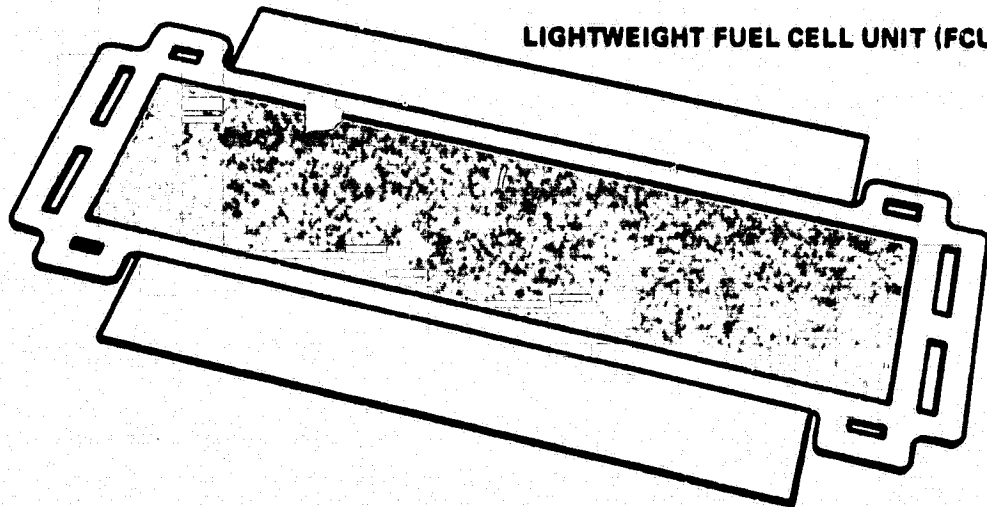

**LIGHTWEIGHT FUEL CELL UNIT (FCU)**

**Exhibit 1-12. Performance Model Cells**

### Baseline Subsystem Characteristics

A common shape and layout was chosen for all subsystem configurations which consists of a polygon-shaped cross-section with a fixed outside diameter consistent with the Shuttle payload bay width and a variable length, L. This is shown in Exhibit 1-13 for the NiCd subsystems, Exhibit 1-14 for the NiH<sub>2</sub> subsystems and Exhibit 1-15 for the fuel cell subsystems. In each case, algorithms were developed to relate weight, dimensions and volume to such parameters as Battery Cell AH capacity, Fuel Cell Unit (FCU) active area, numbers of cells per module, numbers of FCUs (or electrolysis cell units, ECUs), numbers of power channels, etc. Volumes were required to determine Shuttle space transportation costs for the cases where these costs were volume constrained as opposed to weight constrained. The configuration for the fuel cell/electrolysis cell ancillary equipment (i.e., the tanks, pumps, filters, valves required for the O<sub>2</sub> and H<sub>2</sub> gases and water feed/storage systems) assumes a three compartment, common bulkhead, ellipse-domed storage/pressure tank as shown in Exhibit 1-15. Algorithms were included in the model to vary the capacities and pressures of these tanks.

The baseline subsystems parameter values and LCC are summarized in Exhibit 1-16a for the NiCd battery subsystems, Exhibit 1-16b for the NiH<sub>2</sub> battery subsystems, and Exhibit 1-16c for the fuel cell subsystems.

In reviewing and comparing the baseline subsystems data contained in the exhibits, it must be recognized that these are baselines, not necessarily optimum designs. For better comparisons the parameters for each baseline design must be varied to determine the LCC relative to such parameters as DOD, current density, cell capacity, maintenance cycles, discharge and charge rates, etc. The model may be used to do this (and should be), however, the primary objective of the study is to determine the dependence of LCC on the various technology parameters in order to evaluate potential dollar benefits of technology investigations and development.

Exhibit 1-17 shows the type of data outputs which the Model will provide. Exhibit 1-17(a) is for the NiCd battery subsystems, Exhibit 1-17(b) for NiH<sub>2</sub> battery subsystems, and Exhibit 1-17(c) for fuel cell subsystems.

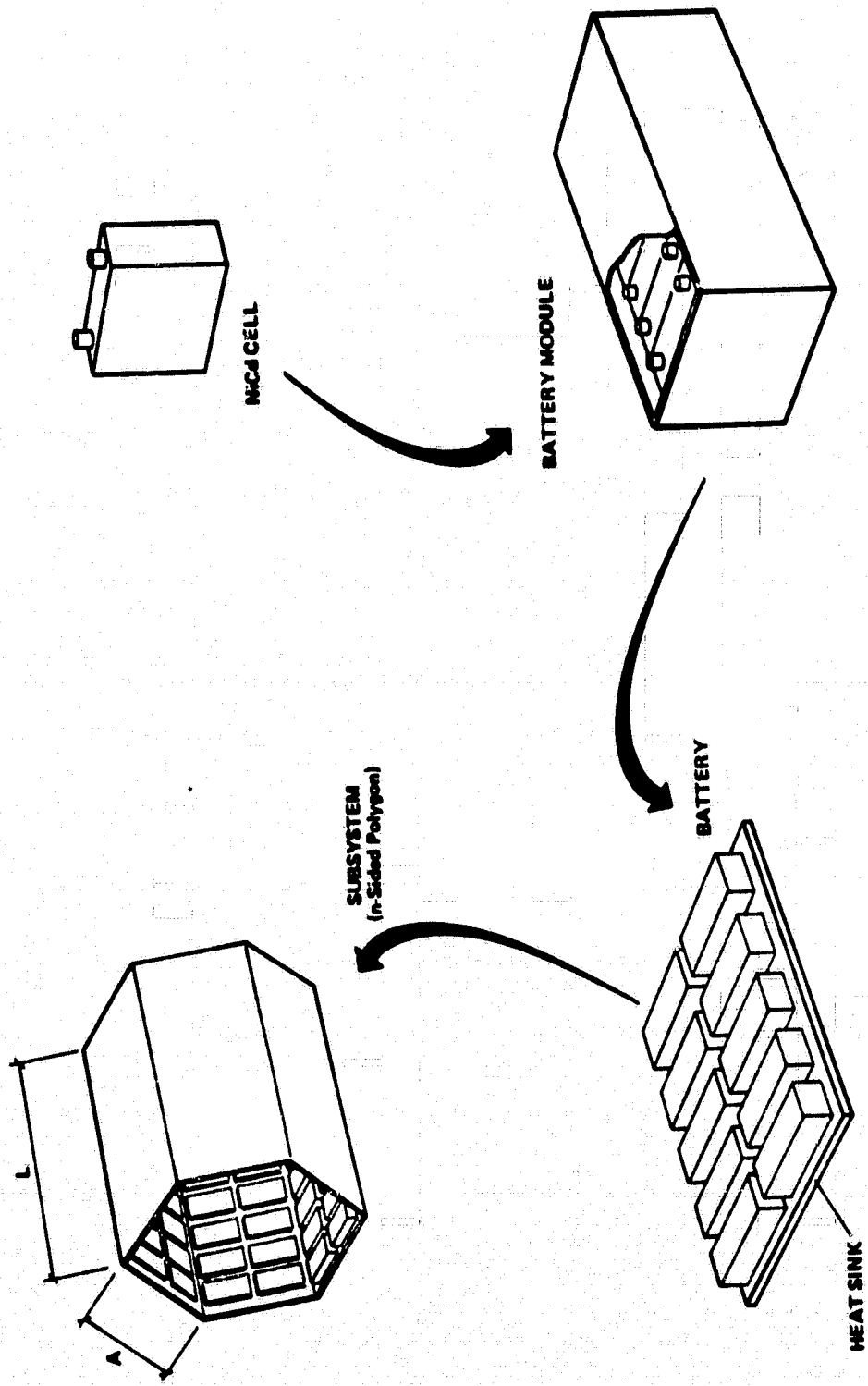

*Exhibit 1-13. NiCd Hierarchy/Configuration*

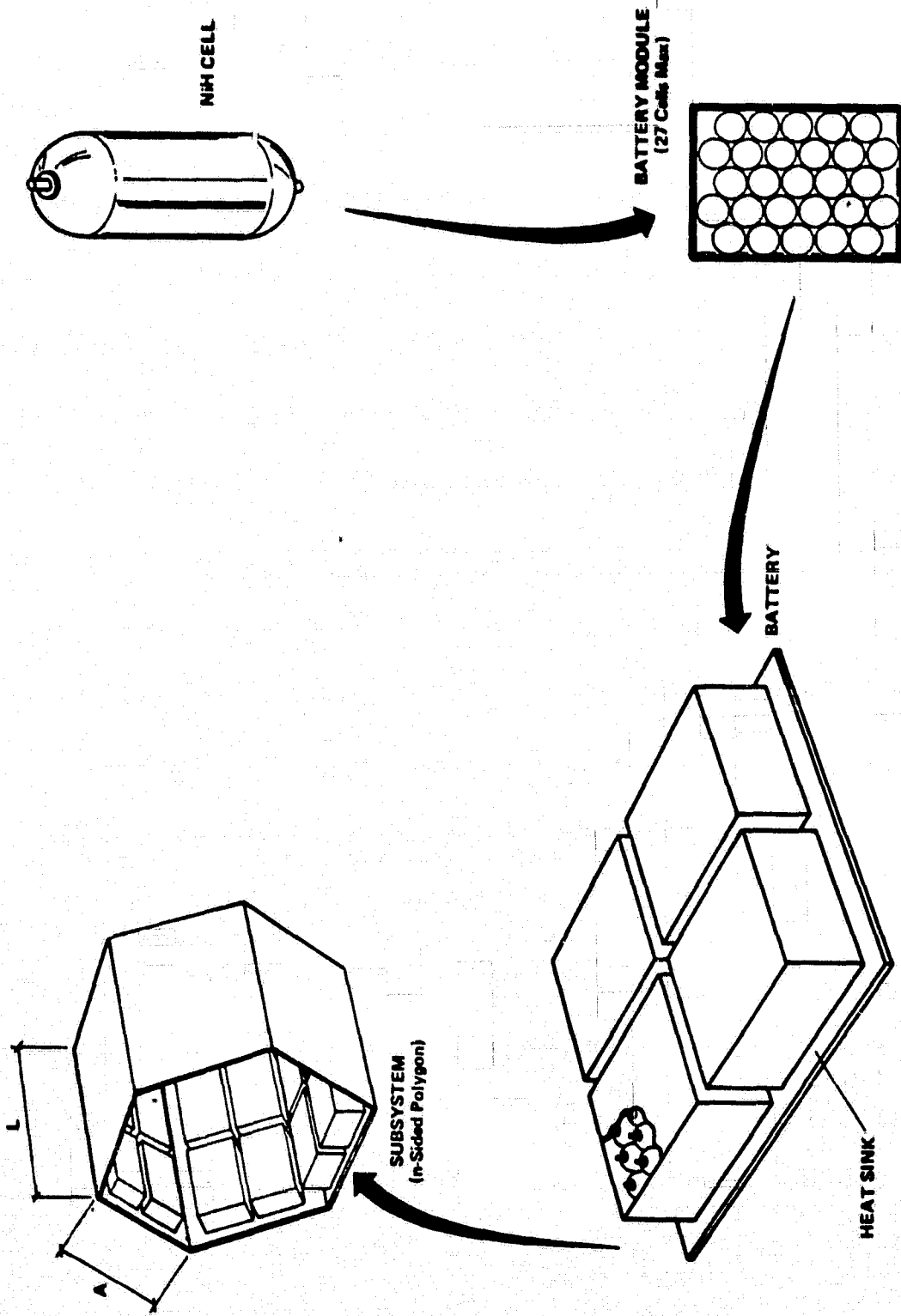

**Exhibit 1-14. NiH Hierarcy/Configuration**

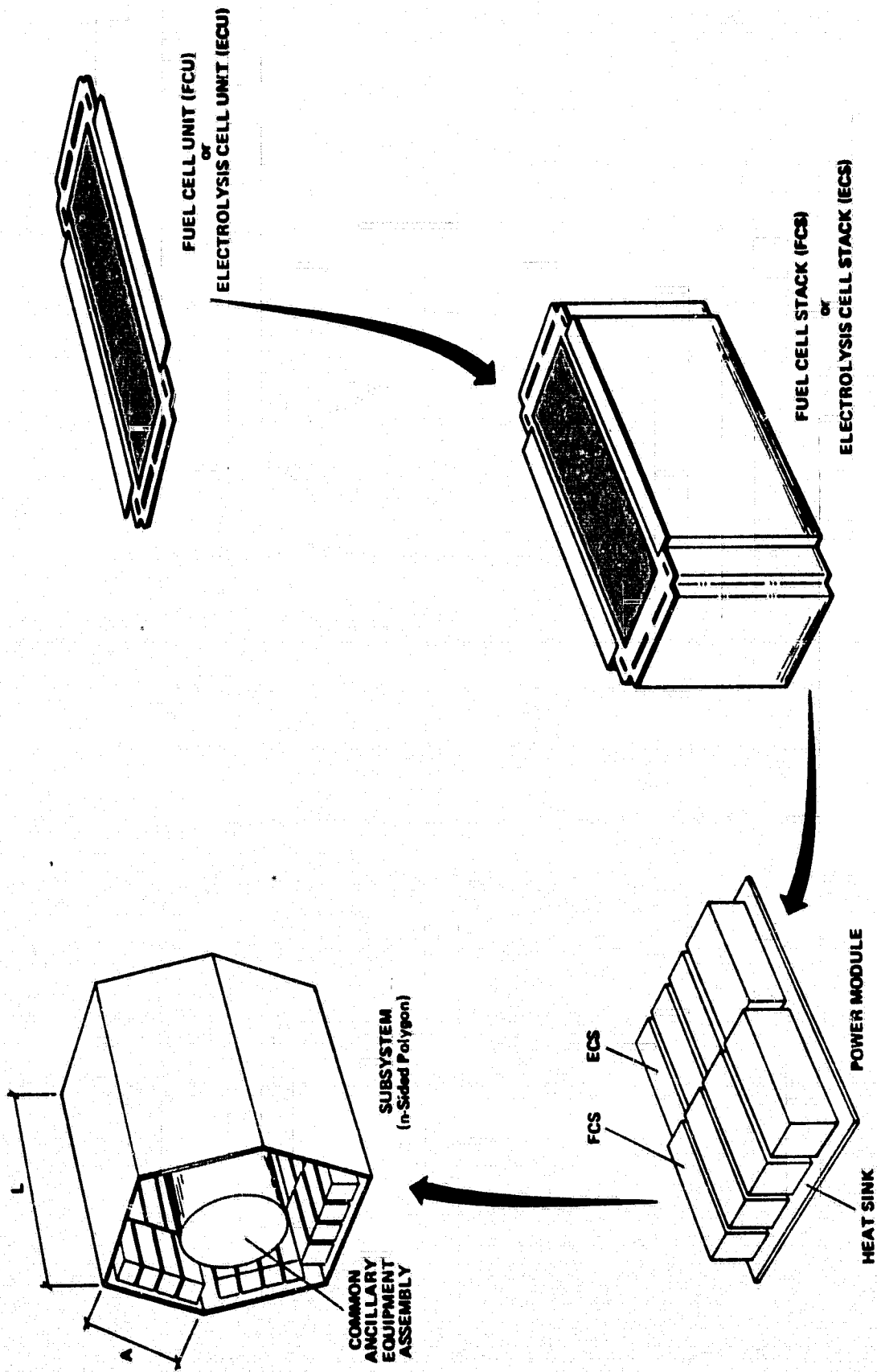

Exhibit 1-15. Fuel Cell/Electrolysis Hierarchy/Configuration



NiCd BATTERY ENERGY STORAGE SUBSYSTEM	LEO				GEO
	25kW	50kW	100kW	250kW	25kW
<b>CELL PERFORMANCE PARAMETERS</b>					
Hardware Life Cycle	4	4	4	4	1
Minimum Battery Life (Yr)	7,000	7,000	6,000	6,000	1,011
Rated Cell Capacity (Ah)	50	50	50	50	50
Maximum Depth of Discharge	.260	.260	.260	.267	.332
Operating Temperature (deg-K)	283	283	283	283	283
Max. Discharge Current (A)	17,013	17,013	16,163	16,379	20,190
Minimum Voltage (V)	1.110	1.110	1.109	1.100	1.100
Recharge Fraction	1.030	1.030	1.030	1.030	1.020
Charge Current (A)	12,037	12,037	13,100	13,290	1,237
Charge Voltage (V)	1.639	1.639	1.666	1.667	1.606
Watt-Hour Efficiency	.625	.625	.622	.620	.620
<b>PHYSICAL CHARACTERISTICS</b>					
Total Number of Cells	1300	2016	3007	14762	1000
Number of Parallel Batteries	13	20	31	126	10
Number of Modules per Battery	0	0	0	0	0
Battery Cell Weight (Kg)	2,027	2,027	2,027	2,027	2,027
Battery Cell Volume (cm <sup>3</sup> )	723	723	723	723	723
ESS Weight (Kg)	416	821	1642	2796	2796
ESS Volume (m <sup>3</sup> )	20.000	30.216	107.110	260.030	20.000
<b>LIFE CYCLE COSTS (1980\$)</b>					
DBT&K Cost	10,900	14,203	21,120	20,287	6,912
Production Cost	10,000	22,700	69,334	136,460	46,882
Operations & Maintenance Cost	121,979	236,900	602,056	1128,309	3000
ESS LIFE CYCLE COST	142,879	273,803	692,510	1285,056	53,794
Solar Array Cost	234,230	400,100	712,223	1407,232	140,077
Thermal Control Cost	7,204	9,207	12,200	23,715	5,034
Power Conditioning Cost	1,761	1,100	5,611	11,002	1,809
TOTAL LIFE CYCLE COST	386,772	703,213	1276,010	2823,305	72,214

(a)

NiH <sub>2</sub> BATTERY ENERGY STORAGE SUBSYSTEM	LEO				GEO
	25kW	50kW	100kW	250kW	25kW
<b>CELL PERFORMANCE PARAMETERS</b>					
Hardware Life Cycle	4	4	4	4	1
Minimum Battery Life (Yr)	7,700	7,117	7,117	6,900	1,306
Rated Cell Capacity (Ah)	50	50	50	50	50
Maximum Depth of Discharge	.400	.400	.400	.407	.707
Operating Temperature (deg-K)	283	283	283	283	283
Max. Discharge Current (A)	20,960	20,073	20,073	21,292	30,000
Minimum Voltage (V)	1.150	1.121	1.121	1.127	1.121
Recharge Fraction	1.072	1.072	1.072	1.072	1.373
Charge Current (A)	21,290	22,715	22,715	22,924	2,306
Charge Voltage (V)	1.663	1.701	1.701	1.700	1.600
Watt-Hour Efficiency	.638	.621	.621	.617	.592
<b>PHYSICAL CHARACTERISTICS</b>					
Total Number of Cells	906	1710	3620	8510	749
Number of Parallel Batteries	9	15	30	75	7
Number of Modules per Battery	0	0	0	0	0
Battery Cell Weight (Kg)	1,136	1,136	1,136	1,136	1,136
Battery Cell Volume (cm <sup>3</sup> )	2020	2020	2020	2020	2020
ESS Weight (Kg)	2170	4480	8974	20771	1796
ESS Volume (m <sup>3</sup> )	10,000	20,137	72,273	189,300	15,616
<b>LIFE CYCLE COSTS (1980\$)</b>					
DBT&K Cost	9,900	10,700	14,301	19,059	7,934
Production Cost	12,593	20,471	20,100	63,227	31,403
Operations & Maintenance Cost	59,424	99,464	191,217	461,211	3000
ESS LIFE CYCLE COST	77,417	130,635	245,618	643,497	39,737
Solar Array Cost	225,476	412,437	716,908	1406,908	120,034
Thermal Control Cost	7,223	9,565	13,007	27,433	5,644
Power Conditioning Cost	1,100	1,900	2,276	7,094	1,042
TOTAL LIFE CYCLE COST	310,216	554,537	978,813	2127,820	60,779

(b)

FUEL CELL ENERGY STORAGE SUBSYSTEM	LEO				GEO
	25kW	50kW	100kW	250kW	25kW
<b>CELL PERFORMANCE</b>					
Hardware Life Cycle	4	4	4	4	1
Minimum FCU Life (Hr)	17426	10362	10047	15066	4173
Peak Period Power (W)	42,53	83,73	66,91	67,13	100,26
Peak Period Voltage (V)	1.437	1.413	1.403	1.401	1.362
Active Cell Area (cm <sup>2</sup> )	232,26	232,26	232,26	232,26	232,26
Current Density (mA/cm <sup>2</sup> )	130,43	139,12	162,92	166,92	241,70
Operating Pressure (kg/cm <sup>2</sup> )	1.125	1.125	1.125	1.125	1.125
Operating Temperature (deg-K)	353	353	353	353	353
<b>CELL SUBSYSTEM PERFORMANCE</b>					
Light Period Power (W)	34,05	34,73	36,07	36,91	117,21
Light Period Voltage (V)	1.462	1.477	1.496	1.500	1.493
<b>CELL SUBSYSTEM PERFORMANCE</b>					
Number of Maintenance Cycles	4	4	4	4	1
Minimum Pump Life (Hr)	62393	62393	62393	62393	10519
ES Storage Weight (Kg)	1,214	2,061	3,230	11,393	2,430
ES Factor	.000	.000	.000	.000	.000
Watt-Hour Efficiency	.423	.412	.407	.406	.410
<b>PHYSICAL CHARACTERISTICS</b>					
Total Number of FCU	720	1300	2000	6624	100
Total Number of ECU	1600	2020	6092	15120	24
ESS Weight (Kg)	2097	4102	8110	20210	646
ESS Volume (m <sup>3</sup> )	15,031	20,000	37,501	60,151	9,302
<b>LIFE CYCLE COSTS (1980\$)</b>					
DBT&K Cost	16,203	23,952	24,452	55,407	6,007
Production Cost	20,982	26,165	66,555	165,630	16,210
Operations & Maintenance Cost	61,790	77,905	162,219	310,603	3000
ESS LIFE CYCLE COST	99,403	128,022	249,226	526,640	22,217
Solar Array Cost	226,217	597,629	1046,071	2106,613	175,590
Thermal Control Cost	5,965	6,779	8,400	13,267	6,419
Power Conditioning Cost	1,100	1,900	2,477	7,317	1,042
TOTAL LIFE CYCLE COST	422,691	744,690	1299,112	3720,120	50,690

(c)

Exhibit 1-16. Baseline ESS Performance and Life Cycle Cost

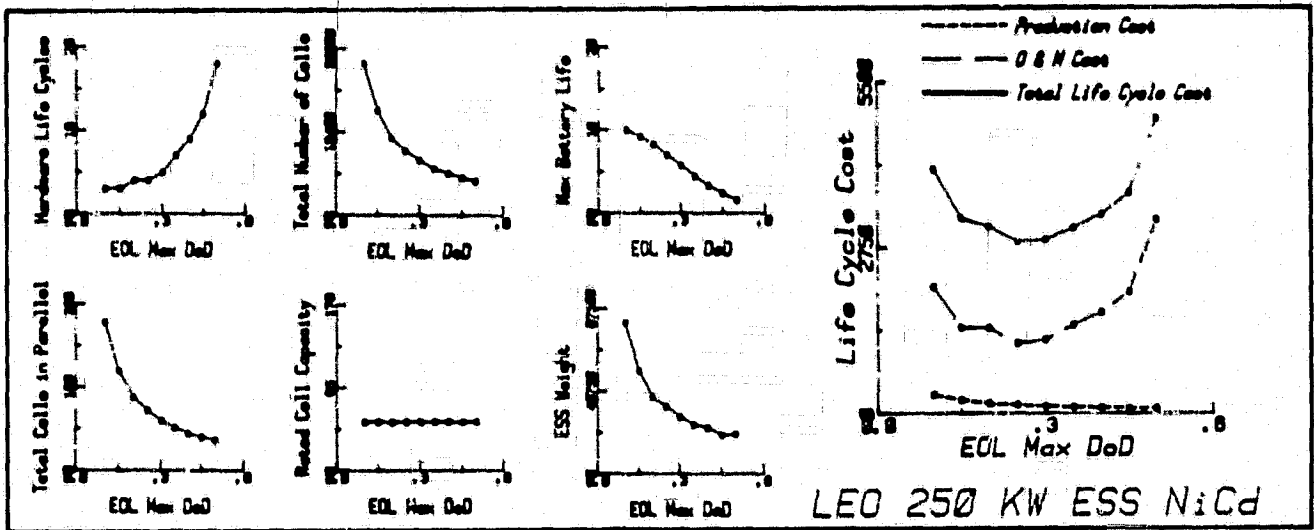

Exhibit 1-17a. EOL Maximum DOD (Capacity Fixed) NiCd

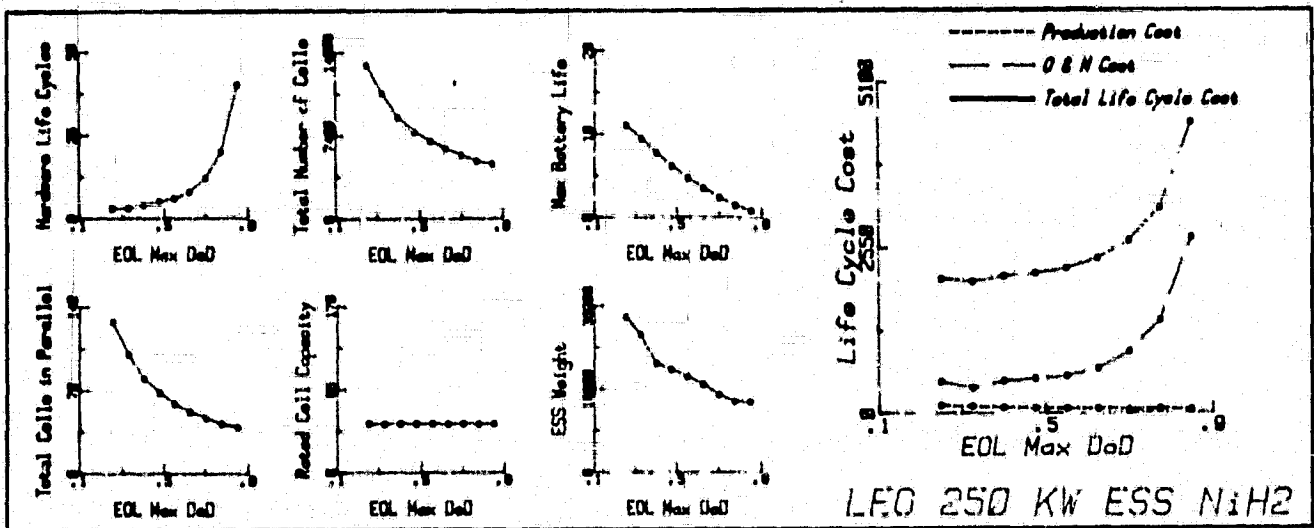

Exhibit 1-17b. EOL Maximum DOD (Capacity Fixed) NiH<sub>2</sub>

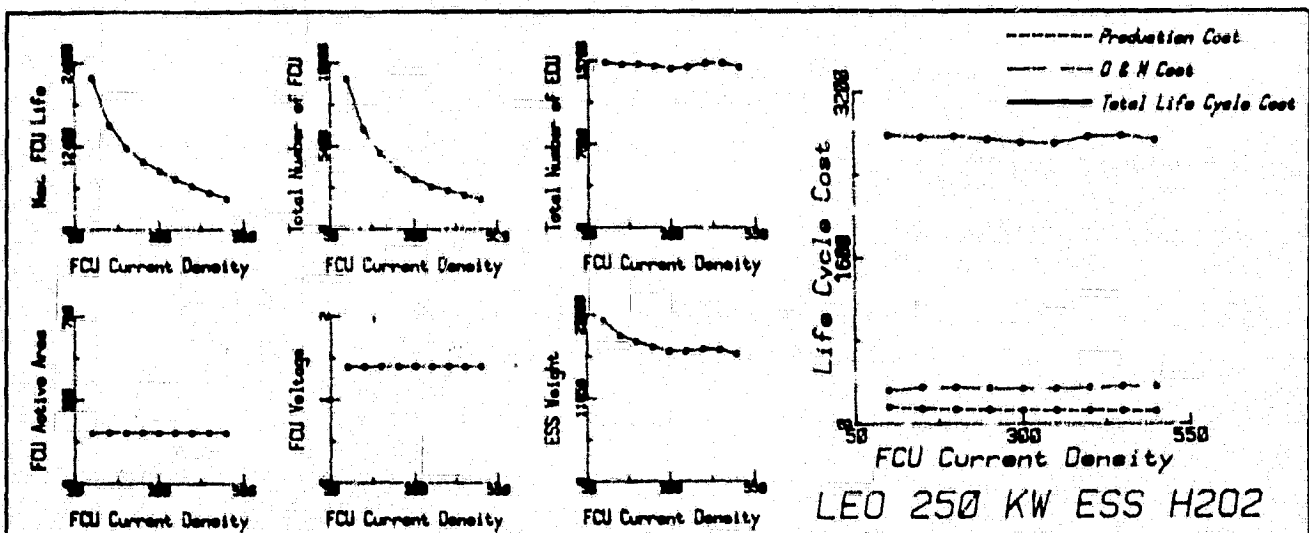

Exhibit 1-17c. FCU Current Density - Fuel Cell

#### 1.3.4 Results and Conclusions

The models provide an extensive and detailed series of mathematically expressed relationships between individual system components/parameters and life cycle costs. Graphic representations of these relationships are provided in Volume II (Appendix G).

The conclusions of the research are presented in Exhibit 1-18 and summarized in Section 5.0. As noted earlier - within the limitations of available data, some of the more pertinent conclusions are as follows:

- The life cycle costs of NiCd systems are approximately twice those of comparable NiH<sub>2</sub> systems.
- The life cycle costs of NiH<sub>2</sub> systems are comparable to those of comparable fuel cell systems.
- The driving parameters of battery systems have a greater impact on life cycle costs than do comparable parameters for fuel cell systems.

#### 1.3.5 Areas for Further Study

Numerous areas for further study having high potential returns on investment for readily apparent. These are presented in Exhibit 1-19 and discussed in detail in Section 6.0. Four of the more promising areas are:

- The conduct of life cycle cost sensitivity analyses on designated system parameters by varying only one designated parameter while holding all else constant.
- The conduct of comparative life cycle cost analyses on the development of alternative component technologies and on the configuration of alternative system designs.
- The modification and use of the models, as guides, to plan and coordinate future component/system development and test programs, thereby maximizing the use of available resources.
- The modification and use of the models to optimize specified system performance parameters for given levels of life cycle funding.

CONCLUSIONS: BATTERY DRIVING PARAMETERS		
BATTERY PARAMETER	LCC SENSITIVITY	
	LEO	GEO
DOD (CAPAC. VARIABLE)	VERY STRONG	STRONG
LIFE (CAPAC. VARIABLE)	VERY STRONG	MODERATE
DOD (CAPAC. FIXED)	STRONG	STRONG
LIFE (CAPAC. FIXED)	STRONG	STRONG
CAPACITY	STRONG	MODERATE
HARDWARE LIFE CYCLES (CAPAC. VARIABLE)	MODERATE	--
DISCHARGE CURRENT (CAPAC. FIXED)	MODERATE	STRONG
HARDWARE LIFE CYCLES (CAPAC. FIXED)	MODERATE	--

(a)

CONCLUSIONS: FUEL CELL DRIVING PARAMETERS		
FUEL CELL PARAMETER	LCC SENSITIVITY	
	LEO	GEO
CURRENT DENSITY	MODERATE	STRONG
VOLTAGE	MODERATE	MODERATE
ACTIVE AREA	WEAK	MODERATE
LIFE	WEAK	WEAK
HARDWARE LIFE CYCLES	WEAK	--

(b)

OTHER CONCLUSIONS
<ul style="list-style-type: none"> <li>● NiCd LCC <math>\approx</math> 2X NiH<sub>2</sub> LCC</li> <li>● FUEL CELL LCC <math>\approx</math> NiH<sub>2</sub> LCC</li> <li>● BATTERY DRIVING PARAMETERS HAVE A STRONGER EFFECT ON LCC THAN FUEL CELL DRIVING PARAMETERS</li> </ul>

(c)

## RECOMMENDATIONS

- VARY PERFORMANCE/COST MODEL PARAMETERS WITHOUT INTERACTIONS (e.g., VARY DOD WITHOUT EFFECTING LIFE) TO DETERMINE INDEPENDENT LCC VARIATIONS
- USE PERFORMANCE/COST MODEL TO DETERMINE POTENTIAL LCC SAVINGS VS DEVELOPMENT COSTS REQUIRED TO ACHIEVE DESIRED PERFORMANCE
- USE PERFORMANCE/COST MODEL TO PLAN AND COORDINATE UPCOMING BATTERY AND FUEL CELL DEVELOPMENT/TEST PROGRAMS
- DEVELOP AN OPTIMIZED ESS DESIGN - MODIFY THE PROGRAM
- DEVELOP AN INTEGRATED ELECTRICAL POWER SYSTEM PERFORMANCE/COST MODEL

MISSION	SOLAR ARRAY	ESS	PDCS	USER
● LEO	● Si	● Batteries	● DC/DC	● Variation in Load Power
● GEO	● GaAs (1 toN)	● Fuel Cells	● DC/AC	
			● Etc.	

- DEVELOP A TOTAL SPACE PLATFORM MODEL
- DEVELOP AND USE A  $\text{NiH}_2$  AND FUEL CELL DATA CENTER
  - Data Base
  - Test Requirements
  - Design Handbooks
  - Standard Cell Specifications

*Exhibit 1-19. Recommendations*

## 2.0 ESS PERFORMANCE MODEL

This section describes the ESS performance model which was developed for this study. Described in this section are a battery ESS performance model with two applications (nickel cadmium and nickel hydrogen), and a fuel cell/electrolysis cell ESS model with one application (hydrogen-oxygen). As shown by the Battery ESS Performance Model Schematic, Exhibit 2-1, the Battery ESS consists of identical power channels which are connected in parallel. As shown by the Fuel Cell ESS Performance Model Schematic, Exhibit 2-2, the fuel cell ESS consists of a variable combination of chargers, electrolysis cells and fuel cells, with common storage tanks for the reactants.

### 2.1 General Methodology

A general methodology was incorporated into all three ESS performance models. This provides a basis for making comparisons between the three different types of Energy Storage Subsystems, and also provides a methodology to compare different types of technologies (e.g., AgCd Battery, HCl fuel cell, etc.). Exhibits 2-3 and 2-4, respectively, are block diagrams of the Battery and Fuel Cell ESS Performance Models. A brief description of the general methodology is as follows:

- Mission Requirements

The mission requirements are reflected by life cycle scenarios for each of the three types of subsystems. These requirements include the appropriate orbits, power users and on-board maintenance scenarios for each of the LEO and GEO missions.

- ESS Requirements

The ESS requirements are based on common performance and configuration requirements for each of three types of subsystems. These performance requirements include 25 kW, 50 kW, 100 kW and 250 kW continuous power for LEO and 25 kW continuous power for GEO. The configuration requirements include a polygon shaped ESS which is compatible with Space Shuttle transportation to LEO and Shuttle/IUS transportation to GEO.

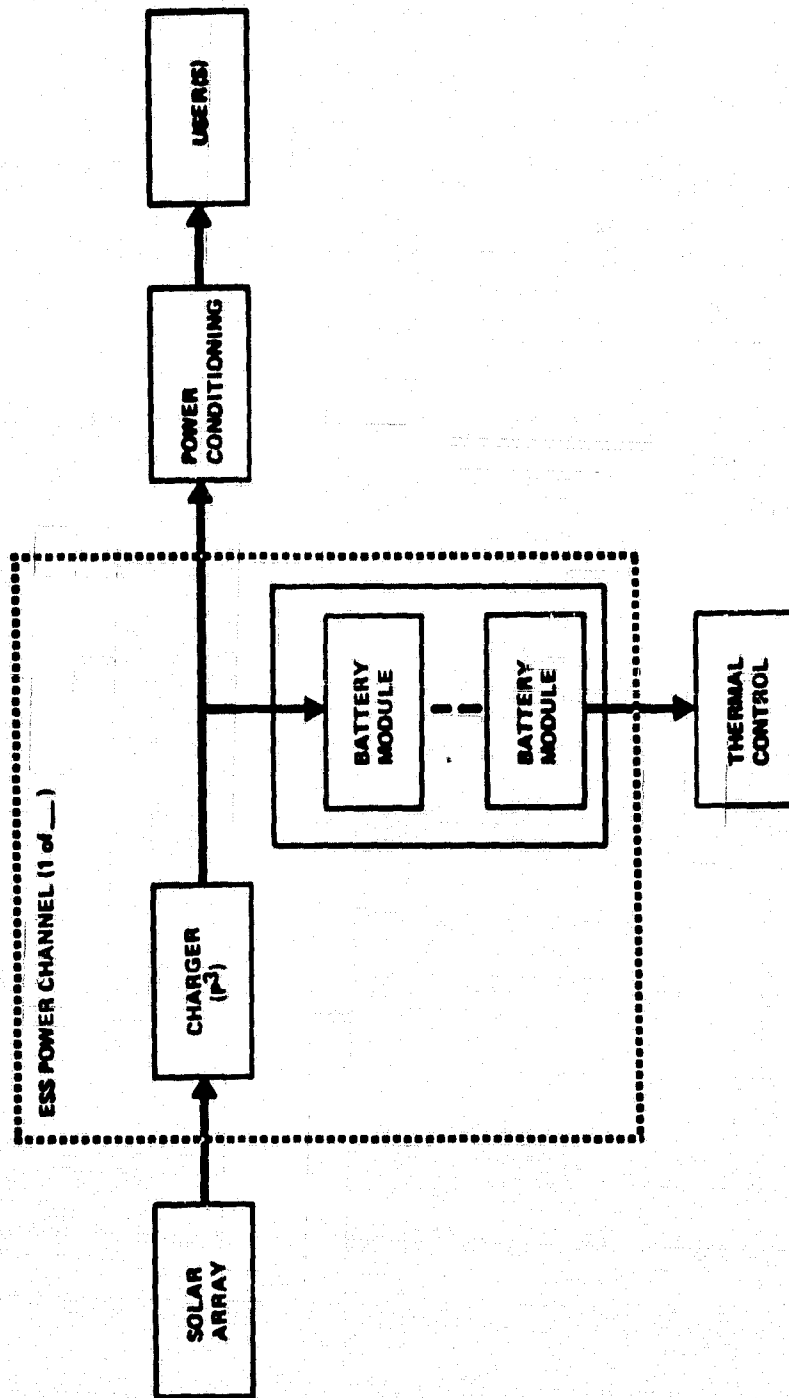

Exhibit 2-1. Battery ESS Performance Model Schematic

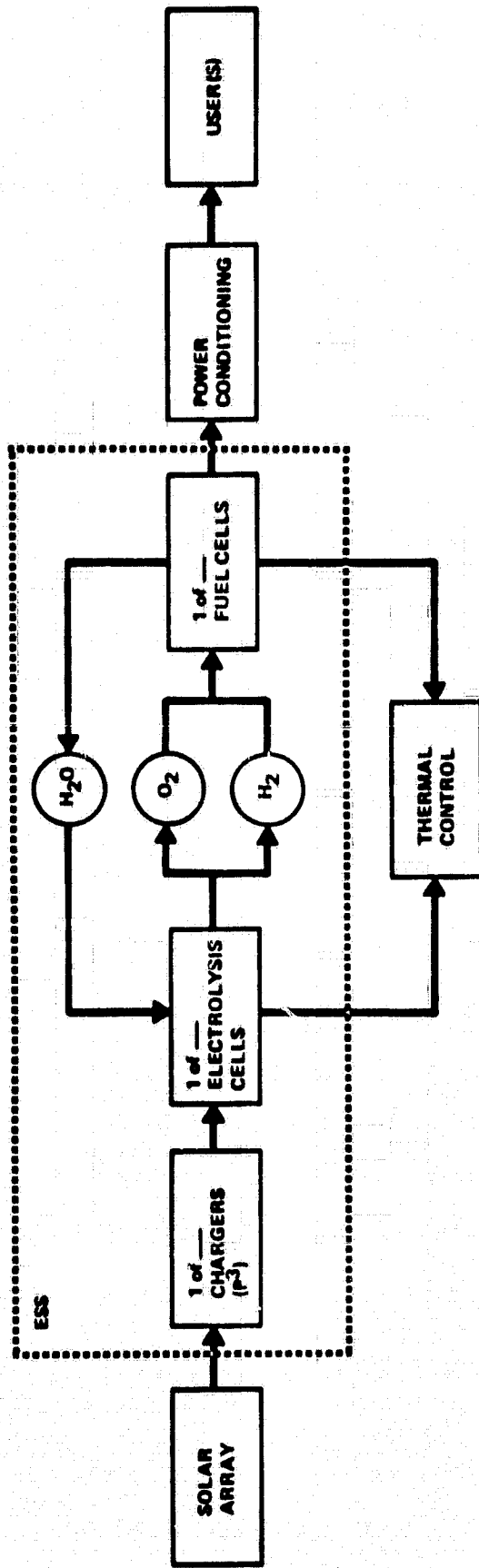
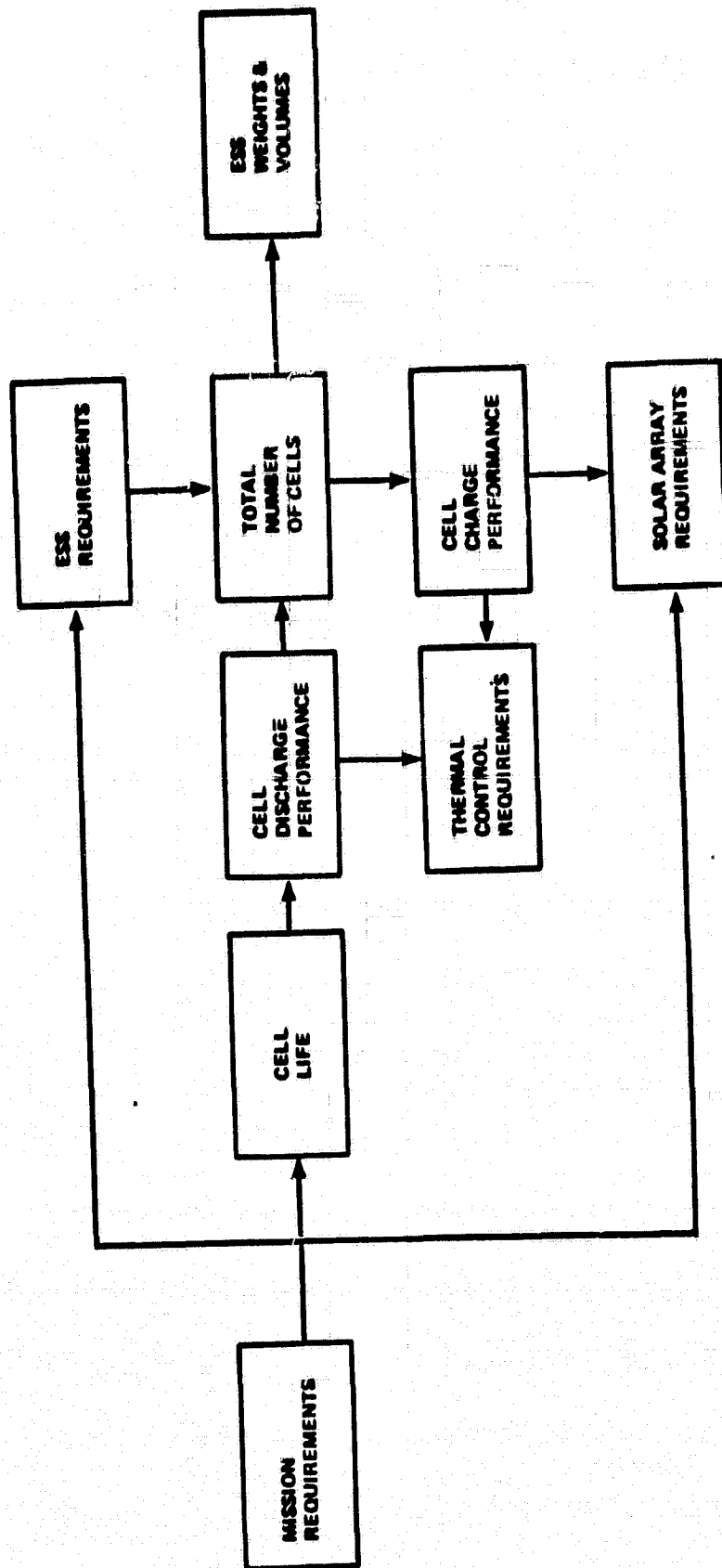

Exhibit 2-2. Fuel Cell ESS Performance Model Schematic





*Exhibit 2.3. Block Diagram of Battery ESS Performance Model*

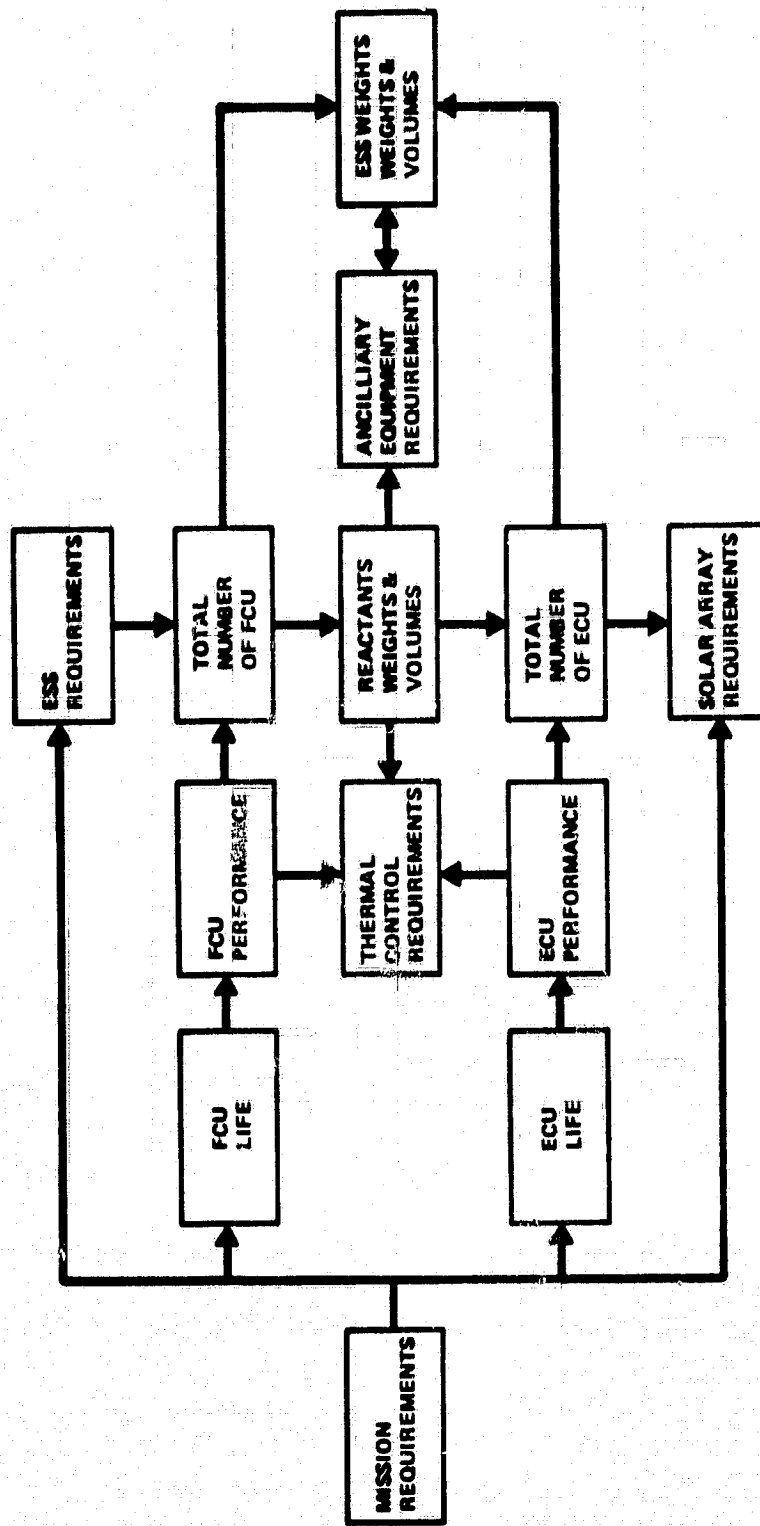

Exhibit 2-4. Block Diagram of Fuel Cell ESS Performance Modes

- Cell Discharge Performance

The unit cell discharge performance at EOL is used to determine the quantity of battery cells or fuel cells which are needed to produce the required power. For a fuel cell type of ESS, the fuel cell "discharge" performance also determines the ancillary equipment storage requirements. The discharge performance is a function of the cell life and vice versa. Hence, a trade must be made between cell performance and ESS maintenance requirements. In addition, the unit cell discharge performance effects the ESS power conditioning requirements and provides a component of the ESS thermal control heat load.

- Cell Charge Performance

The unit cell charge performance at EOL is used to determine the ESS solar array input power requirement. In addition, the unit cell charge performance provides one component of the total ESS thermal control heat load. For a fuel cell/electrolysis cell type of ESS, the electrolysis cell "charge" performance is used to determine the quantity of electrolysis cells, as well as some of the ancillary equipment requirements. The electrolysis cell performance also is a function of cell life and vice versa, which requires a trade between cell performance and ESS maintenance requirements. The combined discharge and charge thermal control heat loads provide the basis for determining the overall ESS watt-hour efficiency.

- Interface Requirements

As described above, the ESS directly impacts the power conditioning, the solar array, and the thermal control subsystem of a space platform. The impact on the subsystems, in turn effects the interface costs, which also must be included in the total ESS life cycle cost, to give the "complete picture."

- ESS Weights and Volumes

The ESS weights and volumes include all major components of hardware. This provides a realistic basis for determining the ESS transportation costs and other life cycle costs based on weight or volume for the different types of energy storage subsystems.

### 2.1.1 ESS Battery Performance

As stated previously, the Battery ESS Performance Model has two distinct applications - one for nickel cadmium and one for nickel hydrogen battery cells. The configurations of these types of cells are shown in Exhibits 2-5a and b. Due to the extensive test data and space use experience available for nickel cadmium, the NiCd performance model (Appendix B) was constructed first and validated using data for 20 AH GE nickel cadmium battery cells from various sources. Then, the nickel hydrogen performance model (Appendix C) was constructed using the more limited nickel hydrogen data, requiring in some cases extrapolations/interpolations from comparable nickel cadmium data. However, despite this limitation, the nickel hydrogen performance model is also a valid, useful model; and provides an accurate picture of the performance for a nickel hydrogen energy storage subsystem.

### 2.1.2 ESS Fuel Cell Performance

The fuel cell/electrolysis cell ESS performance model (Appendix D) was constructed using light-weight fuel cell technology (Exhibit 2-5c), which is presently being developed by UTC for NASA LeRC and MSFC. The electrolysis cell performance is assumed to be a mirror image of the fuel cell performance with respect to the theoretical Gibbs free energy of a hydrogen-oxygen fuel cell. The ancillary equipment capacity is sized based on "normal use" being 80 percent of the total quantity of reactants stored. This provides a 25 percent safety factor above normal use. For more realistic performance results, the life performance requirements for each of three major component groups (e.g., fuel cells, electrolysis cells, and ancillary equipment pumps) are specified independently.

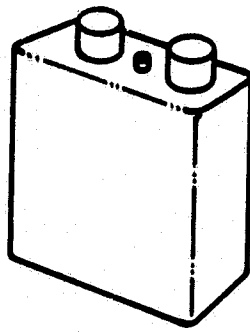

**NiCd CELL**

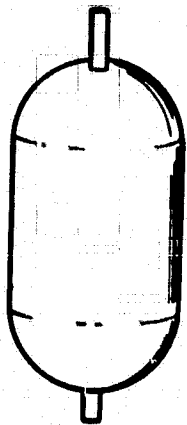

**NiH<sub>2</sub> CELL**

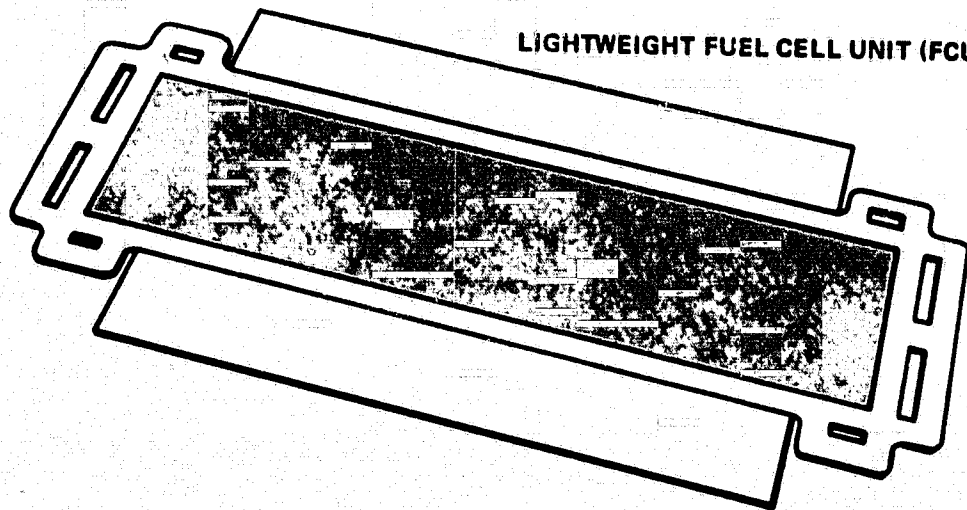

**LIGHTWEIGHT FUEL CELL UNIT (FCU)**

## 2.2 ESS Performance Relationships

Each ESS performance model consists of a myriad of specific relationships. To individually discuss each of these relationships listed in Appendices B, C, and D is not practical. However, certain key relationships which give a general "road map" for each model are discussed in the following paragraphs.

### 2.2.1 Battery Performance Relationships

Several key battery model relationships are discussed in conjunction with Exhibits 2-6, 2-7, and 2-8. Exhibits 2-6 and 2-7 are for NiCd, while Exhibit 2-8 is for NiH<sub>2</sub> cells respectively. The relationships are as follows:

- Maximum Cell Life

The relationship of DOD versus Cell Life versus Temperature for a NiCd battery cell is shown in Exhibit 2-6a. This relationship was derived from Figure 1 of a paper written by Barry Trout of LBJ Space Center (Energy Storage for Low Earth Orbit Operations at High Power) plus Figure 57 of NASA RP 1052 (Sealed Cell NiCd Battery Applications Manual). A comparable relationship for a NiH<sub>2</sub> Battery Cell is shown in Exhibit 2-8a. The NiH<sub>2</sub> relationship was derived from the Barry Trout paper in conjunction with extrapolated data from the derived NiCd relationship.

- Number of Cells in Parallel

The basic ampere-hour balance equation for all battery systems is:

$$\text{Number Cells in Parallel} \times \text{Cell Capacity} \times \text{DOD} \times \text{Capacity Degradation} =$$

(Required ESS Power ÷ Required ESS Voltage × Max Eclipse (Dark) Period.

- Cell Discharge Voltage

The relationship of cell discharge voltage versus DOD versus charge current for a NiCd battery cell at 10°C is shown in Exhibit 2-6b. This relationship was derived from data in NASA RP 1052 (Sealed Cell NiCd Battery Applications Manual). Other curves for different temperatures were also derived and used. For NiH<sub>2</sub> model, these relationships were derived from Tyco Laboratories test data

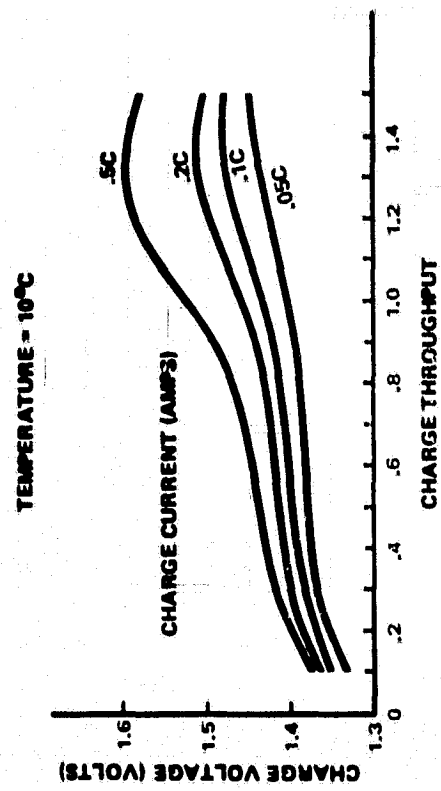
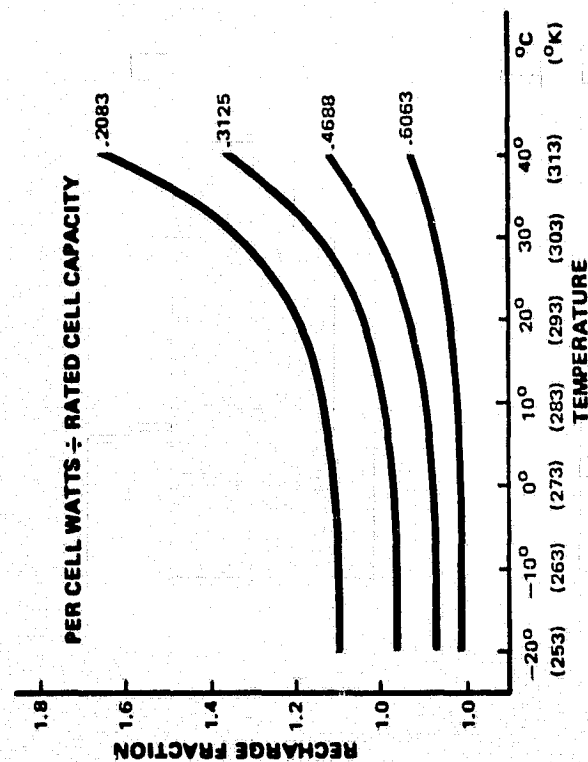
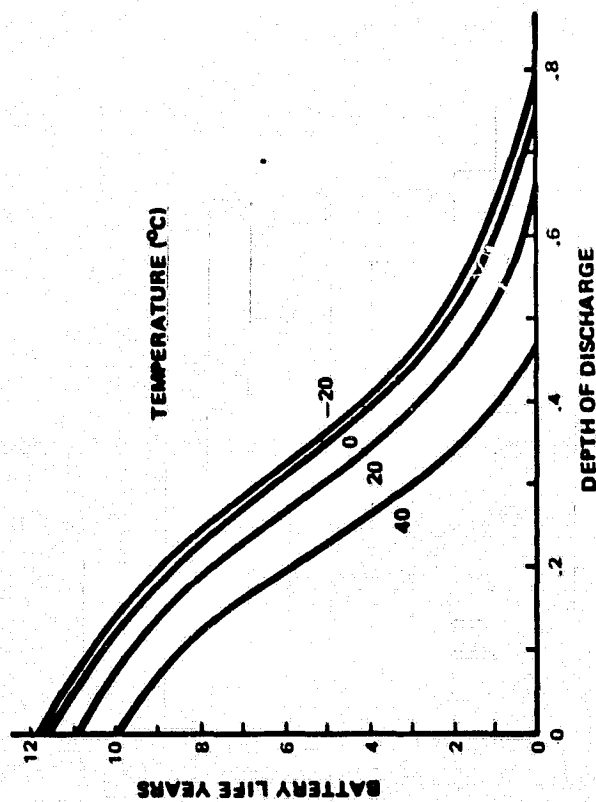
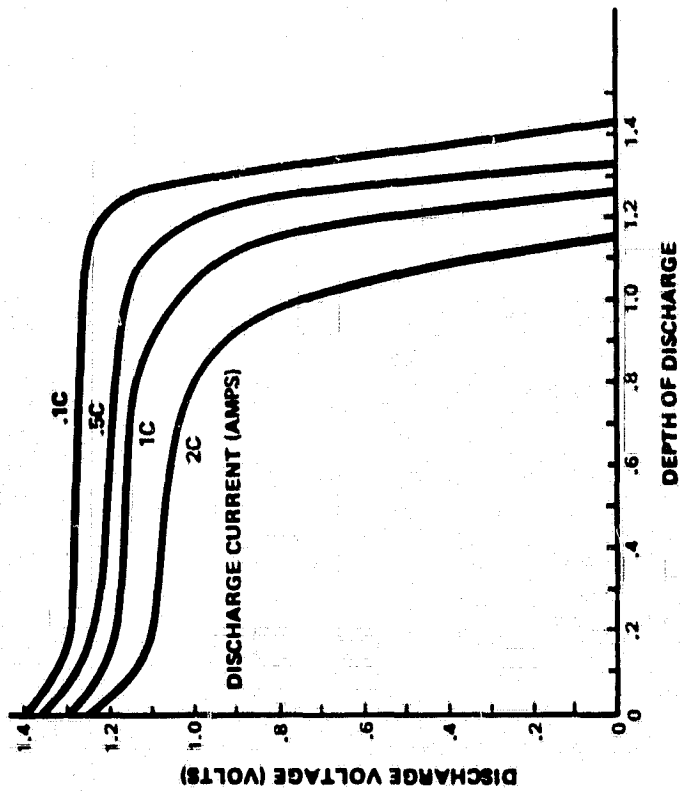

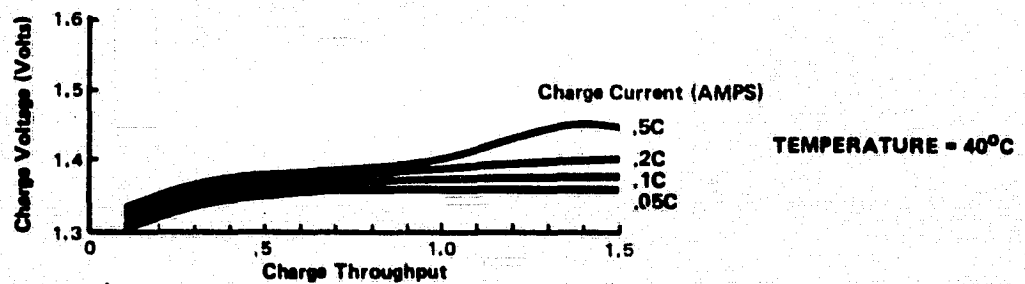
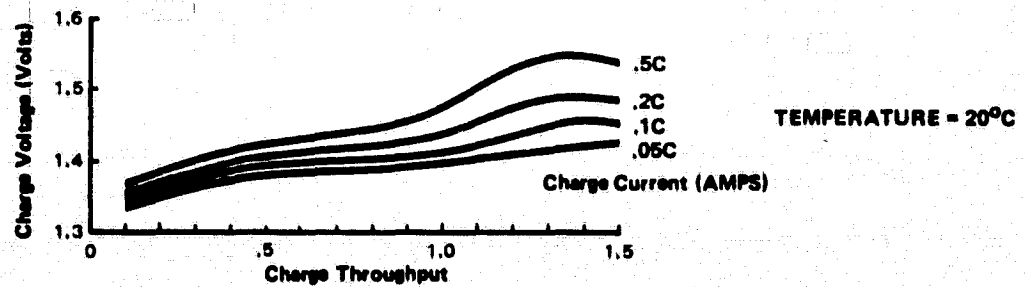
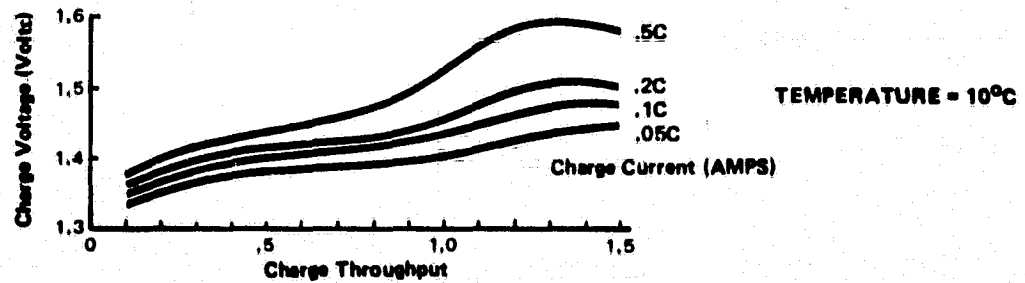
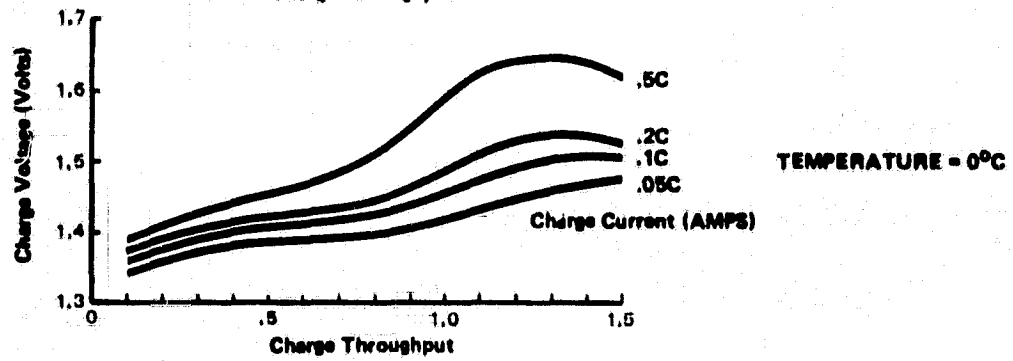
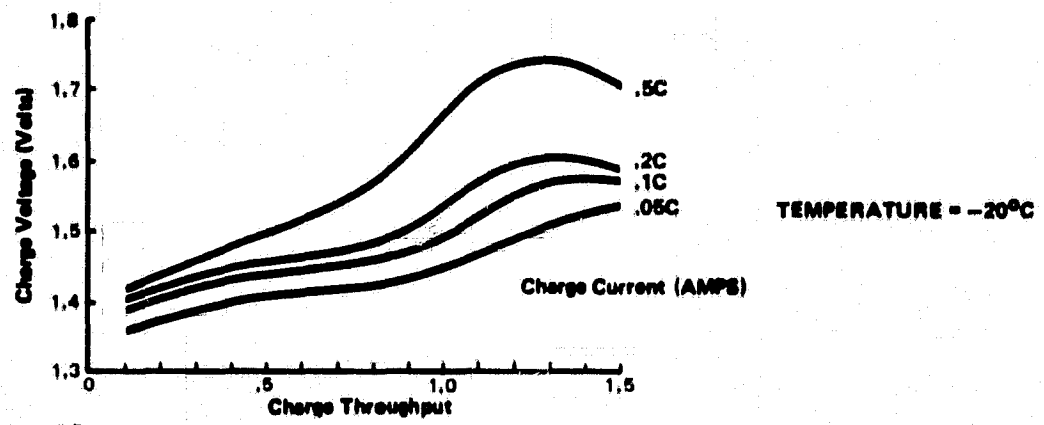

Exhibit 2.7: Example of Three-Dimensional Performance Curves  
(NiCd Charge Voltage vs Charge Throughput, Charge Current and Temperature)



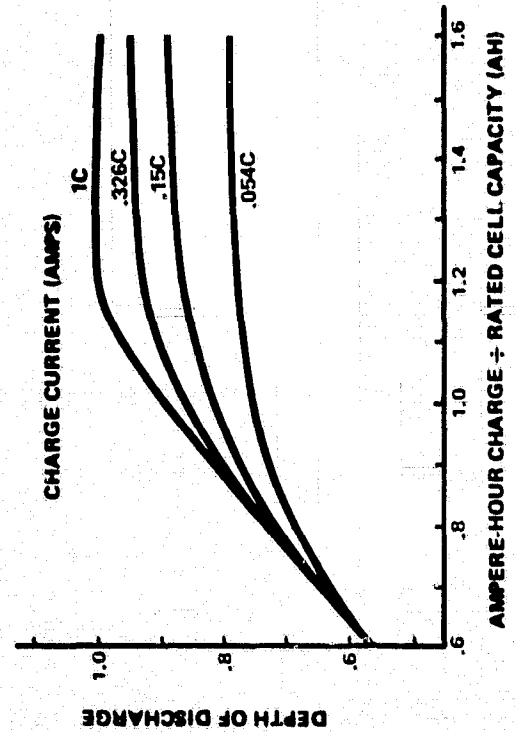
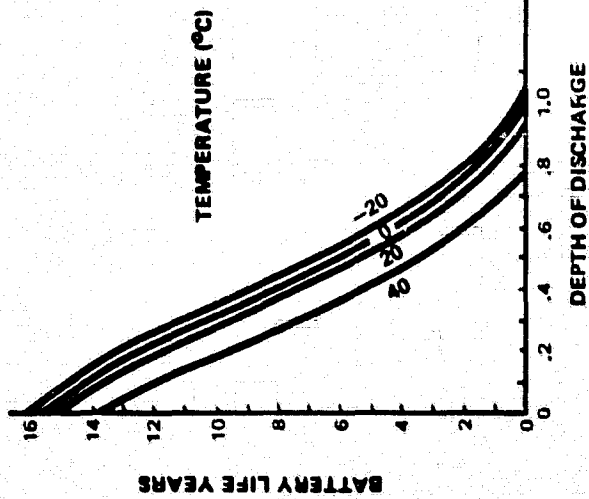
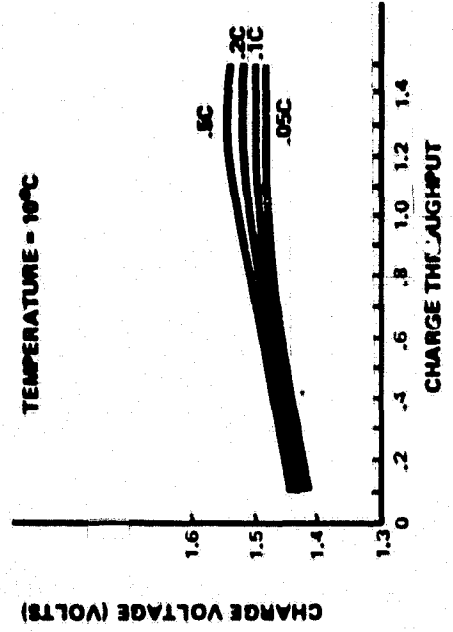
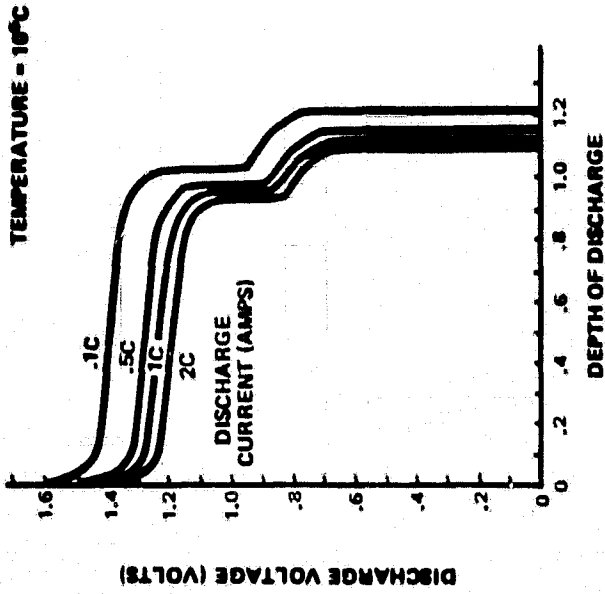

Exhibit 2-8. NiH<sub>2</sub> Performance Curves

(Hydrogen Nickel Regenerative Fuel Cells) plus McDonnell Douglas data (Nickel Hydrogen Prototype Cell Evaluation Tests).

NOTE: The output from these relationships are adjusted to EOL by multiplying the curve value by the voltage degradation factor.

- Number of Cells in Series

The basic battery system relationships is:

Number of Cells in Series = Required ESS Voltage ÷ EOL Cell Voltage

- Recharge Fraction

The relationship for the recharge fraction of a NiCd Battery Cell is shown in Exhibit 2-6c and a comparable relationship for NiH<sub>2</sub> is shown in Exhibit 2-8c. The NiCd relationship was obtained from NASA MSFC Report 40M22430 (The Apollo Telescope Mount Electrical Power System Post Mission Design and Performance Review). The NiH<sub>2</sub> relationship was obtained from Rockwell International test data published by AIAA in 1980 (Test Data Analysis and Application of Nickel Hydrogen Cells).

- Cell Charge Voltage

Exhibit 2-6d shows the relationship of charge voltage versus charge throughput versus charge current for a NiCd Battery Cell. It should be noted that this relationship is actually three dimensional (e.g., temperature is also included as shown in Exhibit 2-7). This relationship was obtained from NASA RP 1052 (Sealed Cell NiCd Battery Applications Manual). A similar relationship for NiH<sub>2</sub> is shown in Exhibit 2-8d. This relationship was derived from Tyco Laboratories test data (Hydrogen-Nickel Regenerative Fuel Cells) plus McDonnell Douglas data (Nickel-Hydrogen Prototype Cell Evaluation Tests).

- Watt-Hour Efficiency

Watt-Hour Efficiency =  $\frac{\text{Discharge Current} \times \text{Discharge Voltage} \times \text{Discharge Time}}{\text{Charge Current} \times \text{Charge Voltage} \times \text{Charge Time}}$

The watt-hour efficiency is a function of discharge power (current x voltage), charge power, and the discharge/charge periods of time e.g.,  $\text{Discharge Energy} \div \text{Charge Energy}$ ). It should be noted that the discharge and charge heat loads are included in the watt-hour efficiency. Part of the input charge energy is lost as the light period heat load; while the remainder is stored. In turn, part of the stored energy is lost as the dark period heat load; while the remainder is the output discharge energy.

### 2.2.2 Fuel Cell Performance Relationships

Several key fuel cell model relationships are discussed in conjunction with Exhibit 2-9. The source for the data in Exhibit 2-9 is the UTC Final Report FCR-1656 (Lightweight Fuel Cell Powerplant Components Program). While Exhibit 2-9 applies only to fuel cell life and performance, it is also the basis for electrolysis cell life/performance characteristics. As stated previously, the electrolysis cell performance is assumed to be a mirror image of the fuel cell performance with respect to the theoretical Gibbs free energy of a hydrogen-oxygen fuel cell. It should be noted, that the fuel cell unit (FCU) used in the fuel cell ESS model is the same as the two cell module (TCM) defined on pages 50-54 of the UTC report FCR-1656. This means that the FCU voltage in this report is 2x the unit cell voltage as defined by the UTC report.

- Maximum FCU Life

As shown in Exhibit 2-9, the degradation of cell voltage varies with the operating current density. The data used is based upon BOL operation versus operation to 2500 hours at the same power level. Since the voltage is degrading during this period of time, the current (e.g., current density for a fixed cell active area) was increased to maintain constant output power. From this the model is constructed assuming (1) a constant current density and (2) a linear degradation to EOL, at the same rate of degradation as the degradation from BOL to 2500 hours.

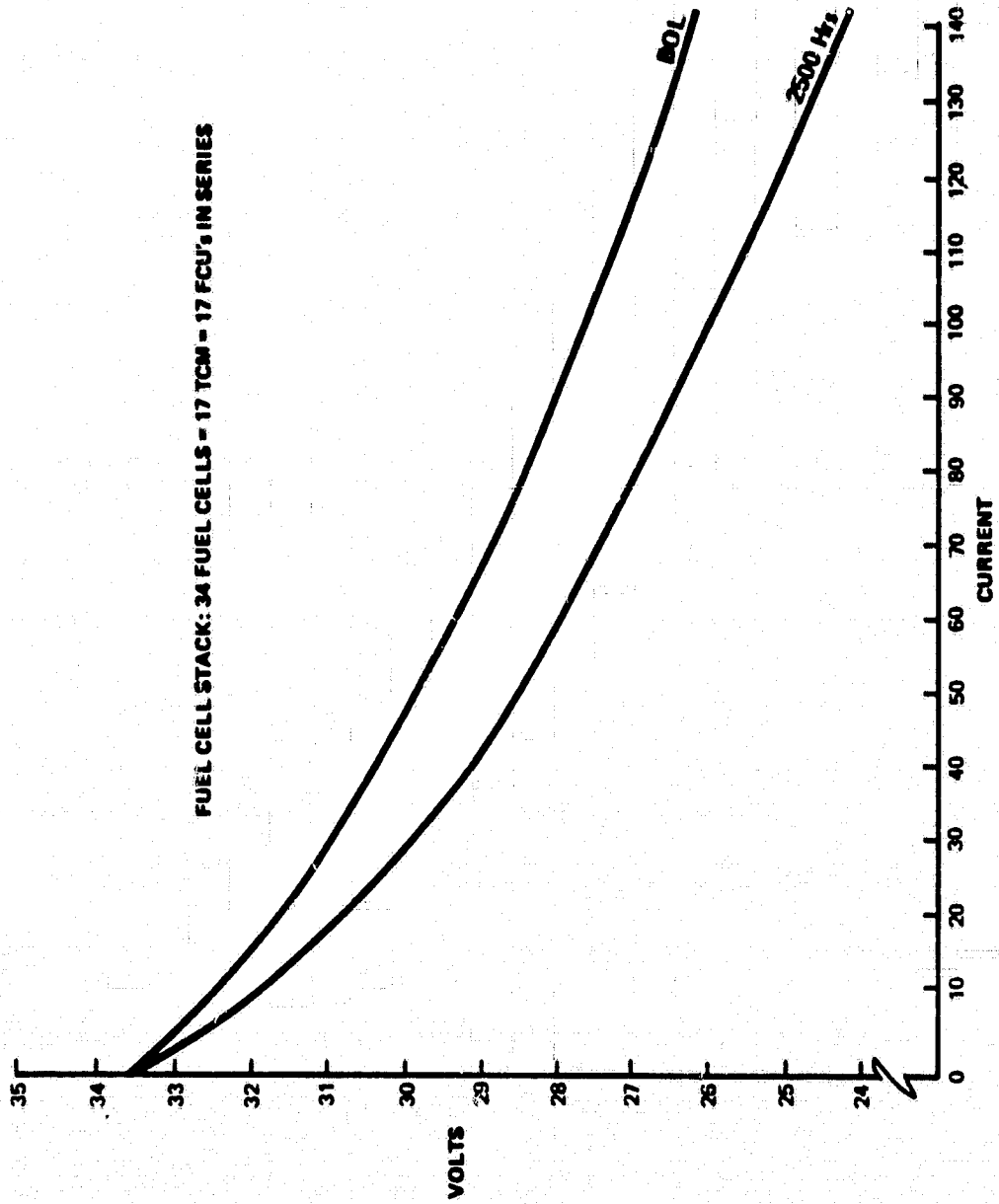

**Voltage vs Current at 16 PSI and 82°C**

*Exhibit 2-9. Fuel Cell - Life vs Performance*

- Number of FCU in Parallel

The basic current balance equation for all fuel cell systems is:

$$\text{Number of FCU in Parallel} \times \text{FCU Active Area} \times \text{FCU Current Density} = \text{ESS Power} \div \text{ESS Voltage}$$

- FCU Voltage

The relationship of FCU voltage versus current density versus cell life is shown in Exhibit 2-9. From this relationship, it is possible to project an FCU voltage at EOL for an expected FCU life and corresponding current density which is assumed to be constant throughout the entire FCU life.

- Number of FCU in Series

The basic relationship is:

$$\text{Number FCU in Series} = \text{Required ESS Voltage} \div \text{EOL Cell Voltage}$$

- Total Number of ECU

The basic relationship is:

$$\text{Total Number of ECU} \times \text{Total H}_2 \text{ Generation Per ECU} = \text{Total Number of FCU} \times \text{H}_2 \text{ Consumption Per FCU}$$

It should be noted that this relationship includes the efficiencies of both ECUs and FCUs which are inherent in the reactants generation and consumption rates respectively.

- ECU Voltage

The ECU voltage is projected for EOL in a manner similar to the FCU voltage, except that the voltage which results from the cell degradation is shown in Exhibit 2-9 is added to the Gibbs free energy for the reactant combination of hydrogen and oxygen. The source for this methodology is UTC Final Report FCR-1656 (Light Weight Fuel Cell Powerplant Components Program) plus General Electric Study ECOES-12 (Electrochemical Cell Technology for Orbital Energy Storage).

- Watt-Hour Efficiency

$$\text{Watt-Hour Efficiency} = \text{ESS Output Power} \times \text{Dark Period Time} \div (\text{ESS Input Power} \times \text{Light Period Time})$$

This relationship for a fuel cell ESS system is equivalent to a similar relationship for a battery ESS system. Similar comments pertaining to the discharge (dark) and charge (light) period heat loads apply as well.

### 2.3 ESS Physical Characteristics

Given unit cell performance, which in turn determines the total number of unit cells, the ESS physical characteristics are then derived. To provide a basis for comparison between the different types of technology, essentially the same ESS configurations are hypothesized for NiCd, NiH<sub>2</sub> and fuel cell subsystems. These configurations are discussed in the following paragraphs.

#### 2.3.1 Battery Subsystem Physical Characteristics

The ESS Battery WBS, which is shown in Exhibit 2-10, provides the "skelton" for the NiCd and NiH<sub>2</sub> Battery ESS configurations. The NiCd Hierarchy and NiH<sub>2</sub> Hierarchy Configurations are shown in Exhibits 2-11 and 2-12 respectively. The battery cells are the basic building block. A battery module is a group of battery cells which are electrically and mechanically interconnected. A battery in turn is a group of interconnected battery modules. The batteries are then integrated into an Energy Storage Subsystem, which is configured as an N-sided polygon with a variable length, depending upon the number of batteries. The Battery performance model determines the quantities of the various hardware items so that the resultant combination is reasonably optimized with respect to a weight versus volume packing density.

#### 2.3.2 Fuel Cell Subsystem Physical Characteristics

The ESS Fuel Cell WBS and Fuel Cell/Electrolysis Hierarchy Configuration are shown in Exhibits 2-13 and 2-14 respectively. For this ESS configuration, the fuel cell unit and the electrolysis cell unit are the two basic building blocks. A fuel cell stack is a group of FCUs which are electrically and mechanically interconnected. An electrolysis cell stack is a group of interconnected ECUs. A power module consists of a group of FC stacks and EC stacks which are mechanically interconnected. A power channel consists of a group of electrically interconnected FC stacks. It should be noted that the number of

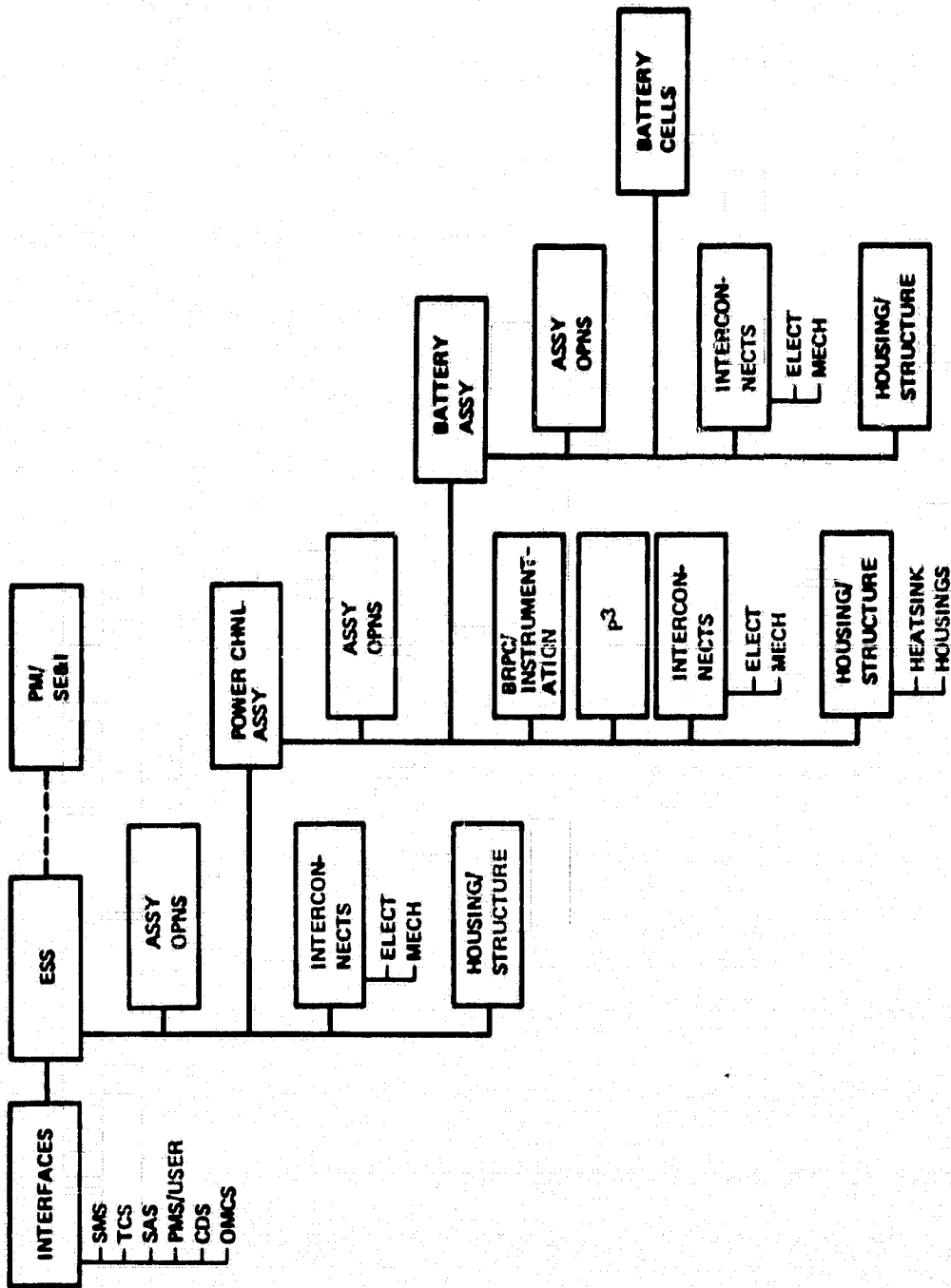
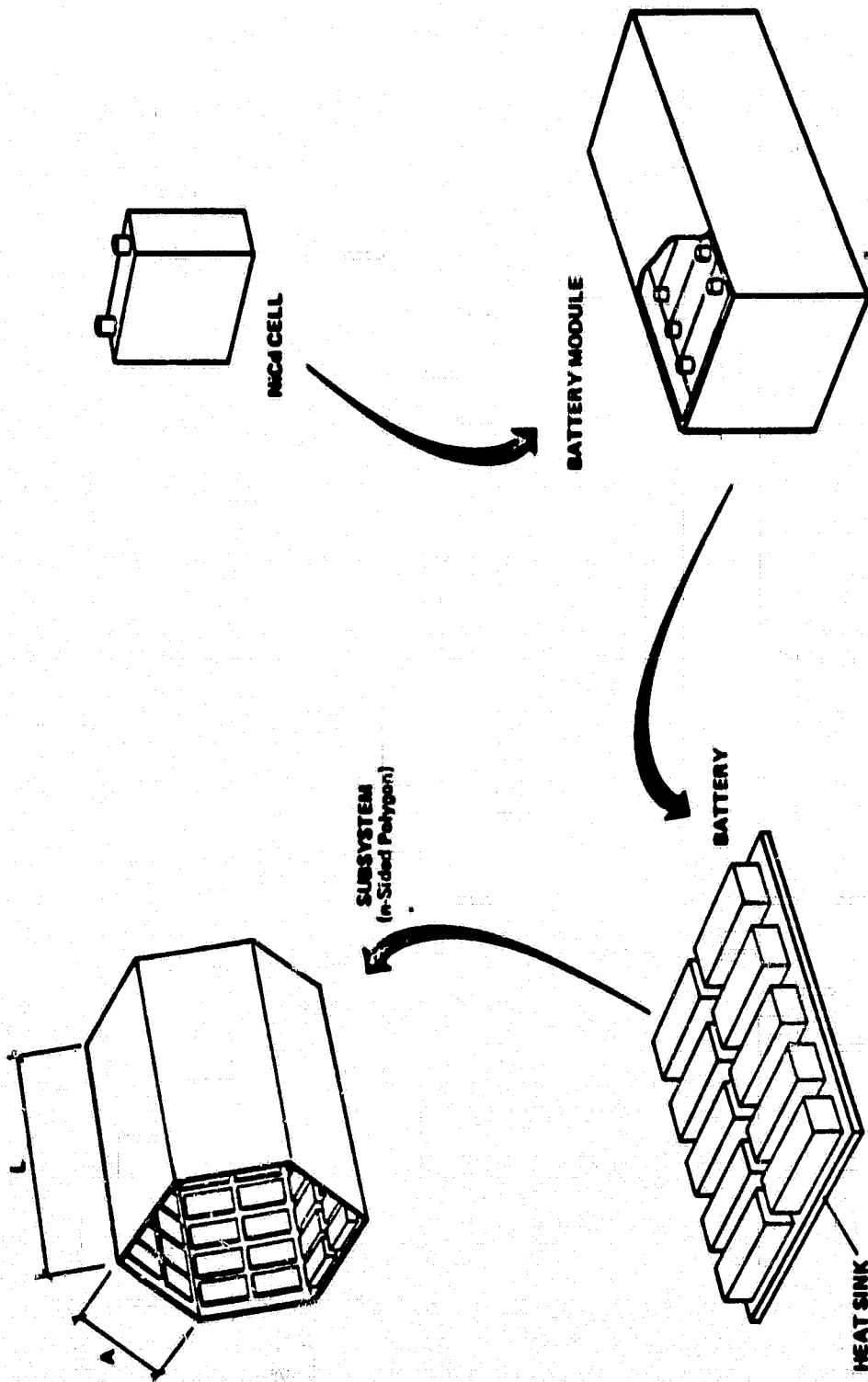

Exhibit 2-10. ESS Battery WBS



**Exhibit 2-11. NiCd Hierarchy/Configuration**



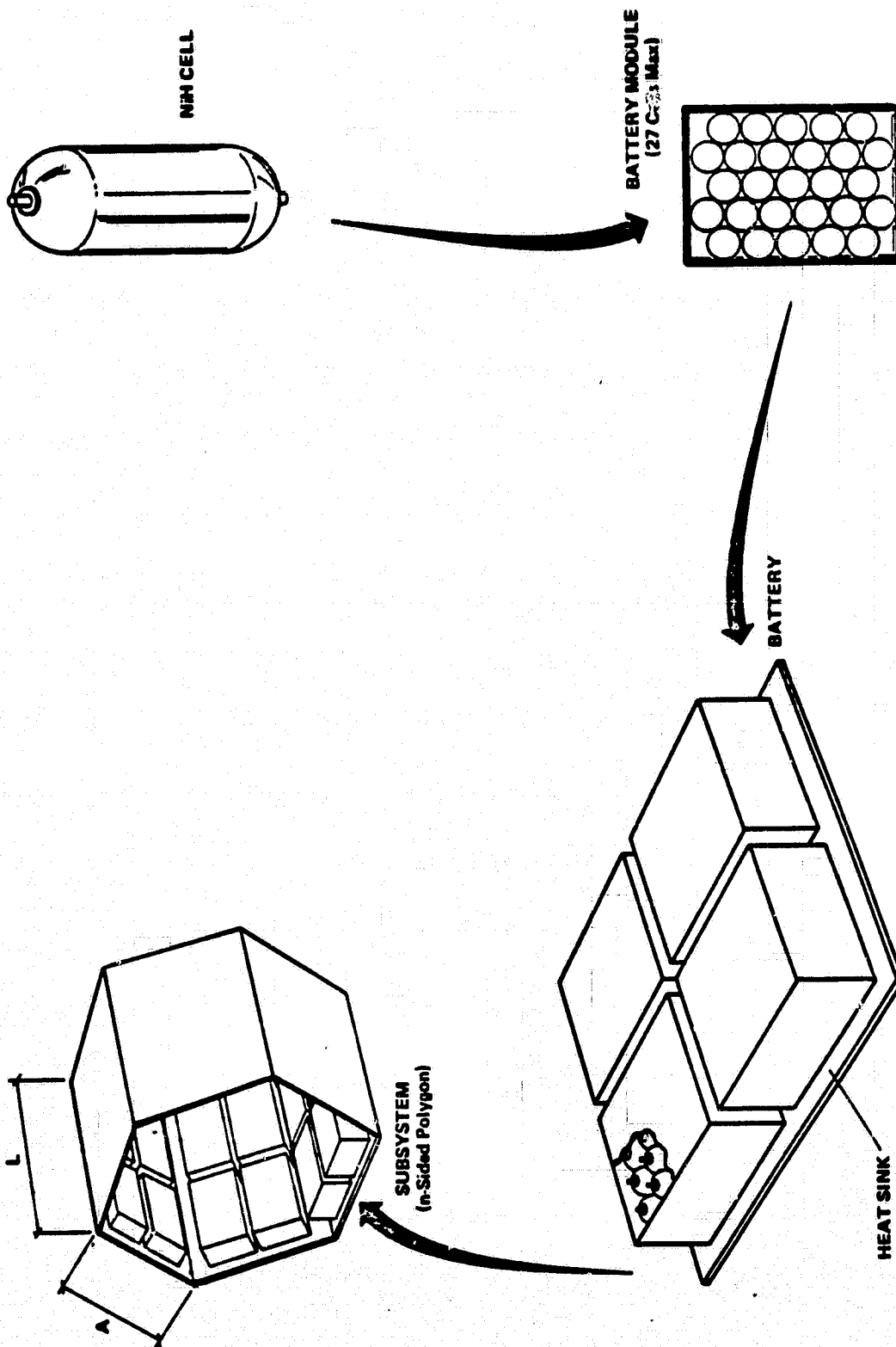

Exhibit 2-12. NiH Hierarchy/Configuration

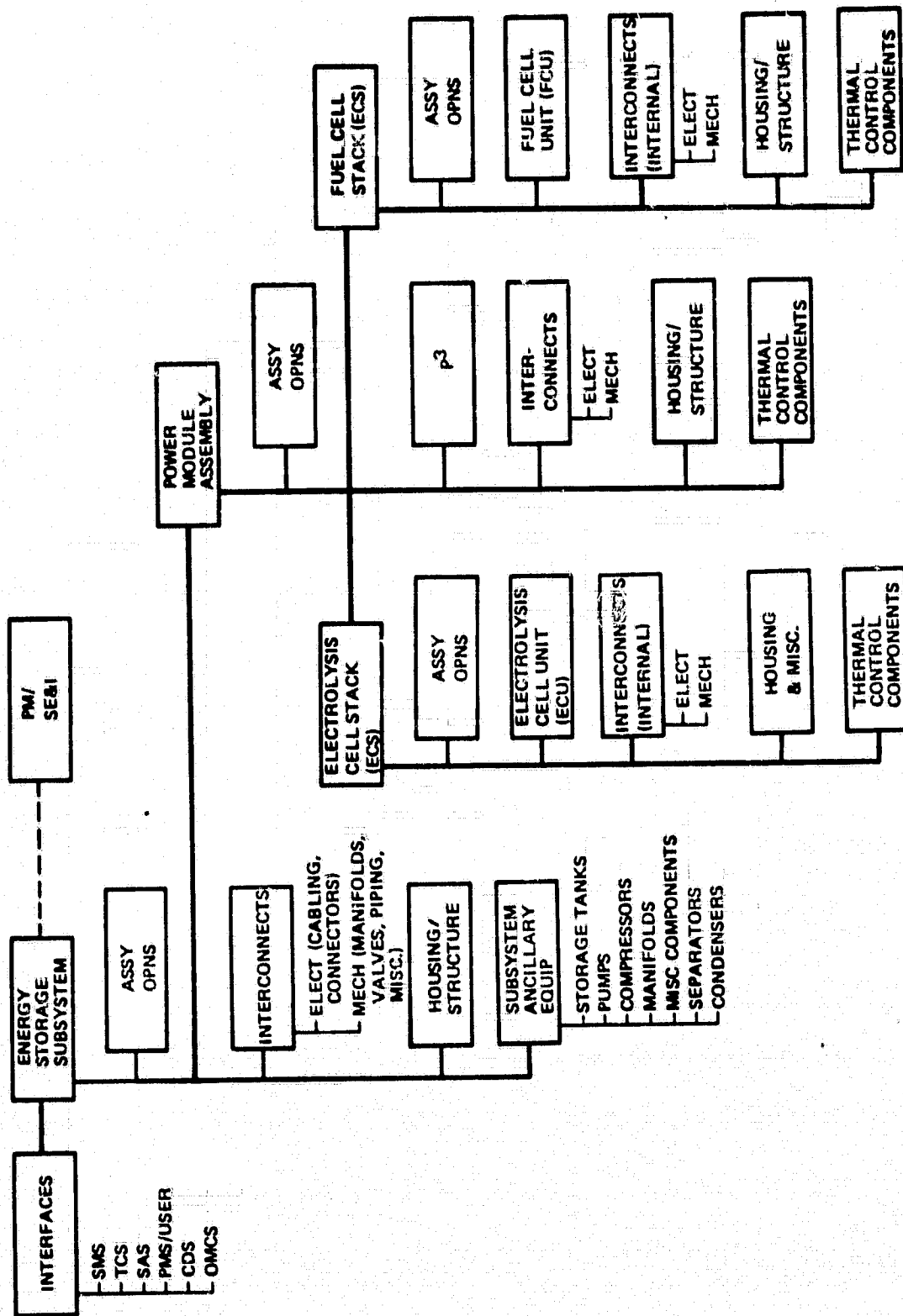
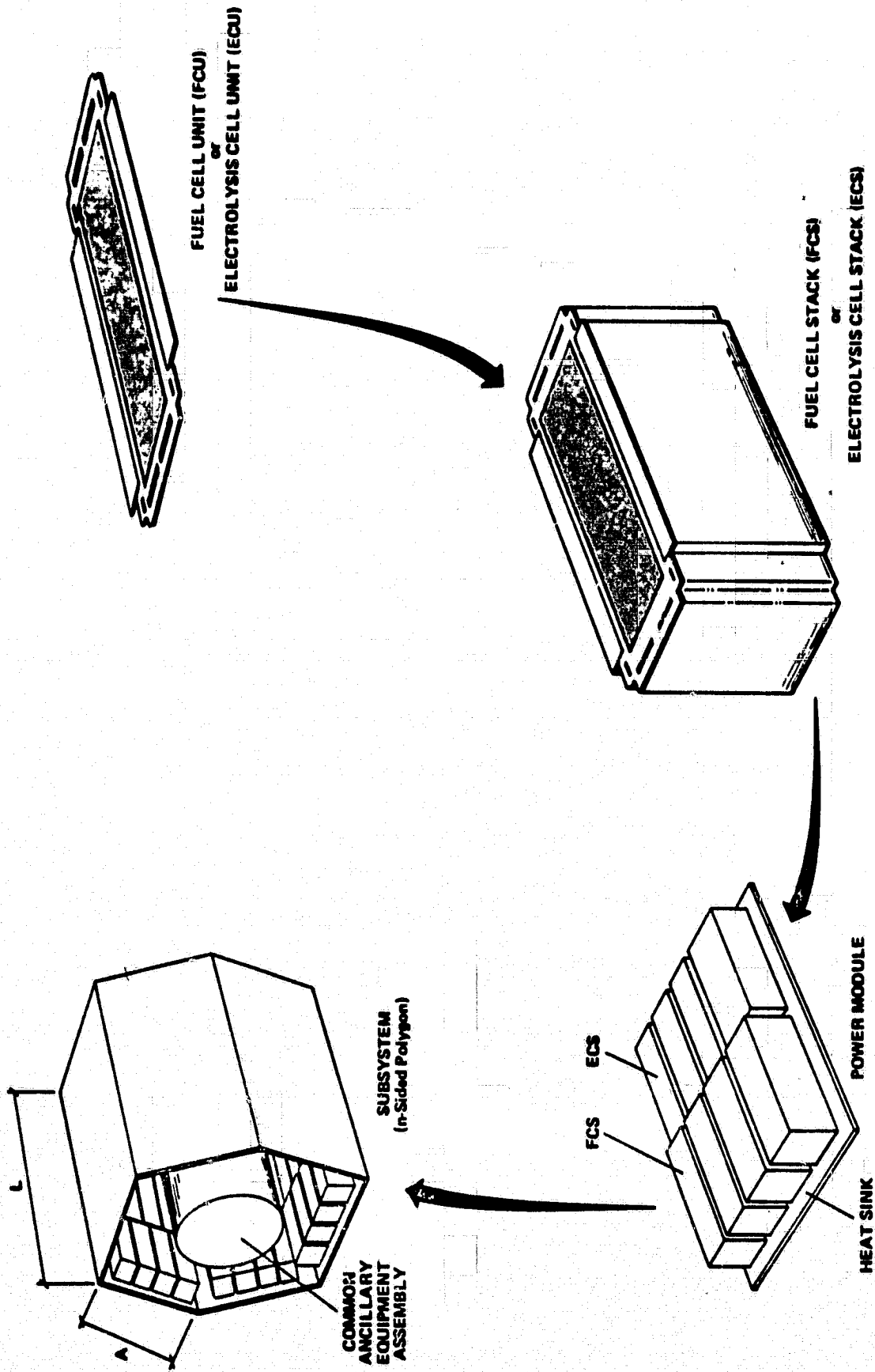

Exhibit 2-13. ESS Fuel Cell WBS



*Exhibit 2-14. Fuel Cell/Electrolysis Hierarchy/Configuration*

FC stacks will not be equal to the number of EC stacks. The power modules, together with a common ancillary equipment assembly, are integrated into an Energy Storage Subsystem, which is configured as an N-sided polygon, with variable length. The fuel cell performance model determines the quantities of the various hardware items so that the resultant combination is reasonably optimized with respect to a weight versus volume packing density.

#### 2.4 ESS Baseline Configurations

The ESS baseline configurations were derived by exercising the respective performance models, with certain basic ground rule assumptions which were common to all three models. For example, mission requirements such as the orbit and the number of hardware life cycles were common for all LEO missions. For the purpose of this study, hardware life cycle is one set of hardware which is used and maintained in LEO over a given period of time, which is one segment of the total ESS subsystem life. In GEO there is only one hardware life cycle which is equal to the subsystem life, and no maintenance is performed during the cycle. A comparable set of mission requirements were common for all GEO missions. The power levels were sized at 25 kW, 50 kW, 100 kW and 250 kW for LEO missions and 25 kW for GEO missions. Another basic ground rule was that 50 AH battery cells were used for all NiCd and NiH<sub>2</sub> ESS baseline configurations, while the same FCU and ECU were used for all fuel cell configurations. This was done so that actual hardware which is presently available, representing state-of-the-art technology, would be used and comparable results between the baselines could be achieved.

##### 2.4.1 NiCd Baseline Configurations

Exhibit 2-15 summarizes the NiCd baseline configurations. It should be noted that this is a short "Table" version of a more complete and detailed "Chart" listing of performance parameters and physical characteristics. A "Chart" listing for each baseline configuration is contained in Appendix E. Each chart listing also includes life cycle costs which are discussed in later sections of this report.

NiCd BATTERY ENERGY STORAGE SUBSYSTEM	LEO				GEO
	25kW	50kW	100kW	250kW	
<b>EOL PERFORMANCE PARAMETERS</b>					
Number of Hardware Cycles	4	4	4	4	1
Maximum Battery Life (Yr)	7.096	7.096	6.953	6.866	1.011
Rated Cell Capacity (AH)	50	50	50	50	50
Maximum Depth of Discharge	.248	.248	.254	.257	.552
Operating Temperature (deg-K)	283	283	283	283	283
Max. Discharge Current (A)	17.813	17.813	18.163	18.379	23.156
Minimum Voltage (V)	1.113	1.113	1.109	1.106	1.195
Recharge Fraction	1.058	1.058	1.055	1.054	1.028
Charge Current (A)	12.937	12.937	13.160	13.298	1.237
Charge Voltage (V)	1.659	1.659	1.664	1.667	1.404
Watt-Hour Efficiency	.635	.635	.632	.630	.828
<b>PHYSICAL CHARACTERISTICS</b>					
Total Number of Cells	1508	3016	5967	14742	1080
Number of Parallel Batteries	13	26	51	126	10
Number of Modules per Battery	8	8	8	8	6
Battery Cell Weight (Kg)	2.027	2.027	2.027	2.027	2.027
Battery Cell Volume (CM <sup>3</sup> )	725	725	725	725	725
ESS Weight (Kg)	4116	8231	16426	37794	2726
ESS Volume (M <sup>3</sup> )	29.608	59.216	107.110	244.830	20.580

Exhibit 2-15. Baseline NiCd Battery ESS Parameters and Characteristics

#### 2.4.2 NiH<sub>2</sub> Baseline Configurations

The NiH<sub>2</sub> baseline configurations are summarized in Exhibit 2-16. The basic comment applies concerning the "Tables" version shown and the detailed "Chart" printouts for the NiH<sub>2</sub> baselines in Appendix E. The formats for the NiCd and NiH<sub>2</sub> "Table" and "Chart" printouts are essentially identical to allow a detailed performance comparison of the two techniques.

#### 2.4.3 Fuel Cell Baseline Configurations

The Fuel Cell/Electrolysis Cell baseline configurations are summarized in Exhibit 2-17. Again, a more detailed "Chart" printout for each baseline is contained in Appendix E. For comparison with the NiCd and NiH<sub>2</sub> baselines, the FCU performance corresponds to the battery cell discharge performance and the ECU performance to the battery cell charge performance, while the Ancillary Equipment is unique to the Fuel Cell/Electrolysis Cell ESS.

#### 2.5 ESS Performance Comparisons

A performance comparison of the three different technology ESS baselines is shown in Exhibit 2-18. As can be seen, the NiH<sub>2</sub> battery cell provides almost twice the output of the NiCd battery cell due to the effect of DOD on cell life, which limits the maximum DOD of NiCd compared to NiH<sub>2</sub>. The NiCd cell is also considerably heavier which results in almost half the power density per cell compared to NiH<sub>2</sub>. It should be noted that the maximum DOD for the NiH<sub>2</sub> baselines is somewhat restrained because of the ground rule to have the same number of hardware life cycles for all three baselines. The watt-hour efficiencies for the two battery baselines in LEO are very comparable. The difference in watt-hour efficiencies at GEO is partially due to a lower limit on the charge current for NiH<sub>2</sub> which is not included in NiCd. This difference in limits was due to the different data bases and the difference in methodology for determining the recharge fractions of the two ESS technologies. (See Exhibit 2-6c versus Exhibit 2-8c).

The Fuel Cell Configurations are very comparable with the NiH<sub>2</sub> configurations, particularly for unit cell power divided by total ESS power density at LEO. It should be noted that the results for cell physical density and cell

power density are for the fuel cells only. Hence, it is not really possible to compare these numbers with the battery cell numbers because the battery cell includes both the fuel and electrolysis cell functions plus the ancillary equipment functions. It should be noted that the fuel cell ESS life cycle costs are also very comparable to the  $\text{NiH}_2$  cost at LEO, which will be further discussed in Section 3. Note that the fuel cell ESS has a very distinct advantage at GEO compared to either battery ESS.

NiH <sub>2</sub> BATTERY ENERGY STORAGE SUBSYSTEM	LEO				GEO
	25kW	50kW	100kW	250kW	
<b>EOL PERFORMANCE PARAMETERS</b>					
Number of Hardware Cycles	4	4	4	4	1
Maximum Battery Life (Yr)	7.785	7.117	7.117	6.968	1.304
Rated Cell Capacity (AH)	50	50	50	50	50
Maximum Depth of Discharge	.400	.430	.430	.437	.787
Operating Temperature (deg-K)	283	283	283	283	283
Max. Discharge Current (A)	28.946	30.875	30.875	31.292	33.080
Minimum Voltage (V)	1.150	1.131	1.131	1.127	1.213
Recharge Fraction	1.072	1.072	1.072	1.072	1.375
Charge Current (A)	21.296	22.715	22.715	23.022	3.756
Charge Voltage (V)	1.683	1.701	1.701	1.706	1.499
Watt-Hour Efficiency	.638	.621	.621	.617	.588
<b>PHYSICAL CHARACTERISTICS</b>					
Total Number of Cells	904	1710	3420	8510	749
Number of Parallel Batteries	8	15	30	74	7
Number of Modules per Battery	5	5	5	5	4
Battery Cell Weight (Kg)	1.134	1.134	1.134	1.134	1.134
Battery Cell Volume (CM <sup>3</sup> )	2020	2020	2020	2020	2020
ESS Weight (Kg)	2178	4488	8974	22771	1796
ESS Volume (M <sup>3</sup> )	18.068	36.137	72.273	189.280	15.816

Exhibit 2-16. Baseline NiH<sub>2</sub> Battery ESS Parameters and Characteristics



FUEL CELL ENERGY STORAGE SUBSYSTEM	LEO				GEO
	25kW	50kW	100kW	250kW	
<b>EOL FCU PERFORMANCE</b>					
Number of Hardware Life Cycles	4	4	4	4	1
Maximum FCU Life (Hr)	17436	16542	16047	15944	1175
Dark Period Power (W)	43.53	45.73	46.91	47.15	189.26
Dark Period Voltage (V)	1.437	1.415	1.403	1.401	1.562
Active Cell Area (cm <sup>2</sup> )	232.26	232.26	232.26	232.26	232.26
Current Density (Ma/cm)	130.43	139.12	143.92	144.92	521.70
Operating Pressure (Kg/cm <sup>2</sup> )	1.125	1.125	1.125	1.125	1.125
Operating Temperature (Deg-K)	355	355	355	355	355
<b>EOL ECU PERFORMANCE</b>					
Light Period Power (W)	34.05	34.71	34.87	34.91	117.21
Light Period Voltage (V)	3.442	3.477	3.496	3.500	3.493
<b>EOL SUBSYSTEM PERFORMANCE</b>					
Number of Hardware Life Cycles	4	4	4	4	1
Maximum Pump Life (Hr)	62393	62393	62393	62393	10519
H2 Storage Weight (Kg)	1.314	2.681	5.358	13.393	2.439
DoD Factor	.800	.800	.800	.800	.300
Watt-Hour Efficiency	.423	.413	.407	.406	.410
<b>PHYSICAL CHARACTERISTICS</b>					
Total Number of FCU	720	1380	2668	6624	166
Total Number of ECU	1496	3026	6052	15130	34
ESS Weight (Kg)	2057	4102	8118	20250	446
ESS Volume (M <sup>3</sup> )	15.051	20.800	37.501	88.151	9.302

Exhibit 2-17. Baseline Fuel Cell ESS Parameters and Characteristics

ESS POWER (kW)	NiCd BATTERY						
	CELL CAPACITY (AH)	CELL POWER ÷ TOTAL ESS POWER	ESS WATT-HOUR EFFICIENCY	DENSITY (Kg/cm <sup>3</sup> )		EOL POWER DENSITY (W/Kg)	
				CELL	ESS	CELL	ESS
25 LEO	50	.000663	.63	.0028	.000139	9.78	7.28
50 LEO	50	.000332	.63	.0028	.000139	9.78	7.27
100 LEO	50	.000168	.63	.0028	.000153	8.08	7.32
250 LEO	50	.000068	.63	.0028	.000154	10.03	7.93
25 GEO	50	.000926	.63	.0028	.000132	13.64	10.96

(a)

ESS POWER (kW)	NiH <sub>2</sub> BATTERY						
	CELL CAPACITY (AH)	CELL POWER ÷ TOTAL ESS POWER	ESS WATT-HOUR EFFICIENCY	DENSITY (Kg/cm <sup>3</sup> )		EOL POWER DENSITY (W/Kg)	
				CELL	ESS	CELL	ESS
25 LEO	50	.00111	.64	.00066	.00012	29.3	13.8
50 LEO	50	.00058	.62	.00056	.00012	30.8	13.3
100 LEO	50	.00029	.62	.00056	.00012	30.8	13.3
250 LEO	50	.00012	.62	.00056	.00012	31.1	13.2
25 GEO	50	.00134	.59	.00056	.00011	35.4	16.7

(b)

ESS POWER (kW)	FUEL CELL/ELECTROLYSIS CELL						
	CELL ACTIVE AREA (cm <sup>2</sup> )	CELL POWER ÷ TOTAL ESS POWER	ESS WATT-HOUR EFFICIENCY	DENSITY (Kg/cm <sup>3</sup> )		EOL POWER DENSITY (W/Kg)	
				CELL <sup>(1)</sup>	ESS	CELL	ESS
25 LEO	232	.00139	.42	.00082	.00014	87.0	15.2
50 LEO	232	.00073	.41	.00082	.00019	91.4	15.4
100 LEO	232	.00038	.41	.00082	.00022	93.7	15.4
250 LEO	232	.00015	.41	.00082	.00023	75.6	15.4
25 GEO	232	.00606	.41	.00080	.00005	378.1	70.4

(1) FC STACK

(c)

Exhibit 2-18. ESS Performance Comparisons

### 3.0 TOTAL LIFE CYCLE COST MODEL (LCCM)

The purpose of the LCCM is to (1) estimate the Life Cycle Cost (LCC) of the baseline Energy Storage Subsystems (ESS) and (2) evaluate the LCC of the ESS as the technology, performance and physical characteristics parameters are varied through a range of values. The LCCM is integral with the ESS performance model in the sense that it accepts input parameter values as determined by the performance model. The relationship of the LCCM to the performance model is shown in Exhibit 3-1. The input parameters consist generally of quantities, weights, volumes, life, reliability, power output, and efficiencies; and the thermal load and solar array input power level as shown in the exhibit. The input parameters are specified in detail in Appendices B & C for the NiCd and NiH<sub>2</sub> battery ESS and Appendix E for the fuel cell ESS respectively.

The makeup of the LCCM is shown in Exhibit 3-2 which shows how the DDT&E, Production, O&M and interfacing subsystems costs make up the total LCC. The makeup of the LCC is common to both battery and fuel cell ESS at all power levels and for both LEO and GEO missions. For the GEO mission, the training and maintenance functions involve ground monitoring and control.

#### 3.1 LCCM Ground Rules and Assumptions

The top level ground rules and assumptions used in the LCCM are listed below. Assumptions made which are peculiar to a particular phase, i.e., DDT&E, Production and O&M are presented within the discussion of each phase in later sections.

##### Top Level Ground Rules/Assumptions

- All estimated costs are in \$1980
- A dedicated factory facility supports DDT&E, Production and O&M.
- The Production phase ends and O&M begins at completion of ESS space deployment and checkout.
- Shuttle and IUS flights are dedicated to the Space Services Platform System (SSPS) of which the ESS is a subsystem.

PRECEDING PAGE BLANK NOT FILMED

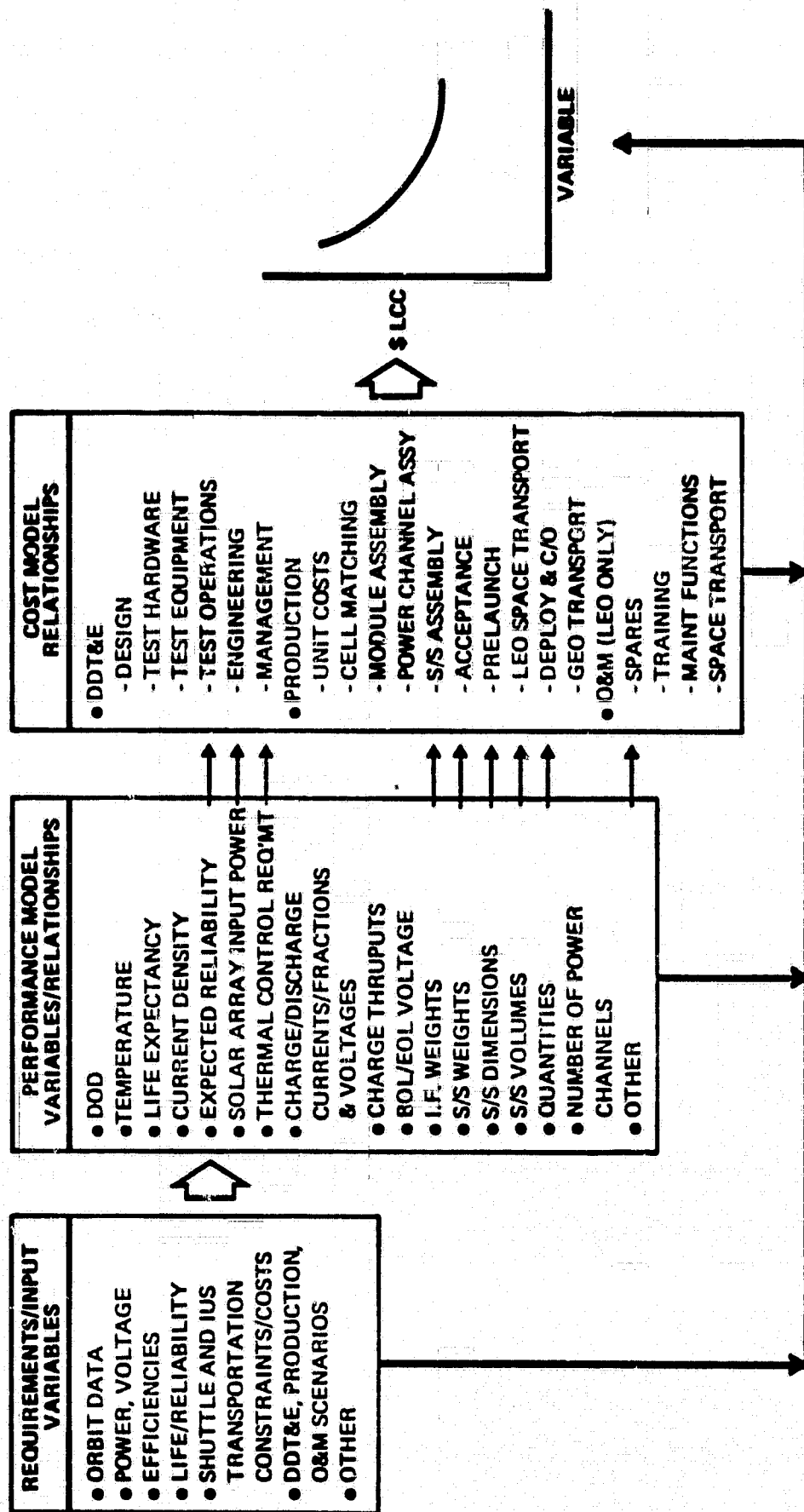

Exhibit 3-1. Generalized Performance and Cost Model Parameters

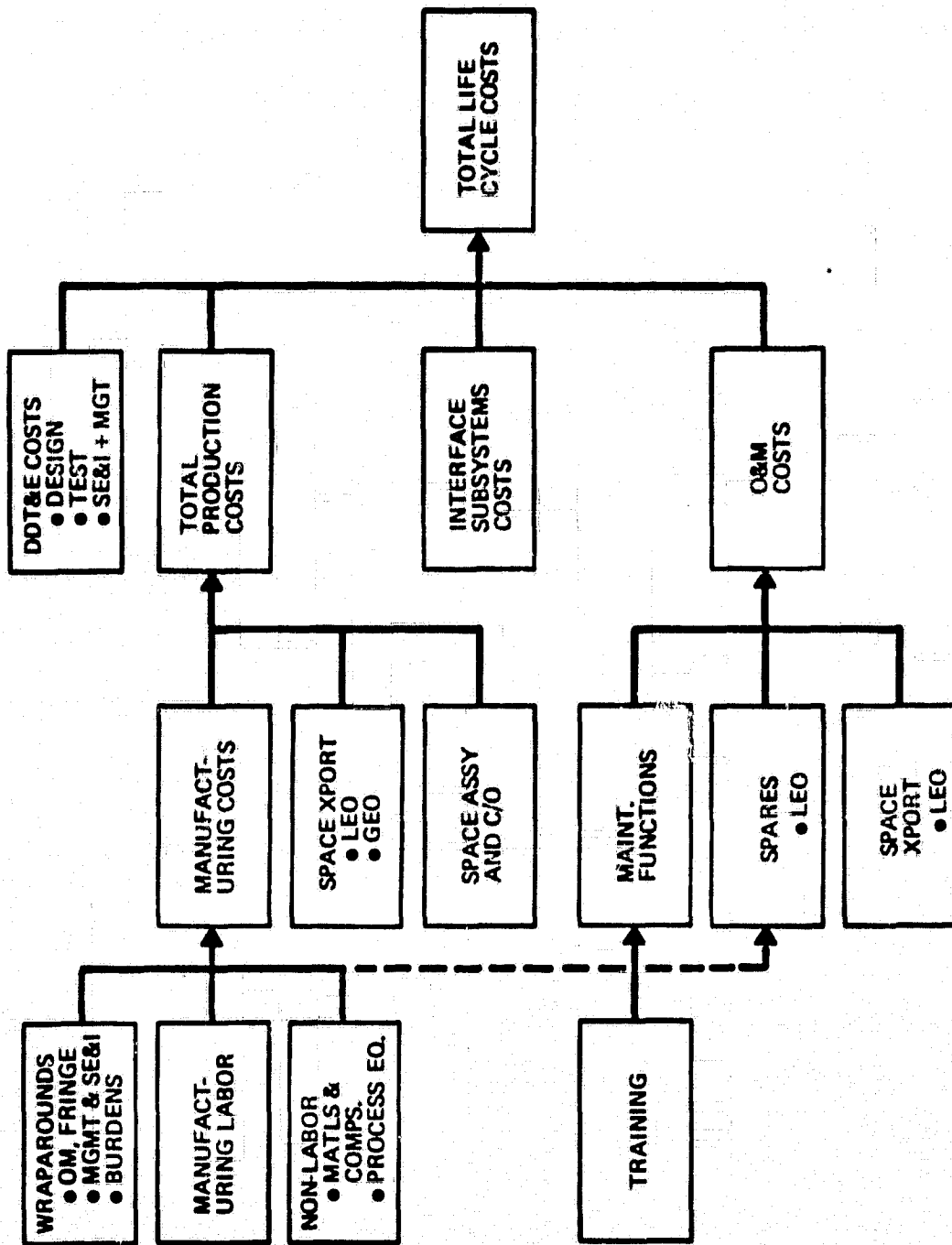

Exhibit 3-2. Top Level Elements of LCC

### 3.2 Functional Flow Diagrams

The basis for the LCCM structures are the battery and fuel cell work breakdown structures (WBS) described in Section 2.0. The WBS's were developed into the functional flow diagrams shown in exhibits as tabulated:

#### Battery ESS Flow Diagrams

DDT&E	Exhibit 3-3 (Common)
Production	Exhibit 3-4
O&M	Exhibit 3-6 (Common)

#### Fuel Cell ESS Flow Diagrams

DDT&E	Exhibit 3-3 (Common)
Production	Exhibit 3-5
O&M	Exhibit 3-6 (Common)

Wherein, as indicated, the DDT&E and O&M functional flows are common to both battery and fuel cell ESS's.

### 3.3 DDT&E Phase of the LCCM

The DDT&E flow diagram is shown in Exhibit 3-3, and is applicable to both battery and fuel cell ESS. The DDT&E cost equation is:

\$ DDT&E equals the sum of

\$ Design and Development	(D&D) = F1(1)
\$ Subsystem Test Hardware	(STH) = F1(2)
\$ STH Assembly	(STHA) = F1(3)
\$ System Test Operations	(STO) = F1(4)
\$ Test Support Equipment	(TSE) = F1(5)
\$ Systems Engineering and Integration	(SE&I) = F1(6)
\$ DDT&E Management	(MGT) = F1(7)

Historical CER's provide the basis for each cost element of DDT&E. These equations were adjusted by sets of factors (one set for battery ESS and one set for fuel cell ESS) to take into account the economies of size and modularity, use of flight hardware for qualification testing where feasible, and degree of complexity. The basic set of CER equations are (in K\$):

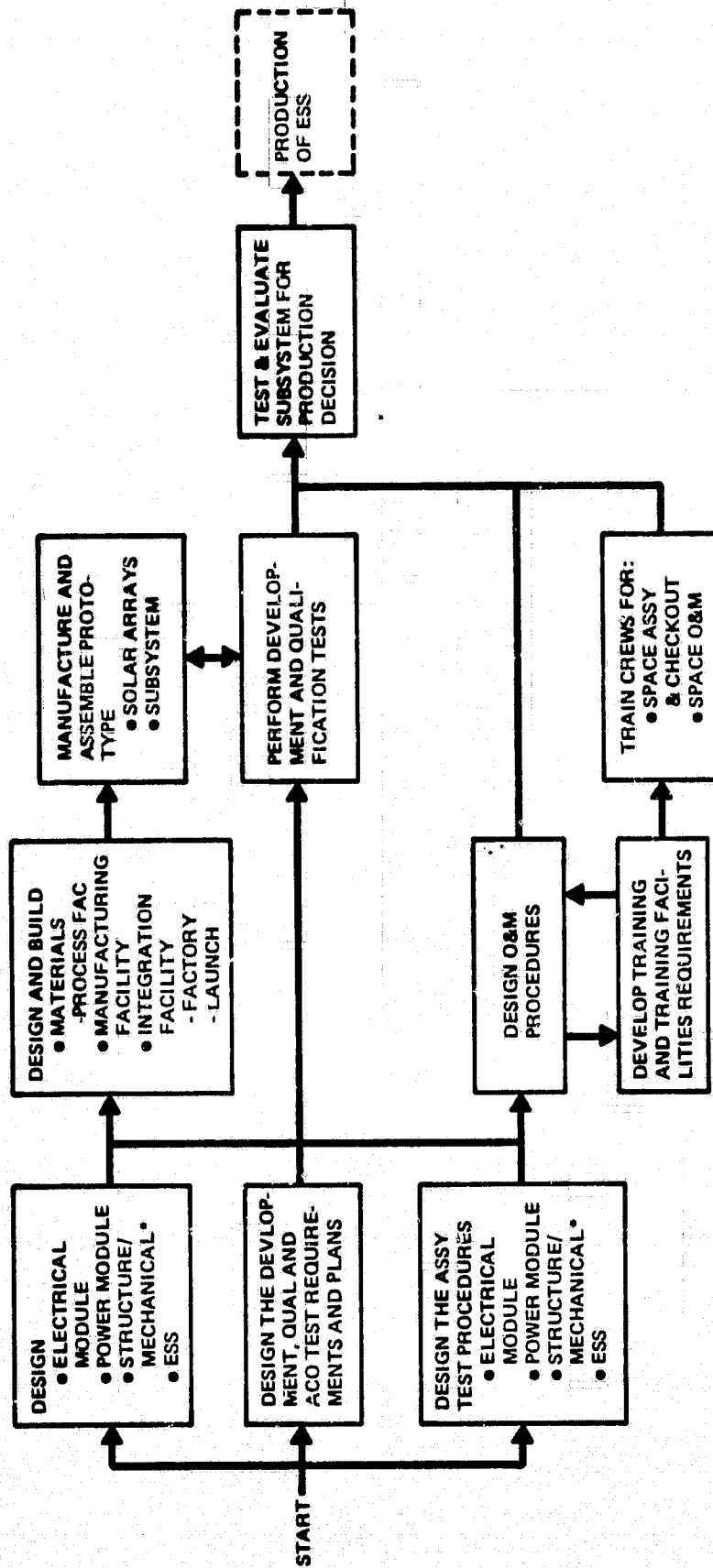

\* Includes Ancillary Equipment for Fuel Cell ESS

Exhibit 3-3. DDT&E Functional Flow

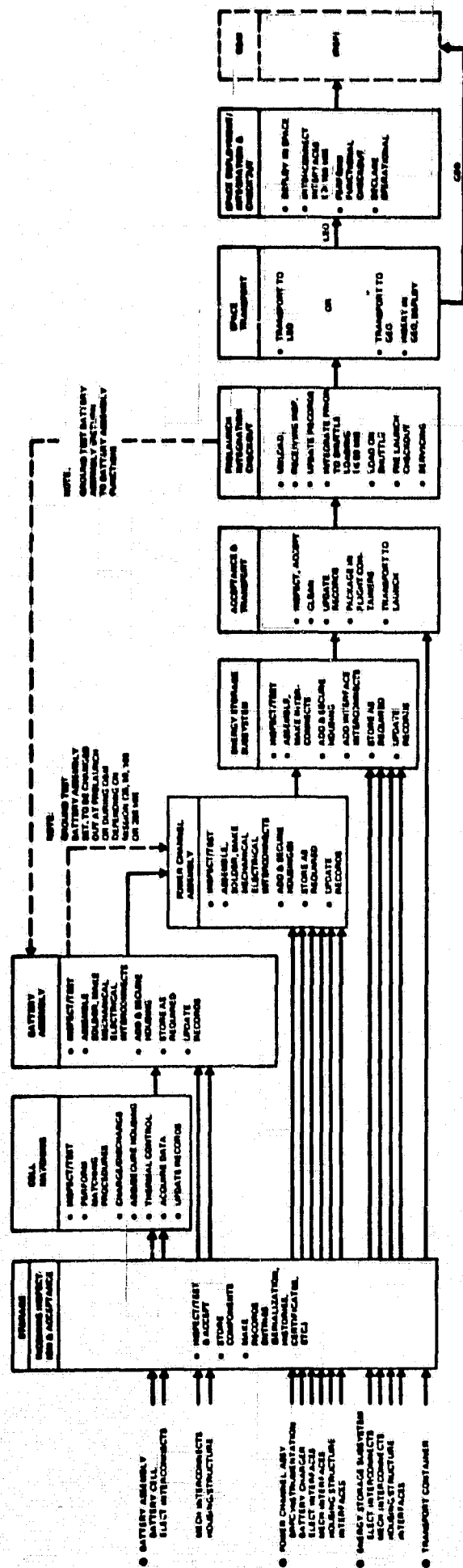

Exhibit 3-4. Battery ESS Production and Space Transportation/Assembly & Checkout Flow Diagram



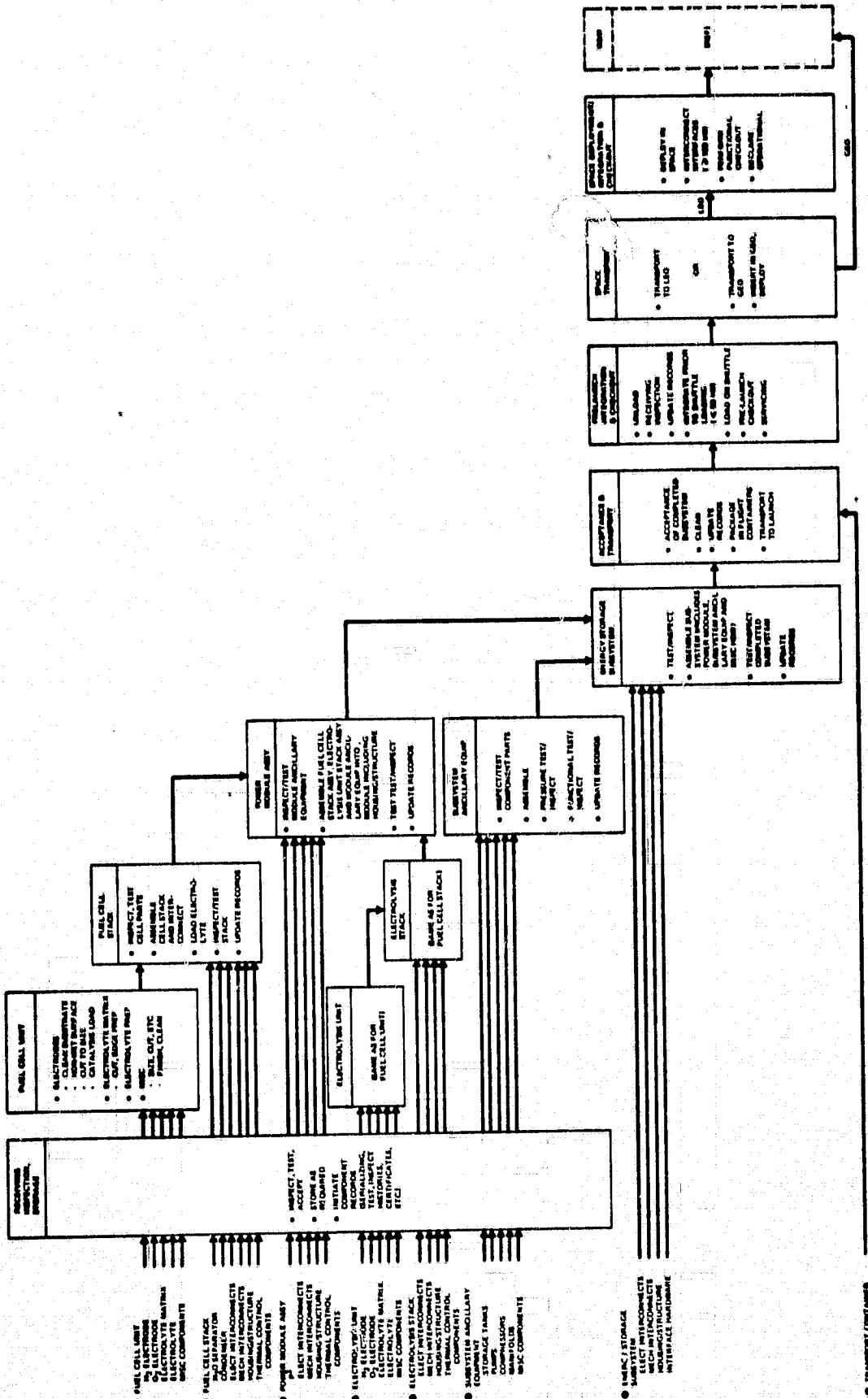

Exhibit 3-5. Fuel Cell ESS Production and Space Transportation/Assembly & Checkout Flow Diagram

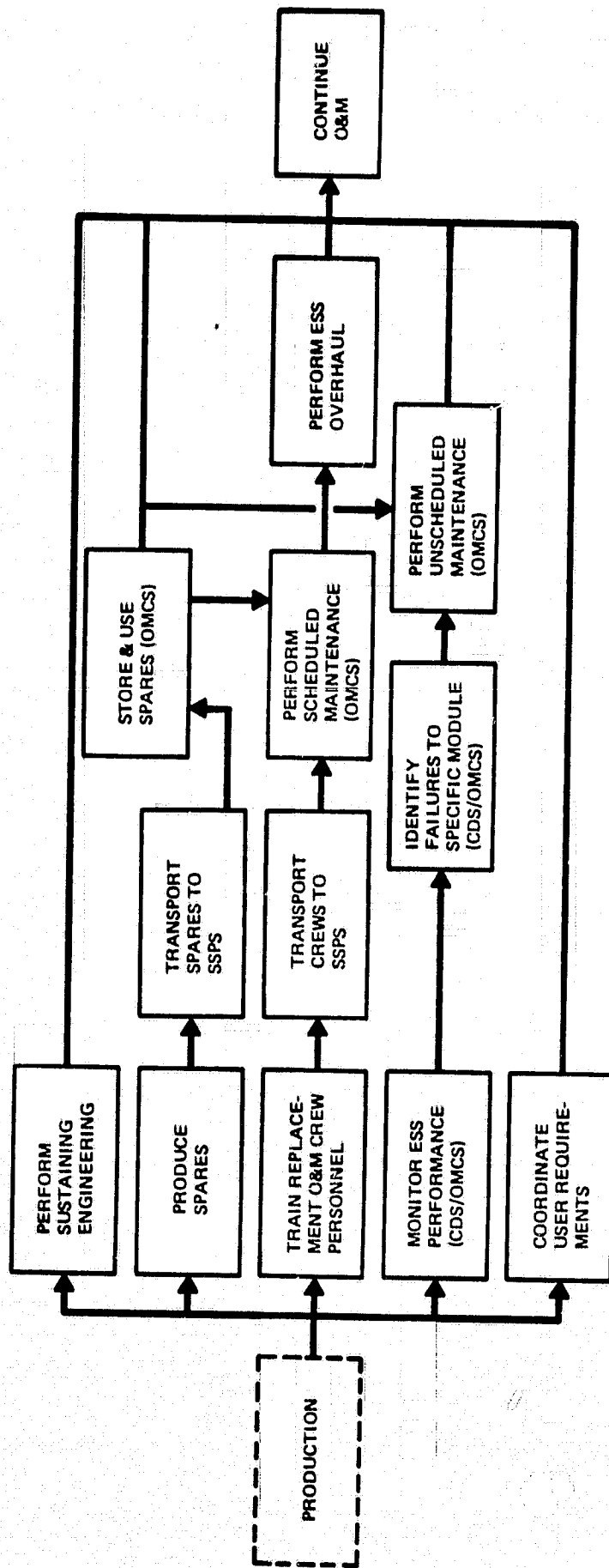

Exhibit 3-6. O&M Functional Flow

$$F1(1) = 844 [\text{ESS Weight}]^{0.203}$$

$$F1(2) = 989 [\text{Flight Hardware Cost}]^{1.064}$$

$$F1(3) = 217 [F1(2)]^{.789}$$

$$F1(4) = 828 [F1(2)]^{.397}$$

$$F1(5) = 109 [F1(1) + F1(2) + F1(3) + F1(4)]^{1.025}$$

$$F1(6) = 94 [F1(1) + F1(2) + F1(3) + F1(4) + F1(5)]^{.865}$$

$$F1(7) = 131 [F1(1) + F1(2) + F1(3) + F1(4) + F1(5) + F1(6)]^{.865}$$

Where ESS Total Weight and Flight Hardware Production Cost are the inputs to the DDT&E equations.

The LCCM computes the value of these equations based on the input values, and then applies the sets of factors shown in Exhibit 3-7 to arrive at the final DDT&E costs. Appendices B thru D provide a complete listing of all LCCM CER's, which are presented in computer symbology.

### 3.4 Production Phase of the LCCM

The production flow diagram is shown in Exhibit 3-4 for the battery ESS and in Exhibit 3-5 for the fuel cell ESS. The production flows correspond to the WBS's which are present in Section 2.0.

The ground rules and assumptions which apply to the production phase of the LCCM are as follows:

- Production of the ESS will be performed over a one-year period; the life of the dedicated factory facility is assumed as 20 years straight line depreciation to zero value.

COST ELEMENT	RATIONALE FOR FACTOR	25 kW	50 kW	100 kW	250 kW
D&D	ONE POWER CHANNEL + STRUCTURE, INTERFACES	.50	.40	.30	.25
STH	UTILIZE FLIGHT HARDWARE, REFURBISH FOR FLIGHT	.35	.35	.35	.20
STHA	UTILIZE FLIGHT HARDWARE, REFURBISH FOR FLIGHT	.20	.20	.20	.20
STO	NOT NECESSARY TO PERFORM ALL TESTING AT ALL-UP S/S LEVEL	.40	.35	.30	.25
TSE	LESS COMPLEX, SOMEWHAT OFFSET BY NEED FOR I.F. SIMUL. USED FOR ACCEPTANCE TESTING	.50	.45	.40	.35
SE&I	LESS COMPLEX, SOMEWHAT OFFSET BY INTERFACE PROBLEM	.50	.45	.40	.35
MGT	LESS COMPLEX, SOMEWHAT OFFSET BY INTERFACE PROBLEM	.50	.45	.40	.35

**BATTERY SUBSYSTEMS COST ADJUSTMENT FACTORS**

COST ELEMENT	RATIONALE FOR FACTOR	25 kW	50 kW	100 kW	250 kW
D&D	ONE POWER CHANNEL + STRUCTURE, INTERFACES, COMMON TANKAGE	.80	.65	.50	.45
STH	UTILIZE FLIGHT HARDWARE, REFURBISH FOR FLIGHT	.45	.45	.40	.30
STHA	UTILIZE FLIGHT HARDWARE, REFURBISH FOR FLIGHT	.20	.20	.20	.20
STO	NOT NECESSARY TO PERFORM ALL TESTING AT ALL-UP S/S LEVEL	.50	.45	.40	.35
TSE	LESS COMPLEX, SOMEWHAT OFFSET BY NEED FOR I.F. SIMUL. USED FOR ACCEPTANCE TESTING	.50	.45	.40	.35
SE&I	LESS COMPLEX, SOMEWHAT OFFSET BY INTERFACE PROBLEM	.50	.45	.40	.35
MGT	LESS COMPLEX, SOMEWHAT OFFSET BY INTERFACE PROBLEM	.50	.45	.40	.35

**FUEL CELL SUBSYSTEMS COST ADJUSTMENT FACTORS**

*Exhibit 3-7. Factors for Adjusting Basic CER Results*

- Factory direct labor is assumed to be \$20 per hour.
- Astronaut labor is computed at \$250 per hour which includes all burdens.
- The production cost development procedure and the wraparound percentages (O.M., burden, etc.) are as shown in Exhibit 3-8.

The following sections discuss the battery ESS production costs (3.4.1) and the fuel cell ESS production costs (3.4.2).

### 3.4.1 Battery ESS Production Costs

The production of the battery ESS consists of cost elements FØ (1) through FØ (9):

- FØ (1) = Cell Unit Costs (NiCd or NiH<sub>2</sub>) (included in FØ(2))
- FØ (2) = Cell Matching Costs (includes FØ (1))
- FØ (3) = Battery Module Assembly Costs
- FØ (4) = Power Channel Assembly Costs
- FØ (5) = Subsystem Assembly Costs
- FØ (6) = Acceptance & Transport Costs
- FØ (7) = Prelaunch & Integration Costs
- FØ (8) = LEO or LEO/GEO Space Transport Costs
- FØ (9) = Space Deployment and Checkout Costs

The following sections discuss each of the above cost elements.

#### FØ (2): Battery Cell Matching (includes FØ(1)) Costs

This functional element consists of (1) the purchase of battery cells (FØ(1): NiCd or NiH<sub>2</sub> cells), (2) acceptance inspection, test and matching of accepted cells, and (3) preparation of cells for integration into battery modules.

- Labor cost = \$340 per cell, or  
in \$K, = .340 (N4) (FØ(1))  
where N4 = total number of cells  
.0014 = material burden factor  
FØ(1) = cell unit cost

For NiCd, in dollars

$$FØ(1) = (.0414(C1))^2 + 3.123 (C1) + 700) * N4 \Lambda - .1047$$

## ESS PRODUCTION COST

### • LABOR

- DIRECT LABOR (D/L) \$20/MH
- FRINGES @20% D/L
- OVERHEAD @125% D/L
- ODC @10% D/L

LABOR SUBTOTAL

### • TOTAL MANUFACTURING

- S/T LABOR
- S/T NON-LABOR  
MANUFACTURING S/T
- PROJECT MGT (PM) @5.8%  
OF MANU. S/T
- SYS. ENG. (SE) @4.8%  
OF MANU. S/T
- G&A @15% OF  
MANU. + PM + SE

SUBTOTAL

- FEE @10%

### • TOTAL PRODUCTION

- TOTAL MANUFACTURING
- TOTAL SPACE TRANSPORT

TOTAL

### • NON-LABOR

- MTLs. & COMPS (M&C)
- M&C BURDEN % M&C
- EQUIPMENT (EQ)
- EQ MAINT. @7% EQ
- SPCL EQ
- SURFACE TRANSPORT  
NON-LABOR SUBTOTAL

### • SPACE TRANSPORT (& DEPLOYMENT)

- SHUTTLE/IUS
- SPACE ASSY & C/O  
(\$250/MH)

### LEGEND

- MH = MANHOUR
- D/L = DIRECT LABOR
- OH = OVERHEAD
- ODC = OTHER DIRECT CHARGES
- EQ = EQUIPMENT
- SPCL = SPECIAL
- S/T = SUBTOTAL
- C/O = CHECKOUT
- PM = PROJECT MANAGEMENT
- SE = SYSTEMS ENGINEERING

Exhibit 3-8. Production Cost Development Procedure

For  $NiH_2$  in dollars

$$F\phi(1) = (20 C1 + 1000) (N4 \wedge - .1047)$$

- Process Equipment cost = \$727K

In \$K, the cost estimating relationship for  $F\phi(2)$  is:

$$F\phi(2) = .34 (N4) + .0014 (N4) (F\phi(1)) + 727$$

where  $N4$  = Total number of cells

$F\phi(1)$  = Battery cell unit cost

$C1$  = Battery cell capacity

**$F\phi(3)$ : Battery Module Assembly Costs**

This functional element consists of (1) integrating the battery cells into battery modules both mechanically and electrically, (2) performing functional tests and inspections, and (3) preparing the modules for integration into the power channel assembly.

- Labor Costs = \$250 per cell, or in \$K,  
= .250 ( $N4$ )
- M&C Costs = \$130 per cell unit weight, or in \$K  
= .130 ( $N4$ ) ( $S4(1)$ )
- Process  
Equipment  
Costs = \$1049

The overall Battery Module cost element,  $F\phi(3)$ , is (in \$K):

$$F\phi(3) = .25 (N4) + .13 (N4) S4(1) + 1049$$

where  $N4$  = number of cells, and

$S4(1)$  = cell unit weight (kg)

**$F\phi(4)$ : Battery Power Channel Assembly Costs**

This functional element consists of (1) mounting the required number of battery modules on the structure/heat sink plate, (2) performing mechanical and electrical interconnections, (3) mounting the  $P^3$  charger and BRPC components and making the

necessary mechanical and electrical interconnections, and (4) testing the assembled power channel electrically and structurally using interface simulators for the solar array and thermal control subsystems.

- Labor Costs = \$165 per module per channel unit weight  
or, in K\$ = .165 (N2) (U) (S4(2))
- M&C Costs = \$540 per module per channel unit weight  
or, in K\$ = .54 (N2) (U) (S4(2))
- Process  
Equipment = \$607K

The overall Power Channel cost element,  $F\phi(4)$ , is (in \$K):

$$F\phi(4) = .165 (N2) (U) (S4(2)) + .54 (N2) (U) (S4(2)) + 607$$

where N2 = Number of power channels

U = Number of battery modules per power channel

S4(2) = Weight of battery module

**F $\phi$  (5): Battery Subsystem Assembly Costs**

This functional element consists of (1) mechanically and electrically connecting the power channel assemblies into the ESS subsystem assembly, (2) testing the subsystem as an entity using interface subsystem simulators (SAS, TCS) and (3) preparing the ESS for acceptance by the procuring agency. At this level, assembly jigs will be used to check the ESS for meeting proper tolerances for mounting in the Shuttle bay. Mass properties will be measured and documented.

- Labor Costs = \$120 per channel unit weight, or in  
K\$ = .320 \* (N2) \* [S4(6)]
- M&C Costs = \$52 per channel unit weight, or in  
K\$ = .52 \* (N2) \* [S4(5) + S4(6)]
- Process  
Equipment  
Costs = \$1329K



The overall ESS subsystem assembly cost element,  $F\phi(5)$ , is (in \$K):

$$F\phi(5) = .172 (N2) [S4(5) + S4(6)] + 1329$$

where  $N2$  = Number of power channels  
 $S4(5)$  = Weight of power channel assembly  
 $S4(6)$  = Weight of power channel interfaces

**$F\phi(6)$ : Battery Subsystem Acceptance and Transportation Costs**

This functional element consists of (1) a complete subsystem functional test with data evaluation and documentation, (2) a complete quality assurance review, (3) cleaning and preparation for shipment and (4) shipment to the launch site.

- Labor Costs = \$320 per cell unit weight  
or, in \$K =  $.320 * N4$
- M&C Costs = \$45 per subsystem total weight  
or, in K\$ =  $.45 * S4(7)$
- Process Equipment Costs = \$694K

The overall ESS Acceptance cost element,  $F\phi(6)$ , (in \$K)

$$F\phi(6) = .32 (N4) + .045 (S4(7)) + 694$$

where  $N4$  = Total number of cells  
 $S4(7)$  = ESS weight (Kg)

**$F\phi(7)$ : Battery Prelaunch Integration and Checkout Costs**

This functional element consists of (1) receiving inspection and checkout prior to Shuttle (or Shuttle/IUS) integration, (2) Shuttle (or Shuttle/IUS) integration, (3) prelaunch monitoring of subsystem parameters, and (4) launch.

- Labor Costs = \$39 per subsystem weight, (in kg)  
or in \$K =  $.039 (S4(7))$

- M&C Costs - Negligible
- Equipment Costs = \$60K

The overall prelaunch integration and checkout cost element,  $F\emptyset(7)$ , is (in \$K):

$$F\emptyset(7) = .039 (S4(7)) + 60$$

where  $S4(7) = \text{ESS weight (kg)}$

**$F\emptyset(8)$ : Battery Space Transportation Costs**

This functional element consists of

- A. Transportation to LEO by Shuttle, or
  - B. Transportation to LEO/GEO by Shuttle/IUS
- A. Transportation to LEO (444 km, 56° incl.):

The cost of transportation to LEO is \$1990 per kg\* if weight constrained; adjusted by the factor,  $K6$ , if volume constrained.  $K6$  is applied only for the condition that,

$$K6 = 14.126 (\text{ESS Length} + \text{ESS Weight} > 1 \text{ (else } K6 = 1))$$

The LEO cost equation (in \$K) is:

$$F\emptyset(8) \text{ LEO} = 1.99 (S4(7)) (K6)$$

where  $S4(7) = \text{ESS weight (kg)}$

- B. Transportation to LEO/GEO by Shuttle/IUS (twin stage):

The cost of transportation to LEO/GEO by Shuttle IUS is developed as follows:

- Basic Data:
  - Space Shuttle to 160 N.M.: \$1100/kg\*
  - Cost of 2-stage IUS: \$11.58M (1980)\*
  - Weight of IUS: 14,515 kg\*\*
  - IUS P/L Capability: 2270 kg to GEO (from 160 N.M. LEO)\*\*

\* Source: "Methods of Estimating and Evaluating the Cost Impact of Shuttle Charges for GSFC Payloads" PRC/Contract NAS5-22699, dated 4 May 1979.

\*\* Source: "STS Space Transportation Handbook," JSC, June 1977.

- Weight to LEO:
  - = Subsystem weight + IUS Weight
  - = (S/S WT) + (14,515 + 2270) (S/S WT.)
  - = (S/S WT) (7.4)
- Cost to LEO (in \$K):
  - = (1.1) (7.4) (S/S WT) (K6)
  - = 8.14 (K6) (S/S WT)
- Cost from LEO to GEO (in \$K):
  - = (11580 + 2270) (S/S WT)
  - = 5.1 (S/S WT)
- Total cost to LEO/GEO (in \$K):
  - = (S/S WT.) [(5.1 + 8.14 (K6))]

The LEO/GEO cost equation is (in \$K)

$$F\phi(8) \text{ LEO/GEO} = S4(7) [5.1 + 8.14 (K6)]$$

where  $K6 = 14.136 (\text{ESS Length} + \text{ESS Weight}) > 1$  else  $K6 = 1$   
 $S4(7) = \text{ESS weight (kg)}$

**F $\phi$ (9): LEO Space Deployment and Checkout Costs**

This functional element consists of (1) deploying the ESS from the Shuttle bay, (2) translating and connecting the ESS to the SSPS structural mount, (3) mechanically interconnecting the ESS to the other subsystems (SAS, TCS, PDCS, (4) performing pre-mate electrical checks, (5) electrical mating and (6) all up subsystem/system checkout.

- Labor Costs = \$11 per kg ESS  
 or in \$K = .011 (S4(7))

The overall LEO Deployment and checkout cost element, F $\phi$ (9) is (in \$K):

$$F\phi(9) = .011 (S4(7))$$

where  $S4(7) = \text{ESS weight (kg)}$

### 3.4.2 Fuel Cell ESS Production Costs

The production of the fuel cell ESS consists of cost elements Fø(1) through Fø(12)

- Fø(1) = Fuel Cell Unit (FCU) unit cost
- Fø(2) = Electrolysis Cell Unit (ECU) unit cost
- Fø(3) = Fuel Cell Stack (FCS) costs
- Fø(4) = Electrolysis Cell Stack (ECS) costs
- Fø(5) = Ancillary Equipment (AE) costs
- Fø(6) = Power Channel Assembly (PCA) costs
- Fø(7) = Subsystem Assembly (S/SA) costs
- Fø(8) = S/S Acceptance & Ground Transport (A&GT) costs
- Fø(9) = Prelaunch Integration & Checkout (PI&C) costs
- Fø(10) = LEO Transport (LEO X) costs
- Fø(11) = LEO Deploy & Checkout (LEO D&C) costs
- Fø(12) = GEO Transport (GEO X) costs

The following sections provide the rationale and relationships for each functional element of the Production costs.

#### Fø (1): Fuel Cell Unit (FCU) Unit Cost

A fuel cell unit (FCU) is an entity which is combined with additional FCU's to form a fuel cell stack (FCS). The number of FCU's in an FCU is determined by the voltage output required. The output current of the FCS is determined by the active area of the electrode, Cl. The basic performance and physical characteristics of the FCU have been based on the light weight fuel cell under development by UTC and NASA MSFC.

The Shuttle fuel cell provides a basis for the FCU cost. This basis must be adjusted for level of assembly and technology. The average cost of the Space Shuttle fuel cell can be derived from Rockwell firm proposal, "Orbiter Production Increment 3A", Volume VII, (Pratt & Whitney subcontract). These costs are shown below for 9 F.C. units, and the adjustments made for year dollars, average unit costs, and assembly level and technology adjustments.

A.	Year	Costs (\$M)	Factor For Escalation	1980\$
	78	1.381	1.222	1.688
	79	1.343	1.115	1.497
	80	.883	1.000	.883
	81	.230	.891	.205
TOTAL, 9 Units				4.273

- B. Unit Fuel Cell cost = .475 \$M/unit
- C. Unit Fuel Cell power = 12.5 kW (max. power)
- D. Cost per kilowatt = .038/kW
- E. Assume hypothetical, FCU costs \$.038M/kW
- F. Assume the hypothetical FCU's costs are 2/3 of the complete FC and that this is offset by technology considerations.
- G. Therefore, for a .206 kW FCU (1FCU = 1TCM = 1/17 \* 3.5 kW)  
C (FCU, 1st Unit) = \$7828

The average cost of FCU's C(FCU, AVG) are subject to quantity savings because of learning. A learning curve of 90% is assumed. From established formulae for learning,

$$C(\text{FCU, AVG}) = C(1) = C(\text{FCU, 1st Unit}) \frac{1}{1+b} \times \frac{(N1)^{(1+b)}}{(N1)}$$

where for 90% learning,

$$b = \log_{10} (.9) + .30103 = .152$$

$$(1+b)^{-1} = 1.18$$

Therefore,

$$\begin{aligned} C(\text{FCU, AVG}) &= C(\text{FCU, 1st Unit}) \times \frac{1.18 (N1)^{.848}}{N1} \\ &= 7.828 \times 1.18 (N1)^{-.152} \text{ ($K)} \\ &= 9.237 (N1)^{-.152} \text{ ($K)} \end{aligned}$$

Further adjustment is required to consider savings in per unit cost due to FCU active area, Cl. The baseline FCU active area, Cl(1) is .25 ft.<sup>2</sup> = 232.26cm<sup>2</sup>. The larger the FCU active area, the fewer items which require handling, cutting, etc. Assuming

a slope of 0.8, then,

$$C(\text{FCU, AVG}) = 9.237 (N1)^{-.152} \times \left(\frac{C1}{232.26}\right)^{.8}$$

In \$K, the CER for FØ(1) is:

$$FØ(1) = 9.237 [C1 / 232.26]^{.8} \times (N1)^{-.152}$$

where C1 = FCU Area

N1 = Total Number FCU

FØ (2): Electrolysis Cell Unit (ECU) Cost

An electrolysis cell unit (ECU) is an entity which is combined with additional ECU's to form an electrolysis cell stack, (ECS). It is defined as a reverse FCU, (see FØ(1)).

The same basic cost estimate rationale is used as for the FCU. Also, the same cost equation applies as for the FCU except that the ECU active area is now C2, and the number of ECU's is N2. In \$K:

$$FØ(2) = 9.237 [C2 / 232.26]^{.8} \times (N2)^{-.152}$$

where C2 = ECU Area

N2 = Total Number ECU

FØ (3): Fuel Cell Stack (FCS) Cost

This function consists of the assembly and test of the FCS's. For each FCS the individual FCU's are interconnected, electrically and mechanically to form the basic stacks. These interconnects involve the electrodes, the H<sub>2</sub>, and O<sub>2</sub> and H<sub>2</sub>O ports, and the stack compression lugs. The thermal control components and condensers are added to the stacks. Then, the stack housings are added, and each stack assembly is subjected to functional testing using simulation equipment which provides variable electrical load, the required O<sub>2</sub> and H<sub>2</sub>, the H<sub>2</sub>O interface, and the required variable heat sink. The simulation equipment also measures all pertinent parameters such as current, voltage, temperature, gas and liquid flow rates. Once the integrity of the stacks is

established, the completed stack is subjected to a vibration and shock test at proof levels, (operational levels plus 30%), with the simulation equipment operating and recording. A thorough data analysis and physical inspection is made and results are logged for each of the stacks by serial number. (Earlier, logs are also established for each FCU by serial number and stack location.)

The costs included in this element include the (1) cost of the basic FCU's for the total subsystem, (2) the manhours required for assembly, test and inspection, and data records, and (3) the process equipment consisting of stacking jigs, handling equipment, simulation equipment and recording, computation and print-out of data.

The cost of the subsystem FCU's is the average unit cost,  $F\phi(1)$  times the numbers of FCU's required for the subsystem,  $N1$  or,  $F\phi(1) \times (N1)$ .

The labor manhours are assumed to be both a function of numbers of FCU's ( $N1$ ) and the total weight of FCU's, ( $N1$ ) ( $W1$ ). At 3.33 manhours/FCU and 1.73 manhours/kg:

$$\text{Cost (labor)} = .25(N1) + .13 (N1) (W1).$$

The cost of materials and components is basically the cost of FCU's ( $N1$  ( $F\phi(1)$ ) times 1.1 to cover cost of housings, miscellaneous mechanical and electrical interconnects and interface hardware.

$$\text{Cost (M\&C)} = 1.1 (N1) (F\phi(1))$$

The cost of process equipment is based on historical data and engineering judgment.

$$\text{Cost (P.E.)} = \$525,000$$

In \$K, the overall cost relationship for the FCS function is:

$$F\phi(3) = .25(N1) + .13(N1) (W1) + 1.1 (N1) (F\phi(1)) + 525$$

where  $N1$  = Total Number FCU

$W1$  = FCU weight

$F\phi(1)$  = FCU total production cost

**Fø (4): Electrolysis Cell Stack (ECS) Cost**

This function consists of the same operations as for the FCS, (Fø(3)) except that the simulator will provide input power, simulating the solar array/P<sup>3</sup> chargers.

The development of the cost estimate is identical to that for the FCS, except the numbers of ECU's symbol is N2, the ECU weight is W2, and the unit cost is Fø(4). Therefore, in \$K:

$$Fø(4) = .25 (N2) + .13 (N2)(W2) + 1.1 (N2)(Fø(2)) + 525$$

where N2 = Total number ECU

W2 = ECU weight

Fø(2) = ECU total production cost

**Fø (5): Fuel Cell Power Module Assembly Cost**

This function consists of (1) mounting FCS and ECS modules and P<sup>3</sup> chargers on the thermal control active radiator (which serves as heat sink as well as the subsystem structure), (2) interconnecting, mechanically and electrically, the FCS modules and the ECS modules, (3) preparing the H<sub>2</sub> and O<sub>2</sub> and H<sub>2</sub>O interfaces for mating (in the next production function) and (4) functionally testing each power channel. The testing will consist of simulating power input to the ECS modules, power output from the FCS module, O<sub>2</sub>, H<sub>2</sub> and H<sub>2</sub>O feed, and thermal control functions. These functions are performed on each of the N electrical power modules.

Logs will be maintained by component serial number of all inspection/test data.

It is estimated that 2.2 technician and inspection manhours are required per kg of weight to perform the functions described above. The cost of 2.2 manhours, at \$20/mh is developed as follows:



2.2 mh/kg x \$20/mh	= \$ 44/kg
Fringe @32%	= 14
O.H. @125%	= 55
O.D.C. @10%	= 4
	<hr/>
Labor S/T	\$117
Pgm Mgt @5.8%	= 7
SE&I @4.8%	= 6
	<hr/>
	\$130
G&A @15%	= 20
	<hr/>
S/T	\$150
Fee @10%	= 15 .
	<hr/>
TOTAL	\$165/kg

The cost of labor is, (in \$K):

$$C(\text{labor}) = (.165) \times [(N3)(W3) + (N4)(W4)]$$

It is estimated that the cost of materials and components is \$540 per kg of FCS and ECS weight. This cost covers the P<sup>3</sup> chargers, the thermal active radiator control, miscellaneous thermal control lines, valves and control components (sensors and actuators), miscellaneous mechanical and electrical interconnects and gas and water lines required to provide interface with the AE. The cost of M&C is, in \$K:

$$C(\text{M\&C}) = .54 [(N3)(W3) + (N4)(W4)]$$

The cost of process equipment for this is estimated as \$607,000. The total cost estimate for this function is, in \$K:

$$F\emptyset(5) = 200 * N5(1) \wedge .848 + .705 \times [(N3)(W3) + (N4)(W4)] + 607$$

where N5(1) = Number of P<sup>3</sup> chargers

N3 = Total FC stacks

W3 = Average FC stack weight

W4 = Average EC stack weight

**F∅(6): Fuel Cell Ancillary Equipment (AE) Cost**

This function consists of (1) the procurement, manufacturing and assembly of the common H<sub>2</sub>/O<sub>2</sub>/H<sub>2</sub>O tank, valves, pumps, compressors, tubing and manifolds and miscellaneous hardware, and (2) testing and inspecting of the subassembly prior to subsystem

assembly. The testing will require simulation equipment and proof pressure testing to assure subassembly physical and functional integrity. Test logs will be maintained by component serial number.

The basis for the cost of the ancillary equipment (AE) is the STS Orbiter Propellant Reactant Storage and Distribution (PRSD) assembly of the electrical power subsystem. The PRSD subcontract cost for vehicle 3 was \$840,000 in 1978 dollars. This assembly provides the Orbiter fuel cells with O<sub>2</sub> and H<sub>2</sub> system, and it stores O<sub>2</sub> and H<sub>2</sub> crogenically. Also, the PRSD is sized to hold approximately seven days of reactants at a use rate of 7 kW, or 1176 kwh. This gives \$840,000 ÷ 1176 kwh = \$714/kwh. The following adjustments are made to this cost parameter.

PRSD	Cost Factor	Adjusted Cost Parameter
1978 dollars		\$ 714/kwh
1980 dollars	1.18	843
Cryogenic, not gas	.70	590
No electrolysis	1.70	1003
Comparatively short life	7.00	\$ 7021/kwh

The basic cost relationship of \$7021/kwh is used for the ESS. This basic cost represents a baseline tank pressure of 63 kg/cm<sup>2</sup> for O<sub>2</sub> and 18 kg/cm<sup>2</sup> for H<sub>2</sub>, or an average 41 kg/cm<sup>2</sup>, and a system weight (dry) of 598 kg. To adjust for variation in weight and pressure, both of which are cost drivers, the cost relationship becomes \$.29 per kwh per kg/cm<sup>2</sup> per kg.

An estimate of \$50,000 for the 25 kW subsystem is made for the cost of the simulation and pressure test equipment and for assembly jigs and handling equipment.

The cost relationship for this cost element is, in \$K:  

$$F\emptyset(6) = .0175 \times P7 \times [P6(1)/28.12) \wedge .6] \times [(L3/43830) \wedge .9]$$
 where P7 = Total ESS output power (W)  
 P6(1) = H<sub>2</sub> storage tank pressure  
 L3 = Expected pump life

F0 (7): Fuel Cell Subsystem Assembly Cost

This function consists of the assembly and testing of the complete subsystem. The assembly consists of (1) structurally connecting the power channel thermal plate/structures together to form the polygonic-shaped subsystem structure, and attaching the stiffener plates and thermal control channel interconnects, and (2) installing the AE assembly and making the necessary electrical, gas and water interconnections to the FCS, ECS and P<sup>3</sup> components. The subsystem will be serviced with the required amount of reactants.

Testing will consist of operational simulation of solar array power, load, and environmental conditions. The environmental condition simulation will include shock, vibration, and thermal/vacuum conditions expected in space transportation and mission operations.

Inspection/test data will be taken and analyzed before and after the environmental testing. Again logs will be maintained on all components as required.

It is estimated that 1.17 technician, inspection and engineering manhours are required per kg of weight to perform the functions described above.

$$C(\text{labor}) = .087 (W7)$$

The cost of materials and components is estimated to be \$85 per kg. of subsystem weight. This cost covers the miscellaneous hardware required to interconnect, mechanically and electrically, (1) the power channels and (2) the AE with the power channels, including the reactants. In \$K:

$$C (M\&C) = .085 (W7)$$

The process equipment includes jigs, fixtures and handling equipment and the test equipment and facilities required to perform the required vibration, shock and thermal/vacuum tests. The cost is estimated to be \$1,329,000. In \$K:

$$C \text{ (P.E.)} = 1,329$$

The total cost estimate for this function is, in \$K:

$$F\emptyset(7) = .087 (W7) + .085 (W7) + 1,329$$

where W7 = Total ESS weight

**F $\emptyset$  (8): Fuel Cell Acceptance and Transportation Cost**

This function consists of (1) running a series of subsystem operational and environmental simulation tests, (2) a thorough review of all test/inspection data by the contractor and by the procuring agency, and (3) final cleaning and preparation for shipment to the launch site.

It is estimated that 4.27 mh per (FCU + ECU) and 2 mh per kg of AE will be required for test and data collection and analyses, and subsystem handling during test and in preparation for shipment. At \$75/manhour, the labor cost equation in \$K is:

$$C \text{ (labor)} = .32 (N1 + N2) + .150 (W6)$$

The cost of special equipment (transport cannister) is estimated as \$43 per kg of subsystem weight. In \$K:

$$C \text{ (S.E.)} = .043 (W7)$$

The cost of process equipment is estimated to be \$694,000. The cost of Earth transport is typically \$2/kg of weight shipped.

The total cost estimate for this function is, in \$K:

$$F\emptyset(8) = .32 [(N1 + N2)] + .15 (W6) + .045 (W7) + 694$$

where N1 = Total number of FCU

N2 = Total number of ECU

W6 = Ancillary equipment weight (kg)

W7 = Total ESS weight

**F $\emptyset$  (9): Fuel Cell Prelaunch Integration and Checkout Cost**

This function consists of launch site activities up to actual launch. The activities include: (1) launch site receiving inspection, (2) pre-integration functional tests and

preparations for Shuttle integration, (3) Shuttle integration, (4) pre-launch integrated checkout, and (5) final servicing and launch countdown subsystem monitoring.

From historical data, prelaunch integration and checkout (or launch operations) requires .52 manhours of technician and QA labor per kg of subsystem weight. In \$K:

$$C (\text{labor}) = .039 * W7$$

The cost of handling and testing equipment is estimated to be \$60,000.

$$C (\text{P.E.}) = 60$$

The total cost estimate for this function is, in \$K:

$$F\phi(9) = .039 (W7) + 60$$

where  $W7 = \text{Total ESS weight (kg)}$

**F $\phi$ (10): LEO Space Transport Cost**

This function consists of delivery by Space Shuttle of the ESS to LEO (444 km, circular, 56° inclination).

For delivery to this orbit by Shuttle the cost of \$31M provides a total payload capability of 15,578 kgs, or \$1990/kg.

$$C (\text{LEO XPORT}) = (1.99) (W7) (K8)$$

where  $K8$  applies if,  $14,136 (S7(1)) + (W7) > 1$  else  $K8 = 1$

$K8 = \text{Wt./Vol. determinant}$

$S7(1) = \text{Subsystem length (Cm)}$

$W7 = \text{Total ESS weight (kg)}$

**F $\phi$ (11): Fuel Cell Space Deployment, Checkout Cost Estimate**

This function consists of the deployment of the ESS (LEO mission only) from the Space Shuttle, performing any necessary assembly of the subsystem, integration of the subsystem with the SSPS and performance of final subsystem and integrated system checkout to verify operational readiness. This is a manual operation as opposed to automated.

It is estimated that .044 manhours per kg of astronaut assembly and inspection time will be required to perform the assembly and checkout functions. At \$250 per mh, in \$K, the cost is,

$$F\phi(11) = .011 (W7)$$

$$W7 = \text{Total ESS weight (kg)}$$

F\phi(12): LEO/GEO Space Transport Costs

For delivery to GEO by Shuttle/IUS the costs are developed as follows:

- Shuttle costs to LEO (160 N.M.)\* = \$1100/kg
- Two-stage IUS, cost\* = \$11.58M
- Wt of IUS\*\* = 14,515 kg
- IUS payload\*\* = 2270 kg to GEO from 160 N.M.

Assume that ESS will share the IUS with other subsystems/ components of the GEO SSPS. The weight to LEO (160 N.M.) by the Space Shuttle is:

$$W (\text{LEO}), 160 \text{ N.M.}) = W (\text{ESS}) + W (\text{IUS})$$

Under the sharing assumption,

$$W (\text{IUS}) = (14,515 + 2270) (W(\text{ESS}))$$

Therefore,

$$\begin{aligned} W (\text{LEO}, 160 \text{ N.M.}) &= W(\text{ESS}) (1 + 6.4) \\ &= 7.4 (W(\text{ESS})) \end{aligned}$$

The cost to LEO, in \$K:

$$\begin{aligned} C (\text{LEO}, 160 \text{ N.M.}) &= (1.1) (7.4) (W(\text{ESS})) \\ &= \$8.14 (W7) \end{aligned}$$

---

\* "Methods of Estimating and Evaluating the Cost Impact of Shuttle Charges for GSFC Payloads", PRC/GSFC Contract NAS5-22699, dated May 4, 1979.

\*\*"STS Space Transportation Handbook", JSC, June 1977.

The cost to GEO from LEO, in \$K:

$$C (\text{GEO}) = \$11,580 + 2270 = \$5.1 \text{ (W7)}$$

The total cost to GEO, in \$K:

$$C (\text{GEO XPORT}) = 13.24 \text{ (W7)}$$

Finally, in \$K:

$$F\bar{g}(12) = (W7) (5.1 + 8.14 (K8) )$$

$$\text{where } K8 = 14.136 (S7(1)) + (W7) > 1$$

$$\text{else } K8 = 1$$

$K8 = \text{Wt./Vol. determinant}$

and  $S7(1) = \text{Subsystem length (cm)}$

$W7 = \text{Total ESS weight (kg)}$

### 3.5 O&M Phase of the LCCM

The O&M flow diagram is shown in Exhibit 3-6, and is applicable to both battery and fuel cell ESS.

The assumptions made in developing the O&M CER's were:

- The LEO SSPS/ESS will be operational for thirty years,
- Overhauls will be accomplished periodically at the battery module, fuel cell stack (FCS) and electrolysis cell stack (ECS) levels (of assembly) by astronaut technicians.
- Scheduled (preventive) maintenance will be performed by astronaut technicians.
- Unscheduled maintenance will be performed based on random failure rates. Repair will be limited to the module or stack levels (as above).
- Cost of training will be \$250,000 per O&M trainee. Astronaut attrition will be 25% per year.
- Each astronaut round-trip to space, is based on 600 kg per astronaut (includes life support, equipment and expendables)
- Astronaut costs will be \$250 per hour; a six hour work day and 5 day work week are assumed.

- Maintenance manhours required will be as shown in the following table:

Maintenance Manyears Required

	<u>Battery ESS</u>	<u>Fuel Cell ESS</u>
Preventive Maintenance (per year)	.002 per Module	.144 per 72 FCS + ECS
Random Failures (per year)	.001 per Module	.032 per 72 FCS + ECS
Overhaul (per overhaul)	.0015 per Module	.324 per 72 FCS + ECS

- Space Transportation of astronauts and spares will be based on \$1990 per kilogram to KEO, (444 km, 56° inclination).
- The GEO SSPS/ESS will be operational for 5 years, with ESS monitoring and control accomplished by an earth-based engineering function.

The following sections discuss the battery ESS O&M costs (3.5.1) and the fuel cell ESS costs (3.5.2).

**3.5.1 Battery ESS O&M Costs**

The O&M of the battery ESS consists of cost elements F2(1) through F2(4):

- F2(1) = O&M Spares Costs
- F2(2) = O&M Training Costs
- F2(3) = O&M Maintenance Functions Costs
- F2(4) = O&M Space Transportation Costs

The following sections discuss each of the above cost elements

**F2(1): O&M Spares Cost**

This function consists of the production of spare battery modules to support (1) periodic space overhaul and (2) random failures. The function does not include space transportation (see F2(4)).

The cost of spares is a function of number of overhauls (mission life + component life - 1) and the random failure rate. The basic spares element is the battery module (NiCd or NiH<sub>2</sub>).



# spares for overhaul =  $N8 - 1$   
# spares for random failure =  $(N8) (S5(1))$   
let  $S5(2) = N8 - 1 + (N8) (S5(1))$   
= total number of modules for spares

The cost of spares, therefore, is in \$K:

$$F2(1) = S5(2) ( F\phi(2) + F\phi(3) )$$

where  $F\phi(2)$  = production cost of cells and cell matching

$F\phi(3)$  = production cost of battery module assembly

$N8$  = Number of battery hardware life cycles

$S5(2)$  = Total number of modules for spares

F2(2): O&M Training Cost

This function consists of the training of astronauts to perform the O&M functions of (1) routine maintenance and servicing, (2) repair of random failures and (3) overhaul of the ESS at stated periods.

The cost of training is a function of astronaut manyears required over the life of the ESS, and the estimated attrition rate.

- Routine maintenance per year will require .002 manyears per module
- Random failures per year will require .001 manyears per module failure
- Overhaul (on a per year basis) will require .0015 manyears per overhaul.

The cost of this element, in \$K:

$$F2(2) = (.25) (.25) (S5(3))$$

where .25 is cost/trainee (\$250,000)

.25 is estimated attrition rate

$$S5(3) = (L1) (.002(N2)(U) + .001(N8) \times \text{CEIL}((N2)(U)(S5(1)) + .0015(N8 - 1)(N2)(U))$$

S5(3) = Total astronaut manyears

L1 = Total number of channels

N2 = Total cells in parallel

U = Number of modules per channel

S5(1) = Random failure rate

N8 = Total number of subsystem sets required over L1.

**F2(3): O&M Maintenance Functions Costs**

This function consists of the cost of labor (at \$250/manhour) required to perform the O&M functions of (1) routine maintenance and servicing, (2) repair of random failures, and (3) overhaul at the required intervals. It does not include spares costs, training costs nor space transportation costs.

The cost of maintenance functions is at 130 hours per month and \$250 per manhour is, in \$K:

$$F2(3) = 390 (S5(3))$$

where S5(3) = total astronaut manyears (see F2(2))

**F2(4): O&M Space Transportation Costs**

This function consists of the space transportation costs involved with astronaut crew cycling (3 months in space per astronaut between R&R) and delivery/retrieval of spares/failed parts.

The cost of space transportation is a function of:

- S5(3) = total astronaut manyears
- Number of trips to/from Earth per manyear = 4
- Weight per astronaut = 454 kg/trip
- Cost per kg space transport = \$1990/kg

The cost of crew transportation is

$$C(\text{crew}) = (Sf(3)) (3.6)$$

where 3.6 is transport cost per astronaut manyear

S5(3) = total astronaut manyears

The cost of spares/failed parts transportation is a function of the weight of spares required for replacement of random failures and overhaul.

$W \text{ (spares)} = (S5(2)) [S4(2)] (K6)$

The cost of space transportation in \$K is:

$F2(4) = 3.6(S5(3)) + 1.99 (K6) (S5(2)) (S4(2)) (N2) (U)$

where S5(3) = total manyears

S5(2) = total number of modules for spares

S4(2) = weight per module (kg)

K6 = volume constraint factor (see F0(8) for battery ESS)

N2 = total cells in parallel

U = number of modules/battery

### 3.5.2 Fuel Cell ESS O&M Costs

The O&M of the fuel cell ESS consists of cost elements F2(1) through F2(4):

F2(1) = O&M Spares Costs

F2(2) = O&M Training Costs

F2(3) = O&M Maintenance Functions Costs

F2(4) = O&M Space Transportation Costs

The following sections discuss each of the above cost elements.

#### F2(1): O&M Spares Cost

This function consists of the production of FCS, ECS and AE spares to support (1) periodic space overhaul and (2) random failures. The function does not include space transport.

C-2

The cost of spares is a function of number of overhauls, (mission life + component life - 1) and the random failure rate. The major elements are the FCS's, ECS's and components of the AE, such as pumps, valves and filters.

The number of FCS's required for overhaul =  $(N3) (N\phi(1))$ . The number of ECS's =  $(N4) (N\phi(2))$ . The overhaul of the AE is assumed to be 20% of the components.

The cost per unit FCS and ECS is the cost of the FCS and ECS functions divided by the numbers of FCS & ECS, respectively:

$$\text{Cost per unit FCS} = F\phi(3) \div N3$$

$$\text{Cost per unit ECS} = F\phi(4) \div N4$$

Also,

$$\text{Cost of 20\% AE} = F\phi(6) (H6(2))$$

$$\text{where } H6(2) = .2$$

Therefore,

The total cost of spares for overhaul:

$$C(\text{overhaul}) = (F\phi(3)) (N\phi(1) - 1) + (F\phi(4)) (N\phi(2) - 1) + (H6(2)) (F\phi(6)) (N\phi(3) - 1)$$

The cost of spares required to support random failures is a function of random failure rates.

$$C(\text{random failure}) = (K3) (F\phi(3)) ((L1) + (L3)) + (K4) (F\phi(4)) ((L1) + (L4)) + (K6) (F\phi(6)) ((L1) + (L6)) (H6(1))$$

Where  $K3$  = FCS random failure fraction

$K4$  = ECS random failure fraction

$K5$  = AE random failure fraction

$$H6(1) = .1$$

Which represents the average cost of repairing the AE.

The total cost of spares, in \$K:

$$\begin{aligned} F2(1) = & (F\phi(3)) (N\phi(1) - 1) + \\ & (F\phi(4)) (N\phi(2) - 1) + \\ & (H6(2)) (F\phi(6)) (N\phi(3) - ) + \\ & (K3) (F\phi(3)) (N\phi(1)) + \\ & (K4) (F\phi(4)) (N\phi(2)) + \\ & (K6) (F\phi(6)) (N\phi(3)) (H6(1)) \end{aligned}$$

where

- $F\phi(3)$  = FCS total production cost
- $N\phi(1)$  = number of maintenance cycles (FCU)
- $F\phi(4)$  = ECS total production cost
- $N\phi(2)$  = number of maintenance cycles (ECU)
- $H6(2)$  = overhaul replacement factor
- $F\phi(6)$  = ancillary equipment total production cost
- $N\phi(3)$  = number of maintenance cycles (pump)
- $K3$  = FCS failure rate fraction
- $K4$  = ECS failure rate fraction
- $K6$  = AE failure rate fraction
- $H6(1)$  = failure replacement factor

F2(2): O&M Training Costs

This function consists of the training of astronauts to perform the O&M function in space. The function consists of (1) routine maintenance and servicing, (2) repair of random failures, and (3) overhaul of the ESS.

The cost of training is a function of total astronaut manyears required over the life of the subsystem and the estimated attrition rate.

It is assumed that each FCS or ECS will require, for routine maintenance, .002 manyears per year and the AE will require .03 manyears per year. Therefore,

$$\frac{\text{M.Y. (Routine Maint.)}}{\text{Year}} = .002 (N3 + N4) + .03$$

The repair of random failures will be a function of manhours per repair times the number of failures per year. It is assumed that an FCS or ECS will require .001 manyear per failure, and the AE will require .002 manyear per failure.

$$\begin{aligned} \frac{\text{M.Y. (Random Failure)}}{\text{Year}} &= .001 (N3) (K3) + \\ &= .001 (N4) (K4) + \\ &\quad .002 (K6) \end{aligned}$$

Manyears per year for overhaul of the ESS will be a function of number of overhauls and the manyears per overhaul. All FCS and ECS units and 20% of the AE will require replacement at overhaul. In this case, the manyears per year is estimated as .0015 overhaul manyears per year, for each FCS and ECS, and .02 overhaul manyears per year for the AE. Therefore,

$$\begin{aligned} \frac{\text{M.Y. (Overhaul)}}{\text{Year}} &= .0015 (N3) (N\emptyset(1) - 1) + \\ &\quad .0015 (N4) (N\emptyset(2) - 1) + \\ &\quad .02 (N\emptyset(3) - 1). \end{aligned}$$

The total astronaut manyears, H7, is the product of required mission life, L1, and the sum of the above three equations:

$$\begin{aligned} H7 &= .002 (N3 + N4) + .03 + \\ &\quad .001 (N3) (K3) + \\ &\quad .001 (N4) (K4) + .002 (K6) + \\ &\quad .0015 (N3) (N\emptyset(1) - 1) + \\ &\quad .0015 (N4) (N\emptyset(2) - 1) + \\ &\quad .02 (N\emptyset(3) - 1). \end{aligned}$$

where

- N3 = total FC stacks
- N4 = total EC stacks
- K3 = FCS failure rate fraction
- K4 = ECS failure rate fraction
- K6 = AE failure rate fraction
- N $\emptyset$ (1) = number of maintenance cycles (FCU)

$N\emptyset(2)$  = number of maintenance cycles (ECU)  
 $N\emptyset(3)$  = number of maintenance cycles (pump)

$$\begin{aligned} H7 &= .002 (N3 + N4) + .03 + \\ &.001 (N3) (K3) + \\ &.001 (N4) (K4) + .002 (K6) + \\ &.0015 (N3) (N\emptyset(1) - 1) + \\ &.0015 (N4) (N\emptyset(2) - 1) + \\ &.02 (N\emptyset(3) - 1). \end{aligned}$$

The total cost of training, at 25% attrition, and \$250,000 per training is:

$$F2(2) = 062.5 (H7)$$

**F2(3): O&M Maintenance Functions Costs**

This function consists of the cost of labor (at \$250/space manhour) required to perform the O&M functions of (1) routine maintenance and servicing, (2) repair of random failures, and (3) overhaul of the ESS. It does not include cost of spares or training, which are covered in cost elements F2(1) and F2(2).

The cost of maintenance functions is, at 130 hrs/month and \$250/mh, in K\$

$$F2(3) = H7 (390)$$

Where  $H7$  = total astronaut manyears.

**F2(4): O&M Space Transportation Costs**

This function consists of the space transportation costs involved with astronaut crew cycling (3 months in space per astronaut) and delivery/retrieval of spares/failed parts.

The cost of space transportation is a function of:

- $H7$ , total astronaut manyears
- number of trips to/from Earth per manyear (= 4)

- weight of astronaut per space trip, (450 kg)
- cost per kg for space transport, \$1500 per kg.

The cost of space transportation of O&M crew is:

$$C (\text{crew}) = 3.6 (H7)$$

The cost of space transportation of spares is a function of the weight of spares required for replacement of random failures W(SRF) and for overhaul W(SOH):

$$W(\text{SRF}) = (W3) (N3) (N\emptyset(1)) (K3) + \\ (W4) (N4) (N\emptyset(2)) (K4) + \\ (W6) (N\emptyset(3)) (K6) H6(1)$$

$$W(\text{SOH}) = (W3) (N3) (N\emptyset(1) - 1) + \\ (W4) (N4) (N\emptyset(2) - 1) + \\ (W6) (N\emptyset(3) - 1) (H6(2))$$

Where

- W3 = Average FC stack weight
- N3 = Total FC stacks
- N $\emptyset$ (1) = Number of maintenance cycles (FCU)
- K3 = FCS failure rate fraction
- W4 = Average EC stack weight
- N4 = Total EC stacks
- N $\emptyset$ (2) = Number of maintenance cycles (ECU)
- K4 = ECS failure rate fraction
- W6 = Ancillary equipment total weight
- N $\emptyset$ (3) = Number of maintenance (pump)
- K6 = AE failure rate fraction
- H6(1) = Failure replacement factor
- H6(2) = Overhaul replacement factor

Where H6(1) = .1 and H6(2) = .2

The cost of space transportation of spares and crew is  
 $F2(4) = (3.6) (H7) + (1.99) (W(\text{SRF}) + W(\text{SOH}))$

Where H7 = Total astronaut manyear



### 3.6 Interface Subsystem Costs

To provide a more complete estimate of the total life cycle for a given ESS, the costs of three interfacing subsystems are also included in the ESS LCCM. These subsystems are Solar Array, Thermal Control, and Power Conditioning. The resultant interface costs are for only those elements required to interface directly with the ESS. For example, the solar array cost reflects only the solar array power required to charge the ESS, and does not include any additional solar array to support other power functions. The solar array costs are based on data from the Silicon Solar Array Study for LeRC (NAS3-21926). The LEO costs reflect two 15-year hardware life cycles. The GEO costs include one hardware life cycle of five years plus transportation to GEO using the Shuttle/IUS combination. The thermal control costs are based on data from "Study of Thermal Control Systems for Orbiting Power Systems, Book 1, Executive Summary" by Vought Corporation. The power conditioning costs are based on cost data for the same P3 Programmable Power Processor which is used for the charging units.

### 3.7 Baseline ESS LCC and LCCM Relationships

The baseline ESS designs and the parameters that represent the designs are presented in Section 2.0; Exhibits 2-15, 2-16, 2-17. The corresponding LCC for the baselines are shown for each cost element of DDT&E, Production, O&M and the interfacing subsystems in Exhibits 3-9, 3-10 and 3-11. Exhibit 3-12 provides a summary level LCC showing totals for DDT&E, Production, (manufacturing and space transport), O&M (basic O&M and O&M space transport) and interfacing subsystems. Note that the DDT&E costs for a NiH<sub>2</sub> ESS is lower than that for NiCd due to the lower NiH<sub>2</sub> ESS weights.

A listing of all cost element CER's: (DDT&E, Production, O&M) for the NiCd and NiH<sub>2</sub> battery ESS and the fuel cell ESS are included in Appendices B thru D respectively. Appendices B thru D also include the performance model logic for the respective ESS's.

BASELINE NiCd ESS LIFE CYCLE COSTS (1980\$M)	LEO				GEO	
	25 kW	50 kW	100 kW	250 kW	25 kW	25 kW
DDT&E	10.905	14.383	21.126	29.387		8.912
PRODUCTION	18.688	32.780	60.534	136.460		44.882
Battery Cell	(.446)	(.415)	(.386)	(.351)		(.462)
Cell Matching	2.181	3.505	5.980	12.983		1.793
Module Assembly	1.823	2.598	4.113	8.620		1.804
Channel Assembly	2.881	5.156	9.608	22.849		2.237
Subsystem Assembly	1.984	2.639	3.920	7.736		1.798
Acceptance & Surface Transport	1.362	2.030	3.343	7.112		1.162
Prelaunch Integration & Checkout	.221	.381	.701	1.534		.166
Space Transport	8.191	16.380	32.688	75.210		36.092
Space Deployment & Checkout	.045	.091	.181	.416		.030
OPERATIONS & MAINTENANCE	172.975	238.986	463.056	1132.589		.500
Spares Production	13.614	20.750	34.316	73.450		—
Crew Training	1.350	2.693	5.280	13.043		—
Labor	8.424	16.801	32.947	81.385		.500
Space Transport	99.587	198.742	390.513	964.711		—
ESS LIFE CYCLE COST	152.568	286.149	544.716	1298.436		54.294
INTERFACE COSTS						
Solar Array	232.239	405.188	712.320	1487.352		10.677
Thermal Control	7.204	9.207	13.358	25.715		5.834
Power Conditioning	1.761	3.169	5.611	12.082		1.409
TOTAL LIFE CYCLE COST	393.772	703.713	1276.010	2823.585		72.214

Exhibit 3-9. NiCd ESS Baseline LCC

BASELINE NH <sub>2</sub> ESS LIFE CYCLE COSTS (1980\$M)	LEO				GEO 25 kW
	25 kW	50 kW	100 kW	250 kW	
DDT&E	8.998	10.788	14.591	19.059	7.954
PRODUCTION	12.593	20.471	36.164	83.337	31.405
Battery Cell	(.981)	(.917)	(.853)	(.775)	(1.000)
Cell Matching	2.276	3.504	5.974	12.854	2.030
Module Assembly	1.408	1.729	2.408	4.431	1.347
Channel Assembly	1.622	2.534	4.461	10.200	1.446
Subsystem Assembly	1.703	2.046	2.762	4.898	1.638
Acceptance & Surface Transport	1.081	1.443	2.192	4.442	1.015
Prelaunch Integration & Checkout	.145	.235	.410	.948	.130
Space Transport	4.334	8.931	17.858	45.314	23.779
Space Deployment & Checkout	.024	.049	.089	.250	.020
OPERATIONS & MAINTENANCE	55.824	99.444	191.317	461.213	.500
Spares Production	12.526	17.792	28.499	58.769	—
Crew Training	.518	.974	1.941	4.787	—
Labor	3.229	6.078	12.110	29.870	.500
Space Transport	39.551	74.600	148.767	367.787	—
ESS LIFE CYCLE COST	77.415	130.703	242.072	563.609	39.859
INTERFACE COSTS					
Solar Array	232.476	412.037	718.908	1514.082	14.034
Thermal Control	7.223	9.545	13.887	27.435	5.844
Power Conditioning	1.156	1.968	3.578	7.894	1.042
TOTAL LIFE CYCLE COST	318.280	554.273	978.445	2112.820	60.779

BASELINE FUEL CELL ESS LIFE CYCLE COST (1980\$M)	LEO				GEO 25 kW
	25 kW	50 kW	100 kW	250 kW	
DDT&E	16.283	23.952	34.482	55.487	6.869
PRODUCTION	20.962	36.165	64.555	145.659	16.310
FCU	( 3.398)	( 3.078)	( 2.785)	( 2.425)	( 4.247)
ECU	( 3.040)	( 2.732)	( 2.459)	( 2.139)	( 5.404)
FC Stack	3.443	5.632	9.539	20.282	1.353
EC Stack	5.999	10.572	18.802	40.881	.738
Power Module Assembly	3.326	5.682	9.980	22.181	.894
Ancillary Equipment	.754	1.518	3.010	7.511	.152
Subsystem Assembly	1.683	2.035	2.725	4.812	1.406
Acceptance & Surface Transport	1.501	2.298	3.868	8.611	.787
Prelaunch Integration & Checkout	.140	.220	.377	.850	.077
Space Transport	4.093	8.163	16.155	40.298	10.903
Space Deployment & Checkout	.023	.045	.089	.223	—
OPERATIONS & MAINTENANCE	43.798	77.985	141.319	319.603	.500
Spares Production	32.585	56.065	98.286	212.795	—
Crew Training	.030	.055	.103	.249	—
Labor	.190	.341	.643	1.551	.500
Space Transport	10.993	21.524	42.287	105.008	—
ESS LIFE CYCLE COST	81.043	138.102	240.356	520.749	23.679
INTERFACE COSTS					
Solar Array	334.317	597.829	1046.871	2186.613	19.550
Thermal Control	5.965	6.779	8.408	13.247	6.419
Power Conditioning	1.166	1.988	3.477	7.517	1.042
TOTAL LIFE CYCLE COST	422.491	744.698	1299.112	2728.126	50.690

Exhibit 3-11. Fuel Cell ESS Baseline ICC

S/S POWER (kW)	NiCd BATTERY					INTER. SUBSYS.	TOTAL LCC
	DDT&E	PRODUCTION		O&M			
		MANU	XPORT	BASIC	XPORT		
25 LEO	11	11	8	23	100	241	394
50 LEO	14	16	17	40	199	418	704
100 LEO	21	28	33	72	391	731	1276
250 LEO	29	61	75.5	168	965	1526	2823.5
25 GEO	9	9	36	.5	—	18	72.5

a. NiCd Battery Baseline LCC

S/S POWER (kW)	NH <sub>2</sub> BATTERY					INTER. SUBSYS.	TOTAL LCC
	DDT&E	PRODUCTION		O&M			
		MANU	XPORT	BASIC	XPORT		
25 LEO	9	8	4	16	40	241	318
50 LEO	11	11	9	26	74.5	423.5	554
100 LEO	15	18	18	42	149	736.5	978.5
250 LEO	19	38	45.5	93	363	1549.5	2113
25 GEO	8	7.5	24	.5	—	21	61

b. NH<sub>2</sub> Battery Baseline LCC

S/S POWER (kW)	FUEL CELL /ELECTROLYSIS CELL					INTER. SUBSYS.	TOTAL LCC
	DDT&E	PRODUCTION		O&M			
		MANU	XPORT	BASIC	XPORT		
25 LEO	16	17	4	33	11	341.5	442.5
50 LEO	24	28	8	56	22	606.5	744.5
100 LEO	34.5	48.5	16	99	42	1059	1299
250 LEO	55.5	105	40.5	215	105	2207	2728
25 GEO	6.5	5.5	11	.5	—	27	50.5

c. Fuel Cell Baseline LCC

**NOTES:**

- COSTS ARE 1980 \$ IN MILLIONS.
- PRODUCTION LCC WAS DIVIDED INTO MANUFACTURING \$, AND SPACE TRANSPORTATION (XPORT) \$.
- O&M LCC HAS BEEN DIVIDED INTO BASIC O&M \$, AND SPACE TRANSPORTATION (XPORT) \$.

## 4.0 TECHNOLOGY VARIATIONS vs LIFE CYCLE COST

### 4.1 General

This section summarizes the analysis and results of using the ESS Battery and Fuel Cell Performance/Cost Models, which are described in Sections 2 and 3, to quantify technology variations vs Life Cycle Cost. Conclusions to be drawn from the study results are valid in the vicinity of the various baselines under the assumptions, requirements, and scenarios of this study report. In other words, dependences and trends should be emphasized rather than actual numerical results.

### 4.2 Methodology

The study results were achieved by addressing each technology area separately and varying key technology related parameters in the models to determine the resultant variations in life cycle cost. The variations in numerous performance parameters were also observed. This was accomplished for LEO power levels of 25 kW, 50 kW, 100 kW, and 250 kW, and for a GEO power level of 25 kW. The basic methodology consisted of the following:

- Selection of technology input parameters to be varied.
- Variation of one technology input parameter at a time.
- Determine resultant effect on performance and life cycle cost.
- Determine relative magnitude of effect on LCC.
- Plot and print in final format, the technology input parameters which have the greatest effect on LCC.

### 4.3 Technology Parameters to be Varied

With coordination, which included comments from LeRC technical personnel, the following list of technical parameters to be varied was established for both of the battery and the fuel cell subsystems:

#### Batteries

- Voltage
- Depth of Discharge (DOD)

PRECEDING PAGE BLANK NOT FILMED

- Temperature
- Efficiency
- Ampere-Hour
- Thermal conductivity
- Charge/discharge rates
- Reliability/cycle life
- Size, shape, weight & volume

#### Fuel Cells w/dedicated electrolysis

- Voltage
- Current density
- Pressure
- Temperature
- Depth of Discharge (as couple)
- Heat transfer and rejection
- Cell reliability and operation life
- Moisture removal and humidity
- Efficiency
- Pump reliability and operational life
- Size, shape, weight and volume

#### 4.4 Major Technology Parameters

Appendix E contains the baseline printouts for the various missions and power levels. For each baseline, a set of performance and life cycle cost parameters are listed which describe the respective type of ESS (i.e., battery or fuel cell). To perform a technology variation, one of the performance parameters is varied and the resultant effect on life cycle cost is determined. In terms of actual output, this means that the parameter is varied through nine distinct values and a set of "baseline printouts" are generated, one "printout" for each value of the varied parameter. The resultant output is a nine column matrix with ESS parameters corresponding to the list of parameter titles shown in the Appendix E printouts.

This is the basic process for determining the effect on a technology variation on LCC (i.e., compute the nine distinct ESS configurations and LCC's which result from varying a technology parameter over nine distinct

input values). As a result of this process, major technology parameters were identified, which are discussed in subsequent paragraphs. Supporting data for these parameters is contained in exhibits which are in Appendix G.

#### 4.4.1 NiCd Battery Parameters

Approximately 30 NiCd battery performance parameters were evaluated to determine their sensitivity vs LCC. It should be noted that these evaluations were entirely within the performance envelope defined by state-of-the-art technology (i.e., if DOD was varied, a corresponding change in cell life resulted, the following NiCd Battery parameters were determined to have the greatest impact on ESS life cycle cost.

<u>NiCd Battery Parameter</u>	<u>Appendix G Exhibit #'s</u>
1. Depth of Discharge (Capacity Variable)	1 [A - E]
2. Cell Life (Capacity Variable)	2 [A - E]
3. Depth of Discharge (Capacity Fixed)	3 [A - E]
4. Cell Life (Capacity Fixed)	4 [A - E]
5. Rated Cell Capacity	5 [A - E]
6. Hardware Life (Capacity Variable)	6 [A - D]
7. Discharge Current (Capacity Variable)	7 [A - E]
8. Hardware Life (Capacity Fixed)	8 [A - D]

#### 4.4.2 NiH<sub>2</sub> Battery Parameters

As in NiCd, approximately 30 NiH<sub>2</sub> battery performance parameters were evaluated to determine their sensitivity vs LCC. As a result of these evaluations, the same battery parameters as for NiCd were determined to have the greatest impact on ESS life cycle cost. These parameters and the corresponding exhibits in Appendix G are listed on the following pages.



<u>NiH<sub>2</sub> Battery Parameter</u>	<u>Appendix G Exhibit #'s</u>
1. Depth of Discharge (Capacity Variable)	9 [A - E]
2. Cell Life (Capacity Variable)	10 [A - E]
3. Depth of Discharge (Capacity Fixed)	11 [A - E]
4. Cell Life (Capacity Fixed)	12 [A - E]
5. Rated Cell Capacity	13 [A - E]
6. Hardware Life Cycles (Capacity Variable)	14 [A - D]
7. Discharge Current (Capacity Variable)	15 [A - E]
8. Hardware Life Cycles (Capacity Fixed)	16 [A - D]

#### 4.4.3 Discussion of Battery Parameters

Since the same parameters were found to be the most sensitive to LCC, both the NiCd and NiH<sub>2</sub> parameters are discussed together in subsequent paragraphs.

##### 4.4.3.1 Depth of Discharge (Capacity Variable)

The effect of varying the cell depth of discharge, while at the same time holding fixed the total cells in parallel (number of power channels) and causing the rated cell capacity to vary, is shown in Exhibits 1[A - E] and 9 [A - E] in Appendix G. For both a NiCd and a NiH<sub>2</sub> battery cell, increasing the DOD causes a decrease in cell life, which in turn causes an increase in the number of hardware life cycles for LEO. This is reflected by a dramatic increase in the O&M LCC. A secondary effect is a decrease in cell voltage, which causes an increase in the total number of cells. By allowing the capacity to vary at the same time, the rated cell capacity goes down. While the total number of cells increases, the decrease in the weight per cell is greater, and thus the total ESS weight decreases. This causes a corresponding decrease in production cost (and O&M cost, which is not readily

apparent due to the overriding effect of cycle life).

For GEO, since there is only one hardware life cycle, there is no effect on O&M cost. However, the effect on production cost is more pronounced. Both the ESS weight and the space transport cost are greater due to differences in the rated cell capacity between 25 kW LEO and 25 kW GEO. The resultant change in cell life also affects the cell voltage, in addition to the other effects which correspond to LEO.

#### 4.4.3.2 Cell Life (Capacity Variable)

Exhibits 2 [A - E] and 10 [A - E] in Appendix G show the effect of varying the cell life, while holding fixed the number of cells in parallel, thus causing the rated cell capacity to vary. For LEO, this case is really a mirror image of DOD with Capacity Variable. As battery life is increased, the number of hardware life cycles decreases, causing a decrease in the O&M cost. The resultant decrease in DOD, which must occur to allow the increase in life, causes an increase in cell voltage, and thus a decrease in number of cells. However, the decrease in DOD also causes an increase in Rated Cell Capacity, which causes an increase in ESS weight, which in turn causes an increase in production cost.

For GEO, the mirror image still occurs. There is no change in O&M cost, while the production cost increases. The change in ESS weight due to the interaction between rated cell capacity variations and total number of cells is present. In addition the change in cell voltage is more pronounced, due to the change in cell life.

#### 4.4.3.3 Depth of Discharge (Capacity Fixed)

For LEO, refer to Exhibits 3 [A - D] and 11 [A - D] in Appendix G. The same basic comments for variable capacity depth of discharge apply here, except for the effect of cell capacity variations. Changes in the DOD effect - in turn - the cell life, the number of hardware life cycles and the O&M costs; as well as the cell voltage and the number of cells in series. With the cell capacity fixed, the number of cells in parallel varies which also effects the total number of cells. The resultant, combined effect is that both the total number of cells and the ESS weight decrease, which in turn reduces the Production Cost.

For GEO, refer to Exhibits 3E and 11E. Here the increase in DOD decreases the battery life and the cell voltage, together which increase the number of cells in series. However, with a fixed capacity, the number of cells in parallel decreases, which has a greater effect on total number of cells, which also decreases. This in turn causes the ESS weight and the production cost to decrease. It should be noted that both the total number of cells and the ESS weight are inputs to the life cycle cost model. Hence, the decrease in total number of cells decreases the life cycle cost directly, as well as indirectly through the ESS and other hardware weights.

#### 4.4.3.4 Cell Life (Capacity Fixed)

Exhibits 4 [A - D] and 12 [A - D] apply to LEO for this case. Here, the cell life effects both the DOD and the number of hardware life cycles. The resultant decrease in DOD for an increase in cell life, causes an increase in the number of cells in parallel and a decrease in the cell voltage, which in turn causes an increase in the number of cells in parallel. The combined increase in total number of cells from both factors, results in a higher ESS weight and production cost. A decrease in cell life causes an increase in the number of hardware life cycles which causes a decrease in the O&M costs. However, since both the total number of cells and the ESS weights are increasing, this also causes an increase in O&M cost. The resultant net effect is an initial decrease in O&M cost as battery life is increased and then an increase as the quantity and weights of spares increase during O&M. Hence, an optimum cell life would be indicated for LEO, for a cell of a given capacity.

Exhibit 4E and 12E pertain to GEO. Since there is no space O&M costs, the initial decrease in LCC observed for LEO does not occur. Hence, the message for GEO is to use the lowest cell life possible, which will allow the highest DOD, which in turn will reduce the LCC.

#### 4.4.3.5 Rated Cell Capacity

For LEO, refer to Exhibits 5 [A - D] and 13 [A - D] in Appendix G. When the cell capacity is increased, the number of cells in parallel decreases. This causes a corresponding change in the total number of cells and ESS weights. However, there is an upper limit to the cell capacity due to the ESS power

level, which will cause this effect. Hence, the optimum cell capacity for a given power level will increase as the power level increases. To go above this optimum cell capacity for a given power level, does not further decrease the LCC unless the DOD is also decreased, in which case it would be possible to increase the cell life, reduce the number of hardware life cycles, and hence the O&M cost.

For GEO, refer to Exhibits 5E and 13E. Here the above statement concerning the optimum cell capacity is quite evident because GEO does not provide any advantage in decreasing the DOD or increasing the cell life as discussed previously.

#### 4.4.3.6 Hardware Life Cycles (Capacity Variable)

Exhibits 6 [A - D] and 14 [A - D] in Appendix G pertain to LEO. Here the comments for an increase in DOD apply. The bottom line is that an increase in hardware life cycles (i.e., planned overhauls causes a much greater increase in O&M cost than the corresponding decrease in production cost.

This case does not apply to GEO, since the basic assumption involves no hardware life cycles.

#### 4.4.3.7 Discharge Current (Capacity Variable)

The corresponding LEO Exhibits in Appendix G are 7 [A - D] and 15 [A - D]. The basic effect for this technology variation is the increase in cell capacity which must occur to accommodate the increase in discharge current. From there, the same comments which apply to the cell capacity case apply here. The end result is an optimum discharge current and cell capacity for a given power level. While not shown in the exhibits, it would be possible to decrease the DOD and further increase the cell capacity for a given discharge current, and thus realize a corresponding benefit in O&M costs.

The corresponding GEO exhibits in Appendix G are 7E and 15E. Here again, the same basic effect as for cell capacity would occur, while the O&M costs would not be a factor.

#### 4.4.3.8 Hardware Life Cycles (Capacity Fixed)

For LEO, refer to Exhibits 8 [A - D] and 16 [A - D]. Increasing the number of hardware life cycles has essentially the same effect as increasing the DOD. Hence, the same comments apply. The initially high O&M costs is due to spares production cost and spares transport cost during O&M due to all quantities and ESS weight. As the number of hardware life cycles increases, the O&M costs increase due to the number of overhauls.

There is no corresponding case for GEO for this technology variation (i.e., GEO has no planned overhauls or repair of failed equipment).

#### 4.4.4 Fuel Cell Parameters

Due to the limitation of available data and constraints due to time, not all of the fuel cell parameters were evaluated using the same basic methodology as for batteries. However, based upon an evaluation of the sensitivity of certain basic effects for a Fuel Cell ESS with respect to LCC, it was possible to determine the major technology parameters. These were then evaluated using the "baseline printout" methodology. The major technology parameters for a Fuel Cell ESS are as follows:

<u>Fuel Cell Parameter</u>	<u>Appendix G Exhibit #'s</u>
1. FCU Current Density	17 [A - E]
2. FCU Voltage	18 [A - E]
3. FCU Active Area	19 [A - E]
4. FCU Life	20 [A - D]
5. FCU Maintenance Cycles	21 [A - D]

#### 4.4.5 Discussion of Fuel Cell Parameters

The major technology variation parameters vs LCC for a Fuel Cell ESS are discussed in subsequent paragraphs.

##### 4.4.5.1 FCU Current Density

Exhibits 17 [A - D] pertain to LEO for FCU Current Density. One effect of increasing the FCU current density is the resultant decrease in FCU life.

This in turn increases the number of FCU hardware life cycles and the O&M cost. A second effect is a decrease in the number of FCU, which in turn causes a decrease in both the ESS weight and the ESS production cost. However, due to the rounding caused by selecting only even values of FCU current density, the total number of ECU also varies, which in turn cause variations in the solar array interface cost. Unfortunately, these "artificial" variations in the solar array cost are predominate compared to the changes in ESS production and O&M costs.

Exhibit 17E presents the GEO case for FCU current density. Here there is no effect on O&M cost. Hence, the production cost is greater; and as a result, the ESS LCC decreases as the FCU density is increased. Again, the solar array costs predominate.

#### 4.4.5.2 FCU Voltage

For LEO, refer to Exhibit 18 [A - D]. Here the LCC trend is to initially decrease and then later increase as the FCU voltage is increased. Note that the FCU life is held constant while the FCU voltage is allowed to vary. Note also, that an increase in FCU voltage corresponds to a decrease in FCU current density. This in turn causes an increase in the total number of FCU, but a decrease in the total number of ECU. The combined result is first a decrease and then an increase in both the ESS weight and the life cycle cost.

In the GEO case, the same basic trends occur, with the exceptions: (1) The total number of ECU's remain relatively constant, and (2) Initially the FCU current density is limited to a maximum value.

#### 4.4.5.3 FCU Active Area

Exhibits 19 [A - D] present this technology variation for LEO. As expected, the total number of FCU decreases as the FCU active area increases. However, this does not cause a significant change in LCC since the FCU is only part of the total ESS subsystem. Consequently, even though a large variation is observed in the quantity of FCU, this is not reflected in a large change in ESS weight or LCC, since the ECU's and ancillary equipment are largely unaffected.

For GEO (Exhibit 19E) the same basic comments apply as for LEO.

#### 4.4.5.4 FCU Life

For LEO, refer to Exhibits 20 [A - D]. In LEO, the FCU life effects both the current density and the number of hardware life cycles. The effect on the current density in turn causes an increase in the total number of FCU and ECU, and the ESS weight. This in turn causes an increase in the production cost. The decrease in hardware life cycles causes a decrease in the O&M cost. Since the production cost increases while the O&M cost decreases due to an increase in FCU life, there is an optimum FCU life for a fuel cell ESS, at a given power level.

There is no GEO application, since the FCU life is presumed to be the same as the total life of the system.

#### 4.4.5.5 FCU Hardware Life Cycles

Refer to Exhibits 21 [A - D] for the LEO application of these technology variation. The number of hardware life cycles effects the O&M cost due to the number of overhauls. The number of hardware life cycles also effects the FCU life, which in turn effects the FCU current density. This leads to a reduction in the total number of FCU and the ESS weight as the number of hardware life cycles is increased. As a result, the production costs go down and the O&M costs go up for an increase in the number of hardware life cycles. Hence, an optimum number of cycles exist for a Fuel Cell ESS, which corresponds to the optimum FCU life discussed in the previous paragraph.

There is no application of this technology variation to GEO, since the basic ground rule for GEO is no equipment overhaul and no repair of failed equipment.

## 5.0 CONCLUSIONS

As stated previously quantitative relationships and computer models were developed which enable examination of the effects on life cycle cost resulting from varying technical parameters of the subsystem.

This section discusses the conclusions reached as a result of this study. The conclusions are presented in three groups.

### 5.1 Battery Conclusions

Of all the variables analyzed for the Battery ESS models (~30 for each model), eight were found to have a significant effect on life cycle cost. Because of the strong similarity between the two battery ESS performance/LCC models, the same conclusions apply to both NiCd and NiH<sub>2</sub> Batteries. Exhibit 5-1(a) presents these conclusions, with the eight parameters ranked according to the relative LCC sensitivity in a LEO application. As can be seen, the GEO application produces a different result. These parameters were rated simply by the variation in LCC (max-min) which resulted during the technology variations described in Section 4.

### 5.2 Fuel Cell Conclusions

The fuel cell ESS conclusions are presented in Exhibit 5-1. There the number of parameters "ranked" is five, of which two (Life and Hardware Life Cycles) are really duplicates. As stated before, the smaller number of significant parameters is due to two factors: (1) The fuel cell is only one of three major items in a fuel cell/electrolysis cell ESS with ancillary equipment; and hence, its "leverage" on LCC is smaller; (2) A lack of available Fuel Cell ESS data, did not allow a complete and thorough evaluation of all parameters. However, based upon the results which were achieved, it is believed that few, if any, of the parameters which were not addressed, would have a significant effect on LCC. Again, the results for GEO are different than the results for LEO.

### 5.3 Other Conclusions

Three general conclusions were reached as the result of this study:

(1) The LCC for a NiCd ESS is approximately 2A that for NiH<sub>2</sub>. It appears that



<b>CONCLUSIONS: BATTERY DRIVING PARAMETERS</b>		
<b>BATTERY PARAMETER</b>	<b>LCC SENSITIVITY</b>	
	<b>LEO</b>	<b>GEO</b>
DOD (CAPAC. VARIABLE)	VERY STRONG	STRONG
LIFE (CAPAC. VARIABLE)	VERY STRONG	MODERATE
DOD (CAPAC. FIXED)	STRONG	STRONG
LIFE (CAPAC. FIXED)	STRONG	STRONG
CAPACITY	STRONG	MODERATE
HARDWARE LIFE CYCLES (CAPAC. VARIABLE)	MODERATE	—
DISCHARGE CURRENT (CAPAC. FIXED)	MODERATE	STRONG
HARDWARE LIFE CYCLES (CAPAC. FIXED)	MODERATE	—

(a)

<b>CONCLUSIONS: FUEL CELL DRIVING PARAMETERS</b>		
<b>FUEL CELL PARAMETER</b>	<b>LCC SENSITIVITY</b>	
	<b>LEO</b>	<b>GEO</b>
CURRENT DENSITY	MODERATE	STRONG
VOLTAGE	MODERATE	MODERATE
ACTIVE AREA	WEAK	MODERATE
LIFE	WEAK	WEAK
HARDWARE LIFE CYCLES	WEAK	—

(b)

<b>OTHER CONCLUSIONS</b>
<ul style="list-style-type: none"> <li>● NiCd LCC <math>\approx</math> 2X NiH<sub>2</sub> LCC</li> <li>● FUEL CELL LCC <math>\approx</math> NiH<sub>2</sub> LCC</li> <li>● BATTERY DRIVING PARAMETERS HAVE A STRONGER EFFECT ON LCC THAN FUEL CELL DRIVING PARAMETERS</li> </ul>

(c)

**Exhibit S-1. Conclusions**

a greater depth of discharge is allowable for  $\text{NiH}_2$  without a greater degradation in cell life and a lighter weight for the  $\text{NiH}_2$  cell compared to the  $\text{NiCd}$  cell; (2) The LCC for the  $\text{NiH}_2$  Battery ESS and the  $\text{H}_2\text{O}_2$  Fuel Cell ESS are comparable. However, since the Fuel Cell ESS is less efficient, the solar array interface cost is significantly greater for a fuel cell ESS, than for a  $\text{NiH}_2$  ESS; (3) The battery parameters are more LCC sensitive than fuel cell parameters, due to the greater complexity and a quantity of hardware in a Fuel Cell ESS as compared to a battery ESS.

## 6.0 RECOMMENDATIONS

During the course of this study, many potential uses of the ESS Performance and LCC Models became evident. Some of these uses would be applicable with the models as they are presently configured, while other uses would require modification and/or expansion of the existing programs. Exhibit 6-1 presents the more significant uses/recommendations which are as follows:

- Vary Parameters Without Interactions

This recommendation has two potential applications. First, direct effects on LCC for a given parameter could be determined. While this would not be a realistic life situation, it would give valuable insight into what are the primary effects for a given technology variation, without reduction or masking by secondary effects (i.e., comparable to theoretical efficiency of an electronic component or device). A second application, although not entirely without interactions, would allow the insertion of hypothetical or actual characteristics into an ESS model to determine the potential LCC benefit and/or compare competitive technologies.

- Determine Potential LCC Savings vs Development Costs

This is very closely related to the application just discussed. The point to be made is that the models in this study were constructed based upon actual, state-of-the-art interactions between parameters. Yet the use of these models must not be limited accordingly. Not only is it important that models could be used to determine "design" type trades for one given technology; it is equally important that competitive technologies be compared with respect to LCC. In addition, it is important that whoever is making a financial decision has the appropriate insight into the total picture.

- Plan and Coordinate Development/Test Programs

During the development of the ESS models discussed in this report, it rapidly became very evident that the test data available was not necessarily obtained with the total life cycle cost picture in mind.

PRECEDING PAGE BLANK NOT FILMED

## RECOMMENDATIONS

- VARY PERFORMANCE/COST MODEL PARAMETERS WITHOUT INTERACTIONS (e.g., VARY DOD WITHOUT EFFECTING LIFE) TO DETERMINE INDEPENDENT LCC VARIATIONS

- USE PERFORMANCE/COST MODEL TO DETERMINE POTENTIAL LCC SAVINGS VS DEVELOPMENT COSTS REQUIRED TO ACHIEVE DESIRED PERFORMANCE

- USE PERFORMANCE/COST MODEL TO PLAN AND COORDINATE UPCOMING BATTERY AND FUEL CELL DEVELOPMENT/TEST PROGRAMS

- DEVELOP AN OPTIMIZED ESS DESIGN - MODIFY THE PROGRAM

- DEVELOP AN INTEGRATED ELECTRICAL POWER SYSTEM PERFORMANCE/COST MODEL

MISSION	SOLAR ARRAY	ESS	PDCS	USER
● LEO	● Si	● Batteries	● DC/DC	● Variation in Load Power
● GEO	● GaAs (1 toN)	● Fuel Cells	● DC/AC	
			● Etc.	

- DEVELOP A TOTAL SPACE PLATFORM MODEL

- DEVELOP AND USE A  $NH_2$  AND FUEL CELL DATA CENTER

- Data Base
- Test Requirements
- Design Handbooks
- Standard Cell Specifications

*Exhibit 6-1. Recommendations*

Too often, only the individual cell was addressed, and even then, the data available for the various cell performance parameters was not a complete set. For example, even the NiCd data in NASA 1052 (Sealed Cell Nickel-Cadmium Applications Manual), which is an excellent reference, was a composite of a multitude of different tests, rather than a planned and coordinated test program, implemented specifically to provide a standard set of curves. Of course, this all goes back to the independent development of various batteries and different configurations over a long period of time. The point is, that given a very limited budget, the models in this report can be used to optimize the effective use of these monetary resources and achieve a coordinate and complete result.

- Develop Optimized ESS

This recommendation has a very significant application. Given a program which would provide an optimized configuration, it would be possible to "work backwards" and arrive at a required configuration, from a predetermined life cycle cost figure. This would allow a Program Manager to control his program and it would assist the designer to get the most out of the resources available to him.

- Develop Integrated EPS Model

The ESS is only one part of the total electrical power system. It is possible to optimize the LCC of a given ESS configuration and not have an optimized LCC for the total power system. An integrated model would provide the same capability on the EPS that was just discussed for the ESS.

- Develop a Total Space Platform Model

The same comments apply here as for the ESS and EPS models respectively. While it would probably become exceedingly more difficult to have a complete and accurate model for such a large application, this problem could be minimized by a LCC impact analysis using integrated

smaller models to determine the most significant technologies vs LCC, and then structure the Space Platform Model accordingly.

- Develop and Use a NiH<sub>2</sub> and Fuel Cell Data Center

Most of the comments previously made concerning the planning and coordinating of development/test programs also apply to this recommendation. The point is that given limited monetary resources, it is very important that there not be duplication or significant gaps in the respective data base. The models described in this report could be used to determine the most significant parameters, and to prioritize what should be done if a choice must be made between two or more competing courses of action.

## 7.0 BIBLIOGRAPHY

An extensive bibliography was used during the performance of this study. The data sources and references listed in Exhibit 7-1(a-c) are only the major ones which were ultimately used. It should be noted that a vast amount of data collection, research, and reading was involved in this study; and only after culling down to the items which were meaningful, was a bibliography constructed. Based upon the applicability of the respective documents, Exhibit 7-1 is divided into five general areas: (1) General, (2) Batteries-General, (3) Nickel Cadmium Battery, (4) Nickel Hydrogen Battery, and (5) Fuel Cell. Again it should be stressed that the ESS Performance/LCC models constructed for this study are the result of synthesizing a myriad of relationships from numerous data sources; hence only the key references are contained therein.

TITLE	SOURCE	DATE	DATA
HANDBOOK OF CHEMISTRY AND PHYSICS, 42ND EDITION	THE CHEMICAL RUBBER PUBLISHING COMPANY	1960	MOLECULAR WEIGHTS
MARKS' STANDARD HANDBOOK FOR MECHANICAL ENGINEERS, 8TH EDITION	McGRAW-HILL BOOK COMPANY	1969	P, V, T RELATIONSHIPS
SYNCHRONOUS ORBIT POWER TECHNOLOGY NEEDS	NASA TECHNICAL MEMO 80280	APRIL 1979	MISSION REQUIREMENTS
SPACE TRANSPORTATION SYSTEM USER HANDBOOK	NASA	JUNE 1977	SKUTTLE & IUS COSTS, WEIGHTS, PAYLOAD CAPABILITY
HEAT TRANSFER AND THERMAL CONTROL SYSTEMS	VOL. 60, PROCESS IN ASTRONAUTICS AND AERONAUTICS	1977	HEAT LOAD IMPACT ON THERMAL CONTROL S/S
STUDY OF THERMAL CONTROL SYSTEMS FOR ORBITING POWER SYSTEMS, BOOK 1, EXECUTIVE SUMMARY	VOUGHT CORPORATION	MAY 15, 1980	HEAT LOAD IMPACT ON THERMAL CONTROL S/S
FUTURE ORBITAL POWER SYSTEMS TECHNOLOGY	LeRC		MISSION REQUIREMENTS
ENERGY STORAGE FOR LEO OPERATIONS AT HIGH POWER	TROUT	1978-1979	REQUIREMENTS, PERFORMANCE
SPACE POWER DISTRIBUTION SYSTEM TECHNOLOGY STUDY	TRW	JUNE 1980	GENERAL COST & TECHNICAL DATA



TITLE	SOURCE	DATE	DATA
THE 1977 GODDARD SPACE FLIGHT CENTER BATTERY WORKSHOP	NASA CONFERENCE PUBLICATION 2041	NOVEMBER 1977	NiCd, NiH <sub>2</sub> DATA ON PHYSICAL AND PERFORMANCE CHARACTERISTICS
THE 1979 GODDARD SPACE FLIGHT CENTER BATTERY WORKSHOP	NASA CONFERENCE PUBLICATION 2117	NOVEMBER 1979	NiCd, NiH <sub>2</sub> DATA ON PHYSICAL AND PERFORMANCE CHARACTERISTICS

Exhibit 7-1b. Bibliography - Batteries, General

TITLE	SOURCE	DATE	DATA
SEALED-CELL NICKEL-CADMIUM BATTERY APPLICATIONS MANUAL	NASA REFERENCE PUBLICATION 1052	DECEMBER 1979	NiCd PERFORMANCE AND PHYSICAL CHARACTERISTICS AND COSTS
NWSC NiCd SPACECRAFT CELL ACCELERATED LIFE TEST PROGRAM DATA ANALYSIS AND ACCELERATED LIFE TEST DESIGN	AEROSPACE POWER DIVISION; WRIGHT-PATTERSON AFB	SEPTEMBER 1979	NiCd PERFORMANCE AND PHYSICAL CHARACTERISTICS AND COSTS
ACCELERATED TEST PROGRAM, INTERIM REPORT	NASA/NAVAL WEAPONS SUPPORT CENTER	MAY 3, 1979	NiCd PERFORMANCE AND PHYSICAL CHARACTERISTICS AND COSTS
THE APOLLO TELESCOPE MOUNT ELECTRICAL POWER SYSTEM POSTMISSION DESIGN AND PERFORMANCE REVIEW	NASA/MSFC REPORT, NO. 4DM22430	SEPTEMBER 1974	NiCd PERFORMANCE AND PHYSICAL CHARACTERISTICS AND COSTS
HEAT DISSIPATION AND INSTANTANEOUS CHARGE EFFICIENCY IN SEALED NICKEL-CADMIUM CELLS	TRW, INC., NO. 809318	1980	NiCd PERFORMANCE AND PHYSICAL CHARACTERISTICS AND COSTS

Exhibit 7-1c. Bibliography - Nickel Cadmium Battery

TITLE	SOURCE	DATE	DATA
NICKEL HYDROGEN ENERGY STORAGE FOR SATELLITES	HUGHES AIRCRAFT CO., AD/A-006 427	NOVEMBER 1974	NiH <sub>2</sub> PHYSICAL AND PERFORMANCE CHARACTERISTICS AND COSTS
HYDROGEN-NICKEL REGENERATIVE FUEL CELLS	TYCO LABORATORIES, INC., AD-784 902	APRIL 1974	NiH <sub>2</sub> PHYSICAL AND PERFORMANCE CHARACTERISTICS AND COSTS
NICKEL HYDROGEN CELL EVALUATION	GENERAL ELECTRIC SPACE DIVISION	DECEMBER 11, 1979	NiH <sub>2</sub> PHYSICAL AND PERFORMANCE CHARACTERISTICS AND COSTS
STATUS OF NICKEL-HYDROGEN CELL TECHNOLOGY EXCERPT FROM SYNCHRONOUS ENERGY TECHNOLOGY	AERO PROPULSION LAB/NASA CONFERENCE PUB. 2154	APRIL 1980	NiH <sub>2</sub> PHYSICAL AND PERFORMANCE CHARACTERISTICS AND COSTS
TEST DATA ANALYSIS AND APPLICATION OF NICKEL HYDROGEN CELLS	ROCKWELL INTERNATIONAL, NO. 809391	1980	NiH <sub>2</sub> PHYSICAL AND PERFORMANCE CHARACTERISTICS AND COSTS

Exhibit 7-1d. Bibliography - Nickel Hydrogen Battery

TITLE	SOURCE	DATE	DATA
ADVANCED TECHNOLOGY LIGHT WEIGHT FUEL CELL PROGRAM, FINAL REPORT	UNITED TECHNOLOGIES CORPORATION, NASA CR-159807, FCR-1657	MARCH 4, 1980	FUEL CELL PERFORMANCE AND PHYSICAL CHARACTERISTICS AND COSTS
ELECTROCHEMICAL CELL TECHNOLOGY FOR ORBITAL ENERGY STORAGE	GENERAL ELECTRIC NO. ECOES-12	NOVEMBER 19, 1979	FUEL CELL PERFORMANCE AND PHYSICAL CHARACTERISTICS AND COSTS
LIGHTWEIGHT FUEL CELL POWER PLANT COMPONENTS PROGRAM	UNITED TECHNOLOGIES CORPORATION, NASA FCR-1656	FEBRUARY 22, 1980	FUEL CELL PERFORMANCE AND PHYSICAL CHARACTERISTICS & COSTS
ADVANCED TECHNOLOGY ALKALINE FUEL CELL PROGRAMS	POWER SYSTEMS DIVISION	OCTOBER 21, 1980	FUEL CELL PERFORMANCE AND PHYSICAL CHARACTERISTICS & COSTS
FUEL CELLS	ANGUS McDOUGALL - JOHN WILEY & SONS	1976	FUEL CELL PERFORMANCE AND PHYSICAL CHARACTERISTICS & COSTS
FUEL CELLS FOR PUBLIC UTILITY AND INDUSTRIAL POWER	NOYES DATA CORPORATION	1977	FUEL CELL PERFORMANCE AND PHYSICAL CHARACTERISTICS & COSTS
FUEL CELLS - THEORY AND APPLICATION	MODERN ELECTRICAL STUDIES - CHAPMAN AND HALL, LTD.	1967	FUEL CELL PERFORMANCE AND PHYSICAL CHARACTERISTICS & COSTS
THE ROLE OF FUEL CELLS IN NASA'S SPACE POWER SYSTEMS	BEEB, PAPER PUBLISHED BY ACS	1979	REQUIREMENTS, PERFORMANCE AND PHYSICAL CHARACTERISTICS

Exhibit 7-1c. Bibliography - Fuel Cell

*SPECIFICATION*

---

**BASELINE ENERGY STORAGE  
SUBSYSTEMS REQUIREMENTS**

Prepared For  
**NASA LEWIS RESEARCH CENTER  
CLEVELAND, OHIO 44135**

March 1980  
Contract NAS3-21982

**prc**

**PRC/SSC Energy Storage Subsystems Project Office  
7911 Charlotte Drive, Huntsville, Alabama 35802**

## TABLE OF CONTENTS

	<u>Page</u>
1.0 INTRODUCTION AND SCOPE.....	1
2.0 APPLICABLE DOCUMENTS.....	1
3.0 REQUIREMENTS.....	3
3.1 System Level Requirements.....	3
3.1.1 System Level Description.....	3
3.1.2 Mission Requirements.....	6
3.2 Subsystem Performance and Interface Requirements and Constraints.....	10
3.2.1 Electrical Performance and Interface Requirements.	10
3.2.2 Structural/Mechanical/Thermal Performance and Interface Requirements and Constraints.....	11
3.2.3 Transportation/Transportability.....	12
3.2.4 Life and Reliability.....	13
3.2.5 Safety.....	13
3.2.6 Maintenance/Maintainability.....	13
3.2.7 Environment.....	14
3.3 Design & Construction.....	15
3.3.1 Materials Properties.....	15
3.4 Verification Requirements.....	16
3.5 Personnel & Training Requirements.....	16
4.0 VERIFICATION.....	16

## 1.0 INTRODUCTION AND SCOPE

Under contract to NASA LeRC, baseline Energy Storage Subsystems (ESS) conceptual design is being developed for the purpose of determining the influence of varied technology on the life cycle costs of the subsystems and interfacing elements.

This specification defines the requirements on Energy Storage Subsystems for 25, 50, 100 & 250 kW power ranges. These subsystems are subsystems of a hypothetical Space Services Platform System, (SSPS), created for the purposes of defining missions, mission requirements and subsystems/subsystem interface requirements.

This is a top level subsystem specification. The relationship of this specification to the SSPS hierarchy of specifications is contained in Section 2.0.

## 2.0 APPLICABLE DOCUMENTS

- 2.1 The SSPS System specification tree is shown in Exhibit 2-1.
- 2.2 JSC 07700 Volume XIV, Space Shuttle Payload Accommodations, September 22, 1978.
- 2.3 The applicability of other specifications, standards and other documents is TBD.

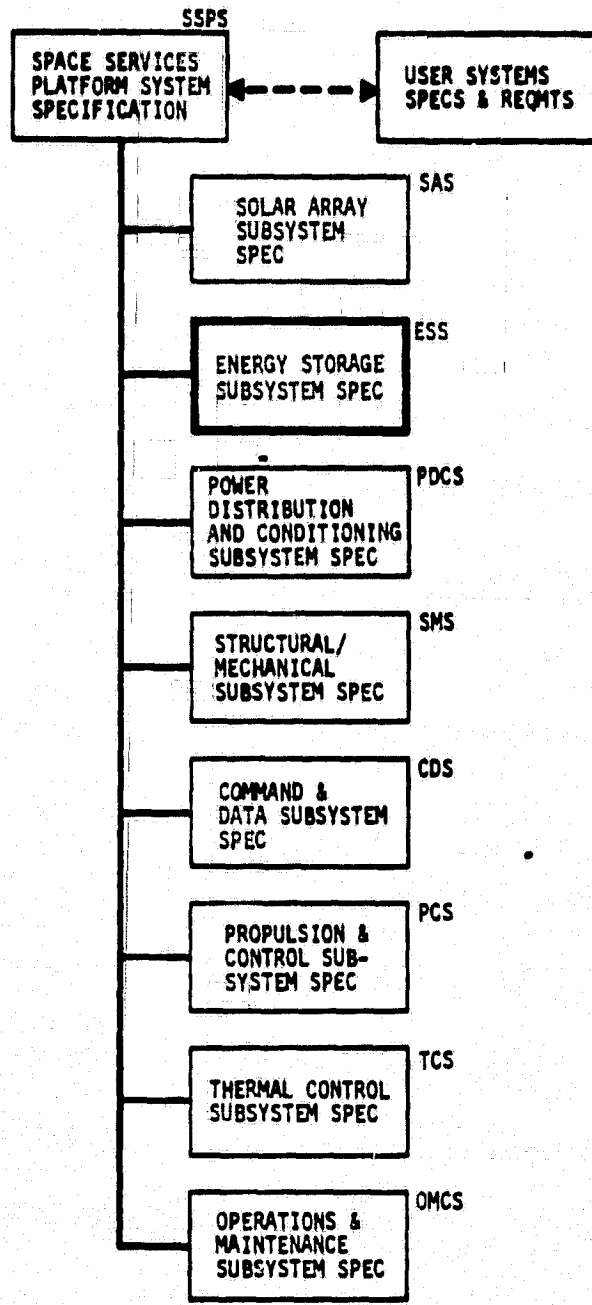

**EXHIBIT 2-1. SSPS SPECIFICATION TREE EXHIBIT**



### 3.0 REQUIREMENTS

#### 3.1 System Level Requirements

These requirements apply to the system level (the Space Service Platform System, SSPS) directly. The requirements on the ESS Subsystem derive from the system level requirements and are specified in Sections 3.2 through 3.5. Verification requirements are specified in Section 4.0.

##### 3.1.1 System Level Description

The purpose of the Space Services Platform System (SSPS) is to provide services to varied User Systems. The User Systems may be engaged in materials processing, astronomy, solar system and earth observation, life sciences, communications, life support, and other operations. The User Systems may be secured to the platform or docked for servicing or short term operations.

The general concept of the SSPS is shown in Exhibit 3-1. The subsystems of the SSPS, their functions and major interfaces are identified in Exhibit 3-2. The User Systems will interface with the SSPS subsystems as follows:

- Power Distribution and Conditioning - PDCS
- Energy Storage Subsystem - ESS
- Thermal control - TCS
- Structure/Mechanical - SMS
- Instrumentation - CDS
- Operations/Maintenance - OMCS
- Gross Pointing Stability - CDS  
PCS

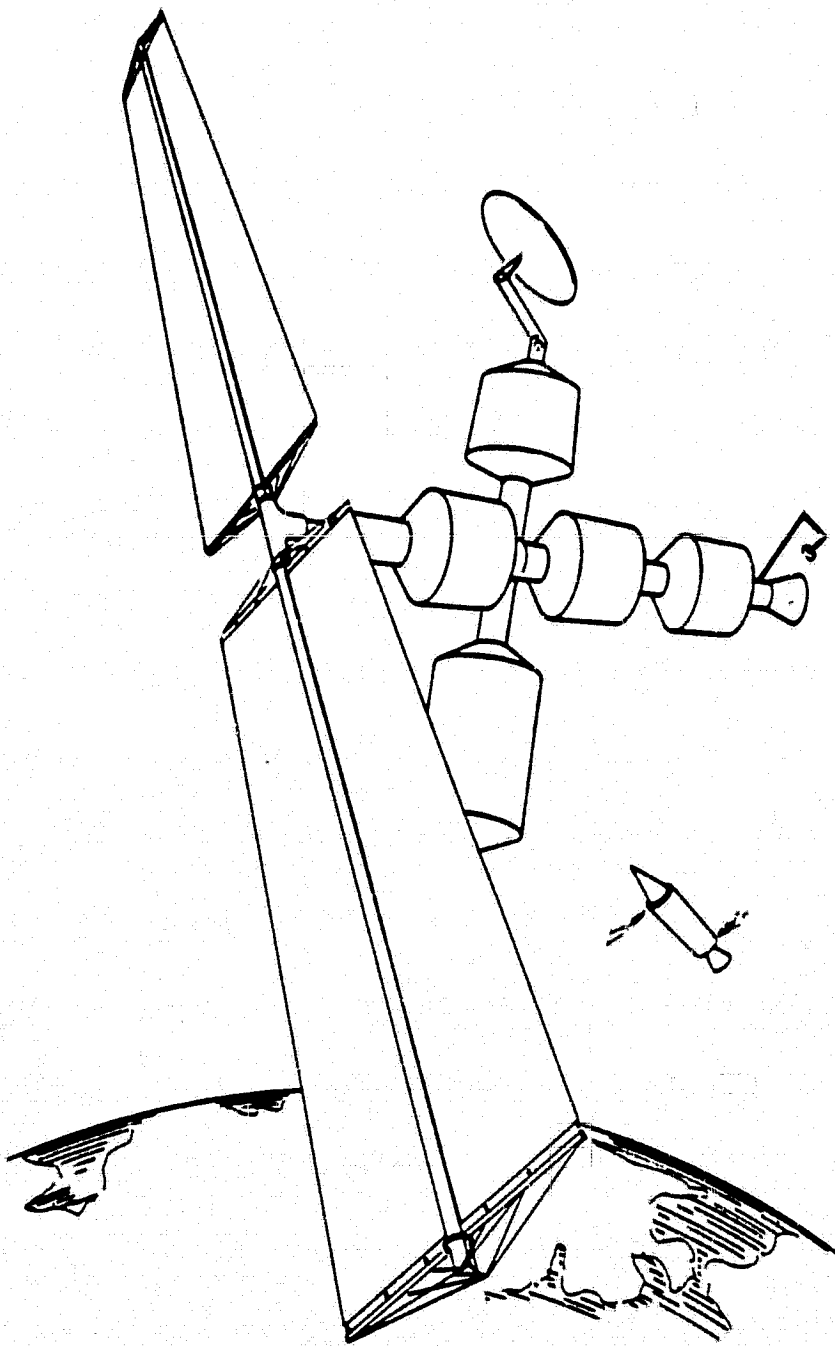

- SOLAR ARRAY
  - POWER DISTRIBUTION & CONDITIONING
  - ENERGY STORAGE
  - THERMAL CONTROL
  - STRUCTURAL/MECHANICAL
  - COMMAND & DATA
  - ORBIT CREW
  - PROPULSION & CONTROL
- SAS
  - PDCS
  - ESS
  - TCS
  - SMS
  - CDS
  - OMCS
  - PCS



**EXHIBIT 3-1. SSFS CONCEPT CONFIGURATION**

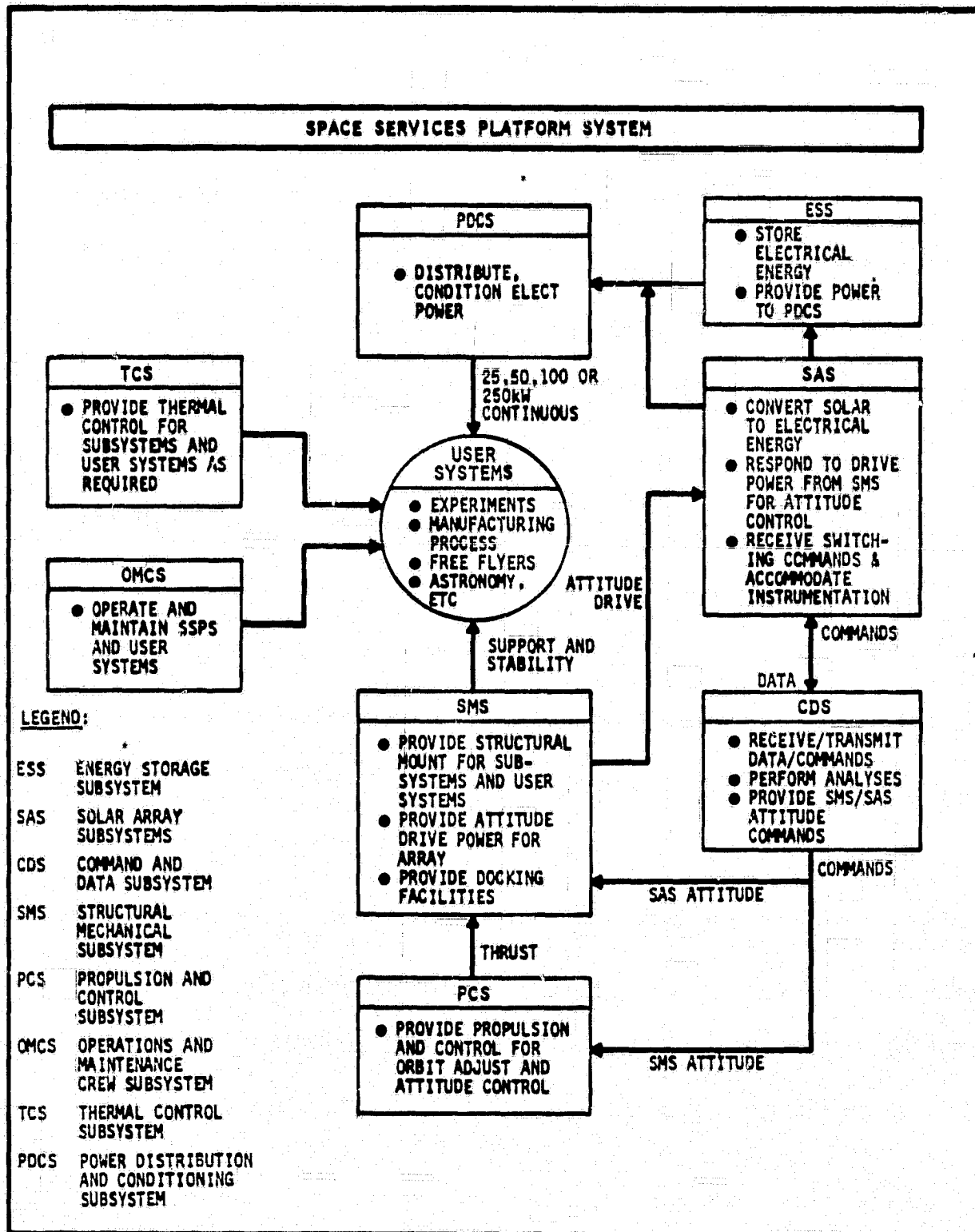

**EXHIBIT 3-2. SSPS SUBSYSTEM FUNCTIONS AND INTERFACES**

### 3.1.2 Mission Requirements

The following characteristics shall be used in the system and subsystem design.

#### 3.1.2.1 General

- System operational 1985-1990
- State-of-art (1979) design
- Transportation to LEO: Shuttle

#### 3.1.2.2 Orbit and Mission Parameters

- LEO circular, 444 km. Inclination 56°.
  - Orbital period: 87.3 minutes
  - Time in sun: 54.0 minutes, minimum
  - Time in eclipse: 33.3 minutes, maximum
  - Number in eclipses: 60,239/10 years.

#### 3.1.2.3 Types of Energy Storage Subsystems

This specification applies to the energy storage subsystem types and power ranges shown:

<u>TYPE</u>	<u>MISSION POWER LEVELS (kW, CONTINUOUS TO LOAD)</u>			
Battery	25	50	100	250
Fuel Cell	25	50	100	250

#### 3.1.2.4 Load Power Requirements/Design Requirements

The load (user) power requirements for 25kW, 50kW, 100kW and 250kW power levels are specified in the following sections.

##### 3.1.2.4.1 25kW Power Level Mission

###### (1) Mission Requirements

- Shuttle orbiter and payloads in Sortie Mode.

- Free flying payloads including Material Processing, Space Science, Earth Observation, etc. without shuttle.

(2) Design Requirements

- Provide 14kW at 30V nominal to support Orbiter and 11kW at 30V nominal to spacelab/payloads through Orbiter interface.
- Provide up to 25kW at 30V nominal to support payloads in free flying mode for extended period of time.

3.1.2.4.2 50kW Power Level Mission

(1) Mission Requirements

- In Sortie Mode, Support Shuttle Orbiter, Space Lab and associated payloads while on orbit with 25kW and 30V nominal. At same time provide 25kW at 120V nominal to other payloads.
- Support free flying payloads with 50kW at 120V nominal with a 30V bus available for special or existing equipment. Total power not to exceed 50kW average. Payloads requiring this level of power include, Solar Terrestrial Obser., Public service, Space Science, Materials Processing, etc. or combinations.

Support a limited manned habitat for payloads requiring specialists on board.

(2) Design Requirements

- Provide 14kW at 30V nominal to support Orbiter and 11kW at 30V nominal to Spacelab/payloads through Orbiter Interface. Provide additional 25kW at 120V nominal to other payloads through a different interface.
- Provide 50kW at 120V nominal to user bus. Establish 30V bus for existing 30V equipment. Total power to users not to exceed 50kW average.

3.1.2.4.3 100kW Power Level Mission

(1) Mission Requirements

- Support the Shuttle Orbiter in the Sertie Mode. Therefore, a capability to supply 25kW at 30V nominal at the Orbiter interface must be maintained.
- Requirements for this power level in the free flying mode include the support of a manned habitat, in addition to supporting some of the payloads stated for the lower power levels. Support some base construction activities.

(2) Design Requirements

- Same requirement for Shuttle Orbiter support as stated for lower power levels.
- Bus voltages same as for 50kW power level with total power of 100kW.

3.1.2.4.4 250kW Power Level Mission

(1) Mission Requirements

- Missions involving manned habitats and power consuming activities such as space base construction, industrialization of space, materials processing, etc.
- Support the low voltage power system of the Shuttle Orbiter when it is attached.

(2) Design Requirements

- Provide high power at high voltage to the various activities ranging from life support systems to manufacturing machinery and equipment. Special converters must be provided for special requirements.

### 3.2 Subsystem Performance and Interface Requirements and Constraints

These requirements apply to the Energy Storage Subsystem (ESS) the Space Services Platform System (SSPS); and have been derived from the system level requirements of Section 3.1.

#### 3.2.1 Electrical Performance and Interface Requirements

##### 3.2.1.1 ESS/SAS/PDCS Electrical Interfaces

- The SAS shall provide electrical power to the ESS and PDCS for energy storage, distribution and conditioning. The PDCS will provide the electrical power/energy to the Users Bus.
- The SAS shall provide electrical power to the ESS and/or PDCS at the 2 axis drive/slip ring assembly output.
- The fixed current options shall be implementable during ground operations and/or in space. The in-space capability shall be achieved by manual operations.
- The variable current options shall be implementable during ground operations (blanket level or lower)
- Total power output to the ESS and PDCS shall be as required by the system power requirements.

##### 3.2.1.2 ESS Electrical Performance

- Energy Storage. The ESS will receive energy from the SAS during the time in the sun portion of the orbit (min. 54.0 minutes) and furnish energy to the PDSC during the time in the eclipse (max. 33.3 minutes). The amount of



energy stored will be based on the energy balance equation developed for the design configuration chosen for each ESS mission power level. With the anticipated solar array design, the input power processor of the ESS must be capable of accepting voltage limits from 375 V DC open circuit of a cold array at BOL to a fully loaded array voltage of 180V. DC. at EOL. The ESS will deliver energy to the PDCS within the limits of 128V. to 165 V. DC.

#### 3.2.1.3 ESS/TCS Interface

The ESS will have a major interface with the SSPS Thermal Control subsystem. The power processors and batteries or fuel cells and electrolysis unit will require temperature controls within specified limits. Heat loads will depend on the size of the ESS. Mechanical interfaces must be determined during ESS system design.

### 3.2.2 Structural/Mechanical/Thermal Performance and Interface Requirements and Constraints

#### 3.2.2.1 ESS Structural/Mechanical Performance

- The ESS shall be capable of withstanding orbit changes of altitude and inclination.
- Loads: 0.01G in all axes.

#### 3.2.2.2 ESS/SMS Structural and Mechanical Interfaces

The ESS interfaces with the SMS shall be:

- Structural Attachment: The SMS shall provide the mounting assembly which secures the ESS to the SMS structure.

3.2.2.3 ESS/EDCS Interface: TBD

3.2.2.4 ESS/PCS Interface

- Thruster induced loads shall be consistent with structural/mechanical requirements of Section 3.2.3.1.
- Contaminant and charged particle constraints and tolerances shall be TBD.

3.2.2.5 ESS/TCS Interface

The ESS thermal control requirements and mechanical interfaces shall be as specified in 3.2.1.3.

3.2.2.6 ESS/CDS Interface

- The ESS shall provide accommodations for command and data instruments which shall be components of the CDS. The CDS shall provide electrical power for command and data channels which interface with the ESS.
- The command and data channel list for ESS shall be: TBD.
- Data channel requirements for space assembly and check-out shall be (TBD).

3.2.2.7 ESS/QMCS Interface

- This interface is covered in Section 3.2.6.

3.2.3 Transportation/Transportability

3.2.3.1 The ESS components shall be transportable to space by the Space Shuttle.

3.2.3.2 The ESS design, as stowed for transportation shall meet the transportation environment specified in Section 3.2.7.

### 3.2.4 Life and Reliability

3.2.4.1 The ESS shall be designed for a five year operational life, with maintenance as specified in 3.2.6.

3.2.4.2 The design shall be such that failures will be non-proliferating.

3.2.4.3 Reliability specifications shall be subject to life cycle cost trade analyses.

3.2.4.4 Storage life is TBD.

### 3.2.5 Safety

The ESS design and procedures for all phases of production, earth and space integration, transportation and O&M, shall assure the chance of serious injury or death over a 5 year period is less than one in  $10^7$  man-hours.

### 3.2.6 Maintenance/Maintainability

#### 3.2.6.1 Logistics and Spares

The normal supply mode shall be a set of on-hand (in space) modular spares and materials sufficient for one year's operation. The spares set shall be delivered by the Space Shuttle.

#### 3.2.6.2 Overhaul

The ESS shall be designed for overhaul and return to operational service at the end of five years.

#### 3.2.6.3 Maintenance

- The ESS shall be modularized for removal and replacement with serviceable modules.

- In place (on-array) repair shall be limited to the cell level or higher.
- In-space, shop repair of modules or lower level of assembly shall be: TBD
- The ESS design shall enable repair/replacement (and checkout) time of 6 manhours per module.
- The ESS design shall permit automatic fault isolation to the failed module.
- The ESS shall be capable of assembly and checkout in space. Assembly will include hook-up and attachment to the (SMS) and other subsystems of the SSPS system.

### 3.2.7 Environment

#### 3.2.7.1 Natural Environment

The design shall meet the requirements of this specification within the natural environment (worst case 20 year prognosis) of the earth orbit range of: 300 to 1900 km, all inclinations. This environment shall include effects due to U.V. radiation, solar flares, trapped radiation and micrometeorites.

#### 3.2.7.2 Transportation Induced

- Earth surface/air transport:  
TBD
- Launch and ascent to LEO
  - Axial acceleration of 5g
  - Lateral acceleration of 0.5g
  - Decaying sinusoidally of 7g at 16 Hz

- Sinusoidal vibration (three mutually perpendicular directions) +1 g peak from 2 to 40 Hz
- Random vibration (gaussian amplitude distribution)  $0.1 \text{ g}^2/\text{Hz}$  from 10 to 60 Hz,  $0.4 \text{ g}^2/\text{Hz}$  from 60 to 2,000 Hz
- Acoustic noise (decibels re 0.0002 microbar) up to 150 db (3 minutes duration) 45 to 11,200 Hz

- Ascent Venting Profile - TBD

### 3.2.7.3 Operational Induced

- The induced operational environments shall be as specified in Section 3.2 interface requirements.
- Contaminants - TBD

## 3.3 Design & Construction

### 3.3.1 Materials Properties

#### 3.3.1.1 Materials Compatibility

TBD

#### 3.3.1.2 Outgassing

TBD

#### 3.3.1.3 Insulation Resistance

TBD

#### 3.3.1.4 Voltage Breakdown

TBD

**3.3.1.5 Contaminants Sources**

TBD

**3.4 Verification Requirements**

The requirements of this specification shall be as specified in Section 4.0, verification.

**3.5 Personnel & Training Requirements**

TBD

**4.0 VERIFICATION**

TBD

SYMBOLPARAMETER

C0	Total ESS Capacity (AH)
C1	Battery Cell Rated Capacity (AH)
C4	Battery Cell Charge Throughput
D0	Battery Cell Maximum Depth of Discharge
D9	Depth of Discharge (first approximation)
E0	Battery Cell EOL Maximum Discharge (AH)
F	Total Life Cycle Cost (1980 \$ M)
F0	Production Cost
F0(1)	Battery Cell Unit Cost
F0(2)	Cell Matching Cost
F0(3)	Module Assembly Cost
F0(4)	Power Channel Assembly Cost
F0(5)	Subsystem Assembly Cost
F0(6)	Acceptance & Surface Transport Cost
F0(7)	Prelaunch Integration & Checkout Cost
F0(8)	Space Transport Cost
F0(9)	Space Deployment & Checkout Cost
F1	DDT&E Cost
F1(1)	D&D Cost
F1(2)	Subsystem Test Hardware Cost
F1(3)	Subsystem Test Hardware Assembly Cost
F1(4)	Subsystem Test Operations Cost
F1(5)	Test Support Equipment Cost
F1(6)	Subsystem Engineering & Integration Cost
F1(7)	Subsystem Program Management Cost
F2	Operations and Maintenance Cost
F2(1)	Spares Manufacturing Cost
F2(2)	Training Cost
F2(3)	Labor Cost
F2(4)	Space Transport Cost
F3	ESS Life Cycle Cost
F4	Solar Array Interface Cost
F5(1)	Thermal Control Interface Cost

SYMBOL (Continued)PARAMETER

F5(2)	Power Conditioning Interface Cost
HØ	Orbit Altitude (Km)
IØ	Battery Cell Maximum Discharge Current (A)
I1	Battery Cell Charge Current (A)
KØ	Adjust Factor for % of Orbits During Which Battery Cycling Occurs
K1	Capacity Degradation Factor
K2	Voltage Degradation Factor
K5	Thermal Conductivity Factor
K6	Weight/Volume Determinant
LØ	Required Battery Cell Life (Yr)
L1	Total ESS Life (Yr)
L2	Expected Battery Cell Life (Yr)
N	Number of ESS Sides
NØ	Total Number of Battery Cycles
N1	ESS-to-Subsystems Efficiency
N2	Total Cells in Parallel
N3	Total Cells in Series
N4	Total Number of Cells
N5	ESS-to-Solar Array Efficiency
N6	ESS-to-Load Efficiency
N7	Watt-Hour Efficiency
N8	Number of Maintenance Cycles
PØ	Total Load Power (W)
P1	Subsystems Power (W)
P2	Battery Cell Minimum Discharge Power (W)
P3	ESS Minimum Power (W)
P4	Battery Cell Charge Power (W)
P5	Maximum Solar Array Power (W)
P6	Total ESS Power Required
Q(3)	ESS Length Factor
QØ	ESS Maximum Discharge Heat Load (W)
Q1	ESS Maximum Charge Heat Load (W)
Q2	ESS Maximum Cycle Heat Load (W)



SYMBOL (Continued)PARAMETERS

Q3	ESS Length Factor
RØ	Battery Cell Recharge Fraction
SØ(1)	Battery Cell Width (cm)
SØ(2)	Battery Module Width (cm)
SØ(3)	BRPC Width (cm)
SØ(4)	Charger (P3) Width (cm)
SØ(5)	Length of ESS Side (Channel Width) (cm)
SØ(6)	ESS Diameter (cm)
S1(1)	Battery Cell Thickness (cm)
S1(2)	Maximum Battery Module Length (cm)
S1(3)	Minimum Battery Module Length (cm)
S1(4)	BRPC Length (cm)
S1(5)	Charger (P3) Length (cm)
S1(6)	Channel Length (cm)
S1(7)	ESS Length (cm)
S2(1)	Battery Cell Height (cm)
S2(2)	Battery Module Height
S2(3)	BRPC Height (cm)
S2(4)	Charger (P3) Height (cm)
S2(5)	Channel Height (cm)
S3(1)	Battery Cell Volume (cm <sup>3</sup> )
S3(2)	Large Battery Module Volume (cm <sup>3</sup> )
S3(3)	Small Battery Module Volume (cm <sup>3</sup> )
S3(4)	BRPC Volume (cm <sup>3</sup> )
S3(5)	Charger (P3) Volume (cm <sup>3</sup> )
S3(6)	Channel Volume (cm <sup>3</sup> )
S3(7)	ESS Volume (cm <sup>3</sup> )
S4(1)	Battery Cell Weight (Kg)
S4(2)	Battery Module Weight (Kg)
S4(3)	BRPC Weight (Kg)
S4(4)	Charger (P3) Weight (Kg)
S4(5)	ESS Channel Weight (Kg)
S4(6)	ESS Channel Interface Weight (Kg)
S4(7)	Total ESS Weight

SYMBOL (Continued)PARAMETER

S5(1)	Spares Factor
S5(2)	Total Number of Modules Produced During O&M
S5(3)	Total Man-Years During O&M
TØ	Orbit Period (Hr)
T1	Maximum Discharge Time (Hr)
T2	Transition Time Between Solar Array Power & ESS Power (Hr)
T3	Battery Cell Average Operating Temperature (°K)
T4	Maximum Charge Time (First Approximation) (Hr)
T5	Design Margin to Allow for Variations in Battery Cells
T6	Maximum Charge Time (Hr)
U	Number of Modules/Battery
U1	Number of Battery Cells Per Module (Avg)
VØ	Minimum ESS Voltage Required (V)
V1	Battery Cell EOL Minimum Voltage (V)
V2	Battery Cell Enthalpy Voltage (V)
V3	Battery Cell Charge Voltage (V)
V4	ESS Total Voltage (V)
W(1)	D&D Cost Factor
W(2)	Subsystem Test Hardware Cost Factor
W(3)	Subsystem Test Hardware Assembly Cost Factor
W(4)	Subsystem Test Operations Cost Factor
W(5)	Test Support Equipment Cost Factor
W(6)	Subsystem Engineering and Integration Cost Factor
W(7)	Subsystem Program Management Cost Factor
WØ	Maximum Solar Array Weight (Kg)
W1	Maximum Thermal Control Weight (Kg)

PARAMETER	RELATIONSHIP	VARIABLES	BOI	EOL
Total ESS power required	$P6 = \frac{P\emptyset}{N6} + \frac{P1}{N1}$	<p>P6 = Total ESS power required</p> <p>_____</p> <p>P<math>\emptyset</math> = Total load power (W)</p> <p>N6 = ESS-to-load efficiency</p> <p>P1 = Subsystems power (W)</p> <p>N1 = ESS-to-subsystems efficiency</p>		
Total ESS capacity required	$C\emptyset = \frac{P6 \times T1}{V\emptyset}$	<p>C<math>\emptyset</math> = Total ESS capacity required (AH)</p> <p>_____</p> <p>P6 = Total ESS Power Required (W)</p> <p>T1 = Maximum discharge time (Hr)</p> <p>V<math>\emptyset</math> = Minimum ESS voltage (V)</p>		
Total battery life	$L\emptyset = L2 = N\emptyset N8 / 5840$	<p>L<math>\emptyset</math> = Required battery cell life (Yr)</p> <p>L2 = Expected battery cell life (Hr)</p> <p>_____</p> <p>N<math>\emptyset</math> = Total number of Battery Cycles</p> <p>N8 = Number of maintenance cycles</p>		

PARAMETER	RELATIONSHIP	VARIABLES	BOL	EOL
Depth of discharge (first approximation)	$D9 = f(L\phi, T3)$	<p>D9 = Maximum battery cell depth of discharge</p> <p>L<math>\phi</math> = Required battery cell life (Yr)</p> <p>T3 = Battery cell average operating temperature (<math>^{\circ}</math>K)</p>		
Battery cell EOL maximum discharge	$E\phi = \frac{C\phi}{N2}$	<p>E<math>\phi</math> = EOL maximum discharge (AH)</p> <p>C<math>\phi</math> = Total ESS capacity (AH)</p> <p>N2 = Total cells in parallel</p>		
Capacity degradation factor, voltage degradation factor	$K1, K2 = (.891)^{L\phi/L2}$	<p>K1 = Capacity degradation factor</p> <p>K2 = Voltage degradation factor</p> <p>L<math>\phi</math> = Total battery life (Yr)</p> <p>L2 = Expected battery cell</p>		
<p>Battery Cell Rated Capacity</p> <p>Battery cell EOL maximum discharge</p>	<p>If D = 0 Then (a) else (b)</p> <p>(a)</p> <p>C1 = 50</p> <p>E<math>\phi</math> = C1 * K1 * D9</p>	<p>C1 = Battery Cell Rated Capacity</p> <p>E<math>\phi</math> = Battery Cell EOL Maximum Discharge (AH)</p>		

PARAMETER	RELATIONSHIP	VARIABLES	EOL	EOL
Battery cell EOL maximum discharge	$E\emptyset = C\emptyset/N2$	<p><math>E\emptyset</math> = Battery cell EOL maximum discharge (AH)</p> <p>_____</p> <p><math>C\emptyset</math> = Total ESS capacity (AH)</p> <p><math>N2</math> = Total cells in parallel</p>		
Battery cell rated capacity	<p>(b)</p> <p><math>C1 = \text{CEIL} (E\emptyset/K1/D9/5) * 5</math></p>	<p><math>C1</math> = Battery cell capacity (AH)</p> <p>_____</p> <p><math>E\emptyset</math> = Battery cell EOL maximum discharge (AH)</p> <p><math>K1</math> = Capacity degradation factor</p> <p><math>D9</math> = Depth of discharge (first approximation)</p>		

PARAMETER	RELATIONSHIP	VARIABLES	BOL	EOL
Battery cell maximum discharge current	$I\emptyset = \text{CEIL} \frac{(E\emptyset/Tl * 1000)}{1000}$	$I\emptyset$ = Battery cell maximum discharge current (A)  $E\emptyset$ = Battery cell EOL maximum discharge (AH) $Tl$ = Maximum discharge time (Hr)		
Battery cell EOL maximum discharge	$E\emptyset = I\emptyset * Tl$	$E\emptyset$ = Battery cell EOL maximum discharge (AH)  $I\emptyset$ = Battery cell maximum discharge current (A) $Tl$ = Maximum discharge time (Hr)		
Battery cell maximum depth of discharge	$D\emptyset = E\emptyset/Cl/Kl$	$D\emptyset$ = Maximum battery cell depth of discharge  $E\emptyset$ = Battery cell EOL maximum discharge (AH) $Kl$ = Capacity degradation factor $Cl$ = Battery cell capacity (AH)		

PARAMETER	RELATIONSHIP	VARIABLES	BOL	EOL
Battery cell EOL minimum voltage	$V1 = \text{FLOOR} [K2 \times f(I\phi, D\phi, T3)]$	<p>V1 = Minimum EOL battery cell voltage (V)</p> <p>K2 = Voltage degradation factor</p> <p>I<math>\phi</math> = Battery cell maximum discharge current (A)</p> <p>D<math>\phi</math> = Battery cell maximum depth of discharge</p> <p>T3 = Battery cell average operating temperature (°K)</p>		
Total cells in series	$N3 = \text{CEIL} \left( \frac{V\phi}{V1} \right)$	<p>N3 = Total cells in series</p> <p>V<math>\phi</math> = Minimum ESS voltage (V)</p> <p>V1 = Minimum EOL battery cell voltage (V)</p>		
ESS total voltage	$V4 = N3 \times V1$	<p>V4 = ESS total voltage (V)</p> <p>N3 = Total cells in series</p> <p>V1 = Minimum EOL battery cell voltage (V)</p>		

PARAMETER	RELATIONSHIP	VARIABLES	BOL	EOL
Total number of cells	$N4 = N2 + N3$	<p>N4 = Total number of cells</p> <p>N2 = Total cells in parallel</p> <p>N3 = Total cells in series</p>		
Battery cell enthalpy voltage	$V2 = K2 \times f(T3)$	<p>V2 = Battery cell enthalpy voltage (V)</p> <p>K2 = Voltage degradation factor</p> <p>T3 = Battery cell average operating temperature (°K)</p>		
ESS maximum discharge heat load	$Q\emptyset = \text{CEIL} [I\emptyset \times (V2 - V1) \times N4]$	<p><math>Q\emptyset</math> = ESS maximum discharge heat load (W)</p> <p><math>I\emptyset</math> = Battery cell maximum discharge current (A)</p> <p>V2 = Battery cell enthalpy voltage (V)</p> <p>V1 = Minimum EOL battery cell voltage (V)</p> <p>N4 = Total number of cells</p>		



PARAMETER	RELATIONSHIP	VARIABLES	BOL	EOL
Battery cell minimum discharge power	$P2 = V1 \times I\phi$	<p>P2 = Battery cell minimum discharge power (W)</p> <p>V1 = Minimum EOL battery cell voltage (V)</p> <p>I<math>\phi</math> = Battery cell discharge current (A)</p>		
ESS minimum power	$P3 = P2 \times N4$	<p>P3 = ESS minimum power (W)</p> <p>P2 = Battery cell minimum discharge power (W)</p> <p>N4 = Total number of cells</p>		
Battery cell recharge fraction (NiCd)	$R\phi = f(P2, T3)$	<p>R<math>\phi</math> = Battery cell recharge fraction</p> <p>P2 = Battery cell minimum discharge power (W)</p> <p>T3 = Battery cell average operating temperature (<math>^{\circ}</math>K)</p>		
Battery cell charge throughput	$C4 = 1 - D\phi + R\phi \times D\phi$	<p>C4 = Battery cell charge throughput</p> <p>D<math>\phi</math> = Battery cell maximum depth of discharge</p> <p>R<math>\phi</math> = Maximum battery cell recharge fraction</p>		

PARAMETER	RELATIONSHIP	VARIABLES	SOL	EOL
Maximum charge time (first approximation)	$T4 = T\phi - T1 - T5$	<p>T4 = Maximum charge time (first approximation) (Hr)</p> <p>T<math>\phi</math> = Orbit period (Hr)</p> <p>T1 = Maximum discharge time (Hr)</p> <p>T5 = Design margin to allow for variations in battery cells (Hr)</p>		
Battery cell charge current	$I1 = \text{CEIL} \left( \frac{R\phi \times E\phi}{T4 \times 1000} \right)$	<p>I1 = Battery cell charge current (A)</p> <p>R<math>\phi</math> = Battery cell recharge fraction</p> <p>E<math>\phi</math> = Battery cell EOL maximum discharge (AH)</p> <p>T4 = Maximum charge time (Hr)</p>		
Battery cell charge voltage	$V3 = \text{CEIL} \left[ \frac{f(C4, I1, T3)}{K2} \right]$	<p>V3 = Battery cell charge voltage (V)</p> <p>C4 = Battery cell charge throughput</p> <p>I1 = Battery cell charge current (A)</p> <p>T3 = Battery cell average operating temperature (<math>^{\circ}</math>K)</p> <p>K2 = Voltage degradation factor</p>		

PARAMETER	RELATIONSHIP	VARIABLES	BOL	EOL
Maximum charge time	$T6 = \frac{R\emptyset \times E\emptyset}{I1}$	<p>T6 = Maximum charge time (Hr)</p> <p>R<math>\emptyset</math> = Maximum battery cell re-charge fraction</p> <p>E<math>\emptyset</math> = Battery cell discharge (AH)</p> <p>I1 = Battery cell charge rate (A)</p>		
Battery cell charge power	$P4 = I1 \times V3$	<p>P4 = Maximum battery cell input power (W)</p> <p>I1 = Battery cell charge rate (A)</p> <p>V3 = Maximum battery cell charge voltage (V)</p>		
Watt-hour efficiency	$N7 = P2 \times T1/P4/T6$	<p>N7 = Minimum battery cell watt-hour charge efficiency</p> <p>P2 = Minimum battery cell discharge power (W)</p> <p>T1 = Maximum discharge time (Hr)</p> <p>P4 = Maximum battery cell input charge power (W)</p> <p>T6 = Maximum charge time (Hr)</p>		

PARAMETER	RELATIONSHIP	VARIABLES	DOL	EOL
Maximum solar array power	$P5 = \frac{P4 \times N4}{N5}$	<p>P5 = Maximum solar array power (W)</p> <p>P4 = Battery cell charge power (W)</p> <p>N4 = Total number of cells</p> <p>N5 = ESS-to-solar array efficiency</p>		
Maximum solar array weight	$W\phi = \text{CEIL} (.0205 \times P5)$	<p>W<math>\phi</math> = Maximum solar array weight (Kg)</p> <p>P5 = Maximum solar array power (W)</p>		
ESS maximum charge heat load	$Q1 = \frac{\text{CEIL} [P4 \times N4 - (P3 + Q\phi) \times T1]}{T6}$	<p>Q1 = ESS maximum charge heat load (W)</p> <p>P4 = Battery cell charge power (W)</p> <p>N4 = Total number of cells</p> <p>P3 = ESS minimum power (W)</p> <p>Q<math>\phi</math> = ESS maximum discharge heat load (W)</p> <p>T1 = Maximum discharge time (Hr)</p> <p>T6 = Maximum charge time (Hr)</p>		

PARAMETER	RELATIONSHIP	VARIABLES	BOL	EOL
ESS maximum cycle heat load	$Q2 = \text{CEIL} \left[ \text{MAX} \left( \frac{Q\beta}{2}, Q1 \right) \right]$	<p>Q2 = ESS maximum cycle heat load (W)</p> <p>Qβ = ESS maximum discharge heat load (W)</p> <p>Q1 = ESS maximum charge heat load (W)</p>		
Maximum thermal control weight	$W1 = \text{CEIL} \left[ \frac{Q2}{(4.716 \times 10^{-9}) \times K5 \times (T3^4 - 255^4)} \right]$	<p>W1 = Maximum thermal control weight (Kg)</p> <p>Q2 = ESS maximum cycle heat load (W)</p> <p>K5 = Thermal conductivity factor</p> <p>T3 = Battery cell average operating temperature (°K)</p>		
Battery cell width	$S\beta(1) = \begin{matrix} 5.4 \text{ for } 6 < Cl < 9 \\ 7.6 \text{ for } 10 < Cl < 30 \\ 12.7 \text{ for } 31 < Cl < 60 \\ 18.2 \text{ for } 61 < Cl < 135 \\ 27.8 \text{ for } 136 < Cl < 300 \end{matrix}$	<p>Sβ(1) = Battery cell width (cm)</p> <p>Cl = Battery cell capacity (AH)</p>		
Battery cell thickness	$S1(1) = \begin{matrix} 2.1 \text{ for } 6 < Cl < 9 \\ 2.3 \text{ for } 10 < Cl < 30 \\ 3.3 \text{ for } 31 < Cl < 60 \\ 3.9 \text{ for } 61 < Cl < 135 \\ 5.7 \text{ for } 136 < Cl < 300 \end{matrix}$	<p>S1(1) = Battery cell thickness (cm)</p> <p>Cl = Battery cell capacity (AH)</p>		

PARAMETER	RELATIONSHIP	VARIABLES	BOL	EOL
Battery cell height	$S2(1) = \text{INT} [(11.26 \times (-4.074 + 12.98 \times Cl) / S\phi(1)) / SI(1) + .5] / 10$	<p>S2(1) = Battery cell height (cm)</p> <p>Cl = Battery cell capacity (AH)</p> <p>Sφ(1) = Battery cell width (cm)</p> <p>SI(1) = Battery cell thickness (cm)</p>		
Battery module height	$S2(2) = (1.34 \times S2(1) + .5) / 10$	<p>S2(2) = Battery module height (cm)</p> <p>S2(1) = Battery cell height</p>		
ESS diameter	$S\phi(6) = 457$	<p>Sφ(6) = ESS diameter (cm)</p>		
Number of ESS sides	<p>If N2 &gt; 8 then <math>N = \frac{N2}{8}</math></p> <p>Else N = N2</p>	<p>N = Number of ESS sides</p> <p>N2 = Total cells in parallel</p>		
Length of ESS side (channel width)	$S\phi(5) = \text{INT} (S\phi(6) \times \text{SIN} (180/N) \times 10 + .5) / 10$	<p>Sφ(5) = Length of ESS side (channel width) (cm)</p> <p>N = Number of ESS sides</p> <p>Sφ(6) = ESS diameter (cm)</p>		

PARAMETER	RELATIONSHIP	VARIABLES	BOL	EOL
Number of modules/ battery	$U = 2 \times \text{CEIL} \left[ \frac{N3}{2} / S\emptyset(5) - \right. \\ \left. 2 \times S2(2) \times \text{TAN} (180/N) \right. \\ \left. \times 2.2 \times 1.402 \times SI(1) \right]$	<p>U = Number of modules/battery</p> <p>N3 = Total cells in series</p> <p>S<math>\emptyset</math>(5) = Length of ESS side (channel width) (cm)</p> <p>S2(2) = Battery module height (cm)</p> <p>N = Number of ESS sides</p> <p>SI(1) = Battery cell thickness (cm)</p>		
Number of battery cells per module	$U1 = \text{INT} (N3/U \times 100 + .5) / 100$	<p>U1 = Number of battery cells per module (Avg)</p> <p>N3 = Total cells in series</p> <p>U = Number of modules/battery</p>		
Battery cell weight	$S4(1) = .05685 + .03941 \times C1$	<p>S4(1) = Battery cell weight (Kg)</p> <p>C1 = Battery cell capacity (AH)</p>		
Battery module weight	$S4(2) = 1.037 \times [N3/U \times S4(1)] + .03 \times I\emptyset$	<p>S4(2) = Battery module weight (Kg)</p> <p>N3 = Total cells in series</p> <p>U = Number of modules/channel</p> <p>S4(1) = Battery cell weight (Kg)</p> <p>I<math>\emptyset</math> = Battery cell maximum discharge current (A)</p>		

PARAMETER	RELATIONSHIP	VARIABLES	BCZ	EOL
Small battery module volume	$S3(3) = \text{INT}(S1(3) \times S\emptyset(2) \times S2(2) + .5)$	<p>S3(3) = Small battery module volume (cm<sup>3</sup>)</p> <p>_____</p> <p>S1(3) = Minimum battery module length (cm)</p> <p>S\emptyset(2) = Battery module width (cm)</p> <p>S2(2) = Battery module height (cm)</p>		
BRPC length	$S1(4) = \text{INT}(20.3 \times N3/T1 + .5) / 10$	<p>S1(4) = BRPC length (cm)</p> <p>_____</p> <p>N3 = Total cells in series</p> <p>T1 = Maximum discharge time (Hr)</p>		
BRPC volume	$S3(4) = S1(4) \times S\emptyset(3) \times S2(3)$	<p>S3(4) = BRPC volume (cm<sup>3</sup>)</p> <p>_____</p> <p>S1(4) = BRPC length (cm)</p> <p>S\emptyset(3) = BRPC width (cm)</p> <p>S2(3) = BRPC height (cm)</p>		
Charger (P3) volume	$S3(5) = S1(5) \times S\emptyset(4) \times S2(4)$	<p>S3(5) = Charger (P3) volume (cm<sup>3</sup>)</p> <p>_____</p> <p>S1(5) = Charger (P3) length (cm)</p> <p>S\emptyset(4) = Charger (P3) width (cm)</p> <p>S2(4) = Charger (P3) height (cm)</p>		



PARAMETER	RELATIONSHIP	VARIABLES	BOL	EOL
Channel length	$S1(6) = \text{INT}[(12.5 \times (\text{CELL}(U) / 2)) \times S\phi(2) + S2(4) + .5] / 10$	<p>S1(6) = Channel length (cm)</p> <p>U = Number of modules/battery</p> <p>S<math>\phi</math>(2) = Battery module width (cm)</p> <p>S2(4) = Charger height</p>		
ESS total weight	$S4(7) = \text{CEIL}(N2 \times (S4(5) + S4(6)) + .015 \times (Q(3) \times N - N2) \times S1(6) \times S\phi(5) + .5)$	<p>S4(7) = ESS total weight (Kg)</p> <p>N = Number of ESS sides</p> <p>N2 = Total cells in parallel</p> <p>Q(3) = ESS length factor</p> <p>S4(5) = ESS channel weight (kg)</p> <p>S1(6) = Channel length (cm)</p> <p>S4(6) = ESS channel interface weight</p> <p>S<math>\phi</math>(5) = Length of ESS side (channel width) (cm)</p>		
Channel height	$S2(5) = \text{INT}(10.75 \times \text{MAX}(S2(2), S\phi(4)) + .5) / 10$	<p>S2(5) = Channel height (cm)</p> <p>S2(2) = Battery module height (cm)</p> <p>S<math>\phi</math>(4) = Charger (P3) width (cm)</p>		

PARAMETER	RELATIONSHIP	VARIABLES	BOL	EOL
Channel volume	$S3(6) = \text{INT}(S1(6) \times S\emptyset(5) \times S2(5)) + .5$	<p>S3(6) = Channel volume (cm<sup>3</sup>)</p> <p>S1(6) = Channel length (cm)</p> <p>S∅(5) = Length of ESS side (Channel width) (cm)</p> <p>S2(5) = Channel height (cm)</p>		
ESS length	$S1(7) = S1(6) \times Q(3)$	<p>S1(7) = ESS length (cm)</p> <p>Q(3) = ESS length factor</p> <p>S1(6) = Channel length (cm)</p>		
ESS volume	$S3(7) = \text{INT}(S1(7) \times \frac{N}{4} [S\emptyset(5)]^2 \times \text{COT}(\frac{180}{N}) + .5)$	<p>S3(7) = ESS volume (cm<sup>3</sup>)</p> <p>S1(7) = ESS length (cm)</p> <p>N = Number of ESS sides</p> <p>S∅(5) = Length of ESS side (Channel width) (cm)</p>		
Battery cell unit cost	$F\emptyset(1) = \text{INT}((.0414 \times C1)^2 + 3.123 \times C1 + 700) \times N4 - .1047 + .5$	<p>F∅(1) = Battery cell unit cost (1980 \$M)</p> <p>C1 = Battery cell capacity (AM)</p> <p>N4 = Total number of cells</p>		

PARAMETER	RELATIONSHIP	VARIABLES	BOL	EOL
Cell matching cost	$F\emptyset(2) = \text{INT}(.34 * N4 + .0014 * F\emptyset(1) * N4 + 723 + .5)/1000$	<p><math>F\emptyset(2)</math> = Cell matching cost (1980 \$K)</p> <p>_____</p> <p><math>N4</math> = Total number of cells</p> <p><math>F\emptyset(1)</math> = Battery cell unit cost (1980 \$K)</p>		
Module assembly cost	$F\emptyset(3) = \text{INT}(.25 * N4 + .13 * N4 * S4(1) + 1049 + .5)/1000$	<p><math>F\emptyset(3)</math> = Module Assembly Cost (1980 \$M)</p> <p>_____</p> <p><math>N4</math> = Total number of cells</p> <p><math>S4(1)</math> = Battery cell weight (Kg)</p>		
Power channel assembly cost	$F\emptyset(4) = \text{INT}(.705 * N2 * U * S4(2) + 607 + .5)/1000$	<p><math>F\emptyset(4)</math> = Power channel assembly cost (1980 \$M)</p> <p>_____</p> <p><math>N2</math> = Total cells in parallel</p> <p><math>U</math> = Number of modules/battery</p> <p><math>S4(2)</math> = Battery module weight (Kg)</p>		
Subsystem assembly cost	$F\emptyset(5) = \text{INT}(.172 * N2 * S4(5) + S4(6)) + 1329 + .5)/1000$	<p><math>F\emptyset(5)</math> = Subsystem assembly cost (1980 \$M)</p> <p>_____</p> <p><math>N2</math> = Total cells in parallel</p> <p><math>S4(5)</math> = ESS channel weight (Kg)</p> <p><math>S4(6)</math> = ESS channel interface weight (Kg)</p>		

PARAMETER	RELATIONSHIP	VARIABLES	BOL	EOL
Acceptance & surface transport cost	$F\emptyset(6) = \text{INT}(.32 * N4 + .045 * S4(7) + 694 + .5) / 1000$	$F\emptyset(6) = \text{Acceptance and surface transport cost (1980\$M)}$ $N4 = \text{Total number of cells}$ $S4(7) = \text{ESS total weight (Kg)}$		
Prelaunch integration and checkout cost	$F\emptyset(7) = \text{INT}(.039 * S4(7) + 60 + .5) / 1000$	$F\emptyset(7) = \text{Prelaunch integration and checkout cost (1980\$M)}$ $S4(7) = \text{ESS total weight (Kg)}$		
Wt./Vol. determinant	$K6 = \text{CEIL}(14.136 * S7(1)) / S4(7)$	$K6 = \text{Wt./Vol. determinant}$ $S7(1) = \text{ESS length (cm)}$ $S4(7) = \text{ESS total weight (Kg)}$		
Space transport cost	$L = 5, \text{ GEO}$ If L = 5 Then $F\emptyset(8) = \text{INT}(5.1 + 8.14 * K6) * S4(7) + .5) / 1000$ $L \neq 5, \text{ LEO}$ If L # 5 Then $F\emptyset(8) = \text{INT}(1.99 * K6 * S4(7) + .5) / 1000$	$F\emptyset(8) = \text{Space transport cost (1980 \$M)}$ $K6 = \text{Wt./Vol. determinant}$ $S4(7) = \text{ESS total weight (Kg)}$		
Space deployment & checkout cost	$F\emptyset(9) = \text{INT}(.011 * S4(7) + .5) / 1000$	$F\emptyset(9) = \text{Space deployment & checkout cost (1980 \$M)}$ $S4(7) = \text{ESS total weight (Kg)}$		

PARAMETER	RELATIONSHIP	VARIABLES	BOL	EOL
Production cost	$F\emptyset = F\emptyset(2) + F\emptyset(3) + F\emptyset(4) + F\emptyset(5) + F\emptyset(6) + F\emptyset(7) + F\emptyset(8) + F\emptyset(9)$	<p><math>F\emptyset</math> = Production cost (1980 \$M)</p> <p>_____</p> <p><math>F\emptyset(2)</math> = Cell matching cost</p> <p><math>F\emptyset(3)</math> = Module assembly cost</p> <p><math>F\emptyset(4)</math> = Power Channel assembly cost</p> <p><math>F\emptyset(5)</math> = Subsystem assembly cost</p> <p><math>F\emptyset(6)</math> = Acceptance &amp; surface transport cost</p> <p><math>F\emptyset(7)</math> = Prelaunch integration &amp; checkout cost</p> <p><math>F\emptyset(8)</math> = Space transport cost</p> <p><math>F\emptyset(9)</math> = Space deployment &amp; checkout cost</p>		
D&D cost	$F1(1) = \text{INT}(844 * S4(7) \cdot 203 + .5/1000)$	<p><math>F1(1)</math> = D&amp;D cost (1980 \$M)</p> <p>_____</p> <p><math>S4(7)</math> = ESS total weight (Kg)</p>		
Subsystem test hardware cost	$F1(2) = \text{INT}[989 * ((1 + S5(1)) * F\emptyset(2) + F\emptyset(3) + F\emptyset(4) + F\emptyset(5) + F\emptyset(6))]1.064 + .5/1000$	<p><math>F1(2)</math> = Subsystem test hardware cost (1980 \$M)</p> <p>_____</p> <p><math>S5(1)</math> = Spares factor</p> <p><math>F\emptyset(2)</math> = Cell matching cost</p> <p><math>F\emptyset(3)</math> = Module assembly cost</p> <p><math>F\emptyset(4)</math> = Power channel assembly cost</p> <p><math>F\emptyset(5)</math> = Subsystem assembly cost</p> <p><math>F\emptyset(6)</math> = Acceptance &amp; surface transport cost</p>		

PARAMETER	RELATIONSHIP	VARIABLES	BOL	EOL
Subsystem test hardware assembly cost	$F1(3) = INT(217 * F1(2) * .789 + .5) / 1000$	$F1(3) =$ Subsystem test hardware assembly cost (1980 \$M)  $F1(2) =$ Subsystem test hardware cost		
Subsystem test operations cost	$F1(4) = INT(828 * F1(2) * .397 + .5) / 1000$	$F1(4) =$ Subsystem test operations cost (1980 \$M)  $F1(2) =$ Subsystem test hardware cost		
Test support equipment cost	$F1(5) = INT(109 * F1(1) + F1(2) + F1(3) + F1(4)) * 1.025 + .5) / 1000$	$F1(5) =$ Test support equipment cost (1980 \$M)  $F1(1) =$ D&D cost $F1(2) =$ Subsystem test hardware cost $F1(3) =$ Subsystem test hardware assembly cost $F1(4) =$ Subsystem test operations cost		
Subsystem engineering and integration cost	$F1(6) = INT(94 * F1(1) + F1(2) + F1(3) + F1(4) + F1(5)) * .865 + .5) / 1000$	$F1(6) =$ Subsystem engineering & integration cost (1980\$M)  $F1(1) =$ D&D cost $F1(2) =$ Subsystem test hardware cost		

PARAMETER	RELATIONSHIP	VARIABLES	BOL	EOL
Subsystem engineering and integration cost (Continued)		F1(3) = Subsystem test hardware assembly cost F1(4) = Subsystem test operations cost F1(5) = Test support equipment cost		
Subsystem program management cost	$F1(7) = INT(131 * (F1(1) + F1(2) + F1(3) + F1(4) + F1(5) + F1(6)) * .865 + .5) / 1000$	F1(7) = Subsystem program management cost (1980\$M) _____ F1(1) = D&D cost F1(2) = Subsystem test hardware cost F1(3) = Subsystem test hardware assembly cost F1(4) = Subsystem test operations cost F1(5) = Test support equipment cost F1(6) = Subsystem engineering and integration cost		

PARAMETER	RELATIONSHIP	VARIABLES	BOL	EOL
DVT&E cost	$F1 = W(1) * F1(1) + W(2) * F1(2) + W(3) * F1(3) + W(4) * F1(4) + W(5) * F1(5) + W(6) * F1(6) + W(7) * F1(7)$ $F1 = INT(F1 * 1000 + .5) / 1000$	<p>F1 = DVT&amp;E Cost (1980 \$M)</p> <hr/> <p>W(1) = D&amp;D cost factor  F1(1) = D&amp;D cost</p> <p>W(2) = Subsystem test hardware cost factor  F1(2) = Subsystem test hardware cost</p> <p>W(3) = Subsystem test hardware assembly cost factor  F1(3) = Subsystem test hardware assembly cost</p> <p>W(4) = Subsystem test operations cost factor  F1(4) = Subsystem test operations cost</p> <p>W(5) = Test support equipment cost factor  F1(5) = Test support equipment cost</p> <p>W(6) = Subsystem engineering &amp; integration cost factor  F1(6) = Subsystem engineering &amp; integration cost</p>		



PARAMETER	RELATIONSHIP	VARIABLES	BOL	EOL
DDT&E cost (Continued)		<p>W(7) = Subsystem program management cost factor</p> <p>F1(7) = Subsystem program management cost</p>		
Total number of modules produced during O&M	$S5(2) = N8 - 1 + N8 * S5(1)$	<p>S5(2) = Total number of modules produced during O&amp;M</p> <p>N8 = Number of maintenance cycles</p> <p>S5(1) = Spares Factor</p>		
Total man-years during O&M	$S5(3) = L1 * (.002 * N2 * U + .001 * N8 * CEIL(N2 + U * S5(1))) + .0015 * (N8 - 1) * N2 * U$	<p>S5(3) = Total man-years during O&amp;M</p> <p>L1 = Total ESS life (Yr)</p> <p>N2 = Total cells in parallel</p> <p>U = Number of modules/battery</p> <p>N8 = Number of maintenance cycles</p> <p>S5(1) = Spares factor</p>		
Spares manufacturing cost	$F2(1) = INT(S5(2) * F\emptyset(2) + F\emptyset(3)) * 1000 + .5) / 1000$	<p>F2(1) = Spares manufacturing cost (1980 \$M)</p> <p>S5(2) = Total number of modules produced during O&amp;M</p> <p>F\emptyset(2) = Cell matching cost</p> <p>F\emptyset(3) = Module assembly cost</p>		

PARAMETER	RELATIONSHIP	VARIABLES	BOL	EOL
Training cost	$F2(2) = INT(62.5 * S5(3) + .5) / 1000$	F2(2) = Training cost (1980 \$M) S5(3) = Total man-years during OEM		
Labor cost	$F2(3) = INT(390 * S5(3) + .5) / 1000$	F2(3) = Labor cost (1980 \$M) S5(3) = Total man-years during OEM		
Space transport cost	$F2(4) = INT(3600 * S5(3) + 1.99 * K6 * S5(2) * S4(2) * N2 * U + .5) / 1000$	F2(4) = Space transport cost (1980 \$M) S5(3) = Total man-years during OEM K6 = Weight/volume determinant S5(2) = Total number of modules produced during OEM S4(2) = Battery module weight (Kg) N2 = Total cells in parallel U = Number of modules/battery		
Operations and maintenance cost	$F2 = F2(1) + F2(2) + F2(3) + F2(4)$	F2 = Operations & Maintenance cost (1980 \$M) F2(1) = Spares manufacturing cost F2(2) = Training cost F2(3) = Labor cost F2(4) = Space transport cost		

PARAMETER	RELATIONSHIP	VARIABLES	BOL	EOL
ESS life cycle cost	$F3 = F\emptyset + F1 + F2$	<p>F3 = ESS life cycle cost (1980\$M)</p> <p>F<math>\emptyset</math> = Production cost</p> <p>F1 = DDT&amp;E cost</p> <p>F2 = Operations and maintenance cost</p>		
Solar array inter-face cost	<p><math>F4 = \text{IF } L = 5 \text{ Then } M = 23.8</math>  Else <math>M = 36.25 + .545 * L1</math></p> <p><math>F4 = \text{INT}(M * P5 \wedge .803 + .5) / 1000</math></p>	<p>F4 = Solar array interface cost (1980 \$M)</p> <p>M = Intermediate variable</p> <p>L1 = Total ESS life (Yr)</p> <p>P5 = Maximum solar array power (W)</p>		
Thermal control interface cost	$F5(1) = \text{INT}(5200 + .0825 * Q2 + 1.5 * W1 + .5) / 1000$	<p>F5(1) = Thermal control interface cost (1980 \$M)</p> <p>Q2 = ESS maximum cycle heat load (W)</p> <p>W1 = Maximum thermal control weight (Kg)</p>		
Power conditioning interface cost	$F5(2) = \text{INT}(200 * N2^{.848} + .5) / 1000$	<p>F5(2) = Power conditioning interface cost (1980 \$M)</p> <p>N2 = Total cells in parallel</p>		

PARAMETER	RELATIONSHIP	VARIABLES	BOL	EOL
Total life cycle cost	$F = F3 + F4 + F5(1) + F5(2)$	<p>F = Total life cycle cost (1980\$M)</p> <p>F3 = ESS life cycle cost</p> <p>F4 = Solar array interface cost</p> <p>F5(1) = Thermal control interface cost</p> <p>F5(2) = Power conditioning interface cost</p>		

SYMBOLPARAMETER

C0	Total ESS Capacity (AH)
C1	Battery Cell Rated Capacity (AH)
C4	Battery Cell Charge Throughput
D0	Battery Cell Maximum Depth of Discharge
D9	Depth of Discharge (first approximation)
E0	Battery Cell EOL Maximum Discharge (AH)
F	Total Life Cycle Cost (1980 \$ M)
F0	Production Cost
F0(1)	Battery Cell Unit Cost
F0(2)	Cell Matching Cost
F0(3)	Module Assembly Cost
F0(4)	Power Channel Assembly Cost
F0(5)	Subsystem Assembly Cost
F0(6)	Acceptance & Surface Transport Cost
F0(7)	Prelaunch Integration & Checkout Cost
F0(8)	Space Transport Cost
F0(9)	Space Deployment & Checkout Cost
F1	DDT&E Cost
F1(1)	D&D Cost
F1(2)	Subsystem Test Hardware Cost
F1(3)	Subsystem Test Hardware Assembly Cost
F1(4)	Subsystem Test Operations Cost
F1(5)	Test Support Equipment Cost
F1(6)	Subsystem Engineering & Integration Cost
F1(7)	Subsystem Program Management Cost
F2	Operations and Maintenance Cost
F2(1)	Spares Manufacturing Cost
F2(2)	Training Cost
F2(3)	Labor Cost
F2(4)	Space Transport Cost
F3	ESS Life Cycle Cost
F4	Solar Array Interface Cost
F5(1)	Thermal Control Interface Cost

SYMBOL (Continued)PARAMETER

F5(2)	Power Conditioning Interface Cost
H $\emptyset$	Orbit Altitude (Km)
I $\emptyset$	Battery Cell Maximum Discharge Current (A)
I1	Battery Cell Charge Current (A)
K $\emptyset$	Adjustment Factor for % of Orbits During Which Battery Cycling Occurs
K1	Capacity Degradation Factor
K2	Voltage Degradation Factor
K5	Thermal Conductivity Factor
K6	Weight/Volume Determinant
L $\emptyset$	Required Battery Cell Life (Yr)
L1	Total ESS Life (Yr)
L2	Expected Battery Cell Life (Yr)
N	Number of Sides
N(1)	Number of Large Modules/Power Channel Length
N(2)	Number of Small Modules/Power Channel Length
N(3)	Number of Modules/Power Channel Length
N(4)	Number of Modules/Power Channel Width
N $\emptyset$	Total Number of Battery Cycles
N1	ESS-to-Subsystem Efficiency
N2	Total Cells in Parallel
N3	Total Cells in Series
N4	Total Number of Cells
N5	ESS-to-Solar Array Efficiency
N6	ESS-to-Load Efficiency
N7	Watt-Hour Efficiency
N8	Number of Maintenance Cycles
P $\emptyset$	Total Load Power (W)
P1	Subsystems Power (W)
P2	Battery Cell Minimum Discharge Power (W)
P3	ESS Minimum Power (W)
P4	Battery Cell Charge Power (W)
P5	Maximum Solar Array Power (W)
P6	Total ESS Power Required
Q(3)	ESS Length Factor
Q $\emptyset$	ESS Maximum Discharge Heat Load (W)

SYMBOL (Continued)PARAMETER

Q1	ESS Maximum Charge Heat Load (W)
Q2	ESS Maximum Cycle Heat Load (W)
R $\emptyset$	Battery Cell Recharge Fraction
S $\emptyset$ (1)	Maximum Battery Module Width (cm)
S $\emptyset$ (2)	Minimum Battery Module Width (cm)
S $\emptyset$ (3)	BRPC Width (cm)
S $\emptyset$ (4)	Charger (P3) Width (cm)
S $\emptyset$ (5)	Length of ESS Side (Power Channel Width) (cm)
S $\emptyset$ (6)	ESS Diameter (cm)
S1(1)	Battery Cell Diameter (cm)
S1(2)	Battery Module Length (cm)
S1(3)	Maximum Usable Power Channel Width (cm)
S1(4)	BRPC Length (cm)
S1(5)	Charger (P3) Length (cm)
S1(6)	Power Channel Length (cm)
S1(7)	ESS Length (cm)
S2(1)	Battery Cell Length (cm)
S2(2)	Battery Module Height
S2(3)	BRPC Height (cm)
S2(4)	Charger (P3) Height (cm)
S2(5)	Power Channel Height (cm)
S3(1)	Battery Cell Volume (cm <sup>3</sup> )
S3(2)	Large Battery Module Volume (cm <sup>3</sup> )
S3(3)	Small Battery Module Volume (cm <sup>3</sup> )
S3(4)	BRPC Volume (cm <sup>3</sup> )
S3(5)	Charger (P3) Volume (cm <sup>3</sup> )
S3(6)	Power Channel Volume (cm <sup>3</sup> )
S3(7)	ESS Volume (cm <sup>3</sup> )
S4(1)	Battery Cell Weight (Kg)
S4(2)	Battery Module Weight (Kg)
S4(3)	BRPC Weight (Kg)
S4(4)	Charger (P3) Weight (Kg)
S4(5)	Power Channel Weight (Kg)

SYMBOL (Continued)PARAMETER

S4(6)	Power Channel Interface Weight (Kg)
S4(7)	Total ESS Weight
S5(1)	Spares Factor
S5(2)	Total Number of Modules, Produced During O&M
S5(3)	Total Manyears During O&M
TØ	Orbit Period (Hr)
T1	Maximum Discharge Time (Hr)
T2	Transition Time Between Solar Array Power & ESS Power (Hr)
T3	Battery Cell Average Operating Temperature (°K)
T4	Maximum Charge Time (first approximation) (Hr)
T5	Design Margin to Allow for Variations in Battery Cells (Hr)
T6	Maximum Charge Time (Hr)
U	Number of Modules/Battery
U1	Number of Battery Cells Per Module (Avg)
VØ	Minimum ESS Voltage Required (V)
V1	Battery Cell EOL Minimum Voltage (V)
V2	Battery Cell Enthalpy Voltage (V)
V3	Battery Cell Charge Voltage (V)
V4	ESS Total Voltage (V)
W(1)	D&D Cost Factor
W(2)	Subsystem Test Hardware Cost Factor
W(3)	Subsystem Test Hardware Assembly Cost Factor
W(4)	Subsystem Test Operations Cost Factor
W(5)	Test Support Equipment Cost Factor
W(6)	Subsystem Engineering and Integration Cost Factor
W(7)	Subsystem Program Management Cost Factor
WØ	Maximum Solar Array Weight (Kg)
W1	Maximum Thermal Control Weight (Kg)



PARAMETER	RELATIONSHIP	VARIABLES	BOL	EOL
Orbit period	$T\emptyset = \frac{(2.7645 \times 10^{-6}) \times (6375 + H\emptyset)^{3/2}}{T\emptyset}$	<p><math>T\emptyset</math> = Orbit period (Hr)</p> <p><math>H\emptyset</math> = Orbit altitude (Km)</p>		
Total number of battery cycles	$N\emptyset = \frac{8766 \times K\emptyset}{T\emptyset} \times L1$	<p><math>N\emptyset</math> = Total number of battery cycles</p> <p><math>K\emptyset</math> = Adjustment factor for # of orbits during which battery cycling occurs</p> <p><math>T\emptyset</math> = Orbit period (Hr)</p> <p><math>L1</math> = Total ESS life (Yr)</p>		
Maximum discharge time	$T1 = \frac{T\emptyset}{180} [90 - \cos^{-1} \left( \frac{6375}{6375 + H\emptyset} \right)] + T2$	<p><math>T1</math> = Maximum discharge time (Hr)</p> <p><math>T\emptyset</math> = Orbit period (Hr)</p> <p><math>H\emptyset</math> = Orbit altitude (Km)</p> <p><math>T2</math> = Transition time between solar array power and ESS power (Hr)</p>		

PARAMETER	RELATIONSHIP	VARIABLES	BOL	EOL
Total ESS power required	$P6 = \frac{P\phi}{N6} + \frac{P1}{N1}$	P6 = Total ESS power required Pφ = Total load power (W) N6 = ESS-to-load efficiency P1 = Subsystems power (W) N1 = ESS-to-subsystems efficiency		
Total ESS capacity required	$C\phi = \frac{P6 \times T1}{V\phi}$	Cφ = Total ESS capacity required (AH) P6 = Total ESS power required (W) T1 = Maximum discharge time (Hr) Vφ = Minimum ESS voltage required (V)		
Total battery life	$L\phi, L2 = N\phi/N8/5840$	Lφ = Required battery cell life (Yr) L2 = Expected battery cell life (Yr) Nφ = Total number of battery cycles N8 = Number of maintenance cycles		

PARAMETER	RELATIONSHIP	VARIABLES	BOL	EOL
Depth of discharge (first approximation)	$D9 = f(L\phi, T3)$	D9 = Maximum battery cell depth of discharge  L $\phi$ = Required battery cell life (Yr) T3 = Battery cell average operating temperature ( $^{\circ}$ K)		
Battery cell EOL maximum discharge	$E\phi = \frac{C\phi}{N2}$	E $\phi$ = EOL maximum discharge (AH)  C $\phi$ = Total ESS capacity (AH) N2 = Total cells in parallel		
Capacity degradation factor, voltage degradation factor	$K1, K2 = (.891)^{L\phi/L2}$	K1 = Capacity degradation factor K2 = Voltage degradation factor  L $\phi$ = Total battery life (Yr) L2 = Expected battery cell		
Battery Cell Rated Capacity  Battery cell EOL maximum discharge	If D = 0 Then (a) else (b) (a) C1 = 50  E $\phi$ = C1 * K1 * D9	C1 = Battery Cell Rated Capacity  E $\phi$ = Battery Cell EOL Maximum Discharge (AH)		

PARAMETER	RELATIONSHIP	VARIABLES	BOL	EOL
Battery cell EOL maximum discharge	$E\phi = C\phi/N2$	<p><math>E\phi</math> = Battery cell EOL maximum discharge (AH)</p> <p>_____</p> <p><math>C\phi</math> = Total ESS capacity (AH)</p> <p><math>N2</math> = Total cells in parallel</p>		
Battery cell rated capacity	<p>(b)</p> <p><math>C1 = CEIL (E\phi/K1/D9/5) * 5</math></p>	<p><math>C1</math> = Battery cell capacity (AH)</p> <p>_____</p> <p><math>E\phi</math> = Battery cell EOL maximum discharge (AH)</p> <p><math>K1</math> = Capacity degradation factor</p> <p><math>D9</math> = Depth of discharge (first approximation)</p>		

PARAMETER	RELATIONSHIP	VARIABLES	BOL	EOL
Battery cell maximum discharge current	$I\phi = \text{CEIL} \frac{(E\phi/Tl * 1000)}{1000}$	<p><math>I\phi</math> = Battery cell maximum discharge current (A)</p> <p>_____</p> <p><math>E\phi</math> = Battery cell EOL maximum discharge (AH)</p> <p><math>Tl</math> = Maximum discharge time (Hr)</p>		
Battery cell EOL maximum discharge	$E\phi = I\phi * Tl$	<p><math>E\phi</math> = Battery cell EOL maximum discharge (AH)</p> <p>_____</p> <p><math>I\phi</math> = Battery cell maximum discharge current (A)</p> <p><math>Tl</math> = Maximum discharge time (Hr)</p>		
Battery cell maximum depth of discharge	$D\phi = E\phi/Cl/Kl$	<p><math>D\phi</math> = Maximum battery cell depth of discharge</p> <p>_____</p> <p><math>E\phi</math> = Battery cell EOL maximum discharge (AH)</p> <p><math>Kl</math> = Capacity degradation factor</p> <p><math>Cl</math> = Battery cell capacity (AH)</p>		

PARAMETER	RELATIONSHIP	VARIABLES	BOL	EOL
Battery cell maximum discharge current	$I\phi = \text{CEIL} \left( \frac{E\phi/T1 * 1000}{1000} \right)$	<p><math>I\phi</math> = Battery cell maximum discharge current (A)</p> <p><math>E\phi</math> = Battery cell EOL maximum discharge (AH)</p> <p><math>T1</math> = Maximum discharge time (Hr)</p>		
Battery cell EOL maximum discharge (AH)	$E\phi = I\phi * T1$	<p><math>E\phi</math> = Battery cell EOL maximum discharge (AH)</p> <p><math>I\phi</math> = Battery cell maximum discharge current (A)</p> <p><math>T1</math> = Maximum discharge time (Hr)</p>		
Battery cell maximum depth of discharge	$D\phi = E\phi/C1/K1$	<p><math>D\phi</math> = Maximum battery cell depth of discharge</p> <p><math>E\phi</math> = Battery cell EOL maximum discharge (AH)</p> <p><math>K1</math> = Capacity degradation factor</p> <p><math>C1</math> = Battery cell capacity (AH)</p>		
Battery cell EOL minimum voltage	$V1 = \text{FLOOR} [K2 * f(I\phi, D\phi, T3)]$	<p><math>V1</math> = Minimum EOL battery cell voltage (V)</p> <p><math>K2</math> = Voltage degradation factor</p> <p><math>I\phi</math> = Battery cell maximum discharge current (A)</p>		

PARAMETER	RELATIONSHIP	VARIABLES	BOL	EOL
Battery cell EOL minimum voltage (Continued)		<p>DØ = Battery cell maximum depth of discharge</p> <p>T3 = Battery cell average operating temperature (°K)</p>		
Total cells in series	$N3 = \text{CELL} \left( \frac{VØ}{V1} \right)$	<p>N3 = Total cells in series</p> <p>_____</p> <p>VØ = Minimum ESS voltage (V)</p> <p>V1 = Minimum EOL battery cell voltage (V)</p>		
ESS total voltage	$V4 = N3 * V1$	<p>V4 = ESS total voltage (V)</p> <p>_____</p> <p>N3 = Total cells in series</p> <p>V1 = Minimum EOL battery cell voltage (V)</p>		
Total number of cells	$N4 = N2 * N3$	<p>N4 = Total number of cells</p> <p>_____</p> <p>N2 = Total cells in parallel</p> <p>N3 = Total cells in series</p>		
Battery cell enthalpy voltage	$V2 = K2 * f(T3)$	<p>V2 = Battery cell enthalpy voltage (V)</p> <p>_____</p> <p>K2 = Voltage degradation factor</p> <p>T3 = Battery cell average operating temperature (°K)</p>		

PARAMETER	RELATIONSHIP	VARIABLES	BOL	EOL
ESS maximum discharge heat load	$Q\emptyset = \text{CEIL} \left[ \frac{I\emptyset \times (V2 - V1)}{N4} \right]$	<p><math>Q\emptyset</math> = ESS maximum discharge heat load (W)</p> <p><math>I\emptyset</math> = Battery cell maximum discharge current (A)</p> <p><math>V2</math> = Battery cell enthalpy voltage (V)</p> <p><math>V1</math> = Minimum EOL battery cell voltage (V)</p> <p><math>N4</math> = Total number of cells</p>		
Battery cell minimum discharge power	$P2 = V1 \times I\emptyset$	<p><math>P2</math> = Battery cell minimum discharge power (W)</p> <p><math>V1</math> = Minimum EOL battery cell voltage (V)</p> <p><math>I\emptyset</math> = Battery cell discharge current (A)</p>		
ESS minimum power	$P3 = P2 \times N4$	<p><math>P3</math> = ESS minimum power (W)</p> <p><math>P2</math> = Battery cell minimum discharge power (W)</p> <p><math>N4</math> = Total number of cells</p>		



PARAMETER	RELATIONSHIP	VARIABLES	BOL	EOL
Maximum charge time (first approximation)	$T4 = T\phi - T1 - T5$	<p><math>T4</math> = Maximum charge time (first approximation) (Hr)</p> <p><math>T\phi</math> = Orbit period (Hr)</p> <p><math>T1</math> = Maximum discharge time (Hr)</p> <p><math>T5</math> = Design margin to allow for variations in battery cells (Hr)</p>		
Battery cell re-charge fraction (NiH <sub>2</sub> )	$R\phi = f(D\phi, T3)$	<p><math>R\phi</math> = Battery cell recharge fraction</p> <p><math>D\phi</math> = Battery cell maximum depth of discharge</p> <p><math>T3</math> = Battery cell average operation temperature (°K)</p>		
Battery cell charge throughput	$C4 = 1 - D\phi + R\phi \times D\phi$	<p><math>C4</math> = Battery cell charge throughput</p> <p><math>D\phi</math> = Battery cell maximum depth of discharge</p> <p><math>R\phi</math> = Maximum battery cell re-charge fraction</p>		
Maximum charge time	IF L = 5 then T = T4 Else T = T6	<p>T = Intermediate Variable</p> <p>T4, T6 = Maximum charge time (Hr)</p>		

PARAMETER	RELATIONSHIP	VARIABLES	BOL	EOL
Battery cell charge current	$I1 = \text{CEIL} \left( \frac{R\emptyset \times E\emptyset / T}{1000} \right) \times$	$I1 =$ Battery cell charge current (A)  $R\emptyset =$ Battery cell recharge fraction $E\emptyset =$ Battery cell EOL maximum discharge (AH) $T =$ Maximum charge time (Hr)		
Battery cell charge voltage	$V3 = \text{CEIL} \left[ \frac{f(C4, I1, T3)}{K2} \right]$	$V3 =$ Battery cell charge voltage (V)  $C4 =$ Battery cell charge throughput $I1 =$ Battery cell charge current (A) $T3 =$ Battery cell average operating temperature ( $^{\circ}K$ ) $X2 =$ Voltage degradation factor		
Maximum charge time	If L#5 Then $T = \frac{R\emptyset \times E\emptyset}{I1}$	$T =$ Maximum charge time (Hr)  $R\emptyset =$ Battery cell recharge fraction $E\emptyset =$ Battery cell EOL maximum discharge (AH) $I1 =$ Battery cell charge current (A)		

PARAMETER	RELATIONSHIP	VARIABLES	BOL	EOL
Battery cell charge power	$P4 = I1 \times V3$	<p>P4 = Battery cell charge power (A)</p> <p>I1 = Battery cell charge current (A)</p> <p>V3 = Battery cell charge voltage (V)</p>		
Watt-hour efficiency	$N7 = P2 \times T1/P4/T$	<p>N7 = Watt-hour efficiency</p> <p>P2 = Battery cell minimum discharge power (W)</p> <p>T1 = Maximum discharge time (Hr)</p> <p>P4 = Battery cell charge power (W)</p> <p>T = Maximum charge time (Hr)</p>		
Maximum solar array power	$P5 = \frac{P4 \times N4}{N5}$	<p>P5 = Maximum solar array power (W)</p> <p>P4 = Battery cell charge power (W)</p> <p>N4 = Total number of cells</p> <p>N5 = ESS-to-Solar array efficiency</p>		

PARAMETER	RELATIONSHIP	VARIABLES	ROL	EOL
Maximum solar array weight	$W\phi = \text{CEIL} (.0205 \times P5)$	<p><math>W\phi</math> = Maximum solar array weight (Kg)</p> <p><math>P5</math> = Maximum solar array power (W)</p>		
ESS maximum charge heat load	$Q1 = \text{CEIL} \left[ \frac{P4 \times N4 - (P3 + Q\phi) \times T1}{T} \right]$	<p><math>Q1</math> = ESS maximum charge heat load (W)</p> <p><math>P4</math> = Battery cell charge power (W)</p> <p><math>N4</math> = Total number of cells</p> <p><math>P3</math> = ESS minimum power (W)</p> <p><math>Q\phi</math> = ESS maximum discharge heat load (W)</p> <p><math>T1</math> = Maximum discharge time (Hr)</p> <p><math>T</math> = Maximum charge time (Hr)</p>		
ESS maximum cycle heat load	$Q2 = \text{CEIL} \left[ \text{MAX} \left( \frac{Q\phi}{2}, Q1 \right) \right]$	<p><math>Q2</math> = ESS maximum cycle heat load (W)</p> <p><math>Q\phi</math> = ESS maximum discharge heat load (W)</p> <p><math>Q1</math> = ESS maximum charge heat load (W)</p>		

C-3

PARAMETER	RELATIONSHIP	VARIABLES	BOL	EOL
Maximum thermal control weight	$W1 = \text{CEIL} \left[ \frac{Q2}{(4.716 \times 10^{-9}) \times K5 \times (T3^4 - 255^4)} \right]$	<p>W1 = Maximum thermal control weight required (Kg)</p> <p>Q2 = ESS maximum cycle heat load (W)</p> <p>K5 = Thermal conductivity factor</p> <p>T3 = Battery cell average operating temperature (°K)</p>		
Battery cell dimensions	<p>If C1 &lt; 50 Then S1(1) = 9.32 @ S2(1) = 19.28 + INT (9.031 * C1 .2115 + .5)/100</p> <p>If C1 &gt; 50 Then S1(1) = 11.98 @ S2(1) = 24.79 + INT (10.686 * C1<sup>1.0014</sup> + .5)/100</p>	<p>S1(1) = Battery cell diameter (cm)</p> <p>S2(1) = Battery cell length (cm)</p> <p>C1 = Battery cell rated capacity (AH)</p>		
Battery module height	$S2(2) = \text{INT}(125 * S2(1) + .5)/100$	<p>S2(2) = Battery module height (cm)</p>		
ESS diameter	$S\emptyset(6) = 457$	<p>S∅(6) = ESS diameter (cm)</p>		
Length of ESS side/power channel width	$S\emptyset(5) = \text{INT}(110 * S\emptyset(6) * \text{SIN}(180/N + .5)/10$	<p>S∅(5) = Length of ESS side (power channel width) (cm)</p> <p>S∅(6) = ESS diameter (cm)</p> <p>N = Number of ESS sides</p>		

PARAMETER	RELATIONSHIP	VARIABLES	BOL	EOL
Number of modules/ battery	$U = \text{CEIL} (N3/28)$	U = Number of modules/battery  N3 = Total cells in series		
Number of battery cells/module	$U1 = \text{INT} (N3/U \times 100 + .5) / 100$	U1 = Number of battery cells per module (Avg)		
Battery cell weight	$S4(1) = .02268 * C1$	S4(1) = Battery cell weight (Kg)  C1 = Battery cell rated capacity (AH)		
Battery module weight	$S4(2) = 1.32 * N3/U * S4(1) + .075 * I\phi$	S4(2) = Battery module weight (Kg)  N3 = Total cells in series U = Number of modules/battery S4(1) = Battery cell weight (Kg) I $\phi$ = Battery cell maximum discharge current (A)		
BRPC weight	$S4(3) = .02 * N3$	S4(3) = BRPC weight  N3 = Total cells in series		
Charger (P3) weight (Kg)	$S4(4) = 24.95$	S4(4) = Charger (P3) weight (Kg)		

PARAMETER	RELATIONSHIP	VARIABLES	DOL	EOL
power channel weight	$S4(5) = 1.105 * (U * S4(2) + S4(3) + S4(4) + .7 * I\emptyset + .0096 * Q2/N2)$	<p>S4(5) = Power channel weight (Kg)</p> <p>U = Number of modules/battery</p> <p>S4(2) = Battery module weight (Kg)</p> <p>S4(3) = BRPC weight (Kg)</p> <p>S4(4) = Charger (P3) weight (Kg)</p> <p>I<math>\emptyset</math> = Battery cell maximum discharge current (A)</p> <p>Q2 = ESS maximum cycle heat load (W)</p> <p>N2 = Total cells in parallel.</p>		
Power channel inter-face weight	$S4(6) = \text{INT} (47 * S4(5) + .5) / 1000$	<p>S4(6) = Power channel interface weight (Kg)</p>		
Battery cell volume	$S3(1) = \text{INT} (PI * (S1(1)/2)^2 * S2(1) * 100 + .5) / 100$	<p>S4(5) = Power channel weight (Kg)</p> <p>S3(1) = Battery cell volume (cm<sup>3</sup>)</p> <p>PI = 3.14159265359</p> <p>S1(1) = Battery cell diameter (cm)</p> <p>S2(1) = Battery cell length (cm)</p>		
Maximum usable power channel width	$S1(3) = S\emptyset(5) - 2 * S2(2) * \text{TAN} (180/N)$	<p>S1(3) = Maximum usable power channel width (cm)</p> <p>S<math>\emptyset</math>(5) = Length of ESS side (power channel width) (cm)</p>		

PARAMETER	RELATIONSHIP	VARIABLES	BOL	EOL
Maximum usable power channel width (Continued)		S2(2) = Battery module height (cm) N = Number of ESS sides		
Number of modules/power channel width	$N(4) = \text{FLOOR} (SI(2)/4.464/ SI(1))$	N(4) = Number of modules/power channel width  SI(3) = Maximum usable power channel width (cm) SI(1) = Battery cell diameter (cm)		
Number of modules/power channel length	$N(3) = \text{CEIL} (U/N(4))$	N(3) = Number of modules/power channel length  U = Number of modules/battery N(4) = Number of modules/power channel width		
Number of large modules/power channel length	$N(1) = \text{FP}(N3/U) * U$ IF N(1) #0 Then N(1) = CEIL (N(4)/FP(N3/U)/U)	N(1) = Number of large modules/power channel length  N(4) = Number of modules/power channel width N3 = Total cells in series U = Number of modules/battery		
Number of small modules/power channel length	$N(2) = N(3) - N(1)$	N(2) = Number of small modules/power channel length  N(3) = Number of modules/power channel length		



PARAMETER	RELATIONSHIP	VARIABLES	BOL	EOL
Number of small modules/power channel length (Continued)		$N(1)$ = Number of large modules/power channel length		
Maximum battery module width	$S\phi(1) = f[S1(1), S1(3)]$	$S\phi(1)$ = Maximum battery module width (cm)  $S1(1)$ = Battery cell diameter (cm) $S1(3)$ = Maximum usable power channel width (cm)		
Minimum battery module width (cm)	$S\phi(2) = f[S1(1), S1(3)]$	$S\phi(2)$ = Minimum battery module width (cm)  $S1(1)$ = Battery cell diameter (cm) $S1(3)$ = Maximum usable power channel width (cm)		
Battery module length	$S1(2) = \text{INT} (140.2 * 4.46 * S1(1) + .5) / 100$	$S1(2)$ = Battery module length (cm)  $S1(1)$ = Battery cell diameter (cm)		
Power channel length	$S1(6) = 1.25 * N(1) * S\phi(1) + S1(6) * S\phi(2)$	$S1(6)$ = Power channel length (cm)  $N(1)$ = Number of large modules/power channel length $S\phi(1)$ = Maximum battery module width		

PARAMETER	RELATIONSHIP	VARIABLES	BOL	EOL
Power channel length (Continued)		<p>N(2) = Number of small modules/ channel length</p> <p>SØ(2) = Minimum battery module width</p>		
Total ESS weight	$S4(7) = \text{CEIL}(N2 * (S4(5) + S4(6))) + .015 * (Q3 * N - N2) * S1(6) * SØ(5) + .5$	<p>S4(7) = Total ESS weight (Kg)</p> <hr/> <p>N2 = Total cells in parallel</p> <p>S4(5) = Power channel weight (Kg)</p> <p>S4(6) = Power channel interface weight (Kg)</p> <p>Q3 = ESS length factor</p> <p>N = Number of ESS sides</p> <p>S1(6) = Power channel length (cm)</p> <p>SØ(5) = Length of ESS side/power channel width (cm)</p>		
Large battery module volume	$S3(2) = \text{INT}(S1(2) * SØ(1) * S2(2) + .5)$	<p>S3(2) = Large battery module volume (cm<sup>3</sup>)</p> <hr/> <p>S1(2) = Battery module length (cm)</p> <p>SØ(1) = Maximum battery module width (cm)</p> <p>S2(2) = Battery module height (cm)</p>		

PARAMETER	RELATIONSHIP	VARIABLES	BOL	EOL
Small battery module volume	$S3(3) = \text{INT}(S1(2) * S\emptyset(2) * S2(2) + .5)$	<p>S3(3) = Small battery module volume (cm<sup>3</sup>)</p> <p>S1(2) = Battery module length (cm)</p> <p>S∅(2) = Minimum battery module width (cm)</p> <p>S2(2) = Battery module height (cm)</p>		
BRPC length	$S1(4) = \text{INT}(20.3 * N3/11 + .5)/10$	<p>S1(4) = BRPC length (cm)</p> <p>N3 = Total cells in series</p>		
BRPC width	$S\emptyset(3) = 12.7 @ S2(3) = 6.4$	<p>S∅(3) = BRPC width (cm)</p> <p>S2(3) = BRPC height (cm)</p>		
BRPC volume	$S3(4) = \text{INT}(S1(4) * S\emptyset(3) * S2(3) + .5)$	<p>S3(4) = BRPC volume (cm<sup>3</sup>)</p> <p>S1(4) = BRPC length (cm)</p> <p>S∅(3) = BRPC width (cm)</p> <p>S2(3) = BRPC height (cm)</p>		

PARAMETER	RELATIONSHIP	VARIABLES	BOL	EOL
Charger (P3) volume	$S3(5) = S1(5) * S\emptyset(4) * S2(4)$	<p><math>S3(5)</math> = Charger (P3) volume (cm<sup>3</sup>)</p> <p><math>S1(5)</math> = Charger (P3) length (cm)</p> <p><math>S\emptyset(4)</math> = Charger (P3) width (cm)</p> <p><math>S2(4)</math> = Charger (P3) height (cm)</p>		
Power channel height	$S2(5) = INT(10.75 * MAX(S2(2) * S\emptyset(4)) + .5) / 10$	<p><math>S2(5)</math> = Power channel height (cm)</p> <p><math>S2(2)</math> = Battery module height (cm)</p> <p><math>S\emptyset(4)</math> = Charger (P3) width (cm)</p>		
Power channel volume	$S3(6) = INT(S1(6) * S\emptyset(5) * S2(5) + .5)$	<p><math>S3(6)</math> = Power channel volume (cm<sup>3</sup>)</p> <p><math>S1(6)</math> = Power channel length (cm)</p> <p><math>S\emptyset(5)</math> = Length of ESS side (power channel width) (cm)</p> <p><math>S2(5)</math> = Power channel height (cm)</p>		
ESS length	$S1(7) = S1(6) * Q3$	<p><math>S1(7)</math> = ESS length (cm)</p> <p><math>S1(6)</math> = Power channel length (cm)</p> <p><math>Q3</math> = ESS length factor</p>		

PARAMETER	RELATIONSHIP	VARIABLES	BOI	EOL
ESS volume	$S3(7) = INT(S1(7) * N/4 * S\emptyset(5)^2 * COT(180/N + .5))$	<p>S3(7) = ESS volume (cm<sup>3</sup>)</p> <p>S1(7) = ESS length (cm)</p> <p>N = Number of ESS sides</p> <p>S\emptyset(5) = Length of ESS side (power channel width) (cm)</p>		
Battery cell unit cost	$F\emptyset(1) = INT((20 * C1 + 1000) * N^4 -.1047 + .5)$	<p>F\emptyset(1) = Battery cell unit cost (1980 \$K)</p> <p>C1 = Battery cell rated capacity (AH)</p> <p>N4 = Total number of cells</p>		
Cell matching cost	$F\emptyset(2) = INT(.34 * N4 + .0014 * F\emptyset(1) * N4 + 727 + .5)/1000$	<p>F\emptyset(2) = Cell matching cost (1980 \$K)</p> <p>N4 = Total number of cells</p> <p>F\emptyset(1) = Battery cell unit cost (1980 \$K)</p>		
Module assembly cost	$F\emptyset(3) = INT(.25 * N4 + .13 * N4 * S4(1) + 1049 + .5)/1000$	<p>F\emptyset(3) = Cell assembly cost (1980 \$K)</p> <p>N4 = Total number of cells</p> <p>S4(1) = Battery cell weight (Kg)</p>		

PARAMETER	RELATIONSHIP	VARIABLES	BOL	EOL
Power channel assembly cost	$F\phi(4) = \text{INT}(.705 * N2 * U * S4(2) + 607 + .5) / 1000$	<p><math>F\phi(4)</math> = Power channel assembly cost (1980 \$M)</p> <p>_____</p> <p><math>N2</math> = Total cells in parallel</p> <p><math>U</math> = Number of modules/battery</p> <p><math>S4(2)</math> = Battery module weight (Kg)</p>		
Subsystem assembly cost	$F\phi(5) = \text{INT}(.172 * N2 * (S4(5) + S4(6)) + 1329 + .5) / 1000$	<p><math>F\phi(5)</math> = Subsystem assembly cost (1980 \$M)</p> <p>_____</p> <p><math>N2</math> = Total cells in parallel</p> <p><math>S4(5)</math> = Power channel weight (Kg)</p> <p><math>S4(6)</math> = Power channel interface weight (Kg)</p>		
Acceptance & surface transport cost	$F\phi(6) = \text{INT}(.32 * N4 + .045 * S4(7) + 694 + .5) / 1000$	<p><math>F\phi(6)</math> = Acceptance and surface transport cost (1980 \$M)</p> <p>_____</p> <p><math>N4</math> = Total number of cells</p> <p><math>S4(7)</math> = Total ESS weight (Kg)</p>		
Prelaunch integration and checkout cost	$F\phi(7) = \text{INT}(.039 * S4(7) + 60 + .5) / 1000$	<p><math>F\phi(7)</math> = Prelaunch integration and checkout cost (1980 \$M)</p> <p>_____</p> <p><math>S4(7)</math> = Total ESS weight (Kg)</p>		

PARAMETER	RELATIONSHIP	VARIABLES	DOL	EOL
Wt./Vol. determinant	$K6 = \text{CEIL}(14.136 * S1(7)) / S4(7)$	$K6 = \text{Wt./Vol. determinant}$ $S1(7) = \text{ESS length (cm)}$ $S4(7) = \text{Total ESS weight (Kg)}$		
Space transport cost	$L = 5, \text{ GEO}$ $\text{IF } L = 5 \text{ Then}$ $F\emptyset(8) = \text{INT}((5.1 + 8.14 * K6) * S4(7) + .5) / 1000$ $L \# 5, \text{ LEO}$ $\text{IF } L \# 5 \text{ Then}$ $F\emptyset(8) = \text{INT}(1.99 * K6 * S4(7) + .5) / 1000$	$F\emptyset(8) = \text{Space transport cost (1980 \$M)}$ $K6 = \text{Wt./Vol. determinant}$ $S4(7) = \text{Total ESS weight (Kg)}$		
Space deployment & checkout cost	$F\emptyset(9) = \text{INT}(.011 * S4(7) + .5) / 1000$	$F\emptyset(9) = \text{Space deployment \& checkout cost (1980 \$M)}$ $S4(7) = \text{Total ESS weight (Kg)}$		
Production cost	$F\emptyset = F\emptyset(2) + F\emptyset(3) + F\emptyset(4) + F\emptyset(5) + F\emptyset(6) + F\emptyset(7) + F\emptyset(8) + F\emptyset(9)$	$F\emptyset = \text{Production cost (1980 \$M)}$ $F\emptyset(2) = \text{Cell matching cost}$ $F\emptyset(3) = \text{Module assembly cost}$ $F\emptyset(4) = \text{Channel assembly cost}$ $F\emptyset(5) = \text{Subsystem assembly cost}$ $F\emptyset(6) = \text{Acceptance \& surface transport cost}$ $F\emptyset(7) = \text{Prelaunch integration \& checkout cost}$		

PARAMETER	RELATIONSHIP	VARIABLES	DOL	EOL
Production cost (Continued)		FØ(8) = Space transport cost FØ(9) = Space deployment & check-out cost		
D&D cost	$F1(1) = INT(844 * S4(7) \cdot 203 + .5)/1000$	F1(1) = D&D cost (1980 \$M)  S4(7) = Total ESS weight (Kg)		
Subsystem test hardware cost	$F1(2) = INT[989 * ((1 + S5(1)) * FØ(2) + FØ(3) + FØ(4) + FØ(5) + FØ(6))] 1.064 + .5/1000$	F1(2) = Subsystem test hardware cost (1980 \$M)  S5(1) = Spares factor FØ(2) = Cell matching cost FØ(3) = Module assembly cost FØ(4) = Channel assembly cost FØ(5) = Subsystem assembly cost FØ(6) = Acceptance & surface transport cost		
Subsystem test hardware assembly cost	$F1(3) = INT(217 * F1(2) \cdot 789 + .5)/1000$	F1(3) = Subsystem test hardware assembly cost (1980 \$M)  F1(2) = Subsystem test hardware cost		
Subsystem test operations cost	$F1(4) = INT(828 * F1(2) \cdot 397 + .5)/1000$	F1(4) = Subsystem test operations cost (1980 \$M)  F1(2) = Subsystem test hardware cost		



PARAMETER	RELATIONSHIP	VARIABLES	BOL	EOL
Test support equipment cost	$F1(5) = INT(109 * F1(1) + F1(2) + F1(3) + F1(4)) * 1.025 + .5) / 1000$	<p>F1(5) = Test support equipment cost (1980 \$M)</p> <hr/> <p>F1(1) = D&amp;D cost</p> <p>F1(2) = Subsystem test hardware cost</p> <p>F1(3) = Subsystem test hardware assembly cost</p> <p>F1(4) = Subsystem test operations cost</p>		
Subsystem engineering and integration cost	$F1(6) = INT(94 * F1(1) + F1(2) + F1(3) + F1(4) + F1(5)) * .863 + .5) / 1000$	<p>F1(6) = Subsystem engineering &amp; integration cost (1980\$M)</p> <hr/> <p>F1(1) = D&amp;D cost</p> <p>F1(2) = Subsystem test hardware cost</p> <p>F1(3) = Subsystem test hardware assembly cost</p> <p>F1(4) = Subsystem test operations cost</p> <p>F1(5) = Test support equipment cost</p>		

PARAMETER	RELATIONSHIP	VARIABLES	BOL	EOL
Subsystem program management cost	$  \begin{aligned}  Fl(7) &= INT(131 * Fl(1) + \\  & Fl(2) + Fl(3) + Fl(4) \\  & + Fl(5) + Fl(6)) * .865 \\  & + .5 / 1000  \end{aligned}  $	<p>Fl(7) = Subsystem program management cost (1980\$M)</p> <hr/> <p>Fl(1) = D&amp;D cost</p> <p>Fl(2) = Subsystem test hardware cost</p> <p>Fl(3) = Subsystem test hardware assembly cost</p> <p>Fl(4) = Subsystem test operations cost</p> <p>Fl(5) = Test support equipment cost</p> <p>Fl(6) = Subsystem engineering and integration cost</p>		
DDT&E cost	$  \begin{aligned}  Fl &= W(1) * Fl(1) + W(2) * \\  & Fl(2) + W(3) * Fl(3) + \\  & W(4) * Fl(4) + W(5) * \\  & Fl(5) + W(6) * Fl(6) + \\  & W(7) * Fl(7) \\  \\  Fl &= INT(Fl * 1000 + .5) / \\  & 1000  \end{aligned}  $	<p>Fl = DDT&amp;E Cost (1980 \$M)</p> <hr/> <p>W(1) = D&amp;D cost factor</p> <p>Fl(1) = D&amp;D cost</p> <p>W(2) = Subsystem test hardware cost factor</p> <p>Fl(2) = Subsystem test hardware cost</p> <p>W(3) = Subsystem test hardware assembly cost factor</p> <p>Fl(3) = Subsystem test hardware assembly cost</p>		

PARAMETER	RELATIONSHIP	VARIABLES	BOL	EOL
DDT&E Cost (Continued)		<p>W(4) = Subsystem test operations cost factor</p> <p>Fl(4) = Subsystem test operations cost</p> <p>W(5) = Test support equipment cost factor</p> <p>Fl(5) = Test support equipment cost</p> <p>W(6) = Subsystem engineering &amp; integration cost factor</p> <p>Fl(6) = Subsystem engineering &amp; integration cost</p> <p>W(7) = Subsystem program management cost factor</p> <p>Fl(7) = Subsystem program management cost</p>		
Total number of modules produced during O&M	$S5(2) = N8 - 1 + N8 * S5(1)$	<p>S5(2) = Total number of modules produced during O&amp;M</p> <p>N8 = Number of maintenance cycles</p> <p>S5(1) = Spares factor</p>		
Total man-years during O&M	$S5(3) = L1 * (.002 * N2 * U + .001 * N8 * CEIL(N2 + U * S5(1)) + .0015 * (N8 - 1) * N2 * U$	<p>S5(3) = Total man-years during O&amp;M</p> <p>L1 = Total ESS life (Yr)</p> <p>N2 = Total cells in parallel</p>		

PARAMETER	RELATIONSHIP	VARIABLES	BOL	EOL
Total man-years during OEM (Continued)		U = Number of modules/battery N8 = Number of maintenance cycles S5(1) = Spares factor		
Spares manufacturing cost	$F2(1) = \frac{\text{INT}(S5(2) * F\emptyset(2) + F\emptyset(3)) * 1000 + .5}{1000}$	F2(1) = Spares manufacturing cost (1980 \$M)  S5(2) = Total number of modules produced during OEM F\emptyset(2) = Cell matching cost F\emptyset(3) = Module assembly cost		
Training cost	$F2(2) = \frac{\text{INT}(62.5 * S5(3) + .5)}{1000}$	F2(2) = Training cost (1980 \$M)  S5(3) = Total man-years during OEM		
Labor cost	$F2(3) = \frac{\text{INT}(390 * S5(3) + .5)}{1000}$	F2(3) = Labor cost (1980 \$M)  S5(3) = Total man-years during OEM		
Space transport cost	$F2(4) = \frac{\text{INT}(3600 * S5(3) + 1.99 * K6 * S5(2) * S4(2) * N2 * U + .5)}{1000}$	F2(4) = Space transport cost (1980 \$M)  S5(3) = Total man-years during OEM		

PARAMETER	RELATIONSHIP	VARIABLES	BOL	EOL
Space transport cost (Continued)		KG = Weight/volume determinant S5(2) = Total number of modules produced during O&M S4(2) = Battery module weight (Kg) N2 = Total cells in parallel U = Number of modules/battery		
Operations and maintenance cost	$F2 = F2(1) + F2(2) + F2(3) + F2(4)$	F2 = Operations & maintenance cost (1980 \$M)		
ESS life cycle cost	$F3 = F0 + F1 + F2$	F2(1) = Spares manufacturing cost F2(2) = Training cost F2(3) = Labor cost F2(4) = Space transport cost F3 = ESS life cycle cost (1980\$M)		
Solar array interface cost	If L = 5 Then M = 23.8 Else M = 36.25 + 545 * L1 Else F4 = INT(M * P5 ^ .803 + .5)/1000	F0 = Production cost F1 = DDT&E cost F2 = Operations and maintenance cost F4 = Solar array interface cost (1980\$M)		
		L1 = Total ESS life (Yr) M = Intermediate variable P5 = Maximum solar array power		

PARAMETER	RELATIONSHIP	VARIABLES	BOL	EOL
Thermal control interface cost	$F5(1) = INT(5200 + .0825 * Q2 + 1.5 * W1 + .5) / 1000$	<p>F5(1) = Thermal control interface cost (1980 \$M)</p> <p>Q2 = ESS maximum cycle heat load (M)</p> <p>W1 = Maximum thermal control weight (Kg)</p>		
Power conditioning interface cost	$F5(2) = INT(200 * N2 * .848 + .5) / 1000$	<p>F5(2) = Power conditioning interface cost (1980 \$M)</p> <p>N2 = Total cells in parallel</p>		
Total life cycle cost	$F = F3 + F4 + F5(1) + F5(2)$	<p>F = Total life cycle cost (1980\$M)</p> <p>F3 = ESS life cycle cost</p> <p>F4 = Solar array interface cost</p> <p>F5(1) = Thermal control interface cost</p> <p>F5(2) = Power conditioning interface cost</p>		

<u>SYMBOL</u>	<u>PARAMETER</u>
C1	FCU Area (Cm <sup>2</sup> )
C2	ECU Area (Cm <sup>2</sup> )
DØ	Total ESS Energy
D(1)	ESS-to-Load Efficiency
D(2)	ESS-to-Subsystem Efficiency
D7(1)	Distribution Efficiency For Internal ESS Power
D8	ESS-to-Solar Array Efficiency
EØ	Total ESS Voltage Required (V)
E1	FCU Dark Period Output Voltage (V)
E1(1)	Minimum FCU Voltage
E2	ECU Light Period Input Voltage (V)
E2(1)	Maximum ECU Voltage (V)
E7	Total ESS Output Voltage (V)
E8	Total ESS Light Period Input Voltage (V)
E8(1)	Total Solar Array Voltage Required (V)
E8(2)	Input ESS Voltage (V)
F	Total Life Cycle Cost
FØ	Total Production Cost
FØ(1)	FCU Total Production Cost
FØ(2)	ECU Total Production Cost
FØ(3)	FCS Total Production Cost
FØ(4)	ECS Total Production Cost
FØ(5)	Power Module Total Production Cost
FØ(6)	Ancillary Equipment Total Production Cost
FØ(7)	Subsystem Assembly Total Production Cost
FØ(8)	Subsystem Acceptance Total Production Cost
FØ(9)	Prelaunch Acceptance Total Production Cost
FØ(10)	LEO Transport Total Production Cost
FØ(11)	LEO Deployment Total Production Cost
FØ(12)	LEO/GEO Transport Total Production Cost

SYMBOL (Continued)PARAMETER

F1	Total Cost for DDT&E
F1(1)	D&D Cost for DDT&E
F1(2)	STH Cost for DDT&E
F1(3)	STHA Cost for DDT&E
F1(4)	STO Cost for DDT&E
F1(5)	TSE Cost for DDT&E
F1(6)	SE&I Cost for DDT&E
F1(7)	Management Material Cost for DDT&E
F2	O&M Total Cost
F2(1)	Spares Cost, O&M
F2(2)	Training Cost, O&M
F2(3)	Maintenance Cost, O&M
F2(4)	Space Transport Cost, O&M
F7	Total ESS Cost
F8	Solar Array Cost
F9(1)	Thermal Control Cost
F9(2)	Power Conditioning Cost
H $\emptyset$	Orbit Attitude (Km)
H2	ECU Ideal Gibbs Free Energy
H6	ESS Storage "DOD" Factor
H6(1)	Failure Replacement Factor
H6(2)	Overhaul Replacement Factor
H7	Total Astronaut Manyear
I $\emptyset$	Total ESS Current Required (A)
I1	FCU Dark Period Current (A)
I2	ECU Light Period Input Current (A)
I7	Total ESS Output Current (A)
I8	Total ESS Light Period Input Current (A)
J1(1)	FCU Dark Period Current Density (Ma/cm <sup>2</sup> )
J1(2)	FCU Light Period Current Density (Ma/cm <sup>2</sup> )
J2(1)	ECU Dark Period Current Density (Ma/cm <sup>2</sup> )



SYMBOL (Continued)PARAMETER

J2(2)	ECU Light Period Current Density (Ma/cm <sup>2</sup> )
KØ(1)	Adjustment Factor for % of Orbits During Which Battery Cycling Occurs
KØ(2)	Eclipse Averaging Factor
K1(1)	FCU Dark Period Heat Load Factor (W/cm <sup>2</sup> )
K1(2)	FCU Light Period Heat Load Factor (W/cm <sup>2</sup> )
K2(1)	ECU Dark Period Heat Load Factor (W/cm <sup>2</sup> )
K2(2)	ECU Light Period Heat Load Factor
K3	FCS Failure Rate Fraction
K4	ECS Failure Rate Fraction
K5(1)	DDT&E Adjustment Factor
K5(2)	DDT&E Adjustment Factor
K5(3)	DDT&E Adjustment Factor
K5(4)	DDT&E Adjustment Factor
K5(5)	DDT&E Adjustment Factor
K5(6)	DDT&E Adjustment Factor
K5(7)	DDT&E Adjustment Factor
K6	AE Failure Rate Fraction
K7	S/S Failure Rate
K8	Wt./Vol. Determinant
K9	Thermal Conductivity Factor
LØ	Total ESS Life
L1	FCU Life (Yr)
L(1)	FCU Life Required (Hr)
L2	ECU Life (Yr)
L(2)	ECU Life Required (Hr)
L3	Expected Pump Life
L(3)	Required Pump Life
N	Number of ESS Sides
NØ	Total Number of ESS Cycles

**SYMBOL (Continued)****PARAMETER**

<b>Nø (1)</b>	<b>Number of Maintenance Cycles (FCU)</b>
<b>Nø (2)</b>	<b>Number of Maintenance Cycles (ECU)</b>
<b>Nø (3)</b>	<b>Number of Maintenance Cycles (Pump)</b>
<b>N (1)</b>	<b>Number of Maintenance Cycles Required (FCU)</b>
<b>N1</b>	<b>Total Number FCU</b>
<b>N1 (1)</b>	<b>Total Parallel FCU</b>
<b>N1 (2)</b>	<b>Total Series FCU</b>
<b>N1 (3)</b>	<b>Average Number FCU/FC Stack</b>
<b>N (2)</b>	<b>Number of Maintenance Cycles Required (ECU)</b>
<b>N2</b>	<b>Total Number ECU</b>
<b>N2 (1)</b>	<b>Total Parallel ECU</b>
<b>N2 (2)</b>	<b>Total Series ECU</b>
<b>N2 (3)</b>	<b>Average Number ECU/EC Stack</b>
<b>N3</b>	<b>Total FC Stacks</b>
<b>N (3)</b>	<b>Required Pump Maintenance Cycles</b>
<b>N3 (1)</b>	<b>Number Parallel FC Stacks/Channel</b>
<b>N3 (2)</b>	<b>Number Series FC Stacks/Channel</b>
<b>N3 (3)</b>	<b>Total FC Stacks/Channel</b>
<b>N4</b>	<b>Total EC Stacks</b>
<b>N4 (1)</b>	<b>Number Parallel EC Stacks/Channel</b>
<b>N4 (2)</b>	<b>Number Series FC Stacks/Channel</b>
<b>N4 (3)</b>	<b>Total EC Stacks/Channel</b>
<b>N5</b>	<b>Number of Channels</b>
<b>N5 (1)</b>	<b>Number of P3 Chargers</b>
<b>N5 (2)</b>	<b>Number of Power Conditioners</b>
<b>N7 (1)</b>	<b>Number of FC/EC Stacks in ESS Side Direction</b>
<b>N7 (2)</b>	<b>Number of FC/EC Stacks in ESS Length Direction</b>
<b>Pø</b>	<b>Total ESS Power Required (W)</b>
<b>P1</b>	<b>FCU Dark Period Output Power (W)</b>
<b>P (1)</b>	<b>Total Load Power (W)</b>
<b>P1 (1)</b>	<b>FCU Averaging Operating Pressure (Kg/cm<sup>2</sup>)</b>

SYMBOL (Continued)PARAMETER

P2	ECU Light Period Input Power (W)
P(2)	Subsystems Power (W)
P2(1)	ECU Average Operating Pressure (Kg/cm <sup>2</sup> )
P6(1)	H <sub>2</sub> Storage Tank Pressure (Kg/cm <sup>2</sup> )
P6(2)	O <sub>2</sub> Storage Tank Pressure (Kg/cm <sup>2</sup> )
P7	Total ESS Output Power (W)
P7(1)	Internal ESS Power Required (W)
P8	Total ESS Light Period Input Power (W)
P8(1)	Total Solar Array Power Required (W)
Q1(1)	FCU Dark Period Heat Load (W)
Q1(2)	FCU Light Period Heat Load (W)
Q2(1)	ECU Dark Period Heat Load (W)
Q2(2)	ECU Light Period Heat Load (W)
Q7	Total ESS Maximum Cycle Heat Load (W)
Q7(1)	Total ESS Dark Period Heat Load
Q7(2)	Total ESS Light Period Heat Load
R1(1)	FCU H <sub>2</sub> Consumption Rate (Kg/hr/a)
R2(1)	ECU H <sub>2</sub> Generation Rate (Kg/a/hr)
S1(1)	FCU Active Length (Cm)
S1(2)	FCU Active Width (Cm)
S1(3)	FCU Thickness (Cm)
S2(1)	ECU Active Length (Cm)
S2(2)	ECU Active Width (Cm)
S2(3)	ECU Thickness (Cm)
S3(1)	FC Stack Length (Cm)
S3(2)	FC Stack Width (Cm)
S3(3)	Minimum FC Stack Height (Cm)
S3(4)	Maximum FC Stack Height (Cm)
S4(1)	EC Stack Length (Cm)
S4(2)	EC Stack Width (Cm)
S4(3)	Minimum EC Stack Height (Cm)
S4(4)	Maximum EC Stack Height (Cm)
S5(1)	Power Module Length (Cm)

## SYMBOL (Continued)

PARAMETER

S5 (2)	Power Module Width (Cm)
S5 (3)	Power Module Height (Cm)
S5 (4)	Usable Power Module Width (Cm)
S5 (5)	P <sub>3</sub> Length (Cm)
S5 (6)	P <sub>3</sub> Width (Cm)
S5 (7)	P <sub>3</sub> Height (Cm)
S6 (1)	ESS Total Ancillary Equipment Diameter (Cm)
S6 (2)	ESS Total Ancillary Equipment Length (Cm)
S7 (1)	ESS Length (Cm)
S7 (2)	ESS Diameter (Cm)
S7 (3)	Length of ESS Side (Cm)
S7 (4)	ESS Radius of Inscribed Circle (Cm)
T $\emptyset$	Orbit Period (Hr)
T $\emptyset$ (1)	Transition Time Between Solar Array Power and ESS Power (Hr)
T $\emptyset$ (2)	Design Margin to Allow for Variations in FCU's and ECU's
T1	Maximum Dark Period (Hr)
T1 (1)	FCU Average Operation Temperature ( $^{\circ}$ K)
T2	Minimum Light Period (Hr)
T2 (1)	ECU Average Operating Temperature ( $^{\circ}$ K)
T3	Average Dark Period (Hr)
T4	Average Light Period (Hr)
T5	Power Module Average Operating Temperature ( $^{\circ}$ K)
T6	ESS Storage Tank Temperature ( $^{\circ}$ K)
U $\emptyset$	Intermediate Variables
U1 (1)	Temperature Adjustment Factor
U1 (2)	Pressure Adjustment Factor
V1	FCU Volume (Cm <sup>3</sup> )
V2	ECU Volume (Cm <sup>3</sup> )
V3 (1)	Minimum FC Stack Volume (Cm <sup>3</sup> )

SYMBOL (Continued)PARAMETER

V3 (2)	Maximum FC Stack Volume ( $\text{Cm}^3$ )
V4 (1)	Minimum EC Stack Volume ( $\text{Cm}^3$ )
V4 (2)	Maximum EC Stack Volume ( $\text{Cm}^3$ )
V5	Power Module Volume ( $\text{Cm}^3$ )
V5 (1)	P <sup>3</sup> Volume ( $\text{Cm}^3$ )
V6	ESS Total Ancilliary Equipment Volume (Cm)
V6 (1)	ESS Total H <sub>2</sub> Volume ( $\text{Cm}^3$ )
V6 (2)	ESS Total O <sub>2</sub> Volume ( $\text{Cm}^3$ )
V6 (3)	ESS Total H <sub>2</sub> O Volume ( $\text{Cm}^3$ )
V7	ESS Volume
W $\emptyset$ (1,1)	FCU Maximum Dark Period H <sub>2</sub> Consumption
W $\emptyset$ (1,2)	FCU Minimum Light Period H <sub>2</sub> Consumption
W $\emptyset$ (1,3)	FCU Maximum Total H <sub>2</sub> Consumption (Kg)
W $\emptyset$ (2,1)	ECU Maximum Dark Period H <sub>2</sub> <u>Generation</u> (Kg)
W $\emptyset$ (2,2)	ECU Minimum Light Period H <sub>2</sub> <u>Generation</u> (Kg)
W $\emptyset$ (2,3)	ECU Maximum Total H <sub>2</sub> <u>Generation</u> (Kg)
W1	FCU Weight (Kg)
W2	ECU Weight (Kg)
W3	Average FC Stack Weight (Kg)
W4	Average EC Stack Weight (Kg)
W5	Power Module Weight (Kg)
W5 (1)	P <sup>3</sup> Weight
W5 (2)	ESS Maximum Total H <sub>2</sub> Consumption (Kg)
W6	Ancillary Equipment Total Weight (Kg)
W6 (1,1)	ESS Total H <sub>2</sub> Storage (Kg)
W6 (1,2)	ESS Total O <sub>2</sub> Storage (Kg)
W6 (1,3)	ESS Total H <sub>2</sub> O Storage (Kg)
W6 (2,1)	H <sub>2</sub> Storage Tank Dry Weight (Kg)
W6 (2,2)	O <sub>2</sub> Storage Tank Dry Weight (Kg)
W6 (2,3)	H <sub>2</sub> O Storage Tank Dry Weight (Kg)

SYMBOL (Continued)

PARAMETER

W6(3,1)	H <sub>2</sub> Storage Tank Maximum Wet Weight (Kg)
W6(3,2)	O <sub>2</sub> Storage Tank Maximum Wet Weight (Kg)
W6(3,3)	H <sub>2</sub> O Storage Tank Maximum Wet Weight (Kg)
W7	Total ESS Weight (Kg)
W8	Maximum Solar Array Weight (Kg)
W9(1)	Maximum Thermal Control Weight (Kg)
W9(2)	Maximum Power Conditioning Weight

PARAMETER	RELATIONSHIP	VARIABLES	BOL	EOL
Orbit period	$T\emptyset = 2.7645 E-6 * (6375 + H\emptyset)^{3/2}$	$T\emptyset$ = Orbit period (Hr) $H\emptyset$ = Orbit altitude (Km)		
Total number of ESS cycles	$N\emptyset = \frac{8766 * K\emptyset(1)}{T\emptyset} * L\emptyset$	$N\emptyset$ = Total number of ESS cycles $K\emptyset(1)$ = Adjustment factor for # or orbits during which battery cycling occurs $T\emptyset$ = Orbit period (Hr) $L\emptyset$ = Total ESS life (Yr)		
Maximum "dark" period	$T1 = \frac{T\emptyset}{180} * [90 - \cos^{-1}(\frac{6375 + H\emptyset}{6375 + H\emptyset})] + T\emptyset(1)$	$T1$ = Maximum dark period (Hr) $T\emptyset$ = Orbit period (Hr) $H\emptyset$ = Orbit altitude (Km) $T\emptyset(1)$ = Transition time between solar array power and ESS power (Hr)		
Minimum light period	$T2 = T\emptyset - T1 - T\emptyset(2)$	$T2$ = Minimum light period (Hr) $T\emptyset$ = Orbit period (Hr) $T1$ = Maximum dark period (Hr) $T\emptyset(2)$ = Design margin to allow for variations in FCU's and ECU's		

PARAMETER	RELATIONSHIP	VARIABLES	BOL	EOL
Average dark period	$T3 = K\phi(2) * T1$	<p>T3 = Average dark period (Hr)</p> <p>_____</p> <p>K<math>\phi</math>(2) = Eclipse averaging factor</p> <p>T1 = Maximum dark period (Hr)</p>		
Average light period	$T4 = T\phi - K\phi(2) * (T\phi - T2)$	<p>T4 = Average light period (Hr)</p> <p>_____</p> <p>T<math>\phi</math> = Orbit period (Hr)</p> <p>K<math>\phi</math>(2) = Eclipse averaging factor</p> <p>T2 = Minimum light period (Hr)</p>		
Total ESS power required	$P\phi = \left( \frac{P(1)}{D(1)} + \frac{P(2)}{D(2)} + \frac{P7(1)}{D7(1)} \right)$	<p>P<math>\phi</math> = Total ESS power required (W)</p> <p>_____</p> <p>P(1) = Total load power (W)</p> <p>D(1) = ESS-to-load efficiency</p> <p>P(2) = Subsystems power (W)</p> <p>D(2) = ESS-to-subsystems efficiency</p> <p>P7(1) = Internal ESS power required (W)</p> <p>D7(1) = Distribution efficiency for internal ESS power</p>		



PARAMETER	RELATIONSHIP	VARIABLES	BOL	EOL
Total ESS current required	$I\phi = P\phi / E\phi$	$I\phi$ = Total ESS current required (A) $P\phi$ = Total ESS power required (W) $E\phi$ = Total ESS voltage required (V)		
FCU life required	$L(1) = INT(T3 * N\phi / N(1) + .5)$	$L(1)$ = FCU life required (Hr) $T3$ = Average dark period (Hr) $N\phi$ = Total number of ESS cycles $N(1)$ = Number of maintenance cycles required (FCU)		
FCU dark period current density	$J1(1) = f[L(1), T1(1), P1(1)]$	$J1(1)$ = FCU dark period current density (Ma/cm <sup>2</sup> ) $L(1)$ = FCU life required (Hr) $T1(1)$ = FCU average operation temperature (°K) $P1(1)$ = FCU average operation pressure (Kg./cm <sup>2</sup> )		
FCU Area (cm <sup>2</sup> )	$C1 = S1(1) * S1(2)$	$C1$ = FCU area (cm <sup>2</sup> ) $S1(1)$ = FCU Active length (cm) $S1(2)$ = FCU Active width (cm)		

PARAMETER	RELATIONSHIP	VARIABLES	BOL	EOL
FCU dark period current	$I1 = J1(1) * C1/1000$	<p><math>I1</math> = FCU dark period current (A)</p> <p>_____</p> <p><math>J1(1)</math> = FCU dark period current density (Ma/cm<sup>2</sup>)</p> <p><math>C1</math> = FCU area (cm<sup>2</sup>)</p>		
Total Parallel FCU	$N1(1) = CEIL(I\emptyset(I1))$	<p><math>N1(1)</math> = Total parallel FCU</p> <p>_____</p> <p><math>I\emptyset</math> = Total ESS current required (A)</p> <p><math>I1</math> = FCU dark period output current (A)</p>		
Number of channels	<p><math>N5 = N1(1)/N3(1)</math></p> <p>(NOTE: <math>N3(1) = 1</math> for all calculations unless otherwise defined.)</p>	<p><math>N5</math> = Number of channels</p> <p>_____</p> <p><math>N1(1)</math> = Total parallel FCU</p> <p><math>N3(1)</math> = Number parallel FC stacks/channel</p>		
FCU dark period output current	$I1' = I\emptyset/N1(1)$	<p><math>I1</math> = FCU dark period output current (A)</p> <p>_____</p> <p><math>I\emptyset</math> = Total ESS current required (A)</p> <p><math>N1(1)</math> = Total parallel FCU</p>		

PARAMETER	RELATIONSHIP	VARIABLES	BOL	EOL
FCU dark period current density	$J1(1) = I1/C1 * 1000$	<p><math>J1(1)</math> = FCU dark period current density (Ma/cm<sup>2</sup>)</p> <p><math>I1</math> = FCU dark period output current (A)</p> <p><math>C1</math> = FCU area (cm<sup>2</sup>)</p>		
FCU life	$L1 = f [J1(1), T1(1), P1(1)]$	<p><math>L1</math> = FCU life (Hr)</p> <p><math>J1(1)</math> = FCU dark period current density (Ma/cm<sup>2</sup>)</p> <p><math>T1(1)</math> = FCU average operating temperature (°K)</p> <p><math>P1(1)</math> = FCU average operating pressure (Kg/cm<sup>2</sup>)</p>		
L(1) Loop	<p>(a) <math>N\emptyset(1) = CEIL(T3 * N\emptyset/L1)</math></p> <p>(b) <math>U9 = INT(T3 * N\emptyset/N\emptyset(1) + .5)</math></p> <p>(c) If <math>L(1) \neq U9</math> then  <math>L(1) = U9</math> with loop back to 10</p>	<p><math>N\emptyset(1)</math> = Number of maintenance cycles (FCU)</p> <p><math>T3</math> = Average dark period (Hr)</p> <p><math>N\emptyset</math> = Total number of ESS cycles</p> <p><math>L1</math> = FCU life (Hr)</p> <p><math>L(1)</math> = FCU life required (Hr)</p>		

PARAMETER	RELATIONSHIP	VARIABLES	BOL	EOL
Total ESS output current (A)	$I7 = I1 * N1(1)$	<p><math>I7</math> = Total ESS output current (A)</p> <p><math>I1</math> = FCU dark period output current (A)</p> <p><math>N1(1)</math> = Total parallel FCU</p>		
FCU dark period EOL minimum voltage	$E1 = f[J1(1), T1(1), P1(1), L1, E1(1)] * 2$	<p><math>E1</math> = FCU dark period EOL minimum voltage (V)</p> <p><math>J1(1)</math> = FCU dark period current density (<math>M\alpha/cm^2</math>)</p> <p><math>T1(1)</math> = FCU average operating temperature (<math>^{\circ}K</math>)</p> <p><math>P1(1)</math> = FCU averaging operating pressure (<math>Kg/cm^2</math>)</p> <p><math>L1</math> = FCU life (Hr)</p> <p><math>E1(1)</math> = Minimum FCU voltage</p>		
FCU dark period EOL minimum power	$P1 = E1 * I1$	<p><math>P1</math> = FCU dark period output minimum power (W)</p> <p><math>E1</math> = FCU dark period output voltage (V)</p> <p><math>I1</math> = FCU dark period output current (A)</p>		
Total series FCU	$N1(2) = CEIL (E0/E1)$	<p><math>N1(2)</math> = Total series FCU</p> <p><math>E0</math> = Total ESS voltage req. (V)</p> <p><math>E1</math> = FCU dark period output vol. (V)</p>		

PARAMETER	RELATIONSHIP	VARIABLES	BOL	EOL
Total ESS output voltage	$E7 = E1 * N1(2)$	E7 = Total ESS output voltage (V) E1 = FCU dark period output voltage (V) N1(2) = Total series FCU		
Total ESS output power	$P7 = E7 * I7$	P7 = Total ESS output power (W) E7 = Total ESS output voltage (V) I7 = Total ESS output current (A)		
Number series FC stacks/channel	$N3(2) = \text{CEIL} [N1(2)/60]$	N3(2) = Number series FC stacks/channel N1(2) = Total series FCU		
Average number FCU/FC stack	$N1(3) = N1(2)/N3(2)$	N1(3) = Average number FCU/FC stack N1(2) = Total Series FCU N3(2) = Number series FC stacks/channel		
Total FC stacks/channel	$N3(3) = N3(1) * N3(2)$	N3(3) = Total FC stacks/channels N3(1) = Number parallel FC stacks/channel N3(2) = Number series FC stacks/channel		

PARAMETER	RELATIONSHIP	VARIABLES	BOL	EOL
Total number FCH	$N1 = N1(1) * N1(2)$	<p>N1 = Total number FCU</p> <p>N1(1) = Total parallel FCU</p> <p>N1(2) = Total series FCU</p>		
Total FC stacks	$N3 = N3(3) * N5$	<p>N3 = Total FC stacks</p> <p>N3(3) = Total FC stacks/channel</p> <p>N5 = Number of channels</p>		
FCU dark period heat load factor	$K1(1) = f [J1(1)]$	<p>K1(1) = FCU dark period heat load factor (W/cm<sup>2</sup>)</p> <p>J1(1) = FCU dark period current density (Ma/cm<sup>2</sup>)</p>		
FCU dark period heat load	$Q1(1) = K1(1) * C1$	<p>Q1(1) = FCU dark period heat load (W)</p> <p>K1(1) = FCU dark period heat load factor (W/cm<sup>2</sup>)</p> <p>C1 = FCU area (cm<sup>2</sup>)</p>		
FCU light period heat load factor	$K1(2) = f [J1(2)]$	<p>K1(2) = FCU light period heat load factor (W/cm<sup>2</sup>)</p> <p>J1(2) = FCU light period current density (Ma/cm<sup>2</sup>)</p>		

PARAMETER	RELATIONSHIP	VARIABLES	BOL	EOL
FCU light period heat load	$Q1(2) = KI(2) * CI$	$Q1(2)$ = FCU light period heat load (w) _____ $KI(2)$ = FCU light period heat load factor (W/cm <sup>2</sup> ) $CI$ = FCU area (cm <sup>2</sup> )		
FCU maximum dark period H <sub>2</sub> consumption	$W\emptyset(1,1) = RI(1) * II * T1$	$W\emptyset(1,1)$ = FCU maximum dark period H <sub>2</sub> consumption (KG) _____ $RI(1)$ = FCU H <sub>2</sub> consumption rate (Kg/a/hr) $II$ = FCU dark period current (A) $T1$ = Maximum dark period (Hr)		
FCU minimum light period H <sub>2</sub> consumption	$W\emptyset(1,2) = RI(1) * JI(2) * CI * T2/1000$	$W\emptyset(1,2)$ = FCU minimum light period H <sub>2</sub> consumption (Kg) _____ $RI(1)$ = FCU H <sub>2</sub> consumption rate (Kg/a/hr) $JI(2)$ = FCU light period current density (Ma/cm <sup>2</sup> ) $CI$ = FCU area (cm <sup>2</sup> ) $T2$ = Minimum light period (Hr)		

PARAMETER	RELATIONSHIP	VARIABLES	BOL	EOL
FCU maximum total H <sub>2</sub> consumption	$W\theta(1,3) = W\theta(1,1) + W\theta(1,2)$	$W\theta(1,3)$ = FCU maximum total H <sub>2</sub> consumption (Kg)  $W\theta(1,1)$ = FCU maximum dark period H <sub>2</sub> consumption (Kg) $W\theta(1,2)$ = FCU minimum light period H <sub>2</sub> consumption (Kg)		
ESS maximum total H <sub>2</sub> consumption	$W5(2) = W\theta(1,3) * N1$	$W5(2)$ = ESS maximum total H <sub>2</sub> consumption (Kg)  $W\theta(1,3)$ = FCU maximum total H <sub>2</sub> consumption (Kg) N1 = Total number of FCU		
ESS total H <sub>2</sub> storage	$W6(1,1) = W5(2)/H6$	$W6(1,1)$ = ESS total H <sub>2</sub> storage (Kg)  $W5(2)$ = ESS maximum total H <sub>2</sub> consumption (Kg) H6 = ESS storage "DOD" factor		
ECU area	$C2 = S2(1) * S2(2)$	$C2$ = ECU area (cm <sup>2</sup> )  $S2(1)$ = ECU active length (cm) $S2(2)$ = ECU active width (cm)		



PARAMETER	RELATIONSHIP	VARIABLES	BOL	EOL
ECU minimum dark period H <sub>2</sub> generation	$W\phi(2,1) = R2(1) * J2(1) * C2 * TI/1000$	<p>Wφ(2,1) = ECU maximum dark period H<sub>2</sub> generator (Kg)</p> <hr/> <p>R2(1) = ECU H<sub>2</sub> generation rate (Kg/a/hr)</p> <p>J2(1) = ECU dark period current density (Ma/cm<sup>2</sup>)</p> <p>C2 = ECU area (cm<sup>2</sup>)</p> <p>TI = Maximum dark period (Hr)</p>		
ECU life required	$L(2) = INT(T4 * N\phi/N(2) + .5)$	<p>L(2) = ECU life required (Hr)</p> <hr/> <p>T4 = Average light period (Hr)</p> <p>Nφ = Total number of ESS cycles</p> <p>N(2) = Number of maintenance cycles required (ECU)</p>		
ECU light period current density	$J2(2) = f[L(2), T2(1), P2(1)]$	<p>J2(2) = ECU light period current density (Ma/cm<sup>2</sup>)</p> <hr/> <p>L(2) = ECU life required</p> <p>T2(1) = ECU average operating temperature (°K)</p> <p>P2(1) = ECU average operating pressure (Kg/cm<sup>2</sup>)</p>		

PARAMETER	RELATIONSHIP	VARIABLES	BOL	EOL
ECU light period input current	$I2 = J2(2) * C2/1000$	<p><math>I2 =</math> ECU light period input current (A)</p> <p><math>J2(2) =</math> ECU light period current density (Ma/cm<sup>2</sup>)</p> <p><math>C2 =</math> ECU area (cm<sup>2</sup>)</p>		
ECU minimum light period H <sub>2</sub> generation	$W\phi(2,2) = R2(1) * I2 * T2$	<p><math>W\phi(2,2) =</math> ECU minimum light period H<sub>2</sub> generation (Kg)</p> <p><math>R2(1) =</math> ECU H<sub>2</sub> generation rate (Kg/a/hr)</p> <p><math>I2 =</math> ECU light period input current (A)</p> <p><math>T2 =</math> Minimum light period (Hr)</p>		
ECU maximum total H <sub>2</sub> generation	$W\phi(2,3) = W\phi(2,1) * W\phi(2,2)$	<p><math>W\phi(2,3) =</math> ECU maximum total H<sub>2</sub> generation (Kg)</p> <p><math>W\phi(2,1) =</math> ECU maximum dark period H<sub>2</sub> generation (Kg)</p> <p><math>W\phi(2,2) =</math> ECU minimum light period H<sub>2</sub> generation (Kg)</p>		

PARAMETER	RELATIONSHIP	VARIABLES	BOL	EOL
Total number ECU	$N2 = \text{CEIL}[W5(2)/W\phi(2,3)]$	<p><math>N2 = \text{Total number ECU}</math></p> <p><math>W5(2) = \text{ESS maximum total } H_2 \text{ consumption (Kg)}</math></p> <p><math>W\phi(2,3) = \text{ECU maximum total } H_2 \text{ generation (Kg)}</math></p>		
Total series ECU	$N2(2) = \text{Floor}(E8(2)/E2(1))$	<p><math>N2(2) = \text{Total series ECU}</math></p> <p><math>E8(2) = \text{Input ESS voltage (V)}</math></p> <p><math>E2(1) = \text{Maximum ECU voltage (V)}</math></p>		
Total parallel ECU	$N2(1) = \text{CEIL}(N2/N2(2))$	<p><math>N2(1) = \text{Total parallel ECU}</math></p> <p><math>N2 = \text{Total number ECU}</math></p> <p><math>N2(2) = \text{Total series ECU}</math></p>		
Total number ECU	$N2 = N2(1) * N2(2)$	<p><math>N2 = \text{Total number ECU}</math></p> <p><math>N2(1) = \text{Total parallel ECU}</math></p> <p><math>N2(2) = \text{Total series ECU}</math></p>		

PARAMETER	RELATIONSHIP	VARIABLES	BOL	EOL
ECU maximum total H <sub>2</sub> generation	$W\phi(2,3) = W5(2)/N2$	$W\phi(2,3)$ = ECU maximum total H <sub>2</sub> generation (Kg) _____ $W5(2)$ = ESS maximum total H <sub>2</sub> consumption (Kg) $N2$ = Total number ECU		
ECU minimum light period H <sub>2</sub> generation	$W\phi(2,2) = W\phi(2,3) - W\phi(2,1)$	$W\phi(2,2)$ = ECU minimum light period H <sub>2</sub> generation (Kg) _____ $W\phi(2,3)$ = ECU maximum total H <sub>2</sub> generation (Kg) $W\phi(2,1)$ = ECU maximum dark period H <sub>2</sub> generation (Kg)		
ECU light period current density	$J2(2) = W\phi(2,2)/R2(1)/C2/T2 * 1000$	$J2(2)$ = ECU light period current density (Ma/cm <sup>2</sup> ) _____ $W\phi(2,2)$ = ECU minimum light period H <sub>2</sub> generation (Kg) $R2(1)$ = ECU H <sub>2</sub> generation rate (Kg/a/hr)		

PARAMETER	RELATIONSHIP	VARIABLES	BOL	EOL
ECU light period current density (Cont)		C2 = ECU area (cm <sup>2</sup> ) T2 = Minimum light period (Hr)		
ECU light period input voltage	E2 = f[J2(2), T2(1), P2(1), L2] * 2 U9 = Floor (E8(2)/E2) If N2(2) # U9 then N2(2) = U9 @ go to N2(1) calculation	E2 = ECU light period input voltage (V)  J2(2) = ECU light period current density (Ma/cm <sup>2</sup> ) T2(1) = ECU average operating temperature (°K) P2(1) = ECU Average Operating pressure (Kg/cm <sup>2</sup> ) L2 = ECU life (Hr) U9 = Intermediate variable E8(2) = Input ESS voltage (V) E2 = ECU light period input voltage (V) N2(2) = Total series ECU		
ECU life	L2 = f[J2(2), T2(1), P2(1)]	L2 = ECU life (Hr)  J2(2) = ECU light period current density (Ma/cm <sup>2</sup> ) T2(1) = ECU average operating temperature (°K) P2(1) = ECU average operating pressure (Kg/cm <sup>2</sup> )		

PARAMETER	RELATIONSHIP	VARIABLES	BOL	EOL
ECU life loop	(a) $N\emptyset(2) = \frac{CELL(T4 * N\emptyset)}{I2}$ (b) $U9 = INT(T4 * N\emptyset / N\emptyset(2) + .5)$ (c) If I(2) # U9 then I(2) = U9 with loop back to J2(2) calculation	$N\emptyset(2)$ = Number of maintenance cycles (ECU) T4 = Average light period (Hr) $N\emptyset$ = Total number of ESS cycles I2 = ECU life (Hr) L(2) = ECU life required (Hr)		
ECU light period input current	$I2 = J2(2) * C2 / 1000$	I2 = ECU light period input current (A) J2(2) = ECU light period current density (Ma/cm <sup>2</sup> ) C2 = ECU area (cm <sup>2</sup> )		
ECU light period input power	$P2 = E2 * I2$	P2 = ECU light period input power (W) E2 = ECU light period input voltage (V) I2 = ECU light period input current (A)		
Number series FC stacks/channel	$N4(2) = \frac{CELL[N2(2)/60]}$	N4(2) = Number series FC stacks/channel N2(2) = Total series ECU		

PARAMETER	RELATIONSHIP	VARIABLES	BOL	EOL
Average number ECU/EC stack	$N2(3) = N2(2) / N4(2)$	<p><math>N2(3)</math> = Average number ECU/EC stack</p> <p>_____</p> <p><math>N2(2)</math> = Total series ECU</p> <p><math>N4(2)</math> = Number series FC stacks/channel</p>		
Number parallel EC stacks/channel	$N4(1) = N2(1) / N5$	<p><math>N4(1)</math> = Number parallel EC stacks/channel</p> <p>_____</p> <p><math>N2(1)</math> = Total parallel ECU</p> <p><math>N5</math> = Number of channels</p>		
Total EC stacks/channel	$N4(3) = N4(1) * N4(2)$	<p><math>N4(3)</math> = Total EC stacks/channel</p> <p>_____</p> <p><math>N4(1)</math> = Number parallel EC stacks/channel</p> <p><math>N4(2)</math> = Number series FC stacks/channel</p>		
Total EC stacks	$N4 = N4(3) * N5$	<p><math>N4</math> = Total EC stacks</p> <p>_____</p> <p><math>N4(3)</math> = Total EC stacks/channel</p> <p><math>N5</math> = Number of channels</p>		

PARAMETER	RELATIONSHIP	VARIABLES	BOL	EOL
Total ESS light period input voltage	$E8 = E2 * N2(2)$	<p>E8 = Total ESS light period input voltage (V)</p> <p>E2 = Total ECU light period input voltage (V)</p> <p>N2(2) = Total series ECU</p>		
Total ESS light period input current	$I8 = I2 * N2(1)$	<p>I8 = Total ESS light period input current (A)</p> <p>I2 = Total ECU light period input current (A)</p> <p>N2(1) = Total parallel ECU</p>		
Total ESS light period input power	$P8 = INT(E8 * I8 + .5)$	<p>P8 = Total ESS light period input power (W)</p> <p>E8 = Total ESS light period input voltage (V)</p> <p>I8 = Total ESS light period input current (A)</p>		
Total ESS watt-hour efficiency	$D\emptyset = P7 * T1/P8/T2$	<p>D<math>\emptyset</math> = Total ESS watt-hour efficiency</p> <p>P7 = Total ESS output power (W)</p> <p>T1 = Maximum dark period (Hr)</p> <p>P8 = Total ESS light period input power (W)</p> <p>T2 = Minimum light period (Hr)</p>		



PARAMETER	RELATIONSHIP	VARIABLES	BOL	EOL
Total solar array voltage required	$E8(1) = E8/D8$	<p><math>E8(1)</math> = Total solar array voltage required (V)</p> <p><math>E8</math> = Total ESS light period input voltage (V)</p> <p><math>D8</math> = ESS-to-solar array efficiency</p>		
Total solar array power required	$P8(1) = INT(E8(1) * I8 + .5)$	<p><math>P8(1)</math> = Total solar array power required (W)</p> <p><math>E8(1)</math> = Total solar array voltage required (V)</p> <p><math>I8</math> = Total ESS light period input current (A)</p>		
ECU dark period heat load factor	$K2(1) = f[J2(1)]$	<p><math>K2(1)</math> = ECU dark period heat load factor (W/cm<sup>2</sup>)</p> <p><math>J2(1)</math> = ECU dark period current density (Ma/cm<sup>2</sup>)</p>		
ECU dark period heat load	$Q2(1) = K2(1) * C2$	<p><math>Q2(1)</math> = ECU dark period heat load (W)</p> <p><math>K2(1)</math> = ECU dark period heat load factor (W/cm<sup>2</sup>)</p> <p><math>C2</math> = ECU area (cm<sup>2</sup>)</p>		

PARAMETER	RELATIONSHIP	VARIABLES	BOL	EOL
ECU light period heat load factor	$K2(2) = f[J2(2)]$	<p><math>K2(2)</math> = ECU light period heat load factor (W/cm<sup>2</sup>)</p> <p><math>J2(2)</math> = ECU light period current density (Ma/cm<sup>2</sup>)</p>		
ECU light period heat load	$Q2(2) = K2(2) * C2$	<p><math>Q2(2)</math> = ECU light period heat load (W)</p> <p><math>K2(2)</math> = ECU light period heat load factor (W/cm<sup>2</sup>)</p> <p><math>C2</math> = ECU area (m<sup>2</sup>)</p>		
Total ESS dark period heat load	$Q7(1) = INT(Q1(1) * N1 + Q2(1) * N2 + .5)$	<p><math>Q7(1)</math> = Total ESS dark period heat load (W)</p> <p><math>Q1(1)</math> = FCU dark period heat load (W)</p> <p><math>N1</math> = Total number FCU</p> <p><math>Q2(1)</math> = ECU dark period heat load (W)</p> <p><math>N2</math> = Total number ECU</p>		

PARAMETER	RELATIONSHIP	VARIABLES	BOL	EOL
Total ESS light period heat load	$Q7(2) = \text{INT}[Q1(2) * N1 + Q2(2) * N2 + .5]$	<p>Q7(2) = Total ESS light period heat load</p> <p>Q1(2) = FCU light period heat load (W)</p> <p>N1 = Total number FCU</p> <p>Q2(2) = ECU light period heat load (W)</p> <p>N2 = Total number ECU</p>		
Total ESS maximum cycle heat load	$Q7 = \text{CEIL}[\text{MAX}(Q7(1))/2, Q7(2)]$	<p>Q7 = Total ESS maximum cycle heat load (W)</p> <p>Q7(1) = Total ESS dark period heat load (W)</p> <p>Q7(2) = Total ESS light period heat load (W)</p>		
FCU Volume	$V1 = \text{INT}[\text{S1}(1) + 5.08] * [\text{S1}(2) + 5.08] * \text{S1}(3) * 100 + .5 / 100$	<p>V1 = FCU volume (cm<sup>3</sup>)</p> <p>S1(1) = FCU active length (cm)</p> <p>S1(2) = FCU active width (cm)</p> <p>S1(3) = FCU thickness (cm)</p>		

PARAMETER	RELATIONSHIP	VARIABLES	BOL	EOL
ECU volume	$V2 = \text{INT}[\text{S2}(1) + 5.08] * [\text{S2}(2) + 5.08] * \text{S2}(3) * 100 + .5) / 100$	<p><math>V2 = \text{ECU volume (cm}^3)</math></p> <p>_____</p> <p><math>\text{S2}(1) = \text{ECU active length (cm)}</math>  <math>\text{S2}(2) = \text{ECU active width (cm)}</math>  <math>\text{S2}(3) = \text{ECU thickness (cm)}</math></p>		
Maximum FC stack height	$\text{S3}(4) = \text{INT}[(\text{S1}(3) * \text{CEIL}[\text{N1}(3)] + 9.57) * 100 + .5) / 100$	<p><math>\text{S3}(4) = \text{Maximum FC stack height (cm)}</math></p> <p>_____</p> <p><math>\text{S1}(3) = \text{FCU thickness (cm)}</math>  <math>\text{N1}(3) = \text{Average number FCU/FC stack}</math></p>		
Minimum FC stack height	$\text{S3}(3) = \text{INT}[(\text{S1}(3) * \text{FLOOR}[\text{N1}(3)] + 9.57) * 100 + .5) / 100$	<p><math>\text{S3}(3) = \text{Minimum FC stack height (cm)}</math></p> <p>_____</p> <p><math>\text{S1}(3) = \text{FCU thickness (cm)}</math>  <math>\text{N1}(3) = \text{Average number FCU/FC stack}</math></p>		
FC stack width	$\text{S3}(2) = \text{S1}(2) + 10.16$	<p><math>\text{S3}(2) = \text{FC stack width (cm)}</math></p> <p>_____</p> <p><math>\text{S1}(2) = \text{FCU active width (cm)}</math></p>		
FC stack length	$\text{S3}(1) = \text{S1}(1) + 6.35$	<p><math>\text{S3}(1) = \text{FC stack length (cm)}</math></p> <p>_____</p> <p><math>\text{S1}(1) = \text{FCU active length (cm)}</math></p>		

PARAMETER	RELATIONSHIP	VARIABLES	BOL	EOL
Maximum FC stack volume	$V3(2) = S3(1) * S3(2) * S3(4)$	$V3(2) = \text{Maximum FC stack volume (cm}^3\text{)}$ <hr/> $S3(1) = \text{FC stack length (cm)}$ $S3(2) = \text{FC stack width (cm)}$ $S3(4) = \text{Maximum FC stack height (cm)}$		
Minimum FC stack volume	$V3(1) = S3(1) * S3(2) * S3(3)$	$V3(1) = \text{Minimum FC stack volume (cm}^3\text{)}$ <hr/> $S3(1) = \text{FC stack length (cm)}$ $S3(2) = \text{FC stack width (cm)}$ $S3(3) = \text{Minimum FC stack height (cm)}$		
Maximum EC stack height	$S4(4) = \text{INT}[(S2(3) * \text{CEIL}[N2(3)] + 9.57) * 100 + .5] / 100$	$S4(4) = \text{Maximum EC stack height (cm)}$ <hr/> $S2(3) = \text{ECU thickness (cm)}$ $N2(3) = \text{Average number ECU/EC stack}$		
Minimum EC stack height	$S4(3) = \text{INT}[(S2(3) * \text{FLOOR}[N2(3)] + 9.57) * 100 + .5] / 100$	$S4(3) = \text{Minimum EC stack height (cm)}$ <hr/> $S2(3) = \text{ECU thickness (cm)}$ $N2(3) = \text{Average number ECU/EC stack}$		

PARAMETER	RELATIONSHIP	VARIABLES	BOL	EOL
EC stack width	$S4(2) = S2(2) + 10.16$	$S4(2) =$ EC stack width (cm)  $S2(2) =$ ECU active width (cm)		
EC stack length	$S4(1) = S2(1) + 6.35$	$S4(1) =$ EC stack length (cm)  $S2(1) =$ ECU active length (cm)		
Maximum EC stack volume	$V4(2) = S4(1) * S4(2) * S4(4)$	$V4(2) =$ Maximum EC stack volume (cm <sup>3</sup> )  $S4(1) =$ EC stack length (cm) $S4(2) =$ EC stack width (cm) $S4(4) =$ Maximum EC stack height (cm)		
Minimum EC stack volume	$V4(1) = S4(1) * S4(2) * S4(3)$	$V4(1) =$ Minimum EC stack volume (cm <sup>3</sup> )  $S4(1) =$ EC stack length (cm) $S4(2) =$ EC stack width (cm) $S4(3) =$ Minimum EC stack height (cm)		
ESS diameter	$S7(2) = 457$	$S7(2) =$ ESS diameter (cm)		
Number of ESS sides	$N = 5$	$N =$ Number of ESS sides		

PARAMETER	RELATIONSHIP	VARIABLES	DOL	EOL
Power modules width/ length of ESS side	$S5(2), S7(3) = S7(2) * SIN(180/N)$	S5(2) = Power modules width (cm) S7(3) = Length of ESS side (cm)  S7(2) = ESS diameter (cm) N = Number of ESS sides		
Power module height	$S5(3) = INT[(MAX[S3(4), S4(4)] + 15.24) * 100 + .5] / 100$	S5(3) = Power module height (cm)  S3(4) = Maximum FC stack height (cm) S4(4) = Maximum EC stack height (cm)		
Usable power module width	$S5(4) = S5(2) - 2 * S5(3) * TAN(180/N)$	S5(4) = Usable power module width (cm)  S5(2) = Power module width (cm) S5(3) = Power module height (cm) N = Number of ESS sides		
Number of FC/EC stacks in ESS side direction	$N7(1) = FLOOR[S5(4)/MAX(S3(2), S4(2))] + 3.4925]$	N7(1) = Number of FC/EC stacks in ESS side direction  S5(4) = Usable power module width (cm) S3(2) = FC stack width (cm) S4(2) = EC stack width (cm)		

PARAMETER	RELATIONSHIP	VARIABLES	BOL	EOL
Number of FC/EC stacks in ESS length direction	$N7(2) = \text{CEIL}((N3 + N4)/N) / N7(1)$	<p><math>N7(2)</math> = Number of FC/EC stacks in ESS length direction</p> <p>_____</p> <p><math>N3</math> = Total FC stacks</p> <p><math>N4</math> = Total EC stacks</p> <p><math>N</math> = Number of ESS sides</p> <p><math>N7(1)</math> = Number of FC/EC stacks in ESS side direction</p>		
Number of P3 chargers	$N5(1) = \text{CEIL}(N2(1) * I2/35)$	<p><math>N5(1)</math> = Number of P3 chargers</p> <p>_____</p> <p><math>N2(1)</math> = Total parallel ECU</p> <p><math>I2</math> = ECU light period input current (A)</p>		
P3 length	$S5(5) = 63.5 @ S5(6) = 26.9$ $@ S5(7) = 16.5$	<p><math>S5(5)</math> = P3 length (cm)</p> <p>_____</p> <p><math>S5(6)</math> = P3 width (cm)</p> <p><math>S5(7)</math> = P3 height (cm)</p>		
P3 volume	$V5(1) = S5(5) * S5(6) * S5(7)$	<p><math>V5(1)</math> = P3 volume (cm<sup>3</sup>)</p> <p>_____</p> <p><math>S5(5)</math> = P3 length (cm)</p> <p><math>S5(6)</math> = P3 width (cm)</p> <p><math>S5(7)</math> = P3 height (cm)</p>		



PARAMETER	RELATIONSHIP	VARIABLES	DOL	EOL
Power module/ESS length	<p>(a) <math>U\phi = \text{CEIL}[(N3 + N4)/N/N7(1)]</math></p> <p>(b) <math>U1 = \text{FLOOR}[N3/N/N7(1)]</math></p> <p>(c) <math>U2 = \text{FLOOR}[N4/N/N7(1)]</math></p> <p>(d) <math>S5(1), S7(1) = U1 * [S3(1) + 5.08] + U2 * [S4(1) + 5.08] + (U\phi - U1 - U2) * \text{MAX}(S3(1), S4(1) + 5.08) + 33.02</math></p>	<p>S5(1) = Power module length (cm)</p> <p>S7(1) = ESS length (cm)</p> <p>_____</p> <p><math>U\phi, U1, U2</math> = Intermediate variable</p> <p>N3 = Total FC stacks</p> <p>N4 = Total EC stacks</p> <p>N = Number of ESS sides</p> <p>N7(1) = Number of FC/EC stacks in ESS side direction</p> <p>S5(1) = Power module length (cm)</p> <p>S7(1) = ESS length (cm)</p> <p>S3(1) = FC stack length (cm)</p> <p>S4(1) = EC stack length (cm)</p>		
ESS radius of inscribed circle	$S7(4) = S7(3)/2 * \text{COT}(180/N)$	<p>S7(4) = ESS radius of inscribed circle (cm)</p> <p>S7(3) = Length of ESS side (cm)</p> <p>N = Number of ESS sides</p>		
Power module volume	$V5 = [S5(2) * S7(4) - S5(4) * (S7(4) - S5(3))] * S5(1)/2$	<p>V5 = Power module volume (cm<sup>3</sup>)</p> <p>_____</p> <p>S5(2) = Power module width (cm)</p> <p>S7(4) = ESS radius of inscribed circle (cm)</p> <p>S5(4) = Usable power module width (cm)</p>		

PARAMETER	RELATIONSHIP	VARIABLES	BOL	EOL
Power module volume (Continued)		<p>S5(3) = Power module height (cm)</p> <p>S5(1) = Power module length (cm)</p>		
ESS total ancillary equipment diameter	$S6(1) = 1.5 * [S7(4) - S5(3)]$	<p>S6(1) = ESS total ancillary equipment diameter (cm)</p> <p>_____ = ESS radius of inscribed circle (cm)</p> <p>S7(4) = Power module height (cm)</p>		
ESS total ancillary equipment length	$S6(2) = .8 * S7(1)$	<p>S6(2) = ESS total ancillary equipment length (cm)</p> <p>_____ = ESS length (cm)</p>		
ESS total ancillary equipment volume	$V6 = PI * [S6(1)/2]^2 * S6(2)$	<p>V6 = ESS total ancillary equipment volume (cm)</p> <p>S6(1) = ESS total ancillary equipment diameter (cm)</p> <p>S6(2) = ESS total ancillary equipment length (cm)</p>		
ESS volume	$V7 = S7(1) * N/4 * S7(3)^2 * COT (180/N)$	<p>V7 = ESS volume (cm<sup>3</sup>)</p> <p>_____ = ESS length (cm)</p> <p>N = Number of ESS sides</p> <p>S7(3) = Length of ESS side</p>		

PARAMETER	RELATIONSHIP	VARIABLES	BOL	EOL
FCU weight	$W1 = \text{INT}(11.9 * V1 + .5) / 10,000$	<p>W1 = FCU weight (Kg)</p> <p>V1 = FCU volume (cm<sup>3</sup>)</p>		
ECU weight	$W2 = \text{INT}(11.9 * V2 + .5) / 10,000$	<p>W2 = ECU weight (Kg)</p> <p>V2 = ECU volume (cm<sup>3</sup>)</p>		
Average FC stack weight	$W3 = 122.6 * N1(3) * W1 + .5) / 100$	<p>W3 = Average FC stack weight (Kg)</p> <p>N1(3) = Average number FCU/FC stack</p> <p>W1 = FCU weight (Kg)</p>		
Average EC stack weight	$W4 = \text{INT}(122.6 * N2(3) * W2 + .5) / 100$	<p>W4 = Average EC stack weight (Kg)</p> <p>N2(3) = Average number ECU/EC stack</p> <p>W2 = ECU weight (Kg)</p>		
P3 weight	$W5(1) = 24.95$	W5(1) = P3 weight (Kg)		
Power module weight	$W5 = [1.025 * (W3 * N3 + W4 * N4 + W5(1) * N5(1))] + .25 * (I1 * N3 + I2 * N4) + .0096 * Q7 / N$	<p>W5 = Power module weight (Kg)</p> <p>W3 = Average FC stack weight (Kg)</p> <p>N3 = Total FC stacks</p> <p>W4 = Average EC stack weight (Kg)</p> <p>N4 = Total EC stacks</p>		

PARAMETER	RELATIONSHIP	VARIABLES	BOL	EOL
Power module weight (Continued)		<p>W5(1) = P3 weight (Kg)</p> <p>N5(1) = Number of Pc chargers</p> <p>I1 = FCU dark period current (A)</p> <p>I2 = ECU light period input current (A)</p> <p>Q7 = Total ESS maximum cycle heat load</p> <p>N = Number of ESS Sides</p>		
ESS total O <sub>2</sub> storage	$W6(1,2) = 7.9365 * W6(1,1)$	<p>W6(1,2) = ESS total O<sub>2</sub> storage (Kg)</p>		
ESS total H <sub>2</sub> O storage	$W6(1,3) = 8.9365 * W6(1,1)$	<p>W6(1,1) = ESS total H<sub>2</sub> storage (Kg)</p> <p>W6(1,3) = ESS total H<sub>2</sub>O storage (Kg)</p>		
ESS total H <sub>2</sub> volume	$V6(1) = \frac{.84790 * W6(1,1)}{2.016 * T6/P6(1)}$	<p>W6(1,1) = ESS total H<sub>2</sub> storage (Kg)</p> <p>V6(1) = ESS total H<sub>2</sub> volume (cm<sup>3</sup>)</p> <p>W6(1,1) = ESS total H<sub>2</sub> storage (Kg)</p> <p>T6 = ESS storage tank temperature (°K)</p> <p>P6(1) = H<sub>2</sub> storage tank pressure (Kg/cm<sup>2</sup>)</p>		

PARAMETER	RELATIONSHIP	VARIABLES	BOL	EOL
ESS total O <sub>2</sub> volume	$V6(2) = \frac{.84790 * W6(1,2)}{16 * T6/P6(2)}$	<p>V6(2) = ESS total O<sub>2</sub> volume (cm<sup>3</sup>)</p> <p>W6(1,2) = ESS total O<sub>2</sub> storage (Kg)</p> <p>T6 = ESS storage tank temperature (°K)</p> <p>P6(2) = O<sub>2</sub> storage tank pressure (Kg/cm<sup>3</sup>)</p>		
ESS total H <sub>2</sub> O volume	$V6(3) = 1000 * W6(1,3)$	<p>V6(3) = ESS total H<sub>2</sub>O volume (cm<sup>3</sup>)</p> <p>W6(1,3) = ESS total H<sub>2</sub> storage (Kg)</p>		
ESS total ancillary equipment volume	<p>(a) <math>U9 = [V6(1) + V6(2)] / [.9 * V6 + V6(3)]</math></p> <p>(b) If <math>U9 &lt; 1</math> then <math>S6(1) = S6(1) * U9 \wedge (1/3)</math> @ <math>S6(2) = S6(2) * U9 \wedge (1/3)</math> @ <math>V6 = V6 * U9</math></p> <p>(c) If <math>U9 &gt; 1</math> then <math>P6(1) = P6(1) * U9</math> @ <math>P6(2) = P6(2) * U9</math> @ <math>V6(1) = V6(1)/U9</math> @ <math>V6(2) = V6(2)/U9</math></p>	<p>V6 = ESS total ancillary equipment volume (cm<sup>3</sup>)</p> <p>S6(1) = ESS total ancillary equipment diameters (cm)</p> <p>S6(2) = ESS total ancillary equipment length (cm)</p> <p>V6(1) = ESS total H<sub>2</sub> volume (cm<sup>3</sup>)</p> <p>V6(2) = ESS total O<sub>2</sub> volume (cm<sup>3</sup>)</p> <p>V6(3) = ESS total H<sub>2</sub>O volume (cm<sup>3</sup>)</p> <p>P6(1) = H<sub>2</sub> storage tank pressure (Kg/cm<sup>2</sup>)</p> <p>P6(2) = O<sub>2</sub> storage tank pressure (Kg/cm<sup>2</sup>)</p>		

PARAMETER	RELATIONSHIP	VARIABLES	BOL	EOL
H <sub>2</sub> storage tank dry weight	$W6(2,1) = f[V6(1), P6(1)]$	<p><math>W6(2,1) = H_2</math> storage tank dry weight (Kg)</p> <p>_____</p> <p><math>V6(1) = ESS</math> total H<sub>2</sub> volume (cm<sup>3</sup>)</p> <p><math>P6(1) = H_2</math> storage tank pressure (Kg/cm<sup>2</sup>)</p>		
O <sub>2</sub> storage tank dry weight	$W6(2,2) = f[V6(2), P6(2)]$	<p><math>W6(2,2) = O_2</math> storage tank dry weight (Kg)</p> <p>_____</p> <p><math>V6(2) = ESS</math> total O<sub>2</sub> volume (cm<sup>3</sup>)</p> <p><math>P6(2) = O_2</math> storage tank pressure (Kg/cm<sup>2</sup>)</p>		
H <sub>2</sub> O storage tank dry weight	$W6(2,3) = .001 * V6(3)$	<p><math>W6(2,3) = H_2O</math> storage tank dry weight (Kg)</p> <p>_____</p> <p><math>V6(3) = ESS</math> total H<sub>2</sub>O volume (cm<sup>3</sup>)</p>		
H <sub>2</sub> storage tank maximum wet weight	$W6(3,1) = W6(1,1) + W6(2,1)$	<p><math>W6(3,1) = H_2</math> storage tank maximum wet weight (Kg)</p> <p>_____</p> <p><math>W6(1,1) = ESS</math> total H<sub>2</sub> storage (Kg)</p> <p><math>W6(2,1) = H_2</math> storage tank dry weight (Kg)</p>		

PARAMETER	RELATIONSHIP	VARIABLES	BOL	EOL
O <sub>2</sub> storage tank maximum wet weight	$W6(3,2) = W6(1,2) + W6(2,2)$	$W6(3,2) = O_2$ storage tank maximum wet weight (Kg) <hr/> $W6(1,2) = ESS$ total O <sub>2</sub> storage (Kg) $W6(2,2) = O_2$ storage tank dry weight (Kg)		
H <sub>2</sub> O storage tank maximum wet weight	$W6(3,3) = W6(1,3) + W6(2,3)$	$W6(3,3) = H_2O$ storage tank maximum wet weight (Kg) <hr/> $W6(1,3) = ESS$ total H <sub>2</sub> storage (Kg) $W6(2,3) = H_2O$ storage tank dry weight (Kg)		
Ancillary equipment total weight	$W6 = INT(135 * (W6(2,1) + W6(2,2) + W6(2,3) + W6(1,3)) + .5) / 100$	$W6 =$ Ancillary equipment total weight (Kg) <hr/> $W6(2,1) = H_2$ storage tank dry weight (Kg) $W6(2,2) = O_2$ storage tank dry weight (Kg) $W6(2,3) = H_2O$ storage tank dry weight (Kg) $W6(1,3) = ESS$ total H <sub>2</sub> storage (Kg)		

PARAMETER	RELATIONSHIP	VARIABLES	BOL	EOL
Total ESS weight	$W7 = INT(W5 * N + W6 + .5)$	<p>W7 = Total ESS weight (Kg)</p> <p>W5 = Power module weight (Kg)</p> <p>N = Number of ESS Sides</p> <p>W6 = Ancillary equipment total weight (Kg)</p>		
Maximum solar array weight	$W8 = CEIL [.0205 * P8(1)]$	<p>W8 = Maximum solar array weight (Kg)</p> <p>P8(1) = Total solar array power required (W)</p>		
Maximum thermal control weight	$W9(1) = CEIL \left[ \frac{Q7}{(4.716 \times 10^{-9} / K9)} \right]$ $/ (T5(1) \Lambda 4 - 255 \Lambda 4)]$	<p>W9(1) = Maximum thermal control weight (Kg)</p> <p>Q7 = Total ESS maximum cycle heat load (W)</p> <p>K9 = Thermal conductivity factor</p> <p>T5(1) = Power module average operating temperatures (°K)</p>		



PARAMETER	RELATIONSHIP	VARIABLES	BOL	EOL
Maximum power conditioning weight (Kg)	$W9(2) = N5(2) * W5(1)$ If L = 5 then $N5(2) = \text{CELL}(N1(1) * I1/35)$ Else $N5(2) = N5$	$W9(2)$ = Maximum power conditioning weight (Kg) $N5(2)$ = Number of power conditioners $W5(1)$ = P <sup>3</sup> weight $N1(1)$ = Total parallel FCU $I1$ = FCU dark period current $N5$ = Number of channels		
Required and expected pump life	$L(3), I3 = T\emptyset * N\emptyset/N(3)$	$L(3), I3$ = Required and expected pump life $T\emptyset$ = Orbit period (Hr) $N\emptyset$ = Total number of ESS cycles $N(3)$ = Required pump maintenance cycles		
FCU total production cost	$F\emptyset(1) = \text{INT}(10.9 * C1/232.26) \wedge .8 * N1 \wedge -.152 * 1000 + .5/1000$	$F\emptyset(1)$ = FCU total production cost $C1$ = FCU area (cm <sup>2</sup> ) $N1$ = Total number FCU		
ECU total production cost	$F\emptyset(2) = \text{INT}(10.9 * (C2/232.26) \wedge .8 * N2 -.152 * 1000 + .5) / 1000$	$F\emptyset(2)$ = ECU total production cost $C2$ = ECU area (cm <sup>2</sup> ) $N2$ = Total number ECU		

PARAMETER	RELATIONSHIP	VARIABLES	BOL	EOL
FCS total production cost	$F\phi(3) = \text{INT}(.25 * N1 + .13 * N1 * W1 + 1.1 * N1 * F\phi(1) + 525.5) / 1000$	<p>F<math>\phi</math>(3) = FCS total production cost</p> <p>N1 = Total number FCU</p> <p>W1 = FCU weight (Kg)</p> <p>F<math>\phi</math>(1) = FCU total production cost</p>		
ECS total production cost	$F\phi(4) = \text{INT}(.25 * N2 + .13 * N2 * W2 + 1.1 * N2 * F\phi(2) + 525.5) / 1000$	<p>F<math>\phi</math>(4) = ECS total production cost</p> <p>N2 = Total number ECS</p> <p>W2 = ECU weight (Kg)</p> <p>F<math>\phi</math>(2) = ECU total production cost</p>		
Power module total production cost	$F\phi(5) = \text{INT}(.705 * N3 * W3 + N4 * W4) + 200 * N5(1) \wedge .848 + 607.5 / 1000$	<p>F<math>\phi</math>(5) = Power module total production cost</p> <p>N3 = Total FC stacks</p> <p>N4 = Total EC stacks</p> <p>W3 = Average FC stack weight (Kg)</p> <p>W4 = Average EC stack weight (Kg)</p> <p>N5(1) = Number of chargers</p>		
Ancillary equipment total production cost	$F\phi(6) = \text{INT}(.0175 * P7 * (P6(1) / 28.12) \wedge .6 * (L3 / 43,830) \wedge .9 + .5) / 1000$	<p>F<math>\phi</math>(6) = Ancillary equipment total production cost</p> <p>P7 = Total ESS output power (W)</p> <p>P6(1) = H<sub>2</sub> storage tank pressure (Kg/cm<sup>2</sup>)</p> <p>L3 = Expected pump life</p>		

PARAMETER	RELATIONSHIP	VARIABLES	BOI	EOL
Subsystem assembly total production cost	$F\phi(7) = \text{INT}(.172 * W7 + 1329.5)/1000$	$F\phi(7)$ = Subsystem assembly total production cost  W7 = Total ESS weight (Kg)		
Subsystem acceptance total production cost	$F\phi(8) = \text{INT}(.32 * (N1 + N2) + .15 * W6 + .045 * W7 + 694.5)/1000$	$F\phi(8)$ = Subsystem acceptance total production cost  N1 = Total number FCU N2 = Total number ECU W6 = Ancillary equipment total weight W7 = Total ESS weight (Kg)		
Wt./Vol. determinant	$K8 = \text{CEIL}(14.136 * S7(1))/W7$	K8 = Wt./Vol. determinant  S7(1) = ESS length (cm) W7 = Total ESS weight (Kg)		
LEO transport total production cost	$F\phi(10) = \text{INT}(1.99 * W7 * K8 + .5)/1000$  (NOTE: $K8 < 1$ , $K8 = 1$ )	$F\phi(10)$ = LEO transport total production cost  W7 = Total ESS weight (Kg) K8 = Wt./Vol. determinant		

PARAMETER	RELATIONSHIP	VARIABLES	BOL	EOL
LEO Deployment total production cost	$F\phi(11) = \text{INT}(.011 * W7 + .5) / 1000$ (LEO mission only)	$F\phi(11)$ = LEO deployment total production cost  W7 = Total ESS weight (Kg)		
LEO/GEO transport cost	$F\phi(12) = \text{INT}(5.1 + 8.14 * K8) * W7 + .5) / 1000$ (GEO mission only) (NOTE: K8 < 1, K8 = 1)	$F\phi(12)$ = LEO/GEO Transport total production cost  K8 = Wt./Vol. Determinant W7 = Total ESS weight (Kg)		
Total production cost	$F\phi = F\phi(3) + \dots + F\phi(11)$ LEO $= F\phi(3) + \dots + F\phi(9) + F\phi(12)$ GEO	$F\phi$ = Total production cost  F $\phi$ (3) = FCS total production cost F $\phi$ (4) = ECS total production cost F $\phi$ (5) = Power module total production cost F $\phi$ (6) = Ancillary equipment total production cost F $\phi$ (7) = Subsystem assembly total production cost F $\phi$ (8) = Subsystem acceptance total production cost F $\phi$ (9) = Prelaunch acceptance total production cost F $\phi$ (10) = LEO transport total production cost F $\phi$ (11) = LEO deployment total production cost		

PARAMETER	RELATIONSHIP	VARIABLES	BOL	EOL
Total production cost (Continued)		$F\phi(1,2) = \text{LEO/GEO transport total production cost}$		
D&D cost for DDT&E	$F1(1) = \text{INT}(844 * K5(1) * W7 \wedge .203 + .5)/1000$	$F1(1) = \text{D&D cost for DDT&E}$  W7 = Total ESS weight (Kg) $K5(1) = \text{DDT&E cost adjustment factor}$		
STH cost for DDT&E	$F1(2) = \text{INT}(989 * K5(2) * (1 + K7) (F\phi(3) + \dots + F\phi(8) \wedge 1.064 + .5)/1000$	$F1(2) = \text{STH cost for DDT&E}$  $K5(2) = \text{DDT&E cost adjustment factor}$  K7 = Subsystem failure rate $F\phi(3) = \text{FCS total production cost}$ $F\phi(4) = \text{ECS total production cost}$ $F\phi(5) = \text{Power module total production cost}$ $F\phi(6) = \text{Ancillary equipment total production cost}$ $F\phi(7) = \text{Subsystem assembly total production cost}$ $F\phi(8) = \text{Subsystem acceptance total production cost}$		

PARAMETER	RELATIONSHIP	VARIABLES	BOL	EOL
STHA cost for DDT&E	$F1(3) = \frac{\text{INT}(217 * K5(3) * F1(2) \wedge .789 + .5)}{1000}$	<p>F1(3) = STHA cost for DDT&amp;E</p> <p>_____</p> <p>F1(2) = STH cost for DDT&amp;E</p> <p>K5(3) = DDT&amp;E cost adjustment factor</p>		
STO cost for DDT&E	$F1(4) = \frac{\text{INT}(828 * K5(4) * F1(2) \wedge .397 + .5)}{1000}$	<p>F1(4) = STO cost for DDT&amp;E</p> <p>_____</p> <p>F1(2) = STH cost for DDT&amp;E</p> <p>K5(4) = DDT&amp;E adjustment factor</p>		
TSE cost for DDT&E	$F1(5) = \text{INT}(109 * (F1(1) + \dots + F1(4)) \wedge 1.025 * K5(5))$	<p>F1(5) = TSE cost for DDT&amp;E</p> <p>_____</p> <p>F1(1) = DeD cost for DDT&amp;E</p> <p>F1(2) = STH cost for DDT&amp;E</p> <p>F1(3) = STHA cost for DDT&amp;E</p> <p>F1(4) = STO cost for DDT&amp;E</p> <p>K5(5) = DDT&amp;E adjustment factor</p>		
SE&L cost for DDT&E	$F1(6) = \text{INT}(.094 * (F1(1) + \dots + F1(5)) \wedge .865 * K5(6))$	<p>F1(6) = SE&amp;L cost for DDT&amp;E</p> <p>_____</p> <p>F1(1) = DeD cost for DDT&amp;E</p> <p>F1(2) = STH cost for DDT&amp;E</p> <p>F1(3) = STHA cost for DDT&amp;E</p> <p>F1(4) = STO cost for DDT&amp;E</p> <p>F1(5) = TSE cost for DDT&amp;E</p>		

PARAMETER	RELATIONSHIP	VARIABLES	BOL	EOL
SE&L cost for DDT&E (Continued)		K5(6) = DDT&E adjustment factor		
Management cost for DDT&E	$F1(7) = INT(131 * (F1(1) + \dots F1(6) \wedge .865 * K5(7))$	F1(7) = Management material cost for DDT&E  _____ F1(1) = D&D cost for DDT&E F1(2) = STH cost for DDT&E F1(3) = STHA cost for DDT&E F1(4) = STO cost for DDT&E F1(5) = TSE cost for DDT&E F1(6) = SE&I cost for DDT&E K5(7) = DDT&E adjustment factor		
Total cost for DDT&E	$F1 = F1(1) + F1(2) + \dots F1(7)$	F1 = Total cost for DDT&E  _____ F1(1) = D&D cost for DDT&E F1(2) = STH cost for DDT&E F1(3) = STHA cost for DDT&E F1(4) = STO cost for DDT&E F1(5) = TSE cost for DDT&E F1(6) = SE&I cost for DDT&E F1(7) = Management material cost for DDT&E		

PARAMETER	RELATIONSHIP	VARIABLES	BOL	EOL
	$F2(1) = F\phi(3) * N\phi(1) - 1) + F\phi(4) * N\phi(2) - 1) + F\phi(6) * N\phi(3) - 1) * H6(2) + K3 * F\phi(3) * N\phi(1) + K4 * F\phi(4) * N\phi(2) + K6 * F\phi(6) * N\phi(3)) * H6(1)$ $F2(1) = INT(F2(1) * 1000 + .5) / 1000$	<p>F2(1) = Spares cost, OEM</p> <p>F<math>\phi</math>(3) = FCS total production cost</p> <p>F<math>\phi</math>(4) = ECS total production cost</p> <p>F<math>\phi</math>(6) = Ancillary equipment total production cost</p> <p>K3 = FCS failure rate fraction</p> <p>K4 = ECS failure rate fraction</p> <p>K6 = AE failure rate fraction</p> <p>N<math>\phi</math>(1) = Number of maintenance cycles (FCU)</p> <p>N<math>\phi</math>(2) = Number of maintenance cycles (ECU)</p> <p>N<math>\phi</math>(3) = Number of maintenance cycles (pump)</p> <p>H6(2) = Overhaul replacement factor</p> <p>H6(1) = Failure replacement factor</p>		



PARAMETER	RELATIONSHIP	VARIABLES	BOL	EOL
Total Astronaut manyear	<p>F2(2) H7</p> <p>(a) Determine H7 =  <math>.002 * (N3 + N4) + .03</math>  <math>+ .001 * N3 * K3 + .001</math>  <math>* N4 * K4 + .002 * K6</math>  <math>+ .0015 * N3 * NØ(1)</math>  <math>-1) + .0015 * N4 *</math>  <math>(NØ(2) -1) + .02 *</math>  <math>(NØ(3) - 1)</math></p> <p>(b) <math>F2(2) = INT(62.5 *</math>  <math>H7 + .5)/1000</math></p>	<p>F2(2) = Training cost, O&amp;M</p> <p>H7 = Total astronaut manyear</p> <p>N3 = Total FC stacks</p> <p>N4 = Total EC stacks</p> <p>NØ(1) = Number of maintenance cycles (FCU)</p> <p>NØ(2) = Number of maintenance cycles (FCU)</p> <p>NØ(3) = Number of maintenance cycles (pump)</p> <p>K3 = FCS failure rate fraction</p> <p>K4 = ECS failure rate fraction</p> <p>K6 = AE failure rate fraction</p>		
Maintenance cost, O&M	<p><math>F2(3) = INT(H7 * 390 + .5) /</math>  <math>1000</math></p>	<p>F2(3) = Maintenance cost, O&amp;M</p> <p>H7 = Total astronaut manyear</p>		
Space transport cost	<p><math>F2(4) = (W3 * N3 * (NØ(1)) * K3 + W4 * N4 * (NØ(2)) * K4 + W6 * (NØ(3)) * K6 * H6(1) + W3 * N3 * (NØ(1) -1) + W4 * N4 * (NØ(2) -1) + W6 * (NØ(3) -1) * H6(2) * 1.99 + 3600 * H7 + .5) / 1000</math></p>	<p>F2(4) = Space transport cost, O&amp;M</p> <p>W3 = Average FC stack weight (Kg)</p> <p>W4 = Average EC stack weight (Kg)</p> <p>W6 = Ancillary equipment total weight (Kg)</p> <p>N3 = Total FC stacks</p>		

PARAMETER	RELATIONSHIP	VARIABLES	BOL	EOL
Space transport cost (Continued)		N4 = Total EC stacks NØ (1) = Number of maintenance cycles (FCU) NØ (2) = Number of maintenance cycles (ECU) NØ (3) = Number of maintenance cycles (pump) K3 = FCS failure rate fraction K4 = ECS failure rate fraction K6 = AE failure rate fraction H7 = Total astronaut manyear H6 (1) = Failure replacement factor H6 (2) = Overhaul replacement factor		
O&M total cost	$LEO, F2 = F2(1) + F2(2) + F2(3) = F2(4)$ $GEO, F2 = 100 * IØ$	F2 = O&M total cost F2 (1) = Spares cost, O&M F2 (2) = Training cost, O&M F2 (3) = Maintenance cost, O&M F2 (4) = Space transport cost IØ = Total ESS life (Yr)		

PARAMETER	RELATIONSHIP	VARIABLES	BOL	EOL
ESS life cycle cost	$F7 = F\emptyset + F1 + F2$	<p>F7 = Total ESS cost</p> <p>F<math>\emptyset</math> = Total production cost</p> <p>F1 = Total cost for DDTEE</p> <p>F2 = O&amp;M total cost</p>		
Solar array cost	<p>If L = 5 Then M = 23.8</p> <p>Else M = <math>36.25 + .545 * L\emptyset</math> F8 = <math>INT(M * P8(1) \wedge .803 + .5) / 1000</math></p>	<p>F8 = Solar array cost</p> <p>M = Intermediate variable</p> <p>L<math>\emptyset</math> = Total ESS life</p> <p>P8(1) = Total solar array power required (W)</p>		
Thermal control cost	$F9(1) = INT(5200 + .0825 * Q7 + 1.5 * W9(1) + .5) / 1000$	<p>F9(1) = Thermal control cost (1980\$M)</p> <p>Q7 = Total ESS maximum cycle heat load (W)</p> <p>W9(1) = Maximum thermal control weight (Kg)</p>		
Power conditioning cost	$F9(2) = INT(200 * N5(2) \wedge .848 + .5) / 1000$	<p>F9(2) = Power conditioning cost (1980\$M)</p> <p>N5(2) = Number of power conditioners</p>		

PARAMETER	RELATIONSHIP	VARIABLES	BOL	EOL
Total life cycle cost	$F = F7 + F8 + F9(1) + F9(2)$	<p>F = Total life cycle cost (1980 \$M)</p> <hr/> <p>F7 = ESS life cycle cost (1980\$M)</p> <p>F8 = Solar array cost (1980\$M)</p> <p>F9(1) = Thermal control cost</p> <p>F9(2) = Power conditioning cost</p>		

LEO 25KW ESS (NiCd)

MISSION PARAMETERS

1 Total Number of Battery Cycles	160320
2 Maximum Discharge Time (Hr)	.62355
3 Minimum Charge Time (Hr)	.90808
4 Total ESS Life (Yr)	30
5 Number of Hardware Life Cycles	4

ESS PERFORMANCE REQUIREMENTS

1 Total Power Required (W)	29825
2 Total Voltage Required (V)	128.8
3 Required Battery Life (Yr)	6.863

ESS PERFORMANCE PARAMETERS

1 Maximum Battery Life (Yr)	7.0958
2 Capacity Degratation Factor	.89438
3 Voltage Degratation Factor	.89438
4 EOL Minimum Power (W)	29901
5 EOL Minimum Voltage (V)	129.12

BATTERY CELL QUANTITIES

1 Total Number of Cells	1508
2 Total Cells in Parallel	13
3 Total Cells in Series	116
4 Number of Modules/Battery	8
5 Number of Cells/Module (Ave)	14.5

-----  
BATTERY CELL DISCHARGE  
PARAMETERS

1 Rated Cell Capacity (AH)	50
2 EOL Max. Depth of Discharge	.24837
3 EOL Max. Discharge (AH)	11.107
4 Max. Discharge Current (A)	17.813
5 EOL Min. Voltage (V)	1.1131

-----  
BATTERY CELL CHARGE PARAMETERS

1 Recharge Fraction	1.0577
2 Charge Throughput	1.0143
3 Charge Current (A)	12.937
4 Charge Voltage (V)	1.6586
5 Watt-Hour Efficiency	.63454

-----  
ESS THERMAL PARAMETERS

1 Average Operating Temperature (Deg-K)	283
2 Battery Cell Enthalpy Voltage (V)	1.2779
3 Maximum Discharge Heat Load (W)	4427
4 Maximum Charge Heat Load (W)	8786
5 Maximum Cycle Heat Load (W)	8786

-----  
ESS INTERFACE PARAMETERS

1 Max Solar Array Power (W)	34607
2 Max Solar Array Weight (Kg)	710
3 Max Thermal Control Weight (Kg)	853

---

WEIGHTS (Kg)

1 Battery Cell (incl terminals)	2 0274
2 Battery Module (Rve)	31.019
3 BRPC	2.32
4 Charger (P3)	24.95
5 Channel (less interfaces)	288.78
6 Channel Interfaces	4.043
7 ESS (incl Interfaces)	4116 (*)

---

DIMENSIONS (CM)

1 Battery Cell (incl terminals) (LxWxH)	12.70 x	3.30 x	17.30
2 Large Battery Module (LxWxH)	69.40 x	16.60 x	23.20
3 Small Battery Module (LxWxH)	64.80 x	16.60 x	23.20
4 BRPC (LxWxH)	21.40 x	12.70 x	6.40
5 Charger (P3) (LxWxH)	63.50 x	26.90 x	16.50
6 Channel (LxWxH)	103.60 x	198.30 x	28.90
7 ESS (LxDxS)	207.20 x	457.00 x	198.30

---

VOLUMES (cm<sup>3</sup>)

1 Battery Cell (incl terminals)	725
2 Large Battery Module	26727
3 Small Battery Module	24956
4 BRPC	1739
5 Charger (P3)	28184
6 Channel (less Interfaces)	593720
7 ESS (incl Interfaces)	29608000

---

LIFE CYCLE COSTS (1980\$M)

DDTWE		10.985
PRODUCTION		18.838
a Battery Cell	(.446)	
1 Cell Matching	2.181	
2 Module Assembly	1.823	
3 Channel Assembly	2.881	
4 Subsystem Assembly	1.984	
5 Acceptance & Surface Transport	1.262	
6 Prelaunch Integration & Checkout	.221	
7 Space Transport	8.191	
8 Space Deployment & Checkout	.045	
OPERATIONS & MAINTENANCE		122.975
1 Spares Production	13.614	
2 Crew Training	1.358	
3 Labor	8.424	
4 Space Transport	99.587	
ESS LIFE CYCLE COST		152.558
INTERFACE COSTS		
1 Solar Array	232.239	
2 Thermal Control	7.284	
3 Power Conditioning	1.761	
TOTAL LIFE CYCLE COST		393.772

ORIGINAL PAGE IS  
OF POOR QUALITY



LEO            50KW ESS            (NiCd)

MISSION PARAMETERS

1 Total Number of Battery Cycles	160320
2 Maximum Discharge Time (Hr)	.62355
3 Minimum Charge Time (Hr)	.90808
4 Total ESS Life (Yr)	30
5 Number of Hardware Life Cycles	4

-----  
ESS PERFORMANCE REQUIREMENTS

1 Total Power Required (W)	59650
2 Total Voltage Required (V)	128.8
3 Required Battery Life (Yr)	6.863

-----  
ESS PERFORMANCE PARAMETERS

1 Maximum Battery Life (Yr)	7.0958
2 Capacity Degratation Factor	.89438
3 Voltage Degratation Factor	.89438
4 EOL Minimum Power (W)	59801
5 EOL Minimum Voltage (V)	129.12

-----  
BATTERY CELL QUANTITIES

1 Total Number of Cells	3016
2 Total Cells in Parallel	26
3 Total Cells in Series	116
4 Number of Modules/Battery	8
5 Number of Cells/Module (Ave)	14.5

---

BATTERY CELL DISCHARGE  
PARAMETERS

1 Rated Cell Capacity (AH)	50
2 EOL Max. Depth of Discharge	.24837
3 EOL Max. Discharge (AH)	11.107
4 Max. Discharge Current (A)	17.813
5 EOL Min. Voltage (V)	1.1131

---

BATTERY CELL CHARGE PARAMETERS

1 Recharge Fraction	1.0577
2 Charge Throughput	1.0143
3 Charge Current (A)	12.937
4 Charge Voltage (V)	1.6586
5 Watt-Hour Efficiency	.63454

---

ESS THERMAL PARAMETERS

1 Average Operating Temperature (Deg-K)	283
2 Battery Cell Enthalpy Voltage (V)	1.2779
3 Maximum Discharge Heat Load (W)	8854
4 Maximum Charge Heat Load (W)	17572
5 Maximum Cycle Heat Load (W)	17572

---

ESS INTERFACE PARAMETERS

1 Max Solar Array Power (W)	69213
2 Max Solar Array Weight (Kg)	1419
3 Max Thermal Control Weight (Kg)	1705

---

ORIGINAL PAGE IS  
OF POOR QUALITY

-----  
HEIGHTS (K\*)

1 Battery Cell (incl terminals)	2 0274
2 Battery Module (Hva)	31 019
3 BRPC	2.32
4 Charger (#3)	24.95
5 Channel (less interfaces)	288.78
6 Channel Interfaces	4.043
7 ESS (incl Interfaces)	8231 (*)

-----  
DIMENSIONS (CM)

1 Battery Cell (incl terminals) (LxWxH)	12.70 x	3.30 x	17.30
2 Large Battery Module (LxWxH)	69.40 x	16.60 x	23.20
3 Small Battery Module (LxWxH)	64.80 x	16.60 x	23.20
4 BRPC (LxWxH)	21.40 x	12.70 x	6.40
5 Charger (#3) (LxWxH)	63.50 x	26.90 x	16.50
6 Channel (LxWxH)	103.60 x	198.30 x	28.90
7 ESS (LxDxS)	414.40 x	457.00 x	198.30

-----  
VOLUMES (cm3)

1 Battery Cell (incl terminals)	725
2 Large Battery Module	26727
3 Small Battery Module	24956
4 BRPC	1739
5 Charger (#3)	28184
6 Channel (less Interfaces)	593720
7 ESS (incl Interfaces)	59216000

LIFE CYCLE COSTS (1980\$M)

DDT&E		14.383
PRODUCTION		32.780
a Battery Cell	(.415)	
1 Cell Matching	3.505	
2 Module Assembly	2.598	
3 Channel Assembly	5.156	
4 Subsystem Assembly	2.639	
5 Acceptance & Surface Transport	2.030	
6 Prelaunch Integration & Checkout	.381	
7 Space Transport	16.380	
8 Space Deployment & Checkout	.091	
OPERATIONS & MAINTENANCE		238.986
1 Spares Production	20.750	
2 Crew Training	2.693	
3 Labor	16.801	
4 Space Transport	198.742	
ESS LIFE CYCLE COST		286.149
INTERFACE COSTS		
1 Solar Array	405.188	
2 Thermal Control	9.207	
3 Power Conditioning	3.169	
TOTAL LIFE CYCLE COST		703.713

ORIGINAL PAGE IS  
OF POOR QUALITY

LEO 100KW ESS (NiCd)

MISSION PARAMETERS

1 Total Number of Battery Cycles	160320
2 Maximum Discharge Time (Hr)	.62355
3 Minimum Charge Time (Hr)	.90815
4 Total ESS Life (Yr)	30
5 Number of Hardware Life Cycles	4

ESS PERFORMANCE REQUIREMENTS

1 Total Power Required (W)	119300
2 Total Voltage Required (V)	128.8
3 Required Battery Life (Yr)	6.863

ESS PERFORMANCE PARAMETERS

1 Maximum Battery Life (Yr)	6.9534
2 Capacity Degradation Factor	.89234
3 Voltage Degradation Factor	.89234
4 EOL Minimum Power (W)	120170
5 EOL Minimum Voltage (V)	129.73

BATTERY CELL QUANTITIES

1 Total Number of Cells	5967
2 Total Cells in Parallel	51
3 Total Cells in Series	117
4 Number of Modules/Battery	8
5 Number of Cells/Module (Ave)	14.63

---

BATTERY CELL DISCHARGE  
PARAMETERS

1 Rated Cell Capacity (AH)	50
2 EOL Max. Depth of Discharge	.25385
3 EOL Max. Discharge (AH)	11.326
4 Max. Discharge Current (A)	18.163
5 EOL Min. Voltage (V)	1.1088

---

BATTERY CELL CHARGE PARAMETERS

1 Recharge Fraction	1.0552
2 Charge Throughput	1.014
3 Charge Current (A)	13.16
4 Charge Voltage (V)	1.6638
5 Watt-Hour Efficiency	.63152

---

ESS THERMAL PARAMETERS

1 Average Operating Temperature (Deg-K)	283
2 Battery Cell Enthalpy Voltage (V)	1.275
3 Maximum Discharge Heat Load (W)	18613
4 Maximum Charge Heat Load (W)	35775
5 Maximum Cycle Heat Load (W)	35775

---

ESS INTERFACE PARAMETERS

1 Max Solar Array Power (W)	139740
2 Max Solar Array Weight (Kg)	2865
3 Max Thermal Control Weight (Kg)	3471

---

-----  
WEIGHTS (Kg)

1 Battery Cell (incl terminals)	2.0274
2 Battery Module (Ave)	31.293
3 BRPC	2.34
4 Charger (#3)	24.95
5 Channel (less interfaces)	291.33
6 Channel Interfaces	4.079
7 ESS (incl Interfaces)	16426 (#)

-----

DIMENSIONS (CM)

1 Battery Cell (incl terminals) (LxWxH)	12.70 x	3.30 x	17.30
2 Large Battery Module (LxWxH)	69.40 x	16.60 x	23.20
3 Small Battery Module (LxWxH)	64.80 x	16.60 x	23.20
4 BRPC (LxWxH)	21.60 x	12.70 x	6.40
5 Charger (#3) (LxWxH)	63.50 x	26.90 x	16.50
6 Channel (LxWxH)	103.60 x	174.90 x	28.90
7 ESS (LxDxS)	725.20 x	457.00 x	174.90

-----

VOLUMES (cm3)

1 Battery Cell (incl terminals)	725
2 Large Battery Module	26727
3 Small Battery Module	24956
4 BRPC	1756
5 Charger (#3)	28184
6 Channel (less Interfaces)	523660
7 ESS (incl Interfaces)	107110000

-----

ORIGINAL PAGE IS  
OF POOR QUALITY

LIFE CYCLE COSTS (1980\$M)

DOT&E		21.126
PRODUCTION		60.534
a Battery Cell	(.386)	
1 Cell Machine	5.980	
2 Module Assembly	4.113	
3 Channel Assembly	9.608	
4 Subsystem Assembly	3.920	
5 Acceptance & Surface Transport	3.343	
6 Prelaunch Integration & Checkout	.701	
7 Space Transport	32.688	
8 Space Deployment & Checkout	.181	
OPERATIONS & MAINTENANCE		463.056
1 Spares Production	34.316	
2 Crew Training	5.280	
3 Labor	32.947	
4 Space Transport	390.513	
ESS LIFE CYCLE COST		544.716
INTERFACE COSTS		
1 Solar Array	712.325	
2 Thermal Control	13.358	
3 Power Conditioning	5.611	
TOTAL LIFE CYCLE COST		1276.010



LEO 250KW ESS (NiCd)

MISSION PARAMETERS

1 Total Number of Battery Cycles	150320
2 Maximum Discharge Time (Hr)	.62355
3 Minimum Charge Time (Hr)	.90815
4 Total ESS Life (Yr)	30
5 Number of Hardware Life Cycles	4

ESS PERFORMANCE REQUIREMENTS

1 Total Power Required (W)	298250
2 Total Voltage Required (V)	128.8
3 Required Battery Life (Yr)	6.863

ESS PERFORMANCE PARAMETERS

1 Maximum Battery Life (Yr)	6.8655
2 Capacity Degradation Factor	.89104
3 Voltage Degradation Factor	.89104
4 EOL Minimum Power (W)	299660
5 EOL Minimum Voltage (V)	129.4

BATTERY CELL QUANTITIES

1 Total Number of Cells	14742
2 Total Cells in Parallel	126
3 Total Cells in Series	117
4 Number of Modules/Battery	8
5 Number of Cells/Module (Ave)	14.63

ORIGINAL PAGE IS  
OF POOR QUALITY

BATTERY CELL DISCHARGE  
PARAMETERS

1 Rated Cell Capacity (AH)	50
2 EOL Max. Depth of Discharge	.25723
3 EOL Max. Discharge (AH)	11.46
4 Max. Discharge Current (A)	18.379
5 EOL Min. Voltage (V)	1.106

-----

BATTERY CELL CHARGE PARAMETERS

1 Recharge Fraction	1.0538
2 Charge Throughput	1.0138
3 Charge Current (A)	13.298
4 Charge Voltage (V)	1.6671
5 Watt-Hour Efficiency	.62957

-----

ESS THERMAL PARAMETERS

1 Average Operating Temperature (Deg-K)	283
2 Battery Cell Enthalpy Voltage (V)	1.2731
3 Maximum Discharge Heat Load (W)	45275
4 Maximum Charge Heat Load (W)	89978
5 Maximum Cycle Heat Load (W)	89978

-----

ESS INTERFACE PARAMETERS

1 Max Solar Array Power (W)	349540
2 Max Solar Array Weight (Kg)	7166
3 Max Thermal Control Weight (Kg)	8728

WEIGHTS (Kg)

1 Battery Cell (incl terminals)	2.0274
2 Battery Module (Avg)	31.299
3 BRPC	2.34
4 Charger (P3)	24.95
5 Channel (less interfaces)	291.55
6 Channel Interfaces	4.082
7 ESS (incl Interfaces)	37794 (*)

DIMENSIONS (CM)

1 Battery Cell (incl terminals) (LxWxH)	12.70 x	3.30 x	17.30
2 Large Battery Module (LxWxH)	69.40 x	16.60 x	23.20
3 Small Battery Module (LxWxH)	64.80 x	16.60 x	23.20
4 BRPC (LxWxH)	21.60 x	12.70 x	6.40
5 Charger (P3) (LxWxH)	63.50 x	26.90 x	16.50
6 Channel (LxWxH)	103.60 x	174.90 x	28.90
7 ESS (LxDxS)	1657.60 x	457.00 x	174.90

VOLUMES (cm3)

1 Battery Cell (incl terminals)	725
2 Large Battery Module	26727
3 Small Battery Module	24956
4 BRPC	1756
5 Charger (P3)	28184
6 Channel (less Interfaces)	523660
7 ESS (incl Interfaces)	244830000

ORIGINAL PAGE IS  
OF POOR QUALITY

LIFE CYCLE COSTS (1980\$M)

DDT&E		29.387
PRODUCTION		136.460
a Battery Cell	(.351)	
1 Cell Matching	12.983	
2 Module Assembly	6.620	
3 Channel Assembly	22.849	
4 Subsystem Assembly	7.736	
5 Acceptance & Surface Transport	7.112	
6 Prelaunch Integration & Checkout	1.534	
7 Space Transport	75.210	
8 Space Deployment & Checkout	.416	
OPERATIONS & MAINTENANCE		1132.589
1 Spares Production	73.450	
2 Crew Training	13.043	
3 Labor	81.385	
4 Space Transport	964.711	
ESS LIFE CYCLE COST		1298.436
INTERFACE COSTS		
1 Solar Array	1487.352	
2 Thermal Control	25.715	
3 Power Conditioning	12.082	
TOTAL LIFE CYCLE COST		2823.585

GEO 25KW ESS (NiCd)

MISSION PARAMETERS

1 Total Number of Battery Cycles	439.55
2 Maximum Discharge Time (Hr)	1.1813
3 Minimum Charge Time (Hr)	22.721
4 Total ESS Life (Yr)	5
5 Number of Hardware Life Cycles	1

---

ESS PERFORMANCE REQUIREMENTS

1 Total Power Required (W)	29825
2 Total Voltage Required (V)	128.8
3 Required Battery Life (Yr)	.075265

---

ESS PERFORMANCE PARAMETERS

1 Maximum Battery Life (Yr)	1.0114
2 Capacity Degradation Factor	.99145
3 Voltage Degradation Factor	.99145
4 EOL Minimum Power (W)	29875
5 EOL Minimum Voltage (V)	129.02

---

BATTERY CELL QUANTITIES

1 Total Number of Cells	1080
2 Total Cells in Parallel	10
3 Total Cells in Series	108
4 Number of Modules/Battery	6
5 Number of Cells/Module (Ave)	18

---

BATTERY CELL DISCHARGE  
PARAMETERS

1 Rated Cell Capacity (AH)	50
2 EOL Max. Depth of Discharge	.5518
3 EOL Max Discharge (AH)	27.354
4 Max. Discharge Current (A)	23.156
5 EOL Min. Voltage (V)	1.1946

BATTERY CELL CHARGE PARAMETERS

1 Recharge Fraction	1.0275
2 Charge Throughput	1.0152
3 Charge Current (A)	1.237
4 Charge Voltage (V)	1.4043
5 Watt-Hour Efficiency	.82793

ESS THERMAL PARAMETERS

1 Average Operating Temperature (Deg-K)	283
2 Battery Cell Enthalpy Voltage (V)	1.4166
3 Maximum Discharge Heat Load (W)	5552
4 Maximum Charge Heat Load (W)	35
5 Maximum Cycle Heat Load (W)	2776

ESS INTERFACE PARAMETERS

1 Max Solar Array Power (W)	2006.5
2 Max Solar Array Weight (Kg)	42
3 Max Thermal Control Weight (Kg)	270

WEIGHTS (Kg)

1 Battery Cell (incl terminals)	2.6274
2 Battery Module (RVA)	38.538
3 BRPC	2.16
4 Charger (#3)	24.95
5 Channel (less interfaces)	268.73
6 Channel Interfaces	3.762
7 ESS (incl Interfaces)	2726 (#)

DIMENSIONS (CM)

1 Battery Cell (incl terminals) (LxWxH)	12.70 x	3.30 x	17.30
2 Large Battery Module (LxWxH)	83.30 x	16.60 x	23.20
3 Small Battery Module (LxWxH)	83.30 x	16.60 x	23.20
4 BRPC (LxWxH)	19.90 x	12.70 x	6.40
5 Charger (#3) (LxWxH)	63.50 x	26.90 x	16.50
6 Channel (LxWxH)	82.90 x	268.60 x	28.90
7 ESS (LxDxS)	165.80 x	457.00 x	268.60

VOLUMES (cm3)

1 Battery Cell (incl terminals)	725
2 Large Battery Module	32080
3 Small Battery Module	32080
4 BRPC	1617
5 Charger (#3)	28184
6 Channel (less Interfaces)	643520
7 ESS (incl Interfaces)	20580000

ORIGINAL PAGE IS  
OF POOR QUALITY

LIFE CYCLE COSTS (1990\$M)

DDT&E		8.912
PRODUCTION		44.882
a Battery Cell	0.462	
1 Cell Matching	1.793	
2 Module Assembly	1.604	
3 Channel Assembly	2.237	
4 Subsystem Assembly	1.798	
5 Acceptance & Surface Transport	1.162	
6 Prelaunch Integration & Checkout	.155	
7 Space Transport	36.892	
8 Space Deployment & Checkout	.030	
OPERATIONS & MAINTENANCE		.500
1 Spares Production	0.000	
2 Crew Training	0.000	
3 Labor	.500	
4 Space Transport	0.000	
ESS LIFE CYCLE COST		54.294
INTERFACE COSTS		
1 Solar Array	10.677	
2 Thermal Control	5.834	
3 Power Conditioning	1.409	
TOTAL LIFE CYCLE COST		78.214



LEO 25KW ESS (NIH2)

MISSION PARAMETERS

1 Total Number of Battery Cycles	150000
2 Maximum Discharge Time (Hr)	.62355
3 Minimum Charge Time (Hr)	90813
4 Total ESS Life (Yr)	30
5 Number of Hardware Life Cycles	1

ESS PERFORMANCE REQUIREMENTS

1 Total Power Required (W)	29925
2 Total Voltage Required (V)	128.8
3 Required Battery Life (Yr)	6.863

ESS PERFORMANCE PARAMETERS

1 Maximum Battery Life (Yr)	7.7853
2 Capacity Degradation Factor	.99327
3 Voltage Degradation Factor	.99327
4 EOL Minimum Power (W)	30087
5 EOL Minimum Voltage (V)	129.93

BATTERY CELL QUANTITIES

1 Total Number of Cells	904
2 Total Cells in Parallel	8
3 Total Cells in Series	113
4 Number of Modules/Battery	5
5 Number of Cells/Module (Ave)	22.5

ORIGINAL PAGE IS  
OF POOR QUALITY

-----  
BATTERY CELL DISCHARGE  
PARAMETERS

1 Rated Cell Capacity (AH)	50
2 EOL Max. Depth of Discharge	.39964
3 EOL Max. Discharge (AH)	18.049
4 Max. Discharge Current (A)	28.946
5 EOL Min. Voltage (V)	1.1498

-----

BATTERY CELL CHARGE PARAMETERS

1 Recharge Fraction	1.0715
2 Charge Throughput	1.0286
3 Charge Current (A)	21.296
4 Charge Voltage (V)	1.6829
5 Watt-Hour Efficiency	.63764

-----

ESS THERMAL PARAMETERS

1 Average Operating Temperature (Deg-K)	283
2 Battery Cell Enthalpy Voltage (V)	1.3097
3 Maximum Discharge Heat Load (W)	4185
4 Maximum Charge Heat Load (W)	8867
5 Maximum Cycle Heat Load (W)	8867

-----

ESS INTERFACE PARAMETERS

1 Max Solar Array Power (W)	34651
2 Max Solar Array Weight (Kg)	711
3 Max Thermal Control Weight (Kg)	861

---

WEIGHTS (lb)

1 Battery Cell (incl terminals)	1.1340
2 Battery Module (Ave)	36.000
3 BRPC	2.25
4 Charger (#3)	24.95
5 Channel (less interfaces)	259.87
6 Channel Interfaces	12.214
7 ESS (incl Interfaces)	2178 (#)

---

DIMENSIONS (CM)

1 Battery Cell (incl terminals) (Dia x L)	9.32 x 29.61
2 Large Battery Module (L x W x H)	58.33 x 51.26 x 37.01
3 Small Battery Module (L x W x H)	58.33 x 46.60 x 37.01
4 BRPC (L x W x H)	20.90 x 12.70 x 6.40
5 Charger (#3) (L x W x H)	63.50 x 26.90 x 16.50
6 Channel (L x W x H)	122.33 x 174.90 x 39.80
7 ESS (L x D x S)	122.33 x 457.00 x 174.90

---

VOLUMES (cm<sup>3</sup>)

1 Battery Cell (incl terminals)	2020
2 Large Battery Module	110660
3 Small Battery Module	100600
4 BRPC	1699
5 Charger (#3)	28184
6 Channel (less Interfaces)	851540
7 ESS (incl Interfaces)	18068000

LIFE CYCLE COSTS (1980\$M)

DDT&E		8.998
PRODUCTION		12.593
a Battery Cell	(.981)	
1 Cell Matching	2.276	
2 Module Assembly	1.408	
3 Channel Assembly	1.622	
4 Subsystem Assembly	1.703	
5 Acceptance & Surface Transport	1.081	
6 Prelaunch Integration & Checkout	.145	
7 Space Transport	4.334	
8 Space Deployment & Checkout	.024	
OPERATIONS & MAINTENANCE		55.824
1 Spares Production	12.526	
2 Crew Training	.518	
3 Labor	3.229	
4 Space Transport	39.551	
ESS LIFE CYCLE COST		77.415
INTERFACE COSTS		
1 Solar Array	232.476	
2 Thermal Control	7.223	
3 Power Conditioning	1.166	
TOTAL LIFE CYCLE COST		318.280

LEO 50kW ESS (NiH2)

MISSION PARAMETERS

1 Total Number of Battery Cycles	160320
2 Maximum Discharge Time (Hr)	.62355
3 Minimum Charge Time (Hr)	.90815
4 Total ESS Life (Yr)	30
5 Number of Hardware Life Cycles	4

---

ESS PERFORMANCE REQUIREMENTS

1 Total Power Required (W)	59650
2 Total Voltage Required (V)	128.8
3 Required Battery Life (Yr)	6.863

---

ESS PERFORMANCE PARAMETERS

1 Maximum Battery Life (Yr)	7.117
2 Capacity Degradeation Factor	.89468
3 Voltage Degradeation Factor	.89468
4 EDL Minimum Power (W)	59734
5 EDL Minimum Voltage (V)	128.98

---

BATTERY CELL QUANTITIES

1 Total Number of Cells	1710
2 Total Cells in Parallel	15
3 Total Cells in Series	114
4 Number of Modules/Battery	5
5 Number of Cells/Module (Ave)	22.8

---

ORIGINAL PAGE IS  
OF POOR QUALITY

C - 4

---

BATTERY CELL DISCHARGE  
PARAMETERS

1 Rated Cell Capacity (AH)	50
2 EOL Max. Depth of Discharge	.43037
3 EOL Max. Discharge (AH)	19.252
4 Max. Discharge Current (A)	30.875
5 EOL Min. Voltage (V)	1.1314

---

BATTERY CELL CHARGE PARAMETERS

1 Recharge Fraction	1.0715
2 Charge Throughput	1.0308
3 Charge Current (A)	22.715
4 Charge Voltage (V)	1.7012
5 Watt-Hour Efficiency	.62068

---

ESS THERMAL PARAMETERS

1 Average Operating Temperature (Deg-K)	283
2 Battery Cell Enthalpy Voltage (V)	1.2973
3 Maximum Discharge Heat Load (W)	8759
4 Maximum Charge Heat Load (W)	19052
5 Maximum Cycle Heat Load (W)	19052

---

ESS INTERFACE PARAMETERS

1 Max Solar Array Power (W)	70673
2 Max Solar Array Weight (Kg)	1449
3 Max Thermal Control Weight (Kg)	1849

WEIGHTS (kg)

---

1 Battery Cell (incl terminals)	1.1340
2 Battery Module (Hvs)	36.444
3 BRPC	2.28
4 Charger (#3)	24.95
5 Channel (less interfaces)	265.25
6 Channel Interfaces	12.467
7 ESS (incl Interfaces)	4488 (*)

---

DIMENSIONS (CM)

1 Battery Cell (incl terminals) (DlxL)	9.32 x 29.61
2 Large Battery Module (LxWxH)	58.33 x 51.26 x 37.01
3 Small Battery Module (LxWxH)	58.33 x 46.50 x 37.01
4 BRPC (LxWxH)	21.00 x 12.70 x 6.40
5 Charger (#3) (LxWxH)	63.50 x 26.90 x 16.50
6 Channel (LxWxH)	122.33 x 174.90 x 39.80
7 ESS (LxDxS)	244.66 x 457.00 x 174.90

---

VOLUMES (cm<sup>3</sup>)

1 Battery Cell (incl terminals)	2020
2 Large Battery Module	110650
3 Small Battery Module	100600
4 BRPC	1707
5 Charger (#3)	28184
6 Channel (less Interfaces)	851540
7 ESS (incl Interfaces)	36137000

LIFE CYCLE COSTS (1980\$M)

DOT&E		10.788
PRODUCTION		20.471
a Battery Cell	(.917)	
1 Cell Matching	3.504	
2 Module Assembly	1.729	
3 Channel Assembly	2.534	
4 Subsystem Assembly	2.046	
5 Acceptance & Surface Transport	1.443	
6 Prelaunch Integration & Checkout	.235	
7 Space Transport	8.931	
8 Space Deployment & Checkout	.049	
OPERATIONS & MAINTENANCE		99.444
1 Spares Production	17.792	
2 Crew Training	.974	
3 Labor	6.078	
4 Space Transport	74.600	
ESS LIFE CYCLE COST		130.703
INTERFACE COSTS		
1 Solar Array	412.037	
2 Thermal Control	9.545	
3 Power Conditioning	1.988	
TOTAL LIFE CYCLE COST		554.273

ORIGINAL PAGE IS  
OF POOR QUALITY



LEO 100KW ESS (NiH2)

MISSION PARAMETERS

1 Total Number of Battery Cycles	160320
2 Maximum Discharge Time (Hr)	.62355
3 Minimum Charge Time (Hr)	.90815
4 Total ESS Life (Yr)	30
5 Number of Hardware Life Cycles	4

ESS PERFORMANCE REQUIREMENTS

1 Total Power Required (W)	119300
2 Total Voltage Required (V)	128.8
3 Required Battery Life (Yr)	6.863

ESS PERFORMANCE PARAMETERS

1 Maximum Battery Life (Yr)	7.117
2 Capacity Degradation Factor	.89468
3 Voltage Degradation Factor	.89468
4 EOL Minimum Power (W)	119470
5 EOL Minimum Voltage (V)	128.98

BATTERY CELL QUANTITIES

1 Total Number of Cells	3420
2 Total Cells in Parallel	30
3 Total Cells in Series	114
4 Number of Modules/Battery	5
5 Number of Cells/Module (Ave)	22.8

---

BATTERY CELL DISCHARGE  
PARAMETERS

1 Rated Cell Capacity (AH)	50
2 EOL Max. Depth of Discharge	.43037
3 EOL Max Discharge (AH)	19.252
4 Max. Discharge Current (A)	30.875
5 EOL Min. Voltage (V)	1.1314

---

BATTERY CELL CHARGE PARAMETERS

1 Recharge Fraction	1.0715
2 Charge Throughput	1.0308
3 Charge Current (A)	22.715
4 Charge Voltage (V)	1.7012
5 Watt-Hour Efficiency	.62068

---

ESS THERMAL PARAMETERS

1 Average Operating Temperature (Deg-K)	283
2 Battery Cell Enthalpy Voltage (V)	1.2973
3 Maximum Discharge Heat Load (W)	17518
4 Maximum Charge Heat Load (W)	38101
5 Maximum Cycle Heat Load (W)	38101

---

ESS INTERFACE PARAMETERS

1 Max Solar Array Power (W)	141350
2 Max Solar Array Weight (Kg)	2898
3 Max Thermal Control Weight (Kg)	3696

---

---

WEIGHTS (Kg)

1 Battery Cell (incl terminals)	1.1340
2 Battery Module (Ave)	36.444
3 BRPC	2.26
4 Charger (#3)	24.95
5 Channel (less interfaces)	265.25
6 Channel Interfaces	12.467
7 ESS (incl Interfaces)	8974 (*)

---

DIMENSIONS (CM)

1 Battery Cell (incl terminals) (DiaXL)	9.32 x 29.61
2 Large Battery Module (LxWxH)	58.33 x 51.26 x 37.01
3 Small Battery Module (LxWxH)	58.33 x 46.60 x 37.01
4 BRPC (LxWxH)	21.00 x 12.70 x 6.40
5 Charger (#3) (LxWxH)	63.50 x 26.90 x 16.50
6 Channel (LxWxH)	122.33 x 174.90 x 39.80
7 ESS (LxDxS)	489.32 x 457.00 x 174.90

---

VOLUMES (cm3)

1 Battery Cell (incl terminals)	2020
2 Large Battery Module	110660
3 Small Battery Module	100600
4 BRPC	1707
5 Charger (#3)	28184
6 Channel (less Interfaces)	851540
7 ESS (incl Interfaces)	72273000

LIFE CYCLE COSTS (1980\$M)

ODT&E		14.591
PRODUCTION		36.164
a Battery Cell	(.853)	
1 Cell Matching	5.974	
2 Module Assembly	2.408	
3 Channel Assembly	4.461	
4 Subsystem Assembly	2.762	
5 Acceptance & Surface Transport	2.192	
6 Prelaunch Integration & Checkout	.410	
7 Space Transport	17.858	
8 Space Deployment & Checkout	.099	
OPERATIONS & MAINTENANCE		191.317
1 Spares Production	28.499	
2 Crew Training	1.941	
3 Labor	12.110	
4 Space Transport	148.767	
ESS LIFE CYCLE COST		242.072
INTERFACE COSTS		
1 Solar Array	718.908	
2 Thermal Control	13.887	
3 Power Conditioning	3.578	
TOTAL LIFE CYCLE COST		978.445

LEO 250KW ESS (NiH2)

MISSION PARAMETERS

1 Total Number of Battery Cycles	160320
2 Maximum Discharge Time (Hr)	.62355
3 Minimum Charge Time (Hr)	.90814
4 Total ESS Life (Yr)	30
5 Number of Hardware Life Cycles	4

ESS PERFORMANCE REQUIREMENTS

1 Total Power Required (W)	298250
2 Total Voltage Required (V)	128.8
3 Required Battery Life (Yr)	6.863

ESS PERFORMANCE PARAMETERS

1 Maximum Battery Life (Yr)	6.968
2 Capacity Deterioration Factor	.89255
3 Voltage Deterioration Factor	.89255
4 EOL Minimum Power (W)	300110
5 EOL Minimum Voltage (V)	129.61

BATTERY CELL QUANTITIES

1 Total Number of Cells	8510
2 Total Cells in Parallel	74
3 Total Cells in Series	115
4 Number of Modules/Battery	5
5 Number of Cells/Module (Ave)	23

-----  
BATTERY CELL DISCHARGE  
PARAMETERS

1 Rated Cell Capacity (AH)	50
2 EOL Max. Depth of Discharge	.43722
3 EOL Max. Discharge (AH)	19.512
4 Max. Discharge Current (A)	31.292
5 EOL Min. Voltage (V)	1.127

-----

BATTERY CELL CHARGE PARAMETERS

1 Recharge Fraction	1.0715
2 Charge Throughput	1.0313
3 Charge Current (A)	23.022
4 Charge Voltage (V)	1.7056
5 Watt-Hour Efficiency	.61668

-----

ESS THERMAL PARAMETERS

1 Average Operating Temperature (Deg-K)	283
2 Battery Cell Enthalpy Voltage (V)	1.2942
3 Maximum Discharge Heat Load (W)	44525
4 Maximum Charge Heat Load (W)	97520
5 Maximum Cycle Heat Load (W)	97520

-----

ESS INTERFACE PARAMETERS

1 Max Solar Array Power (W)	357380
2 Max Solar Array Weight (Kg)	7327
3 Max Thermal Control Weight (Kg)	9460

-----

---

WEIGHTS (kg)

1 Battery Cell (incl terminals)	1.1340
2 Battery Module (AVe)	36.775
3 BRPC	2.38
4 Charger (#3)	24.95
5 Channel (less interfaces)	267.85
6 Channel Interfaces	12.589
7 ESS (incl Interfaces)	22771 (*)

---

DIMENSIONS (CM)

1 Battery Cell (incl terminals (Dia x L))	9.32 x 29.51
2 Large Battery Module (LxWxH)	58.33 x 51.26 x 37.01
3 Small Battery Module (LxWxH)	58.33 x 51.26 x 37.01
4 BRPC (LxWxH)	21.20 x 12.70 x 6.40
5 Charger (#3) (LxWxH)	63.50 x 26.90 x 16.50
6 Channel (LxWxH)	128.15 x 174.90 x 39.80
7 ESS (LxDxS)	1281.50 x 457.00 x 174.90

---

VOLUMES (cm<sup>3</sup>)

1 Battery Cell (incl terminals)	2020
2 Large Battery Module	110650
3 Small Battery Module	110650
4 BRPC	1723
5 Charger (#3)	28184
6 Channel (less Interfaces)	892060
7 ESS (incl Interfaces)	189280000

LIFE CYCLE COSTS (1980\$M)

DDT&E		19.059
PRODUCTION		83.337
a Battery Cell	(.775)	
1 Cell Matching	12.854	
2 Module Assembly	4.431	
3 Channel Assembly	10.200	
4 Subsystem Assembly	4.898	
5 Acceptance & Surface Transport	4.442	
6 Prelaunch Interation & Checkout	.948	
7 Space Transport	45.314	
8 Space Deployment & Checkout	.250	
OPERATIONS & MAINTENANCE		461.213
1 Spares Production	58.769	
2 Crew Training	4.787	
3 Labor	29.870	
4 Space Transport	367.787	
ESS LIFE CYCLE COST		563.609
INTERFACE COSTS		
1 Solar Array	1514.082	
2 Thermal Control	27.435	
3 Power Conditioning	7.694	
TOTAL LIFE CYCLE COST		2112.820

ORIGINAL PAGE IS  
OF POOR QUALITY



GEO 25KW ESS (NiH2)

MISSION PARAMETERS

1 Total Number of Battery Cycles	439.55
2 Maximum Discharge Time (Hr)	1.1813
3 Minimum Charge Time (Hr)	22.726
4 Total ESS Life (Yr)	5
5 Number of Hardware Life Cycles	1

ESS PERFORMANCE REQUIREMENTS

1 Total Power Required (W)	29825
2 Total Voltage Required (V)	128.8
3 Required Battery Life (Yr)	.075265

ESS PERFORMANCE PARAMETERS

1 Maximum Battery Life (Yr)	1.304
2 Capacity Degradation Factor	.99336
3 Voltage Degradation Factor	.99336
4 EOL Minimum Power (W)	30049
5 EOL Minimum Voltage (V)	129.77

BATTERY CELL QUANTITIES

1 Total Number of Cells	749
2 Total Cells in Parallel	7
3 Total Cells in Series	107
4 Number of Modules/Battery	4
5 Number of Cells/Module (Ave)	26.75

BATTERY CELL DISCHARGE  
PARAMETERS

1 Rated Cell Capacity (AH)	50
2 EOL Max. Depth of Discharge	.78676
3 EOL Max. Discharge (AH)	39.077
4 Max. Discharge Current (A)	33.08.
5 EOL Min. Voltage (V)	1.2128

BATTERY CELL CHARGE PARAMETERS

1 Recharge Fraction	1.3749
2 Charge Throughput	1.285
3 Charge Current (A)	3.756
4 Charge Voltage (V)	1.499
5 Watt-Hour Efficiency	.58848

ESS THERMAL PARAMETERS

1 Average Operating Temperature (Deg-K)	283
2 Battery Cell Enthalpy Voltage (V)	1.4404
3 Maximum Discharge Heat Load (W)	5640
4 Maximum Charge Heat Load (W)	1270
5 Maximum Cycle Heat Load (W)	2820

ESS INTERFACE PARAMETERS

1 Max Solar Array Power (W)	4510.2
2 Max Solar Array Weight (Kg)	93
3 Max Thermal Control Weight (Kg)	274

WEIGHTS (Kg)

1 Battery Cell (incl terminals)	1 1340
2 Battery Module (Ave)	42.523
3 BRPC	2.14
4 Charger (#3)	24.95
5 Channel (less interfaces)	244.91
6 Channel Interfaces	11.511
7 ESS (incl Interfaces)	1796 (K)

DIMENSIONS (CM)

1 Battery Cell (incl terminals) (Di x L)	9.32 x 29.61
2 Large Battery Module (LxWxH)	69.65 x 41.94 x 37.01
3 Small Battery Module (LxWxH)	69.65 x 46.60 x 37.01
4 BRPC (LxWxH)	19.70 x 12.70 x 6.40
5 Charger (#3) (LxWxH)	63.50 x 25.90 x 16.50
6 Channel (LxWxH)	110.60 x 198.30 x 39.00
7 ESS (LxDxS)	110.60 x 457.00 x 198.30

VOLUMES (cm<sup>3</sup>)

1 Battery Cell (incl terminals)	2020
2 Large Battery Module	108110
3 Small Battery Module	120120
4 BRPC	1601
5 Charger (#3)	28184
6 Channel (less Interfaces)	873520
7 ESS (incl Interfaces)	15816000

ORIGINAL PAGE IS  
OF POOR QUALITY

LIFE CYCLE COSTS (1980\$M)

DOT&E		7.954
PRODUCTION		31.405
* Battery Cell	(1.000)	
1 Cell Matching	2.030	
2 Module Assembly	1.347	
3 Channel Assembly	1.445	
4 Subsystem Assembly	1.538	
5 Acceptance & Surface Transport	1.015	
6 Prelaunch Integration & Checkout	.130	
7 Space Transport	23.779	
8 Space Deployment & Checkout	.020	
OPERATIONS & MAINTENANCE		.500
1 Spares Production	0.000	
2 Crew Training	0.000	
3 Labor	.500	
4 Space Transport	0.000	
ESS LIFE CYCLE COST		39.859
INTERFACE COSTS		
1 Solar Array	14.034	
2 Thermal Control	5.844	
3 Power Conditioning	1.042	
TOTAL LIFE CYCLE COST		60.779

LEO 25KW ESS (H202)

MISSION PARAMETERS

1 Total Number of ESS Cycles	160320
2 Maximum Dark Period (Hr)	.62355
3 Minimum Light Period (Hr)	.90815
4 Total ESS Life (Hr)	30
5 Number of FCU Hardware Life Cycles	4
6 Number of ECU Hardware Life Cycles	4
7 Number of Pump Hardware Life Cycles	4

---

ESS PERFORMANCE REQUIREMENTS

1 Total Power Required (W)	31214
2 Total Voltage Required (V)	128.8
3 Required FCU Life (Hr)	15910
4 Required ECU Life (Hr)	45844
5 Required Pump Life (Hr)	62393

---

---

### ESS PERFORMANCE PARAMETERS

1 EOL Minimum Power (W)	31342
2 EOL Minimum Voltage (V)	129.33
3 Maximum FCU Life (Hr)	17436
4 Maximum ECU Life (Hr)	46201
5 Maximum Pump Life (Hr)	62393
6 Number of ESS Sides	5
7 Number of ESS Channels	8

---

### FUEL CELL UNIT QUANTITIES

1 Total Number of FCU	720
2 Total Parallel FCU	8
3 Total Series FCU	90
4 Number of FC Stacks	16
5 Number of FCU/FC Stack (Ave)	45

---

### FUEL CELL UNIT PERFORMANCE PARAMETERS

1 EOL Min. Dark Period Power (W)	43.531
2 EOL Min. Dark Period Voltage (V)	1.437
3 Active Cell Area (cm <sup>3</sup> )	232.26
4 EOL Dark Period Current Density (Ma/cm)	130.43
5 EOL Light Period Current Density (Ma/cm)	2.5

---

-----  
ELECTROLYSIS CELL UNIT  
QUANTITIES

1 Total Number of ECU	1496
2 Total Parallel ECU	44
3 Total Series FCU	34
4 Number of EC Stacks	44
5 Number of ECU/EC Stack (Ave)	34

-----

ELECTROLYSIS CELL UNIT  
PERFORMANCE PARAMETERS

1 EOL Max. Light Period Power (W)	34.046
2 EOL Max. Light Period Voltage (V)	3.442
3 Active Cell Area (cm <sup>2</sup> )	232.25
4 EOL Dark Period Current Density (Ma/cm)	2.5
5 EOL Light Period Current Density (Ma/cm)	42.587

-----

ESS THERMAL PARAMETERS

1 FCU Average Operating Pressure (Kg/cm <sup>2</sup> )	1.1248
2 FCU Average Operating Temperature (Deg-K)	355
3 ECU Average Operating Pressure (Kg/cm <sup>2</sup> )	1.1248
4 ECU Average Operating Temperature (Deg-K)	355
5 Maximum Dark Period Heat Load (W)	13837
6 Maximum Light Period Heat Load (W)	6968
7 Maximum Cycle Heat Load (W)	6968

-----

---

TOTAL ESS PARAMETERS

1 Watt-Hour Efficiency	.42251
2 DoD Factor	.8
3 Storage Temperature (Deg-K)	50
4 H2 Storage Pressure (Kg/cm2)	28.12
5 H2 Storage Volume (cm3)	98251
6 H2 Storage Weight (Kg)	1.3138
7 H2 Storage Tank Weight (Kg)	6.161
8 O2 Storage Pressure (Kg/cm2)	14.06
9 O2 Storage Volume (cm3)	196500
10 O2 Storage Weight (Kg)	10.427
11 O2 Storage Tank Weight (Kg)	6.6651
12 H2O Storage Pressure (Kg/cm2)	1.3357
13 H2O Storage Volume (cm3)	11741
14 H2O Storage Weight (Kg)	11.741
15 H2O Storage Tank Weight (Kg)	.6567

-----

ESS INTERFACE PARAMETERS

1 Max Solar Array Power (W)	54476
2 Max Solar Array Voltage (V)	125.17
3 Max Solar Array Weight (Kg)	1117
4 Max Thermal Control Weight (Kg)	127
5 Max Power Conditioning Weight (Kg)	199.6

-----



-----  
WEIGHTS (Kg)

1 FCU	.5005
2 ECU	.5005
3 FC Stack (Ave)	27.61
4 EC Stack (Ave)	20.86
5 Charger (#3)	24.95
6 Power Module	404.58
7 Ancilliary Equipment	34.05
8 ESS (incl Interfaces)	2057 (*)

-----

DIMENSIONS (cm)

1 FCU (Active Area)	(LxW)	30.48 x 7.62
2 ECU (Active Area)	(LxW)	30.48 x 7.62
3 FC Stack (Max)	(LxWxH)	36.83 x 17.78 x 51.48
4 EC Stack (Max)	(LxWxH)	36.83 x 17.78 x 41.23
5 Charger (#3)	(LxWxH)	63.50 x 26.90 x 16.50
6 Power Module	(LxWxH)	121.24 x 268.62 x 66.72
7 Ancilliary Equipment	(DiaxL)	91.50 x 50.00
8 ESS	(LxDxS)	121.24 x 457.00 x 268.62

-----

VOLUMES (cm<sup>3</sup>)

1 FCU	420.59
2 ECU	420.59
3 FC Stack	33711
4 EC Stack	26999
5 Charger (#3)	28184
6 Power Module	1780800
7 Ancilliary Equipment	329300
8 ESS (incl Interfaces)	15051000

-----

ORIGINAL PAGE IS  
OF POOR QUALITY

LIFE CYCLE COSTS (1980\$M)

DDT&E		15.283
PRODUCTION		20.962
a FCU	(3.398)	
b ECU	(3.048)	
1 FC Stack	3.443	
2 EC Stack	5.969	
3 Power Module Assembly	3.525	
4 Ancilliary Equipment	.754	
5 Subsystem Assembly	1.563	
6 Acceptance & Surface Transport	1.501	
7 Prelaunch Integration & Checkout	.140	
8 Space Transport	4.093	
9 Space Deployment & Checkout	.023	
OPERATIONS & MAINTENANCE		43.798
1 Spares Production	32.585	
2 Crew Training	.030	
3 Labor	.190	
4 Space Transport	10.993	
ESS LIFE CYCLE COST		81.043
INTERFACE COSTS		
1 Solar Array	334.317	
2 Thermal Control	5.965	
3 Power Conditioning	1.166	
TOTAL LIFE CYCLE COST		432.491

LEO 50KW ESS (H202)

MISSION PARAMETERS

1 Total Number of ESS Cycles	160320
2 Maximum Dark Period (Hr)	.62355
3 Minimum Light Period (Hr)	.90815
4 Total ESS Life (Hr)	30
5 Number of FDU Hardware Life Cycles	4
6 Number of ECU Hardware Life Cycles	4
7 Number of Pump Hardware Life Cycles	4

---

ESS PERFORMANCE REQUIREMENTS

1 Total Power Required (W)	62428
2 Total Voltage Required (V)	128.8
3 Required FDU Life (Hr)	15910
4 Required ECU Life (Hr)	45844
5 Required Pump Life (Hr)	62393

---

### ESS PERFORMANCE PARAMETERS

1 EOL Minimum Power (W)	63113
2 EOL Minimum Voltage (V)	130.21
3 Maximum FCU Life (Hr)	16542
4 Maximum ECU Life (Hr)	45844
5 Maximum Pump Life (Hr)	62393
6 Number of ESS Sides	5
7 Number of ESS Channels	15

---

### FUEL CELL UNIT QUANTITIES

1 Total Number of FCU	1380
2 Total Parallel FCU	15
3 Total Series FCU	92
4 Number of FC Stacks	30
5 Number of FCU/FC Stack (Ave)	46

---

### FUEL CELL UNIT PERFORMANCE PARAMETERS

1 EOL Min. Dark Period Power (W)	45.733
2 EOL Min. Dark Period Voltage (V)	1.4153
3 Active Cell Area (cm <sup>2</sup> )	332.86
4 EOL Dark Period Current Density (Ma/cm)	139.12
5 EOL Light Period Current Density (Ma/cm)	2.5

---

ELECTROLYSIS CELL UNIT  
QUANTITIES

1 Total Number of ECU	3026
2 Total Parallel ECU	89
3 Total Series FCU	34
4 Number of EC Stacks	89
5 Number of ECU/EC Stack (Ave)	34

ELECTROLYSIS CELL UNIT  
PERFORMANCE PARAMETERS

1 EOL Max. Light Period Power (W)	34 713
2 EOL Max. Light Period Voltage (V)	3.4768
3 Active Cell Area (cm <sup>2</sup> )	232.26
4 EOL Dark Period Current Density (Ma/cm)	2.5
5 EOL Light Period Current Density (Ma/cm)	42.987

ESS THERMAL PARAMETERS

1 FCU Average Operating Pressure (Kg/cm <sup>2</sup> )	1 1248
2 FCU Average Operating Temperature (Deg-K)	355
3 ECU Average Operating Pressure (Kg/cm <sup>2</sup> )	1 1248
4 ECU Average Operating Temperature (Deg-K)	355
5 Maximum Dark Period Heat Load (W)	28746
6 Maximum Light Period Heat Load (W)	14283
7 Maximum Cycle Heat Load (W)	14373

ORIGINAL PAGE IS  
OF POOR QUALITY

## TOTAL ESS PARAMETERS

1 Watt-Hour Efficiency	.41255
2 DoD Factor	.8
3 Storage Temperature (Deg-K)	50
4 H2 Storage Pressure (Kg/cm2)	28.12
5 H2 Storage Volume (cm3)	200530
6 H2 Storage Weight (Kg)	2.6814
7 H2 Storage Tank Weight (Kg)	10.514
8 O2 Storage Pressure (Kg/cm2)	14.06
9 O2 Storage Volume (cm3)	401050
10 O2 Storage Weight (Kg)	21.281
11 O2 Storage Tank Weight (Kg)	11.912
12 H2O Storage Pressure (Kg/cm2)	1.3357
13 H2O Storage Volume (cm3)	23962
14 H2O Storage Weight (Kg)	23.962
15 H2O Storage Tank Weight (Kg)	.63278

---

## ESS INTERFACE PARAMETERS

1 Max Solar Array Power (W)	112344
2 Max Solar Array Voltage (V)	126.43
3 Max Solar Array Weight (Kg)	2304
4 Max Thermal Control Weight (Kg)	262
5 Max Power Conditioning Weight (Kg)	374.25

---

WEIGHTS (kg)

1 FCU	.5005
2 ECU	.5005
3 FC Stack (Ave)	26.23
4 EC Stack (Ave)	20.86
5 Charger (#3)	24.95
6 Power Module	807.68
7 Ancillary Equipment	63.48
8 ESS (incl Interfaces)	4102 (X)

DIMENSIONS (cm)

1 FCU (Active Area)	(LxW)	30.48 x 7.62
2 ECU (Active Area)	(LxW)	30.48 x 7.62
3 FC Stack (Max)	(LxWxH)	36.83 x 17.78 x 52.41
4 EC Stack (Max)	(LxWxH)	36.83 x 17.78 x 41.23
5 Charger (#3)	(LxWxH)	63.50 x 25.90 x 16.50
6 Power Module	(LxWxH)	167.55 x 268.62 x 67.65
7 Ancillary Equipment	(DiaxL)	104.02 x 79.30
8 ESS	(LxDxB)	167.55 x 457.00 x 268.62

VOLUMES (cm<sup>3</sup>)

1 FCU	420.56
2 ECU	420.56
3 FC Stack	34320
4 EC Stack	26999
5 Charger (#3)	28184
6 Power Module	2487500
7 Ancillary Equipment	673940
8 ESS (incl Interfaces)	20800000

LIFE CYCLE COSTS (1980\$M)

DDT&E		23.952
PRODUCTION		36.165
a FCU	(3.078)	
b ECU	(2.732)	
1 FC Stack	5.632	
2 EC Stack	10.572	
3 Power Module Assembly	5.682	
4 Ancillary Equipment	1.518	
5 Subsystem Assembly	2.035	
6 Acceptance & Surface Transport	2.298	
7 Prelaunch Integration & Checkout	.220	
8 Space Transport	8.163	
9 Space Deployment & Checkout	.045	
OPERATIONS & MAINTENANCE		77.985
1 Spares Production	56.065	
2 Crew Training	.055	
3 Labor	.341	
4 Space Transport	21.524	
ESS LIFE CYCLE COST		138.102
INTERFACE COSTS		
1 Solar Array	597.829	
2 Thermal Control	6.779	
3 Power Conditioning	1.988	
TOTAL LIFE CYCLE COST		744.698



LEO 100KW ESS (H202)

MISSION PARAMETERS

1 Total Number of ESS Cycles	160320
2 Maximum Dark Period (Hr)	.62355
3 Minimum Light Period (Hr)	.90815
4 Total ESS Life (Hr)	30
5 Number of FCU Hardware Life Cycles	4
6 Number of ECU Hardware Life Cycles	4
7 Number of Pump Hardware Life Cycles	4

ESS PERFORMANCE REQUIREMENTS

1 Total Power Required (W)	124856
2 Total Voltage Required (V)	128.8
3 Required FCU Life (Hr)	15910
4 Required ECU Life (Hr)	45844
5 Required Pump Life (Hr)	62393

ORIGINAL PAGE IS  
OF POOR QUALITY

### ESS PERFORMANCE PARAMETERS

1 EOL Minimum Power (W)	125157
2 EOL Minimum Voltage (V)	129.11
3 Maximum FCU Life (Hr)	16047
4 Maximum ECU Life (Hr)	45879
5 Maximum Pump Life (Hr)	62393
6 Number of ESS Sides	5
7 Number of ESS Channels	29

---

### FUEL CELL UNIT QUANTITIES

1 Total Number of FCU	2668
2 Total Parallel FCU	29
3 Total Series FCU	92
4 Number of FC Stacks	58
5 Number of FCU/FC Stack (Ave)	46

---

### FUEL CELL UNIT PERFORMANCE PARAMETERS

1 EOL Min. Dark Period Power (W)	46.911
2 EOL Min. Dark Period Voltage (V)	1.4034
3 Active Cell Area (cm <sup>3</sup> )	232.26
4 EOL Dark Period Current Density (Ma/cm)	143.92
5 EOL Light Period Current Density (Ma/cm)	2.5

---

ELECTROLYSIS CELL UNIT  
QUANTITIES

1 Total Number of ECU	6052
2 Total Parallel ECU	176
3 Total Series FCU	34
4 Number of EC Stacks	178
5 Number of ECU/EC Stack (Ave)	34

ELECTROLYSIS CELL UNIT  
PERFORMANCE PARAMETERS

1 EOL Max. Light Period Power (W)	34.873
2 EOL Max. Light Period Voltage (V)	3.496
3 Active Cell Area (cm <sup>3</sup> )	232.26
4 EOL Dark Period Current Density (Ma/cm)	2.5
5 EOL Light Period Current Density (Ma/cm)	42.948

ESS THERMAL PARAMETERS

1 FCU Average Operating Pressure (Kg/cm <sup>2</sup> )	1 1248
2 FCU Average Operating Temperature (Deg-K)	355
3 ECU Average Operating Pressure (Kg/cm <sup>2</sup> )	1 1248
4 ECU Average Operating Temperature (Deg-K)	355
5 Maximum Dark Period Heat Load (W)	58438
6 Maximum Light Period Heat Load (W)	28359
7 Maximum Cycle Heat Load (W)	29215

ORIGINAL PAGE IS  
OF POOR QUALITY

TOTAL ESS PARAMETERS

1 Watt-Hour Efficiency	.40718
2 DoD Factor	.8
3 Storage Temperature (Deg-K)	50
4 H2 Storage Pressure (Kg/cm2)	28.12
5 H2 Storage Volume (cm3)	400690
6 H2 Storage Weight (Kg)	5.358
7 H2 Storage Tank Weight (Kg)	18.388
8 O2 Storage Pressure (Kg/cm2)	14.06
9 O2 Storage Volume (cm3)	801390
10 O2 Storage Weight (Kg)	42.524
11 O2 Storage Tank Weight (Kg)	22.7
12 H2O Storage Pressure (Kg/cm2)	1.3357
13 H2O Storage Volume (cm3)	47882
14 H2O Storage Weight (Kg)	47.882
15 H2O Storage Tank Weight (Kg)	.62964

---

ESS INTERFACE PARAMETERS

1 Max Solar Array Power (W)	225714
2 Max Solar Array Voltage (V)	127.12
3 Max Solar Array Weight (Kg)	4628
4 Max Thermal Control Weight (Kg)	532
5 Max Power Conditioning Weight (Kg)	723.55

---

WEIGHTS (Kg)

1 FDU	.5005
2 ECU	.5005
3 FC Stack (Ave)	28.23
4 EC Stack (Ave)	20.86
5 Charger (P3)	24.95
6 Power Module	1599.5
7 Ancilliary Equipment	120.96
8 ESS (incl Interfaces)	8118 (*)

DIMENSIONS (cm)

1 FDU (Active Area)	(LxW)	30.48 x 7.62
2 ECU (Active Area)	(LxW)	30.48 x 7.62
3 FC Stack (Max)	(LxWxH)	36.83 x 17.78 x 52.41
4 EC Stack (Max)	(LxWxH)	36.83 x 17.78 x 41.23
5 Charger (P3)	(LxWxH)	63.50 x 26.90 x 16.50
6 Power Module	(LxWxH)	302.00 x 268.62 x 67.65
7 Ancilliary Equipment	(DiexL)	107.60 x 148.01
8 ESS	(LxDxS)	302.00 x 457.00 x 268.62

VOLUMES (cm<sup>3</sup>)

1 FDU	420.59
2 ECU	420.59
3 FC Stack	34320
4 EC Stack	26999
5 Charger (P3)	28184
6 Power Module	4485000
7 Ancilliary Equipment	1347900
8 ESS (incl Interfaces)	37501000

LIFE CYCLE COSTS (1980\$M)

DDT&E		34.482
PRODUCTION		64.555
a FCU	(2.785)	
b ECU	(2.459)	
1 FC Stack	9.539	
2 EC Stack	18.802	
3 Power Module Assembly	9.990	
4 Ancilliary Equipment	3.010	
5 Subsystem Assembly	2.725	
6 Acceptance & Surface Transport	3.868	
7 Prelaunch Integration & Checkout	.377	
8 Space Transport	16.155	
9 Space Deployment & Checkout	.089	
OPERATIONS & MAINTENANCE		141.319
1 Spares Production	98.286	
2 Crew Training	.103	
3 Labor	.643	
4 Space Transport	42.287	
ESS LIFE CYCLE COST		240.356
INTERFACE COSTS		
1 Solar Array	1046.871	
2 Thermal Control	8.408	
3 Power Conditioning	3.477	
TOTAL LIFE CYCLE COST		1299.112

LEO 250KW ESS (H202)

MISSION PARAMETERS

1 Total Number of ESS Cycles	160320
2 Maximum Dark Period (Hr)	.62355
3 Minimum Light Period (Hr)	.90815
4 Total ESS Life (Hr)	30
5 Number of FCU Hardware Life Cycles	4
6 Number of ECU Hardware Life Cycles	4
7 Number of Pump Hardware Life Cycles	4

---

ESS PERFORMANCE REQUIREMENTS

1 Total Power Required (W)	312141
2 Total Voltage Required (V)	128.8
3 Required FCU Life (Hr)	15910
4 Required ECU Life (Hr)	45844
5 Required Pump Life (Hr)	62393

---

---

### ESS PERFORMANCE PARAMETERS

1 EOL Minimum Power (W)	312341
2 EOL Minimum Voltage (V)	126.88
3 Maximum FCU Life (Hr)	15944
4 Maximum ECU Life (Hr)	45687
5 Maximum Pump Life (Hr)	62393
6 Number of ESS Sides	5
7 Number of ESS Channels	72

---

### FUEL CELL UNIT QUANTITIES

1 Total Number of FCU	6624
2 Total Parallel FCU	72
3 Total Series FCU	92
4 Number of FC Stacks	144
5 Number of FCU/FC Stack (Ave)	46

---

### FUEL CELL UNIT PERFORMANCE PARAMETERS

1 EOL Min. Dark Period Power (W)	47.154
2 EOL Min. Dark Period Voltage (V)	1.4009
3 Active Cell Area (cm <sup>2</sup> )	232.26
4 EOL Dark Period Current Density (Ma/cm)	144.92
5 EOL Light Period Current Density (Ma/cm)	2.5

---



ELECTROLYSIS CELL UNIT  
QUANTITIES

1 Total Number of ECU	15130
2 Total Parallel ECU	445
3 Total Series ECU	34
4 Number of EC Stacks	445
5 Number of ECU/EC Stack (Avg)	34

ELECTROLYSIS CELL UNIT  
PERFORMANCE PARAMETERS

1 EOL Max Light Period Power (W)	34.906
2 EOL Max. Light Period Voltage (V)	3.5
3 Active Cell Area (cm <sup>2</sup> )	232.25
4 EOL Dark Period Current Density (Ma/cm)	2.5
5 EOL Light Period Current Density (Ma/cm)	42.939

ESS THERMAL PARAMETERS

1 ECU Average Operating Pressure (Kg/cm <sup>2</sup> )	1.1248
2 ECU Average Operating Temperature (Deg-K)	355
3 ECU Average Operating Pressure (Kg/cm <sup>2</sup> )	1.1248
4 ECU Average Operating Temperature (Deg-K)	355
5 Maximum Dark Period Heat Load (W)	146560
6 Maximum Light Period Heat Load (W)	70866
7 Maximum Cycle Heat Load (W)	73280

ORIGINAL PAGE IS  
OF POOR QUALITY

TOTAL ESS PARAMETERS

1 Watt-Hour Efficiency	.40686
2 DoD Factor	.8
3 Storage Temperature (Deg-K)	50
4 H2 Storage Pressure (Kg/cm2)	28.12
5 H2 Storage Volume (cm3)	1001600
6 H2 Storage Weight (Kg)	13.393
7 H2 Storage Tank Weight (Kg)	43.537
8 O2 Storage Pressure (Kg/cm2)	14.06
9 O2 Storage Volume (cm3)	2003100
10 O2 Storage Weight (Kg)	106.29
11 O2 Storage Tank Weight (Kg)	55.083
12 H2O Storage Pressure (Kg/cm2)	1.3357
13 H2O Storage Volume (cm3)	119690
14 H2O Storage Weight (Kg)	119.69
15 H2O Storage Tank Weight (Kg)	1.1419

-----

ESS INTERFACE PARAMETERS

1 Max Solar Array Power (W)	564824
2 Max Solar Array Voltage (V)	127.27
3 Max Solar Array Weight (Kg)	11579
4 Max Thermal Control Weight (Kg)	1334
5 Max Power Conditioning Weight (Kg)	1796.4

-----

---

WEIGHTS (Kg)

1 FCU	.5005
2 ECU	.5005
3 FC Stack (Ave)	28.23
4 EC Stack (Ave)	20.65
5 Charger (#3)	24.95
6 Power Module	3998.8
7 Ancillary Equipment	296.26
8 ESS (incl Interfaces)	20250 (#)

---

DIMENSIONS (cm)

1 FCU (Active Area)	(LxW)	30.48 x 7.62
2 ECU (Active Area)	(LxW)	30.48 x 7.62
3 FC Stack (Max)	(LxWxH)	36.83 x 17.78 x 52.41
4 EC Stack (Max)	(LxWxH)	36.83 x 17.78 x 41.23
5 Charger (#3)	(LxWxH)	63.50 x 26.90 x 16.50
6 Power Module	(LxWxH)	710.07 x 268.62 x 67.65
7 Ancillary Equipment	(DiaxL)	109.93 x 355.17
8 ESS	(LxDxS)	710.07 x 457.00 x 268.62

---

VOLUMES (cm<sup>3</sup>)

1 FCU	420.59
2 ECU	420.59
3 FC Stack	34320
4 EC Stack	26999
5 Charger (#3)	28184
6 Power Module	10542000
7 Ancillary Equipment	3371100
8 ESS (incl Interfaces)	88151000

---

LIFE CYCLE COSTS (1980\$M)

DOT&E		55 487
PRODUCTION		145 659
* FCU	(2.425)	
* ECU	(2.139)	
1 FC Stack	20.282	
2 EC Stack	40.691	
3 Power Module Assembly	22.181	
4 Ancillary Equipment	7.511	
5 Subsystem Assembly	4.812	
6 Acceptance & Surface Transport	8.511	
7 Prelaunch Integration & Checkout	.850	
8 Space Transport	40.298	
9 Space Deployment & Checkout	.223	
OPERATIONS & MAINTENANCE		319.603
1 Spares Production	212.795	
2 Crew Training	.249	
3 Labor	1.551	
4 Space Transport	105.008	
ESS LIFE CYCLE COST		520.749
INTERFACE COSTS		
1 Solar Array	2186.613	
2 Thermal Control	13.247	
3 Power Conditioning	7.517	
TOTAL LIFE CYCLE COST		2728.126

GEO

25KW ESS

(H202)

MISSION PARAMETERS

1 Total Number of ESS Cycles	439.55
2 Maximum Dark Period (Hr)	1.1813
3 Minimum Light Period (Hr)	22.726
4 Total ESS Life (Hr)	5
5 Number of FDU Hardware Life Cycles	1
6 Number of ECU Hardware Life Cycles	1
7 Number of Pump Hardware Life Cycles	1

-----

ESS PERFORMANCE REQUIREMENTS

1 Total Power Required (W)	31214
2 Total Voltage Required (V)	128.8
3 Required FDU Life (Hr)	408
4 Required ECU Life (Hr)	10103
5 Required Pump Life (Hr)	10519

-----

---

### ESS PERFORMANCE PARAMETERS

1 EOL Minimum Power (W)	31417
2 EOL Minimum Voltage (V)	129.64
3 Maximum FCU Life (Hr)	4174.8
4 Maximum ECU Life (Hr)	16795
5 Maximum Pump Life (Hr)	10519
6 Number of ESS Sides	5
7 Number of ESS Channels	2

---

### FUEL CELL UNIT QUANTITIES

1 Total Number of FCU	166
2 Total Parallel FCU	2
3 Total Series FCU	83
4 Number of FC Stacks	4
5 Number of FCU/FC Stack (Ave)	41.5

---

### FUEL CELL UNIT PERFORMANCE PARAMETERS

1 EOL Min. Dark Period Power (W)	189.26
2 EOL Min. Dark Period Voltage (V)	1.5619
3 Active Cell Area (cm <sup>2</sup> )	232.26
4 EOL Dark Period Current Density (Ma/cm)	521.7
5 EOL Light Period Current Density (Ma/cm)	3.5

---

ELECTROLYSIS CELL UNIT  
QUANTITIES

1 Total Number of ECU	34
2 Total Parallel ECU	1
3 Total Series FCU	34
4 Number of EC Stacks	1
5 Number of ECU/EC Stack (Ave)	34

---

ELECTROLYSIS CELL UNIT  
PERFORMANCE PARAMETERS

1 EDL Max. Light Period Power (W)	117.31
2 EDL Max. Light Period Voltage (V)	3.4931
3 Active Cell Area (cm <sup>2</sup> )	252.25
4 EDL Dark Period Current Density (Ma/cm)	2.5
5 EDL Light Period Current Density (Ma/cm)	144.47

---

ESS THERMAL PARAMETERS

1 FCU Average Operating Pressure (Kg/cm <sup>2</sup> )	1.1248
2 FCU Average Operating Temperature (Deg-K)	355
3 ECU Average Operating Pressure (Kg/cm <sup>2</sup> )	1.1248
4 ECU Average Operating Temperature (Deg-K)	355
5 Maximum Dark Period Heat Load (W)	22200
6 Maximum Light Period Heat Load (W)	772
7 Maximum Cycle Heat Load (W)	11100

---

## TOTAL ESS PARAMETERS

1 Watt-Hour Efficiency	.4098
2 DoD Factor	.8
3 Storage Temperature (Deg-K)	50
4 H <sub>2</sub> Storage Pressure (Kg/cm <sup>2</sup> )	28.12
5 H <sub>2</sub> Storage Volume (cm <sup>3</sup> )	182380
6 H <sub>2</sub> Storage Weight (Kg)	2.4388
7 H <sub>2</sub> Storage Tank Weight (Kg)	9.9052
8 O <sub>2</sub> Storage Pressure (Kg/cm <sup>2</sup> )	14.06
9 O <sub>2</sub> Storage Volume (cm <sup>3</sup> )	364770
10 O <sub>2</sub> Storage Weight (Kg)	19.356
11 O <sub>2</sub> Storage Tank Weight (Kg)	10.934
12 H <sub>2</sub> O Storage Pressure (Kg/cm <sup>2</sup> )	1.3357
13 H <sub>2</sub> O Storage Volume (cm <sup>3</sup> )	21794
14 H <sub>2</sub> O Storage Weight (Kg)	21.794
15 H <sub>2</sub> O Storage Tank Weight (Kg)	.63501

---

## ESS INTERFACE PARAMETERS

1 Max Solar Array Power (W)	4262
2 Max Solar Array Voltage (V)	127.03
3 Max Solar Array Weight (Kg)	88
4 Max Thermal Control Weight (Kg)	202
5 Max Power Conditioning Weight (Kg)	174.65

---



WEIGHTS (Kg)

1	FCU	.5005
2	ECU	.5005
3	FC Stack (Ave)	25.46
4	EC Stack (Ave)	20.86
5	Charger (#3)	24.95
6	Power Module	77.492
7	Ancillary Equipment	.50 41
8	ESS (incl Interfaces)	446

DIMENSIONS (cm)

1	FCU (Active Area)	(LxW)	30.48 x 7.62
2	ECU (Active Area)	(LxW)	30.48 x 7.62
3	FC Stack (Max)	(LxWxH)	36.83 x 17.78 x 40.60
4	EC Stack (Max)	(LxWxH)	36.83 x 17.78 x 41.23
5	Charger (#3)	(LxWxH)	63.50 x 26.90 x 16.50
6	Power Module	(LxWxH)	74.93 x 268.62 x 63.92
7	Ancillary Equipment	(DiaxL)	133.51 x 44.12
8	ESS	(LxDxS) (#)	74.93 x 457.00 x 268.62

VOLUMES (cm<sup>3</sup>)

1	FCU	420.59
2	ECU	420.59
3	FC Stack	31877
4	EC Stack	26996
5	Charger (#3)	28184
6	Power Module	1064100
7	Ancillary Equipment	617500
8	ESS (incl Interfaces)	9302100

LIFE CYCLE COSTS (1980\$M)

DDT&E		6.800
PRODUCTION		16.310
a FCU	(4.247)	
b ECU	(5.404)	
1 FC Stack	1.353	
2 EC Stack	.738	
3 Power Module Assembly	.894	
4 Ancilliary Equipment	.152	
5 Subsystem Assembly	1.406	
6 Acceptance & Surface Transport	.787	
7 Prelaunch Integration & Checkout	.077	
8 Space Transport	10.903	
9 Space Deployment & Checkout	0.000	
OPERATIONS & MAINTENANCE		.500
1 Spares Production	0.000	
2 Crew Training	0.000	
3 Labor	.500	
4 Space Transport	0.000	
ESS LIFE CYCLE COST		23.670
INTERFACE COSTS		
1 Solar Array	19.550	
2 Thermal Control	6.419	
3 Power Conditioning	1.042	
TOTAL LIFE CYCLE COST		50.690