

NASA Conference Publication 2196

# Office of Space and Terrestrial Applications (OSTA)/Applications Data Service (ADS) Data Systems Standards

NASA-CP-2196 19820007222

LIBRARY COPY

MAY 27 1982

LANGLEY RESEARCH CENTER  
LIBRARY, NASA  
HAMPTON, VIRGINIA

FOR INFORMATION

NOT TO BE VALUED FROM THIS ROOM

*Proceedings of a workshop held at  
Goddard Space Flight Center  
Greenbelt, Maryland  
May 27-29, 1981*





# **Office of Space and Terrestrial Applications (OSTA)/Applications Data Service (ADS) Data Systems Standards**

*Barbara A. Walton, Editor  
Goddard Space Flight Center  
Greenbelt, Maryland*

Proceedings of a workshop held at  
Goddard Space Flight Center  
Greenbelt, Maryland  
May 27-29, 1981

**NASA**

National Aeronautics  
and Space Administration

**Scientific and Technical  
Information Branch**



## CONTENTS

	<u>Page</u>
Summary of Workshop Conclusions . . . . .	vii
Workshop Summary . . . . .	S-1
1.0 Introduction . . . . .	1
2.0 Welcome Paul Schneck . . . . .	1
3.0 Introduction to the Workshop Barbara Walton . . . . .	1
4.0 OSTA Data Systems Planning Workshop Recommendations Richard desJardins . . . . .	5
5.0 The Role of Pilots J. Patrick Gary . . . . .	11
6.0 The OSTA/ADS Standards Development Process Barbara Walton . . . . .	19
7.0 Overview of the Current MITRE Effort Terry Kuch/Rick Sakamoto . . . . .	27
8.0 User Requirements for ADS Standards and Guidelines Paul Clemens . . . . .	30
9.0 ADS Pilot Methodologies as Candidates for ADS Standards Paul Giragosian . . . . .	32
10.0 Panel Activities . . . . .	35
11.0 Panel A Report: Standards Needed to Interconnect ADS Pilots for Data Sharing for Catalogs, Directories, and Dictionaries . . . . .	38
12.0 Panel B Report: Standards Needed to Interconnect ADS Pilots for Data Sharing for User Interfaces . . . . .	45
13.0 Panel C Report: Standards Needed for the Use of ISO Open Systems Interconnection - Basic Reference Model . . . . .	55
14.0 Panel D Report: Standards Needed to Interconnect ADS Pilots for Data Sharing in Data Formats and Descriptions . . . . .	67
15.0 Workshop Summary Barbara Walton . . . . .	71
16.0 Action Items John Kiebler . . . . .	71

CONTENTS (continued)

	<u>Page</u>
Glossary of Terms . . . . .	73
Appendix A - Overview of the Current MITRE Effort Presentation Material . . . . .	A-1
Appendix B - User Requirements for ADS Standards Presentation Material . . . . .	B-1
Appendix C - ADS Pilot Methodologies as Candidates for ADS Standards Presentation Material . . . . .	C-1
Appendix D - List of Reference Materials . . . . .	D-1
Appendix E - Unpublished Preworkshop Documentation Invitation . . . . . Preworkshop Documentation Memo . . . . . Instructions to Panels . . . . .	E-1 E-3 E-5
Appendix F - List of Attendees . . . . .	F-1

## LIST OF ILLUSTRATIONS

<u>Figure</u>		<u>Page</u>
3-1	Objectives of the OSTA/ADS Data Systems Standards Workshop . . . . .	4
4-1	OSTA Data Systems Planning Workshop . . . . .	6
4-2	Integrated Discipline Requirements . . . . .	7
4-3	OSTA Data System Concept . . . . .	9
4-4	OSTA Overall Data System Concept and Recommendations . . . . .	10
5-1	Summary of Overall ADS Program . . . . .	12
5-2	Common Goals/Objectives of OSTA/ADS Pilots . . . . .	13
5-3	Promotion of ADS Concepts through Pilot Data Systems Activities . . . . .	14
5-4	Near-Term ADS Requirements . . . . .	15
5-5	Relationship of OSTA/ADS Pilots to the Standards Development Process . . . . .	16
5-6	ADS Program Review . . . . .	18
6-1	OSTA/ADS Data Systems Standards and Guidelines Program Overview . . . . .	20
6-2	OSTA Data and Data Systems Standards Requirements . . . . .	21
6-3	OSTA/ADS Data Systems Standards Program Working Relationships . . . . .	22
6-4	Approach to OSTA/ADS Data Systems Standards Program . . . . .	23
6-5	OSTA/ADS Data Systems Standards Program Phase 1 - ADS Focus . . . . .	24
6-6	OSTA/ADS Data Systems Standards Program Phase 2 - OSTA/Core ADS Focus . . . . .	25
6-7	OSTA/ADS Data Systems Standards Program Phase 3 - OSTA/Full ADS Focus . . . . .	26
10-1	Introduction to Panels . . . . .	36
10-2	Panel Assignments . . . . .	37

ILLUSTRATIONS (continued)

<u>Figure</u>		<u>Page</u>
11-1	ADS Directory/Catalog Architecture Model . . . . .	40
12-1	User View of Network Services . . . . .	46
12-2	User View of Network Topology . . . . .	48
12-3	Directory/Catalog User View . . . . .	50
13-1	Actual and Virtual Data Flow . . . . .	57
13-2	Near-Term Configuration . . . . .	61
13-3	Integrated Configuration Candidate . . . . .	64

LIST OF TABLES

<u>Table</u>		<u>Page</u>
1-1	OSTA/ADS Data Systems Standards Workshop Agenda . . . . .	2
12-1	Pilot Network Functional Requirements . . . . .	49
13-1	OSI Reference Model Layers . . . . .	56
13-2	Scenario . . . . .	59
13-3	Protocols Required to Support Scenario . . . . .	60
15-1	Recommendation to OSTA on a Data Product Preparation Standard . . . . .	72



## SUMMARY OF WORKSHOP CONCLUSIONS

The Office of Space and Terrestrial Applications (OSTA)/Applications Data Service (ADS) Data Systems Standards Workshop was held at the Goddard Space Flight Center in Greenbelt, Maryland on May 27-29, 1981. The purpose of the workshop was to identify standards needed to interconnect ADS pilots for data sharing; to assess current pilot methodologies; and to make recommendations for future work. The theme of the four workshop panels was "Standards Needed to Interconnect ADS Pilots for Data Sharing." Their topics were: Catalogues, Directories, and Dictionaries; User Interfaces; The Use of ISO Open Systems Interconnection - Basic Reference Model; and Data Formats and Descriptions.

Panel A identified a preliminary set of requirements for guidelines and standards for catalogues, directories, and dictionaries, which are found in Section 11 of this document. The panel found it necessary to identify and define a structure for repository of information about data and defined the following terms:

**DIRECTORY Definition:** High-level description of data sets available to all ADS users. The directory is accessed by means of a standard user interface.

**LOCAL CATALOG Definition:** Detailed description of data sets. The local catalogs are maintained by the organization that is also responsible for maintaining those data sets.

The structure below the directory may contain intermediate levels of directories which are both local- and network-implementation dependent. Standards in the near term need only to be specified for the DIRECTORY.

Panel A recommended:

(1) A continuing Directory/Catalog Standards Working Group to advise the ADS Standards Program on Directory/Catalog matters and to provide advisory review of contractor products related to Directories and Catalogs with membership from each of the pilots and the OSTA/ADS Standards Program.

(2) A Directory/Catalog Implementation Working Group to provide: assessment of current ADS pilot methodologies, studies for alternative implementation methods of the directory, detailed design of the directory, determination of software functional requirements, design of interface between directory and local catalogs of pilots, and consideration of library and information science methodologies for its relevance.

(3) Policy be set concerning the release of information about data to ADS.

(4) Adoption or modifications of the WALLOPS definitions for data levels.

(5) Continuing discipline user working groups be established.

Panel B viewed the "user" as a discipline scientist at a terminal trying to get data out of the network. It was assumed that the user is primarily associated with one of the local systems, such as VAS or the Ocean Pilot. In the short and intermediate term, users will connect to their "home" system and obtain network services through it. Network services will be visible to the user as separate from local system services. The panel considered the requirements for standards and guidelines in the areas of User Interfaces; their report is in Section 12.

Panel B recognized a need for a continuing oversight body for maintaining and monitoring standards and guidelines. The panel recommended that there be a continued panel existence more or less as a design review committee to influence and monitor TAE, RSS, and allied efforts from the point of view of user interface, with members represented from pilots, ADS Standards Office, NASA Headquarters, other TAE users, and TAE developers. The panel also recommended that a liaison be maintained with CODASYL and ANSI to monitor work in command languages.

In order to determine the relevance of the OSI Reference Model for addressing ADS requirements, Panel C considered a scenario representing a broad class of capabilities which were considered required to interconnect the pilots for data sharing. The interconnection protocols needed to support this scenario were then identified, and these protocols were then classified in terms of standard layers within the OSI Reference Model. Panel C's report is in Section 13.

Panel C considered three basic approaches which could be considered for an integrated ADS pilot network system and the advantages and disadvantages associated with each. The approach favored by the panel, to adopt existing and emerging national and international telecommunication standards to the greatest possible degree, involves the tentative acceptance of protocols which are so new and unproven that they exist only as draft standards. It is anticipated that, after an extensive review process, these protocols will become FIPS and be required for future telecommunications support on U.S. Government systems.

Panel C recommended that a working group be established to continue to investigate identified issues and to track the progress toward a successful interconnector of ADS pilots. Some specific topics for the Working Group investigations recommended are:

- (1) Review currently identified requirements versus other panels for consistency and completeness.
- (2) Develop functional specification of input parameters for each application to be supported (input to layer 7).
- (3) Develop design specifications of output strings/packets/message blocks for each application to be supported (output "from 6 to 5").
- (4) Evaluate existing layer 4 and 5 protocols, including the NBS proposed standard, and recommend selection for pilot system and future ADS use.

(5) Perform a requirements analysis for the ADS at the combined layers 1-3.

(6) Specify core requirements expected for each protocol layer for pilots and future ADS use.

It was the consensus of Panel D that data exchange standards should be developed to be of general future utility, though the near-term activity should be constrained to focus on the problems of interconnecting the ADS pilots. The panel report is in Section 14.

Panel D recommended:

(1) ADS should establish a standard vocabulary of terms, units, descriptions, and definitions.

(2) ADS should provide a machine-readable standard mechanism, which is medium and machine independent, for describing data content, structures, numeric representations, and character codes.

(3) ADS should establish a set of preferred numeric representations, a preferred character code, preferred units, and preferred descriptions.

(4) ADS should establish a permanent, dedicated team to pursue this effort further and recommended the following near-term outline.

- a. The permanent team should begin by analyzing the data formats, codes and representations used in existing pilots.
- b. The team should analyze existing and proposed data interchange standards.
- c. The team should adopt or create Strawman standards for review by data base administrators for each pilot and associated NASA data base.
- d. The team should establish an ADS data standards administration function to approve, disseminate, maintain and provide visibility for these standards.
- e. The team should provide top-level coordination for the development of catalogs, in order to provide to the catalog designers the mechanisms for describing data sets and to evaluate the adequacy of the catalog structures to enable users to access and select data.

Before adjourning, the workshop unanimously recommended the development of a standard for data product preparation to ensure quality data sets. The recommendation prepared by Richard desJardins, as given in Table 15-1, was adopted. The workshop emphasized that there is a lot of work to be done in the standards area.



## WORKSHOP SUMMARY

### 1. INTRODUCTION

The Office of Space and Terrestrial Applications (OSTA)/Applications Data Service (ADS) Data Systems Standards Workshop was held at the Goddard Space Flight Center in Greenbelt, Maryland on May 27-29, 1981. The purpose of the workshop was to identify standards needed to interconnect ADS pilots for data sharing, to assess current pilot methodologies, and to make recommendations for future work. The theme of the four workshop panels was "Standards Needed to Interconnect ADS Pilots for Data Sharing." Their topics were: Catalogues, Directories, and Dictionaries; User Interfaces; The Use of ISO Open Systems Interconnection - Basic Reference Model; and Data Formats and Descriptions.

Dr. Paul B. Schneck opened the workshop by welcoming the participants to the Goddard Space Flight Center. He set the stage for the workshop by stressing the importance of ADS in NASA's future.

Barbara Walton said that the near-term goal for OSTA/ADS is to provide the capability for interconnecting the pilots for data sharing. There are three major pilots within ADS at the present time: Oceans Pilot at JPL, Earth Resources Pilot at Johnson Space Center, and the Atmospheres Pilot at the Goddard Space Flight Center. The plan is to form a network (interconnection) to share data between disciplines and users.

### 2. OSTA DATA SYSTEMS PLANNING WORKSHOP

Dick desJardins presented the OSTA Data Systems Planning Workshop recommendations. The purpose of the OSTA Data Systems Planning Workshop, held at Wallops Island on October 9-12, 1979, was to recommend a data system concept and requirements to OSTA. A concept includes "a means for identifying the work that has to be done, identifying the relationships between the people who have to do the work, and some kind of a modularization scheme for the system." The purpose of flying spacecraft is not to fly hardware but to build data sets from remote sensing. Panels were composed of people who had problems and people who had solutions. Disciplines represented were agriculture; land resources; hydrology; geology and geodynamics; atmosphere; and oceans. There were also panels on overall data systems; onboard data systems; data acquisition, distribution and operations; information extraction and processing, and user facilities; and data base storage and management.

The integrated discipline requirements identified by the OSTA Workshop participants are:

(1) Quality data sets are needed which are clean, useful, and processable. The project or discipline must produce parameter data sets (of physical phenomena) which meet the program objectives. OSTA needs a systematic treatment of problems with present data. Scientific data management personnel should be responsible for the quality of the product, the planning of the product, and seeing that users get the data that they want. The pedigree of the data is important. Sun angle, calibration, algorithms for parameterizations, etc. are needed.

(2) OSTA needs a single integrated data catalog or "Master Directory." ADS should be one means to access the catalog to help the researcher find out how to get the data and avoid wasting time doing it.

(3) OSTA needs continuity of data formats. A single format is not necessary; there should be a few, fairly standardized formats. Data levels should be defined.

(4) OSTA needs to reference its data to a standard geographic and time basis. Every piece of data should be marked with latitude, longitude, altitude and Universal Time.

(5) OSTA needs data delivery. Usually there is no need for immediate access to data. What is needed is easy accessibility: ability to get data by means of mail or electronic transmission. Each project has a "freshness" requirement.

(6) OSTA needs appropriate data archives to provide a place to store data. There is a need for uniformity in policy for keeping, indexing, or managing that data. A policy of active archives is required. Scientific data management should provide accessible data.

(7) Cooperation with user agencies is necessary for OSTA. USGS and NOAA, as examples, have similar needs and problems, and NASA needs to be in harmony with operational data from other agencies.

Figure 1 shows the overall OSTA Data System Concept. Working storage is provided for researchers. At the level shown in the figure, ADS tells us what standards are necessary for making data available. ADS would provide consultation and a Master Directory. The concept should be cost-accountable; it should produce Level 1A data sets. It could be phased over to commercial service. It was never a concept for electronic data dissemination. The data have to cost-effectively satisfy multiple objectives. The policy recommended was to store all the information that a user needs along with the raw measurement: sensor measurement data, sensor ancillary data, calibration with instrument, etc. The data must be stored in a form such that original data may be recovered. To do all this, OSTA must implement research in data input and data dissemination to meet its needs.

### 3. THE ROLE OF THE ADS PILOTS

J. Patrick Gary addressed the role of pilots. This workshop is effectively a working group for standards. We now need more detailed specification of hardware interfaces, communications protocols, data exchange services, etc. This workshop should be viewed as a working group to define areas within the data systems concept where standards are required.

The overall goals of the ADS Program are to provide OSTA data users with timely and effective access to needed data and information within and outside of NASA and to provide standards/guidelines for future OSTA programs to evolve data systems and data management towards compatibility where appropriate. OSTA data users require timely and effective access to needed data in a uniform way. We must not overstandardize. The pilots are

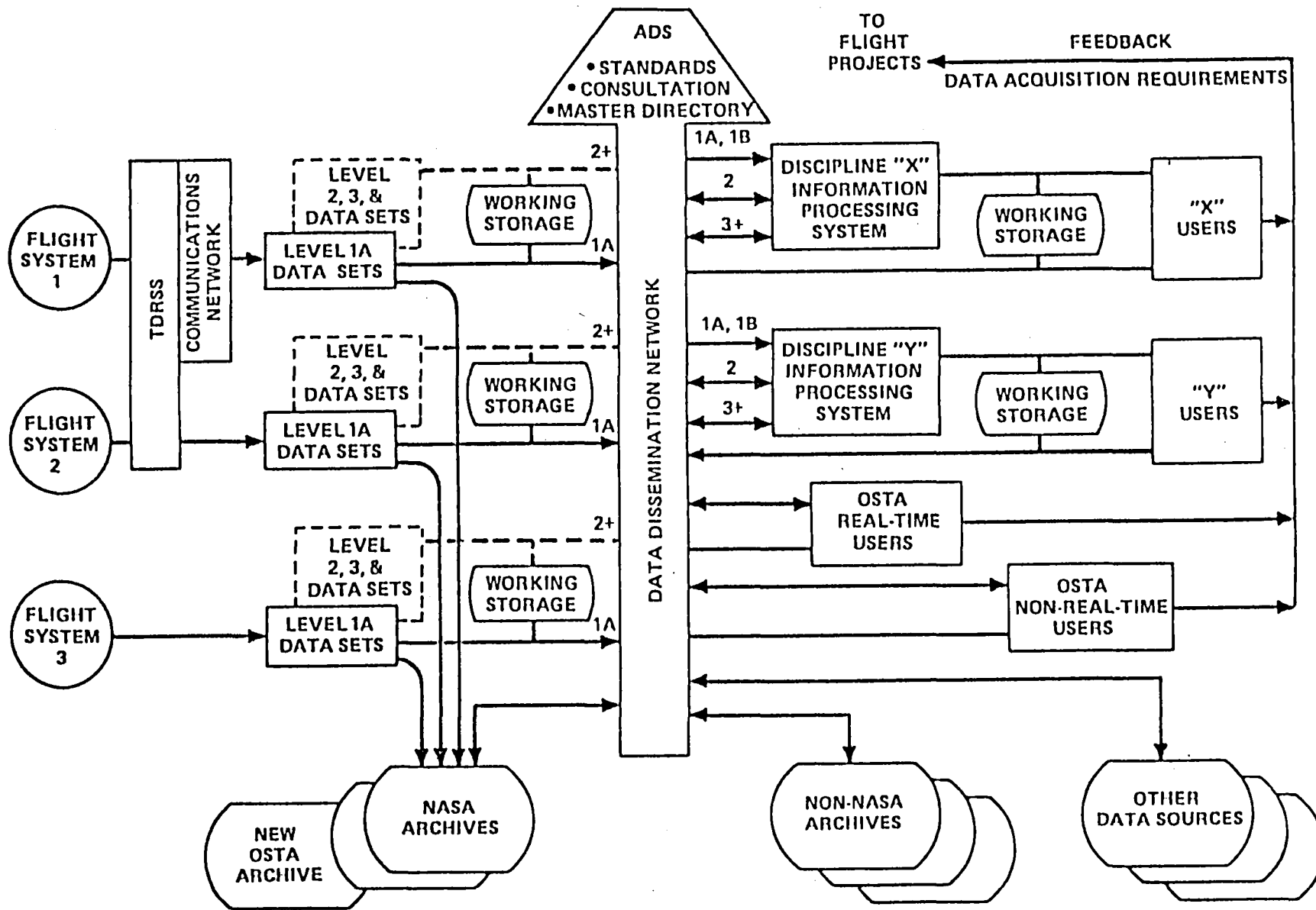

Figure 1. OSTA Data System Concept

planned to evaluate the utilization of current techniques and technologies in the use and exchange of data and to facilitate access to data (DBMS, Data Management, etc.).

The pilots are to provide demonstrations of the use of advanced technologies, provide a test-bed environment for data handling technique evaluation, evolve ADS requirements and capabilities (long-term goal), and document validated methodologies as standards and guidelines for OSTA data system use. These objectives are carried out in order to apply technology in a service capacity in support of the research programs of the application disciplines. The three pilots, when they interconnect, have a chance to "test bed" distributed processing and data sharing concepts needed to meet ADS near-term requirements. In time, they will come to test concepts applicable to much of NASA. To interconnect the ADS pilots for data sharing, two key functions are needed: 1) Users must know what data are available, and 2) data must be exchangeable among facilities.

The relationship of pilot program activities to the standards development process is shown in Figure 2. Inputs and evaluative criticism from the users, pilots, and Headquarters are required in the standards development process. The process starts with requirements for standards, but we must not overstandardize. Standards are useful to describe: 1) how to describe; 2) how to build; and 3) how to apply. Should ADS find that the current standards or methodologies are not adequate or applicable to its needs, the pilots can test new methodologies or proposed standards and develop them. The establishment and dissemination of standards is a high level management function. A result of this standards development process feeding back to the pilots will be standards useful to the design and the specification of new systems.

Figure 3 shows the overall ADS development approach with its gradual expansion of capabilities. The process is iterative; feedback to and from working groups, such as a standards working group, is essential for progress.

#### 4. THE OSTA/ADS STANDARDS DEVELOPMENT PROCESS

Barbara Walton stated that the goals of the OSTA/ADS Data Systems Standards Program were formulated in response to the need for standards for sharing data. The goal of the program is to provide effective data exchange and data system interface, standards and guidelines for OSTA programs. Its objectives are to: 1) identify and recommend use of data system standards and guidelines applicable to OSTA/ADS; 2) develop and maintain OSTA/ADS-unique data system standards and guidelines; and 3) coordinate with OSTA programs, ADS pilots and pertinent standards activities within and outside NASA. Applicable standards of the National Bureau of Standards and other existing standards can be used, but ADS and OSTA have unique problems. NASA has already dealt with some of the unique problems, such as the Landsat images CCT (Computer-Compatible Tape) standards; however, there are other development efforts that NASA will be dealing with in the near future.



RELATIONSHIP OF OSTA/ADS PILOTS TO THE STANDARDS DEVELOPMENT PROCESS

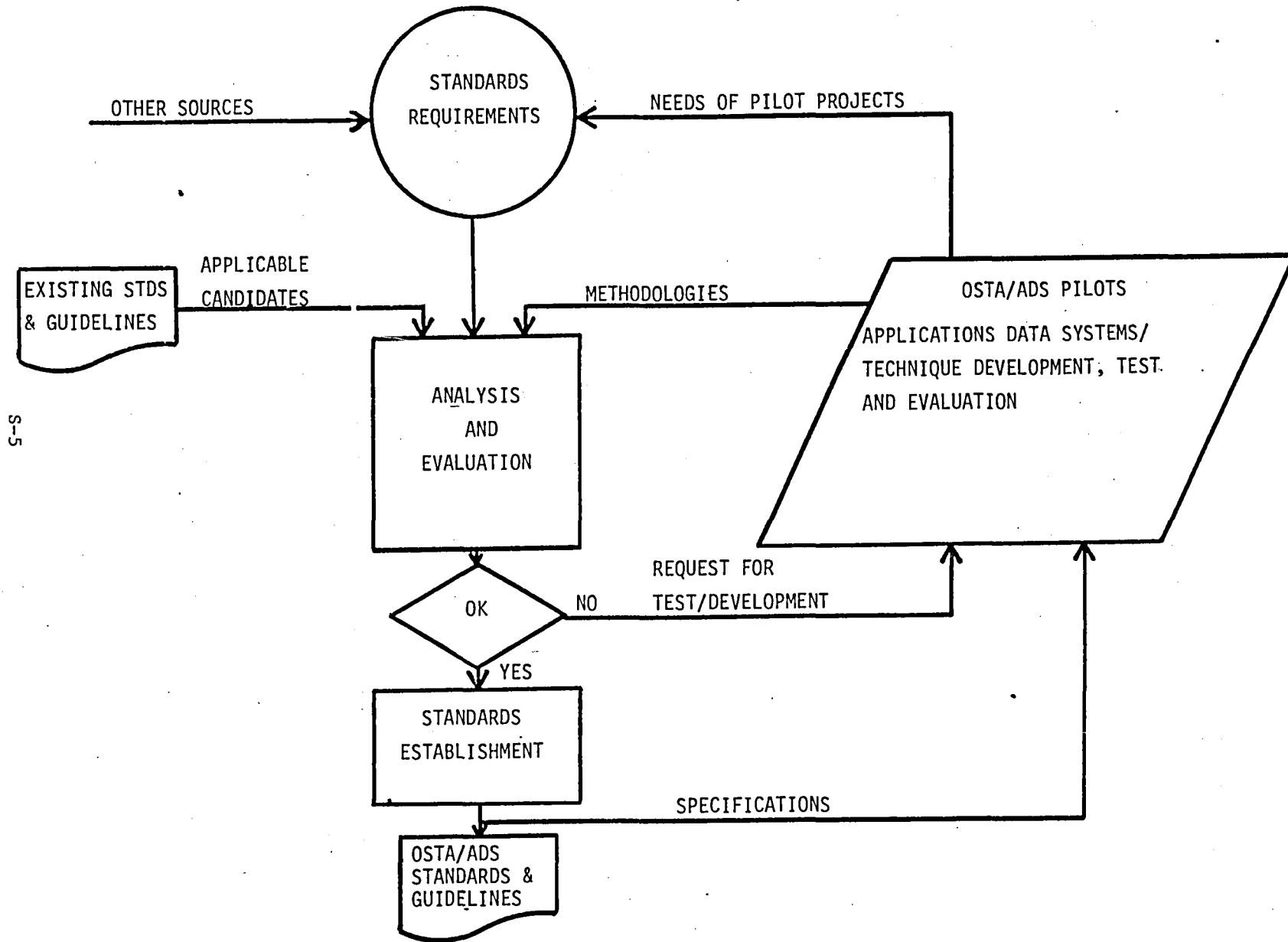

S-5

Figure 2

ADS PROGRAM REVIEW

ADS DEVELOPMENT APPROACH

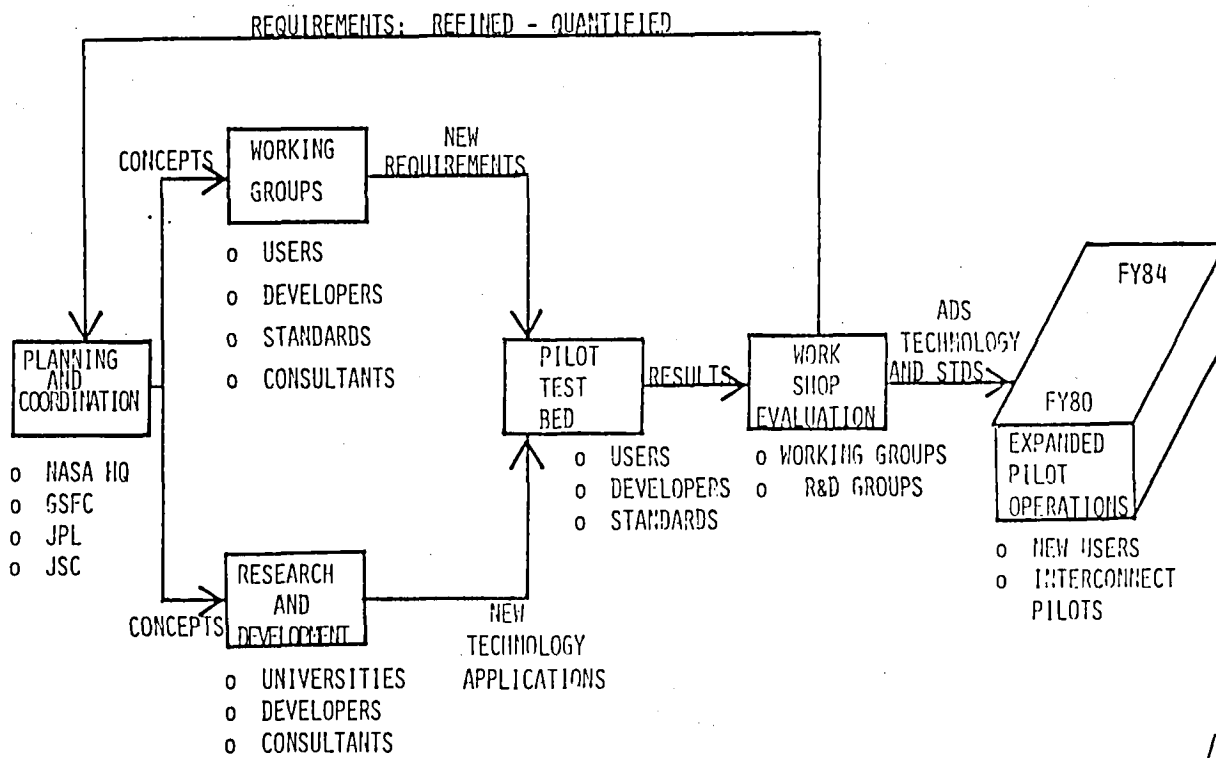

Figure 3



In 1980, a phased approach was developed for the program. FY81 Phase 1 projects focused on ADS and included a standards survey, standards requirements study, pilot methodology survey, and evaluation process and criteria. "Candidate" standards will be produced and the results are due to be published this year. This program builds on the results of the OSTA Workshop and the feasibility study reported on by Dick desJardins. This workshop will review, modify, and evaluate these processes so that those standards which might be applicable to ADS may become candidate standards for ADS.

The following remains to be done: ADS planning, interim standards, a concept for implementation of a "Core ADS," definition of OSTA data systems policy, and full-capability ADS definition. Phase 2, in FY82 and FY83, expands the focus to OSTA data systems and "Core ADS." Phase 3, focuses on the future goal of a "full-capability ADS." Once a full set of standards has been developed, a systematic review and periodic update will be needed. Standards will evolve as needs evolve.

## 5. THE CURRENT MITRE EFFORT

Terry Kuch and Rick Sakamoto presented an introduction to MITRE's support of the OSTA/ADS standards and guidelines program. The three MITRE presentations at the workshop concentrated on functions needed for near-term data sharing among ADS member systems. Sharing of computational facilities and software were considered to be longer-term ADS goals.

MITRE adopted a logical view of ADS as a distributed system, which distinguishes among seven components of such a system: 1) providers of data; 2) providers of applications software; 3) providers of computational facilities; 4) users of data, software, or computational facilities; 5) administrative services; 6) technical services such as documentation and location support for data, software, and computational facilities; and 7) support for data communication. Based on this logical view, MITRE developed a hierarchical classification scheme of ADS features at a level of detail (70 nodes) appropriate to the level of detail addressed by most Federal, national, and international information processing standards. This feature classification provided the framework for a preliminary assessment of the applicability of Federal, national, and international standards to ADS. These standards were gathered, screened, documented briefly, and reported in NASA contractor report CR 166675.

Two key efforts were initiated to survey methodologies of the three ADS pilots and to identify the requirements for standards of ADS members based on a survey of the pilots and on representative potential future members. Preliminary results of the requirements survey were used in the development of a process and criteria for the evaluation of potential standards for OSTA/ADS. An overview of the evaluation process was presented and examples of standards passed through the process.

Paul Clemens presented the results of a survey of ADS member requirements for standards and guidelines. This survey was carried out in four steps: 1) identify a representative number of planned and prospective ADS members from ADS pilots, key OSTA programs, and other sources; 2) survey the

identified members; 3) define and document members' needs for ADS system capabilities and services; and 4) derive ADS standards and guidelines requirements from this survey of members' needs.

The survey included the interpretation and analysis of functional requirements from three sources: 1) earlier OSTA/ADS data system studies, 2) current ADS pilot activities, studies, and documentation, and 3) prospective ADS members' activities and documentation. Requirements in each case were then reviewed and modified as needed to reflect the overall scope of ADS.

The resultant requirements were then tabulated and mapped into the ADS feature classification. The findings were analyzed for commonality of purpose and function and, from this analysis, overall standards requirements determined.

Paul Giragosian presented the results of a survey of the methodologies employed by the ADS pilot programs (Atmospheres, Oceanic, Earth Resources). At various stages in their development, the ADS pilots have implemented or planned to adopt certain practices, procedures, standards, or conventions. The collection of these practices as applied toward a specific development function or operational objective constitutes the notion of a "methodology." The primary objective of the survey was to provide an information base for the evaluation of these methods and their applicability to the future development of ADS standards and guidelines.

## 6. PANEL ACTIVITIES

Barbara Walton presented the following panel instructions: 1) critique the MITRE representation of pilot methodologies for accuracy and completeness; 2) identify the requirements for standards and guidelines needed in your panel's area to interconnect the ADS pilots for data sharing; 3) make a preliminary assessment of the adequacy of currently identified pilot methodologies and external standards in meeting these requirements; 4) identify any other methodologies you are aware of which may contribute to the solution to your panel's aspect of the problem; 5) make recommendations for future work, providing descriptions and estimate of effort where possible; and 6) provide the panel's consensus on the need for a continuing working group in this area and suggest membership thereof.

She then introduced the following panel topics and assignments:

### Standards Needed to Interconnect ADS Pilots for Data Sharing

Panel A - Catalogues, Directories, and Dictionaries

Chairman: Jose Urena, JPL

Panel B - User Interfaces

Chairman: Jim Brown, JPL

Panel C - Use of ISO Open Systems Interconnection - Basic Reference Model

Chairman: Ed Greene, GSFC

Panel D - Data Formats and Descriptions  
Chairman: Ed Greenberg, JPL

The panels convened briefly, then broke for dinner.

James Burrows, Director of the Institute for Computer Science and Technology of the National Bureau of Standards, was the dinner speaker on the first day of the workshop. He discussed the NBS Data Systems Standards Program and emphasized the communications protocol development program.

The panels continued their work on the following days with presentations by the panel chairmen on the last day of the workshop. The full text of the panel reports is contained in Sections 11 through 14 of the proceedings.

#### 7. PANEL A: STANDARDS NEEDED TO INTERCONNECT ADS PILOTS FOR DATA SHARING FOR CATALOGUES, DIRECTORIES, AND DICTIONARIES

Panel A identified a preliminary set of requirements for guidelines and standards.

(1) The panel found it necessary to identify and define a top-level repository of information about data in order to consider standards requirements. The term assigned to this "highest" level repository is "DIRECTORY."

DIRECTORY Definition: High-level description of data sets available to all ADS users. The directory is accessed by means of a standard user interface.

The detailed information about data resides in the "lowest" level repository. The term "LOCAL CATALOG" was assigned to it:

LOCAL CATALOG Definition: Detailed description of data sets. The local catalogs are maintained by the organization that is also responsible for maintaining those data sets.

The structure below the directory may contain intermediate levels of directories which are both local- and network-implementation dependent. This potential requirement was not addressed by the panel.

The above definitions identify a structure with at least two levels. Standards in the near-term need only to be specified for the top level (DIRECTORY).

The ADS Directory/Catalog architectural model is depicted in Figure 4. The user accesses the information in the directory by means of a standard user interface, and logical links connect the directory with the local catalogs or with the intermediate level directories. The dashed lines show possible future logical links between the user and the local catalogs, intermediate directories, and data sets, that would require new standard interfaces.

S-10

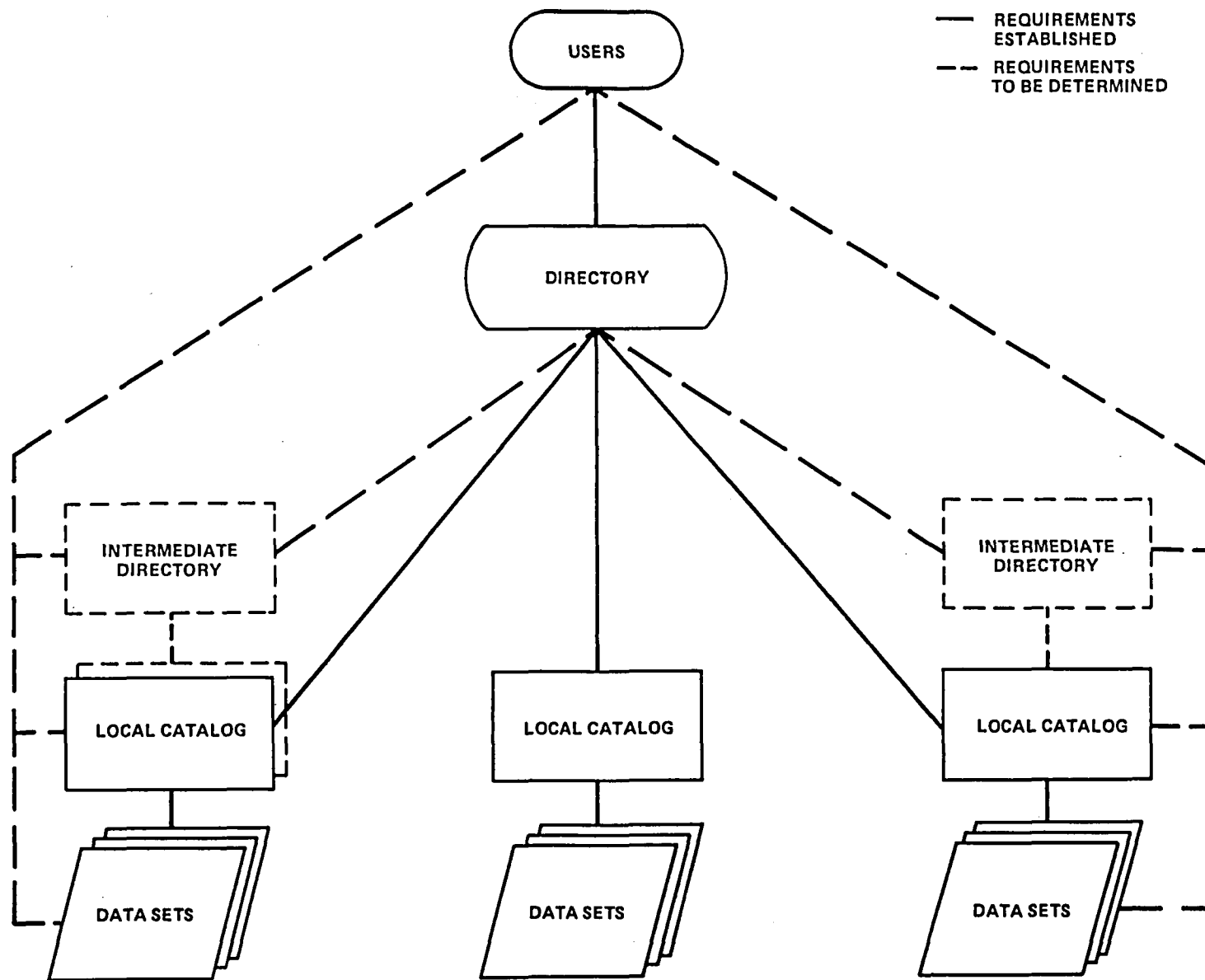

Figure 4. ADS Directory/Catalog Architecture Model

(2) A set of requirements for standards that were identified for the directory by Panel A is listed in the panel report (Section 11.2.2).

(3) Definitions and conventions for terminology of directory attributes are necessary.

(4) The panel identified a set of guidelines for the local catalog which are given in Section 11.2.4.

(5) A Directory User's Guide is required.

The panel recommended:

(1) A Continuing Directory/Catalog Standards Working Group

- a. Functions of the working group would be to advise the ADS Standards Program on Directory/Catalog matters and to provide advisory review of contractor products related to Directories and Catalogs.
- b. Membership should include at least one representative from each one of the pilots and the OSTA/ADS Standards Program.
- c. The group should consider of the need for a standard user interface to local catalogs and intermediate directories and investigate methods for incorporating terminology definitions accepted by recognized discipline user bodies.

(2) A Directory/Catalog Implementation Working Group to provide: a) assessment of current ADS pilot methodologies; b) studies for alternative implementation methods of the directory and selection of one; c) detailed design of the directory; d) determination of software functional requirements; e) design of interface between directory and local catalogs of pilots; and f) consideration of library and information science methodologies for its relevance. The directory could allow structured data retrieval and retrieval of unstructured indexed textual information.

(3) Further Recommendations

- a. Policy be set concerning the release of information about data to ADS.
- b. Adoption or modifications of the WALLOPS definitions for data levels (under area of work of Panel D on Data Formats and Descriptions).
- c. There is a need for continuing discipline user working groups.
- d. Study alternatives to "in-person" meetings.

## 8. PANEL B: STANDARDS NEEDED TO INTERCONNECT ADS PILOTS FOR DATA SHARING FOR USER INTERFACES

Panel B viewed the "user" as a discipline scientist at a terminal trying to get data out of the network. It was assumed that the user is primarily associated with one of the local systems, such as VAS or the Ocean Pilot.

The panel discussed how the user views the network. Figure 5 shows some possibilities of the user's concept of the network services. Illustration (a) shows the user terminal connected to each local system with ADS invisible as a networking function. After discussing this arrangement, the panel decided that it was probably not realistic; the user would probably not view the system that way. Representation (c) of the system is more in line with the long-term ADS picture. The users dial into a system called ADS with its data system and information extraction services. However, in the short term with the three pilots that we now have, that view is not realistic. The resulting user view of the network systems is shown in view (b). The user is aware of the ADS network added on to the local system. Part of the user interface will be influenced by the network and part will not. This view does take into account the actual network as it is likely to exist with the three pilots.

In the short and intermediate term, users will connect to their "home" system and obtain network services through it. Network services will be visible to the user as separate from local system services. The interface may have to be different, except where TAE or a similar "transportable executive" is used for both.

The panel recognized a need for a continuing oversight body for maintaining and monitoring standards and guidelines. They considered the requirement for standards and guidelines in the following areas:

(1) Dial-up Procedures. Users are connected to each local system and know that each one of these local systems can connect in some way with any other independent of location. With the exception of such things as retrieval time and cost, it would not be apparent to the user if the connection were by local or long-haul network. Since users will connect to local systems, no standard or guideline is needed.

(2) Terminals. A guideline or standard based on what is needed to correctly support a Menu System (processor) in a user-friendly way is required. This implies a minimum of 1200 baud "dumb" CRT; 300 baud hardcopy is marginally acceptable.

(3) Common Capabilities. The panel developed a model of the user's view of the catalogs and directories to use as a basis for a standard user interface. This model shows the local catalog(s) as transparent to the user. The user would deal with the high-level directory, standardized over the network. The linkage between the directory and the actual data set would be invisible. If the users have to see a local catalog or directory, that interface could not be standardized. ADS should seek to standardize the user's view of the interface to a high-level directory.



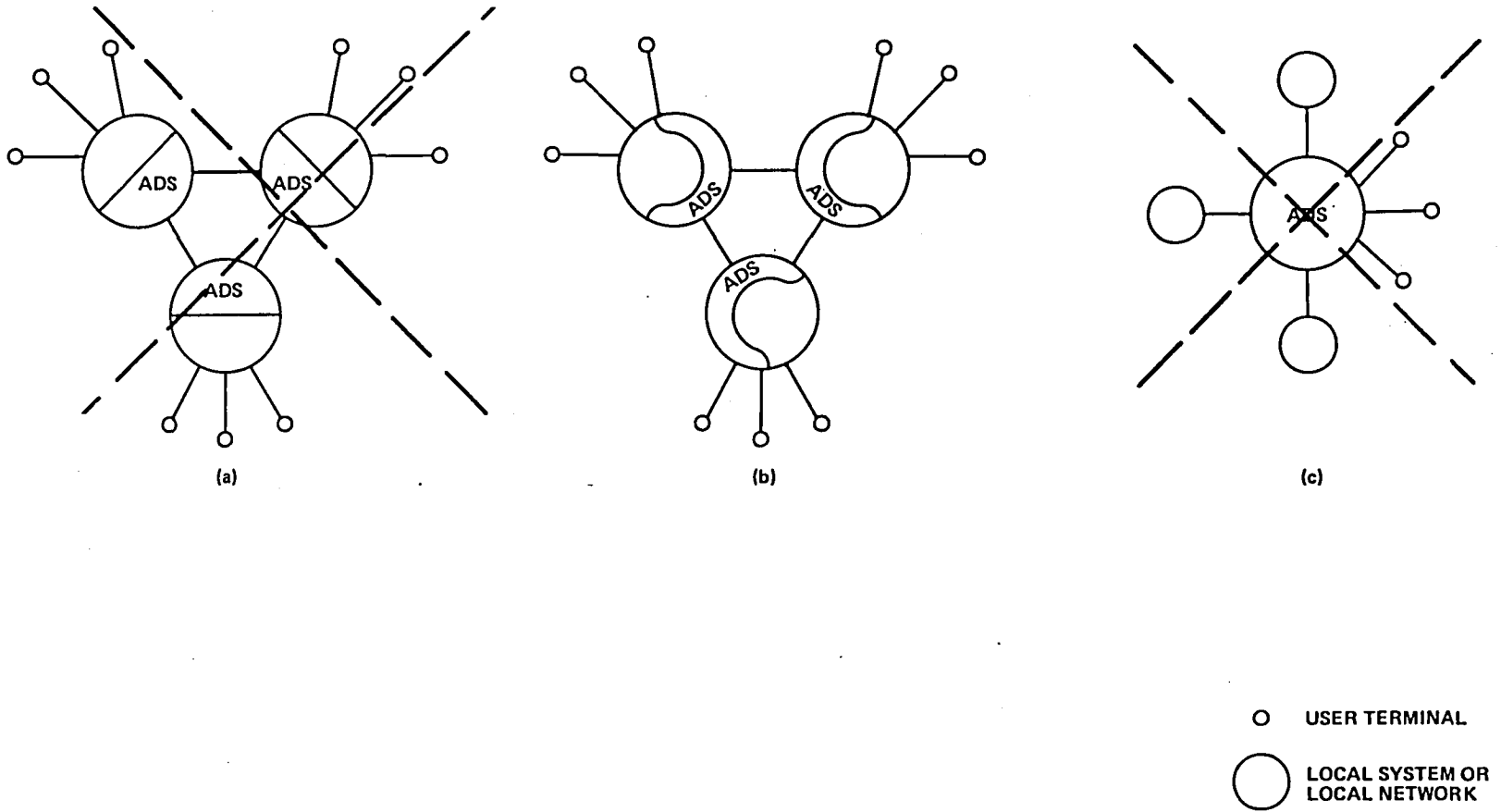

Figure 5. User View of Network Services

The panel prioritized the functional requirements for the pilot network for which standard user interfaces would be needed. These requirements are grouped in Table 1 based, not necessarily on functional importance, but on the need for standard user interface. Clarification is needed for functional requirements shown to accurately reflect the directory/catalog concept and criteria established by Panel A. This is an item for future work.

The panel anticipates that the user will want sample data sets--the larger the data set, the greater the need for a variety of different samples. The user may want to look at smaller data sets quickly prior to operating on larger data sets. (This is a strong requirement in the Oceans Pilot.) The value of this function depends on the typical size of the data set with which one is dealing. The user should be aware that sample data sets exist and should be aware of how to get them even if the directory-pointing mechanism is transparent. This requirement is shown in Group 3 to indicate that it is a longer term effort.

(4) Language Interfaces. It is hoped that TAE and RSS will develop into the defacto standard for the three pilots, with possible modifications based on current pilot methodologies and external standards.

(5) User Consultant. There should be a human user consultant available to be used for human-to-human assistance. Guidelines are needed for a user consultant. The scope of the guidelines includes who, how many, organization (local system, local network, ADS network), functions, and expertise.

The panel recommended that there be a continued panel existence more or less as a design review committee to influence and monitor TAE, RSS, and allied efforts from the point of view of user interface, with members represented from pilots, ADS Standards Office, NASA Headquarters, other TAE users, and TAE developers.

There is a need to clarify TAE maintenance and control policy, organization, and authority of the review committee. The charter of the TAE/RSS review committee should be to test and evaluate the software to be used; to recommend changes to be done; to review documentation.

The panel recommended that liaison be maintained with CODASYL and ANSI to monitor work in command languages. The panel also recommended that there be a study to understand user interface procedures of technology transfer organizations, e.g., Eastern Regional Remote Sensing Applications Center (ERRSAC), etc. for both human training and computer methodologies.

#### 9. PANEL C: STANDARDS NEEDED FOR THE USE OF ISO OPEN SYSTEMS INTERCONNECTION - BASIC REFERENCE MODEL

All three pilot programs were represented on Panel C. Given the diverse background of the participants and the limited time available for discussion, the panel was unable to explore the many detailed interface considerations needed to thoroughly analyze the relevance of the OSI

TABLE 1  
PILOT NETWORK FUNCTIONAL REQUIREMENTS

GROUP 1 - MANDATORY

- COPY "FILE"
- DISPLAY DIRECTORY CONTENTS
- DIRECTORY ATTRIBUTE SEARCH
- CREATE DIRECTORY ENTRY
- MODIFY DIRECTORY ENTRY (SOME ATTRIBUTES PROTECTED)
- DELETE DIRECTORY ENTRY (AND CORRESPONDING DATA SET)
- HELP
- DISPLAY STATUS OF ANY OF THE ABOVE PROCESSES (IF APPROPRIATE)

PRIORITY GROUP 2

- DISPLAY NETWORK STATUS/STATISTICS
- SEND MESSAGE
  - TO LOGGED-ON USER
  - TO MAILBOX

PRIORITY GROUP 3

- PROVIDE SAMPLE DATA SETS
  - PRE-CANNED
  - FIRST N POINTS, RECORDS, ...
  - [- SAMPLED, AVERAGED, ...]
- PROVIDE ESTIMATES OF "COST" BEFORE EXECUTING A NETWORK OPERATION
  - DATA SET SIZE
  - ELAPSED TIME
  - COST (IF USED)
- BROWSE
- SEND MESSAGE TO BILLBOARD

GROUP 4\*

- NETWORK LOG ON/OFF
  - TRANSPARENT TO USER
- ESTABLISH/REMOVE/MODIFY USER AUTHORIZATION
  - NOT AVAILABLE TO USER
- RUN/CANCEL EXPLICIT PROCESS
  - FUNCTION NOT NEEDED IN SHORT TERM
- SEND BROADCAST MESSAGE
  - NOT AVAILABLE TO USER
- DIAL-UP, LOCAL SYSTEM LOG ON/OFF
  - CANNOT STANDARDIZE

\*Functions may be required, but user interface standards/guidelines are not required.

Reference Model to the ADS. Nevertheless, the panel concentrated its efforts by performing a top-level mapping between the conjectured ADS requirements and the identified layers within the OSI Reference Model. A number of issues of a more detailed nature were identified for further study.

The OSI Reference Model represents a conceptual architecture for telecommunication interconnections which consists of a hierarchical structure composed of seven layers. The principal functions performed or services rendered by each layer is shown in Table 2. At each level, there is an illusion of a direct peer-to-peer protocol connecting the two systems. However, in reality, the actual control and data communication is between adjacent layers. The N-th layer protocol performs identifiable services to the (N+1)-st layer and, in turn, requests services from the (N-1)-st layer. If the two systems are distinct, then the actual signal communication is performed at the Physical Layer (layer 1). The interface to the applications process is at the Applications Layer (layer 7).

At the lowest three layers, there are existing protocols that conform substantially with the OSI Reference Model. Beyond layer 3, there are no nonproprietary general-purpose protocols which have been extensively tested; however, this is a field of active research within both the U.S. and European communities. Draft standards have been issued by the National Bureau of Standards (NBS) for both a Transport Layer and a Session Layer protocol. It is anticipated that these draft standards may emerge as mandatory Federal Information Processing Standards (FIPS) (for U.S. government systems) after these protocols have been extensively reviewed and tested. Both IBM and Digital Equipment Corporation have telecommunications software (SNA and DECNET, respectively) that provides services at all layers for networking among compatible-computer systems.

Table 2  
OSI Reference Model Layers

<u>Layer</u>	<u>Name</u>	<u>Description</u>
1	Physical	Physical signal interconnect from point-to-point
2	Link Control	Data interconnect from point-to-point
3	Network	End-to-End data interconnect (Source DTE to Destination DTE)
4	Transport	Host-to-Host data transfer
5	Session	Dialogue synchronization between hosts
6	Presentation	Data conversion services
7	Application	Interface to application processes

In order to determine the relevance of the OSI Reference Model for addressing ADS requirements, Panel C considered a scenario, described in Section 13.3, representing a broad class of capabilities which were considered required to interconnect the pilots for data sharing. The interconnection protocols needed to support this scenario were then identified, and these protocols were then classified in terms of standard layers within the OSI Reference Model.

The scenario consisted of a series of steps in which an investigator utilizes a terminal to perform a search of a nonlocal data base, initiates the execution of a process resident on a remote processor using the selected data set as input data, copies the generated data set to a different processor where it is added to the data base, the corresponding directories and catalogs are updated, and an electronic mail notification of the new data set is given to selected colleagues.

To support this scenario, the protocols listed in Table 3 are required. Items 1, 2, 5, and 9 are essential layer 5 functions, and the remaining items are combined layer 6 and layer 7 functions. Since nonlocal intercomputer communication is required by this scenario, layer 1, 2, 3, and 4 protocols are required to support the higher layer protocols.

Other capabilities were discussed as appropriate for long-term ADS consideration, but beyond the scope of that needed to interconnect ADS pilots for data sharing, included distributed data bases, multiprocessor application processing, and generalized word processing (interoperability among equipment from diverse manufacturers). Additional layer 5, 6, and 7 protocol services would be needed to support these functions.

Table 3  
Protocols Required to Support Scenario

1. Terminal support
  - Local
  - Dial-in through network\*
2. Automatic login/accounting to applications manager
3. Catalog manager command/response interaction, data base inquiry and response (command language, data descriptors)
4. File transfer
5. Applications executive interaction (suspend/resume, etc.)
6. Privacy/security services
7. Message to operator/mailboxes
8. JSC word processor access\*
9. Automatic log off

\*Additional near-term capability not directly derived from scenario

The Pilot Atmospheres Data System (PADS) at the Goddard Space Flight Center and the Earth Resources Pilot System (ERPS) at the Lyndon B. Johnson Space Center have developed and adapted telecommunications software to service the needs of their individual pilot demonstrations. The computer system for the Oceans Pilot System (OPS) at the Jet Propulsion Laboratory will be delivered this summer and is expected to utilize the DECNET software for intrapilot networking. Figure 6 shows the initial telecommunications software that is being implemented for each pilot. The classification of the software into OSI Reference Model layers is only approximate.

The panel considered three basic approaches which could be considered for an integrated ADS pilot network system and the advantages and disadvantages associated with each. The approach favored by the panel, to adopt existing and emerging national and international telecommunication standards to the greatest possible degree, involves the tentative acceptance of protocols which are so new and unproven that they exist only as draft standards. The NBS has issued specifications of a layer 4 (Transport) and layer 5 (Session) protocol which appear to be the leading contenders for standard protocols at these levels. It is anticipated that, after an extensive review process, these protocols will become FIPS and be required for future telecommunications support on U.S. Government systems. The proposed draft layer 4 protocol is intended to provide the proper interface to the major existing layer 3 protocol such as X.25 and X.21.

Above layer 5, the processing functions become so diverse that there appears little hope for the development of a single standard protocol at layer 6 or layer 7 in the near future. Instead, it is likely that a series of standard modules will be developed which perform certain well-defined functions at layers 6/7 and which interface to the standard layer 5 protocol. One such module, the NBS File Transfer Protocol, is scheduled to be released in draft form in early 1982. Other standard modules will undoubtedly be developed but probably not on a timeframe that will benefit the ADS.

The panel did not have the time to assess the adequacy of the NBS draft protocols at layers 4 and 5. Nevertheless, the consensus of the panel was that this approach deserves cautious support. While this approach is likely to be the most frustrating and difficult on a short-term basis, it is the only approach which offers a potentially viable solution for the effective networking among non-homogeneous systems. Figure 7 illustrates some of the protocols that are needed for the candidate ADS configuration and their relationship to the OSI Reference Model.

Panel C recommended that a working group be established to continue to investigate these issues and to track the progress toward a successful interconnection of ADS pilots. Listed below are some specific topics for the Working Group investigations:

- (1) Review currently identified requirements versus other panels for consistency and completeness.

Panel C identified the need for protocols to support the functions identified in Table 3. These requirements need be compared with the requirements identified by other panels for consistency and completeness.

NEAR TERM CONFIGURATION

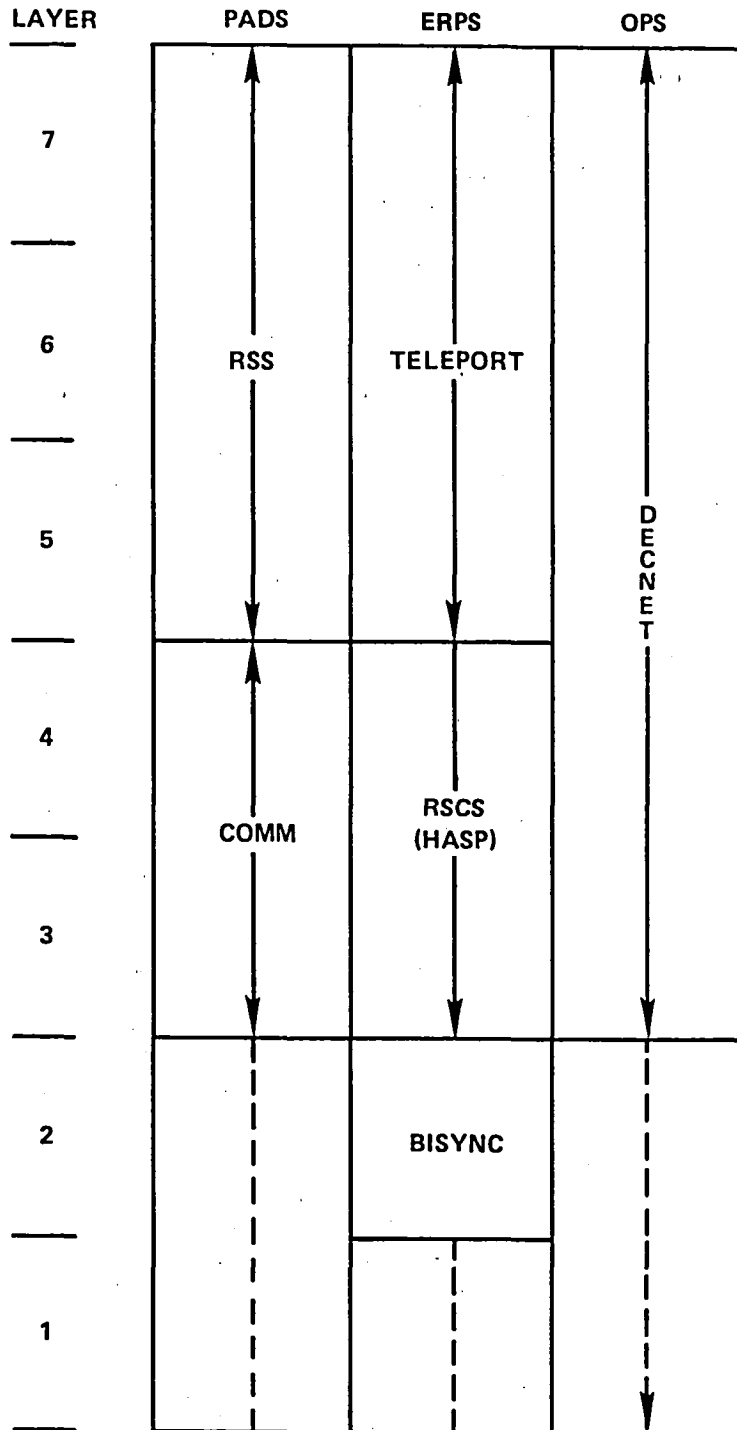

Figure 6. Near-Term Configuration

**INTEGRATED CONFIGURATION CANDIDATE  
(TWO OR MORE YEARS IN FUTURE)**

LAYER

7	NBS FILE TRANSFER PROTOCOL	DATA ACCESS PROTOCOL (FUTURE)	?
6			
5	NBS SESSION		
4	NBS TRANSPORT		
3			
2	X. 25 SERVICE	X. 21 OR OTHER DEDICATED LINE SERVICE	OTHER (LOCAL AREA NET, SATELLITE TDMA, ETC.)
1			

Figure 7. Integrated Configuration Candidate



The intent is to direct attention to provide or plan protocols to meet any extra requirements.

(2) Develop functional specification of input parameters for each application to be supported (input to layer 7).

After the requirements of an ADS network have been identified, each application must be isolated, and a functional or performance specification must be described. Once this information is known, the functional specification of the application can be broken down into subfunctional groups that will describe the input parameters. These parameters are the user interface between the application process and the protocol of the application layer in the ISO model. The specification of the input parameter functions can then be used to develop design specifications for each parameter.

(3) Develop design specifications of output strings/packets/message blocks for each application to be supported (output "from 6 to 5").

Pilot implementation of the identified application functions (e.g., remote catalog manager request/response, file transfer, process initiation, and user message exchange) requires detailed specification of the strings, packets, and/or message blocks which will be output from one host system's layer 6 protocol function for input to another host. Currently, with the exception of file transfer, no federal standards exist to guide the design effort needed by the ADS pilot system to provide mutually compatible services for these functions.

Detailed descriptions of the information content, format, and layout of the message blocks to be exchanged and the encode/decode processing to be applied to the message blocks must be specified.

(4) Evaluate existing layer 4 and 5 protocols, including the NBS proposed standard, and recommend selection for pilot system and future ADS use.

The purpose of this effort is to evaluate and recommend approach for the implementation of the transport and session layers of the OSI. This will be accomplished by a review of existing pilot system implementations, proposed standards (e.g., NBS), and other existing protocols (e.g., SNA). Additional points of consideration include a cost analysis of "build versus buy," that portion of the pilot systems' charter which effects the exploration of new technologies, the possible addition of new nodes to the ADS network, existing hardware and software in the centers involved, and the facility with which a near-term implementation may evolve into a longer term solution.

The output of this task should include recommendations of technologies and methods for a near-term implementation and longer term analyses and studies pointing toward a solution for future ADS system.

(5) Perform a requirements analysis for the ADS at the combined layers 1-3.

The service requirements for the interconnection of the pilots and for future ADS capabilities will determine which services are best suited (packet switched, dedicated line, other). No new standards are required for these layers; ADS has to select those it needs. Traffic between nodes will determine service required. X.25 is not cost-effective, under current tariff structure, for use of more than 2 hours/day--dedicated line would be cheaper. Satellite communication links have to be considered for high-data rates. The reliance on local area networks at the member nodes has to be considered for impact on the ADS network.

(6) Specify core requirements expected for each protocol layer for pilots and future ADS use.

In general, standard protocols provide a large number of options and services, not all of which are germane to a specific application. Because of this, most implementations of protocols consist of a subset of the full capability defined by the standard. Incompatibilities arise when different user systems adopt different subsets of the standards, and the logical intersection of the various subsets are insufficient to provide the necessary services. This task is concerned with developing guidelines for each applicable protocol which identify the core functions and capabilities expected from each user implementation to support the future ADS interconnection uses.

#### 10. PANEL D: STANDARDS NEEDED FOR DATA FORMATS AND DESCRIPTIONS TO INTERCONNECT ADS PILOTS FOR DATA SHARING

It was the consensus of Panel D that data exchange standards should be developed to be of general future utility, though the near-term activity should be constrained to focus on the problems of interconnecting the ADS Pilots. The intent is to use the three pilot nodes to evaluate the generalized applications of the ADS. The panel agreed that the following considerations were important when standards are designed:

a. DBMS catalogs should be accessible and understandable to remote users (both humans and applications processors).

b. Formatting conventions should be constrained to have minimal impact on existing archival data sets or on currently-generating data sources (e.g., Landsat), though they should be designed to provide guidance for future DBMS developments.

c. Archival data records and their data descriptions should be available in globally-identifiable, machine readable and interpretable form so that users can automatically interact with variable, non-affiliated data sets from remote DBMS nodes. The format of the records and descriptions should be machine and medium independent.

d. Terminology must be scrupulously defined. Definitions, words, units and general vocabulary should be standardized. Everyone should have the same understanding of the same word or definition.

e. Each DBMS node should have the option to optimize its data formats (at the discretion of the local authority) as long as minimal constraints imposed by global standards are met.

Panel D recommended:

(1) ADS should establish a standard vocabulary of terms, units, descriptions, and definitions. This must be accomplished in the immediate future. Although the early versions of the vocabulary need not be complete, they must provide the foundation for enabling the definitions of requirements and specifications to proceed.

(2) ADS should provide a machine-readable standard mechanism, which is medium and machine independent, for describing data content, structures, numeric representations, and character codes. It is vital that these definition mechanisms should be adopted as soon as possible in order to facilitate the pilot interchange of data, and in order to provide guidance for the future data sets which will be generated in coming years. The mechanisms adopted MUST be adequately defined, with user guides and examples, and MUST have expansion capabilities.

(3) ADS should establish a set of preferred numeric representations, a preferred character code, preferred units, and preferred descriptions. The ADS vocabulary should recognize and define ALL of the used or usable codes, units, and descriptions which currently exist within the pilots, but a subset of these MUST be identified as the preferred set.

It is highly desirable that each pilot node should perform conversions of those existing data elements that are not in the preferred form, thus reducing the number of conversions which must be performed by each user processor.

(4) The consensus of the panel was that the view of each of the panel participants was limited. The panel members felt that it is critical that the ADS should establish a permanent, dedicated team to pursue these recommendations further. While impractical for the panel to recommend detailed specific items for the team, it proposed that the following near-term outline be pursued:

- a. The permanent team should begin by analyzing the data formats, codes and representations used in existing pilots.
- b. The team should analyze existing and proposed data interchange standards.
- c. The team should adopt or create Strawman standards for review by data base administrators for each pilot and associated NASA data base.
- d. The team should establish an ADS data standards administration function to approve, disseminate, maintain and provide visibility for these standards.

e. The team should provide top-level coordination for the development of catalogs, in order to provide to the catalog designers the mechanisms for describing data sets and to evaluate the adequacy of the catalog structures to enable users to access and select data.

#### 11. WORKSHOP CLOSING

Before adjourning, the workshop unanimously recommended the development of a standard for data product preparation to ensure quality data sets. The recommendation prepared by Richard desJardins, as given in Table 4, was adopted.

The workshop emphasized that there is a lot of work to be done in the standards area. The panels' detailed requirements and the recommendations for future work are vital for the ADS program. Many of the workshop attendees will be called upon in the future for participation in working groups.

Critique of the MITRE presentation of the ADS pilot methodologies, one of the intents of the workshop, was deferred to the pilots for action and reporting in a few weeks' time.

Table 4  
Recommendation to OSTA on a Data Product Preparation Standard

Users of ADS may acquire some data only to find that crucial aspects of the data are unknown or missing, e.g., the position and time of data taking, the processing steps performed, the calibration curves used. While these aspects are of little consequence for systems interconnection protocols, they may be crucial for effective utilization of the data.

Therefore OSTA should develop a standard or guideline for Data Product Preparation. The intent of this standard would be to provide to data preparation personnel a checklist to assure the "quality" of the data as defined by the 1979 OSTA Data Systems Planning Workshop. The term "quality" was used at that workshop to signify the quality of the data preparation process rather than the a priori intrinsic goodness of the sensor data.

The scope of the standard would include:

- o data preparation practices (e.g., recommended quality assurance practices, scientific data validation techniques)
- o data labeling and annotation (e.g., source, indications of gaps, comments)
- o ancillary data (e.g., position, time, solar aspect)
- o "pedigree" of the data (e.g., calibrations performed, noise removal technique used, algorithm applied)
- o pointers of references (e.g., name and address of preparer, identification of data control documentation, reference data and software used including version numbers and algorithms)



## 1.0 INTRODUCTION

The Office of Space and Terrestrial Applications (OSTA)/Applications Data Service (ADS) Data Systems Standards Workshop was held at the Goddard Space Flight Center in Greenbelt, Maryland on May 27-29, 1981. The purpose of the workshop was to identify standards needed to interconnect ADS pilots for data sharing; to assess current pilot methodologies; and to make recommendations for future work. The agenda for the 3-day workshop appears as Table 1-1. The theme of the four workshop panel groups was "Standards Needed to Interconnect ADS Pilots for Data Sharing," and their topics were: Catalogues, Directories, and Dictionaries; User Interfaces; The Use of ISO Open Systems Interconnection - Basic Reference Model; and Data Formats and Descriptions.

This document contains reports from the panels; summaries of the talks and discussion presented, which are derived from transcripts and notes taken at the workshop, and view graph presentation material. A list of workshop attendees is given in Appendix F.

## 2.0 WELCOME - Paul B. Schneck, GSFC

Dr. Paul B. Schneck opened the workshop by welcoming the participants to the Goddard Space Flight Center. He set the stage for the workshop by stressing the importance of ADS in NASA's future. He emphasized that the "S" in ADS stands for service, not system, and that ADS must be responsive to the user community. It must be seen as adding value to the data which are processed. Finally, it was emphasized that standards must be applied to ADS to heighten its usability and accessibility, and not to the user to be able to adapt to ADS.

## 3.0 INTRODUCTION TO THE WORKSHOP - Barbara Walton, GSFC

The near-term goal for OSTA/ADS is to provide the capability for interconnecting the pilots for data sharing (Figure 3-1). There are three major pilots within ADS at the present time: Oceans Pilot at JPL, Earth Resources Pilot at Johnson Space Center, and the Atmospheres Pilot at the Goddard Space Flight Center. The plan is to form a network (interconnection) to share data between disciplines and users. The theme of this workshop is "Standards Needed to Interconnect ADS Pilots for Data Sharing." The first objective of this workshop is to establish the requirements for standards in the areas of (a) Catalogues, directories, and dictionaries, (b) User interfaces, (c) Use of ISO reference model, and (d) Data formats and descriptions. These topics are to be addressed by the four panels, and their members will be making recommendations at the close of the workshop. A second objective of the workshop is to review for accuracy and completeness the methodologies of the pilots as compiled to date and to make preliminary assessment of their adequacy in meeting these standards requirements. The final and perhaps most important objective is to make recommendations for future standards work and the need for continuing standards working groups. These are the key results expected from the meeting.

Table 1-1

Office of Space and Terrestrial Applications/  
Applications Data Service (OSTA/ADS) Data Systems Standards Workshop

Theme: Standards Needed to Interconnect  
ADS Pilots for Data Sharing

- AGENDA -

May 27-29, 1981  
Goddard Space Flight Center

Wednesday, May 27

8:30 am	Registration	
9:00 am	Welcome	Paul Schneck, GSFC
9:15 am	Introduction to the Workshop	Barbara Walton, GSFC
9:45 am	Background	
	- OSTA Data Systems Planning Workshop Recommendations	Dick desJardins, CTA
	- Role of Pilots	Pat Gary, GSFC
10:30 am	Coffee Break	
10:45 am	The OSTA/ADS Standards Development Process	Barbara Walton, GSFC
11:00 am	Overview of Current MITRE Effort	Terry Kuch/Rick Sakamoto, MITRE
12:00 pm	Lunch	
1:15 pm	User Requirements for ADS Standards	Paul Clemens, MITRE
2:15 pm	Refreshment Break	
2:30 pm	ADS Pilot Methodologies as Candidates for ADS Standards	Paul Giragosian/Tom Burns MITRE
3:45 pm	Panel Assignments and Introduction	Barbara Walton, GSFC

Subject: Standards Needed to Interconnect  
ADS Pilots for Data Sharing

Panel A - Catalogues, Directories, and Dictionaries  
Panel B - User Interfaces  
Panel C - Use of ISO Open Systems Interconnection-  
Basic Reference Model  
Panel D - Data Formats and Descriptions



Table 1-1 (continued)

4:00 pm Panels Convene

6:30 pm Dinner - Speaker: James Burrows, Director  
Institute for Computer Science and Technology  
National Bureau of Standards

Mr. Burrows will speak on the National Bureau of Standards Data Systems Standards Program.

Thursday, May 28

9:00 am Panels Reconvene

10:30 am Coffee Break

12:00 pm Lunch

1:15 pm Panels Reconvene

3:00 pm Refreshment Break

3:15 pm Joint Discussion of Panels' Progress

4:00 pm Panels Reconvene

Friday, May 29

9:00 am Panels Reconvene

10:00 am Panel Reports and Joint Discussion

11:30 am Conclusions  
- Workshop Summary  
- Action Items

Barbara Walton, GSFC  
John Kiebler, NASA HQ

12:00 pm Adjourn

NEAR-TERM GOAL FOR OSTA/ADS - PROVIDE THE CAPABILITY FOR INTERCONNECTING THE PILOTS FOR DATA SHARING

OBJECTIVES OF THE OSTA/ADS DATA SYSTEMS STANDARDS WORKSHOP - MAY 1981

1. ESTABLISH REQUIREMENTS FOR STANDARDS IN THE FOLLOWING AREAS
  - A - CATALOGUES, DIRECTORIES, AND DICTIONARIES
  - B - USER INTERFACES
  - C - USE OF ISO REFERENCE MODEL
  - D - DATA FORMATS AND DESCRIPTIONS
2. REVIEW THE COMPILED METHODOLOGIES OF THE PILOTS FOR ACCURACY AND COMPLETENESS AND MAKE PRELIMINARY ASSESSMENT OF THEIR ADEQUACY IN MEETING THESE STANDARDS REQUIREMENTS.
3. MAKE RECOMMENDATIONS FOR FUTURE STANDARDS WORK AND NEED FOR CONTINUING STANDARDS WORKING GROUPS.

Figure 3-1

#### 4.0 OSTA DATA SYSTEMS PLANNING WORKSHOP RECOMMENDATIONS - Dick desJardins, CTA

The purpose of the OSTA Data Systems Planning Workshop held at Wallops Island on October 9-12, 1979 was to recommend a data system concept and requirements to OSTA. A great amount of time was spent trying to find out "What is a data system concept?" A concept includes "a means for identifying the work that has to be done, identifying the relationships between the people who had to do the work, and some kind of a modularization scheme for the system." The purpose of flying spacecraft is not to fly hardware but to build data sets from remote sensing. Panels were composed of people who had problems and people who had solutions; the Data Systems Panel served as an integration function. All disciplines in the OSTA were represented as shown in Figure 4-1.

Figure 4-2 summarizes the Integrated Discipline Requirements identified by the OSTA Workshop participants as presented in the following paragraphs. Quality data sets are needed which are clean, useful, and processable. Either the project or discipline must produce parameter data sets (of physical phenomena) which meet the program objectives. There are problems with data: OSTA needs a systematic treatment of problems with present data. In the operations phase, scientific data management personnel should be responsible for the quality of the product, the planning of the product, and seeing that users get the data that they want. The pedigree of the data is important; data from a sensor are useless as is. Sun angle, calibration, algorithms for parameterizations, etc. are needed.

OSTA needs a single integrated data catalog or "Master Directory." ADS should be one means to access the catalog to help the researcher find out how to get the data and avoid wasting time doing it. Since most of the data exist, it is estimated that these would solve over 50 percent of the problem.

OSTA needs continuity of data formats. A single format is not needed; there should be a few, fairly standardized formats. Data levels should be defined. Users should be able to select the format they want. (There was a divergence of opinion expressed by participants. Either the formats now existing could be translated for the user--a value-added service--or the onus is on the user--he translates the data; ADS just gets the data.)

OSTA needs to reference its data to a standard geographic and time basis. Every piece of data should be marked with latitude, longitude, and altitude (georeference), Universal Time. The user must be provided with at least a spacecraft clock and swath which are fundamental elements. The user also needs codes/algorithms, clock to UTC, geographic algorithms, etc.

OSTA needs data delivery. Usually there is no need for immediate access to data. What is needed is easy accessibility: ability to get data by means of mail or electronic transmission. Some projects (operational demonstrations) have found that real-time information is useful; each project has a "freshness" requirement.



## OSTA DATA SYSTEMS PLANNING WORKSHOP

---

- WORKSHOP HELD OCT 9-12, 1979, AT WALLOPS
- PURPOSE: IDENTIFY AND RECOMMEND TO OSTA AN OVERALL DATA SYSTEM CONCEPT FOR PROVIDING USERS OF INFORMATION FROM EARTH-WATCHING SPACECRAFT WITH TIMELY AND READILY USABLE RESEARCH DATA
- 6 DISCIPLINE PANELS: AGRICULTURE; LAND RESOURCES; HYDROLOGY; GEOLOGY AND GEODYNAMICS; ATMOSPHERE; OCEANS
- 5 DATA SYSTEMS PANELS: OVERALL DATA SYSTEM; ONBOARD DATA SYSTEMS; DATA ACQUISITION, DISTRIBUTION AND OPERATIONS; INFORMATION EXTRACTION AND PROCESSING, AND USER FACILITIES; DATA BASE STORAGE AND MANAGEMENT

Figure 4-1



## INTEGRATED DISCIPLINE REQUIREMENTS

---

1. QUALITY DATA SETS
  - PROJECTS DELIVER TIMELY QUALITY DATA SETS AS SUCCESS CRITERION
  - DISCIPLINE "PROJECTS" PREPARE QUALITY PARAMETER DATA SETS
  - RECTIFY CRITICAL EXISTING PROBLEMS
  - INVOLVE SCIENTIFIC DATA MANAGEMENT
  - PROVIDE DETAILED ANNOTATIONS, "PEDIGREE", WITH DATA
2. DATA CATALOG(S)
3. DATA FORMATS
  - SEVERAL STANDARD FORMATS AND LEVELS
  - USER SELECTABLE FORMATS AND LEVELS
  - REFERENCED TO COMMON GEOGRAPHIC AND TIME BASES (LAT/LONG AND UT PREFERRED)
4. DATA DELIVERY
5. ARCHIVE(S)
6. COOPERATION WITH USER AGENCIES
7. ORDERLY EVOLUTION

Figure 4-2

OSTA needs appropriate data archives to provide a place to store data. There is a need for uniformity in policy for keeping, indexing, or managing that data. A policy of active archives is required. Scientific data management should provide accessible data.

Cooperation with user agencies is necessary for OSTA. USGS and NOAA, as examples, have similar needs and problems, and NASA needs to be in harmony with operational data from other agencies. Very few of NASA's Applications Programs are able to function in isolation. OSTA must implement research in data input and data dissemination to meet its needs.

Figure 4-3 shows the overall OSTA Data System Concept, a simple concept whose requirements include production of Level 1A data sets. Working storage is provided for researchers. At the level shown in the figure, ADS tells us what standards are necessary for making data available. ADS would provide consultation and a Master Directory; this workshop is an example of consultation. Researchers need to be able to "get to the root of the tree" in ADS. For long-term planning, the concept should be based on data sets.

The overall data system concept and recommendations are shown in Figure 4-4. The concept should be cost-accountable; it should produce Level 1A data sets. It could be phased over to commercial service. It was never a concept for electronic data dissemination. The concept included browse data, then place order. There was a fundamental problem with Level 1. The data have to cost-effectively satisfy multiple objectives. There was a need for a general policy. The policy recommended was to store all the information that a user needs along with the raw measurement: sensor measurement data, sensor ancillary data, calibration with instrument, etc. The data must be stored in a form such that original data may be recovered. To do all this, OSTA needs a research and technology thrust!

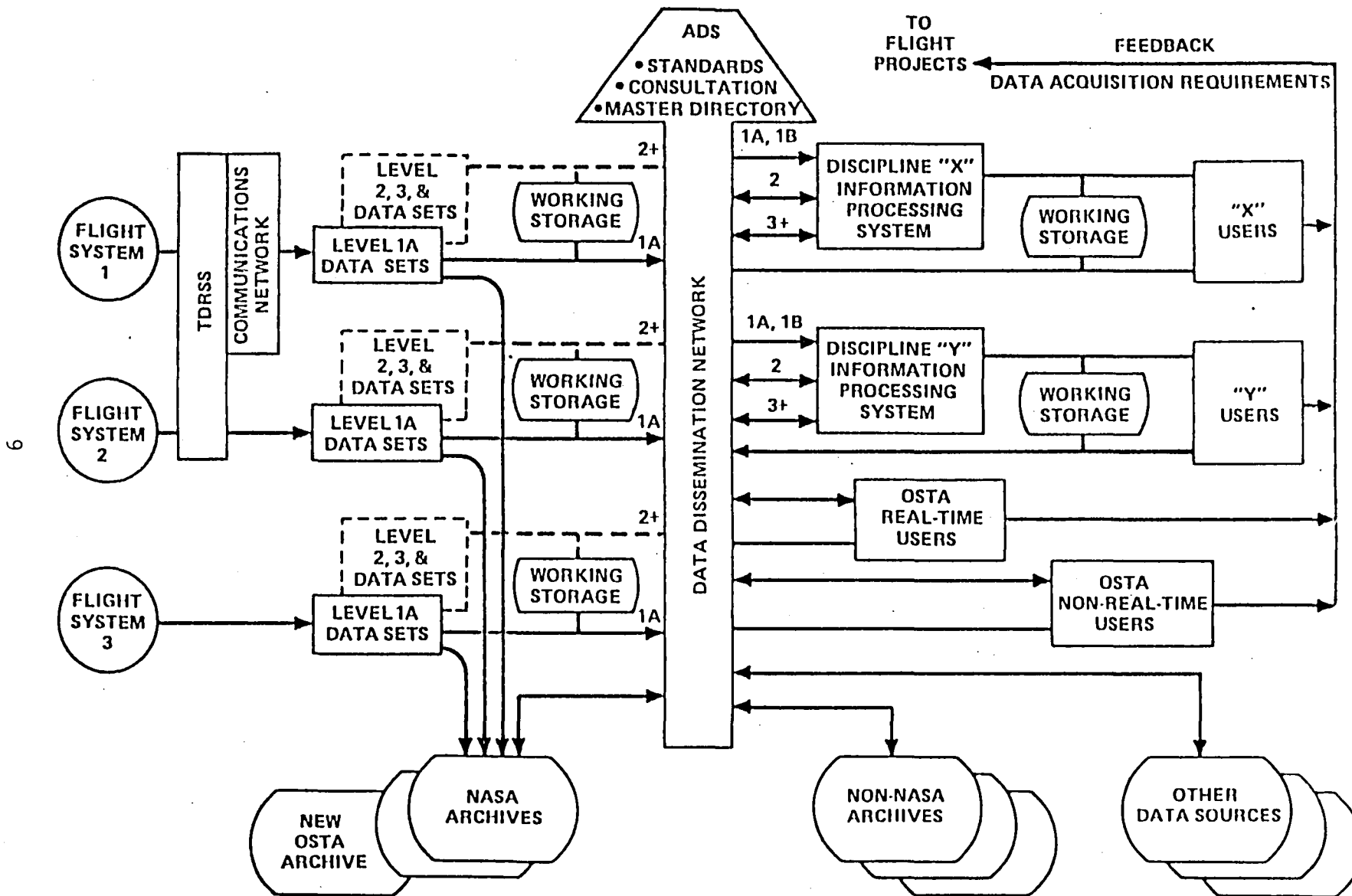

Figure 4-3. OSTA Data System Concept



## OSTA OVERALL DATA SYSTEM CONCEPT AND RECOMMENDATIONS

---

- OSTA OVERALL DATA SYSTEM CONCEPT
  - RECOMMENDED AS LONG TERM PLANNING BASIS
  - BASED ON DATA SETS AS INTERFACES BETWEEN PROGRAMMATIC ACTIVITIES
  - COST ACCOUNTABLE PROJECT ORIENTED DATA SYSTEMS TO PRODUCE LEVEL 1A DATA
  - DISCIPLINE ORIENTED DATA SYSTEMS TO PERFORM HIGHER LEVEL PROCESSING
  - ARCHIVES TO RETAIN DATA SETS AND MAKE THEM READILY AVAILABLE
  - COMMON DATA CATALOGING AND DISSEMINATION NETWORK SERVICE
- LEVEL 1 DATA
- FLIGHT PROJECT RESPONSIBILITY
- DISCIPLINE INFORMATION PROCESSING SYSTEMS
- ARCHIVE(S)
- APPLICATIONS DATA SERVICE (ADS)
- ENDORSEMENT OF DISCIPLINE REQUIREMENTS
- INFORMATION SCIENCE R&T



## 5.0 THE ROLE OF PILOTS - J. Patrick Gary, GSFC

This workshop is effectively considered a working group for standards. The OSTA/ADS Data System Concept was described in broad terms by Richard desJardins. We now need more detailed specification of hardware interfaces, communications protocols, data exchange services, etc. Hence, this workshop should be viewed less as a formal review committee but more as a working group to define areas within the data systems concept where standards are required.

The overall goals of the ADS Program, as shown in Figure 5-1, are broad. OSTA data users require timely and effective access to needed data in a uniform way. We must not overstandardize. OSTA has sponsored and is sponsoring three pilot programs deeply imbedded in the scientific disciplines: at GSFC, the Atmospheres Pilot involved with severe storms research, the VAS Demonstration project, and related atmospheres programs in weather and climate research; at JPL, the Oceans Pilot starting with an interest centered around Seasat data; and at JSC, the Resources Pilot tied strongly with the AgRISTARS program.

These pilots are planned to evaluate the utilization of current techniques and technologies in the use and exchange of data and to facilitate access to data (DBMS, Data Management, etc.). Figure 5-2 shows the common goals and objectives of pilots. Specifically, the pilots are to provide demonstrations of the use of advanced technologies, provide a test-bed environment for data handling technique evaluation, evolve ADS requirements and capabilities (long-term goal), and where applicable, document validated methodologies as standards and guidelines for OSTA data systems planning use. The pursuit of all of the above objectives is to be carried out under the prime directive to apply technology in a service capacity in support of the data handling research programs of the application disciplines. The three pilots, when they interconnect, have a chance to "test bed" distributed processing and data sharing concepts needed to meet ADS near-term requirements. In time, they will come to test concepts applicable to much of NASA.

Figure 5-3 shows the Promotion of ADS Concepts through Pilot Data Systems Activities. There must be feedback: Does the data handling concept serve the data users' need? Four areas relating to the technical concepts are: 1) User-oriented catalog system, 2) Data set management, 3) Network communication system, and 4) User interface.

Figure 5-4 shows the near-term requirements to be accomplished by the ADS Program. To interconnect the ADS pilots for data sharing, two key functions are needed: 1) Users must know what data are available, and 2) Data must be exchangeable among facilities. No utopian systems are planned in the near-term, where processes or algorithms are exchanged or forms of load leveling are attempted, but these concepts may need to be addressed in the future.

The relationship of pilot program activities to the standards development process is shown in Figure 5-5. Inputs and evaluative criticism from the users, pilots, and Headquarters are required in the standards development process. The process starts with requirements for standards, but we must

## SUMMARY OF OVERALL ADS PROGRAM

### GOAL

- PROVIDE OSTA DATA USERS WITH TIMELY AND EFFECTIVE ACCESS TO NEEDED DATA AND INFORMATION WITHIN AND OUTSIDE OF NASA
- PROVIDE STANDARDS/GUIDELINES FOR FUTURE OSTA PROGRAMS TO EVOLVE DATA SYSTEMS AND DATA MANAGEMENT TOWARDS COMPATIBILITY WHERE APPROPRIATE

### APPROACH

- EVOLUTIONARY DEVELOPMENT THROUGH PILOTS TO MEET APPLICATIONS USER REQUIREMENTS

#### OSTA/ADS PILOTS

ATMOSPHERES PILOT SYSTEM  
OCEANS PILOT SYSTEM  
RESOURCES PILOT SYSTEM

#### RTOP MANAGEMENT

GSFC  
JPL  
JSC

### CONCEPTS

- USER ACCESS TO INFORMATION ABOUT DATA AND TO THE DATA ITSELF THROUGH
  - o APPLICATION OF DATA CATALOGING AND MANAGEMENT TECHNOLOGIES
  - o INTERCONNECTION OF APPLICATIONS DATA SYSTEMS TO FACILITATE DATA EXCHANGE

Figure 5-1

## COMMON GOALS/OBJECTIVES OF OSTA/ADS PILOTS

- o PROVIDE USEFUL DEMONSTRATIONS AND CAREFUL EVALUATIONS OF CAPABILITIES TO LINK DATA USERS AND PRODUCERS FOR SELECTED OSTA PROGRAMS
- o PROVIDE TEST BEDS TO EXPLORE TECHNOLOGIES AND TECHNIQUES FOR CATALOGS, DATA ORDERING, DATA EXCHANGE, AND OTHER RELATED ADS CONCEPTS
- o EVOLVE AND VERIFY THE REQUIREMENTS AND SPECIFICATIONS FOR A FUTURE FULL CAPABILITY ADS
- o DEVELOP STANDARDS FOR OSTA DATA SYSTEMS IN COOPERATION WITH OTHER NASA PROGRAM OFFICES AND OTHER AGENCIES

PROMOTION OF ADS CONCEPTS  
THROUGH PILOT DATA SYSTEMS ACTIVITIES

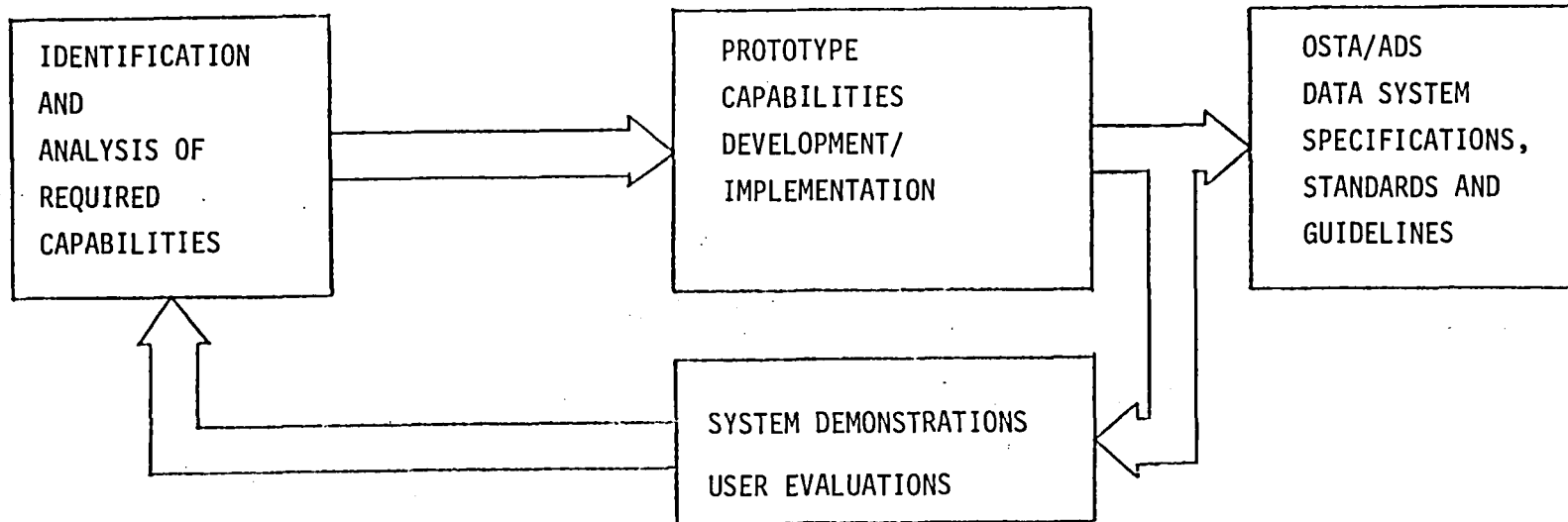

ADS TECHNICAL CONCEPTS

- o USER ORIENTED CATALOG SYSTEM
  - INFORMATION CONTENT/ORGANIZATION
  - CREATE/UPDATE CATALOG ENTRIES
  - INTERACTIVE CATALOG ACCESS
  - CATALOG ACCESS SECURITY
- o DATA SET MANAGEMENT
  - ON-LINE/OFF-LINE STORAGE
  - FILE PROTECTION/ACCESS PRIVILEGES
  - SELECTIVE DATA SUBSETTING
  - DATA EXCHANGE FORMATS
- o NETWORK COMMUNICATION SYSTEM
  - HIGH AND LOW SPEED LINES
  - ISO LAYERED DATA SYSTEM INTERFACES
  - USAGE STATISTICS MONITORING
  - GATEWAYS TO OTHER NETS
- o USER INTERFACE
  - HELP FUNCTIONS
  - LOCAL/REMOTE CATALOG QUERY
  - DATA SET ACCESS/EXCHANGE
  - LOCAL/REMOTE PROCESS INITIATION

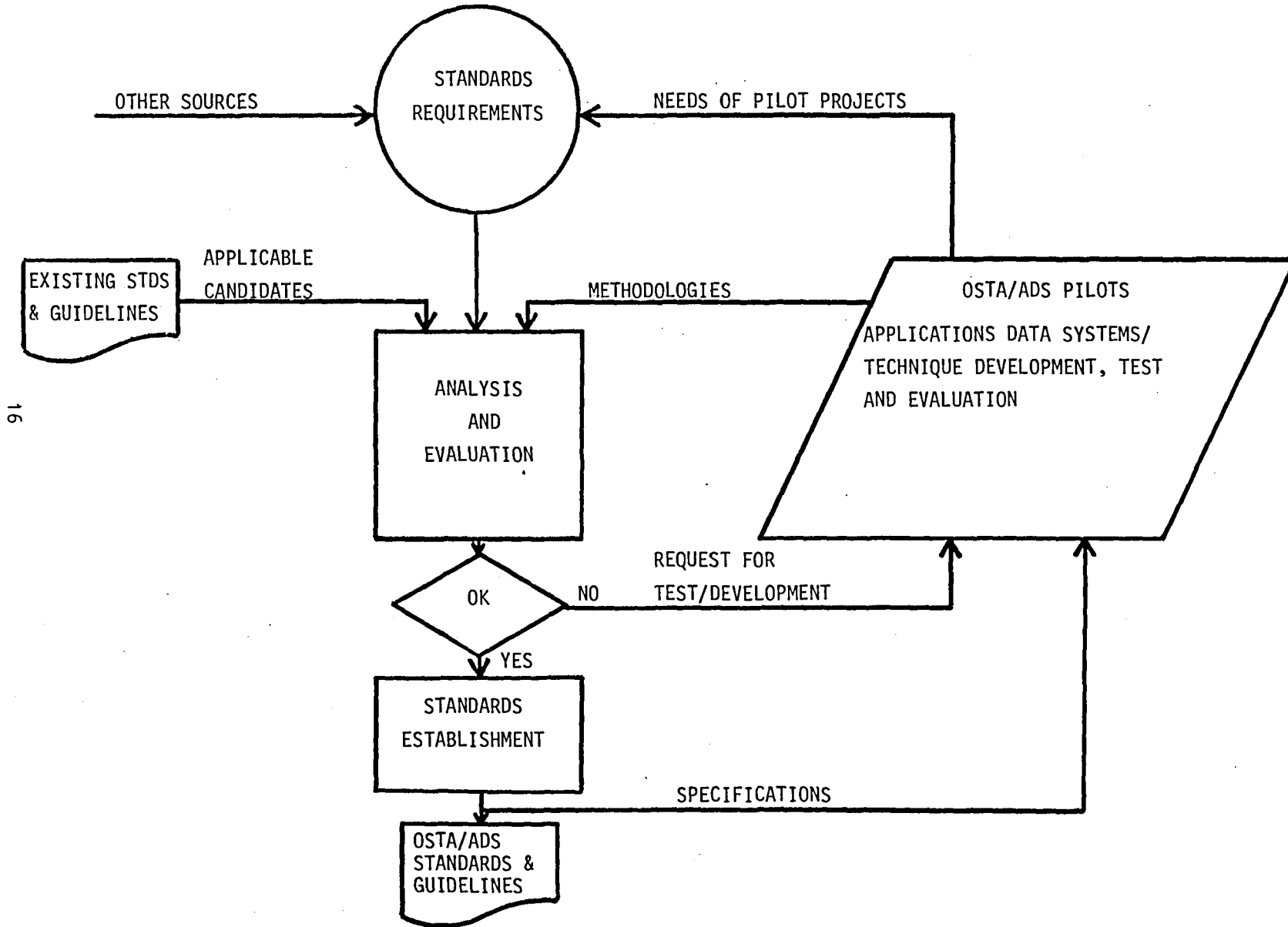

Figure 5-3

## NEAR-TERM ADS REQUIREMENTS

- o INTERCONNECT ADS PILOTS FOR DATA SHARING
  - PROVIDE USER ACCESS TO INFORMATION ABOUT  
AVAILABLE DATA
  - PROVIDE DATA SET ACCESS/EXCHANGE/DISSEMINATION  
AMONG SYSTEMS

RELATIONSHIP OF OSTA/ADS PILOTS TO THE STANDARDS DEVELOPMENT PROCESS



16

Figure 5-5

not overstandardize. Standards are useful to describe 1) How to describe; 2) How to build; and 3) How to apply. Should ADS find that the current standards or methodologies are not adequate or applicable to its needs, the pilots can test new methodologies or proposed standards and develop them. The establishment and dissemination of standards is a high level management function (OSTA, NASA). A result of this standards development process feeding back to the pilots will be standards useful to the design and the specification of new systems.

Figure 5-6 shows the overall ADS development approach with its gradual expansion of capabilities. The process is iterative; feedback to and from working groups, such as a standards development working group, is essential for progress. FY84 is planned as a target completion date for the development of an ADS working model.

ADS PROGRAM REVIEW

ADS DEVELOPMENT APPROACH

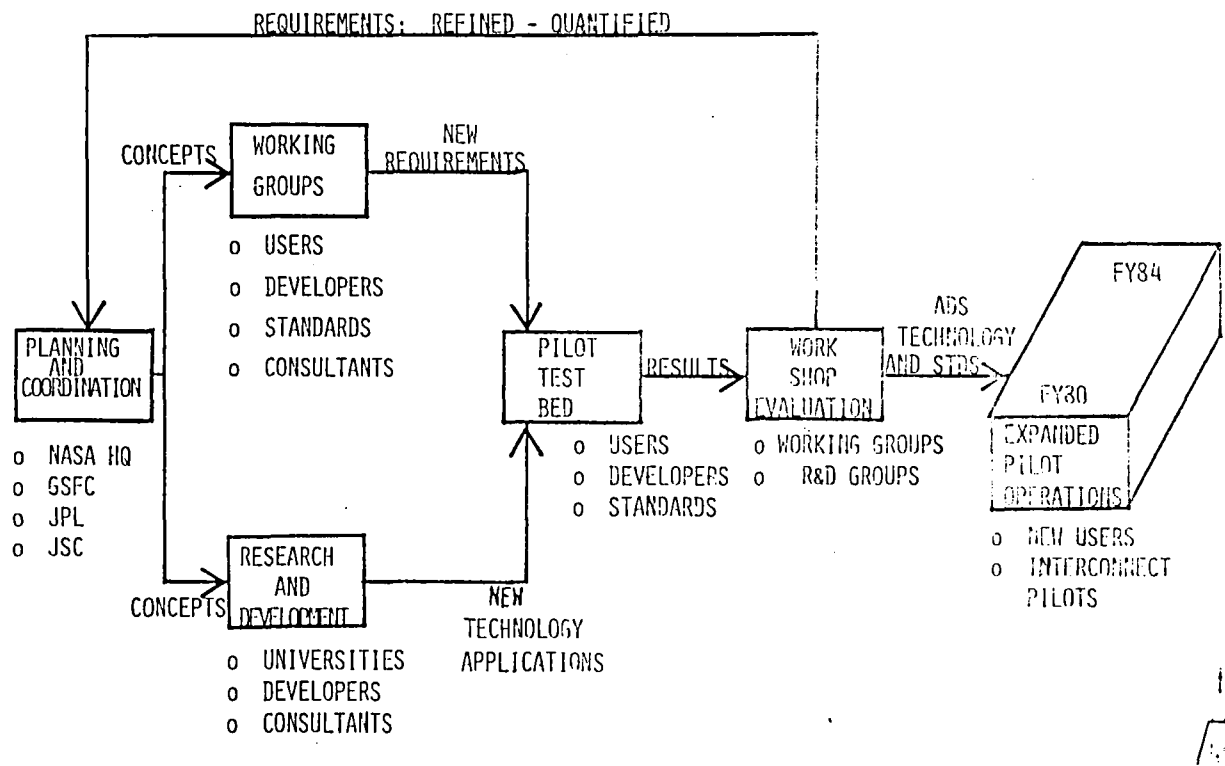

Figure 5-6



## 6.0 THE OSTA/ADS STANDARDS DEVELOPMENT PROCESS - Barbara Walton, GSFC

The goals of the OSTA/ADS Data Systems Standards Program were formulated in response to the need for standards for sharing data. The overview of the program is shown in Figure 6-1. Applicable standards of the National Bureau of Standards and other existing standards can be used, but ADS and OSTA have unique problems. NASA has already dealt with some of the unique problems, such as the Landsat images CCT (Computer-Compatible Tape) standards; however, there are other development efforts that NASA will be dealing with in the near future. The coordination with the OSTA programs and the pilots is an objective of the Program.

Figure 6-2, dated August 1979, lists the requirements for the OSTA data and data systems standards at that time. In August of 1980, I began work on ADS standards and developed a phased approach to the problem. In FY82 and FY83 the focus will expand to include all OSTA data systems. Hopefully, in FY84 and beyond there will be a "full" OSTA/ADS Standards and Guidelines production.

Resources of the OSTA/ADS Data Systems Standards Program are shown in Figure 6-3, which is an organization chart of parts of NASA. At Goddard we have standards efforts in Cataloging, under Karen Posey; PADS is directed by Pat Gary; Dave Howell is the head of TAE; and, the GSFC Aerospace Data Systems Standards Program (not shown) is directed by Bill Poland.

The three phases of the Approach to OSTA/ADS Data Systems Standards Program are shown in Figure 6-4. What has been done? The standards survey, user requirements, methodology survey, and evaluation criteria are all FY81 Phase 1 projects. "Candidate" standards will be produced and the results are due to be published in August of this year. The following remains to be done: ADS planning, interim standards, a concept for implementation of a "Core ADS", definition of OSTA data systems policy, and full-capability ADS definition.

Results are shown in the Phase 1 (Figure 6-5) chart. This is basically this year's program which builds on the results of the OSTA Workshop and the feasibility study reported on by Dick desJardins. Standards surveys, examination of pilot methodologies, and criteria development have been done. At the workshop today we hope to review/modify/evaluate these processes so that those standards which might be applicable to ADS may become candidate standards for ADS.

Figure 6-6, Phase 2, shows the expanded focus on OSTA data systems and "Core ADS." Figure 6-7, Phase 3, focuses on the future goal of a "full-capability ADS." Once we get a full set of standards, we will need to have a systematic review and periodic update. Standards will evolve as needs evolve; the ADS effort will continue to grow.

## OSTA/ADS DATA SYSTEMS STANDARDS AND GUIDELINES PROGRAM OVERVIEW

### GOAL

- PROVIDE EFFECTIVE DATA EXCHANGE AND DATA SYSTEM INTERFACE STANDARDS AND GUIDELINES FOR OSTA PROGRAMS

### OBJECTIVES

- IDENTIFY AND RECOMMEND USE OF DATA SYSTEM STANDARDS AND GUIDELINES APPLICABLE TO OSTA/ADS
- DEVELOP AND MAINTAIN OSTA/ADS - UNIQUE DATA SYSTEM STANDARDS AND GUIDELINES
- COORDINATE WITH OSTA PROGRAMS, ADS PILOTS AND PERTINENT STANDARDS ACTIVITIES WITHIN AND OUTSIDE NASA

## OSTA DATA AND DATA SYSTEMS STANDARDS REQUIREMENTS

- USER TERMINALS (INTERFACES AND VIRTUAL TERMINAL PROTOCOLS)
- DATA SYSTEMS (FILE STRUCTURE, DATA MANAGEMENT, AND ACCESS PROTOCOLS)
- FORMATS (DATA REFERENCE FRAMES--GEOGRAPHIC, TEMPORAL; DATA FORMATS, CODES AND CONVENTIONS INCLUDING GEOCODING STANDARDS)
- LANGUAGES (INTERACTIVE DATA QUERY LANGUAGE, DATA DESCRIPTION LANGUAGE--DATA DICTIONARY)
- DIRECTORIES/CATALOGS (PRODUCER AND USER DATA SOURCES AND PRODUCT LISTS WITH LOCATIONS AND ACCESSING INFORMATION)
- INTERCONNECTION (NETWORK PROTOCOLS, INTERFACES, AND GRADES OF SERVICE)
- DATA PREPARATION (STANDARD LEVELS OF VALIDATION PERFORMED AND CERTIFICATION CRITERIA; STANDARD DEFINITIONS OF INFORMATION LEVELS)
- SOFTWARE (SOFTWARE ENGINEERING STANDARDS, STANDARDS OF DOCUMENTATION)

Figure 6-2

# OSTA/ADS DATA SYSTEMS STANDARDS PROGRAM WORKING RELATIONSHIPS

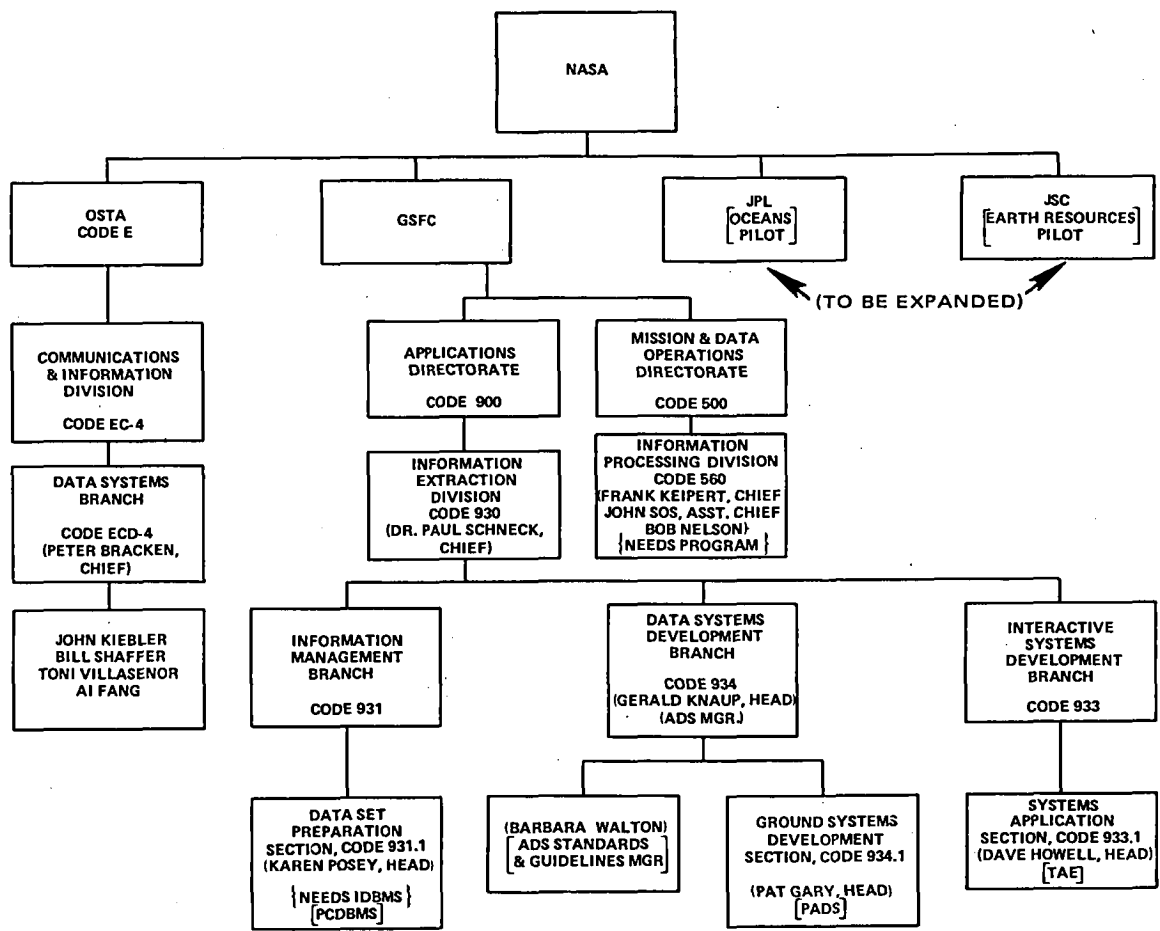

Figure 6-3

APPROACH TO OSTA/ADS DATA SYSTEMS STANDARDS PROGRAM

PHASE 1 - FY81

FOCUS ON ADS

ASSESS REQUIREMENTS

SURVEY EXISTING STANDARDS AND GUIDELINES

EXAMINE PILOT METHODOLOGIES

DEVELOP STANDARDS EVALUATION CRITERIA

PRODUCE "CANDIDATE" STANDARDS AND GUIDELINES

PHASE 2 - FY82 AND 83

EXPAND FOCUS TO OSTA

DEVELOP IMPLEMENTATION AND MAINTENANCE PROCEDURES

SPECIFY MAJOR STANDARDS DEVELOPMENT EFFORTS FOR NEAR-TERM ADS GOALS

PRODUCE "INTERIM" STANDARDS AND GUIDELINES FOR "CORE ADS"

PHASE 3 - FY84 AND BEYOND

CONTINUE STANDARDS REQUIREMENTS ASSESSMENT

EVALUATE STANDARDS AS TESTED IN PILOTS

PUT IN PLACE IMPLEMENTATION AND MAINTENANCE PROCEDURES, REVIEW BOARDS

AND POLICY

PRODUCE OSTA/ADS DATA SYSTEMS STANDARDS AND GUIDELINES CAPABLE OF

SUPPORTING "FULL" CAPABILITY ADS

# OSTA/ADS DATA SYSTEMS STANDARDS PROGRAM

## PHASE 1 – ADS FOCUS

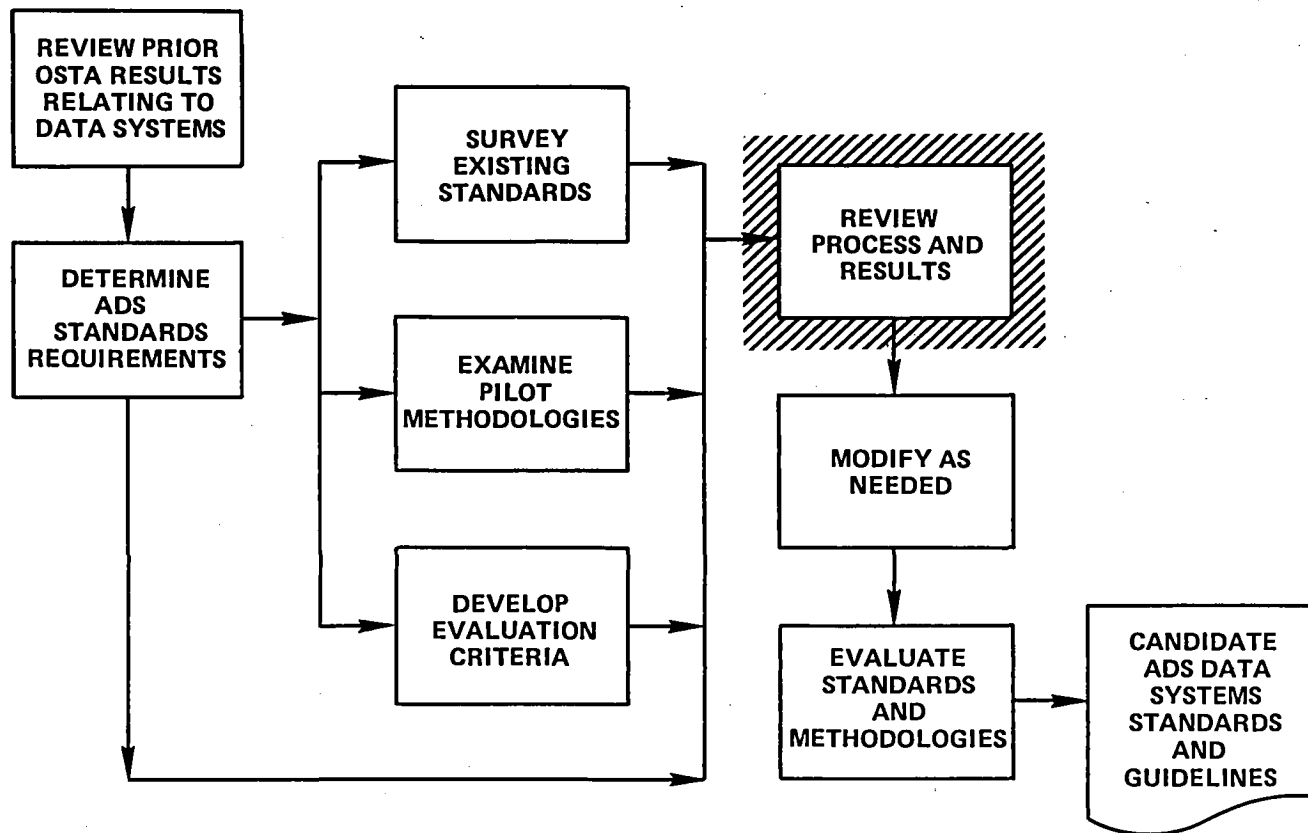
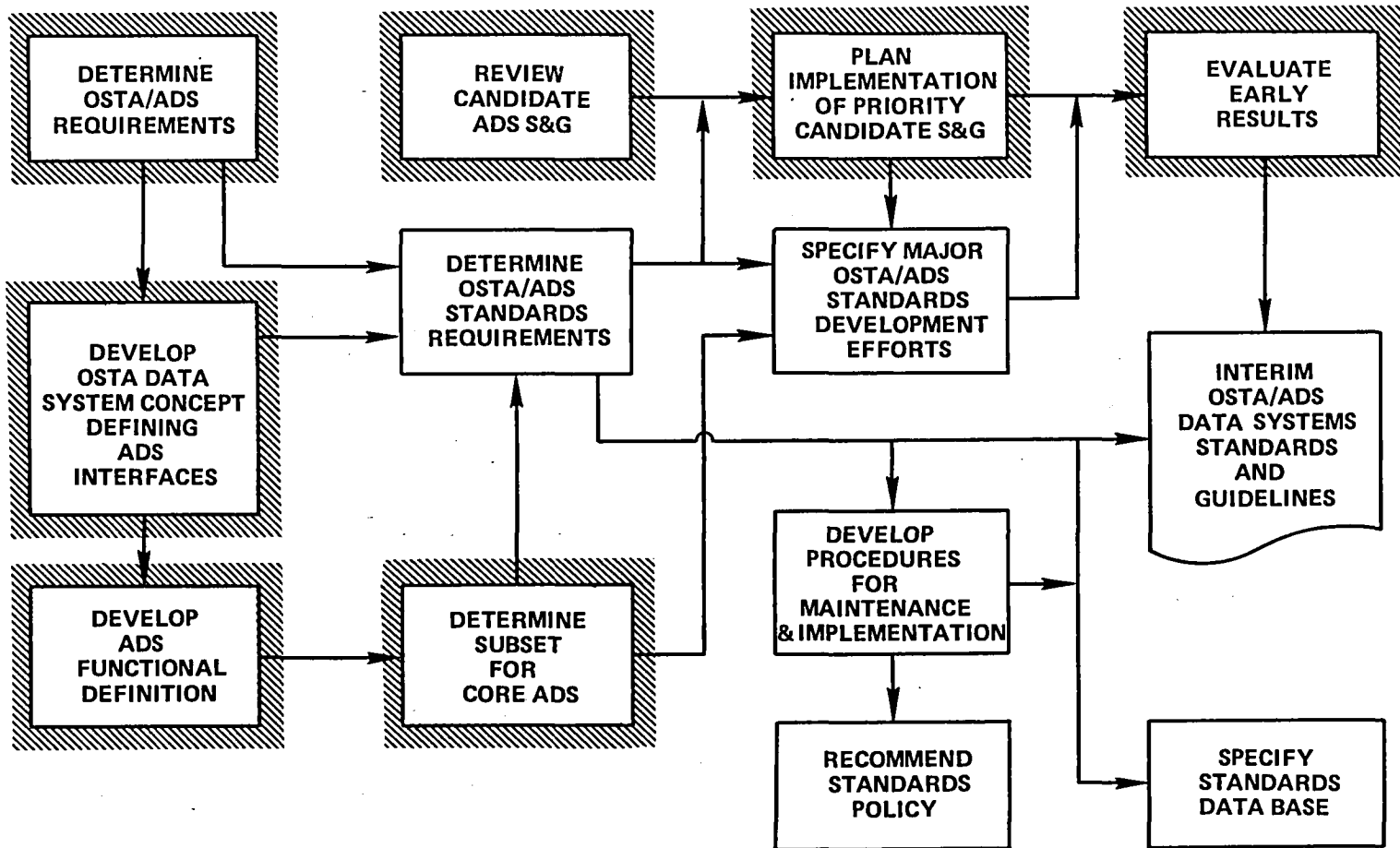

Figure 6-5

# OSTA/ADS DATA SYSTEMS STANDARDS PROGRAM

## PHASE 2 – OSTA/CORE ADS FOCUS



25

Figure 6-6

# OSTA/ADS DATA SYSTEMS STANDARDS PROGRAM

## PHASE 3 – OSTA/FULL ADS FOCUS

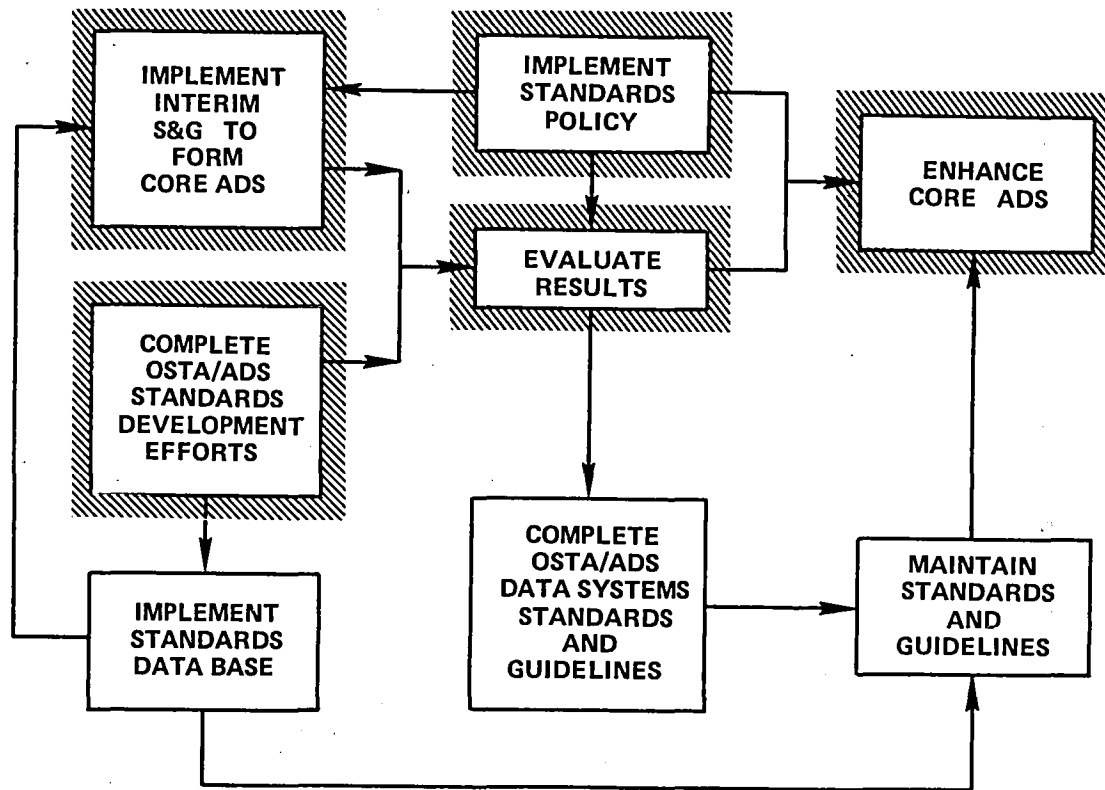

Figure 6-7



## 7.0 OVERVIEW OF THE CURRENT MITRE EFFORT - Terry Kuch/Rick Sakamoto, MITRE

Following is a summary of the first of three MITRE presentations at the workshop. View graphs used in this presentation are reproduced in Appendix A.

Terry Kuch and Rick Sakamoto presented an introduction to MITRE's support of the OSTA/ADS standards and guidelines program. The three MITRE presentations at the workshop dealt primarily with functions needed for near-term data sharing among ADS member systems. Sharing of computational facilities and software were considered to be longer-term ADS goals.

MITRE adopted a logical view of ADS as a distributed system, which distinguishes among seven components of such a system:

- o Members
  - 1) Providers of data
  - 2) Providers of applications software
  - 3) Providers of computational facilities
  - 4) Users of data, software, or computational facilities
- o Support services
  - 5) Administrative services
  - 6) Technical services such as documentation and location support for data, software, and computational facilities
  - 7) Support for data communication

Based on this logical view, MITRE developed a hierarchical classification scheme of ADS features at a level of detail (70 nodes) appropriate to the level of detail addressed by most Federal, national, and international information processing standards.

This feature classification provided the framework for a preliminary assessment of the applicability of Federal, national, and international standards to ADS. These standards were gathered, screened, and documented briefly. Some 300 standards were examined, of which 187 were reported in NASA contractor report CR 166675.

This survey of standards was enlarged to incorporate standards from NASA Headquarters and centers. At the same time, two key efforts were initiated to:

- o Survey methodologies of the three ADS pilots.
- o Identify the requirements for standards of ADS members based on a survey of the pilots and on representative potential future members.

Preliminary results of the requirements survey were used in the development of criteria for the evaluation of candidate standards for OSTA/ADS. An evaluation process was designed incorporating these criteria.

An overview of the evaluation process was presented in this session, and examples of candidate standards were passed through the process.

## 7.1 GOALS OF THE SESSION

The goals of this session were to familiarize those attending the workshop with MITRE's work in support of ADS, and to invite comment on this work, especially on:

- o Applicable standards
- o Evaluation process
- o Evaluation criteria

## 7.2 PRESENTATION DISCUSSION

Dr. Adrian Hooke asked, "With reference to view graph 4, what happens when you do items 3 and 4 and find a requirement for standards that doesn't fit in item 5?"

Terry Kuch replied that in this case a standard should be developed outside the flow shown in the diagram, perhaps under contract.

Richard desJardin commented that the principal recommendation of the OSTA Data Systems Planning Workshop is missing from the current standards effort - QUALITY DATA SETS. The main thing programmatically you have to tell people is what constitutes quality.

Quality is: Description  
Annotation and Pedigree  
Certification and Algorithms used to process the data

Where is the policy standard?

William Shaffer replied that it is a policy standard. There are two points to be made here: First, it hasn't been done [in the past]. Second, Goddard has changed that and it is being done--for 3 months already. Project Managers are responsible for their data--for quality data. Bob Lynn has solved this.

After further discussion, which pointed out that the current effort is on ADS and that this is an OSTA problem, Richard desJardin agreed to draft a recommendation for consideration by this workshop which was later adopted in the closing session (see Section 15.0).

Anthony Villasenor commented that NASA Headquarters takes the position that the purpose of this workshop is to evolve standards for ADS. The OPEN/UARS programs point the way. There is a need for creating data and the management of data--a realizable goal. We hope the workshop will give input to which standards will be policy, which will be technical.

William Poland observed that the chart on characteristics is deficient and needs augmenting.

Gerald Knaup commented on what is and is not a standard--we don't have a standard catalog, rather we want to look at a number of technologies to implement. We can then come up with areas and a cooperative agreement, not a rigid standard.

Tony Villasenor said that for the full ADS, Headquarters needs and expects a commercialized service. A specification on this service is needed for an ADS interconnection. We will need it by Phase 3. The ultimate ADS will be a commercial service, not government service.

## 8.0 USER REQUIREMENTS FOR ADS STANDARDS AND GUIDELINES - Paul Clemens, MITRE

Paul Clemens presented the results of a survey of ADS member requirements for standards and guidelines; his view graphs are in Appendix B. This survey was carried out in four steps:

- o Identify a representative number of planned and prospective ADS members from ADS pilots, key OSTA programs, and other sources.
- o Survey the identified members.
- o Define and document members' needs for ADS system capabilities and services.
- o Derive ADS standards and guidelines requirements from this survey of members' needs.

The survey included the interpretation and analysis of functional requirements from three sources: (1) earlier OSTA/ADS data system studies, (2) current ADS pilot activities, studies, and documentation, and (3) prospective ADS members' activities and documentation. Requirements in each case were then reviewed and modified as needed to reflect the overall scope of ADS.

The resultant requirements were then tabulated and mapped into the ADS feature classification. The findings were analyzed for commonality of purpose and function and, from this analysis, overall standards requirements were determined.

This session prioritized requirements in the areas to be addressed by the workshop panels: data catalogs, user interfaces, the ISO model for open systems interconnection, and data formats.

### 8.1 GOALS OF THE SESSION

The goals of the session were to elicit comments on the adequacy of MITRE's findings, especially as to:

- 1) Functional areas requiring standards,
- 2) Utility and applicability of the identified requirements for standards,
- 3) Completeness of the survey as presented, and
- 4) Any misrepresentations in the survey and analysis.

### 8.2 PRESENTATION DISCUSSION

A question from the audience at the end of view graph 50: Is it more fruitful to describe data formats and not data elements? One may argue the point that some need data elements described, too. A solution might be to say rather, that it is "sufficient for standardization requirements."

Paul Clemens agreed that this is a good point.

Another question asked from the audience: If you know what to do, do you carry it out in an optimum way--on the satellite, ground, or air?

Barbara Walton replied that ADS does not preclude doing sorting (for example) on the spacecraft.

9.0 ADS PILOT METHODOLOGIES AS CANDIDATES FOR ADS STANDARDS - Paul Giragosian, MITRE

The third MITRE presentation was made by Paul Giragosian; his view graphs are in Appendix C.

At various stages in their development, the ADS pilots have implemented or planned to adopt certain practices, procedures, standards, or conventions. The collection of these practices as applied toward a specific development function or operational objective constitutes the notion of a "methodology."

This session presented the results of a survey of the methodologies employed by the ADS pilot programs (Atmospheres, Oceanic, Earth Resources).

MITRE surveyed, identified, and documented methodologies for each of the ADS pilot systems. Major methodology categories include:

- o Methods for system interconnection
- o User interface
- o System directory/catalog structure
- o Data definition/structure

The primary objective of the survey was to provide an information base for the evaluation of these methods and their applicability to the future development of ADS standards and guidelines.

An illustrative example of Pilot communications methodologies follows:

The Pilot Atmospheres Data Systems (PADS) has been implemented on three Digital Equipment Corporation (DEC) applications processors: two PDP 11/70 and a VAX 11/780 in a star configuration with a DEC PDP-11/34 functioning as the central communications processor. User terminals are hardwired to the applications processors.

Communication is accomplished using the Remote Services Subsystem (RSS) and a communications software package, COMM. These software packages were developed specifically for PADS. On-site processor communication uses the Digital Data Communications Message Protocol (DDCMP) while off-site communication will use a subset of the ANSI Advanced Data Communications Control Procedure (ADCCP) protocol.

The Earth Resources Pilot uses the IBM bisynchronous protocol with the IBM communications package, Remote Spooling and Communications Service (RSCS) to transmit and process data sets within the Earth Resources Data Applications Network. The network is composed of two host processors: an IBM 3031 with a front-end 3670 COMTEN communications processor at Purdue University and an AS/3000 with a front-end 3650 COMTEN communications processor at the Johnson Space Center. Two 9600-baud lines connect the hosts. User communication is accomplished using 300-baud and 1200-baud lines asynchronously linked to either host.

The Oceanic Pilot System hardware configuration consists of a DEC VAX 11/780 with a PDP 11/44 serving as a front-end communication processor. Users communicate via 300-bit/sec and 1200-bit/sec asynchronous lines. The system will utilize Digital Equipment Corporation's DECNET communications software.

## 9.1 GOALS OF THE SESSION

The goal of the session was to obtain critical assessment of the completeness and accuracy of the pilot methodology survey.

## 9.2 PRESENTATION DISCUSSION

Following view graph 8 on PADS, a member of the audience asked if the Communications Package (COMM) of the Pilot Atmospheres Data Package (PADS) will be tied to commercial use.

Paul Giragosian replied that both COMM and RSS (Remote Services Subsystem) serve layers within the OSI model and will also be used as a basis for interfacing with a commercial network.

Bill Shaffer asked how far along the PADS/System of Networked Applications Processors (SNAP) is.

Paul answered that it is now running in the current initial configuration.

Bill Shaffer asked about the need for standards for SNAP.

Pat Gary replied that dissimilar DBMS exchange has demonstrated that a file format structure standard was needed. The Pilot Climate Data Base Management System (PCDBMS) will manage different information. This is also a problem. So we really need standards now.

A member of the audience commented (after view graph 21 on PADS attribute mapping) that the PADS "Superset" approach works for a smaller set and asked, "What is now meant by a 'small' set? Big?"

Dr. Samuel Steppel replied that there are 200 bytes per slot. About 60 spare attributes now exist (some in 2, 4, 8-byte attributes). The advantage is that each system worries only about its own attributes--no translation. If we had lots of data though, it is no good.

Portia Bachman asked, in reference to view graphs 30 and 31, how the data base for all of ERPS is accessed.

Paul answered that we use CMS to get the catalog. Then we use the catalog to search the entire data base.

Edward Greville asked (after view graph 37) if DECNET currently supports PCL-11.

John Johnson answered that the present phase of it does.

Pat Gary (after view graph 40) commented: "You [at OPS] won't use it [SFDU] internally? Why abandon it?"

John Johnson replied that we will probably use what's already there because of convenience.

Dr. Dennis Fife, (after view graph 53) asked if there is any precedence or prototype for this SFDU.

Dr. Edward Greenberg stated that we will steal from any standard that exists. There is a draft in the NASA Office of Advanced Space Technology (OAST).

Adrian Hooke commented that we are trying to draft this as a new standard.

Someone from the audience asked why this is highlighted if it is not being used? How do you pace this development? Before JPL puts out standards, we should take a breath.

Adrian commented that this [SFDU] was mission unique but this uniqueness will go away.

Ed Greenberg commented that this was to be used to use data; it is an expandable set. You hope to have it in a good form for cataloging. We are still in the process of understanding how to pick a version.

After the conclusion, someone in the audience asked how the strengths [of the pilots] were developed, and was answered that the goals of the pilots conditioned these. As an example, Dr. James W. Brown commented that the thing that drove OPS was the idea of the pilot as a data archive (active), with active access to subsets. The idea of data management gives the impression of a large number of small data sets ... whereas Oceans Pilot has a small number of very large data sets. The pilots are just different.

Ed Greene stated that he has sympathy with the SFDU approach but the concept is still immature. Trying to impose a structure now would stifle the innovation. It's still developing.



## 10.0 PANEL ACTIVITIES

Barbara Walton presented the introduction to the panels as shown in Figure 10-1. She then gave the panel assignments as shown in Figure 10-2. The panels convened briefly before breaking for dinner.

James Burrows, Director of the Institute for Computer Science and Technology of the National Bureau of Standards, was the dinner speaker on the first day of the workshop. He discussed the NBS Data Systems Standards Program and emphasized the communications protocol development program.

He offered an inside view of the European Standards effort and noted that U.S. companies use Europe as a forum due to anti-trust laws. He explained the National Telecommunication Information Administration (NTIA)/National Bureau of Standards (NBS) relationship within the Department of Commerce. One comparative example illustrated that government communication services such as telephone, telegram, and postal services are handled by one government entity in most European countries, while in the United States standards development for such services would go through the State Department.

The panels continued their work on the following day with presentations given by the panel chairmen on the last day of the workshop. The panel reports follow in Sections 11 through 14.

OSTA/ADS DATA SYSTEMS STANDARDS WORKSHOP  
INTRODUCTION TO PANELS

"STANDARDS NEEDED TO INTERCONNECT ADS PILOTS FOR DATA SHARING"

1. CRITIQUE THE MITRE REPRESENTATION OF PILOT METHODOLOGIES FOR ACCURACY AND COMPLETENESS.
2. IDENTIFY THE REQUIREMENTS FOR STANDARDS AND GUIDELINES NEEDED IN YOUR PANEL'S AREA TO INTERCONNECT THE ADS PILOTS FOR DATA SHARING.
3. MAKE A PRELIMINARY ASSESSMENT OF THE ADEQUACY OF CURRENTLY IDENTIFIED PILOT METHODOLOGIES AND EXTERNAL STANDARDS IN MEETING THESE REQUIREMENTS.
4. IDENTIFY ANY OTHER METHODOLOGIES YOU ARE AWARE OF WHICH MAY CONTRIBUTE TO THE SOLUTION TO YOUR PANEL'S ASPECT OF THE PROBLEM.
5. MAKE RECOMMENDATIONS FOR FUTURE WORK, PROVIDING DESCRIPTIONS AND ESTIMATE OF EFFORT WHERE POSSIBLE.
6. PROVIDE THE PANEL'S CONSENSUS ON THE NEED FOR A CONTINUING WORKING GROUP IN THIS AREA AND SUGGEST MEMBERSHIP THEREOF.



## 11.0 PANEL A REPORT: STANDARDS NEEDED TO INTERCONNECT ADS PILOTS FOR DATA SHARING FOR CATALOGUES, DIRECTORIES, AND DICTIONARIES

### 11.1 INTRODUCTION

One of the primary goals of the OSTA/ADS concept is to provide the user of the ADS service with coherent and comprehensive information about the data that may be of interest to him. This information about the data (sometimes called "metadata"), is usually made available in the form of electronic or printed catalogs, dictionaries or directories. The objectives of this panel were to specify the requirements for the minimum set of standards that are necessary for an effective sharing of information about data among all the ADS member installations.

The meetings of the panel took place during the May 27-29, 1981 OSTA/ADS Data Systems Standards Workshop, and its membership consisted of the following:

Jose Urena, JPL, Chairman	Roy Saltman, NBS
Manju Bewtra, CSC	Peter Smith, GSFC
Steve Haight, ORI	Ellen Stolarik, OAO Corporation
Stan Klein, ORI	Frank Stone, OAO Corporation
Lou Kramer, LARS	Barbara Walton, GSFC
Terry Kuch, MITRE Corp.	James Wilkinson, Lockheed Corporation

### 11.2 REQUIREMENTS FOR GUIDELINES AND STANDARDS

The panel identified a preliminary set of requirements for guidelines and standards that are described below. These requirements will be revised and will eventually be used to develop guidelines and standards in subsequent working sessions of the panel.

#### 11.2.1 Layered Directory/Datalog Architecture and Definition of Terms

The panel found it necessary to identify and define a top-level repository of information about data upon which standards can be specified. The term assigned to this "highest" level repository is "DIRECTORY."

**DIRECTORY Definition:** High-level description of data sets available to all ADS users. The directory is accessed by means of a standard user interface.

The detailed information about data resides in the "lowest" level repository. The term "LOCAL CATALOG" was assigned to it:

LOCAL CATALOG Definition: Detailed description of data sets. The local catalogs are maintained by the organization that is also responsible for maintaining those data sets.

The structure below the directory may contain intermediate levels of directories which are both local- and network-implementation dependent. This potential requirement was not addressed by the panel.

The above definitions identify a structure with at least two levels. Standards in the near-term need only to be specified for the top level (DIRECTORY).

The ADS Directory/Catalog architectural model is depicted in Figure 11-1. The user accesses the information in the directory by means of a standard user interface, and logical links connect the directory with the local catalogs or with the intermediate level directories. The dashed lines show possible future logical links between the user and the local catalogs, intermediate directories, and data sets, that would require new standard interfaces. These interfaces are not being considered for ADS at the present time, and they were not addressed by this panel.

Only those terms needed to support the model presented here have been defined by the panel. The use of other terms such as inventory, or terminology for intermediate directories is to be determined.

The use of terms presented here is compatible with the National Bureau of Standards terminology, and it is consistent with some concepts used by the International Standards Organization in the Reference Model for Open Systems Interconnection.

The panel also agreed on the definition of the following term:

ATTRIBUTE Definition: A data element of a directory or a catalog. [reference: FIPS PUB 20 for definition of the data element. (1)]\*

\*(1) DATA ELEMENT: A basic unit of identifiable and definable information. It has an identifying name and value or values for expressing a specific fact.

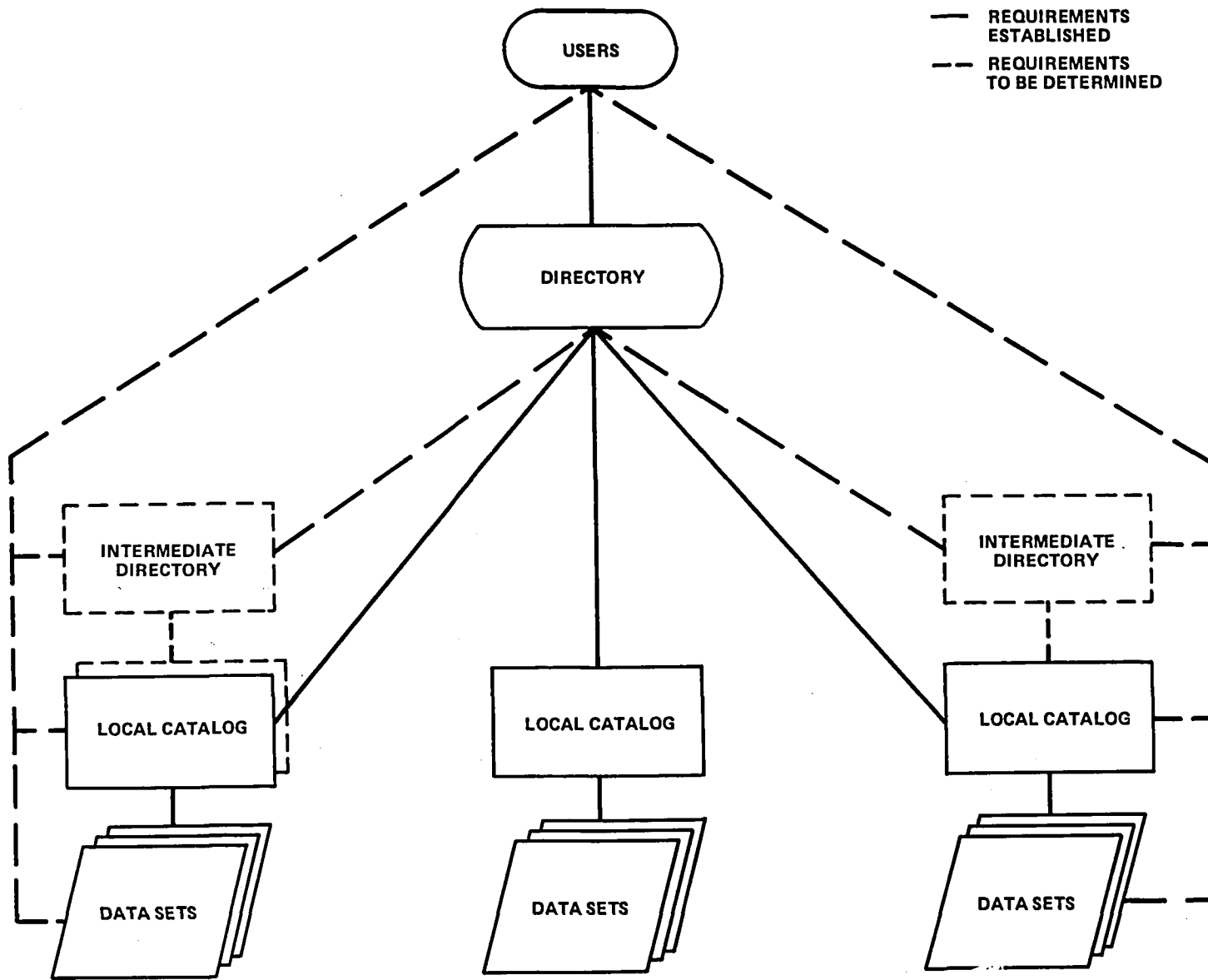

Figure 11-1. ADS Directory/Catalog Architecture Model

### 11.2.2 Standards Required for the DIRECTORY

The following is the set of requirements for standards that were identified for the directory by Panel A:

- a. Contents
  1. Temporal and spatial coverage
  2. Data type
  3. Source
  4. Responsible organization
    - a. Data generation
    - b. Data production
    - c. Data archival
  5. Status (existing/planned)
  6. Data level
  7. Etc. (to possibly include an extensive list of additional items).
- b. Structure
  1. Standard format
  2. Attribute representation
- c. User Interface
  1. Common query method
  2. Interactive search of logical combinations of attributes and their values. All attributes are searchable.
- d. Interface to lower levels
  1. Short term: identification of local catalogs or intermediate level directories
  2. Long term: transparent to user

- e. Administrative responsibilities, policies and procedures
  - 1. Currency of directory
  - 2. Quality assurance of directory
  - 3. Access control

#### 11.2.3 Definitions/Conventions for Terminology of Directory Attributes

#### 11.2.4 Guidelines for the Local Catalog

The diversity of implementations and the peculiarities of the local catalogs used by the different ADS member organizations makes standardization of the local catalogs unfeasible. The panel, however, has identified a set of guidelines that can be specified for the local catalog:

- a. Functions
  - 1. Provide detailed description of data sets
  - 2. Assist in obtaining access to the data
- b. Document structure, access methods, etc.
- c. Should provide definitions of terms used to describe the data sets.
- d. Provide definitions/descriptions of data formats and code conventions, etc. (see FIPS Pub. 20).
- e. Contents should include an amplification of items 1, 2, and 3 under directory contents.

#### 11.2.5 Directory User's Guide

### 11.3 RECOMMENDATIONS

#### 11.3.1 Need for a Continuing Directory/Catalog Standards Working Group

- a. Functions of the Directory/Catalog Standards Working Group:
  - 1) Advise the ADS Standards Program on Directory/Catalog matters.
  - 2) Provide advisory review of contractor products related to Directories and Catalogs.
- b. Membership should include at least one representative from each one of the pilots and the OSTA/ADS Standards Program.
- c. The group should consider the need for a standard user interface to local catalogs and intermediate directories.



- d. Investigate methods for incorporating terminology definitions accepted by recognized discipline user bodies.

#### 11.3.2 Need for a Directory/Catalog Implementation Working Group

- a. Assessment of current ADS pilot methodologies to be done in the future.
- b. Studies for alternative implementation methods of the directory. Selection of one.
- c. Detailed design of the directory.
- d. Determination of software functional requirements.
- e. Design interface between directory and local catalogs of pilots.
- f. Consideration of library and information science methodologies for its relevance. (See panel references.)
- g. The directory could allow structured data retrieval and retrieval of unstructured indexed textual information.

#### 11.3.3 Further Recommendations

- a. Policy be set concerning the release of information about data to ADS.
- b. Adoption or modifications of the WALLOPS definitions for data levels (under area of work of Panel D on Data Formats and Descriptions).
- c. There is a need for continuing discipline user working groups.
- d. Study alternatives to "in-person" meetings.

#### 11.4 PANEL A PRESENTATION DISCUSSION

Pat Gary asked if it matters if the Directory is centralized.

Jose Urena answered that it is immaterial.

## 11.5 PANEL A REFERENCES

The following citations contain concepts relevant to the issues in the ADS directory system from a library and information science perspective.

1. Svenonuis, Elaine, "Directions of Research in Indexing, Classification, and Cataloging," Library Resources and Technical Services, Jan./Mar. 1981, pp. 88-103.
2. Foskett, Anthony C., The Subject Approach to Information, 3rd ed., Hamden, Conn., 1977.
3. Lancaster, Frederick W., Vocabulary Control for Information Retrieval, Washington, D.C., 1972.
4. Thesauri and Thesauri Construction: ASLIB Bibliography No. 7, Compiled by Maxine MacCafferty, ASLIB London, 1977.
5. Kazlauskas, Edward J., "The Application of the Minicomputer to Thesaurus Construction," Journal of the American Society for Information Science, Sept. 1980, pp. 363-368.
6. "On Indexing, Retrieval and the Meaning of About," Journal of the American Society for Information Science, Jan. 1977, pp. 38-43.
7. The Information Age in Perspective: Proceedings of the ASIS Annual Meeting 1978, Vol. 15, 41st Annual Meeting.
8. Report on the Conference on Cataloguing and Information Services for Machine-Readable Data Files, Airlie House, Warrenton, VA, March 29-31, 1978, Arlington, VA, Data Use and Access Laboratories, 1978.

NOTE: Citations 1-7 were provided by Jody Engbretson, ORI.

## 12.0 PANEL B REPORT: STANDARDS NEEDED TO INTERCONNECT ADS PILOTS FOR DATA SHARING FOR USER INTERFACES

### 12.1 INTRODUCTION

Some key elements recommended prior to the workshop for the panel's consideration were: (1) Dial-up procedures, (2) Terminals (minimum, desirable, extended capability), (3) Common capabilities, (4) Language interfaces (query, command, menu), and (5) Display capabilities. It was the group's goal to identify the requirements for standards and guidelines with regard to user interfaces for the near-term interconnection of the pilots, bearing in mind that it must not cause any long-term problems. The key elements listed were considered though not always as separately identified topics.

The meetings of the panel were held on May 27-29, 1981 at the Goddard Space Flight Center OSTA/ADS Data Systems Standards Workshop, and its membership consisted of the following:

James W. Brown, JPL, Chairman

Portia Bachman, GSFC

William Benton, Lockheed Corporation

Paul Giragosian, MITRE Corporation

Ronald Glaser, CSC

David Howell, GSFC

Richard Sakamoto, MITRE Corporation

William Shaffer, NASA Headquarters

David Stowell, OAO Corporation

### 12.2 DEFINITION OF USER

The "user," as defined for the purposes of this panel, though not necessarily for the purpose of the whole workshop, is viewed as a discipline scientist at a terminal trying to get data out of the network. It is assumed that the user is primarily associated with one of the local systems, such as VAS or the Ocean Pilot.

### 12.3 USER VIEW OF PILOT NETWORK

The panel discussed how the user views the network. Figure 12-1 shows some possibilities of the user's concept of the network services. Illustration (a) shows the user terminal connected to each local system with ADS invisible as a networking function. After discussing this arrangement, the

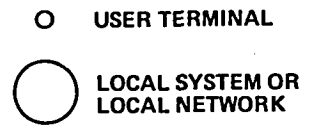
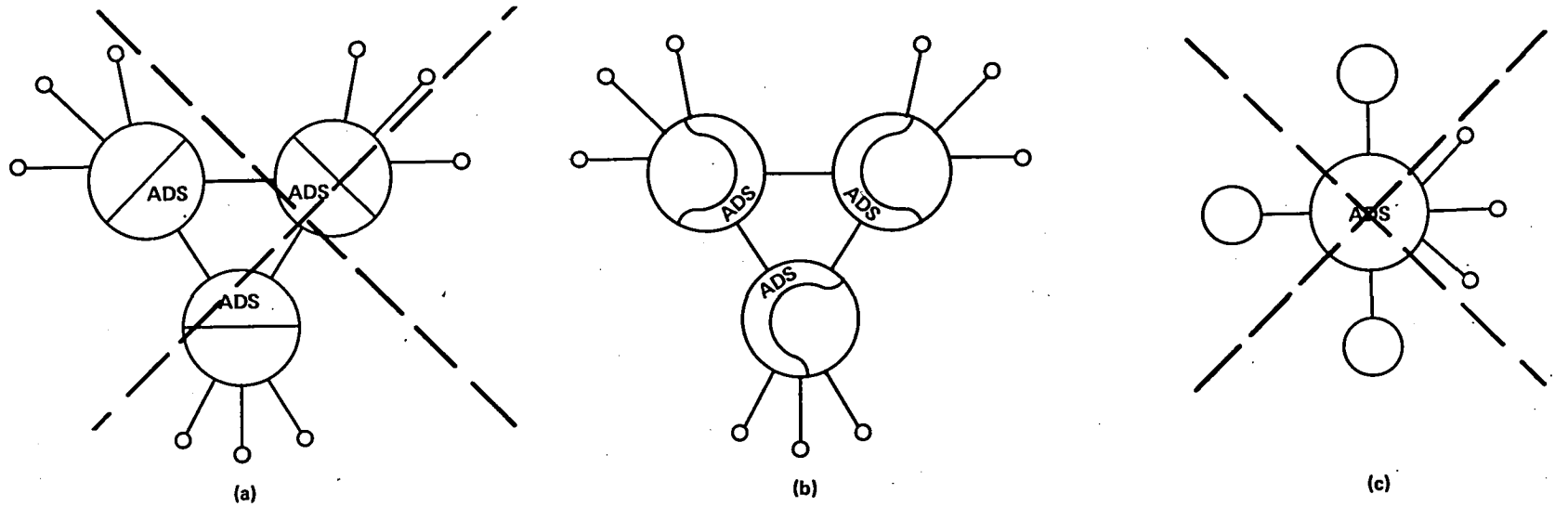

Figure 12-1. User View of Network Services

panel decided that it was probably not realistic; the user would probably not view the system that way. Representation (c) of the system is more in line with the long-term ADS picture. The users dial into a system called ADS with its data system and information extraction services. However, in the short term with the three pilots that we now have, that view is not realistic. The resulting user view of the network systems is shown in view (b). The user is aware of the ADS network added on the local system. Part of the user interface will be influenced by the network and part will not. This view does take into account the actual network as it is likely to exist with the three pilots.

In the short and intermediate term, users will connect to their "home" system and obtain network services through it. Network services will be visible to the user as separate from local system services. The interface may have to be different, except where TAE or a similar "transportable executive" is used for both.

#### 12.4 REQUIREMENTS FOR STANDARDS AND GUIDELINES

There is a need for a continuing oversight body for maintaining and monitoring standards and guidelines. Standards should be self-enforcing; guidelines not necessarily so--they must be monitored to see compliance. There is a need for maintenance, and there should be some way to get feedback as to whether guidelines are of any use or validity.

##### 12.4.1 Dial-up Procedures

Figure 12-2 (a) shows that for a near-term view the network should not be considered as transparent. This would reflect GSFC users connected to the "GSFC network" and JPL users connected to the "JPL network"; this is not realistic in the near term. Users connected to each local system and the user view that each one of these local systems can connect in some way with any other, independent of location, as shown in (b), is more realistic. With the exception of such things as retrieval time and cost, it would not be apparent to the user if the connection were by local or long-haul network. Since users will connect to local systems, no standard or guideline is needed.

##### 12.4.2 Terminals

The basic network functions defined in Table 12-1 don't need more than basic (300 baud hardcopy) ASCII capability, but menu support may need such additional functions as screen clear, cursor addressing, scrolling, and a higher data rate. A guideline or standard based on what is needed to correctly support a Menu System (processor) in a user-friendly way is required. This implies a minimum of 1200 baud "dumb" CRT; 300 baud hardcopy is marginally acceptable.

##### 12.4.3 Common Capabilities

Figure 12-3 is the panel's model of the user's view of the catalogs and directories. The panel developed this model as a basis for a standard user interface. This model shows the local catalog(s) as transparent to the user. The user would deal with the high-level directory, standardized over

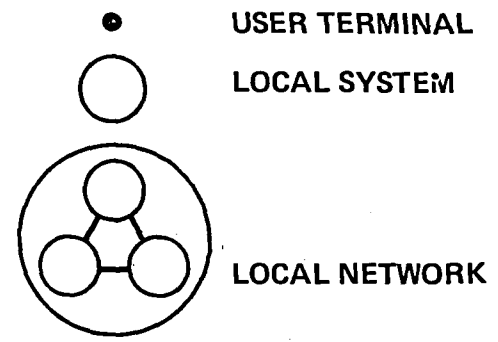
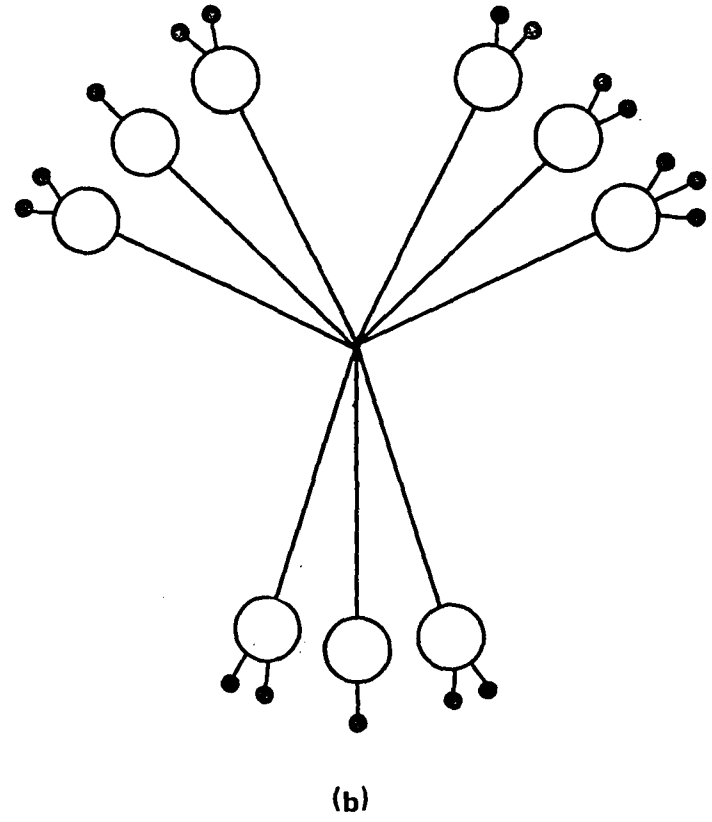
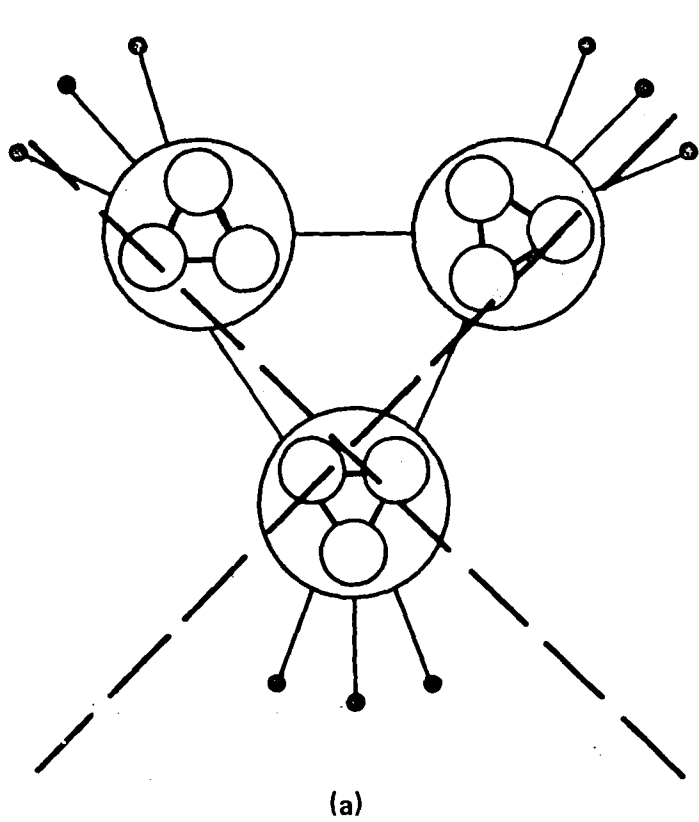

Figure 12-2. User View of Network Topology

TABLE 12-1  
PILOT NETWORK FUNCTIONAL REQUIREMENTS

GROUP 1 - MANDATORY

- COPY "FILE"
- DISPLAY DIRECTORY CONTENTS
- DIRECTORY ATTRIBUTE SEARCH
- CREATE DIRECTORY ENTRY
- MODIFY DIRECTORY ENTRY (SOME ATTRIBUTES PROTECTED)
- DELETE DIRECTORY ENTRY (AND CORRESPONDING DATA SET)
- HELP
- DISPLAY STATUS OF ANY OF THE ABOVE PROCESSES (IF APPROPRIATE)

PRIORITY GROUP 2

- DISPLAY NETWORK STATUS/STATISTICS
- SEND MESSAGE
  - TO LOGGED-ON USER
  - TO MAILBOX

PRIORITY GROUP 3

- PROVIDE SAMPLE DATA SETS
  - PRE-CANNED
  - FIRST N POINTS, RECORDS, ...
  - [- SAMPLED, AVERAGED, ...]
- PROVIDE ESTIMATES OF "COST" BEFORE EXECUTING A NETWORK OPERATION
  - DATA SET SIZE
  - ELAPSED TIME
  - COST (IF USED)
- BROWSE
- SEND MESSAGE TO BILLBOARD

GROUP 4\*

- NETWORK LOG ON/OFF
  - TRANSPARENT TO USER
- ESTABLISH/REMOVE/MODIFY USER AUTHORIZATION
  - NOT AVAILABLE TO USER
- RUN/CANCEL EXPLICIT PROCESS
  - FUNCTION NOT NEEDED IN SHORT TERM
- SEND BROADCAST MESSAGE
  - NOT AVAILABLE TO USER
- DIAL-UP, LOCAL SYSTEM LOG ON/OFF
  - CANNOT STANDARDIZE

\*Functions may be required, but user interface standards/guidelines are not required.

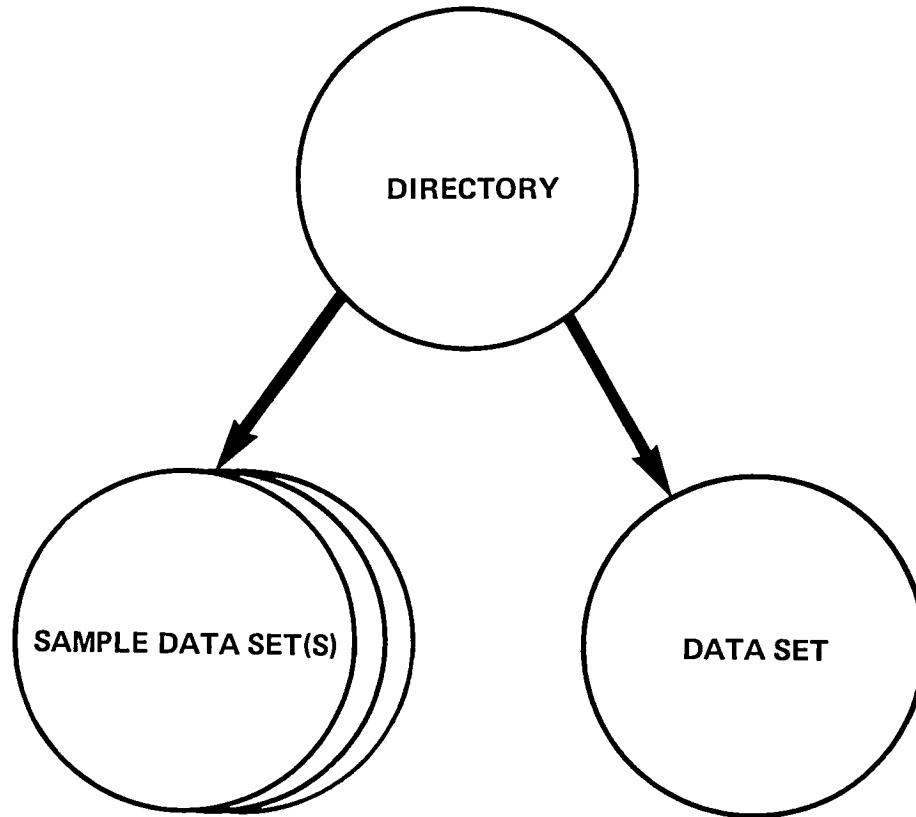

Figure 12-3. Directory/Catalog User View



the network. The linkage between the directory and the actual data set would be invisible. If the users have to see a local catalog or directory, that interface could not be standardized. ADS should seek to standardize the user's view of the interface to a high-level directory.

The panel prioritized the functional requirements for the pilot network for which standard user interfaces would be needed. These requirements are grouped in Table 12-1 based not necessarily on functional importance but on the need for standard user interface. Clarification is needed for functional requirements shown to accurately reflect the directory/catalog concept and criteria established by Panel A. This is an item for future work.

The panel anticipates that the user will want sample data sets--the larger the data set, the greater the need for a variety of different samples. The user may want to look at smaller data sets quickly prior to operating on larger data sets. (This is a strong requirement in the Oceans Pilot.) The value of this function depends on the typical size of the data set with which one is dealing. The user should be aware that sample data sets exist and should be aware of how to get them even if the directory-pointing mechanism is transparent. This requirement is shown in Group 3 to indicate that it is a longer term effort.

#### 12.4.4 Language Interfaces

It is hoped that TAE and RSS will develop into the defacto standard for the three pilots. This may be modified by current pilot methodologies and external standards.

#### 12.4.5 User Consultant

There should be a human user consultant available to be used for human-to-human assistance. Guidelines are needed for a user consultant. The scope of the guidelines includes who, how many, organization (local system, local network, ADS network), functions, and expertise.

### 12.5 RECOMMENDATIONS FOR FUTURE WORK

12.5.1 It is recommended that there be a continued panel existence more or less as a design review committee to influence and monitor TAE, RSS, and allied efforts from the point of view of user interface, with members represented from:

- o Pilots
- o ADS Standards Office
- o NASA Headquarters
- o Other TAE users
- o TAE developers

There is a need to clarify TAE maintenance and control policy, organization, and authority of the review committee. The charter of the TAE/RSS review committee should be:

- o To test and evaluate the software to be used;
- o To recommend changes to be done;
- o To review documentation.

This will consume resources and time; a minimum estimate is 1/4 person per pilot. It should not be necessary for this committee to meet frequently. Most of its work can be done by mail, with occasional teleconferences.

12.5.2 Liaison should be maintained with CODASYL and ANSI to monitor work in command languages, using mechanisms available to influence both in the public sector by:

- o Including ADS standards people and TAE developers on mailing lists;
- o Contacting Capt. Bruce Hogman and William LaPlant (Pentagon, DOD software standards) who might provide current status of ANSI/X3H1 and CODASYL COSCL to D.C. area people.

12.5.3 There should be a study to understand user interface procedures of technology transfer organizations, e.g., Eastern Regional Remote Sensing Applications Center (ERRSAC), etc. for both human training and computer methodologies.

## 12.6 ADDITIONAL COMMENTS

- a. Critique of MITRE methodologies must be done by each pilot, not in this panel.
- b. In Priority Group 3 (Table 12-1), the functions represented in the first two bullets may be interpreted by others as ADS value-added functions and therefore inappropriate for an early ADS, or even an interim ADS.
- c. The CSC-distributed document available at the workshop seems to imply from the start an attempt at an ADS central facility. This would be a policy decision, and is not yet firm.
- d. There is at least a partial impression that the viewpoint in Figure 12-1 of the "User View" and our definition of "user" does not agree with the Panel D viewpoint. This must be reconciled before candidate standards can be written or tested.

## 12.7 PANEL B PRESENTATION DISCUSSION

Pat Gary asked if Panel B's concept of the directory is consistent with that of Panel A's description, and if there exists a single standardized directory at the top.

Jim Brown answered that he didn't say that there was a single one. In the long term it is desirable that the user view of ADS is a single, top-level directory that is global. It isn't known if it will be practical in the future, but it is not now. The panel didn't discuss how to deal with it, but it is something to work on with regard to interconnecting these pilots. He expects that the likely case for the top-level directories is that they will be physically distributed but will be logically centralized.

Pat Gary commented that when the user realizes that the data set he is seeking is not to be found locally, then he is going to make further queries through that user interface at a remote site. Pat asked if that interface will vary depending on location. Is it acceptable or desirable on the short term that the user have a specific, non-standard interface for each local catalog?

Jim answered that it is desirable that the user not even be aware that there is a local catalog. Given current implementations, that probably is not practical in the short term. The Ocean Pilot is consistent with this model - the local catalog is invisible to the user, but it isn't known if it is true for the other pilots. For the panel's purpose, they assumed that it was not true in general and that there are some local catalogs. Even though it's desirable to standardize them, in the short term they do not hope to standardize local detailed interfaces. It is desirable but not practical.

Someone from the audience asked what the difference is between the broadcast message (Group 4 - Table 12-1) and the billboard "teleconferencing" (Group 3).

Jim answered that broadcast is something that you get on your terminal whether or not you want it, and billboard is read-at-discretion.

Another member of the audience commented on User Commands, Priority Group 1, that maintenance of the directory would be done off line and not by users, and that there is no command for interfacing with lower level catalogs.

Jim answered that the assumption for directory maintenance is that, as in RSS, a file copy operation would create a user-owned file and corresponding directory entry. If this is the case, then the user needs directory manipulation facilities. This is a policy issue that needs to be worked. The three pilots agree substantially on what users are allowed to modify. Commands for interfacing with lower level catalogs could not be standardized due to lack of information regarding local catalogs; prefer a transport interface.

Barbara Walton commented that there is a question of long and short term and transparency rather than functionality. Panel A didn't see the link as transparent in the short term; they had a problem with that. Panel B's view was that the local user saw the directory and not the local catalog; in Panel A they saw that as desirable in the long term but not possible in the short term.

There was agreement with Barbara's comment.

Ed Schlosser asked if the panel had determined if user interface is conversational and stated that conversational interaction has some problems.

Jim answered that it is implicit that the interface is basically interactive and that it is explicit that no operation will tie up the terminal. The implication is that status posting is required for any process which cannot be completed within a few seconds.

Dave Stowell commented regarding user requirements that "human/human consultancy" should be flagged as existing. It is an important item.

13.0 PANEL C REPORT: STANDARDS NEEDED FOR THE USE OF ISO OPEN SYSTEMS INTERCONNECTION - BASIC REFERENCE MODEL

13.1 INTRODUCTION

Panel C of the Application Data Service (ADS) Data Systems Standards Workshop met to discuss the recently developed International Standards Organization (ISO) Open System Interconnection (OSI) Reference Model (1) and to explore its relevance to interconnecting the ADS pilots for data sharing. All three pilot programs were represented on this panel as well as participants with broadly based experience in related fields. Given the diverse background of the participants and the limited time available for discussion, the panel was unable to explore the many detailed interface considerations needed to thoroughly analyze the relevance of the OSI Reference Model to the ADS. Nevertheless, the panel concentrated its efforts by performing a top-level mapping between the conjectured ADS requirements and the identified layers within the OSI Reference Model. A number of issues of a more detailed nature were identified for further study. Panel C attendees are as follows:

Richard Berman, CSC	Edward Greene, GSFC, Chairman
Joseph L. Bishop, NASA HQ.	Adrian J. Hooke, JPL
William Bisignani, MITRE	John Johnson, JPL
Albert Bowers, MITRE	John Kiebler, NASA HQ
Gary Brammer, LARS	James Moulton, NBS
Paul Clemens, MITRE	William Poland, Jr., GSFC
Richard desJardins, CTA	Al Skopetz, GSFC
David Freeman, LARS	Robert Stephens, NASA HQ
J. Patrick Gary, GSFC	Phil Yu, GSFC

## 13.2 OVERVIEW OF OSI REFERENCE MODEL

The OSI Reference Model represents a conceptual architecture for telecommunication interconnections which consists of a hierarchical structure composed of seven layers. The principal functions performed or services rendered by each layer is shown in Table 13-1. Figure 13-1 illustrates the actual data flow (dotted line) and the virtual data flow (solid lines) between two application processes running in systems that are, in general, distinct and geographically separated. At each level, there is an illusion of a direct peer-to-peer protocol connecting the two systems. However, in reality, the actual control and data communication is between adjacent layers. The N-th layer protocol performs identifiable services to the (N+1)-st layer and, in turn, requests services from the (N-1)-st layer. If the two systems are distinct, then the actual signal communication is performed at the Physical Layer (layer 1). The interface to the applications process is at the Applications Layer (layer 7).

Table 13-1  
OSI Reference Model Layers

<u>Layer</u>	<u>Name</u>	<u>Description</u>
1	Physical	Physical signal interconnect from point-to-point
2	Link Control	Data interconnect from point-to-point
3	Network	End-to-End data interconnect (Source DTE to Destination DTE)
4	Transport	Host-to-Host data transfer
5	Session	Dialogue synchronization between hosts
6	Presentation	Data conversion services
7	Application	Interface to application processes

OPEN SYSTEMS

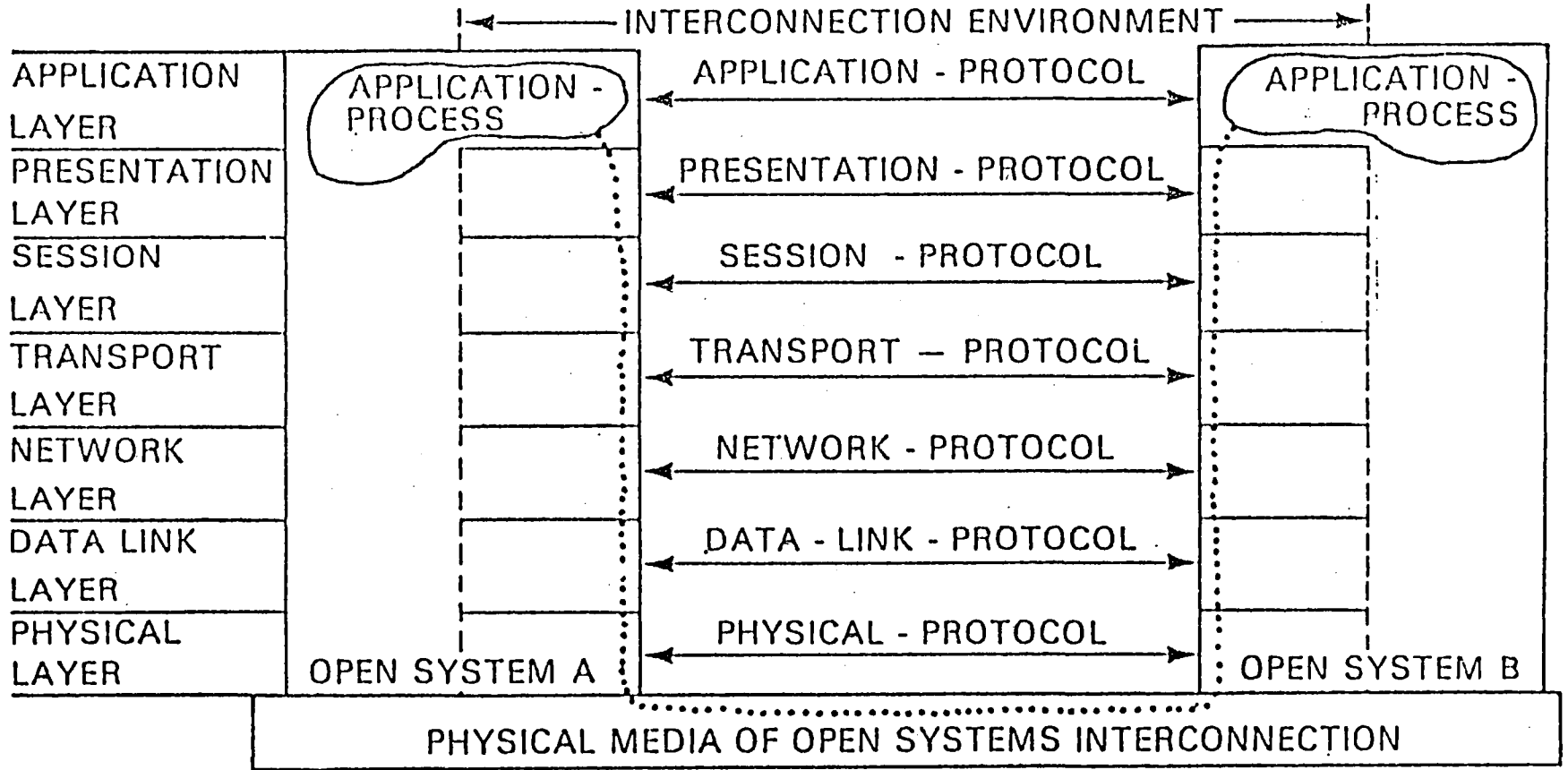

57

Figure 13-1. Actual and Virtual Data Flow

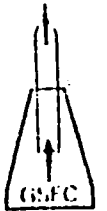

At the lowest three layers, there are existing protocols that conform substantially with the OSI Reference Model. Some of the possible choices are:

<u>Layer</u>	<u>Name</u>	<u>Examples</u>
1	Physical	EIA RS-232-C, RS-422-A, RS-423-A CCITT V.28, V.35 MIL STD-188C
2	Data Link	Binary Synchronous Communication (Bi-Sync) ADCCP, SDLC, HDLC
3	Network	X.21, X.22, X.25, X.75

Beyond layer 3, there are no nonproprietary general-purpose protocols which have been extensively tested; however, this is a field of active research within both the U.S. and European communities. Draft standards have been issued by the National Bureau of Standards (NBS) for both a Transport Layer and a Session Layer protocol. It is anticipated that these draft standards may emerge as mandatory Federal Information Processing Standards (FIPS) (for U.S. government systems) after these protocols have been extensively reviewed and tested. Both IBM and Digital Equipment Corporation have telecommunications software (SNA and DECNET, respectively) that provides services at all layers for networking among compatible-computer systems.

### 13.3 ADS REQUIREMENTS IDENTIFICATION

In order to determine the relevance of the OSI Reference Model for addressing ADS requirements, the Panel considered a scenario representing a broad class of capabilities which were considered required to interconnect the pilots for data sharing. The interconnection protocols needed to support this scenario were then identified, and these protocols were then classified in terms of standard layers within the OSI Reference Model.

The scenario consisted of a series of steps described in Table 13-2. In essence, an investigator utilizes a terminal to perform a search of a nonlocal data base, initiates the execution of a process resident on a remote processor using the selected data set as input data, copies the generated data set to a different processor where it is added to the data base, the corresponding directories and catalogs are updated, and an electronic mail notification of the new data set is given to selected colleagues.



Table 13-2  
Scenario

Research user sits down at alphanumeric terminal and performs the following functions:

1. Attaches to local host
2. Remote data base inquiry
  - o Accesses root of directory in local host
  - o Linked to remote host for secondary directory services
  - o Submit request for information about data of interest
  - o Receives data descriptors/pointer
  - o Iterates process to locate data set of interest
3. Request remote processing of data set. Activate resource estimation/accounting function
4. Copy generated data set to local or remote data base and add to catalog
5. Notify colleagues of new data set by electronic mail
6. Terminate link/logoff

To support this scenario, the protocols listed in Table 13-3 are required. Items 1, 2, 5, and 9 are essential layer 5 functions, and the remaining items are combined layer 6 and layer 7 functions. Since nonlocal intercomputer communications is required by this scenario, layer 1, 2, 3, and 4 protocols are required to support the higher layer protocols.

Other capabilities discussed as appropriate for long-term ADS consideration, but beyond the scope of that needed to interconnect ADS pilots for data sharing included:

- a. distributed data bases,
- b. multiprocessor application processing, and
- c. generalized word processing (interoperability among equipment from diverse manufacturers). Additional layer 5, 6, and 7 protocol services would be needed to support these functions.

Table 13-3  
Protocols Required to Support Scenario

1. Terminal support
  - Local
  - Dial-in through network\*
2. Automatic login/accounting to applications manager
3. Catalog manager command/response interaction, data base inquiry and response (command language, data descriptors)
4. File transfer
5. Applications executive interaction (suspend/resume, etc.)
6. Privacy/security services
7. Message to operator/mailboxes
8. JSC word processor access\*
9. Automatic log off

\*Additional near-term capability not directly derived from scenario

#### 13.4 NEAR-TERM TELECOMMUNICATION SUPPORT METHODOLOGY IN ADS PILOTS

The Pilot Atmospheres Data System (PADS) at the Goddard Space Flight Center and the Earth Resources Pilot System (ERPS) at the Lyndon B. Johnson Space Center have developed and adapted telecommunications software to service the needs of their individual pilot demonstration. The computer system for the Oceanic Pilot System (OPS) at the Jet Propulsion Laboratory will be delivered this summer and is expected to utilize the DECNET software for intrapilot networking. Figure 13-2 shows the initial telecommunications software that is being implemented for each pilot. The classification of the software into OSI Reference Model layers is only approximate.

#### 13.5 INTEGRATED TELECOMMUNICATIONS CANDIDATE

The following are three basic approaches which could be considered for an integrated ADS pilot network system:

Approach 1: modify the software of the near-term configuration (Figure 13-2) to permit interpilot telecommunications,

Approach 2: adopt a computer manufacturer sponsored telecommunications package such as SNA or DECNET,

Approach 3: adopt existing and emerging national and international telecommunication standards to the greatest possible degree.

NEAR TERM CONFIGURATION

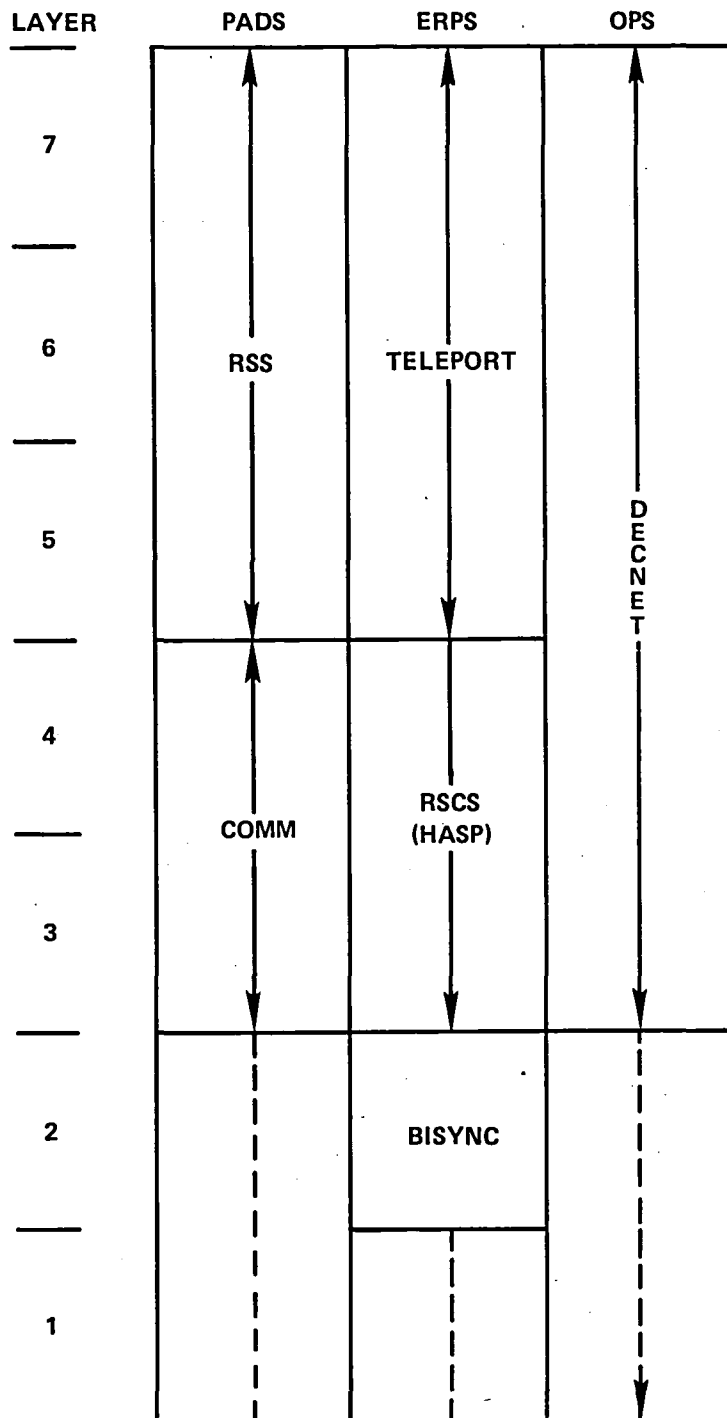

Figure 13-2. Near-Term Configuration

There are advantages and disadvantages associated with each of these approaches.

Approach 1 offers the advantage of providing the potentially easiest means of transferring bits between two computers. With a minimum of effort, it is anticipated that software modifications could be made so that the raw bit streams representing data and control messages could be interchanged among the three pilots. However, it is not enough to reliably transfer a sequence of bits; we need to be able to exchange information. This is a great deal harder to do via approach 1, since the command language structure and codes are not uniform among the three pilots. This lack of uniformity in command language structure and data structures is likely to result in a very awkward telecommunications capability. Either some very "kludgy" software would have to be written to translate between the native codes of the three pilots, or the user would have to employ different conventions and utilize different command languages, depending on the host computer to which the user was attached. Either alternative is considered very undesirable and the panel rejected this approach.

Since two of the pilot systems (PADS and OPS) are oriented towards the DEC computers and the ERPS is oriented toward IBM or IBM lookalike computers, approach 2 considers the adoption of DECNET or SNA as the ADS telecommunications system. Both DECNET and SNA provide a rich variety of file transfer and data base services; however, they are parochially adapted to the hardware and software system supplied by the respective manufacturer. This is not to say that it is impossible to use the DECNET structure on a non-DEC system or the SNA structure on a non-IBM system; however, the non-native equipment would tend to experience inferior performance if it could not exactly emulate the system for which the proprietary software was designed. Hence, the adoption of a proprietary telecommunication system would tend to give a specific manufacturer a significant advantage over its competition. For this reason, the panel chooses not to recommend approach 2.

The third approach involves the tentative acceptance of protocols which are so new and unproven that they exist only as draft standards. The NBS has issued specifications (2,3) of a layer 4 (Transport) and layer 5 (Session) protocol which appear to be the leading contenders for standard protocols at these levels. It is anticipated that, after an extensive review process, these protocols will become FIPS and be required for future telecommunications support on U.S. Government systems. The proposed draft layer 4 protocol is intended to provide the proper interface to the major existing layer 3 protocol such as X.25 and X.21.

Above layer 5, the processing functions become so diverse that there appears little hope for the development of a single standard protocol at layer 6 or layer 7 in the near future. Instead, it is likely that a series of standard modules will be developed which perform certain well-defined functions at layers 6/7 and which interface to the standard layer 5 protocol. One such module, the NBS File Transfer Protocol, is scheduled to be released in draft form in early 1982. Other standard modules will undoubtedly be developed but probably not on a timeframe that will benefit the ADS. Approach 3 involves making a tentative commitment to use the NBS proposed layer 4 and 5 protocols and the File Transfer Protocol (layer 6/7)

when available. Other essential layer 6/7 functions needed by the ADS would have to be specially developed for the ADS and should interface to the standard layer 5 protocol.

The panel did not have the time to assess the adequacy of the NBS draft protocols at layers 4 and 5. Nevertheless, after rejecting approach 1 and 2, the consensus of the panel was that approach 3 deserves cautious support. While this approach is likely to be the most frustrating and difficult on a short-term basis, it is the only approach which offers a potentially viable solution for the effective networking among non-homogeneous systems. Figure 13-3 illustrates some of the protocols that are needed for the candidate ADS configuration and their relationship to the OSI Reference Model.

### 13.6 CONCLUSIONS

Considering the diversity of experience among Panel C attendees, the breadth of the topic to examine, and the very limited time available for deliberation and discussion, the panel could only provide tentative advice regarding the choice of protocols for an integrated ADS network demonstration. The recommended approach discussed in the preceding section is fraught with many uncertainties. Nevertheless, it is the consensus of the panel that the OSI Reference Model represents an orderly architecture for the ADS networking planning and that the standard protocols being developed by the NBS offer the best available implementation approach.

### 13.7 RECOMMENDATIONS

The issues considered by this panel cannot be satisfactorily resolved by a diverse group during a 2-day workshop. It is the panel's recommendation that a working group be established to continue to investigate these issues and to track the progress toward a successful interconnection of ADS pilots. Listed below are some specific topics for the Working Group investigations:

13.7.1 Review currently identified requirements versus other panels for consistency and completeness.

Panel C identified the need for protocols to support the functions identified in Table 13-3. These requirements need be compared with the requirements identified by other panels for consistency and completeness. The intent is to direct attention to provide or plan protocols to meet any extra requirements.

13.7.2 Develop functional specification of input parameters for each application to be supported (input to layer 7).

After the requirements of an ADS network have been identified, each application must be isolated, and a functional or performance specification must be described. Once this information is known, the functional specification of the application can be broken down into subfunctional groups that will describe the input parameters. These parameters are the user interface between the application process and the protocol of the application layer in the ISO model. The specification of the input

**INTEGRATED CONFIGURATION CANDIDATE  
(TWO OR MORE YEARS IN FUTURE)**

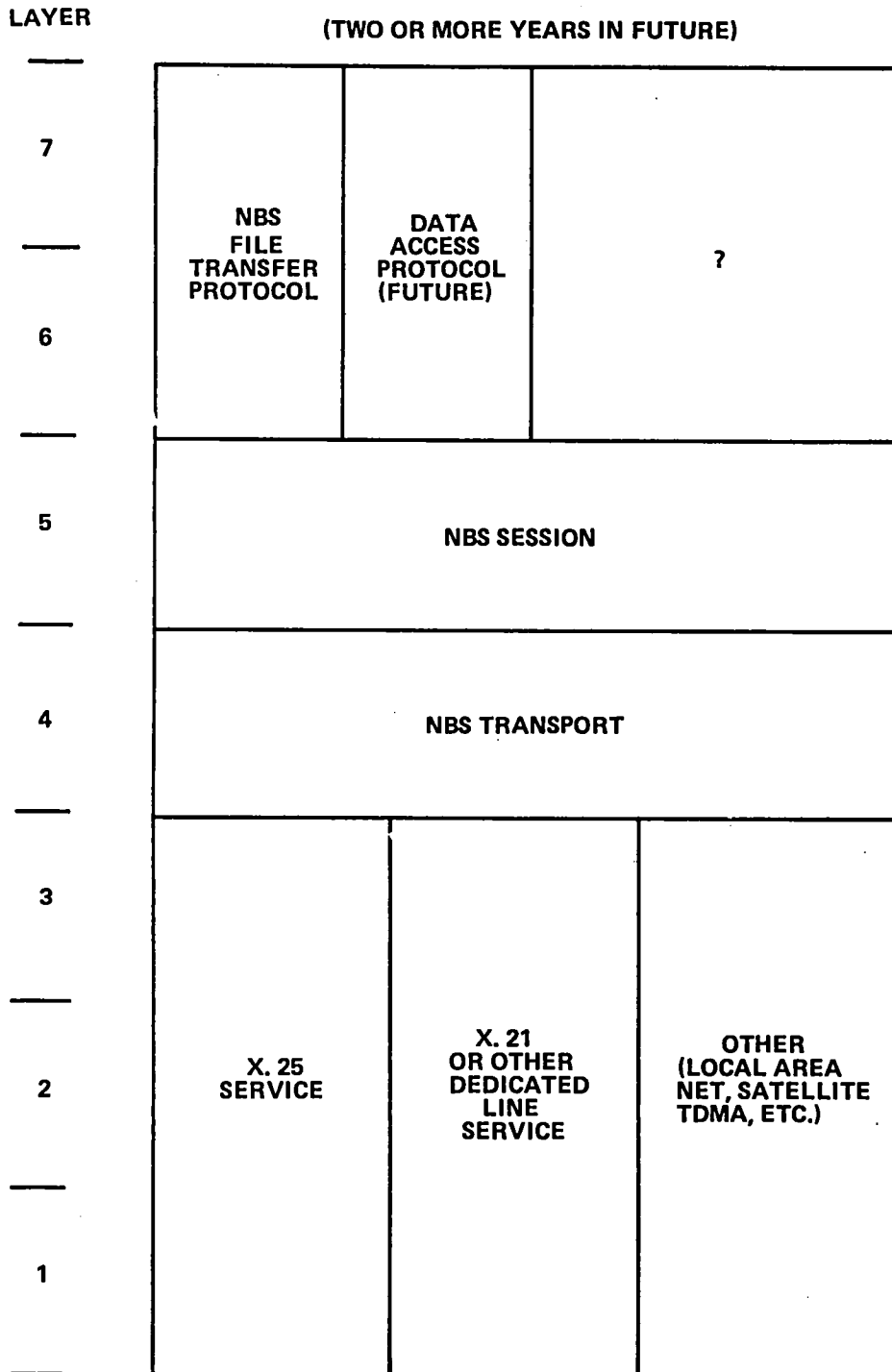

Figure 13-3. Integrated Configuration Candidate

parameter functions can then be used to develop design specifications for each parameter.

13.7.3 Develop design specifications of output strings/packets/message blocks for each application to be supported (output "from 6 to 5").

Pilot implementation of the identified application functions (e.g., remote catalog manager request/response, file transfer, process initiation, and user message exchange) requires detailed specification of the strings, packets, and/or message blocks which will be output from one host system's layer 6 protocol function for input to another host. Currently, with the exception of file transfer, no federal standards exist to guide the design effort needed by the ADS pilot system to provide mutually compatible services for these functions.

Detailed descriptions of the information content, format, and layout of the message blocks to be exchanged and the encode/decode processing to be applied to the message blocks must be specified.

13.7.4 Evaluate existing layer 4 and 5 protocols, including the NBS proposed standard, and recommend selection for pilot system and future ADS use.

The purpose of this effort is to evaluate and recommend approach for the implementation of the transport and session layers of the OSI. This will be accomplished by a review of existing pilot system implementations, proposed standards (e.g., NBS), and other existing protocols (e.g., SNA). Additional points of consideration include:

- a. a cost analysis of "build versus buy,"
- b. that portion of the pilot systems' charter which effects the exploration of new technologies,
- c. the possible addition of new nodes to the ADS network,
- d. existing hardware and software in the centers involved, and
- e. facility with which a near-term implementation may evolve into a longer term solution.

The output of this task should include the following recommendations:

- a. technologies and methods for a near-term implementation, and
- b. longer term analyses and studies pointing toward a solution for future ADS system.

13.7.5 Perform a requirements analysis for the ADS at the combined layers 1-3.

The service requirements for the interconnection of the pilots and for future ADS capabilities will determine which services are best suited (packet switched, dedicated line, other).

- o No new standards required for these layers; ADS just has to select those it needs.
- o Traffic between nodes will determine service required.
- o X.25 not cost-effective, under current tariff structure, for use of more than 2 hours/day--dedicated line would be cheaper.
- o Satellite communication links have to be considered for high-data rates.
- o The reliance on local area networks at the member nodes has to be considered for impact on the ADS network.

13.7.6 Specify core requirements expected for each protocol layer for pilots and future ADS use.

In general, standard protocols provide a large number of options and services, not all of which are germane to a specific application. Because of this, most implementations of protocols consist of a subset of the full capability defined by the standard. Incompatibilities arise when different user systems adopt different subsets of the standards, and the logical intersection of the various subsets are insufficient to provide the necessary services. This task is concerned with developing guidelines for each applicable protocol which identify the core functions and capabilities expected from each user implementation to support the future ADS interconnection uses.

### 13.8 PANEL C PRESENTATION DISCUSSION

Tom Burns asked if the panel had a chance to look at tradeoffs between packet switching and datagram connection.

Ed Greene replied that it might be approved for both but that it is an economics decision and should go into the "further-work category."

Someone from the audience stated that a phone call or telegram is a connectionless concept in the model and asked if there is a requirement.

Ed answered that it is not considered in this model; it is an anticipated interactive requirement.



## 14.0 PANEL D REPORT: STANDARDS NEEDED TO INTERCONNECT ADS PILOTS FOR DATA SHARING IN DATA FORMATS AND DESCRIPTIONS

### 14.1 BACKGROUND

At this point in the development of information and communications systems technology in general, and the growing multitude of space-related data bases in particular, it is appropriate that data interchange between distributed, non-affiliated (foreign) data bases be pursued by NASA in order to gain experience with such systems and nurture a future user community. The ADS Standards activity has thus been formed to provide for the creation of data interchange rules and protocols, and to serve as a "brass board" for the generation of long term techniques and standards for this far reaching technology.

The universal need for access to CATALOG data from non-affiliated data bases is repeatedly expressed in ADS workshop reports. This reflects a real user requirement to be able to interrogate various data bases to see what products are archived. The demand for networked access to multi-source data products from multiple data bases is less clearly defined; this is probably a result of justifiable caution within the user community, who are wary of grandiose systems which promise wonderful things but do not deliver. The challenge of the ADS pilots is therefore to demonstrate that such systems can in fact be made to work, and to develop the framework for future operational systems.

The charter of the Data Formats and Descriptions Panel was to identify the scope of data specification standards that need to be adopted in order to facilitate the interchange of information between the archival pilots nodes. A list of panel participants follows.

Thomas Burns, MITRE

Dennis Fife, NBS

Edward Greenberg, JPL, Chairman

Edgar M. Greville, CSC

Larry Herath, GSFC

Merv MacMedan, JPL

Ed Schlosser, Lockheed

Valerie L. Thomas, GSFC

## 14.2 SUMMARY OF PANEL DISCUSSIONS

It was the consensus of the panel that data exchange standards should be developed to be of general future utility, though the near-term activity should be constrained to focus on the problems of interconnecting the ADS Pilots. The intent is to use the three pilot nodes to evaluate the generalized applications of the ADS. The panel agreed that the following considerations were important when standards are designed:

a. DBMS catalogs should be accessible and understandable to remote users (both humans and applications processors).

b. Formatting conventions should be constrained to have minimal impact on existing archival data sets or on currently-generating data sources (e.g., Landsat), though they should be designed to provide guidance for future DBMS developments.

c. Archival data records and their data descriptions should be available in globally-identifiable, machine readable and interpretable form so that users can automatically interact with variable, non-affiliated data sets from remote DBMS nodes. The format of the records and descriptions should be machine and medium independent.

d. Terminology must be scrupulously defined. Definitions, words, units and general vocabulary should be standardized. Everyone should have the same understanding of the same word or definition.

e. Each DBMS node should have the option to optimize its data formats (at the discretion of the local authority) as long as minimal constraints imposed by global standards are met.

## 14.3 PANEL RECOMMENDATIONS

The specific recommendations that this panel extends are as follows:

14.3.1 The ADS should establish a standard vocabulary of terms, units, descriptions, and definitions. This must be accomplished in the immediate future. Although the early versions of the vocabulary need not be complete, they must provide the foundation for enabling the definitions of requirements and specifications to proceed.

14.3.2 The ADS should provide a machine-readable standard mechanism, which is medium and machine independent, for describing data content, structures, numeric representations, and character codes. It is vital that these definition mechanisms should be adopted as soon as possible in order to facilitate the pilot interchange of data, and in order to provide guidance for the future data sets which will be generated in coming years. The mechanisms adopted **MUST** be adequately defined, with user guides and examples, and **MUST** have expansion capabilities.

14.3.3 The ADS should establish a set of preferred numeric representations, a preferred character code, preferred units, and preferred descriptions. The ADS vocabulary should recognize and define ALL of the used or usable codes, units, and descriptions which currently exist within the pilots, but a subset of these MUST be identified as the preferred set. It is highly desirable that each pilot node should perform conversions of those existing data elements that are not in the preferred form, thus reducing the number of conversions which must be performed by each user processor.

14.3.4 The consensus of the panel was that the view of each of the panel participants was limited. The panel members felt that it is critical that the ADS should establish a permanent, dedicated team to pursue these recommendations further. While it is impractical for the panel to recommend detailed specific items for the team, we propose that the following near-term outline be pursued:

a. The permanent team should begin by analyzing the data formats, codes and representations used in existing pilots.

b. The team should analyze existing and proposed data interchange standards.

c. The team should adopt or create Strawman standards for review by data base administrators for each pilot and associated NASA data base.

d. The team should establish an ADS data standards administration function to approve, disseminate, maintain and provide visibility for these standards.

e. The team should provide top-level coordination for the development of catalogs, in order to:

i) Provide to the catalog designers the mechanisms for describing data sets.

ii) Evaluate the adequacy of the catalog structures to enable users to access and select data.

#### FOOTNOTE:

Owing to the shortness of time allowed, the MITRE presentation on pilot standards methodologies was not critiqued by the panel. We would however like to commend the MITRE assessment of the standards that need to be developed to support Pilot Data interchange: this presentation showed substantial technical insight.

#### 14.4 PANEL D PRESENTATION DISCUSSION

Pat Gary asked if the panel hopes for short- or long-term activity.

Ed Greenberg answered that the panel didn't address time; they addressed urgency. Data must be described in a standard way and it must be done now.

Tom Burns commented that the standard visibility requirement (see 14.3.4) must be emphasized.

Ed Greenberg said that we need electronic access to what people are doing.

Pat Gary stated that it would be a good thing if we built an on-line data base.

John Kiebler asked where specific formats went which were there at the start but are not there now.

Ed Greenberg replied that the panel did not have all of the details of the other formats.

## 15.0 WORKSHOP SUMMARY - Barbara Walton, GSFC

The workshop unanimously recommended the development of a standard for data product preparation to ensure quality data sets. The recommendation prepared by Richard desJardins, as given in Table 15-1, was adopted.

There is a lot of work to be done in the standards area. The panels' detailed requirements and the recommendations for future work are vital for the ADS program. Many of the workshop attendees will be called upon in the future for participation in working groups.

A document with the proceedings of the workshop, including the participants' addresses, will be distributed to all of the attendees of the workshop.

### 15.1 WORKSHOP SUMMARY DISCUSSION

Ed Greene agreed with Richard desJardins' recommendation to OSTA and commented that it presumes quite a sophisticated data configuration management, under strict control.

Richard desJardins said that it might be considered a goal, an ideal, but it may never be implemented.

Jim Brown commented that it has been done (for instance, with the Seasat Altimeter).

## 16.0 ACTION ITEMS - John Kiebler, NASA Headquarters

Draft panel reports are due to Barbara Walton in two weeks with a final version due in one month.

The panels didn't do much critiquing of the MITRE representation of the ADS pilot methodologies, which was one of the intents of the workshop, so it is up to the pilots to review the methodologies and report in a few weeks' time.

A meeting of the Steering Group will be held in room 206 at 2 p.m., to which panel chairmen are invited.

John thanked the participants and said that he thought the workshop had proven productive.

Table 15-1

Recommendation to OSTA on a Data Product Preparation Standard

Users of ADS may acquire some data only to find that crucial aspects of the data are unknown or missing, e.g., the position and time of data taking, the processing steps performed, the calibration curves used. While these aspects are of little consequence for systems interconnection protocols, they may be crucial for effective utilization of the data.

Therefore OSTA should develop a standard or guideline for Data Product Preparation. The intent of this standard would be to provide to data preparation personnel a checklist to assure the "quality" of the data as defined by the 1979 OSTA Data Systems Planning Workshop. The term "quality" was used at that workshop to signify the quality of the data preparation process rather than the a priori intrinsic goodness of the sensor data.

The scope of the standard would include:

- o data preparation practices (e.g., recommended quality assurance practices, scientific data validation techniques)
- o data labeling and annotation (e.g., source, indications of gaps, comments)
- o ancillary data (e.g., position, time, solar aspect)
- o "pedigree" of the data (e.g., calibrations performed, noise removal technique used, algorithm applied)
- o pointers of references (e.g., name and address of preparer, identification of data control documentation, reference data and software used including version numbers and algorithms)

## Glossary of Terms

ADCCP	Advanced Data Communications Control Procedure
ADS	Applications Data Service
ANSI	American National Standards Institute
CCT	Computer-Compatible Tape
CODASYL	Conference on Data Systems Languages
COSCL	Common Operating System Command Language
CMS	Command Management System
DBMS	Data Base Management System
DDCMP	Digital Data Communications Message Protocol
DEC	Digital Equipment Corporation
DOD	Department of Defense
ERPS	Earth Resources Pilot System
ERRSAC	Eastern Regional Remote Sensing Applications Center
FIPS	Federal Information Processing Standards
GSFC	Goddard Space Flight Center
IDBMS	Integrated Data Base Management System
IPS	Information Processing System
ISO	International Standards Organization
JPL	Jet Propulsion Laboratory
JSC	Johnson Space Center
NASA	National Aeronautics and Space Administration
NBS	National Bureau of Standards
NEEDS	NASA End-to-End Data System
NOAA	National Oceanic and Atmospheric Administration
NTIA	National Telecommunication Information Administration
OAST	Office of Advanced Space Technology
OPS	Oceanic Pilot System
OSI	Open System Interconnection
OSTA	Office of Space and Terrestrial Applications
PADS	Pilot Atmospheres Data System
PCDBMS	Pilot Climate Data Base Management System
R&D	Research and Development
R&T	Research and Technology
RSCS	Remote Spooling and Communications Service
RSS	Remote Services Subsystem
RTOP	Research and Technology Objectives and Plans

S&G	Standards and Guidelines
SFDU	Standard Format Data Unit
SNA	Systems Network Architecture
SNAP	System of Networked Applications Processors
TAE	Transportable Applications Executive
TDMA	Time Division Multiple Access
USGS	United States Geological Survey
VAS	VISSR Atmospheric Sounder
VISSR	Visible Infrared Spin Scan Radiometer



APPENDIX A

OSTA/ADS DATA SYSTEMS STANDARDS AND GUIDELINES DEVELOPMENT PROGRAM

OVERVIEW OF THE CURRENT MITRE EFFORT

A-1

TERRY KUCH  
RICK SAKAMOTO  
THE MITRE CORPORATION  
MCLEAN, VIRGINIA

OSTA/ADS DATA SYSTEMS  
STANDARDS WORKSHOP  
MAY 27, 1981

THE OSTA/ADS DATA SYSTEMS STANDARDS AND GUIDELINES DEVELOPMENT PROGRAM IS A COLLABORATIVE ACTIVITY. THIS WORKSHOP PROVIDES THE OPPORTUNITY FOR ENHANCEMENT OF ADS STANDARDS AND GUIDELINES THROUGH INTERACTION WITH WORKSHOP PARTICIPANTS.

PURPOSE OF THIS PRESENTATION

- 0 PRESENT AN OVERVIEW OF THE CURRENT EFFORT
- 0 PRESENT A TERMINOLOGY AND CONCEPTUALIZATION OF ADS FOR STANDARDS DEVELOPMENT PURPOSES
- 0 PROVIDE A CONTEXT FOR THE NEXT TWO PRESENTATIONS
  - USER REQUIREMENTS
  - PILOT METHODOLOGIES

## OUTLINE OF BRIEFING

- 0 OVERVIEW OF CURRENT MITRE ACTIVITIES
- 0 ADS TERMINOLOGY
- 0 ADS AS A DISTRIBUTED SYSTEM
- 0 A FUNCTIONAL CLASSIFICATION OF ADS FEATURES
- 0 A STANDARDS EVALUATION PROCESS FOR ADS

MITRE ACTIVITIES: OVERVIEW

1. DEVELOP NASA-DEFINED APPROACH TO OSTA/ADS DATA SYSTEMS STANDARDS AND GUIDELINES.
2. EXTEND KNOWLEDGE OF DATA SYSTEMS STANDARDS AND GUIDELINES ORGANIZATIONS AND PROCESSES.
3. DETERMINE ADS MEMBERS' REQUIREMENTS FOR STANDARDS AND GUIDELINES. } FOLLOWING PRESENTATIONS
4. SURVEY AND ANALYZE METHODOLOGIES OF PILOTS. }
5. SURVEY EXISTING DATA SYSTEMS STANDARDS AND GUIDELINES.
6. COMPILE A PRELIMINARY CANDIDATE SET OF OSTA/ADS STANDARDS AND GUIDELINES.
7. DEVELOP OSTA/ADS STANDARDS AND GUIDELINES EVALUATION PROCESS AND CRITERIA.
8. EVALUATE PRELIMINARY CANDIDATE STANDARDS AND GUIDELINES.
9. DEVELOP CANDIDATE STANDARDS AND GUIDELINES REPORT.

MAJOR PRODUCTS:

- . MITRE SURVEY REPORT MTR-81W5 (MARCH 1981)
- . ADS CANDIDATE STANDARDS AND GUIDELINES REPORT (AUGUST 1981)

MITRE ACTIVITIES: 1

DEVELOP NASA-DEFINED APPROACH TO OSTA/ADS DATA SYSTEMS STANDARDS & GUIDELINES.

- 0 EXAMINE NASA AND CONTRACTOR DOCUMENTATION.
- 0 DISCUSS ADS CONCEPTS WITH GSFC AND CONTRACTOR PERSONNEL.
- 0 ESTABLISH CONSISTENT USE OF TERMS.
- 0 DEVELOP LOGICAL VIEW OF ADS FOR A STANDARDS DEVELOPMENT EFFORT.
- 0 DEVELOP OSTA/ADS FUNCTIONAL CLASSIFICATION SCHEME.

## TERMINOLOGY FOR THE ADS STANDARDS PROGRAM

- o STANDARD
- o GUIDELINE
- o METHODOLOGY
- o DISCIPLINE USER
- o MEMBER
- o CENTRAL SYSTEM FUNCTION

GENERAL CHARACTERISTICS OF STANDARDS, GUIDELINES, AND METHODOLOGIES

Standard	Guideline	Methodology
Administratively compelling (required at some administrative level)	Advisory	Informational
Exhaustive (complete within its scope)	Exhaustive or selective, as required	Selective
Detailed	Not necessarily detailed; may be used to set boundaries within which standards may be defined	Detailed; based on actual implementation
Adopted formally by key organizations	Agreeable to key organizations, not necessarily adopted formally	May be unique to one or a few organizations
Broad scope of application to many systems and organizations	Broad scope of application	Limited scope of application
Product-oriented	Activity-oriented	Product-oriented or outcome-oriented
Compatible with other standards and guidelines	Compatible with other standards and guidelines	Not necessarily compatible with any standard, guideline, or other methodology
Fully developed and stable, subject to evolution	Less fully developed	Not necessarily fully developed
Addressed to technical staff or to technical project management or to both	Addressed to technical project management or to program management or to both	Addressed to working-level technical staff

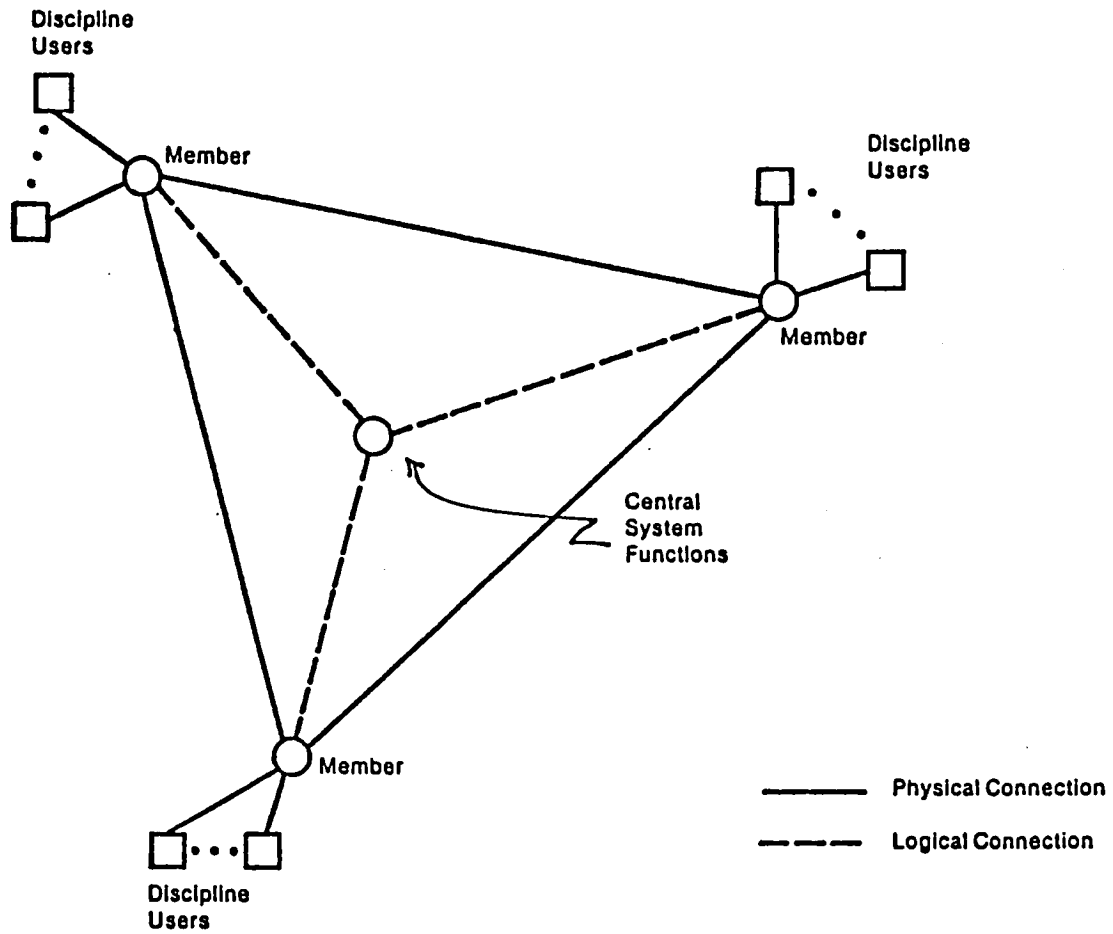



DISCIPLINE USERS ARE SCIENTISTS WHO USE AN ADS NETWORK MEMBER FACILITY IN THEIR RESEARCH.

MEMBERS ARE FACILITIES WHICH PARTICIPATE IN ADS. EACH MEMBER PROVIDES A SERVICE TO DISCIPLINE USERS. A MEMBER FACILITY MAY OPERATE INDEPENDENTLY OF ADS AS WELL AS BEING PART OF ADS.

ADS CENTRAL SYSTEM FUNCTIONS ENCOMPASS TECHNICAL SERVICES TO MEMBERS:

- o DATA COMMUNICATION
- o CATALOGING
- o ADMINISTRATIVE SERVICES (SUCH AS RESOURCE ACCOUNTING)
- o USER ASSISTANCE
- o VALUE-ADDED SERVICES (SUCH AS DATA INTEGRATION).

CENTRAL SYSTEM FUNCTIONS MAY BE PERFORMED BY ONE OR MORE MEMBERS OR DISTRIBUTED OVER THE NETWORK.



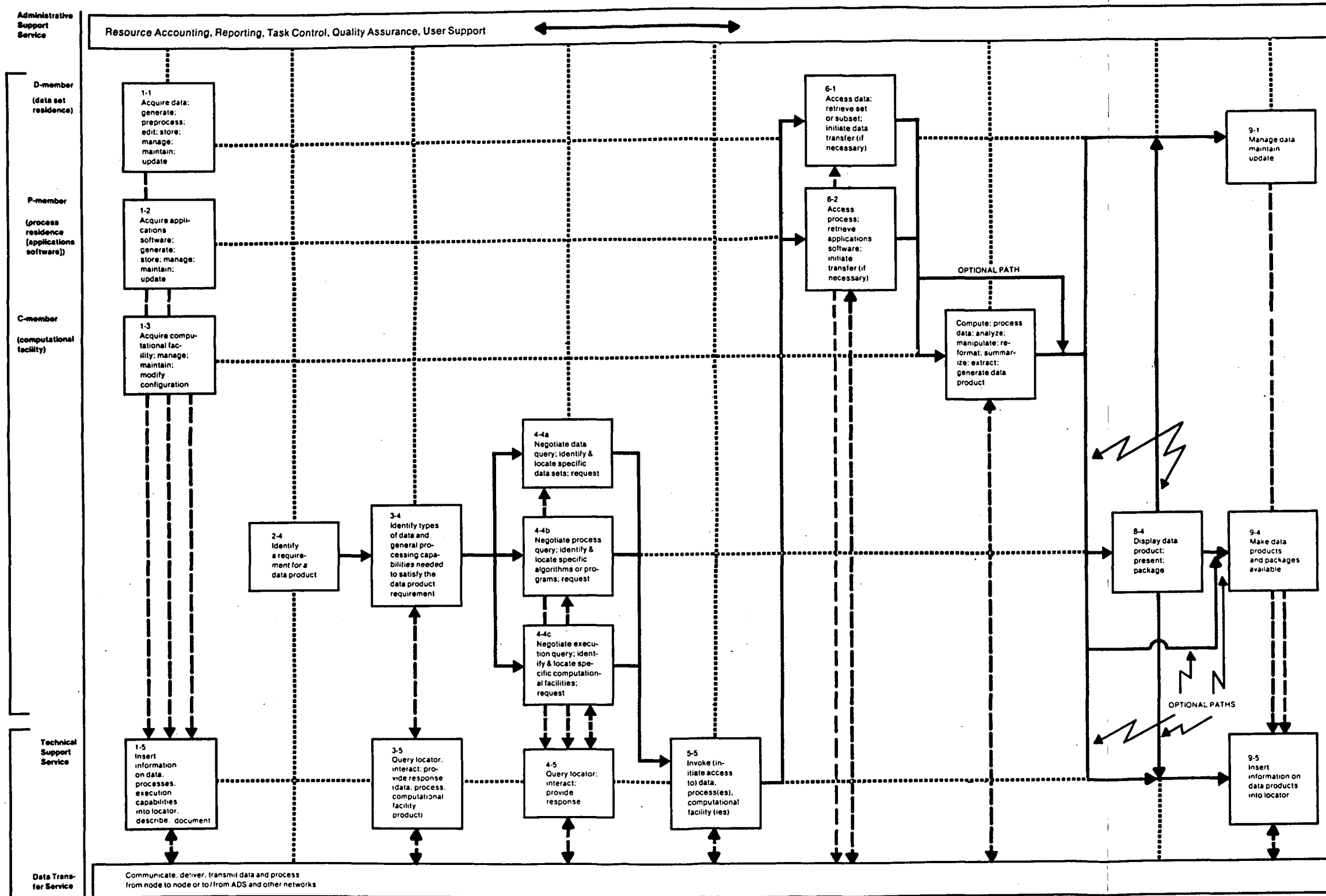

ACTIVITIES IN A DISTRIBUTED SYSTEM



# A FUNCTIONAL CLASSIFICATION OF OSTA/ADS FEATURES

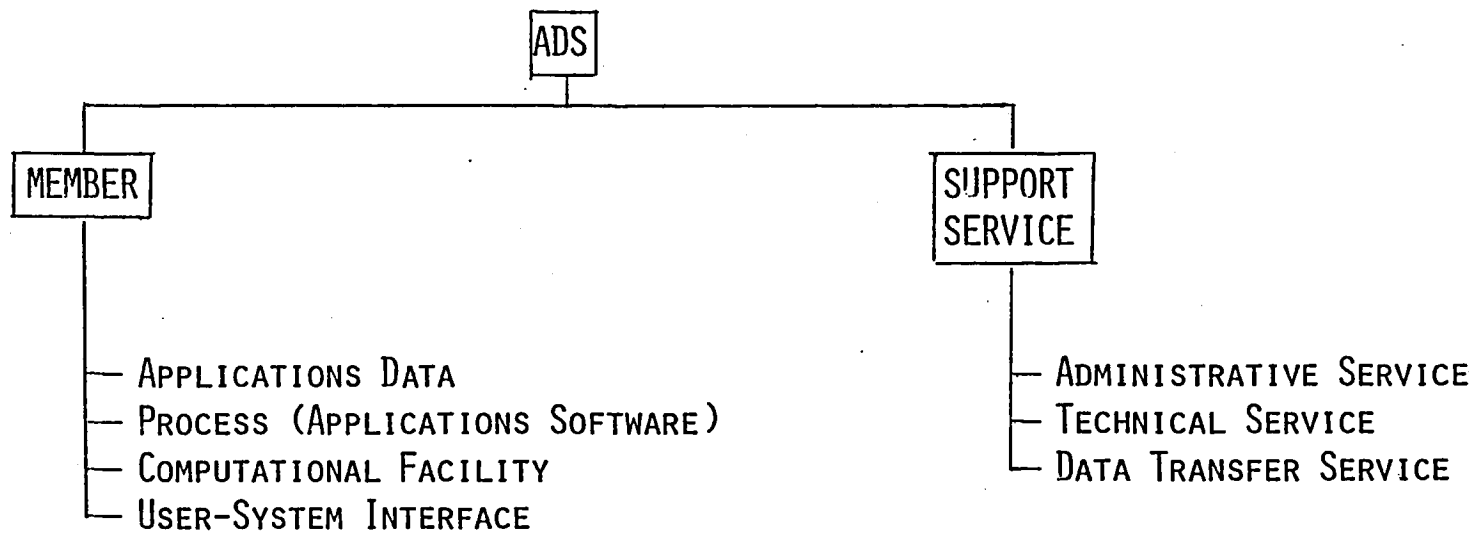



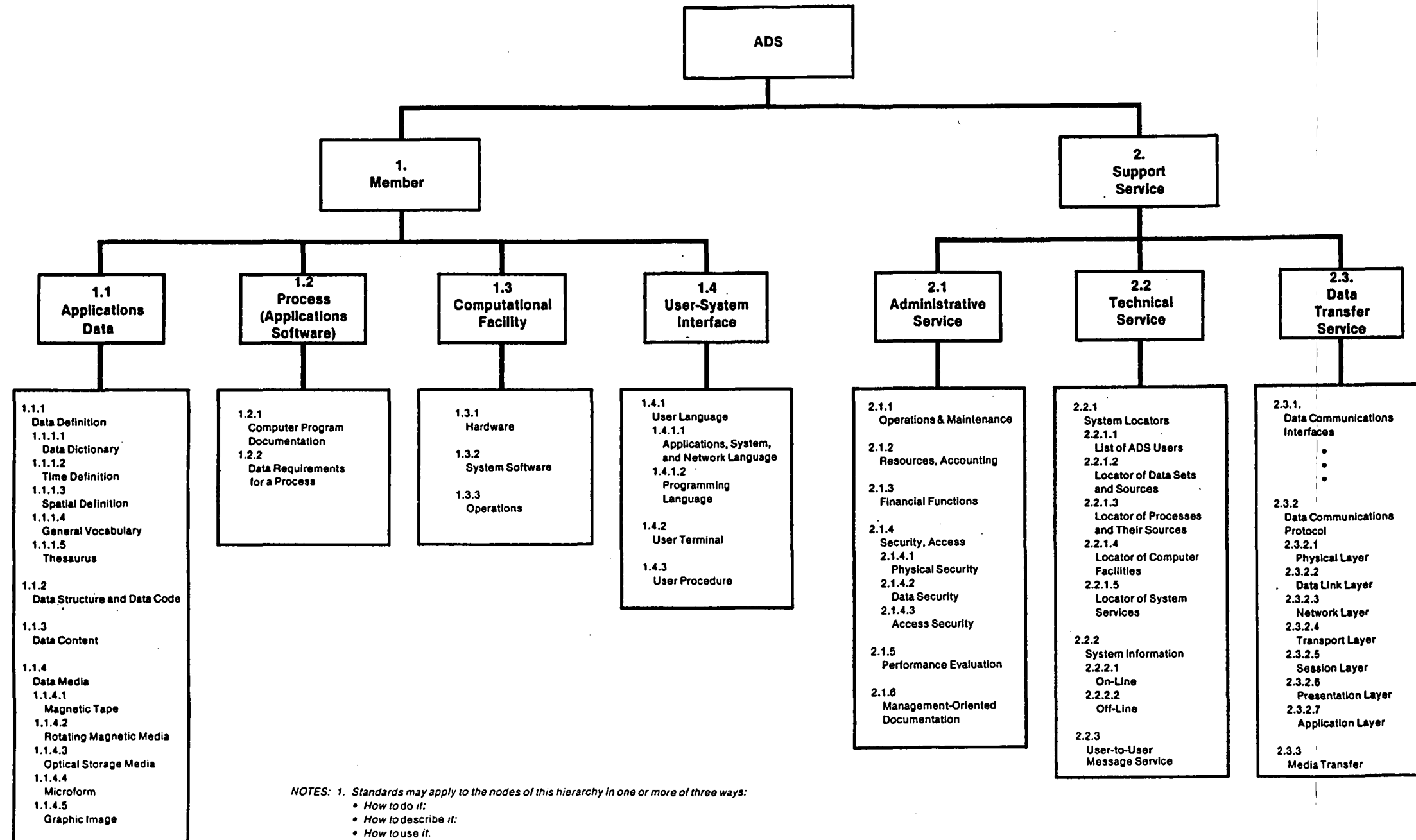

NOTES: 1. Standards may apply to the nodes of this hierarchy in one or more of three ways:

- How to do it;
- How to describe it;
- How to use it.

2. For each node of this hierarchy there may be kernel standards which apply to the system as a whole, and extension standards which apply to one or more, but not necessarily to all, ADS disciplines (user communities).





MITRE ACTIVITIES: 2

EXTEND KNOWLEDGE OF DATA SYSTEMS STANDARDS AND GUIDELINES ORGANIZATIONS AND PROCESSES.

- 0 IDENTIFY STANDARDS-PROCESSING ORGANIZATIONS.
- 0 COLLECT STANDARDS AND GUIDELINES LISTS AND CATALOGS, AND COPIES OF STANDARDS AND GUIDELINES.
- 0 ESTABLISH CONTACTS WITH STANDARDS-PROCESSING ORGANIZATIONS (ANSI, NBS, ETC.).
- 0 IDENTIFY EXISTING PROCEDURES FOR EVALUATION OF CANDIDATE STANDARDS.

MITRE ACTIVITIES: 3

DETERMINE ADS MEMBERS' REQUIREMENTS FOR DATA SYSTEMS STANDARDS AND GUIDELINES

- 0 REVIEW PREVIOUS WORK ON ADS STANDARDS REQUIREMENTS.
- 0 VISIT THREE PILOTS, COLLECT INFORMATION ON THEIR FUNCTIONAL REQUIREMENTS PRACTICES, METHODS, FRAMEWORKS, DOCUMENTS, ETC., ESPECIALLY IN THE AREAS OF DATA STRUCTURES, DATA COMMUNICATIONS, AND DATA IDENTIFICATION AND CATALOGING.
- 0 VISIT ORGANIZATIONS AND OPERATIONS OUTSIDE THE THREE PILOTS WHICH MAY BECOME ADS MEMBERS, OR MIGHT BE TYPICAL OF FUTURE ADS MEMBERS IN SOME WAY. COLLECT REQUIREMENTS INFORMATION AS ABOVE.
- 0 CONSIDER HOW THESE COMMON FUNCTIONAL REQUIREMENTS MAY BE SATISFIED BY THE IDENTIFICATION AND DEVELOPMENT OF STANDARDS AND GUIDELINES.
- 0 REPORT ON STANDARDS AND GUIDELINES AS SOLUTIONS TO PROBLEMS ENCOUNTERED IN ADS.

MITRE ACTIVITIES: 4

SURVEY AND ANALYZE METHODOLOGIES OF  
ADS PILOTS.

- o VISIT THREE PILOTS, COLLECT DETAILED INFORMATION ON PILOT METHODOLOGIES ESPECIALLY IN THE AREAS OF DATA STRUCTURES, DATA COMMUNICATIONS, AND DATA IDENTIFICATION AND CATALOGING.
- o CONSIDER WHICH METHODOLOGIES MAY BE SUITABLE FOR ADS-WIDE USE.
- o PRESENT FINDINGS.

MITRE ACTIVITIES: 5

SURVEY EXISTING DATA SYSTEMS STANDARDS AND GUIDELINES

- 0 CATEGORIZE, LIST, AND INDEX NON-NASA STANDARDS AND GUIDELINES WHICH MAY BE APPLICABLE TO ADS BASED ON A PRELIMINARY SCREEN TO ELIMINATE STANDARDS AND GUIDELINES WHICH ARE GROSSLY TECHNICALLY OR ADMINISTRATIVELY INAPPROPRIATE FOR ADS.
- 0 PUBLISH A SURVEY DOCUMENT (MITRE MTR-81W5).
- 0 PREPARE AND ISSUE A SUPPLEMENT TO THE SURVEY DOCUMENT INCORPORATING STANDARDS AND GUIDELINES FROM NASA PROGRAMS AND CENTERS, AND UPDATING PREVIOUSLY PUBLISHED SURVEY INFORMATION.

MITRE ACTIVITIES: 6

COMPILE PRELIMINARY CANDIDATE SET OF  
OSTA/ADS DATA SYSTEMS STANDARDS AND  
GUIDELINES

- o COMPILER THE PILOT METHODOLOGIES AND THE  
APPLICABLE NASA AND NON-NASA STANDARDS  
AND GUIDELINES INTO A SET TO BE EVALUATED  
TO PRODUCE THE CANDIDATE ADS STANDARDS  
AND GUIDELINES DOCUMENT.

MITRE ACTIVITIES: 7

DEVELOP OSTA/ADS DATA SYSTEMS STANDARDS AND GUIDELINES EVALUATION PROCESS AND CRITERIA.

- O CONSIDER EVALUATION CRITERIA USED BY STANDARDS-PROCESSING ORGANIZATIONS SUCH AS ANSI AND NBS.
- O CONSIDER ADS STANDARDS REQUIREMENTS IDENTIFIED IN A PREVIOUS TASK.
- O DEVELOP A PROCESS FOR EVALUATION OF POTENTIAL ADS STANDARDS AND GUIDELINES.
- O DEVELOP CRITERIA FOR USE IN THE PROCESS TO EVALUATE POTENTIAL ADS STANDARDS AND GUIDELINES.

# OSTA/ADS Standards and Guidelines Evaluation Process

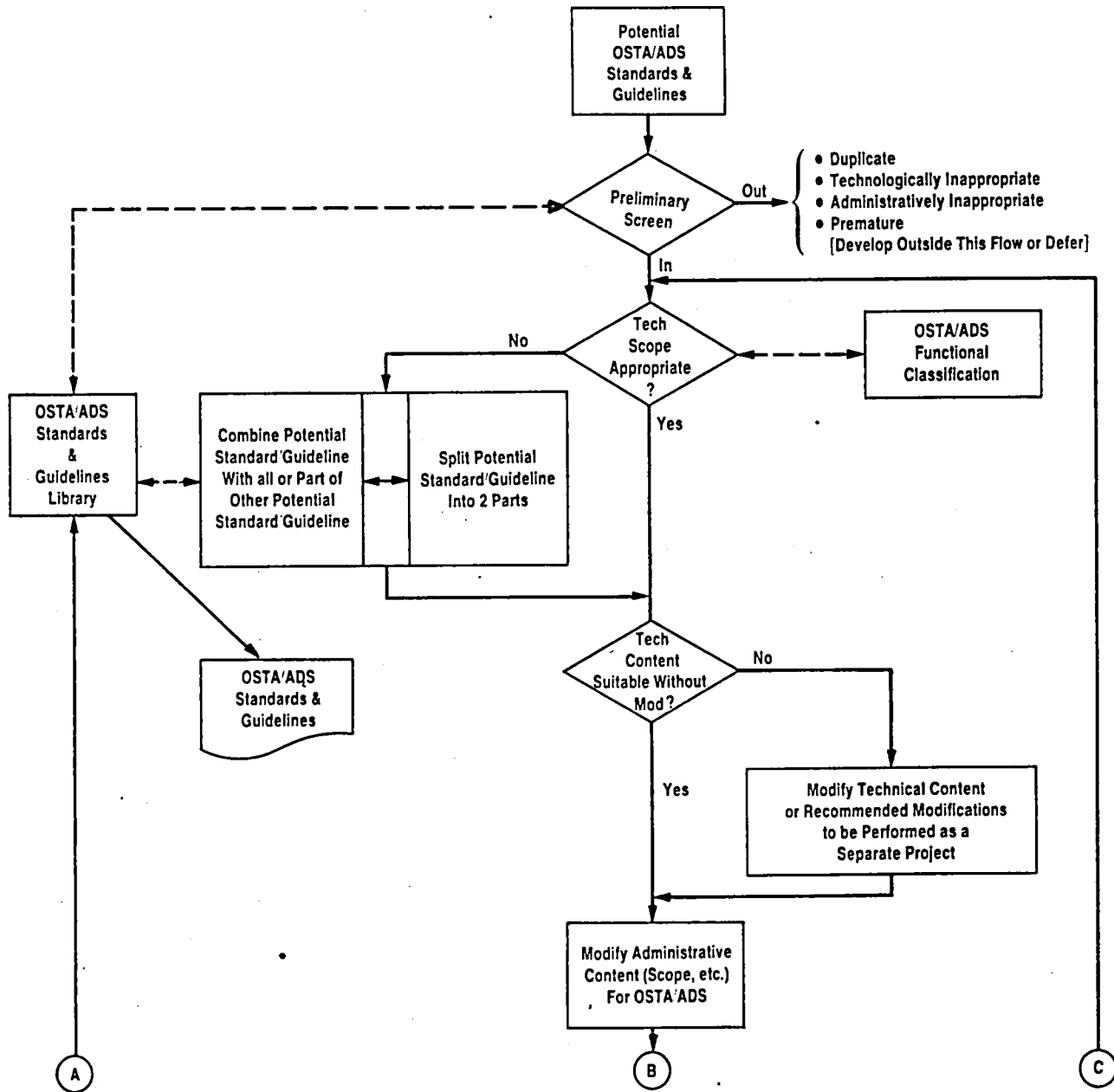

# OSTA/ADS Standards and Guidelines Evaluation Process (Continued)

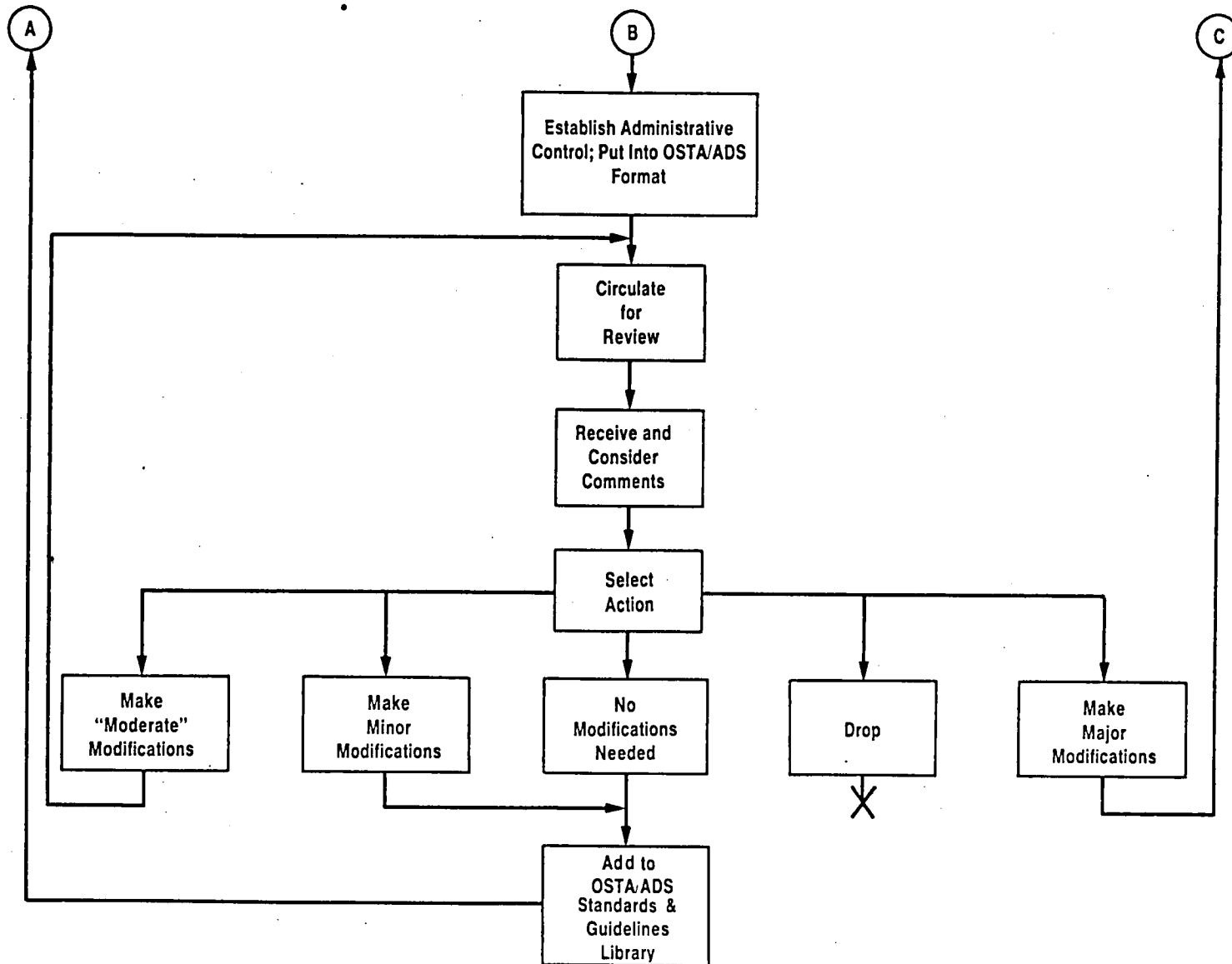



MITRE ACTIVITIES: 8

EVALUATE PRELIMINARY CANDIDATE  
STANDARDS AND GUIDELINES

- 0 PASS THE SET OF PRELIMINARY CANDIDATE  
STANDARDS AND GUIDELINES THROUGH THE  
EVALUATION PROCESS.

MITRE ACTIVITIES: 9

DEVELOP CANDIDATE OSTA/ADS DATA SYSTEMS  
STANDARDS AND GUIDELINES REPORT

- O ORGANIZE THE SET OF CANDIDATE OSTA/  
ADS STANDARDS AND GUIDELINES; CATE-  
GORIZE; INDEX; PUT INTO AN OSTA/ADS  
STANDARD FORMAT.
  
- O PREPARE, PRODUCE, AND PUBLISH THE  
SET OF CANDIDATE OSTA/ADS DATA SYSTEMS  
STANDARDS AND GUIDELINES.

APPENDIX B

OSTA/ADS DATA SYSTEMS STANDARDS AND  
GUIDELINES DEVELOPMENT PROGRAM

USER REQUIREMENTS  
FOR  
ADS STANDARDS AND GUIDELINES

B-1

PAUL CLEMENS  
THE MITRE CORPORATION  
MCLEAN, VIRGINIA

MAY 27, 1981  
BC-097

## PURPOSE

- 0 PRESENT RESULTS OF A SURVEY OF REPRESENTATIVE ADS NETWORK MEMBERS TO IDENTIFY REQUIREMENTS FOR ADS STANDARDS AND GUIDELINES

## GOAL

- 0 INVITE COMMENT AND DISCUSSION ON
  - FUNCTIONAL AREAS REQUIRING STANDARDS
  - ADEQUACY OF IDENTIFIED STANDARDS REQUIREMENTS
  - COMPLETENESS OF SURVEY

## OUTLINE OF BRIEFING

- o TASK OVERVIEW
- o GENERAL FINDINGS
- o PILOT INTERCONNECTION FUNCTIONAL REQUIREMENTS
- o STANDARDS REQUIRED FOR PILOT INTERCONNECTION  
FOR DATA SHARING
- o ISO OPEN SYSTEM INTERCONNECTION REFERENCE  
MODEL LAYER CHARACTERISTICS
- o CONCLUSIONS

## TASK OVERVIEW - 2

### DEVELOPMENT OF STANDARDS REQUIREMENTS

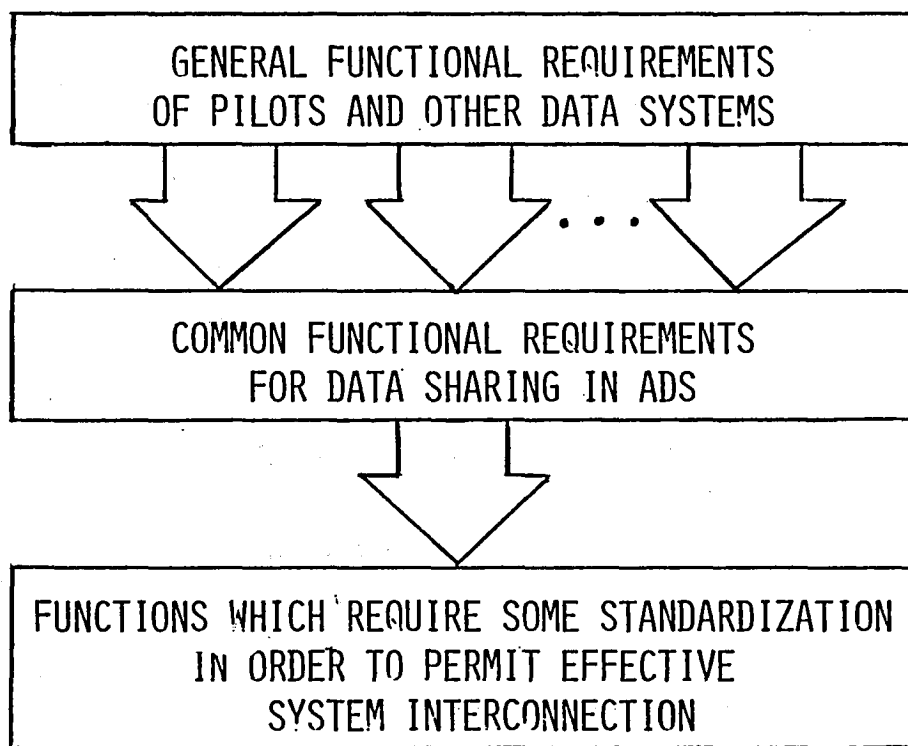

## TASK OVERVIEW - 2

- o REVIEWED OSTA, ADS, AND OTHER DISTRIBUTED DATA PROCESSING DOCUMENTATION TO DETERMINE THOSE FUNCTIONS REQUIRING STANDARDS IN A DISTRIBUTED ENVIRONMENT SUCH AS ADS.

### PRIMARY SOURCES INCLUDED:

- WALLOPS WORKSHOP SUMMARIES (GSFC)
- STANDARDS SURVEY (MITRE)
- DBMS WORKSHOP SUMMARIES (JPL)
- PADS METHODOLOGIES REPORT (CSC)
- ADS GENERIC REQUIREMENTS (CSC)
- DISTRIBUTED DATA PROCESSING STANDARDS FORECAST (NAC)
- PCDBMS USER REQUIREMENTS STUDY (OAO)
- ADS RESOURCES PILOT PROGRAM 5-YR PLAN (JSC)

## TASK OVERVIEW - 3

- o SURVEY MEANT TO ELICIT CONCERNS, INTERESTS, NATURE OF PROGRAMS IN ADDITION TO STANDARDS REQUIREMENTS, METHODOLOGIES, AND PRIORITIES
  
- o VISITED AND SURVEYED PILOT PROJECTS AND OTHER DATA SERVICES TO DETERMINE
  - FUNCTIONAL REQUIREMENTS
  - DESIGNS, PLANS, METHODOLOGIES
  - CURRENT USE OF STANDARDS
  - PLANNED INTERACTION WITH ADS
  - ROLE OF STANDARDS FOR ADS INTERCONNECTION
  - SUGGESTIONS FOR STANDARDS DEVELOPMENT
  - SUGGESTED STANDARDS & GUIDELINES



## TASK OVERVIEW - 4

### O ORGANIZATIONS AND PROJECTS VISITED

- PILOT ATMOSPHERES DATA SYSTEM (GSFC)
- EARTH RESOURCES PILOT (JSC)
- OCEANIC PILOT SYSTEM (JPL)
- NATIONAL SPACE SCIENCE DATA CENTER (GSFC)
- ENVIRONMENTAL DATA AND INFORMATION SERVICE (NOAA)
- U. S. GEOLOGICAL SURVEY (DOI)

## TASK OVERVIEW - 5

- 0 DETERMINED GENERAL ADS REQUIREMENTS FOR STANDARDS
  - INTERPRETED AND INTEGRATED DATA TO ESTABLISH COMMON FUNCTIONAL REQUIREMENTS (TO THE EXTENT POSSIBLE WITHOUT A FIRM ADS FUNCTIONAL DEFINITION)
  - IDENTIFIED FUNCTIONAL AREAS NEEDING THE SUPPORT OF STANDARDS AND GUIDELINES
  
- 0 CATEGORIZED REQUIREMENTS FOR STANDARDS ACCORDING TO ADS FEATURE CLASSIFICATION
  
- 0 IDENTIFIED AND PRIORITIZED THAT SUBSET OF STANDARDS REQUIRED TO EFFECT THE INTERCONNECTION OF PILOT SYSTEMS FOR DATA SHARING

## GENERAL FINDINGS - 1

### OBSERVATIONS

- o DE FACTO STANDARDS PREVAIL
  - USE OF IBM OR IBM LOOK-ALIKE EQUIPMENT AND IBM-COMPATIBLE VENDOR PRODUCTS
  - USE OF DEC EQUIPMENT AND PRODUCTS
  - OFF-THE-SHELF PRODUCTS ARE CHEAPER BUT DO NOT SUPPORT THE INTERCONNECTION OF DISSIMILAR SYSTEMS
  
- o TRADE-OFF BETWEEN STANDARDS AND TRANSLATIONS OR REFORMATTING
  - DIFFERENT REQUIREMENTS FOR SHORT AND LONG TERM
  - NSSDC SUPPORTS WHATEVER FORMAT IS DESIRED ON INPUT OR OUTPUT - THIS "SELLS" WELL, BUT REQUIRES SIGNIFICANT TIME AND MONEY

## GENERAL FINDINGS - 2

### ROLE OF STANDARDS IN ADS

- o STANDARDS AND GUIDELINES PROVIDE SOLUTIONS TO THE PROBLEMS ENCOUNTERED IN INTERCONNECTING DISSIMILAR SYSTEMS FOR DATA SHARING
  - VARYING TERMINOLOGY
  - DIFFERENT DATA FORMATS
  - DIFFERENT COMPUTING EQUIPMENT
  - DIFFERENT OPERATING SYSTEMS
  - VARIOUS DATA BASE MANAGEMENT SYSTEMS
  - DIFFERENT COMMUNICATIONS FACILITIES
  - WIDE VARIETY OF DATA SETS
  - INCOMPATIBILITY OF CATALOGS

## GENERAL FINDINGS - 3

### AREAS OF CONCERN

- 0 STANDARDS ARE EITHER INADEQUATE OR TOO COMPLICATED
- 0 STANDARDS ARE REQUIRED ONLY TO CONNECT DISSIMILAR SYSTEMS
- 0 MORE FRUITFUL TO STANDARDIZE WAYS OF TALKING ABOUT DATA THAN TO STANDARDIZE DATA
- 0 LET INDUSTRY DEVELOP STANDARDS - UTILIZE WHAT'S AVAILABLE
- 0 STANDARDS WORK SHOULD BE PRACTICAL, REFLECT THE REAL WORLD

FUNCTIONAL REQUIREMENTS  
FOR PILOT SYSTEM INTERCONNECTION

- O REQUIREMENTS FOR STANDARDS AND GUIDELINES  
CORRELATED WITH ADS FEATURE CLASSIFICATION
  - HIGH LEVEL, TOP-DOWN MODEL OF ADS
  
- O REQUIREMENTS FOR STANDARDS AND GUIDELINES  
FOR PILOT SYSTEM INTERCONNECTION FOR DATA  
SHARING
  - FOUR OF SEVEN COLUMNS OF ADS CLASSIFICATION
  - CORRELATE WITH WORKSHOP PANEL SUBJECTS

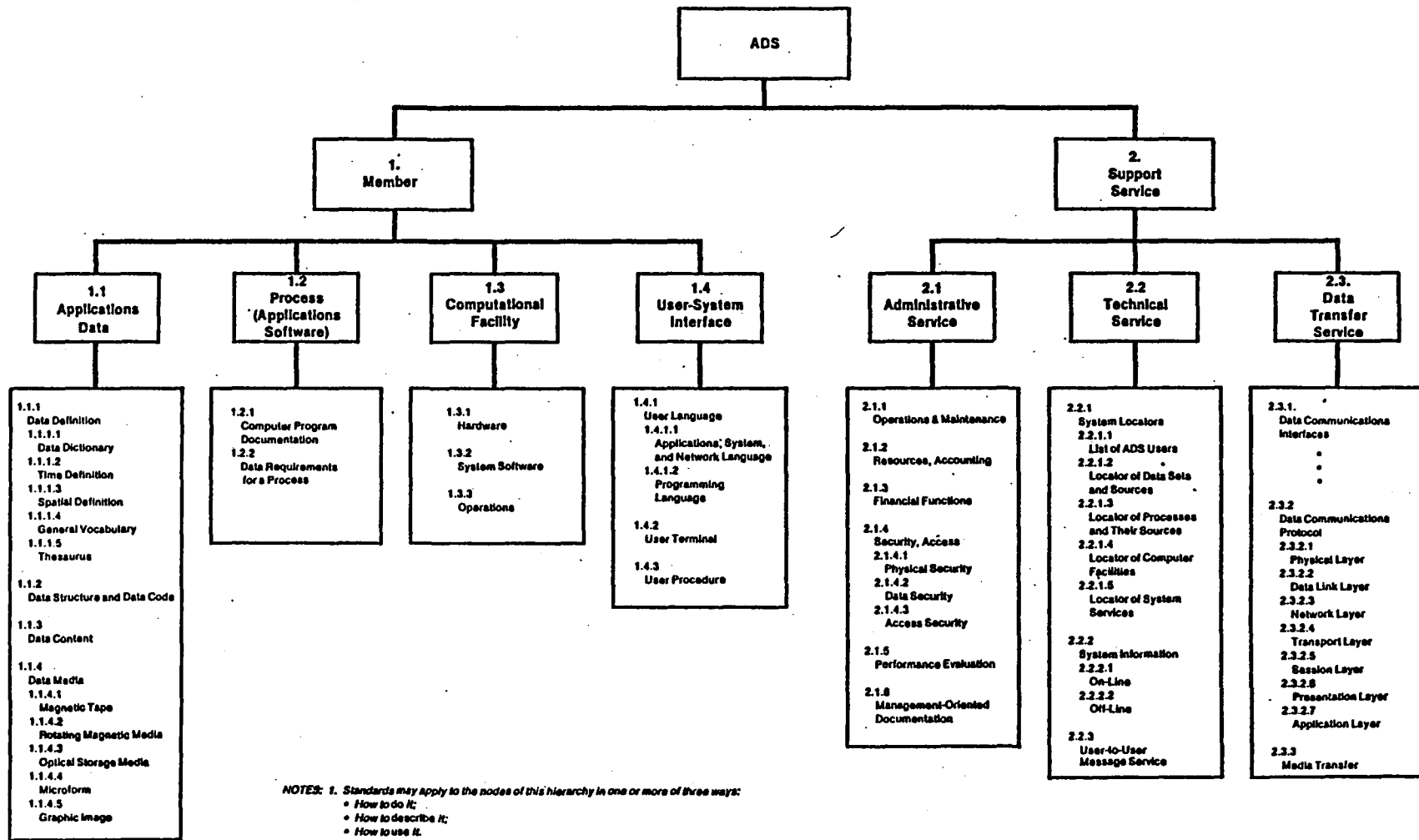

NOTES: 1. Standards may apply to the nodes of this hierarchy in one or more of three ways:

- How to do it;
- How to describe it;
- How to use it.

2. For each node of this hierarchy there may be kernel standards which apply to the system as a whole, and extension standards which apply to one or more, but not necessarily to all, ADS disciplines [user communities].

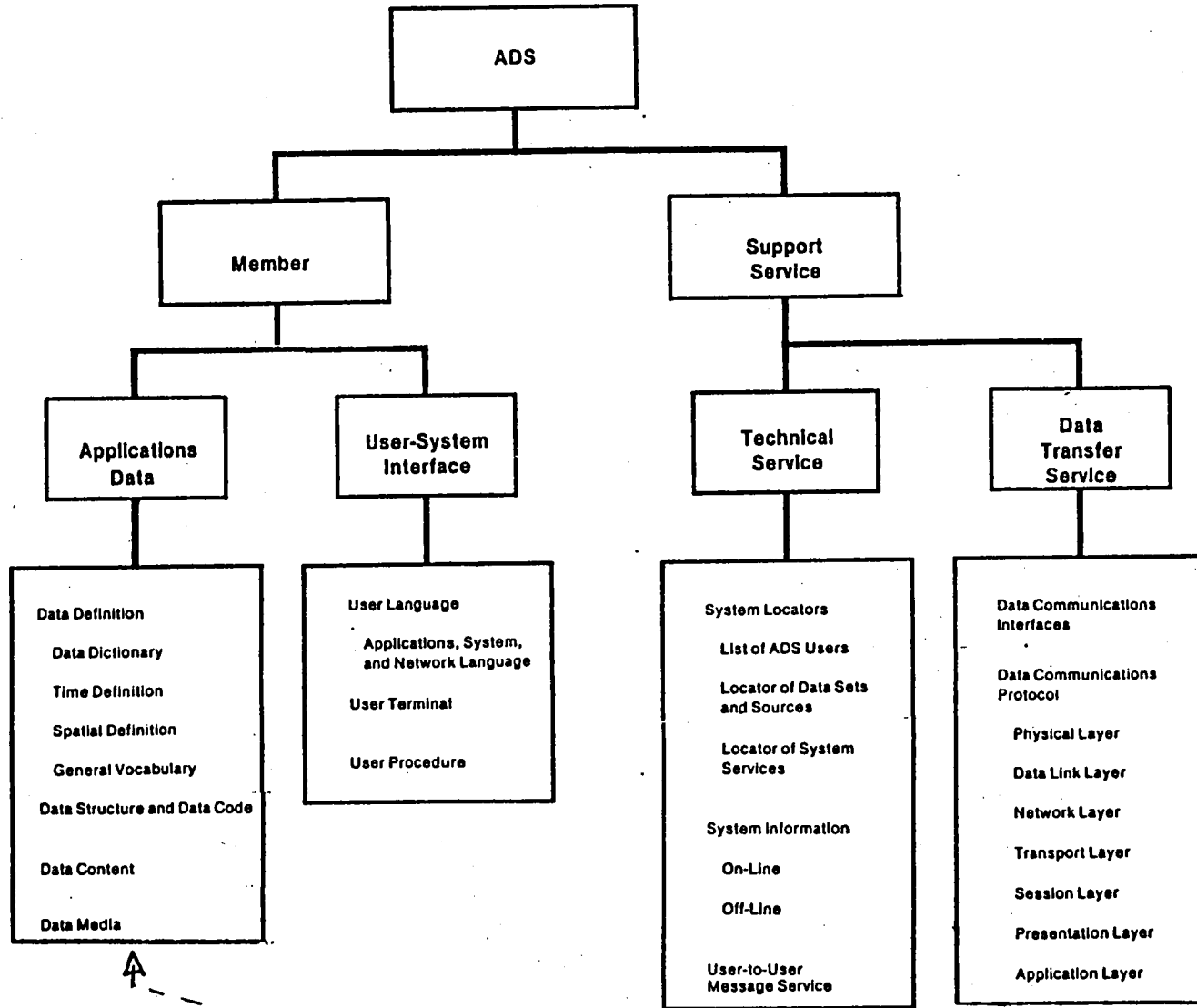

B-14

DATA FORMATS  
& DESCRIPTIONS

USER  
INTERFACE

CATALOGS  
DIRECTORIES &  
DICTIONARIES

ISO/OSI  
MODEL

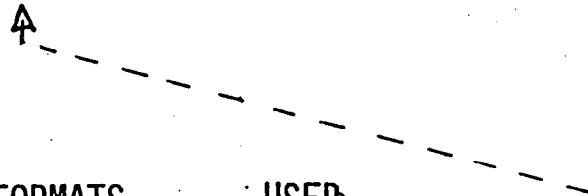



RELATIONSHIP BETWEEN FUNCTIONAL,  
TECHNICAL, AND STANDARDS REQUIREMENTS

ADS CAPABILITIES	REQUIRED TECHNOLOGY	REQUIRED STANDARDS
LIST OF DATA HOLDINGS	o PRINT	o TERMINOLOGY o DATA DESCRIPTION
REMOTE ACCESS TO CATALOGS	o DIAL-UP COMM. o DBMS/FILE MGMT.	o VIRTUAL TERMINAL PROTO. o CATALOG LOCATORS o CATALOG STRUCTURE o QUERY LANGUAGE
REMOTE ACCESS TO DATA	o HIGH-SPEED COMM. o LARGE VOLUME DATA MGMT.	o DATA FORMATS o COMM. PROTOCOLS o OP. SYS. INTERFACE o DBMS INTERFACE
DISTRIBUTED NETWORK	o DISTRIBUTED SYSTEM SOFTWARE (COMM., OP. SYS., DBMS)	o NETWORK DIRECTORY o TASK ADDRESSING

STANDARDS REQUIREMENTS FOR  
APPLICATIONS DATA - 1

- o ADS STANDARDS FOR DATA SHARING ARE  
REQUIRED IN FOUR GENERAL AREAS:
  - DATA DESCRIPTION
  - DATA FORMATS, STRUCTURES, AND CODES
  - DATA CONTENT REPRESENTATION
  - DATA MEDIA

## STANDARDS REQUIREMENTS FOR APPLICATIONS DATA - 2

### DATA DESCRIPTION

- o GUIDELINES ARE REQUIRED FOR THE DESCRIPTION OF DATA CHARACTERISTICS
  - SPACECRAFT AND SENSORS USED
  - SENSOR CHARACTERISTICS
  - ASPECTS OF REALITY DESCRIBED BY THE DATA
  - GEOGRAPHICAL COVERAGE
  - TEMPORAL CHARACTERISTICS OF DATA
  - FORM OF THE DATA (GRAPHIC, NUMERIC, TEXTUAL)
  - PARAMETERS ASSOCIATED WITH FORM OF DATA
  - QUALITY OF THE DATA
  - PROCESSING PERFORMED ON THE DATA
  - DATA IDENTIFICATION SCHEME

STANDARDS REQUIREMENTS FOR  
APPLICATIONS DATA - 3

- o GENERAL VOCABULARY STANDARDS ARE REQUIRED IN ORDER TO TALK ABOUT DATA & DATA-RELATED ACTIVITIES
  - DEFINITIONS
  - WORDS
  - TERMS
  - UNITS
  
- o STANDARD SET OF KEY ELEMENTS OR CODE NAMES FOR DATA SUBELEMENTS
  
- o SPATIAL DEFINITION STANDARDS FOR BOTH DESCRIBING AND FOR LABELING DATA
  - SPATIAL RESOLUTION
  - SPATIAL LOCATION (GRIDS, COORDINATE SYSTEMS)
  - LABELING STANDARDS
  - CONVERSION PARAMETERS

## STANDARDS REQUIREMENTS FOR APPLICATIONS DATA - 4

### DATA FORMATS, STRUCTURES, AND CODES

- o TWO FORMAT STANDARDIZATION APPROACHES
  - STANDARDIZE THE ARRANGEMENT AND REPRESENTATION OF DATA.
  - STANDARDIZE THE MECHANISM FOR DESCRIBING WHAT EXISTS WITHIN THE ADS MEMBERSHIP.
  
- o STANDARD DATA INTERCHANGE FORMATS ARE REQUIRED FOR USE BETWEEN MEMBER-NODES
  - STANDARD DATA DESCRIPTORS (HEADERS)
  - STANDARD NUMBER REPRESENTATIONS
  - STANDARD CHARACTER CODES
  - STANDARD RECORD STRUCTURE DESCRIPTION

STANDARDS REQUIREMENTS FOR  
APPLICATIONS DATA - 5

- o STANDARD TERMINOLOGY AND GUIDELINES ARE REQUIRED FOR THE USE OF DATA AGGREGATES SUCH AS:
  - STRINGS
  - ARRAYS
  - LISTS
  - TREES
  - PACKETS
  
- o A METHODOLOGY FOR DESCRIBING DATA CONTENT IN A UNIFORM OR STANDARDIZED MANNER IS NECESSARY.
  - GEOGRAPHIC CODING AND REFERENCING
  - NULL, MISSING, OR FUTURE DATA

# STANDARDS REQUIREMENTS FOR APPLICATIONS DATA - 6

## DATA CONTENT REPRESENTATION

- o STANDARD DATA FORMATS ARE REQUIRED TO REPRESENT APPROPRIATE CATEGORIES OF DATA, SUCH AS
  - IMAGE DATA
  - GRAPHIC DATA
  - MULTIDIMENSIONAL DATA SETS
  - TEXTUAL DATA

## DATA MEDIA

- o A FAMILY OF STANDARD MEDIA FOR THE STORING AND PHYSICAL TRANSFER OF ADS DATA IS NEEDED
  - MAGNETIC TAPE
  - ROTATING MAGNETIC MEDIA
  - OPTICAL STORAGE MEDIA

## STANDARDS REQUIREMENTS FOR USER-SYSTEM INTERFACE - 1

- o STANDARD MAN-MACHINE INTERFACE LANGUAGE(S)  
(COMMAND LANGUAGE, MENU, CONVERSATIONAL INTER-  
ACTION, OR COMBINATION) TO
  - ESTABLISH INTERACTIONS WITH ADS
  - REQUEST HELP IN USING ADS
  - SEARCH CATALOGS OF DATA PRODUCTS AND SERVICES
  - REQUEST DATA PRODUCTS AND SERVICES
  - REQUEST ACCOUNTING AND BILLING INFORMATION
  - REPORT PROBLEMS

[USER LANGUAGE(S) TO DO ABOVE WOULD REQUIRE  
TRANSLATION PROTOCOLS FOR

- QUERY REPRESENTATION
- DBMS RESPONSE
- FILE STRUCTURES
- DATA ACCESS
- CATALOG STRUCTURES]



## STANDARDS REQUIREMENTS FOR USER-SYSTEM INTERFACE - 2

- o STANDARD DATA MANIPULATION FUNCTIONS
  - SCALING
  - SUMMING
  - COMBINING
  
- o STANDARD EDITING FUNCTIONS
  
- o STANDARD BACKUP/RECOVERY PROCEDURES
  
- o GUIDELINES FOR TERMINAL EQUIPMENT TO BE SUPPORTED BY ADS
  
- o VIRTUAL TERMINAL PROTOCOL STANDARD
  
- o USER PROCEDURE GUIDELINES

## STANDARDS REQUIREMENTS FOR TECHNICAL SERVICES - 1

- 0 STANDARDS ARE REQUIRED FOR NAMING DATA SETS, PROCESSES, AND MEMBERS WITHIN ADS
  - PROVIDE USER INTERFACE TO ADS RESOURCES
  - STANDARD FORMATS FOR INFORMATION EXCHANGE
  - ACCESSABLE BY USER LANGUAGE
  - "HELP" FUNCTION

STANDARDS REQUIREMENTS FOR  
TECHNICAL SERVICES - 2

- o STANDARD FORMAT(S) FOR LISTING ADS MEMBERS IS REQUIRED THAT WOULD LIST SUCH ITEMS AS:
  - NAME AND ADDRESS
  - TYPE OF MEMBERSHIP
  - EQUIPMENT (TERMINAL, HOST)
  - OPERATING SYSTEM
  - DBMS
  - TRAFFIC CAPACITY
  
- o SUMMARY LEVEL DATA DESCRIPTION STANDARDS ARE REQUIRED FOR DATA LOCATION
  - CONVENTIONS FOR THE EXISTENCE, LOCATION, AND USE OF REDUNDANT DATA ENTITIES
  - CONVENTIONS FOR DATA BASE VALIDATION
  - CONVENTIONS FOR DISPLAY OF LOCATOR RESPONSES
  - STANDARD REFERENCE FRAMES (GEOGRAPHICAL & TEMPORAL)

STANDARDS REQUIREMENTS FOR  
TECHNICAL SERVICES - 3

O STANDARD FORMATS ARE REQUIRED FOR LISTING SYSTEM  
RESOURCES

- APPLICATIONS SOFTWARE PACKAGES

- . SOURCE
- . DOCUMENTATION
- . PROCESS RESIDENCE

- COMPUTATIONAL FACILITIES

- . LOCATION
- . CAPABILITIES/RESOURCES
- . AVAILABILITY
- . CHARGES
- . EQUIPMENT

- SYSTEM SERVICES

O STANDARDS ARE REQUIRED FOR UPDATING, ADDING, AND  
DELETING INFORMATION ENTITIES

- DATA
- MEMBERS
- SYSTEM RESOURCES

## STANDARDS REQUIREMENTS FOR DATA TRANSFER SERVICES - 1

- o STANDARDS ARE REQUIRED TO FACILITATE THE TRANSFER OF DATA THROUGHOUT THE ADS NETWORK
  - PHYSICAL INTERCONNECTION OF DISSIMILAR SYSTEMS
  - RULES AND PROCEDURES FOR TRANSMITTING DATA ACROSS THE INTERCONNECTION OF DISSIMILAR SYSTEMS
  
- o ISO REFERENCE MODEL FOR OPEN SYSTEM INTERCONNECTION (ISO/TC97/SC16 N227) PROVIDES A FRAMEWORK FOR DEFINING THESE STANDARDS

## STANDARDS REQUIREMENTS FOR DATA TRANSFER SERVICES - 2

O INTERCONNECTION STANDARDS ARE REQUIRED FOR PHYSICAL INTERFACE AND THE METHODOLOGIES, CONTROL PROCEDURES, AND RULES WHICH ALLOW DATA INTERCHANGE, SOME EXAMPLES ARE:

- DATA LINK CHARACTERISTICS
  - . SPEED
  - . ERROR RATE
  
- TRANSMISSION CHARACTERISTICS
  - . HALF OR FULL DUPLEX
  - . SYNCHRONOUS OR ASYNCHRONOUS
  
- DATA ORIENTATION
  - . LINE ORIENTED
  - . CHARACTER (BYTE) ORIENTED
  - . BIT ORIENTED
  - . PACKET ORIENTED
  
- DATA CODES
  - . ASCII
  - . EBCDIC
  
- ERROR CONTROL
  - . REDUNDANCY
  - . PARITY
  - . CYCLICAL REDUNDANCY CHECK

- TERMINAL CHARACTERISTICS

- . SPEEDS
- . CODES
- . COUPLING (DIRECT, MODERN, OR ACOUSTIC)
- . BUFFERING AND ERROR CONTROL

## STANDARDS REQUIREMENTS FOR DATA TRANSFER SERVICES - 3

O STANDARD INTERFACES ARE REQUIRED FOR THE TRANSFER OF FILES AMONG MEMBER NODES OF ADS NETWORK.

- FILES INCLUDE:

- . DATA SETS
- . INFORMATION ABOUT DATA SETS
- . GENERAL OF SYSTEMS INFORMATION
- . MESSAGES/QUERIES
- . APPLICATIONS SOFTWARE

- MEMBER NODES MAY INCLUDE:

- . INDIVIDUALS
- . FACILITIES
- . PROCESSES
- . DATA

- TRANSFER CAN BE:

- . PHYSICAL
- . ELECTRONIC (MANY DEGREES OF TRANSPARENCY)



## STANDARDS REQUIREMENTS FOR DATA TRANSFER SERVICES - 4

- o ISO/OSI MODEL REQUIRES THAT STANDARDS BE DEFINED  
IN TWO AREAS
  - STANDARD ADS SERVICES HAVE TO BE DEFINED  
FOR EACH OF THE MODEL'S LAYERS
    - . FUNCTIONS TO BE PERFORMED IN EACH LAYER
    - . PRIMITIVES (REQUEST AND RESPONSES) TO BE  
PASSED BETWEEN LAYERS
    - . PARAMETER INFORMATION REQUIRED TO SUPPORT  
SERVICES
  - STANDARD PEER PROTOCOLS ARE REQUIRED TO PROVIDE  
NECESSARY PROCEDURES FOR THE FUNCTIONAL UNITS  
WITHIN A SPECIFIC LAYER, BUT DISTRIBUTED  
THROUGHOUT THE NETWORK, TO INTERACT WITH EACH  
OTHER AND EXCHANGE INFORMATION

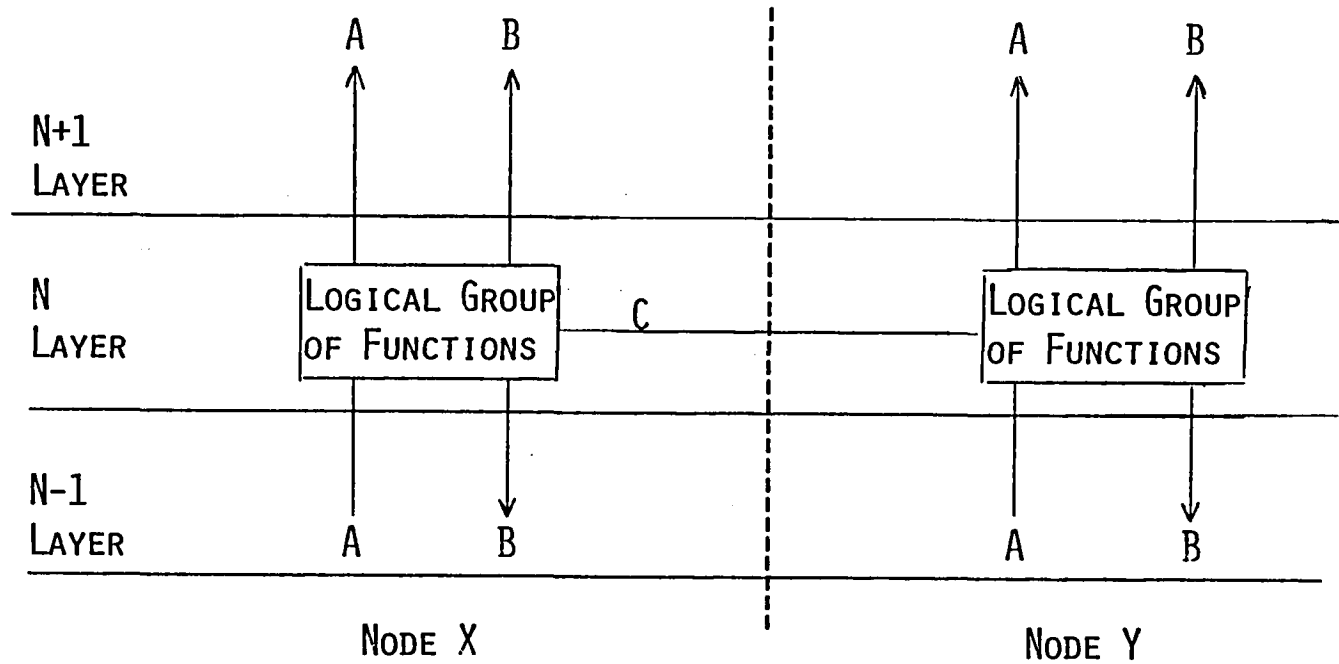

A = LAYER SERVICES  
 B = PRIMITIVES / PARAMETERS  
 C = PEER PROTOCOL

- o EXCHANGE OF PRIMITIVES AND PARAMETERS SUPPORT SERVICES PROVIDED BY A LAYER TO ITS NEXT HIGHER LAYER
- o PEER PROTOCOLS HANDLE INTERACTION BETWEEN UNITS OF THE SAME LAYER

# OSI LAYER CHARACTERISTICS - 1

## PHYSICAL LAYER

### o TYPE OF SERVICES PROVIDED

- PHYSICAL CONNECTION
- DATA UNIT TRANSMISSION
- FAULT CONDITION NOTIFICATION

### o TYPE OF FUNCTIONS PERFORMED

- ACTIVATION
- DEACTIVATION
- UPWARD MULTIPLEXING
- FAULT DETECTION

### o PRIMITIVE / PARAMETER EXAMPLES

- CONNECTION REQUEST
- CONNECTION INDICATION
- FAULT INDICATION / NATURE OF FAULT

## OSI LAYER CHARACTERISTICS - 2

### O REPRESENTATIVE PROTOCOLS

- EIA RS-232-C
- EIA RS-449
- CCITT X.21

## OSI LAYER CHARACTERISTICS - 3

### DATA LINK LAYER

- 0 TYPE OF SERVICES PROVIDED
  - ACTIVATE, MAINTAIN, DEACTIVATE DATA LINKS
  - FRAME SYNCHRONIZATION
  - ERROR DETECTION AND RECOVERY
  
- 0 TYPE OF FUNCTIONS PERFORMED
  - DATA LINK ESTABLISHMENT
  - DATA UNIT TRANSFER
  - ERROR NOTIFICATION
  - FLOW CONTROL
  - DOWNWARD MULTIPLEXING

## OSI LAYER CHARACTERISTICS - 4

### o PRIMITIVE / PARAMETER EXAMPLES

- ESTABLISHMENT REQUEST / ADDRESS, FACILITY, CLASS OF SERVICE
- RESET REQUEST
- RECALL REQUEST / CHANGE CONNECTION PARAMETERS

### o REPRESENTATIVE PROTOCOLS

- CHARACTER-ORIENTED
  - . ISO 1745 AND ANSI X3.28
  - . IBM BINARY SYNCHRONYMS COMMUNICATIONS PROTOCOL (BSC)
- BIT-ORIENTED
  - . ISO HIGH LEVEL DATA-LINK CONTROL (HDLC)
  - . ANSI ADVANCED DATA COMMUNICATIONS CONTROL PROCEDURE (ADCCP)
- OTHERS
  - . LAP/LAP-B PORTION OF ANSI X.25
  - . IBM SYNCHRONOUS DATA LINK CONTROL (SDLC)

## OSI LAYER CHARACTERISTICS - 5

### NETWORK LAYER

- o TYPE OF SERVICES PROVIDED
  - NETWORK CONNECTION
  - CONNECTION ENDPOINT IDENTIFICATION
  - ERROR NOTIFICATION
  - SEQUENCE CONTROL (OPTIMAL)
  - DATA UNIT DELIVERY CONFIRMATION
  
- o TYPE OF FUNCTIONS PERFORMED
  - ROUTING AND SWITCHING
  - RESET
  - TERMINATION
  - RECALL
  - UPWARD MULTIPLEXING

## OSI LAYER CHARACTERISTICS - 6

- SEGMENTING AND BLOCKING
- ERROR DETECTION
- ERROR RECOVERY
- MAPPING NETWORK ADDRESSES WITH THE TRANSPORT ADDRESSES
- RESOURCE MANAGEMENT
- RELAYING (TRANSPARENT FORWARDING OF DATA UNITS FROM ONE NETWORK ENTITY TO ANOTHER)

### o PRIMITIVE / PARAMETER EXAMPLES

- ESTABLISHMENT REQUEST / ADDRESS, FACILITY CLASS OF SERVICE
- RESET REQUEST
- RECALL REQUEST / NETWORK CONNECTION PARAMETERS

### o REPRESENTATIVE PROTOCOLS

- CCITT X.25 (PACKET SWITCHED)
- CCITT X.21 (SYNCHRONOUS CIRCUIT SWITCHED)
- CCITT .20 (ASYNCHRONOUS PUBLIC DATA NET)
- RS-366-A (AUTO-CALLING FOR TELEPHONE)



## OSI LAYER CHARACTERISTICS - 7

### TRANSPORT LAYER

- o TYPE OF SERVICES PROVIDED
  - CONNECTION ESTABLISHMENT
  - DATA TRANSFER
  - FLOW CONTROL
  
- o TYPE OF FUNCTIONS PERFORMED
  - SELECTING APPROPRIATE NETWORK SERVICE
  - MULTIPLEXING TRANSPORT CONNECTIONS
  - ESTABLISHING AN OPTIMUM DATA UNIT SIZE
  - MAPPING TRANSPORT ADDRESSES ONTO THE NETWORK
  - DETECTING ERRORS IN RECEIVED DATA
  - BYPASSING FLOW CONTROL FOR EXPEDITED DATA
  - PURGING DATA TO FACILITATE RECOVERY

## OSI LAYER CHARACTERISTICS - 8

### 0 PRIMITIVE / PARAMETER EXAMPLES

- CONNECTION REQUEST / CALLING & CALLED ADDRESSES, REQUIRED FACILITIES, QUALITY OF SERVICE
- CLEAR INDICATION / NETWORK FAILURE

### 0 REPRESENTATIVE PROTOCOLS

- CCITT RECOMMENDATION S.70 (TELETAX)
- ARPA TRANSMISSION CONTROL PROTOCOL (TCP VERSION 4)

## OSI LAYER CHARACTERISTICS - 9

### SESSION LAYER

#### 0 TYPE OF SERVICES PROVIDED

- SESSION ESTABLISHMENT
- SESSION MANAGEMENT
- USER DATA EXCHANGE
- DATA QUARANTINE (RESTRICTION OF WHICH DATA ARE SENT OR RECEIVED)
- INTERACTION MANAGEMENT

## OSI LAYER CHARACTERISTICS - 10

### o TYPE OF FUNCTIONS PERFORMED

- BIND PRESENTATION ENTITIES INTO A COOPERATING RELATIONSHIP
- ENABLE PRESENTATION ENTITIES TO DETERMINE UNIQUE VALUES OF OPERATING PARAMETERS
- SUPPORT TRANSFER OF UNIT OF DATA
- YIELDS CONTROL OF DATA UNIT TO SENDING PRESENTATION ENTITY
- PROVIDES DIALOG CONTROL USED TO ESTABLISH 2-WAY SIMULTANEOUS INTERACTION, 2-WAY ALTERNATE INTERACTION, OR 1-WAY INTERACTION
- MAPPING SESSION CONNECTIONS INTO TRANSPORT CONNECTIONS
- FLOW CONTROL
- CONNECTION RECOVERY

### o PRIMITIVES / PARAMETERS NOT WELL DEFINED

### o REPRESENTATIVE PROTOCOLS

- BELL SYSTEM'S VERSION OF X.25 (BX.25) WHICH DESCRIBES A SESSION LAYER PROTOCOL TO WORK WITH X.25 NETWORK SERVICES.

## OSI LAYER CHARACTERISTICS - 11

### PRESENTATION LAYER

#### 0 TYPE OF SERVICES PROVIDED

- DATA TRANSFORMATION: CODE AND CHARACTER SET TRANSLATIONS
- INFORMATION FORMATTING: MODIFICATION OF DATA LAYOUT
- SYNTAX SELECTION: INITIAL SELECTIONS AND SUBSEQUENT MODIFICATION OF THE TRANSFORMATIONS AND FORMATS USED

#### 0 TYPE OF FUNCTIONS PERFORMED

- PRESENTATION-SERVICE ESTABLISHMENT
- SERVICE INITIALIZATION
- IMAGE NEGOTIATION (DETERMINE NECESSARY CONVERSION)
- INFORMATION TRANSFORMATION AND FORMATTING
- PRESENTATION-SERVICE RELEASE

#### 0 PRIMITIVE / PARAMETER EXAMPLE

- PRESENTATION CONNECTION REQUEST / CODE, FORMAT

## OSI LAYER CHARACTERISTICS - 12

### 0 TYPE OF PROTOCOLS UNDER DEVELOPMENT

- VIRTUAL TERMINAL PROTOCOL
  - . HANDLE A NUMBER OF TERMINAL CLASSES AND PARAMETER PROFILES TO ACCOMMODATE DIFFERENT APPLICATIONS
- VIRTUAL FILE PROTOCOL
  - . FORMATTING OF FILE-STORE COMMANDS
  - . COMMUNICATION OF FILE INFORMATION
  - . CODE CONVERSION
- JOB TRANSFER AND MANIPULATION PROTOCOL
  - . CONTROL OF RECORD STRUCTURES AND RELATED DEVICES
  - . COMMAND FORMATTING
  - . DATA FORMATTING

## OSI LAYER CHARACTERISTICS - 13

### APPLICATION LAYER

#### 0 TYPE OF SERVICES PROVIDED

- IDENTIFICATION OF INTENDED COMMUNICATIONS PARTNERS
- AGREEMENT ON PRIVACY MECHANISMS
- AUTHENTICATION OF INTENDED COMMICANTS
- DETERMINATION OF COST OF ALLOCATION METHODOLOGY
- DETERMINATION OF ADEQUACY OF REQUIRED RESOURCES
- DETERMINATION OF THE ACCEPTABLE QUALITY OF SERVICE
- AGREEMENT ON RESPONSIBILITY FOR ERROR RECOVERY
- INFORMATION TRANSFER

#### 0 TYPE OF FUNCTIONS PERFORMED

- INITIATION OF THE INTERCONNECTION
- TERMINATION OF THE INTERCONNECTION
- SYNCHRONIZATION
- COMMITMENT OF RESOURCES
- TASKING
- INFORMATION TRANSFER

## OSI LAYER CHARACTERISTICS - 14

- o PRIMITIVES ARE UNDEFINED
- o TYPE OF PROTOCOLS TO BE DEVELOPED
  - SYSTEM MANAGEMENT
    - . ACTIVATION/DEACTIVATION MANAGEMENT
    - . MONITORING
    - . ERROR CONTROL
    - . RECOVERY
  - APPLICATIONS MANAGEMENT
    - . AUTHENTICATION
    - . ACCESS CONTROL
    - . ACCOUNTING
    - . DEADLOCK RECOVERY
    - . COMMITMENT
  - USER APPLICATION
    - . REMOTE JOB ENTRY
    - . SUBPROCESS SELECTION
    - . FILE ACCESS
    - . (ADDITIONAL USER SPECIFIC)



## CONCLUSIONS - 1

- o REQUIREMENTS OF PILOTS FOR STANDARDS REFLECT THE FUNCTIONAL PRIORITIES AND SCOPE OF EACH PILOT
  - PADS IS CURRENTLY DEALING WITH THE INTERCONNECTION OF DISSIMILAR OPERATING SYSTEMS AND DBMSs TO PROVIDE ACCESS TO DISTRIBUTED ATMOSPHERIC DATA AND CATALOGS
  - OPS PRESENT EMPHASIS IS ON THE MANAGEMENT OF OCEANIC DATA AND PROVIDING ACCESS TO THESE LARGE GEOREFERENCED DATA BASES TO REMOTE USERS
  - ERP IS DEALING PRIMARILY WITH THE CATALOGING AND PROVISION OF THE WIDE VARIETY OF DATA ASSOCIATED WITH EARTH RESOURCES (LANDSAT IMAGERY, METEOROLOGICAL DATA, CROP STATISTICS) AND THE DEVELOPMENT OF TECHNIQUES FOR MULTI-TEMPORAL/MULTI-SENSOR DATA CORRELATION

## CONCLUSIONS - 2

### CSC / PADS STANDARDS REQUIREMENTS

- o ADS STANDARD DATA SET DESCRIPTOR LANGUAGE
- o ADS TRANSMISSION DATA FORMAT
- o ADS DATA UNITS STANDARD
- o ADS DATA LABELS STANDARDS
- o ADS DATA ORGANIZATION STANDARDS
- o DATA QUALITY STATUS
- o STANDARD FOR DBMS CALL YIELDING ATTRIBUTE SET/  
STRUCTURE INFORMATION
- o ADS STANDARD QUERY LANGUAGE
  - OPERATOR INTERFACE
  - REQUEST TRANSMISSION
  - DBMS INTERFACE
- o ADS DATA MANIPULATION LANGUAGE
- o ADS DATA SECURITY SPECIFICATIONS
- o ADS INTERPROCESSOR COMMAND/STATUS MESSAGE FORMAT
- o DIRECTORY ENTRY FORMAT
- o MAN-MACHINE INTERFACE

## CONCLUSIONS - 3

### OCEAN PILOT SYSTEM STANDARDS REQUIREMENTS

- O CATALOGING AND DIRECTORY STANDARDS
  - TERMINOLOGY
- O COMMUNICATIONS PROTOCOLS
- O DATA STRUCTURES
- O DATA DEFINITION
  - DATA ELEMENT DICTIONARY
  - DBA FUNCTION
- O SOFTWARE TRANSPORTABILITY
  - TAE, VICAR
- O ADS SYSTEM/NETWORK CHARACTERISTICS
  - DISTRIBUTION OF DATA
  - DATA TO BE SHARED
  - STANDARDS FOR USER INTERFACE

## CONCLUSIONS - 4

### EARTH RESOURCES PILOT STANDARDS REQUIREMENTS

- o GLOBAL DATA DIRECTORY
  - FORMAT AND STRUCTURE STANDARDS
  
- o ACCESS TO CATALOGS
  - DATA DESCRIPTION STANDARDS
  
- o ACCESS TO DATA
  - EXTERNAL DATA FORMAT STANDARDS
  - COMMUNICATION PROTOCOL STANDARDS
  - STANDARD INTERFACES TO
    - . OPERATING SYSTEMS
    - . DBMS
    - . USERS
  
- o STANDARDS FOR SOFTWARE TRANSPORTABILITY

## CONCLUSIONS - 5

### 0 SUGGESTED PRIORITIES FOR ADS STANDARDS DEVELOPMENT

- TERMINOLOGY
- DATA DESCRIPTION
- DATA LOCATIONS
- EXTERNAL DATA FORMAT(S)
- USER (COMMAND, QUERY) LANGUAGE
- SOFTWARE TRANSPORTABILITY
- DISSIMILAR OPERATING SYSTEM INTERFACES
- DISSIMILAR DBMS INTERFACES



APPENDIX C

OSTA/ADS STANDARDS AND GUIDELINES DEVELOPMENT PROGRAM

ADS PILOT METHODOLOGIES AS CANDIDATES FOR ADS STANDARDS

C-1

PAUL A. GIRAGOSIAN  
THE MITRE CORPORATION  
MCLEAN, VIRGINIA

OSTA/ADS DATA SYSTEMS  
STANDARDS WORKSHOP  
MAY 27, 1981  
BC-103

## PRESENTATION OUTLINE

### OBJECTIVE

TO IDENTIFY AND DOCUMENT METHODOLOGIES OF THE ADS PILOTS:

- PILOT ATMOSPHERES DATA SYSTEM (PADS)  
AT GODDARD SPACE FLIGHT CENTER (GSFC)
- EARTH RESOURCES PILOT SYSTEM (ERPS)  
AT JOHNSON SPACE CENTER (JSC)
- OCEANIC PILOT SYSTEM (OPS)  
AT JET PROPULSION LABORATORY (JPL)

METHODOLOGIES MAY SERVE AS A BASIS FOR THE INTERCONNECTION OF ADS  
PILOTS FOR DATA SHARING



OUTLINE  
(CONTINUED)

METHODOLOGY DEFINITION:

PRACTICES, CONVENTIONS, PROCEDURES, OR STANDARDS WHICH ARE UTILIZED  
IN THE DESIGN, DEVELOPMENT, AND IMPLEMENTATION OF THE PILOT SYSTEMS.

OUTLINE  
(CONTINUED)

PILOT ATMOSPHERES DATA SYSTEM (PADS)

- OVERVIEW
- PADS COMMUNICATION
  - SYSTEM OF NETWORK APPLICATION PROCESSORS (SNAP)
  - COMMUNICATION CONTROL SOFTWARE (COMM)
  - REMOTE SERVICES SUBSYSTEM (RSS)
- USER INTERFACE
- CATALOG STRUCTURE
- CATALOG INTERFACE
- COMMUNICATION FACILITY INDEPENDENCE
- SOFTWARE DEVELOPMENT METHODOLOGY
- FUTURE METHODOLOGY ENHANCEMENTS

## OUTLINE

(CONTINUED)

### EARTH RESOURCES PILOT SYSTEM (ERPS)

- OVERVIEW
- ERP COMMUNICATIONS
- USER INTERFACE
- RESEARCH, TEST & EVALUATION (RT&E) DATA BASE
  - RT&E DIRECTORY
  - RT&E CATALOG STRUCTURE
- DATA DEFINITION STRUCTURE
  - DATA PROVISIONING
  - DATA HANDLING TECHNIQUES
- FUTURE METHODOLOGY EVALUATION PROGRAMS

## OUTLINE

(CONTINUED)

### OCEANIC PILOT SYSTEM (OPS)

- OVERVIEW
- OPS COMMUNICATION
- USER INTERFACE
- DATA STRUCTURE/DEFINITION
  - STANDARD FORMAT DATA UNIT (SFDU)
  - DATA HANDLING METHODS
- CATALOG STRUCTURE
- SOFTWARE DEVELOPMENT METHODOLOGY
- FUTURE ENHANCEMENTS

### CONCLUSIONS

PILOT ATMOSPHERES DATA SYSTEM (PADS)

## PADS COMMUNICATION

- SYSTEM OF NETWORK APPLICATIONS PROCESSORS (SNAP)
- COMMUNICATIONS CONTROL SOFTWARE (COMM)
- REMOTE SERVICES SUBSYSTEM (RSS)

INITIAL CONFIGURATION OF SYSTEM OF NETWORKED APPLICATIONS PROCESSORS (SNAP)

( VISIBLE INFRARED SPIN SCAN RADIOMETER (VISSR)

ATMOSPHERE SOUNDERS (VAS) PROCESSOR

PDP - 11/70

RSX - 11M

VAS DATA MANAGEMENT SYSTEM (VASDM)

( INTEGRATED DATA BASE MANAGEMENT SYSTEM (IDBMS) PROCESSOR

VAX - 11/780

VAX/VMS

SEED

ATMOSPHERIC AND OCEANOGRAPHIC INFORMATION PROCESSING SYSTEM (AOIPS)

( PDP - 11/70

RSX - 11D

VAS DATA MANAGEMENT SYSTEM

CENTRAL COMMUNICATIONS PROCESSOR (CCP)

( PDP - 11/34

RSX - 11M

# INITIAL CONFIGURATION OF SYSTEM OF NETWORKED APPLICATIONS PROCESSORS (SNAP)

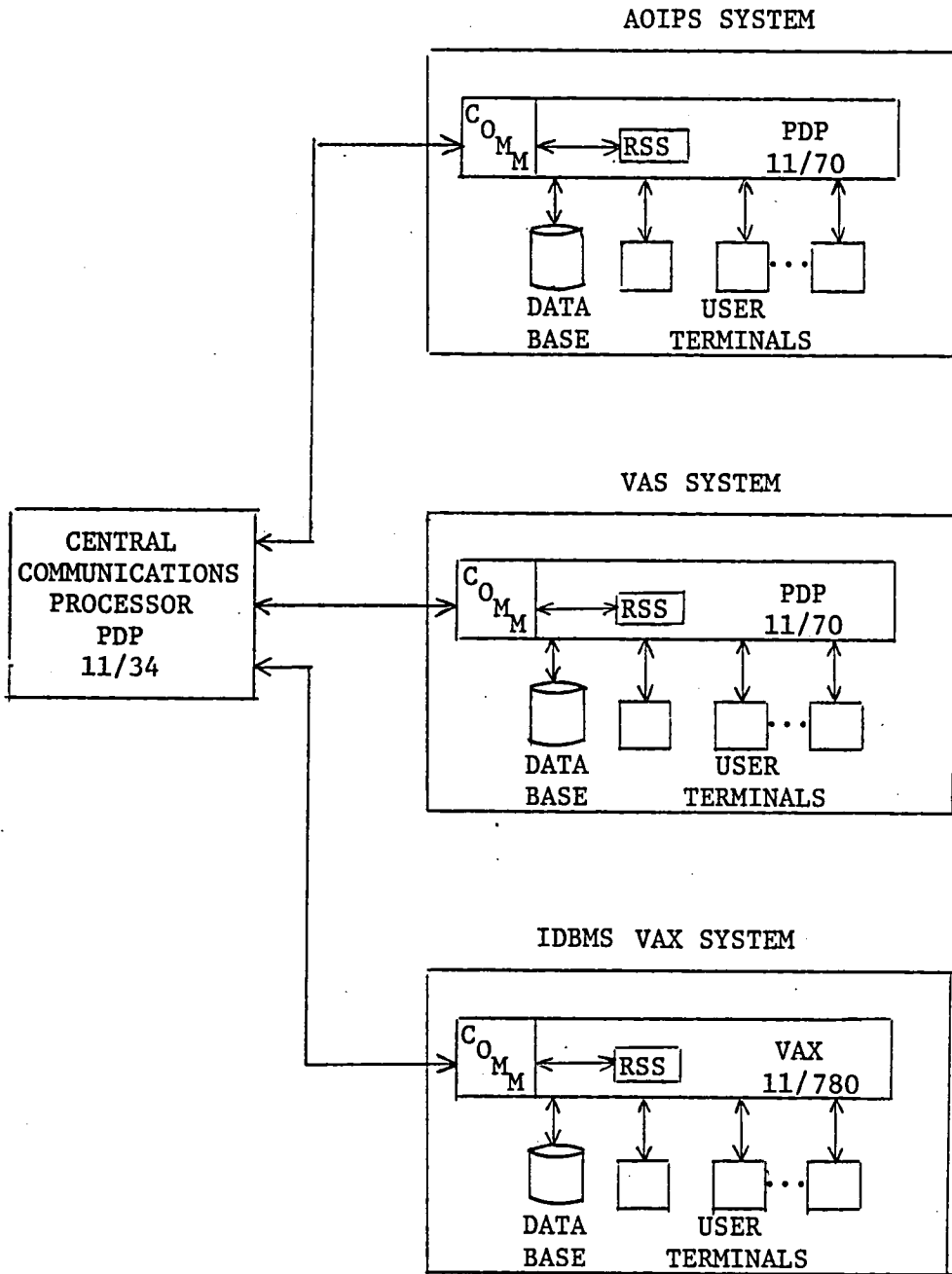



## CURRENT PADS/RSS CAPABILITIES

- LOGON/LOGOFF VIA INTERACTIVE TERMINAL
- ESTABLISH/REMOVE USER ID AND PASSWORD
- DISPLAY CATALOG INFORMATION
- MODIFY ATTRIBUTE VALUES FOR LOCAL CATALOG ENTRY
- ALLOCATE NEW CATALOG ENTRY AND ALLOCATE DISK SPACE
- COPY A CATALOGED DATA SET
- DELETE A CATALOG ENTRY AND DATA SET
- SEND MESSAGE TO OTHER LOGGED-ON USER(S)
- NETWORK STATISTICS FOR NETWORK COMMUNICATION

**PADS/RSS PROVIDES:**

- **COMMUNICATION FACILITY INDEPENDENCE**
- **USER INTERFACE**
- **CATALOG INTERFACE**

## PADS/RSS COMMUNICATION FACILITY INDEPENDENCE

- PACKET COMMUNICATIONS
- VIRTUAL CIRCUIT CONNECTION

## TRANSMISSION TYPES\*

- REQUEST FOR A DISPLAY OF PREDEFINED, COMPLETION OR ERROR MESSAGE
- REQUEST FOR DATA TRANSMISSION
- APPLICATION DATA SET
- TEMPORARY DATA SET FOR USER DISPLAY
- REMOTE SERVICE REQUEST

\*EACH TRANSMISSION TYPE HAS A UNIQUE HEADER FORMAT.

## PADS/RSS COMMUNICATION FUNCTIONS

- REQUEST VIRTUAL CIRCUIT
- RESPOND TO CONNECTION REQUEST BY VIRTUAL CIRCUIT COMPLETION.
- SEND DATA RECORD
- RECEIVE DATA RECORD
- SEND EOF
- DISCONNECT VIRTUAL CIRCUIT

PADS/RSS NETWORK SNAP COMMUNICATIONS

LAYER

7

APPLICATION

RSS

{ FILE TRANSFER  
CATALOG INTERFACE  
MESSAGE TRANSFER

6

PRESENTATION

RSS

FORMATTING SERVICE

5

SESSION

RSS

OPERATING SYSTEM INTERFACE ROUTINES

4

TRANSPORT  
END-TO-END

COMM

3

NETWORK CONTROL

COMM

2

LINK

ADCCP/DDCMP

1

PHYSICAL

RS-232C/DMC-11 COAXIAL CABLE

PADS USER INTERFACE

- USER INTERFACE IS ACCOMPLISHED VIA A MENU PROCESSOR

## PADS CATALOG STRUCTURE

### 3 LEVEL HIERARCHICAL STRUCTURE

#### FIRST LEVEL

- OSTA DATA SET DIRECTORY
  - TEST BED IMPLEMENTATION IN JUNE 1981
  - AND UTILIZING VISTA DBMS

#### SECOND LEVEL

- PILOT CLIMATE CATALOG
  - SUMMARY PART UTILIZING ORACLE DBMS
  - TEXT ACCESSED AS AN EDIT FILE
  - IMPLEMENTATION SCHEDULED FOR JULY 1981

#### THIRD LEVEL

- RSS/SNAP INVENTORIES AS DEFINED BY VAS DM/TAE DEMONSTRATION



## CATALOG INTERFACE DEFINITION

- OPEN THE CATALOG
- INSERT NEW CATALOG ENTRY
- DELETE CATALOG ENTRY
- MODIFY EXISTING ATTRIBUTE VALUES
- EXTRACT HOST SYSTEM DATA SET ID
- EXTRACT USER DEFINED NAME AND ATTRIBUTE OF CATALOGED DATA SETS
- EXTRACT MULTIPLE SETS OF CATALOG ENTRIES USING SEARCH CRITERIA (NAME QUANTIFIER)
- CLOSE CATALOG

## METHODOLOGY FOR INTERSYSTEM CATALOGING OF DATA SET ATTRIBUTES

- ATTRIBUTE MAPPING AND VALUE TRANSACTION MECHANISM NEEDED.
- PADS USES "SUPER SET" APPROACH.

# SUPERSET APPROACH

EACH SYSTEM MAPS ITS OWN  
ATTRIBUTES INTO A MASTER  
EXTERNAL SUPERSET

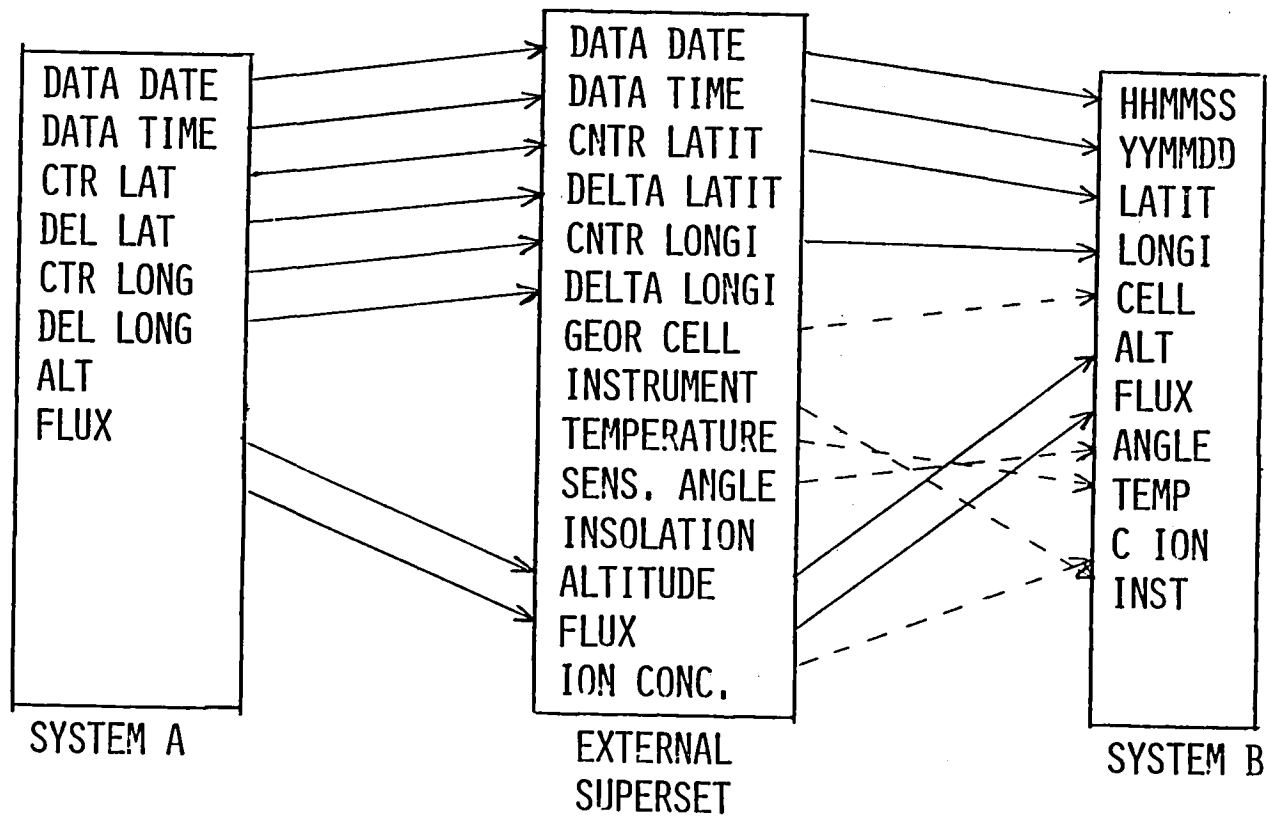

## RSS SOFTWARE DEVELOPMENT

- SOFTWARE MODULARITY
- STANDARDIZED LANGUAGE
- ISOLATION OF OPERATING SYSTEM AND CATALOG MANAGEMENT DEPENDENT ROUTINES

## RSS SOFTWARE MODULARITY

- STRUCTURED ANALYSIS
- MODULE SIZE LIMITATION
- MODULE PROLOG DOCUMENTATION

## ISOLATION OF OPERATING SYSTEM DEPENDENT ROUTINES

SYSTEM DEPENDENT CODE IS LIMITED TO:

- INTERFACE TO DISSIMILAR OPERATING SYSTEMS AND DATA CATALOGS
- ENCODE AND DECODE DATA TRANSFER PACKETS

## FUTURE METHODOLOGY ENHANCEMENTS IN THE PADS PROGRAM

- EXTEND PRESENT SNAP CONFIGURATION TO INCLUDE ADDITIONAL SYSTEMS
  - VAS ASSESSMENT PROCESSOR (VAX 11/780 OPERATING UNDER TAE)
  - GODDARD MODELING & SIMULATION FACILITY (AMDAHL 470 V/7B OPERATING UNDER VM)
  - PILOT CLIMATE DATA BASE MANAGEMENT SYSTEM (VAX 11/780)
  
- PROVIDE ADDITIONAL USER-ORIENTED SNAP CAPABILITIES
  - INTERFACE TO TESTBED CENTRAL DIRECTORY OF DATA BASES
  - INTERFACE TO OTHER CATALOGS/INVENTORIES (PCDMS)
  - CATALOG SEARCH-BY-ATTRIBUTE QUERY

## FUTURE METHODOLOGY ENHANCEMENTS IN THE PADS PROGRAM

(CONTINUED)

- UTILIZATION OF ALTERNATE NETWORK COMMUNICATIONS TECHNOLOGY
  - HYPERCHANNEL LOCAL AREA NETWORK
  - DECNET
  - PUBLIC PACKET SWITCHING NETWORK



EARTH RESOURCES PILOT SYSTEM (ERPS)

EARTH RESOURCES PILOT COMMUNICATIONS

MULTIPLE HOST:

JOHNSON SPACE  
CENTER (JSC)

{ AS/3000  
3650 COMTEN COMMUNICATIONS PROCESSOR  
VM/CMS

LABORATORY FOR  
APPLICATIONS IN  
REMOTE SENSING  
(LARS)

{ IBM 3031  
3670 COMTEN COMMUNICATIONS PROCESSOR  
VM/CMS

IBM BISYNCHRONOUS PROTOCOL

REMOTE SPOOLING AND COMMUNICATIONS SUBSYSTEM (RSCS)

TWO 9600 BAUD LINES CONNECT THE HOSTS

# EARTH RESOURCES DATA APPLICATIONS NETWORK

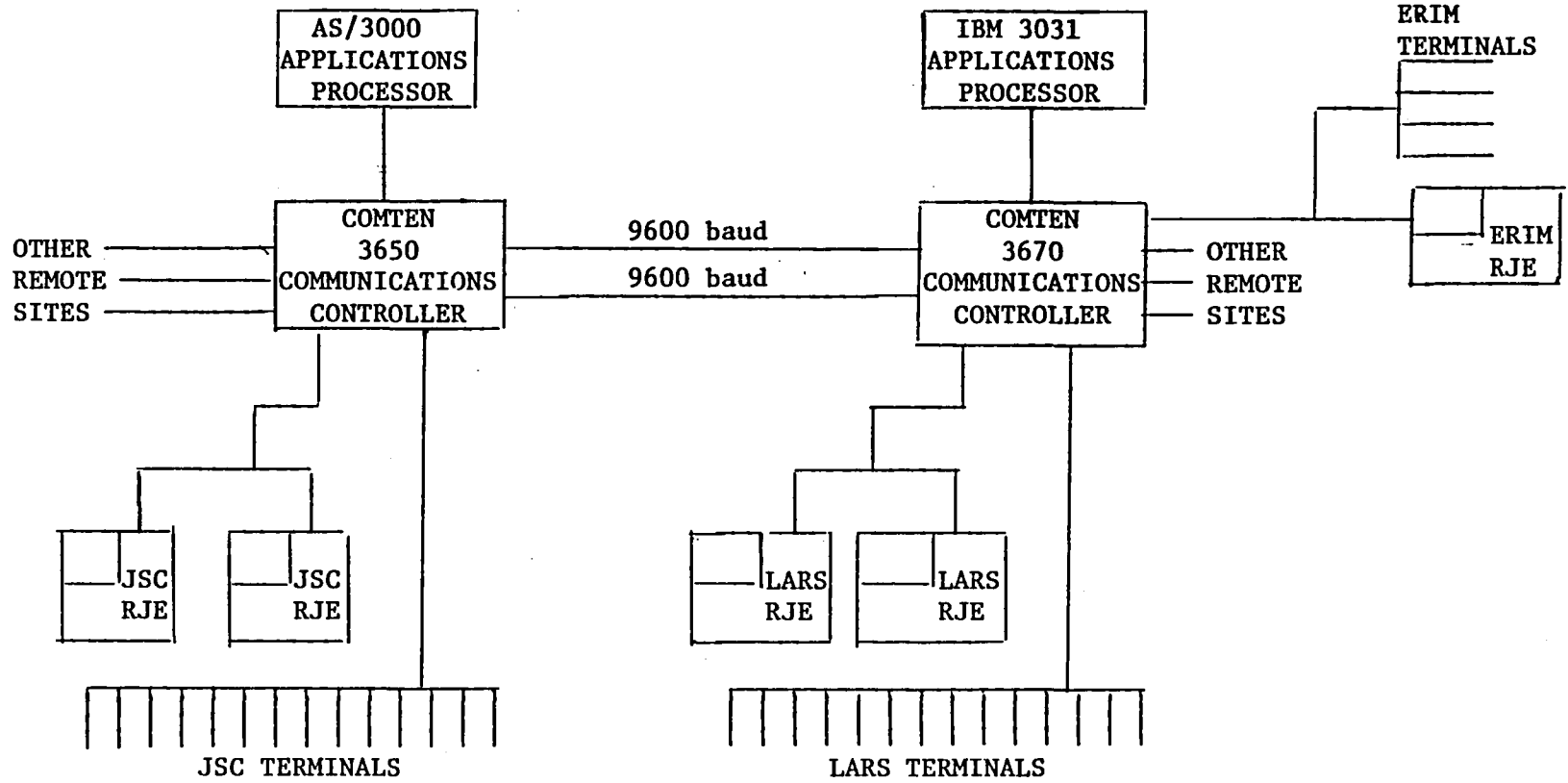

C-29

## EARTH RESOURCES USER INTERFACE

- CMS COMMAND LANGUAGE PROVIDES THE USER WITH ACCESS TO ERDANET CAPABILITIES.

## RT&E DIRECTORY FOR LANDSAT AND GROUND TRUTH DATA

- USER ACCESS: SUBSET
- USER CAN SEARCH RT&E CATALOG USING 32 DIFFERENT SELECTION CRITERIA IN ANY COMBINATION OF LOGICAL OPERATIONS. PROVISIONS HAVE BEEN MADE TO ACCOMODATE UP TO 50 DIFFERENT SEARCH PARAMETERS.
- USER IS SUPPLIED WITH SEGMENT NUMBER AND ACQUISITION DATE INFORMATION NECESSARY FOR CATALOG ACCESS.

## RT&E CATALOG STRUCTURE

### THREE LEVEL HIERARCHICAL STRUCTURE

- FIRST LEVEL PROVIDES ACCESS BY DATA TYPE AND LATITUDE AND LONGITUDE
- SECOND LEVEL PROVIDES ACCESS TO:
  - METEOROLOGICAL DATA BY BLOCK NUMBER AND STATION NUMBER
  - LANDSAT DATA BY SEGMENT NUMBER, ACQUISITION DATE AND CROP YEAR
  - GROUND TRUTH DATA BY SEGMENT NUMBER AND ACQUISITION DATE
- THIRD LEVEL PROVIDES USER WITH LOCATION OF DATA

## DATA DEFINITION/STRUCTURE

- STANDARD HEADER RECORD FORMATS FOR
  - LANDSAT
  - METEOROLOGICAL DATA

## FUTURE METHODOLOGY EVALUATION PROGRAMS

- LARS WILL SEEK TO STANDARDIZE ON FORTRAN 77 PROGRAMMING LANGUAGE.
- JSC WILL CONTINUE TO IDENTIFY AND EVALUATE MACHINE INDEPENDENT LANGUAGES SUCH AS ADA.
- EXPLORE WIDE BANDWIDTH COMMUNICATIONS METHODS TO INCLUDE SATELLITE, MICROWAVE, FIBER-OPTICS.



# OCEANIC PILOT SYSTEM (OPS)

## OCEANIC PILOT COMMUNICATIONS

- VAX/VMS DEC VAX-11/780 APPLICATIONS PROCESSOR
- RSX-11M DEC PDP-11/44 COMMUNICATIONS PROCESSOR
- PCL-11 Bus
- DECNET
- DZ-11 ASYNCHRONOUS MULTIPLEXER AUTO-ANSWER MODEM WILL SERVICE DIAL-UP TERMINALS AT 300 AND 1200 BPS.

OCEANIC CONFIGURATION

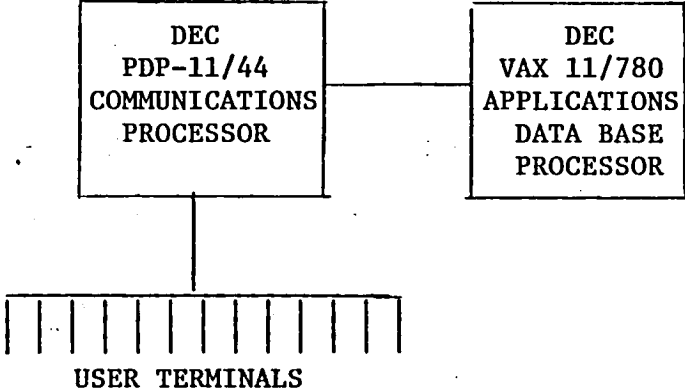

## USER INTERFACE

- MENU DRIVEN INTERFACE
- COMMAND LANGUAGE INTERFACE
- TRANSPORTABLE APPLICATIONS EXECUTIVE (TAE)
- DATA BASE QUERY PROCESSOR

## MENU PROCESSOR

- RANDOM ACCESS FILE OF MENU PAGES
  
- THREE KINDS OF MENU SUBTASKS:
  - INPUT PROMPTING
  - DISPLAY DYNAMIC SYSTEM INFORMATION
  - ACTIVATION AND SCHEDULING OF SYSTEM FUNCTIONS

## STANDARD FORMAT DATA UNIT (SFDU)

- DATA WILL BE STORED, PROCESSED, AND TRANSMITTED IN THE PROPOSED STANDARD FORMAT DATA UNIT (SFDU) STRUCTURE.

# SFDU STRUCTURE

## MESSAGE DATA UNIT (MDU)

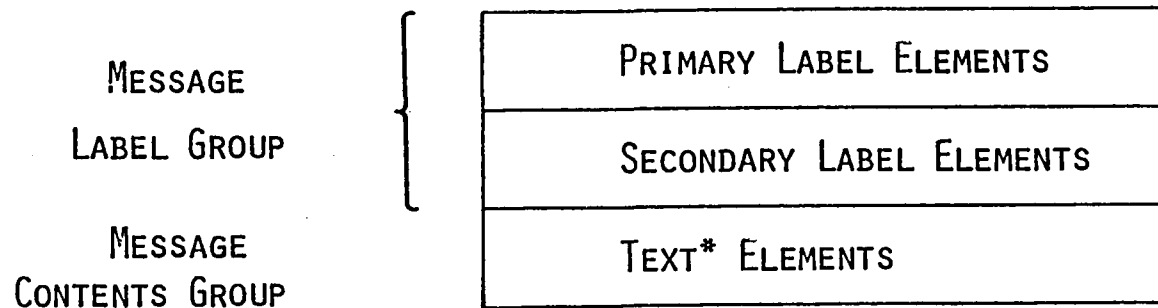

MESSAGE: SINGLE MDU

BATCH: MULTIPLE MDUs

TRANSMISSION: MULTIPLE BATCHES

\* TEXT MAY INCLUDE NUMERIC

BATCH DATA UNIT

PRIMARY  
MESSAGE DATA  
UNIT

PRIMARY LABEL

SECONDARY LABEL

TEXT

SECONDARY  
MESSAGE DATA  
UNIT #1

PRIMARY LABEL

SECONDARY LABEL

TEXT

SECONDARY  
MESSAGE DATA  
UNIT #N

PRIMARY LABEL

SECONDARY LABEL

TEXT



PRIMARY LABEL

DATA UNIT SPECIFICATION
CHARACTER SET SPECIFICATION*
DATA UNIT CONTENTS CLASSIFICATION
BATCH DATA UNIT TOTAL LENGTH*
MESSAGE DATA UNIT TOTAL LENGTH
START OF MESSAGE CONTENTS POINTER*

\* OPTIONAL

## PRIMARY LABEL STRUCTURE CHARACTERISTICS

- APPLICATIONS INDEPENDENT, GLOBAL
- PHYSICAL CHARACTERISTICS OF DATA UNIT TO INCLUDE DATA UNIT LENGTH, POINTERS TO START OF MESSAGE CONTENTS, CHARACTER SET
- ORGANIZATIONAL CONTROL
- TYPE OF DATA
- SYSTEM ELEMENT
- MEMBER WHICH CREATED OR MODIFIED DATA UNIT

# DATA UNIT SPECIFICATION

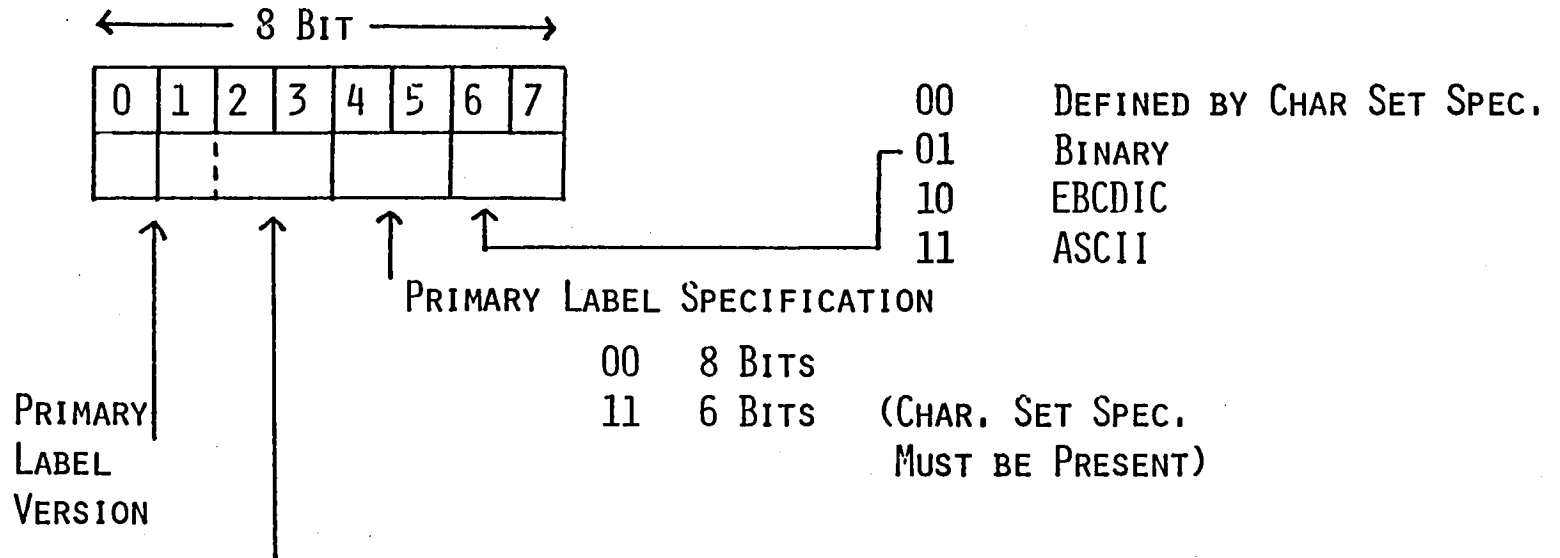

## PRIMARY LABEL SPECIFICATION

- 00    8 BITS
- 11    6 BITS    (CHAR. SET SPEC. MUST BE PRESENT)

## DATA UNIT TYPE

- 0 - MESSAGE
- 1 - BATCH (BATCH UNIT TOTAL LENGTH)
- 0 TYPE -1 (NO CONTENTS GROUP)
- 1 TYPE 2 (MESSAGE LABEL GROUP LENGTH MUST BE PRESENT)

## PRIMARY LABEL INTERPRETATION

CHARACTER SET SPECIFICATION

CHARACTER #1	CHARACTER #2
--------------	--------------

ANSI X3.4 - 1977 } ANSI WORKING PAPER  
X3.41 - 1974 } X3L5/80 - 16F

DEFINES SPECIFIC CHARACTER SET  
FOR MESSAGE LABEL GROUP

DATA UNIT CONTENTS

← 3 BYTES OR 9 CHAR. →

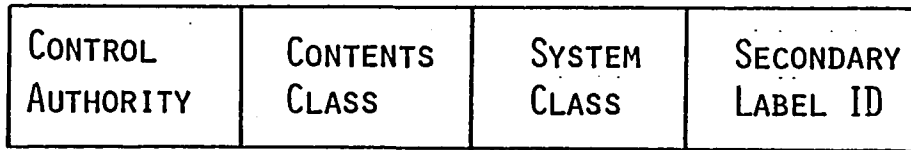

← SECONDARY LABEL IDENTIFIES  
SECONDARY LABEL STRUCTURE  
ASSOC. WITH SYSTEM CLASS.

BINARY LABEL - 7 BITS  
CHAR. LABEL - 3 CHAR.



CONTROL AUTHORITY DEFINES  
OR CONTROLS CONTENTS OF  
REMAINDER OF DATA UNIT.  
BINARY LABELS - 6 BITS  
CHAR. LABELS - 2 CHAR.

CONTENTS CLASSIFICATION  
DEFINES GROSS LOGICAL  
ASSOCIATION OF APPLICATION  
DATA.  
BINARY LABELS - 5 BITS  
CHAR. LABELS - 2 CHAR.

SYSTEM CLASS RELATES  
COMPONENT SYSTEM  
BINARY LABEL - 6 BITS  
CHAR. LABEL - 2 CHAR.

BATCH DATA UNIT TOTAL LENGTH

← 4 BYTES OR 5 CHARACTERS →



DEFINES THE OVERALL LENGTH OF THE COMPLETE BATCH DATA, STARTING AT THE FIRST BIT OF THIS ELEMENT AND INCLUDING ALL OF THE REMAINING ELEMENTS WITHIN THE PRIMARY AND SECONDARY MESSAGE DATA UNITS WHICH COMPRISE THE BATCH.

BINARY LABELS: 4 OCTETS (32 BITS) TOTAL NUMBER OF OCTETS ENCLOSED BETWEEN THE FIRST BIT OF THIS ELEMENT AND THE LAST BIT OF THE LAST MDU WITHIN THE BATCH DATA UNIT. CHAR. LABELS: 5 CHAR. (30 OR 40 BITS) TOTAL NUMBER OF CHARACTERS BETWEEN THE FIRST BIT OF THIS ELEMENT AND THE LAST BIT OF THE LAST MDU WITHIN THE BATCH DATA UNIT.

MESSAGE DATA UNIT TOTAL LENGTH

← 4 BYTES OR 5 CHARACTERS →

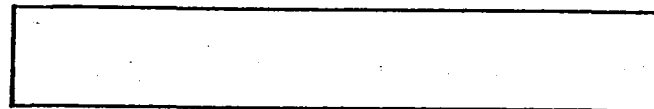

DEFINES LENGTH OF MESSAGE DATA UNIT FROM FIRST BIT OF THIS ELEMENT INCLUDING REMAINING LABELING AND TEXT ELEMENTS. IF SFDU IS A BATCH DATA UNIT, THIS FIELD DEFINES LENGTH OF PRIMARY MESSAGE DATA UNIT.

BINARY LABELS: 32 BITS - CONTAINS SUBELEMENT DENOTING NUMBER OF 8 BIT GROUPS FROM FIRST BIT OF ELEMENT TO LAST BIT OF THE MSDU. CHAR. LABELS: 5 CHAR. (30 OR 40 BITS) SHALL DEFINE TOTAL NUMBER OF CHARACTERS BETWEEN FIRST BIT OF THIS ELEMENT AND THE LAST BIT OF MESSAGE DATA UNIT.

START OF MESSAGE CONTENTS POINTER

← 16 BITS/4 CHAR. →



SPECIFIES THE NUMBER OF BYTES (OCTETS OR CHARACTERS) TO BEGINNING OF MESSAGE.

FOR BINARY LABELS, 2 OCTETS (16 BITS) AND CONTAINS BINARY QUANTITY WHICH SPECIFIES THE NUMBER OF OCTETS BETWEEN FIRST BIT OF THIS ELEMENT AND LAST BIT OF LABEL STRUCTURE AT START OF DATA UNIT CONTENTS.

FOR CHAR. LABELS 4 CHARACTERS DEFINE THE TOTAL NUMBER OF CHARACTERS BETWEEN FIRST BIT OF THIS ELEMENT AND LAST BIT OF LABEL STRUCTURE PRECEDING START OF DATA UNIT.



SECONDARY LABEL STRUCTURE

ORIGINATOR IDENTIFICATION
MODIFIER IDENTIFICATION
ANTECEDENT PROCESS IDENTIFICATION
DATA UNIT STATUS TAG
MESSAGE CONTENTS GROUP COUNTER
APPLICATIONS KEYS

TEXT OR NEXT LABEL



## SECONDARY LABEL STRUCTURE

- APPLICATION DEPENDENT
- DEFINED BY SECONDARY LABEL ID FIELD WITHIN PRIMARY LABEL
- MAY CONTAIN FIXED FORMAT TEXT ELEMENTS
- PROVIDES A WIDE VARIETY OF APPLICATION KEYING FUNCTIONS
- ACTUAL LENGTH OF ANY FIELD IS SPECIFIED BY SECONDARY LABEL IDENTIFIER
- NUMBER OF INSTANCES WITHIN ANY FIELD IS VARIABLE

## SECONDARY LABEL STRUCTURE

- ORIGINATOR IDENTIFICATION ELEMENT
  - SPECIFIC ADDRESS OF APPLICATION NODE WHICH FIRST CREATED DATA UNIT
- MODIFIER IDENTIFICATION ELEMENT
  - IDENTIFIES SPECIFIC ADDRESS WHICH LAST MODIFIED ANY COMPONENT OF THE DATA
- ANTECEDENT PROCESS IDENTIFICATION
  - IDENTIFIES AN AUDIT TRAIL WHICH COMPLETELY SPECIFIES PROCESSES WHICH HAVE BEEN APPLIED TO DATA UNIT SINCE CREATION
- DATA UNIT STATUS INDICATION ELEMENT
  - USED TO RECORD ERRORS DETECTED DURING DATA UNIT FORMATION. ALSO INDICATES SEQUENCE OF DATA SEGMENTS CONTAINED WITHIN TEXT AND TO SPECIFY CORRECTIONS TO SUBSEQUENT SECONDARY LABEL FIELDS WHICH FORM APPLICATION ACCESS KEYS FOR TEXT DATA.

## SECONDARY LABEL STRUCTURE

- MESSAGE CONTENTS GROUP COUNTER
  - DEFINES NUMBER OF STANDALONE ITEMS OF TEXT ARE INCLUDED IN THE MESSAGE CONTENTS GROUP. FOR EXAMPLE, HOW MANY SEPARATE DATA PACKETS ARE EMBEDDED WITHIN MESSAGE DATA UNIT.
  
- APPLICATION KEYS
  - PROVIDE A MECHANISM WHEREBY TEXT DATA MAY BE ASSOCIATED WITH APPLICATION DEPENDENT REFERENCE KEYS FOR CATALOG IDENTIFICATIONS AND ACCESS.

## DATA HANDLING METHODS

- MAGNETIC TAPE MEDIA
  - 9 TRACK
  - 800/1600 BPI (INITIAL CAPABILITY)
  - 1000/6250 BPI (LATER CAPABILITY)
  - HEADER RECORD FOR EACH TAPE WILL BE MODIFIED TO SFDU FORMAT
  
- DISK MEDIA
  - 1 MEGABYTE LIMITATION
  - SFDU FORMAT
  - TIME DURATION FOR ONLINE RESIDENCE

OCEANIC CATALOG INTERFACE

ONLINE CATALOG ACCESS, SEARCH, AND DISPLAY IS  
PROVIDED THROUGH MENU PROCESSOR.

## OCEANIC CATALOG STRUCTURE

### TWO LEVEL HIERARCHICAL STRUCTURE

- FIRST LEVEL CONTAINS A DESCRIPTIVE OVERVIEW OF THE DATA SET
- SECOND LEVEL PROVIDES THE DATA SET LOCATION

## OCEANIC PILOT CATALOG PRELIMINARY DESIGN

- CATALOG FEATURES
  - DATA SET NAME
  - DATA SET COVERAGE
  - DATA SET SIZE
  - GEOPHYSICAL PARAMETERS
  - SAMPLING FREQUENCY
  - DATA SET RESIDENCE



## SOFTWARE DEVELOPMENT METHODOLOGIES

- STRUCTURED ANALYSIS
- TOP DOWN DEVELOPMENT
- MODULAR DESIGN
- STANDARD LANGUAGE
- DOCUMENTATION AND CODING STANDARDS

## OCEANIC FUTURE ENHANCEMENTS

- COMMAND LANGUAGE
- TRANSPORTABLE APPLICATIONS EXECUTIVE UTILIZATION
- DATA BASE QUERY LANGUAGE
- UTILIZATION OF HIGH TECHNOLOGY CONCEPTS
  - DIGITAL OPTICAL DISK
  - DATA COMPRESSION TECHNIQUES

## CONCLUSION

- EACH ADS PILOT EXHIBITS  
A METHODOLOGY STRENGTH  
IN DIFFERENT AREAS

## PADS METHODOLOGY STRENGTHS

- DATA COMMUNICATIONS
- USER INTERFACE
- DATA CATALOG STRUCTURE

## ERPS METHODOLOGY STRENGTHS

- DATA DEFINITION/STRUCTURE
- DATA CATALOG STRUCTURE

## OPS METHODOLOGY STRENGTHS

- DATA FORMAT
- DATA CATALOG STRUCTURE

## CONCLUSIONS

- SFDU CONCEPT PROVIDES A BASIC FRAMEWORK FOR AN OSTA/ADS STANDARD DATA FORMAT
  - OSI COMPATIBLE
  - APPLICATIONS ORIENTED
  - COMMUNICATIONS INDEPENDENT
  - SELF-DEFINING
  - PROVIDES DISTRIBUTED CONTROL
  - APPLICABLE TO ALL THREE PILOTS





## Appendix D

### OSTA/ADS Data Systems Standards Workshop - List of Reference Materials

1. "The Pilot Atmospheres Data System: Its Methodologies and General Applicability," Preliminary Draft, CSC/TM-81/6037, Computer Sciences Corporation, January 1981.
2. "The Transportable Applications Executive: A Conceptual Design," Computer Sciences Corporation, November 1980.
3. "Software Engineering Standards and Practices," Ronald W. Durachka, January 1981.
4. "Structured Programming Series. Volume VII, Addendum: Documentation Standards," AD-A016 414, IBM Federal Systems Division, April 1975.
5. "Software Acquisition Management Guidebook: Regulations, Specifications and Standards," AD-A016 401, MITRE Corporation, October 1975.
6. "Programming Language Standards," AD/A-016 771, IBM Corporation, March 1975.
7. "Telemetry Computation Branch Quality Assurance Procedures Programming and Documentation Standards," CSC/TM-76/6115, Computer Sciences Corporation, May 1976.
8. "Standards Guide for Space and Earth Sciences Computer Software," X-601-72-7 Preprint, Goddard Space Flight Center, January 1972.
9. "Federal Computer Network Protocol Standards Program: An Overview," Institute for Computer Sciences and Technology, National Bureau of Standards.
10. "Federal Information Processing Standards Publications (FIPS PUBS)," Revision, Institute for Computer Sciences and Technology, National Bureau of Standards, February 1980.
11. "Architectural Considerations for Federal Database Standards," Seymour Jeffery, Dennis Fife, Donald Deutsch and Gary Sockut, Systems and Software Division, National Bureau of Standards, December 1978.
12. "DBMS Standards: Current Status and Future Directions," Donald R. Deutsch and Eric K. Clemons.
13. "Conversion of Federal ADP Systems: A Tutorial," Joseph Collica, Mark Skall, Gloria Bolotsky, Institute for Computer Sciences and Technology, National Bureau of Standards, August 1980.
14. "Features of Network Interprocess Communication Protocols," Draft Report, ICST/HLNP-80-12, Systems and Network Architecture Division, National Bureau of Standards, September 1980.
15. "Formal Description Techniques for Network Protocols," Draft Report, ICST/HLNP-80-3, Systems and Network Architecture Division, National Bureau of Standards, June 1980.
16. "Features of the File Transfer Protocol (FTP) and the Data Presentation Protocol (DPP)," Draft Report, ICST/HLNP-80-6, Systems and Network Architecture Division, National Bureau of Standards, September 1980.
17. "Features of Internetwork Protocol," Draft Report, ICST/HLNP-80-8, Systems and Network Architecture Division, National Bureau of Standards, July 1980.

18. "Service Specification of the File Transfer Protocol (FTP) and the Data Presentation Protocol (DPP)," Draft Report, ICST/HLNP-80-9, Systems and Network Architecture Division, National Bureau of Standards, October 1980.
19. "Service Specification of an Internetwork Protocol," Draft Report, ICST/HLNP-80-11, Systems and Network Architecture Division, National Bureau of Standards, September 1980.
20. "Common Command Language Feature Analysis," Draft Report, ICST/HLNP-80-4, Systems and Network Architecture Division, National Bureau of Standards, June 1980.
21. "Specification of The Transport Protocol," Draft Report, ICST/HLNP-81-1, Systems and Network Architecture Division, National Bureau of Standards, February 1981.
22. "Features of the Transport and Session Protocols," Draft Report, ICST/HLNP-80-1, Systems and Network Architecture Division, National Bureau of Standards, March 1980.
23. "Specification of The Session Protocol," Draft Report, ICST/HLNP-81-2, Systems and Network Architecture Division, National Bureau of Standards, March, 1981.
24. "Guideline for Planning and Management of Database Applications," FIPS PUB 77, National Bureau of Standards, September 1980.
25. "Prospectus for Data Dictionary System Standard," NBSIR 80-2115, Institute for Computer Sciences and Technology, National Bureau of Standards, September 1980.
26. "Survey of Representative Scientific Database Systems," Draft, Kofi Apenyo, Jet Propulsion Laboratory, November 15, 1980.
27. "Data Management and Computation: Issues and Recommendations," Draft 7, National Academy of Sciences National Research Council, September 1980.
28. "Survey of Standards Applicable to a Data Base Management Systems," Draft, Jose L. Urena, Jet Propulsion Laboratory, November 15, 1980.
29. "Functional Requirements for an Applications Data Base Management System," Draft, Guy M. Lohman, Jet Propulsion Laboratory, November 15, 1980.
30. "Software Development Plan for NAFEC's Air Traffic Control Simulation Facility (ATCSF) Volume II: Software Development Standards," CSC/TR-79/60616, Computer Sciences Corporation, March 1980.
31. "NASA Pilot Climate Data Base Catalog," Preliminary, OAO, January 1981.
32. "Oceanic Pilot System Standard Proctices," L.A. Meredith, Jet Propulsion Laboratory, July 31, 1980.
33. "Standard Format for the Transfer of Geocoded Polygon Data," CCRS Research Report 79-3, Spacial Data Transfer Committee, December 1979.
34. "A Proposed Logical Standard for Image Data Exchange," Alicia C. Anderson, May 1980.

35. "Standardization of Computer Compatible Tape Formats for Remote Sensing Data," Valerie L. Thomas and Florian E. Guertin.
36. "User Computer Compatible Tape (CCT) Format Family Requirements," CCB-CCT-0001A, October 16, 1978.
37. "Landsat-D User CCT Tape Format," FOR-LSD-0001 A, August 28, 1979.
38. "The CCT Family of Tape Formats," CCB-CCT-0002 A, August 28, 1979.
39. "EDIS Data Dictionary System, Version I User's Guide," Environmental Data and Information Service, NOAA, June 1980.
40. "Aerospace Data Systems Standards," X-560-63-Z, Goddard Space Flight Center, January, 1963.
41. "NASA End-to-End Data System (NEEDS) Guidelines for Data Communications Standards; Packet Telemetry," Needs Modular Data Transport System Team, January 30, 1981.
42. "Applications Data Service (ADS) Study Report," R.F. desJardins, NASA/Goddard Space Flight Center, May 1981.
43. "OSTA Data Systems Planning Workshop Report," R.F. desJardins, NASA/Goddard Space Flight Center, May 1981.
44. "Survey of Federal, National, and International Standards Applicable to the NASA Applications Data Service," T. Kuch and R. Sakamoto, NASA Contract Report 166675, NASA, March 1981.
45. "Data Processing - Open Systems Interconnection - Basic Reference Model," 7498, International Standards Organization, December 3, 1980.
46. "Guidelines for the Organization and Representation of Data Elements for Data Interchange," 7352, International Standards Organization, November, 1980.
47. "Overview and Status of the ISO/ANSI Reference Model of Open Systems Interconnection," Richard desJardins, NASA/Goddard Space Flight Center.
48. "Multimission End-to-End Information System (EEIS) 'Standard Format Data Unit' Development Guidelines and Standards," Preliminary Review Draft, 663-11, Jet Propulsion Laboratory, January 15, 1981.
49. "An Automated Registration System," N.Y. Chu and R.L. Nugent, Lockheed, December 1980.
50. "A Case Study in Data Management in a Research and Operational Composite Environment," J.A. Wilkinson, Lockheed, December 1980.
51. "AgRISTARS Interim Catalog Ground Data Summary, Data Acquisition Year 1978," H.M. Doyle and V.L. Cook, JSC - 17120, March 1981.

52. "Lockheed Support for Detailed Data Requirements Submission," J.A. Wilkinson, JSC-17279, December 1980.
53. "Intra-GSFC Interface Control Documentation; Content And Formal Requirements," T. Chen and J. Ishikawa, MITRE Working Paper 6626, MITRE, January 18, 1980.
54. "Handbook for the Preparation of Interface Control Documentation," Thomas Chen, MITRE Technical Report MTR-4827, MITRE, September 1980.
55. "Alternative System Architectures for Data Catalogs in a Distributed Data Base Environment," Terry Kuch, May 7, 1981.
56. "Common Operating System Command Language," CODASYL, Journal of Development, September 1980.
57. "Operating System Command and Response Language - Design Criteria," ANSI, September 1980.
58. "Operating System Command and Response Language - Draft Language Specification," ANSI, April 1981.
59. "Draft Vocabulary for Use by X3H1," S.J. Mellor, University of California, February 2, 1981.
60. "Virtual Terminal Feature Analysis," Draft Report, ICST/HLNP-81-3, Systems And Network Architecture Division, National Bureau of Standards, March 1981.
61. "Specification And Analysis of Local Area Network Architecture Based on the ISO Reference Model," Draft Report, ICST/LANP-81-1, Systems & Network Architecture Division, National Bureau of Standards, April 1981.
62. "Service Specification of a Network Interprocess Communication Protocol," Draft Report, ICST/HLNP-80-15, Systems & Network Architecture Division, National Bureau of Standards, October 1980.
63. "Formal Methods for Communication Protocol Specification & Verification," Draft Report, ICST/HLNP-80-7, Systems & Network Architecture Division, National Bureau of Standards, June 1980.
64. "Coming of Age: A Long-Awaited Standard for Heterogeneous Nets," Harold C. Folts, Data Communications, January 1981.
65. "A Data Dictionary for Distributed Data Bases," Martella and Schreiber in Distributed Data Bases eds Delobel and Litwin, North-Holland, 1980.
66. "Parallel Grouped Binary Time Code for Space and Ground Applications - PB5," draft, NASA/GSFC, Aerospace Data Systems Standard 5.6, December 16, 1980.

67. "American National Standard Specification for an Information Interchange Data Descriptive File," X3L5/80-16F, Subcommittee Working Paper, March 24, 1980.
68. "The Standard Family of CCT Formats," Valerie L. Thomas and Florian E. Guertin, April 1981.
69. "Interface Control Document Between NASA Goddard Space Flight Center (GSFC) and Department of Interior EROS Data Center (EDC) for Landsat-D, Fully and Partially Processed Multispectral Scanner Computer Compatible Tape (CCT-AM/PM)," ORI, Inc., Contract NAS5-26167. April 17, 1981.
70. "Proposal for a Universal Time Code Structure and New Standard Timecode Formats," Greenberg, Hooke and MacMedan, Jet Propulsion Laboratory, June 17, 1981.
71. "Overview of Reference Model of Open Systems Interconnection," Harold C. Folts, National Communications System and Richard desJardins, Computer Technology Associates, January 29-30, 1981.
72. "Service Specification of Transport and Session Protocols," Draft Report No. ICST/HLNP-80-2 of the National Bureau of Standards Institute for Computer Sciences and Technology, Center for Computer Systems Engineering, Systems and Network Architecture Division, March 1980.



APPENDIX E

UNPUBLISHED PREWORKSHOP DOCUMENTATION





National Aeronautics and  
Space Administration



**Goddard Space Flight Center**  
Greenbelt, Maryland  
20771

Reply to Attn of: 934

**TO: Distribution**

**FROM: 934/Coordinator OSTA/ADS Data Systems Standards Workshop**

**SUBJECT: Office of Space and Terrestrial Applications/Applications  
Data Service (OSTA/ADS) Data Systems Standards Workshop**

You are cordially invited to attend the Office of Space and Terrestrial Applications/Applications Data Service (OSTA/ADS) Data Systems Standards Workshop to be held at Goddard Space Flight Center in Greenbelt, Maryland May 27-29, 1981. During the meeting, the work of the ADS Standards contractor MITRE will be reviewed and guidance and suggestions will be given for consideration in preparing the Preliminary OSTA/ADS Standards and Guidelines, planned for August publication. Related information and plans will also be shared.

The planned agenda for the workshop is enclosed. Your attention is called to the panel sessions Thursday afternoon. The purpose of the panels is to provide in-depth discussion on high priority subjects among persons with expertise in these areas. Five topics have been identified which may be superseded by issues or items of greater importance that are identified during the workshop.

The evening dinner session scheduled for Wednesday, May 27th, will feature James Burrows, Director of the Institute for Computer Science & Technology of the National Bureau of Standards. He will discuss the NBS Data Systems Standards Program.

The workshop is scheduled to begin at 9:00 a.m. Wednesday, May 27 in Building 26, Room 205, with registration beginning at 8:30. A map of the Center is enclosed for your convenience. Your name will be given to the Gatehouse for a security pass to be picked up when you enter the facility. During the conference, messages may be left for attendees at (301)344-5831.

The conference room is equipped with a viewgraph machine and screen. If you are a speaker and require any additional audio-visual equipment, please inform us as soon as possible. Presentors are asked to bring original artwork or good xerox copies of their viewgraph material in order to simplify art reproduction for the conference report.

There are no registration fees as such associated with the workshop. There will, however, be a fee of approximately \$6.00 for refreshments during the conference and at the Thursday evening panel working session. The Wednesday evening dinner session will be held at a local restaurant. Dinner tickets may be purchased at registration for approximately \$10.00.

The Systems and Applied Sciences Corporation (SASC) is assisting the sponsor in coordinating the Workshop. If you need help with transportation or reservations, or have any general logistic questions, please direct them to Ms. Linda Mason, SASC, (301)699-5400 or (800)638-0925. Questions regarding the technical program should be directed to Barbara Walton, FTS 344-9413.

Included with this letter is a list of hotels/motels in the Greenbelt area. Those individuals coming from out of town should make reservations at the hotel of their choice as soon as possible. You are also asked to fill out the enclosed form indicating your intention to attend and return it to the address below.

Ms. Linda Mason  
Conference Management  
Systems And Applied Sciences Corporation  
6811 Kenilworth Avenue  
Riverdale, Maryland 20840

Barbara Walton

Enclosures

National Aeronautics and  
Space Administration



**Goddard Space Flight Center**  
Greenbelt, Maryland  
20771

Reply to Attn of 934

**TO:** Respondents  
**FROM:** Coordinator, OSTA/ADS Data Systems Standards Workshop  
**SUBJECT:** Pre-Workshop Documentation

This pre-workshop mailing is being made to aid participants in preparing for the Office of Space and Terrestrial Applications/Applications Data Service Data Systems Standards Workshop to be held at Goddard Space Flight Center May 27-29, 1981. The theme of the workshop is "Standards Needed to Interconnect ADS Pilots for Data Sharing." The following documentation is attached:

1. OSTA/ADS Data Systems Standards Workshop - Instructions to Panels
2. OSTA/ADS Data Systems Standards Workshop - List of Reference Materials
3. Abstract and goal of each MITRE Workshop session
4. Excerpts from "Applications Data Service (ADS) Study Report"
5. Excerpts from "OSTA Data Systems Planning Workshop Report"
6. Excerpts from "Survey of Federal, National, and International Standards Applicable to the NASA Applications Data Service"
7. "Data-Processing - Open Systems Interconnection - Basic Reference Model"
8. "Guidelines for the Organization and Representation of Data Elements for Data Interchange"
9. "Overview and Status of the ISO/ANSI Reference Model of Open Systems Interconnection"
10. "Multimission End-to-End Information System (EEIS) 'Standard Format Data Unit' Development Guidelines and Standards," Preliminary Review Draft

In addition, a "library" of reference materials for use by the panels is being gathered. A list of the references which have been gathered to date is attached. Please bring any additional references to the workshop or mail to

Barbara A. Walton  
Code 934  
Goddard Space Flight Center  
Greenbelt, Maryland 20771

in time for arrival by May 26, 1981.

Please review the enclosed material prior to the meeting. Items 1 and 3, sections 6 and 10 of 4, section 13 of 5, and section 2 of 6 are especially critical for your participation. Additionally, the executive summaries of 4 and 5 provide excellent background material if you are unfamiliar with ADS. The remaining material is more specific to individual panel concerns.

Page 2

If you have any general logistic questions, please contact Linda Mason, Systems and Applied Sciences Corporation, 301-699-6279. Questions regarding the technical program should be directed to Barbara Walton at FTS 344-9413.

*Barbara C. Walton*

Barbara Walton

Enclosures

## OSTA/ADS Data Systems Standards Workshop - Instructions to Panels

The theme of this workshop, being held May 27-29, 1981, is "Standards Needed to Interconnect ADS Pilots for Data Sharing." The materials you have been sent are intended to help in your preparation for the workshop. Please try to read at least the sections mentioned in the cover memo and bring them with you to the workshop. General instructions for panels during the workshop follow.

1. Critique the MITRE representation of pilot methodologies for accuracy and completeness.
2. Identify the requirements for standards and guidelines needed in your panel's area to interconnect the ADS pilots for data sharing. Describe these requirements as separate elements and establish an orderly method for identifying and grouping the elements. (This identification method is to be used in all the following steps to track, trace, or label related information).
3. Make a preliminary assessment of the adequacy of currently identified pilot methodologies and external standards in meeting these requirements.
4. Identify any other methodologies you are aware of which may contribute to the solution to your panel's aspect of the problem.
5. Make recommendations for future work, providing descriptions and estimate of effort where possible.
6. Provide the panel's consensus on the need for a continuing working group in this area and suggest membership thereof.

Each panel will be asked to draft a short report summarizing its results. Secretarial support will be provided to facilitate this. More specific information for each panel area and additional issues to be addressed follow.

## Standards Needed to Interconnect ADS Pilots for Data Sharing

### Panel A - Catalogues, Directories, and Dictionaries

Chairman: Jose Urena, JPL - FTS 792-3428

Multiple definitions for the above terms are in current use within OSTA/ADS. Consideration needs to be made of the functional layers of information about data and the responsibilities for producing that information within the OSTA. These layers should be refined and terminology to reference each recommended in order to facilitate future communication.

## Standards Needed to Interconnect ADS Pilots for Data Sharing

### Panel B - User Interfaces

Chairman: Jim Brown, JPL - FTS 792-5109

Some of the key elements of this area are:

- (1) Dial-up procedures
- (2) Terminals (minimum, desirable, extended capability)
- (3) Common capabilities
- (4) Language interfaces (query, command, menu)
- (5) Display capabilities

Standards Needed to Interconnect ADS Pilots for Data Sharing

Panel C - Use of ISO Open Systems Interconnection - Basic Reference Model

Chairman: Ed Greene, GSFC - 344-8685

This panel will address the question of which layer(s) should be used for pilot interconnection, which protocol to use and what interfaces between higher layers are needed. More specifically, the panel is asked to come to consensus as to what each layer means within OSTA/ADS. Use of X.25, TELENET, DECNET and PADS RSS should be examined for potential impact.



**Standards Needed to Interconnect ADS Pilots for Data Sharing**

**Panel D - Data Formats and Descriptions**

**Chairman: Ed Greenberg, JPL - FTS 792-3387**

**Some of the key elements of this area are:**

- (1) Structure/organization of data sets**
- (2) Header content and format**
- (3) Character codes**
- (4) Data codes**

**Please note that data description as used by this panel is information about data required for processing data, whereas catalogs contain information required to locate data and request access.**



Appendix F

OSTA/ADS Data Systems Standards Workshop - List of Attendees

Portia W. Bachman  
Goddard Space Flight Center  
Code 934  
Greenbelt, MD 20771  
(301) 344-9415

Earl Beard  
Goddard Space Flight Center  
Code 565  
Greenbelt, MD 20771  
(301) 344-5623

William Benton  
Lockheed  
1830 NASA Road 1  
Houston, TX 77058

Richard L. Berman  
Computer Sciences Corp.  
8728 Colesville Road  
Silver Spring, MD 20910  
(301) 589-1545 x228 or x770

Manju Bewtra  
Computer Sciences Corp.  
8728 Colesville Road  
Silver Spring, MD 20910  
(301) 589-1545 x771

Joseph Bishop  
NASA HQ, Code TS  
600 Independence Ave., SW  
Washington, DC 20546  
(202) 755-2430

William Bisignani  
MITRE Corp.  
1820 Dolley Madison Blvd.  
McLean, VA 22102  
(703) 827-6806

Albert W. Bowers  
MITRE Corporation  
1820 Dolley Madison Blvd.  
McLean, VA 22102  
(703) 827-6871

Gary Brammer  
LARS  
Purdue University  
1220 Potter Drive  
West Lafayette, IN 47906  
(317) 749-2052

James W. Brown  
Jet Propulsion Laboratory  
Code 125/128  
4800 Oak Grove Drive  
Pasadena, CA 91109  
(213) 354-5109 or FTS 792-5109

Thomas Burns  
MITRE Corporation  
1820 Dolley Madison Blvd.  
McLean, VA 22102  
(703) 827-6886

James Burrows  
National Bureau of Standards  
Room A200, Building 101  
Washington, DC 20234  
(202) 921-3151

Paul Clemens  
MITRE Corporation  
1820 Dolley Madison Blvd., Rm. W665  
McLean, VA 22102  
(703) 827-6659

Christopher J. Daly  
Goddard Space Flight Center  
Code 565.1  
Greenbelt, MD 20771  
(301) 344-6605

Richard desJardins  
Computer Technology Associates  
1501 Wilson Blvd.  
Arlington, VA 22209  
(703) 841-0787

Ai C. Fang  
NASA HQ, Code ECD-4  
600 Independence Ave., SW  
Washington, DC 20546  
(202) 755-8573

Dennis Fife  
National Bureau of Standards  
Room A257, Building 225  
Washington, DC 20234  
(202) 921-3491

David Freeman  
LARS  
Purdue University  
1220 Potter Drive  
West Lafayette, IN 47906

J. Patrick Gary  
Goddard Space Flight Center  
Code 934  
Greenbelt, MD 20771  
(301) 344-6079

Paul Giragosian  
MITRE Corporation  
1820 Dolley Madison Blvd.  
McLean, VA 22102  
(703) 827-6924

Ronald C. Glaser  
Computer Sciences Corporation  
9504 Dragon Claw  
Columbia, MD 21046  
(301) 596-3946

Alan Goldfine  
National Bureau of Standards  
Washington, DC 20234

Edward Greenberg  
Jet Propulsion Laboratory  
MS 233-208  
4800 Oak Grove Drive  
Pasadena, CA 91109  
(213) 354-3387

Edward Greene  
Goddard Space Flight Center  
Code 503  
Greenbelt, MD 20771  
(301) 344-8685

Edgar M. Greville  
Computer Sciences Corporation  
8728 Colesville Road  
Silver Spring, MD 20910  
(301) 589-1545 x696

Steve Haight  
ORI, Inc.  
1400 Spring Street  
Silver Spring, MD 20910  
(301) 588-6180 x265

Larry Herath  
Goddard Space Flight Center  
Code 931.2  
Greenbelt, MD 20771  
(301) 344-9521

Adrian Hooke  
Jet Propulsion Laboratory  
4800 Oak Grove Drive  
Pasadena, CA 91109  
(213) 354-3063

David Howell  
Goddard Space Flight Center  
Code 933.1  
Greenbelt, MD 20771  
(301) 344-9041

John Johnson  
Jet Propulsion Laboratory  
Code 79-6  
4800 Oak Grove Drive  
Pasadena, CA 91109  
FTS 792-2143

Leon Jordan  
Computer Sciences Corporation  
8728 Colesville Road  
Silver Spring, MD 20910

John Kiebler  
NASA HQ, Code ECD-4  
600 Independence Ave., SW  
Washington, DC 20546  
(202) 755-8573

Stan Klein  
ORI, Inc.  
1400 Spring Street  
Silver Spring, MD 20910

Gerald M. Knaup  
Goddard Space Flight Center  
Code 934  
Greenbelt, MD 20771  
(301) 344-6034

Lou Kramer  
LARS  
Purdue University  
1220 Potter Drive  
West Lafayette, IN 47906

Terry Kuch  
MITRE Corporation  
1820 Dolley Madison Blvd., Rm. W27  
McLean, VA 22102  
(703) 827-7124

Robert R. Lovell  
NASA HQ, Code EC-4  
600 Independence Avenue, SW  
Washington, DC 20546

Merv MacMedan  
Jet Propulsion Laboratory  
Code 233-208  
4800 Oak Grove Drive  
Pasadena, CA 91109  
FTS 792-7004 or 5793

James Moulton  
National Bureau of Standards  
Room B219, Building 225  
Washington, DC 20234  
(202) 921-2601

Lawrence V. Novak  
Goddard Space Flight Center  
Code 931  
Greenbelt, MD 20771  
(301) 344-9538

William Poland  
Goddard Space Flight Center  
Code 730.4  
Greenbelt, MD 20771  
(301) 344-8592

Richard D. Sakamoto  
MITRE Corporation  
1820 Dolley Madison Blvd.  
Room W657  
McLean, VA 22102  
(703) 827-7022

Roy G. Saltman  
National Bureau of Standards  
Building 225  
Washington, DC 20234  
(202) 921-3491

Ed Schlosser  
Lockheed  
1830 NASA Road  
Houston, TX 77058

William Shaffer  
NASA HQ, Code ECD-4  
600 Independence Avenue, SW  
Washington, DC 20546

Al Skopetz  
Goddard Space Flight Center  
Code 730.4  
Greenbelt, MD 20771  
(301) 344-8593

Peter M. Smith  
Goddard Space Flight Center  
Code 931.2  
Greenbelt, MD 20771  
(301) 344-9489

Robert R. Stephens  
NASA HQ, Code TS  
600 Independence Avenue, SW  
Washington, DC 20546  
(202) 755-2430

Sam Steppel  
Computer Sciences Corporation  
8728 Colesville Road  
Silver Spring, MD 20910  
(301) 589-1545 x674

Ellen G. Stolarik  
OAO Corporation  
5050 Powder Mill Road  
Beltsville, MD 20705  
(301) 937-3090

Frank Stone  
OAO Corporation  
5050 Powder Mill Road  
Beltsville, MD 20705

David Stowell  
OAO Corporation  
5050 Powder Mill Road  
Beltsville, MD 20705

Valerie L. Thomas  
Goddard Space Flight Center  
Code 563  
Greenbelt, MD 20771  
(301) 344-5252

Jose Urena  
Jet Propulsion Laboratory  
Code 138-308  
4800 Oak Grove Drive  
Pasadena, CA 91109  
FTS 792-3428

Anthony Villasenor  
NASA HQ, Code ECD-4  
600 Independence Avenue, SW  
Washington, DC 20546  
(202) 755-8573

Barbara A. Walton  
Goddard Space Flight Center  
Code 934  
Greenbelt, MD 20771  
(301) 344-9413

Noreen Welch  
ORI, Inc.  
1400 Spring Street  
Silver Spring, MD 20910

Jim Wilkinson  
Lockheed  
1830 NASA Road  
Houston, TX 77058

Fred Wulff  
NASA HQ, Code T  
600 Independence Avenue, SW  
Washington, DC 20546  
(202) 755-2430

Frank Yap  
Computer Sciences Corporation  
8728 Colesville Road  
Silver Spring, MD 20910  
(301) 589-1545 x773

Phil Yu  
Goddard Space Flight Center  
Code 934  
Greenbelt, MD 20771  
(301) 344-9414









## BIBLIOGRAPHIC DATA SHEET

1. Report No. NASA CP-2196	2. Government Accession No.	3. Recipient's Catalog No.	
4. Title and Subtitle OFFICE OF SPACE AND TERRESTRIAL APPLICATIONS (OSTA)/APPLICATIONS DATA SERVICE (ADS) DATA SYSTEMS STANDARDS		5. Report Date December 1981	
		6. Performing Organization Code 934	
7. Author(s) Barbara A. Walton, editor		8. Performing Organization Report No.	
9. Performing Organization Name and Address Goddard Space Flight Center Greenbelt, MD 20771		10. Work Unit No.	
		11. Contract or Grant No.	
		13. Type of Report and Period Covered  Conference Publication	
12. Sponsoring Agency Name and Address National Aeronautics and Space Administration Washington, DC 20546		14. Sponsoring Agency Code	
15. Supplementary Notes			
16. Abstract This volume contains the proceedings of the Office of Space and Terrestrial Applications (OSTA)/Applications Data Service (ADS) Data Systems Standards Workshop, held May 27-29, 1981 at Goddard Space Flight Center in Greenbelt, Maryland. The purpose of the workshop was to identify standards needed to interconnect ADS pilots for data sharing, to assess current pilot methodologies, and to make recommendations for future work. The theme of the panel groups was "Standards Needed to Interconnect ADS Pilots for Data Sharing." The panel topics were: catalogs, directories, and dictionaries; user interfaces; use of ISO open systems interconnection - basic reference model; and data formats and descriptions. This document contains reports from the panels, summaries of the talks and discussions, and view-graph presentation material.			
17. Key Words (Selected by Author(s)) Applications Data Service Data Systems Standards Guidelines Data Sharing Network		18. Distribution Statement  Unlimited - Unclassified  Subject Category 14	
19. Security Classif. (of this report) Unclassified	20. Security Classif. (of this page) Unclassified	21. No. of Pages 276	22. Price* A13

\*For sale by the National Technical Information Service, Springfield, Virginia 22161.

GSFC 25-44 (10/77)



National Aeronautics and  
Space Administration

SPECIAL FOURTH CLASS MAIL  
BOOK

Postage and Fees Paid  
National Aeronautics and  
Space Administration  
NASA-451



Washington, D.C.  
20546

Official Business  
Penalty for Private Use, \$300

**NASA**

POSTMASTER: If Undeliverable (Section 158  
Postal Manual) Do Not Return

---