

## N O T I C E

THIS DOCUMENT HAS BEEN REPRODUCED FROM  
MICROFICHE. ALTHOUGH IT IS RECOGNIZED THAT  
CERTAIN PORTIONS ARE ILLEGIBLE, IT IS BEING RELEASED  
IN THE INTEREST OF MAKING AVAILABLE AS MUCH  
INFORMATION AS POSSIBLE



# Biomedical Applications Team

Applications of Aerospace Technology in Biology and Medicine

Quarterly Report April 1979—June 1979

by

Mr. R. Beadles  
Dr. H. C. Beall  
Dr. J. N. Brown, Jr.  
Dr. W. H. Clingman

Ms. D. J. Rouse  
Ms. M. W. Courtney  
Dr. M. McCartney  
Dr. R. W. Searce  
Mr. B. Wilson

RTI/1411/00-07Q

NASA Contract No. NAS1-14708

Technical Monitor: Mr. John Samos      Alternate: Ms. Sheila Ann T. Long

Technology Utilization and Applications Programs Office  
Langley Research Center  
**NATIONAL AERONAUTICS AND SPACE ADMINISTRATION**  
Hampton, Virginia 23665

RESEARCH TRIANGLE INSTITUTE, P.O. BOX 12194, RESEARCH TRIANGLE PARK, NORTH CAROLINA 27709



# Biomedical Applications Team

Applications of Aerospace Technology in Biology and Medicine

Quarterly Report April 1979—June 1979

by

Mr. R. Beadles	Ms. D. J. Rouse
Dr. H. C. Beall	Ms. M. W. Courtney
Dr. J. N. Brown, Jr.	Dr. M. McCartney
Dr. W. H. Clingman	Dr. R. W. Searce
	Mr. B. Wilson

RTI/1411/00-07Q  
NASA Contract No. NAS1-14708

Technical Monitor: Mr. John Samos      Alternate: Ms. Sheila Ann T. Long

Technology Utilization and Applications Programs Office  
Langley Research Center  
NATIONAL AERONAUTICS AND SPACE ADMINISTRATION  
Hampton, Virginia 23665

RESEARCH TRIANGLE INSTITUTE, P.O. BOX 12194, RESEARCH TRIANGLE PARK, NORTH CAROLINA 27709

## PREFACE

This report covers the activities of the Research Triangle Institute's Biomedical Applications Team for the period of 1 April 1979 through 30 June 1979. The work was performed in the Center for Technology Applications under the direction of Dr. J. N. Brown, Jr. Ms. D. J. Rouse coordinated the technical activities of the program. Other participants in the program were Dr. H. C. Beall, Dr. R. W. Searce, Dr. Michael McCartney, Mr. Robert Beadles, Mr. Blake Wilson, and Ms. M. W. Courtney. Assistance with the development of marketing strategy was provided by Dr. W. H. Clingman of W. H. Clingman and Company, Inc., a marketing and management consulting firm.

The work reported herein was supported by the National Aeronautics and Space Administration under Contract No. NAS1-14708. Mr. John Samos, Head, Technology Utilization and Applications Programs Office, Langley Research Center, was the Technical Monitor.

In order to streamline the reporting process, section of an introductory nature (e.g., team objectives or summary overview) will be omitted in this and future quarterly reports. This information will continue to be updated and included as a normal part of forthcoming annual reports.

TABLE OF CONTENTS

	<u>Page</u>
Preface . . . . .	ii
1.0 INTRODUCTION. . . . .	1
2.0 ACTIVE PROJECTS. . . . .	2
3.0 STATUS OF ACTIVE TRANSFER PROJECTS. . . . .	3
Breast Cancer Screening Technique. . . . .	3
Composite Material Applications . . . . .	7
Controlled Rate of Freezing a Liquid . . . . .	9
Female Incontinence Device . . . . .	13
Gait Analysis Data Bank. . . . .	16
Hydrocephalus Shunt. . . . .	17
Improved Optics for Vitrectomy Surgery . . . . .	19
Microliter Fluid Deliver System . . . . .	21
Neonate Thermal Control Garment. . . . .	23
Neuropathic Patient Tester . . . . .	26
New Method for Cleaning Teeth. . . . .	28
Portable Cooling System for Quadriplegics . . . . .	29
Powered Rim Control Wheelchair . . . . .	31
Pressure Transducer Calibrator . . . . .	33
Prosthetic Urinary Sphincter . . . . .	35
Teletype Test Set . . . . .	37
TTY Keyboard Tester. . . . .	40
Weight Alleviation Device . . . . .	42
4.0 NEW PROBLEMS. . . . .	44
Enhancement of Photo Images. . . . .	44
Nondigital Pseudocolor Enhancement . . . . .	45
Ophthalmic Screening Device. . . . .	47
Rotating Lens Elements . . . . .	49
5.0 TISSUE FREEZING DEVICE MARKET STUDY. . . . .	50
6.0 INACTIVATED PROJECTS. . . . .	54
High Speed DC Logarithmic Amplifier. . . . .	54
Microwave Thermography. . . . .	54
Neuroelectric Control . . . . .	54
7.0 CONFERENCES AND TRAVEL. . . . .	55

## 1.0 INTRODUCTION

The team is continuing the use of a bipolar donor-recipient model of medical technology transfer as the basis for its methodology. That methodology is designed (1) to identify medical problems and NASA technology that in combination constitute opportunities for successful medical products, (2) to obtain the early participation of industry in the transfer process, and (3) to obtain acceptance by the medical community of new medical products based on NASA technology.

The team now has 26 active projects, which are listed in section 2.0. During the second quarter of 1979 the team pursued problem solving and transfer activities on 22 of these projects. The progress of 18 of these projects is detailed in section 3.0.

Four new projects were accepted during the reporting period. Problem descriptions and activity reports are presented in section 4.0. The results of a market study conducted this quarter on the tissue freezing device are presented in section 5.0.

The team inactivated three projects in the second quarter of 1979. Discussions of these closings are presented in section 6.0.

## 2.0 ACTIVE PROJECTS

Breast Cancer Screening Technique  
Composite Material Applications  
Controlled Rate of Freezing a Liquid  
Enhancement of Photo Images  
Enhancement of X-Ray Diffraction Images  
Female Incontinence Device  
Fiber Optics for Knee Surgery  
Gait Analysis Data Bank  
Horizontal Shower  
Hydrocephalus Shunt  
Improved Optics for Vitrectomy Surgery  
Microliter Fluid Deliver System  
Neonate Thermal Control Garment

Neuropathic Patient Tester  
New Method for Cleaning Teeth  
Nondigital Pseudocolor Enhancement  
Ophthalmic Screening Device  
Portable Cooling System for Quadriplegics  
Powered Rim Control Wheelchair  
Pressure Transducer Calibrator  
Prosthetic Urinary Sphincter  
Rotating Lens Elements  
Teletype Test Set  
Tissue Viability  
TTY Keyboard Tester  
Weight Alleviation Device

### 3.0 STATUS OF ACTIVE TRANSFER PROJECTS

#### BREAST CANCER SCREENING TECHNIQUE

BA Team Personnel: Dr. Richard W. Searce, Mr. Robert Beadles

#### Problem

Breast cancer is the leading cause of cancer deaths in U.S. women. Early detection and treatment may decrease the breast cancer mortality rate, but periodic screening of 100 million women is not practical. Periodic screening of only those women likely to develop breast cancer would be possible if they could be reliably identified. Dr. John N. Wolfe of Detroit has described a risk-identification system, and several other medical groups have verified it. The technique is based on the breast's radiographic appearance and requires a radiologist to study each mammogram. However, to be useful for mass screening, the technique must be automated.

#### NASA Technology

Image processing and analysis techniques developed for analyzing images from Earth Resources Satellites are being used to identify Dr. Wolfe's cancer-risk categories automatically.

#### Principals

Mr. Robert L. Butterfield, Image Analysis Branch, Kennedy Space Center (KSC).  
Dr. Robert McLelland, Department of Radiology, Duke University Medical School, Durham, N.C.

#### Cost to NASA

KSC has submitted research and technology objectives and plans (RTOP) for \$50,000 to NASA. Anticipated National Cancer Institute (NCI) cofunding is \$50,000.

#### Commercialization Strategy

A manufacturer under contract to NCI is developing digital x-ray mammography equipment. This manufacturer will incorporate the KSC-developed software into microprocessors and will integrate the microprocessors into the mammography equipment. Units should be available within 3 years.

#### Status

Dr. McLelland and Mr. Butterfield are evaluating the feasibility of automatically identifying risk levels. Using the NASA-developed image analysis techniques, Mr. Butterfield is analyzing a test set of 40 mammograms.



Action

The RTI team will monitor the feasibility evaluation. If feasibility is demonstrated, the team will work with Mr. Butterfield and Dr. McLelland to finalize the development and commercialization strategy and to seek joint funding.

# BREAST CANCER SCREENING TECHNIQUE

- AUTOMATICALLY IDENTIFY WOMEN WHO ARE HIGH RISK FOR DEVELOPING BREAST CANCER

- DUKE UNIVERSITY MEDICAL SCHOOL, DURHAM, NORTH CAROLINA

- NASA-DEVELOPED IMAGE ANALYSIS TECHNIQUES

- DR. JOHN N. WOLFE'S BREAST CANCER RISK CLASSIFICATION TECHNIQUE

- N1 - LOWEST RISK
- P1
- P2
- DY - HIGHEST RISK

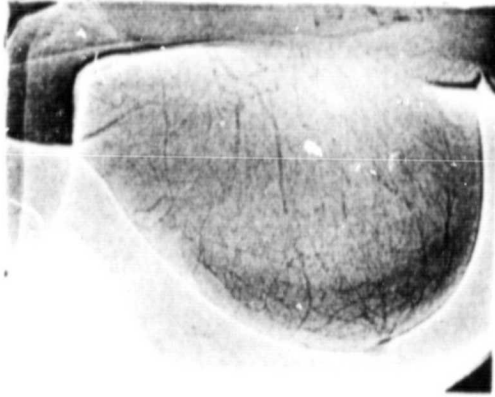

(a) N1 = NORMAL BREAST

LOW RISK



(b) P1 = SOME PROMINENT DUCT PATTERNS

MODERATE RISK

ORIGINAL PAGE IS  
OF POOR QUALITY

# BREAST CANCER SCREENING TECHNIQUE

(continued)

- AUTOMATICALLY IDENTIFY WOMEN WHO ARE HIGH RISK FOR DEVELOPING BREAST CANCER

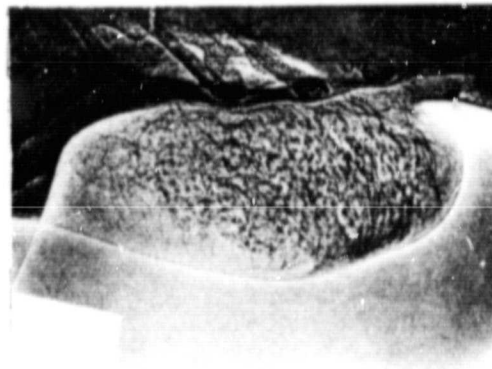

(c) P2 = SEVERE DUCT INVOLVEMENT

SIGNIFICANT RISK

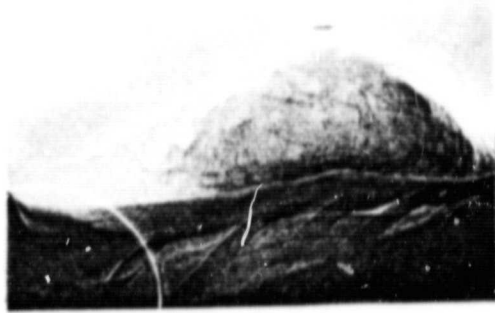

(d) DY = DENSE PARENCHYMA PATTERN

HIGHEST RISK

ORIGINAL PAGE IS  
OF POOR QUALITY

## COMPOSITE MATERIAL APPLICATIONS

BA Team Personnel: Dr. Richard W. Searce, Dr. H. Clark Beall

### Problem

NASA has demonstrated the feasibility of utilizing composite materials in orthotics to meet the need for high-strength, lightweight materials. However, to achieve widespread use of this technology, two tasks remain: (1) to identify additional appropriate applications of composites, and (2) to develop manufacturing techniques suitable for use in the orthotic shop. Mississippi Methodist Rehabilitation Center has received a contract from Langley Research Center to meet these objectives.

### NASA Technology

Composite material technology, developed to meet the space application need for lightweight and high-strength materials, is being applied to needs in rehabilitation medicine.

### Principals

Mr. Robert M. Baucom, Material Applications Branch, Langley Research Center.

Ms. Sheila T. Long, Technology Utilization Office, Langley Research Center.

Dr. Ernest Harrison, Director of Biomedical Engineering, Mississippi Methodist Rehabilitation Center, Jackson, Miss.

### Cost to NASA

This is a 3-year project funded under an RTOP for \$45,700.

### Commercialization Strategy

Working closely with Mr. Baucom, Dr. Harrison will study three manufacturing techniques (flat-plate construction, tubular construction, and injection molding) and three applications (foot plate, lightweight walker, and lightweight wheelchair). New products will be clinically evaluated. The RTI team will identify appropriate orthotic shops and will introduce the perfected manufacturing techniques and products into these shops.

### Status

In early June, Dr. Harrison accepted the task of fabricating McFadden aneurism clips from carbon composite material. Carbon clips will not interfere with CAT scans or other x-ray procedures. Dr. Harrison also visited Raleigh, N.C., to observe a new technique for forming carbon composite tubes that could be used in wheelchairs and walkers. The manufacturer will produce 21 tubes and donate them for use in the assembly of three patient walkers.

### Action

The RTI team will monitor Dr. Harrison's progress, offering assistance when necessary.

ORIGINAL PAGE IS  
OF POOR QUALITY

ORIGINAL PAGE  
COLOR

## COMPOSITE MATERIAL APPLICATIONS

- REDUCE WEIGHT OF BRACES, PROSTHETIC DEVICES, WHEELCHAIRS, WALKERS, ETC.
- SEEK MEDICAL APPLICATIONS OF NASA-DEVELOPED COMPOSITE MATERIALS AND RELATED MANUFACTURING TECHNIQUES
- MISSISSIPPI METHODIST REHABILITATION CENTER, JACKSON, MISSISSIPPI
- WEIGHT SAVINGS — AT LEAST 50%

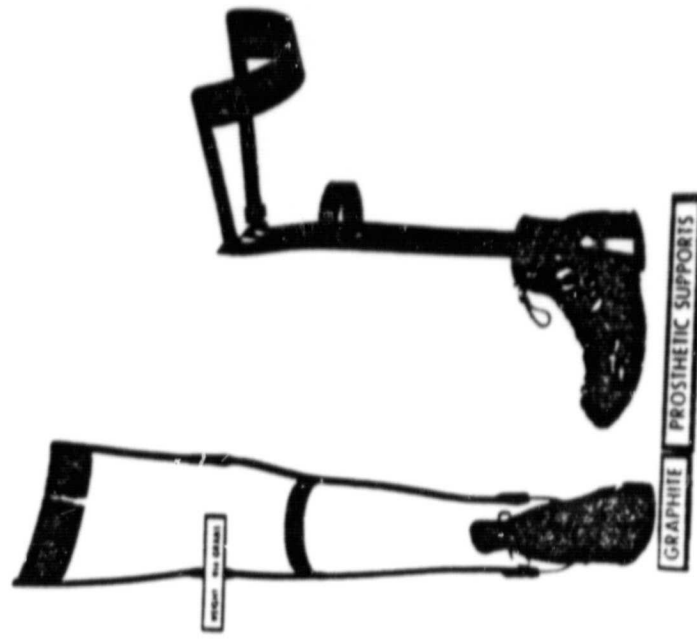

GRAPHITE EPOXY  
LONG LEG BRACE

## CONTROLLED RATE OF FREEZING A LIQUID

BATeam Personnel: Dr. Richard W. Searce, Dr. James N. Brown, Jr.

### Problem

The treatment of several forms of cancer and certain other diseases requires the infusion of large quantities of stem cells or other blood components such as red cells or white cells. To obtain the necessary quantities, the cells are collected, frozen, and stored for later use. Unfortunately, many of the cells are damaged by the traditional freezing process. Some authorities suggest that the nonlinear rate of freezing causes the damage.

### NASA Technology

Goddard Space Flight Center personnel have developed a blood-freezing unit. The Center has used computer-analysis techniques developed for such applications as ensuring the thermal balance in spacecraft.

### Principals

Mr. Thomas E. Williams and Mr. Thomas A. Cygnarowicz, Goddard Space Flight Center (GSFC), Greenbelt, Md.  
Dr. Herbert Kaizer, Johns Hopkins University Medical School, Baltimore, Md.  
Dr. W. E. Bristow, Director of Blood Bank Division, Wadley Institute, Dallas, Tex.

### Cost to NASA

Cost of development was \$700k. Additional funding may be required to explore the unit's commercial potential.

### Commercialization Strategy

Two potential markets exist. The instrument may be developed to perform freezing research, or to commercially freeze special materials such as blood. For both applications, the device requires modifications. GSFC and the RTI team are evaluating a manufacturer's proposal to develop and commercialize a laboratory instrument. A study on the commercial potential of the freezing device was conducted during this quarter and may be found in section 5 of this report.

Status

Dr. Kaizer has evaluated the freezing device and has published the results. The team has investigated a manufacturer that wishes to commercialize the device. Currently, the RTI team is working with Mr. Donald Friedman, Technology Utilization Officer at GSFC, to develop a commercialization plan. GSFC is evaluating the feasibility of lending a prototype of the NASA freezing unit to Dr. Bristow to examine the device's potential in other applications.

Action

The team will work with Mr. Friedman to finalize the commercialization plan.

## CONTROLLED RATE OF FREEZING A LIQUID

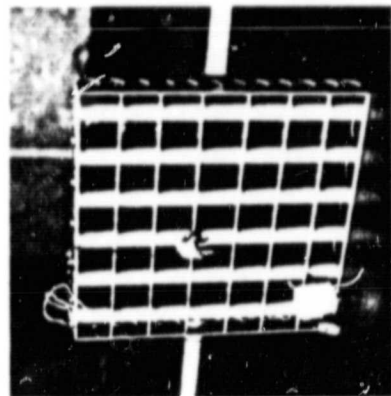

- LONG-TERM PRESERVATION OF PLATELETS, WHITE CELLS AND OTHER BLOOD COMPONENTS
- NONLINEAR FREEZING RATE IS BELIEVED TO DAMAGE THE BLOOD COMPONENTS
- APPLIED NASA-DEVELOPED THERMAL CONTROL CONCEPTS TO PRODUCE A LINEAR-FREEZING-RATE DEVICE
- NATIONAL CANCER INSTITUTE
- JOHNS HOPKINS MEDICAL SCHOOL, BALTIMORE, MARYLAND

(a) LINEAR-FREEZING-RATE SYSTEM

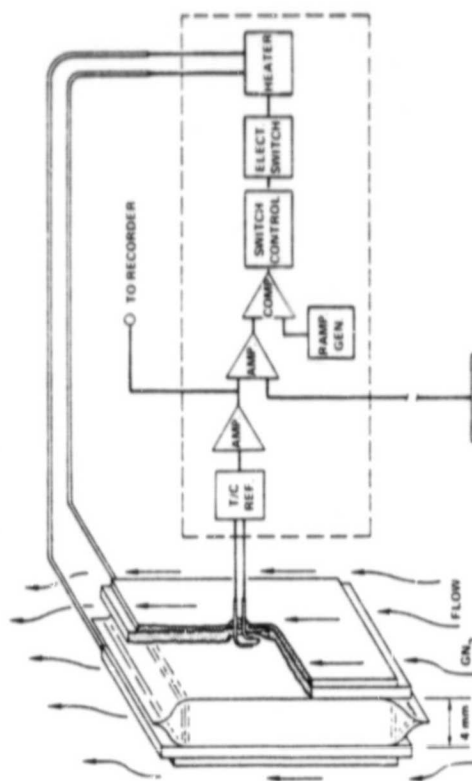

(b) SYSTEM SCHEMATIC

ORIGINAL PAGE IS  
OF POOR QUALITY



# CONTROLLED RATE OF FREEZING A LIQUID (continued)

- LINEAR-FREEZING-RATE SYSTEM

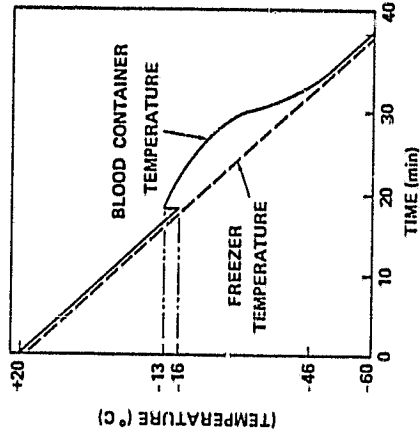

(c) BLOOD CELL NONLINEAR FREEZING RATE

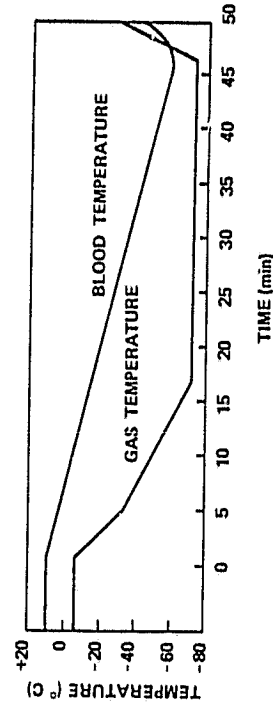

(d) WHITE CELL FREEZING CURVE FROM NASA-DEVELOPED FREEZING DEVICE

## FEMALE INCONTINENCE DEVICE

BA Team Personnel: Ms. Doris Rouse

### Problem

A roll-on latex cuff and collection bag attached to the leg are often used in the management of male urinary incontinence. This closed collection system overcomes many social and health problems resulting from exposure of the urine to the air and the skin. However, a successful closed collection system for females is not available. Urine incontinence in females must be managed by diapers, pads, or catheterization. An external urine collection device for females is needed that is leakproof, comfortable, and easy to wear, remove, and keep clean.

### NASA Technology

NASA technology in personal hygiene systems and custom molding procedures and materials has been utilized in the design and fabrication of a female external urine-collection device. The system consists of a collection element containing a urine-collection chamber and an inlet that mates to the urethral opening of the user. A drainage conduit connected to the collection chamber provides a pathway for urine flow away from the inlet. A vaginal flap prevents the entry of urine into the vagina.

### Principals

Mr. Roger Michaud, contractor, Johnson Space Center (JSC).  
Texas Institute for Rehabilitation Research (TIRR), Houston, Tex.  
Chesebrough-Ponds, Inc., Trumbull, Conn.

### Cost to NASA

NASA cost to date has been \$140,000. The Rehabilitation Services Administration and the National Institute on Aging have agreed to cofund with NASA the next evaluation phase on healthy and incontinent females. However, a transfer of this technology to a medical-device manufacturer could shift the responsibility for further evaluation to the private sector.

### Commercialization Strategy

The female incontinence device has a promising commercialization potential. A major medical-device manufacturer met at JSC in January 1979 with the RTI team and JSC personnel to review the technical aspects and patent status of the female incontinence device. This company is very interested in completing the development and evaluation of the device as a potential product if market protection is available. Market protection normally requires an exclusive patent position. Currently, there is one patent on the device. A second application, including recent modifications, has just been filed.

Status

An initial fit and function test of the device has been successfully completed on a healthy volunteer subject. The subject was able to wear the device for 12 hours as specified by the protocol with no discomfort. A second evaluation with 15 subjects at the Texas Institute for Rehabilitation Research is being considered. Chesebrough-Ponds, Inc., a major manufacturer of incontinence devices, has applied for an exclusive license for the original patent on the device. A decision on this application is expected in the next quarter.

Action

The RTI team will work with JSC and the FEMUICA Management Advisory Panel to plan the TIRR evaluation. The team will continue to monitor the transfer of the project to a manufacturer, providing assistance when necessary.

# FEMALE INCONTINENCE

- NASA PERSONAL HYGIENE SYSTEMS
- TEXAS INSTITUTE FOR REHABILITATION RESEARCH
- NONINVASIVE URINE COLLECTION FOR AMBULATORY AND BEDRIDDEN WOMEN

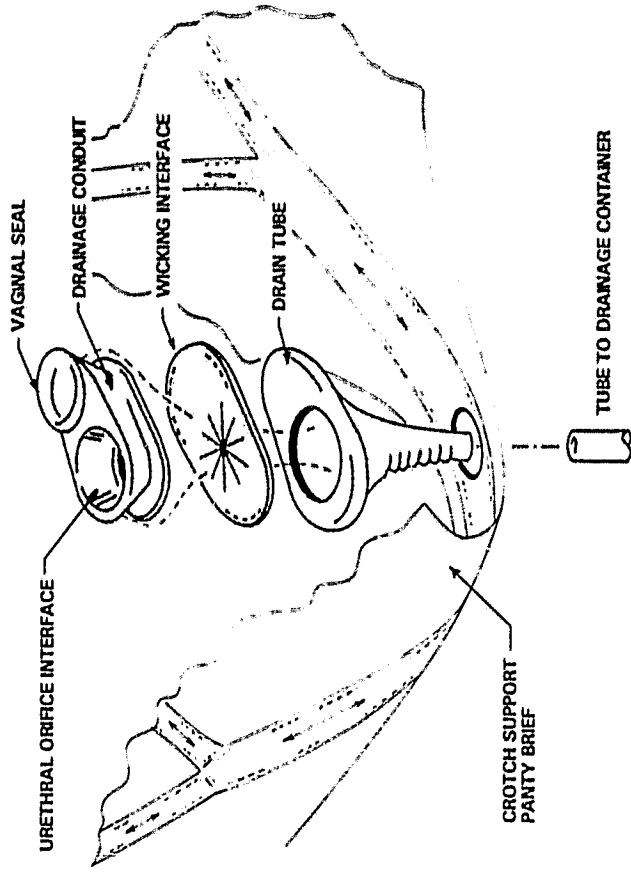

## GAIT ANALYSIS DATA BANK

BA Team Personnel: Dr. Richard W. Searce, Dr. James N. Brown, Jr.

### Problem

Technology advances are making gait analysis a more useful rehabilitation tool. For example, EMG electrodes, force plates, and motion picture cameras document gait patterns; computers rapidly analyze the large quantities of data; and graphic displays present the integrated data for study and analysis. Researchers are compiling the resulting gait-analysis records into data banks. From this growing volume of data, clinicians identify parameters that correlate with specific disease states. Use of NASA-developed data-processing, analysis, and storage techniques could speed this correlation process.

### NASA Technology

Data-processing, analysis, and storage techniques, which were developed by the Jet Propulsion Laboratory and applied in the development of the Duke Cardiovascular Data Bank, are being adopted to this gait analysis need.

### Principals

Dr. C. Frank Starmer, Division of Cardiology, Duke University Medical School, Durham, N.C.  
Dr. Sheldon R. Simon, Rehabilitation Engineering Center, The Children's Hospital Medical Center, Boston, Mass.

### Cost to NASA

None.

### Commercialization Strategy

The team has surveyed commercial groups that market computerized data-processing systems. Several of these organizations are interested in marketing specialized medical data banks. As clinical gait-analysis techniques are improved, the team will pursue this commercialization opportunity.

### Status

Dr. Simon inspected the Duke Cardiovascular Data Bank. The data storage and analysis techniques were directly applicable to his needs, but the software required some rewriting to be compatible with his data system. The rewriting will be completed in 6 months. Dr. Starmer plans to give Dr. Simon a copy of the new software, which is expected to save him years of software development effort.

### Action

The RTI team will work with Dr. Simon and Dr. Starmer to complete the transfer of technology. Dr. Simon will continue to upgrade his computer system's bulk-storage equipment.

## HYDROCEPHALUS SHUNT

BA Team Personnel: Dr. Richard W. Searce, Ms. Doris Rouse

### Problem

Hydrocephalus is a condition of abnormal enlargement of the cerebral ventricles resulting from a rise in pressure of the cerebrospinal fluid. To relieve this pressure, surgeons implant a shunt to drain the excess fluid into other cavities of the body. These shunts frequently fail because their inlet is blocked by an ingrowth of choroid plexus, or the accumulation of cellular or fibrin debris. A proposed multiended inlet catheter, with hundreds of tiny inlets formed by ion-etching techniques, could minimize this problem. The small holes would inhibit tissue ingrowth, and the multiplicity of holes would reduce the possibility of blockage.

### NASA Technology

Technology developed in NASA's Ion Propulsion Engine Program is being used to cut tiny holes in small-diameter catheters.

### Principals

Mr. Bruce A. Banks, Ion Beam Applications Section, Lewis Research Center.  
Dr. John Shillito, Department of Neurosurgery, The Children's Hospital Medical Center, Boston, Mass.

### Cost to NASA

An RTOP totaling \$123,000 was submitted in 1978. First-year funding of \$41,000 was approved. Five thousand dollars was also allocated to acquire the opinion of other medical experts before beginning the second year of the project.

### Commercialization Strategy

A manufacturer of ventricular catheters is assisting Mr. Banks. They will perform the clinical testing and market the shunt if results are favorable.

### Status

As part of the preengineering design review, Dr. Shillito visited Lewis Research Center. In his written report, he noted several catheter design problems and suggested possible solutions. Five other medical experts are scheduled to review the catheter design.

### Action

The RTI team will work with Mr. Banks to evaluate the reviews, and to develop and implement strategy based on the recommendations of the medical panel.

# HYDROCEPHALUS SHUNT

- REDESIGN VENTRICULAR CATHETER TO REDUCE INCIDENCE OF BLOCKAGE
- MULTIENDED INLET CATHETER WITH HUNDREDS OF TINY INLET HOLES FORMED BY ION-ETCHING TECHNIQUES
- ION GENERATION AND CONTROL TECHNOLOGY FROM NASA'S ION PROPULSION SYSTEMS DEVELOPMENT
- THE CHILDREN'S HOSPITAL MEDICAL CENTER, BOSTON, MASSACHUSETTS



(a) PRESENTLY USED VENTRICULAR CATHETER DESIGN



(b) NASA'S PROPOSED DESIGN, POLYTETRAFLUOROETHYLENE TUBE FILAMENTS ON VENTRICULAR CATHETER

ORIGINAL PAGE IS  
OF POOR QUALITY

ORIGINAL PAGE IS  
OF POOR QUALITY

## IMPROVED OPTICS FOR VITRECTOMY SURGERY

BATeam Personnel: Ms. Doris Rouse

### Problem

Several ophthalmic diagnostic procedures require photography of the fundus, the posterior portion of the eye's interior. Many eye disorders involve blood flow. To diagnose and access these disorders, a dye is injected into the bloodstream and observed in its course through the retinal vessels. This fluorescein angiography is expensive and uncomfortable for the patient. A fundus camera with a clear image and a wide angle (100 degrees) of viewing would provide greater information than the current instruments, which have a field of view ranging from 30 degrees to 60 degrees. This additional information would result in fewer of the repeat procedures often required with narrow-angle cameras.

Sickle cell disease and retinitis pigmentosa first manifest their symptoms in the peripheral retinal areas. Earlier detection of these diseases would be possible with wide-angle fundus photography. Treatment of diabetic retinopathy, the second leading cause of blindness, could be improved by this system. Previous attempts to develop wide-angle fundus cameras have been unsuccessful due to the hazy image quality. Various scanning methods have been used by manufacturers to solve this problem but with no success.

### NASA Technology

Mr. Don Buchele derived the equations to design a new scanning system to reduce the glare caused by light-scattering media. Mr. Buchele developed this application from optical techniques to improve visibility under the sea as described in W. H. Wells's "Optics of the Sea" (AGARD-LS-61, Lecture 5.4 [1973], NASA, Langley Field, Va.).

### Principals

Mr. Don Buchele, NASA Lewis Research Center.  
Dr. Oleg Pomerantzeff, Eye Research Institute, The Retina Foundation, Boston, Mass.

### Cost to NASA

An RTOP for approximately \$30,000 is being considered.



#### Commercialization Strategy

Dr. Pomerantzeff was enthusiastic about the improvement in fundus photography quality that this system could bring. He has suggested that Mr. Buchele patent the device immediately. A major ophthalmic instruments manufacturer visited Mr. Buchele recently with a BA Team member. This manufacturer wants to investigate the feasibility of adapting Mr. Buchele's scanning concepts to a wide-angle fundus camera. Engineers in this firm agree with Dr. Pomerantzeff that this NASA scanning system is a potentially significant improvement over past scanning attempts.

#### Status

The National Eye Institute reviewed the project and raised two important questions: First, would the NASA system significantly improve visualization of the retina through a cloudy medium? Second, would practicing ophthalmologists purchase the system if a wider field of view were the only advantage?

#### Action

The RTI team will discuss the project with the NASA/Lewis engineer to determine how well the system works in a cloudy medium. In addition, the team will interview more ophthalmologists to predict their acceptance of a wide-angle fundus camera.

## MICROLITER FLUID DELIVERY SYSTEM

BATeam Personnel: Dr. H. Clark Beall

### Problem

Two NASA devices, a fluid flow sensor and a gas-driven infusion pump, are to be combined into an infusion pump system that will be superior to any similar device on the market. The two devices are expected to be able to operate synergistically in a feedback design in order to deliver superior performance at reasonable cost. This system would be useful in clinical applications where long-term infusion at well-controlled low flow rates are necessary.

### NASA Technology

Both items of NASA technology are from the NASA Johnson Space Center (JSC) and have been described in NASA Tech Briefs (the flow sensor in MSC-18112, and the infusion pump in MSC-14905).

### Principals

The infusion pump: Johnson Space Center Life Sciences.

The fluid flow sensor: Johnson Space Center, Mr. Gene Winkler, Wastewater Quality Monitor System. ORION, Cambridge, Mass.

### Cost to NASA

None anticipated.

### Commercialization Strategy

A patent application has been filed by ORION, the NASA contractor, for the fluid flow sensor to be used in this infusion pump system. Dr. Bill Clingman, marketing consultant to the RTI BATeam, has been active in determining the status of the CRION patent waiver request and in planning team commercialization strategy for this device.

### Status

Mr. Clingman has determined that the flow sensor is the more valuable innovation of the two items listed above. Many styles of pumps currently in production could operate satisfactorily with the flow sensor. Therefore, Dr. Clingman will pursue commercialization of the fluid flow sensor exclusively.

### Action

ORION has requested a patent waiver on the fluid flow sensor. JSC has decided to recommend that the waiver be granted after consultation with the patent office of NASA headquarters. ORION is now in a position to commercialize the device.

# MICROLITER FLUID DELIVERY SYSTEM

- NASA BELLOWS INFUSION PUMP
- NASA FLUID FLOW SENSOR
- ADJUSTABLE RELIABLE FLOW RATES

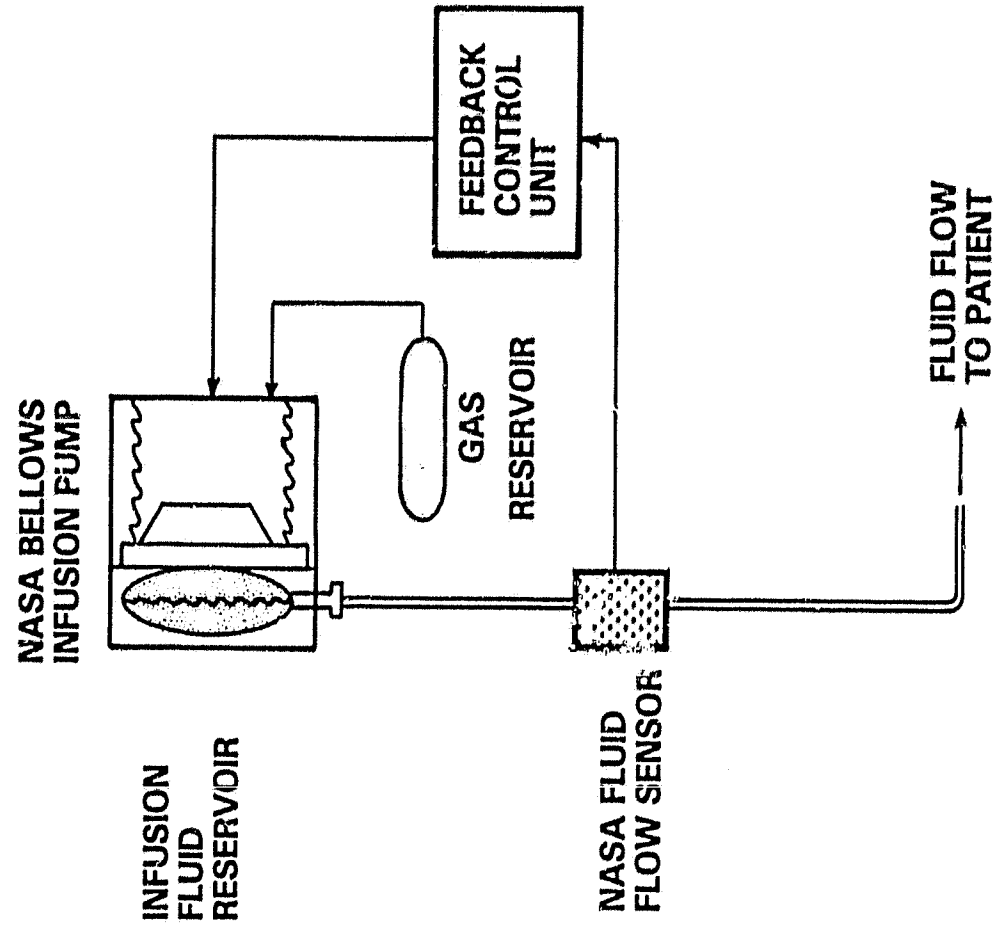

## NEONATE THERMAL CONTROL GARMENT

BA Team Personnel: Ms. Doris Rouse

### Problem

A newborn child's inability to compensate for body heat loss in the operating room can lead to serious metabolic and respiratory difficulties. Surgery is especially hazardous in the first 4 weeks of life. Efforts to solve this problem include the use of heated operating tables, elevated room temperatures, and infrared radiation sources. Each method has an undesirable side effect such as hot spots on the infant, unacceptable working conditions for the surgical team, or uneven heating of the infant.

### NASA Technology

Technology from the development of thermal control garments to protect the astronauts has been used to make a neonate suit for use in surgery.

### Principals

Dr. Bill Williams and Ms. Pat Kirk, Environmental Control Research Branch, NASA Ames Research Center.  
Dr. Ernest Kraybill, Department of Pediatrics, University of North Carolina School of Medicine in Chapel Hill.

### Cost to NASA

This project is one of nine funded under the Partitional Cooling RTOP totaling \$72,000 over 4 years. No further cost is anticipated.

### Commercialization Strategy

Representatives from a major medical-device manufacturer visited RTI and Dr. Kraybill to discuss the market potential for the neonate garment. A firm commitment to develop a product from this NASA technology was deferred pending Dr. Kraybill's documentation of the garment's efficacy in surgery. A market study by one manufacturer indicated that the device would be useful to the neonate surgeon, but that it would not be a high-volume disposable item. A second manufacturer is evaluating the garment as a potential new product.

### Status

Efforts to repair a defective water bath and pumping unit delayed the clinical evaluation for several months. A new unit will be shipped to Dr. Kraybill for use in evaluating two neonate garment designs.

### Action

The team will work with Dr. Kraybill in preparing for the surgical evaluation. In addition, the team will discuss Dr. Kraybill's plans and the market study conclusions with the interested manufacturer.

# NEONATE THERMAL CONTROL GARMENT

- MAINTAIN INFANT BODY TEMPERATURE DURING SURGERY
- PREVENT POST-SURGICAL COMPLICATIONS
- NASA THERMAL CONTROL TECHNOLOGY
- UNIVERSITY OF NORTH CAROLINA SCHOOL OF MEDICINE—PEDIATRICS

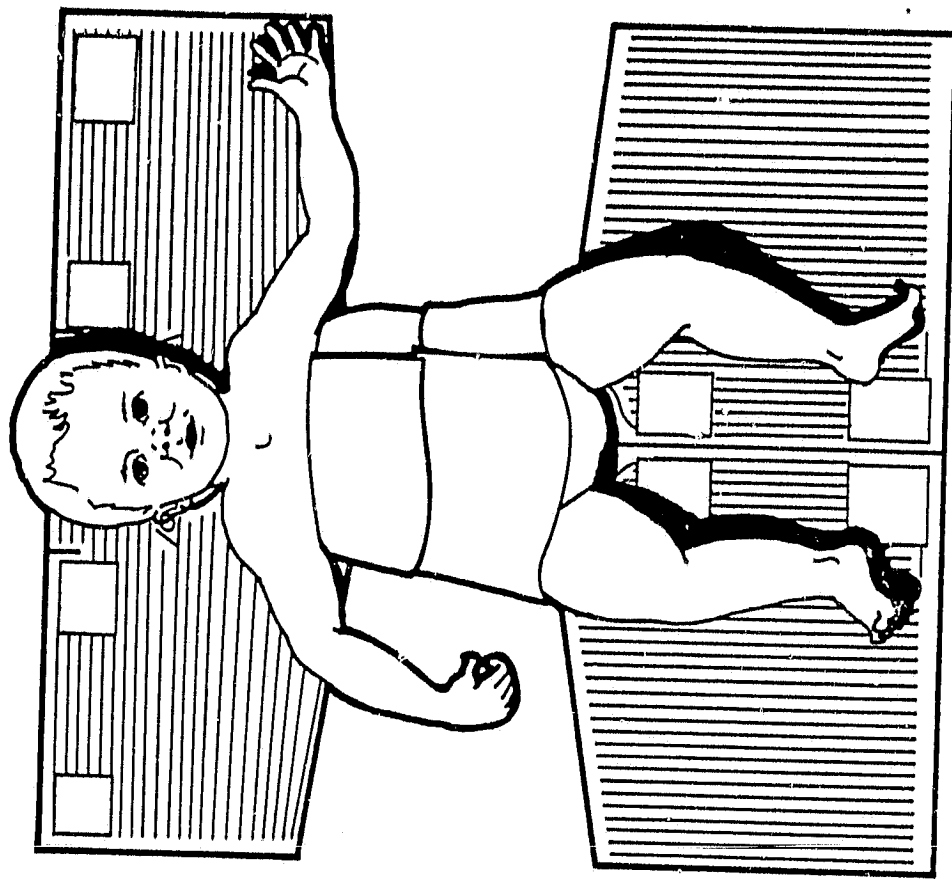

# NEONATE THERMAL CONTROL GARMENT

- TEMPERATURE CHANGES DURING NEONATAL SURGERY

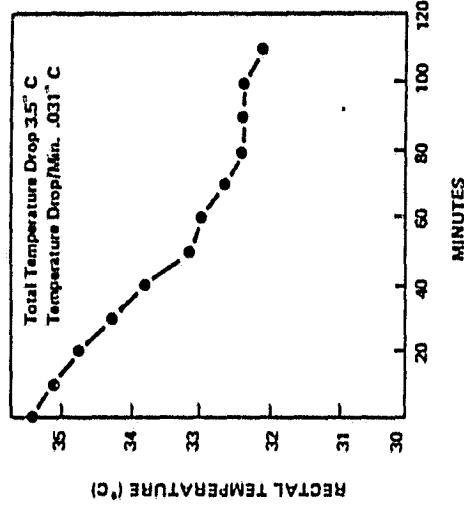
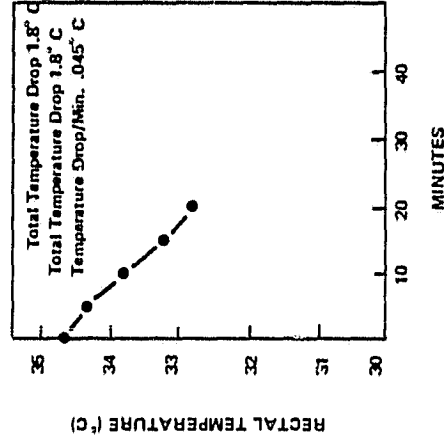
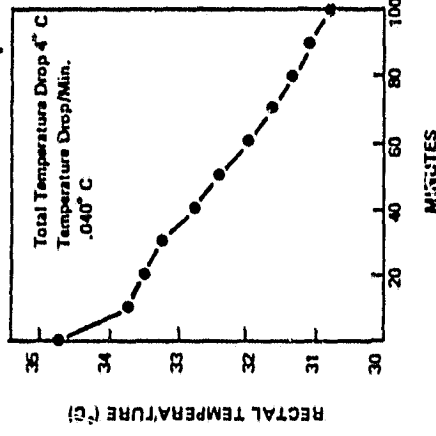
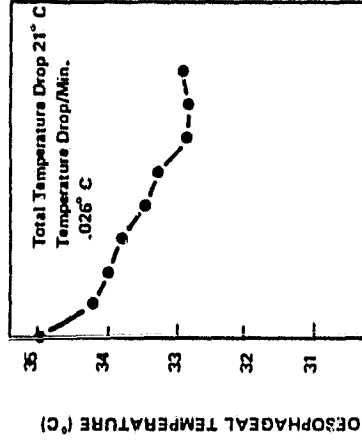

## NEUROPATHIC PATIENT TESTER

BATeam Personnel: Dr. Richard W. Scarce, Dr. James N. Brown, Jr.

### Problem

An instrument would have significant clinical and research value if it could precisely evaluate a patient's ability to move his limbs in preselected geometrical patterns (e.g., a 10-inch-diameter circle with the hand). This instrument would be especially useful in diagnosing and evaluating therapy for several neuromuscular disorders, including Parkinson's disease.

### NASA Technology

Technologies developed to evaluate the aircraft control system were used to develop a neuropathic patient tester.

### Principals

Mr. Hugh P. Bergeron, Flight Dynamics and Control Division, Langley Research Center.  
Dr. George G. Somjen, Department of Neurophysiology, Duke University Medical School, Durham, N.C.  
Dr. Donald B. Calne, National Institute of Neurological and Communicative Disorders and Stroke, National Institutes of Health.

### Cost to NASA

The manufacturer received \$1,500 to design a commercial version of the unit. No other special funding has been involved.

### Commercialization Strategy

A manufacturer interested in marketing the device will design and fabricate a commercial version of the tester. When the commercial model is available, Dr. Calne will clinically test the unit and publish the test results. The commercial version initially would be sold as a research tool, but its eventual market would be primarily as a diagnostic device.

### Status

A design for a commercial version of the device has been completed. The RTI team is working with the National Institute of Neurological and Communicative Disorders and Stroke to arrange for a clinical evaluation of the device.

### Action

The team will continue to work closely with Dr. Somjen, Dr. Calne, and the manufacturer to complete development and testing of a commercial version of the neuropathic tester.

# NEUROPATHIC PATIENT TESTER

- BETTER EVALUATE THE THERAPY OF PATIENTS SUFFERING FROM PARKINSONISM AND OTHER NEUROMUSCULAR DISEASES
- MINIMIZE TESTING OF PATIENT'S COGNITIVE AND SEEING ABILITIES
- MAXIMIZE TESTING OF PATIENT'S NEUROMUSCULAR CONTROL
- NASA'S CONTROL SYSTEMS ENGINEERING TECHNIQUES USED TO EVALUATE PILOT/AIRCRAFT CONTROL SYSTEM INTERFACE
- DUKE UNIVERSITY MEDICAL SCHOOL, DURHAM, NORTH CAROLINA

ORIGINAL PAGE IS  
OF POOR QUALITY



(a) NEUROPATHIC PATIENT TESTER

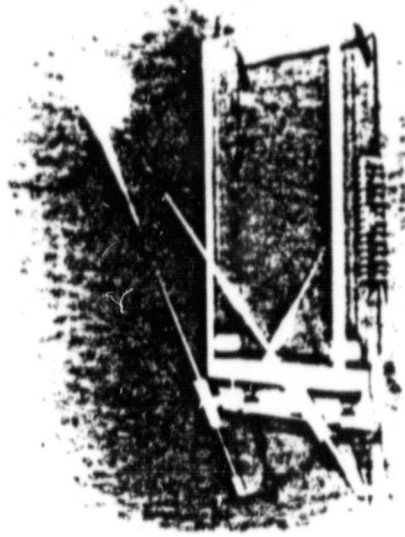

(b) TRACKING DEVICE

ORIGINAL PAGE IS  
OF POOR QUALITY



## NEW METHOD FOR CLEANING TEETH

BATeam Personnel: Dr. Richard W. Searce, Dr. Michael McCartney

### Problem

Available personal oral-hygiene techniques reduce the buildup of dental plaque, but they do not prevent this material from slowly collecting under the gum and between the teeth. If not removed, the plaque will irritate the gums and will cause periodontal disease, which contributes to tooth loss. A personal oral-hygiene technique that prevents plaque buildup would significantly improve dental health and thus reduce dental costs.

### NASA Technology

NASA has used ultrasound in numerous quality-control and manufacturing applications. Technologies from both applications are used to couple ultrasound into a water jet. Powered by the ultrasound energy, diatomaceous earth suspended in the water will clean the teeth.

### Principals

Dr. Joseph S. Heyman, Instrument Research Division, Langley Research Center.  
Dr. Robert C. Coker, School of Dentistry, Louisiana State University, New Orleans, La.

### Cost to NASA

Costs have not been estimated.

### Commercialization Strategy

When feasibility tests are successfully completed, the team will identify a manufacturer interested in developing this device. Contacts with several manufacturers have already verified their interest.

### Status

In August 1978, Dr. Heyman submitted a patent application for this device. Work schedules have delayed his fabricating a functional prototype, which is needed to prove the concept to the manufacturers.

### Action

Dr. McCartney will work closely with Dr. Heyman to encourage building of the prototype. Upon completion of the prototype, the team and Dr. Heyman will select a manufacturer, identify funding sources, and develop and implement the commercialization strategy.

## PORTABLE COOLING SYSTEM FOR QUADRIPLEGICS

BA Team Personnel: Ms. Doris Rouse

### Problem

Quadriplegics are vulnerable to heat stress because they cannot perspire below the level of injury. This condition is the result of interruption of autonomic neural pathways that mediate thermoregulatory perspiration and vasomotion. Quadriplegics exposed to even moderately high temperatures risk hyper-ventilation, increased heart rate, and heat stroke. A portable cooling garment would eliminate this risk, thus opening new employment and daily living opportunities for individuals previously confined to a temperature-controlled environment.

### NASA Technology

Technology from the development of thermal control garments to protect astronauts has been used to make a water-cooled vest for quadriplegics.

### Principals

Dr. Bill Williams and Ms. Pat Kirk, Environmental Control Research Branch, NASA Ames Research Center.  
Dr. S. L. Stover, Department of Rehabilitation Medicine, the University of Alabama in Birmingham.  
Mr. Charles Dyal, the University of Georgia in Athens.

### Cost to NASA

This project is one of nine funded under the Partitioned Cooling RTOP totaling \$72,000 over 4 years.

### Commercialization Strategy

The results of a system evaluation, planned for this summer, will be published and distributed to potential manufacturers. Currently, the team is exploring other applications of the system that may expand the market potential.

### Status

Engineers at Ames Research Center have designed a small, lightweight water-cooling pumping unit and vest based on suggestions by the quadriplegics who will participate in the early evaluation of the system. Ames Research Center expects the pump and vests to be ready for testing by August 1979.

### Action

The team will work with Dr. Stover and Mr. Dyal in planning the evaluation. When the vests and pumps are ready, the team will monitor their use, offering assistance when necessary.

# PORTABLE COOLING SYSTEM FOR QUADRIPLEGICS

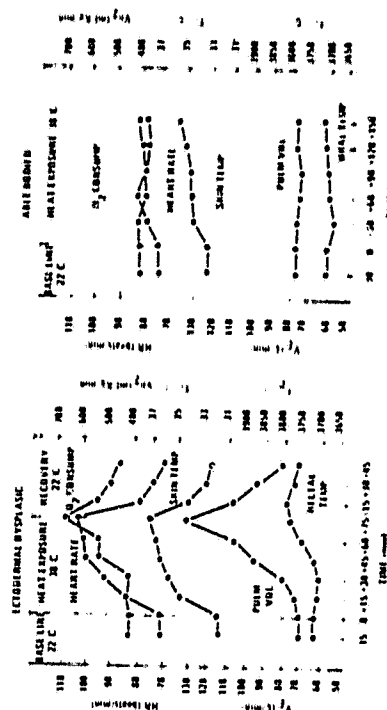
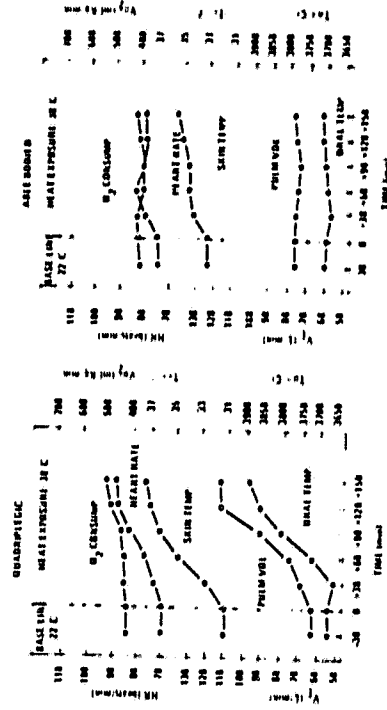

- QUADRIPLEGICS UNABLE TO PERSPIRE BELOW LEVEL OF INJURY. VULNERABLE TO HEAT STRESS

- NASA THERMAL CONTROL TECHNOLOGY
- UNIVERSITY OF GEORGIA—ATHENS
- DEPT. REHABILITATION UNIVERSITY OF ALABAMA—BIRMINGHAM

From G. L. Tittel, "Physiological Responses to Heat of Resting Man With Impaired Sweating Capacity," *J. Appl. Physiol.* 37, 1974, p. 346.

## POWERED RIM CONTROL WHEELCHAIR

BA Team Personnel: Dr. Richard W. Scearce, Ms. Doris Rouse

### Problem

A two-axis joystick is the mechanism commonly used to control powered wheelchairs. However, elderly persons and persons with muscular deficiencies often lack the necessary skill and reaction time to operate this control safely. They may be capable of operating nonpowered wheelchairs with the hand-rim control, but they tire quickly. Thus these individuals are confined to their homes. With a powered wheelchair that uses a modified hand-rim control system, they would regain much of their lost mobility and independence.

### NASA Technology

NASA technology is applicable to at least three of the wheelchair subsystems: high-efficiency power drive, integrated electronic control circuitry, and battery technology.

### Principals

Dr. Woodrow Seamone, Applied Physics Laboratory, Johns Hopkins University, Baltimore, Md.  
Dr. Zaven S. Khachatryan, National Institute on Aging, National Institutes of Health.

### Cost to NASA

Funded by the Veterans Administration, Dr. Seamone developed and fabricated several demonstration models of the powered rim control wheelchair. Several limited evaluation tests were performed. Results have been favorable, but more engineering development is needed. The National Institute on Aging and NASA plan to jointly fund this proposed \$150,000 redesign project. To date, NASA's share has not been specified.

### Commercialization Strategy

To clearly demonstrate the value of this wheelchair design, the RTI team will arrange a user evaluation of the demonstration models. If the results are favorable, the team and Dr. Seamone will develop the funding and commercialization strategy.

### Status

Dr. Seamone is fabricating several demonstration models of the wheelchair. Unfortunately, this effort does not include the engineering development required to make this wheelchair a viable commercial product. The utility of this wheelchair must be clearly demonstrated before the NIA will consider funding this project.

Action

The team will work closely with Dr. Seamone and Dr. Khachaturian to plan and to monitor the demonstration tests. Dr. Seamone and the team will develop the funding and commercialization strategy if the test results are favorable.

## PRESSURE TRANSDUCER CALIBRATOR

BA Team Personnel: Dr. Richard W. Searce, Dr. James N. Brown, Jr.

### Problem

Since fluid-filled catheters are reliable and relatively inexpensive, most surgical teams use them for monitoring blood pressure. Bubbles within these catheters or misadjusted instrumentation, however, can significantly distort the pressure measurement. If, during surgery, the catheter tip could be inserted into a sterile fluid-pressure source, a dynamic pressure test signal could quickly verify the readiness of the instrumentation.

### NASA Technology

A NASA-developed pressure transducer calibrator is being converted into a portable pressure generator that can be sterilized.

### Principals

Dr. William H. Clingman, W. H. Clingman and Company, Inc., Dallas, Tex.  
Dr. James K. Alexander, Professor of Cardiology at Baylor College of Medicine, Houston, Tex.

### Cost to NASA

None.

### Commercialization Strategy

Dr. Clingman is working closely with a major manufacturer of pressure transducers to evaluate the device's commercial potential. If the test-signal-generator concept proves practical, the manufacturer will develop and market a commercial version of the tester.

### Status

The calibrator is currently being modified in preparation for feasibility testing.

### Action

The team will work with Dr. Clingman and the manufacturer to plan the evaluation. If the tester proves to be practical, the team will monitor the commercialization effort, offering assistance when necessary.

# PRESSURE TRANSDUCER CALIBRATOR

- SYSTEM FOR USE DURING SURGERY TO VERIFY THE OPERATIONAL STATUS OF FLUID-FILLED CATHETERS AND ASSOCIATED INSTRUMENTATION
- GENERATES A SIMULATED BLOOD PRESSURE-PULSE
- DETECTS PRESENCE OF AIR BUBBLES AND MISADJUSTED AND MALFUNCTIONING INSTRUMENTATION
- NASA-DEVELOPED PRESSURE TRANSDUCER CALIBRATION TECHNIQUES
- BAYLOR UNIVERSITY COLLEGE OF MEDICINE, HOUSTON, TEXAS

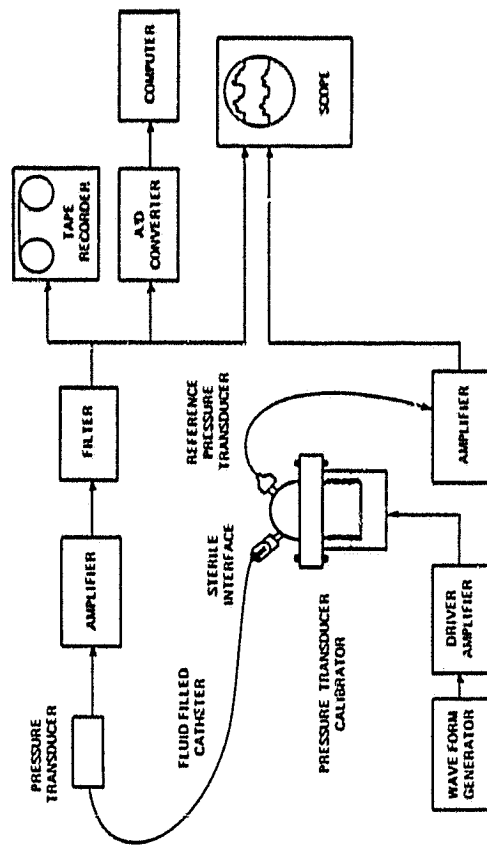

FLUID-FILLED CATHETER VERIFICATION SYSTEM,  
FOR USE IN SURGERY

## PROSTHETIC URINARY SPHINCTER

BATeam Personnel: Ms. Doris Rouse

### Problem

A malfunctioning urethral sphincter is often responsible for the inability to control emptying of the bladder. This condition may result from congenital, traumatic, postsurgical, or neurogenic disorders. Continence can sometimes be restored by an implanted device that occludes the urethra and allows voluntary voiding by manual release of the occluding pressure. Two factors prevent widespread acceptance of current systems by the medical community: (1) surgical complexity of the implantation procedure, and (2) high rate of device malfunction, often the result of valve failure. A simpler, more reliable system would represent a significant advance in the management of urinary incontinence.

### NASA Technology

The low-pressure, "zero" leakage, high-reliability valves used in the Viking project have been adapted for use in a prosthetic urinary sphincter.

### Principals

Mr. Ray Helms, NASA-Marshall Space Flight Center.  
Mr. John B. Tenney, Department of Surgery, Rochester General Hospital.  
Mr. Robert Reinicke, Parker-Hannifin Corporation.

### Cost to NASA

NASA's total cost is estimated to be \$188,000 through FY80.

### Commercialization Strategy

A major prosthetics manufacturer will fabricate the cuff assembly for the animal trials. The manufacturer is awaiting the results of the market study and the animal trials before making a commitment on the clinical trials and eventual marketing.

### Status

The final valve configuration has been established. Parker-Hannifin has begun fabrication of the animal implant valves. Rochester General Hospital and the prosthetics manufacturer are preparing protocols to meet FDA requirements. The BATeam is assisting in this effort.

### Action

The team will continue to assist Rochester General Hospital in planning for FDA requirements. Currently, the team is arranging a meeting with the hospital at NASA headquarters to discuss the patent situation and the potential manufacturer.



# PROSTHETIC URINARY SPHINCTER

- 2-5% OF POPULATION SUFFERS URINARY INCONTINENCE
- NASA TECHNOLOGY IN MINIATURIZED, HIGHLY RELIABLE VALVE SYSTEMS
- ROCHESTER GENERAL HOSPITAL DEPARTMENT OF SURGERY

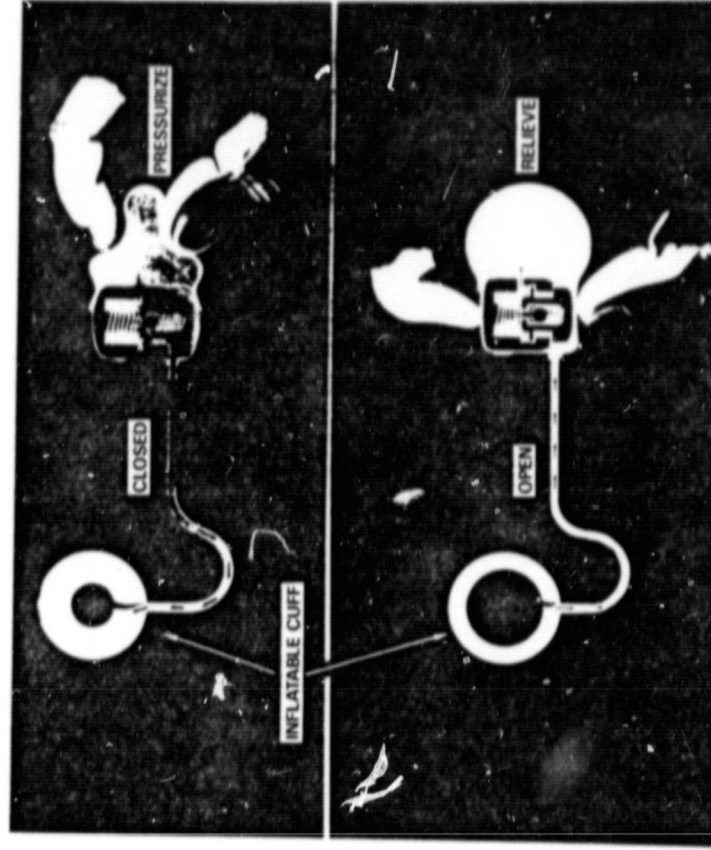

ORIGINAL PAGE IS  
OF POOR QUALITY

NASA PRESS/RELIEVE VALVE  
CONCEPT OF PROSTHETIC URINARY SPHINCTER

## TELETYPE TEST SET

BATeam Personnel: Dr. H. Clark Beall

### Problem

Teletype (TTY) machines and acoustic phone couplers are often used by the deaf for phone communication. The repair and maintenance of these devices would be simplified by a portable electronic test set that generates signals for diagnostic simulation. A device of this type would be used by repairmen servicing TTY units for the deaf.

### NASA Technology

The portable TTY test set problem was solved by Mr. Richard Couch, an electronics engineer at NASA Langley Research Center. His expertise in digital logic design enabled him to design and implement the device using CMOS-integrated circuits for low battery drain.

### Principals

Mr. Richard Couch, NASA Langley Research Center, FED-Electromagnetics Research Branch.  
Gallaudet College, Washington, D.C.  
Guilford County Communications Center for the Deaf, Greensboro, N.C.  
Phone-TTY, Inc., Fair Lawn, N.J.

### Cost to NASA

No cost to date, and no cost is anticipated to achieve commercialization.

### Commercialization Strategy

Phone-TTY, Inc., of Fair Lawn, N.J., has begun manufacturing the TTY test set. The unit is manufactured as a companion to a Teletype distortion analyzer. The two devices are housed together to enable them to share a common power supply. The manufacturer plans to assemble 100 units in the first production run. The device will be sold nationwide through the manufacturer's representatives and by direct mail order from the manufacturer.

### Status

The NASA Langley Research Center has originated a Tech Brief describing the TTY test set.

### Action

The BATeam plans to maintain close contact with the manufacturer, who is eager to develop and manufacture new devices for the handicapped.

## TELETYPE TEST SET

- AN AID FOR PHONE-TTY COMMUNICATION BY THE DEAF
- DEVELOPED IN RESPONSE TO A REQUEST FROM THE GUILFORD COUNTY COMMUNICATIONS CENTER FOR THE DEAF, GREENSBORO, NC
- A BATTERY-OPERATED, PORTABLE TEST SET DESIGNED TO FACILITATE MAINTENANCE OF TTY IN THE HOME OF THE DEAF
- BAUDOT TELETYPE SIGNAL GENERATOR (MODEM TONES AND RELAY OUTPUT)
- NASA LANGLEY DIGITAL DESIGN
- COMMERCIALY AVAILABLE FROM PHONE-TTY, INC., FAIR LAWN, NJ

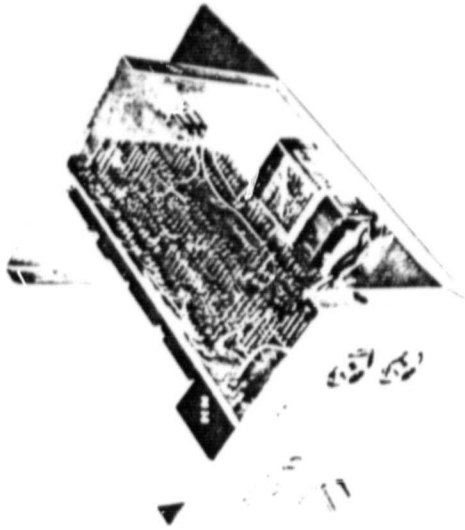

(Prototype)

ORIGINAL PAGE IS  
OF POOR QUALITY

# "TEST PROTOCOL FOR TTY TEST SET"

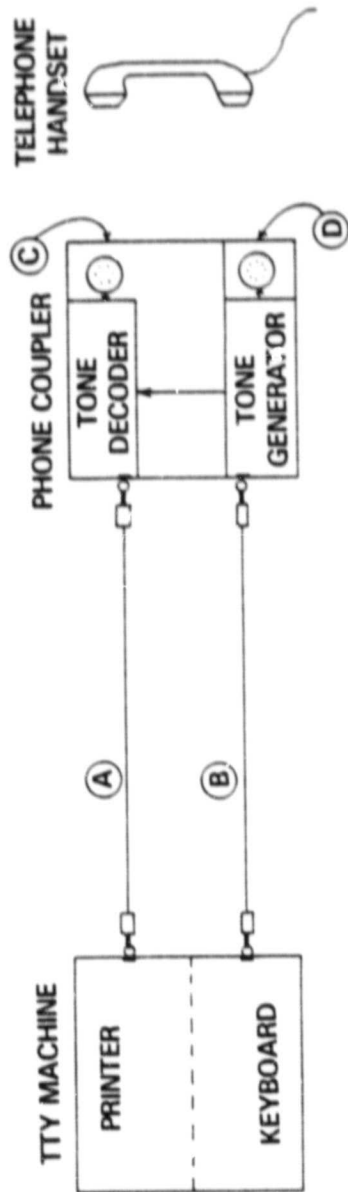

\* JACK RELAY IN SERIES WITH LINE AT POINT A TO CERTIFY OPERATION OF PRINTER. THEN DISCONNECT TEST SET.

\* PLACE LOUDSPEAKER INTO EARPIECE RECEPTACLE, C, TO CERTIFY PROPER OPERATION OF TONE DECODER (AND PRINTER). THEN DISCONNECT TEST SET.

\* PLACE RELAY IN SERIES WITH LINE AT POINT B TO CERTIFY OPERATION OF TONE GENERATOR (AND DECODER AND PRINTER). THEN DISCONNECT TEST SET.

\* AFTER ABOVE TEST PROTOCOL, IF MISPRINT OCCURS WHEN TYPING ON KEYBOARD, THE KEYBOARD IS DEFECTIVE.

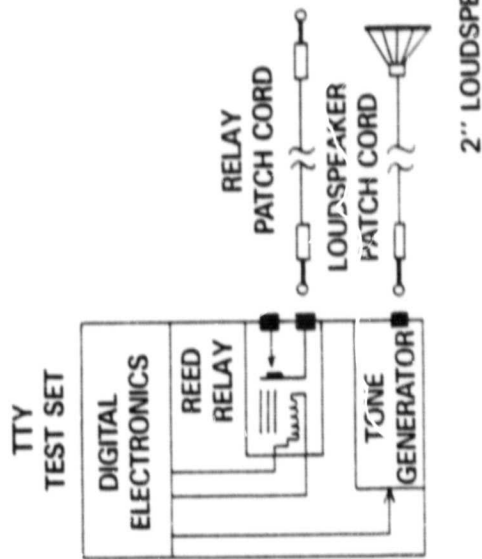

## TTY KEYBOARD TESTER

BATeam Personnel: Dr. H. Clark Beall

### Problem

Many of the deaf in the United States have a Baudot Teletype and a phone coupler in the home to enable them to communicate by phone with others similarly equipped. Experience has shown that the TTY keyboard mechanism is the item most prone to malfunction. A small, portable test set is needed to enable a maintenance person to assess the performance quality of the electromechanical TTY keyboard mechanism and to readjust the mechanism to specifications.

### NASA Technology

Engineers at the NASA Langley Research Center have the expertise to design a TTY keyboard tester from discrete circuits used in their daily work. They believe they can utilize digital integrated circuits and light-emitting-diode display devices to design a test set that will facilitate the troubleshooting of a TTY keyboard. The plan is to utilize the circuitry designed to display the "Times Square" moving characters in NASA airborne equipment.

### Principals

NASA Langley Research Center digital design personnel.  
Guilford County Communications Center for the Deaf, Greensboro, N.C.  
Phone-TTY, Inc., Fair Lawn, N.J.

### Cost to NASA

No cost to date. An RTOP is planned for FY80 to fund the Langley engineering hours required to complete the prototype design.

### Commercialization Strategy

Phone-TTY, Inc., has expressed a strong interest in marketing this device. No patent application by NASA is anticipated.

### Status

A design of the device has been blocked into functional steps. The detail design and prototype assembly awaits RTOP funding.

Action

Phone-TTY has expressed interest in NASA's design. This company has had years of experience with Teletype for the deaf. Phone-TTY personnel realize that precision adjustment of the electromechanical TTY keyboard has always been a problem. Present plans call for close cooperation with this manufacturer. Phone-TTY is a not-for-profit company that already manufactures TTY devices for the deaf and other devices for the handicapped. Therefore, no matching funds are anticipated from this company.

## WEIGHT ALLEVIATION DEVICE

BATeam Personnel: Dr. Richard W. Searce, Dr. James N. Brown, Jr.

### Problem

An evaluation of the weight alleviation device demonstrated that this NASA-developed system could significantly reduce the time required for training the severely handicapped to transfer into and out of a wheelchair. This training, called transfer training, normally must be delayed until the patient has regained his strength. With this device, transfer training and strength-building therapy may be done concurrently, thus reducing the hospital stay as much as 3 weeks.

### NASA Technology

A weight alleviation device developed to acclimate astronauts to 1/3 gravity has been modified to make a transfer-training device for use in rehabilitating the severely handicapped.

### Principals

Mr. Moses J. Long, Systems Engineering Division, Langley Research Center.  
Dr. Ernest Harrison, Mississippi Methodist Rehabilitation Center, Jackson, Miss.

### Cost to NASA

Adapting the NASA-developed unit for transfer training cost \$1400. Other minor costs are expected, but the exact amounts are unknown at present.

### Commercialization Strategy

The RTI team has provided the potential manufacturer with a letter on how the device is used and why a rehabilitation center would want one. This manufacturer plans to have commercial prototypes of the unit evaluated for safety and efficacy at four rehabilitation centers.

### Status

The weight alleviation device was first evaluated at the Mississippi Methodist Rehabilitation Center. The test results were favorable. An evaluation of the device by two other rehabilitation centers confirmed its utility in rehabilitation.

### Action

The RTI team and the Technology Utilization Office at Langley Research Center are working with the manufacturer to facilitate testing of the device in four more rehabilitation centers.

## WEIGHT ALLEVIATION DEVICE

- REDUCE TIME AND COST OF TRAINING THE SEVERELY HANDICAPPED TO TRANSFER FROM THEIR WHEELCHAIRS TO CHAIRS, BEDS, ETC.

- CAN SHORTEN HOSPITAL STAY BY 3 WEEKS

- NASA-DEVELOPED DEVICE TO AID ASTRONAUTS ACCLIMATE TO REDUCED GRAVITY

- MISSISSIPPI METHODIST REHABILITATION CENTER, JACKSON, MISSISSIPPI

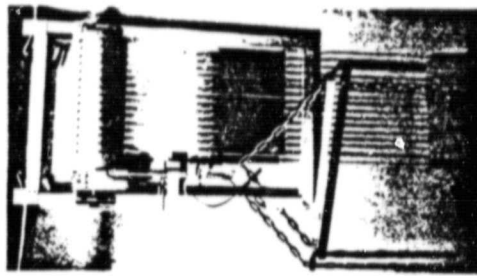

A. NASA-DEVELOPED TRANSFER TRAINING DEVICE

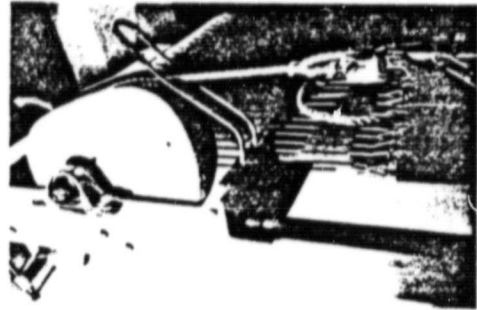

B. DETAIL VIEW OF CAM

ORIGINAL PAGE IS  
OF POOR QUALITY

ORIGINAL PAGE IS  
OF POOR QUALITY



#### 4.0 NEW PROBLEMS

##### ENHANCEMENT OF PHOTO IMAGES

BATeam Personnel: Dr. H. Clark Beall

Problem:

The first BATeam transfer of this technology was for the audioradiographic enhancement of x-ray diffraction images. Another transfer opportunity recently has been identified for the enhancement of underexposed photographic film records of fluorescein angiography. In this medical procedure, a dye is injected into the bloodstream and its progress through the ocular blood vessels at the rear surface of the eye can be documented by time-sequence photography. The fundus camera takes one 35-mm photograph per second, beginning with the first flush of dye into the eye. The developed film often contains underexposed images.

NASA Technology

Ms. Barbara Askins, of the NASA Marshall Space Flight Center (MSFC), was named 1978 National Inventor of the Year for her development of an autoradiographic photographic enhancement process. The procedure can be used, without modification, to increase the contrast of the fluorescein angiography photographs.

Principals

Ms. Barbara Askins, NASA Marshall Space Flight Center.  
Medical Photographer, VA Hospital, Houston, Tex.

Status

The technology is a photographic process, not a device. As a photographic process, it can be applied to many fields of science and technology. The process has been described in detail in three scientific papers. Thus, the technology is mature, and it can be practiced without further NASA help by any person familiar with photographic film processing. However, most potential users of the technology are reluctant to invest the \$500 needed for equipment until they can be certain of the efficacy of the process. As a result, the potential users of the technology wish to test the NASA technique and request that MSFC accept samples of photographic film for processing by the audioradiographic technique. In order to handle these frequent inquiries, the MSFC TU office is planning to fund a photographic laboratory in Birmingham, Ala., to perform the audioradiographic processing.

Action

Ms. Askins has already processed one set of fluorescein angiography photographs at the request of the RTI BATeam. She has requested additional fundus camera images to process because the audioradiographic technique seems to be very successful in enhancing the contrast of these images.

## NONDIGITAL PSEUDOCOLOR ENHANCEMENT

BATeam Personnel: Dr. H. Clark Beall

### Problem

Digital pseudocolor analysis of photographic data is not appropriate for biological research because of the expensive viewing equipment, the expensive computer hardware and software, and the technical skill required of the system operator.

A simple, low-cost technique is needed for producing pseudocolor images from sets of black-and-white photographic negatives and positives. The technique should be solidly based on color theory so that the color of at least one target area within the pseudocolor image could be selected a priori.

Color diazo is probably the best material for producing pseudocolor because many discrete spectral tints are available, and the film can be easily processed in large sizes. A system based upon color photography would be the second choice.

### NASA Technology

At virtually all NASA field centers, image processing is performed by digital means and by other methods. The nondigital techniques are not well documented in the NASA literature. The purpose of this BATeam project is to identify one or more nondigital pseudocolor techniques, document the techniques, and evaluate them for their utility as analytical tools for biomedical photographic data.

### Principals

Duke University Medical Center, Durham, N.C.

### Cost to NASA

No cost is anticipated for 3 months.

### Commercialization Strategy

An extensive commercial strategy has not yet been identified for this new problem. The NASA pseudocolor techniques identified as useful for biomedical applications will be presented to commercial organizations.

### Status

A formal problem statement has been prepared and forwarded to the NASA field centers. An extensive NASA literature search on nondigital image processing and analysis has been completed.

Action

Any photographic or diazo pseudocolor technique must be further documented and perhaps formalized into a protocol that can be specified by the output of a data analysis program run on a hand-held calculator.

## OPHTHALMIC SCREENING DEVICE

BATeam Personnel: Dr. H. Clark Beall

### Problem

Amblyopia is a childhood disease of the eye that affects approximately 4 percent of the population. Amblyopia is defined as poor vision despite correction with glasses for any refractive problem. If the condition can be detected by an eye examination, and then corrected, no permanent vision damage results. Experts recommend at least two vision tests for children before age seven. Because the great majority of children have 20/20 vision, a simple screening test would be adequate to identify the small percentage of children with vision problems.

### NASA Technology

A NASA-patented optical correlator, developed at the NASA Marshall Space Flight Center, will be adapted to analyze photographic images produced by a special flash camera during screening tests of children's vision. The flash camera is used to record the retinal reflex response of the test subjects.

### Principals

Mr. Joseph H. Kerr, President, Electro-Optics Consultants, Inc., Huntsville, Ala.  
Dr. S. Hutson Hay, ophthalmologist, Huntsville, Ala.  
Mr. Al Bailey, Project Monitor, NASA Marshall Space Flight Center.

### Cost to NASA

A biomedical RTOP has been prepared to contribute (1:4) to the joint funding of the development and test project by the manufacturer and the ophthalmologist.

### Commercialization Strategy

Electro-Optics Consultants, Inc., plans to manufacture the vision screening device. The device should be ready for commercial introduction within 3 years. Most of this time will be devoted to building a data bank to demonstrate the utility and accuracy of the device.

### Status

Dr. Hay is using the special flash camera to gather photographic data for analysis by the NASA optical correlator.

### Action

The BATeam has helped prepare the information for the NASA RTOP. Continued support and assistance will be given this project.

# DIAGRAM OF OPTICS UTILIZED IN RETINAL REFLEX PHOTOMETRY

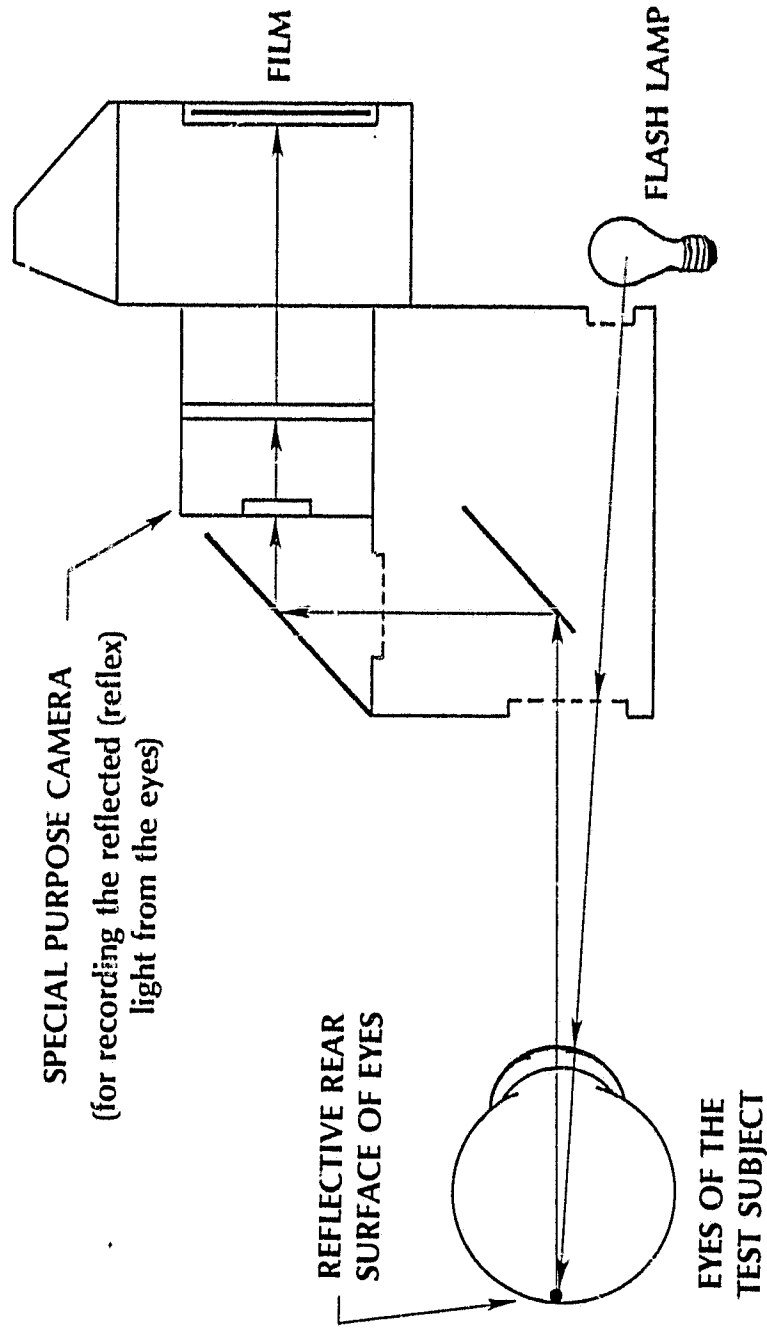

## ROTATING LENS ELEMENTS

BATeam Personnel: Dr. H. Clark Beall

### Problem

Infants with serious visual impairments, such as crossed or divergent eyes, are usually referred to a surgeon. Because only about 30 percent of the surgical corrections are successful, the surgical procedure often results in a cosmetic rectification of the visual problem. The problem originator, an optometrist, believes that muscle control of the eye can be developed by therapy and exercise. He has been quite successful in designing training protocol and hardware that can exercise and strengthen the eyeball muscles of children.

The optometrist has requested assistance for a novel means of rotating Fresnel lens elements within special eyeglass frames which have provisions for individually rotating the lens of both eye openings. The combined weight of the special eyeglass frames and tiny motors that are used now is too great, and the size too large, for children to wear longer than a few minutes.

### NASA Technology

A problem statement has been circulated to the NASA field centers. The more promising suggestions favored all-electronic eye-tracking systems instead of a mechanical system. One suggestion described how a pattern of light emitting diodes (LEDs) could be mounted within the visual field of the eye instead of a Fresnel lens element. The motion of the image through a Fresnel lens could be effectively simulated by electronically switching the LED on and off in a programmed manner. This suggestion will be presented to the optometrist for his evaluation.

### Principals

Dr. Sidney Slavin, optometrist, Richmond, Va.

### Cost to NASA

No cost is anticipated for the next 3 months.

### Commercialization Strategy

No strategy has been initiated.

### Status

The problem is still in the stage of evaluation of appropriate technology.

### Action

The various suggestions received in response to the problem statement will be presented to Dr. Slavin.

## 5.0 TISSUE FREEZING DEVICE MARKET STUDY

The NASA tissue freezing device, as covered in NASA Technical Paper 1165, provides an improved performance over units now commercially available. This is the conclusion of Dr. Herbert Kaizer at Johns Hopkins University Hospital, who has been evaluating the NASA device. What Dr. Kaizer means by "improved performance" is that a linear temperature-time curve can be obtained as the tissue temperature is lowered through the freezing point. This has not been the case with commercially available freezing units. If these units are set to obtain a linear temperature-time curve, then the tissue temperature rises a few degrees at the freezing point. This damages certain cells, and the completely linear curve obtained with the NASA unit is an improvement. Cryoson is improving their commercial unit to accomplish the same end result. The first model will be delivered in the fall to M. D. Anderson Hospital in Houston. Until then it will not be known how its performance compares with the NASA unit.

Three different applications for the freezing unit were evaluated, and each would have its own market. These are the freezing of bone marrow stem cells, platelets, and white cells. The linear freezing curve is thought to be beneficial for stem cells and platelets.<sup>1</sup> The optimum freezing curve for preserving white cells is still being explored. Each application is discussed below.

The freezing of bone marrow cells is linked to a new procedure for treating cancer. This application was discussed with Dr. Kaizer at Johns Hopkins and Dr. Karel Dicke at M. D. Anderson Hospital in Houston. Briefly, the patient's bone marrow is removed and preserved by freezing. The patient is then given intensive radiation or chemotherapy treatment, which destroys the rest of his bone marrow. The preserved stem cells are then thawed and transplanted into the patient. Dr. Dicke said that this procedure is being used with end-stage leukemia patients after all other methods have failed. Sixty percent of those receiving the treatment have gone into remission. The procedure has also been used at M. D. Anderson as a primary treatment of lung cancer. The tumors have disappeared from every patient receiving the treatment. Insufficient time has elapsed, however, to know how many cases will recur.

According to Drs. Kaizer and Dicke, a linear freezing rate is well accepted as the optimum method of freezing stem cells. Dr. Dicke has recently found<sup>2</sup> that a 6° C rise in temperature at the freezing point reduced the viability of the stem cells by 60-70 percent. This temperature rise is held to a minimum by manual control of the freezing process. This provides enough preserved stem cells for two transplants in about 70 percent of the cases. In the other cases only enough cells survive the freezing for one transplant. A higher yield of viable cells is probable with a freezing unit that has the performance claimed for the NASA unit.

About 10 teaching hospitals now use this bone marrow transplant procedure. Each is a potential customer for one freezing unit. At both M. D. Anderson and Johns Hopkins hospitals only about five procedures are done per week, and only one unit would be required. During the next 2 to 3 years, use of the procedure is expected to spread to other teaching hospitals. In 1977 there were a total of 402 such hospitals.<sup>3</sup> The procedure requires extensive support of the patient for about a month after the transplant of the stem cells. For this reason, hospitals are not expected to use this method. Thus, the potential total available market is 402 units.

The second market sector investigated was the freezing of platelets. These are now isolated and sold as a product by some blood collection centers. The platelets are isolated from whole blood by centrifuging, and they can only be stored for 72 hours. They are not frozen because a linear freezing curve is required and suitable equipment is not available.

Three different types of blood collection centers were interviewed regarding their potential use of a NASA freezing unit: centers using paid donors, volunteer centers associated with hospitals, and independent centers. Centers that collect whole blood of paid donors are rapidly going out of business. None were found in the areas interviewed. Because of the hepatitis problem, state laws are being passed to greatly restrict the use of blood from paid donors. Paid donors are also used by firms collecting plasma only, but these firms do not separate out platelets or other components.

The second type of blood collection center is directly associated with a hospital. Volunteer donors are generally relatives or friends of the patients. If platelets are separated out at all, they are usually for a specific patient and storage is not a relevant question. Freezing also increases costs and such collection centers seldom freeze even red cells. Procedures for the latter have been available for some time. Normally the red cell concentrate is frozen as rapidly as possible with no control over the freezing curve. This increases costs by about \$70 to \$75 per unit of red cells. For these reasons the hospital collection center is not considered a potential customer for the NASA device.

The third type of collection center is an independent organization usually serving community needs. There are 510 independent collection centers.<sup>4</sup> Of these, 291 centers collect whole blood and then concentrate and sell platelets. Blood is collected from volunteers, often using a mobile facility. Timing has little if anything to do with the need for platelets. Those centers would find it advantageous to use the NASA device to freeze and preserve platelets because donor frequency does not correlate with need. The demand for platelets is such, however, that most centers could get by with just one NASA device. Thus the total available market for this second application is estimated at 291 units.



In the freezing of white cells, the same factors are valid as for platelets. Only independent blood collection centers would be potential customers. About 80 centers presently separate out white cells. The optimum freezing curve has not been determined but it is expected to be different from a linear curve. Even so, the NASA unit could be useful in achieving better control over the freezing process. White cells are very sensitive to small changes in the freezing curve. The total available market for this third application is 80 units.

Each of these market sectors is in a different state of development. If a commercial NASA unit performed as well as the prototype at Johns Hopkins there could be immediate application to stem cell freezing. There is an initial market of 10 units, and over 100 units will be needed in the next few years. The eventual demand could grow to 402 units. Development of this market sector depends only on the general acceptance in the medical community of the bone marrow transplant procedure.

Use of the NASA device for platelet preservation would require FDA approval. Clinical evaluation of prototype units and publication of these studies would be necessary. Thus, this sector of the market would require further development by the manufacturer of the freezing unit. Sales would not be available from this sector during the first 2 to 3 years of manufacturing the device.

The same is true of white cell freezing except that, in this case, the proper freezing procedure has not been worked out. There is an opportunity to evaluate the NASA device in an experimental project to establish that procedure. This project is at the Wadley Institute in Dallas. To take advantage of this opportunity, a prototype unit should be provided to them by fall 1979.

Before delivery to Wadley, this same prototype could be compared to the new Cryoson unit at M. D. Anderson Hospital. This would determine if the NASA unit still represents an improvement in the state of the art. If this is the case, an RFP should be issued to prospective manufacturers to complete development of a commercial unit. The largest supplier of freezing units is Union Carbide. Other potential manufacturers include competitors which have not entered the medical market, such as Airco. Another group of firms have expertise in cryogenic engineering but do not have the medical marketing experience. Finally, Spectroterm has shown a specific interest in the project. This firm is thought to have the marketing experience although it may be somewhat weaker in engineering.

In summary, potential applications have been analyzed with a total available market of 770 units. There is an immediate market for 10 units, which is expected to grow to 400 units within the next 2 to 3 years. Further growth to the full 770 units would take place as platelet and white cell freezing become established procedures. Evaluation of a second prototype at M. D. Anderson Hospital in Houston is recommended. This would verify that the device is still an advance over the state of the art. If NASA wishes to pursue commercialization of the tissue freezing technology, the development of a commercial prototype should be initiated in the next 3 to 5 months.

References

1. Peter Mazur, "Cryobiology: The Freezing of Biological Systems," Science, Vol. 168, 939 (1970).
2. Karel Dicke, Experimental Hematology of Today, in press.
3. Anthony T. Kruzas, ed., Medical and Health Information Directory, Gale Research Co., Detroit, 1977.
4. Craig T. Norback and Peter G. Norback, eds., The Health Care Directory 77-78, Medical Economics Co., Oradell, N.J.

## 6.0 INACTIVATED PROJECTS

### HIGH SPEED DC LOGARITHMIC AMPLIFIER

BATeam Personnel: Dr. H. Clark Beall

Before a prototype logarithmic converter could be assembled for evaluation, the problem originators moved from Duke University Medical Center. Also, several manufacturers have introduced logarithmic amplifiers whose performance specifications overlap those anticipated from the NASA design.

### MICROWAVE THERMOGRAPHY

BATeam Personnel: Dr. H. Clark Beall

The medical researcher had requested the loan of a microwave radiometer from Hughes Aircraft through the auspices of the Hughes Medical Research Foundation laboratory situated at Duke University Medical Center. In April 1979, Hughes Aircraft said that they did not have a passive microwave radiometer that would be appropriate to the researchers' application.

### NEUROELECTRIC CONTROL

BATeam Personnel: Dr. Richard W. Searce

After consideration of the requirements of this project, JPL personnel have determined that a collaborative effort is not feasible at this time.

## 7.0 CONFERENCES AND TRAVEL

On 3 April 1979, Clark Beall visited NASA Langley Research Center to interview NASA engineers concerning topics in photoacoustic spectroscopy and fiber optics for knee surgery.

On 4 April 1979, Clark Beall visited NASA Goddard Space Flight Center to observe the operation of the Plant Biomass Radiometer. A diazo pseudocolor process was also demonstrated.

On 6 April 1979, Richard Searce attended a meeting at NASA Headquarters on transportation for the handicapped.

On 11 April 1979, Doris Rouse visited Dr. Floyd Davis's laboratory at Rush Medical Center, Chicago, to observe the use of NASA liquid-cooled garments in multiple sclerosis therapy.

On 13 April 1979, Richard Searce visited Dr. Colin McLaurin at the University of Virginia to discuss improved wheelchair designs.

On 17 April 1979, Richard Searce visited Langley Research Center to explore the new applications for composite material technology with John Samos.

On 24 April 1979, Richard Searce met with Sarah Newcomb of the New York State Education Department in Albany, N.Y., to discuss special education needs.

On 25 April 1979, Richard Searce met with Dr. G. Baum at the Albert Einstein College of Medicine in New York to discuss ultrasound image analysis.

On 3 May 1979, Doris Rouse attended a NASA-Lewis Research Center-sponsored symposium in Cleveland on dental implants.

On 3 May 1979, Clark Beall visited Phone-TTY, Inc., at Fair Lawn, N.J., to confirm their plans to build a BA Team device, the TTY test set.

On 21 May 1979, Richard Searce visited the Jet Propulsion Laboratory to discuss biomedical RTOPs.

On 22 May 1979, Richard Searce attended an implantable infusion pump commercialization meeting at Parker-Hannifin, Inc., in Irvine, Calif.

On 29 May 1979, Clark Beall traveled to the NASA Marshall Space Flight Center to help plan for the RTOP entitled "Ophthalmic Screening Device."

On 30 May 1979, Doris Rouse visited Langley Research Center to discuss the lung sound modeling project.

On 6 June 1979, Richard Scarce gave a presentation to the Eastern North Carolina Medical Society on the NASA Biomedical Technology Utilization Program.

On 12 June 1979, Doris Rouse and Dr. Jim Beebe met with Dr. Tom O'Brien of the National Eye Institute to discuss fundus photography.

On 20 June 1979, Doris Rouse and Dr. Jim Beebe met with Dr. John Watson at the National Heart, Lung, and Blood Institute to discuss RTOP proposals.

On 21 June 1979, Doris Rouse attended a planning session for the implantable infusion pump at the Applied Physics Laboratory, Laurel, Md.