

NOTICE

THIS DOCUMENT HAS BEEN REPRODUCED FROM
MICROFICHE. ALTHOUGH IT IS RECOGNIZED THAT
CERTAIN PORTIONS ARE ILLEGIBLE, IT IS BEING RELEASED
IN THE INTEREST OF MAKING AVAILABLE AS MUCH
INFORMATION AS POSSIBLE

NASA Technical Memorandum 82743
AIAA-81-2637

(NASA-TM-82743) COMPARISON OF TWO
PARALLEL/SERIES FLOW TURBOFAN PROPULSION
CONCEPTS FOR SUPERSONIC V/STOL (NASA) 15 p
HC A02/MF A01 CSCI 01A

82-18178

Unclas

G3/02 08418

Comparison of Two Parallel/Series Flow Turbofan Propulsion Concepts for Supersonic V/STOL

R. W. Luidens, G. E. Turney, and J. Allen
Lewis Research Center
Cleveland, Ohio

Prepared for the
V/STOL Conference
cosponsored by the American Institute of Aeronautics
and Astronautics and NASA Ames Research Center
Palo Alto, California, December 7-9, 1981



NASA

COMPARISON OF TWO PARALLEL/SERIES FLOW TURBOFAN PROPULSION CONCEPTS FOR SUPERSONIC V/STOL

R. W. Luidens, G. E. Turney, and J. Allen

National Aeronautics and Space Administration
Lewis Research Center
Cleveland, Ohio

ABSTRACT

E-1056

The thrust, specific fuel consumption, and relative merits of the tandem fan and the dual reverse flow front fan propulsion systems for a supersonic V/STOL aircraft are discussed. Consideration is given to: fan pressure ratio, fan air burning, and variable core supercharging. The special propulsion system components required are described, namely: the deflecting front inlet/nozzle, the aft subsonic inlet, the reverse pitch fan, the variable core supercharger and the low pressure forward burner. The potential benefits for these unconventional systems are indicated.

INTRODUCTION

The military services desire to develop aircraft with STOL and VTOL capability. The Navy is considering VTOL aircraft for operation from small carriers, destroyers, and merchant ships in wartime. The Air Force's interest lies in operation from airfields with bombed and damaged runways. Subsonic V/STOL aircraft also have civil applications for rescue missions, transportation in undeveloped areas and into city centers.

V/STOL aircraft can be grouped into three categories: rotorcraft, subsonic cruise aircraft, and supersonic cruise aircraft. The present discussion deals with the latter.

Vertical operation at take-off and landing places special requirements on the propulsion system. The center of thrust must pass through the airplane center of gravity. This can be an especially difficult requirement for a supersonic airplane, which must also have a low frontal area, which generally favors the propulsive jet being at or near the rear of the airplane. A number of airplane arrangements are shown in figure 1 (ref. 1). The simplest way to achieve the desired arrangement of thrust and c.g. is to take-off and land the airplane in the vertical attitude, figure 1(a). The pilots tend to object to this even though the cockpit region of the airplane itself might be made to tilt to horizontal. The remaining airplanes shown take-off and land in the horizontal attitude.

Also, for vertical operations the airplane thrust must exceed the airplane weight. In the airplane of figure 1(b) lift engines are added immediately behind the cockpit to both increase the total vertical thrust and to balance the pitching moment of the vertical thrust from the aft deflected jets. This approach has the disadvantage that the thrust available for airplane acceleration and maneuver, compared to the take-off thrust, is reduced because the lift engines are shut down after take-off.

In the airplane of figure 1(c) some of the fan air from the main turbofan engines is bled from the engine and ducted forward and burned to achieve both a balance in pitching moment and an increase in thrust. The forward ducting adds to the propulsion system and airplane frontal area.

In the airplane of figure 1(d), the fan stages are spaced apart on a common shaft. For vertical operation, the front fan airflow is exhausted from a nozzle as far forward on the airplane as possible to achieve a balance of the airplane pitching moments. The airflow passing through the rear fan is supplied by an auxiliary inlet. This airflow, part of which passes through the engine core, is exhausted through a thrust vectoring nozzle at the rear of the engine. Thus, in this mode of operation, each fan is supplied by a separate inlet, and the bypass ratio of this engine is relatively large. The large bypass ratio can be effective in augmenting the thrust for vertical operation.

For supersonic operation, the flow of the front fan passes through the second fan just as in a conventional two stage fan engine. The front fan nozzle and aft fan inlet are closed in this operating mode.

There are variations of all the airplane types shown. The purpose of this paper is to discuss some variations on the tandem fan that may be advantageous. The airplane pitching moment and layout advantages will be shown and the performance advantages of various engine cycle changes will be presented. The special propulsion system components required will be illustrated.

DISCUSSION

Airplane/Engine Concepts

Airplane layouts. - The basic airplane layouts to be considered are shown in figure 2. The reference engine used in these airplanes is also shown. It has a two stage fan with each fan stage having a pressure ratio of about 1.4. These fans are driven by a core engine and the overall engine bypass ratio, (i.e., ratio of mass flow around the core to mass flow through the core engine) in the conventional operating mode is about 2.0.

The airplane to the left in figure 2 is the tandem fan airplane. Compared with the reference engine above, the two fans are spread apart but still on a common axis. At take-off, the air from the front fan is discharged forward of the airplane c.g. A second inlet is required to supply airflow to the second fan and core. Note that in this airplane layout, the engines are spaced apart laterally, increasing the airplane frontal area. Also, the second fan and core are not as far rearward as they could be. This is to keep the shaft to the front fan reasonable in length. Note also that the inlet is of the axisymmetric type to minimize its length and hence its overlap on the pilot's canopy. This inlet type has limited angle of attack tolerance, and this inlet location may be subject to exhaust gas recirculation.

The airplane arrangement on the right of figure 2 is generally very similar to the tandem fan. The key difference is that the front fan can reverse its direction of flow whereupon and the front fan inlet becomes the front fan exhaust nozzle. This arrangement permits the two engine systems to move rearward and closer together. It also increases the moment arm of the front jet, and permits the use of a two dimensional inlet which has better angle of attack capability than the axisymmetric inlet. In VTOL operation, the aft inlet must now supply the air for both the front and aft fans. This inlet arrangement should also reduce exhaust reingestion, (ref. 2).

The important conclusion thus far is that the reverse flow fan system offers significant, and important airplane layout advantages. The special components required for this system are described more fully later.

Engine cycle variations. - Figure 3 shows the engine cycle variations that will be considered. The tandem and reverse flow fan are basically the same engine cycle. The cycle variations are: variable core supercharging, fan air burning, and a parallel flow operating mode for subsonic cruise. Recall that during supersonic flight the fans operate in a series mode. The effect of these cycle changes can be quantified by analysis, and is discussed next.

Engine Performance

The engine cycle variations shown in figure 3 are evaluated in this section in terms of the engine performance parameters of thrust per unit frontal area and specific fuel consumption.

Take-off, no fan air burning. - Figure 4 presents the relative thrust, at static conditions, for several variations of the reference engine, which has two fan stages, each with a design fan pressure ratio $(FPR)_D = 1.40$. This is about the lowest fan pressure ratio to avoid gearing between the fan and core. The first bar is for the reference engine in which the two fans operate in series. In this case the nozzle pressure ratio (NPR) is $NPR = (FPR)_D^2$. The core is sized to drive the fans and has a relative power of unity. During parallel operation (the second bar) the relative thrust increases about 2 percent. The engine bypass ratio has increased which tends to increase the thrust. However, the core power has dropped because the core supercharging effect of the front fan stage has been lost. This loss in power tends to decrease the thrust. Thus, the bypass ratio effect and the core power effect tend to offset each other.

Take-off with core supercharging. - Adding a variable core supercharging stage, (third bar) increases the thrust 14 percent over the reference case. The fan and nozzle pressure ratios are now about 1.5, corresponding to the mechanical speed limit of the fans. Of course the fans must be capable of generating this pressure ratio. The combination of parallel operating fans and variable core supercharging offers the potential for a significant thrust increase at take-off.

The efficiency of producing the the thrust is not of great importance at take-off because of the short take-off time involved. This is potentially important to the reverse pitch front fan because one might anticipate that its fan efficiency may be less in reverse flow, than in conventional flow.

Next consider the question of the required take-off thrust. For some supersonic missions, the engines for the aircraft are sized for the transonic acceleration or maneuver and then have excess thrust at take-off. This situation would again make a reduced efficiency of the reverse pitch fan acceptable. The unique feature of the reverse flow front fan is its ability to produce an airplane nose up pitching moment. The potential for increased thrust by variable core supercharging may, be of secondary importance for some airplane missions.

Take-off with fan air burning. - The engine thrust will increase with increasing cycle temperature as shown in figure 5, providing the burner losses associated with the flame holder and momentum pressure drop can be kept small. The results shown are for a burner inlet Mach number of 0.2.

The problems with achieving this are discussed later. The thrust should increase approximately as the square root of the temperature ratio which accounts for the general shape of the curve. Parallel fan operation gives the larger thrust increase because this mode of operation handles more air-flow. However, the problem of maintaining low losses is aggravated at the lower fan pressure ratio of parallel operation. A thrust increase of up to 45 percent is available at 2000°R burner temperature. Burning in only the front fan air would also increase the airplane nose up pitching moment.

Subsonic cruise. - The airplane we are considering has supersonic capability, but it may be advantageous from a range point of view to perform parts of the mission with a subsonic cruise segment. While thrust was of prime importance at take-off, specific fuel consumption (SFC) is of prime importance at subsonic cruise. An engine sized for vertical take-off, or for transonic maneuverability, will be oversized for subsonic cruise. Figure 6 shows the relative SFC versus relative thrust for $M=0.8$ cruise for parallel and series fan operation. A typical cruise operating thrust level is indicated at about 1/4 the maximum series-mode engine thrust capability. At this degree of part throttle the SFC is on the verge of sharp increase with further decreases in power. At this thrust level, parallel fan operation offers about a 4 percent advantage in SFC, but at the expense of special inlets and nozzles.

The special propulsion systems components required for these engine cycles are discussed next.

Special Engine Components

Three categories of components are considered: (1) The nacelle components of inlets and nozzles, (2) rotating machinery, and (3) burners. The nacelle components for the tandem fan are shown in figure 7. The geometry of each component is shown arranged vertically for; take-off (or landing), subsonic cruise, and supersonic flight.

Aft nozzle. - The discussion starts with the aft nozzle because this component is common to all the engines discussed herein. The nozzle shown is two dimensional with a width to height ratio of about 1 or 2. For take-off (upper right hand sketch) the exhaust flow is deflected downward by an arc of a cylinder which has been rotated into the appropriate position. The proper nozzle exit area is achieved by deflecting the lower lip of the nozzle downward. The exit area is relatively large because it is assumed the engine flow has been heated to a high temperature to increase the thrust.

For subsonic cruise (right, middle sketch) the jet is directed straight aft. The deflecting cylindrical arc has been rotated to a stowed position. The lower lip has been rotated up to the horizontal position, and the whole lower nozzle segment has been rotated aft and up to reduce the exit area. Compared with vertical take-off, the cruise condition requires less thrust and correspondingly less nozzle area.

For the supersonic cruise (right lower sketch) more thrust is provided by afterburning, so the nozzle throat area is increased by retracting the lower nozzle segment, and some supersonic expansion is achieved by deflecting the upper nozzle lip upward. This particular type of nozzle is a single ramp expansion nozzle in contrast to a nozzle which is symmetric about the horizontal center line and referred to as a double ramp expansion nozzle. The type shown is more adaptable to the required 90° take-off deflection.

In the tandem fan engine, at take-off, the aft nozzle handles the aft fan and core engine gas flows.

Tandem fan front nozzle. - For the tandem fan at take-off (center, upper sketch) the flow through the front fan must also be deflected downward. This is accomplished by four rotatable segments that can be deployed across the duct between the front and aft fans, as shown in the upper sketch, and then stowed leaving a clear duct for subsonic cruise, as shown in the lower two sketches. The same result could be obtained by a series of variable angle vanes across the duct which deflect to form the nozzle for take-off and are feathered in the flow for series operation.

Tandem fan front inlet. - The tandem fan airplane was shown with an axisymmetric supersonic inlet characterized by a sharp lip. For good static take-off performance, the centerbody is collapsed to open up the inlet throat area, and blow-in-doors are dispersed around as much of the inlet duct circumference as possible to open inlet area with well rounded, or slotted lips.

At subsonic cruise (left, middle sketch) the inlet area with a collapsed centerbody may closely match the airflow required by the engine so the blow in doors may be closed.

At supersonic cruise, the blow in doors are not required and the centerbody is expanded to give the required supersonic compression. As mentioned earlier, this inlet type is short but has a limit angle of attack tolerance.

Tandem fan aft inlet. - At take-off, the tandem fan aft fan and core engine require a separate inlet (center, upper sketch). This inlet is formed by folding the upper quadrants of the inlet duct about longitudinal hinge lines to form generous radii for the inlet side lips (sec. AA). The aft, highly aerodynamically loaded, lip may be thin and require a slat as shown. At subsonic and supersonic cruise the aft inlet doors are closed forming smooth internal and external surfaces.

The aft inlet is restricted to the upper duct surfaces to minimize re-ingestion of deflected exhaust gases due to recirculation near the ground.

Reverse flow fan nacelle. - The reverse flow fan inlet and nozzle components are shown in figure 8. The aft nozzle is the same as that for the tandem fan. With the reversing flow front fan, the front inlet must also function as a nozzle for VTOL. Because of the airplane-engine arrangement, described earlier, a two dimensional inlet is an option for the forward inlet.

Reverse flow fan front inlet/nozzle. - The reverse flow fan requires the inlet to also function as a 90° deflecting nozzle at take-off (left upper sketch). The inlet compression ramps are retracted, the lower inlet lip is deflected downward, and a cylindrical arc is deployed to provide the desired jet deflection in a manner very similar to the aft exhaust nozzle.

For subsonic cruise, (left, middle sketch) the cylindrical arc deflecting surface is retracted, the lower inlet lip is raised. The inlet compression ramps remain retracted.

For supersonic cruise (left, lower sketch) the inlet ramps are deployed to accomplish the required supersonic compression and subsequent subsonic diffusion. There is some inlet throat bleed between the two ramps. This air is discharged through the inlet upper surface.

Reverse flow fan aft inlet. - At take-off, the aft inlet (upper center sketch) must provide air for not only the aft fan and core engine as it did for the tandem fan, but also for the front fan which is flowing in reverse. The inlet is similar to that described for the tandem fan with longitudinally hinged side quadrants (sec. AA) but in this case with slats on both the forward and aft lips. The aft inlet flow area and length are about

twice that for the tandem fan, but still about the same length as the aft inlet plus front nozzle for the tandem fan. This means that the axial spacing between the two fans for the two systems (i.e., tandem fan, and reversing fan) is about the same.

If the propulsion system operates with the fans flowing in series during subsonic and supersonic flight, then the top inlet doors are closed yielding smooth internal and external surfaces as illustrated in the lower center sketch.

Parallel flow subsonic cruise. - One of the possibilities suggested in the engine cycle analysis was to cruise at subsonic speeds with the fans operating in the parallel mode. The geometry for an aft inlet and front nozzle for this operating mode are illustrated by the center middle sketch. The idea here is to approximate the geometry of the short aft inlet that showed good performance in reference 3.

The inlet and nozzle geometry to accommodate both take-off and subsonic cruise with parallel fan flows remains to be designed.

Reverse flow fan. - A key component in the reverse flow fan system is the fan with reverse flow capability. To start this discussion, consider the front fan for the tandem fan system. This stage consists of variable inlet guide vanes (VIGV's), rotor and stator. The blades are all appropriately twisted from hub to tip, to yield the desired radial blade loading. The variable inlet guide vane has a variable trailing edge flap which can be used in conjunction with a similar VIGV set on the aft fan stage to vary the thrust split between the front and aft fan, at constant shaft power, to achieve airplane pitch control.

The reverse pitch fan stage is shown in figure 9. The basic method of changing the fan flow direction is by changing the fan blade pitch, hence a variable pitch rotor (VPR) is used. The assumption is made that high take-off thrust with the fan flow in reverse is of equal importance to achieving high thrust for aircraft acceleration and supersonic flight with conventional fan flow. This rationale leads to selecting a compromise fan blade with an untwisted but still cambered fan rotor blade shape.

If we rotate the blade to a pitch angle to achieve the desired loading at the blade tip, then the untwisted blade is loaded too lightly toward the root. The desired loading can be achieved by segmented variable inlet guide vanes designed to load up the rotor root region. This is accomplished by deflecting the flow through the inlet guide vanes counter to the rotor direction of rotation, as shown in the upper left part of figure 9. The exit guide vanes are also variable (VEGV's) to function as properly designed stators. For reverse fan flow, the rotor blade can be changed in pitch so that blade camber remains correct but the blade leading edge now becomes its trailing edge, e.g. point a. The function of the VIGV's and VEGV's are now interchanged. Thus, the whole stage is designed symmetrically.

The Quiet Clean STOL Experimental Engine (QCSEE) for the under the wing (UTW) airplane design was designed with a variable pitch rotor. (ref. 4) It had about 87 percent fan efficiency in forward flow and about 80 percent in reverse flow. But in the the QCSEE application the required reverse thrust level was only 35 percent of the forward thrust. The special requirements for VTOL call for a revised fan design as discussed, and a research effort would be required to develop fan designs exhibiting high efficiency in both flow directions. (A high fan efficiency in reverse is not necessarily of great importance if the required thrust can be produced in spite of a lower efficiency. This can occur if the core has adequate

power. In this case the low fan efficiency only reflects in the fuel consumption at take-off which is relatively small).

Variable core supercharger. - This component of the rotating machinery is shown in figure 10. It's located between the second fan stage and the basic core engine. Its function is to supercharge the core engine and increase the power output of the engine for parallel flow operation. The variable core supercharger (VCS) consists of a variable inlet guide vane stage, a rotor, and a stator. The concept of its operation is the following: When the two fan stages are operating in series (the upper sketch) the flow approaching the core inlet has passed through both fan stages and the pressure ratio of the air approaching the core is near 2.0. In this case the core supercharging stage is not needed so the VIGV's are set to yield a pressure ratio of unity. The VIGV's turn the flow in the direction of the rotor rotation as shown. This causes some air to spill around the core inlet as is also shown by the dashed streamline.

In the parallel mode of fan operation (the lower sketch) the air passing through the front fan is exhausted through a thrust nozzle, and ambient pressure air is drawn into the second fan. The pressure ratio of the air approaching the core inlet is 1.4 compared with 2.0 for series operation. With a supercharging stage just ahead of the core, the pressure at the front face of the main compressor can be increased. The core can now accept a higher flowrate and thereby produce a higher power output. Without the variable core supercharger, core power is reduced by about 30 percent in parallel fan operation. With the VCS, the core power output can be increased and the thrust output of the fans can be improved. Ideally, the VIGV's of VCS are set so the VCS generates a pressure ratio of 1.4 and air entering the core is again at a pressure ratio of 2.0. The entrance to the VCS has been sized to handle the core design airflow for approach air flow at a pressure ratio of 1.4 as indicated by the straight-in dashed streamline.

In the engine cycle results discussed in figure 4 the fans in the parallel operating mode are capable of absorbing only a part of the power of a fully supercharged core. In that case, the combination of the core and core supercharging stage can be designed so the core supercharging stage operates over a pressure ratio range of about 1.1 to 1.2.

Fan air burners. - In principle the thrust of a jet should be proportional to with the square root of the jet temperature for any value of fan pressure ratio. In reality, achieving a thrust increase depends on heat addition at low flow Mach numbers to keep the losses low, and at relatively high initial temperatures for a good burning rate. The low fan pressure ratio can cause problems in both areas. The sketches in figure 11 show several approaches to these problems.

The upper sketch considers the flow Mach number problem. If the fan has a fan face Mach number of 0.6 and a pressure ratio of 1.4 the flow exit Mach number in a constant area duct will be about 0.4, which is too high for burning. However, with a 90° turn, as is required for take-off the flow can be decelerated to a Mach number of 0.2 through an angled cascade. Several other possibilities for a compact burner now exist. Fuel injection ahead of the fan can use fan generated turbulence to promote fuel-air mixing. The required flame holder can be combined with the turning vanes. These systems will have to be retracted or feathered for series fan operation. In this case, the 90° turn has offered the opportunity for a low

duct Mach number without an increase in frontal area, although adequate duct length is required.

The problems of initial gas temperature and fan Mach number are addressed in another way in the lower sketch. Here high pressure, moderately high temperature air is bled from the core engine to a series of burners dispersed circumferentially about the fan. This core air is burned to a high temperature but is still fuel rich. This mixture is ejected into the fan air stream. The front nozzle fan thrust is now augmented by the high momentum of the burned core air, the temperature rise of the fan air due to mixing with the core gases, plus burning of the excess fuel. Of course, the core engine would have to be designed to accommodate the required bleed flow.

Swirling of the combustor stream is another way to improve the burning stability (ref. 5).

It should be noted that take-off (or landing) thrust is required for only a short time so a high burner efficiency is not of key importance. Accepting a low combustion efficiency helps shorten the required combustor length.

Low pressure fan air burners for short duration use are a new area requiring research effort.

Transition Between Operating Modes

One of the inherent problems associated with the tandem fan propulsion system is the in-flight transition of the system from one operating mode to another. For example, during vertical take-off the tandem fan propulsion system operates in the parallel flow mode. Once the aircraft reaches a reasonable height above the ground, the forward and aft vectoring nozzles are positioned so as to provide a thrust component in the forward flight direction. As the forward flight speed of the aircraft increases, more lift is provided by aerodynamic forces; and at some forward speed (corresponding to a flight Mach number of about 0.3), the aerodynamic forces provide all the lift required for support of the aircraft.

At this point in the mission, the transition can be made from the parallel flow operating mode to the series flow operating mode. In order to accomplish the transition, several physical changes must be made to the propulsion system in an orderly and timely fashion. With the conventional tandem fan engine, these changes include:

- (a) Closing of the auxiliary inlet and forward nozzle
- (b) Adjustments to the throttle setting and aft nozzle flow area
- (c) Adjustments to the fan blade (or IGV) settings
- (d) Positioning of the aft nozzle to provide the thrust vector in the direction of flight.

With the reverse flow tandem fan concept, the transition from parallel flow to series flow includes several other steps: reversing the fan pitch and the transition of the forward inlet/nozzle section from a nozzle to an inlet.

Further study is needed to evaluate the operational problems associated with these transitions.

SUMMARY

For an airplane with supersonic capability, the tandem and dual reverse flow fan engine arrangements offer engine thrust and efficiency cycle advantages at take-off and subsonic cruise. Parallel operation of the two fans is advantageous for vertical take-off and landing, while series operation is advantageous for high speed (transonic or supersonic) operation. In the parallel operating mode further thrust augmentation for take-off or landing can be obtained by combustion in the fan air flow, and by core supercharging.

The reverse flow fan system offers important potential advantages in airplane layout in terms of higher fuselage fineness ratio, better pitching moment control, and reduced likelihood of exhaust gas reingestion into the inlet.

Both propulsion systems require technology advances in the propulsion system components of inlets, nozzles, and rotating machinery. Unique new research areas include; the low pressure fan air deflector and burner, and the high efficiency reverse flow fan, and inlet that also functions as a nozzle.

CONCLUDING REMARKS

This paper has examined several candidate propulsion systems. In examining supersonic type V/STOL aircraft it becomes evident that there are many candidate propulsion systems with many variations within each system. Many new operating requirements are placed on the propulsion system components. The propulsion systems for supersonic V/STOL can be a most fruitful area for research, and a substantial research effort is warranted.

REFERENCES

1. Boruff, W. R., and Roch, A. J., "Impact of Mission Requirements on V/STOL Propulsion Concept Selection," Journal of Aircraft, Vol. 18, No. 1, Jan. 1981.
2. Kuhn, R. E., "Design Concepts for Minimizing Hot-Gas Ingestion in V/STOL Aircraft", AIAA Paper No. 81-1624, Aug. 1981.
3. Ybarra, A. H., "Additional Testing of the Inlets Designed for a Tandem Fan V/STOL Nacelle", NASA CR-165310, June 1981.
4. Kock, C. C., "QCSEE Fan Aerodynamic Design and Performance", Proceedings of Quiet, Powered-Lift Propulsion Conference, NASA-Lewis Research Center, Cleveland, Ohio, Nov. 14-15, 1978, pp. 31-52, NASA CP-2077.
5. Lohmann, R. P., and Mador, R. J., "Experimental Evaluation of a Low Emissions High Performance Duct Burner for Variable Cycle Engines (VCE)", NASA CR-159694; 1979.

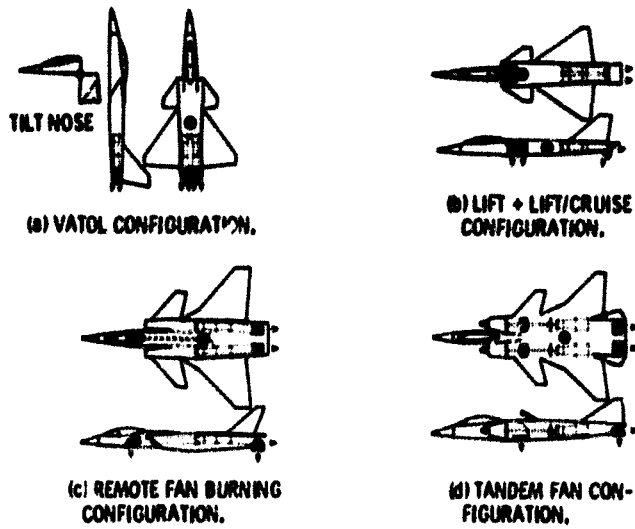

Figure 1. - Supersonic V/STOL airplane types.

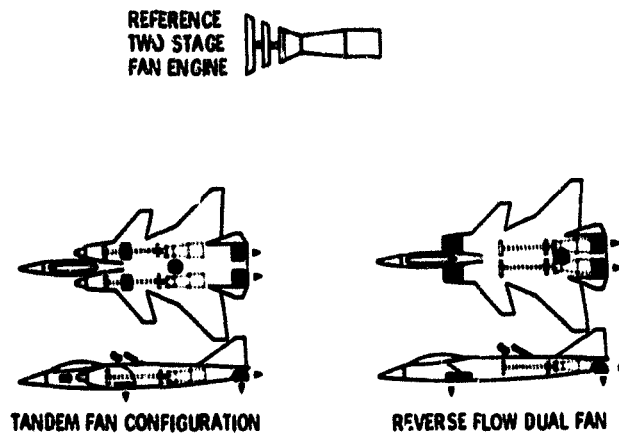

Figure 2. - Airplane variations.

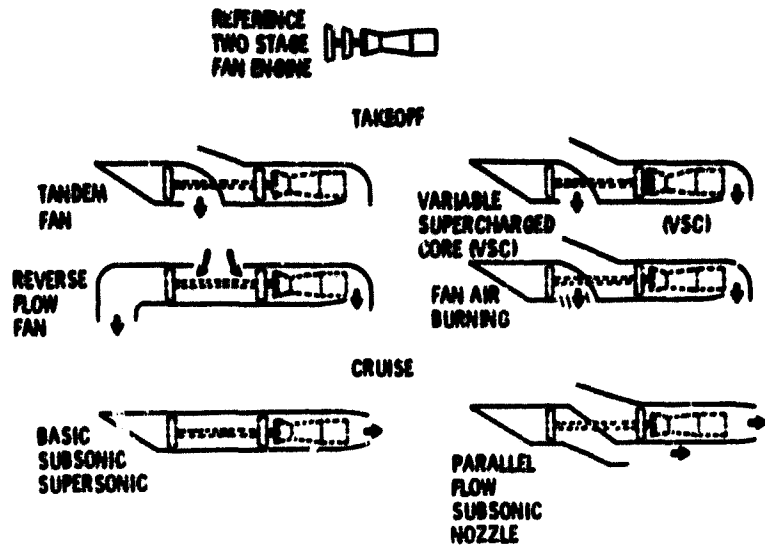

Figure 3. - Engine cycle variations.

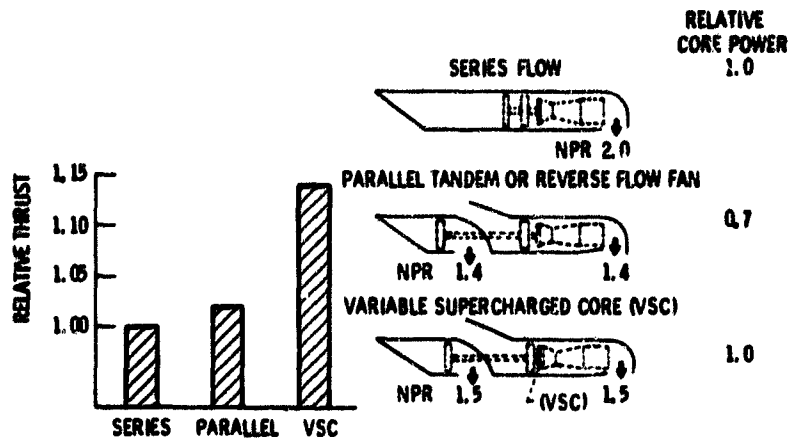

Figure 4. - Takeoff engine performance.

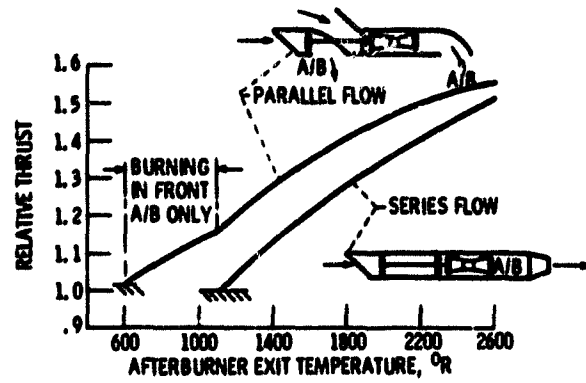

Figure 5. - Effect of afterburner temperature for parallel and series operating modes (FPR)_{DES} = 1.4.

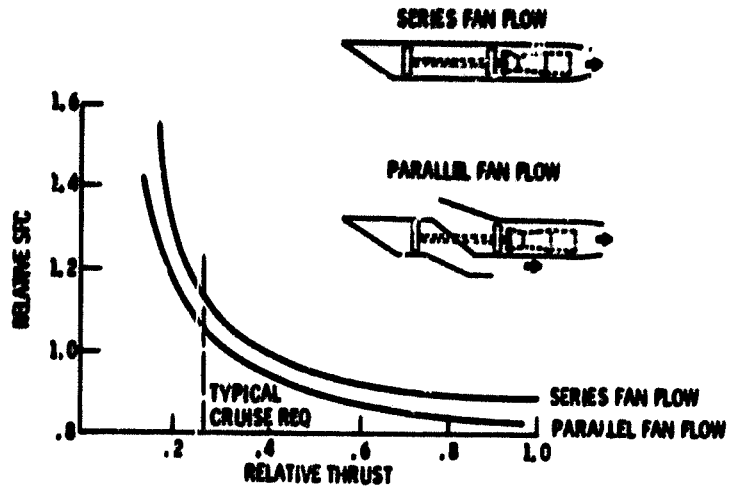

Figure 6. - Subsonic cruise specific fuel consumption $M_0 = 0.8$
 $WPR_{DES} = 1.4$

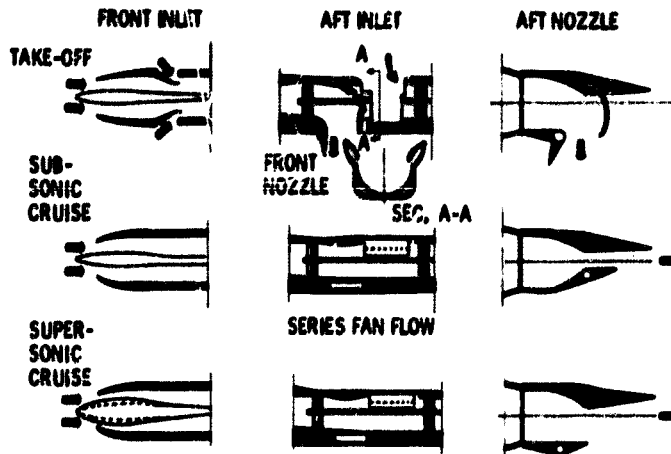

Figure 7. - Inlets and nozzles for tandem fan propulsion systems.

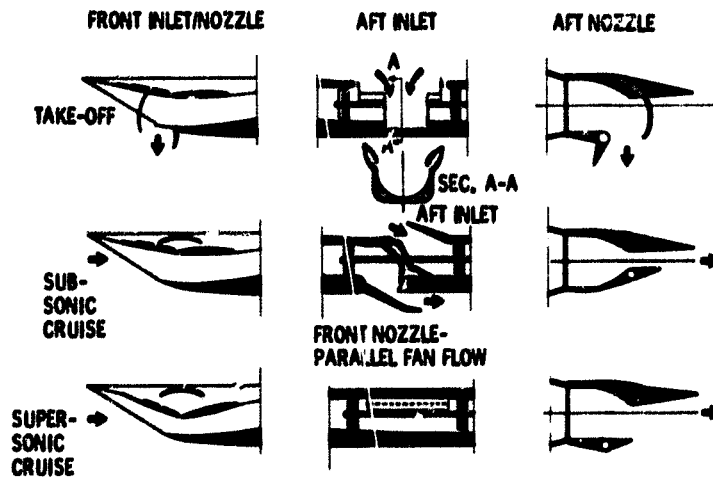

Figure 8. - Inlets and nozzles for reverse flow fan propulsion system.

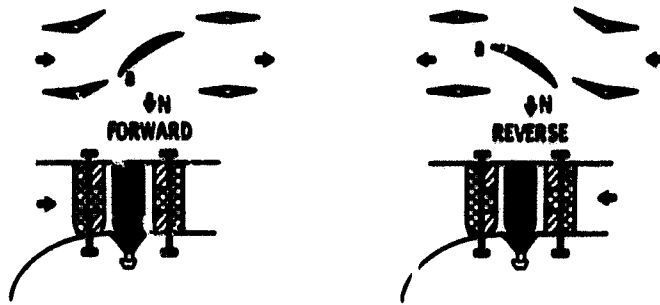

Figure 9. - Reverse flow fan concept (blade root sections).

FAN OPERATING MODE

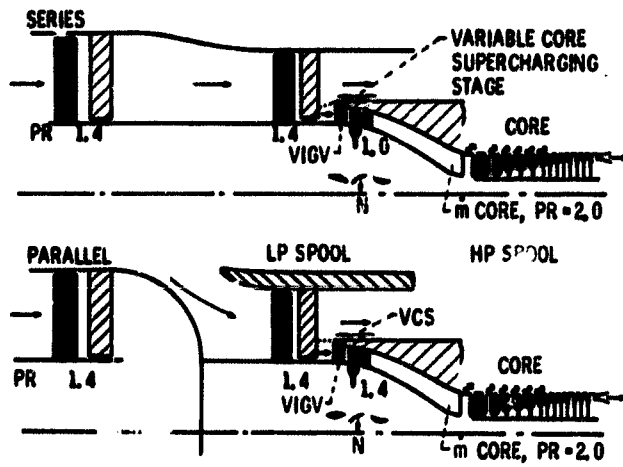

Figure 10. - Variable core supercharger.

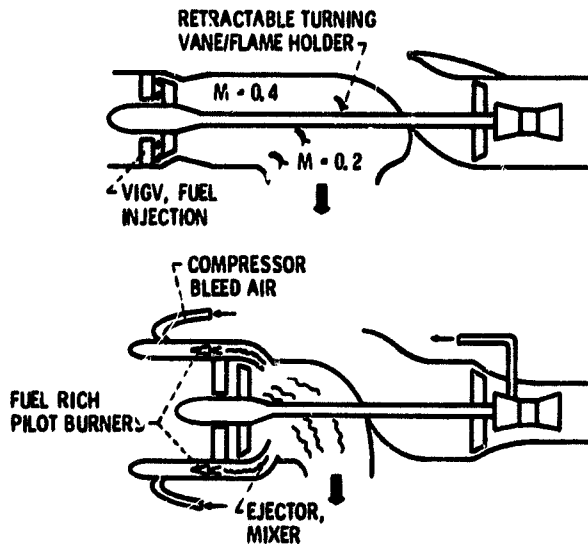

Figure 11. - Fan air burners.