

NASA CR-165459
PWA-5594-164

NASA-CR-165459
19820014390



ENERGY EFFICIENT ENGINE
EXHAUST MIXER MODEL TECHNOLOGY REPORT

by:

H. Kozłowski and M. Larkin

UNITED TECHNOLOGIES CORPORATION
Pratt & Whitney Aircraft Group
Commercial Products Division

Prepared for
NATIONAL AERONAUTICS AND SPACE ADMINISTRATION
Lewis Research Center
Cleveland, Ohio
Contract NAS3-20646



NF01561



**UNITED
TECHNOLOGIES
PRATT & WHITNEY
AIRCRAFT**

400 Main Street
East Hartford, Connecticut 06108

Commercial Products Division

In reply please refer to:
WBG: WS (5419n) - E1M3
LC-82-30

26 March 1982

To: National Aeronautics and Space Administration
Lewis Research Center
21000 Brookpark Road
Cleveland, Ohio 44135

Attention: Mr. Carl C. Ciepluch, Mail Stop 301-4

Subject: Submittal of the Energy Efficient Engine Exhaust Mixer
Model Technology Report, NASA CR-165459 (PWA-5594-164)

Reference: (a) Contract No. NAS3-20646
(b) Letter, J.W. Schaefer to W.B. Gardner, "Contract
NAS3-20646 - Approval of Exhaust Mixer Model
Technology Report" dated October 5, 1981, ref. 2321

Enclosures: Twenty copies of the subject report

In accordance with the requirements of references (a) and (b), we are pleased to submit twenty copies of the subject report, which includes all revisions to the draft accompanying the reference (b) letter.

Distribution is being made in accordance with the reference (b) letter.

Sincerely yours,

UNITED TECHNOLOGIES CORPORATION
Pratt & Whitney Aircraft Group
Commercial Products Division

W.B. Gardner
Program Manager

cc: Administrative Contracting Officer
Air Force Plant Representative Office
Pratt & Whitney Aircraft Group
East Hartford, Connecticut 06108

1. REPORT NO. NASA-CR-165459		2. GOVERNMENT AGENCY		3. RECIPIENT'S CATALOG NO.	
4. TITLE AND SUBTITLE Energy Efficient Engine Exhaust Mixer Model Technology Report				5. REPORT DATE June 1981	
				6. PERFORMING ORG. CODE	
7. AUTHOR(S) H. Kozlowski and M. Larkin				8. PERFORMING ORG. REPT. NO. PWA-5594-164	
9. PERFORMING ORG. NAME AND ADDRESS UNITED TECHNOLOGIES CORPORATION Pratt & Whitney Aircraft Group Commercial Products Division				10. WORK UNIT NO.	
				11. CONTRACT OR GRANT NO. NAS3-20646	
12. SPONSORING AGENCY NAME AND ADDRESS National Aeronautics and Space Administration Lewis Research Center 21000 Brookpark Road, Cleveland, Ohio 44135				13. TYPE REPT./PERIOD COVERED Technology Report	
				14. SPONSORING AGENCY CODE	
15. SUPPLEMENTARY NOTES NASA Project Manager, Mr. C. C. Ciepluch, NASA-Lewis Research Center					
16. ABSTRACT An exhaust mixer test program was conducted to define the technology required for the Energy Efficient Engine Program. A total of 44 model configurations of 1/10 scale were tested in two phases. Phase I was generally parametric exploring a variety of mixer design options, the impact of residual low pressure turbine swirl and integration of the mixer with the structural pylon of the nacelle. Phase II was more restricted in scope, concentrating on improving the mixer itself by extrapolating the Phase I trends. Nozzle performance characteristics were obtained along with exit profiles and oil smear photographs. Phase I established the sensitivity of nozzle performance to tailpipe length, lobe number and mixer penetration as well as mixer modifications like scalloping and cutbacks. The best practical configuration yielded a 2.1 percent reduction of thrust specific fuel consumption, with approximately 60 percent mixing. Residual turbine swirl was found to be detrimental to exhaust system performance and the low pressure turbine system for Energy Efficient Engine was designed so that no swirl would enter the mixer. Phase II expanded upon the Phase I results. The impact of mixer/plug gap was established, along with importance of scalloping, cutbacks, hoods and plug angles on high penetration mixers. The best configuration tested in Phase II provided a reduction of 2.7 percent in thrust specific fuel consumption with approximately 85 percent mixing. This configuration was selected for adaptation to the Intergrated Core/Low Spool.					
17. KEY WORDS (SUGGESTED BY AUTHOR(S)) Energy Efficient Engines Forced Exhaust Mixers			18. DISTRIBUTION STATEMENT Unclassified - Unlimited		
19. SECURITY CLASS THIS (REPT) Unclassified		20. SECURITY CLASS THIS (PAGE) Unclassified		21. NO. PGS	22. PRICE *

FOREWORD

The Energy Efficient Engine Component Development and Integration Program is being conducted under parallel National Aeronautics and Space Administration (NASA) contracts to Pratt & Whitney Aircraft Group and General Electric Company. The overall project is under the direction of Mr. C. C. Ciepluch. Mr. John W. Schaefer is the NASA Project Manager for the Pratt & Whitney Aircraft effort under National Aeronautics and Space Administration Contract NAS3-20646, and Mr. Gerald Kraft is the Project Engineer responsible for the portion of the project described in this report. Mr. William B. Gardner is Manager of the Energy Efficient Engine Project at Pratt & Whitney Aircraft Group. The authors H. Kozlowski and M. Larkin wish to thank L. Davis for his technical contribution to this report.

Table of Contents

<u>Section</u>	<u>Title</u>	<u>Page</u>
1.0	SUMMARY	1
2.0	INTRODUCTION	2
3.0	MIXER MODEL AEROMECHANICAL DESIGN	6
3.1	List of Symbols	6
3.2	Design Requirements and Criteria	7
3.3	Mixer Test Configurations	8
3.3.1	Phase I Test Configurations	8
3.3.2	Phase II Test Configurations	11
3.3	Model Fabrication	23
4.0	TEST FACILITY AND TEST PROGRAM	25
4.1	Test Facility	25
4.2	Test Instrumentation	25
4.3	Test Program	30
4.3.1	Test Conditions	30
4.3.2	Data Acquisition and Reduction	33
4.3.3	Data Repeatability	44
5.0	TEST RESULTS AND ANALYSIS	46
5.1	Phase I Test Results	46
5.1.1	Tailpipe Length	46
5.1.2	Lobe Variations	48
5.1.3	Mixer Penetration	51
5.1.4	Cutback	51
5.1.5	Turbine Swirl	51
5.1.6	Pylon Integration	55
5.1.7	Phase I Test Summary	58
5.2	Phase II Test Results	59
5.2.1	Mixer Length and Diameter Variations	59
5.2.2	Mixer/Plug Gap	59
5.2.3	Exhaust System Modification	64
5.2.4	Phase II Test Summary	70
6.0	CONCLUSIONS AND CONCLUDING REMARKS	73
	APPENDIXES	74
A	Test Data Tabulation	74
B	Exit Traverse Profiles	111
C	Flow Visualization Results	137

LIST OF ILLUSTRATIONS

<u>Number</u>	<u>Title</u>	<u>Page</u>
1	Propulsion System with Exhaust Mixer	3
2	Exhaust/Mixer Program Logic Diagram	4
3	Test Variables	8
4	Free Mixer Configurations 1, 2, 21 and 22	10
5	Phase I Mixer: Basic Forced Mixer Design	10
6	Configuration 19	12
7	Configurations 3, 4, 5, and 8	12
8	Configurations 3, 4, 5, and 8	13
9	Configuration 3 and 6	13
10	Configurations 3 and 7	14
11	Configuration 27, 23 (15 degree Swirl), 24 (36 degree Swirl)	14
12	Configurations 3, 9, 10 and 11	15
13	Configurations 13, 14, 15, 16, 28 and 30	15
14	Configurations 13, 14, 15, 16, 28 and 30	16
15	Configuration 29	16
16	Configurations 17 and 18	17
17	Configurations 17 and 18	17
18	Configuration 25	18
19	Configuration 26	18
20	Lower Bifurcator Ending Upstream of the Mixer Simulated in these Tests	19
21	Configurations 33, 41, 42 and 45	21

LIST OF ILLUSTRATIONS (Continued)

<u>Number</u>	<u>Title</u>	<u>Page</u>
22	Configuration 34	21
23	Configurations 35, 40, 46 and 47	22
24	Configurations 36, 37 and 38	22
25	Configurations 39, 43, 48 and 49	22
26	Channel 11 Facility Layout	26
27	Airflow for the Two Streams Oriented in a Concentric Fashion to Supply the Test Nozzle	27
28	Charging Station Instrumentation Housed in the Model Adapter Section	27
29	Fan Stream Charging Station Instrumentation	28
30	Primary Stream Charging Station Instrumentation	29
31	Traverse Rake Assembly	31
32	Actual Installation of the Traverse Probes	32
33	Data Processing Procedure	34
34	Equivalent Change in Thrust Specific Fuel Consumption Relative to the Optimized Separate Flow Exhaust System	37
35	Calculation of Mixing Efficiency	40
36	Procedure Used to Calculate Pressure Loss in Excess of Skin Friction	40
37	Resultant Plot Sample	42
38	Resultant Plot Sample	42
39	Flow Visualization Photographs, Configuration 49	43
40	Phase I Free Mixer Data Configuration 1	44
41	Phase II Free Mixer Data Configuration 1	45

LIST OF ILLUSTRATIONS (Continued)

<u>Number</u>	<u>Title</u>	<u>Page</u>
42	Thrust Specific Fuel Consumption Variation with Tailpipe Length	47
43	Percent Mixing and Excess Pressure Variation with Tailpipe Length	47
44	Temperature Pattern Measured at Tailpipe Exit	48
45	Thrust Specific Fuel Consumption Variation with Number of Lobes	49
46	Percent Mixing and Excess Pressure Variation with Number of Lobes	49
47	Comparison of Temperature Traverses at the Tailpipe Exit	50
48	Thrust Specific Fuel Consumption Variation with Penetration	52
49	Percent Mixing and Excess Pressure Loss Variation with Penetration	52
50	Impact of Increased Mixer Penetration on the Temperature Traverse Pattern at the Tailpipe Exit	53
51	Thrust Specific Fuel Consumption Variation with Cutback Angle	54
52	Energy Efficient Engine Phase I Mixer Performance Diagnostic Information	54
53	Impact of Turbine Discharge Swirl on Nozzle Performance	55
54	Flow Patterns Developed on Free and Forced Mixers for 36 degrees of Swirl	56
55	Flow Visualization Pictures Obtained on Short and Long Pylon Configurations	57
56	Four Basic Forced Mixer Designs	60
57	Results of Testing the Four Basic Mixers -- Mixer Size	60
58	Temperature Traverses Measured for the Four Basic Mixers	61

LIST OF ILLUSTRATIONS (Continued)

<u>Number</u>	<u>Title</u>	<u>Page</u>
59	Results of Testing the Four Basic Mixers -- Mixer/Plug Gap	62
60	Loss in Mixing is Evidenced in the Tailpipe Exit Surveys	62
61	Pressure Loss Reduction is Associated with Reduced Flow Disturbance on the Plug Near the Mixer	63
62	Scalloped Mixer Produces a Large Performance Improvement	65
63	Temperature Patterns Measured at the Tailpipe Exit	66
64	Modified Lobes Yield Thrust Specific Fuel Consumption Improvements	67
65	Tailpipe Traverses Confirm the Loss in Penetration	67
66	General Improvement in the Flow Field Around the Mixer Due to Hoods	68
67	Impact of Scalloping on Tailpipe Temperature Traverses	69
68	Steeper Plug Produces an Improvement in Thrust Specific Fuel Consumption	71
69	Geometry Differences Between in Series 35 and 36 are Evident	72

LIST OF TABLES

<u>Table</u>	<u>Title</u>	<u>Page</u>
I	Phase I Design Variables	9
II	Phase II Design variables	20
III	Test Configuration Components	24
IV	Phase I Test Matrix	33
V	Corrections to "Hot" Data at PTMPA = 2.5	36
VI	Phase I Test Summary	58
VII	Phase II Test Summary	71

1.0 SUMMARY

An exhaust mixer test program was conducted to define the technology required for the Energy Efficient Engine Program. A total of 44 model configurations of 1/10 scale were tested, in two phases simulating a 6.5 bypass ratio engine. Phase I was generally parametric exploring a variety of mixer design options, the impact of residual low pressure turbine swirl and integration of the mixer with the structural pylon of the nacelle. Phase II was more restricted in scope, concentrating on improving the mixer itself by extrapolating the Phase I trends. Nozzle performance characteristics were obtained along with exit profiles and oil smear photographs.

Phase I established the sensitivity of nozzle performance to tailpipe length, lobe number and mixer penetration as well as mixer modifications like scalloping and cut-backs. The best practical forced mixed configuration yielded a 2.1 percent reduction of thrust specific fuel consumption, with approximately 60 percent mixing. A free mixer, by comparison, provided 0.5 percent reduction in thrust specific fuel consumption with about 20 percent mixing. Residual turbine swirl was found to be detrimental to exhaust system performance and the low pressure turbine system for the Energy Efficient Engine was designed so that no swirl would enter the mixer. In addition, tests of representative pylon fairings integrated with the mixer indicated only a very small impact on mixer performance.

Phase II confirmed the Phase I trend that high penetration mixers were effective. The impact of mixer/plug gap was established, along with this importance of scalloping, cutbacks, hoods and plug angles on high penetration mixers. The best configuration tested in Phase II provided a reduction of 2.7 percent in thrust specific fuel consumption with approximately 85 percent mixing. Additional gains are felt possible with continued development.

The best mixer configuration from Phase II was selected for adaptation to the Integrated Core/Low Spool.

2.0 INTRODUCTION

The objective of the National Aeronautics and Space Administration Energy Efficient Engine Component Development and Integration Project is to develop, evaluate, and demonstrate the technology for achieving lower installed fuel consumption and lower operating costs in future commercial turbofan engines. National Aeronautics and Space Administration has set minimum goals of a 12 percent reduction in thrust specific fuel consumption, a 5 percent reduction in direct operating cost, and a 50 percent reduction in performance degradation for the Energy Efficient Engine (flight propulsion system) relative to the JT9D-7A reference engine. In addition, environmental goals on emissions (meet the proposed Environmental Protection Agency 1981 regulation) and noise (meet Federal Aviation Regulations 36-1978 standards) have been established.

The Pratt & Whitney Aircraft program effort is based on an engine concept defined under the National Aeronautics and Space Administration-sponsored Energy Efficient Engine Preliminary Design and Integration Study Program, Contract NAS3-20628. This program was completed under an earlier contract effort, and is discussed in detail in NASA Report CR-135396. The Pratt & Whitney Aircraft engine is a twin-spool, direct drive, mixed-flow exhaust configuration, utilizing an integrated engine-nacelle structure. A short, stiff, high rotor and a single stage high-pressure turbine are among the major features in providing for both performance retention and major reductions in maintenance and direct operating costs. Improved active clearance control in the high pressure compressor and turbines, advanced single crystal materials in turbine blades and vanes, and shroudless fan blades are among the major features providing performance improvement. The present propulsion system, with the exhaust mixer, is shown in Figure 1. The exhaust mixer is a scalloped design for reduced pressure loss, increased efficiency and light weight.

To meet the program objectives, four technical tasks were established by the Pratt & Whitney Aircraft Project Team:

- Task 1 Propulsion System Analysis, Design and Integration
- Task 2 Component Analysis, Design and Development
- Task 3 Core Design, Fabrication and Test
- Task 4 Integrated Core/Low Spool Design, Fabrication and Test

The work described in this report is a technology program conducted as part of the exhaust mixer system effort in Task 2. This activity was aimed at establishing the basic technology required to define a high performance mixed flow exhaust system for high bypass ratio engines. The performance objective was to demonstrate overall mixed flow exhaust system performance which is equivalent to a reduction of 3.3 percent thrust specific fuel consumption, over an optimized separate flow exhaust system equivalent to the Preliminary Design base-line engine of September, 1978. This technology would directly support the design of the Energy Efficient Engine Flight Propulsion System and the experimental integrated core/low spool engine. The interaction between the mixer technology program, the engine component program and the complete engine design is illustrated in Figure 2.

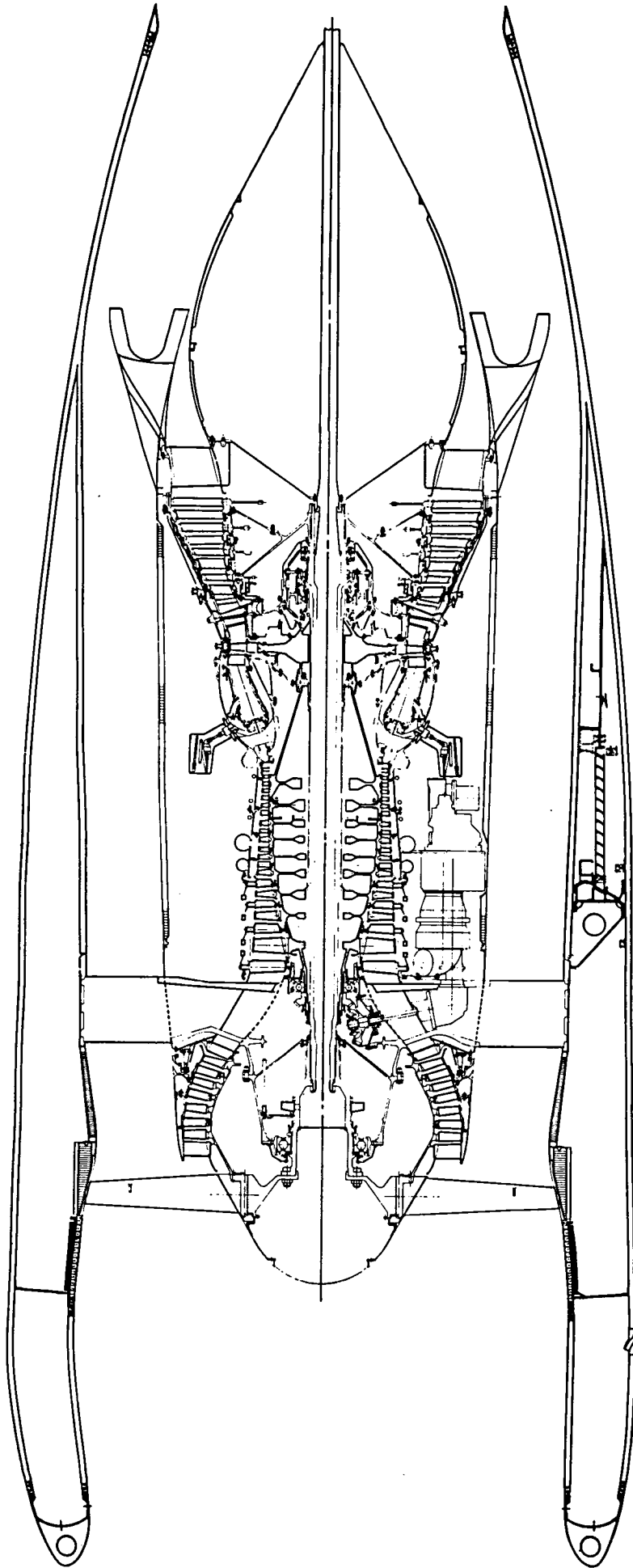
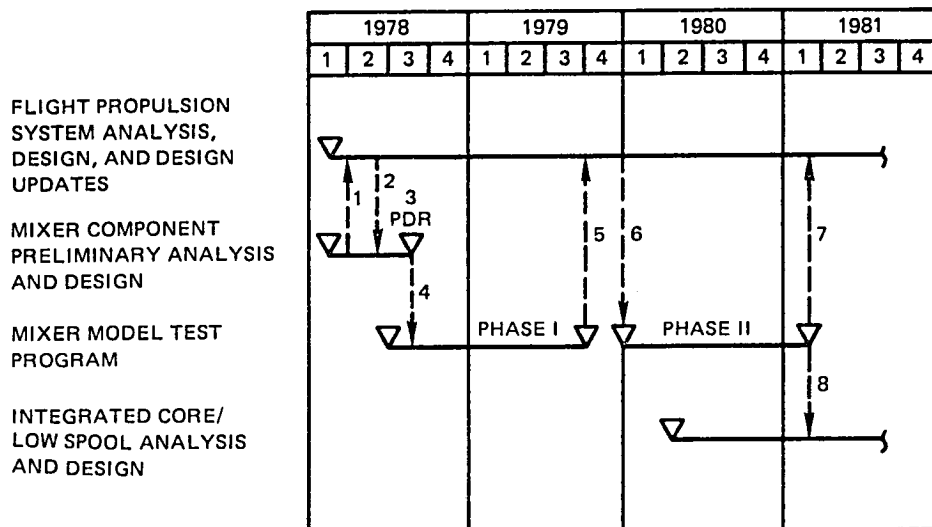

Figure 1 Propulsion System with Exhaust Mixer



- 1 - PRELIMINARY MIXER LAYOUT DEFINED FOR INCORPORATION INTO FLIGHT PROPULSION SYSTEM NACELLE DESIGN.
- 2 - EVALUATION OF PRELIMINARY NACELLE DESIGN COMPLETED, COMPONENT DESIGN REFINEMENT CONTINUES.
- 3 - COMPONENT PRELIMINARY DESIGN COMPLETED
- 4 - COMPONENT DESIGN DETAILS PROVIDED TO MODEL PROGRAM TO ESTABLISH BASELINE MODEL DESIGN
- 5 - PHASE I MODEL TEST RESULTS UTILIZED TO UPDATE FLIGHT PROPULSION SYSTEM MIXER DESIGN
- 6 - UPDATED FLIGHT PROPULSION SYSTEM MIXER DESIGN DETAILS PROVIDED TO MODEL PROGRAM TO ESTABLISH BASELINE DESIGN FOR PHASE II TESTS
- 7 - PHASE II MODEL TEST RESULTS UTILIZED TO REFINE FLIGHT PROPULSION SYSTEM MIXER DESIGNS
- 8 - PHASE II MODEL TEST RESULTS PROVIDED TO INTEGRATED CORE/LOW SPOOL ANALYSIS AND DESIGN TASK FOR COMPLETION OF EXHAUST/MIXER COMPONENT DESIGN

Figure 2 Exhaust/Mixer Program Logic Diagram

During the detail design of the mixed flow flight propulsion system, the engine became longer and its flow path was modified. The optimized separate flow exhaust system used for comparative purposes, in the mixer technology test program, was unchanged. This resulted in the performance benefit for the mixed flow configuration being reduced to 3.1 percent. The data presented in this report is in the context of the 3.1 percent benefit.

The mixer technology test program itself consisted of two phases spanning approximately 2 1/2 years (Figure 2). The first phase employed 28 test configurations covering a wide range of design variables such as tailpipe length, mixer lobe details, turbine swirl and integration of the structural pylon. After coordinating the results from Phase I with the updated engine design requirements, Phase II was conducted employing 16 configurations evaluating additional mixer refinements. This resulted in an improved mixed flow exhaust system which was subsequently adopted for the integrated core/low spool design.

The testing was conducted in the Channel 11 static thrust facility at Fluidyne Engineering Corporation, Minneapolis, Minnesota. Nozzle gross thrust and flow coefficients were measured at both "hot" and "cold" conditions. The "hot" conditions simulated the Energy Efficient Engine flow conditions with a fan/primary total pressure ratio (P_{T7}/P_{T8}) of approximately 1.1 and primary/fan total temperature ratio (TRAT) of approximately 2.5. The "cold" conditions used uniform flow conditions (i.e., $P_{T7}/P_{T8} = 1.0$ and $TRAT = 1.0$). This allowed mixing levels to be calculated and total pressure loss characteristics to be defined for each test configuration, providing important diagnostic information. In addition, total pressure and temperature traverses were taken at the exit of the tailpipe on many of the test configurations, along with oil smear photographs providing flow visualization in interesting regions of the exhaust system.

This report contains a complete description of the mixer model aeromechanical design, a description of the test facility and test program, and an in-depth discussion of the test results. Major conclusions and concluding remarks are also included. Finally, a complete tabulation of the measured data, the exit traverses and flow visualization photographs are presented in the Appendixes.

The mixer model aeromechanical design (Section 3.0) contains the requirements and criteria used in the model design, definition of the test configurations for Phase I and II and mixer model fabrication techniques.

The test facility and test program description (Section 4.0) includes detailed test conditions, data acquisition techniques and data reduction methods and data repeatability characteristics.

Phase I and II test results (Section 5.0) are discussed in detail and include correlation of mixer geometry with performance. Also included are test summaries which identify the more significant geometric variables for all configurations tested.

3.0 MIXER MODEL AEROMECHANICAL DESIGN

3.1 List of Symbols

A	Cross Sectional Area
AGAP	Mixer/Plug Gap Area
AMIX	Mixing Plane Area
APEN	Penetration Area
BPR	Bypass Ratio - Ratio of Measured Fan to Primary Flow
C _f	Skin Friction Coefficient
C _{DMIX}	Mixed Model Flow Coefficient
C _V "	Full Scale Model Thrust Coefficient
C _V "	Overall Gross Thrust Coefficient
C _{VMIX}	Mixed Model Thrust Coefficient
C _{VEXIT}	Exit Plane Thrust Coefficient
2r	Equivalent Duct Diameter
d _l	Incremental Duct Length
D	Tailpipe Diameter at the Mixing Plane
F _g	Gross Thrust
h	Enthalpy
H ₂	Forced Balance Axial Thrust Component
L	Tailpipe Length Measured From Mixing Plane to Exit
MIXP	Ideal Nozzle Performance Gain Available From Mixing
M _n	Mach Number
M _{nFAN}	Mixing Plane Fan Stream Mach Number
M _{nPRI}	Mixing Plane Primary Stream Mach Number
P	Static Pressure
PAM	Ambient Pressure
PRAT	Ratio of Mixing Plane Fan to Primary Stream Total Pressure
P _T	Total Pressure
PTEPAM	Mixing Plane Primary Stream Total to Ambient Nozzle Pressure Ratio
PTFPAM	Mixing Plane Fan Stream Total to Ambient Nozzle Pressure Ratio
PTMPA	Fully Mixed Total to Ambient Nozzle Pressure Ratio
PT7PAM	Charging Station Fan Stream Total to Ambient Nozzle Pressure Ratio
PT8PAM	Charging Station Primary Stream Total to Ambient Nozzle Pressure Ratio
R	1/2 Diameter at Mixing Plane
T	Static Temperature
T _o	Balance Temperature
TRAT	Ratio of Primary to Fan Stream Total Temperature
T _T	Total Temperature
T _{TMIX}	Full Mixed Total Temperature
T _{T7}	Charging Station Fan Stream Total Temperature
T _{T8}	Charging Station Primary Stream Total Temperature
V	Velocity
W _{aFAN}	Fan Stream Flow
W _{aPRI}	Primary Stream Flow

GREEK LETTERS

α	Angle Between Engine Lobe Peak and Mixer Side Wall
β	Average Swirl Angle
γ	Ratio of Specific Heats
η_m	Mixer Efficiency
θ	Angle Between Engine Lobe Peak and Fan Valley
ρ	Density
ψ	Mixer Cutback Angle
Δ	Difference in Levels

SUBSCRIPTS

C-D	Convergent Divergent Nozzle Effect
F	Fan Stream
M-FS	Model Full Scale Correction
P	Primary Stream
7	Fan Stream Charging Station
8	Primary Stream Charging Station
j	Jet

3.2 Design Requirements and Criteria

The requirements and criteria used in the model design for Phases I and II consist of simulated geometric flow paths and power conditions obtained from the Energy Efficient Engine Flight Propulsion System.

The test configurations were designed as one-tenth scale simulations of the mixed flow exhaust system with the fan duct flow path simulated downstream of the fan case and the primary flow path simulated downstream of the turbine exit. The following areas were simulated from the Flight Propulsion System design (except for some specific model variations noted in the discussion).

	Mixing Plane Area (A_{MIX})	= 269.35 cm ² (41.75 in. ²)
At mixing plane -- Primary Stream Area (A_P)	= 68.84 cm ² (10.67 in. ²)	
At mixing plane -- Fan Stream Area (A_F)	= 200.52 cm ² (31.08 in. ²)	
Jet Area (A_j)	= 214.58 cm ² (33.26 in. ²)	

In addition, the model configurations were designed using the Flight Propulsion System 100 percent maximum cruise power conditions, which are defined as:

Primary Nozzle Pressure Ratio (P_{T8}/P_{AM})	= 2.35
Fan to Primary Total Pressure Ratio (P_{T7}/P_{T8})	= 1.1
Primary to Fan Total Temperature Ratio (TRAT)	= 2.5

After the mixer model test program began, the Flight Propulsion System was lengthened and scaled down which effectively increased the model scale to 1/9.38.

The exhaust system design requirements dictate that the exhaust system be compatible with the Flight Propulsion System nacelle envelope and that it incorporate the shortest, smallest and most efficient mixing system. The Phase I program was constructed with these guidelines, employing variations of tail-pipe length, mixer lobe number, scalloping, penetration and cutback.

The requirements of the Phase II program were to capitalize on the trends established during Phase I, evaluating parameters which would further improve overall performance. These trends were applied to the best Phase I model configuration. It consisted of 18 lobes and a tailpipe length to diameter ratio of 0.61. These parameters were held constant while the penetration level was increased to 0.75, based on Phase I performance trends. With these parameters defined, the mixer length and diameter were varied.

In addition, mixer/plug gap, scalloping, cutback, mixer hoods, and plug angle were evaluated. A sketch defining the major design variables is shown in Figure 3.

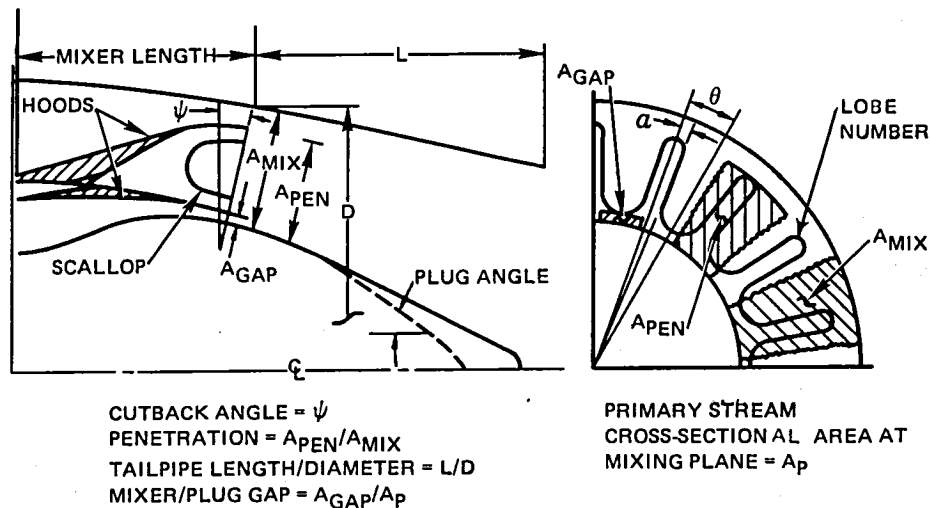

Figure 3 Test Variables

3.3 Mixer Model Test Configurations

Definition of the test configurations for Phases I and II is contained in Sections 3.2.1 and 3.2.2, respectively. The test configurations included are a free mixer in addition to 43 forced mixers. Major design variables are outlined and variations from the baseline design requirements are identified.

3.3.1 Phase I Configurations

Twenty-eight configurations were evaluated in the Phase I program. Four of the twenty-eight involved a free mixer (i.e., one having a simple splitter between the primary and fan streams). A description of each model configuration and its purpose is provided below.

A summary table identifying significant characteristics of the configurations tested in Phase I is presented in Table I.

TABLE I
PHASE I DESIGN VARIABLES

<u>Configuration Type</u>	<u>No.</u>	<u>No. of Lobes</u>	<u>Tailpipe Length/Diameter</u>	<u>Special Features</u>	<u>Penetration</u>	<u>Gap</u>	<u>α/θ **</u>
Free Mixer	1	--	0.50		---		
	21	--	0.50	15° Swirl	---		
	22	--	0.50	36° Swirl	---		
	2	--	1.00		---		
Blue	19	12	0.50		0.50	0.06	0.56
Green	3	12	0.50	Mixer Scarf Angle 0°	0.65	0.12	0.36
	4	12	0.75		0.65	0.12	0.36
	5	12	1.00		0.65	0.12	0.36
	8	18	0.50		0.65	0.12	0.36
	6	12	0.50	Modified Tailpipe	0.65	0.12	0.36
	7	12	0.50	Modified Mixer Lobes*	0.65	0.12	0.36
	27	12	0.50	Mixer Hoods*	0.65	0.12	0.36
	23	12	0.50	15° Swirl	0.65	0.13	0.36
	24	12	0.50	36° Swirl	0.65	0.12	0.36
	9	12	0.50	Mixer Scarf Angle -5°	0.63	0.12	0.38
	10	12	0.50	Mixer Scarf Angle-10°	0.61	0.13	0.39
11	12	0.50	Mixer Scarf Angle-15°	0.58	0.14	0.41	
Red	13	12	0.50		0.57	0.11	0.44
	30	12	0.50	Scalloped Mixer	0.57	0.11	0.44
	14	12	1.00		0.57	0.11	0.44
	15	18	0.50		0.57	0.11	0.44
	16	18	0.50	Scalloped Mixer	0.57	0.11	0.44
	29	18	0.61	Cutback Mixer	0.51	0.22	0.50
	28	18	1.00	Scalloped Mixer	0.57	0.11	0.44
Orange	17	18	0.50		0.49	0.09	0.57
	18	18	1.00		0.49	0.09	0.57
Green	25	12	0.50	Short Pylon	0.58	0.14	0.41
Green	26	12	0.50	Long Pylon	0.58	0.14	0.41

* - constant lobe width

** - at mixer exit, defined in figure 3

Note - Configurations 12, 20, 31, 32 were not tested.

3.3.1.1 Free Mixer Nozzle

The free mixer shown in Figure 4 consists of a conical splitter between the fan and primary streams, and was designed with two tailpipe lengths (configurations 1 and 2). These tailpipe lengths correspond to the extremes of those used with the forced mixer configurations. Establishing the performance level of the free mixer nozzle provided a method for evaluating the accuracy and repeatability of the test facility. In addition to tailpipe length, the free mixer was tested with 15 degrees and 36 degrees of turbine discharge swirl. These are configurations 21 and 22. It should be noted that the free mixer was designed with the following areas at the mixing plane.

$$\begin{aligned}
 \text{Mixing Plane Area (A}_{\text{MIX}}) &= 332.19 \text{ cm}^2 \text{ (51.49 in.}^2\text{)} \\
 \text{Primary Stream Area (A}_p) &= 97.42 \text{ cm}^2 \text{ (15.10 in.}^2\text{)} \\
 \text{Fan Stream Area (A}_F) &= 234.77 \text{ cm}^2 \text{ (36.39 in.}^2\text{)}
 \end{aligned}$$

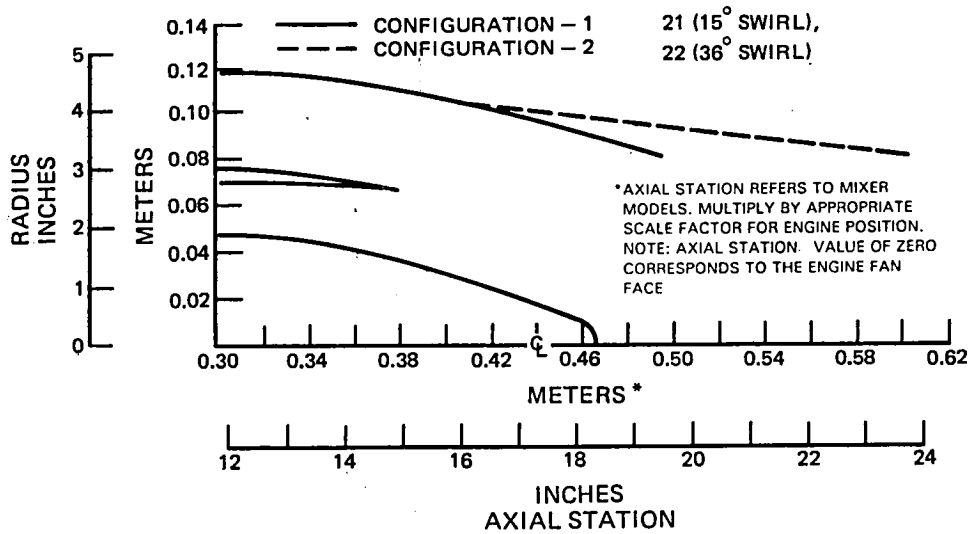

Figure 4 Free Mixer Configurations 1, 2, 21 and 22

The large mixing area was necessary in order to obtain free mixer and plug wall angles that minimize the possibility of separation within the nozzle length restrictions defined by the forced mixers designs.

3.3.1.2 Forced Mixer Configurations

Three basic mixer design families were chosen for Phase I representing different degrees of flow turning through the mixer as shown in Figure 5. The "blue" configuration represented the shortest, steepest design. It had a high degree of primary flow turning along with a steep fan valley angle and therefore had the lowest penetration of Phase I. The "green" and "red" series relaxed the amount of flow turning in stages and therefore were progressively longer and generally allowed a higher level of mixer penetration. An additional mixer design, the "orange" series, evaluated an enlarged mixing plane area. It had the same mixer length as the "red" series. These mixer designs were evaluated with an assortment of basic design variables such as tailpipe length, mixer lobe number, scalloping, etc.

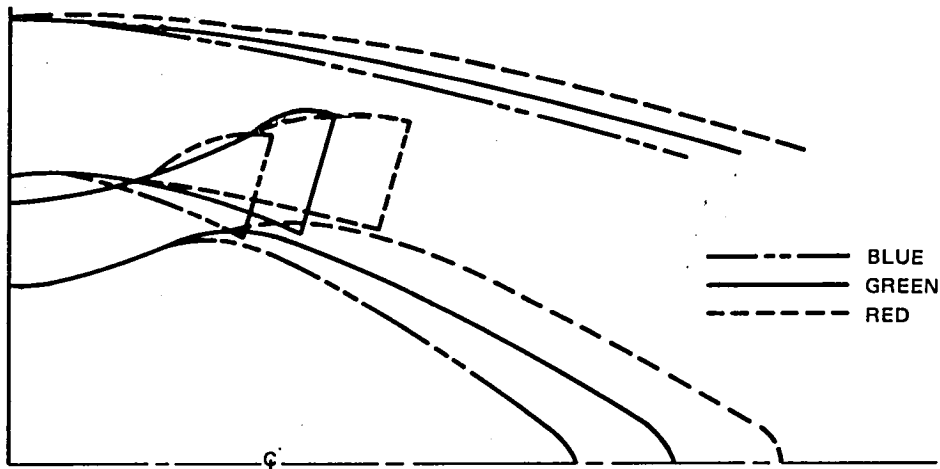

Figure 5 Phase I Mixer: Basic Forced Mixer Design

The "blue" configuration was confined to one mixer designed with 12 lobes and evaluated with a tailpipe length ratio (L/D) of 0.5. This was configuration 19 (see Figure 6).

The "green" series comprised a large number of configurations. Configurations 3, 4, and 5 varied tailpipe length using a 12 lobe mixer. Configuration 8 investigated the impact of increasing the mixer lobe number to 18 (see Figures 7 and 8). Configuration 6 had a modified tailpipe with a significantly larger flow area relative to configuration 3 (see Figure 9). Configuration 7 was designed with the same axial cross-section as configuration 3, but with constant width lobes ($\alpha / \Theta = K$) (see Figure 10). Mixer lobe hoods were evaluated with configuration 27. Hoods were attached to each lobe (fan and primary side), of the configuration 7 mixer and faired into the cylindrical section of the mixer (see Figure 11). This hooded mixer was also evaluated with 15 degrees and 36 degrees of turbine discharge swirl (configurations 23 and 24, respectively). The effects of mixer cutback was determined with configurations 9, 10, and 11. The mixer for configuration 3 was cutback in 5 degree increments to form the cutback matrix (see Figure 12).

The "red" series, which employed mixers somewhat longer than used with the "green" series, also investigated tailpipe length, scalloping, lobe number, and mixer cutback. Configurations 13 and 14 varied tailpipe length using a 12 lobe mixer (see Figures 13 and 14). Configuration 15 evaluated the importance of lobe number (i.e., 18). The mixers in this series were designed to allow scalloping of the mixer side walls, which was done with 12 (configuration 30) and 18 (configuration 16) lobes. The effects of scalloping with increased tailpipe length were investigated with configuration 28. Finally, a severe mixer cutback was investigated with configuration 29. This cutback reduced the amount of flow turning in the core, or primary stream, and increased the mixer/plug gap (see Figure 15).

The "orange" series, which had the same mixer length as the red series, was designed to study the interaction of increased mixing plane area and tailpipe length (configurations 17 and 18) (see Figures 16 and 17). This series was designed with the following areas in the mixing plane:

$$\begin{aligned} \text{Mixing Plane Area (A}_{\text{MIX}}) &= 320.64 \text{ cm}^2 (49.70 \text{ in.}^2) \\ \text{Primary Stream Area (A}_p) &= 89.68 \text{ cm}^2 (13.90 \text{ in.}^2) \\ \text{Fan Stream Area (A}_f) &= 230.97 \text{ cm}^2 (35.80 \text{ in.}^2) \end{aligned}$$

Two approaches to integrating the mixer with the structural pylon were evaluated with configurations 25 and 26 (see Figures 18 and 19). Configuration 25 had a short pylon which ended at the mixer exit; configuration 26 was tested with a longer, larger design which extended over the mixer and ended in the tailpipe. The mixer used in this test was the same as the one in configuration 11. A lower bifurcator ending upstream of the mixer was also simulated in these tests and is shown in Figure 20.

3.3.2 Phase II Configurations

The Phase II configurations varied mixer lengths and diameter while penetration level (0.75), tailpipe length to diameter ratio 0.61 and lobe number (18) were held constant. In addition, mixer/plug gap, scalloping, cutback, mixer hoods, and plug angle were evaluated in order to round out the data base for high penetration mixers.

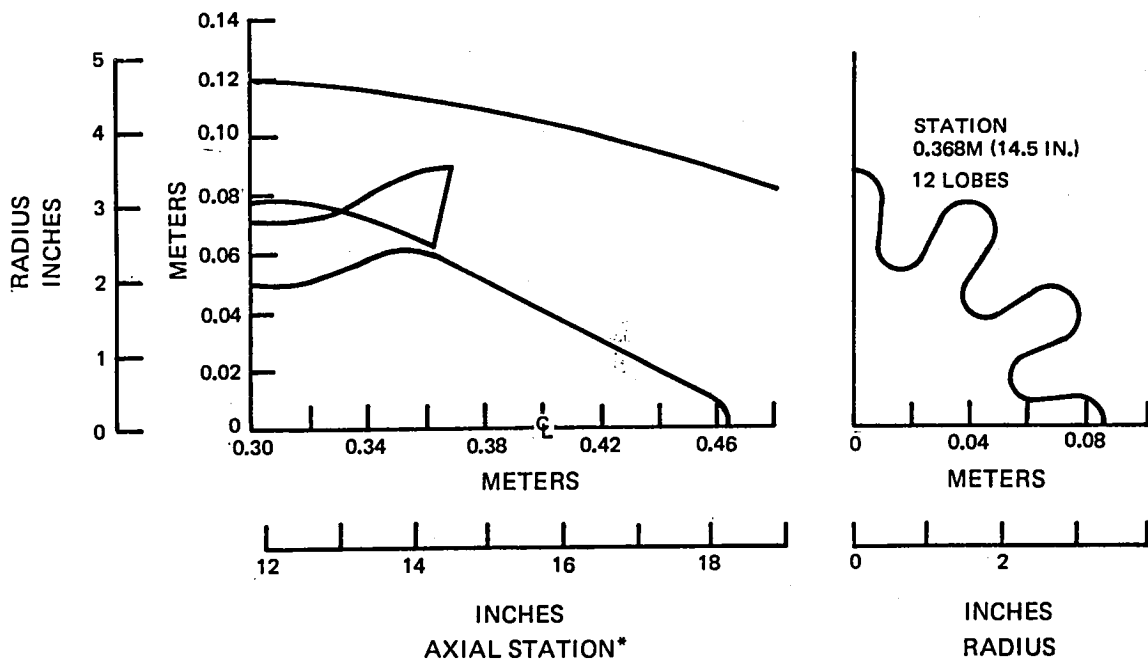

*AXIAL STATION REFERS TO MIXER MODELS.
 MULTIPLY BY APPROPRIATE SCALE FACTOR
 FOR ENGINE POSITION

Figure 6 Configuration 19

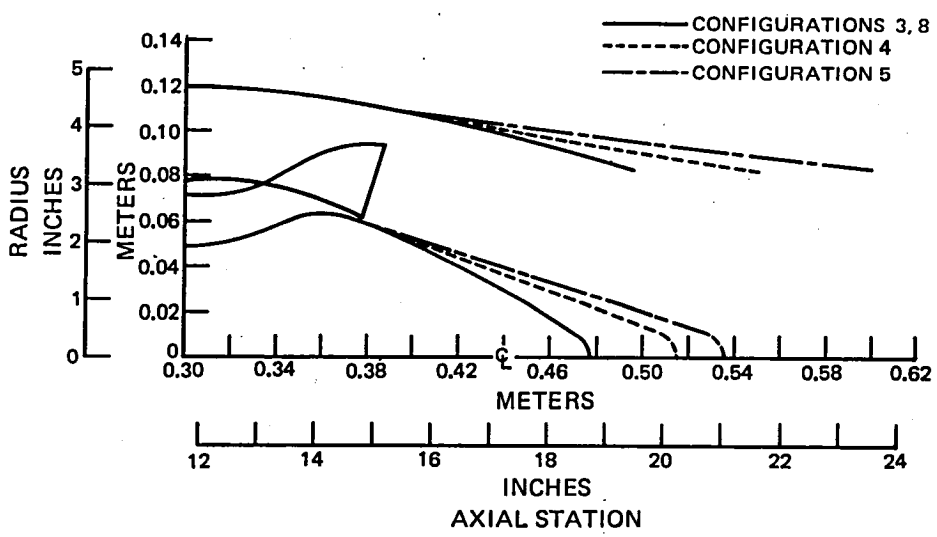

Figure 7 Configurations 3, 4, 5, and 8

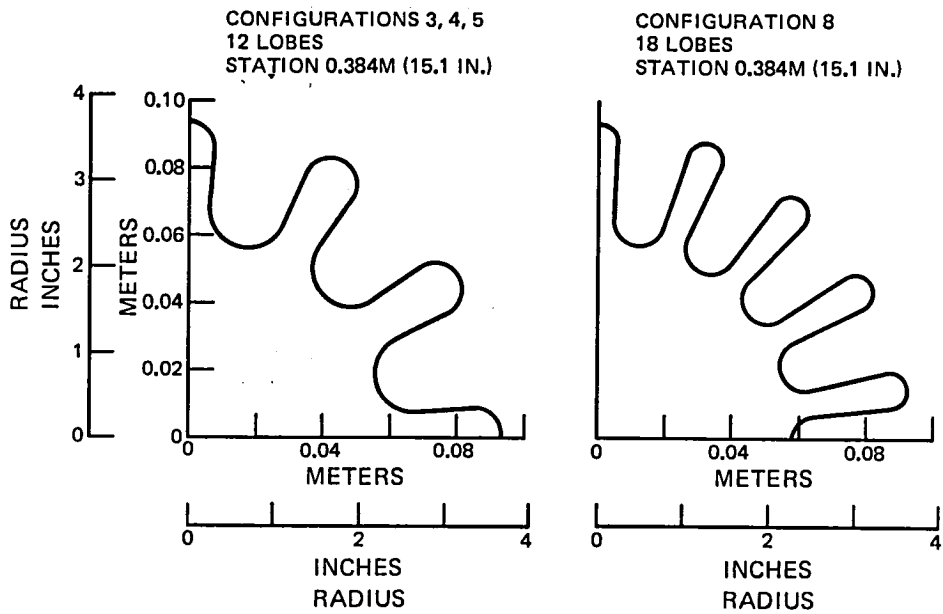

Figure 8 Configurations 3, 4, 5, and 8

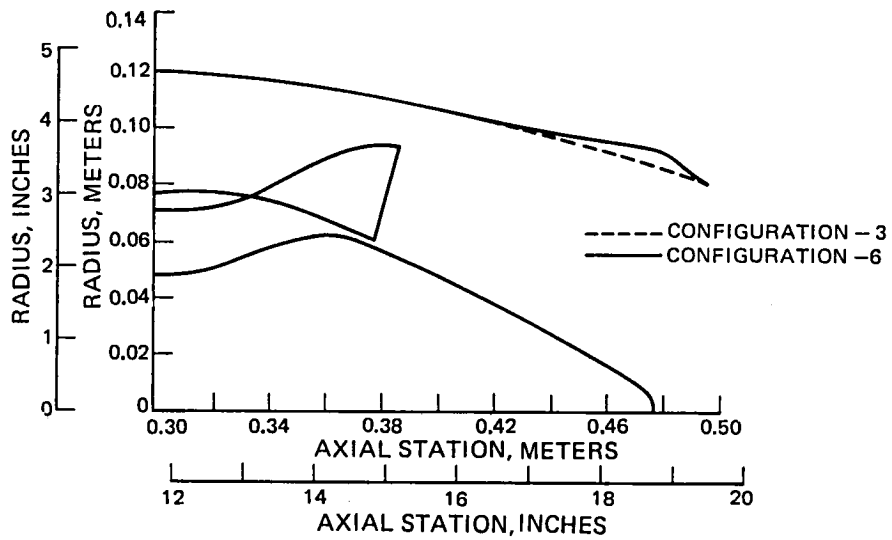

Figure 9 Configurations 3 and 6

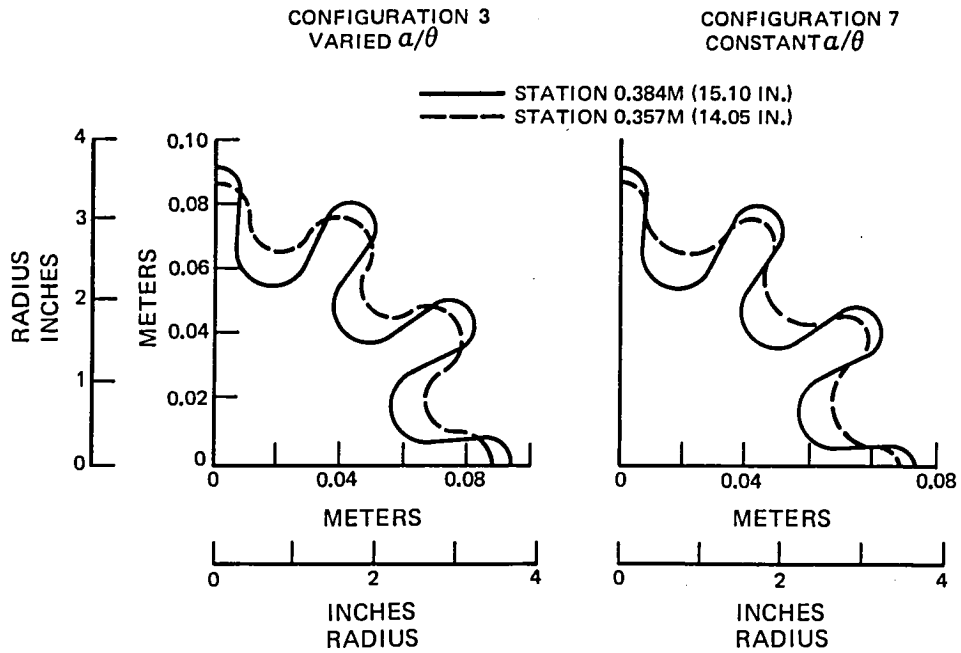

Figure 10 Configurations 3 and 7

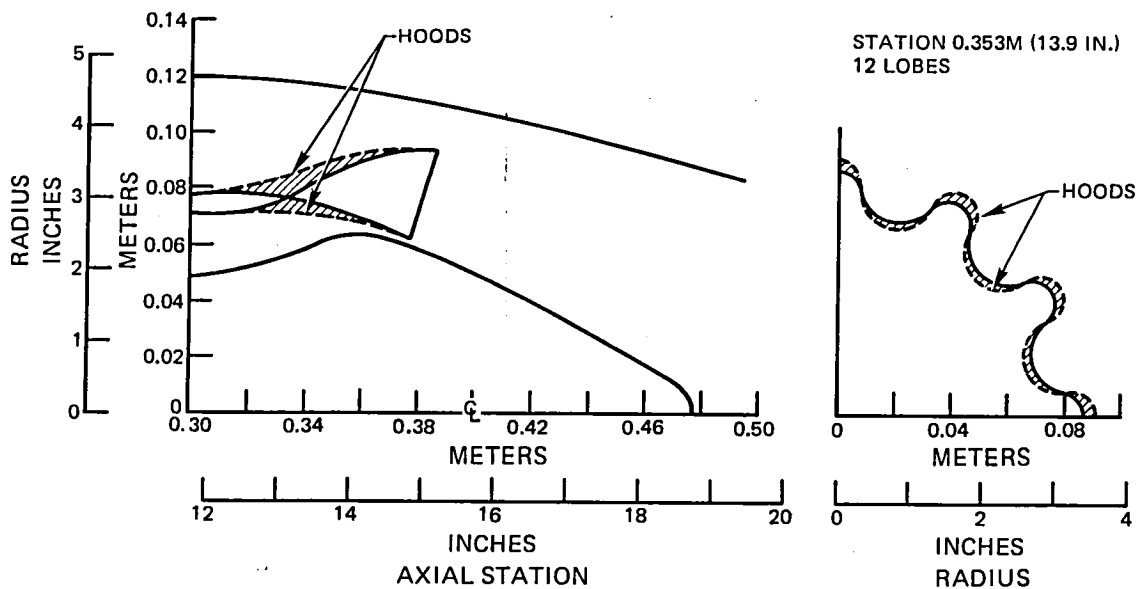

Figure 11 Configuration 27, 23 (15 degree Swirl), 24 (36 degree Swirl)

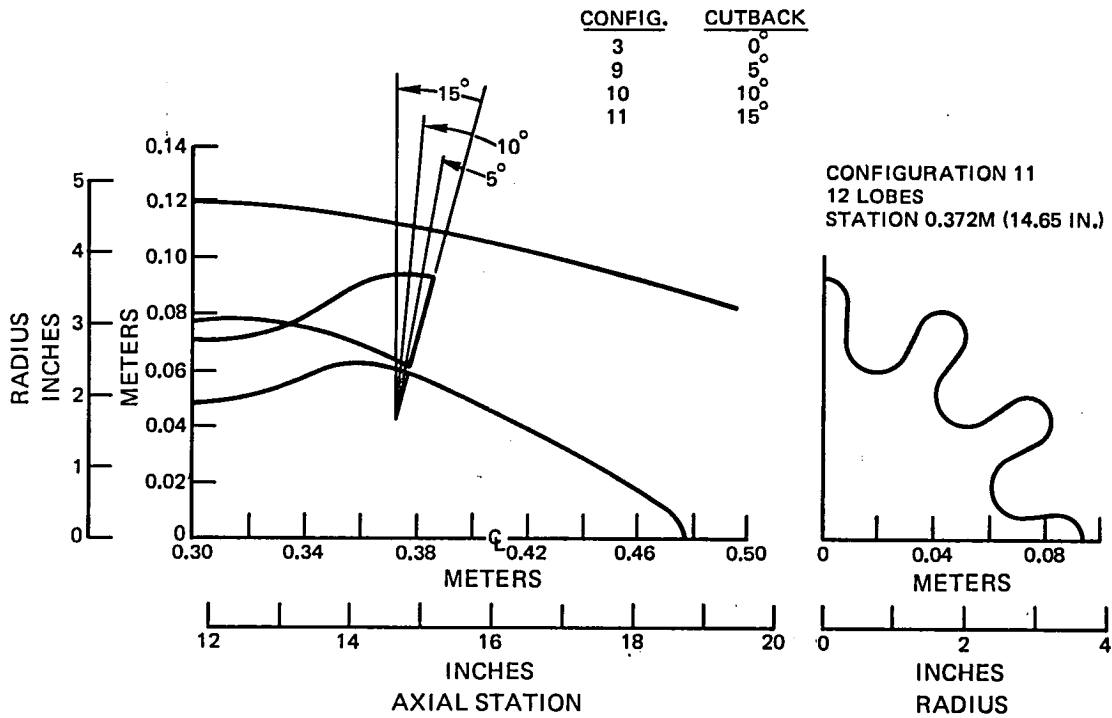

Figure 12 Configurations 3, 9, 10 and 11

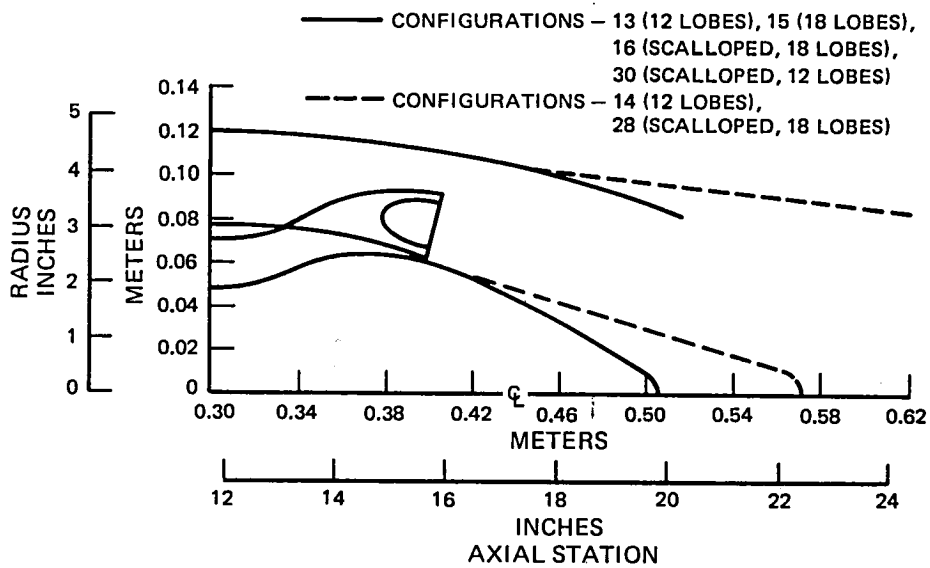

Figure 13 Configurations 13, 14, 15, 16, 28 and 30

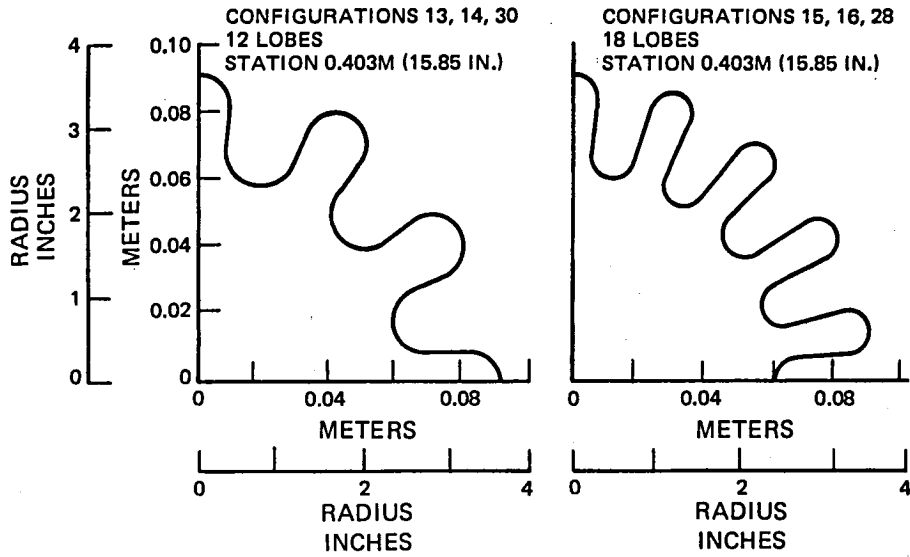

Figure 14 Configurations 13, 14, 15, 16, 28 and 30

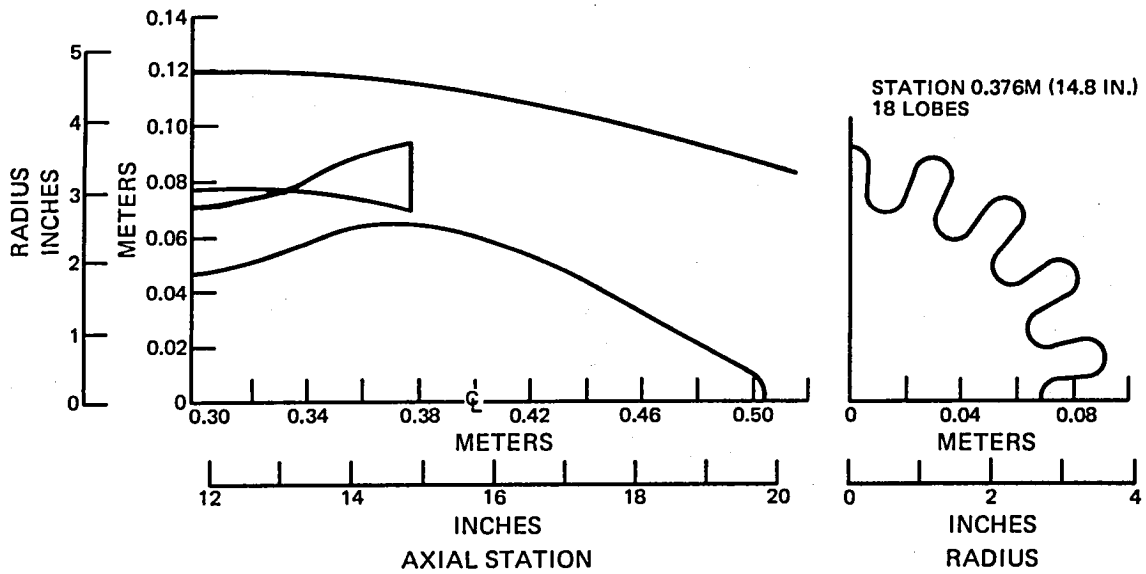

Figure 15 Configuration 29

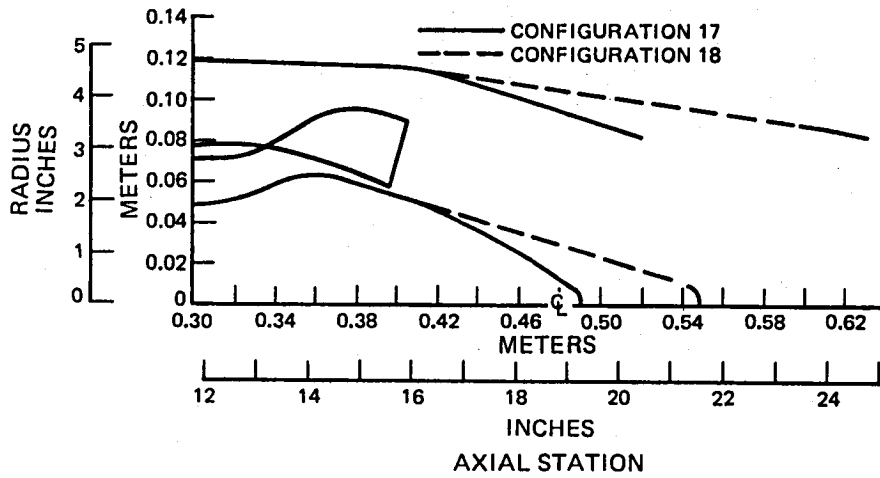

Figure 16 Configurations 17 and 18

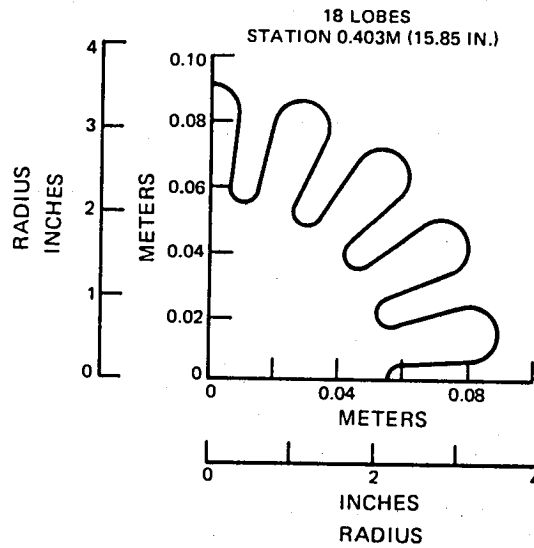

Figure 17 Configurations 17 and 18

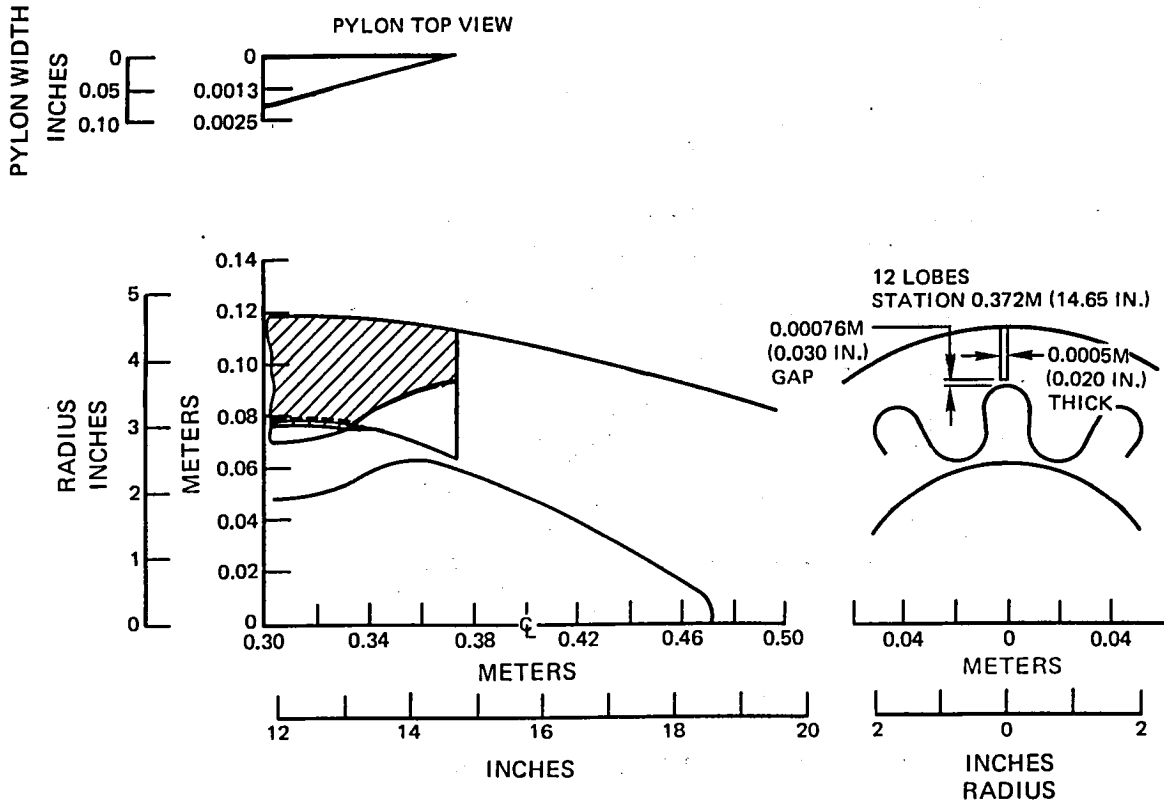

Figure 18 Configuration 25

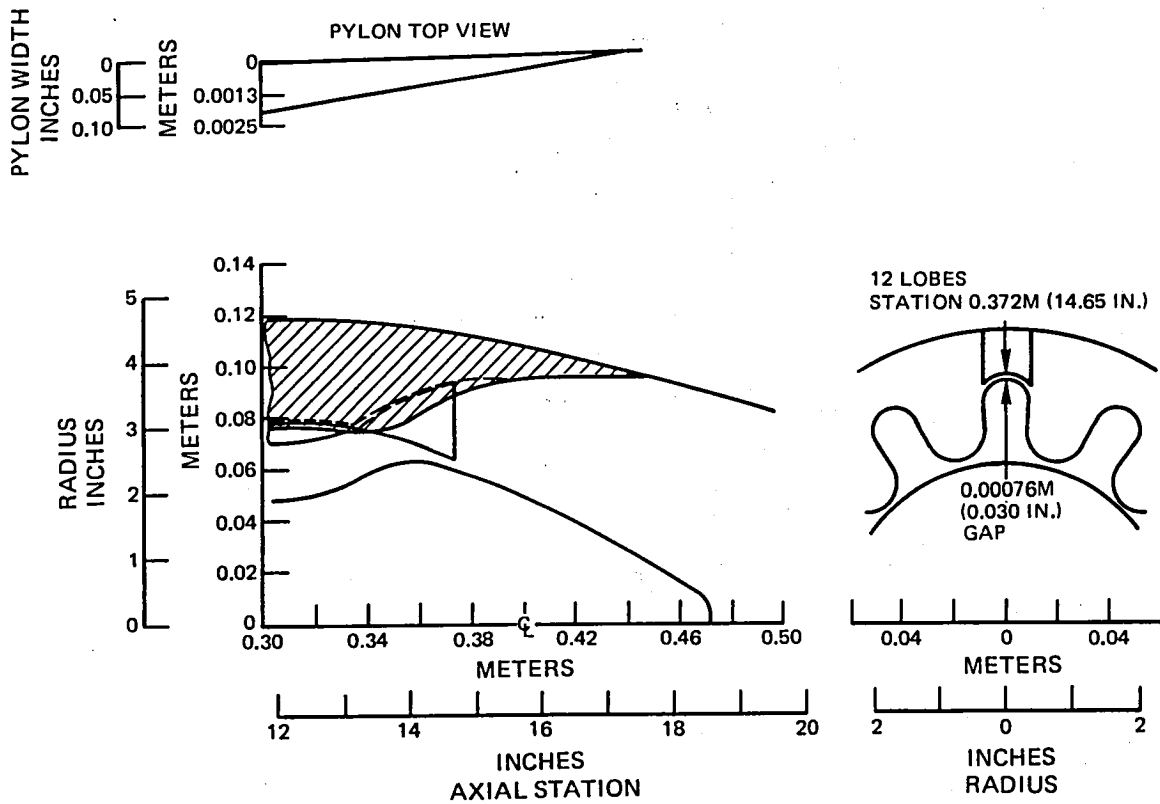

Figure 19 Configuration 26

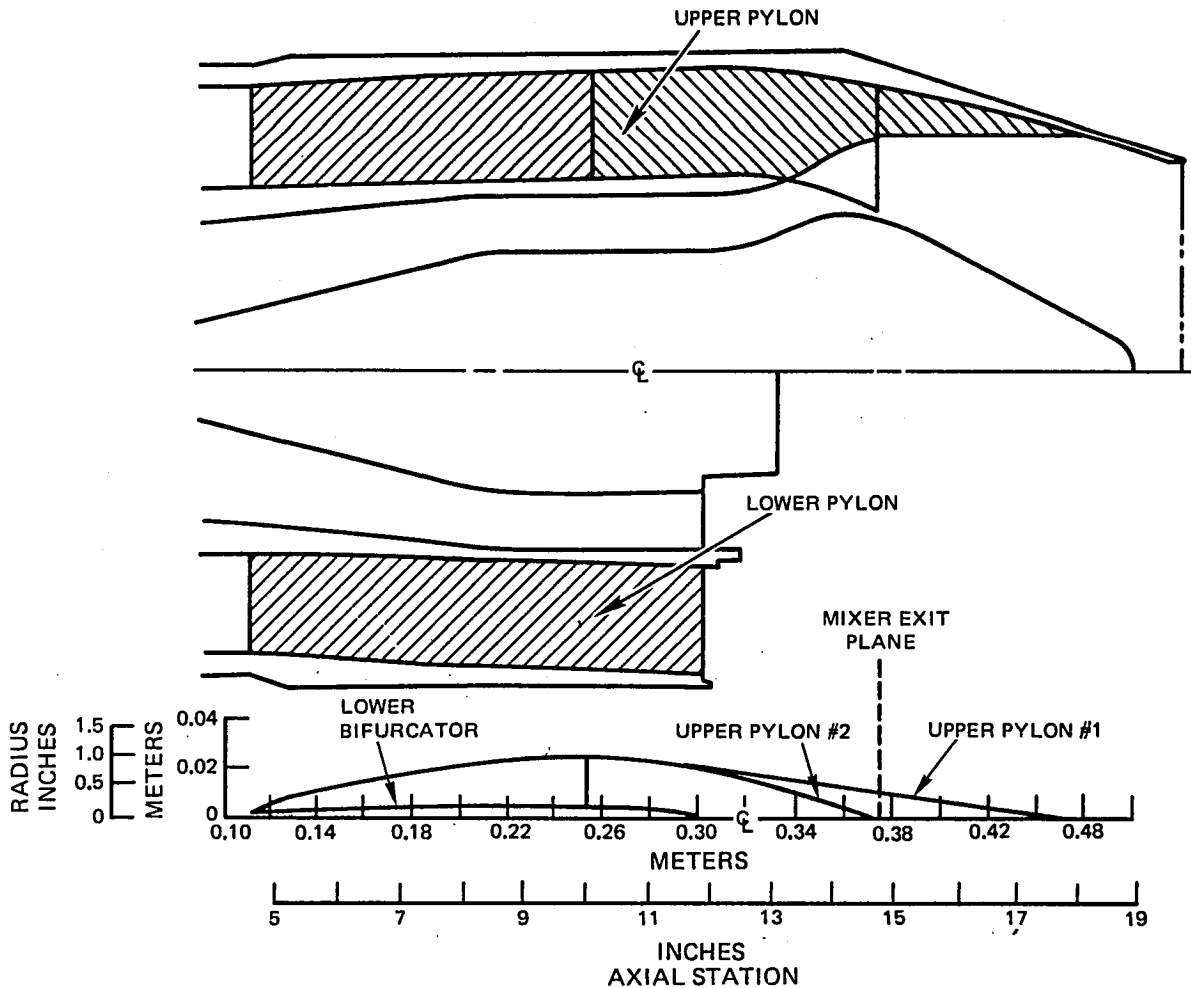

Figure 20 Lower Bifurcator Ending Upstream of the Mixer Simulated in these Tests

Eighteen mixer configurations were tested in the Phase II program. Sixteen were new configurations. The remaining two configurations consisted of the free mixer nozzle (configuration 1) and configuration 29 from the Phase I program. Retest of these configurations provided monitoring of data repeatability and improved accuracy. A summary of significant design variables and special features is shown in Table II.

Four basic series, which evaluated mixer size (length and diameter), were designed with variations in mixer/plug gap, scalloping, cutbacks, mixer hoods, and plug angle. These were the black, purple, brown and yellow series, beginning with configurations 33, 34, 35 and 36, respectively, as summarized in Table II. These designs are illustrated in Figures 21 through 25.

Mixer length variations included 2 short (configurations 33 and 34) and 2 long mixers (configurations 35 and 36). The short mixers were the same length as the best performing mixer from Phase I (configuration 29). The longer mixers +0.152m (+6 in) full scale provided an improved flowpath, with less severe turning through the mixer.

Mixer/plug gap variations were designed into configurations 37 and 38 which have 12 percent and 32 percent gaps, respectively. These two configurations use the mixer from configuration 36.

TABLE II
PHASE II DESIGN VARIABLES

Configuration Type	No.	No. of Lobes	Tailpipe length/ Diameter	Special Features	Penetration	Gap	α/θ **
Black	33	18	0.61		0.75	0.22	0.25*
	41	18	0.61	Scalloped Mixer	0.75	0.22	0.25*
	42	18	0.61	Scalloped Mixer, Modified Tailpipe	0.75	0.22	0.25*
	45	18	0.61	Scalloped and Cutback Mixer	0.75	0.35	0.25*
Purple	34	18	0.61		0.75	0.22	0.26*
Brown	35	18	0.61		0.75	0.22	0.27*
	40	18	0.61	33° Plug	0.75	0.22	0.27*
	46	18	0.61	Scalloped and Cutback Mixer, 33° Plug	0.75	0.37	0.27*
	47	18	0.61	Scalloped and Cutback Mixer, 39° Plug	0.75	0.37	0.27*
Yellow	36	18	0.61		0.75	0.22	0.26*
	37	18	0.61		0.75	0.12	0.26*
	38	18	0.61		0.75	0.32	0.26*
	39	18	0.61	Mixer Hoods	0.72	0.26	0.26*
	43	18	0.61	Mixer Hoods, Scallop 1 Mixer	0.72	0.26	0.26*
	48	18	0.61	Mixer Hoods, Scallop 1 Mixer, 37° Plug	0.72	0.26	0.26*
	49	18	0.61	Mixer Hoods, Scallop 2 Mixer	0.72	0.26	0.26*

* - constant lobe width

** - at mixer exit, defined in figure 3

Note - Configuration 44 was not tested.

A scalloping modification was designed for configuration 33 producing configuration 41. Since it was felt that scalloping might shift the bypass ratio of the system for this particular design, an insert was designed for the tailpipe (see configuration 42) which would correct the bypass ratio back to its original level. A cutback of the inner lobe of configuration 41 was selected (see configuration 45) to determine if this produced the same gap effect that changing plug diameter had on other configurations.

Modifications were also designed for configuration 36. These included mixer hoods (see configuration 39), scallops (see configuration 43 and 49) and a steeper plug (configuration 48) which changed the tailpipe flow area distribution.

Design modifications were also selected for configuration 35 to investigate steep plug angles (see configurations 40 and 47) along with scallops and cutbacks (see configuration 46).

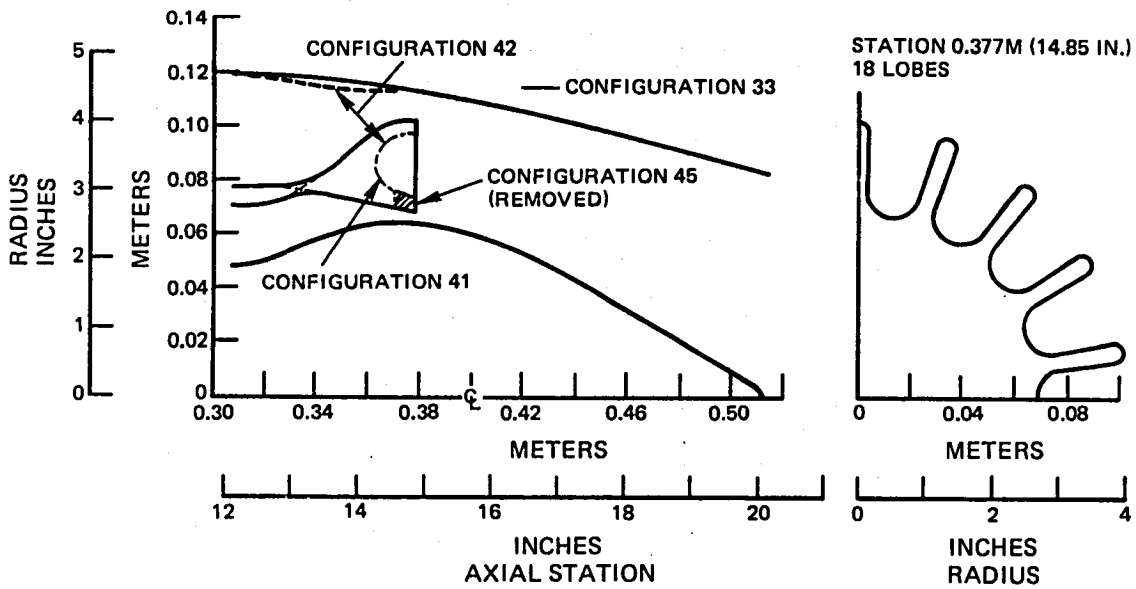

Figure 21 Configurations 33, 41, 42 and 45

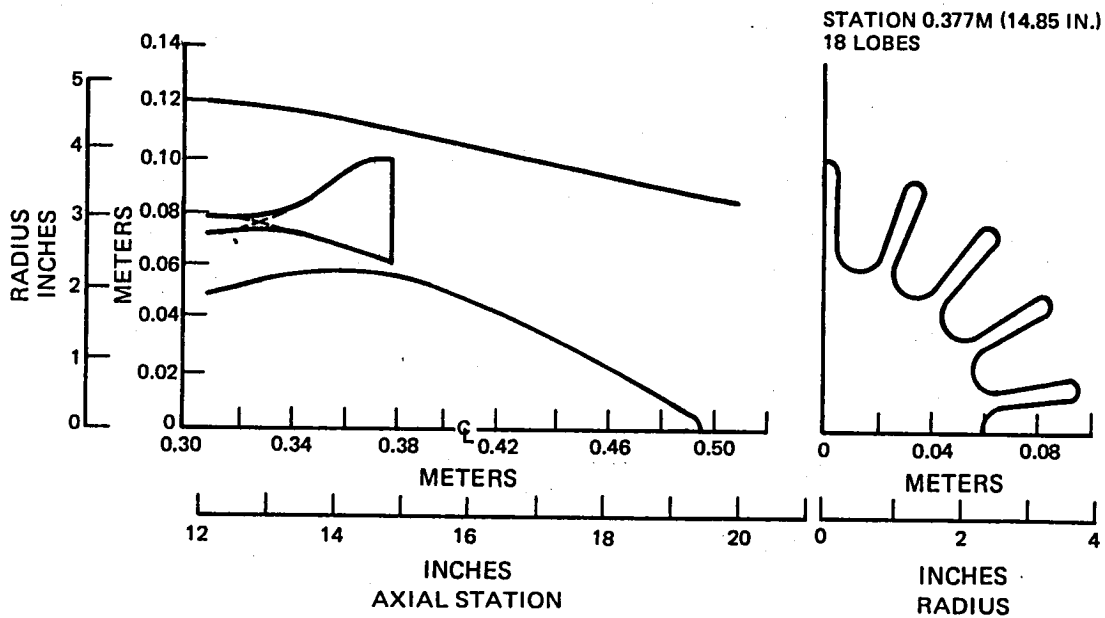

Figure 22 Configuration 34

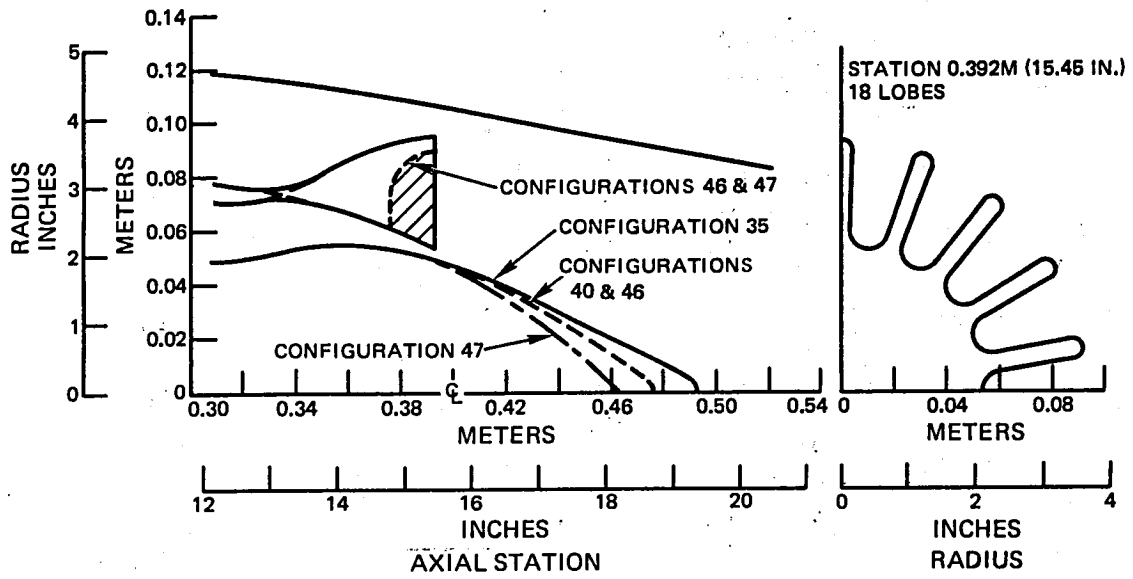

Figure 23 Configurations 35, 40, 46 and 47

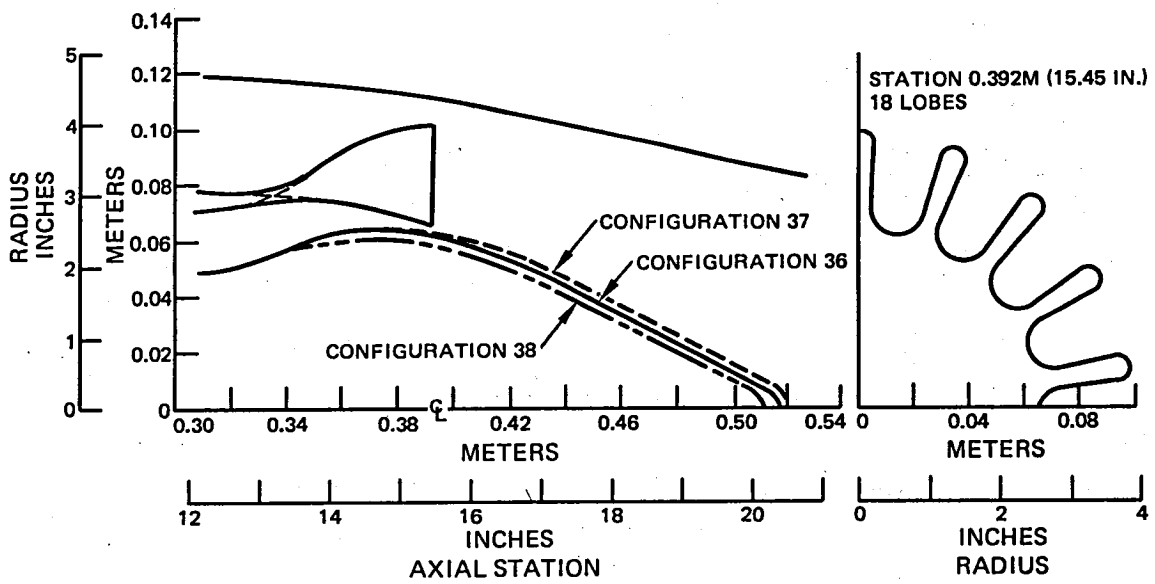

Figure 24 Configurations 36, 37 and 38

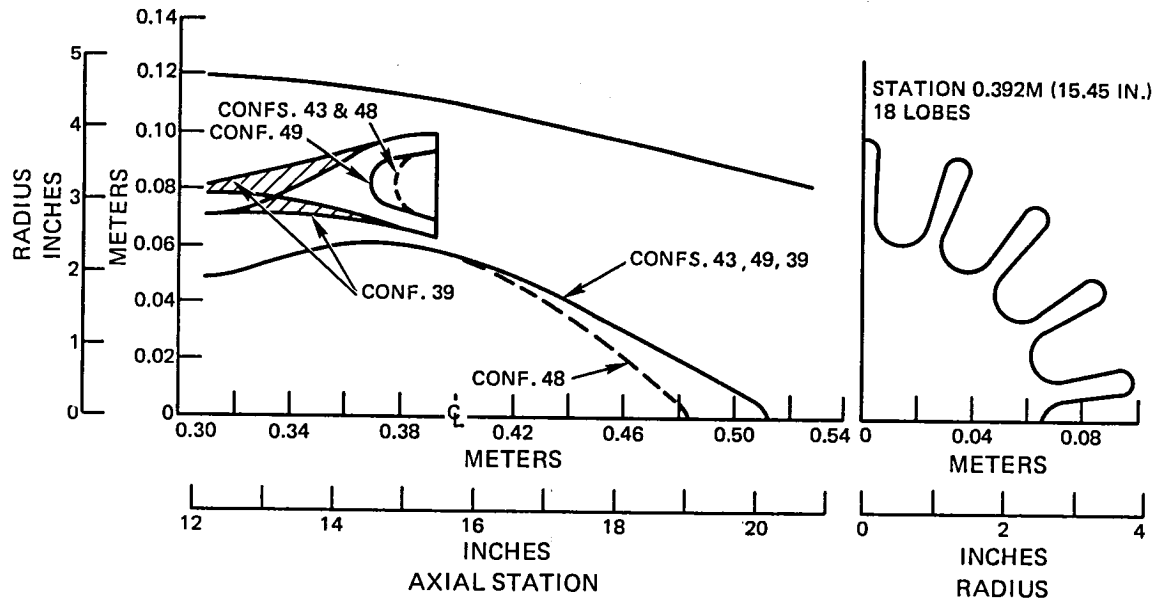

Figure 25 Configurations 39, 43, 48 and 49

3.4 Model Fabrication

Model hardware for both test phases was fabricated at FluidDyne Engineering Corporation. The mixers and plugs were fabricated from 416 stainless steel, tailpipes from mild steel, and bifurcators from aluminum. The mixers were machined from solid steel blanks to 0.00086m (0.034 in) wall thickness. The trailing edge of the mixers was handworked to 0.00025m (0.010 in).

Several Phase I configurations were obtained by modifying the original mixers. Mixer number 3 was modified by adding hoods (fairings) on both inner and outer surfaces. The hoods were stamped out on a pre-determined pattern and silver soldered in place. Mixer numbers 5 and 6 were modified by machining scallops in the trailing edge, and mixer 6 was further modified by shortening the length (cutback). Mixer 2 was progressively cut back to change the length and exit angle.

For Phase II, mixer number 9 was modified twice (scallops, cutback); mixer number 11 was modified once (scallops and cutback) and mixer number 12 was modified three times (lobe fairings, scallops, modified scallops).

The mixer, tailpipe and plug components, identified by number, for each test configuration are summarized in Table III. This table, when used with Figures 4 through 25, identifies the tailpipe and plug used with each mixer modification.

TABLE III

TEST CONFIGURATION COMPONENTS

	<u>Configuration</u>	<u>Mixer</u>	<u>Tailpipe</u>	<u>Plug</u>	<u>Mixer Modification</u>
PHASE I	1	1	1	1	
	2	1	2	1	
	3	2	1	2	
	4	2	3	3	
	5	2	2	4	
	6	2	4	2	
	7	3	1	1	
	8	4	1	1	
	9	2	1	1	Cut Back 5° Scarf Angle
	10	2	1	1	Cut Back 10° Scarf Angle
	11	2	1	1	Cut Back 15° Scarf Angle
	13	5	5	5	
	14	5	6	6	
	15	6	5	5	Scalloped
	16	6	5	5	
	17	7	7	7	
	18	7	8	8	
	19	8	9	9	
	21	1	1	1	
	22	1	1	1	
	23	3	1	2	Hooded
	24	3	1	2	Hooded
	25	2	1	2	
	26	2	1	2	
	27	3	1	2	Hooded
	28	6	6	6	Scalloped
	29	6	5	5	Cutback
	30	5	5	5	Scalloped
PHASE II	33	9	10	10	
	34	10	11	11	
	35	11	12	12	
	36	12	13	13	
	37	12	13	14	
	38	12	13	15	
	39	12	13	15	Hooded
	40	11	12	16	
	41	9	10	10	Scalloped
	42	9	14	10	Scalloped
	43	12	13	15	Hooded and Scalloped (#1)
	45	9	10	10	Scalloped and Cutback
	46	11	12	16	Scalloped and Cutback
	47	11	12	17	Scalloped and Cutback
	48	12	13	18	Hooded and Scalloped (#1)
	49	12	13	15	Hooded and Scalloped (#2)

4.0 TEST FACILITY AND TEST PROGRAM

4.1 Test Facility

The test facility used in this program was the Channel 11 static thrust stand at the Medicine Lake Laboratory of Fluidyne Engineering Corporation, Minneapolis, Minnesota. The facility, shown schematically in Figure 26, is capable of supplying two streams with different properties to the test nozzle. The airflow for each stream is obtained from a high pressure, dry air, storage system. The airflow for the hot stream is passed through a regenerative storage heater, and mixed with unheated bypass air to achieve the desired temperature. In both streams the airflow is throttled and metered through a long-radius ASME nozzle and then ducted to the nozzle assembly. A three component force balance is used to establish nozzle thrust.

The air heater used for the hot stream contains alumina pebbles which are preheated to approximately 537 C (1000°F). The heater capacity is nominally 18 kg (40 lbs/sec) at 537 C (1000°F).

The airflow for the two streams is oriented in a concentric fashion as illustrated in Figure 27 to supply the test nozzle. Facility measurements provide mass flow rates in each stream and the overall nozzle thrust. Instrumentation at the model charging stations (7 and 8) allows the desired conditions to be set.

Static and total pressures were measured with multiple-tube mercury manometers and recorded with Polaroid cameras. The Polaroid pictures were read and input into a WANG computer system, along with the total temperatures and force balance measurements obtained using a digital data acquisition system. The total temperature probes were shielded chromel/alumel thermocouples.

4.2 Test Instrumentation

The charging station instrumentation is housed in the model adapter section, illustrated in Figure 28, which provides the transition from the facility plumbing to the test nozzle models. The fan passage includes an upstream choke plate and two screens, followed by a bellmouth contraction to the fan duct charging station. Downstream of the charging station is the common fan shroud adapter, simulating the fan duct of the engine, and the tailpipe. Adapters for the core passage consists of an insulated duct, 2 choke plates, two screens, a center-body and a common core shroud adapter. During selected tests, swirl was introduced in the core stream by means of a swirl vane assembly just upstream of the model connection plane. The test configurations described in Section 3.2 were attached to the adapting hardware at the model connection plane.

Instrumentation in the fan passage which is illustrated in Figure 29, includes four 12-tube, area-weighted total pressure rakes, two 5-probe, total temperature thermocouple rakes and four static taps on the inner as well as the outer wall. Instrumentation in the primary passage, illustrated in Figure 30, includes four 7-tube, area-weighted total pressure rakes, and two area-weighted total temperature rakes, one having 4 probes and the other having 3. There are four static taps each on both the inner and outer walls.

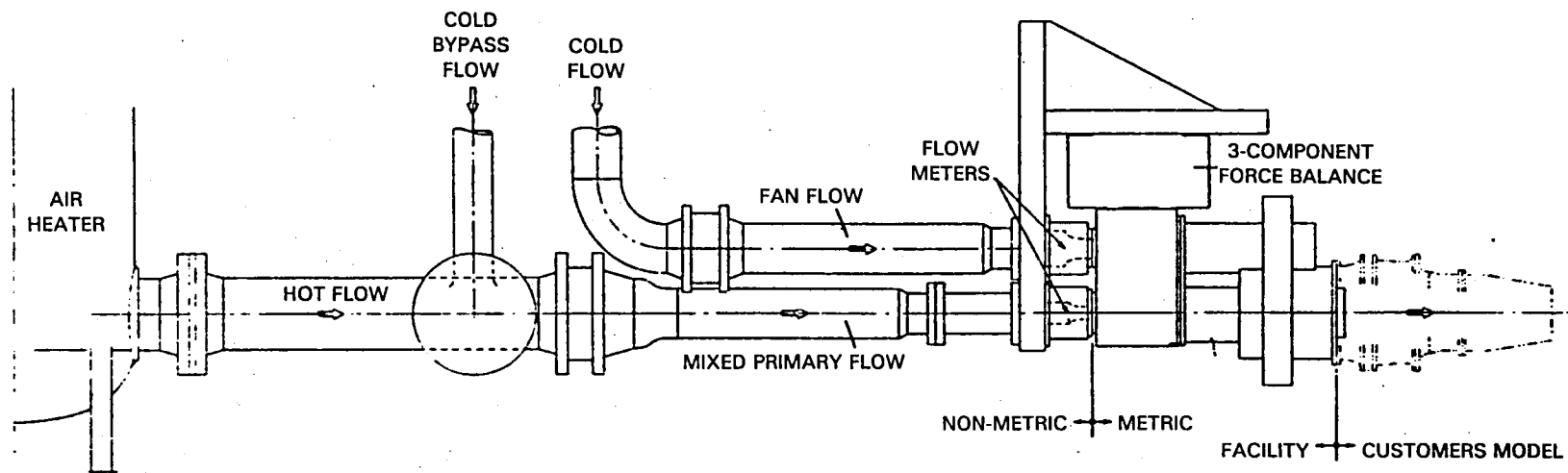

REV		DATE		BY		CHKD		APP'D		FACILITY	
1											
2											
3											
4											
5											
6											
7											
8											
9											
10											
11											
12											
13											
14											
15											
16											
17											
18											
19											
20											
21											
22											
23											
24											
25											
26											
27											
28											
29											
30											
31											
32											
33											
34											
35											
36											
37											
38											
39											
40											
41											
42											
43											
44											
45											
46											
47											
48											
49											
50											
51											
52											
53											
54											
55											
56											
57											
58											
59											
60											
61											
62											
63											
64											
65											
66											
67											
68											
69											
70											
71											
72											
73											
74											
75											
76											
77											
78											
79											
80											
81											
82											
83											
84											
85											
86											
87											
88											
89											
90											
91											
92											
93											
94											
95											
96											
97											
98											
99											
100											

Figure 26 Channel 11 Facility Layout

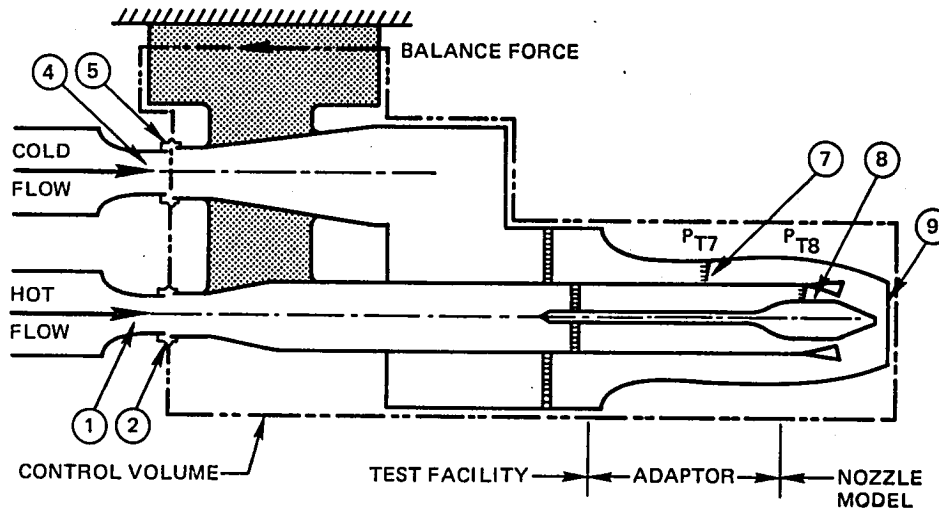

<u>STATION</u>	<u>DESCRIPTION</u>
1	ASME METER THROAT (CORE FLOW)
2	FLEXIBLE SEAL (CORE FLOW)
4	ASME METER THROAT (FAN FLOW)
5	FLEXIBLE SEAL (FAN FLOW)
7	FAN NOZZLE
8	CORE NOZZLE
9	FINAL NOZZLE EXIT

Figure 27 Airflow for the Two Streams Oriented in a Concentric Fashion to Supply the Test Nozzle

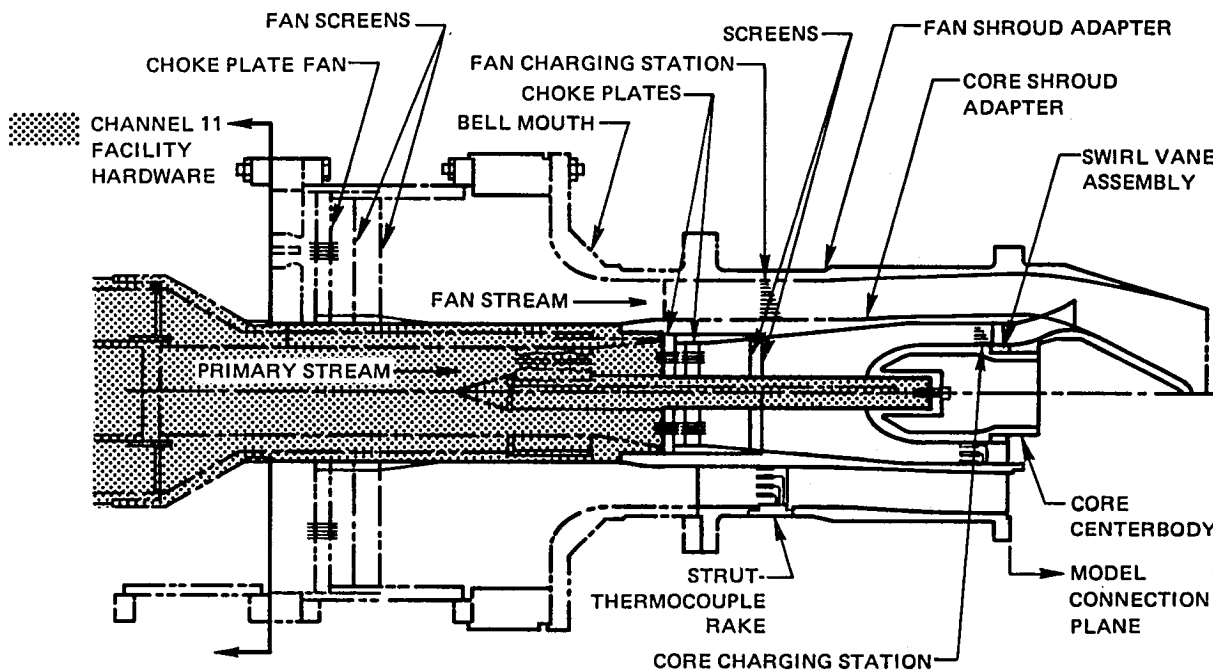
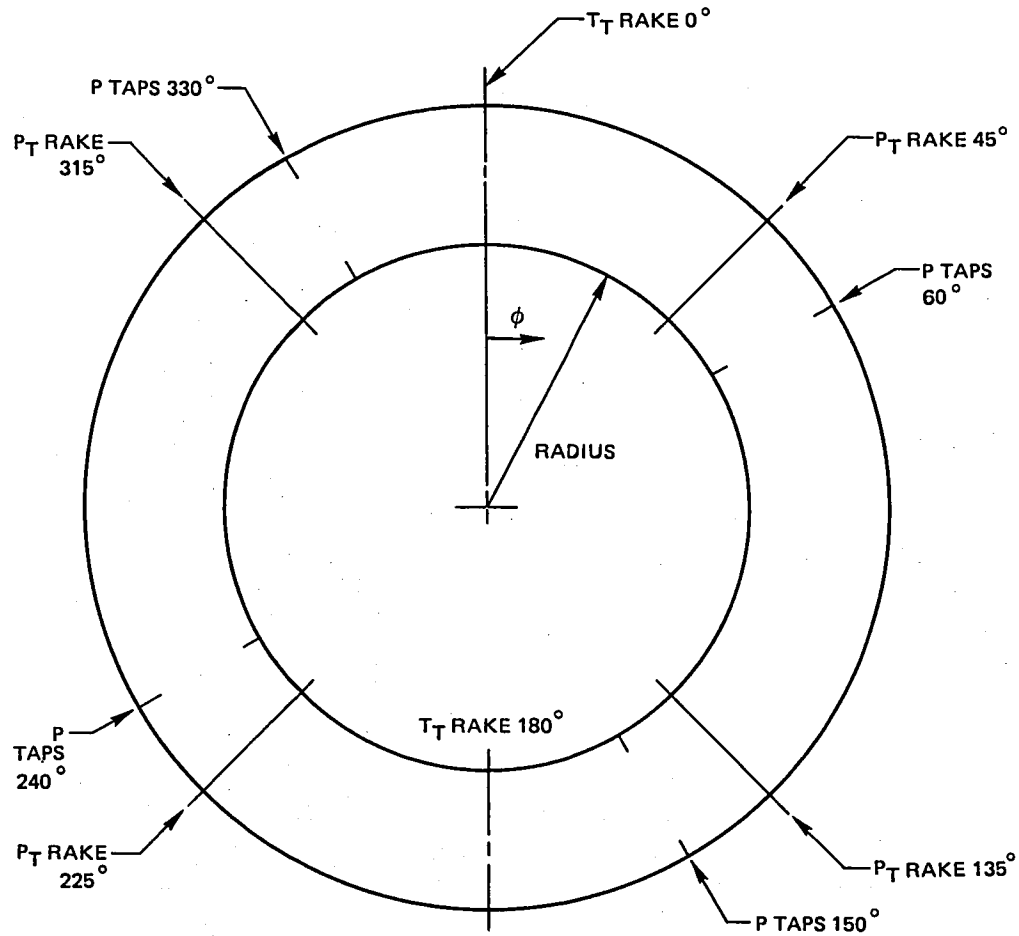
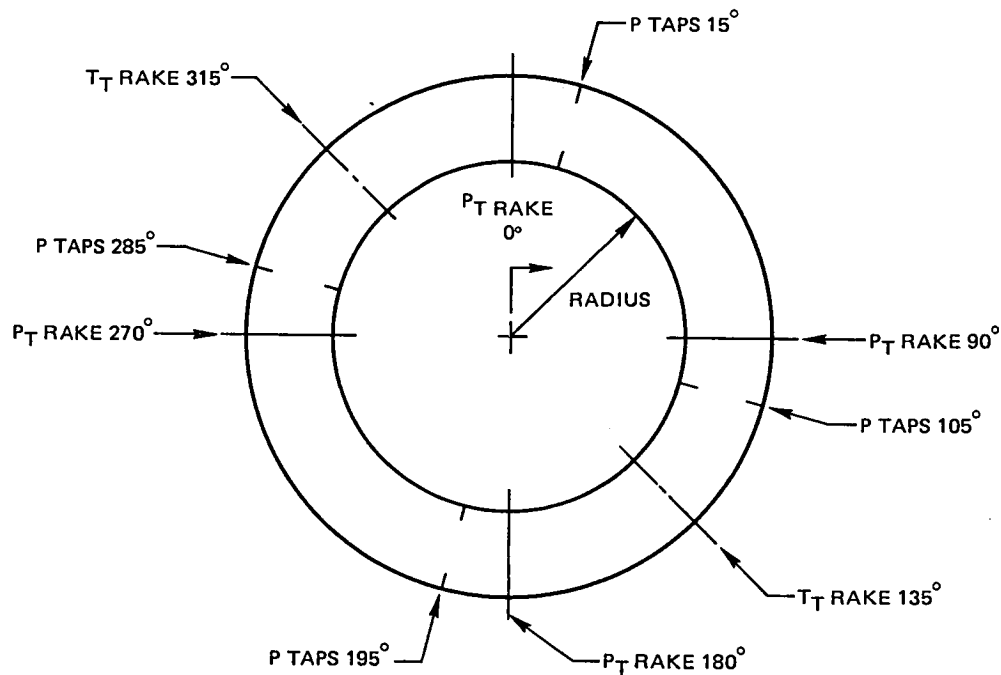

Figure 28 Charging Station Instrumentation Housed in the Model Adapter Section



TOTAL PRESSURE RAKE LOCATIONS						
ϕ				RADIUS		
45°	135°	225°	315°	METERS	INCHES	
PROBE NUMBER						
37	49	61	73	0.0737	2.903	
38	50	62	74	0.0788	3.104	
39	51	63	75	0.0825	3.249	
40	52	64	76	0.0861	3.388	
41	53	65	77	0.0895	3.523	
42	54	66	78	0.0928	3.652	
43	55	67	79	0.0959	3.776	
44	56	68	80	0.0990	3.897	
45	57	69	81	0.1020	4.014	
46	58	70	82	0.1049	4.128	
47	59	71	83	0.1077	4.239	
48	60	72	84	0.1109	4.368	
TOTAL TEMPERATURE RAKE LOCATIONS						
ϕ		RADIUS				
0	180	METERS	INCHES			
PROBE NUMBER						
7	12	0.0742	2.920			
8		0.0816	3.213			
	13	0.0869	3.422			
9		0.0919	3.620			
	14	0.0967	3.807			
10		0.1012	3.985			
	15	0.1056	4.156			
11	16	0.1105	4.350			
STATIC PRESSURE TAP LOCATIONS						
RADIUS = 0.1191M (4.69 IN.)		RADIUS = 0.0775M (3.05 IN.)		ϕ		
TAP NUMBER	TAP NUMBER					
85	89			60°		
86	90			150°		
87	91			240°		
88	92			330°		

Figure 29 Fan Stream Charging Station Instrumentation



TOTAL PRESSURE RAKE LOCATIONS					
ϕ				RADIUS	
0°	90°	180°	270°	METERS	INCHES
PROBE NUMBER					
1	8	15	22	0.0491	1.933
2	9	16	23	0.0540	2.126
3	10	17	24	0.0573	2.254
4	11	18	25	0.0605	2.381
5	12	19	26	0.0635	2.501
6	13	20	27	0.0664	2.616
7	14	21	28	0.0698	2.748
TOTAL TEMPERATURE RAKE LOCATIONS					
ϕ		RADIUS			
135°	315°	METERS	INCHES		
PROBE NUMBER					
	4	0.0495	1.950		
1		0.0559	2.201		
	5	0.0605	2.381		
2		0.0647	2.548		
3	6	0.0693	2.730		
STATIC PRESSURE TAP LOCATIONS					
RADIUS = 0.0706M (2.78 IN.)		RADIUS = 0.0483M (1.9 IN.)		ϕ	
TAP NUMBER	TAP NUMBER				
29	33	15°			
30	34	105°			
31	35	195°			
32	36	285°			

Figure 30 Primary Stream Charging Station Instrumentation

The final charging station total pressures in each stream were determined as mass-momentum averaged values from the individual probe readings. Charging station total temperatures were determined as area-weighted averages of the individual thermocouple readings.

Special instrumentation was employed to survey the nozzle exit for selected test configurations. The traverse rake illustrated in Figure 31 consists of a temperature rake with thirteen probes and a pressure rake with 12 probes. For Phase I, the temperature and pressure was separated by a 30 degrees angle and during each test, data were acquired at 5 degrees angular intervals covering a 60 degrees segment of the nozzle exit. This resulted in a total of 169 temperature and 156 pressure data points per test. In Phase II, the temperature and pressure rakes were separated by a 40 degrees angle and data were acquired at 2.5 degrees angular intervals covering a 40 degrees segment of the nozzle exit for a total of 225 temperature and 204 pressure data points per test. The actual installation of the traverse probes is shown in Figure 32.

In addition, a flow visualization technique was also applied to selected configurations. The surface of the model was first spray painted white and then a mixture of lampblack and glycerine was applied in an array of spots covering the region of interest. A cold flow test run was then made to establish the airflow pattern on the surface of the models; the model was then disassembled and photographed.

4.3 Test Program

This section consists of the actual test conditions, data acquisition and reduction, and an evaluation of the data repeatability. The test conditions were based on simulation of Flight Propulsion System flow conditions. The data acquisition and reduction section describes the aerodynamic performance parameters acquired, the exit plane traverse measurements which were made, and the flow visualization information which was obtained. Finally, data repeatability is evaluated with a statistical evaluation of the free mixer test data, which represents the largest sampling of data available.

4.3.1 Test Conditions

The test conditions covered in the Phase I program simulated a range of cruise power settings for the Flight Propulsion System, at Mach 0.8, 10,668 m (35,000 feet). The Phase II program concentrated only on the maximum cruise power setting. The appropriate pressure ratios in each stream were simulated, as was the total temperature ratio between the two streams.

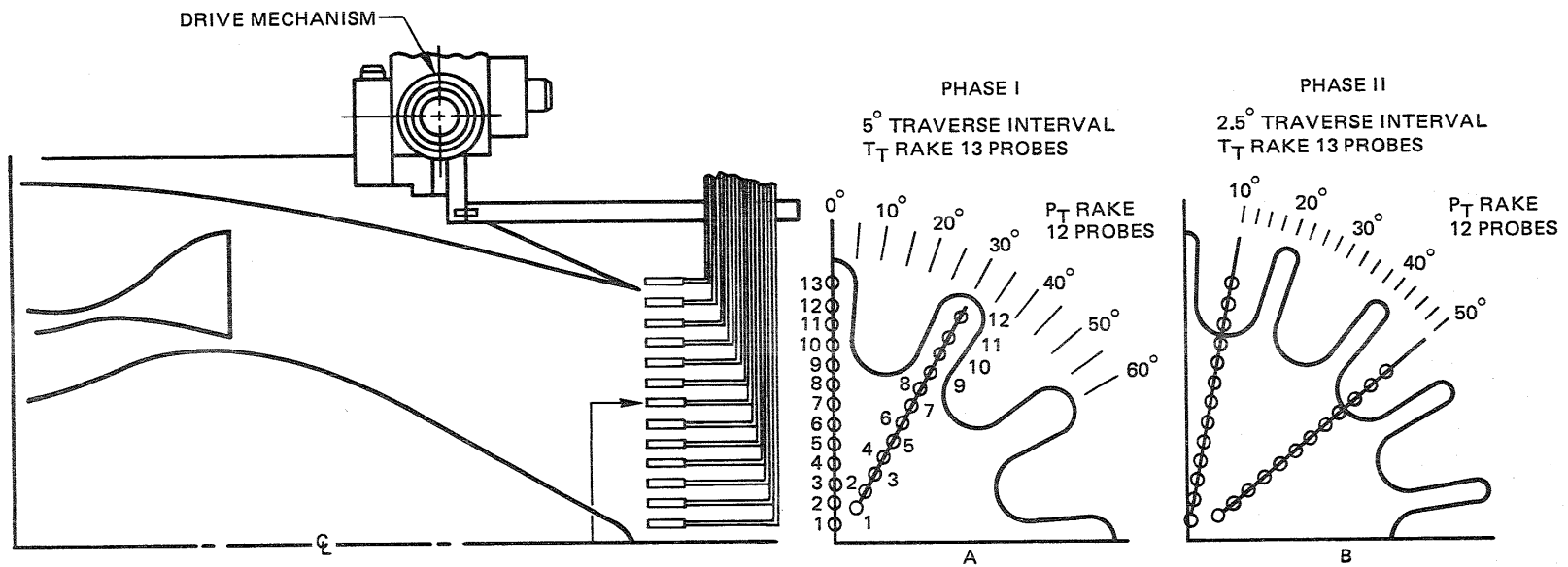

TRAVERSE RAKE PROBE LOCATIONS PHASE I AND II											
T _T	P _T	RADIUS		T _T	P _T	RADIUS		T _T	P _T	RADIUS	
PROBE #	PROBE #	METERS	INCHES	PROBE #	PROBE #	METERS	INCHES	PROBE #	PROBE #	METERS	INCHES
1		0.0066	0.26	5	4	0.0330	1.30	9	8	0.0594	2.34
2	1	0.0137	0.54	6	5	0.0396	1.56	10	9	0.0660	2.60
3	2	0.0198	0.78	7	6	0.0462	1.82	11	10	0.0726	2.86
4	3	0.0264	1.04	8	7	0.0528	2.08	12	11	0.0792	3.12
								13	12	0.0859	3.38

Figure 31 Traverse Rake Assembly

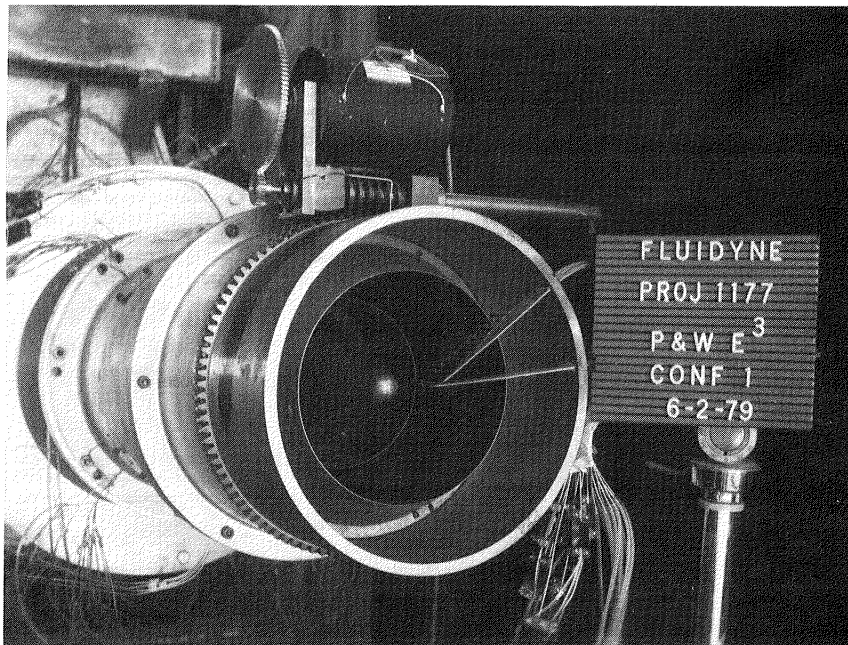

Figure 32 Actual Installation of the Traverse Probes

Phase I

The test matrix for each configuration in Phase I is presented in Table IV which covers a range of cruise power settings from approximately 55 percent to 110 percent. Each hot flow test point is defined by a primary stream pressure ratio (PT_{8PAM}), a fan to primary stream total pressure ratio (P_{T7}/P_{T8}) and a primary to fan stream total temperature ratio (TRAT). The cold flow tests consisted of a range of pressure ratios which duplicated the range of mixed pressure ratios associated with the engine power setting variation. This facilitated calculation of the level of mixing and the amount of excess pressure loss exhibited by the test configuration.

The nozzle exit traverses were made at a high power setting, near maximum cruise operation; the flow visualization tests were conducted at a comparable cold flow condition.

Phase II

The tests of each Phase II configuration were conducted at a single power setting which represented the maximum cruise condition. Each point was repeated five times to improve data reliability. A hot flow point consisted of setting the primary stream total pressure ratio (PT_{8PAM}) at 2.35, the fan to primary total pressure ratio (P_{T7}/P_{T8}) at 1.1 and the primary to fan total temperature ratio (TRAT) at 2.5. The cold flow primary stream pressure ratio was 2.5 and the fan to primary total pressure and total temperature ratio were both held at 1.0.

The nozzle exit traverses were made at the hot flow condition, and the flow visualization tests were conducted at the cold flow test condition.

TABLE IV
PHASE I TEST MATRIX

Hot Flow Tests

Condition Number	Primary Stream Pressure Ratio (PT8PAM)	Fan to Primary Stream Pressure Ratio (PT7/PT8)	Fan to Primary Stream Temperature Ratio (TRAT)
1	1.8	1.16	2.33
2	2.0	1.14	2.38
3	2.1	1.13	2.44
4	2.2	1.11	2.44
5	2.3	1.10	2.50
6	2.4	1.09	2.56

Cold Flow Tests:

1	2.0	1.00	1.00
2	2.2	1.00	1.00
3	2.3	1.00	1.00
4	2.4	1.00	1.00
5	2.5	1.00	1.00
6	2.6	1.00	1.00

Nozzle Exit Traverse: (see condition 5 of the hot flow test series)

Flow Visualization:

PT8PAM = PT7PAM = 2.5
 TRAT = 1.0

4.3.2 Data Acquisition and Reduction

The experimental data produced during the program are described in this section. This includes the major aerodynamic performance parameters (i.e., thrust and flow coefficients), exit plane traverse measurements, and flow visualization information.

4.3.2.1 Thrust and Flow Coefficient

The determination of overall gross thrust coefficient and its equivalent change in thrust specific fuel consumption was the primary objective for the various configurations tested. Exhaust system performance was assessed through the use of mixed thrust and flow coefficients that were non-dimensionalized by fully mixed ideal thrust and flow terms in order to reflect the thrust gain available from the mixing process. The basic model thrust coefficient was then corrected for model to full scale differences. Finally, the full scale model data were adjusted to reflect the adaptation of a convergent-divergent nozzle, in place of the convergent nozzle tested in the scale models. The general procedure used to calculate the coefficients and the equivalent change in thrust specific fuel consumption is outlined in Figure 33.

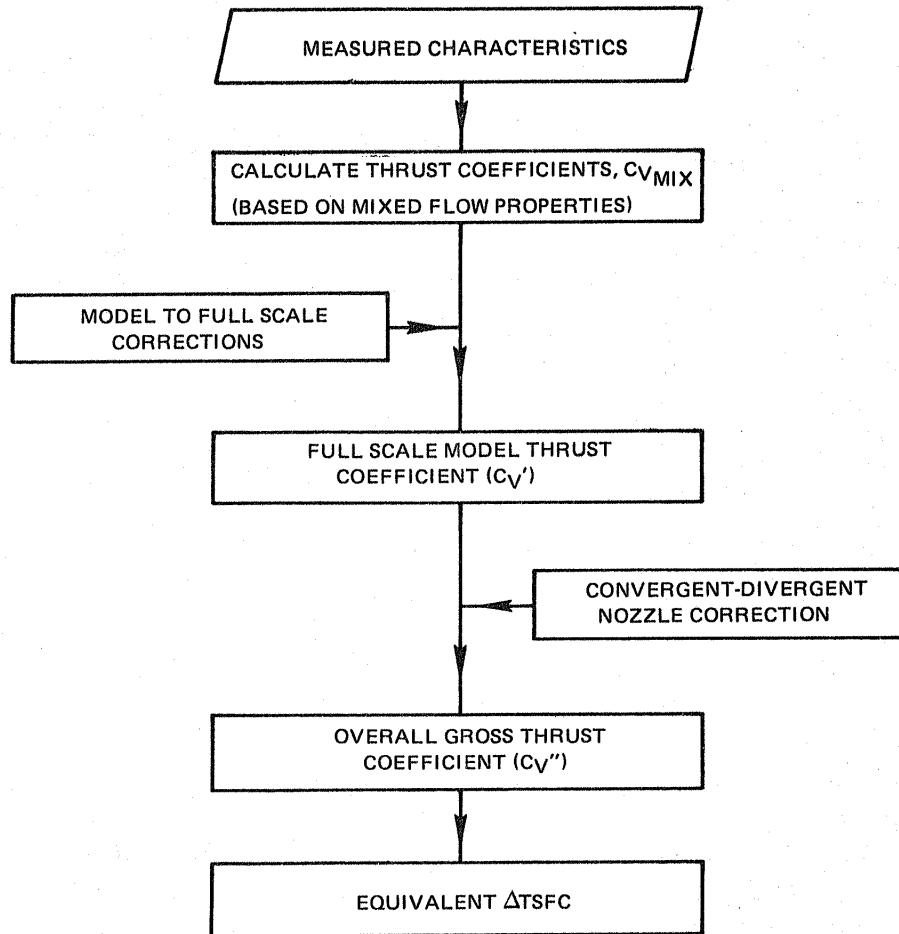

Figure 33 Data Processing Procedure

The procedure begins with the measured thrust and the airflow through each stream, along with the charging station pressures and temperatures. Since the most meaningful thrust coefficient ($C_{V\text{ MIX}}$) is based on mixed flow properties at the exit plane of the mixer, it is necessary to estimate the stream properties at the mixing plane. This can best be done by accounting for the total pressure loss in each stream, from the charging station to mixing plane. This one dimensional calculation is defined as:

$$\frac{\Delta PT}{PT} = \int_{\text{CHARGING STATION}}^{\text{MIXING PLANE}} -4 C_f \frac{dl}{2r} \frac{\gamma Mn_{\text{local}}^2}{2}$$

where

C_f is skin friction coefficient
 Mn_{local} is the local Mach number
 dl is incremental duct length
 $2r$ is equivalent duct diameter

Once the charging station pressures have been adjusted, the fully mixed values of pressure ($P_{T\text{ MIX}}$) temperature ($T_{T\text{ MIX}}$), used in the calculation of ideal thrust and flow, can be determined. The procedure used to calculate the fully mixed conditions is discussed in detail in Appendix A.

The mixed model thrust coefficient is defined as:

$$C_{V\text{ MIX}} = \frac{F_{g\text{ measured}}}{F_{g\text{ fully mixed}})_{\text{ideal}}}$$

$$\text{where } F_{g\text{ fully mixed}})_{\text{ideal}} = \left[W_{a\text{ fan}} + W_{a\text{ pri}} \right]_{\text{measured}} (\text{Velocity ideal})$$

$$\text{and Velocity} \sim f(P_{T\text{ MIX}}, T_{T\text{ MIX}})$$

In addition, the mixed model flow coefficient is defined as:

$$C_{V\text{ MIX}} = \frac{\left[W_{a\text{ fan}} + W_{a\text{ pri}} \right]_{\text{measured}}}{W_{a\text{ fully mixed}})_{\text{ideal}}}$$

$$\text{where } W_{a\text{ fully mixed}})_{\text{ideal}} = (\rho_{\text{exit}}) (A_{j\text{ measured}}) (\text{Velocity ideal})$$

The full scale model thrust coefficient (C_V') is obtained by correcting the mixed model thrust coefficient ($C_{V\text{ MIX}}$) to account for model-to-full scale differences.

$$C_V' = C_{V\text{ MIX}} + \Delta C_{V\text{ M-FS}}$$

where $\Delta C_{V\text{ M-FS}}$ = model to full scale corrections

The model to full scale corrections consist of pressure loss differences which include a Reynolds number correction for size and surface roughness and a full scale acoustic treatment loss estimate. The model-to-full scale correction is defined as:

$$\Delta C_{V\text{ M-FS}} = \left[\left(\frac{\Delta P_T}{P_T} \right)_{\text{model}} - \left(\frac{\Delta P_T}{P_T} \right)_{\text{full scale}} \right] \frac{\Delta C_V}{\Delta P_T/P_T}$$

where $\frac{\Delta P_T}{P_T}$ = Total Pressure Loss (Skin Friction)

$$\frac{\Delta C_V}{\Delta P_T / P_T} = \text{Thrust Coefficient Sensitivity } \sim f \left[\begin{array}{l} \text{Nozzle Pressure} \\ \text{Ratio} \end{array} \right]$$

e.g. at $P_{TMPA} = 2.5$, $\frac{\Delta C_V}{\Delta P_T / P_T} = 0.48$

A tabulation of ΔC_{VM-FS} for Phase I and II "HOT" data are presented in Table V.

TABLE V
CORRECTIONS TO "HOT" DATA AT $P_{TMPA} = 2.5$

CONFIGURATION	$\Delta C_{VMODEL-FULL SCALE}$
1	-0.0005
2	-0.0006
3	-0.0008
4	-0.0009
5	-0.0009
6	-0.0008
7	-0.0008
8	-0.0008
9	-0.0008
10	-0.0008
11	-0.0008
13	-0.0008
14	-0.0010
15	-0.0008
16	-0.0008
17	-0.0008
18	-0.0009
19	-0.0008
21	-0.0005
22	-0.0005
23	-0.0008
24	-0.0008
25	-0.0008
26	-0.0008
27	-0.0008
28	-0.0010
29	-0.0008
30	-0.0008
33	-0.0008
34	-0.0008
35	-0.0008
36	-0.0008
37	-0.0008
38	-0.0008
39	-0.0008
40	-0.0007
41	-0.0008
42	-0.0008
43	-0.0008
45	-0.0008
46	-0.0007
48	-0.0008
49	-0.0008

For the majority of the configurations the ΔC_{VM-FS} correction was 0.0008.

The final correction made to the data accounts for the fact that the flight propulsion system would have a convergent-divergent nozzle, rather than a convergent nozzle as tested on the models. This convergent-divergent effect is defined as:

$$\Delta C_{VC-D} = C_{V \text{ convergent divergent nozzle}} - C_{V \text{ convergent nozzle}}$$

The assumed convergent-divergent nozzle was selected to have an area ratio of 1.02. At a mixed pressure ratio of 2.5, the correction $\Delta C_{VC-D} = +0.001$. The overall gross thrust coefficient is therefore defined as:

$$C_V'' = C_V' + \Delta C_{VC-D}$$

The equivalent change in thrust specific fuel consumption, $\Delta TSFC$, is established in Figure 34. The base level of overall thrust coefficient (i.e., at $TSFC = 0$) is the analytically established level selected for an optimized separate flow exhaust system.

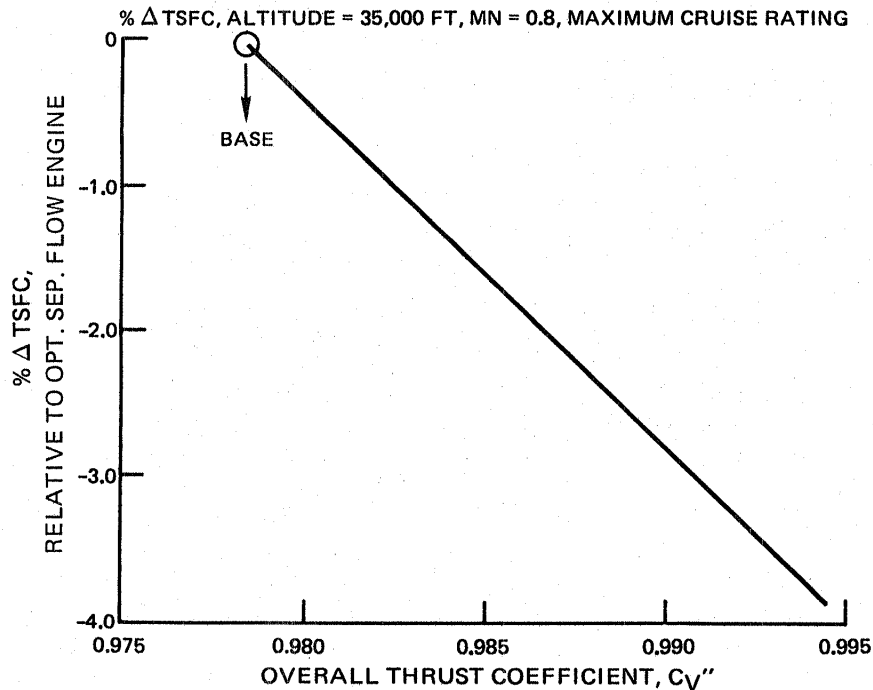

Figure 34 Equivalent Change in Thrust Specific Fuel Consumption Relative to the Optimized Separate Flow Exhaust System

To support the overall change in thrust specific fuel consumption evaluations, two other indicators, mixing efficiency (η_m) and the excess pressure loss ($\Delta P_T/P_T$), were also calculated. The amount of mixing coupled with the total pressure loss incurred in achieving that mixing determines the overall system performance. Mixing efficiency relates the actual nozzle performance gain to the ideal nozzle performance gain available from mixing. The fundamental definition is:

$$\eta_m = \frac{\text{actual nozzle performance gain}}{\text{ideal nozzle performance gain}} = \frac{\left[C_{V_{MIX_{Hot}}} - C_{V_{MIX_{Unmixed}}} \right]_{\text{actual}}}{\left[\frac{F_{g_{fully\ mixed}} - F_{g_{unmixed}}}{F_{g_{fully\ mixed}}} \right]_{\text{ideal}}}$$

$$\text{where } C_{V_{MIX_{Hot}}} = \frac{F_{g_{\text{actual}}}}{F_{g_{fully\ mixed}}}_{\text{ideal}} \left. \begin{array}{l} \text{at fan to primary pressure ratio} \\ P_{T7}/P_{T8} = K1 \\ \text{and temperature ratio (TRAT)} = K2 \end{array} \right\}$$

$$\text{where } C_{V_{MIX_{Unmixed}}} = \frac{\left[F_{g_{\text{primary}}} + F_{g_{\text{fan}}} \right]_{\text{actual}}}{F_{g_{fully\ mixed}}}_{\text{ideal}} \left. \begin{array}{l} \text{at } P_{T7}/P_{T8} = K1 \text{ and TRAT} = K2 \\ \text{(requires no mixing between} \\ \text{fan and primary stream)} \end{array} \right\}$$

$$\text{and } \left[\frac{F_{g_{fully\ mixed}} - F_{g_{unmixed}}}{F_{g_{fully\ mixed}}} \right]_{\text{ideal}} = \text{ideal nozzle performance gain} \left. \begin{array}{l} \text{at } P_{T7}/P_{T8} = K1 \\ \text{and TRAT} = K2 \end{array} \right\}$$

$$\text{where } F_{g_{fully\ mixed}}}_{\text{ideal}} = f(P_{T_{MIX}}, T_{T_{MIX}})$$

$$\text{and } F_{g_{unmixed}}}_{\text{ideal}} = F_{g_{\text{primary}}}_{\text{ideal}} + F_{g_{\text{fan}}}_{\text{ideal}}$$

The fully mixed flow properties ($P_{T_{MIX}} + T_{T_{MIX}}$) are obtained from the mixing calculation procedure outlined in Appendix A.

Since the $C_{V_{MIX_{unmixed}}}$ cannot be measured (because it requires that no mixing take place between the fan and primary streams) it must be calculated by subtracting the ideal nozzle performance gain from the fully mixed performance.

$$C_{V_{MIX_{unmixed}}} = C_{V_{MIX_{fully\ mixed}}} - \text{ideal nozzle performance gain}$$

$$\text{where } C_{V_{MIX_{fully\ mixed}}} = C_{V_{MIX_{Cold}}} = \frac{F_{g_{measured}}}{F_{g_{fully\ mixed}}} \Bigg|_{\text{ideal}} \left. \vphantom{\frac{F_{g_{measured}}}{F_{g_{fully\ mixed}}}} \right\} \begin{array}{l} \text{at } P_{T7}/P_{T8} = 1.0 \\ \text{and TRAT} = 1.0 \end{array}$$

The definition of mixing then becomes:

$$\eta_m = \frac{C_{V_{MIX_{Hot}}} - (C_{V_{MIX_{Cold}}} - \text{ideal nozzle performance gain})}{\text{ideal nozzle performance gain}}$$

$$\eta_m = 1 - \frac{[C_{V_{MIX_{Cold}}} - C_{V_{MIX_{Hot}}}] \text{ actual}}{\text{ideal nozzle performance gain}}$$

The definition was used in the data reduction and its calculation requires separate tests of the exhaust system; (1) with both streams at the same temperature (cold flow, TRAT = 1.0) and pressure ($P_{T7}/P_{T8} = 1.0$), and (2) with both streams at simulated engine operating temperatures (hot flow, TRAT = K2) and pressure ($P_{T7}/P_{T8} = K1$). With both streams at the same level of temperature and pressure, a uniform flow field will exist in the mixing region since the velocity difference between the two streams is zero. This simulates fully mixed flow ($C_{V_{MIX_{Cold}}}$). Since the cold stream Mach numbers approximate those of the desired operating conditions, the pressure losses for hot and cold flow tests are approximately equal. Therefore, the difference in thrust coefficient levels between the hot ($C_{V_{MIX_{Hot}}}$) and cold ($C_{V_{MIX_{Cold}}}$) flow tests is a measure of the nozzle performance change due to the mixing process between the two streams. The calculation of mixing efficiency is graphically illustrated in Figure 35 where the actual nozzle performance gain is obtained from relating the measured hot data and the unmixed performance level. The latter is derived by subtracting the ideal nozzle performance gain from the fully mixed performance level.

In addition to the mixing level, that portion of the exhaust system total pressure loss which is in excess of skin friction loss was selected as a meaningful parameter in evaluating mixer performance. The procedure used to calculate pressure loss in excess of skin friction is outlined in Figure 36.

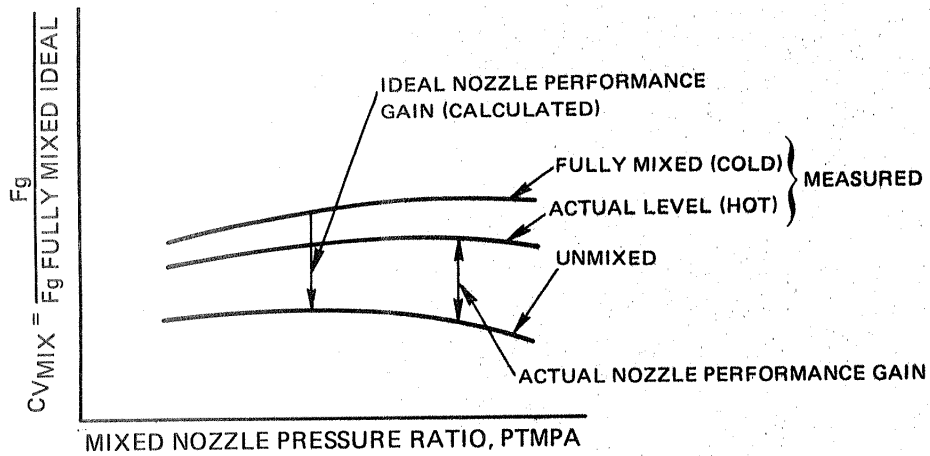

Figure 35 Calculation of Mixing Efficiency

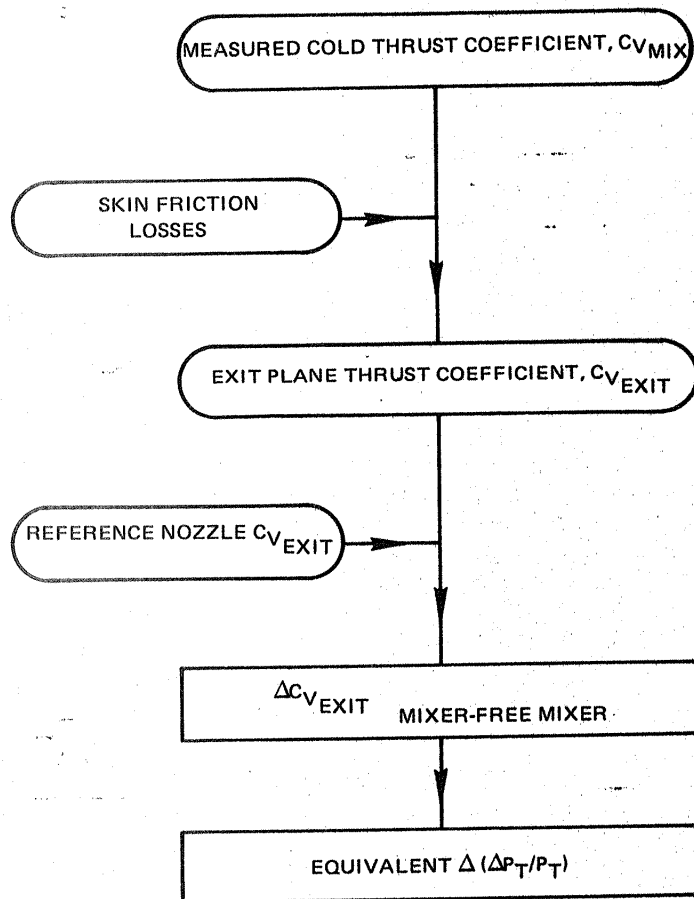

Figure 36 Procedure Used to Calculate Pressure Loss in Excess of Skin Friction

The procedure begins with the measured cold flow thrust coefficient ($C_{V \text{ MIX}}$), for the mixer configuration of interest, which is adjusted to the exit plane of the tailpipe by adding in the equivalent change in thrust coefficient due to the skin friction losses of the tailpipe.

$$C_{V \text{ EXIT}} = C_{V \text{ MIX Cold}} + \Delta C_{V \text{ Tailpipe}}$$

where $\Delta C_{V \text{ Tailpipe}} = \left(\frac{\Delta P_T}{P_T} \right)$ tailpipe skin friction $\left(\frac{\Delta C_V}{\Delta P_T/P_T} \right)$

and $\frac{\Delta C_V}{\Delta P_T/P_T} = \text{Sensitivity factor}$

Once the exit plane thrust coefficient is calculated for the mixer configurations, it is compared to the exit plane thrust coefficient of the free mixer. The free mixer is assumed to have skin friction losses only, therefore, the difference between the two can be attributed to pressure losses above skin friction with forced mixer configuration. The total pressure loss in excess of skin friction is, therefore, defined as:

$$\Delta \left(\frac{\Delta P_T}{P_T} \right) \text{ excess of skin friction} = \left[C_{V \text{ exit free mixer}} - C_{V \text{ forced mixer}} \right] \frac{1}{\frac{\Delta C_V}{\Delta P_T/P_T}}$$

where $\frac{\Delta C_V}{\Delta P_T/P_T} = \text{Sensitivity factor}$

4.3.2.2 Nozzle Exit Plane Traverses

Traverse plots were obtained by surveying the nozzle exit plane of selected configurations in Phase I and all the configurations in Phase II. At a single simulated engine operating point, total pressure and total temperature were measured and non-dimensionalized relative to the corresponding ideal mixed property. A sample of the resultant plots is shown in Figures 37 and 38. The charging station conditions for each stream (fan stream = station 7 and primary stream = station 8) are identified. The absolute level of the fully mixed reference is also identified. A complete presentation of all the traverse plots is made in Appendix B. The location of the primary lobe peaks are indicated by arrows.

4.3.2.3 Flow Visualization Photographs

Flow visualization tests were made for selected configurations in Phase I and for all of the Phase II configurations. These tests were conducted with uniform cold flow at a nozzle pressure ratio of 2.5 to provide a general indication of the flow field through the exhaust system. A sample photograph is presented in Figure 39. The streaks result from placing an array of dots (using a lampblack/glycerine mixture) on the painted surface of the model prior to a test run. A complete set of photographs is presented in Appendix C.

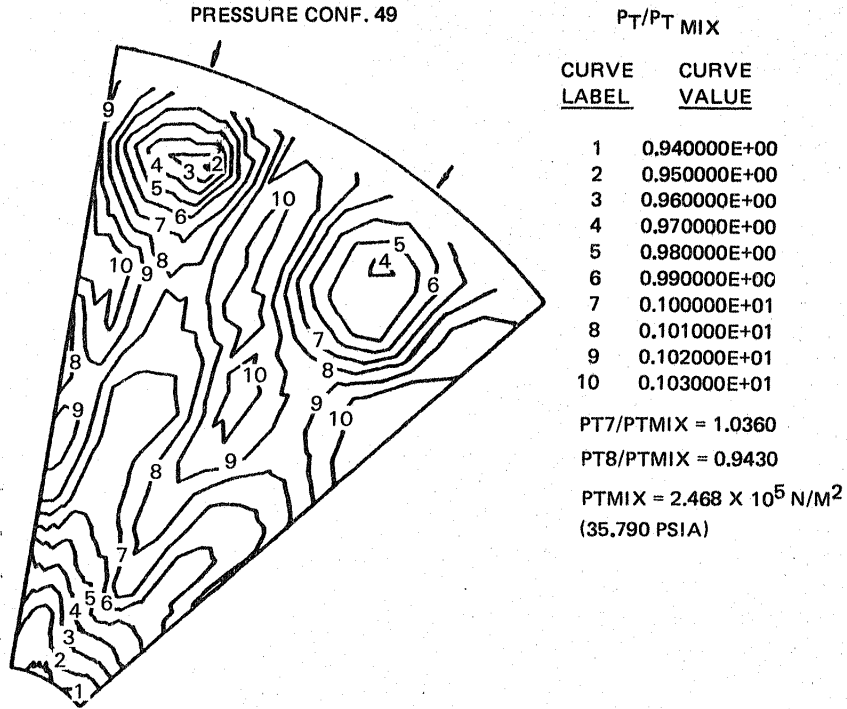

Figure 37 Resultant Plot Sample

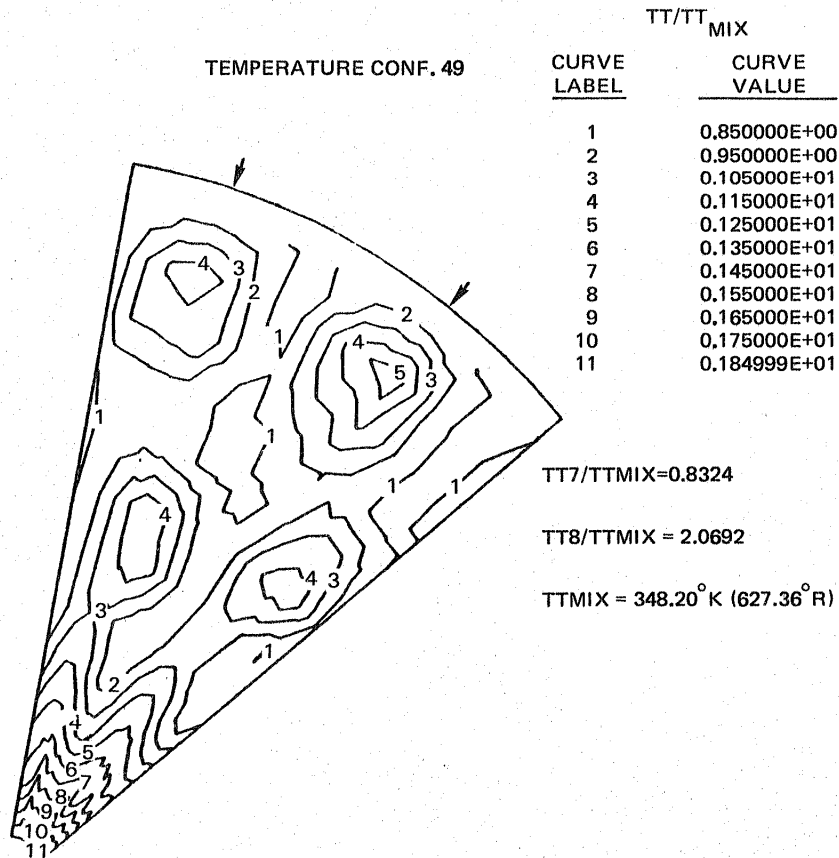

Figure 38 Resultant Plot Sample

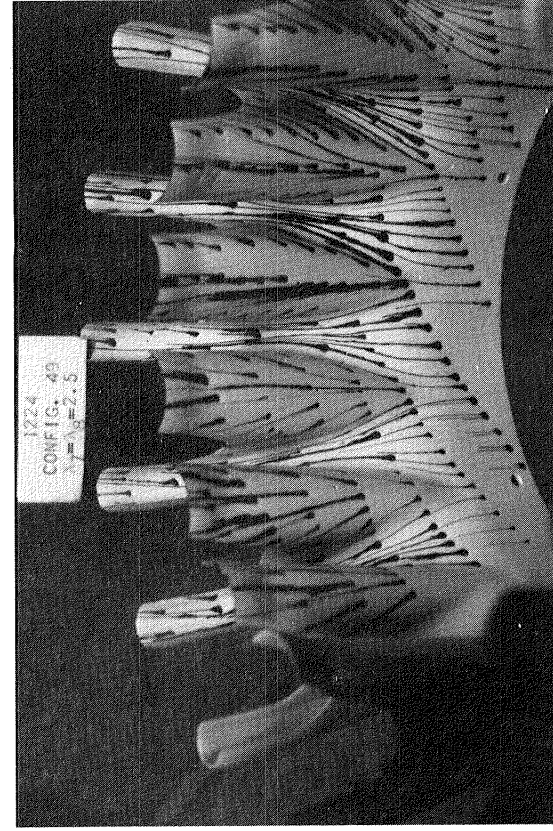
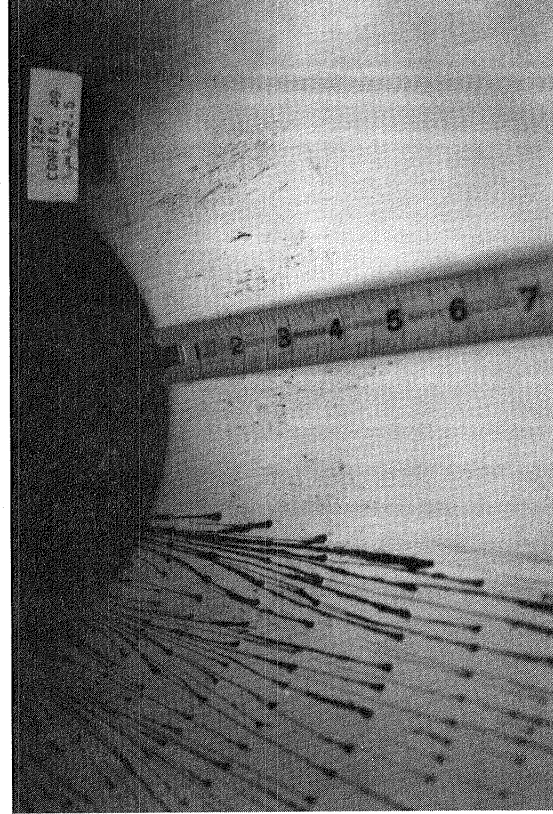
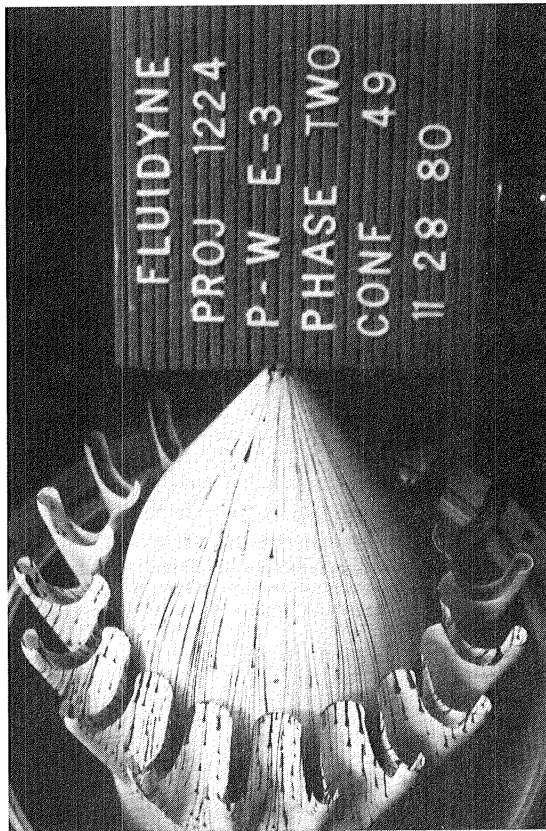
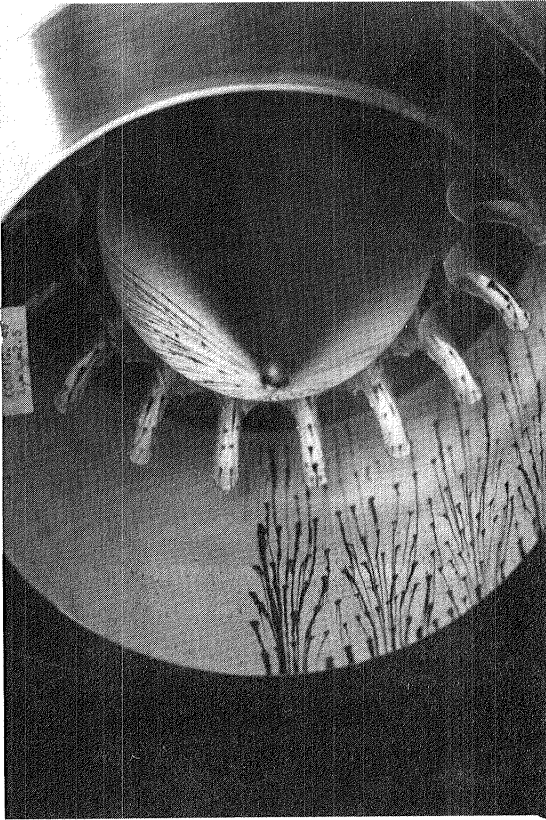

Figure 39 Flow Visualization Photographs, Configuration 49

4.3.3 Data Repeatability

The free mixer configuration was tested at the beginning, several times during, and at the end of Phase I and Phase II test programs to establish data repeatability. The repeatability of the thrust coefficient ($C_{V MIX}$) data was analyzed at relatively high nozzle pressure ratio, spanning the key pressure ratio (2.5) used in the parametric evaluations.

The cold data from Phase I, illustrated in Figure 40, had a standard deviation equal to ± 0.0004 . The Phase I "hot" flow data (Figure 40) are stratified into two groups according to total pressure split. The higher thrust coefficient reflects the desired pressure split schedule and has a standard deviation equal to ± 0.0008 . The lower "hot" flow line reflects an early set of test points conducted with a total pressure split schedule approximately 2 percent less than desired and has a standard deviation equal to ± 0.0005 . The difference in thrust coefficient level between these two lines can be traced to the difference in the potential thrust gain available from mixing because of the differences in pressure split. This level shift or stratification tends to collapse, around the higher thrust coefficient level, when the early data are corrected for the pressure split difference.

COLD DATA				HOT DATA			
SYMBOL	RUN NO.	PTMPA	PRAT	SYMBOL	RUN NO.	PTMPA	PRAT
○	4	2.374	0.994	○	10.3	2.370	1.115
○	5	2.481	0.992	○	11.3	2.454	1.102
○	6	2.575	0.992	○	12.3	2.546	1.093
□	4.1	2.376	0.991	△	240	2.366	1.111
□	5.1	2.475	0.991	△	241	2.454	1.099
□	6.1	2.574	0.991	△	242	2.537	1.089
◇	4.11	2.391	1.005	○	10.1	2.343	1.095
◇	5.11	2.486	1.004	○	11.1	2.436	1.086
◇	6.11	2.585	1.003	○	12.1	2.522	1.078
△	4.4	2.395	1.003	△	10	2.346	1.093
△	5.4	2.488	1.002	△	11	2.436	1.086
△	6.4	2.584	1.003	△	12	2.521	1.078

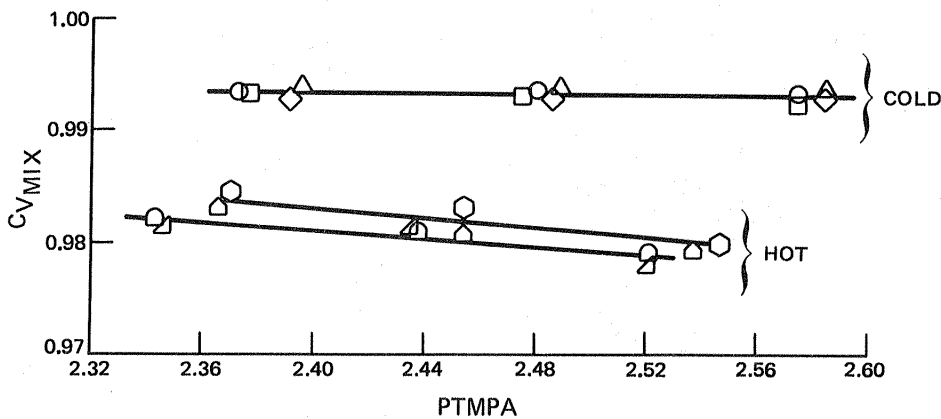

Figure 40 Phase I Free Mixer Data Configuration 1

It should be noted that the stratification of thrust coefficient due to pressure split variations essentially disappears with forced mixer configurations since they have mixing levels several times higher than the free mixer nozzle.

During Phase II, the "cold" flow tests had a standard deviation equal to ± 0.0006 as illustrated in Figure 41. The "hot" flow tests had a standard deviation equal to ± 0.0004 . In general, the repeatability for each phase is somewhat better than that achieved with previous experimental programs in Channel 11 at Fluidyne Engineering Corporation.

Although the amount of available data is relatively small, an indication of the amount of data bias between Phase I and Phase II testing is provided by comparing the mean hot and cold thrust coefficient levels of the free mixer configuration. At a mixed nozzle pressure ratio of 2.5, the cold flow bias shift is 0.0012 and the hot flow bias shift is 0.0010. In general, the trends from each phase of the program were used independently. Therefore, this bias is not particularly troublesome.

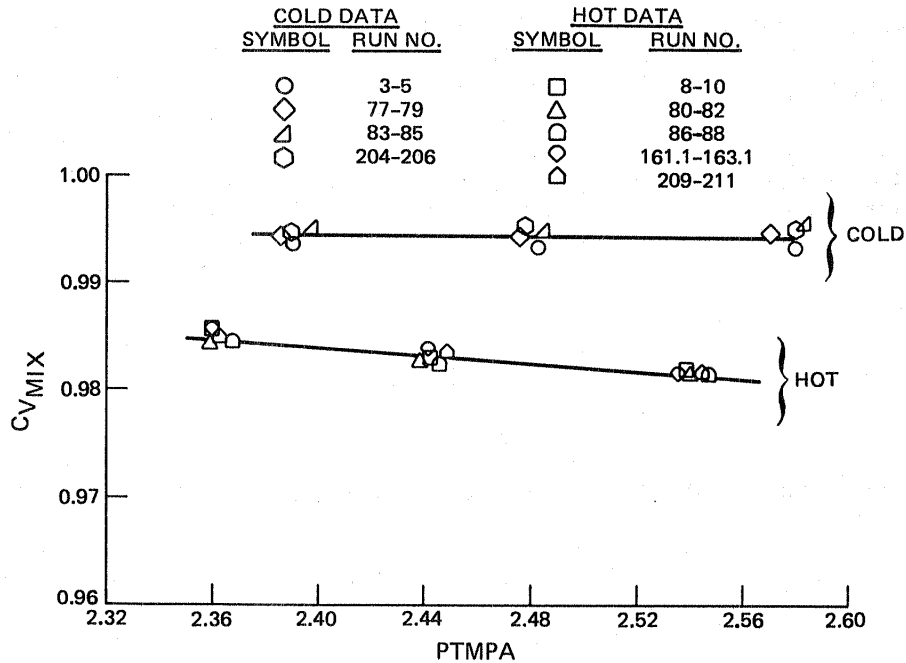

Figure 41 Phase II Free Mixer Data Configuration 1

5.0 TEST RESULTS

5.1 Phase I Results

The data from the Phase I mixer model test program were analyzed and correlated to determine the effects of mixer geometry on performance. The exhaust system variables evaluated were (1) tailpipe length, (2) number of mixer lobes, (3) scalloping, (4) penetration, (5) cutback, (6) turbine swirl, and (7) pylon integration. Each of these variables is discussed in the following paragraphs. The best measure of overall performance is the equivalent change in thrust specific fuel consumption which is a function of the measured nozzle gross thrust coefficient. In addition, the results are presented in terms of "percent mixing" and "excess pressure loss" $\Delta(\Delta P_t/P_t)$ to provide diagnostic insight into mixer performance.

5.1.1 Tailpipe Length

An increase in tailpipe length resulted in a substantial improvement in thrust specific fuel consumption in four basic mixer designs (Figure 42). These performance gains resulted primarily from the improved mixing efficiency caused by the tailpipe lengthening, while the corresponding excess pressure loss was not changed, as shown in Figure 43. (Note: the lines in Figure 42, and subsequent summary curves were established by cross-correlation of the performance trends shown in Figures 42 through 52, which clarify the trends and provide consistency. It should be noted that experimental accuracy (i.e., one standard deviation) would yield a variation of 0.15 percent thrust specific fuel consumption, 7 percent in mixing level, and 0.001 in pressure loss. Additional discussions of data repeatability and accuracy can be found in Section 4.3.3.) The change in mixing, with increased tailpipe length, is further illustrated in Figure 44, which shows the temperature pattern measured at the tailpipe exit. The longer tailpipe exhibited a mixing level nearly twice that of the shorter tailpipe, which is evidenced by the reduced gradients. The shaded areas on the traverses define the region where an essentially mixed temperature exists:

$$(1.05 \geq \frac{T_T}{T_{T \text{ MIX}}} \geq 0.95)$$

This provides a quick convenient guide to distinguish the primary from the fan stream.

A brief study of the overall propulsion system indicated that the internal performance gains generated by longer tailpipes would be virtually eliminated by the additional external skin friction drag. In addition, the extra weight and potential installation problems of a larger nacelle make the shorter system more desirable.

A design modification of the short tailpipe for the green series, providing increased flow area, was also evaluated in this segment of the program (configuration 6). As indicated in Figure 42, the overall performance was essentially equal to the original design. The corresponding mixing and excess pressure loss is illustrated in Figure 43. The increased mixing level, generally associated with reduced internal Mach number, tends to be offset by a large increase in excess pressure loss. The latter occurrence is currently not understood.

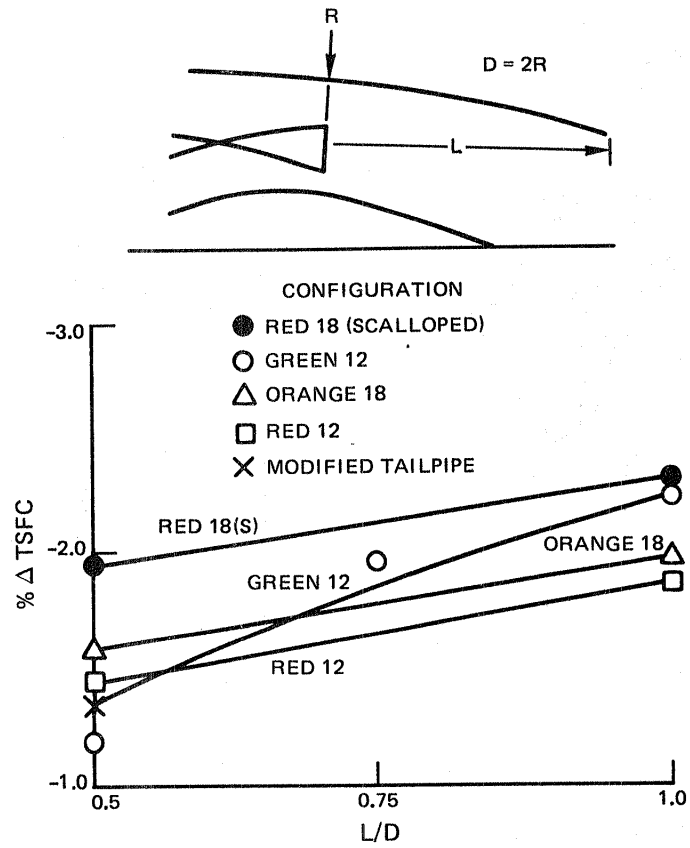

Figure 42 Thrust Specific Fuel Consumption Variation with Tailpipe Length

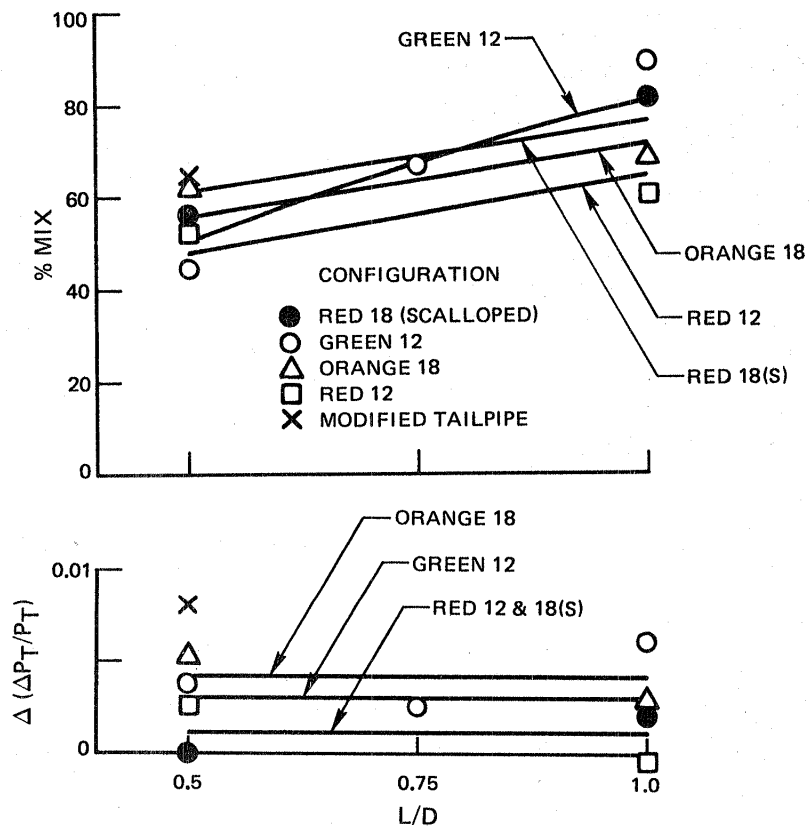

Figure 43 Percent Mixing and Excess Pressure Variation with Tailpipe Length

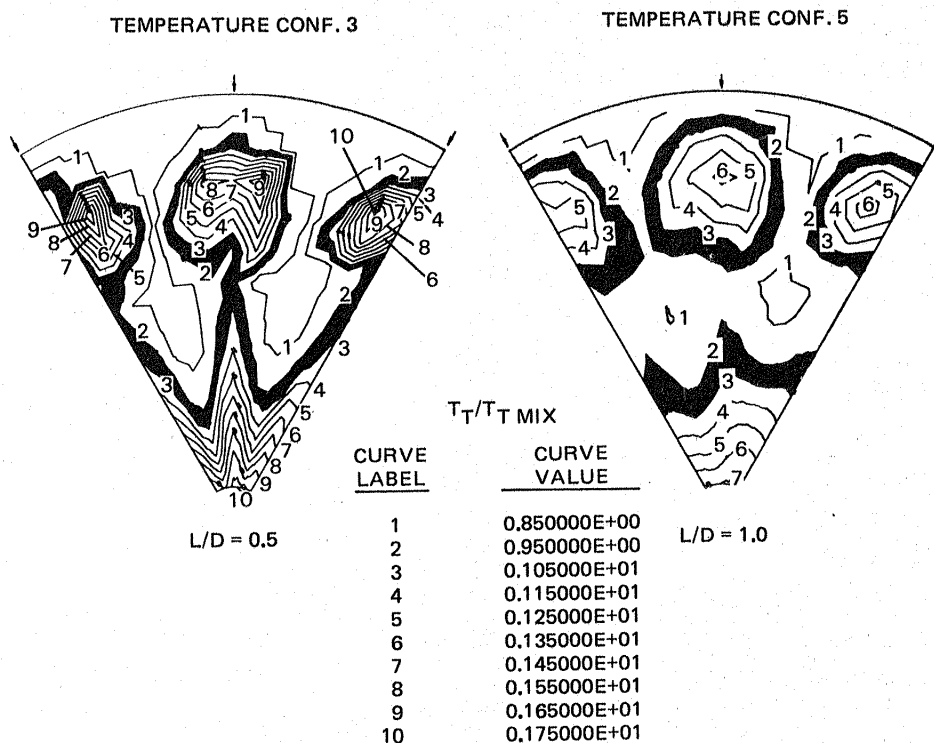

Figure 44 Temperature Pattern Measured at Tailpipe Exit

5.1.2 Lobe Variations

The results obtained from testing 12 and 18 lobe versions of two basic configurations indicated that the 18 lobe designs offered increased performance benefits. The influence of lobe number is presented in Figure 45. The overall performance gain is primarily due to an increase in the degree of mixing obtained even though it is partially offset by the increased pressure loss which also accompanies an increase in lobe number (see Figure 46). A comparison of the temperature traverses at the tailpipe exit is presented in Figure 47, showing the increased mixing. In many of the test configurations which were traversed, circulation patterns were noted aft of the primary lobes, inducing fan stream flow into the primary flow region and thus enhancing mixing between the two streams. This circulation, believed to be created by the secondary flow system within the tailpipe, tends to eliminate the initial character of the primary flow, especially behind the lower half of each lobe. This also creates a hoof print pattern.

The collection of primary flow near the centerline is also typical of the mixers tested, being the result of the gap between the mixer and the centerbody. This allows a portion of the primary flow to avoid the mixing process.

Most of the mixers were designed with lobes that were slightly converging in the axial direction, when viewed from the top (i.e., variable α/θ). This was done to provide additional control of the flow area distribution through the mixer. One mixer was designed with simplified constant width lobes (configuration 7). This modified green mixer configuration provided an improvement of approximately 0.4 percent thrust specific fuel consumption (as shown in

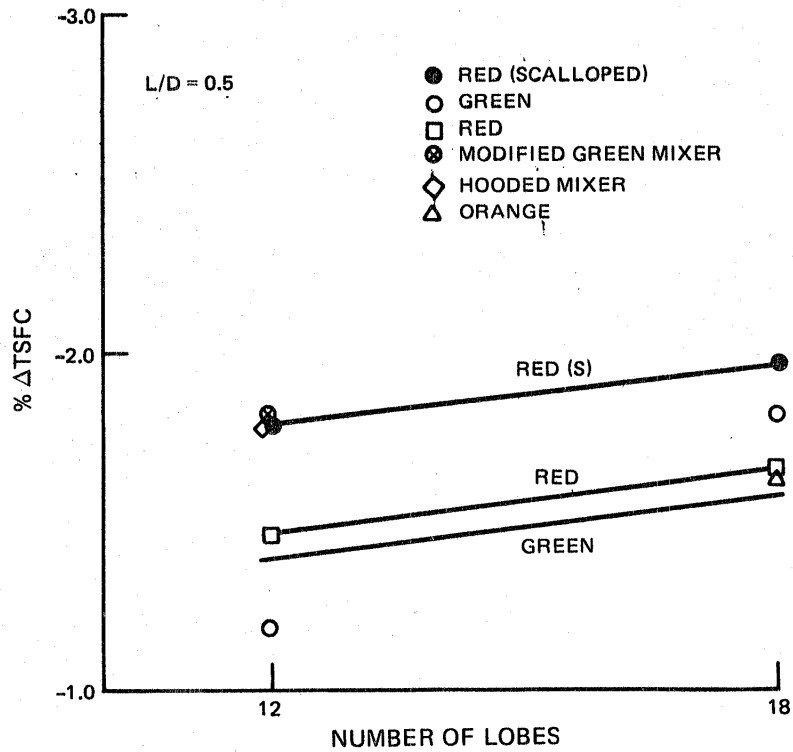

Figure 45 Thrust Specific Fuel Consumption Variation with Number of Lobes

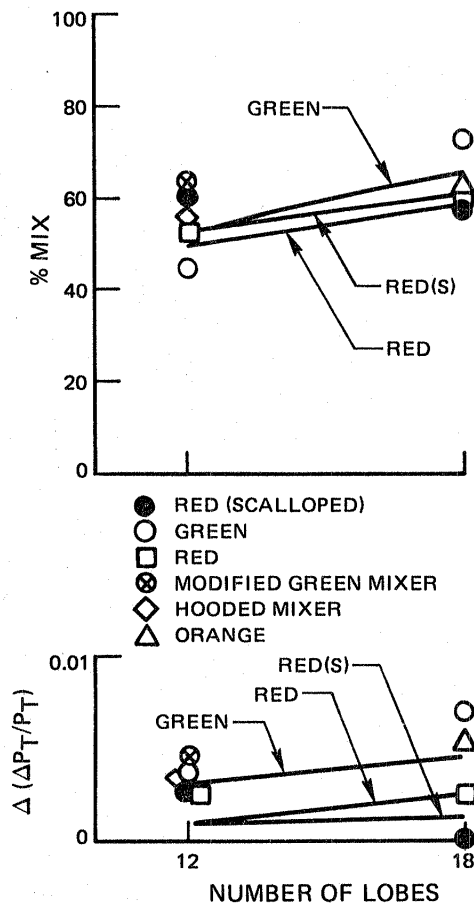

Figure 46 Percent Mixing and Excess Pressure Variation with Number of Lobes

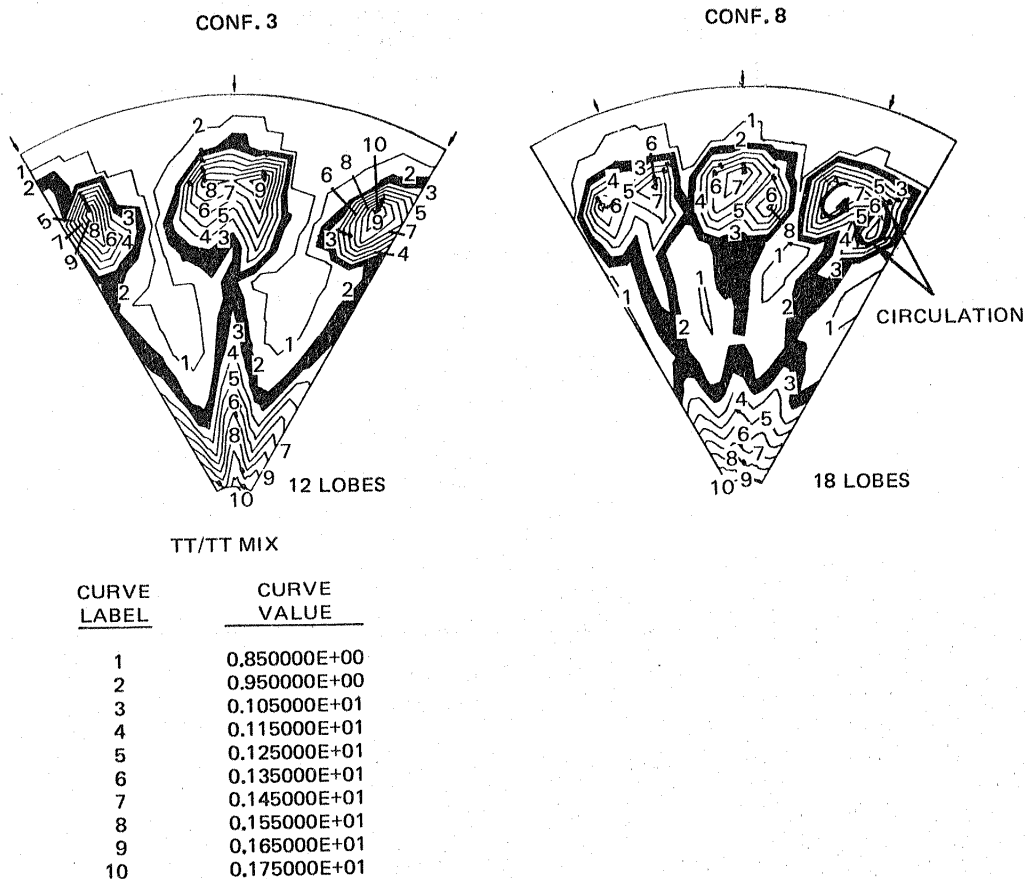

Figure 47 Comparison of Temperature Traverses at the Tailpipe Exit

Figure 45). The performance improvement was due to a substantial increase in the level of mixing as illustrated in Figure 46. A set of hoods or fairings was then added to this mixer to form configuration 27. The measured overall performance (shown in Figure 45) was essentially the same as the basic configuration. This may be somewhat pessimistic, since the cold flow test indicated the excess pressure loss was reduced. The flow visualization photographs also indicated the flow quality was improved.

In addition to the mixer lobe details described above, the importance of mixing plane area was also evaluated. The red and green series were designed with the same critical areas throughout the mixer. The orange series was designed with an increased mixing plane area (+19 percent A_{MIX}). The overall performance for the orange design, as illustrated in Figure 45, was essentially the same (within experimental accuracy) as the red and green series. It should be noted the orange series had a penetration of 0.49 while the red and green had 0.57 and 0.65 respectively. The penetration trends (in Section 5.1.3) suggest the orange series performance should have been significantly worse than the red and green but this effect was probably offset by the larger A_{MIX} (lower Mach number) and therefore the overall performance was essentially the same.

Scalloping the mixer produces a substantial performance improvement for both 12 and 18 lobe designs, as illustrated in Figure 45. This is a result of a combination of an increase in mixing and a decrease in excess pressure loss as illustrated in Figure 46.

5.1.3 Mixer Penetration

A correlation of the Phase I data indicated that increased mixer penetration could improve overall performance as shown in Figure 48. Increasing the penetration moves the primary stream radially outward and enhances the contact between the two streams. The mixing and pressure loss characteristics associated with increased penetration are illustrated in Figure 49. The data scatter about the performance curves is believed to be due to geometrical differences between the configurations such as mixer length and local angles. For example, configuration 19 had a short mixer with a high degree of primary flow turning. It showed signs of flow instability in the primary flow stream (as observed from the flow visualization photos) which could account for the high pressure loss seen in Figure 49.

The impact of increased mixer penetration on the temperature traverse pattern at the tailpipe exit is shown in Figure 50. In addition to the residual primary hot spot moving radially outward, the intensity of the primary flow region is diminished, reflecting the increased mixing.

Higher penetration mixer designs were subsequently evaluated in Phase II of the mixer technology program and are discussed in Section 5.2.

5.1.4 Cutback

The impact of mixer exit plane orientation (i.e., cutback) is shown in Figure 51. This illustrates the performance change for one excursion in exit plane geometry. It suggests that there may be an optimum exit plane orientation for a basic mixer design. The corresponding mixing and pressure loss characteristics are presented in Figure 52. Both diagnostic terms increase considerably with cutback.

5.1.5 Turbine Swirl

Simulated turbine discharge swirl was introduced into the mixer in order to support the study of simplified turbine system designs, offering improved turbine performance. The goal was to have no additional loss in the mixer. The importance of turbine discharge swirl on nozzle performance was established for the free mixer configurations (i.e., one having a simple splitter between the primary and fan streams) and a forced mixer configuration, as illustrated in Figure 53. As expected, the free mixer experienced severe performance losses as swirl angle increased. The forced mixer greatly reduces the performance losses associated with swirl, but still exhibits significant losses. The flow patterns developed on both configurations, for 36 degrees of swirls are shown in Figure 54. As illustrated, the mixer has a considerable amount of swirling flow remaining along the centerbody. Since turbine swirl produced a performance loss in the mixer which was much larger than the anticipated gains associated with a simplified turbine, it was decided to proceed by eliminating swirl exiting the turbine.

SYMBOL	L/D	PENETRATION	CONFIGURATION
□	0.5	0.50	19
□	0.5	0.57	13
□	0.5	0.65	3
○	1.0	0.57	14
○	1.0	0.65	5

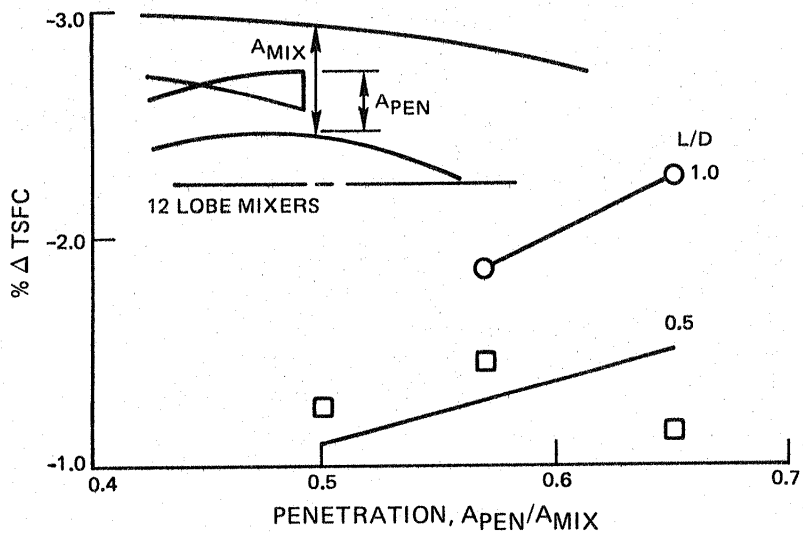

Figure 48 Thrust Specific Fuel Consumption Variation with Penetration

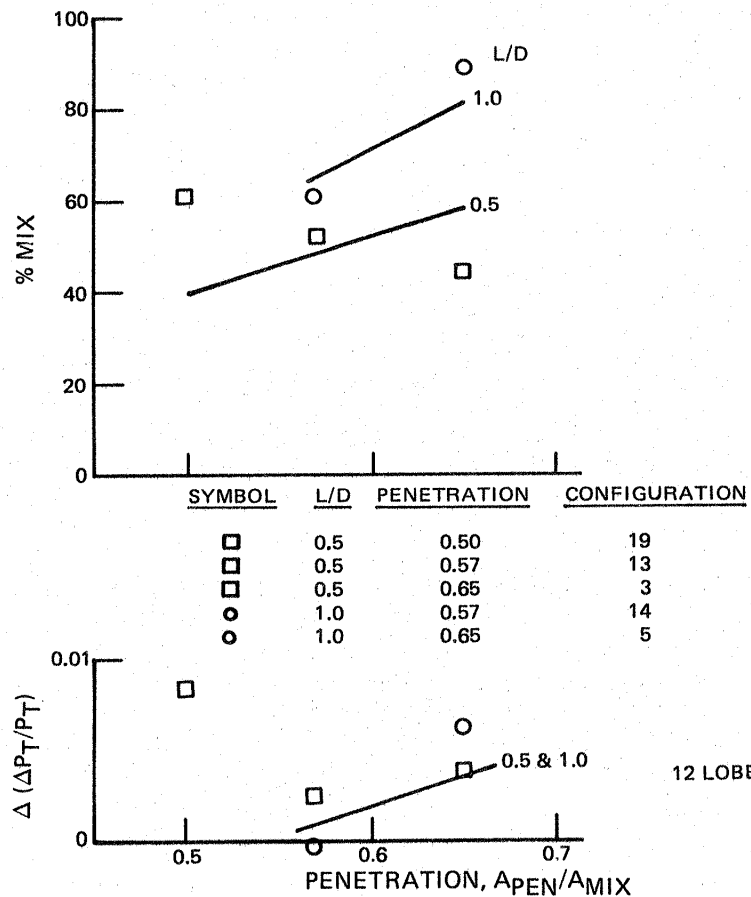

Figure 49 Percent Mixing and Excess Pressure Loss Variation with Penetration

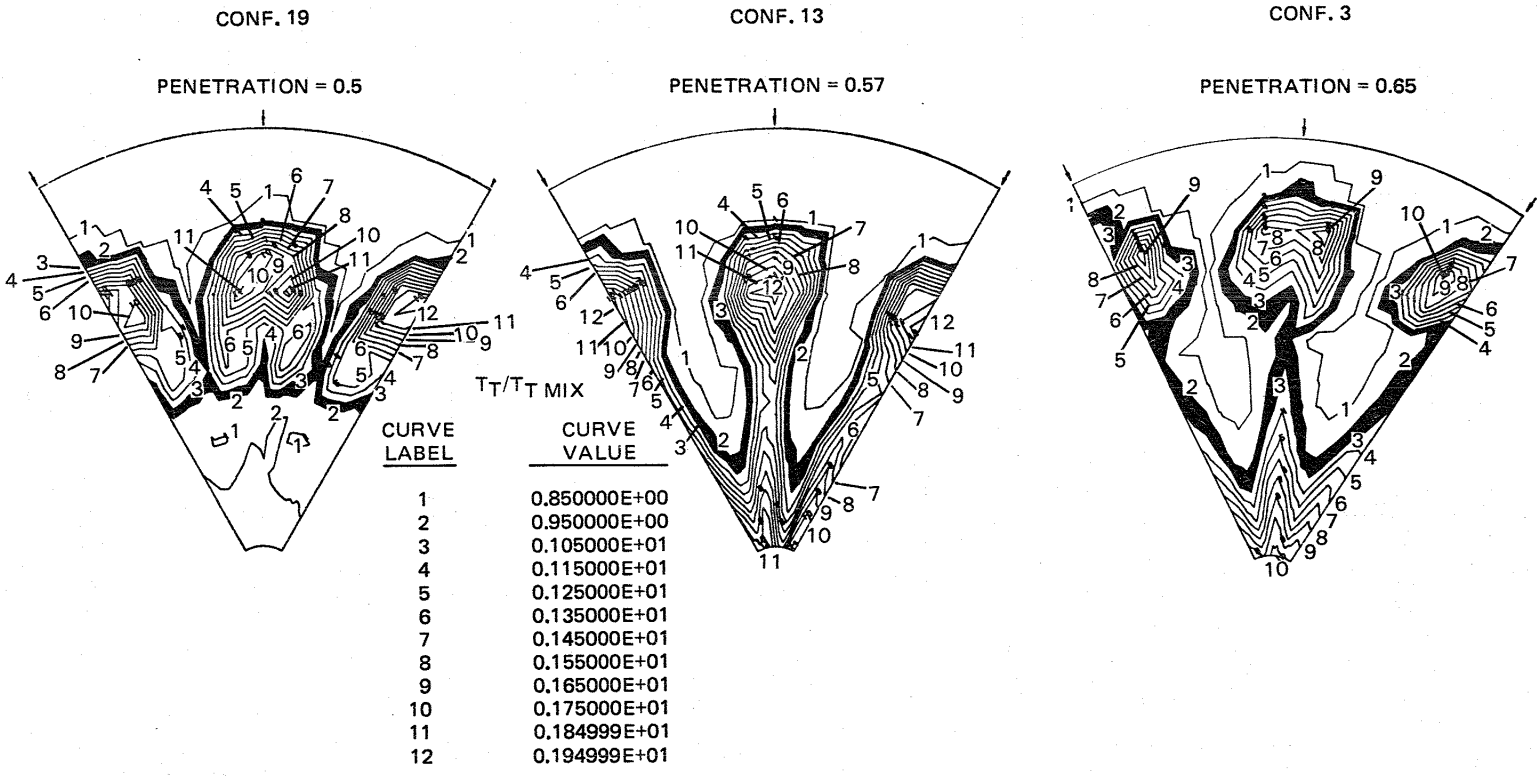

Figure 50 Impact of Increased Mixer Penetration on the Temperature Traverse Pattern at the Tailpipe Exit

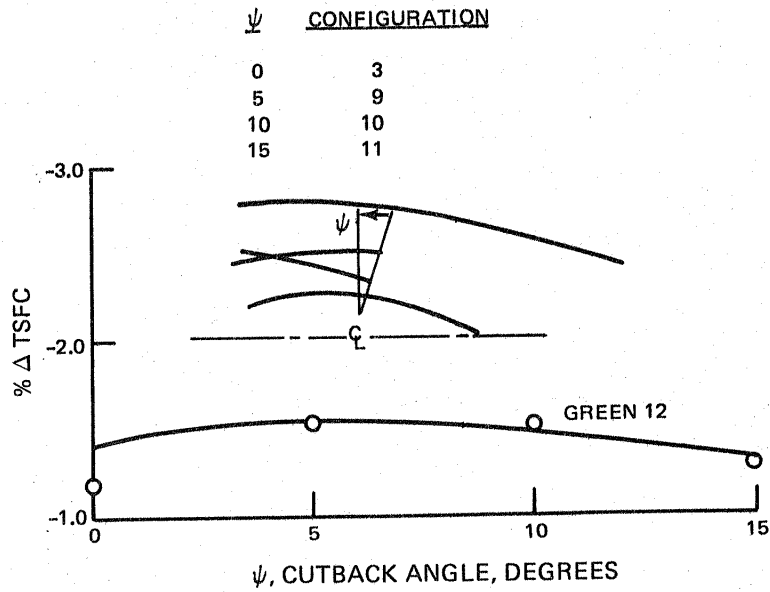

Figure 51 Thrust Specific Fuel Consumption Variation with Cutback Angle

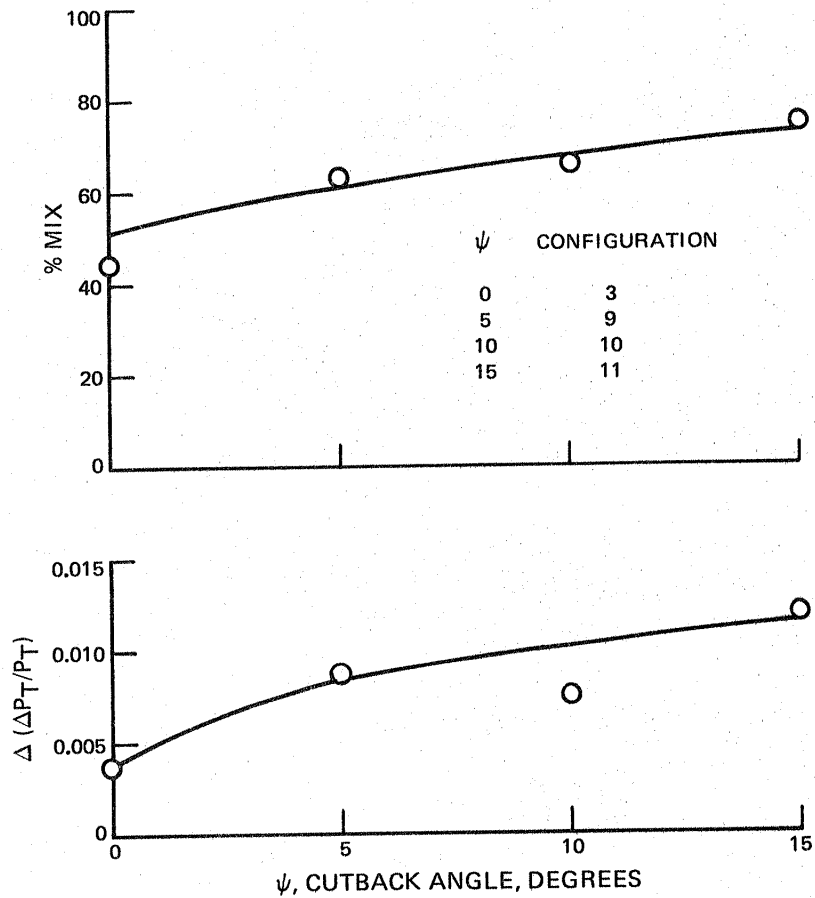

Figure 52 Energy Efficient Engine Phase I Mixer Performance Diagnostic Information

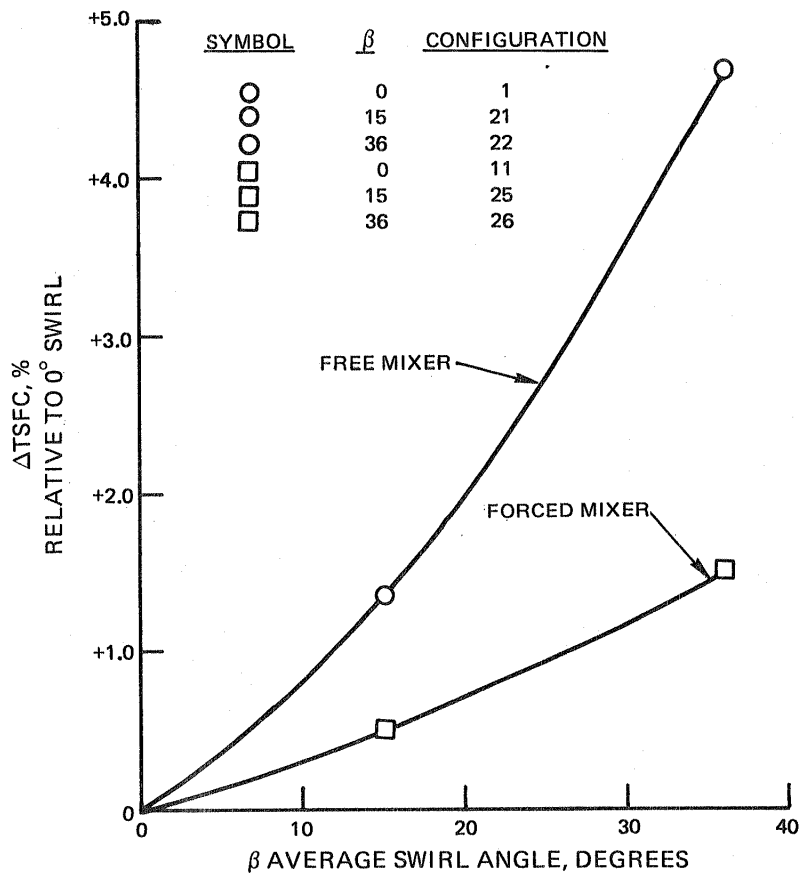
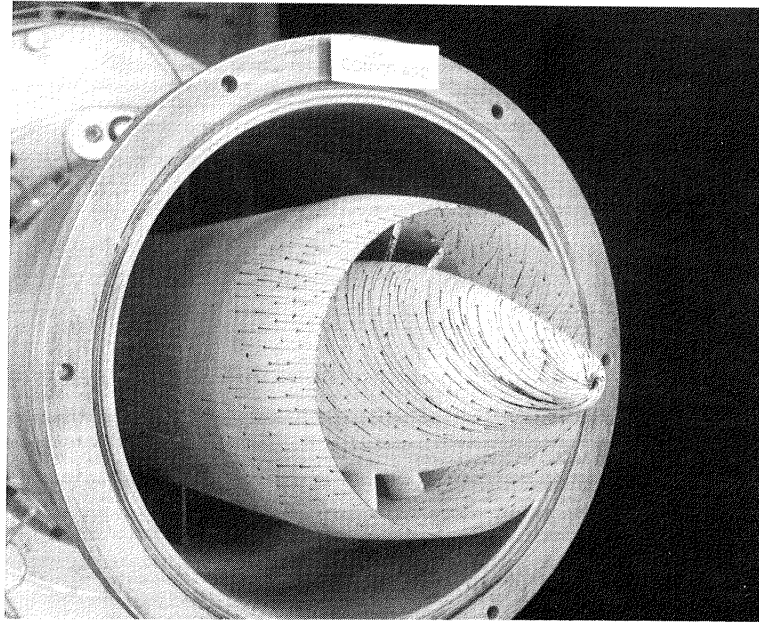

Figure 53 Impact of Turbine Discharge Swirl on Nozzle Performance

5.1.6 Pylon Integration

Integration of one of the mixers with two potential pylon fairings was also evaluated in the test matrix. A short pylon, ending at the mixer exit, was tested along with a longer design which extended over the mixer and ended well down the tailpipe. The flow visualization pictures obtained on both configurations are shown in Figure 55. The longer pylon appears to provide an improved flow field, relative to short design in the region where the pylon integrates into the lobe. However, the thrust measurements indicated both designs were essentially equal with the mixing efficiency and pressure loss being the same. A small loss in performance (a thrust specific fuel consumption change of approximately 0.1 percent) was noted for both, relative to the mixer configuration without a pylon simulation. This was a result of the mixing efficiency and pressure loss increasing by approximately 4 percent and 0.002, respectively, relative to the no pylon configuration.



A) FREE MIXER

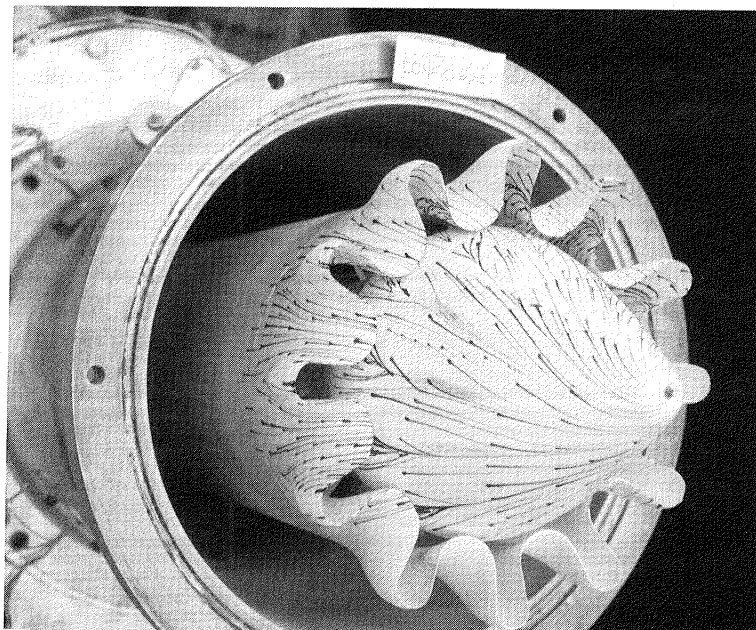

B) FORCED MIXER

Figure 54 Flow Patterns Developed on Free and Forced Mixers for 36 Degrees of Swirl

A complete summary of the performance characteristics of the configurations tested in Phase I is presented in Table VI. The major conclusions drawn from Phase I were:

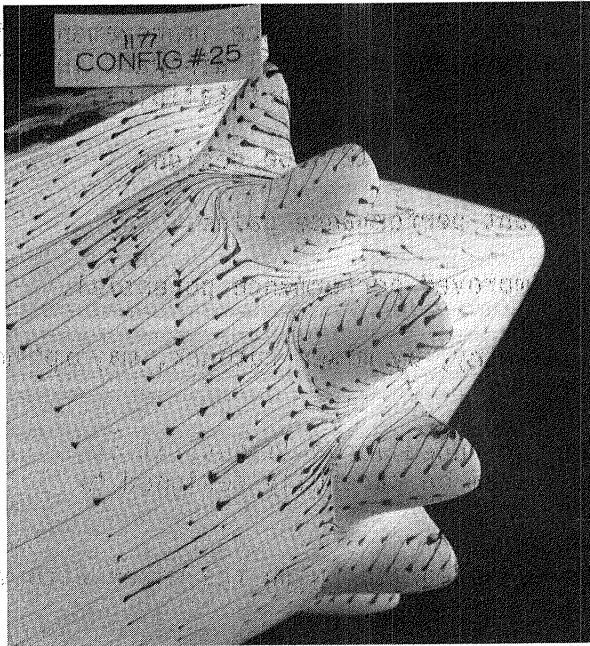

A) SHORT PYLON

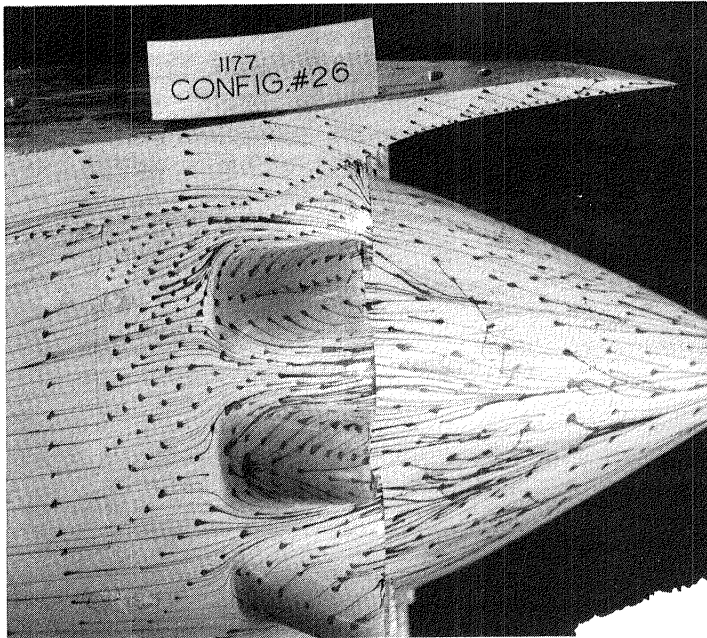
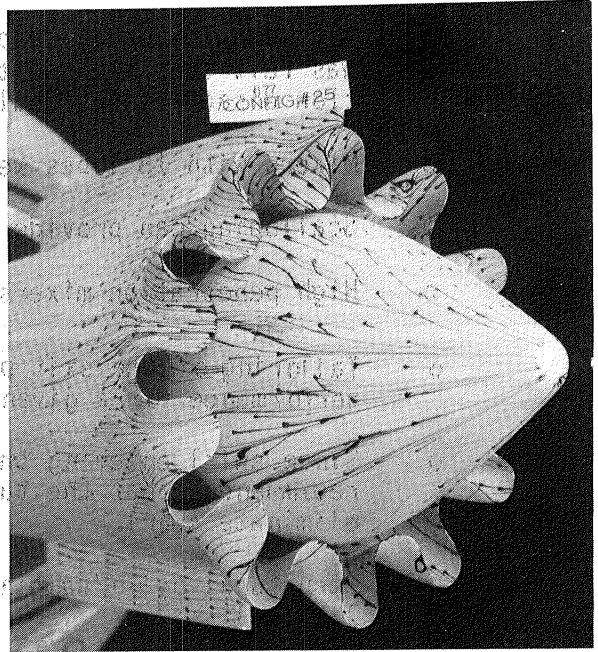

B) LONG PYLON

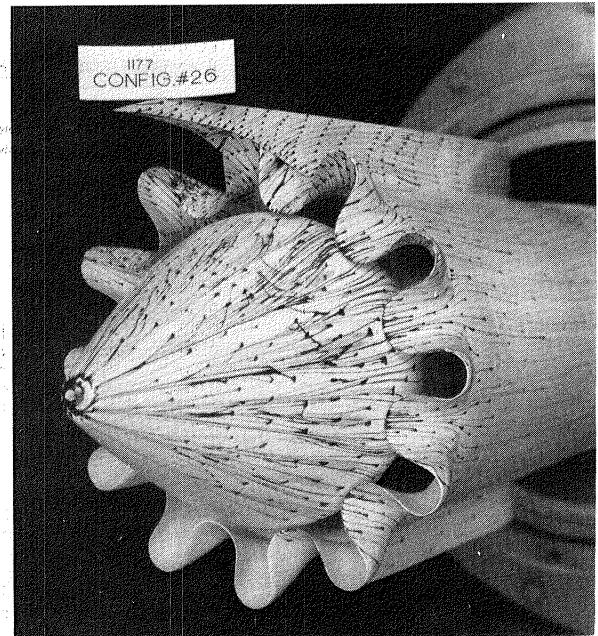

Figure 55 Flow Visualization Pictures Obtained on Short and Long Pylon Configurations

5.1.7 Phase I Test Summary

A complete summary of the performance characteristics of the configurations tested in Phase I is presented in Table VI. The major conclusions drawn from Phase I were:

- o Although longer tailpipes offered some performance improvement, it was felt that the additional weight and potential aircraft installation disadvantages would favor a relatively short tailpipe.
- o Mixers with 18 lobes were preferred over 12 lobe designs.
- o Scalloping can provide significant performance gains.
- o High penetration mixers offer improved performance potential.
- o Tailoring of the exit plane geometry, by mixer cutback, may optimize performance for a given mixer.
- o Since swirl entering the mixer produced large losses, it is recommended that the turbine system be carefully designed to eliminate swirl.
- o Structural pylon/fairings can be integrated with the mixer with very little loss.

TABLE VI
PHASE I TEST SUMMARY

Configuration Type/No.	Lobe No.	Tailpipe Length/Diameter	Special Features	Penetration	% Mixing	$\Delta(\Delta PT/PT)^*$	CV ¹	Thrust Specific Fuel Consump.** percent
Free	1	--		--	19.5	0.0001	0.9795	-0.55
Mixer	21	--	15° Swirl	--	--	---	0.9739	+0.81
	22	--	36° Swirl	--	--	---	0.9602	+4.13
	2	--		--	23.5	-.0002	0.9791	-0.45
Blue	19	12		0.5	61.5	0.0084	0.9825	-1.27
Green	3	12	Mixer Scarf Angle-0°	0.65	44.7	0.0038	0.9821	-1.18
	4	12		0.65	67.8	0.0026	0.9854	-1.98
	5	12		0.65	89.4	0.0062	0.9866	-2.27
	8	18		0.65	73	0.0070	0.9848	-1.82
	6	12	Modified Tailpipe	0.65	63.1	0.0081	0.9831	-1.42
	7	12	Modified Mixer Lobes***	0.65	63	0.0045	0.9848	-1.82
	27	12	Mixer Hoods***	0.65	55.4	0.0034	0.9846	-1.78
	23	12	15° Swirl	0.65	--	---	0.9826	-1.29
	24	12	36° Swirl	0.65	--	---	0.9784	-0.28
	9	12	Mixer Scarf Angle - 5°	0.63	64	0.0088	0.9836	-1.53
	10	12	Mixer Scarf Angle -10°	0.61	66.3	0.0076	0.9835	-1.51
	11	12	Mixer Scarf Angle -15°	0.58	74.7	0.0118	0.9826	-1.28
Red	13	12		0.57	52.6	0.0025	0.9833	-1.47
	30	12	Scalloped Mixer	0.57	60.5	0.0025	0.9847	-1.80
	14	12		0.57	60.7	-0.0003	0.9850	-1.88
	15	18		0.57	58.8	0.0025	0.9841	-1.67
	16	18	Scalloped Mixer	0.57	57.5	0	0.9854	-1.98
	29	18	Cutback Mixer	0.51	58.5	-0.0007	0.9859 ¹	-2.11
	28	18	Scalloped Mixer	0.57	80.7	0.0024	0.9868	-2.32
Orange	17	18		0.49	61.6	0.0054	0.9839	-1.62
	18	18		0.49	68.4	0.0030	0.9854	-1.98
Green	25	12	Short Pylon	0.58	78.1	0.0139	0.9821	-1.18
Green	26	12	Long Pylon	0.58	78.4	0.0136	0.9822	-1.20

* In excess of skin friction losses.

** Relative to optimized separate flow exhaust system.

*** Constant lobe width.

1 Avg. of Phase I and II

5.2 Phase II Results

Phase II testing was based on applying the significant Phase I performance trends to the best model in Phase I which was Configuration 29. It consisted of 18 lobes and a tailpipe length to diameter ratio of 0.6. These parameters were held constant for Phase II. It was decided to expand the Phase I trends and evaluate high penetration mixer designs; therefore, 0.75 penetration was selected and held constant. The Phase II portion of the program was developed with four basic mixer designs as shown in Figure 56. In addition to the basic matrix, variations of the promising configurations were tested to establish the impact of mixer/plug gap, scalloping, cut back, mixer hoods, and plug angles. The variations tested with each of the basic mixers are described separately below.

5.2.1 Mixer Length and Diameter Variations

The results of testing the four basic mixers are summarized in Figure 57. The longer mixer configurations (configurations 35 and 36) have considerably higher overall performance than the shorter pair of mixers (configurations 33 and 34). Although the latter pair exhibit more mixing, they also have higher pressure losses. The changes in mixing are believed due to slight differences in mixer exit plane geometry. The shorter configurations discharge the primary flow nearly horizontally, while the longer mixers are canted slightly toward the model centerline tending to reduce the amount of mixing achieved. The temperature traverses measured for the four basic mixers, shown in Figure 58, indicate a small reduction in penetration with configurations 35 and 36. The excess pressure loss appears to be a function of both mixer length and the degree of turning within the mixer. The two longer configurations (i.e., 35 and 36) have lower losses than the two shorter configurations (i.e., 33 and 34). In addition the configurations with more turning in a given length have higher losses than the configurations with relatively less turning (i.e., 33 versus 34 and 36 versus 35). This indicates that these two aspects of mixer geometry must be balanced to arrive at an optimum configuration.

5.2.2 Mixer/Plug Gap

The importance of mixer/plug gap was established using the configuration 36 mixer in combination with two additional plugs. This resulted in gaps ranging from 12 percent of primary flow area to 32 percent. As the gap is increased, so did the primary area and as a result the mixing plane Mach number decreases, however, these incremental changes were not enough to significantly change the mixing potential for the configurations being evaluated. A slight performance advantage appears to exist with a 22 percent gap, as shown in Figure 59. In general, as the gap is increased the amount of mixing which is achieved decreases, along with the excess pressure loss. The loss in mixing is evidenced in the tailpipe exit surveys (Figure 60) which show the growth in the unmixed flow surrounding the model centerline as the gap is increased. The pressure loss reduction is associated with reduced flow disturbance and Mach number on the plug near the mixer, as illustrated in Figure 61.

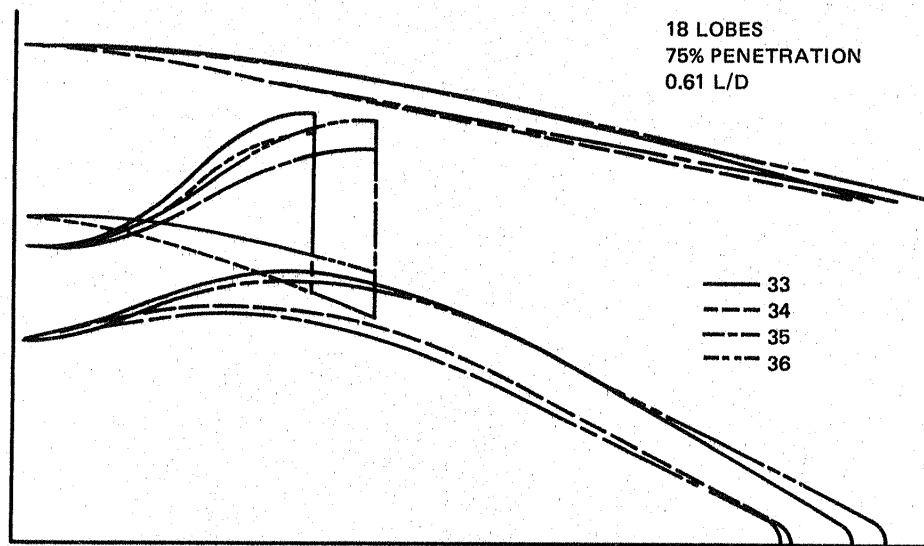

Figure 56 Four Basic Forced Mixer Designs

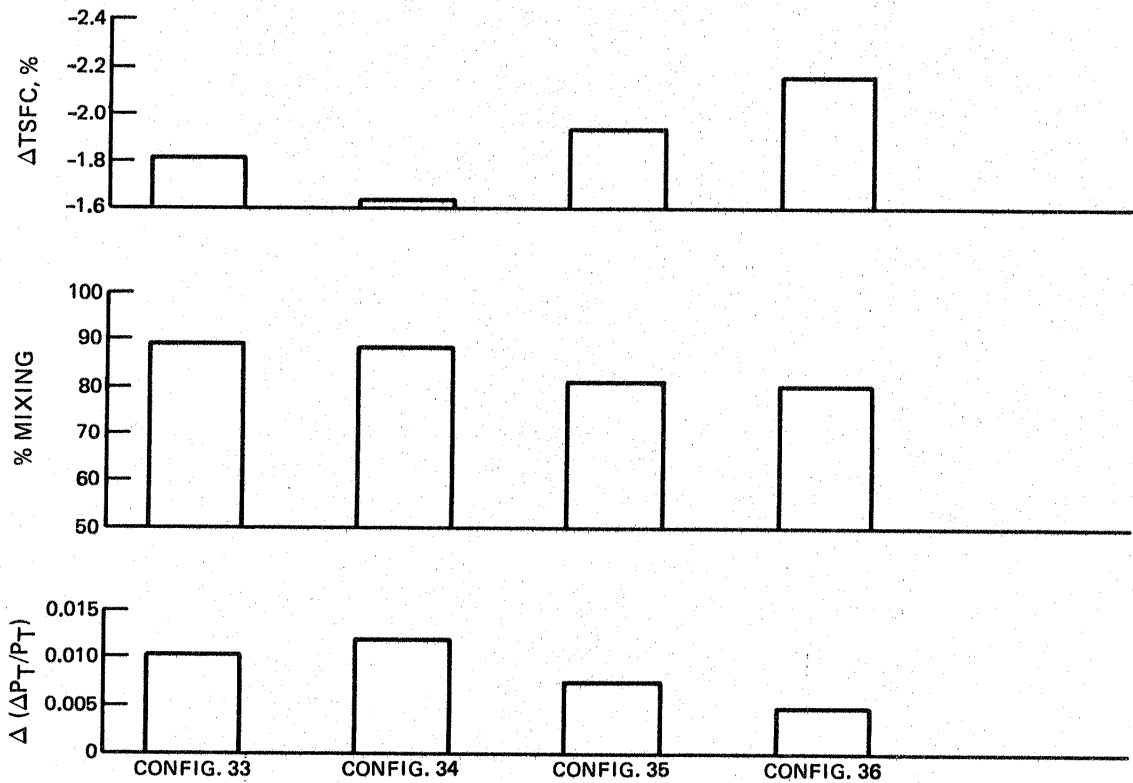

Figure 57 Results of Testing the Four Basic Mixers -- Mixer Size

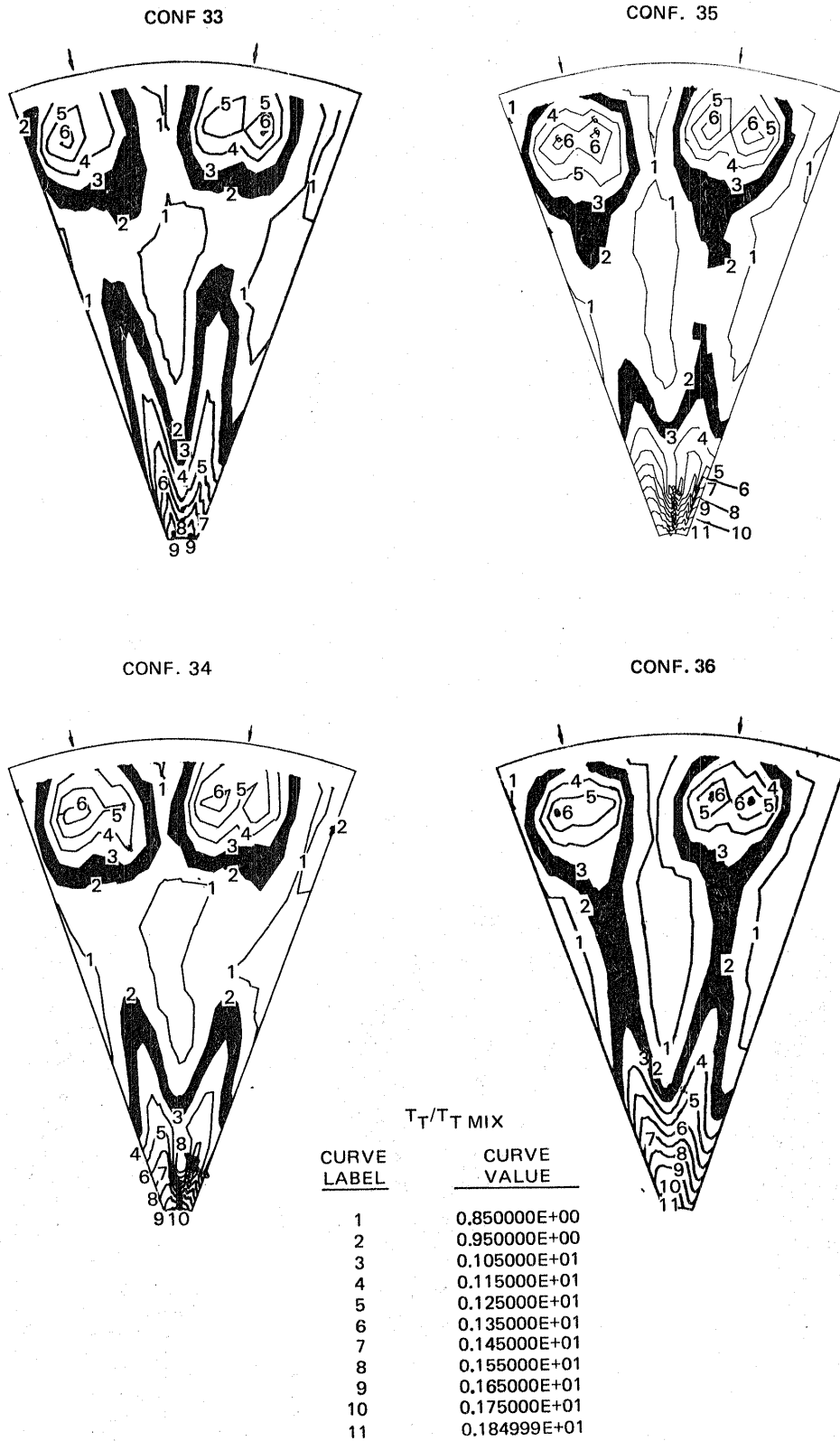

Figure 58 Temperature Traverses Measured for the Four Basic Mixers

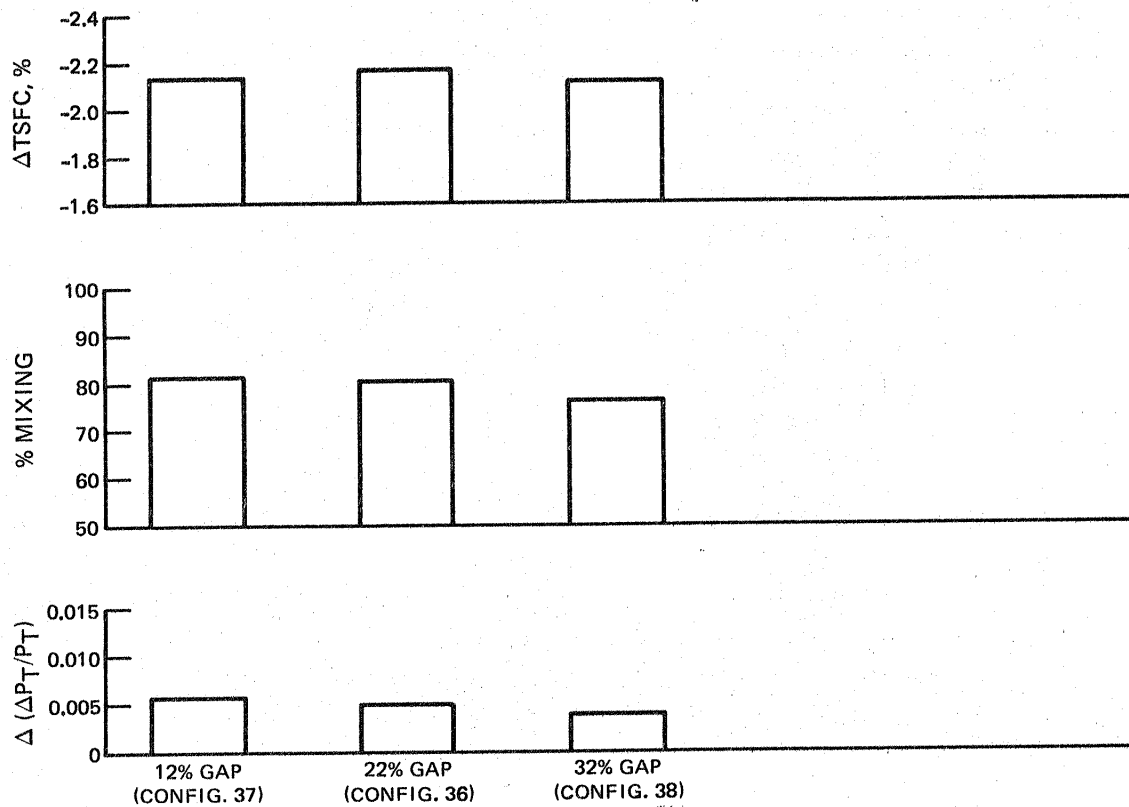

Figure 59 Results of Testing the Four Basic Mixers -- Mixer/Plug Gap

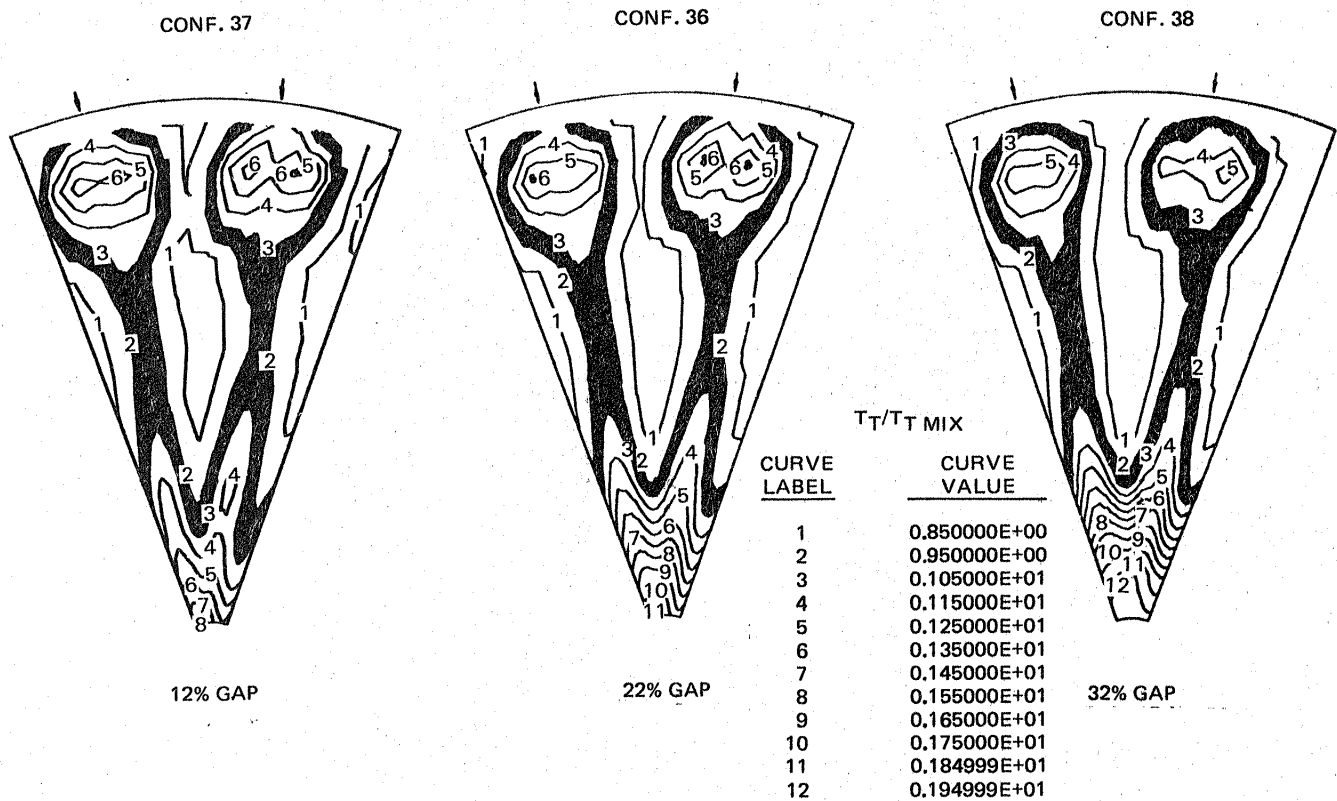
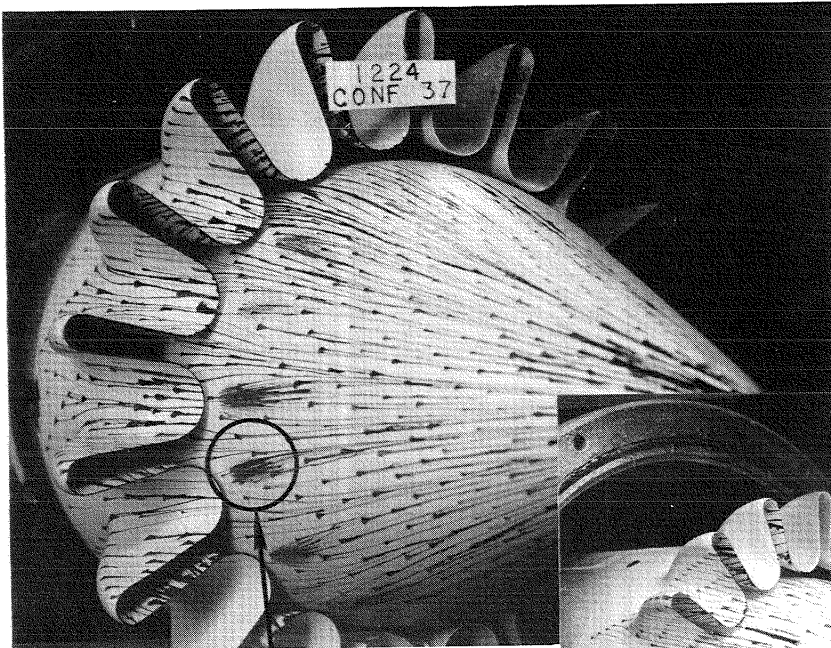

Figure 60 Loss in Mixing is Evidenced in the Tailpipe Exit Surveys



12% GAP

37

FLOW DISTURBANCE

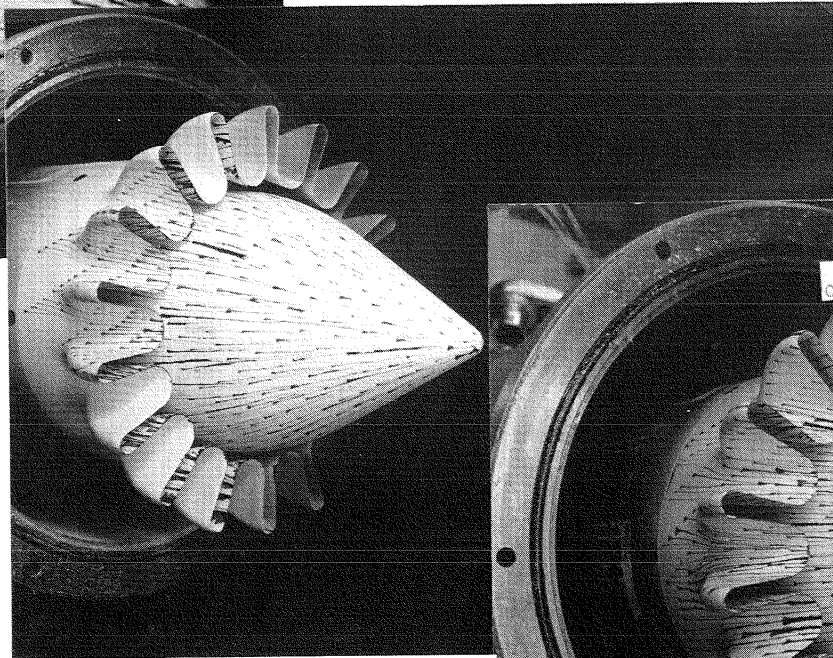

22% GAP

36

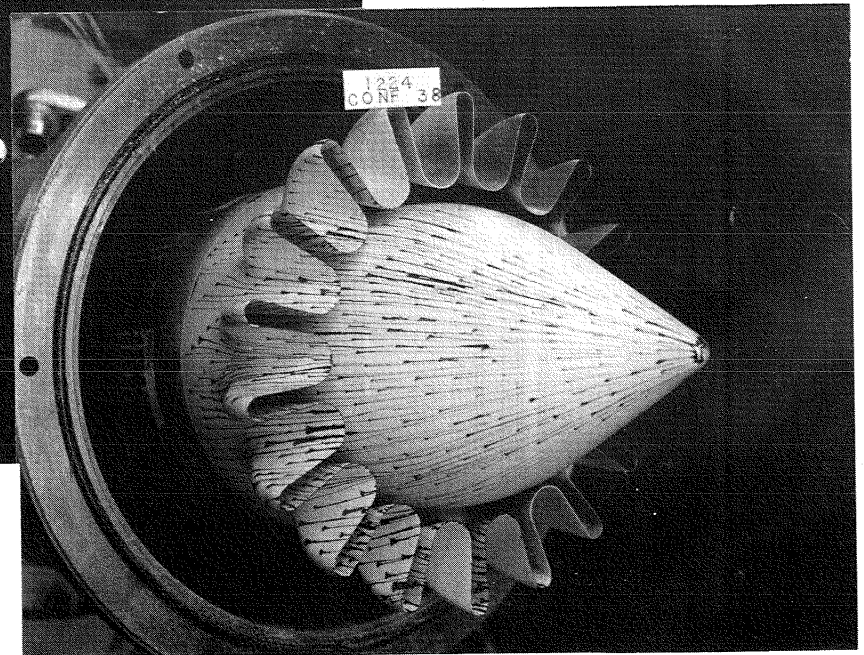

32% GAP

38

Figure 61 Pressure Loss Reduction is Associated with Reduced Flow Disturbance on the Plug Near the Mixer

5.2.3 Exhaust System Modifications

5.2.3.1 Series 33

Several modifications were made sequentially to configuration 33. The mixer was first scalloped, producing a large performance improvement (0.39 percent in thrust specific fuel consumption) as illustrated in Figure 62. The performance improvement is a combination of more mixing and less pressure loss. Since scalloping the mixer produced an increase of approximately 6 percent in the bypass ratio of the exhaust system, an insert was added to the tailpipe (configuration 42) to reduce the bypass ratio back to its original level. The insert produced this desired effect, but also reduced overall performance because of a change in the amount of mixing obtained. An analysis of this configuration indicated the tailpipe insert changed the local flow field and reduced the local Mach number near the outer portion of the mixer, increasing the local static pressure which essentially suppressed the mixer. It should be noted that this shift in bypass ratio with scalloping is not necessarily a general case. If a scalloped configuration is selected as a baseline, the areas in each stream can be designed to achieve the required bypass ratio (without inserts, etc.).

The next configuration (i.e., 45) consisted of cutting back the inner portion of mixer used in configuration 41 in order to increase the mixed/plug gap (to 35 percent) and thereby reduce total pressure loss. As indicated in Figure 62, the pressure loss was reduced, but the amount of mixing also decreased such that the overall performance did not change. The increments in both the pressure loss and mixing levels are consistent with the mixer/plug gap performance trends discussed earlier.

The temperature patterns measured at the tailpipe exit for this series of tests are presented in Figure 63. A dramatic change in the pattern is created by introducing scallops (configuration 33 versus configuration 41). This is believed due to increased circulation created in the tailpipe. The impact of cutback is also illustrated, by comparing configuration 45 to 41, where the increase in unmixed primary flow is evident.

5.2.3.2 Series 36

Modifications were also made sequentially to configuration 36. These included hoods, scallops and plug changes which constituted configurations 39, 43, 48, and 49.

The first modification consisted of adding hoods or fairings to both the primary and fan side of the mixer (configuration 39) in order to reduce the excess pressure loss. Unfortunately in the brazing process the mixer lobes shrunk inward reducing the penetration from 0.75 to 0.72. This necessitated an adjustment to the subsequent test data. An increment of 5 percent (taken from Phase I trends) was added to the measured mixing level to reflect the original design. No adjustment was made to pressure loss because the shrinkage was near the end of the mixer and it was felt that it would not change the basic pressure loss characteristic. The final overall level of performance for the hooded configurations was 0.14 percent thrust specific fuel consumption better than the baseline design as shown in Figure 64. The tailpipe traverses, presented in Figure 65 confirm the loss in penetration. The general improvement in the flow field around the mixer is shown in Figure 66.

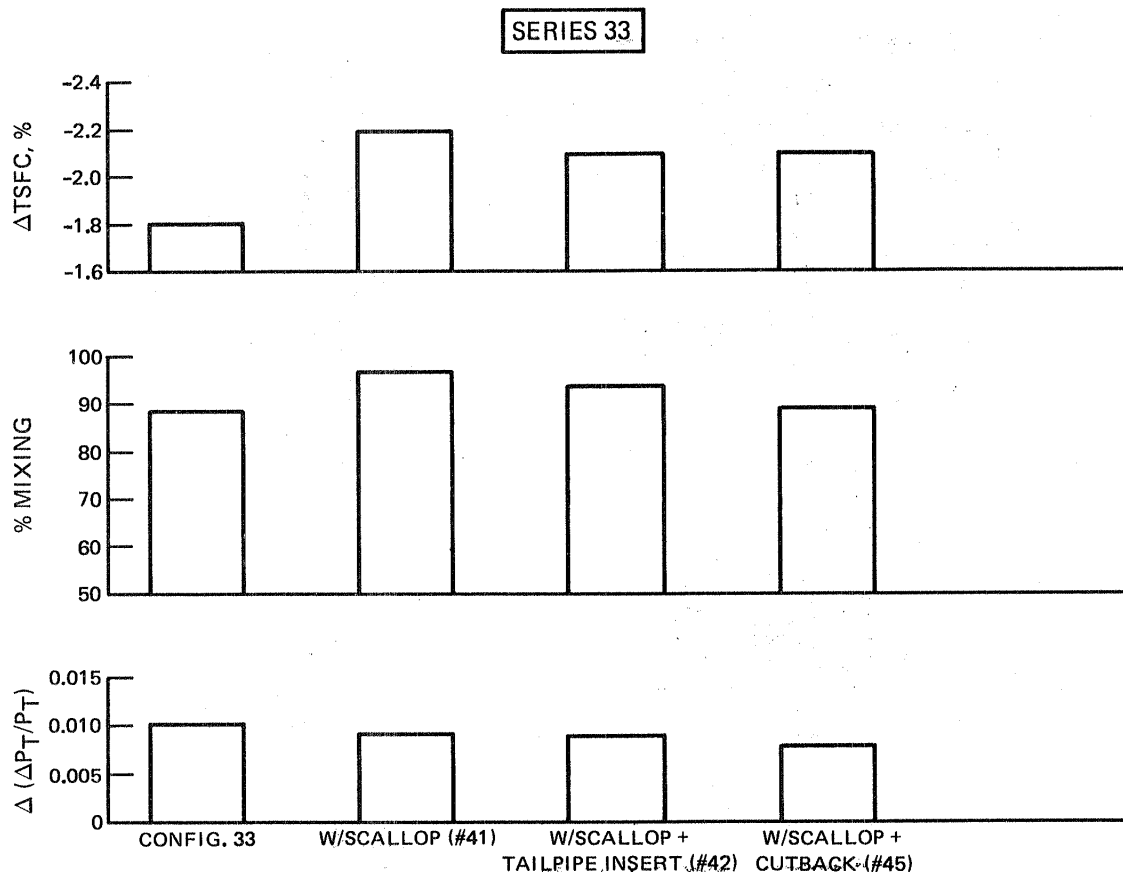

Figure 62 Scalloped Mixer Produces a Large Performance Improvement

Scallops were then added to configuration 39, producing configuration 43. As experienced earlier, the mixing level improved and the total pressure losses decreased to yield an overall performance increment of 0.22 percent thrust specific fuel consumption (configuration 43 versus configuration 39).

An alternate plug design was introduced in configuration 48 to vary the tailpipe area distribution. A performance loss of 0.12 percent thrust specific fuel consumption was observed with this mixer. The original plug was replaced and the mixer scallops were extended upstream resulting in configuration 49. This configuration produced the highest performance measured during the test program; 2.67 percent change in thrust specific fuel consumption relative to the optimized separate flow exhaust system.

The impact of scalloping on tailpipe temperature traverses is illustrated in Figure 67. Scalloping increases the circulation within the tailpipe thereby weakening the primary flow hot spots and increasing the overall mixing level.

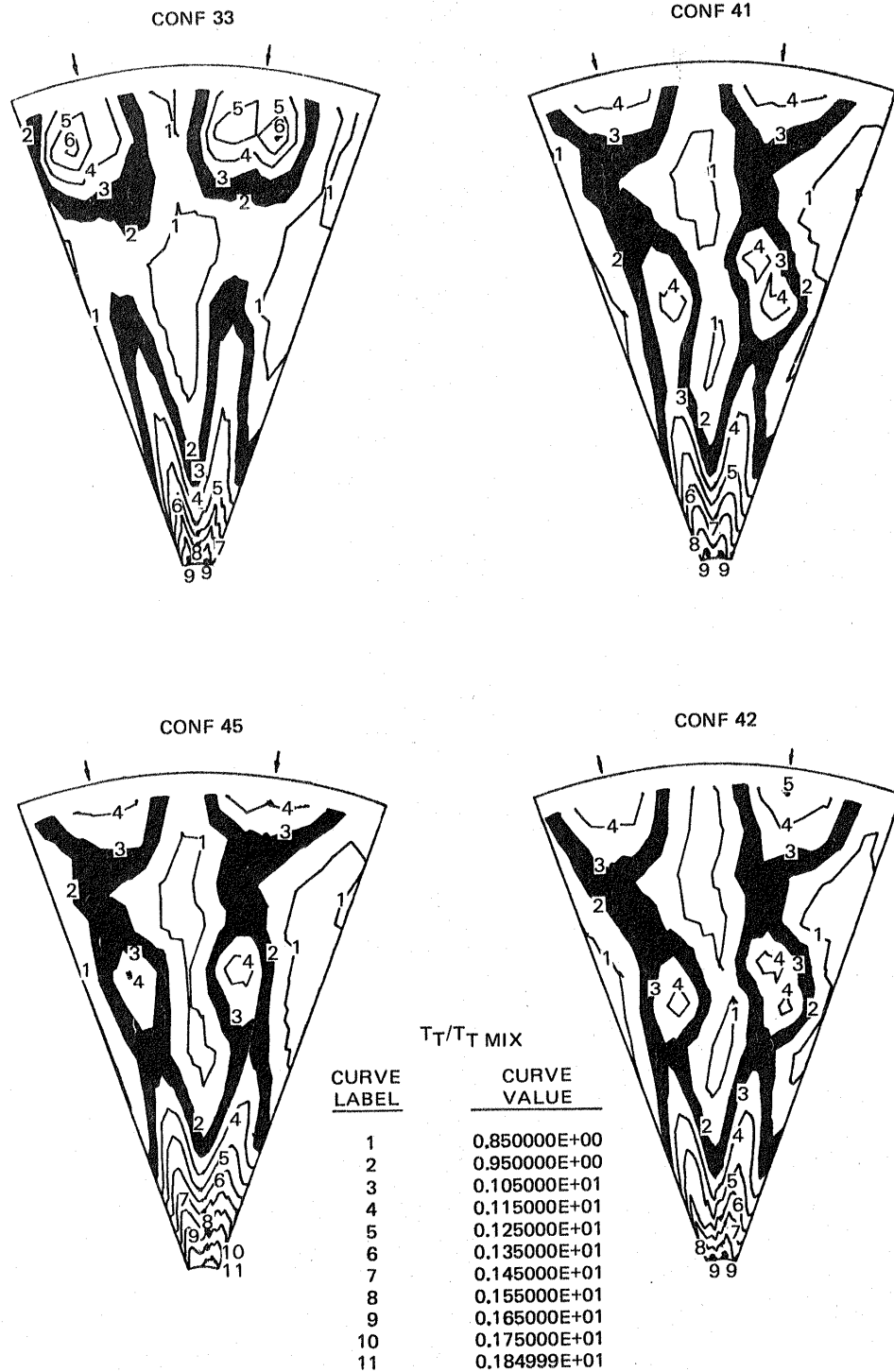

Figure 63 Temperature Patterns Measured at the Tailpipe Exit

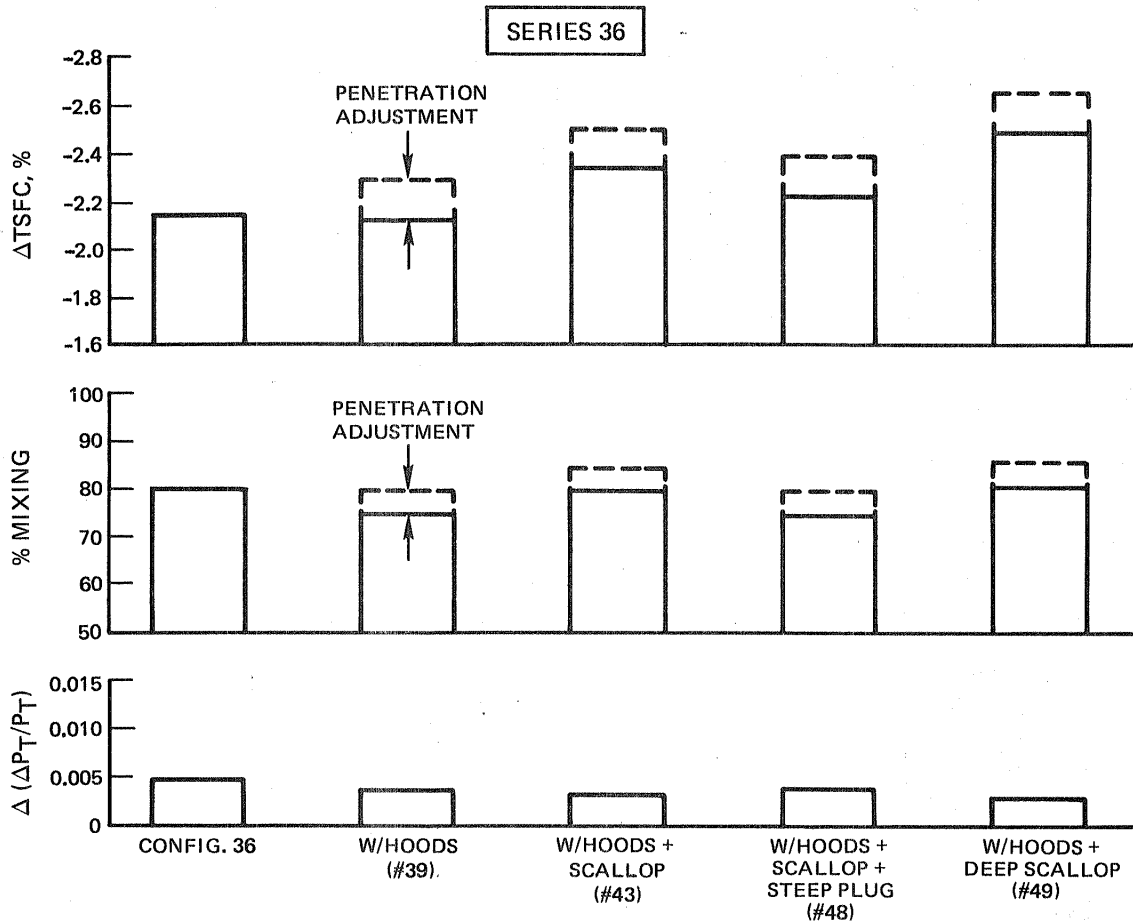

Figure 64 Modified Lobes Yield Thrust Specific Fuel Consumption Improvements

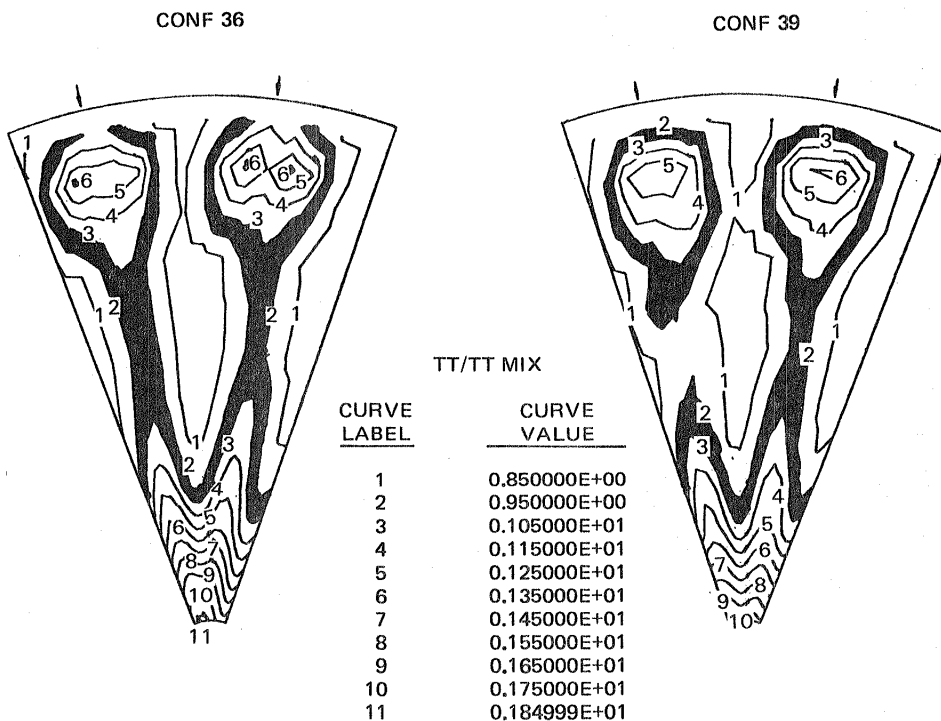
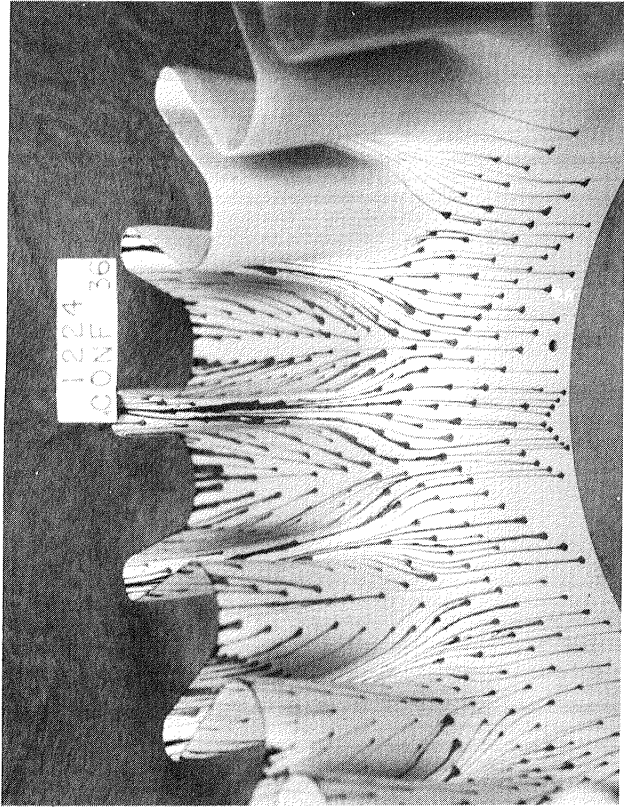
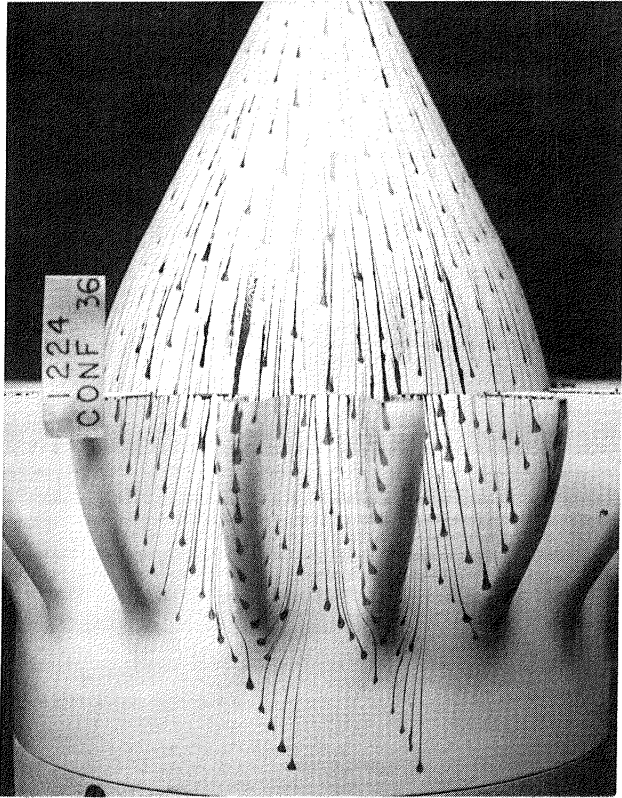

Figure 65 Tailpipe Traverses Confirm the Loss in Penetration

W/O HOODS



W/HOODS

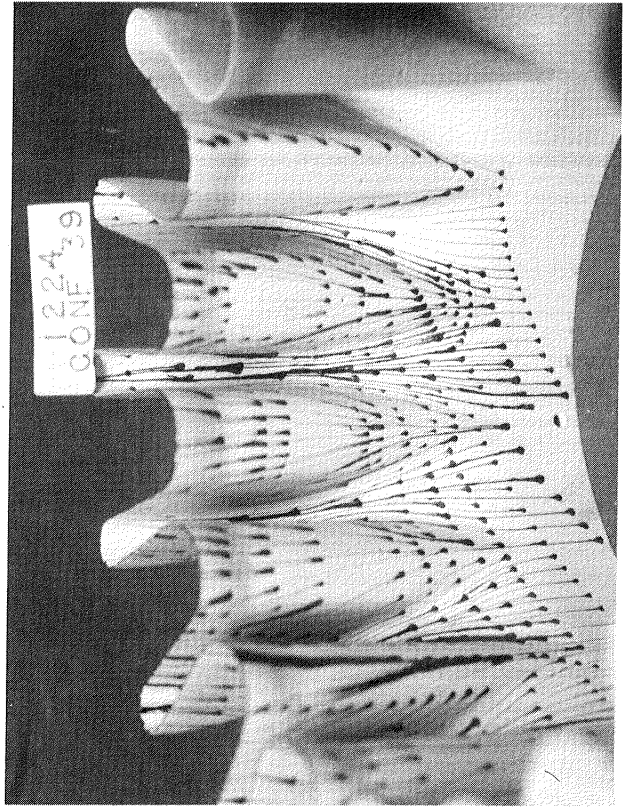
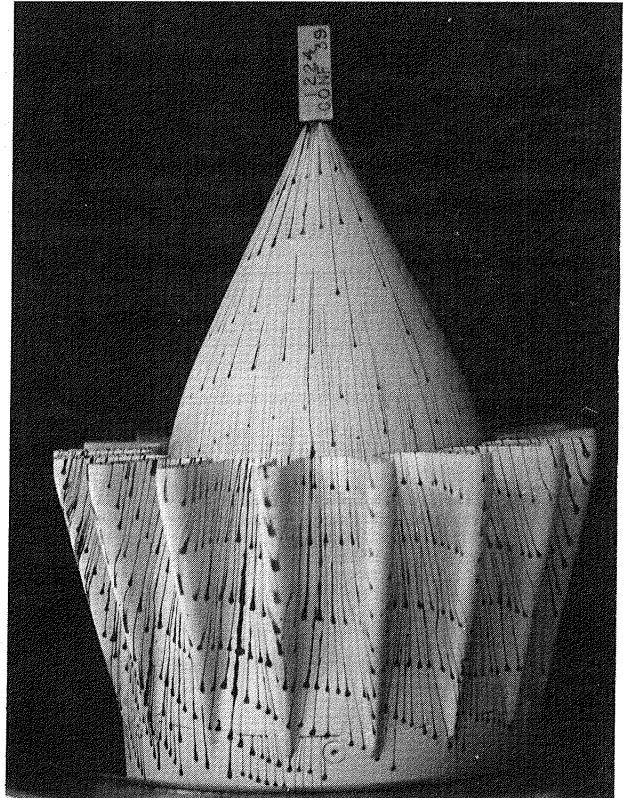

Figure 66 General Improvement in the Flow Field Around the Mixer Due to Hoods

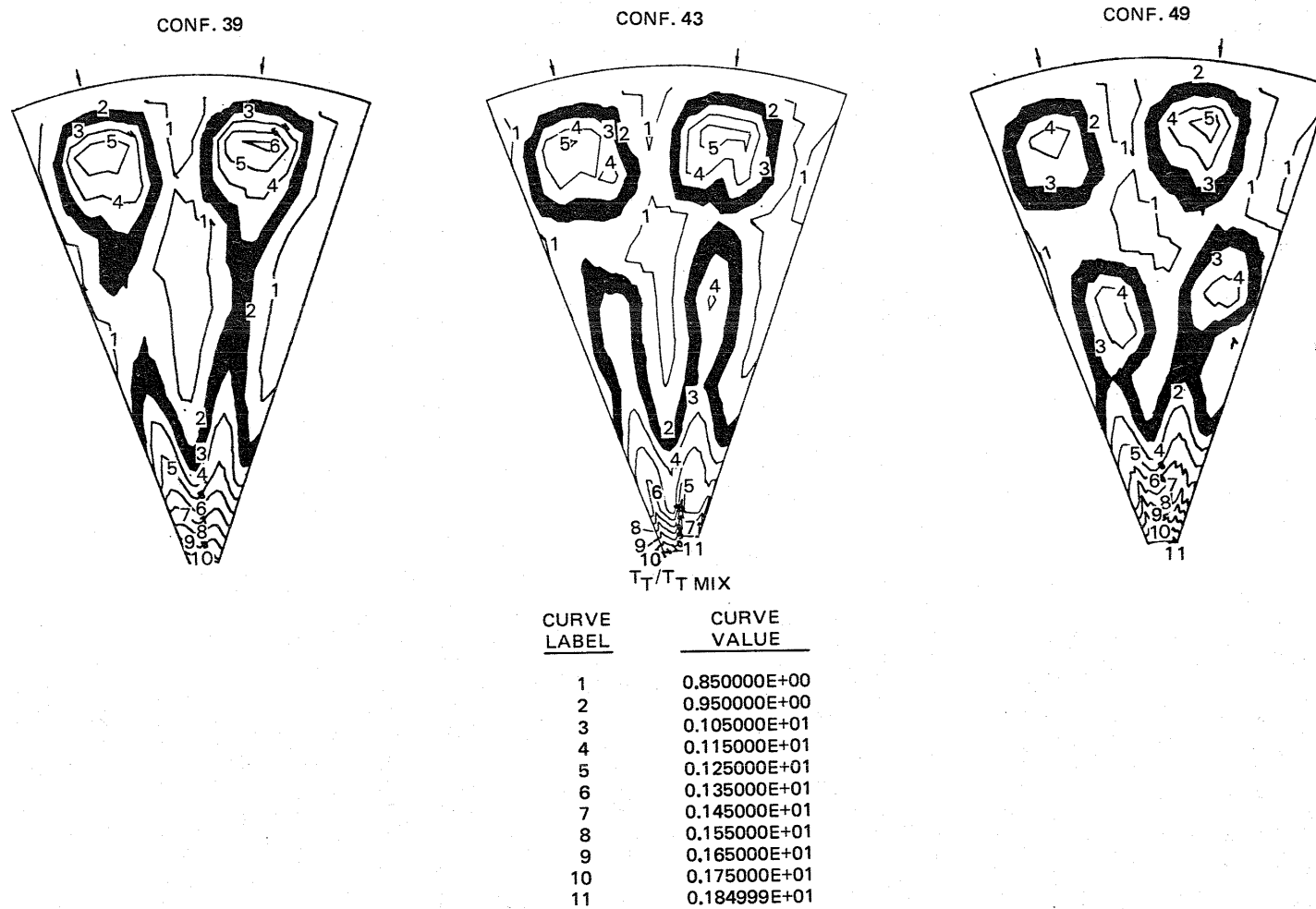

Figure 67 Impact of Scalloping on Tailpipe Temperature Traverses

5.2.3.3 Series 35

Configuration 35 was also modified sequentially to explore its performance potential. A steeper plug was first introduced (i.e., configuration 40), producing an improvement of 0.17 percent thrust specific fuel consumption (Figure 68). This was observed to be due to a pressure loss reduction. This configuration was then scalloped and cutback at the same time (configuration 46) which resulted in virtually no performance change (-0.05 percent change in thrust specific fuel consumption). The positive benefit of scalloping appears to have been eliminated by cutting back the mixer and producing a larger mixer/plug gap (37 percent). The next configuration incorporated an even steeper plug (configuration 47). The cold flow test of configuration 47 indicated the excess pressure loss had not changed (configuration 46), as noticed in the earlier tests with steep plugs, and so the hot tests of this configuration were not conducted.

A subsequent analysis of the plug variations in Series 35 and 36 indicated that the performance increments were probably due to the local diffusion taking place along the surface of the plug. A very rapid change in the radial profiles is believed to take place in the region between the end of the plug and the tailpipe exit. Series 35 showed a performance improvement and Series 36 did not. This is felt to be associated with the geometry differences between the two configurations. Series 35 had smaller shorter plugs, providing a much different flow area distribution through the tailpipe relative to Series 36 which had a very rapid acceleration region near the end of the tailpipe as illustrated in Figure 69.

5.2.4 Phase II Test Summary

A complete summary of the performance characteristics of the configurations tested in Phase II is presented in Table VII. The major conclusions drawn from Phase II were:

- o High penetration mixers offer improved performance.
- o Relatively long mixers are required for low internal losses.
- o As mixer/plug gap is increased, the amount of mixing which is achieved decreases, along with the excess pressure loss.
- o Scalloping improves the performance of high penetration mixers.
- o Mixer hoods improved the flow field around the mixer and result in improved performance.
- o Varying tailpipe area distribution through modified plug design can reduce pressure loss.

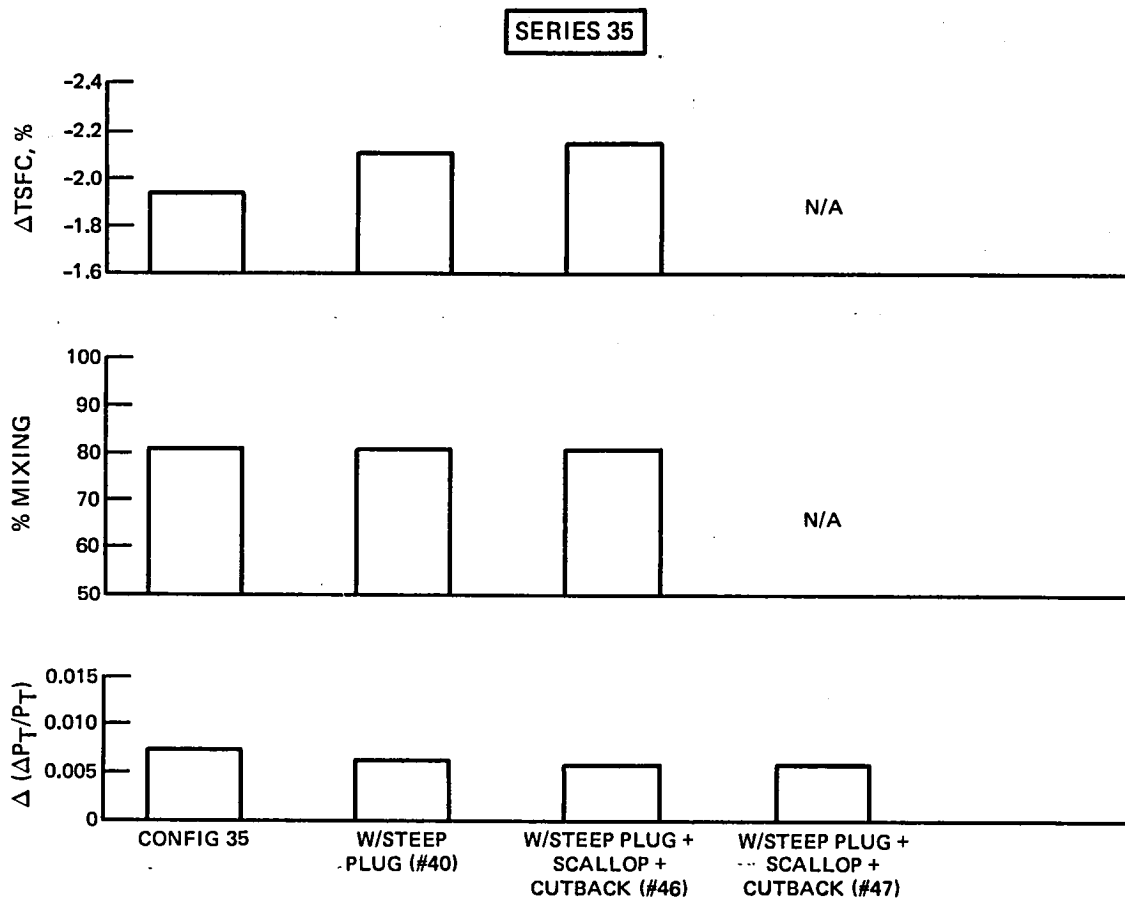

Figure 68 Steeper Plug Produces an Improvement in Thrust Specific Fuel Consumption

TABLE VII
PHASE II TEST SUMMARY

Lobe No. = 18
Tailpipe L/D = .61
Penetration = .75

Config. Type	No.	Special Features	% Mixing	$\Delta (\Delta PT/PT)^*$	CV'	Thrust Specific Fuel Consumption**, percent
Black	33		89.5	0.0106	0.9847	-1.82
	41	Scalloped	97.8	0.0097	0.9863	-2.21
	42	Scalloped and Modified Tailpipe	94.4	0.0095	0.9859	-2.11
	45	Scalloped and Cutback	90.0	0.0083	0.9859	-2.11
Purple	34		88.8	0.0122	0.9839	-1.63
Brown	35		81.3	0.0078	0.9852	-1.94
	40	33° Plug	81.3	0.0067	0.9859	-2.11
	46	33° Plug and Scalloped and Cutback	81.3	0.0063	0.9861	-2.16
	47	39° Plug and Scalloped and Cutback	---	0.0063	---	---
Yellow	36		80.7	0.0051	0.9861	-2.16
	37	12 percent Gap	81.5	0.0060	0.9860	-2.13
	38	32 percent Gap	76.2	0.0039	0.9859	-2.11
	39	Hoods	79.9	0.0039	0.9867	-2.30
	43	Hoods and Scalloped (#1)	85.0	0.0037	0.9876	-2.52
	48	Hoods and Scalloped (#1) and 37° Plug	79.9	0.0039	0.9871	-2.40
	49	Hoods and Scalloped (#2)	86.0	0.0029	0.9882	-2.67

* In excess of skin friction losses.

** Relative to optimized separate flow exhaust system.

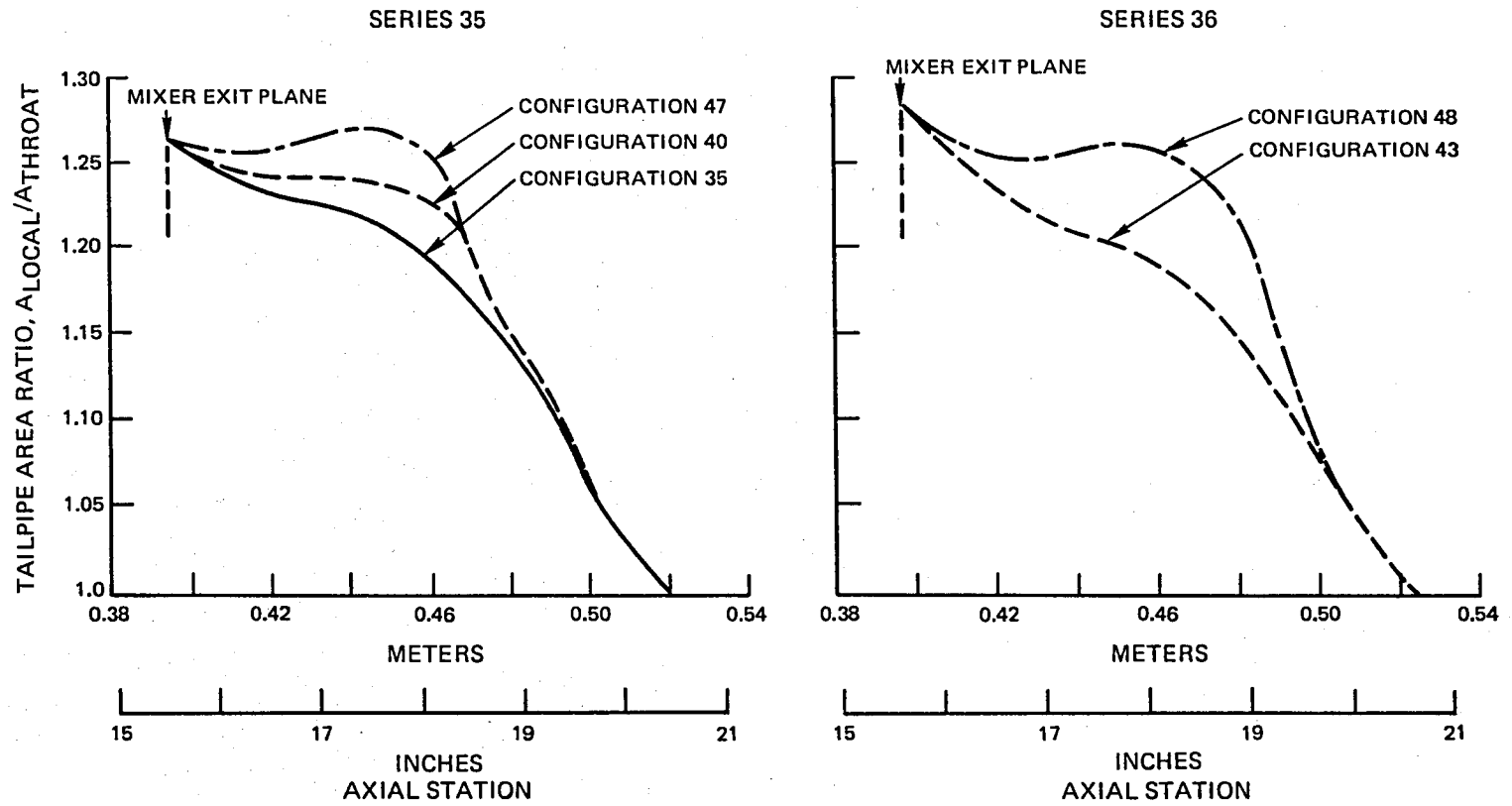

Figure 69 Geometry Differences Between in Series 35 and 36 are Evident

6.0 CONCLUSIONS AND CONCLUDING REMARKS

- o This program has provided a substantial data base for high bypass ratio exhaust mixers.
- o An improvement of 2.7 percent in thrust specific fuel consumption relative to an optimized separate flow exhaust system has been demonstrated. Additional performance gains are likely by extrapolation of the trends that have been identified.
- o Scalloped high penetration mixer designs offer the most performance potential. Mixing levels as high as 98 percent have been demonstrated; however, high attendant pressure losses have lowered overall performance. It may be possible to reduce the internal losses while maintaining high mixing levels to improve overall performance. Careful attention to mixer contours, exit plane geometry and tailpipe area distribution is required to achieve the full potential.
- o Residual swirl in the turbine discharge has been defined as generally detrimental with both free and forced mixer configurations. The turbine system should be selected to eliminate residual swirl.
- o Integration of the mixer with the structural pylon in the nacelle has been shown to be only a minor problem, with very small overall penalties.

APPENDIX A

A tabulation of the key model test data are presented in this appendix. The data are grouped in order of the test configuration number, with a definition of the terms presented at the end of this section. The $C_{y\text{ MIX}}$ and $C_{D\text{ MIX}}$ data has been processed to reflect fully mixed flow properties for the reference ideal conditions. The procedure to calculate the fully mixed conditions is also presented in this section. Finally, this appendix includes a thrust balance temperature correction definition required for Phase I thrust coefficients. This correction compensates for the varying temperatures of the thrust balance.

The contents of this appendix consists of the following:

1. Definition of Symbols	75
2. Test Data Listing	76
3. Fully Mixed Conditions Calculation Procedure	106
4. Thrust Balance Temperature Correction	107

DEFINITION OF SYMBOLS

Defined At Model Mixing Plane

- $C_{V \text{ MIX}}$ - Mixed Model Thrust Coefficient = $F_{g \text{ MEASURED}} / F_{g \text{ FULLY MIXED}} \Big)_{\text{IDEAL}}$
- $C_{D \text{ MIX}}$ - Mixed Model Flow Coefficient = $(W_{a \text{ FAN}} + W_{a \text{ PRI}})_{\text{MEASURED}} / W_{a \text{ FULLY MIXED}} \Big)_{\text{IDEAL}}$
- $PTMPA$ - Fully Mixed Total to Ambient Nozzle Pressure Ratio
- $PTFPAM$ - Fan Stream Total to Ambient Nozzle Pressure Ratio
- $PTEPAM$ - Primary Stream Total to Ambient Nozzle Pressure Ratio
- $PRAT$ - Ratio of $PTFPAM$ to $PTEPAM$
- $MIXP$ - Ideal Nozzle Performance Gain Available From Mixing = $\left[\frac{(F_{g \text{ FULLY MIXED}} - F_{g \text{ UNMIXED}}) / F_{g \text{ FULLY MIXED}}}{\text{IDEAL}} \right]$
- $F_G(3)$ - Fully Mixed Ideal Thrust = $F_{g \text{ FULLY MIXED}} \Big)_{\text{IDEAL}} \sim \text{LBS.}$
- MN_{FAN} - Fan Stream Mach Number
- MN_{PRI} - Primary Stream Mach Number

Defined at Model Charging Station

- $PT7PAM$ - Fan Stream Total to Ambient Nozzle Pressure Ratio
- $PT8PAM$ - Primary Stream Total to Ambient Nozzle Pressure Ratio
- $TT7$ - Fan Stream Total Temperature - $^{\circ}R$
- $TT8$ - Primary Stream Total Temperature - $^{\circ}R$
- $TRAT$ - Ratio of $TT8$ to $TT7$
- PAM - Ambient Pressure $\sim \text{LBS}/\text{IN}^2$
- BPR - Bypass Ratio = $(W_{a \text{ FAN}} / W_{a \text{ PRI}})_{\text{MEASURED}}$

1) TEST DATA LISTING

Phase I Configurations

Page

1	77, 78
2	79
3	79
4	80
5	80
6	81
7	82
8	83
9	83, 84
10	84
11	85
13	85
14	86
15	86
16	87
17	87
18	88
19	88
21	89
22	89
23	90
24	90
25	91
26	91
27	92, 93
28	93, 94
29	94
30	95

Phase II Configurations

Page

1	95, 96, 97
29	97
33	98
34	98
35	99
36	99
37	100
38	100
39	101
40	101
41	102
42	102
43	103
45	103
46	104
47	104
48	105
49	105

E3 MIXER NO. 1 CONF 1 RUNS 1-6,COLD							
CVMIX	1	.99572	.99534	.99498	.99498	.99412	.99431
CDMIX	2	.96027	.96678	.96884	.96979	.97003	.97137
PTMPA	3	1.9834	2.1807	2.2771	2.3736	2.4806	2.5748
PTFPAM	4	1.9777	2.1758	2.2708	2.3693	2.4741	2.5684
PTEPAM	5	1.9964	2.1917	2.2913	2.3834	2.4954	2.5896
PRAT	6	.99063	.99277	.99109	.99408	.99147	.99180
MIXP	7	-.84933E-05	-.30135E-05	-.12933E-04	.13182E-05	-.69171E-05	.30325E-05
FG (3)	8	689.88	810.16	868.39	926.02	988.26	1046.6
MNFAN	9	.39970	.40424	.40445	.40654	.40530	.40619
MNPRI	10	.41671	.41727	.42046	.41717	.42059	.42088
PT7PAM	11	1.9872	2.1864	2.2819	2.3810	2.4862	2.5810
PT8PAM	12	2.0109	2.2080	2.3084	2.4012	2.5141	2.6089
TT7	13	510.66	511.51	508.25	514.99	522.09	518.19
TT8	14	513.75	514.18	511.10	516.87	522.22	519.39
TRAT	15	1.0061	1.0052	1.0056	1.0037	1.0002	1.0023
PAM	16	14.332	14.343	14.343	14.343	14.327	14.343
BPR	17	2.2567	2.2526	2.2498	2.2647	2.2445	2.2603

E3 MIXER NO. 1 CONF 1 ,RUNS 4.1-5.1-6.1 COLD				
CVMIX	1	.99369	.99341	.99288
CDMIX	2	.96858	.96933	.97033
PTMPA	3	2.3759	2.4746	2.5736
PTFPAM	4	2.3693	2.4679	2.5665
PTEPAM	5	2.3910	2.4902	2.5899
FRAT	6	.99092	.99102	.99095
MIXP	7	-.10780E-04	-.78550E-05	-.93184E-05
FG (3)	8	905.87	963.51	1021.8
MNFAN	9	.40425	.40473	.40522
MNPRI	10	.42058	.42084	.42145
PT7PAM	11	2.3610	2.4800	2.5791
PT8PAM	12	2.4088	2.5086	2.6091
TT7	13	515.83	518.90	522.14
TT8	14	520.07	522.66	525.65
TRAT	15	1.0082	1.0072	1.0067
PAM	16	14.028	14.028	14.028
BPR	17	2.2656	2.2741	2.2695

E3 MIXER NO. 1 CONF 1 ,RUNS 4.11-5.11-6.11 COLD				
CVMIX	1	.99397	.99388	.99387
CDMIX	2	.96750	.96910	.96957
PTMPA	3	2.3914	2.4861	2.5846
PTFPAM	4	2.3952	2.4893	2.5867
PTEPAM	5	2.3823	2.4786	2.5797
PRAT	6	1.0054	1.0043	1.0027
MIXP	7	.89201E-05	.22245E-05	.32667E-05
FG (3)	8	930.57	987.74	1046.3
MNFAN	9	.41151	.41174	.41110
MNPRI	10	.40175	.40397	.40622
PT7PAM	11	2.4073	2.5017	2.5997
PT8PAM	12	2.3989	2.4962	2.5976
TT7	13	524.97	522.58	527.67
TT8	14	526.88	525.12	528.90
TRAT	15	1.0036	1.0049	1.0023
PAM	16	14.286	14.286	14.286
BPR	17	2.3682	2.3502	2.3648

E3 MIXER NO. 1 CONF 1 ,RUNS 4.4-5.6-6.4 COLD				
CVMIX	1	.99331	.99327	.99293
CDMIX	2	.96783	.96948	.97025
PTMPA	3	2.3945	2.4882	2.5838
PTFPAM	4	2.3965	2.4894	2.5858
PTEPAM	5	2.3897	2.4854	2.5788
PRAT	6	1.0029	1.0016	1.0027
MIXP	7	.49545E-05	.10816E-04	.62750E-05
FG (3)	8	936.26	993.14	1050.5
MNFAN	9	.41024	.41043	.41142
MNPRI	10	.40508	.40751	.40655
PT7PAM	11	2.4086	2.5021	2.5990
PT8PAM	12	2.4059	2.5021	2.5962
TT7	13	510.31	513.16	516.50
TT8	14	515.20	518.18	521.58
TRAT	15	1.0096	1.0098	1.0098
PAM	16	14.340	14.340	14.340
BPR	17	2.4026	2.4123	2.4144

E3 MIXER NO. 1 CONF 1 ,RUNS 7-12 HOT							
CVMIX	1	.98932	.98582	.98484	.98240	.98217	.97897
CDMIX	2	.95915	.97104	.97368	.97850	.98217	.98597
PTMPA	3	1.9946	2.1806	2.2749	2.3458	2.4360	2.5213
PTFPAM	4	2.0636	2.2496	2.3469	2.4108	2.5012	2.5864
PTEPAM	5	1.8050	2.0117	2.1034	2.2067	2.3023	2.3986
PRAT	6	1.1432	1.1182	1.1158	1.0925	1.0864	1.0783
MIXP	7	.62198E-02	.10316E-01	.11755E-01	.13999E-01	.15512E-01	.17660E-01
FG (3)	8	694.76	812.08	869.64	915.94	973.03	1027.9
MNFAN	9	.49272	.47687	.47579	.46039	.45689	.45221
MNPRI	10	.21723	.25452	.25890	.28963	.29854	.31018
PT7PAM	11	2.0775	2.2641	2.3619	2.4254	2.5162	2.6015
PT8PAM	12	1.8093	2.0182	2.1104	2.2159	2.3123	2.4101
TT7	13	511.91	502.61	515.08	507.67	518.59	512.49
TT8	14	1172.1	1177.4	1233.8	1219.6	1271.1	1297.0
TRAT	15	2.2897	2.3427	2.3953	2.4023	2.4511	2.5308
PAM	16	14.315	14.315	14.315	14.315	14.315	14.315
BPR	17	7.6411	6.4599	6.3867	5.5821	5.4758	5.2566

E3 MIXER NO. 1 CONF 1 ,RUNS 10.1-11.1-12.1 HOT							
CVMIX	1	.98168	.98074	.97886			
CDMIX	2	.97613	.98049	.98442			
PTMPA	3	2.3426	2.4363	2.5221			
PTFPAM	4	2.4081	2.5011	2.5850			
PTEPAM	5	2.2003	2.3031	2.4034			
PRAT	6	1.0945	1.0859	1.0755			
MIXP	7	.13759E-01	.15490E-01	.17472E-01			
FG (3)	8	894.41	952.97	1007.1			
MNFAN	9	.46078	.45582	.44960			
MNPRI	10	.28574	.29804	.31256			
PT7PAM	11	2.4227	2.5160	2.6001			
PT8PAM	12	2.2091	2.3131	2.4149			
TT7	13	520.50	523.20	525.90			
TT8	14	1245.2	1280.0	1317.4			
TRAT	15	2.3923	2.4464	2.5051			
PAM	16	14.042	14.042	14.042			
BPR	17	5.6663	5.4775	5.2164			

E3 MIXER NO. 1 CONF 1 ,RUNS 10.3-11.3-12.3 HOT							
CVMIX	1	.98366	.98188	.97954			
CDMIX	2	.97621	.98035	.98473			
PTMPA	3	2.3701	2.4539	2.5461			
PTFPAM	4	2.4445	2.5268	2.6188			
PTEPAM	5	2.1931	2.2923	2.3963			
PRAT	6	1.1146	1.1023	1.0929			
MIXP	7	.12182E-01	.14453E-01	.16393E-01			
FG (3)	8	928.74	982.50	1042.1			
MNFAN	9	.47558	.46747	.46212			
MNPRI	10	.26156	.27825	.29215			
PT7PAM	11	2.4602	2.5426	2.6347			
PT8PAM	12	2.2005	2.3010	2.4065			
TT7	13	524.50	527.25	530.05			
TT8	14	1258.2	1297.8	1332.3			
TRAT	15	2.3989	2.4615	2.5135			
PAM	16	14.324	14.324	14.324			
BPR	17	6.3788	5.9980	5.6716			

E3 MIXER NO. 1 CONF 1 ,RUNS 237-242 HOT							
CVMIX	1	.99095	.98702	.98455	.98386	.98170	.97992
CDMIX	2	.95780	.96903	.97148	.97616	.98044	.98485
PTMPA	3	2.0154	2.2008	2.2905	2.3657	2.4537	2.5371
PTFPAM	4	2.0903	2.2768	2.3676	2.4399	2.5258	2.6075
PTEPAM	5	1.7965	2.0024	2.0995	2.1959	2.2976	2.3950
PRAT	6	1.1636	1.1370	1.1277	1.1111	1.0993	1.0887
MIXP	7	.38333E-02	.86938E-02	.10476E-01	.12554E-01	.14616E-01	.16706E-01
FG (3)	8	704.22	820.42	875.01	923.48	979.75	1034.0
MNFAN	9	.50944	.49102	.48465	.47375	.46575	.45914
MNPRI	10	.19408	.23163	.24425	.26698	.28242	.29698
PT7PAM	11	2.1052	2.2921	2.3831	2.4552	2.5413	2.6232
PT8PAM	12	1.7999	2.0078	2.1059	2.2039	2.3068	2.4055
TT7	13	504.63	512.67	507.49	515.88	510.84	519.39
TT8	14	1152.7	1202.6	1210.1	1235.5	1255.9	1309.1
TRAT	15	2.2842	2.3459	2.3846	2.3950	2.4585	2.5204
PAM	16	14.284	14.284	14.284	14.284	14.284	14.284
BPR	17	8.6754	7.2145	6.7739	6.0774	5.8154	5.5656

E3 MIXER NO. 1 CONF 2 ,RUNS 14-19 COLD							
CV MIX	1	.99325	.99310	.99288	.99278	.99249	.99206
CD MIX	2	.98544	.98798	.98836	.98877	.98877	.98890
PTMPA	3	1.9864	2.1790	2.2847	2.3812	2.4796	2.5762
PTFPAM	4	1.9825	2.1761	2.2807	2.3769	2.4731	2.5700
PTEPAM	5	1.9958	2.1858	2.2942	2.3916	2.4952	2.5911
PRAT	6	.99333	.99556	.99409	.99386	.99115	.99186
MIXP	7	.10365E-04	.38585E-05	.85443E-05	.13193E-04	.48701E-06	.50635E-05
FG (3)	8	706.61	822.55	835.77	943.74	1002.6	1060.7
MNFAN	9	.41447	.41699	.41640	.41650	.41514	.41556
MNPRI	10	.42612	.42467	.42680	.42731	.43068	.42987
PT7PAM	11	1.9929	2.1877	2.2928	2.3895	2.4862	2.5836
PT8PAM	12	2.0104	2.2017	2.3110	2.4091	2.5135	2.6102
TT7	13	515.43	520.14	517.30	521.78	519.17	524.27
TT8	14	524.53	530.07	526.49	531.64	528.94	537.44
TRAT	15	1.0177	1.0191	1.0178	1.0189	1.0188	1.0251
PAM	16	14.271	14.271	14.271	14.271	14.271	14.271
BPR	17	2.3543	2.3791	2.3685	2.3656	2.3551	2.3598

E3 MIXER NO. 1 CONF 2 ,RUNS 20-25 HOT							
CV MIX	1	.98880	.98599	.98397	.98285	.98131	.97972
CD MIX	2	.99534	.99970	1.0012	1.0032	1.0053	1.0076
PTMPA	3	1.9921	2.1808	2.2711	2.3480	2.4351	2.5235
PTFPAM	4	2.0573	2.2494	2.3394	2.4113	2.4983	2.5864
PTEPAM	5	1.8033	1.9995	2.1048	2.2070	2.3023	2.4006
PRAT	6	1.1409	1.1250	1.1115	1.0926	1.0851	1.0774
MIXP	7	.67386E-02	.95949E-02	.11998E-01	.13617E-01	.15365E-01	.17063E-01
FG (3)	8	717.97	834.87	890.15	938.88	993.35	1050.1
MNFAN	9	.49997	.49030	.48127	.46913	.46439	.45980
MNPRI	10	.23942	.26197	.27928	.30321	.31290	.32311
PT7PAM	11	2.0729	2.2657	2.3557	2.4273	2.5145	2.6028
PT8PAM	12	1.8077	2.0055	2.1121	2.2160	2.3123	2.4119
TT7	13	520.94	511.74	524.93	515.83	528.42	520.10
TT8	14	1192.6	1196.2	1255.6	1234.7	1295.9	1307.9
TRAT	15	2.2893	2.3374	2.3920	2.3936	2.4525	2.5147
PAM	16	14.289	14.296	14.289	14.296	14.289	14.296
BPR	17	7.8046	6.9900	6.4454	5.8012	5.6479	5.4510

E3 MIXER NO. 2 CONF 3 ,RUNS 26-31 COLD							
CV MIX	1	.99079	.99228	.99133	.99119	.99147	.99103
CD MIX	2	.94817	.95648	.95710	.95936	.96055	.96040
PTMPA	3	1.9776	2.1681	2.2760	2.3691	2.4754	2.5652
PTFPAM	4	1.9720	2.1614	2.2684	2.3607	2.4677	2.5553
PTEPAM	5	1.9953	2.1889	2.2992	2.3950	2.4991	2.5956
PRAT	6	.98829	.98744	.98663	.98568	.98744	.98447
MIXP	7	.36126E-06	.95661E-05	.31452E-05	.10733E-05	.62896E-05	.76211E-05
FG (3)	8	675.81	791.17	853.87	909.90	970.41	1025.1
MNFAN	9	.51585	.52224	.52248	.52400	.52556	.52446
MNPRI	10	.53278	.54018	.54155	.54435	.54338	.54649
PT7PAM	11	1.9857	2.1768	2.2846	2.3777	2.4854	2.5737
PT8PAM	12	2.0095	2.2048	2.3161	2.4127	2.5177	2.6150
TT7	13	505.07	498.51	508.83	501.44	521.07	513.12
TT8	14	514.14	506.96	517.17	509.89	526.63	521.31
TRAT	15	1.0180	1.0169	1.0164	1.0169	1.0107	1.0160
PAM	16	14.287	14.287	14.287	14.287	14.251	14.287
BPR	17	3.0929	3.0846	3.0661	3.0706	3.0534	3.0514

E3 MIXER NO. 2 CONF 3 ,RUNS 32-37 HOT							
CV MIX	1	.98711	.98605	.98545	.98518	.98426	.98373
CD MIX	2	.94897	.95730	.96110	.96281	.96433	.96749
PTMPA	3	1.9943	2.1791	2.2696	2.3435	2.4349	2.5190
PTFPAM	4	2.0566	2.2444	2.3333	2.4034	2.4957	2.5784
PTEPAM	5	1.8037	1.9963	2.1059	2.2020	2.3014	2.4023
PRAT	6	1.1403	1.1243	1.1080	1.0915	1.0844	1.0733
MIXP	7	.76962E-02	.96761E-02	.11457E-01	.12301E-01	.13757E-01	.14978E-01
FG (3)	8	683.04	794.84	850.18	894.45	948.93	1001.2
MNFAN	9	.56477	.56212	.55584	.54950	.54629	.54291
MNPRI	10	.35484	.37966	.39932	.41835	.42615	.44008
PT7PAM	11	2.0734	2.2624	2.3517	2.4220	2.5148	2.5977
PT8PAM	12	1.8112	2.0059	2.1170	2.2146	2.3152	2.4178
TT7	13	508.74	512.67	519.57	515.66	522.09	518.68
TT8	14	1173.5	1201.8	1248.8	1237.5	1287.3	1299.6
TRAT	15	2.3067	2.3441	2.4035	2.3998	2.4656	2.5056
PAM	16	14.228	14.228	14.228	14.228	14.228	14.228
BPR	17	7.8571	7.2787	6.9588	6.5259	6.4245	6.1652

E3 MIXER NO. 2 CONF 4 ,RUNS 39-44 COLD							
CVHIX	1	.98814	.98995	.98998	.99000	.99041	.99026
CDMIX	2	.97328	.97717	.97834	.97787	.97881	.97892
PTHPA	3	1.9826	2.1773	2.2759	2.3822	2.4776	2.5742
PTFPAM	4	1.9760	2.1706	2.2686	2.3732	2.4691	2.5665
PTEPAM	5	2.0035	2.1982	2.2989	2.4106	2.5046	2.5985
PRAT	6	.98626	.98746	.98680	.98447	.98582	.98769
MIXP	7	.56822E-05	.22180E-04	.17574E-04	.13746E-04	.25171E-04	.28011E-04
FG (3)	8	687.45	803.54	861.32	923.54	979.65	1037.2
MNFAN	9	.53570	.53932	.54011	.53898	.54021	.54087
MNPRI	10	.55489	.55677	.55846	.56053	.55990	.55796
PT7PAM	11	1.9908	2.1871	2.2858	2.3912	2.4879	2.5861
PT8PAM	12	2.0184	2.2147	2.3163	2.4288	2.5234	2.6180
TT7	13	523.96	520.68	525.59	522.89	526.83	525.99
TT8	14	538.26	538.83	541.15	542.39	545.74	549.91
TRAT	15	1.0273	1.0349	1.0296	1.0373	1.0359	1.0455
PAM	16	14.100	14.110	14.100	14.110	14.100	14.110
BPR	17	3.1246	3.1432	3.1284	3.1380	3.1504	3.1704

E3 MIXER NO. 2 CONF 4 ,RUNS 45-50 HOT							
CVHIX	1	.98682	.98632	.98687	.98668	.98575	.98528
CDMIX	2	.97752	.98101	.98338	.98293	.98437	.98478
PTHPA	3	1.9910	2.1807	2.2717	2.3456	2.4347	2.5231
PTFPAM	4	2.0531	2.2462	2.3378	2.4074	2.4962	2.5843
PTEPAM	5	1.8071	2.0036	2.1013	2.2016	2.3020	2.4037
PRAT	6	1.1361	1.1211	1.1125	1.0934	1.0844	1.0751
MIXP	7	.80406E-02	.10083E-01	.11282E-01	.12220E-01	.13629E-01	.14989E-01
FG (3)	8	695.32	808.08	863.21	906.07	959.74	1011.5
MNFAN	9	.58098	.57602	.57282	.56428	.56008	.55541
MNPRI	10	.38702	.40541	.41524	.43462	.44394	.45294
PT7PAM	11	2.0709	2.2652	2.3574	2.4270	2.5163	2.6047
PT8PAM	12	1.8156	2.0142	2.1128	2.2149	2.3163	2.4194
TT7	13	528.38	529.44	529.66	531.20	531.07	532.66
TT8	14	1214.6	1245.9	1274.1	1272.7	1308.5	1340.9
TRAT	15	2.2988	2.3533	2.4054	2.3960	2.4639	2.5175
PAM	16	14.100	14.100	14.100	14.100	14.100	14.090
BPR	17	7.6001	7.1332	7.0417	6.5174	6.4423	6.2740

E3 MIXER NO. 2 CONF 5 ,RUNS 51-56 COLD							
CVHIX	1	.98917	.98983	.99026	.98943	.99023	.98946
CDMIX	2	.97912	.98301	.98320	.98237	.98388	.98286
PTHPA	3	1.9761	2.1712	2.2677	2.3706	2.4633	2.5661
PTFPAM	4	1.9691	2.1639	2.2610	2.3624	2.4545	2.5559
PTEPAM	5	1.9934	2.1946	2.2891	2.3966	2.4918	2.5987
PRAT	6	.98536	.98600	.98773	.98573	.98505	.98354
MIXP	7	.11716E-04	.14878E-04	.34042E-05	.68985E-05	.40018E-05	.47147E-05
FG (3)	8	687.66	804.09	860.61	920.15	976.12	1035.7
MNFAN	9	.54027	.54376	.54445	.54312	.54421	.54287
MNPRI	10	.56050	.56303	.56137	.56279	.56477	.56555
PT7PAM	11	1.9844	2.1809	2.2787	2.3809	2.4738	2.5759
PT8PAM	12	2.0128	2.2106	2.3057	2.4142	2.5099	2.6177
TT7	13	512.23	516.99	514.19	519.61	515.88	522.32
TT8	14	519.80	523.59	521.78	525.77	523.85	528.64
TRAT	15	1.0148	1.0128	1.0148	1.0119	1.0154	1.0121
PAM	16	14.100	14.100	14.100	14.100	14.100	14.100
BPR	17	3.1918	3.1839	3.2030	3.1712	3.1880	3.1658

E3 MIXER NO. 2 CONF 5 ,RUNS 57-62 HOT							
CVHIX	1	.98713	.98701	.98656	.98712	.98703	.98657
CDMIX	2	.98047	.98417	.98452	.98430	.98668	.98622
PTHPA	3	1.9913	2.1788	2.2701	2.3468	2.4352	2.5221
PTFPAM	4	2.0526	2.2424	2.3342	2.4065	2.4940	2.5818
PTEPAM	5	1.8036	2.0018	2.1030	2.2037	2.3034	2.4029
PRAT	6	1.1380	1.1202	1.1100	1.0920	1.0827	1.0744
MIXP	7	.77103E-02	.97896E-02	.11186E-01	.12000E-01	.12786E-01	.14727E-01
FG (3)	8	696.74	808.59	862.28	906.93	961.18	1012.0
MNFAN	9	.58321	.57720	.57201	.56413	.56146	.55586
MNPRI	10	.38694	.40846	.41822	.43668	.44795	.45460
PT7PAM	11	2.0709	2.2618	2.3541	2.4265	2.5146	2.6026
PT8PAM	12	1.8117	2.0119	2.1142	2.2164	2.3172	2.4180
TT7	13	523.16	530.19	526.04	532.92	527.80	536.01
TT8	14	1200.2	1242.2	1264.9	1274.9	1275.8	1346.9
TRAT	15	2.2942	2.3429	2.4046	2.3923	2.4171	2.5128
PAM	16	14.086	14.086	14.086	14.086	14.086	14.086
BPR	17	7.8290	7.3127	7.1301	6.6964	6.5383	6.4266

E3 MIXER NO. 2 CONF 6 ,RUNS 64-69 COLD

CVMIX	1	.99068	.99078	.99091	.99098	.99085	.99025
CDMIX	2	.90868	.91998	.92359	.92696	.92864	.93047
PTMPA	3	1.9773	2.1802	2.2779	2.3741	2.4723	2.5739
PTFPAM	4	1.9726	2.1746	2.2722	2.3677	2.4668	2.5658
PTEPAM	5	1.9919	2.1974	2.2957	2.3940	2.4896	2.5990
PRAT	6	.99029	.98964	.98977	.98902	.99085	.98724
MIXP	7	.12118E-04	.13734E-04	.11887E-04	.23908E-04	.25593E-04	.24565E-04
FG (3)	8	644.71	764.38	821.57	878.21	934.84	993.84
MNFAN	9	.48583	.49410	.49688	.49923	.50116	.50132
MNPRI	10	.50068	.50970	.51230	.51560	.51474	.52023
PT7PAM	11	1.9850	2.1887	2.2871	2.3834	2.4831	2.5829
PT8PAM	12	2.0046	2.2119	2.3110	2.4101	2.5063	2.6166
TT7	13	509.50	514.23	511.47	517.66	513.79	520.68
TT8	14	524.96	532.08	526.99	536.65	531.08	541.60
TRAT	15	1.0303	1.0347	1.0303	1.0367	1.0337	1.0402
PAM	16	14.232	14.232	14.232	14.232	14.232	14.232
BPR	17	3.1311	3.1300	3.1251	3.1337	3.1334	3.1269

E3 MIXER NO. 2 CONF 6 ,RUNS 70-75 HOT

CVMIX	1	.98776	.98758	.98640	.98630	.98606	.98490
CDMIX	2	.90492	.91820	.92348	.92813	.93153	.93611
PTMPA	3	2.0014	2.1865	2.2767	2.3498	2.4403	2.5252
PTFPAM	4	2.0605	2.2483	2.3392	2.4080	2.4974	2.5829
PTEPAM	5	1.8057	2.0013	2.1020	2.2029	2.3059	2.4040
PRAT	6	1.1411	1.1234	1.1128	1.0931	1.0831	1.0744
MIXP	7	.70912E-02	.94794E-02	.11043E-01	.12267E-01	.13523E-01	.15216E-01
FG (3)	8	654.76	765.97	820.32	865.21	919.18	971.61
MNFAN	9	.53817	.53618	.53348	.52667	.52324	.52141
MNPRI	10	.30994	.34250	.35881	.38528	.39859	.41159
PT7PAM	11	2.0759	2.2650	2.3564	2.4253	2.5153	2.6011
PT8PAM	12	1.8116	2.0091	2.1111	2.2137	2.3177	2.4176
TT7	13	519.34	523.47	521.43	526.08	523.96	528.33
TT8	14	1193.2	1229.0	1254.0	1263.9	1285.9	1331.2
TRAT	15	2.2976	2.3478	2.4048	2.4024	2.4543	2.5197
PAM	16	14.225	14.225	14.225	14.225	14.225	14.225
BPR	17	8.5500	7.7814	7.4380	6.8246	6.6823	6.3959

E3 MIXER NO. 3 CONF 7 ,RUNS 76-81 COLD

CVMIX	1	.99001	.99104	.99108	.99106	.99058	.99095
CDMIX	2	.94554	.95264	.95575	.95630	.95789	.95837
PTMPA	3	1.9883	2.1874	2.2861	2.3826	2.4697	2.5861
PTFPAM	4	1.9868	2.1857	2.2833	2.3797	2.4629	2.5822
PTEPAM	5	1.9931	2.1932	2.2949	2.3919	2.4920	2.5990
PRAT	6	.99686	.99657	.99497	.99492	.98832	.99354
MIXP	7	.23818E-04	.13206E-04	.14292E-04	.13950E-04	.55588E-05	.11142E-04
FG (3)	8	676.52	794.97	854.09	910.09	966.23	1029.9
MNFAN	9	.51702	.52260	.52455	.52499	.52417	.52623
MNPRI	10	.52157	.52739	.53175	.53225	.54078	.53540
PT7PAM	11	2.0008	2.2014	2.2998	2.3969	2.4807	2.6010
PT8PAM	12	2.0086	2.2105	2.3132	2.4110	2.5123	2.6200
TT7	13	509.95	512.05	513.83	515.97	516.01	517.66
TT8	14	515.24	516.67	518.11	519.80	523.20	521.05
TRAT	15	1.0104	1.0090	1.0083	1.0074	1.0139	1.0065
PAM	16	14.214	14.214	14.214	14.214	14.278	14.214
BPR	17	3.3412	3.3374	3.3242	3.3205	3.2889	3.3087

E3 MIXER NO. 3 CONF 7 ,RUNS 79.1-80.1-81.1 COLD

CVMIX	1	.99054	.99085	.99061			
CDMIX	2	.95697	.95853	.95912			
PTMPA	3	2.3885	2.4853	2.5831			
PTFPAM	4	2.3868	2.4846	2.5811			
PTEPAM	5	2.3939	2.4875	2.5895			
PRAT	6	.99705	.99885	.99677			
MIXP	7	.17236E-04	.18243E-04	.19381E-04			
FG (3)	8	906.54	963.53	1020.4			
MNFAN	9	.52624	.52808	.52789			
MNPRI	10	.53043	.52971	.53249			
PT7PAM	11	2.4042	2.5028	2.6000			
PT8PAM	12	2.4127	2.5071	2.6100			
TT7	13	521.74	524.44	526.79			
TT8	14	527.77	530.43	533.68			
TRAT	15	1.0116	1.0114	1.0131			
PAM	16	14.096	14.096	14.096			
BPR	17	3.3673	3.3781	3.3698			

E3 MIXER NO. 3 CONF 7 ,RUNS 82-87 HOT

CVMIX	1	.98757	.98602	.98582	.98533	.98458	.98394
CDMIX	2	.94901	.95716	.96083	.96318	.96624	.96825
PTMPA	3	1.9978	2.1851	2.2737	2.3495	2.4327	2.5231
PTFPAM	4	2.0570	2.2465	2.3361	2.4079	2.4900	2.5814
PTEPAM	5	1.8042	2.0045	2.0974	2.2013	2.2994	2.3996
PRAT	6	1.1401	1.1207	1.1138	1.0939	1.0829	1.0758
MIXP	7	.72518E-02	.95786E-02	.10618E-01	.11876E-01	.13156E-01	.14607E-01
FG (3)	8	676.76	788.53	842.04	887.40	938.09	992.23
MNFAN	9	.56340	.55894	.55750	.55009	.54659	.54390
MNPRI	10	.35298	.38152	.39157	.41529	.42895	.43754
PT7PAM	11	2.0738	2.2645	2.3549	2.4267	2.5092	2.6010
PT8PAM	12	1.8127	2.0155	2.1094	2.2154	2.3150	2.4168
TT7	13	512.81	520.37	515.17	523.67	518.28	527.54
TT8	14	1176.2	1222.7	1235.3	1258.7	1274.0	1329.4
TRAT	15	2.2936	2.3497	2.3979	2.4036	2.4582	2.5201
PAM	16	14.056	14.056	14.056	14.056	14.056	14.056
BPR	17	8.3452	7.6889	7.5777	6.9943	6.8012	6.6406

E3 MIXER NO. 3 CONF 7 ,RUNS 85.1-86.1-87.1 HOT

CVMIX	1	.98602	.98547	.98376			
CDMIX	2	.95986	.96337	.96641			
PTMPA	3	2.3641	2.4539	2.5411			
PTFPAM	4	2.4258	2.5170	2.6033			
PTEPAM	5	2.1965	2.2952	2.3995			
PRAT	6	1.1044	1.0966	1.0849			
MIXP	7	.11091E-01	.12645E-01	.14232E-01			
FG (3)	8	893.79	948.62	1002.0			
MNFAN	9	.55288	.55074	.54651			
MNPRI	10	.40138	.41198	.42615			
PT7PAM	11	2.4449	2.5366	2.6233			
PT8PAM	12	2.2097	2.3099	2.4158			
TT7	13	531.91	533.28	534.86			
TT8	14	1262.5	1306.2	1346.9			
TRAT	15	2.3735	2.4494	2.5183			
PAM	16	14.074	14.074	14.074			
BPR	17	7.2503	7.0868	6.8922			

E3 MIXER NO. 4 CONF 8 ,RUNS 88-93 COLD

CVMIX	1	.99094	.99068	.99049	.99045	.98989	.99018
CDMIX	2	.94619	.95217	.95430	.95542	.95659	.95795
PTMPA	3	1.9854	2.1862	2.2844	2.3804	2.4682	2.5791
PTFPAM	4	1.9827	2.1840	2.2823	2.3764	2.4626	2.5743
PTEPAM	5	1.9938	2.1929	2.2911	2.3926	2.4862	2.5941
PRAT	6	.99445	.99595	.99612	.99323	.99050	.99237
MIXP	7	.64980E-05	.28252E-04	.20319E-04	.21480E-04	.15962E-04	.15455E-04
FG (3)	8	676.29	795.03	853.09	909.28	963.61	1026.8
MNFAN	9	.51640	.52167	.52343	.52336	.52343	.52513
MNPRI	10	.52443	.52747	.52899	.53304	.53707	.53601
PT7PAM	11	1.9973	2.2004	2.2994	2.3943	2.4813	2.5938
PT8PAM	12	2.0086	2.2095	2.3086	2.4111	2.5051	2.6142
TT7	13	495.04	497.79	500.85	504.85	518.28	510.04
TT8	14	503.02	505.38	508.11	511.77	525.21	516.02
TRAT	15	1.0161	1.0152	1.0145	1.0137	1.0134	1.0117
PAM	16	14.234	14.234	14.234	14.234	14.271	14.234
BPR	17	3.1989	3.1926	3.1931	3.1570	3.1840	3.1599

E3 MIXER NO. 4 CONF 8 ,RUNS 94-99 HOT

CVMIX	1	.98740	.98633	.98654	.98679	.98603	.98514
CDMIX	2	.94486	.95320	.95615	.95926	.96166	.96355
PTMPA	3	1.9960	2.1844	2.2738	2.3475	2.4317	2.5230
PTFPAM	4	2.0569	2.2464	2.3383	2.4071	2.4907	2.5835
PTEPAM	5	1.8064	2.0123	2.1018	2.2031	2.3013	2.3988
FRAT	6	1.1387	1.1163	1.1125	1.0926	1.0823	1.0770
MIXP	7	.75637E-02	.99843E-02	.11056E-01	.12125E-01	.13606E-01	.14803E-01
FG (3)	8	672.61	784.66	837.71	882.41	932.80	987.06
MNFAN	9	.56123	.55520	.55476	.54747	.54347	.54163
MNPRI	10	.35249	.38397	.39019	.41411	.42625	.43294
PT7PAM	11	2.0743	2.2650	2.3575	2.4265	2.5105	2.6037
PT8PAM	12	1.8146	2.0231	2.1134	2.2166	2.3162	2.4151
TT7	13	533.63	535.74	535.43	537.50	537.28	539.09
TT8	14	1216.6	1249.4	1275.5	1280.8	1314.4	1345.7
TRAT	15	2.2798	2.3321	2.3822	2.3828	2.4463	2.4963
PAM	16	14.053	14.053	14.053	14.053	14.053	14.053
BPR	17	7.9069	7.2044	7.1178	6.6291	6.4509	6.3112

E3 MIXER NO. 2 CONF 9 ,RUNS 101-106 COLD

CVMIX	1	.98857	.98917	.98954	.98970	.98968	.99046
CDMIX	2	.94421	.95159	.95370	.95550	.95637	.95861
PTMPA	3	1.9940	2.1901	2.2947	2.3956	2.4940	2.5880
PTFPAM	4	1.9933	2.1900	2.2960	2.3958	2.4935	2.5898
PTEPAM	5	1.9958	2.1903	2.2902	2.3948	2.4954	2.5823
PRAT	6	.99874	.99983	1.0025	1.0004	.99926	1.0029
MIXP	7	.18467E-04	.46336E-05	.18350E-04	.10186E-04	.16394E-04	.10010E-04
FG (3)	8	674.25	790.34	851.52	910.77	968.00	1024.4
MNFAN	9	.51633	.52257	.52519	.52590	.52620	.52928
MNPRI	10	.51816	.52278	.52156	.52531	.52723	.52514
PT7PAM	11	2.0071	2.2054	2.3123	2.4129	2.5113	2.6084
PT8PAM	12	2.0099	2.2061	2.3067	2.4122	2.5135	2.6013
TT7	13	517.43	522.09	519.08	524.00	521.16	525.95
TT8	14	520.34	524.31	521.70	525.63	523.34	527.14
TRAT	15	1.0056	1.0043	1.0050	1.0031	1.0042	1.0023
PAM	16	14.120	14.120	14.120	14.120	14.120	14.120
BPR	17	3.1036	3.1027	3.1266	3.1046	3.1096	3.1070

E3 MIXER NO. 2 CONF 9 ,RUNS 104.4-105.5-106.4 COLD

CVMIX	1	.98896	.98928	.98982			
CDMIX	2	.95483	.95669	.95822			
PTMPA	3	2.3668	2.4636	2.5592			
PTFPAM	4	2.3612	2.4578	2.5531			
PTEPAM	5	2.3835	2.4808	2.5774			
FRAT	6	.99066	.99073	.99055			
MIXP	7	.40548E-05	.58434E-05	.95923E-06			
FG (3)	8	903.15	960.95	1018.1			
MNFAN	9	.52194	.52348	.52466			
MNPRI	10	.53531	.53671	.53813			
PT7PAM	11	2.3777	2.4751	2.5711			
PT8PAM	12	2.4015	2.4996	2.5971			
TT7	13	511.82	514.63	517.66			
TT8	14	517.40	519.95	523.29			
TRAT	15	1.0109	1.0103	1.0109			
PAM	16	14.270	14.270	14.270			
BPR	17	3.0093	3.0154	3.0162			

E3 MIXER NO. 2 CONF 9 ,RUNS 107-112 HOT							
CVMIX	1	.98677	.98668	.98549	.98539	.98441	.98379
CDMIX	2	.94692	.95467	.95794	.96034	.96154	.96402
PTMPA	3	2.0142	2.2046	2.2972	2.3681	2.4578	2.5438
PTFPAM	4	2.0831	2.2762	2.3702	2.4355	2.5281	2.6138
PTEPAM	5	1.8021	2.0035	2.1014	2.2054	2.2923	2.3926
PRAT	6	1.1559	1.1361	1.1279	1.1043	1.1028	1.0924
MIXP	7	.69631E-02	.93781E-02	.10679E-01	.12057E-01	.13063E-01	.14600E-01
FG (3)	8	679.18	791.33	846.27	888.54	940.64	992.15
MNFAN	9	.57308	.56727	.56453	.55466	.55379	.54965
MNPRI	10	.33899	.36655	.37732	.40385	.40545	.41758
PT7PAM	11	2.0999	2.2942	2.3889	2.4541	2.5473	2.6334
PT8PAM	12	1.8096	2.0132	2.1121	2.2182	2.3057	2.4075
TT7	13	516.68	520.76	517.79	523.03	521.07	525.02
TT8	14	1181.2	1217.7	1238.1	1250.7	1277.0	1317.3
TRAT	15	2.2862	2.3383	2.3911	2.3912	2.4507	2.5090
PAM	16	13.948	13.948	13.948	13.948	13.948	13.948
BPR	17	7.9525	7.3119	7.1451	6.5175	6.5803	6.3635

E3 MIXER NO. 2 CONF 9 ,RUNS 110.2-111.2-112.2 HOT							
CVMIX	1	.98512	.98511	.98389			
CDMIX	2	.95892	.96176	.96364			
PTMPA	3	2.3396	2.4303	2.5087			
PTFPAM	4	2.4033	2.4944	2.5697			
PTEPAM	5	2.1895	2.2903	2.3927			
PRAT	6	1.0977	1.0891	1.0740			
MIXP	7	.12314E-01	.13757E-01	.15430E-01			
FG (3)	8	886.66	941.70	989.07			
MNFAN	9	.55038	.54734	.54067			
MNPRI	10	.40938	.41988	.43641			
PT7PAM	11	2.4215	2.5130	2.5884			
PT8PAM	12	2.2024	2.3046	2.4088			
TT7	13	527.27	529.26	530.98			
TT8	14	1260.8	1297.8	1332.1			
TRAT	15	2.3911	2.4521	2.5087			
PAM	16	14.198	14.198	14.198			
BPR	17	6.4095	6.2660	5.9756			

E3 MIXER NO. 2 CONF 10,RUNS 113-118 COLD							
CVMIX	1	.98718	.98807	.98819	.98875	.98829	.98813
CDMIX	2	.94370	.95031	.95276	.95425	.95535	.95517
PTMPA	3	1.9931	2.1879	2.2925	2.3903	2.4867	2.5856
PTFPAM	4	1.9944	2.1885	2.2926	2.3905	2.4890	2.5875
PTEPAM	5	1.9889	2.1856	2.2918	2.3894	2.4795	2.5796
PRAT	6	1.0028	1.0013	1.0004	1.0004	1.0038	1.0031
MIXP	7	.11894E-04	.80076E-05	.24000E-04	.17134E-04	.50418E-05	.10238E-04
FG (3)	8	677.38	792.70	854.49	911.90	968.47	1025.4
MNFAN	9	.51739	.52208	.52368	.52490	.52700	.52660
MNPRI	10	.51333	.52015	.52313	.52428	.52153	.52217
PT7PAM	11	2.0079	2.2036	2.3085	2.4071	2.5063	2.6056
PT8PAM	12	2.0037	2.2022	2.3092	2.4078	2.4986	2.5993
TT7	13	514.45	519.34	515.26	521.56	518.10	523.96
TT8	14	518.98	523.16	519.53	524.87	522.06	527.13
TRAT	15	1.0088	1.0074	1.0083	1.0063	1.0076	1.0060
PAM	16	14.204	14.204	14.204	14.204	14.204	14.204
BPR	17	3.0288	3.0182	3.0191	3.0096	3.0245	3.0323

E3 MIXER NO. 2 CONF 10,RUNS 119-124 HOT							
CVMIX	1	.98521	.98522	.98490	.98534	.98401	.98310
CDMIX	2	.94435	.95273	.95560	.95795	.95955	.96175
PTMPA	3	2.0135	2.1983	2.2909	2.3637	2.4554	2.5402
PTFPAM	4	2.0857	2.2731	2.3656	2.4351	2.5282	2.6123
PTEPAM	5	1.8026	1.9967	2.1023	2.1951	2.2924	2.3915
PRAT	6	1.1571	1.1384	1.1253	1.1093	1.1029	1.0923
MIXP	7	.72574E-02	.96603E-02	.11281E-01	.12364E-01	.13586E-01	.15195E-01
FG (3)	8	689.63	800.96	856.38	900.35	954.84	1006.2
MNFAN	9	.57383	.56836	.56278	.55600	.55317	.54840
MNPRI	10	.33815	.36428	.37947	.39748	.40478	.41641
PT7PAM	11	2.1020	2.2906	2.3835	2.4532	2.5468	2.6312
PT8PAM	12	1.8107	2.0070	2.1140	2.2083	2.3068	2.4075
TT7	13	529.84	534.16	532.13	535.74	534.11	537.37
TT8	14	1211.8	1249.9	1272.9	1286.4	1309.6	1351.7
TRAT	15	2.2872	2.3400	2.3920	2.4012	2.4519	2.5155
PAM	16	14.210	14.210	14.210	14.210	14.210	14.210
BPR	17	7.5644	7.0469	6.7466	6.3964	6.2768	6.1091

E3 MIXER NO. 2 CONF 11,RUNS 125-130 COLD							
CVMIX	1	.98497	.98586	.98573	.98669	.98658	.98651
CDMIX	2	.94170	.94754	.95002	.95140	.95251	.95349
PTMPA	3	1.9953	2.1936	2.2913	2.3903	2.4892	2.5938
PTFPAM	4	1.9957	2.1947	2.2928	2.3909	2.4905	2.5956
PTEPAM	5	1.9940	2.1900	2.2866	2.3880	2.4853	2.5885
PRAT	6	1.0008	1.0021	1.0027	1.0012	1.0021	1.0027
MIXP	7	.16271E-04	.12342E-04	.86287E-05	.16159E-04	.15952E-04	.10477E-04
FG (3)	8	675.22	791.28	848.82	906.50	964.23	1025.3
MNFAN	9	.51311	.51820	.52036	.52090	.52209	.52311
MNPRI	10	.51197	.51508	.51639	.51911	.51908	.51915
PT7PAM	11	2.0089	2.2094	2.3083	2.4071	2.5074	2.6133
PT8PAM	12	2.0096	2.2073	2.3048	2.4071	2.5053	2.6091
TT7	13	511.87	518.23	513.65	520.23	515.79	522.72
TT8	14	515.97	521.58	517.48	523.09	519.72	525.25
TRAT	15	1.0080	1.0065	1.0075	1.0055	1.0076	1.0048
PAM	16	14.162	14.162	14.162	14.162	14.162	14.162
BPR	17	2.9308	2.9375	2.9382	2.9269	2.9324	2.9522

E3 MIXER NO. 2 CONF 11,RUNS 131-136 HOT							
CVMIX	1	.98473	.98427	.98418	.98411	.98330	.98332
CDMIX	2	.94276	.95110	.95407	.95508	.95808	.96141
PTMPA	3	2.0086	2.1977	2.2927	2.3647	2.4527	2.5382
PTFPAM	4	2.0813	2.2729	2.3704	2.4381	2.5251	2.6102
PTEPAM	5	1.8066	2.0054	2.1024	2.1967	2.2971	2.3977
PRAT	6	1.1521	1.1334	1.1275	1.1098	1.0993	1.0886
MIXP	7	.77069E-02	.10114E-01	.11459E-01	.12521E-01	.14011E-01	.15813E-01
FG (3)	8	683.62	796.77	853.46	895.49	948.89	1001.6
MNFAN	9	.56989	.56425	.56229	.55366	.54914	.54490
MNPRI	10	.34119	.36707	.37490	.39335	.40546	.41804
PT7PAM	11	2.0971	2.2898	2.3879	2.4557	2.5432	2.6286
PT8PAM	12	1.8155	2.0167	2.1148	2.2108	2.3124	2.4148
TT7	13	532.00	536.49	533.63	538.60	536.14	540.67
TT8	14	1215.2	1252.1	1276.1	1287.5	1314.9	1364.3
TRAT	15	2.2843	2.3338	2.3913	2.3904	2.4525	2.5234
PAM	16	14.167	14.167	14.167	14.167	14.167	14.167
BPR	17	7.1498	6.6528	6.5483	6.1568	6.0442	5.8632

E3 MIXER NO. 5 CONF 13,RUNS 150-155 COLD							
CVMIX	1	.99235	.99256	.99206	.99211	.99174	.99150
CDMIX	2	.94721	.95358	.95573	.95750	.95817	.95935
PTMPA	3	1.9743	2.1758	2.2734	2.3717	2.4702	2.5684
PTFPAM	4	1.9685	2.1711	2.2693	2.3662	2.4651	2.5634
PTEPAM	5	1.9906	2.1891	2.2848	2.3874	2.4849	2.5824
PRAT	6	.98890	.99180	.99322	.99110	.99203	.99264
MIXP	7	.10624E-04	.17412E-04	.81129E-05	.12743E-04	.20436E-05	.13222E-04
FG (3)	8	666.43	785.21	842.60	900.48	955.71	1015.5
MNFAN	9	.51429	.52040	.52263	.52328	.52421	.52533
MNPRI	10	.53027	.53216	.53233	.53602	.53563	.53585
PT7PAM	11	1.9822	2.1865	2.2855	2.3830	2.4828	2.5816
PT8PAM	12	2.0105	2.2112	2.3081	2.4120	2.5097	2.6092
TT7	13	507.00	510.26	509.01	513.21	524.13	517.17
TT8	14	514.54	518.24	517.21	520.82	529.49	525.60
TRAT	15	1.0149	1.0156	1.0161	1.0148	1.0102	1.0163
PAM	16	14.146	14.146	14.146	14.146	14.117	14.146
BPR	17	2.8417	2.8550	2.8585	2.8398	2.8831	2.8370

E3 MIXER NO. 5 CONF 13,RUNS 156-161 HOT							
CVMIX	1	.98774	.98575	.98550	.98467	.98345	.98291
CDMIX	2	.94381	.95397	.95819	.96123	.96446	.96789
PTMPA	3	1.9913	2.1790	2.2695	2.3450	2.4300	2.5170
PTFPAM	4	2.0594	2.2490	2.3411	2.4122	2.4958	2.5830
PTEPAM	5	1.7948	1.9973	2.0952	2.1972	2.2958	2.3961
PRAT	6	1.1474	1.1260	1.1173	1.0979	1.0871	1.0780
MIXP	7	.76753E-02	.10337E-01	.11730E-01	.13039E-01	.14200E-01	.15879E-01
FG (3)	8	668.78	781.58	836.38	882.05	933.79	987.28
MNFAN	9	.56721	.56183	.55974	.55202	.54829	.54520
MNPRI	10	.34560	.37662	.38893	.41147	.42454	.43574
PT7PAM	11	2.0762	2.2670	2.3596	2.4308	2.5148	2.6023
PT8PAM	12	1.8049	2.0107	2.1104	2.2150	2.3154	2.4179
TT7	13	532.70	535.87	533.98	537.68	535.88	539.22
TT8	14	1218.5	1258.1	1279.4	1292.7	1309.2	1353.6
TRAT	15	2.2874	2.3477	2.3960	2.4043	2.4430	2.5103
PAM	16	14.045	14.045	14.045	14.045	14.045	14.045
BPR	17	7.4232	6.7845	6.5377	6.0529	5.8906	5.7125

E3 MIXER NO. 5 CONF 14,RUNS 163-168 COLD							
CVMIX	1	.98993	.99017	.99026	.99104	.99060	.99009
CDMIX	2	.97981	.98293	.98335	.98424	.98285	.98354
PTMPA	3	1.9796	2.1702	2.2698	2.3672	2.4670	2.5672
PTFPAM	4	1.9762	2.1661	2.2664	2.3625	2.4627	2.5618
PTEPAM	5	1.9895	2.1822	2.2795	2.3808	2.4794	2.5831
PRAT	6	.99333	.99261	.99429	.99231	.99326	.99175
MIXP	7	.16098E-04	.17823E-04	.17186E-04	.17177E-04	.25265E-04	.20951E-04
FG (3)	8	682.49	794.47	852.35	909.62	966.32	1025.5
MNFAN	9	.54244	.54483	.54576	.54583	.54501	.54505
MNPRI	10	.55173	.55504	.55364	.55646	.55434	.55646
PT7PAM	11	1.9915	2.1830	2.2841	2.3810	2.4821	2.5818
PT8PAM	12	2.0095	2.2045	2.3028	2.4053	2.5043	2.6097
TT7	13	524.53	526.21	527.89	529.88	533.54	531.91
TT8	14	536.95	537.67	539.00	541.61	544.79	545.48
TRAT	15	1.0237	1.0218	1.0210	1.0221	1.0211	1.0255
PAM	16	13.944	13.944	13.944	13.944	13.944	13.944
BPR	17	2.9869	2.9686	2.9709	2.9581	2.9995	2.9587

E3 MIXER NO. 5 CONF 14,RUNS 169-174 HOT							
CVMIX	1	.98699	.98589	.98640	.98562	.98563	.98509
CDMIX	2	.98551	.98991	.99135	.99117	.99291	.99328
PTMPA	3	1.9853	2.1754	2.2657	2.3367	2.4263	2.5160
PTFPAM	4	2.0528	2.2444	2.3355	2.4022	2.4912	2.5812
PTEPAM	5	1.7977	2.0036	2.0998	2.1962	2.2964	2.3982
PRAT	6	1.1419	1.1202	1.1122	1.0938	1.0848	1.0763
MIXP	7	.80661E-02	.10408E-01	.11610E-01	.12700E-01	.13790E-01	.15250E-01
FG (3)	8	690.44	803.90	857.71	899.01	953.15	1006.2
MNFAN	9	.59043	.58264	.57905	.57053	.56690	.56229
MNPRI	10	.39107	.41598	.42399	.44204	.45153	.45936
PT7PAM	11	2.0712	2.2639	2.3556	2.4223	2.5118	2.6021
PT8PAM	12	1.8097	2.0189	2.1163	2.2152	2.3169	2.4208
TT7	13	518.90	524.41	521.12	527.05	523.20	529.13
TT8	14	1189.8	1228.6	1248.2	1263.2	1277.4	1321.5
TRAT	15	2.2930	2.3428	2.3953	2.3968	2.4415	2.4974
PAM	16	13.958	13.958	13.958	13.958	13.958	13.958
BPR	17	7.1103	6.5627	6.4792	6.0365	5.9382	5.7724

E3 MIXER NO. 6 CONF 15,RUNS 175-180 COLD							
CVMIX	1	.99239	.99191	.99206	.99175	.99157	.99176
CDMIX	2	.94564	.95203	.95429	.95513	.95548	.95824
PTMPA	3	1.9760	2.1758	2.2723	2.3729	2.4657	2.5651
PTFPAM	4	1.9716	2.1721	2.2682	2.3664	2.4613	2.5600
PTEPAM	5	1.9880	2.1860	2.2837	2.3909	2.4782	2.5792
PRAT	6	.99176	.99365	.99322	.98975	.99319	.99254
MIXP	7	.12459E-04	.87201E-05	.14520E-04	.54317E-05	.84601E-05	.86806E-05
FG (3)	8	666.27	783.92	840.71	898.94	952.31	1012.5
MNFAN	9	.51400	.51979	.52143	.52084	.52241	.52433
MNPRI	10	.52598	.52891	.53117	.53553	.53218	.53510
PT7PAM	11	1.9857	2.1879	2.2847	2.3837	2.4795	2.5788
PT8PAM	12	2.0112	2.2119	2.3109	2.4198	2.5071	2.6106
TT7	13	508.12	509.68	512.36	514.50	518.23	516.90
TT8	14	514.21	515.13	517.53	519.31	524.70	522.00
TRAT	15	1.0120	1.0107	1.0101	1.0093	1.0125	1.0099
PAM	16	14.146	14.146	14.146	14.146	14.144	14.146
BPR	17	2.7892	2.7900	2.7886	2.7645	2.8319	2.7706

E3 MIXER NO. 6 CONF 15,RUNS 181-186 HOT							
CVMIX	1	.98761	.98675	.98605	.98553	.98463	.98452
CDMIX	2	.94124	.95167	.95437	.95745	.96217	.96475
PTMPA	3	1.9873	2.1745	2.2658	2.3366	2.4238	2.5107
PTFPAM	4	2.0563	2.2455	2.3373	2.4032	2.4921	2.5770
PTEPAM	5	1.7981	1.9984	2.0976	2.1961	2.2881	2.3928
PRAT	6	1.1436	1.1236	1.1143	1.0943	1.0892	1.0769
MIXP	7	.79721E-02	.10593E-01	.11908E-01	.13263E-01	.14559E-01	.16137E-01
FG (3)	8	661.09	772.95	826.46	869.11	922.97	975.08
MNFAN	9	.56502	.56026	.55651	.54841	.54807	.54286
MNPRI	10	.34900	.37827	.38938	.41234	.42067	.43432
PT7PAM	11	2.0733	2.2637	2.3561	2.4220	2.5115	2.5966
PT8PAM	12	1.8106	2.0146	2.1156	2.2172	2.3110	2.4184
TT7	13	515.48	521.56	517.79	523.91	520.45	526.17
TT8	14	1178.6	1223.6	1239.4	1258.2	1282.3	1324.3
TRAT	15	2.2864	2.3460	2.3936	2.4017	2.4639	2.5169
PAM	16	13.968	13.968	13.968	13.968	13.968	13.968
BPR	17	7.0009	6.4626	6.2923	5.8151	5.7518	5.5557

E3 MIXER NO. 6 CONF 16,RUNS 187-192 COLD

CVMIX	1	.99044	.99123	.99114	.99143	.99104	.99165
CDMIX	2	.94320	.94982	.95113	.95254	.95383	.95535
PTMPA	3	1.9871	2.1900	2.2896	2.3883	2.4856	2.5825
PTFPAM	4	1.9907	2.1938	2.2951	2.3942	2.4906	2.5884
PTEPAM	5	1.9773	2.1799	2.2750	2.3725	2.4720	2.5665
PRAT	6	1.0067	1.0064	1.0088	1.0091	1.0075	1.0085
MIXP	7	.11233E-04	.49219E-05	.91747E-05	.93973E-05	.85889E-05	.15021E-04
FG (3)	8	673.76	793.65	851.53	909.29	966.46	1023.9
MNFAN	9	.51795	.52301	.52501	.52625	.52665	.52824
MNPRI	10	.50812	.51375	.51229	.51308	.51578	.51603
PT7PAM	11	2.0044	2.2092	2.3112	2.4111	2.5083	2.6068
PT8PAM	12	2.0023	2.2078	2.3042	2.4027	2.5040	2.5998
TT7	13	530.63	533.45	531.91	535.57	533.23	537.33
TT8	14	532.47	535.03	533.34	536.74	534.65	538.49
TRAT	15	1.0035	1.0030	1.0027	1.0022	1.0027	1.0022
PAM	16	14.209	14.209	14.209	14.209	14.209	14.209
BPR	17	2.6882	2.6900	2.7002	2.7167	2.6901	2.6990

E3 MIXER NO. 6 CONF 16,RUNS 193-198 HOT

CVMIX	1	.99014	.98851	.98814	.98763	.98685	.98568
CDMIX	2	.93964	.94912	.95174	.95402	.95772	.96076
PTMPA	3	2.0028	2.1935	2.2871	2.3605	2.4459	2.5364
PTFPAM	4	2.0769	2.2713	2.3661	2.4353	2.5197	2.6116
PTEPAM	5	1.7973	1.9964	2.0976	2.1951	2.2951	2.3921
PRAT	6	1.1556	1.1377	1.1280	1.1094	1.0978	1.0917
MIXP	7	.75002E-02	.10087E-01	.11573E-01	.12824E-01	.14386E-01	.15909E-01
FG (3)	8	677.62	792.15	847.53	891.42	943.90	999.14
MNFAN	9	.57134	.56677	.56269	.55431	.54989	.54762
MNPRI	10	.33691	.36321	.37452	.39503	.40887	.41646
PT7PAM	11	2.0941	2.2897	2.3851	2.4543	2.5390	2.6315
PT8PAM	12	1.8094	2.0121	2.1153	2.2156	2.3180	2.4168
TT7	13	531.91	537.72	534.16	539.88	536.23	542.42
TT8	14	1213.6	1257.9	1277.2	1292.4	1314.9	1365.8
TRAT	15	2.2817	2.3393	2.3911	2.3938	2.4521	2.5180
PAM	16	14.159	14.159	14.159	14.159	14.159	14.159
BPR	17	7.1627	6.6258	6.4081	5.9670	5.7759	5.7163

E3 MIXER NO. 7 CONF 17,RUNS 199-204 COLD

CVMIX	1	.99194	.99283	.99195	.99152	.99184	.99164
CDMIX	2	.94914	.95666	.95748	.95847	.96012	.96084
PTMPA	3	1.9855	2.1872	2.2839	2.3841	2.4791	2.5825
PTFPAM	4	1.9839	2.1865	2.2844	2.3830	2.4773	2.5788
PTEPAM	5	1.9897	2.1890	2.2826	2.3870	2.4839	2.5923
PRAT	6	.99710	.99888	1.0008	.99834	.99736	.99480
MIXP	7	.10458E-04	.18365E-05	.65765E-05	.14181E-04	.37794E-05	.49790E-05
FG (3)	8	677.03	797.65	853.83	912.42	968.96	1029.7
MNFAN	9	.41301	.41796	.41931	.41871	.41917	.41838
MNPRI	10	.41813	.41993	.41792	.42162	.42380	.42751
PT7PAM	11	1.9969	2.2011	2.2997	2.3990	2.4940	2.5961
PT8PAM	12	2.0075	2.2088	2.3032	2.4088	2.5067	2.6165
TT7	13	506.15	508.70	511.29	513.74	516.63	519.12
TT8	14	510.74	512.96	515.25	517.10	519.32	521.14
TRAT	15	1.0091	1.0084	1.0077	1.0065	1.0052	1.0039
PAM	16	14.202	14.202	14.202	14.202	14.202	14.202
BPR	17	2.7390	2.7463	2.7610	2.7368	2.7358	2.7028

E3 MIXER NO. 7 CONF 17,RUNS 205-210 HOT

CVMIX	1	.99134	.98802	.98784	.98668	.98502	.98381
CDMIX	2	.94548	.95495	.95829	.96088	.96407	.96839
PTMPA	3	2.0074	2.1959	2.2890	2.3637	2.4480	2.5321
PTFPAM	4	2.0709	2.2617	2.3564	2.4288	2.5120	2.5940
PTEPAM	5	1.8062	2.0084	2.1033	2.1973	2.2938	2.3960
PRAT	6	1.1465	1.1261	1.1203	1.1054	1.0951	1.0827
MIXP	7	.52699E-02	.90190E-02	.10449E-01	.11951E-01	.13830E-01	.15902E-01
FG (3)	8	689.26	803.97	860.49	906.11	958.17	1011.7
MNFAN	9	.49595	.48388	.48056	.47123	.46491	.45798
MNPRI	10	.21441	.24694	.25594	.27677	.29096	.30903
PT7PAM	11	2.0887	2.2804	2.3756	2.4479	2.5314	2.6135
PT8PAM	12	1.8123	2.0173	2.1132	2.2094	2.3076	2.4121
TT7	13	507.49	518.63	510.31	513.03	515.79	526.34
TT8	14	1158.0	1214.4	1222.5	1227.1	1265.3	1319.8
TRAT	15	2.2818	2.3416	2.3955	2.3918	2.4531	2.5076
PAM	16	14.253	14.252	14.253	14.253	14.253	14.253
BPR	17	8.8443	7.6283	7.4250	6.7291	6.4483	6.0611

E3 MIXER NO. 7 CONF 18,RUNS 212-217 COLD							
CVHIX	1	.99201	.99201	.99210	.99194	.99151	.99222
CDMIX	2	.97128	.97605	.97710	.97759	.97705	.97946
PTHPA	3	1.9853	2.1880	2.2844	2.3800	2.4808	2.5811
PTFPAM	4	1.9842	2.1867	2.2824	2.3782	2.4796	2.5779
PTEPAM	5	1.9883	2.1916	2.2898	2.3852	2.4840	2.5901
PRAT	6	.99794	.99776	.99680	.99704	.99820	.99530
MIXP	7	.13736E-04	.14682E-04	.92376E-05	.39428E-05	.74159E-06	.12794E-04
FG (3)	8	693.16	814.83	872.16	928.80	987.63	1049.5
MNFAN	9	.42564	.42823	.42839	.42878	.42899	.42903
MNPRI	10	.42920	.43208	.43391	.43385	.43208	.43726
PT7PAM	11	1.9985	2.2025	2.2989	2.3953	2.4974	2.5966
PT8PAM	12	2.0055	2.2110	2.3102	2.4066	2.5065	2.6135
TT7	13	503.95	506.24	508.48	511.82	514.72	517.88
TT8	14	509.11	510.97	513.08	515.84	518.06	520.42
TRAT	15	1.0102	1.0093	1.0090	1.0079	1.0065	1.0049
PAM	16	14.211	14.211	14.211	14.211	14.211	14.211
BPR	17	2.8835	2.8657	2.8501	2.8423	2.8267	2.8285

E3 MIXER NO. 7 CONF 18,RUNS 218-223 HOT							
CVHIX	1	.99081	.98934	.98882	.98819	.98692	.98637
CDMIX	2	.97250	.97847	.97982	.98062	.98241	.98446
PTHPA	3	2.0052	2.1996	2.2896	2.3631	2.4488	2.5375
PTFPAM	4	2.0678	2.2641	2.3549	2.4253	2.5087	2.5968
PTEPAM	5	1.7966	2.0058	2.1034	2.1995	2.3028	2.4034
PRAT	6	1.1509	1.1287	1.1196	1.1027	1.0894	1.0805
MIXP	7	.54337E-02	.87514E-02	.10438E-01	.12060E-01	.13927E-01	.15766E-01
FG (3)	8	707.84	826.24	880.47	924.60	977.15	1032.0
MNFAN	9	.50640	.49284	.48690	.47614	.46786	.46255
MNPRI	10	.22524	.25735	.26946	.29137	.30855	.32063
PT7PAM	11	2.0874	2.2845	2.3757	2.4458	2.5293	2.6177
PT8PAM	12	1.8026	2.0144	2.1133	2.2115	2.3168	2.4192
TT7	13	514.50	519.79	516.86	522.72	519.70	525.59
TT8	14	1186.2	1218.2	1238.5	1253.6	1275.4	1324.4
TRAT	15	2.3055	2.3436	2.3963	2.3983	2.4541	2.5198
PAM	16	14.257	14.257	14.257	14.257	14.257	14.257
BPR	17	9.2807	8.0155	7.6369	6.9121	6.5372	6.3020

E3 MIXER NO. 8 CONF 19,RUNS 224-229 COLD							
CVHIX	1	.98991	.98979	.98990	.98922	.99069	.99016
CDMIX	2	.94297	.94984	.95149	.95313	.95329	.95635
PTHPA	3	1.9905	2.1840	2.2895	2.3872	2.4849	2.5805
PTFPAM	4	1.9892	2.1822	2.2872	2.3839	2.4817	2.5761
PTEPAM	5	1.9944	2.1894	2.2963	2.3971	2.4944	2.5935
PRAT	6	.99737	.99671	.99601	.99450	.99490	.99330
MIXP	7	.26039E-04	.17003E-04	.13194E-04	.69888E-05	.65792E-05	.11454E-04
FG (3)	8	675.06	789.70	851.18	908.26	964.80	1023.1
MNFAN	9	.50387	.50886	.50988	.51059	.51088	.51267
MNPRI	10	.50780	.51371	.51572	.51865	.51831	.52244
PT7PAM	11	2.0014	2.1958	2.3015	2.3989	2.4974	2.5925
PT8PAM	12	2.0077	2.2043	2.3121	2.4137	2.5114	2.6115
TT7	13	501.93	504.00	506.28	509.46	512.67	516.19
TT8	14	507.48	509.32	511.42	512.47	512.67	519.91
TRAT	15	1.0111	1.0106	1.0102	1.0059	1.0000	1.0072
PAM	16	14.195	14.195	14.195	14.190	14.195	14.195
BPR	17	2.9939	2.9877	2.9781	2.9596	2.9731	2.9669

E3 MIXER NO. 8 CONF 19,RUNS 230-235 HOT							
CVHIX	1	.98529	.98505	.98408	.98452	.98247	.98242
CDMIX	2	.94481	.95431	.95780	.95962	.96302	.96617
PTHPA	3	2.0075	2.2025	2.2895	2.3652	2.4497	2.5408
PTFPAM	4	2.0762	2.2732	2.3611	2.4334	2.5160	2.6097
PTEPAM	5	1.8014	2.0106	2.1012	2.2000	2.3026	2.3982
PRAT	6	1.1525	1.1306	1.1237	1.1061	1.0927	1.0882
MIXP	7	.73303E-02	.99106E-02	.11031E-01	.12188E-01	.13782E-01	.15256E-01
FG (3)	8	687.86	806.13	859.14	904.45	956.76	1013.1
MNFAN	9	.56232	.55594	.55362	.54595	.54058	.53955
MNPRI	10	.32779	.35935	.36866	.38895	.40499	.41167
PT7PAM	11	2.0913	2.2894	2.3779	2.4503	2.5332	2.6273
PT8PAM	12	1.8082	2.0197	2.1110	2.2114	2.3154	2.4124
TT7	13	524.57	530.10	526.65	531.73	528.82	533.54
TT8	14	1206.7	1241.9	1259.4	1271.3	1296.1	1342.3
TRAT	15	2.3003	2.3427	2.3913	2.3908	2.4510	2.5158
PAM	16	14.235	14.235	14.235	14.235	14.235	14.235
BPR	17	7.8082	7.0691	7.0025	6.4932	6.2654	6.1455

E3 MIXER NO. 1 CONF 21,RUNS 243-248 COLD							
CVMIX	1	.97741	.97949	.98012	.98098	.98089	.98121
CDMIX	2	.94004	.94656	.94815	.95012	.95072	.95106
PTMPA	3	1.9884	2.1833	2.2862	2.3827	2.4799	2.5770
PTFPAM	4	1.9967	2.1937	2.2968	2.3942	2.4911	2.5887
PTEPAM	5	1.9683	2.1577	2.2604	2.3542	2.4525	2.5483
PRAT	6	1.0144	1.0167	1.0161	1.0170	1.0157	1.0158
MIXP	7	-.42996E-04	-.62029E-04	-.48468E-04	-.54829E-04	-.43010E-04	-.44221E-04
FG (3)	8	675.71	791.12	851.27	908.37	964.98	1021.4
MNFAN	9	.40237	.40702	.40751	.40900	.40858	.40881
MNPRI	10	.37546	.37593	.37753	.37741	.37941	.37944
PT7PAM	11	2.0064	2.2046	2.3083	2.4063	2.5037	2.6017
PT8PAM	12	2.0043	2.1976	2.3027	2.3979	2.4988	2.5961
TT7	13	514.59	521.25	516.72	524.75	519.48	527.05
TT8	14	519.25	524.50	520.77	527.52	523.17	529.47
TRAT	15	1.0091	1.0062	1.0078	1.0053	1.0071	1.0046
PAM	16	14.279	14.279	14.279	14.279	14.279	14.279
BPR	17	2.5567	2.5691	2.5592	2.5765	2.5572	2.5615

E3 MIXER NO. 1 CONF 21,RUNS 249-254 HOT							
CVMIX	1	.98645	.98265	.97996	.97825	.97621	.97388
CDMIX	2	.95237	.96123	.96301	.96662	.96871	.97211
PTMPA	3	2.0206	2.2033	2.2936	2.3651	2.4544	2.5370
PTFPAM	4	2.0962	2.2806	2.3708	2.4396	2.5270	2.6095
PTEPAM	5	1.7954	1.9950	2.0953	2.1866	2.2887	2.3814
PRAT	6	1.1675	1.1432	1.1315	1.1157	1.1041	1.0958
MIXP	7	.34113E-02	.80220E-02	.10052E-01	.12064E-01	.13883E-01	.15954E-01
FG (3)	8	702.86	814.84	868.69	913.60	967.93	1020.0
MNFAN	9	.51114	.49328	.48420	.47305	.46426	.45893
MNPRI	10	.18561	.21885	.23311	.25411	.26824	.27983
PT7PAM	11	2.1111	2.2960	2.3864	2.4550	2.5426	2.6252
PT8PAM	12	1.8050	2.0095	2.1125	2.2077	2.3128	2.4088
TT7	13	524.84	530.14	527.36	532.57	530.36	534.33
TT8	14	1200.5	1244.3	1258.8	1278.2	1297.2	1344.2
TRAT	15	2.2874	2.3472	2.3870	2.4000	2.4460	2.5157
PAM	16	14.277	14.277	14.277	14.277	14.277	14.277
BPR	17	9.0787	7.6442	7.1473	6.4625	6.1661	5.9250

E3 MIXER NO. 1 CONF 22,RUNS 255-260 COLD							
CVMIX	1	.93767	.94598	.94768	.95082	.95196	.95396
CDMIX	2	.89110	.90081	.90178	.90399	.90397	.90505
PTMPA	3	1.9865	2.1840	2.2828	2.3806	2.4863	2.5830
PTFPAM	4	1.9937	2.1924	2.2916	2.3906	2.4954	2.5930
PTEPAM	5	1.9652	2.1592	2.2571	2.3512	2.4596	2.5535
PRAT	6	1.0145	1.0154	1.0153	1.0168	1.0146	1.0155
MIXP	7	-.54703E-04	-.44165E-04	-.46031E-04	-.56115E-04	-.40903E-04	-.40381E-04
FG (3)	8	638.21	751.80	806.18	861.45	919.19	973.39
MNFAN	9	.37745	.38257	.38304	.38489	.38369	.38468
MNPRI	10	.34829	.35210	.35282	.35179	.35498	.35419
PT7PAM	11	2.0034	2.2034	2.3030	2.4026	2.5079	2.6061
PT8PAM	12	2.0083	2.2069	2.3079	2.4033	2.5149	2.6103
TT7	13	522.05	526.79	523.51	528.64	525.28	530.32
TT8	14	524.33	528.19	525.48	529.36	527.00	530.55
TRAT	15	1.0044	1.0027	1.0038	1.0014	1.0033	1.0004
PAM	16	14.251	14.251	14.251	14.251	14.251	14.251
BPR	17	3.0553	3.0883	3.0590	3.0956	3.0658	3.0893

E3 MIXER NO. 1 CONF 22,RUNS 261-266 HOT							
CVMIX	1	.97609	.96893	.96767	.96287	.96138	.95828
CDMIX	2	.93345	.93552	.93715	.93349	.93583	.93502
PTMPA	3	2.0227	2.2082	2.2977	2.3761	2.4623	2.5478
PTFPAM	4	2.0916	2.2787	2.3687	2.4404	2.5290	2.6136
PTEPAM	5	1.7939	1.9923	2.0869	2.1937	2.2823	2.3788
PRAT	6	1.1660	1.1438	1.1350	1.1125	1.1081	1.0987
MIXP	7	.22785E-02	.64096E-02	.82535E-02	.10542E-01	.11997E-01	.13988E-01
FG (3)	8	690.58	796.46	848.39	889.30	940.37	988.08
MNFAN	9	.50231	.48310	.47564	.45460	.45222	.44392
MNPRI	10	.16618	.19320	.20398	.22767	.23578	.24673
PT7PAM	11	2.1067	2.2942	2.3845	2.4559	2.5448	2.6295
PT8PAM	12	1.8071	2.0115	2.1088	2.2200	2.3124	2.4125
TT7	13	515.34	522.58	517.70	525.19	520.72	528.11
TT8	14	1175.5	1219.1	1236.5	1257.6	1273.6	1327.2
TRAT	15	2.2810	2.3328	2.3885	2.3945	2.4458	2.5132
PAM	16	14.288	14.288	14.288	14.288	14.288	14.288
BPR	17	10.457	8.9561	8.5772	7.7498	7.4127	7.1363

E3 MIXER NO. 3 CONF 23,RUNS 267-272 COLD

CVMIX	1	.98653	.98793	.98784	.98821	.98800	.98869
COMIX	2	.94371	.95100	.95327	.95384	.95518	.95737
PTMPA	3	1.9903	2.1941	2.2927	2.3927	2.4895	2.5873
PTFPAM	4	1.9964	2.2017	2.2997	2.4001	2.4961	2.5949
PTEPAM	5	1.9696	2.1684	2.2687	2.3675	2.4668	2.5612
PRAT	6	1.0136	1.0153	1.0137	1.0138	1.0119	1.0132
MIXP	7	.65271E-05	.43058E-05	.85981E-06	.26845E-05	.98541E-05	.52409E-05
FG (3)	8	673.28	793.81	851.84	909.44	966.25	1024.8
MNFAN	9	.52127	.52759	.52881	.52929	.52971	.53191
MNPRI	10	.50144	.50548	.50907	.50952	.51267	.51306
PT7PAM	11	2.0106	2.2177	2.3166	2.4177	2.5145	2.6141
PT8PAM	12	1.9986	2.2007	2.3025	2.4028	2.5039	2.6000
TT7	13	520.63	525.55	522.45	527.58	524.31	529.92
TT8	14	527.17	531.50	528.82	533.52	531.56	537.39
TRAT	15	1.0126	1.0113	1.0122	1.0113	1.0138	1.0141
PAM	16	14.150	14.150	14.150	14.150	14.150	14.150
BPR	17	3.4924	3.5062	3.5108	3.5082	3.5003	3.4997

E3 MIXER NO. 3 CONF 23,RUNS 273-278 HOT

CVMIX	1	.98745	.98684	.98551	.98486	.98394	.98248
COMIX	2	.94832	.95598	.95804	.96032	.96266	.96512
PTMPA	3	2.0205	2.2081	2.3014	2.3739	2.4647	2.5482
PTFPAM	4	2.0865	2.2780	2.3722	2.4427	2.5340	2.6184
PTEPAM	5	1.7931	1.9869	2.0896	2.1814	2.2814	2.3771
PRAT	6	1.1636	1.1466	1.1352	1.1198	1.1107	1.1015
MIXP	7	.59396E-02	.82606E-02	.96772E-02	.10808E-01	.12029E-01	.13637E-01
FG (3)	8	694.04	806.47	861.58	905.29	960.00	1010.9
MNFAN	9	.57564	.57140	.56668	.56060	.55713	.55376
MNPRI	10	.32841	.35396	.36733	.38568	.39681	.40805
PT7PAM	11	2.1040	2.2968	2.3914	2.4620	2.5539	2.6386
PT8PAM	12	1.8073	2.0051	2.1103	2.2050	2.3074	2.4062
TT7	13	514.19	522.66	517.19	525.43	520.09	528.45
TT8	14	1169.0	1218.7	1233.2	1258.8	1272.9	1327.4
TRAT	15	2.2735	2.3317	2.3845	2.3958	2.4475	2.5119
PAM	16	14.159	14.159	14.159	14.159	14.159	14.159
BPR	17	8.9278	8.2697	7.9434	7.4913	7.3087	7.0508

E3 MIXER NO. 3 CONF 24,RUNS 279-284 COLD

CVMIX	1	.97589	.97783	.97871	.97901	.98004	.98039
COMIX	2	.93110	.93725	.93931	.94081	.94210	.94410
PTMPA	3	1.9901	2.1889	2.2868	2.3861	2.4841	2.5887
PTFPAM	4	1.9979	2.1991	2.2963	2.3969	2.4947	2.5989
PTEPAM	5	1.9624	2.1526	2.2533	2.3479	2.4463	2.5522
PRAT	6	1.0181	1.0216	1.0191	1.0209	1.0198	1.0183
MIXP	7	-.25462E-04	-.35848E-04	-.13192E-04	-.23321E-04	-.18576E-04	-.12359E-04
FG (3)	8	661.59	776.38	832.82	889.85	946.27	1007.5
MNFAN	9	.51293	.51886	.51956	.52137	.52196	.52301
MNPRI	10	.48603	.48700	.49156	.49067	.49298	.49632
PT7PAM	11	2.0121	2.2150	2.3129	2.4143	2.5129	2.6179
PT8PAM	12	2.0043	2.1987	2.3022	2.3987	2.4995	2.6080
TT7	13	510.80	517.21	512.85	519.97	514.94	522.98
TT8	14	517.72	523.63	519.36	525.86	521.61	528.94
TRAT	15	1.0135	1.0124	1.0127	1.0113	1.0130	1.0114
PAM	16	14.095	14.095	14.095	14.095	14.095	14.095
BPR	17	3.6830	3.7170	3.6885	3.7063	3.7034	3.6924

E3 MIXER NO. 3 CONF 24,RUNS 285-290 HOT

CVMIX	1	.98249	.98143	.98091	.98013	.97907	.97666
COMIX	2	.94148	.94770	.95052	.95153	.95248	.95400
PTMPA	3	2.0263	2.2158	2.3055	2.3783	2.4657	2.5494
PTFPAM	4	2.0930	2.2859	2.3780	2.4481	2.5349	2.6183
PTEPAM	5	1.7871	1.9839	2.0736	2.1703	2.2701	2.3717
PRAT	6	1.1712	1.1522	1.1468	1.1280	1.1166	1.1040
MIXP	7	.55464E-02	.78727E-02	.90104E-02	.10264E-01	.11399E-01	.13255E-01
FG (3)	8	690.11	801.29	854.45	896.72	947.40	996.82
MNFAN	9	.57502	.56852	.56700	.55828	.55295	.54698
MNPRI	10	.31248	.33881	.34675	.36792	.38057	.39469
PT7PAM	11	2.1105	2.3046	2.3974	2.4676	2.5547	2.6383
PT8PAM	12	1.8073	2.0099	2.1020	2.2033	2.3068	2.4130
TT7	13	526.05	530.65	528.17	533.04	530.71	535.06
TT8	14	1200.9	1238.7	1261.9	1276.7	1289.7	1342.5
TRAT	15	2.2828	2.3344	2.3893	2.3951	2.4301	2.5090
PAM	16	14.115	14.115	14.115	14.115	14.115	14.115
BPR	17	9.4637	8.7140	8.5765	7.9619	7.6840	7.3908

E3 MIXER NO. 2 CONF 25,RUNS 291-296 COLD

CVHIX	1	.98372	.98540	.98540	.98639	.98574	.98582
CDMIX	2	.93914	.94585	.94802	.94946	.95028	.95056
PTMPA	3	1.9882	2.1865	2.2816	2.3784	2.4824	2.5788
PTFPAM	4	1.9887	2.1869	2.2820	2.3784	2.4832	2.5797
PTEPAM	5	1.9868	2.1851	2.2803	2.3780	2.4800	2.5758
PRAT	6	1.0009	1.0008	1.0007	1.0002	1.0013	1.0015
MIXP	7	.21534E-04	.19871E-04	.11705E-04	.15787E-04	.95293E-05	.16356E-04
FG (3)	8	680.24	798.61	855.16	912.40	973.55	1029.9
MNFAN	9	.51118	.51641	.51805	.51898	.52003	.52034
MNPRI	10	.50981	.51508	.51694	.51870	.51812	.51814
PT7PAM	11	2.0040	2.2042	2.3000	2.3973	2.5030	2.6002
PT8PAM	12	2.0019	2.2021	2.2980	2.3966	2.4995	2.5961
TT7	13	512.76	518.86	514.41	520.90	516.28	523.25
TT8	14	517.38	522.68	518.50	524.42	520.53	526.89
TRAT	15	1.0090	1.0074	1.0080	1.0068	1.0082	1.0070
PAM	16	14.391	14.391	14.391	14.391	14.391	14.391
BPR	17	2.9594	2.9564	2.9663	2.9537	2.9556	2.9536

E3 MIXER NO. 2 CONF 25,RUNS 297-302 HOT

CVHIX	1	.98503	.98407	.98434	.98317	.98291	.98300
CDMIX	2	.94323	.95135	.95476	.95725	.95877	.96324
PTMPA	3	2.0026	2.1874	2.2812	2.3579	2.4392	2.5253
PTFPAM	4	2.0764	2.2634	2.3585	2.4299	2.5100	2.5955
PTEPAM	5	1.7954	1.9928	2.0911	2.1959	2.2886	2.3884
PRAT	6	1.1565	1.1358	1.1279	1.1065	1.0967	1.0867
MIXP	7	.73108E-02	.99143E-02	.11322E-01	.12785E-01	.13941E-01	.15647E-01
FG (3)	8	691.90	804.25	861.56	908.43	957.50	1012.6
MNFAN	9	.57279	.56593	.56294	.55326	.54849	.54524
MNPRI	10	.33718	.36504	.37482	.39821	.40846	.42135
PT7PAM	11	2.0950	2.2832	2.3790	2.4505	2.5311	2.6172
PT8PAM	12	1.8040	2.0040	2.1033	2.2103	2.3040	2.4054
TT7	13	508.16	516.13	511.17	520.11	513.83	523.64
TT8	14	1163.3	1207.9	1227.4	1253.4	1261.9	1322.0
TRAT	15	2.2892	2.3402	2.4011	2.4098	2.4560	2.5246
PAM	16	14.401	14.401	14.401	14.401	14.401	14.401
BPR	17	7.2580	6.6671	6.5794	6.1025	6.0024	5.8736

E3 MIXER NO. 2 CONF 26,RUNS 303-308 COLD

CVHIX	1	.98473	.98571	.98585	.98618	.98612	.98712
CDMIX	2	.94114	.94732	.95010	.95067	.95264	.95274
PTMPA	3	1.9881	2.1892	2.2832	2.3824	2.4825	2.5795
PTFPAM	4	1.9890	2.1895	2.2838	2.3824	2.4823	2.5808
PTEPAM	5	1.9850	2.1881	2.2811	2.3824	2.4830	2.5755
PRAT	6	1.0020	1.0007	1.0012	1.0000	.99972	1.0021
MIXP	7	.25793E-04	.22852E-04	.19069E-04	.22928E-04	.26013E-04	.30975E-04
FG (3)	8	681.50	801.25	857.81	915.76	976.06	1032.5
MNFAN	9	.52394	.52846	.53092	.53096	.53264	.53342
MNPRI	10	.52107	.52753	.52926	.53098	.53307	.53051
PT7PAM	11	2.0043	2.2065	2.3018	2.4011	2.5019	2.6013
PT8PAM	12	2.0008	2.2059	2.2997	2.4018	2.5033	2.5964
TT7	13	524.84	530.23	526.57	532.66	529.04	536.01
TT8	14	538.01	543.85	539.14	546.62	543.38	552.95
TRAT	15	1.0251	1.0257	1.0239	1.0262	1.0271	1.0316
PAM	16	14.389	14.389	14.389	14.389	14.389	14.389
BPR	17	2.9263	2.9127	2.9255	2.9204	2.9241	2.9466

E3 MIXER NO. 2 CONF 26,RUNS 309-314 HOT

CVHIX	1	.98460	.98394	.98355	.98373	.98316	.98290
CDMIX	2	.94258	.95187	.95437	.95626	.95937	.96257
PTMPA	3	2.0009	2.1860	2.2805	2.3560	2.4372	2.5276
PTFPAM	4	2.0779	2.2655	2.3620	2.4307	2.5109	2.6013
PTEPAM	5	1.7918	1.9878	2.0848	2.1906	2.2869	2.3889
PRAT	6	1.1597	1.1397	1.1330	1.1096	1.0980	1.0889
MIXP	7	.75554E-02	.10012E-01	.11481E-01	.12741E-01	.14275E-01	.15852E-01
FG (3)	8	690.25	803.68	860.54	906.14	956.61	1013.0
MNFAN	9	.58304	.57761	.57463	.56353	.55896	.55544
MNPRI	10	.34837	.37599	.38347	.40740	.42068	.43116
PT7PAM	11	2.0961	2.2850	2.3823	2.4510	2.5316	2.6226
PT8PAM	12	1.8009	1.9996	2.0975	2.2052	2.3031	2.4066
TT7	13	525.64	528.97	527.52	531.62	529.72	533.81
TT8	14	1204.1	1236.2	1268.0	1278.2	1303.8	1349.3
TRAT	15	2.2906	2.3370	2.4037	2.4043	2.4612	2.5277
PAM	16	14.398	14.398	14.398	14.398	14.398	14.398
BPR	17	7.0333	6.5050	6.4589	6.0321	5.8383	5.7474

E3 MIXER NO. 3 CONF 27,RUNS 315-320 COLD

CVMIX	1	.98838	.98936	.98926	.98953	.99029	.98960
CDMIX	2	.94553	.95197	.95372	.95513	.95719	.95675
PTMPA	3	2.0001	2.1987	2.2963	2.3965	2.4996	2.5988
PTFPAM	4	2.0031	2.2025	2.2998	2.3999	2.5028	2.6029
PTEPAM	5	1.9897	2.1856	2.2842	2.3850	2.4886	2.5846
PRAT	6	1.0067	1.0077	1.0068	1.0062	1.0057	1.0071
MIXP	7	.26883E-04	.22016E-04	.23684E-04	.22965E-04	.23274E-04	.20101E-04
FG (3)	8	681.12	798.44	855.58	914.26	975.55	1032.4
MNFAN	9	.52037	.52578	.52685	.52778	.52924	.52936
MNPRI	10	.51049	.51465	.51709	.51887	.52113	.51922
PT7PAM	11	2.0174	2.2185	2.3165	2.4174	2.5212	2.6221
PT8PAM	12	2.0047	2.2022	2.3017	2.4033	2.5078	2.6044
TT7	13	532.75	536.09	534.42	537.50	535.83	539.00
TT8	14	544.84	548.92	547.48	551.06	552.56	556.52
TRAT	15	1.0227	1.0239	1.0244	1.0252	1.0312	1.0325
PAM	16	14.172	14.172	14.172	14.172	14.172	14.172
BPR	17	3.4584	3.4653	3.4646	3.4639	3.4741	3.4844

E3 MIXER NO. 3 CONF 27,RUNS 315.2-318.1-320.1 COLD

CVMIX	1	.98944	.99020	.99109			
CDMIX	2	.94712	.95732	.95852			
PTMPA	3	1.9995	2.3948	2.5944			
PTFPAM	4	2.0022	2.3973	2.5967			
PTEPAM	5	1.9903	2.3860	2.5863			
PRAT	6	1.0060	1.0047	1.0040			
MIXP	7	.20618E-04	.12174E-04	.27913E-04			
FG (3)	8	686.77	922.47	1040.8			
MNFAN	9	.52132	.52902	.52975			
MNPRI	10	.51267	.52227	.52404			
PT7PAM	11	2.0165	2.4149	2.6159			
PT8PAM	12	2.0053	2.4044	2.6061			
TT7	13	519.30	520.10	540.23			
TT8	14	525.49	527.90	560.04			
TRAT	15	1.0119	1.0150	1.0367			
PAM	16	14.272	14.282	14.297			
BPR	17	3.4384	3.4451	3.4940			

E3 MIXER NO. 3 CONF 27,RUNS 318.2-319.4-320.2 COLD

CVMIX	1	.99084	.99068	.99056			
CDMIX	2	.95660	.95823	.95893			
PTMPA	3	2.3977	2.4929	2.5934			
PTFPAM	4	2.4004	2.4956	2.5964			
PTEPAM	5	2.3885	2.4838	2.5829			
PRAT	6	1.0050	1.0047	1.0052			
MIXP	7	.11111E-04	.14205E-04	.19974E-04			
FG (3)	8	922.83	979.68	1038.9			
MNFAN	9	.52854	.52976	.53051			
MNPRI	10	.52140	.52298	.52303			
PT7PAM	11	2.4180	2.5140	2.6156			
PT8PAM	12	2.4068	2.5028	2.6030			
TT7	13	526.43	523.16	528.95			
TT8	14	532.08	529.15	535.32			
TRAT	15	1.0107	1.0114	1.0120			
PAM	16	14.272	14.272	14.272			
BPR	17	3.4437	3.4528	3.4320			

E3 MIXER NO. 3 CONF 27,RUNS 321-326 HOT

CVMIX	1	.98739	.98607	.98573	.98554	.98339	.98234
CDMIX	2	.94623	.95490	.95760	.96010	.96255	.96543
PTMPA	3	2.0228	2.2121	2.3093	2.3758	2.4679	2.5516
PTFPAM	4	2.0886	2.2815	2.3810	2.4431	2.5371	2.6208
PTEPAM	5	1.7995	1.9988	2.0967	2.1928	2.2896	2.3881
PRAT	6	1.1607	1.1414	1.1356	1.1142	1.1081	1.0974
MIXP	7	.63577E-02	.87901E-02	.99332E-02	.11174E-01	.12520E-01	.14015E-01
FG (3)	8	694.33	808.41	866.36	906.85	962.39	1013.9
MNFAN	9	.57282	.56824	.56645	.55777	.55571	.55189
MNPRI	10	.32958	.35865	.36663	.39169	.39948	.41258
PT7PAM	11	2.1059	2.2999	2.4001	2.4622	2.5568	2.6408
PT8PAM	12	1.8073	2.0092	2.1080	2.2061	2.3042	2.4044
TT7	13	532.37	535.48	534.03	536.99	535.82	538.59
TT8	14	1216.3	1253.5	1277.8	1285.7	1318.4	1356.2
TRAT	15	2.2847	2.3408	2.3927	2.3943	2.4605	2.5180
PAM	16	14.170	14.170	14.170	14.170	14.170	14.170
BPR	17	8.8300	8.0538	7.9427	7.3106	7.1966	6.9474

E3 MIXER NO. 3 CONF 27,RUNS 321.1-324.1-326.1 HOT

CVMIX	1	.98809	.98670	.98470
CDMIX	2	.94836	.96178	.96651
PTMPA	3	2.0215	2.3789	2.5463
PTFPAM	4	2.0877	2.4462	2.6120
PTEPAM	5	1.7909	2.1914	2.3895
PRAT	6	1.1657	1.1163	1.0931
MIXP	7	.61029E-02	.10975E-01	.13547E-01
FG (3)	8	701.63	918.85	1021.5
MNFAN	9	.57617	.55957	.55094
MNPRI	10	.32551	.39056	.41840
PT7PAM	11	2.1053	2.4657	2.6321
PT8PAM	12	1.7983	2.2043	2.4056
TT7	13	538.74	537.73	541.49
TT8	14	1234.5	1287.5	1343.3
TRAT	15	2.2915	2.3943	2.4808
PAM	16	14.302	14.304	14.304
BPR	17	9.1467	7.4792	6.9285

E3 MIXER NO. 3 CONF 27,RUNS 324.2-325.2-326.2 HOT

CVMIX	1	.98636	.98541	.98386
CDMIX	2	.96117	.96373	.96628
PTMPA	3	2.3757	2.4621	2.5506
PTFPAM	4	2.4435	2.5287	2.6188
PTEPAM	5	2.1845	2.2895	2.3862
PRAT	6	1.1185	1.1045	1.0975
MIXP	7	.10807E-01	.12405E-01	.13777E-01
FG (3)	8	913.50	966.27	1020.6
MNFAN	9	.56021	.55462	.55236
MNPRI	10	.38767	.40393	.41304
PT7PAM	11	2.4630	2.5486	2.6390
PT8PAM	12	2.1972	2.3038	2.4020
TT7	13	532.14	528.22	535.70
TT8	14	1273.7	1297.5	1346.6
TRAT	15	2.3935	2.4563	2.5137
PAM	16	14.259	14.259	14.259
BPR	17	7.5435	7.2411	7.0580

E3 MIXER NO. 6 CONF 28,RUNS 327-329 COLD

CVMIX	1	.98935	.98935	.98912
CDMIX	2	.98107	.98156	.98178
PTMPA	3	2.3898	2.4964	2.5948
PTFPAM	4	2.3952	2.5023	2.6011
PTEPAM	5	2.3745	2.4797	2.5770
PRAT	6	1.0087	1.0091	1.0094
MIXP	7	.94048E-05	.10520E-04	.60090E-05
FG (3)	8	934.52	997.90	1056.4
MNFAN	9	.54903	.54961	.54990
MNPRI	10	.53695	.53692	.53689
PT7PAM	11	2.4141	2.5221	2.6216
PT8PAM	12	2.4042	2.5108	2.6096
TT7	13	524.49	527.05	529.48
TT8	14	526.56	528.42	530.34
TRAT	15	1.0039	1.0026	1.0016
PAM	16	14.167	14.167	14.167
BPR	17	2.8533	2.8545	2.8373

E3 MIXER NO. 6 CONF 28,RUNS 327.1-328.1-329.1 COLD

CVMIX	1	.98960	.98951	.98985
CDMIX	2	.98209	.98178	.98261
PTMPA	3	2.3929	2.4885	2.5852
PTFPAM	4	2.3986	2.4950	2.5928
PTEPAM	5	2.3765	2.4698	2.5635
PRAT	6	1.0093	1.0102	1.0114
MIXP	7	.24502E-04	.19225E-04	.15404E-04
FG (3)	8	946.57	1003.2	1061.9
MNFAN	9	.55008	.55018	.55131
MNPRI	10	.53723	.53598	.53554
PT7PAM	11	2.4177	2.5149	2.6134
PT8PAM	12	2.4058	2.5002	2.5952
TT7	13	532.17	534.24	535.87
TT8	14	543.08	546.85	552.63
TRAT	15	1.0205	1.0236	1.0313
PAM	16	14.307	14.307	14.307
BPR	17	2.9047	2.9166	2.9241

E3 MIXER NO. 6 CONF 28,RUNS 330-332 HOT

CVMIX	1	.98600	.98635	.98624
CDMIX	2	.98315	.98578	.99036
PTMPA	3	2.3629	2.4487	2.5293
PTFPAM	4	2.4436	2.5312	2.6106
PTEPAM	5	2.1859	2.2759	2.3754
PRAT	6	1.1179	1.1121	1.0990
MIXP	7	.12497E-01	.13757E-01	.15679E-01
FG (3)	8	921.10	974.32	1026.9
MNFAN	9	.57799	.57590	.57117
MNPRI	10	.41361	.42037	.43548
PT7PAM	11	2.4640	2.5522	2.6319
PT8PAM	12	2.2080	2.2997	2.4019
TT7	13	530.58	532.47	534.03
TT8	14	1272.9	1307.7	1352.4
TRAT	15	2.3991	2.4559	2.5324
PAM	16	14.176	14.176	14.176
BPR	17	5.9696	5.9155	5.7283

E3 MIXER NO. 6 CONF 28,RUNS 330.1-331.1-332.1 HOT

CVMIX	1	.98780	.98713	.98694
CDMIX	2	.98694	.98795	.99096
PTMPA	3	2.3606	2.4435	2.5266
PTFPAM	4	2.4403	2.5224	2.6045
PTEPAM	5	2.1836	2.2802	2.3801
PRAT	6	1.1175	1.1062	1.0943
MIXP	7	.12315E-01	.13880E-01	.15504E-01
FG (3)	8	932.35	982.93	1035.9
MNFAN	9	.58012	.57411	.56941
MNPRI	10	.41712	.42746	.44051
PT7PAM	11	2.4611	2.5435	2.6259
PT8PAM	12	2.2054	2.3039	2.4066
TT7	13	527.85	530.64	533.35
TT8	14	1265.1	1304.6	1342.2
TRAT	15	2.3967	2.4584	2.5165
PAM	16	14.315	14.315	14.315
BPR	17	6.0423	5.9096	5.7038

E3 MIXER NO. 6 CONF 29,RUNS 333-338,COLD

CVMIX	1	.99000	.99246	.99262	.99192	.99267	.99224
CDMIX	2	.94227	.94644	.94795	.94944	.95304	.95225
PTMPA	3	1.9965	2.1900	2.2944	2.3949	2.4866	2.5867
PTFPAM	4	1.9970	2.1932	2.2969	2.3978	2.4895	2.5898
PTEPAM	5	1.9947	2.1805	2.2867	2.3862	2.4778	2.5774
PRAT	6	1.0012	1.0058	1.0044	1.0048	1.0047	1.0048
MIXP	7	.16120E-04	.16287E-04	.13415E-04	.74766E-05	.22132E-04	.15677E-04
FG (3)	8	681.54	794.48	855.33	914.32	970.74	1027.8
MNFAN	9	.48512	.48989	.49041	.49163	.49412	.49362
MNPRI	10	.48331	.48094	.48361	.48423	.48698	.48629
PT7PAM	11	2.0091	2.2067	2.3110	2.4126	2.5051	2.6060
PT8PAM	12	2.0091	2.1961	2.3033	2.4035	2.4960	2.5961
TT7	13	516.77	521.56	518.68	524.35	520.37	527.36
TT8	14	523.80	528.30	525.54	530.89	528.37	535.06
TRAT	15	1.0136	1.0129	1.0132	1.0125	1.0154	1.0146
PAM	16	14.275	14.275	14.275	14.275	14.275	14.275
BPR	17	2.9717	3.0072	2.9928	3.0026	3.0058	3.0080

E3 MIXER NO. 6 CONF 29,RUNS 339-344,HOT

CVMIX	1	.98992	.99025	.98862	.98904	.98685	.98562
CDMIX	2	.94061	.94960	.95191	.95187	.95591	.95691
PTMPA	3	2.0116	2.2072	2.2942	2.3689	2.4539	2.5456
PTFPAM	4	2.0834	2.2821	2.3706	2.4414	2.5251	2.6174
PTEPAM	5	1.7940	1.9998	2.0906	2.1879	2.2880	2.3897
PRAT	6	1.1614	1.1412	1.1339	1.1159	1.1036	1.0953
MIXP	7	.64812E-02	.93142E-02	.10720E-01	.12024E-01	.13632E-01	.15256E-01
FG (3)	8	688.74	806.74	858.54	901.39	954.36	1008.5
MNFAN	9	.55249	.54486	.54133	.53093	.52576	.52106
MNPRI	10	.29204	.32134	.33038	.34941	.36511	.37423
PT7PAM	11	2.0985	2.2982	2.3872	2.4580	2.5420	2.6345
PT8PAM	12	1.8007	2.0068	2.1006	2.1994	2.3010	2.4040
TT7	13	523.43	528.45	526.03	530.77	528.37	533.82
TT8	14	1199.1	1237.3	1261.1	1273.5	1297.2	1343.5
TRAT	15	2.2908	2.3415	2.3974	2.3994	2.4550	2.5168
PAM	16	14.272	14.272	14.272	14.272	14.272	14.272
BPR	17	8.0429	7.2805	7.1168	6.6329	6.3831	6.2135

E3 MIXER NO. 5 CONF 30,RUNS 345-347 COLD

CVMIX	1	.99112	.99123	.99097
CDMIX	2	.95387	.95538	.95540
PTMPA	3	2.3892	2.4866	2.5917
PTFPAM	4	2.3952	2.4926	2.6006
PTEPAM	5	2.3730	2.4706	2.5679
FRAT	6	1.0094	1.0089	1.0127
MIXP	7	.53775E-05	.12139E-04	.19752E-04
FG (3)	8	908.01	965.41	1025.9
MNFAN	9	.52735	.52840	.52998
MNPRI	10	.51402	.51565	.51171
PT7PAM	11	2.4114	2.5095	2.6183
PT8PAM	12	2.4001	2.4989	2.5971
TT7	13	528.47	531.51	534.86
TT8	14	540.31	543.75	550.24
TRAT	15	1.0224	1.0230	1.0288
PAM	16	14.162	14.162	14.162
BPR	17	2.7245	2.7263	2.7545

E3 MIXER NO. 5 CONF 30,RUNS 348-350 HOT

CVMIX	1	.98617	.98569	.98424
CDMIX	2	.95771	.96007	.96373
PTMPA	3	2.3578	2.4460	2.5313
PTFPAM	4	2.4376	2.5282	2.6141
PTEPAM	5	2.1867	2.2770	2.3760
PRAT	6	1.1148	1.1103	1.1002
MIXP	7	.12874E-01	.14152E-01	.15999E-01
FG (3)	8	893.38	946.34	999.39
MNFAN	9	.56059	.55889	.55497
MNPRI	10	.39460	.40004	.41217
PT7PAM	11	2.4555	2.5466	2.6328
PT8PAM	12	2.2062	2.2980	2.3997
TT7	13	530.27	533.48	535.02
TT8	14	1270.2	1308.1	1348.1
TRAT	15	2.3954	2.4520	2.5196
PAM	16	14.160	14.160	14.160
BPR	17	5.7661	5.7223	5.5120

E3 MIXER NO. 1 CONF 1 ,RUNS 1-5,COLD

CVMIX	1	.99347	.99267	.99375	.99317	.99316
CDMIX	2	.96594	.96793	.96927	.97112	.97062
PTMPA	3	2.1803	2.2691	2.3907	2.4818	2.5787
PTFPAM	4	2.1749	2.2629	2.3878	2.4779	2.5758
PTEPAM	5	2.1926	2.2834	2.3975	2.4907	2.5855
PRAT	6	.99193	.99103	.99595	.99485	.99622
MIXP	7	-.10941E-04	-.91203E-05	-.15771E-05	-.34735E-05	.10558E-04
FG (3)	8	803.35	856.61	928.80	984.01	1040.5
MNFAN	9	.40339	.40400	.40731	.40773	.40817
MNPRI	10	.41796	.42012	.41459	.41686	.41493
PT7PAM	11	2.1855	2.2740	2.3997	2.4903	2.5887
PT8PAM	12	2.2087	2.3000	2.4145	2.5086	2.6041
TT7	13	520.24	517.27	522.44	519.72	523.95
TT8	14	521.13	518.59	522.43	520.50	522.79
TRAT	15	1.0017	1.0026	.99998	1.0015	.99779
PAM	16	14.239	14.239	14.239	14.239	14.239
BPR	17	2.2627	2.2759	2.3229	2.3139	2.3090

E3 MIXER NO. 1 CONF 1 ,RUNS 77-79,COLD

CVMIX	1	.99410	.99407	.99447
CDMIX	2	.96906	.97018	.97167
PTMPA	3	2.3857	2.4760	2.5699
PTFPAM	4	2.3851	2.4757	2.5684
PTEPAM	5	2.3871	2.4768	2.5734
PRAT	6	.99914	.99954	.99805
MIXP	7	.99988E-05	.77073E-05	.79904E-05
FG (3)	8	927.85	981.97	1038.8
MNFAN	9	.40888	.40969	.40968
MNPRI	10	.41043	.41051	.41316
PT7PAM	11	2.3970	2.4881	2.5813
PT8PAM	12	2.4040	2.4944	2.5918
TT7	13	510.19	513.54	517.43
TT8	14	512.99	515.78	518.86
TRAT	15	1.0055	1.0044	1.0028
PAM	16	14.272	14.272	14.272
BPR	17	2.3376	2.3366	2.3272

E3 MIXER NO. 1 CONF 1 ,RUNS 83-85,COLD

CVMIX	1	.99465	.99447	.99529
CDMIX	2	.96728	.96856	.97120
PTMPA	3	2.3964	2.4835	2.5814
PTFPAM	4	2.3957	2.4846	2.5794
PTEPAM	5	2.3980	2.4807	2.5859
PRAT	6	.99902	1.0016	.99748
MIXP	7	.19375E-04	.30158E-05	.92348E-05
FG (3)	8	919.85	971.44	1031.0
MNFAN	9	.40785	.40996	.40913
MNPRI	10	.40978	.40707	.41367
PT7PAM	11	2.4077	2.4972	2.5923
PT8PAM	12	2.4148	2.4979	2.6044
TT7	13	521.25	523.83	525.83
TT8	14	527.20	529.44	532.13
TRAT	15	1.0114	1.0107	1.0120
PAM	16	14.080	14.080	14.080
BPR	17	2.3559	2.3736	2.3354

E3 MIXER NO. 1 CONF 1 ,RUNS 202-206,COLD

CVMIX	1	.99460	.99524	.99421	.99470	.99491
CDMIX	2	.96639	.96854	.96919	.97083	.97203
PTMPA	3	2.1780	2.2692	2.3892	2.4772	2.5795
PTFPAM	4	2.1770	2.2679	2.3899	2.4801	2.5835
PTEPAM	5	2.1802	2.2720	2.3874	2.4706	2.5702
PRAT	6	.99853	.99820	1.0010	1.0038	1.0051
MIXP	7	.15716E-04	.59409E-05	.19341E-04	.14831E-05	.46525E-06
FG (3)	8	807.78	862.99	934.11	987.67	1049.5
MNFAN	9	.40715	.40810	.41000	.41239	.41375
MNPRI	10	.40981	.41132	.40810	.40547	.40449
PT7PAM	11	2.1877	2.2790	2.4018	2.4925	2.5964
PT8PAM	12	2.1960	2.2888	2.4046	2.4883	2.5888
TT7	13	519.93	516.70	521.84	519.66	524.32
TT8	14	521.89	519.09	523.47	521.57	525.42
TRAT	15	1.0038	1.0046	1.0031	1.0037	1.0021
PAM	16	14.335	14.335	14.335	14.335	14.335
BPR	17	2.2924	2.2788	2.3193	2.3356	2.3359

E3 MIXER NO. 1 CONF 1 ,RUNS 6-10,HOT

CVMIX	1	.98763	.98577	.98531	.98269	.98179
CDMIX	2	.96850	.97214	.97599	.98064	.98471
PTMPA	3	2.1927	2.2838	2.3593	2.4410	2.5381
PTFPAM	4	2.2666	2.3561	2.4309	2.5093	2.6059
PTEPAM	5	1.9975	2.1018	2.1890	2.2907	2.4002
PRAT	6	1.1347	1.1210	1.1105	1.0954	1.0857
MIXP	7	.88656E-02	.10958E-01	.12415E-01	.14864E-01	.16873E-01
FG (3)	8	807.82	863.72	911.23	963.53	1025.0
MNFAN	9	.48846	.47831	.47188	.46181	.45625
MNPRI	10	.23266	.25013	.26544	.28573	.29967
PT7PAM	11	2.2819	2.3716	2.4465	2.5249	2.6217
PT8PAM	12	2.0028	2.1081	2.1964	2.2995	2.4105
TT7	13	529.50	530.06	530.83	530.81	531.97
TT8	14	1240.3	1262.6	1272.7	1307.6	1341.5
TRAT	15	2.3425	2.3821	2.3976	2.4634	2.5218
PAM	16	14.155	14.155	14.155	14.155	14.155
BPR	17	7.2651	6.8054	6.3446	5.9260	5.6236

E3 MIXER NO. 1 CONF 1 ,RUNS 80-82,HOT

CVMIX	1	.98415	.98238	.98156
CDMIX	2	.97603	.98109	.98474
PTMPA	3	2.3583	2.4376	2.5382
PTFPAM	4	2.4299	2.5057	2.6056
PTEPAM	5	2.1882	2.2891	2.3976
PRAT	6	1.1104	1.0946	1.0868
MIXP	7	.12418E-01	.14844E-01	.16036E-01
FG (3)	8	916.87	968.51	1032.1
MNFAN	9	.47185	.46174	.45717
MNPRI	10	.26562	.28722	.29849
PT7PAM	11	2.4454	2.5212	2.6216
PT8PAM	12	2.1956	2.2981	2.4075
TT7	13	526.14	529.31	531.89
TT8	14	1262.2	1299.7	1320.3
TRAT	15	2.3990	2.4555	2.4824
PAM	16	14.251	14.251	14.251
BPR	17	6.3355	5.8495	5.6684

E3 MIXER NO. 1 CONF 1 ,RUNS 86-88,HOT				
CVMIX	1	.98418	.98236	.98132
CDMIX	2	.97398	.97978	.98340
PTMPA	3	2.3668	2.4462	2.5462
PTFPAM	4	2.4393	2.5141	2.6141
PTEPAM	5	2.1908	2.2977	2.4079
PRAT	6	1.1134	1.0942	1.0856
MIXP	7	.12022E-01	.14874E-01	.16850E-01
FG (3)	8	908.45	960.19	1022.5
MNFAN	9	.47321	.46075	.45566
MNPRI	10	.26032	.28664	.29895
PT7PAM	11	2.4551	2.5297	2.6299
PT8PAM	12	2.1978	2.3065	2.4181
TT7	13	527.51	531.48	534.10
TT8	14	1263.0	1305.6	1345.0
TRAT	15	2.3943	2.4566	2.5183
PAM	16	14.073	14.073	14.073
BPR	17	6.5020	5.8795	5.6296

E3 MIXER NO. 1 CONF 1 ,RUNS 160-163.1,HOT					
CVMIX	1	.98608	.98531	.98355	.98155
CDMIX	2	.97273	.97545	.97983	.98475
PTMPA	3	2.2785	2.3599	2.4416	2.5356
PTFPAM	4	2.3514	2.4340	2.5115	2.6069
PTEPAM	5	2.0963	2.1806	2.2884	2.3873
PRAT	6	1.1217	1.1162	1.0975	1.0920
MIXP	7	.10986E-01	.11975E-01	.14664E-01	.16232E-01
FG (3)	8	865.73	915.91	968.22	1028.7
MNFAN	9	.47932	.47617	.46360	.46122
MNPRI	10	.25012	.25859	.28335	.29269
PT7PAM	11	2.3668	2.4498	2.5271	2.6228
PT8PAM	12	2.1026	2.1876	2.2973	2.3972
TT7	13	526.43	526.90	527.60	527.67
TT8	14	1256.7	1265.1	1295.0	1324.5
TRAT	15	2.3872	2.4009	2.4545	2.5101
PAM	16	14.230	14.230	14.230	14.225
BPR	17	6.7734	6.5196	5.8858	5.7232

E3 MIXER NO. 1 CONF 1 ,RUNS 207-211,HOT						
CVMIX	1	.98855	.98649	.98479	.98318	.98139
CDMIX	2	.97087	.97425	.97692	.98184	.98496
PTMPA	3	2.1923	2.2839	2.3606	2.4476	2.5441
PTFPAM	4	2.2660	2.3591	2.4329	2.5186	2.6151
PTEPAM	5	1.9981	2.0960	2.1902	2.2938	2.3985
PRAT	6	1.1341	1.1255	1.1108	1.0980	1.0903
MIXP	7	.88299E-02	.10586E-01	.12264E-01	.14587E-01	.16340E-01
FG (3)	8	821.35	878.23	926.09	982.71	1043.8
MNFAN	9	.48868	.48335	.47304	.46522	.46035
MNPRI	10	.23495	.24771	.26645	.28469	.29523
PT7PAM	11	2.2813	2.3747	2.4485	2.5341	2.6309
PT8PAM	12	2.0035	2.1024	2.1978	2.3029	2.4088
TT7	13	520.15	521.09	518.51	520.28	522.96
TT8	14	1217.2	1238.0	1238.2	1273.4	1310.0
TRAT	15	2.3401	2.3758	2.3881	2.4475	2.5050
PAM	16	14.360	14.360	14.360	14.360	14.360
BPR	17	7.2202	6.7818	6.2390	5.7995	5.6161

E3 MIXER NO. 6 CONF 29,RUNS 89-92,HOT					
CVMIX	1	.98718	.98745	.98668	.98655
CDMIX	2	.95887	.95764	.95754	.95732
PTMPA	3	2.4912	2.4914	2.4922	2.4912
PTFPAM	4	2.5629	2.5621	2.5628	2.5607
PTEPAM	5	2.3311	2.3320	2.3320	2.3342
PRAT	6	1.0994	1.0987	1.0990	1.0970
MIXP	7	.14668E-01	.14534E-01	.14360E-01	.14437E-01
FG (3)	8	965.65	964.73	964.91	964.14
MNFAN	9	.52463	.52353	.52363	.52235
MNPRI	10	.37154	.37129	.37083	.37250
PT7PAM	11	2.5799	2.5792	2.5799	2.5778
PT8PAM	12	2.3448	2.3455	2.3455	2.3476
TT7	13	533.37	529.13	524.80	521.13
TT8	14	1333.2	1321.1	1305.9	1298.8
TRAT	15	2.4997	2.4967	2.4885	2.4923
PAM	16	14.078	14.078	14.078	14.078
BPR	17	6.3033	6.3430	6.3464	6.3432

E3 MIXER NO. 9 CONF 33,RUNS 44-48,COLD

CVMIX	1	.98608	.98678	.98709	.98706	.98789
CDMIX	2	.95549	.95594	.95616	.95513	.95614
PTMPA	3	2.4814	2.4810	2.4793	2.4802	2.4768
PTFPAM	4	2.4816	2.4810	2.4781	2.4795	2.4759
PTEPAM	5	2.4805	2.4811	2.4826	2.4821	2.4792
PRAT	6	1.0005	.99996	.99819	.99897	.99867
MIXP	7	.25711E-04	.22141E-04	.18084E-04	.10194E-04	.11224E-04
FG (3)	8	959.06	959.31	958.52	957.99	957.07
MNFAN	9	.52864	.52882	.52837	.52783	.52854
MNPRI	10	.52798	.52887	.53092	.52930	.53044
PT7PAM	11	2.4995	2.4988	2.4959	2.4973	2.4938
PT8PAM	12	2.5009	2.5016	2.5030	2.5023	2.4995
TT7	13	509.87	504.16	501.24	516.77	515.21
TT8	14	519.90	512.31	509.22	522.39	519.92
TRAT	15	1.0197	1.0162	1.0159	1.0109	1.0091
PAM	16	14.103	14.103	14.103	14.103	14.103
BPR	17	3.0388	3.0216	3.0259	3.0329	3.0317

E3 MIXER NO. 9 CONF 33,RUNS 49-53,HOT

CVMIX	1	.98591	.98558	.98542	.98559	.98488
CDMIX	2	.96519	.96448	.96372	.96402	.96281
PTMPA	3	2.4787	2.4781	2.4804	2.4795	2.4805
PTFPAM	4	2.5506	2.5499	2.5520	2.5520	2.5527
PTEPAM	5	2.3263	2.3251	2.3266	2.3237	2.3246
PRAT	6	1.0964	1.0967	1.0969	1.0983	1.0981
MIXP	7	.14421E-01	.14357E-01	.14281E-01	.14212E-01	.14215E-01
FG (3)	8	968.28	967.24	967.81	967.63	967.01
MNFAN	9	.55548	.55510	.55468	.55574	.55477
MNPRI	10	.41865	.41761	.41670	.41578	.41464
PT7PAM	11	2.5699	2.5692	2.5713	2.5713	2.5721
PT8PAM	12	2.3433	2.3419	2.3433	2.3405	2.3412
TT7	13	523.22	519.64	516.03	516.15	512.64
TT8	14	1305.5	1297.2	1287.5	1285.7	1279.0
TRAT	15	2.4951	2.4963	2.4950	2.4910	2.4949
PAM	16	14.121	14.121	14.121	14.121	14.121
BPR	17	6.1692	6.2007	6.2274	6.2070	6.2406

E3 MIXER NO.10 CONF 34,RUNS 55-59,COLD

CVMIX	1	.98613	.98633	.98637	.98617	.98669
CDMIX	2	.96870	.96847	.96868	.96896	.96894
PTMPA	3	2.4754	2.4758	2.4761	2.4768	2.4777
PTFPAM	4	2.4763	2.4756	2.4756	2.4780	2.4781
PTEPAM	5	2.4724	2.4759	2.4772	2.4728	2.4761
PRAT	6	1.0016	.99991	.99935	1.0021	1.0008
MIXP	7	.15025E-04	.16779E-04	.20776E-04	.21289E-04	.19777E-04
FG (3)	8	974.91	974.90	975.32	974.75	975.25
MNFAN	9	.53893	.53814	.53811	.53931	.53885
MNPRI	10	.53672	.53827	.53903	.53638	.53770
PT7PAM	11	2.4949	2.4942	2.4942	2.4966	2.4966
PT8PAM	12	2.4942	2.4977	2.4991	2.4945	2.4981
TT7	13	510.47	504.76	498.88	504.53	499.83
TT8	14	517.70	512.19	507.07	513.23	507.33
TRAT	15	1.0142	1.0147	1.0164	1.0172	1.0150
PAM	16	14.197	14.197	14.197	14.179	14.179
BPR	17	3.0163	3.0070	3.0073	3.0282	3.0032

E3 MIXER NO.10 CONF 34,RUNS 60-64,HOT

CVMIX	1	.98539	.98461	.98444	.98449	.98466
CDMIX	2	.97943	.97842	.97821	.97793	.97787
PTMPA	3	2.4824	2.4833	2.4844	2.4747	2.4736
PTFPAM	4	2.5560	2.5568	2.5581	2.5450	2.5443
PTEPAM	5	2.3298	2.3306	2.3294	2.3324	2.3297
PRAT	6	1.0971	1.0970	1.0982	1.0911	1.0921
MIXP	7	.14317E-01	.14308E-01	.14182E-01	.14483E-01	.14405E-01
FG (3)	8	988.24	987.77	988.19	982.20	981.52
MNFAN	9	.56513	.56439	.56478	.56122	.56171
MNPRI	10	.43004	.42910	.42768	.43439	.43327
PT7PAM	11	2.5762	2.5769	2.5783	2.5649	2.5642
PT8PAM	12	2.3483	2.3490	2.3476	2.3512	2.3483
TT7	13	515.27	510.30	505.32	508.71	504.77
TT8	14	1283.4	1272.4	1260.0	1267.9	1258.2
TRAT	15	2.4907	2.4934	2.4935	2.4925	2.4926
PAM	16	14.176	14.176	14.176	14.176	14.176
BPR	17	6.0668	6.0810	6.1269	5.9946	6.0145

E3 MIXER NO.11 CONF 35,RUNS 66-70,COLD

CVMIX	1	.98912	.98895	.98857	.98811	.98851
CDMIX	2	.97628	.97638	.97566	.97626	.97640
PTMPA	3	2.4656	2.4659	2.4681	2.4661	2.4660
PTFPAM	4	2.4655	2.4669	2.4690	2.4669	2.4669
PTEPAM	5	2.4657	2.4629	2.4650	2.4637	2.4630
PRAT	6	.99993	1.0016	1.0016	1.0013	1.0016
MIXP	7	.19204E-04	.15458E-04	.82232E-05	.20943E-04	.29170E-04
FG (3)	8	978.91	979.21	979.74	979.21	979.25
MNFAN	9	.54215	.54264	.54225	.54261	.54282
MNPRI	10	.54231	.54060	.53994	.54081	.54064
PT7PAM	11	2.4859	2.4873	2.4895	2.4873	2.4873
PT8PAM	12	2.4923	2.4895	2.4916	2.4902	2.4895
TT7	13	514.69	509.88	504.23	500.86	497.40
TT8	14	521.13	516.02	511.03	508.04	504.24
TRAT	15	1.0125	1.0120	1.0135	1.0143	1.0138
PAM	16	14.228	14.228	14.228	14.228	14.228
BPR	17	2.9412	2.9480	2.9446	2.9556	2.9550

E3 MIXER NO.11 CONF 35,RUNS 71-75,HOT

CVMIX	1	.98683	.98585	.98511	.98633	.98575
CDMIX	2	.98679	.98586	.98465	.98640	.98541
PTMPA	3	2.4746	2.4765	2.4787	2.4750	2.4758
PTFPAM	4	2.5517	2.5524	2.5545	2.5509	2.5509
PTEPAM	5	2.3166	2.3210	2.3220	2.3183	2.3207
PRAT	6	1.1015	1.0997	1.1001	1.1004	1.0992
MIXP	7	.14471E-01	.14534E-01	.14380E-01	.14317E-01	.14376E-01
FG (3)	8	996.66	996.85	997.00	996.50	996.02
MNFAN	9	.57037	.56868	.56809	.56960	.56814
MNPRI	10	.43029	.43089	.42939	.43099	.43085
PT7PAM	11	2.5740	2.5747	2.5768	2.5733	2.5733
PT8PAM	12	2.3390	2.3432	2.3439	2.3404	2.3425
TT7	13	533.49	531.14	528.80	533.09	529.65
TT8	14	1328.8	1325.6	1316.7	1323.1	1318.7
TRAT	15	2.4907	2.4958	2.4900	2.4819	2.4899
PAM	16	14.258	14.258	14.258	14.258	14.258
BPR	17	5.9912	6.0167	6.0508	6.0130	6.0545

E3 MIXER NO.12 CONF 36,RUNS 11-15,COLD

CVMIX	1	.98973	.98979	.98971	.99015	.98936
CDMIX	2	.96787	.96815	.96886	.96846	.96824
PTMPA	3	2.4754	2.4759	2.4745	2.4731	2.4744
PTFPAM	4	2.4767	2.4774	2.4759	2.4745	2.4766
PTEPAM	5	2.4715	2.4715	2.4702	2.4688	2.4675
PRAT	6	1.0021	1.0024	1.0023	1.0023	1.0037
MIXP	7	.15437E-04	.13934E-04	.18664E-04	.18189E-04	.19674E-04
FG (3)	8	980.57	981.15	981.05	979.83	980.33
MNFAN	9	.53666	.53697	.53753	.53721	.53755
MNPRI	10	.53370	.53366	.53427	.53395	.53231
PT7PAM	11	2.4963	2.4970	2.4956	2.4942	2.4963
PT8PAM	12	2.4984	2.4984	2.4970	2.4956	2.4942
TT7	13	521.04	516.94	512.17	519.48	516.50
TT8	14	525.73	521.28	517.10	523.12	519.79
TRAT	15	1.0090	1.0084	1.0096	1.0070	1.0064
PAM	16	14.301	14.301	14.301	14.301	14.301
BPR	17	2.9238	2.9284	2.9346	2.9301	2.9346

E3 MIXER NO.12 CONF 36,RUNS 18-20,16.1,17.1,HOT

CVMIX	1	.98691	.98668	.98715	.98684	.98691
CDMIX	2	.97687	.97594	.97633	.97686	.97708
PTMPA	3	2.4784	2.4786	2.4763	2.4726	2.4720
PTFPAM	4	2.5543	2.5537	2.5513	2.5484	2.5476
PTEPAM	5	2.3205	2.3232	2.3205	2.3182	2.3171
PRAT	6	1.1008	1.0992	1.0995	1.0993	1.0995
MIXP	7	.14419E-01	.14456E-01	.14360E-01	.14645E-01	.14560E-01
FG (3)	8	980.89	980.08	980.04	975.50	975.42
MNFAN	9	.56379	.56246	.56288	.56310	.56333
MNPRI	10	.42243	.42314	.42321	.42412	.42397
PT7PAM	11	2.5758	2.5751	2.5727	2.5696	2.5689
PT8PAM	12	2.3426	2.3454	2.3426	2.3409	2.3394
TT7	13	517.67	515.79	513.13	525.23	521.44
TT8	14	1292.3	1286.5	1278.6	1311.3	1301.9
TRAT	15	2.4964	2.4943	2.4918	2.4966	2.4967
PAM	16	14.151	14.151	14.164	14.123	14.123
BPR	17	6.0412	6.0107	6.0262	5.9501	5.9857

E3 MIXER NO.12 CONF 37,RUNS 22-26,COLD

CVMIX	1	.98913	.98969	.98908	.98909	.98942
CDMIX	2	.96555	.96685	.96589	.96594	.96612
PTMPA	3	2.4731	2.4695	2.4728	2.4710	2.4737
PTFPAM	4	2.4734	2.4712	2.4741	2.4713	2.4734
PTEPAM	5	2.4718	2.4634	2.4682	2.4698	2.4744
PRAT	6	1.0007	1.0032	1.0024	1.0006	.99960
MIXP	7	.16981E-04	.18744E-04	.11235E-04	.23993E-04	.11226E-04
FG (3)	8	977.67	976.86	977.84	976.85	978.62
MNFAN	9	.55504	.55701	.55590	.55536	.55520
MNPRI	10	.55416	.55265	.55263	.55452	.55572
PT7PAM	11	2.4942	2.4921	2.4949	2.4921	2.4942
PT8PAM	12	2.4991	2.4907	2.4956	2.4970	2.5019
TT7	13	520.17	517.01	513.42	514.84	511.25
TT8	14	524.12	520.83	517.75	518.96	515.60
TRAT	15	1.0076	1.0074	1.0084	1.0084	1.0085
PAM	16	14.313	14.313	14.313	14.313	14.313
BPR	17	3.2454	3.2545	3.2452	3.2543	3.2359

E3 MIXER NO.12 CONF 37,RUNS 27-31,HOT

CVMIX	1	.98638	.98696	.98689	.98683	.98688
CDMIX	2	.97474	.97385	.97338	.97314	.97215
PTMPA	3	2.4807	2.4802	2.4800	2.4809	2.4816
PTFPAM	4	2.5523	2.5517	2.5503	2.5517	2.5524
PTEPAM	5	2.3214	2.3208	2.3243	2.3230	2.3231
PRAT	6	1.0995	1.0995	1.0972	1.0984	1.0987
MIXP	7	.13560E-01	.13517E-01	.13575E-01	.13471E-01	.13438E-01
FG (3)	8	979.69	978.54	977.98	978.26	977.72
MNFAN	9	.57790	.57726	.57585	.57631	.57578
MNPRI	10	.44300	.44212	.44374	.44242	.44110
PT7PAM	11	2.5748	2.5741	2.5726	2.5741	2.5748
PT8PAM	12	2.3443	2.3436	2.3471	2.3457	2.3457
TT7	13	518.90	515.25	511.65	512.14	509.33
TT8	14	1294.4	1285.1	1277.4	1276.0	1268.9
TRAT	15	2.4944	2.4942	2.4966	2.4916	2.4914
PAM	16	14.145	14.145	14.145	14.145	14.145
BPR	17	6.5698	6.5817	6.5721	6.5831	6.5950

E3 MIXER NO.12 CONF 38,RUNS 33-37,COLD

CVMIX	1	.99064	.99035	.99026	.99080	.98988
CDMIX	2	.97143	.97217	.97194	.97287	.97188
PTMPA	3	2.4752	2.4757	2.4743	2.4717	2.4736
PTFPAM	4	2.4768	2.4775	2.4761	2.4733	2.4761
PTEPAM	5	2.4709	2.4707	2.4695	2.4674	2.4668
PRAT	6	1.0024	1.0028	1.0027	1.0024	1.0037
MIXP	7	.20812E-04	.18563E-04	.16105E-04	.12644E-04	.10412E-04
FG (3)	8	985.37	986.39	985.37	984.74	984.85
MNFAN	9	.51625	.51697	.51676	.51738	.51715
MNPRI	10	.51281	.51294	.51286	.51377	.51169
PT7PAM	11	2.4951	2.4958	2.4944	2.4916	2.4944
PT8PAM	12	2.4972	2.4972	2.4958	2.4937	2.4930
TT7	13	522.30	518.59	514.33	516.42	513.40
TT8	14	523.40	520.43	517.15	519.46	516.37
TRAT	15	1.0021	1.0035	1.0055	1.0059	1.0058
PAM	16	14.320	14.320	14.320	14.320	14.320
BPR	17	2.5837	2.5808	2.5928	2.5916	2.5997

E3 MIXER NO.12 CONF 38,RUNS 38-42,HOT

CVMIX	1	.98686	.98659	.98613	.98690	.98705
CDMIX	2	.98151	.98210	.98142	.98236	.98212
PTMPA	3	2.4774	2.4767	2.4771	2.4769	2.4778
PTFPAM	4	2.5588	2.5573	2.5579	2.5572	2.5585
PTEPAM	5	2.3258	2.3259	2.3241	2.3254	2.3242
PRAT	6	1.1002	1.0995	1.1006	1.0997	1.1008
MIXP	7	.15689E-01	.15652E-01	.15483E-01	.15468E-01	.15340E-01
FG (3)	8	983.14	983.34	982.90	983.72	984.04
MNFAN	9	.54916	.54902	.54924	.54934	.54989
MNPRI	10	.40396	.40495	.40323	.40491	.40360
PT7PAM	11	2.5789	2.5775	2.5782	2.5775	2.5789
PT8PAM	12	2.3474	2.3474	2.3453	2.3467	2.3453
TT7	13	526.87	523.92	519.49	518.85	516.25
TT8	14	1314.4	1307.7	1295.4	1292.8	1284.8
TRAT	15	2.4948	2.4960	2.4936	2.4916	2.4887
PAM	16	14.126	14.126	14.126	14.126	14.126
BPR	17	5.3593	5.3871	5.4243	5.4098	5.4342

E3 MIXER NO.12 CONF 39,RUNS 149-153,COLD

CVMIX	1	.99008	.99048	.99072	.99044	.99029
CDMIX	2	.96961	.97086	.97054	.96959	.97012
PTMPA	3	2.4723	2.4719	2.4726	2.4707	2.4700
PTFPAM	4	2.4717	2.4709	2.4731	2.4695	2.4695
PTEPAM	5	2.4738	2.4744	2.4709	2.4740	2.4711
PRAT	6	.99914	.99858	1.0009	.99819	.99935
MIXP	7	.17711E-04	.10868E-04	.15921E-04	.14183E-04	.15700E-04
FG (3)	8	964.93	965.93	966.05	963.99	964.10
MNFAN	9	.51276	.51351	.51410	.51242	.51324
MNPRI	10	.51404	.51557	.51276	.51505	.51416
PT7PAM	11	2.4918	2.4911	2.4932	2.4897	2.4897
PT8PAM	12	2.4982	2.4989	2.4954	2.4962	2.4954
TT7	13	516.35	513.75	511.64	518.45	517.48
TT8	14	519.20	516.24	514.00	519.27	518.46
TRAT	15	1.0055	1.0048	1.0046	1.0016	1.0019
PAM	16	14.074	14.074	14.074	14.074	14.074
BPR	17	3.0582	3.0537	3.0555	3.0616	3.0621

E3 MIXER NO.12 CONF 39,RUNS 154-158,HOT

CVMIX	1	.98754	.98680	.98666	.98647	.98636
CDMIX	2	.97841	.97724	.97746	.97700	.97644
PTMPA	3	2.4790	2.4806	2.4803	2.4806	2.4810
PTFPAM	4	2.5497	2.5518	2.5511	2.5518	2.5525
PTEPAM	5	2.3231	2.3226	2.3234	2.3226	2.3214
PRAT	6	1.0976	1.0987	1.0980	1.0987	1.0996
MIXP	7	.14365E-01	.14311E-01	.14354E-01	.14370E-01	.14279E-01
FG (3)	8	988.64	988.45	988.52	988.18	987.89
MNFAN	9	.54222	.54212	.54177	.54190	.54198
MNPRI	10	.39914	.39692	.39765	.39664	.39525
PT7PAM	11	2.5716	2.5738	2.5731	2.5738	2.5745
PT8PAM	12	2.3434	2.3427	2.3434	2.3427	2.3412
TT7	13	529.53	528.22	527.29	528.18	527.09
TT8	14	1320.2	1316.9	1316.7	1319.1	1315.6
TRAT	15	2.4932	2.4932	2.4972	2.4974	2.4961
PAM	16	14.236	14.236	14.236	14.236	14.236
BPR	17	6.3058	6.3335	6.3535	6.3402	6.3714

E3 MIXER NO.11 CONF 40,RUNS 93-97,COLD

CVMIX	1	.98956	.98907	.98905	.98952	.98939
CDMIX	2	.97639	.97615	.97566	.97638	.97606
PTMPA	3	2.4775	2.4773	2.4798	2.4764	2.4764
PTFPAM	4	2.4776	2.4783	2.4804	2.4767	2.4774
PTEPAM	5	2.4769	2.4741	2.4775	2.4752	2.4731
PRAT	6	1.0003	1.0017	1.0012	1.0006	1.0017
MIXP	7	.16428E-04	.14690E-04	.14427E-04	.22663E-04	.18435E-04
FG (3)	8	980.87	980.53	981.49	980.30	979.99
MNFAN	9	.54239	.54269	.54209	.54251	.54264
MNPRI	10	.54204	.54032	.54044	.54165	.54021
PT7PAM	11	2.4982	2.4989	2.5011	2.4974	2.4981
PT8PAM	12	2.5032	2.5004	2.5039	2.5016	2.4995
TT7	13	524.30	521.19	516.19	525.04	522.97
TT8	14	532.85	527.79	522.59	531.65	527.87
TRAT	15	1.0163	1.0127	1.0124	1.0126	1.0094
PAM	16	14.154	14.154	14.154	14.155	14.155
BPR	17	2.9762	2.9724	2.9633	2.9626	2.9622

E3 MIXER NO.11 CONF 40,RUNS 98-102,HOT

CVMIX	1	.98746	.98662	.98599	.98658	.98637
CDMIX	2	.98643	.98504	.98501	.98549	.98498
PTMPA	3	2.4766	2.4773	2.4779	2.4773	2.4795
PTFPAM	4	2.5527	2.5534	2.5540	2.5534	2.5556
PTEPAM	5	2.3214	2.3202	2.3203	2.3215	2.3242
PRAT	6	1.0996	1.1005	1.1007	1.0999	1.0995
MIXP	7	.14505E-01	.14356E-01	.14368E-01	.14537E-01	.14583E-01
FG (3)	8	989.31	988.31	988.67	988.74	989.51
MNFAN	9	.56914	.56868	.56868	.56854	.56803
MNPRI	10	.43147	.42943	.42909	.43028	.43018
PT7PAM	11	2.5750	2.5757	2.5764	2.5757	2.5778
PT8PAM	12	2.3437	2.3423	2.3423	2.3437	2.3465
TT7	13	524.48	523.34	522.88	525.38	525.01
TT8	14	1309.5	1303.4	1304.0	1313.2	1312.9
TRAT	15	2.4968	2.4906	2.4938	2.4995	2.5006
PAM	16	14.140	14.140	14.140	14.140	14.140
BPR	17	6.0019	6.0280	6.0529	6.0184	6.0034

E3 MIXER NO. 9 CONF 41,RUNS 106-110,COLD

CVMIX	1	.98734	.98732	.98767	.98751	.98737
CDMIX	2	.95642	.95658	.95590	.95660	.95559
PTMPA	3	2.4799	2.4816	2.4808	2.4806	2.4826
PTFPAM	4	2.4776	2.4783	2.4777	2.4769	2.4798
PTEPAM	5	2.4869	2.4918	2.4904	2.4918	2.4911
PRAT	6	.99628	.99461	.99489	.99405	.99546
MIXP	7	.20554E-04	.16474E-04	.23599E-04	.22063E-04	.18257E-04
FG (3)	8	962.13	963.28	962.12	962.69	962.84
MNFAN	9	.52797	.52753	.52706	.52735	.52700
MNPRI	10	.53327	.53520	.53435	.53582	.53347
PT7PAM	11	2.4952	2.4959	2.4952	2.4945	2.4973
PT8PAM	12	2.5037	2.5087	2.5072	2.5087	2.5080
TT7	13	514.06	509.11	502.76	503.93	499.47
TT8	14	523.78	517.83	512.65	512.59	507.58
TRAT	15	1.0189	1.0171	1.0197	1.0172	1.0162
PAM	16	14.147	14.147	14.147	14.147	14.147
BPR	17	3.1694	3.1580	3.1625	3.1545	3.1588

E3 MIXER NO. 9 CONF 41,RUNS 111-115,HOT

CVMIX	1	.98774	.98775	.98737	.98661	.98603
CDMIX	2	.96385	.96287	.96168	.96245	.96074
PTMPA	3	2.4862	2.4867	2.4886	2.4853	2.4891
PTFPAM	4	2.5561	2.5569	2.5583	2.5532	2.5553
PTEPAM	5	2.3272	2.3266	2.3288	2.3313	2.3392
PRAT	6	1.0984	1.0990	1.0985	1.0952	1.0924
MIXP	7	.13945E-01	.13918E-01	.13896E-01	.13941E-01	.13931E-01
FG (3)	8	979.37	978.69	978.58	967.95	968.45
MNFAN	9	.55455	.55418	.55307	.55203	.54949
MNPRI	10	.41429	.41279	.41205	.41592	.41706
PT7PAM	11	2.5753	2.5760	2.5774	2.5723	2.5745
PT8PAM	12	2.3408	2.3401	2.3422	2.3447	2.3525
TT7	13	528.56	528.37	528.05	513.67	507.20
TT8	14	1320.2	1319.6	1319.4	1285.8	1269.5
TRAT	15	2.4978	2.4976	2.4986	2.5031	2.5030
PAM	16	14.239	14.239	14.239	14.100	14.100
BPR	17	6.5861	6.6027	6.6353	6.6018	6.6090

E3 MIXER NO. 9 CONF 42,RUNS 116-120,COLD

CVMIX	1	.98750	.98712	.98708	.98787	.98796
CDMIX	2	.95602	.95559	.95551	.95535	.95628
PTMPA	3	2.4774	2.4790	2.4796	2.4787	2.4777
PTFPAM	4	2.4756	2.4777	2.4770	2.4756	2.4748
PTEPAM	5	2.4828	2.4828	2.4871	2.4878	2.4864
PRAT	6	.99709	.99796	.99596	.99508	.99535
MIXP	7	.12689E-04	.20188E-04	.15009E-04	.19680E-04	.17342E-04
FG (3)	8	942.76	943.27	943.47	942.81	943.20
MNFAN	9	.52844	.52839	.52763	.52720	.52808
MNPRI	10	.53257	.53129	.53336	.53419	.53459
PT7PAM	11	2.4941	2.4962	2.4955	2.4941	2.4933
PT8PAM	12	2.5005	2.5005	2.5049	2.5056	2.5041
TT7	13	518.95	517.91	517.41	518.49	518.48
TT8	14	528.34	523.53	521.71	524.63	522.33
TRAT	15	1.0181	1.0109	1.0083	1.0118	1.0074
PAM	16	13.889	13.889	13.889	13.889	13.889
BPR	17	3.0709	3.0617	3.0499	3.0559	3.0520

E3 MIXER NO. 9 CONF 42,RUNS 121-125,HOT

CVMIX	1	.98684	.98635	.98608	.98746	.98668
CDMIX	2	.96275	.96126	.96035	.96016	.96080
PTMPA	3	2.4858	2.4872	2.4884	2.4950	2.4875
PTFPAM	4	2.5572	2.5586	2.5608	2.5653	2.5586
PTEPAM	5	2.3320	2.3321	2.3294	2.3434	2.3329
PRAT	6	1.0966	1.0971	1.0993	1.0947	1.0968
MIXP	7	.14302E-01	.14238E-01	.14152E-01	.14356E-01	.14206E-01
FG (3)	8	965.62	964.95	964.71	963.69	964.71
MNFAN	9	.55422	.55345	.55392	.55140	.55300
MNPRI	10	.41667	.41469	.41166	.41609	.41447
PT7PAM	11	2.5772	2.5786	2.5807	2.5852	2.5786
PT8PAM	12	2.3467	2.3467	2.3439	2.3579	2.3474
TT7	13	521.42	519.03	516.66	524.54	507.78
TT8	14	1300.6	1294.9	1289.6	1308.0	1269.0
TRAT	15	2.4943	2.4947	2.4960	2.4937	2.4992
PAM	16	14.058	14.058	14.058	13.991	14.058
BPR	17	6.2504	6.2863	6.3270	6.2768	6.2956

E3 MIXER NO.12 CONF 43,RUNS 169-173,COLD						
CVMIX	1	.99067	.99035	.98973	.99089	.99105
CDMIX	2	.97129	.97077	.97020	.97108	.97123
PTMPA	3	2.4786	2.4802	2.4826	2.4795	2.4792
PTFPAM	4	2.4791	2.4805	2.4833	2.4791	2.4798
PTEPAM	5	2.4769	2.4790	2.4803	2.4804	2.4769
PRAT	6	1.0009	1.0006	1.0012	.99948	1.0012
MIXP	7	.19677E-04	.81134E-05	.17686E-04	.17458E-04	.22130E-04
FG (3)	8	992.61	993.01	993.88	992.89	992.87
MNFAN	9	.51466	.51419	.51396	.51401	.51472
MNPRI	10	.51341	.51325	.51216	.51475	.51301
PT7PAM	11	2.4990	2.5003	2.5031	2.4990	2.4997
PT8PAM	12	2.4983	2.5003	2.5017	2.5017	2.4983
TT7	13	523.20	521.58	520.33	521.38	520.45
TT8	14	528.99	525.28	523.57	525.83	523.54
TRAT	15	1.0111	1.0071	1.0062	1.0085	1.0059
PAM	16	14.398	14.398	14.398	14.398	14.398
BPR	17	3.1565	3.1481	3.1382	3.1477	3.1469

E3 MIXER NO.12 CONF 43,RUNS 174-178,HOT						
CVMIX	1	.98839	.98769	.98702	.98789	.98763
CDMIX	2	.97813	.97731	.97660	.97699	.97658
PTMPA	3	2.4888	2.4895	2.4903	2.4894	2.4897
PTFPAM	4	2.5596	2.5596	2.5610	2.5596	2.5596
PTEPAM	5	2.3262	2.3277	2.3264	2.3277	2.3278
PRAT	6	1.1003	1.0996	1.1008	1.0997	1.0995
MIXP	7	.14071E-01	.14002E-01	.13931E-01	.14019E-01	.13902E-01
FG (3)	8	993.22	992.79	992.60	992.42	992.22
MNFAN	9	.54289	.54205	.54225	.54193	.54160
MNPRI	10	.39528	.39525	.39338	.39498	.39467
PT7PAM	11	2.5812	2.5812	2.5826	2.5812	2.5812
PT8PAM	12	2.3436	2.3450	2.3436	2.3450	2.3450
TT7	13	528.86	525.35	523.02	524.20	522.89
TT8	14	1321.5	1310.6	1305.2	1308.1	1302.6
TRAT	15	2.4987	2.4947	2.4955	2.4955	2.4911
PAM	16	14.222	14.222	14.222	14.222	14.222
BPR	17	6.5619	6.5719	6.5952	6.5547	6.5850

E3 MIXER NO. 9 CONF 45,RUNS 127-131,COLD						
CVMIX	1	.98809	.98736	.98753	.98872	.98866
CDMIX	2	.95683	.95617	.95637	.95667	.95680
PTMPA	3	2.4766	2.4766	2.4773	2.4822	2.4822
PTFPAM	4	2.4740	2.4754	2.4760	2.4792	2.4813
PTEPAM	5	2.4844	2.4803	2.4810	2.4912	2.4849
PRAT	6	.99580	.99800	.99799	.99518	.99853
MIXP	7	.17969E-04	.16461E-04	.15438E-04	.14058E-04	.23844E-04
FG (3)	8	964.67	964.05	964.64	972.52	972.70
MNFAN	9	.52815	.52837	.52852	.52781	.52906
MNPRI	10	.53411	.53120	.53137	.53463	.53112
PT7PAM	11	2.4910	2.4924	2.4931	2.4963	2.4984
PT8PAM	12	2.5009	2.4967	2.4974	2.5075	2.5012
TT7	13	526.87	526.54	526.36	517.03	515.58
TT8	14	526.66	526.23	526.18	518.73	517.39
TRAT	15	.99960	.99941	.99966	1.0033	1.0035
PAM	16	14.207	14.207	14.207	14.277	14.277
BPR	17	3.0806	3.0965	3.0988	3.1024	3.1128

E3 MIXER NO. 9 CONF 45,RUNS 132-136,HOT						
CVMIX	1	.98714	.98646	.98653	.98723	.98624
CDMIX	2	.96379	.96205	.96268	.96216	.96208
PTMPA	3	2.4883	2.4906	2.4883	2.4883	2.4891
PTFPAM	4	2.5574	2.5596	2.5581	2.5581	2.5595
PTEPAM	5	2.3330	2.3351	2.3290	2.3283	2.3283
PRAT	6	1.0962	1.0961	1.0984	1.0987	1.0993
MIXP	7	.14071E-01	.14034E-01	.13869E-01	.13797E-01	.13919E-01
FG (3)	8	981.06	980.60	979.93	979.39	979.79
MNFAN	9	.55334	.55226	.55380	.55363	.55381
MNPRI	10	.41646	.41494	.41321	.41257	.41168
PT7PAM	11	2.5762	2.5783	2.5769	2.5769	2.5783
PT8PAM	12	2.3459	2.3480	2.3417	2.3410	2.3410
TT7	13	526.04	524.76	523.91	525.11	524.70
TT8	14	1316.5	1311.5	1307.8	1308.2	1312.0
TRAT	15	2.5026	2.4992	2.4963	2.4912	2.5005
PAM	16	14.246	14.246	14.246	14.246	14.246
BPR	17	6.5597	6.5519	6.6026	6.6047	6.6110

E3 MIXER NO.11 CONF 46,RUNS 138-142,COLD

CVMIX	1	.98951	.98942	.98957	.98990	.98901
CDMIX	2	.97750	.97726	.97695	.97744	.97691
PTMPA	3	2.4777	2.4789	2.4784	2.4760	2.4776
PTFPAM	4	2.4792	2.4813	2.4814	2.4772	2.4793
PTEPAM	5	2.4729	2.4716	2.4694	2.4721	2.4722
PRAT	6	1.0025	1.0039	1.0049	1.0020	1.0029
MIXP	7	.18326E-04	.12872E-04	.14614E-04	.17355E-04	.17348E-04
FG (3)	8	985.81	986.30	985.67	984.73	985.13
MNFAN	9	.54411	.54441	.54450	.54389	.54374
MNPRI	10	.54062	.53894	.53770	.54103	.53973
PT7PAM	11	2.4988	2.5009	2.5009	2.4967	2.4988
PT8PAM	12	2.4960	2.4945	2.4924	2.4952	2.4952
TT7	13	519.07	516.87	515.69	515.99	515.89
TT8	14	527.33	522.47	520.05	521.51	519.59
TRAT	15	1.0159	1.0108	1.0085	1.0107	1.0072
PAM	16	14.207	14.207	14.207	14.207	14.207
BPR	17	2.9748	2.9746	2.9622	2.9578	2.9554

E3 MIXER NO.11 CONF 46,RUNS 143-145,146.1,147.1,HOT

CVMIX	1	.98852	.98817	.98717	.98660	.98634
CDMIX	2	.98868	.98779	.98745	.98821	.98775
PTMPA	3	2.4788	2.4794	2.4798	2.4771	2.4786
PTFPAM	4	2.5535	2.5542	2.5542	2.5514	2.5527
PTEPAM	5	2.3235	2.3242	2.3256	2.3256	2.3258
PRAT	6	1.0990	1.0990	1.0983	1.0971	1.0976
MIXP	7	.14368E-01	.14397E-01	.14506E-01	.14539E-01	.14443E-01
FG (3)	8	1005.1	1004.6	1004.4	996.64	997.06
MNFAN	9	.56998	.56943	.56867	.56883	.56876
MNPRI	10	.43381	.43299	.43314	.43510	.43419
PT7PAM	11	2.5749	2.5756	2.5756	2.5726	2.5740
PT8PAM	12	2.3423	2.3430	2.3444	2.3447	2.3447
TT7	13	533.95	533.03	532.27	524.47	523.03
TT8	14	1331.3	1329.3	1331.9	1312.4	1307.3
TRAT	15	2.4932	2.4939	2.5022	2.5024	2.4995
PAM	16	14.315	14.315	14.315	14.215	14.215
BPR	17	6.1251	6.1110	6.1309	6.0579	6.0904

E3 MIXER NO.11 CONF 46,RUNS 143.1,144.1,145.1,HOT

CVMIX	1	.98618	.98581	.98536		
CDMIX	2	.98768	.98706	.98666		
PTMPA	3	2.4777	2.4796	2.4796		
PTFPAM	4	2.5516	2.5544	2.5537		
PTEPAM	5	2.3255	2.3242	2.3257		
PRAT	6	1.0972	1.0990	1.0980		
MIXP	7	.14410E-01	.14358E-01	.14294E-01		
FG (3)	8	997.43	997.94	997.58		
MNFAN	9	.56863	.56905	.56832		
MNPRI	10	.43457	.43225	.43284		
PT7PAM	11	2.5729	2.5757	2.5750		
PT8PAM	12	2.3445	2.3431	2.3445		
TT7	13	523.10	521.59	520.63		
TT8	14	1305.3	1302.4	1297.9		
TRAT	15	2.4953	2.4971	2.4930		
PAM	16	14.229	14.229	14.229		
BPR	17	6.0717	6.1029	6.1061		

E3 MIXER NO.11 CONF 47,RUNS 164-168,COLD

CVMIX	1	.98975	.98935	.98930	.99018	.98958
CDMIX	2	.97800	.97756	.97700	.97849	.97737
PTMPA	3	2.4732	2.4748	2.4759	2.4723	2.4748
PTFPAM	4	2.4740	2.4761	2.4769	2.4740	2.4762
PTEPAM	5	2.4707	2.4707	2.4728	2.4670	2.4707
PRAT	6	1.0013	1.0022	1.0017	1.0028	1.0022
MIXP	7	.20927E-04	.11088E-04	.13103E-04	.15886E-04	.11594E-04
FG (3)	8	968.30	968.79	968.87	968.23	968.60
MNFAN	9	.54410	.54406	.54339	.54506	.54391
MNPRI	10	.54230	.54096	.54107	.54110	.54079
PT7PAM	11	2.4934	2.4955	2.4962	2.4934	2.4955
PT8PAM	12	2.4941	2.4941	2.4962	2.4905	2.4941
TT7	13	519.23	518.16	517.49	518.75	518.91
TT8	14	522.38	520.62	519.57	521.53	520.52
TRAT	15	1.0061	1.0047	1.0040	1.0054	1.0031
PAM	16	13.985	13.985	13.985	13.985	13.985
BPR	17	2.9297	2.9273	2.9200	2.9234	2.9223

E3 MIXER NO.12 CONF 48,RUNS 180-184,COLD

CVMIX	1	.99092	.99050	.99041	.99058	.99051
CDMIX	2	.97430	.97369	.97308	.97367	.97323
PTMPA	3	2.4777	2.4791	2.4790	2.4784	2.4804
PTFPAM	4	2.4760	2.4781	2.4782	2.4768	2.4789
PTEPAM	5	2.4827	2.4820	2.4814	2.4833	2.4847
PRAT	6	.99730	.99843	.99870	.99737	.99766
MIXP	7	.11851E-04	.15551E-04	.15315E-04	.19509E-04	.14806E-04
FG (3)	8	988.84	989.08	988.39	988.64	989.34
MNFAN	9	.51570	.51562	.51523	.51524	.51501
MNPRI	10	.51960	.51789	.51722	.51906	.51841
PT7PAM	11	2.4960	2.4981	2.4981	2.4967	2.4988
PT8PAM	12	2.5044	2.5037	2.5030	2.5051	2.5065
TT7	13	520.71	518.74	517.62	520.75	520.21
TT8	14	521.47	520.00	519.20	521.14	520.76
TRAT	15	1.0015	1.0024	1.0031	1.0007	1.0011
PAM	16	14.307	14.307	14.307	14.307	14.307
BPR	17	3.1198	3.1233	3.1263	3.1084	3.1085

E3 MIXER NO.12 CONF 48,RUNS 186-189,185.1,HOT

CVMIX	1	.98746	.98693	.98715	.98597	.98786
CDMIX	2	.98070	.98066	.98109	.97924	.98051
PTMPA	3	2.4886	2.4878	2.4889	2.4940	2.4815
PTFPAM	4	2.5591	2.5590	2.5591	2.5647	2.5506
PTEPAM	5	2.3263	2.3222	2.3282	2.3306	2.3241
PRAT	6	1.1001	1.1020	1.0992	1.1005	1.0975
MIXP	7	.13963E-01	.13818E-01	.13998E-01	.13947E-01	.14086E-01
FG (3)	8	997.45	996.99	998.03	999.17	987.97
MNFAN	9	.54440	.54541	.54431	.54371	.54294
MNPRI	10	.39773	.39575	.39905	.39602	.40023
PT7PAM	11	2.5809	2.5809	2.5809	2.5865	2.5723
PT8PAM	12	2.3437	2.3394	2.3458	2.3479	2.3416
TT7	13	528.46	525.92	526.10	525.38	529.54
TT8	14	1317.6	1309.5	1310.8	1310.2	1320.5
TRAT	15	2.4932	2.4899	2.4915	2.4939	2.4937
PAM	16	14.247	14.247	14.247	14.247	14.174
BPR	17	6.5686	6.6030	6.5255	6.5791	6.5243

E3 MIXER NO.12 CONF 49,RUNS 191-195,COLD

CVMIX	1	.99056	.99068	.99090	.99109	.99123
CDMIX	2	.97065	.97108	.97102	.97100	.97082
PTMPA	3	2.4748	2.4744	2.4746	2.4753	2.4753
PTFPAM	4	2.4732	2.4725	2.4725	2.4726	2.4726
PTEPAM	5	2.4796	2.4802	2.4809	2.4835	2.4836
PRAT	6	.99741	.99691	.99664	.99560	.99557
MIXP	7	.19949E-04	.61559E-05	.15266E-04	.39381E-05	.15263E-04
FG (3)	8	991.28	991.49	991.53	991.90	991.72
MNFAN	9	.51296	.51312	.51297	.51260	.51246
MNPRI	10	.51675	.51761	.51788	.51901	.51891
PT7PAM	11	2.4929	2.4922	2.4922	2.4922	2.4922
PT8PAM	12	2.4998	2.5005	2.5012	2.5040	2.5040
TT7	13	516.91	515.36	514.78	517.38	517.15
TT8	14	520.27	518.45	517.58	519.19	518.72
TRAT	15	1.0065	1.0060	1.0054	1.0035	1.0030
PAM	16	14.421	14.421	14.421	14.421	14.421
BPR	17	3.1763	3.1651	3.1636	3.1455	3.1508

E3 MIXER NO.12 CONF 49,RUNS 196-200,HOT

CVMIX	1	.98929	.98807	.98757	.98901	.98754
CDMIX	2	.97661	.97533	.97529	.97659	.97491
PTMPA	3	2.4845	2.4870	2.4875	2.4851	2.4885
PTFPAM	4	2.5521	2.5541	2.5556	2.5535	2.5563
PTEPAM	5	2.3262	2.3285	2.3271	2.3242	2.3285
PRAT	6	1.0971	1.0969	1.0982	1.0987	1.0978
MIXP	7	.13756E-01	.13699E-01	.13684E-01	.13674E-01	.13703E-01
FG (3)	8	1001.9	1002.0	1002.3	1002.2	1002.5
MNFAN	9	.54014	.53916	.53991	.54103	.53946
MNPRI	10	.39695	.39587	.39458	.39534	.39462
PT7PAM	11	2.5736	2.5757	2.5771	2.5750	2.5778
PT8PAM	12	2.3424	2.3445	2.3431	2.3403	2.3445
TT7	13	523.09	519.38	517.14	519.39	518.37
TT8	14	1299.9	1291.3	1286.1	1290.4	1289.0
TRAT	15	2.4850	2.4862	2.4870	2.4845	2.4867
PAM	16	14.404	14.404	14.404	14.404	14.404
BPR	17	6.6580	6.7021	6.6842	6.6622	6.6887

2) Procedure to Calculate Fully Mixed Conditions

Establishing the fully mixed properties required to calculate nozzle coefficients involves solving a set of 4 equations iteratively in velocity using the following assumptions:

- o one dimensional flow
- o fan and primary flow has equal static pressure at mixing plane
- o flow becomes fully mixed
- o mixing duct is constant area

The equations involved are:

Continuity

$$\dot{m}_p + \dot{m}_f = \rho_M A_M V_M \quad (1)$$

Momentum

$$P_1 A_M - P_M A_M = \rho_M A_M V_M^2 - \dot{m}_p V_{1p} - \dot{m}_f V_{1f}$$

Energy

$$\dot{m}_M \left(h_M + \frac{V_M^2}{2} \right) = \dot{m}_p \left(h_{1p} + \frac{V_{1p}^2}{2} \right) + \dot{m}_f \left(h_{1f} + \frac{V_{1f}^2}{2} \right) \quad (3)$$

Equation of State

$$P_M \sim f(P_M, h_M) \quad (4)$$

where

1 is the point at which both streams come together (mixing plane) for first time.

f is fan duct at mixing plane.

p is primary duct at mixing plane.

M is the point at which both flows are fully mixed.

\dot{m} is mass flow.

The known quantities are:

$\dot{m}_p, \dot{m}_f, p_l,$
 $V_{lp}, V_{lf}, h_{lp}, h_{lf},$
 A_M assumed to be mixing plane area.

The unknown quantities are:

$\rho_M, p_M, h_M,$ and V_M

where ρ is density and h is enthalpy.

Equation (1) through (4) represent a proper set of 4 equations and 4 unknowns. The equations are solved iteratively in velocity. The Gas Tables are used in place of equation (4). Once solved, fully mixed Mach number, total pressure and temperature can be calculated.

$$\begin{aligned} M_{nM} &= f(V_M, T_M) \\ P_{T_{MIX}} &= f(p_M, M_{nM}) \\ T_{T_{MIX}} &= f(T_M, M_{nM}) \end{aligned}$$

The ideal thrust and flow used in the model thrust ($C_{V_{MIX}}$) and flow ($C_{D_{MIX}}$) coefficients are calculated with these conditions.

3) Thrust Balance Temperature Correction: $\Delta C_{V_{TEMP}}$

At the completion of Phase I model testing, it was determined that a correction to the measured thrust was necessary because the measured thrust was observed to be a function of balance temperature. Since balance temperature was not measured during Phase I testing it was assumed to be essentially equal to ambient temperature which was obtained from the National Weather Bureau and the Minneapolis Tribune, as a function of date and time of day. The temperature correction is defined as:

$$\Delta C_{V_{TEMP}} = \frac{\Delta \text{CORRECTED AXIAL THRUST}}{F_G(3)} = \frac{H_2 (.0001513(T_0) - .01053)}{F_G(3)}$$

where: H_2 - UNCORRECTED AXIAL BALANCE FORCE POUNDS
 T_0 - BALANCE TEMPERATURE °F
 $F_G(3)$ - 100% MIXED IDEAL THRUST POUNDS

This correction was added to the original thrust coefficient to estimate the real model thrust coefficient for Phase I, where

$$C_{V'}^{\text{corrected}} = C_{V'} + \Delta C_{V_{TEMP}}$$

A tabulation of this correction, averaging approximately +0.0004 C_V , is presented in Table I for a cruise PTMPA = 2.5. In general this correction significantly improves the consistency of the Phase I data. The ambient temperature history for all of Phase I is presented in Table II.

During the Phase II testing the thrust balance temperature was measured directly and incorporated into the basic data reduction.

TABLE A-1

CRUISE CONDITION PTMPA = 2.5

<u>CONFIGURATION</u>	HOT	COLD
	<u>CVTEMP</u>	<u>CVTEMP</u>
1	-0.0001	-0.0005
2	-0.0005	-0.0004
3	-0.0010	-0.0005
4	0.0010	0.0010
5	0.0009	-0.0008
6	-0.0011	-0.0013
7	0.0011	0.0002
8	0.0006	-0.0005
9	0.0003	-0.0001
10	0.0008	0.0011
11	0	0.0006
13	0.0011	-0.0002
14	0.0008	0.0019
15	0.0003	-0.0003
16	0.0002	0.0013
17	0.0003	-0.0010
18	-0.0002	-0.0006
19	0.0006	-0.0011
21	-0.0006	-0.0010
22	0.0008	0
23	0	0.0014
24	0.0012	0.0003
25	0	0.0003
26	0	0.0004
27	0.0012	0.0012
28	0.0011	0.0013
29	0.0002	0.0004
30	0.0005	0.0005

TABLE A-2
AMBIENT TEMPERATURE LOG

<u>CONFIG.</u>	<u>RUN NO.</u>	<u>DATE</u>	<u>TIME</u>	<u>T_{AMB}</u>
1	2, 3, 4, 6	5/24/79	8:12	55°F
1	1	5/24	12:45	64°F
1	5	5/24	13:30	63°F
1	4.1-6.1	6/7	10:16	64°F
1	4.11-6.11	6/22	10:20	59°F
1	6.4, 5.6, 4.4	7/18	10:15	75°F
1	7-12	5/25	8:20	57°F
1	10.1-12.3	7/18	10:15	75°F
1	237-242	6/22	12:45	60°F
1	10.3-12.3	7/18	12:38	81°F
2	14-19	5/25	2:30	66°F
2	21, 23, 25	5/25	11:50	64°F
2	20, 22, 24	5/25	12:55	64°F
3	26, 27, 28, 29, 31	6/1	7:55	48°F
3	30	6/1	14:09	70°F
3	32, 33, 35, 37	5/31	4:00	58°F
3	34.1, 36.1	5/31	4:31	60°F
4	40, 42, 44	5/29	1:00	81°F
4	39, 41, 43	5/29	1:30	81°F
4	45-50	5/29	2:30	81°F
5	51-56	5/30	8:45	61°F
5	57-62	5/29	4:30	81°F
6	64-69	5/31	12:50	56°F
6	70-75	5/31	12:00	56°F
7	76-79, 81	6/9	12:11	64°F
7	80	6/8	13:40	56°F
7	79.1-81.1	6/14	11:00	84°F
7	82-87	6/7	14:50	75°F
7	85.1, 37.1	5/14	14:17	91°F
8	92	6/8	16:36	64°F
8	93, 91-88	6/9	11:10	66°F
8	94-99	6/7	16:10	77°F
9	101- 06	6/19	13:17	79°F
9	104.4, 105.5, 106.4	6/22	8:12	59°F
9	107-112	6/20	11:09	74°F
9	110.2-112.2	6/21	15:00	74°F
10	113-118	6/29	10:42	82°F
10	119-124	6/29	14:00	80°F
11	125-130	7/3	10:40	76°F
11	131-136	7/3	14:22	71°F
13	150-155	6/5	7:22	61°F
13	156-161	6/4	16:47	83°F
14	163-168	6/6	13:50	85°F

TABLE A-2 (Cont'd)

14	167	6/6	15:54	95°F
14	169-174	6/6	12:35	80°F
15	175-180	6/5	8:05	64°F
15	179	6/5	10:35	70°F
15	181-186	6/6	10:38	74°F
16	187-192	7/2	14:20	84°F
16	193-198	7/3	15:34	72°F
17	199-204	6/9	14:44	60°F
17	205-210	6/12	10:39	74°F
18	212-217	6/9	13:45	64°F
18	218-223	6/19	9:07	68°F
19	224-229	6/9	16:23	58°F
19	230-235	6/12	15:51	77°F
21	243-248	6/22	9:13	60°F
21	249-254	6/22	15:30	63°F
22	255-260	6/26	16:08	70°F
22	261-266	6/27	13:41	80°F
23	267-272	7/12	13:00	85°F
23	273-278	7/14	8:30	71°F
24	279-284	7/13	9:17	78°F
24	285-290	7/13	16:11	85°F
25	291-296	7/16	16:30	73°F
25	297-302	7/17	10:27	71°F
26	303-308	7/17	12:44	74°F
26	309-314	7/17	11:45	71°F
27	315-320	7/11	16:30	89°F
27	320.1	7/18	16:45	80°F
27	318.1	7/19	10:25	77°F
27	315.2,319.4,318.2,320.2	7/19	14:18	82°F
27	321-326	7/11	15:30	89°F
27	321.1-326.1	7/18	16:13	80°F
27	324.2-326.2	7/19	16:45	83°F
28	328-329	7/10	12:45	85°F
28	328.1, 329.1	7/18	15:39	81°F
28	331-332	7/11	13:00	80°F
28	330.1, 332.1	7/18	14:40	84°F
29	333-338	7/20	9:13	74°F
29	339-344	7/20	11:08	73°F
30	345-347	7/4	10:15	75°F
30	340-350	7/14	9:25	76°F

Appendix B

Nozzle Exit Plane Traverses

Traverse plots were obtained by surveying the nozzle exit plane of selected configurations in Phase I and all the configurations in Phase II. At a single simulated engine operating point, total pressure and total temperature were measured and non-dimensionalized relative to the corresponding ideal mixed property. The charging station conditions for each stream (fan stream = station 7 and primary stream = station 8) are identified along with the absolute level of the fully mixed reference. The location of the primary lobe peaks is indicated by an arrow.

Exit Survey

Table of Contents

Temperature Traverse

<u>Configuration Number</u>	<u>Page</u>
1	113
3	113
5	114
8	114
13	115
17	115
19	116
29	116
33	117
34	117
35	118
36	118
37	119
38	119
39	120
40	120
41	121
42	121
43	122
45	122
46	123
48	123
49	124

Pressure Traverse

1	125
3	125
5	126
8	126
13	127
17	127
19	128
29	128
33	129
34	129
35	130
36	130
37	131
38	131
39	132
40	132
41	133
42	133
43	134
45	134
46	135
48	135
49	136

TEMPERATURE CONF 1

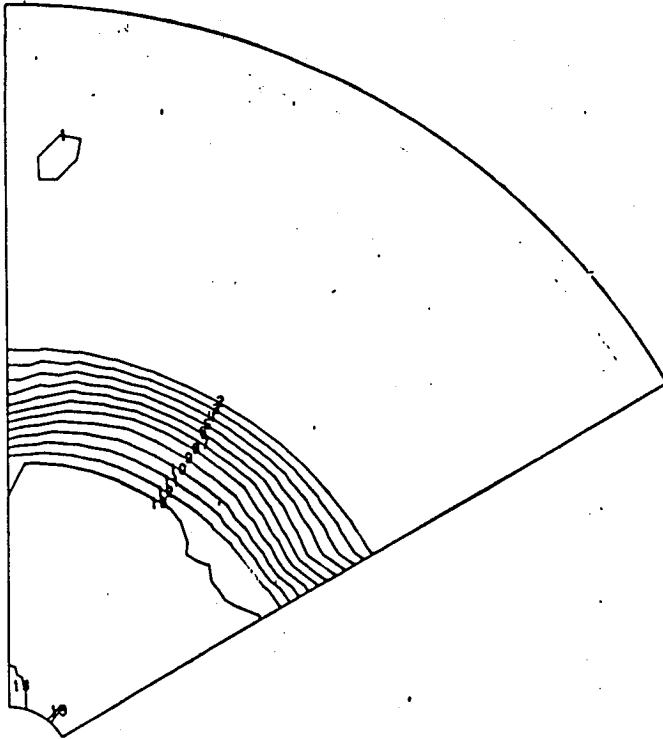

T_T/T_{TMIX}

CURVE LABEL	CURVE VALUE
1	0.800000E+00
2	0.900000E+00
3	0.100000E+01
4	0.110000E+01
5	0.120000E+01
6	0.130000E+01
7	0.140000E+01
8	0.150000E+01
9	0.160000E+01
10	0.170000E+01
11	0.180000E+01
12	0.189999E+01
13	0.199999E+01

TT7/TTMIX=0.81

TT8/TTMIX=2.00

TTMIX = 355.99°K (641.38°R)

TEMPERATURE CONF 3

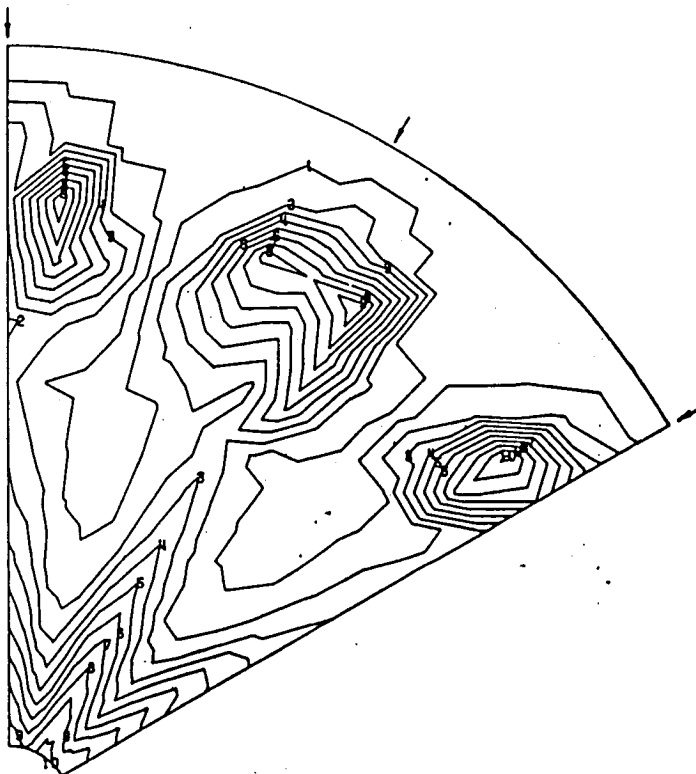

T_T/T_{TMIX}

CURVE LABEL	CURVE VALUE
1	0.850000E+00
2	0.950000E+00
3	0.105000E+01
4	0.115000E+01
5	0.125000E+01
6	0.135000E+01
7	0.145000E+01
8	0.155000E+01
9	0.165000E+01
10	0.175000E+01

TT7/TTMIX=0.83

TT8/TTMIX=2.05

TTMIX = 347.14°K (625.45°R)

TEMPERATURE CONF. 5

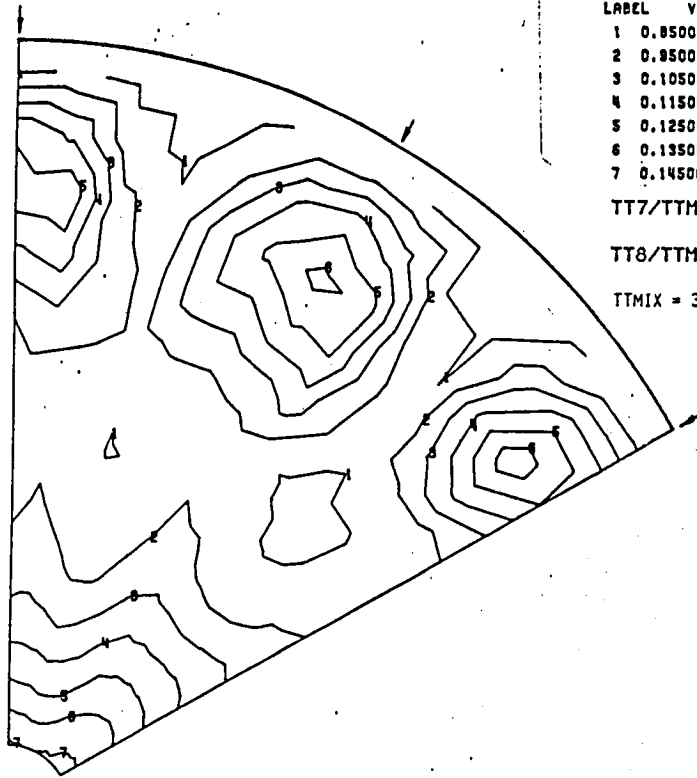

T_T/T_{TMIX}

CURVE LABEL	CURVE VALUE
1	0.850000E+00
2	0.950000E+00
3	0.105000E+01
4	0.115000E+01
5	0.125000E+01
6	0.135000E+01
7	0.145000E+01

$TT7/TTMIX=0.83$

$TT8/TTMIX=2.03$

$TTMIX = 349.53^{\circ}K (629.76^{\circ}R)$

TEMPERATURE CONF. 8

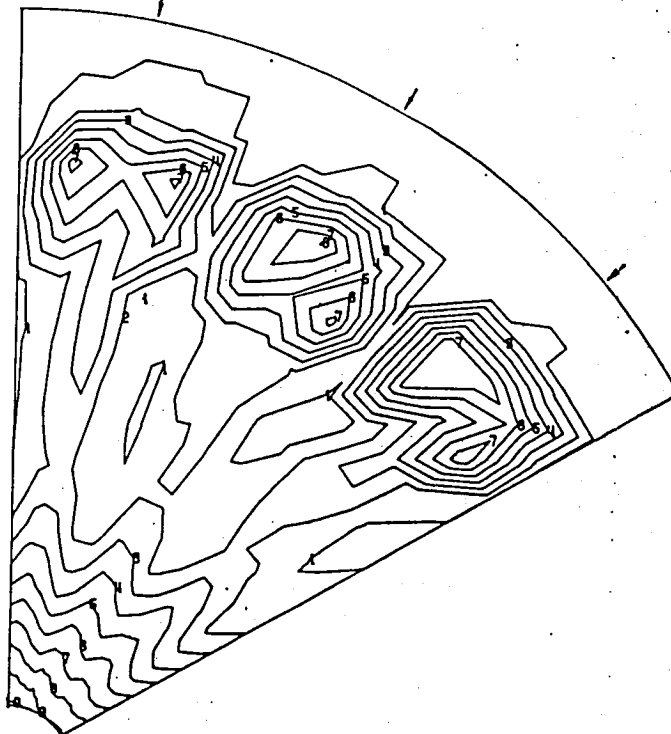

T_T/T_{TMIX}

CURVE LABEL	CURVE VALUE
1	0.850000E+00
2	0.950000E+00
3	0.105000E+01
4	0.115000E+01
5	0.125000E+01
6	0.135000E+01
7	0.145000E+01
8	0.155000E+01
9	0.165000E+01
10	0.175000E+01

$TT7/TTMIX=0.84$

$TT8/TTMIX=2.03$

$TTMIX = 363.59^{\circ}K (655.06^{\circ}R)$

TEMPERATURE CONF 13

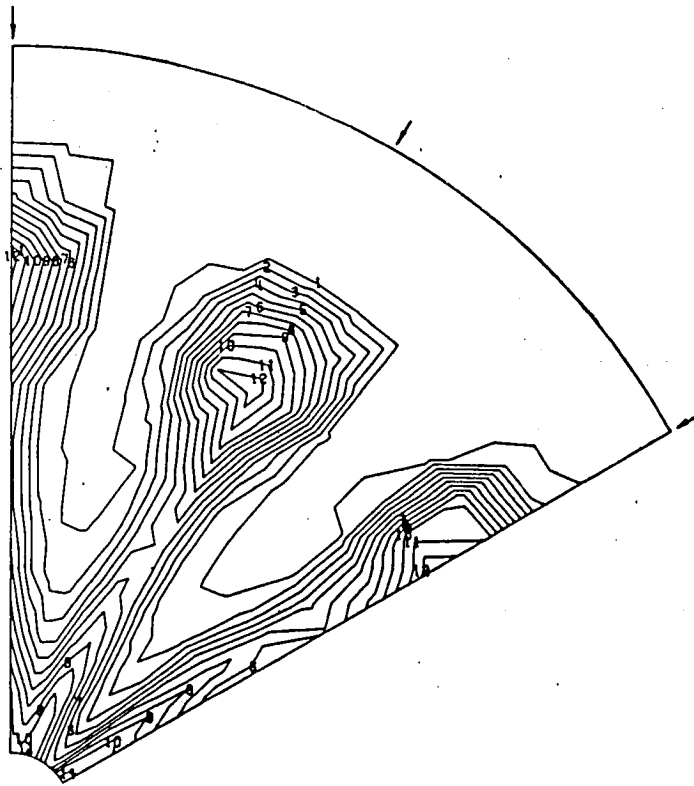

t/T_{TMIX}

CURVE LABEL	CURVE VALUE
1	0.085000E+00
2	0.095000E+00
3	0.105000E+01
4	0.115000E+01
5	0.125000E+01
6	0.135000E+01
7	0.145000E+01
8	0.155000E+01
9	0.165000E+01
10	0.175000E+01
11	0.184988E+01
12	0.184988E+01

TT7/TTMIX=0.82

TT8/TTMIX=2.02

TTMIX = 357.92°K (644.83°R)

TEMPERATURE CONF 17

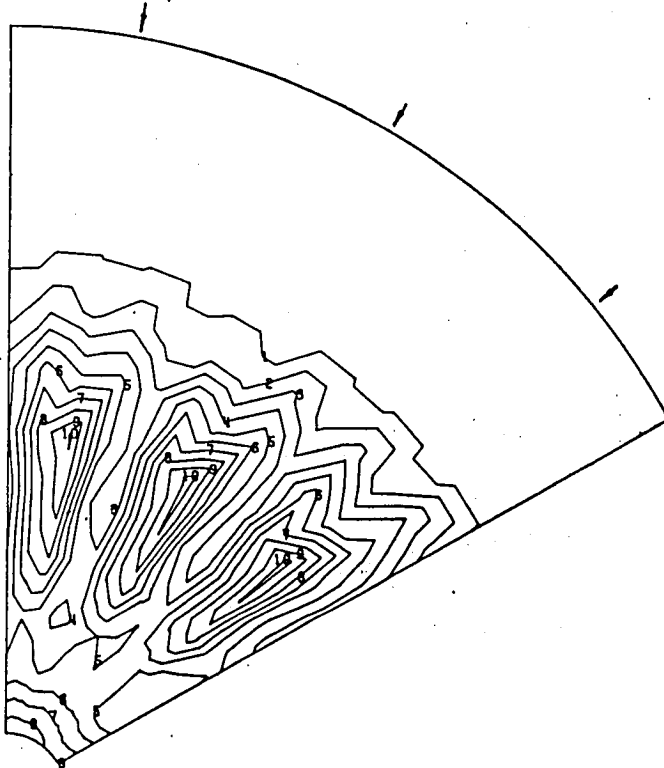

T/T_{TMIX}

CURVE LABEL	CURVE VALUE
1	0.085000E+00
2	0.095000E+00
3	0.105000E+01
4	0.115000E+01
5	0.125000E+01
6	0.135000E+01
7	0.145000E+01
8	0.155000E+01
9	0.165000E+01
10	0.175000E+01

TT7/TTMIX=0.83

TT8/TTMIX=2.05

TTMIX = 349.61°K (629.89°R)

TEMPERATURE CONF 19

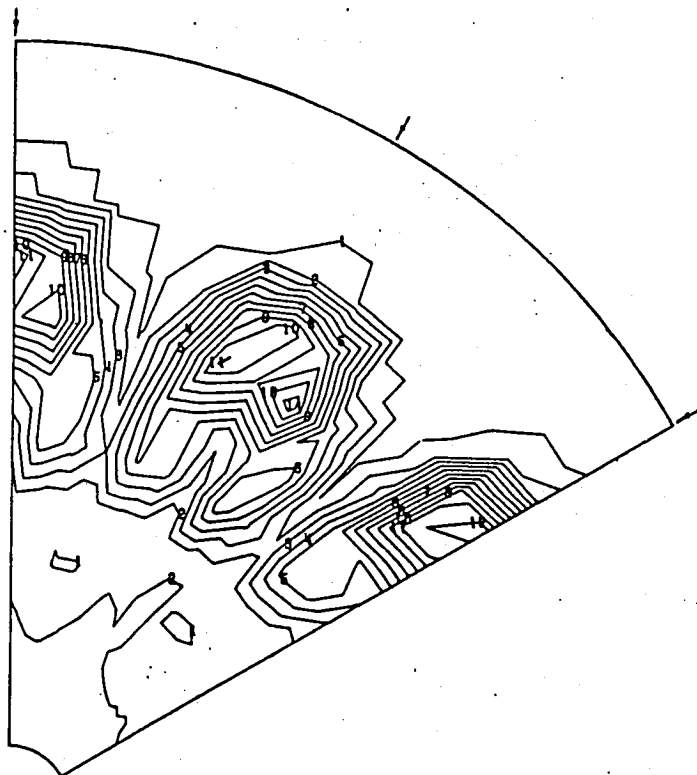

T_T/T_{TMIX}

CURVE LABEL	CURVE VALUE
1	0.050000E+00
2	0.050000E+00
3	0.105000E+01
4	0.115000E+01
5	0.125000E+01
6	0.135000E+01
7	0.145000E+01
8	0.155000E+01
9	0.165000E+01
10	0.175000E+01
11	0.184888E+01
12	0.184888E+01

TT7/TTMIX=0.83
 TT8/TTMIX=2.04
 TTMIX = 348.57°K (628.03°R)

TEMPERATURE CONF 29

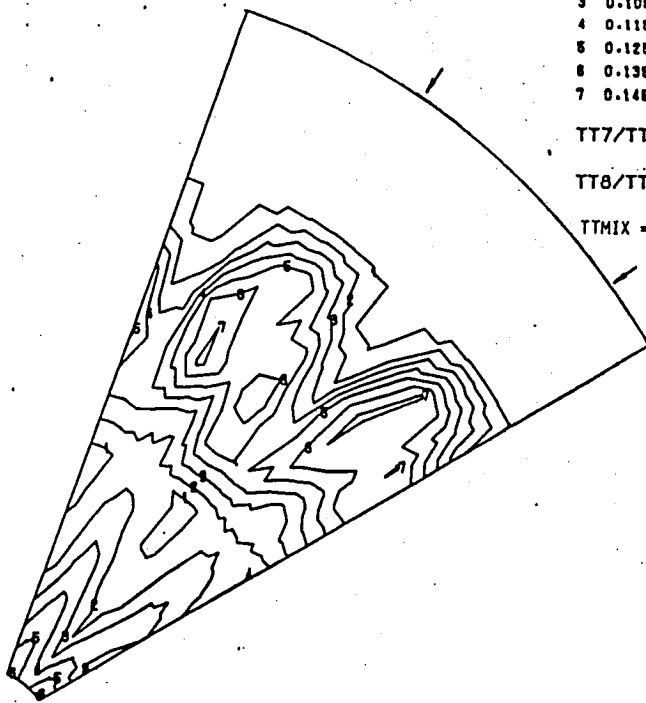

T_T/T_{TMIX}

CURVE LABEL	CURVE VALUE
1	0.050000E+00
2	0.050000E+00
3	0.105000E+01
4	0.115000E+01
5	0.125000E+01
6	0.135000E+01
7	0.145000E+01

TT7/TTMIX=0.8262
 TT8/TTMIX=2.0637
 TTMIX = 357.82°K (644.68°R)

TEMPERATURE CONF 33

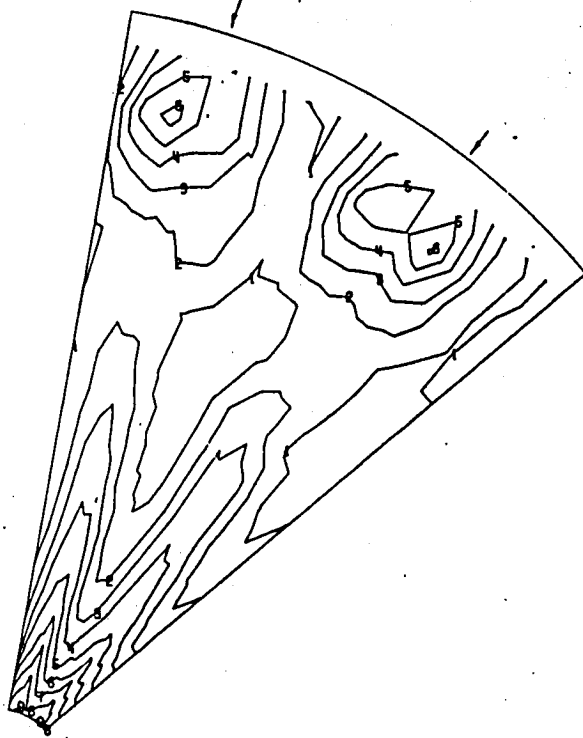

T_T/T_{TMIX}

CURVE LABEL	CURVE VALUE
1	0.085000E+00
2	0.095000E+00
3	0.105000E+01
4	0.115000E+01
5	0.125000E+01
6	0.135000E+01
7	0.145000E+01
8	0.155000E+01
9	0.185000E+01

TT7/TTMIX=0.8232

TT8/TTMIX=2.0511

TTMIX = 353.11°K (636.20°R)

TEMPERATURE CONF 34

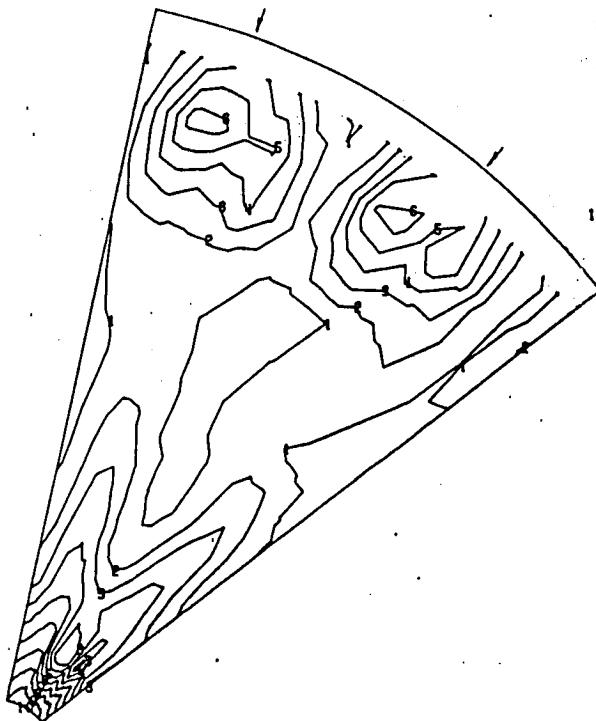

T_T/T_{TMIX}

CURVE LABEL	CURVE VALUE
1	0.085000E+00
2	0.095000E+00
3	0.105000E+01
4	0.115000E+01
5	0.125000E+01
6	0.135000E+01
7	0.145000E+01
8	0.155000E+01
9	0.185000E+01
10	0.175000E+01

TT7/TTMIX=0.8222

TT8/TTMIX=2.0536

TTMIX = 354.48°K (638.67°R)

TEMPERATURE CONF 35

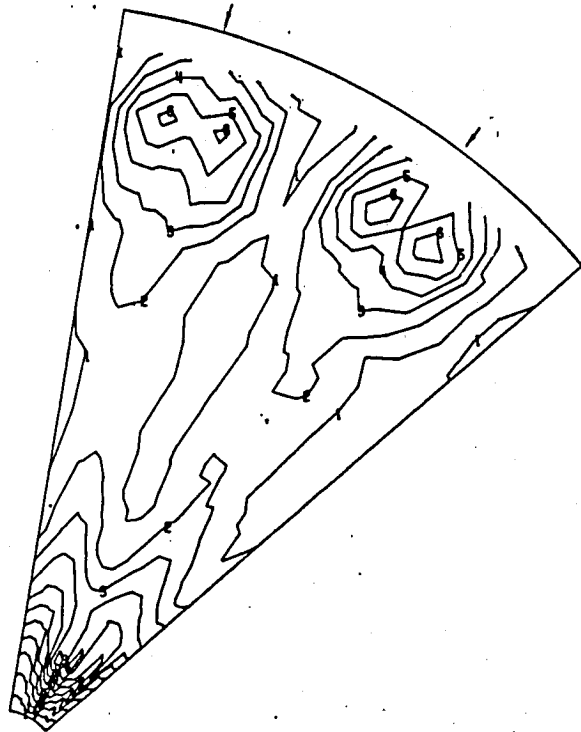

T_T/T_{TMIX}

CURVE LABEL	CURVE VALUE
1	0.850000E+00
2	0.950000E+00
3	0.105000E+01
4	0.115000E+01
5	0.125000E+01
6	0.135000E+01
7	0.145000E+01
8	0.155000E+01
9	0.165000E+01
10	0.175000E+01
11	0.184999E+01

$TT7/TTMIX=0.8197$

$TT8/TTMIX=2.0467$

$TTMIX = 358.07^{\circ}K (645.13^{\circ}R)$

TEMPERATURE CONF 36

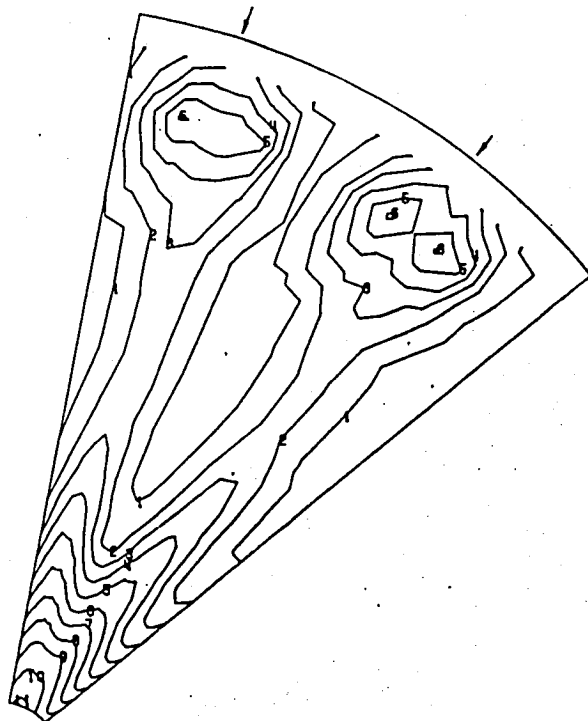

T_T/T_{TMIX}

CURVE LABEL	CURVE VALUE
1	0.850000E+00
2	0.950000E+00
3	0.105000E+01
4	0.115000E+01
5	0.125000E+01
6	0.135000E+01
7	0.145000E+01
8	0.155000E+01
9	0.165000E+01
10	0.175000E+01
11	0.184999E+01

$TT7/TTMIX=0.8124$

$TT8/TTMIX=2.0284$

$TTMIX = 355.18^{\circ}K (639.92^{\circ}R)$

TEMPERATURE CONF 37

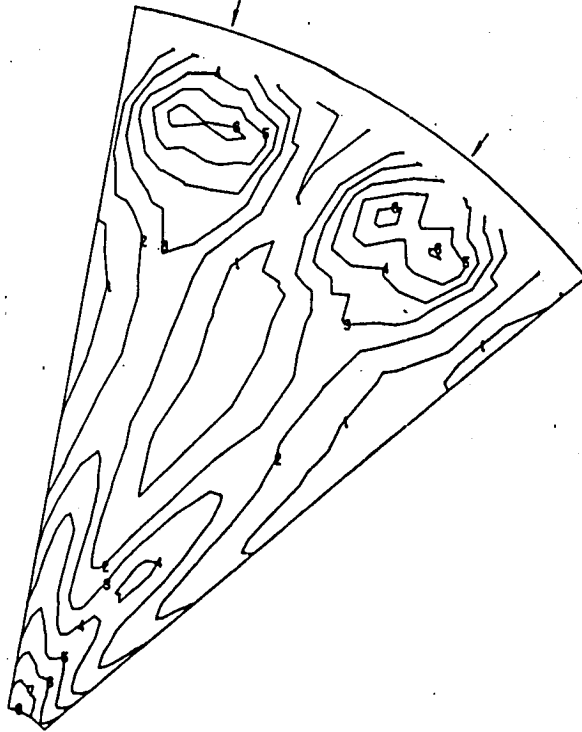

T_t/T_{TMIX}

CURVE LABEL	CURVE VALUE
1	0.060000E+00
2	0.080000E+00
3	0.105000E+01
4	0.115000E+01
5	0.125000E+01
6	0.135000E+01
7	0.145000E+01
8	0.155000E+01

TT7/TTMIX=0.8316

TT8/TTMIX=2.0726

TTMIX = 347.75°K (626.55°R)

TEMPERATURE CONF 38

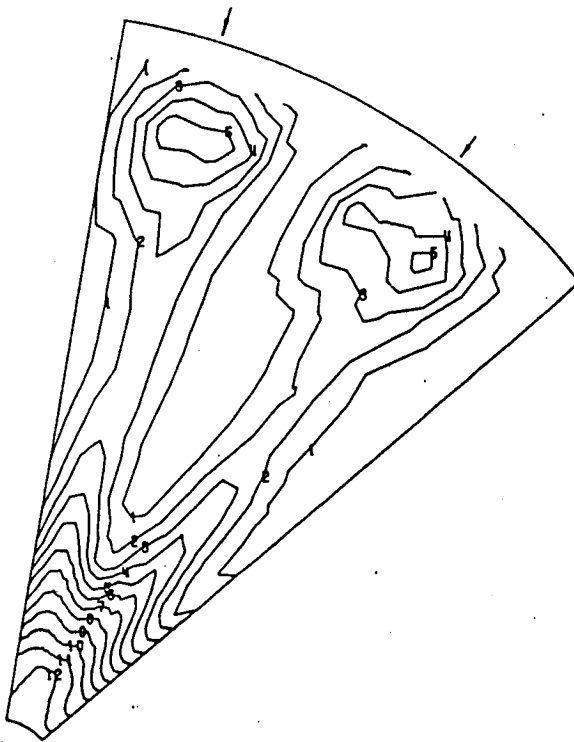

T_t/T_{TMIX}

CURVE LABEL	CURVE VALUE
1	0.050000E+00
2	0.080000E+00
3	0.105000E+01
4	0.115000E+01
5	0.125000E+01
6	0.135000E+01
7	0.145000E+01
8	0.155000E+01
9	0.165000E+01
10	0.175000E+01
11	0.184999E+01
12	0.194999E+01

TT7/TTMIX=0.8062

TT8/TTMIX=2.0103

TTMIX = 366.68°K (660.62°R)

TEMPERATURE CONF 39

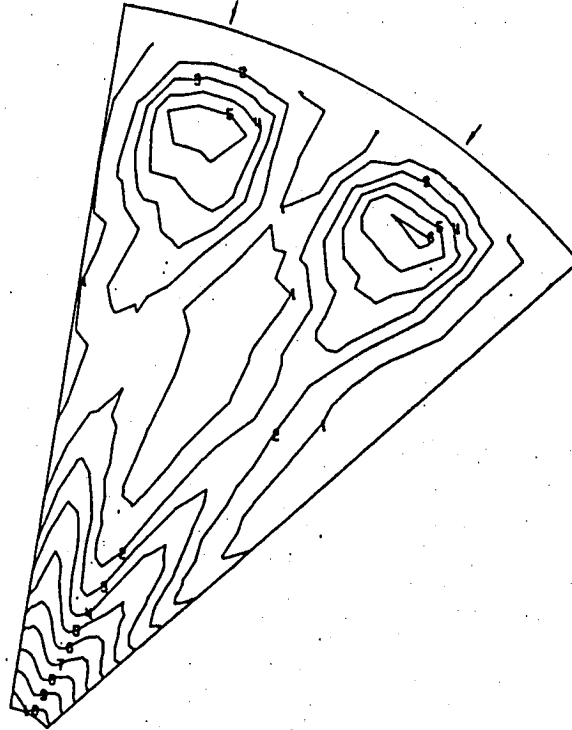

T_T/T_{TMIX}

CURVE LABEL	CURVE VALUE
1	0.050000E+00
2	0.050000E+00
3	0.105000E+01
4	0.115000E+01
5	0.125000E+01
6	0.135000E+01
7	0.145000E+01
8	0.155000E+01
9	0.185000E+01
10	0.175000E+01

$TT7/TTMIX=0.8262$

$TT8/TTMIX=2.0628$

$TTMIX = 355.89^{\circ}K (641.20^{\circ}R)$

TEMPERATURE CONF 40

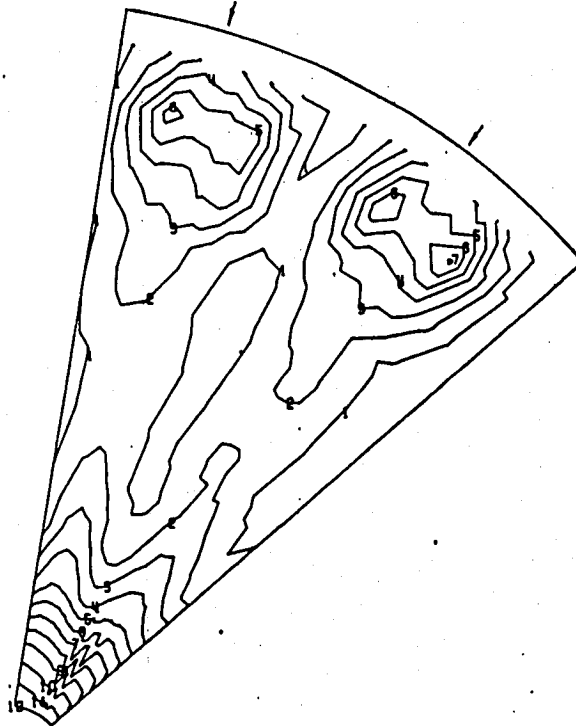

T_T/T_{TMIX}

CURVE LABEL	CURVE VALUE
1	0.050000E+00
2	0.050000E+00
3	0.105000E+01
4	0.115000E+01
5	0.125000E+01
6	0.135000E+01
7	0.145000E+01
8	0.155000E+01
9	0.185000E+01
10	0.175000E+01
11	0.184999E+01
12	0.184999E+01

$TT7/TTMIX=0.8213$

$TT8/TTMIX=2.0490$

$TTMIX = 356.43^{\circ}K (642.17^{\circ}R)$

TEMPERATURE CONF 41

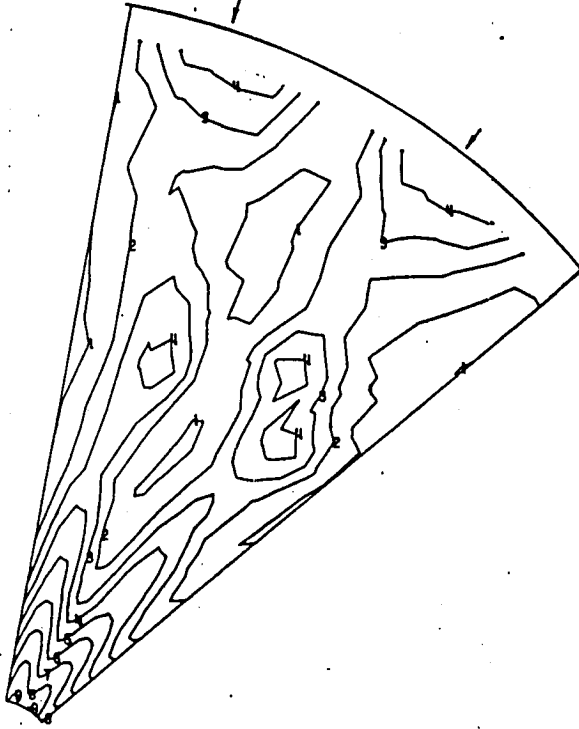

T_T/T_{TMIX}

CURVE LABEL	CURVE VALUE
1	0.850000E+00
2	0.950000E+00
3	0.105000E+01
4	0.115000E+01
5	0.125000E+01
6	0.135000E+01
7	0.145000E+01
8	0.155000E+01
9	0.165000E+01

TT7/TTMIX=0.8311

TT8/TTMIX=2.0744

TTMIX = 351.12°K (632.61°R)

TEMPERATURE CONF 42

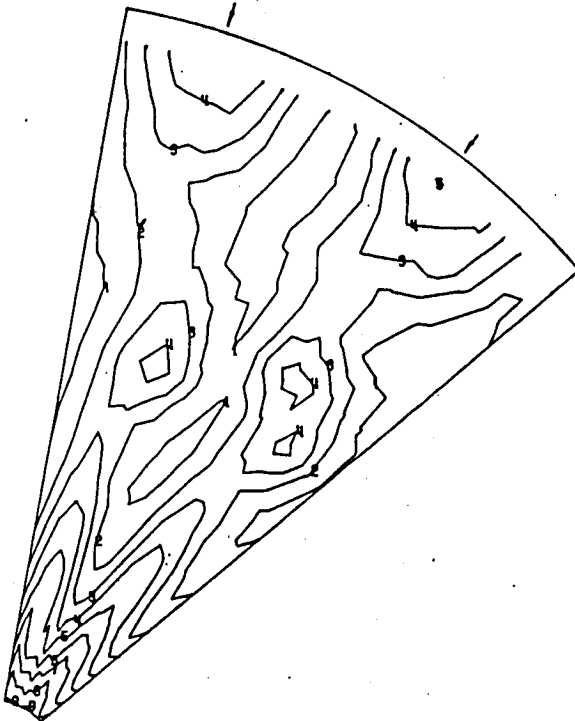

T_T/T_{TMIX}

CURVE LABEL	CURVE VALUE
1	0.850000E+00
2	0.950000E+00
3	0.105000E+01
4	0.115000E+01
5	0.125000E+01
6	0.135000E+01
7	0.145000E+01
8	0.155000E+01
9	0.165000E+01

TT7/TTMIX=0.8238

TT8/TTMIX=2.0543

TTMIX = 355.98°K (641.37°R)

TEMPERATURE CONF 43

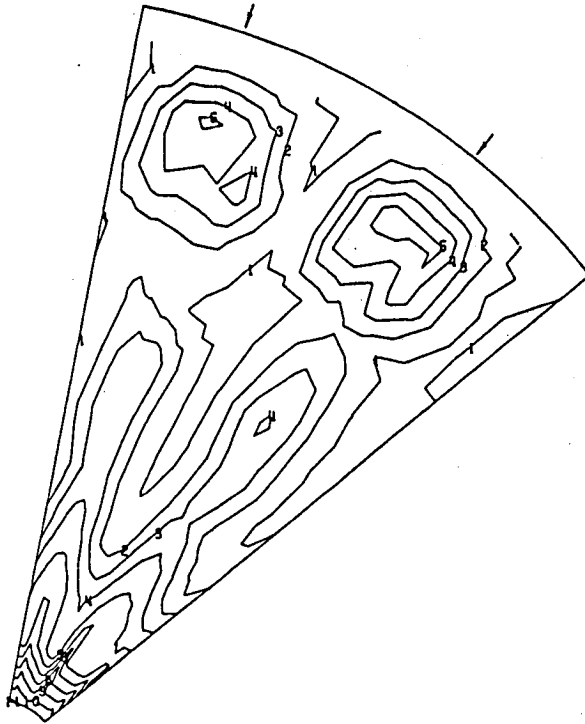

T/T_{MIX}

CURVE LABEL	CURVE VALUE
1	0.850000E+00
2	0.950000E+00
3	0.105000E+01
4	0.115000E+01
5	0.125000E+01
6	0.135000E+01
7	0.145000E+01
8	0.155000E+01
9	0.165000E+01
10	0.175000E+01
11	0.184999E+01

$TT7/TTMIX=0.8292$

$TT8/TTMIX=2.0707$

$TTMIX = 354.44^{\circ}K (638.60^{\circ}R)$

TEMPERATURE CONF 45

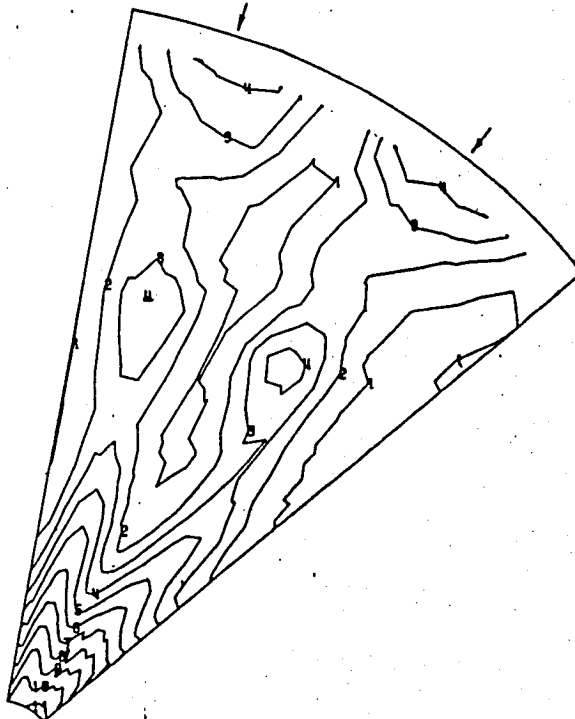

T/T_{MIX}

CURVE LABEL	CURVE VALUE
1	0.850000E+00
2	0.950000E+00
3	0.105000E+01
4	0.115000E+01
5	0.125000E+01
6	0.135000E+01
7	0.145000E+01
8	0.155000E+01
9	0.165000E+01
10	0.175000E+01
11	0.184999E+01

$TT7/TTMIX=0.8301$

$TT8/TTMIX=2.0715$

$TTMIX = 347.99^{\circ}K (626.99^{\circ}R)$

TEMPERATURE CONF 48

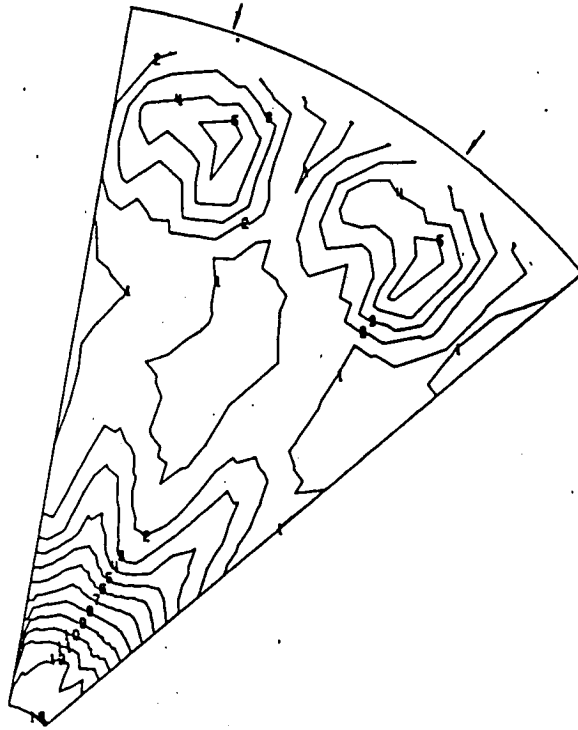

T_T/T_{TMIX}

CURVE LABEL	CURVE VALUE
1	0.050000E+00
2	0.050000E+00
3	0.105000E+01
4	0.115000E+01
5	0.125000E+01
6	0.135000E+01
7	0.145000E+01
8	0.155000E+01
9	0.165000E+01
10	0.175000E+01
11	0.184999E+01
12	0.184999E+01
13	0.204999E+01

TT7/TTMIX=0.8202

TT8/TTMIX=2.0488

TTMIX = 350.16^oK (630.89^oR)

TEMPERATURE CONF 48

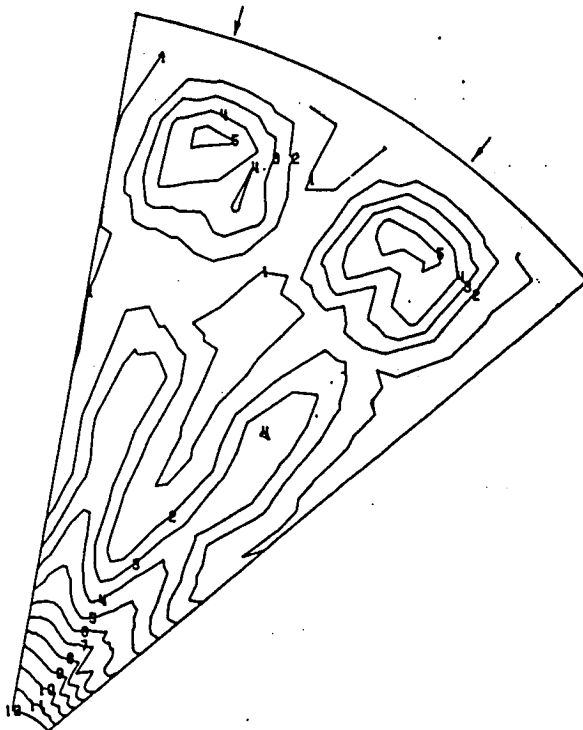

T_T/T_{TMIX}

CURVE LABEL	CURVE VALUE
1	0.050000E+00
2	0.050000E+00
3	0.105000E+01
4	0.115000E+01
5	0.125000E+01
6	0.135000E+01
7	0.145000E+01
8	0.155000E+01
9	0.165000E+01
10	0.175000E+01
11	0.184999E+01
12	0.184999E+01

TT7/TTMIX=0.8299

TT8/TTMIX=2.0688

TTMIX = 351.54^oK (633.38^oR)

TEMPERATURE CONF 49

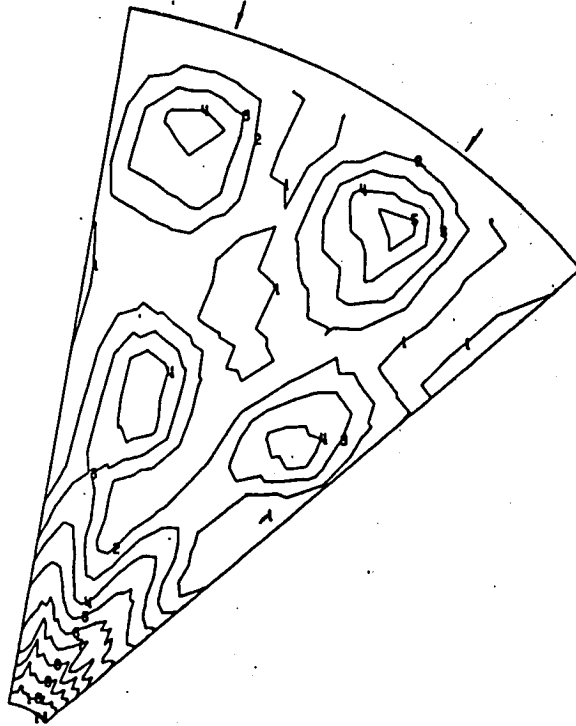

T/T_{MIX}

CURVE LABEL	CURVE VALUE
1	0.850000E+00
2	0.950000E+00
3	0.105000E+01
4	0.115000E+01
5	0.125000E+01
6	0.135000E+01
7	0.145000E+01
8	0.155000E+01
9	0.165000E+01
10	0.175000E+01
11	0.184998E+01

$TT7/TTMIX=0.8324$

$TT8/TTMIX=2.0692$

$TTMIX = 348.20^{\circ}K (627.36^{\circ}R)$

PRESSURE CONF 1



P_T/P_{TMIX}

CURVE LABEL	CURVE VALUE
1	0.950000E+00
2	0.960000E+00
3	0.970000E+00
4	0.980000E+00
5	0.990000E+00
6	0.100000E+01
7	0.101000E+01
8	0.102000E+01

PT7/PTMIX=1.03

PT8/PTMIX=0.95

PTMIX = $2.385 \times 10^5 \text{ N/m}^2$ (34.59 PSIA)

PRESSURE CONF 3

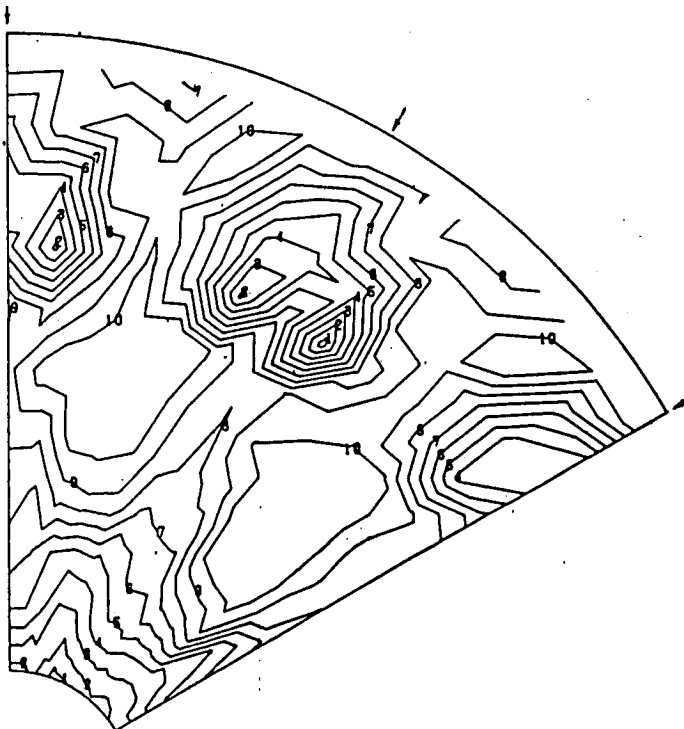

P_T/P_{TMIX}

CURVE LABEL	CURVE VALUE
1	0.930000E+00
2	0.940000E+00
3	0.950000E+00
4	0.960000E+00
5	0.970000E+00
6	0.980000E+00
7	0.990000E+00
8	0.100000E+01
9	0.101000E+01
10	0.102000E+01

PT7/PTMIX=1.03

PT8/PTMIX=0.95

PTMIX = $2.358 \times 10^5 \text{ N/m}^2$ (34.20 PSIA)

PRESSURE CONF 5

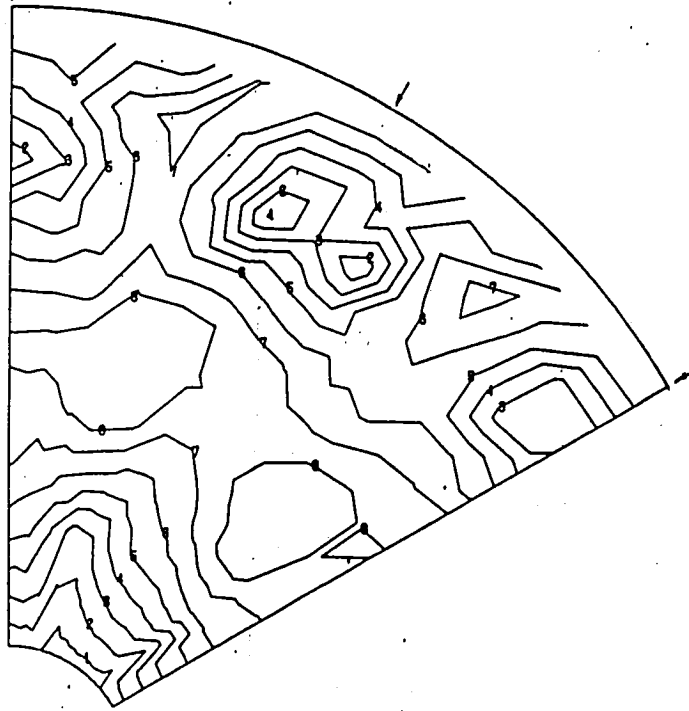

P_T/P_{TMIX}

CURVE LABEL	CURVE VALUE
1	0.960000E+00
2	0.960000E+00
3	0.970000E+00
4	0.980000E+00
5	0.990000E+00
6	0.100000E+01
7	0.101000E+01
8	0.102000E+01

PT7/PTMIX=1.03

PT8/PTMIX=0.95

PTMIX = $2.356 \times 10^5 \text{ N/m}^2$ (34.17 PSIA)

PRESSURE CONF 8

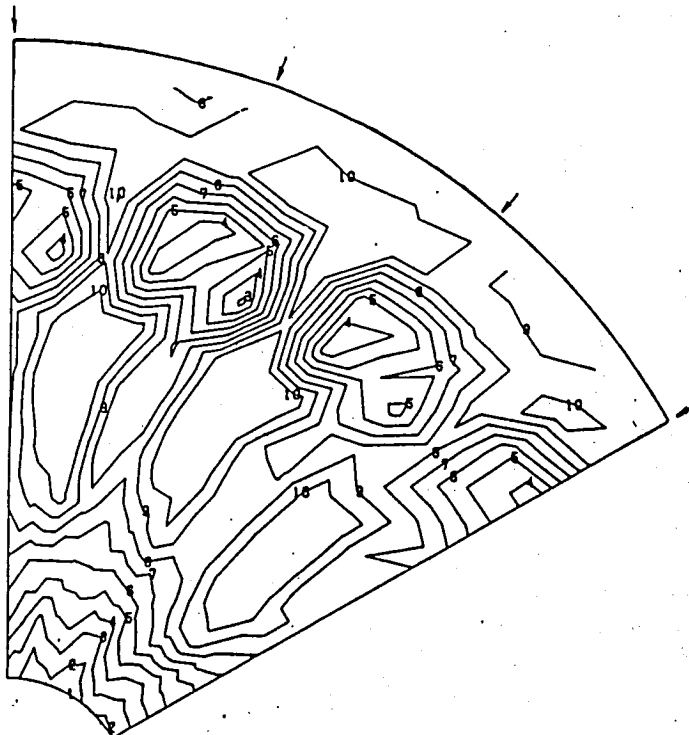

P_T/P_{TMIX}

CURVE LABEL	CURVE VALUE
1	0.930000E+00
2	0.940000E+00
3	0.960000E+00
4	0.980000E+00
5	0.970000E+00
6	0.990000E+00
7	0.990000E+00
8	0.100000E+01
9	0.101000E+01
10	0.102000E+01

PT7/PTMIX=1.03

PT8/PTMIX=0.95

PTMIX = $2.355 \times 10^5 \text{ N/m}^2$ (32.41 PSIA)

PRESSURE CONF 13

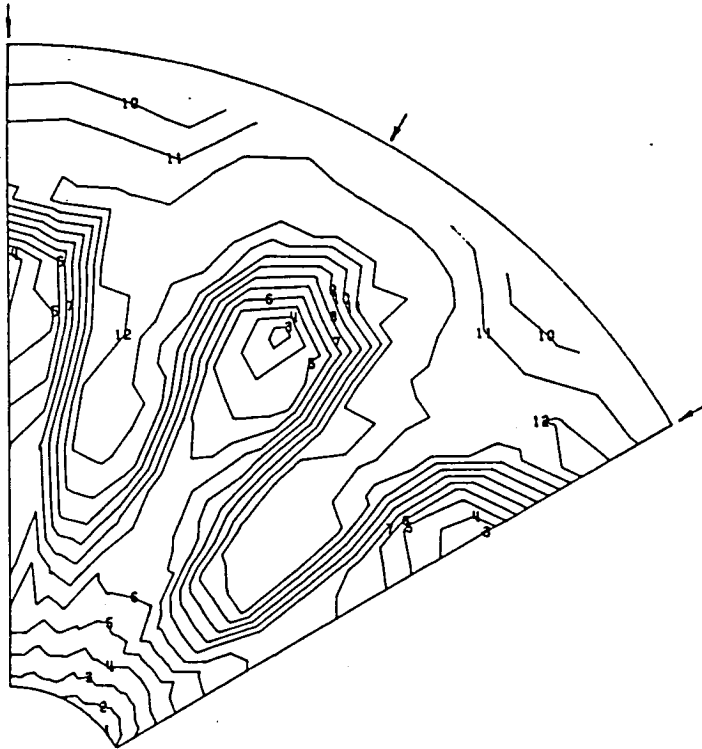

P_T/P_{TMIX}

CURVE LABEL	CURVE VALUE
1	0.920000E+00
2	0.930000E+00
3	0.940000E+00
4	0.950000E+00
5	0.960000E+00
6	0.970000E+00
7	0.980000E+00
8	0.990000E+00
9	0.100000E+01
10	0.101000E+01
11	0.102000E+01
12	0.103000E+01

P_{T7}/P_{TMIX}=1.04

P_{T8}/P_{TMIX}=0.95

P_{TMIX} = 2.395x10⁵N/m² (34.74 PSIA)

PRESSURE CONF 17

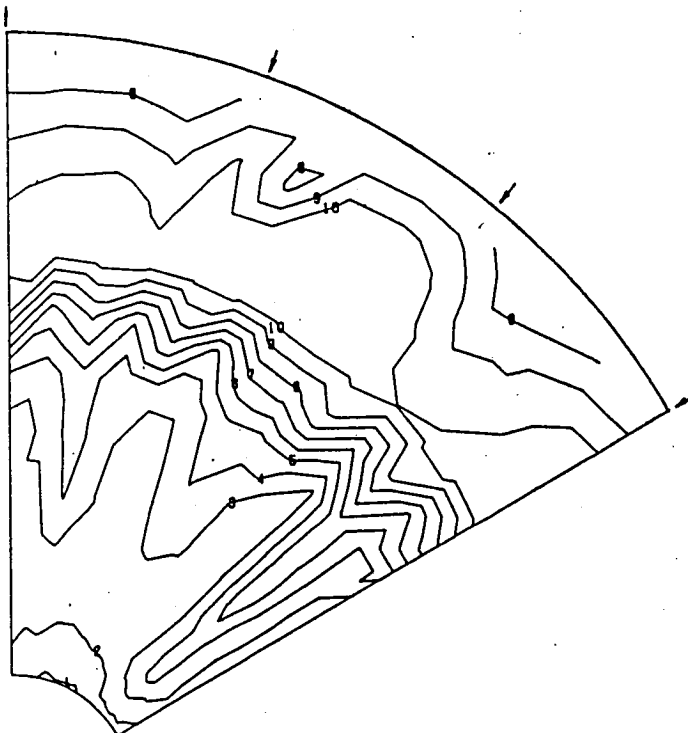

P_T/P_{TMIX}

CURVE LABEL	CURVE VALUE
1	0.940000E+00
2	0.950000E+00
3	0.960000E+00
4	0.970000E+00
6	0.980000E+00
6	0.990000E+00
7	0.100000E+01
8	0.101000E+01
9	0.102000E+01
10	0.103000E+01

P_{T7}/P_{TMIX}=1.03

P_{T8}/P_{TMIX}=0.94

P_{TMIX} = 2.405x10⁵N/m² (34.88 PSIA)

PRESSURE CONF 19

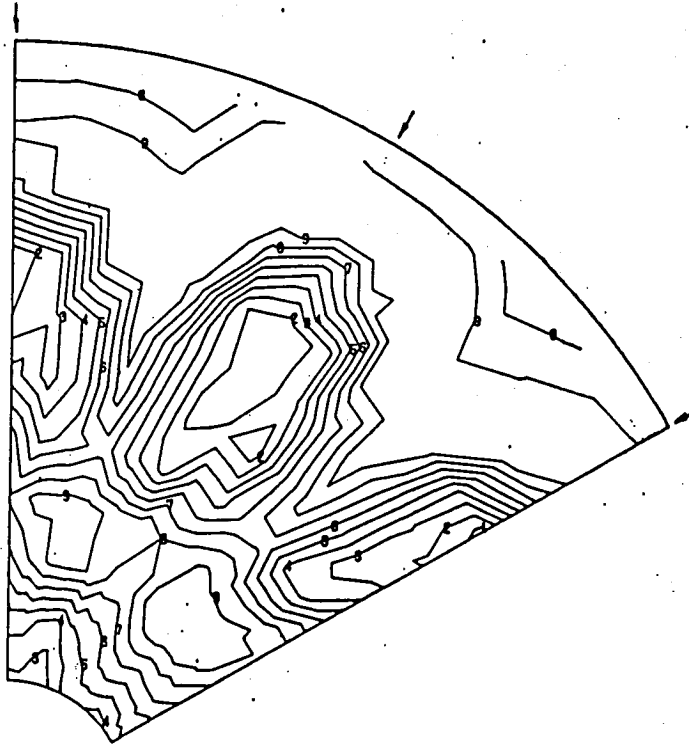

P_T/P_{TMIX}

CURVE LABEL	CURVE VALUE
1	0.940000E+00
2	0.950000E+00
3	0.960000E+00
4	0.970000E+00
5	0.980000E+00
6	0.990000E+00
7	0.100000E+01
8	0.101000E+01
9	0.102000E+01

PT7/PTMIX=1.03

PT8/PTMIX=0.94

PTMIX = $2.403 \times 10^5 \text{ N/m}^2$ (34.85 PSIA)

PRESSURE CONF 29

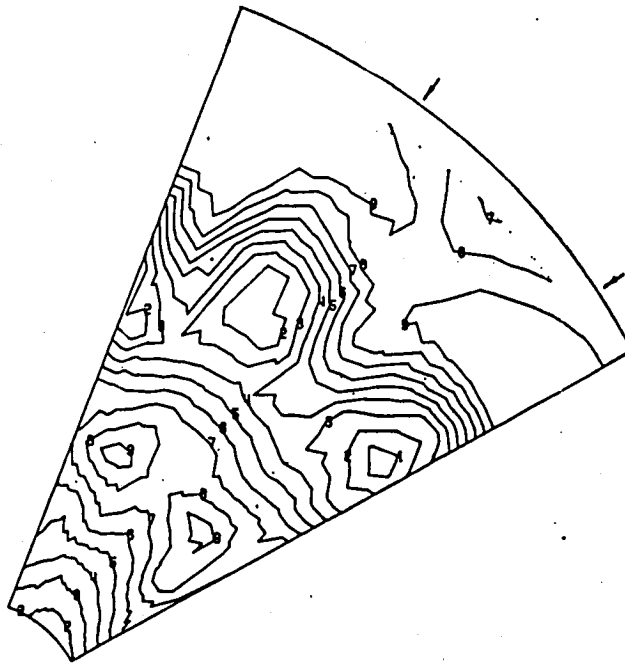

P_T/P_{TMIX}

CURVE LABEL	CURVE VALUE
1	0.950000E+00
2	0.960000E+00
3	0.970000E+00
4	0.980000E+00
5	0.990000E+00
6	0.100000E+01
7	0.101000E+01
8	0.102000E+01
9	0.103000E+01

PT7/PTMIX=1.0358

PT8/PTMIX=0.9406

PTMIX = $2.355 \times 10^5 \text{ N/m}^2$ (32.41 PSIA)

PRESSURE CONF 33

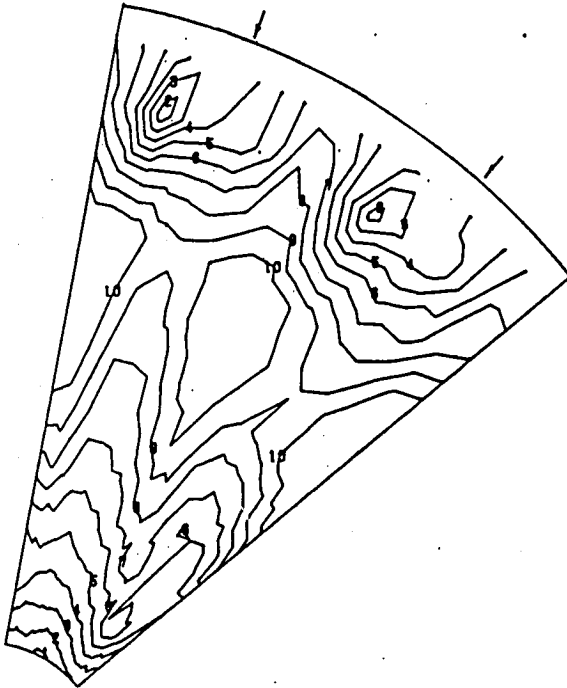

P_T/P_{TMIX}

CURVE LABEL	CURVE VALUE
1	0.840000E+00
2	0.850000E+00
3	0.860000E+00
4	0.870000E+00
5	0.880000E+00
6	0.890000E+00
7	0.100000E+01
8	0.101000E+01
9	0.102000E+01
10	0.103000E+01

PT7/PTMIX=1.0369

PT8/PTMIX=0.9449

PTMIX = $2.412 \times 10^5 \text{ N/m}^2$ (34.97 PSIA)

PRESSURE CONF 34

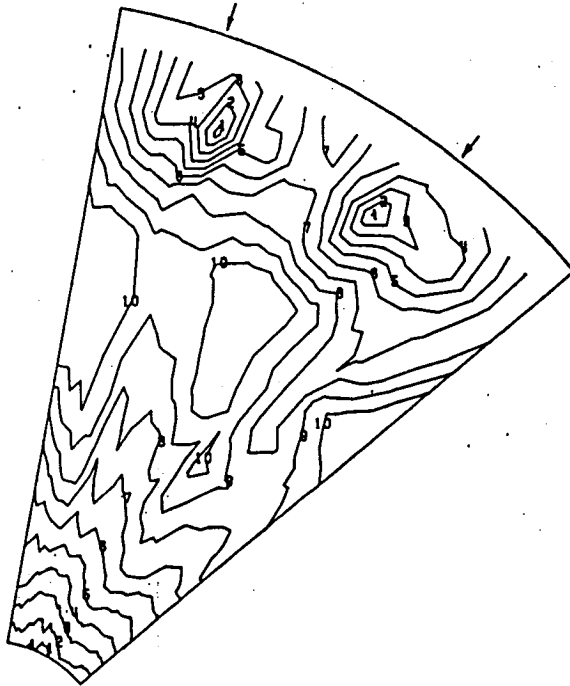

P_T/P_{TMIX}

CURVE LABEL	CURVE VALUE
1	0.940000E+00
2	0.950000E+00
3	0.960000E+00
4	0.970000E+00
5	0.980000E+00
6	0.990000E+00
7	0.100000E+01
8	0.101000E+01
9	0.102000E+01
10	0.103000E+01

PT7/PTMIX=1.0382

PT8/PTMIX=0.9446

PTMIX = $2.436 \times 10^5 \text{ N/m}^2$ (35.33 PSIA)

PRESSURE CONF 35

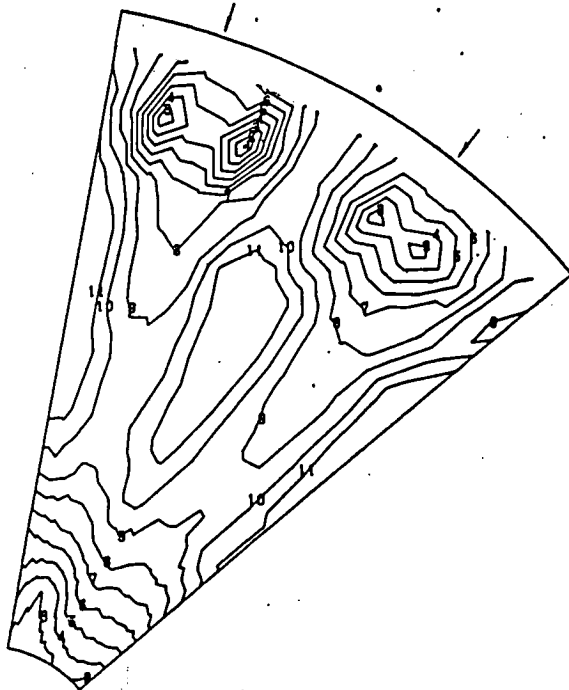

P_T/P_{TMIX}

CURVE LABEL	CURVE VALUE
1	0.830000E+00
2	0.840000E+00
3	0.850000E+00
4	0.860000E+00
5	0.870000E+00
6	0.880000E+00
7	0.890000E+00
8	0.100000E+01
9	0.101000E+01
10	0.102000E+01
11	0.103000E+01

PT7/PTMIX=1.0400

PT8/PTMIX=0.9454

PTMIX = $2.432 \times 10^5 \text{ N/m}^2$ (35.28 PSIA)

PRESSURE CONF 36

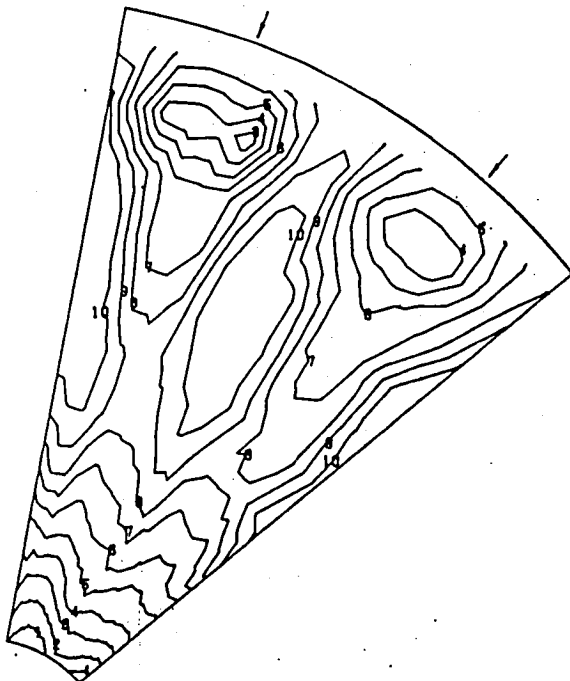

P_T/P_{TMIX}

CURVE LABEL	CURVE VALUE
1	0.840000E+00
2	0.850000E+00
3	0.860000E+00
4	0.870000E+00
5	0.880000E+00
6	0.890000E+00
7	0.100000E+01
8	0.101000E+01
9	0.102000E+01
10	0.103000E+01

PT7/PTMIX=1.0390

PT8/PTMIX=0.9470

PTMIX = $2.418 \times 10^5 \text{ N/m}^2$ (35.07 PSIA)

PRESSURE CONF 37

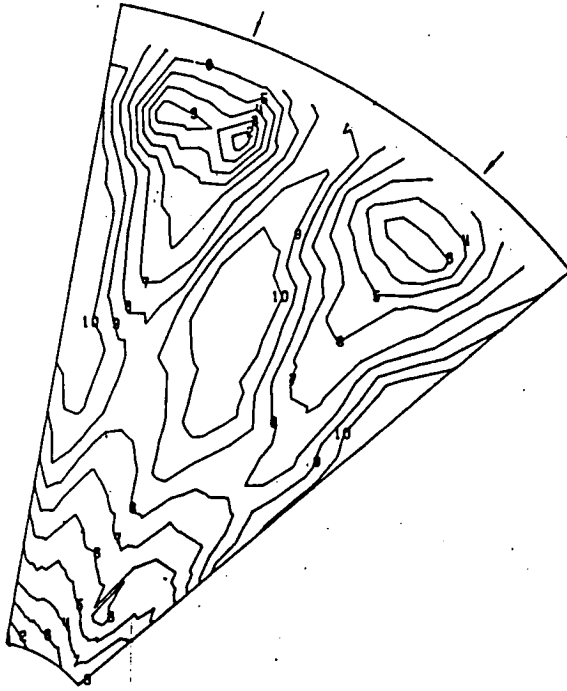

P_T/P_{TMIX}

CURVE LABEL	CURVE VALUE
1	0.940000E+00
2	0.950000E+00
3	0.960000E+00
4	0.970000E+00
5	0.980000E+00
6	0.990000E+00
7	0.100000E+01
8	0.101000E+01
9	0.102000E+01
10	0.103000E+01

PT7/PTMIX=1.0379

PT8/PTMIX=0.9446

PTMIX = $2.417 \times 10^5 \text{N/m}^2$ (35.05 PSIA)

PRESSURE CONF 38

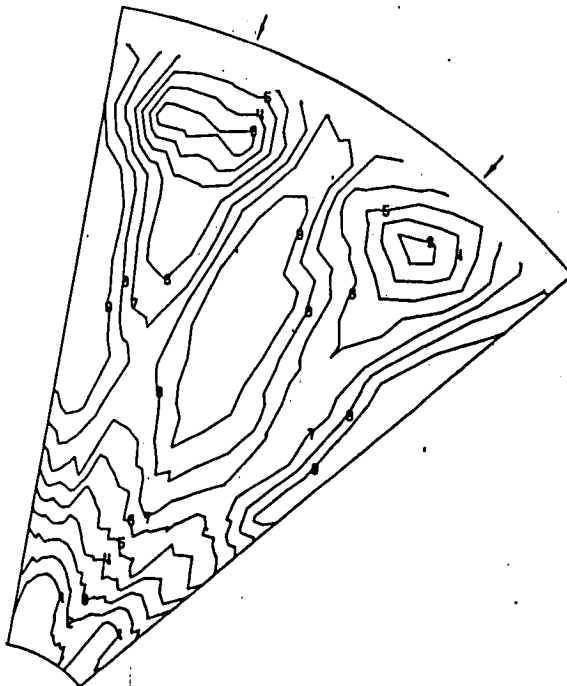

P_T/P_{TMIX}

CURVE LABEL	CURVE VALUE
1	0.950000E+00
2	0.960000E+00
3	0.970000E+00
4	0.980000E+00
5	0.990000E+00
6	0.100000E+01
7	0.101000E+01
8	0.102000E+01
9	0.103000E+01

PT7/PTMIX=1.0412

PT8/PTMIX=0.9478

PTMIX = $2.410 \times 10^5 \text{N/m}^2$ (34.96 PSIA)

PRESSURE CONF 39

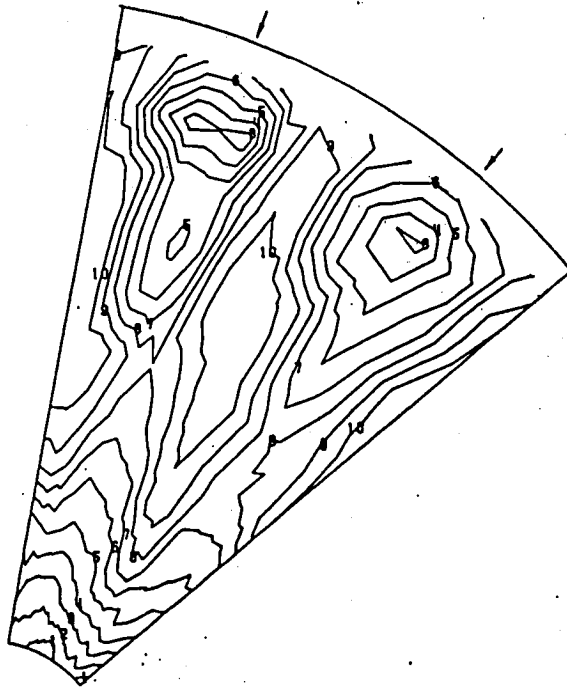

P_T/P_{TMIX}

CURVE LABEL	CURVE VALUE
1	0.940000E+00
2	0.950000E+00
3	0.960000E+00
4	0.970000E+00
5	0.980000E+00
6	0.990000E+00
7	0.100000E+01
8	0.101000E+01
9	0.102000E+01
10	0.103000E+01

PT7/PTMIX=1.0373

PT8/PTMIX=0.9448

PTMIX = $2.436 \times 10^5 \text{ N/m}^2$ (35.33 PSIA)

PRESSURE CONF 40

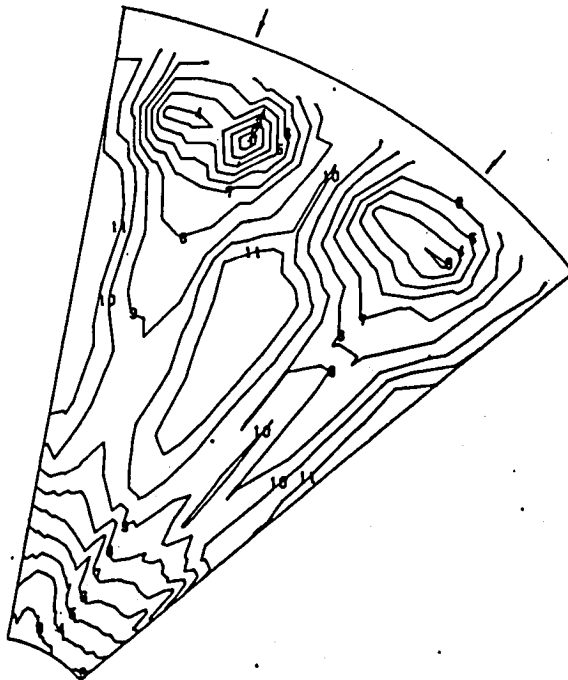

P_T/P_{TMIX}

CURVE LABEL	CURVE VALUE
1	0.830000E+00
2	0.840000E+00
3	0.850000E+00
4	0.860000E+00
5	0.870000E+00
6	0.880000E+00
7	0.890000E+00
8	0.100000E+01
9	0.101000E+01
10	0.102000E+01
11	0.103000E+01

PT7/PTMIX=1.0394

PT8/PTMIX=0.9454

PTMIX = $2.413 \times 10^5 \text{ N/m}^2$ (34.99 PSIA)

PRESSURE CONF 41

P_T/P_{TMIX}

CURVE LABEL	CURVE VALUE
1	0.940000E+00
2	0.950000E+00
3	0.960000E+00
4	0.970000E+00
5	0.980000E+00
6	0.990000E+00
7	0.100000E+01
8	0.101000E+01
9	0.102000E+01
10	0.103000E+01

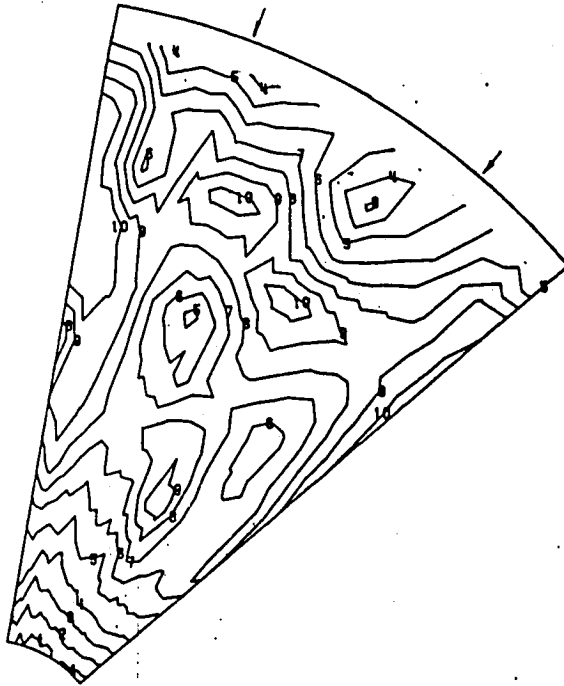

PT7/PTMIX=1.0360

PT8/PTMIX=0.9413

PTMIX = 2.441x10⁵N/m² (35.41 PSIA)

PRESSURE CONF 42

P_T/P_{TMIX}

CURVE LABEL	CURVE VALUE
1	0.940000E+00
2	0.950000E+00
3	0.960000E+00
4	0.970000E+00
5	0.980000E+00
6	0.990000E+00
7	0.100000E+01
8	0.101000E+01
9	0.102000E+01
10	0.103000E+01

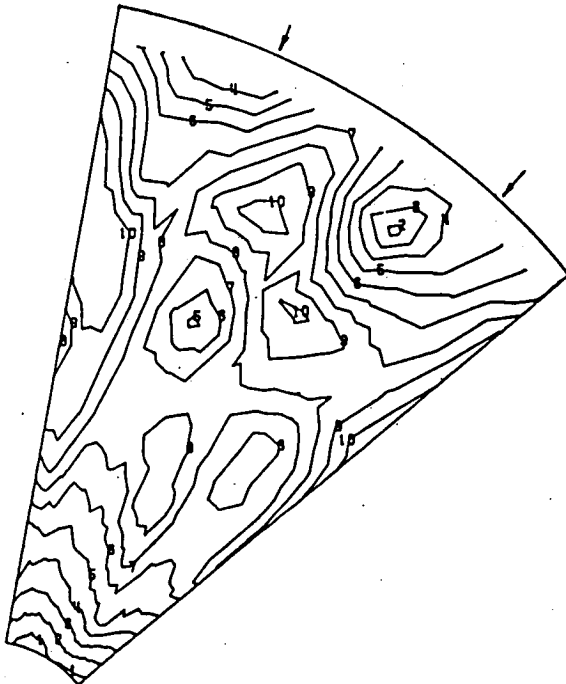

PT7/PTMIX=1.0377

PT8/PTMIX=0.9428

PTMIX = 2.441x10⁵N/m² (35.41 PSIA)

PRESSURE CONF 43

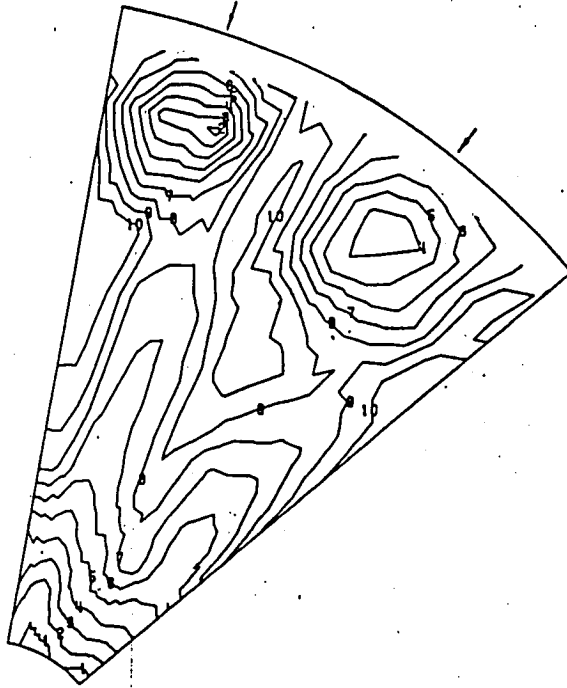

PT/PTMIX

CURVE LABEL	CURVE VALUE
1	0.940000E+00
2	0.950000E+00
3	0.960000E+00
4	0.970000E+00
5	0.980000E+00
6	0.980000E+00
7	0.100000E+01
8	0.101000E+01
9	0.102000E+01
10	0.103000E+01

PT7/PTMIX=1.0364

PT8/PTMIX=0.9441

PTMIX = $2.436 \times 10^5 \text{ N/m}^2$ (35.32 PSIA)

PRESSURE CONF 45

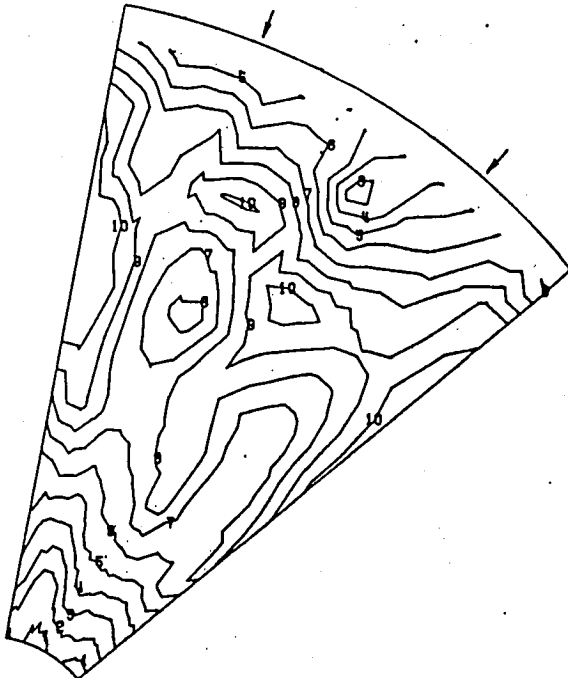

PT/PTMIX

CURVE LABEL	CURVE VALUE
1	0.940000E+00
2	0.950000E+00
3	0.960000E+00
4	0.970000E+00
5	0.980000E+00
6	0.980000E+00
7	0.100000E+01
8	0.101000E+01
9	0.102000E+01
10	0.103000E+01

PT7/PTMIX=1.0349

PT8/PTMIX=0.9440

PTMIX = $2.457 \times 10^5 \text{ N/m}^2$ (35.64 PSIA)

PRESSURE CONF 48

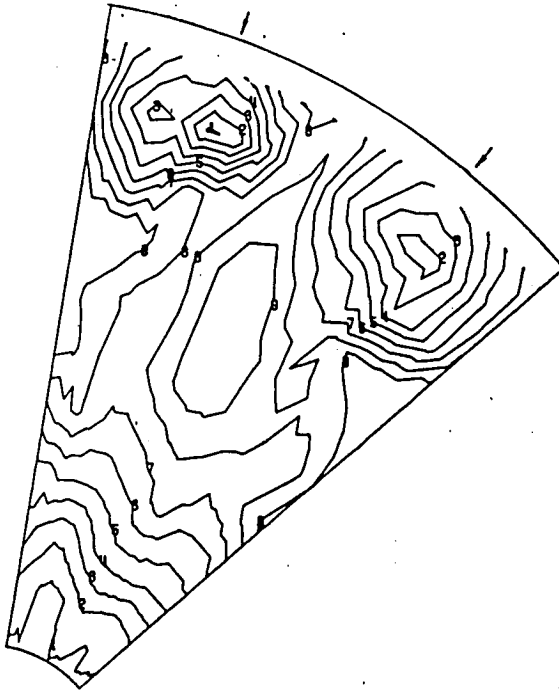

P_T/P_{TMIX}

CURVE LABEL	CURVE VALUE
1	0.950000E+00
2	0.960000E+00
3	0.970000E+00
4	0.980000E+00
5	0.990000E+00
6	0.100000E+01
7	0.101000E+01
8	0.102000E+01
9	0.103000E+01

PT7/PTMIX=1.0387

PT8/PTMIX=0.9462

PTMIX = $2.446 \times 10^5 \text{ N/m}^2$ (35.48 PSIA)

PRESSURE CONF 48

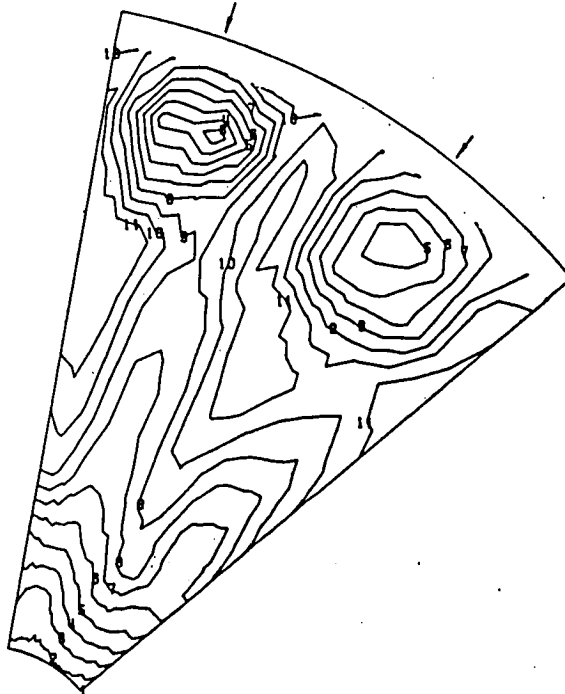

P_T/P_{TMIX}

CURVE LABEL	CURVE VALUE
1	0.930000E+00
2	0.940000E+00
3	0.950000E+00
4	0.960000E+00
5	0.970000E+00
6	0.980000E+00
7	0.990000E+00
8	0.100000E+01
9	0.101000E+01
10	0.102000E+01
11	0.103000E+01

PT7/PTMIX=1.0371

PT8/PTMIX=0.9424

PTMIX = $2.446 \times 10^5 \text{ N/m}^2$ (35.47 PSIA)

PRESSURE CONF 49

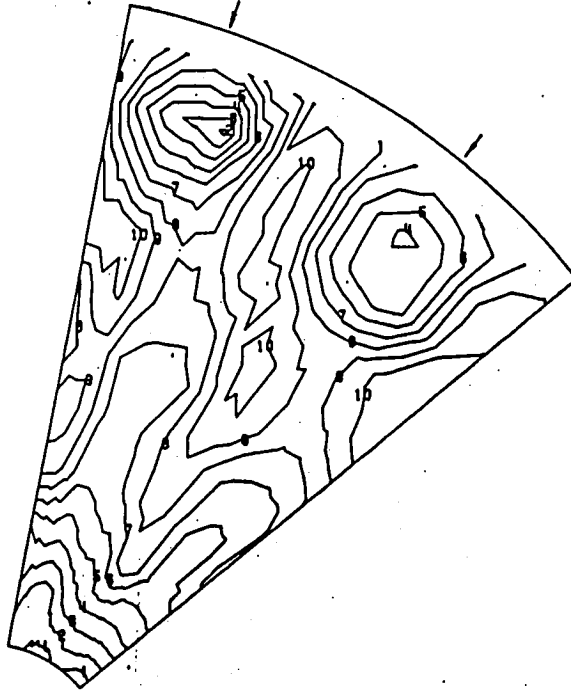

PT/PTMIX

CURVE LABEL	CURVE VALUE
1	0.940000E+00
2	0.950000E+00
3	0.960000E+00
4	0.970000E+00
5	0.980000E+00
6	0.990000E+00
7	0.100000E+01
8	0.101000E+01
9	0.102000E+01
10	0.103000E+01

PT7/PTMIX=1.0360

PT8/PTMIX=0.9430

PTMIX = $2.448 \times 10^5 \text{ N/m}^2$ (35.79 PSIA)

Appendix C

Flow Visualization Photographs

Flow visualization tests were made for selected configurations in Phase I and for all of the Phase II configurations. These tests were conducted with uniform cold flow at a nozzle pressure ratio of 2.5 to provide a general indication of the flow field through the exhaust system. The streaks result from placing an array of dots (using a lamplack/glycerine mixture) on the painted surface of the model prior to a test run.

Flow Visualization

Table of Contents

<u>Configuration Number</u>	<u>Page</u>
1	139
3	140
7	141
8	142
9	143
10	144
11	145
13	146
14	147
15	148
16	149
17	150
19	151
22	152
23	153
24	154
25	155, 156
26	157, 158
27	159
29	160
30	161
33	162
34	163
35	164
36	165
37	166
38	167
39	168
40	169
41	170
42	171
43	172
45	173
46	174
47	175
48	176
49	177

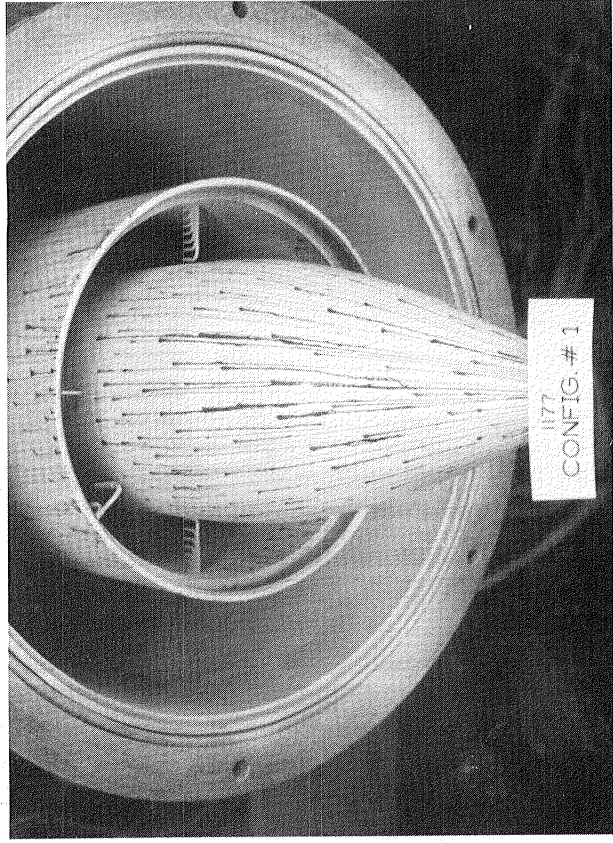
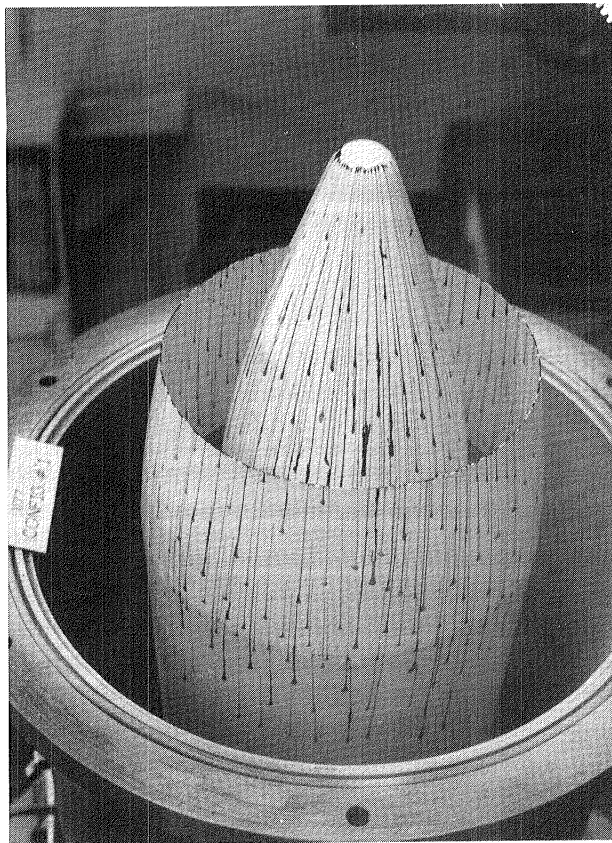
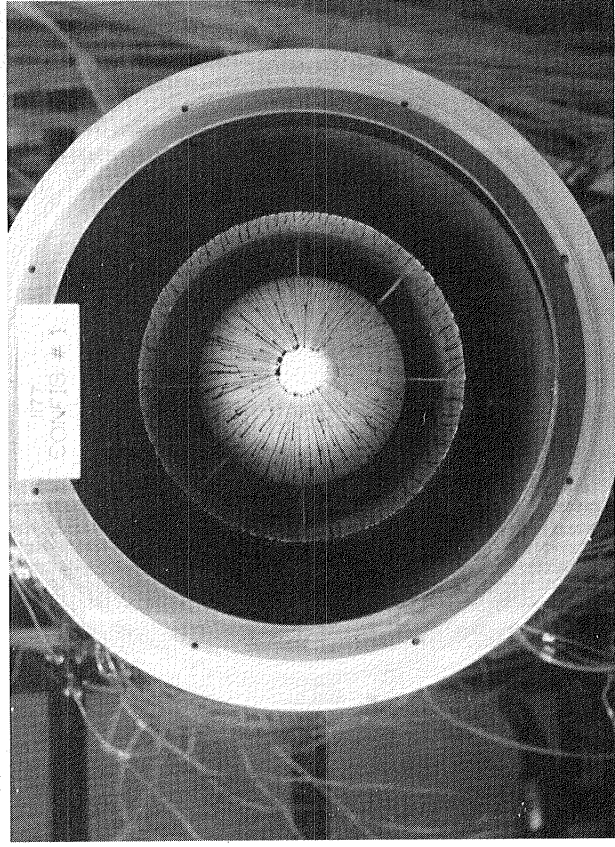
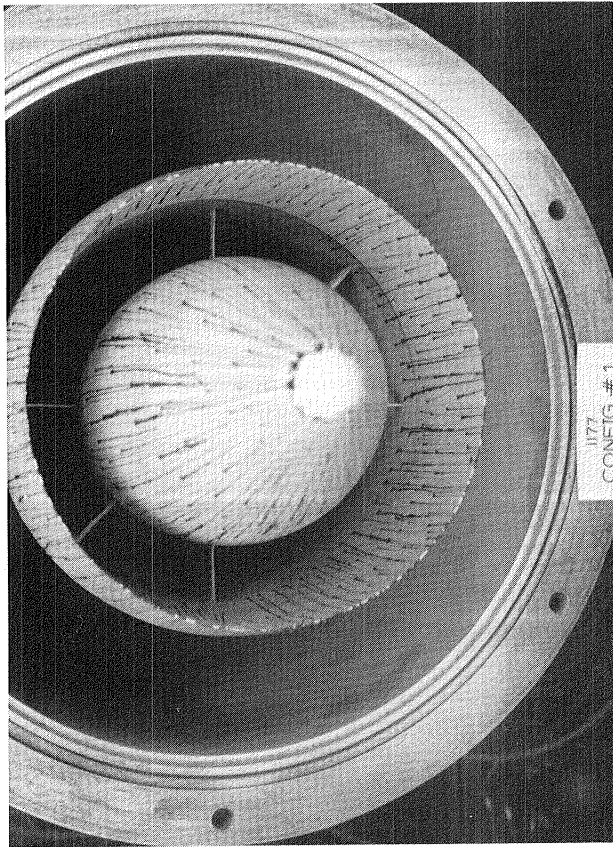

Flow Visualization Photographs, Configuration 1

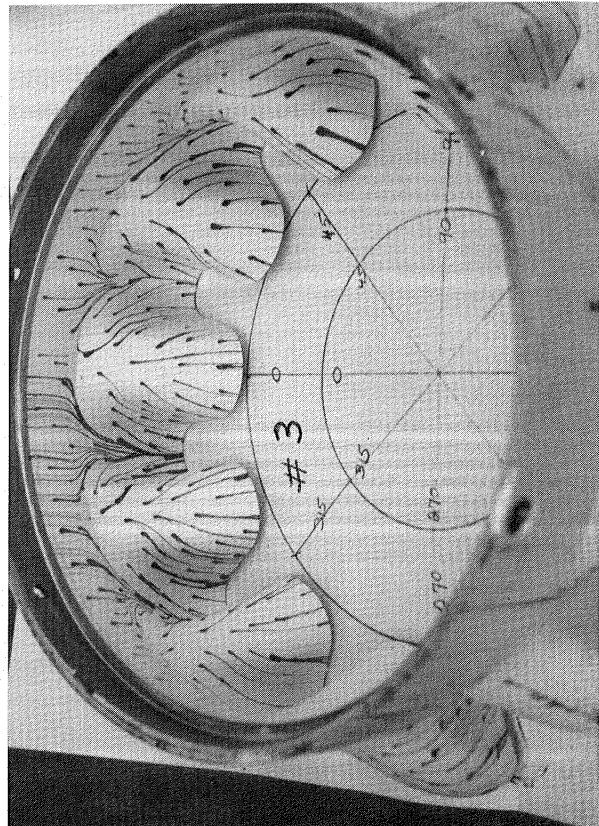
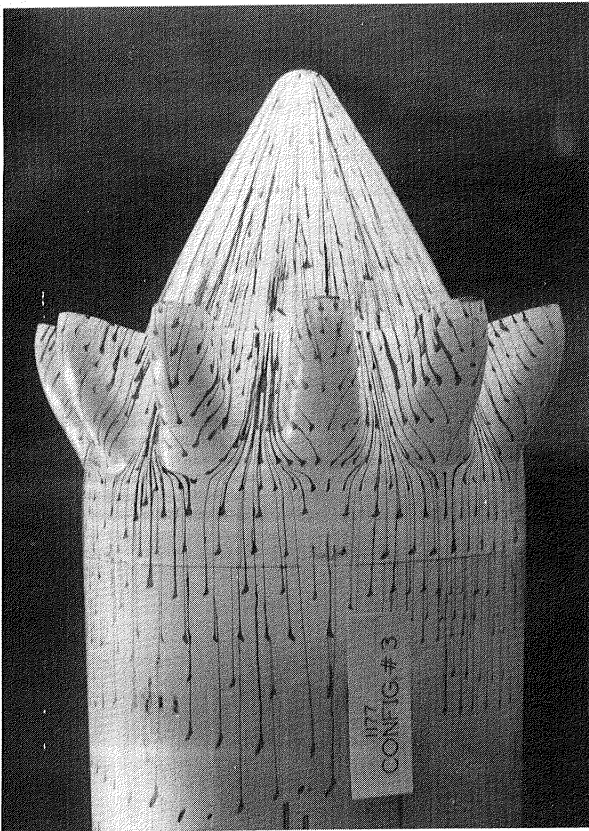
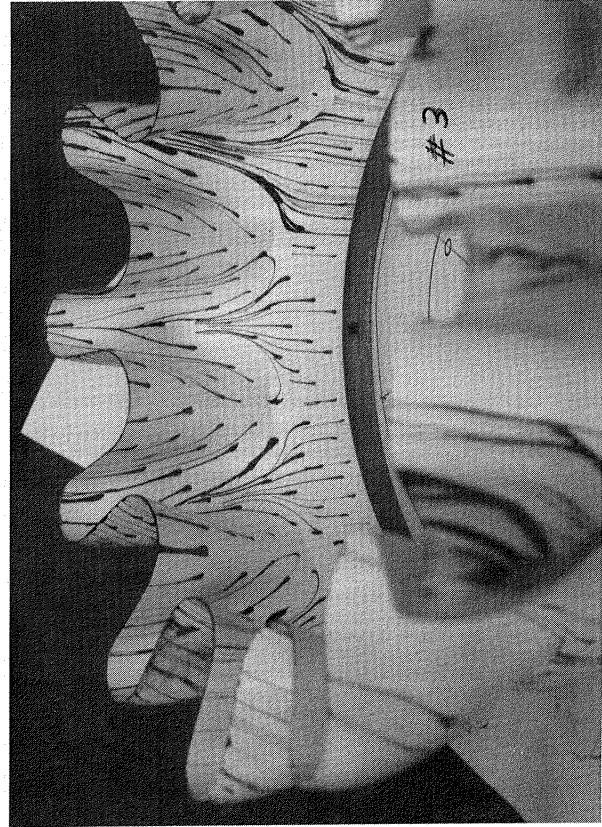
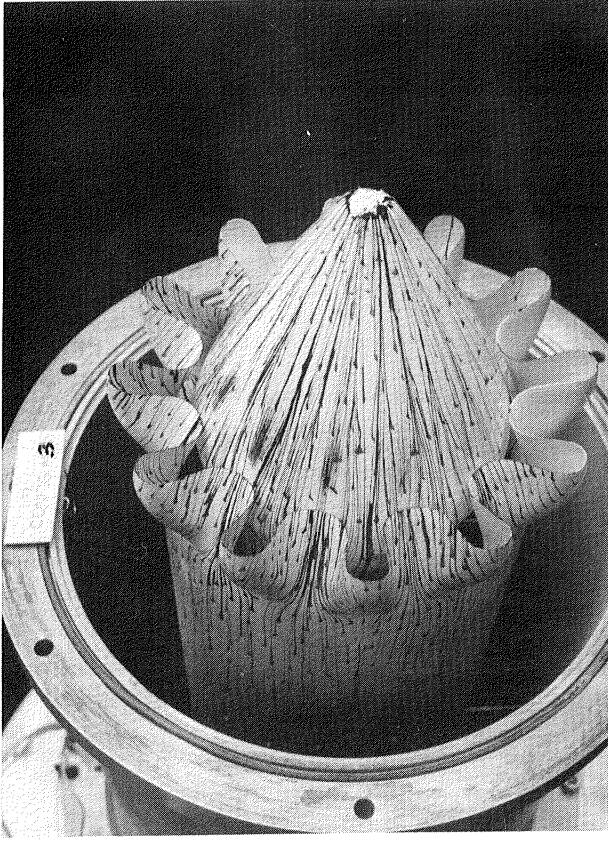

Flow Visualization Photographs, Configuration 3

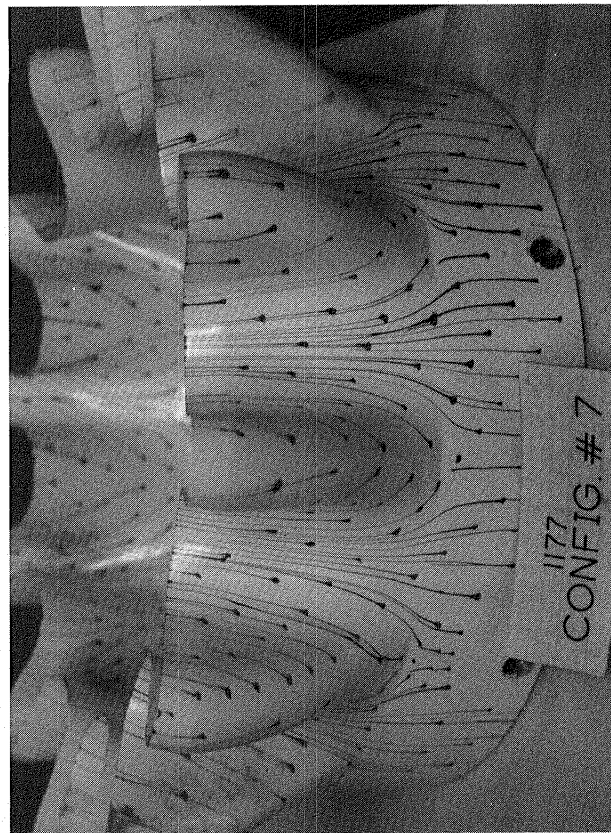
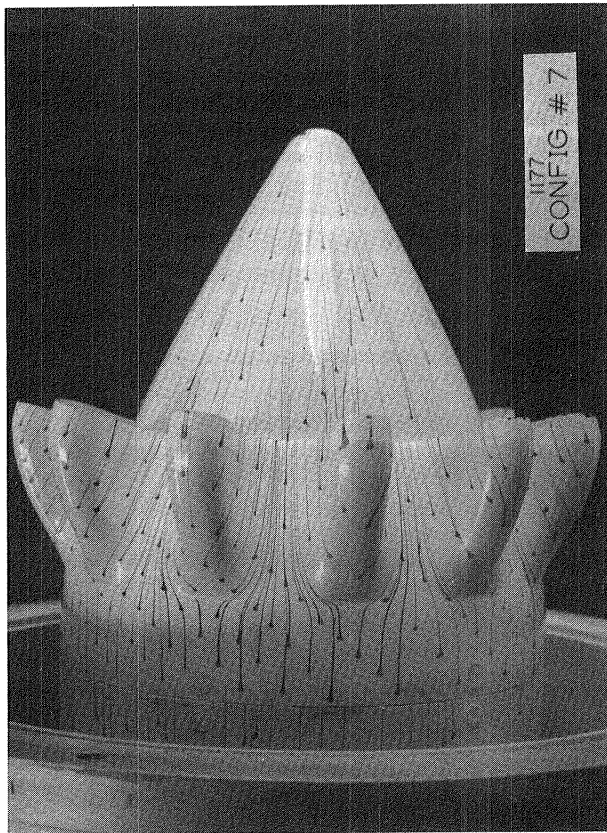
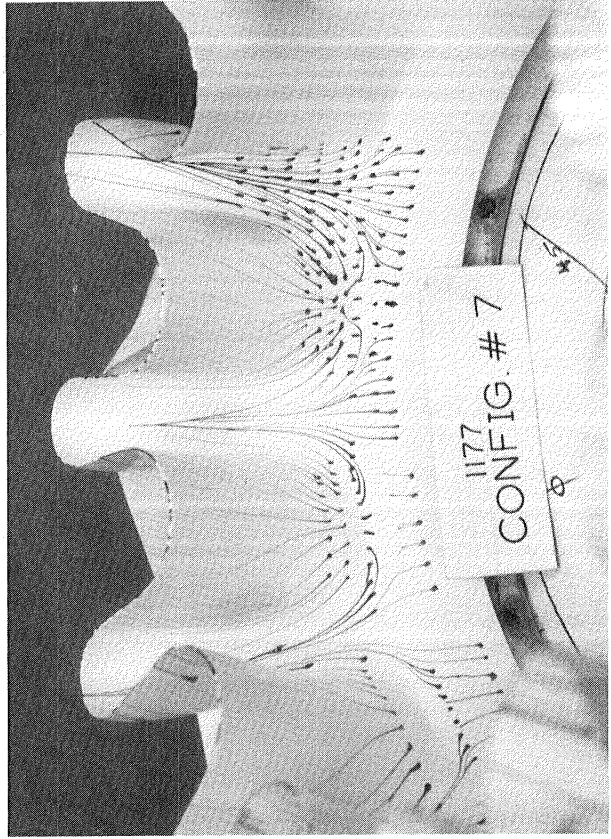
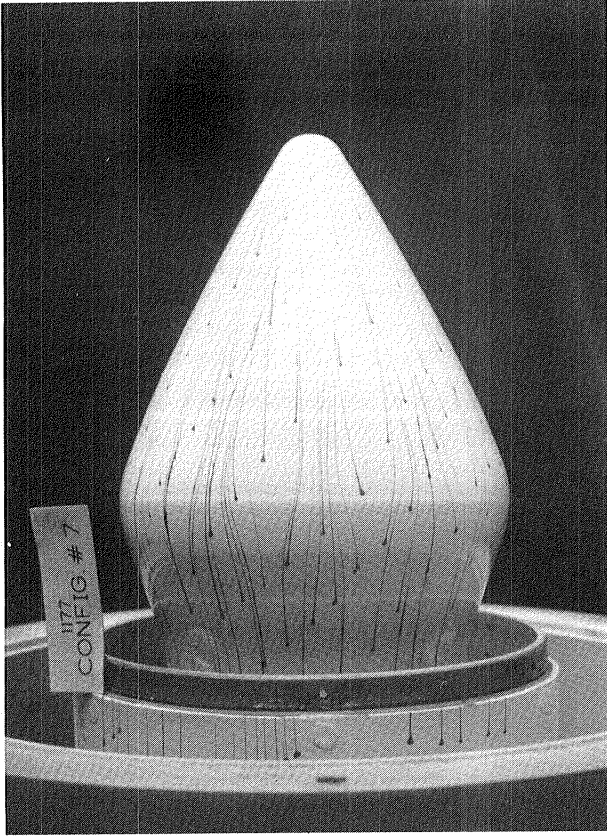

Flow Visualization Photographs, Configuration 7

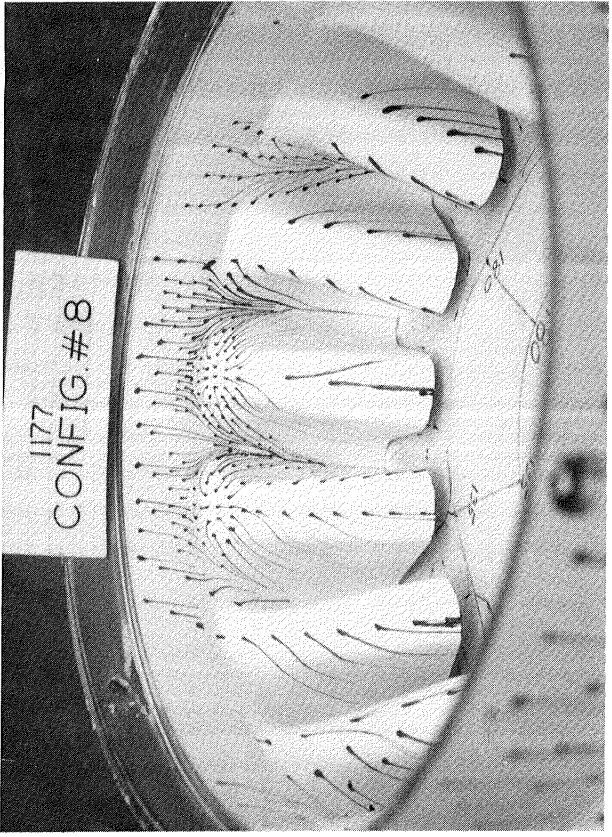
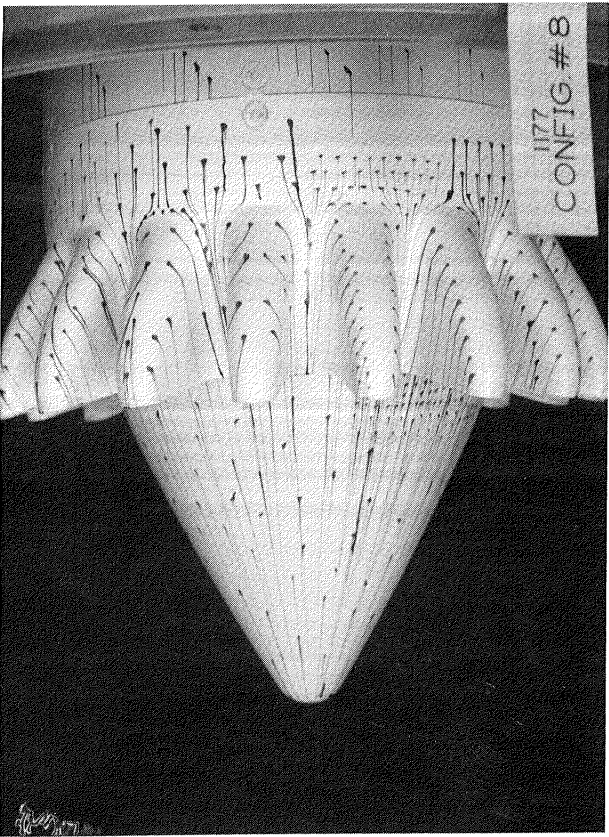
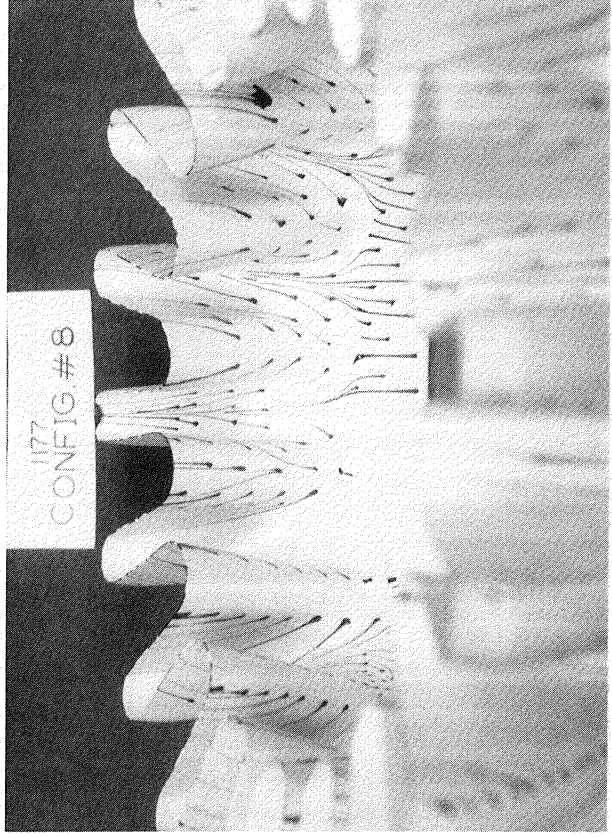
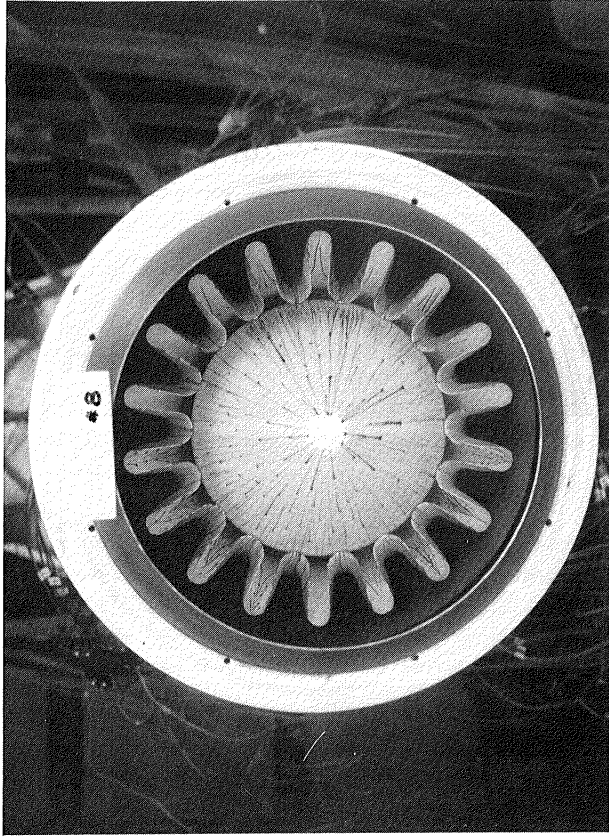

Flow Visualization Photographs, Configuration 8

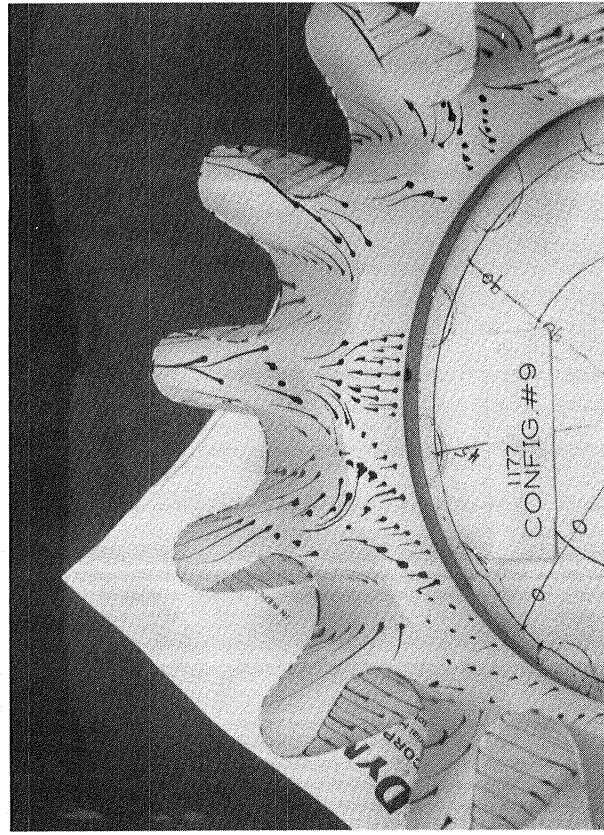
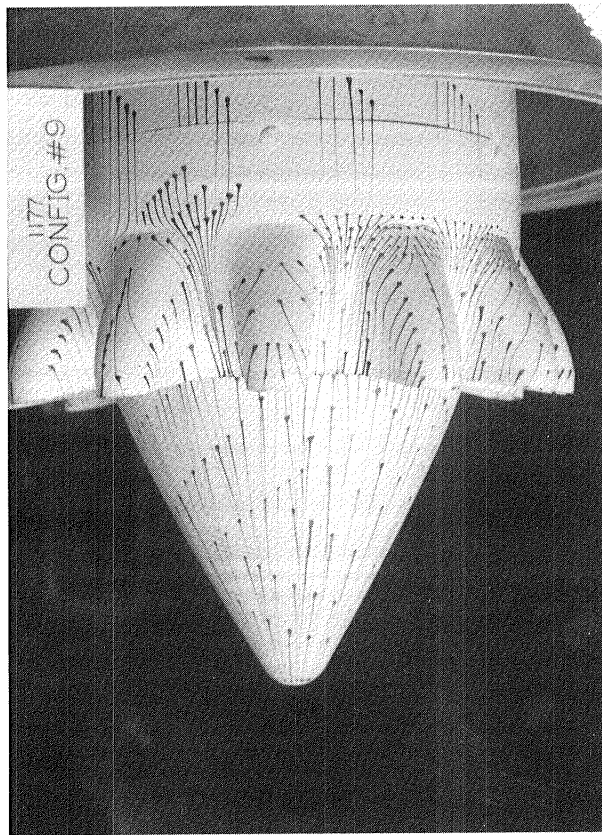
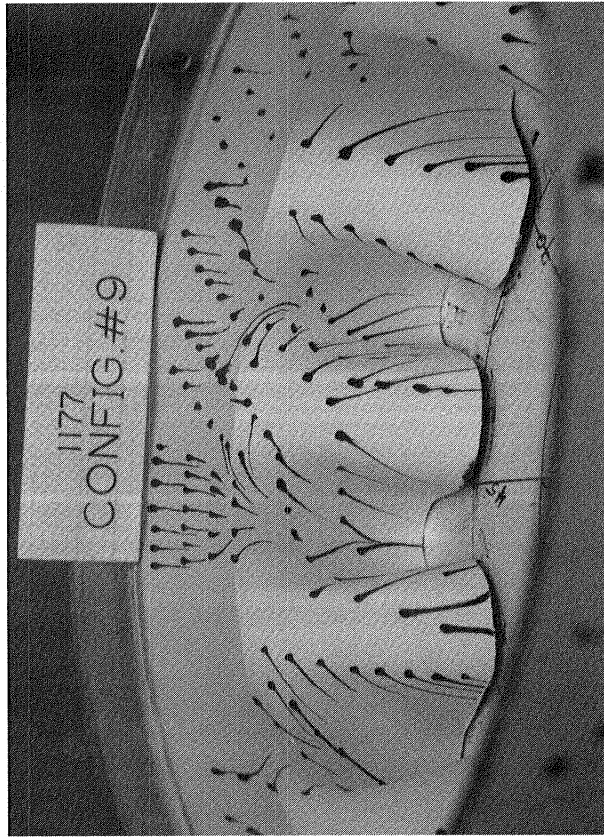
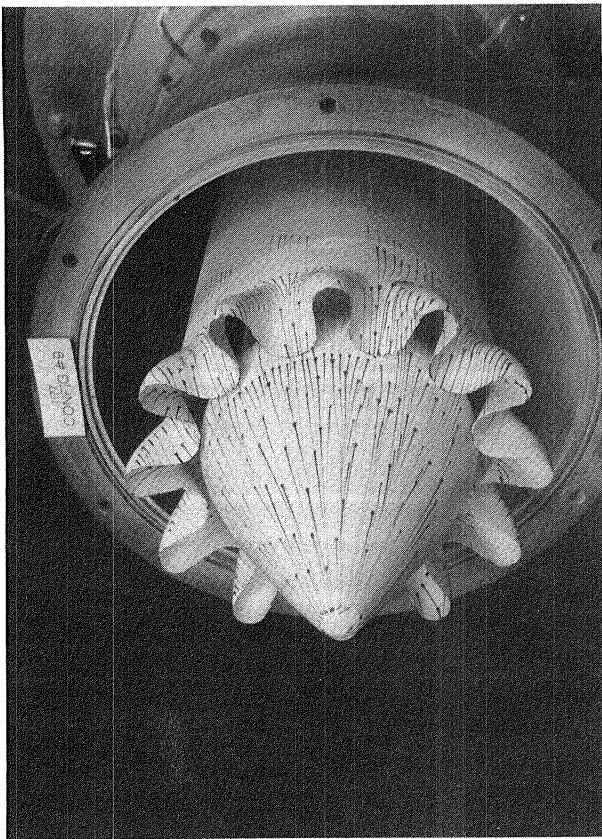

Flow Visualization Photographs, Configuration 9

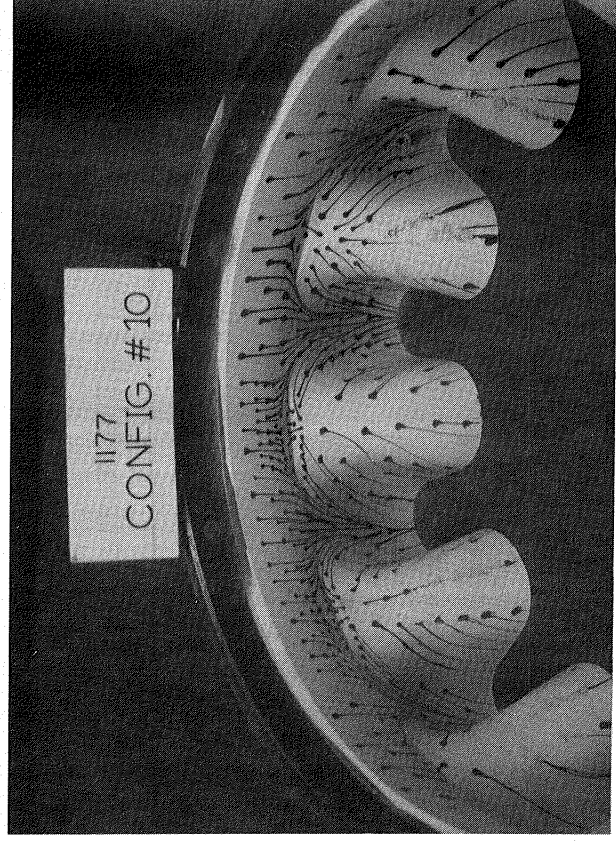
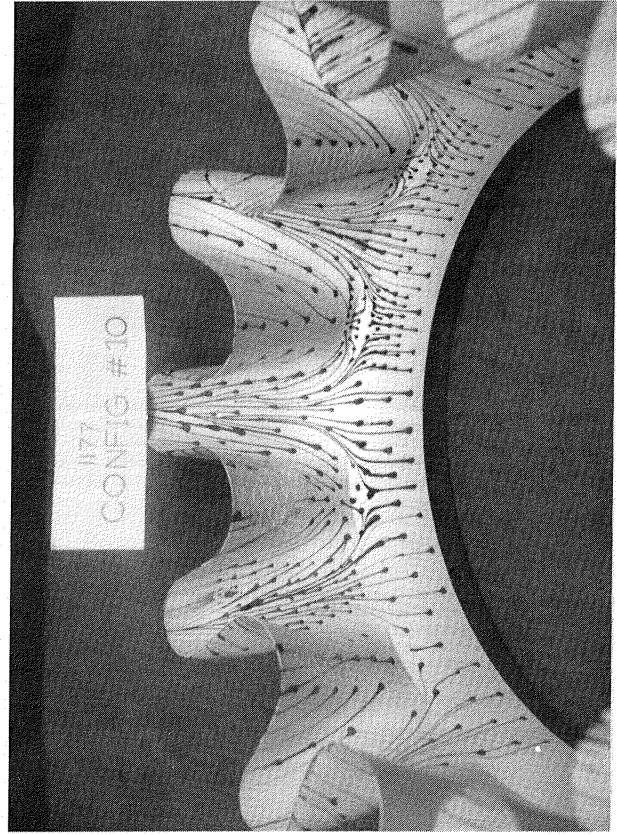
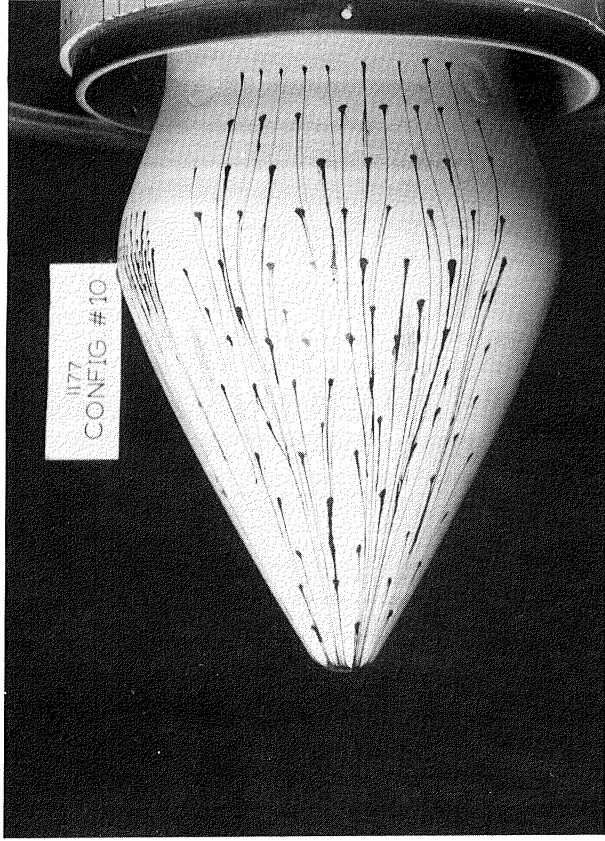
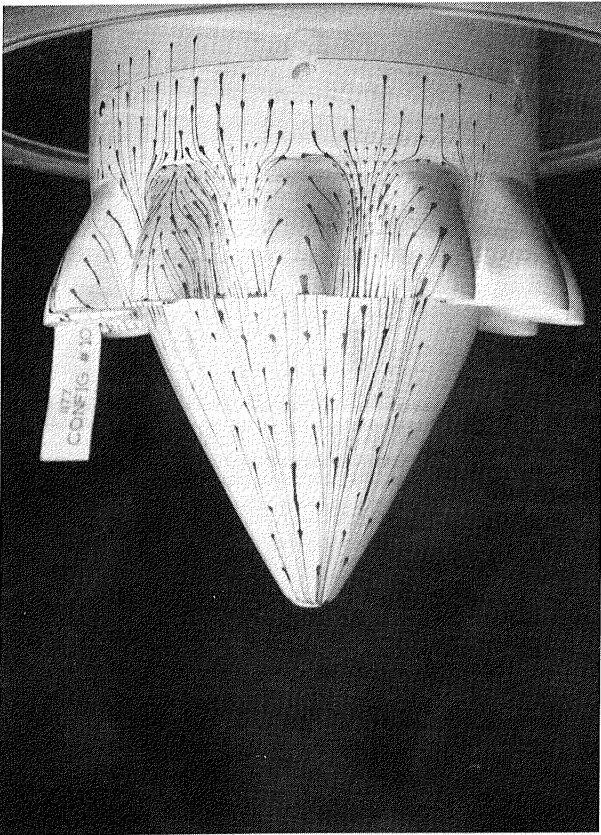

Flow Visualization Photographs, Configuration 10

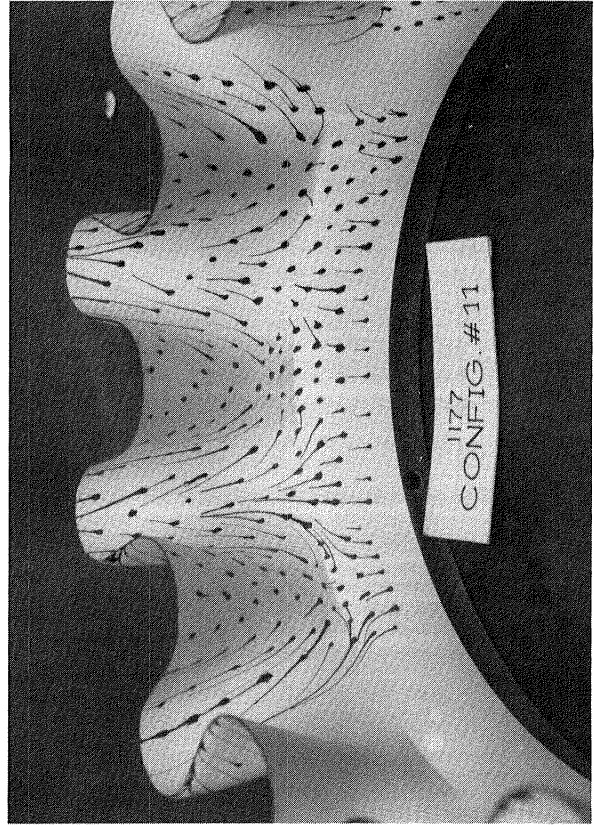
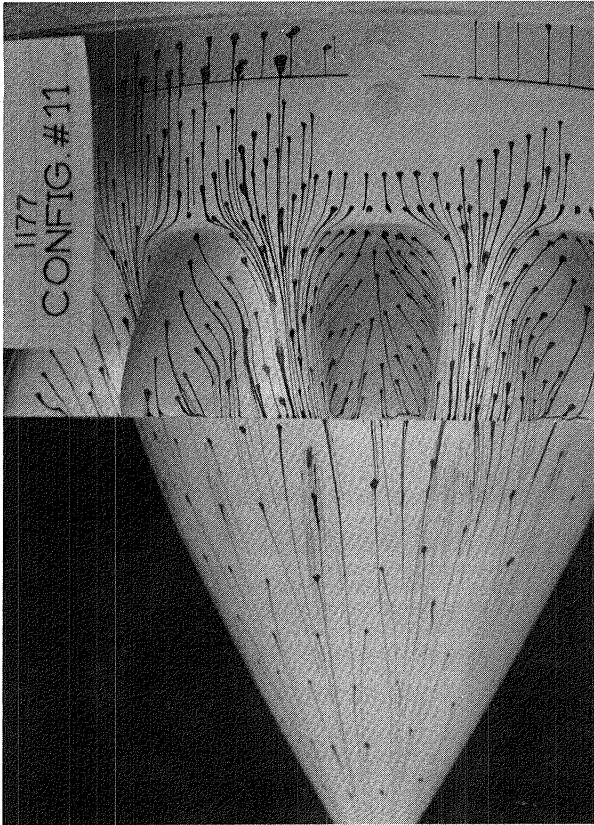
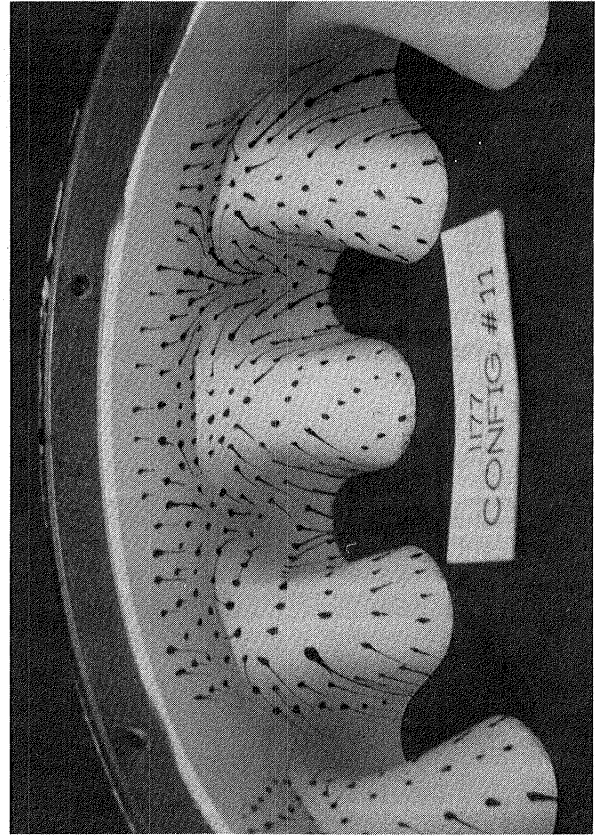
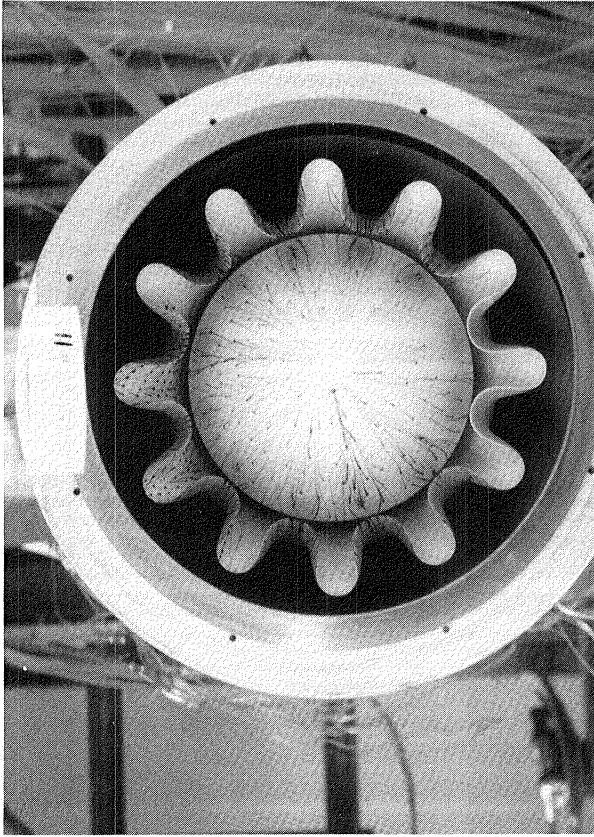

Flow Visualization Photographs, Configuration 11

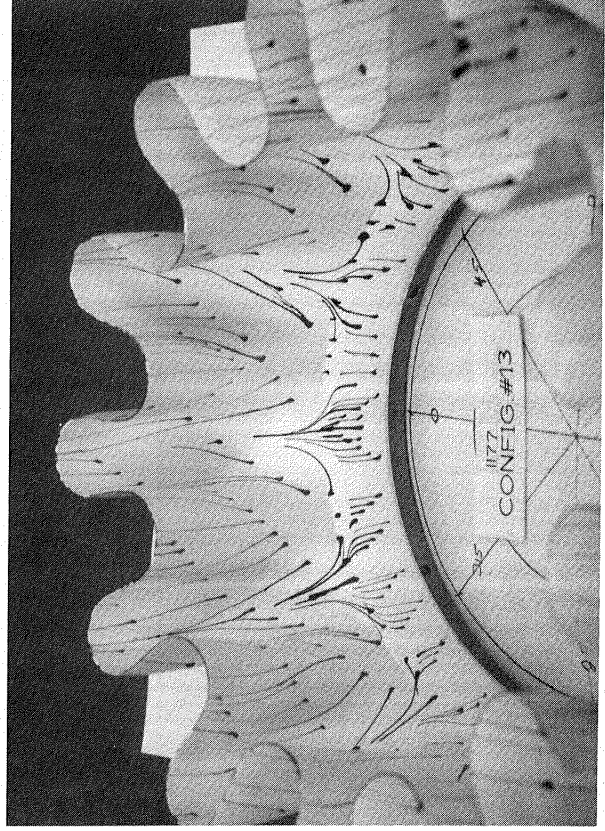
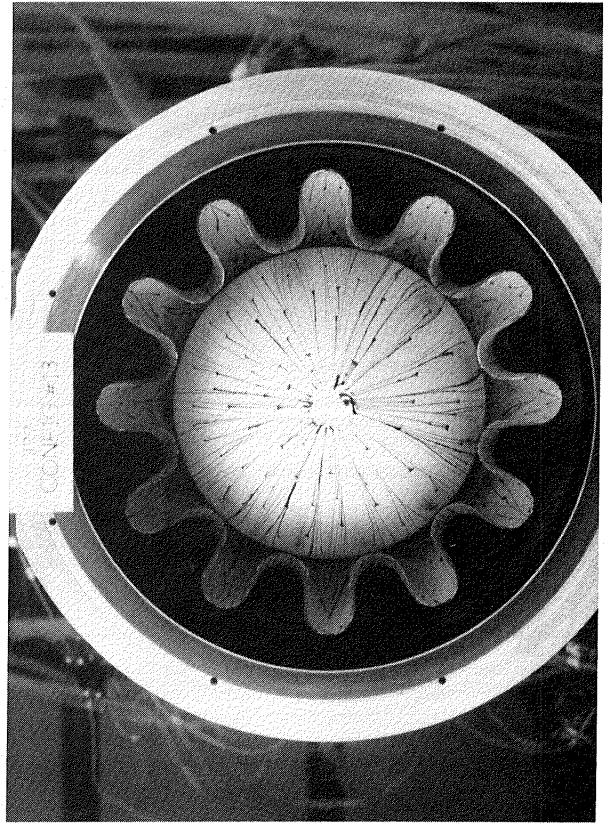
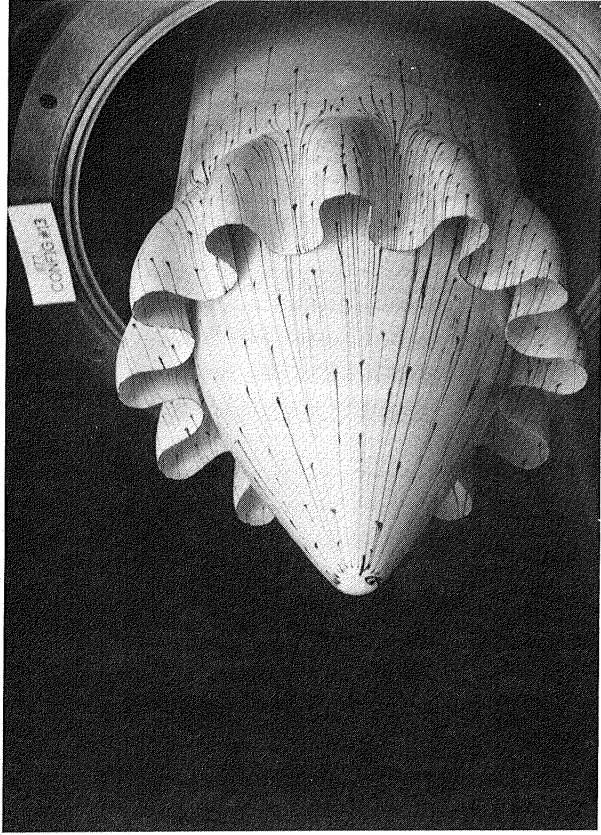
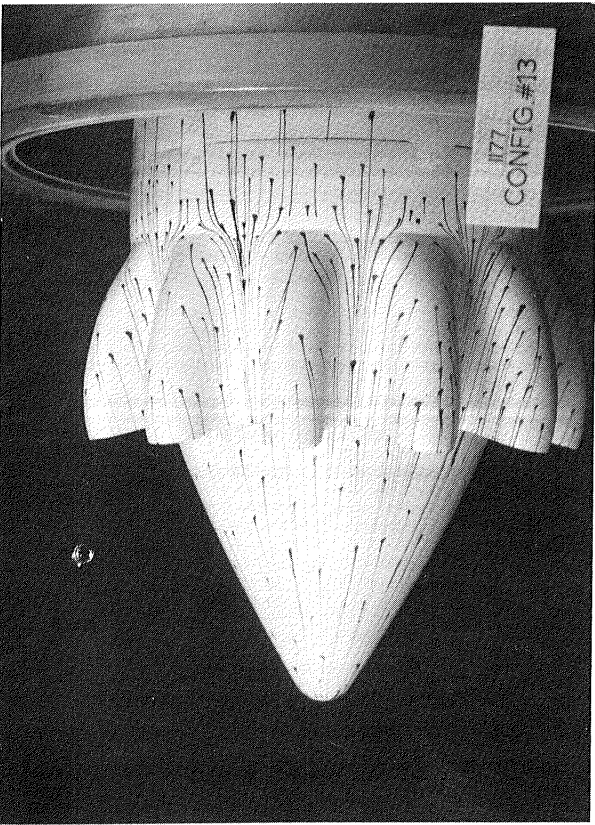

Flow Visualization Photographs, Configuration 13

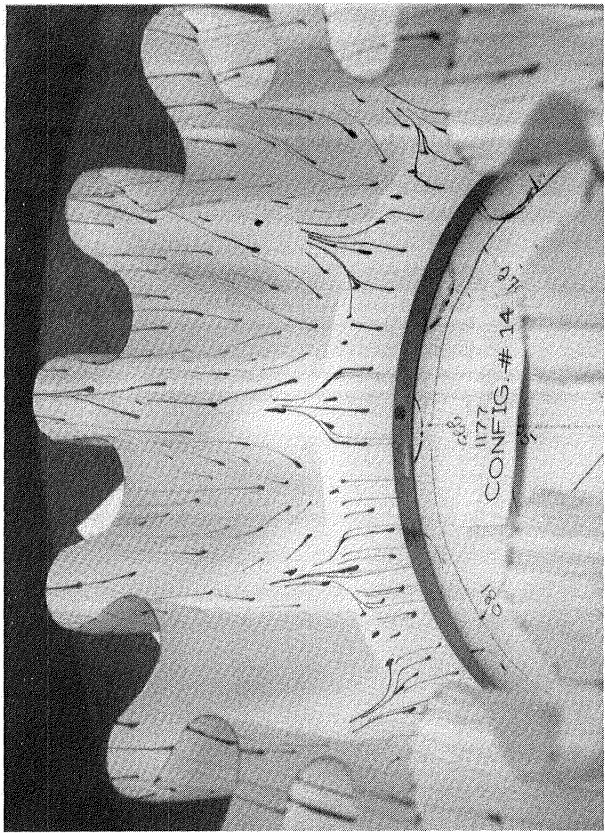
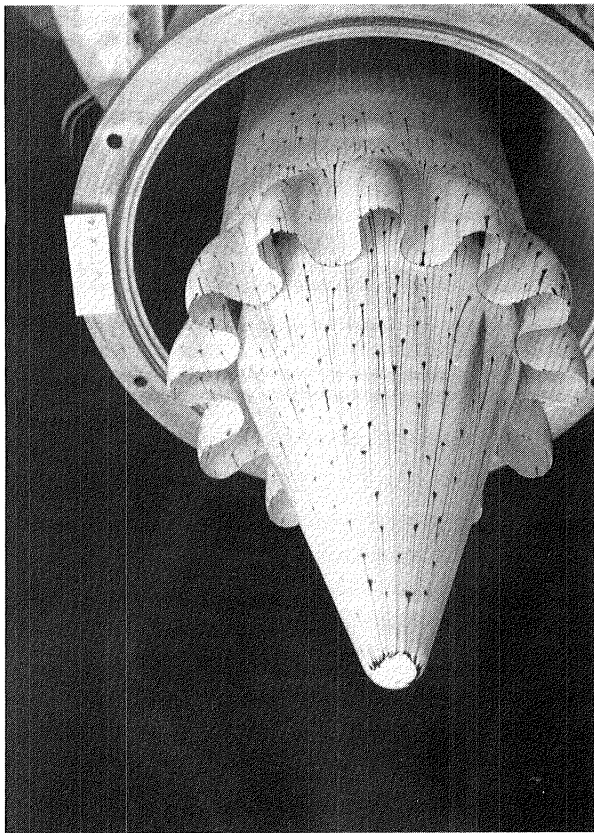
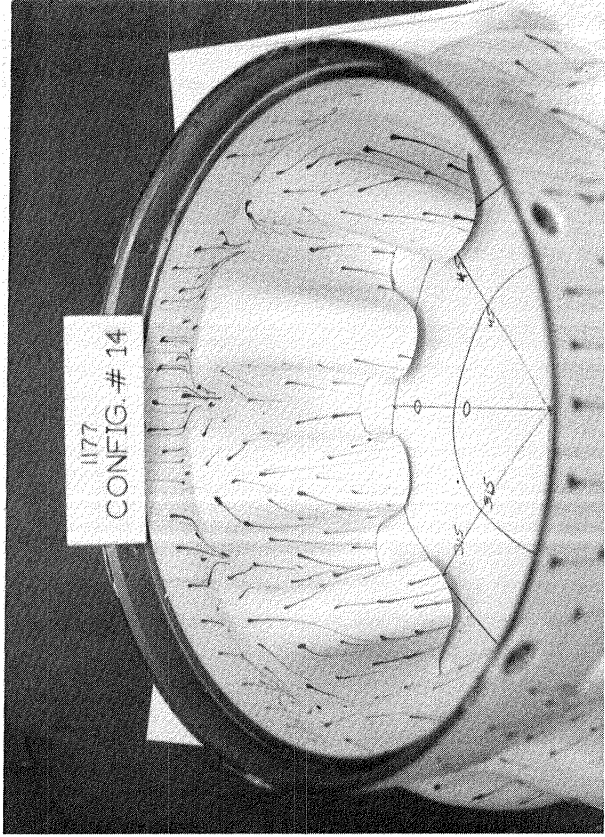
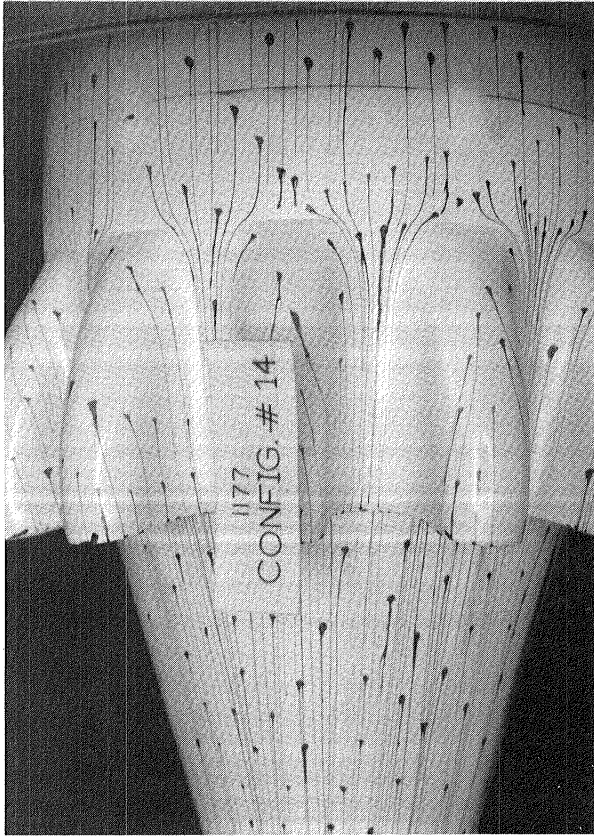

Flow Visualization Photographs, Configuration 14

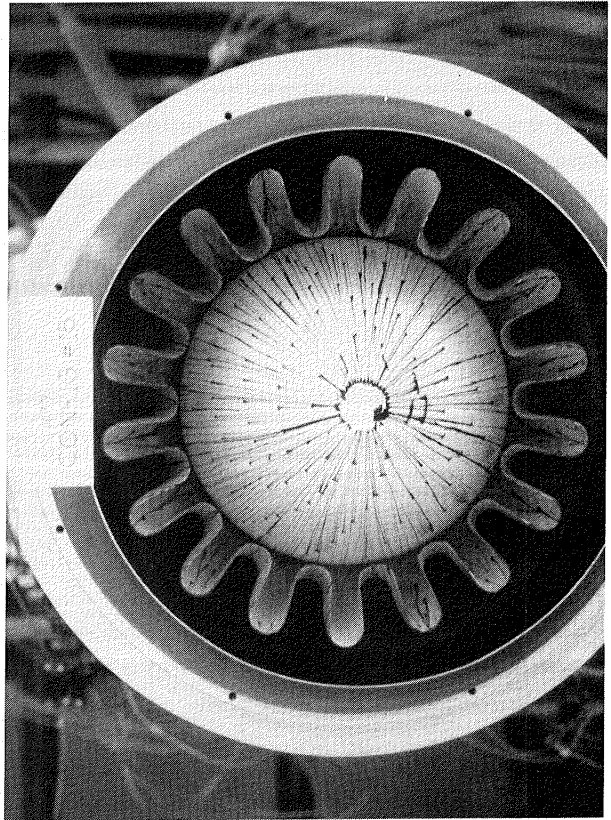
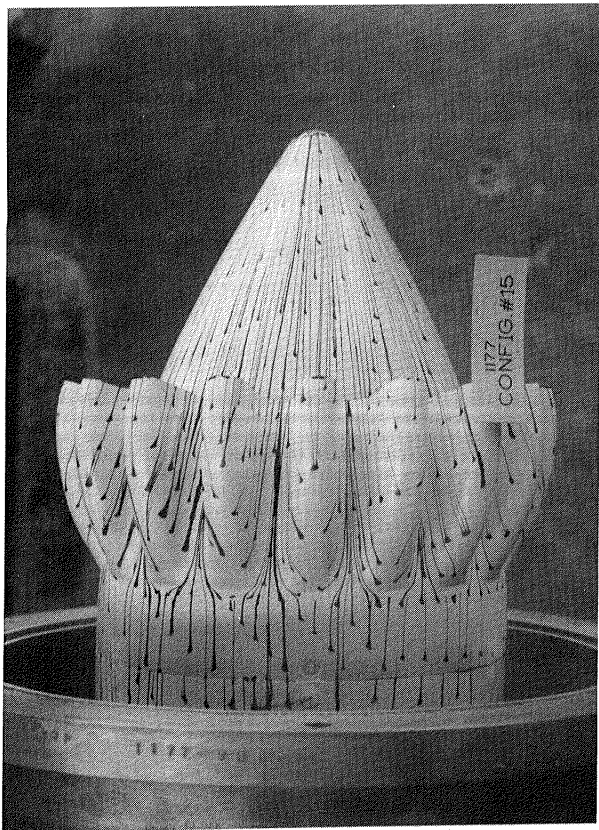
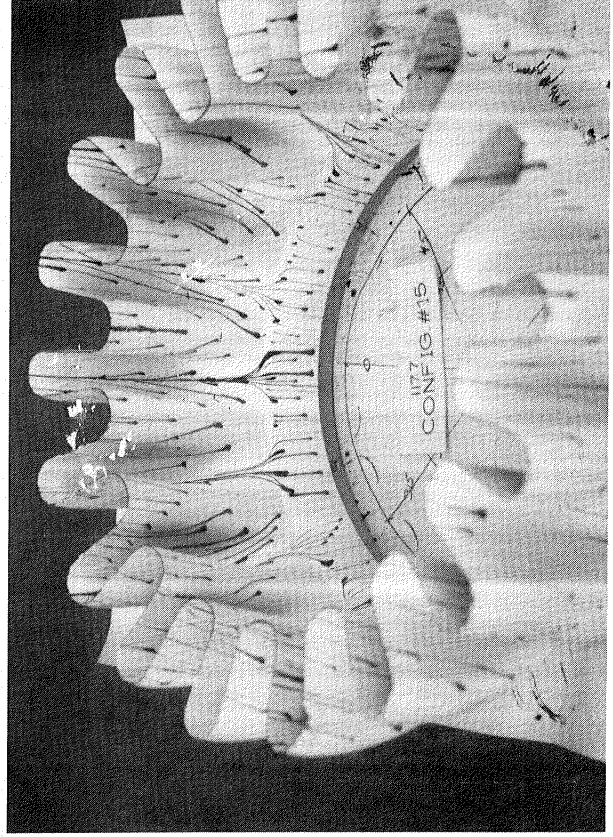
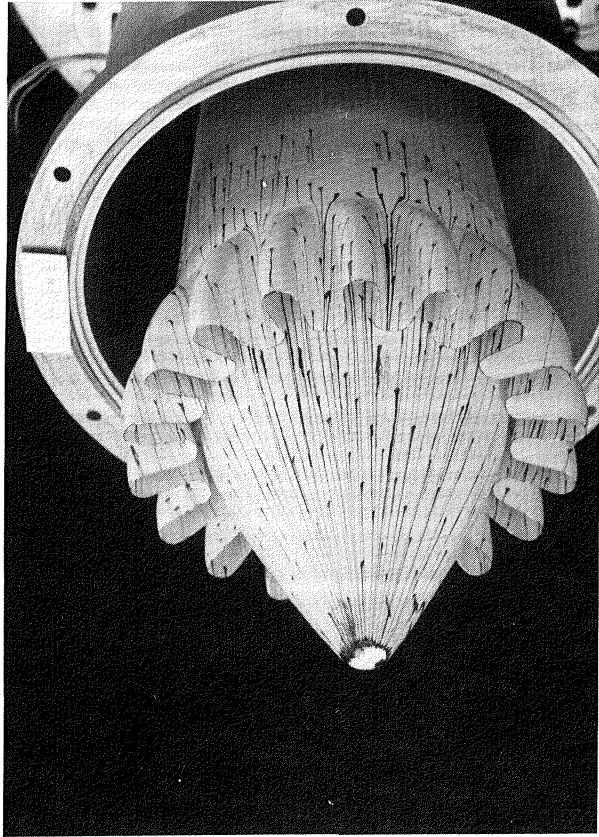

Flow Visualization Photographs, Configuration 15

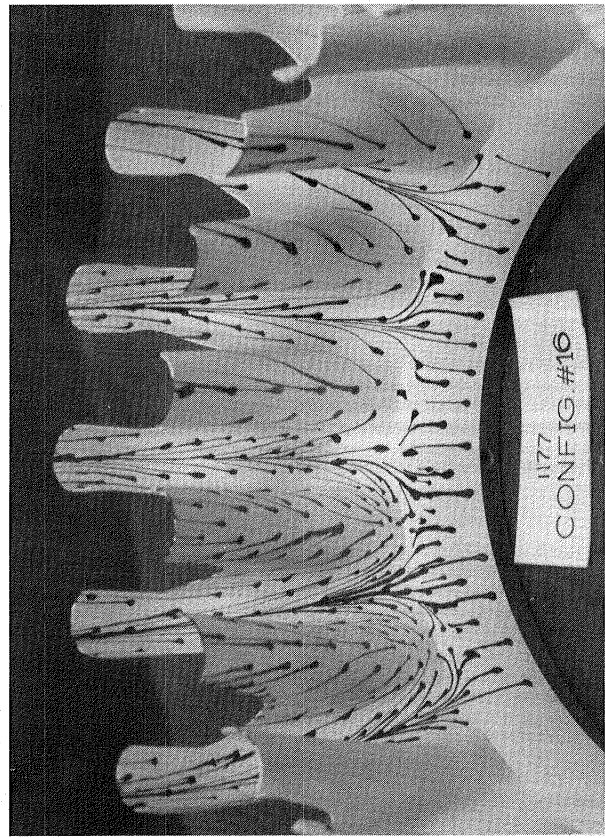
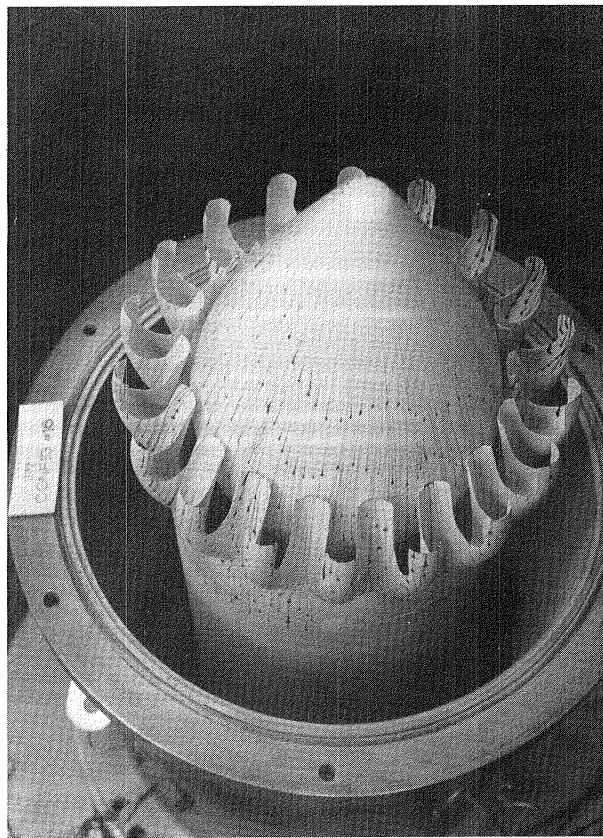
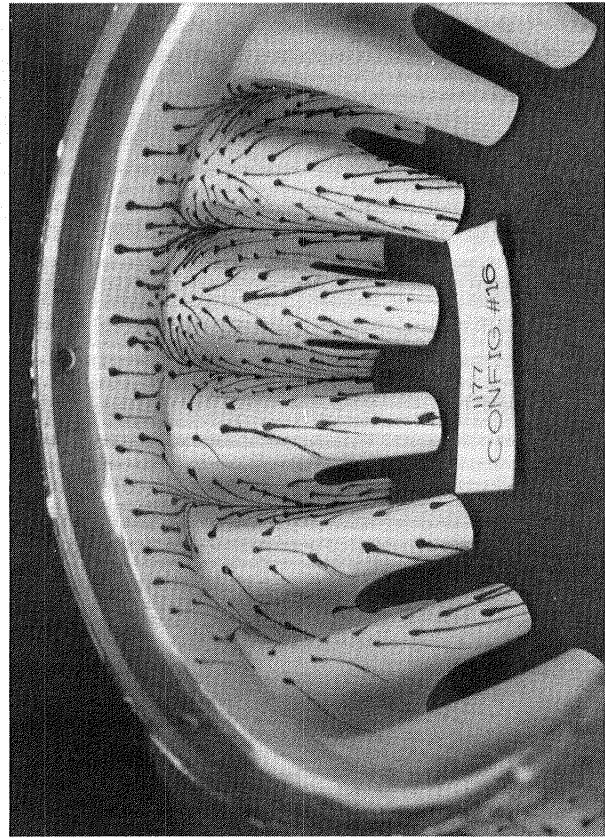
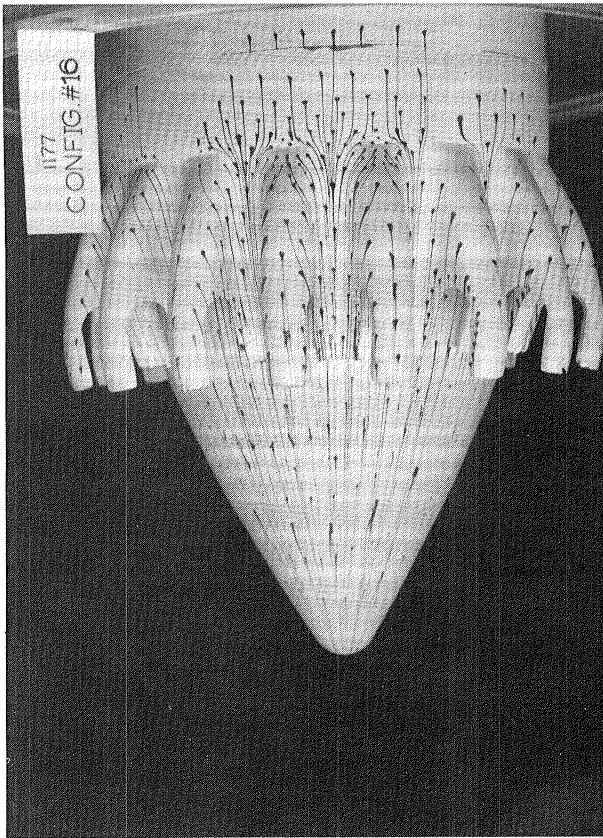

Flow Visualization Photographs, Configuration-16

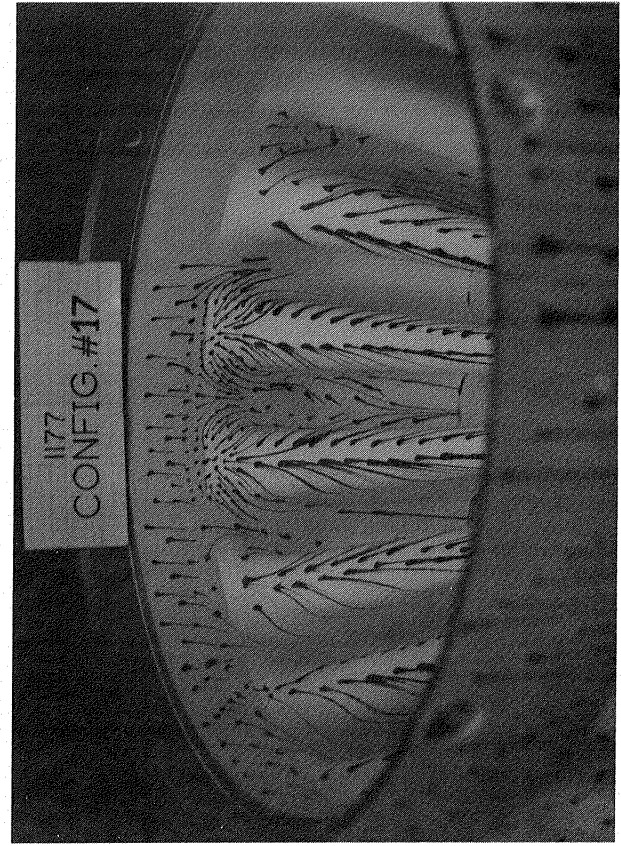
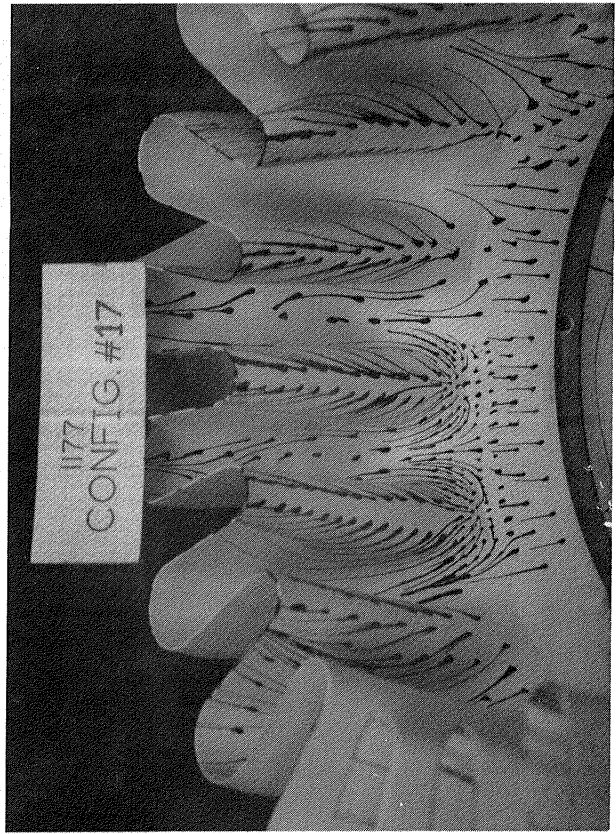
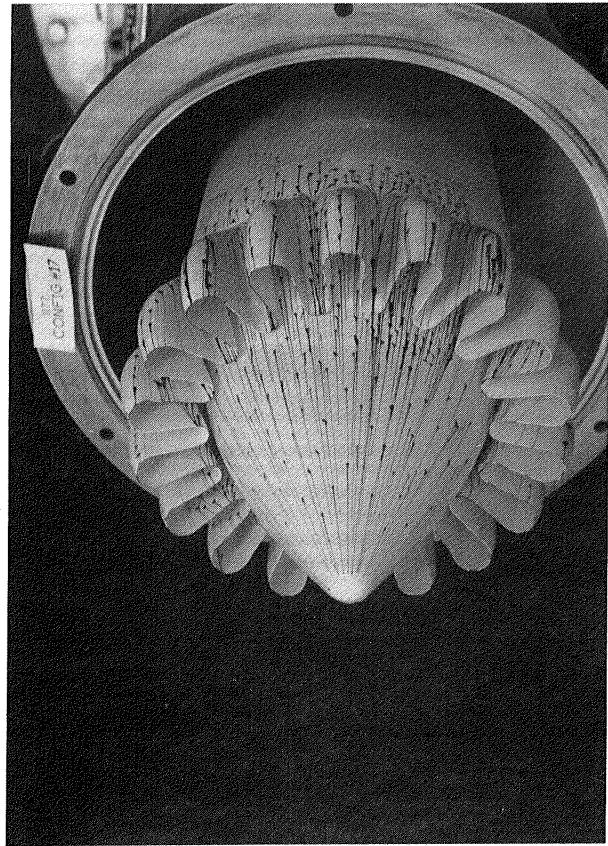
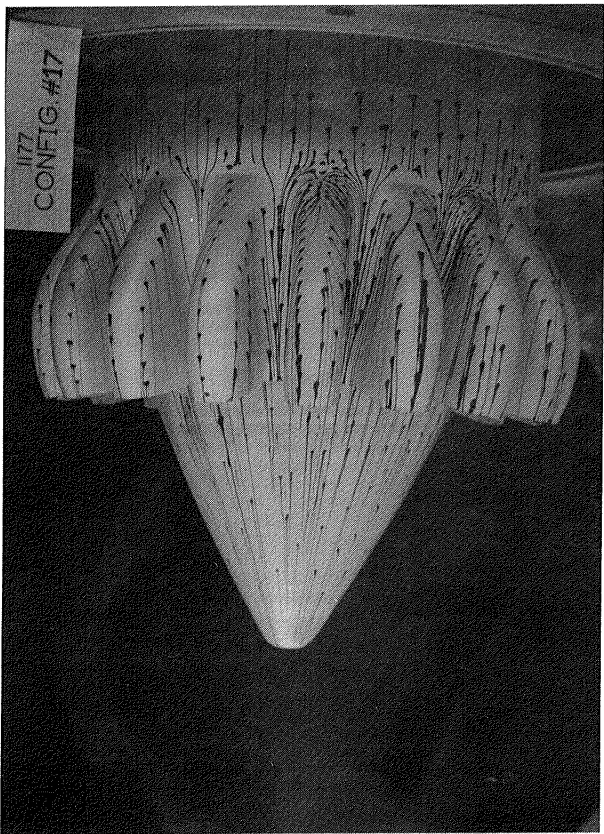

Flow Visualization Photographs, Configuration 17

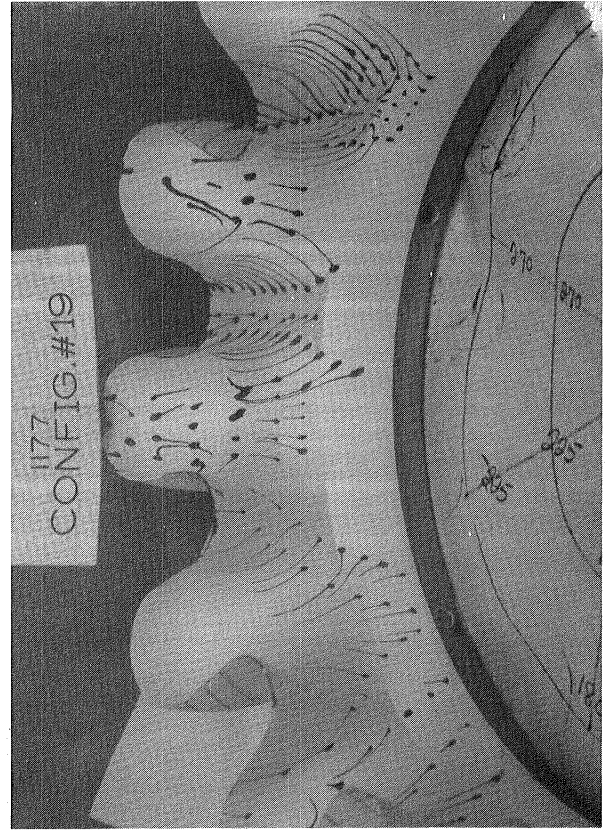
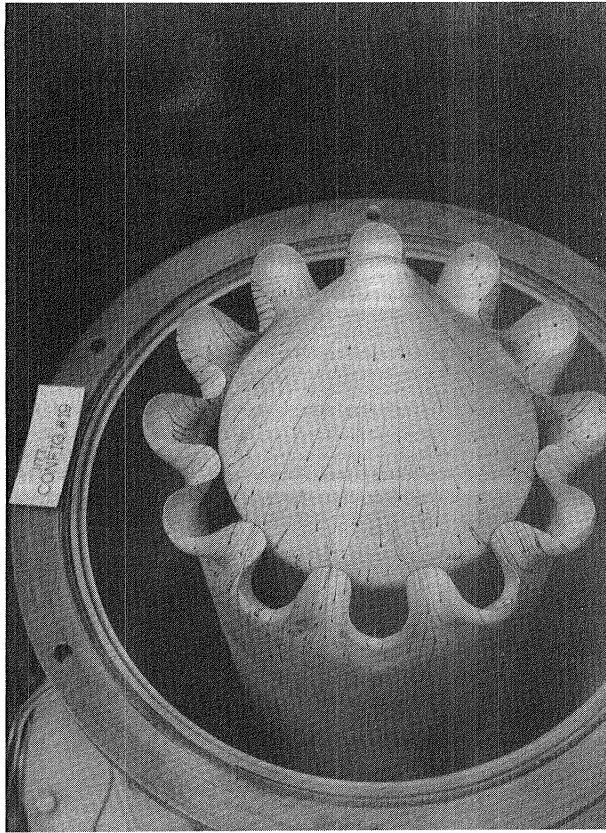
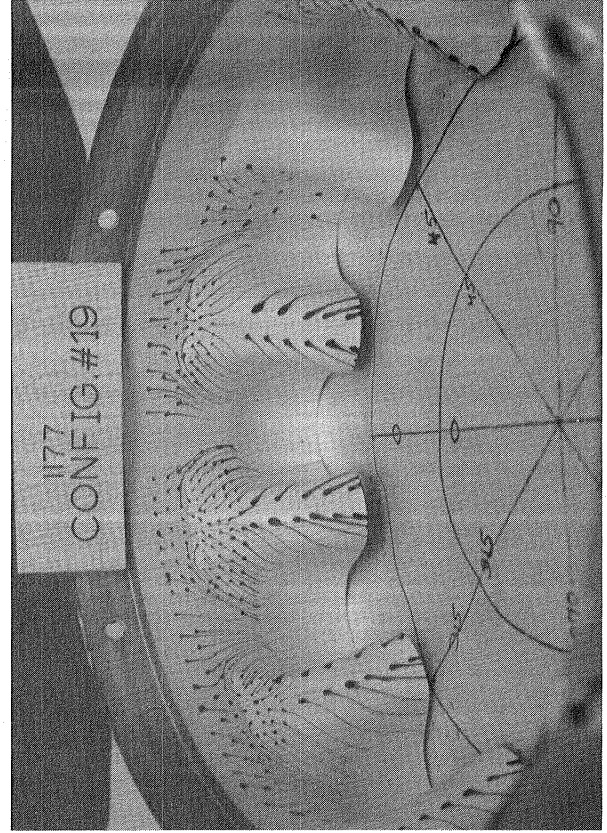
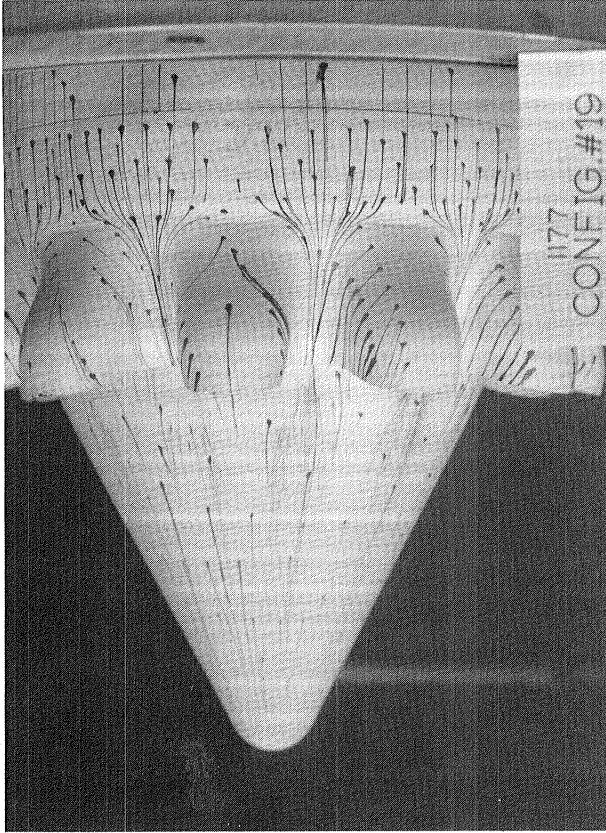

Flow Visualization Photographs, Configuration 19

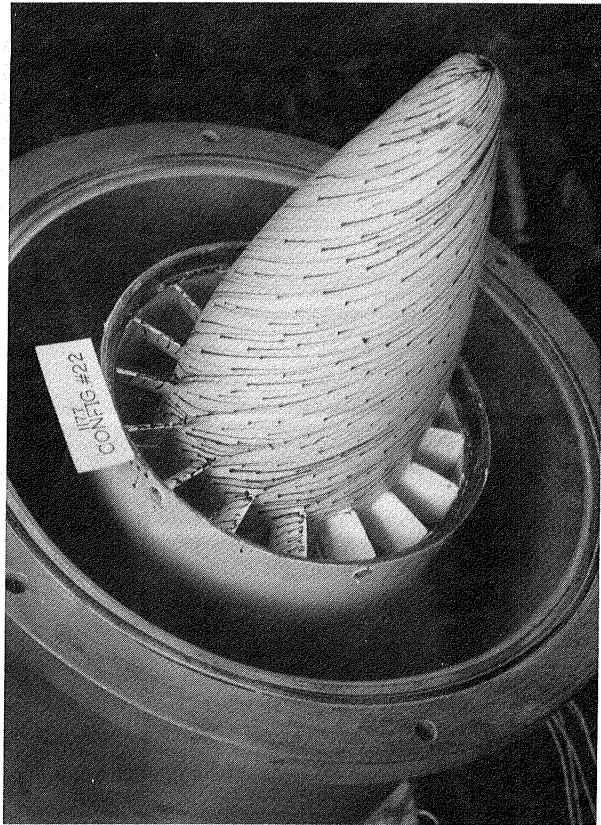
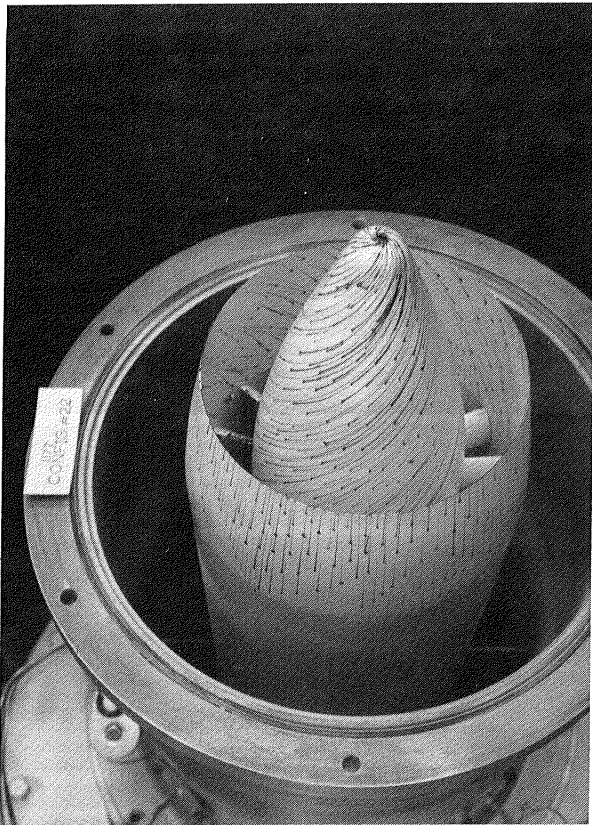
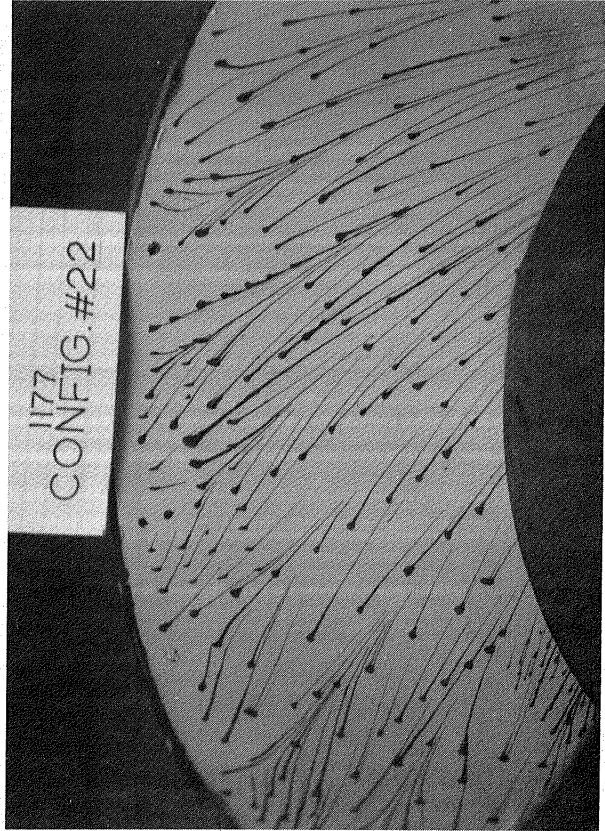
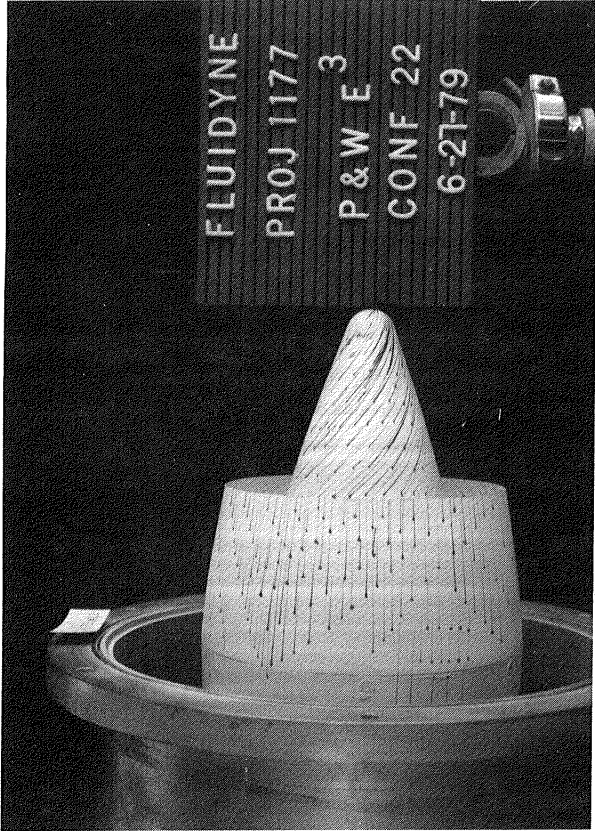

Flow Visualization Photographs, Configuration 22

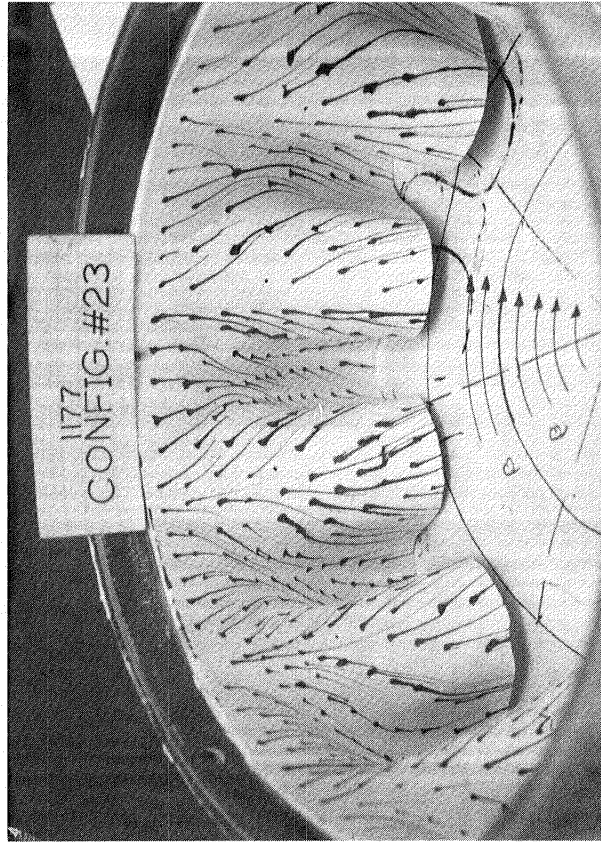
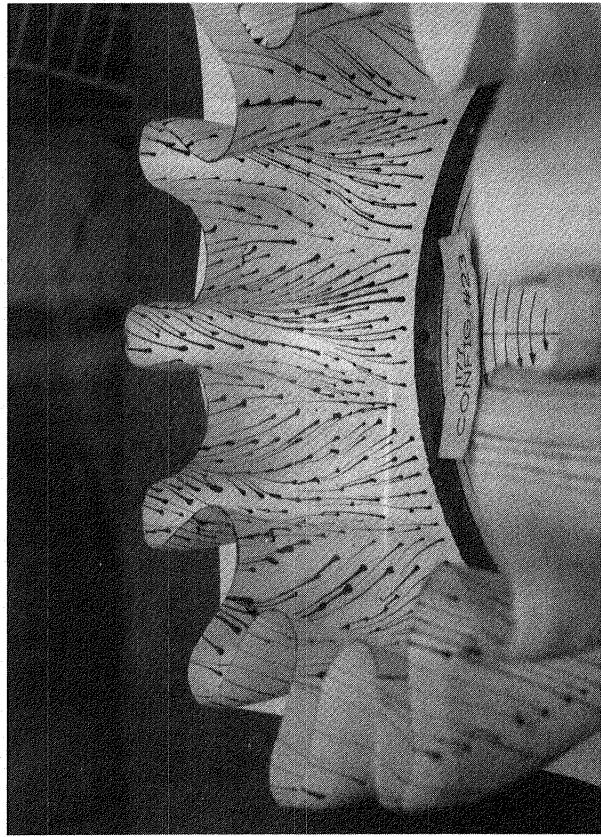
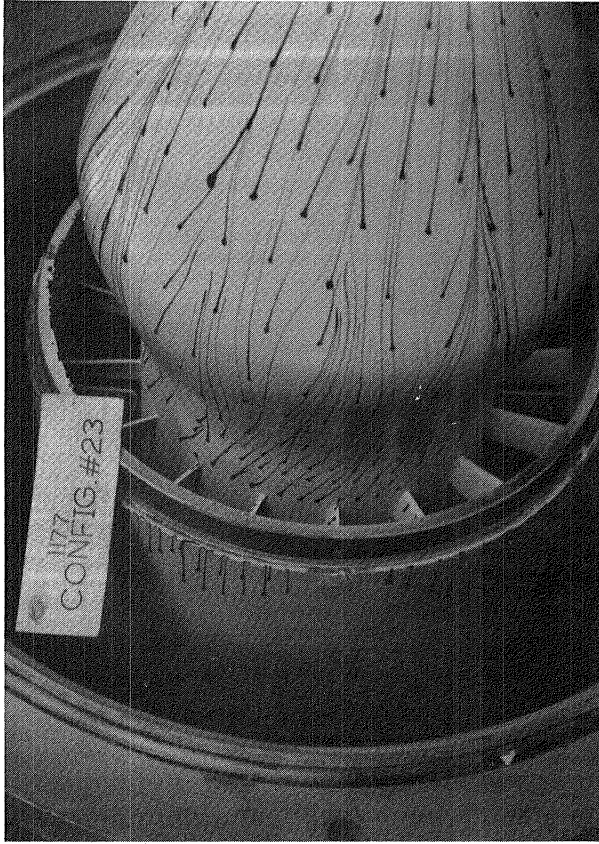
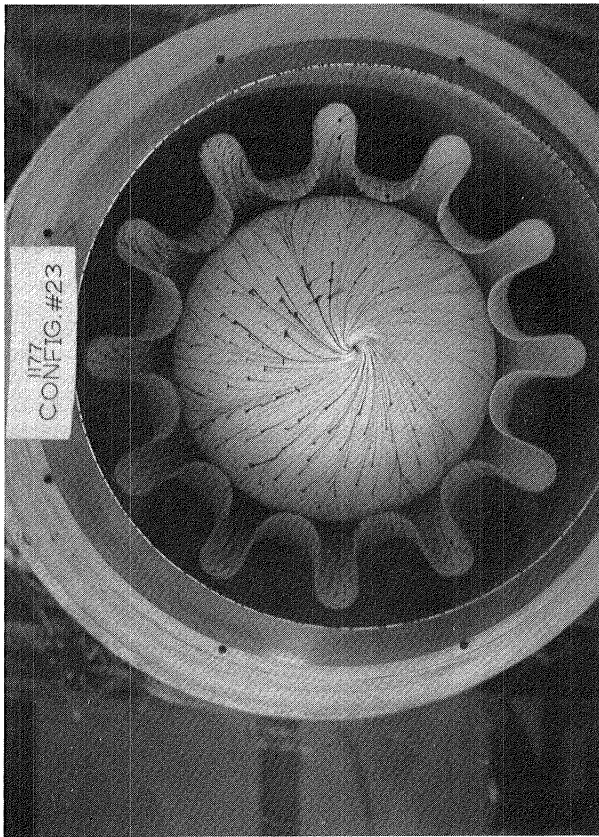

Flow Visualization Photographs, Configuration 23

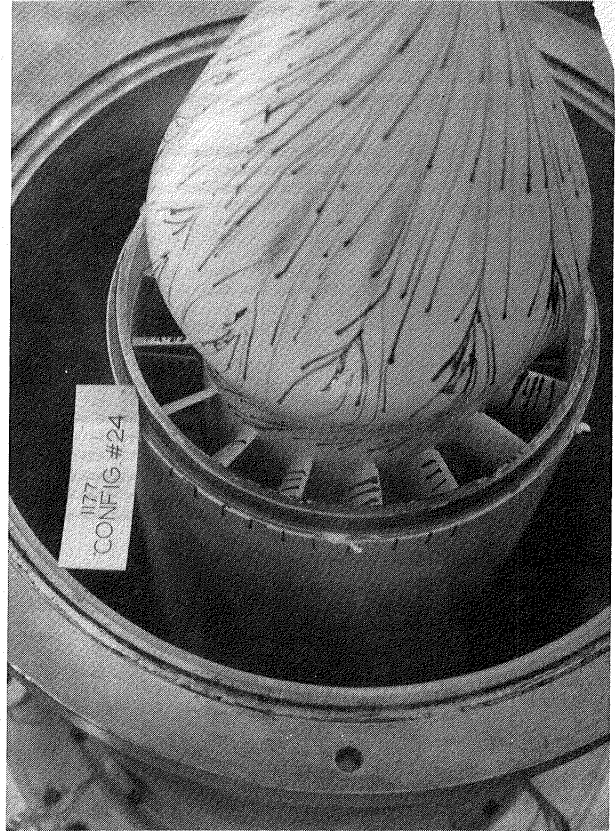
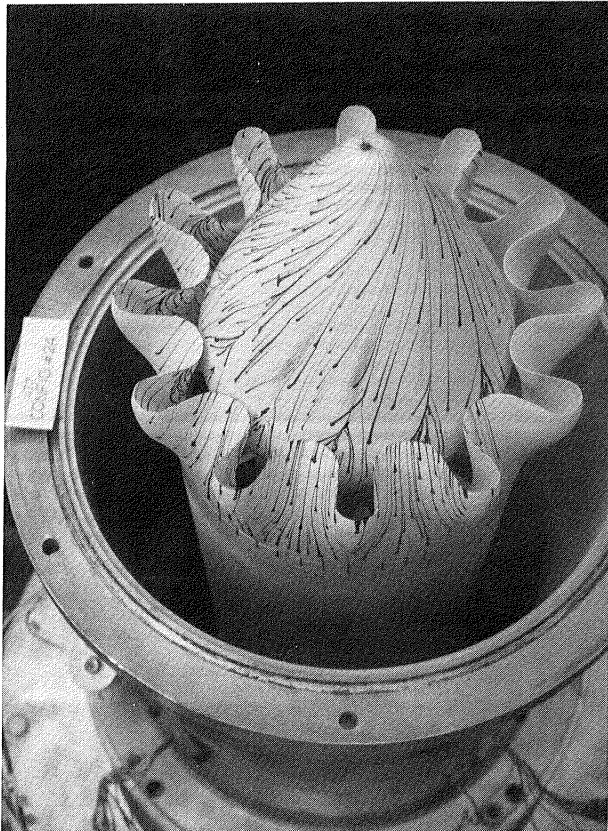
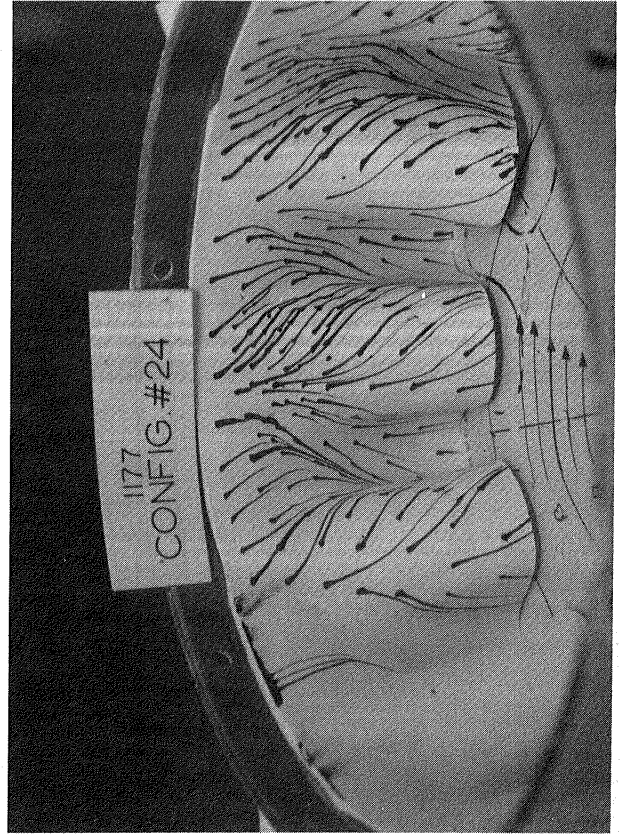
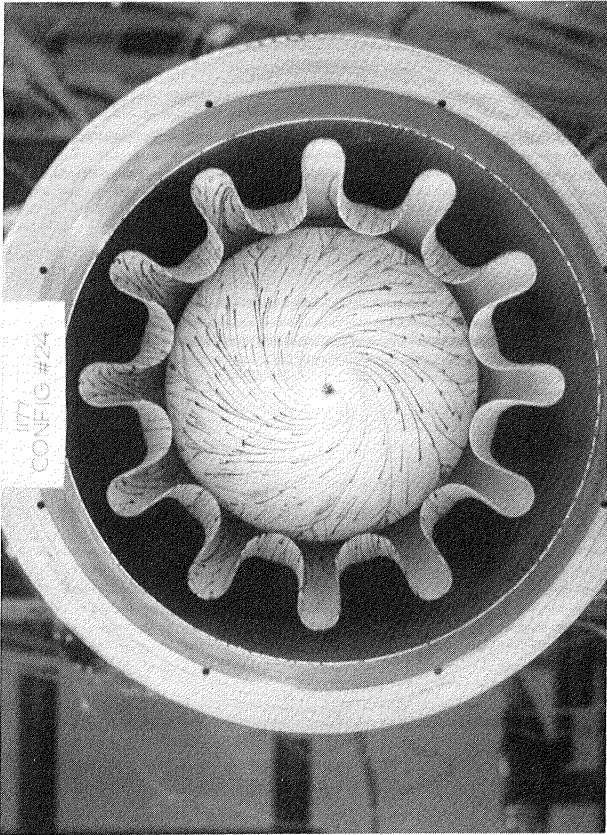

Flow Visualization Photographs, Configuration 24

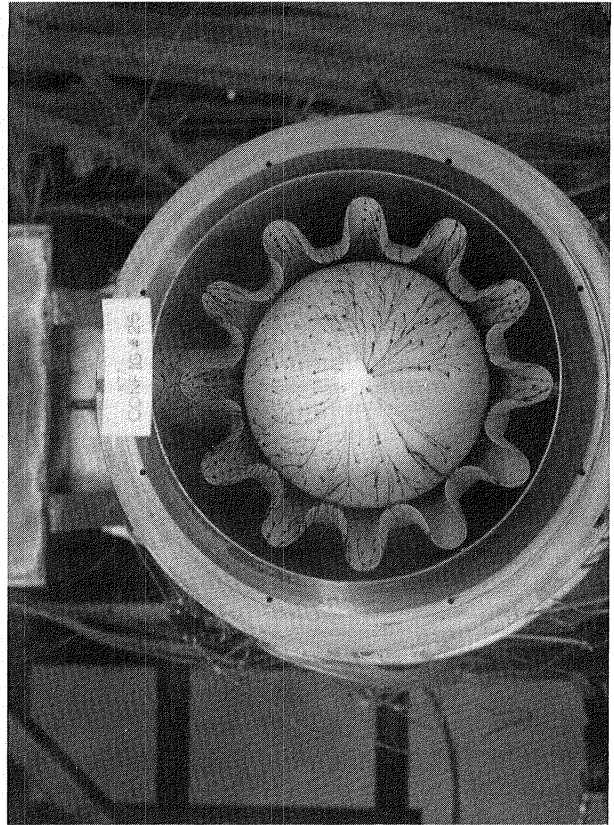
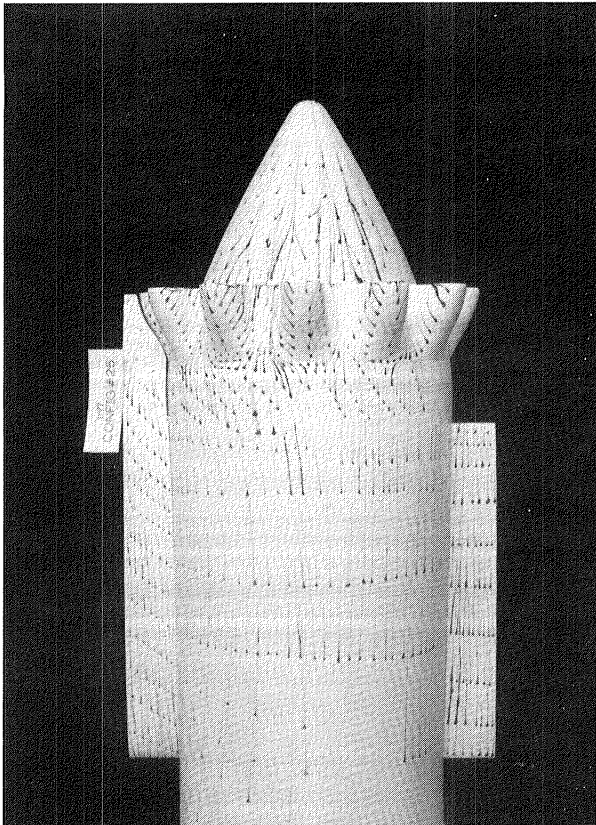
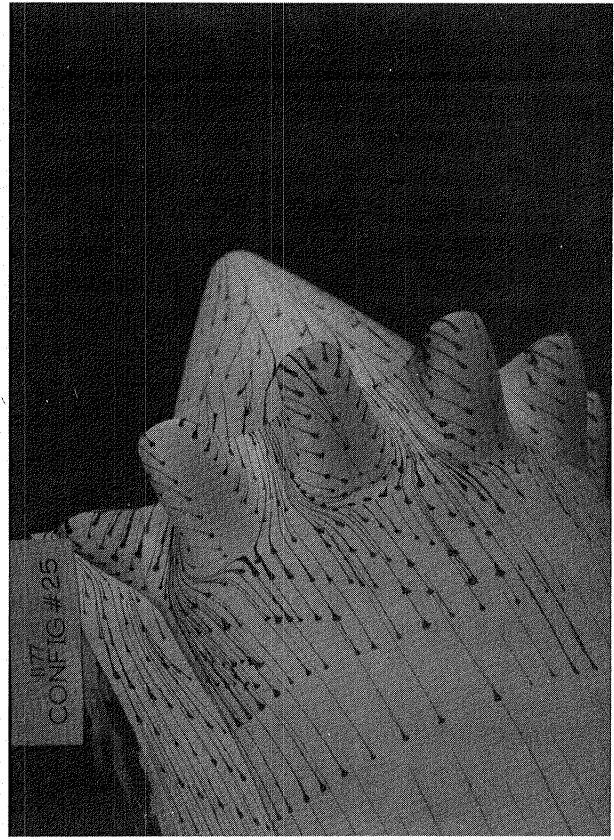
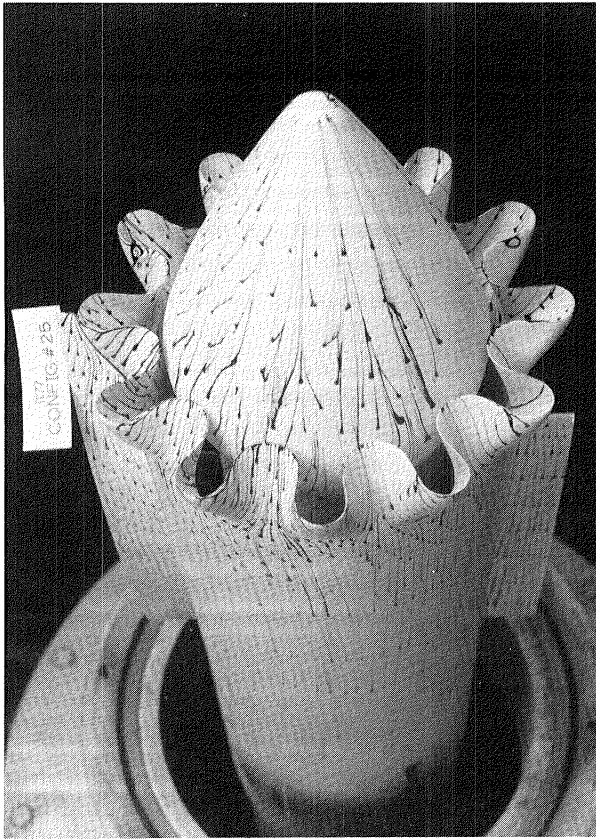

Flow Visualization Photographs, Configuration 25

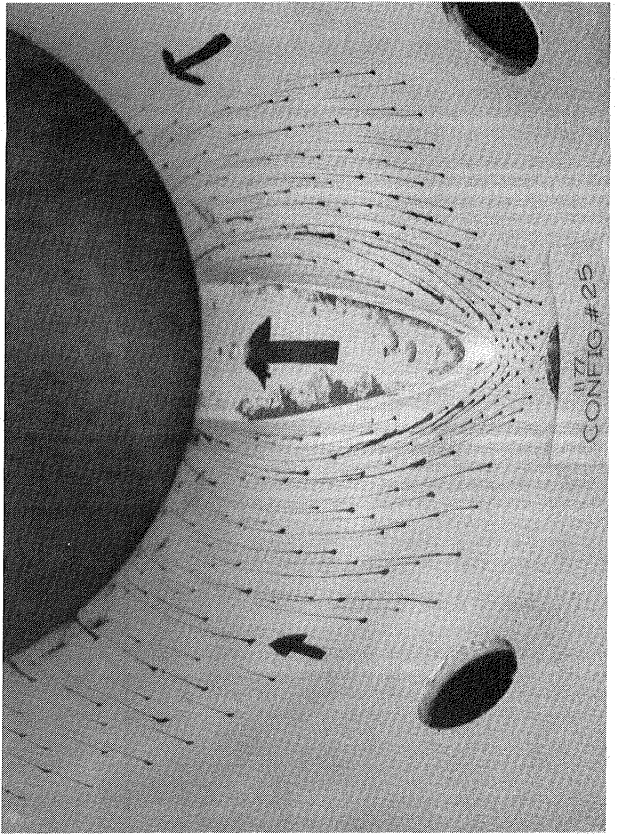
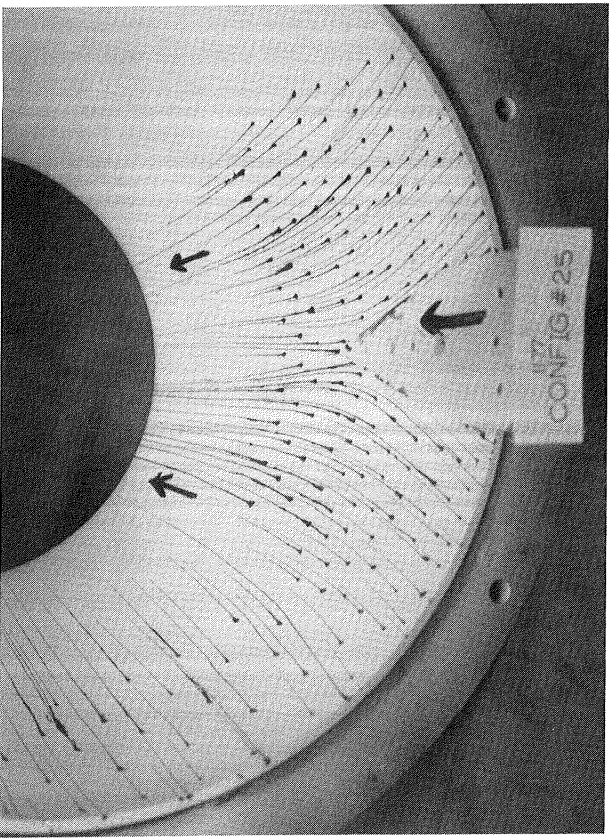
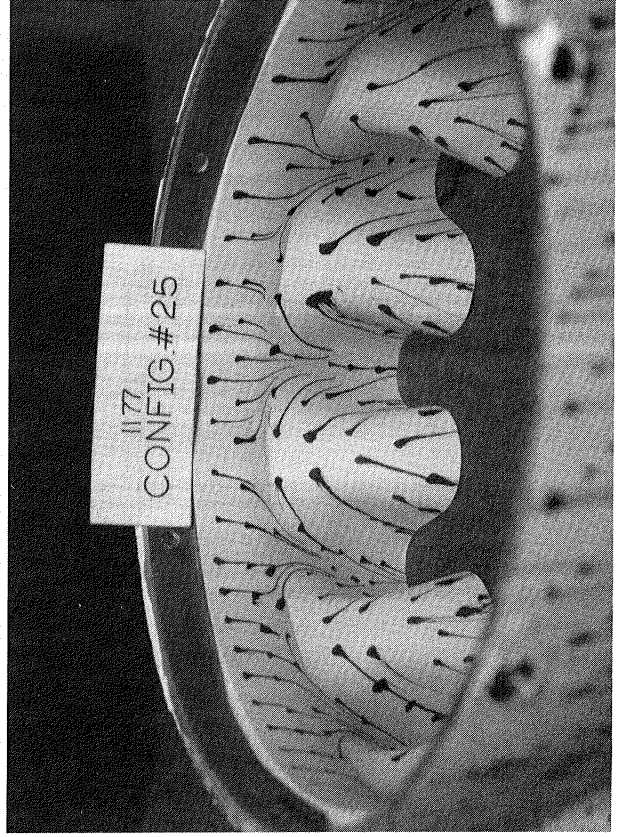
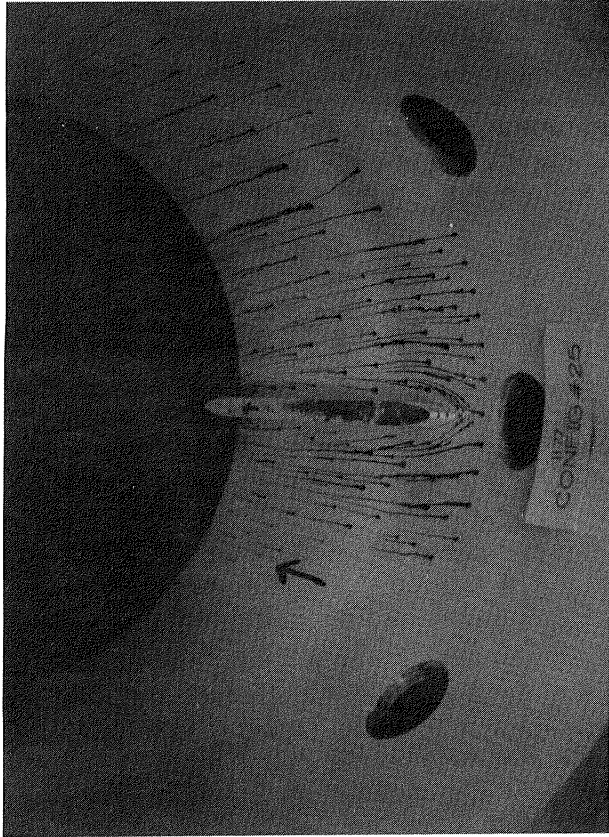

Flow Visualization Photographs, Configuration 25

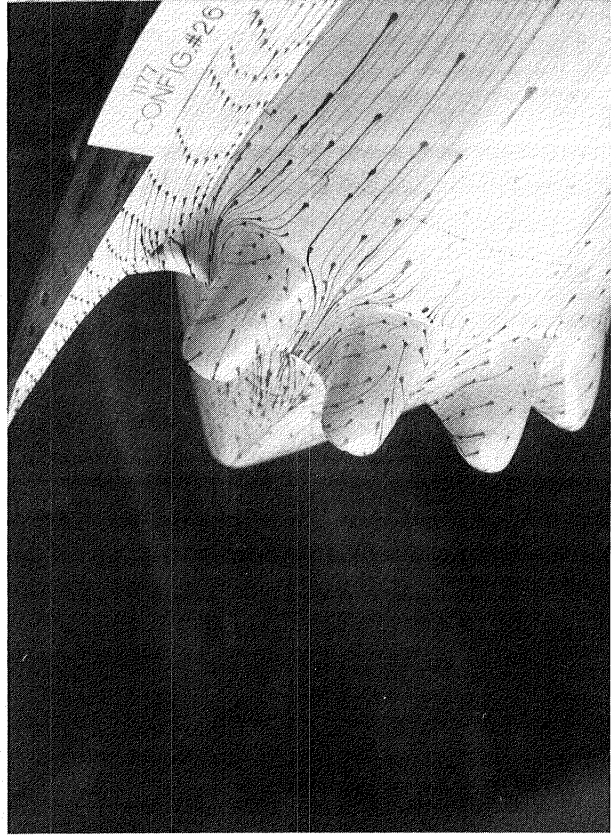
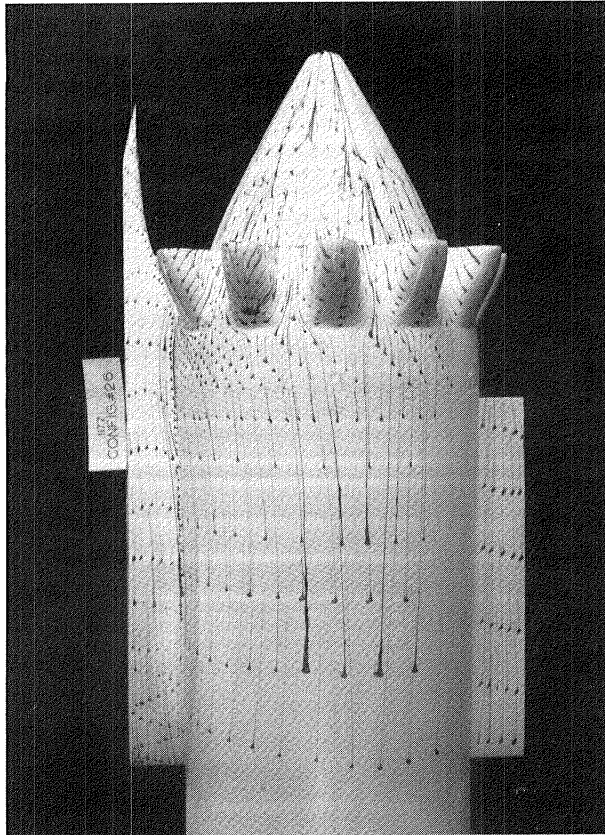
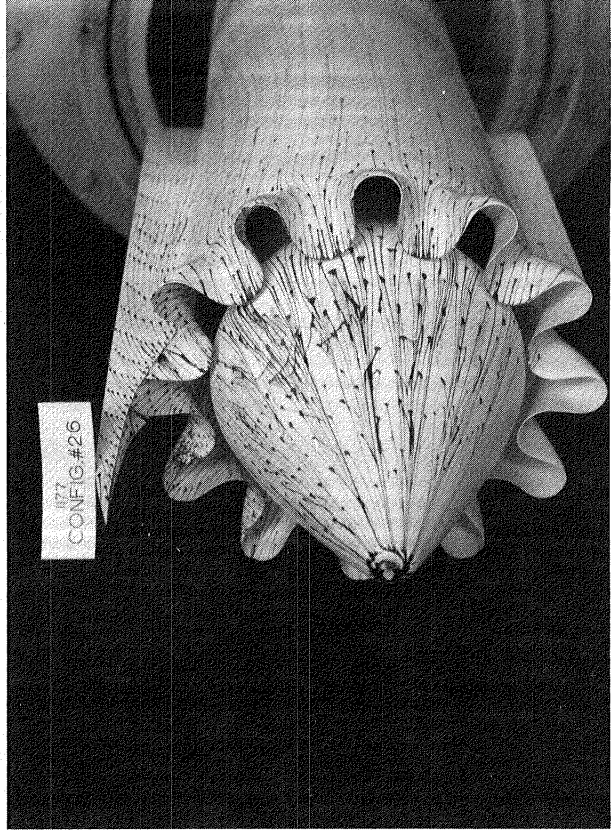
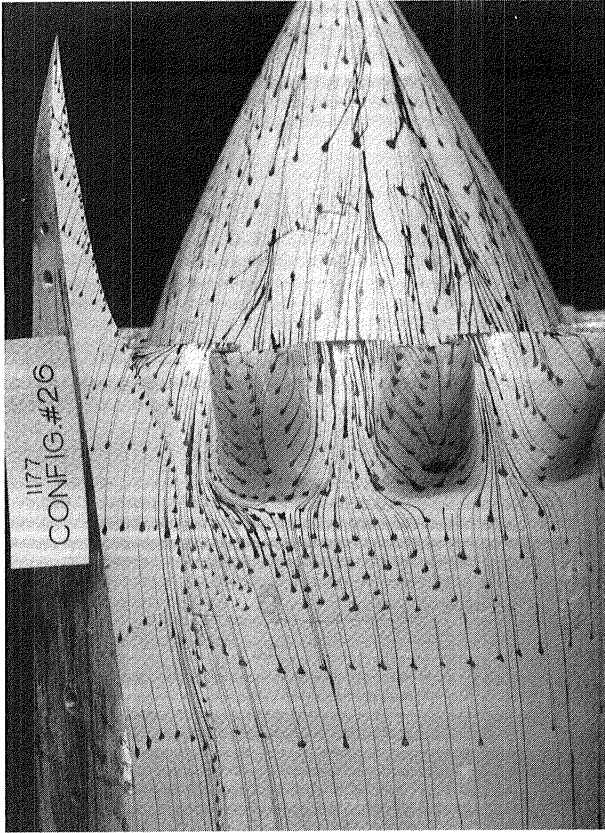

Flow Visualization Photographs, Configuration 26

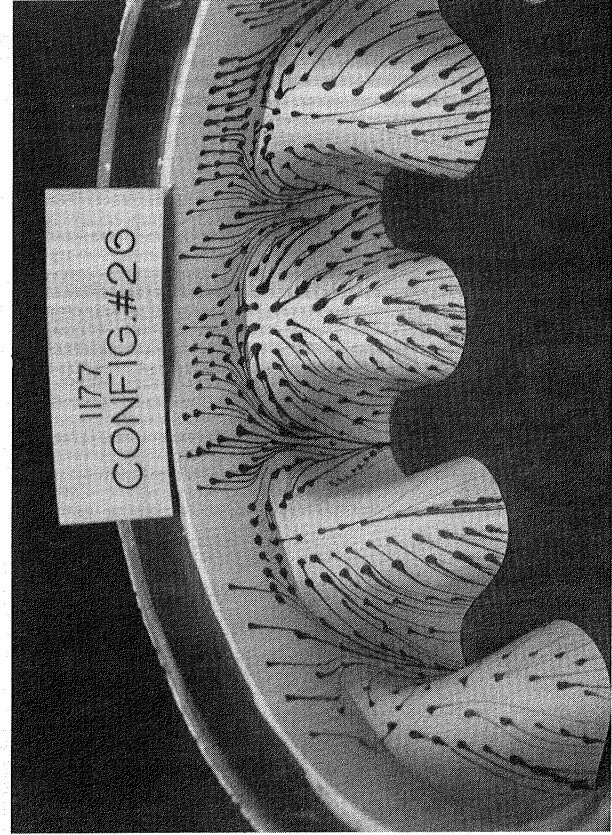
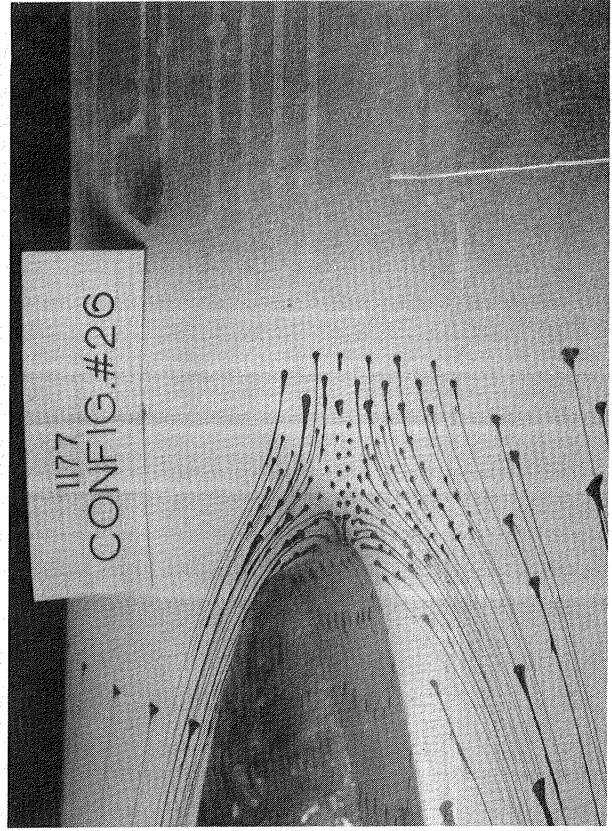
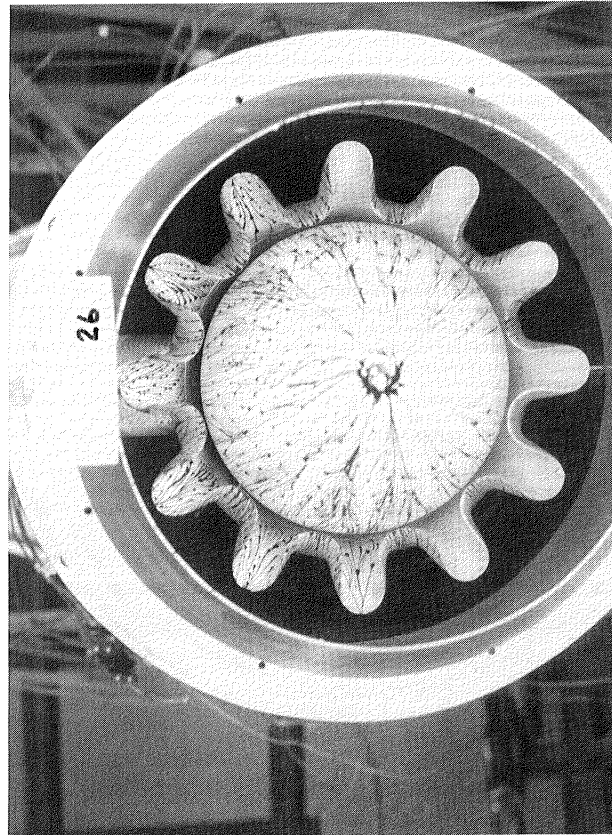
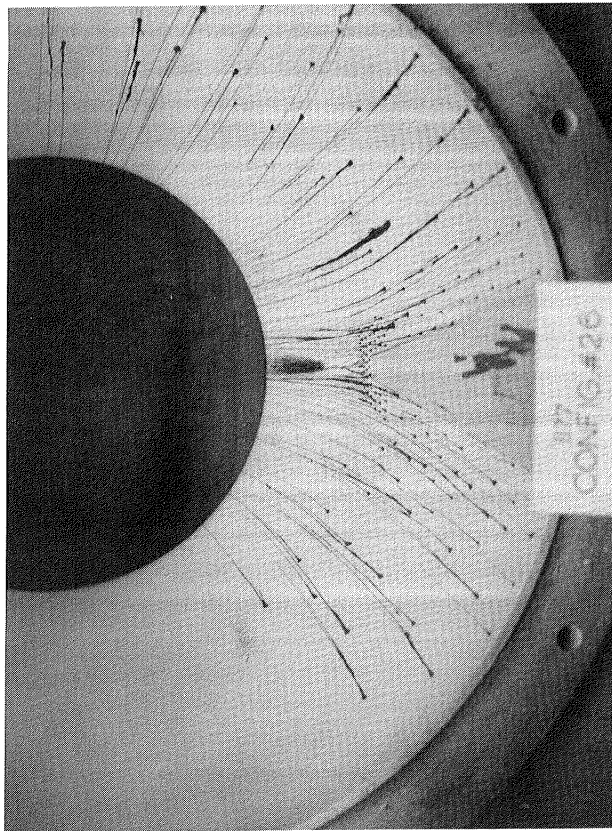

Flow Visualization Photographs, Configuration 26

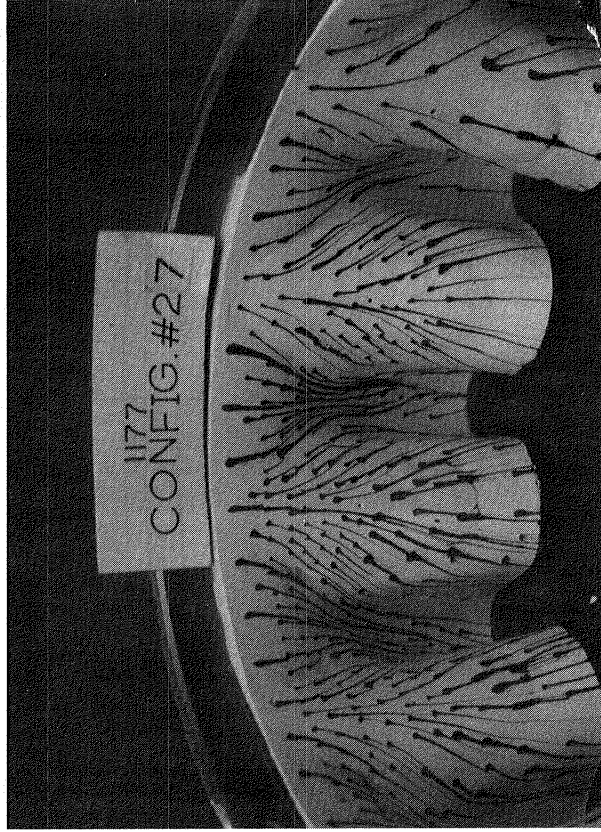
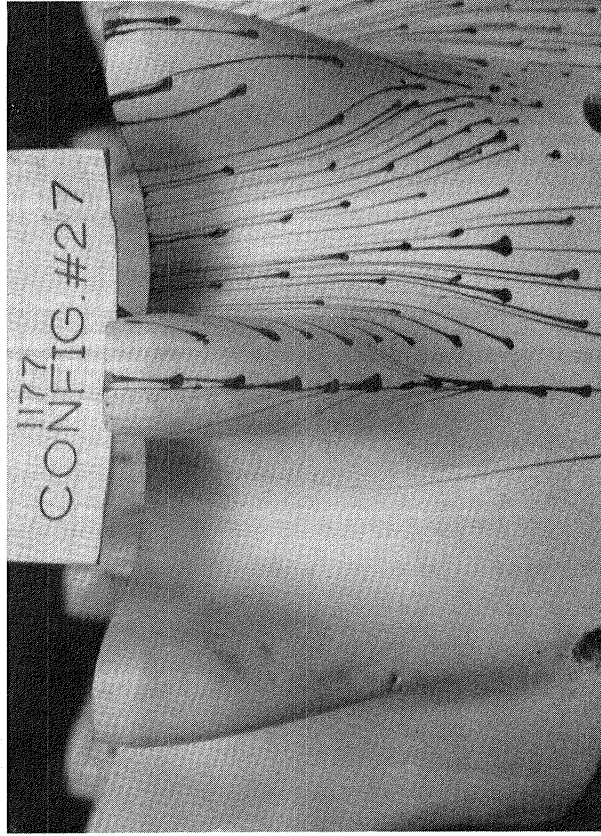
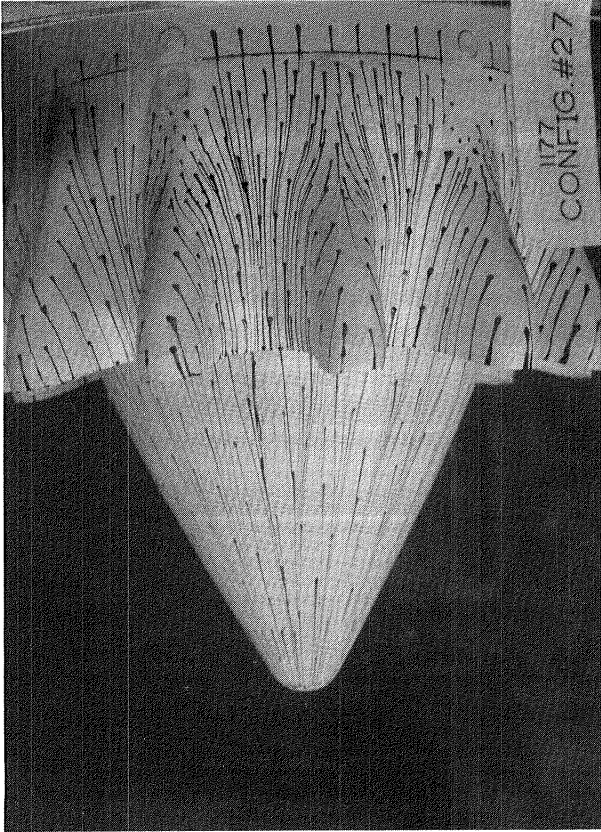
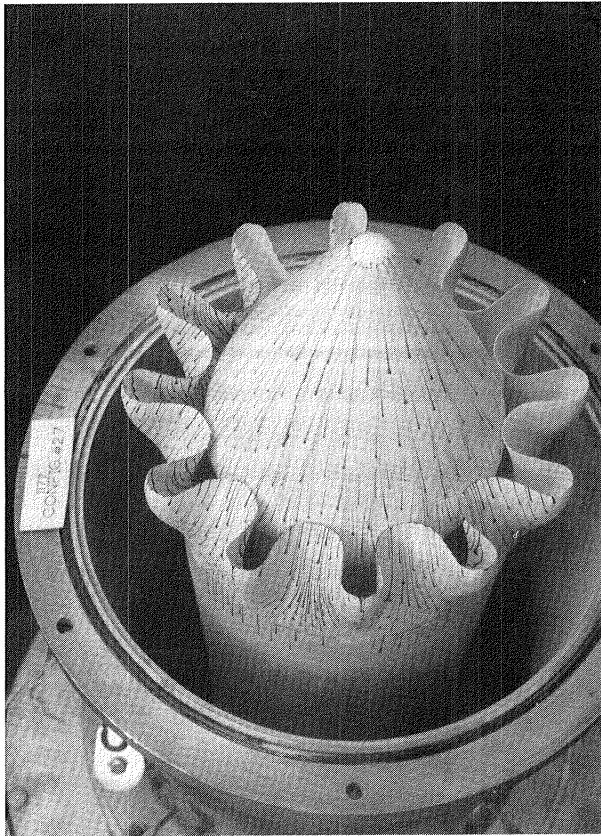

Flow Visualization Photographs, Configuration 27

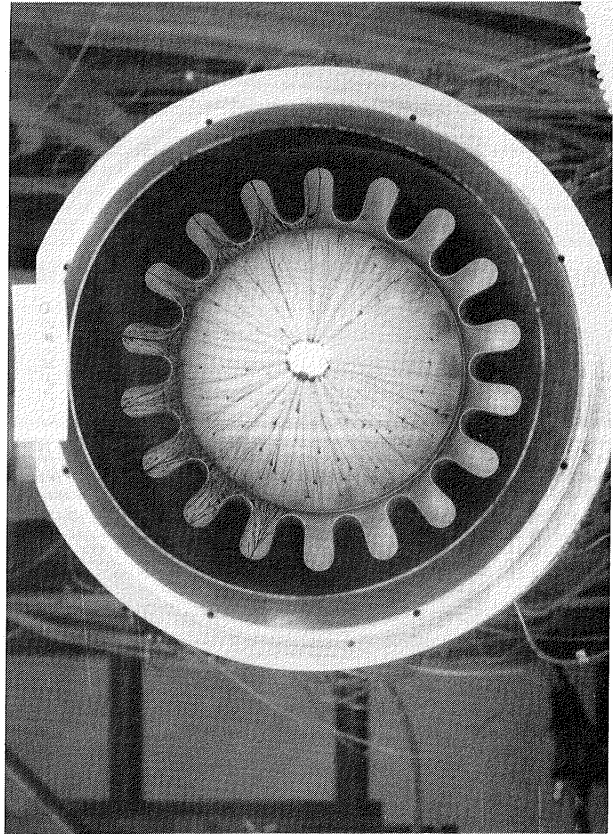
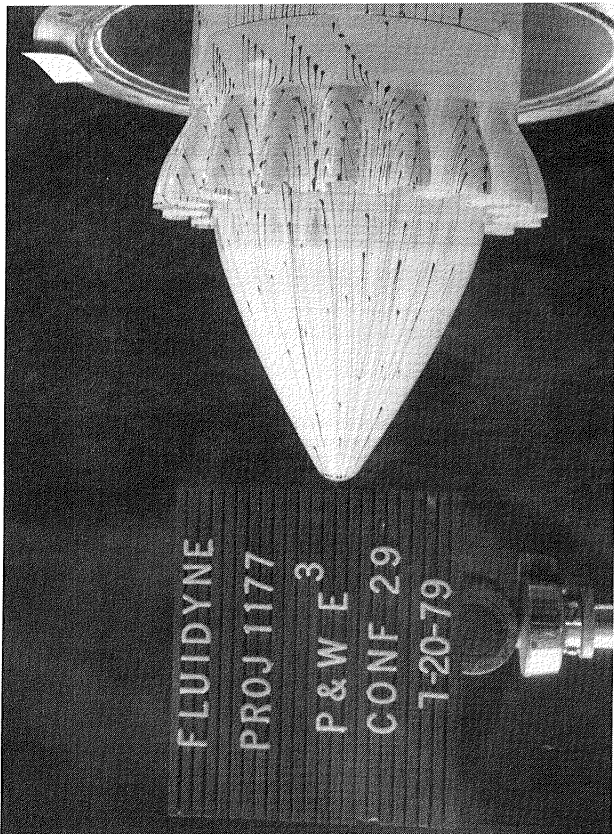
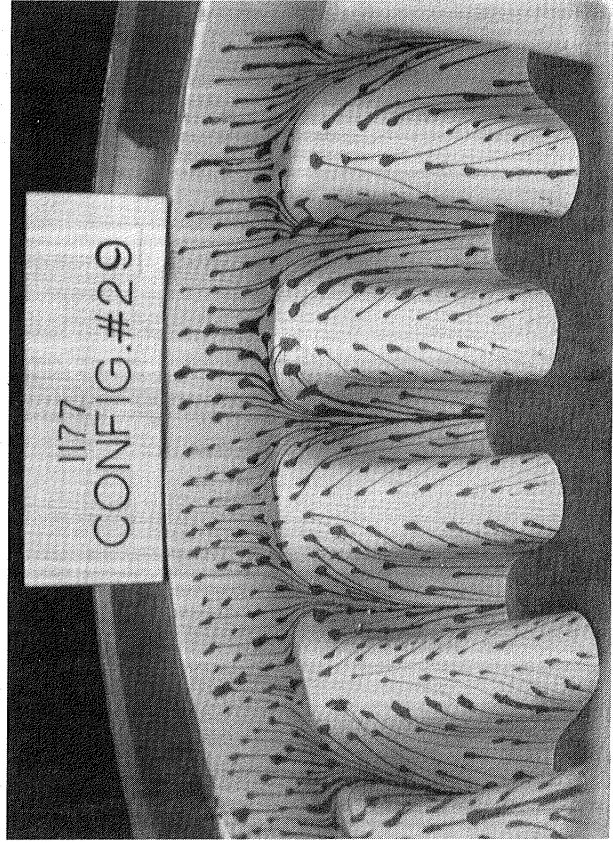
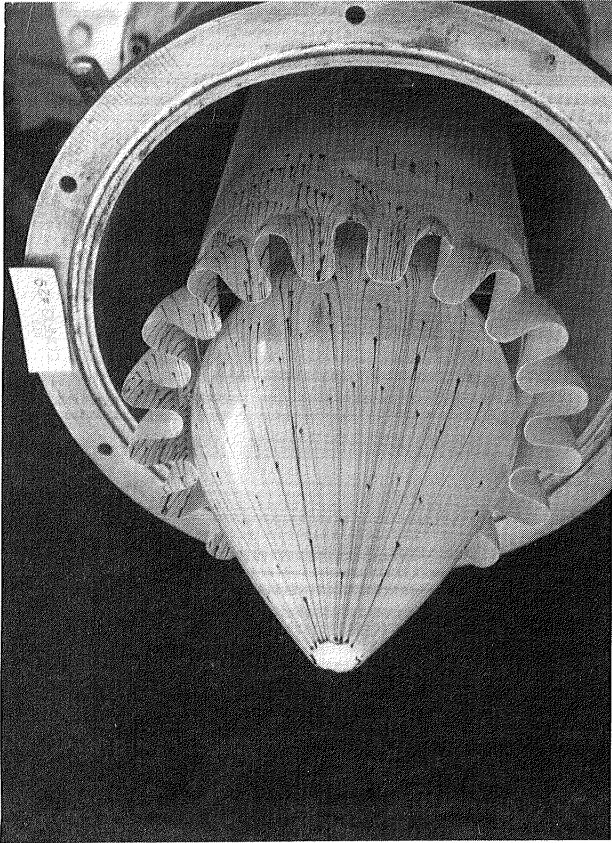

Flow Visualization Photographs, Configuration 29

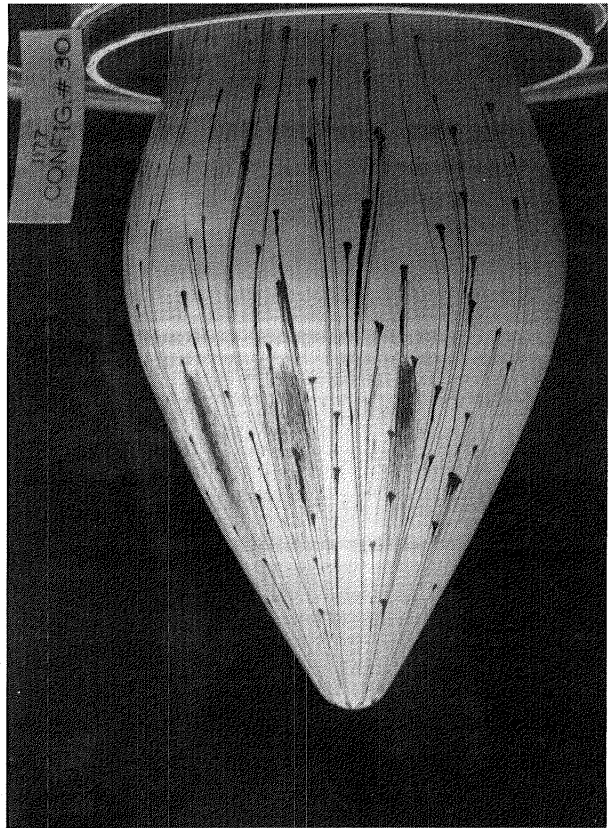
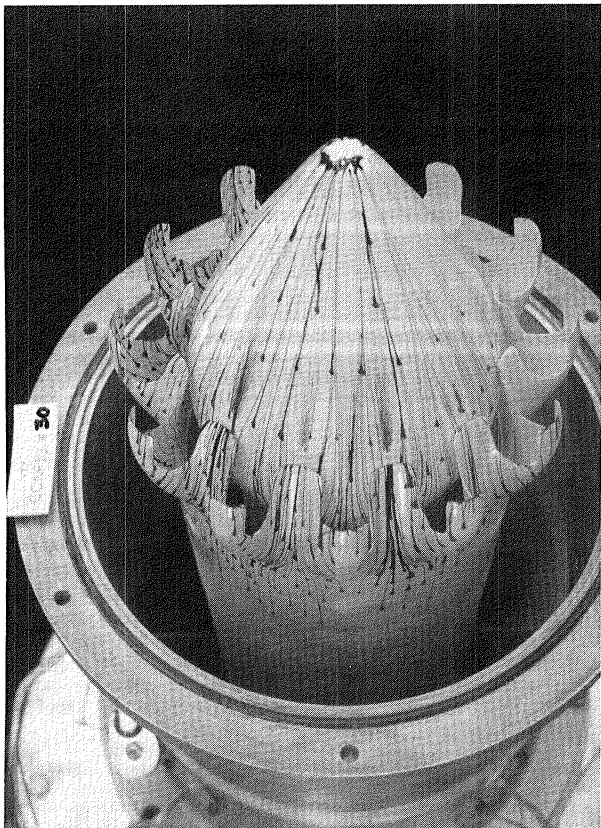
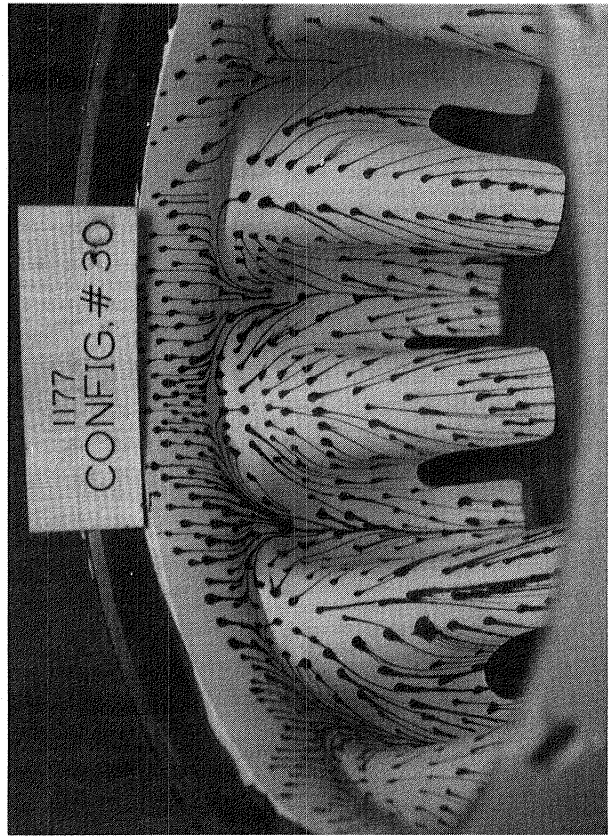
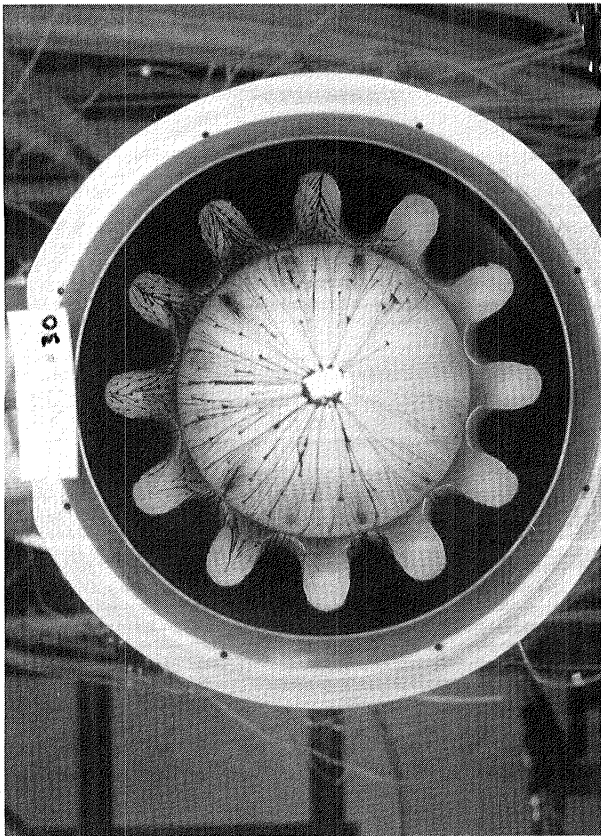

Flow Visualization Photographs, Configuration 30

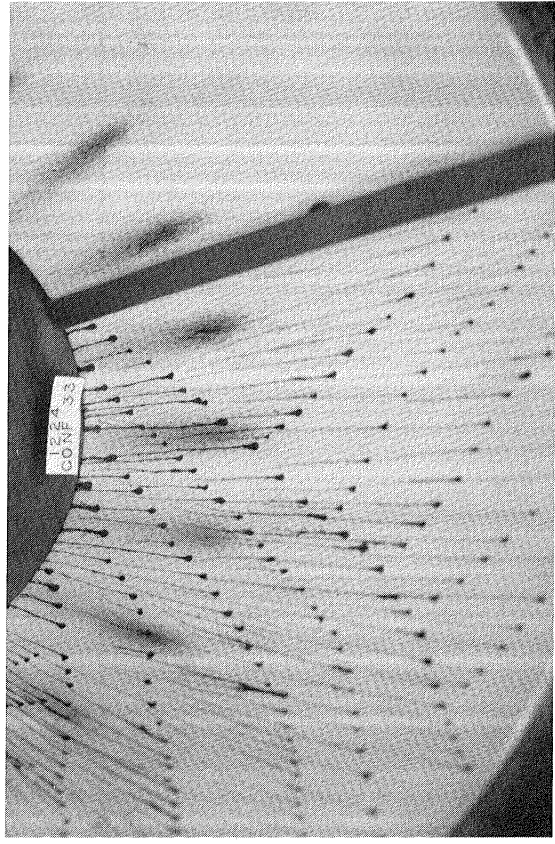
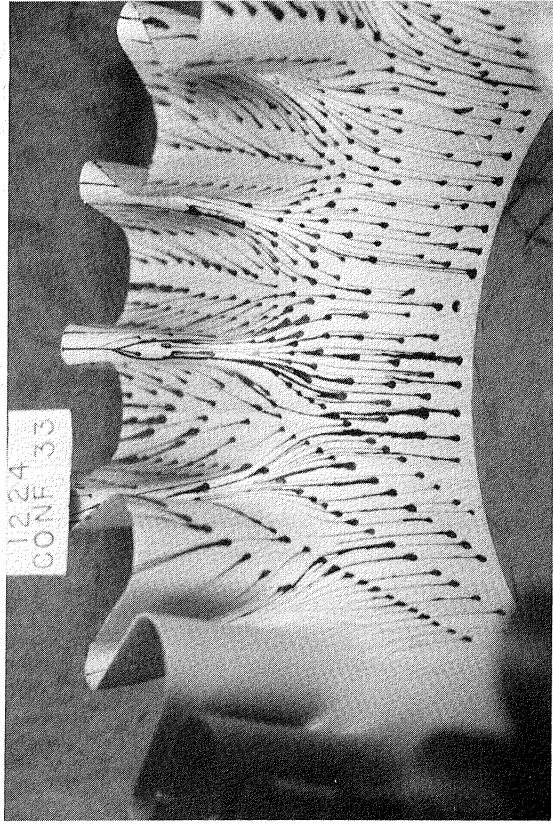
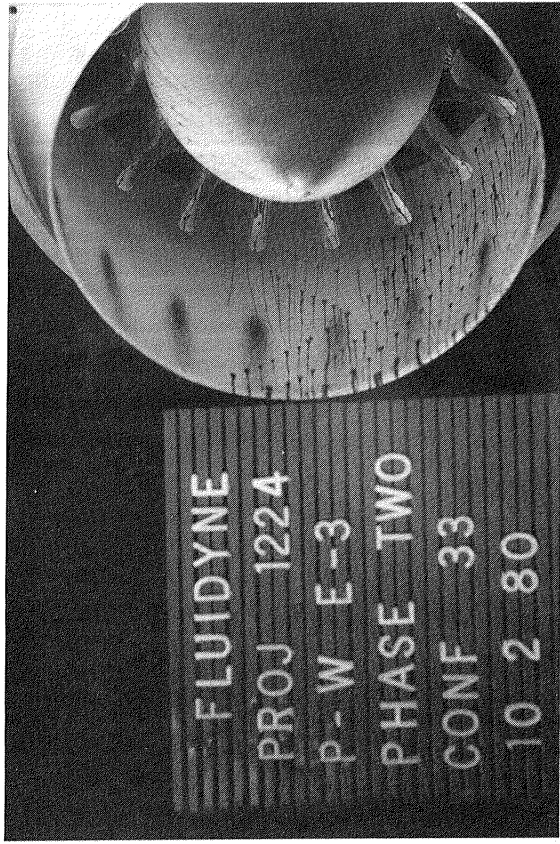
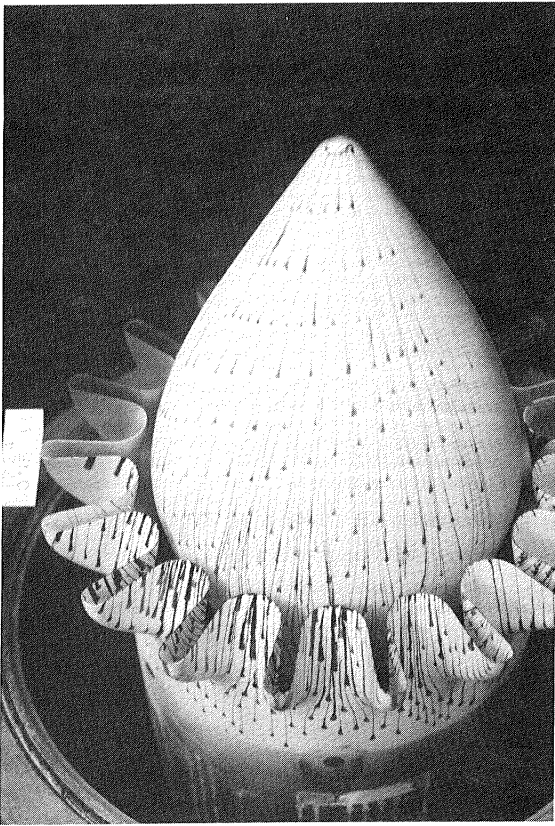

Flow Visualization Photographs, Configuration 33

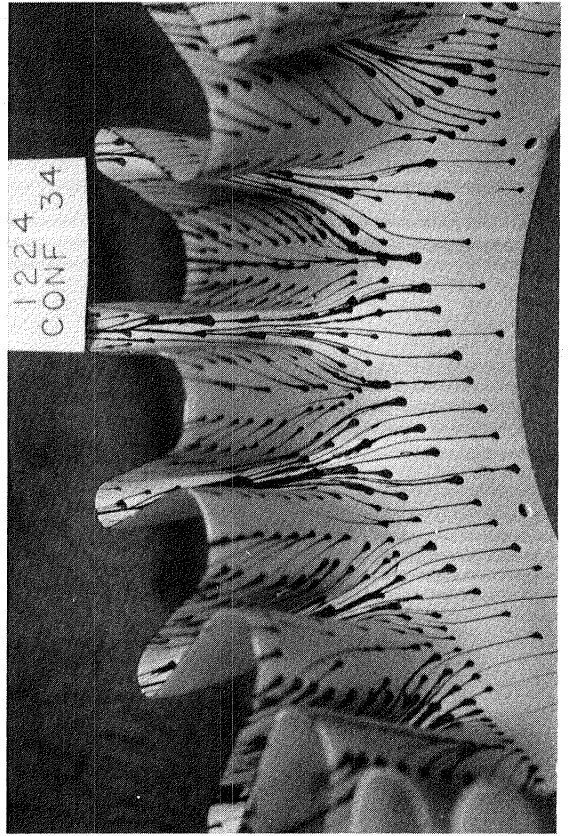
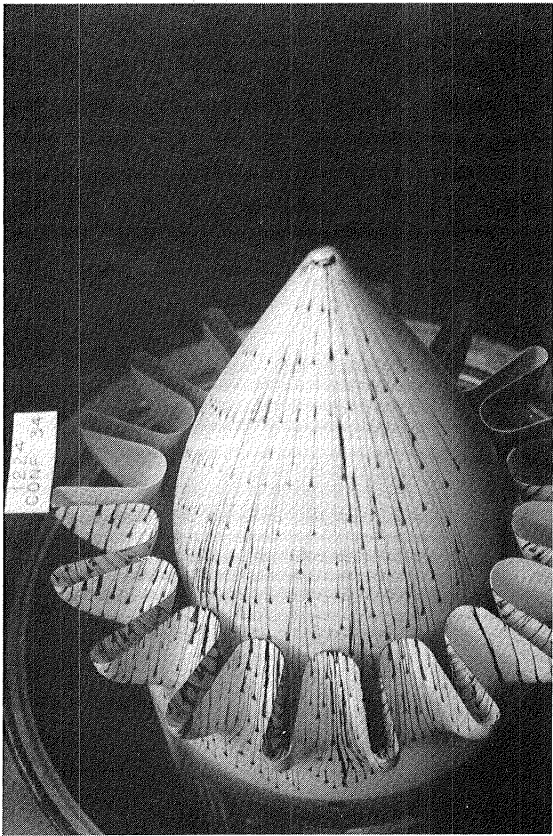
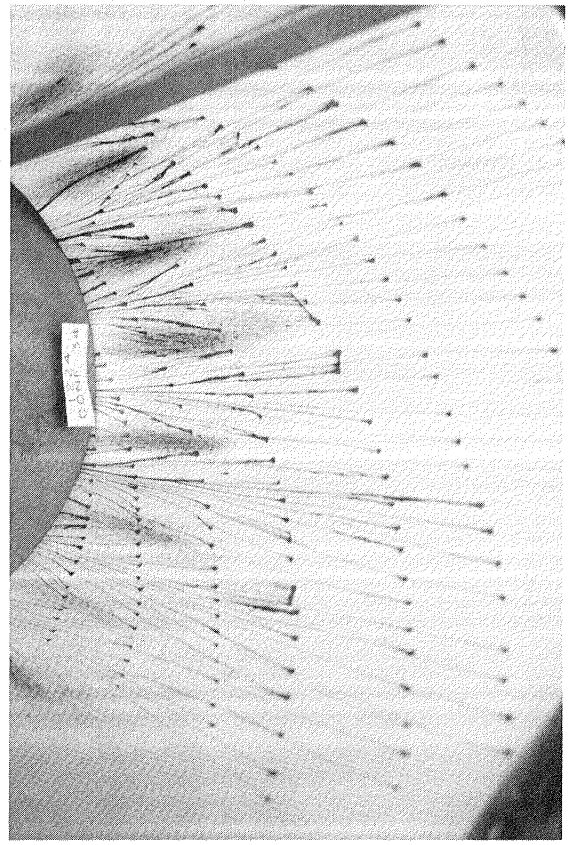
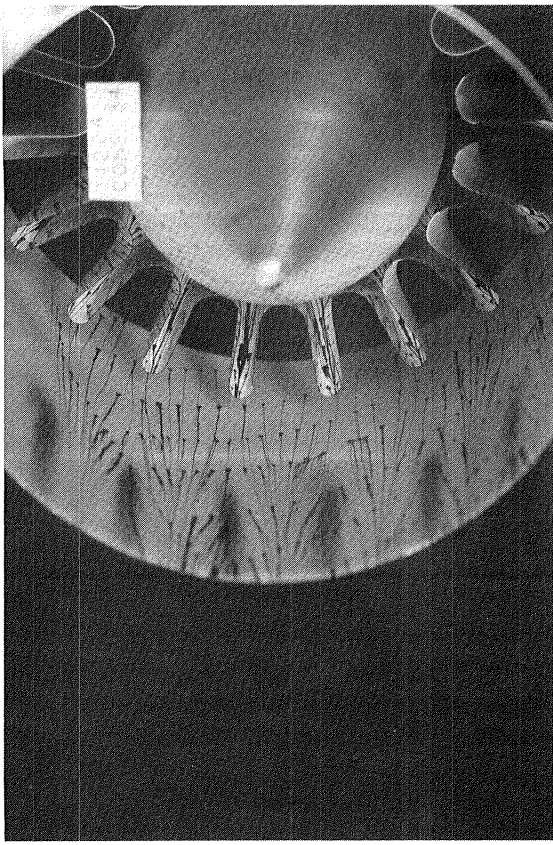

Flow Visualization Photographs, Configuration 34

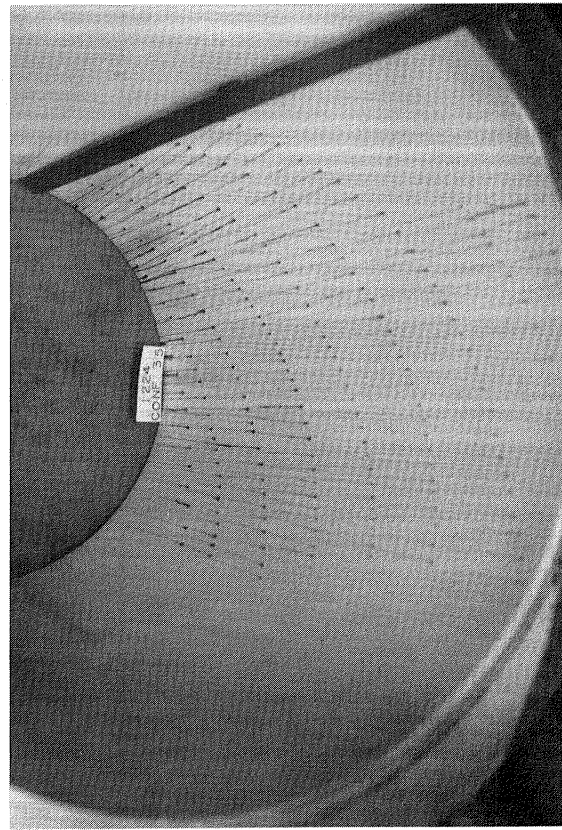
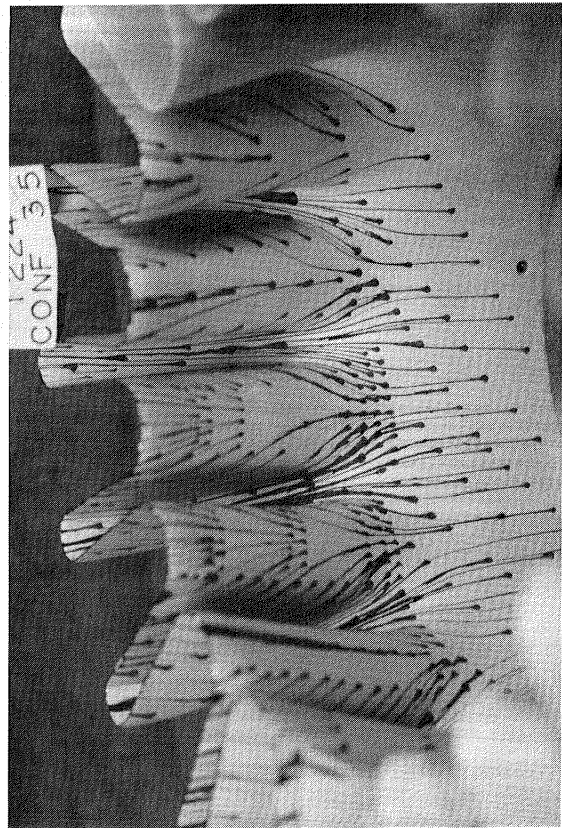
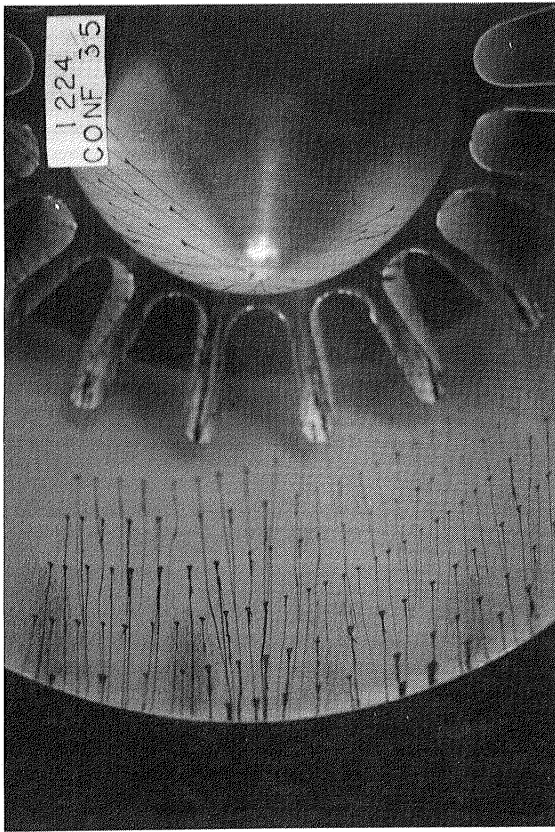
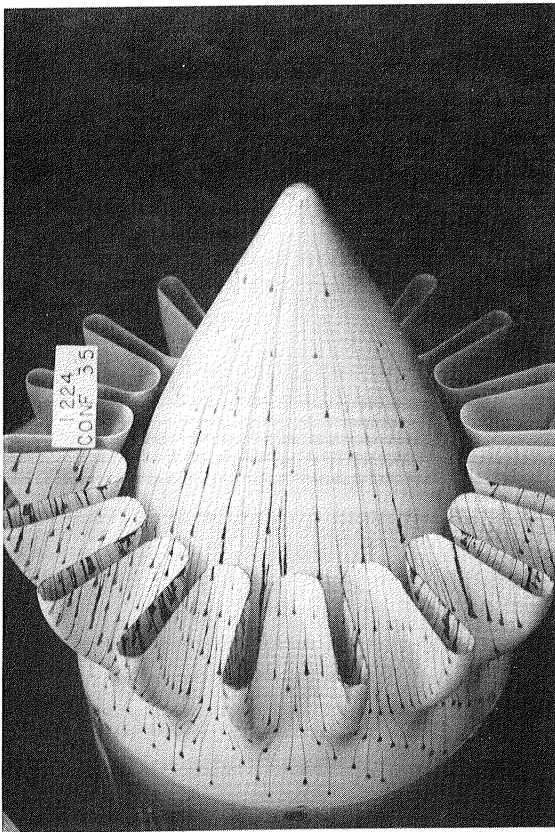

Flow Visualization Photographs, Configuration 35

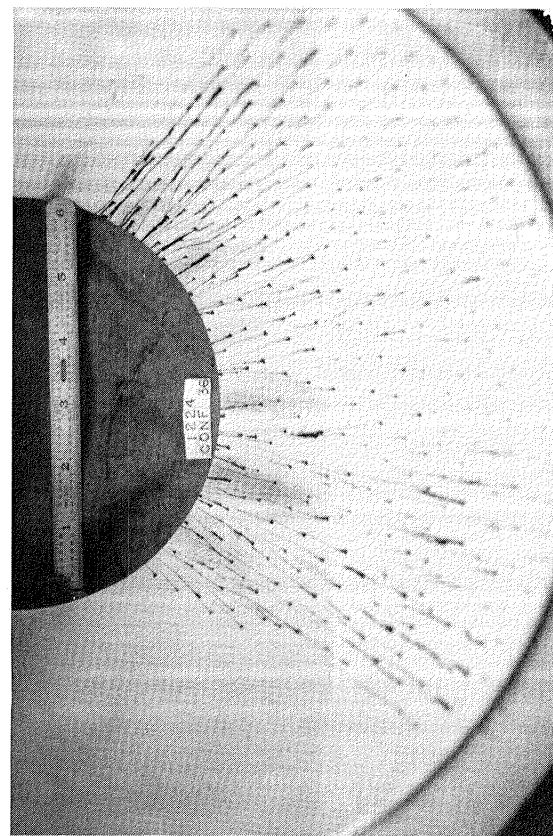
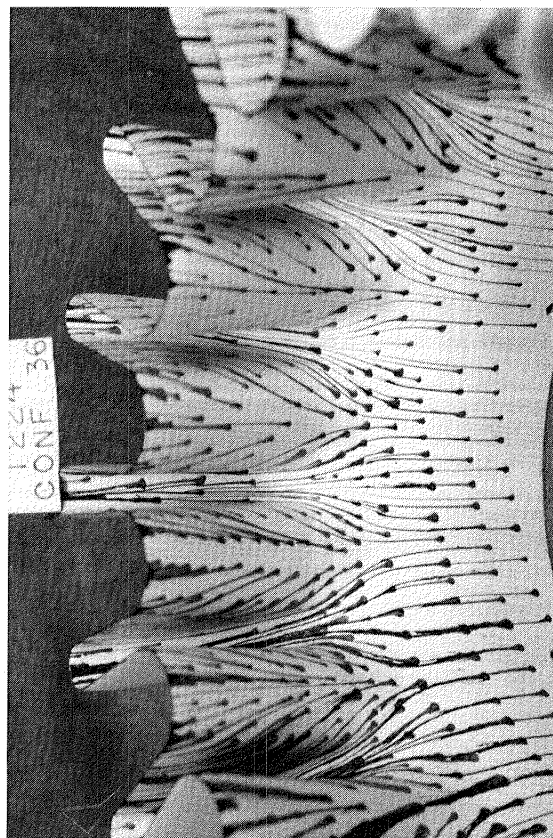
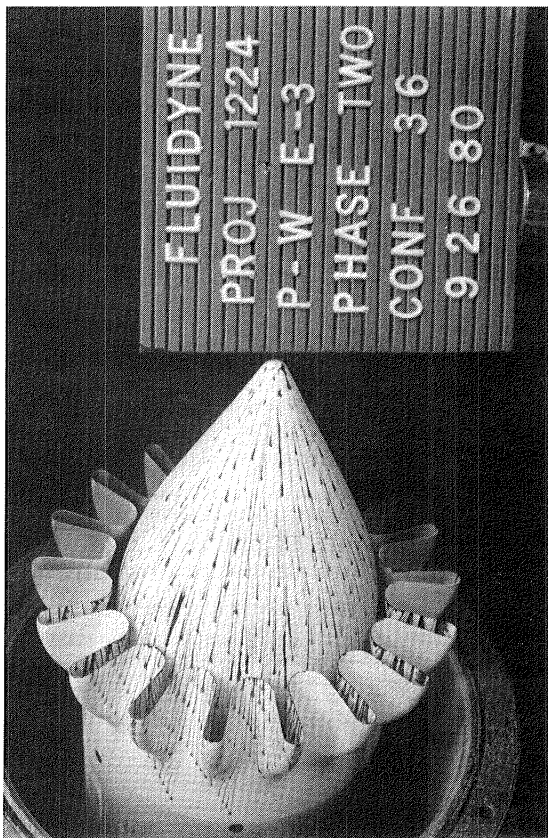

Flow Visualization Photographs, Configuration 36

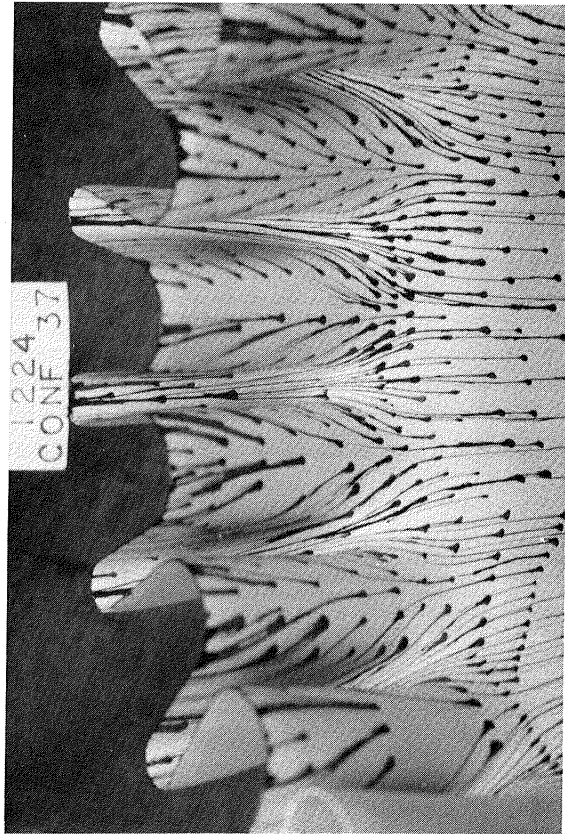
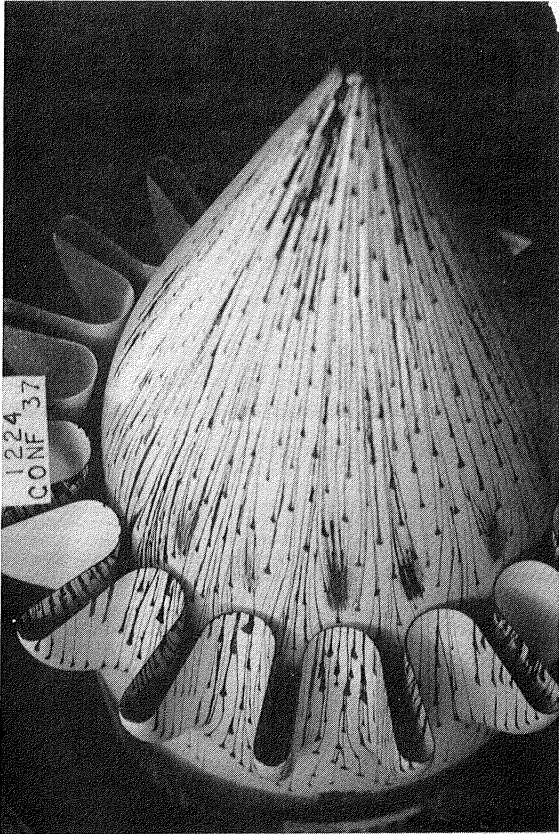
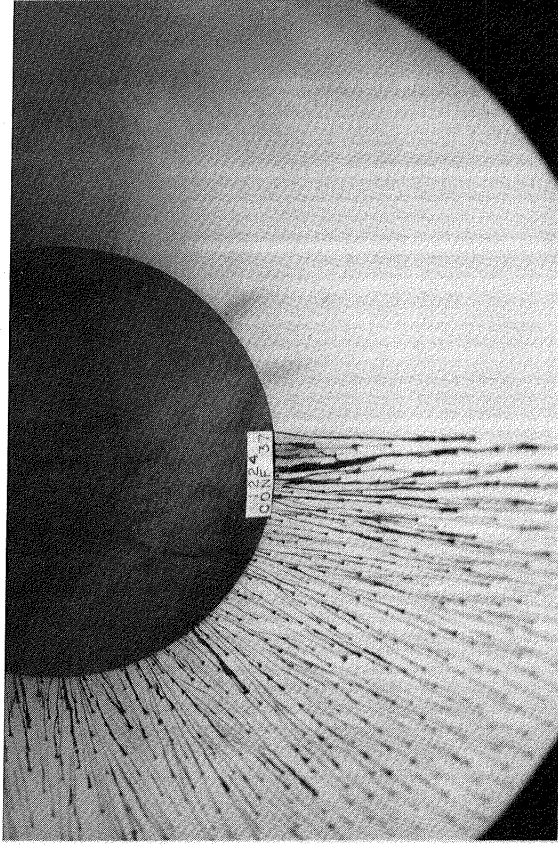
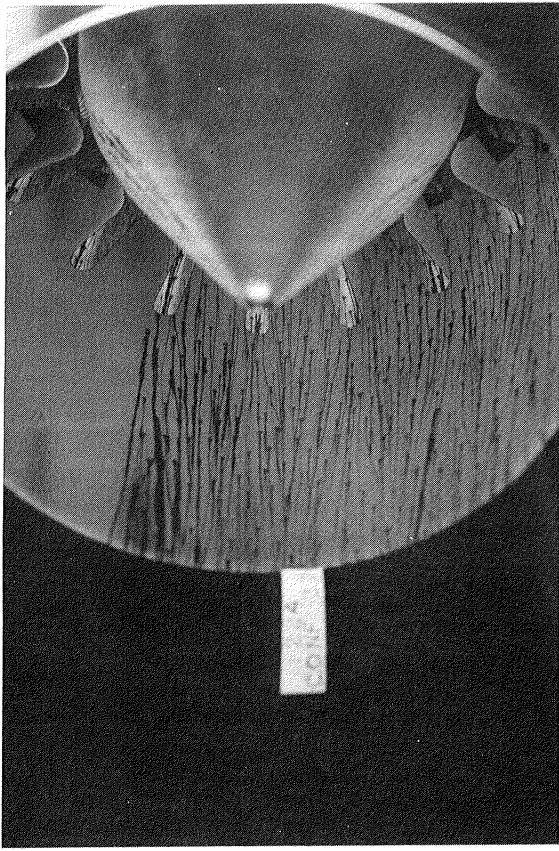

Flow Visualization Photographs, Configuration 37

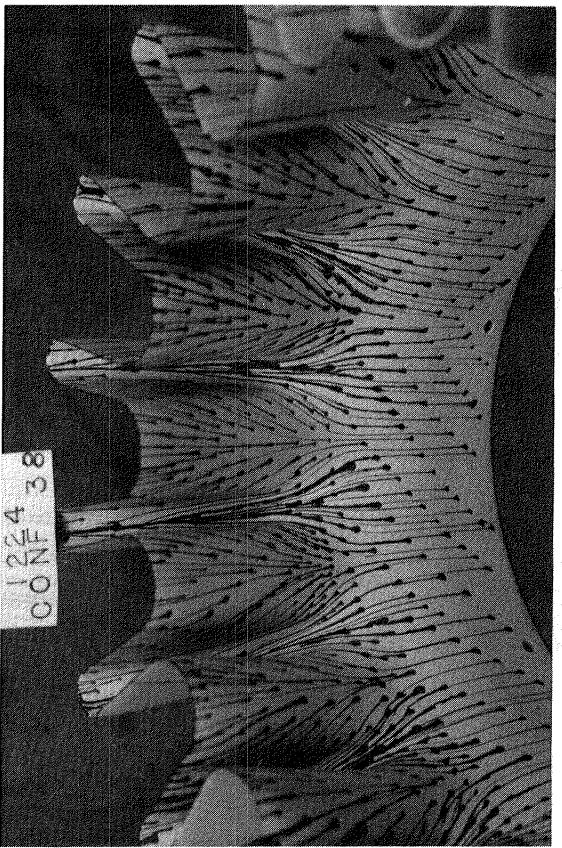
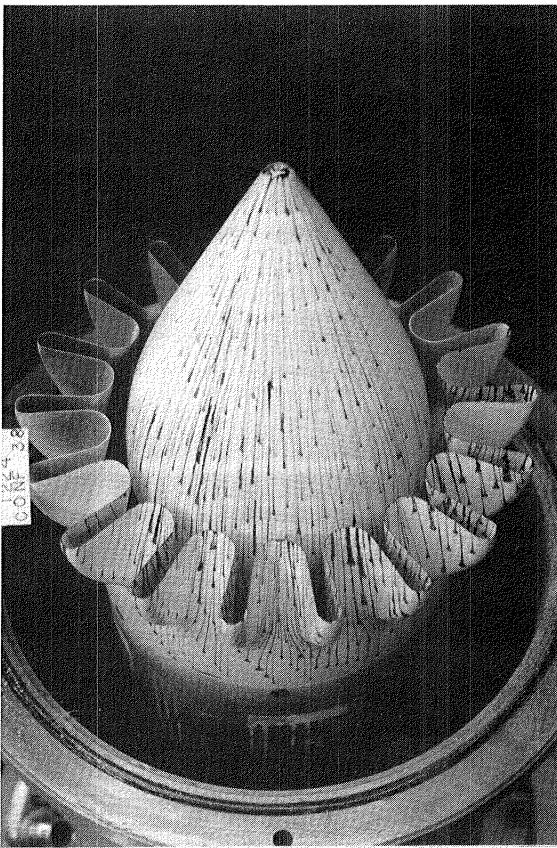
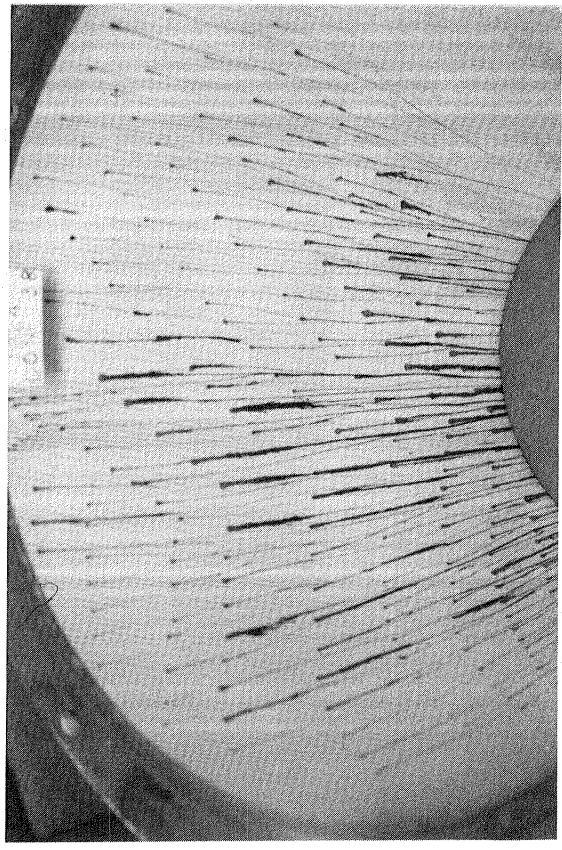
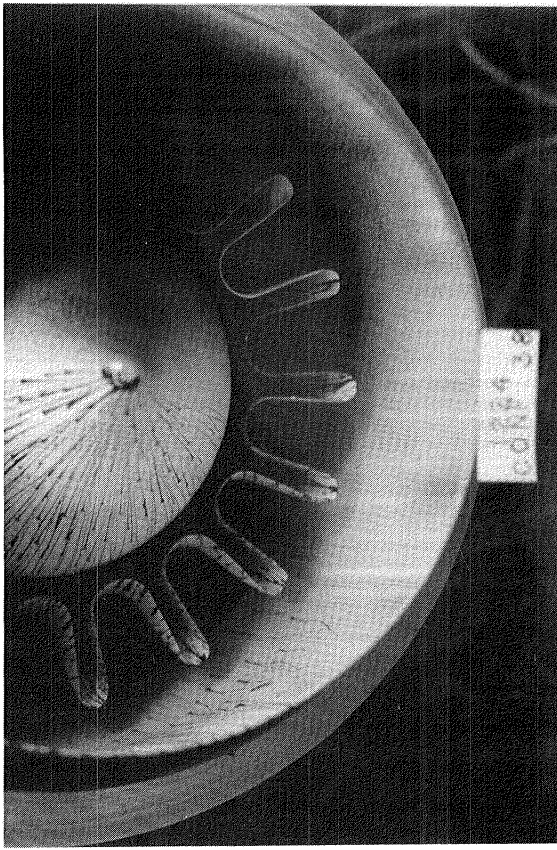

Flow Visualization Photographs, Configuration 38

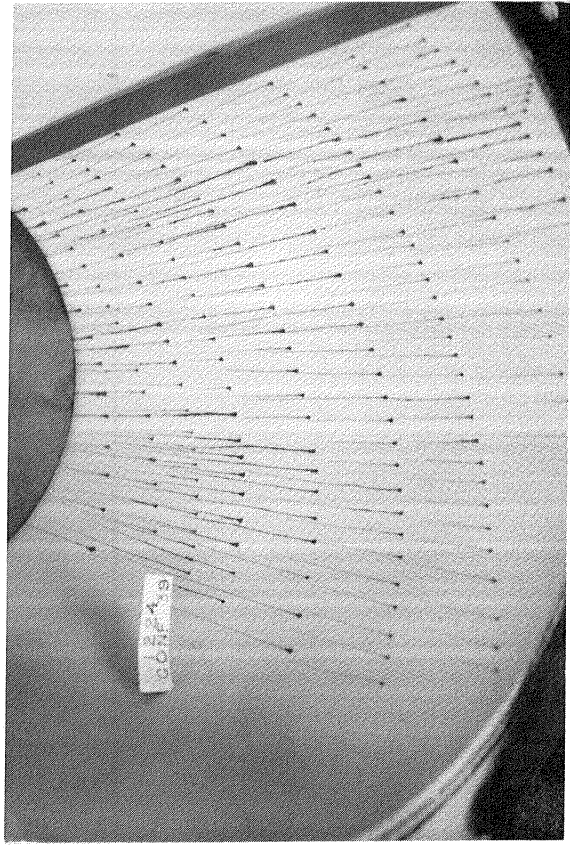
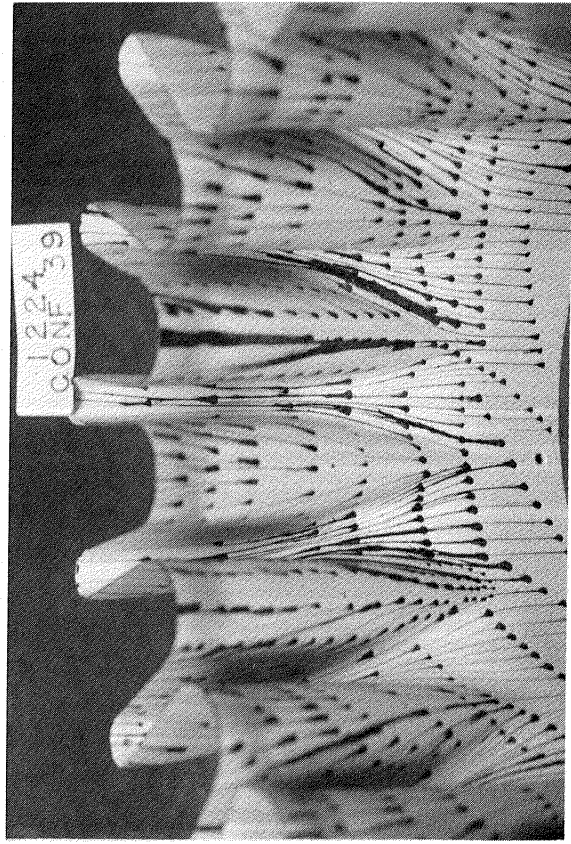
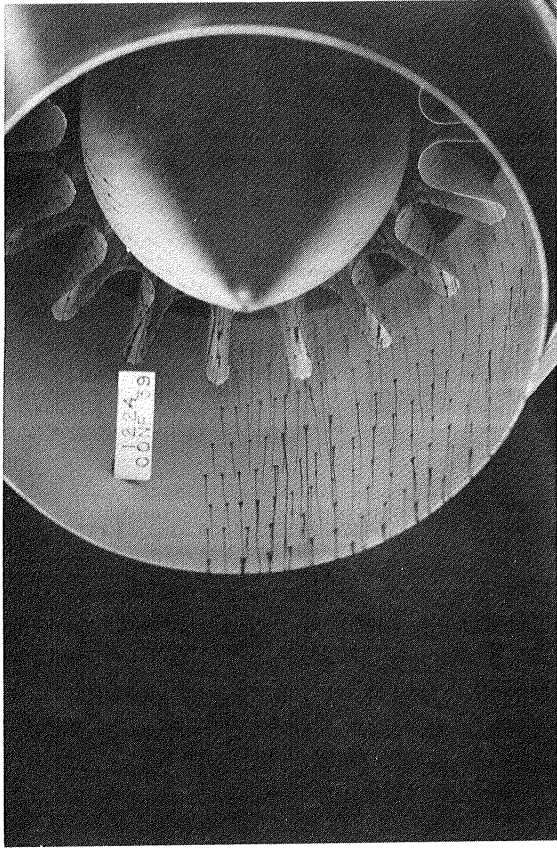
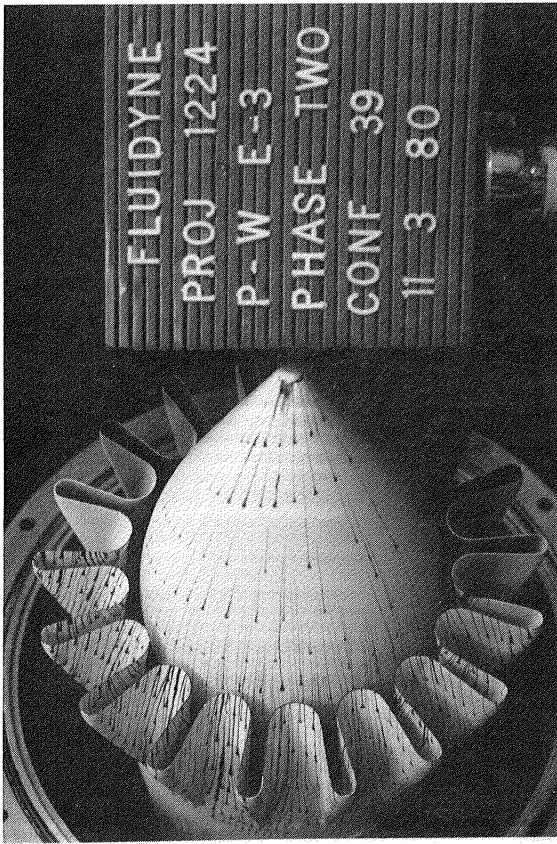

Flow Visualization Photographs, Configuration 39

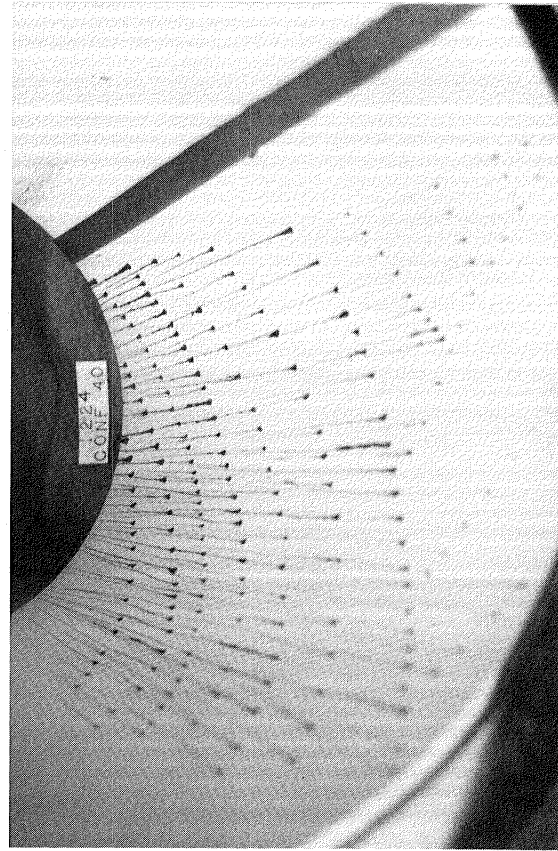
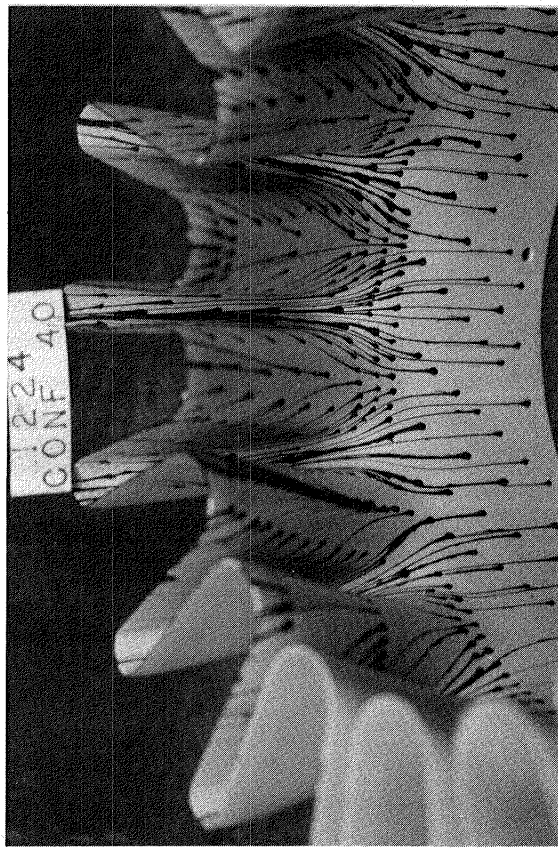
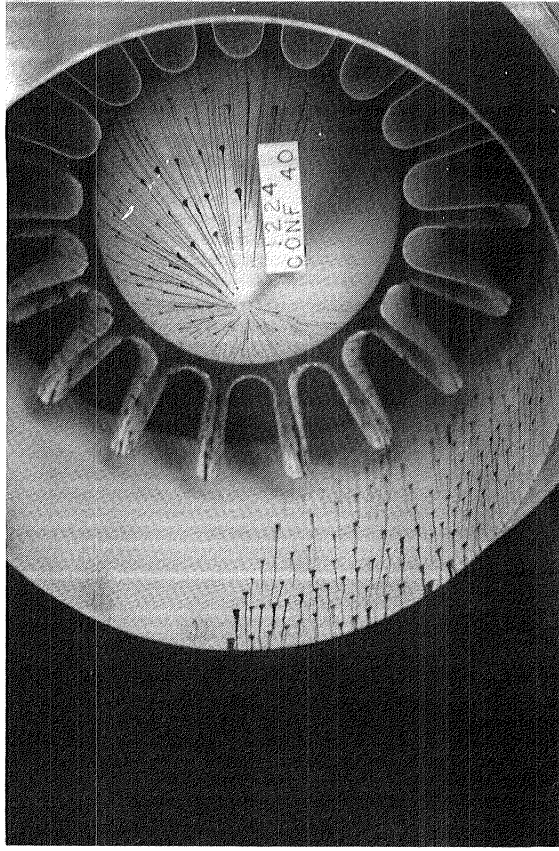
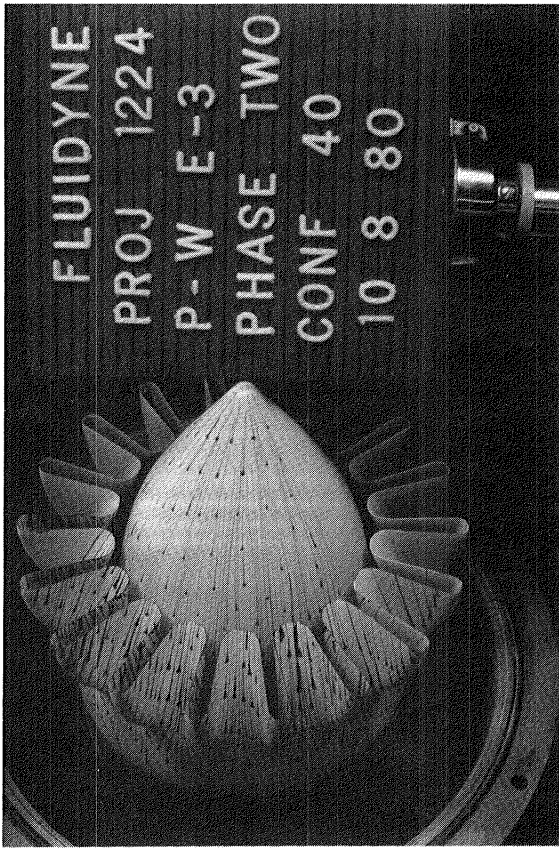

Flow Visualization Photographs, Configuration 40

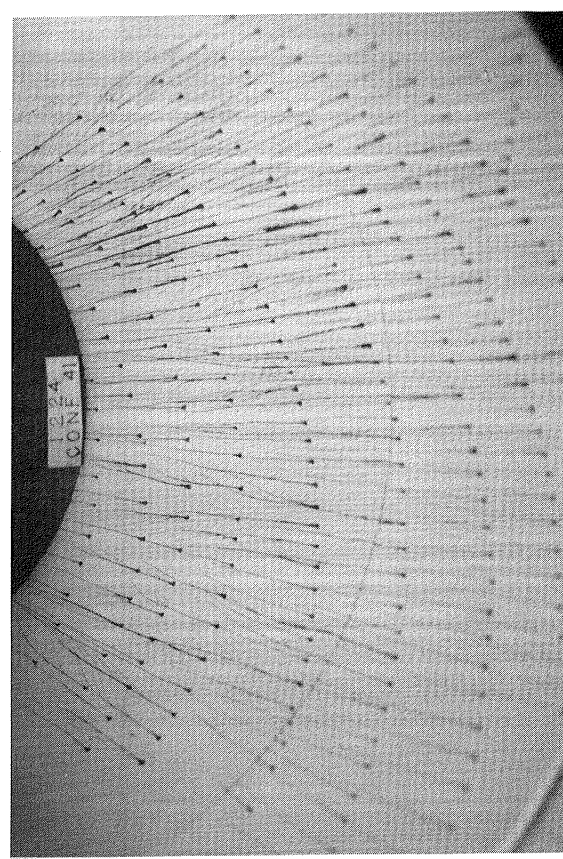
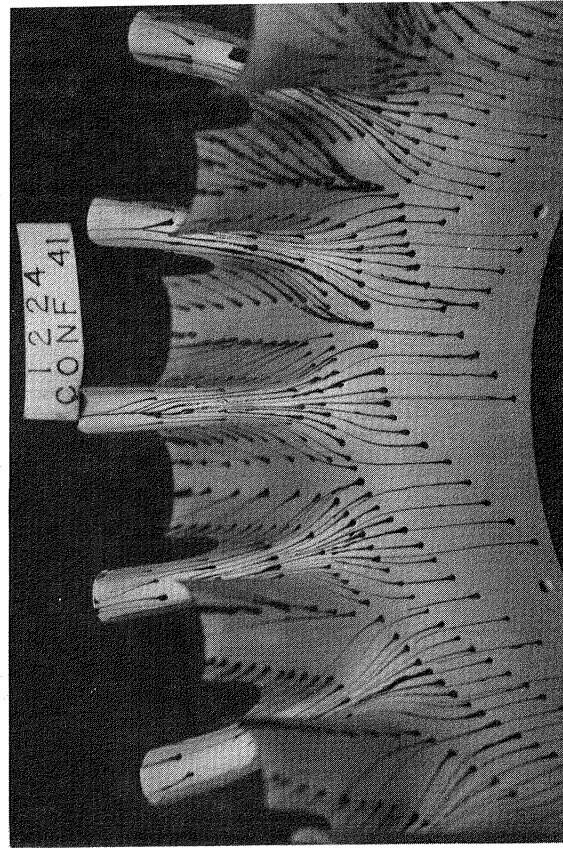
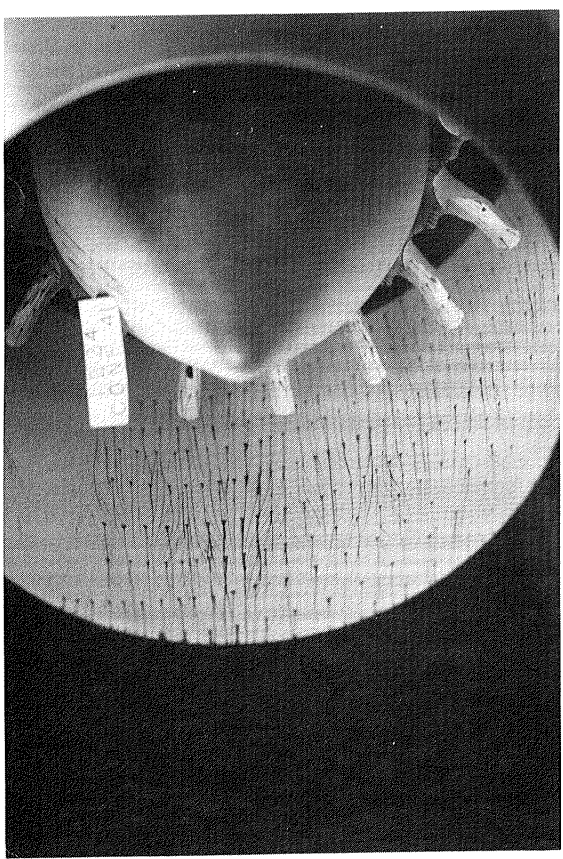
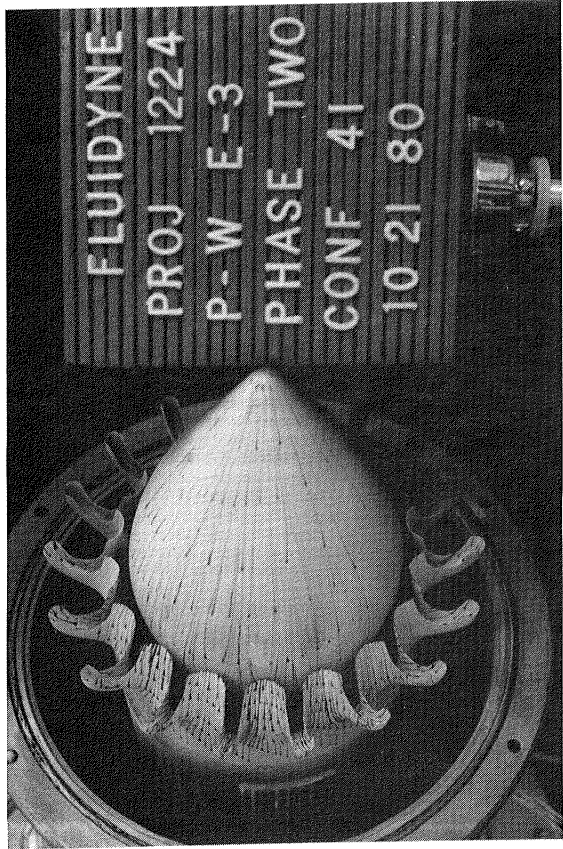

Flow Visualization Photographs, Configuration 41

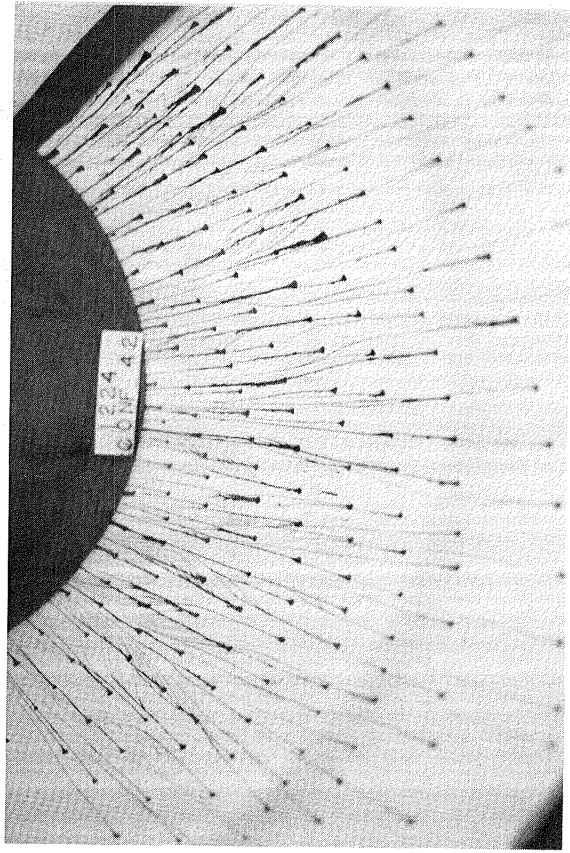
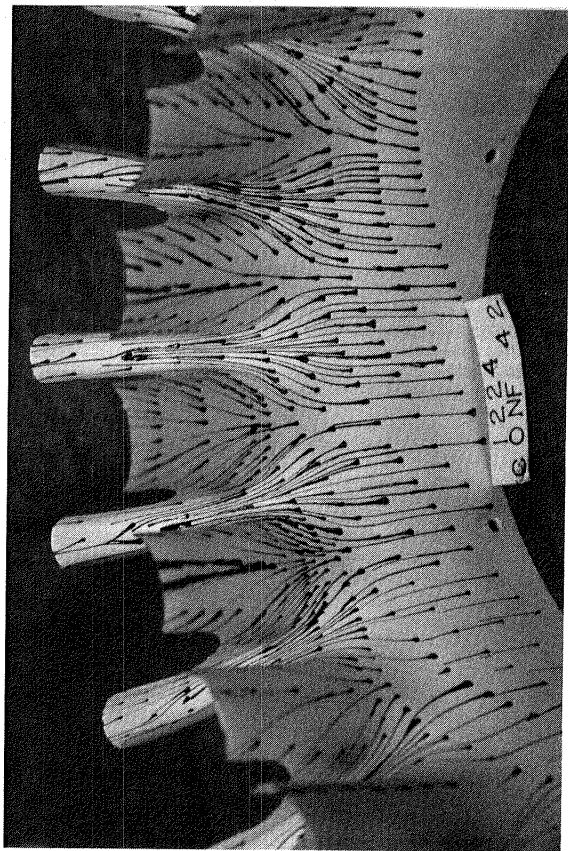
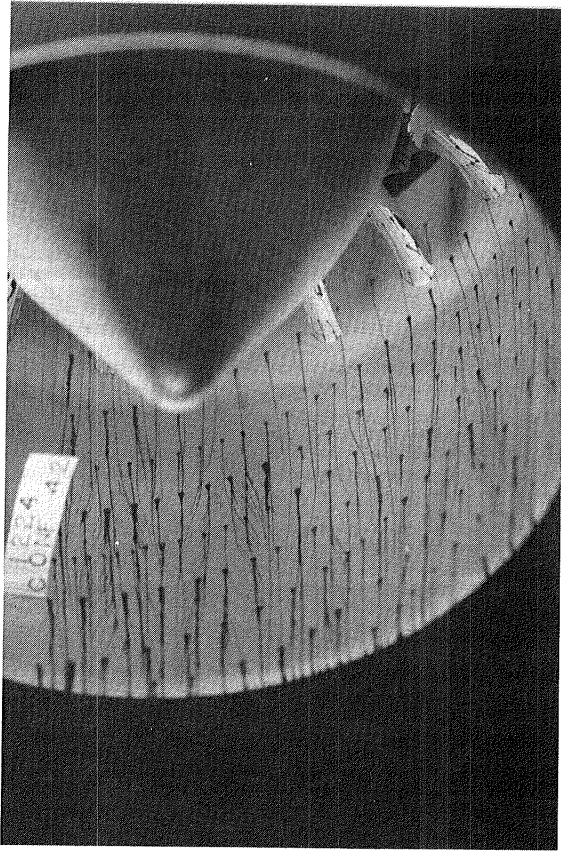
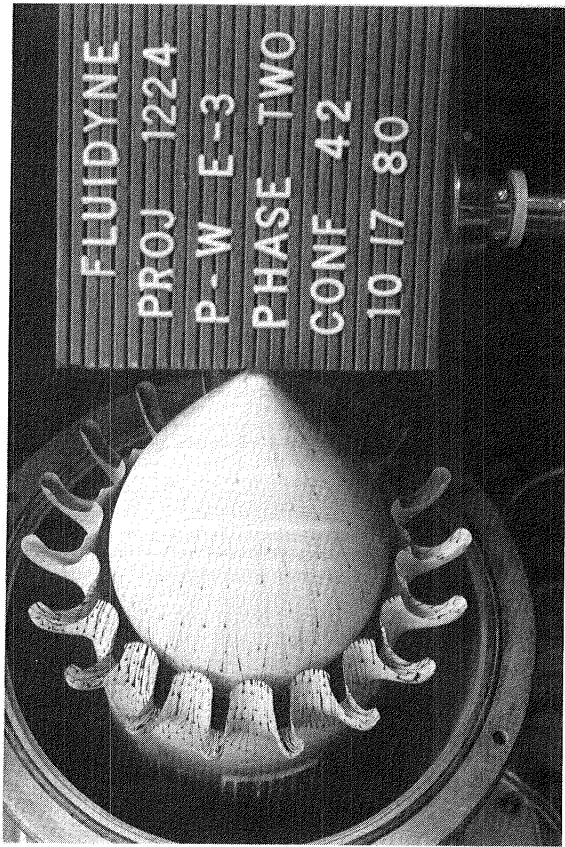

Flow Visualization Photographs, Configuration 42

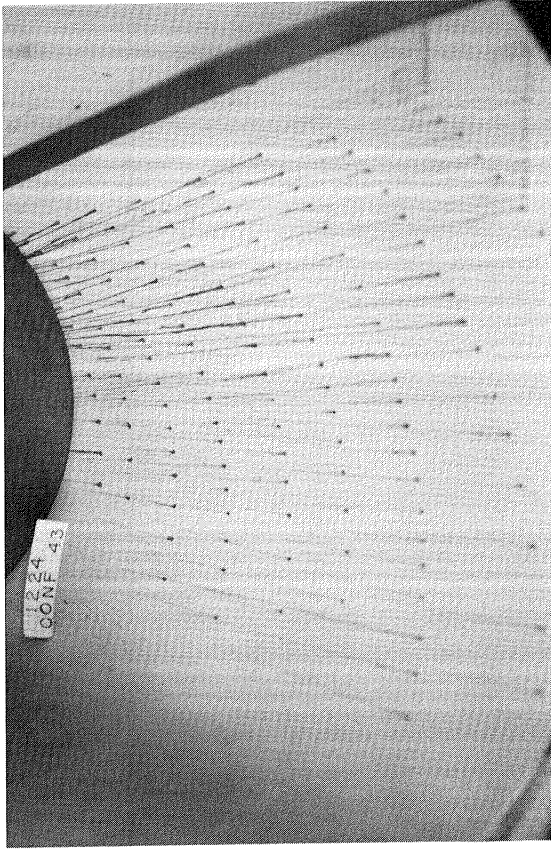
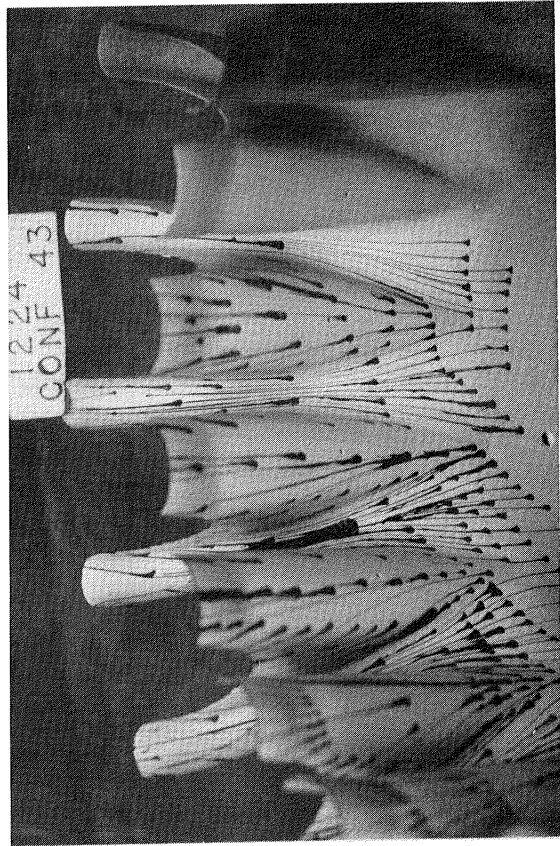
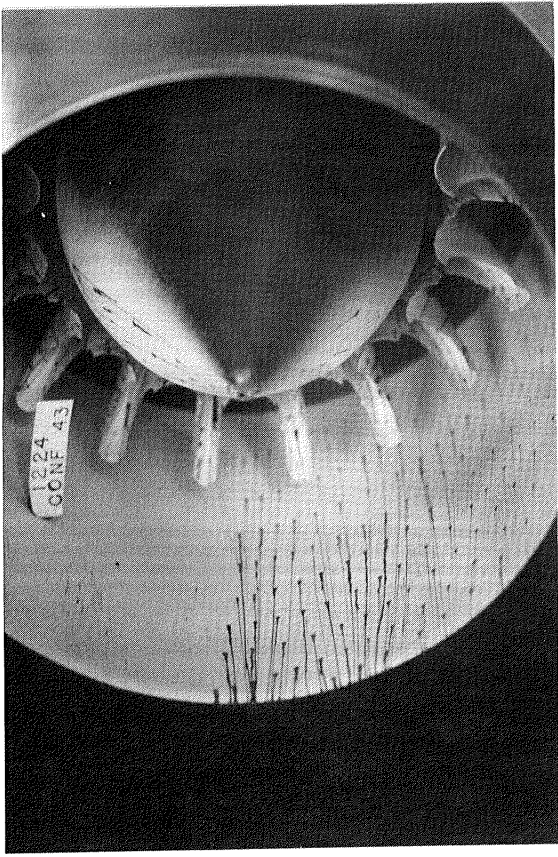
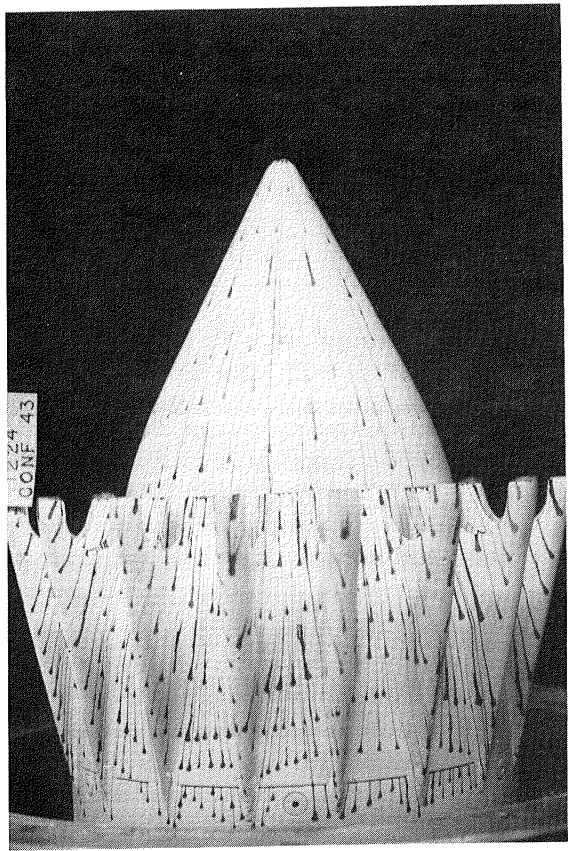

Flow Visualization Photographs, Configuration 43

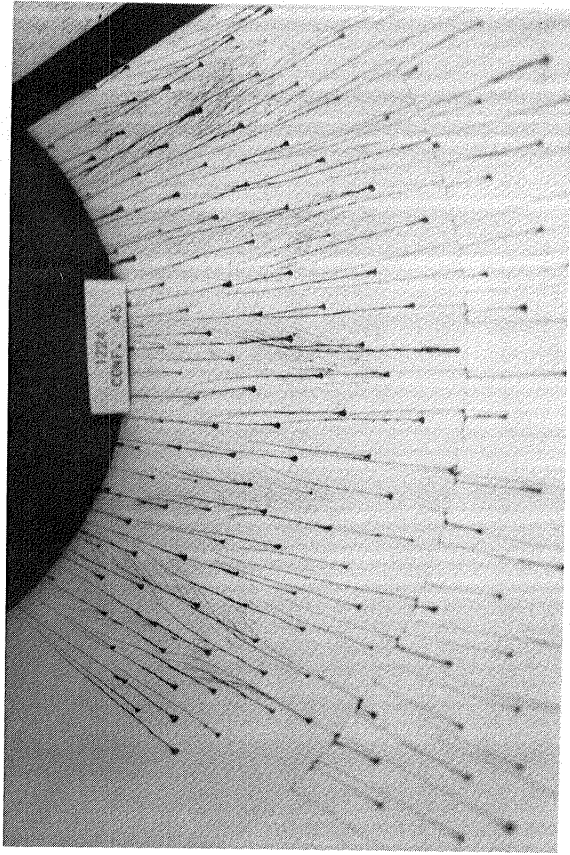
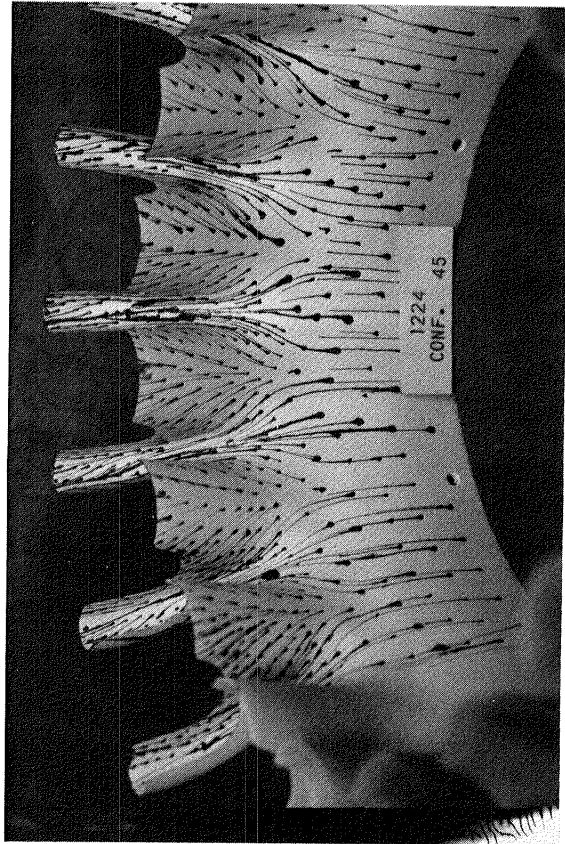
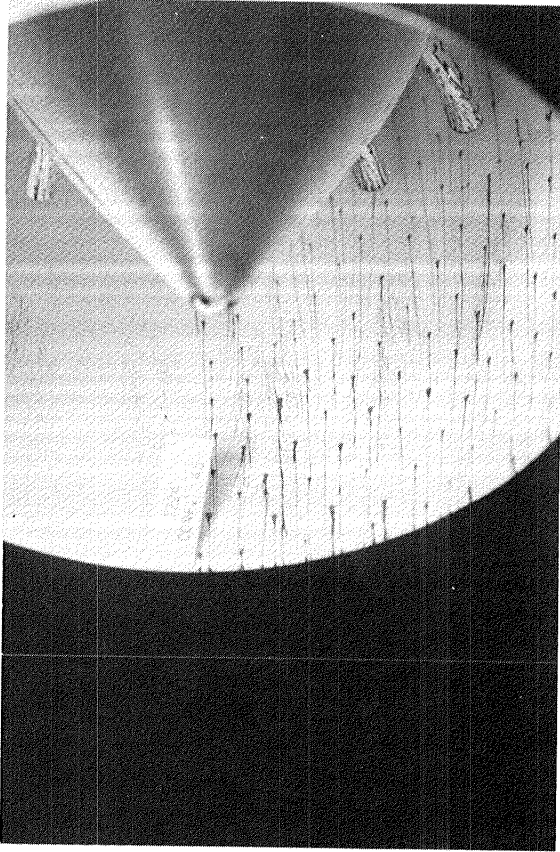
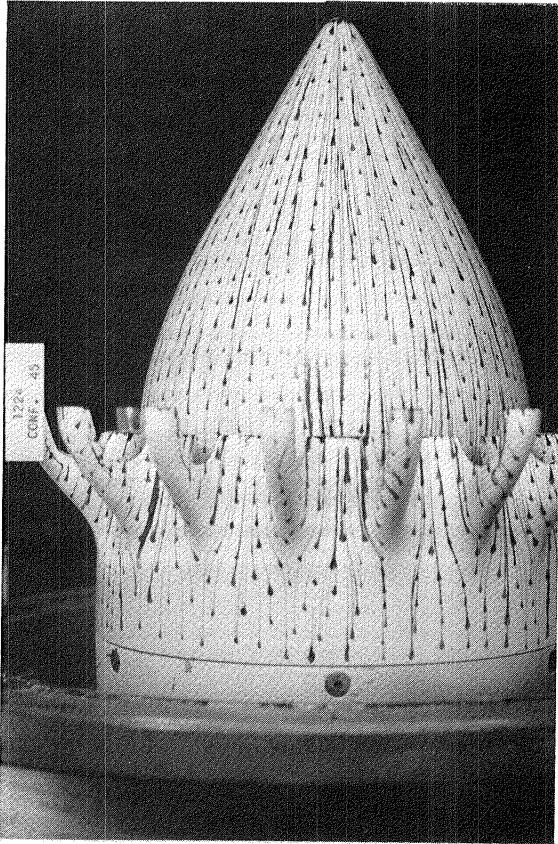

Flow Visualization Photographs, Configuration 45

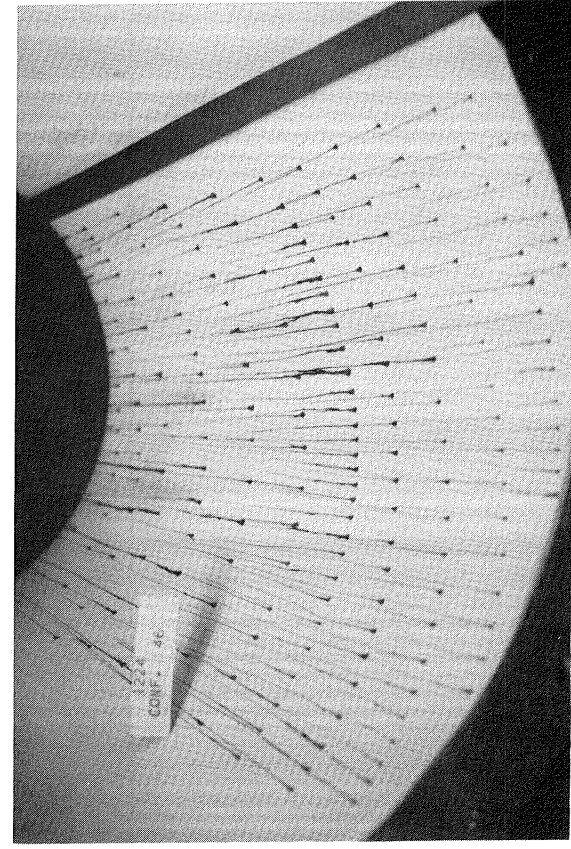
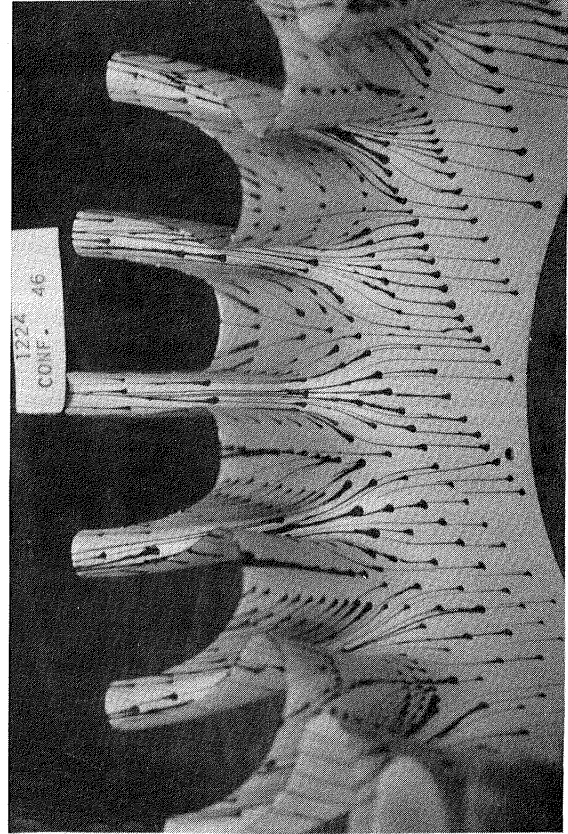
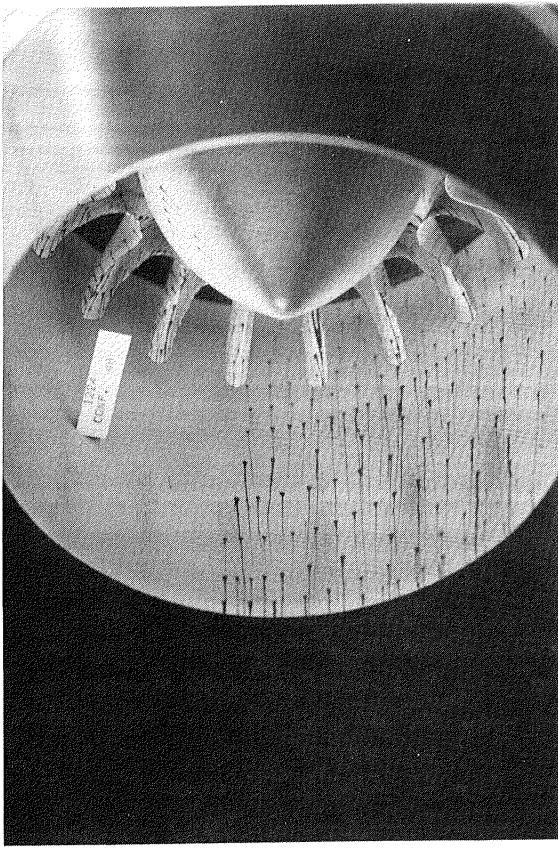
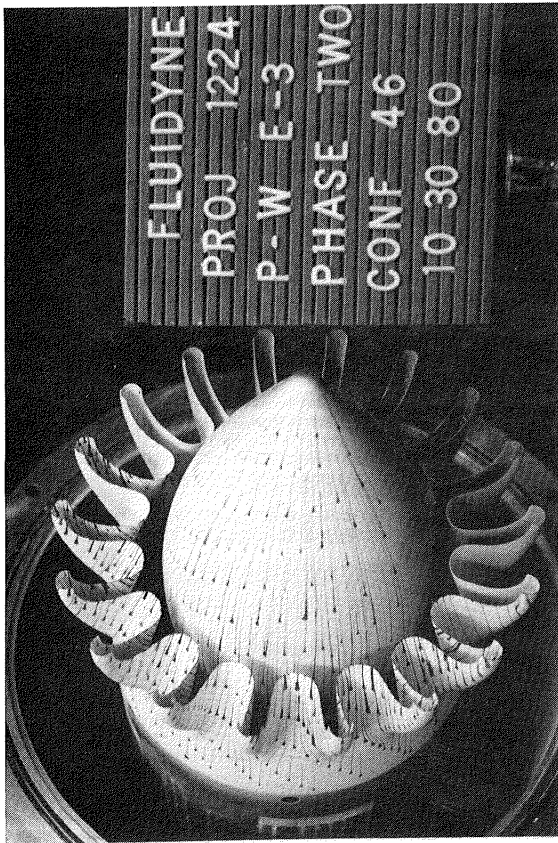

Flow Visualization Photographs, Configuration 46

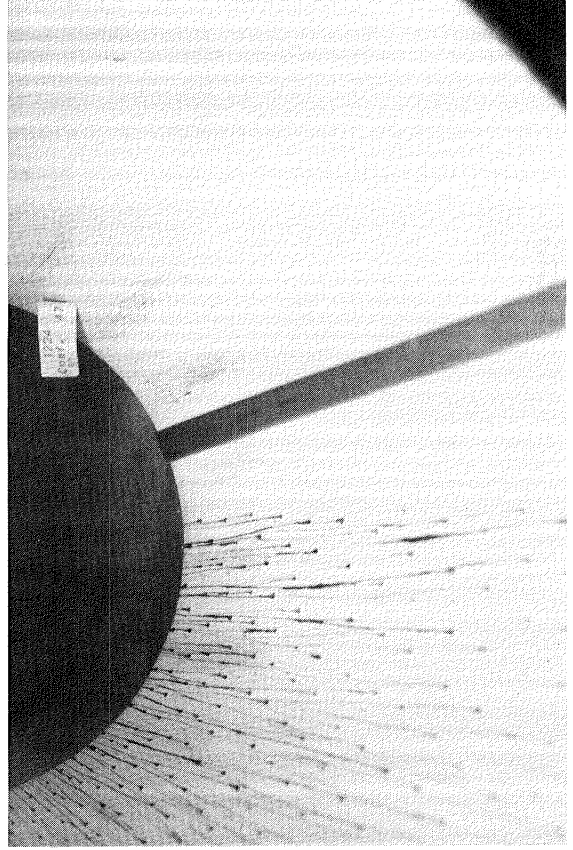
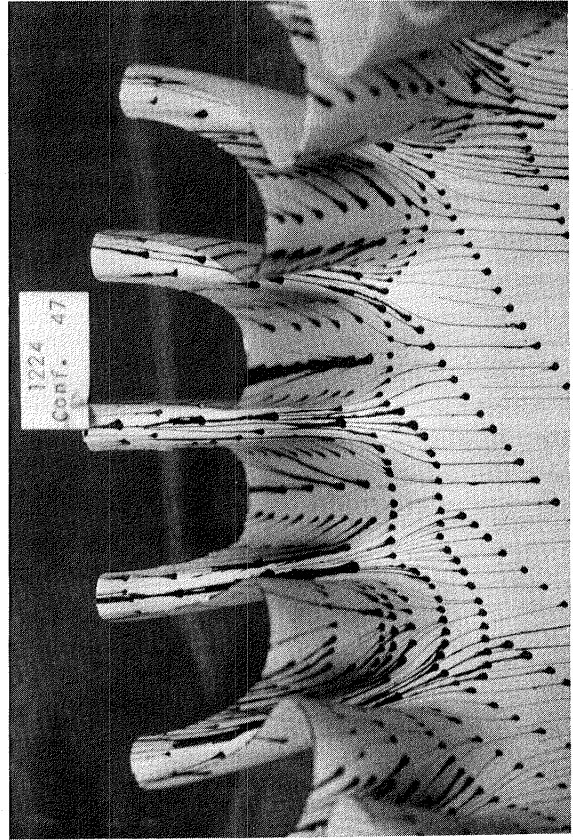
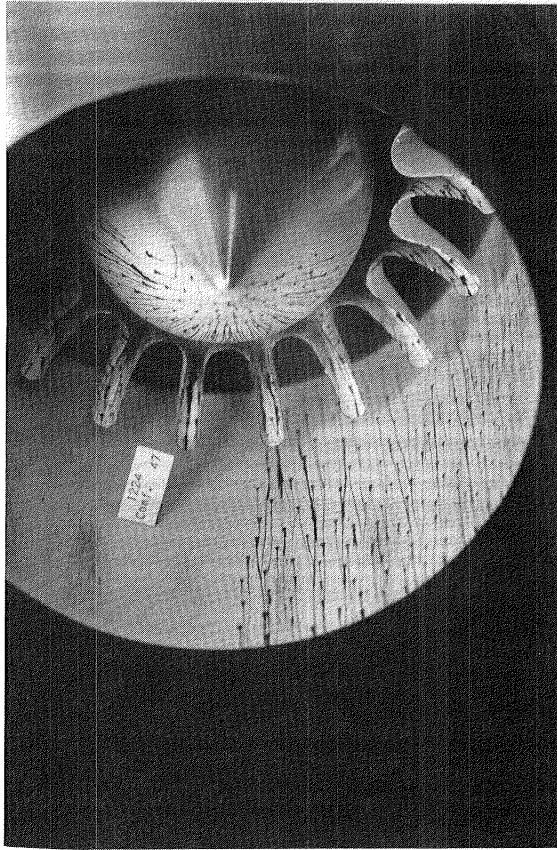
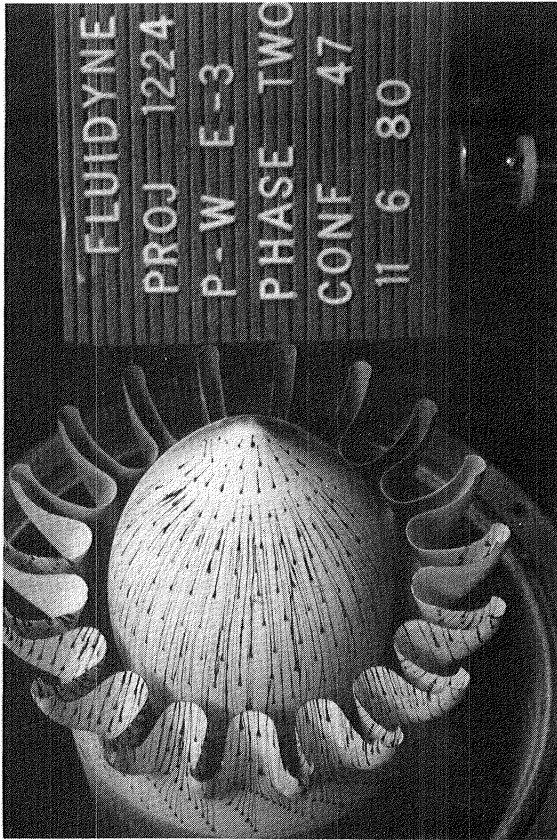

Flow Visualization Photographs, Configuration 47

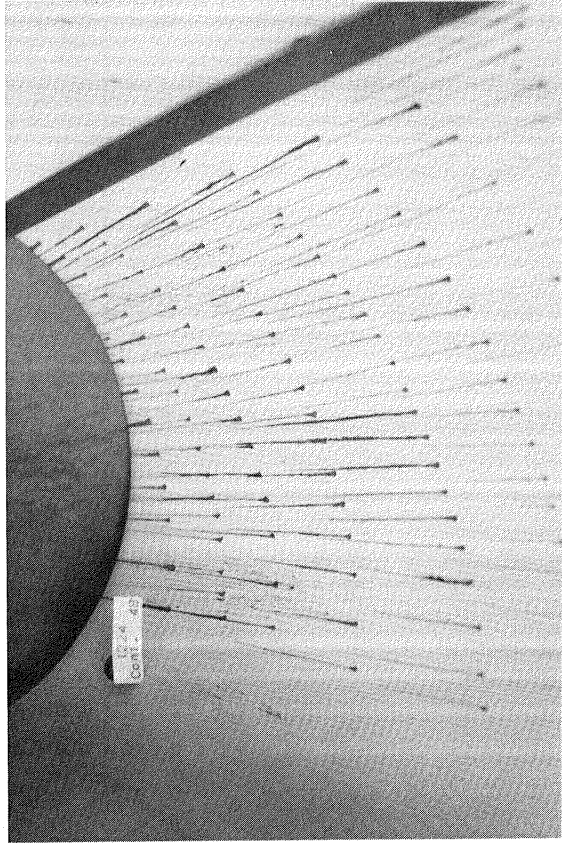
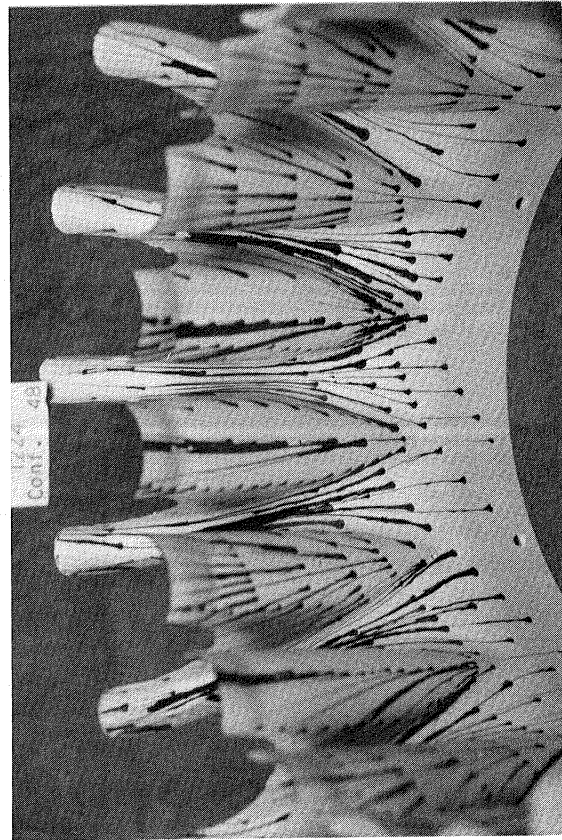
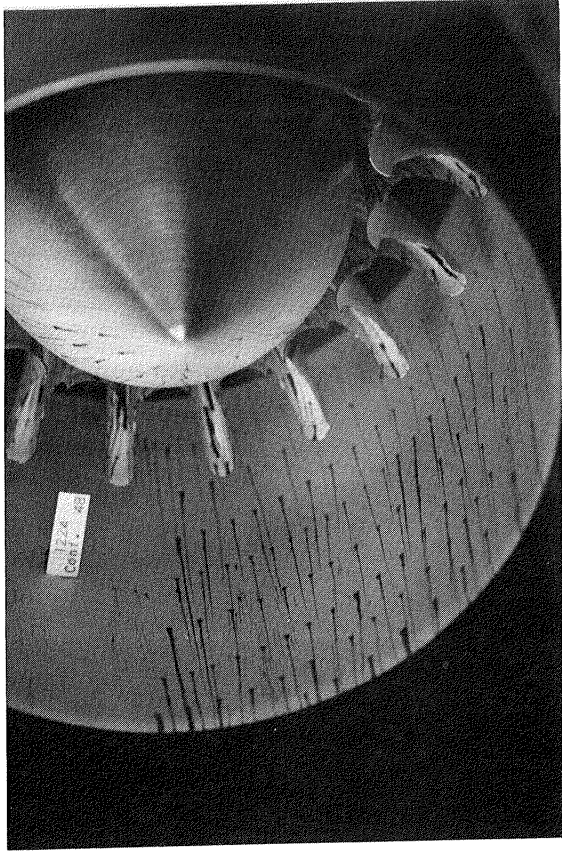
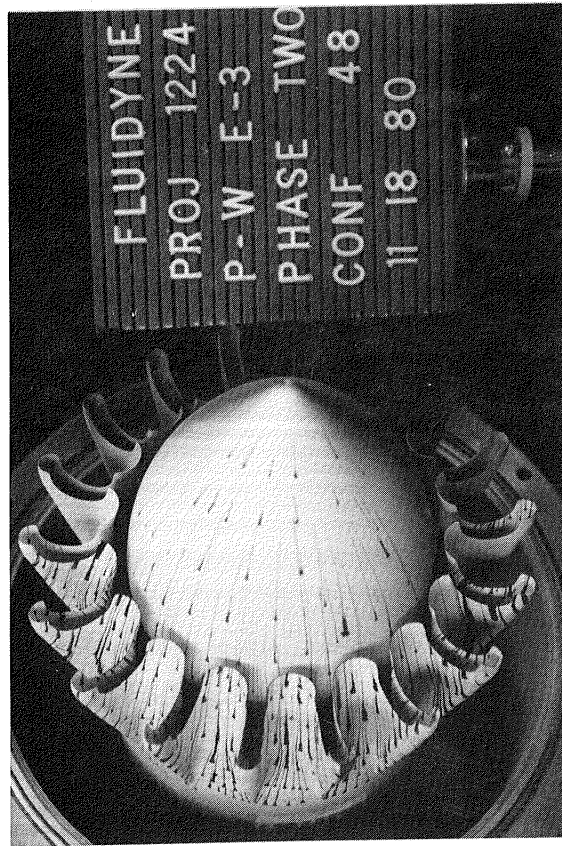

Flow Visualization Photographs, Configuration 48

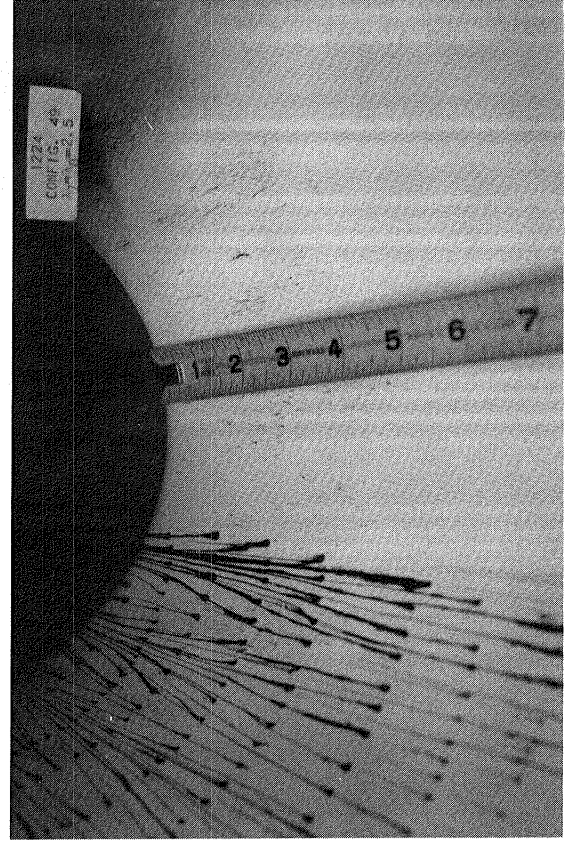
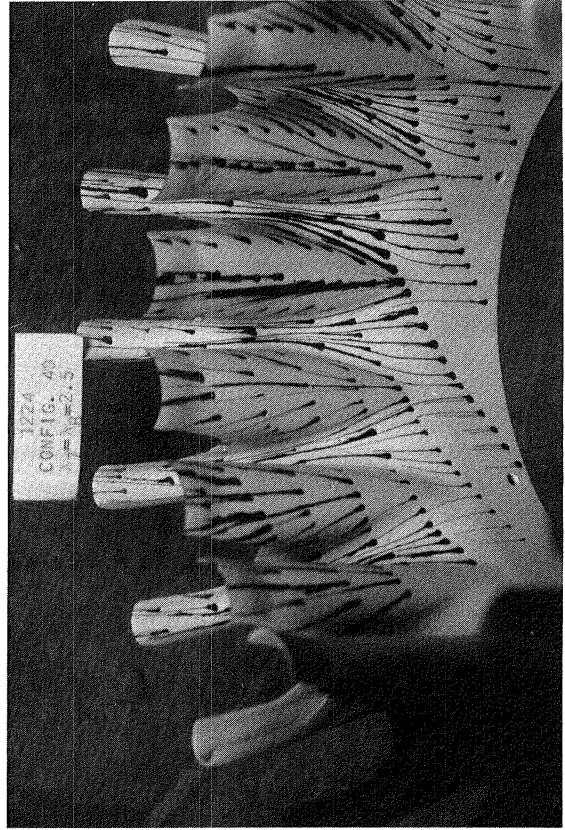
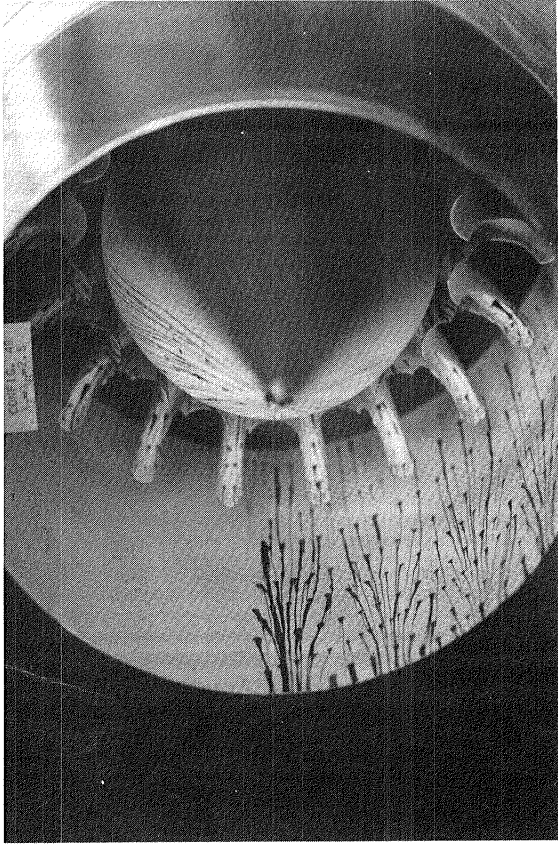
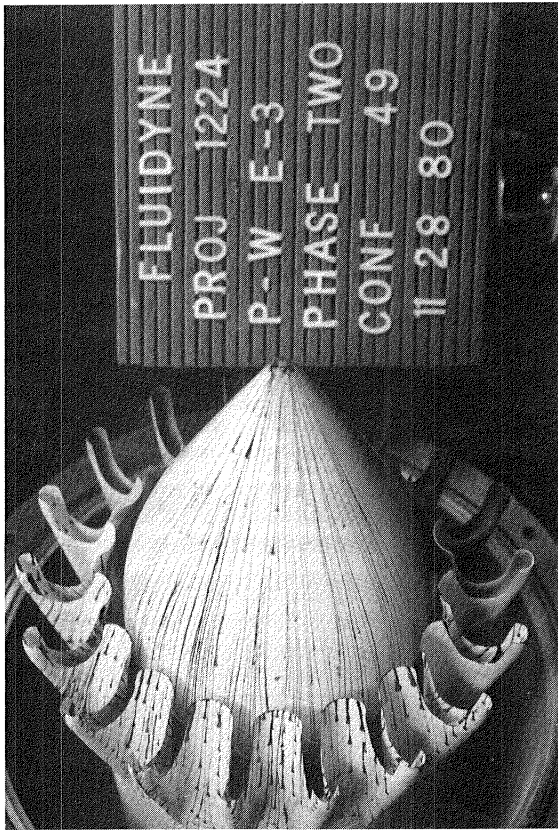

Flow Visualization Photographs, Configuration 49

DISTRIBUTION LIST

GOVERNMENT AGENCIES

NASA Headquarters
600 Independence Ave., SW
Washington, D.C. 20546
Attention: RTP-6/R.S. Colladay
RTP-6/C.C. Rosen
RTP-6/L. Harris
RRP-6/J. Facey
Library

NASA-Lewis Research Center
21000 Brookpark Road
Cleveland, OH 44135
Attention: D. L. Nored
C. C. Ciepluch
J. W. Schaefer
P. G. Batterton
G. K. Sievers
Library
Report Control Office
Tech Utilization Office
M. A. Beheim
M. J. Hartmann
R. A. Rudey
R. A. Weber
W. C. Strack
T. P. Maffitt
A. Long
W. M. Braithwaite
L. Reid
AFSC Liaison Office
Army R&T Propulsion Lab
R. E. Jones
L. J. Kiraly
D. C. Mikkelson
J. F. Groeneweg
R. L. Davies
R. H. Johns
L. J. Kaszubinski
J. R. Mihalow
D. W. Drier
R. W. Niedzwiecki

MS 301-2
MS 301-4 (20 copies)
MS 301-4
MS 301-4
MS 301-2
MS 60-3 (2 copies)
MS 5-5
MS 3-19
MS 3-5
MS 5-3
MS 60-4
MS 500-127
MS 501-10
MS 77-2
MS 500-305
MS 500-208
MS 5-9
MS 501-3
MS 302-2
MS 86-6
MS 23-2
MS 86-1
MS 54-3
MS 106-1
MS 49-6
MS 86-2
MS 100-1
MS 86-2
MS 86-6

DISTRIBUTION LIST

NASA Headquarters 600 Independence Ave. SW Washington, D. C. 20546 Attention: R. S. Colladay	RT-6	NASA-Lewis Research Center 21000 Brookpark Road Cleveland, Ohio 44135 Attention: P.G. Batterton	MS 301-4
NASA Headquarters 600 Independence Ave. SW Washington, D. C. 20546 Attention: C. C. Rosen	RTP-6	NASA-Lewis Research Center 21000 Brookpark Road Cleveland, Ohio 44135 Attention: G.M. Sievers	MS 301-2
NASA Headquarters 600 Independence Ave. SW Washington, D. C. 20546 Attention: L. Harris	RTM-6	NASA-Lewis Research Center 21000 Brookpark Road Cleveland, Ohio 44135 Attention: Library	MS 60-3 2 Copies
NASA Headquarters 600 Independence Ave. SW Washington, D. C. 20546 Attention: J. Facey	RTP-6	NASA-Lewis Research Center 21000 Brookpark Road Cleveland, Ohio 44135 Attention: Report Control Office	MS 5-5
NASA Headquarters 600 Independence Ave. SW Washington, D. C. 20546 Attention: Library		NASA-Lewis Research Center 21000 Brookpark Road Cleveland, Ohio 44135 Attention: Tech Utilization Office	MS 3-19
NASA-Lewis Research Center 21000 Brookpark Road Cleveland, Ohio 44135 Attention: D.L. Nored	MS 301-2	NASA-Lewis Research Center 21000 Brookpark Road Cleveland, Ohio 44135 Attention: M.A. Beheim	MS 3-5
NASA-Lewis Research Center 21000 Brookpark Road Cleveland, Ohio 44135 Attention: C.C. Ciepluch	MS 301-4 20 Copies	NASA-Lewis Research Center 21000 Brookpark Road Cleveland, Ohio 44135 Attention: M.J. Hartmann	MS 3-7
NASA-Lewis Research Center 21000 Brookpark Road Cleveland, Ohio 44135 Attention: J.W. Schaefer	MS 301-4	NASA-Lewis Research Center 21000 Brookpark Road Cleveland, Ohio 44135 Attention: R.A. Rudey	MS 86-5

DISTRIBUTION LIST (Cont'd)

NASA-Lewis Research Center 21000 Brookpark Road Cleveland, Ohio 44135 Attention: R.J. Weber	MS 500-127	NASA-Lewis Research Center 21000 Brookpark Road Cleveland, Ohio 44135 Attention: Army R&T Propulsion	MS 302-
NASA-Lewis Research Center 21000 Brookpark Road Cleveland, Ohio 44135 Attention: W.C. Strack	MS 501-10	NASA-Lewis Research Center 21000 Brookpark Road Cleveland, Ohio 44135 Attention: D.C. Mikkelson	MS 86-1
NASA-Lewis Research Center 21000 Brookpark Road Cleveland, Ohio 44135 Attention: T.P. Moffitt	MS 77-2	NASA-Lewis Research Center 21000 Brookpark Road Cleveland, Ohio 44135 Attention: J.F. Groeneweg	MS 54-3
NASA-Lewis Research Center 21000 Brookpark Road Cleveland, Ohio 44135 Attention: R.E. Jones	MS 86-6	NASA-Lewis Research Center 21000 Brookpark Road Cleveland, Ohio 44135 Attention: R.L. Davies	MS 106-1
NASA-Lewis Research Center 21000 Brookpark Road Cleveland, Ohio 44135 Attention: L.J. Kiraly	MS 23-2	NASA-Lewis Research Center 21000 Brookpark Road Cleveland, Ohio 44135 Attention: R.H. Johns	MS 49-6
NASA-Lewis Research Center 21000 Brookpark Road Cleveland, Ohio 44135 Attention: A. Long	MS 500-305	NASA-Lewis Research Center 21000 Brookpark Road Cleveland, Ohio 44135 Attention: L.J. Kaszubinski	MS 86-2
NASA-Lewis Research Center 21000 Brookpark Road Cleveland, Ohio 44135 Attention: W.M. Braithwaite	MS 500-20 ^o	NASA-Lewis Research Center 21000 Brookpark Road Cleveland, Ohio 44135 Attention: J.R. Mihalow	MS 100-1
NASA-Lewis Research Center 21000 Brookpark Road Cleveland, Ohio 44135 Attention: L. Reid	MS 5-9	NASA-Lewis Research Center 21000 Brookpark Road Cleveland, Ohio 44135 Attention: D.W. Drier	MS 86-2
NASA-Lewis Research Center 21000 Brookpark Road Cleveland, Ohio 44135 Attention: AFSC Liaison Office	MS 501-3	NASA-Lewis Research Center 21000 Brookpark Road Cleveland, Ohio 44135 Attention: R.W. Niedzwiecki	MS 86-6

DISTRIBUTION LIST (Cont'd)

NASA Ames Research Center
Moffett Field, CA 94035
Attention: 202-7/M. H. Waters
Library

NASA Langley Research Center
Langley Field, VA 23365
Attention: R. Leonard
D. Maiden
L.J. Williams
Library

NASA Dryden Flight Research Center
P.O. Box 273
Edwards, CA 93523
Attention: J. A. Albers
Library

NASA Scientific and Technical Information
Facility
P.O. Box 8757
B.W.I. Airport, MD 21240
Attention: Acquisition Branch (10 copies)

Department of Defense
Washington, D.C. 20301
Attention: R. Standahar 3D1089 Pentagon

Wright-Patterson Air Force Base
Dayton, Ohio 45433
Attention: APL Chief Scientist AFWAL/PS

Wright-Patterson Air Force Base
Dayton, Ohio 45433
Attention: E.E. Abell ASD/YZE

Wright-Patterson Air Force Base
Dayton, Ohio 45433
Attention: H.I. Bush AFWAL/POT

Wright-Patterson Air Force Base
Dayton, Ohio 45433
Attention: E.E. Bailey (NASA Liaison)
AFWAL/NASA

Wright-Patterson Air Force Base
Dayton, Ohio 45433
Attention: R.P. Carmichael ASD/XRHI

Wright-Patterson Air Force Base
Dayton, Ohio 45433
Attention: R. Ellis ASD/YZN

Wright-Patterson Air Force Base
Dayton, Ohio 45433
Attention: W.H. Austin, Jr. ASD/ENF

Eustis Directorate
U.S. Army Air Mobility
R&D Laboratory
Fort Eustis, VA 23604
Attention: J. Lane, SAVDL-EJ-Tapp

Navy Department
Naval Air Systems Command
Washington, D. C. 20361
Attention: W. Koven AIR-03E

Navy Department
Naval Air Systems Command
Washington, D. C. 20361
Attention: J.L. Byers AIR-53602

Navy Department
Naval Air Systems Command
Washington, D. C. 20361
Attention: E.A. Lichtman AIR-330E

Navy Department
Naval Air Systems Command
Washington, D. C. 20361
Attention: G. Derderian AIR-5362C

NAVAL AIR Propulsion Test Center
Trenton, NJ 08620
Attention: J. J. Curry
A. A. Martino

DISTRIBUTION LIST (Cont'd)

U.S. Naval Air Test Center
Code SY-53
Patuxent River, MD 20670
Attention: E. A. Lynch

Detroit Diesel Allison Div. G.M.C.
P.O. Box 974
Indianapolis, IN 46206
Attention: W. L. McIntire
V. D. Baker

USAVRAD Command
PO Box 209
St. Louis, MO 63166
Attention: Robert M. Titus (ASTIO)

Cummins Engine Co.
Technical Center
500 S. Poplar
Columbus, IN 47201
Attention: J. R. Drake

Department of Transportation
NASA/DOT Joint Office of Noise Abatement
Washington, D.C. 20590
Attention: C. Foster

AVCO/Lycoming
550 S. Main Street
Stratford, CT 06497
Attention: H. Mbellmann

Federal Aviation Administration
Noise Abatement Division
Washington, D.C. 20590
Attention: E. Sellman AEE-120

Detroit Diesel Allison Div. G.M.C.
333 West First Street
Dayton, Ohio 45402
Attention: F. H. Walters

Environmental Protection Agency
1035 K Street, NW
Washington, D.C. 20460
Attention: J. Schettino
J. Tyler

The Garrett Corporation
AIRsearch Manufacturing Co.
Torrance, CA 90509
Attention: F. E. Faulkner

Environmental Protection Agency
2565 Plymouth Road
Ann Arbor, MI 48105
Attention: R. Munt

The Garrett Corporation
AIRsearch Manufacturing Co.
402 S. 36 Street
Phoenix, AZ 85034
Attention: Library

Federal Aviation Administration
12 New England Executive Park
Burlington, MA 01803
Attention: Jack A. Sain, ANE-200

General Electric Co./AEG
One Jimson Road
Evendale, Ohio 45215
Attention: R.W. Bucy (3 copies)
T. F. Donohue

Curtiss Wright Corporation
Woodridge, NJ 07075
Attention: S. Lombardo
S. Mskowitz

Pratt & Whitney Aircraft Group/UTC
Government Products Division
P.O. Box 2681
West Palm Beach, FL 33402
Attention: B. A. Jones

DISTRIBUTION LIST (Cont'd)

The Garrett Corporation
AIRsearch Aviation Co.
19201 Susana Road
Compton, CA 90221
Attention: N. J. Palmer

AIRsearch Manufacturing Co.
111 South 34th Street
P.O. Box 5217
Phoenix, AZ 85010
Attention: C. E. Corrigan
(93-120/503-4F)

Williams Research Co.
2280 W. Maple Road
Walled Lake, MI 48088
Attention: R. VanNimwegen
R. Horn
N. Hawk
B. Krap

Teledyne CAE, Turbine Engines
1330 Laskey Road
Toledo, Ohio 43612
Attention: R. H. Gaylord

General Electric Co./AEG
1000 Western Ave.
Lynn, MA 01910
Attention: R. E. Neitzel

Pratt & Whitney Aircraft Group/UTC
Commercial Products Division
East Hartford, Ct 06108
Attention: W. Gardner
I. Mendelson

Boeing Commercial Airplane Co.
P.O. Box 3707
Seattle, WA 98124
Attention: P. E. Johnson MS 9H-46
D. C. Nordstrom MS 73-01

Boeing Aerospace Co.
P.O. Box 3999
Seattle, Wa 98124
Attention: D. S. Miller MS 40-26
H. Higgins

The Boeing Co., Wichita Division
Wichita, KS 67210
Attention: D. Tarkelson

Douglas Aircraft Company
McDonnell Douglas Corp.
3855 Lakewood Boulevard
Long Beach, CA 90846
Attention: R. T. Kawai Code 36-41
M. Klotzsche

Lockheed California Co.
Burbank, CA 91502
Attention: J. F. Stroud, Dept. 75-42
R. Tullis, Dept. 75-21
J. I. Benson

General Dynamics Convair
P. O. Box 80847
San Diego, CA 92138
Attention: S. Campbell, MZ 632-00

Rockwell International
International Airport
Los Angeles Division
Los Angeles, CA 90009
Attention: A. W. Martin

Gates Learjet Corp.
P. O. Box 7707
Wichita, KS 67277
Attention: E. Schiller

McDonnell Aircraft Co.
McDonnell Douglas Corp.
P. O. Box 516
St. Louis, MO 63166
Attention: F. C. Claser Dept. 243

DISTRIBUTION LIST (Cont'd)

Lockheed Georgia Co.
Marietta, GA 30060
Attention: H. S. Sweet

Grumman Aerospace Corp.
South Oyster Bay Road
Bethpage, New York 11714
Attention: C. Hoeltzer

American Airlines
Maint. & Engr. Center
Tulsa, OK 74151
Attention: W. R. Neeley

Eastern Airlines
International Airport
Miami, FL 33148
Attention: A. E. Fishbein

Delta Airlines, Inc.
Hartsfield-Atlanta International Airport
Atlanta, GA 30320
Attention: C. C. Davis

TransWorld Airlines
605 Third Avenue
New York, NY 10016
Attention: A. E. Carroll

Pan American World Airways, Inc.
JFK International Airport
Jamica, NY 11430
Attention: A. MacLarty

United Airlines
San Francisco International Airport
Maint. Operations Center
San Francisco, CA 94129
Attention: J. J. Overton

Hamilton Standard
Bradley Field
Windsor Locks, CT 06096
Attention: P. J. Dumais, MS 1A-3-1
A. T. Reiff, MS 1-2-2

Fluidyne Engineering Corp.
5900 Olson Memorial Highway
Minneapolis, MN 55422
Attention: J. S. Haldhusen
J. Berger

Rohr Corporation
P.O. Box 878
Foot & H Street
Chula Vista, CA 92012
Attention: Library

Solar Division
International Harvester
2200 Pacific Highway
San Diego, CA 92112
Attention: Library

Gas Dynamics Laboratories
Aerospace Engineering Building
University of Michigan
Ann Arbor, MI 48106
Attention: Dr. C. W. Kaufmann

Massachusetts Inst. of Technology
Dept. of Astronautics & Aeronautics
Cambridge, MA 02139
Attention: Library

Massachusetts Inst. of Technology
Dept. of Structural Mechanics
Cambridge, MA 02139
Attention: James Mar

DISTRIBUTION LIST (Cont'd)

Westinghouse Electric Corp.
P.O. Box 5837
Beulah Road
Pittsburgh, PA 15236
Attention: Library

University of Tennessee
Space Institute
Tullahoma, TN 37388
Attention: Dr. V. Smith

TRW Equipment Group
TRW Inc.
23555 Euclid Ave.
Cleveland, OH 44117
Attention: I. Toth

Aerospace Corporation
R & D Center
Los Angeles, CA 90045
Attention: Library

George Shevlin
P.O. Box 1^25
Washington, D.C. 20013

Brunswick Corporation
2000 Brunswick Lane
Deland, Fl 32720
Attention: A. Erickson

KVB Inc*
18006 Skypark Blvd.
P.O. Box 1^51°
Irvine CA 92714
Attention: A. M. Mellor

End of Document