

General Disclaimer

One or more of the Following Statements may affect this Document

- This document has been reproduced from the best copy furnished by the organizational source. It is being released in the interest of making available as much information as possible.
- This document may contain data, which exceeds the sheet parameters. It was furnished in this condition by the organizational source and is the best copy available.
- This document may contain tone-on-tone or color graphs, charts and/or pictures, which have been reproduced in black and white.
- This document is paginated as submitted by the original source.
- Portions of this document are not fully legible due to the historical nature of some of the material. However, it is the best reproduction available from the original submission.

"Made available under NASA sponsorship
in the interest of early and wide dis-
semination of Earth Resources Survey
Program information and without liability
for any use made thereof."

Fourth

JUSTIF
E82-10323
CR-168902

QUARTERLY REPORT

period ending Dec. 31, 1981

for

NASA Contract NAS 5-26425

"Use of MAGSAT anomaly data for crustal structure
and mineral resources in the U.S. Midcontinent"

from

Robert S. Carmichael et al
Department of Geology
UNIVERSITY OF IOWA
Iowa City, Iowa 52242

Project Scientist: Dr. R. A. Langel
NASA Goddard Space Flight Center

Technical Officer: Mr. H. Oseroff

RECEIVED

JAN 12, 1982

SIS/902.6

M-001

TYPE II

December 31, 1981

(E82-10323) USE OF MAGSAT ANOMALY DATA FOR
CRUSTAL STRUCTURE AND MINERAL RESOURCES IN
THE US MIDCONTINENT Quarterly Report,
period ending 31 Dec. 1981 (Iowa Univ.)
31 p HC A03/MF A01

N82-24596

Unclass

CSCI 08G G3/43 00323

Quarterly Report

The final preprocessed Investigator-B Magsat data for our geographically-selected area (the U.S. Midcontinent) have arrived from NASA/Goddard as follows:

July 10, 1981 -- for mission period 11/2/79 to 1/19/80
intermediate-attitude-corrected
has better d.c. value (i.e. field model etc.) than
earlier test data

Aug. 19, 1981 -- second tape of data set

Nov. 12, 1981 -- "final output", for mission period 1/19/80 to
5/19/80, quiet data

Our initial major computer study of the bulk of the data for our study area has resulted in the following analysis and preliminary interpretation.

The data processing has included:

- i) removal of spurious data points (isolated "spikes")
- ii) statistical smoothing along individual data tracks, to reduce the effect of geomagnetic transient disturbances
- iii) comparison of data profiles spatially coincident in track location but acquired at different times, to compensate for "base-level" changes caused by pre-processing or temporal geomagnetic conditions
- iv) reduction of data by weighted averaging to a grid with $1^{\circ} \times 1^{\circ}$ latitude/longitude spacing, and with elevations interpolated and weighted to a common datum of 400 km from the orbit range of 350-560 km
- v) wavelength filtering, to remove (or retain) anomaly features of desired wavelengths
- vi) reduction of the anomaly map "to the magnetic pole", to aid in interpretation.

The X- and Y-component magnetic data were striped along the track directions, and simple wavelength filtering did not ameliorate the problem. The Z-component (i.e. vertical) and magnitude (i.e. scalar) data were less severely striped, and the filtering removed much of this effect. Reduction to the magnetic pole compensates for the variation of magnetic inclination with latitude, and renders the anomaly map more spatially relatable to causative crustal features. This process moved positive

scalar anomaly features to the north by one to two degrees of latitude, and reduced anomaly asymmetry.

Figure 1 shows the Magsat total-field (i.e. scalar) anomaly map we have extracted from the NASA data. As is the case for the subsequent figures, it is for the magnitude data as calculated from the X-, Y-, and Z-component vector data. The data are weighted-averaged on a $1^{\circ} \times 1^{\circ}$ grid, with weighting heavier for data closer to the grid-prism center (see diagram).

The actual area of processed data is about 50% larger than shown here, and this beltway around the study area was used to prevent "edge effects" in the processing to follow.

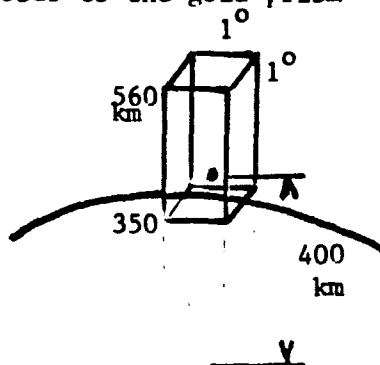

Figure 2 shows the above map, now filtered with a low-cut wavelength filter which removes wavelengths less than about 400 km.

This map is similar to maps of previous satellite studies over the U.S., but more detailed and revealing because of:

- i) the care taken in removing "bad" data (points, and tracks), and comparing profiles to optimize the consistency and reliability of the final data set,
- ii) treating the data on a finer $1^{\circ} \times 1^{\circ}$ grid rather than the customary coarser $2^{\circ} \times 2^{\circ}$ grid spacing used for global-scale maps.

For comparison with our Figure 2, Figure 3 shows the Magsat anomaly map for the U.S. midcontinent, as extracted from a preliminary global data set (NASA, March 1981). There is less detail in this, and it is a prime purpose of our study to assess how far the resolution can be "pushed" by processing to reveal crustal structure and properties.

Figure 4 shows the data of Figure 2 now reduced to the magnetic pole. While there are some changes, of consequence in relating anomaly magnitudes and gradients to causative crustal features, the alteration is not dramatic. This is because of the relatively high magnetic latitude (about $45-65^{\circ}$ N.) of the study area with respect to the north magnetic pole. Note that the major magnetic highs have been shifted to

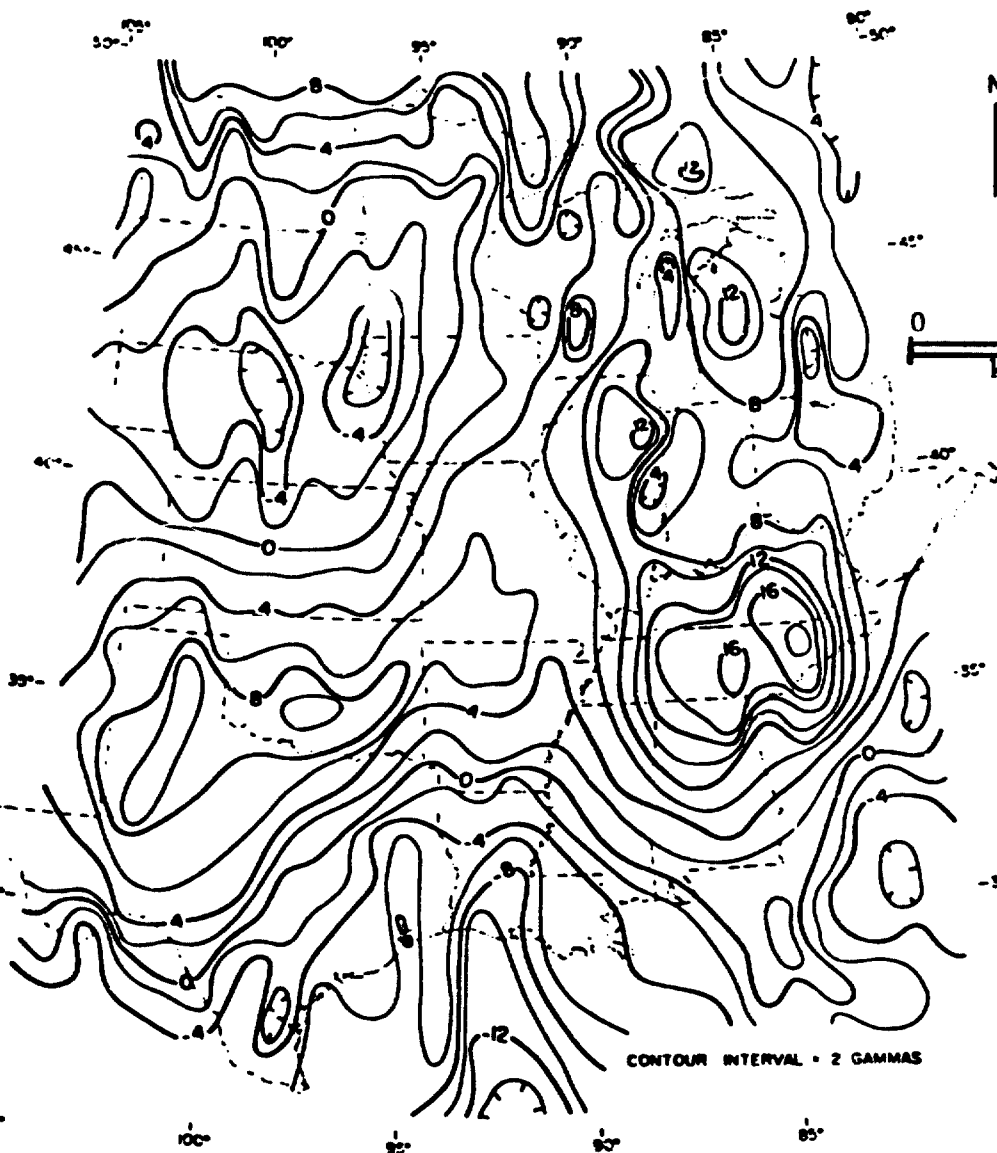

FIGURE 1. $1^{\circ} \times 1^{\circ}$ weighted-averaged Magsat scalar (magnitude) data, for the U.S. midcontinent. Albers equal-area projection. Plot by Black (1981).

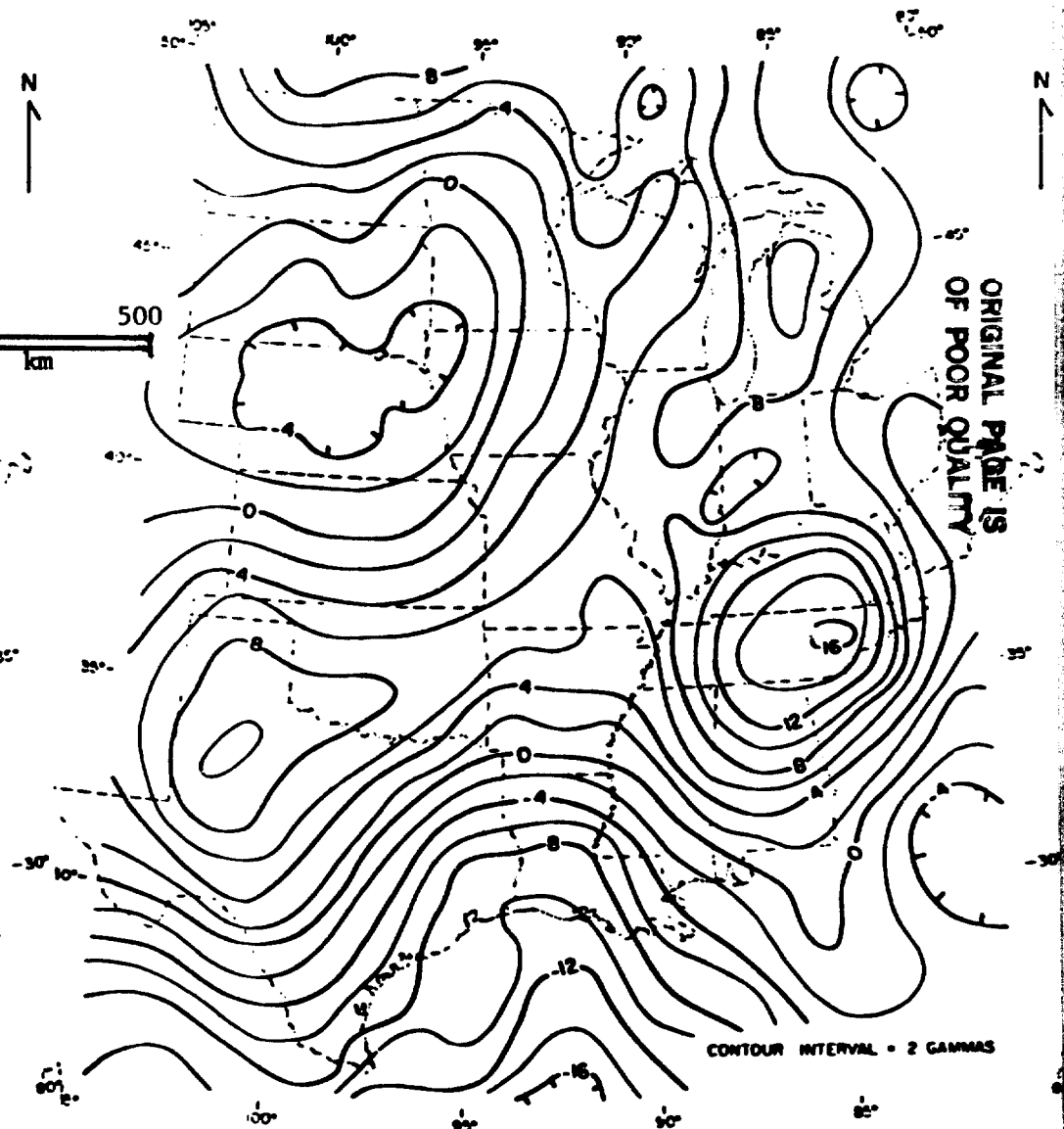
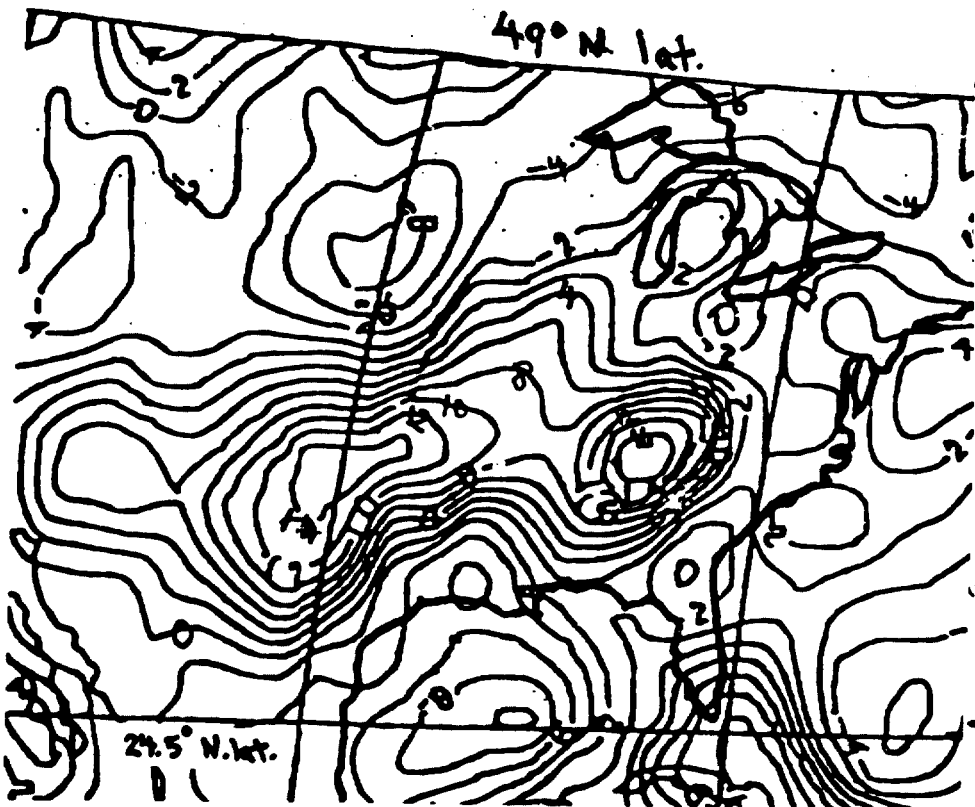
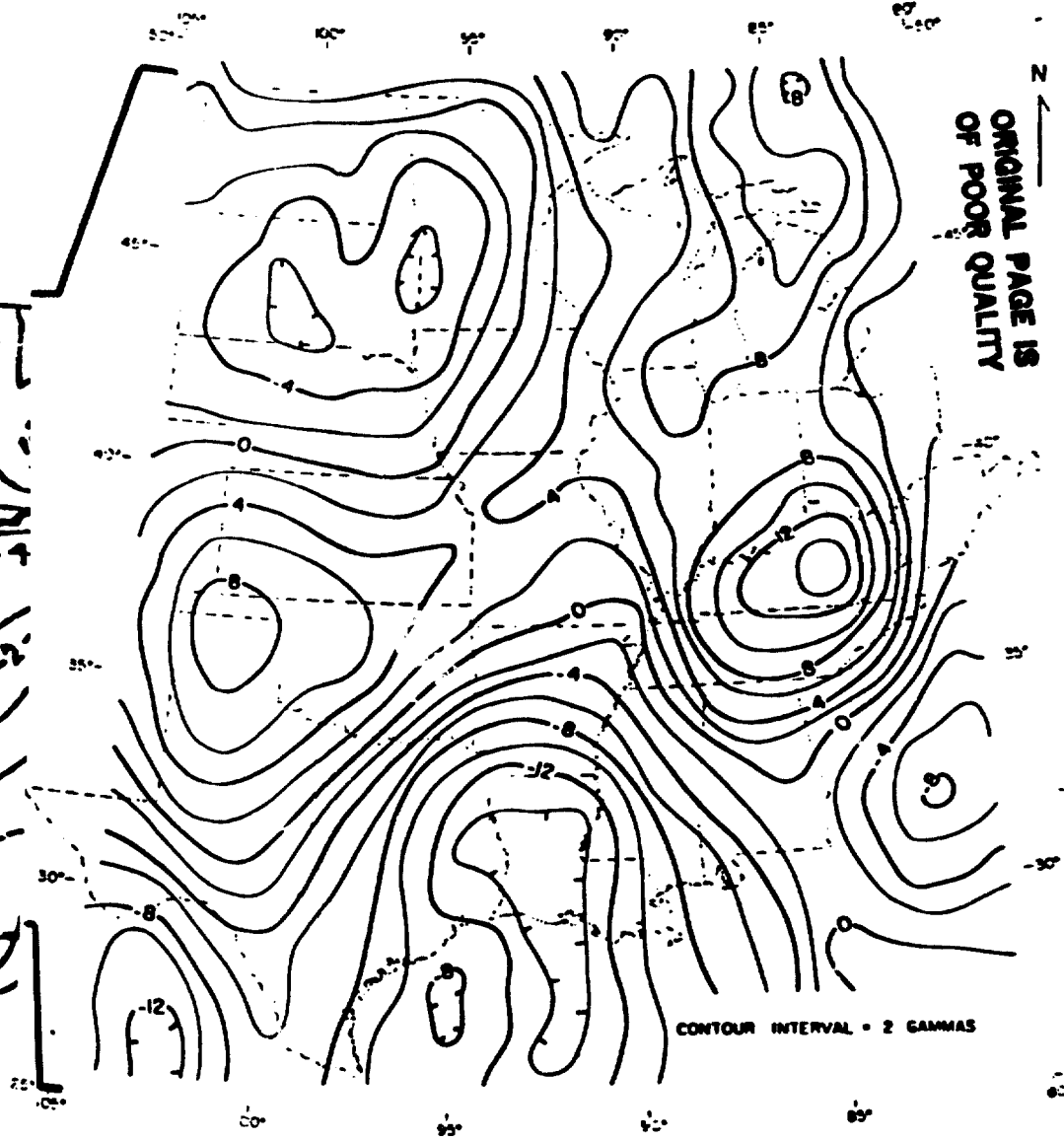

FIGURE 2. Low-cut (400 km) wavelength-filtered scalar data of Fig. 1

ORIGINAL PAGE IS
OF POOR QUALITY



Contour Interval = 2 gammas



CONTOUR INTERVAL = 2 GAMMAS

FIGURE 3. NASA's preliminary Magsat scalar anomaly map. Data from below 400 km, on 2°x2° blocks.

FIGURE 4. 1°x1° scalar data at 400 km altitude, high-pass filtered and reduced to the magnetic pole.

the north--the North Texas one up to the Oklahoma border, and the "Tennessee" one up into Kentucky.

The agreement between the magnitude-data anomaly map and the reduced-to-the-pole map supports the general assumption that, on a large (long-wavelength) scale, it is induced crustal magnetization which is responsible for the major anomalies. This is because the reduction routine employed here requires the assumption that the direction of magnetization is known, and it was chosen as that for the local inducing field of the Earth. The detection of remanence would be highly interesting and potentially useful, and it may be that, at these latitudes, the X and Y vector-component data would better yield any presence of remanent magnetization than would the Z-component and scalar data.

Several major anomalous features are observed on the processed scalar magnitude map (Black, 1981) of Figure 4. They are:

- i) a bullseye magnetic high over Kentucky
 - also noted on previous POGO satellite data, and studied by Mayhew and other workers
 - origin probably due to a mafic basement rock complex, and basic intrusion in the lower crust
- ii) a magnetic low over the Mississippi embayment/rift
 - as also noted by Hinze and others
 - origin probably associated with a combination of crustal thinning accompanying failed (paleo)rifting, petrologic character of the lower crust, and elevated Curie-temperature isotherm
- iii) a magnetic low over South Dakota
 - origin possibly due to elevated Curie-temperature isotherm, or crustal thinning, or petrology anomaly in the lower crust
- iv) an arcuate magnetic high extending from its maximum over northern Texas up to the northeast and Lake Michigan area.

While the latter pronounced magnetic high over Texas/Oklahoma was noted on POGO data, its continuation in a genetically-linked trend up to the northeast is better evidenced in this data. The origin of this feature on the magnetic map is probably due to greater crustal thickness developed in late Precambrian time, either during the Mazatzal orogeny (tectonic/deformation episode, possibly at a convergent plate boundary) of 1.6-1.7

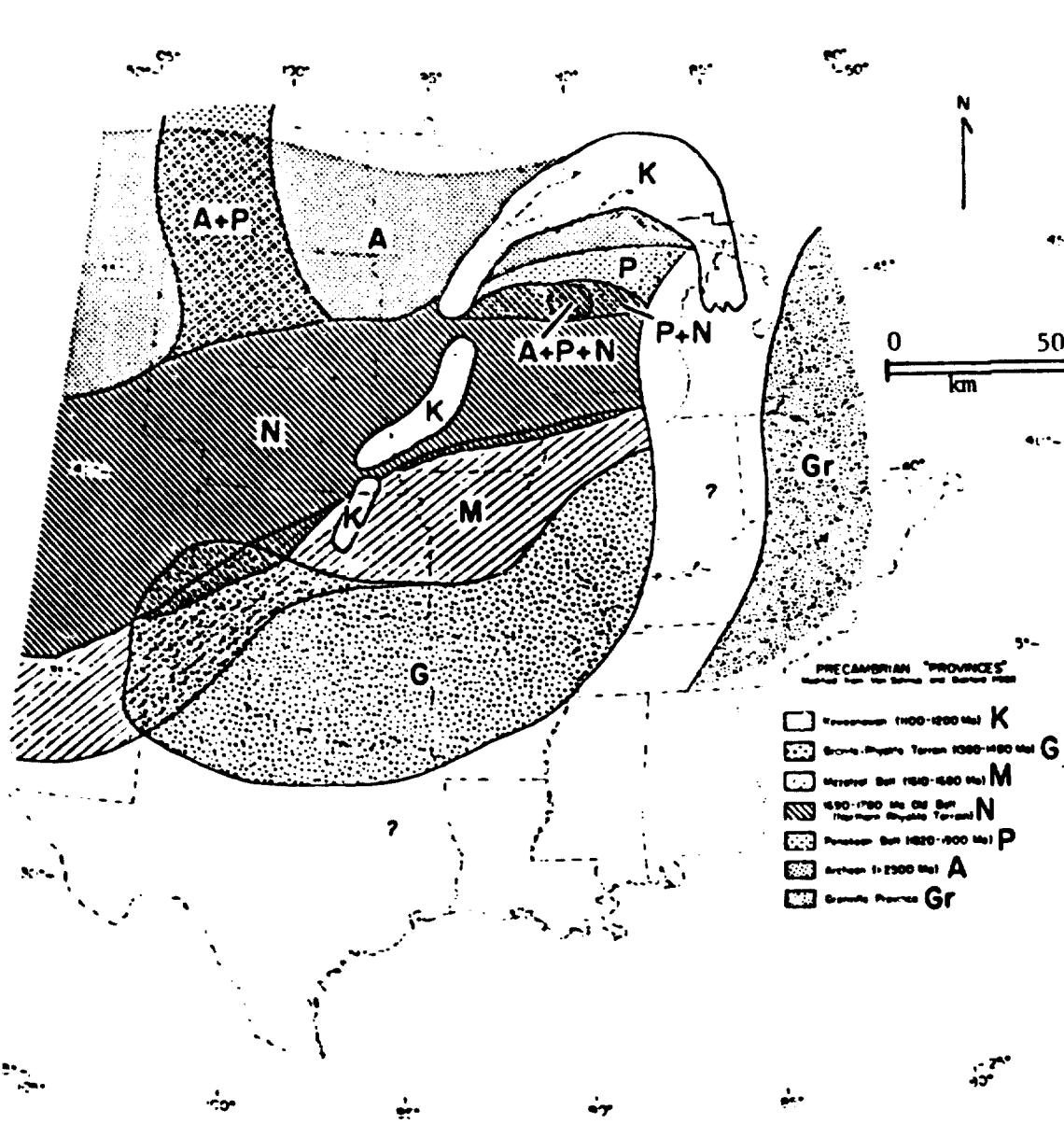

FIGURE 5. Precambrian geologic provinces of the Midcontinent, from radiometric ages and petrology. (modified from Van Schmus and Bickford, 1981)

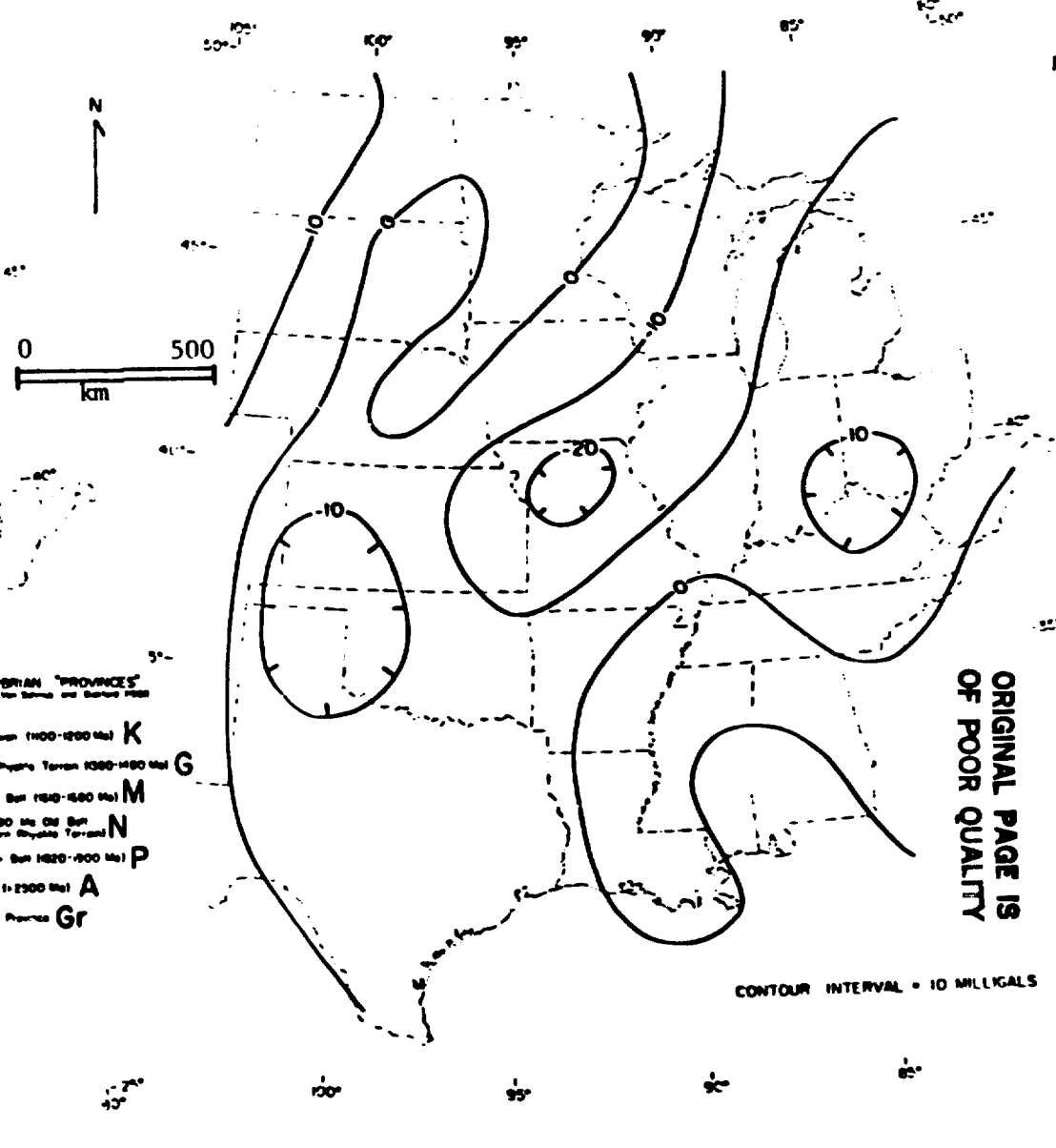

FIGURE 6. Wavelength-filtered, 1°x1° free-air gravity anomaly. (from Von Frese et al, 1980)