

NASA CR-162,029

A Reproduced Copy OF

NASA-CR-162029
19820017397

NASA CR-162,029

Reproduced for NASA

by the

NASA Scientific and Technical Information Facility

LIBRARY COPY

12 1965

LANGLEY RESEARCH CENTER
LIBRARY NASA
HAMPTON, VIRGINIA



NF01673

BATTELLE

(NASA-CR-162029) PRELIMINARY RISK
ASSESSMENT FOR NUCLEAR WASTE DISPOSAL IN
SPACE, VOLUME 2 (Battelle Columbus Labs.,
Ohio.) 263 p HC A12/MP A01

N82-25273

Report To

CSCI 22A

Unclas
G3/12 22749

National Aeronautics and Space Administration

Marshall Space Flight Center Huntsville, Alabama

VOLUME II
of
TECHNICAL REPORT
on
PRELIMINARY RISK ASSESSMENT FOR
NUCLEAR WASTE DISPOSAL IN SPACE
to
NATIONAL AERONAUTICS AND
SPACE ADMINISTRATION
MARSHALL SPACE FLIGHT CENTER
(Contract Number NAS8-34512)
DPD No. 608, DR No. 4
February 28, 1982

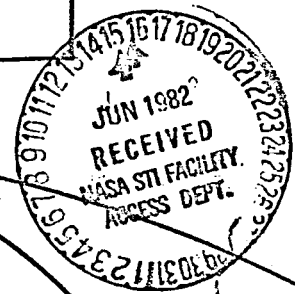

BATTELLE

**Columbus Laboratories
Columbus, Ohio 43201**

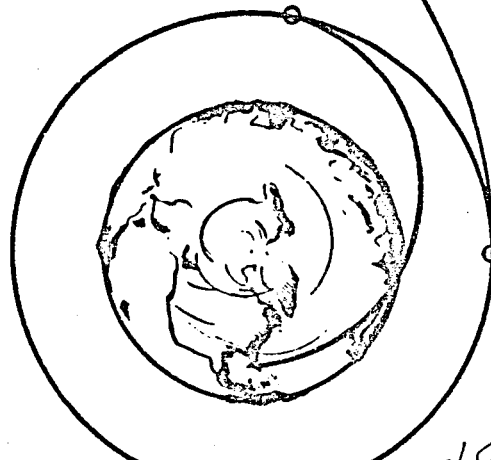

N82-25273 #

VOLUME II
OF
TECHNICAL REPORT

ON

PRELIMINARY RISK ASSESSMENT FOR
NUCLEAR WASTE DISPOSAL IN SPACE

TO

NATIONAL AERONAUTICS AND
SPACE ADMINISTRATION
MARSHALL SPACE FLIGHT CENTER
(Contract Number NAS8-34512)
DPD No. 608, DR No. 4

February 28, 1982

by

Eric E. Rice, BCL
Richard S. Denning, BCL
Alan L. Friedlander, SAI

E. E. Rice

E. E. Rice, Project Manager
Battelle Columbus Laboratories
Columbus, Ohio

C. C. Priest

C. C. Priest, COR
NASA/Marshall Space Flight Center
Huntsville, Alabama

BATTELLE
Columbus Laboratories
505 King Avenue
Columbus, Ohio 43201

FOREWORD

The study summarized in this report was a part of an analysis to determine the feasibility, desirability, and preferred approaches for disposal of selected high-level nuclear wastes in space. The Battelle Columbus Laboratories (BCL) study was an integral part of the Office of Nuclear Waste Isolation (ONWI)-managed DOE/NASA program for study of nuclear waste disposal in space, and was conducted in parallel with efforts at Battelle Pacific Northwest Laboratory; Boeing Aerospace Company; and Science Applications, Inc. (SAI - under subcontract to Battelle and reported here). The research effort reported here was performed by Battelle Columbus Laboratories (with SAI being a subcontractor) under NASA Contract NAS8-34512 from June 1981 through February 1982. The study objective was to provide NASA and DOE with preliminary space disposal risk estimates and estimates of risk uncertainty, such that potential total system risk benefits of space disposal of certain waste components could be evaluated.

The information developed during the study period is contained in this two-volume final report. The title of each volume is listed below.

Volume I Executive Summary
Volume II Technical Report

Inquiries regarding this study should be addressed to:

C. C. (Pete) Priest, COR
NASA/Marshall Space Flight Center
Attention: PS01
Huntsville, Alabama 35812
Telephone: (205) 453-0413

Eric E. Rice, Project Manager
Battelle Columbus Laboratories
505 King Avenue
Columbus, Ohio 43201
Telephone: (614) 424-5103

ACKNOWLEDGMENTS

The principal authors, Eric E. Rice, Richard S. Denning, and Alan L. Friedlander (SAI), acknowledge the assistance of the following individuals who provided contributions to the technical content of this report:

James B. Baeker (Wiggins Co.)	Fred L. Leverenz
Warren E. Berry	Sean J. McKenna
Anthony A. Bojarski	Lisa A. Miller
Walter K. Boyd	A. George Mourad
Michael S. Bridgman	William S. Pope
Richard S. Burian	Fred G. Rea
Frank Cibelli (NASA/KSC)	Richard P. Reinert (Boeing)
David C. Cox	Robert C. Reynolds
Arthur J. Coyle (ONWI)	Sam G. Sampath
Thomas C. Davis	Dwight L. Suiter (NASA/JSC)
Richard W. Earhart	Chen-sayh Tsay
James M. Hudson (Wiggins Co.)	G. Walker (Univ. of Hawaii)
Lewis E. Hulbert	Albert E. Weller
Kenneth D. Kok	William C. Wells (SAI)
Donald J. Kessler (NASA/JSC)	Kenneth R. Yates
Robert E. Kurth	

Recognition is given to Robert F. McCallum and his study team at Battelle Pacific Northwest Laboratory (PNL) for their input to this study. Their study results formed the basis for the possible risk benefit of space disposal, complementing the mined geologic repository.

Acknowledgment is also made to the outstanding guidance and cooperation by the NASA/MSFC study monitor, Claude C. (Pete) Priest. Also, special thanks must go to Ralph E. Best, Program Manager at the U.S. Department of Energy (DOE) Office of Nuclear Waste Isolation (ONWI), Columbus, Ohio, and Philip R. Compton, Energy Systems Division, Office of Aeronautics and Space Technology, NASA/Headquarters, Washington, DC, for their thoughtful guidance throughout the study.

TABLE OF CONTENTS

	<u>Page</u>
FOREWORD	1
ACKNOWLEDGMENTS.	11
1.0 INTRODUCTION.	1
2.0 SYSTEM SAFETY DESIGN GUIDELINES FOR REFERENCE CONCEPT	3
2.1 General Safety Guidelines	3
2.1.1 Radiation Exposure and Shielding.	4
2.1.2 Containment	4
2.1.2.1 Containment/Philosophy	7
2.1.2.2 Parameters.	7
2.1.2.2.1 Thermal	8
2.1.2.2.2 Mechanical Strength	8
2.1.2.2.3 Chemical.	8
2.1.2.3 Containment Components.	8
2.1.2.3.1 Waste Form.	12
2.1.2.3.2 Primary Container/Core.	13
2.1.2.3.3 Radiation Shield.	13
2.1.2.3.4 Impact Absorber and Ablation Shield.	14
2.1.2.3.5 Shipping Cask	14
2.1.2.4 Mission Phases.	14
2.1.2.4.1 Fabrication/Assembly.	15
2.1.2.4.2 Terrestrial Transport	15
2.1.2.4.3 Launch Site Handling.	15
2.1.2.4.4 Launch to Earth Orbit	15
2.1.2.4.5 Orbit Transfer to Destination	15
2.1.3 Accident Environments	16
2.1.3.1 Shipping Accident Environments.	16
2.1.3.2 Ground Handling Environments.	17
2.1.3.3 On- or Near-Pad or Ascent Booster Accident Environments	17
2.1.3.4 Reentry Accidents	18
2.1.4 Criticality	19
2.1.5 Postaccident Recovery	19
2.1.6 Monitoring System	19
2.1.7 Isolation	19
2.2 Specific Safety Guidelines.	20
2.2.1 Waste Form.	20
2.2.2 Waste Processing and Payload Fabrication Facilities	20
2.2.3 Shipping Casks and Ground Transport Vehicles.	20
2.2.4 Payload Primary Container/Core.	20

TABLE OF CONTENTS
(Continued)

	<u>Page</u>
2.2.5 Radiation Shield	20
2.2.6 Reentry Systems	21
2.2.7 Launch Site Facilities	21
2.2.8 Uprated Space Shuttle Launch Vehicle	21
2.2.9 Earth Parking Orbits	22
2.2.10 Orbit Transfer Systems	22
2.2.11 Space Destination	22
2.3 Definition of Terms	22
 3.0 SPACE DISPOSAL CONCEPT DEFINITION	 25
3.1 Overall Reference Mission	25
3.1.1 Nuclear Waste Processing and Payload Fabrication	25
3.1.2 Nuclear Waste Ground Transport	29
3.1.3 Payload Preparation at Launch Site	29
3.1.4 Prelaunch Activities	29
3.1.5 Launch Vehicle Operations	30
3.1.6 Orbit Transfer System	31
3.1.7 Payload Monitoring	32
3.2 Reference System Elements and Operation Definitions and/or Requirements	32
3.2.1 Waste Source	32
3.2.2 Waste Mix	34
3.2.3 Waste Form	34
3.2.4 Waste Payload System	34
3.2.5 Ground Transport Vehicles and Casks	36
3.2.6 Launch Site Facilities	36
3.2.7 Uprated Space Shuttle Vehicle	37
3.2.8 Shuttle Derived Vehicle	38
3.2.9 Orbit Transfer Vehicle (OTV)	38
3.2.10 Solar Orbit Insertion Stage (SOIS)	41
3.2.11 Rescue Vehicle	41
3.2.12 Flight Support System	41
3.2.13 Space Destination	42
3.3 Accident and Malfunction Contingency Plans for Reference Concept	42
3.3.1 Ground Transportation	43
3.3.2 Preflight Operations	43
3.3.3 Launch Operations	43
3.3.4 Orbital Operations	44
3.3.5 Rescue Operations	46
3.4 Reference Projected Traffic Model, Hardware, and Propellant Requirements	46

TABLE OF CONTENTS
(Continued)

	<u>Page</u>
3.5 Alternate Payload Definitions	47
3.5.1 Technetium Payload.	47
3.5.2 Iodine Payload.	47
4.0 OVERALL RISK MODEL APPROACH	51
5.0 SPACE DISPOSAL RISK ESTIMATES	53
5.1 Space Accident Identification	53
5.2 Mission Phase and Fault Tree Development.	55
5.3 Failure and Event Probability Estimates	57
5.3.1 Space Systems Failure Probabilities	57
5.3.1.1 Standard (SRB) Space Shuttle.	57
5.3.1.2 Up-rated (LRB) Space Shuttle	61
5.3.1.3 Orbit Transfer and Rescue Systems	67
5.3.1.4 Payload Systems	68
5.3.2 Short-Term Space Event Probabilities.	68
5.3.2.1 Collision Probability Estimates for Meteoroid Impacts	68
5.3.2.2 Collision Probability Estimates for Man-Made On-Orbit Debris Impacts.	70
5.4 Payload Response Analysis	72
5.4.1 Reentry Analysis.	72
5.4.1.1 Geometry.	73
5.4.1.2 Material Properties	75
5.4.1.3 Initial Orbital Conditions.	75
5.4.1.4 Stability Mode.	75
5.4.1.5 Results and Discussion.	78
5.4.1.5.1 Case 1 - Graphite Aeroshell Included (Orbital Decay).	78
5.4.1.5.2 Case 2 - Orbital Decay Reentry of Waste Plus Shield Only (i.e., Graphite Aeroshell Removed).	80
5.4.1.5.3 Case 3 - Steep Reentry of Waste Form Plus Shield Plus Graphite Aeroshell	81
5.4.1.5.4 Case 4 - Orbital Decay Reentry of Waste Form Chunks.	82
5.4.2 Postburial Meltdown Analysis.	83
5.4.3 Granite Impact Analysis	83
5.4.3.1 Impact Model Description.	84
5.4.3.2 Results of Impact Calculation	85
5.4.3.3 Conclusions	93

TABLE OF CONTENTS
(Continued)

	<u>Page</u>
5.5 Consequence Evaluation	93
5.5.1 Long-Term Corrosion, Ocean	93
5.5.1.1 Radiation Shield Corrosion.	98
5.5.1.2 Waste Form Leach Rate	99
5.5.1.3 Corrosion and Leaching Models	99
5.5.1.3.1 Corrosion Model	100
5.5.1.3.2 Leaching Model.	100
5.5.1.3.3 Cumulative Release Calculation.	102
5.5.2 Impact on Hard Rock	102
5.5.3 Impact on Volcano	103
5.5.4 Soil Meltdown	104
5.5.5 On-Orbit Collisions	104
5.5.6 Long-Term Corrosion, Soil	104
5.5.7 High-Velocity Impact on Water	104
5.5.8 High-Velocity Impact on Rock.	104
5.5.9 High-Velocity Impact on Soil.	106
5.5.10 Deep-Space - Intact Payload Return to Earth	106
5.5.11 Deep Space - Meteoroid Collision.	110
5.5.12 Deep Space - Payload/Payload Collision.	114
5.5.13 Deep Space - Payload/Comet Collision.	115
5.5.14 Deep Space - Erosion.	115
5.5.15 Leaching and Corrosion Consequences for Alternate Payloads.	115
5.6 Preliminary Space Disposal Risk Estimates	115
6.0 TERRESTRIAL DISPOSAL RISK ESTIMATES (FROM PNL STUDY).	123
6.1 PNL Waste-Processing Risk Estimates	124
6.2 PNL Risk Estimates From a Repository Release.	124
6.2.1 Fault Risk Estimates.	129
6.2.2 Drilling Event Risk Estimates	129
6.3 Summary of PNL Terrestrial Risk Data.	135
7.0 INTEGRATED RISK BENEFIT/DISBENEFIT FOR DISPOSAL SYSTEMS COMPLEMENTED BY SPACE DISPOSAL OF NUCLEAR WASTE	139
7.1 HLW Disposal in Space - 15 EPA Isotopes	140
7.1.1 Reference MGR Risk (No Space Disposal).	140
7.1.2 Complemented MGR Risk	140
7.1.3 Space Risk.	140
7.2 HLW Disposal in Space - Eight Actinides	142
7.2.1 Reference MGR Risk (No Space Disposal).	142
7.2.2 Complemented MGR Risk	142
7.2.3 Space Risk.	142
7.3 HLW Disposal in Space - Tc-99 Risk.	142
7.3.1 Reference MGR Risk (No Space Disposal).	142

TABLE OF CONTENTS
(Continued)

	<u>Page</u>
7.3.2 Complemented MGR Risk	145
7.3.3 Space Risk.	145
7.4 I-129 Disposal in Space - I-129 Risk.	145
7.5 Tc-99 Disposal in Space - Tc-99 Risk.	145
8.0 SUMMARY OF RESULTS	149
9.0 CONCLUSIONS.	151
10.0 RECOMMENDATIONS	151
APPENDIX A: REFERENCES.	A-1
APPENDIX B: ACRONYMS AND ABBREVIATIONS.	B-1
APPENDIX C: METRIC/ENGLISH UNIT CONVERSION FACTORS.	C-1
APPENDIX D: SPACE DISPOSAL FAULT TREE DIAGRAMS.	D-1
APPENDIX E: DISCUSSION OF CATASTROPHIC UPDATED SHUTTLE FAILURES FOR IGNITION TO MECO.	E-1
APPENDIX F: DISCUSSION OF CATASTROPHIC UPDATED SHUTTLE FAILURES FOR MECO TO PAYLOAD SEPARATION.	F-1
APPENDIX G: FAILURE PROBABILITIES FOR FAULT TREES	G-1
APPENDIX H: COMPUTER PLOTS OF PAYLOAD/GRANITE IMPACT RESPONSE	H-1

LIST OF TABLES

	<u>Page</u>
Table 2-1. Normal Operations Exposure Limits for Individuals in Controlled and Uncontrolled Areas	5
Table 2-2. Radiation Exposure Limits for Space Shuttle Flight Crews. .	6
Table 2-3. Specific Components of Containment.	9
Table 2-4. Thermal Guidelines for Containment of High-Level Waste for Space Disposal.	9
Table 2-5. Mechanical Guidelines for Containment of High-Level Waste for Space Disposal.	10
Table 2-6. Chemical Guidelines for Containment of High-Level Waste for Space Disposal.	11
Table 3-1. Twenty-Five Year Projected U.S. Nuclear Power Generation and Possible Commercial High-Level Wastes Available for Space Disposal (100,000 MTHM Basis).	33
Table 3-2. Mass Summary for Uprated Space Shuttle Vehicle	39
Table 3-3. Major Hardware Requirements Estimates for High-Level Commercial Nuclear Waste Disposal in Space (100,000 MTHM). .	48
Table 3-4. On-Board Propellant Requirements for Each Reference Nuclear Waste Disposal Mission	49
Table 5-1. Possible Insults to the Space Disposal Payload	55
Table 5-2. Mission Phase and Timeline Definition.	56
Table 5-3. Space Disposal Probability Data (Short-Term Events).	60
Table 5-4. Wiggins Data for Standard Shuttle Critical Failure Rates (Liftoff to MECO).	62
Table 5-5. Wiggins Data for Standard Shuttle Critical Failure Rates (MECO to Payload Separation)	63
Table 5-6. Summary of Modified Wiggins Critical Failure Rate Data for LRB Shuttle (Liftoff to MECO).	64
Table 5-7. Summary of Modified Wiggins Critical Failure Rate Data for LRB Shuttle (MECO to Payload Separation).	65

LIST OF TABLES
(Continued)

	<u>Page</u>
Table 5-8. Predicted Up-rated STS Critical Failure Probabilities During Each Mission Phase.	66
Table 5-9. Failure Probability Comparison (STD SRB Shuttle vs Up-rated LRB Shuttle).	67
Table 5-10. Predicted OTV/SOIS/Rescue Vehicle Success Probabilities . .	67
Table 5-11. Material Properties as a Function of Temperature.	77
Table 5-12. Other Material Properties of Interest	78
Table 5-13. Surface Recession and Node Temperatures at Impact for Stable Reentry Mode	79
Table 5-14. Surface Recession and Node Temperatures at Impact for Spinning Reentry Configuration.	79
Table 5-15. Surface Recession and Node Temperature at Impact for Stable Reentry Mode Ring Temperature (K).	80
Table 5-16. Surface Recession and Node Temperature at Impact for Spinning Reentry Mode	81
Table 5-17. Thermal Conductivity in Impact Medium Needed to Allow Temperature Conditions Given.	84
Table 5-18. Structural Properties of Materials Used in Analysis	87
Table 5-19. Summary of Release of Events for Space Disposal	96
Table 5-20. Payload Radionuclide Inventories (in Curies) as a Function of Time.	97
Table 5-21. Expected Cumulative Source Term (Curies) for Event 1, Long-Term Corrosion/Leaching in the Ocean	98
Table 5-22. Expected Cumulative Source Term (Curies) for Event 2, Hard Rock Impact.	103
Table 5-23. Expected Cumulative Source Term (Curies) for Event 7, High-Velocity Impact on Water	105
Table 5-24. Cumulative Reentry Source Risk (Ci) for Reference Mission: Cermet Payload Intact Payload Return from Deep Space. . . .	109

LIST OF TABLES
(Continued)

	<u>Page</u>
Table 5-25. Cumulative Wet Soil Impact Risk (Ci) for Reference Mission: Intact Payload Return from Deep Space	111
Table 5-26. Cumulative Ocean Impact Risk (Ci) for Reference Mission: Intact Payload Return from Deep Space	111
Table 5-27. Cumulative Deep-Space Risks (Ci) for Alternative Waste Payloads.	112
Table 5-28. Cumulative Upper Atmosphere Burnup Risk (Ci) for Reference Mission: Small Particle Return	114
Table 5-29. Cumulative Leaching Consequences (Ci) for Reference Mission Launch Accident	116
Table 5-30. Cumulative Corrosion and Leaching Consequences (Ci) for Reference Mission Launch Accident	116
Table 5-31. Cumulative Leaching Consequences (Ci) for Tc-99 Disposal Mission Launch Accident	117
Table 5-32. Cumulative Corrosion and Leaching Consequences (Ci) for Tc-99 Disposal Mission Accidents.	117
Table 5-33. LOG ₁₀ Cumulative Risks (Ci) for Space Disposal of HLW, Less Cs, and Sr, 750 Missions	118
Table 5-34. LOG ₁₀ Cumulative Risks (Ci) for Space Disposal of Iodine and Technetium Payloads (100,000 MTHM Equivalent.	119
Table 6-1. Nuclide Fractions Sent to Space Disposal.	125
Table 6-2. Nuclide Fractions Sent to Geologic Disposal	126
Table 6-3. Short-Term Reprocessing Releases to the Biosphere (Ci/100,000 MTHM)	127
Table 6-4. Short-Term Partitioning Releases to the Biosphere (Ci/100,000 MTHM)	128
Table 6-5. Potential Disruptive Phenomena for Waste Isolation Repositories.	130
Table 6-6. Cumulative Consequences and Release Risks for Fault Scenario, Reference MGR	131

LIST OF TABLES
(Continued)

	<u>Page</u>
Table 6-7. Cumulative Consequences and Release Risks for Fault Scenario, Complemented by Removal of HLW, Less 95 Percent Cs and Sr.	132
Table 6-8. Cumulative Release Risks (Curies) From Drilling Events Occurring Over Period up to 1×10^6 Years at a Bedded Salt Repository, Reference MGR	133
Table 6-9. Cumulative Release Risks (Curies) From Drilling Events Occurring Over Period up to 1×10^6 Years at a Bedded Salt Repository, Complemented MGR by Removal of HLW, Less 95 Percent Cs and Sr.	134
Table 6-10. LOG_{10} of Total Expected MGR Risks (Curies) for PNL Reprocessing Scenarios.	136
Table 6-11. LOG_{10} of Expected Cumulative MGR Risks (Curies) for PNL Drilling Scenarios.	137
Table 6-12. LOG_{10} of Expected Cumulative MGR Risks (Curies) for PNL Fault Scenarios	138
Table E-1. Failed Vehicle Response Modes	E-5
Table F-1. Vehicle Response Modes for MECO to Payload Separation . . .	F-3
Table G-1. Per Mission Probability Estimates for Phase 1	G-2
Table G-2. Per Mission Probability Estimates for Phase 2	G-4
Table G-3. Per Mission Probability Estimates for Phase 3	G-6
Table G-4. Per Mission Probability Estimates for Phase 4	G-12
Table G-5. Per Mission Probability Estimates for Phase 5	G-18
Table G-6. Per Mission Probability Estimates for Phase 6	G-24

LIST OF FIGURES

	<u>Page</u>
Figure 2-1. Recommended Design Criteria for Shuttle Crash Impact Angle	18
Figure 3-1. Overview of Reference Concept for Initial Nuclear Waste Disposal in Space.	26
Figure 3-2. Ground and Space Operations for Reference Space Disposal Mission.	27
Figure 3-3. Waste Payload Assembly Facility (from Boeing Study).	28
Figure 3-4. Possible Concept for a Nuclear Payload Preparation Facility (NPPF) (from Boeing Study).	29
Figure 3-5. Reference OTV/SOIS Mission Profile	31
Figure 3-6. Waste Payload Package for Space Disposal	35
Figure 3-7. Uprated Space Shuttle Vehicle.	37
Figure 3-8. Shuttle Derived Vehicle (SDV).	40
Figure 3-9. Reference OTV/SOIS/Waste Payload Configuration	40
Figure 3-10. Flight Support System Operation.	42
Figure 5-1. Approach for Estimating Space Disposal Risk.	54
Figure 5-2. Phase 1 Fault Tree - Ignition to Impact Point Clears Coastline (T = 0 to 24 sec).	58
Figure 5-3. Phase 2 Fault Tree - Impact Point Clears Coastline to LRB Staging (T = 24 to 124 sec).	59
Figure 5-4. Payload Orbital Ground Tracks from Liftoff Through OTV Burn	69
Figure 5-5. Internal Nodal Structure Used to Model the Transient Heating Response of Various Waste Form Material Configurations	74
Figure 5-6. Ring Geometry for Two Major Configurations Analyzed.	74
Figure 5-7. On-Orbit Steady-State Pre-Reentry Temperature Condition.	76
Figure 5-8. Percent Waste Form Mass Loss for Unprotected Waste Form as a Function of Radius	82

LIST OF FIGURES
(Continued)

	<u>Page</u>
Figure 5-9. Finite-Element Model for Nuclear Waste Payload Impacting Granite.	86
Figure 5-10. Deformed Shape of the Shielded Waste Payload for Various Times During Impact (442 m/s Initial Velocity)	89
Figure 5-11. Contours of Von Mises Stress After 1 ms of Impact (442 m/s Initial Velocity)	90
Figure 5-12. Contours of Hoop Stress After 1 ms of Impact (442 m/s Initial Velocity Figure)	91
Figure 5-13. Deformed Shape of the Shielded Waste Payload for Various Times During Impact (152 m/s Initial Velocity)	92
Figure 5-14. Contours of Von Mises Stress After 1 ms of Impact (152 m/s Initial Velocity)	94
Figure 5-15. Contours of Hoop Stress After 1 ms of Impact (152 m/s Initial Velocity)	95
Figure 5-16. Earth Reentry Probability Distribution for a Single Payload Launch Without Rescue ($N=0$); Reduce Scale by 10^{-5} for Rescue ($R_R=0.944$, $N=4$)	107
Figure 5-17. Expected Cumulative Space Risk Comparison for HLW Disposal in Space.	120
Figure 5-18. Expected Cumulative Space Risk Comparisons for I-129 and Tc-99 Disposal in Space.	121
Figure 7-1. Integrated Expected Cumulative Release Risk Comparisons (in Curie Sum of 15 EPA Isotopes) for HLW Disposal in Space.	141
Figure 7-2. Integrated Expected Cumulative Release Risk Comparisons (in Curie Sum of Eight EPA Actinides) for HLW Disposal in Space	143
Figure 7-3. Integrated Expected Cumulative Release Risk Comparisons (in Curies of Tc-99) for HLW Disposal in Space	144
Figure 7-4. Integrated Expected Cumulative Release Risk Comparisons (in Curies of I-129) for I-129 Disposal in Space	146
Figure 7-5. Integrated Expected Cumulative Release Risk Comparisons (in Curies of Tc-99) for Tc-99 Disposal in Space	147

LIST OF FIGURES
(Continued)

	<u>Page</u>
Figure E-1. Inadvertent LRB Separation	E-2
Figure H-1. Contours of Von Mises Stress After 0.25 ms of Impact (442 m/s Impact Velocity).	H-2
Figure H-2. Contours of Von Mises Stress After 0.50 ms of Impact (442 m/s Impact Velocity).	H-3
Figure H-3. Contours of Von Mises Stress After 0.75 ms of Impact (442 m/s Impact Velocity).	H-4
Figure H-4. Contours of Von Mises Stress After 1.0 ms of Impact (442 m/s Impact Velocity).	H-5
Figure H-5. Contours of Hoop Stress After 0.25 ms of Impact (442 m/s Impact Velocity).	H-6
Figure H-6. Contours of Hoop Stress After 0.50 ms of Impact (442 m/s Impact Velocity).	H-7
Figure H-7. Contours of Hoop Stress After 0.75 ms of Impact (442 m/s Impact Velocity).	H-8
Figure H-8. Contours of Hoop Stress After 1.0 ms of Impact (442 m/s Impact Velocity).	H-9
Figure H-9. Contours of Von Mises Stress After 0.25 ms of Impact (152 m/s Impact Velocity).	H-10
Figure H-10. Contours of Von Mises Stress After 0.50 ms of Impact (152 m/s Impact Velocity).	H-11
Figure H-11. Contours of Von Mises Stress After 0.75 ms of Impact (152 m/s Impact Velocity).	H-12
Figure H-12. Contours of Von Mises Stress After 1.0 ms of Impact (152 m/s Impact Velocity).	H-13
Figure H-13. Contours of Hoop Stress After 0.25 ms of Impact (152 m/s Impact Velocity).	H-14
Figure H-14. Contours of Hoop Stress After 0.50 ms of Impact (152 m/s Impact Velocity).	H-15

LIST OF FIGURES
(Continued)

	<u>Page</u>
Figure H-15. Contours of Hoop Stress After 0.75 ms of Impact (152 m/s Impact Velocity).	H-16
Figure H-16. Contours of Hoop Stress After 1.0 ms of Impact (152 m/s Impact Velocity).	H-17

1.0 INTRODUCTION

This volume (Volume II) summarizes the results of the 1981-1982 Battelle Columbus Laboratories preliminary assessment of the risk of nuclear waste disposal in space. The study objective was to provide NASA and DOE/Office of Nuclear Waste Isolation with preliminary space disposal risk estimates and estimates of space risk uncertainty, such that potential total (mined geologic repository risks included) system risk benefits of space disposal of certain nuclear waste components could be evaluated. To accomplish the objective of the study, the following work areas were defined:

- Review Risk Models and Appropriate Data (Task 1)
- Formulate a Risk Model Approach (Task 2)
- Define Safety Requirements (Task 3)
- Estimate Space Disposal Risks (Tasks 4 and 5)
- Integrate Mined Geologic Repository (MGR) Risks with Space Disposal Risks to Determine Possible Risk Benefits (Task 6)
- Define a Reference Space Disposal Concept (Task 7).

The various sections of the final report are reviewed below.

Section 2.0 provides an update/revision to previous system safety design guidelines that have been developed for space disposal over the years. The section first presents what is called "general safety guidelines", a presentation of guidelines related to such things as: (1) radiation exposure and shielding, (2) containment, (3) accident environments, (4) criticality, (5) postaccident recovery, (6) monitoring systems, and (7) isolation. The discussion provides guidance in these areas on how to minimize exposure to humans and the environment to the radioactive waste materials during space disposal missions. A discussion of how these "general" guidelines relate to the specific aspects of the current (February 1982) Reference Concept for space disposal is presented in Section 2.2. A definition of terms is presented at the end of the section.

Section 3.0 provides a summary of the current space disposal concept. The overall Reference Concept is discussed in Section 3.1. Specific definitions of space disposal system elements are given in Section 3.2. Accident and malfunction contingency plans for the Reference Concept are presented in Section 3.3. Section 3.4 assesses the projected quantities of hardware items and propellants required to carry out the Reference Traffic Model. Section 3.5 provides a brief discussion of the alternative Tc-99 and I-129 payloads.

Section 4.0 briefly discusses the overall risk model approach used in this study.

Section 5.0 provides a technical discussion of how the space disposal release risk estimates were made. Specific sections include the following topics: (1) space accident identification, (2) mission phase and fault tree development, (3) failure probability estimates, (4) payload response analysis, (5) consequence analysis, and (6) preliminary space disposal risk estimates.

Terrestrial disposal risk estimates, as generated by Pacific Northwest Laboratory, under contract to DOE's Office of Nuclear Waste Isolation, are summarized in Section 6.0.

Section 7.0 of this report integrates the "space risk estimates" of Section 5.0 and the "terrestrial risk estimates (PNL)" of Section 6.0. The results of the integration and discussion of benefits and disbenefits for various release risk scenarios are provided.

Section 8.0 provides a summary of results of the study, Section 9.0 states the study conclusions, and Section 10.0 presents the study recommendations.

Appendix A contains all the references cited in the final report. Appendix B provides definitions of acronyms and abbreviations. Appendix C presents a handy metric/English unit conversion factors table. The space disposal fault trees for all nine mission phases are given in Appendix D. Appendices E and F give a brief discussion of Uprated Space Shuttle failures that can occur. Appendix G provides a summary log of the failure probabilities that match the fault trees given in Appendix D. Appendix H presents figures and plots related to the waste payload ground impact response.

2.0 SYSTEM SAFETY DESIGN GUIDELINES FOR REFERENCE CONCEPT

One of the most important factors in the ultimate decision-making process for the space disposal concept is public health safety. For space disposal to be an acceptable approach, it is likely that the total long-term health risk of a space disposal concept coupled with terrestrial disposal must be at a comparable or preferably at a much lower level than that of terrestrial disposal of all the waste. The short-term health risk must be at an acceptable level.

Over the years of studying space disposal, a "safety concept" has been developing. The various aspects of this safety concept are presented in this section. Work done on safety specifications for radioisotope thermal generators (U.S. DOE, 1977)*, was included in the development of safety guidelines for space disposal. As a result of the current study, the safety guidelines have been modified.

This section defines system safety guidelines for the nuclear waste disposal in space missions and helps to assure that nuclear waste payloads and their associated handling may be considered acceptable and radiologically safe. These guidelines should be used for current studies and modified as new information and understandings evolve.

The following subsections describe the general and specific system guidelines for nuclear waste disposal in space missions. The general system safety guidelines are based upon the assumption that the waste payload is carried into space by the uprated, liquid rocket boosted Space Shuttle vehicle and is processed at the launch site in a facility named the Nuclear Payload Preparation Facility (NPPF). Definitions of terms are located at the end of this section. References are shown in Appendix A.

2.1 General Safety Guidelines

The general safety objectives for the nuclear waste disposal in space mission are: (1) to contain the solid radioactive waste materials, and (2) to limit the exposure of humans and the environment to the radioactive waste materials. For normal operations, complete containment and minimal radiological exposure are required. For potential accident situations, the degrees of containment and interaction shall result in an acceptable risk to humans and the environment and be as low as reasonably achievable (ALARA). Many of the general safety guidelines have been selected using our best judgment and do not have the benefit of detailed analysis.

The general system safety guidelines for the nuclear waste disposal in space mission involve the following safety aspects:

*See Appendix A for references.

- (1) Radiation Exposure and Shielding
- (2) Containment
- (3) Accident Environments
- (4) Criticality
- (5) Postaccident Recovery
- (6) Monitoring Systems
- (7) Isolation.

The information given below defines the guidelines that should be followed for the development of any nuclear waste disposal in space mission, employing conventional space technology approaches such as the Space Shuttle.

2.1.1 Radiation Exposure and Shielding

Radiation exposure guidelines for normal operations for the public and ground crews are those contained in ERDA-MC-0524 (U.S. DOE, 1975) and shown in Table 2-1. Radiation exposure limits for astronaut crew members during normal operations are those contained in the Space Shuttle Flight and Ground Specification, JSC 07700 (NASA/JSC, 1979) and shown in Table 2-2.

The normal radiation exposure limits for the current terrestrial transportation of nuclear waste materials would also apply to ground transportation of nuclear waste payloads. The radiation limits [49 CFR 173.393(j)] are given as:

- 1 m from external container surface...1000 mrem/hr (closed transport vehicle only)
- External surface of transport vehicle...200 mrem/hr (closed transport vehicle only)
- 2 m from external surface of transport vehicle...10 mrem/hr
- Normally occupied position of transport vehicle...2 mrem/hr.

For accident conditions of terrestrial transport, the postaccident dose rates are limited to 1000 mrem/hr at 1 m from the external surface of the waste package.

A general guideline for the waste package shipped to space is that the radiation dose at 1 m from the flight shield surface is not greater than 1000 mrem/hr. This value can be obtained by including shielding contributions from outer layers of the payload. In the absence of these layers, no more than 2000 mrem/hr at 1 m should be allowed. The shield should be carried all the way to the destination.

2.1.2 Containment

Containment must be defined for the various portions of the disposal mission. Five general mission phases include fabrication/assembly of the

TABLE 2-1. NORMAL OPERATIONS EXPOSURE LIMITS FOR INDIVIDUALS
IN CONTROLLED AND UNCONTROLLED AREAS

<u>INDIVIDUALS IN CONTROLLED AREAS:</u>		
Type of Exposure	Exposure Period	Dose Equivalent (Dose or Dose Commitment ^(a) , rem)
Whole body, head and trunk, gonads, lens of the eye ^(b) , red bone marrow, active blood-forming organs.	Year	5 ^(c)
	Calendar Quarter	3
Unlimited areas of the skin (except hands and forearms). Other organs, tissues, and organ systems (except bone).	Year	15
	Calendar Quarter	5
Bone.	Year	30
	Calendar Quarter	10
Forearms. ^(d)	Year	30
	Calendar Quarter	10
Hands ^(d) and feet.	Year	75
	Calendar Quarter	25

<u>INDIVIDUALS IN UNCONTROLLED AREAS:</u>		
Annual Dose Equivalent or Dose Commitment (rem) ^(e)		
Type of Exposure	Based on Dose to Individuals at Points of Maximum Probable Exposure	Based on an Average Dose to a Suitable Sample of Exposed Population
Whole body, gonads, or bone marrow	0.5	0.17
Other organs	1.5	0.5

- (a) To meet the above dose commitment standards, operations must be conducted in such a manner that it would be unlikely that an individual would assimilate in a critical organ, by inhalation, ingestion, or absorption, a quantity of a radionuclide(s) that would commit the individual to an organ dose which exceeds the limits specified in the above table.
- (b) A beta exposure below an average energy of 700 Kev will not penetrate the lens of the eye; therefore, the applicable limit for these energies would be that for the skin (15 rem/yr).
- (c) In special cases with the approval of the Director, Division of Operational Safety, a worker may exceed 5 rem/yr provided his average exposure per year since age 18 will not exceed 5 rem/yr.
- (d) All reasonable efforts shall be made to keep exposures of forearms and hands to the general limit for the skin.
- (e) In keeping with ERDA policy on lowest practicable exposure, exposures to the public shall be limited to as small a fraction of the respective annual dose limits as is practicable.

TABLE 2-2. RADIATION EXPOSURE LIMITS FOR SPACE SHUTTLE FLIGHT CREWS^(a)

Constraints, rem	Bone Marrow, 5 cm	Skin, 0.1 mm	Eye, 3 mm	Testes ^(c)
1-year average daily rate	0.2	0.6	0.3	0.1
30-day maximum	25	75	37	13
Quarterly maximum ^(b)	35	105	52	18
Yearly maximum	75	225	112	38
Career limit	400	1200	600	200

(a) These exposure limits and exposure rate constraints apply to all sources of radiation exposure. In making trade-offs between man-made and natural sources of radiation, adequate allowance must be made for the contingency of unexpected exposure. These data are from Space Shuttle Flight and Ground Specification, JSC 07700, Volume X, Revision F, Chapter 7.4 (NASA/JSC, 1979). Estimated doses for Shuttle crew members, as based upon STS-1 launch, are ~0.01 rem per day; worst normal case dose estimate for Shuttle crew members performing Reference disposal mission is expected to be less than 0.10 rem per mission.

(b) May be allowed for two consecutive quarters followed by 6 months of restriction from further exposure to maintain yearly limit.

(c) These dose and dose rate limits are applicable only where the possibility of oligospermia and temporary infertility are to be avoided. For most manned space flights, the allowable exposure accumulation to the the germinal epithelium (3 cm) will be the subject of a risk/gain decision for the particular program, mission, and individuals concerned.

waste form, terrestrial transport, launch site handling, launch to Earth orbit, and orbit transfer to destination. For all normal operations, the systems should be designed so that no release of radioactive material occurs. For accident environments the system should be designed so that the risk to the public is acceptable. Current U.S. federal regulations cover little beyond transportation and general handling aspects. The discussion below outlines the general guidelines for containment of the high-level waste form during each phase of the space disposal mission.

2.1.2.1 Containment/Philosophy

The ideal goal for containment of high-level waste material is to (1) provide an absolute barrier between the waste and the environment, and (2) minimize the radiation exposure to humans under all normal and accident conditions. Various governmental regulations have been developed and applied to current terrestrial transportation activities involving radioactive materials, including irradiated nuclear fuel. No regulation applies to the space transport of high-level waste. Consequently, the containment guidelines developed here are based on considering existing regulations for other radioactive material handling, storage, and transport activities. The containment philosophy is applied first to meet current regulations and, second, to minimize human exposure to as low as reasonably achievable (ALARA) where regulations do not exist.

The acceptable amount of radioactive material that may be released should be a function of the mission phase, accident severity, and frequency of the loading condition, keeping in mind ALARA criteria. Allowable releases from the primary container are expected to range from zero, for normal conditions, to minimal values (ALARA), for extremely severe, low-probability accidents.

Containment guidelines are presented in terms of three independent categories: (1) specific parameters indicative of the response of various containment systems; (2) specific systems for containing the waste (waste form, container, etc.); and (3) various mission phases during which specific levels of containment conditions are required. Table 2-3 lists the components of these categories. These three levels of containment categories can be used to define any aspect of containment.

2.1.2.2 Parameters

Containment guidelines take the form of specific limits for key parameters. For the space disposal mission, the significant parameters can be grouped into three major categories: (1) thermal, (2) mechanical, and (3) chemical. Within each category, many specific parameters can be included if the design is known; only the generic parameters are included in this discussion. Once a conceptual design is known/postulated, specific technical data (temperatures, etc.) may be substituted to obtain specific working guidelines.

2.1.2.2.1 Thermal

Thermal guidelines consider only limiting conditions which, irrespective of critical parameters in other areas, serve as upper bounds to determine permissible designs and responses. In interrelations with other major parameters, a single parameter is considered as the limiting guideline and, through its dependence upon other parameters, in effect produces corresponding limits. Thus, parameters such as melting temperature will be independent limits, while yield strength will be a function of temperature. The limiting thermal conditions for all forms of containment and mission phases should require that the containment barrier not be altered in physical or chemical phase during operations that are not remote from the human environment. For normal conditions, 40 percent of the material melt absolute temperature is the guideline (material creep not expected to be significant below this). If the melt absolute temperature is not known, then 90 percent of the fabrication absolute temperature is the guideline. For accident conditions, the temperature limit is 90 percent of the melt absolute temperature. (See Table 2-4.)

2.1.2.2.2 Mechanical Strength

For all normal mission phases, and containment barriers, the mechanical strength must maintain stress and strain limits within 90 percent of the normal yield limits for given temperature conditions (standard 0.2 percent offset). For accident conditions, where stress/strain limits are provided, one should not exceed 90 percent of ultimate strength requirements at the temperature anticipated. Mechanical strength limits are assumed to be dependent on temperature and loading conditions. In addition, it is assumed that all containment barriers must also have sufficient fracture toughness, fatigue endurance, and buckling stability to withstand normal and accident conditions. (See Table 2-5.) For accidents associated with reentry, total mechanical integrity for all components is not feasible. Rather, a guideline to be used would be to allow deformation but not allow major breach of containment.

2.1.2.2.3 Chemical

Containment materials shall be compatible with adjacent media to the extent that no significant detrimental chemical reactions occur and the material is nonpyrophoric in an air environment at sea-level (SL) pressure. For conditions not covered by existing U.S. federal regulations, guidelines are provided for the various containment barriers and mission phases. (See Table 2-6.)

2.1.2.3 Containment Components

Containment components constitute the barrier between the payload and the external environment. Depending on the mission phase, the containment barrier may be a single item (e.g., waste primary container) or multiple items (e.g., primary container, radiation shield, impact absorber, etc.).

TABLE 2-3. SPECIFIC COMPONENTS OF CONTAINMENT

Parameters	Components	Mission Phases
<ul style="list-style-type: none"> ● Thermal ● Mechanical ● Chemical 	<ul style="list-style-type: none"> ● Waste Form ● Primary Container* ● Radiation Shield* ● Impact Absorber* ● Ablation Shield ● Shipping Cask 	<ul style="list-style-type: none"> ● Fabrication/Assembly ● Terrestrial Transport ● Launch Site Handling ● Launch to Earth Orbit ● Orbit Transfer to Destination

*Note: These may be combined.

TABLE 2-4. THERMAL GUIDELINES FOR CONTAINMENT OF HIGH-LEVEL WASTE FOR SPACE DISPOSAL

Component	Mission Phase				
	Fabrication/ Assembly	Terrestrial Transport	Launch Site Handling	Launch to Earth Orbit	Orbit Transfer to Destination
Waste Form	40% Melt/ 90% Melt**	40% Melt/ 90% Melt	40% Melt/ 90% Melt	40% Melt/ 90% Melt	40% Melt/ 90% Melt
Primary Container	40% Melt/ 90% Melt	40% Melt/ 90% Melt	40% Melt/ 90% Melt	40% Melt/ 90% Melt	40% Melt/ 90% Melt
Flight Radia- tion Shield	40% Melt/ 90% Melt	40% Melt/ 90% Melt	40% Melt/ 90% Melt	40% Melt/ 90% Melt	40% Melt/ 90% Melt
Impact Absorber	--	--	40% Melt/ 90% Melt	40% Melt/ 90% Melt	40% Melt/ 90% Melt
Ablation Shield	--	--	40% Ablation/--	40% Ablation/--	40% Ablation/--
Shipping Cask	--	DOT, NRC Reg.	--	--	--

**Note: The normal absolute temperature limit is given first; the accident absolute temperature limit is given second. If the melt absolute temperatures are not appropriate for the material in question, then 90 percent of the fabrication absolute temperature should apply.

TABLE 2-5. MECHANICAL GUIDELINES FOR CONTAINMENT OF
HIGH-LEVEL WASTE FOR SPACE DISPOSAL

Component	Mission Phase				
	Fabrication/ Assembly	Terrestrial Transport	Launch Site Handling	Launch to Earth Orbit	Orbit Transfer to Destination
Waste Form	90% Yield/ 90% Ultimate*	90% Yield/ 90% Ultimate	90% yield/ 90% Ultimate	90% Yield/ No Breach at 95% Confidence	90% Yield/ No Breach at 95% Confidence
Primary Container	90% Yield/ 90% Ultimate	DOT, NRC Reg.	90% Yield/ 90% Ultimate	90% Yield/--	90% Yield/--
Flight Radia- tion Shield	90% Yield/ 90% Ultimate	90% Yield/ 90% Ultimate	90% Yield/ 90% Ultimate	90% Yield/--	90% Yield/--
Impact Absorber	--	--	90% Yield/--	90% Yield/--	90% Yield/--
Ablation Shield	--	--	90% Yield/--	90% Yield/--	90% Yield/--
Shipping Cask	--	DOT, NRC Reg.	--	--	--

*Note: The normal mechanical limit is given first; the accident mechanical limit is given second.

TABLE 2-6. CHEMICAL GUIDELINES FOR CONTAINMENT OF
HIGH-LEVEL WASTE FOR SPACE DISPOSAL

Component	Mission Phase				
	Fabrication/ Assembly	Terrestrial Transport	Launch Site Handling	Launch to Earth Orbit	Orbit Transfer to Destination
Waste Form	Container Compatible, Nonpyrophoric in Air at SL	Container Compatible, Nonpyrophoric in Air at SL	Container Compatible, Nonpyrophoric in Air at SL	Container Compatible, Nonpyrophoric in Air at SL	Container Compatible, Nonpyrophoric in Air at SL
Primary Container	Similar to DOT, NRC Reg.	DOT, NRC Reg.	Similar to DOT, NRC Reg.	Similar to DOT, NRC Reg.	Waste Form Compatible Nonpyrophoric in Air at SL
Flight Radia- tion Shield	Similar to DOT, NRC Reg.	Similar to DOT, NRC Reg.	Similar to DOT, NRC Reg.	Similar to DOT, NRC Reg.	Container Compatible, Nonpyrophoric in Air at SL
Impact Absorber	Similar to DOT, NRC Reg.	Similar to DOT, NRC Reg.	Similar to DOT, NRC Reg.	Similar to DOT, NRC Reg.	Shield Compatible Nonpyrophoric in Air at SL
Ablation Shield	--	--	Similar to DOT, NRC Reg.	Similar to DOT, NRC Reg.	Impact Absorber Compatible Nonpyrophoric in Air
Shipping Cask	--	DOT, NRC Reg.	--	--	--

Consequently, a particular component may not be a part of containment in all mission phases. If it is not a part of the containment barrier, then the specific limits for containment, as applied to a particular subsystem, do not apply.

2.1.2.3.1 Waste Form

The principal containment barrier for the space disposal option is the primary container. A strong, nondispersible, waste form is required to minimize the possibility and quantity of nuclide release. To meet these requirements, the waste form will still have limits for thermal, mechanical, and chemical parameters. The nuclear waste mix and form will be designed to meet the criticality limit specified in later paragraphs.

A meeting was held at Battelle Columbus Laboratories on July 19, 1979, to evaluate waste forms for the space disposal of commercial and defense high-level waste (HLW). Participants included ONWI, NASA, BCL, and DOE-Richland Operations (former NPO) personnel and waste form experts from Battelle Pacific Northwest Laboratory, Oak Ridge National Laboratory, Idaho Chemical Processing Plant, and Sandia Laboratories. During that meeting, the following set of parameters (listed in order of priority) was determined to be applicable and important to the selection of a space disposal waste form.

High waste loading - This is an important parameter when considering the disposal of the large mass of commercial or defense HLW. Waste forms having high waste loadings will require fewer launches, thus not only lowering operational costs but also yielding lower construction costs for dedicated launch facilities. Rating: primary importance.

High thermal conductivity - Commercial HLW, especially in waste forms having high waste loadings, generates a significant quantity of heat. To prevent central regions from becoming excessively hot, the waste form should possess a relatively high heat transfer coefficient. Similarly, upon unplanned reentry of a waste package, the waste form should be capable of rapidly conducting heat away from the container surface. Low heat waste payloads imply that this is not an important consideration. Rating: primary importance.

Toughness - An aspect of dispersion resistance is material toughness. The waste form should be shatter- and abrasion-resistant upon impact, and should deform to absorb impact. Retrieval of the waste form as a single piece rather than many fragmented parts is desirable. Powdered forms are not desirable; liquid forms are unacceptable. Rating: primary importance.

Thermochemical stability - In launch pad or reentry accidents, the waste form should remain chemically stable. It should not degrade, decompose, or otherwise be altered in its chemical form in such a way that a significant release of radionuclides occurs during such postulated accidents. Rating: primary importance.

Resistance to thermal shock - The waste form should be resistant to shattering which may be caused by thermal shock. This property will help in achieving low dispersibility of the waste form. Rating: secondary importance.

Resistance to leaching - A low leach rate may be important if the waste form package impacts into water after an unplanned reentry. While leach rate may be important, it is not as important as in terrestrial disposal where radionuclide transport by ground water is considered the most probable mechanism for loss of isolation. Rating: secondary importance.

Resistance to oxidation - Another aspect of dispersion resistance is waste form resistance to oxidation. If an unplanned reentry of the damaged waste package occurs, the surface of the waste form should not rapidly oxidize and break away from the main body of the waste package. Rating: secondary importance.

Economics and resource utilization - Waste form materials and fabrication processes should not be prohibitively expensive. Also, waste form materials should not severely deplete valuable raw materials. Since the cost of a booster launch is expected to be the major part of the total cost, waste form material and process costs will not be overly important. Rating: secondary importance.

For the waste form, the maximum temperature limit for normal conditions is 90 percent of the fabrication or creep absolute temperature; for accident conditions the limit is 90 percent of the melting absolute temperature. Mechanical limits, when applicable for containment, are yield (normal) and ultimate strengths or low dispersion (accident). Chemical limits require that the waste form be compatible with container materials, exhibit low reactivity, and be nonpyrophoric. It is also required that a subcritical condition be maintained at all times (see discussion on criticality in Section 2.1.4).

2.1.2.3.2 Primary Container/Core

The primary container, designed to enclose the waste form throughout all mission phases beyond waste form fabrication, is also the primary containment boundary. The thermal limit for normal conditions is 40 percent of the melt absolute temperature. For accident conditions, 90 percent of the melt absolute temperature is the guideline. Mechanical limits are yield (normal) and ultimate strengths or low dispersion (accident). Chemical limits are covered by existing federal regulations (U.S. NRC, 1978).

2.1.2.3.3 Radiation Shield

The radiation shield for flight should be designed to function during all mission phases through transfer to the final destination. The radiation

shield should be supplemented with auxiliary shielding materials, as needed during various mission phases, such that radiation exposure limits are not reached. For mechanical strength, 90 percent of the yield (normal) and 90 percent of the ultimate (accident) stress limits apply (ultimate does not apply for launch and orbit transfer operations). Thermal limits are 40 percent of the melt absolute temperature (normal conditions) and 90 percent of the melt absolute temperature (accident conditions). Chemical requirements will be similar to those in existing federal regulations (U.S. NRC, 1978).

Radiation shielding limits for the payload package (1000 mrem/hr at 1 m) have been assumed for conditions not covered by existing regulations. Conservative limits (such as those for transportation) have not been selected due to the sensitivity of the overall system design (payload/shield mass ratio) to the dose limits. Rather, the guideline limits chosen reflect the fact that the waste payload package will be isolated from the general public throughout all but a small fraction of its lifetime.

2.1.2.3.4 Impact Absorber and Ablation Shield

The impact absorber and ablation shield have similar containment limits. For thermal guidelines, 40 percent of the melt (normal) and 90 percent of the melt (accident) absolute temperatures apply to the impact absorber; 40 percent of the minimum ablation temperature (absolute) applies as the upper limit for the ablation shield under normal conditions. For mechanical strength, yield (normal) limits exist. The absorber and ablation shield will be chemically nonreactive with other containment layers (similar to other DOT/NRC regulations). They will be nonpyrophoric. The impact absorber is designed to absorb mechanical energy during accidents. The yield strength of the absorber material is expected to be exceeded. Therefore, the ablation shield, which is designed to reduce heating effects during possible reentry phases, is not expected to survive ground or water impact.

2.1.2.3.5 Shipping Cask

During ground-based Earth transport, the high-level waste package will be enclosed within a shipping cask. Current U.S. federal regulations [10 CFR 71 (U.S. NRC, 1978), 49 CFR 173 (U.S. DOT, 1979) and the 1973 IAEA Safety Series Number 6] define the requirements for this component, which is expected to be similar to conventional shipping cask designs.

2.1.2.4 Mission Phases

As described previously, the containment guidelines are also a function of mission phases, and, more specifically, the conditions within each phase. The definition of mission phase, as used for containment guidelines, is chronological.

2.1.2.4.1 Fabrication/Assembly

This phase begins with the insertion of the waste form into the primary container, and ends with the beginning of transport of the flight-shielded primary container out of the fabrication facility. During this phase, auxiliary cooling and additional shielding may be required. The primary container is the principal containment barrier during this phase.

2.1.2.4.2 Terrestrial Transport

This phase begins at the time of loading of the waste container and shield into the shipping cask and ends with the unloading at the launch site. Throughout this phase, active auxiliary cooling may be required to maintain thermal limits. At both ends of the phase, additional shielding may be required. The requirements are defined for irradiated nuclear materials in existing U.S. regulations. They are expected to be similar to regulations governing transport of processed waste. While in the shipping cask, the cask vessel will be the principal containment barrier during transport.

2.1.2.4.3 Launch Site Handling

This phase, similar to the initial one, begins with the arrival of the shipping cask at the launch site and ends with the completion of transfer into the launch system. Auxiliary cooling, and additional shielding, may be required during this phase depending on the waste form characteristics. The principal containment barrier remains the primary container.

2.1.2.4.4 Launch to Earth Orbit

This phase begins with the loading of the waste payload into the launch system, and ends after Earth orbit has been achieved. Auxiliary cooling may be required for most of this phase depending on the waste form characteristics. Containment will rely principally on the primary container. Accident conditions that might occur during this phase are among the most severe. The guidelines during this phase allow for (1) no melting, and (2) no significant failure of the waste container.

2.1.2.4.5 Orbit Transfer to Destination

This mission phase commences with the removal of the waste payload from the launch system upon arrival at Earth orbit, and concludes with the payload arrival at the final destination. No active auxiliary cooling will be required during this phase. Containment guidelines for this phase (and the long term) are expected to be less restrictive than those for near-term phases involving greater chances of public exposure. The radiation shield, primary container, and waste form provide the principal containment barrier for the waste.

2.1.3 Accident Environments

The accident environments that need to be considered in the design of containment and other auxiliary systems are as follows:

- Shipping accidents
- Ground handling accidents
- On-pad or near-pad booster vehicle failures
- Reentry accidents.

2.1.3.1 Shipping Accident Environments

DOT and NRC regulations, as defined in 49 CFR 170 to 179 (U.S. DOT, 1979) and 10 CFR 71 (U.S. NRC 1978), will be assumed for the ground shipment of nuclear waste payloads from the waste payload fabrication facility to the launch site. Sequential test environments for shipping cask accidents are given below. Initial conditions are assumed the same as for the normal condition.

- A 9-m drop in worst orientation onto an unyielding surface
- A 1-m drop in the worst orientation onto the end of 15-cm-diameter, 20-cm-high bar (mild steel)
- A 30-min ground fire at 800 C followed by 3 hours of no artificial cooling, with a cask emissivity of 0.9 and cask absorptivity of 0.8
- An 8-hour immersion in 0.9 m of water.

At the end of this test, the shipment will meet the conditions specified in 10 CFR 71.36, including:

- (1) An external radiation dose rate not exceeding 1000 mrem/hr at 1 m from the external surface of the waste package
- (2) No release of radioactive material from the package, except for gases and contaminated coolant containing total radioactivity exceeding neither:
 - (a) 0.1 percent of the total radioactivity of the package contents; nor
 - (b) 0.01 Ci of Group I radionuclides
0.5 Ci of Group II radionuclides
10 Ci of Group III radionuclides
10 Ci of Group IV radionuclides, and
1000 Ci of inert gases irrespective of transport group.

2.1.3.2 Ground Handling Environments

The payload systems, auxiliary support equipment, and facilities must be designed to minimize the occupational radiation exposure to workers (see Table 2-1). Care must also be taken to ensure that if certain subsystem failures occur during ground handling, radiation exposure and contamination are kept to as low as reasonably achievable. The waste payload preparation facility at the launch site should be designed as a total containment facility.

2.1.3.3 On- or Near-Pad or Ascent Booster Accident Environments

The payload package must be designed to survive the predicted accident environments for a given time in the flight for a given vehicle (see Rice et al, 1980a) in expected sequence without a major breach of primary containment. Initial conditions are assumed to be the normal condition. An example of predicted environments is given below for the on- or near-pad for liquid boosted Space Shuttle (from Rice et al, 1980a). This example would generally provide the worst-case accident potential, assuming proper consideration of ground impact.

- A blast side-on overpressure of 250 N/cm², a reflected overpressure of 1700 N/cm², and side-on and reflected impulses of 2.0 and 15.0 N·s/cm², respectively, in worst orientation based upon a 10 percent explosive yield of the External Tank (ET) propellants.
- A potential edge-on penetration of 1 impacting fragment per m², assumed to be a disc 100 cm in diameter and 0.56 cm thick, having a mass of 12 kg, and moving at 500 m/s (assuming the worst orientation).
- A heat flux of 3500 kW/m² for 15 seconds from a liquid propellant fireball.
- A 60-min ground fire at 1100 C followed by 2 hours of no artificial cooling.
- An impact in the worst orientation onto an unyielding surface at 10 percent higher than the predicted impact velocity; or an impact onto land such that the payload is buried, in low conductivity soil ($k = 0.35 \text{ W/m}^2\cdot\text{C}$), but does not reach 90 percent of the melt absolute temperature.
- An impact in the worst orientation into 25 C water at a velocity 10 percent higher than the predicted impact velocity, followed by a descent into the ocean to a depth corresponding to a hydrostatic pressure of 12,000 N/cm².

- An impact while restrained in the flight support system mounted in the Orbiter cargo bay at any of the combinations of velocity and direction as shown in Figure 2-1, followed by a TBD crushing load imposed by the Orbiter structure (see Reinert et al, 1981).

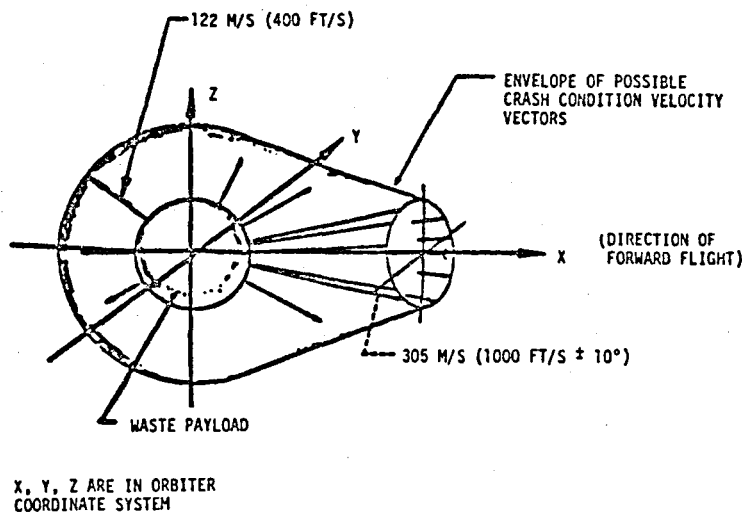

FIGURE 2-1. RECOMMENDED DESIGN CRITERIA FOR SHUTTLE CRASH IMPACT ANGLE

2.1.3.4 Reentry Accidents

The payload package shipped to its space destination must be able to withstand inadvertent reentry into the Earth's atmosphere and impact onto the Earth's surface without the dispersion of significant quantities of radioactive material. The reentry environments that must be considered for the space disposal mission are defined as follows:

- A decaying reentry trajectory (shallow angle Skylab type) to provide maximum heating energy possible.
- A reentry trajectory (steep angle) which provides the maximum heating flux possible.
- An impact in the worst orientation onto an unyielding surface (western granite) at a velocity 10 percent higher than the predicted impact velocity, or an impact onto land such that the reentering waste payload is buried in low conductivity soil ($k = 0.35 \text{ W/m}^2 \cdot \text{C}$), but the waste form does not reach 90 percent of the melt absolute temperature.

- An impact in the worst orientation into 25 C water at a velocity 10 percent higher than the predicted impact velocity, followed by a descent into the ocean to a depth corresponding to a hydrostatic pressure of 12,000 N/cm².

The response of the payload package to the reentry environments mentioned above should be calculated after the possible reentry conditions have been determined by analysis for a specific disposal mission type.

2.1.4 Criticality

The radioactive waste payload package must be subcritical (calculated K-effective $+3\sigma < 0.95$) for normal operations or any possible credible accident during processing, fabrication, handling, storage, or transport to the space destination. Calculations should show that any credible change in waste form geometry and any credible grouping of packages will not cause K-effective $+3\sigma$ to exceed 0.95.

2.1.5 Postaccident Recovery

Postaccident recovery teams should be made part of the operational disposal system. They should be responsible for all accident recovery operations, including accidents involving processing, payload fabrication and railroad shipment, payload preparation at the launch site, the launch, and possible reentry. Special recovery equipment should be developed and provided for possible use in postaccident recovery activities. Every credible eventuality should be considered in developing recovery plans. Every effort should be made to recover as much waste material as possible.

2.1.6 Monitoring Systems

Monitoring systems should be developed for the overall system such that overall mission safety can be assured. Examples of such systems include: devices for measuring radiation; temperature and pressure in the waste payload package; instruments to provide data for tracking the payload during its transit to its desired destination; and permanent labeling specifying the product, contents, history, and radiation projection of the waste contents.

2.1.7 Isolation

The nominal space destination should ensure, at a minimum, an expected isolation time from the Earth's biosphere in excess of one million years, and should not adversely interfere with normal space operations projected to be carried out by future generations. Careless contamination of celestial bodies should be avoided.

2.2 Specific Safety Guidelines

The following paragraphs define specific safety design guidelines established (based upon the general guidelines) for the Reference Concept for space disposal of nuclear waste (as defined in Section 3.0). Safety aspects not stated here are inferred from the general safety guidelines. As the Reference Concept changes, these guidelines may also change. The safety guidelines are discussed in terms of Reference Concept elements.

2.2.1 Waste Form

For normal conditions, a cermet temperature of 1050 C (90 percent of fabrication absolute temperature) shall not be exceeded. For accident conditions, a cermet temperature of 1050 C (90 percent of melt absolute temperature) shall not be exceeded. Criticality requirements shall also be met.

2.2.2 Waste Processing and Payload Fabrication Facilities

The design and operation of these facilities will follow current proposed regulations, as specified for reprocessing plants.

2.2.3 Shipping Casks and Ground Transport Vehicles

Shipping casks and ground transport vehicles will comply with DOT and NRC regulations. The maximum outside diameter of the shipping cask will be 3.05 m (10 ft). When required for heat rejection, a redundant cooling system for the shipping cask will be required.

2.2.4 Payload Primary Container/Core

For normal conditions, the outer surface of the primary 316 stainless steel container/core shall not exceed a temperature of 416 C (40 percent of melt absolute temperature). No chemical nor physical interaction will occur between the cermet waste form and the container. For accident conditions, the primary container must not exceed a temperature of 1280 C (90 percent of melt absolute temperature).

2.2.5 Radiation Shield

The radiation shield, including outer layer shielding contributions for flight systems, will be designed to limit radiation to no more than 1000 mrem/hr at 1 m from the package surface under normal conditions. The Inconel-625 shield itself, when stripped of all outer "nonshielding" layers of the payload package, will not exceed 2000 mrem/hr at 1 m from the shield. Auxiliary shielding will be designed such that radiation exposure limits (see Tables 2-1 and 2-2) for ground personnel and flight crews are not exceeded during handling or flight operations.

For normal conditions, the temperature limit for the flight radiation shield is 363 C (40 percent of melt absolute temperature). For accident conditions, the stainless steel radiation shield must not exceed the temperature of 1157 C (90 percent of melt absolute temperature).

2.2.6 Reentry Systems

The reentry system for the Reference Concept includes two basic systems: the booster vehicle reentry system and the payload package reentry system.

The booster vehicle reentry system is the Space Shuttle Orbiter. It has the capability to detach from the ET and perform a controlled maneuver to a proper safe landing site (return-to-launch site, abort-to-contingency landing strip, abort-to-orbit, abort-to-sea, or abort-to-land) at almost any time in the flight. The Orbiter has sophisticated and redundant guidance and control systems, an elaborate thermal protection system, as well as a manned crew, which will all aid in the safe return to Earth of the payload package as a result of a critical ascent booster system failure. In addition, the Orbiter will carry a structural pallet (to support the waste during launch) that will reduce the Orbiter crash-landing loads placed on the payload package. Also, the Orbiter will provide systems which will allow for Orbiter flotation in the event of a ditching at sea.

The reentry system for the waste payload package must include provisions to survive expected on-pad and reentry accident environments. The system must include: (1) provisions for absorbing the expected external impact loads, (2) a fire and reentry thermal protection system, and (3) a transmitter for recovery. The thermal protection system will not ablate more than 50 percent of its initial thickness during postulated worst-case reentry environments. The outer side of the package will have proper labeling.

2.2.7 Launch Site Facilities

The launch pad used for launching nuclear waste into space should be a dedicated pad. The Nuclear Payload Preparation Facility (NPPF) should be designed as a total containment facility.

2.2.8 Uprated Space Shuttle Launch Vehicle

The Uprated Space Shuttle launch vehicle design will reflect considerations of keeping on-pad accident environments as low as possible. Every effort will be made to save the payload and crew from adverse accident environments.

2.2.9 Earth Parking Orbits

Intermediate Earth parking orbits shall be incorporated into the flight profiles of space transportation systems to allow a minimum of 6 months before orbital decay of the nuclear waste payload package could occur.

2.2.10 Orbit Transfer Systems

Achievement of payload delivery is defined as starting in the proper Earth parking orbit and ending within the bounds of the following: 0.85 ± 0.01 A.U. and 1.00 ± 0.20 degrees inclination.

2.2.11 Space Destination

The nominal space destination solar orbit at 0.85 A.U., 1 degree from the Earth's orbital plane, will be verified by proper analysis to provide an expected isolation time of at least one million years.

2.3 Definition of Terms

The following terms are defined in the context of the safety guidelines as used in this section:

Ablation Shield - a layer of protective package material attached to the outside surface of the payload. It is designed to reduce the heating effects during inadvertent atmospheric reentry.

Accident Conditions - as contrasted to normal conditions, are low in probability and high in severity. The corresponding philosophy for the containment barrier is to survive accidents with low consequences rather than remain in an operable state.

ALARA - less than maximum allowable and as low as reasonably achievable. Federal regulations require this principle to be used in most nuclear technology license applications.

Barrier - any medium or mechanism by which either release of encapsulated radioactive waste material is retarded significantly or human access is restricted. Examples of barriers are the waste form, the primary container, and isolation.

Containment - a condition in which a hazardous material is isolated from the environment to an acceptable degree.

Criticality - a measure of the capability of sustaining a nuclear chain reaction in a package containing fissile materials.

Decomposition - any significant change in physical or chemical properties resulting in a reduction in mechanical strength, etc.

DOT - U.S. Department of Transportation; regarding handling of nuclear materials, Title 49 of the Code of Federal Regulations, Parts 173.389-173.399.

Fabrication - that stage of the waste treatment process in which the waste form is fabricated to its proper shape and placed within the primary container.

Fracture Toughness - the measure of a material's ability to absorb energy during plastic deformation; resistance to fracture.

High-Level Waste - the waste product resulting from the first separation step of Purex fuel-reprocessing operations.

Impact Absorber - that portion of a nuclear waste payload package intended to be an energy absorber while reducing impact forces transmitted to the payload.

Launch Site - the location on Earth's surface from which the space disposal missions are launched.

Material Interaction - the behavior of materials in contact with one another where a significant change in physical or chemical properties results.

Normal Conditions - conditions that result from normal handling and transportation operations. No irreversible effects shall result to a containment barrier.

NPPF - Nuclear Payload Preparation Facility; that launch site facility providing interim storage and remote handling operations for the waste payload from the time of receipt at the launch site until launch operations begin.

NRC - U.S. Nuclear Regulatory Commission; regarding transportation of nuclear materials, Title 10 of the Code of Federal Regulations, Part 71.

Primary Container/Core - the shell or vessel, adjacent to the high-level waste form, that provides containment throughout all mission phases.

Radiation Shield - that component of the payload package which is intended to reduce the nuclear radiation environment to acceptable levels.

Rem - roentgen equivalent, man; a unit of radiation dose which takes into account the relative biological effectiveness of radiation energy deposition.

Shipping Package - an enclosure and its systems licensed to transport radioactive materials (including high-level waste).

SOIS - Solar Orbit Insertion Stage used to insert (circularize) the payload package into the proper 0.85 A.U. solar orbit.

Up-rated Space Shuttle - reference launch vehicle for nuclear waste disposal in space. Vehicle uses Liquid Rocket Boosters and has a payload capability of 45,400 kg.

3.0 SPACE DISPOSAL CONCEPT DEFINITION

The purpose of this section is to summarize the various concept definitions currently envisioned for the nuclear waste disposal in space mission. The concept definitions described herein have developed over the years and represent the works of PNL and Boeing during the 1981-1982 time period (see Reinert et al, 1982 and McCallum et al, 1982). One "Reference Concept", defined for use in this study, was selected by a committee made up of NASA, ONWI, BCL, PNL, SAI, and Boeing representatives. Considerations that were given in selecting the Reference Concept included: (1) potential for risk benefit, (2) short- and long-term safety, (3) cost, (4) current state of technology, and (5) expected directions of NASA developments. An overview of the Reference Concept is given in Figure 3-1. Section 3.1 defines the overall Reference mission, giving emphasis to operational or procedural aspects. Definitions for specific Reference mission elements (e.g., waste payload characteristics, space systems, and facilities) are provided in Section 3.2; emphasis is on hardware and facilities. Section 3.3 describes the major contingency plans and systems that have been defined for the overall Reference mission to minimize effects caused by possible accidents and/or malfunctions. General space system hardware and propellant requirements for the waste disposal activity are identified in Section 3.4. Section 3.5 provides definition of alternative waste payloads (e.g., technetium and iodine).

3.1 Overall Reference Mission

The major aspects of the Reference mission defined in this section are illustrated in the pictorial view in Figure 3-2. This mission profile has been divided into seven major activities. The first two activities are expected to be the responsibility of the U.S. Department of Energy (DOE), and the last five are expected to be NASA's. These are:

- (1) Nuclear Waste Processing and Payload Fabrication
- (2) Nuclear Waste Ground Transport
- (3) Payload Preparation at Launch Site
- (4) Prelaunch Activities
- (5) Launch Vehicle Operations
- (6) Orbit Transfer System Operations
- (7) Payload Monitoring.

Rescue and recovery systems are discussed in Sections 3.2 and 3.3. Definitions and requirements for individual system elements are discussed in Section 3.2.

3.1.1 Nuclear Waste Processing and Payload Fabrication

Typically, spent fuel rods from domestic power plants would be transported to the waste processing and payload fabrication sites via conventional

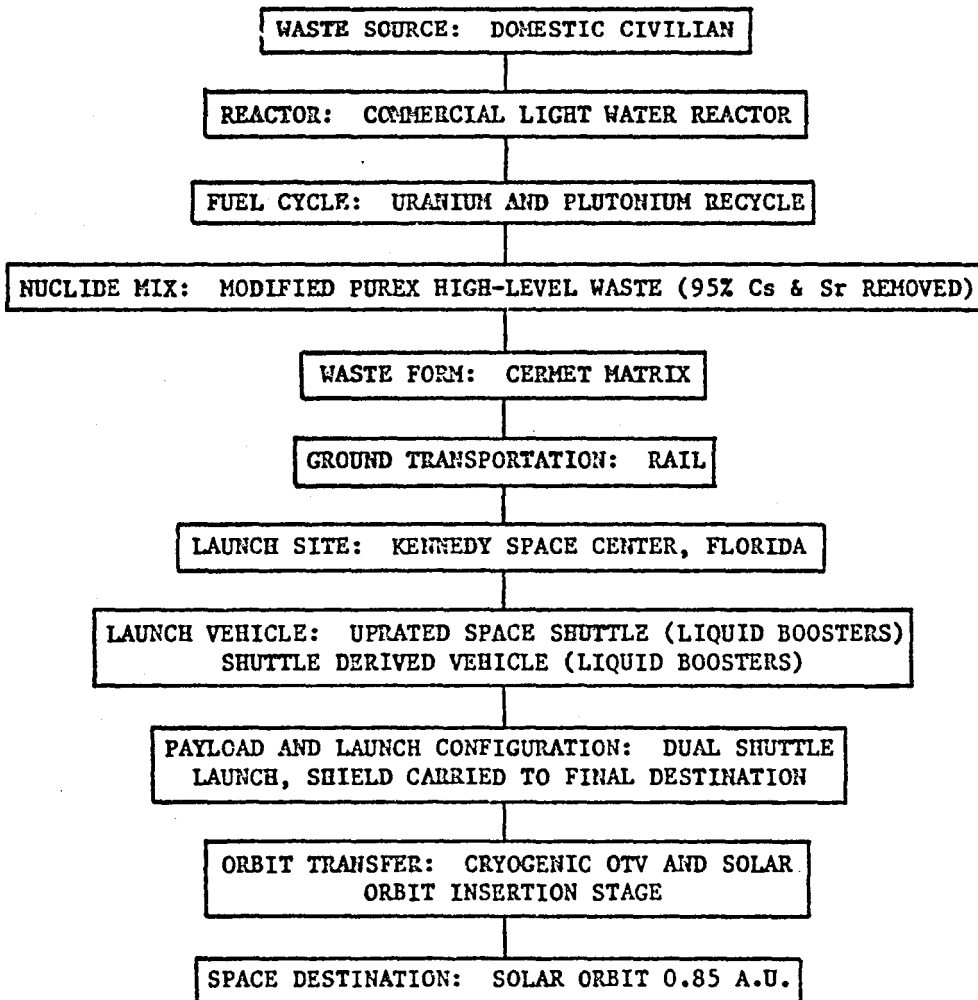

FIGURE 3-1. OVERVIEW OF REFERENCE CONCEPT FOR INITIAL NUCLEAR WASTE DISPOSAL IN SPACE

ORIGINAL PAGE IS
OF POOR QUALITY

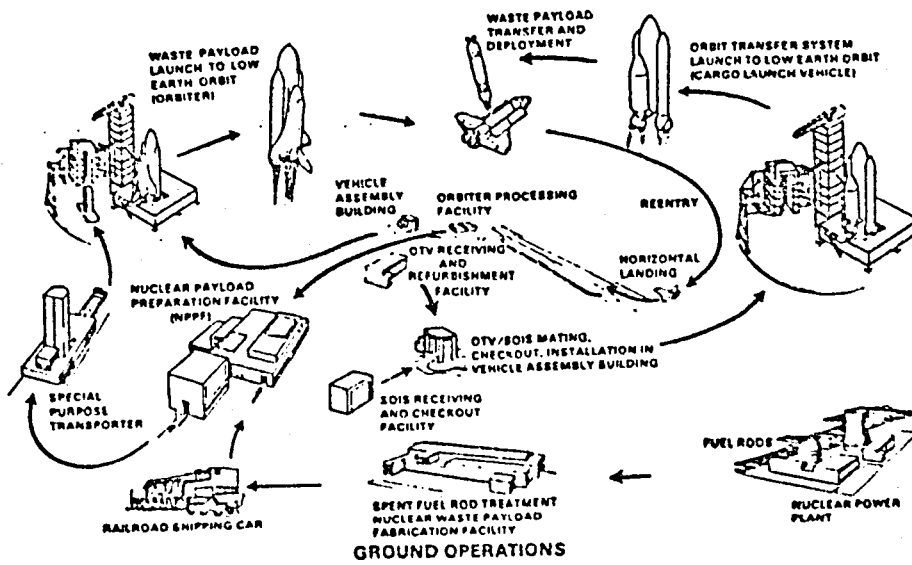
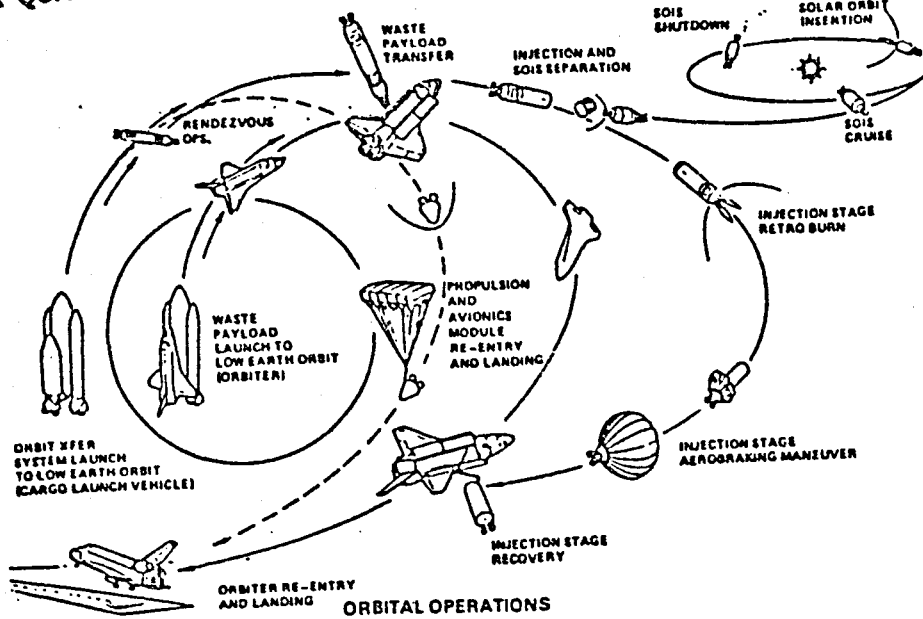

FIGURE 3-2. GROUND AND SPACE OPERATIONS FOR REFERENCE SPACE DISPOSAL MISSION

ORIGINAL PAGE IS
OF POOR QUALITY

28

shipping casks. Using a Purex process, high-level waste containing fission products and actinides, including 0.5 percent plutonium and 0.1 percent uranium, would be processed from these spent fuel rods. Additional processing would remove 95 percent of the cesium and strontium for disposal in the mined geologic repository. Additional plutonium, processed from transuranic (TRU) wastes, would be added to the mix for space disposal. The mix would be aged for roughly 50 years.* The resulting high-level waste for space disposal would be formed into a cermet matrix by a calcination and hydrogen reduction process. At the appropriate time, the waste form would be fabricated into cylindrical billets (3167 billets, each 5.858 cm in diameter). The waste billets would have a mass of 3000 kg. Within a remote shielded cell, the waste billets would be loaded into a spherical container/core; the container/core would be closed and sealed, inspected, decontaminated, and packaged into a flight-weight gamma radiation shield assembly (see Figure 3-3).

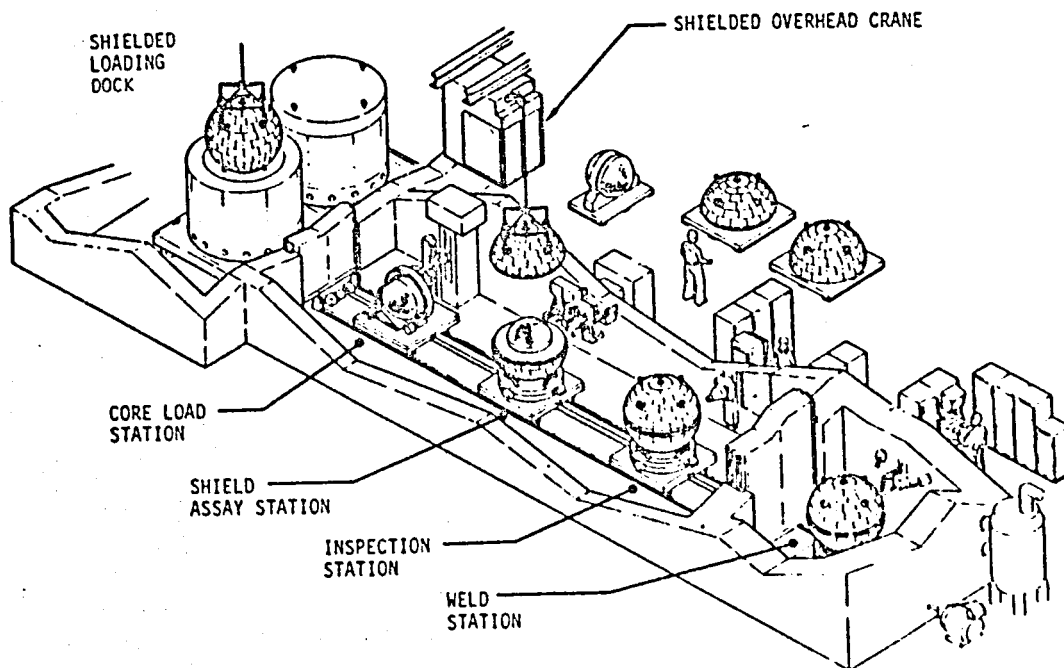

FIGURE 3-3. WASTE PAYLOAD ASSEMBLY FACILITY (FROM BOEING STUDY)

*Note: Fifty-year aging was recommended by PNL to be the most sensible way of reducing the heat production in the waste, such that postburial meltdown would not occur should there be inadvertent reentry (see Safety Guidelines, Section 2.1.2, Containment).

3.1.2 Nuclear Waste Ground Transport

The shielded waste container would be loaded into a ground transportation shipping cask. This cask, which would provide additional shielding and thermal and impact protection for the waste container to comply with the NRC/DOT regulations, would then be loaded onto a specially designed rail car for transporting the waste container from the waste payload fabrication site to the Kennedy Space Center (KSC), Florida launch site. Once the cask reaches the launch site, it would be unloaded into the shielded loading dock of the Nuclear Payload Preparation Facility (NPPF).

3.1.3 Payload Preparation at Launch Site

The Nuclear Payload Preparation Facility (NPPF) would provide interim storage capability for a number of shielded waste payloads, affording efficient preparation for launches plus capacity for unplanned delays (see Figure 3-4). During storage, additional radiation shielding, thermal control, monitoring, and inspection of the waste payloads would be provided.

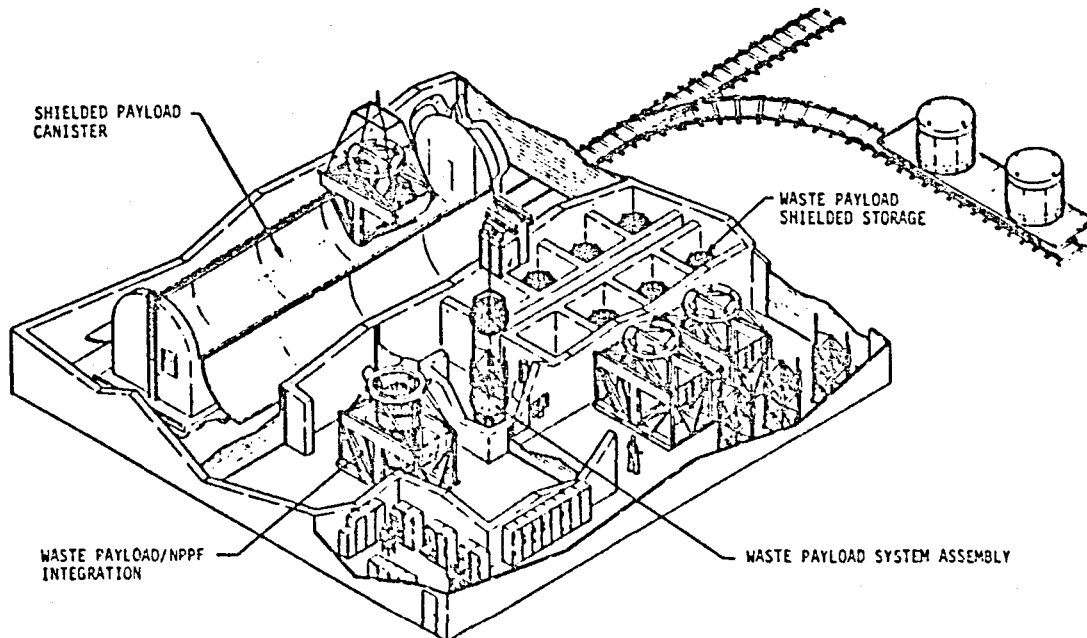

FIGURE 3-4. POSSIBLE CONCEPT FOR A NUCLEAR PAYLOAD PREPARATION FACILITY (NPPF) (FROM BOEING STUDY)

3.1.4 Prelaunch Activities

In preparation for launch, the nuclear waste payloads are prelaunch-checked in the NPPF. The first waste payload (waste form, core, radiation shield, and graphite/steel tiles) is mounted on the build-up frame in the assembly canyon (see Figure 3-4). The interpayload support structure is

remotely installed on the waste payload. The second waste payload is then mounted on the interpayload support structure. The installations are accomplished using a shielded crane. The waste payload system is installed in the flight support system, and is either stored for later flight or installed into a shielded canister. The payload canister is shielded to further reduce the external dose rate and is designed to provide commonality with the Rotating Service Structure (RSS) and Orbiter interfaces and to accommodate remote installation and removal of the waste payload system. The canister is transported to an area where it is erected and taken to the RSS at the Launch Complex.

Transfer of the payload and supporting structure to the launch pad's Rotating Service Structure (RSS) is accomplished by a special-purpose transporter which maintains the Shuttle payload and its supporting structure in the proper position for installation in the Orbiter cargo bay. Payload transfer from the NPPF to the pad is made after the Shuttle vehicle installation at the launch pad has been completed. The waste payload is remotely installed in the Orbiter using a payload ground-handling mechanism. After payload installation and final systems checkout have occurred, and the OTV/SOIS has been properly positioned on orbit, the decision to launch is made.

The OTV, which provides escape from low-Earth orbit and insertion into the heliocentric transfer trajectory, and the SOIS, which circularizes the waste payload into the solar orbit disposal destination, are prepared for launch in the OTV Processing Facility.

3.1.5 Launch Vehicle Operations

One Uprated Space Shuttle and one Shuttle Derived Vehicle (SDV) would be readied for launch for a given disposal mission. Pad C, which is to be constructed at KSC Launch Complex 39, would be used to launch the nuclear-payload-carrying Uprated Space Shuttle. Pads A or B would be used for the SDV launch.

The SDV would be launched first to place the orbit transfer system (OTV/SOIS) in a 370-km circular orbit inclined 38 degrees to the equator. The SDV propulsion and avionics module would reenter and be recovered for reuse.

Approximately four hours after SDV launch, the Uprated Space Shuttle, with two waste packages, would be launched to rendezvous with the orbiting OTV/SOIS. The Shuttle Orbiter would approach the OTV/SOIS using its vernier thrusters. There would be a soft docking, at which point the Orbiter's attitude control would be shut down. Several hours later a transfer of the payload to the OTV/SOIS in the cargo bay of the Orbiter would occur. The Orbiter and OTV/SOIS would then separate, and the Orbiter would back off from the OTV/SOIS/payload at a velocity of 0.5 m/s.

After the OTV delivers the nuclear waste payload and SOIS to the desired trajectory and returns to a low-Earth orbit, the Orbiter would rendezvous with the OTV and return it to the launch site to be refurbished for use on a later mission.

3.1.6 Orbit Transfer System

After the OTV/SOIS/waste payload system has passed final systems checkouts, the OTV propulsive burn will place the SOIS and its attached waste payload on the proper Earth-escape trajectory. Control of the propulsive burn from low-Earth orbit will be from the aft deck payload control station on the Orbiter, with backup provided by a ground control station. After the burn is complete, the SOIS/waste payload is then released. In approximately 165 days the payload and the cryogenic LOX/LH₂ propellant SOIS will travel to its perihelion at 0.85 A.U. about the Sun. [One astronomical unit (A.U.) is equal to the average distance from the Earth to the Sun.] The SOIS will place the payload in its final space disposal destination by reducing the aphelion from 1.0 to 0.85 A.U. To aid in obtaining the desired orbital lifetimes, this orbit will be inclined to the Earth's orbital plane by 1 degree.

Recovery burns using the remaining OTV propellant and aerobraking will return the OTV to low-Earth orbit for rendezvous with the Shuttle Orbiter for subsequent recovery, refurbishment, and reuse of the OTV on a later mission. The reference OTV/SOIS mission profile is shown in Figure 3-5.

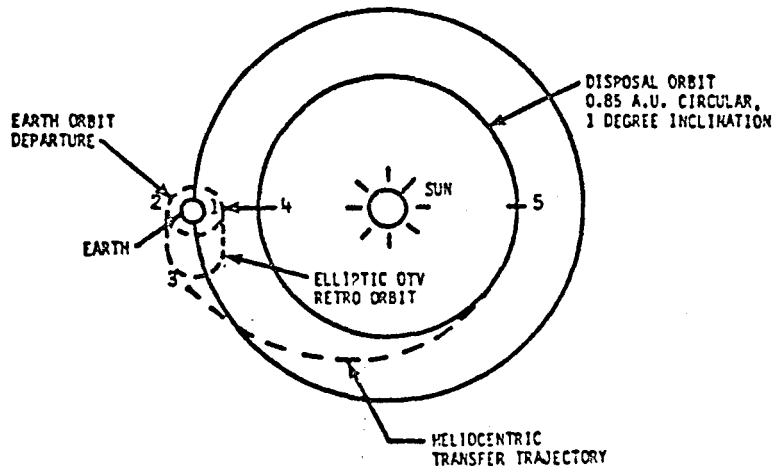

- 1-2 Up-rated Space Shuttle (45,400-kg payload) and Shuttle Derived Vehicle ascent from Earth to a 370-km circular orbit with a 38-degree inclination.
- 2-3 Prime OTV burn of approximately 32 min for escape from low-Earth orbit on elliptic solar orbit transfer trajectory with perihelion of 0.85 A.U. and 1-degree of inclination to the Earth's orbital plane. The ΔV for this maneuver is 3390 m/s.
- 3 OTV separation from the SOIS/nuclear waste payload and retro burn to an elliptic Earth orbit. The ΔV for this maneuver is 400 m/s. The OTV lifetime for return to the Orbiter is approximately 67 hours. The apogee for this orbit is 61,000 km.
- 4 OTV circularization into the 370-km, 38-degree inclination recovery orbit. The ΔV is 120 m/s.
- 5 SOIS and payload circularization into 0.85 A.U., 1-degree inclination to the Earth's orbital plane. The ΔV is 1280 m/s.

FIGURE 3-5. REFERENCE OTV/SOIS MISSION PROFILE

3.1.7 Payload Monitoring

Monitoring of the Earth escape trajectory of the SOIS/waste payload would be accomplished by ground-based radar systems and telemetry from the SOIS and OTV. The achievement of the final disposal orbit would be monitored by NASA's Deep Space Network. Once the proper disposal orbit has been verified, no additional monitoring is necessary. However, monitoring could be reestablished in the future if required.

3.2 Reference System Elements and Operation Definitions and/or Requirements

The definitions for Reference mission system and operation elements are described below. Thirteen major system elements have been identified for definition here:

- (1) Waste Source
- (2) Waste Mix
- (3) Waste Form
- (4) Waste Payload System
- (5) Shipping Casks and Ground Transport Vehicles
- (6) Launch Site Facilities
- (7) Up-rated Space Shuttle Vehicle
- (8) Shuttle Derived Vehicle
- (9) Orbit Transfer Vehicle
- (10) Solar Orbit Insertion Stage
- (11) Rescue Vehicle
- (12) Flight Support System
- (13) Space Destination.

Definitions for the Reference mission system elements follow.

3.2.1 Waste Source

The primary waste source would be nuclear waste generated by the operation of commercial nuclear power plants and recovered by reprocessing. Table 3-1 provides the most realistic projections of waste generation (assuming 200 GWe by the year 2000) found in the literature (Yates and Park, 1979). By assuming that the waste must be at least 10 years old before it can be reprocessed and be available for disposal, and that reprocessing capacities are able to process the waste according to the proposed schedule, the annual total amount of waste available for disposal is given. Projections of the mass available for eventual space disposal are also given. The mass of waste available annually for eventual space disposal, in cermet form, will increase to 227 metric tons (MT) by the year 2012 (launches would actually occur over a 25-year period beginning in the 2030-2040 time frame). Also shown in the table are projections for technetium and iodine disposal in space.

TABLE 3-1. TWENTY-FIVE YEAR PROJECTED U.S. NUCLEAR POWER GENERATION AND POSSIBLE COMMERCIAL HIGH-LEVEL WASTES AVAILABLE FOR SPACE DISPOSAL (100,000 MTHM BASIS)

Year	Cumulative ^(a) Power, GWe Waste, MTHM		Annual Nuclear Waste Available for Disposal, MTHM/yr	Annual High-Level Purex Waste in Cermet Form ^(b) Available for 30- to 40- Year Storage Before Space Disposal, MT/yr ^(c)	Annual Technetium Waste in Metallic Form Available for Space Disposal, MT/yr ^(d)	Annual Iodine Waste as PbI ₂ Form Available for Space Disposal MT/yr ^(e)
1979	61.9	5890 ^(f)	0	0	0	0
1980	74.8	7690	0	0	0	0
1981	87.3	9790	0	0	0	0
1982	101.1	12,220	0	0	0	0
1983	115.4	14,990	0	0	0	0
1984	131.4	18,140	0	0	0	0
1985	144.3	21,600	0	0	0	0
1986	157.1	25,370	0	0	0	0
1987	164.9	29,330	0	0	0	0
1988	174.0	33,510	0	0	0	0
1989	180.9	37,850	5890 ^(f)	279	4.42	2.36
1990	186.5	42,330	1800	85	1.35	0.72
1991	188.9	46,860	2100	100	1.57	0.84
1992	190.1	51,420	2430	115	1.82	0.97
1993	192.5	56,040	2770	131	2.08	1.11
1994	194.0	60,700	3150	149	2.36	1.26
1995	195.0	65,380	3460	164	2.60	1.38
1996	196.0	70,080	3770	166	2.83	1.51
1997	197.0	74,810	3960	188	2.97	1.58
1998	198.0	79,560	4180	198	3.14	1.67
1999	199.0	84,340	4340	206	3.26	1.74
2000	200.0	89,140	4480	212	3.36	1.79
2001	200.0	93,940	4530	214	3.40	1.81
2002	200.0	98,740	4560	216	3.42	1.83
2003	52.4 ^(g)	100,000 ^(g)	4620	219	3.46	1.85
2004	-- ^(h)	-- ^(h)	4660	221	3.50	1.86
2005	--	--	4680	222	3.51	1.87
2006	--	--	4700	223	3.52	1.88
2007	--	--	4730	224	3.55	1.89
2008	--	--	4750	225	3.56	1.90
2009	--	--	4780	227	3.58	1.91
2010	--	--	4800	227	3.60	1.92
2011	--	--	4800	227	3.60	1.92
2012	--	--	4800	227	3.60	1.92
2013	--	--	1260 ^(g)	60	0.94	0.51
TOTALS		100,000		4725	75.00	40.00

- (a) Projections through 2000 from: Yates, K. R., and U. Y. Park, "Projections of Commercial Nuclear Capacity and Spent-Fuel Accumulation in the United States", *Transactions of the American Nuclear Society*, pp. 350-352 (June 1979).
- (b) Assumes 31.94 kg/MTHM waste for space disposal (including removal of 95 percent of the cesium and strontium) and cermet waste form loading of 67.4 percent (McCallum et al, 1982).
- (c) The waste must be decayed an additional 30 to 40 years before it can be flown into space, given the current Safety Guidelines and payload packaging concept.
- (d) Based on 0.75 kg technetium metal per 1 MTHM (McCallum et al, 1982).
- (e) Based on 0.40 kg PbI₂ per 1 MTHM (McCallum et al, 1982).
- (f) Includes 4400 MTHM existing as of 1978.
- (g) Data match cumulative 100,000 MTHM for MGR Reference Case used in this risk study.
- (h) For purposes of this study, data beyond this point are not shown.

3.2.2 Waste Mix

The waste mix to be disposed of in space is reprocessed high-level waste (containing 0.5 percent of the plutonium and 0.1 percent of the uranium present in the fuel rods at the time of reprocessing) that has been out of the reactor for approximately 50 years. Also, at the time of reprocessing, 95 percent of the strontium and cesium is removed. Gases and TRU wastes, plus 95 percent of strontium and cesium, would go to disposal in the mined repository. Plutonium would be processed out of the TRU wastes; this fraction would be added to the mix and go into space for disposal. The combination of cesium and strontium removal and the 50-year aging of the waste is needed to avoid postburial meltdown for the "Reference-sized" sphere packages flown on a given mission. (Smaller spheres or dilution of the waste form would allow the space disposal of 10-year-old waste.) Waste mix for space disposal amounts to 31.94 kg/MTHM.

3.2.3 Waste Form

The Reference waste form for space disposal is the Oak Ridge National Laboratory (ORNL) iron/nickel-based cermet (ceramic/metal matrix), a dispersion of ceramic particles in a continuous metallic phase. This waste form has been chosen over others because of its expected responses to possible accident environments. The cermet is expected to have a waste loading of the order of 67.4 percent, where 100 percent is defined as high-level waste in oxide form. The thermal conductivity is expected to be about 9.5 W/m·C, and the density is about 6.5 g/cc.

3.2.4 Waste Payload System

The cermet waste form would be made into cylindrical billets that are 5.852 cm long and 5.858 cm in diameter. They would be placed into a 316 stainless steel spherical waste form support structure or core. The core has 241 parallel holes bored in it to accommodate the stacked cylindrical billets (see Figure 3-6). At the waste payload fabrication facility (see Figure 3-3), the billets would be installed in the core using an automatic loading machine. Covers at both ends of each bore would be installed to retain the billets. The loaded core would then be lowered into the lower half of the Inconel-625 container/integral shield. The upper half of the integral shield would then be lowered into place and the upper and lower shield halves electron-beam welded together. Graphite/steel tiles would be preinstalled on the shield halves, except that a "belt" around the equator would be left free of tiles to allow the electron-beam weld. Following the weld, the remaining closeout tiles would be installed using remote-handling equipment. The waste payload is then ready to be placed in a shipping cask for transport to the launch site.

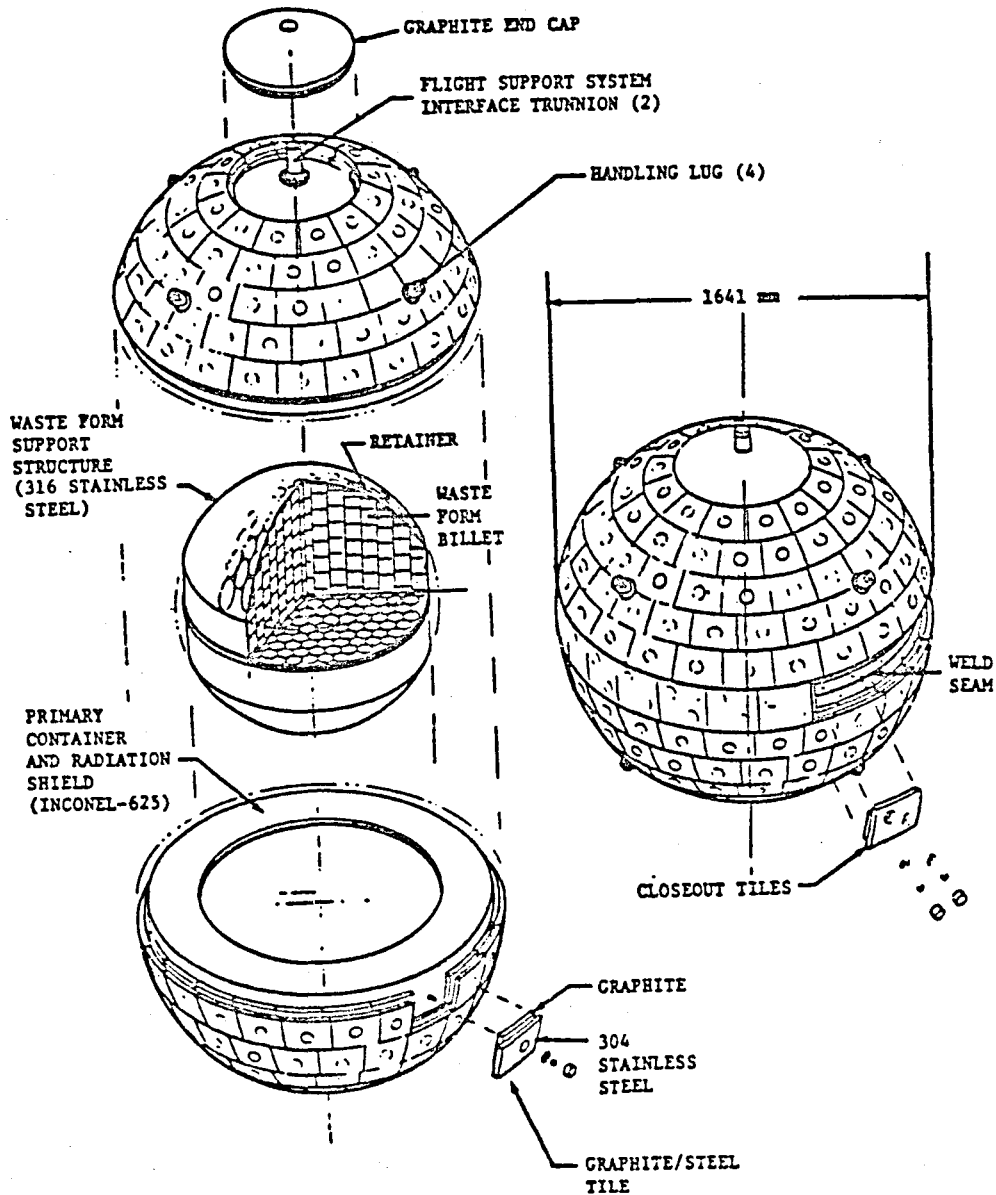

FIGURE 3-6. WASTE PAYLOAD PACKAGE FOR SPACE DISPOSAL

3.2.5 Ground Transport Vehicles and Casks

For transport from the waste fabrication facility to the launch site, the integral waste container shielding would be housed in a shipping cask which would afford additional shielding and thermal and impact protection to meet the Nuclear Regulatory Commission/Department of Transportation regulations (U.S. NRC, 1978). The cask is expected to be licensed by the Nuclear Regulatory Commission. The cask would be transported from the payload fabrication facilities to the KSC launch site on a specially designed rail car which would adequately support and distribute the weight of the cask and provide acceptable tie downs.

3.2.6 Launch Site Facilities

The reference launch site for launching nuclear waste payloads during the early phase of the program is Launch Complex 39 at Kennedy Space Center, Florida. Facilities required to support the Reference Concept for space disposal are given below.

- (1) A secure, sealed, environmentally controlled, Nuclear Payload Preparation Facility (NPPF) to store, cool, monitor, assemble, and checkout the waste payload systems from the time the shielded nuclear waste container arrives at KSC until the time the loaded payload reentry vehicle is moved to the launch pad.
- (2) A dedicated, special-purpose transporter to move the nuclear waste payload from the NPPF to the Rotating Service Structure (RSS) at the launch pad. This includes construction of a roadway or tracks for the transporter to use.
- (3) A dedicated Space Shuttle launch pad (Pad C) for launching nuclear waste payloads. The waste payload would be installed in the Shuttle Orbiter at the pad.
- (4) A Mobile Launch Platform (MLP) for transporting built-up Shuttles from the Vehicle Assembly Building (VAB) to the launch pads. Four MLPs would be required.
- (5) A third firing room in the Launch Control Center (LCC) would have to be activated to handle the increased number of Space Shuttle flights dedicated to the nuclear waste disposal program. This firing room would be used exclusively for the waste disposal missions.
- (6) Processing facilities, including bays, support shops, workstands, and storage, would be needed for:

Orbiter - Two would be required to refurbish the Orbiters and the SDV propulsion and avionics modules between flights.

LRBs - One would be required to checkout LRBs prior to integration in VAB and to refurbish LRBs between flights.

ET - One would be required to buildup and checkout ETs prior to integration in VAB.

Orbit Transfer System - One would be required to integrate and checkout the Orbit Transfer System prior to integration with SDV in VAB and to refurbish the OTVs between flights.

3.2.7 Uprated Space Shuttle Vehicle

During the early years of a space disposal program, the Uprated Space Shuttle (45,400-kg payload to low-Earth orbit, see Figure 3-7) would represent an ideal vehicle to carry out the boost phase of the space transport. The National Aeronautics and Space Administration is now managing the development of the Space Shuttle (to be operational at Kennedy Space Center in 1982), a new class of space booster that is a reusable, low-cost vehicle that can transport payloads to low-Earth orbit and back. Also, the Space Shuttle is a manned piloted vehicle, with an intact mission-abort capability, thus making it much safer than previous manned launch vehicles. It is anticipated that a continued, evolutionary uprating of the Space Shuttle vehicle will occur in the twenty-first century. The uprating assumed here involves the use of the more powerful and environmentally cleaner Liquid Rocket Booster (LRB) as a replacement for the Solid Rocket Booster (SRB).

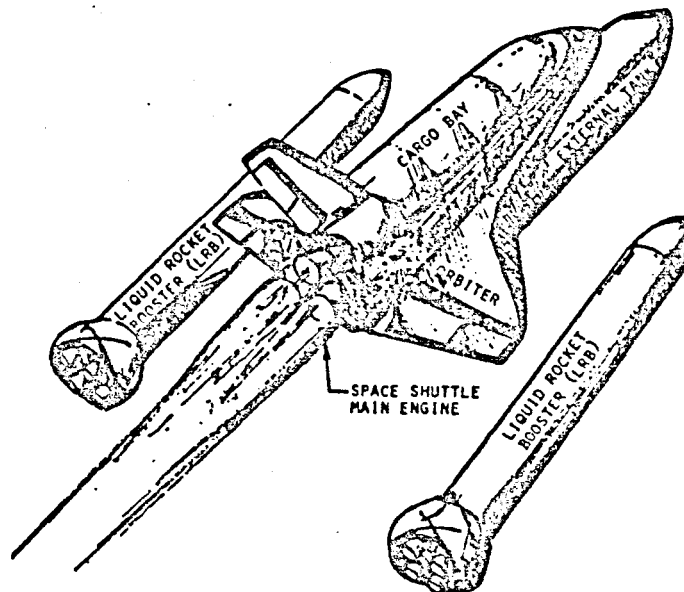

FIGURE 3-7. UPRATED SPACE SHUTTLE VEHICLE

The Up-rated Space Shuttle consists of a piloted reusable orbiting vehicle (the Orbiter) mounted on an expendable External Tank (ET) containing hydrogen/oxygen propellants and two recoverable and reusable Liquid Rocket Boosters (NASA/MSFC, 1979). The propellants for the LRBs are RP-1 (kerosene) and liquid oxygen (LOX), having an oxidizer-to-fuel ratio of 2.9. The Orbiter will have three main hydrogen/oxygen liquid rocket engines and a cargo bay 18.29 m long and 4.57 m in diameter. At launch, both the LRBs and the Orbiter's three liquid rocket engines will burn simultaneously. After approximately 124 seconds and after the Space Shuttle vehicle attains an altitude of approximately 45 km, the LRBs will be separated and subsequently recovered from the Atlantic Ocean. The ET is jettisoned before the Orbiter goes into orbit. The Orbital Maneuvering System (OMS) is then used to propel the Orbiter into the desired Earth orbit. The Orbiter with its crew and payload (weighing up to 45,400 kg) will remain in orbit to carry out its mission. When the mission is completed and the Orbiter has retrieved the OTV, the Orbiter is deorbited and piloted back to the launch site for an unpowered landing on the runway at KSC. The Orbiter and LRBs would subsequently be refurbished and flown on other space missions. NASA/MSFC (1979) provides data on LRBs for the Up-rated Space Shuttle. Table 3-2 provides a Reference mass summary for the Up-rated Space Shuttle Vehicle.

3.2.8 Shuttle Derived Vehicle

The Shuttle Derived Vehicle (SDV), shown in Figure 3-8, consists of: (1) a large aerodynamic payload shroud (cargo bay 7 m in diameter and 30 m long), with the SSME propulsion and avionics pod mounted piggy-back on an expendable External Tank (ET); (2) the ET to supply propellants to the main engines; and (3) two reusable Liquid Rocket Boosters (LRBs) also attached to the ET. The propellants in the ET are liquid hydrogen (LH₂) and liquid oxygen (LOX), while the LRBs use RP-1 (kerosene) and LOX. At launch, both the LRBs and the three liquid rocket engines of the Space Shuttle Main Engine (SSME) pod will burn simultaneously. After approximately 124 s and after the Space Shuttle vehicle attains an altitude of approximately 45 km, the LRBs will be separated and subsequently recovered from the Atlantic Ocean. The ET is jettisoned before the vehicle goes into orbit. During ascent, the payload shroud is jettisoned and reenters and falls into the ocean. After the propulsion and avionics pod carries out its delivery mission, it reenters and is recovered for use on other missions.

3.2.9 Orbit Transfer Vehicle (OTV)

The OTV (see Figure 3-9) is the injection stage which places the SOIS and waste payload into the heliocentric transfer orbit. It would use two RL10-IIB engines in a dual-failure-tolerant main propulsion system. The engines would use LOX and LH₂ as propellants for an oxidizer-to-fuel (O/F) mixture ratio of 6.0 and a specific impulse of 465 s. A ballute deceleration system would be used for aerobraking to reduce velocity when returning to low-Earth orbit. Two Global Positioning System receivers would be used to provide redundancy in navigation of the aerobraking maneuver. The OTV would also have redundant avionics (dual-string system with two computers). With a

TABLE 3-2. MASS SUMMARY FOR UPRATED SPACE SHUTTLE VEHICLE

Vehicle Component/Element	Mass, kg	Weight, lb
<u>Orbiter</u>		
Dry (Less Engines)	63,875	140,821
Engines	9,063	19,980
Personnel and Equipment	1,197	2,640
Residuals and Reserves	<u>4,212</u>	<u>9,285</u>
Total Inert	78,347	172,726
OMS/RCS Propellants	<u>12,322</u>	<u>27,166</u>
Total at Liftoff	90,669	199,892
<u>External Tank (ET)</u>		
Dry	32,757	72,217
Residuals and Reserves	<u>4,276</u>	<u>9,428</u>
Total Inert	37,034	81,645
Usable Propellants (LOX/LH ₂)	<u>711,196</u>	<u>1,567,918</u>
Total at Liftoff	748,230	1,649,563
<u>Liquid Rocket Boosters (Both)</u>		
Dry	126,269	278,376
Residuals	<u>4,853</u>	<u>10,700</u>
Total Inert	131,122	289,076
Usable Propellants (LOX/RP)	<u>1,080,480</u>	<u>2,382,050</u>
Total at Liftoff	1,211,602	2,671,126
Payload	<u>45,360</u>	<u>100,000</u>
Total Vehicle at Liftoff	2,095,861	4,620,581

Source: NASA/MSFC, 1979.

ORIGINAL PAGE IS
OF POOR QUALITY

40

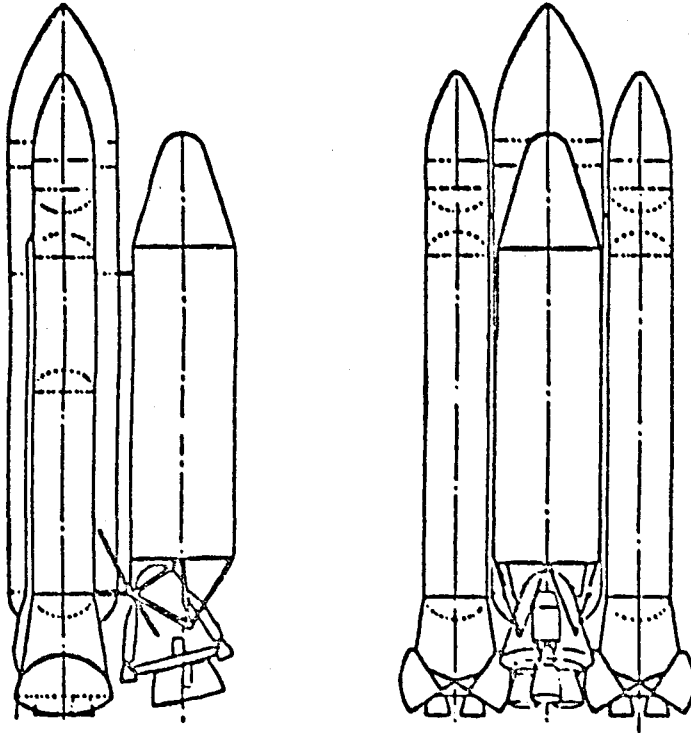

FIGURE 3-8. SHUTTLE DERIVED VEHICLE (SDV)

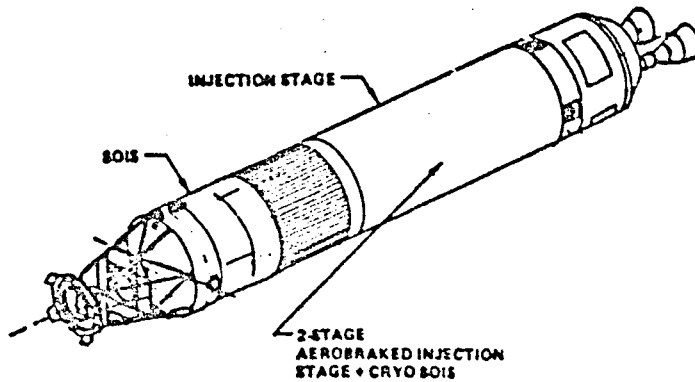

FIGURE 3-9. REFERENCE OTV/SOIS/WASTE PAYLOAD CONFIGURATION

20-mission service life, the OTV is designed to be refurbished after recovery for use again on a later mission.

3.2.10 Solar Orbit Insertion Stage (SOIS)

The Solar Orbit Insertion Stage (see Figure 3-9) is a smaller version of the OTV. The SOIS would use one RL10-IIB engine which has a thrust level of 66.720 N and a specific impulse of 465 s. Redundancy would be built into the guidance and control system with redundant guidance and navigation sensors, three command units (each of which can execute all control functions independently), and two transceivers (transponder, power amplifier, and diplexer) for communications between the SOIS and ground control. The SOIS would be designed to adequately withstand the adverse nuclear radiation and space environments experienced while coasting 165 days before firing.

A payload docking adapter system would be mounted to the front of the SOIS and would be compatible with the Flight Support System docking system. The adapter provides structural support for the waste payload during Orbit Transfer System operations. In case rescue operations should be necessary, redundant rendezvous transponders would be mounted on the payload adapter.

3.2.11 Rescue Vehicle

The rescue vehicle is a Shuttle-launched Orbit Transfer System. It would include appropriate provisions for targeting and docking with the nuclear waste container attached to an OTV/SOIS, the nuclear waste container attached to an SOIS only, or a separated waste container only. It would be reusable or expendable, depending upon the rescue mission. This vehicle would be required to have an on-orbit stay time of at least 308 days, with little reduction expected in reliability or performance. The rescue vehicle may be returned to Earth by the Shuttle Orbiter at the end of the cycle for refurbishment, if recoverable.

3.2.12 Flight Support System

The dual waste payload system is supported in the cargo bay by the flight support system (FSS). The FSS also consists of an extendable docking collar, tilt table, and guide rails. The docking collar is stowed away during launch, but is extended to allow docking of the Orbit Transfer System. The tilt table and guide rails assist transfer of the waste payload to the Orbit Transfer System.

Flight operation of the FSS is described below and is shown in Figure 3-10.

- The Orbit Transfer System docks to the extended docking collar
- The waste payload is rotated 90 degrees by the tilt table

- The waste payload is translated along the docking collar to the Orbit Transfer System, waste payload support system.

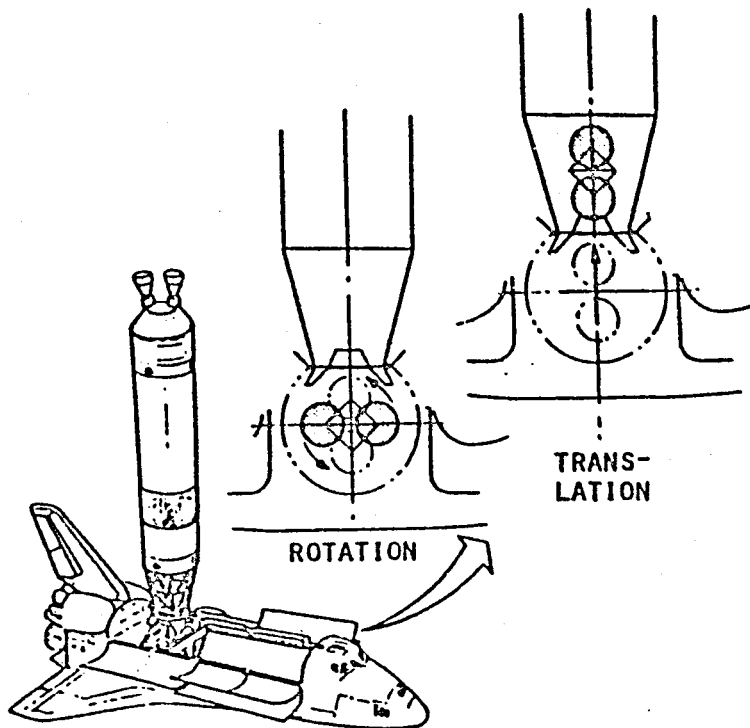

FIGURE 3-10. FLIGHT SUPPORT SYSTEM OPERATION

3.2.13 Space Destination

The Reference space destination for the nuclear waste disposal mission is defined as an orbital region between the orbits of the Earth and Venus. The nominal circular orbit is defined as 0.85 ± 0.01 A.U. The orbital inclination about the Sun is defined as 1 degree from the Earth's orbital plane.

3.3 Accident and Malfunction Contingency Plans for Reference Concept

There are five general phases of the space disposal mission which require development of accident and malfunction contingency plans:

- Ground transportation from the payload fabrication sites to the launch site
- Preflight operations prior to ignition of the Shuttle's engines
- Launch operations from the launch pad to achieving parking orbit
- Orbital operations
- Rescue operations.

Preliminary contingency plans for each of these operational phases are addressed in the following sections.

3.3.1 Ground Transportation

Ground transport (via rail) of the shipping cask would be assigned to the U.S. Department of Energy (DOE), which would supply the necessary accident recovery plans and systems, as needed. Two types of incidents that must be considered are: (1) loss of auxiliary cooling to the waste container, and (2) possible breach of the waste container with a loss of radioactive material. In case of cooling loss, adequate provisions should be made to have self-contained, auxiliary cooling units available within a reasonable time. Monitoring equipment for both container temperature and radiation will be required during all ground transport operations. A continuous capability to cope with a container breach will be necessary. A specially trained accident recovery crew will always be ready to act, if necessary.

3.3.2 Preflight Operations

Contingency plans should be provided for potential malfunctions and accidents that could occur while waste payload packages are in the Nuclear Payload Preparation Facility (NPPF), being transported to the launch pad, being transferred from the pad Payload Changeout Room (PCR) to the Up-rated Space Shuttle cargo bay, and awaiting liftoff in the Shuttle. Accidents and contingency plans would be similar to those discussed in the paragraph above.

3.3.3 Launch Operations

Contingency plans, procedures, and systems envisioned to minimize the hazard caused by on- or near-pad failures are given below. These would minimize the effects of severe blast wave, high-velocity fragments, fire, and possible high-velocity impact.

- A two-Shuttle launch option will allow the two waste payload packages to be launched in a cargo bay completely dedicated to the support of the payload package. This allows additional safety in that (1) no propellant-loaded Orbit Transfer Vehicle is available

to contribute to the close-in accident environment (explosion, fire, high-velocity fragments), and (2) an additional structure can be used to protect the payload packages in the event of a crash landing or catastrophic failure.

- Engine shutdown is an important factor in vehicle survivability as a result of subsystem failures. For the Uprated Space Shuttle, all booster engines are liquid-fueled, and as such, they can be shut down if a failure occurs during the engine start-up process, and prior to actual liftoff. This capability is expected to greatly reduce the probability of an on-pad catastrophic vehicle failure. Also, the abort modes mentioned below become possible.
- Flotation gear and locator beacons in the Orbiter will assist in the recovery operation after ditching at sea.
- Conservatively designed containment systems (e.g., container, shielding impact, and thermal protection systems) will maximize the probability of surviving the possible hostile environments.
- A tough, solid waste form will be used that is not easily dispersed under adverse conditions.
- Appropriate launch constraints (e.g., wind direction) will be applied to reduce human radiological exposure resulting from a potential containment breach from a catastrophic launch accident.
- A recovery team will be ready to rescue the payload at sea or on land.

Systems and procedures, in addition to some of those mentioned above, which would minimize the hazard caused by subsystem failures during the boost phase are as follows:

- Intact aborts can be implemented after a few seconds into the flight. Three types of intact aborts are possible for the Uprated Space Shuttle: (1) the return-to-launch-site (RTLS), (2) abort-once-around (AOA), and (3) abort-to-orbit (ATO).
- Contingency aborts could lead to either a return-to-land (runway or crash landing) or to a ditching at sea.
- Design of the boost trajectory to avoid land overflight, for example the 38-degree inclination orbit, should help in reducing overall risk for the early portion of the flight.

3.3.4 Orbital Operations

The Orbit Transfer Vehicle (OTV) propulsion phase provides for transportation from low-Earth orbit to the intermediate destination. In the

initial years* of the disposal mission, the OTV would be a high-thrust, chemical propulsion (LH₂/LOX) stage. To minimize possible failures the following systems, procedures, and design guidelines are envisioned:

- The use of command OTV engine shutdown in the event of a grossly inaccurate propulsive burn
- The capability to separate the Solar Orbit Insertion Stage (SOIS) and attached payload from the OTV and the use of the SOIS to place the payload in a safe orbit for eventual recovery by a rescue vehicle or Shuttle Orbiter
- The use of a rescue vehicle to retrieve a waste payload stranded in any given orbit
- The use of redundant systems, where effective, to ensure high reliability
- On-orbit OTV launch crew to obtain instantaneous visual and telemetric status of the OTV propulsive burn (from the Orbiter)
- The proper design of trajectories and propulsive burns of the OTV to reduce the probability for reentry, if a failure occurs
- A waste form which helps ensure intact reentry and recovery of the payload, should an unplanned reentry occur, and the requirement that the waste payload will not melt after self-burial in low-conductivity soil
- The use of thermal protection material on the outside of the package to reduce the risk of atmospheric dispersal on the ground and in the air, as well as an outer steel shield to protect the reentry material in the case of explosion
- The use of a relatively high-melting-point container/core (316 stainless steel) and shield material (Inconel-625) to reduce the risk of atmospheric disposal of waste.

The SOIS provides for transportation from an intermediate to the final destination. For the Reference Concept, the SOIS is used to reduce the aphelion from 1.0 to 0.85 A.U. Systems, procedures, and design requirements envisioned to minimize hazards due to SOIS failures are:

*Later on, low-thrust technology (e.g., solar electric propulsion using argon propellant) might be used. With low-thrust systems, both the probability of reentry and magnitude of an explosion are decreased. In addition, there is a much longer decision and response time available in case of a malfunction of the low-thrust propulsion systems while in low Earth orbit. However, because of the large solar arrays needed, the probability of solar array damage caused by an impact with on-orbit, man-made debris could become significant in the future.

- The use of a rescue vehicle to retrieve a cooperative or non-cooperative payload stranded in any orbit in heliocentric or Earth orbital space
- The use of redundant SOIS systems where effective to ensure high reliability
- The proper use of trajectories and orbits inclined to the Earth's orbital plane that exhibit long-term orbital stability
- The use of long-lived tracking systems on board the SOIS to aid in deep-space rescue operations.

3.3.5 Rescue Operations

Provisions must be made to rescue the SOIS and the nuclear waste payload in Earth orbit in the event of a failure of the OTV during the Earth-escape burn. The approach is to rendezvous and dock the rescue OTV with the SOIS and continue the mission from the failed orbit. The rescue mission is based on the premise that, with proper control of the OTV launch, any failure of the OTV will result in an elliptic orbit about Earth. The mission profile for payload rescue is to deliver a rescue OTV to low-Earth orbit, transfer by a burn of the OTV to a phase-adjust orbit, and transfer from the phase-adjust orbit at the proper time for rendezvous and docking with the failed system. The lifetime of the rescue OTV, considering the coast time in the phase-adjust orbit, must be as much as 310 days, compared to the 3 days for OTV lifetime on the nominal Reference mission.

After injection into deep space, the nuclear waste payload could fail to achieve its stable destination orbit, because of a premature shutdown of the OTV engine beyond Earth-escape conditions or a failure of the SOIS to ignite at solar orbit conditions. Studies that address the probability of Earth reentry under these failure conditions have recommended the use of a deep-space rescue mission capability as a way of further reducing the overall risk during this phase of the mission (Rice et al, 1980a). The deep-space rescue mission would begin with the launch of the rescue system into a heliocentric transfer orbit with perihelion less than 0.85 A.U. The first burn of the rescue system would lower aphelion to 0.85 A.U. A second burn would match velocity for rendezvous and docking with the failed SOIS.

3.4 Reference Projected Traffic Model, Hardware, and Propellant Requirements

The projected traffic model, hardware, and propellant requirements for major Reference mission elements have been estimated for the initial 25-year disposal activity.

For the Reference mission definition, an upper bound of 750 Up-rated Space Shuttle flights and 750 SDV flights are required to dispose of all of the U.S. high-level commercial nuclear wastes generated through the year 2003

(100,000 MTHM). Consideration of development flights and aborted missions would be expected to increase this number somewhat. The projected number of missions for high-level nuclear waste disposal is 30 per year for 25 years for a total of 750 missions. Table 3-3 shows the major mission elements, the hardware use factor assumed, and the total number of hardware requirements.

The on-board propellant requirements per disposal mission are given in Table 3-4. Total requirements can be estimated by multiplying these data by 30 missions/year. Actual propellant requirements will be somewhat higher than shown due to losses from propellant transfer and cryogenic propellant boiloff.

3.5 Alternate Payload Definitions

Two alternate payloads were defined by Boeing, with the aid of PNL, for inclusion in the overall risk assessment of space disposal of nuclear waste. These are technetium in metal form and iodine in the form of PbI_2 . These are discussed below. The reader is referred to McCallum et al, 1982, and Reinert et al, 1982, for details.

3.5.1 Technetium Payload

The technetium waste form would be fabricated as right cylindrical billets whose heights are equal to their diameter. The size of the individual billets (6 cm) was selected to be the same as for the cermet waste form, which was limited by constraints imposed by the press and sintering fabrication process (McCallum et al, 1982). Several thousand of the technetium metal billets would be stored in a hexagonally close-packed array (as in the Reference Concept) to provide maximum volumetric efficiency in packing the spherical radiation shield and primary container.

For a discussion of the waste processing needed to partition technetium out of the HLW, the reader should see McCallum et al, 1982. The mass properties of the Tc-99 payload are provided in Section 5.5, Table 5-20.

3.5.2 Iodine Payload

The PNL study (McCallum et al, 1982) provides a detailed discussion of the waste processing required for disposing of iodine in space. PNL also suggests the use of lead iodide (PbI_2) as the waste form. The PbI_2 waste form would be melted and cast in place within the spherical radiation shield and primary container to yield a monolithic spherical waste form. Although, theoretically, 100 percent volumetric efficiency could be approached when using this method, a more conservative figure of 90 percent was assumed to allow for voids and shrinkage during the casting process (Reinert et al, 1982). The mass properties of the I-129 payload are provided in Section 5.0, Table 5-20.

TABLE 3-3. MAJOR HARDWARE REQUIREMENTS ESTIMATES
FOR HIGH-LEVEL COMMERCIAL NUCLEAR WASTE
DISPOSAL IN SPACE (100,000 MTHM)(a)

Hardware Element	Use Factor	Number Required
Vehicle Hardware		
- Orbiters	100	8
- ETs	1	1500
- LRBs (2 LRBs per Flight)	20	150
- SSME/Avionics Pods	55	14
- Payload Shrouds	1	750
Orbit Transfer System Hardware		
- OTVs	20	38
- SOISs	1	750
Waste Payload Systems		
- Container Cores	1	1500
- Radiation Shields	1	1500
- Crew Shields and Flight Structure	100	8
- Cooling Systems (Flight)	100	8
- Rail Cars and Casks	200	8

(a) Table assumes 750 Uprated Space Shuttle flights and 750 SDV flights to dispose of high-level commercial nuclear waste.

TABLE 3-4. ON-BOARD PROPELLANT REQUIREMENTS FOR EACH REFERENCE
NUCLEAR WASTE DISPOSAL MISSION

BATTELLE - COLUMBUS

Vehicle	Propellants, MT				
	Liquid Hydrogen (LH ₂)	Liquid Oxygen (LOX)	RP-1 (Kerosene) (RP)	Nitrogen Tetroxide (NTO)	Monomethyl Hydrazine (MMH)
External Tank (ET)	204	1220	--	--	--
Liquid Rocket Booster (LRB)	--	1606	554	--	--
Orbiter	--	--	--	15.16	9.48
Orbit Transfer Vehicle (OTV)	8.5	50.5	--	--	--
Solar Orbit Insertion Stage (SOIS)	<u>1.7</u>	<u>9.6</u>	<u>--</u>	<u>--</u>	<u>--</u>
Totals	214.1	2886.1	554	15.16	9.48

This Page Intentionally Left Blank

PRECEDING PAGE BLANK NOT FILMED

51

4.0 OVERALL RISK MODEL APPROACH

The overall risk model approach that has been developed for the current study is to estimate the nonrecoverable, cumulative, expected radionuclide release in curies to the Earth's biosphere for different options of the disposal of nuclear waste.

The risk estimates for the disposal of the waste in a mined geologic repository (MGR) are based upon analyses of accident sequences performed by Battelle Pacific Northwest Laboratory (McCallum et al, 1982). The space risk estimates were developed by Battelle's Columbus Laboratories

Although it would have been preferable to represent the consequences of accidental releases in terms of direct health effects to the human population, funding limitations did not permit this level of analysis. Instead, the consequences of accidents are characterized in terms of the release of radionuclides in curies to the biosphere (air, ground, and sea). In those cases where release might occur from the waste package, but for which cleanup operations would be anticipated (in the near term), credit was taken for the recovery of material.

Frequently, risk results are presented as the product of the probability and the consequences of accident sequences. Rigorously, this common definition of risk is the first moment (expectation value) of the probability density function for accident consequences (probability of an accident within the interval dC about C). To provide a complete description of the risk, it would be necessary to present the entire density function rather than a single moment of the density function. This is particularly desirable if the risk includes very-high-consequence accidents of low probability. Because of the aversion of the public to high-consequence events (e.g., airplane crashes, tornados, and earthquakes), this part of the risk spectrum is of particular concern.

In the case of waste disposal, either for the MGR or for the space disposal of waste, no single events have been identified that would be radiologically catastrophic in the sense of representing an immediate health threat to a number of human lives. The expected consequence is therefore an appropriate characterization of the risk. For each identified accident sequence, the probability and consequence is estimated and the risk is calculated as:

$$R = \sum_i C_i P_i$$

where R = risk in C_i
 C_i = consequences of accident i in C_i
 P_i = probability of accident i .

Four sets of radionuclide groups have been selected to illustrate the results: (1) the sum of 15 important long-lived radionuclides (as given in the draft EPA release limit guidelines), (2) the sum of important actinide

elements (AC), (3) Tc-99, and (4) I-129. The time span considered in the study is one million years. Not only could events occur at various times in the future, the release of radioactive material to the biosphere could be distributed over extended time periods following an accident. In the presentation of the results, the expected release rate of radionuclides is integrated over time to obtain the cumulative expected release in Curies, and this integral is plotted versus time. Short- and long-term risks are provided in the same figures.

For comparative purposes the risks from (1) the Reference MGR, (2) the MGR complemented for each space disposal option without space disposal accidents, and (3) accidents directly associated with space disposal are each displayed separately. By adding the space disposal risk to the complemented MGR risk and comparing the Reference case, the potential benefits/disbenefits of the space waste disposal options could be determined.

5.0 SPACE DISPOSAL RISK ESTIMATES

This section of the report describes how space disposal risks were estimated. Various approaches were evaluated before this effort was initiated. The basic approach to determining preliminary estimates of space disposal risk, as defined in Section 4.0, was developed by considering what would be the most cost-effective method (because of limited funding for this effort). Basically the approach used drew on (1) past data bases developed for space disposal (Pardue et al, 1977; Edgecombe et al, 1978; and Rice et al, 1980a); (2) STS failure rates developed by the Wiggins Company (Baeker, 1981; Hudson, 1979); (3) previous works by A. Friedlander on long-term risk (see Rice et al, 1980a); (4) expert opinion where easily obtainable; (5) new response analysis, where practical; (6) engineering estimates; and (7) technical data provided by Boeing (Reinert et al, 1982). The desired format for "space risk" was determined by the format developed by McCallum (1982) for geologic disposal, both the Reference case and the various "complemented" cases. The major goal was to develop "space risk" in terms of probabilistic cumulative releases (unrecoverable) to the biosphere from launch through to one million years. It was assumed that short-term risks could be mitigated by accident recovery and rescue, although these would not always be either successful or complete. For longer time frames (beyond 100 years after launch), recovery and rescue were not included in the analysis.

Figure 5-1 provides an overview of the approach used for estimating space disposal risks. The following subsections provide discussion of this approach and related study results. The following shows the organization of topics:

- Space Accident Identification (payload insults)
- Mission Phase and Fault Tree Development
- Failure and Event Probability Estimates
- Payload Response Analysis
- Consequence Evaluation
- Preliminary Space Disposal Risk Estimates.

5.1 Space Accident Identification

Accidents that involve the nuclear waste payload were the only ones considered here. Previous analyses (Edgecombe et al, 1978) presented a list of possible accidents for a space disposal mission. Since that work and other follow-on work (Rice et al, 1980a) have been completed, significant changes in the Reference space disposal concept have been made (see current Reference Concept, Section 3.0). Because accidents involving the release of radioactive material are the only ones of current interest, many previously studied accidents/events involving the payload have not been included here.

ORIGINAL PAGE IS
OF POOR QUALITY

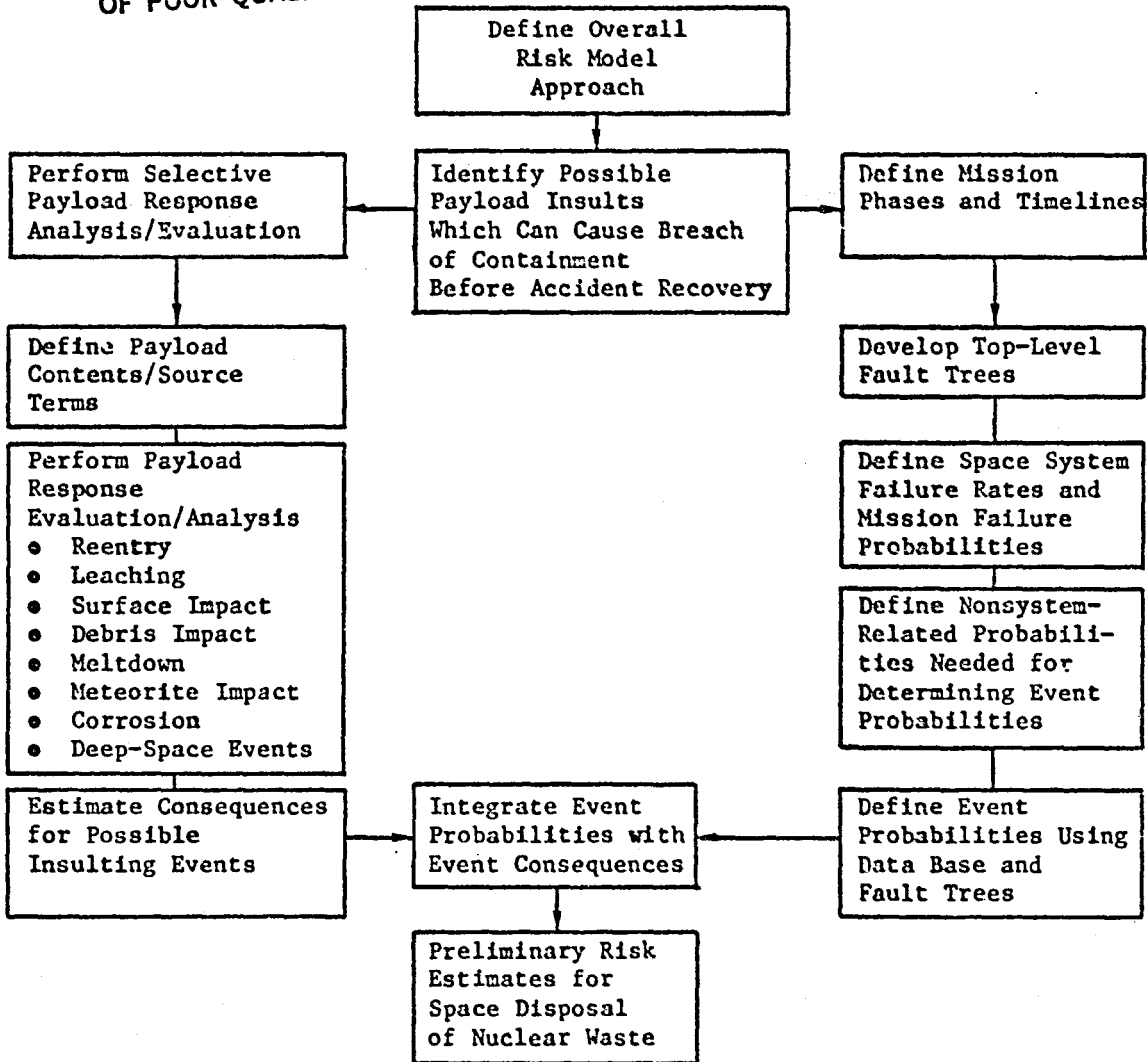

FIGURE 5-1. APPROACH FOR ESTIMATING SPACE DISPOSAL RISK

Table 5-1 provides a summary of the possible insults to the currently defined Reference nuclear waste payload. The probability of occurrence of the events listed was not considered. This list of possible insults to the payload was used to define the events that could lead to breach of containment during and after launch. This is discussed further in the next section.

TABLE 5-1. POSSIBLE INSULTS TO THE SPACE DISPOSAL PAYLOAD

Impact	Melting	Corrosion
<u>On Ground</u>	<u>On Ground</u>	<u>On Ground</u>
<ul style="list-style-type: none"> ● Rock ● Man-Made Structures ● Soils ● Ice ● Water ● Explosion Fragments 	<ul style="list-style-type: none"> ● Impact-Related <ul style="list-style-type: none"> - Insulation ($k < k_{limit}$) - Certain Soils - Certain Minerals ● Volcano ● Chemical Plant/Storage ● Tank Farm ● Processing Furnaces ● On-Pad Accident/Fire 	<ul style="list-style-type: none"> ● Aqueous <ul style="list-style-type: none"> - Fresh Water - Ocean Water - Severe (Brines, H_2S, etc.) - Reducing ● Nonaqueous <ul style="list-style-type: none"> - Salt Beds ● Special <ul style="list-style-type: none"> - Chemical Plant/Storage ● Soils
<u>In Space</u>	<u>In Flight</u>	<u>In Space</u>
<ul style="list-style-type: none"> ● Meteoroids ● On-Orbit Debris ● On-Orbit Vehicles ● Celestial Bodies ● Other Waste Payloads ● Explosion Fragments ● Comet 	<ul style="list-style-type: none"> ● Reentry <ul style="list-style-type: none"> - Intact - Damaged - Aged/Degraded - Fragmented 	<ul style="list-style-type: none"> ● Sputtering/Erosion

5.2 Mission Phase and Fault Tree Development

After the list of possible payload insults was developed (see Table 5-1), the space disposal mission was divided up into mission phases which allowed the treatment of certain types of accidents. This was necessary because the character of accidents changed with the time during the mission. The payload altitude and velocity, instantaneous impact point location, potential for damage by STS explosion, potential reentry velocity, and the potential for deep-space events are constantly changing throughout the mission.

Previous study results (Rice et al, 1980a) have indicated that an on-pad accident involving the catastrophic failure of the launch vehicle [Uprated (LRB) Space Shuttle] will not result in a breach of the current Reference payload concept. Environments considered include (1) the on-pad fireball, (2) on-pad residual propellant fire, (3) blast overpressure, (4) fragment impact, and (5) hard surface impact. Even in an STS power dive, it is predicted that the maximum velocity of the payload would never exceed 250 m/s, a velocity much lower than would be expected to breach a normal payload (one with no undetected defects). Intact aborts (noncatastrophic) have been eliminated from consideration here, as well as Orbiter crash landings (total recovery anticipated for this event). Payload impacts onto chemical, munitions, or steel plants have also been eliminated because it is believed that their probability is very small and that the payload would not be insulted by the chemical or thermal environment, that it would "fly through it" and end up below it in the ground.

The phases and timelines for the disposal mission are listed in Table 5-2. The timelines were developed from data presented in the Boeing report (Reinert et al, 1982).

TABLE 5-2. MISSION PHASE AND TIMELINE DEFINITION

Phase Number	Description	Timeline, s ^(a)
1	Ignition to Impact Point Clears Land	0-24
2	Clear Land Impact to LRB Staging	24-124
3	LRB Staging to MECO ^(b)	124-518
4	MECO to LEO Attainment ^(b)	518-2,734
5	LEO Attainment to OTV Ignition	2,734-35,024
6	OTV Ignition to Earth Escape	35,024-36,926
7	Earth Escape to OTV Shutdown	36,926-37,005
8	SOIS Coast Through SOIS Burn	37,005-14,295,107
9	Placement	14,295,107-3.15E13

(a) Data derived from Boeing study (Reinert et al, 1982).

(b) MECO is main engine cutoff; LEO is low-Earth orbit.

The fault tree analysis method was selected as most appropriate for use in this study. Fault tree analysis is a technique by which the component failures leading to system failures can be logically deduced. Application of the technique yields combinations of basic events whose occurrences cause the undesired failure events (containment breaches). These event combinations can then be evaluated by various screening techniques to determine the high-risk scenarios and their probability of occurrence. For its application, the fault tree method requires probability information about all of the individual

component failures. The fault tree technique is well-suited to analyzing rapid events (such as space launches, which have discrete probabilities). Fault tree analysis, however, is not well-suited to analyzing the slow processes for which event ordering, interdependencies, and time-phasing are important. Therefore, it has only been carried through Phase 6 (see Table 5-2). Phases 7 through 9 have been analyzed differently (see long-term events discussed in Section 5.5).

The fault trees developed for the nine mission phases include consideration of both short- and long-term events. Many iterations among BCL staff occurred, and suggestions provided by NASA/MSFC, ONWI, PNL, and Boeing were incorporated into the current versions. The fault trees for Phases 1 and 2 are given as Figures 5-2 and 5-3. (Figures D-1 through D-9 in Appendix D provide schematics of all nine fault trees.) (The probabilities for the events in the trees have been estimated; see discussion in Section 5.3 and values for each event in Appendix G.)

5.3 Failure and Event Probability Estimates

The failure and event probability estimates developed to determine the probabilities of certain accidents used in this risk study are discussed here. The reader is referred to the fault trees, shown in Section 5.2 and Appendix G, for a summary of all the probabilities used in the fault tree analyses (Phases 1 through 6; the space risks for Phases 7 through 9 are presented in Section 5.5). Table 5-3 provides a summary of probability data developed for mission Phases 1 through 6 (see Appendix G for basis). Discussion here is broken down into space systems failure probabilities and short-term space event probabilities.

5.3.1 Space Systems Failure Probabilities

This section briefly discusses the sources of information for space system failure probabilities. Systems to be discussed include: (1) the standard (SRB) Space Shuttle; (2) the Uprated (LRB) Space Shuttle; (3) orbit transfer systems including the Orbit Transfer Vehicle (OTV), the Solar Orbit Insertion Stage (SOIS), and On-Orbit Rescue Vehicles; and (4) the payload.

5.3.1.1 Standard (SRB) Space Shuttle

NASA does not publish or have in its possession "official" reliability or failure rate data for the Space Shuttle. The current experience (as of February, 1982) finds the Shuttle to have successfully flown twice during its developmental test flight program. Plans are to continuously upgrade problem areas as they are encountered on flights. The failure rates for the Shuttle are actually corollaries to ALARA (as low as reasonably achievable, as in nuclear radiation risk).

Because of a NASA need to evaluate whether or not a destruct system on the Shuttle during the early portion of the flight is worthwhile, NASA/KSC contracted with Wiggins Company, Redondo Beach, California, to perform a study

ORIGINAL PAGE IS
OF POOR QUALITY

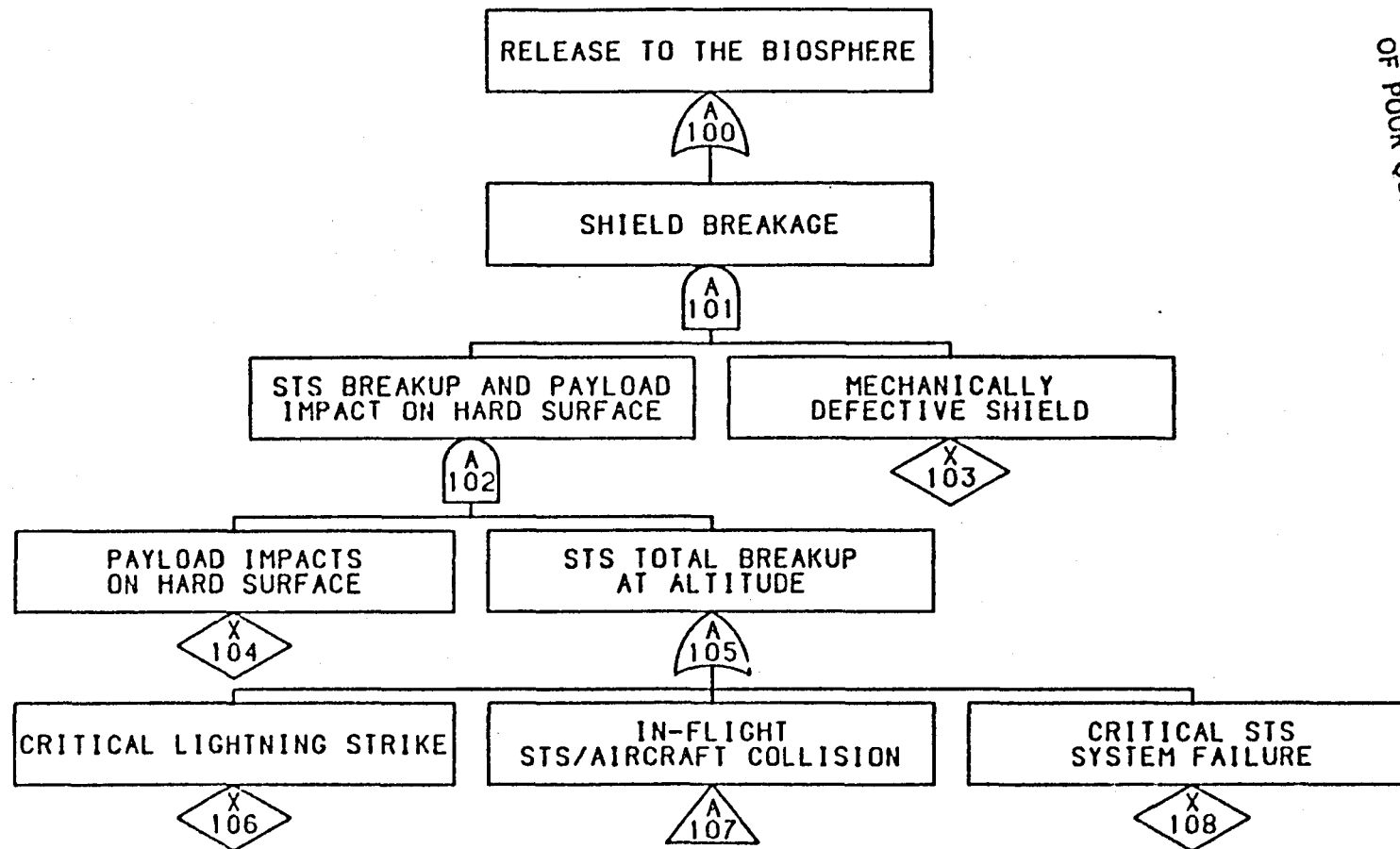

58

FIGURE 5-2. PHASE 1 FAULT TREE: IGNITION TO IMPACT POINT CLEARS COASTLINE (T = 0 to 24 s)

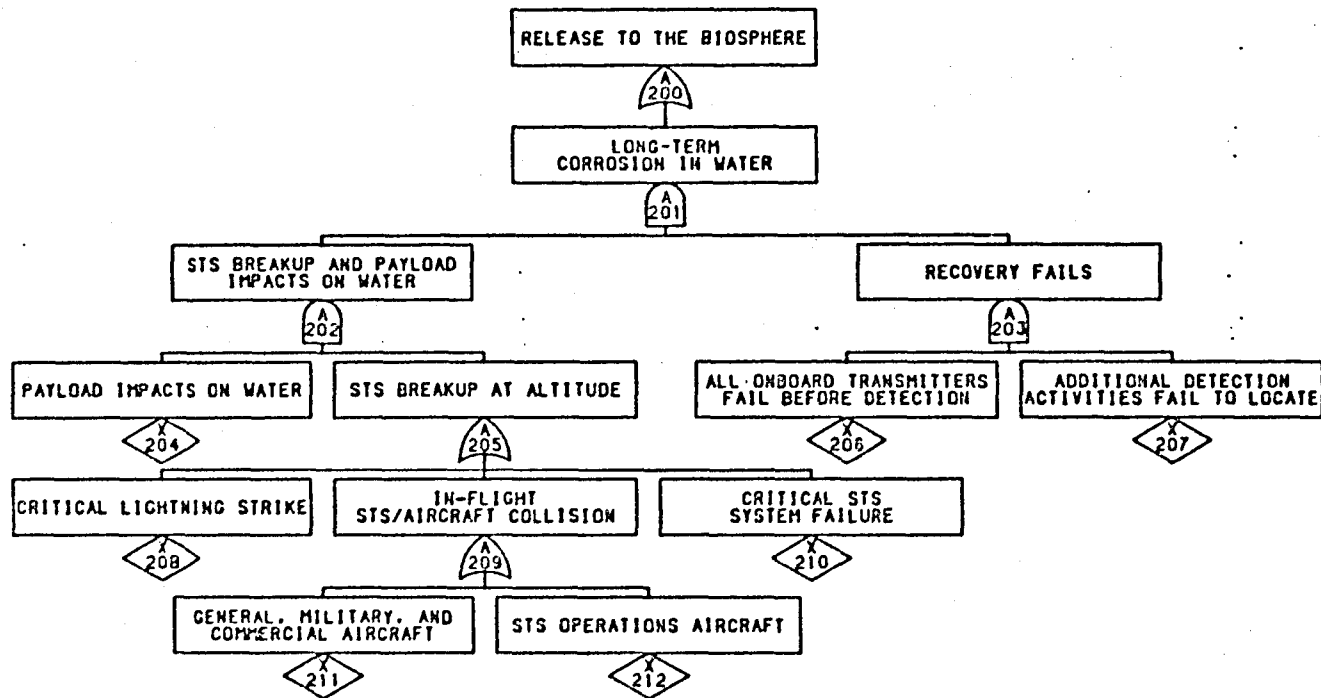

FIGURE 5-3. PHASE 2 FAULT TREE: IMPACT POINT CLEARS COASTLINE TO LRB STAGING (T = 24 to 124 s)

TABLE 5-3. SPACE DISPOSAL PROBABILITY DATA (SHORT-TERM EVENTS)

ORIGINAL PAGE IS
OF POOR QUALITY

Mission Phase	Release Events								
	1 Long-Term Corrosion, Ocean	2 Impact on Hard Rock ^(a)	3 Impact on Volcano	4 Soil Meltdown	5 On-Orbit Collision	6 Long-Term Corrosion, Soil	7 High-Velocity Impact on Water	8 High-Velocity Impact on Rock	9 High-Velocity Impact on Soil
1	--	4.2E-8	--	--	--	--	--	--	--
2	1.1E-10	--	--	--	--	--	--	--	--
3	2.3E-9	2.3E-8	2.3E-17	2.3E-15	1.3E-13	9.2E-13	--	--	--
4	8.6E-9	1.1E-5	1.1E-14	1.1E-12	7.7E-13	4.3E-10	--	--	--
5	1.0E-11	2.3E-8	2.0E-17	1.9E-15	1.1E-11	8.5E-14	--	--	--
6	<u>1.3E-13</u>	<u>3.6E-10</u>	<u>1.7E-19</u>	<u>2.3E-17</u>	<u>2.5E-12</u>	<u>5.6E-16</u>	<u>6.3E-10</u>	<u>4.8E-10</u>	<u>2.1E-9</u>
Total	1.1E-8	1.1E-5	1.1E-14	1.1E-12	1.4E-11	4.3E-10	6.3E-10	4.8E-10	2.1E-9

(a) Data for the case where impact safety requirements would be met are: Phase 1 - 2.1E-12; Phase 3 - 1.2E-12; Phase 4 - 5.6E-10; Phase 5 - 3.5E-10; Phase 6 - 8.0E-11; and Total - 9.9E-10.

BATELLE - COLUMBUS

involving the hazards to the public of a failing Shuttle (Baeker, 1981). Another Wiggins study (Hudson, 1979) has also been conducted for the latter portions of the flight profile to evaluate hazards when flying nuclear payloads (e.g., Galileo). The failure rates developed in these studies were based upon data developed for hardware in WASH-1400 (U.S. NRC, 1975) and upon NASA committee reliability estimates for the Solid Rocket Booster. The analysis was accomplished for only single-point failure modes, as have been identified in NASA/MSFC, 1977; NASA/JSC, 1978; Rockwell International, 1978a, 1978b, 1979; and Martin Marietta, 1977. The Wiggins data (Baeker, 1981) also include changes/modifications to failure rates resulting from an in-depth review by NASA Space Shuttle engineers. The results of all this appear in Baeker (1981) and are summarized in Table 5-4 for STS ignition through MECO (main engine cutoff). Earlier work by Hudson (1979) is summarized in Table 5-5. Log-normal distributions were assumed for the failure rates.

5.3.1.2 Uprated (LRB) Space Shuttle

The vehicle used for nuclear waste disposal missions (see Section 3.0) is the Uprated Space Shuttle, with two Liquid Rocket Boosters (LRBs) replacing the two Solid Propellant Boosters (SRBs) of the standard Space Shuttle vehicle. To utilize the Wiggins' data, certain modifications were necessary to provide a best estimate for the Uprated Shuttle with LRBs. The approach used was to eliminate failure rates related to the solid propellant motors, but replace each of them with the equivalent of an SSME/ET configuration, to represent a typical LRB substitution. Resources were not available to carry out a Monte Carlo analysis. Because pure substitution was used, the data generated should be conservative (higher failure rates than the data base would support through rigorous Monte Carlo analyses). The critical failure rates for the LRB Shuttle are shown in Tables 5-6 and 5-7. Ten critically failed vehicle response modes are indicated in these tables. Appendices E and F further discuss the basis for these data. Note that the data in Tables 5-5 and 5-7 are identical, with the same vehicle configuration from MECO through to payload separation.

When the failure rate (per second) data of Tables 5-6 and 5-7 are integrated into the mission phase (with timelines) of the nuclear waste disposal mission, Table 5-8 results. This shows the predicted Uprated Shuttle failure probabilities during each of the five mission phases involving the Shuttle. An interesting comparison between the Standard (SRB) Shuttle and the Uprated (LRB) Shuttle is shown in Table 5-9. The variation shown for the Standard Shuttle is due to the NASA expert's view that the SRB critical failure rate component for the solid propellant motors was between 1/1000 to 1/10,000 for a man-rated system (see Baeker, 1981). This variation results in an overall critical failure probability estimate for the Standard Shuttle of between 1/1000 and 1/360. The corresponding value for the Uprated Space Shuttle is 1/1300. Basically, this implies that one catastrophic Shuttle failure is expected to occur every 1300 flights. The probability that one or more critical failures will occur in 1300 flights is 63 percent ($1 - [1 - 1/1300]^{1300}$). For 750 missions of a nuclear waste disposal mission scenario equivalent to one 100,000 MTHM repository, there is about a 44 percent ($1 - [1 - 1/1300]^{750}$) chance that at least one critical STS failure will occur.

TABLE 5-4. WIGGINS DATA FOR STANDARD SHUTTLE CRITICAL FAILURE RATES (LIFTOFF TO MECO)

Failed Vehicle Response Mode	No. of Component Failure Modes	No. of Components	(a) Failure Rates		
			Mean	Lower	Upper
1. Tipover on Pad	7	14	3.3E-5(b)	1.6E-5(b)	6.0E-5(b)
2. Loss of Control and Tumble	--		2.0E-3 to 2.0E-4(c)		
3. Inadvertent Separation at an SRB/ET Aft Attachment					
• Liftoff to 100 Seconds	5	34	4.5E-9	3.1E-9	6.5E-9
• 100 Seconds to Staging	6	36	5.3E-9	3.6E-9	7.4E-9
4. Inadvertent Separation at an SRB/ET Forward Attachment	3	8	1.5E-9	7.2E-10	2.4E-9
5. Corkscrew Motion (Resulting from an SRB TVC Failure)	38	442	4.2E-7	2.3E-7	7.4E-7
6. External Tank Punctured					
• Liftoff to Staging	99	538	2.0E-7	8.4E-8	4.6E-7
• Staging to MECO	93	445	1.8E-7	7.5E-8	4.1E-7
7. ET Intertank and/or Aft LOX Tank Failure(d)	15	98	7.7E-8	2.6E-8	1.6E-7
8. SRB Recontact at Separation	18	168	1.1E-5(b)	7.1E-6(b)	1.7E-5(b)
9. Loss of ME Propulsion					
• Liftoff to Staging	18	60	6.6E-9	1.2E-9	2.3E-8
• Staging to MECO	23	71	3.4E-8	3.9E-9	1.2E-7

Source: Baeker, 1981.

(a) Probability of failure per second (except for Response Modes 1 and 8); 90 percent confidence assumed.

(b) Probability of failure per event.

(c) Engineering judgment from NASA for man-rated solid propellant boosters.

(d) This mode is much more likely to occur during Stage 1 flight when the loads and heating are high.

TABLE 5-5. WIGGINS DATA FOR STANDARD SHUTTLE CRITICAL FAILURE RATES
(MECO TO PAYLOAD SEPARATION)

Failed Vehicle Response Mode	No. of Component Failure Modes	No. of Components	Failure Rates (a)		
			Mean	Lower	Upper
a. External Tank Punctured					
• MECO to Start RCS Separation Burn	50	255	1.8E-7	7.5E-8	4.2E-7
• During RCS Separation Burn	73	461	1.3E-6	5.5E-7	2.1E-6
b. Loss of Maneuverability and Orbiter Tumbles to Earth					
• MECO to Start RCS Separation Burn	15	93	6.0E-8	1.6E-8	1.1E-7
• During RCS Separation Burn ^(b)	4	11	--	--	--
• End RCS Separation Burn to OMS-1 Complete	46	360	2.2E-7	9.0E-8	4.6E-7
c. Loss of Maneuverability on Orbit (Orbital Decay)					
• OMS-1 Complete to Payload Separation	46	360	2.2E-7	9.0E-8	4.6E-7
d. Fire and Explosion in Main Engine Compartment					
• End RCS Separation Burn to Orbit Insertion (OMS-1 Complete)	23	185	1.1E-7	4.4E-8	3.0E-7

Source: Hudson, 1979.

(a) Probability of failure per second; 90 percent confidence assumed.

(b) Values are insignificant.

TABLE 5-6. SUMMARY OF MODIFIED WIGGINS CRITICAL FAILURE RATE DATA FOR LRB SHUTTLE (LIFTOFF TO MECO)

Failed Vehicle Response Mode	No. of Component Failure Modes	No. of Components	(a)		
			Mean	Lower	Upper
1. Inadvertent Separation at an LRB/ET Aft Attachment					
• Liftoff to 100 Seconds	5	34	4.5E-9	3.1E-9	6.5E-9
• 100 Seconds to LRB Staging	6	36	5.3E-9	3.6E-9	7.4E-9
2. Inadvertent Separation at an LRB/ET Forward Attachment	3	8	1.5E-9	7.2E-10	2.4E-9
3. Propellant Tanks Punctured					
• Liftoff to Staging	99	1614	6.0E-7	2.5E-7	1.4E-6
• Staging to MECO	93	445	1.8E-7	7.5E-8	4.1E-7
4. Intertank and/or Aft LOX Tank Failures					
• Liftoff to Staging	15	294	2.3E-7	7.8E-8	4.8E-7
• Staging to MECO	15	98	7.7E-8	2.6E-8	1.6E-7
5. LRB Recontact at Separation	18	168	1.3E-5 ^(b)	7.1E-6 ^(b)	1.7E-5 ^(b)
6. Loss of Propulsion					
• Liftoff to Staging	18	180	2.0E-8	3.6E-9	6.9E-8
• Staging to MECO	23	71	3.4E-8	3.9E-9	1.2E-7

(a) Probability of failure per second (except for Response Mode 5); 90 percent confidence assumed.

(b) Probability of failure per event.

TABLE 5-7. SUMMARY OF MODIFIED WIGGINS CRITICAL FAILURE RATE DATA FOR LRB SHUTTLE (MECO TO PAYLOAD SEPARATION)

Failed Vehicle Response Mode	No. of Component Failure Modes	No. of Components	(a) Failure Rates		
			Mean	Lower	Upper
7. External Tank Punctured					
• MECO to Start RCS Separation Burn	50	255	1.8E-7	7.5E-8	4.2E-7
• During RCS Separation Burn	73	461	1.3E-6	5.5E-7	2.1E-6
8. Loss of Maneuverability and Orbiter Tumbles to Earth					
• MECO to Start RCS Separation Burn	15	93	6.0E-8	1.6E-8	1.1E-7
• During RCS Separation Burn ^(b)	4	11	--	--	--
• End RCS Separation Burn to First OMS Burn Complete	46	360	2.2E-7	9.0E-8	4.5E-7
9. Loss of Maneuverability on Orbit (Orbital Decay)					
• First OMS Burn Complete to Payload Separation	46	360	2.2E-7	9.0E-8	4.5E-7
10. Fire and Explosion in Main Engine Compartment					
• End RCS Separation Burn to Orbit Insertion (First OMS Burn Complete)	23	185	1.2E-7	4.4E-8	3.0E-7

Source: Wiggins Company report (Hudson, 1979).

(a) Probability of failure per second; 90 percent confidence assumed.

(b) Values are insignificant.

TABLE 5-8. PREDICTED UPDATED STS CRITICAL FAILURE
PROBABILITIES DURING EACH MISSION PHASE(a)

Phase	Time, s	STS Component	Failure Probabilities		
			Mean	Lower	Upper
1. Ignition to Clear Land	0-24	Shuttle/ET/LRB	2.1E-5	8.0E-6	4.7E-5
2. Clear Land to LRB Staging	24-124	Shuttle/ET/LRB	1.1E-4	4.1E-5	7.3E-5
3. LRB Staging to MECO	124-518	Shuttle/ET	1.15E-4	4.1E-5	2.7E-4
4. MECO to LEO Orbit Attainment	518-2,734	Shuttle	5.4E-4	2.2E-4	1.1E-3
5. LEO Orbit Attainment to OTV Ignition	2,734-35,024	Shuttle	7.1E-3	2.9E-3	1.5E-2

(a) Derived from Wiggins Company reports on predicted STS failure rates (see Baeker, 1981 and Hudson, 1979).

TABLE 5-9. FAILURE PROBABILITY COMPARISON (STD SRB SHUTTLE VS UPATED LRB SHUTTLE)

	STD SRB Shuttle	Upated LRB Shuttle
<u>Liftoff to MECO</u>		
SRB-Related Failures	1/3600-1/480	None
Non-SRB-Related Failures	1/5900	1/4300
<u>MECO to Orbit</u>		
Non-SRB-Related Failures	<u>1/1850</u>	<u>1/1850</u>
TOTAL	1/1000-1/360	1/1300

5.3.1.3 Orbit Transfer and Rescue Systems

Boeing's space systems study (Reinert et al, 1982) provided the success probabilities for the Orbit Transfer Vehicle (OTV) and Solar Orbit Insertion Stage (SOIS). The success probability for a rescue mission was estimated by Boeing to be achievable. These data are shown in Table 5-10. Boeing's study also concluded that the probability of an CTV and SOIS not failing in a safe condition was $1.0E-6$ (Reinert et al, 1982).

TABLE 5-10. PREDICTED OTV/SOIS/RESCUE VEHICLE SUCCESS PROBABILITIES^(a)

	OTV	SOIS	Rescue Vehicle
Startup	0.9986	0.9986	--
End Point	0.9875	0.9969	0.944

(a) Data from Boeing Company study (Reinert et al, 1982).

5.3.1.4 Payload Systems

Two issues to be discussed here relate to (1) what is an undetected mechanical defect in the payload shield and the likelihood that it occurs, and (2) what is the failure rate for the payload's transmitters after ground/ocean impact.

A review of WASH-1285 (U.S. AEC, 1974a) provided data on vessel defects. WASH-1285 reports that Phillips and Warwick analyzed 12,700 pressure vessels and found four preexisting defects. Also reported in WASH-1285 are data collected by Kellerman and Seidel which found six preexisting defects out of 7000 possible in high pressure steam drums. As a result of combining these data, we have an undetected mechanical defect rate of 10/19,700, or 5E-4. When we consider that more stringent quality control standards would be employed for the space disposal shield, we reduce this value by a factor of 10 to 5E-5. We assume that, if this undetected defect is present, the shield will break upon impact on a hard surface.*

The Reference payload employs six on-board radio transmitters/sonar beacons to help pinpoint the reentry trajectory and location in the ocean (for ocean impact). The failure rate (for ocean impact) assumed per instrument was 0.1. It was also assumed that of the six total, three would be knocked out by being on the side of the impact. Therefore, the probability of having all fail after a water impact would be $(0.1)^3$ or 1E-3.

5.3.2 Short-Term Space Event Probabilities

This section discusses the estimated collision probabilities for short-term events that occur in space which are reported in Appendix G for Phases 1 through 6 of the fault trees. Events included are meteoroid impacts and man-made on-orbit debris impacts. Also, Figure 5-4 was generated using Battelle's Interactive Graphics Orbit Selection (IGOS) program to support the estimates of land and ocean impact probabilities early in the mission.

5.3.2.1 Collision Probability Estimates for Meteoroid Impacts

The analytical approach for calculating the probabilities associated with payload/meteoroid fragmentation events was developed in a previous study of this risk pathway for nuclear waste payloads (Friedlander and Wells, 1980). Basic source data for such an analysis were derived from the published scientific literature dealing with the meteoroid flux environment and the destruction mechanics of high-velocity impact.

*The current payload design is not expected to meet the safety guideline of being able to survive hard rock impact (see Sections 2.1.3 and 5.4). The current risk data assume that shield breakage will occur and radioactive material would be released to the atmosphere, if the payload impacts on hard rock.

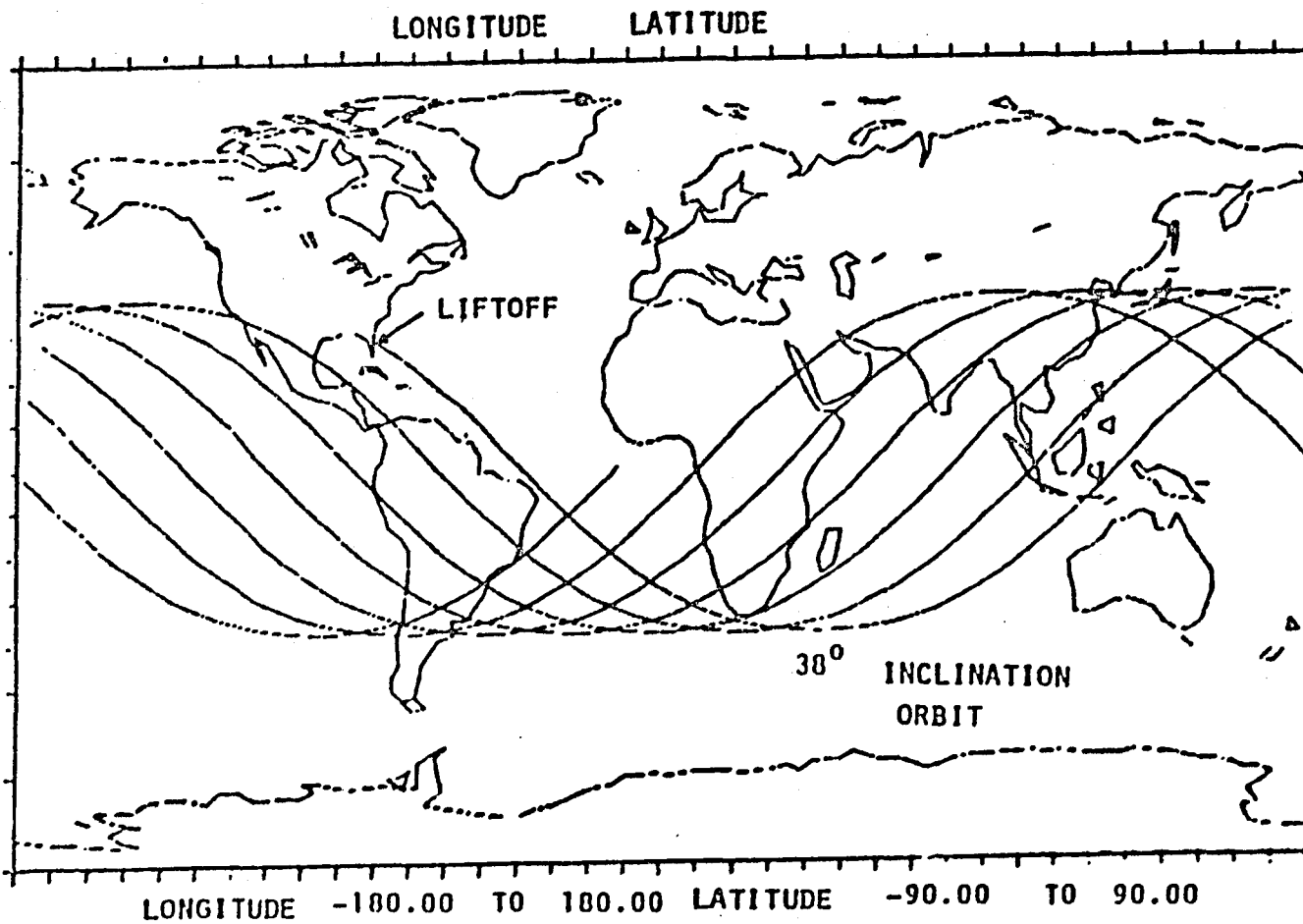

ORIGINAL PAGE IS
OF POOR QUALITY

FIGURE 5-4. PAYLOAD ORBITAL GROUND TRACKS FROM LIFTOFF THROUGH OTV BURN

Experiments with high-energy projectiles impacting basalt targets led to the development of mathematical models expressing the relationship between fragmentation energy, projectile mass, and target mass release in small particle distribution. These results were scaled to a space system/payload target assuming a tenfold increase in material strength relative to basalt. A critical energy/target mass ratio E_p/M_t of about 7500 joules/kg would begin to release mass in catastrophic collision, e.g., beyond simple cratering collision. The projectile (meteoroid) kinetic energy is

$$E_p = 1/2 M_p V_r^2 \quad (1)$$

where M_p is the projectile mass and V_r is the relative velocity of impact. At $E_p/M_t = 7500$ joules/kg and $V_r = 17,500$ m/s, the critical projectile size is then estimated to be 0.76 kg (7.8 cm diameter at 3 g/cm^3) to begin partial fragmentation of a single payload sphere ($M_t = 15,493$ kg).

The target fractional mass release in small particle distribution is given by the expression

$$\frac{M(b < 1 \text{ mm})}{M_t} = 7.94 \times 10^{-9} (E_p/M_t)^{1.44} \quad (2)$$

Small particle mass release at the critical energy level of 7500 joules/kg is only 0.3 percent. Total catastrophic breakup requires an energy level of 4.2×10^5 joules/kg which would result from a projectile mass of 42.7 kg (30 cm) impacting a single payload sphere.

The probability factor is introduced by the meteoroid flux distribution, or collision frequency

$$F(M > M_p) = 1.23 \times 10^{-9} M_p^{-0.9} A_t \quad (3)$$

in units of impacts/year for a target of area A_t in units of meters square. Hence, for a single mission (two spheres at 2.12 m^2 each), the probabilities of payload/meteoroid impacts are: (1) 6.69×10^{-9} /yr at the critical fracture limit, and (2) 1.78×10^{-10} /yr at the total catastrophic breakup limit. Corresponding probabilities for other system elements (OTV, SOIS) are calculated by area scaling. Finally, the effective collision probabilities for Mission Phases 3 through 6 are obtained by multiplying by the time interval over which the system configuration is at risk.

5.3.2.2 Collision Probability Estimates for Man-Made On-Orbit Debris Impacts

The continuous use of Earth-orbital space during the past two decades has resulted in a population of space "junk" or debris which poses a collision hazard for current and future operations. This debris includes spent payloads, rocket bodies, and numerous explosion fragments. It is estimated that

the debris population will continue to increase because the primary source operations continue, and because secondary collisions between such objects will feed this growth. Recent analyses of this problem have provided the data base for estimating the risk posed to space disposal of nuclear waste (Kessler, 1980; Chobotov, 1981; Reynolds, 1980). In this investigation we have used Reynolds' projection of the debris population to the year 2030, based on an annual growth rate of 5 percent.

The collision probability may be calculated from the mean-free path model which states: A target with an effective cross-sectional area A_t moving with an average relative velocity V_r will sweep out a volume $V_r A_t \Delta t$ in the time interval Δt . The number of debris objects encountered is the product of this volume and particle number density $N(h)$ of the debris where the explicit dependence on altitude h is indicated. Since this product is generally much smaller than unity, the collision probability may be calculated as

$$P_c = N(h)V_r A_t \Delta t. \quad (4)$$

Reynolds has taken the projected density distribution as a function of altitude and, assuming an average impact speed $V_r = 8$ km/s, this provided an altitude histogram distribution of collision probability in normalized units of collisions/cm² s. These data show that at the nominal deployment altitude, during Mission Phases 3 through 5, the debris collision probability is 8×10^{-18} cm⁻² s⁻¹ and reaches a peak value of about 10^{-16} cm⁻² s⁻¹ at 800 km altitude. This then falls off to a value of 5×10^{-19} cm⁻² s⁻¹ at 4000 km altitude near the point of OTV burnout (end of Phase 6).

The time lines (Δt) used for the various mission phases have been given previously in Table 5-2. The cross-sectional areas assumed are as follows:

Shuttle Orbiter	250 m ²
OTV/SOIS/Payload Configuration. . .	117 m ²
OTV.	74.9 m ²
SOIS	37.9 m ²
Payload (two spheres).	4.24 m ²

An example calculation is the STS Orbiter/debris collision probability during Phase 3 (see Fault Tree Event No. 323 in Table G-3 of Appendix G). This probability entry is obtained as

$$(8 \times 10^{-18} \text{ cm}^{-2} \text{ s}^{-1}) \times (2.5 \times 10^6 \text{ cm}^2) \times (394 \text{ s}) = 7.9 \times 10^{-9}$$

A second example relates to Mission Phase 6, OTV ignition through attainment of Earth-escape conditions. Here the cumulative debris collision probability is found by integrating the collision distribution over time (altitude), yielding 5.94×10^{-14} cm⁻². Hence, for the total configuration area of 1.17×10^6 cm², the probability is 7×10^{-8} , which is the entry appearing in Table G-6 for Fault Tree Event No. 676.

A final comment may be made regarding the potential damage caused by space debris impact. While the debris number density above a given size object is fairly well known from radar tracking data, there is considerable uncertainty regarding the size distribution of such debris below 4 cm diameter. Consider a single payload sphere of mass 15,493 kg and area 2.12 m². At $V_r = 8$ km/s, the critical fragmentation energy of $E_p/M_c = 7500$ joules/kg would result from an impacting projectile mass of about 3.6 kg (10 cm diameter at 8 g/cm³ density). A 200 kg object (36 cm) would be expected to cause total catastrophic breakup of the cermet payload sphere. Although the occurrence of space debris with these characteristics is very unlikely (personal conversation with Don Kessler, NASA/JSC), this event was considered to occur one in every 1000 impacts.

5.4 Payload Response Analysis

Various payload response analyses were needed to verify the expected response of the payload to certain accident environments. Emphasis was placed on areas where it was felt that easy answers could be provided and where accidents were expected to play a predominant role in the risk estimate for space disposal.

The following accident environments and payload responses were analyzed: (1) reentry, (2) postburial meltdown, and (3) impact on granite.

5.4.1 Reentry Analysis

This subsection summarizes efforts to predict the payload thermal response for inadvertent atmospheric reentry. The basic configurations that were examined are:

- Waste form with Inconel-625 shield and carbon carbon (C/C) reentry tiles (orbital decay and vertical reentry)
- Waste form with Inconel-625 shield only (i.e., C/C tiles removed, orbital decay reentry)
- Waste form chunks resulting from on-orbit payload collisions.

The RETAC (Reentry Thermal Analysis Code) was used to provide the thermal response analysis. This code includes a complex thermal response model for determining the in-depth response of a material system to an external heat flux. Furthermore, internal heat generation is provided for as a code input. The external flux variation with time can be specified on input cards (e.g., to model a fire environment) or be calculated by the code's trajectory subroutines (the aerodynamic flux due to a vehicle reentering the Earth's atmosphere). A detailed surface energy balance is included to account for reradiation, conduction, and surface mass loss effects. The conductivity, specific heat, heat of fusion, heat generation, and density of various internal and surface material components are also input to the code to model the complex response of the material components to the input and internal heat

fluxes. Variations of the above material properties with temperature are also included where appropriate.

RETAC code inputs can be placed in several categories:

- Geometric considerations (i.e., size, shape, and weight)
- Initial temperature conditions
- Material properties as a function of temperature (i.e., conductivity, specific heat, emittance, density, and heat of fusion)
- Initial orbit conditions (i.e., velocity, altitude, relative flight path angle, and ballistic coefficient)
- Vehicle stability (i.e., spinning versus stable).

The input variables used in the reentry analysis are given below.

5.4.1.1 Geometry

Geometric parameters are inputted into the code to define various material boundaries. This geometric definition essentially divides the body into a series of nodal regions which interact with one another as heat is transferred between the various nodes. An example of this complex nodal structure is shown in Figure 5-5. Note that for two-dimensional (2-D) calculations the body is usually divided into five sectors defined by six input angles (θ in Figure 5-5a) from 0 to 180 degrees. The 3-D shape of each sector is produced by rotation of the 2-D representation about the $\theta = 0$ axis (i.e., symmetry axis). For example, the conically shaped 3-D representation of sector No. 2 is shown crosshatched in Figure 5-5a.

The spherical body is further subdivided into a series of up to 10 concentric rings (see Figure 5-5b). The various ring radii usually define spherical shell regions of the body such as the waste boundary, but several rings can also be used within a given material to better define the temperature distribution within that material. The combination of rings and sectors define various nodal regions throughout the body. The location of the (sector = 2, ring = 2) node is shown in Figure 5-5b. It is one of the 20 nodal regions shown in this figure. For 2-D calculations, up to 50 nodal regions were used with a preponderance of nodes being located in the region of highest heat flux. For 1-D calculations, such as a spinning reentry or a fire environment, only one sector from 0 to 180 degrees was used. Hence, the nodes reduced to a maximum of 10 concentric spherical shells. Regions of radiation gaps can also be conveniently defined using the ring geometry. Heat transfer across a radiation gap is incorporated in the code, and material emissivity is accounted for as an input variable.

For the particular cases of interest, the geometric model used a series of nine or ten concentric spherical rings as shown in Figure 5-6. The location of each ring was dependent upon the case analyzed. A summary of ring radii is also given in Figure 5-6.

ORIGINAL PAGE IS
OF POOR QUALITY

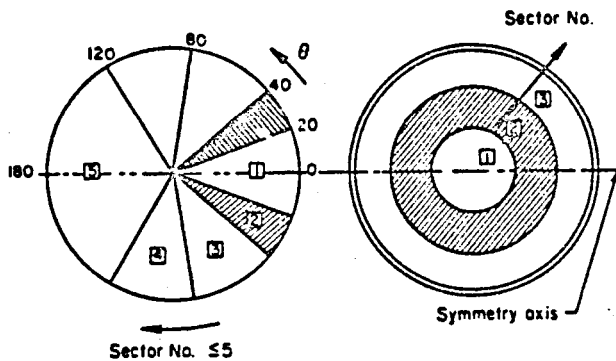

(a) Sector Geometry

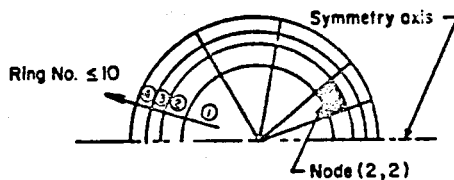

(b) Ring Geometry

FIGURE 5-5. INTERNAL NODAL STRUCTURE USED TO MODEL THE TRANSIENT HEATING RESPONSE OF VARIOUS WASTE FORM MATERIAL CONFIGURATIONS

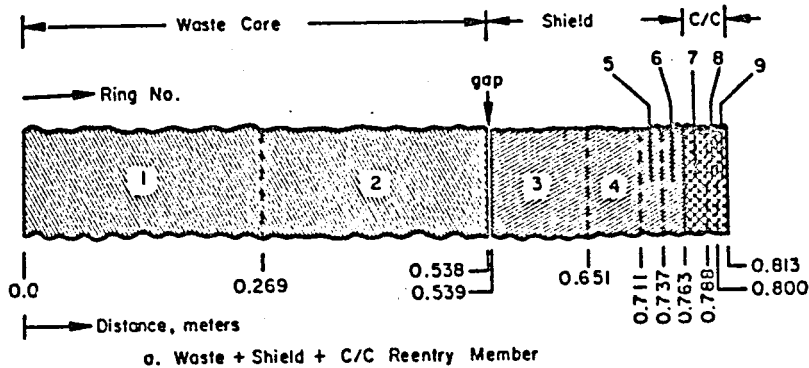

a. Waste + Shield + C/C Reentry Member

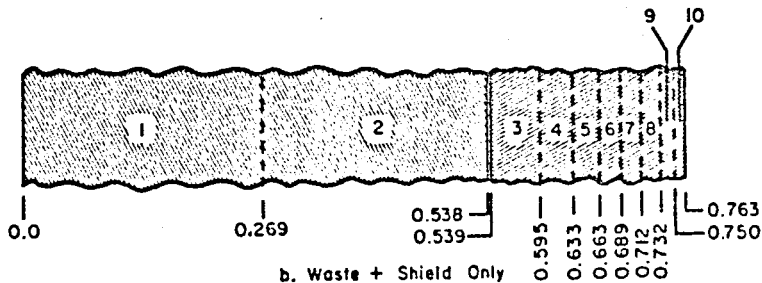

b. Waste + Shield Only

FIGURE 5-6. RING GEOMETRY FOR TWO MAJOR CONFIGURATIONS ANALYZED

The initial temperature distribution of each node (i.e., ring if the initial distribution is spherically symmetric) is an important code input. The temperature distributions used in the present accident response analyses are shown in Figure 5-7.

5.4.1.2 Material Properties

The nominal material conductivity and specific heat used in the analyses are given in Table 5-11 as a function of material temperature. The waste form was assumed to thermally resemble the material called Invar. Inconel-625 properties were used for the shield and ATJ-S was assumed for a generic graphite material. In Table 5-11, the code linearly interpolates between the thermal conductivity values when the temperature lies between the given values. However, for the specific heat, C_p , a stepwise approach is used whereby the value given in the table is constant up to the tabulated temperature. This procedure allows the inclusion of the heat of fusion as a step jump in the specific heat for a specific temperature increment. The area of this step (i.e., $\Delta C_p \times \Delta T = \Delta H_{\text{fusion}}$). Other material properties are listed in Table 5-12.

5.4.1.3 Initial Orbital Conditions

The initial orbital conditions for the reentry scenarios of interest were as follows:

Orbital decay: Velocity = 7620 m/s
Altitude = 91.4 km
Flight path angle = -1 degree

Steep reentry: Velocity = 11,315 m/s
Altitude = 121.95 km
Flight path angle = -60 degrees

The initial ballistic coefficients for the intact payload reentry cases were calculated from the total vehicle weight and frontal area using a drag coefficient of 1.00 to obtain values of

C/C added: $W/C_D A = 7228.6 \text{ kg/m}^2$
C/C removed: $W/C_D A = 7818.9 \text{ kg/m}^2$.

5.4.1.4 Stability Mode

Another code input is the vehicle stability mode (i.e., randomly spinning or stable at supersonic speeds). The vehicle may also be allowed to randomly tumble at subsonic speed. For the stable condition, calculated temperature will be different for each sector and ring. However, for a totally spinning reentry only, the ring temperature varies as the heat is spread evenly among the various sectors. A mixed stable/spinning trajectory

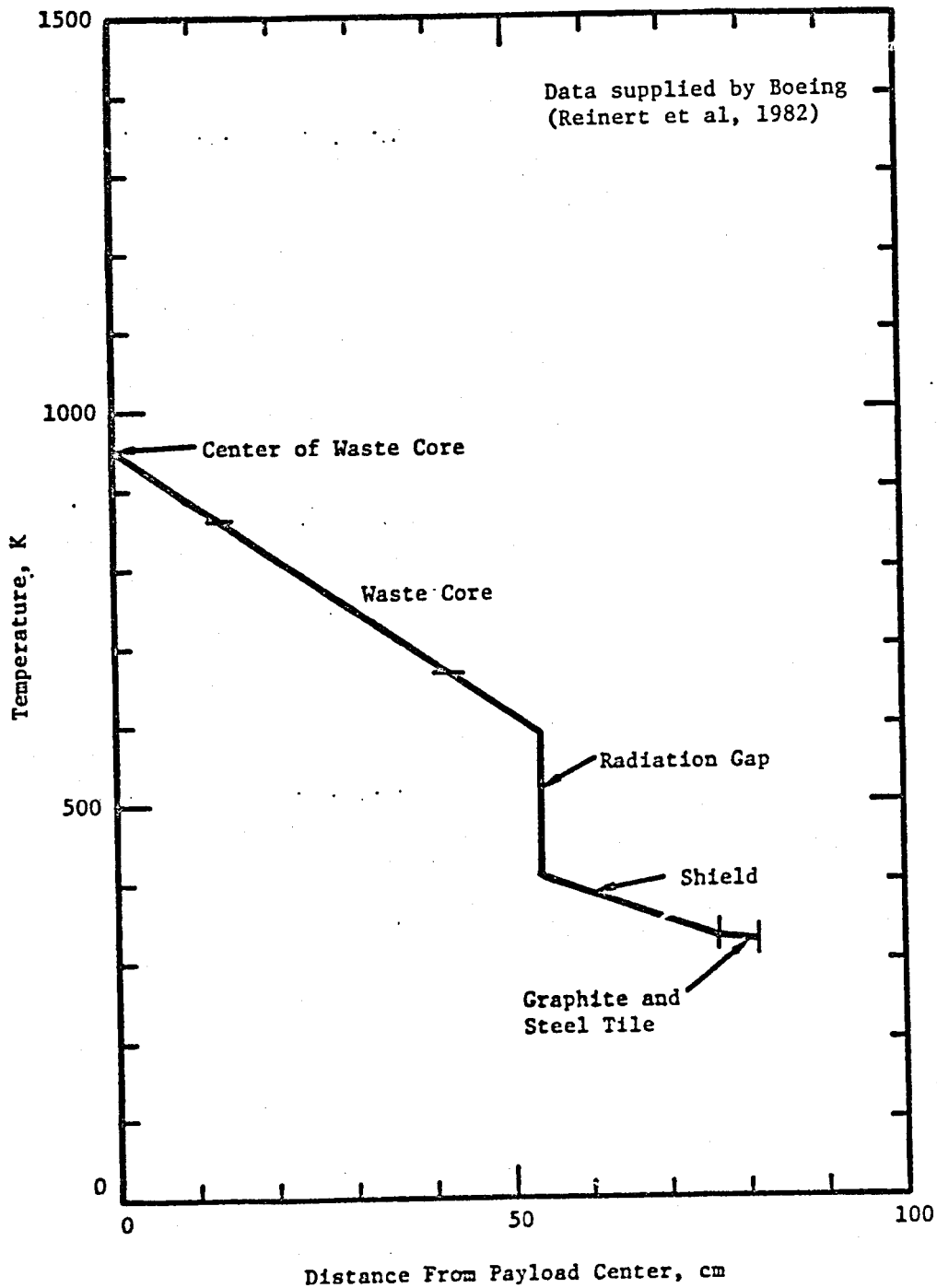

FIGURE 5-7. ON-ORBIT STEADY-STATE PRE-REENTRY TEMPERATURE CONDITION

TABLE 5-11. MATERIAL PROPERTIES AS A FUNCTION OF TEMPERATURE

Temperature, K	Waste Core (Invar)		Shield (Inconel-625)		Graphite (ATJ-S)	
	k, W/mK	Cp, W-s/kg K	k, W/mK	Cp, W-s/kg K	k, (W/mK)	Cp, (W-s/kg K)
44.4	2.1E-04	3.97E-05	8.90E-05	3.10E-05	1.611E-03	
88.9			8.90E-05			
111.1	2.1E-04	3.97E-05				
233.3						
255.6	3.0E-04		1.18E-04	3.10E-05		9.05E-05
300.0					1.611E-03	
400.0		3.97E-05				
477.8	3.8E-04		1.60E-04	3.54E-05		
533.3					1.242E-03	1.08E-04
600.0	4.1E-04	4.49E-05				
700.0			2.03E-04	3.94E-05		
800.0	4.8E-04					
811.1	5.0E-04				9.45E-04	1.24E-04
922.2		4.23E-05	2.45E-04	4.33E-05		
1088.9	5.8E-04				7.38E-04	1.39E-04
1144.4			2.94E-04	4.77E-05		
1255.6			3.30E-04			
1366.7		4.62E-05			6.25E-04	1.50E-04
1561.1				5.17E-05		
1603.3				6.69E-04(a)		
1644.4		4.94E-05			5.53E-04	1.57E-04
1922.2		5.40E-05			5.05E-04	1.63E-04
2200.0					4.73E-04	1.66E-04
2477.8					4.49E-04	1.69E-04
2755.6					4.33E-04	1.70E-04
3033.3					4.16E-04	
5811.1	5.8E-04	4.98E-05	3.30E-04	5.17E-05	4.16E-04	1.70E-04

(a) Accounts for ΔH_{fusion} .

can also be computed with the final result of differing temperatures for each node.

TABLE 5-12. OTHER MATERIAL PROPERTIES OF INTEREST

Material Property	Waste Form	Shield	Graphite Aeroshell
Density (g/cm ³)	6.84	8.44	1.83
Emissivity	0.80	0.80	0.90
Heat of Fusion (cal/g)	65.0	80.6	--
Internal Heat Generation (cal/cm ³)	1.2E-03	0	0
Melting Temperature (K)	1720	1560	--

5.4.1.5 Results and Discussion

Using the above code inputs, the thermal response of a shielded waste form container and waste form chunks was analyzed for several scenarios. Code outputs include node temperatures as a function of time during entry. Trajectory data are also provided. Impact conditions are noted by observing the properties at the time of Earth impact. The code's analysis scheme accounted for the mass loss of either graphite or a metal material (i.e., melting ablation). The resultant mass loss was thereby accounted for automatically throughout the reentry.

5.4.1.5.1 Case 1 - Graphite Aeroshell Included (Orbital Decay)

The first case involved reentry of the waste form plus shield and graphite aeroshell. The ring radii are given in Figure 5-6a, and the sectors are defined by $\theta = 0, 20, 40, 80, 120,$ and 180 degrees. An orbital decay trajectory was assumed in this case. Results of surface mass loss and nodal temperatures for stable and randomly spinning reentry modes are given in Tables 5-13 and 5-14, respectively. The impact velocity was predicted to be 442 m/s.

TABLE 5-13. SURFACE RESSION AND NODE TEMPERATURES
AT IMPACT FOR STABLE REENTRY MODE

θ , deg	Total Recession, cm	Ring Temperature, K ^(a)								
		1 C	2 C	3 S	4 S	5 S	6 S	7 A	8 A	9 A
0 (nose)	0.45	853	678	383	352	402	765	1541	1640	1616
20	0.43	853	678	383	351	396	738	1496	1598	1582
40	0.33	853	678	383	251	376	639	1293	1392	1402
80	0.10	853	678	383	350	348	467	791	824	833
120	0	853	678	383	349	339	386	524	535	538
180	0									

(a) C = Core; S = Shield; A = Ablator.

TABLE 5-14. SURFACE RESSION AND NODE TEMPERATURES AT
IMPACT FOR SPINNING REENTRY CONFIGURATION

θ , deg	Total Recession, cm	Ring Temperature, K ^(a)								
		1 C	2 C	3 S	4 S	5 S	6 S	7 A	8 A	9 A
0-180	0.112	853	678	383	350	364	580	1162	1247	1267

(a) C = Core; S = Shield; A = Ablator.

These results indicate that, for an orbital decay trajectory, the graphite-protected waste form and shield will survive intact to Earth impact, regardless of reentry stability mode.

5.4.1.5.2 Case 2 - Orbital Decay Reentry of Waste Plus
Shield Only (i.e., Graphite Aeroshell Removed)

In this case, the graphite aeroshell is assumed to be lost due to some malfunction, and the waste form inadvertently reenters on an orbital decay trajectory with only the Inconel-625 metal shield to protect it. The ring radii are given in Figure 5-6b and the sectors are defined by $\theta = 0, 15, 30, 45, 60, \text{ and } 180$ degrees.

In this case a melting ablator mass loss calculation was assumed whereby material nodes were dropped when their temperature reached the melting point and the heat of fusions was supplied. No liquid layer effects were accounted for in the analysis. Hence, the mass loss results are expected to be conservative. These surface recession data and nodal temperatures for stable and randomly spinning reentry modes are given in Tables 5-15 and 5-16, respectively. Impact velocity was calculated to be 470 m/s.

TABLE 5-15. SURFACE RECESSION AND NODE TEMPERATURE AT IMPACT
FOR STABLE REENTRY MODE RING TEMPERATURE (K)

θ , deg	Total Recession, cm	Ring Temperature, K ^(a)									
		1 C	2 C	3 S	4 S	5 S	6 S	7 S	8 S	9 S	10 S
0 (nose)	16.33	836	678	457	-(b)	-	-	-	-	-	-
15	15.72	836	678	398	592	-	-	-	-	-	-
30	13.64	836	678	389	503	-	-	-	-	-	-
45	11.05	836	678	381	380	558	-	-	-	-	-
60	6.91	836	678	380	353	346	389	537	-	-	-
180	0.00										

(a) C = Core; S = Shield.

(b) Material node is not present at impact (i.e., it ablated away during reentry).

TABLE 5-16. SURFACE RESSION AND NODE TEMPERATURE AT IMPACT FOR SPINNING REENTRY MODE

θ, deg	Total Recession, cm	Ring Temperature, K									
		1 C	2 C	3 S	4 S	5 S	6 S	7 S	8 S	9 S	10 S
0-100	1.68	836	678	380	353	346	383	539	866	1058	-

These results indicate that, for an orbital decay trajectory, the shield will remain essentially intact if the vehicle randomly spins during reentry. However, if the body remains stable, a large portion of its nose region is eroded away during reentry (see Table 5-15). Therefore, shielding of the waste form will be reduced in that area and impact protection will also be adversely affected.

5.4.1.5.3 Case 3 - Steep Reentry of Waste Form Plus
Shield Plus Graphite Aeroshell

This last case involved reentry of the waste form, shield, and graphite aeroshell at a steep (60 degrees) angle and at a high reentry velocity (11,315 m/s). Analysis of this case is extremely difficult due to the high rate of heat flux to the vehicle. For the spinning mode of entry, the analysis was completed, but a very long run time would have been required to obtain results for the stable reentry configuration. A summary of the impact results obtained for the spinning case are:

T shield (surface) = 542 K
 T shield (bulk) = Unchanged (350 K)
 Surface recession = 0.048 cm.

Based upon the results of the orbital decay trajectory calculations the nose recession for the stable case would be approximately four times that of the spinning case. Therefore, it is expected that the stable nose recession would not have exceeded 0.20 cm. For both reentry configurations, the impact velocity was calculated to be 5328 m/s. (A 90 degree reentry results in an impact velocity of 5912 m/s.)

Calculations and estimates given above indicate that the graphite aeroshell will protect the waste form plus shield prior to Earth impact. However, the very high impact velocities determined for this steep entry case may provide another set of problems for this reentry scenario.

5.4.1.5.4 Case 4 - Orbital Decay Reentry of Waste Form Chunks

Several calculations were made to help evaluate the waste form burn-fractions for different-sized waste form chunks. These pieces are believed sible when a catastrophic on-orbit collision (meteoroid or debris) occurs. reentry conditions were those given for orbital decay (see Section .1.3), with the assumption that the chunks were spherical and spinning. smallest size (3.35 cm radius) approximated an individual billet. The ults are given below:

<u>Radius, cm</u>	<u>Recession, cm</u>
3.35	3.35 (all)
10.16	3.78
20.32	2.55
81.26	1.68

ure 5-8 shows a plot of these data. It may be concluded that total burnup the waste form will likely occur for pieces less than about 9 cm in radius.

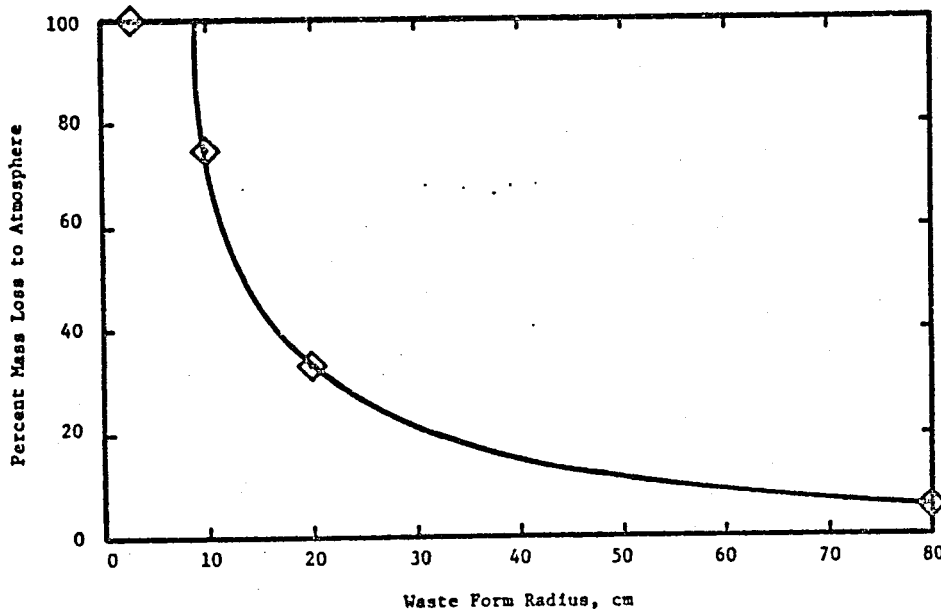

FIGURE 5-8. PERCENT WASTE FORM MASS LOSS FOR UNPROTECTED WASTE FORM AS A FUNCTION OF RADIUS

5.4.2 Postburial Meltdown Analysis

The waste payload generates heat due to the decay of radioisotopes. If the payload were subjected to a sufficiently insulating environment, the waste generation has the potential to cause the waste form core to melt internally. This may lead to the melting of the shield and breach of containment, followed by release to the biosphere.

In the event of an accidental payload reentry, it is possible for the payload to bury itself in an insulating material, such as dry sand. If the payload were not recovered within some critical time period (T_{cr}), a melt release could occur. To analyze the possibility of this release, it was necessary to perform a thermal analysis on the payload to determine the conditions required for melting to occur. In particular, it was necessary to determine the limiting thermal conductivity, k_{limit} , of the insulating environment which would cause melting. The value established in this analysis was then used to estimate the percentage of the Earth in which material of sufficiently low thermal conductivity exists (see fault tree discussion).

The analysis was performed as follows. Since the center of the waste form would be the hottest point, a limiting temperature (90 percent of the waste form formation absolute temperature; see General Safety Guidelines) was established below which no melting (with safety factor) would occur. The temperature drops for the cermet, the gap, the Inconel-625 shield, and the graphite thermal protection system (TPS) were then calculated. This resulted in the critical surface temperature which could result in melting. This temperature, along with the surface area and ambient temperature, was then used to calculate the limiting thermal conductivity, k_{limit} .

In performing this analysis, several assumptions were made. Constant values were used for the properties of the cermet, Inconel-625, and graphite. This assumption was proper since the temperature drops turn out to be small. Another conservative assumption was made that the payload was buried deeply in an insulating medium. The results of these calculations are displayed in Figure 5-17.

5.4.3 Granite Impact Analysis

The objective of this dynamic finite-element impact analysis was to perform a preliminary analytical response assessment of the reentry impact of the waste payload on hard rock (granite) in support of predicting the release risk. For this analysis, simplifying assumptions were made for the material behavior of the payload and the granite target. By not allowing failure to occur in the target, the results presented here are conservative.

The DYNA2D finite-element computer program, developed at Lawrence Livermore National Laboratory, was used in the analyses. DYNA2D is an explicit, time integration code and contains a four-noded quadrilateral element that is based on the Galerkin-Petrov formulation. Features within the program which are significant in terms of the model employed in this analysis include:

TABLE 5-17. THERMAL CONDUCTIVITY IN IMPACT MEDIUM NEEDED TO ALLOW TEMPERATURE CONDITIONS GIVEN

Core Center Temperature, C	Core Surface Temperature, C	Outer Shield Temperature, C	Limiting Thermal Conductivity, W/mC
1050	1000	--	0.32
1200	1150	--	0.28
--	1200	1170	0.26
--	1450	1435	0.21
--	1450	1450(a)	< 0.21

Melt condition for outer part of radiation shield.

- (1) A bilinear representation with isotropic strain hardening for elastic-plastic stress-strain response of the material.
- (2) Calculations based on large deflection and finite strain theories.
- (3) Slidelines that allow modeling of initial separation and subsequent contact as a result of impact.

is particularly significant that the analysis was devoid of any material failure criterion, thus allowing stresses to exceed thresholds such as the yield or rupture stress. This implies that the calculated results, in terms of the extent of damage through failure, would be conservative on account of the simulation of the target.

5.4.3.1 Impact Model Description

The finite-element analysis is based on the assumption that the components of the waste payload can be considered as homogeneous, spherically symmetric core material representing the cermet waste form and the primary shell core structure, surrounded by the Inconel-625 radiation shield shell, a thin outer steel impact absorber and the thermal ablation shield (tiles) assumed to be structurally insignificant and, hence, were not modeled. The waste payload with the Inconel shield was assumed to impact a 66-cm-thick concrete layer which was assumed to be supported by a rigid foundation.

An axisymmetric finite-element grid was developed, and is shown in Figure 5-9. It consists of 334 nodal points and 262 elements, of which the impact slab accounted for 80 elements, the radiation shield was represented by 92 elements, and the waste core was represented by 90 elements. Slidelines were prescribed in the model which allowed separation or contact as a result of deformation between the waste core and the radiation

shield, and between the shield and the granite surface. These slidelines, as indicated in Figure 5-9, allowed free sliding between the respective surfaces.

The material representing the waste core (cermet waste form and its encapsulating steel core) was assumed to have mechanical properties corresponding to Hastelloy X, while the radiation shield material was modeled as Inconel-625. The stress-strain curves for both these materials were cast into bilinear forms to account for elastic and plastic responses. These representation forms were dictated by the computer program. The granite layer was modeled as linear elastic.

The effect of a temperature distribution within the primary containment and the radiation shield layer on the structural deformation was also sought. Details of the assumed temperature distribution after reentry and just before ground impact may be found in Section 5.4.1. It was assumed that the contribution of temperature gradients toward nodal point loads applied to the model is relatively small and can be neglected. However, the effect of temperature on the material yield properties was considered important and, hence, was included by assuming that the temperature distribution remains unchanged during deformation of the containment. Table 5-18 contains the mechanical property data assumed for the three material constituents in the finite element model. The data were either directly obtained from references (Tama, 1978; Manson, 1976; or MIL-HDBK-5B, 1971) or derived through interpolation/extrapolation.

The data set defining the model also included certain viscosity parameters. It is usual to prescribe such parameters when modeling dynamics of impact through explicit time integration methods so as to smooth the shock fronts as well as prevent hourglassing or keystoneing effects (Hallquist, 1980).

Two sets of computations, corresponding to two impact velocities, were carried out to determine the deformations suffered by the waste payload. The impact velocities assumed were 442 m/s and 152 m/s. The higher velocity corresponds to the expected velocity at impact following inadvertent payload reentry due to a decaying orbital condition (see Section 5.4.1 for reentry calculation). The second velocity was selected for analysis based upon the thought that the payload survival could be achieved at this value, and that this value was possible in the early portion of the flight phase of the shuttle.

5.4.3.2 Results of Impact Calculation

The DYNA2D computer program (given the modeling assumptions previously stated) calculated stresses and deflections of the finite-element grid at various instants following initiation of impact. For the case corresponding to the impact velocity of 442 m/s, it was found that the kinetic energy was almost entirely dissipated after 1.5 ms. Obviously, during this time interval, the kinetic energy is converted into elastic and plastic deformations. The elastic part of the deformations would induce the payload to rebound after the kinetic energy has approached the zero level.

Assumptions

Velocity of impact = 442 m/s.

The effect of temperature gradient
on material properties is accounted
for in the model; thermal load
effects are ignored.

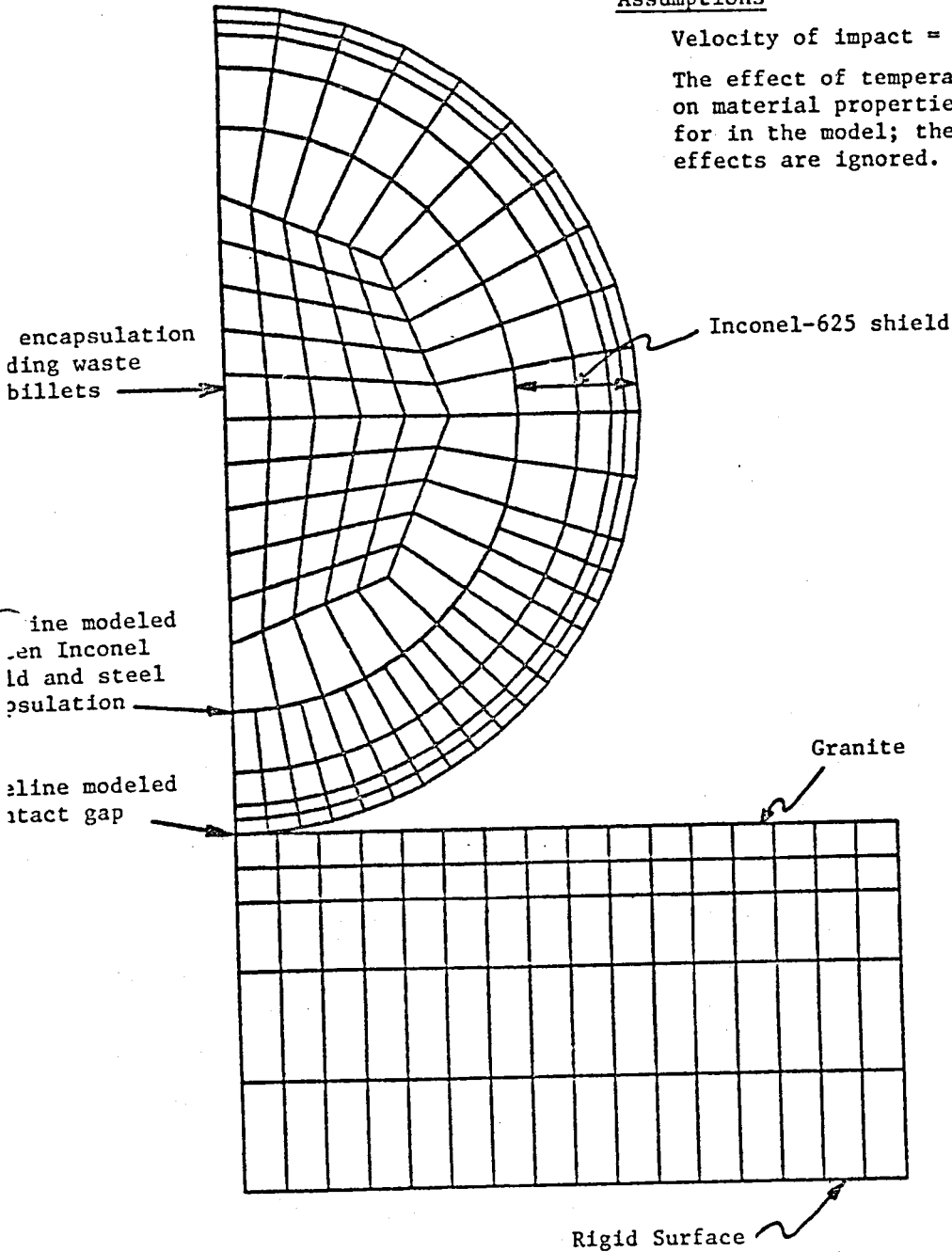

FIGURE 5-9. FINITE-ELEMENT MODEL FOR NUCLEAR WASTE
PAYLOAD IMPACTING GRANITE

TABLE 5-18 STRUCTURAL PROPERTIES OF MATERIALS USED IN ANALYSIS

	Temperature, C	Density, g/cc	Young's Modulus N/cm ²	Poisson's Ratio	Yield Stress, N/cm ²	Plastic Modulus, N/cm ²
Hasteloy	835	6.83	1.05E7	0.3	1.79E4	1.10E6
	660	6.83	1.21E7	0.3	2.07E4	1.21E6
Inconel-625	365	8.45	1.86E7	0.31	4.03E4	3.47E5
	335	8.45	1.89E7	0.31	4.07E4	3.47E5
	350	8.45	1.88E7	0.31	4.06E4	3.47E5
	560	8.45	1.76E7	0.32	3.79E4	3.47E5
Granite	25	2.49	8.19E6	0.036	--	--

B
A
T
T
E
L
L
E
-
C
O
L
U
M
B
U
S

87

Sources: Lama (1978), Manson (1976), and MIL-HDBK-5B(1971).

Figure 5-10 illustrates the deformed shape of the modeled payload at various times following initial impact on granite. It may be seen that the payload progressively undergoes significant distortion, especially in the region within the radiation shield close to the impact point. Distortions of the order evident in Figures 5-10e and 5-10f lead to numerical errors in the computations when using a Lagrangian-based code like DYNA2D. It would have been possible to activate the rezoning feature existing within DYNA2D to counteract the problem of mesh distortion, but such an undertaking would have meant significant, additional work.

The reason for the deformation in the granite slab being small in comparison with those for the waste payload is because the elastic modulus of granite is significantly larger than the plastic modulus or the secant modulus corresponding to the stress condition of the Inconel and Hastelloy components. Figures 5-11 and 5-12 present computer graphics of the von Mises stress (equivalent stress) and the hoop stress (stress perpendicular to the plane of the model) at 1 ms after impact (see Appendix H for additional plots at different times).

The von Mises stress ($\bar{\sigma}$) is a measure of the triaxial stress state that can usually be directly correlated against data derived from a uniaxial tensile test. It may be seen in Figure 5-11 (and in figures in Appendix H) that $\bar{\sigma}$ is particularly severe at the edge of the contact zone. This result is similar to what has been observed in other simulations. It is also evident that the maximum value of $\bar{\sigma}$ during the course of deformation exceeds typical ultimate stress values (at specific locations) for austenitic steels. This signifies failure at these locations fairly early within the impact duration. However, due to the absence of a failure criterion, $\bar{\sigma}$ is seen to progressively far exceed the ultimate stress range. This inadequacy in the model prevents a redistribution of stresses that would occur as a result of failure of a certain region. Qualitatively, it may be said that a larger region would exceed the ultimate stress, were redistribution allowed to occur.

While the magnitude of $\bar{\sigma}$ is an index of stress criticality, the likely mode of failure can only be obtained by inspecting the stress components. It was found that the hoop stress (plotted in Figure 5-12) was the predominant tensile component, thus suggesting the possibility of the containment splitting open in two or more pieces (see Appendix H for hoop stress plots at all four selected times). But at the edge of the contact zone, the radial component of stress was also tensile to an extent that suggests failure through spalling.

It must be noted that the model also fails to account for the finite material strength of the granite; thus the calculations made overestimate the damage to the payload.

Figure 5-13 depicts the deformed shape of the waste payload at various times following impact on a granite slab at 152 m/s. The computations were carried out through 1.5 milliseconds from the time of initial impact. Inspection of the results corresponding to 1.5 milliseconds indicates that the payload will be in a state of rebound at that time. At the time

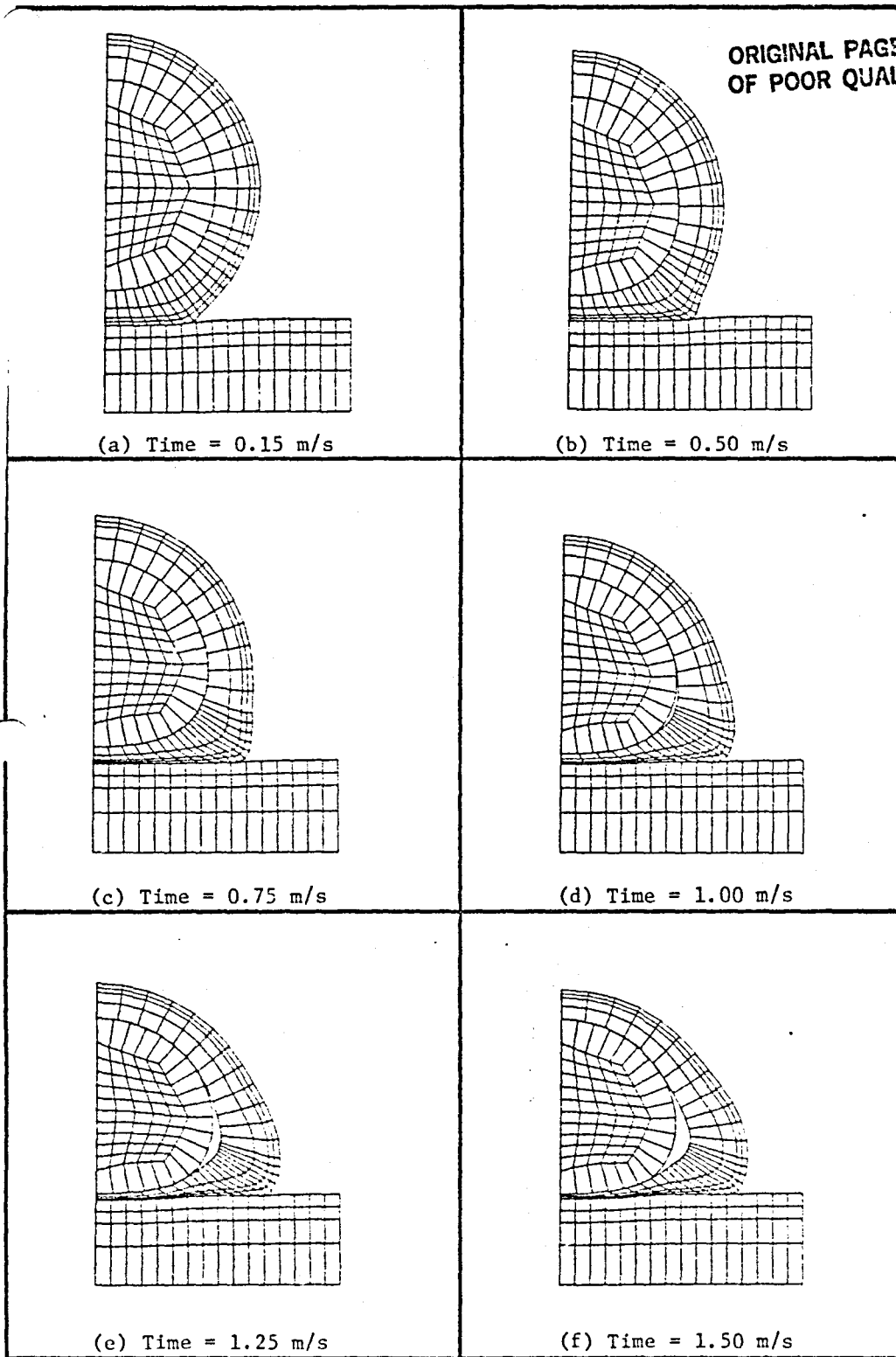

FIGURE 5-10. DEFORMED SHAPE OF THE SHIELDED WASTE PAYLOAD FOR VARIOUS TIMES DURING IMPACT (442 m/s INITIAL VELOCITY)

.001000

SIGMA EQ

□	50000.00	×	400000.00
○	100000.00	◇	500000.00
△	200000.00	⊕	600000.00
+	300000.00	⊗	700000.00

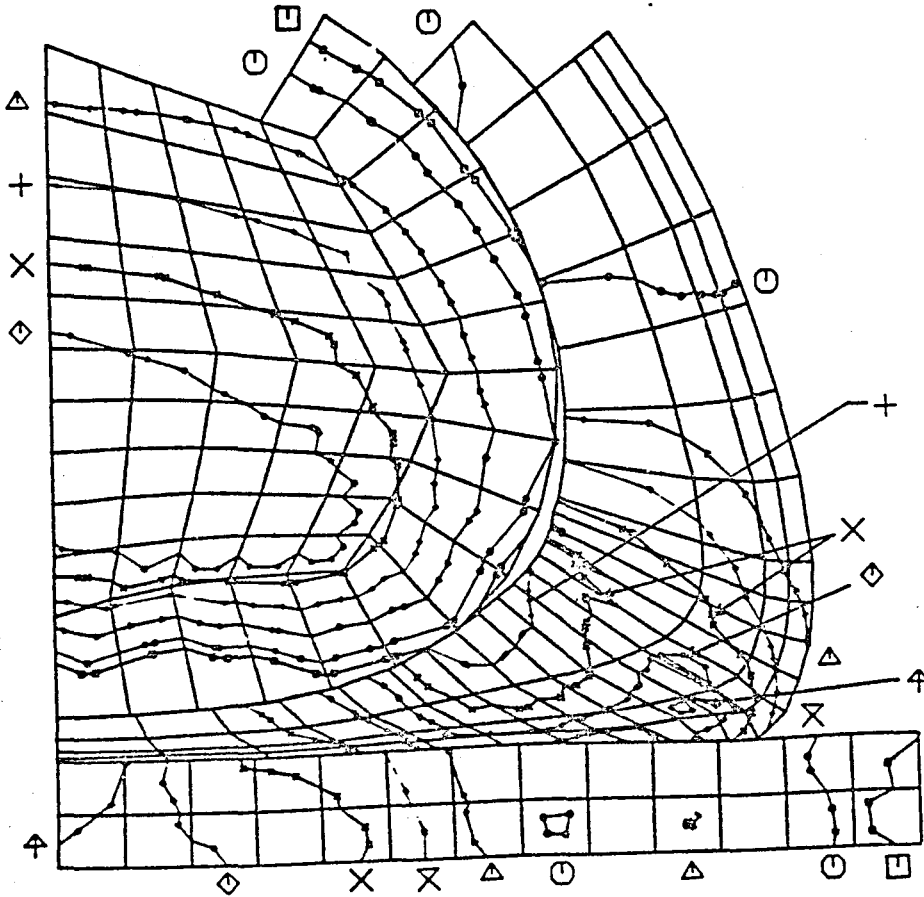

FIGURE 5-11. CONTOURS OF VON MISES STRESS AFTER 1 ms OF
IMPACT (442 m/s INITIAL VELOCITY)

.001000

SIGMA T

□	-800000.00	↑	0.00
○	-700000.00	×	300000.00
△	-600000.00	Y	400000.00
+	-500000.00	⋈	500000.00
X	-400000.00	*	600000.00
◇	-300000.00		

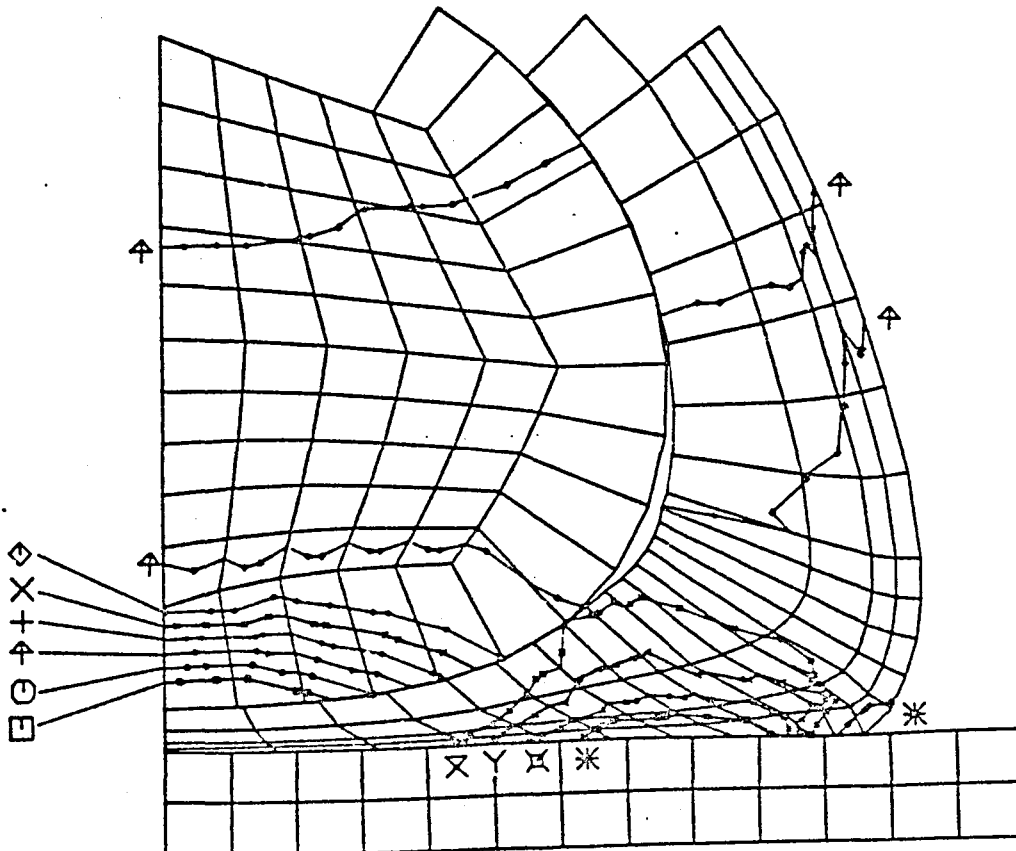

FIGURE 5-12. CONTOURS OF HOOP STRESS AFTER 1 ms OF
IMPACT (442 m/s INITIAL VELOCITY FIGURE)

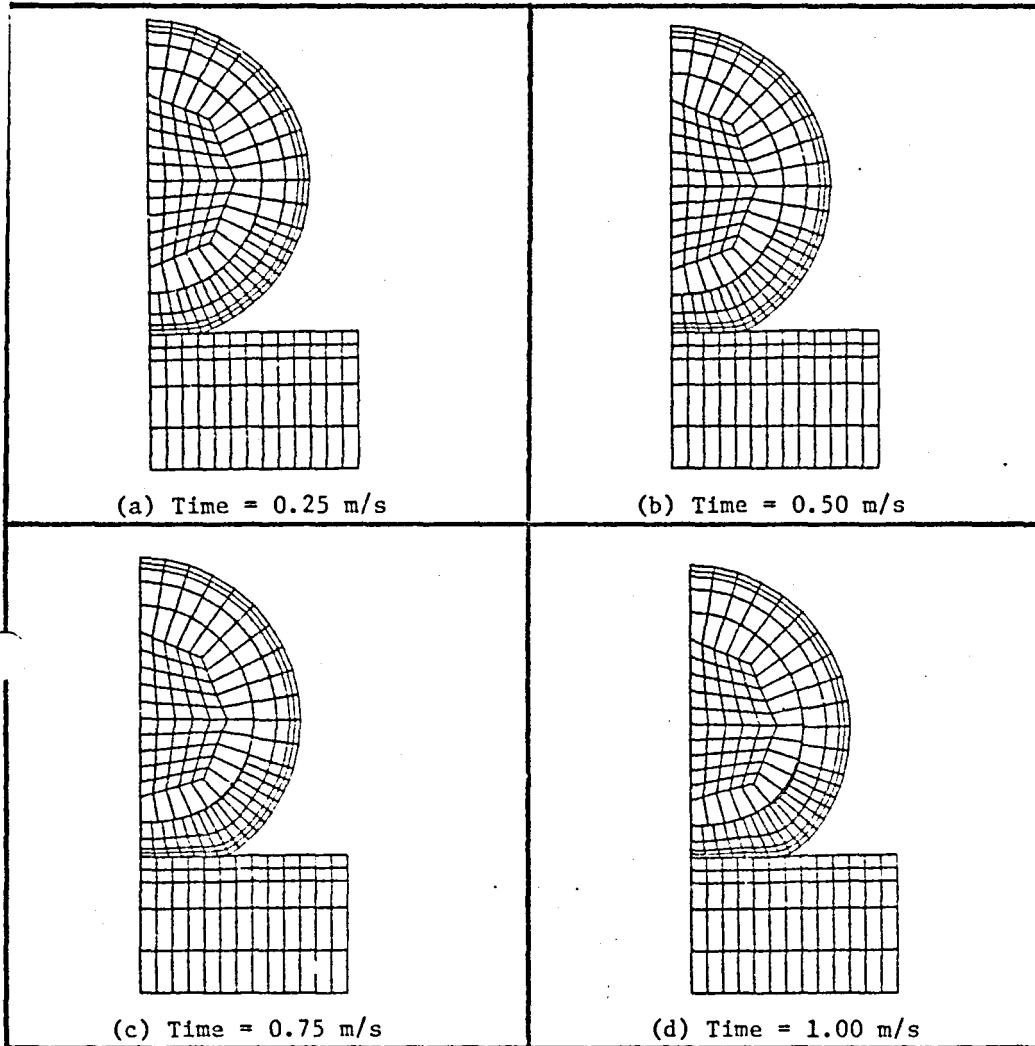

FIGURE 5-13. DEFORMED SHAPE OF THE SHIELDED WASTE PAYLOAD FOR VARIOUS TIMES DURING IMPACT (152 m/s INITIAL VELOCITY)

stant of 1.0 milliseconds (see Figure 5-13d), the kinetic energy corresponding to the initial condition was observed to be almost entirely dissipated.

Figures 5-14 and 5-15 show the contour plots of the von Mises stress and the hoop stress in the payload for 1 ms after impact (at 152 m/s). The other plots for different times are provided in Appendix H. It may be noted that the stresses are still calculated to reach high levels and failure of the radiation shield looks to be likely. However, as expected, the magnitude of the stress and the likely extent of damage of the waste payload is muted for the case of $V = 152$ m/s when compared with the results of $V = 442$ m/s. Again, the reader is reminded of the conservative model assumptions.

5.4.3.3 Conclusions

The major conclusion reached by conducting this preliminary and conservative impact analysis is that the radiation shield likely will not be able to withstand the impact and will fail (at $V = 442$ m/s). As a result, the possibility of release of the enclosed waste form will need to be considered in the risk analysis.

Consequence Evaluation

This section discusses the various analyses conducted to evaluate the consequences of events shown at the top of the fault trees described and shown in Section 5.2. Based upon the fault tree development, the events listed in Table 5-19 have been evaluated as to their potential consequences. Table 5-20 defines the radionuclide inventories (in Curies) as a function of time for the reference cermet HLW payload, the technetium payload, and the iodine payload.

15 isotopes listed were selected such that the space disposal risk estimates could be made compatible with the MGR risk estimates provided by EPA. The 15 isotopes are related to draft EPA repository release limits (see Allum et al, 1982).

The consequences of each event shown in Table 5-19 are discussed in the following sections. At the beginning of each section, a brief discussion of each event is presented, followed by an appropriate discussion of technical issues.

5.5.1 Long-Term Corrosion, Ocean

This event occurs when the nuclear waste payload impacts the ocean, impact recovery attempts fail, and the payload is lost forever. The release scenario is governed by the corrosion of the Inconel-625 radiation shield, followed by waste form leaching. Corrosion of the shield is estimated to occur based upon corrosion rates of 0.1 mils/yr with range of 0.3 mils/yr to 1 mils/yr (see Section 5.5.1.1). This means that after 87,800 years to 300 years to 878,000 years) the core will be available for leaching. For leaching, a leach rate of 10^{-6} g/cm²·day, with 90 percent confidence that

.001000

SIGMA EQ

□	30000.00	×	300000.00
○	50000.00	◇	400000.00
△	100000.00	⊕	500000.00
+	200000.00	⊗	600000.00

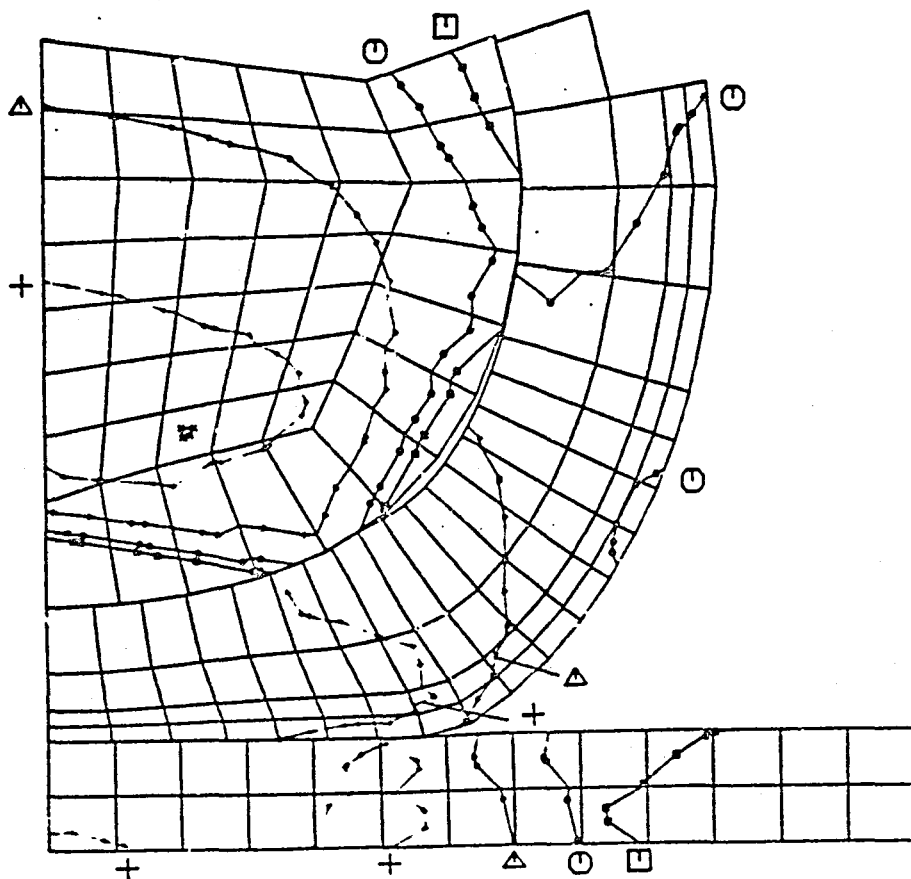

FIGURE 5-14. CONTOURS OF VON MISES STRESS AFTER 1 ms OF
IMPACT (152 m/s INITIAL VELOCITY)

ORIGINAL PAGE IS
OF POOR QUALITY

95

.001000

SIGMA T

□	-800000.00	⊕	0.00
○	-700000.00	⊗	300000.00
△	-600000.00	⋈	400000.00
+	-500000.00	⊙	500000.00
X	-400000.00	⊛	600000.00
◇	-300000.00		

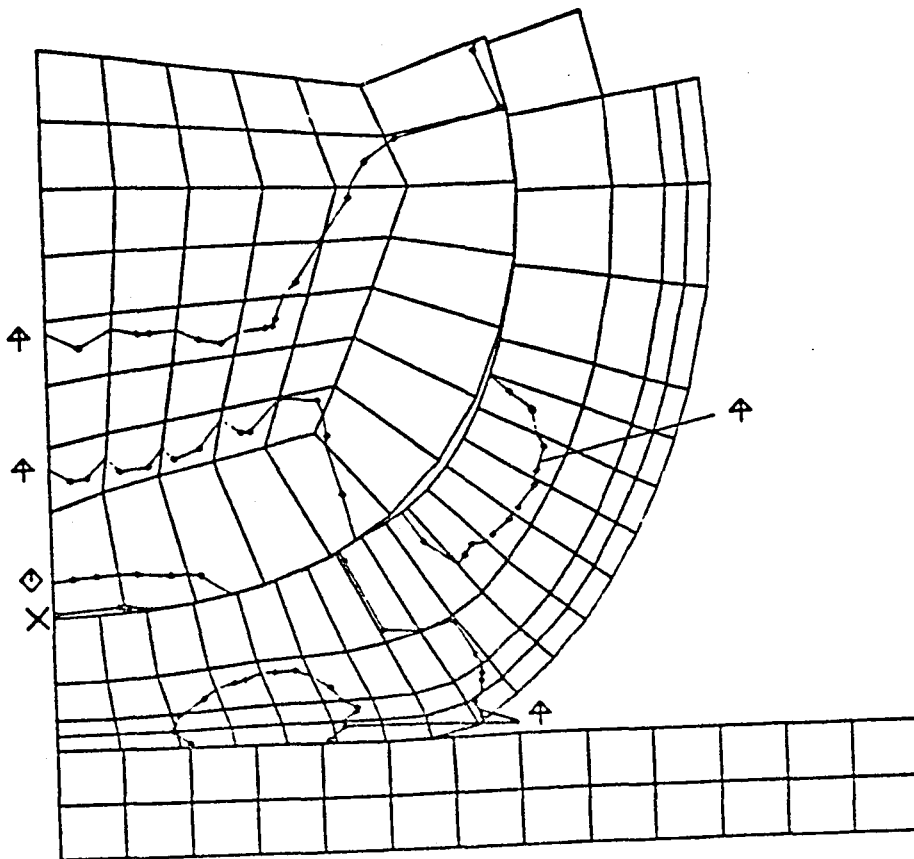

FIGURE 5-15. CONTOURS OF HOOP STRESS AFTER 1 ms OF
IMPACT (152 m/s INITIAL VELOCITY)

ORIGINAL PAGE IS
OF POOR QUALITY

96

TABLE 5-19. SUMMARY OF RELEASE OF EVENTS FOR SPACE DISPOSAL(a)

Title	Description
Long-Term Corrosion, Ocean	Payload impacts ocean, intact, recovery fails, and payload is lost forever.
Impact on Hard Rock(b)	Payload impacts rock at nominal decaying reentry velocity, and is recovered within reasonable time.
Impact on Volcano	Payload impacts on active volcano, melts, mixes, and disperses into lava.
Soil Meltdown(b)	Payload impacts on a highly insulating material $k < k_{limit}$; is not recovered, heats up, and melts.
On-Orbit Collision	On-orbit payload/debris or payload/meteorite collision occurs with payload breakup followed by reentry.
Long-Term Corrosion, Soil	Payload impacts wet soil, intact, recovery fails, and payload is lost forever.
High-Velocity Impact on Water	Payload impacts ocean, intact, but then breaches and leaches, no recovery assumed.
High-Velocity Impact on Rock(b)	Payload impacts rock, intact, but then breaches, releasing fraction of material to atmosphere, fraction remaining is recovered.
High-Velocity Impact on Soil(b)	Payload impacts soil, recovery fails, the payload is breached and leaches to biosphere.
Deep Space - Payload Return to Earth	Payload returns to Earth because of OTV/SOIS failure after escape, all material released to biosphere.
Deep Space - Meteoroid Collision	Payload collides with meteoroid, breaks up, and some material travels way back to Earth.
Deep Space - Payload/Payload Collision	A payload/payload collision occurs, payload breaks up, and material returns to Earth.
Deep Space - Payload/Comet Collision	A payload/comet collision occurs, payload breaks up, and material returns to Earth.
Deep Space - Erosion	Long-term erosion of the payload shield in deep space.

sed upon the current Reference Concept (see Section 3.0).
cident recovery possible.

TABLE 5-20. PAYLOAD RADIONUCLIDE INVENTORIES (IN CURIES)
AS A FUNCTION OF TIME

Isotope(s)	Age of Waste, Years					
	50	100	10 ³	10 ⁴	10 ⁵	10 ⁶
<u>Reference Payload^(a)</u>						
99Tc	1.71E3	1.71E3	1.70E3	1.65E3	1.21E3	53.5
241Am	8.97E4	8.31E4	1.94E4	1.04E2	0	0
243Am	6.21E3	6.18E3	5.65E3	2.52E3	0.73	0
238Pu	8.50E3	6.97E3	1.33E2	0	0	0
239Pu	2.49E2	2.57E2	4.02E2	1.19E3	1.83E2	0
240Pu	2.65E3	2.96E3	2.74E3	1.09E3	0.1	0
242Pu	2.70	2.78	3.13	3.44	3.04	0.58
237Np	54.9	56.2	69.3	73.5	71.8	53.7
226Ra	4.26E-5	9.26E-5	8.39E-3	4.49E-1	3.62	0.83
AC	(1.07E5)	(9.95E4)	(2.84E4)	(4.98E3)	(2.62E2)	(5.51E1)
129I	0	0	0	0	0	0
14C	74.6	74.2	66.1	22.3	0	0
135Cs	2.08	2.08	2.08	2.07	2.02	1.54
137Cs	1.95E5	6.27E4	1.84E-5	0	0	0
90Sr	1.18E5	3.57E4	8.00E-6	0	0	0
126Sn	73.0	73.0	72.5	68.1	36.5	7.1E-2
FP	(3.13E5)	(9.78E4)	(1.41E2)	(9.25E1)	(3.85E1)	(5.67E1)
15 EPA Isotopes	(4.22E5)	(2.00E5)	(3.02E4)	(6.72E3)	(1.51E3)	(1.10E2)
Other Isotopes	<u>6.38E6</u>	<u>2.08E6</u>	<u>7.90E3</u>	<u>3.38E3</u>	<u>7.90E2</u>	<u>7.99E2</u>
Total	6.80E6	2.28E6	3.81E4	1.01E4	2.30E3	9.09E2
<u>Technetium Payload^(b)</u>						
99Tc	1.5E5	1.5E5	1.49E5	1.45E5	1.06E5	4.69E3
<u>Iodine Payload^(c)</u>						
129I	646.4	646.4	646.4	646.4	646.4	620.6

(a) Based on 47.39 kg waste form per 1 MTHM, 133.2 MTHM/mission equivalent, 2 spheres at 6312 kg cermet.

(b) Based on 0.75 kg waste form per 1 MTHM, 11,800 MTHM/mission equivalent, 2 spheres at 8850 kg Tc metal.

(c) Based on 0.40 kg waste form per 1 MTHM, 18,750 MTHM/mission equivalent, 2 spheres at 7500 kg PbI₂.

It is within 10^{-5} to 10^{-7} , has been assumed, based upon a conversation with Scott Aaron, ORNL (see discussion below). Two leach models were possible to use. The first (more conservative) assumed that all billets are available for leaching at the given expected rate. The second assumes that only a spherical surface area is available. Data for the billet leaching model are used here; the spherical model would reduce the release risk by about one order of magnitude (McKenna, 1982).

The source terms used for this event for each of the three payloads considered for space disposal are given in Table 5-21. The discussion that follows provides an overview of the assumptions made and the model used.

Payload/Isotope(s)	Time, Years									
	8.8E4	8.9E4	9.1E4	9.3E4	9.7E4	1.0E5	1.1E5	1.2E5	1.41E5	1.0E6
<u>Reference Payload</u>										
Tc-99	0	0	0	0	0	6.7E2	9.8E2	1.1E3	1.2E3	----->
AC	0	0	0	0	0	1.6E2	2.2E2	2.5E2	2.6E2	----->
15 EPA Isotopes	0	0	0	0	0	8.7E2	1.3E3	1.4E3	1.5E3	----->
<u>Technetium Payload</u>										
Tc-99	0	4.0E4	8.2E4	1.0E5	1.1E5	----->	----->	----->	----->	----->
<u>Iodine Payload</u>										
I-129	6.5E2	----->	----->	----->	----->	----->	----->	----->	----->	----->

TABLE 5-21. EXPECTED CUMULATIVE SOURCE TERM (CURIES) FOR EVENT 1,
LONG-TERM CORROSION/LEACHING IN THE OCEAN

5.5.1.1 Radiation Shield Corrosion

In the search for establishing a reasonable value and range for the corrosion of the radiation shield in seawater, staff at ONWI, Sandia (the Subseabed Disposal Program), and Battelle were questioned. Based upon the discussions, it was determined that Battelle and Walt Boyd were the experts that should provide answers to the questions. Mr. Walt Boyd, nationally known corrosion expert, recommended that we consider titanium, Inconel-625, or Hastelloy C-276 for our radiation shield, such that low-shield corrosion would be possible. This recommendation was given to Boeing, and we selected the

Inconel-625 shield for the Reference mission, considering its shielding and strength aspects as well. Boyd indicated that the expected corrosion rate for Inconel-625 was on the order of 0.1 mils/yr or so. He said it would not be affected by temperature and, for all practical purposes, it just would not corrode. Stainless steel, on the other hand is subject to crevice corrosion. Battelle's Metals and Ceramics Information Center recently published Corrosion of Metals in Marine Environments, by W. K. Boyd and I. W. Fink (1978). This document contains much information about the various types of corrosion (general, crevice, galvanic, pitting, etc.) that are possible for different materials.

The corrosion rate values for Inconel-625 are too numerous to review here; however, in reviewing data in Battelle's Metals and Ceramics Information Center, an expected value of 0.1 mils/yr was chosen, with an upper boundary of 3 mils/yr and a lower bound of 0.01 mils/yr.

5.5.1.2 Waste Form Leach Rate

Mr. Scott Aaron, ORNL, one of the leading experts on cermet waste form technology, was asked (in a telephone conversation December 7, 1981) what would be appropriate cermet leach rates in the ocean for long-term space disposal accidents. His reply is summarized as follows. Because cesium (Cs) and strontium (Sr) have been removed from the waste (95 percent), and because residual Cs and Sr will have long decayed (allowing time for Inconel-625 corrosion), Aaron suggests that the lower and upper bounds would likely be 1×10^{-7} and 1×10^{-5} , respectively. Galvanic coupling of the cermet and Inconel-625 (for nonuniform Inconel corrosion) or cermet and core stainless steel could be possible. Mr. Aaron stated that 304 stainless steel could be either "active" or "passive". If it is active, then the leach rate of cermet could be slower than the expected value. We will assume that we can use a steel material for the core that would allow this to be true. The lower limit of 10^{-7} is based upon the fact that actinide leach rates are very low, on the order of 10^{-8} to 10^{-9} . Therefore, for purposes of this preliminary space disposal risk assessment, we assumed for long-term space disposal accidents a cermet leach rate of 10^{-6} g/cm²·day, with 90 percent confidence that it is within the range of 10^{-5} to 10^{-7} .

5.5.1.3 Corrosion and Leaching Models

One possible consequence of a space deployment accident is that the nuclear waste payload could return to the Earth's surface intact (i.e., without significant breakup) and be deposited in a "wet" environment, such as the ocean. For short-term accidents, the nominal response is to recover the payload, but if such recovery were to fail, then long-term radioactive releases could occur. Corrosion of the Inconel-625 shield barrier and subsequent leaching of waste form material represent a time-delay mechanism for eventual release of radioactivity to the biosphere. This section presents the corrosion and leaching models employed in the calculation of such releases.

5.5.1.3.1 Corrosion Model

All waste form payloads (Reference HLW in cermet, technetium, and iodine) are assumed to be packaged inside an Inconel shield approximately 22.3 inches thick. It is further assumed that waste form leaching does not begin until the shield is completely corroded. The corrosion model is therefore quite simple, with the result stated in terms of the corrosion delay time, t_c , equal to the thickness divided by rate of corrosion. The following table gives these data for the nominal and bounded values of corrosion rate discussed previously (see Section 5.5.1.1).

	<u>Corrosion Rate</u>	<u>Corrosion Time, t_c (years)</u>
	0.1 mils/yr = $2.54E-5$ cm/yr	878,000
Nominal	0.1 mils/yr = $2.54E-4$ cm/yr	87,800
	0.3 mils/yr = $7.62E-4$ cm/yr	29,300

Note that even the shortest value of 29,300 years provides for a significant delay for many of the isotopes in the cermet waste form to decay to low levels of radioactivity.

5.5.1.3.2 Leaching Model

Nominal leaching characteristics, for the three waste forms under evaluation, have been estimated based upon discussions with DOE's waste form experts, although there is uncertainty due to a lack of experimental data for the specific physical and environmental conditions. The leach rates are estimated as (1) 10^{-6} g/cm²·day for cermet, (2) 10^{-5} g/cm²·day for the technetium payload, and (3) effectively instantaneous for the iodine payload. Since the cermet and technetium waste forms are both packaged in the waste form core as numerous small billets, a conservative leach model was applied on an individual billet basis, assuming that the water leach source can contact all billets simultaneously.

Each billet is cylindrical in shape with initial radius (r_0) and length (l_0). To convert the specific area leach rates (L_R) given above to mass loss rate (\dot{m}), it is assumed that the billet size will reduce in proportion to its initial size, i.e.,

$$\dot{r} = (L_R / r_0) r \quad (1)$$

$$\dot{l} = (L_R / r_0) l \quad (2)$$

mass loss rate can be stated in terms of the instantaneous surface area the size/density parameters.

$$\dot{m} = L_R A_s = 2\pi r^2 (1 + \ell_0/r_0) L_R \quad (3)$$

$$\dot{m} = \rho \pi (2r \dot{r} + r^2 \ddot{r}) = 3\rho \pi (\ell_0/r_0) r^2 \dot{r} \quad (4)$$

Combining (3) and (4) yields the constant value of \dot{r} and the time for complete leaching.

$$\dot{r} = \frac{2L_R}{3\rho} (1 + r_0/\ell_0) \quad (5)$$

$$t_L = r_0/\dot{r} \quad (6)$$

The quantities are evaluated below for the design billet size of $r_0 = 2.6$ cm and $\ell_0 = 5.858$ cm.

	<u>Cermet Billet</u>	<u>Technetium Billet</u>
ρ , g/cm ³	6.50	10.93
L_R , g/cm ² ·yr	3.65E-4	3.65E-3
\dot{r} , cm/yr	5.54E-5	3.34E-4
t_L , yr	5.28E+4	8.76E+3

The next step is to calculate the mass release fraction as a function of time. Since the billet mass is $\rho \pi r^2 \ell$, the release fraction is given by

$$f_R = M_R/M_0 = 1 - M/M_0 = 1 - (r/r_0)^3 \quad (7)$$

where

$$r = r_0 - \dot{r}t \quad (8)$$

The following table illustrates the release time characteristic.

Cermet Payload		Technetium Payload	
t(years)	$f_R = M_R/M_0$	t(years)	$f_R = M_R/M_0$
0	0	0	0
1.0E2	0.0057	1.0E2	0.0339
1.0E3	0.0557	1.0E3	0.3049
1.0E4	0.4673	2.0E3	0.5405
2.0E4	0.7602	5.0E3	0.9210
5.28E4	1.0	8.76E3	1.0

5.5.1.3.3 Cumulative Release Calculation

Let $A(t)$ represent the radioactivity (in Curies) of a given isotope as a function of time, combination of isotopes, or the total payload, whichever is of interest. Then the cumulative release to the biosphere as a function of time up to total release can be calculated by the integral formulas:

(1) Leaching Only (shield breakup)

$$A(T) = \int_0^{T < t_L} A(t) \dot{f}_R(t) dt = \int_0^{f_R(T) < 1} A df_R \quad (9)$$

(2) Corrosion and Leaching

$$A(T) = \int_{t_c}^{T < t_c + t_L} A(t) \dot{f}_R(t-t) dt \quad (10)$$

Trapezoidal integration was found to be quite adequate for numerical calculations.

5.5.2 Impact on Hard Rock

This event occurs when the nuclear waste payload impacts at the nominal reentry velocity of 442 m/s (see Section 5.4.1) on hard rock, intact, and is recovered by rescue teams within a reasonable time period (assumed here to be two days). Based upon the payload response analysis for the payload impacting on a rigid granite surface, the payload is expected to split open at the top, with deformed billets falling out on to the ground with some release to the atmosphere in the form of particulate material. The waste form billets

d not be very hot; they are expected to be on the order of 400 C at t and cool further. With no analytical data to calculate the release tial, we have assumed that the amount released to the atmosphere is rtional to the releases from ground impacts of radioisotope thermal ators (RTGs). Typical atmospheric releases for RTGs are on the order of of plutonium for the RTG payload containing approximately 200,000 Ci , 1975). For the period prior to recovery, we assumed that the payload ce would be in a rainwater leaching condition for a period of one hour. : assumptions lead to the releases shown in Table 5-22.

TABLE 5-22. EXPECTED CUMULATIVE SOURCE TERM (CURIES)
FOR EVENT 2, HARD ROCK IMPACT

Payload/Isotopes	Short-Term Release	
	Atmosphere	Ground Water ^(a)
<u>Reference Payload</u>		
Tc-99	8.6E-3	4.2E-7 ^(b)
AC	5.3E-1	2.5E-5
15 EPA Isotopes	2.1E0	1.0E-4
<u>Technetium Payload</u>		
Tc-99	7.5E-1	1.8E-4 ^(c)
<u>Iodine Payload</u>		
I-129	3.2E-3	1.3E-4 ^(d)

(a) Assumes a leachable surface of 36,600 cm² for each payload.

(b) Cermet leach rate of 1.0E-6 g/cm²·day (Aaron, ORNL).

(c) Technetium leach rate of 0.7E-5 g/cm²·day (McCallum, PNL).

(d) Iodine leach rate of 1.0E-3 g/cm²·day (estimate).

5.5.3 Impact on Volcano

This event occurs when a nuclear waste payload inadvertently impacts active volcano and meets within a certain time, mixes with the lava, disses, and is transported to other areas and later solidified. For proper luation, we need to estimate how much of this is then leached by either und water or rainwater, or how much is released via an eruption or off-sing while material is in molten lava. For the purpose of analysis, we e conservatively assumed a 100 percent release (see Table 5-20, the 50-column).

5.5.4 Soil Meltdown

Analysis and discussion in Section 5.4.2 have forced us to conclude this event is not credible. Therefore, it has been dropped from further consideration in this analysis.

5.5.5 On-Orbit Collisions

Should a catastrophic payload/meteoroid or payload/debris collision occur in orbit, payload fracture followed by relatively immediate reentry is expected. Pieces are expected to be the size of billets for the Reference Event. Reentry analysis indicates that individual billets will be expected to disperse and disperse above about 60 km altitude (see Section 5.4.1). Thus, for smaller fragments, the release is expected to be 100 percent into the atmosphere. For larger fragments, it is possible that some will make it to land and water, contaminating both via leaching processes. For purposes of this study, we have conservatively assumed a 100 percent atmospheric release likely. Release data are assumed to be identical with the 50-year column Table 5-20.

5.5.6 Long-Term Corrosion, Soil

This event occurs when the nuclear waste payload impacts wet soil, recovery attempts fail and the payload is lost forever. For simplicity, the releases are assumed to be the same as long-term corrosion in the Reference Event (see Table 5-21 for data).

5.5.7 High-Velocity Impact on Water

This event occurs when the OTV fails in a certain way (orbit adjustment errors cause immediate reentry at high velocity) just prior to Earth escape. The impact velocities could be on the order of 3000 to 6000 m/s. Water impact analysis could not be conducted because of limited funds available for this study. A conservative estimate of the release scenario has been assumed, in the absence of needed analytical data. It has been assumed that the payload containment will be breached upon ocean surface impact and the entire payload (Reference and technetium payloads leaching of billet-sized waste form pieces) will be available for immediate leaching. Table 5-23 provides the relative source term for this event.

5.5.8 High-Velocity Impact on Rock

The releases for this event are estimated to be a factor of 100 times greater than the releases in Event 2 (with an impact velocity of 442 m/s). Refer to the values in Table 5-22 and multiply by 100.

TABLE 5-23. EXPECTED CUMULATIVE SOURCE TERM (CURIES) FOR EVENT 7, HIGH-VELOCITY IMPACT ON WATER

BATTELLE - COLUMBUS

Payload/Isotope(s)	Time, Years									
	1.0E2	1.0E3	2.0E3	5.0E3	8.8E3	1.0E4	2.0E4	5.3E4	1.0E5	1.0E6
<u>Reference Payload</u>										
Tc-99	9.8E0	9.5E1	1.9E2	4.4E2	7.0E2	7.8E2	1.3E3	1.6E3	----->	
AC	5.7E2	3.3E3	4.4E3	5.8E3	6.8E3	7.1E3	8.2E3	8.6E3	----->	
15 EPA Isotopes	1.4E3	4.5E3	5.7E3	7.4E3	8.6E3	9.0E3	1.0E4	1.1E4	----->	
<u>Technetium Payload</u>										
Tc-99	5.1E3	4.6E4	8.1E4	1.4E5	1.5E5	----->				
<u>Iodine Payload</u>										
I-129	6.5E2(a)----->									

105

(a) Occurs when event occurs, in the short term.

5.5.9 High-Velocity Impact on Soil

If a high-velocity impact occurs on soil, a large 100 to 300-meter crater will likely be formed (Baldwin, 1963), and the payload will likely break open and mix with the target soil. For purposes of analysis, it is assumed that recovery of the radioactive material would be more difficult than the rock impact case, and it was assumed that the fraction lost to the soil would be a factor of 200 more than that given for Event 2. Therefore, the cumulative source term is calculated by multiplying the 50-year data in Table 5-20 by 0.001.

5.5.10 Deep Space - Intact Payload Return to Earth

This event can occur as a long-term orbital evolution result of a failure of the OTV injection (after Earth-escape conditions are met), but principally as a result of a SOIS failure during the solar orbit placement maneuver. The characteristics and mathematical model describing this event have been treated extensively in earlier studies (Friedlander et al, 1977a and 1977b; Friedlander and Davis, 1978). To summarize this event, let T denote the long-term time interval after launch for measuring the probability of such an event. The cumulative probability of Earth collision (reentry) is given by the expression

$$P_{EC}(T) = \int_0^{t_f} P_{EC}(T/t) \left| \frac{dR(t)}{dt} \right| dt \quad (11)$$

where $P_{EC}(T/t)$ is the conditional probability of reentry within the interval T given a failure occurrence of time t (deployment sequence timeline), $R(t)$ is the reliability function of the deployment system. The propulsion system reliability is stated in terms of a startup reliability R_s and an operational reliability $R(t) = e^{-\lambda t}$, where λ is a constant failure rate given by $\lambda = -\ln R_{EP}/t_B$, where t_B is the stage burn time and R_{EP} is the end-point reliability at burnout.

In evaluating Equation (11) above, the conditional probability $P_{EC}(T/t)$ is obtained by Monte Carlo simulation of the planetary close encounter/collision problem (effectively a random process) initiated at each failure stage. The integration was carried out using the OTV and SOIS stage reliability parameters listed previously in Table 5-10. Numerical results showed a very smooth variation with T and were well represented by the quadratic least-squares fit

$$\ln P_{EC_0}(T) = -22.1821 + 1.7862 (\ln T) - 0.0500 (\ln T)^2 \quad (12)$$

This function, which is plotted in Figure 5-16, represents the Earth reentry probability distribution for a single payload launch without rescue. Rescue capability for failed payloads in solar orbit has been shown to be a practical response offering orders-of-magnitude reduction in risk (Friedlander and Davis, 1978). Allowing for rescue mission redundancy to order N , the long-term probability of Earth reentry is obtained as

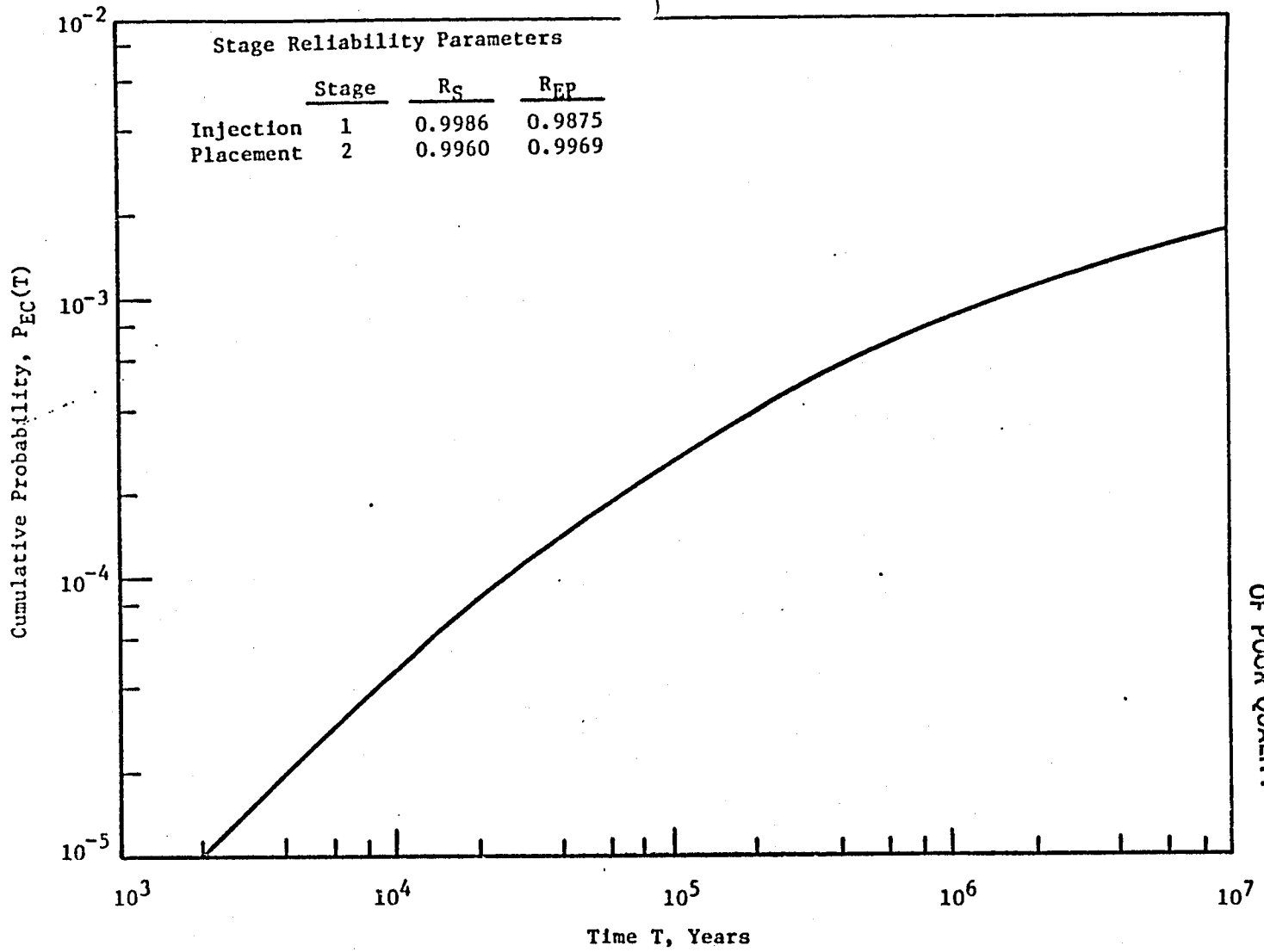

107 ORIGINAL PAGE IS OF POOR QUALITY

FIGURE 5-16. EARTH REENTRY PROBABILITY DISTRIBUTION FOR A SINGLE PAYLOAD LAUNCH WITHOUT RESCUE ($N=0$); REDUCE SCALE BY 10^{-5} FOR RESCUE ($R_R=0.944$, $N=4$)

$$P_{EC}(T) = P_{EC_0}(T) \times (1-R_R)^N \quad (13)$$

The R_R is the effective reliability (or success probability) of each mission attempted. Each such attempt would require a time interval of up to 2 years. It is most desirable that the rescue mode be "cooperative", i.e., the payload attitude control and communication/tracking systems remain operational. This can be assured to an extremely high level of reliability (through system redundancy) for perhaps a period of up to 10 years after launch. Hence, for the present risk assessment we will assume a rescue mission redundancy level of $N = 4$. With the estimated value of $R_R = 0.9444$, the probability of rescue mission success (see Table 5-10), we obtain a five orders-of-magnitude reduction of the Earth reentry probability.

<u>T (years)</u>	<u>P_{EC}</u>
10 ²	5.0 x 10 ⁻¹²
10 ³	5.0 x 10 ⁻¹¹
10 ⁴	4.6 x 10 ⁻¹⁰
10 ⁵	2.6 x 10 ⁻⁹
10 ⁶	8.6 x 10 ⁻⁹

Since this is a cumulative distribution, it should be interpreted as follows: the probability that Earth reentry will occur sometime within 10⁴ years after launch is 4.6 x 10⁻¹⁰; the probability that this event will occur within the interval 10⁴ to 10⁵ years after launch is 2.6 x 10⁻⁹ - 4.6 x 10⁻¹⁰ = 2.14 x 10⁻⁹.

The final step in this analysis is to integrate the reentry event probability with the consequence as measured in Curies of radioactivity. Let $A(T)$ represent the radioactivity of selected isotopes or groups of isotopes in the nuclear waste payload (see Table 5-20). We define $R_s(T)$ as "cumulative source risk at the time of reentry as measured in units of Curies". This source risk is calculated by the integral expression

$$R_s(T) = \int_0^T A P_{EC} dT = \int_0^{P_{EC}(T)} A dP_{EC} \quad (14)$$

In general, the second form of this expression has been employed with numerical integration used to generate the numerical results.

Table 5-24 presents the single mission, cumulative reentry source risk for each of the 15 EPA isotopes in the Reference cermets payload. Also listed are risk values for the group of eight actinides, five fission products (including Tc-99), and the total of the 15 EPA isotopes. For times up to 10³ years, the risk is dominated by Am-241, Cs-137, and Sr-90 isotopes. Between 10³ and 10⁵ years the major risk contributors are Am-241, Am-243, Pu-239, Pu-240, and Tc-99. After 10⁵ years the dominant risk isotope is Tc-99. It should be noted, however, that the cumulative risk of the 15-isotope sum does not exceed 1.8 x 10⁻⁵ Curies over 10⁶ years, and builds up to 10 percent of this value during the first few hundred years.

TABLE 5-24. CUMULATIVE REENTRY SOURCE RISK (C1)
FOR REFERENCE MISSION: CERMET PAYLOAD
INTACT PAYLOAD RETURN FROM DEEP SPACE^(a)

Isotope	Time, years				
	1E2	1E3	1E4	1E5	1E6
Tc-99	8.6E-9	8.5E-8	7.7E-7	3.9E-6	7.1E-6
I-129	0	0	0	0	0
Am-241	4.2E-7	2.3E-6	3.2E-6	3.2E-6	3.2E-6
Am-243	3.1E-8	3.0E-8	1.9E-6	2.8E-6	2.8E-6
Pu-238	3.4E-8	8.7E-8	8.7E-8	8.7E-8	8.7E-8
Pu-239	1.3E-9	1.6E-8	3.6E-7	1.8E-6	1.8E-6
Pu-240	1.5E-8	1.4E-7	8.9E-7	1.1E-6	1.1E-6
Pu-242	1.4E-11	1.5E-10	1.5E-9	8.5E-9	1.8E-8
Np-237	2.8E-10	3.1E-9	3.2E-8	1.9E-7	5.6E-7
Ra-226	6.3E-16	8.1E-13	2.5E-11	2.8E-9	1.3E-8
AC	(5.0E-7)	(2.6E-6)	(6.5E-6)	(9.2E-6)	(9.6E-6)
C-14	3.7E-10	3.5E-9	2.0E-8	2.6E-8	2.6E-8
Cs-135	1.0E-11	1.0E-10	9.6E-10	5.3E-9	1.6E-8
Cs-137	3.8E-7	4.2E-7	4.2E-7	4.2E-7	4.2E-7
Sr-90	2.2E-7	2.5E-7	2.5E-7	2.5E-7	2.5E-7
Sn-126	3.7E-10	3.6E-9	3.3E-8	1.5E-7	2.1E-7
FP	(6.1E-7)	(7.6E-7)	(1.5E-6)	(4.8E-6)	(8.0E-6)
15 EPA Isotopes	1.1E-6	3.4E-6	8.0E-6	1.4E-5	1.8E-5

(a) Single mission data; two spheres.

Table 5-25 presents the single mission, cumulative risk for impacting wet soil. These results are based on the reentry source risk data multiplied by the probability of impacting wet soil (0.0118), and suitably delayed in time by the cermet leaching characteristics as discussed earlier in Section 5.1.3. Note that the waste payload Inconel shield is assumed here to be shattered upon high-velocity impact.

Table 5-26 presents similar data for ocean impact risk. In this case the reentry source risk multiplication factor is 0.667 representing the probability of ocean impact, and shield corrosion as well as cermet leaching is included in the time-delayed release profile.

Table 5-27 lists the cumulative deep-space risks in the various release categories for the alternative I-129 and Tc-99 waste payloads. Included as item 5 in this table is the risk associated with small particle return and subsequent upper atmosphere burnup. This pathway results from possible payload breakup caused by meteoroid impact in deep space, a topic to be discussed in the next section of this report. It may be noted that this release risk is negligible by comparison to other types of releases, except at very long times approaching 10^6 years when the risk becomes larger than the intact payload reentry source risk.

5.5.11 Deep Space - Meteoroid Collision

The contribution of this event to the risk scenario occurs for the most part after the waste payload has successfully been placed at the nominal solar orbit (0.85 A.U.) destination. Although the probability rate of a meteoroid impact (collisions/year) is very small, the long time scale ($\sim 10^6$ years) in this orbit acts to increase the potential risk. If a hit of sufficient energy breaks up the payload into a distribution of small particles (≤ 1000 microns), and if some fraction of this material eventually returns to Earth, the radionuclide release mechanism is total burnup in the upper atmosphere.

The problem of payload breakup due to meteoroid collision and the long-term orbital evolution of a small particle distribution has been treated in depth in a previous study (Rice et al, 1980a). The principal orbit dispersion pathway leading to possible material return to Earth is induced by the dominant nongravitational perturbations, namely solar radiation pressure and electromagnetic forces on charged particles, and their interaction with gravitational close encounters of these particles with the Earth and Venus. We will not reiterate these characteristics here, but simply apply the methodology developed earlier to the space disposal application defined in the present study, and report the major results.

With reference to the discussion in Section 5.3.2.1, the single-mission (two payload spheres) probability of being hit by a meteoroid of sufficient size to initiate payload breakup at the orbital energy limit is $6.69 \times 10^{-9}/\text{yr}$. The probability of being hit by a large enough meteoroid to cause total catastrophic breakup (100 percent release in small particles) is estimated to be $1.78 \times 10^{-10}/\text{yr}$. For the present analysis, we assumed a

TABLE 5-25. CUMULATIVE WET SOIL IMPACT RISK (C1) FOR REFERENCE MISSION: INTACT PAYLOAD RETURN FROM DEEP SPACE(a)

Component	Time, years				
	1E2	1E3	1E4	1E5	1E6
99	1.4E-13	1.4E-11	1.2E-09	2.4E-08	5.8E-08
29	0	0	0	0	0
8)	8.1E-12	3.5E-10	4.9E-09	2.4E-08	3.1E-08
EPA Isotopes	1.4E-11	3.8E-10	6.3E-09	4.8E-08	9.2E-08

) Single mission data; two spheres, with leaching.

TABLE 5-26. CUMULATIVE OCEAN IMPACT RISK (C1) FOR REFERENCE MISSION: INTACT PAYLOAD RETURN FROM DEEP SPACE(a)

Component	Time, years				
	$\leq 8.8E4$	1.0E5	2.0E5	5.0E5	1.0E6
-99	0	6.6E-08	9.4E-07	2.0E-06	2.3E-06
129	0	0	0	0	0
(8)	0	1.4E-08	1.7E-07	3.7E-07	4.7E-07
EPA Isotopes	0	8.2E-08	1.1E-06	2.4E-06	2.8E-06

) Single mission data; two spheres.

TABLE 5-27. CUMULATIVE DEEP-SPACE RISKS (C1) FOR
ALTERNATIVE WASTE PAYLOADS^(a)

Type of Release	Time, years				
	1E2	1E3	1E4	1E5	1E6
Intact Payload Reentry Source Risk					
I-129	3.2E-9	3.2E-8	3.0E-7	1.7E-6	5.5E-6
Tc-99	7.5E-7	7.5E-6	6.8E-5	3.3E-4	6.2E-4
Intact Payload Return - Hard Rock Impact					
I-129 Payload	2.9E-10	2.9E-9	2.7E-8	1.5E-7	4.9E-7
Tc-99 Payload	6.7E-8	6.7E-7	6.1E-6	3.0E-5	5.6E-5
Intact Payload Return - Wet Soil Impact (leach)					
I-129 Payload	3.8E-11	3.8E-10	3.5E-9	2.0E-8	6.3E-8
Tc-99 Payload	7.5E-11	6.9E-9	3.4E-7	3.3E-6	6.3E-6
Intact Payload Return - Ocean Impact (Corrode/ Leach)					
I-129 Payload	0	0	0	2.4E-7	3.4E-6
Tc-99 Payload	0	0	0	1.6E-5	2.5E-4
Payload Breakup Into Small Particle Distribution Upper Atmosphere Burnup					
I-129 Payload	0	0	4.2E-14	2.2E-12	4.9E-5
Tc-99 Payload	0	0	8.0E-12	3.4E-10	8.4E-4

1) Single mission data; two spheres.

2) Impact probabilities used were: ocean, 0.6673; wet soil, 0.0118;
rock, 0.0898; other, 0.0384.

continuum meteoroid flux over a range of mass (size) and allowed for a time-integrated distribution of impacts resulting in material release from the payload. The integrated mass release rate for a single payload sphere (shield plus cermet) is 2.3×10^{-6} kg/yr. The cermet release rate for a single mission (two spheres) is estimated in proportion to cermet/payload mass ratio, i.e.,

$$\dot{M}_{\text{RISK}} = \left(2 \times \frac{6,312}{15,493} \right) \times \left(2.3 \times 10^{-6} \right) = 9.4 \times 10^{-7} \text{ kg/yr} .$$

Over a period $T = 10^6$ years, the probable, cumulative cermet released in deep space is just under 1.0 kg. Only a small fraction of this release will find its way back to Earth, as described below. Furthermore, the material that does return will do so, not at one point in time, but rather as a distribution over time.

The probable mass return to Earth has two components, each of which is induced by the Poynting-Robertson effect of solar radiation pressure causing the small particle (size) distribution to spiral in toward the Sun. These components are: (1) an intermediate time-scale effect for particles reaching the close vicinity of the Sun, swept outward with the solar wind, and then some fraction being intercepted by Earth; and (2) a longtime-scale effect for particles coming into close gravitational encounter with Venus during their spiral toward the Sun, and then some fraction being deflected into an Earth-crossing orbit, with some smaller fraction then colliding with Earth on reentry trajectories. For the solar wind effect, it has been estimated that the probability of a solar wind ion being intercepted by the Earth's magnetosphere and subsequently being transported into the atmosphere (1 percent transport efficiency) is $(5 \times 10^{-7}) \times (10^{-2}) = 5 \times 10^{-9}$.

The two tables that follow present the probable cermet mass return-to-Earth reentry as a cumulative function of time after launch for a single mission.

• Poynting-Robertson → Sun → Solar Wind → Earth

<u>T (years)</u>	<u>\bar{M}_R (kg)</u>
$< 3 \times 10^3$	0
10^4	1.4×10^{-12}
10^5	4.2×10^{-11}
10^6	1.4×10^{-9}

• Poynting-Robertson → Venus → Earth

<u>T (years)</u>	<u>\bar{M}_R (kg)</u>
$< 2.05 \times 10^5$	0
2.15×10^5	1.4×10^{-6}
5.10×10^5	6.7×10^{-5}
10^6	5.8×10^{-4}

ese data were integrated with the cermet radionuclide inventory and decay profile to obtain the risk (in Curies) associated with small particle return. e results are presented in Table 5-28.

TABLE 5-28. CUMULATIVE UPPER ATMOSPHERE BURNUP RISK (Ci) FOR REFERENCE MISSION: SMALL PARTICLE RETURN^(a)

Component	Time, years				
	<3.0E3	1.0E4	1.0E5	2.0E5	1.0E6
99	0	3.7E-13	9.4E-12	2.2E-09	1.3E-05
29	0	0	0	0	0
3)	0	1.6E-12	8.5E-12	2.7E-09	5.8E-06
EPA Isotopes	0	2.0E-12	1.8E-11	1.9E-08	1.9E-05

Single mission data; two spheres.

5.5.12 Deep Space - Payload/Payload Collision

In this section and the two that follow we briefly present supporting data for several risk mechanisms that have negligible contribution to the total risk profile for space disposal. The first of these considers possible collisions between nuclear waste payload spheres placed into the destination orbit region on different missions. The payload orbits (at 0.85 A.U.) are all assumed to be inclined by 1 degree to the ecliptic plane, but the various orbits are not coplanar since they do not have identical values of the ascending node, i.e., the orbits will intersect in spatial orientation by 1-degree relative inclinations. The relative speed of potential collisions is 564 m/s, and the kinetic energy of impact is 2.4×10^9 Joules for a payload sphere mass of 15,493 kg. The energy-to-mass ratio, E_p/M_t , is 1.6×10^5 Joules/kg, which is considerably greater than the critical fragmentation energy level of 7500 Joules/kg. In fact, such a collision would be expected to release 25 percent of the payload mass in small particle distribution (< 1000 microns).

The annular spherical volume of orbits at $r = 0.85$ A.U. and $i = 1$ degree is 1.5×10^{32} m³. For 750 missions at two spheres each, the number density is 5.0×10^{-30} m³. Hence, the collision probability for any two spheres of 2.12 m² cross-sectional area is 3.8×10^{-19} /yr. The single mission risk measured in terms of cermet mass release in space is 6.0×10^{-16} kg/yr. For the total of 750 missions deployed, the collision probability is 2.8×10^{-16} /yr and the probable cermet mass release is 4.5×10^{-13} kg/yr. This is several orders of magnitude less than the meteoroid collision risk.

5.5.13 Deep Space - Payload/Comet Collision

So-called "new comets" are believed to emanate from a source of material loosely bound to the solar system at very great distances. Occasionally this material is deflected on near-parabolic trajectories toward the Sun, perhaps by gravitational perturbations of nearby stars. Based on hundreds of years of observational data and recent theories of comet source dynamics, it has been estimated that the cometary flux within 1.0 A.U. of the Sun lies in the range of 2/yr to 19.5/yr. We will conservatively assume the larger flux. The probability of collision between any one payload sphere and a comet is estimated to be 2.1×10^{-23} . We will assume complete destruction of the payload if such a collision should occur.

The single-mission (two spheres) collision probability is 8.1×10^{-22} /yr, and the risk measured in terms of probable cermet mass release in space is 5.1×10^{-18} kg/yr. For the total of 750 missions deployed, the collision probability is 6.1×10^{-19} /yr and the probable cermet mass release is 3.8×10^{-15} kg/yr. This is two orders of magnitude less than the payload/payload risk, and many orders of magnitude less than the meteoroid collision risk.

5.5.14 Deep Space - Erosion

The occurrence of sputtering and erosion of the payload shield due to impingement of solar wind ions is estimated to be 1 angstrom/yr = 10^{-8} cm/yr. Since the shield is 22 cm thick, the material recession even in 10^6 years is inconsequential. No cermet mass release is expected from this insult.

5.5.15 Leaching and Corrosion Consequences for Alternate Payloads

The leaching and corrosion consequences of a launch accident involving alternate payloads are summarized in Tables 5-29, 5-30, 5-31, and 5-32.

5.6 Preliminary Space Disposal Risk Estimates

Based upon the work reported in the previous subsection, the short- and long-term space risks can be integrated. Tables 5-33 and 5-34 provide the data necessary to plot and compare a short- and long-term space disposal risk for the Reference Mission, and the two alternative missions (Tc-99 and I-129 to space). Figures 5-17 and 5-18 present plots of these data.

Considerable uncertainty exists in the data. The accomplishment of a Monte Carlo analysis needed to help define uncertainty was beyond the scope of this study. However, based upon mathematically carrying through the high- and low-probability data and estimated uncertainty in source terms, we believe there are at least two orders of magnitude on either side of the "expected" space risk data.

Section 7.0 discusses how these data relate to the MGR and complemented MGR cases.

TABLE 5-29. CUMULATIVE LEACHING CONSEQUENCES (C1) FOR REFERENCE MISSION LAUNCH ACCIDENT^(a)

Isotope(s)	Time, years				
	1E2	1E3	1E4	2E4	>5.3E4
Tc-99	9.8E0	9.5E1	7.8E2	1.3E3	1.6E3
U(8)	5.7E2	3.3E3	7.1E3	8.2E3	8.6E3
15 EPA Isotopes	1.4E3	4.5E3	9.0E3	1.0E4	1.1E4

(a) Single mission data; two spheres.

TABLE 5-30. CUMULATIVE CORROSION AND LEACHING CONSEQUENCES (C1) FOR REFERENCE MISSION LAUNCH ACCIDENT^(a)

Isotope(s)	Time, years				
	<8.8E4	1.0E5	1.1E5	1.2E5	>1.4E5
Tc-99	0	6.7E2	9.8E2	1.1E3	1.2E3
U(8)	0	1.6E2	2.2E2	2.5E2	2.6E2
15 EPA Isotopes	0	8.7E2	1.3E3	1.4E3	1.5E3

(a) Single mission data; 2 spheres.

TABLE 5-31. CUMULATIVE LEACHING CONSEQUENCES (C1) FOR
Tc-99 DISPOSAL MISSION LAUNCH ACCIDENT(a)

Isotope(s)	Time, years				
	1E2	1E3	2E4	5E4	>8.8E3
Tc-99	5.1E3	4.6E4	8.1E4	1.4E5	1.5E5

TABLE 5-32. CUMULATIVE CORROSION AND LEACHING CONSEQUENCES (C1)
FOR Tc-99 DISPOSAL MISSION ACCIDENTS(a)

Isotope(s)	Time, years				
	8.8E4	8.9E4	9.1E4	9.3E4	>9.7E4
Tc-99	0	4.0E4	8.2E4	1.0E5	1.1E5

TABLE 5-33. LOG₁₀ CUMULATIVE RISKS (Ci) FOR SPACE DISPOSAL
OF HLW, LESS Cs AND Sr, 750 MISSIONS

Isotope(s)	Time, years					
	1E1	1E2	1E3	1E4	1E5	1E6
<u>Short-Term Events</u>						
Tc-99	-4.03	-4.01	-3.86	-3.33	-2.18	-1.95
AC	-2.24	-2.22	-2.13	-2.00	-1.95	-1.92
15 EPA Isotopes	-1.64	-1.63	-1.60	-1.57	-1.45	-1.39
<u>Long-Term Events</u>						
Tc-99	--	-5.19	-4.20	-3.24	-2.53	-1.82
AC	--	-3.43	-2.71	-2.31	-2.16	-1.94
15 EPA Isotopes	--	-3.08	-2.59	-2.22	-1.98	-1.56
<u>Total</u>						
Tc-99	-4.03	-3.98	-3.69	-2.98	2.02	-1.58
AC	-2.24	-2.19	-2.02	-1.82	1.74	-1.62
15 EPA Isotopes	-1.64	-1.61	-1.56	-1.48	1.34	-1.17

TABLE 5-34. LOG₁₀ CUMULATIVE RISKS (C1) FOR SPACE
DISPOSAL OF IODINE AND TECHNETIUM
PAYLOADS (100,000 MTHM EQUIVALENT)

Isotope(s)	Time, years					
	1E1	1E2	1E3	1E4	1E5	1E6
<u>Iodine Payload(a)</u>						
<u>Short-Term Events</u>						
I-129	-5.61	-5.61	-5.61	-5.61	-4.26	-4.26
<u>Long-Term Events</u>						
I-129	--	-7.77	-7.77	-5.80	-5.02	-3.54
<u>Total</u>						
I-129	-5.61	-5.61	-5.61	-5.39	-4.19	-3.46
<u>Technetium Payload(b)</u>						
<u>Short-Term Events</u>						
Tc-99	-4.01	-3.93	-3.47	-3.05	-1.95	-1.95
<u>Long-Term Events</u>						
Tc-99	--	-5.20	-4.20	-3.24	-2.55	-2.28
<u>Total</u>						
Tc-99	-4.04	-3.91	-3.39	-2.83	1.81	-1.78

(a) Calculated for 5.33 missions over 25 years to satisfy 100,000 MTHM.

(b) Calculated for 8.47 missions over 25 years to satisfy 100,000 MTHM.

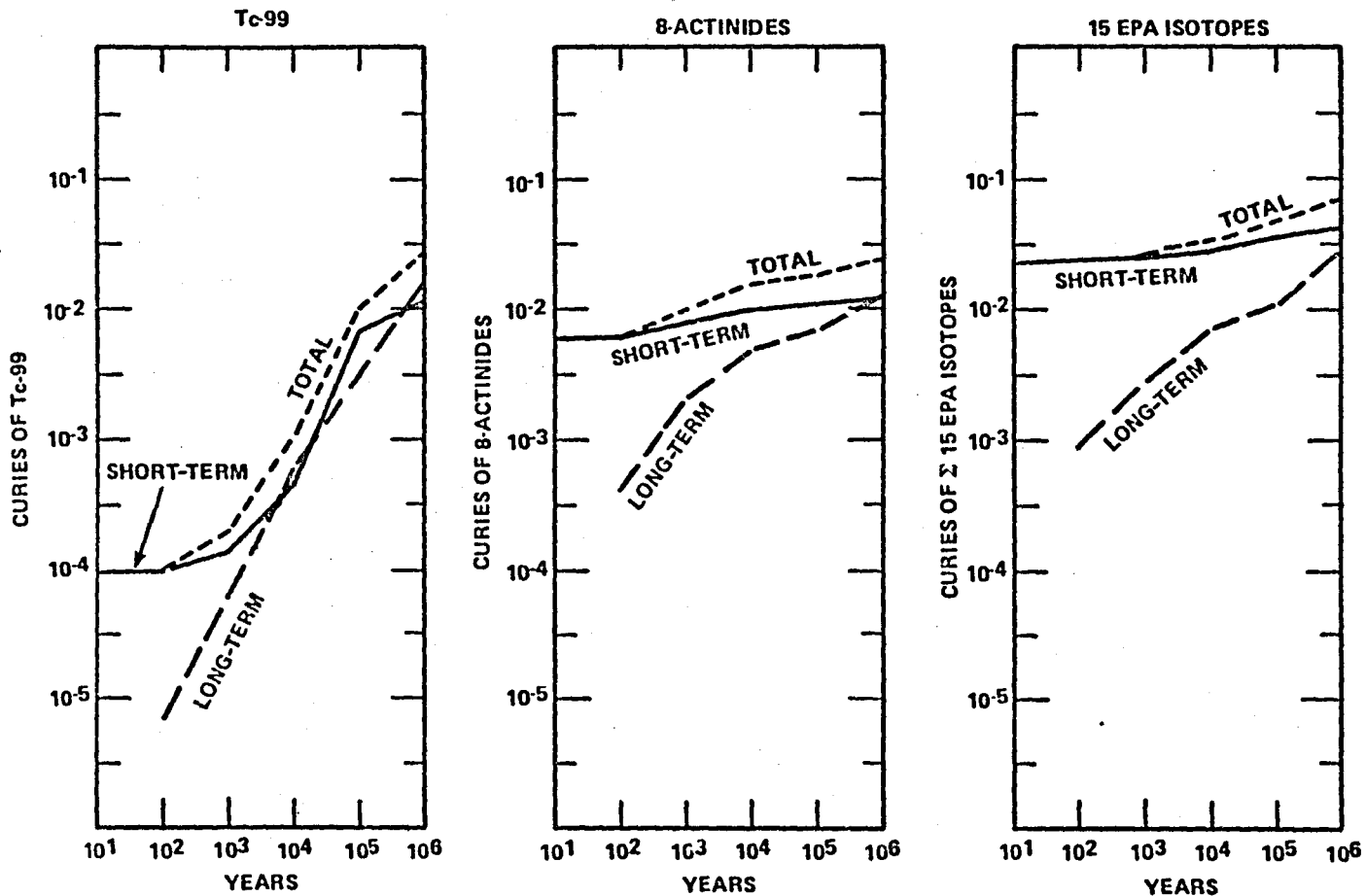
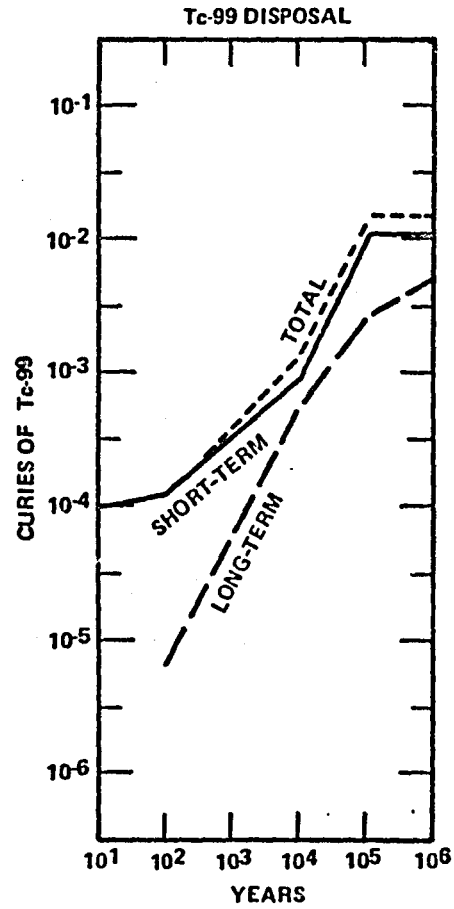
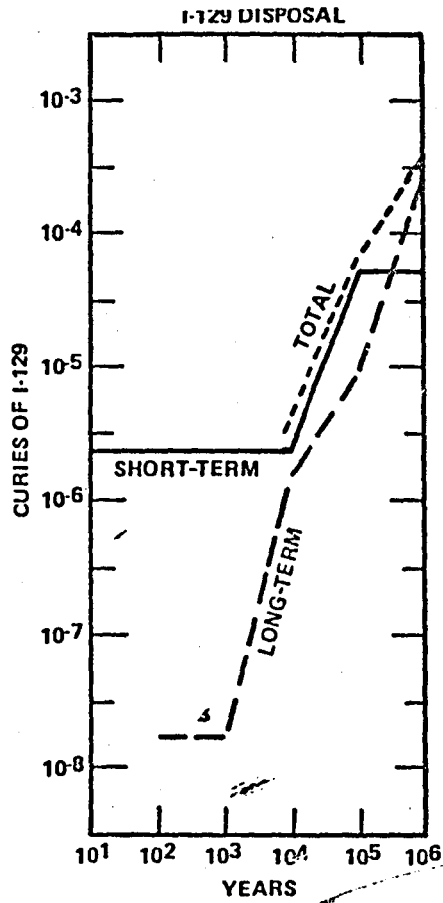

FIGURE 5-17. EXPECTED CUMULATIVE SPACE RISK COMPARISON FOR HLW DISPOSAL IN SPACE



ORIGINAL PAGE IS
OF POOR QUALITY

FIGURE 5-18. EXPECTED CUMULATIVE SPACE RJSK COMPARISONS FOR I-129 AND Tc-99 DISPOSAL IN SPACE

This Page Intentionally Left Blank

6.0 TERRESTRIAL DISPOSAL RISK ESTIMATES (FROM PNL STUDY)

This section provides an overview of PNL-generated MGR risk data that are used in this preliminary risk assessment of nuclear waste disposal in space. The Waste Mixes Study, by McCallum and his coworkers (1982), was performed during 1981. The objectives of the study were to:

- Determine if removal of selected isotopes (or waste mixes) from HLW and TRU waste would reduce the potential impacts of geologic disposal
- Determine if partitioning of the selected isotopes is feasible from the standpoint of cost and technology
- Determine an acceptable waste form(s) for disposal of selected isotopes in space
- Compare any reduction in repository impact to the increase in waste treatment, storage, and transportation impacts incurred as a result of the partitioning activity.

The potential waste mixes identified in the PNL study have been used throughout this report as a basis for evaluating the risk benefit or disbenefit of nuclear waste disposal in space. (Risk is defined as expected cumulative releases to the biosphere.) The PNL analyses led to defining five alternative waste management systems:

- Reference Case - Dispose of all HLW and TRU waste in a mined geologic repository (MGR).
- Alternative A - Dispose of iodine (I-129) in space and the balance in the MGR.
- Alternative B - Dispose of technetium (Tc-99) in space and the balance in MGR.
- Alternative C - Age for 50 years and then dispose of 95 percent of both cesium (Cs-137) and strontium (Sr-90) in a repository; dispose the balance of the HLW in space; separate plutonium from the TRU waste for recycle; and dispose of the balance of the TRU waste in MGR.
- Alternative D - Age HLW for 50 years and then dispose of in space; separate plutonium from TRU waste and dispose of in space; and dispose of the balance of the TRU waste in a MGR.

For each of the alternatives, the "terrestrial risk" is made up of two parts:

- Releases during reprocessing and partitioning (what we refer to as processing)
- Releases from accidents that occur during processing or after the waste is placed in the repository.

The potential for risk benefit for the MGR depends on the degree of separation and losses to the biosphere. Risks from short-term accidents during waste processing or placement in the MGR have been shown to be negligible (McCallum et al, 1982) and will not be included in the discussion here.

1 PNL Waste-Processing Risk Estimates

The five PNL waste management alternatives differ by the fraction of each isotope which is sent to space. The nuclide fractions sent to space for some of the more important isotopes are presented in Table 6-1. The fraction remaining is then sent to a terrestrial disposal site. These fractions are presented in Table 6-2.

Each of the waste management alternatives requires processing. With each additional processing step an additional fraction of certain isotopes could be released to the biosphere. The fraction lost to the biosphere due to normal reprocessing (Reference MGR Case) has been estimated by PNL and is given in Table 6-3. The short-term partitioning (additional waste processing over and above the Reference Case) releases to the biosphere have also been estimated by PNL and are presented in Table 6-4. These releases have been used in the overall risk estimates (see Section 7.0). It should be pointed out that the releases shown in these tables are dominated by C-14 release during reprocessing (see 15 EPA isotope values in Table 6-3). But, more importantly, they are completely overshadowed by a total tritium release of 2.2×10^7 Ci for a 100,000 MTHM repository equivalent (McCallum et al, 1982). For all alternatives, this tritium release dominates the expected total dose to the population for reprocessing and partitioning. The value provided by PNL is approximately 1000 man-rems. Based on the PNL data, therefore, it is concluded that the total actual health risk of waste reprocessing does not significantly change (within 2 to 9 percent) with additional partitioning steps in support of space disposal. For additional information regarding these reprocessing and partitioning releases, the reader is urged to review the PNL Waste Mixes Study report (McCallum et al, 1982).

.2 PNL Risk Estimates From a Repository Release

PNL has assumed that the Reference repository is a mined geologic repository (MGR) in bedded salt (at Paradox Basin). The HLW waste is stored in containers which are assumed to have a design life of at least 1000 years, and institutional control of the site will be for a 100-year period after closure.

During the time period considered in this risk assessment (out to 10^6 years), the repository could be subjected to a number of disruptions.

TABLE 6-1. NUCLIDE FRACTIONS SENT TO SPACE DISPOSAL

Isotopes	Reference	Disposal Alternative			
		Aged HLW to Space	Cs/Sr Separation	Tc Separation	I Separation
<u>Fission Products</u>					
Tc-99	0	1.0	0.99	0.98	0
I-129	0	0	0	0	0.985
Cs	0	1.0	0.05	0	0
Sr	0	1.0	0.05	0	0
Ru	0	1.0	1.0	0.01	0
Zr	0	1.0	0.4	0	0
Mo	0	1.0	1.0	0	0
Rare Earths	0	1.0	0.99	0	0
<u>Actinides</u>					
Pu	0	0.005	0.004	0	0
Np	0	1.0	1.0	0	0
Am, Cm	0	1.0	0.99	0	0

Source: McCallum et al, 1982.

TABLE 6-2. NUCLIDE FRACTIONS SENT TO GEOLOGIC DISPOSAL

Isotopes	Reference	Disposal Alternative			
		Aged HLW to Space	Cs/Sr Separation	Tc Separation	I Separation
<u>Fission Products</u>					
Tc-99	1.0	0	0.01	0.02	1.0
I-129	1.0	1.0	1.0	1.0	0.014
Cs	1.0	0	0.95	1.0	1.0
Sr	1.0	0	0.95	1.0	1.0
Ru	1.0	0	0	0.99	1.0
Zr	1.0	0	0.6	1.0	1.0
Mo	1.0	0	0	1.0	1.0
Rare Earths	1.0	0	0.01	1.0	1.0
<u>Actinides</u>					
Pu	0.011	0.0001	0.0002	0.011	0.011
Np	1.0	0	0	1.0	1.0
Am, Cm	1.0	0	0.010	1.0	1.0

Source: McCallum et al, 1982.

TABLE 6-3. SHORT-TERM REPROCESSING RELEASES TO THE BIOSPHERE (Ci/100,000 MTHM)

Isotope(s)	All Wastes to Reference MGR	HLW to Space, Reference Space Disposal	Technetium to Space	Iodine to Space
Tc-99	1.7E-8(a)	1.7E-8	1.7E-8	1.7E-8
I-129	3.5E0	3.5E0	3.5E0	3.5E0
8 Actinides	1.3E-2	1.3E-2	1.3E-2	1.3E-2
15 EPA Isotopes	5.6E2(b)	5.6E2(b)	5.6E2(b)	5.6E2(b)

Source: PNL Waste Mixes Study, by R. McCallum et al, 1982.

(a) Believed to be low - see GEIS (Refer to Section 3 of McCallum et al, 1982).

(b) Carbon-14 is 5.6E2 Ci; not included in this is tritium, which is 2.2E7 Ci.

TABLE 6-4. SHORT-TERM PARTITIONING RELEASES TO THE BIOSPHERE (Ci/100,000 MTHM)

Isotope(s)	All Wastes to Reference MGR(a)	HLW to Space, Reference Space Disposal	Technetium to Space	Iodine to Space
Tc-99	0	5.2E-2	2.6E-1	0
I-129	0	0	0	0(b)
8 Actinides	0	2.0E-2	0	0
15 EPA Isotopes	0	0	0	0

Source: PNL Waste Mixes Study, by R. McCallum et al, 1982.

(a) Zero by definition of the terms reprocessing vs. partitioning; reprocessing releases given in Table 6-3.

(b) Releases included in reprocessing losses (see Table 6-3).

Table 6-5 (from Greenberg et al, 1978) represents a list of some of the postulated challenges to the integrity of the repository. These events could possibly lead to a release to the biosphere. Quantitative estimates for two of the events (see boxed items in Table 6-5) were made in the Waste Mixes Study (McCallum et al, 1982). The two events considered by PNL, a drilling event into bedded salt and a natural fault (bedded salt) are believed by PNL to provide the most significant contribution to the overall risk of the MGR. These events, along with PNL's models and assumptions, are described in the next two subsections.

6.2.1 Fault Risk Estimates

The natural event chosen by PNL for analysis was a seismic (fault) event occurring 1000 years after repository closure, followed by ground water entering and exiting a region of the repository. Raymond et al (1980) previously addressed this scenario. Raymond's work formed the basis for the release mechanism assumed by PNL in the study. Using a leach rate of 1.0×10^{-5} g/cm²·day and other parameters (detailed in McCallum et al, 1982) which were believed by PNL to be conservative, cumulative releases over 10,000, 100,000, and 1,000,000 years to the accessible environment were estimated for isotopes identified by the EPA (U.S. EPA, 1981 and U.S. NRC, 1981) to be of concern for long-term risk. The accessible environment is defined by the EPA (U.S. EPA, 1981) as surface waters, land surfaces, the atmosphere, and underground formations greater than one mile from the repository boundary which might provide ground water for human consumption. The one-mile boundary was selected by PNL as the measure in this study.

The results of the PNL calculations for the fault case, with and without HLW disposal in space, are presented in Tables 6-6 and 6-7. These tables display the cumulative consequences and risk out to one million years.

For removal of iodine and technetium, PNL recommended reducing Tc-99 and I-129 values in Table 6-6 by factors of 0.014 and 0.020, respectively.

PNL compared these releases to the draft EPA release limits for repositories (U.S. EPA, 1981) and found that the predicted releases, even assuming the fault occurs at 1000 years, were well below the limits.

6.2.2 Drilling Event Risk Estimates

PNL also used EPA estimates of future drilling rates to determine the consequences of possible human intrusion. Drilling for resources, etc., was assumed to commence after the first 100 years, when institutional controls have ended (200-year-old waste). The consequences and risk of a drilling event were estimated by PNL. The results in terms of expected cumulative releases to the biosphere (land, top soil, and air) are presented in Tables 5-8 and 6-9 for the Reference MGR and MGR complemented by removing HLW, less 95 percent cesium and strontium. A detailed explanation of the rationale behind these assumptions is presented in the PNL report (McCallum et al, 1982).

TABLE 0-3. POTENTIAL DISRUPTIVE EVENTS

Natural Processes	Natural Events	Man-Caused Events	Repository-Caused Processes
<ul style="list-style-type: none"> ● Climatic Fluctuations ● Sea-Level Fluctuations ● Glaciation ● River Erosion ● Sedimentation ● Tectonic Forces ● Volcanic Extrusion ● Igneous Intrusion ● Diapirism ● Diagenesis ● New or Undetected Fault Rupture ● Hydraulic Fracturing ● Dissolution ● Aquifer Flux Variation 	<ul style="list-style-type: none"> ● Flood Erosion ● Seismically Induced Shaft Seal Failure ● Meteorite 	<p>Improper Design/Operation:</p> <ul style="list-style-type: none"> ● Shaft Seal Failure ● Improper Waste Emplacement <p>Undetected Past Intrusion:</p> <ul style="list-style-type: none"> ● Undiscovered Boreholes or Mine Shafts <p>Inadvertent Future Intrusion:</p> <ul style="list-style-type: none"> ● Archeological Exhumation ● Weapons Testing ● Nonnuclear Waste Disposal ● Resource Mining (Mineral, Hydrocarbon, Geothermal, Salt) ● Storage of Hydrocarbons or Compressed Air <p>Intentional Intrusion:</p> <ul style="list-style-type: none"> ● War ● Sabotage ● Waste Recovery <p>Perturbation of Ground Water System:</p> <ul style="list-style-type: none"> ● Irrigation ● Reservoirs ● Intentional Artificial Recharge ● Establishment of Population Center 	<p>Thermal, Chemical Potential, Radiation, and Mechanical Force Gradients:</p> <ul style="list-style-type: none"> ● Induced Local Fracturing ● Chemical or Physical Changes in Local Geology ● Induced Ground Water Movement ● Waste Container Movement ● Increase in Internal Pressure ● Shaft Seal Failure

BATTELLE - COLUMBUS

130

ORIGINAL PAGE IS
OF POOR QUALITY

Source: Waste Isolation Safety Assessment Program Scenario Analysis Methods for Use in Assessing the Safety of the Geologic Isolation of Nuclear Waste, by J. Greenberg et al, Pacific Northwest Laboratory, PNL-2643 (November 1978).

TABLE 6-6. CUMULATIVE CONSEQUENCES AND RELEASE RISKS
FOR FAULT SCENARIO, REFERENCE MGR

Isotope(s)	Consequences (Ci) for Cumulative Release to Accessible Environment			Probabilistic Risks (Ci) for Cumulative Release to Accessible Environment ^(a)		
	10 ⁴ yr	10 ⁵ yr	10 ⁶ yr	10 ⁴ yr	10 ⁵ yr	10 ⁶ yr
Tc-99	9.9E3	1.3E4	1.3E4	9.9E-3	1.3E-1	1.3E0
I-129	2.7E1	3.5E1	3.5E1	2.7E-5	3.5E-4	3.5E-3
Am-241	0	0	0	0	0	0
Am-243	0	0	0	0	0	0
Pu-238	0	0	0	0	0	0
Pu-239	0	0	5.0E-5	0	0	5.0E-9
Pu-240	0	0	0	0	0	0
Pu-242	0	0	1.0E1	0	0	1.0E-3
Np-237	0	5.5E2	5.5E2	0	5.5E3	5.5E-2
Ra-226	1.8E-2	1.2E2	2.1E2	1.8E-8	1.2E-3	2.1E-2
AC	(1.8E-2)	(6.7E2)	(7.7E2)	(1.8E-8)	(6.7E-3)	(7.7E-2)
C-14	2.2E2	3.5E2	3.5E2	2.2E-4	3.5E-3	3.5E-2
Cs-135	0	3.1E2	3.1E2	0	3.1E-3	3.1E-2
Cs-137	0	0	0	0	0	0
Sr-90	0	0	0	0	0	0
Sn-126	0	4.7E2	4.7E2	0	4.7E-3	4.7E-2
FP	<u>(2.7E2)</u>	<u>(1.1E3)</u>	<u>(1.1E3)</u>	<u>(2.2E-4)</u>	<u>(1.1E-2)</u>	<u>(1.1E-1)</u>
TOTAL	1.01E4	1.48E4	1.49E4	1.01E-2	1.48E-1	1.49E0

Source: PNL Waste Mixes Study (McCallum et al, 1982).

(a) Probability of fault occurring estimated by PNL/ONWI to be $\sim 10^{-10}$ /year; consequence data multiplied by the probability for event in that given period.

TABLE 6-7. CUMULATIVE CONSEQUENCES AND RELEASE RISKS FOR
 FAULT SCENARIO, COMPLEMENTED BY REMOVAL OF HLW,
 LESS 95 PERCENT Cs AND Sr

Isotope(s)	Consequences (Ci) for Cumulative Release to Accessible Environment			Probabilistic Risks (Ci) for Cumulative Release to Accessible Environment(a)		
	10 ⁴ yr	10 ⁵ yr	10 ⁶ yr	10 ⁴ yr	10 ⁵ yr	10 ⁶ yr
Tc-99	9.9E1	1.3E2	1.3E2	9.9E-5	1.3E-3	1.3E-2
I-129	2.7E1	3.5E1	3.5E1	2.7E-5	3.5E-4	3.5E-3
Am-241	0	0	0	0	0	0
Am-243	0	0	0	0	0	0
Pu-238	0	0	0	0	0	0
Pu-239	0	0	9.1E-7	0	0	9.1E-11
Pu-240	0	0	0	0	0	0
Pu-242	0	0	1.8E-1	0	0	1.8E-5
Np-237	0	5.5E0	5.5E0	0	5.5E-5	5.5E-4
Ra-226	1.8E-4	7.2E0	2.1E0	1.8E-10	7.2E-5	2.1E-4
AC	(1.8E-4)	(1.3E1)	(7.6E0)	(1.8E-10)	(1.3E-4)	(7.6E-4)
C-14	2.2E2	3.5E2	3.5E2	2.2E4	3.5E-3	3.5E-2
Cs-135	0	2.9E2	2.9E2	0	2.9E-3	2.9E-2
Cs-137	0	0	0	0	0	0
Sr-90	0	0	0	0	0	0
Sn-126	0	0	0	0	0	0
FP	(2.2E2)	(6.4E2)	(6.4E2)	(2.2E-4)	(6.4E-3)	(6.4E-2)
TOTAL	3.46E2	8.18E2	8.13E2	3.46E-4	8.18E-3	8.13E-2

Source: PNL Waste Mixes Study (McCallum et al, 1982).

(a) Probability of fault occurring estimated by PNL/ONWI to be $\sim 10^{-10}$ /year; consequence data multiplied by the probability for event in that given period.

TABLE 6-8. CUMULATIVE RELEASE RISKS (CURIES) FROM DRILLING EVENTS OCCURRING OVER PERIOD UP TO 1×10^6 YEARS AT A BEDDED SALT REPOSITORY, REFERENCE MGR^(a)

Isotopes	Time, years				
	200	1E3	1E4	1E5	1E6
Tc-99	3.8E-1	1.6E0	1.5E1	1.3E2	4.6E2
I-129	1.1E-3	4.5E-3	4.2E-2	4.1E-1	4.0E0
Am-241	1.8E-1	4.8E1	6.1E1	6.3E1	6.3E1
Am-243	1.4E0	5.8E0	3.7E1	8.6E1	8.6E1
Pu-238	1.1E0	1.4E0	1.4E0	1.4E0	1.4E0
Pu-239	5.8E-2	2.4E-1	2.1E0	5.7E1	9.0E1
Pu-240	6.6E-1	2.7E0	1.8E1	3.8E1	3.8E1
Pu-242	6.2E-4	2.6E-3	2.6E-2	2.9E-1	1.6E0
Np-237	4.0E-3	9.4E-2	1.3E-1	6.0E0	5.7E1
Ra-226	4.7E-8	6.0E-2	6.1E-2	2.5E-1	1.7E0
AC	(3.4E0)	(5.8E1)	(1.2E2)	(2.5E2)	(3.4E2)
C-14	1.7E-2	6.8E-2	4.0E-1	5.7E-1	5.7E-1
Cs-135	9.3E-3	3.9E-2	3.6E-1	3.7E0	3.2E1
Cs-137	1.1E2	1.2E2	1.2E2	1.2E2	1.2E2
Sr-90	5.9E1	6.1E1	6.1E1	6.1E1	6.1E1
Sn-126	1.6E-2	6.9E-2	6.4E-1	4.8E0	9.5E0
FP	<u>(1.7E2)</u>	<u>(1.8E2)</u>	<u>(1.8E2)</u>	<u>(1.9E2)</u>	<u>(2.2E2)</u>
TOTAL	1.7E2	2.4E2	3.2E2	5.7E2	1.0E3

Source: PNL Waste Mixes Study (McCallum et al, 1982).

(a) Assumes the EPA (1980) first estimates of drilling rates, the release parameters in the DOE (1980) disruptive event, and a 100,000 MTHM repository.

TABLE 6-9. CUMULATIVE RELEASE RISKS (CURIES) FROM DRILLING EVENTS OCCURRING OVER PERIOD UP TO 1×10^6 YEARS AT A BEDDED SALT REPOSITORY, COMPLEMENTED MGR BY REMOVAL OF HLW, LESS 95 PERCENT Cs AND Sr^(a)

Isotopes	Time, years				
	200	1E3	1E4	1E5	1E6
Tc-99	3.8E-3	1.6E-2	1.5E-1	1.3E0	4.6E0
I-129	1.1E-3	4.5E-3	4.2E-2	3.9E-1	3.8E0
Am-241	1.8E-3	4.8E-1	6.1E-1	6.3E-1	6.3E-1
Am-243	1.4E-2	5.8E-2	3.7E-1	8.6E-1	8.6E-1
Pu-238	4.0E-3	5.2E-3	5.2E-3	5.2E-3	5.2E-3
Pu-239	2.1E-4	8.8E-4	7.6E-3	2.1E-1	3.3E-1
Pu-240	2.4E-3	1.0E-2	6.4E-2	1.4E-1	1.4E-1
Pu-242	2.2E-6	9.6E-6	9.6E-5	1.0E-3	6.0E-3
Np-237	4.0E-5	9.4E-4	1.3E-3	6.0E-2	5.7E-1
Ra-226	4.7E-10	6.0E-4	6.1E-4	2.5E-3	1.7E-2
AC	(2.2E-2)	(5.6E-1)	(1.1E0)	(1.9E0)	(2.6E0)
C-14	1.7E-2	6.8E-2	4.0E-1	5.7E-1	5.7E-1
Cs-135	8.8E-3	3.7E-2	3.4E-1	3.5E0	3.0E1
Cs-137	1.0E2	1.1E2	1.1E2	1.1E2	1.1E2
Sr-90	5.6E1	5.8E1	5.8E1	5.8E1	5.8E1
Sn-126 ^(b)	1.1E-3	4.5E-3	4.2E-2	3.9E-1	3.8E0
FP	<u>(1.6E2)</u>	<u>(1.7E2)</u>	<u>(1.7E2)</u>	<u>(1.7E2)</u>	<u>(2.0E2)</u>
TOTAL	1.6E2	1.7E2	1.7E2	1.8E2	2.1E2

Source: PNL Waste Mixes Study (McCallum et al, 1982).

(a) Assumes the U.S. EPA (1980) first estimates of drilling rates, the release parameters in the U.S. DOE (1980) disruptive event, and a 100,000 MTHM repository.

(b) Some fraction of this isotope would remain in a repository; however, this point was not examined in the PNL study.

PNL concluded that, from a human intrusion-risk standpoint, there may be some incentive to remove the actinides from the repository inventory; however, PNL's results also show that the release rates were within the draft EPA limits.

3 Summary of PNL Terrestrial Risk Data

A summary of the PNL MGR risk data for waste processing, the fault, and drilling events is given in Tables 6-10, 6-11, and 6-12. The cumulative risks, in Ci, are provided in terms of Log_{10} . This facilitated the plotting of the values (see Section 7.0).

TABLE 6-10. LOG₁₀ OF TOTAL EXPECTED MGR RISKS (CURIES)
FOR PNL PROCESSING SCENARIOS

Scenario	Log ₁₀ Total Curies Released for 100,000 MTHM
<u>Reference MGR</u>	
Tc-99	-7.77(a)
I-129	0.54
AC(8)	-1.89
15 EPA Isotopes	2.75(b)
<u>Complemented MGR (HLW, less Cs and Sr to Space)</u>	
Tc-99	-1.28
I-129	0.54
AC(8)	-1.48
15 EPA Isotopes	2.75(b)
<u>Complemented MGR (Tc-99 to Space)</u>	
Tc-99	-0.58
I-129	0.54
AC(8)	-1.89
15 EPA Isotopes	2.75(b)
<u>Complemented MGK (I-129 to Space)</u>	
Tc-99	-7.77
I-129	0.54
AC(8)	-1.89
15 EPA Isotopes	2.75(b)

(a) From FEIS (U.S. DOE, 1980); PNL believes should be much higher.
(b) Mostly C-14.

TABLE 6-11. LOG₁₀ OF EXPECTED CUMULATIVE MGR RISKS
(CURIES) FOR PNL DRILLING SCENARIOS

Scenario	Time, years				
	200	1E3	1E4	1E5	1E6
<u>Reference MGR</u>					
Tc-99	-0.42	0.20	1.08	2.11	2.66
I-129	-2.69	-2.35	-1.38	-0.39	0.60
AC(8)	0.53	1.76	2.08	2.39	2.45
15 EPA Isotopes	2.24	2.38	2.50	2.76	3.01
<u>Complemented MGR (HLW less Cs and Cr to space)</u>					
Tc-99	-2.42	-1.80	-0.82	0.11	0.66
I-129	-2.96	-2.35	-1.38	-0.41	-0.58
AC(8)	-1.65	-0.256	0.0246	0.280	0.405
15 EPA Isotopes	2.19	2.23	2.23	2.25	2.32
<u>Complemented MGR (Tc-99 to space)</u>					
Tc-99	-2.12	-1.50	-0.62	0.41	0.96
I-129	-2.96	-2.35	-1.38	-0.39	0.60
AC(8)	0.53	1.76	2.08	2.39	2.45
15 EPA Isotopes	2.24	2.38	2.48	2.65	2.76
<u>Complemented MGR (I-129 to space)</u>					
Tc-99	-0.42	0.20	1.08	2.11	2.66
I-129	-4.81	-4.20	-3.23	-2.24	-1.25
AC(8)	0.53	1.76	2.08	2.39	2.45
15 EPA Isotopes	2.24	2.38	2.50	2.76	3.01

TABLE 6-12. LOG₁₀ OF EXPECTED CUMULATIVE MGR RISKS
(CURIES) FOR PNL FAULT SCENARIOS

Scenario	Time, years		
	1E4	1E5	1E6
<u>Reference MGR</u>			
Tc-99	-2.00	-0.89	0.11
I-129	-4.57	-3.46	-2.46
AC(8)	-7.75	-2.17	-1.11
15 EPA Isotopes	-2.00	-0.83	0.17
<u>Complemented MGR (HLW, less Cs and Sr to space)</u>			
Tc-99	-4.00	-2.89	-1.89
I-129	-4.57	-3.46	-2.46
AC(8)	-9.74	-3.88	-3.11
15 EPA Isotopes	-3.46	-2.09	-1.09
<u>Complemented MGR (Tc-99 to space)</u>			
Tc-99	-3.69	-2.59	-1.59
I-129	-4.57	-3.46	-2.46
AC(8)	-7.75	-2.17	-1.11
15 EPA Isotopes	-3.39	-1.69	-0.67
<u>Complemented MGR (I-129 to space)</u>			
Tc-99	-2.00	-0.89	-0.11
I-129	-6.42	-5.31	-4.31
AC(8)	-7.75	-2.17	-1.11
15 EPA Isotopes	-2.00	-0.83	-0.17

7.0 INTEGRATED RISK BENEFIT/DISBENEFIT FOR DISPOSAL SYSTEMS COMPLEMENTED BY SPACE DISPOSAL OF NUCLEAR WASTE

This section integrates the results of both the PNL (Section 6.0) and BCL (Section 5.0) release risk assessments for the total nuclear waste disposal systems considered in the current year study program. Risk is defined as cumulative Curies released to the accessible environment (what we refer to as the "biosphere"). The terrestrial disposal risk is comprised of the following components: (1) expected waste-processing releases to the biosphere, (2) probabilistic waste releases to the biosphere via a fault event, and (3) probabilistic waste releases to the biosphere due to a drilling scenario. The space disposal risk is comprised of probabilistic releases to the biosphere resulting from credible accidents that can occur from the launch pad to the final destination. Space accidents include:

- Long-term corrosion in the ocean and in wet soil
- Hard rock impact
- Volcano impact
- Meteoroid/debris impact
- High-velocity impacts on soil, rock, and water
- Deep-space meteoroid impacts
- Deep-space payload return over the long term.

Based upon the data in Sections 5.0 and 6.0, we will discuss and compare the various cumulative release risk contributions for the noncomplemented MGR (no space disposal) and the space-complemented MGR systems. The approach for discussing the integrated risk is as follows. For the five scenarios listed below, the risk of the noncomplemented MGR will be discussed first, followed by the complemented MGR risk, assuming that an "ideal" or "zero" risk disposal system could handle the waste removed from the complemented MGR. Then, the total integrated risks (complemented MGR plus space risk) for each scenario will be compared to the noncomplemented MGR. Potential risk benefits or disbenefits based upon the available data will be discussed.

These five scenarios are considered and discussed:

- (1) The cumulative release risk for the sum of the 15 EPA isotopes (see McCallum et al, 1982) for HLW disposal in space
- (2) The cumulative release risk for the sum of eight actinides (see McCallum et al, 1982) for HLW disposal in space
- (3) The cumulative release risk of Tc-99 for HLW disposal in space
- (4) The cumulative release risk of I-129 for I-129 disposal in space
- (5) The cumulative release risk of Tc-99 for Tc-99 disposal in space.

7.1 HLW Disposal in Space - 15 EPA Isotopes

Figure 7-1 presents the cumulative release risk data for 15 EPA isotopes, as cited in Sections 5.0 and 6.0 of this report, for the case of HLW disposal in space (the Reference space disposal mission). The magnitudes of the four major risk contributors (processing, drilling, fault, and space) are designated by the appropriate shading (see legend).

7.1.1 Reference MGR Risk (No Space Disposal)

The cumulative release risk for the Reference MGR case, no space disposal (see Figure 7-1a), indicates that short-term waste-processing releases dominate the cumulative release risk (mostly due to C-14). The computed risk for drilling events dominates over the fault case by about three orders of magnitude.

7.1.2 Complemented MGR Risk

Because of the dominance of the waste-processing releases, even an ideal disposal system for HLW would not appear to reduce the cumulative release risk for the disposal system (see Figure 7-1b). If one ignores the short-term processing releases, then about a factor of three reduction in the cumulative release risk for the drilling event in the long term is indicated, assuming an ideal disposal system for HLW. The fact that TRU is always present in the MGR contributes to this fact. For the fault case, about one order of magnitude improvement is possible for the sum of the 15 EPA isotopes. The cumulative release risk for both the Reference MGR and complemented MGR in the event of the postulated fault case is at or below the 1 Ci cumulative release line. This is a very low risk in both cases. PNL indicates that this is well below the draft EPA release limits for mined geologic repositories.

7.1.3 Space Risk

The space release risk estimate (see Figure 7-1c) is extremely small compared to processing volumes and drilling releases. It is about the same order of magnitude as the release risk for the complemented fault (see Figure 7-1b). Because of the uncertainty in the data, possible benefits/disbenefits of space disposal for the MGR fault scenario only are uncertain. All that can be concluded is that the expected cumulative release risk of the 15 EPA isotopes for the space disposal of HLW is that the risk benefits are possible in the very long term, but are not likely to be important. One must look to other discriminators, such as the actinides and technetium, to see if there are any possible benefits for specific problem areas in the MGR.

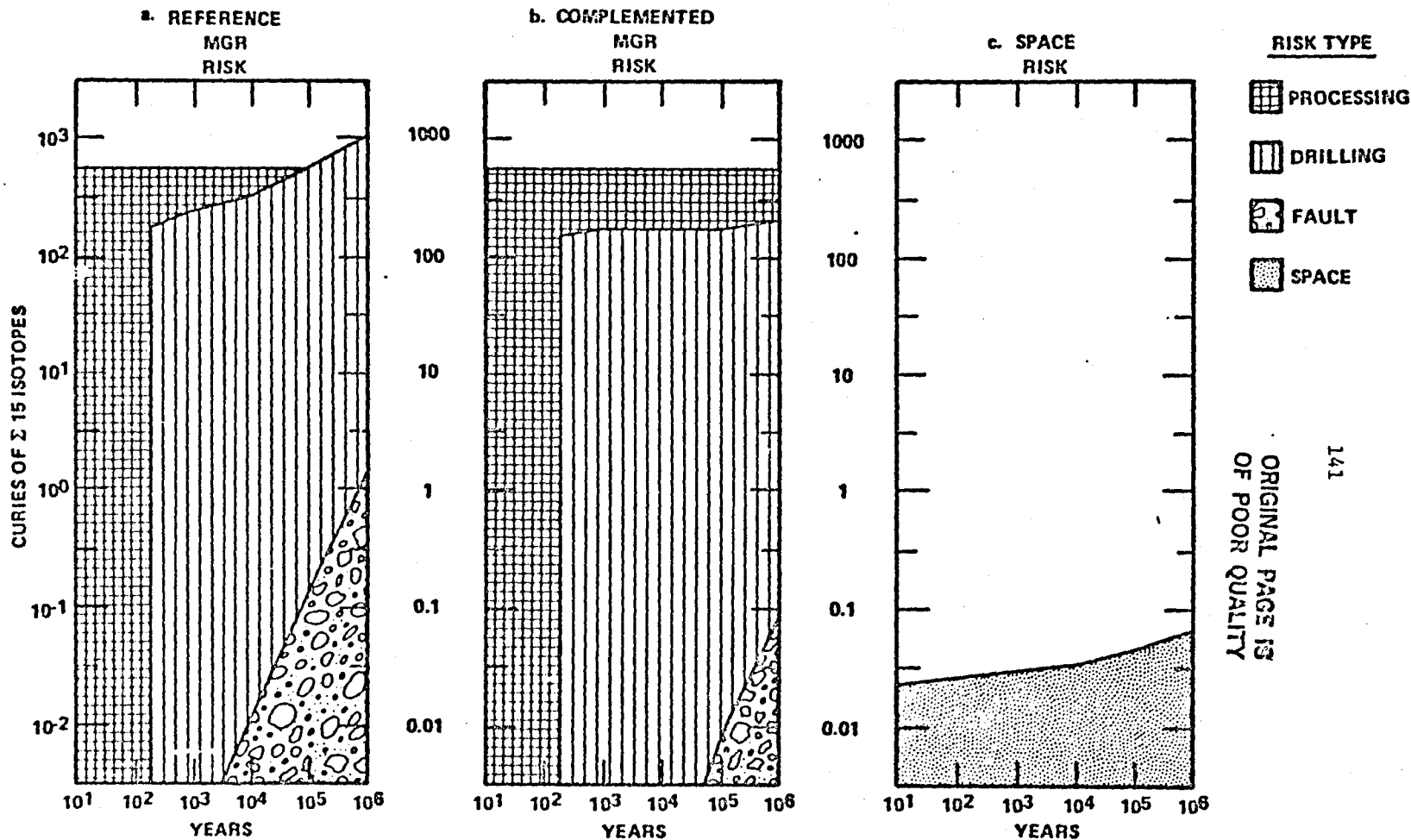

ORIGINAL PAGE IS
OF POOR QUALITY

FIGURE 7-1. INTEGRATED EXPECTED CUMULATIVE RELEASE RISK COMPARISONS (IN CURIE SUM OF 15 EPA ISOTOPES) FOR HLW DISPOSAL IN SPACE

7.2 HLW Disposal in Space - Eight Actinides

Figure 7-2 presents the cumulative release risk data for the sum of eight actinides, as cited in Sections 5.0 and 6.0 of this report for the case of HLW disposal in space.

7.2.1 Reference MGR Risk (No Space Disposal)

The cumulative actinide release risk for the Reference MGR case (see Figure 7-2a) indicates that the drilling event significantly dominates over the risks for waste processing and the fault. The actinide release risk from faulting is insignificantly small and comparable to the processing releases for the actinides.

7.2.2 Complemented MGR Risk

Figure 7-2b indicates only a slight insignificant increase in waste-processing releases in the short term. The release risk from the fault case moves from insignificant values to two orders of magnitude less (see Figures 7-2a and 7-2b). For an ideal disposal system for HLW, a benefit can be realized when one considers the drilling event postulated by PNL. About a factor of 100 reduction in the long-term risk can be realized for the actinides.

7.2.3 Space Risk

As shown in Figure 7-2c, the space risk is again very small and comparable to the risk of waste processing and the risk of faulting in the Reference MGR case. It appears, even with the uncertainty that it does not make sense to dispose of the actinides in space if one considers only waste processing and the fault release risk. A significant disbenefit is possible. However, if human intrusion (drilling) is considered to be an important factor in the risk, then space disposal of the actinides can provide a cumulative release risk benefit by about a factor of 100, even with a space risk component increase by two orders of magnitude.

7.3 HLW Disposal in Space - Tc-99 Risk

Figure 7-3 presents the cumulative release risk data for Tc-99, as cited in Sections 5.0 and 6.0 of this report for the case of HLW disposal in space.

7.3.1 Reference MGR Risk (No Space Disposal)

Figure 7-3a indicates, when compared to Figure 7-1a, that Tc-99 is an important contributor to the release risk in an MGR (only in terms of Curies released). Figure 7-3a also indicates that the drilling event dominates the

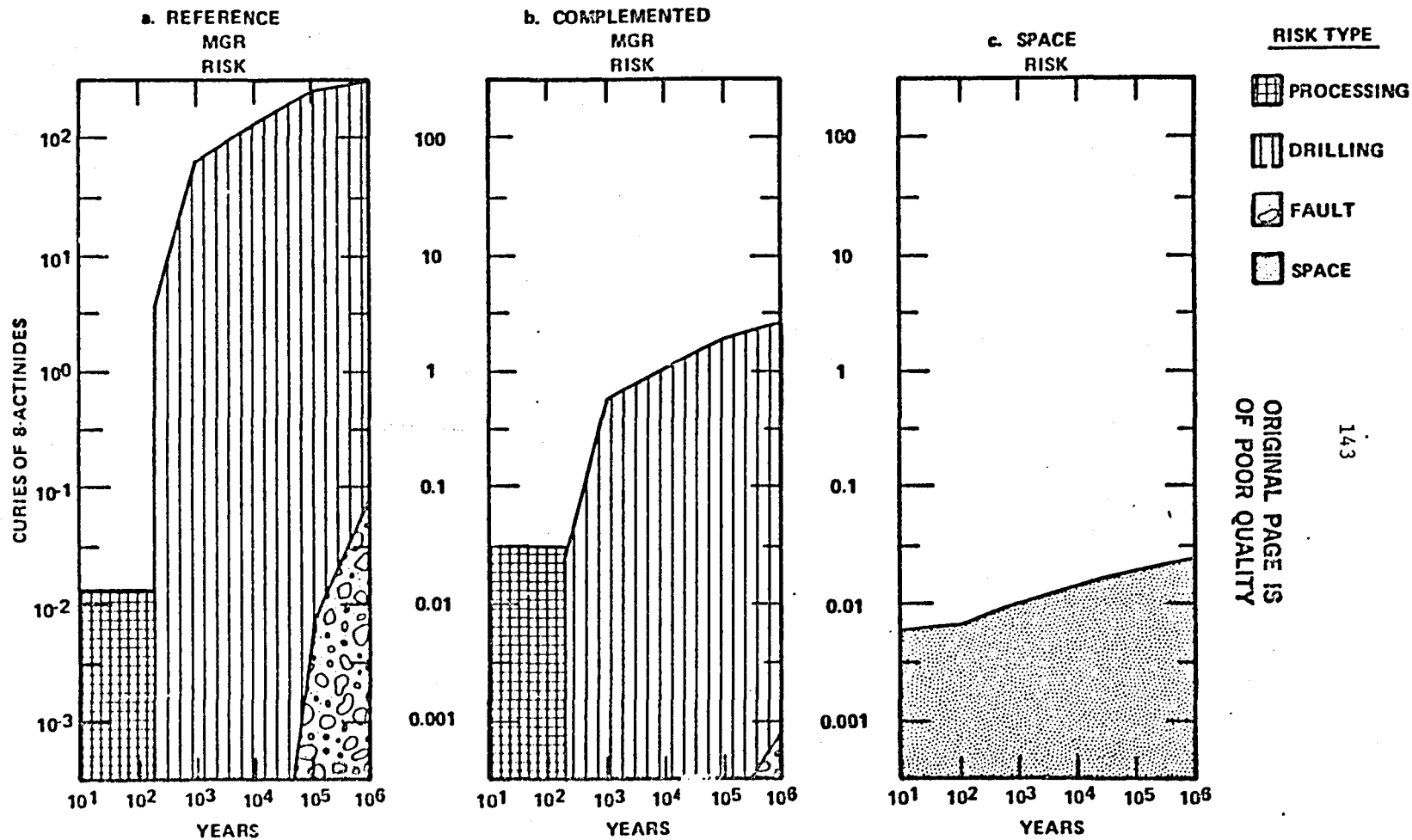
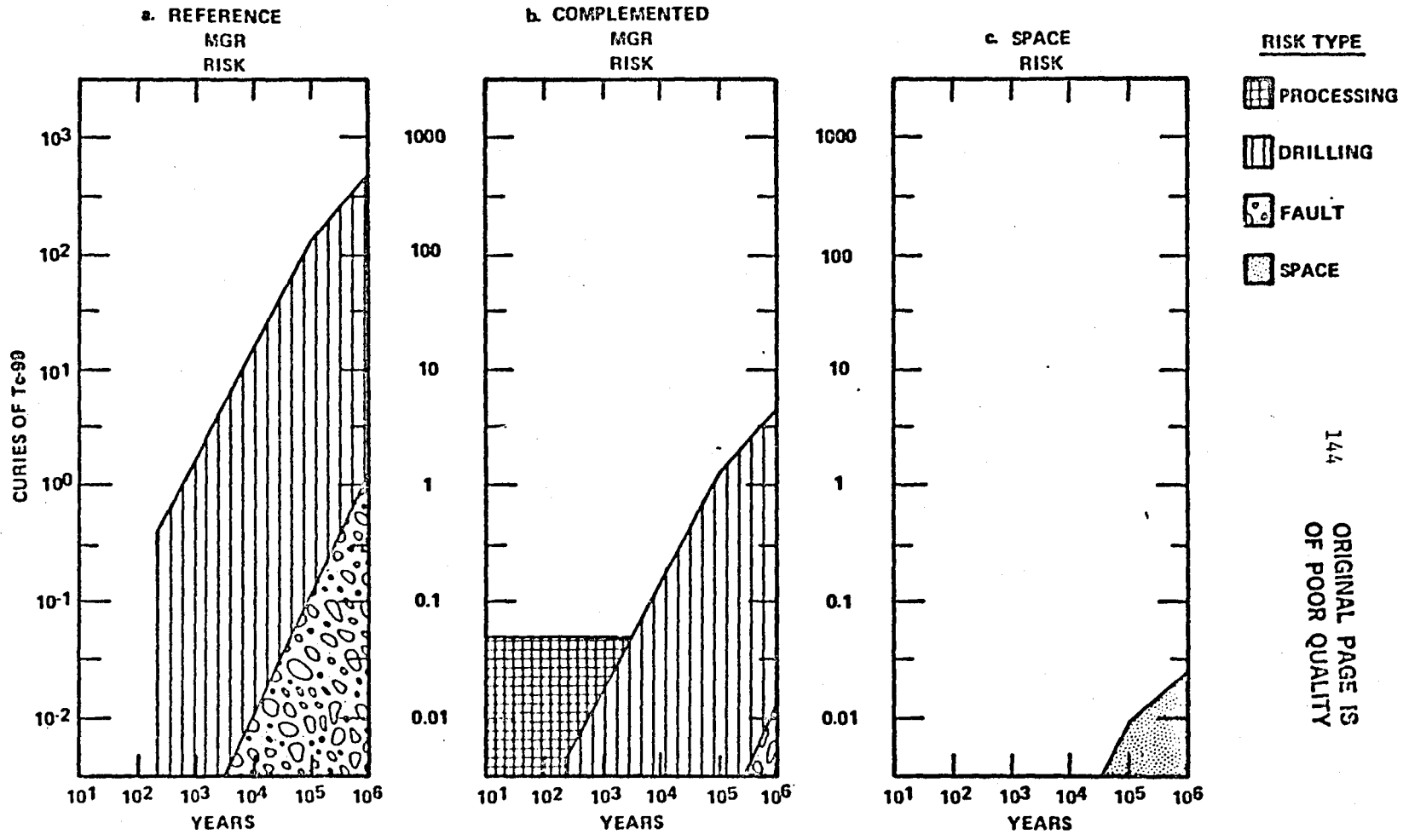

FIGURE 7-2. INTEGRATED EXPECTED CUMULATIVE RELEASE RISK COMPARISONS (IN CURIE SUM OF EIGHT EPA ACTINIDES) FOR HLW DISPOSAL IN SPACE



144 ORIGINAL PAGE IS OF POOR QUALITY

FIGURE 7-3. INTEGRATED EXPECTED CUMULATIVE RELEASE RISK COMPARISONS (IN CURIES OF Tc-99) FOR HLW DISPOSAL IN SPACE

ossible releases. PNL says that processing releases of Tc-99 were predicted by the FEIS (U.S. DOE, 1980) to be very small; therefore, they do not appear in the graph.

7.3.2 Complemented MGR Risk

Figure 7-3b indicates that about a factor of 100 improvement in the long-term release risk for Tc-99 can be obtained for an ideal disposal system. However, because of short-term processing releases, the benefit becomes a slight disbenefit in the short term.

7.3.3 Space Risk

The space risk (see Figure 7-3c), is very small compared to the complemented MGR risk envelope. It is, however, comparable to the risk of the fault case. Due to the uncertainties that exist in the data base, little can be said for technetium disposal, if one does not include human intrusion (drilling). Benefit is possible if one considers that human intrusion is possible. However, this benefit would be better realized by partitioning technetium and shipping it to space (see Section 7.5).

7.4 I-129 Disposal in Space - I-129 Risk

Figure 7-4 indicates that because of the large processing releases anticipated in the short term (see Section 6.0), no benefit is possible for disposing of I-129 in space. If improvement can be made in the processing of the iodine, than benefits are possible with space disposal. However, these benefits are believed to be technically insignificant (see the 1-Ci line in the figure). The space disposal risk is exceedingly insignificant (see Figure 7-4c).

7.5 Tc-99 Disposal in Space - Tc-99 Risk

Figure 7-5 indicates that the short-term risk due to waste processing for Tc-99 disposal in space is increased to a "relatively insignificant" level (see the 1-Ci line). Long-term benefits are possible if one considers human intrusion (drilling). There do not appear to any technical benefits for Tc-99 in space if one excludes human intrusion. More efficient partitioning processes could improve the potential benefit for technetium disposal in space. The space risk component is an insignificant contributor when compared with waste-processing and drilling events.

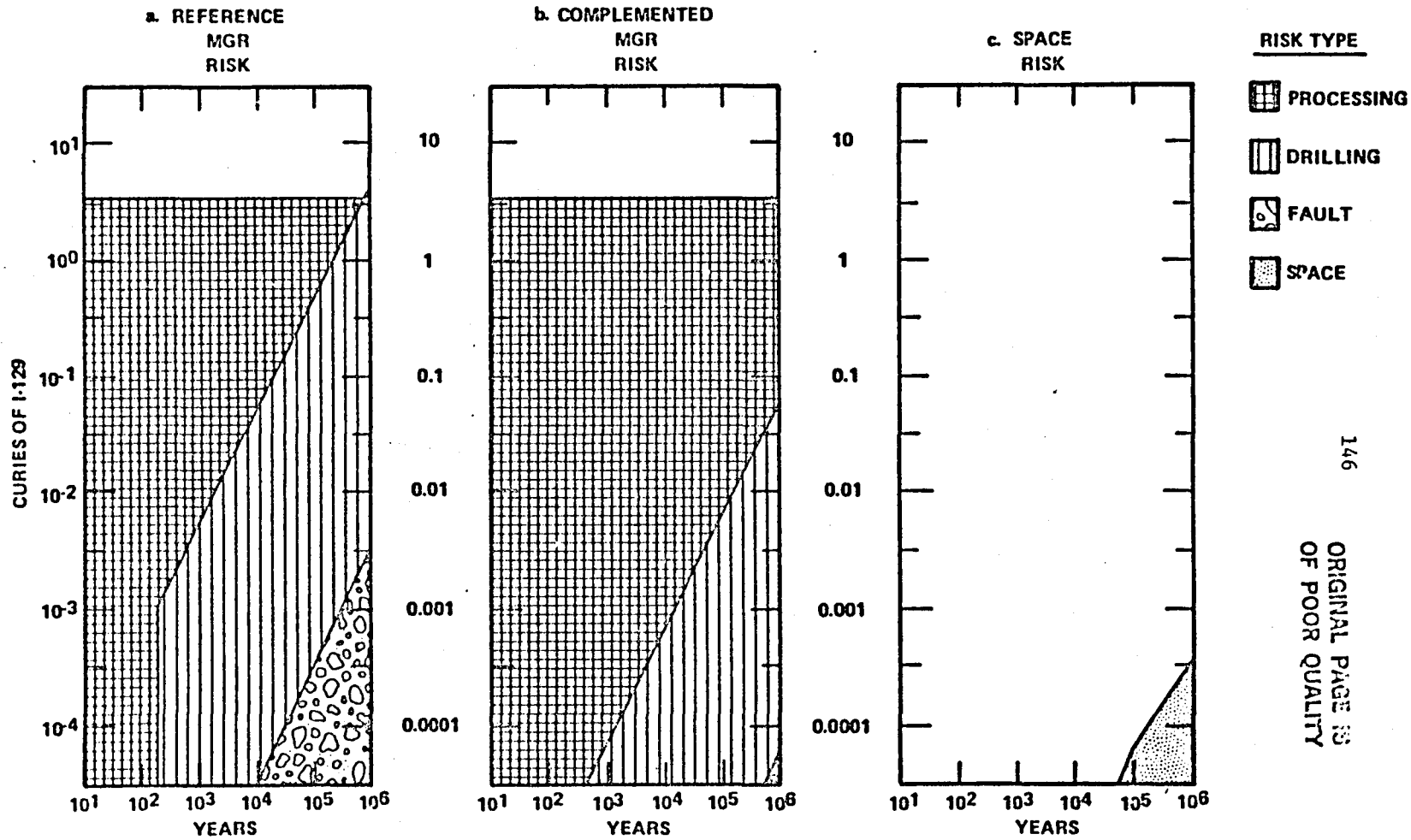

FIGURE 7-4. INTEGRATED EXPECTED CUMULATIVE RELEASE RISK COMPARISONS (IN CURIES OF I-129) FOR I-129 DISPOSAL IN SPACE

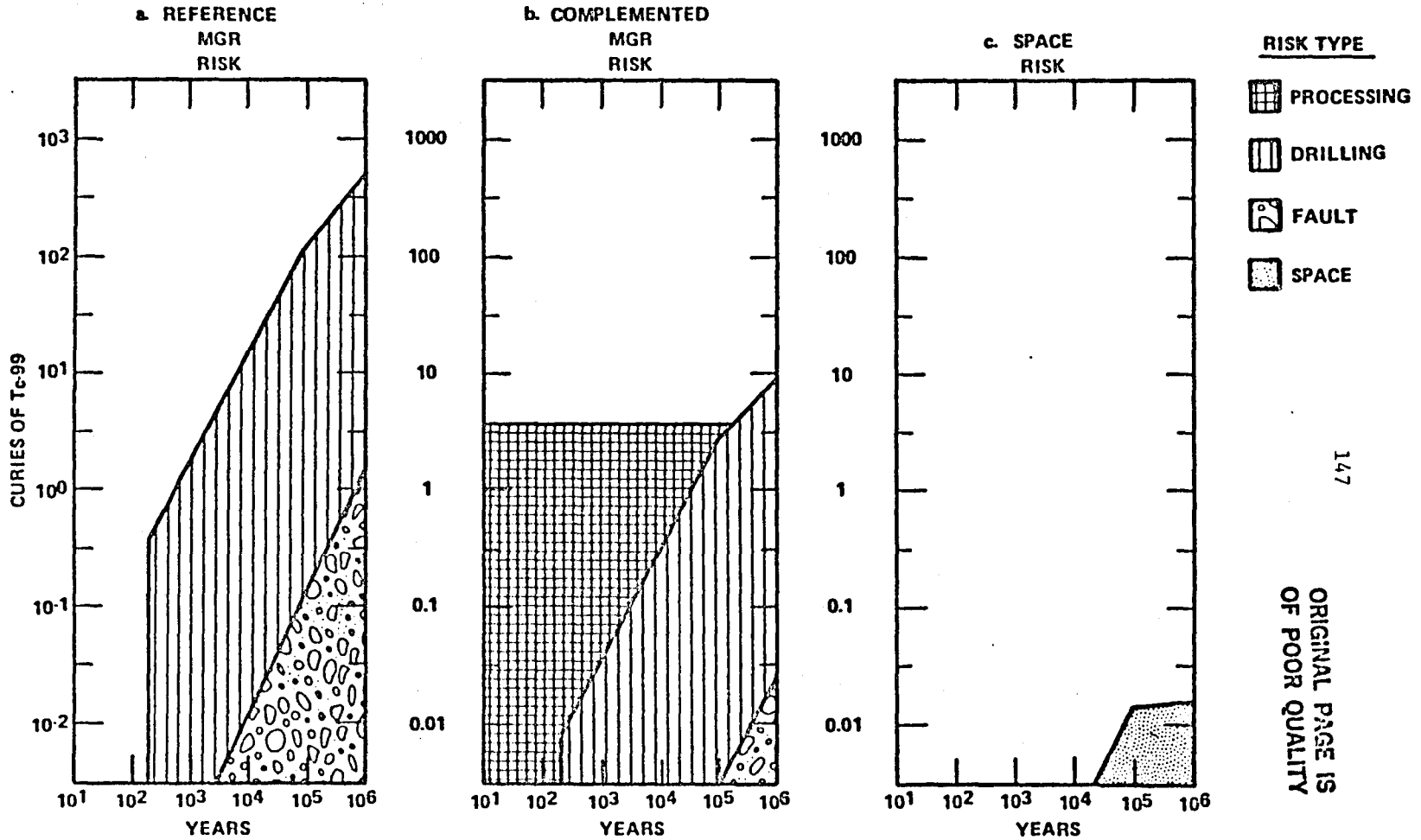

FIGURE 7-5. INTEGRATED EXPECTED CUMULATIVE RELEASE RISK COMPARISONS (IN CURIES OF Tc-99) FOR Tc-99 DISPOSAL IN SPACE

This Page Intentionally Left Blank

8.0 SUMMARY OF RESULTS

This section summarizes a few of the major results of this study. The results given have considered the uncertainty in the calculated values for the releases for both the MGR and space disposal. The results listed are organized by topic area:

Based Upon Data Derived in the PNL Study

- (1) The risk to future populations from the mined geologic disposal of radioactive waste appears to be extremely small.
- (2) In terms of Curies released, the escape of fission products during normal reprocessing would be expected to be as large as the total amount released (due to a natural fault or human intrusion) over the subsequent one million years.
- (3) The release of actinide elements dominates the escape of radionuclides over the expected period of possible human intervention (drilling events) in the MGR.
- (4) The release of Tc-99 appears to dominate the escape of radionuclides in MGR seismic events. Actinide releases are expected to be small.
- (5) Since some radioactive material would be disposed of in an MGR for each of the space disposal options examined, space disposal could reduce but not eliminate this element of risk. For some radionuclides, the additional waste processing required for space options would actually increase the waste-reprocessing component of the risk.
- (6) The potential for risk benefit is limited by the degree of separation and release in waste processing and the inclusion of TRU wastes in the MGR.
- (7) Current technology indicates that there is no potential for re-release risk benefit for the space disposal of I-129. Potential exists for Tc-99 and the actinides for current waste-processing technology.

Based Upon BCL Preliminary Space Risk Estimates

- (8) The risk of space disposal appears to be very small.
- (9) Short-term space disposal release risk (space component) is dominated by payload reentry, impact on hard rock, and complete breakup and reentry due to direct meteoroid/payload or debris/payload collisions.

- (10) Long-term release risk (space component) is dominated by the failure to locate reentered payloads in the ocean, intact payload return from deep space after rescue attempts fail, and small particle return after deep-space meteoroid collisions.
- (11) Short-term accident events dominate the space risk component, but not by much (well within any uncertainty band).
- (12) An uncertainty analysis was not possible under the scope of this study; however, the uncertainty for the space disposal risk is believed to be within two orders of magnitude of the expected value.
- (13) From examination of the release risk for space disposal (space component), it is evident that a few contributors to the risk would be very difficult to reduce (e.g., meteoroid impact); however, most of the risk contributors can be controlled by proper design.

Based Upon Integrated PNL/BCL Risk Data

- (14) Ignoring probabilities, no single accident event examined in the study, for either space disposal or mined geologic disposal, would be catastrophic in terms of an immediate threat to a large number of human lives or an extensive impact on the environment.
- (15) Although space disposal appears to offer some potential for reduction in risk, it should be recognized that the uncertainties in the risk estimates are large and that the predicted risk of mined geologic disposal is extremely small to begin with.
- (16) The results of this study only indicate possible benefits/disbenefits of space disposal. To obtain more realistic and meaningful results, pathway models resulting in dose estimates are needed.

9.0 CONCLUSIONS

This section summarizes three major conclusions that come from this preliminary risk assessment of nuclear waste disposal in space:

- (1) Preliminary estimates of space disposal risk are low, even with the estimated uncertainty bounds.
- (2) If calculated MGR release risks remain low, e.g., as given in the PNL Waste Mixes Study (McCallum et al, 1982), and the EPA requirements continue to be met, then no additional space disposal study effort is warranted.
- (3) If risks perceived by the public are significant in the acceptance of mined geologic repositories, then consideration of space disposal as an MGR complement is warranted.

10.0 RECOMMENDATIONS

As a result of this study, the following recommendations are made to NASA and the U.S. DOE:

- (1) During the continued evaluation of the mined geologic repository risk over the years ahead by DOE, if any significant increase in the calculated health risk is predicted for the MGR, then space disposal should be reevaluated at that time.
- (2) The risks perceived by the public for MGR should be evaluated on a broad basis by an independent organization to evaluate acceptance.
- (3) If, in the future, MGR risks are found to be significant due to some presently unknown technical or social factor, and space disposal is selected as an alternative that may be useful in mitigating the risks, then the following space disposal study activities are recommended:
 - Improvement in chemical processing technology for wastes
 - Payload accident response analysis
 - Risk uncertainty analysis for both MGR and space disposal
 - Health risk modeling that includes pathway and dose estimates

- Space disposal cost modeling
- Assessment of space disposal perceived (by public) risk benefit
- Space systems analysis supporting risk and cost modeling.

APPENDIX A
REFERENCES

APPENDIX A

REFERENCES

ndrus, P. G., and L. E. Walkup, 1969. Electrostatic Hazards During Launch Vehicle Flight Operations, BMI-NLVP-TM-69-1, Battelle Columbus Laboratories, Columbus, OH.

aecker, J. B., 1981. Space Shuttle Range Safety Hazards Analysis, Technical Report No. 81-1329, J. H. Wiggins Company, Redondo Beach, CA.

aldwin, R. B., 1963. The Measure of the Moon, The University of Chicago Press, Chicago, IL.

oyd, W. K., and I. W. Fink, 1978. Corrosion of Metals in Marine Environments, MCIC-78-37, Metals and Ceramics Information Center, Battelle Columbus Laboratories, Columbus, OH.

hobotov, V. A., 1981. The Probability of Collision in Space, Paper AAS 81-148, AAS/AIAA Astrodynamics Conference (August 3-5, 1981), Lake Tahoe, NV.

Edgecombe, D. S., E. E. Rice, N. E. Miller, K. R. Yates, and R. J. Conlon, 1978. Evaluation of the Space Disposal of Defense Nuclear Waste - Phase II, Volumes I, II, and III, Battelle Columbus Laboratories, Columbus, OH.

Friedlander, A. L., et al, 1977a. Analysis of Long-Term Safety Associated with Space Disposal of Hazardous Material, SAI-1-120-676-T11, Science Applications, Inc., Schaumburg, IL.

Friedlander, A. L., et al, 1977b. Aborted Space Disposal of Hazardous Material: The Long-Term Risk of Earth Reencounter, SAI-1-120-676-TS, Science Applications, Inc., Rolling Meadows, IL.

Friedlander, A. L., and D. R. Davis, 1978. Long-Term Risk Analysis Associated with Nuclear Waste Disposal in Space, Report No. SAI-1-120-062-T12, Science Applications, Inc., Schaumburg, IL.

Friedlander, A. L., and W. C. Wells, 1980. Risks of Nuclear Waste Disposal in Space - Part III: Long-Term Orbital Evaluation of Small Particle Distribution, Paper AIAA-80-12672, AIAA/AAS Astrodynamics Conference (August 11-13, 1980), Danvers, MA.

General Electric, 1974. Updated Safety Analysis Presentation - Multi-Hundred Watt RTG Program, LES 8/9 Mission, Contract No. AT (29-2)-2831, General Electric Energy Systems Programs, Space Division, Philadelphia, PA.

General Electric, 1975. Multi-Hundred Watt Radioisotope Thermoelectric Generator Program, Vols. I & II, GEMS-419, General Electric, Nuclear Programs, Space Division, Philadelphia, PA.

Greenberg, J., et al, 1978. Waste Isolation Safety Assessment Program Scenario Analysis Methods for Use in Assessing the Safety of the Geologic Isolation of Nuclear Waste, PNL-2643, Pacific Northwest Laboratory, Richland, WA.

Hudson, J. M., 1979. Development of STS Failure Probabilities - MECO to Payload Separation, Technical Report No. 79-1359, J. H. Wiggins Company, Redondo Beach, CA.

Iman, R. L., J. C. Helton, and J. E. Campbell, 1978. Risk Methodology for Geologic Disposal of Radioactive Waste: Sensitivity Analysis Techniques, NUREG/CR-0394, SAND78-0912, by Sandia Laboratories for the U.S. Nuclear Regulatory Commission, Washington, DC.

Kessler, D. J., et al, 1980. "Collision Avoidance in Space", IEEE Spectrum (June 1980).

Lama, R. D., and V. S. Vutukuri, 1978. Handbook on Mechanical Properties of Rocks - Vol. II, Series on Rock and Soils, Trans. Tech. Publication, Switzerland, pp. 120-121.

Manson, S. S., 1976. "Nonferrous Alloys", in Aerospace Structural Metals Handbook, Belfour Stulen, Inc.

Martin-Marietta, 1977. Space Shuttle External Tank Critical Items List (CIL), MMC-ET-RA04b-A, Michoud Operations, Martin-Marietta Corporation, New Orleans, LA.

McCallum, R. F., H. T. Blair, R. W. McKee, D. J. Silveira, and J. L. Swanson, 1982. Waste Mixes Study for Space Disposal, Pacific Northwest Laboratory, Richland, WA.

McKenna, S. J., 1982. Time History of Nuclear Waste Leaching to Biosphere from Two Simple Waste Container Models, Battelle Columbus Laboratories (internal memorandum), Columbus, OH.

Military Standardization Handbook - Metallic Materials and Elements for Aerospace Vehicle Structure, 1971. MIL-HDBK-5B, Vol. 1.

NASA/JSC, 1978. Orbiter 102 Critical Item List, JSC 10686, NASA/Lyndon B. Johnson Space Center, Houston, TX.

NASA/JSC, 1979. Space Shuttle Flight and Ground Specifications, JSC 07700, Volume X, Revision F, Chapter 7.4, NASA/Lyndon B. Johnson Space Center, Houston, TX.

NASA/MSFC, 1977. Critical Items List for the Space Shuttle Solid Rocket Booster, NASA SE019-127-2H, NASA/Marshall Space Flight Center, Huntsville, AL.

NASA/MSFC, 1979. Shuttle Liquid Rocket Booster Study - Conceptual Design/Feasibility Analysis Study, NASA/Marshall Space Flight Center, Huntsville, AL.

Pardue, W. M., E. E. Rice, N. E. Miller, and D. K. Davis, 1977. Preliminary Evaluation of the Space Disposal of Nuclear Waste, 8-32391(100), Battelle Memorial Institute, Columbus, OH.

Priest, C. C., 1979. Nuclear Waste Management (Space Option) - Historical Activity Summary, NASA/Marshall Space Flight Center, Huntsville, AL.

Priest, C. C., 1980. Concept Definition Document for Nuclear Waste Disposal in Space, NASA/Marshall Space Flight Center, Huntsville, AL.

Puthoff, R. L., 1972. A 1055 Ft/Sec Impact Test of a Two Foot Diameter Model Nuclear Reactor Containment System Without Fracture, NASA TM X-68103, NASA/Lewis Research Center, Cleveland, OH.

Raymond, J. R., et al, 1980. Test Case Release Consequence Analysis for a Spent Fuel Repository in Bedded Salt, PNL-2782, Pacific Northwest Laboratory, Richland, WA.

Reinert, R. P., et al, 1981. Analysis of Space Systems - Study for the Space Disposal of Nuclear Waste, Contract NAS8-33847, Boeing Aerospace Company, Seattle, WA.

Reinert, R. P., et al, 1982. Analysis of Space Systems - for the Space Disposal of Nuclear Waste Follow-on Study, Boeing Aerospace Company, Seattle, WA.

Reynolds, R. C., 1980. The Hazard Presented to the Shuttle by the Other Satellites in Its Operating Environment, CPIA Publication 313, paper presented at the 1980 JANNAF Safety and Environmental Protection Session (March, 1980), pp. 101-136.

Rice, E. E., N. E. Miller, K. R. Yates, W. E. Martin, and A. L. Friedlander, 1980a. Analysis of Nuclear Waste Disposal in Space - Phase III - Final Report, NASA CR-161419, Battelle Columbus Laboratories, Columbus, OH.

Rice, E. E., C. C. Priest, and A. L. Friedlander, 1980b. U.S. Program Assessing Nuclear Waste Disposal in Space: A Status Report, International Astronautical Federation, XXXI Congress, Tokyo, Japan, Paper No. 80-IAA-50 (September 21-28, 1980).

Rice, E. E., D. S. Edgecombe, and P. R. Compton, 1981a. Safety Aspects of Nuclear Waste Disposal in Space, International Astronautical Federation, XXXII Congress, Rome, Italy, Paper No. IAA-81-252 (September 6-12, 1981).

Rice, E. E., D. S. Edgecombe, P. R. Compton, and R. E. Best, 1981b. U.S. Program Assessing Nuclear Waste Disposal in Space: A 1981 Status Report, International Astronautical Federation, XXXII Congress, Rome, Italy, Paper No. IAF-81-188 (September 6-12, 1981).

Rockwell International, 1978a. SSME Failure Mode and Effects Analysis and Critical Items List, RSS-8553-6, Rockwell International, Rocketdyne Division, Canoga Park, CA.

Rockwell International, 1978b. SSME Critical Items List Baseline, Internal Letter No. RPS 78-513 SSME 78-238, Rockwell International, Downey, CA.

Rockwell International, 1979. Orbiter Vehicle 102 Orbital Flight Test Configuration, Critical Items List, 3 Vol: Mechanical/Fluid Systems, ECLSS/Power Systems, Propulsion and Avionics Systems, SD75-SH-0003L, Rockwell International, CA.

Stevens, C. A., R. R. Fullwood, and S. L. Basin, 1980. Risk Assessment Methodology Development for Waste Isolation in Geologic Media, NUREG/CR-1672, SAI-219-80-PA, by Science Applications, Inc. for the U.S. Nuclear Regulatory Commission, Washington, DC.

Sutcliffe, W. G., K. G. Feller, N. K. Madsen, and G. D. Pollak, 1981. "Uncertainties and Sensitivities in the Long-Term Performance of Mined Geologic Repositories", in Proceedings of the 1981 National Waste Terminal Storage Information Meeting (November 1981), DOE/NWTS-15, Office of NWTS Integration, Columbus, OH, pp. 205-212.

Teledyne, 1974. SNAP 19/Viking Final Safety Analysis Report, Vol. I and II, ESD-3069-15, Teledyne Isotopes, Energy Systems Divisions, Timonium, MD.

U.S. Air Force, 1975. Candidate Environmental Impact Statement for LES 8 and 9, Kirkland AFB.

U.S. Atomic Energy Commission, 1974a. Overall Safety Manual - Volume 1, Summary, prepared by the NUS Corporation, Rockville, MD.

U.S. Atomic Energy Commission, 1974b. Report on the Integrity of Reactor Vessels for Light Water Power Reactors, by the Advisory Committee on Reactor Safeguards, WASH-1285, U.S. Atomic Energy Commission, Washington, DC.

U.S. Department of Energy, 1975. U.S. Energy Research and Development Administration (now U.S. DOE) - ERDA Manual, Chapter 0524, Standards for Radiation Protection, Washington, DC.

U.S. Department of Energy, 1977. Safety Specification for Plutonium-238 Developmental Heat Sources, NRA-3, Division of Nuclear Research and Applications, Energy Research and Development Administration (now U.S. DOE), Washington, DC.

U.S. Department of Energy, 1980. Final Environmental Impact Statement: Management of Commercially Generated Radioactive Waste, DOE/EIS-0046F, Washington, DC.

U.S. Department of Transportation, 1979. "Requirements for Transportation of Radioactive Materials", Title 49, Parts 170-179, Code of Federal Regulations, U.S. Department of Transportation, U.S. Government Printing Office, Washington, DC.

U.S. Environmental Protection Agency, 1980. Technical Support of Standards for High-Level Radioactive Waste Management, EPA 520/4-79-0070, Washington, DC.

U.S. Environmental Protection Agency, 1981. Environmental Standards and Federal Radiation Protection Guidance for Management and Disposal of Spent Nuclear Fuel, High-Level and Transuranic Radioactive Wastes, Working Draft Number 19, Washington, DC.

U.S. Nuclear Regulatory Commission, 1975. Reactor Safety Study - An Assessment of Accident Risks in U.S. Commercial Nuclear Power Plants, WASH-1400, Washington, DC.

U.S. Nuclear Regulatory Commission, 1978. "Packaging Radioactive Materials for Transport", Title 10, Part 71, Code of Federal Regulations, U.S. Nuclear Regulatory Commission, U.S. Government Printing Office, Washington, DC.

U.S. Nuclear Regulatory Commission, 1981. "Disposal of High-Level Radioactive Wastes in Geologic Repositories", 10 CFR 60, Federal Register, Vol. 46, No. 130, Washington, DC., pp. 35280-35296.

Yates, K. R., and U. Y. Park, 1979. "Projections of Commercial Nuclear Capacity and Spent-Fuel Accumulation in the United States", Transactions of the American Nuclear Society, Volume 32, pp. 350-352.

APPENDIX B
ACRONYMS AND ABBREVIATIONS

BATTELLE - COLUMBUS

APPENDIX B

ACRONYMS AND ABBREVIATIONS

AC	actinide elements
AEC	U.S. Atomic Energy Commission
ALARA	as low as reasonably achievable
AOA	abort-once-around
ATO	abort-to-orbit
A.U.	astronomical unit
BCL	Battelle Columbus Laboratories, Columbus, Ohio
C	degrees centigrade
cc	cubic centimeters (cm ³)
C/C	carbon/carbon
CFR	Code of Federal Regulations
Ci	Curies
cm	centimeters
COR	Contracting Officer's Representative
C _p	specific heat
DOE	U.S. Department of Energy
DOT	U.S. Department of Transportation
EPA	U.S. Environmental Protection Agency
ERDA	U.S. Energy Research and Development Administration
ESMC	Eastern Space and Missile Center
ET	Space Shuttle's External Tank
FSS	Flight Support System
g	grams
GWe	gigawatts electric
HLW	high-level waste
IAEA	International Atomic Energy Agency
IGOS	Interactive Graphics Orbit Selection
JSC	NASA's Johnson Space Center, Houston
k	thermal conductivity
kg	kilogram
km	kilometer
KSC	Kennedy Space Center, Florida
kW	kilowatt
LCC	Launch Control Center (Shuttle's at KSC)
LEO	low-Earth orbit
LH ₂	liquid hydrogen
LOX	liquid oxygen
LRB	Liquid Rocket Booster (Up-rated Shuttle)
LWR	light water reactor
m	meters
ME	main engine
MECO	main engine cutoff
MGR	mined geologic repository
MLP	Mobile Launch Platform (Shuttle's at KSC)
MNH	monomethyl hydrazine
mrem	millirem

m/s	meters per second
MSFC	NASA's Marshall Space Flight Center, Huntsville, Alabama
MT	metric tons
MTHM	metric tons of heavy metal
N	Newtons
NASA	National Aeronautics and Space Administration
N/cm ²	Newtons per square centimeter
NPO	National Waste Terminal Storage Program Office (formerly DOE-Richland Operations Office in Columbus, OH)
NPPF	Nuclear Payload Preparation Facility
NRC	U.S. Nuclear Regulatory Commission
NTO	nitrogen tetroxide
O/F	oxidizer-to-fuel ratio
OMS	Orbital Maneuvering System (Shuttle)
ONWI	Office of Nuclear Waste Isolation (DOE's)
ORNL	Oak Ridge National Laboratory
OTV	Orbit Transfer Vehicle
PCR	Payload Changeout Room
PL	payload
PNL	Pacific Northwest Laboratory, Richland, Washington
RCS	Reaction Control System (Shuttle)
rem	roentgen equivalent, man
RETAC	Reentry Thermal Analysis Code
RP-1	rocket propellant number 1 (kerosene)
RSS	Rotating Service Structure (Shuttle)
RTG	radioisotope thermal generator
RTLS	return-to-launch-site
SAI	Science Applications, Inc., Schaumburg, Illinois
SDV	Shuttle Derived Vehicle
SL	sea-level
SOIS	Solar Orbit Insertion Stage
SRB	Solid Rocket Booster
SS	Space Shuttle
SSME	Space Shuttle Main Engine
STD	Standard
STS	Space Transportation System
ΔT	change in temperature
TBD	to be determined
TPS	thermal protection system
TRU	transuranic waste
TVC	thrust vector control
USAF	United States Air Force
ΔV	change in velocity
VAB	Vehicle Assembly Building (Shuttle's at KSC)
W	Watt

APPENDIX C
METRIC/ENGLISH UNIT CONVERSION FACTORS

BATTELLE - COLUMBUS

APPENDIX C

METRIC/ENGLISH UNIT CONVERSION FACTORS

<u>To convert</u>	<u>into</u>	<u>multiply by</u>
atmospheres (atm)	pounds per square inch (psi) . .	14.70
atmospheres (atm)	pounds per square ft (psf) . . .	2116.8
calories (cal)	British thermal units (Btu) . . .	3.9685×10^{-3}
calories per gram (cal/g)	British thermal units per pound (Btu/lb)	1.80
centimeters (cm)	inches (in)	0.3937
centimeters (cm)	feet (ft)	3.281×10^{-2}
centimeters (cm)	yards (yd)	1.094×10^{-2}
cubic centimeters (cm ³)	cubic inches (in ³)	0.0610
cubic meters (m ³)	cubic feet (ft ³)	35.32
cubic meters (m ³)	gallons (gal)	264.2
degrees Centigrade (°C)	degrees Fahrenheit (°F)	$1.8 C + 32^*$
degrees Kelvin (°K)	degrees Rankine (°R)	1.8
grams (g)	pounds (lb)	2.205×10^{-3}
kilograms (kg)	pounds (lb)	2.205
kilometers (km)	statute miles (mi)	0.6214
kilometers (km)	nautical miles (n.mi.)	0.540
kilometers (km)	feet (ft)	3281
kilowatts (kW)	Btu per hour (Btu/hr)	3413
meters (m)	inches (in)	39.37

*NOTE: Multiply by 1.8 and then add 32.

<u>To convert</u>	<u>into</u>	<u>multiply by</u>
meters (m)	feet (ft)	3.281
meters (m)	yards (yd).	1.094
meters per second (m/s).	feet per second (ft/s).	3.281
metric tons (MT)	pounds (lb)	2205
metric tons (MT)	tons (T).	1.102
micrometers (μ)	meters (m).	1.0×10^{-6}
Newtons (N).	pounds force (lbf).	0.2248
Newtons per cm^2 (N/cm^2).	pounds per square inch (psi).	1.4504

APPENDIX D
SPACE DISPOSAL FAULT TREE DIAGRAMS

BATTELLE - COLUMBUS

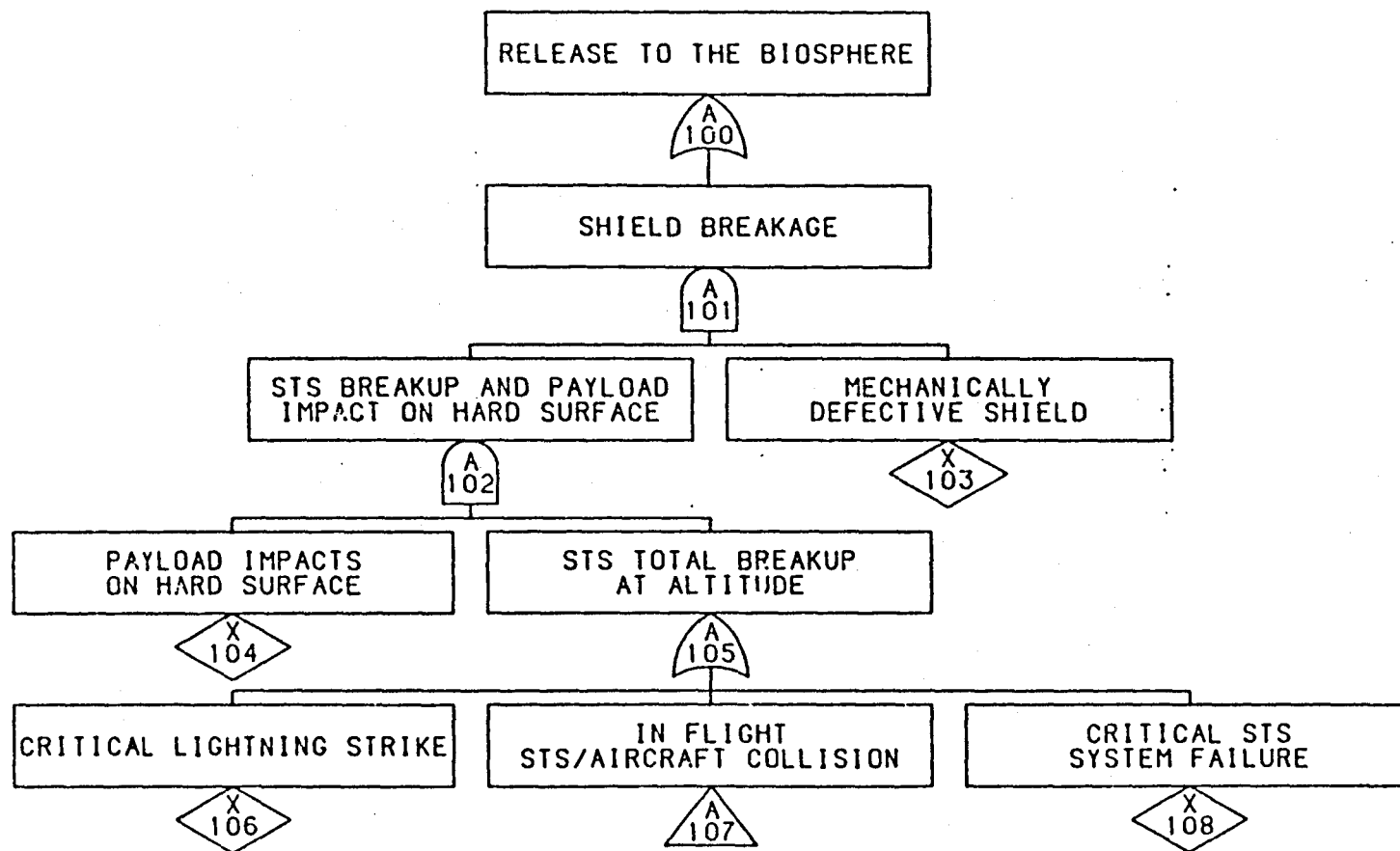

ORIGINAL PAGE IS
OF POOR QUALITY

FIGURE D-1. PHASE 1 FAULT TREE--IGNITION TO IMPACT POINT CLEARS COASTLINE (T = 0 to 24 sec)

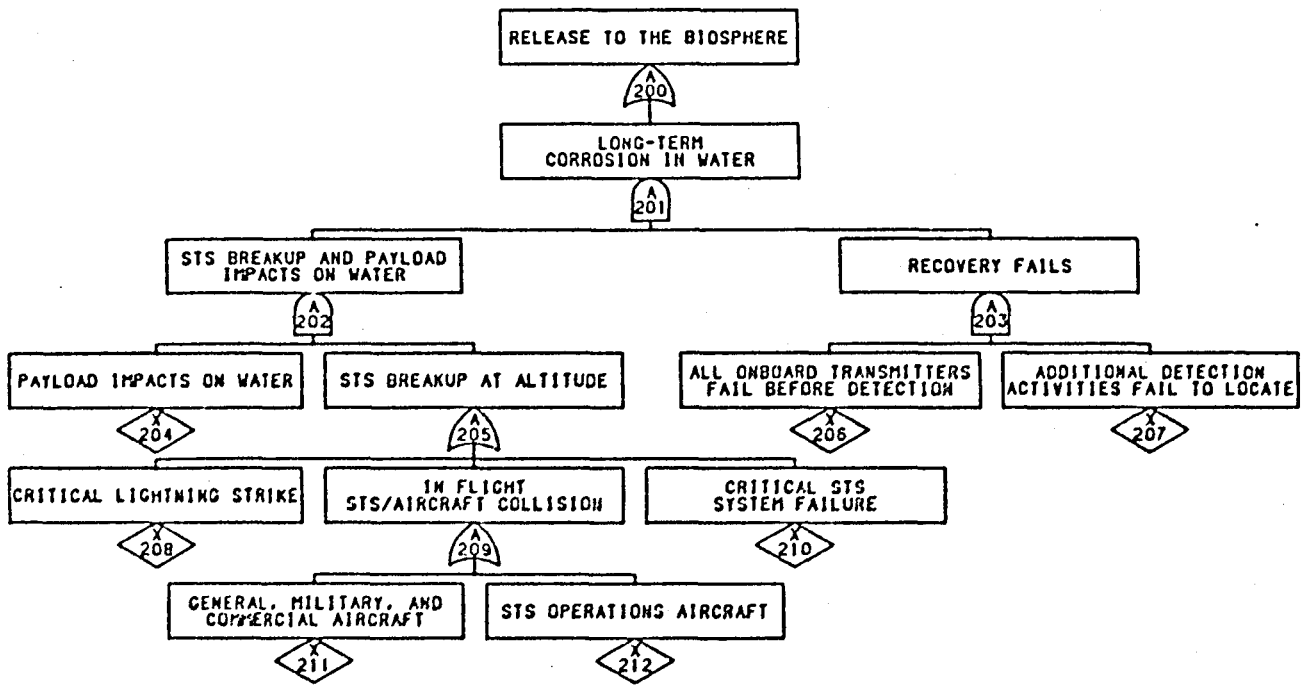

ORIGINAL PAGE IS
OF POOR QUALITY

FIGURE D-2. PHASE 2 FAULT TREE--IMPACT POINT CLEARS COASTLINE TO LRB STAGING (T = 24 to 124 sec)

NOMINAL PAGE IS
POOR QUALITY

~~ORIGINAL PAGE IS
OF POOR QUALITY~~

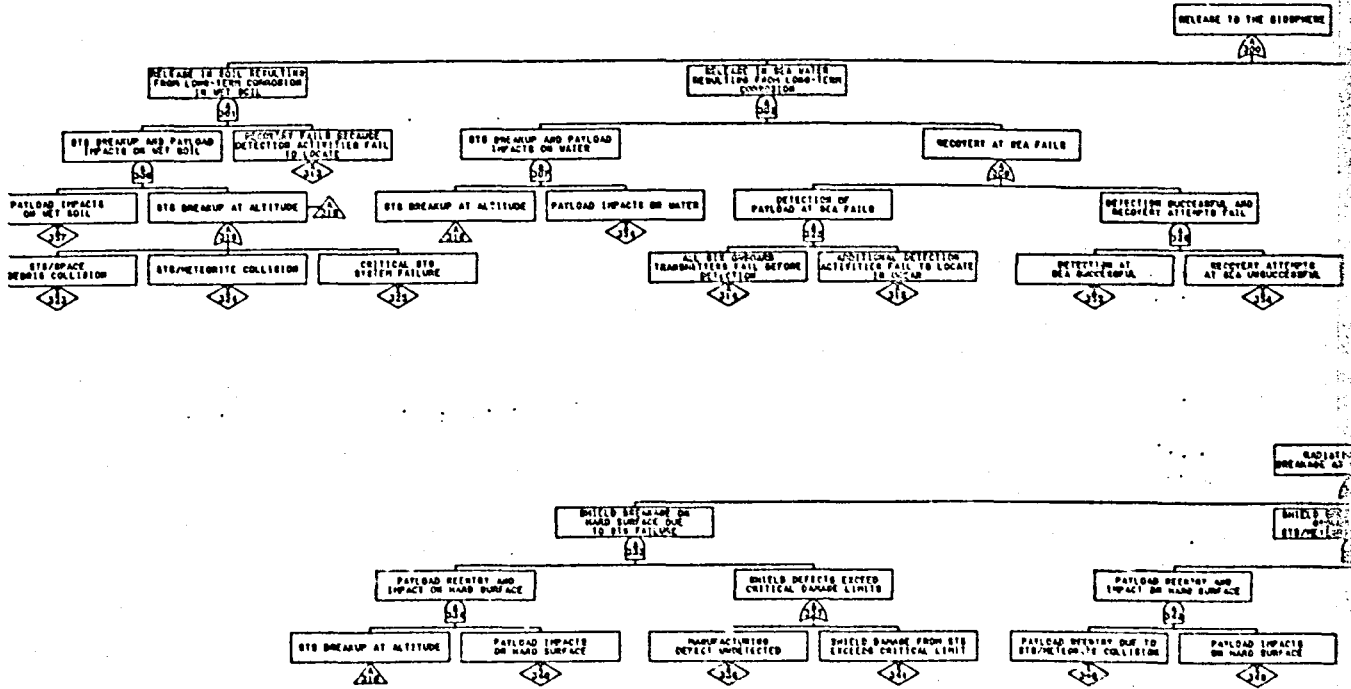
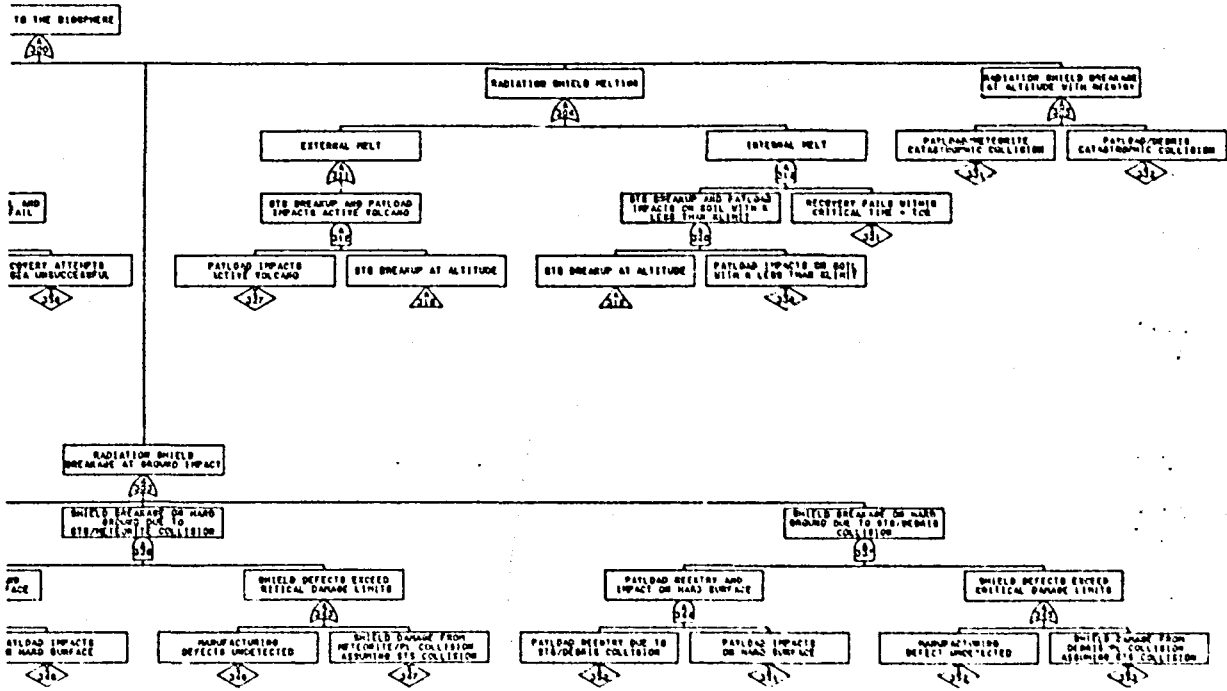

FIGURE D-3. PHASE 3 FAULT TREE--LRB STAGING TO SHUTTLE MAIN

FOLDOUT FRAME

ORIGINAL PAGE IS
OF POOR QUALITY.



TITLE MAIN ENGINE CUTOFF (MECO) (T = 124 to 518 sec)

END OF FRAME 2

ORIGINAL PAGE IS
OF POOR QUALITY.

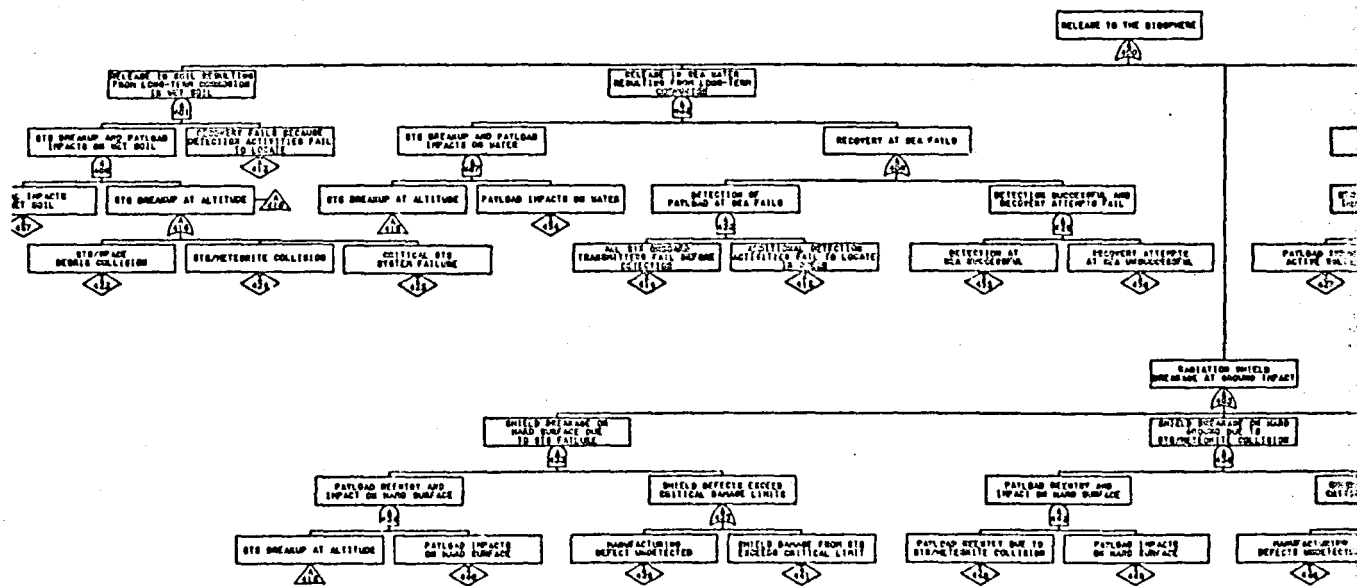
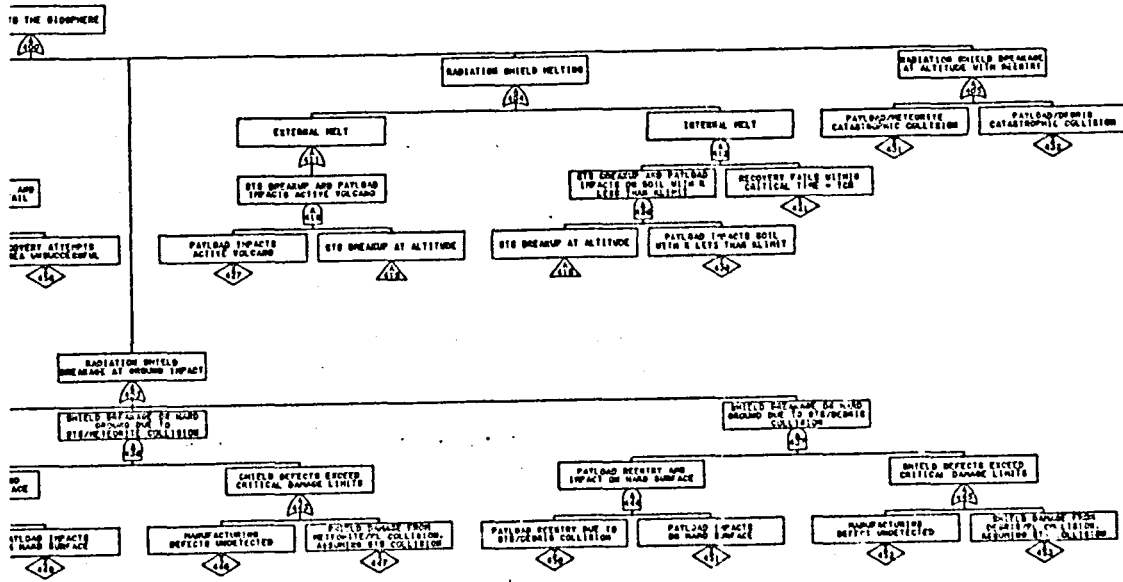

FIGURE D-4. PHASE 4 FAULT TREE--MECO TO EARTH ORBIT ACHIEVEMENT

OLDOUT FRAME

ORIGINAL PAGE IS
OF POOR QUALITY



IRTH ORBIT ACHIEVEMENT (T = 518 to 2,734 sec)

FOLDOUT FRAME 2

ORIGINAL PAGE IS
OF POOR QUALITY

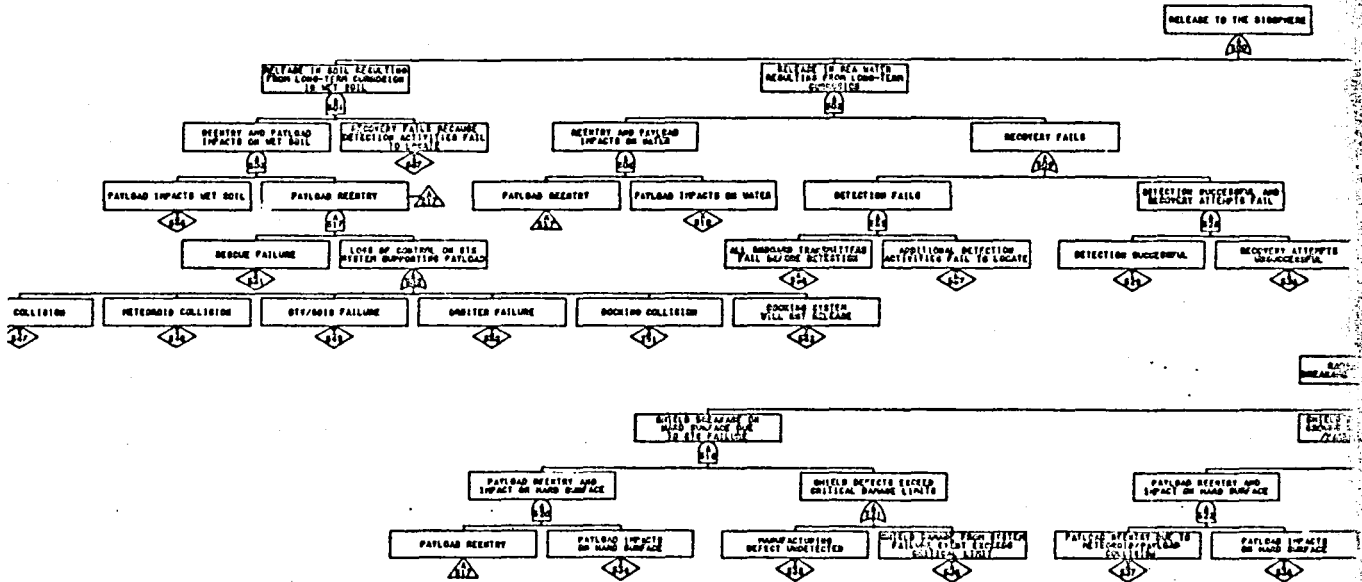
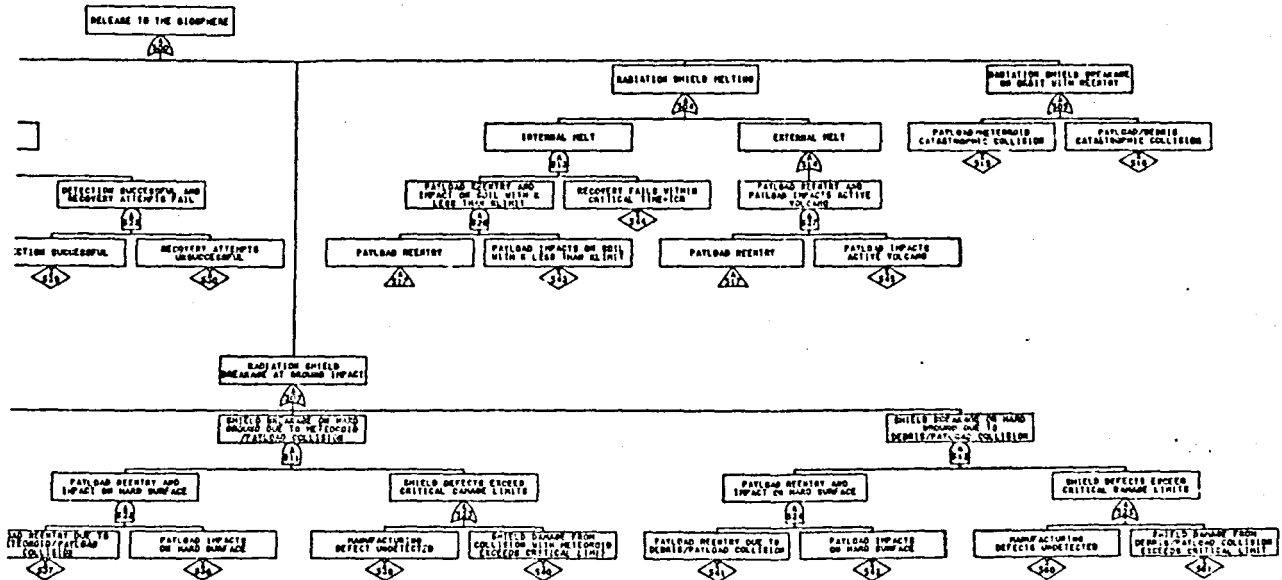

FIGURE D-5. PHASE 5 FAULT TREE--EARTH ORBITAL OPERATIONS PRIOR

HOLDOUT FRAME

ORIGINAL PAGE IS
OF POOR QUALITY



OPERATIONS PRIOR TO OTV IGNITION (T = 2,734 to 35,024 sec)

FOLDOUT FRAME 2

ORIGINAL PAGE IS
OF POOR QUALITY

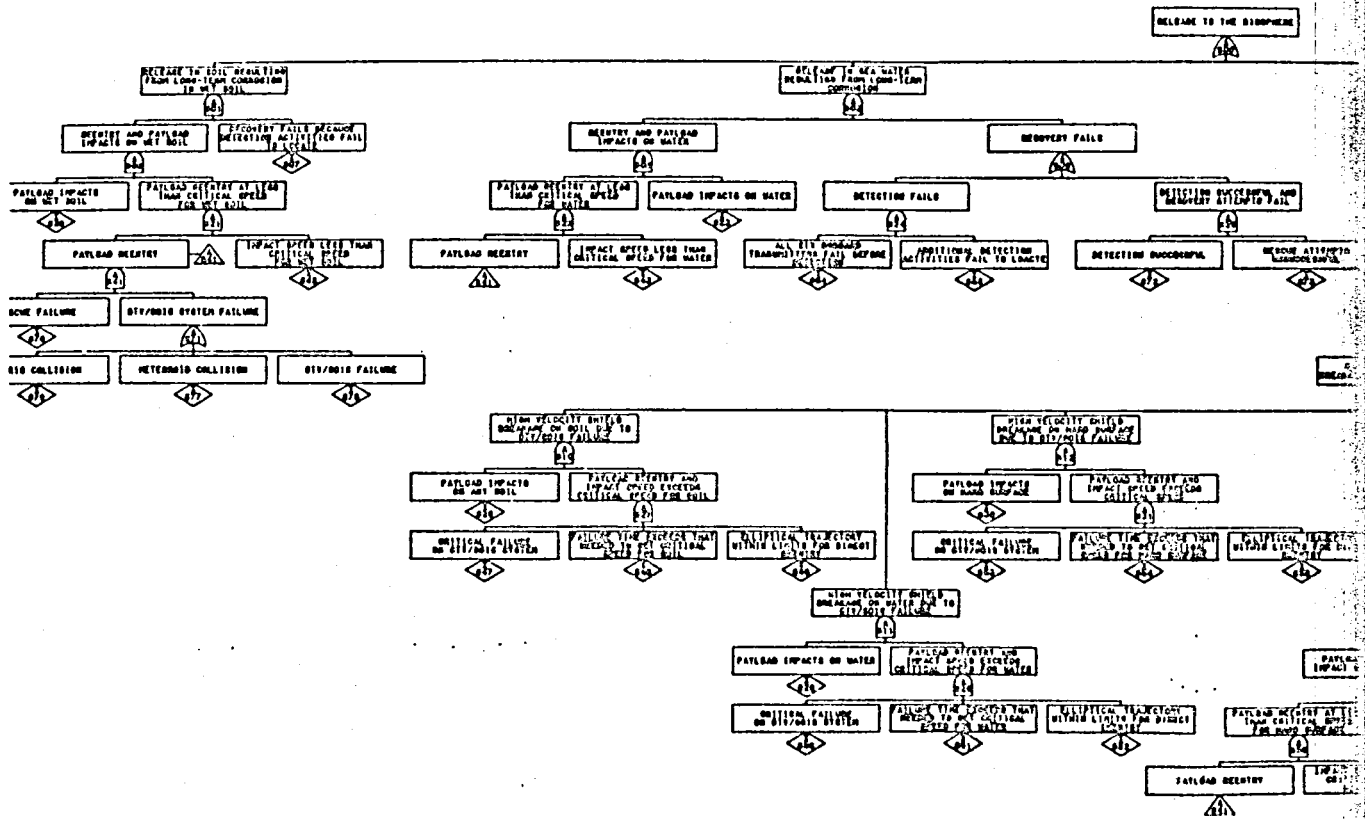

FIGURE D-6. PHASE 6 FAULT TREE--OTV IGNITION TO EARTH ESCAPE

FOLDOUT FRAME

ORIGINAL PAGE IS
OF POOR QUALITY

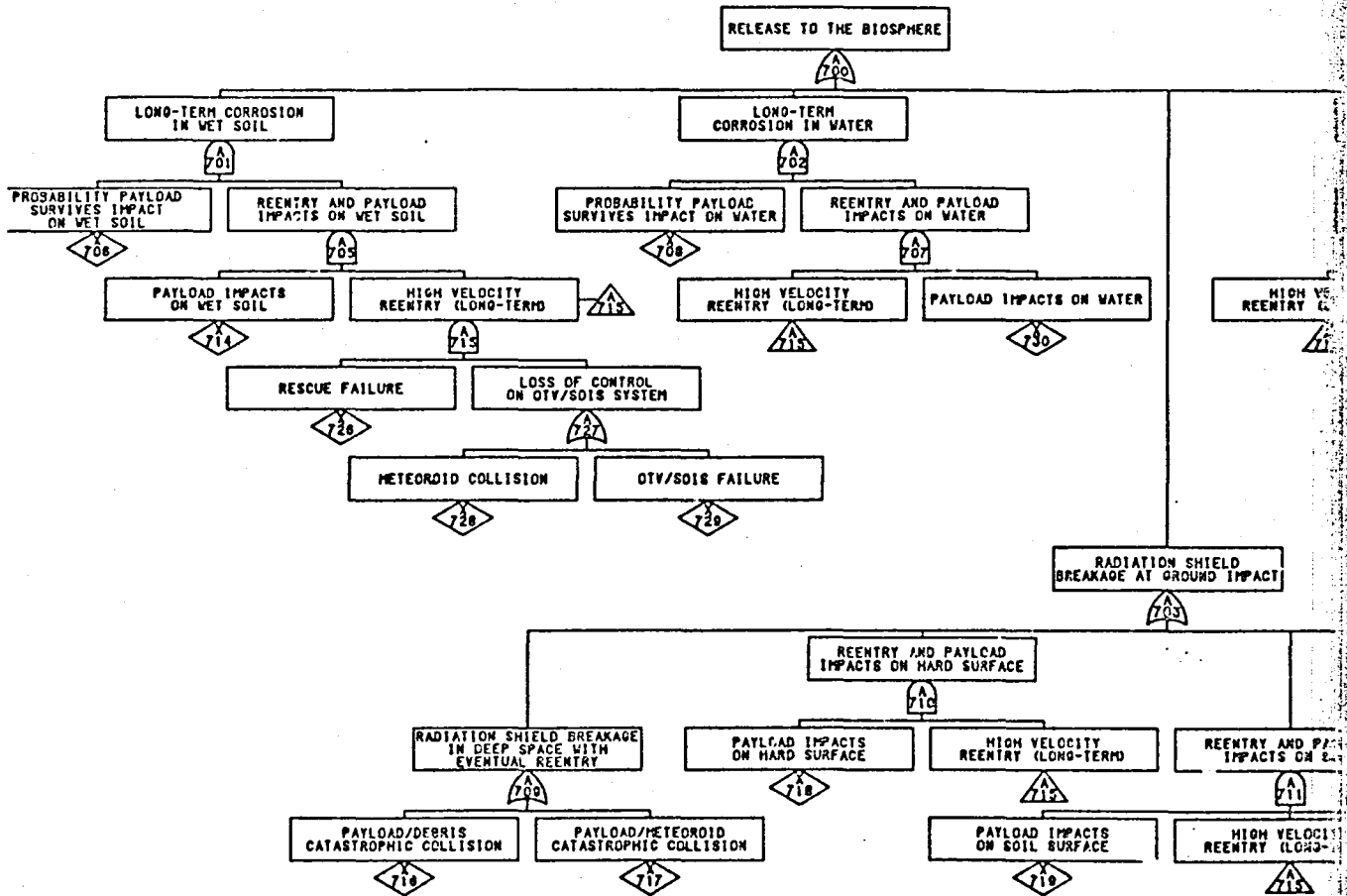
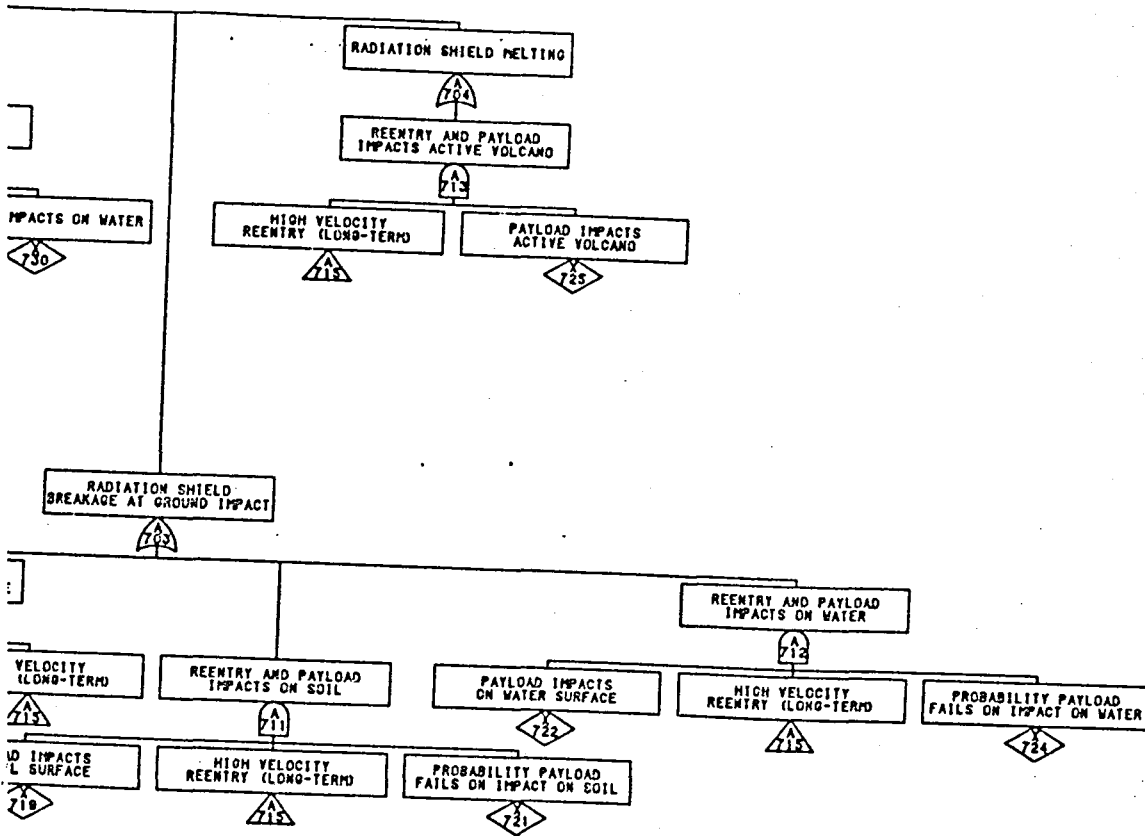

FIGURE D-7. PHASE 7 FAULT TREE--EARTH ESCAPE TO NOMINAL OTV BUR

BOUNDOUT FRAME

ORIGINAL PAGE IS
OF POOR QUALITY



PE TO NOMINAL OTV BURNOFF (T = 36,926 to 37,005 sec)

FOLDOUT FRAME 2

SIGNAL PATH IS
 A POOR QUALITY

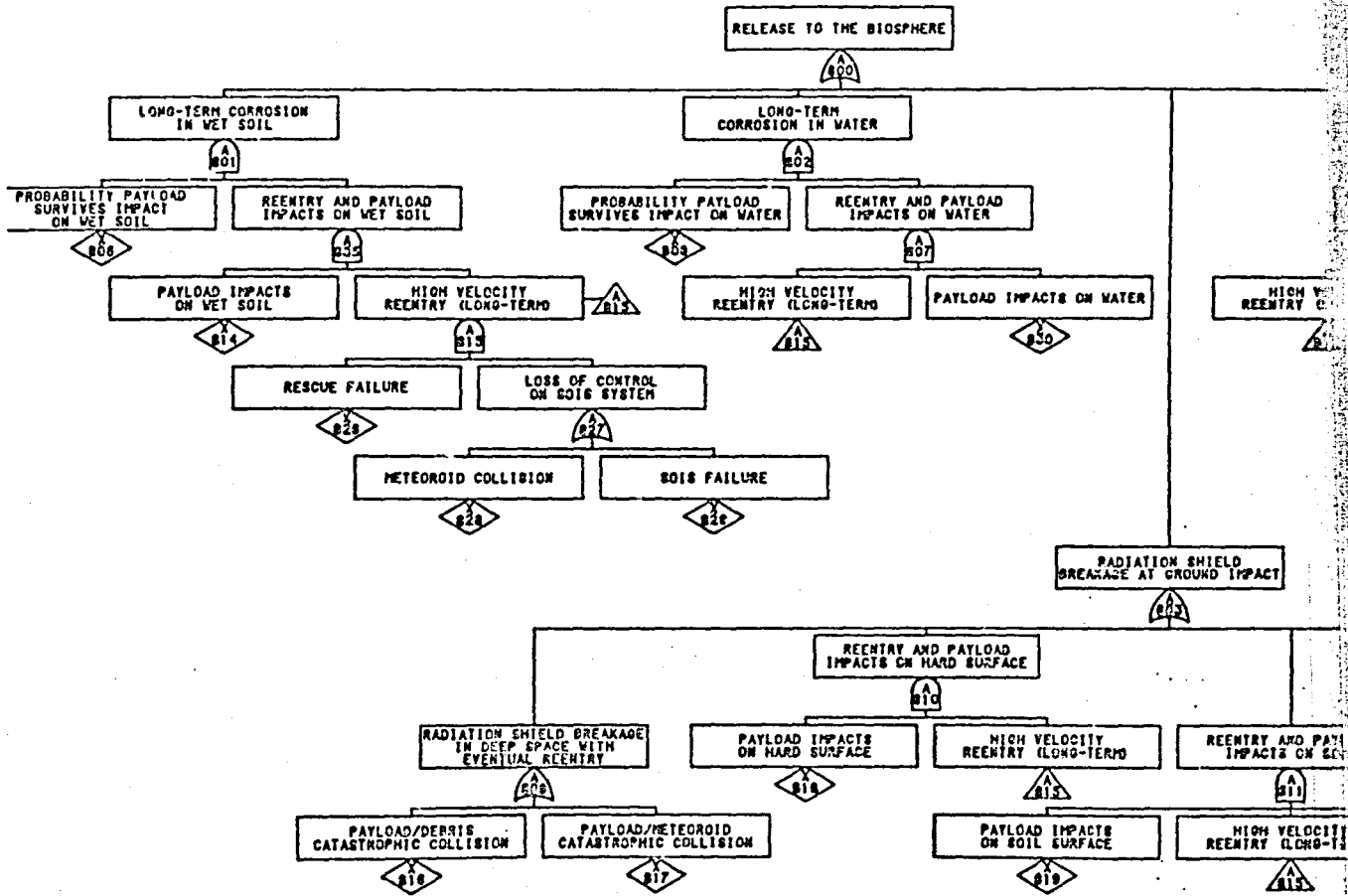
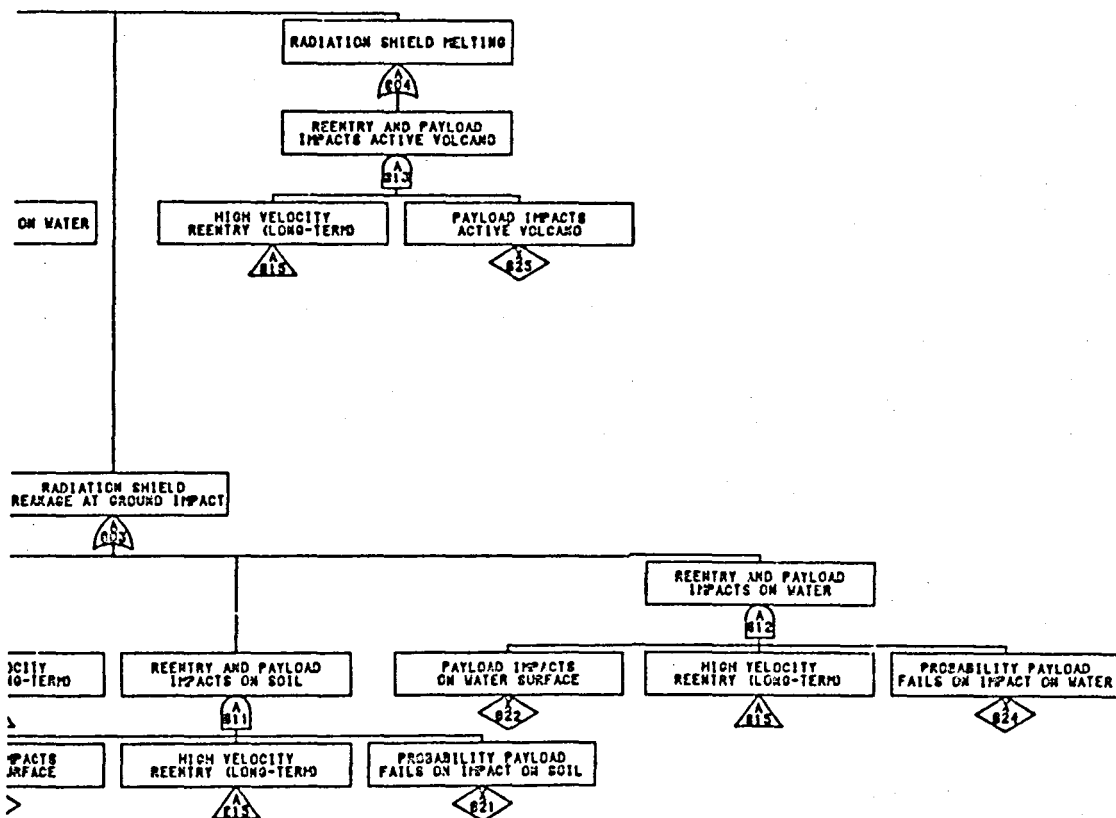

FIGURE D-8. PHASE 8 FAULT TREE--SOIS/PL. COAST (T = 37,005

FOLDOUT FRAME



PL. COAST (T = 37,005 to 14,295,107 sec)

FOLDOUT FRAME 2

ORIGINAL PAGE 13
 OF 1000 PAGES

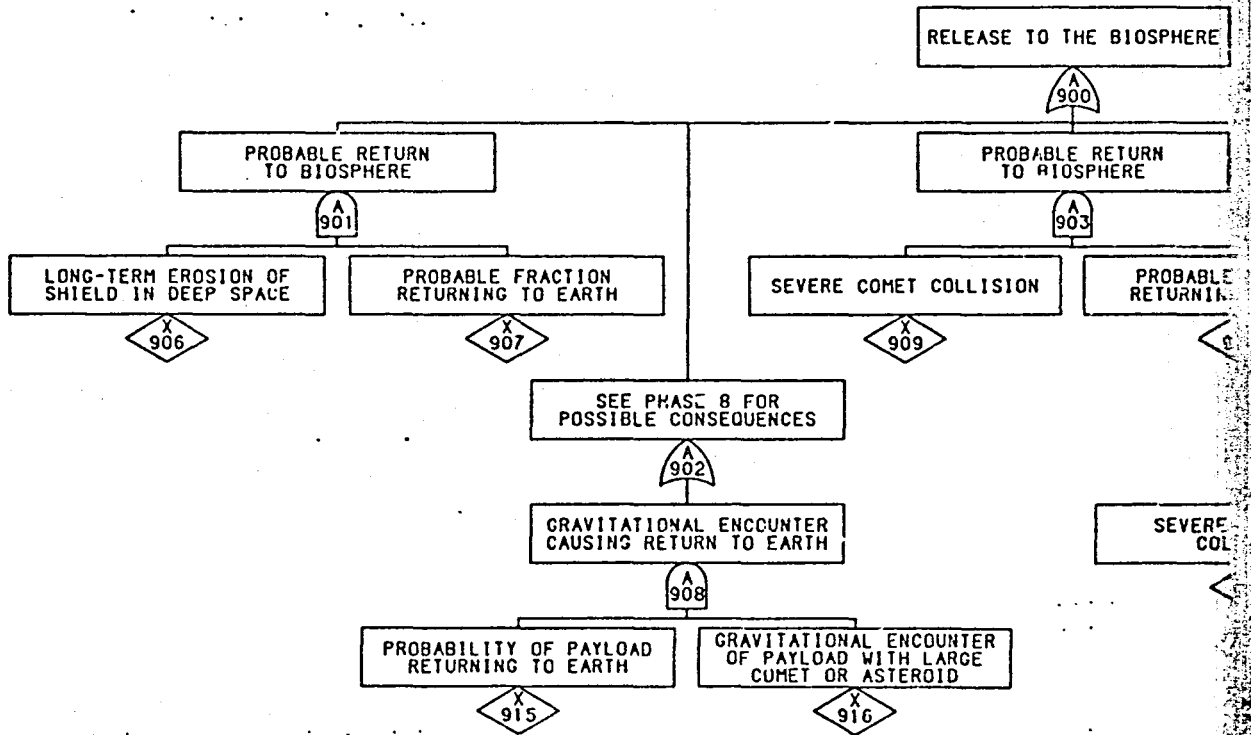
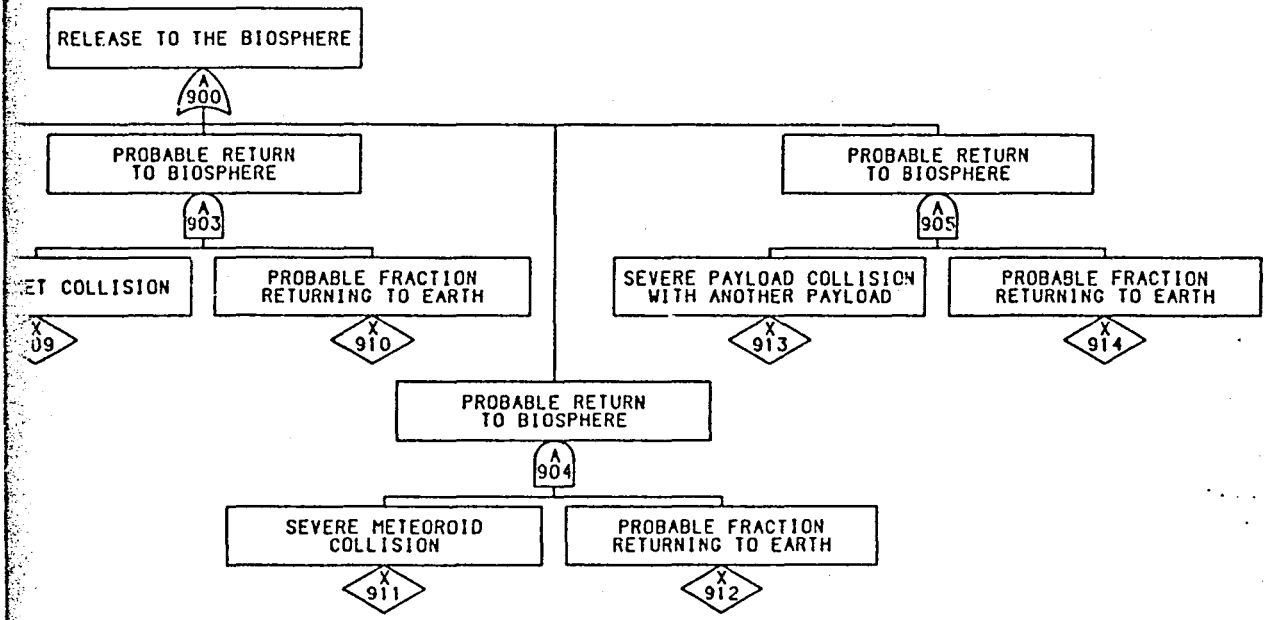

FIGURE D-9. PHASE 9 FAULT TREE--PLACEMENT ACHIEVED (T = 14)

FOLDOUT FRAME

ORIGINAL PAGE IS
OF PAPER QUALITY



ENCOUNTER WITH LARGE METEOROID

PLACEMENT ACHIEVED (T = 14,295,107 sec to 1 million years)

FOLDOUT FRAME

C-3

APPENDIX E
DISCUSSION OF CATASTROPHIC UPRATED
SHUTTLE FAILURES FOR IGNITION TO MECO

APPENDIX E

DISCUSSION OF CATASTROPHIC UPRATED SHUTTLE
FAILURES FOR IGNITION TO MECO

Catastrophic Uprated Shuttle failures are defined to be those failures which can result in a loss and breakup of the vehicle. Six catastrophic vehicle response modes have been defined for the period from ignition to main engine cutoff (MECO). These six modes cover all of the categories of vehicle catastrophic response which are expected to result from vehicle component (hardware, subsystem) failures. The component failures considered are single-point failures and are primarily the criticality one failure modes defined by NASA for the standard Shuttle. The six response modes and related descriptions presented in this appendix have been derived from the Wiggins study (Baeker, 1981). The Wiggins Company developed data for the standard Shuttle from a series of meetings and telephone conversations with NASA, NASA contractors, and Eastern Space and Missile Center (ESMC) range safety personnel; and from engineering judgment. For the purpose of this BCL study, two LRBs are assumed to replace the SRBs to form the Uprated Space Shuttle vehicle, used for the nuclear waste disposal mission.

The six failed vehicle response modes for the LRB Uprated Shuttle are as follows:

- (1) Inadvertent separation at an LRB/ET aft attachment. This response mode involves a failure or inadvertent separation of the LRB from the External Tank at the aft attachment. The aft end of the LRB would be expected to rotate away from the ET about the forward attachment, and the entire vehicle would be expected to start tumbling rapidly. The separating LRB would be expected to puncture the LH₂ and/or the LOX tank. The scenario is depicted in Figure E-1(a). The separating LRB is expected to rotate about the forward (thrust) attachment until it fails, resulting in a separated but rapidly tumbling LRB.
- (2) Inadvertent separation at an LRB/ET forward attachment. This response mode involves a failure or inadvertent separation at a forward attachment. The forward attachment is the thrust fitting which carries the LRB thrust load into the ET. The aft attachment is not designed to carry the LRB thrust load and will fail almost immediately. The thrusting LRB will move forward relative to the ET, with the LRB probably striking the ET aft dome and puncturing the LH₂ tank. The situation is depicted in Figure E-1(b).
- (3) Propellant tanks punctured. This response mode consists of a sudden puncturing or rupturing of one of the propellant tanks due to such things as shrapnel from an engine explosion, loss of tank ullage, or a thermal protection system (TPS) failure. A tank puncture is expected to rapidly result in a loss of vehicle

ORIGINAL PAGE IS
OF POOR QUALITY

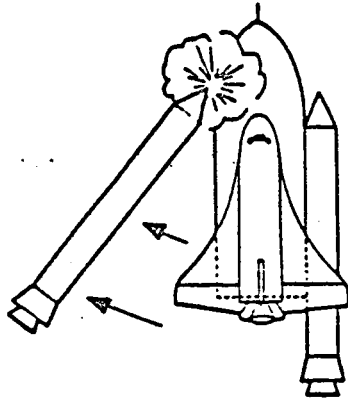

(a) Aft Attachment

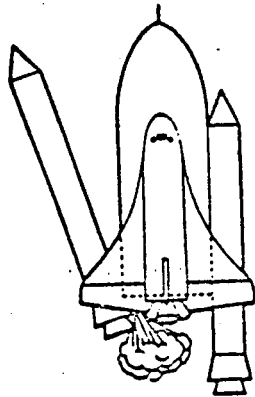

(b) Forward Attachment

Source: Baeker, J. B., 1981.

FIGURE E-1. INADVERTENT LRB SEPARATION

control, initiation of vehicle breakup including a puncturing of other propellant tanks, and a mixing of propellants resulting in a low-order explosion. No significant dispersion of the vehicle from the nominal trajectory is expected prior to initiation of breakup.

- (4) Intertank and/or aft LOX tank dome failure. This response mode consists of a structural failure of the intertank or aft dome of the LOX tank in the ET or LRBs. The expected result is a rupturing of the aft LOX tank dome and the forward fuel tank dome with a mixing of the liquid propellants in the forward section of the fuel tank. Penetration of the fuel tank results either from LOX contact with the LRB thrust load-carrying cross beam or from the fuel tank impact of the LOX from the ruptured LOX tank. The mixing of propellants in this case is largely confined, although some of the LOX may escape through punctures in the intertank skin. This internal mixing condition is expected to result in a higher yield explosion than for those cases which result in external mixing of propellants (5 to 10 percent yield versus 0.5 to 1 percent). This response mode is much more likely to occur while the flight loads and heating are high.
- (5) LRB recontact at separation. This response mode occurs only at LRB separation and involves a recontact of an LRB with the ET due to a failure of the LRB separation system. The recontact is likely to cause a rupturing of both propellant tanks, but could also cause a buckling of the ET intertank.
- (6) Loss of engine propulsion. This response mode involves a loss of propulsion from all three Orbiter main engines and/or engines on the two boosters. If a critical loss or critical failure of engines occurs during the early portion of flight, any one of two hazardous conditions could result: (1) the vehicle may fail structurally and break up prior to LRB staging, and (2) the LRBs may recontact the Orbiter/ET at separation.

A critical loss of main engines from LRB staging to MECO is expected to result in the following:

- LRB staging (124 seconds) to 168 seconds - Orbiter ditched, ET impacts intact
- 168 to 250 seconds - Orbiter breaks up, ET impacts intact
- 250 to 500 seconds - Orbiter breaks up, ET breaks up
- 500 seconds to MECO (518 seconds) - Orbiter ditched, ET breaks up.

The flight times presented above are approximate and are based on the orbital flight test-1 trajectory.

The six failed vehicle response modes are further defined in Table E-1. The table summarizes the vehicle dispersion and breakup characteristics assumed for each of the modes, defines the categories of component failures which can lead to each mode, and presents important assumptions and key comments. The comments section reiterates the possible variations on vehicle response and breakup discussed above. Note, however, that the models presented under the breakup column of the table are considered to represent the most probable scenarios.

TABLE E-1. FAILED VEHIC) RESPONSE MODES*

CASE NO.	HAZARD CONDITION		FAILURE MODES CAUSING HAZARD	ASSUMPTIONS	COMMENTS
	VEHICLE RESPONSE MODE	ESTIMATED VEHICLE BREAKUP			
1	Inadvertent Separation at an LRB/ET Aft Attachment	<p>A. <7 Secs: Vehicle w/o LRB Impacts Intact, ET and Remaining LRB Tanks Explode (10-50X TNT Equivalency), Errant LRB Impacts Intact and Explodes</p> <p>B. >7 Secs:</p> <ul style="list-style-type: none"> Separating LRB Punctures LH₂ and/or LOX Tank(a) Other Tank Ruptures, Fuels Mix and Explode With Low Yield Orbiter (With the Wings and Additional Tiles Assumed to Break Free) and ET Expected to Break up as per Destruct System Breakup Study 	<p>1. Structural Failure at the Aft LRB/ET Attachment</p> <p>2. Inadvertent Detonation of the Attachment Fitting</p> <p>3. TPS Failure at the Aft LRB Attachment Ring (1) (100-124 Secs only)</p>	(a) LRB at the Aft Attachment Area Is Driven into Aft Area of ET, Possibly Driving Strut Through LH ₂ Tank or Otherwise Rupturing Tank; and/or LRB Rotates Away from ET About Front Attachment Driving Nose of the LRB Toward and Into LOX Tank as Forward Attachment Breaks	1) TPS Failure results in a failure of the ET/LRB Attachment Strut
2	Inadvertent Separation at an LRB/ET Forward Attachment	<ul style="list-style-type: none"> LRB Bangs ET as it Tears Free at Aft Attachment, Aft LRB Skirt Strikes ET Aft Dome as LRB Moves Forward Relative to ET Breakup as in Case 1, Except Errant LRB Stays Intact to Impact and Explodes for all Failure Times 	<p>1. Structural Failure at the Forward LRB/ET Attachment</p> <p>2. Inadvertent Detonation of the Forward Attachment Fitting</p>		

BATTELLE - COLUMBUS

E-5

ORIGINAL PAGE IS
OF POOR QUALITY

*NOTE: The basic information contained in this table has been derived from Baeker, J. B., 1981, by eliminating the SRB and replacing it with an LRB.

TABLE E-1. FAILED VEHICLE RESPONSE MODES (CONTINUED)

CASE NO.	HAZARD CONDITION		FAILURE MODES CAUSING HAZARD	ASSUMPTIONS	COMMENTS
	VEHICLE RESPONSE MODE	ESTIMATED VEHICLE BREAKUP			
3	Propellant Tanks Punctured	<p>A. ≤ 7 Secs: Vehicle Impacts Essentially Intact, ET and LRB Tanks Explode (10-50% TNT Equivalency)</p> <p>B. > 7 Secs: (2)</p> <ul style="list-style-type: none"> • Fuel and/or Oxidizer Tank Punctured Due to Orbiter Impact, Shrapnel, or TPS Failure • Other Tanks Rupture, Propellants Mix Externally • Low-Yield Explosion, Results Similar to Destruct System • Fragmentation of Orbiter, ET and LRBs as in 1B 	<p>1. Fire/Explosion in the Engine Compartments (b)</p> <p>2. Engine Nozzle Collision Due to TVC Loss (c)</p> <p>3. Fire/Explosion in the OMS/RCS Pod which Propagates to the Engine Compartments (d)</p> <p>4. Failure at an Orbiter/ET Attachment (e)</p> <p>5. TPS Failure and Blow-out at the Fuel Tank Barrels or LOX Tank Ogives (100-124 Sec Only) or at the LH₂ Tank Aft Domes (Lift-off)</p> <p>6. TPS Failure at the LRB Thermal Curtain Heat Shield</p> <p>7. Loss of Avionics Causing Loss of Engine TVC and Collision of Nozzles</p>	<p>(b) The Explosion Creates Shrapnel Which Punctures the LH₂ Tank(s).</p> <p>(c) The Collision Causes an Explosion in the Engine Compartment. The TVC Loss Results in a Nozzle Collision 50% of the Time During the Time from Lift-off to MECO. Otherwise the Engine is Safely Shut Down.</p> <p>(d) An OMS/RCS Pod Explosion Propagates to the Engine Compartments, Causing an Engine Explosion 20% of the Time. Otherwise, Press to Orbit or RTLS.</p>	<p>(2) Failures Which Result in a Puncture of the LH₂ Tank Not Caused By An Orbiter Breaking Free May Not Result in a LOX Tank Rupture and an Explosion. The LH₂ May Merely Bleed Out, Causing Loss of the Engines. If, However, the Puncture Results from an Engine Compartment Explosion It Is Likely That the Vehicle will Break up and a Low-Yield Explosion Will Result. Also, Shrapnel from the Engine Explosion Could Cause an ET/LRB Tank Rupture.</p>

BATTELLE - COLUMBUS

E-6 ORIGINAL PAGE IS OF POOR QUALITY

TABLE E-1. FAILED VEHICLE RESPONSE MODES (CONTINUED)

CASE NO.	HAZARD CONDITION		FAILURE MODES CAUSING HAZARD	ASSUMPTIONS	COMMENTS
	VEHICLE RESPONSE MODE	ESTIMATED VEHICLE BREAKUP			
4	Intertank and/or Aft Lox Tank Dome Failures	<p>A. <7 Secs: Vehicle Impacts Essentially Intact (1), Explodes (10-50% TNT Equivalency)</p> <p>B. >7 Secs:</p> <ul style="list-style-type: none"> • LOX Tank Ruptures (g) • LOX Pours onto and Collapses the Forward LH₂ Dome (3) • Propellants Mix Internally, Explosion Results (~10% TNT Equivalency) • LRBs Explode 	<p>8. Loss of LH₂ Tank Ullage (Joint, Relief Valve, Line, Etc. Failure): Gross Leaks Only</p> <p>9. Rupture of the External LOX Feed Line</p> <p>10. Rupture of the LOX Line (Through MECO) and LH₂ Line (Prior to LRB Staging Only) Internal to the Orbiter</p> <p>1. TPS Failure at the ET Intertank (n)</p> <p>2. Structural Failure of the LOX Tank Aft Dome (Weld Failure, Loss of Ullage, etc.)</p>	<p>(e) Orbiter Ruptures LH₂ Tank as it Wrenches Free</p> <p>(f) TPS Failure at the Thermal Curtain Heat Shield Results in a Hydrazine Explosion and Shrapnel into the LH₂ Dome 50% of the Time</p> <p>(g) An Intertank Collapse Causes the LOX Tank to Strike the Cross Beam and Split Open</p> <p>(h) TPS Failure Results in Excessive Structural Temperatures and Structural Failure. Assumed to Occur Near Staging (100-124 Secs)</p>	<p>(3) Since the Intertank Cannot Withstand Overpressures as High as the Forward Dome of a Pressurized LH₂ Tank, the Intertank May Rupture First Releasing LOX Outside of the ET. This May Reduce the Potential for Internal Mixing and a High Yield Explosion.</p>

ORIGINAL PAGE IS
OF POOR QUALITY

E-7

TABLE E-1. FAILED VEHICLE RESPONSE MODES (CONTINUED)

CASE NO.	HAZARD CONDITION		FAILURE MODES CAUSING HAZARD	ASSUMPTIONS	COMMENTS
	VEHICLE RESPONSE MODE	ESTIMATED VEHICLE BREAKUP			
5	LRB Recontact at Separation	<ul style="list-style-type: none"> • ET LH₂ Tank and Intertank Shattered into Small Fragments; LOX Tank Breaks as in Destruct Study • Forward Half of Orbiter Shattered; Aft Half as for Destruct Except Wings and Additional Tiles Torn Free • LRB Punctures LH₂ Tank (4) • LOX Tank Ruptures and Propellants Mix Externally • Low-Yield Explosion Results Similar to Destruct System • LRBs Reenter Normally • ET and Orbiter (with the Wings and Additional Tiles Assumed to Break Free) Expected to Break up as per Destruct System Breakup Study 	<ol style="list-style-type: none"> 1. Failure to Fracture at the Forward or Aft LRB/ET Attachment 2. TPS Failure at the Aft Separation Motor (j) 3. Premature Operation of the Forward or Aft Separation Motors 	<p>(i) Breakup and an Explosion May Be Initiated Prior to Impact, But the Major Explosion Will Occur at Impact</p> <p>(j) TPS Failure Causes Separation Motors to Fire Prior to Separation</p>	<p>(4) If the Recontact Occurs at the Forward End of the ET, the ET Intertank Could Buckle and a Higher Order Explosion Result</p>
6	Loss of Propulsion	<ul style="list-style-type: none"> • See (5) • ET May Break up on Reentry (6), Otherwise Explodes at Impact 	<ol style="list-style-type: none"> 1. Loss of 3 or more MEs 2. Puncture of the LH₂ Feed Lines (Through MECO) 	<p>(5) A Loss of 3 or More Engines May Result in Structural Failure and Breakup or in Recontact at LRB Staging</p>	

BATTELLE - COLUMBUS

E-8

ORIGINAL PAGE IS
OF POOR QUALITY

TABLE E-1. FAILED VEHICLE RESPONSE MODES (CONTINUED)

CASE NO.	HAZARD CONDITION		FAILURE MODES CAUSING HAZARD	ASSUMPTIONS	COMMENTS
	VEHICLE RESPONSE MODE	ESTIMATED VEHICLE BREAKUP			
		<ul style="list-style-type: none"> Orbiter Ditched for a Failure Before 168 Secs (Of-1). Orbiter Breaks Up on Reentry for Failures From 168 to Approximately 500 Secs; Ditched for Failures >500 Secs. 			(6) Breakup Only for Loss Engines After Approximately 250 Secs.

BATTELLE - COLUMBUS

ORIGINAL PAGE IS
OF POOR QUALITY

E-9

APPENDIX F
DISCUSSION OF CATASTROPHIC UPRATED SHUTTLE
FAILURES FOR MECO TO PAYLOAD SEPARATION

APPENDIX F

CATASTROPHIC UPDATED SHUTTLE FAILURES FOR
MECO TO PAYLOAD SEPARATION

Information contained in this Appendix is directly supported by the Wiggins study (Hudson, 1979).

For part of the mission from MECO to payload separation, vehicle failure modes have been assigned to four categories (in addition to the first six defined in Appendix E) in terms of expected effects on the updated STS from MECO to payload separation. These are the following:

- (7) External Tank punctured
- (8) Loss of maneuverability and Orbiter tumbles to Earth (prior to orbit insertion)
- (9) Loss of maneuverability on orbit
- (10) Fire and explosion in main engine compartment and Orbiter tumbles to Earth.

With respect to Response Mode 9, loss of maneuverability on orbit, the Orbiter will eventually tumble to Earth. The first OMS burn puts the STS into an elliptical orbit. The second burn puts the STS into a circular orbit at 300 km altitude, and the third burn phases the STS to a rendezvous with the OTV/SOIS. If the first and second burns are not successful, then the Orbiter will reenter. If the third OMS burn is not successful, the Orbiter will eventually reenter. Thus, the end result will be the same as for Response Mode 8, except that the time scale will be extended, i.e., all failures listed for Response Mode 9 will eventually result in the Orbiter tumbling to Earth. The necessary conditions for each category of vehicle behavior to occur are listed in Table F-1. Table F-1 also outlines the critical time periods in which these critical vehicle behavior modes could occur.

Failures which in themselves would not lead to loss of the Orbiter, but which, if they propagate, could lead to such loss, have been included. These types of propagated failures can be considered to be a special case of common-cause failures. Although common-cause failures have been excluded from the analysis, it is important to include failures which can propagate and lead to the critical conditions listed. An example of this type of propagated failure is rupture of an atmospheric revitalization system tank subassembly, which results in loss of all three inertial measuring units. The failure rates quoted for these types of propagated failures recognize that propagation is not a certainty given that the initial failure occurs. In these circumstances, therefore, the failure rates have been factored accordingly.

The most critical time for loss of RCS/Avionics is immediately after T separation and before the first OMS burn. The RCS/Avionics are needed for

pitch control of the Orbiter away from the External Tank. If either were lost, the Orbiter could pitch down and collide with the External Tank. The most extreme case would result in vehicle damage, as outlined in Vehicle Response Mode 7. The most benign case could result in loss of some thermal tiles from the Orbiter which would render it unsafe for reentry.

The most critical time for loss of OMS and/or RCS in one pod would be during the first OMS burn. This corresponds to the highest mass of the Orbiter and payload combination. It is difficult to switch over to the remaining OMS engine and do so correctly. However, the mission should be able to be completed with only one OMS engine remaining. The flight controller is, however, likely to abort the mission. Vehicle Response Modes 8 and 9 consider such losses of the OMS and/or RCS in one pod. The failures included, however, do not allow cross-feeding to the other OMS engine, a necessary condition for survival.

Failures of the OMS and/or RCS which propagate to the main engine compartment can have catastrophic results if the residual oxygen and hydrogen have not been completely vented to the atmosphere. The resulting explosion could cause the Orbiter to break up and tumble to Earth. This type of behavior is outlined under Response Mode 10 of Table F-1, where venting of residual fuel is considered to be completed by the end of the first OMS burn.

Failures of the forward reaction control assembly items could result in a pitching of the Orbiter. If the Orbiter were to pitch during External Tank separation, collision with the External Tank could occur, causing loss of the Orbiter. If the failure occurs in the OMS or RCS propellant tank assemblies, feedlines, or fittings and pitching did not result, then loss of maneuverability of the vehicle could occur with the Orbiter tumbling to Earth.

Failures in the aft reaction control assembly or Orbiter maneuvering system could also result in a collision between the Orbiter and the External Tank or could result in the loss of Orbiter maneuverability. Loss of Orbiter maneuverability could also be the result of propagated failures within the electrical power or atmospheric revitalization systems.

Failures in the main propulsion system, the separation mechanism linking the Orbiter and External Tank, or the Orbiter/External Tank forward or aft attachment could result in the Orbiter impacting the External Tank. The critical time period for these failures is between MECO and External Tank separation. Orbiter/External Tank impact could also occur as a result of an OMS/RCS fire and explosion which propagates to the Orbiter main engine compartment. Until all residual propellants are vented, fire and explosion in the main engine compartment are possible as a result of failures which propagate from the aft reaction control assembly or from the OMS.

The failure modes involving liquid oxygen or hydrogen relief lines or gaseous oxygen or hydrogen lines or valve assemblies in the main propulsion system are not included here. These failures, if they occurred after MECO, are unlikely to seriously endanger the vehicle. Failures in the liquid hydrogen or oxygen pressurization lines, vent relief assembly lines, cable tray, etc., could directly or indirectly result in loss of ullage pressure and

ORIGINAL PAGE IS
OF POOR QUALITY

F-3

TABLE F-1. VEHICLE RESPONSE MODES FOR MECO TO PAYLOAD SEPARATION

Category	Vehicle Behavior	Critical Time Period	Necessary Conditions
(7)	External Tank Punctured	MECO to ET separation (MECO to MECO + 16 seconds) During Orbiter/ET separation maneuver (MECO + 11 seconds to end of RCS separation burn) MECO to MECO + 11 seconds	<ul style="list-style-type: none"> • Failures in Main Engine (ME) Propulsion System releasing residual propellant into aft ME compartment and ignition from within ME compartment • LH₂ tank rupture • Failures in the Orbiter/ET Separation System • Failures of forward or aft Orbiter/ET attachments • Failure of the forward or aft RCS system • Failures of the OMS systems which propagate and cause loss of RCS • Aft RCS or OMS failures which propagate to ME compartment and cause fire and explosion with residual ME propellants
(8)	Loss of Maneuverability & Orbiter Tumbles to Earth	MECO to orbit insertion (end of first OMS burn)	<ul style="list-style-type: none"> • Failures of forward RCS which propagate and cause failure of all 3 IMUs • Failures of aft RCS which propagate and lead to loss of OMS in one pod (with lost capability to cross feed to other OMS engine). • Failures of OMS in one pod (with lost capability to cross-feed to other OMS engine) • Failures of electrical power or atmosphere revitalization system tank subassemblies which propagate and cause failure of all 3 IMUs
(9)	Loss of Maneuverability on Orbit	End first OMS burn to IUS deployment	<ul style="list-style-type: none"> • Same conditions as for (8)
(10)	Fire & Explosion in ME Compartment and Orbiter Tumbles to Earth	MECO + 16 seconds to orbit insertion (end first OMS burn)	<ul style="list-style-type: none"> • Failures in the aft RCS or OMS which propagate to the ME compartment causing fire and explosion

F-4

possible hydrogen or oxygen tank rupture, prior to MECO. However, after MECO, the loss of ullage pressure is not likely to lead to rupture of either of these tanks, and hence, will not be a problem for the Orbiter.

APPENDIX G
FAILURE PROBABILITIES FOR FAULT TREES

APPENDIX G

FAILURE PROBABILITIES FOR FAULT TREES

This appendix documents the probability data used in the fault trees to estimate the critical paths through the fault trees, as well as provide an expected and range of values for the probabilities of various events. Tables G-1 through G-6 were used to generate the overall space disposal risk estimates, as discussed in Section 5.0 of this report. The entries in the tables that follow match the event numbers for the fault trees shown in Section 5.2. The description of the event, the expected value, the 90 percent confidence range on the expected value, and a brief comment on how the expected values were derived are given in the tables that follow.

Most of the values in the tables are truly estimates; a more rigorous analysis would be necessary to improve on these values. However, it is hoped that the ranges provided on the expected value (with 90 percent confidence) should include the values that would result from a more detailed analysis. The basis for many of the numbers comes from "expert" opinion. People that provided information used in the generation of the data are listed below, along with the area of support.

<u>Person</u>	<u>Support Area</u>
J. B. Baeker (Wiggins Co.)	Critical STS Failure Rates
F. Cibelli (NASA/KSC)	Range Safety - Aircraft Collisions
A. J. Coyle (ONWI)	Ocean Recovery
T. C. Davis (BCL)	General and Integration
R. S. Denning (BCL)	General, Integration, and Nuclear
R. W. Earhart (BCL)	General and Integration
A. L. Friedlander (SAI, Chicago)	Meteorite Impact
J. M. Hudson (Wiggins Co.)	Critical STS Failure Rates
D. J. Kessler (NASA/JSC)	Debris Damage
W. S. Pope (BCL)	Ocean Recovery
R. P. Reinert (Boeing Co.)	OTV/SOIS Reliability
R. C. Reynolds (BCL)	Debris Impact
E. E. Rice (BCL)	General and Integration
D. L. Suiter (NASA/JSC)	Launch Vehicle Lightning Strikes
G. Walker (Univ. of Hawaii)	Volcano Impact
A. E. Weller (BCL)	General and Integration
K. R. Yates (BCL)	General and Nuclear Waste Form

Also, numerous published sources were used in developing these estimates, the major one being the 1974 edition of the Overall Safety Manual, developed by the NUS Corporation for the U.S. Atomic Energy Commission, Space Nuclear Systems Division (U.S. AEC, 1974a).

TABLE G-1. PER MISSION PROBABILITY ESTIMATES FOR PHASE 1

Fault Tree* Event No.	Event Description	Per Mission Event Probabilities			Basis for Estimate
		Expected Value	90% Confidence		
			Upper	Lower	
100	Release to the biosphere	2.1E-12	9.5E-11	8.0E-15	Same as [101]
101	Shield breakage	2.1E-12	9.5E-11	8.0E-15	Product of [102] x [103]
102	STS breakup and payload impact on hard surface	4.2E-8	1.9E-7	1.6E-9	Product of [104] x [105]
103	Mechanically defective shield (undetected)	5.0E-5	5.0E-4	5.0E-6	Based upon data on defects found in nuclear reactor pressure vessels (Wash 1285, U.S. AEC, 1974b).
104	Payload impacts on hard surface	2.0E-3	4.0E-3	2.0E-4	Based on twice Shuttle runway area divided by KSC area (2 x 5E5m ² /5.7E8m ²) = 2E-3.
105	STS total breakup at altitude	2.1E-5	4.7E-5	8.0E-6	Sum of [106] + [107] + [108]
106	Critical lightning strike	1.0E-7	1.0E-6	1.0E-8	Dwight Suiter, NASA/JSC; Suiter's estimate reduced by factor of 5 because of LRB replacing SRB. 2E-7 divided equally between Phases 1 and 2.

te: Refer to fault trees, Section 5.2.

TABLE G-1. PER MISSION PROBABILITY ESTIMATES FOR PHASE 1 (Continued)

Fault Tree* Event No.	Event Description	Expected Value	Per Mission Event Probabilities		Basis for Estimate
			90% Confidence Upper	Lower	
107	In-flight STS/ aircraft collision - STS operations air- craft	7.5E-10	7.5E-9	7.5E-12	$(2 \times 150\text{m}^2 / 2\text{E}8\text{m}^2) \times (1/1000) = 7.5\text{E}-10$. Assumes 2 aircraft and a 1 in 1000 chance and half in Phase 1 and half in Phase 2 (some data provided by F. Cibelli, NASA/KSC, Range Safety Office). Not possible for non-STs operations aircraft to contribute to event.
108	Critical STS system failure	2.1E-5	4.7E-5	8.0E-6	Derived from Wiggins data (J.B. Baeker, 1981) for LRB replacing SRB.

*Note: Refer to fault trees, Section 5.2.

TABLE G-2. PER MISSION PROBABILITY ESTIMATES FOR PHASE 2

Fault Tree* Event No.	Event Description	Per Mission Event Probabilities			Basis for Estimate
		Expected Value	90% Confidence		
			Upper	Lower	
200	Release to the biosphere	1.1E-10	7.3E-8	4.1E-14	Same as [201]
201	Long-term corrosion in sea-water	1.1E-10	7.3E-8	4.1E-14	Product of [202] x [203]
202	STS breakup and payload impacts on water	1.1E-4	7.3E-4	4.1E-5	Product of [204] x [205]
203	Recovery fails	1.0E-6	1.0E-4	1.0E-9	Product of [206] x [207]
204	Payload impacts on water	1.0E-0	1.0E-0	1.0E-0	If failure occurs, will likely land in ocean.
205	STS breakup at altitude	1.1E-4	7.3E-4	4.1E-5	Sum of [208] + [209] + [210]
206	All six on-board transmitters fail before detection	1.0E-3	1.0E-2	1.0E-5	(0.1) ³ assumed three destroyed by impact, other three estimated to have 0.9 reliability each.
207	Additional detection activity fail to locate	1.0E-3	1.0E-2	1.0E-4	Estimate based upon conversations with Art Coyle, ONWI, and William Pope, BCL.
208	Critical lightning strike	1.0E-7	1.0E-6	1.0E-8	(See [106])
209	In-flight STS/ aircraft collision	8.5E-10	1.7E-8	1.7E-11	Sum of [211] + [212]

*Note: Refer to fault trees, Section 5.2.

ORIGINAL PAGE IS
OF POOR QUALITY

G-5

TABLE G-2. PER MISSION PROBABILITY ESTIMATES FOR PHASE 2 (Continued)

Fault Tree* Event No.	Event Description	Expected Value	Per Mission Event Probabilities		Basis for Estimate
			90% Confidence Upper	Lower	
210	Critical STS system failure	1.1E-4	7.3E-4	4.1E-5	Derived from Wiggins data (J. B. Baeker, 1981) for LRB replacing SRB.
211	General, military, and commercial aircraft collision	1.0E-10	1.0E-8	1.0E-11	Estimate based upon a frequency of 1 violation in 50 flights during 2- hour critical control period (F. Cibelli, KSC) and an area ratio of [150/(200 E6)] and a 30- second vulnerable time from t = 30 to 60 sec.
212	STS operations aircraft collision	7.5E-10	7.5E-9	7.5E-12	$(2 \times 150 \text{ m}^2 / 200 \text{ E6 m}^2) \times$ $(1/1000) = 7.5E-10$ (See [107])

*Note: Refer to fault trees, Section 5.2.

TABLE G-3. PER MISSION PROBABILITY ESTIMATES FOR PHASE 3

Fault Tree* Event No.	Event Description	Per Mission Event Probabilities			Basis for Estimate
		Expected Value	90% Confidence		
			Upper	Lower	
300	Release to the biosphere	2.3E-9	3.2E-7	4.5E-11	Sum of [301] + [302] + [303] + [304] + [305]
301	Release in soil resulting from long-term corrosion in wet soil	9.2E-13	2.2E-10	3.3E-15	Product of [306] x [313]
302	Release in sea-water resulting from long-term corrosion	2.3E-9	3.2E-7	4.5E-11	Product of [307] x [308]
303	Radiation shield breakage at ground impact	1.2E-12	2.8E-10	4.7E-15	Sum of [333] + [336] + [337]
304	Radiation shield melting	2.3E-15	5.4E-13	8.6E-20	Sum of [311] + [312]
305	Radiation shield breakage at altitude with reentry	1.3E-13	1.3E-12	1.3E-15	Sum of [331] + [332]
306	STS breakup and payload impacts on wet soil	9.2E-9	2.2E-7	3.3E-10	Product of [357] x [316]
307	STS breakup and payload impacts on water	1.15E-4	2.7E-4	4.1E-5	Product of [316] x [354]
308	Recovery at sea fails	2.0E-5	1.2E-3	1.1E-6	Sum of [328] + [329]
311	STS breakup and payload impacts active volcano	2.3E-17	5.4E-15	8.2E-20	Sum of [316] + [327]

te: Refer to fault trees, Section 5.2.

TABLE G-3. PER MISSION PROBABILITY ESTIMATES FOR PHASE 3 (Continued)

Fault Tree* Event No.	Event Description	Per Mission Event Probabilities			Basis for Estimate
		Expected Value	90% Confidence		
			Upper	Lower	
312	Internal melt	2.3E-15	5.4E-13	4.1E-21	Product of [320] x [321]
313	Recovery fails because detection activities fail to locate	1.0E-4	1.0E-3	1.0E-5	Estimate - based on ability to track from space and take time to find.
314	All six on-board transmitters fail before detection	1.0E-3	1.0E-2	1.0E-4	See [206]
315	Additional activi- ties fail to locate in ocean	1.0E-2	2.0E-2	1.0E-3	Estimate - based on discussions with Art Coyle, ONWI, and William Pope, BCL.
316	STS breakup at altitude	1.15E-4	2.7E-4	4.1E-5	Sum of [323] + [324] + [325]
318	STS breakup and payload impacts active volcano	2.3E-17	5.4E-15	8.2E-20	See [311]
320	STS breakup and payload impacts on soil with k less than k_{limit}	2.3E-13	2.7E-11	4.1E-18	Product of [316] x [330]
321	Recovery fails within critical time = T_{cr}	1.0E-2	2.0E-2	1.0E-3	Estimate

*Note: Refer to fault trees, Section 5.2.

ORIGINAL PAGE IS
OF POOR QUALITY

G-8

TABLE G-3. PER MISSION PROBABILITY ESTIMATES FOR PHASE 3 (Continued)

Fault Tree* Event No.	Event Description	Expected Value	Per Mission Event Probabilities		Basis for Estimate
			90% Confidence		
			Upper	Lower	
323	STS/space debris collision	7.9E-9	7.9E-8	7.9E-11	From BCL's R. C. Reynolds debris data base, arrive at a collision rate of $8E-18 \text{ cm}^{-2} \text{ s}^{-1}$. Multiply this by 394 s for Phase 3 and 250 m^2 for Orbiter average area and arrive at 7.9E-9.
324	Payload reentry due to STS/meteorite collision	4.9E-12	4.9E-10	4.7E-14	Based on A. Friedlander's (SAI) data of $3.5E-7$ collisions per year times 394 s divided by seconds in a year (for Orbiter).
325	Critical STS system failure	1.15E-4	2.7E-4	4.1E-5	Derived from Wiggins data (J. B. Baeker, 1981) for LRB replacing SRB.
327	Payload impacts active volcano	2.0E-13	2.0E-11	2.0E-15	Estimate based on data from G. Walker, Univ. of Hawaii: 1 km^2 of lava at 600 C, worldwide, and 1% of this having molten condition ($1 \text{ km}^2 / 0.34 \times 5.1E8 \text{ km}^2 (1/100) (1/50 \times 1/10) (2)$).
328	Detection of payload fails at sea	1.0E-5	2.0E-4	1.0E-7	Product of [314] x [315]
329	Detection successful and recovery attempts fail	1.0E-5	1.0E-3	1.0E-6	Product of [355] x [356]
330	Payload impacts on soil with k less than limit	2.0E-9	1.0E-7	1.0E-13	$(1/50 \times 1/10) \times (E-6) = 2E-9$; see [340]; E-6 is estimate.

*Note: Refer to fault trees, Section 5.2.

TABLE G-3. PER MISSION PROBABILITY ESTIMATES FOR PHASE 3 (Continued)

Fault Tree* Event No.	Event Description	Expected Value	Per Mission Event Probabilities		Basis for Estimate
			90% Confidence		
			Upper	Lower	
331	Payload/meteorite catastrophic collision	2.2E-15	2.2E-13	2.2E-17	1.78E-10 per year x 394/ (3600 x 24 x 365) from Friedlander, SAI.
332	Payload/debris catastrophic collision	1.3E-13	1.3E-12	1.3E-15	Multiply [323] x 4.24 m ² / 250 m ² and divide by 1000, becomes very unlikely that debris will cause breakup - per data from Don Kessler, NASA/JSC.
333	Shield breakage on hard surface due to STS failure	1.2E-12	2.8E-10	4.2E-15	Product of [334] x [335]
334	Payload reentry and impact on hard surface	2.3E-8	5.4E-7	8.2E-10	Product of [340] x [316]
335	Shield defects exceed damage limits	5.1E-5	5.1E-4	5.1E-6	Sum of [338] + [341]
336	Shield breakage on hard ground due to STS/meteorite collision	1.7E-17	3.9E-14	1.7E-21	Product of [342] x [343]
337	Shield breakage on hard surface due to STS/debris collision	2.7E-14	2.7E-11	2.7E-18	Product of [344] x [345]
338	Manufacturing defect undetected	5.0E-5	5.0E-4	5.0E-6	See [103]

*Note: Refer to fault trees, Section 5.2.

TABLE G-3. PER MISSION PROBABILITY ESTIMATES FOR PHASE 3 (Continued)

Fault Tree* Event No.	Event Description	Per Mission Event Probabilities			Basis for Estimate
		Expected Value	90% Confidence		
			Upper	Lower	
340	Payload impacts on hard surface	2.0E-4	2.0E-3	2.0E-5	$(1/10 \times 1/50) \times (1/10) = 2E-4$ (probability of impacting land during Phase 3) x (probability of impacting rock on land).
341	Shield damage exceeds critical limit	1.0E-6	1.0E-5	1.0E-7	Estimate - damage from STS critical failure not likely to damage payload in any significant way.
342	Payload reentry and impact on hard surface	1.0E-15	2.3E-13	9.8E-19	Product of [348] x [349]
343	Shield damage exceeds critical limits	1.7E-2	1.7E-1	1.7E-3	Sum of [346] + [347]
344	Payload reentry and impact on hard surface	1.6E-12	1.6E-10	1.6E-15	Product of [350] x [351]
345	Shield defects exceed critical damage limits	1.7E-2	1.7E-1	1.7E-3	Sum of [352] + [353]
346	Manufacturing defect undetected	5.0E-5	5.0E-4	5.0E-6	Same as [338] and [352], see [103]
347	Shield damage from meteorite/payload collision, assuming STS collision	1.7E-2	1.7E-1	1.7E-3	Area ratio of payload (2 spheres) to an average Orbiter cross-section ($4.24 \text{ m}^2/250 \text{ m}^2$).
348	Payload reentry due to STS/meteorite collision	4.9E-12	4.9E-10	4.7E-14	Same as [324], see [324]

*Note: Refer to fault trees, Section 5.2.

TABLE G-3. PER MISSION PROBABILITY ESTIMATES FOR PHASE 3 (Continued)

Fault Tree* Event No.	Event Description	Per Mission Event Probabilities			Basis for Estimate
		Expected Value	90% Confidence		
			Upper	Lower	
349	Payload impacts on hard surface	2.0E-4	2.0E-3	2.0E-5	Same as [340] and [351], see [340]
350	STS/space debris collision	7.9E-9	7.9E-8	7.9E-11	Same as [323], see [323]
351	Payload impacts on hard surface	2.0E-4	2.0E-3	2.0E-5	Same as [340] and [349], see [340]
352	Manufacturing defect undetected	5.0E-5	5.0E-4	5.0E-6	Same as [338] and [346], see [103]
353	Shield damage from debris/payload collision, assuming STS collision	1.7E-2	1.7E-1	1.7E-3	See [347]
354	Payload impacts on water	0.998	0.98	0.9998	Complement of land impact, see [340]
355	Detection at sea successful	1.0E-0	1.0E-0	1.0E-0	$1 - [328] = 1$
356	Recovery attempts at sea unsuccessful	1.0E-5	1.0E-3	1.0E-6	Estimate - based on discussion with Art Coyle, ONWI, and William Pope, BCL.
357	Payload impacts on wet soil	8.0E-5	8.0E-4	8.0E-6	$(1/10 \times 1/50) \times (1/50) \times (2)$ (see [340]) \times (fresh water) $\times 2$. Assuming that wet soils are approximated by two times fresh water. Fresh water data from U.S. AEC, 1974a.

*Note: Refer to fault trees, Section 5.2.

G-12

TABLE G-4. PER MISSION PROBABILITY ESTIMATES FOR PHASE 4

Fault Tree* Event No.	Event Description	Per Mission Event Probabilities			Basis for Estimate
		Expected Value	90% Confidence Upper Lower		
400	Release to the biosphere	9.6E-9	1.2E-6	1.9E-10	Sum of [401] + [402] + [403] + [404] + [405]
401	Release in soil resulting from long-term corrosion in wet soil	4.3E-10	1.8E-8	8.8E-12	Product of [406] x [413]
402	Release in sea water resulting from long-term corrosion	8.6E-9	1.2E-6	1.7E-10	Product of [407] x [408]
403	Radiation shield breakage at ground impact	5.6E-10	2.2E-8	1.1E-11	Sum of [433] + [436] + [437]
404	Radiation shield melting	1.1E-12	4.6E-11	4.8E-16	Sum of [411] + [412]
405	Radiation shield breakage at altitude with reentry	7.7E-13	8.8E-12	7.7E-15	Sum of [431] + [432]
406	STS breakup and payload impacts on wet soil	4.3E-6	1.8E-5	8.8E-7	Product of [457] x [416]
407	STS breakup and payload impacts on water	4.3E-4	1.0E-3	1.5E-4	Product of [416] x [454]
408	Recovery at sea fails	2.0E-5	1.2E-3	1.1E-6	Sum of [428] + [429]
411	STS breakup and payload impacts active volcano	1.1E-14	2.2E-12	4.4E-17	Product of [427] x [416]

* Refer to fault trees, Section 5.2.

TABLE G-4. PER MISSION PROBABILITY ESTIMATES FOR PHASE 4 (Continued)

Fault Tree* Event No.	Event Description	Expected Value	Per Mission Event Probabilities		Basis for Estimate
			90% Confidence		
			Upper	Lower	
412	Internal melt	1.1E-12	4.4E-11	4.4E-16	Product of [420] x [421]
413	Recovery fails because detection activities fail to locate	1.0E-4	1.0E-3	1.0E-5	Estimate - based on ability to track from space and take time to find.
414	All six on-board transmitters fail before detection	1.0E-3	1.0E-2	1.0E-4	See [206]
415	Additional activities fail to locate in ocean	1.0E-2	2.0E-2	1.0E-3	Estimate - based on discussing with Art Coyle, ONWI.
416	STS breakup at altitude	5.4E-4	1.1E-3	2.2E-4	Sum of [423] + [424] + [425]
418	STS breakup and payload impacts active volcano	1.1E-14	2.2E-12	4.4E-17	See [411]
420	STS breakup and payload impacts on soil with k less than k_{limit}	1.1E-10	2.2E-9	4.4E-13	Product of [416] x [430]
421	Recovery fails within critical time = T_{cr}	1.0E-2	2.0E-2	1.0E-3	Estimate
423	STS/space debris collision	4.5E-8	4.5E-7	4.5E-10	See [350], but with 2216 s replacing 394 s.
424	Payload reentry due to STS/meteorite collision	2.5E-11	2.5E-9	2.5E-13	See [348], but with 2216 s replacing 394 s.

Note: Refer to fault trees, Section 5.2.

TABLE G-4. PER MISSION PROBABILITY ESTIMATES FOR PHASE 4 (Continued)

Fault Tree* Event No.	Event Description	Per Mission Event Probabilities			Basis for Estimate
		Expected Value	90% Confidence		
			Upper	Lower	
425	Critical STS system failure	5.4E-4	1.1E-3	2.2E-4	Derived from Wiggins data (J. B. Baeker, 1981) for LRB replacing SRB.
427	Payload impacts active volcano	2.0E-11	2.0E-9	2.0E-13	See [327]; but replacing (1/50 x 1/10) by 49/50 x 1/5).
428	Detection of payload fails at sea	1.0E-5	2.0E-4	1.0E-7	Product of [414] x [415]
429	Detection successful and recovery attempts fail	1.0E-5	1.0E-3	1.0E-6	Product of [455] x [456]
430	Payload impacts on soil with k less than k _{limit}	2.0E-7	2.0E-6	2.0E-9	(49/50 x 1/5) x (E-6) = 2E-7, see [340]; E-6 is estimate.
431	Payload/meteorite catastrophic collision	1.2E-14	1.2E-12	1.2E-16	1.78E-10 per year x (2216/3600 x 24 x 365) (from Friedlander, SAI).
432	Payload/debris catastrophic collision	7.6E-13	7.6E-12	7.6E-15	Multiply [423] x 4.24m ² /250m ² and divide by 1000, see [332].
433	Shield breakage on hard surface due to STS failure	5.5E-10	2.2E-8	1.1E-11	Product of [434] x [435]
434	Payload reentry and impact on hard surface	1.1E-5	4.4E-5	2.2E-6	Product of [440] x [416]
435	Shield defects exceed damage limits	5.0E-5	5.0E-4	5.0E-6	Sum of [438] + [441]

Note: Refer to fault trees, Section 5.2.

TABLE G-4. PER MISSION PROBABILITY ESTIMATES FOR PHASE 4 (Continued)

Fault Tree* Event No.	Event Description	Expected Value	Per Mission Event Probabilities		Basis for Estimate
			90% Confidence		
			Upper	Lower	
436	Shield breakage on hard ground due to STS/meteorite collision	8.5E-15	1.7E-11	4.2E-18	Product of [442] x [443]
437	Shield breakage on hard surface due to STS/debris collision	1.5E-11	3.1E-10	7.6E-15	Product of [444] x [445]
438	Manufacturing defect undetected	5.0E-5	5.0E-4	5.0E-6	See [103]
440	Payload impacts on hard surface	2.0E-2	4.0E-2	1.0E-2	$(1/5 \times 49/50) \times (1/10) = (1/50)$ (probability of impacting land during Phase 4) x (probability of impacting rock on land).
441	Shield damage exceeds critical limit	5.0E-7	5.0E-6	5.0E-8	Estimate - half the value of [341] because fewer propellants available.
442	Payload reentry and impact on hard surface	5.0E-13	1.0E-10	2.5E-15	Product of [448] x [449]
443	Shield damage exceeds critical limit	1.7E-2	1.7E-1	1.7E-3	Sum of [446] + [447]
444	Payload reentry and impact on hard surface	9.0E-10	1.8E-9	4.5E-12	Product of [450] x [451]
445	Shield defects exceed critical damage limits	1.7E-2	1.7E-1	1.7E-3	Sum of [452] + [453]

Note: Refer to fault trees, Section 5.2.

TABLE G-4. PER MISSION PROBABILITY ESTIMATES FOR PHASE 4 (Continued)

Fault Tree* Event No.	Event Description	Expected Value	Per Mission Event Probabilities		Basis for Estimate
			90% Confidence Upper	Lower	
446	Manufacturing defect undetected	5.0E-5	5.0E-4	5.0E-6	See [103]
447	Shield damage from meteorite/payload collision, assuming STS collision	1.7E-2	1.7E-1	1.7E-3	See [347]
448	Payload reentry due to STS/meteorite collision	2.5E-11	2.5E-9	2.5E-13	See [424]
449	Payload impacts on hard surface	2.0E-2	4.0E-2	1.0E-2	See [440]
450	STS/space debris collision	4.5E-8	4.5E-7	4.5E-10	See [423]
451	Payload impacts on hard surface	2.0E-2	4.0E-2	1.0E-2	See [440]
452	Manufacturing defect undetected	5.0E-5	5.0E-4	5.0E-6	See [103]
453	Shield damage from debris/payload collision, assuming STS collision	1.7E-2	1.7E-1	1.7E-3	See [347]
454	Payload impacts on water	0.8	0.9	0.7	4/5 chance of hitting water \pm 20%.
455	Detection at sea successful	1.0E-0	1.0E-0	1.0E-0	1 - [428] = 1
456	Recovery attempts at sea unsuccessful	1.0E-5	1.0E-3	1.0E-6	Estimate - based on discussions with Art Coyle, ONWI.

*Note: Refer to fault trees, Section 5.2.

TABLE G-4. PER MISSION PROBABILITY ESTIMATES FOR PHASE 4 (Continued)

Fault Tree* Event No.	Event Description	Expected Value	Per Mission Event Probabilities		Basis for Estimate
			90% Confidence Upper	Lower	
457	Payload impacts on wet soil	8.0E-3	1.6E-2	4.0E-3	1/5 chance of hitting land on nominal track, with 1/25 chance of hitting wet soil - see [357].

*Note: Refer to fault trees, Section 5.2.

TABLE G-5. PER MISSION PROBABILITY ESTIMATES FOR PHASE 5

Fault Tree* Event No.	Event Description	Per Mission Event Probabilities			Basis for Estimate
		Expected Value	90% Confidence		
			Upper	Lower	
500	Release to the biosphere	3.7E-10	7.5E-9	3.4E-13	Sum of [501] + [502] + [503] + [504] + [505]
501	Release in soil resulting from long-term corrosion in wet soil	8.5E-14	3.6E-12	1.4E-18	Product of [506] x [507]
502	Release in sea-water resulting from long-term corrosion	1.0E-11	2.8E-9	4.5E-16	Product of [508] x [509]
503	Radiation shield breakage at ground impact	3.5E-10	4.6E-9	2.3E-13	Sum of [510] + [511] + [512]
504	Radiation shield melting	1.9E-15	1.6E-13	1.7E-21	Sum of [514] + [513]
505	Radiation shield breakage on orbit with reentry	1.1E-11	1.3E-10	1.1E-13	Sum of [515] + [516]
506	Reentry and payload impacts on wet soil	8.5E-9	1.8E-7	1.4E-12	Product of [517] x [558]
507	Recovery fails because detection activities fail to locate	1.0E-5	2.0E-5	1.0E-6	Estimate - have much more time to prepare for eventual reentry.
508	Reentry and payload impacts on water	5.2E-7	2.3E-6	4.1E-10	Product of [517] x [518]
509	Recovery fails	2.0E-5	1.2E-3	1.1E-6	Sum of [555] + [528]

*Note: Refer to fault trees, Section 5.2.

TABLE G-5. PER MISSION PROBABILITY ESTIMATES FOR PHASE 5 (Continued)

Fault Tree* Event No.	Event Description	Expected Value	Per Mission Event Probabilities		Basis for Estimate
			90% Confidence		
			Upper	Lower	
510	Shield breakage on hard surface due to STS failure	2.8E-12	1.4E-10	6.8E-17	Product of [520] x [521]
511	Shield breakage on hard ground due to meteoroid/ payload collision	2.2E-13	2.8E-11	1.4E-17	Product of [523] x [522]
512	Shield breakage on hard ground due to debris/ payload collision	3.5E-10	4.4E-9	2.2E-13	Product of [524] x [525]
513	Internal melt	1.9E-15	1.6E-13	1.6E-21	Product of [544] x [526]
514	External melt	2.0E-17	8.7E-15	1.7E-22	Same as [527]
515	Payload/meteoroid catastrophic collision	1.8E-13	1.8E-11	1.8E-15	1.78E-10 per year x [32,290/(3600 x 24 x 365)].
516	Payload/debris catastrophic collision	1.1E-11	1.1E-10	1.1E-13	8E-18 cm ⁻² s ⁻¹ x 42, 400 cm ² x 32,290 s x (1/1000), see [332].
517	Payload reentry	7.1E-7	3.0E-6	5.8E-10	Product of [532] x [531]
518	Payload impacts on water	7.3E-1	7.6E-1	7.0E-1	For 38-degree inclination orbit random reentry, from U.S. AEC, 1974a.
520	Payload reentry and impact on hard surface	2.3E-8	1.2E-7	1.2E-11	Product of [517] x [534]
521	Shield defects exceed damage limits	1.2E-4	1.2E-3	5.7E-6	Sum of [535] + [536]

*Note: Refer to fault trees, Section 5.2.

TABLE G-5. PER MISSION PROBABILITY ESTIMATES FOR PHASE 5 (Continued)

Fault Tree* Event No.	Event Description	Expected Value	Per Mission Event Probabilities		Basis for Estimate
			90% Confidence Upper	Lower	
522	Payload reentry and impact on hard surface	2.2E-13	2.8E-11	1.4E-15	Product of [537] x [538]
523	Shield defects exceed critical damage limits	1.0E-0	1.0E-0	1.0E-2	Sum of [539] + [540]
524	Payload reentry and impact on hard surface	3.5E-10	4.4E-9	2.2E-11	Product of [541] x [542]
525	Shield defects exceed damage limits	1.0E0	1.0E0	1.0E-2	Sum of [561] + [560]
526	Payload reentry and impact on soil with k less than k_{limit}	1.9E-13	8.1E-12	1.6E-18	Product of [543] x [517]
527	Payload reentry and payload impacts active volcano	2.0E-17	8.7E-15	1.7E-22	Product of [517] x [545]
528	Detection success- ful and recovery attempts fail	1.0E-5	1.0E-3	1.0E-6	Product of [529] x [530]
529	Detection successful	1.0E-0	1.0E-0	1.0E-0	1 - [555] = 1
530	Recovery attempts at sea unsuccess- ful	1.0E-5	1.0E-3	1.0E-6	See [456]
531	Rescue failure	1.0E-4	2.0E-4	1.0E-7	Estimate

*Note: Refer to fault trees, Section 5.2.

TABLE G-5. PER MISSION PROBABILITY ESTIMATES FOR PHASE 5 (Continued)

Fault Tree* Event No.	Event Description	Per Mission Event Probabilities			Basis for Estimate
		Expected Value	90% Confidence		
			Upper	Lower	
532	Loss of control on STS system supported by payload	7.1E-3	1.5E-2	2.9E-3	Sum of [547] + [548] + [549] + [550] + [551] + [552]
534	Payload impacts on hard surface	3.2E-2	4.0E-2	2.0E-2	From U.S. AEC, 1974a, <u>Overall Safety Manual</u> , 38-degree orbit random reentry
535	Manufacturing defect undetected	5.0E-5	5.0E-4	5.0E-6	See [103]
536	Shield damage from system failure event exceeds critical limit	7.0E-5	7.0E-4	7.0E-7	1% of Orbiter failures, see [550].
537	Payload reentry to meteoroid/payload collision	6.9E-12	6.9E-10	6.9E-14	6.7E-9 collisions per year for an area of 4.24 m ² x 32,290 s divided by seconds in a year.
538	Payload impacts on hard surface	3.2E-2	4.0E-2	2.0E-2	See [534]
539	Manufacturing defect undetected	5.0E-5	5.0E-4	5.0E-6	See [103]
540	Shield damage from collision with meteoroid exceeds critical limit	1.0E-0	1.0E-0	1.0E-2	Estimate
541	Payload reentry due to debris/payload collision	1.1E-8	1.1E-7	1.1E-9	8E-18 cm ⁻² s ⁻¹ x 42,400 cm ² x 32,290 s = 1.1E-8 (see [323]).

*Note: Refer to fault trees, Section 5.2.

TABLE G-5. PER MISSION PROBABILITY ESTIMATES FOR PHASE 5 (Continued)

Fault Tree* Event No.	Event Description	Expected Value	Per Mission Event Probabilities		Basis for Estimate
			90% Confidence		
			Upper	Lower	
542	Payload impacts on hard surface	3.2E-2	4.0E-2	2.0E-2	See [534]
543	Payload impacts on soil with k less than k_{limit}	2.7E-7	2.7E-6	2.7E-9	For 38-degree inclination orbit, random reentry probability of land impact is 0.267. Probability of exceeding k_{limit} is estimated at 1.0E-6.
544	Recovery fails within critical time = T_{cr}	1.0E-2	2.0E-2	1.0E-3	Estimate (see 421)
545	Payload impacts active volcano	2.9E-11	2.9E-9	2.9E-13	$(1 \text{ km}^2 / 0.267 \times 5.1E-8 \text{ km}^2) \times (1/100) \times (1/5) \times (2)$, see [327].
547	Debris collision	3.0E-7	3.0E-6	3.0E-8	$8E-18 \text{ cm}^{-2} \text{ s}^{-1} \times 1,170,000 \text{ cm}^2 \times 32,290 \text{ s} = 3.0E-7$, debris rate from BCL's Reynolds.
548	Meteoroid collision	1.9E-10	1.9E-8	1.9E-12	Based on A. Friedlander's (SAI) data of 1.85E-7 collision per year times 32,290 s divided by seconds in a year.
549	OTV/SOIS failure	1.0E-7	1.0E-6	1.0E-8	0.999999 + E-6; put in 10% here, rest in OTV flight phase.
550	Orbiter failure	7.1E-3	1.5E-2	2.9E-3	From Wiggins data (J. Hudson, 1979).
551	Docking collision	1.0E-6	1.0E-4	1.0E-8	Estimate

*Note: Refer to fault trees, Section 5.2.

TABLE G-5. PER MISSION PROBABILITY ESTIMATES FOR PHASE 5 (Continued)

Fault Tree* Event No.	Event Description	Expected Value	Per Mission Event Probabilities		Basis for Estimate
			90% Confidence		
			Upper	Lower	
552	Docking system will not release	1.0E-6	1.0E-7	1.0E-8	Estimate
555	Detection fails	1.0E-5	2.0E-4	1.0E-7	Product of [556] + [557]
556	All six trans- mitters fail before detection	1.0E-3	1.0E-2	1.0E-4	See [206]
557	Additional detec- tion activities fail to locate in ocean	1.0E-2	2.0E-2	1.0E-3	See [415]
558	Payload impacts on wet soil	1.2E-2	6.0E-2	2.4E-3	Fresh water x 2, for random reentry 38-degrees (U.S. AEC, 1974a).
560	Manufacturing defects undetected	5.0E-5	5.0E-4	5.0E-6	See [535]
561	Shield damage from debris/ payload collision exceeds critical limit	1.0E0	1.0E0	1.0E-2	Some damage may occur due to debris impact - assume worst case for expected value.

*Note: Refer to fault trees, Section 5.2.

TABLE G-6. PER MISSION PROBABILITY ESTIMATES FOR PHASE 6

Fault Tree* Event No.	Event Description	Per Mission Event Probabilities			Basis for Estimate
		Expected Value	90% Confidence		
			Upper	Lower	
600	Release to the biosphere	3.3E-9	1.3E-7	1.5E-11	Sum of [601] + [602] + [603] + [604] + [605]
601	Release to soil resulting from long-term corrosion in wet soil	1.0E-14	2.0E-12	2.1E-18	Product of [606] x [607]
602	Release in sea water resulting from long-term corrosion	1.3E-13	1.6E-10	6.6E-17	Product of [608] x [609]
603	Shield breakage on hard surface due to OTV/SOIS failure	3.3E-9	1.3E-7	1.5E-11	Sum of [610] + [611] + [612] + [613] + [614] + [615]
604	Radiation shield melting	2.3E-17	9.2E-15	2.3E-22	Sum of [616] + [617]
605	Radiation shield breakage on orbit with eventual reentry (long-term)	2.5E-12	2.5E-10	2.5E-13	Sum of [618] + [619]
606	Reentry and payload impacts on wet soil	1.0E-10	1.0E-8	2.1E-13	Product of [620] x [621]
607	Recovery fails because detection activities fail to locate	1.0E-4	2.0E-4	1.0E-5	Estimate - have less time in some failure modes than in [507]
608	Reentry and payload impacts on water	6.3E-9	1.3E-7	6.0E-11	Product of [622] x [623]

*Note: Refer to fault trees, Section 5.2.

TABLE G-6. PER MISSION PROBABILITY ESTIMATES FOR PHASE 6 (Continued)

Fault Tree* Event No.	Event Description	Expected Value	Per Mission Event Probabilities		Basis for Estimate
			90% Confidence Upper	Lower	
609	Recovery fails	2.0E-5	1.2E-3	1.1E-6	Sum of [624] + [625]
610	High-velocity shield breakage on soil due to OTV/SOIS failure	2.1E-9	9.5E-8	6.0E-12	Product of [626] x [627]
611	High-velocity breakage on water due to OTV/SOIS failure	6.3E-10	2.1E-8	3.0E-12	Product of [629] x [628]
612	High-velocity surface breakage on hard surface due to OTV/SOIS	4.8E-10	1.3E-8	5.7E-12	Product of [630] x [631]
613	Shield breakage on hard surface due to OTV/SOIS failure	1.4E-14	3.2E-12	1.1E-17	Product of [632] x [633]
614	Shield breakage on hard surface due to meteoroid payload collision	1.3E-14	1.5E-12	1.0E-17	Product of [634] x [635]
615	Shield breakage on hard surface due to debris/payload collision	8.0E-11	9.5E-10	6.5E-14	Product of [636] x [637]
616	Internal melt	2.3E-17	9.2E-15	2.3E-22	Product of [638] x [639]
617	External melt	1.7E-19	3.4E-16	1.7E-23	Same as [640]
618	Payload/meteoroid catastrophic collision	1.1E-14	1.1E-12	1.1E-16	[515] x (1902/32,290)

*Note: Refer to fault trees, Section 5.2.

TABLE G-6. PER MISSION PROBABILITY ESTIMATES FOR PHASE 6 (Continued)

Fault Tree* Event No.	Event Description	Per Mission Event Probabilities			Basis for Estimate
		Expected Value	90% Confidence Upper	Lower	
619	Payload/debris catastrophic collision	2.5E-12	2.5E-10	2.5E-13	[676] x (4.24/117) x (1/1000)
620	Payload impacts on wet soil	1.2E-2	6.0E-2	2.4E-3	See [558]
621	Payload reentry at less than critical speed for wet soil	8.6E-9	1.7E-7	8.6E-11	Product of [641] x [642]
622	Payload reentry at less than critical speed for water	8.6E-9	1.7E-7	8.6E-11	Product of [641] x [643]
623	Payload impacts on water	7.3E-1	7.6E-1	7.0E-1	0.73 from U.S. AEC, 1974a Overall Safety Manual for 38-degree orbit, random reentry.
624	Detection of payload fails at sea	1.0E-5	2.0E-4	1.0E-7	Product of [684] x [685]
625	Detection successful and recovery attempts fail	1.0E-5	1.0E-3	1.0E-6	Product of [672] x [673]
626	Payload impacts on any soil	2.4E-1	3.4E-1	1.4E-1	Soil impact probability for 38-degree inclination orbit from U.S. AEC, 1974a.
627	Payload reentry and impact speed exceeds critical speed for soil	8.6E-9	2.8E-7	4.3E-11	Product of [647] x [648] x [649]

Note: Refer to fault trees, Section 5.2.

TABLE G-6. PER MISSION PROBABILITY ESTIMATES FOR PHASE 6 (Continued)

Fault Tree* Event No.	Event Description	Per Mission Event Probabilities			Basis for Estimate
		Expected Value	90% Confidence Upper	Lower	
628	Payload impacts on water	7.3E-1	7.6E-1	7.0E-1	See [623]
629	Payload reentry and impact exceeds critical speed for water	8.6E-10	2.8E-8	4.3E-12	Product of [650] x [651] x [652]
630	Payload impacts on hard surface	3.2E-2	3.8E-2	2.6E-2	See [542]
631	Payload reentry and impact speed exceeds critical speed	1.5E-8	3.4E-7	2.2E-10	Product of [653] x [654] x [655]
632	Payload reentry and impact on hard surface	2.8E-10	6.5E-9	2.2E-12	Product of [656] x [657]
633	Shield defects exceed damage limits	5.0E-5	5.0E-4	5.0E-6	Sum of [658] + [659]
634	Payload reentry and impact on hard surface	1.3E-14	1.5E-12	1.0E-16	Product of [660] x [661]
635	Shield defects exceed critical damage limits	1.0E0	1.0E0	1.0E-1	Sum of [663] + [662]
636	Payload reentry and impacts on hard surface	8.0E-11	9.5E-10	6.5E-12	Product of [664] x [665]
637	Shield defects exceed critical damage limits	1.0E0	1.0E0	1.0E-2	Sum of [667] + [666]

*Note: Refer to fault trees, Section 5.2.

TABLE G-6. PER MISSION PROBABILITY ESTIMATES FOR PHASE 6 (Continued)

Fault Tree* Event No.	Event Description	Per Mission Event Probabilities			Basis for Estimate
		Expected Value	90% Confidence		
			Upper	Lower	
638	Payload reentry and impacts on soil with k less than k_{limit}	2.3E-15	4.6E-13	2.3E-19	Product of [644] x [645]
639	Recovery fails within critical time = T_{cr}	1.0E-2	2.0E-2	1.0E-3	Estimate (see [421])
640	Payload reentry and impacts active volcano	1.7E-19	3.4E-16	1.7E-23	Product of [641] x [646]
641	Payload reentry	8.6E-9	1.7E-7	8.6E-11	Product of [67C] x [671]
642	Impact speed less than critical speed for wet soil	1.0E0	1.0E0	1.0E0	Estimate for nominal reentries (decaying type)
643	Impact speed less than critical speed for water	1.0E0	1.0E0	1.0E0	Estimate for nominal reentries (decaying type)
644	Payload reentry at less than critical speed for soil	8.6E-9	1.7E-7	8.6E-11	Product of [641] x [674]
645	Payload impacts soil with k less than k_{limit}	2.7E-7	2.7E-6	2.7E-9	See [543]
646	Payload impacts active volcano	2.0E-11	2.0E-9	2.0E-13	See [545]
647	Critical failure on OTV/SOIS system	8.6E-7	8.6E-6	8.6E-8	0.999999 → E-6, put 86% of it here, 4% in Phase 7, 10% in Phase 5 (per Boeing recommendation)

Note: Refer to fault trees, Section 5.2.

TABLE G-6. PER MISSION PROBABILITY ESTIMATES FOR PHASE 6 (Continued)

Fault Tree* Event No.	Event Description	Per Mission Event Probabilities			Basis for Estimate
		Expected Value	90% Confidence		
			Upper	Lower	
648	Failure time exceeds that needed to get critical speed for soil	5.0E-1	8.0E-1	1.0E-1	Estimate
649	Elliptical trajectory within limits for direct reentry	2.0E-2	4.0E-2	5.0E-3	Estimate
650	Critical failure on OTV/SOIS system	8.6E-7	8.6E-6	8.6E-8	See [647]
651	Failure time exceeds that needed to get critical speed for water	5.0E-2	8.0E-2	1.0E-2	[648] = (10), estimate.
652	Elliptical trajectory within limits for direct reentry	2.0E-2	4.0E-2	5.0E-3	See [649]
653	Critical failure on OTV/SOIS system	8.6E-7	8.6E-6	8.6E-8	See [647]
654	Failure time exceeds that needed to get critical speed on hard surface	9.0E-1	1.0E-0	5.0E-1	Estimate
655	Elliptical trajectory within limits for direct reentry	2.0E-2	4.0E-2	5.0E-3	See [649]
656	Payload reentry at less than critical speed for hard surface	8.6E-9	1.7E-7	8.6E-11	Product of [668] x [641]
657	Payload impacts on hard surface	3.2E-2	3.8E-2	2.6E-2	See [542]

*Note: Refer to fault trees, Section 5.2.

TABLE G-6. PER MISSION PROBABILITY ESTIMATES FOR PHASE 6 (Continued)

Fault Tree* Event No.	Event Description	Per Mission Event Probabilities			Basis for Estimate
		Expected Value	90% Confidence		
			Upper	Lower	
658	Manufacturing defect undetected	5.0E-5	5.0E-4	5.0E-6	See [535]
659	Shield damage from system failure event exceeds critical limit	1.0E-7	1.0E-6	1.0E-10	Estimate
660	Payload reentry (less than critical speed) from meteoroid collision	4.0E-13	4.0E-11	4.0E-15	[677] x (4.24/117)
661	Payload impacts on hard surface	3.2E-2	3.8E-2	2.6E-2	See [542]
662	Manufacturing defect undetected	5.0E-5	5.0E-4	5.0E-6	See [535]
663	Shield damage from collision with meteoroid exceeds critical limit	1.0E0	1.0E0	1.0E-1	Estimate see [540]
664	Payload reentry (at less than critical speed) from debris/payload collision	2.5E-9	2.5E-8	2.5E-10	[676] x (4.24/117)
665	Payload impact on hard surface	3.2E-2	3.8E-2	2.6E-2	See [542]
666	Manufacturing defect undetected	5.0E-5	5.0E-4	5.0E-6	See [535]

*Note: Refer to fault trees, Section 5.2.

TABLE G-6. PER MISSION PROBABILITY ESTIMATES FOR PHASE 6 (Continued)

Fault Tree* Event No.	Event Description	Expected Value	Per Mission Event Probabilities		Basis for Estimate
			90% Confidence Upper	Lower	
667	Shield damage from debris/payload collision exceeds critical limit	1.0E0	1.0E0	1.0E-2	See [561]
668	Impact speed less than critical speed for hard surface	1.0E0	1.0E0	1.0E0	Expected for nominal reentry
669	Payload reentry due to meteoroid/payload collision	4.0E-13	4.0E-11	4.0E-15	[677] x (4.24/117)
670	Rescue failure	8.6E-7	8.6E-6	8.6E-8	Estimate - based on 6 tries at 0.94 chance of success; however, must not exceed [647].
671	OTV/SOIS system failure	1.0E-2	2.0E-2	1.0E-3	Sum of [676] + [677] + [678]
672	Detection successful	1.0E0	1.0E0	1.0E0	1 - [624] = 1
673	Recovery attempts fail	1.0E-5	1.0E-3	1.0E-6	Estimate see [456]
674	Impact speed less than critical speed for soil	1.0E0	1.0E0	1.0E0	Estimate - see [642]
676	Debris/collision (with configuration)	7.0E-8	7.0E-7	7.0E-9	Integrated through debris belt based upon configuration area of 117 m ² (Al Friedlander, SAI)
677	Meteoroid collision (with configuration)	1.1E-11	1.1E-9	1.1E-13	6.7E-9 per yr x [1902/ (365 x 24 x 3600)] x [117/4.24]

*Note: Refer to fault trees, Section 5.2.

TABLE G-6. PER MISSION PROBABILITY ESTIMATES FOR PHASE 6 (Continued)

Fault Tree* Event No.	Event Description	Per Mission Event Probabilities			Basis for Estimate
		Expected Value	90% Confidence		
			Upper	Lower	
678	OTV/SOIS failure	1.0E-2	2.0E-2	1.0E-3	Based on 0.98 delivery reliability taken during the 1902-s period (Boeing reliability number)
684	All six on-board transmitters fail before detection	1.0E-3	1.0E-2	1.0E-4	See [206]
685	Additional detection activities fail to locate in ocean	1.0E-2	2.0E-2	1.0E-3	Estimate, see [415]

*Note: Refer to fault trees, Section 5.2.

APPENDIX H
COMPUTER PLOTS OF PAYLOAD/GRANITE IMPACT RESPONSE

H-1

APPENDIX H
COMPUTER PLOTS OF PAYLOAD/GRANITE IMPACT RESPONSE

The plots (Figure H-1 through H-16) show the DYNA2D-generated von Mises stress (equivalent stress) and the hoop stress (stress perpendicular to the plane of the model) for 0.25, 0.50, 0.75, and 1.0 ms after the impact process starts (nuclear waste payload impacting granite). Refer to Section 5.4.3.2 of the report for technical discussion.

.000250

SIGMA EQ

□	50000.00	×	400000.00
○	100000.00	◇	500000.00
△	200000.00	↑	600000.00
+	300000.00	⋈	700000.00

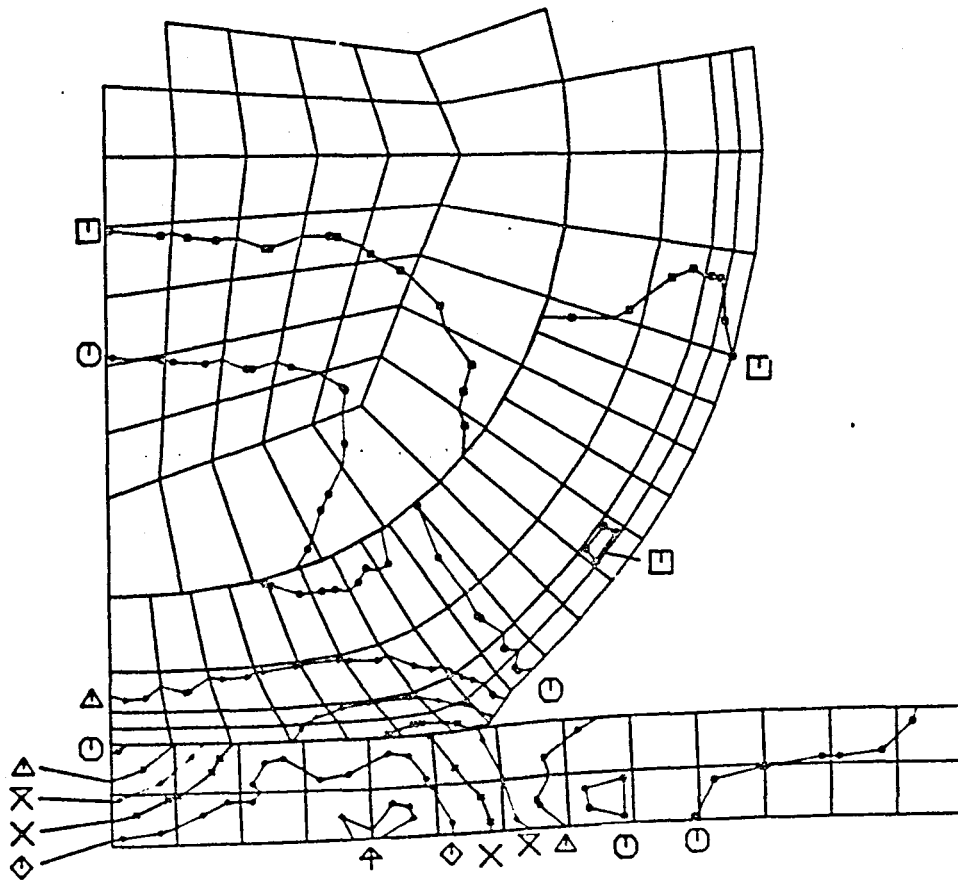

FIGURE H-1. CONTOURS OF VON MISES STRESS AFTER 0.25 ms
OF IMPACT (442 m/s IMPACT VELOCITY)

H-3

ORIGINAL PAGE IS
OF POOR QUALITY

.000500

SIGMA EQ

□	50000.00	×	400000.00
○	100000.00	◇	500000.00
△	200000.00	⊕	600000.00
+	300000.00	⊗	700000.00

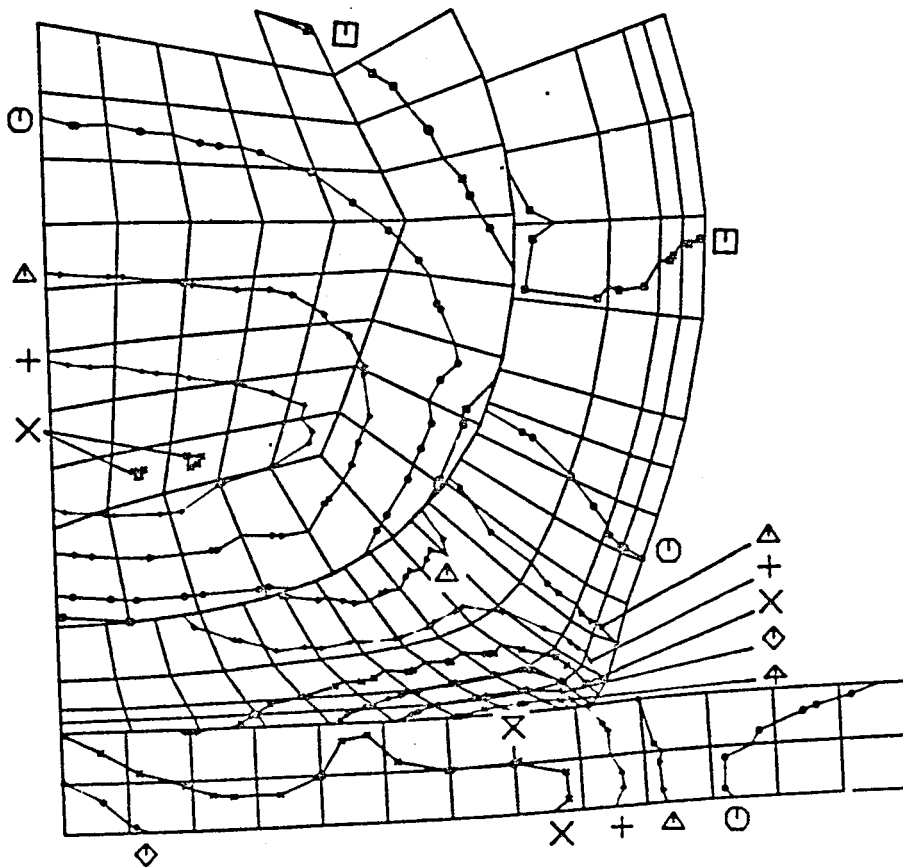

FIGURE H-2. CONTOURS OF VON MISES STRESS AFTER 0.50 ms
OF IMPACT (442 m/s IMPACT VELOCITY)

.000750

SIGMA EQ

□	50000.00	×	400000.00
○	100000.00	◇	500000.00
△	200000.00	⋈	600000.00
+	300000.00	⋈	700000.00

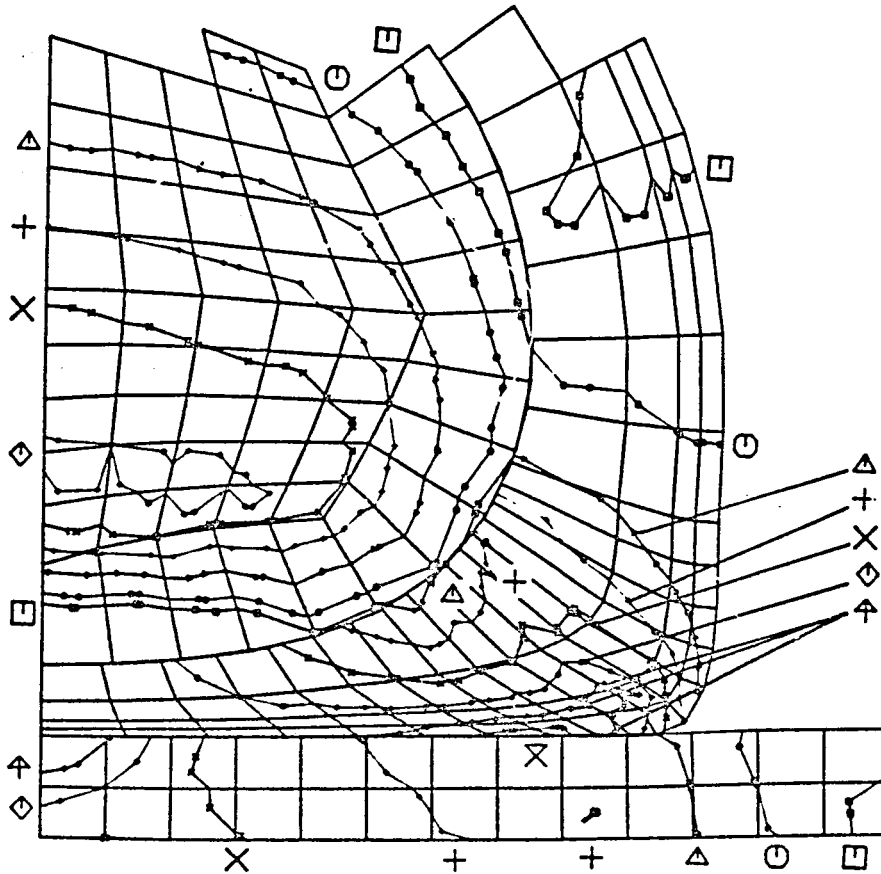

FIGURE H-3. CONTOURS OF VON MISES STRESS AFTER 0.75 ms
OF IMPACT (442 m/s IMPACT VELOCITY)

ORIGINAL PAGE IS
OF POOR QUALITY

.001000

SIGMA EQ

□	50000.00	X	400000.00
○	100000.00	◇	500000.00
△	200000.00	⋈	600000.00
+	300000.00	⋈	700000.00

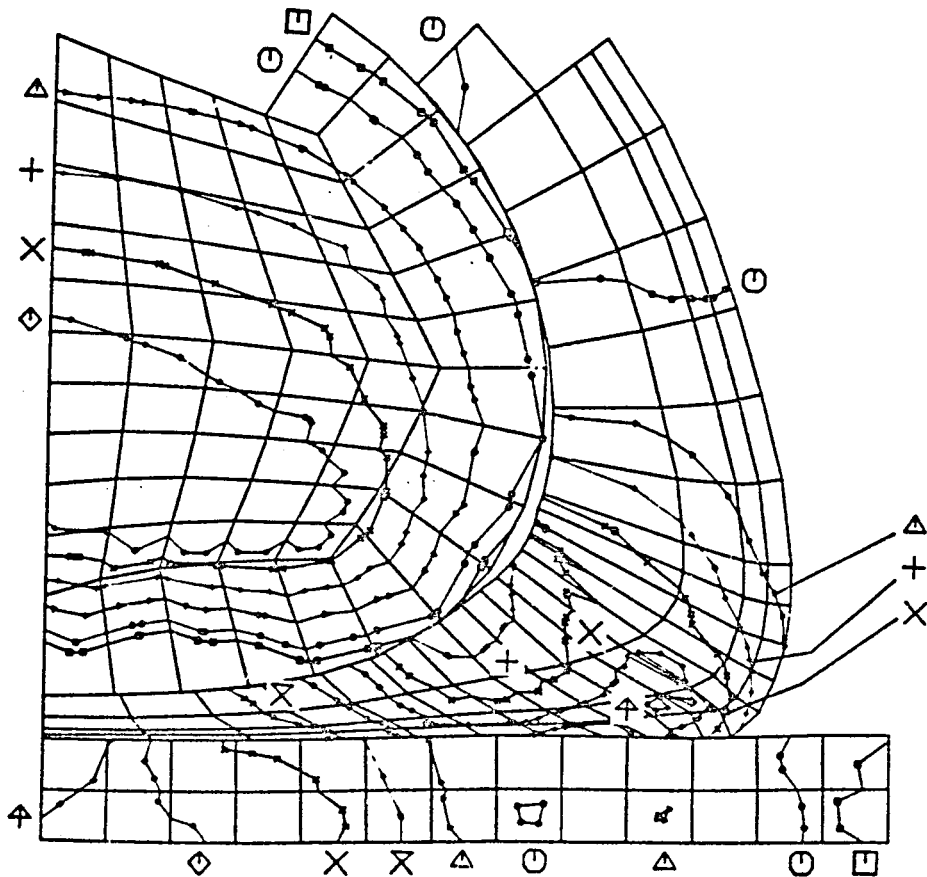

FIGURE H-4. CONTOURS OF VON MISES STRESS AFTER 1.0 ms
OF IMPACT (442 m/s IMPACT VELOCITY)

.000250

SIGMA T

□	-800000.00	↑	0.00
○	-700000.00	×	300000.00
△	-600000.00	Y	400000.00
+	-500000.00	⋈	500000.00
X	-400000.00	*	600000.00
◇	-300000.00		

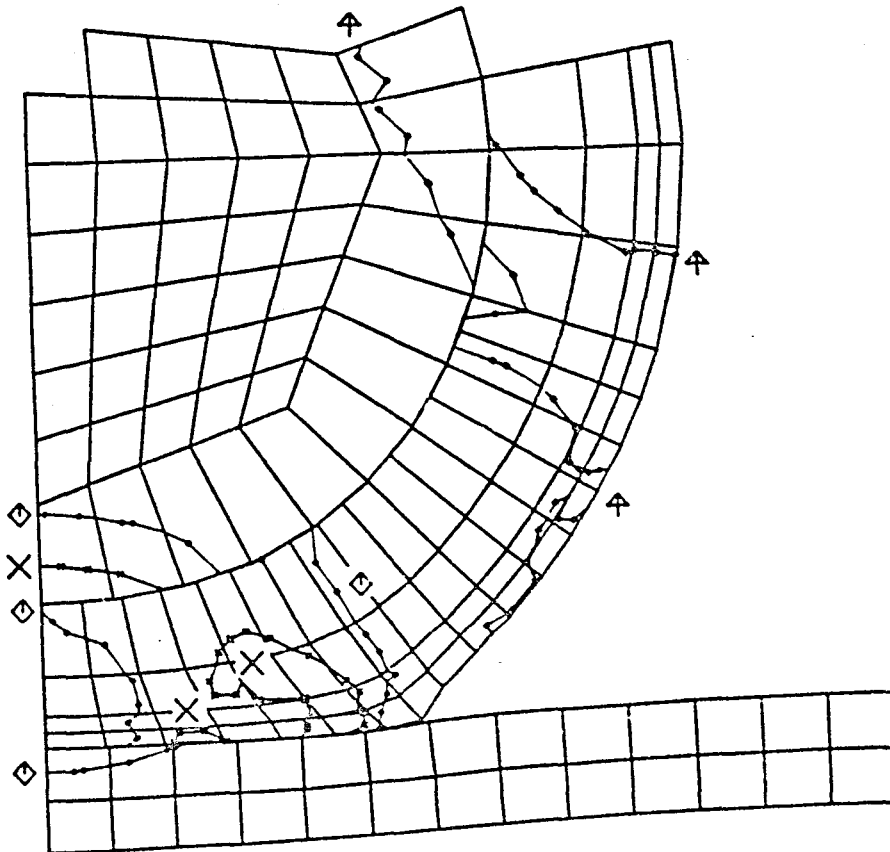

FIGURE H-5. CONTOURS OF HOOP STRESS AFTER 0.25 ms
OF IMPACT (442 m/s IMPACT VELOCITY)

.000500

H-7

ORIGINAL PAGE IS
OF POOR QUALITY

SIGMA T

□	-800000.00	⊕	0.00
⊙	-700000.00	⊗	300000.00
△	-600000.00	∨	400000.00
+	-500000.00	⊘	500000.00
X	-400000.00	*	600000.00
◇	-300000.00		

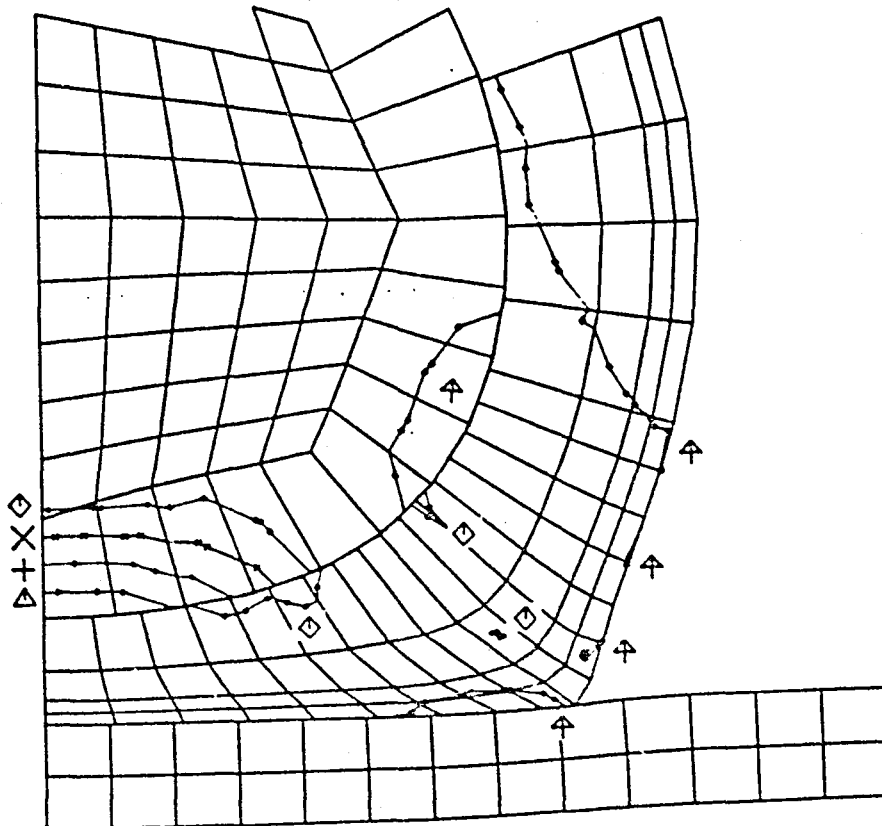

FIGURE H-6. CONTOURS OF HOOP STRESS AFTER 0.50 ms
OF IMPACT (442 m/s IMPACT VELOCITY)

H-8

ORIGINAL PAGE IS
OF POOR QUALITY

.000750

SIGMA T

□	-800000.00	↑	0.00
○	-700000.00	×	300000.00
△	-600000.00	Y	400000.00
+	-500000.00	⊗	500000.00
X	-400000.00	*	600000.00
◇	-300000.00		

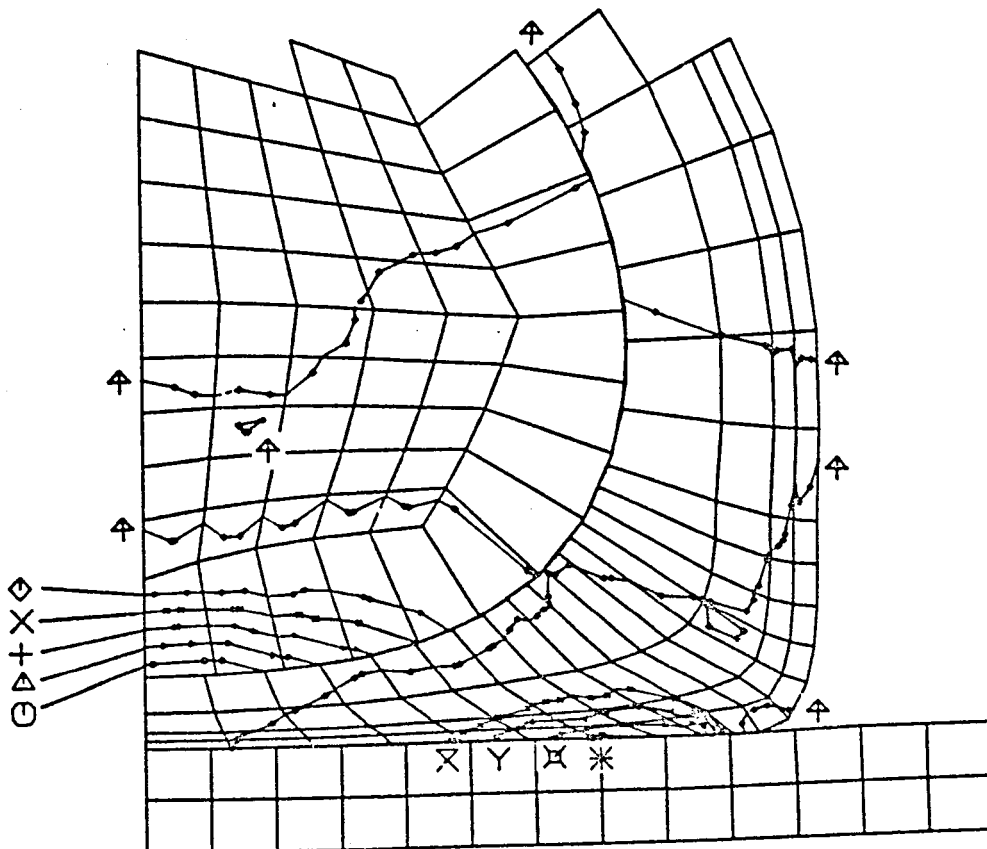

FIGURE H-7. CONTOURS OF HOOP STRESS AFTER 0.75 ms
OF IMPACT (442 m/s IMPACT VELOCITY)

H-9

ORIGINAL PAGE IS
OF POOR QUALITY

.001000

SIGMA T

□	-800000.00	⊕	0.00
⊙	-700000.00	⊗	300000.00
△	-600000.00	Υ	400000.00
+	-500000.00	⊘	500000.00
×	-400000.00	*	600000.00
◇	-300000.00		

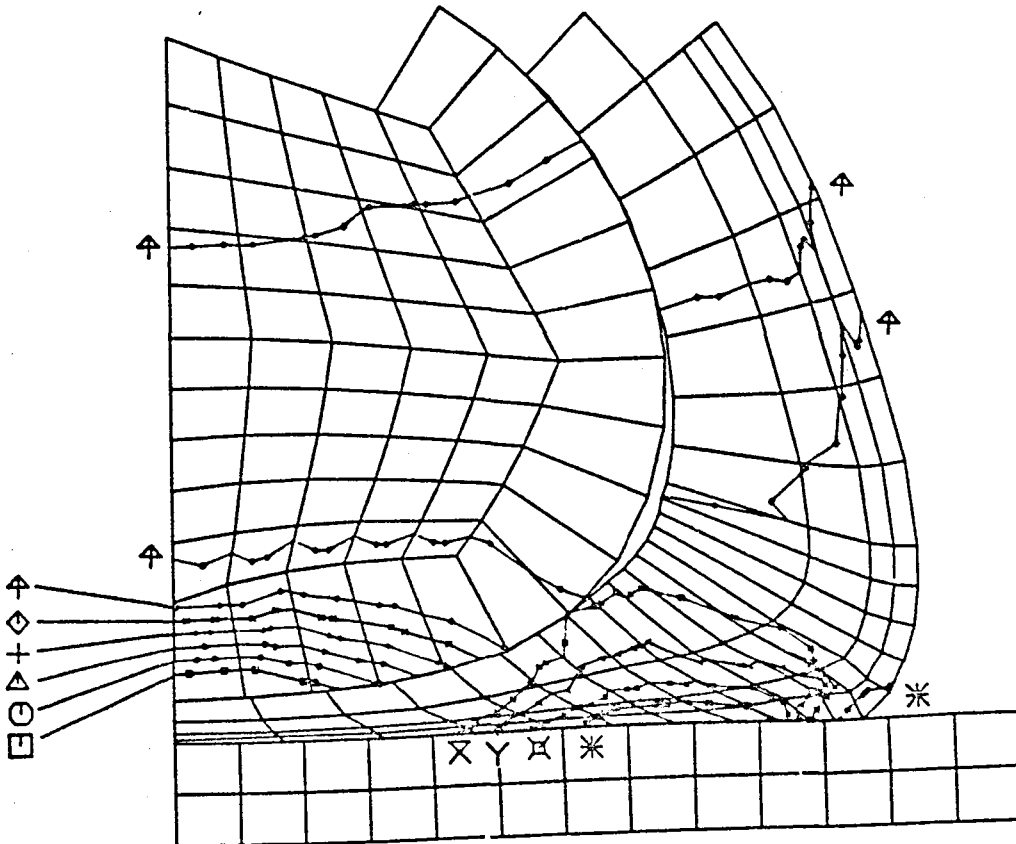

FIGURE H-8. CONTOURS OF HOOP STRESS AFTER 1.0 ms
OF IMPACT (442 m/s IMPACT VELOCITY)

H-10

ORIGINAL PAGE IS
OF POOR QUALITY

.000250

SIGMA EQ

□	30000.00	×	300000.00
○	50000.00	◇	400000.00
△	100000.00	⋈	500000.00
+	200000.00	⋈	600000.00

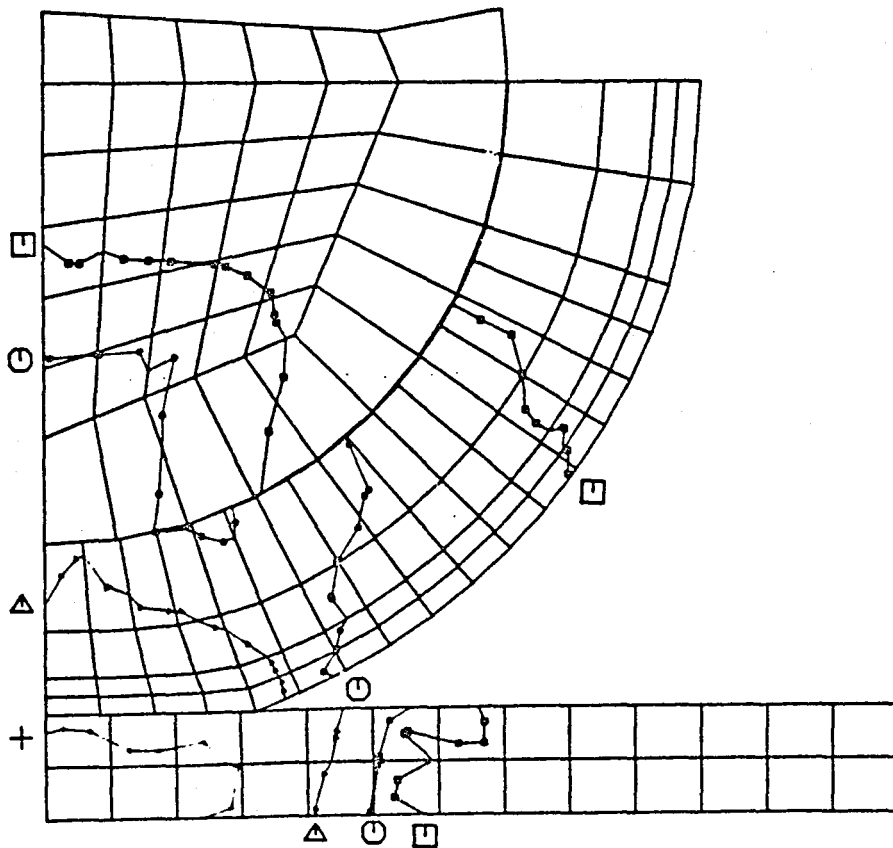

FIGURE H-9. CONTOURS OF VON MISES STRESS AFTER 0.25 ms
OF IMPACT (152 m/s IMPACT VELOCITY)

ORIGINAL PAGE IS
OF POOR QUALITY

.000500

SIGMA EQ

□	30000.00	×	300000.00
○	50000.00	◇	400000.00
△	100000.00	⋈	500000.00
+	200000.00	⋈	600000.00

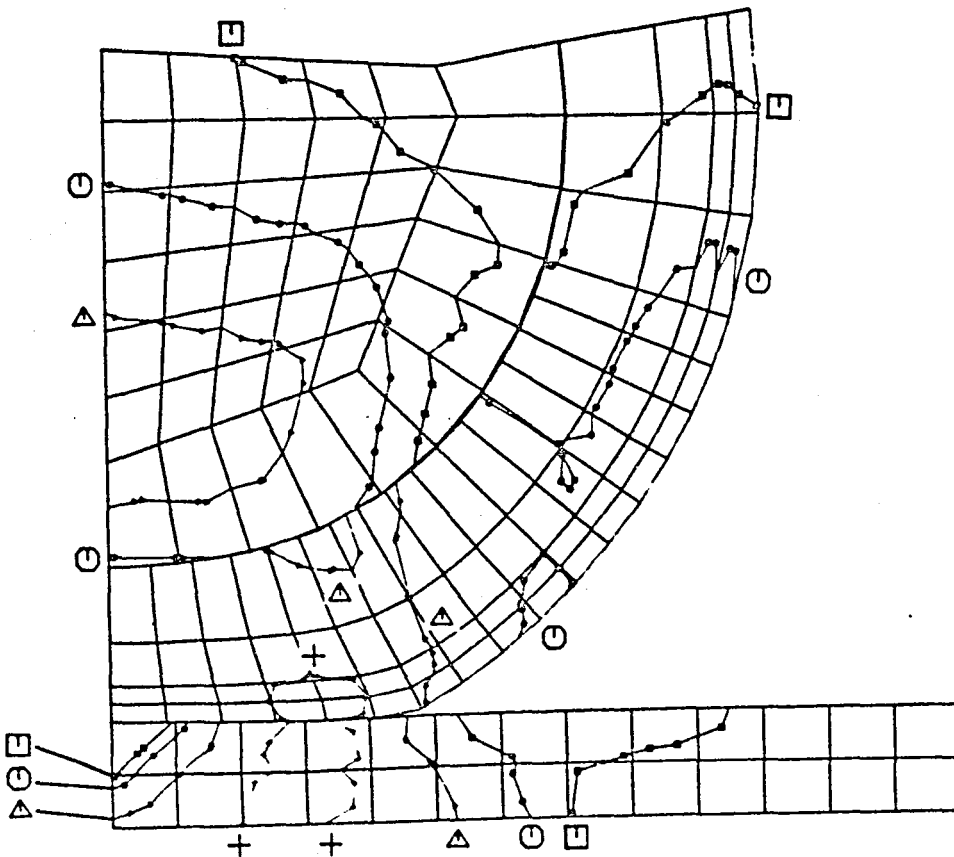

FIGURE H-10. CONTOURS OF VON MISES STRESS AFTER 0.50 ms
OF IMPACT (152 m/s IMPACT VELOCITY)

ORIGINAL PAGE IS
OF POOR QUALITY

.000750

SIGMA EQ

□	30000.00	×	300000.00
○	50000.00	◇	400000.00
△	100000.00	⋈	500000.00
+	200000.00	⊗	600000.00

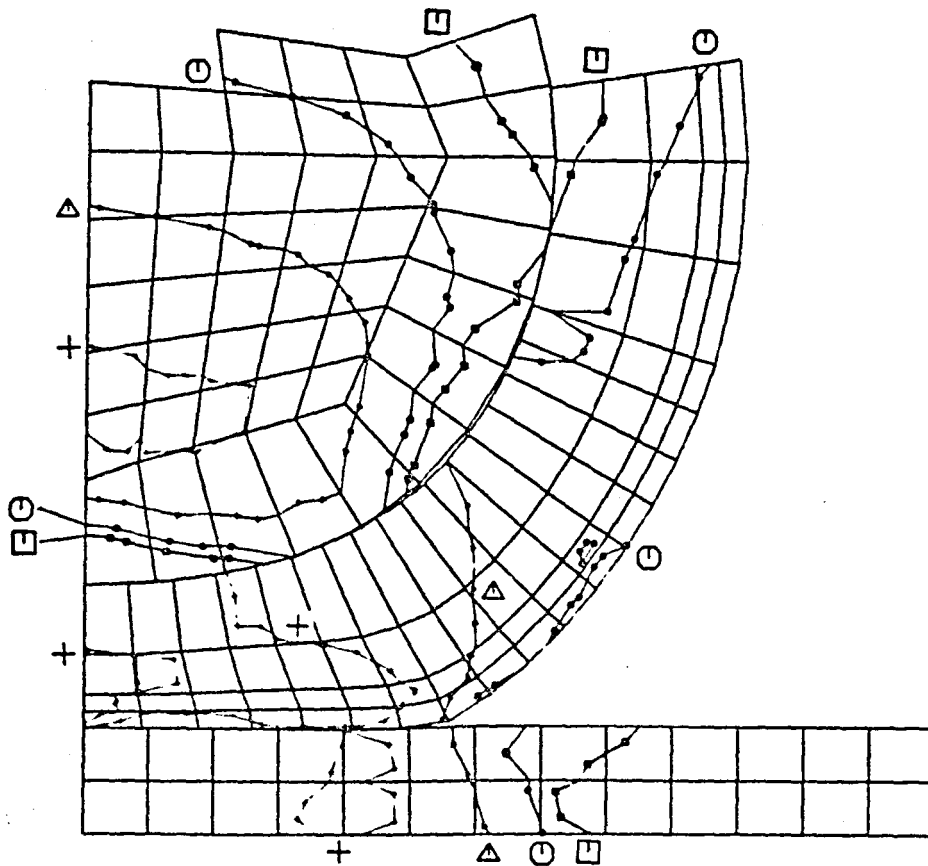

FIGURE H-11. CONTOURS OF VON MISES STRESS AFTER 0.75 ms
OF IMPACT (152 m/s IMPACT VELOCITY)

ORIGINAL PAGE IS
OF POOR QUALITY

.001000

SIGMA EQ

□	30000.00	×	300000.00
○	50000.00	◇	400000.00
△	100000.00	⋈	500000.00
+	200000.00	⋈	600000.00

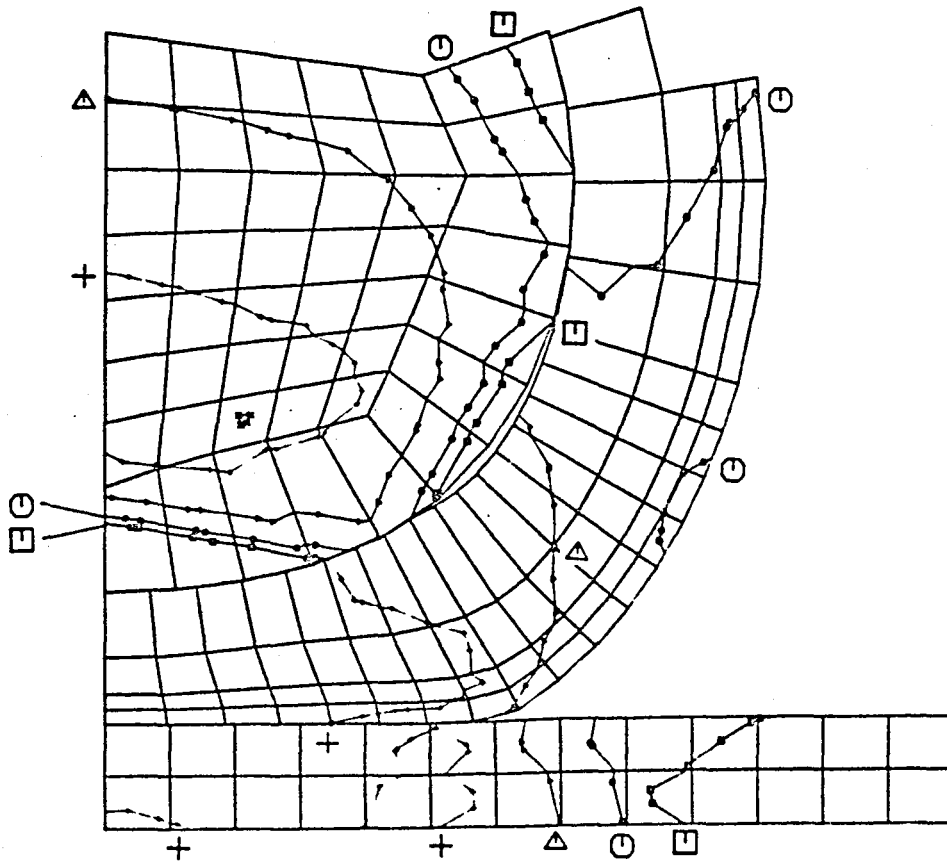

FIGURE H-12. CONTOURS OF VON MISES STRESS AFTER 1.0 ms
OF IMPACT (152 m/s IMPACT VELOCITY)

.000250

SIGMA T

▣	-800000.00	⊕	0.00
⊙	-700000.00	⊗	300000.00
△	-600000.00	⋈	400000.00
+	-500000.00	⋊	500000.00
×	-400000.00	⋋	600000.00
◇	-300000.00		

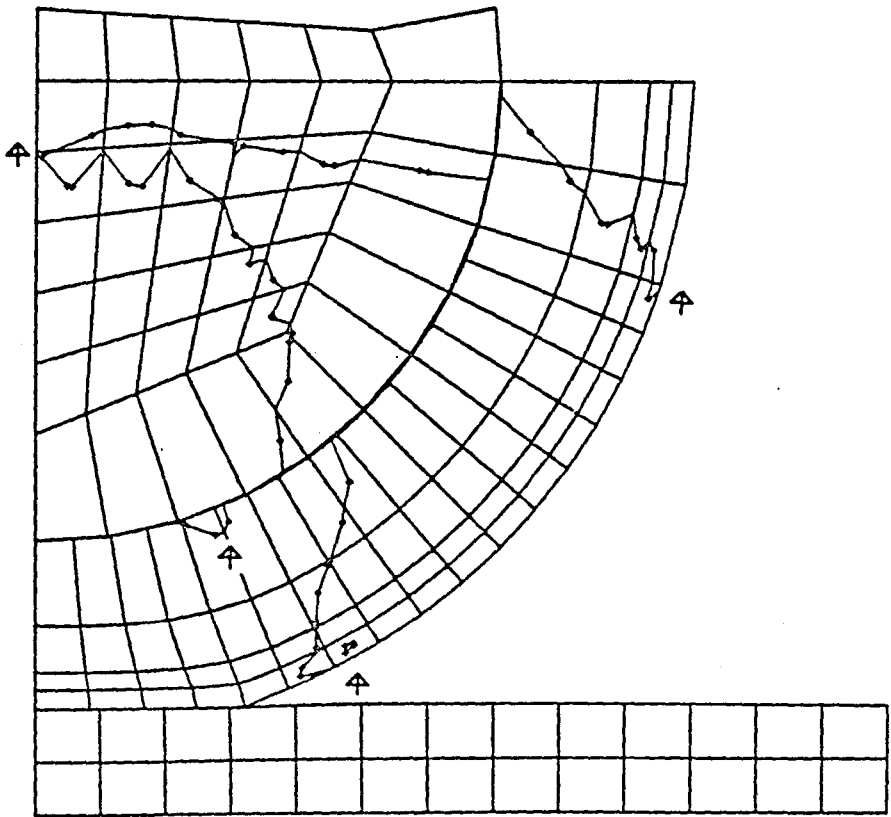

FIGURE H-13. CONTOURS OF HOOP STRESS AFTER 0.25 ms
OF IMPACT (152 m/s IMPACT VELOCITY)

H-15

.000500

ORIGINAL PAGE IS
OF POOR QUALITY

SIGMA T

□	-800000.00		
○	-700000.00	↑	0.00
△	-600000.00	×	300000.00
+	-500000.00	Y	400000.00
X	-400000.00	⋈	500000.00
◇	-300000.00	*	600000.00

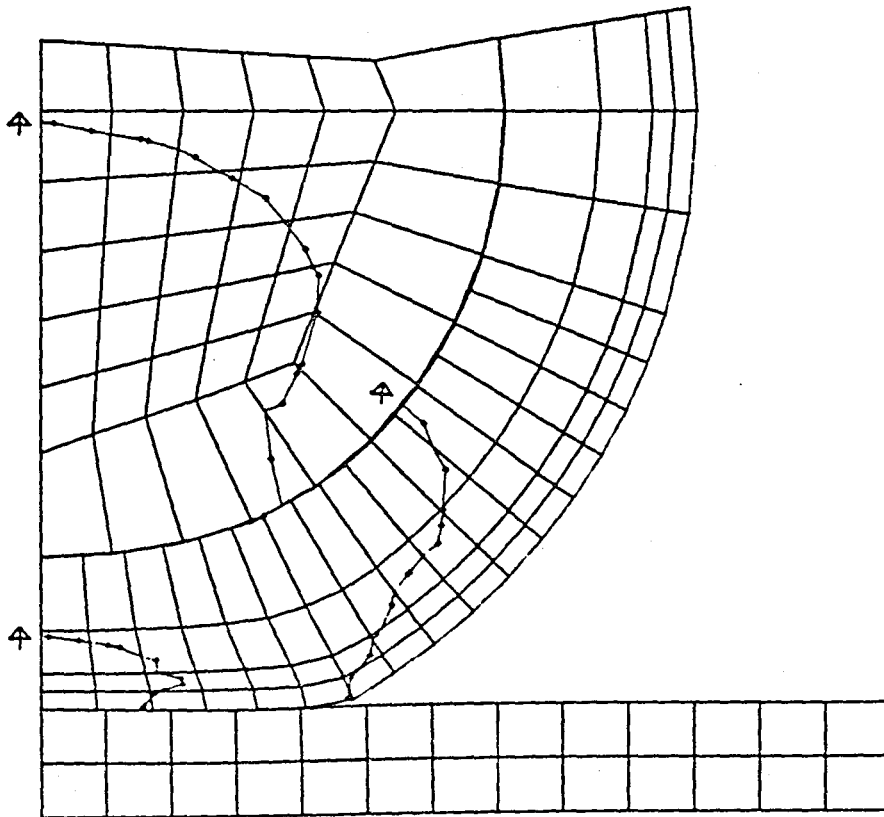

FIGURE H-14. CONTOURS OF HOOP STRESS AFTER 0.50 ms
OF IMPACT (152 m/s IMPACT VELOCITY)

H-16

.000750

ORIGINAL PAGE IS
OF POOR QUALITY

SIGMA T

▣	-800000.00		
⊙	-700000.00	↑	0.00
△	-600000.00	×	300000.00
+	-500000.00	Y	400000.00
X	-400000.00	⋈	500000.00
◇	-300000.00	*	600000.00

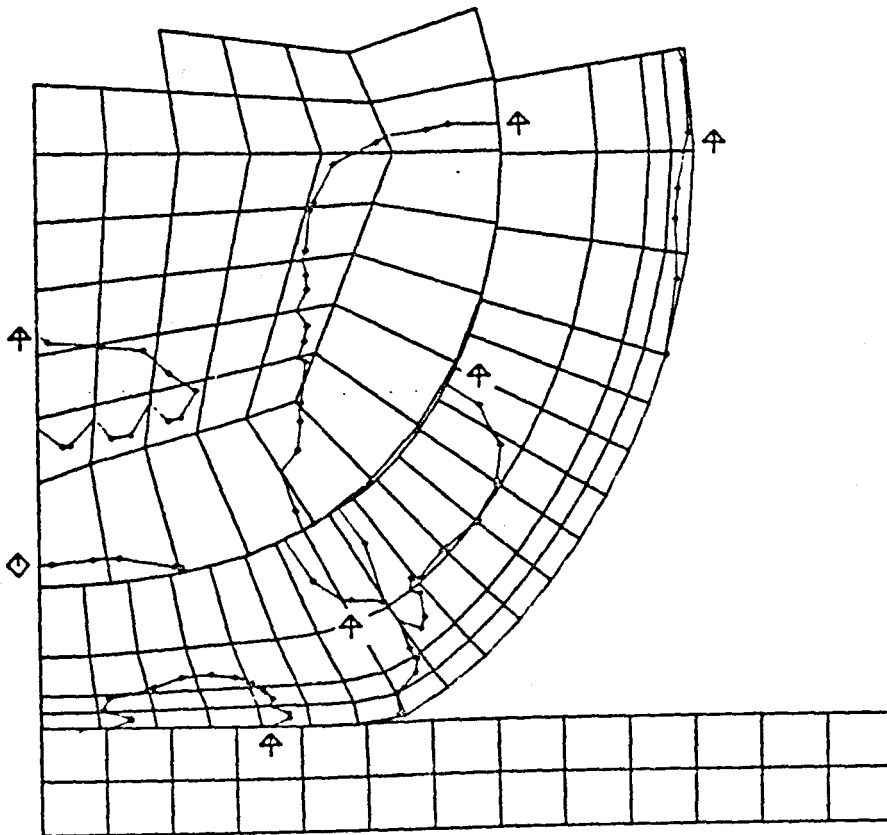

FIGURE H-15. CONTOURS OF HOOP STRESS AFTER 0.75 ms
OF IMPACT (152 m/s IMPACT VELOCITY)

H-17

.001000

ORIGINAL PAGE IS
OF POOR QUALITY

SIGMA T

□	-800000.00		
○	-700000.00	↑	0.00
△	-600000.00	×	300000.00
+	-500000.00	Y	400000.00
X	-400000.00	⊗	500000.00
◇	-300000.00	*	600000.00

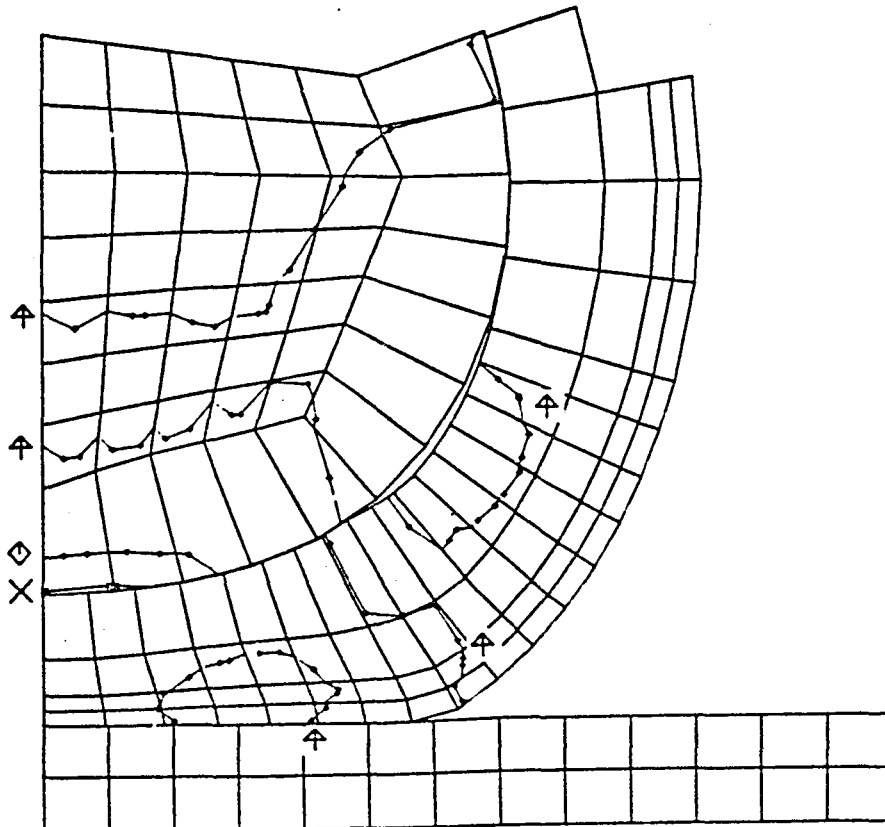

FIGURE H-16. CONTOURS OF HOOP STRESS AFTER 1.0 ms
OF IMPACT (152 m/s IMPACT VELOCITY)

END
DATE
FILMED

AUG 13 1982

End of Document