

NASA-CP-2223-VOL-2
19820018258

NASA Conference Publication 2223

Vibrational-Rotational Spectroscopy for Planetary Atmospheres

Volume II

*Proceedings of a workshop held at
Annapolis, Maryland
March 17-19, 1980*

NASA

NASA Conference Publication 2223

Vibrational-Rotational Spectroscopy for Planetary Atmospheres

Volume II

Edited by
Michael J. Mumma
Goddard Space Flight Center

Kenneth Fox
University of Tennessee

John Hornstein
Computer Sciences Corporation

Proceedings of a workshop held at
Annapolis, Maryland
March 17-19, 1980

NASA

National Aeronautics
and Space Administration

**Scientific and Technical
Information Branch**

1982

Volume I

CONTENTS

	<u>Page</u>
PREFACE	iii
INTRODUCTION	1
EXECUTIVE SUMMARY	3
PARTICIPANTS	7
A ROUND TABLE DISCUSSION ON PROSPECTS FOR OBSERVATIONS IN THE NEXT DECADE (1980-1990)	13
The Space Telescope – John Caldwell	14
The Future of Ground-Based Near-IR Observations – Uwe Fink	17
The Next Decade in Space-Based Observations – Rudi Hanel	19
Next Generation Infrared Spectroscopy of the Planets – Michael Mumma	20
The 10 μ m Region – Alan Tokunaga	23
INTRODUCTION TO PLANETARY SPECTROSCOPY	27
Molecular Spectroscopy and Planetary Exploration from Space – Rudolph A. Hanel ..	29
Radiative Transfer and Remote Sensing – Barney J. Conrath	47
Rayleigh, Raman and Particulate Scattering – William D. Cochran	63
REVIEW OF THEORETICAL AND EXPERIMENTAL SPECTROSCOPIC METHODS ...	87
Prediction of Molecular Infrared Band and Line Intensities – Willis B. Person	89
New Theoretical and Experimental Methods for Pressure-Broadened Linewidths and Their Interpretation – Jack J. Gelfand	125
Laboratory Molecular Spectroscopy – Jack Margolis	149
Microwave Rotational Spectroscopy – H. Pickett	171
SPECTROSCOPIC DATA COMPILATIONS	189
The JPL Millimeter, Sub-Millimeter, and Microwave Line Catalog – Herbert Pickett	191
The AFGL Molecular Line Atlases – Laurence Rothman	195

*Volume I of II

CONTENTS (Continued)

	<u>Page</u>
THE TERRESTRIAL PLANETS – CURRENT KNOWLEDGE	209
Thermal Balance of Venus – Martin Tomasko	211
Neutral Species in the Atmosphere of Venus – Andrew Young	229
Transient Species on Mars and Venus – Yuk L. Yung	243
SPECTROSCOPY PERTINENT TO THE INNER PLANETS	253
Gaseous Infrared Absorption in the Lower Atmosphere of Venus – C. Chackerian, Jr. and R. W. Boese	255
The Spectroscopy of Venus – Reinhard Beer	271
Spectroscopic Measurements of Mars and Venus with Heterodyne Techniques – Albert Betz	277
Infrared Absorption by OH-Containing Compounds – John J. Hillman	295
Infrared Absorption of Sulfur-Bearing Compounds	311
THE OUTER PLANETS – CURRENT KNOWLEDGE	331
Thermal Structure of Jupiter and Saturn – Glen Orton	333
Composition of Jupiter – Ronald Prinn	363
Voyager IRIS Measurements of the Jovian Atmosphere – Virgil G. Kunde	387
Jupiter and Saturn from 2 to 6 μm – Harold P. Larson	407

Volume II

CONTENTS

	<u>Page</u>
LABORATORY SPECTROSCOPY PERTINENT TO THE OUTER PLANETS	429
H ₂ and HD Spectroscopic Status – Jack Margolis	431
Collision-Induced Sharp Features in the Infrared Spectrum of HD – R. M. Herman	439
Far Infrared Spectra of H ₂ and Mixtures of H ₂ -CH ₄ and H ₂ -He* – George Birnbaum	449
A Review of Acetylene, Ethylene and Ethane Molecular Spectroscopy for Planetary Applications – W. C. Maguire	473
Current Studies of CH ₄ from 2.5 to 7 μm – Linda Brown	503
Line Intensities from Band and Diode Laser Measurements: ν ₄ of CH ₄ – Kenneth Fox	529
Random Walks with the 6420- and 6825-Å Features of Methane: Lost in the Wilderness – Barry Lutz	549
Current Band Model Studies of CH ₄ at Wavelengths Less than 2.5 Microns – Uwe Fink	559
Long-Pathlength Absorption Spectroscopy of CH ₄ – Peter Silvaggio	585
Current Studies of CH ₃ D: Ye Olde Line Drive – Barry Lutz	599
Spectra of Ammonia – K. Narahari Rao	611
Current Studies of PH ₃ – A. Goldman	635
SPECTROSCOPY OF MINOR BODIES	655
Gaseous SO ₂ on Io – John Pearl	657
Titan on the Eve of Voyager Encounter – John Caldwell	673
Organic Chemistry in Titan's Atmosphere – Thomas Scattergood	679
Spectroscopy of Triton and Pluto: Status and Prospects – Dale Cruikshank	699
Comments on Pluto's Atmosphere – L. Trafton	709
Speculations on the Infrared Molecular Spectra of Comets – Michael J. Mumma	717
SUMMARY OF THE WORKING SESSION	745

LABORATORY SPECTROSCOPY PERTINENT TO THE OUTER PLANETS

	<u>Page</u>
H ₂ and HD Spectroscopic Status – Jack S. Margolis	431
Collision-Induced Sharp Features in the Infrared Spectrum of HD – R. M. Herman	439
Far Infrared Spectra of H ₂ and Mixtures of H ₂ -CH ₄ and H ₂ -HE* – George Birnbaum	449
A Review of Acetylene, Ethylene and Ethane Molecular Spectroscopy for Planetary Applications – W. C. Maguire	473
Current Studies of CH ₄ from 2.5 to 7 μm – Linda Brown	503
Line Intensities from Band and Diode Laser Measurements: ν ₄ of CH ₄ – Kenneth Fox	529
Random Walks with the 6420- and 6825-Å Features of Methane: Lost in the Wilderness – Barry Lutz	549
Current Band Model Studies of CH ₄ at Wavelengths Less than 2.5 Microns – Uwe Fink	559
Long-Pathlength Absorption Spectroscopy of CH ₄ – Peter Silvaggio	585
Current Studies of CH ₃ D: Ye Olde Line Drive – Barry Lutz	599
Spectra of Ammonia – K. Narahari Rao	611
Current Studies of PH ₃ – A. Goldman	635

H₂ and HD Spectroscopic Status

Jack S. Margolis (JPL)

H₂ and the isotope HD, by virtue of being the simplest kinds of neutral molecules, are also the most thoroughly studied. The state of the theory has been pushed aggressively and deeply by many investigators; the most aggressive probably being W. Kolos and L. Wolniewicz (who have used facilities and collaborated with a number of groups around the world). The many papers of these two authors will provide an extensive bibliography of the significant work on this topic.

The state of the theory is such that it is roughly as accurate as experiment for many of the physical parameters of the molecules. This is true for the most sophisticated theoretical methods which include relativistic and radiative corrections. The agreement of D_0 (D_0 = dissociation energy) is $\sim 0.4 \text{ cm}^{-1}$ in 36000 cm^{-1} . The theoretical wave functions for H₂ are based on multi-term variational wave functions which are designed to give good values for the energy. The number of terms that have been included in the best variational calculation is 130 for the 1978 wave function of Kolos et al. The wave functions so obtained are very accurate and may be used to calculate vibration - rotation energy levels and transition probabilities. But the variational wave function is biased toward small values of R (=the internuclear separation), whereas the calculation of the quadrupole transition probability is biased toward large values of R . The computed values of the quadrupole transition probability for H₂ turn out to be very good nevertheless.

The situation for HD is different. Because of the nuclear asymmetry HD may exhibit electric dipole transitions. The asymmetry effect on the electronic wave functions is small and subtle and the electric dipole transitions are weak. But they are much stronger than the quadrupole transitions which are extremely weak (on the order of 10^{-6} or 10^{-7} x the usual electric dipole transition strength). The calculation of the strength of these electric dipole transitions represents a difficult challenge to the theoretician and one which they, evidently, have not yet overcome. The dipole transition exists by virtue of an asymmetric coupling of the nuclear motions and the electronic motion. The theoreticians call this a non-adiabatic effect. There are, in fact, a number of other important spectral properties that sophisticated theory does not compute unequivocally, namely: Pressure effects on the spectrum such as pressure shifts, pressure broadening and collisional narrowing.

In any case, reliable data must be obtained from laboratory measurements in order to verify the theory and to use in interpreting observations. As is well known, the H_2 and HD transitions are very difficult to observe because of their weakness. Nevertheless, the frequencies for many of the transitions of the vibration - rotation bands are well known from UV Spectra which are relatively easy to obtain. Lambert et al list up to $J=10$ in the 1-0 band (including oscillator strengths), and quadrupole transition moments are computed in several places for vibration - rotation bands with little significant disagreement.

It is much more difficult to obtain good absorption spectra directly in the vibration - rotation bands. The absorption strengths are extremely small (usually measured in $cm^{-1}/km\text{-amagat}$) and, ordinarily, extremely long optical paths are required for their observation. However, because H_2 and HD are very light molecules they are also very anharmonic and the strength of their overtones decreases slowly as the overtone increases.

The requirement for long optical path has been alleviated in several ways:

1. Electric field induced absorption. The electric field mixes states of opposite parity. Therefore, dipole transitions between levels differing by $J = 0 \pm 2$ are observed. These are the same selection rules as for quadrupole transitions, and this method has been used to examine the pressure broadening of H_2 lines.
2. Opto-acoustic Detectors, which are extremely sensitive detectors of weak absorptions, have been used in several institutions [Princeton, Washington University at Saint Louis and Ecole Normal Sup. (France)] to obtain absorption strengths of H_2 and HD.

These techniques exhibit some very favorable advantages: The standard absorption studies of the vibration - rotation bands of H_2 and HD have used White Cells of enormous size to get path lengths up to 3 km and have used up to 500 liters of gas. The amount of gas necessary for an opto-acoustic measurement is measured in milli-liters for equivalent sensitivity. The OAD's may be operated within a laser cavity in order to get high laser power and obtain a sensitivity of $\sim 10^{-8} cm^{-1}/watt$ for signal/Noise ~ 1 . Recent application of classical methods to H_2 and HD spectra has produced new data and first time observations of the 4 - 0 transitions of H_2 . The first observations were made by Bergstrahl et al at KPNO using the one meter FTS and a 6 meter White Cell and, simultaneously, by Michelson and Trauger at Dennison University in Ohio who used a 25 meter White cell and Fabry-Perot etalons (a PEPSIOS device). Unfortunately, both first measurements of the 4-0 S (1) line were in agreement with each other, but in disagreement with

subsequent measurements made at KPNO with higher signal/noise.

The first KPNO measurements were based on observing a very weak absorption with high signal/noise: path length ~ 400 m, broad band filter with 150 \AA pass band, four hours of integration and a peak-peak signal ~ 5000 . That yielded a signal/noise in the line of only about 2. These measurements were repeated at KPNO by William H. Smith with some important improvements. He used a 3 \AA bandpass filter to decrease photon noise, a longer integration time and better detectors supplied by KPNO. With these improvements the peak-peak noise in the continuum was reduced so that signal/noise ≥ 70000 , and the signal/noise in the S(1) 4-0 line was > 50 . The absorption strength, under these conditions, was determined to be nearly twice the value determined in the first laboratory detections, and in good agreement with the theoretical predictions. Other lines in the 4-0 band up to $J = 3$ were measured. They have not yet been reported, but have been indicated to be in agreement with theoretical predictions (e.g. Dalgarno et al). These measurements were recently repeated at KPNO by the same group of investigators with more improvements and a more extensive frequency coverage. The 1-0 band was observed up to $J \leq 5$; the 2-0 band up to $J \leq 4$; the 3-0 and 4-0 bands up to $J = 3$. The 5-0 band was looked for, but not observed. These latest observations are the subject of a Ph.D. dissertation and have not yet been published.* Until these spectra are analyzed the state of knowledge of the H_2 strengths is as shown in Table 1.

HD spectra have been studied in the UV about as thoroughly as those of H_2 . The vibration - rotation line positions are known very accurately for more transitions than are important in planetary atmosphere spectroscopy. However, as mentioned before, the theory does not do well in calculating the absorption strengths (Table 2). These tend to be stronger than the quadrupole strengths for H_2 and so more lines have been measured.

The state of knowledge of the HD line positions is summarized in Table 3 of vibration - rotation constants. Ford and Browne have summarized the HD absorption strength measurements as of 1977 and following that Mickelson et al made some new measurements. A summary of absorption strengths for HD is tabulated below:

*The dissertation work is being carried out by S. L. Bragg, Department of Earth and Planetary Sciences, Washington University at St. Louis.

Bibliography

1. J. W. Brault, W. H. Smith, Ap. J., 235, L177 (1980)
2. A. Dalgarno, A. C. Allison, J. C. Browne, J. Atmos, Sciences 26, 946 (1969)
3. A. Lewis Ford, J. C. Browne, Phys. Rev. A16, 1992 (1977)
4. W. Kolos and L. Wolniewicz, Can. J. Physics 53, 2189 (1975)
5. W. Kolos, J. Mol. Structure 46, 73 (1978)
6. D. L. Lambert, A. L. Brooke, T. G. Barnes, Ap. J., 186, 573 (1973)

Table 1
Line Strengths for H₂ (cm⁻¹/km-amagat)

<u>LINE</u>	<u>OBS.</u> <u>STRENGTH</u>	<u>THEORY</u>	<u>FREQ (cm⁻¹)</u>
1 - 0 BAND			
Q(1)	.450	.0590	4155.2575
Q(2)	.0065	.0072	4143.4668
Q(3)	.0044	.0049	4125.8718
S(0)	.0280	.0296	4497.8385
S(1)	.0900	.0866	4712.9088
S(2)	.0140	.0121	4917.0118
S(3)	.0084	.0075	5108.4066
2 - 0 BAND			
O(2)	5.13 x 10 ⁻⁴	6.12 x 10 ⁻⁴	7732.6305
O(3)	2.02 x 10 ⁻⁴	5.45 x 10 ⁻⁴	7488.275
Q(1)	6.49 x 10 ⁻³	7.1 x 10 ⁻³	8075.3090
Q(2)	7.14 x 10 ⁻⁴	9.87 x 10 ⁻⁴	8051.9883
Q(3)	4.99 x 10 ⁻⁴	6.94 x 10 ⁻⁴	8017.1854
S(0)	3.83 x 10 ⁻³	4.33 x 10 ⁻³	8406.3625
S(1)	1.15 x 10 ⁻²	1.42 x 10 ⁻²	8604.2174
S(2)	2.38 x 10 ⁻³	2.31 x 10 ⁻³	8785.5298
S(3)			8948.6159
3 - 0 BAND			
Q(1)		7.7 x 10 ⁻⁴	11764.948
S(0)		4.1 x 10 ⁻⁴	12084.651
S(1)	1.3 x 10 ⁻³	1.3 x 10 ⁻³	12265.543
S(2)		2.1 x 10 ⁻⁴	12424.443
4 - 0 BAND			
S(0)			
S(1)	1.54 x 10 ⁻⁴	1.63 x 10 ⁻⁴	
Q(1)			

Table 2
Absorption Strengths for HD ($\text{cm}^{-1}/\text{km-amagat}$)

<u>LINE</u>	<u>OBS.</u> <u>(McKELLAR)</u>	<u>OBS.</u> <u>(MICKELSON)</u>	<u>THEORY</u> <u>(F. AND B.)</u>
1 - 0 BAND			
P(3)	1.74		2.57
P(2)	2.44		2.95
P(1)	2.51		2.92
R(0)	9.87		11.7
R(1)	7.48		8.8
R(2)	8.45		8.7
R(3)	9.13		9.0
2 - 0 BAND			
P(1)	.714		.77
R(0)	2.68		2.7
R(1)	1.98		1.96
3 - 0 BAND			
R(0)	.703		.75
R(1)	.475		.52
4 - 0 BAND			
P(2)		.057	
P(1)	.078	.059	.071
R(0)	.26	.22	.23
R(1)	.18		.16
R(2)	.19		.16
R(3)	.22		.147
5 - 0 BAND			
R(0)	.016		.020
R(1)	.057	.044	.066
R(2)	.013		.014

Table 3
Vibration – Rotation Constants for HD

v	G	B	D
0	0	44.667	.0259
1	3,632.10	42.741	.0255
2	7,086.83	40.857	.0247
3	10,367.67	38.990	.0240
4	13,476.83	37.157	.0235
5	16,416.02	35.312	.0228
6	19,185.15	33.461	.0221
7	21,783.27	31.605	.0219
8	24,207.62	29.689	.0214

Collision-Induced Sharp Features in the Infrared Spectrum of HD

R.M. Herman (The Pennsylvania State University)

For some time now, collisionally induced spectra in atoms and molecules have been of considerable interest. Fundamentally, they provide a means of studying the intermolecular interactions which underlie such diverse phenomena as liquid structure, phase transitions, dielectric phenomena, etc., in gases and liquids. In terms of current scientific applications, these phenomena are of prime importance in studies of the Earth's atmospheric opacity, and far wing absorption of radiation in excimer laser physics and in multiphoton ionization processes. Here, we will be interested primarily in the collision induced spectra of HD and H₂, and their application to the study of planetary (and planetary satellite) atmospheres.

Until quite recently, it was felt that pressure induced features fell into three categories:

(1) A superposition of relatively narrow features arising from long-lived complexes (van der Waals molecules, for example) which become more numerous at higher pressures (proportional to the product $n_1 n_2$, where n_1 and n_2 are number densities of different species, or n^2 for any species by itself);

(2) pressure-induced absorption or emission taking place in the far wings of otherwise sharp dipole-allowed lines. (The line centers, generally speaking, are described through impact theories within a few linewidths from the line centers, while more complicated means of description must be utilized further away from the line centers. Quite possibly, the "statistical theory" for broadening still offers a reasonable semiquantitative guide, very far from the line centers); and

(3) broad features arising from the collisional induction of dipole transitions at various frequencies which are otherwise not allowed. The collisionally induced vibration-rotation spectrum of molecular hydrogen and methane are examples of the latter. These spectra have traditionally played a primary role in the study of planetary atmospheres, inasmuch as H_2 was first discovered in the atmospheres of Saturn, Uranus, and Neptune through absorption in the (0-3) band,¹ and CH_4 leads to broad collisionally induced features which are similar in appearance and competitive with those of H_2 in giving rise to important opacity contributions² at wavelengths associated with the H_2 (0-4) band. Because the absorption (or emission) in #2 or 3, above, takes place only during collisions of short duration (10^{-13} sec), these induced features are typically of the order of 100 cm^{-1} in width.

Very recently, in the case of one molecule of astrophysical interest--the heteronuclear isotope, HD, of hydrogen--a fourth type of collisionally-induced feature has been identified and explained.³ In looking at the R- and P-branch ($J \rightarrow J+1$) fundamental band ($v=0 \rightarrow 1$) vibration-rotation lines associated with the very small permanent dipole moment which exists in HD due to the mass asymmetry, Prasad et al.⁴ concluded that the intensities of the sharp features in HD-Kr and HD-Xe mixtures become anomalously large as the foreign gas density is increased. Only recently⁵ have these observations been linked with a more detailed earlier study by McKellar⁶ on the sharp line spectrum of pure HD at various densities in which the collisions have an opposite effect--that of decreasing the sharp feature intensities. At the same time, in pure HD, they cause a substantial alteration in the line shapes, leading to a Fano lineshape. . .that is, a superposition of a pressure-broadened Lorentz contour,

which predominates at lower pressures (≤ 20 atm), and a dispersion-shape contour which predominates at higher pressures (≥ 50 atm). To date, no studies have yet been carried out on the sharp lines induced in HD by gases other than Xe, Kr, or HD itself, and no detailed information exists on the shapes and pressure dependences in any case other than pure HD.

The sharp HD lines have figured prominently in the determination of the isotopic abundance of D relative to that of H in the atmosphere of Jupiter.⁷ The relative strengths of the weak HD dipole lines and the weak H₂ quadrupole lines seem ideally suited to this purpose, in view of the fact that the absorption strengths may be approximately proportional to density to relatively great depths in atmospheres. (The relative strengths of CH₄ and CH₃D absorptions also act as reasonable candidates for such determinations, although there is no guarantee that the [D]/[H] ratios in methane and hydrogen molecules will be the same, due to differing fractionation ratios.) In the cases of Jupiter and Saturn, one can see only to depths corresponding to fairly low pressures (perhaps two to five atmospheres), limited by opaque cloud layers. While pressure-induced changes in HD line intensities may not be very great for the (0-1) band under these conditions (of order 10%), these effects could well be substantial for the observed (0-4) band lines. In Uranus, Neptune, and Titan, according to present knowledge, one can see to greater depths, limited by collisionally induced broad absorption features or by Rayleigh scattering. Estimates of the densities corresponding the limiting depths from which radiation in the visible can emerge vary, but 10-20 amagats appears to be reasonable. In this context, then, the pressure dependence of the HD vibration-rotation line strengths takes on greater significance. For

example, in the $R_1(0)$ line in pure HD at 77 K, 20 amagats density leads to a decrease of approximately 20% in absorption strengths compared with what one would expect on the assumption of a simple linear dependence on HD density.⁶ At the actual temperatures encountered (up to 150 K) the decrease in absorption intensity will probably be a great deal larger, in view of the prominent role played by short range forces in producing these effects. The substitution of H_2 for HD as the perturbing molecule probably causes little change in this assessment.

In the (0-4) absorption band, for which the HD line $S_4(1)$ has been observed⁷ in the atmosphere of Jupiter, no one at present knows by what fraction these strengths will be altered by H_2 pressure. Theoretical means must be developed for inferring the pressure induced changes in overtone band intensities to be expected in the sharp line spectra of HD, either from existing data on pressure induced overtone band intensities and band shapes in H_2 , or by calculation from more basic considerations.

The existence of the very narrow (widths \approx collisionally induced linewidths for dipole-allowed lines) collisionally-induced features was quite mysterious up to approximately one year ago, inasmuch as collisions were regarded as leading to coherent amplitudes only for very short times, which should therefore lead to the very broad features mentioned above, as opposed to the pressure-induced features, $< 1 \text{ cm}^{-1}$ in width, as observed. The explanations for these phenomena have been developed for the first time in the past year by the present author³ who applied his theory to HD-rare gas mixtures. Herman, Tipping and Poll⁵ then extended this treatment and applied it in explaining the sharp features in pure HD. By and large, the major reason for the collisionally induced intensity changes in sharp lines is that there

exists a small component of the collisionally induced dipole which is fixed in the HD molecular frame, which is associated with the displacement between the geometric and mass centers in the molecule. This dipole component is very difficult to dephase throughout collisions or collisional sequences. (The resistance to dephasing may be expected in view of the very narrow linewidths in HD at all pressures,⁶ and also the extremely sharp (Doppler limited) quadrupole and Raman spectra in H₂.⁸) Accordingly, even though subsequent collisional events occur at random in collisional sequences, the phase of the collisionally induced dipole contribution is indeed quite fixed from one collision to the next, so that there exists a long-duration intercollisional interference between dipoles induced in successive collisions in a sequence of collisions. This represents the natural occurrence of (overlapping) series of Ramsey double resonances⁹ which have been useful in improving the resolution in atomic beam, neutron bottle and hydrogen maser experiments; however, in the present case, the collisions themselves (rather than externally produced fields) randomly and multiply turn on and off the interaction between HD and the applied field. In addition, in view of the fact that the small permanent dipole moment (obviously) remains fixed in the HD frame, an interference between the collisionally induced moment and the permanent moment also exists. In the case of the intercollisional interference, the interference is necessarily constructive in all cases, while the collisional-permanent dipole interference may be either constructive or destructive. (It is, in fact, constructive in the case of HD-rare gas interactions, while being destructive in HD-HD collisions.) Because the dephasing of both permanent and collisionally induced components of the transition dipole occurs through collisional broadening, all contributions

to the narrow features are characterized by the pressure induced linewidths.

Finally, if some dephasing should occur in the most direct dipole-producing collisions (as opposed to the full range of collisions involved in pressure-broadening per se) there occur two effects: the degradation of the two interference effects described above; and the mixing of components having dispersion shape into the otherwise Lorentz-shaped contours. These effects have been identified and the density dependences of the various effects have been quantitatively established⁵ in the case of the $R_1(0)$ line of pure HD, for which good data at various densities exist. In general, any effects which depend solely on the small permanent electric dipole moment are represented by a Lorentzian line shape having total intensity $\sim n_{\text{HD}}$, with pressure broadened contour; those arising from permanent--collision-induced moment interference have density dependent integrated intensities $\sim n_{\text{HD}}^2$ with pressure-broadened linewidth parameters (in both the Lorentz- and dispersion-shaped components); and finally the effects which depend on intercollisional interference (both components) vary as n_{HD}^3 (again with pressure broadened linewidth parameters). Prior to the discovery of the collisional interference effects described above, all such sharp components were supposed to be Lorentz-shaped and to have intensities simply proportional to n_{HD} . (It should be mentioned, here, that Poll et al.¹⁰ showed, in effect, that if collisional-permanent dipole interference were to exist, this mechanism could explain the order of magnitude of the collisional enhancement of the allowed features in HD-Kr mixtures. These authors lacked a detailed mechanism for the interference, however, and as such were unable to obtain lineshapes--or, for that matter, any theoretical indication that the interference features should indeed be sharp).

The importance of phase shifts in the production of Fano-shaped sharp lines in HD leads one to question whether similar phase shifts might have equal importance in modifying more conventional collisionally induced spectral features in pure H_2 , as well. Theories describing intercollisional dips in the overlap contributions to the induced Q-branches have not yet incorporated these potentially important effects.¹¹ Preliminary considerations¹² indicate that the Q-dips indeed must possess a Fano lineshape, notwithstanding current predictions of a Lorentz shape. Such modifications undoubtedly alter the hydrogen opacity in regions corresponding to the various induced Q-branches, and accordingly could have some significance in atmospheric modeling.

In summary, the appearance of narrow collisionally induced components is manifested in HD for the following reasons:

- (1) Permanent dipole transitions, while allowed, are very weak, thereby causing minimal competition with collisionally induced components;
- (2) the induced dipoles may be resolved into components one of which has the same dependence on internal HD coordinates as does the permanent dipole moment;
- (3) the latter component is, in turn, independent of the angular coordinates of the intermolecular displacement. (We refer to this as scalar intercollisional interference, in view of the scalar coupling to the external degrees of freedom¹²); and
- (4) collisional dephasing during dipole-producing collisions is small enough that phase memory exists between various HD collisions with many different collision partners. (If this were not true, each collisionally-induced dipole would lose its correlation with the dipoles induced in

neighboring collisions and with the permanent dipole, which continues to absorb radiation between collisions.)

(5) The Fano lineshape arises from phase shifts associated with the most important dipole-producing collisions. The same mechanism is expected to produce Fano-shaped Q-dips in the spectrum of H_2 .

References

- ¹See, for example, M. J. S. Belton and H. Spinrad, *Ap. J.* 185, 363 (1973).
- ²T. Owen, B. L. Lutz, C. C. Porco, and J. H. Woodman, *Ap. J.* 189, 379 (1974).
- ³R. M. Herman, *Phys. Rev. Lett.* 42, 1206 (1979).
- ⁴R. D. G. Prasad and S. P. Reddy, *J. Chem. Phys.* 66, 707 (1977).
- ⁵R. M. Herman, R. H. Tipping and J. D. Poll, *Phys. Rev.* A20, 2006 (1979).
- ⁶A. R. W. McKellar, *Can. J. Phys.* 51, 389 (1973).
- ⁷J. T. Trauger, F. L. Roesler, N. P. Carleton, and W. A. Traub, *Ap. J. (Letters)* 184; L137 (1973).
- ⁸J. V. Foltz, D. H. Rank, and T. A. Wiggins, *J. Mol. Spectry.* 21, 203 (1966).
- ⁹N. F. Ramsey, Molecular Beams (Oxford, Clarendon Press, London, 1956).
- ¹⁰J. D. Poll, R. H. Tipping, R. D. G. Prasad, and S. P. Reddy, *Phys. Rev. Lett.* 36, 248 (1976).
- ¹¹J. C. Lewis and J. van Kranendonk, *Can. J. Phys.* 50, 352 (1972).
- ¹²R. M. Herman, to be published.

FAR INFRARED SPECTRA OF H₂ AND MIXTURES OF

H₂-CH₄ AND H₂-He *

George Birnbaum
National Bureau of Standards
Washington, DC 20234

1. Introduction

The purpose of this report is to present some recent laboratory measurements of the far infrared absorption of H₂ and of mixtures of H₂ with CH₄ and He, and to describe fits to the pure H₂ spectra with a semi-empirical line shape. Such results are needed in analyzing the thermal emission from the atmospheres of the outer planets.

The spectra discussed here are forbidden in the isolated molecule. They occur in groups of molecules due to dipoles induced in colliding molecules by their electric fields. At the relatively low densities of interest here, where bimolecular collisions predominate, the absorption coefficient ($\alpha(\nu)/\text{cm}^{-1}$) is proportional to the density squared at every frequency throughout the band. This is because the line shape, which is controlled by the duration of collision, is independent of the density. Because the time of collision is so small, the line widths encountered in collision-induced absorption are large and, except for H₂ where the rotational constant is unusually great, unresolved rotational bands of overlapping lines are observed.

*This work was supported in part by the Office of Space Science, National Aeronautics and Space Administration.

2. Experimental Arrangement

The spectra extending from about 20 to 2000 cm^{-1} were obtained with two grating spectrometers, one operating from 20 to 700 cm^{-1} , using a high-pressure mercury arc source, and the other operating from 550 cm^{-1} to higher frequencies, using a Nernst glower source.* A sensitive Ge bolometer, cooled by liquid He to 4.2°K in a dewar containing a number of He-cooled low-pass filters, was used with both spectrometers. The gas was contained in light pipe cells of different lengths, usually about 3 meters, and fitted with high pressure windows which had to be changed according to the spectral region. The transmission coefficient of the empty cell, I_0 , and the cell filled with gas, I , were obtained on a point by point basis by integrating the power received by the bolometer. The absorption coefficient given by

$$\alpha = L^{-1} \ln(I_0/I), \quad (1)$$

where L is the length of the cell, was plotted as α/ρ^2 , where ρ is the density in amagats. The spectral resolution used with the low frequency spectrometer was of the order of 10 cm^{-1} and was better with the high frequency instrument. Such resolution was adequate for accurately delineating the very broad spectra studies here.

The gases were carefully dried. All gases containing hydrogen were passed slowly through a catalyst to obtain an equilibrium mixture of the ortho and para species.

3. CH₄, CH₄-H₂

Since greenhouse models of the atmosphere of Titan require a knowledge of the far infrared absorption of dilute mixtures of CH₄ in H₂,¹ it is important to determine the spectrum due to CH₄-H₂ collisions. To do this, it is necessary

*The low frequency spectrometer has been described by I.F. Silvera and G. Birnbaum, *Appl. Optics* 9, 617 (1970). The high frequency spectrometer is a P.E. model 112 converted for use with gratings.

to subtract the absorption due to $\text{CH}_4\text{-CH}_4$ and $\text{H}_2\text{-H}_2$ collisions from that for a given $\text{H}_2\text{-CH}_4$ mixture. The absorption coefficient, $\alpha(\nu)$, of the mixture is given by

$$\alpha(\nu) = \rho_1^2 \alpha_{11}(\nu) + \rho_2^2 \alpha_{22}(\nu) + \rho_1 \rho_2 \alpha_{12}(\nu) . \quad (2)$$

Here ρ_1 and ρ_2 are the densities of components 1 and 2, respectively, and α_{11} , α_{22} , α_{12} are the absorption coefficients per (amagat)² due to the type of collisions indicated by the subscripts.

Figure 1 shows the collision-induced spectrum of pure CH_4 , which extends from 20 to 900 cm^{-1} . The data below 500 cm^{-1} were obtained previously.² The spectrum is mainly due to dipolar rotational transitions induced by the octupole moment, Ω , giving the selection rules $\Delta J = \underline{+1}, \underline{+2}, \underline{+3}$, and induced by the hexadecapole moment Φ giving the selection rules $\Delta J = \underline{+1}, \dots, \underline{+4}$.³ There is also a weak translational band due to these induction mechanisms at low frequencies ($\Delta J = 0$). These rotational transitions occur in only one of the molecules in a colliding pair. Figure 2 shows how the Ω - and Φ -induction mechanisms contribute to the absorption. The computed curve was obtained by assuming that each rotational line may be represented by the Van Vleck-Weisskopf (VW) line shape with a fixed half width of 20 cm^{-1} . The magnitude of Ω and Φ control the amplitudes of their respective spectrum. Although other induction mechanisms may be operative, (overlap forces, for example) we see that Ω - and Φ -induction give a fair representation of the experimental spectrum. The discrepancies between computed and measured spectra can be attributed in part to the inadequacy of the VW shape for collision-induced absorption.

By subtracting the $\text{CH}_4\text{-CH}_4$ (Fig. 1) and the $\text{H}_2\text{-H}_2$ contributions (Fig. 4) from the spectrum of the $\text{H}_2\text{-CH}_4$ mixture, we obtain the reduced (difference) spectrum shown in Fig. 3. This is essentially the quadrupole induced spectrum of H_2 with CH_4 acting as the polarizable collision partner. The

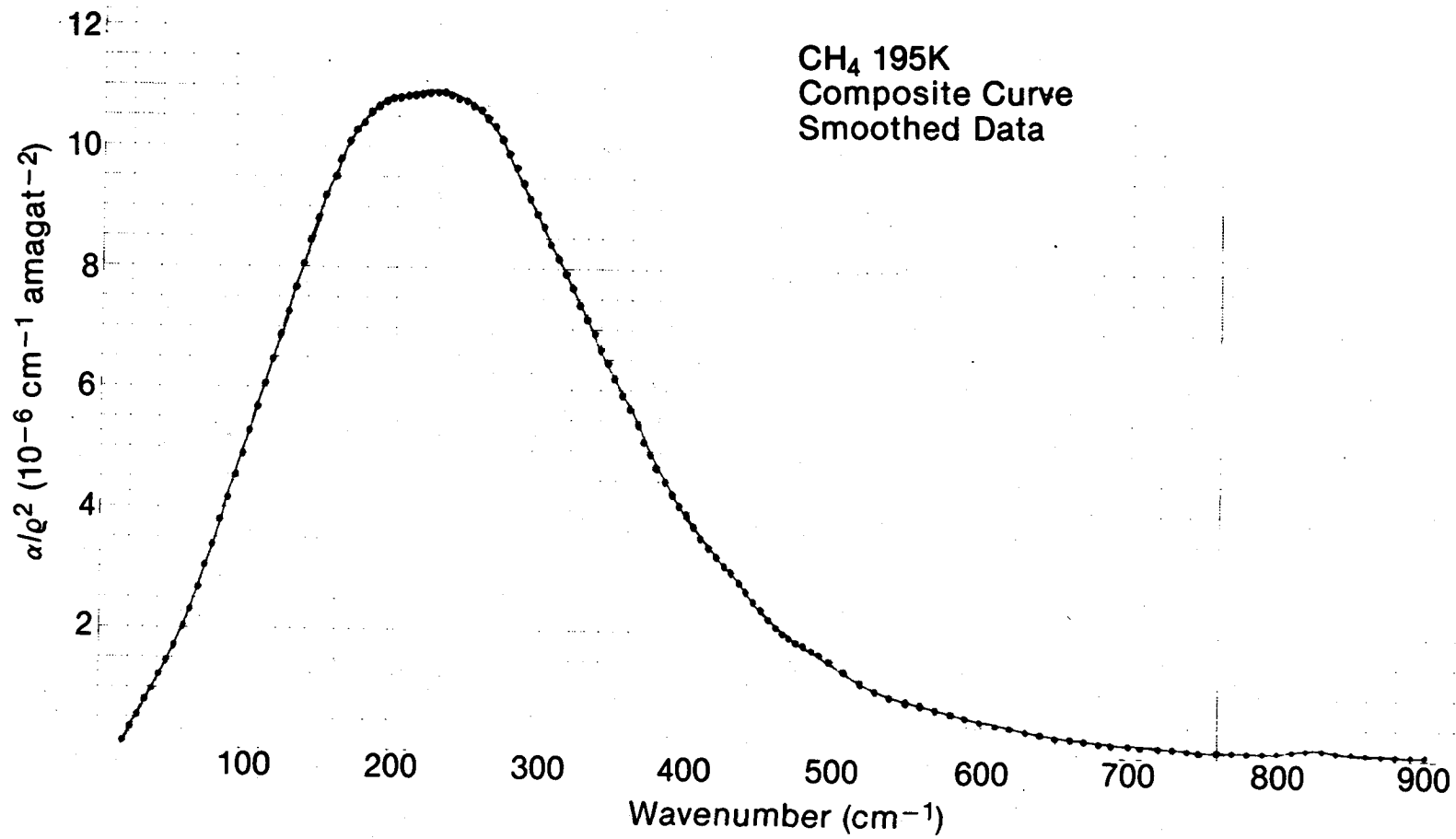

Figure 1. Spectrum of CH₄ at 195K.

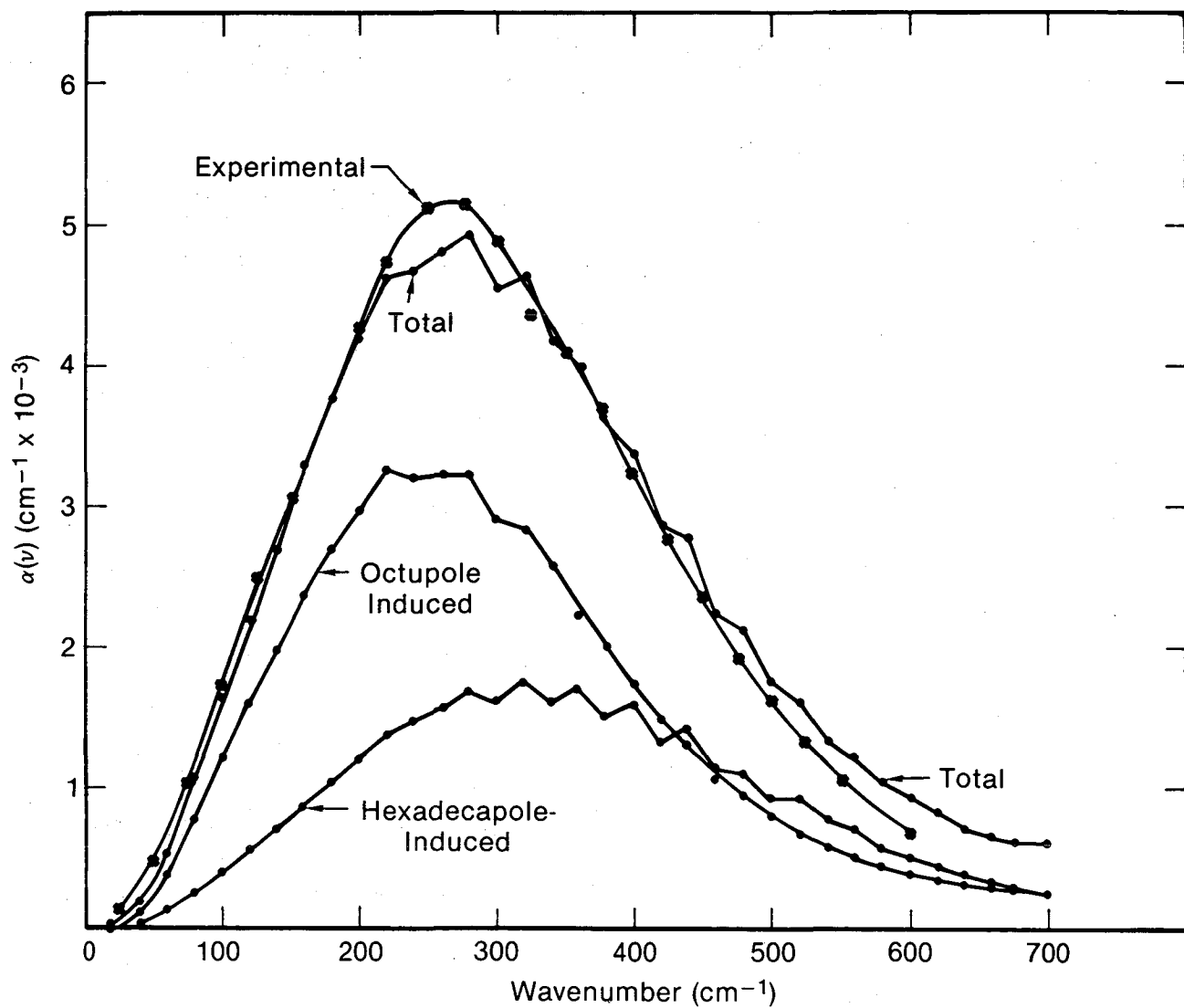

Figure 2. Comparison of experimental and theoretical (total) collision-induced spectrum of CH_4 at 296K, 24.1 amagats (from ref. 2). The separate octupole and hexadecapole induced contributions are shown.

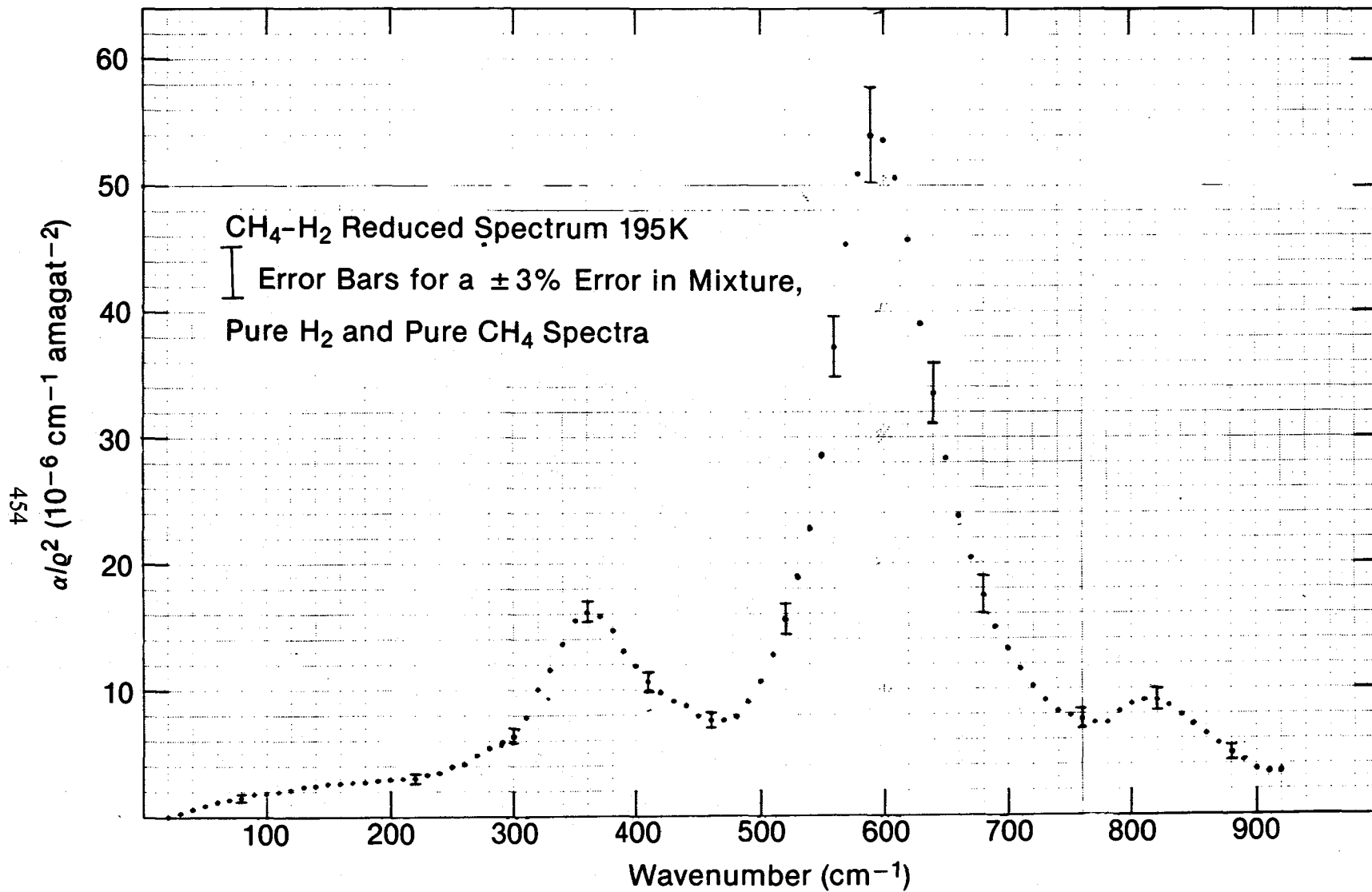

Figure 3. Spectrum due to H₂-CH₄ collisions at 195K. The error bars are estimated on the assumption that the error in measuring the absorption in H₂, CH₄ and the H₂-CH₄ mixture is $\pm 3\%$.

relatively large error, even with accurate data for H_2 , CH_4 and the H_2 - CH_4 mixture, results from subtracting large numbers to obtain a small difference. This problem is much more aggravated in obtaining the reduced H_2 -He spectrum and results in considerably larger errors.

4. H_2 - H_2 and H_2 -He

Previous measurements of the H_2 - H_2 absorption⁴ were repeated and new results from 800 to 2000 cm^{-1} have been obtained. The spectra obtained at 195 and 295K are shown in Fig. 4 and more accurate plots of the results above 1200 cm^{-1} are shown on expanded scales in Figs. 5-7. To maintain a more or less uniform fractional accuracy in the measurements, the density was progressively increased with increasing frequency. In the far wings, the square-law dependence of the absorption coefficient with density continues to high densities. The translational band ($\Delta J=0$), seen at frequencies less than 200 cm^{-1} , and the S(0) and S(1) rotational lines ($\Delta J=\pm 2$) are only partially resolved. These features, and the S(2) line, are more clearly delineated in H_2 - CH_4 (Fig. 3) because the lines are sharper. This results from the greater reduced mass of H_2 - CH_4 compared with H_2 - H_2 which leads to a longer duration of collision,

$$\tau = \bar{R}/\bar{v}, \quad (3)$$

where \bar{R} is the range of the induction interaction and \bar{v} is a mean relative velocity. The line width $\Delta\nu$ is related to τ by $\Delta\nu = (2\pi\tau)^{-1}$.

The spectrum due to H_2 -He collisions at 195K is shown in Fig. 8 where we see an intense translational band. This arises from the isotropic overlap induction mechanism, which is forbidden by symmetry in single-component systems such as H_2 - H_2 and CH_4 - CH_4 . This band is particularly prominent in H_2 -He because the transitions due to quadrupole induction are so small due to the small polarizability of He. In the H_2 - CH_4 spectrum, on the other hand, the intensity of the translation band, although due in part to isotropic overlap forces, is

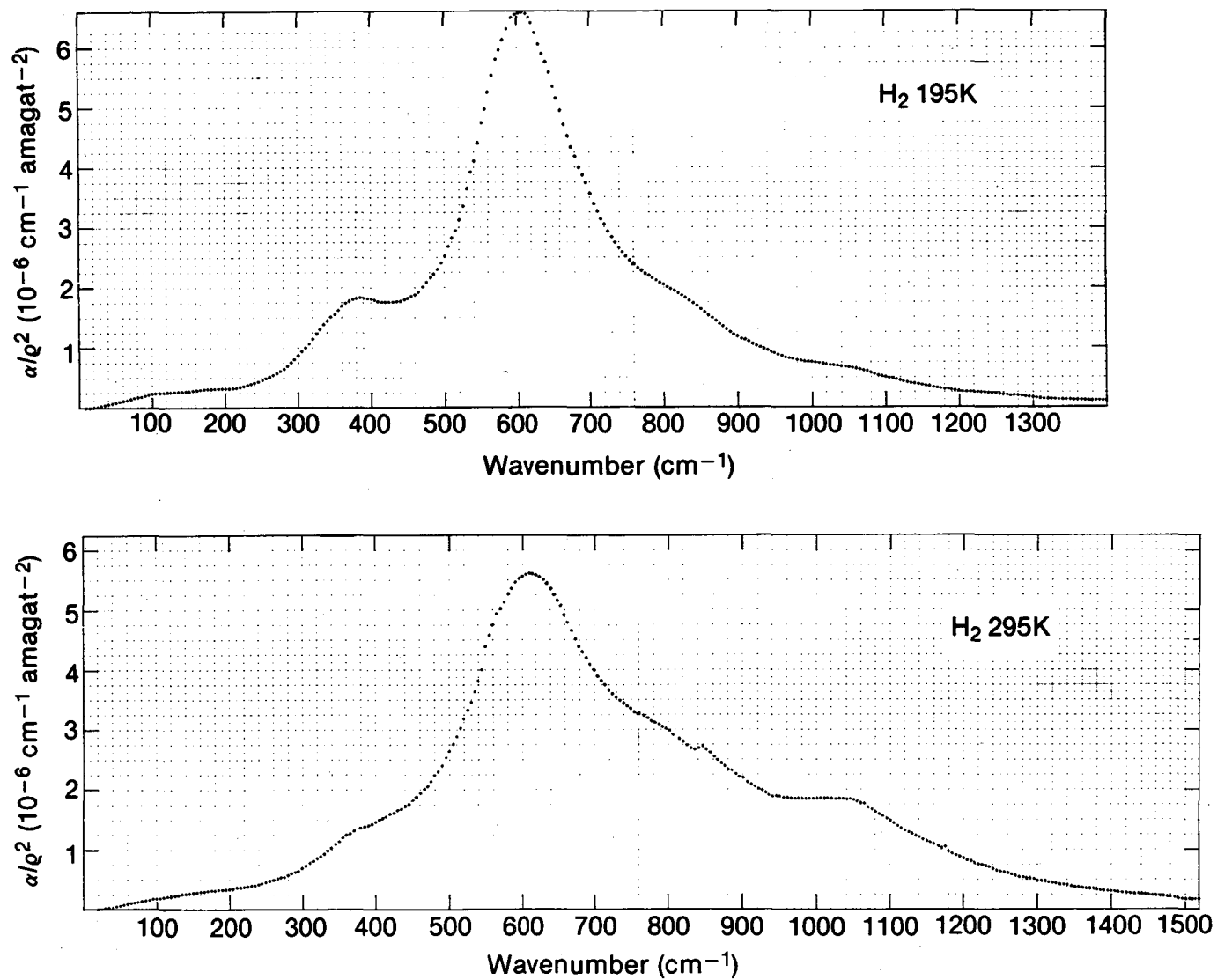

Figure 4. The translational-rotational spectrum of H₂ at 195 and 295K.

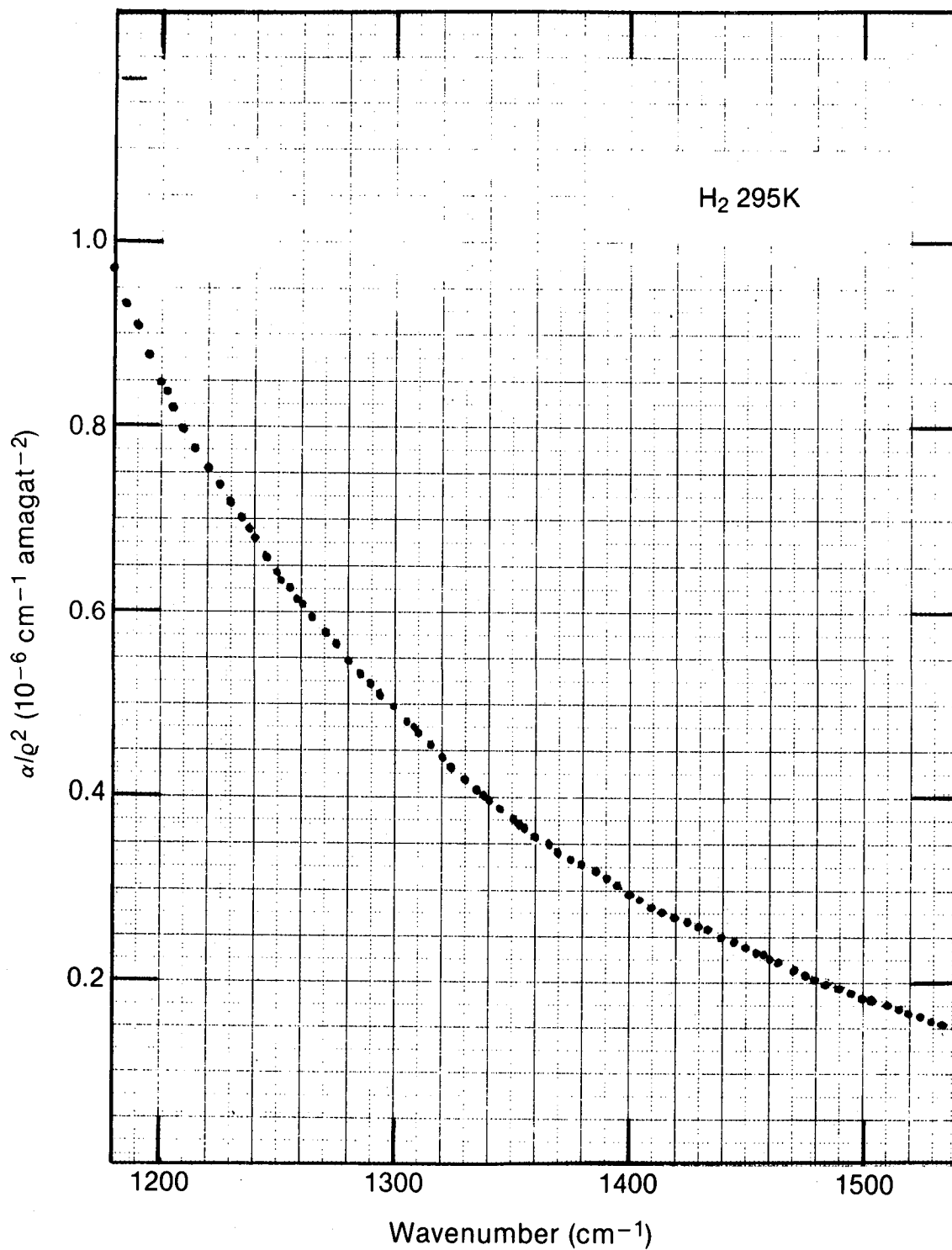

Figure 5. High frequency absorption in H₂ at 295K from 1180 to 1540 cm⁻¹.

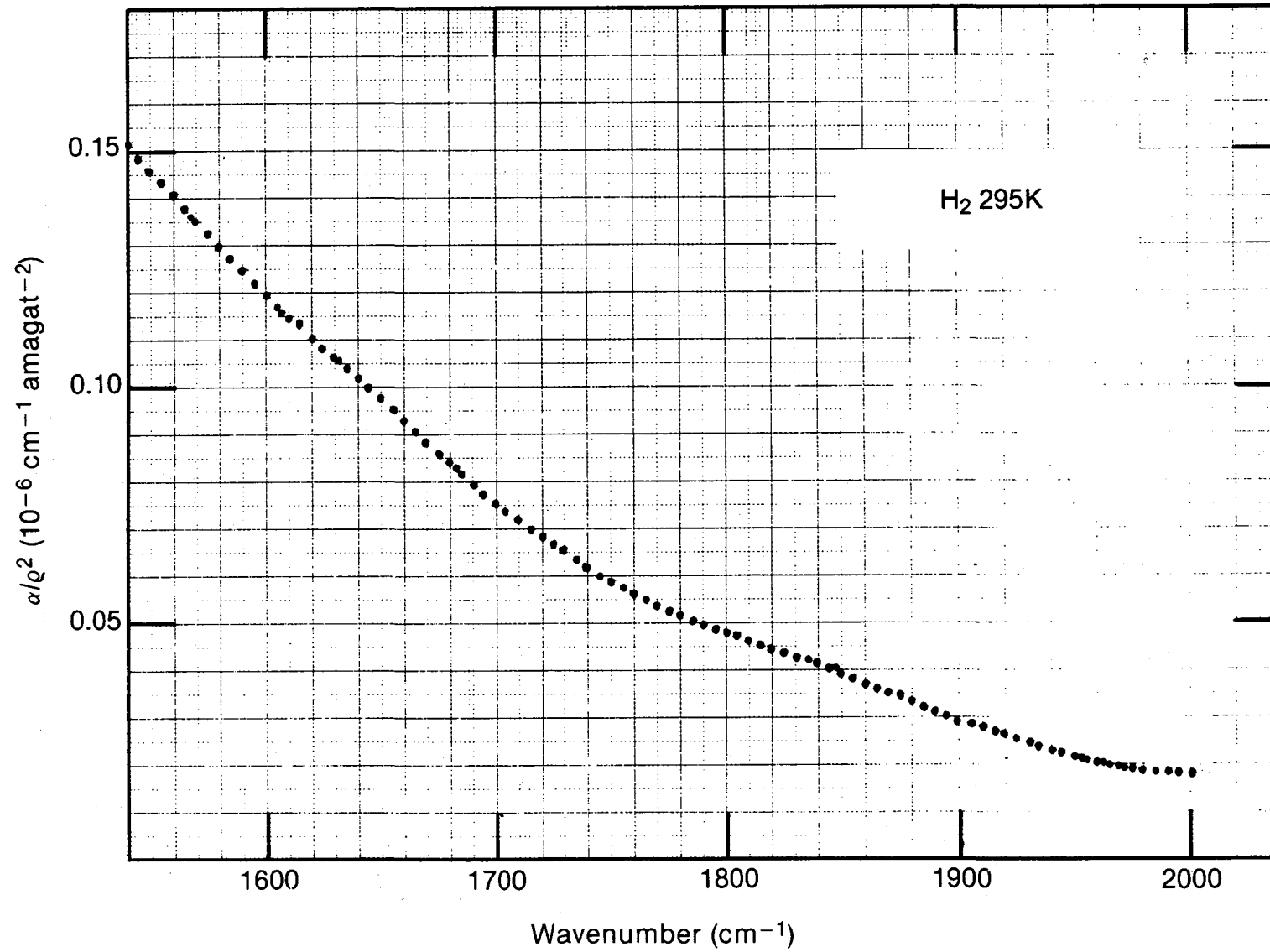

Figure 6. High frequency absorption in H₂ at 295K from 1540 to 2000 cm^{-1} .

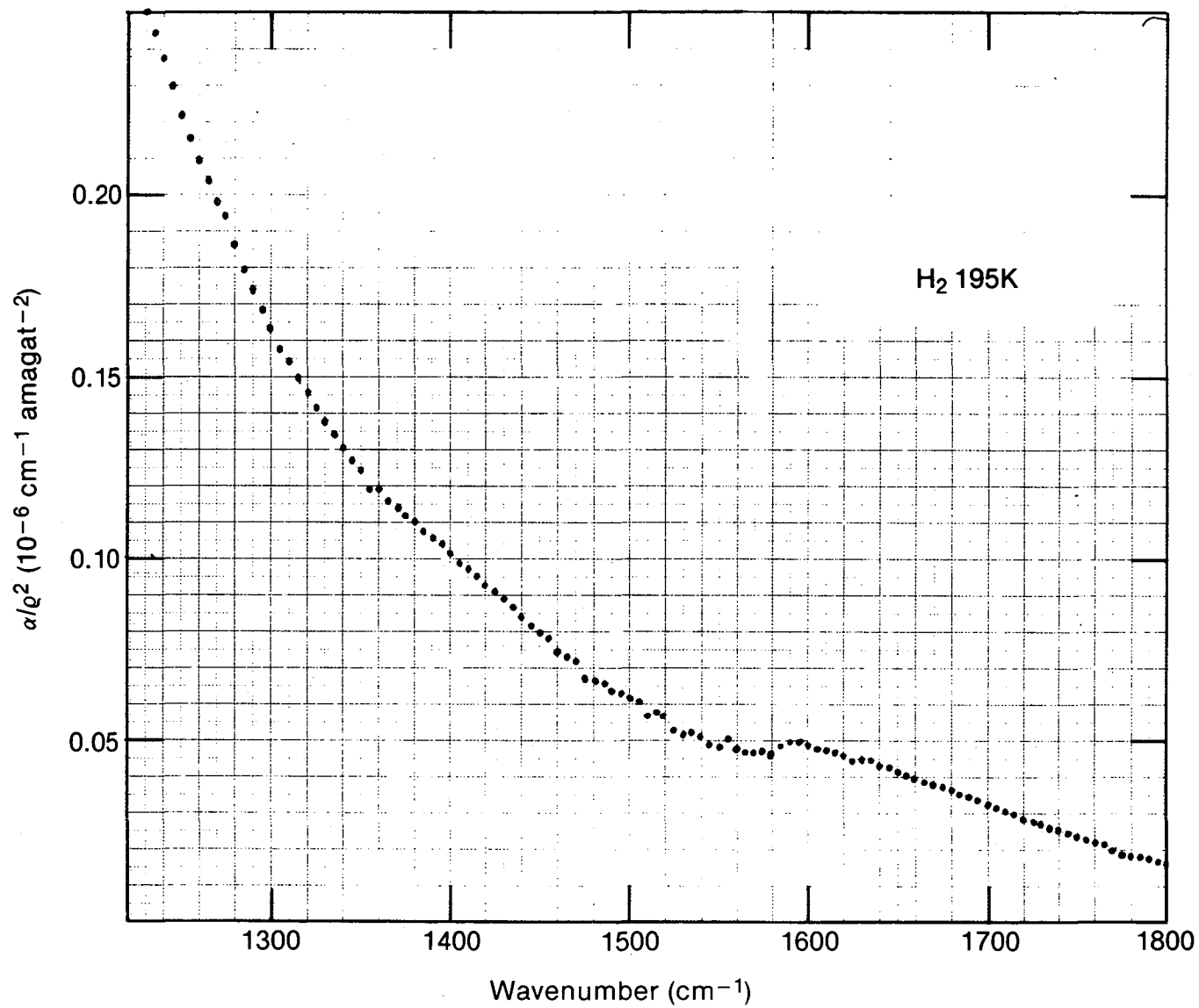

Figure 7. High frequency absorption in H₂ at 195K from 1220 to 1800 cm^{-1} .

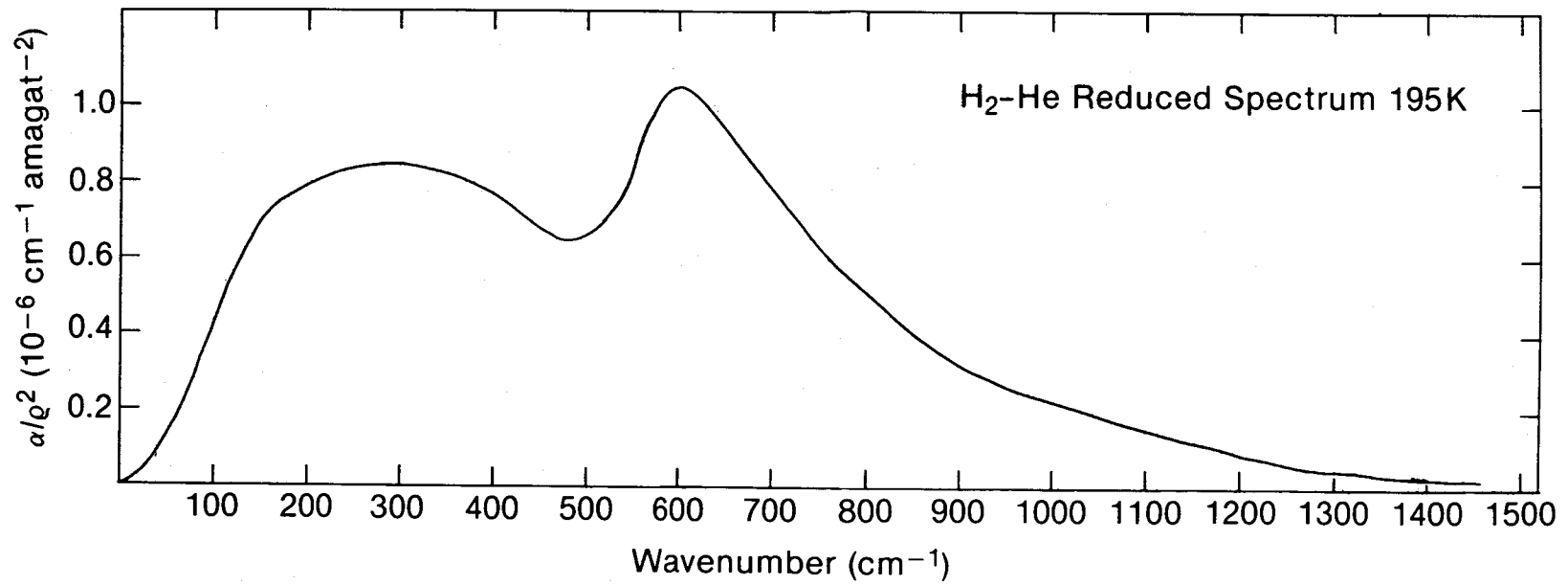

Figure 8. Translational-rotational spectrum due to H₂-He collisions at 195K.

small compared to the intensity of the rotational lines because of the relatively large value of the polarizability of CH_4 . The role of the polarizability in the intensity of a band due to multipolar induction may be seen from the average of the (induced dipole)²,

$$\langle \mu_\ell^2 \rangle \propto \frac{Q_\ell^2 \alpha^2}{\sigma^{2\ell+1}}, \quad (4)$$

where Q_ℓ is the magnitude of the multipole ($Q_2 = \Theta$, the quadrupole moment, for example), α is the isotropic polarizability and σ is a molecular diameter.³

5. Analysis of the Spectra

The results of analytically representing the spectra presented in Sections 3 and 4 are not yet available. However, we shall present some examples of fitting the $\text{H}_2\text{-H}_2$ spectra⁵ measured earlier.⁴ These data are plotted in the form,

$$D(\nu) = \frac{\alpha(\nu)/n_1 n_2}{\nu \tanh(h\nu c/2kT)}, \quad (5)$$

which is related to a transition probability. Here n_1 and n_2 are the densities, respectively, of species 1 and 2. For a single component system, $n_1 n_2$ is replaced by n^2 . The advantage of representing the data according to (5) is that it emphasizes the low frequencies, i.e., the translational band, as shown in Figs. 9 and 10. We see here the results of fitting the $\text{H}_2\text{-H}_2$ spectrum at 77 and 195K by a semi-empirical line shape which contains two time parameters, one controlling the line width and the other the exponential-like decay in the wings.^{3,5,6} The translational and rotational line shapes are seen to be the same, as required theoretically when the potential function is isotropic.⁷ The line is asymmetric, with the high frequency side decaying more slowly than the low frequency side, as required by detailed balance,

$$D(\nu') = D(-\nu') e^{-h\nu' c/kT}, \quad (6)$$

where ν' is measured from the resonance or zero frequencies.

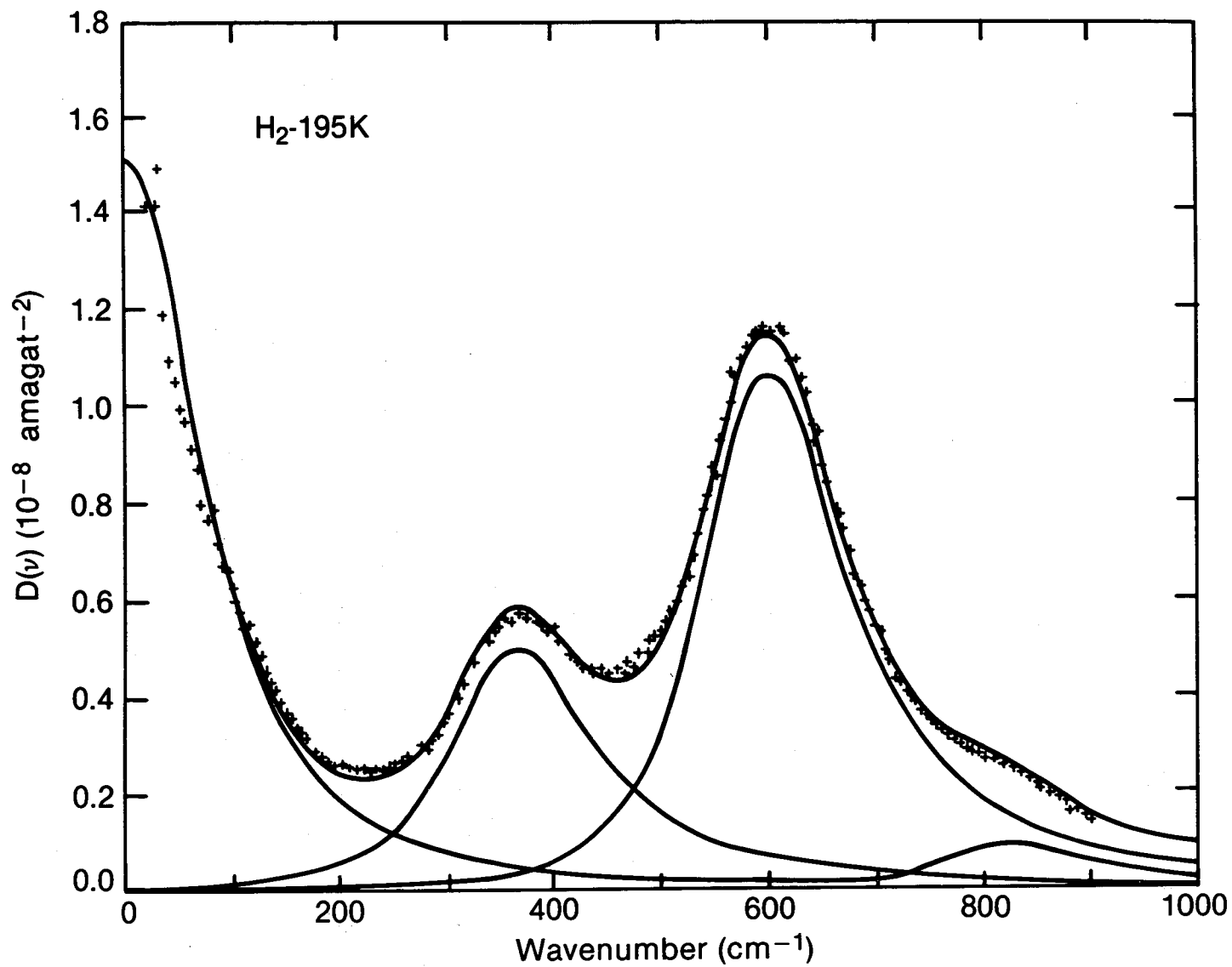

Figure 9. Three parameter fit obtained by adjusting an amplitude parameter and two time parameters (defined in ref. 5) to the spectrum of H₂ at 195K (ref. 4). The total spectrum as well as the translational and rotational components are shown.

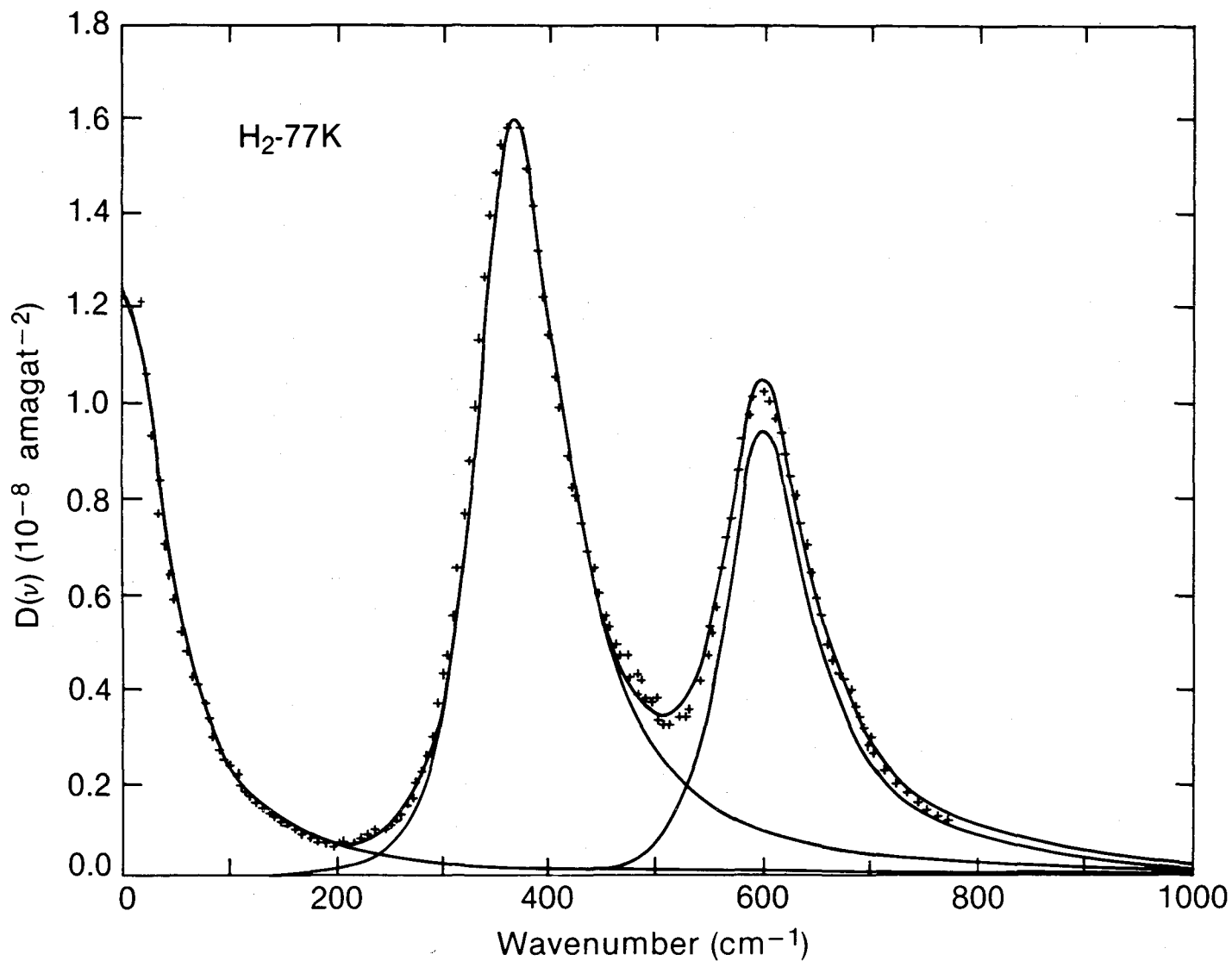

Figure 10. Three parameters fit obtained by adjusting an amplitude parameter and two time parameters (defined in ref. 5) to the spectrum of H₂ at 77K (ref. 4). The total spectrum as well as the translational and rotational components are shown.

These fits, obtained with just one set of time parameters at each temperature, deviate from the experimental points on the average by no more than several percent. Recent measurements of the collision-induced fundamental band of H_2 have been successfully fitted by the same line shape.⁸ At room temperature, where a direct comparison of these results and the present results can be made, the time parameters have the same values within the errors of the fittings. It may be possible, in view of this, to represent the H_2 spectrum extending from the millimeter to infrared wavelengths by a simple analytical function.

It is planned to fit the new data presented here with the same line shape,^{3,5,6} although in the case of the H_2 -He reduced spectrum further measurements with improved accuracy will be made. A line shape analysis of the H_2 - H_2 and H_2 -He translation-rotation spectra, which have now been measured in the far high-frequency wing, may help to determine the contribution of anisotropic overlap induction, a question which has not yet been settled. However, it is important to first test the empirical shape^{3,5,6} against an exact quantum calculation of the line shape.⁹

Experimental work in progress includes a study of the far infrared spectrum of NH_3 broadened by H_2 , particularly the absorption in the trough between the lines and the high frequency continuum. Future efforts will involve the determination of this spectrum in the 5-micron region. Also planned are further studies of the far infrared H_2 - H_2 and H_2 -He spectra at low temperatures, like 100 and 44K, of interest for planetary applications. Additional measurements of the H_2 -He spectra at higher temperatures with improved accuracy are desirable. Finally, it would be valuable to develop an atlas of these and related spectra. A compilation of reliable experimental results and a simple analytical representation of such spectra which would allow easy extrapolation to various conditions of temperature and pressure would be important for the investigation of the thermal emission from planetary atmospheres.

6. Acknowledgements

The measurements reported here were accomplished in collaboration with Drs. P. Dore, G. Bachet and H. Sutter. The author thanks Dr. G. Orton and V. Kunde for many helpful comments.

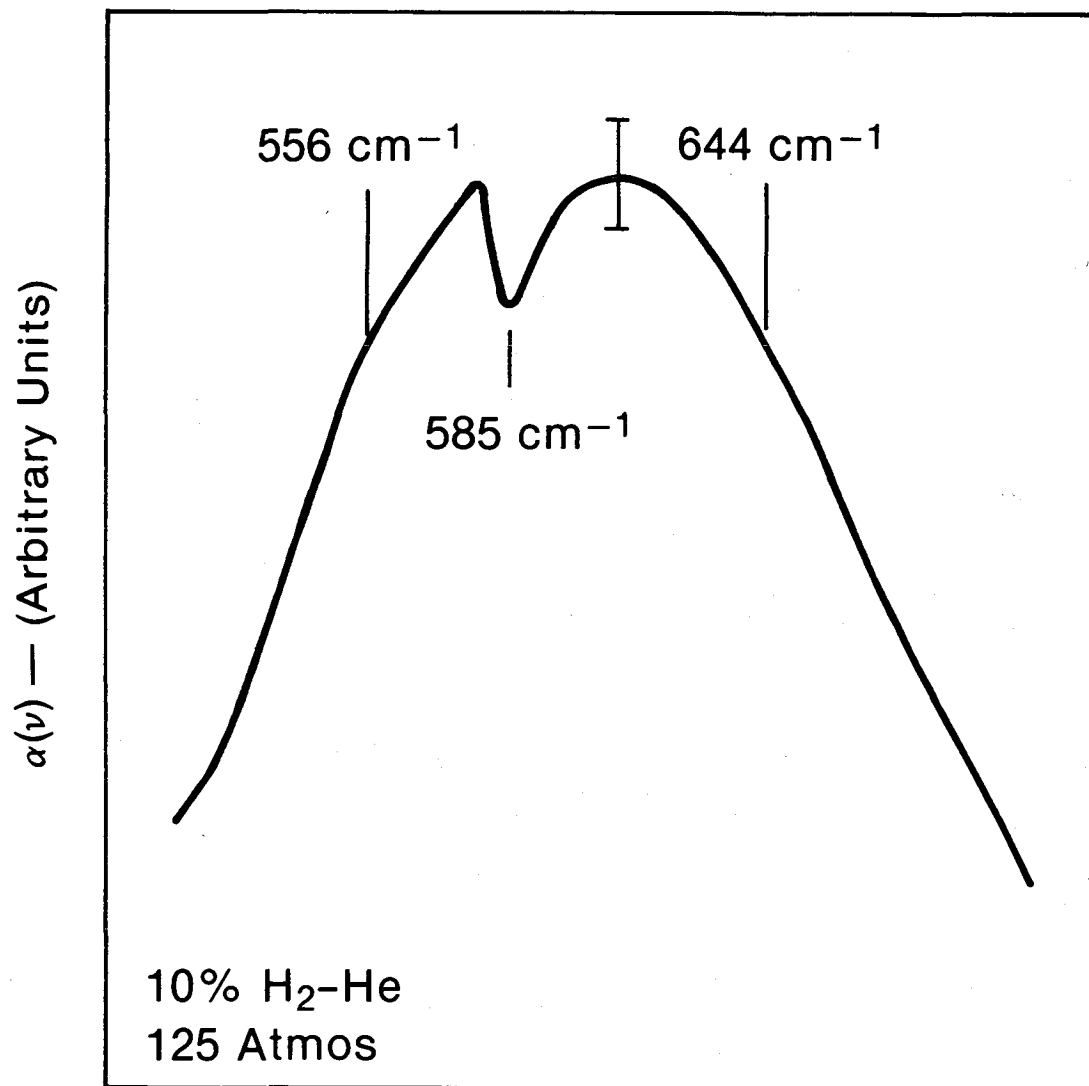

Figure 11. The S(1) line observed in a 10% H₂-He mixture (125 atmos) at room temperature showing the intercollisional interference dip. Spectral resolution somewhat less than 10 cm^{-1} . The data has been smoothed. The error bar indicated the fluctuation in the data.

References

1. J. B. Pollack, *Icarus* 19, 43 (1973).
2. G. Birnbaum, *J. Chem. Phys.* 62, 59 (1975).
3. G. Birnbaum in "Intermolecular Spectroscopy and Dynamical Properties of Dense Systems," Ed., J. Van Kranendonk, Proc. of E. Fermi International School of Physics, Course LXXV, North-Holland Pub. Co., pp. 111-145 (1980).
4. G. Birnbaum, *J. Quant. Spectrosc. Radiat. Transfer* 19, 51 (1978).
5. E. R. Cohen and G. Birnbaum, "Analysis of the Shape of the Far-Infrared Spectra of H₂-H₂ and H₂-He Collisions, National Bureau of Standards Report NBSIR 80-2175, April 1981.
6. G. Birnbaum and E. R. Cohen, *Can. J. Phys.* 54, 593 (1976).
7. J. D. Poll, Ph.D. Thesis, Univ. of Toronto, Toronto, Ontario (1960).
8. D. Goorvitch, P. M. Silvaggio and R. W. Boese, *J. Quant. Spectrosc. Radiat. Transfer* 25, 3 (1981).
9. L. M. Trafton, *Astrophys. J.* 146, 558 (1966); 147, 765 (1967).
10. J. W. Mactaggart and H. L. Welsh, *Can. J. Phys.* 51, 158 (1973).
11. S. P. Reddy and K. S. Chang, *J. Mol. Spectrosc.* 47, 22 (1973).

Discussion

Question: Regarding the spectrum of CH_4 , Fig. 2, what is the difference between "experimental" and "total"?

Response: "Total" refers to the computed spectrum, and corresponds to the rotational lines resulting from octupole-induced and hexadecapole-induced dipole transitions. "Experimental" refers to the laboratory measurements.

Question (K. Fox): As you know, Ozier and I roughly estimated the CH_4 spectrum a number of years ago. Is there any comparison between what we calculated and you have?

Response: The spectrum you and Ozier estimated was based upon octupole-induced transitions. These do not give sufficient intensity in the high frequency portion of the spectrum. The required intensity may be supplied by hexadecapole-induced transitions; however, other mechanisms may have to be considered.

Question (K. Fox): That is true for pure methane, but when H_2 is added the situation may change.

Response: The situation indeed changes when H_2 is added, since there is now quadrupole induction due to H_2 . In dilute mixtures of CH_4 in H_2 , the spectrum is dominated by this induction mechanism and gives rise to an H_2 -like spectrum as shown in Fig. 2.

Question (P. Varanasi): In the H_2 - CH_4 spectrum, Fig. 2, is the absorption induced by H_2 - CH_4 collisions or does it arise from H_2 - CH_4 complexes (dimers)?

Response: The absorption is due primarily to "fly-by" collisions and not to permanent complexes. In these collisions, the quadrupole moment of H_2 induces a dipole in CH_4 which is larger than in H_2 - H_2 collisions because the

polarizability of CH_4 is larger than that of H_2 . The molecular octupole and hexadecapole moments of CH_4 induce smaller dipoles in H_2 , in part because of the smaller polarizability of H_2 .

Question (P. Varanasi): In calculating the absorption coefficient in $\text{H}_2\text{-CH}_4$, which is the absorber? How does the absorption depend on the amount of H_2 and CH_4 ?

Response: In collision-induced absorption at low density, the absorption arises from the total dipole moment induced in a pair of interacting molecules. The intensity of the absorption is thus proportional to the number of interacting pairs, which is proportional to $\rho_1\rho_2$, where ρ_1 and ρ_2 are the densities of components 1 and 2, respectively. In multipolar induction, the induced-dipole may be considered to reside in the polarizable collision partner.

Comment: There seems to be a sharp feature in the H_2 spectrum at 195K, Fig. 4.

Response: The small feature at about 840 cm^{-1} is readily apparent because of the lack of noise in this spectrum. I don't know the origin of this feature, although I suspect it is an artifact. I plan to remeasure this region of the spectrum and to determine whether it is real.

Comment (L. Wallace): There are bumps in the H_2 spectra; they are not smooth.

Response: These bumps are due to the unresolved rotational transitions $J = 3 \leftarrow 1, 4 \leftarrow 2$, etc. Very weak double (two-molecule) transitions are also possible.

Comment (L. Wallace): I am very glad to see experiments at realistic planetary temperatures.

Comment (J. Caldwell): As I will point out in my talk tomorrow morning, there is great uncertainty about what is going on in the case of Titan. We will probably know more about Titan after Voyager goes past it, but there are some other experiments that conceivably could be of interest. In particular, Don Huntten's suggestion that N_2 has accumulated over geological time means that N_2 - CH_4 mixtures are of great interest. Unless N_2 is ruled out by Voyager, work on N_2 - CH_4 mixtures would be desirable. I also want to emphasize what Lloyd Wallace just said: If you are absolutely sure you can extrapolate to low temperatures, fine, but this is a source of concern.

Response: Because of the uncertainty in the detailed theory of the spectrum, a purely theoretical extrapolation at present would be uncertain, and measurements in the neighborhood of the planetary temperatures should be made.

Question (G. Orton): Could you mention something about the dip in the H_2 -He spectra?

Response: There has been a great deal of interest in such dips, which are due to an intercollisional interference effect involving the successive collision of H_2 with two He atoms. The phase coherence of the rotational and vibrational motion of the induced dipole component may be diminished but not lost in these collisions and the two successive induced dipoles destructively interfere. We noticed such a dip near the peak of the $S_0(1)$ line in a 10% H_2 -He mixture at 295°K and at 125 atmospheres, in a preliminary observation shown in Fig. 11.

Question: How broad is the dip?

Response: Since the spectral resolution was a little less than 10 cm^{-1} and the feature appears to have a full width of about the same order of magnitude, this preliminary observation should be checked at a higher resolution. It is interesting to compare our results with those observed in the $S_1(1)$ line

of the fundamental vibrational band of H_2 (10 amagats) in a mixture with He (130 amagats),¹⁰ nearly the same densities we used. A small dip appears in the $S_1(1)$ line which may be comparable with that in the pure rotational spectrum.

Comment: The $0 \rightarrow 1$ band of H_2 is being examined at Ames at $1/4 \text{ cm}^{-1}$ resolution, and we do see some structure that looks suspiciously like a dip. We got around to looking at it after George Birnbaum came out to visit. I would suggest that people looking into this problem consider high-resolution work.

Question (K. Fox): Concerning the far infrared H_2 -He experiment, what was the pressure, and was there any indication of a pressure dependence that did not go as the square of the pressure?

Response: Most of the measurements were made at H_2 -He densities, ρ , less than 130 amagats. In checks at several frequencies, we have not seen any definite evidence of a ρ^3 -dependence at these densities. Although, such studies have not been made near the peak of the $S(0)$ and $S(1)$ lines, the density used there is much smaller.

Question (G. Orton): Has the dip been seen in other H_2 mixtures?

Response: The effect appears to be most pronounced in H_2 -He mixtures. It has also been observed in H_2 -Ne mixtures.¹¹

Question (G. Orton): So the dip does really appear in laboratory spectra.

Response: Yes. The indication of the dip in the pure rotational $S_0(1)$ line in an H_2 -He mixture is the first such observation. However, it should be verified by repeating the measurement at high pressures and with higher resolution.

Question (P. Varanasi): What kinds of windows do you use? In this spectral region it is hard to find transparent materials to work with.

Response: There are a number of window materials which are transparent in different parts of the far infrared region. I use two types of windows: high density polyethylene from 10 to 500 cm^{-1} , and KRS-5 from 300 to 2000 cm^{-1} . One could use some of the alkali halide windows, but some of these are relatively soft and readily extrude under pressure. Such window distortion can change the intensity of the transmitted radiation significantly.

Question (P. Varanasi): What kind of gaskets do you use for the windows?

Response: With high-density polyethylene (HDP), no gaskets are used. Rings are machined in flat steel flanges between which the HDP is sandwiched. On compressing the HDP between the flanges, the HDP flows into the grooves and creates its own O-ring. KRS-5 is more difficult to seal, particularly at low temperatures, and requires the use of sealing compounds.

Comment (R. Herman): In connection with Glen Orton's question about Ne producing a dip, when both Ne and He are in the same mixture with H_2 their respective Q-dips do not sum. In fact, the heavier and more polarizable component could easily erase any effects of the Q-dip of the other component.

A Review of Acetylene, Ethylene and Ethane
Molecular Spectroscopy for Planetary Applications

W. C. Maguire, NASA/GSFC

I will discuss selected examples of spectroscopic work in acetylene, ethylene and ethane, which are of particular interest since the Voyager IRIS team is currently analyzing observations of Jupiter. We see acetylene and ethane but not ethylene in the Jovian spectrum. Two fundamental bands of the observed gases are used to determine the spatial distribution of these hydrocarbons on Jupiter and to illuminate the photochemistry of these species. In lieu of a comprehensive survey of the spectroscopy of C_2H_2 , C_2H_4 and C_2H_6 , the 100-4000 cm^{-1} region will be discussed and selected examples of current laboratory work will be given.

We are interested not only in identifying constituents in the atmospheres of the outer planets but in determining whether current photochemical models adequately explain the observed amounts and spatial distributions of methane photochemistry products. The Jovian models then will be compared to Saturn and particularly to Titan when Voyager IRIS encounters Saturn in October 1980. As we've seen from Ron Prinn's discussion this morning and Glenn Orton's talk, and as illustrated by Fig. 1, acetylene, ethylene and ethane are key gases in methane photochemistry. We want to understand not only the spectroscopy of the stable molecules in the chain but also the reaction rates of pertinent radicals. Laboratory measurements are needed by planetary scientists in two key areas - spectroscopy and reaction chemistry. Although I won't discuss the spectroscopic requirements for ethylene in much detail, it will become clear from the presentation that the state of spectroscopy of acetylene and ethane parallels that of ethylene.

Figure 2 shows a portion of the Jovian spectrum obtained with Voyager IRIS. We have plotted the observed brightness temperature for the 200-1400 cm^{-1} region. Also shown is the calculated spectrum, displaced by 20K from the observed for clarity. Strong ammonia features dominate the 950-1000 cm^{-1} range. We see the ν_5 Q branch of acetylene at 729 cm^{-1} and the ν_9 band of ethane at 825 cm^{-1} . In generating the synthetic spectrum, a constant mixing

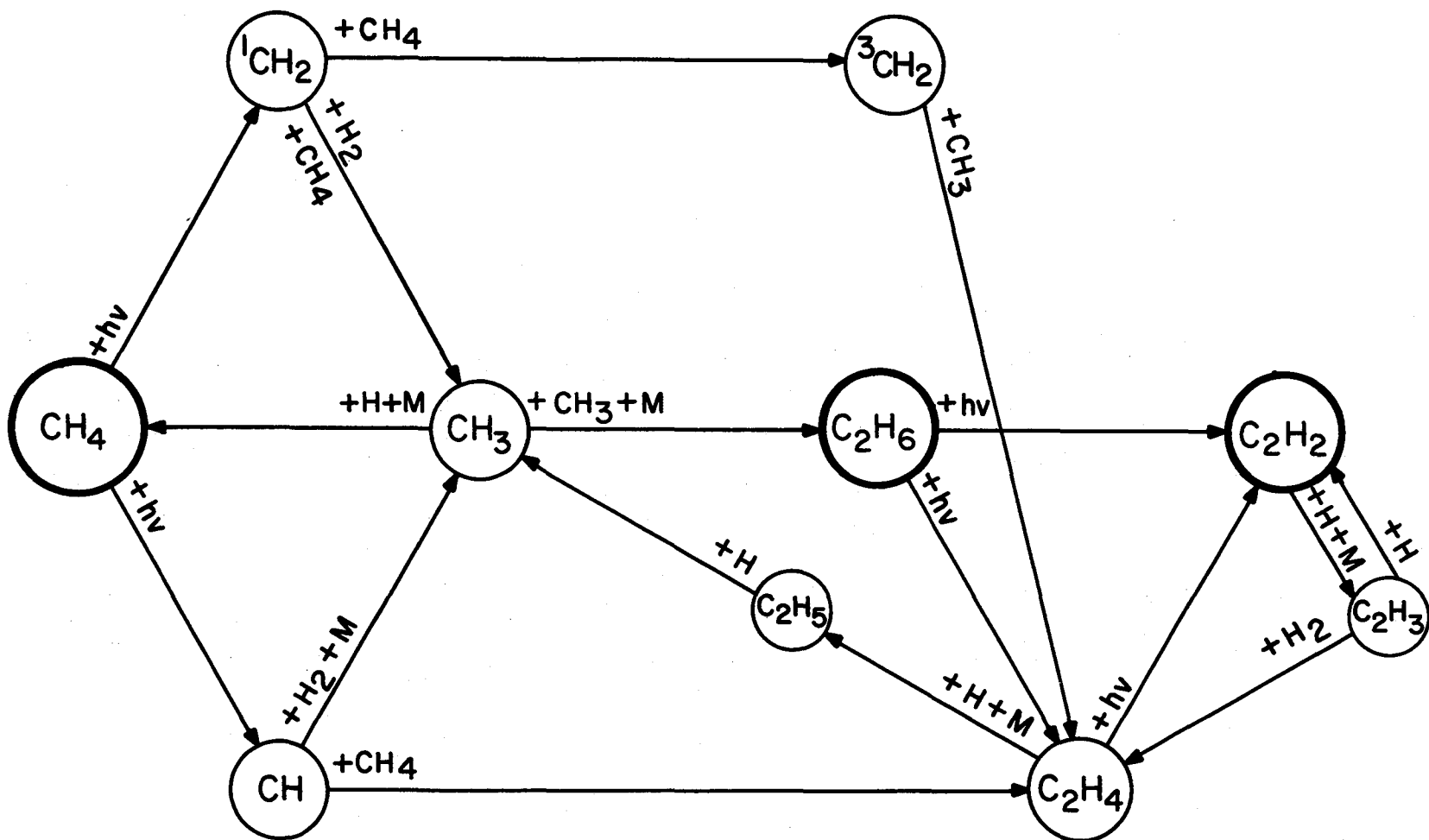

Figure 1. Principal photochemical pathways postulated for synthesis of acetylene, ethylene and ethane from methane in outer planetary atmospheres. (From Strobel, 1973).

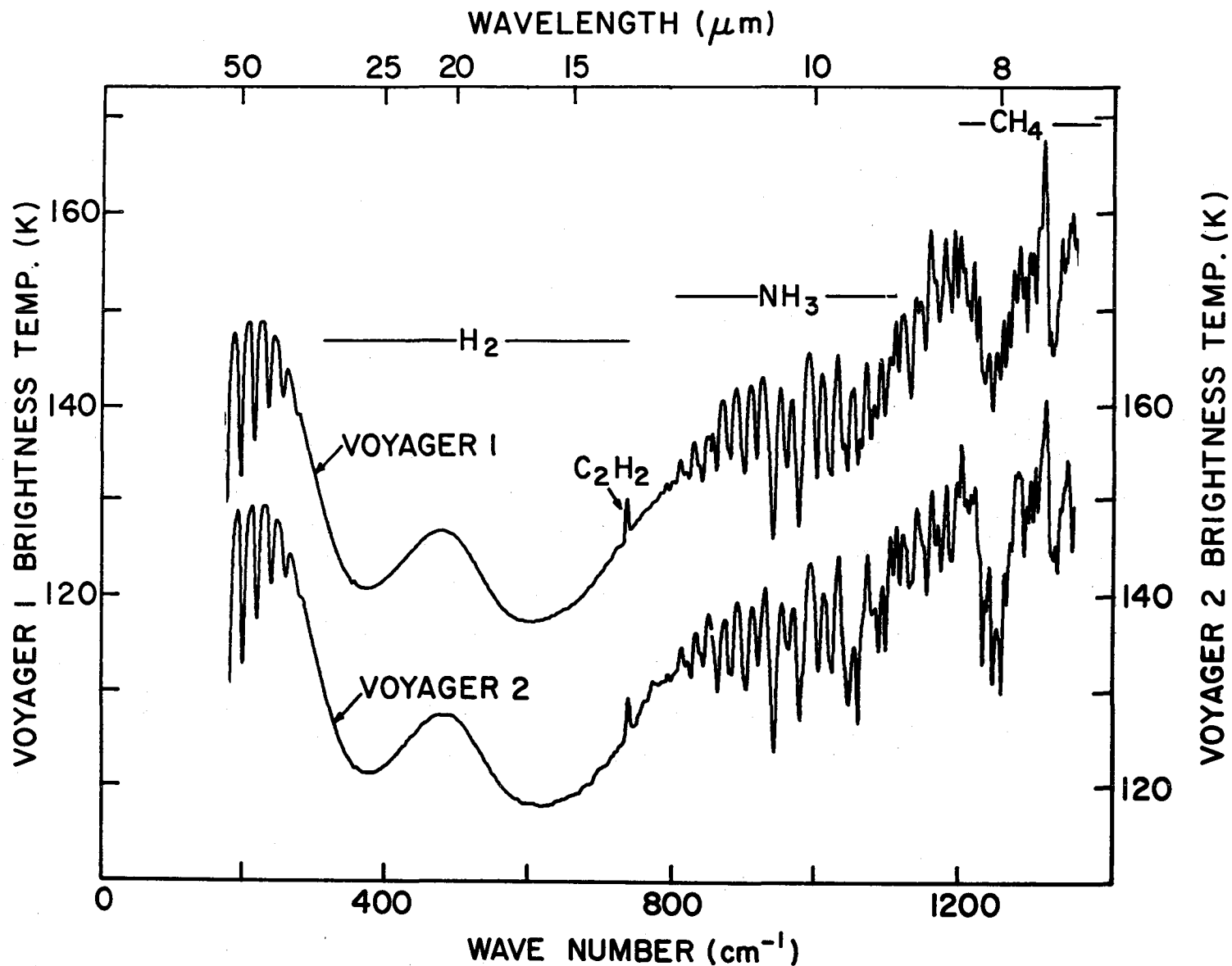

Figure 2. Voyager 1 IRIS Jovian spectrum. Observed and synthetic brightness temperatures are shown versus wave number. Strong emission features due to stratospheric hydrocarbons are seen at 729 cm^{-1} (C_2H_2) and 825 cm^{-1} (C_2H_6); strong absorption features in the $850\text{--}1000\text{ cm}^{-1}$ range are due to NH_3 .

ratio has been assumed for ethane while the acetylene distribution follows Orton's model (Orton and Aumann, 1977). We reproduce the observed spectrum by assuming a vertical distribution and then obtaining hydrocarbon mixing ratios from the data by an iterative least squares procedure. Mixing ratios are retrieved as a function of latitude for several latitudinal averages on the planet.

Considering ethylene briefly, the ν_7 fundamental of ethylene is strong but it's not observed in the Voyager IRIS spectrum. However, it is important to model ethylene's fundamentals generally, and in particular ν_7 , because it may be contributing non-negligibly to the Jovian opacity. Using line-by-line calculations together with a large number of spectra averaged together, one can difference the observed and synthetic spectra and examine the residual for minor constituents, of which ethylene is an example.

Interruption

Question (Mike Mumma): What should be the relative strength of ν_7 of C_2H_4 versus ν_5 of C_2H_2 at 120K?

Response: The strengths of ν_7 and ν_5 are comparable at 120K. However, photochemical models of the Jovian atmosphere predict the C_2H_4 abundance to be much less than that of C_2H_6 , by a factor of roughly 10^3 . On the basis of photochemical models, C_2H_4 is not expected to be observed, and the IRIS spectra provide a way to verify this.

Comment (Caldwell): I would point out that according to publications from the 1940's the intrinsic strength of ν_7 of C_2H_4 is some thirty times stronger than the visible ethane band. The reason you don't see it is my favorite mechanism. It's got a much stronger ultraviolet absorption cross-section.

Talk Resumes: Figure 3 is intended to illustrate some of the ethylene fundamentals in which we're interested in the $100-4000\text{ cm}^{-1}$ region. In particular, as we'll see later on, there's been a considerable amount of work on the ν_9 band of ethane (Fig. 4). For acetylene (Fig. 3), the ν_5 band is

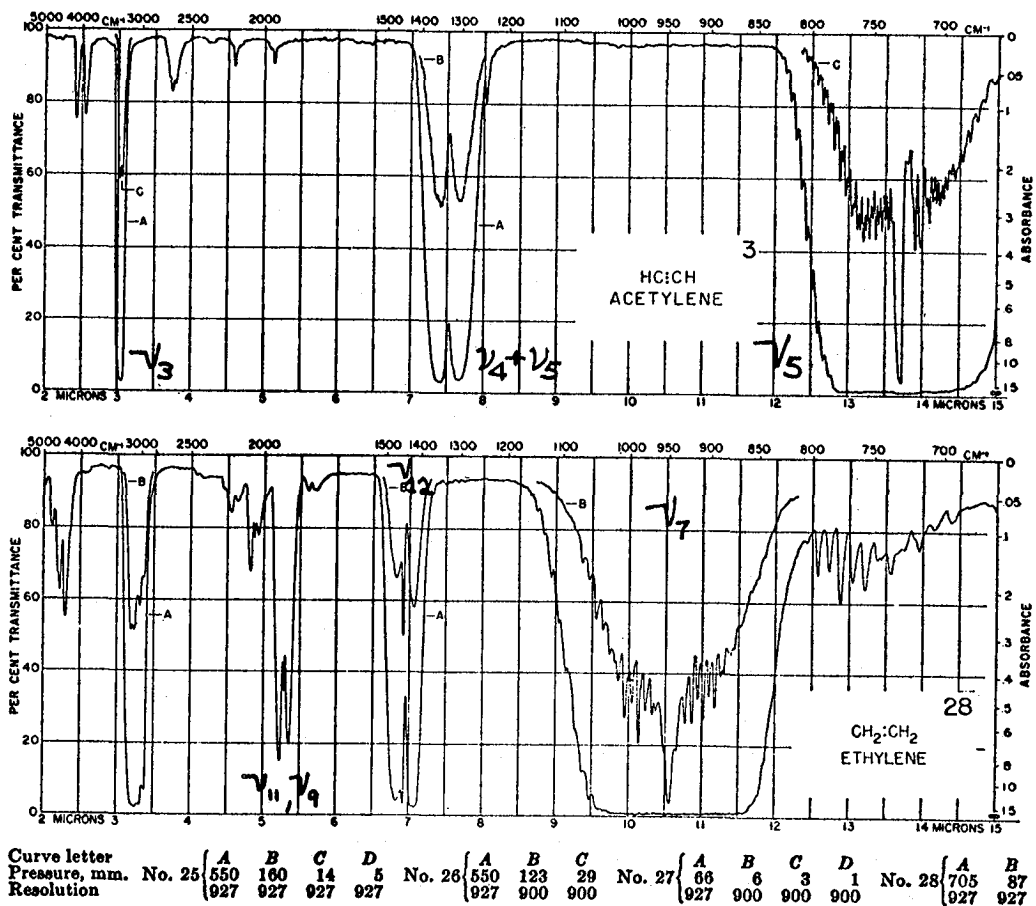
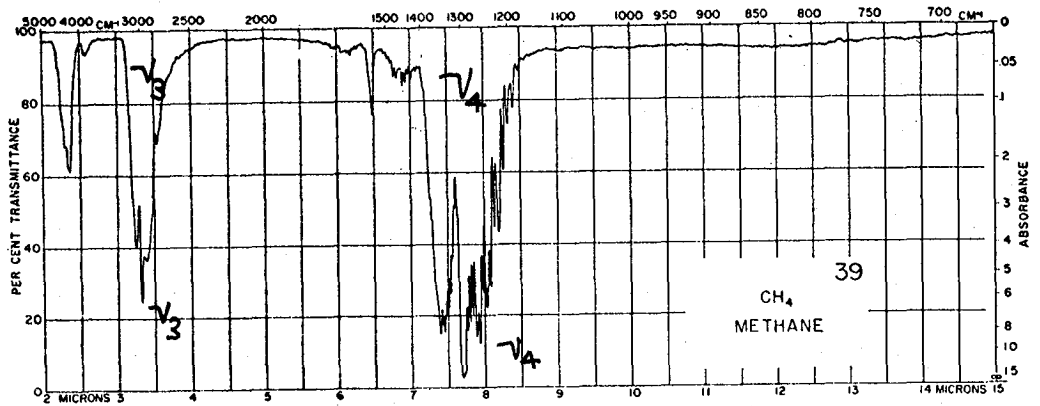

Figure 3. Laboratory infrared spectra of C_2H_2 and C_2H_4 . (From Pierson, 1956).



Curve letter	A		B		A		B		C		D		A		B	
Pressure, mm.	65		3		702		196		51		12		702		927	
Resolution	927		927		927		927		900		900		927		927	

* Absorbance at about
6.1 and 6.25 μ probably
due to NO₂.

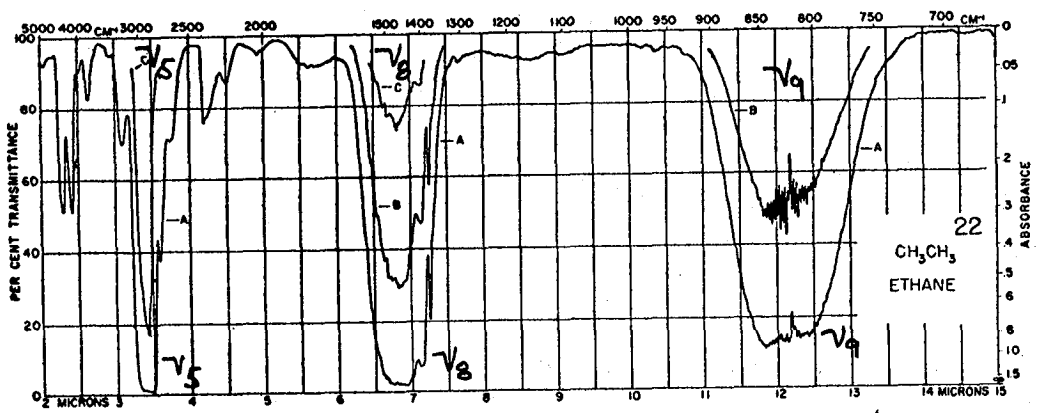

Figure 4. Laboratory infrared spectra of CH₄ and C₂H₆. (From Pierson, 1956).

very well studied, but problems remain in this region because of hot bands associated with ν_5 ($2\nu_5 - \nu_5$, for example) so our understanding of that spectral region has to be based on considering a large number of bands interacting together. The laboratory problems associated with analyzing complex, interacting bands like these have been well illustrated by other speakers. The $\nu_4 + \nu_5$ band of acetylene lies near $7.5\mu\text{m}$ and, as I'll illustrate shortly, some work has been done on this. The ν_3 band of acetylene lies near $3\mu\text{m}$.

Now, I'd like to summarize what we've seen earlier in this Workshop. Figure 4 illustrates some of the significant weaker bands of ethane out to 4000 cm^{-1} . We want to measure some of these in the outer planets' atmospheres. Due to lack of measurements at representative planetary temperatures, pressures and path lengths, one must frequently go into a laboratory and make his own measurements. The next series of tables will show gaps in the information required for interpreting planetary spectra. What we need to synthesize spectra are line positions, strengths, lower state energies, half widths, and temperature dependence, including in particular low temperature measurements of spectra. These data exist in rather spotty form. We need a more comprehensive treatment of many of these bands.

Professor Rao's work at Ohio State University has included a survey of twenty-seven bands of acetylene in the $600\text{--}6000\text{ cm}^{-1}$ range (Table 1).^{1*} The nomenclature of Table 1 is: P, S, and H indicate measurements of line positions, strengths, or half-widths, respectively. The resolution in cm^{-1} or the strength in $\text{cm}^{-2}\text{ atm}^{-1}$ at a particular temperature are given parenthetically. Now, let's proceed quickly through the measurements listed in these tables. The C_2H_2 tables survey not only the main isotopic variety of acetylene but also deuterated forms.^{2,6} In addition, we list some difference bands to which I referred earlier.³ In general, those measurements are of line positions only and don't include strength or half-width measurements. However, Varanasi and his colleagues⁴ in 1974 measured the Q-branch and the overall P-, Q- and R-branch of ν_5 of C_2H_2 so that we use those values for strengths in our abundance determinations. Here [in a succeeding entry in

*References are to notes following the text.

Table 1
C₂H₂

Band (Center, cm ⁻¹)	Wave Number (cm ⁻¹)	Investigator	Data Obtained P(Res, cm ⁻¹) S(cm ⁻² atm ⁻¹) H (cm ⁻¹ atm ⁻¹)
Survey ¹² C ₂ H ₂	600-6000 (27 bands)	Palmer et al (1972)	P(0.04 @ 13.7 μm)
Survey ¹² C ₂ HD	600-6000 (40 bands)	Baldacci et al (1976)	P
ν_5 $2\nu_5$ $(\nu_4 + \nu_5)$ (ν 729)	600-850	Scott & Rao (1965)	P
ν_5 (Q)	723-737	Varanasi & Bangaru (1974)	S(384 ± 28 @ 300K)
ν_5	620-820	Varanasi & Bangaru (1974)	S(729 ± 28 @ 300K)
$(\nu_4 + \nu_5)^{0+} - \nu_4^{1f}$ Q-Branches ¹² C ₂ H ₂ , ¹² C ¹³ CH ₂	715-716	Reddy et al (1979)	P ζ ± 0.003
$2\nu_5 - \nu_5$ ¹³ C ₂ H ₂	ν 729	Devi et al (1979)	P ± 0.0005?
$\nu_4 + \nu_5$ (1328)		Varanasi & Bangaru (1974)	S(87 ± 2 @ 300K)

Table 1 (Continued)

$v_2 + v_5^1$ (2701)		Rinsland et al (1979)	S(0.29 @ 300K)
$v_4 + v_5$ (1328)		Varanasi & Bangaru (1974)	S(87 ± 2 @ 330K)
$v_2 + v_5^1$ (2701)		Rinsland et al (1979)	S(0.29 @ 300K)
Q-Branch			
v_3 $^{12}\text{C}_2\text{H}_2$ (3287) $^{12}\text{C}^{13}\text{CH}_2$		Rinsland et al (1979)	P ± 0.005
v_3 $v_2 + v_4^1 + v_5^1$ (3290)	3295 3282	Varanasi & Bangaru (1974)	S(294 ± 6 @ 300K)
$v_1 + v_5^1$ $^{12}\text{C}^{13}\text{CH}_2$ (4091)		Rinsland et al (1979)	P ± 0.005

Table 1] we see some later work⁵ by the Ohio State molecular spectroscopy group in which line positions alone are determined; the accuracy of these line positions is given as about 0.003 cm^{-1} . Earlier in this Workshop, Professor Rao discussed some of their diode laser work, including measurements of difference bands in the carbon-13 variety of acetylene. Further strength determinations, of $\nu_4 + \nu_5$, were made by Varanasi and Bangaru (1974). Rinsland et al. (1979)⁷ have also determined Q-branch strengths of $\nu_2 + \nu_5$. Table 1 illustrates that, in general, comprehensive studies of line positions, strengths and half-widths do not exist. In many cases, only line positions are measured.

Comment (K. Narahari Rao): I can add a comment. Rinsland's data now include measurements of ν_3 of C_2H_2 .

Speaker: Rinsland et al.'s measurements are relevant to interpreting observations of cool carbon stars such as IRC 10216.

At any rate continuing to Tables 2 and 3, the situations for ethylene⁸ and ethane⁹ are demonstrated by the next series of references. Varanasi^{10,11} has made some strength determinations in the ν_9 band of C_2H_6 that we use to derive Jovian abundances. More recently, Daunt et al.¹² and Lin, Blass, and Gailar¹³ at the University of Tennessee have measured the line positions of the ν_9 band at much higher resolution ($0.04\text{--}0.05 \text{ cm}^{-1}$) and the Japanese have worked on deuterated ethane.⁹ The latter is not so critical for purposes of interpreting spectra of the outer planets¹⁴ because the abundances are probably going to be low.

If bands fall together in a wavenumber range, models considering the interacting bands may be required.¹⁵ I referred earlier to lack of knowledge of ν_8 [of C_2H_6]. Susskind¹⁶ has considered vibrational-rotational-torsional interaction in ν_8 , ν_6 , and $\nu_4 + \nu_{12}$. The latter part of Table 3 lists a number of combination bands which have been studied. An example of a comprehensive set of information on a band is that of the C_2H_6 ν_5 band, studied by Cess and

Chin who give a band strength, a line half-width, and line positions to about 0.025 cm^{-1} . It's noteworthy that their paper is oriented to astronomical applications.

Table 2
C₂H₄

Band (Center, cm ⁻¹)	Wave Number (cm ⁻¹)	Investigator	Data Obtained
			P(Res, cm ⁻¹)S(cm ⁻² atm ⁻¹) H (cm ⁻¹ atm ⁻¹)
v ₁₀ (826)	706-1150	Smith and Mills (1963)	P(0.2)
v ₇ (949.1)	700-1150	Smith and Mills (1963)	P(0.2)
v ₁₀ (810.3)		Golike et al (1956)	S
v ₇ (949.2)		Golike et al (1956)	S
v ₁₂ (1443.5)		Golike et al (1956)	S
v ₇ (949)	921-1078	Herlemont et al (1979)	P(< _r 0.0005)
v ₈ + v ₁₀ (1767)	1730-1780	Van Lerberghe & Fayt (1976)	Band center v ₀ = 1767.2 ± 1.0
v ₇ + v ₈	1847-1932	Van Lerberghe & Fayt (1976)	P(0.06)
v ₄ + v ₈ (1969)	1940-2020	Van Lerberghe & Fayt (1976)	R _Q sub-band origins

Table 3
C₂H₆

Band (Center, cm ⁻¹)	Wave Number (cm ⁻¹)	Investigator	Data Obtained P(Res, cm ⁻¹)S(cm ⁻² atm ⁻¹) H (cm ⁻¹ atm ⁻¹)
v ₉ (820.82)	750-900	Varanasi et al (1979)	P(1) S(34 ± 1.6 @ STP)
	800-850 (^R Q ₀)	Tokunaga & Varanasi (1976)	P(0.25) S(0.74 ± 0.09 @ 300K)
	775-900	Daunt et al (unpub-1979)	P(0.04 - 0.05)
v ₅ (CH ₃ CD ₃) (903.75)	908-936 (R Branch)	Nakagawa & Shimanouchi (1971)	P(0.4)
v ₆ (1379.31)	1350-1410	Nakagawa & Smimanouchi (1979)	P(0.4)
v ₄ + v ₁₂ (1414)	1450-1540	Nakagawa & Shimanouchi (1971)	P(0.4)
v ₈ (1486)			
v ₆ (1379)	1430-1560	Susskind (1974)	P(0.04)
v ₄ + v ₁₂			
v ₈	1448-1450	Kawakami (1978)	P ± 10 ⁻²

Table 3 (Continued)

ν_8	1450-1540	Nakagawa & Shimanouchi (1971)	P(0.4)
$\nu_4 + \nu_{11}$ (1757)	1780-1830	Susskind (1974)	P(0.04) \pm 0.005
$\nu_9 + \nu_{12}$	1940-2152	Lin et al (1980)	P(0.025)
$\nu_9 + \nu_{12};$ $\nu_8 + 2\nu_4$	1940-2152	Blass & Lin (1979)	P(0.025)
Survey	2000-5000	Treffers et al (1978)	P(0.3)
$2\nu_{12}, \nu_2 + \nu_9$ (2230)			
$\nu_9 + \nu_{11}$ (2302)			
ν_5 (2954)		Cess & Chen (1975)	S(1020 cm ⁻² ama ⁻¹) H(0.102(300/T)) ^{1/2}
ν_7 (2994)	2850-3100	Cole et al (1969)	P(0.025)
$\nu_6 + 2\nu_9$ $\nu_3 + \nu_9 + \nu_{12}$ (3006)			
$\nu_8 + 2\nu_9$ (3100-3150)			

Table 3 (Continued)

$$2v_4 + v_8 + v_{12}$$

$$v_2 + v_3 + v_9$$

(3185)

$$v_3 + v_9 + v_{11}$$

(3222)

Appended Notes*

1. Palmer, Mickelson and Rao have measured twenty-seven infrared bands of acetylene ($^{12}\text{C}_2\text{H}_2$) in seven selected regions using high resolution vacuum spectrographs. The range included bands in the 1.5 to 15 μm region. Bands near 1.9 and 2.6 μm were studied for the first time using vacuum spectrographs. In the 13.7 μm region a liquid helium cooled Ge:Cu detector was used to improve the long wavelength spectral resolution to about 0.04 cm^{-1} , an improvement over the 0.15 cm^{-1} resolution obtained by Scott and Rao in an earlier study. Some reassignments related to Δ - Π bands have been made. The vibrational band origin of $2\nu_5^2 - \nu_5^1$ has been shifted by about -0.1 cm^{-1} .

In the 7.5 μm region the strongest feature is the $(\nu_4 + \nu_5)^0$ band. The "forbidden" $\Delta_u - \Sigma_g^+$ band $(\nu_4 + \nu_5)^2$ has also been observed due to the effect of strong vibrational-rotational interactions.

These authors list line positions for several hundred lines in the 600-6000 cm^{-1} spectral region.

2. Baldacci, Ghersetti, Hurlock and Rao have observed the rotational structure of about 40 bands of ^{12}CHD in the 600-6000 cm^{-1} region to determine a set of molecular constants for this isotopic species.

3. In 1965, Scott and Rao published an analysis of the bands of acetylene at 13.7 μm , including the ν_5 fundamentals of $^{12}\text{C}_2\text{H}_2$ and $^{12}\text{C}^{13}\text{CH}_2$ and four "difference" bands of $^{12}\text{C}_2\text{H}_2$. Band centers of $^{12}\text{C}_2\text{H}_2$ have been determined for these bands as lying in the range 716-731 cm^{-1} . For purposes of identifying minor constituents in planetary atmospheres in this spectral region, it is important to know the location of the bands, and in particular the location of the Q-branches of these bands.

Scott has developed a computer program which, given rotational constants as input, will calculate line positions of various bands.

*In some cases these notes follow the abstracts of the referenced works.

4. Varanasi and Bangaru have measured the integrated intensity of the acetylene bands at $13.7 \mu\text{m}$ at 300°K using the Wilson-Wells-Penner-Weber technique at a spectral resolution of 0.6 cm^{-1} . They obtained a value of $729 \text{ cm}^{-2} \text{ atm}^{-1}$ with an estimated 4% accuracy for these bands.
5. More recently, the Ohio State group has measured acetylene spectra with tunable diode lasers. Reddy, Devi, Baldacci, Ivancic and Rao have used a tunable diode laser to observe the rotational structure of the Q-branches of the $(\nu_4 + \nu_5)^{0+} - \nu_4^{1f}$ "difference" bands of $^{12}\text{C}_2\text{H}_2$ and $^{12}\text{C}^{13}\text{CH}_2$ at $13.7 \mu\text{m}$. Twenty-three lines from $J = 6$ to 28 for the predominant isotopic variety and fifteen lines from $J = 6$ to 20 for $^{12}\text{C}^{13}\text{CH}_2$ have been identified. They observed the $715.0\text{--}716.5 \text{ cm}^{-1}$ region.
6. Hietanen, Antila, and Kaupinen working in Finland with a Fourier transform spectrometer have investigated the ν_5 band of C_2HD around 700 cm^{-1} . They have also studied the infrared spectrum of $^{12}\text{C}_2\text{HD}$ in the region of the bending fundamental ν_4 around 520 cm^{-1} to a resolution of better than 0.02 cm^{-1} .
7. Rinsland, Rao, Baldacci and Giorgianni have measured positions, accurate to $\pm 0.005 \text{ cm}^{-1}$, for some 3000 lines in the $3 \mu\text{m}$ region of C_2H_2 at a temperature of 160C . This laboratory study was undertaken to support observations of acetylene in cool carbon stars such as IRC + $10^\circ 216$. The elevated temperatures and high resolution allowed molecular constants to be improved for previously assigned bands as well as many new transitions. Absolute strengths for 100 lines in the seven strongest bands in the $3 \mu\text{m}$ region have been measured, including the ν_3 band of $^{12}\text{C}^{13}\text{CH}_2$. Absolute strengths of 1.67 and $0.29 \text{ cm}^{-2} \text{ atm}^{-1}$ at 300K have been determined for the integrated Q-branch strength of the $\nu_1 + \nu_5^1$ band at 4091 cm^{-1} and the $\nu_2 + \nu_5^1$ band at 2701 cm^{-1} , respectively. The total internal partition function of $^{12}\text{C}_2\text{H}_2$ has been evaluated in the temperature range 200 to 350 K from the vibrational and rotational constants of all bands within 2200 cm^{-1} of the ground state.
8. Smith and Mills (1964) have analyzed the ν_7 and ν_{10} perpendicular bands of C_2H_4 at 949 and 826 cm^{-1} with a resolving power of about 0.8 cm^{-1} . The Coriolis interactions between ν_4 , ν_7 and ν_{10} have been explicitly taken into account. Coriolis zeta constants and rotational B values have been derived for ν_7 and ν_{10} . Line positions are listed for about 200 lines in the ν_7 band.

Herlemont et al. (1979) have made laser measurements of the ν_7 band of C_2H_4 . Eleven strong absorption lines have been assigned out of 100 measured. The observed lines are in the $920-1080\text{ cm}^{-1}$ region.

9. Nakagawa and Shimanouchi (1971) have measured the infrared spectrum of CH_3CH_3 , CD_3CD_3 , and CH_3CD_3 at 0.4 cm^{-1} resolution at room temperature. They consider their relative and absolute accuracies for the frequency of an isolated line to be ± 0.02 and $\pm 0.08\text{ cm}^{-1}$, respectively. They have listed the line positions and quantum assignments for 204 lines in the bands $\nu_6(C_2H_6)$, $\nu_5(C_2D_6)$, and ν_2 , ν_5 and $2\nu_3(CH_3CD_3)$. Rotational constants for these three isotopic varieties are listed and compared to other investigators' results.

Kawakami et al. (1978) have measured the $1448-1450\text{ cm}^{-1}$ region of C_2H_6 and several peaks of the ν_8 band. They have resolved the P_{Q_5} band for the first time. They used a $Pb_{1-x}Sn_x$ Te diode laser operating at 77K. They have observed 22 lines and made quantum assignments to 14 of these lines.

10. Varanasi et al. (1974) have measured the absolute intensity and the integrated band intensity for the ν_9 band of C_2H_6 . They measured the intensity as $34 \pm 1.6\text{ cm}^{-2}\text{ atm}^{-1}$ at STP. The measurements were made on a grating spectrophotometer.

11. Tokunaga and Varanasi (1976) have measured the intensity of the R_{Q_0} branch of the ν_9 C_2H_6 fundamental and found it to be $0.74 \pm 0.09\text{ cm}^{-2}\text{ atm}^{-1}$ at 300°K . They measured the ethane spectrum from about 790 to 850 cm^{-1} at a resolution of 0.25 cm^{-1} . They compared the ratio of the measured intensity of the R_{Q_0} branch with the measurement of the entire band referred to above and found the experimental ratio to be only $2/3$ the theoretical ratio. They attribute the discrepancy to a significant contribution by the $(\nu_4+\nu_9)-\nu_4$ hot band.

12. Daunt et al. (1979) have also measured the ν_9 band of C_2H_6 at two resolutions: $\Delta\nu = 0.125-0.500\text{ cm}^{-1}$ and high resolution, $\Delta\nu = 0.04-0.05\text{ cm}^{-1}$. They fit 549 lines to a standard deviation of $6.7 \times 10^{-3}\text{ cm}^{-1}$. They list

quantum number assignments, observed and calculated line positions for 569 lines.

13. Lin, Blass and Gailar (1980) have measured the ethane spectrum from 1940 to 2152 cm^{-1} at a resolution of 0.025 cm^{-1} . More than 1000 transitions have been assigned. They derived ground state parameters B_0 , D_0 and D_0^{JK} for the principal band in this spectral region, $\nu_9 + \nu_{12}$, by using 269 ground state combination differences. Subsequently, the Fermi resonance between $\nu_9 + \nu_{12}$ and $\nu_8 + 2\nu_4$ near $5\text{ }\mu\text{m}$ has been considered by Blass and Lin (1979).

14. Treffers et al. (1978) have measured the infrared spectra of several gases having absorption features in the $5\text{ }\mu\text{m}$ region for purposes of understanding the Jovian spectrum. Ethane was measured in the $2\text{--}5\text{ }\mu\text{m}$ region at relatively low resolution, 2.2 cm^{-1} . Ethane has been detected on Jupiter in the $10\text{ }\mu\text{m}$ region using the ν_9 C_2H_6 band but there is a weak band at 2040 cm^{-1} .

15. Lambeau et al. (1980) have considered the ν_7 , ν_{16} and ν_4 interacting band system of C_2H_4 in the $10\text{ }\mu\text{m}$ region. Experimental data for the study are the 0.06 cm^{-1} resolution spectra of Johansen (1973) of the ν_7 and ν_{10} bands, high resolution (0.0003 cm^{-1}) waveguide laser spectra of 11 lines in the ν_7 band measured by Herlemont et al. (1979), and the diode laser spectra of Montgomery et al. (1975).

Montgomery et al. measured almost continuously a $5\text{--}\text{cm}^{-1}$ region including the ν_7 Q-branch with a resolution of about 0.002 cm^{-1} . The ν_4 fundamental is infrared and Raman inactive and is present in the spectrum only because of Coriolis interaction with ν_7 (948.8 cm^{-1}). Using the interacting band, asymmetric top least-squares programs of Nakagawa (1971), a fit was made to 352 lines and rotational constants for the three levels were derived. Quantum number assignments, positions, and relative intensities are listed for these lines.

Van Lerberghe and Fayt (1976) measured the $\nu_7 + \nu_8$ band of C_2H_4 at 1889 cm^{-1} with a resolution of 0.06 cm^{-1} . They measured the region from 1847 to 1932 cm^{-1} , fitting 288 transitions with a standard deviation of 0.021 cm^{-1} . Eight rotational constants are derived from this fit.

16. Susskind (1974) measured the infrared spectrum of the $\nu_{11}+\nu_4$ C_2H_6 band in the 1700-1850 cm^{-1} region to an effective resolution of about 0.04 cm^{-1} . The measured frequencies are believed to be good to 0.01 cm^{-1} . Quantum number assignments were made to some 200 lines, which were then fit with a root-mean-square deviation of about 0.01 cm^{-1} . This band exhibits a torsion-vibration-rotation interaction, becoming weakly infrared active via xy Coriolis interaction with $\nu_2+\nu_4$. In a succeeding paper he considers the interacting $\nu_{12}+\nu_4$, ν_8 , and ν_6 bands of ethane. The spectrum of ethane was measured from 1341 to 1584 cm^{-1} with a White cell at the University of Minnesota. Again, the effective spectral resolution was about 0.04 cm^{-1} and line positions for isolated lines are estimated to be known to 0.01 cm^{-1} . Features in the spectrum, such as the 1494-1499 cm^{-1} region are not completely understood.

Quantum number assignments were made to about 150 lines in the 1450-1560 cm^{-1} region. The ν_6 band center was calculated as about 1379 cm^{-1} , while $\nu_{12}+\nu_4$ was calculated to be about 1480 cm^{-1} and ν_8 about 1472 cm^{-1} .

References and Sources Cited in the Tables

- R. Antilla, J. Hietanen, and J. Kauppinen, The Infra-red Spectrum of C_2HD Around 700 cm^{-1} , *Mol. Phys.* 37 (1979) 925-935.
- A. Baldacci, S. Ghersetti, S. C. Hurlock, and K. Narahari Rao, Infrared Bands of $^{12}C_2HD$, *J. Mol. Spec.* 59 (1976) 116-125.
- W. E. Blass and R. F. Lin, Analysis of a Fermi Resonance Between $\nu_9 + \nu_{12}$ and $\nu_8 + \nu_4$ of C_2H_6 , Thirty-fourth Symposium on Molecular Spectroscopy, Ohio State University, June 11-15, 1979 (ME4).
- A. R. H. Cole, W. J. Lafferty, and B. J. Thibault, Rotational Fine Structure of the Perpendicular Band, ν_7 , of Ethane, *J. Mol. Spec.* 29 (1969) 365-374.
- S. J. Daunt, W. E. Blass, G.W. Halsey, K. Fox, R. J. Lovell, H. Flicker, and J. D. King, High Resolution Infrared Spectrum and Analysis of the ν_9 Band of Ethane at $12.17\ \mu\text{m}$, to be published in *J. Mol. Spec.*
- V. Malathy Devi, Palash K. Das and K. Narahari Rao, Diode Laser Spectra of Acetylene, Carbon-13, HCN and Other Molecular Species at $14\ \mu\text{m}$, Thirty-Fourth Symposium on Molecular Spectroscopy, Ohio State, June 11-15, 1979 (TE10).
- J. L. Duncan, D. C. McKean, and P. D. Mallinson, Infrared Crystal Spectra of C_2H_4 , C_2D_4 , and $as-C_2H_2D_2$ and the General Harmonic Force Field of Ethylene, *J. Mol. Spec.* 45 (1973) 221-246.
- R. C. Golike, I. M. Mills, W. B. Person and B. Crawford, Jr., Vibrational Intensities. VI. Ethylene and its deuterioisotopes, *J. Chem. Phys.* 25 (1956) 1266-1275.
- F. Herlemont, M. Lyszyk, J. Lemaire, Ch. Lambeau, and A. Fayt, Laser Spectroscopy of Ethylene with Waveguide CO_2 and N_2O Lasers, *J. Mol. Spec.* 74 (1979) 400-408.

- J. Hietanen, R. Antilla, and J. Kauppinen, The Infra-red Spectrum of C_2HD in the Region of the Bending Fundamental ν_4 , Mol. Phys. 38 (1979) 1367-1377.
- Harou Kawakami, Yasukazu Izawa, and Chiyoe Yamanaka, A High Resolution Infrared Spectrum of C_2H_6 Using a $Pb_{0.93}Sn_{0.07}Te$ Diode Laser, Japan J. Appl. Phys. 17 (1978) 461-462.
- D. Van Lerberghe and A. Fayt, High Resolution Study of the $\nu_7 + \nu_8$ Band of Ethylene (C_2H_4) at 1889 cm^{-1} , Mol. Phys. 31 (1976) 1875-1886.
- Aaron Levin and Charles F. Meyer, The Infrared Absorption Spectra of Acetylene, Ethylene and Ethane, J.O.S.A. 16 (1928) 137-164.
- K. F. Lin, W. E. Blass, N. M. Gailar, $\nu_9 + \nu_{12}$ Ethane Spectrum Between 1940 and 2152 cm^{-1} : Ground-State Parameters, J. Mol. Spec. 79 (1980) 151-157.
- G. P. Montgomery, Jr. and J. C. Hill, High-resolution Diode-laser Spectroscopy of the 949.2 cm^{-1} Band of Ethylene, J.O.S.A. 65 (1975) 579-585.
- Ichiro Nakagawa and Takehiko Shimanouchi, Rotation-vibration Spectra and Rotational, Coriolis Coupling and Potential Constants of Ethane, Ethane- d_6 and Ethane-1, 1, 1- d_3 , J. Mol. Spec. 39 (1971) 255-274.
- G. S. Orton and H. H. Aumann, The Abundance of Acetylene in the Atmosphere of Jupiter, Icarus 32 (1977) 431-436.
- Kent F. Palmer, Michael E. Mickelson, and K. Narahari Rao, Investigations of Several Infrared Bands of $^{12}C_2H_2$ and Studies of the Effects of Vibrational Rotational Interactions, J. Mol. Spec. 44 (1972) 131-144.
- R. H. Pierson, Aaron N. Fletcher, and E. St. Clair Gantz, Catalog of Infrared Spectra for Qualitative Analysis of Gases, Analytical Chemistry 28 (1956) 1218-1239.
- S. Paddi Reddy, V. Malathy Devi, A. Baldacci, W. Ivancic and K. Narahari Rao, Acetylene Spectra with a Tunable Diode Laser: $(\nu_4 + \nu_5)^{0+} - \nu_4^{1f} Q$ Branches of $^{12}C_2H_2$ and $^{12}C^{13}CH_2$, J. Mol. Spec. 74 (1979) 217-223.

- S. T. Ridgway, D. N. B. Hall, S. G. Kleinmann, D. Weinberger, and R. S. Wojslaw, Circumstellar Acetylene in the Infrared Spectrum of IRC + 10⁰ 216, *Nature* 264 (1976) 345-346.
- C. P. Rinsland, K. Narahari Rao, A. Baldacci, and S. Giorgianni, Acetylene Spectra Observed in N-type Stars: A Laboratory Study, Thirty-Fourth Symposium on Molecular Spectroscopy, Ohio State, June 11-15, 1979 (FA7).
- J. F. Scott and K. Narahari Rao, Infrared Absorption Bands of Acetylene, Part I. Analysis of the Bands at 13.7 μm , *J. Mol. Spec.* 16 (1965) 15-23.
- J. F. Scott and K. Narahari Rao, Infrared Absorption Bands of Acetylene. Part II. Effect of Vibrational λ -type Doubling, *J. Mol. Spec.* 18 (1965) 152-157.
- W. L. Smith and I. M. Mills, Coriolis Perturbations in the Infrared Spectrum of Ethylene, *J. Chem. Phys.* 40 (1964) 2095-2109.
- D. F. Strobel, The Photochemistry of Hydrocarbons in the Jovian Atmosphere, *J.A.S.* 30 (1973) 489-498.
- Joel Susskind, Theory of Torsion-Vibration-Rotation Interaction in Ethane and Analysis of the Band $\nu_1 + \nu_4$, *J. Mol. Spec.* 49 (1974) 1-17.
- Joel Susskind, Torsion, Vibration-Rotation Interaction in Ethane: The Bands $\nu_{12} + \nu_4$, ν_8 , and ν_6 , *J. Mol. Spec.* 49 (1974) 331-342.
- Alan Tokunaga and Prasad Varanasi, Intensity of the R_{Q_0} Branch in the ν_9 Fundamental of Ethane, *J.Q.S.R.T.* 16 (1976) 1057-1059.
- Richard R. Treffers, Harold P. Larson, Uwe Fink, and Thomas N. Gautier, Upper Limits to Trace Constituents in Jupiter's Atmosphere from an Analysis of its 5- μm Spectrum, *Icarus*, 34 (1978) 331-343.

Prasad Varanasi, Robert D. Cess and Babu R. P. Bangaru, The ν_9 Fundamental of Ethane: Integrated Intensity and Band Absorption Measurements with Application to the Atmospheres of the Major Planets, J.Q.S.R.T. 14 (1974) 1107-1114.

Prasad Varanasi and Babu R. P. Bangaru, Measurement of Integrated Intensities of Acetylene Bands at 3.04, 7.53 and 13.7 μm , J.Q.S.R.T. 14 (1974) 839-844.

Discussion

Question (Ken Fox): Can you briefly describe the story about acetylene in IRC 10216?

Response: Ridgway et. al. searched for acetylene in IRC 10216 and other cool carbon stars to derive temperatures of the outer shell. Rao's group⁷ made some lab measurements relevant to interpreting the stellar spectra.

Question (K. Narahari Rao): Is there a remote possibility of looking for C₂HD in the Jovian spectrum?

Response: I think there is. Of course, the D/H ratio is expected to be small and this hurts you. A requirement in searching for the deuterated version of a molecule is sufficient spectral resolution. In particular, IRIS Voyager spectra have a spectral resolution of 4.3 cm⁻¹ so it is problematic to detect C₂HD in those spectra.

Comment (R. Beer): It might be interesting to find other molecules which contain deuterium because the amount of deuterium fractionation differs from molecule to molecule.

Comment (?): The altitude profile for deuterium fractionation is a very important parameter in an atmosphere, because it is related to the formation chemistry of deuterated molecules deep in the atmosphere. We will never really know the D/H ratio in the major planets until we solve the problem of fractionation.

Comment (Barry Lutz): I'd like to point out that that factor is not even known in the case of CH₃D to CH₄ in the Earth. No one knows the ratio of CH₃D to CH₄ in the planets for methane.

Response (Maguire): We could look at either HD or at deuterated methane (CH₃D). Currently, we use the latter.

Question (Bob Cess): In the 3000 cm^{-1} region, aren't you getting blacked out by the regular methane in the Jovian spectrum?

Answer: For that spectral region that's true.

Question (Bob Cess): Even if you had good laboratory data for ethane or acetylene, it won't help you very much will it?

Answer: That's right. However, we do need additional data for certain regions, and there are several I would recommend for studies. It is important to look at the ν_5 region of acetylene. We need to understand the stronger interacting bands in that region: $2\nu_5 - \nu_5$, $\nu_4 + \nu_5 - \nu_4$, and similar strong bands. Now for ethane, I think ν_8 (1400 cm^{-1} region) is a primary candidate. Methane and ammonia absorb in the same spectral region but ν_8 of ethane is a strong band. More generally, a primary need is for measurements at low temperatures for ethane and acetylene for planetary applications. Also, users need data in tape atlas form such as that provided by the Air Force Geophysics Laboratory. I ask spectroscopists to bear that in mind, even though assembling data in such a format is not the primary purpose of spectroscopic work.

Comment (Alan Tokunaga): This supports Bill's plea for low temperature data. Ground-based spectra of Jupiter show ethane very clearly in emission; notice that the $^R Q_0$ branch at the center is enhanced relative to the other Q-branches. A spectrum of Saturn at 1 wavenumber resolution (the previous spectrum of Jupiter was about .3 wavenumber) shows that the central Q-branch (indicated by the arrow) is lower in intensity than the neighboring Q-branches. I believe this is some kind of temperature effect that I don't understand. These examples show that we do need more data, especially at low temperature to understand features of gases such as ethane.

(Ed. - Tokunaga's Figures not available.)

Question (Mike Mumma): Are the noise levels of those spectra sufficiently low to be certain that this effect is real?

Answer (Alan Tokunaga): I normally would not show this spectrum because of the high noise level. One might perceive a depressed Q-branch because of high noise, but there are confirming data taken by the Lick group with their cryogenic equipment. They also find this central Q-branch to be depressed a little bit relative to the neighboring Q-branches, so it appears to be a real effect. If there is any suggestion as to what could cause this, I'd be interested.

Question (Mike Mumma): What are the brightness temperatures at the peaks of those branches?

Answer (Alan Tokunaga): The brightness temperatures are roughly about 107K in the continuum, and something between 115-120K for the peaks.

Comment (Don Jennings): Strength anomalies have been observed in line-by-line diode laser spectra.

Answer (Alan Tokunaga): One important question is whether those anomalies are due to hot bands.

Response (Don Jennings): There may be a connection. I don't know if there's an explanation for the line-by-line anomalies as well as in the Q-branches.

Question (Glenn Orton): Bill, what molecular constants are you using for IRIS data reduction in the meantime?

Reply (Maguire): I used Scott and Rao's rotational constants for acetylene. For ethane, I used rotational constants given by Tokunaga, however, much better values exist today.¹²

Comment (Glenn Orton): Our problem is always: what are the relevant intensities of overtones and hot bands, too--near fundamental ν_5 for example?

Speaker: In the absence of laboratory measurements, you may use a harmonic oscillator approximation, however the results are often poor.

Response (K. N. Rao): I just want to comment on the need for data. I am aware of some needs, but unless through proceedings like this or written letters, I cannot go and say to my associate that this is an important problem to look at. For instance, a long time ago, several bands of phosphine were recorded by one of our graduate students at several different resolutions. He threw in the towel and said, "Who in the world would be interested in $\nu_1-\nu_3$?" This philosophy does exist among graduate students who want to make an important contribution. I think that NASA, through this type of workshop proceedings, should identify important problems based upon need. If we don't do that, there is a problem unless you have dedicated people (who are becoming smaller and smaller in number in your universities). Part of the problem lies in knowing the type of information needed, and the other part lies in having inadequately detailed information in the published literature. This is a problem in the space requirements, the ratio between the number of textual pages and the number of tabular pages--nobody wants to buy journals which contain only numbers. There must be some text in it. If you need certain information and it's not in the literature, write to me or the office and I'll be very happy to provide you with more information than you need.

Comment (Orton): I suggest a solution to that problem. Do what Alan Robiette did; he tabulated 12,000 lines for ν_2 and ν_4 and sent it to us through the AFGL format. We can now use it in the future in a familiar format.

Comment (Mike Mumma): The purpose of this workshop is to make recommendations, not only to graduate students, but to NASA Headquarters. Our recommendations should consider not only what molecules and bands are important to measure, but also questions such as: should NASA be actively supporting the general molecular effort for atmospheric research?; should there be, for example, a national center for spectroscopy? You will have an opportunity to make your wishes known in the group discussion tomorrow, and to make recommendations.

Comment (Ken Fox): I'd like to clarify the situation that Don Jennings referred to a few minutes ago about strength anomalies in the diode laser spectrum of ethane. Several years ago, I suggested to Reisfeld (Los Alamos)

that his group might be interested in running a diode spectrum of the 12 micron band of ethane. He did, and it revealed some unusual torsional splittings that had not been observed before. This spectrum has not yet been published because the theoretical explanation of the splittings is not yet complete.

CURRENT STUDIES OF CH₄ FROM 2.5 to 7 μ m

Linda Brown (JPL)

The people listed in Figure 1 are working together to analyze the 3.5 μ region of methane. For this, we have measured the positions and strengths of approximately 9000 absorption lines in the region from 2400 to 3200 cm^{-1} . Our spectra were obtained at a resolution of 0.1 cm^{-1} using the Fourier transform spectrometer (FTS) at Kitt Peak National Observatory, and at 0.02 cm^{-1} resolution using the four-passed grating spectrometer at Florida State University. The compilation of line lists with such large numbers of absorptions has not been a routine task for laboratory spectroscopists. Since our analysis of the 3.5 μ m region required the use of spectra of CH₄ in other regions, I will indicate what lies in the methane spectrum from 1200 to 4700 cm^{-1} and demonstrate how the compilation of such lists is accomplished.

With a small optical density of methane gas, one observes absorption at two places in the infrared: at 1300 and 3000 cm^{-1} , corresponding to the two fundamentals ν_4 and ν_3 , respectively (Figure 2). The other two fundamentals of methane are not vibrationally active in the infrared, but do have strong structure in the Raman spectrum: ν_2 at 1533 cm^{-1} and ν_1 at 2917 cm^{-1} . The spectrum shown in Figure 2 is a synthetic spectrum, generated from parameters on the AFGL Tape and plotted at a compressed resolution of .06 cm^{-1} . We've also plotted a small portion at .02 cm^{-1} , to show you the visual texture of the data we analyze. One sees the characteristic features of methane bands: dense Q-branch spectra with P- and R-branch manifolds spaced at fairly regular intervals, representing transitions to the higher values of the angular momentum quantum number, J. There have been many analyses of the fundamentals of methane (1-3 and the references therein), but most of them have been at low optical density. The more recent include the simultaneous fitting of the

WILLIAM BENEDICT

JAMES BRAULT

LINDA BROWN

ROBERT HUNT

JENS-ERIK LOLCK

ALAN ROBIETTE

ROBERT TOTH

KITT PEAK NATIONAL OBSERVATORY

JET PROPULSION LABORATORY

FLORIDA STATE UNIVERSITY

UNIVERSITY OF READING, ENGLAND

UNIVERSITY OF READING, ENGLAND

JET PROPULSION LABORATORY

SPECTRA OBTAINED AT:

0.02 cm^{-1} RESOLUTION WITH THE FOUR-PASSED GRATING
SPECTROMETER AT FLORIDA STATE UNIVERSITY.

0.01 cm^{-1} RESOLUTION (UNAPODIZED) WITH THE FTS AT
KITT PEAK NATIONAL OBSERVATORY

Figure 1. Researchers who have participated in the analysis of the 3.5μ region methane using data recorded at high resolution.

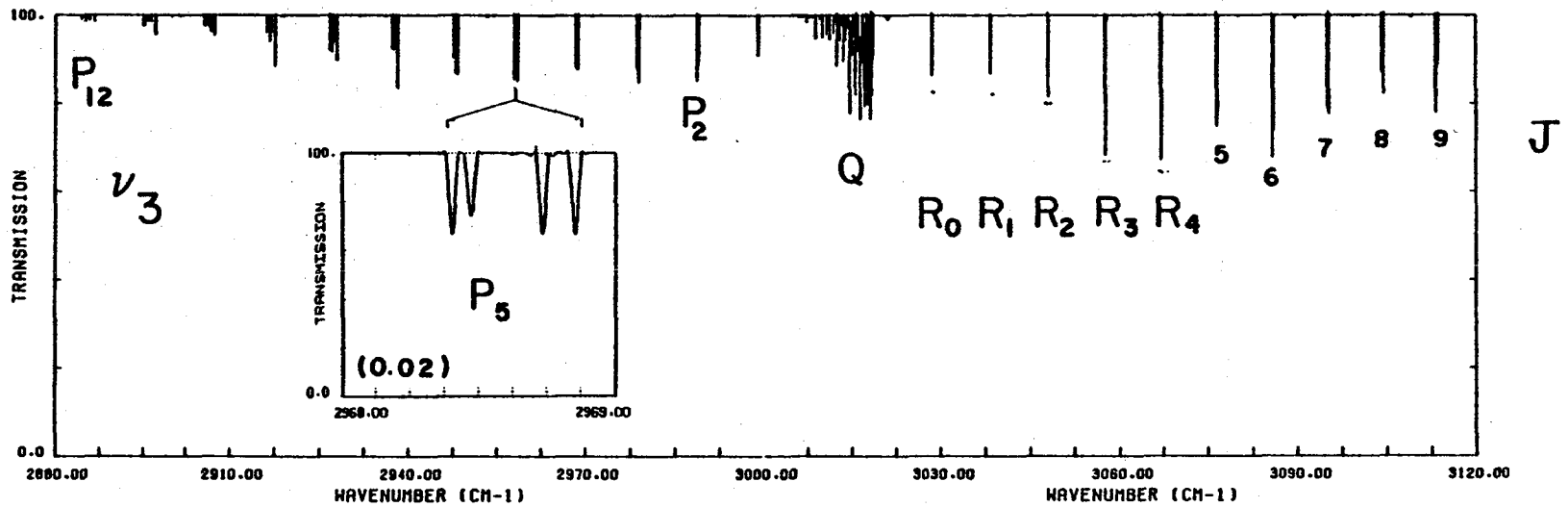
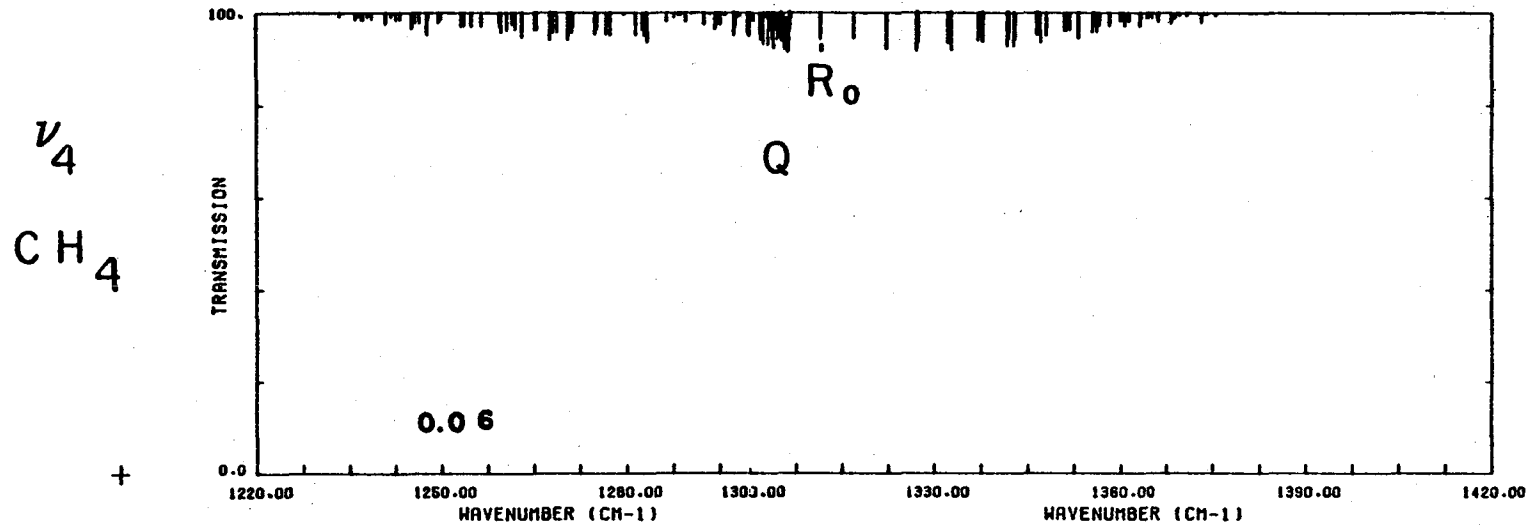

Figure 2. Synthetic spectrum of the ν_3 and ν_4 fundamentals of CH₄ using AFGL parameters. The spectrum is plotted at 0.06cm^{-1} resolution with a small extract plotted at 0.02cm^{-1} to represent a low optical density scan.

positions of the ν_4 band with the less accurately determined positions of the band Raman data (2 and the references therein). Recently, Orton and Robiette have produced a theoretical calculation of the positions and strengths of the ν_2 and ν_4 infrared bands of $^{12}\text{CH}_4$ and $^{13}\text{CH}_4$, extrapolating to $J = 25$ (4).

Imagine increasing the optical density by two orders of magnitude from that shown in Figure 2. Figure 3 shows the same spectral region as it is observed with the high resolution FTS (5), recorded at 1.5 torr, with a path length of 4 meters, and at room temperature. Comparing the spectra of Figures 2 and 3, it is evident that with increased optical density many additional lines are present. Some are high- J lines of the ν_4 band (for example the lines between 1299 and 1301cm^{-1}) and the absorptions of $^{13}\text{CH}_4$ are also present in isotopic abundance. At 1500cm^{-1} , our spectrum contains H_2O absorption lines, marked by the circles, but the remaining lines are the transitions of ν_2 CH_4 , which borrow intensity from the stronger ν_4 fundamental. These ν_2 lines have intensities comparable to the $^{13}\text{CH}_4$ lines of ν_4 , seen in the left panel of Figure 2. This year Jack Margolis has completed the first high resolution infrared analysis of ν_2 and made quantum assignments to as high as $J = 14$ (5).

If we look at the ν_3 region at about the same intermediate optical density as that of Figure 3, we see about 3000 absorptions between 2400 and 3200cm^{-1} . Figure 4 shows a portion of our grating spectrum of ν_3 , recorded at Florida State, at 0.02cm^{-1} resolution with the gas sample at 296K and 160K . The pressure was 10 torr and the path 0.46m . In a separate study, Gray, Robiette and Pine (3) have measured and fitted the strong P, Q and R branch manifolds to $J = 19$. We find that our own individual line strength measurements (6) agree with their measurements to within a few percent and that their calculations of the ν_3 band fairly well represent the positions and strengths, although large deviations occur at the higher J . At this intermediate optical density, the so-called forbidden transitions (for

THE ν_4 AND ν_2 REGIONS OF CH_4

507

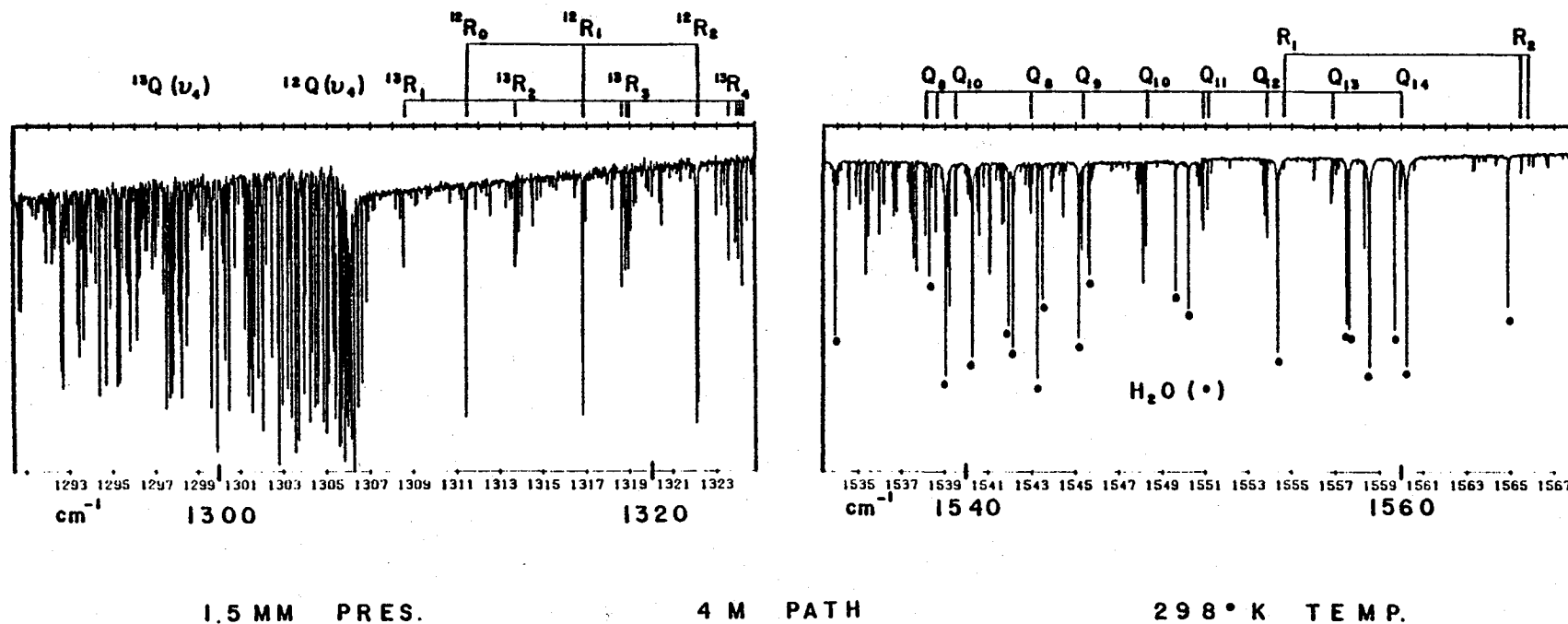

Figure 3. Spectrum of $^{12}\text{CH}_4$ recorded at an intermediate optical density with the FTS at KITT Peak. In the left panel, transitions of the ν_4 fundamental $^{12}\text{CH}_4$ and $^{13}\text{CH}_4$ are labelled. In the right panel, the H_2O lines are indicated, and the remaining lines of ν_2 of $^{12}\text{CH}_4$ have strengths similar to the $^{13}\text{CH}_4$ ν_4 lines observed in isotopic abundance.

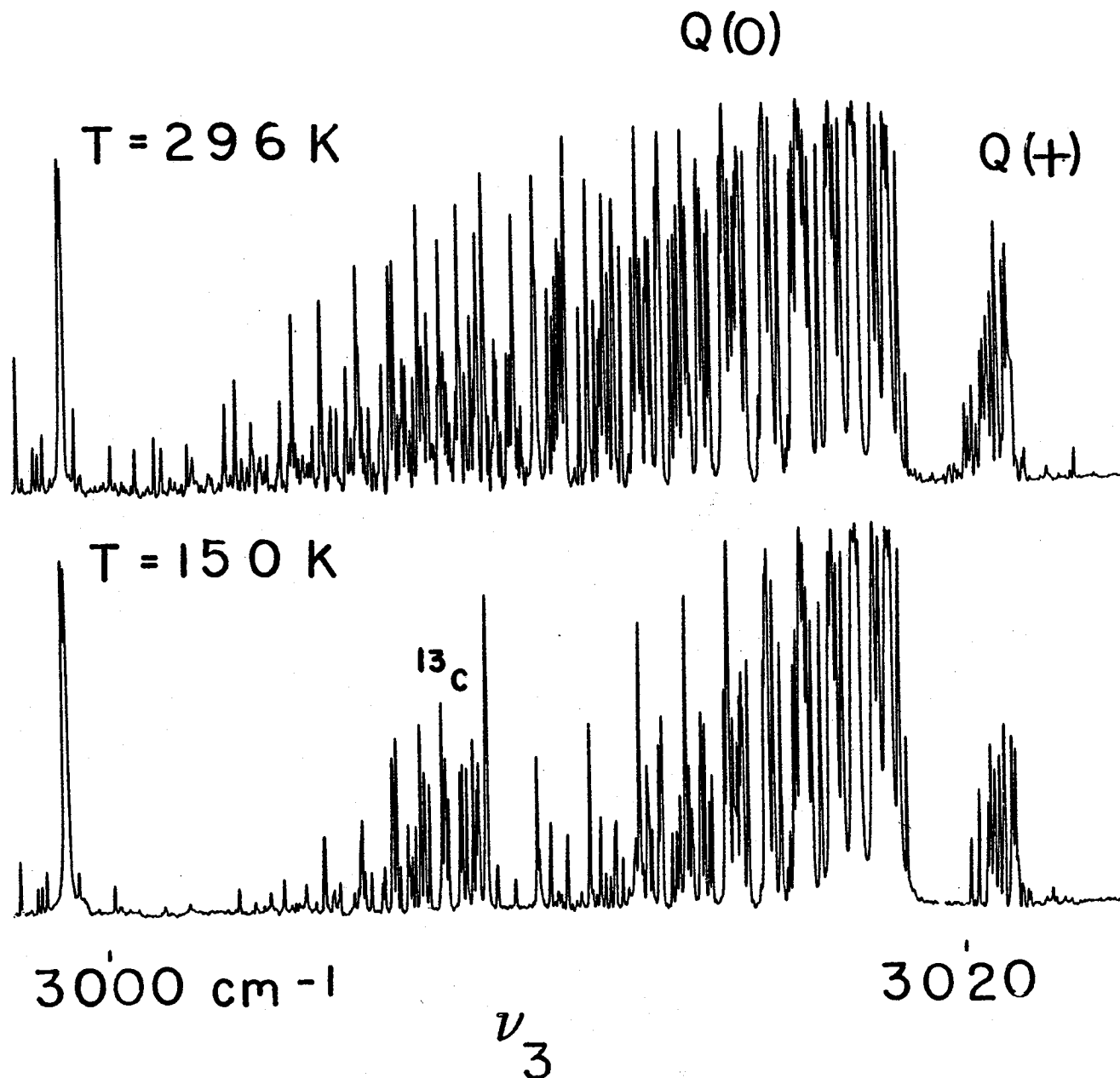

Figure 4. The spectrum of methane at 3000 cm^{-1} recorded at an intermediate optical density at 0.02 cm^{-1} resolution with the Florida State University grating spectrometer with the gas sample at 296 K and 150 K . The allowed $Q(0)$ and forbidden $Q(+)$ branches are indicated, as well as the $^{13}\text{CH}_4$ Q branch, for the ν_3 fundamental.

example, the forbidden Q (+) at 3020cm^{-1}) arise with strengths that are 2 or 3 orders of magnitude weaker than the allowed lines of $^{12}\text{CH}_4$, but similar to that of the $^{13}\text{CH}_4$ lines at 3008cm^{-1} (7). The spectrum of Figure 4 demonstrates how the line strengths change with temperature, according to the value of the lower state energy, specified by J transition. The lines between 3010 and 3015cm^{-1} (present in the 296K spectrum but missing in the 160K spectrum) are the high J lines; lines for J about 10 or less appear in both spectra.

It is very helpful for laboratory spectroscopists to examine a spectrum recorded in this way. However, visual impressions cannot be manipulated by the computer when one is trying to model a particular planetary atmosphere. The lower state energy is needed for each line, which can be obtained using the equation shown in Figure 5. One records the spectrum at two different temperatures as in Figure 4, measures the line strength at those temperatures, and solves for the lower state energy. Having determined the lower state energy, one can recalculate the strength for a wide range of temperatures. In our study, we measured the room temperature strength at three different optical densities for each absorption, to get a good average line strength (to 5% or better) and then re-recorded the spectrum at cold temperatures ($T > 160\text{K}$) and several optical densities to obtain a value of the lower state energy.

Figure 6 shows a list of typical experimental parameters determined in our study: The first three columns are the observed position, the strength at room temperature, and an estimate of the lower state energy. Evidently, it is not always valid to assume that transitions lying in the same spectral region have exactly the same lower state energy. The far right column shows the lower state energy of the line obtained from the quantum assignments determined by us for the line. We find that the true value of the lower state energy falls generally within one J-value of the experimental estimate. These data greatly facilitate identification of absorptions belonging to bands other

LOWER STATE ENERGY, E'' , FROM
 LINE STRENGTH MEASUREMENTS
 AT DIFFERENT TEMPERATURES

$$E'' = \frac{k T T_0}{T_0 - T} \ln \frac{T_0 Q(T_0) S_0}{T Q(T) S}$$

Where S and S_0 are the line strength/atm
 measured at T and T_0

Figure 5. An estimate of the lower state energy can be determined experimentally by measuring the line strengths at two different temperatures.

Position (cm^{-1})	Strength ($\text{cm}^{-2} \text{ atm}^{-1} \times 10^3$)	Experimental Lower State Estimate (cm^{-1})	True Lower State Determined from Quantum Assignment	
			cm^{-1}	Band
2960.143	0.18	980	950.	$2\nu_2$
2960.215	2.68	1460	1460.	$\nu_3 + \nu_4 - \nu_4$
2960.259	0.11	500	291.	CH_3D
2960.388	2.18	770	814.	$\nu_2 + \nu_4$
2960.472	0.21	340	219.	$\nu_2 + \nu_4$
2960.555	0.16	270	128.	CH_3D
2960.620	0.40	280	197.	CH_3D
2960.655	0.98	570	575.	$\nu_2 + \nu_4$
2960.699	1.52	780	814.	$\nu_2 + \nu_4$
2960.767	0.99	520	575.	$\nu_2 + \nu_4$
2960.833	0.16	880		
2960.863	1.10	820	814.	$\nu_2 + \nu_4$
2960.948	27.70	285	293.	$\nu_2 + \nu_4$
2961.003	0.11	400	293.	$\nu_2 + \nu_4$
2961.154	0.86	680	690.	$2\nu_2$
2961.275	0.16	1220	1639.	$\nu_3 + \nu_3 - \nu_2$
2961.325	1.54	1381	1432.	$\nu_3 + \nu_4 - \nu_4$

Figure 6. Experimental values obtained for the 3.5μ study.

than the fundamentals.

Figure 7 shows another FTS spectrum, recorded through a wide band filter from 2600 to 4600 cm^{-1} with the gas sample at 10 torr, a path length of 0.5 meter, and at 160K. Portions of the two bands in the 3.5 μm region ($2\nu_4$ and $\nu_2 + \nu_4$) and three bands in the 2.5 μm ($\nu_1 + \nu_4$, $\nu_3 + \nu_4$ and $\nu_2 + \nu_3$) are evident. One can visually compare the relative intensities of the bands, keeping in mind that the $2\nu_4$ band strength is a small percentage of the fundamental. Good progress has been made in the analysis of all these bands (8-12 and references therein), so that the majority of the strong lines in the region can be assigned to these bands. We have extended the assignments for three of the bands (13, 14, 15) to as high as $J = 14$; and have completed the infrared analysis of $2\nu_2$ (16). One comment about the spectrum in Figure 7; for a linear molecule like CO_2 , the vibration - rotation bands look very similar and the theoretical treatment of positions and strengths is straightforward. That is not true for methane, and the modeling of its positions and strengths is much more difficult. A calculation based on a successful fit of observed positions and strengths could be used to predict the absorptions not directly observed or recognized. However, at present the band models do not permit this for any of the bands (Figure 7) over the range of J assigned and at the accuracy of the data.

Figure 8 shows the FTS spectrum of CH_4 taken at an optical density increased by another two orders of magnitude from that of Figure 7. At this resolution and optical density, the spectrum contains about 10000 absorptions in the region from 2100 to 3300 cm^{-1} . The portion from 2500 to 2700 cm^{-1} looks rather complex, but is actually straightforward to interpret, because it contains only transitions of $2\nu_4$, and the wings of the lowest combination band, $\nu_2 + \nu_4$.

At 3000 cm^{-1} the problem was much more difficult because the transitions of many bands overlap (see Figure 9). For our work, we have made assignments

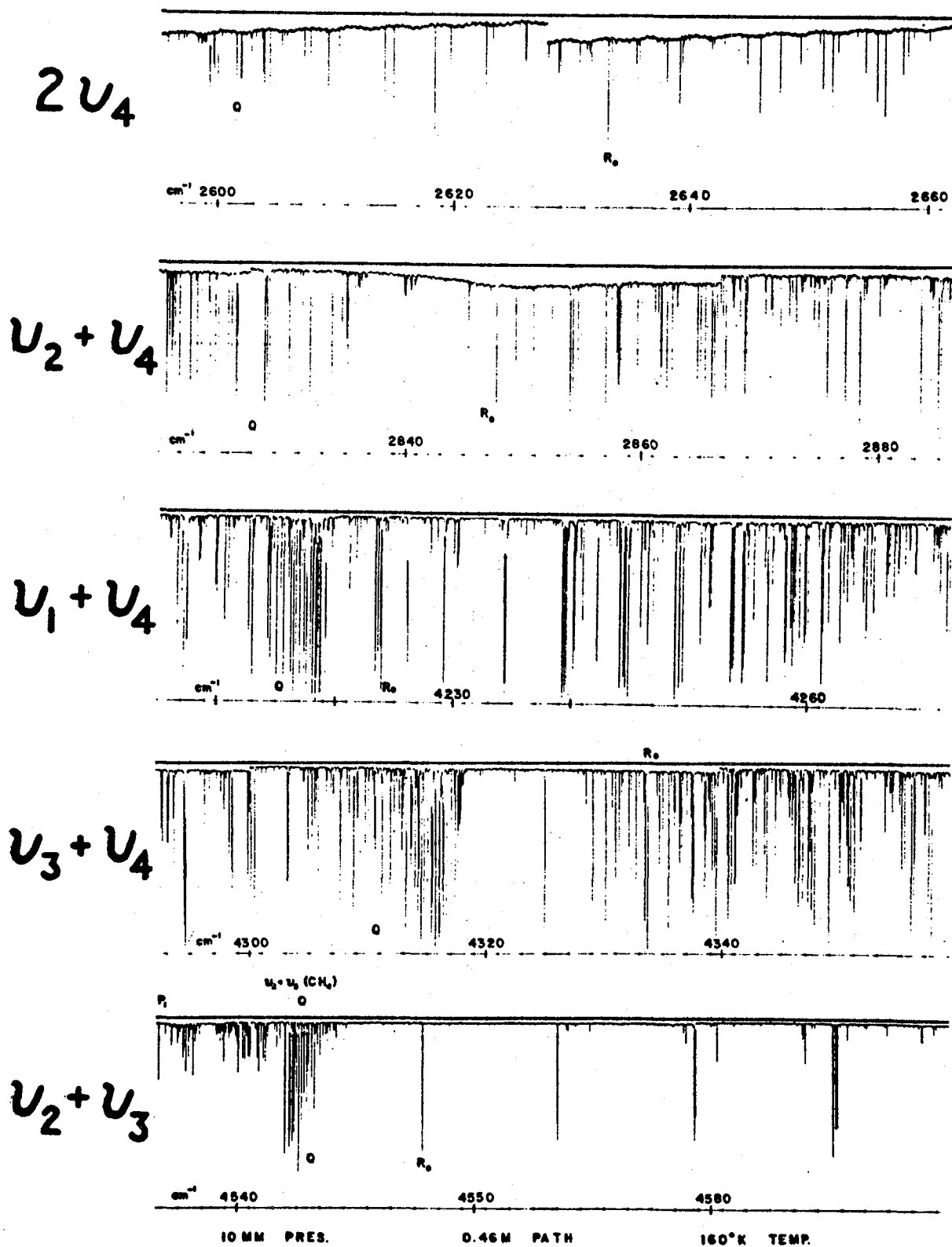
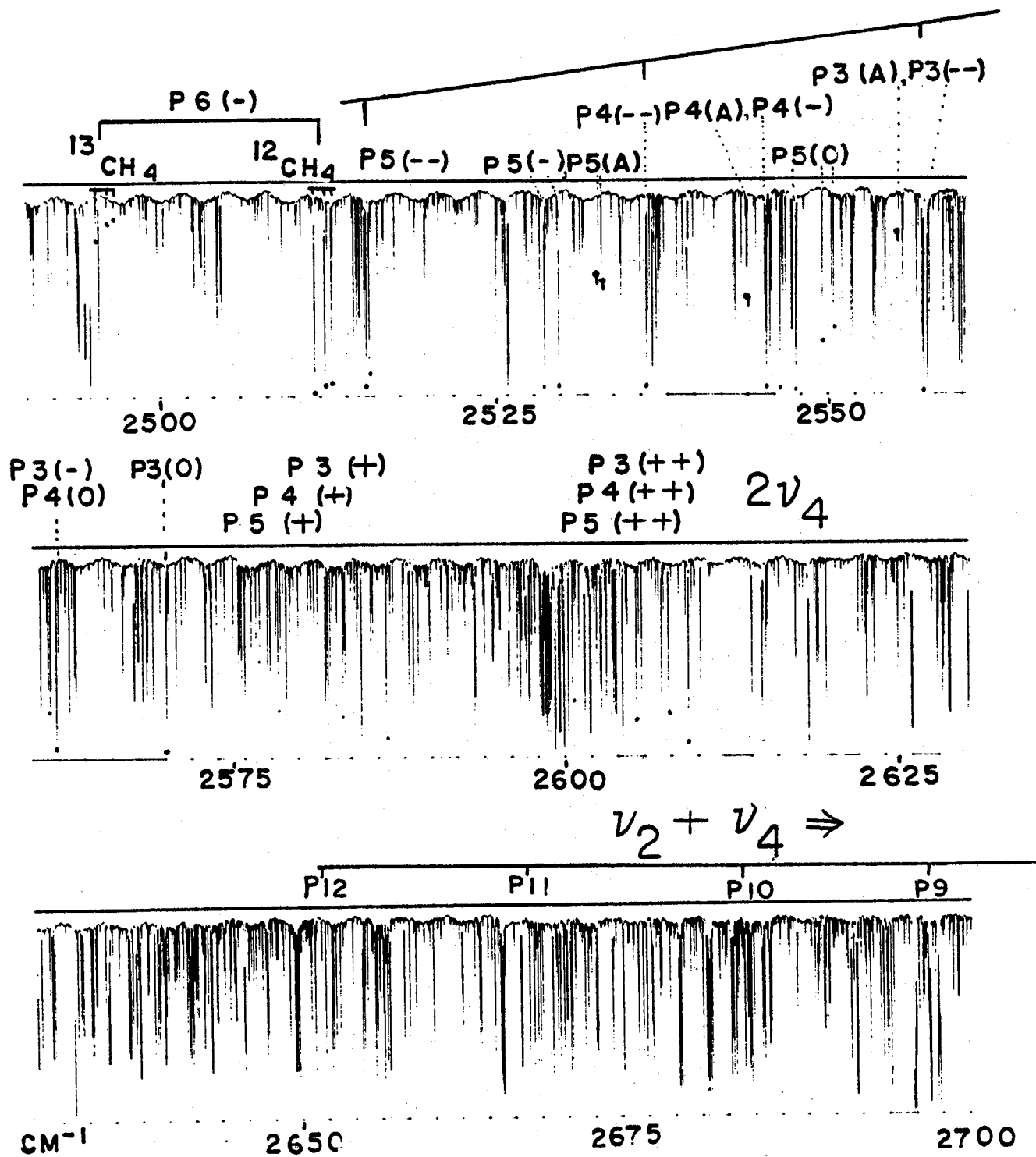

Figure 7. A spectrum of methane recorded with the FTS at an intermediate optical density at 160K showing portions of an overtone and 4 combination bands. Note that the spectral patterns vary greatly from band to band.



INFRARED SPECTRUM OF METHANE

24 M PATH, 10 MM PRESSURE, 0.02 CM⁻¹ RESOLUTION

Figure 8. An FTS spectrum of methane taken at high optical density, labelled with transitions of the 2ν₄ and ν₂ + ν₄ bands.

BAND	APPROX. CENTER
1) $2\nu_2$	3065 cm^{-1}
2) ν_{3b} (CH_3D)	3030
3) ν_3 ($^{12}\text{CH}_4$)	3020
4) ν_3 ($^{13}\text{CH}_4$)	3010
5) $\nu_3 + \nu_4 - \nu_4$	3010
6) $\nu_3 + \nu_2 - \nu_2$	3010
7) ν_{3a} (CH_3D)	2980
8) ν_1	2920
9) $\nu_2 + \nu_4$ ($^{12}\text{CH}_4$)	2830
10) $\nu_2 + \nu_4$ ($^{13}\text{CH}_4$)	2820
11) $2\nu_4$ ($^{12}\text{CH}_4$)	2620
12) $2\nu_4$ ($^{13}\text{CH}_4$)	2604

Figure 9. Strongest methane bands in 3-4 μ region.

to seven bands of $^{12}\text{CH}_4$, 4 bands of $^{13}\text{CH}_4$ and 3 bands of CH_3D (CH_3D assignments taken from the work of Olsen (17)). Figure 10 shows a portion of a grating spectrum,, again just a small interval, from which the relative intensities of some bands in this region can be assessed. Of course, the ν_3 fundamental is the strongest; the line to the right of the R(0) ν_3 line is R(1) of $^{13}\text{CH}_4$, observed in isotopic abundance. The next strongest band is the first combination band, $\nu_2 + \nu_4$. Transitions of this band are also present at 2600cm^{-1} ; at this optical density these bands give rise to absorptions over 500cm^{-1} of the methane spectrum. We also observed in the infrared two Raman active bands: $2\nu_2$ (9) and ν_1 (1), as well as the two hot bands, $\nu_2 + \nu_3 - \nu_2$ and $\nu_3 + \nu_4 - \nu_4$.

The types of transitions discussed so far are from the ground state to some excited state, e.g. $\nu_3 + \nu_4$. Hot bands (e.g. $\nu_3 + \nu_4 - \nu_4$) are transitions between two excited states (Fig. 11). If all the levels associated with the two excited states are experimentally known, the positions of hot bands can be easily predicted by subtractions of levels. Using the analyses that have been done on the overtone and combination bands, one can predict the positions of hot bands that fall in the $7\mu\text{m}$ and $3.5\mu\text{m}$ regions. However, additional work is needed to predict the intensities of the hot band lines. That has only been done for the simplest hot band, $\nu_3 - \nu_4$ (18), and most recently for $2\nu_4 - \nu_4$ and $\nu_2 + \nu_4 - \nu_2$ (19). Experimentally, our group is considering two hot bands in the $3.5\mu\text{m}$ region (20,21) and Jack Margolis is measuring the line strengths of $\nu_3 - \nu_4$, (5).

Figure 12 shows portions of the methane spectrum in the wings of the $5\mu\text{m}$ window as recorded with the FTS at the maximum optical density of 20 torr, with a path length of 20 meters, and at room temperature (5). The H_2O and CO impurities are indicated. At 1900cm^{-1} , the remaining CH_4 lines belong to the R branch of the hot band $\nu_3 - \nu_4$. At 2000cm^{-1} the spectrum will be free of methane absorption, with only the transitions of the CH_3D ν_2 fundamental at

$2\nu_2$ P(4) - P(3) REGION OF METHANE

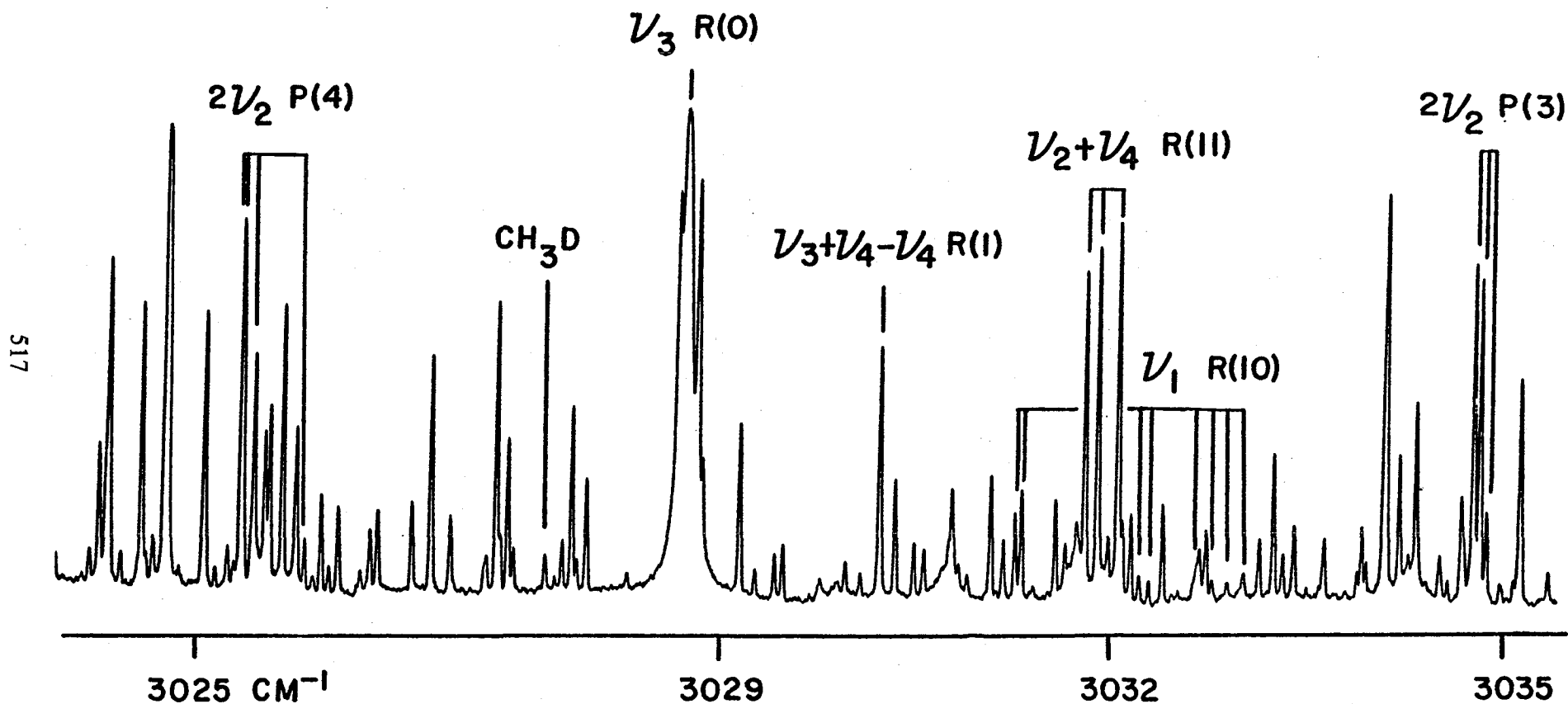

Figure 10. A methane spectrum recorded at 0.02 cm^{-1} resolution with the Florida State grating spectrometer at high optical density. Transitions of $2\nu_2$, ν_3 , CH_3D , $\nu_3 + \nu_4 - \nu_4$, $\nu_2 + \nu_4$ and ν_1 are indicated to show relative intensities of the bands.

CH₄ LEVELS

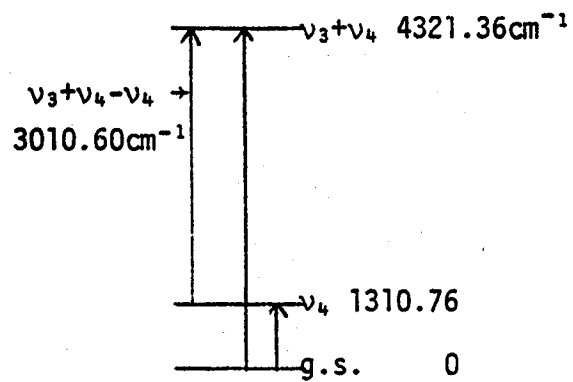

Figure 11. Hot bands like $\nu_3 + \nu_4 - \nu_4$ are transitions between two excited vibrational states, $\nu_3 + \nu_4$ and ν_4 .

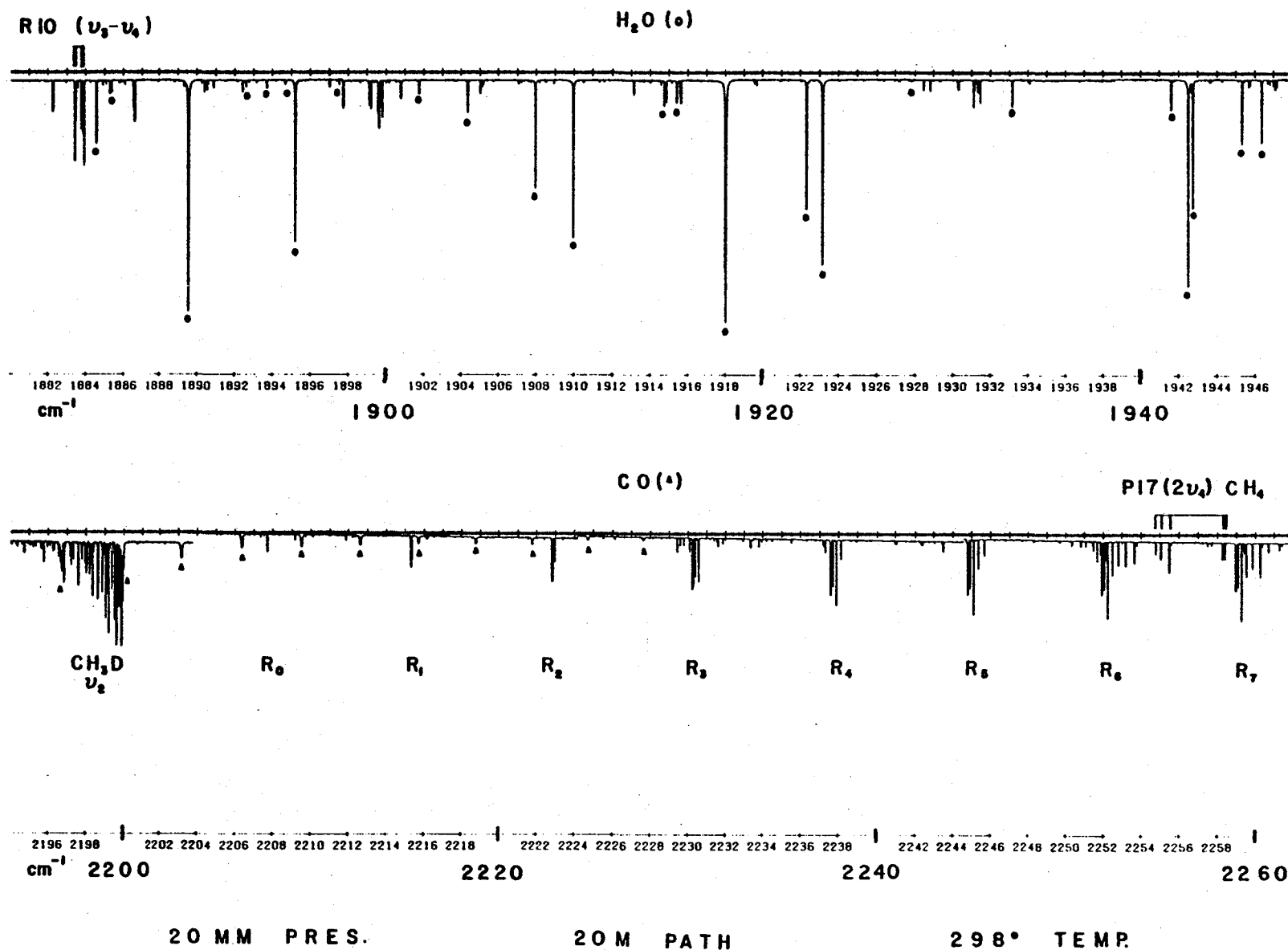

Figure 12. Portions of the methane FTS spectrum at high optical density near the $5\mu\text{m}$ window. Impurities of H₂O and CO are indicated, and the remaining lines belong to $\nu_3 - \nu_4$ of ¹²CH₄, CH₃D and $2\nu_4$ of ¹²CH₄.

2200cm^{-1} , present here at isotopic abundance. Above 2200cm^{-1} , the only methane lines are very weak high-J transitions of that first overtone $2\nu_4$.

Figure 13 shows four portions of the spectrum in the $7\mu\text{m}$ region as recorded at high optical density with the FTS (5). They represent the types of absorptions one finds at this optical density: hot bands, many transitions of the two fundamentals, and CH_3D . Using the Ohio State data and subsequent analysis (22,23), one can identify the CH_3D absorptions in the spectrum. For instance, transitions at 1156cm^{-1} belong to R_{00} of the ν_6 fundamental; all the other CH_3D lines are of this strength or weaker. What are the remaining lines? Some arise from transitions of the ν_4 and ν_2 bands of $^{12}\text{CH}_4$ and $^{13}\text{CH}_4$. Other absorptions belong to the many hot bands, such as $2\nu_4 - \nu_4$ and $\nu_2 + \nu_4 - \nu_2$.

If you are so unfortunate that the planetary analyses mandate an even higher density of methane, we can now guess what types of absorptions will appear in the new laboratory spectrum: more CH_3D , more transitions of the fundamentals, and many more hot bands.

In Figure 14, I've listed some rather subjective judgements about the state of the methane parameters for the three spectral regions presented. I think if we collect all the information on positions, the lines are generally known to an accuracy of $.001\text{cm}^{-1}$ or better for all three regions; this probably encompasses about 25000 or 30000 lines altogether. We are not quite as well off for the individual measurements of line strengths. We have measured the $3.5\mu\text{m}$ region, but the other regions have not been covered thoroughly (Ken Fox will be telling us about the measurements in the ν_4 lines). There are some lower resolution data near $7\mu\text{m}$, taken at intermediate optical density, with an accuracy of about 25%; and in the $2.5\mu\text{m}$ region, Both measured some lines with an accuracy of about 15 to 20%. If we compiled all the quantum assignments known, I think we would find that at least a third of the $7\mu\text{m}$, 80% of the $3.5\mu\text{m}$, and about half of the $2.5\mu\text{m}$ region can be

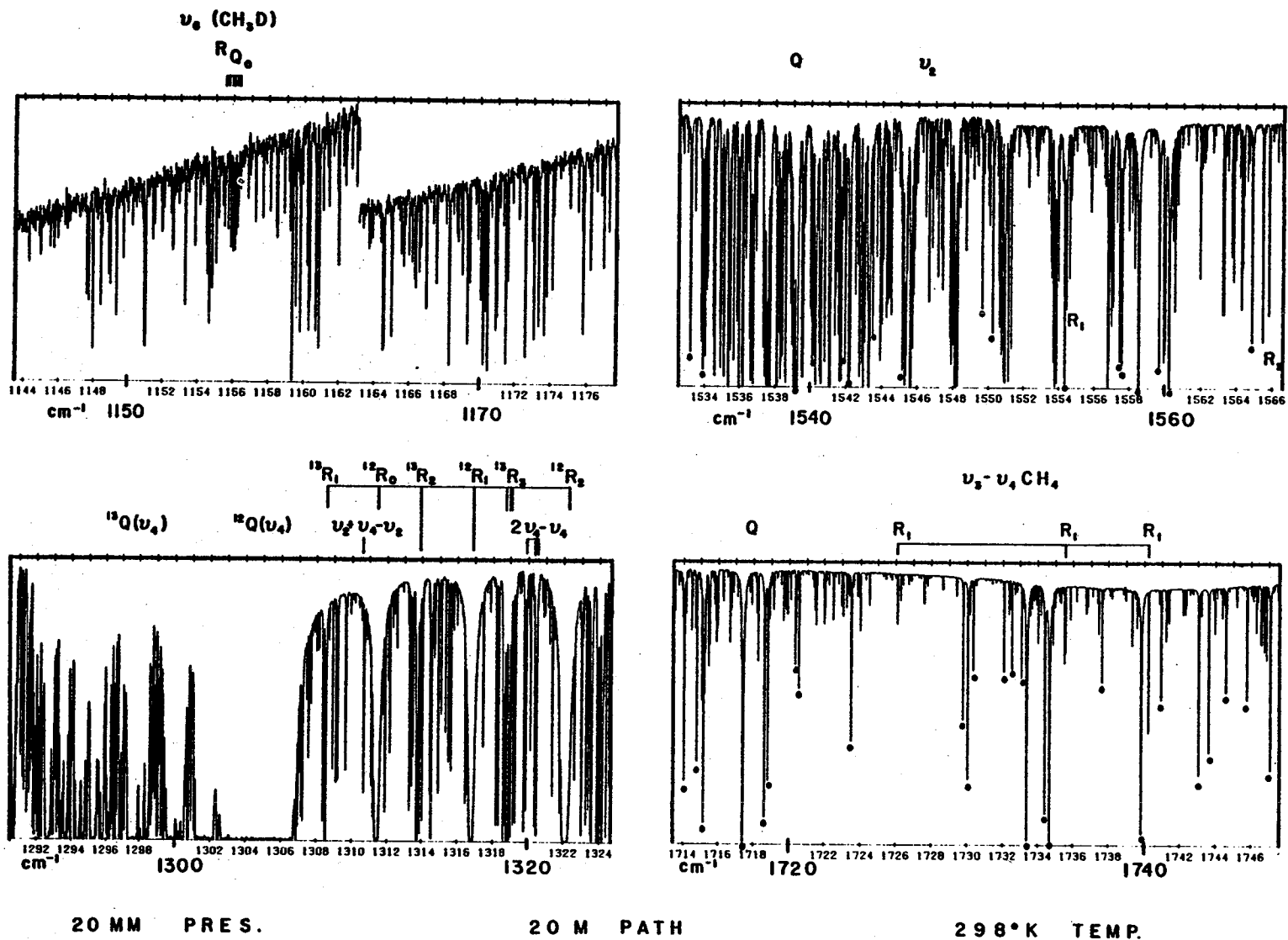

Figure 13. Portions of the methane FTS spectrum at high optical density in the $7\mu\text{m}$ region. The upper left panel indicates the strength of CH_3D absorptions observed in isotopic abundance. The remaining panels show the density of lines arising from ν_4 , ν_2 , $\nu_2 + \nu_4 - \nu_2$, $2\nu_4 - \nu_4$, $\nu_3 - \nu_4$ and other hot bands of both $^{12}\text{CH}_4$ and $^{13}\text{CH}_4$.

LINE PARAMETERS OF METHANE NOW KNOWN

	<u>7 MICRON</u>	<u>3.5 MICRON</u>	<u>2.5 MICRON</u>
POSITIONS (0.001)	YES	YES	YES
STRENGTHS (5%)	MIXED (SOME 25%)	YES	NO (SOME 15%)
TEMPERATURE * DEPENDENCES OF STRENGTHS	$\frac{1}{3}$	$\frac{4}{5}$	$\frac{1}{2}$

* FRACTION OF TOTAL ABSORPTIONS PRESENT AT MAXIMUM DENSITY

CALCULATION OF POSITIONS AND STRENGTHS OF ABSORPTIONS TO
ACCURACY OF THE ABOVE DATA

	<u>FUNDAMENTALS</u>	<u>COMBINATION</u>	<u>CH₃D</u>	<u>HOT BANDS</u>
POSITIONS	GOOD	NEEDS WORK	GOOD	GOOD
STRENGTHS	ν_3 OK OTHERS ?	NEEDS WORK	LITTLE DATA ⁺	NEEDS WORK

+ WITH THE EXCEPTION OF ν_2

Figure 14. Summary of experimental and theoretical progress on CH₄ from 2.5 to 7 μ m.

accounted for. If we include the hot bands, of course, more absorptions can be assigned. How well do we calculate positions and strengths of fundamentals, combination bands, CH_3D and hot bands? The situation is good for positions of lines of fundamental bands ("good", not "excellent"; it is not quite to the accuracy of the data), but the treatments of the combination bands and overtones need a great deal of work. The analysis of strengths suffers from a great lack of data, but it appears that the ν_3 and ν_4 fundamentals will be calculated fairly well. The other bands need more analysis.

Figure 15 shows other measurements that are needed: pressure broadening, pressure shifts, line shapes, and the temperature dependences of all of these quantities. Very little new work has been reported. All the studies are older and were done at a time when knowledge of the methane spectral structure was much more limited. I hope that our work will allow people to leave the fundamentals, and look at higher-J lines of those combinations and overtone bands that are more likely to be separated and not overlapped by other lines.

Our study has been quite an effort for us, and if we attempt similar projects we'll remember certain lessons (Figure 15). We want to use the best possible resolution, because of the high spectral density. We want to continue to use low pressure and long paths with very good signal-to-noise. Considering that we will be looking at high optical density, we must be prepared to consider all the isotopes.

We hope that our line listings (24) will be useful to many different people with quite varied research topics.

ADDITIONAL STUDIES

PRESSURE BROADENING

PRESSURE SHIFTS

LINE WIDTHS

LINE SHAPES

TEMPERATURE DEPENDENCES

LESSONS OF COMPILING LINE PARAMETERS FOR LARGE ABSORBING AMOUNTS

USE BEST RESOLUTION AVAILABLE OVER WIDE SPECTRAL REGION

USE LOW PRESSURE AND LONG PATHS WITH GOOD SIGNAL TO NOISE

BE PREPARED TO CONSIDER ALL THE ISOTOPES

TIME NEEDED TO COMPILE LIST APPROPRIATE FOR SEVERAL DIFFERENT
TYPES OF APPLICATIONS

Figure 15. Additional needed studies and the lessons of compiling large lists of molecular parameters.

REFERENCES

1. A. Owyong, C. W. Patterson, and R. S. McDowell, Chem. Phys. Lett. 61, 636E (1979).
2. D. L. Gray and A. G. Robiette, Mol. Phys. 32, 1609-1625 (1976).
3. D. L. Gray, A. G. Robiette and A. S. Pine, J. Mol. Spectrosc. 77, 440-456 (1979).
4. G. S. Orton and A. G. Robiette, J.Q.S.R.T. (In press).
5. J. Margolis (Private communication).
6. R. A. Toth, L. R. Brown and R. H. Hunt, J. Mol. Spectrosc. 67, 1-33 (1977).
7. L. W. Pinkley, N. K. Rao, M. Dang-Nhu, G. Tarrgo, and G. Poussigue, J. Mol. Spectrosc. 63, 402-444 (1976).
8. P. LePage and R. Saint-Loup, J. Phys. Lett. 40, L63-67 (1979).
9. J. Champion, G. Pierre, H. Berger and J. Cadot, J. Mol. Spectrosc. 79, 281-294 (1980).
10. B. Bobin, J. Phys. Lett. 35, L121-124 (1974).
11. B. Bobin and G. Guelachvili, J. Physique 39, 33-42 (1978).
12. J. C. Hilico, J. Degni, J. P. Champion and G. Guelachvili, J. Mol. Spectrosc. 81, 277-302 (1980).
13. R. H. Hunt, L. R. Brown, R. A. Toth and J. W. Brault, J. Mol. Spectrosc., (In press).
14. L. R. Brown, R. A. Toth, A. G. Robiette, J. E. Lolck, R. H. Hunt, and J. W. Brault (In preparation).
15. A. G. Robiette, J. E. Lolck, L. R. Brown, R. A. Toth, R. H. Hunt, and J. W. Brault (In preparation).
16. R. A. Hunt, J. E. Lolck, A. G. Robiette, L. R. Brown, R. A. Toth (In preparation).
17. W. B. Olsen (Private communication).
18. E. Pascaud and M. Dang-Nhu, J. Mol. Spectrosc. 69, 141-158 (1978).
19. C. Pierre, G. Pierre, J. P. Champion, J. C. Fontanella and M. Delphanque, J. Physique 41, 393-402 (1980).
20. R. H. Hunt, L. R. Brown, R. A. Toth and J. W. Brault, J. Mol. Spectrosc. (In press).
21. L. R. Brown, R. A. Toth, R. H. Hunt and J. W. Brault, (In preparation).

22. L. Pinkley, Dissertation at Ohio State University (1974).
23. G. Tarrago, K. N. Rao and L. W. Pinkley, J. Mol. Spectrosc. 79, 31-46 (1980).
24. R. A. Toth, L. R. Brown, R. H. Hunt and L. Rothman, (In preparation).

DISCUSSION

Comment (R. Beer): I'm concerned about strength discrepancies between identical lines of the ^{12}C and ^{13}C isotopes of methane. The ^{12}C , ^{13}C isotopic ratio is a profoundly important cosmological parameter. If we can't trust the isotopic ratios derived from the "equal strength" hypothesis, we are in real trouble.

Comment (K. Fox): The laboratory measurements are to some extent beginning to contradict the conventional wisdom of "equal strengths." However, conventional wisdom is not based on any data. The conventional wisdom is that if ^{13}C is substituted for ^{12}C in methane (or in fact if any isotope is substituted, say in germane or silane), the line intensities should not change. The results of Pine and co-workers on the ν_3 fundamental of methane indeed bear that out. They showed that the line intensities do not change to within a percent. Jennings and co-workers studied isotopic strengths of the $1.6\mu\text{m}$ band of methane. They were surprised to find that the intensities changed about 30% in going from ^{12}C to ^{13}C , 20% to 40% in going from ^{12}C to ^{14}C . That affects the derivation of isotopic ratios for the planet. Jennings and Margolis and I are going to Kitt Peak to make the same measurements on the 1.1 micron band of methane. That of course is the band needed to derive the isotopic ratios for the outer planets.

Line Intensities from Band and Diode Laser Measurements:

ν_4 of CH_4

Kenneth Fox

University of Tennessee

I will review¹ the experimental data and theoretical work on the 7.7 micron band of methane. Figure 1 reminds us that this band is particularly relevant in studies of the atmospheres of Jupiter, Saturn and the other outer planets (Hanel et al.²). Above are methane spectra taken from the infrared spectrometer (IRIS) aboard Voyager, and below is a temperature profile derived by inverting those data, both for hydrogen and methane. Obviously, extraction of information from planetary spectra requires high quality spectroscopic parameters.

Let me remind you of the important changes in appearance of ν_4 methane spectra taken at a variety of spectral resolutions. The spectra shown in Figure 2 were taken by Gryvnak et al.³ at about 1 cm^{-1} resolution, and look pretty good even though taken at what we might call low resolution. Figure 3 shows what we might call medium resolution (0.2 cm^{-1}) spectra from Ko and Varanasi.⁴ Figure 4 shows a high-resolution spectrum, somewhat like the spectrum Linda Brown showed us (Ed.-this Proceedings). These lines, measured by Pinson and Dupre-Maquaire,⁵ are still from the 7.7 micron band of methane, but more details of the spectrum are revealed at higher resolution ($.01\text{-}0.2 \text{ cm}^{-1}$), so we can only show part of it. Continuing our tour, in Figure 5 we show a fully-resolved tunable semiconductor diode laser scan (top panel), recorded by Aldridge et al.,⁶ of the feature shown in the bottom panel (0.05 cm^{-1} resolution taken by Botineau⁷ with a conventional spectrometer).

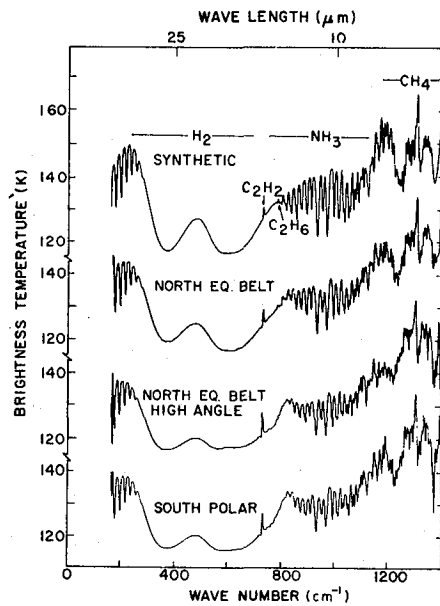

Observed thermal emission spectra for several locations over the Jovian disk. The spectral features observed for the gases H_2 and NH_3 are of tropospheric origin, and C_2H_2 and C_2H_6 are concentrated in the stratosphere. Methane is well mixed throughout both regions. The enhancement of the emission of the stratospheric species with air mass may be seen in the lowest two (high viewing angle) spectra.

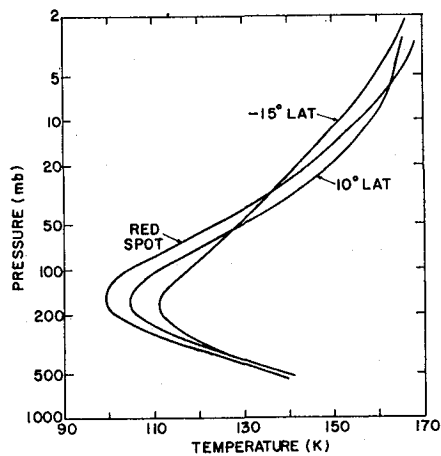

Examples of temperature profiles obtained by inversion of spectral radiances within the $S(0)$ and $S(1)$ hydrogen lines and the ν_4 band of methane. The profile over the Great Red Spot was obtained from an average of six spectra; those at $+10^\circ$ and -15° latitude are from averages of approximately 60 spectra.

Figure 1. Voyager data from Jupiter; Hanel et al. (Ref. 2).

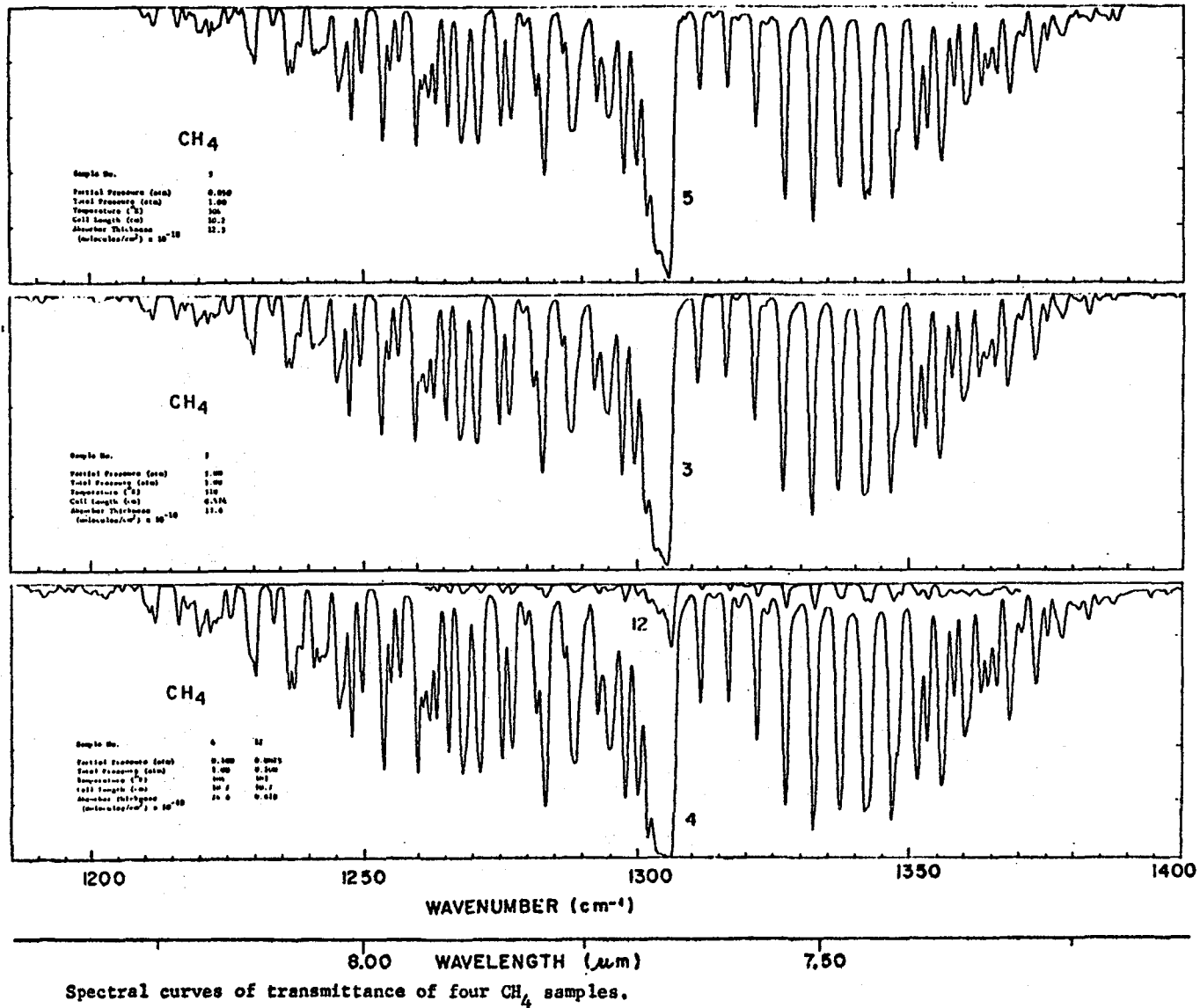
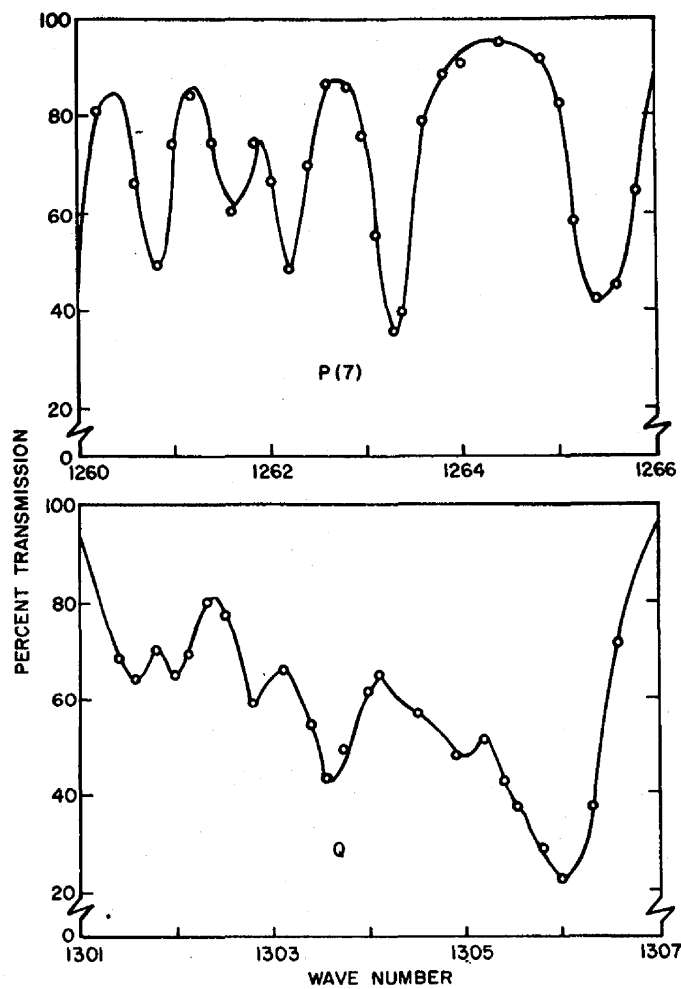
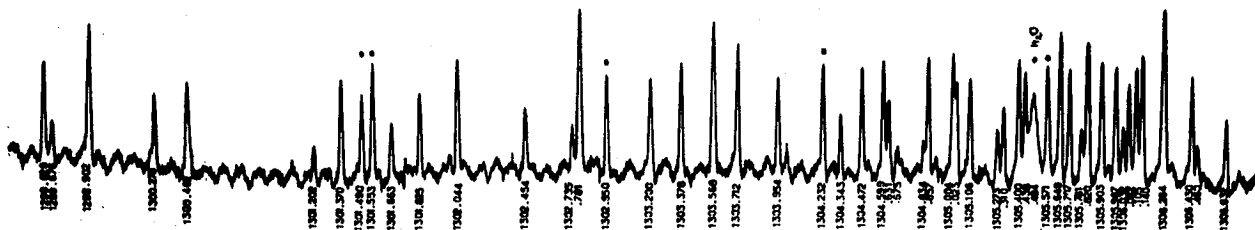

Figure 2. Grating spectrum: Gryvna et al. (Ref. 3).



Percentage spectral transmission through rotational lines in the ν_4 -fundamental of $^{12}\text{CH}_4$ at 300°K. Spectral resolution = 0.2 cm^{-1} ; 5.37% [for $P(7)$], 1.1% (for Q -branch) methane in hydrogen; cell length = 6.1 cm; total pressure = 3 atm.

Figure 3. Grating spectrum: Ko and Varanasi (Ref. 4).



Evident in the upper panel is a complete resolution of two lines which appear to be just barely resolved in the much lower resolution spectrum (lower panel). The resolution of the diode spectrum is two orders of magnitude better, approximately $.0001 \text{ cm}^{-1}$.

Now, what's the problem? The problem has to do with the intensities of lines. Table 1 is a summary, taken from Chedin *et al.*,⁸ containing all the band intensity measurements on ν_4 of CH_4 . Except for one value, all the intensities are between 132 and $147 \text{ cm}^{-2} \text{ atm}^{-1}$ at 300K . There seems to be a consensus among different laboratories at about the same value for the integrated band intensity, a fairly comfortable situation.

Now suppose you want to know about a line intensity. Well, that's easy; to get a line intensity you simply take the band intensity and a suitable theory, and you distribute the band intensity among all the lines to get the intensity of each line. Table 2 contains an example; here are three lines in the 7 micron band, a P-branch line and two Q-branch lines. Chedin *et al.*⁸ got their values using a band intensity of $140 \text{ cm}^{-2} \text{ atm}^{-1}$, a subjective average of all the band intensities in Table 1. Pinson and Dupre-Maquaire⁵ did the same exercise with a band intensity of 132 , and got the line intensities shown. I compared those two sets of results with the line-by-line measurements by Reisfeld and McDowell⁹ using a tunable diode laser, and you see there are some significant differences (on the order of 20% or more). "Are these uncertainties really real?" (to paraphrase Jack Margolis¹⁰). Well, maybe they are and maybe they aren't. I'm afraid I'm not going to leave you with any happy conclusion at the end of this talk because I don't know the answer; I

Table 1
Chedin et al. (Ref. 8)

Comparison Between Several Determinations of the Total Band Intensity of ν_4 of CH_4

References	Total band intensity in	
	$\text{cm}^{-2} \text{ atm}^{-1}$ at 300°K	cm molecule^{-1} at 300°K
R. Rollefson et R. Havens (16) 1940	135	5.51×10^{-18}
A.M. Thorndike (17) 1947	137	5.58×10^{-18}
H.L. Welsh and P.J. Sandiford (18) 1952	143	5.85×10^{-18}
R.E. Hiller and J.W. Straley (19) 1960	136	5.56×10^{-18}
R.L. Armstrong and H.L. Welsh (20) 1960	144	5.88×10^{-18}
J. Heicklen (21) 1961	141	5.76×10^{-18}
L.M. Sverdlov (22) 1961 et 62	136	5.56×10^{-18}
D.E. Burch and D. Williams (15) 1962	168	6.87×10^{-18}
Y.I. Gerlovin and I.N. Orlova (23) 1968	147	6.01×10^{-18}
S. Saeki, M. Mizuno and S. Kondo (24) 1975	146	5.97×10^{-18}
K. Tanabe (25) 1975	136	5.56×10^{-18}
D.A. Gryvnak, D.E. Burch, R.L. Alt, D.K. Zgonc (12) 1976	140	5.39×10^{-18}
F.K. Ko and P. Varanasi (7) 1977	132	5.39×10^{-18}

just want to tell you what the facts are.

Let's look, in Table 3, at line intensities measured at medium resolution. Here we have two lines, R0 and R1, whose intensities have been measured directly. As Linda Brown showed earlier,¹⁰ their spectra are well separated; consequently they are good candidates for line intensity measurements. Ko and Varanasi⁴ obtained $1.05 \text{ cm}^{-2} \text{ atm}^{-1}$, with an error bar of about $\pm 5\%$ as I recall. Lutz et al.¹¹ measured intensities for the same lines and got values that were pretty close. Don Jennings,¹² in some recent diode laser spectroscopy at Goddard, also measured intensities for these lines. He got results which are somewhat different and, in view of the error bars on each set of results, are probably significantly different. Still they do not differ by 20%, so at least here we have a situation where three measurements at different laboratories by different techniques agree to within 10%: the situation does not look too bad.

Next, I'd like to show you two examples of lines measured by diode laser techniques. Figure 6 shows the work of the Los Alamos group.⁹ The significant parameter here for the line shape is the measured line width which is within 2 MHz of the predicted Doppler width. Another example of these very beautiful spectra is Figure 7 from the work of Jennings.¹² This is another line in the 7 micron band of methane, and you see that the signal-to-noise is very high and that the base line is really well determined.

Now, there is another way to calculate line intensities, based on some work I did with Willis Person.¹³ In this method, one measures individual line

Table 2
Line Intensities Derived from Band Strengths

($\text{cm}^{-2} \text{ atm}^{-1} \text{ 300K}$)

		CHEDIN ⁸ <u>et al.</u>	PINSON ⁵ <u>et al.</u>	FOX ⁹ <u>et al.</u>
P7A ₂	1263.33 cm^{-1}	1.187	1.108	1.010
Q9A ₁	1302.95	0.751	0.702	0.562
Q3A ₂	1306.14	2.050	1.887	1.449

Table 3
Line Intensities Measured at Medium Resolution

($\text{cm}^{-2} \text{ atm}^{-1} \text{ 300K}$)

		VARANASI ⁴	LUTZ ¹¹	JENNINGS ¹²
ROA ₁	1311.435 cm^{-1}	1.05	1.01	0.946
R1F ₁	1316.833	1.05	1.05	0.963

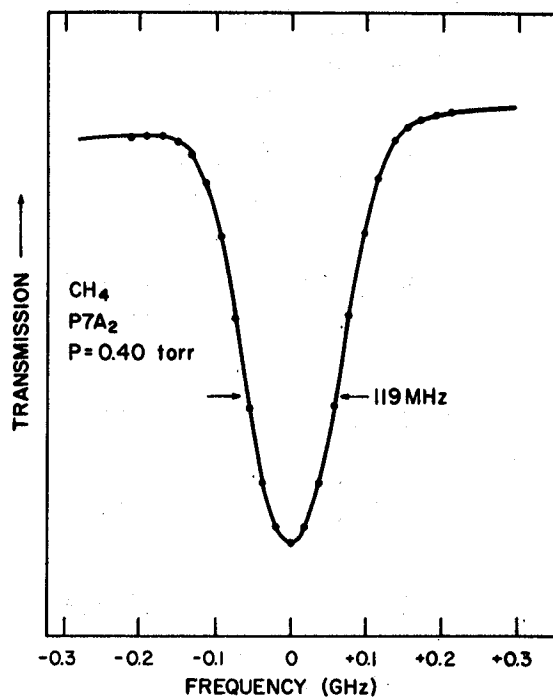

A sample spectrum of the $P7A_2$ line whose peak is at 1263.33 cm^{-1} in the ν_4 band of CH_4 . The experimental conditions were $p = 0.40 \text{ Torr}$, $l = 10 \text{ cm}$, and $T = 296.9 \text{ K}$. The Gaussian fit, indicated by black dots, yielded an experimental line width of 119 MHz .

Figure 6. Diode laser spectrum, Fox et al. (Ref. 9).

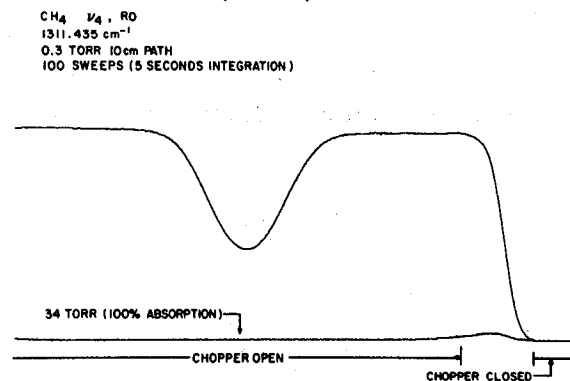

Line intensity data for $R0$ in ν_4 of CH_4 . This spectrum was recorded in the sweep integration mode. The chopper reference generated a laser current modulation that was adjusted to sweep the absorption line during the open phase. A portion of the chopper-closed phase was also swept to provide a 0% transmission reference. This reference was checked with a subsequent scan of the saturated line.

Figure 7. Diode laser spectrum; Jennings (Ref. 12).

intensities S_{if} and from these intensities one derives two parameters which describe the intensities (one hopes) for all lines in the band. The two parameters are μ_{01} and C_4 as indicated in Table 4. So, if there are several well-measured line intensities in a band, these parameters are deduced and then, in principle, all the other line intensities in the band can be calculated.

How well does this method work? It works okay. An indication of how well it works is how well two parameters derived from different data agree. I've deduced these two parameters from the data of Fox, Reinfeld, and McDowell;⁹ Restelli, Cappellani, and Melandrone;¹⁴ and Jennings.¹² You see in Table 5 that for the transition moment μ_{01} the results of Restelli et al.¹⁴ and Jennings¹² are in very good agreement, and about 7% different from the results that Fox et al.⁹ obtained. On the other hand, the parameter C_4 which is not completely negligible has almost the same values for the data of Restelli et al.¹⁴, and Fox et al.,⁹ but a significantly different result for Jennings.¹² I don't want to dwell on that; there are a variety of reasons which I can get into later, none of them devastating. I do want to draw your attention to the band strengths derived from these parameters. From the first data set, the band strength is 103, which is more than 20% lower than the mean value, 140, of intensity measurements in Table 1. Restelli et al.¹⁴ and Jennings¹² have somewhat higher values, within striking range of 140.

How are these discrepancies explained? I'm not sure, but I have some suggestions, as shown in Table 6. From the experimental side, we have a possibility of hot bands, i.e., at high temperature in the laboratory,

Table 4
Line Intensity Parameters

$$\langle \mu_{if} \rangle^2 = 3.734 \times 10^{-41} T^{5/2} e^{7.541(J+1/2)^2/T} \times S_{if}/\nu_{if} \epsilon_i$$

$$\langle \mu_{if} \rangle^2 = \langle \mu_{01} \rangle^2 (2J+1)(1+C_4 m)^2$$

m = -J	P
0	Q
J+1	R

S_{if}	μ_{if}	μ_{01}	C_4	S_{if}
MEAS	CALC	CALC	CALC	CALC

ALTERNATIVELY, MEASURE S & USE THEORETICAL RELATIVE INTENSITIES TO OBTAIN S_{if} BY CALCULATION.

Table 5
Band Intensities Calculated from Diode Laser Line Intensities

$$S = (\mu_{01}/0.1726)^2 \nu_{01} \quad (\text{Ref. 13})$$

	μ_{01} (10^{-18} esu cm)	C_4	S ($\text{cm}^{-2} \text{atm}^{-1}$ 300K)
FOX <u>et al.</u> ⁹	0.0508	-0.0093	103
RESELLI <u>et al.</u> ¹⁴	0.0537	-0.0095	115
JENNINGS ¹²	0.0544	+0.0019	118

Table 6
How to Explain Discrepancies

EXPERIMENT:

"HOT" BANDS	T (LAB.)
	T (PLANET)
"FORBIDDEN" LINES	P (LAB.)
	P (PLANET)
CONTAMINANTS	
S/N	

THEORY:

$$\langle \mu_{if} \rangle^2 = \langle \mu_{01} \rangle^2 (2J' + 1)(1 + C_4 m)^2$$

$$S = \sum S_{if}$$

Table 7
What to Do About Discrepancies

WHAT ARE NEEDS OF PLANETARY PROGRAM AT LOW, MEDIUM AND HIGH RESOLUTION?

WHAT UNCERTAINTIES IN LINE AND BAND INTENSITIES ARE ACCEPTABLE FOR PLANETARY PROGRAM?

IRIS

GROUND-BASED

TEMPERATURE INVERSION

ABUNDANCE

transitions from excited states contribute to an integrated band intensity. In the planetary spectra, where the temperature is lower, hot-band contributions would not be present, at least not to the same extent. We also have forbidden lines, which Linda Brown spoke about earlier;¹⁰ at high pressures they will be present, but at lower pressures (as in planetary upper atmospheres) they won't be as evident. How strong they are depends on how high the pressure is, and if you build up the pressure in the laboratory, you increase the strengths of these forbidden lines. Other considerations are contaminants, which wouldn't be discernable in a lower resolution spectrum, and signal-to-noise. There also may be higher-order correction terms in the theory, which is not that definitive yet. Finally, I have not yet taken into account the effect of the C_4^m term in adding up the intensities of all the lines to give a theoretical band intensity.¹⁵

What do we do about these discrepancies (as indicated in Table 7)? We continue to work at the various theoretical and experimental possibilities.

DISCUSSION

Comment (R. Beer): I think that point deserves further amplification because, although you show spectra that are absolutely gorgeous, the laboratory conditions bear no resemblance to planetary conditions. Could it be that the parameters measured with diode lasers are not transferable to the planets? In the planetary environment we have such very low pressures that they may not in fact be quite the same molecules.

Response (K. Fox): At least several diode laser measurements were made at low pressures, and others were made using grating instruments. The molecules are the same, and the results for intensities should be in agreement, independent of what the conditions are in planetary atmospheres. I think you have a separate question: Why don't the laboratory and theoretical results agree better?

Response (R. Beer): I think the question I'm trying to put is that the kinds of instruments we use for planetary spectra are much more like the old-fashioned lab instruments. We don't use diode lasers to take planetary spectra.

Response (K. Fox): Anyway, that's not the real issue. I think the real issue is: How much confidence do you have in the laboratory and theoretical work, and can you confidently apply it to the planetary situation, whatever it is? I believe that you can scale suitable laboratory and theoretical results to the planetary situation and to the apparatus you're using.

conditions for the atmospheric case. I have found perfect agreement with my own calculations of the line-by-line strengths.

Comments (anon.): Oh, I think the method is fine. But I think you are talking about two things. You are talking about the vibrational band intensity, and then the integrated band intensity. Sometimes they differ. Take the CO_2 cases of perpendicular bands, and you can get a vibrational band intensity called S_{vo} ; and you integrate all those line strengths and you'll find it to be much greater than S_{vo} .

Response (K. Fox): Yes, I understand that. We've taken care of that to a great extent with the parameter C_4 . It is possible that there are other corrections.

Comment (anon.): No, no; S_{vo} times the f factor, which you called $(1 + C_4 m)^2$, that's the individual line strength. What people measure is the integrated line strength, essentially the summation of all those line strengths. To first order, that should be equal to the vibrational strength, but in many cases they differ. In this case it may well be. That was my first point. My second point is that you mentioned that the weaker lines may show up when you run higher density data, and may not show at lower density. You are implying a pressure-induced absorption there, which I don't think you meant to imply at all.

Response (K. Fox): No.

Comment (A. T. Young): I think Reinhard raised a very important point here, which I think is being swept under the rug. That is, when you want to interpret planetary spectra, what you are trying is basically to interpret a photometric problem. People are used to talking about this as a spectroscopic problem, but it's really a photometric problem. Measuring as a function of wavelength ... as in a planetary spectrum. If the lab and planetary spectra are taken under enormously different conditions, different systematic errors can enter into interpreting these measurements. One of the first rules of photometry of any kind is that the calibration measurements should be made under (as nearly as possible) the same conditions as the measurements you're trying to calibrate. This is the point that Reinhard was raising. I think it's getting lost here; I think it's an important source of systematic error that we should worry about.

Comment (M. Mumma): I'm not sure that's right.

Comment (L. Wallace): That's not the problem.

Comment (A. J. Young): That's not the problem that Ken raised, but it is the problem that Reinhard raised, and I don't want it to be pooh-poohed.

Response (K. Fox): I didn't mean to pooh-pooh it. I'm sorry if it sounded like that. I thought I considered it pretty carefully.

Comment (P. Varanasi): I measured in self broadening, in hydrogen broadening and many others, the entire ν_4 band from one end to another, under the

Comment (anon.): Those weaker lines should still be there, even at lower densities, and they should still contribute to the band strength, even if you measure at low densities.

Comment (R. Herman): You stressed the problem of assessing the differences in line strengths for different isotopes. I happen to have along an old reprint of mine, which deals with borrowed intensity problems and all that. But for straightforward problems, the way to assess the differences in line strengths would be the following: In going from one isotope to another, you take the ratio of vibrational frequencies, raised to a power equal to the number of the harmonic.

Response (K. Fox): Yes, undoubtedly, if that is correct; it only makes a small contribution, but nothing like what we are looking for.

References and Footnotes

1. Support from the NASA Planetary Atmospheres Program is gratefully acknowledged; in particular, the good offices of Dr. Robert E. Murphy provided inspirational and fiscal sustenance for my participation in the Workshop and these Proceedings. Fiscal support contributed by the University of Tennessee, Knoxville is much appreciated.
2. R. Hanel, B. Conrath, M. Flasar, V. Kunde, P. Lowman, W. Maguire, J. Pearl, J. Pirraglia, R. Samuelson, D. Gautier, P. Gierasch, S. Kumar, and C. Ponnampuruma, *Science* 204, 972 (1979). Also see R. Hanel et al., *Science* 212, 192 (1981).
3. D. A. Gryvnak, D. E. Burch, R. L. Alt, and D. K. Zgonc, AFGL-TR-76-0246 (December 1976).
4. F. K. Ko and P. Varanasi, *J. Quant. Spectrosc. Radiat. Transfer* 18, 145 (1977).
5. P. Pinson and J. Dupre-Maquaire, *J. Mol. Spectrosc.* 78, 170 (1979).
6. K. Fox, J. P. Aldridge, H. J. Flicker, R. F. Holland, R. S. McDowell, and N. G. Nereson, O.S.U. Molecular Spectroscopy Symposium, 16-20 June 1975, Abstract 24.

7. J. Botineau, J. Mol. Spectrosc. 41, 182 (1972).
8. A. Chedin, N. Husson, N. A. Scott, and D. Gautier, J. Mol. Spectrosc. 71, 343 (1978). For more recent band intensity measurements see, e.g., J. H. G. Bode and W. M. A. Smit, J. Phys. Chem. 84, 198 (1980).
9. K. Fox, M. J. Reinfeld, and R. S. McDowell, J. Chem. Phys. 71, 1058 (1979).
10. Remarks at this Workshop.
11. B. L. Lutz, P. M. Silvaggio, and R. W. Boese, Ap. J. 227, 334 (1979).
12. D. E. Jennings, Appl. Opt. 19, 2695 (1980).
13. K. Fox and W. B. Person, J. Chem. Phys. 64, 5218 (1976).
14. G. Restelli, F. Cappellani, and G. Melandrone, Chem. Phys. Lett. 66, 454 (1979).
15. K. Fox, O.S.U. Molecular Spectroscopy Symposium, 15-19 June 1981, Abstract ME 14; the effect of the C_{4m} term is calculated.

RANDOM WALKS WITH THE 6420- and 6825-Å
FEATURES OF METHANE: LOST IN THE WILDERNESS

Barry L. Lutz

Planetary Research Center
Lowell Observatory

This report is primarily about two spectroscopic dead ends--at least in the sense that little has been done over the past few years because of the difficulty with the laboratory spectra. But it's a story which illustrates how the lack of laboratory data can lead you astray--a long way.

a) The 6420-Å Feature

The first of these is a feature near 6420 Å which appears in the spectra of Uranus and Neptune, and was recently detected in the spectrum of Titan by Danehy (1980).

When originally identified by Spinrad (1963), it was assigned to the pressure-induced 4-0 band of molecular hydrogen, and convincingly so. Not only did the wavelength agree--a small apparent shift was arm-waved away--but when the feature was reduced using a dipole-induced strength, it gave results for H₂ column densities consistent with our best estimates for the sharp quadrupole lines (cf. Poll 1971).

The proverbial fly in the ointment came when Toby Owen and I noticed that in studying the long path spectra of methane, that same feature was also present.

Figure 1 (taken from Owen *et al.* 1974) compares one of our laboratory spectra (a) with a scan of Uranus (b). The scales are somewhat different just to help confuse the issue, but it is beyond any reasonable doubt that the laboratory spectrum does have a feature comparable in strength, in position, and in shape to the planetary feature.

The pressure-induced absorption of H₂ must still be there, but CH₄ appears to account for most of that observed. One must then ask: Where does that leave the calculation of the pressure-induced contribution--and how much can self-consistency arguments be believed?

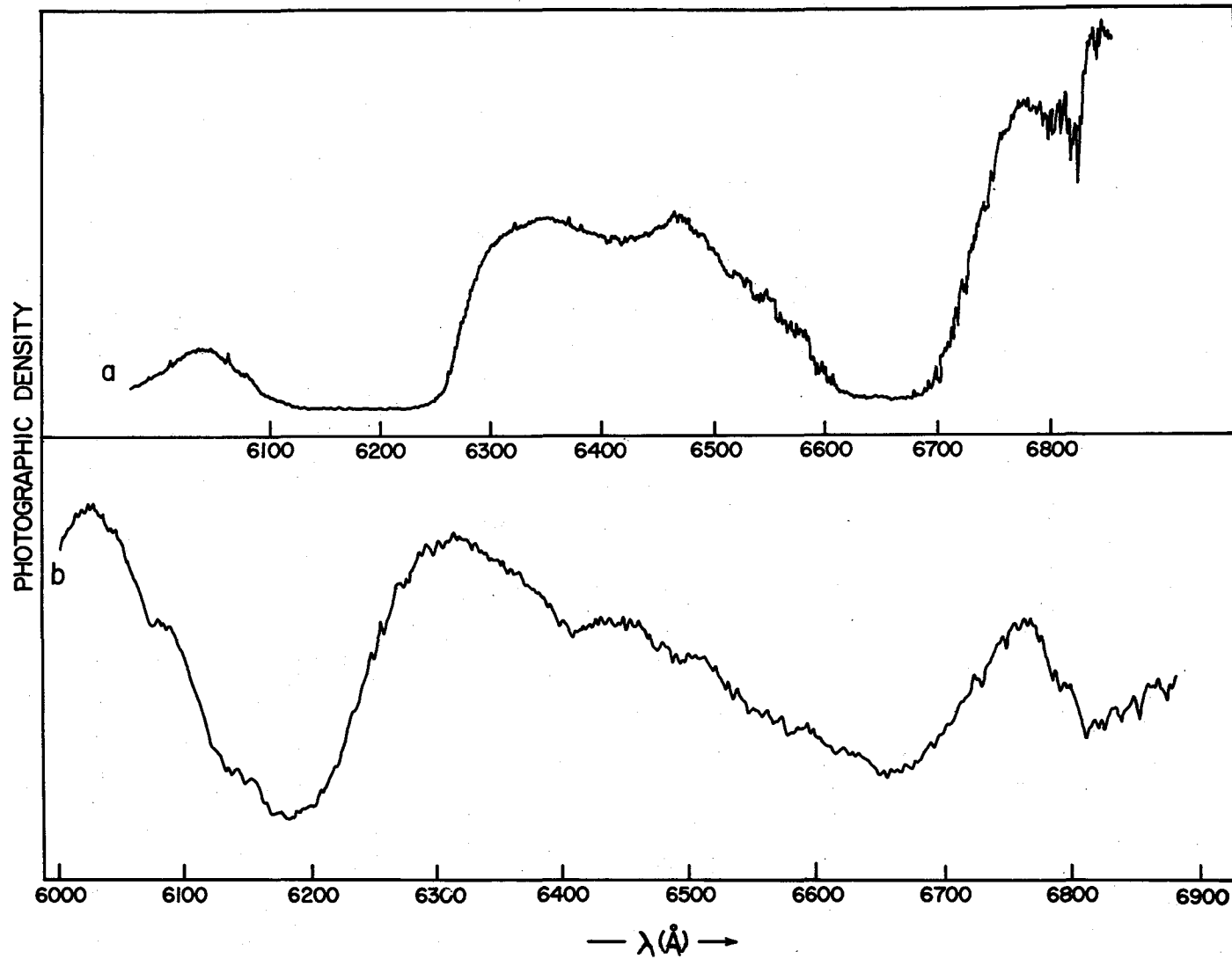

Figure 1. a) Density tracing of the 10.1 km-amagat spectrum of methane. b) Intensity spectrum of Uranus divided by the lunar spectrum. Taken from Owen et al. (1974).

Little has been done since this re-identification, because of the lack of laboratory data--both on CH₄ and the pressure-induced H₂ spectrum. Further advances must await these difficult investigations.

b) The 6825-Å Features

A second similar problem exists with a Uranian feature--indeed, a general planetary feature centered near 6825 Å.

Figure 2 (taken from Owen 1966) shows this band in Uranus and the hints of it in Jupiter. Based on these 1966 spectra, Toby Owen recognized the regular structure of this band and postulated that it could very well be the 5ν₃ band of methane. The region was right, the structure reasonable, and also, if analyzed, the band gave not only a believable methane abundance, but resulted in a rotational temperature in the atmosphere consistent with expectations.

Everyone believed it. In fact, it became fashionable to analyze the 5ν₃ band in more and more sophisticated ways.

Then Bergstrahl (1975), with somewhat better data than available to Owen, analyzed the 6825-Å features in Uranus, obtaining

$$\begin{array}{l|l} T = 100 \text{ K} & \eta N = 2-8 \text{ km-am} \\ T = 100 \text{ K} & N = 0.5-2 \text{ km} \end{array} \quad \left| \begin{array}{l} \text{RLM (reflecting layer model)} \\ \text{HSL (homogeneous, scattering layer)} \end{array} \right.$$

and concluded: "Internal and external consistencies in temperature calculations from the measurements give increased confidence that the band identification, and rotational quantum number assignments to band members, are correct" and then called for high-resolution laboratory work to confirm the Owen assignments.

Belton and Hayes (1975) analyzed the same bands, also obtaining

$$\begin{array}{l|l} T = 109 \text{ K} & \eta N_{\text{CH}_4} = 1.1 \text{ km am} \\ 92 \text{ K} & N_{\text{CH}_4} = 0.5 \text{ km-am} \end{array} \quad \left| \begin{array}{l} \text{RLM} \\ \text{HSL} \end{array} \right.$$

Both efforts assumed a pressure-broadening coefficient for 5ν₃ to be 0.075 cm⁻¹/atm, and theoretical line strengths with a band strength between 7 and 1.6 cm⁻¹/km-am. The first of these band strength estimates is based on some Saturn comparisons and the second on laboratory measurement by Fink and Dick (private communication 1974).

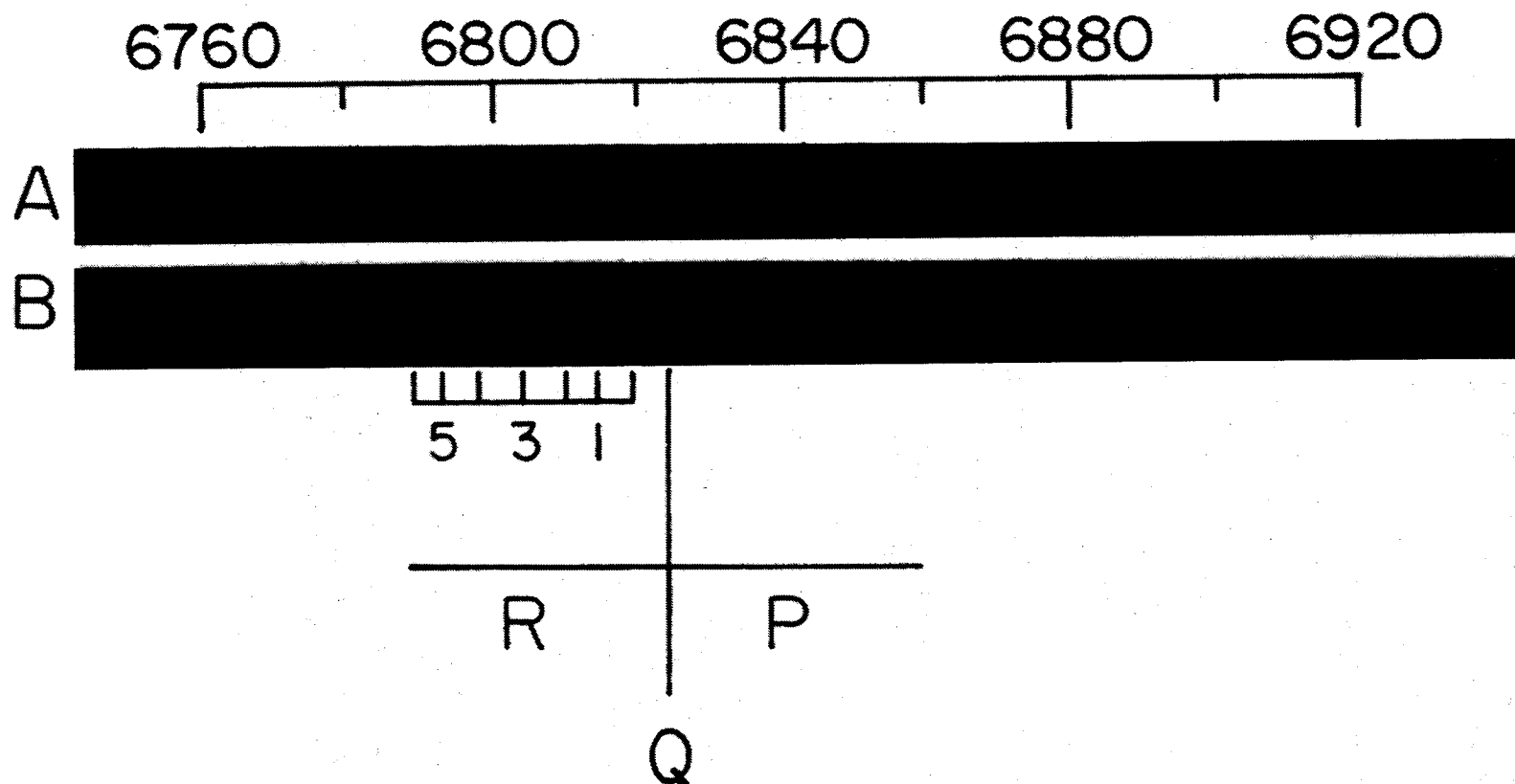

Figure 2. The spectrum of Jupiter (A) and Uranus (B) in the region of the 6825-A feature of methane.
Taken from Owen (1966).

In spite of this rather convincing self-consistent evidence, we noted that our laboratory high-resolution spectrogram showed inconsistencies with this interpretation, and we pursued the identification question.

Figure 3 (Lutz and Owen 1976, 1977) shows our spectrum--and from this it becomes clear that, in the laboratory, the region is very confused. From these data and from high-resolution planetary spectra obtained by Gelfand *et al.* (1977), it became clear that the R-branch separations were not as regular as the lower resolution planetary spectra indicated. Furthermore, a rotational temperature for the laboratory spectra gave 25 K. Now I know that our laboratory spectra were taken in Canada, but to the best of my knowledge, the temperature of the White cell never went that low.

What this also means is the apparent self-consistency of the planetary spectra was just that: apparent. The features originally identified as R-branch members of $5\nu_3$ were fortuitous groupings of numerous rotational lines, and once again we were misled.

But what are these features? $5\nu_3$ must be somewhere, and as other overtone/combination bands, should be present; but that analysis seems beyond us at the present time. Hopefully someday we will understand this region, but what can we do now?

Macy, Gelfand, and Smith (1978) looked at that question and noted that the "R(0)" feature at 6818.9 Å looks like a singlet even at the highest resolution of our laboratory spectrum.

Some progress might be made with this feature, and they attempted to investigate the possibilities. They argued that the line width should be the same as ν_3 , i.e., $0.075 \text{ cm}^{-1}/\text{atm}$ and that the line strength must be greater than $0.1 \text{ cm}^{-1}/\text{km-am}$ based on a band strength of $1.6 \text{ cm}^{-1}/\text{km-am}$ and a reasonable J-value of the line.

On these bases and with their own planetary observations, they obtained for three different models, methane abundances ranging between 3-4 km-am for Uranus and ~ 2.5 -4 km-am for Neptune.

But that's not the end of the story. We (Lutz, Owen, and Cess 1980) continued our laboratory work and obtained a curve of growth for the 6825-Å band which resulted in a band strength $S = 3.6 \text{ cm}^{-1}/\text{km-am}$, more than two times larger than has been used by these various groups.

ROOM TEMPERATURE SPECTRUM OF 4.920 KM-AM METHANE 6785 to 6830 Å

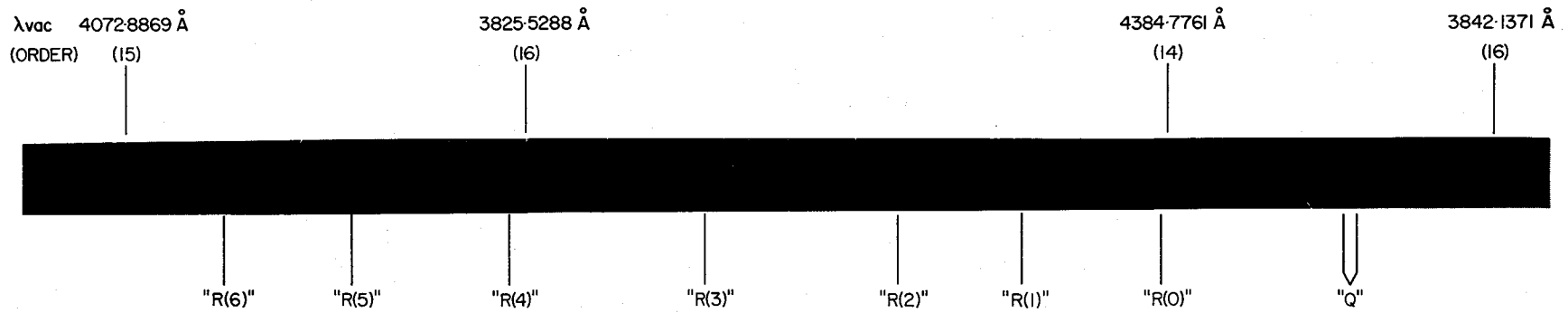

Figure 3. Spectrogram of the 6825-A feature of methane taken at room temperature (295 K) with a total pressure of one atmosphere of methane and a pathlength of 5.26 km. Taken from Lutz and Owen (1976); see also Lutz and Owen (1977).

Furthermore, we (Lutz and de Bergh 1980) have carried out high-resolution line-strength and pressure-broadening studies for the so-called "R(0)" and obtained $S \leq 0.02 \text{ cm}^{-1}/\text{km-am}$, at least five times smaller than estimated by Macy *et al.* (1978), and we found a pressure-broadening coefficient about three times larger than they assumed.

So not only was the identification wrong--but the molecular parameters too, and where does that leave us? Clearly over 14 years since their discovery in the spectrum of Uranus, we still do not have an adequate understanding of this band and no correct analysis of its role in the planetary spectra--but at least we progressed to the point where we know that.

This report and some of the research described have been supported by NASA through grant NSG-7499.

References

- Belton, M. J. S., and Hayes, S. H. (1975). Icarus 24, 348.
Bergstralh, J. T. (1975). Astrophys. J. 202, 832.
Danehy, R. G. (1980). Ph.D. Thesis, State University of New York at Stony Brook.
Gelfand, J., White, R. E. III, Perlsweig, D. M., and Smith, W. H. (1977). Astrophys. J. 215, L43.
Lutz, B. L., and de Bergh, C. (1980). In preparation.
Lutz, B. L., and Owen, T. (1976). Astrophys. J. 208, L99.
Lutz, B. L., and Owen, T. (1977). Astrophys. J. 215, L101.
Lutz, B. L., Owen, T., and Cess, R. D. (1980). In preparation.
Macy, W. Jr., Gelfand, J., and Smith, W. H. (1978). Icarus 34, 20.
Owen, T. (1966). Astrophys. J. 146, 611.
Owen, T., Lutz, B. L., Porco, C. C., and Woodman, J. H. (1974). Astrophys. J. 189, 379.
Poll, J. D. (1971). In Planetary Atmospheres (C. Sagan, ed.), Springer-Verlag, New York, p. 384.
Spinrad, H. (1963). Astrophys. J. 138, 1242.

DISCUSSION

Question (R. Beer): In view of the uncertainties, should we abandon this region for astronomical purposes?

Comment: I think Barry Lutz has made an important point. Greater attention has to be given to the 6825 Angstrom region, because $5\nu_3$ should be there. Astronomers should not believe that apparent band structure corresponds to real band structure without confirming laboratory evidence. There are too many effects that can conspire to mislead you.

Comment (K. Fox): I have been working on the 6280 Å band of methane for many years. The real issue is not whether this structure is $5\nu_3$ or something else, which is a question that can be settled spectroscopically. For astronomy, the real issue is rather whether the band can be understood well enough to be of use in interpreting planetary atmospheres. Also, it is a mistake to assume that just because a line appears to be a singlet under the highest resolution available, that it must be $R(0)$, $R(1)$, or any other particular transition. Further, a band like $3\nu_3$ or even the fundamental, which appears to be simple under laboratory conditions, appears very complicated at high pressure or with a high column abundance of gas.

Comment (A. Young): I would like to make a general remark. Planetary atmospheric spectra often have a lot more structure than we can get in laboratory spectra. Maybe opto-acoustic or other new techniques will eventually allow us to see in the laboratory some of the very weak transitions that show up in planetary spectra, due to the very large path lengths, but at present they are a big problem, at least for the outer planets. For the terrestrial planets we are mostly concerned with simple molecules-diatomics or linear molecules. The theory for these is good; you can use it to extrapolate a lab spectrum to conditions in a planetary atmosphere. But the molecules important on the outer planets are much more complicated, and the theory is inadequate for the extrapolation. We can't get realistic spectra in the lab because we can't get enough gas in the absorption tube, we can't get realistic temperatures, and we can't use theory to take us from obtainable to realistic spectra. This is a real problem in trying to understand the atmospheres of the outer planets. Much theoretical work has to be done on the more complicated molecules, to solve this problem.

Current Band Model Studies of CH₄ at Wavelengths Less Than 2.5 Microns

Uwe Fink

Lunar and Planetary Laboratory, University of Arizona
Tucson, Arizona 85721

The rationale for using band model theories can best be illustrated by reference to a previous paper on high resolution studies of CH₄ by Linda Brown. The spectra she showed were limited to the fundamental bands of CH₄, and used abundances of about 1/2 m-amagat, which are relatively low on a planetary atmosphere's scale. They are a factor of 100 or so smaller than the methane abundances on the major planets. Yet the spectra were quite complex and exhibited thousands of lines. If one moves into the overtone and combination region below 2.5 μm, the bands quickly become very numerous. The number of overtone bands doesn't just increase linearly or even quadratically, but it increases factorially. So below 1 μm there are thousands of methane bands, each consisting of hundreds of lines (Dick and Fink 1977). This illustrates the degree of complexity of the methane spectrum, and the reasons why band models are required to make headway for the bands below ~2.5 μm and large abundances.

Yet, I agree that, in principle, if we knew the monochromatic absorption coefficient at all wavelengths and we also knew the behavior of this absorption coefficient as a function of temperature and pressure, then we could calculate the transmission of the spectrum for any other conditions, including scattering geometries. But we are not in that fortunate state for methane. We therefore have to use band model theories. In a band model we replace the monochromatic absorption coefficient over a small wavelength interval, and introduce an average pressure coefficient.

Two main types of band models have been developed. The first is the "regular" band model, in which the lines in a band are presumed evenly spaced; this is also called the Elsasser band model. In the second type of band model, the lines are randomly spaced; this is often referred to as the Mayer-Goody band model. The methane spectrum is sufficiently irregular that the second band model, the irregular band model, should apply.

The Mayer-Goody random band model gives a simple relationship for the average transmission, \bar{T} , in a spectral interval, as shown below:

$$\bar{T} = \exp \frac{-K_{\nu} a}{\sqrt{\frac{K_{\nu} a}{\pi y_{\nu} p} + 1}}$$

Thus the average transmission can be characterized by an absorption coefficient K_{ν} , $(\text{km-atmagat})^{-1}$, an abundance a (km-atmagat) , a pressure coefficient y_{ν} $(\text{atm})^{-1}$, and a pressure p (atm) . The absorption coefficient K_{ν} can also be defined as the ratio of the mean line intensity σ $(\text{cm}^{-1}/\text{km-atmagat})$ to the mean line spacing δ (cm^{-1}) while the pressure coefficient is equal to the pressure broadening coefficient α_0 $(\text{cm}^{-1}/\text{atm})$ divided by the mean line spacing. For a more detailed discussion of band model theory and nomenclature the reader is referred to Goody (1964).

Fig. 1 shows the behavior of the average transmission as a function of the parameters K_{ν} , y_{ν} , and the abundance. The vertical axis is the transmission, and is plotted against the parameter $K_{\nu} a$, the absorption coefficient times the abundance. If you have a very large pressure coefficient, for example, the transmission behaves according to Lambert's law (a simple exponential law). But for smaller pressure coefficients you get systematic deviations from Lambert's law. Two band models are illustrated: the solid lines are for the random band model (the Mayer-Goody band model) and the

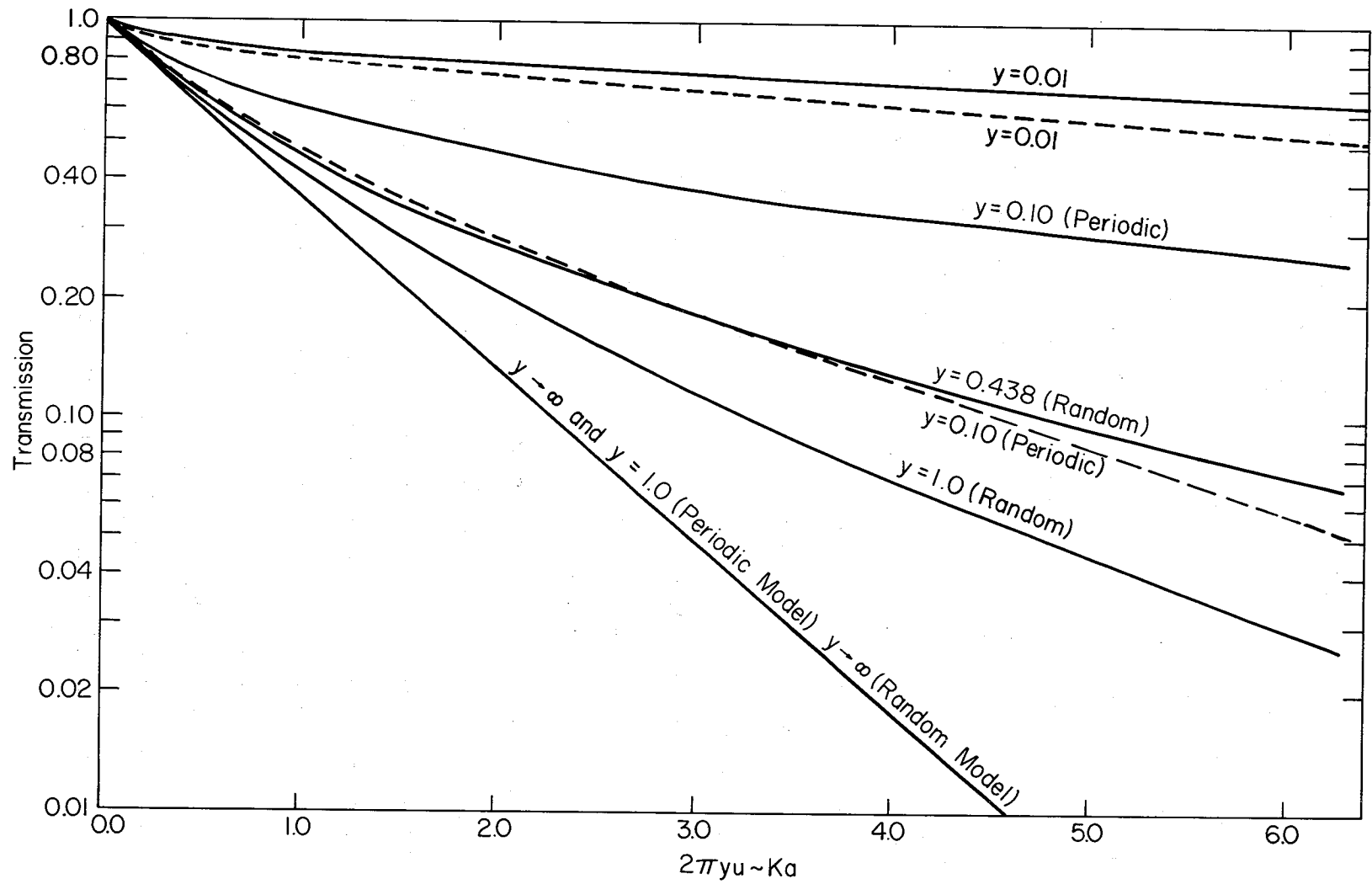

Figure 1. Behavior of the average transmission with K_p , Y_p , and a for the Elsasser (periodic) and Mayer-Goody (random) band models.

dotted curves are for the Elsasser band model. You can see that it is very difficult to distinguish between the two models experimentally unless you have data of very high accuracy, since by suitably choosing the parameters you can fit experimental data to either one of those two band models (cf. curves $y = 0.10$ periodic and $y = 0.438$ random).

Fits of this type have been made by us (Dick and Fink 1977, Fink, Benner, and Dick 1977) and also by Larry Giver at NASA-Ames (Giver 1978), in the region below $1 \mu\text{m}$. The random band model has been chosen because it yields a simple algebraic expression for \bar{T} and seems quite appropriate for the complex CH_4 spectrum. Fig. 2 shows our results for the absorption coefficient per km-amagat for the methane spectrum from about 4000 \AA to somewhat above $1 \mu\text{m}$. The solid line represents the absorption coefficient. In addition to the absorption coefficient we also determined the pressure coefficient, indicated by the dotted line.

We could only determine the pressure coefficient for the two strongest bands in the infrared. One surprising result that came out of this study was the large size of the pressure coefficient. If you recall Fig. 1, a larger pressure coefficient implies a weak dependence of the transmission on the pressure. A pressure coefficient of the order of 10 means that the line half width is 10 times the line spacing so that we have roughly 10 lines per half width of each methane line. This gives you an idea of the density of lines for those two bands. The density of lines is expected to go up even higher for the more complex bands at shorter wavelengths.

Fig. 3 shows some of the data that were used to determine the fitted parameters. The fine line is the original spectrum, and the heavy line is the fit using our final values for the band model parameters. This particular

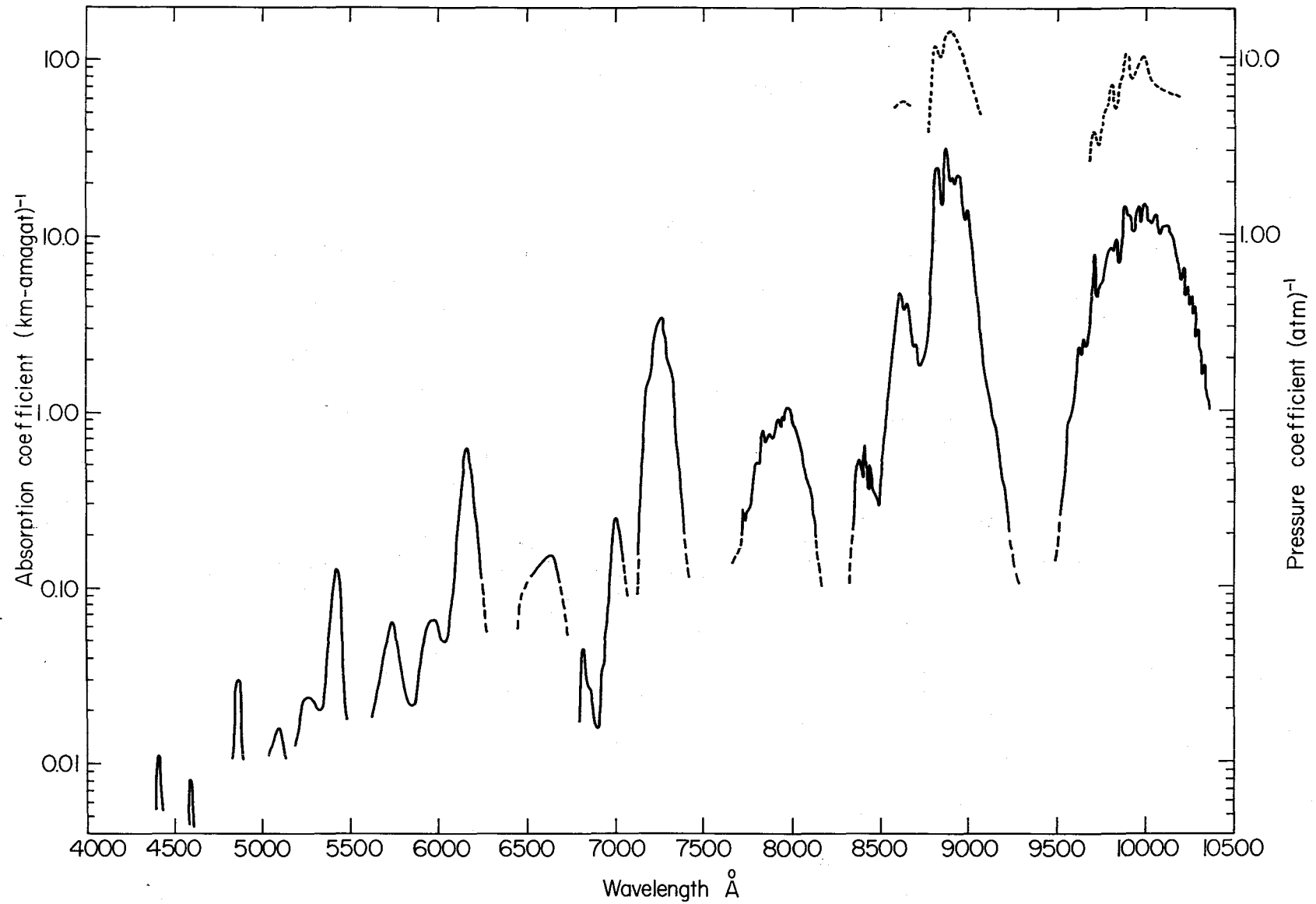

Figure 2. Absorption and pressure coefficients for CH₄ derived from the random band model and experimental results.

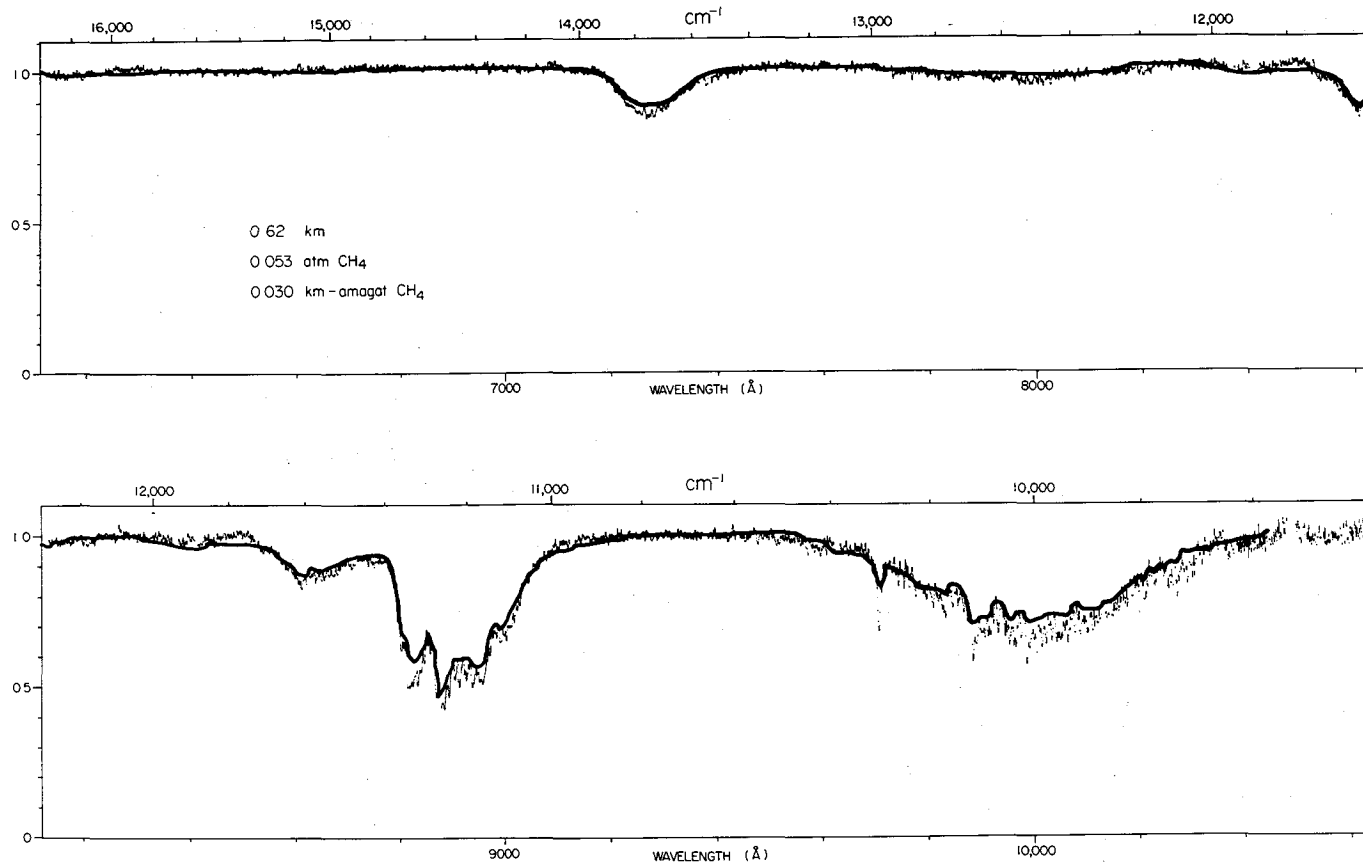

Figure 3. Comparison between experimental CH₄ absorption and fitted spectrum (heavy line) using the random-band model.

methane spectrum corresponds to a path length of 0.62 km and an abundance of 0.03 km-amagat. Fig. 4 shows similar spectra, but with a slightly higher abundance. You can see that after we obtained the band model parameters, we could get quite a good fit to the original spectra that went into determining the parameters of the band model.

Barry Lutz (Lutz, et al. 1976) has done studies somewhat similar to ours, but for bands further in the visible. He has measured the equivalent widths of the bands using standard methods and has found that they are simply linearly related to the abundance as shown in Fig. 5. He has done this for a variety of pressures and finds that there is no discernible pressure effect for these bands. This again demonstrates the pseudo-continuum character of the methane spectrum at these shorter wavelengths: a result of the enormous density of lines.

I now want to say a few words about how this kind of data is obtained, since it has not been discussed at all at this workshop. Fig. 6 shows the optical configuration of a multiple-pass White-cell, which is used in this type of measurement. It consists of three mirrors, A, B, C, with equal radii of curvature. The light comes in at the entrance slit (position 0 at the bottom of Fig. 6a) and diverges to fill mirror A. It is refocused by this mirror to a slit image on mirror C at position 1. Then it is reflected and fills mirror B, goes to position 2, and passes back and forth through the cell a number of times. That is how you obtain rather long path lengths. The slit images on the full-face view of mirror C (Fig. 6c) are numbered, and correspond to the numbers on the side view of mirror C (Fig. 6a); they tell you how many path lengths of methane you have gone through. In this particular case there are 16 traversals of the cell. Our own White-cell at the University of Arizona has a base path length of ~40 m and with ~100 traversals allows easily obtainable total path lengths of ~4 km.

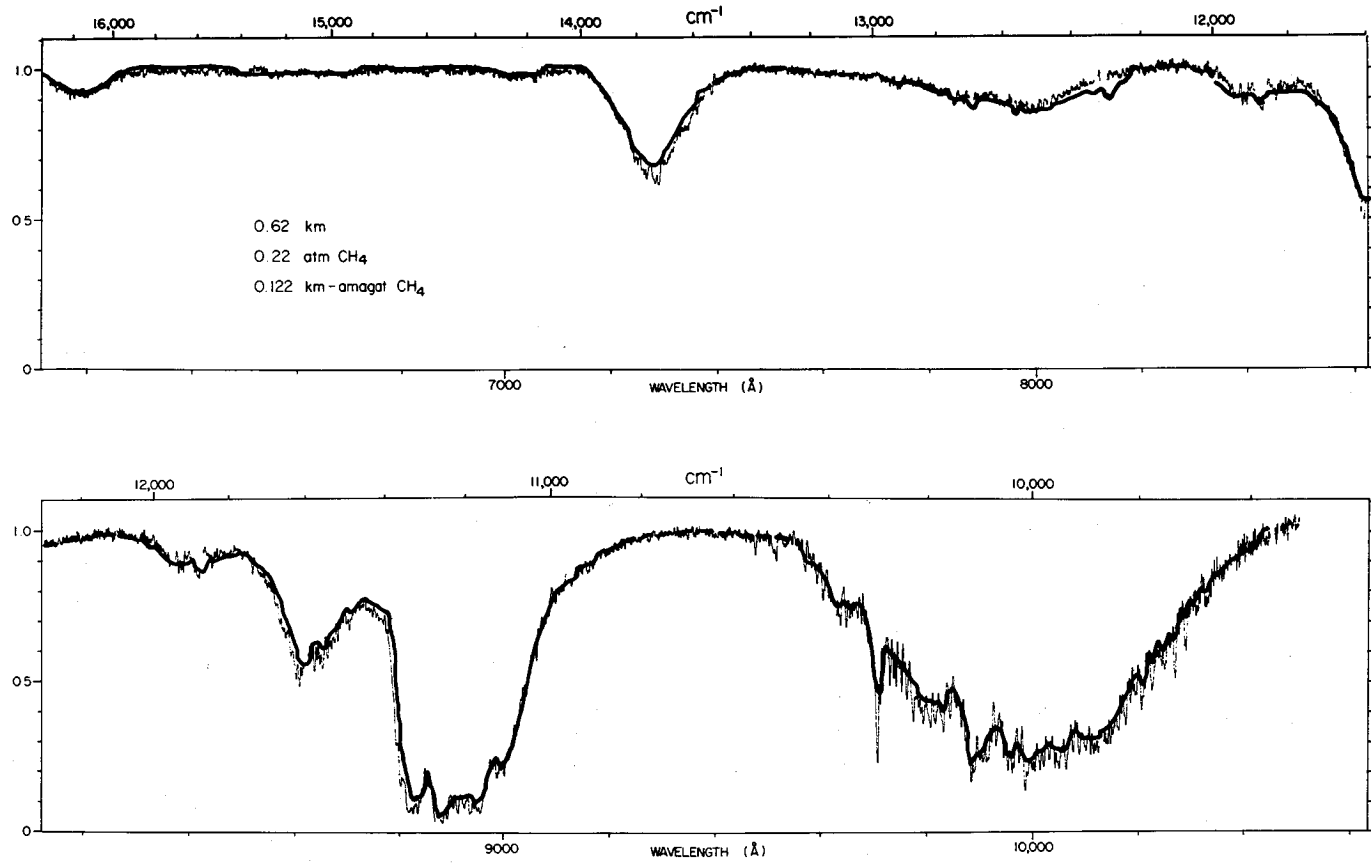

Figure 4. Similar comparison of experimental and modelled results, but with higher density of CH₄.

CURVE OF GROWTH VISIBLE BANDS OF METHANE
 $\lambda\lambda$ 4400 - 6000 Å

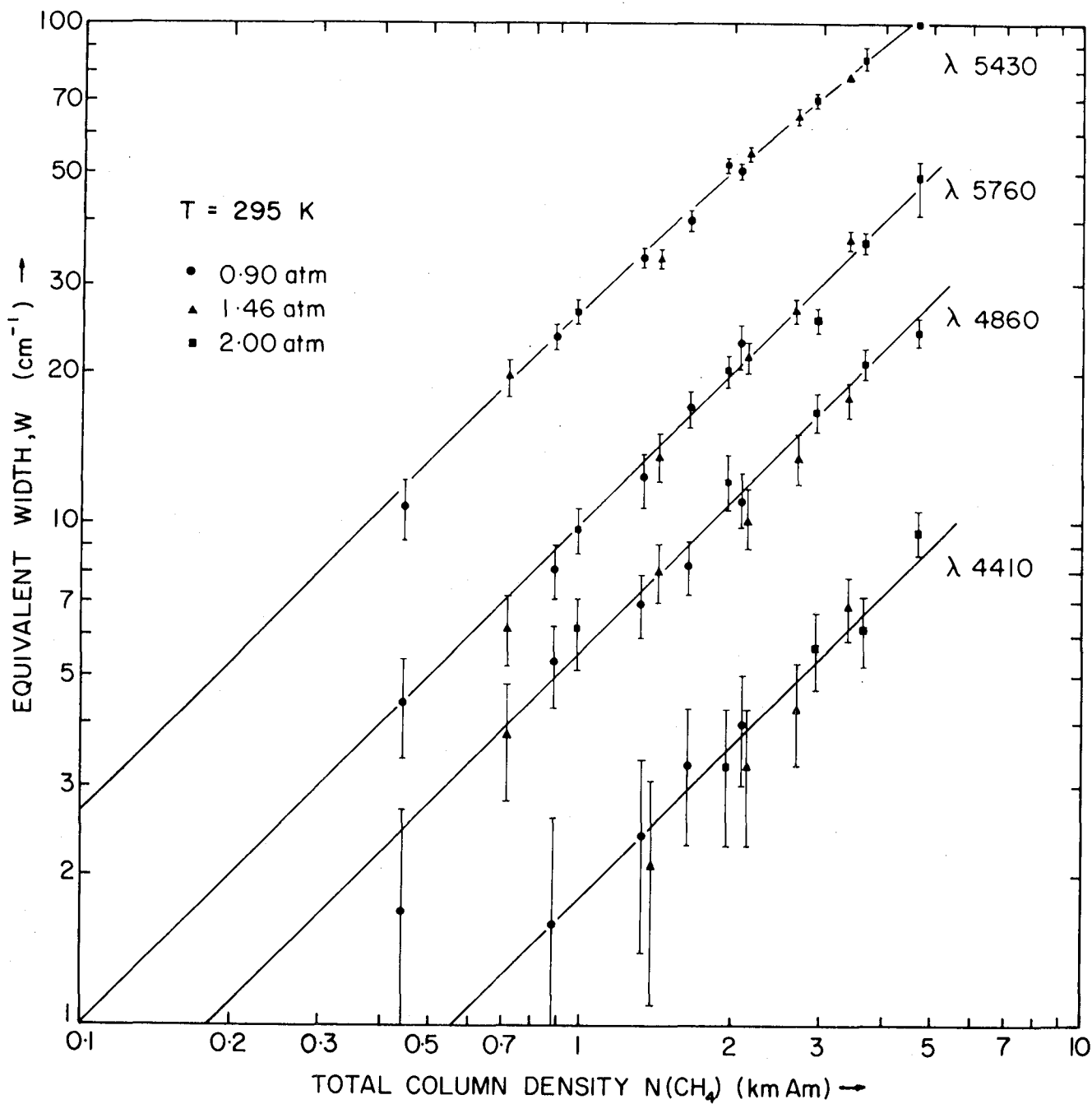

Figure 5. Equivalent width vs. column density for various CH₄ bands (after Lutz et al. 1976) illustrating the linear relationship with abundance.

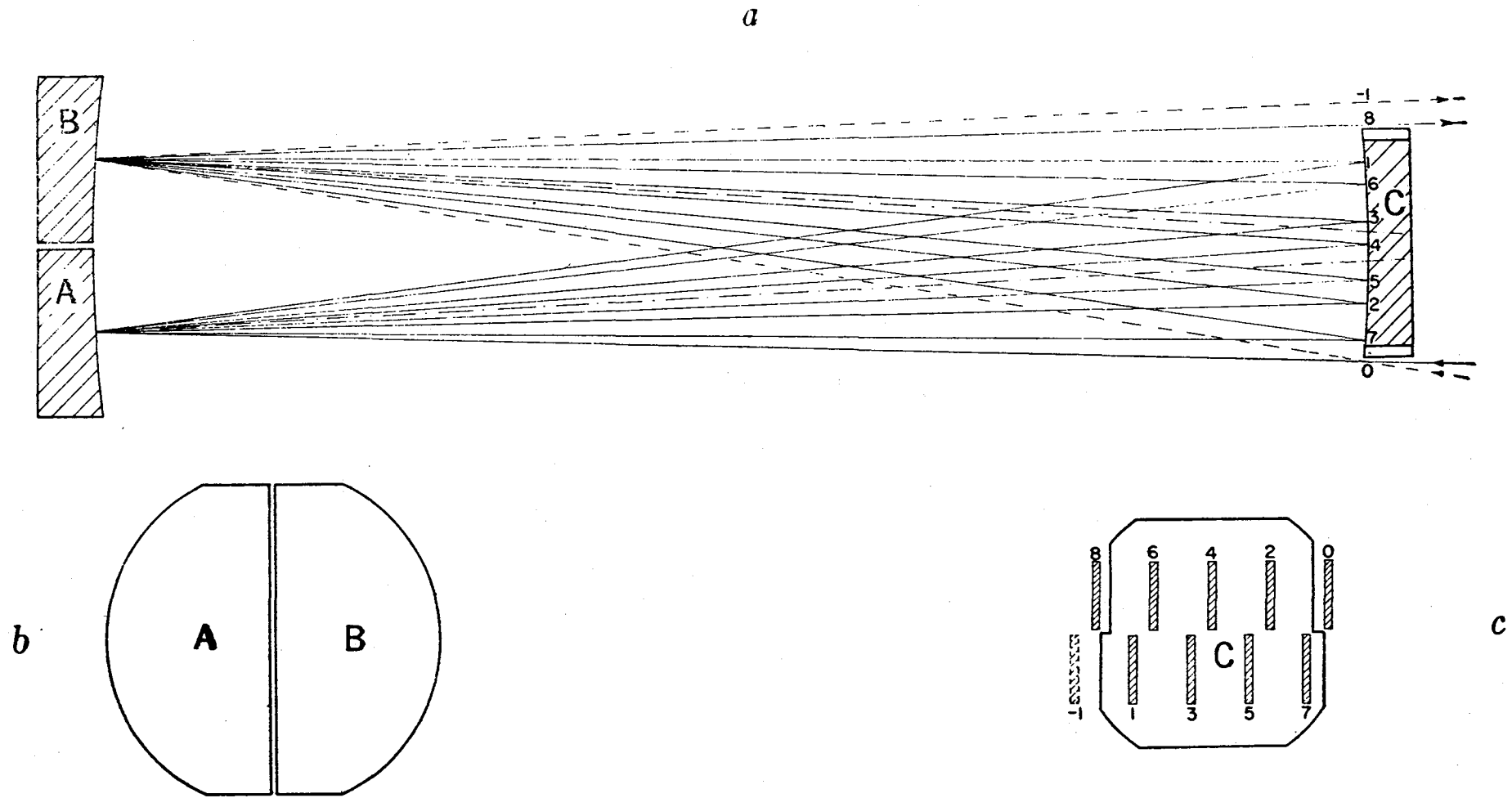

Figure 6. Schematic diagram of a typical multiple-pass absorption cell.

In addition to our measurements below $1 \mu\text{m}$ where we know that the methane spectrum is very complex, we have now started to do band modeling in the region from 1 to $2\text{-}1/2 \mu\text{m}$. This work is being done together with D. C. Benner who is now at NASA-Ames. Our motivation is shown in Fig. 7, which displays a laboratory spectrum of CH_4 (bottom) and spectra of the outer planets from 1 to $2.5 \mu\text{m}$, comparing Jupiter, Saturn, Titan, Uranus, and Neptune (Fink and Larson 1979). All of these bodies display very large methane absorptions: absorptions on the order of several km-amagat. The laboratory spectrum corresponds to 1.5 km-amagat and, as can be seen, is rather similar to the spectrum of Uranus. To make headway in the analysis of the major planets in this spectral region, we need CH_4 band model coefficients.

Fig. 8 shows some of the data that we have taken in this spectral region. This is for a relatively short path length of $\sim 100 \text{ cm}$. These spectra are at low resolution and represent an overview of the whole methane spectrum, as contrasted to the very high resolution spectra that Linda Brown showed. This particular series shows the change in absorption with CH_4 pressure (or abundance) keeping the path length constant. Fig. 9 shows a slightly different wavelength region, containing the ν_3 fundamental, with abundances ranging from 0.15 to 22 cm-amagat . Fig. 10 shows the same region as Fig. 8, i.e., 1 to $2\text{-}1/2 \mu\text{m}$, taken with our White-cell, and thus yielding much larger abundances, starting at 0.048 km-amagat and going up to 2.27 km-amagat . Notice that there is probably still some continuum in the bottoms between the bands for the lowest abundance of 0.048 km-amagat . For 2.27 km-amagat , there is almost certainly no longer any continuum in the bottoms between the bands. This last case is the one that is more nearly applicable to planetary atmospheres, and illustrated the reason why we require band model coefficients in

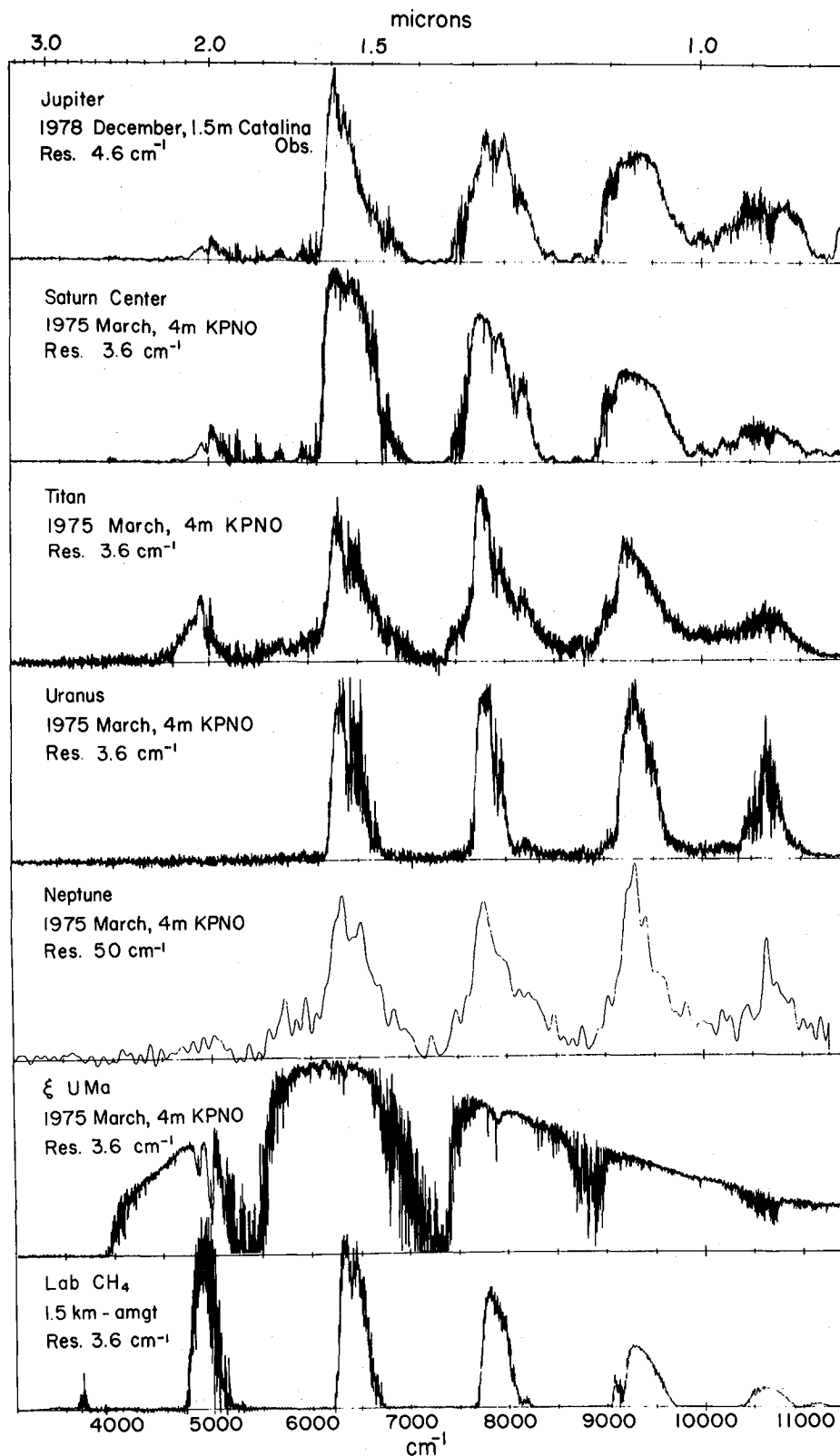

Figure 7. Spectra of the outer planets, a comparison star, and laboratory CH_4 illustrating the importance of CH_4 spectroscopy to the outer planets.

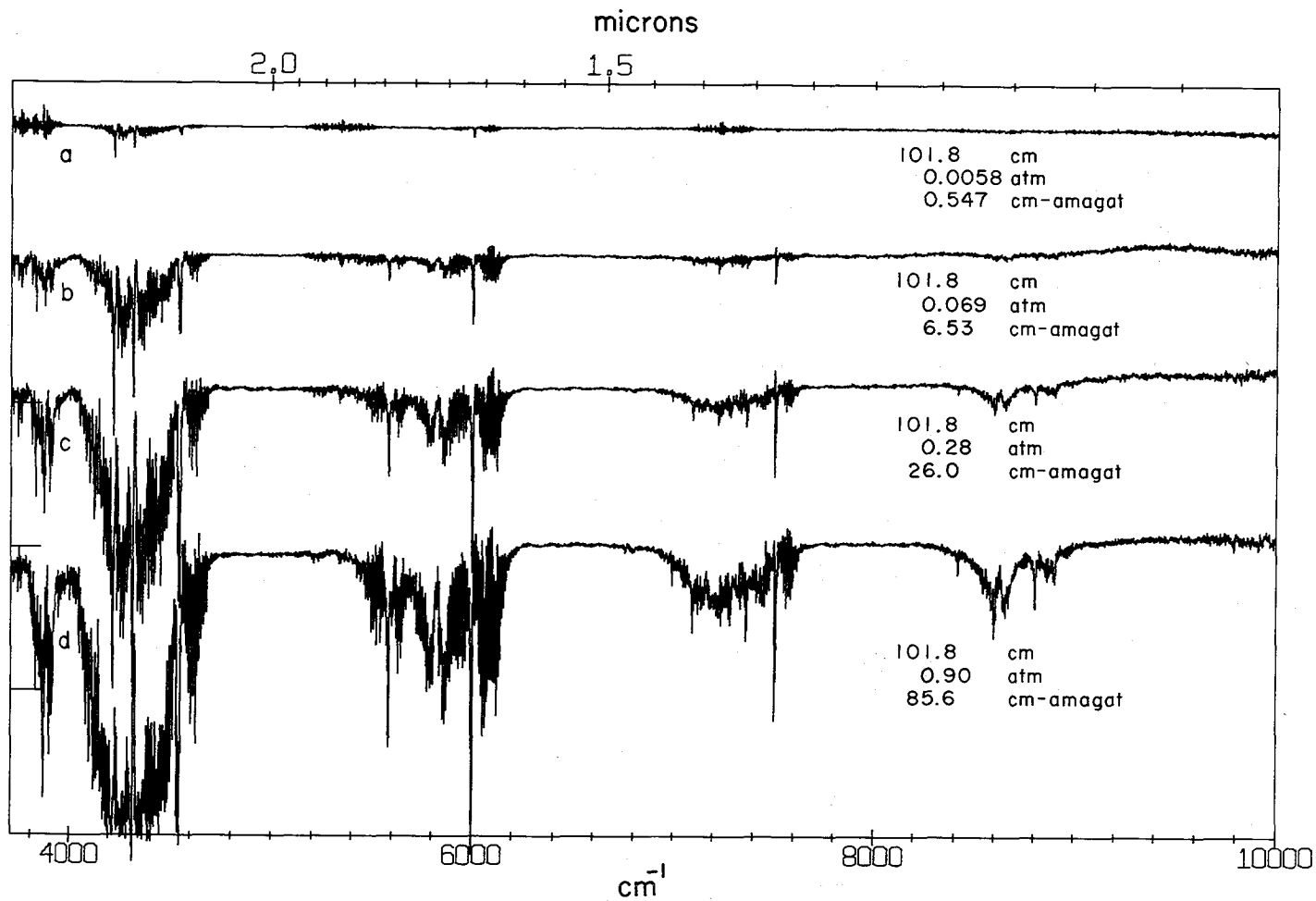

Figure 8. Low resolution overview of the CH₄ spectrum (4000–11,000 cm⁻¹) for various column densities.

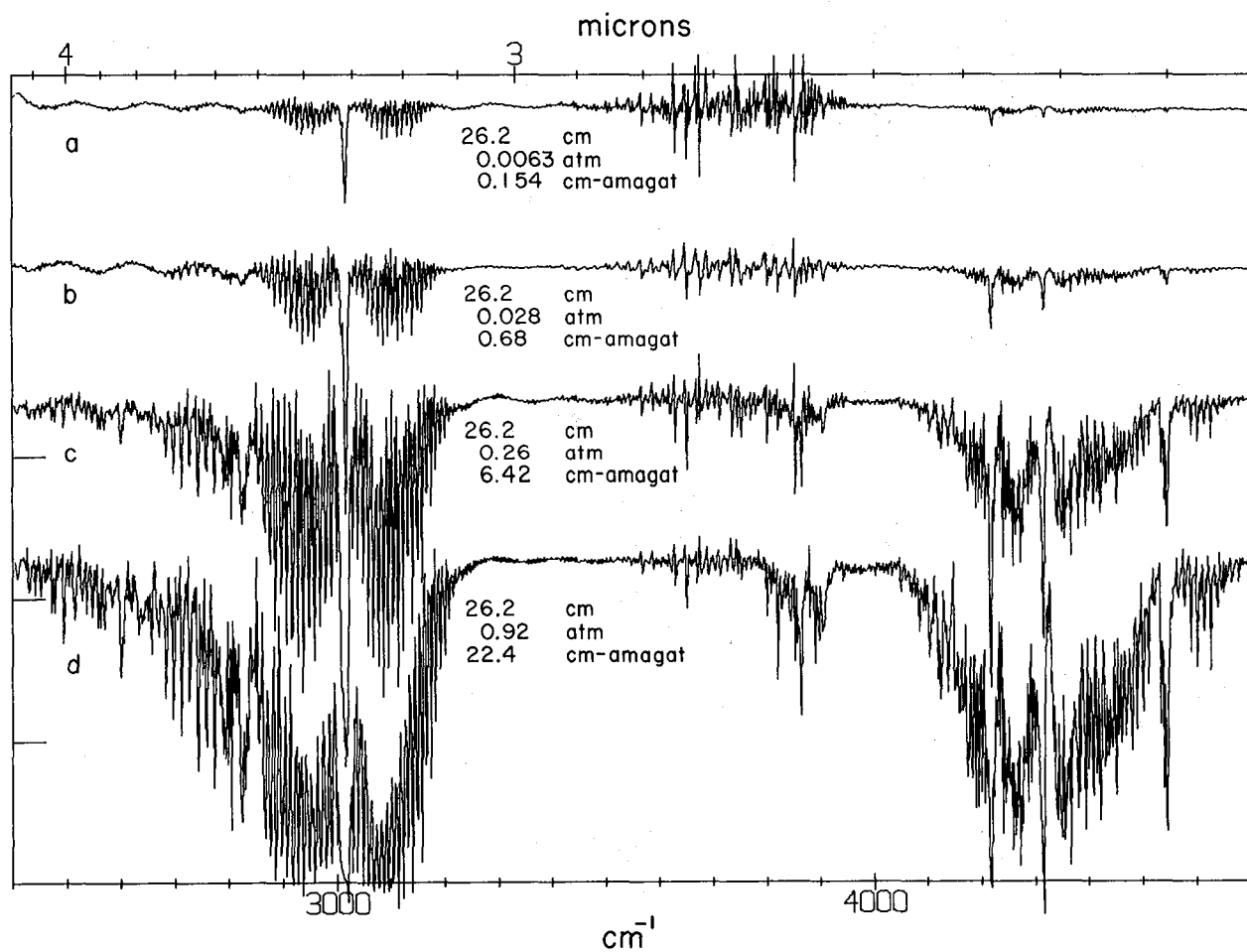

Figure 9. Low resolution spectra of CH_4 ($2400\text{--}4700\text{ cm}^{-1}$) for various column densities.

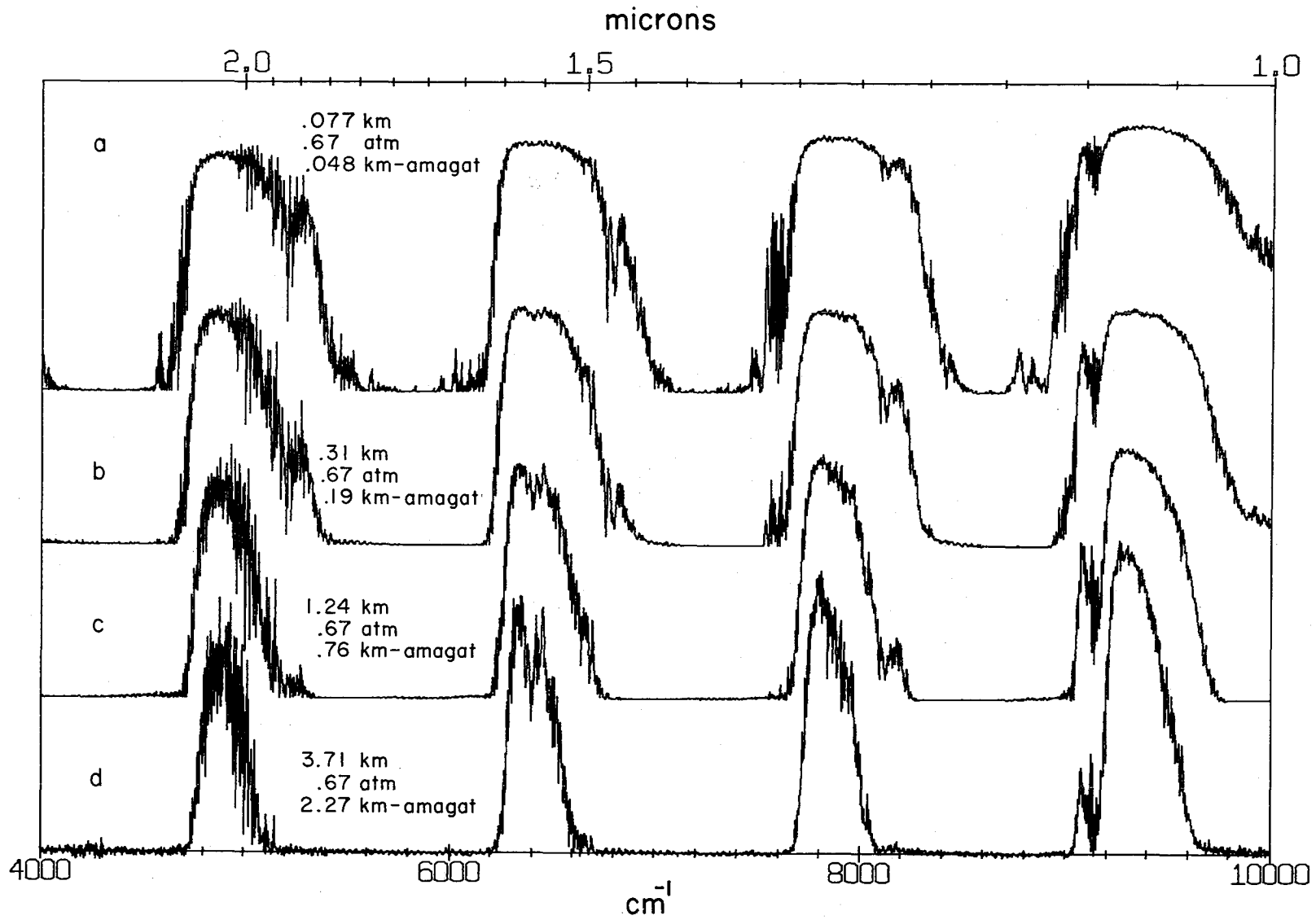

Figure 10. Low resolution spectra of CH_4 ($4000\text{--}10,000\text{ cm}^{-1}$) at higher column densities than shown in Figure 8.

this spectral region.

Band models have one severe drawback: the failure of the multiplicative property. This is illustrated by Fig. 11. Here is what I mean by the multiplicative property. Consider a spectral interval $\Delta\nu$ and assume that we know the real spectrum in that interval; suppose it to be given by the staircase function on the lower left, with transmissions of 0.8, 0.2, and 0.4. The average transmission over this spectral interval is 0.467. We may imagine that this hypothetical spectrum is produced by shining light through a tube filled with a particular gas, illustrated at the top left of Fig. 11. When we put two identical such tubes in series and pass light through them, the true transmission is $0.8 \times 0.8 = 0.64$ for the first spectral sub-interval, 0.04 for the second, and 0.16 for the third, giving 0.280 as the correct average transmission for the two in series. This is quite different from the product of the average transmissions, $(0.467)^2 = 0.218$.

The reason for this result is the correlation of the absorption coefficient in the two layers, i.e., after passing through the first tube the spectrum has a history which is strongly correlated with the second tube, since it is the same gas. Band models provide only an average transmission over an interval $\Delta\nu$ without telling us anything about the transmissions in the sub-intervals. The multiplicative property still applies for two uncorrelated layers (i.e., two different gases) or for spectral intervals small enough so that the monochromatic absorption coefficient is approximately constant (large pressure coefficient). If this is not the case, band models do not allow us to calculate the transmission through a series of layers in which the absorption coefficient is correlated. This limits the application of band models somewhat, particularly for scattering types of calculations

Multiplicative property of transmission for finite spectral intervals

575

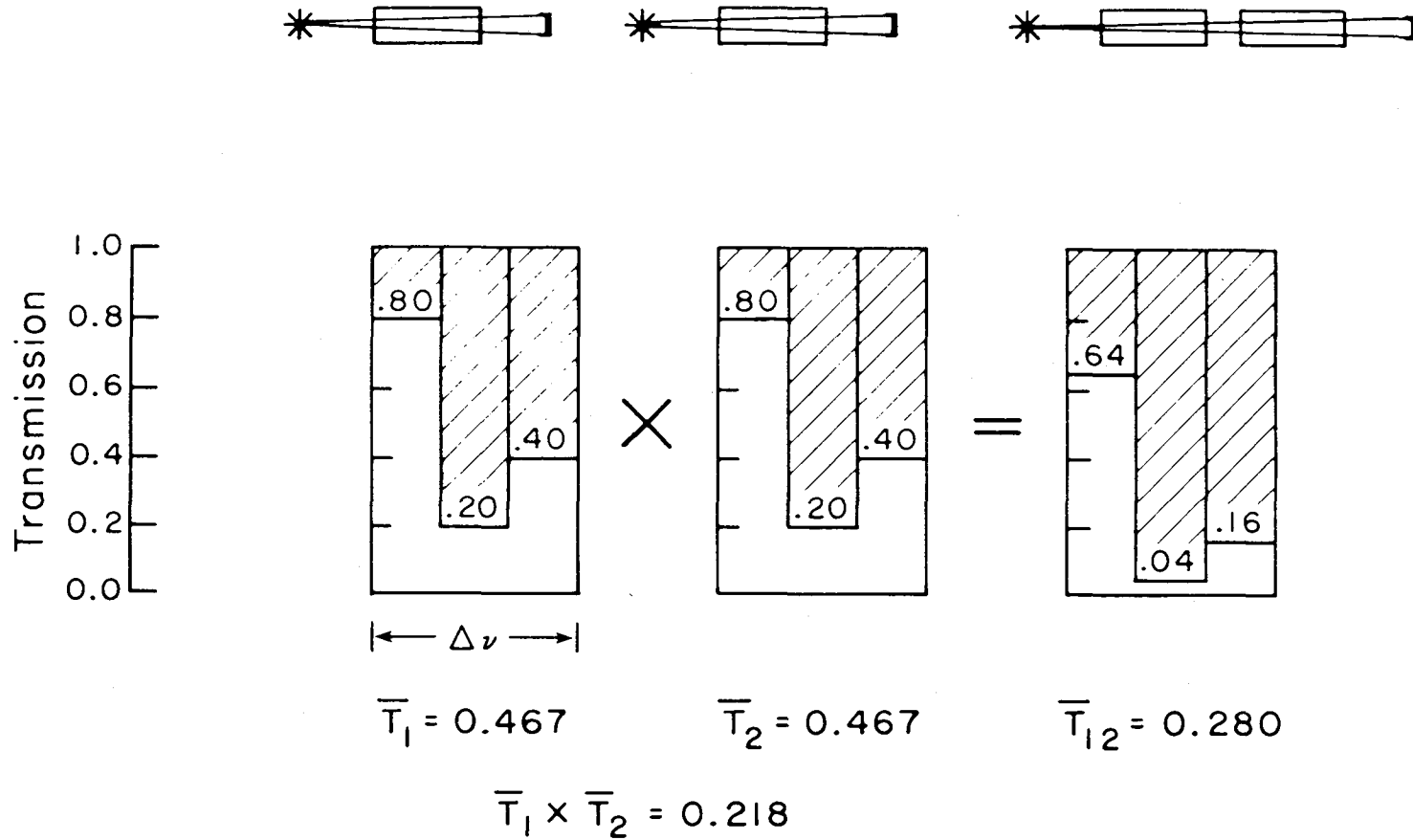

Figure 11. Limitations of band models as illustrated by failure of the multiplication property.

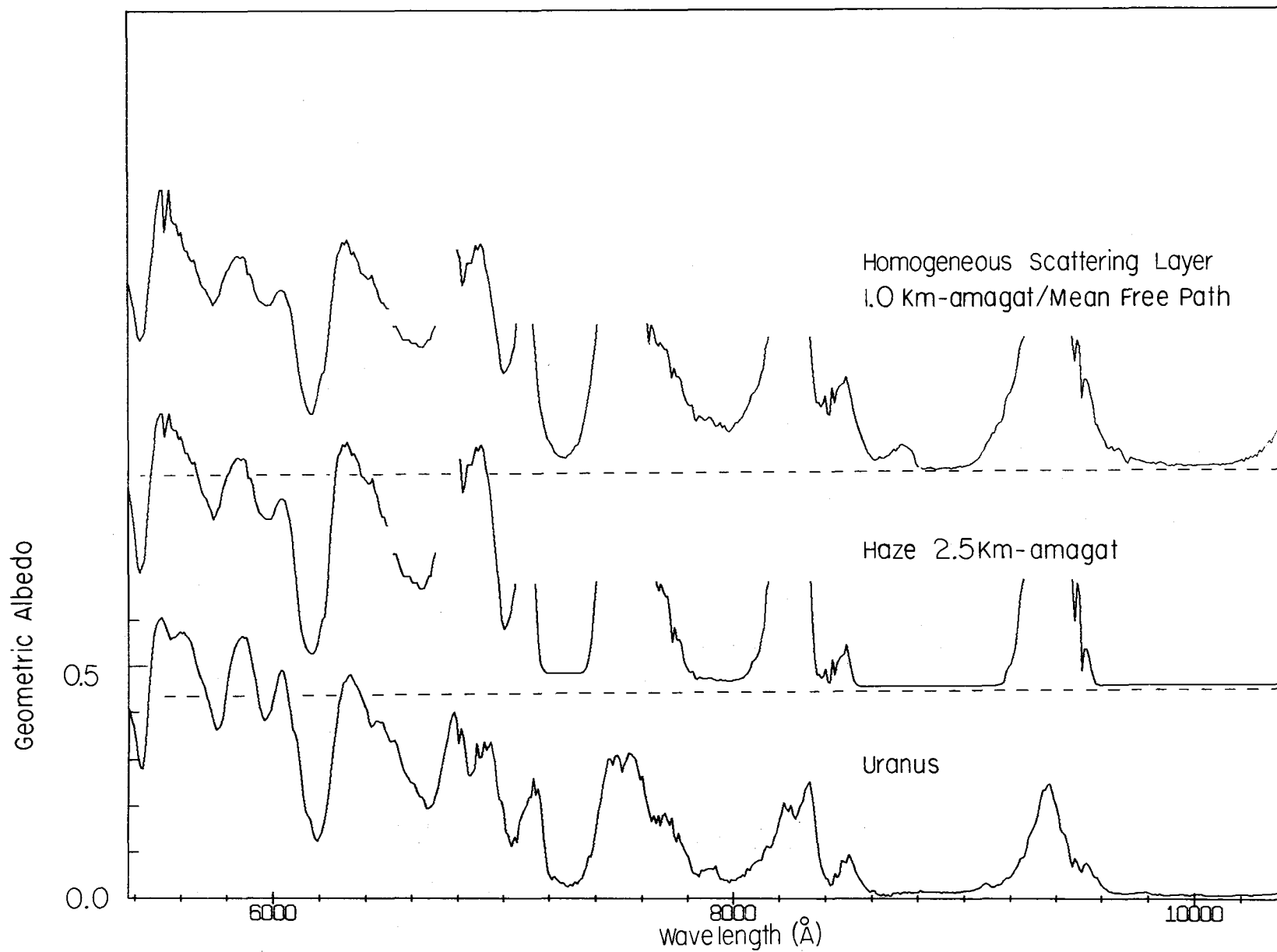

Figure 12. Comparison of observed albedo of Uranus (bottom trace) with two calculated models (after Benner and Fink, 1980).

requiring doubling or adding of layers. It is worth stressing this, because many people are not aware of this problem and have used band models for sequences of layers.

I would like to say something about the temperature dependence of band model coefficients. All the spectra that I have shown have been taken at room temperature, and as everybody knows, the planetary spectra are at a much lower temperature. I believe that the temperature effect on the absorption coefficient for CH_4 is not going to be very severe. This is based on experimental data of liquid CH_4 at $\sim 80^\circ\text{K}$ by Ramaprasad et al. (1978), who have obtained absorption coefficients within $\sim 20\text{-}30\%$ of our room temperature gaseous results. There may be small changes in the wings of the bands, some absorptions may sharpen up, and other absorptions that are only shoulders may become separate peaks (cf. Fig. 4 in Ramaprasad et al. 1978), but the overall integrated intensity and absorption coefficient is not going to change very much.

Quite a different situation is expected for the pressure coefficient. Because of the redistribution of the total band intensity into fewer low J lines at low temperature, the average line spacing is expected to increase considerably. This will result in a smaller pressure coefficient, y_v , at lower temperatures. Estimates made by Benner (1979) for Uranus at a temperature of $\sim 80\text{K}$ show that the average line spacing should increase by about a factor of 4-10. Our recent analysis of the CH_4 atmosphere on Pluto (Fink et al. 1980) assuming a reflecting layer model, have yielded pressure coefficients a factor of 10-18 smaller than the room temperature values.

Band models have been applied to a variety of problems in planetary atmospheres. Russian papers and Wallace and Smith (1977) used our band model coefficients for Jupiter, and both Lloyd Wallace (Wallace 1980) and ourselves (Benner and Fink 1980) have applied them to Uranus. Fig. 12 shows

a very simple example of such an application. At the bottom of the figure is a spectrum of the geometric albedo of Uranus, using data collected from a variety of sources. The upper two parts of the figure are two different types of models which we fitted to the Uranus spectrum. The gaps are regions where the absorption coefficient for methane has not yet been measured because it is very small and it is difficult to establish the correct continuum level. You can see that now, for the first time, a reasonably good agreement between the actual spectrum of Uranus and a scattering model could be obtained. Further details are given in Benner and Fink (1980).

We have also used band models to analyze image tube spectra of Pluto and Triton (Benner, Fink and Cromwell 1978), and give an example of this procedure for Pluto in Fig. 13. Podolak and Giver (1978) have modeled the Titan spectra from 4800 to 11000 Å using band model parameters, and Cruikshank and Silvaggio (1974) have used preliminary band model coefficients, including some at lower temperature, to model absorptions on Triton. Quite recently we have used band model coefficients to determine 27 ± 7 m-amagat of CH₄ on Pluto (Fink et al. 1980) and set an upper limit of ~1 m-amagat for a CH₄ atmosphere on Triton (Johnson et al. 1980).

Summary and Conclusions

Band model coefficients for CH₄ below 1 μm have already shown themselves to be exceedingly useful in the analysis of the atmospheres of the major planets. The methane spectrum in that region is so complex, and the amount of CH₄ on the major planets so large, that band model coefficients are envisaged to continue to play a major role in any future analyses. Band model coefficients will also be very useful for the region from 1-3 μm because of the necessity of matching the deep CH₄ absorptions displayed by the major

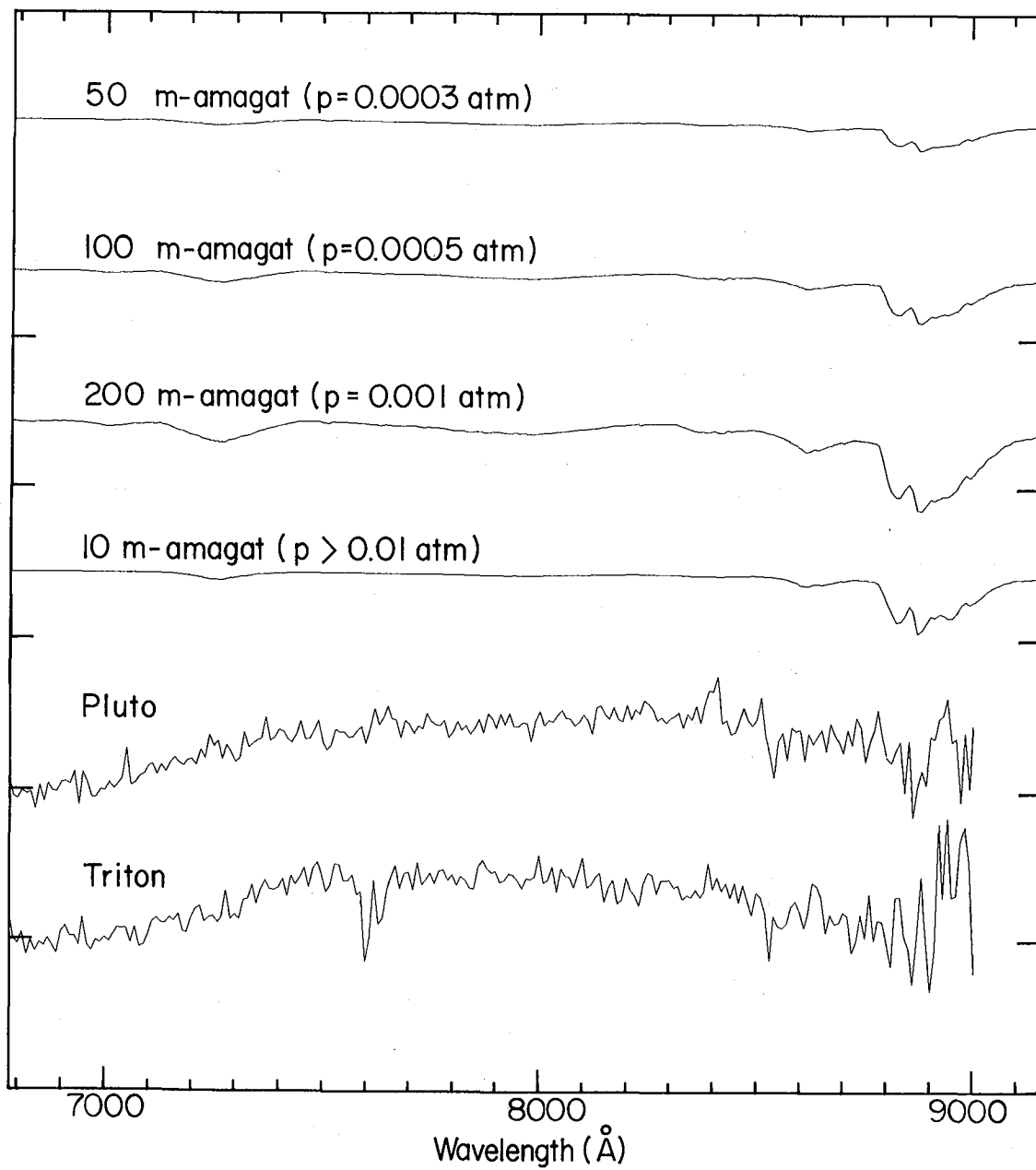

Figure 13. Comparison of observed spectra of Pluto and Triton (Benner et al. 1978) with various random band models.

planets (see Fig. 7). The pressure effect is expected to be much stronger there, so that the absorptions will lose much of their pseudo-continuum character. Sometime in the future, especially near the ν_3 fundamental region, line by line calculations are expected to take over. However, band model parameters will still be highly useful to determine any continuum absorption and make sure that all the interlopers of the many accompanying bands are properly accounted for. Apart from obtaining band model coefficients for the 1-3 μm region, low temperature studies in this region are urgently required, as well as any low temperature studies that can be carried out for the bands below 1 μm . In addition, absorption coefficients between the strong CH_4 bands, below 1 μm , are required to allow a complete analysis of the near IR spectra of the major planets.

The research described in this talk has been supported by NASA grant NSG-7070 and by NASA-Ames grant NSG-2349.

References

- Benner, D. C., Fink, U., and Cromwell, R. H., *Icarus* 36, 82 (1978).
- Benner, D.C., Ph. D. dissertation, University of Arizona (1979).
- Benner, D. C, and Fink, U., *Icarus* 42, 343 (1980).
- Cruikshank, D. P. and Silvaggio, P. M., *Ap. J.* 233, 1016 (1979).
- Dick, K. A. and Fink, U., *J. Quant. Spectr. Radiat. Transfer* 18, 443 (1977).
- Fink, Uwe, Benner, D. C., and Dick, K. A., *J. Quant. Spectr. Radiat. Transfer* 18, 447 (1977).
- Fink, Uwe and Larson, H. P., *Ap. J.* 233, 1021 (1979).
- Fink, U., Smith, B. A., Benner, D.C., Johnson, J. R., Reitsema, H. J. and Westphal, J. A., submitted to *Icarus* 1980.
- Giver, L., *J. Quant. Spectr. Radiat. Transfer* 19, 311 (1978).
- Goody, R. M., *Atmospheric Radiation*, Clarendon Press, Oxford (1964).
- Johnson, J. R., Fink, U., Smith, B.A., and Reitsema, H. J., abstract submitted to 1980 DPS meeting.
- Lutz, B. L., Owen, T., and Cess, R. D., *Ap. J.* 203, 541 (1976).
- Podolak, M. and Giver, L., *Icarus* 37, 361-376 (1979).
- Ramaprasad, K. R., Caldwell, J., and McClure, D. S., *Icarus* 35, 400 (1978).
- Wallace, L., in press *Icarus* (1980).
- Wallace, L. and Smith, G. R., *Ap. J.* 212, 252 (1977).

DISCUSSION

Question: Are there any attempts, either in your group or elsewhere, to put a more exact methane temperature dependence into a band model?

Response: Chris Benner will repeat (at NASA-Ames) some of our 1-2.5 μm CH_4 spectra at colder temperatures to see how the band model coefficients change. Silvaggio has also made some preliminary measurements at colder temperatures.

Comment: (L. Wallace, to P. Silvaggio)
You have some low temperature data in the 8900 \AA band too, don't you? Don't you see differences there between low temperature and high temperature?

Comment: (P. Silvaggio) Yes.

Comment: (L. Wallace) It was mostly in the region of strong absorption that you saw the large difference, was it not? Whereas in the case of the planets, the atmospheres are very dark in these regions; so dark you frequently can't see any structure anyway. We tend to worry more about the window regions, where the absorptions are small, and where the measurements even at room temperatures are very difficult. We wonder how those difficult measurements are going to change with temperature.

Question: Would you comment further on the fact that random band models cannot be used for multiplying transmissions from several layers by each other.

Response: Yes, the failure of the multiplicative property implies that band models cannot be used for scattering geometry models. For a plane reflecting layer model it doesn't make any difference.

Question: (Ken Fox) I'm not very familiar with this random band model technique. Do you randomize the line positions and the line strengths? How many lines do you need, or how wide a spectral range do you need before the random band model works? How many free parameters are there in the random band model?

Response: The lines are randomly located in the spectral interval, and the Myer-Goody model uses an exponential probability distribution for the strengths. Slightly different band models can result depending on the choice of probability distribution for the strengths. As for how many lines you need, it is hard to tell.

Comment: (L. Wallace) Many; but in some cases you can get away with as few as five, ten or twenty.

Response: (U. Fink) This can be tested experimentally by going into regions with smaller line densities. When we go to fundamentals maybe the random band model will break down, especially as the lines become less randomly spaced. As for the number of parameters, the models use only the two parameters - the absorption coefficient and the pressure coefficient - greatly simplifying it. The model then does not require adjustment of a large number of free parameters.

LONG-PATHLENGTH ABSORPTION SPECTROSCOPY OF CH₄

Peter Silvaggio (Lawrence-Livermore)

The work described here was done with Bob Boese at NASA/Ames. Since our instrument has only moderate spectral resolution and cannot resolve all the lines, we formulate our results in terms of the parameters of Goody's model of a random band.¹ Our model is therefore similar to that described by Uwe Fink at this Workshop, and gives good fits to the observed spectra.

We have taken many infrared spectra of methane and ammonia with the apparatus shown schematically in Figure 1. The short multiple-reflection cell can be cooled almost to liquid nitrogen temperatures, or a long (25 meter) multiple-reflection cell can be used at room temperature.

Table 1 describes the methane data base we have accumulated so far. We have covered the spectral region from 4,000 to 6,500 cm^{-1} at moderate resolution (0.15 cm^{-1}), working at three temperatures (118, 191 and 272K), and with the (pressure - pathlength) product ranging over a factor of a thousand. Methane spectra broadened by hydrogen and helium have also been taken. Our normalized spectra are stored on magnetic tapes, at a resolution slightly better than 0.25 cm^{-1} .

Figure 2 shows an example of the spectra available. Notice the complex texture of the spectrum, with lots of fine structure. The texture would look qualitatively the same even at much higher resolution.

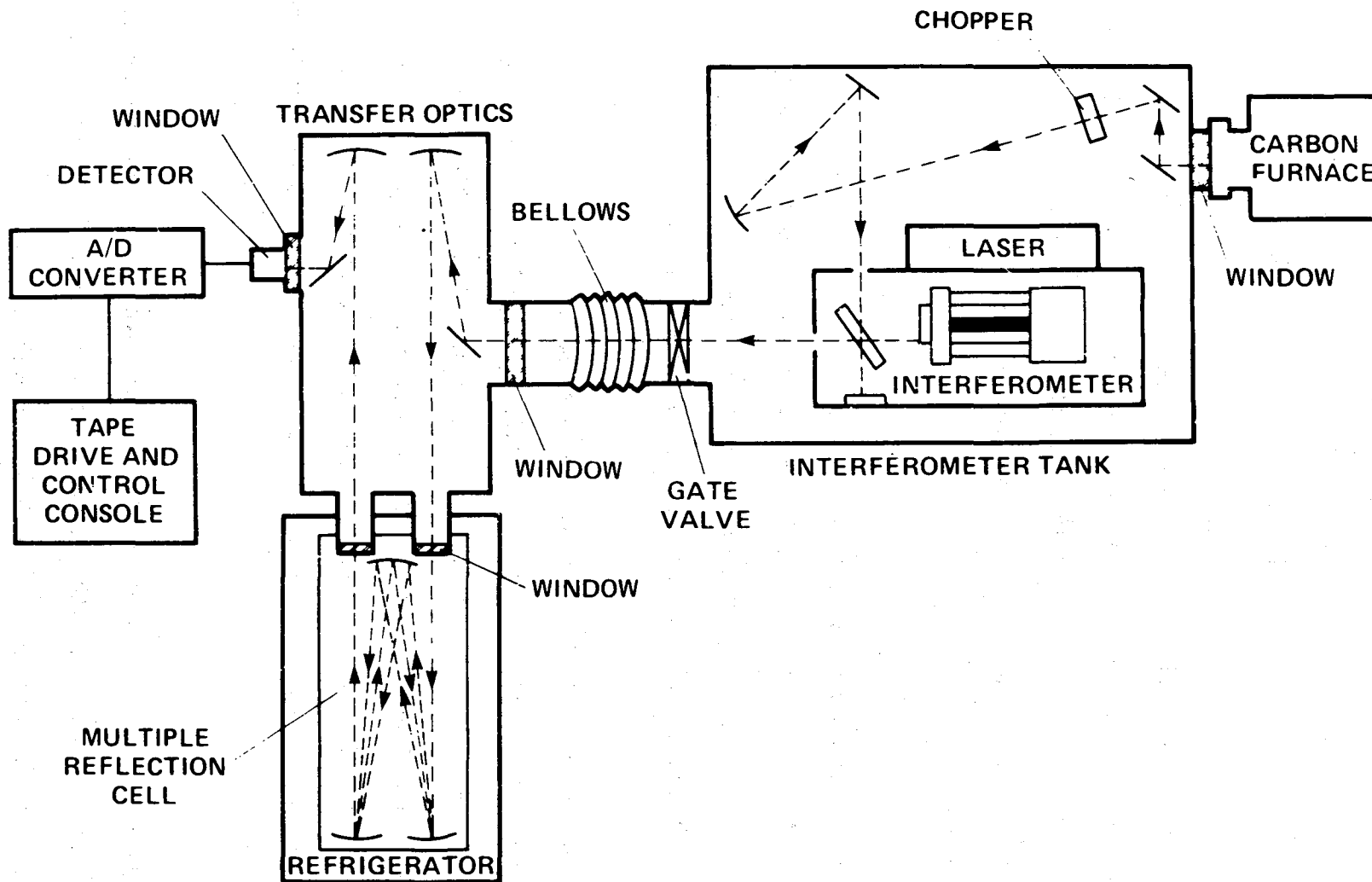

Figure 1. Schematic of apparatus.

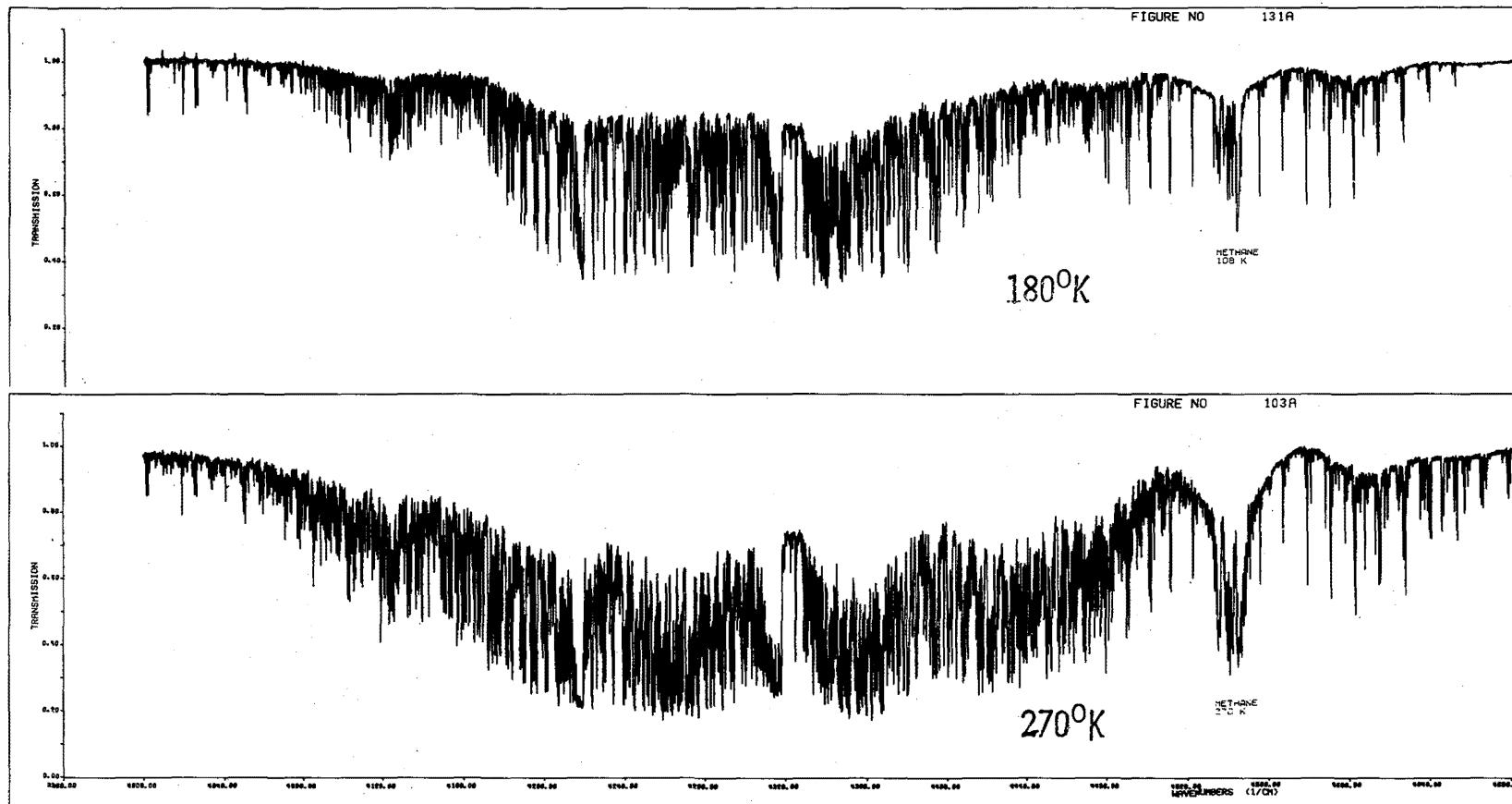

Figure 2. Methane spectra in the 4000 to 4600 cm^{-1} region.

Table 1
A Wide Range of CH₄ Data
are Available

- o 4000-6500 cm⁻¹
- o 0.15 cm⁻¹ resolution
- o <T> = 118, 191, 272K
- o 0.4 ≤ p & ≤ 475 cm-amagat
- o Broadened by H₂ and H_e

Table 2
The Goody Random Band Model Appears to be the Most Promising

Assumptions:

- o Lines randomly spaced
- o Poisson distribution
- o Wings have negligible effect outside interval
- o Voigt line shape

These moderate resolutions were too fine for the purposes of other work I've done with Dave Goorvitch at NASA/Ames. Figure 3 shows the same spectrum as the upper panel of Figure 2, but degraded to a resolution of 50 cm^{-1} . Notice that it still has interesting structure.

Since our resolution isn't high enough for a reliable line-by-line analysis, we present our results in the form of values of the parameters in a Goody random band model.¹ The lines are assumed to be randomly spaced, with intensities drawn from a Poisson distribution, and the wings of the lines assigned to a particular spectral interval are assumed to contribute negligibly to the absorption outside that interval (Table 2). Our model differs from that of Fink and Larson² in our choice of line shape. By using a Voigt shape we are able to infer a few more parameters than other random band models give. We can infer (Table 3) the mean absorption coefficient, the mean line spacing, and coefficients describing the Lorentz self-broadening and broadening by foreign gases. Table 4 gives some of the formulae that we use; the details of the method are discussed in Reference 3.

How useful are the derived band-model parameters for predicting absorption? We have compared predictions from our model with measured data on methane for several combinations of pressure and path length (Table 5). \bar{T}_{obs} is the average transmission over a 10 cm^{-1} interval, as evaluated from spectral data whose resolution is slightly better than 0.25 cm^{-1} , and \bar{T}_{calc} is the prediction of the band model, determined by a non-linear least-squares fit. The model does remarkably well, in fact, deviations from the model are probably due to noise in the measured data rather than errors in the assumptions in the model.

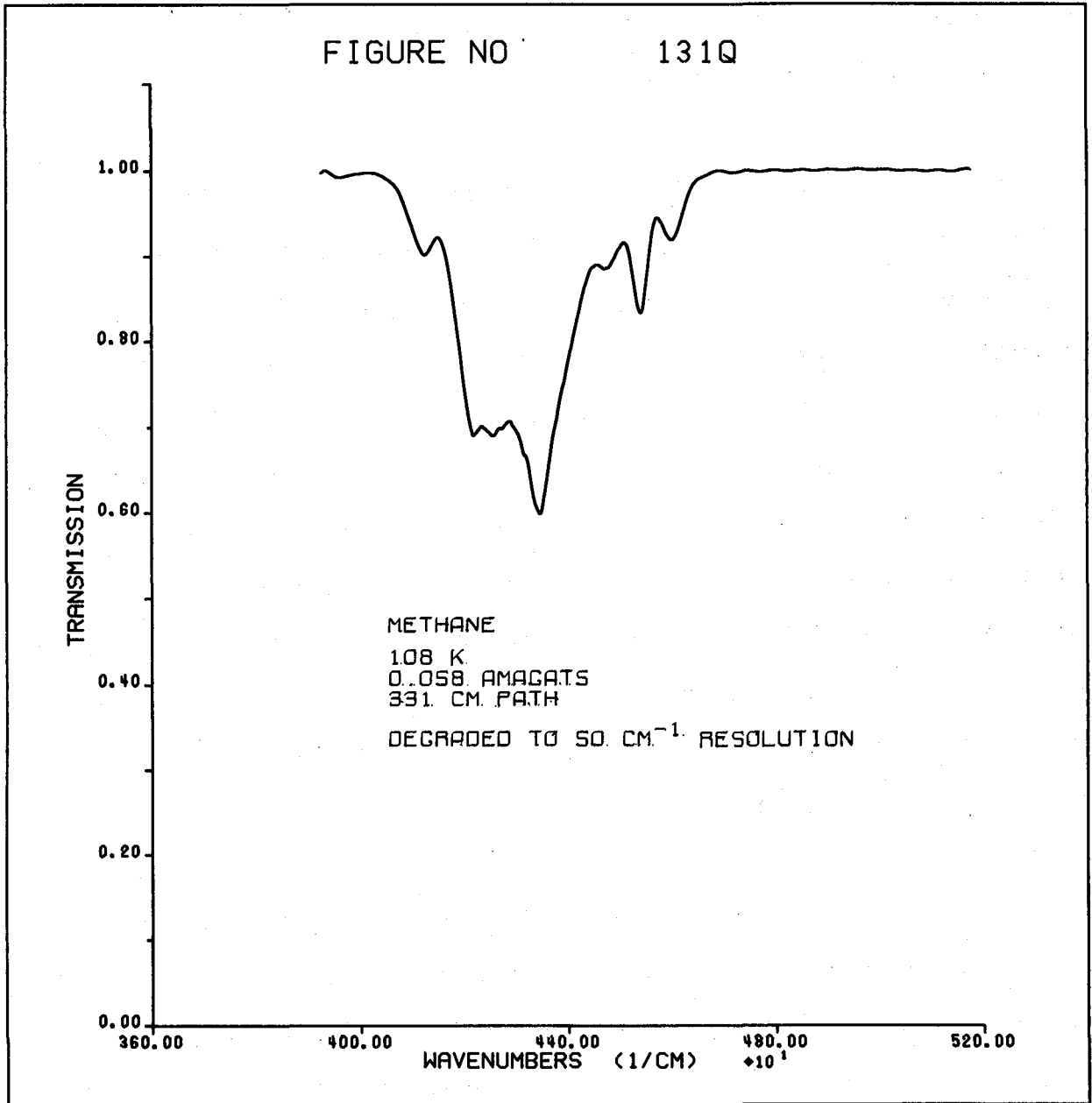

Figure 3. Methane spectrum from 4000 to 4600 cm^{-1} , with resolution degraded to 50 cm^{-1} .

Table 3
Key Parameters Which Can be Derived from Fitting
to a Rondon Band Model

- o Mean absorption coefficient
- o Mean line spacing
- o Lorentz self-broadening coefficient
- o Lorentz foreign gas broadening coefficient
- o JQSRT 23, 221 Feb. 1980

Table 4
Straight-Forward Numerical Algorithms are Used to Calculate Transmissions

$$\bar{T}(\nu, \text{temp}=t) = \exp \left\{ - \frac{2 K(\nu, t)}{\sqrt{\pi}} \rho l \int_0^{\infty} \frac{V(x, y) dx}{1 + \frac{K(\nu, t) \delta(\nu, t) \rho l \sqrt{x} n^2 V(x, y)}{\alpha_D(\nu, t) \sqrt{\pi}}} \right\}$$

$V(x, y) =$ Voigt line shape

$$y = \frac{\sqrt{x} n^2}{\alpha_D(\nu, t)} \left[\alpha_{L,A}^0(\nu, t) P_{\text{absorber}} + \alpha_{L,F}^0(\nu, t) P_{\text{foreign}} \right]$$

Table 5
The Goodness of Fit is Outstanding for Methane in the 4000–6500 cm^{-1} Region

As an example: $4300 \leq \nu \leq 4310 \text{ cm}^{-1}$

<u>P(atm)</u>	<u>L(cm)</u>	<u>T_{obs}</u>	<u>T_{calc}</u>
0.0013	331	0.983	0.985
0.0133	331	0.901	0.901
0.0013	1243	0.950	0.953
0.132	3675	0.071	0.073
0.132	1243	0.223	0.223

Table 6
Currently Available Methane
Parameters

- o 4000–4800 cm^{-1}
- o 5600–6500 cm^{-1}
- o 100 and 10 cm^{-1} intervals
- o 273K temperature
- o $\alpha_L = 0.085 \text{ cm}^{-1}/\text{atm}$

Table 6 shows the portions of the methane spectrum for which we have derived band-model parameters so far. The parameters are available for band intervals of both 100 cm^{-1} and 10 cm^{-1} , but only at 273K. Instead of leaving the Lorentz half-width as an adjustable parameter to be fitted, we fixed it at 0.085 cm^{-1} , on the basis of work by Margolis and others.

The band-model parameters allow us to estimate the half-width of an individual line in the band interval (Ed. - see DISCUSSION following this paper). The value we derived is very close to the correct value obtained by other means. This is important because it means that the band-model fits for methane-hydrogen mixtures can be used to estimate the pressure-broadening coefficient for methane spectra influenced by hydrogen (see Table 7). The pressure-broadening coefficient obtained in this way differs from Varanasi's value by a factor of 2.5, although the uncertainties are large, and the inference of a line parameter from a parameter characterizing a whole band interval may require special precautions, of which we are not yet fully aware. A test of our method really requires that our line width predictions be compared to measurements on a single line, but with our resolution we cannot determine whether any line in our spectrum is single.

Also of interest is some closely related work, done with Dave Goorvitch at Ames. Our highest priority is placed on measurements of pure methane at 118 and 193K, at resolutions of 100 cm^{-1} and 10 cm^{-1} , but we are then planning to refine the parameters for the broadening of methane spectra by hydrogen and helium, in hopes of resolving our disagreements with published values. We will then try to extend our model to band intervals of only 1 cm^{-1} .

Table 7
A Very Preliminary H₂ Broadening
Coefficient for CH₄

- o derived from 4100-4700 cm⁻¹
- o 100 cm⁻¹ intervals
- o $\alpha_{\text{H}_2} (273) = 3 \times 10^{-2} \text{ cm}^{-1}/\text{atm}$
- o uncertainty ± 50%

Even when all this work is completed, some important questions will remain: with what confidence can our parametrizations of the band intervals be extrapolated to lower pressures and higher path lengths? How can they be interpolated or extrapolated in temperature, in the absence of knowledge of the underlying band structure? Are our results skewed by special assumptions in the model, such as the assumption of a Poisson distribution of line strengths? On this last point, we have discussed possible non-Poisson distributions of line strengths with Larry Giver (NASA-Ames); our pressure-path length combinations cover a factor of 1000, and the non-Poisson distributions give no noticeable improvements to the fits over this wide range. But non-Poisson distributions may be important for the low pressure and long path lengths found in the thin atmospheres of the minor bodies. We therefore plan to use the 0.1 km and 1.5 km long absorption cells at Ames, at very low pressures and working at the best resolution we have, to measure spectra at room temperature and possibly at low temperature (near 77K). This will test the conclusions we reached with the 25m cell.

In conclusion, the random band model fits this portion of the methane spectrum very well, and is a useful tool in situations where the individual lines cannot be resolved, whether in the lab or in a planetary spectrum.

REFERENCES

1. R. M. Goody, Atmospheric Radiation, Oxford University Press, 1964, Chapter 4.
2. See the talk by U. Fink in this Proceedings.
3. Journal of Quantitative Spectroscopy and Radiative Transfer 23, 221 (1980).

DISCUSSION

Question (L. Wallace): How can the widths of the individual lines be obtained from a band model? I thought the random band model yielded the ratio of the average line spacing to the Lorentz width, and that the two factors could not be deduced uniquely from their ratio.

Response: That is true when the band model uses a Lorentz shape for the individual lines, however using a Voigt shape does allow the two factors to be separated, as discussed in Reference 3.

Question (L. Wallace): The Voigt shape is usually used to span the Doppler and Lorentz regimes. Is your reason for using it that you span both regimes?

Response: The Lorentz line shape gave bad results when we tried to use it at the pressures (about 1 to 10 mm) in our experiments. We have also used it for experiments on freons, at pressures in the micron range.

Comment (U. Fink): Returning to the question of whether the widths of individual lines can be obtained from a parametrization of a band interval, the parameter called "width of a single line" in the model is just a parameter whose quantitative relation to the true line width is conditioned by the assumptions of the model. Even when it has the correct order of magnitude, the quantitative relation may depend on the underlying structure of the band.

Question: Why did you model the line shapes empirically instead of using the appropriate theoretical shape?

Response: We get much better results with an adjustable shape. We are able to predict the observed transmission to within a fraction of a percent.

Question (W. Maguire): How much of your data base on methane spectra at low temperatures is available from the AFGL Atlas or in a similar form.

Response: None, although we would be happy to have our data added to the AFGL Atlas.

Question (U. Fink): How long was your absorption cell?

Response: It was 0.75 meters physically, but the multiple traversals by the light path allowed effective lengths up to 36 meters.

Question (L. Brown): You are spending a great deal of time and money to obtain spectra at low resolution. Why not get some high resolution equipment and do the job so that it won't have to be re-done?

Response: That decision is in the hands of the people who fund the purchase of instruments!

Comment (U. Fink): Low resolution spectra can be preferable to waiting for the complete analysis of high resolution spectra. Of course it is best to know all the lines in a band, so that a line-by-line analysis can be done, but we don't

know all the lines in this band yet.

Comment (L. Brown): Well, instead of wasting time on band models, let's use that time to determine all the lines.

Comment (U. Fink): At column abundances hundreds or thousands of times those used here, that isn't possible. The spectra will be saturated almost everywhere, so individual lines can't be measured. Besides, continuum absorption between the lines will not show up at all in a line-by-line analysis; this continuum absorption can be important in planetary applications. So instead of being alternatives, the low and high resolution measurements are complementary. After the high resolution measurements have allowed a line-by-line analysis, the total line-contribution to the average transmittance over a band interval can be computed. It can be compared to the measured average transmittance over the band, and the difference can be used as a measure of continuum absorption.

Comment: Even in Doppler-resolved spectroscopy, lines often overlap.

Response (L. Brown): True, but you can still estimate the absorption.

Comment (L. Wallace): I would like to emphasize a point made by Uwe Fink. For many applications to planetary atmospheres, we really need to know the total absorption from all the miserably weak lines in a spectral interval. A high resolution analysis can provide this only if it can be made very complete in this extremely complex region. Until this is done and we have confidence in the results, both low and high resolution work are useful.

CURRENT STUDIES OF CH₃D: YE OLDE LINE DRIVE

Barry L. Lutz

Planetary Research Center
Lowell Observatory

The CH₃D molecule is an intermediate methane which has immediate importance in the study of the chemical composition of the outer planets. The deuterium present in the atmospheres of the giant planets is thought to be representative of the protosolar composition, a quantity of high interest to cosmogonists and to cosmologists. The values of D/H range from about 2×10^{-5} in the interstellar medium to 1.6×10^{-4} in sea water here on Earth. The CH₃D molecule represents a probe of the D/H ratio and is related to it by the formula

$$[\text{CH}_3\text{D}] \sim 4f [\text{CH}_4] [\text{D}/\text{H}],$$

where f is a fractionation factor which allows us to account for the fact that D goes where it wants, despite the demands of statistics. If $[\text{D}/\text{H}] \sim 10^{-4}$ and $f \sim 2$, both ballpark estimates, then

$$[\text{CH}_3\text{D}] \sim 8 \times 10^{-4} [\text{CH}_4].$$

With $[\text{CH}_4]$ ranging from amounts between 50 and 150 m-am in Jupiter to 5 or 10 km-am in Uranus and Neptune (Lutz, Owen, and Cess 1976), CH₃D is pretty well expected to be there, and indeed Beer and Taylor (1973a, 1973b, 1978) have discovered it in Jupiter.

In a search for this molecule which is important because of its relation to the solar system D/H, we need ask: In which spectral regions does one look? As a 5-atom symmetric top, CH₃D has six fundamentals, all of which are infrared active:

$$\begin{array}{l} A_1 \quad \left\{ \begin{array}{l} \nu_1 \text{ (C-H stretching)} \sim 2970 \text{ cm}^{-1} \\ \nu_2 \text{ (C-D stretching)} \sim 2200.03 \\ \nu_3 \text{ (CH}_3 \text{ bending)} \sim 1306.81 \end{array} \right. \\ \\ E \quad \left\{ \begin{array}{l} \nu_4 \text{ (C-H stretching)} \sim 3016.59 \\ \nu_5 \text{ (CH}_3 \text{ bending)} \sim 1473.32 \\ \nu_6 \text{ (C-D bending)} \sim 1161.10 \end{array} \right. \end{array}$$

Since 1972, some intensive work has been done in various laboratories on these fundamentals. Bruce Olson (1972) analyzed the region between

2380 and 3160 cm^{-1} at a nominal resolution ranging from 0.03 cm^{-1} to 0.05 cm^{-1} and determined accurate ground state constants. Although he found it impossible to do a band-by-band analysis in this region because of strong perturbations due to accidental resonances and very large Coriolis mixing between the bending modes, he was able to make extensive assignments to not only the stretching fundamentals ν_1 , ν_2 , and ν_4 , but also to nine additional overtone and combination bands associated with the bending vibrations ν_3 , ν_5 , and ν_6 .

In the same year, Deroch, Graner, and Alamichel (1972) studied the ν_6 fundamental at a resolution of 0.1 cm^{-1} , paying particular attention to the effects of the Coriolis interaction with the nearby ν_3 band.

Sarangi and Varanasi (1975) measured the intensities of a large number of manifolds of ν_2 at 0.2 cm^{-1} resolution at five temperatures from 298 to 100 K and found strong intensity anomalies where their measurements were compared to values calculated from symmetric top formulae.

In 1977, Pinkley *et al.* (1977) analyzed the 8.6 μm (ν_6) band at resolution of 0.04 cm^{-1} , identifying some 669 lines. Again special attention was given to observed perturbations.

The ground state constants were improved by Tarrago *et al.* (1976) through the simultaneous analysis of ν_2 and $2\nu_6$ obtained from spectra recorded at a resolution of 0.02 cm^{-1} .

Most recently, Chackerian and Guelachvili (1980) have completed a detailed analysis of ν_2 at a resolution of 0.005 cm^{-1} , providing accurate line positions and ground state constants. Strengths of their lines are to be forthcoming.

Finally, not to forget the microwave region, Pickett, Cohen, and Phillips (1980) succeeded in obtaining the pure rotational transition 1_0-0_0 , whereas previous studies of the pure rotation spectrum were limited to higher J-values and lower resolution (Ozier, Ho, and Birnbaum 1969).

It is not sufficient to limit the study of CH_3D to the fundamentals, although clearly they are important. In fact, we--being a collaboration with the Ames and Denver groups--are producing a catalogue of line positions and strengths of CH_3D features between 1600 cm^{-1} and 1700 cm^{-1} at a resolution of 0.06 cm^{-1} for room temperature and near 200 K (Goldman *et al.* 1980).

Figure 1 shows a short example of the spectra. But the region-- at least for the ground base--is somewhat limited--and the weaker overtones may provide independent ways to search for CH₃D.

To extend our studies to shorter wavelengths, we have used the long pathlength cell at the Herzberg Institute of Astrophysics in Ottawa and the cold cell at the Observatoire de Meudon. First we pushed our study of this molecule beyond the fundamental region to the near visible (Danehy *et al.* 1977). Figure 2 shows a number of new bands we found with about 130 liters of CH₃D in our pocket.

Of these, we have finished the analysis of the 9613 Å band, shown in Figure 3--as a quite well-behaved, apparently parallel band (Lutz, Danehy, and Ramsay 1978). This band is relatively strong--the hard numbers associated with that statement are still obscured by the lack of our completed analysis of the intensity measurements which we are carrying out at Ames (Danehy, Lutz, and Boese 1980)--and an example is shown in Figure 4. Tentative results for two lines, R(4) and P(4), are given in Figure 5, resulting in a deduced band strength of $4.2 \times 10^{-2} \text{ cm}^{-1}/\text{m-am}$.

The level of their strengths suggests that these lines have equivalent widths of several mÅ in Titan, Uranus, and Neptune--but high resolution at the telescope is required.

Working closer in energy to the fundamentals, we have also obtained FTS spectra between 1 and 3 μm at 295 and 150 K at Meudon (Lutz, de Bergh, and Maillard 1979). Again, three new bands were discovered between 1.5 and 2 μm. The one near 5105 cm^{-1} is shown in Figure 6. This data, with a resolution of 0.005 cm^{-1} , is being reduced for both analysis purposes and line strengths.

But I want to point out some irregularities. Look at the K-numbering!

Similarly there is a strong band near 6425 cm^{-1} , and again the manifolds are peculiar--both in K-line position and in strength.

Although these irregularities are interesting themselves to me as a spectroscopist--they are important to me as an astronomer for other reasons--for they point out the inadequacy of theoretical line strengths and standard molecular formulas when perturbations play a large role. The only way we can search for the detailed spectra of minor constituents is through high resolution, and then only direct laboratory data are sufficiently reliable to provide the basis for this search.

The more promising of these two bands for a near-infrared CH₃D search is the 6425 cm⁻¹ band. Figure 7 shows the very fine-quality planetary spectra of Fink and Larson (1979) with this band superimposed. The intensities reflect a rotational temperature of 100 K, and the fine structure has been smeared to match the 3.6 cm⁻¹ resolution of the planetary data. Although the region is dominated by CH₄, our tentative estimated strength for the CH₃D band would indicate that CH₃D would provide a non-negligible contribution to this region and that a high-resolution planetary search should provide additional detections of CH₃D in the outer planets (Lutz, de Bergh, and Owen 1980).

The research on this important molecule is still progressing. Accurate line positions and strengths are being determined and temperature effects studied. Line-width measurements and pressure-broadening coefficients need to be carried out--ample material for the spectroscopist to ponder. It seems to me that continued high-resolution studies--a line drive as the title of this paper suggests--will greatly benefit both the astronomer and the experimentalist, and a concerted effort should be made.

Funds for this paper and my participation in some of the research discussed here are supported by NASA through grant NSG-7499.

References

- Beer, R., and Taylor, F. W. (1973a). Astrophys. J. 179, 309.
Beer, R., and Taylor, F. W. (1973b). Astrophys. J. 182, L131.
Beer, R., and Taylor, F. W. (1978). Astrophys. J. 219, 763.
Chackerian, C. Jr., and Guelachvili, G. (1980). J. Mol. Spec. (accepted).
Danehy, R. G., Lutz, B. L., and Boese, R. W. (1980). In preparation.
Danehy, R. G., Lutz, B. L., Owen, T., Scattergood, T. W., and Goetz, W. (1977). Astrophys. J. 213, 139.
Deroche, J-C., Graner, G., and Alamichel, C. (1972). J. Mol. Spec. 43, 175.
Fink, U., and Larson, H. P. (1979). Astrophys. J. 233, 1021.
Goldman, A., Lutz, B. L., Giver, L. P., Boese, R. W., and Silvaggio, P. M. (1980). In preparation.
Lutz, B. L., Danehy, R. G., and Ramsay, D. A. (1978). J. Mol. Spec. 72, 128.
Lutz, B. L., de Bergh, C., and Maillard, J. P. (1979). Bull. Amer. Astron. Soc. 11, 590.
Lutz, B. L., de Bergh, C., and Owen, T. (1980). In preparation.
Lutz, B. L., Owen, T., and Cess, R. D. (1976). Astrophys. J. 213 541.

- Olson, W. B. (1972). J. Mol. Spec. 43, 190.
- Ozier, I., Ho, W., and Birnbaum, G. (1969). J. Chem. Phys. 51, 4873.
- Pickett, H. M., Cohen, E. A., and Phillips, T. G. (1980). Astrophys. J. 236, L43.
- Pinkley, L. W., Rao, K. N., Tarrago, G., Poussigue, G., and Dang-Nhu, M. (1977). J. Mol. Spec. 68, 195.
- Sarangi, S., and Varanasi, P. (1975). J.Q.S.R.T. 15, 2911.
- Tarrago, G., Poussigue, G., Dang-Nhu, M., Valentin, A., and Cardinet, P. (1976). J. Mol. Spec. 60, 429.

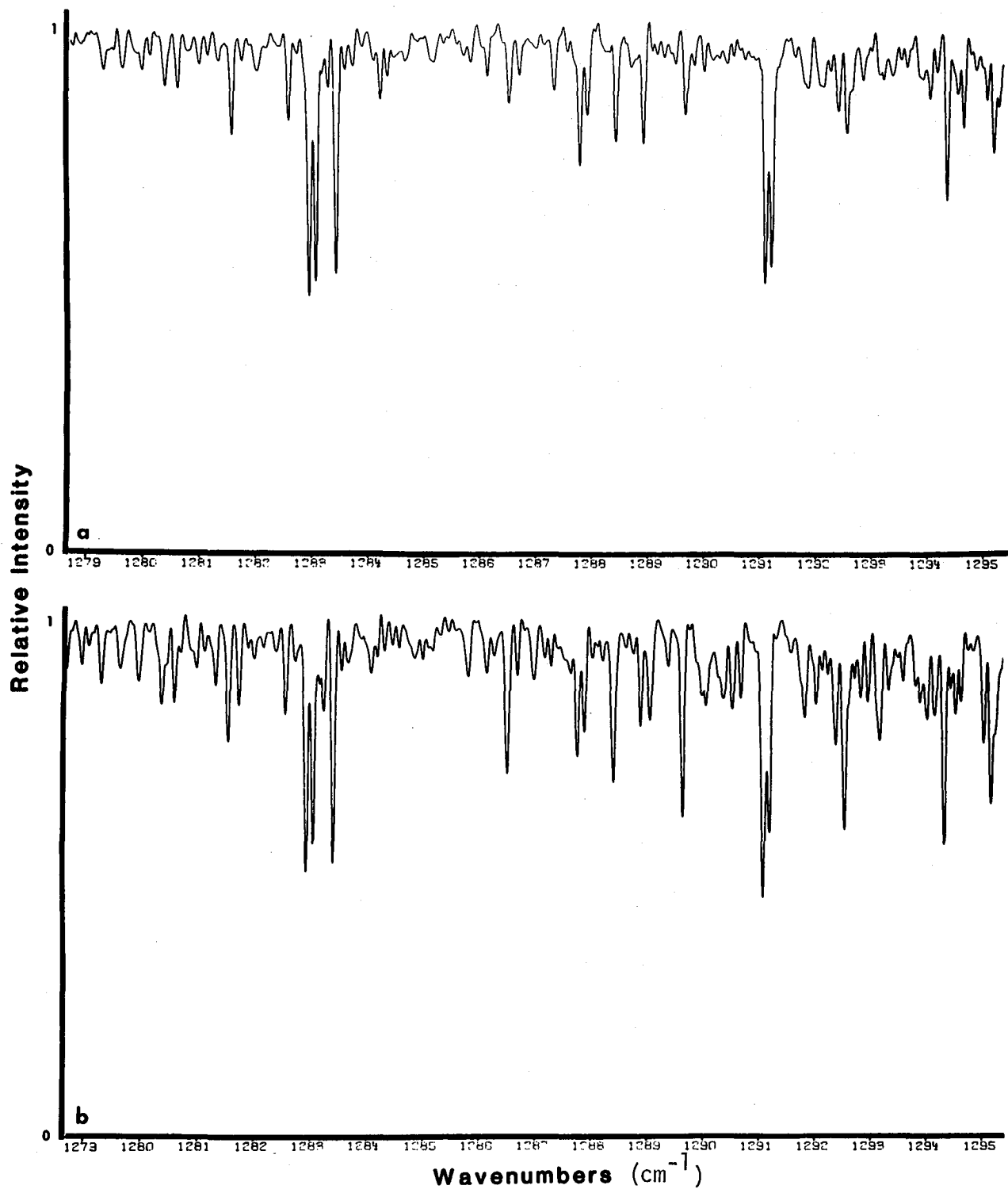

Figure 1. Spectrum of 3.4 cm-am of CH₃D at (a) 206 K and (b) 295 K, obtained at NASA – Ames Research Center.

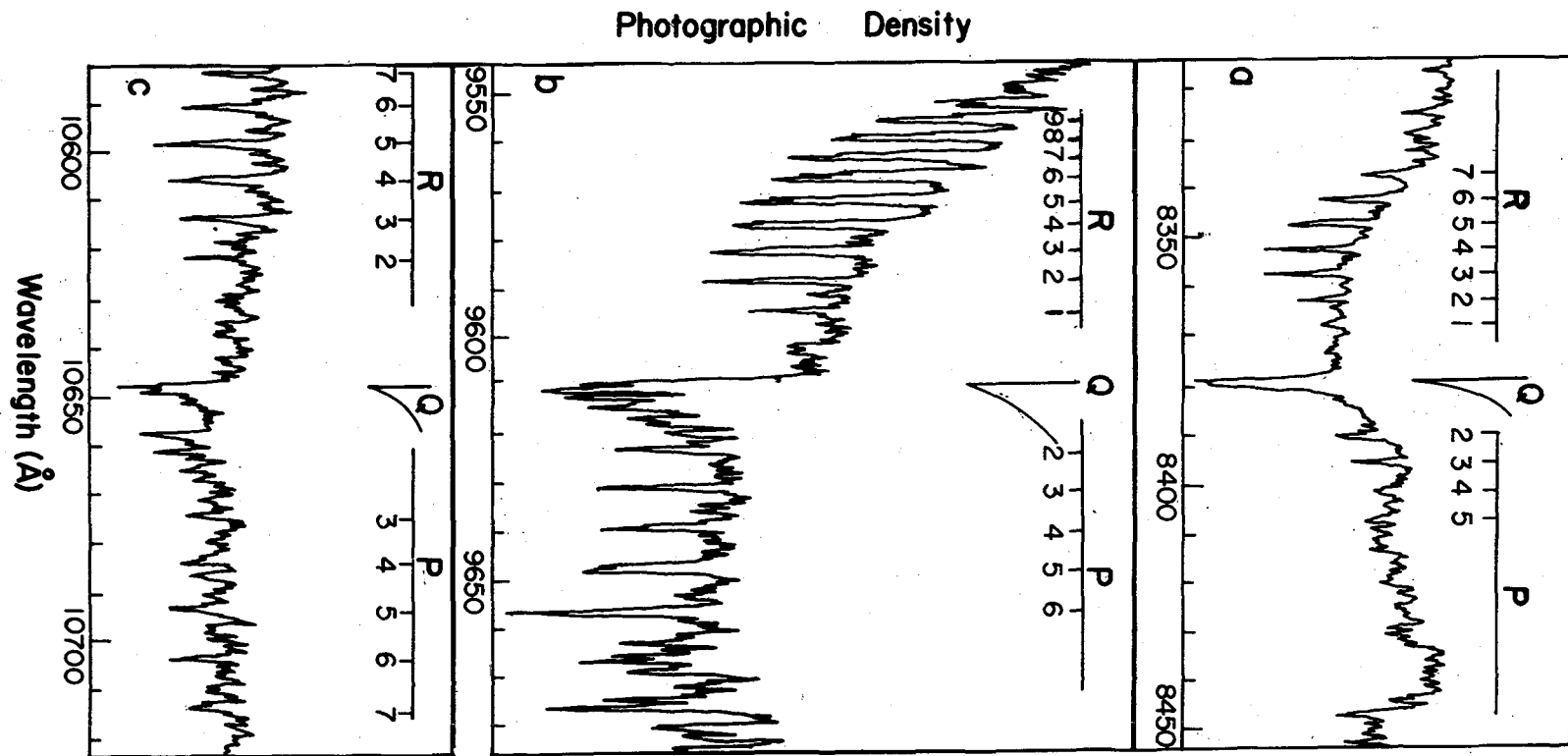

Figure 2. Densitometer tracings of the (a) 8379 \AA , (b) 9613 \AA , and 1.065 μm bands of CH_3D , obtained at 490 m-am total column density. Taken from Danehy et al. (1977).

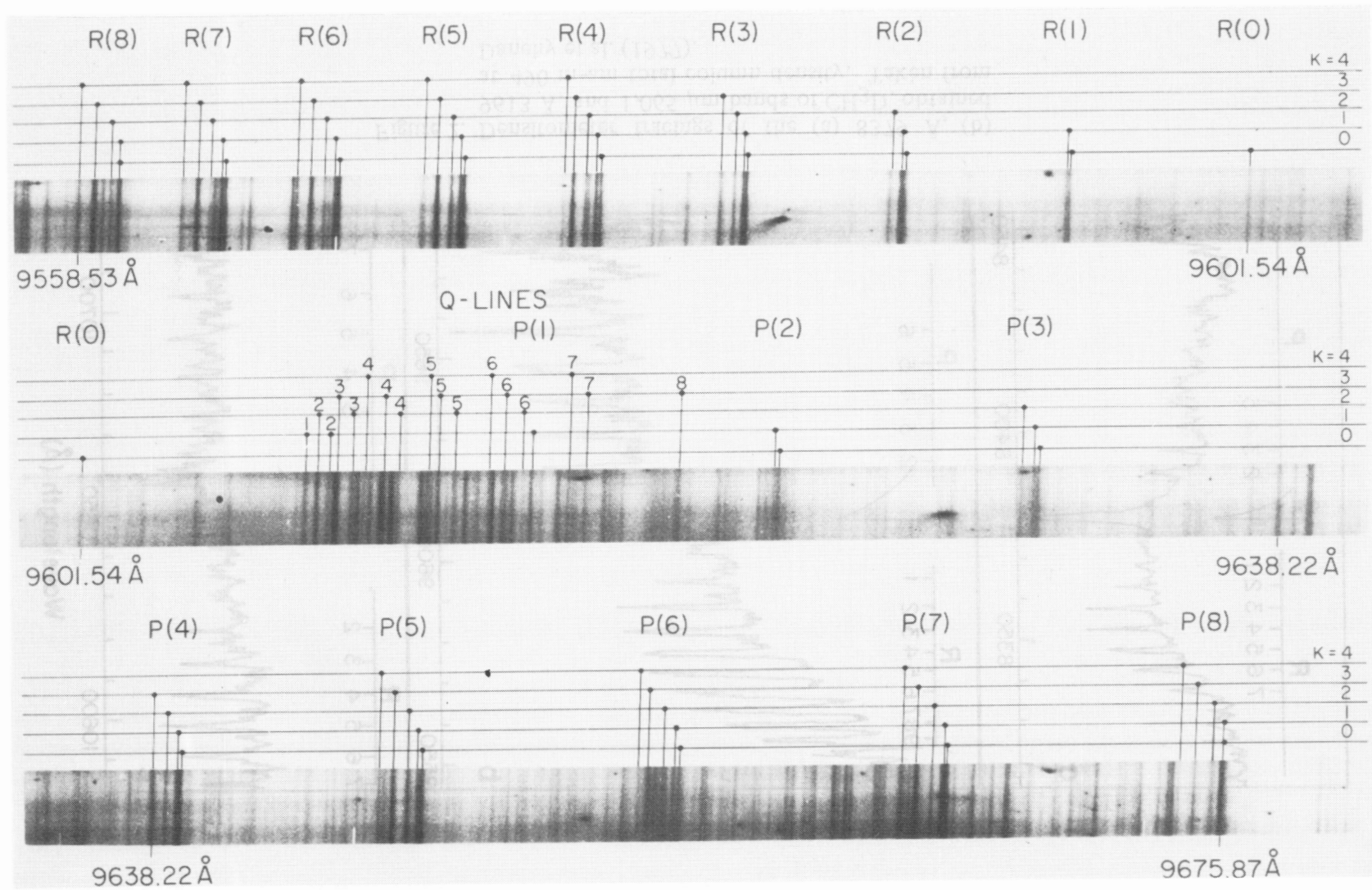

Figure 3. The 9614 Å band of CH₃D photographed at 452 m-am total column density. Taken from Lutz, Danehy, and Ramsay (1978).

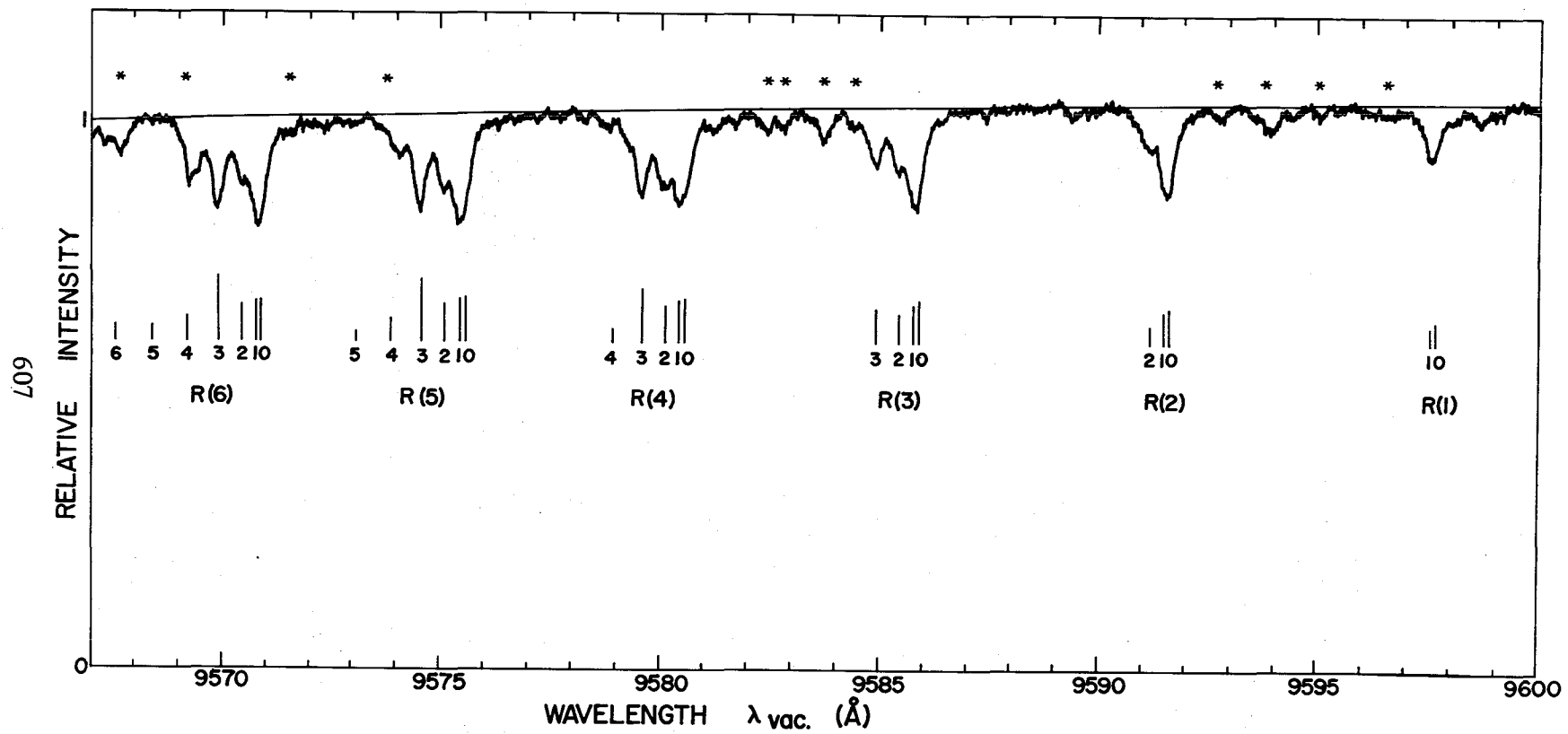

Figure 4. Intensity tracing of the 9613 Å band of CH₃D obtained at NASA-Ames Research Center.

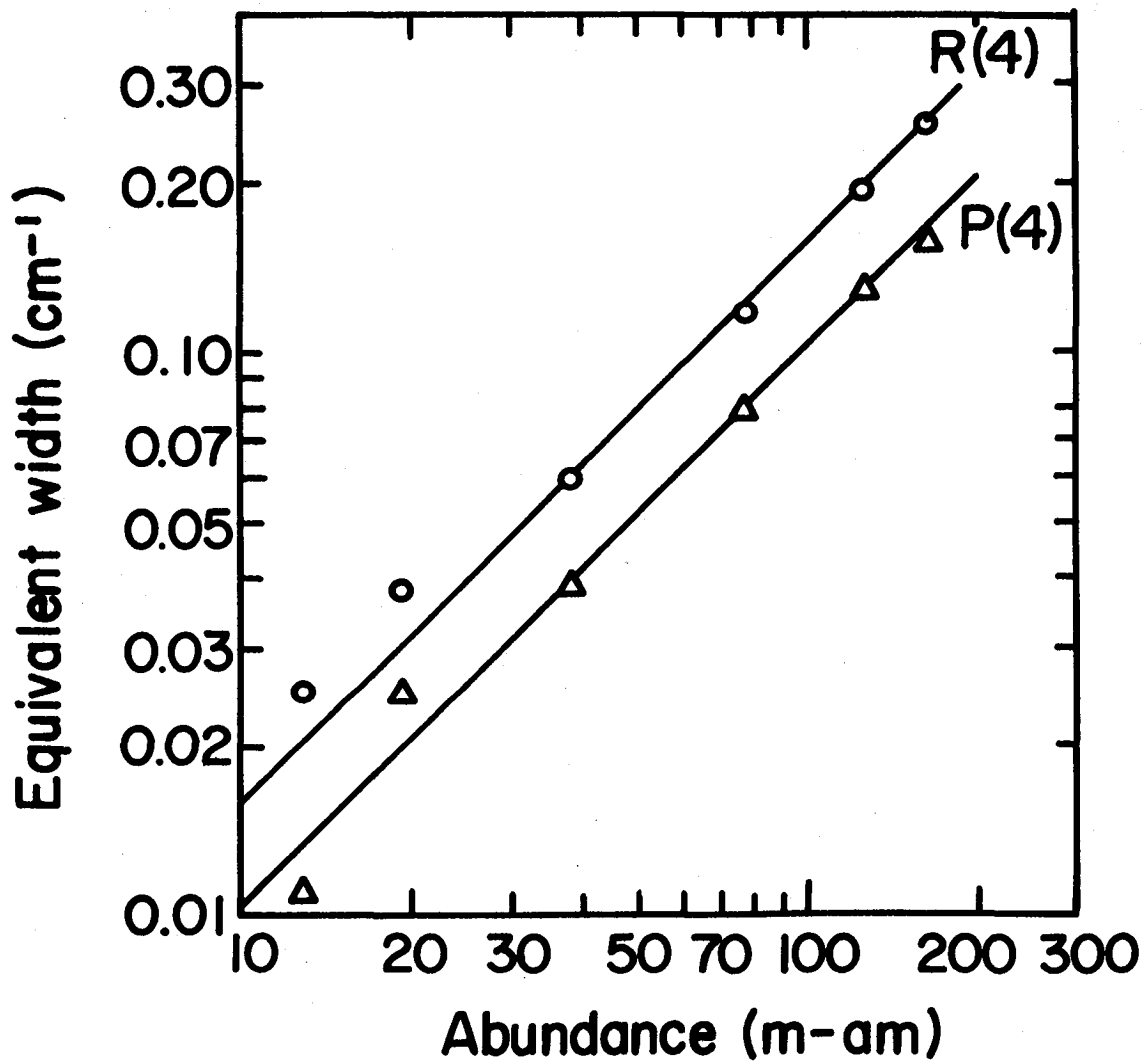

Figure 5. Curves of growth for the R(4) and P(4) lines of the 9613 Å band of CH₃D.

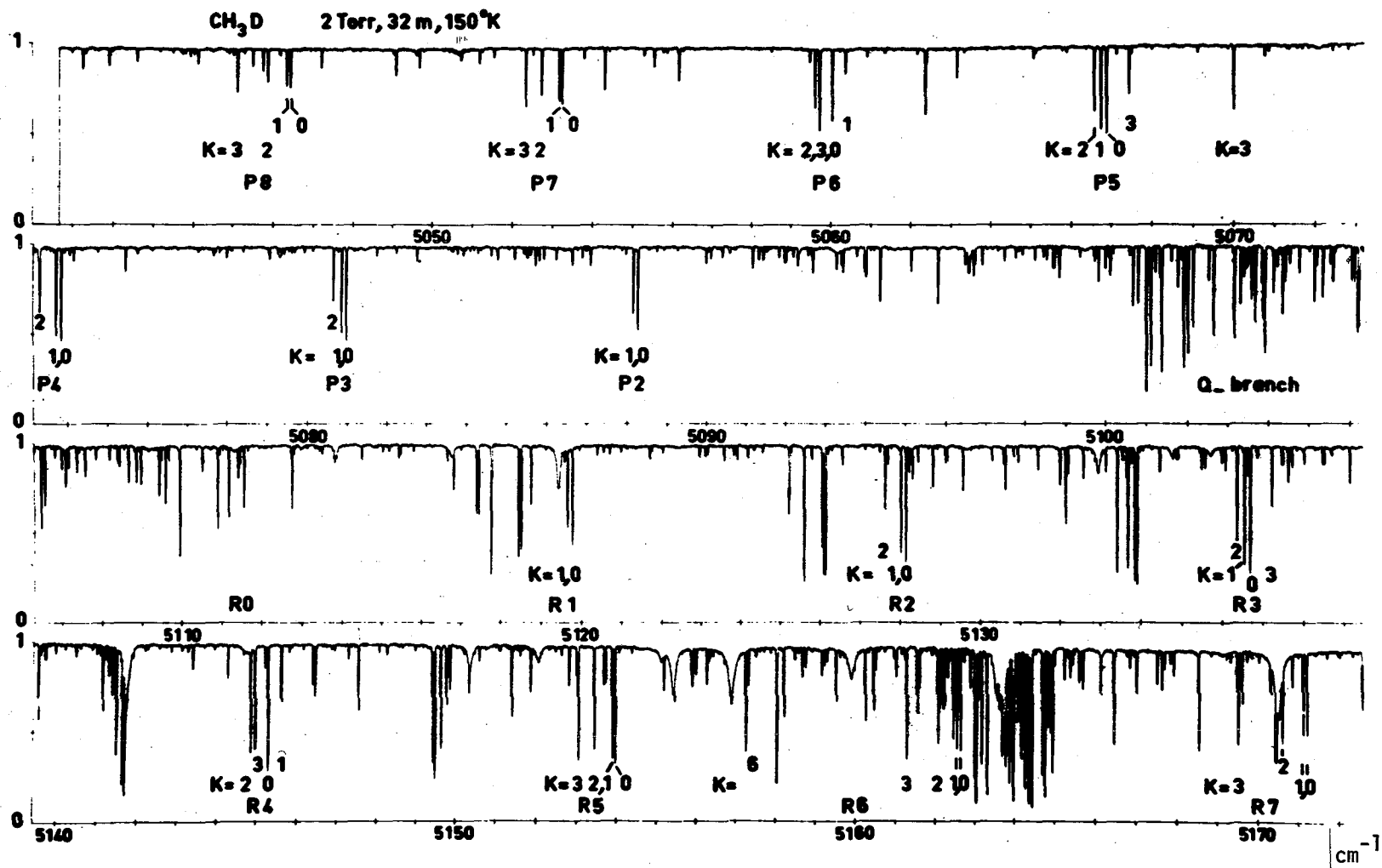

Figure 6. The 5105 cm⁻¹ band of CH₃D obtained at the Observatoire de Meudon.

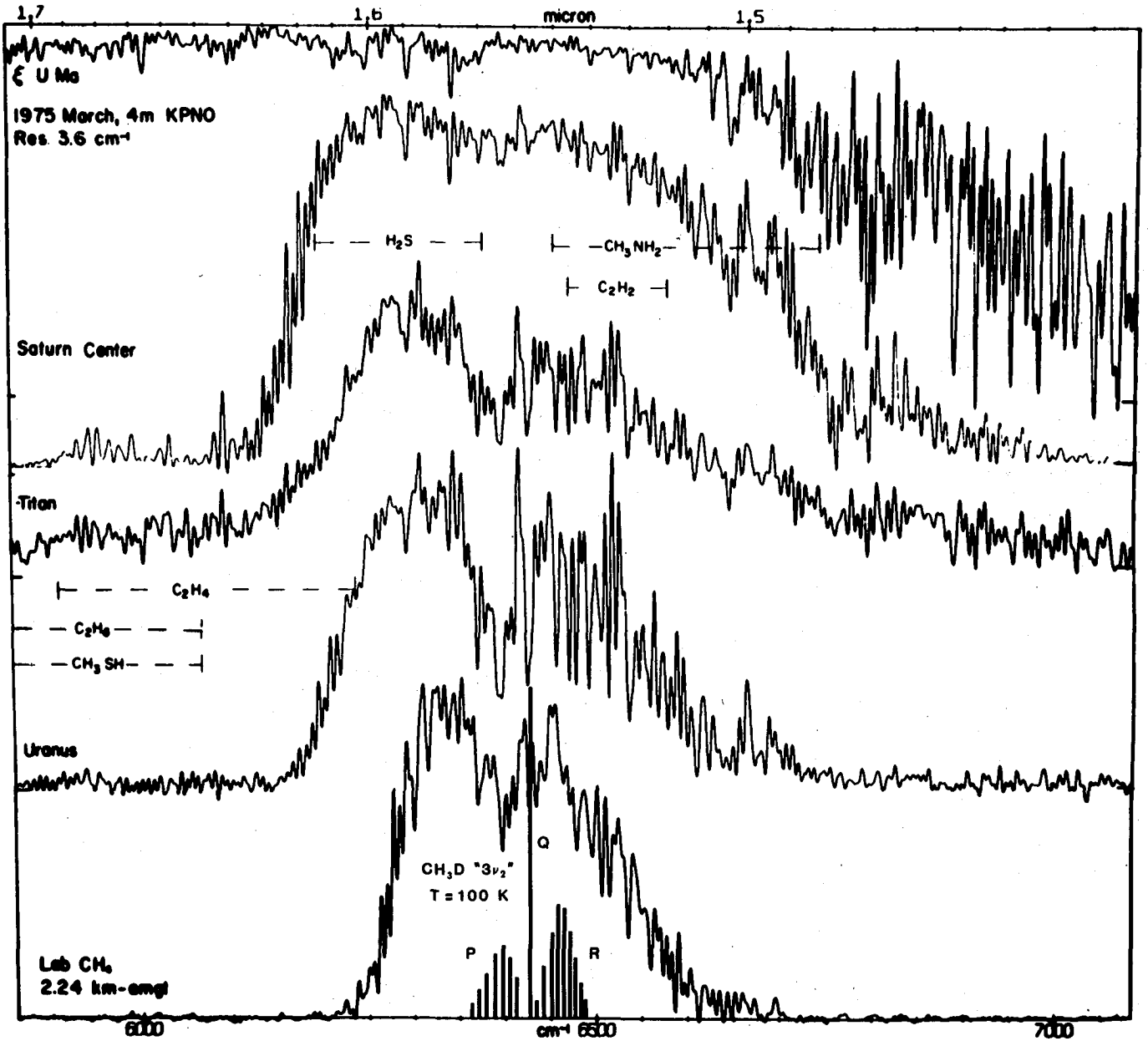

Figure 7. The 6425 cm^{-1} band of CH_3D superimposed on the planetary spectra of Fink and Larson (1979). Relative intensities calculated for 100 K and smeared to match the planetary resolution.

SPECTRA OF AMMONIA

K. Narahari Rao (Ohio State)

The spectra of the ammonia molecule (and for that matter the spectra of pyramidal-type molecules, in general) are very beautiful under any spectral resolution. Over the years the characteristic features of these spectra have captured the interest and imagination of theorists, experimentalists and engineers. Spectacular advances have taken place in molecular theory, astrophysics and laser spectroscopy, as a result, and some of this momentum continues.

To put current research in perspective, the first two figures give the highlights of some of these developments during the past half a century. The microwave investigations have been recognized by Nobel prizes. I realize that pointing out the astrophysical interest to this group would be like carrying coals to Newcastle.

The second figure lists a few of the many noted theorists who have worked on the ammonia problem. Dennison, Hardy and Uhlenbeck presented the first quantum mechanical interpretation of the inversion phenomenon in ammonia, and Fermi in 1932 considered the effect of the centrifugal distortion on this inversion splitting. In associating quantum mechanical states with the rotational structure the late Wm. Benedict did monumental work, and in the 1950's Garing, one of my early associates at

AMMONIA SPECTRA 1934-1972
MICROWAVE AND ASTROPHYSICAL

INVERSION IN AMMONIA--ORIGINS OF MICROWAVE SPECTROSCOPY		1934 & 1946
MOLECULAR BEAM MASER	(TOWNES, BASOV & PROCHOROV)	1955
INTERSTELLAR IDENTIFICATION--FIRST POLYATOMIC MOLECULE IDENTIFIED	(TOWNES ET AL.)	1968
PLANETARY INTEREST (FOR A REVIEW, SEE, FOR EXAMPLE, K. FOX IN MOLECULAR SPECTROSCOPY: MODERN RESEARCH)		1972

Figure 1.

AMMONIA SPECTRA 1934-1976
THEORY AND INTERPRETATION OF IR SPECTRA

DOUBLE-MINIMUM POTENTIAL TUNNELING EFFECT	(DENNISON, UHLENBECK & HARDY) FERMI NIELSEN	1932 1932 1951
ASSIGNMENT OF STRUCTURE IN IR SPECTRA	(BENEDICT & GARING ET AL.)	1956
INVERSION SPLITTINGS AS A FUNCTION OF QUANTUM NUMBERS	(DENNISON ET AL.)	1962
SEXTIC CENTRIFUGAL DISTORTION	(ALIEV & WATSON)	1976
NEW MODEL HAMILTONIAN	(PAPOUŠEK & ŠPIRKO)	1976

Figure 2.

Ohio State, was the first to see the effects of resonances in the ν_2 and ν_4 bands of NH_3 , and demonstrated the need to include higher order terms to the energy expressions. Similar effects were subsequently observed in the spectra of other pyramidal type molecules: PH_3 , ND_3 , NT_3 and AsH_3 . In the late 1950's I was told that these results obtained by Garing were also useful in understanding some of the finer details of the uv spectra of ammonia.

Figure 3 lists the activities currently being undertaken by various groups of investigators in different laboratories of the world. I shall take up the first item here because it represents a remarkable breakthrough in technology by the group headed by Andrei Krupnov, at Gorky, in the USSR.

Employing a backward wave oscillator as a source, and acoustic detection, they measured the inversion and rotation-inversion transitions of $^{14}\text{NH}_3$ and a few forbidden transitions in the ν_2 state. Figure 4 is an energy-level diagram showing these transitions. Since a comprehensive energy level diagram, including all parities, is not available in one place, this diagram was prepared by some of my colleagues at Ohio State. Some of the experimental data in the submillimeter wave regions were published in February 1980 and further work is in press (D. Papousek and V. Spirko, Czech. Acad. Sci.). I have the permission of Dr. Papousek to acquaint you with a few of these new results. The theoretical formulae required to interpret these experimental results were developed by the Czech group, who work with a new model Hamiltonian. Quoting from their description, "In this model the inversion motion is removed from the

RECENT EXPERIMENTS (1976-80)

SUBMILLIMETER WAVE SPECTRA

OBSERVATIONS OF FORBIDDEN TRANSITIONS $\Delta k = \pm 3$

HETERODYNE MEASUREMENTS

DOPPLER LIMITED IR DATA

DOUBLE RESONANCE EXPERIMENTS

OPTICAL PUMPING STUDIES AND NEW
MOLECULAR LASERS ($^{15}\text{NH}_3$)-(ND₂H, NH₂D?)

LASER STARK SPECTROSCOPY

FAR IR FOURIER TRANSFORM SPECTRA (0.01 cm⁻¹)

Figure 3.

CZECHOSLOVAKIA (PRAGUE)

NEW MODEL HAMILTONIAN

FINLAND (OAHU) -

FAR IR 0.01 CM^{-1}
FOURIER TRANSFORM

ITALY (ROME)

PRESSURE EFFECTS ON SPECTRA
USING DIODE LASERS

JAPAN (TOKYO)

STARK SPECTROSCOPY USING
A CO LASER

USA

LOS ALAMOS

OHIO STATE UNIVERSITY

OPTICAL PUMPING EXPTS.

DIODE LASER
& 0.04 CM^{-1} FOURIER WITH
LONG PATH UP TO 1 Km (TEMP
CONTROLLED)

USSR (GORKY)

SUBMILLIMETER WAVE USING
ACOUSTIC DETECTION

Figure 3. (Continued)

NONDEGENERATE VIBRATIONAL STATES OF NH₃: ALLOWED AND FORBIDDEN TRANSITIONS

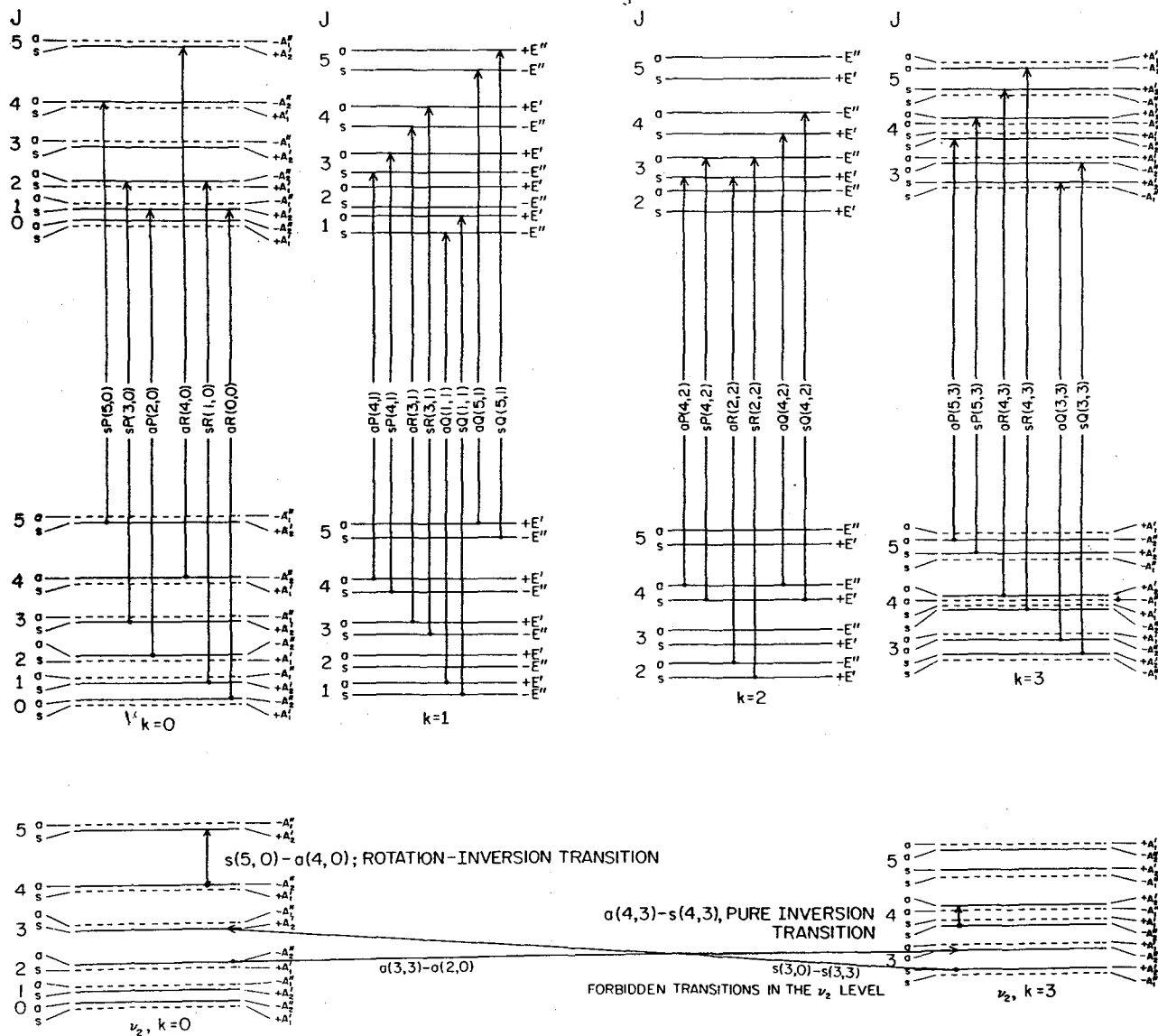

Figure 4. Part 1.

THE ν_3 AND ν_4 BANDS OF NH_3

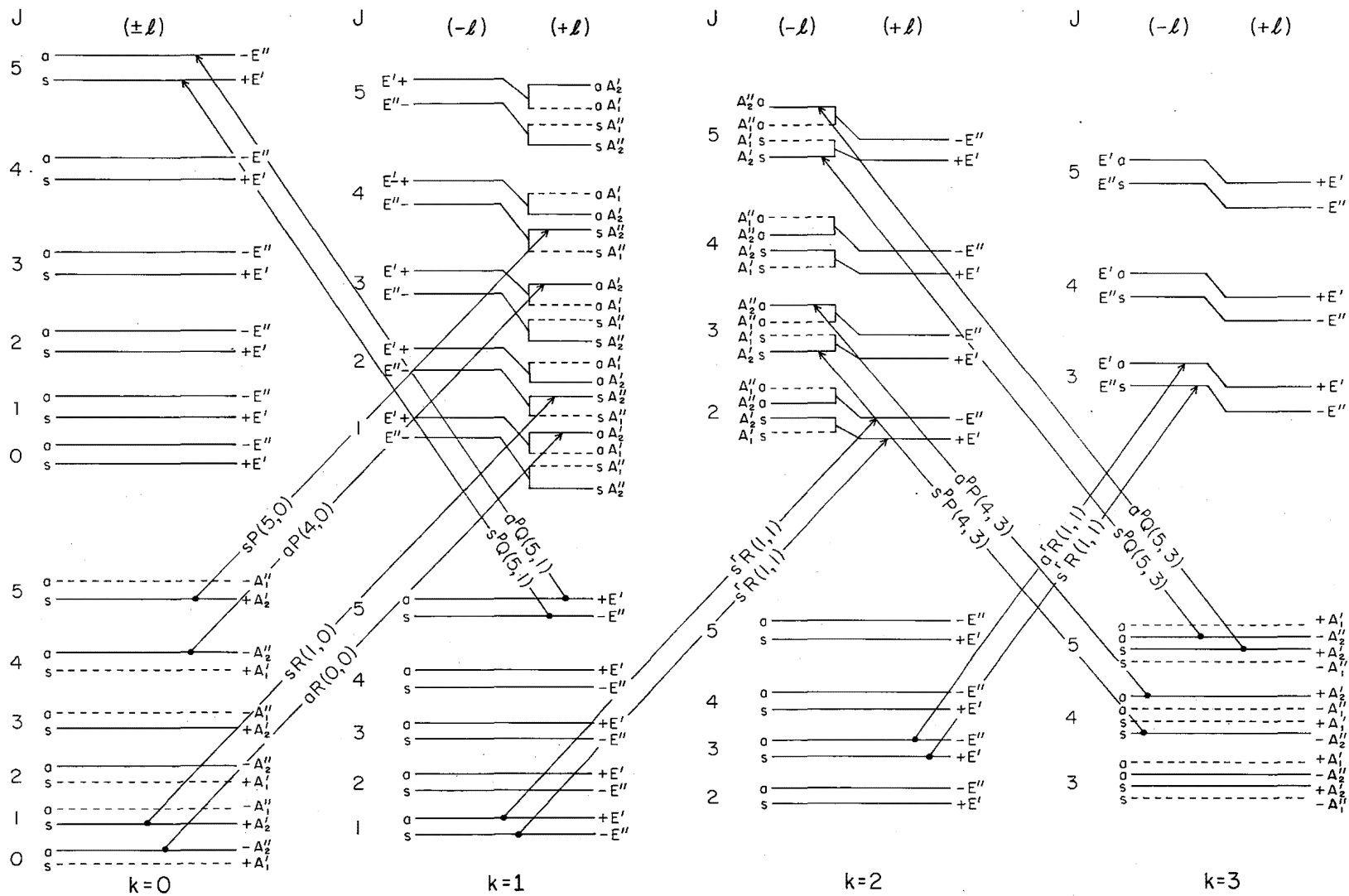

Figure 4. Part 2.

vibrational problem and considered with the rotational problem by allowing the molecular reference configuration to be a function of the large amplitude motion coordinate." A paper describing this theory has already appeared in print (60, 159-178 (1976)).

Data from the submillimeter wave region have been combined with infrared heterodyne measurements made at Goddard and IR-MW two photon data of Oka. The results of a simultaneous analysis of all these data relevant to ground state and ν_2 have been reported in this paper by the Czech and Soviet investigators. These authors conclude: "This is a formidable numerical task of a least squares refinement of approximately 80 molecular constants which is now solved in our laboratories."

This brings up an interesting general point. It would be reassuring to have programming of this complexity repeated elsewhere, to see whether it gives the same results.

Figures 5 and 6 are also from the paper just cited, and show that the measured line center frequencies of the inversion transitions in the ν_2 state are pressure dependent even in the range 0-2 Torr. The (1,1) curve has a negative slope and the (2,2) curve a positive slope.

Dr. Baldacchini and collaborators, in Rome, in an abstract to the 35th Molecular Conference at OSU in June 1980, indicate that they are now embarked on a vigorous program involving measurements of pressure broadening, pressure shifts, etc., of the lines of the ν_2 band in the infrared.

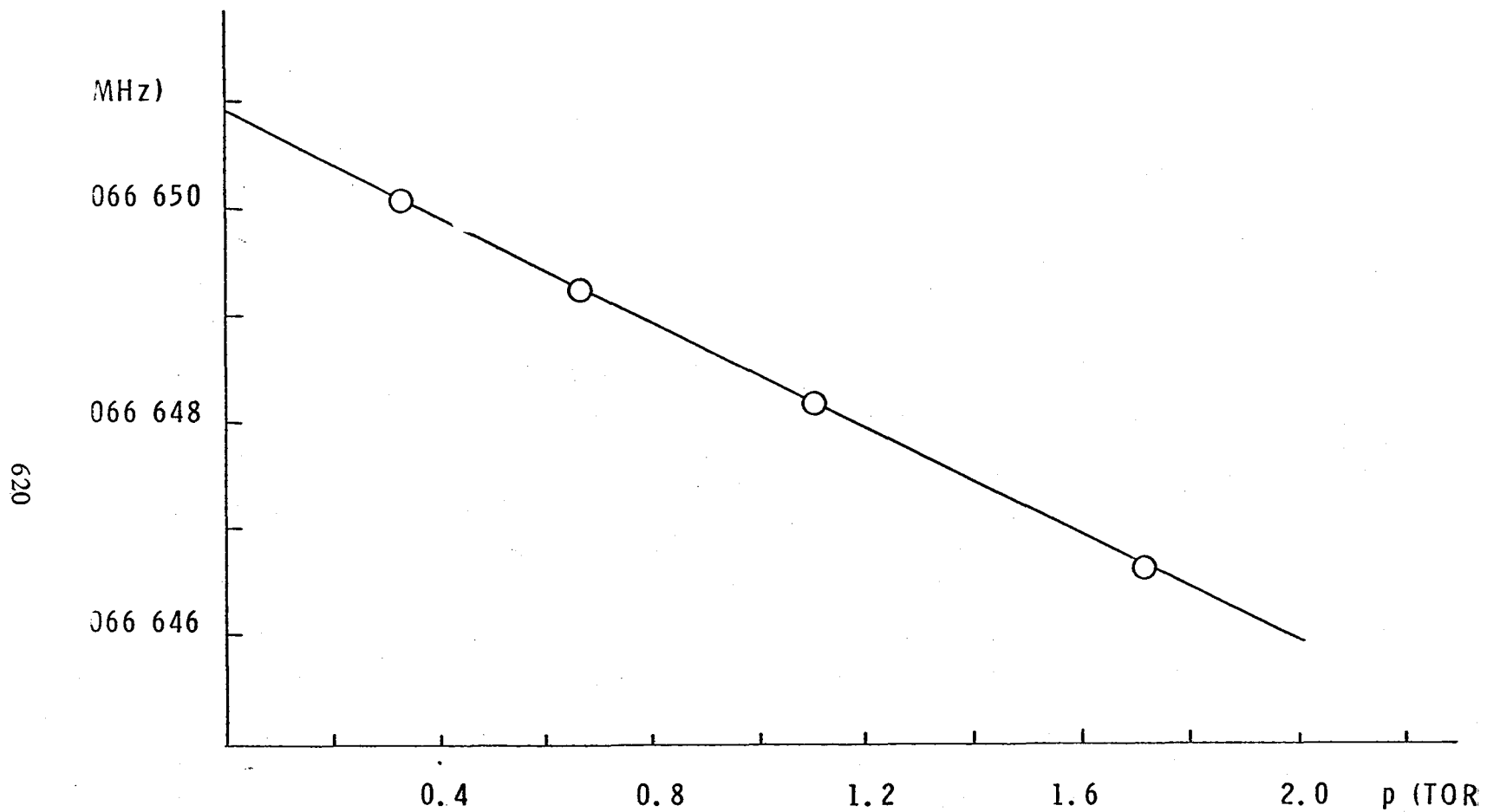

Figure 5. Dependence of the frequency of the (1,1) transition of $^{14}\text{NH}_3$ in the ν_2 state on the pressure of ammonia gas (J. Mol. Spectrosc. 84, 290 (1980)).

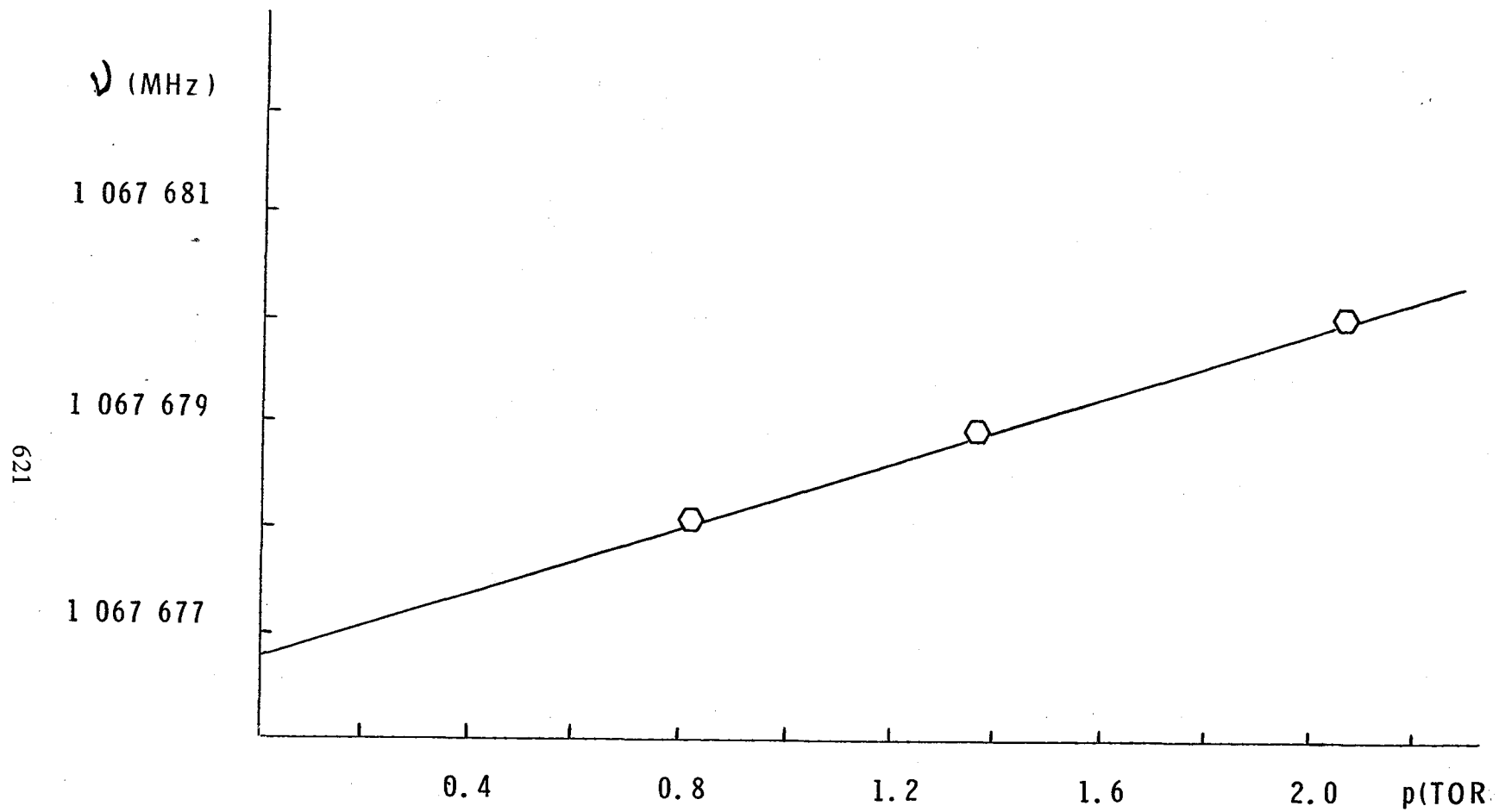
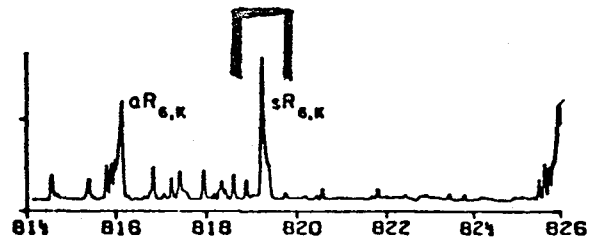

Figure 6. Dependence of the frequency of the (2,2) inversion transition of $^{14}\text{NH}_3$ in the ν_2 state on the pressure of ammonia gas (J. Mol. Spectrosc. 84, 291 (1980)).

Diode lasers give much better spectral resolution than even Fourier transform spectroscopy, which has the highest resolution of the non-laser spectroscopic techniques. This is illustrated in Figures 7, 8, and 9. At Ohio State in spite of heavy commitment to grating technology it seemed necessary to become quickly involved in Doppler-limited spectroscopy. We have a partial solution: we modified one of our grating spectrometers and use it with a diode laser as a source. The remainder of this paper describes our techniques and some results obtained.

Experimental Techniques Of Diode Laser Spectroscopy

In the design of the diode laser spectrometer, several practical considerations have to be taken into account. These practical considerations sometimes conflict with each other, requiring trade-offs. At Ohio State a 2 m focal length Czerny-Turner spectrometer employing a 25 cm x 12.5 cm precision-ruled echelle grating was converted into a diode laser spectrometer. Figure 10 gives the details of the optical system. The precision grating drive on which the grating is mounted is useful in tracking laser modes. The rotation of the grating can be adjusted to any required speed, so that the grating would properly synchronize with the sweep rate of a laser mode controlled by the Laser Control Module (LCM) unit. Also, the exact location of the spectral region being scanned could be identified easily, in view of the already available information about the grating settings. Most other currently used diode laser spectrometers have a shorter focal length spectrometer, and use gratings much smaller than that used here. As we shall see



$^{14}\text{ND}_3$ sR(6,K)

FOURIER TRANSFORM SPECTROMETER
RESOLUTION 0.04 cm^{-1}

L. H. Jones, J. Mol. Spectrosc. 74, 409 (1979)

623

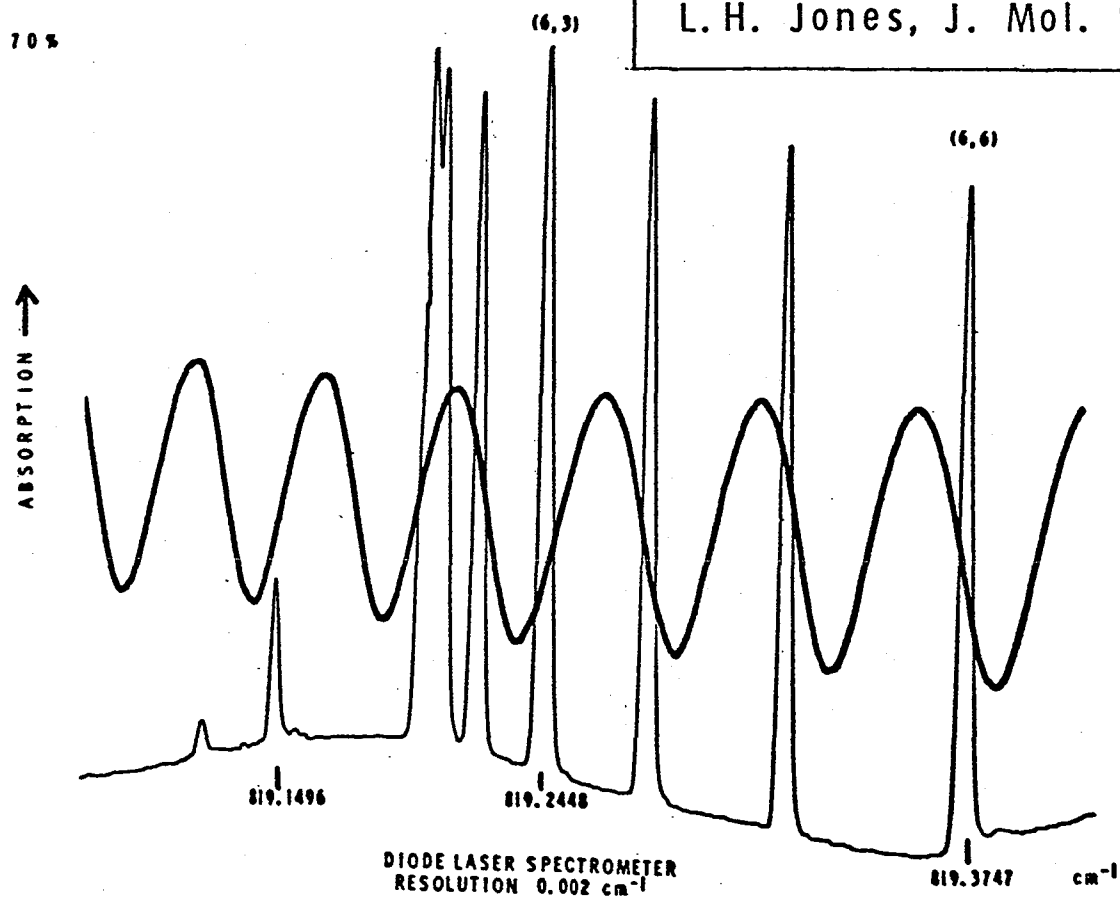

DIODE LASER SPECTROMETER
RESOLUTION 0.002 cm^{-1}

Figure 7. sR (6,K) multiplet in the ν_2 band of $^{14}\text{ND}_3$.

ABSORPTION ↑

624

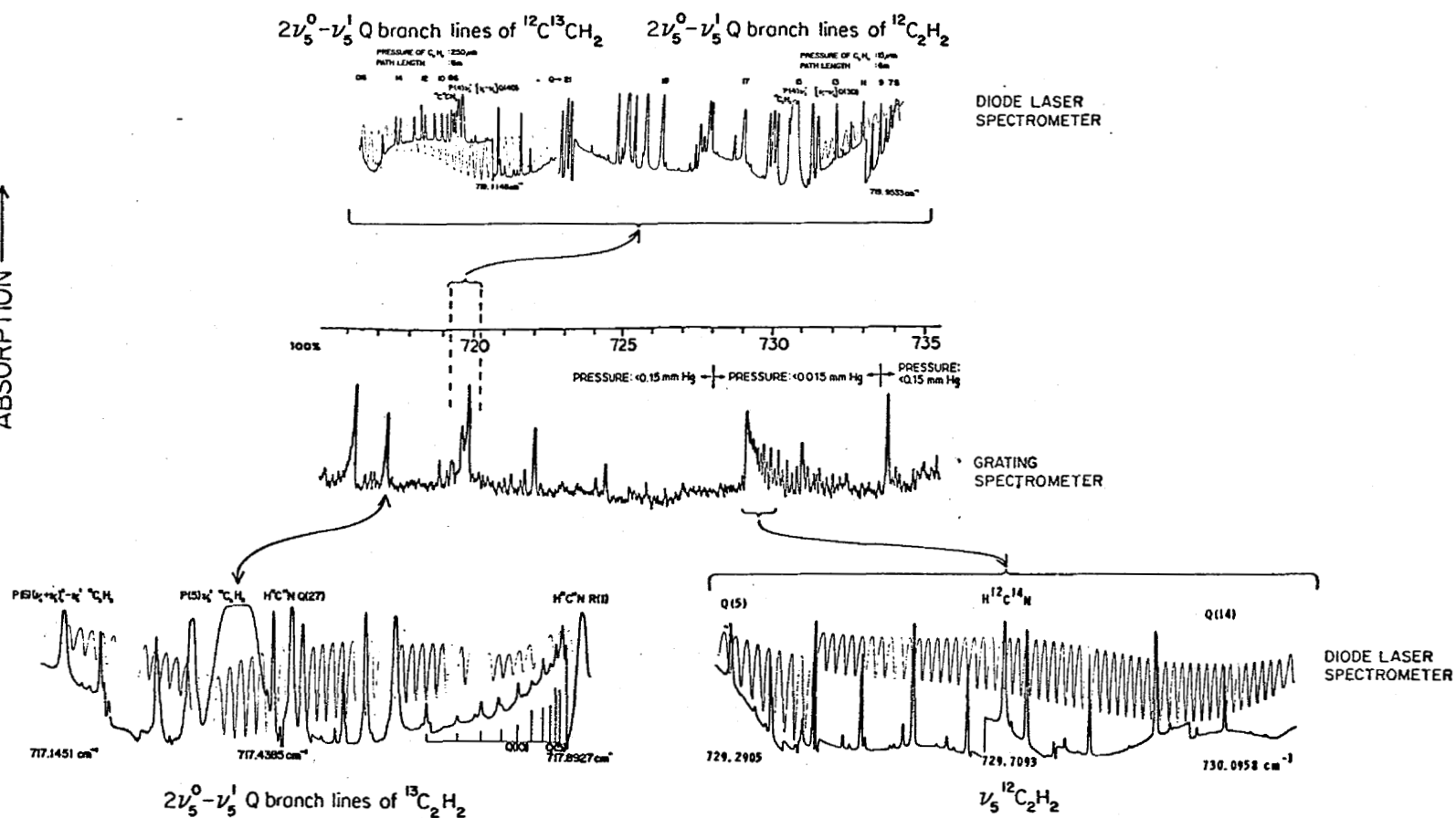

Figure 8. Diode laser spectra of acetylene near the center of the ν_5 band (J. Mol. Spectrosc. 84, 313 (1980)).

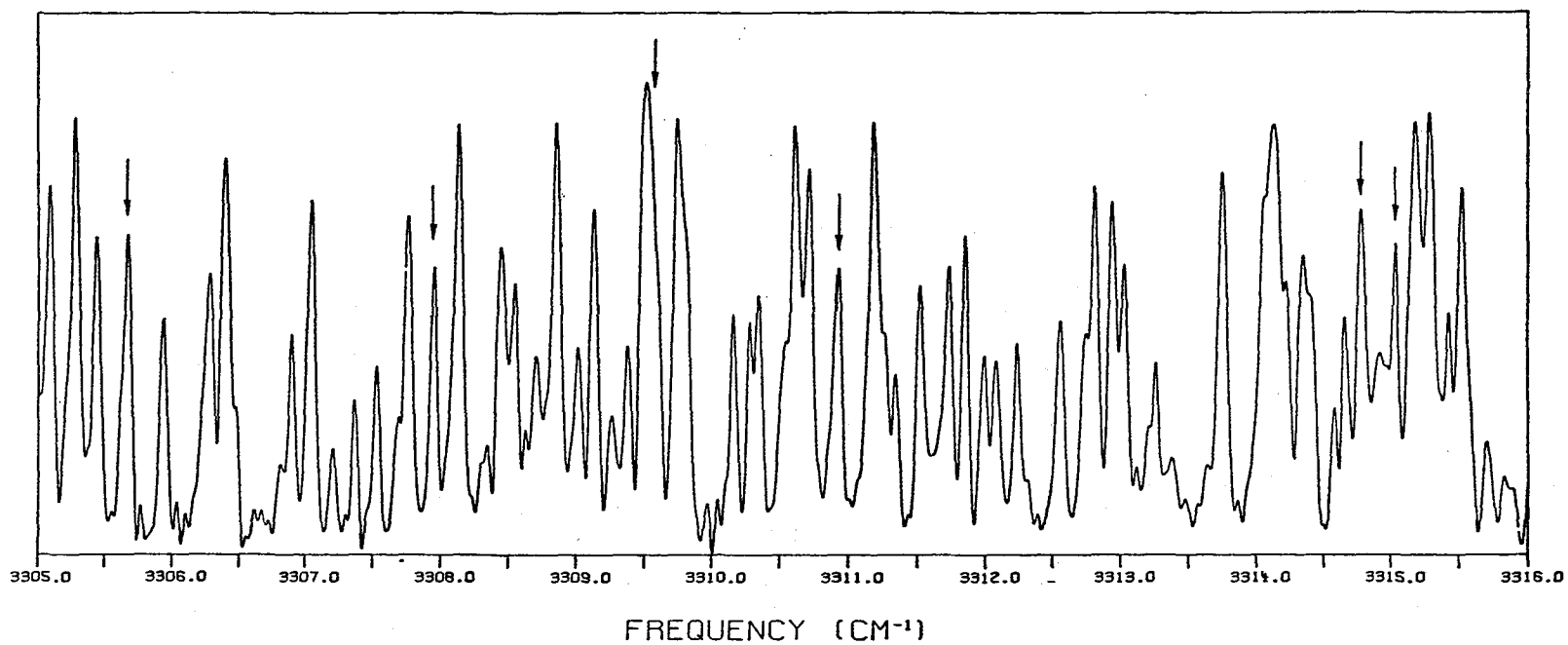

Figure 9. 0.04 cm^{-1} Fourier transform spectra of $^{14}\text{NH}_3$ with a path length of about 300 m and ammonia pressure of a few microns. The arrows are forbidden transitions in the $2\nu_4$ band of $^{14}\text{NH}_3$.

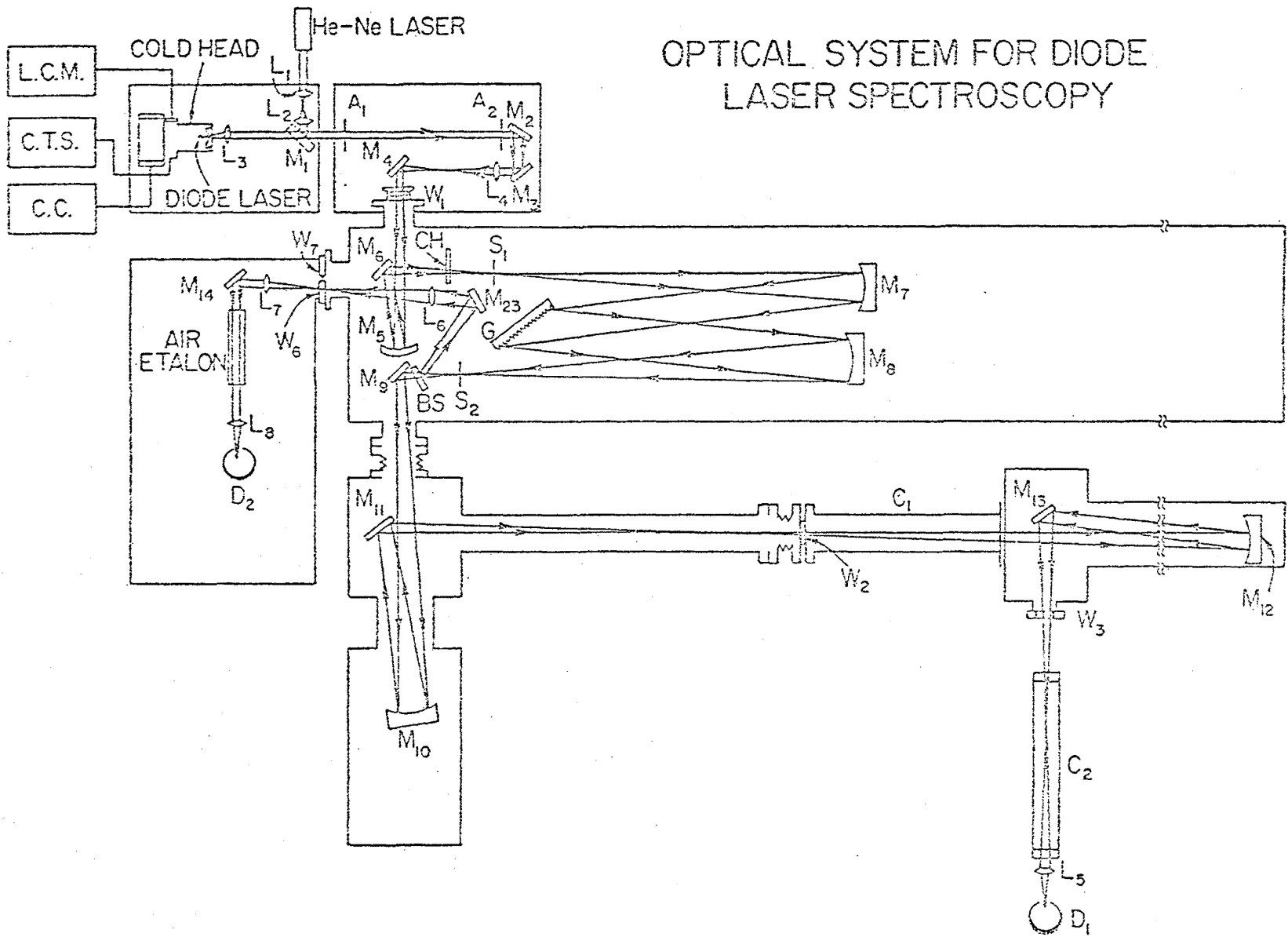

Figure 10.

later, high dispersion has its drawbacks, however.

As indicated in Figure 10, a beam splitter (BS) is used to direct some of the radiation emerging from the exit slit S_2 into a Fabry-Perot etalon system. A wedge shaped beam splitter was used, to avoid interference from reflections from the beam-splitter's front surface before the beam is finally transmitted into the absorption cells. The beam splitter used in the present system is a 2.54 cm diameter, 3 mm thick ZnSe window made into a wedge of about 3° . This ZnSe window was obtained from Harshaw Optical Company, Solon, Ohio.

The experiments were done using an air spaced etalon in the 15 μm region, and a 2.54 cm long Ge etalon in the 12 μm region. The air etalon was 30.09 cm long. The spacer which forms the etalon support structure is a quartz tube with an inner diameter of 2 cm and an outer diameter of 2.5 cm, cut and polished to length, with both ends parallel to within 3 sec of arc. The ends were fitted with 0.5 cm thick KBr windows. The inner window surfaces are coated with silicon less than 2 μm thick, and the exterior surfaces are uncoated. The windows are held in place on the quartz spacer with pressure from 10% deformed viton O-rings, which are mounted between the windows and threaded retainer rings.

There are several advantages of an air spaced etalon as compared to the Ge etalon. The fringes produced by the germanium etalon had a spacing of about 0.05 cm^{-1} , whereas the fringe spacing for the air etalon was only 0.015 cm^{-1} . For a spectral resolution of 0.001 cm^{-1} or less, it is necessary to have more closely spaced fringes. Secondly, it has been

shown¹ that an air etalon is more stable than a germanium etalon by two orders of magnitude, when temperature variations are considered. Unfortunately, the fringe contrast at 12 μm was very poor with the air etalon. Therefore, the germanium etalon was used for this wavelength region. To minimize the effect of variation in fringe spacing due to temperature, the following procedures were adopted.

(a) The etalon was enclosed in a thermally insulated box 40 cm x 15 cm x 15 cm in volume. A heating tape was wrapped around the etalon, and current was passed through the tape to keep the etalon's temperature slightly above room temperature (usually 34 C to 35 C). A platinum probe attached to a temperature controller (VersaTherm) continuously monitored the temperature of the etalon. Any deviation in the etalon's pre-set temperature is compensated by additional current from the temperature controller, to reset the temperature.

(b) The scans were taken quickly, within a few minutes.

The other disadvantage of the germanium etalon was that it could produce fringes even when the laser beam was not parallel to the optical axis of the etalon. Under these conditions, the effective length of the etalon is larger than the actual length, causing the fringe spacing to decrease. To correct this, the modes were adjusted so that there were two calibration lines bracketing the modes. Lines of the ν_1 and the $2\nu_1 - \nu_1$ bands of OCS^2 were used for this purpose.

The double beam system allows the gas spectrum to be measured simultaneously with the etalon fringes. In a single beam, the gas and

etalon are scanned separately. However, the diode laser sometimes drifts in temperature and hence drifts in frequency. This drift causes an uncertainty in the wavenumber scale. The double beam system has one drawback. Flicker et al³ have noted that errors can be introduced into the etalon fringe pattern by changing the angle of illumination of the etalon during a spectral scan. This slight change occurs when the spectrometer that is separating the modes is not scanned synchronously with the diode laser. The error introduced in fringe spacing varies as n^{-2} (where n is the index of refraction of the etalon) and as $dx/d\mu$ (the linear dispersion of the monochromator). For germanium, $n = 4$ while for an air etalon $n = 1$. Therefore, this error is an order of magnitude less for the germanium etalon than for the air etalon. This problem can be minimized either by using a low dispersion monochromator or a solid etalon with a high refractive index. In our experiments we usually minimize this error by making the optical axis normal to the face of the etalon and synchronizing the motion of the grating with the scan of the mode by the LCM.

The diode laser and its associated cryogenic and electronics were obtained from Laser Analytics, MA. The detectors used were a liquid helium cooled Ge:Cu detector in the main arm and a liquid nitrogen cooled HgCdTe detector in the etalon arm. These detectors were bought from Santa Barbara Research Corporation, CA. A block diagram of the electronics is shown in Figure 11.

The gases were contained in pyrex cells with 7.5 cm outer diameter and with lengths ranging from 5 cm to 200 cm, or else in a 1 m base

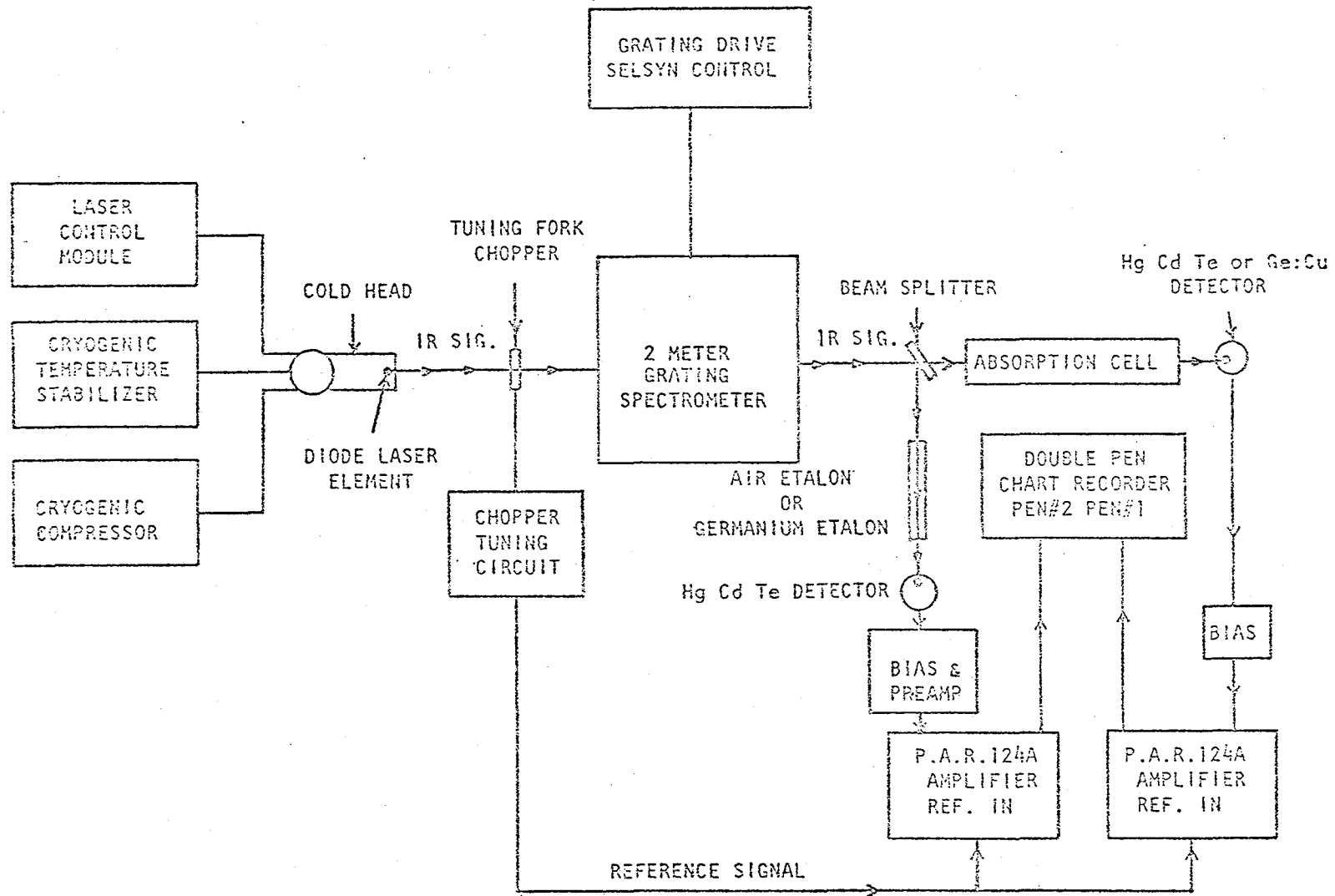
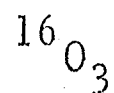
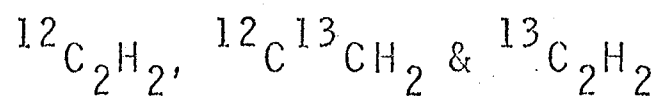
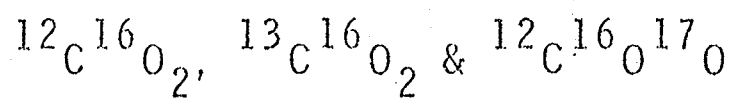
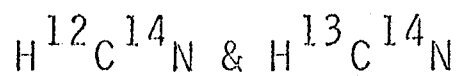

Figure 11.

length multiple-pass cell already available in the laboratory. The latter could be adjusted to give pathlengths of 50 to 60 m. The cells could be pumped down to pressures less than 10^{-7} torr using a diffusion pump. The pressure measurements were made with gauges manufactured by MKS Incorporated, MA. Two such gauges were used, one ranging from 0-1 torr and the other from 0-100 torr. The pressure measurements are believed to be accurate to within 1%.

The spectra of the molecular species listed in Figure 12 were studied with the above diode laser assembly and the details of the results can be obtained from a recent Ph.D. dissertation⁴. Some of the main findings are summarized in Figure 13.

700-750 cm⁻¹



800-850 cm⁻¹

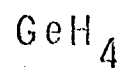
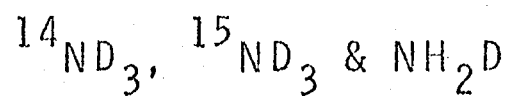
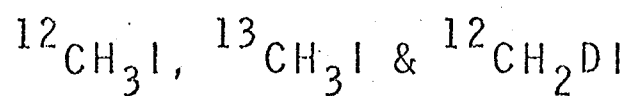
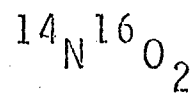
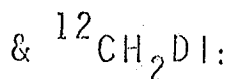
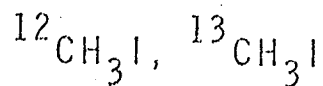
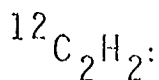

Figure 12.



Nuclear quadrupole splittings arising from spin of iodine have been observed and interpreted.



From lab intensity studies at 3-4 micron region, column density of acetylene in carbon star IRC + 10216 evaluated. From diode laser data at 14-15 micron region, molecular constants were determined.

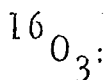

Molecular constants of (010) and (020) states obtained with diode laser data. J. Mol. Spectrosc. 77, 156-159, 1979

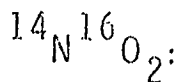

Diode laser results of (010) band led to improved values for the rotational and spin-rotation constants.

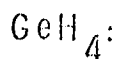

ν_4 band (natural sample having 5 isotopic species) recorded, measured and the analysis completed.

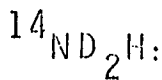
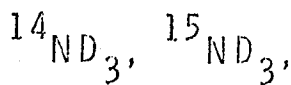

ν_2 band recorded. All the aR(J,K) and sR(J,K) lines observed were completely resolved, leading to improved band centers and rotational constants for ND_3 .

Figure 13.

References

1. S. P. Reddy, W. Ivancic, V. Malathy Devin, A. Baldacci, K. Narahari Rau, A. W. Mantz and R. S. Eng, *Applied Optics* 18, 1350 (1979).
2. A. G. Maki, W. B. Olson and R. L. Sams, *J. Mol. Spectrosc.* 81, 122 (1980).
3. H. Flicker, J. P. Aldridge, H. Filip, N. G. Nereson, M. J. Reisfeld, and W. W. Weber, *Applied Optics* 17, 851 (1978).
4. Palash P. Das, PhD. Dissertation, The Ohio State University, August 1980.

CURRENT STUDIES OF PH₃

A. Goldman

Department of Physics

University of Denver

Denver, Colorado 80208

Recent quantitative spectroscopic studies of the PH₃ fundamentals in the 10 and 4.5 μm regions resulted in line parameters applicable to spectral radiative models of planetary atmospheres. These include theoretical line parameters for the $\{\nu_2(A_1), \nu_4(E)\}$ and $\{\nu_1(A_1), \nu_3(E)\}$ regions, and empirical line parameters for the $2\nu_2$, $2\nu_4$, and $\nu_2 + \nu_4$ bands overlapping the $\{\nu_1, \nu_3\}$ region. The theoretical line parameters were normalized to previously published values⁽¹⁾ derived from low resolution spectra.

The theoretical line parameters for the $\{\nu_2, \nu_4\}$ region were derived from new laboratory spectra obtained at the University of Denver (D.U.) with $\sim 0.05 \text{ cm}^{-1}$ resolution and gas amounts of $\sim 10 \text{ atm-cm}$, and from previously published PH₃ papers. The results⁽²⁾ were prepared with $J_{\text{max}} = 25$. They include $A_1 A_2$ splittings, but exclude "forbidden" transitions. Table I and Figure 1 are from this future publication. These line parameters are totally sufficient for spectral radiative models of resolution no better than 0.1 cm^{-1} .

For the 4.5 μm region, the new D. U. laboratory data, along with laboratory data⁽³⁾ from Ohio State University (which were obtained at higher resolution and lower gas amounts, but with already supplied

quantum-number identifications for most measured lines), were used to (in Table II) generate line parameters $\hat{\nu}$ in a similar fashion to those generated for the ν_2 and ν_4 bands. While the agreement with the observed data is not satisfactory yet, the line parameters are quite sufficient for spectral radiative models which require resolutions of not better than 1 cm^{-1}

Another recent study⁽⁴⁾ of $\{\nu_1, \nu_3\}$, based on the Ohio State data, which includes more interaction parameters than used in Reference 2, yields line parameters which include many "forbidden" lines, but is limited to lower J. The same study also indicates that the vibrational intensity distribution between ν_1 and ν_3 may deviate significantly from the previously assumed values.

The spectroscopic analysis of lines in the $2\nu_4$, $2\nu_2$, and $\nu_2 + \nu_4$ bands has not been accomplished yet. To allow spectral radiative transfer modeling, empirical line parameters have been derived⁽⁵⁾ from the D.U. laboratory data. Figure 2 shows some of the results obtained.

All of the above measurements were performed with pure PH_3 at room temperature, for which a uniform halfwidth of $0.1 \text{ cm}^{-1} \text{ atm}^{-1}$ was estimated.

Future work needed on PH_3 should include

- (i) Initial spectroscopic analysis of $2\nu_2$, $2\nu_4$, $\nu_2 + \nu_4$ and $2\nu_2 - \nu_2$
- (ii) Refined analysis of $\{\nu_2, \nu_4\}$
- (iii) Refined analysis of $\{\nu_1, \nu_3\}$
- (iv) Intensity and halfwidth measurements at various temperatures
- (v) Extended studies to other spectral regions of interest in planetary spectroscopy

REFERENCES

1. McKean, D. C., and P. N. Schatz, J. Chem. Phys. 24, 316 (1956).
2. Goldman, A., G. R. Cook and F. S. Bonomo, "Quantitative Laboratory Spectra and Spectral Line Parameters for the ν_2 and ν_4 Bands of PH_3 Applicable to Spectral Radiative Models of the Atmosphere of Jupiter," J. Q. S. R. T. 1980, in press.
3. Rao, K. N., Private communication, 1979.
4. Baldacci, A., G. Tarrago, V. M. Devi and K. N. Rao, "Absorption of Phosphine at 4-5 μm . Analysis of ν_1 and ν_3 Bands," J. Molec. Spectrosc. 1980, to be published.
5. Goldman, A., Semi-annual Report to NASA Goddard Research Center, Contract NAS5-25097, Dec. 1979.

Table I
Spectroscopic Constants for the ν_2 and ν_4 Bands of PH_3 (in cm^{-1})

	ν_2		ν_4
ν_{02}	992.13 ± 0.03	ν_{04}	1118.30 ± 0.03
B_2	4.3443 ± 0.0022	B_4	4.5202 ± 0.0012
C_2	3.94567 ± 0.00045	C_4	3.89682 ± 0.00032
D_{2J}	$(2.921 \pm 0.55) \times 10^{-5}$	D_{4J}	$(2.001 \pm 0.038) \times 10^{-4}$
D_{2JK}	$(4.657 \pm 1.40) \times 10^{-5}$	D_{4JK}	$(-3.096 \pm 0.085) \times 10^{-4}$
D_{2K}	$(3.295 \pm 0.85) \times 10^{-5}$	D_{4K}	$(2.325 \pm 0.0520) \times 10^{-4}$
H_{2J}	$(-8.518 \pm 1.30) \times 10^{-8}$	H_{4J}	$(1.797 \pm 0.87) \times 10^{-8}$
H_{2JK}	$(1.974 \pm 0.42) \times 10^{-7}$	H_{4JK}	$(-1.746 \pm 2.45) \times 10^{-8}$
H_{2KJ}	$(-1.018 \pm 0.31) \times 10^{-7}$	H_{4KJ}	$(2.535 \pm 1.79) \times 10^{-8}$
S_{band2}	$82(\text{cm}^{-2} \text{atm}^{-1})$	S_{band4}	$102(\text{cm}^{-2} \text{atm}^{-1})$
		ζ_4^z	-0.45620 ± 0.00011
		α	1.508 ± 0.026
		β	0.04878 ± 0.00085

Table II
Spectroscopic Constants for the ν_1 and ν_3 Bands of PH_3 (in cm^{-1})

	ν_1		ν_3
ν_{01}	2321.10 ± 0.05	ν_{03}	2326.90 ± 0.05
B_1	4.4064 ± 0.0057	B_3	4.4069 ± 0.0037
C_1	3.9002 ± 0.0105	C_3	3.9027 ± 0.0065
D_{1J}	$(1.736 \pm 0.89) \times 10^{-4}$	D_{3J}	$(8.061 \pm 6.0) \times 10^{-5}$
D_{1JK}	$(1.008 \pm 0.31) \times 10^{-4}$	D_{3JK}	$(-8.947 \pm 18) \times 10^{-5}$
D_{1K}	$(9.85 \pm 3.2) \times 10^{-4}$	D_{3K}	$(-2.671 \pm 1.4) \times 10^{-4}$
H_{1J}	$(2.298 \pm 3.6) \times 10^{-6}$	H_{3J}	$(-1.033 \pm 2.4) \times 10^{-7}$
H_{1JK}	$(-2.868 \pm 16) \times 10^{-7}$	H_{3JK}	$(1.065 \pm 8.9) \times 10^{-6}$
H_{1KJ}	$(4.62 \pm 1.9) \times 10^{-6}$	H_{3KJ}	$(-1.962 \pm 0.85) \times 10^{-6}$
S_{band}	$260 (\text{cm}^{-2} \text{atm}^{-1})$	ζ_3^z	$(7.052 \pm 9.0) \times 10^{-3}$
		α	0.04827 ± 0.025
		β	-0.000748 ± 0.0010
		S_{band}	$260 (\text{cm}^{-2} \text{atm}^{-1})$

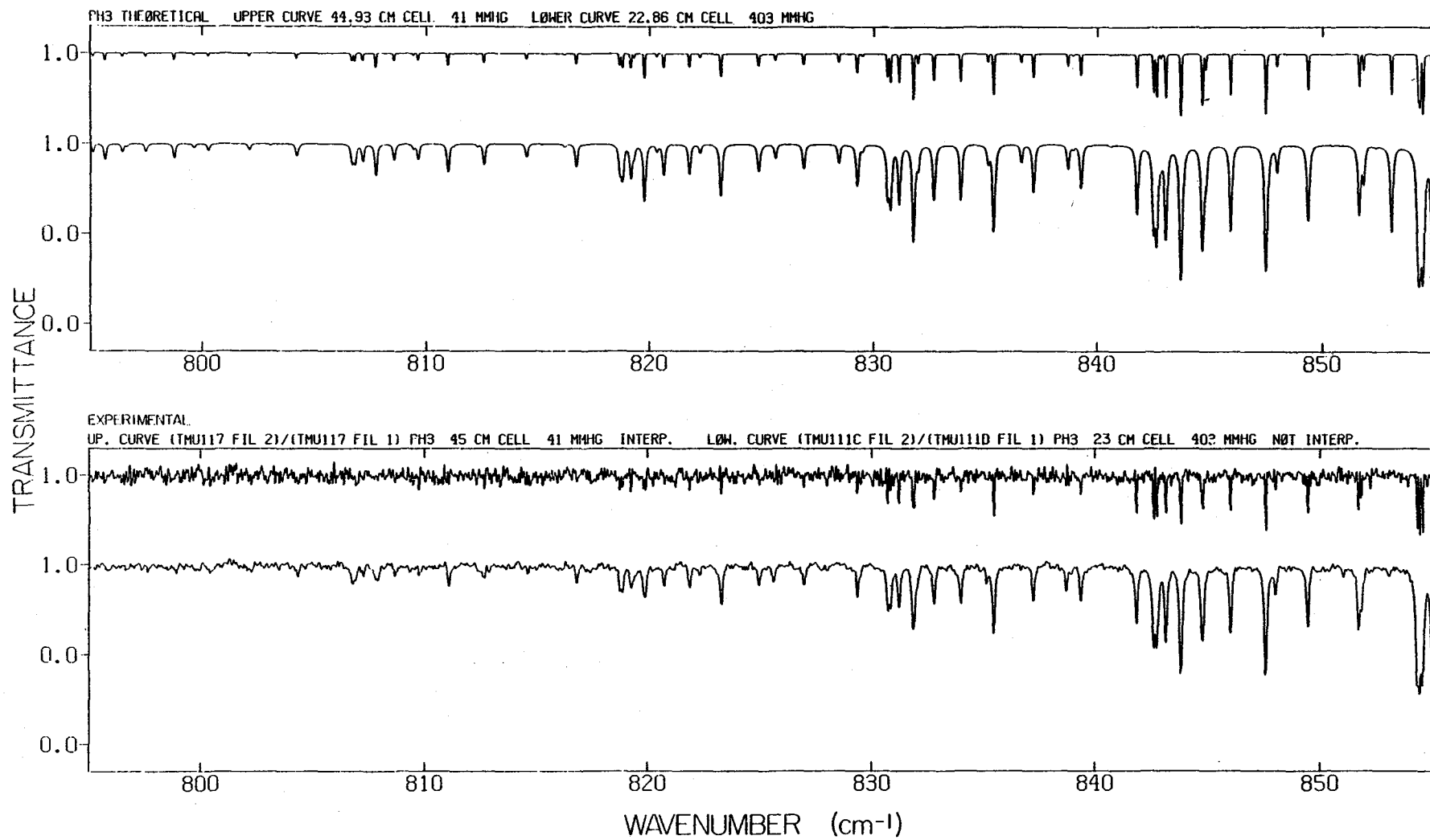

Figure 1. Calculated (upper 2 curves) and measured (lower 2 curves) transmittance of PH_3 at 25°C . The zero lines and the 100% lines are shifted for clarity. See text for details.

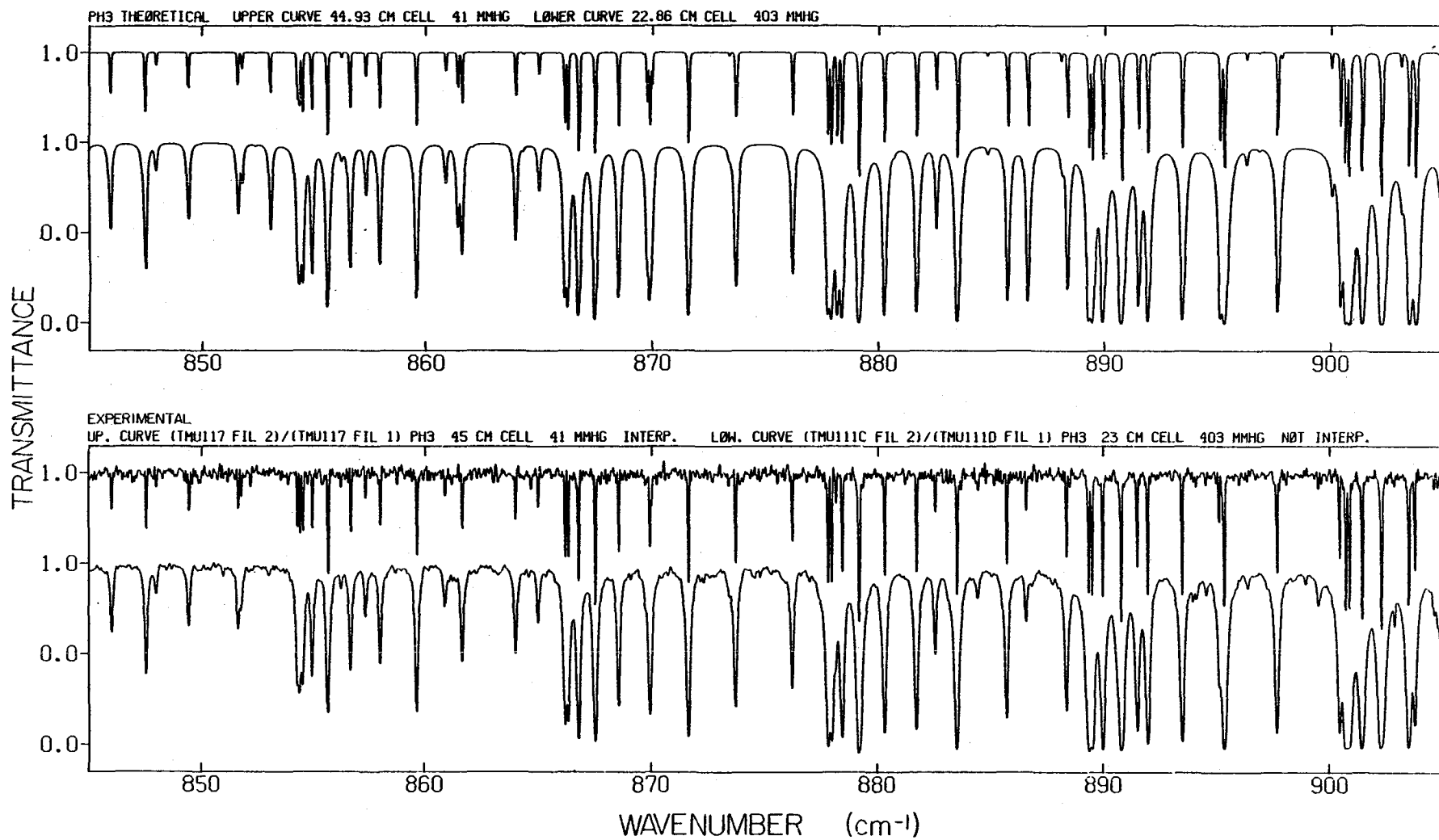

Figure 1. (Continued).

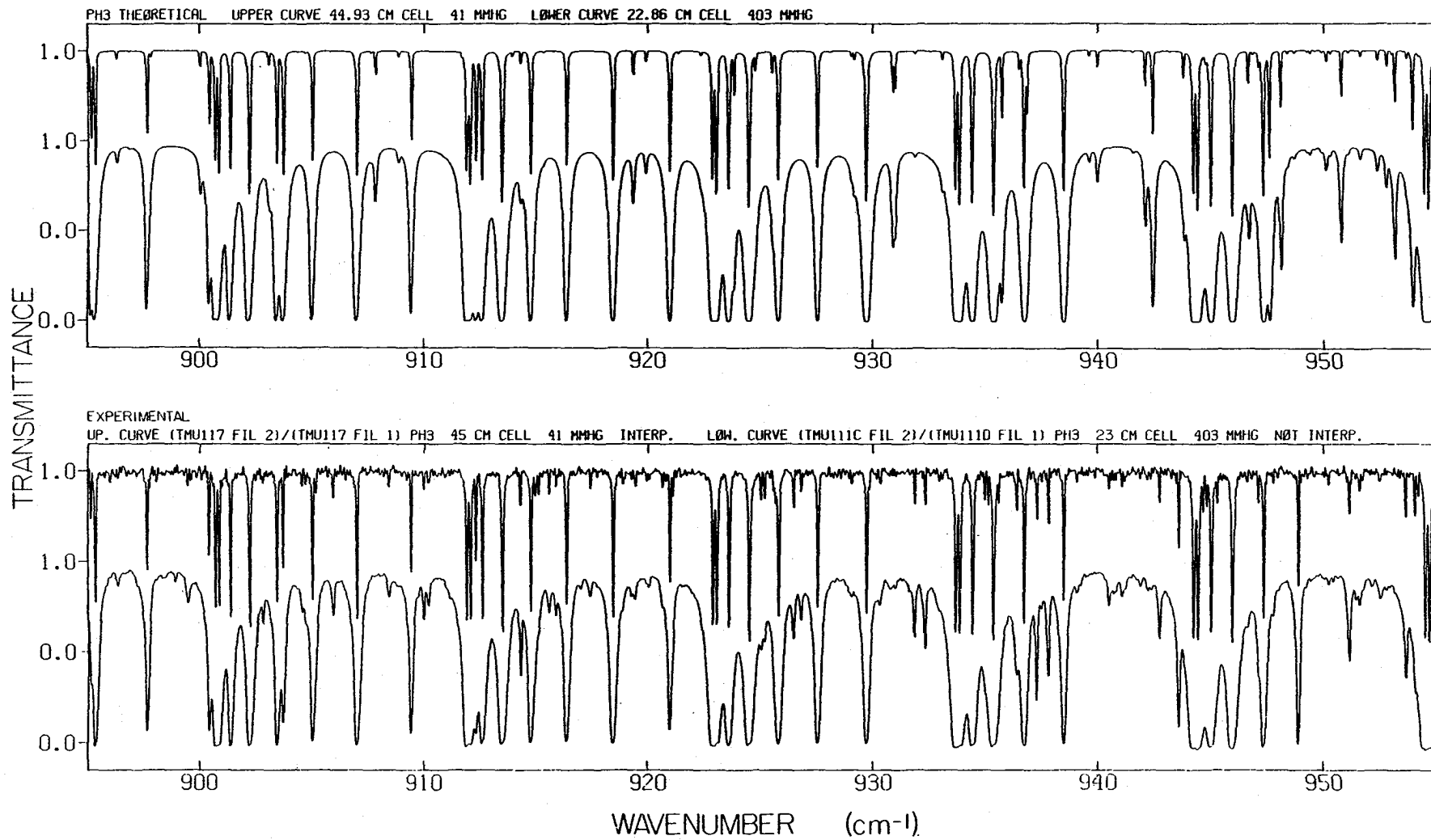

Figure 1. (Continued).

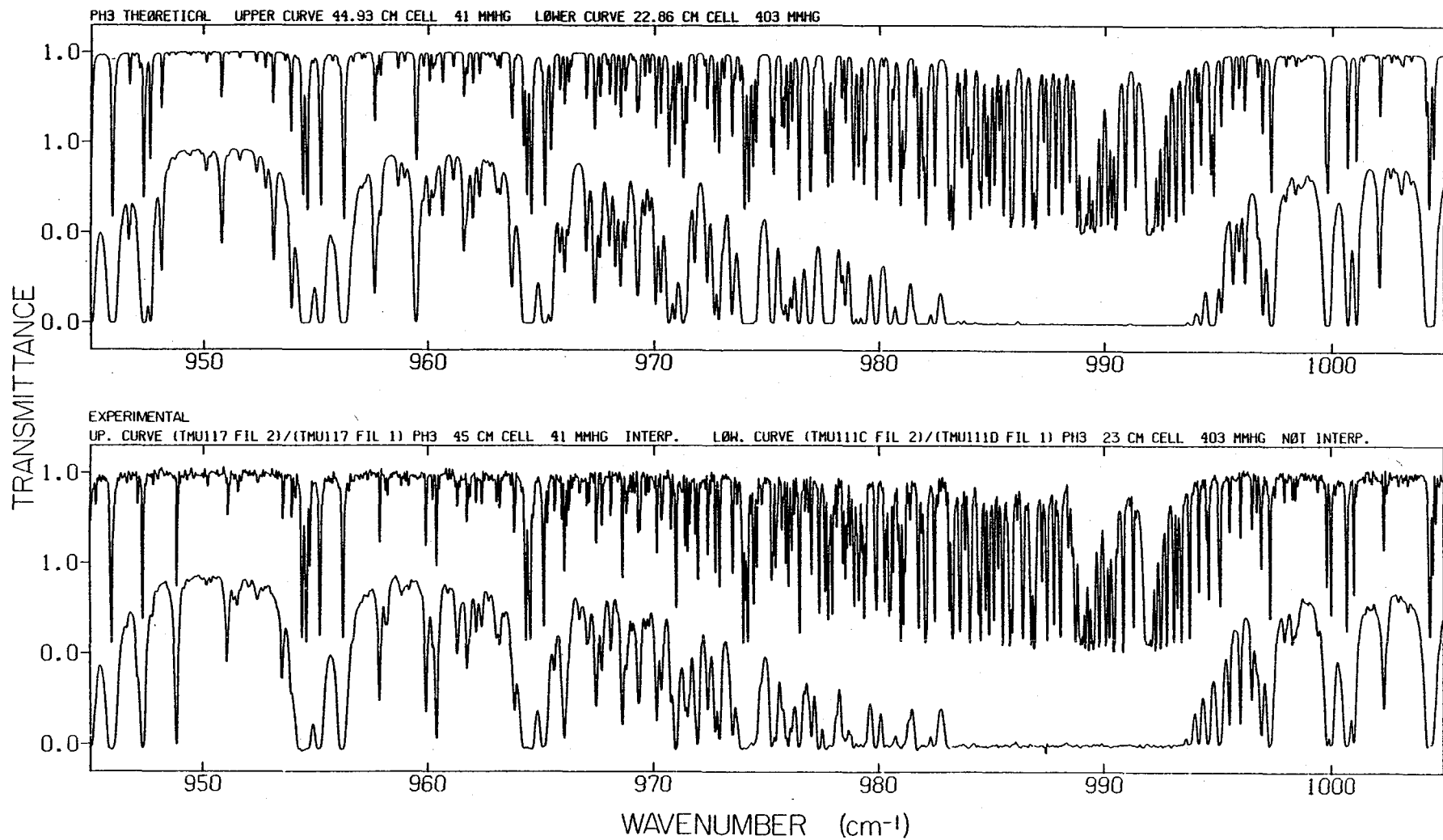

Figure 1. (Continued).

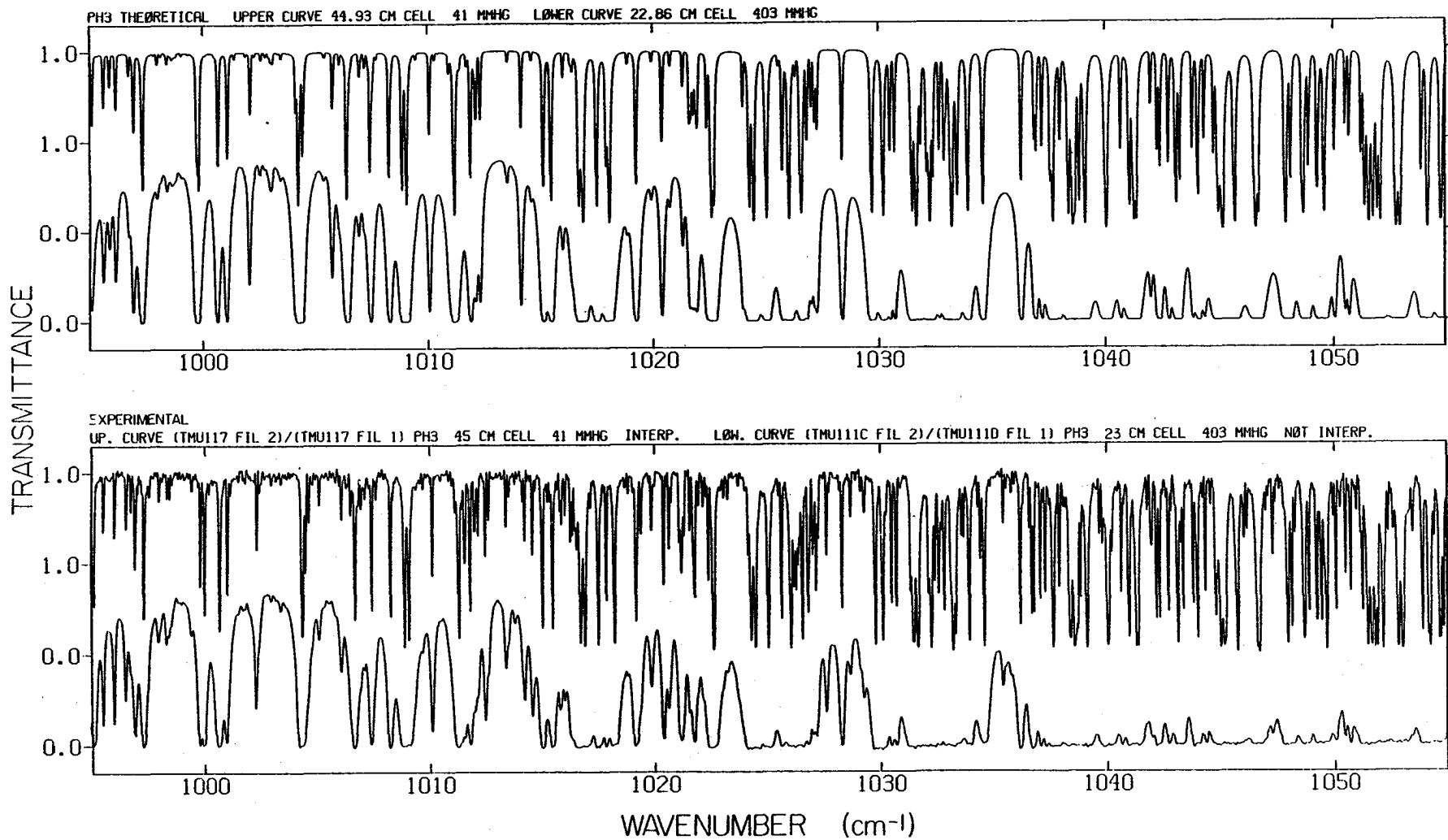

Figure 1. (Continued).

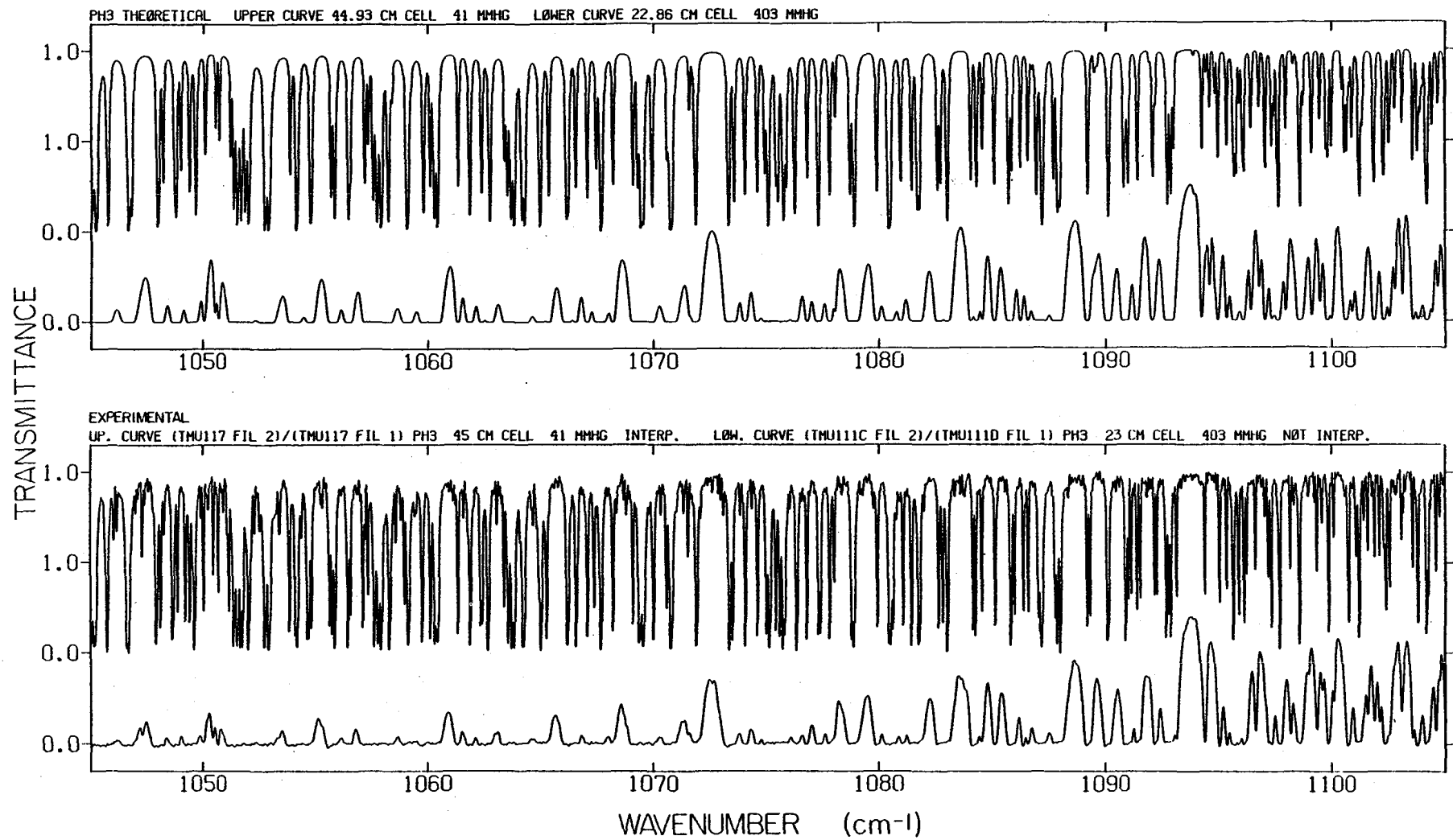

Figure 1. (Continued).

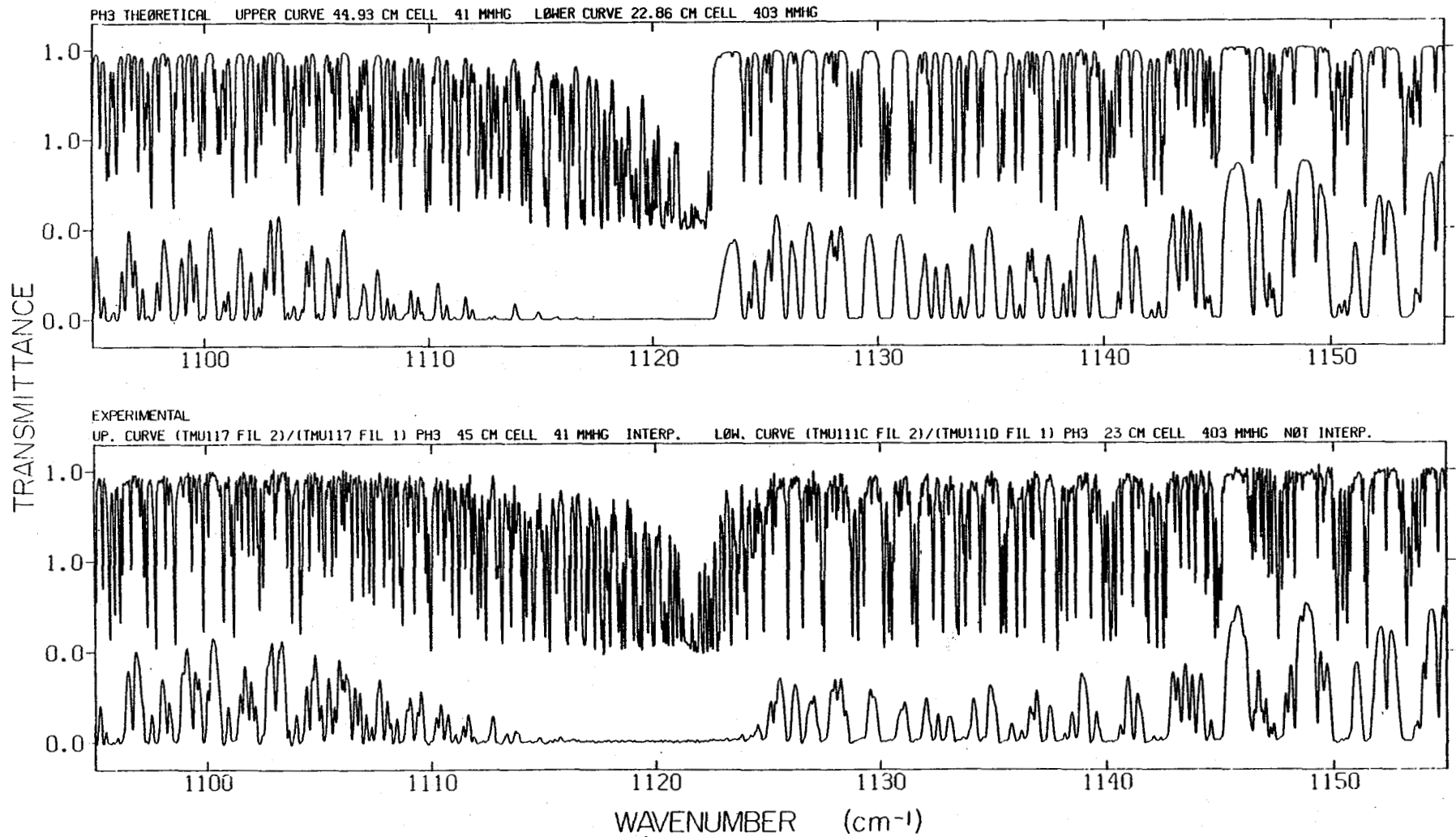

Figure 1. (Continued).

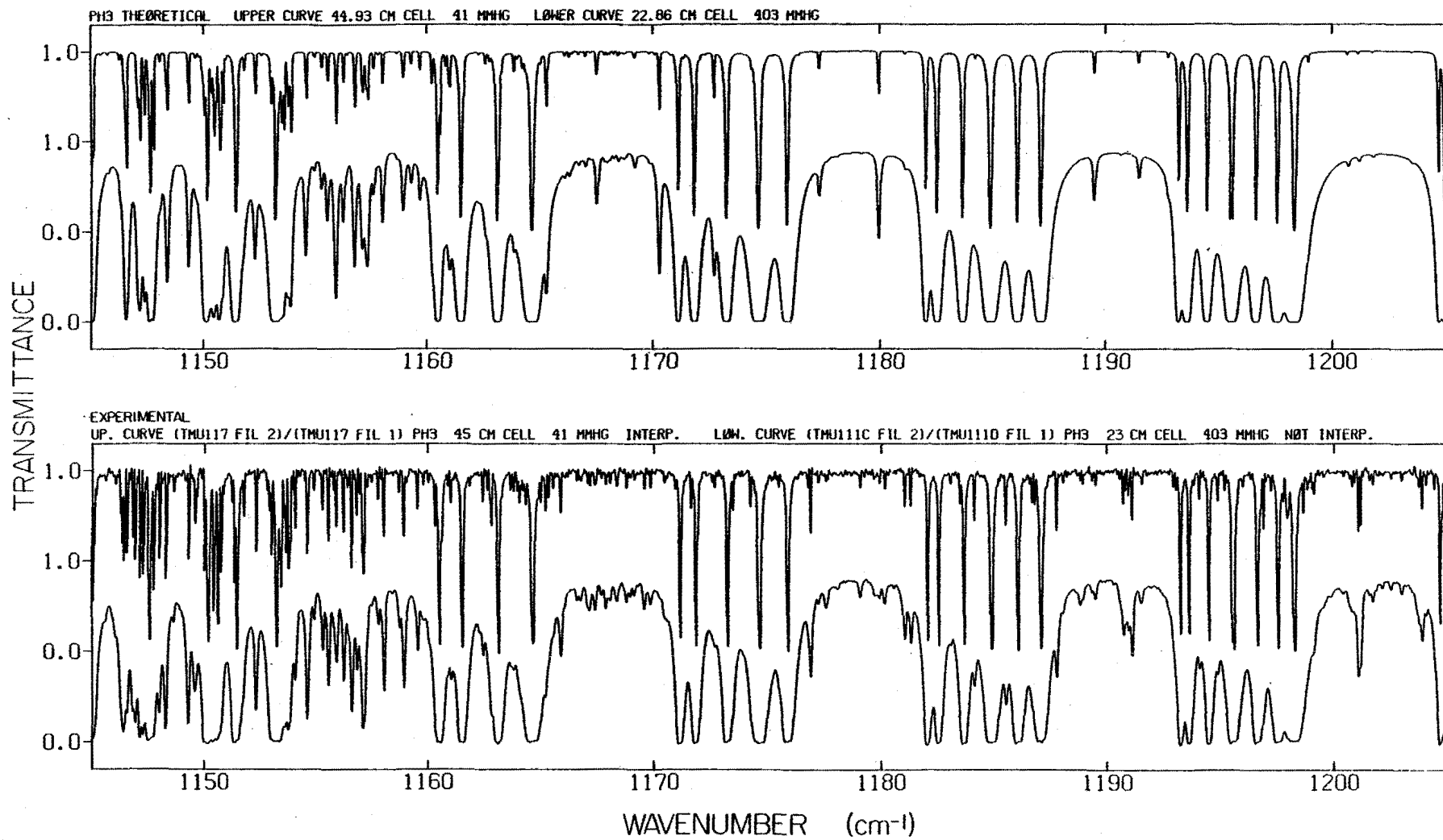

Figure 1. (Continued).

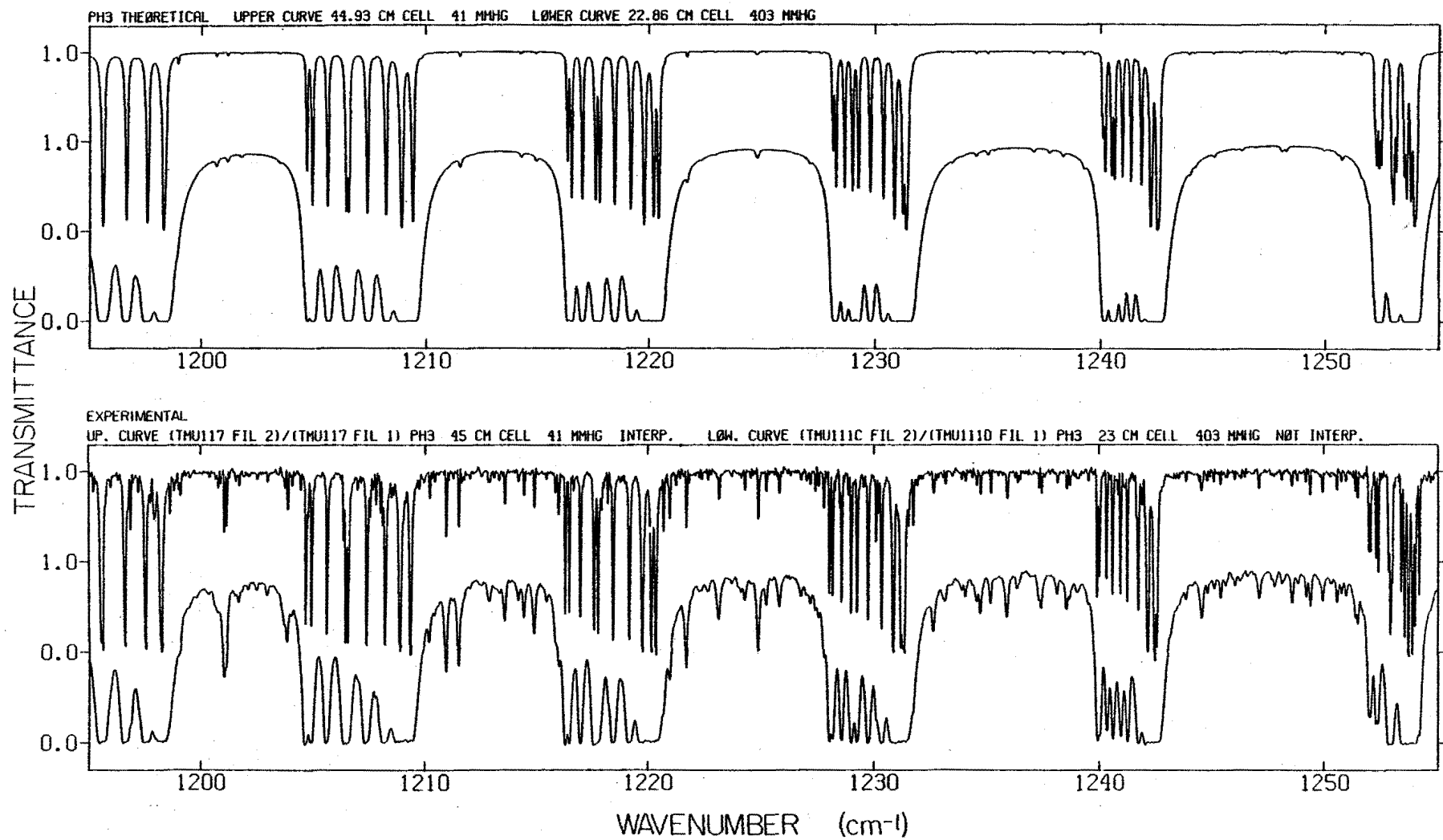

Figure 1. (Continued).

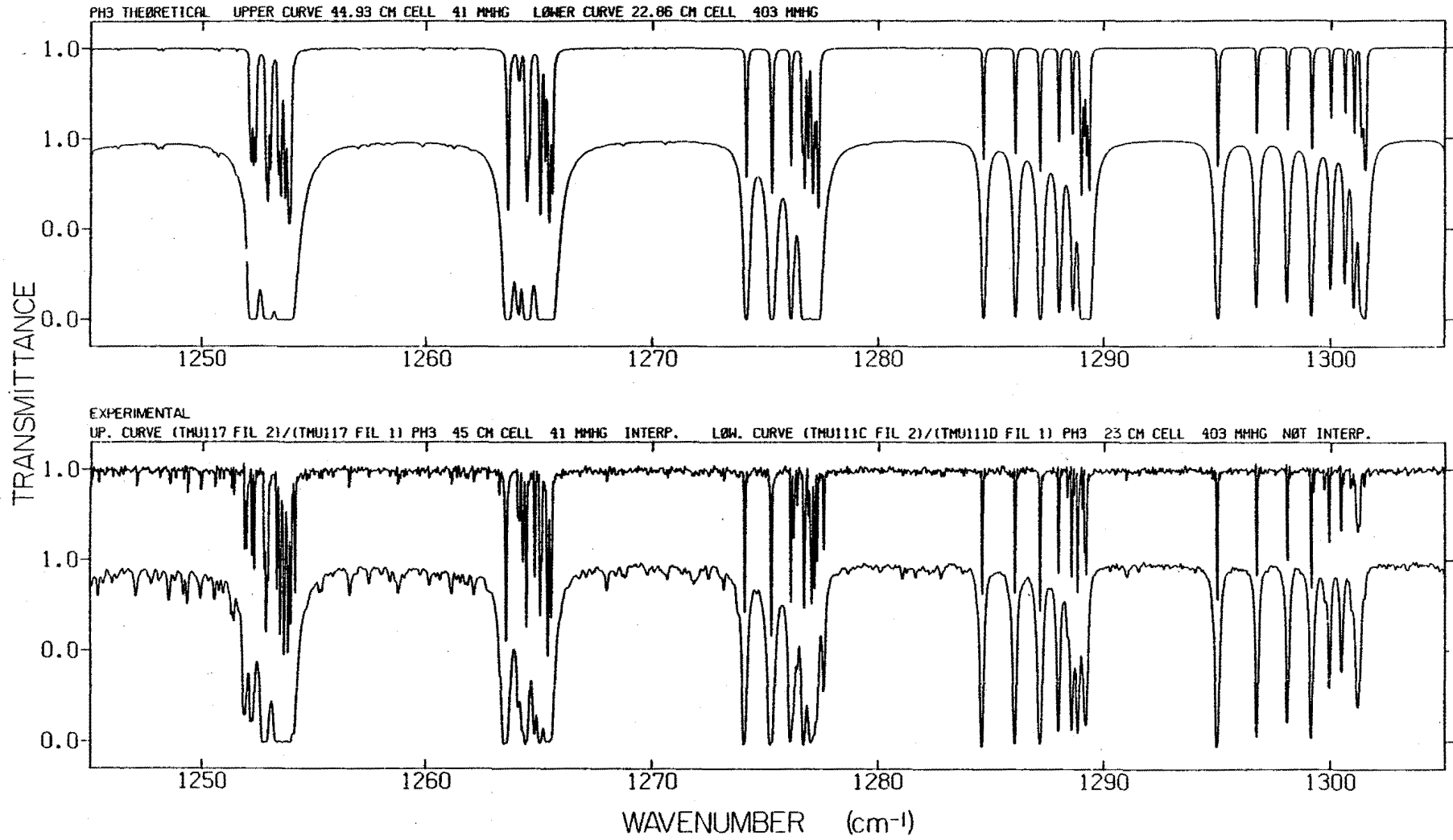

Figure 1. (Continued).

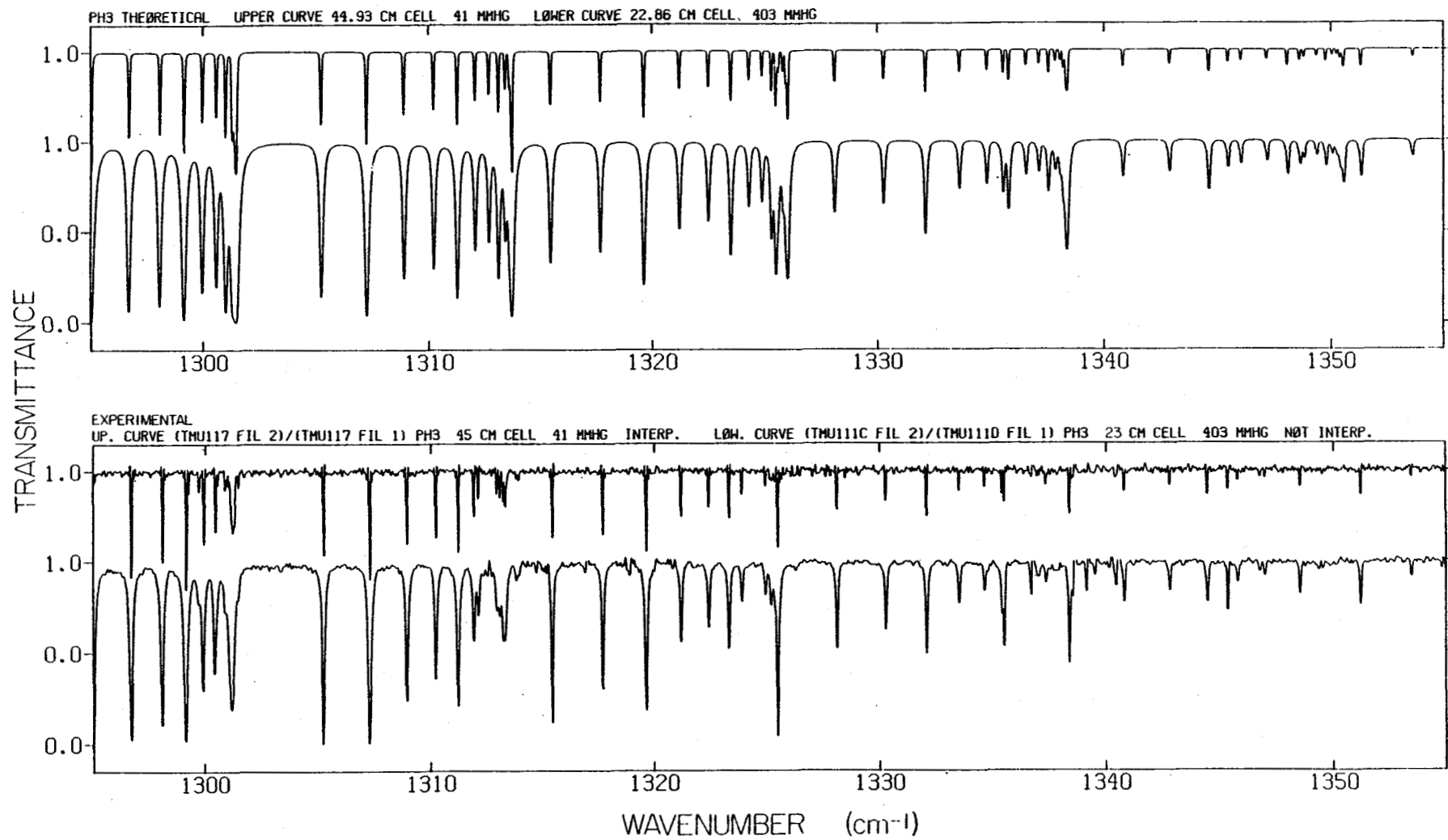

Figure 1. (Continued).

0.0
E200N L48 PH5, TMJ 120, FL 2, B13448 FL 13, L45CH, P400M, DOTS = CAL
XASFC = 1.000000000

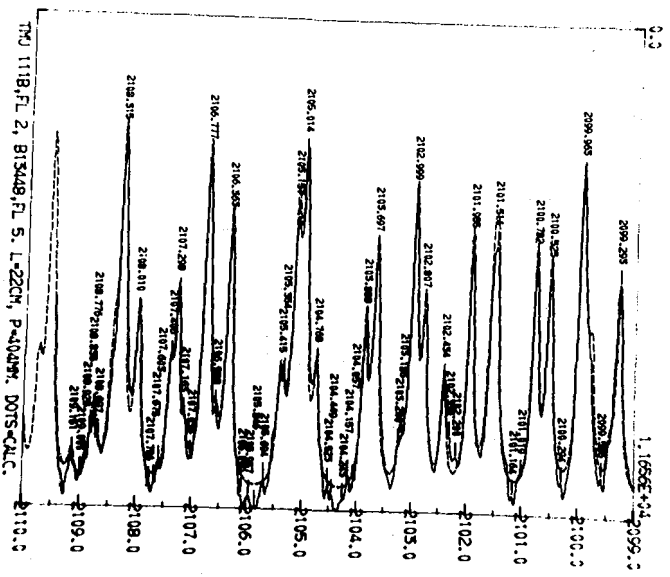
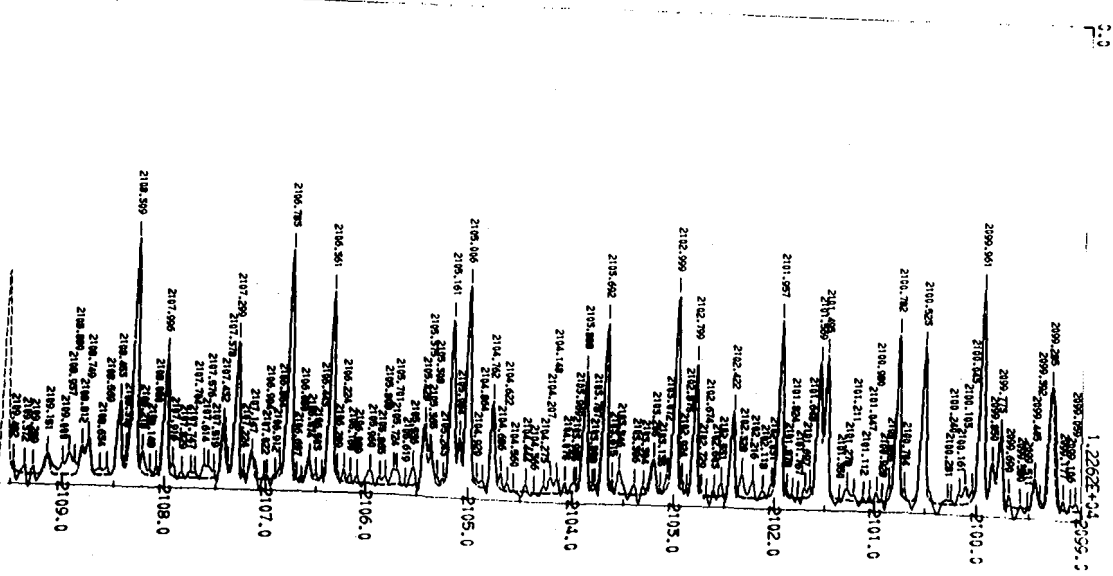

Figure 2. Comparisons of synthetic (broken line) and experimental (solid line) PH₃ spectra in the 2100 cm⁻¹ region. See text for details.

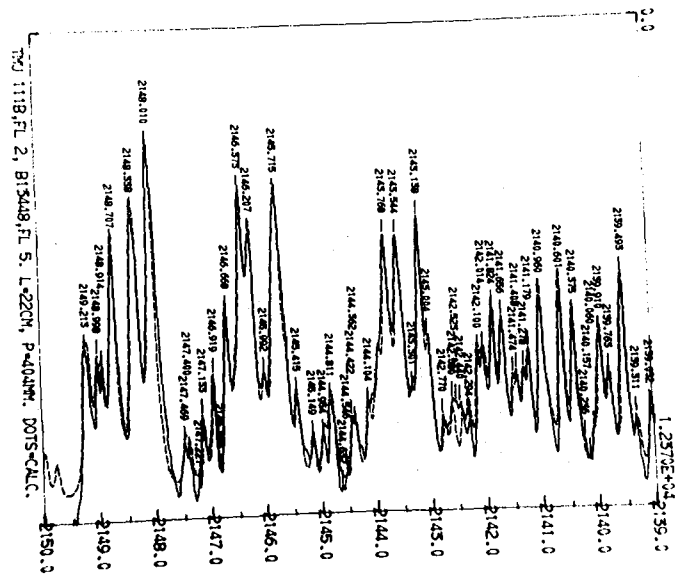
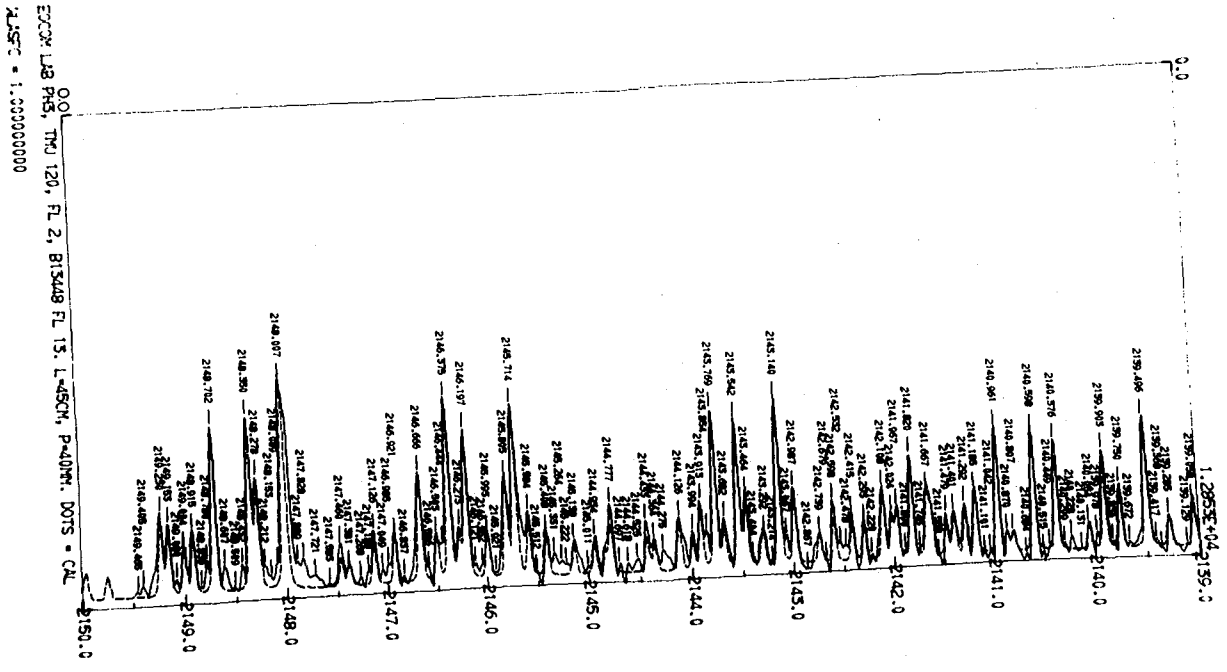

Figure 2. (Continued)

001
 EPOCH 28 P85; T0 120; FL 2; B15348 FL 13; L-45CN; P-404M; DOTS = CAL
 A-1571 = 1.000000000

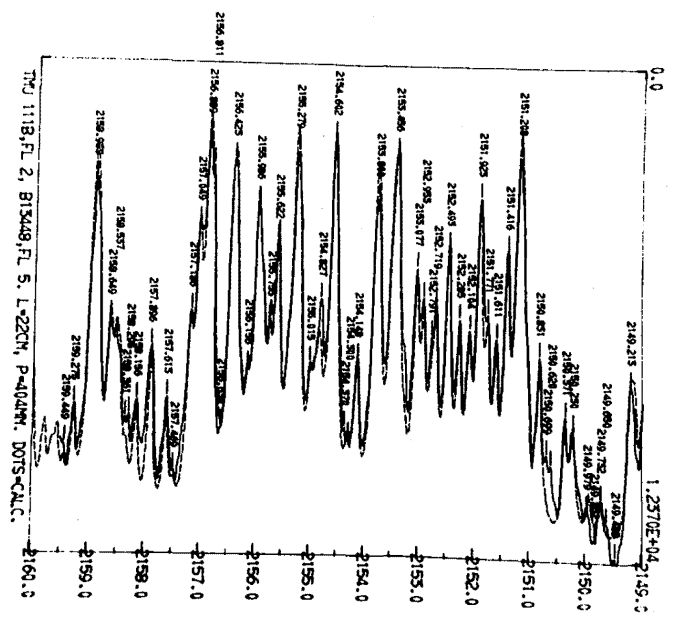
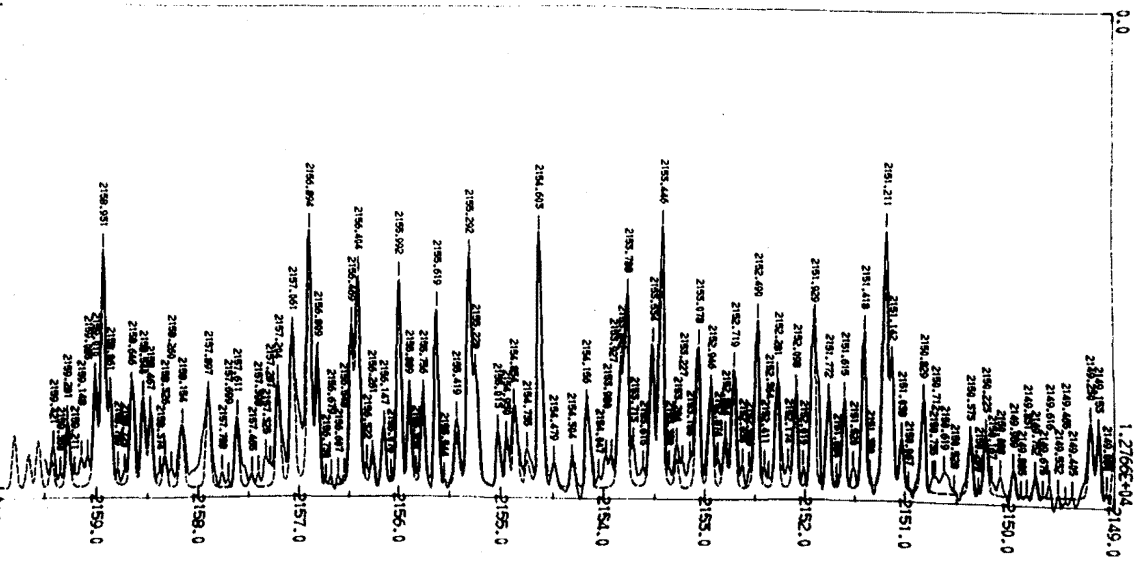

Figure 2. (Continued)

SPECTROSCOPY OF MINOR BODIES

	<u>Page</u>
Gaseous SO ₂ on IO – John Pearl	657
Titan on the Eve of Voyager Encounter – John Caldwell	673
Organic Chemistry in Titan's Atmosphere – Thomas Scattergood	679
Spectroscopy of Triton and Pluto: Current Status and Prospects – Dale Cruikshank	699
Comments on Pluto's Atmosphere – L. Trafton	709
Speculations on the Infrared Molecular Spectra of Comets – Michael J. Mumma	717

Gaseous SO₂ on Io

John Pearl (GSFC)

I propose to deal with gaseous SO₂ on Io. I will discuss the evidence for SO₂ on Io, beginning with the thermal infrared, then the near infrared, some recent and ongoing work in the ultraviolet, and finally some charged particle measurements which support the presence of SO₂.

Figure 1 presents data obtained by the infrared spectrometer on Voyager 1 in the thermal infrared. The situation under which these data were obtained was unique in the sense that the observed region was the only place on the planet that we could see this particular spectral feature. The feature near 1350 cm⁻¹ is identified as the ν_3 band of sulphur dioxide. Note that the baseline is suppressed and the ν_3 SO₂ absorption is only about 10 or 12 percent. The two curves underneath the data are synthetic fits: We took a single-slab model and used a line-by-line program with the abundance as a variable. By inspection, it appears that a good fit to the data would require a column density between 1.0 and 0.1 centimeter-atmospheres. We concluded that 0.2 centimeter-atmospheres, with an uncertainty of a factor of 2, reasonably represented the data. I should point out at this time that the observation here represents a very, very small region of the planet. The 0.2 centimeter-atmosphere abundance is for an area with near local noon conditions, when the surface is as hot as it can be. The surface temperature of the area surrounding the hot region was ~130K, giving us sufficient signal strength to see the 1350 cm⁻¹ feature. At this temperature, the vapor pressure over solid sulfur dioxide would produce a column-abundance of about 0.27 centimeter-atmospheres, so we conclude that we're seeing a vapor-pressure controlled atmosphere, at least in this local region. If we take the nonuniform surface temperature field of Io and suppose for the moment that Io is made of solid SO₂, we calculate that an Earth-based observer might expect to see an average column-abundance of about 0.03 centimeter-atmospheres. The data presented hereafter deal with observations from the ground, and therefore are sensitive to this integrated value.

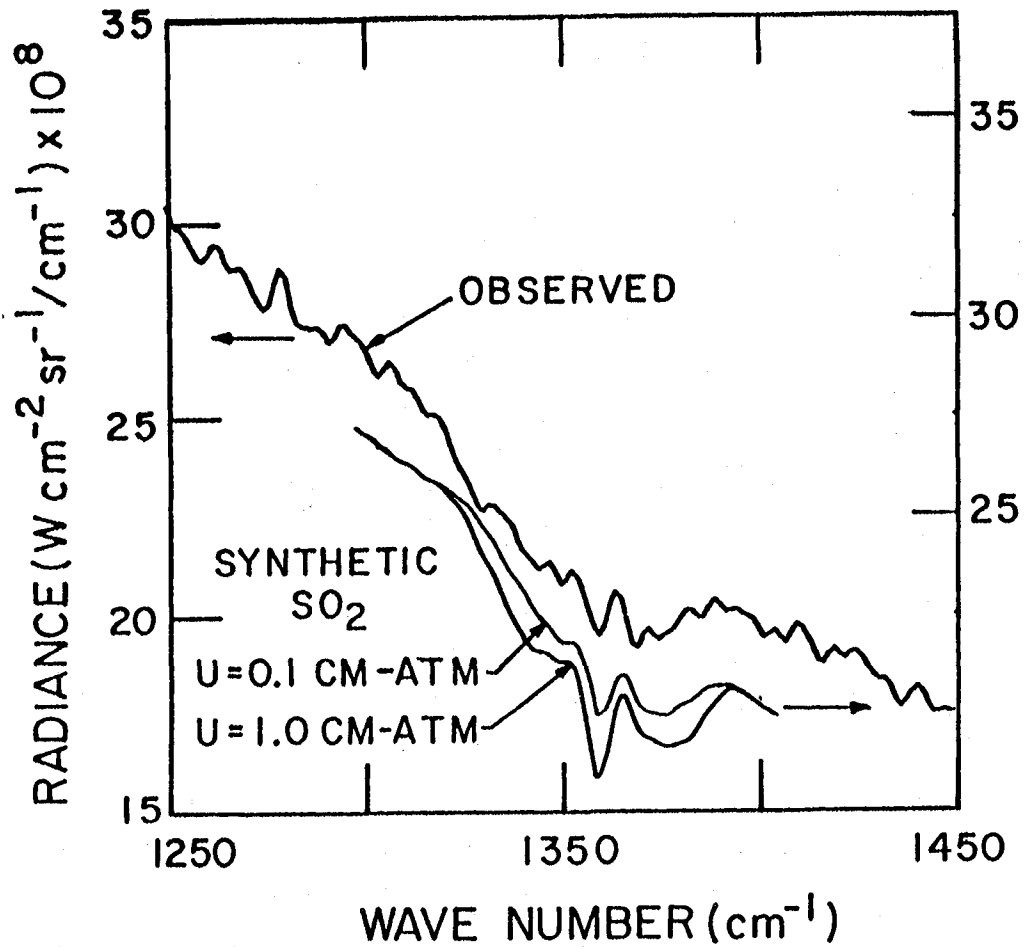

(Pearl et al., Nature 280, 755 (1979))

Figure 1. SO₂ in thermal infrared (gas).

Comment (L. Trafton): Do you mean 0.03 centimeter-amagats for purposes of calculating the total number of molecules?

Response: Yes.

Question: Did you use Doppler profiles for the modelled spectra in Fig. 1?

Answer: We used full Voigt profiles.

Figure 2 shows observational data (points) in the near infrared (from the visible to about 5 microns). The feature of interest is the absorption near 4 microns. The two upper solid curves represent the reflectance of solid sulphur dioxide, and the transmission of the gas. Fanale et al. have identified the absorption in Io's spectrum with the absorption in the reflection spectrum of the solid. The displacement of the solid and gaseous bands (40 cm^{-1}) supports the identification; the gaseous spectrum does not fit the data. Uwe Fink (private communication) has obtained another spectrum of Io at much higher spectral resolution than this. From his measurements he places Io's absorption at about 2467 cm^{-1} , with an uncertainty of about $\pm 10 \text{ cm}^{-1}$. The absorption peak in the solid is at about 2460 cm^{-1} , which makes the identification pretty secure. The gaseous absorption feature in Io's spectrum, given the disk averaged SO_2 abundance, would only be about 1 percent, so the fact that we don't see a double feature in this spectrum is not surprising. We see the solid, not the gas.

Figure 3 presents some recent ultraviolet observations by Butterworth et al. The curve labelled Io represents a spectrum obtained from the International Ultraviolet Explorer satellite. The laboratory ultraviolet absorption spectrum of gaseous SO_2 is shown in the lower panel. Relative to the solar spectrum, Io's spectrum shows no indication of the SO_2 absorption features (indicated by arrows in Fig. 3). Based on the lack of structure, Butterworth et al. put an upper limit of 0.008 centimeter-atmospheres on the disc-averaged abundance of SO_2 . This in itself is not necessarily surprising, since Io is not solid SO_2 anyway. This does put an upper limit on the distribution of the solid across the disc of Io.

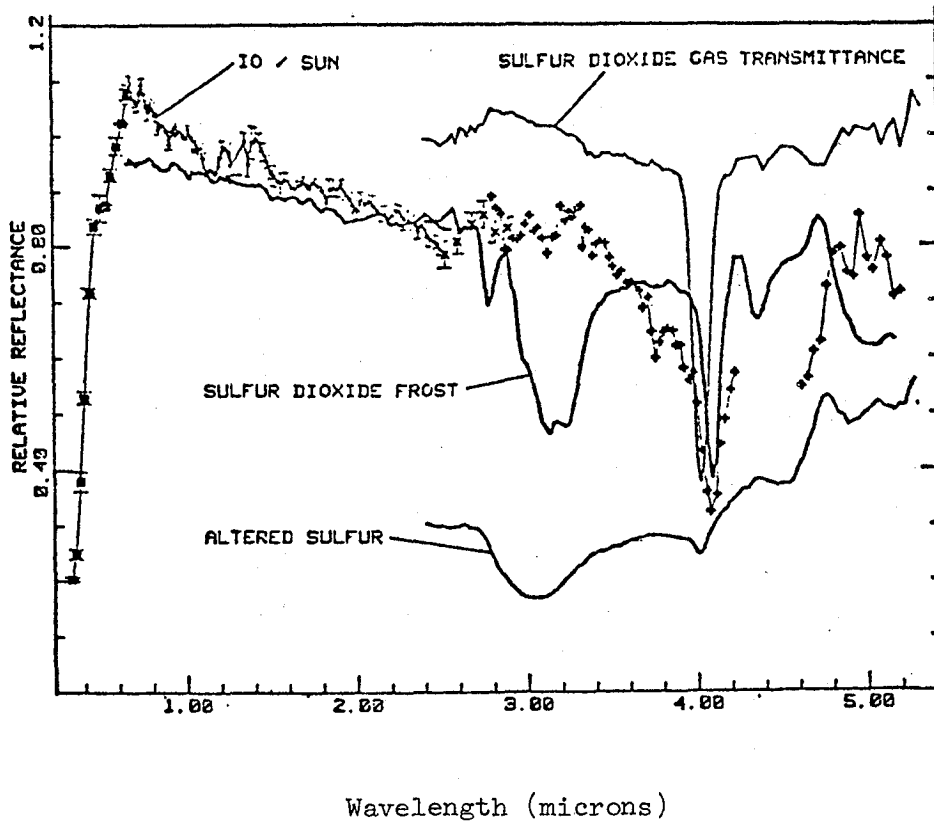

(Fanale et al., Nature 280, 761 (1979))

Figure 2. SO₂ in near infrared (solid).

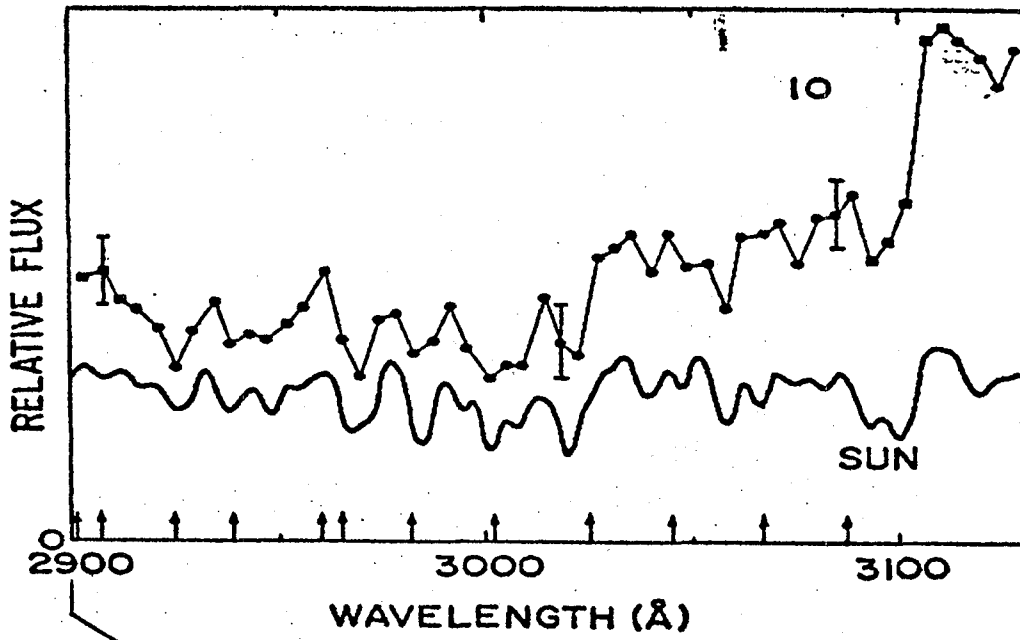

(Butterworth *et al.*, *Nature*, submitted (1980))

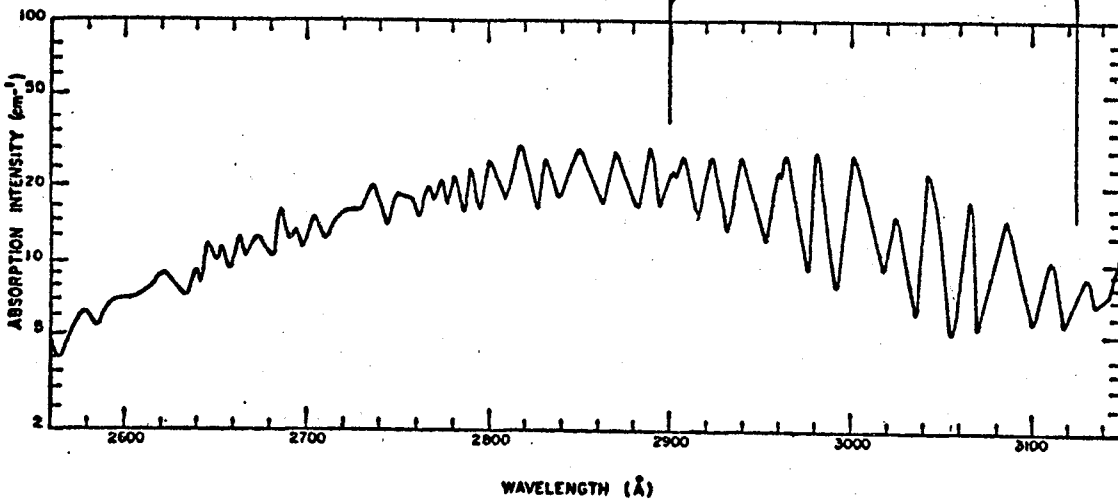

FIG. 2. Absorption intensities of SO_2 at 2560–3150 Å.

(Warneck *et al.*, *J. Chem. Phys.* 40, 1132 (1964))

Figure 3. SO_2 in ultraviolet (gas?).

Question (M. Mumma): Is that the same work that Lonnie Lane was supposed to do?

Answer: Yes. In fact, the data you just saw are near 3000 Å. There's a much stronger SO₂ absorption, by about an order of magnitude, near 2000 Å. Last week, Lane got time on IUE for some long integrations, and is trying to push his spectrum down into the 2000 Å region to look again for absorption due to gaseous SO₂. He told me that there are some stray-light problems that he has to handle, and after he resolves those he will know whether the "signal" which he sees is indeed a signal, or whether it's all just scattered light. That may be a way of pinning down this abundance even better.

The data in Figure 4 are also from Butterworth et al. They took the ratio of Io's spectrum to the solar spectrum, and got the results shown on the top panel. They observed other objects, such as Vesta and Callisto, whose ratioed spectrum was completely flat. Io's spectrum is unique in showing the rapid turn-up near 3100 Å. Laboratory reflectance measurements (Nash et al., 1979) of solid SO₂ show similar behavior in this spectral region. This is believed to be evidence for the presence of solid SO₂ on the surface. As with the near infrared spectra, so it is much easier to identify the presence of an SO₂ atmosphere on Io by looking at the solid-phase ultraviolet spectra than by looking for the vapor phase.

Figure 5 shows data taken by two of the charged-particle experiments on Voyager 2 at a time when the spacecraft was near the orbit of Europa. The data in the upper right corner are particularly relevant. An oxygen peak is on the left, and a sulphur peak on the right. These are measurements made of particles with an energy of about 1 MeV per nucleon (relatively high-energy particles) and the indicated relative numbers of oxygen and sulphur are consistent with sulphur dioxide in the vicinity of Io providing these sulphur and oxygen ions to the magnetosphere. We see a similar situation in the upper portion of the bottom panel, although at higher energies (~10 MeV per nucleon); an oxygen peak and a sulphur peak, again in the vicinity of Europa. The peaks in the lower part of the bottom panel are measured much farther out in the magnetosphere. Evidently a sorting effect occurs. Even so, the

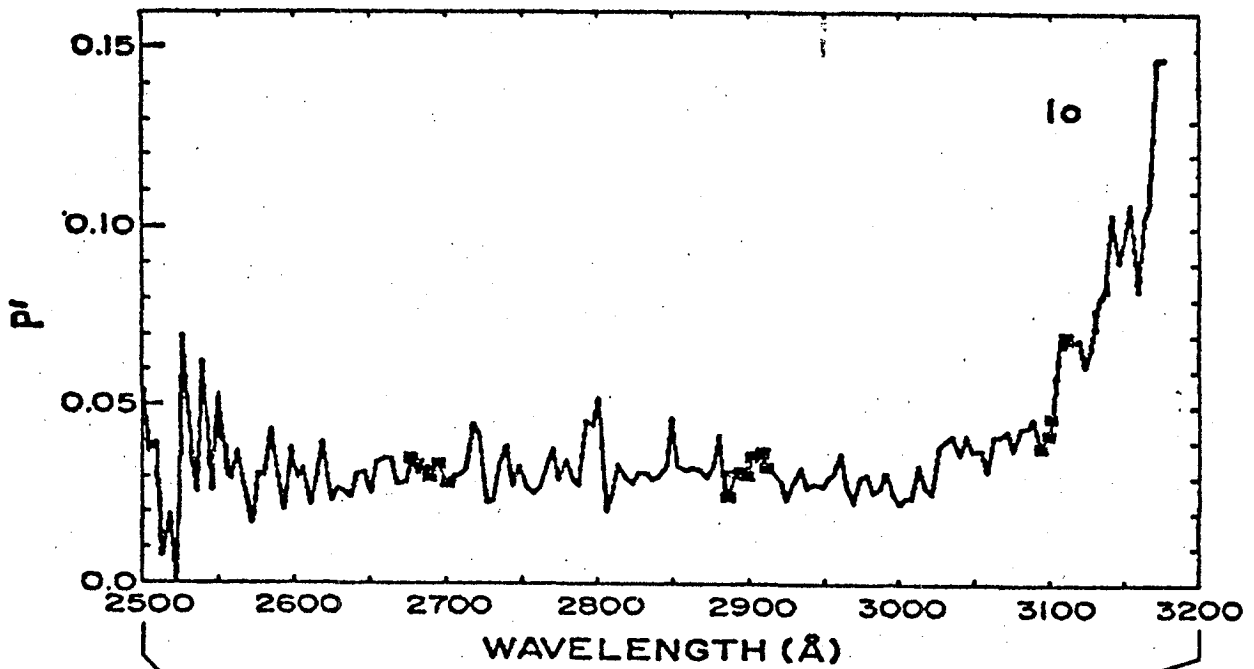

(Butterworth *et al.*, *Nature*, submitted (1980))

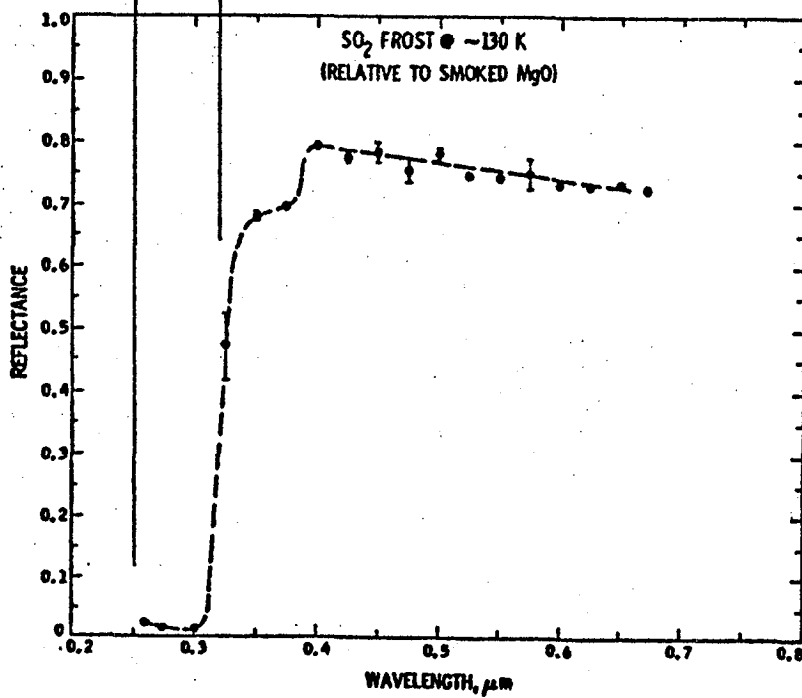

(Nash *et al.*, *B.A.A.S.* 11, 597 (1979))

Figure 4. SO_2 in ultraviolet (solid).

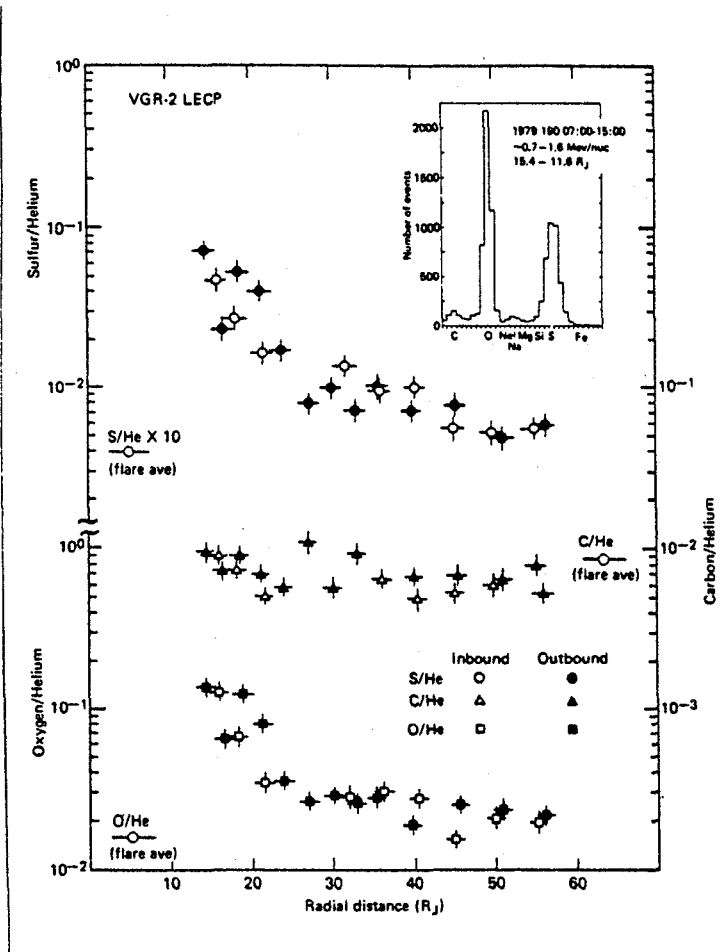

(Krimigis et al., Science 206, 977 (1979))

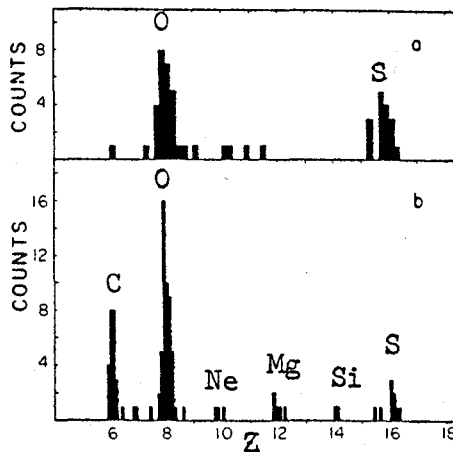

(Vogt et al., Science 206, 984 (1979))

Figure 5. S and O in magnetosphere (ions).

abundances of the other elements (carbon, neon, magnesium, silicon) are approximately in the solar ratio whereas the abundances of oxygen and sulphur are still enhanced, although not as strongly as they are closer in. Again, this is consistent with the idea that gaseous sulphur dioxide is available; it is supplied to the magnetosphere as a result of ionization of SO_2 by ultraviolet radiation, particle radiation, etc.

Investigations involving sulphur dioxide are continuing. One question which I've already alluded to is this: What is the actual global abundance, i.e., what is the global distribution of sulphur dioxide? If one assumes that the gas is controlled by the distribution of surface deposits, then it would be of great interest to know how widespread these are, where they are, etc. What is the state of the atmosphere (by this, I mean how far from local thermodynamic equilibrium is it)? What is the photochemistry and the degree of ionization, etc.? The state of the condensed phases is also at issue; if only bulk solids are assumed, vapor pressures can be calculated and compared with the measured abundances. On the other hand, it's conceivable that the layers are adsorbed, in which case the relevant vapor pressures would be much lower. If the surface has a large component of pure sulphur (which is highly transparent in the near infrared, the spectral region most accessible from the ground), it is conceivable that scattering is important. Therefore, even relatively thin deposits, perhaps on a molecular level, of SO_2 could be responsible for the spectral features, and yet produce a relatively low overall average atmospheric abundance.

What about other atmospheric constituents, in particular, sulphur containing compounds? Upper limits were obtained for many species from the Voyager infrared data. Table 1 lists the species, the particular bands searched for, their spectral positions, and upper limits on abundances. For consistency, I included the vapor pressure over the solid which one would expect at the local surface temperature of 130K; for comparison, the upper limits are also given in the same units. Here we assume that there is a warm atmosphere (250K) over the surface, which is what would be expected from solar UV heating and so on. In all but three cases, our upper limits are much below the vapor pressure one would expect if the material were on the surface. The exceptions are sulphur trioxide, H_2O , and HCl . From the lack of water bands

Table 1
Upper Limits for Various Gases on IO

Gas	Band used (cm^{-1})	Vapor-pressure abundance above solid at 130 K (cm atm)	Upper limit for atmosphere at 250 K (cm atm)
COS	ν_1 859	510	1.5×10^{-4}
CS ₂	ν_3 1,535	1.4×10^{-1}	2.8×10^{-5}
SO ₃	ν_2 497	1.6×10^{-6}	2.4×10^{-5}
H ₂ S	-	(1.2)*	$(7 \times 10^{-2})^*$
CO ₂	ν_2 667	1,050	5.1×10^{-5}
O ₃	ν_1 1,042	- **	1.1×10^{-3}
N ₂ O	ν_1 589	4,780	2.2×10^{-3}
H ₂ O	Rot. 254	6.4×10^{-7}	1.9×10^{-4}
CH ₄	ν_4 1,306	- **	1.7×10^{-3}
NH ₃	ν_2 931	11	3.4×10^{-4}
HCl	Rot. 206	1.8×10^{-4}	3.7×10^{-4}

*Based on stellar occultation near terminator. Surface (solid phase) assumed at 110K.

**No solid phase at this temperature.

(Adapted from Pearl et al., Nature 280, 755 (1979))

in the near infrared, we know that there is very little water. Sulphur trioxide has such a low vapor pressure that we can't see it and the HCl limit is just about at the noise level. It does appear, however, that Io has very little hydrogen, oxygen or nitrogen left.

I would conclude by saying that further progress in the investigation of SO₂ on Io is limited by the observational techniques themselves, and not by the spectroscopic issues. We need a much greater, much enhanced capability for making observations.

Discussion

Question: I don't see sulphur monoxide on your list.

Response: No, we didn't look for that; it's pretty reactive. S_2O would also be very interesting; however we didn't have any line strengths for S_2O .

Question (A. Young): Figure 2 showed the near-infrared spectrum of solid and gas-phase SO_2 . The solid phase laboratory spectrum showed a big absorption band shortward of the one that showed up on Io, yet there wasn't any sign of it in Io's spectrum. Why is that so?

Response: That band is residual water in the laboratory sample.

Question (L. Trafton): What about the state of the solid frost? Would it be advantageous to have spectra of frosts at different temperatures to help interpret the spectral data, to get more information out of it than has been obtained so far?

Response: Godfrey Sill's work (Fink's group) suggests that the only thing one might find by looking at the temperature dependence is a possible phase change. Frost is formed at a very, very low temperature; there might be an amorphous phase. At this point I don't think we can say conclusively whether or not this is the case. Godfrey's SO_2 laboratory data do show some changes there.

Question (L. Trafton): Do you think it worthwhile for the community to try to get such data?

Comment: (U. Fink): We already have the data. There are possibly some very minor changes in the spectrum but, on the whole, the spectrum does not change with temperature at all.

Question (Y. Yung): Was your search for minor constituents carried out in the volcanic plumes?

Response: Yes, the data used to derive the upper limits and the abundance of SO₂ were, as I said, a very restricted data set. Figure 6 shows the situation. There are several areas on the surface of Io which are relatively very hot, being at much higher temperatures than one would expect from steady-state thermal balance with the Sun and radiation to space. The spectrum of Figure 1 corresponded to viewing an area with a mean temperature about 290K, within a surrounding area at about 130K. There is also a plume associated with that general area. However, we did conclude that probably the contribution from the plume was not dominant in that case.

Question (J. Caldwell): Concerning your comment for better observations, at least in the ultraviolet: The spectrum you showed from Butterworth et al., represents essentially the peak of the sensitivity of the currently operating IUE satellite. Toward either wavelength extreme, the sensitivity goes down very rapidly, so one has to make significantly longer exposures to get comparable signals. Lonnie Lane will face quite substantial obstacles. Even though the absorptions of SO₂ are stronger at 2100 Å, the instrumental noise is likely to be somewhat higher, so this represents a real challenge. The best prospect for developing this approach in the near future may be actually trying to do it from the ground and pushing against the ground-based limit of 3000 Å. Presumably, one can integrate for a long time and get a better signal-to-noise ratio. One can't do that very well with IUE.

To make another comment: In the infrared, in the region where you made your discovery observation, Bob Cess and I (Stony Brook) are working with some scientists from the Soviet Union on some observations of the infrared reflection spectrum. We find a solid band that's shifted just a little bit from the gas toward the left of center on Figure 1. We suspect that indeed we may be seeing a small effect in the spectrum due to solid SO₂.

Response (J. Pearl): In regard to Lane's work, what Caldwell says is very true. The Butterworth spectrum, I believe, represents about 40 minutes of integration time; Lane's new spectrum represents 4 or 5 hours, and he still has the problems I've indicated. The IUE sensitivity is not a negligible consideration either. The infrared feature that Caldwell mentioned is in our spectrum (Figure 1); we do see a discrepancy in this region between the

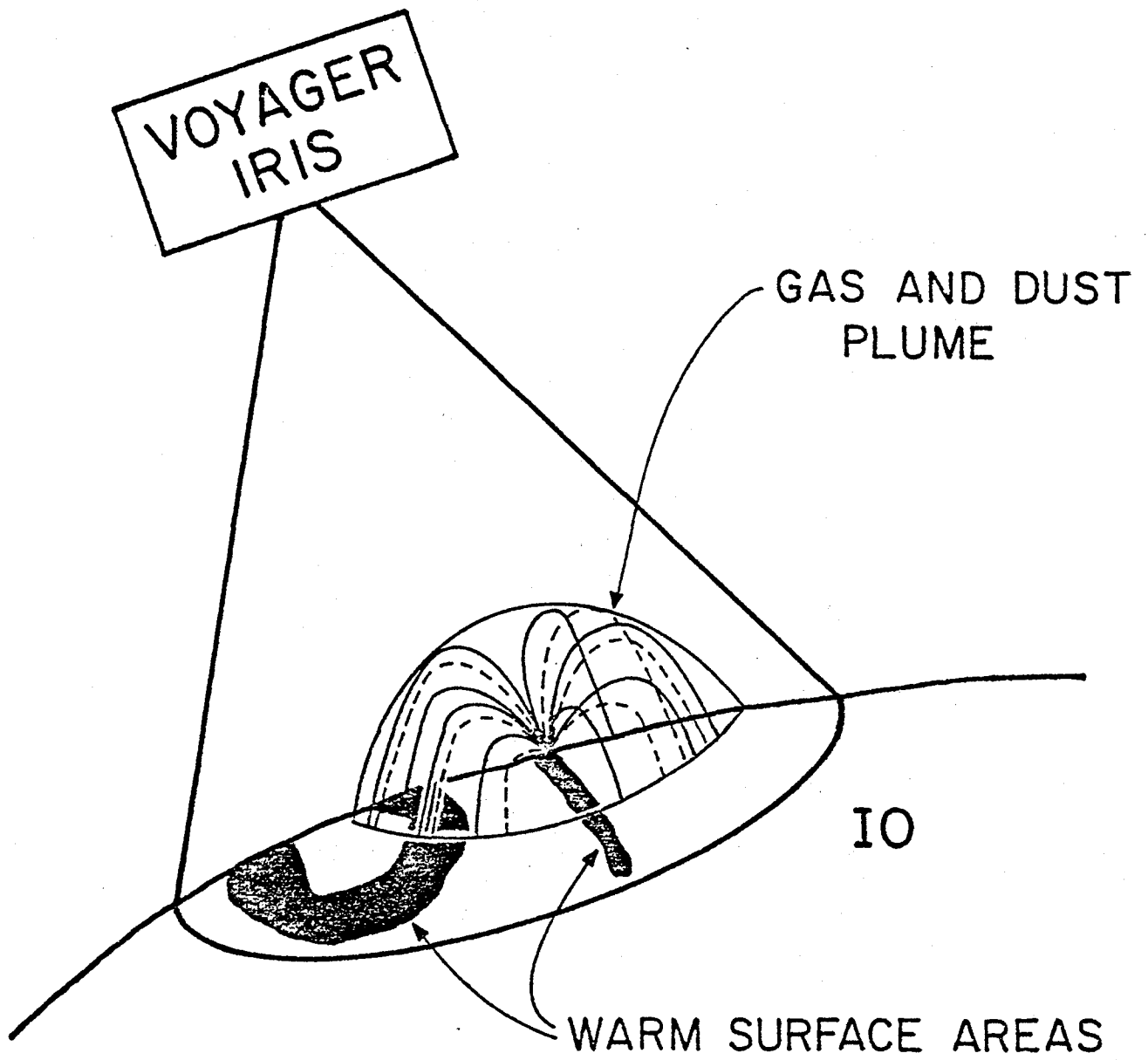

Figure 6. IRIS observations of LIKI hot spot (schematic).

calculated curves and the data. That may turn out to be due to the solid, although the new data that Godfrey (Sill) got, with a well-controlled specimen which was not amorphous, shows the position of that feature to be moved over to the left a bit from what we see in the data.

Comment (A. Young): With regard to Caldwell's remark about doing it from the ground, I think it would be very difficult; look at the trouble Ed Barker had in getting SO₂ on Venus. There is a large amount of ozone in the Earth's atmosphere which absorbs strongly there. The ozone vibrational structure interferes with the SO₂ vibrational structure, and it is extremely difficult to de-convolve the spectra. Since it is difficult to do this for Venus, I think it's going to be extremely difficult to do it for Io from the ground.

Response (J. Caldwell): I don't dispute that. It may be difficult, but it also may be the best opportunity until the Space Telescope is launched, at which point it will be very easy.

Comment (H. Pickett): Speaking of the future, I did a quick calculation here. A number of the rotational transitions of SO₂ would be opaque in Io's atmosphere.

Comment (M. Mumma): I think that spectral region would certainly be difficult to observe with most millimeter telescopes, due to severe beam dilution.

Question (L. Trafton): John, when you constructed your synthetic spectrum, did you have any problems in doing that, or have to make any assumptions with which you felt uncomfortable? Is there a requirement for people in the laboratories to improve data on SO₂?

Response: I don't think that was a consideration. Bill (Maguire) can you address that?

Question (L. Trafton): Are you completely happy with your kinetic model of SO₂ or are there some parameters you'd like to see better measured in the laboratory?

Response (W. Maguire): For this particular problem, I think the parameters are satisfactory, since we are not looking at the spectrum under high resolution.

Comment (J. Pearl): The resolution here is about 6.5 cm^{-1} which is really low resolution.

Comment (A. Young): A comment about this kind of low-pressure atmosphere in general: One of the things that fooled people when they looked at the spectrum of Mars was the fact that practically everything they saw in its spectrum was on the very flat part of the curve of growth, because of the low surface pressure. Of course, you have an even lower surface pressure on Io. Because you are working on the very flat part of the curve of growth, the spectrum looks very different from what you're used to seeing in laboratory spectra. Features tend to be either invisible or all about the same height, even though they have very different heights in the laboratory spectrum. You have to bear that in mind when looking for things in this kind of an atmosphere.

Response (J. Pearl): Our comparison spectra were obtained numerically with a line-by-line program based on molecular constants derived from laboratory data. It is not just artistic comparison with laboratory measurements.

Question (L. Trafton): But it does take the very low pressures into account?

Response (J. Pearl): Yes.

TITAN ON THE EVE OF VOYAGER ENCOUNTER

John Caldwell

Department of Earth and Space Sciences
State University of New York at Stony Brook
New York 11794 USA

ABSTRACT

A decade of intense scientific study of Titan is reviewed. The atmosphere is not well understood at the time of this writing, but it is confidently expected that great progress will be made by the Voyager spacecraft now en route to the Saturn System.

INTRODUCTION

Titan, known historically as the sixth satellite of Saturn, is unique in many respects. In the entire Saturn system, consisting of at least ten satellites which are visible from the Earth, it is the only "large" one, with radius of order 6000 km, comparable to Earth's Moon and Jupiter's Galilean satellites. The other satellites of Saturn are at least a factor of two, and probably ten or more, less in radius [Table V of reference 1]. And in the entire Solar System, it is the only satellite which possesses a thick atmosphere. The main theme of this review will be the uncertainty in just how thick that atmosphere is. However, the most conservative model which is currently viable has a column abundance that is twenty-five times greater than the column abundance in the atmosphere of Mars [2], and some models have column abundances that are two orders of magnitude greater than the minimum model. The column abundance on Titan is six orders of magnitude greater than that on the only other satellite for which a good quantitative abundance is known: Io [3].

Trafton's paper [2] marked the beginning of nearly a decade of intense activity in the study of Titan. This activity, including observations from the satellite ultraviolet through centimeter radio waves, obtained by the most sophisticated ground-based telescopes, by Earth-orbiting vehicles and by a planetary flyby (Pioneer 11), has continuously revealed interesting properties of this mysterious satellite, but there has been little progress in reducing the extreme range between currently viable models.

Titan is therefore also unique in being the object in the Solar System for which the atmosphere is least well understood.

However, this state of ignorance is probably almost over. There is an excellent chance that the imminent encounters of the Saturn system by the two Voyager spacecraft now en route will revolutionize Titan science with their discoveries. Of the two craft, the more important probably will be Voyager 1, which will execute a close encounter of Titan on November 13, 1980, including a variety of important

occultation experiments [4, and following papers]. This prospect is responsible for the title of this paper, which must be considered transient at writing and obsolete after the ides of November.

THE EXTREMES

It is difficult to place bounds on viable models for Titan because the composition as well as the extent of the atmosphere is currently uncertain. At one extreme is the "inversion" model, which was first advocated by Danielson *et al.* [5] and subsequently discussed in more detail by Caldwell [6]. The main features of this model are: a relatively cold surface (80 K), a warmer stratosphere (160 K), a surface pressure of 20 mbar (0.02 atm) and a column abundance of methane (CH_4) of 2 km-atm. An implicit property of this model is that the atmospheric composition is essentially 100% CH_4 , with only traces of minor constituents.

The warm stratosphere, which inspired the name of the model, is inferred from middle infrared spectrophotometry [7] which reveals emission bands of CH_4 and other molecules. Although earlier models did not have a temperature inversion, it is fair to state that all active workers in the field now agree that there is one on Titan. Thus, the name of the model, which distinguished it from contemporary models when it was first proposed, has been retained, although the inversion itself is no longer unique to this one model. The model is extreme however, in its low surface pressure, and high CH_4 mixing ratio.

A very different model has been proposed by Hunten [8]. This model includes an extensive troposphere, a warm surface (at least with respect to the inversion model) and is composed mostly of nitrogen (N_2) of which the source is hypothesized to be photodissociation of primordial ammonia (NH_3). In Hunten's model, CH_4 is a minor and variable constituent, comprising 7% of the troposphere and 0.25% of the stratosphere. The discontinuity results from saturation of CH_4 , which produces a cloud that defines the infrared emitting surface and thereby also fixes the effective temperature (augmented slightly by higher altitude emission from molecular bands in the inversion region).

In its original form, Hunten's model had a surface temperature of 200 K and a pressure of 20 bars, fully three orders of magnitude higher than that of the inversion model! However, these conditions were based mostly on a single millimeter wavelength photometric observation. This measurement has never been independently published by its makers, because it is potentially subject to the contaminating influence of Saturn's flux due to the large effects of diffraction at millimeter wavelengths. In fact, subsequent interferometric measurements at centimeter wavelengths, which should surmount the confusion problem better, strongly suggest that Titan's surface temperature is of order 100 K rather than 200 K [9,10].

If so, much of Hunten's model remains valid. An alternate scenario, in which the surface pressure is ~1-2 bars, with higher altitude thermal structure being unchanged, is also possible.

Speculation concerning the composition of Titan's atmosphere is equally far ranging. Cess and Owen [11] have considered models with neon as a major component. This gas is cosmically abundant, heavy enough to be retained for astronomically significant periods in Titan's weak gravitational field, volatile enough not to freeze on the low temperature surface, and it is completely invisible to previous and current investigations. An even more unusual suggestion came from the late Professor Robert E. Danielson in 1976: primordial carbon monoxide. The presence of large amounts of this gas would impose interesting restrictions on the formation of the satellite. But there is no reason, based on current knowledge, to exclude such a concept. As a last example, Pollack [12] has considered various mixtures of

hydrogen, helium and CH₄, primarily from the point of view of their infrared opacities and their effects on surface temperature.

Although there is not agreement on the molecular composition of the atmosphere, essentially all workers agree that there almost certainly is a high-altitude aerosol constituent present, sometimes called "dust" to distinguish it from possible condensation particles. This aerosol, which may be photochemical in origin, has at least three manifestations on Titan's electromagnetic spectrum. First, its absorption surmounts Rayleigh scattering, making Titan more than an order of magnitude darker in the ultraviolet than would be expected from its molecular atmosphere [6, and references therein]. Second, it thereby heats the upper atmosphere, producing the temperature inversion described above and emits significant radiation in the 10 μm and 20 μm terrestrial windows [5,6]. An third, it scatters red and near infrared light, with extremely complicating effects on any quantitative interpretation of CH₄ bands [13,14].

It is thus impossible to provide in this review an indication of what the best model for Titan's atmosphere is. As indicated above, there is good hope that the next review of Titan will be more definitive.

RECENT OBSERVATIONS

Many of literature references to important observations of Titan have been given in papers already cited, particularly [6] and [8], and are not repeated here. Since those works were completed, a number of additional important contributions have been made, a few of which are summarized below. Unfortunately, these new works have not been sufficient to invalidate any of the classes of models discussed above, although they may ultimately prove to be important in understanding Titan.

Previous satellite observations [6] indicated that Titan's geometric albedo was ~4% at 2600 \AA . Recently, Caldwell *et al.* [15] have presented spectrophotometry from the International Ultraviolet Explorer satellite which show that the darkening persists at least down to 2300 \AA . For the absorber (mentioned above) to suppress Rayleigh scattering so efficiently, it must exist at very high altitudes and cover a very large fraction of the planet's surface, of order $\geq 90\%$.

Two papers have extended previous infrared results. McCarthy *et al.* [16] have presented spectrophotometry from 16 μm to 30 μm at 1 μm resolution. They find that Titan's flux is nearly constant over this region. This may be understood as the sum of two contributions to the net flux. An optically thick, cool layer ($T = 74\text{K}$), which is either the surface or a cloud, from which the flux increases from 16 to 30 μm , and a relatively warm ($T = 160\text{K}$), optically thin layer in which emissivity varies as λ^{-1} , from which the flux decreases from 16 to 30 μm . The substance producing this emission can most plausibly be identified with the ultraviolet absorbing aerosol described above.

Loewenstein *et al.* [17] have pushed farther into the infrared with four broad pass-band measurements between 35 μm and 150 μm . They find a constant brightness temperature (much different from constant flux!) of $76\text{K} \pm 3\text{K}$. A reasonable explanation of [16] and [17] is that longward of 30 μm , the high altitude aerosol is no longer an effective emitter (because the particles are much smaller than such long wavelengths), and Loewenstein *et al.* are therefore observing the optically thick layer in or at the bottom of the atmosphere.

Smith [18] has presented radius measurements for Titan from the Pioneer 11 mission. He finds radii at .64 μm of $2840 \pm 25\text{ km}$ and at .44 μm of $2880 \pm 22\text{ km}$. The difference is real, and may be due to structure in the scattering/absorbing aerosol described above. These results, combined with the surface radius measurement by

the Very Large Array [10] of 2400 + km indicates that the atmosphere of Titan has a significant vertical extent, of order 500 km between the surface and top of the aerosol layer.

Tomasko [19] has summarized the results of polarimetric and limb darkening observations of Titan by Pioneer 11. He finds a particle radius smaller than .09 μm and a 0.64 μm optical depth of ≈ 0.6 above a depolarizing surface, which, unfortunately, is not uniquely identifiable. The data suggest increasing particle size with increasing depth into the atmosphere, suggesting that they grow as they fall to the surface. This is consistent with a high-altitude origin for the particles. The opposite explanation, diffusive separation, would be contrary to the expected general vertical stability of the atmosphere.

Cruikshank and Morgan [20] have discovered near infrared photometric variability in Titan, in strong CH_4 bands. It is very unlikely that this represents a surface phenomenon, as is observed for many other satellites which exhibit orbital phase effects. It may be that they are observing variability in the vertical distribution of the aerosol. Since the CH_4 absorptions are so strong, a minor change in aerosol distribution could produce a relatively large photometric effect in the bands.

This leads to a final speculation about the atmosphere of Titan. Cruikshank and Morgan find their variations don't match the orbital period. They could even be random in orbital phase. Chang *et al.* [21] have suggested that bombardment of Titan's atmosphere by high energy particles might be a means of inducing the chemistry necessary for aerosol production. And Acuna and Ness [22] have pointed out that Titan divides its time approximately 50% each between Saturn's magnetosheath and the interplanetary medium. Perhaps Cruikshank and Morgan are actually monitoring Saturn's magnetic response to variable Solar wind conditions.

ACKNOWLEDGEMENT

This review was performed while the author received support from NASA contracts NSG 7320 and NAS 8-32904.

REFERENCES

1. D. Morrison and D. P. Cruikshank, Space Science Reviews, 15, 641 (1974).
2. L. M. Trafton, Astrophysical Journal 175, 295 (1972)
3. J. Pearl, R. Hanel, V. Kunde, W. Maguire, K. Fox, S. Gupta, C. Ponnampereuma and F. Raulin, Nature 280, 755 (1979).
4. C. E. Kohlhaze and P. A. Penzo, Space Science Reviews 21, 77 (1977).
5. R. E. Danielson, J. J. Caldwell, and D. R. Larch, Icarus 20, 437, 1973.
6. J. Caldwell, in: Planetary Satellites, University of Arizona Press, J. A. Burns editor, 1977, p. 438.
7. F. C. Gillett, Astrophysical Journal 201, L41, 1975.
8. D. M. Hunten, in: The Saturn System, NASA CP 2068, D. M. Hunten and D. Morrison, eds. 1978, p. 127.
9. W. Jaffe, J. Caldwell and T. Owen, Astrophysical Journal 232, L75, 1979.
10. _____, Astrophysical Journal, in press for December 1, 1980.
11. R. Cess and T. Owen, Nature 244, 272 (1973).
12. J. B. Pollack, Icarus 19, 43 (1973).
13. J. Podolak and R. E. Danielson, Icarus 30, 479 (1977).
14. M. Podolak and L. Giver, Icarus 37, 361 (1979).
15. J. Caldwell, T. Owen, V. Moore, R. Rivolo, G. E. Hunt and P. S. Butterworth, Astronomical Journal, submitted June, 1980.
16. J. F. McCarthy, J. B. Pollack, J. R. Houck, and W. J. Forrest, Astrophysical Journal 236, 701 (1980).
17. R. F. Lowenstein, D. A. Harper, R. H. Hildebrand, H. Moseley, E. Shaya and J. Smith, Icarus, in press (1980).

18. P. H. Smith, Journal of Geophysical Research, in press (1980).
19. M. G. Tomasko, Journal of Geophysical Research, in press (1980).
20. D. P. Cruikshank and J. S. Morgan, Astrophysical Journal 235, L53 (1980).
21. S. Chang, T. Scattergood, S. Aronowitz and J. Flores, in The Saturn System, NASA CP2068, D. M. Hunten and D. Morrison, eds., 1978, p. 161.
22. M. H. Acuña and N. F. Ness, Science 207, 444 (1980).

Editor's Note: The Voyager spacecraft observations of Titan's atmosphere occurred in November 1980, 6 months after this paper was given, and have revolutionized our understanding of that important body. Although many of the proposed models and tentative conclusions presented in Caldwell's paper have been radically revised as a result of the flyby, this paper represents a good summary of our knowledge prior to the flyby.

ORGANIC CHEMISTRY IN TITAN'S ATMOSPHERE

Thomas Scattergood (NASA-Ames)

I will talk about laboratory photochemical simulations and other types of chemical simulations that I and other people have done at NASA-Ames. In particular, I will discuss three things:

1. The chemistry of methane, which is the major known constituent of Titan's atmosphere. I will stress what we can learn from photochemistry and particle irradiation (that is, what happens when high energy protons and electrons fall into a methane-dominated atmosphere).
2. The composition of dust that comprises the haze layer, and
3. Isotope fractionation in planetary atmospheres.

The atmosphere of Titan contains a mixture of gases, clouds, and haze about which the details of composition and structure are not yet known. We do know that CH_4 is the major gaseous constituent, that clouds (and haze) are present, and that the temperature of the 'surface', which at present is not well identified, appears to be less than 100°K . Figure 1 is a cartoon of an atmospheric model that Sherwood Chang and I have developed. It is not a precise thermal or pressure model, rather it is a scenario of the chemical structure that we considered in our paper: 'Organic Chemistry on Titan'; Chang, et al. (1979). There are several inaccuracies in the figure - the VLA measurements of Jaffe, Caldwell and Owen (1979) are consistent with an 80°K surface temperature - but the comments that follow are not seriously affected by the change.

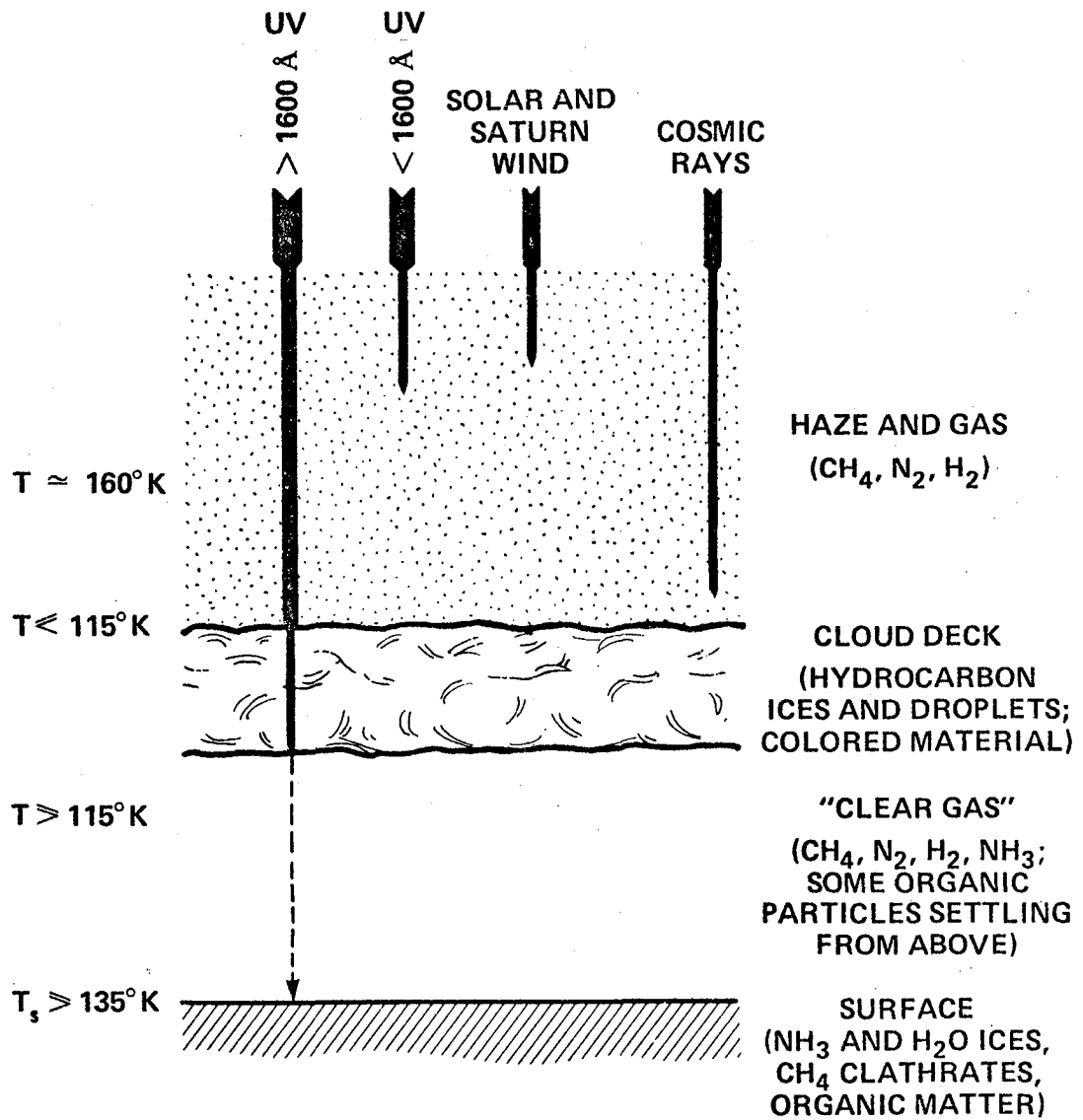

Figure 1. Atmospheric model for Titan.

Figure 1 shows the stratification of Titan's atmosphere, with a haze layer on top, and some kind of cloud layer next, then a "clear" atmospheric layer which may contain some haze, and finally the 'surface'. Included in the figure are various penetrating radiations which arise from radiation belts around Saturn and from the solar wind, protons, cosmic rays, etc. I will discuss mostly the chemistry in the upper atmosphere and a little about the haze.

The known constituents of Titan's atmosphere are methane (CH_4), ethane (C_2H_6), ethylene (C_2H_4), and perhaps acetylene (C_2H_2). These are all photochemical products of methane, and are also products of particle irradiation. Photolysis experiments in our laboratory demonstrate this, as shown by the results given in Figure 2. In the Figure the concentrations of methane and products are plotted versus the photochemical exposure time. The decomposition of CH_4 is shown by the top curve. Only the most abundant product gases are labeled. The abundance of ethane increases quite rapidly at first, while those of the other products increase more slowly.

One thing that needs to be emphasized is the production of propane (C_3H_8) in all our experiments. The figure shows that initially, there is only CH_4 (mixed with H_2 in some cases) at about 2mm pressure. In all cases propane is approximately an order of magnitude more abundant, in any given time interval, than either ethylene or acetylene, implying that its production rate

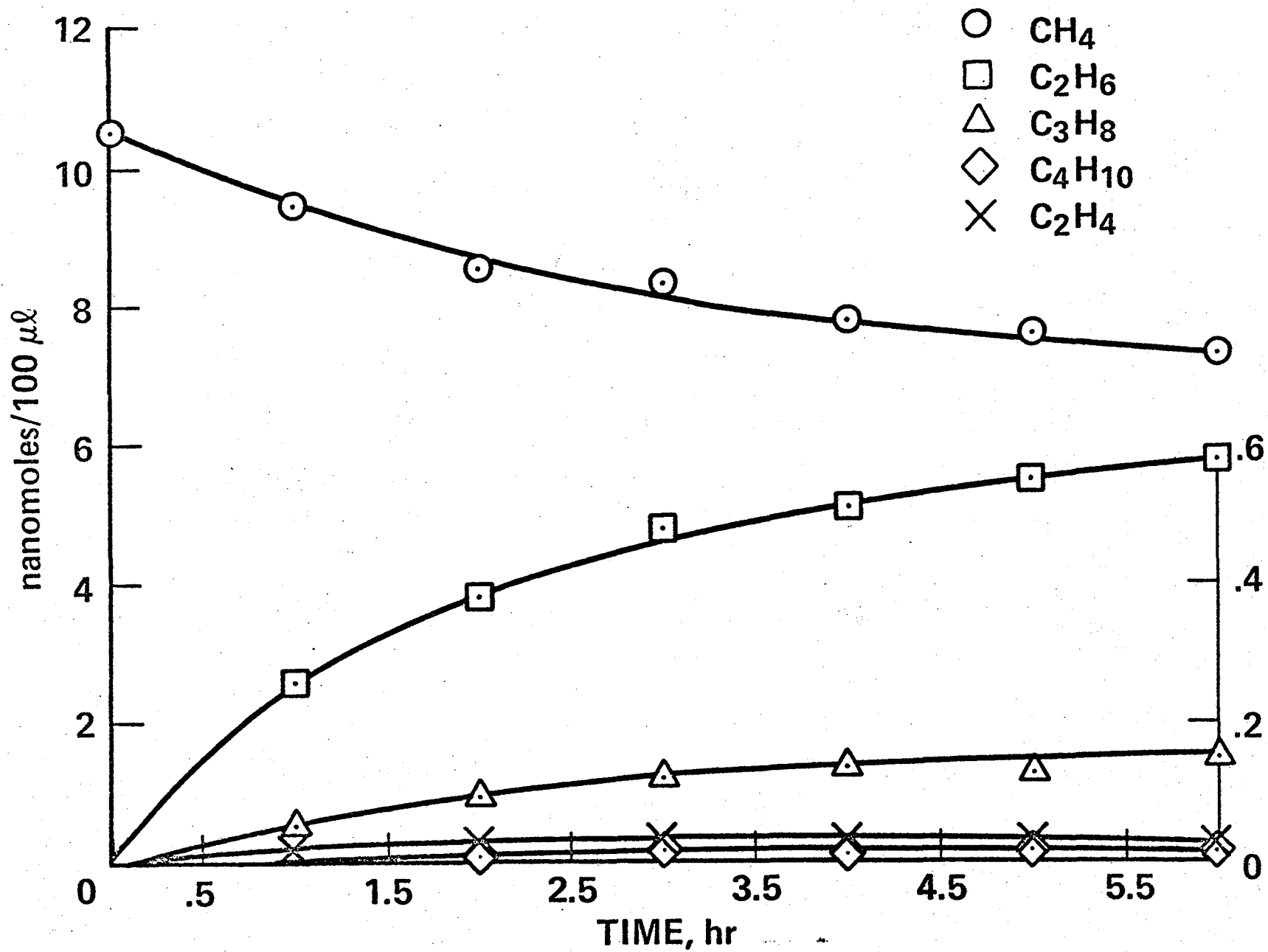

Figure 2. Concentrations of methane and products vs. photochemical exposure time.

is greater than theirs. This is also true for those experiments that included hydrogen (Figure 3), although these may not be particularly relevant for the case of Titan. In Figure 3 the acetylene abundance was multiplied by a factor of 300, to allow everything to be plotted on the same scale. Propane must be multiplied by about 30 to put it on the same scale as acetylene. So propane is a very abundant species, though not as abundant as ethane, by a factor of ten.

What may compensate for the concentration of propane in Titan's atmosphere (or in any other planetary atmosphere) is its much lower vapor pressure at any given temperature. It therefore may not stay very long in the gas phase, instead forming aerosol particles that eventually settle out.

It may be appropriate at this point to raise the question of the presence of a second gas, such as nitrogen for example. One of the most obvious features of Titan is its red color, and none of the products of methane photochemistry are colored, either by themselves or in mixtures, at room temperature. Also, calculations by Kathy Rages and Brian Toon at Ames suggest that 20 millibars of methane cannot support a haze layer in the upper atmosphere, thus suggesting that a thicker atmosphere must be present in order to keep the haze suspended. Calculations by Morris Podolak at Tel Aviv are also consistent with that conclusion. If nitrogen is indeed a major constituent, as abundant or more abundant than methane, then simple photochemistry of methane together with nitrogen will not produce materials other than the hydrocarbons. In fact, there exists only one report in the literature that claimed that photochemistry of

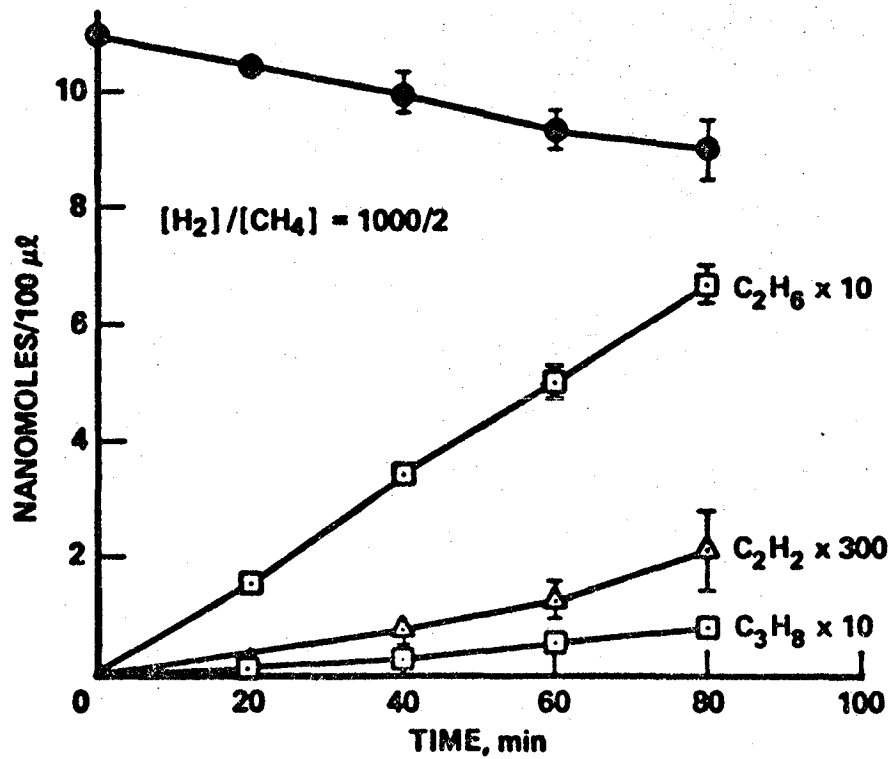

Figure 3. Variation of product concentrations with photolysis time.

methane and nitrogen can produce HCN, (Dodonova, 1966) but those results have not been confirmed. So to produce interesting compounds from methane and nitrogen another energy source is needed. One such source might be trapped protons and electrons in a radiation belt around Saturn - such is not really known yet - or cosmic rays. Decomposition of $\text{CH}_4 + \text{N}_2$ can indeed produce hydrogen cyanide (HCN), acetonitrile (CH_3CN) and also the famous red-brown polymer.

Other possible gases, such as helium or neon, might provide a broadening gas, but would not be interesting to the chemistry since they do not participate. If they were present, the relevant chemistry would still be that of methane and hydrocarbons, and perhaps nitrogen.

Some comments on dust composition, particularly the question of the formation process, are now appropriate. Figure 4 lists three processes under consideration for Titan as well as for Jupiter and Saturn. Photochemistry produces, as was described above, primarily saturated hydrocarbons, but also ethylene, acetylene and probably higher molecular weight unsaturated hydrocarbons. Particle radiation produces quite a bit of both saturated and unsaturated hydrocarbons, in the case of methane alone. But if you have nitrogen or ammonia present you can also make amines and nitriles. Polymerized nitriles are highly colored: reddish brown. Lightning and thunder, which may not be relevant to Titan but certainly are for Jupiter, produce mainly acetylene from methane. This result is from the work of Akiva Bar-Nun at Tel Aviv (Bar-Nun, 1979). So the question to ask about Titan's

RANGE OF COMPOSITIONS POSSIBLE:

DEPENDENT ON FORMATION PROCESSES.

<u>PROCESS</u>	<u>PRODUCTS</u>
PHOTOCHEMISTRY	Saturated Hydrocarbons, C_2H_4 , C_2H_2 , ...
PARTICLE IRRADIATION	Saturated & Unsaturated Hydrocarbons Amines and Nitriles (w/ N_2 or NH_3)
LIGHTNING & THUNDER	Mainly Acetylene (C_2H_2), Hydrocarbons

* * * * *

<u>MATERIAL</u>	<u>COLOR</u>
$(C_2H_2)_n$ & $(C_2H_4)_n$	Pale Yellow
HYDROCARBONS	Colorless
POLYNITRILES	Colorless to Red

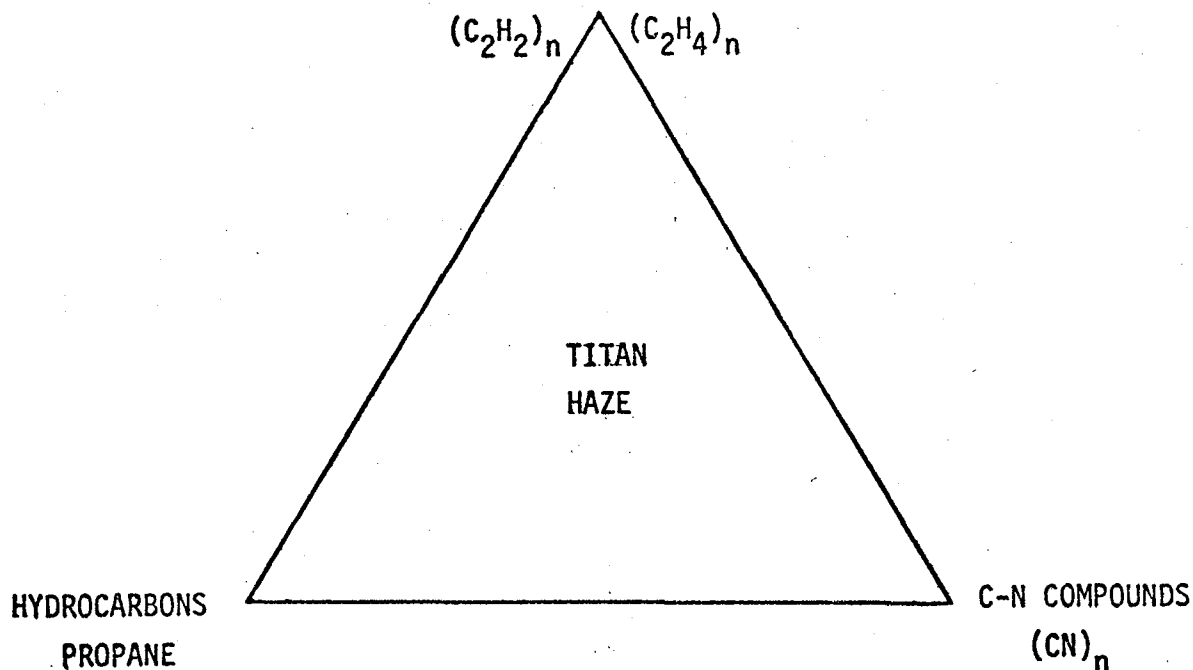
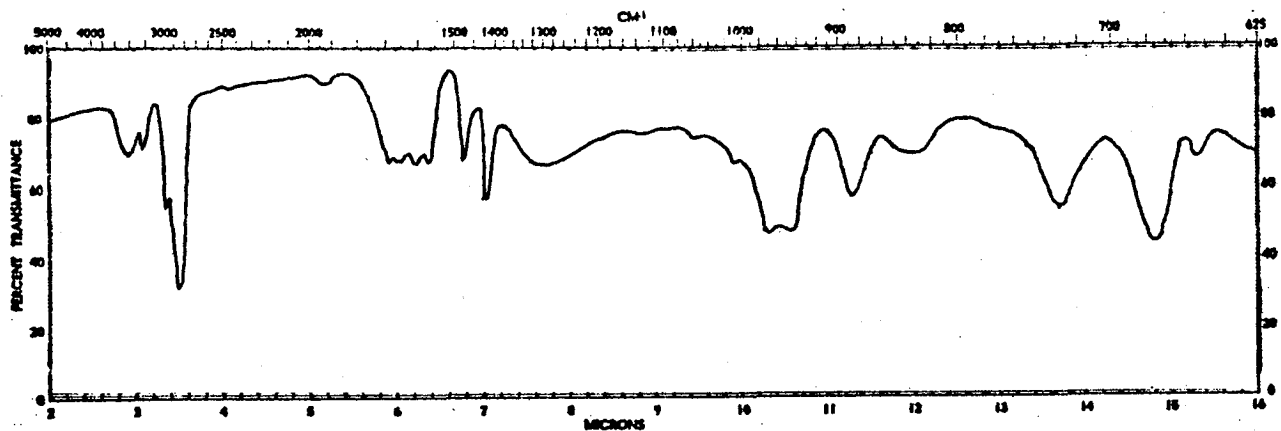

Figure 4. Composition of the dust.

haze becomes: what sources can one envision? The bottom of Figure 4 is a simple ternary diagram for the composition of the dust. Polyacetylenes and polyethylene are one possibility; these may arise from simple polymerization of acetylene and ethylene. Hydrocarbons, such as propane, which may be trapped out or condense together with other materials such as these polymerized hydrocarbons, are another. Also if nitrogen or ammonia is present, then the polynitriles constitute a third possibility. The surface temperature is important for this case: if the temperatures are really as low as the VLA results indicate, gaseous ammonia becomes very unlikely even in the lower atmosphere. However, if the temperature rises to 110 to 115°K, enough ammonia may be present in the vapor phase to allow photochemistry near the surface, and produce some colored compounds, together with the products of particle irradiation.

If any of the complex materials mentioned above are indeed present in Titan's atmosphere, then their detection may be possible by infrared spectroscopy. Figures 5 and 6 show some low resolution IR spectra of various compounds. The first shows polyacetylene made by low energy electron irradiation of acetylene, and there is an absorption feature in the 13μ region. A prominent absorption feature appears in the spectrum of polyethylene, just past 13.7μ . Unlike these, polypropylene, another unsaturated hydrocarbon, doesn't show much at 13μ . However, they do show many bands in other parts of the spectrum;



$(C_2H_2)_n$ POLYACETYLENE (e^-)

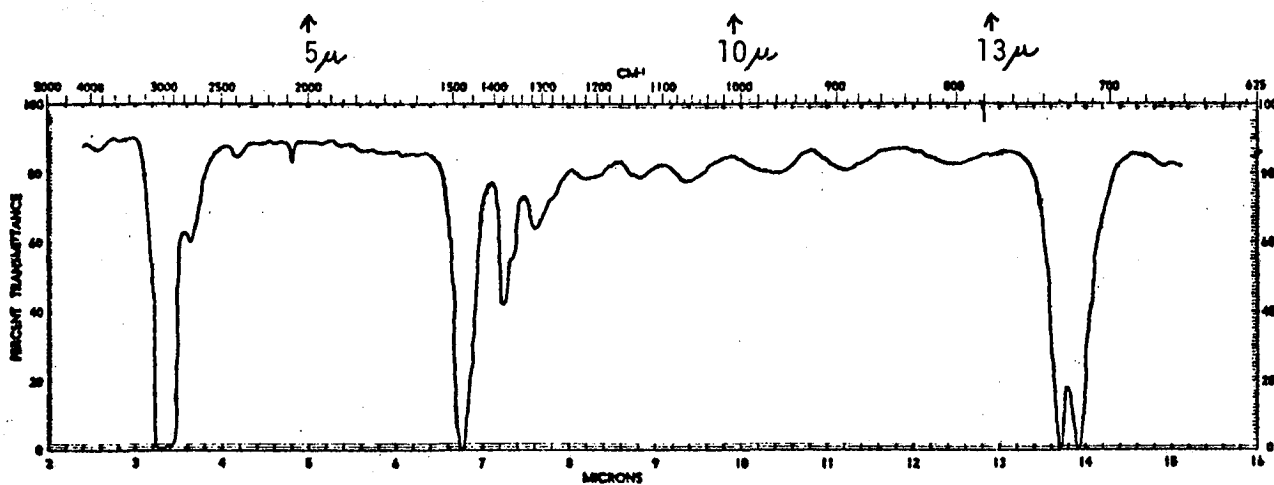

$(C_2H_4)_n$ POLYETHYLENE (ind)

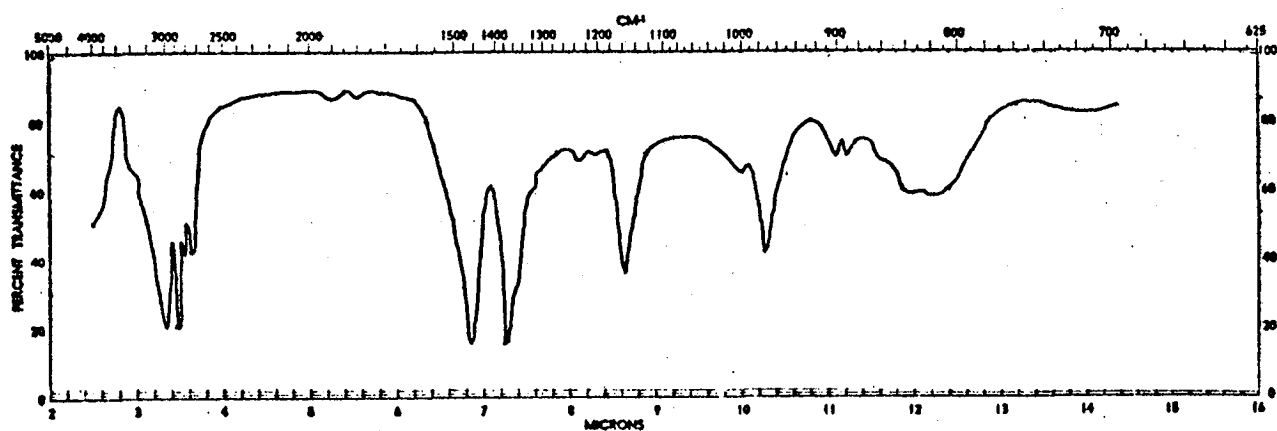

$(\begin{matrix} CH_2CH \\ | \\ CH_3 \end{matrix})_n$ POLYPROPYLENE (heat)

Figure 5. Infrared spectra of condensed phase materials of planetary interest.

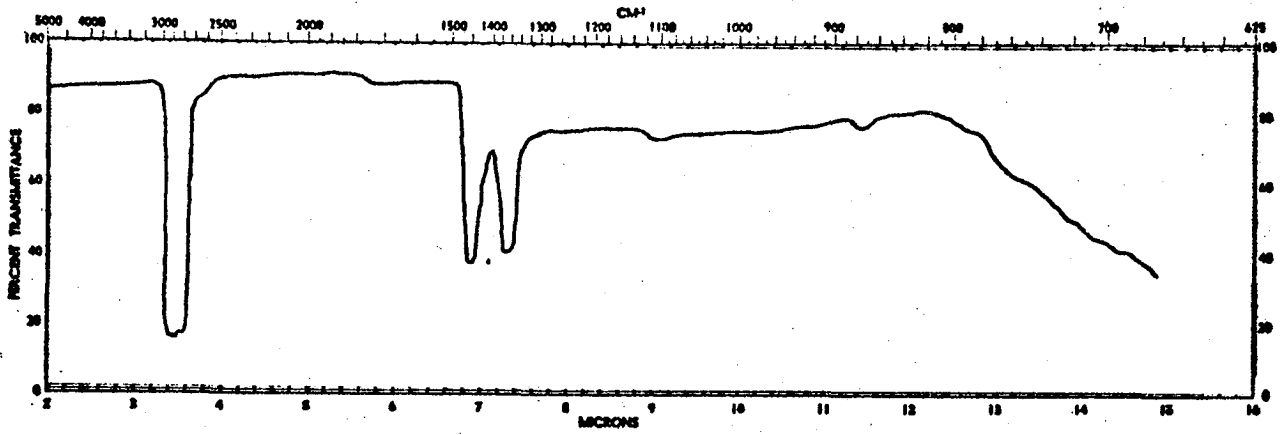

CH₄ + H₂ MIXTURE (p⁺)

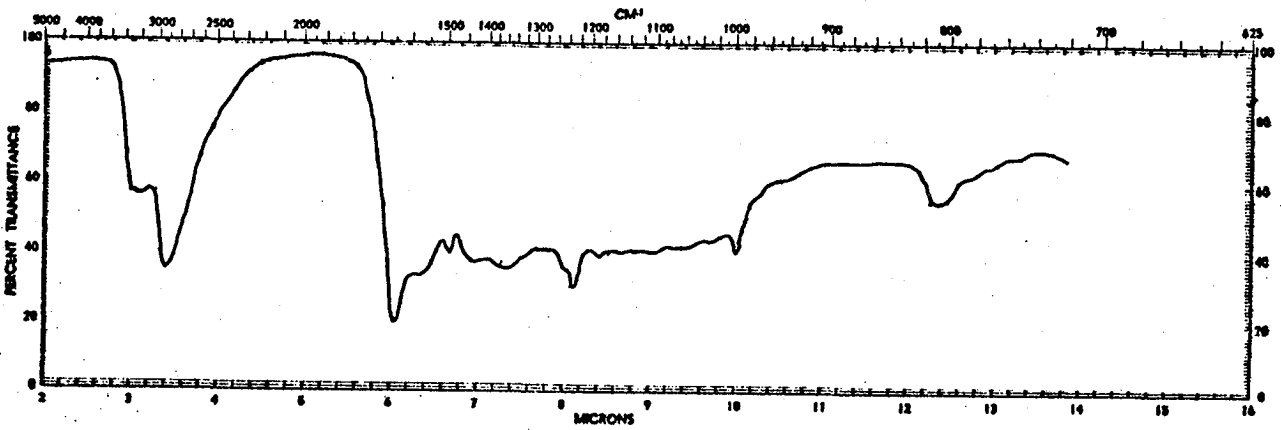

CH₄ + NH₃ MIXTURE (p⁺)

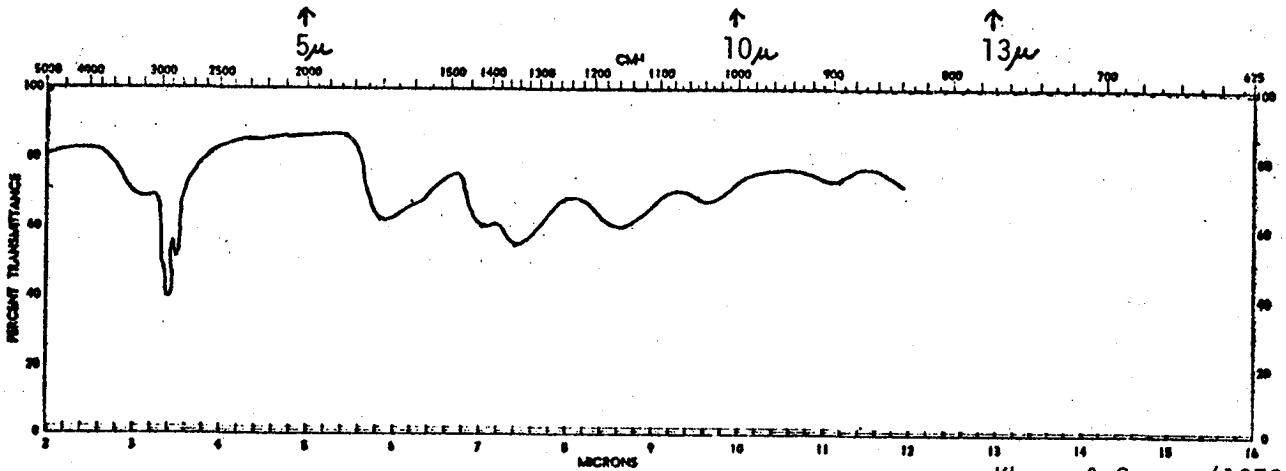

CH₄ + C₂H₆ + NH₃ + H₂S (UV)

Khare & Sagan (1973)

Figure 6. Infrared spectra of condensed phase materials of planetary interest.

if these regions are free of methane and ethane bands, then aerosol features may not be obscured.

To complete the picture for Titan's aerosol, Figure 6 shows spectra for materials made by Bishun Khare of Cornell and myself. The top spectrum is for material formed by proton irradiation of hydrogen and methane. Just the hydrocarbon bands are seen - the CH stretch and the CH bend - with little of a definitive nature in the 13 micron region. The second spectrum is for material formed from a mixture of methane and ammonia; and substitution of N_2 for NH_3 in the mixture has little effect on the IR spectrum. Again there are hydrocarbon features, with some additional features at 6 microns, that may be observable. There is little at 13μ , although there is a weak band at 12.5μ for the $CH_4 + NH_3$ case. For sake of completeness, the bottom spectrum is from a mixture that included hydrogen sulfide and UV irradiation by Bishun Khare at Cornell (Khare and Sagan, 1973).

The final subject to be addressed in this discussion is the question of isotope fractionation in planetary atmospheres. Studies of the organic phases in carbonaceous chondrites, believed to be representative of the least altered material from the solar nebula, show that deuterium, carbon 13 and nitrogen 15 isotopes are enriched by factors of up to two, over their concentrations in terrestrial standards. A discussion with Reinhard Beer suggests that the deuterium in Jupiter's atmosphere may be enriched by as much as a factor of two over the solar ratio. Similar enrichments may

also exist for carbon 13 and nitrogen 15. However, regardless of the actual numbers used, the isotope ratios (D/H , C^{13}/C^{12} , N^{15}/N^{14}) found in the outer solar system are different from those found in the inner solar system. These differences may be due to chemical processes that occurred during the formation of the various bodies, or to isotope differences in the initial volatile reservoirs.

The study of isotopes in planetary atmospheres may establish a correlation between the atmospheres of the outer planets and those of meteorites. For example, as mentioned above both the atmosphere of Jupiter and carbonaceous meteorites appear to be enriched in D. Such a study, along with laboratory studies of how isotopes fractionate under various chemical conditions, such as ultraviolet photolysis, particle irradiation and polymerization, may shed some light on the nature of the volatile reservoir at the time of planetary formation. From that one should be able to place some constraints on the primitive solar nebula, such as whether the nebula was homogeneous or highly fractionated, by comparing the region around the terrestrial planets to the region around the outer planets.

REFERENCES

1. Bar-Nun, A. (1979) "Acetylene Formation on Jupiter: Photolysis or Thunderstorms", *Icarus*, 38, 180-191.
2. Chang, S., Scattergood, T.W., Aronowitz, S. and Flores, J. (1979), "Organic Chemistry on Titan", *Rev. Geophys & Spa. Phys.* 17, 1923-1933.
3. Dodonova, N.Ya., (1966) "Activation of Nitrogen by Vacuum Ultraviolet Radiation", *Russ. J. Phys. Chem.*, 40, 969-970.
4. Jaffe, W., Caldwell, J., and Owen, T., (1979) "The Brightness Temperature of Titan at 6 Centimeters From the Very Large Array", *Astrophys. J.*, 232, L75-L76.
5. Khare, B.N., and Sagan, C. (1973) "Red Clouds in Reducing Atmospheres", *Icarus*, 20, 311-321.

DISCUSSION

Comment (L. Trafton): It seems that Titan may be unique in the solar system in having a dense methane atmosphere, so the opportunities for organic reactions are plentiful.

Question (Y. Yung): In your experiments, where in the reaction volume are the product compounds produced? Are they produced mainly on the walls, or homogeneously throughout the volume? Only the latter case would be relevant for a planetary atmosphere.

Response: This sort of question is always raised in experiments of this kind. It has to be answered empirically. Of course it is difficult, if not impossible, to carry out these (photochemical, etc.) experiments without some type of container, except perhaps by working in the planetary atmospheres themselves. Efforts were made to check that the results are not sensitive to the presence of walls, by changing the volume-to-surface ratio in the reaction vessel. This was done by adding clean quartz wool to the vessel. In my experiment, changing the surface area in the reaction vessel by a factor of 10 changed the results by less than 10 percent. Thus my feeling is that the walls play only a minor role, if none at all. This has been confirmed, at least verbally, by Akiva Bar-Nun, who has done similar types of experiments with ultra-violet radiation.

Question (Y. Yung): Some of the reactions have very high activation energies. Do you do your experiments at the temperature of Titan's atmosphere?

Response: No, unfortunately. My experiments were all done at room temperature. However, Akiva has done some experiments at 200⁰K, and although the quantitative results change somewhat, the qualitative conclusions are the same as those I presented. In particular, he still gets propane produced at a faster rate than acetylene or ethylene, but at a slower rate than for ethane.

Question (J. Caldwell): I wanted to ask a couple things. To get the nitrogen coloration effect, do you have to have essentially equal parts of nitrogen and methane or can you get away with a small fraction of nitrogen? Also, can other constituents accomplish the same thing? As far as I know, there are other reduced species like phosphine (PH₃) and hydrogen sulfide (H₂S), which spectroscopic evidence has not eliminated from Titan. They produce similar effects.

Response: The answer to the first part of the question is yes, you don't need equal (or greater) amounts of nitrogen to produce the colored material. I suspect that at some ratio the efficiency of the process may diminish significantly. Perhaps over geological time the accumulation of product would be

sufficient to be observable. I, myself, have not investigated the variety of mixtures necessary to check this; but based on the experiments that I did do, it appears that the presence of nitrogen is sufficient, even if the nitrogen is not as abundant as the methane. The answer to the second question is that you can get complex chemistry with phosphine and H_2S as well. In the case of the H_2S mixture, I found the material to be yellow in nature, and more of a powdery character, which is indicative of the presence of sulphur (zero-valent sulphur) material. In fact, mass spectrometric analysis of the product showed sulphur to be the dominant constituent. In the case of phosphine, the material that I obtained was also yellow in color, but there was no presence of red phosphorus - no elemental phosphorus in the product. The phosphorus was all tied up in organics of a non-determinable nature, but not elemental red phosphorus.

Comment (M. Mumma): Both your talk and John Caldwell's suggest that propane is one compound whose spectroscopy should be looked into further. I also want to say that I don't understand why you don't find any ammonia on Titan. To say that it is photo-dissociated doesn't seem very satisfactory, because the scale height for ammonia ought to be smaller than that for methane, certainly above the turbopause on Titan, and both molecules are readily photodissociated in the solar radiation field.

Response: The vapor pressure at 80°K

Comment (M. Mumma): No, my comment really is related to the supposed large abundance of H_2 , which is claimed to be produced by photodissociation of ammonia, with the hydrogen escaping. In order to have that mechanism you have to ask what happened to all the methane that was photodissociated at the same time. If it's hydrogen escaped, why isn't there a lot more carbon in the atmosphere in some other form?

Response (J. Caldwell): Well, ammonia is photodissociated by UV wavelengths up to 2,300 Angstroms, and methane is photodissociated only by photons below $1,600\text{\AA}$, or maybe even less than that. The solar flux falls off so rapidly that ammonia's photodissociation cross-section integrated over the solar spectrum is a couple of magnitudes larger than that for CH_4 . Don Hunten nevertheless, claims that the surface of Titan is asphalt.

Comment (Y. Yung): I have a question about the ammonia. If the surface temperature is 80°K , the total ammonia you can get is only 6 centimeter-amagats, for solid ammonia in equilibrium with the vapor. So how does it get into the atmosphere? Also, on the question of what happens to the hydrogen from the photodissociation of methane, we really

got very exciting results. We saw the hydrogen escaping by its emission in Lyman-alpha. So we know that methane is being decomposed and the hydrogen is escaping. As for what happens to the carbon, we think it forms heavy hydrocarbons and falls to the surface. The surface is pitch and tar.

Comment (J. Caldwell): Do you want to speculate about the surface of Titan? In the "thin" model, which has a column abundance of methane of 2 kilometer-atmospheres, there can be vapor pressure equilibrium over the solid at 80°K. This is one argument that makes the "thin" model attractive. But if that is true, then since the annual flux (the solar insolation) at the poles is less than that at the equator, there will be a net migration of gas and methane towards the poles, and over geologic time this will make Titan tend to look like a banana. Obviously that won't happen; instead you will get a return flow somehow. The return flow might take the form of methane glaciers or something like that, which could churn up the surface. So the asphalt might be buried. All kinds of intriguing possibilities exist.

Question (G. Orton): In relation to propane, what spectroscopic data are already available?

Response (J. Caldwell): The lines are listed in Herzberg, but as for the strengths, I don't know.

Response (T. Scattergood): I have a picture of a propane spectrum, showing the 13-micron band.

Question: Is that spectral feature real?

Response: I believe it is. I haven't taken a spectrum of propane myself, to confirm it, but a variety of people have mentioned this feature. However, I cannot comment on whether it actually has the shape shown.

Spectroscopy of Triton and Pluto: Current Status and Prospects*

by

Dale P. Cruikshank (University of Hawaii)

ABSTRACT

Near-infrared spectrophotometry of Triton and Pluto at low spectral resolution and signal precision reveals methane absorption on both bodies. The absorption on Triton is probably gaseous CH_4 , while that on Pluto is a combination of gas and ice of CH_4 .

Using present detectors and telescopes, spectra of Triton and Pluto can be obtained which are 5-10 times better than those published, but such data will not be sufficient to distinguish between gaseous and solid methane on these bodies.

CURRENT STATUS

Spectroscopy of Triton and Pluto in the photo-visual spectral region (0.3 to 1.1 μm) has revealed only hints of absorptions attributable to atmospheres of methane evidenced by a suggestion of an absorption at the position of the 8900- \AA band (1). Until 1976, the infrared region, where most molecular absorptions are stronger than in the photo-visual, had been neglected because of the faintness of the two bodies and the insensitivity of infrared detectors. Two-color photometric observations of Pluto in 1976 (2) suggested the presence of frozen methane through the strong absorption of sunlight at 1.7 μm compared to 1.5 μm . Spectrophotometry at 12 wavelengths between 1.44 and 1.84 μm by Cruikshank and Silvaggio (3) confirmed the presence of an absorption in the region of the strong band of methane near 1.7 μm , both gaseous and solid, while similar data for Triton in the region between 1.44 and 2.52 μm (19 points) showed a moderate absorption at 2.3 μm and very little at 1.7 μm (4).

In the case of Pluto, the 2 μm region has not yet been explored spectroscopically, and the evidence for methane rests largely on the rather crude data in the 1.7 μm region (Figure 1), plus the photometry by Lebofsky et al. (5). Cruikshank and Silvaggio reasoned that gaseous and solid methane cannot be distinguished from one another on Pluto with the existing data because their absorptions in the 1.7 μm region overlap. This situation will not be significantly improved even with broader wavelength coverage in the near infrared because of the overlap problem. Because the absorption at 1.7 μm is strong on Pluto, the presence of the solid material is assumed, and the presence of gaseous methane is inferred from vapor pressure considerations. It is expected that data in the 2 μm region will show a strong absorption at 2.3 μm , an assertion supported by the photometry of Lebofsky et al. (5). Pluto cannot be completely covered by solid methane, because the reflectance of the planet in the photo-visual region (6) is not white, but decreases toward the violet. This behavior is suggestive of exposures or admixtures of silicate material with the ice or frost, as is the case with Europa and Ganymede.

The infrared data for Triton are quite crude, especially in the 1.7 μm region, but they do show a distinct absorption centered at 2.3 μm (Figure 2) attributed to gaseous methane. Cruikshank and Silvaggio (4) consider this to be gaseous methane because of the apparent absence of the strong 1.7 μm absorption that would be expected for the solid form. As with Pluto, the photo-visual reflectance of Triton decreases toward the violet, but it may be variable (6,7). The decrease implies the presence of silicate materials (8) with no evidence for Rayleigh scattering at the shortest wavelengths.

The 2.3 μm absorption of methane on Triton was synthesized from laboratory data and a random absorption band model developed by Silvaggio (8a), with the result that for pure methane the surface column abundance is $(7 \pm 3) \times 10^2$ cm-agt, corresponding to a surface pressure of about $(1 \pm 0.5) \times 10^{-4}$ bars, a value consistent with the calculated vapor pressure of methane gas above methane ice at a temperature of 57-60 K. Thus, the vapor pressure considerations suggest that some frost is present on Triton, and Golitsyn (9) has argued that most of the gas should be cold-trapped on the dark part of the satellite or toward the poles.

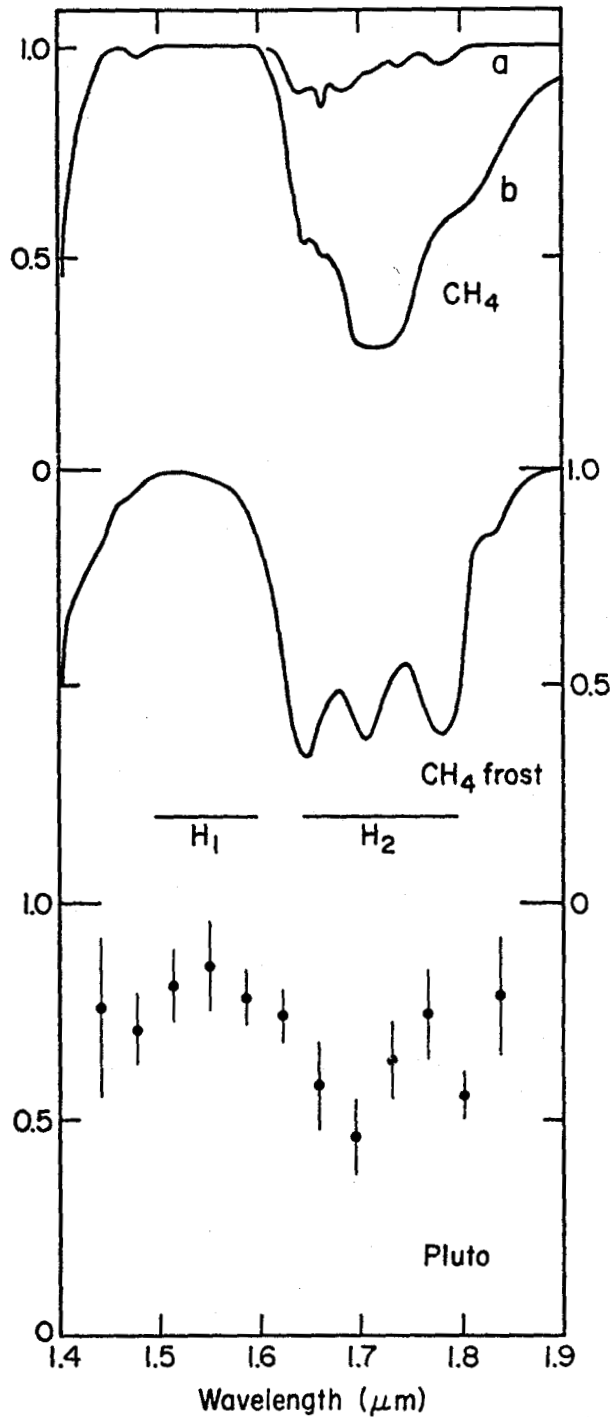

Figure 1. Infrared spectrophotometry of Pluto (data points at bottom). In the schematic CH₄ gas spectra shown at the top, a represents a few cm-atm of CH₄ observed in the laboratory and b represents several m-atm. The frost spectrum is after Kieffer (private communication). H₁ and H₂ show the wavelengths of the two filters used in Ref. 2.

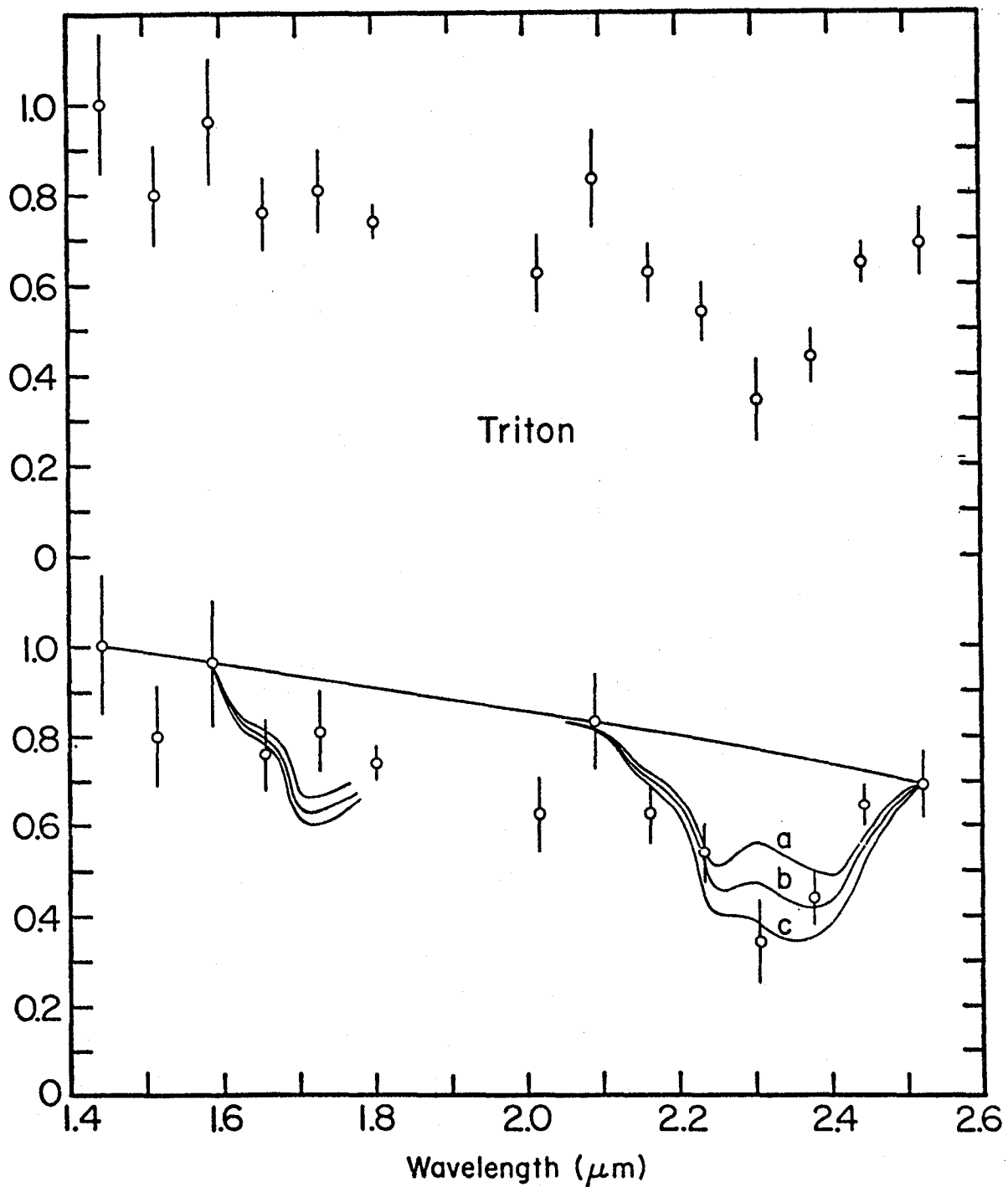

Figure 2. Infrared spectrophotometry of Triton (4). The data are shown twice. At the bottom, synthetic methane gas spectra are superimposed to show the quality of the fit in the 2.3 μm absorption band. Spectrum b represents the best fit to the measured width (EW) of the band in the spectrum of Triton, and spectra a and c have EW corresponding to the error bars on the EW of the Triton spectrum.

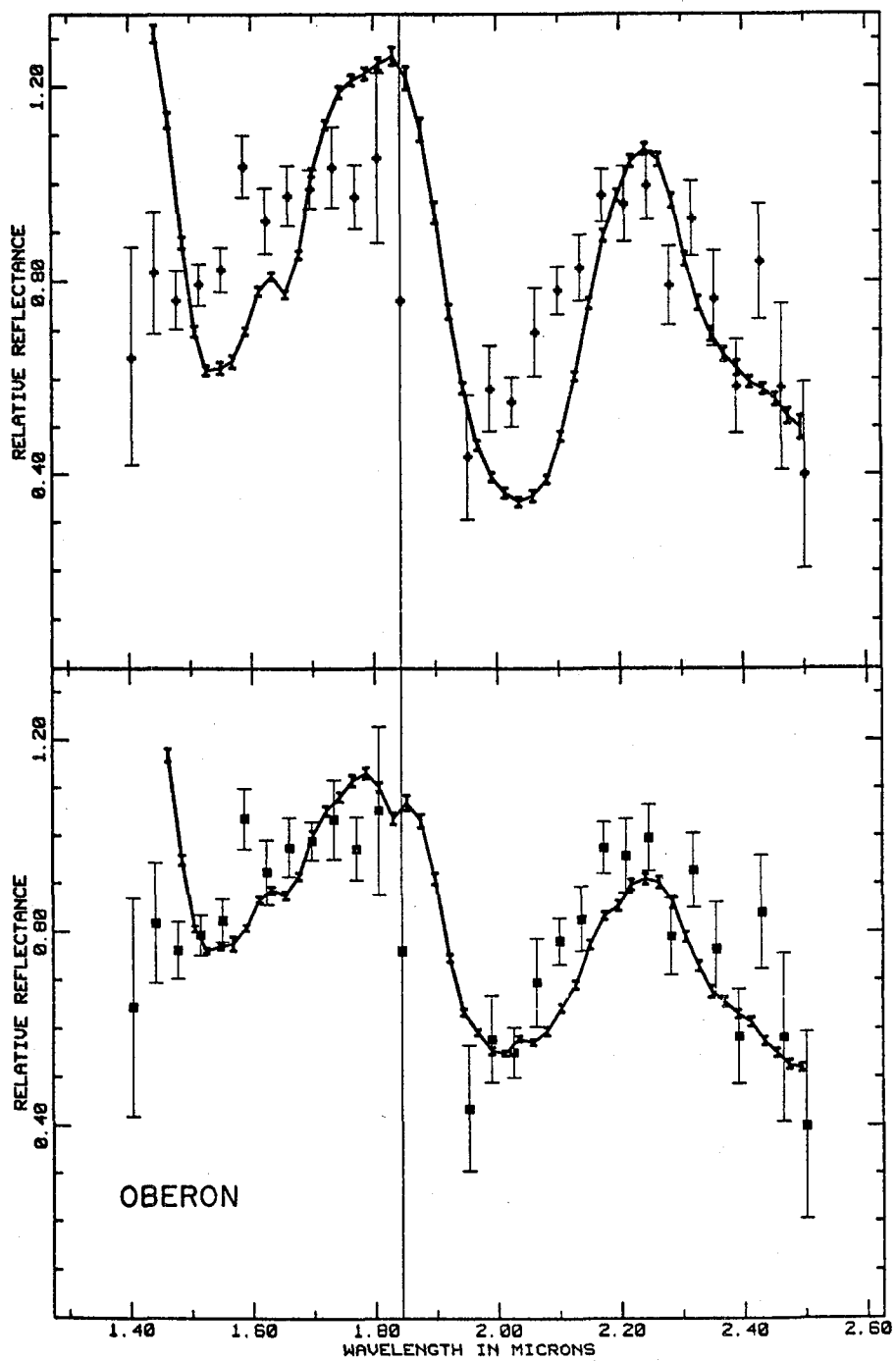

Figure 3. Infrared spectrophotometry of Oberon, showing the quality of data that can now be obtained for Triton and Pluto as well. The solid line in the top of the figure is the spectrum of Saturn's rings (known to consist of H_2O frost), and the solid line in the lower part is the spectrum of Ganymede (also known to contain H_2O frost). The Oberon data are normalized to each of the two comparison objects. The fit is best for the spectrum of Ganymede.

PROSPECTS FOR THE FUTURE

The data thus far described were obtained with the Kitt Peak 4-meter telescope in 1978, with an indium antimonide detector and a circular variable-interference filter. The visual magnitudes of Pluto and Triton were about the same, 13.6. In 1979, I used the same telescope and an improved spectrometer on the Uranian satellites, and obtained a spectrum of Oberon ($m_V = 14.3$) of much higher quality in less observing time. This is shown in Figure 3, where the individual points are for Oberon and the solid lines are spectra of Saturn's rings (on the top) and Ganymede (on the bottom). The same data for Oberon are shown twice, once normalized to Saturn's rings, and once normalized to Ganymede. Clearly, the fit is better for Ganymede, from which it is concluded that Oberon is covered with water ice (10).

It is therefore clear that even with the present spectrometer on the Kitt Peak 4-m telescope, it is possible to improve the Pluto and Triton spectra by at least a factor of 5, and perhaps 10, in signal precision, and about a factor of 3 in spectral resolution. This improvement will not be sufficient to distinguish between gaseous and solid methane because the rotational structure in the bands is still somewhat below the resolution limit that can be presently achieved. The resolution limit of the circular variable-filter (CVF) technique is about 1 percent ($\lambda/\Delta\lambda = 100$), while multiplexing techniques such as the Fourier Transform Spectrometer can yield much higher resolution if the signal can be detected. Continued improvement in detectors and in the spectrometers should make it possible to observe Triton and Pluto with spectral resolution 10 times that of the CVF in the near future.

NOTE ADDED IN PROOF:

Since this report was prepared, a new spectrum of Pluto has been published by Soifer, Neugebauer, and Matthews (11). This is reproduced in Figure 4 together with the Cruikshank and Silvaggio spectrum of Triton (showing additional points omitted in their paper (4) and in Figure 2). The new Pluto spectrum matches very well the reflectance of methane frost plus a neutral additive, as described by Soifer et al. As predicted, there is no evidence for CH₄ gas absorption even in their greatly improved spectrum.

In addition, Cruikshank (in preparation) has obtained a new spectrum of Triton with the Kitt Peak 4-m telescope (2 June 1980) in which the resolution and signal precision are substantially improved over that in Figures 2 and 4. A preliminary analysis of the data shows that the fit of the model CH₄ spectra given in Figure 2 is not significantly different, and the conclusions of Cruikshank and Silvaggio (4) about the Triton atmosphere are not expected to change.

REFERENCES

1. Benner, D. C., Fink, U., and Cromwell, R. H. 1978. Icarus, 36, 82.
2. Cruikshank, D. P., Pilcher, C. B., and Morrison, D. 1976, Science, 194, 835.
3. Cruikshank, D. P., and Silvaggio, P. M. 1980. Icarus, 41, 96.
4. Cruikshank, D. P., and Silvaggio, P. M. 1979. Astrophys. J., 233, 1016.
5. Lebofsky, L. A., Rieke, G. H., and Lebofsky, M. J. 1979. Icarus, 37, 554.
6. Bell, J. F., Clark, R. N., McCord, T. B., and Cruikshank, D. P. 1979. Bull. Amer. Astron. Soc., 11, 570.
7. Otto Franz, private communication, 1979.
8. Cruikshank, D. P., Stockton, A., Dyck, H. M., Becklin, E. E., and Macy, W. Jr. 1979. Icarus, 40, 104.
- 8a. Silvaggio, P. M. 1977. Cornell University, Ph.D. Thesis: Experimental Determination of Molecular Absorption Coefficients for Methane and Ammonia at Low Temperatures and Model Atmospheres for the Major Planets.
9. G. S. Golitsyn, private communication, 1979.
10. Cruikshank, D. P. 1980. Icarus, 41, (in press).
11. Soifer, B. T., Neugebauer, G., and Matthews, K. 1980. Astron. J., 85, 166.

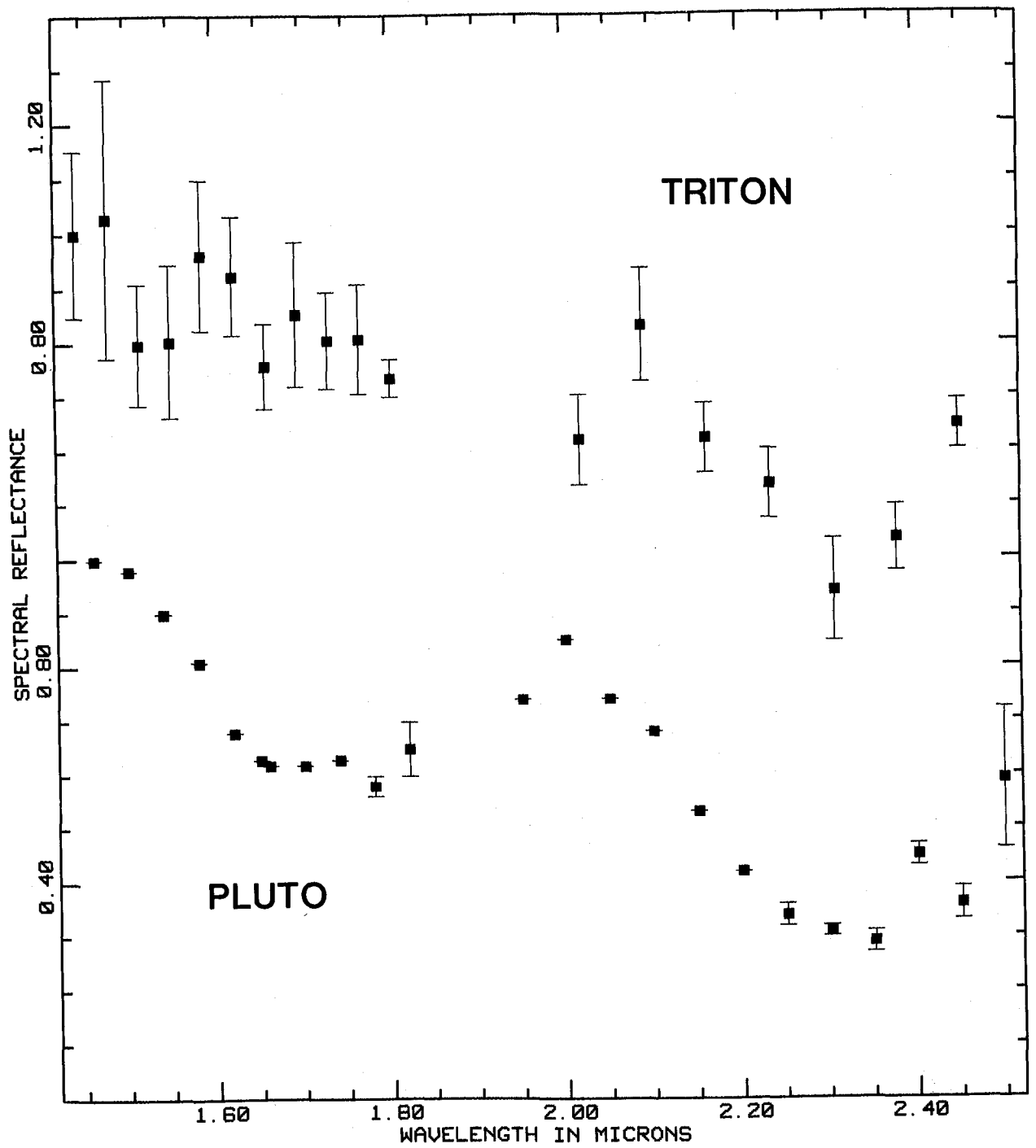

Figure 4. (Upper) Spectrum of Triton (4) with additional points omitted from Fig. 2, and (lower) the spectrum of Pluto (11) showing strong absorption of CH₄ frost.

Discussion

Question (K. Fox): You showed a spectrum of Triton (Fig. 2) in which there was a random band model fit to the 2.3 micron band of methane. I wondered if the same model is consistent with the apparent absence of the band at 1.7 micron.

Response (P. Silvaggio): The uncertainties in the fits are large. Only three points define the 2.3 micron absorption. The resolution used in these observations is about 100 wave-numbers. Furthermore, the shapes of these bands change when you change temperature; the spectra in Cruikshank's Figure 2 were taken at 0. Also, this may not really be a methane feature; these observations do not conclusively identify it as a methane feature.

Question (K. Fox): Let me rephrase the question. Do you interpret the data at 1.7 microns as saying there is methane present?

Response (P. Silvaggio): Yes. If you assume the continuum to be as shown (Fig. 2) and calculate the equivalent width, the result is consistent with that expected for the 1.7 micron band. However, the uncertainty in the profile is large.

Comment (M. Mumma): If I were to draw a continuum in Cruikshank's Figure 2 without any preconceptions, it would be significantly lower than the one shown. I would draw about the same slope, but with an intercept at 0.9 or 0.85. Then no feature would be apparent at 1.7 microns and maybe there would not be one at 2.3 microns either.

Response (P. Silvaggio): We all know that the drawing of a continuum is more of an art than a science.

Comment (L. Wallace): Mike Mumma still has a good point. The way the line is drawn now, it looks like a strong absorption is present, but one could draw the line such that there aren't any absorptions at all.

Question (L. Trafton): You don't really claim there is any strong absorption at 1.7 microns, do you?

Response (P. Silvaggio): No. The absorption at 2.3 microns is the prominent one.

Comment (L. Trafton): This is just the opposite situation from Pluto: while Pluto and Triton both have strong absorptions at 2.3 microns, only Pluto has a pronounced absorption at 1.7 microns.

Comment (M. Mumma): However, the reality of Triton's 2.3 micron absorption suffers from the same continuum ambiguity. One might say that the profile is really defined by only one point. If that point is 3 or 4 standard deviations off, the profile disappears. The profile looks pretty suggestive, but it is certainly not firm, considering the statistical error.

Comment (P. Silvaggio): The error bars are shown on the figure. Cruickshank squeezed as hard as he could with his observations. There are four or five observations at each wavelength, over a series of nights. I don't want to get into the discussion of the spectrum - that is his aspect of the work.

Comment (L. Trafton): There are some other recently published papers on Pluto's 1.7 - 2.3 micron CH₄ spectrum (Lebofsky et al. (1979), Icarus 37, 554; Soifer et al. (1980), A.J. 85, 166). These firmly establish these absorptions in Pluto's spectrum. Our discussion indicates that better observations are needed for Triton.

COMMENTS ON PLUTO'S ATMOSPHERE

L. Trafton (U. of Texas at Austin)

Abstract

A pure CH_4 atmosphere would rapidly escape from Pluto. For such an atmosphere, even CH_4 frosts on Pluto's surface would completely sublime on a time scale short compared to Pluto's life. Observations of CH_4 on Pluto therefore imply that its atmosphere must also contain another gas in significant quantity.

I. The Short Life of a CH_4 Atmosphere

The evidence for CH_4 gas — or at least CH_4 frost — on Pluto has interesting implications, because neither is stable over a long time. A pure CH_4 atmosphere will escape in a few months and CH_4 frost will sublime and escape so rapidly that even a CH_4 iceball the size of Pluto would disappear on a time scale of the age of the solar system. Even though Pluto is cold, its mass is too small to retain a light atmosphere. Its mass is more than an order of magnitude less than Triton's mass (Harrington and Christy, 1980).

Pluto's gravitational field is strong enough to bind an atmosphere, at least temporarily: the atmosphere would gradually be lost due to Jeans escape, but the time scale for this can be quite large for heavy gases. If the surface density is greater than a critical value, a portion of the atmosphere will have a mean kinetic energy density greater than its gravitational potential energy density and so will stream off to space. In a sense, the atmosphere "overflows" its potential well, and is said to be "blowing off." An atmosphere which is blowing off is losing mass rapidly — much more rapidly than for Jeans escape — and blowoff will continue until the density drops below the critical value.

To illustrate the implications for Pluto, Fig. 1 plots the maximum column abundance of gas on Pluto which is just stable against blowoff vs. the molecular weight of the gas. Pluto's radius was assumed to be 1500 km and Pluto's mass was assumed to be $\approx 10^{25}$ g (Lupo and Lewis, 1980; Harrington and Christy, 1980). The values are for an atmospheric temperature of 55 K. Hydrogen would be stable against blowoff for a column abundance less than 10^{-5} cm-Amagat. More than 10 cm-Amagat of Ne would be unstable and lost by blowoff in 8 yrs. On the other hand, 12,100 cm-Amagat of Ar would blow off very slowly, with a time constant of a billion years or so (neglecting condensation). For CH_4 , more than 0.3 cm-Amagat would be unstable

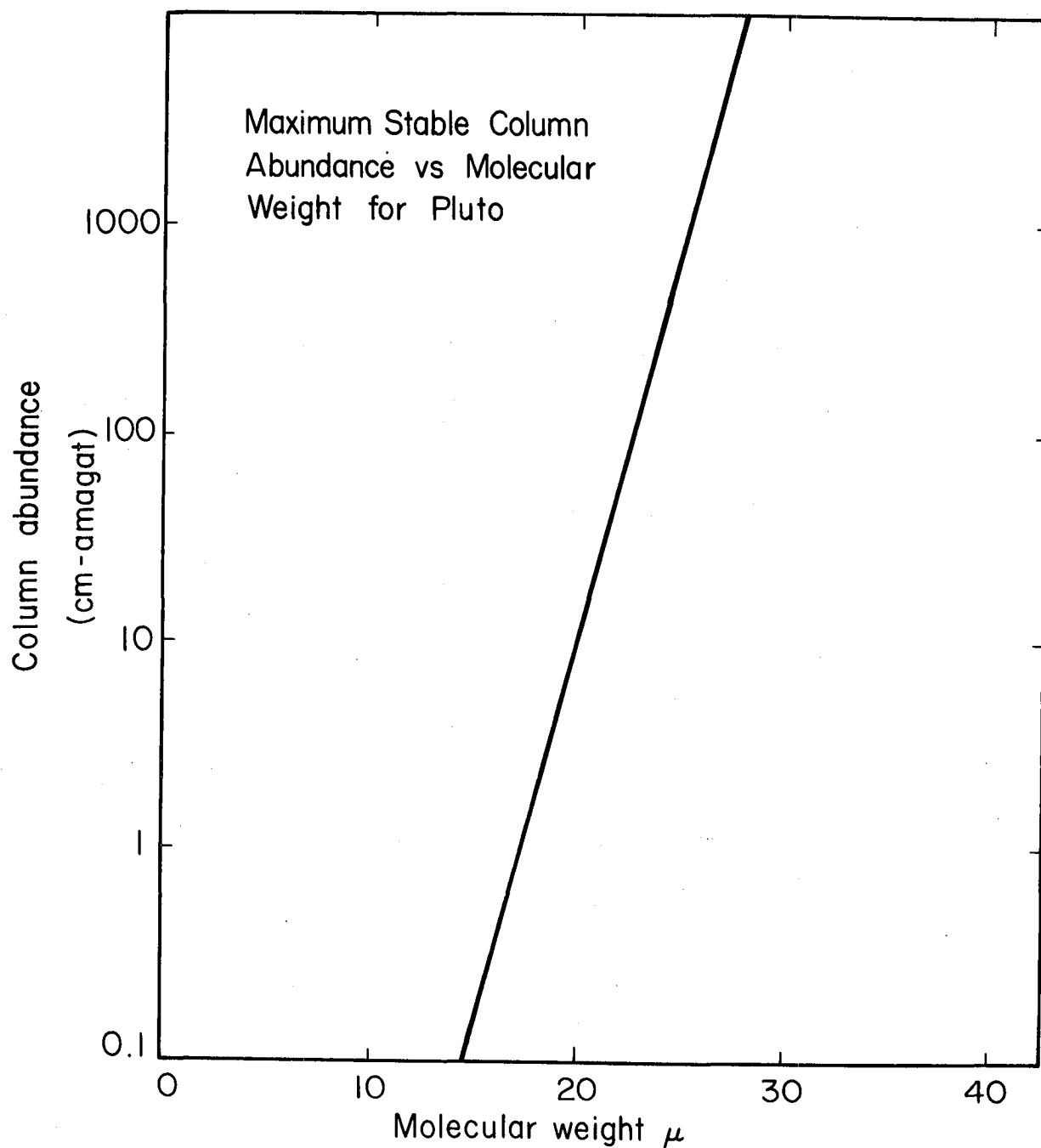

Figure 1. The maximum column abundance of gas stable on Pluto against blowoff vs. molecular weight. Values for the mass, radius, and temperature of 10^{25} g, 1500 km, and 55 K are assumed. See the appendix of Trafton (1980) for method of calculation.

towards blowoff over only 105 days. This amount of CH_4 is much less than the 7 m-Amagat of CH_4 gas Cruikshank and Silvaggio claim to detect from the feature in Pluto's spectrum at 1.7μ .

Let's look at a CH_4 atmosphere on Pluto from a different perspective. Suppose the CH_4 atmosphere is in equilibrium with the CH_4 frost on Pluto's surface. Then the surface pressure of CH_4 will be given by the saturation vapor pressure for CH_4 at the surface temperature. Hydrostatic equilibrium will then result in a CH_4 column abundance which is given by the surface temperature. Figure 2 plots this abundance vs. temperature and also plots the maximum column abundance of CH_4 stable against blowoff vs. temperature for an isothermal atmosphere (Trafton, 1980). For an atmospheric temperature equal to the surface temperature and less than 45 K, a CH_4 atmosphere will be stable against blowoff and in hydrostatic and phase equilibrium. For higher temperatures, however, none of these will be true and CH_4 will be lost rapidly to space. Sublimation will tend to replace CH_4 lost to space but even this is so rapid that a CH_4 ice ball the size of Pluto may evaporate over the age of the solar system. Therefore, even if the 1.7μ and 2.3μ features arise from CH_4 frost instead of CH_4 gas, there is a problem explaining the existence of these features. That some CH_4 sublimated on the day side of Pluto will be deposited on the night side instead of being lost to space just means heat

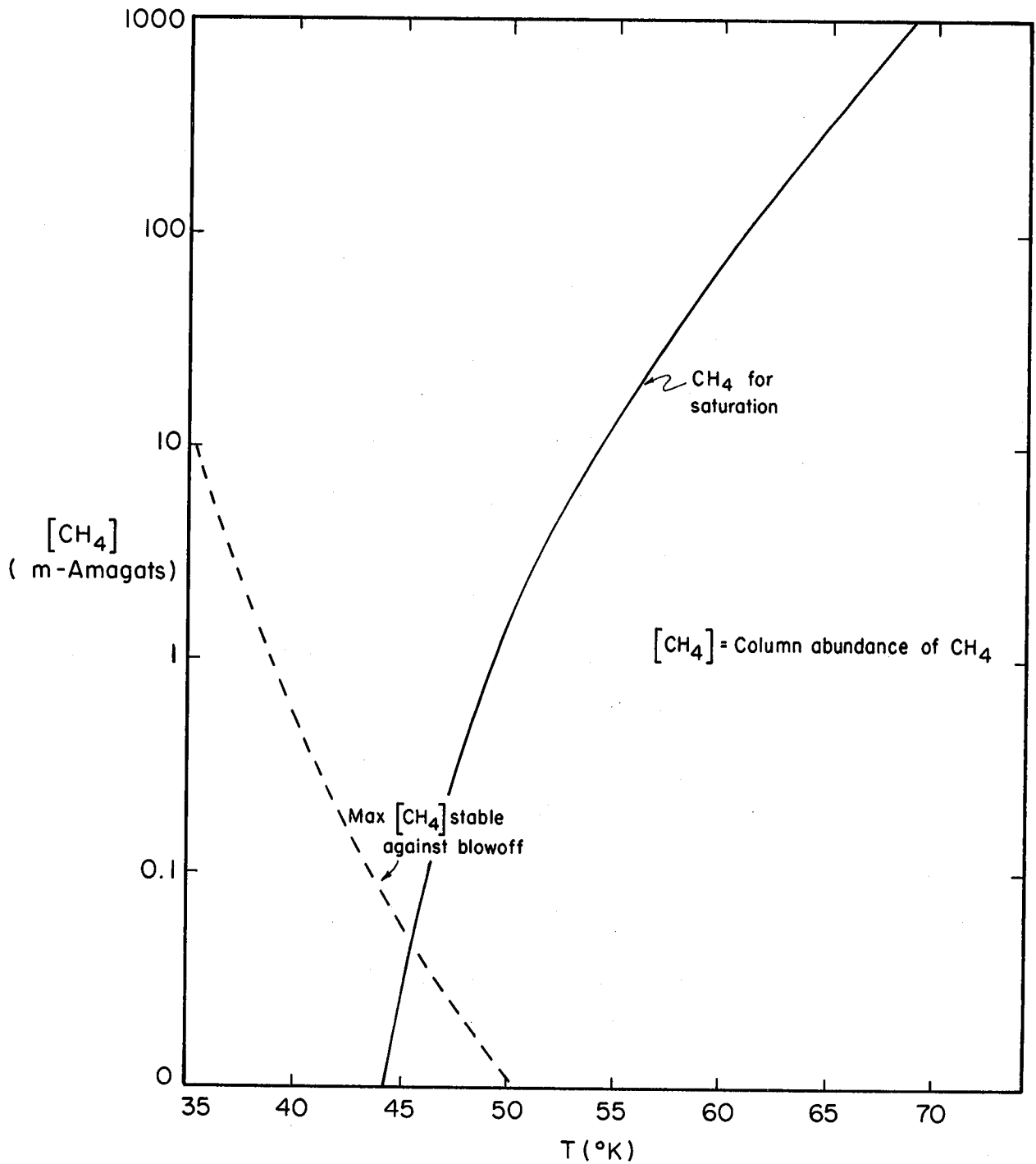

Figure 2. Maximum CH_4 column abundance stable on Pluto against blowoff and the column abundance of CH_4 corresponding to equilibrium between the gas and frost vs. temperature for an isothermal atmosphere. For $T < 45$ K, the atmosphere is stable against blowoff; for $T > 45$ K, sublimation drives blowoff (from Trafton, 1980).

is transferred from the light to the dark hemisphere so that some temperature less than the subsolar temperature is appropriate. But this is still too high to prevent blowoff of a primarily CH_4 atmosphere.

II. Stability for a Mixed Atmosphere

There is a way out of the dilemma presented by these observations. This is to assume that Pluto's atmosphere consists mostly of a gas heavier than CH_4 . The mean molecular weight of the mixture will be greater than for CH_4 , so that the scale height will be less. Therefore, more CH_4 can be contained in Pluto's potential well without blowoff. Furthermore, the other gas, which is more securely bound to Pluto, provides a diffusive barrier to the rapid Jeans escape of CH_4 . For sufficiently small mixing ratios of CH_4 and a molecular weight for the other gas ≥ 40 , the CH_4 loss rate becomes quite small over the age of the solar system (see Trafton, 1980). The CH_4 lost from the atmosphere is easily replaced by CH_4 sublimated from the surface. I conclude that the spectroscopic evidence for CH_4 gas or frost on Pluto implies that Pluto's atmosphere contains another gas in significant quantity.

References

- Harrington, R., and Christy, J. (1980). The satellite of Pluto. II. Astron.J. 85, 168-170.
- Lupo, M., and Lewis, J. (1980). Mass-radius relationships and constraints on the composition of Pluto. Icarus, in press.
- Trafton, L. (1980). Does Pluto have a substantial atmosphere? Icarus, in press.

Discussion

Question (M. Mumma): Do you have candidates for the heavy gas?

Response: Anything heavier than molecular weight 35 or 40 would probably stop blow-out in its tracks: argon for example.

SPECULATIONS ON THE INFRARED MOLECULAR SPECTRA OF COMETS

By

Michael J. Mumma (NASA-Goddard)

No infrared vibration-rotation spectra have yet been seen for any comet, even though molecular emission features in the ultraviolet and visual regions are common, and gaseous matter is the dominant constituent of the coma. This is in part due to instrumental and atmospheric limitations, but also because non-LTE conditions prevail nearly everywhere throughout the coma and tails, leading to unusual spectra. Non-LTE calculations have been applied to ultraviolet (e.g. OH) and to visual (e.g. CN) bands of comets where solar pumping and radiative decay are the dominant excitation and relaxation processes. However, similar attempts to predict the infrared molecular spectra of comets have not been made. Previous talks at this workshop have addressed stable planetary atmospheres, principally those regions where collisional rates are sufficiently high to ensure local thermodynamic equilibrium (LTE). Comets however are radically different, and might be classed as giant planetary exospheres. I will consider certain aspects of cometary physics and non-LTE spectroscopy, and attempt to predict some aspects of the infrared signatures of cometary molecules.

The currently accepted concept of a comet is illustrated in Fig. 1, where the huge HI coma has been omitted since it's scale length is much larger than other scale lengths shown in the Figure. According to this picture, a comet possesses a solid nucleus; a dusty-iceball a few kilometers in diameter. At sufficiently large distances from the sun the nucleus is so cold that the vapor pressures of its constituent gases are negligibly small. As it approaches the

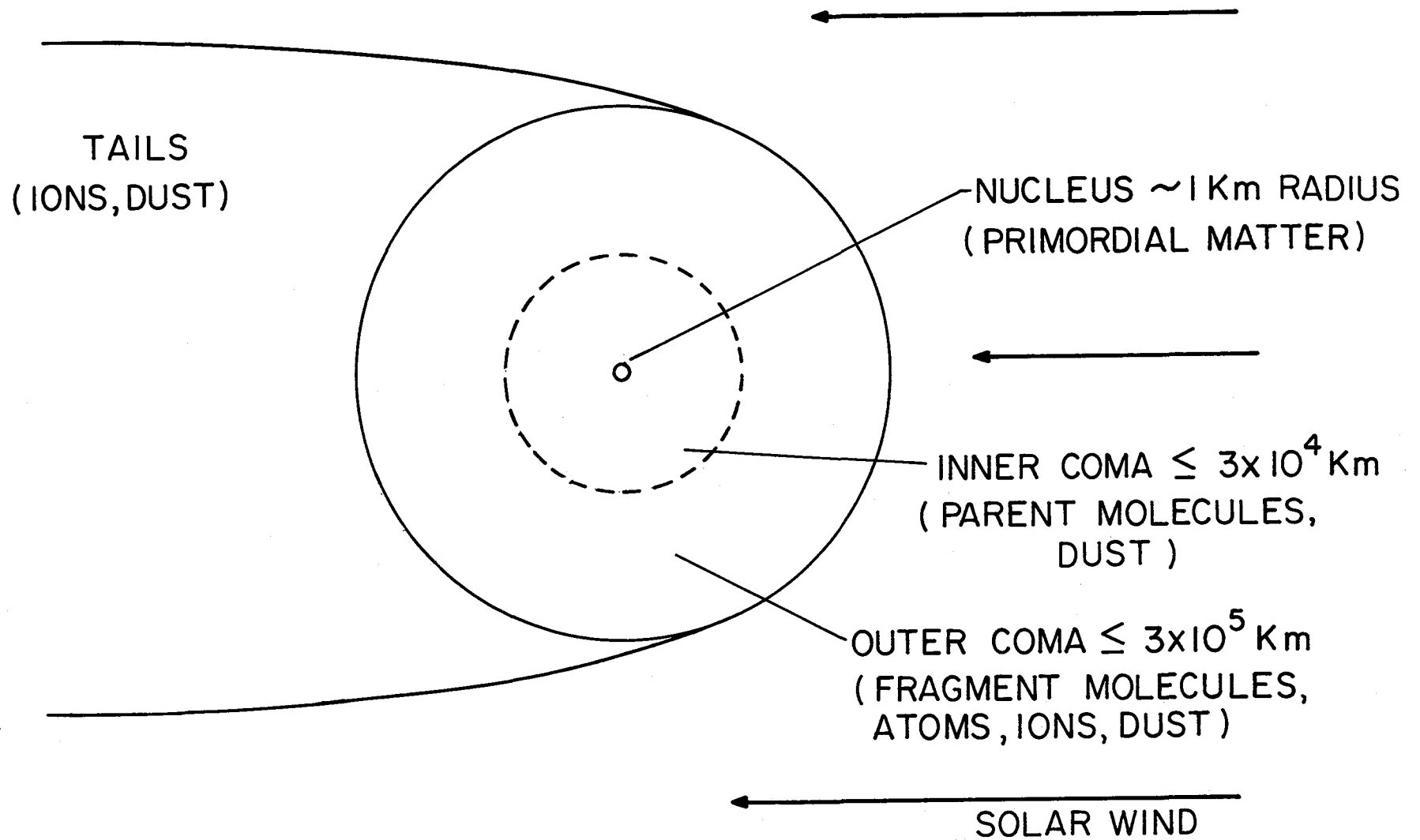

Figure 1. Idealized comet.

sun, warming of the nucleus releases huge quantities of gas and dust in the inner solar system. The sublimated gas is not gravitationally bound to the nucleus, hence it diffuses outward subject to the combined effects of radiation pressure, solar gravitation, ionization/dissociation, and solar wind interactions. These interactions determine the physical structure and compositions of the coma, ion tail, and dust tail in ways that are still imperfectly understood, although great progress has been made in recent years. For example, although species such as OH, CN, C₂, C₃, and CS are commonly observed in the coma it is regarded as unlikely that these free radicals could survive as such in the nucleus and it is believed that these molecules must therefore be produced by dissociation of parent species. The identities of the parent molecules are unknown, as are their dissociation mechanisms, although indirect arguments are made for various parent molecules such as H₂O. It is this elusive group of parent molecules which comprises a major question of cometary physics today. Their identities and abundances constitute the Rosetta stone needed for relating comets to their origins. One commonly held view is that cometary nuclei represent planetesimals which accreted from the pre-solar nebula and that their compositions reflect the thermochemistry of that early medium. Another view holds that comets formed in interstellar clouds, hence that parent molecular abundances should be reflective of known interstellar molecules (Table I). It is generally accepted that H₂O, NH₃, CH₄, N₂ and CO₂ are likely to be represented, with H₂O probably the dominant constituent. I will concentrate on these infrared-active species (neglecting N₂) for the remainder of this paper. This short list may include some principal parent molecules, but even if some are later found to be absent from comets this paper will make an initial attempt at predicting their spectra so that informed searches for them may be made.

Table I
Cometary Molecules and Interstellar Molecules

<u>Comets</u>	<u>Parent Molecules</u>	Mass (A.M.U.)	<u>Interstellar Medium</u>
Observed	Possible		Observed (partial listing)
H		1	H
		2	H ₂
CH, CH ⁺		13	CH, CH ⁺
NH		15	
O, NH ₂	CH ₄	16	
OH, OH ⁺	NH ₃	17	OH, NH ₃
H ₂ O ⁺	H ₂ O	18	H ₂ O
C ₂		24	
CN	C ₂ H ₂	26	CN
HCN		27	HCN
CO ⁺ , N ₂ ⁺ , CO	(N ₂ , CO)	28	CO
		29	CH ₂ NH
		30	H ₂ CO
		32	CH ₃ OH
		34	H ₂ S
C ₃		36	C ₃
		40	CH ₃ C ₂ H
CH ₃ CN		41	CH ₃ CN
		43	HNCO
CS, CO ₂ ⁺	(CO ₂)	44	CH ₃ HCO, SiO, CS
		45	NH ₂ HCO
		46	HCOOH, H ₂ CS
		51	HC ₃ N
	OCS	60	OCS

Since we are interested in detecting these molecules by spectroscopic means, we shall first examine the photon budget of comets (Table II). Particular interest will be directed to the infrared spectral region since the vibration-rotation bands of possible parent molecules lie there. Emission from the nucleus will be neglected since it is unobservable from near-earth or ground-based observatories. We will further neglect the cometary tails since very few parent molecules would survive intact in those regions. The spectral continua of two cometary comae (comet Bennett 1970 II and P/Encke) are shown in Fig. 2, where both reflected solar continua and thermal emission from the cometary dust are evident (after Ney). No molecular features are seen in these photometric observations because of the very low spectral resolution, even though both comets show rich molecular spectra in the visual and ultraviolet when observed at high spectral resolution. It is therefore useful to consider the ways in which infrared molecular signatures may be produced, and whether they would be detectable at higher spectral resolution.

Infrared molecular signatures may be produced in several ways. The first kind of process which might produce infrared molecular signatures is "prompt emission." Sublimating parent molecules are expected to emerge from the nucleus with equal vibrational, kinetic, and rotational temperatures and these will be equal to the temperature of the nucleus, perhaps as high as 200K for a comet near 1AU. The population of molecules in vibrationally excited states will quickly decay to the ground state if an allowed transition exists, because the collisional rate is too small to maintain vibrational LTE except within a few hundred meters of the nuclear surface (I will quantify this statement later). A sub-class of this emission is the production of vibrationally excited daughter molecules by the dissociation process of the parent (e.g. CO($v=3$) from

Table II
Source of Light Emitted by Comets

NUCLEUS: Reflected Solar Continuum ($\approx 6000^{\circ}\text{K}$)
Thermal Emission ($\approx 200^{\circ}\text{K}$ near 1 AU)

COMA: DUST: Reflected Solar Continuum
Thermal Emission

GAS: Prompt Emission
Resonance Fluorescence (Neutrals and Ions)
Impact Excitation (H^+ , H° , e^- , neutral collisions)

TAILS: DUST: Reflected Solar Continuum, Thermal Emission
ION: Assorted Ion Resonance Band Systems

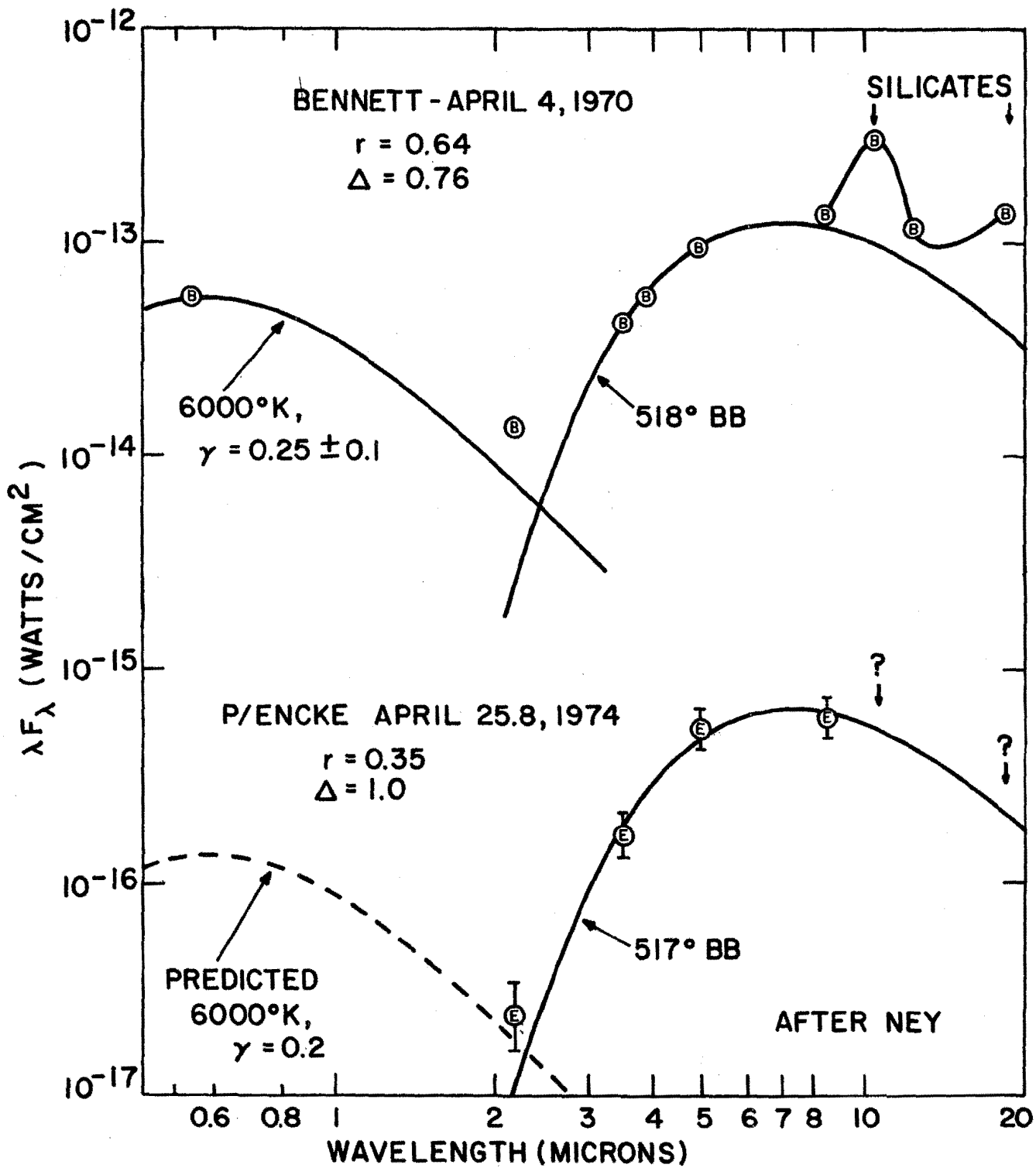

Figure 2. Infrared photometry of two comets.

dissociation of CO_2). This process could produce a very large infrared flux, up to several times larger than the total production rate of the parent molecule if the dissociation yield for vibrationally excited daughter molecules approached unity. Lacking complete knowledge of the dissociation process, we will not treat this interesting possibility further in this paper.

The second kind of process may produce molecular signatures by collisions of the first or second kind with particles (electrons, ions, neutrals) resulting in vibrational excitation of the target molecule. Although this may be important, it will be neglected because insufficient information exists to model this contribution.

The third kind of process is "Franck-Condon pumping", a process by which molecules having resonance electronic transitions in the visual or ultraviolet spectral regions (e.g. CO) may be left in higher vibrational states upon returning to the ground electronic state, and may then emit in the infrared. Thus, pumping of CO in the (14,0) band of the ($A^1\pi-x^1\Sigma^+$) transition by solar Lyman alpha (HI 121.6 nm) photons, followed by radiative decay in the (14,5) band, for example, may leave the molecule in $v=5$ of the ground electronic state, with subsequent infrared emission through vibrational decay. In general, a mismatch in the mean bond-lengths for the upper and lower electronic states will result in a Franck-Condon envelope which is extended over several vibrational levels, and vibrational pumping will result for such molecules. For example, the CN($B^2\Sigma^+-x^2\Sigma^+$) violet system has a narrow Franck-Condon envelope [(0,0) band mainly] and will not give significant vibrational pumping, whereas the CN ($A^2\pi-x^2\Sigma^+$) system has a wide Franck-Condon envelope and solar scattering in this band system will produce extensive vibrational pumping. Although Franck-Condon

pumping works well for diatomic molecules, it will not work well for most polyatomic parent molecules because their upper electronic states are usually pre-dissociated. Thus, those parent molecules lacking a permanent dipole moment and Franck-Condon pumping are expected to exhibit rotational temperatures equal to the nuclear surface temperature, throughout the coma.

The first three kinds of processes produce emission features. The fourth kind of process to be considered here involves direct scattering of infrared quanta by the gas, i.e. either absorption of the thermal dust continuum or of the direct solar flux.

Absorption of the thermal dust continuum might at first be thought to be promising, by analogy with absorption spectroscopy in the laboratory. However, number densities are so low in the coma that collisional relaxation does not compete favorably with radiative vibrational relaxation (for allowed transitions). This means that each photon absorbed from the thermal dust continuum will be re-emitted, and since both dust and gas are isotropic emitters the integrated surface brightness will be unchanged at the position of the vibrational band. This is different from the laboratory case where collisions keep the absorbing gas in LTE, maintaining a local vibrational temperature which is much lower than the brightness temperature of the absorbed laboratory source thereby enabling laboratory absorption spectroscopy to be done. Were the parent molecular cloud much larger in extent than the dust cloud, then optical trapping could result in excess line brightness relative to the thermal dust continuum for slant radii larger than the dust cloud. Unfortunately, the parent molecular cloud is smaller than the dust cloud and this effect is expected to be unimportant for parents, but may play a role for daughter molecules. Actually,

some variation in spectral intensity is expected due to branching effects following absorption, but this will not affect the integrated band intensity. Scattering of the local solar infrared flux by parent molecules will be considered in detail, later in this paper.

We shall first examine the importance of "prompt emission" in producing observable infrared molecular signatures in comets. We will first determine rough estimates for the distance from the nucleus at which vibrational and rotational relaxation from LTE occurs for H_2O , CH_4 , NH_3 , and CO_2 . We will need values for the radiative transition probabilities (Einstein A's) for the vibrational fundamental bands and for pure rotational transitions for these molecules. Table III lists representative values. Note that CO_2 and CH_4 have no allowed rotational transitions, and that J=K levels in NH_3 are also metastable. Note also that CO_2 (10^00) decays through emission to (01^00) in the $\nu_1-\nu_2$ intercombination band, and that CH_4 (1000) is infrared inactive and therefore metastable. All other states listed decay radiatively in an allowed fashion.

Considering only collisions of the first and second kind and radiative relaxation, an approximate rate equation for an excited vibrational level can be written:

$$\frac{dn_u}{dt} = 0 = n_G N_T \sigma_{\uparrow} v - n_u (A + N_T \sigma_{\downarrow} v)$$

where n_u is the local density in the upper state of some species

n_G is the local (total) density in the ground state of the same

Table III
Radiative Relaxation in Polyatomics

CO₂: linear, symmetric: no rotation spectrum

	BAND	ORIGIN (cm ⁻¹)	S cm ⁻² atm ⁻¹	A _{VIB} sec ⁻¹	A _{ROT} sec ⁻¹
100	v ₁ -v ₂	721	8.2	0.12	-
010	v ₂	667	220	2.74	-
001	v ₃	2349	2780	429	-
000	-	-	-	-	-

H₂O: bent, asymmetric rotor: strong rotation spectrum

000	strong rot	-	-	-	5.9(-2)
	weak rot	-	-	-	3(-5)
100	v ₁	3652	10.2	3.8	-
010	v ₂	1595	225	16	-
001	v ₃	3755.8	240	9.5	-

NH₃: pyramidal, symmetric top: strong rotation spectrum

1000	v ₁	3337	20	6.2	-
0100	v ₂	933,968	600	14.6	-
0010	v ₃	3334	13	4.3	-
0001	v ₄	4435	20	11.0	-
0000	J→1, K	-	-	-	2.3(-3)
"	a→s, J=K=1	-	-	-	2(-6)
"	s, J=K	-	-	-	0 ; s

CH₄: tetrahedral, no rotation spectrum

1000	v ₁	2914(R)	0	0	-
0100	v ₂	1526	2	0.13	-
0010	v ₃	3020	300	76.6	-
0001	v ₄	1306	140	6.7	-
1001	v ₁ +v ₄	4216	4.4	2.2	-
0011	v ₃ +v ₄	4313	3.7	1.9	-
0110	v ₂ +v ₃	4546	1.2	0.7	-
0020	2v ₃	6006	1.8	1.8	-
0000	-	-	-	-	SMALL! (10 ⁻⁴ , ΔJ=1)

species

N_T is the total local gas density

σ_{\uparrow} is the collisional excitation cross section

σ_{\downarrow} is the collisional relaxation cross section

and v is the mean molecular thermal speed, as distinct from the bulk flow velocity.

Then, neglecting statistical weights

$$\frac{n_u}{n_g} = \frac{N_T \sigma_{\uparrow} v}{A + N_T \sigma_{\downarrow} v} = \frac{\sigma_{\uparrow}}{\sigma_{\downarrow}} \frac{1}{1 + A/N_T \sigma_{\downarrow} v}$$

$$\frac{n_u}{n_g} = e^{-E_u/kT} \left(1 + \frac{A}{N_T \sigma_{\downarrow} v} \right)^{-1}$$

Thus if $\frac{A}{N_T \sigma_{\downarrow} v} \ll 1$; vibrational LTE holds,

but if $\frac{A}{N_T \sigma_{\downarrow} v} \gg 1$; $\frac{n_u}{n_g} \rightarrow 0$ and vibrational relaxation holds.

Here, I have made the crude assumption that collisional rates between dissimilar gases are roughly the same as those between molecules of the same gas. A rigorous treatment should treat this explicitly.

Nevertheless, we have now arrived at a useful simple relation describing the condition for vibrational relaxation in the coma. Because the total gas number density falls approximately as R^{-2} in the inner coma (Fig. 3), we could

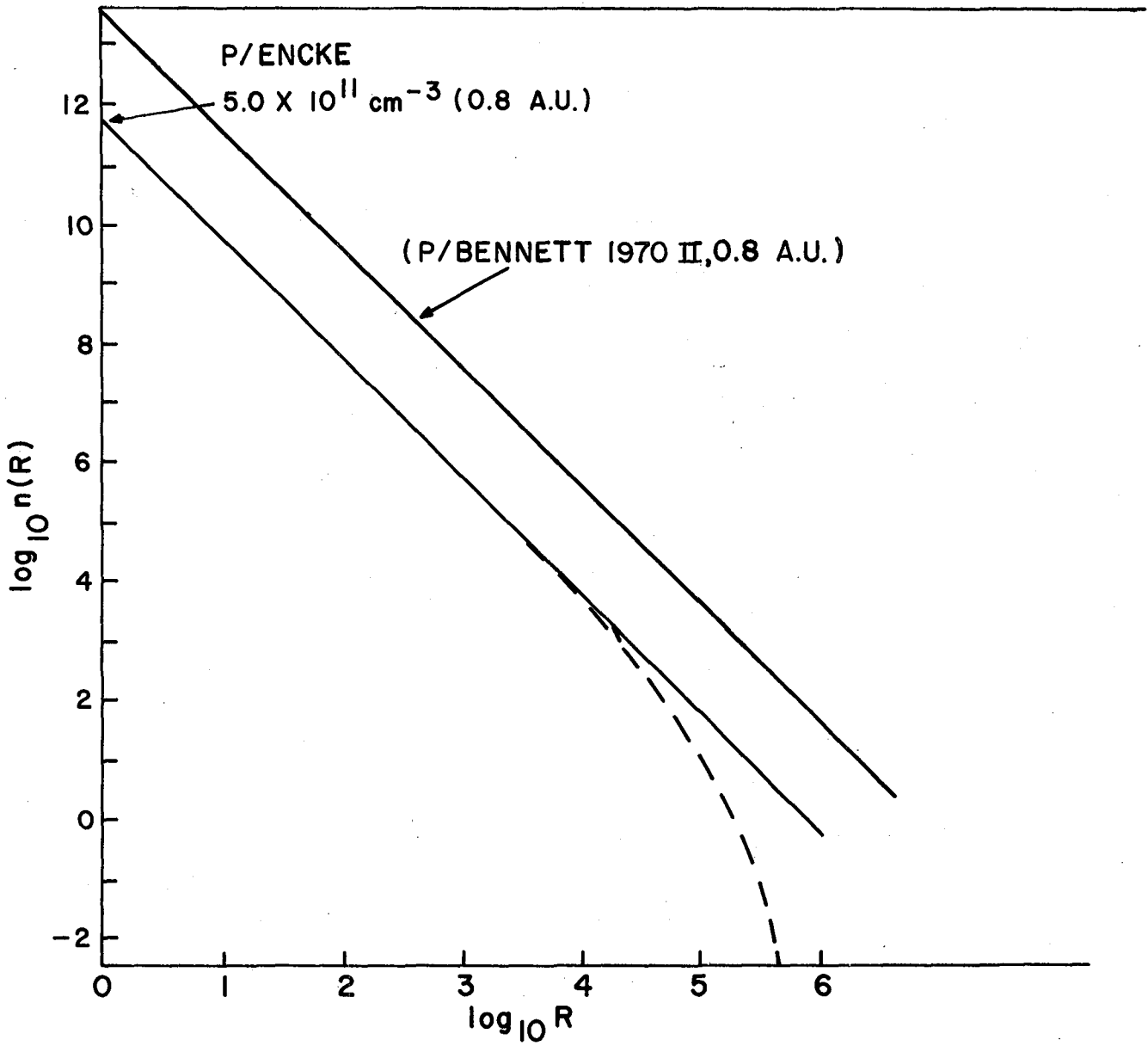

Figure 3. H₂O density vs distance from the nucleus.

relate vibrational LTE failure to a distance from the nucleus if σ_{\downarrow} and v were known. Outflow velocities are approximately 1 km/sec for free-flow expansion of a collisionless gas at 1AU, and cross-sections for vibrational-kinetic relaxation are typically $\sim 10^{-19}$ cm² for many gases. For the moment, we shall take $v \sim 1$ km/sec, equal to the outflow velocity.

A comet produces a total molecular inventory of Q_0 (sec⁻¹) and for a bright comet $Q_0 \sim 10^{30}$ molecules/sec at 1 AU. For spherically symmetric out-flow, the gas density at distance R from the nucleus is roughly

$$N_T = \frac{Q_0}{4\pi VR^2} \quad \text{or} \quad N_T V = \frac{Q_0}{4\pi R^2}$$

Then setting

$$\frac{A}{N_T \sigma_{\downarrow} v} = 1$$

enables definition of the vibrational dis-equilibrium distance (D_V)

$$D_V = \left(\frac{Q_0 \sigma_{\downarrow}}{4\pi A_V} \right)^{1/2} \text{ cm}$$

or $D_V \sim A_V^{-1/2}, \text{ km} .$

Table IV lists values of D_V for vibrational levels of H₂O, NH₃, CH₄, and CO₂. All tabulated levels are vibrationally relaxed beyond 1 km distance from the nucleus, except for CH₄ (1000) which never relaxes. Since the diameters of cometary nuclei are typically a few km, this means that infrared-active

Table IV
Collisional Disequilibrium Distances in Comets: Polyatomics

	μ (debye)	B (cm^{-1})	A_{VIB}^{-1} (sec^{-1})	D_{v} (km)	A_{ROT}^{-1} (sec^{-1})	D_{R} (km)
H_2O Rotation	1.85	27.8(A_0)	-	-	5.9)-2)	129
100			3.8	0.5	-	-
010			16	0.2	-	-
001			9.5	0.3	-	-
CO_2 Rotation	0	0.39	-	-	0	∞
100			0.12	3.0	-	-
010			2.74	0.6	-	-
001			429	0.05	-	-
NH_3 Rotation						
J \neq K	1.47	9.44(A_0)	-	-	2(-3)	700
J=K (a+s)			-	-	2(-6)	2×10^4
J=K (s)			-	-	0	∞
1000			6.2	0.4	-	-
0100			14.6	0.3	-	-
0010			4.3	0.5	-	-
0001			7.4	0.4	-	-
0110			11.0	0.3	-	-
CH_4 Rotation	0				$< 10^{-4}$	∞
1000			0	∞	-	∞
0100			.1	3.0	-	-
0010			76.	0.1	-	-
0001			6.7	0.4	-	-
1001			2.2	0.7	-	-
0011			1.9	0.7	-	-
0110			0.7	1.2	-	-
0020			1.8	0.7	-	-

fundamental levels can remain equilibrated only in the first few hundred meters above the surface. Thus the region available for prompt emission is quite small. The brightness radiated by prompt emission can be estimated from the Boltzman population factors, the total number densities, and the radiative lifetimes for those molecules within the vibrationally equilibrated region.

The distance (D_R) at which rotational dis-equilibrium occurs may be estimated in a similar way, but now using the fact that a change in rotational levels can occur on nearly every collision, i.e. the cross-section $\sigma_{\downarrow R}$ is gas-kinetic or $\gtrsim 10^{-16} \text{ cm}^2$

Then

$$D_R \approx \left(\frac{Q_0 \sigma_{\downarrow R}}{4\pi A_R} \right)^{1/2} \approx \left(\frac{1000}{A_R} \right)^{1/2} \text{ km}$$

Rotational populations remain equilibrated to much greater distances (Table IV) than do vibrational populations, out to distances of hundreds of kilometers for allowed transitions, and to larger distances for metastable levels.

Similar calculations of D_v and D_R for simple diatomic molecules are given in Table V, where the values of D_R for the $J=1$ level have been estimated for each molecule. The values obtained range from ~ 200 km for OH to $\sim 10^5$ km for CO. However, Franck-Condon pumping is important for many diatomics, and D_R should be viewed as indicating the maximum distance from the nucleus for which the rotational distribution will be locked to the kinetic temperature by collisions. For example, since the great majority of OH molecules exist at distances greater than 200km from the nucleus, we expect that cometary OH will exhibit a

Table V
Collisional Disequilibrium Distances in Comets: Diatomics

	μ (debye)	B (cm^{-1})	A_{VIB} (sec^{-1})	R_{DV}^{**} (km)	A_{ROT}^* (sec^{-1})	R_{DR}^{***} (km)
$\text{H}_2, \text{N}_2, \text{C}_2$						
$\text{O}_2 \dots$	0		0	∞	0	∞
$\text{CO}^+ ({}^2\Sigma^+)$?	1.98	≥ 10	< 1	?	?
$\text{CO} ({}^1\Sigma^+)$	0.1	1.93			9(-8)	10^5
$\text{CN} ({}^2\Sigma^+)$	1.44	1.89			1.8(-5)	7×10^3
$\text{OH} ({}^2\Pi)$	1.66	18.86			2.3(-2)	200
$\text{CH}^+ ({}^1\Sigma^+)$?	14.17			?	?
$\text{NH} ({}^3\Sigma^-)$?	16.65			?	?
$\text{CS} ({}^1\Sigma^+)$	1.96	0.82			2.7(-6)	2×10^4
$\text{SiO} ({}^1\Sigma^+)$	3.1	0.73			4.8(-6)	1.4×10^4

* For $J=1 \rightarrow 0$, $A_{\text{ROT}} \approx 1.3 \times 10^{-6} \mu^2 B^3 N^3$

rotational distribution determined by radiative pumping, as is indeed observed to be the case. Conversely, CO will exhibit a rotational distribution locked to the kinetic temperature, at least for the low J levels, while the high J-levels will have populations determined by radiative effects. A distinction is noted between the kinetic temperature, determined from the local relative molecular velocities, and the value which would result from the bulk motion of outflow. The situation is complicated further since dissociation-fragment molecules (e.g. OH) are often produced with excess kinetic energy, relative to the thermal kinetic energy of their parents.

We will now examine the $\text{NH}_3 \nu_2$ band as a specific case. NH_2 has been detected in the visual spectra of comets and NH_3 has been suggested as its parent, although this is by no means certain since other processes (e.g. ion-molecule reactions) may produce the NH_2 instead. From Table IV, we note that NH_3 will be rotationally relaxed to J=K levels at distances beyond ~ 700 Km from the nucleus. Taking the scale length of NH_3 to be ~ 4000 km, the fraction of NH_3 which survives beyond 700 km from the nucleus is $\sim e^{-700/4000}$ or $\sim 85\%$. This means that 85% of the total number of NH_3 molecules will lie at distances beyond 700 km from the nucleus, and these will be vibrationally relaxed to (0000), and rotationally relaxed to J=K levels, s and a states only (Table IV). Furthermore, the rotational population in the J=K levels is frozen to the kinetic temperature at the dis-equilibrium distance (700 km), which is likely to be much less than the nuclear temperature ($\ll 200\text{K}$, for example).

The prompt emission in ν_2 may be calculated from

$$F = \frac{N(0100) A_v}{4\pi} \quad \begin{array}{l} \text{photons} \\ \text{sec sr} \end{array}$$

$$F = \frac{D_v \cdot Q_{\text{NH}_3} \cdot Z_v \cdot A_v}{4\pi v} \approx \frac{Q_{\text{NH}_3} \cdot Z_v \cdot A_v^{1/2}}{4\pi v}$$

where Z_v is the fractional population in the NH_3 (0100) state. Taking $Q_{\text{NH}_3} = 10^{29} \text{ s}^{-1}$, or 10% of the total volatile production rate,

$$F \approx 10^{26} \frac{\text{photons}}{\text{sec sr.}} \quad \text{in the } \nu_2 \text{ band.}$$

Converting this to Watts/cm^2 at an earth based telescope at $\Delta = 0.76 \text{ AU}$ (compare Fig. 2)

$$S = \frac{h\nu F}{\Delta^2} \approx 1.5 \times 10^{-20} \frac{\text{Watts}}{\text{cm}^2}$$

at the surface of an earth based telescope. This is about 10^6 times smaller than the thermal dust flux observed at $10\mu\text{m}$ from Comet Bennett 1970 II by Ney.

The total number of NH_3 molecules in the coma will be

$$N \approx Q_{\text{NH}_3} \tau \quad \text{where } \tau \text{ is the lifetime against dissociation,}$$

or

$$N \approx 4 \times 10^{32} \quad \text{for our model}$$

and $\approx 85\%$ of these will be rotationally relaxed as described above.

The individual line strengths for this relaxed population with $T_{\text{eff}} \approx 220\text{K}$ are shown in Table VI. Note that absorption of the ambient infrared photon field can occur only in Q- and R- branch lines ($J' \geq K'$), and only from $J=K$ levels of the ground-state. Absorption from $(J,K)=(2,2)$ in sQ (2,2), for example, will result in emission of sP (3,2) and of sQ (2,2) only, while absorption of sR (2,2) will result in emission of sP (4,2), sQ (3,2), and sR

Table VI
Strengths of ν_2 Lines in Absorption for Levels Expected for
Cometary NH_3

Model:

J=K levels only

$T_{\text{ROT}} \sim 220\text{K}$, typically

s & a levels equilibrated

P-BRANCH missing

Line Strengths:

J=K		$S(\text{cm}^{-2}\text{atm}^{-1})$	
		Q-BRANCH	R-BRANCH
0	s	0	0
	a	0	23.22
1	s	16.02	16.67
	a	15.34	16.00
2	s	29.55	15.68
	a	28.30	15.07
3	s	71.40	25.75
	a	68.35	24.76
4	s	34.47	9.58
	a	33.28	9.22
5	s	29.22	6.56
	a	27.95	6.32
6	s	43.71	8.33
	a	41.89	8.03
7	s	14.85	2.47
	a	14.21	2.38
8	s	9.29	1.37
	a	8.90	1.33
9	s	10.86	1.45
	a	10.41	1.40
10	s	2.99	0.36
	a	2.87	0.35

CONCLUSION: #of Cometary lines reduced by 10-100 from LTE case.

Doppler limited resolution needed for best chance at detection.

(2,2). When compared with LTE laboratory absorption spectra, the striking reduction in the numbers of lines, enhancements in residual line strengths, and the missing P-Branch are remarkable. As much as ~ 10% of the entire band-strength lies in a single line, sQ (3,3)! Let us calculate the absorption optical depth at line center in order to decide whether scattering will be significant. For a Doppler-broadened line, the absorption coefficient at line center (K_0) is

$$K_0 = \sqrt{\frac{\ln 2}{\pi}} \frac{S}{\Delta\nu_D} \quad \sim 16,500/\text{cm atm}$$

for a Doppler HWHM of $.002 \text{ cm}^{-1}$.

Thus the sQ (3,3) line becomes optically thick at a column density of $\sim 2 \times 10^{15}$ molecules/cm². Now the total number of NH₃ molecules in the coma is $\sim 4 \times 10^{32}$ in our model, and 63% reside within 4000 km of the nucleus. We shall neglect those NH₃ molecules beyond 4000 km from the nucleus and assume a simple R^{-2} density dependence from the nucleus. If these were uniformly distributed (instead of as R^{-2}), the mean number density would be $\sim 10^6/\text{cm}^3$ and the path length through this uniformly filled sphere would vary from 0 to 8000 km. Thus the column density would vary from 0 to $\sim 8 \times 10^{14}/\text{cm}^2$, nearly optically thick at the center of the coma. Using an R^{-2} model, the column density from the nuclear surface ($R_0=1 \text{ km}$) to 4000 km is

$$N \sim \frac{Q_0}{4\pi\nu} \int_1^{4,000} \frac{dR}{R^2} = - \frac{Q_0}{4\pi\nu} \frac{1}{R} \Big|_1^{4,000} = \frac{Q_0}{4\pi\nu} 10^{-5} \text{ cm}^{-2}$$

or $N \sim 8 \times 10^{17}$ molecules cm⁻², ~ 400 optical depths! In other words, optical

depth unity is reached at $R \approx 400$ km from the nucleus along the sun-nucleus direction. The column density for slant distance (D) from the nucleus may be calculated from

$$N_D = \frac{2Q_0}{4\pi v} \frac{10^{-5}}{D(\text{km})} \tan^{-1} \frac{\ell_0}{D}$$

where $\ell_0 = (4000^2 - D^2)^{1/2}$,

and we will require $N_D \geq 2 \times 10^{15} \text{ cm}^{-2}$ for an optically thick line at line center. For our model, this is satisfied if $D \lesssim 1000$ km, i.e., the sq (3,3) line is optically thick at line center throughout the region 1000 km or less from the nucleus.

The solar spectral intensity at 0.64 AU is $602 \text{ ergs cm}^{-2} \text{ s}^{-1} \mu\text{m}^{-1}$ at $10 \mu\text{m}$ (Allen, "Astrophysical Quantities") or

$$F_v = 2 \times 10^{-10} \text{ ergs cm}^{-2} \text{ s}^{-1} \text{ Hz}^{-1}$$

The flux scattered in one Doppler full width ($\approx .004 \text{ cm}^{-1}$ or $\approx 120 \text{ MHz}$) is then

$$F_s \approx \frac{2 \times 10^{-10} \pi (10^8 \text{ cm})^2 \times 1.2 \times 10^8 \text{ Hz}}{4\pi} \text{ ergs/sec sr}$$

$\approx 6 \times 10^{13} \text{ ergs/s sr}$, or $\approx 6 \times 10^6 \text{ watts/sr}$, or $\approx 3 \times 10^{26} \text{ photons s}^{-1} \text{ sr}^{-1}$.

The flux reaching the earth (at $\Delta = 0.76 \text{ AU}$) is then

$$F = \frac{F_s}{\Delta^2} \approx 5 \times 10^{-20} \text{ watts/cm}^2$$

This scattered solar flux will be shared by the sq (3,3) and the sp (4,3) lines

in emission. Since the absorption strength of sQ (3,3) represents ~ 8% of the total band strength (Table VI), the total flux reaching the earth by solar scattering in the ν_2 band will be ~ 6×10^{-19} W cm⁻² or ~ 40 times larger than the contribution from prompt emission calculated earlier. Actually, the amount of scattered solar flux will be somewhat larger than our calculation due to opacity broadening of the line. The total scattered flux in the ν_2 band of NH₃ will be $\geq 10^{-18}$ watts/cm² when opacity broadening is included, but this is still 10^4 smaller than the measured thermal flux from Comet Bennett 1970 II (see Fig. 2).

Of greater interest is the specific brightness (photons/sec Hz) near line center for sQ (3,3) and in the thermal continuum. For the line, the specific intensity is

$$B_{\nu} = \frac{2 \times 10^{-8} \text{ ph}}{\text{sec cm}^2 \text{ Hz}}$$

if the entire flux from the 1000 km radius region is collected. If a 3m telescope were used, the collected spectral intensity would be

$$B = 1.4 \times 10^{-3} \frac{\text{ph}}{\text{sec Hz}}$$

The thermal flux may be estimated from Fig. 2, which shows the quantity $\lambda F_{\lambda} = \nu F_{\nu}$ vs. wavelength. Near 10 μm (3×10^{13} Hz),

$$F_{\nu} \approx \frac{3 \times 10^{-13}}{h\nu^2} \approx 5 \times 10^{-7} \frac{\text{ph}}{\text{cm}^2 \text{ sec Hz}}$$

from a 15 arc-sec beam centered on the coma of Bennett, corresponding to a beam

diameter of 9000 km at 0.76 AU. Comparison with the flux expected from a 518 K blackbody of this size indicates that the mean optical depth of the dust was $\sim 2 \times 10^{-5}$. If the thermal dust continuum were of uniform brightness across the 15 sec beam, the monochromatic brightness within our 1000 km radius region would be ~ 20 times smaller,

or

$$B_{\nu} \sim 5 \times 10^{-7} \frac{\pi(300^2)}{4} 5 \times 10^{-2} \frac{\text{ph}}{\text{sec Hz}}$$

$$\sim 1.8 \times 10^{-3} \frac{\text{ph}}{\text{sec Hz}}$$

i.e. the contrast ratio of line/continuum would be ~ 1 , a favorable number if the S/N is suitable.

Present generation heterodyne spectrometers are well suited to doppler-limited spectroscopy, and have a practical sensitivity limit of

$$B_{\nu} \sim \frac{10}{\sqrt{B\tau}} \sim 1 \times 10^{-5} \frac{\text{ph}}{\text{sec Hz}} \quad \text{for } B = 100 \text{ MHz resolution and } \tau = 10 \text{ sec integration.}$$

The field-of-view, however, is diffraction limited, corresponding to ~ 600 km diameter for a 3m telescope viewing an object at 0.76 AU and leading to a 10-fold reduction in the collected signals.

Thus the expected signal-to-noise ratio for this case would be ~ 36 for the thermal dust continuum (double sideband) and ≥ 14 for the NH_3 SQ (3,3) line.

Hence currently available instrumentation has a good chance of detecting NH_3 in a comet if the NH_3 production rate were $> 2 \times 10^{28} \text{ S}^{-1}$. The detection limit may be lowered significantly by inclusion of other excitation processes.

Similar detailed calculations should be performed for H_2O , CH_4 , and CO_2 in order to establish their expected infrared fluxes as well. This is beyond the scope of this paper, but it seems important to do this since we have demonstrated fairly conclusively that the vibrational spectra of some parent molecules will be detectable with proper instrumentation, and are likely to be very different from laboratory spectra obtained under LTE conditions. Nevertheless, some conclusions have been reached from the arguments presented here (summarized in Table VII), and these provide useful guides for future work.

Table VII
Conclusions on the Expected Infrared Molecular Spectra of Comets

Parent Polyatomics: No IR/UV Resonance Fluorescence Spectra

H₂O - Vibrationally and rotationally relaxed ν_1, ν_2, ν_3 , bands may show strong lines, but few in number due to relaxation.

CH₄ - Vibrationally relaxed, except T_v(1000) \sim 200K

T_R \sim 200K

ν_3, ν_4 strong with full set of lines for T_R \sim 200K

NH₃ - Vibrationally relaxed

Rotationally relaxed to J=K levels; T_R \sim 200K.

$\nu_1, \nu_2, \nu_3, \nu_4$ have small numbers of lines

ν_2 strongest; P-Branch missing

CO₂ - Vibrationally relaxed, T_R \sim 200K

ν_2, ν_3 bands only, full set of lines for T_R \sim 200K

DIATOMICS

Homonuclear (C₂, N₂, H₂, O₂,...) T_R \sim 6000K

Vibrationally hot due to Franck-Condon pumping.

CO - Vibrationally hot, rotationally cold

CN - Vibrationally cold, rotationally cold. A-X bands may produce some vibrational pumping.

CS - Vibrationally cold, rotationally cold.

DISCUSSION

Question (Anon.): It seems that eventually some molecules will be seen by virtue of their vibration - rotation transitions in some comet, and the local pressures will be very low compared to laboratory experiments. Do we have any requirements for getting very low pressure laboratory data on the molecules which have been studied before at higher pressures, for possible interpretation in comets?

Response: The principal advantages of observing comets with sub-Doppler resolution are that great specificity is obtained in searching for parent molecules, and that velocity profiles of individual lines can be measured, leading to direct measurement of bulk flow velocities, thermal velocities, and excitation physics in the cometary coma. This has been done in a preliminary way in the millimeter region for OH, CH₃CN, and HCN. Remember that geocentric velocities can range over $v \pm 80$ km/sec for comets, and that many molecular levels may be under-populated in the coma due to the collisionless environment. It is essential to know the absolute rest frequencies of lines and their radiative transition probabilities before informed searches can be made. I will argue very strongly that we need precise infrared line parameters for molecules expected to be present in comets, and they (frequencies, Einstein A's, and strengths) should be as accurate as possible. The frequencies certainly should be accurate to one part in 10^6 and the strengths should certainly be accurate to the order of 2%. For some molecules having complicated rotational structure, supersonic expansion from a jet orifice in the laboratory will produce

rotational cooling and greatly simplify relating laboratory spectra to cometary spectra.

Question (K. Fox): How good is the infrared data base for ions and radicals?

Response: Very poor. This is an area where ab-initio calculations of strengths would be quite useful, even if the integrated band strength were obtained to within a factor of two. Laboratory spectroscopy can obtain satisfactory line positions for radicals and ions in some cases, but strengths are very hard to measure.

SUMMARY OF THE WORKING SESSION

Summary of the Working Session

J. Hornstein (CSC), K. Fox (Univ. Tenn.), and
M. J. Mumma (NASA-Goddard)

This summary was prepared from transcription of tape recordings of the Working Session on Conclusions and Recommendations and a prior discussion of a possible national center for spectroscopic research, as well as from notes made during the discussions.

The Workshop's recommendations are to be understood as only a "wish list", with priorities indicated only roughly in some cases. Some of the recommendations listed here were only implicit in the Workshop discussions, but could be inferred unambiguously from the points which repeatedly caused controversy. For questions that provoked strong disagreements, the principal arguments on both sides are given including some which did not happen to be mentioned at the Workshop but were obviously pertinent.

I. THEORETICAL STUDIES

Help from theory is needed for quantities that are difficult to obtain experimentally, and for extrapolating spectra to realistic planetary atmospheric temperatures, pressures and path lengths.

1. Line Shapes, Strengths, Widths and Shifts

Line shapes and line strengths are particularly important problems, although line shifts are also of interest. A unified theory of pressure broadened line widths, capable of handling line centers, near and far wings, overlapping lines and complete band centers, is desirable.

Overall, our knowledge of line shapes badly needs improvement. Currently used line shapes are often semi-empirical; for lack of more definite information they are often chosen for simplicity, and are frequently controversial (e.g., for ammonia).

Line shapes are of interest mainly to the planetary atmospheric sciences. Industry and other agencies are unlikely to fund work in this area. Funding by

other agencies for work in related areas is usually for studies of energy transfer rather than aspects of collision dynamics relevant to line shapes. If the line shape problem is to be solved on a useful time scale (roughly, within the next ten years), the funding will have to come from NASA.

The intermolecular potential is an important ingredient in calculating line shapes. Erroneous line shapes are usually blamed on the calculational technique when often the potential is at fault. For simple systems, accurate ab-initio calculations of the potential appear possible. They deserve funding because of their role in the line shape problem.

The theory of the shapes of overlapping lines has not been presented in a form useful for experimenters; consequently, it has not been well tested. Only two theoretical papers have appeared on the subject, and the theoretical results and associated computer programs are too difficult for experimenters to use, at least in addition to their other work. It would be useful to have these results made more digestible, and to have line-shape theorists working with experimenters to test the theories.

In general, the theories of line shapes and line widths have not been well tested experimentally. The lack of accurate potentials and the complexity of the results are only part of the problem. Good experimental data, selected especially for testing these theories, are also lacking. Collision cross sections obtained from molecular beam experiments involve a known initial state but are averaged over final states, making them unsuitable for these tests.

Ab-initio and hybrid techniques (e.g., transferring polar tensors) appear to be particularly useful for the line strengths of radicals and ions. Line intensities for radicals and ions are often difficult to obtain experimentally, and theoretical and semi-empirical methods offer rapid and reasonably accurate access to the needed information.

2. Extrapolating Spectra in Temperature, Pressure and Path Lengths

Temperatures and pressures in planetary atmospheres often differ dramatically from those in the laboratory. Path lengths pertinent to planetary spectra often exceed those achievable in the laboratory by many orders of

magnitude. Because planetary conditions are difficult to duplicate in the laboratory, and also to avoid the need for handling an overwhelming volume of spectral data, it would be extremely desirable to be able to extrapolate spectra over wide temperature and pressure ranges. Indeed, the need for actual or extrapolated spectra at realistic temperatures and pressures was the most frequently repeated request during the Workshop.

Ideally, theory can contribute here. However, its ability to extrapolate on the basis of current spectral knowledge was hotly contested. This dispute emerged again and again, with the views of the disputants seemingly determined by their profession. Experimental spectroscopists were inclined to trust theory in this respect, astronomers were highly suspicious of it, and theorists voiced guarded opinion.

The factors that would enter an extrapolation include the temperature and pressure dependences of line widths, strengths, shapes and shifts (the temperature dependences of pressure broadening and of pressure-induced transitions are implicitly included in this list). In particular, as either the temperature or the path length increases, formerly invisible hot bands and transitions from less common isotopes become evident. Features which are small and lost in the crowd at room temperature, stand out in the less congested spectrum at low temperatures, and when seen in planetary spectra they may provoke a misguided search for a hitherto-unknown exotic species unless appropriate laboratory spectra are available.

The ability of theory to extrapolate a laboratory spectrum to realistic conditions varies from molecule to molecule. In general, it is good for the simple molecules (diatomic and linear molecules) that dominate the atmospheres of the terrestrial planets, and it is less good for the more complicated molecules that dominate the outer planets. Much theoretical work on the more complicated molecules is needed.

The ability of theory to handle some of these factors is rather limited; for others it is quite satisfactory. A study to assess the ability of theory to extrapolate spectra would be worthwhile. What regions of what molecular spectra can it extrapolate reliably, and over what temperature and pressure ranges? (For example, the extrapolation may be more reliable for uncongested spectral

regions.) What is the most limiting missing information? (For example, the lower state energy is needed in calculating the Boltzmann factor at new temperatures, however this is often not determined as well as the observed energy differences. How limiting is that? At what pressure does the lower state energy begin to depend on pressure?) A worthwhile sub-study would be an assessment of how well theory can predict the spectra of various isotopic mixtures from the available spectra; this is presently controversial, and is important since isotopic ratios are important data for theories of the formation of the solar system and for cosmology. What data would be most useful in testing the ability of theory to extrapolate in temperature, pressure, path length, and isotopic mixture?

There do not seem to be much data on temperature dependences, or any systematic attempt to compare the available data with theoretical extrapolations. Even the qualitative importance of temperature variations is presently controversial. For example, there are band model arguments for the weakness of the temperature dependence in congested portions of the CH₄ spectrum, but these arguments seem unpersuasive to many researchers. A review of the data available and of the existing tests of extrapolated spectra would be valuable.

3. Extraction of Molecular Parameters

Data combined from a variety of sources to extract molecular constants, lower state energies, etc., produces useful results for a variety of applications. These constants can be used to predict line strengths and positions (e.g. in particular hot bands) centrifugal distortions at high J, isotopic effects, and Boltzmann factors. They compactly summarize a large body of spectral information, and are thus particularly convenient for comparisons with basic theory.

II. LABORATORY STUDIES

1. Should we try to duplicate planetary conditions in the laboratory?

This was one of the key issues that emerged during the Workshop. It arose in one context after another, and was hotly debated, with laboratory spectroscopists generally favoring semi-empirical synthetic spectra rather than the direct duplication of difficult planetary conditions, while planetary astronomers were suspicious of synthetic spectra.

There were several reasons why planetary astronomers were reluctant to accept synthetic spectra without having at least a few planetary conditions duplicated in the laboratory. The extrapolation from STP to planetary conditions is large. Furthermore, even when a synthetic spectrum is correct in a gross sense it is often not correct in detail, and those details may be crucial for identifying trace species in a planet's atmosphere. For example, in the spectrum of methane there is a feature which can be seen at very low temperatures, but which is totally buried in congestion at room temperature. Unlike a weak feature in an uncongested portion of the spectrum, this type of feature cannot be made to stand out by taking room temperature spectra at longer path lengths. A synthetic low temperature spectrum obtained by extrapolating a room-temperature spectrum would not contain this feature. Astronomers would then scour the spectroscopic literature in search of an exotic trace constituent to explain the presence of this feature in a planetary spectrum.

The Workshop therefore gave high priority to spectroscopic measurements at low temperatures, for both short and long path lengths. Low temperature studies at short path lengths will help map out the gross temperature dependence, which is so poorly known at present that even its importance is still being debated. Short path spectra show only the stronger lines and are therefore less jumbled than long path spectra, so they will help in associating lines with quantum transitions. They will also help pick out buried lines, as discussed in the previous paragraph. Long path studies will show the hot bands and isotopic transitions. These are important both because of the enormous path lengths occurring in planetary atmospheres and because of the intrinsic importance of isotopic abundances for cosmology and theories of the formation of the solar system.

The primary emphasis for such studies must be on the temperature dependence of the line and band strengths. The strengths determine the overall visual appearance of the spectrum, and their temperature dependence is the most important ingredient in extrapolating the spectrum to other temperatures. Pressure broadening at low temperatures is also of great interest. The temperature dependence of the line shapes is of interest in some cases, an example being the 10 micron region of ammonia. In this case, the line positions and even the corresponding energy levels are well known, but the strengths, widths and shapes are not well enough known for some planetary applications. The temperature dependence of line shifts is of interest in some cases, but a preliminary study is needed to determine the species and lines for which line shifts are most needed. As Doppler-limited observations becomes more common for planetary studies, these parameters will become increasingly important.

While the low temperature, long path-length data are being collected, synthetic spectra should be generated specifically for comparison with them. Such comparisons might then settle the question of the reliability of extrapolated spectra.

In this connection, a point made in section I is pertinent. There is need for a study to collate and evaluate the bits and pieces of information and qualitative arguments already available on the temperature dependence of spectra. This need was demonstrated by the controversy at the Workshop over whether temperature effects were important and whether they could be extrapolated reliably, and by the searching quality of the questions that the participants asked one another on these topics.

In addition to spectra at low temperatures, spectra at high temperatures and pressures are needed for selected species. The most notable instance is CO_2 (and $\text{CO}_2\text{-N}_2$ and $\text{CO}_2\text{-H}_2\text{O}$) on Venus. The possibility of windows in the CO_2 opacity bears directly on the controversy regarding the thermal fluxes on Venus, and hence on the thermal balance on Venus.

Spectra are also needed for some condensed phases under planetary conditions: liquids, ices, frosts and snows. For some species, spectra of solid and liquid phases may already be available from engineering studies.

Two general types of pressure-dependent effects were singled out as having

particularly high priority: pressure broadened line widths and pressure-induced transitions.

As discussed in section I, some measurements of pressure broadened widths should be taken specifically for the purpose of testing theories of pressure broadening -- both current theories and a hoped-for future comprehensive theory. The pressure broadened widths of overlapping lines are of particular interest in this respect, as is the self-broadening of H_2 quadrupole lines. Measurements of collision cross sections using molecular beams would be very helpful, but only if the measurements can select a well-defined final state.

Pressure-induced transitions are of great practical importance. Especially important are absorptions that exist by virtue of hydrogen-hydrogen and hydrogen-helium interactions, and pressure-induced absorptions in methane and nitrogen. Pressure-induced line shifts of selected species are needed for determining wind velocities. But as noted earlier, a study should be carried out initially to identify the species and spectral regions of greatest interest.

Spectra of cometary species at low pressure are desirable. The species of interest include CO_2 , ammonia, methane, water and many radicals and ions. Infrared data on radicals and ions are scanty, but can probably be usefully supplemented by ab-initio calculations. For cometary species, precise frequencies and line strengths are particularly important; they are needed for measuring velocity profiles and studying non-LTE conditions.

2. Line Positions and Quantum Identifications; Line Shifts

Line positions are adequately known for many species, apart from line shifts (discussed previously). But for a few species, additional work on line positions is needed. Methane and its isotopes are a notable case in point. Precise line positions are also of interest for cometary species.

Much additional work needs to be done in identifying the quantum transitions responsible for various lines in the highly congested spectrum of methane. The quantum identifications give qualitative and sometimes quantitative information on how a line or band will appear at different temperatures and pressures. Planetary astronomers are therefore reluctant to

use a line whose quantum identification is not established.

3. Line Strengths and Isotopic Effects

Line strengths were assigned fairly high priority, especially for methane and its isotopes. In some portions of the methane spectrum, there are serious discrepancies between strengths measured by different groups. A five percent accuracy for line strength measurement is desired. Accurate line strengths are also of interest for cometary species.

Line strength measurements must be made at high spectral resolution if they are to be reliable. Line strengths inferred from band strengths (which can be measured at lower resolution) have only limited reliability.

4. Relaxation Times

Relaxation times should be derived from spectral data whenever possible. They are useful in understanding strengths (including their temperature and pressure dependence), pressure broadening and non-LTE conditions.

5. Band Models

The continued usefulness of random band models was hotly debated at the Workshop.

Spectroscopists with access to high-resolution equipment felt that band models had been superceded by high resolution data much as the Bohr model of the atom had been superceded by quantum mechanics. According to this school, the use of random band models is an ad hoc technique, tricky to use correctly and subject to severe limitations (e.g., transmittances through successive atmospheric layers cannot be compounded), and had been used only for lack of something better. The "something better" is now available, in the form of high resolution data. Resources spent on these obsolete models could better be invested in high resolution work.

Planetary astronomers and spectroscopists who lacked access to high resolution equipment, however, felt that random band models were still useful.

Spectra obtained with high enough spectral resolution to resolve all features are still not available for some spectral regions for species of interest (notably, methane), and will not become available in the immediate future. Random band models are still necessary in these cases if planetary astronomy is not to simply forego using these spectral regions until the appropriate spectra become available. Admittedly, the detailed interpretation of a high resolution planetary spectrum requires a model of the temperature and pressure dependence of the lines, and therefore requires the quantum mechanical transitions to be identified for the individual lines. This is needed, for example, in deriving temperature and concentration profiles with good vertical resolution, by inverting the radiative transfer equation for nearly monochromatic radiances (the narrower the spectral band, the sharper the radiative transfer weighting function). Useful exploratory work can be done using low resolution planetary spectra, coupled with an inversion of the radiative transfer equation having low vertical resolution, and random band models can be useful in this kind of application. This is particularly relevant for difficult targets like Uranus, Triton, Neptune, and Pluto. Even when fully resolved spectra are available, band models may remain useful for some applications. They offer a compact representation of what may be an otherwise indigestible volume of detailed spectral information. For example, for some radiative transfer applications a line-by-line integration may be too slow and expensive when the spectrum is intricate and congested; as for example, in modelling the total atmospheric thermal balance by calculating the radiative flux at many atmospheric levels for a wide spectral region.

The conclusion was that random band models still serve a useful function, although their applications are fewer than before, and they have severe limitations (e.g., the failure of the multiplicative property for transmittances through successive atmospheric slabs).

6. Scattering

Apart from resonances, scattering becomes more important at shorter wavelengths. Thus it is quite important in the ultraviolet, the visible (e.g., the blue of the sky) and the near infrared, but is often unimportant deeper in the infrared. Its importance also depends on the spectral resolution. It is more important for nearly monochromatic radiative transfer calculations than for

broad band work.

In view of the great importance of scattering at short wavelengths, the Workshop was suspicious of atmospheric abundances derived from spectra in the visible and near infrared. In this region it is essential to take scattering into account in radiative transfer calculations. To resolve ambiguities (thicker or darker clouds versus greater molecular absorption), the original spectral measurements should be taken with this in mind, for example, by including a limb darkening curve in the continuum or data on center-to-limb variations. In very special cases, abundance ratios in the visible and near infrared may be determined without performing detailed scattering calculations: this requires finding two lines or bands for which the scattering process is the same. However, the list of conditions which guarantees this is difficult to verify, and in any case the method does not apply to most species of interest. For most species, the alternatives represent a choice between using model-dependent scattering calculations in the visible or near infrared versus working deeper in the infrared.

Several types of laboratory data would be helpful for scattering calculations. The refractive indices of the liquid phases are needed for calculating Mie scattering by aerosol droplets. Raman spectra are needed for comparison with Raman scattering by individual molecules in planetary atmospheres.

There is some uncertainty on how scattering should be incorporated into atmospheric transmissions calculated with random band models. Despite this uncertainty, useful first steps have been made in interpreting methane absorptions on the outer planets using band models together with scattering effects. Although it has a low priority, a short term experiment or theoretic project might be able to shed some light on this problem.

III. COMMUNICATION BETWEEN PLANETARY ASTRONOMERS AND SPECTROSCOPISTS

At this Workshop, discussions focused on a few topics and involved a large fraction of the participants throughout. Conferences typically do not lead to this type of interaction: small workshops provide a better format for this

purpose. Meetings of principal investigators on NASA planetary atmospheric tasks (PAPI) are also useful, as are special-purpose sessions at larger conferences. However, these latter types of meetings can spare only half a day or a single day to any narrow range of topics, whereas a small workshop can maintain its narrow focus for several days, allowing time for rumination and evolution. The advantages of the longer meeting duration and the greater time available for discussions (about half the total time) were clearly demonstrated in the present Workshop. Key problems could be identified by the way they emerged repeatedly in different contexts. Participants only gradually came to understand what the important differences in attitude were, and they had many opportunities to express ideas they hadn't been quick enough to express in earlier discussions.

The Workshop participants felt that workshops should be scheduled once every two or three years. Yearly workshops would be too intense and time consuming.

The small workshop involves questions of exclusiveness which are not completely resolvable, but are also not disabling. The desired topical focus and broad interaction simply cannot be achieved with more than about forty participants. Many who want to attend cannot be invited; inevitably there are hurt feelings. The small size of the workshop makes it more difficult to assemble a representative group, although the diversity of attitudes and backgrounds at the present Workshop demonstrates that it is possible. These problems are inseparable from the advantages of a small workshop. The group cannot be enlarged significantly without compromising its purpose.

IV. KEY PROBLEMS

Many of the key problems identified at the Workshop have been discussed in general terms. However, it is useful to collect here, those specific problems which were identified in the course of the Workshop. We therefore present the following list of some key specific problems identified by the Workshop. This tabulation is organized primarily by molecule, secondarily by spectral resolution and by its categorization as theoretical or experimental.

Experimental and theoretical studies of pressure-induced absorption in H_2-H_2 and H_2-He at temperatures from 50 to 300 K.

High-resolution measurements of pressure-induced H_2 $v=0 \rightarrow 2$ line, to search for pure quadrupole feature and intracollisional dip.

Analysis of HD quadrupole data.

Self broadening of H_2 quadrupole lines at high vibrational quantum numbers.

Strengths of nitrogen (N_2) quadrupole lines.

Spectra of CH_4 up to 17000 cm^{-1} (5900 \AA) under highest resolution available.

Low-temperature, 0.001 cm^{-1} -resolution studies of CH_4 and other hydrocarbons over the entire spectrum.

Temperature dependence of intensities of CH_4 combination bands in the 1 to $5\text{ }\mu\text{m}$ region.

Continue analysis of ν_4 CH_4 to resolve existing discrepancies and to account for new diode spectral line positions and intensities.

Develop theory to explain observed isotopic intensity anomalies in overtone spectra of $^{13}CH_4$ and $^{12}CH_4$.

Develop theory for quantum-number assignments to lines in high overtone and combination bands of CH_4 , e.g., $5\nu_3$, $4\nu_3 + \nu_1$, $6\nu_3$.

Measure simple-to-analyze CH_4 lines at short wavelengths. $5\nu_3$?

Perform a comprehensive study of CH_4 $3\nu_3$ interlopers.

Study CH_4 spectrum near 6190 \AA for a possible singlet.

CH₄ relaxation time for ν_3 and ν_4 .

Analyses of CH₄ spectra should be more closely tied to specific planetary problems.

Measure NH₃ line shapes, especially for 100 to 6500 cm⁻¹, and develop a theory explaining the observed shapes.

Measure PH₃ spectra at wavelengths shorter than 10 μm .

Measure spectra of sulfur-bearing and heavy hydrocarbon compounds for chemical and photochemical models; specifically S, H₂S, S₂, SO, S₂O, H₂S₂, H₂S_n, S_x, COS; C₂, C₄, C₄H₂, (C₂H₂)_n, (C₂H₄)_n, HCN, CS, CS₂; PH₃, PH, PH₂, P₂, P₄.

Take more laboratory spectra of sulfur dioxide SO₂ at high-resolution.

Measure overtone spectra of HCl, HF, HD, H₂, CH₄, etc.

Measure spectra of isotopic species HD, ¹³CH₄, CH₃D, ¹⁵NH₃, ¹³CO, C¹⁷O, H₂¹⁸O, etc.

Calculate ab initio models for radicals (e.g. CN, CH, NH, NH₂, PH, PH₂, HS, etc.)

Obtain spectra of molecules relevant for astronomers.

Obtain laboratory spectra of potential atmospheric molecules, for "reconnaissance."

Laser spectroscopy should be used to obtain high-resolution, low-temperature, pressure-broadening results; corresponding quantum-mechanical calculations should be done.

Support ultra-high-resolution laboratory facilities as well as high-resolution observing programs.

Support Fourier transform spectroscopy for short-term needs; laser spectroscopy for long-term.

Do heterodyne spectroscopy.

Strongly support oncoming technology.

Do not support measurements with inferior or nearly obsolete technology.

Make measurements of line strengths, widths, and shifts at 5% precision.

Define areas where line-shift measurements are needed.

Make careful linewidth measurements in well-defined ranges of pressure and temperature.

Do experimental work on line shapes, especially in the overlap region.

Do experimental and theoretical work on scattering phenomena.

Measure spectra of hot and cold solids, under simulated planetary conditions.

Measure moderate-resolution spectra of ices and frosts.

Acquire low-pressure laboratory data for cometary species at predicted conditions.

Reduce existing data to a point "useful" to astronomers.

Support predictions for hard-to-measure species using all possible techniques, including ab-initio quantum-mechanical methods, e.g., atomic polar tensors.

Develop complete theories for pressure broadening; include elastic and inelastic effects, overlapping lines, etc.; apply to a system like NH_3 .

Perform close-coupling calculations for rotational-translational cross-sections and for line shapes parameters.

Make predictions for temperature dependence of spectra.

Perform calculations of hot-band spectra.

Do more work on theory of overtones.

V. CENTRAL SPECTROSCOPIC DATA DEPOSITORY AND PROGRAM LIBRARY

Central Spectroscopic Data Depository

A central collection of spectroscopic data would be useful to both spectroscopists and atmospheric scientists. It would collect, evaluate, arrange and disseminate experimental data and inferred quantities (line widths, strengths, and molecular constants). That is, it would comprise molecular line atlases containing spectra of species of interest in planetary atmospheres (for various combinations of temperature and pressure), as well as collections of derived and theoretical spectral and molecular properties, and an information exchange. In particular, it would provide a fast, reliable source for determining the current and prospective status of spectroscopic knowledge on particular molecules.

A. Reasons for Having a Spectroscopic Data Collection

From the point of view of the planetary atmospheric sciences, there are several arguments in favor of a spectroscopic data collection.

1. An enormous volume of spectroscopic data is needed by the planetary atmospheric sciences. There are three reasons for this. First, a wide variety of temperatures and pressures are encountered in planetary atmospheres, and our current ability to extrapolate spectra over large temperature and pressure ranges is limited. Spectra at various temperature-pressure combinations are therefore needed. Second, some kinds of information can only be obtained by working at very high spectral resolution. Wind speeds and departures from local thermodynamic equilibrium are examples; high resolution increases the volume of spectral information to be handled. Third, trace species are often important in chemical chains, in particular in verifying photochemical models and for understanding cloud colorations, and the abundances of less common isotopes are of interest for theories of planetary formation and cosmology. Inclusion of trace species and various isotopes further increases the volume of spectroscopic information to be handled.

2. At present, determining the current and prospective status of spectroscopic knowledge on a particular molecule is an inefficient, haphazard affair. A

person polls the colleagues he can think of, and attempts a literature search. This time consuming and often unreliable approach would be eliminated by a spectroscopic data depository. In particular, the depository would provide a way of finding out who has recently worked on a particular molecule, who is working on it currently and might have preliminary data, and who might be willing to acquire needed spectroscopic information.

3. The AFGL molecular line atlas is heavily used, and has already demonstrated the usefulness of such a data collection (the possible relations between the proposed collection and the AFGL atlas will be discussed presently). Larry Givers' information exchange at NASA/Ames has also proven its value.

These arguments are made from the point of view of the atmospheric sciences. From the point of view of spectroscopy itself, these arguments continue to apply with undiminished force, although the direction of the first argument (volume of data) becomes slightly altered. The new high resolution techniques threaten to swamp the spectroscopist with wonderful high quality (possibly definitive) data. A uniform scheme for storing these data on tape would aid in comparing data taken by different experimenters, in flagging discrepancies, and in guaranteeing the data's permanent availability even if the experimenter moves on to other areas.

B. Disputes and Concerns

There was no dispute about the desirability of a spectroscopic data collection, but there was a great deal of discussion and concern about its implementation.

Most of the discussions and concerns related to the scope of the data collection. Should it contain only data of interest to the planetary atmospheric community or should it contain data selected according to broader criteria? Should it contain infrared data only, or also microwave and millimeter data? Should it contain data for gases only, or also condensed phases? Should it contain preliminary data as well as published data?

1. The Community Served by the Collection

If the spectroscopic data collection is designed primarily to serve the

planetary atmospheric sciences, its source of funding will be more limited than if it were designed to serve a broader community. On the other hand, as soon as it becomes interdisciplinary it becomes interagency, and it is likely to walk away from the relatively small planetary atmospheric community. The agencies likely to be interested are NASA, NOAA, NSF, NBS, DOE and the USAF.

The choice between a narrow or a broad community of users is therefore likely to affect or even pre-determine the answers to many other questions: the priorities for entering various species (and temperatures and pressures) into the data base; wavelength range; gas phase versus condensed species; inclusion of (flagged) preliminary data; and who will critically evaluate the data. If a broad scope and interagency funding are selected, special care will be needed to assure that the planetary atmospheric community retains a voice on these issues, since conflicting priorities are likely. The planetary atmospheric community would need to be able to influence the data collection on a continuous basis, not just in its initial phases.

A particular instance of this question is the relation of the proposed spectroscopic data base to the AFGL Molecular Line Atlas. Although the AFGL Atlas is very useful, there are two reasons for not making the proposed data base merely an extension of it. First, the AFGL format is not the most useful one for astronomers. Second, the Air Force is unlikely to support the large amount of work that will be required to enter data on lines having no (or only indirect) application to the Earth's atmosphere.

2. Wavelength Range

Information useful to the atmospheric sciences is contained in the microwave and millimeter regions as well as the infrared, as discussed by H. Pickett at the Workshop. In particular, molecular constants determined from measurements in this region can be used to predict or to constrain predicted spectra in the infrared. If this region is to be included in the data base, the JPL Submillimeter, Millimeter and Microwave Spectral Line Catalog may provide useful experience with the advantages and disadvantages of various data formats in this region. Alternatively, the existence of this Catalog can be regarded as removing the need for including this region in the proposed data base, as long as some mechanism exists for incorporating into the data base molecular

constants derived from this region.

3. Condensed Phases

Clouds are prominent in the atmospheres of Venus, Earth, Jupiter and Saturn. In particular, there is a possibility of a "mode 0" haze on Venus, with unexpected scattering properties. Therefore the data collection might include spectra of liquid droplets, "snow" crystals and solids. Spectroscopists working in non-astronomical applications already have some of these data.

4. Inclusion of Preliminary Results

Although preliminary data (in particular, unpublished data) have not been reviewed critically, the sentiment at the Workshop was that they should be included but be identified as preliminary in nature. Users could then judge for themselves to what extent they wish to base their own work on preliminary results. They would thus have the opportunity to treat these data exactly as they would treat a preprint. Like preprints, inclusion of preliminary data would notify the community of work in progress on a particular molecule, and would make the information available much sooner than regular publication. Such preliminary data can be useful in exploratory research. The use of such data represents a compromise between reliability and speed, but as long as the data are flagged to indicate the degree of reliability (e.g., "first cut" versus "submitted for publication" versus "published"), the decision to use them should be left to the discretion of the user. The choice is not between preliminary data and critically evaluated data, since both have their uses.

5. Inclusion of Reduced and Theoretical Results

Line widths and line strengths determined from measurements by extensive data reduction (such as the use of fitting programs) should be flagged, to distinguish them from similar quantities determined almost directly from high resolution data. Spectral quantities and molecular constants determined by primarily theoretical means should also be flagged.

6. Miscellaneous Issues

Since the data collection will include critically evaluated data and

molecular constants, mechanisms are needed for involving scientists on a continuing basis.

The data base must credit authors with their work, even for preliminary results.

The most convenient form for submitted data would be in machine readable form, in the format specified by the data collection. In the interest of receiving as much data as possible, experience with the AFGL Atlas suggests that it would be unwise to insist on the data arriving in this form, however. In any case, a large body of existing data would have to be converted into whatever format the data collection decides to use. This will require data entry, programming and extensive proof-reading.

Data will be disseminated in the time-honored fashion of large data catalogs. The user will submit a blank tape, and the requested portions of the catalog will be loaded onto it. There might be a need for the data collection to provide the user with programs that will allow portions of the catalog to be printed. Alternatively, the user would simply be provided with the data format.

For the molecular line atlas, methods must be devised for merging portions of spectra obtained at various temperatures and pressures, and for making information on temperature and pressure dependence available in a digestible form.

Spectroscopic Program Library

Both in spectroscopy and in planetary atmospheric science, certain calculations requiring large computer programs are needed by almost every research group. These include programs for many-parameter fitting calculations, for certain types of data reduction, for molecular structure calculations, for direct and inverse radiative transfer calculations, and programs for listing portions of data from the proposed national spectroscopic data base. A program library of this type would avoid the need for the research group to scout around for an existing program at another institution, or to bear the time and expense of developing its own.

There are additional problems associated with this proposal:

Would the proposed program library pre-test and certify its programs, and offer to maintain them? The alternative is for the program library to merely supply them, with a shrug of its shoulders and a vague caveat.

Particularly in a large, complex program, errors are likely to lurk along never-before traversed paths through the code, or accuracy will degrade with sneaky gradualness as some assumptions of the program cease to be met. To avoid this problem, it would be desirable for the library to have several independently written programs for each type of computation, preferably based on different techniques.

VI. NATIONAL CENTER FOR SPECTROSCOPIC RESEARCH

A national center for spectroscopic research was proposed at the Workshop, but was not favorably received.

In the broadest sense, the controversy was between "big" science (a few large, advanced facilities, absorbing much of the funds available for spectroscopic work) and "little" science (many small research groups using disparate and not always advanced technologies). Molecular spectroscopy is presently a little science, in contrast to big sciences such as experimental high energy physics, space research, fusion research, radio astronomy and mainline optical astronomy. Implicitly, the questions were:

- o Does spectroscopy have to become a big science to take advantage of the newly emerging technologies? Is such a change necessary to obtain definitive spectroscopy and the types and quantity of information planetary astronomers want (spectra obtained at difficult temperatures and pressures, and at really long path lengths, with resolution high enough to resolve all spectral features including work on scarce or dangerous species), and to give accurate line shapes, strengths and shifts?

- o If the answer to the foregoing question is not overwhelmingly "yes", would the disadvantages of becoming a big science outweigh the advantages?

As proposed, the facility would operate along the lines of large optical and radio observatories (such as Kitt Peak and the Very Large Array), or the International Ultraviolet Explorer (IUE) observers' facility, or a large particle accelerator. A resident staff of scientists and engineers would assemble and maintain the equipment and advise visiting scientists. There might be a few theorists on the resident staff, as well. In addition to computers for data acquisition and reduction, the equipment might include computers and software for large-scale number crunching, e.g. calculations of molecular structure and spectra, collision cross sections, simulated spectra from planetary atmospheres, and presumably a spectroscopic data catalog. (Indeed, the spectroscopic research center would be a candidate home for the proposed

national spectroscopic data base and program library discussed in section V.) The proposed center would not be a service organization, providing calibrated spectra complete with error bars and an analysis of systematic errors; rather, it would be a national facility intended primarily for use by visiting scientists.

In favor of the proposed center, it was argued that there is presently no research group with the equipment and manpower capable of providing the amount and quality of spectroscopic information desired by the planetary atmospheric sciences. Although the wish-list developed at this Workshop has not yet been compared in detail to current capabilities, there is clearly some truth in this assertion. Long, cooled absorption cells and high-resolution instruments both exist, but not at the same location (for example, see the talk by Silvaggio at this Workshop). Also, spectra at low temperatures emerged at the Workshop as a key need; but groups working with different equipment at different locations will measure different spectral intervals for different conditions of temperature, pressure and path length. These spectral intervals will have to be pieced together somehow to yield a comprehensive spectrum (for generating synthetic spectra, for evaluating the effects of temperature, and for inclusion in a spectroscopic data base). Experiments at high pressure (and for Venus, high temperature) with perhaps explosive or toxic materials tax the resources of small and medium size institutions*. Finally, a small research group does not have the manpower to keep a large, expensive instrument busy (this same problem arises with large computers and particle accelerators).

*This is illustrated by a quote from Treffers et al., *Icarus* 34, 331 (1978): "Acquiring spectra of some of these gases was not entirely routine. Almost every gas in Table II is flammable or poisonous, or both; all smell. Silane, for example, is spontaneously flammable in air and serves as an excellent leak detector. While everyone is aware of the poisonous nature of HCN, few people realize that AsH_3 and GeH_4 are about 200 times more toxic. In view of these dangers, some of our laboratory experiments were as remotely sensed as the planetary observations in that they were conducted on the roof while observing the instrumentation through binoculars."

The following objections were raised against the proposal.

1. Cross Checking of Results. A national center is likely to reduce the amount of cross checking of results, and thus delay the discovery of discrepancies. In the present decentralized arrangement it is relatively easy for different groups to measure the same region of the spectrum with similar or different equipment, and the measurements are quite independent. But to a central administration such work is likely to look like mere duplication of effort unless a discrepancy has already become apparent, especially in the face of other pressing demands for access to the equipment. Thus, the center would help in resolving discrepancies, but not in bringing them to light. Furthermore, checks carried out on the same apparatus (or even with a different spectrometer but the same absorption cell) are not really independent. This is especially likely to happen if the center is pushing the state of the art in spectroscopic equipment, and has the best apparatus available for the spectral region in question. Checks carried out by other institutions will also be reduced. An institution whose apparatus is good, but not as good as that at the national center, is unlikely to invest the resources needed to repeat work in a spectral region already covered by the more prestigious apparatus. Although the same issues arise in connection with the proposed program library (section V), they are less severe in that case, because of the smaller investment typically involved.

2. Diversity and Creativity. Novel approaches and unfashionable research topics thrive best in a de-centralized arrangement. In funding innovative work, an administration sticks its neck out to some extent. When there are many independent sources of funding, there are many administrators each willing to risk an occasional project that might fail, and each is sympathetic to different unconventional ideas. Someone with a good idea has a good chance of getting funding if he is willing to knock on all doors. This would be less true for the proposed national center. Even if the center's administration were sympathetic to new ideas, research groups with tested techniques, fashionable, important-sounding objectives and guaranteed fruitfulness will always be clamoring for access to its unique and expensive facilities. And no matter how sympathetic it wants to be to new ideas, one group of administrators cannot have as wide a range of sympathies as many independent groups would.

3. Concentration of Funds. A large fraction of the money available for

spectroscopic work would be funneled into the national center. The center would therefore absorb funds that would otherwise have been used for acquiring and enhancing equipment elsewhere. Because of its large capitalization and high visibility, the national center would have first call on spectroscopic funds. Experience shows that if the national center experienced unexpected cost over-runs, they would be made up from whatever funds had been left over for other groups. Taken together, these factors imply the eventual obsolescence and withering of independent research groups.

4. Clout. Would the national center support all kinds of spectroscopic research, or just research directed toward the planetary atmospheric sciences? The former is more likely; industry and other agencies would be asked to participate, both to win Congressional approval and to broaden the base of funding. But then the relatively small community of planetary astronomers will soon count for little in the center's operations. The center's administrators would not relish having to explain to Congress why so much time was allotted to work of use only to planetary astronomers when DOE and industry urgently needed to carry out energy-related research, and DOD and industry wanted to carry out research related to the national defense.

A closely related issue is staffing. Resident astronomers are easy to justify at facilities like IUE, the Very Large Array or the Space Telescope, which were created specifically for astronomical work. They would be harder to justify at a center concerned primarily with spectroscopy, especially for a broad range of applications.

These issues emerge again in less severe form in section V, which discusses the proposed national depository for spectroscopic data.

5. Travel Funds. In the national laboratories for high energy physics, research groups pay for travel to the national facility out of their research grants. When funding is tight, travel money is the first to be cut. Many groups not located close to a national laboratory find that they cannot travel to the facility very often. This has actually become the limiting factor for some research groups.

It is hard to imagine a method of disbursing travel funds that will not

discriminate against geographically distant research groups. Whether the travel funds are provided by an agency or by the national laboratory as part of its grant of permission for access to the facilities, the total travel money will be limited. Consciously or unconsciously the source of travel funds will favor groups that do not require large amounts of travel money, unless the funds for different distance zones are kept in separate pots.

6. The Rhythm of Research. The rhythm of spectroscopic research would change to that typical of visitors to national facilities in other fields. The main problem here occurs when analysis of the data shows additional measurements to be needed. The research group might have to work on other things while waiting for renewed access to the facility.

7. The Centralization of Experimental Competence. One of the advertised benefits of the proposed center is that the resident staff would lend its expertise to visiting scientists, sparing them from having to become thoroughly familiar with the equipment. But this benefit carries the seeds of possible future problems. Only those who have built an apparatus are likely to be aware of its more esoteric problems: the variations between different calibration runs; especially large irregular variations in output at certain configurations of the mechanical elements; the changes that occur as gaskets age. Thus, systematic errors may become more likely in the reduction and interpretation of data. Experienced scientists in other fields (large telescopes, high energy physics) might be able to say whether this is a realistic worry or not. In any case, the population of scientists thoroughly familiar with the development and operation of advanced spectroscopic equipment would decrease.

Although no formal poll was taken, the sentiment at the Workshop was against the proposed national center. Specifically, the participants were not convinced that spectroscopy had to become "big" science to accomplish its present goals, and that given the option, they would prefer to avoid the disadvantages of bigness.

An interesting proposal was mentioned by K. Fox and appears capable of providing many of the advantages of a national center for spectroscopic research, without most of its disadvantages:

"Instead of a national center, could a consortium of existing facilities be

organized into a more directed program? This alternative would preserve diversity of approaches, wider distribution of funding, addition of good facilities as needs arose; and maintain competition among facilities, which sometimes is an important factor."

1. Report No. CP-2223	2. Government Accession No.	3. Recipient's Catalog No.	
4. Title and Subtitle Vibrational-Rotational Spectroscopy for Planetary Atmospheres - Volume II		5. Report Date April 1982	
		6. Performing Organization Code 693	
7. Author(s) Michael Mumma, Kenneth Fox, and John Hornstein		8. Performing Organization Report No. 82B0303	
9. Performing Organization Name and Address Goddard Space Flight Center Greenbelt, Maryland 20771		10. Work Unit No.	
		11. Contract or Grant No.	
		13. Type of Report and Period Covered Conference Publication	
12. Sponsoring Agency Name and Address National Aeronautics and Space Administration Washington, D.C. 20546		14. Sponsoring Agency Code	
15. Supplementary Notes			
16. Abstract <p>Volumes 1 and 2 contain the proceedings of a Workshop on Vibrational-Rotational Spectroscopy relevant to the study of planetary atmospheres. The Workshop was organized by co-chairmen, Michael Mumma, NASA, Goddard Space Flight Center, and Lloyd Wallace, Kitt Peak National Observatory, and by Kenneth Fox, University of Tennessee, and Virgil Kunde, Goddard Space Flight Center, with the sponsorship of NASA Headquarters. The Workshop was held in Annapolis, Maryland, March 17-19, 1980. The Workshop participants included experts in the areas of planetary atmospheres, radiative transfer, molecular structure, photo-chemical modeling, laboratory spectroscopy, and remote sounding.</p> <p>These volumes contain the scientific papers presented by the 39 invited speakers, the edited discussions which followed each paper, the transcriptions of a panel discussion on planetary observations from space in the next decade, an executive summary of recommendations for needed support, and a detailed summary of the working session.</p>			
17. Key Words (Selected by Author(s)) Planetary Atmospheres Vibrational Spectroscopy Molecular Spectra Infrared Spectroscopy		18. Distribution Statement Unclassified-Unlimited Subject Category 91	
19. Security Classif. (of this report) Unclassified	20. Security Classif. (of this page) Unclassified	21. No. of Pages 352	22. Price* A16

*For sale by the National Technical Information Service, Springfield, Virginia 22151.

National Aeronautics and
Space Administration

Washington, D.C.
20546

Official Business
Penalty for Private Use, \$300

SPECIAL FOURTH CLASS MAIL
BOOK

Postage and Fees Paid
National Aeronautics and
Space Administration
NASA-451



NASA

POSTMASTER: If Undeliverable (Section 158
Postal Manual) Do Not Return
