

INTEGRATED CIRCUITS LABORATORY



STANFORD ELECTRONICS LABORATORIES
DEPARTMENT OF ELECTRICAL ENGINEERING
STANFORD UNIVERSITY · STANFORD, CA 94305

TRDXG562-F

Final Report on
Implantable Telemetry
for Small Animals

1 December 1980 - 30 November 1981

This work was supported by
a Cooperative Agreement from the
National Aeronautics and Space Administration
No. NCC 2-38

Issued to
Stanford Electronics Laboratories
Stanford University
Stanford, California 94305
Dr. James D. Meindl, Principal Investigator
Professor, Electrical Engineering

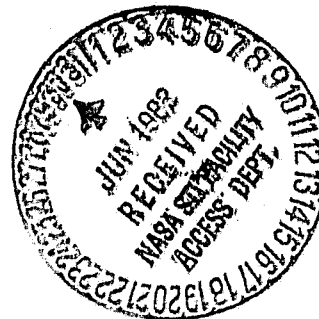

(NASA-CR-169087) IMPLANTABLE TELEMTRY FOR
SMALL ANIMALS Final Report, 1 Dec. 1980 -
30 Nov. 1981 (Stanford Univ.) 41 p
HC A03/MF A01

N82-26375

CSCS 09F

Unclas

G3/17 28214

UNCLASSIFIED

SECURITY CLASSIFICATION OF THIS PAGE (When Data Entered)

REPORT DOCUMENTATION PAGE		READ INSTRUCTIONS BEFORE COMPLETING FORM
1. REPORT NUMBER TR DXG562--F	2. GOVT ACCESSION NO.	3. RECIPIENT'S CATALOG NUMBER
4. TITLE (and Subtitle) Implantable Telemetry for Small Animals		5. TYPE OF REPORT & PERIOD COVERED Final 1 December '80-30 November '81
7. AUTHOR(s)		6. PERFORMING ORG. REPORT NUMBER TR DKG562
9. PERFORMING ORGANIZATION NAME AND ADDRESS Stanford Electronics Laboratories Stanford University Stanford, California 94305		8. CONTRACT OR GRANT NUMBER(s) NCC 2-38
11. CONTROLLING OFFICE NAME AND ADDRESS NASA University Affairs Office, 241-25 Ames Research Center, Moffett Field, CA. 94035		10. PROGRAM ELEMENT, PROJECT, TASK AREA & WORK UNIT NUMBERS
14. MONITORING AGENCY NAME & ADDRESS (if different from Controlling Office) NASA Technical Officer H. Sandler Biomedical Research Division 239-8		12. REPORT DATE March 1982
		13. NUMBER OF PAGES
		15. SECURITY CLASS. (of this report) Unclassified Unrestricted
		15a. DECLASSIFICATION/DOWNGRADING SCHEDULE
16. DISTRIBUTION STATEMENT (of this Report) Distribution unlimited		ORIGINAL PAGE IS OF POOR QUALITY
17. DISTRIBUTION STATEMENT (of the abstract entered in Block 20, if different from Report)		
18. SUPPLEMENTARY NOTES The cooperative agreement is awarded under grant No. NCC2-38, issued by NASA, California.		
19. KEY WORDS (Continue on reverse side if necessary and identify by block number) Implantable telemetry, chronic, CW Doppler ultrasonic flowmeter, aortic blood flow, aortic pressure, dye dilution calibration, cardiac pacing		
20. ABSTRACT (Continue on reverse side if necessary and identify by block number) A series of totally implantable telemetry devices for use in measuring deep body parameters in small animals have been developed by the Stanford Center for Integrated Electronics in Medicine. Under a collaborative agreement with NASA, several of these systems; the continuous wave (CW) Doppler ultrasonic flowmeter, the multichannel telemetry system (MTS), and the inductively-powered dual channel cardiac pacer were evaluated in a series of ten mongrel dogs (15-20 kg.). These systems were		

DD FORM 1473
1 JAN 73EDITION OF 1 NOV 65 IS OBSOLETE
S/N 0102-LF-014-6601

UNCLASSIFIED

SECURITY CLASSIFICATION OF THIS PAGE (When Data Entered)

UNCLASSIFIED

SECURITY CLASSIFICATION OF THIS PAGE(When Data Entered)

used to measure ascending aortic and coronary blood flow, aortic pressure, and subcutaneous EKG. A computer-assisted indicator dye dilution technique for measuring cardiac output was developed in order to calibrate the CW aortic flowmeter.

Four of the ten dogs died during surgery. Of the six surviving surgical and post-op complications, the first two had hardwired (backpacked) CW aortic and coronary flowmeters, aortic pressure and EKG (MTS), and a single channel pacer. The remainder had a totally implanted CW aortic flowmeter, MTS for recording DKG, and a dual pacer.

Only two of the four telemetry dogs were run through the dye dilution/calibration protocol. A total of six calibration points were made, indicating that the CW flowmeter tracked the estimated cardiac output within a factor of two (pacers were used to provide a constant heart rate).

ORIGINAL PAGE IS
OF POOR QUALITY

SECURITY CLASSIFICATION OF THIS PAGE(When Data Entered)

TABLE OF CONTENTS

A. Introduction	1
B. Technical Report	
1) Instrumentation	2
2) Animal Preparation	12
3) Discussion	14
4) Summary	16
C. References	17
D. Personnel	18
E. Tables and Figures	28

ORIGINAL PAGE IS
OF POOR QUALITY

FINAL REPORT
ON
IMPLANTABLE TELEMTRY
FOR
SMALL ANIMALS

1 DECEMBER 1980 - 30 NOVEMBER 1981

This work was supported by
a cooperative agreement from the
NATIONAL AERONAUTICS and SPACE ADMINISTRATION
No. NCC 2-38

James D. Meindl
Stanford Electronics Laboratories
Stanford University Stanford, California

A. Introduction

The Biotelemetry Project of the Stanford Center for Integrated Electronics in Medicine has developed a series of totally implantable telemetry systems for the chronic measurement of deep body parameters in small animals. Under a collaborative agreement with the cardiovascular research lab at NASA-Ames, the continuous wave (CW) Doppler ultrasonic flowmeter, the multichannel telemetry system (MTS), and the inductively powered cardiac pacer were evaluated in a series of ten mongrel dogs. The devices were used to measure ascending aortic and coronary blood flow, aortic pressure, and myocardial biopotentials.

The purpose of this evaluation was threefold. The first was to develop the surgical procedures required to successfully instrument an intermediate-size animal with the various probes and implantable packages. The second objective was to determine the accuracy of the CW flowmeter using a computer-based indicator dye dilution technique for cardiac output. The third objective was to evaluate the overall system performance in smaller animals, including primates, in 24 hour or circadian period monitoring protocols.

The implant strategy consisted of an initial phase using hardwired, backpacked telemetry. This would facilitate the evaluation of probe placement techniques. A second phase followed in which the animals had all of the telemetry electronics totally implanted.

B. Technical Report

1) Instrumentation

CW Doppler Flowmeter

Figure 1 is a block diagram of the basic implantable CW flowmeter. A high-frequency oscillator drives a transducer on one side of a vessel; a second one on the opposite side receives the Doppler returns, shifted in frequency by an amount proportional to the velocity of blood at the intersection of the two beam patterns. These returns are amplified and then heterodyned in two mixers driven by local oscillators differing only in phase (Δ phase = 90°). The two resultant signals are the difference frequency at an arbitrary phase and the difference at the arbitrary phase plus the Δ phase. Directional sensing is retained by the characteristics of the sine and cosine functions

$$\begin{aligned}\cos(-2\pi f_D t) &= \cos(2\pi f_D t) \\ \sin(-2\pi f_D t) &= -\sin(2\pi f_D t) \quad (5).\end{aligned}$$

These two baseband Doppler shift signals are multiplexed together in a format almost identical to the stereo composite for commercial FM stations and transmitted across the skin on an FM carrier in the TV band; demultiplexing is accomplished by a commercial stereo decoder (LM 1800), and the two signals are then heavily attenuated below 100 Hz and above 16 kHz. The quadrature zero-crossing counter compares the phase of the two channels and measures their frequency to produce a bidirectional frequency estimate directly related to flow velocity. The calibration figure is 1.0 kHz equals a velocity of 26.7 cm/sec.

This CW flowmeter requires an ultrasonic oscillator capable

of delivering 10 mW into the exciter transducer, an ultralow noise receiver to amplify the weak returns (0.7-7.0 μ V rms), a multiplexer oscillator, and several stages of gain and filtering must be incorporated into the implanted package. Most of these blocks are also essential in pulsed Doppler applications so that, except for the FM link, only two ICs (a timer-exciter and a Doppler receiver) are necessary in either system if care is taken in the layout of the circuits.

The actual implanted system was modified to enhance its reliability and to reduce its size. The older package (fig. 2a), based on a kitchip (1) IC approach, represents a low level of integration requiring packaging of the FM telemetry link in a separate case. The total volume of this electronics system is 5.0 cm^3 with a parts count of 6 integrated circuits, 17 capacitors, 3 inductors, 3 transformers, 1 resistor, and 1 crystal.

More sophisticated IC signal processing has produced the first prototype of the miniature flowmeter in figure 2b. Electronics volume has been reduced to 1.5 cm^3 , and the total component count has dropped from 30 to 14, including the replacement of 6 circuits and 12 capacitors with 3 ICs which obviate the need for a crystal-controlled oscillator. This 2.5X1.5X0.4 cm package facilitates the implantation of multiple systems in the same animal and is the size required for the research of small laboratory animals.

Figure 3 illustrates the implant package of the older version of the CW flowmeter; the new prototype differs only in the size of the electronics package (one third less). The power pack (2)

can be reduced in volume because of the lower power consumption of the new circuitry, or when the protocol requires a relatively small amount of data. As the battery pack and power switch are configured, an on-time of 100 h is possible and represents 1,200 separate 5-min data sessions, or one reading per day for over 3 years.

Two transducers have been realized for CW applications (fig. 4); both have wide bandwidth, highly efficient piezoelectric elements with $Q = 3$ and a round-trip attenuation (or insertion loss) of 6-8 dB. Developed initially for pulsed applications, the transducer is also of value in CW flowmeters because it minimizes power consumption and its low Q facilitates tuning. The transducer in figure 4a (designed for small vessels such as the coronary arteries) enables near-uniform illumination of the vessel with ultrasound and produces a good estimate of spatial average velocity. No assumption regarding the velocity profile is required to estimate volume flow because the entire cross-section of the vessel is illuminated (3). For large vessels (greater than 3-4 mm), uniform illumination becomes impractical; instead, 2-mm square transducers are placed on opposite sides to measure centerline velocity. The transducers are molded into assemblies that can be used with cuffs of varying sizes (fig. 4b). At the time of implant, the surgeon selects the size corresponding to the outside diameter of the vessel, cements the inserts into the cuff, and places it around the vessel. A precision alignment of beam patterns is possible with this approach, thereby ensuring a known angle and a constant transfer coefficient

between the ultrasonic drive and Doppler return. Note that the ultrasonic CW flowmeter has low angle sensitivity when the transducers are placed on opposite sides of the vessel because the Doppler equation is

$$f_D = f_0 V (\cos \alpha + \cos \beta) / c = kV$$

where c = velocity of sound in blood, V = velocity of blood, f_0 = ultrasonic frequency, α = angle between exciter beam and flow vector, and β = angle between receiver beam and flow vector.

In a fixed cuff, α and β are coupled so that an increase in α reduces β . For α and $\beta = 60^\circ$, a $\pm 15^\circ$ variation in the flow vector produces a change in the Doppler scale factor of only $\pm 3.4\%$ compared to a 40% variation for α or β alone.

Multichannel Telemetry System

The multichannel telemetry system (MTS) was designed (4) to meet the following specifications: (1) ability to measure any combination of parameters up to six channels and to activate such devices as pressure transducers, (2) input bandwidth of 200 Hz and sensitivity of 10 μ V, (3) self-calibration and zeroing with independent zero and calibration for each channel, and (4) total power consumption of less than 5 mA at 2.7 V. Figure 5 is a block diagram of the MTS. Six separate input amplifiers convert the voltage signals from the transducers into currents, and these currents are injected sequentially into a current-controlled oscillator (CCO). The output of the oscillator is then divided down in the CMOS timing chip to determine which input channel is ready for the injection of current and to generate a sync signal to identify channel 1.

As illustrated in figure 6, eight channels are multiplexed together - six for data, one for zeroing, and one for calibration. Each channel is turned on for two complete cycles of the CCO; a half-cycle on each end of this period serves as a buffer for setup time, and one cycle is used for data measurements. A key feature of this approach is the single oscillator used for both multiplexing and data encoding.

Typically, a fixed-frequency oscillator sets the multiplexing rate, and the information is then encoded in the duty cycle of the oscillator (5). This approach produces a constant sampling rate and, theoretically, a slightly lower telemetry bandwidth because the sampling rate is not a variable. To achieve the maximum dynamic range in the telemetry link, these systems operate with a duty cycle as low as 10% which translates into a transmission bandwidth in excess of 100 times the sampling frequency. The following two problems are encountered: (1) the input data must never over- or under-range the duty cycle; otherwise, both the active channel and the subsequent channel will be lost, and (2) additional implanted electronics are required for a linear data/duty-cycle conversion.

The MTS is not affected by the first problem because the circuit remains on each channel long enough to obtain the data. If the channel is saturated toward one extreme, the dwell time is merely doubled over its normal value; if it is saturated in the opposite direction, the time decreases toward zero but is limited by the maximum frequency of oscillation in the circuit. No additional circuitry is necessary; unlike earlier systems,

only a single timing capacitor is required for data processing and multiplexing. This is an important factor and of concern in implantable systems where each chip capacitor may need as much room on the substrate as the integrated circuits with which it may function.

Figure 7 shows the hybrid substrate interconnecting the three integrated circuits used to realize this system. The CMOS timing chip (a CD4022) is a Johnson divide-by-eight decoder; the telemetry is implemented by either pulse code or frequency modulation, and the IC transmitter in figure 7 is configured for operation in either mode (6). A custom IC designed for signal processing contains all six input stages and calibrate circuitry, the CCO, and a divide-by-two that enables the circuit to remain on each channel for two complete cycles of the CCO. The nominal operating range of the CCO is 10-15 kHz which produces a minimum sampling frequency per channel of 625 Hz and a Nyquist frequency of 312 Hz which exceeds the above frequency specification. These values can be adjusted by changing the timing capacitor. The substrate in figure 7 is configured for three differential EKGs, two pressure signals, and one uncommitted channel. The system could be equally well configured for five pressure signals and one EKG by varying the substrates; the ICs do not need to be modified. The finished package for the transmission of three electrograms and one pressure signal is illustrated in figure 8. Its electronics measure 2.7X3.8X0.8 cm (a reduction of 2 in volume has been realized in the hybrid package).

Power for the implant is supplied from a lithium-iodide power cell actuated by a micropower control switch contained in the cylindrical package in figure 8 (6).

A number of transducers have been used to interface with the MTS. Simple electrogram probes measure regional activity, and the plaque electrode localizes sensors on the surface of the heart. The bundle of HIS electrodes has enabled researchers to monitor low-level ($20 \mu\text{V}$) signals after the probe has been sutured in place during open-heart surgery (7). Commercially available 7 mm titanium pressure transducers have obtained the majority of pressure telemetry data; however, experimental fully integrated silicon devices have the distinct advantage of smaller size (2 mm diameter) for the same scale factor. These miniature pressure transducers are easier to implant but, because they are still in the developmental stage, they are less reliable than the best titanium transducers. The final transducer is a simple thermistor for monitoring deep-body temperatures. Other devices that can be or have been interfaced with the telemetry package include Chemfets (8) and silicon strain gauges and accelerometers.

The major element in the realization of the MTS is the 3 X 3 mm custom IC in figure 9. This chip contains over 104 transistors and 75 resistors and draws only $400 \mu\text{A}$ at 2.7 V. The large number of bonding pads on this circuit is the result of the independent zero and calibration adjustments required in each channel (three pads) and the need for differential inputs (two pads) plus a control-line pad to the CMOS multiplexer and power-switch pad for activating high-current devices such as pressure

bridges. Of the 54 bonding points on the IC, 42 are required on the six channels..

The Inductively Powered Cardiac Pacer

The inductively powered cardiac pacer consists of an untuned coil attached directly to a passive half wave rectifier (fig. 10). An output coupling capacitor, as normally found on commercial pacemakers to prohibit any DC current, is not used because of the inability of the rectifier to produce a biphasic pulse. Tissue damage (as assessed by pacing thresholds) and electrode plating have appeared minimally in implants ranging from 3-6 months.

A dual channel (two half-wave rectifiers) version of the pacer is shown in figure 11. A primary coil held within 2-3 cm. of the implanted secondary coil supplies bursts of 500 kHz RF energy. The timing, duration and amplitude of these RF bursts define the DC stimulating pulse characteristics. Since the pacer is a passive device, its output can be regarded as a constant power source. Thus, when using a constant burst width and coupling arrangement, the peak to peak amplitude of the RF burst defines a practical pacing threshold for a particular channel (myocardial load).

Implantable Power Supply and Control

Power supply and control to both the CW flowmeter and MTS devices is obtained through the use of an IC elapsed-time power switch (ETPS) (6). A block diagram of the ETPS is shown in figure 12. After the low-power (7 μ W) RF detector is actuated by a 0.5 sec. burst of 27-MHz RF burst, it sets an R-S latch

which in turn activates an oscillator-divider chain and switches on power to the implant. After a predetermined period of time or count (as determined by several bonding options during construction), the counter resets the latch thereby powering down both the oscillator and implant.

The ETPS was designed to ensure high-noise or false triggering immunity. The counter normally divides down a 300-Hz signal to 3 mHz (5 min.). Several taps from the counter are available over the 2- to 0.5 -Hz range and, by applying one of these outputs to the input of the R-S latch, a 1-sec. time delay is introduced before the ETPS turns on the implanted signal processor. During this first second of operation, the counter chain can be reset if there is a dropout of data from the detector; the setting of the latch wires in a signal similar to the detector output directly to the counter reset, and the counter then believes that an RF signal is still present. The counter can then only be reset to zero after the R-S latch is reset at the predetermined time (1-24 min.). The noise immunity of the circuit is such that even strong arc signals (Bovie) will not turn on the implant accidentally.

The ETPS works in conjunction with a 2.8 volt lithium chloride battery. With small animals in particular, the battery pack is the predominant implant volume. To reduce the implant volume, the general battery assembly, as shown in figure 13, has been modified to use smaller batteries (with subsequent reduced A-hr. ratings) and a more effective RF coil antenna. In addition, the incorporation of a connector assembly for attaching the battery

pack to the signal processor, facilitates the surgical placement (as well as replacement) of the modules. For example, the battery pack can be placed within the abdomen, while the signal processor is located within the chest of a 2-3 kg. rhesus macaque.

2) Animal Preparation

Adult mongrel dogs (10-15 kg) were anesthetized with Nembutal and maintained on Halothane. A right thoracotomy is performed to expose the heart. The ascending aorta is identified and a section cleared of fascia. A slightly loose-fitting cuff is chosen and placed around the vessel. Ultrasonic crystals from the CW flowmeter were then inserted into the cuff. A 2 to 3 mm. diameter section of the circumflex or left anterior descending coronary (LADC) was freed from the local fascia and a special coronary probe from a second CW flowmeter was placed around this segment.

A 6.0 mm. Konigsberg pressure cell from the MTS implant was introduced into the aorta via a stab wound and purse-string suture. A second channel of the MTS provided a bipolar electrode assembly that was directly sutured to the heart or placed subcutaneously in order to get the desired EMG or EKG waveform. Pacing leads for the inductively powered pacer were sutured to the right atrium and left ventricle.

In the hardwire preparations, only the cables and their respective transducers were implanted. The cable ends were potted with a medical grade Silastic adhesive after a functional test. All of the cables were then bundled together in a Dacron mesh pouch which was then positioned into a subcutaneous pouch near the spine. In this manner, all of the cables could be safely exteriorized at any point in the future for attachment to backpacked telemetry.

In the animals with totally implanted electronics, isolated

tubular subcutaneous pockets were established running normal to the main incision. A single electronic package and its battery pack was placed in each pocket. Using this technique, package migration was kept to a minimum as well as providing for the maximal spread of the FM transmission antennae.

3) Discussion

A concise overview of the telemetry-related activity that occurred during the period of the collaborative agreement may be seen in table 1.

The initial phase of this collaborative agreement was to develop surgical implant techniques and observe the effect of the flow probes on local tissue, and an introduction to the overall performance of the telemetry systems. The first two dogs were instrumented with probes only, the telemetry packs to be attached to the leads upon exteriorization at a later point in time. Dogs #3 and #5 survived the implant surgery, and after a period of three months revealed minimal trauma to aortic and coronary tissue by the flow probes. It was decided at this point, in order to reduce surgical mortality, that a simpler instrumentation model consisting of a CW aortic flowmeter and dual channel pacer should be pursued.

Thus the second phase was to involve four adult mongrel dogs instrumented with a totally implanted ascending aortic CW flowmeter and dual channel, inductively-powered cardiac pacer (both leads on the right atrium). These dogs were to be used in a computer-assisted indicator dye dilution cardiac output protocol in order to characterize the accuracy of the CW flowmeter. Scheduling, implant, and computer-related problems limited the calibration scheme to a total of six data points from two dogs (#6, #9). The CW flowmeter tracked the dye dilution cardiac output within a factor of two. Volume flow with the CW flowmeter was calculated using a parabolic

flow profile; a more blunt profile would reduce the observed discrepancy.

The final phase of this collaboration called for additional flow calibrations as well as some simple 24-48 hr. monitoring sessions. It was decided to add an additional channel of temperature to the MTS implant and instrument several more small, primate-size dogs in a similar fashion as Dog #10 (intraabdominal placement of a piggybacked CW aortic flowmeter and MTS using a single common battery). Such a "minimal implant volume" unit was built (CW aortic flow, aortic pressure, EKG, and core temperature) but never deployed throughout the remainder of the collaborative agreement period, as in-house (NASA), proposal writing and COSMOS related activities precluded any further telemetry activity.

The failure analysis of CW flowmeter in Dog #8 revealed a mechanical fault in the impedance matching layer of the receiver crystal. This fault reduces the sensitivity of the crystal to the reflected ultrasound to such an extent that it simulated a no flow situation. This mechanical failure, though rare in occurrence, is now being regularly tested for in every construction batch of crystals. The reduced FM transmission range of the CW flowmeter in Dog #9 was identified as a faulty conductive epoxy (became nonconductive). Tighter control on the shelf life of all epoxies have been enacted along with improved, documented temperature curing techniques.

4) Summary

As a result of the collaborative agreement with the cardiovascular lab at NASA-Ames to evaluate totally implantable telemetry in small animals, the following was accomplished:

- A telemetric CW Doppler ultrasonic flowmeter, multi-channel telemetry system, and dual channel cardiac pacer were developed and used in small and intermediate size animals.
- Surgical implant techniques for small animals were developed and refined.
- Overall implant volume was reduced by "piggybacking" several signal processing modules using a single battery pack.
- A flow calibration (cardiac output) was developed and executed.
- Electrical and mechanical problems were identified with the CW flowmeter and have subsequently been remedied.
- The feasibility of instrumenting a small primate-size dog was demonstrated.

Small, primate-size animals can be chronically instrumented with totally implanted telemetry. Problems associated with implant volume and geometry (primarily battery pack) can be successfully overcome with improved surgical techniques. The overall performance of the various implanted systems suggested that 24 hour or multiple circadian period monitoring protocols could be achieved at the present level of system development.

C. References

- 1) Combs, S.R.; Kitchip.. A superior low-power monolithic device array, Ph.D. Diss, TR No. 4958-6, Stanford University, Stanford (1977).
- 2) Allen, H.V.; Knutti, J.W., and Meindl, J.D.: Integrated power controllers and RF data transmitters for totally implantable telemetry. *Biotelemetry Patient Monitg* 6:147-159 (1979).
- 3) Brody, W.R.: Theoretical analysis of the ultrasonic blood flowmeter, Ph.D. Diss., TR No. 4958-1, Stanford University, Stanford (1971).
- 4) Sander, C.S.; Knutti, J.W., and Meindl, J.D.: A monolithic signal processor for multichannel implantable telemetry. *ISSCC Dig. tech. Papers* 19:189-199 (1976).
- 5) Fryer, T.B.; Sandler, H., and Datnow, B.: A Multichannel Implantable Telemetry System. *Med. Res. Eng.* 8:9-15 (1969).
- 6) Allen, H.V.; Knutti, J.W., and Meindl, J.D.: Integrated power controllers and RF data transmitters for totally implantable telemetry. *Biotelemetry Patient Monitg* 6:147-159 (1979).
- 7) Claude, J.P.; Knutti, J.W.; Allen, H.V., and Meindl, J.D.: Applications of totally implantable telemetry systems to chronic medical research. *Biotelemetry Patient Monitg* 6: 160-171 (1979).
- 8) Session 41: FET Biomedical Transducers. *Proceedings of 30th Alliance for Engineering in Medicine and Biology*, Bethesda 1977, vol. 19, pp. 296-302.

D. Personnel

BIOGRAPHICAL SKETCH

Give the following information for key professional personnel listed on page 2, beginning with the Principal Investigator/Program Director. Photocopy this page for each person.

NAME	TITLE	BIRTHDATE (Mo., Day, Yr.)
James D. Meindl	Professor - Elec. Engr.	04/20/33

EDUCATION (Begin with baccalaureate training and include postdoctoral)

INSTITUTION AND LOCATION	DEGREE	YEAR CONFERRED	FIELD OF STUDY
Carnegie-Mellon University	B.S.	1955	Electrical Engineering
Carnegie-Mellon University	M.S.	1956	Electrical Engineering
Carnegie-Mellon University	Ph.D.	1958	Electrical Engineering

RESEARCH AND/OR PROFESSIONAL EXPERIENCE: Concluding with present position, list in chronological order previous employment, experience, and honors. Include present membership on any Federal Government Public Advisory Committee. List, in chronological order, the titles and complete references to recent representative publications, especially those most pertinent to this application. Do not exceed 2 pages.

Major Research Interest: Integrated Electronics for Medical Applications

Research and/or Professional Experience:

Engineer, Westinghouse Electric Corporation, 1958 to 1959.
 Chief, Microcircuits Sec., U.S. Army Electronics Command, 1959 to 1962.
 Chief, Semiconductor & Microelectronics Br., U.S. Army Electronics Command, 1962 to 1964.
 Director, Integrated Electronics Div., U.S. Army Electronics Command, 1964 to 1967.
 Associate Professor of Electrical Engineering, Stanford University, 1967 to 1970.
 Professor of Electrical Engineering, Stanford University, 1970 to present.
 Director, Stanford Electronics Laboratories, Stanford University, 1972 to present.
 Director, Center for Integrated Systems, Stanford University, 1980 to present.

Editor of IEEE Journal of Solid-State Circuits, 1966 to 1971.
 Program Chairman of 1966 International Solid-State Circuits Conference.
 Author of Micropower Circuits, J. Wiley & Sons, Inc., New York, 1969.
 General Chairman of 1969 International Solid-State Circuits Conference.
 Chairman of the IEEE Solid-State Circuits Council, 1972.
 General Chairman of 28th Annual Conference on Engineering in Medicine and Biology, 1975.

Honors:

Recipient of 1980 J. J. Ebers Award of IEEE Devices Society at IEDM.
 Member National Academy of Engineering.
 Fellow, Institute of Electrical and Electronics Engineers.
 Fellow, American Association for the Advancement of Science.
 Arthur S. Flemming Commission Award, 1967.
 Recipient of IEEE ISSCC Outstanding Paper Awards, 1970, 1974, 1976, 1977 and 1978.
 Member Tau Beta Pi, Eta Kappa Nu, Sigma Xi, Phi Kappa Phi.

Patents: 6

Publications: 240+

ORIGINAL PAGE IS
OF POOR QUALITY

RECENT PUBLICATIONS - James D. Meindl

1. L. Gerzberg and J.D. Meindl, "Power-Spectrum Centroid Detection for Doppler Systems Applications," Ultrasonic Imaging 2(3):232-261, July 1980.
2. L. Gerzberg and J.D. Meindl, "The \sqrt{f} Power-Spectrum Centroid Detector: System Considerations, Implementation, and Performance," Ultrasonic Imaging 2(3):262-289, July 1980.
3. E. Wildi, J.W. Knutti, H.V. Allen and J.D. Meindl, "Dynamics and Limitations of Blood/Muscle Interface Detection Using Doppler Power Returns," IEEE Trans. on Biomedical Engineering BME-27(1):565-573, October 1980.
4. J.D. Meindl, "Biomedical Implantable Microelectronics," Science 210:263-267, 17 October 1980.
5. A.L. Susal, J.T. Walker and J.D. Meindl, "Small-Organ Dynamic Imaging System," J. Clin. Ultrasound 8:421-426, October 1980.
6. J.W. Knutti, H.V. Allen and J.D. Meindl, "Integrated Circuit Implantable Systems," ISA Transactions, 19(4):47-53, 1980.
7. E. Wildi, J.W. Knutti and J.D. Meindl, "A Micropower, Small Input-to-Output Delay, High-Voltage Bipolar Driver/Demultiplexer IC," IEEE J. Solid-State Circuits, SC-16(1):23-30, February 1981.
8. J.D. Meindl, K.N. Ratnakumar, L. Gerzberg and K.C. Saraswat, "Circuit Scaling Limits for Ultra Large Scale Integration," IEEE International Solid-State Circuits Conference, Digest of Technical Papers, February 1981, pp. 36-37.
9. L. Gerzberg, N.C.C. Lu and J.D. Meindl, "A Monolithic Power-Spectrum Centroid Detector," IEEE International Solid-State Circuits Conference, Digest of Technical Papers, February 1981, pp. 164-165.
10. N.C.C. Lu, L. Gerzberg, C-Y Lu and J.D. Meindl, "A New Conduction Model for Polycrystalline Silicon Films," IEEE Electron Device Letters, EDL-2(4):95-98, April 1981.
11. N.C.C. Lu, L. Gerzberg, C.Y. Lu and J.D. Meindl, "Modeling and Optimization of Monolithic Polycrystalline Silicon Resistors," IEEE Trans. on Electron Devices, ED-28(7):8180830, July 1981.
12. K.N. Ratnakumar, J.D. Meindl and D.L. Scharfetter, "New IGFET Short-Channel Threshold Voltage Model," Technical Digest, International Electron Devices Meeting, 1981, pp. 204-206.
13. D. Harame, J. Shott, J. Plummer and J. Meindl, "An Implantable Ion Sensor Transducer," Technical Digest, International Electron Devices Meeting, 1981, pp. 467-470.
14. R.B. Lefferts, R.M. Swanson and J.D. Meindl, "A Recombination Model for the Low Current Performance of Submicron Devices," IEEE International Solid-State Circuits Conference, Digest of Technical Papers, Feb. 1982, pp. 16-17.
15. J.D. Meindl, "Microelectronics and Computers in Medicine," Science, 215:792-797, Feb. 12, 1982.

BIOGRAPHICAL SKETCH

Give the following information for key professional personnel listed on page 2, beginning with the Principal Investigator/Program Director. Photocopy this page for each person.

NAME	TITLE	BIRTHDATE (Mo., Day, Yr.)
Henry V. Allen	Senior Research Associate	05/06/47

EDUCATION (Begin with baccalaureate training and include postdoctoral)

INSTITUTION AND LOCATION	DEGREE	YEAR CONFERRED	FIELD OF STUDY
Dartmouth College	A.B.	1969	Engineering
Dartmouth College	B.E.	1970	Engineering
Stanford University	M.S.	1971	Electrical Engineer
Stanford University	Ph.D.	1977	Electrical Engineer

RESEARCH AND/OR PROFESSIONAL EXPERIENCE: Concluding with present position, list in chronological order previous employment, experience, and honors. Include present membership on any Federal Government Public Advisory Committee. List, in chronological order, the titles and complete references to recent representative publications, especially those most pertinent to this application. Do not exceed 2 pages.

PROFESSIONAL EXPERIENCE:

1969 Senior Technical Aide, Bell Laboratories, Holmdel, New Jersey
1971-75 Research Assistant, Stanford University.
1975-78 Research Associate, Stanford University
1978 - Present Senior Research Associate, Stanford University

AREAS OF SPECIALIZATION:

Integrated Electronics, Micropower Electronics, Biomedical Instrumentation

PROFESSIONAL ASSOCIATIONS:

Member, Sigma Xi
Member, International Society on Biotelemetry.
Member, IEEE

PUBLICATIONS: 40+

SEE ATTACHED PAGE FOR RECENT PUBLICATIONS

KEYWORD DESCRIPTORS:

Implantable instrumentation, Doppler blood flow, research models in animals, high reliability instrumentation, pressure and electrophysiology instrumentation.

ORIGINAL PAGE IS
OF POOR QUALITY.

Henry V. Allen

PUBLICATIONS:

1. H.V. Allen, M.F. Anderson and J.D. Meindl, "Direct Calibration of a Totally Implantable Pulsed Doppler Ultrasonic Blood Flowmeter", Am. J. Physiol., 232(5):H537-544, 1977.
2. H.V. Allen, J.W. Knutti, and J.D. Meindl, "Integrated Circuits for a Bidirectional Implantable Pulsed Doppler Ultrasonic Blood Flowmeter", IEEE Journal of Solid State Circuits, Vol. SC-13, No. 6, pp. 853-863, December 1978.
3. H.V. Allen, J.W. Knutti, and J.D. Meindl, "Integrated Power Controllers and RF Data Transmitters for Totally Implantable Telemetry", Biotelemetry and Patient Monitoring, 147-159, Vol. 6, No. 3, 1979.
4. H.V. Allen, J.W. Knutti, and J.D. Meindl, "Totally Implantable Directional Doppler Flowmeters", Biotelemetry and Patient Monitoring, 118-132, Vol. 6, No. 3, 1979.
5. S.H. Gschwend, J.W. Knutti, H.V. Allen, and J.D. Meindl, "A General Purpose Implantable Multichannel Telemetry System for Physiological Research", Biotelemetry and Patient Monitoring, 107-117, Vol. 6, No. 3, 1979.
6. J.W. Knutti, H.V. Allen, and J.D. Meindl, "Implantable Ultrasonic Telemetry System Architectures, Assembly and Applications", in Biotelemetry V (G. Matsumoto and H.P. Kimmich, eds.), Sapporo, Japan, 1980., pp. 55-58.
7. H.V. Allen, J.W. Knutti, and J.D. Meindl, "A General Purpose Six Channel Implantable Telemetry System" in Biotelemetry V (G. Matsumoto and H.P. Kimmich, eds.), Sapporo, Japan, 1980, pp. 55-58.
8. J.W. Knutti, H.V. Allen, and J.D. Meindl, "An Integrated Circuit Approach to Totally Implantable Telemetry Systems", Biotelemetry and Patient Monitoring, 95-106, Vol. 6, No. 3, 1979.
9. E. Wildi, J.W. Knutti, H.V. Allen, and J.D. Meindl, "Dynamics and Limitations of Blood/Muscle Interface Detection Using Doppler Power Returns", IEEE Transactions on Biomedical Engineering, Vol. BME-27, No. 10, Oct. 1980.
10. T.R. Harrison, J.W. Knutti, H.V. Allen, and J.D. Meindl, "Micropower Linear Compatible I²L Techniques in Biomedical Telemetry", Journal of ISSCC, 1980.
11. H.V. Allen, and J.W. Knutti, "A Fully Integrated RF Actuated Battery Controller", IEEE ISSCC Digest of Technical Papers, 166-167, 1981.
12. J.W. Knutti, H.V. Allen, and J.D. Meindl, "Implantable Telemetry Systems Using Integrated Circuits" (invited), Proceedings Sixth International Symposium on Biotelemetry; Leuven, Belgium; June 1981.

Give the following information for key professional personnel listed on page 2, beginning with the Principal Investigator/Program Director. Photocopy this page for each person.

NAME	TITLE	BIRTHDATE (Mo., Day, Yr.)
James W. Knutti	Senior Research Associate	March 17, 1950

EDUCATION (Begin with baccalaureate training and include postdoctoral)

INSTITUTION AND LOCATION	DEGREE	YEAR CONFERRED	FIELD OF STUDY
Carnegie-Mellon Univ., Pittsburgh, PA.	B.S.	1972	Electrical Engineering
Carnegie-Mellon Univ., Pittsburgh, PA.	M.S.	1972	Electrical Engineering
Stanford University, Stanford, CA.	Ph.D.	1977	Electrical Engineering

RESEARCH AND/OR PROFESSIONAL EXPERIENCE: Concluding with present position, list in chronological order previous employment, experience, and honors. Include present membership on any Federal Government Public Advisory Committee. List, in chronological order, the titles and complete references to recent representative publications, especially those most pertinent to this application. Do not exceed 2 pages.

EXPERIENCE:

9/1971-12/1971 Biomedical Engineering Intern - West Pennsylvania Hospital, Pittsburgh, Pennsylvania
 7/1972-9/1975 Research Assistant, Stanford University
 10/1975-8/1978 Research Associate, Stanford University
 6/1978-Present Associate Director, Center for Integrated Electronics in Medicine
 8/1978-Present Senior Research Associate, Stanford University

ACADEMIC HONORS AND PROFESSIONAL SOCIETIES:

1968 - Steinmetz Mathematics Award - General Electric Co.
 1968 - Wilson Grant (for studying at Carnegie Mellon University)
 1971 - Chapter President - Eta Kappa Nu
 1976 - Sigma Xi

Member: The Institute of Electrical and Electronics Engineers
 International Hybrid Microelectronics Society
 International Society on Biotelemetry, Administrative Council
 and representative of the Society in the U.S.A.

AREAS OF RESEARCH:

1. Implantable telemetry system design - multi-channel pressure, EKG, temperature - bidirectional pulsed ultrasonic flowmeter receiver - implant technology, implantable pulsed dimension sensor.
2. Integrated circuit design and processing including low power bipolar and high frequency bipolar circuits.
3. Ultrasonic transducer field patterns, transducer design, fabrication technology and biocompatibility.
4. Silicon pressure transducer design and fabrication.
5. Design of external signal processing electronics and application of systems to medical problems - clinical and research applications.

PUBLICATIONS: 50+

SEE ATTACHED PAGE FOR RECENT PUBLICATIONS

ORIGINAL FILED IN
OF POOR QUALITY

RECENT PUBLICATIONS:

1. H.V. Allen, J.W. Knutti, and J.D. Meindl, "Integrated Power Controllers and RF Data Transmitters for Totally Implantable Telemetry" Biotelemetry and Patient Monitoring, 147-159, Vol. 6, No. 3, 1979.
2. H.V. Allen, J.W. Knutti, and J.D. Meindl, "Totally Implantable Directional Doppler Flowmeters" Biotelemetry and Patient Monitoring, 118-132, Vol. 6, No. 3, 1979.
3. S.J. Gschwend, J.W. Knutti, H.V. Allen, and J.D. Meindl, "A General Purpose Implantable Multichannel Telemetry System for Physiological Research" Biotelemetry and Patient Monitoring, 107-117, Vol. 6, No. 3, 1979.
4. J.W. Knutti, H.V. Allen, and J.D. Meindl, "An Integrated Circuit Approach to Totally Implantable Telemetry Systems" Biotelemetry and Patient Monitoring, 95-106, Vol. 6, No. 3, 1979.
5. J.W. Knutti, H.V. Allen, and J.D. Meindl, "Implantable Ultrasonic Telemetry System Architectures, Assembly and Applications", in Biotelemetry V (G. Matsumoto and H.P. Kimmich, eds.), Sapporo, Japan, 1980, pp. 55-58.
6. H.V. Allen, J.W. Knutti, and J.D. Meindl, "A General Purpose Six Channel Implantable Telemetry System" in Biotelemetry V (G. Matsumoto and H.P. Kimmich, eds.), Sapporo, Japan, 1980, pp. 55-58.
7. C.S. Sander, J.W. Knutti, and J.D. Meindl, "A Monolithic Capacitive Pressure Sensor with Pulse-Period Output" IEEE Transactions on Electron Devices, Vol. ED-27, No. 5, pp. 927-930, May 1980.
8. E. Wildi, J.W. Knutti, H.V. Allen, and J.D. Meindl, "Dynamics and Limitations of Blood/Muscle Interface Detection Using Doppler Power Returns" IEEE Transactions on Biomedical Engineering, Vol. BME-27, No. 10, Oct. 1980.
9. E. Wildi, J.W. Knutti, J.D. Meindl, "A Micropower, Small Input-to-Output Delay, High-Voltage Bipolar Driver/Demultiplexer IC" IEEE JSSC, Vol. SC-16, No. 1, Feb. 1981.
10. H.V. Allen, and J.W. Knutti, "A Fully Integrated RF Actuated Battery Controller" IEEE ISSCC Digest of Technical Papers, 166-167, 1981.
11. J.W. Knutti, H.V. Allen, J.D. Meindl "Implantable Telemetry Systems Using Integrated Circuits" (invited), Proceedings Sixth International Symposium on Biotelemetry; Leuven, Belgium; June 1981.
12. J.C. Griffen, K.R. Jutzy, J.P. Claude, J.W. Knutti, "Non-electrographic indices of optimal pacemaker rate", Proceedings 34th ACEMB, Houston, September 21-34, 1981.

ORIGINAL PAGE IS
OF POOR QUALITY

BIOGRAPHICAL SKETCH

Give the following information for key professional personnel listed on page 2, beginning with the Principal Investigator/Program Director. Photocopy this page for each person.

NAME John P. Claude	TITLE Research & Development Engineer II	BIRTHDATE (Mo., Day, Yr.) October 30, 1954
------------------------	---	---

EDUCATION (Begin with baccalaureate training and include postdoctoral)

INSTITUTION AND LOCATION	DEGREE	YEAR CONFERRED	FIELD OF STUDY
University of Notre Dame	B.S.	1976	Micromolecular Biology
University of Virginia	M.E.	1978	Biomedical Engineering

RESEARCH AND/OR PROFESSIONAL EXPERIENCE: Concluding with present position, list in chronological order previous employment, experience, and honors. Include present membership on any Federal Government Public Advisory Committee. List, in chronological order, the titles and complete references to recent representative publications, especially those most pertinent to this application. Do not exceed 2 pages.

EXPERIENCE:

- 5/1977-8/1977 Clinical Engineer Intern, University of Virginia Medical Center
- 2/1978-11/1978 Research Assistant, University of Virginia Medical Center
- 2/1979-10/1981 Implant Applications Engineer, Stanford University
- 10/1981-Present Research & Development Engineer, Stanford University

AREAS OF RESEARCH:

1. Pressure transducer design and modeling.
2. Microprocessor-based data acquisition systems for biomedical engineering applications.
3. Microprocessor controlled measurement of capillary blood flow using fibre optics and light absorption techniques.
4. Electrode design for the chronic measurement of cardiac electrophysiologic phenomena.
5. Inductively powered implantable pacing systems.

PUBLICATIONS:

1. J.P. Claude, J.R. Griffin, S.J. Gschwend, J.W. Knutti, H.V. Allen, and J.D. Meindl, "A Chronically Instrumented Animal Model for Electrophysiologic Research" Proc. IEEE/EMBS, Denver, October 1979, pp. 334-336.
2. J.P. Claude, J.W. Knutti, H.V. Allen, and J.D. Meindl, "Applications of Totally Implantable Telemetry Systems to Chronic Medical Research" Biotelemetry and Patient Monitoring, 160-170, Vol. 6, No. 3, 1979.

**ORIGINAL PAGE IS
OF POOR QUALITY.**

Give the following information for key professional personnel listed on page 2, beginning with the Principal Investigator/Program Director. Photocopy this page for each person.

NAME Andrew J. Ford, Jr.	TITLE Scientific & Engineering Associate	BIRTHDATE (Mo., Day, Yr.) December 12, 1956
-----------------------------	--	--

EDUCATION (Begin with baccalaureate training and include postdoctoral)

INSTITUTION AND LOCATION	DEGREE	YEAR CONFERRED	FIELD OF STUDY
University of California, Davis, Calif.	B.S.	1979	Physiology

RESEARCH AND/OR PROFESSIONAL EXPERIENCE: Concluding with present position, list in chronological order previous employment, experience, and honors. Include present membership on any Federal Government Public Advisory Committee. List, in chronological order, the titles and complete references to recent representative publications, especially those most pertinent to this application. Do not exceed 2 pages.

EXPERIENCE:

11/1979-9/1981 Research Assistant, Stanford University
9/1981-Present Scientific & Engineering Associate, Stanford University

AREA OF EXPERIENCE:

Applications of implantable telemetry systems in biomedical research - cardiac arrhythmias, urine transport, organ transplantation, drug induced or natural disease states, and implantation technology.

PUBLICATIONS:

1. D.S. Echt, Griffin J.C., Ford A.J., Knutti J.W., Feldman R.C., Mason J.W., "The Nature of Inducible Ventricular Tachyarrhythmia in the Chronic Canine Infarct Model", Proceedings of the American Heart Association, Dallas, Texas, Nov. 1981.

ORIGINAL PAGE IS
OF POOR QUALITY

Give the following information for key professional personnel.
Principal Investigator/Program Director. Photocopy this page for each person.

NAME Joseph M. Koepnick	TITLE Research and Development Engineer II	BIRTHDATE (Mo., Day, Yr.) June 27, 1957
----------------------------	--	--

EDUCATION (Begin with baccalaureate training and include postdoctoral)

INSTITUTION AND LOCATION	DEGREE	YEAR CONFERRED	FIELD OF STUDY
Ohio Institute of Technology, Columbus, Ohio	A.E.E.T.	1978	Electronic Engr. Tech.
Ohio Institute of Technology, Columbus, Ohio	B.E.E.T.	1980	Electronic Engr. Tech.

RESEARCH AND/OR PROFESSIONAL EXPERIENCE: Concluding with present position, list in chronological order previous employment, experience, and honors. Include present membership on any Federal Government Public Advisory Committee. List, in chronological order, the titles and complete references to recent representative publications, especially those most pertinent to this application. Do not exceed 2 pages.

EXPERIENCE:

- 7/1976-1/1979 Electronics Manufacturing Technician
D & L Electronics, Powell, Ohio
- 3/1980-Present Research & Development Engineer II, Center for Integrated
Electronics in Medicine, Stanford University

AREAS OF RESEARCH:

1. Micro-circuit implantable telemetry systems assembly techniques, processing and computer controlled testing.
2. Biocompatibility of implantable telemetry systems transducers and electrodes.

AREAS OF EXPERIENCE:

1. Implantable telemetry systems design support.
2. Knowledge of high reliability micro-circuit assembly techniques, processing, testing and equipment. Also, knowledge of micropower signal processing and capability to program computer controlled testing equipment.
3. Design and fabrication of hybrid substrates.
4. Maintenance of all equipment associated with high reliable implantable systems construction and testing.

ORIGINAL PAGE IS
OF POOR QUALITY

E. Tables and Figures

<u>Date</u>	<u>Activity</u>
11-20-80	Dog #1 died during the surgery.
11-27-80	Dog #2 died during the surgery.
12-1-80	Dog #3 instrumented with hardwired aortic and coronary flowmeters, aortic pressure, and one packing lead.
12-9-80	Dog #4 died immediately post-op.
12-19-80	Dog #5 successfully instrumented in a similar fashion as Dog #3.
1-12-81	Cable exteriorization date for Dog #3 and #5, postponed till 1-30-81.
1-30-81	Exteriorization again postponed by NASA till 2-10-81.
2-10-81	Cables exteriorized on Dog #3 and #5. All systems working well except that the coronary probe on Dog #5 appears to be "riding high" on the vessel.
2-12-81	Dog #6 instrumented with totally implanted aortic CW flowmeter and dual pacer.
3-25-81	Dogs #3 and #5 posted in order to observe the effects of the various probes on local tissue.
4-16-81	Dog #7 died during surgery.
4-27-81	Dog #8 instrumented with a totally implanted CW aortic flowmeter and dual channel pacer.
5-5-81	Dog #9 successfully instrumented exactly as Dog #8.
5-10-81	Dogs #6 and #9 have good flows and pacing. Dog #8 has an operating CW flowmeter but no flow signal.
5-14-81	Flow calibration using Dog #9, 3 runs made.
5-20-81	Dog #8 posted in order to recover faulty CW aortic flowmeter. Failure analysis revealed mechanical failure of one flow crystal.
6-9-81	Dog #10, a 3 kg puppy, was instrumented with a piggybacked CW aortic flowmeter and MTS for subcutaneous EKG. This dog was to simulate the size of a typical primate.
6-22-81	Dog #6 run through 3 flow calibration trials. The animal was then posted because of a chronic infection.
6-22-81	Flow calibration of Dog #10 cancelled due to time constraints imposed by COSMOS project.
7-22-81	Dog #9 underwent a battery replacement. Flow system still working though at a reduced FM transmission range.
10-2-81	Dog #9 posted because it was not being used for anything. CW flowmeter recovered to analyze FM transmission problem.

Table 1 - Summary of Telemetry Activity

ORIGINAL PAGE IS
OF POOR QUALITY

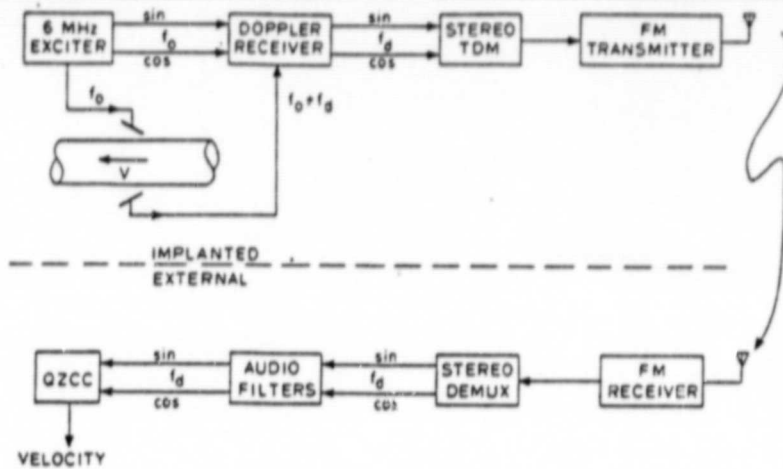

Fig. 1. Block diagram of implantable CW Doppler flowmeter.

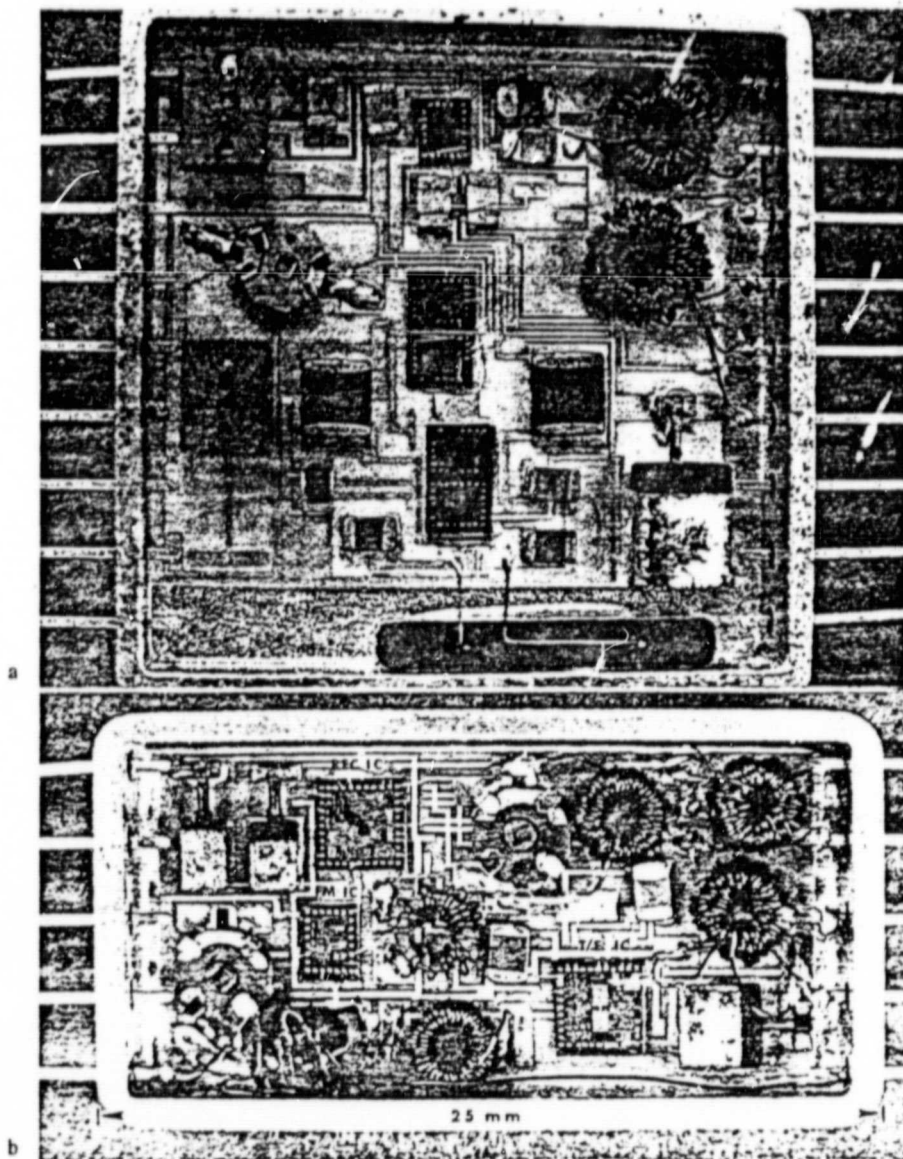

Fig. 2a. Hybrid CW flowmeter realized using kitchip ICs.
Fig. 2b. CW flowmeter package with fully custom ICs.

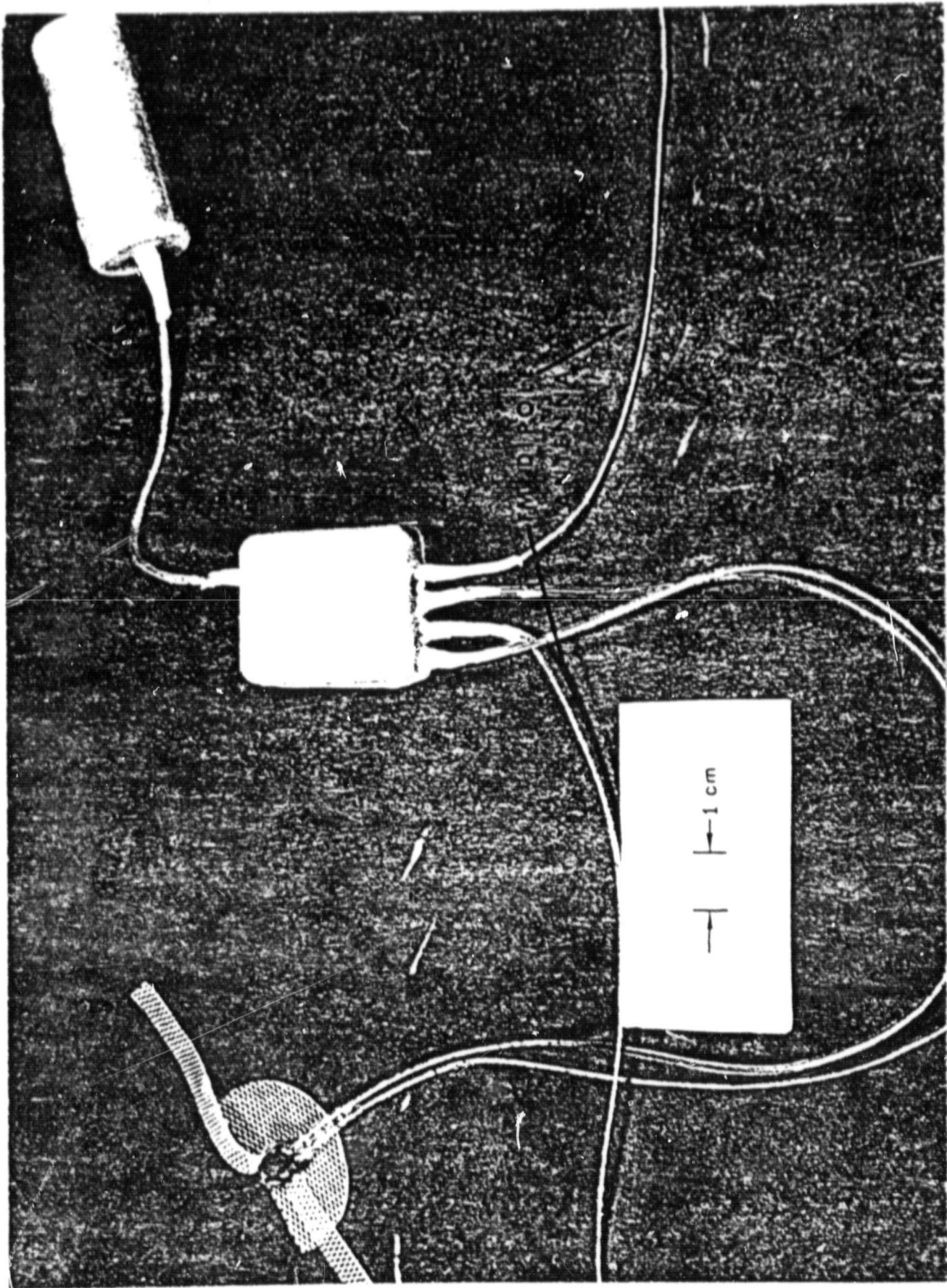

Fig. 3. The CW Doppler Ultrasonic Flowmeter. The flow probe shown attached to the system has been superseded by the probe shown in Fig. 4a.

ORIGINAL PAGE IS
OF POOR QUALITY

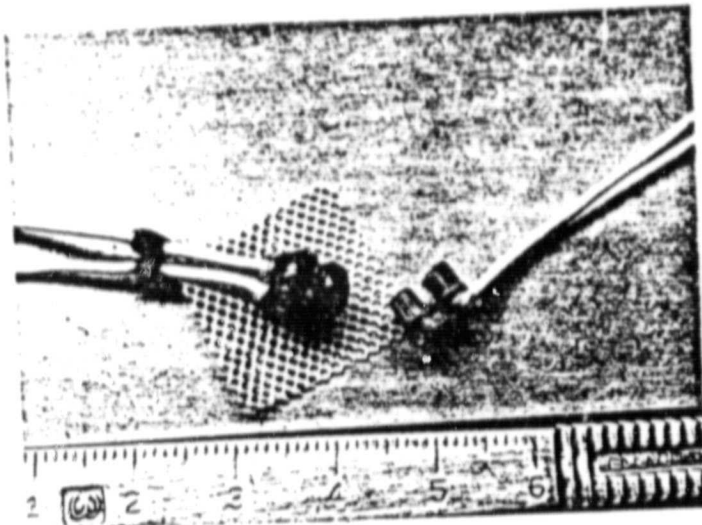

Fig. 4a. The coronary flow probe. This probe may be used on vessels 2-4 mm. in diameter. The probe on the left is ready for implant (Black beads on cables are splices).

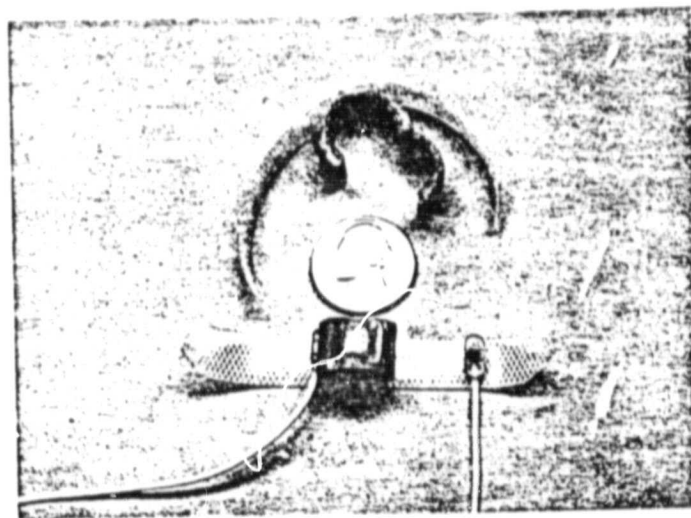

Fig. 4b. The Piezoelectric Ultrasonic Crystals and Epoxy Flow Cuff.

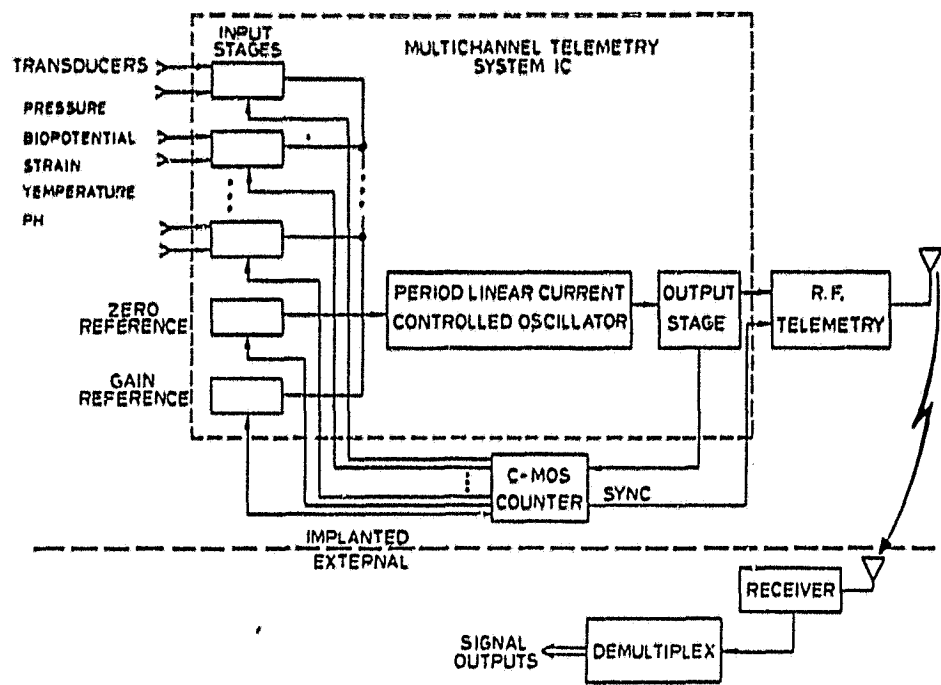

Fig. 5. Block diagram of the multichannel telemetry system.

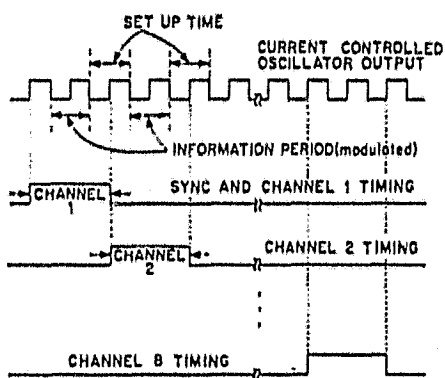

Fig. 6 Basic timing diagram for MTS.

ORIGINAL PAGE IS
OF POOR QUALITY

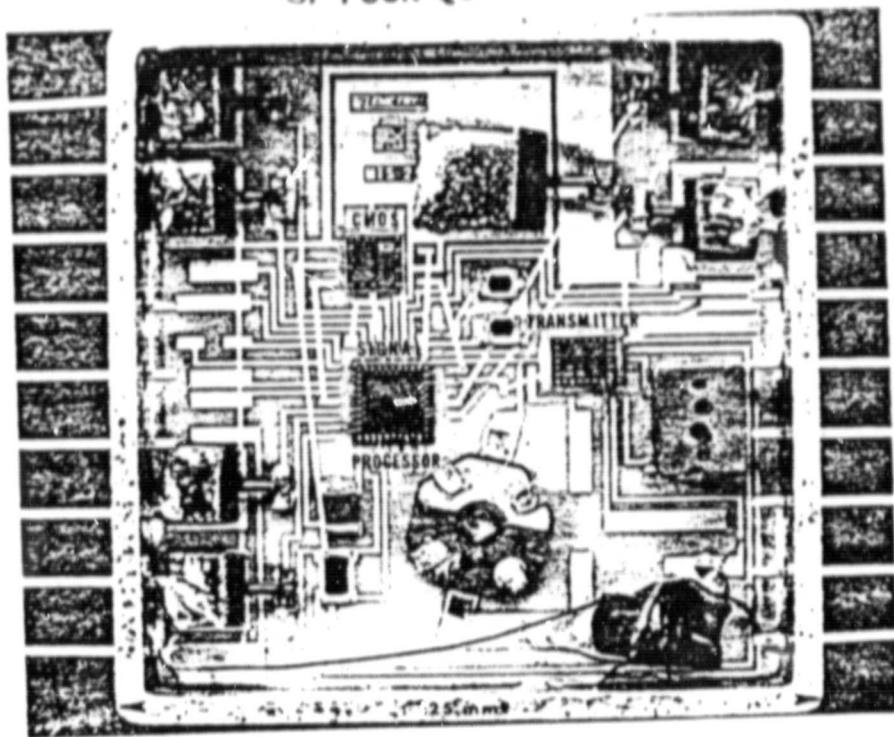

Fig. 7. Two-layer hybrid integrated circuit package.

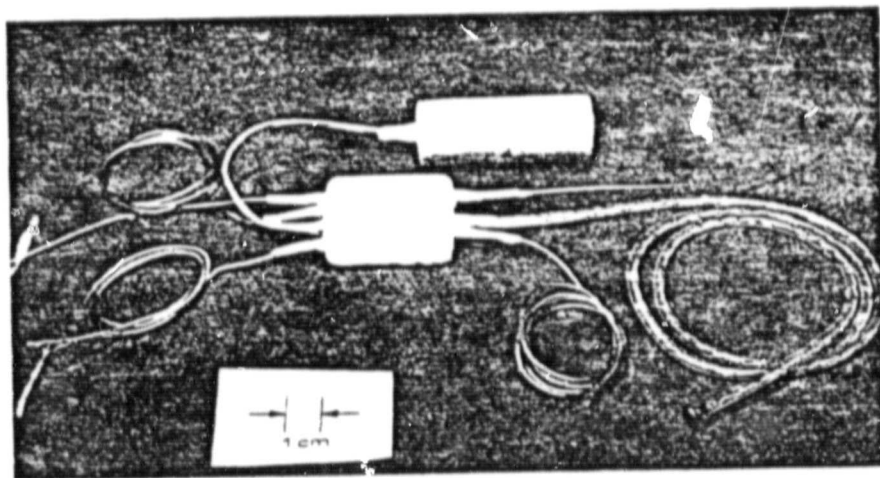

Fig. 8. MTS package with one pressure transducer
and three electrogram leads.

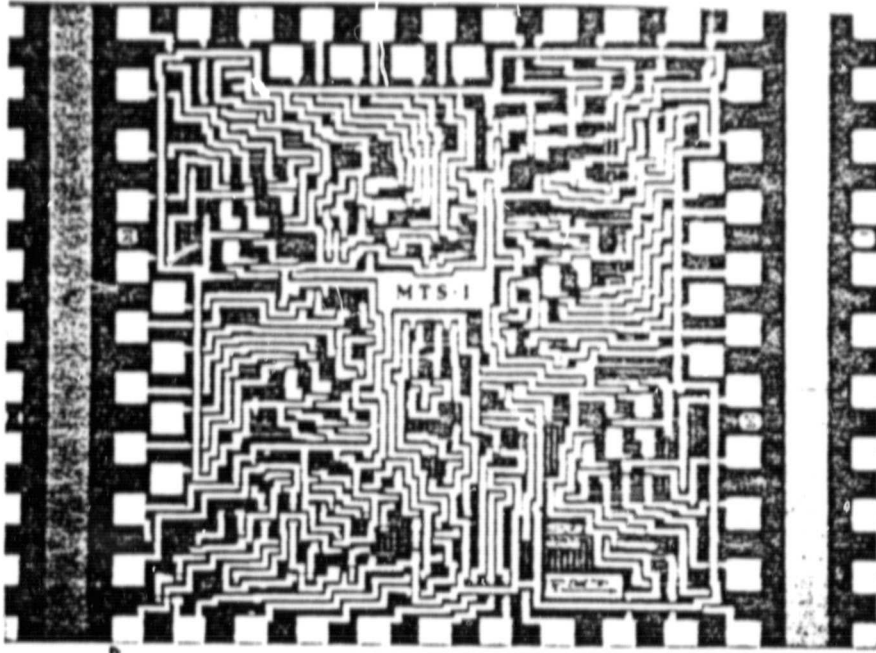

Fig. 9. Photomicrograph of MTS integrated circuit.

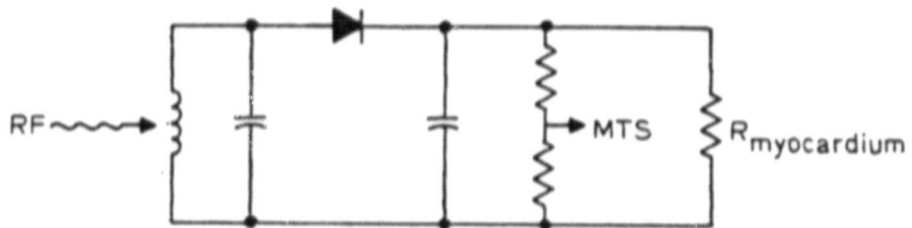

Fig. 10. Pacer Schematic.

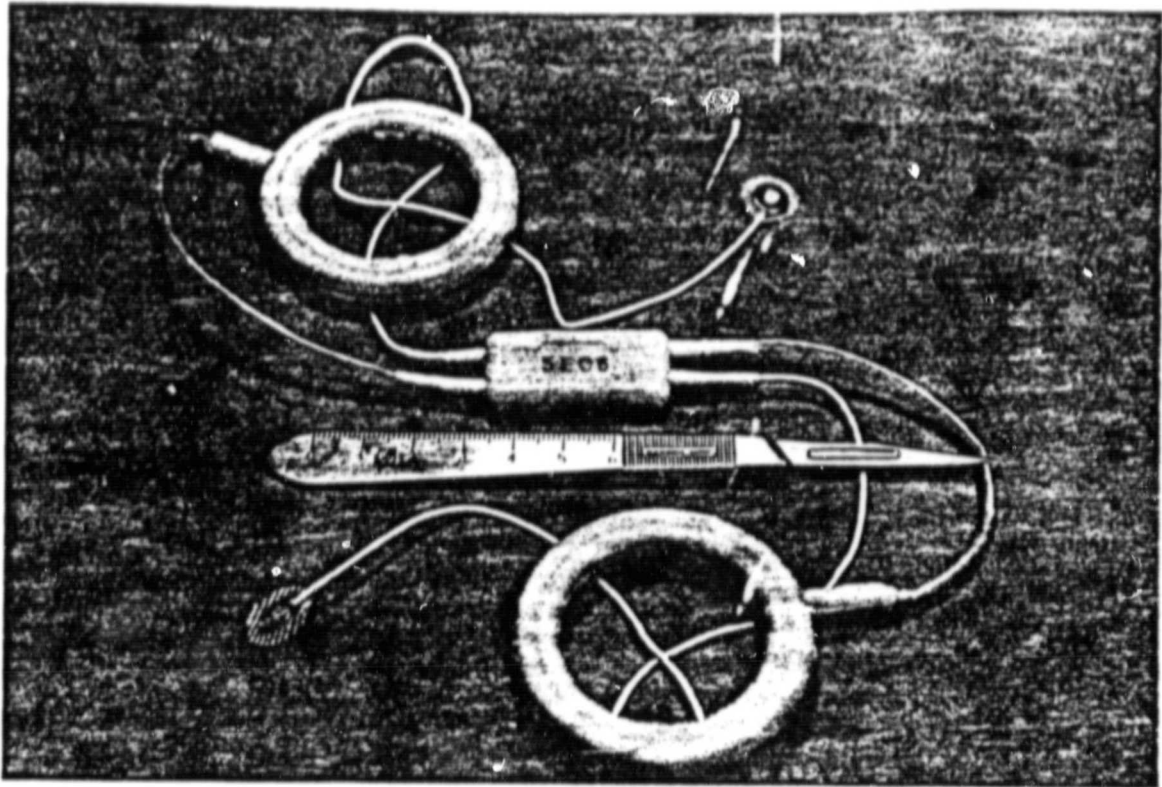

Fig. 11. A dual channel inductively powered cardiac pacer. The electronics consist of a simple passive half-wave rectifier for each channel.

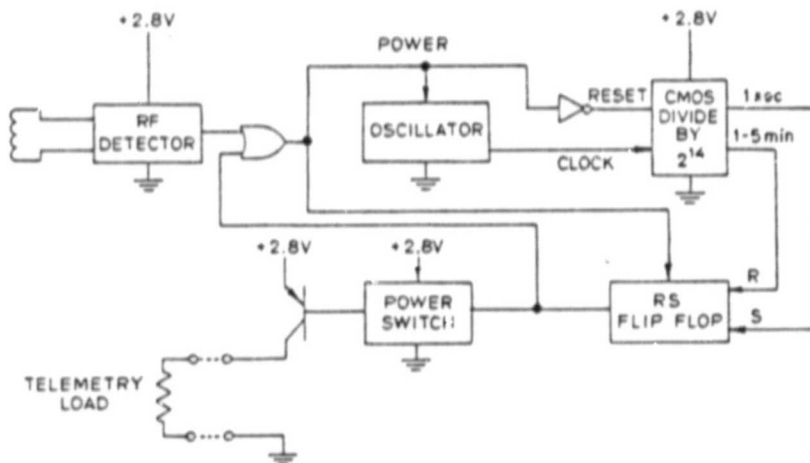

Fig. 12. Block diagram of the Elapsed Time Power Switch

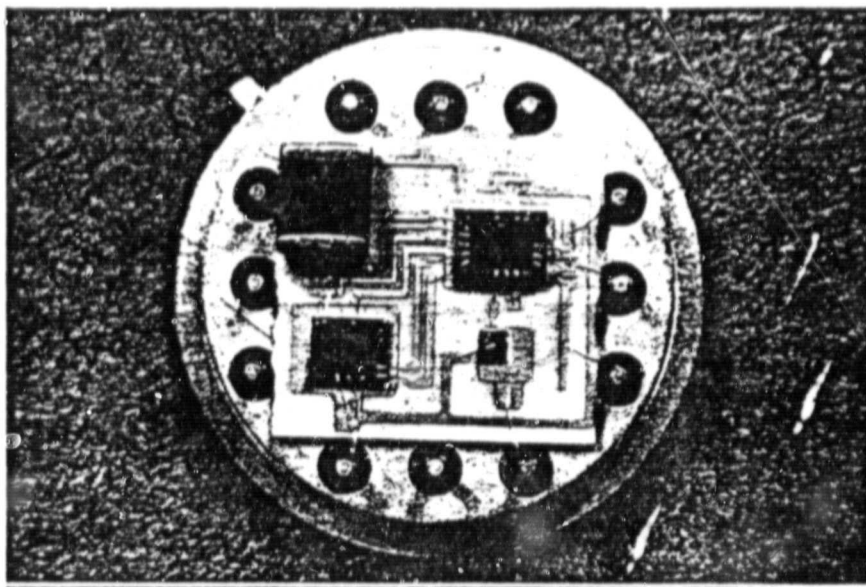

Fig. 13a. The hybrid substrate for the ETPS

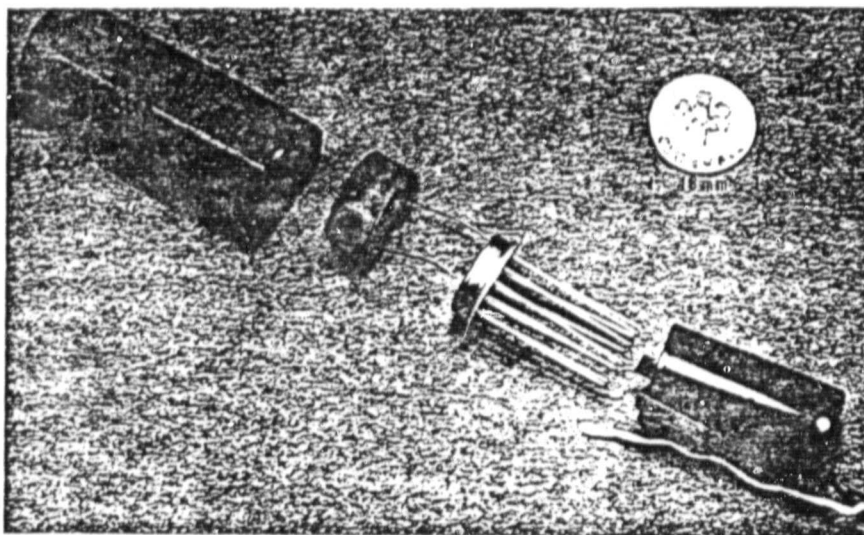

Fig. 13b. Exploded view of the battery pack assembly.
From the top: tubular molding piece, potted
torroid antenna, ETPS, and battery.