

General Disclaimer

One or more of the Following Statements may affect this Document

- This document has been reproduced from the best copy furnished by the organizational source. It is being released in the interest of making available as much information as possible.
- This document may contain data, which exceeds the sheet parameters. It was furnished in this condition by the organizational source and is the best copy available.
- This document may contain tone-on-tone or color graphs, charts and/or pictures, which have been reproduced in black and white.
- This document is paginated as submitted by the original source.
- Portions of this document are not fully legible due to the historical nature of some of the material. However, it is the best reproduction available from the original submission.



NASA CR-165434

National Aeronautics and
Space Administration

**INTERLAMINAR CRACK GROWTH IN
FIBER REINFORCED COMPOSITES DURING FATIGUE**

Final Report - Part III

by

S.S. Wang and H.T. Wang

**Department of Theoretical and Applied Mechanics
UNIVERSITY OF ILLINOIS
at Urbana-Champaign**

prepared for

NATIONAL AERONAUTICS AND SPACE ADMINISTRATION

NASA Lewis Research Center
Grant NSG 3044



(NASA-CR-165434) INTERLAMINAR CRACK GROWTH
IN FIBER REINFORCED COMPOSITES DURING
FATIGUE, PART 3 Final Report (Illinois
Univ., Urbana-Champaign.) 37 p
HC A03/MF A01

N82-26715

Unclas
28169

CSSL 20K G3/39

1. Report No. NASA CR-165434		2. Government Accession No.		3. Recipient's Catalog No.	
Title and Subtitle Interlaminar Crack Growth in Fiber Reinforced Composites During Fatigue				5. Report Date February 1981	
				6. Performing Organization Code	
Author(s) S. S. Wang and H. T. Wang				8. Performing Organization Report No.	
				10. Work Unit No.	
Performing Organization Name and Address University of Illinois Urbana, IL 61801				11. Contract or Grant No. NSG 3044	
				13. Type of Report and Period Covered Final Report - Part III	
Sponsoring Agency Name and Address National Aeronautics and Space Administration Washington DC 20546				14. Sponsoring Agency Code	
Supplementary Notes Project Manager: C. C. Chamis NASA Lewis Research Center, Structures & Mechanical Technologies Division 21000 Brookpark Road, Mail Stop 49-6 Cleveland, OH 44135					
Abstract Interlaminar crack growth behavior in fiber-reinforced composites subjected to fatigue loading was investigated experimentally and theoretically. In the experimental phase of the study, interlaminar crack propagation rates and mechanisms were determined for the cases of various geometries, laminate parameters and cyclic stress levels. An advanced singular hybrid-stress finite element method was used in conjunction with the experimental results to examine the local crack-tip behavior and to characterize the crack propagation during fatigue. Results elucidate the basic nature of the cyclic delamination damage, and relate the interlaminar crack growth rate to the range of mixed-mode crack-tip stress intensity factors. The results show that crack growth rates to be related directly to the range of the mixed-mode cyclic stress intensity factors by a power law relationship.					
Key Words (Suggested by Author(s)) fiber composites, stress intensity, mix-mode, crack growth, hybrid element, stress analysis, finite element, experiments				18. Distribution Statement Unclassified, Unlimited	
Security Classif. (of this report) Unclassified		20. Security Classif. (of this page) Unclassified		21. No. of Pages	22. Price*

TABLE OF CONTENTS

	Page
TABLE OF CONTENTS	ii
FOREWORD	iii
ABSTRACT	1
INTRODUCTION	2
EXPERIMENTAL PROGRAM	4
Materials and Specimen Preparation	4
Experimental Procedure	4
Advantages of Present Test Method	5
ANALYTICAL PROGRAM	6
Mechanical Model and Assumptions	6
Method of Analysis	7
RESULTS AND DISCUSSION	10
Interlaminar Crack Growth During Fatigue	11
Interlaminar Crack-Tip Response	12
Fatigue Crack Growth Rate Characterization	13
Limitations of Current Study	15
SUMMARY AND CONCLUSION	16
ACKNOWLEDGMENTS	17
REFERENCES	18
LIST OF FIGURE CAPTIONS	21
FIGURES	22

FOREWORD

This report describes a portion of the results obtained on NASA Grant NSG 3044. This work was done under subcontract to the University of Illinois, Urbana, with Prof. S.S. Wang as the Principal Investigator. The prime grantee was the Massachusetts Institute of Technology, with Prof. F.J. McGarry as the Principal Investigator and Dr. J.F. Mandell as a major participant. The NASA - LeRC Project Manager was Dr. G.G. Chamis.

Efforts in this project are primarily directed towards the development of finite element analyses for the study of flaw growth and fracture of fiber composites. This report presents analytical and experimental results for delamination crack growth in fatigue. The work is a follow-up to an earlier interim report NASA CR-135248. H.T. Wang was a research assistant at M.I.T. when the experimental work was performed.

Abstract

This paper presents an investigation of interlaminar crack growth behavior in fiber-reinforced composites subjected to fatigue loading. In the experimental phase of the study, interlaminar crack propagation rates and mechanisms were determined for the cases of various geometries, laminate parameters and cyclic stress levels. An advanced singular hybrid-stress finite element method was used in conjunction with the experimental results to examine the local crack-tip behavior and to characterize the crack propagation during fatigue. Results elucidate the basic nature of the cyclic delamination damage, and relate the interlaminar crack growth rate to the range of mixed-mode crack-tip stress intensity factors. The study provides fundamental insight into the problem, reveals several important features of the interlaminar fatigue failure, and should be of practical importance in selection, testing and design of composite materials.

INTRODUCTION

Damage tolerance has been of great concern for the structural reliability and integrity of fiber-reinforced composites in their advanced engineering applications. Interlaminar cracking, sometimes also called delamination, is considered one of the most frequently encountered types of damage occurring in the material subjected to fatigue loading. It is commonly initiated at geometric discontinuities, processing and manufacturing defects, machining and service flaws, and takes the form of separation of plies under mechanical, thermal and/or environmental loading. The presence and growth of an interlaminar crack may result in (1) significant reduction of stiffness, (2) exposure of the interior to adverse environmental attack, and the degradation of the composite, which may lead to the final failure of the structure. Thus, understanding the interlaminar crack growth behavior under cyclic stresses is of fundamental importance in the application of composite materials.

Laminated composites generally consist of a number of plies with different fiber orientations separated by resin-rich interlaminar regions as shown in Fig. 1. The interlaminar region usually has a dimension of one twentieth to one tenth of the individual ply thickness, depending on manufacturing and processing methods. Since the strength is usually low and stresses are high in the interlaminar region, almost all kinds of defects such as voids, inclusions, broken plies, etc., unavoidably tend to grow in an interlaminar mode at very low nominal stress levels and to propagate along preferential paths. This phenomenon is unique to composites and is particularly significant when the materials are subjected to cyclic loading. The development of a through-the-thickness crack from a defect or flaw in a

real composite may be difficult in many cases. This is in contrast to the flaw growth behavior in monolithic metals in which defects usually develop into a through-the-thickness crack during fatigue.

The importance of the fatigue delamination has long been recognized, but research progress has been slow, since this kind of real-life defect is characteristically difficult to study due to the inherent complexities of the crack geometry, the material anisotropy and discontinuity, and the crack-tip singularity. Because of the matrix-dominated and localized fracture behavior of the delamination, it would be unwise to make any simplification which fails to consider the important resin-rich interlaminar region. Numerous studies have been conducted to investigate the initiation of an interlaminar crack in composites caused by geometric discontinuities [1-3]*, processing and manufacturing defects [4, 5]. Relatively little work concerning the interlaminar crack growth behavior has been reported [6, 7], especially that associated with in-service and manufacturing defects under repeated stresses. This paper presents an experimental and analytical investigation of the crack growth behavior of an interlaminar crack initiated from a service-induced surface notch in a composite laminate subjected to cyclic loading. Unidirectional composites, which have the simplest laminate configuration, are examined first to explore the fundamental nature of the interlaminar crack. Interlaminar fatigue failure behavior of more complicated angle-ply composites is then studied and compared with the results obtained from the basic unidirectional fiber configuration.

*Numbers in brackets designate References at end of paper.

EXPERIMENTAL PROGRAM

One of the central concepts in this experimental program is to develop a suitable test technique in which stable interlaminar crack growth can be obtained under cyclic fatigue without being affected by the complex three-dimensional edge effect [8]. Experiments were conducted to identify the influential geometric and laminate parameters, to examine the interlaminar failure mechanisms, and to characterize rationally the fatigue damage behavior in the composites. They also helped to establish a realistic mechanical model for later analytical study and provided experimental data to validate the results.

Materials and Specimen Preparation

Scotchply Type 1003 E-glass/epoxy (manufactured by 3M Company, Minneapolis, Minn.) was used in the fabrication of all test specimens. The material was received in a unidirectional prepreg form. Test composites were made by a compressive molding process following manufacturer's instructions. Specimens used in the study were eight-ply composite laminates of various fiber orientations and stacking sequences. An interlaminar crack initiator was introduced in the form of a surface notch penetrating one or more plies as desired by cutting individual plies with a razor blade, prior to the laminate assembly. The specimen had a gauge length of six inches and a width of one inch, and the surface notch extended completely across the specimen width as shown in Fig. 2.

Experimental Procedures

All interlaminar crack growth tests were conducted at room temperature in a laboratory environment. Fatigue experiments were run on an Instron

Model 1211 dynamic cycler. Specimens were cycled under a controlled sinusoidal load-time condition with a minimum tensile stress of 1.0 ksi and some maximum tension at a frequency of approximately 5 cycles per second (Fig. 3). No significant heating of the specimen was observed at this frequency during the test. A traveling optical microscope mounted on the testing facilities was used periodically to monitor the interlaminar crack extension in the specimen under transmitted light and to measure accurately the delamination crack length after a given number of cycles. Fatigue crack growth data were obtained for several cases in which interlaminar cracks were initiated at different depths under the surface. Experimental results, expressed by delamination length versus number of loading cycles, are reported in the next section.

Advantages of Present Test Method

The present experimental method has several advantages particularly suitable for studying the cyclic interlaminar crack growth behavior in composites. As mentioned previously, the initiation of delamination from geometric discontinuities is complicated by the three-dimensional edge effect. Thus, the growth of the interlaminar crack may be expected to be influenced also by the edges of the laminate. Better appreciation of the nature of the problem can be obtained by investigating the delamination growth by itself without being affected by geometric boundaries. This purpose may be achieved in the current experiments by using specimens wide enough to minimize the localized edge effect on the propagating interlaminar crack front. The experiment can also provide a controlled, stable delamination growth at a desired depth and enables the crack length

to be measured accurately and conveniently. Moreover, the specimen geometry is considered relatively easy to model in the analytic study, which will be discussed in the next section.

ANALYTICAL APPROACH

The current analytical approach, using an advanced singular finite-element method of the hybrid-stress model, has a capability to overcome the aforementioned difficulties and can provide a numerically exact solution for the problem. The method, pioneered by Pian et al. [9], gives a rapid rate of solution convergence and enables an accurate description of the crack-tip response by introducing a crack-tip superelement including singular and higher order terms based on the complex variable formulation of Muskhelishvili stress functions. It is particularly suitable for studying crack problems in composites, since the complex crack geometry, laminate properties and traction boundary conditions of crack surfaces can be exactly modeled. Additional features of the method include the flexibility of formulation, the selection of element characteristics, and the expedient achievement of interelement compatibility.

Mechanical Model and Assumptions

Microscopic observation in the experimental study indicated that interlaminar crack growth is clearly a matrix-dominated progressive failure mechanism occurring in a resin-rich interlaminar region. Thus, the composite laminate is modeled as an assembly of anisotropic plies bonded together by thin resin interlayers subjected to an in-plane cyclic stress. Each fiber

reinforced lamina of thickness t_0 has its material axis oriented from the loading direction by an angle θ_1 . The resin-rich interlayer is assumed to have a uniform thickness, t_1 , and perfectly bonded with the plies everywhere except the region where a crack is initiated from the surface notch tip. The crack geometry and laminate configuration are conveniently expressed by $(\underline{\theta_1/\theta_2} // \theta_3/\theta_4/\theta_5/\dots\dots\dots)$, where the double slash and the underline represent the location of the interlaminar crack and the penetration depth of the surface notch, respectively. The interlaminar crack is modeled, for simplicity without losing generality, as a flaw completely embedded in a resin-rich interlayer as shown in Fig. 4. Studies on other extreme cases such as the crack located at a vanishing interlayer or at a ply/interlayer interface, giving a more complicated oscillating three-dimensional singular stresses, are reported elsewhere [10].

Method of Analysis

General procedure of formulating the plane crack problem in the composite is described in this section. Details of the formulation for the crack-tip superelement and surrounding non-singular elements have been given elsewhere [11, 12] and are not repeated here. Briefly, the formulation of the analysis is based on the variational principle of modified complementary energy. Following Muskhelishvili's formulation [13], the stress and displacement fields may be expressed in terms of two stress functions, $\phi(z)$ and $\psi(z)$, of a complex variable z . A mapping function $w(\xi)$ is then introduced to transfer the singular crack domain to a ξ -plane by $z = w(\xi) = \xi^2$ where $-\pi/2 \leq \arg \xi \leq \pi/2$. The functions $\phi(\xi)$ and $\psi(\xi)$ are analytical and interrelated by the traction boundary condition along crack surfaces.

In the crack-tip superelement formulation, $\phi(\xi)$ is assumed to have the form

$$\phi(\xi) = \sum_1^n b_j \xi^j \quad (1)$$

and function $\psi(\xi)$ may be obtained as

$$\psi(\xi) = - \sum_1^n [\bar{b}_j (-1)^j + \frac{1}{2} j b_j] \xi^j \quad (2)$$

where $b_j = \beta_j + i \beta_{n+j}$ (non-symmetric case) (3)

or $b_j = \beta_j$ (symmetric case) (4)

and β_s are real constants to be determined. Using Eqs. 1 and 2, the stress and displacement fields may be expressed in terms of the stress coefficients β_s . The boundary traction \underline{T} can be calculated by

$$\underline{T}_i = \sigma_{ij} v_j \quad (5)$$

Interpolating boundary displacements $\underline{\tilde{u}}$ in terms of nodal displacements $\underline{\tilde{q}}$ and inserting \underline{g} and \underline{T} into the variational principle, the crack-tip super-element stiffness matrix may be obtained.

Surrounding non-singular element stiffness matrices are formulated by a conventional hybrid-stress finite element method through a minimum complementary energy principle [14]. The anisotropic elastic properties of each glass/epoxy lamina are considered in the analysis by introducing an appropriate compliance matrix in the element stiffness formulation. Since boundary displacement functions are independently assumed for the crack element and non-singular elements, interelement compatibility can be ensured by a suitable choice of interpolation functions.

The assembled governing equations for the whole system may be written as

$$\underline{K}\underline{q} = \underline{Q} \quad (6)$$

where K is the global stiffness matrix, and Q , the consistent loading vector. After solving q from Eq. 6 by an appropriate solution scheme, the stress and strain fields can be determined. Stress intensity factors K_I and K_{II} corresponding to an applied stress level and an interlaminar crack length may be found from the relation

$$K_I = \sqrt{2\pi} \beta_1 \quad (7)$$

$$K_{II} = \sqrt{2\pi} \beta_{n+1} \quad (8)$$

The associated elastic energy release rates G_I and G_{II} can be obtained by standard procedure.

The accuracy and convergence assessments of the solutions are complicated by several unusual features of the problem and of the method of analysis due to the inherently singular nature of the interlaminar crack. A study of the accuracy and convergence of the analysis, and solution stability has been conducted by testing cases for which independent solutions are available. Excellent agreements with existing closed-form solutions were obtained. The results indicated that accuracy within approximately one percent of the converged solutions of K_I and K_{II} can be achieved by the optimum mesh arrangements used in the current study. Details of the study were reported [12].

For the cases of cyclic loading, the ranges of interlaminar crack-tip stress intensity factors, ΔK_I and ΔK_{II} , may be determined by

$$\Delta K_I = (K_I)_{\max} - (K_I)_{\min} \quad (9)$$

$$\Delta K_{II} = (K_{II})_{\max} - (K_{II})_{\min} \quad (10)$$

where $(K_I)_{\max}$ and $(K_{II})_{\max}$ are opening and shearing mode stress intensity

factors corresponding to a maximum cyclic stress level σ_{\max} for the delamination crack of length ℓ_d , and $(K_I)_{\min}$ and $(K_{II})_{\min}$ are the values associated with a minimum cyclic stress level σ_{\min} . Numerical results of $(K_I)_{\max}$, $(K_{II})_{\max}$, $(K_I)_{\min}$ and $(K_{II})_{\min}$ were accurately computed for the delamination test specimens by the computer-aided numerical method.

RESULTS AND DISCUSSION

Typical results of the crack growth study of the eight-ply fiberglass composites subjected to nominal cyclic stresses are presented in this section. In the experimental phase, interlaminar crack growth rates were determined by the constant load-amplitude fatigue tests. In the analytical phase of the study, the crack-tip stress field and the ranges of the cyclic stress intensity factors were obtained for the laminates with various geometric and ply configurations. Interlaminar crack growth rates during fatigue were then characterized by the ranges of the mixed-mode cyclic stress intensity factors. The individual glass/epoxy lamina used in the analytical modeling had a thickness dimension of 0.01 inch, and the interlaminar layer was taken as one-twentieth of the ply thickness as observed in the microscope. Elastic constants for each lamina were given by

$$E_{LL} = 5.0 \times 10^6 \text{ psi}$$

$$G_{Lz} = 0.75 \times 10^6 \text{ psi}$$

$$E_{zz} = 1.5 \times 10^6 \text{ psi}$$

$$\nu_{Lz} = 0.25$$

The interlaminar epoxy resin phase has the properties:

$$E_m = 0.5 \times 10^6 \text{ psi}$$

$$\nu_m = 0.35$$

$$G_m = 0.185 \times 10^6 \text{ psi}$$

Interlaminar Crack Growth During Fatigue

Microscopic observation in the fatigue experiments revealed that delamination was initiated after a few load cycles. It propagated in a stable manner and was clearly a matrix-dominated, progressive failure mechanism occurring in a resin-rich region between plies. This suggested an appropriate mechanical model used later in the analytical study. Measurements were made on the change of the subcritical crack length during cyclic loading. Typical fatigue crack growth data in unidirectional and $(\pm 45^\circ)_{4S}$ glass/epoxy composites are presented in Figs. 5 and 6. Test results shown in the figures for several maximum cyclic stress levels indicate that crack lengths change drastically with the number of load cycles and that crack growth rates are very distinct between the unidirectional and angle-ply laminates. The growth rates of the delamination dl_d/dN were determined by a computational procedure based on the first derivatives of crack growth curves fitted by experimental data. The crack extension rates were found to increase continuously during the course of fatigue, and rapid crack propagation occurred when the ultimate delamination resistance of the composite was approached. Intralaminar failure, which may lead to a complete fracture of the composites, were often observed in $(\underline{45^\circ/-45^\circ//45^\circ/-45^\circ/-45^\circ/45^\circ/-45^\circ/45^\circ})$ and quasi-isotropic $(\underline{45^\circ/-45^\circ//0^\circ/90^\circ/90^\circ/0^\circ/-45^\circ/45^\circ})$ glass/epoxy prior to large-scale delamination. The number of loading cycles to fracture versus applied cyclic stress for the two composite systems is shown in Fig. 7. The ultimate static strengths (σ_{UTS}) of these laminates were 14.7 and 44.55 Ksi, respectively.

Interlaminar Crack-Tip Response

The driving force of the interlaminar crack growth depends primarily on local crack-tip stresses. Thus, it is necessary to have accurate information on the crack-tip behavior. Since the geometry and material properties are very complex in the problem, the response of the composite to the damage may be best illustrated by isostress contours. These contours were plotted from the analytical solutions obtained by the aforementioned hybrid finite element analysis. Figure 8 gives the distribution of the in-plane stress $\sigma_{xx}/\sigma_{\infty}$ around the crack with $l_d = 0.8$ inch in a $(0^\circ/0^\circ//0^\circ/0^\circ/0^\circ/0^\circ/0^\circ/0^\circ)$ glass/epoxy. The computer plot provides a graphic description of the solutions and an overall view of the damage behavior. It reveals several salient features of the problem: (i) the intensified stress field caused by interlaminar damage is very localized within the matrix-rich interlaminar region ahead of the crack tip, (ii) a large stress gradient exists through the laminate thickness with high concentration in adjacent plies, and (iii) a local compressive in-plane stress component is developed along the lower crack flank. Figures 9 and 10 show the contour plots of interlaminar shear and transverse normal stress distributions in the near field. Both stress components reach extremely high levels within the thin interlaminar region when the crack tip is approached. The interlaminar stresses extend continuously through the interface into the adjacent plies.

A more accurate description of the near field stresses may be expressed by a $\log \sigma_{ij}$ versus $\log r$ representation, where r is the distance ahead of the crack tip. The numerical results near the crack tip give straight lines with a slope of $-\frac{1}{2}$, indicating a classical fracture mechanics solution, i.e., a $1/\sqrt{r}$ singularity; details of the results may be found in [15]. The opening

and shearing mode stress components are observed to have the same order of magnitude at the interlaminar crack tip when a uniaxial nominal stress is applied. The singular stress domain is rather small and is embedded in the resin-rich interlayer region.

The redistribution of laminate stresses due to the propagating interlaminar crack will have a significant effect on the deformation and fracture of the composite. For example, the compressive stress in the lower crack flank may introduce severe local buckling of the delaminated plies in the vicinity of the surface notch. This phenomenon was experimentally observed in [16,17]. The highly nonuniform stress distributions in the transverse direction shown in the isostress contour plots suggest that the classical laminate theory may not be applicable to a delaminated composite. The stress concentration may also introduce a transition from interlaminar to intralaminar fracture mode when different ply orientations are used [18]. Furthermore, the presence of the interlaminar crack may become detrimental to the serviceability of the material when used in an adverse environment such as moisture and corrosive chemicals, because not only does the crack expose the interior of the composite to environmental attack, but also the stress concentration in the near field may enhance the rate-dependent degradation process, which is evident by the results in [19].

Fatigue Crack Growth Rate Characterization

The stable extension of an interlaminar crack in glass/epoxy composites reveal several features of the progressive interlaminar fatigue damage, which can be used to probe the nature of the delamination growth behavior. Since the interlaminar crack growth is observed as a matrix-dominated failure process and since it is strongly affected by the local crack-tip response, it may be appropriate to postulate, as in the cases of metals and polymers [20,21],

that ΔK_I and ΔK_{II} are critical controlling factors in the fatigue damage. The ranges of the cyclic stress intensity factors are, in turn, related to the crack length, the cyclic stress, the geometry and laminate properties. In the current fatigue test, stress intensity factors change continuously as the load and the interlaminar crack length increase, and the corresponding crack growth rate varies accordingly. For a given crack length and laminate configuration, exact stress intensity factors may be computed by using the present analytical method. Therefore, ΔK_I and ΔK_{II} can be precisely determined from Eqs. 9 and 10. It may be reasonable, at this point, to postulate further that ΔK_I and ΔK_{II} independently affect the interlaminar crack growth rate. Thus, $d\ell_d/dN$, obtained from the experiments, may be related to both the ΔK_I and the ΔK_{II} simultaneously as shown in Figs. 11 and 12 for the glass/epoxy composites with two distinct ply orientations. Strong correlation between $d\ell_d/dN$ and ΔK s is observed from the results, and a power law relationship of the following form may be established,

$$\frac{\log\left(\frac{d\ell_d}{dN}\right)}{\alpha_1} = \frac{\log(\Delta K_I) + C_1}{\alpha_2} = \frac{\log(\Delta K_{II}) + C_2}{\alpha_3} \quad (11)$$

where α_1 s are the directional cosines of the lines determined by a least-square curve-fitting method, and C_1 and C_2 are constants associated with the threshold values of the mixed-mode stress intensity factor ranges.

This functional relationship in Eq. 11 suggests that

$$\frac{d\ell_d}{dN} \sim (\Delta K_I)^{\lambda_1} \quad (12a)$$

or

$$\frac{d\ell_d}{dN} \sim (\Delta K_{II})^{\lambda_2} \quad (12b)$$

where the exponents λ_1 and λ_2 are related to the laminate configuration, the crack geometry and the material properties of composites. The results in

Figs. 11 and 12 give respective λ_1 and λ_2 the values of 7.32 and 7.42, for 0° and 7.52 and 7.74 for $\pm 45^\circ$. The strong correlation between the interlaminar crack propagation rate and the ranges of cyclic stress intensity factors are very informative. Further study is needed to identify the nature of the interlaminar crack under more complex fatigue loading and to construct the crack growth rate surface of mixed-mode failure so as to characterize fully the interlaminar fatigue behavior, and the relative dominance of each individual fracture mode.

Limitations of Current Study

It should be noted here that several geometric and material complications in composites have not been included in the current analytical modeling, such as the nonuniformity of the resin-rich interlaminar region thickness, the heterogeneity of the fiber and matrix phases, and other types of commonly encountered defects (e.g. voids, inclusions, broken plies, etc.). These complications are statistical in nature and almost always exist in the material. Their presence may have significant effects on the interlaminar crack growth behavior, but has not been fully explored yet. The anti-plane mode deformation and fracture (mode III), which may have an important contribution to the progressive fatigue failure of the materials, especially in the angle-ply composite laminates, have not been considered in the present study. A recent study on edge delamination [10] reveals that the mode III component of the crack-tip field has a very high value, which may be primarily responsible for the interlaminar crack growth and failure of the composites, including the $\pm 45^\circ$ case. Furthermore, residual stresses due to ply differential thermal contraction during the curing process may strongly affect the crack growth behavior. This effect has not been included in the present investigation.

SUMMARY AND CONCLUSION

A combined experimental and analytical investigation of interlaminar crack growth in fiber-reinforced composites under cyclic loading has been presented. The unidirectional ply configuration was studied first to elucidate the fundamental failure behavior and, later, served as a reference for studying more complex angle-ply composite laminates. In the experimental phase, microscopic observation of failure mechanisms revealed that delamination is clearly a matrix-dominated, progressive failure occurring in the resin-rich interlaminar region. Interlaminar crack growth rates under tension-tension fatigue were obtained, and test results were further used in conjunction with analytical characterization. The analytical study of the problem was based on an advanced hybrid-stress finite element method, formulated by using Muskhelishvili's complex stress functions through a modified complementary energy principle. Numerical solutions clarify the basic nature of the cyclic interlaminar failure. Implications of the results in the applicability of classical laminate theory to the delamination problem due to the localized interlaminar crack-tip singularity and the stress concentration in the adjacent plies were discussed. Fatigue crack growth rates were found to be related directly to the ranges of the mixed-mode cyclic stress intensity factors by a power law relationship. The study elucidates many important features of the delamination problem, provides insight into the interlaminar fatigue behavior, and should be of practical importance in the testing and design of composites materials.

Acknowledgments

The work described in this paper was supported in part by NASA-Lewis Research Center, Cleveland, Ohio under Grant NSG 3044. The authors are grateful to Dr. C. C. Chamis for his encouragement and cooperation. Fruitful discussion with Dr. J. F. Mandell of the Massachusetts Institute of Technology is deeply acknowledged.

REFERENCES

- 1 Pipes, R. D., Kaminski, B. E. and Pagano, N. J., "Influence of the Free Edge upon the Strength of Angle-Ply Laminates," *Analysis of the Test Methods for High Modulus Fibers and Composites*, ASTM STP 521, American Society for Testing and Materials, 1973, pp. 218-228.
- 2 Wang, S. S., Mandell, J. F. and McGarry, F. J., "Three Dimensional Solution for a Through-Thickness Crack with Crack Tip Damage in a Cross-Plyed Laminate," *Fracture Mechanics of Composites*, ASTM STP 593, American Society for Testing and Materials, 1975, pp. 61-85.
- 3 Reifsnider, K. L., Henneke, E. G., II and Stinchcomb, W. W., "Delamination in Quasi-isotropic Graphite-Epoxy Laminates," *Composite Materials: Testing and Design (Fourth Conference)*, ASTM STP 617, American Society for Testing and Materials, 1977, pp. 93-105.
- 4 Verett, R. M. and Demuts, E., "Effects of Manufacturing and In-Service Defects on Composite Materials," *Proceedings of the Army Symposium on Solid Mechanics, 1976-Composite Materials: The Influence of Mechanics of Failure on Design*, AMMRC MS 76-72, Army Mechanics and Materials Research Center, Watertown, Mass., 1976, pp. 123-137.
- 5 Wang, S. S., "Delamination Fracture from Surface Notch in $(\pm 45^\circ/0^\circ/90^\circ)_s$ Graphite/Epoxy Composites," *Proceedings of the Second International Conference on Composite Materials (ICCM-II)*, TMS-AIME, 1978.
- 6 Erdogan, F. and Arin, K., "A Sandwich Plate with a Part-Through and Debonding Crack," *Engineering Fracture Mechanics*, Vol. 4, 1972, pp. 449-458.
- 7 Kulkarni, S. V. and Frederick, D., "Propagation of Delamination in a Layered Cylindrical Shell," *International Journal of Fracture*, Vol. 9, 1973, pp. 113-115.

- 8 Pipes, R. B. and Pagano, N. J., "Interlaminar Stresses in Composite Laminates under Uniform Axial Extension," *Journal of Composite Materials*, Vol. 4, 1970, pp. 538-548.
- 9 Pian, T. H. H., Tong, P. and Luk, C. H., "Elastic Crack Analysis by a Finite Element Method," *Proceedings of the Third Conference on Matrix Methods in Structural Mechanics* 1971, pp. 661-682.
- 10 Wang, S. S., "An Analysis of Edge Delamination Crack in Composite Laminate under Uniform Axial Extension," NASA CR-165439, National Aeronautics and Space Administration, Washington, D.C., 1981.
- 11 Tong, P., Pian, T. H. H. and Lasry, S., "A Hybrid-Element Approach to Crack Problems in Plane Elasticity," *International Journal for Numerical Methods in Engineering*, Vol. 7, 1973, pp. 297-308.
- 12 Wang, S. S., Mandell, J. F. and McGarry, F. J., "An Analysis of the Crack Tip Stress Field in DCB Adhesive Fracture Specimens," *International Journal of Fracture*, Vol. 14, No. 1, Feb., 1978, pp. 39-58.
- 13 Muskhelishvili, N. I., *Some Basic Problems of Mathematical Theory of Elasticity*, P. Noordhoff, Groningen, The Netherlands, 1953.
- 14 Pian, T. H. H., "Derivation of Element Stiffness Matrix by Assumed Stress Distribution," *American Institute of Aeronautics and Astronautics Journal*, Vol. 2, 1964, pp. 1333-1336.
- 15 Wang, S. S. and Mandell, J. F., "Analysis of Delamination in Unidirectional and Crossplied Fiber Reinforced Composites Containing Surface Cracks," NASA Technical Report NASA-CR-135248, May, 1977.

- 16 Sendeckyj, G. P., Stalnaker, H. D., Kleismit, R. A., "Effect of Temperature on Frequency Response of Surface-Notched $[(0^\circ, \pm 45^\circ, 0^\circ)_B]_3$ Graphite-Epoxy Laminate", *Fatigue of Filamentary Composite Materials*, ASTM STP 636, K. L. Reifsnider and K. N. Lauraitis, Eds., American Society for Testing and Materials, 1977, pp. 123-140.
- 17 Sendeckyj, G. P., "Surface Notches in Composites", submitted for publication, Air Force Flight Dynamics Laboratory, Wright-Patterson AFB, Ohio, 1978.
- 18 Wang, S. S., "Failure Modes of Interlaminar Crack in Quasi-isotropic Fiber-Reinforced Composites Containing a Surface Notch," in *Failure Modes and Processing of Composites IV*, TMS-AIME, Oct., 1977.
- 19 Mandell, J. F., "Origin of Moisture Effects on Crack Propagation in Composites," Research Report R77-4, Department of Materials Science and Engineering, M.I.T., Dec., 1977.
- 20 Hertzberg, R. W., in *Deformation and Fracture Mechanics of Engineering Materials*, Chap. 13, John Wiley and Sons, Inc., New York, 1976, pp. 465-520.
- 21 Manson, J. A. and Hertzberg, R. W., "Fatigue Failure in Polymers," *Critical Reviews in Macromolecular Science*, Vol. 1, No. 4, 1973, pp. 433-500.

LIST OF CAPTIONS FOR FIGURES

- Fig. 1 Micrograph of Graphite Fiber Reinforced Composite Showing Individual Plies and Resin-Rich Interlayers Between Plies
- Fig. 2 Fatigue Test Specimen for Interlaminar Crack Growth Study
- Fig. 3 Stress vs. Time During Fatigue Test
- Fig. 4 Interlaminar Crack Geometry, Coordinate System, and Hybrid-Stress F.E.M. Mesh Configuration in Composites
- Fig. 5 Interlaminar Crack Growth During Fatigue in (0°/0°// 0°/0°/0°/0°/0°/0°) Glass/Epoxy
- Fig. 6 Interlaminar Crack Growth During Fatigue in (45°/-45°// 45°/-45°/-45°/45°/-45°/45°) Glass/Epoxy
- Fig. 7 Fatigue Stress vs. Number of Cycles to Failure for Glass/Epoxy Composites with Different Laminate Configurations
- Fig. 8 In-plane Longitudinal Stress Contours $\sigma_{xx}/\sigma_{\infty}$ Near Interlaminar Crack Tip in (0°/0°// 0°/0°/0°/0°/0°/0°) Glass/Epoxy
- Fig. 9 Transverse Normal Stress Contours $\sigma_{zz}/\sigma_{\infty}$ Near Interlaminar Crack Tip in (0°/0°// 0°/0°/0°/0°/0°/0°) Glass/Epoxy
- Fig. 10 Interlaminar Shear Stress Contours $\sigma_{xz}/\sigma_{\infty}$ Near Interlaminar Crack Tip in (0°/0°// 0°/0°/0°/0°/0°/0°) Glass/Epoxy
- Fig. 11 Interlaminar Crack Growth Rate $d\ell_d/dN$ as a Function of the Ranges of Mixed-Mode Stress Intensity Factors, ΔK_I and ΔK_{II} for (0°/0°// 0°/0°/0°/0°/0°/0°) Glass/Epoxy
- Fig. 12 Interlaminar Crack Growth Rate $d\ell_d/dN$ as a Function of the Ranges of Mixed-Mode Stress Intensity Factors ΔK_I and ΔK_{II} for (45°/-45°// 45°/-45°/-45°/45°/-45°/45°) Glass/Epoxy

ORIGINAL PAGE IS
OF POOR QUALITY

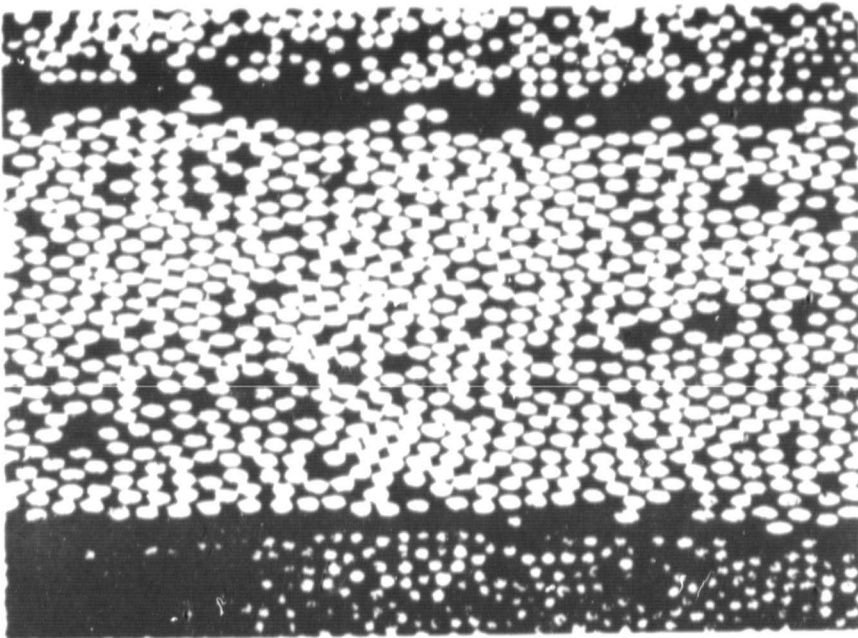

FIG. 1 MICROGRAPH OF GRAPHITE FIBER REINFORCED
COMPOSITE SHOWING INDIVIDUAL PLYS AND
RESIN-RICH INTERLAYERS BETWEEN PLYS.

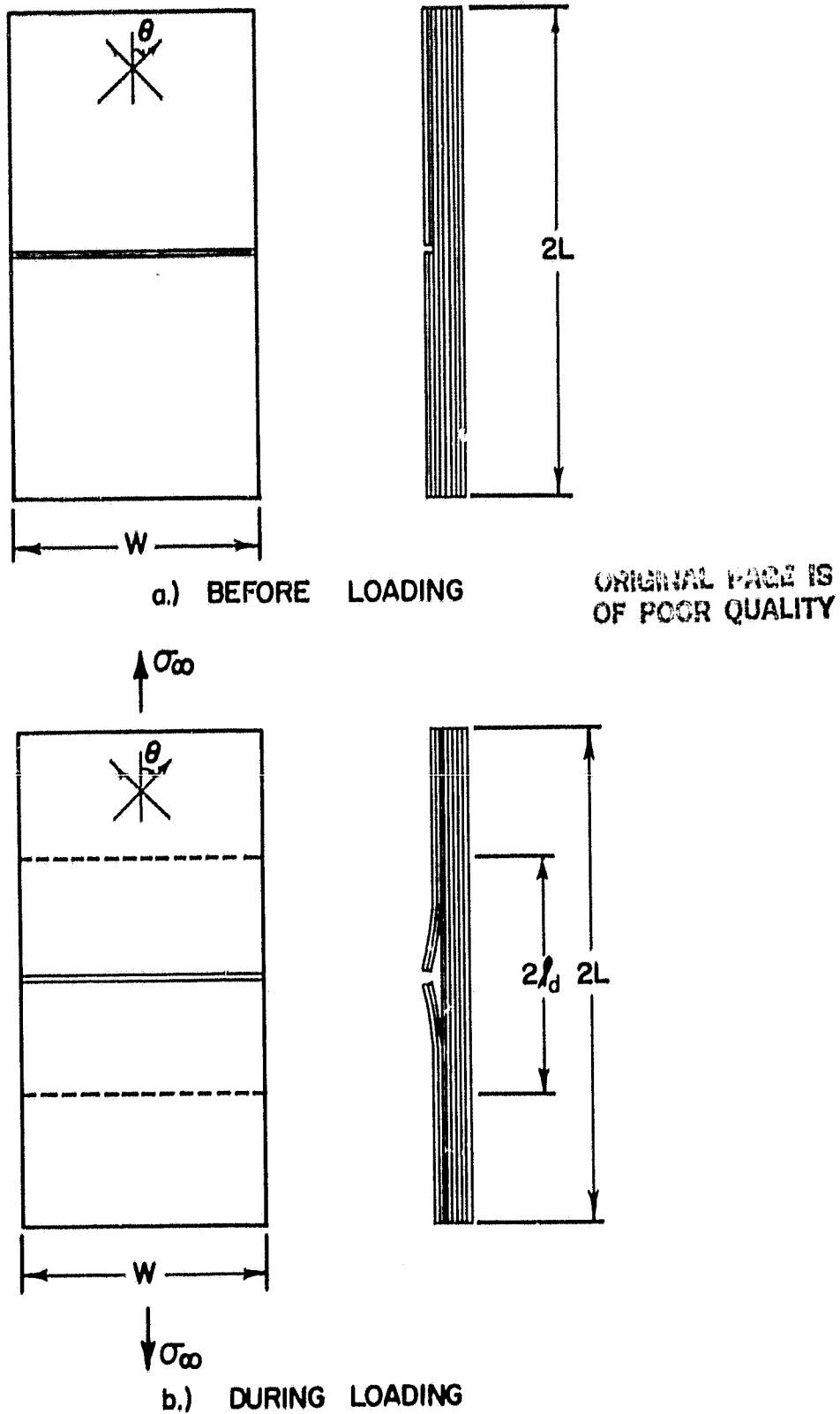

FIG. 2 FATIGUE TEST SPECIMEN FOR INTERLAMINAR CRACK GROWTH STUDY ($2L = 6.0$ in.; $W = 1.0$ in.)

ORIGINAL PAGE IS
OF POOR QUALITY

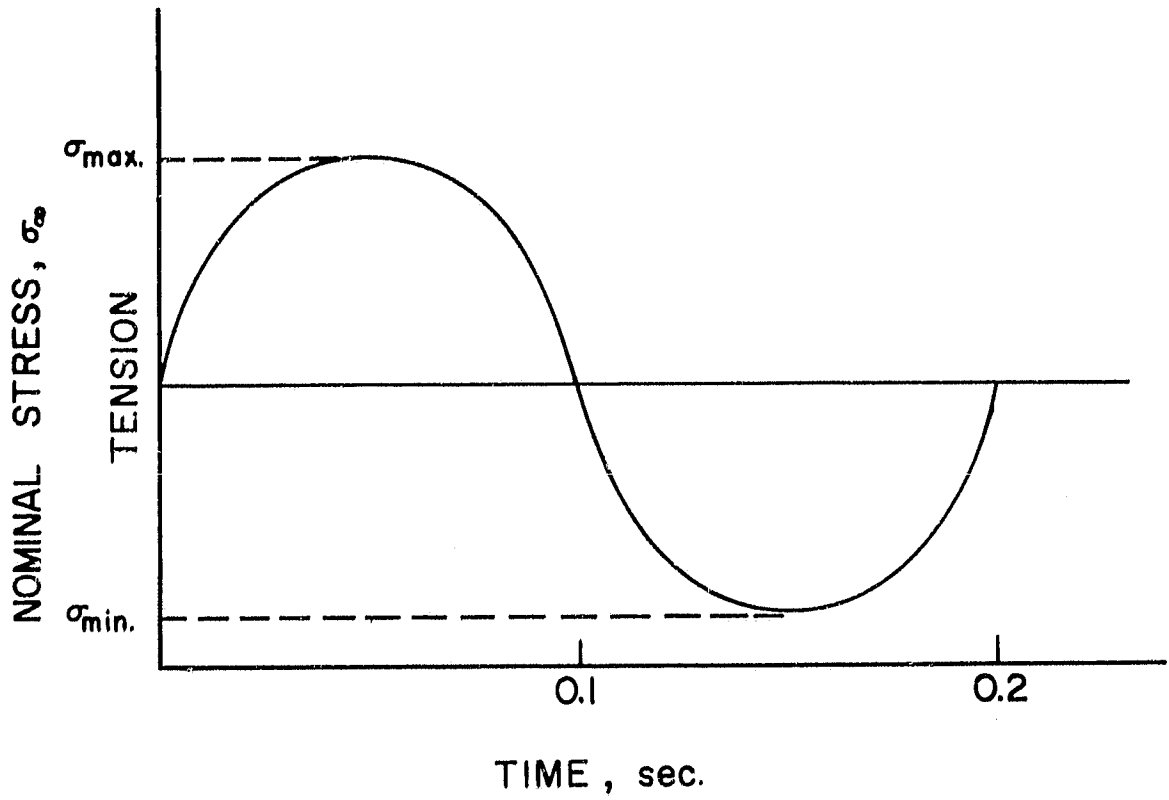

FIG. 3 STRESS vs. TIME FOR FATIGUE TEST

ORIGINAL PAGE IS
OF POOR QUALITY

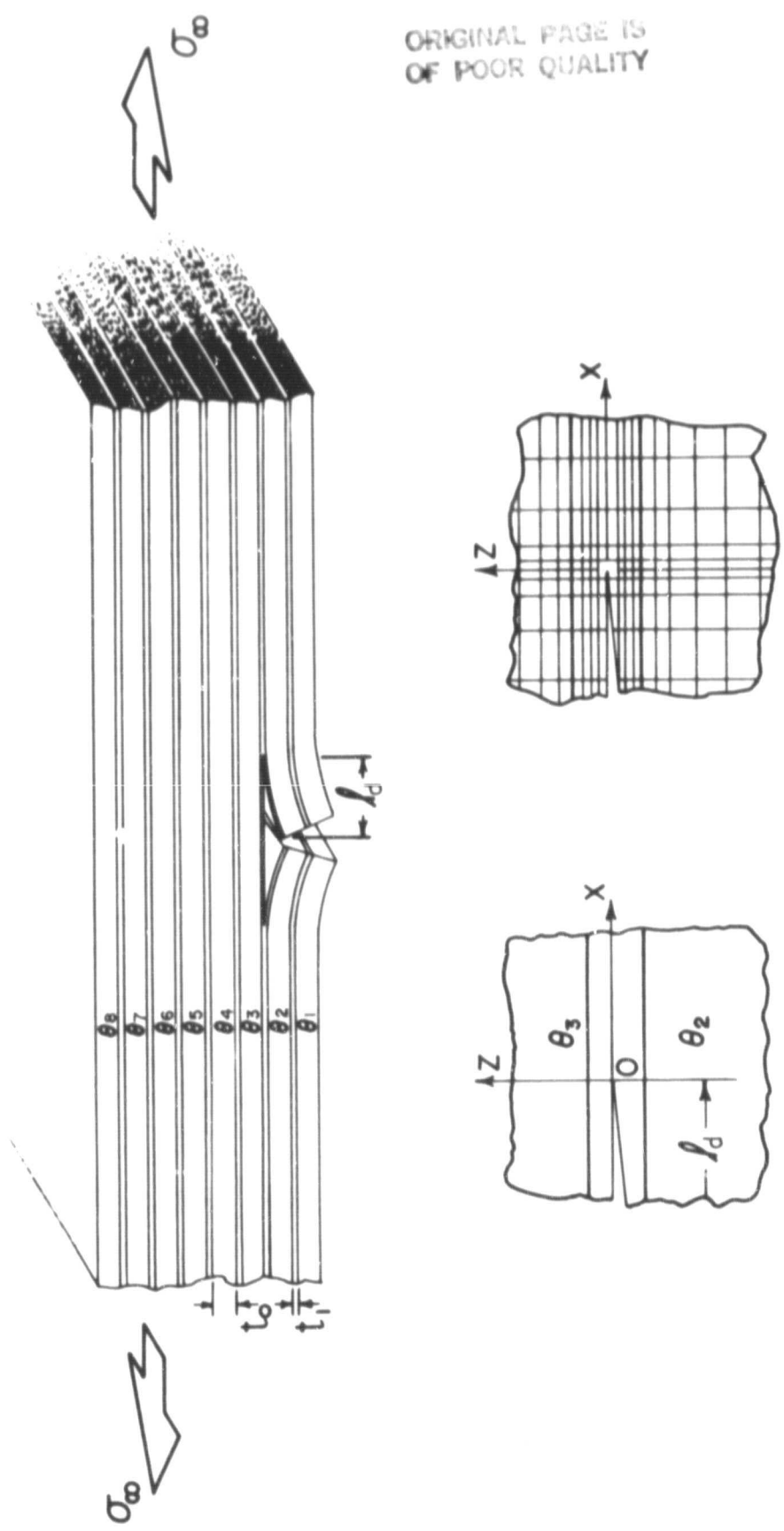

FIG. 4 INTERLAMINAR CRACK GEOMETRY, COORDINATE SYSTEM AND HYBRID-STRESS F.E.M. MESH CONFIGURATION IN COMPOSITES

ORIGINAL PHOTO IS
OF POOR QUALITY

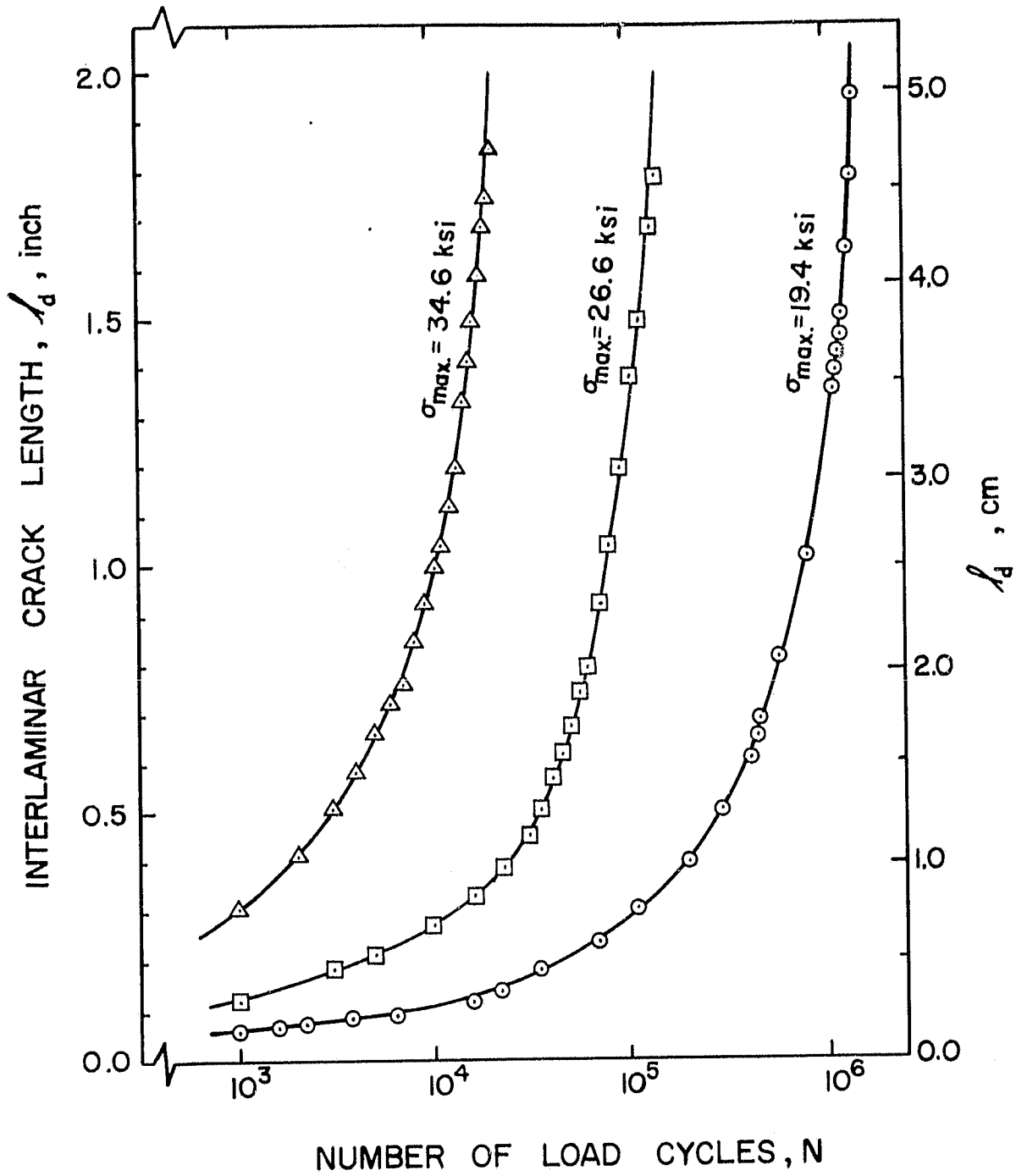

FIG. 5 INTERLAMINAR CRACK GROWTH DURING FATIGUE
IN (0%0%0%0%0%0%0%) GLASS/EPOXY

ORIGINAL PAGE IS
OF POOR QUALITY

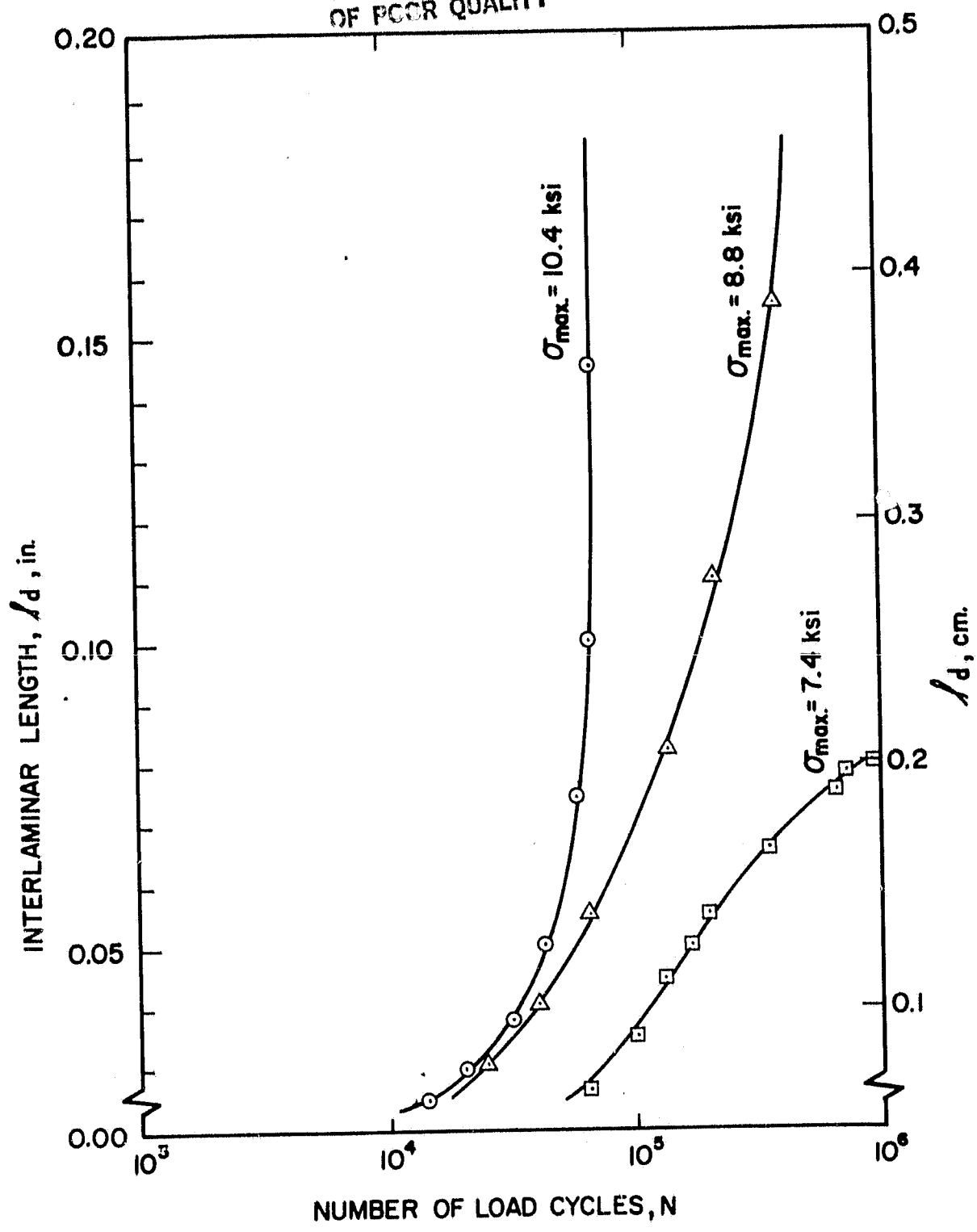

FIG. 6 INTERLAMINAR CRACK GROWTH DURING FATIGUE IN
(45°-45°//45°-45°-45°/45°-45°/45°) GLASS/EPOXY

ORIGINAL PAGE IS
OF POOR QUALITY

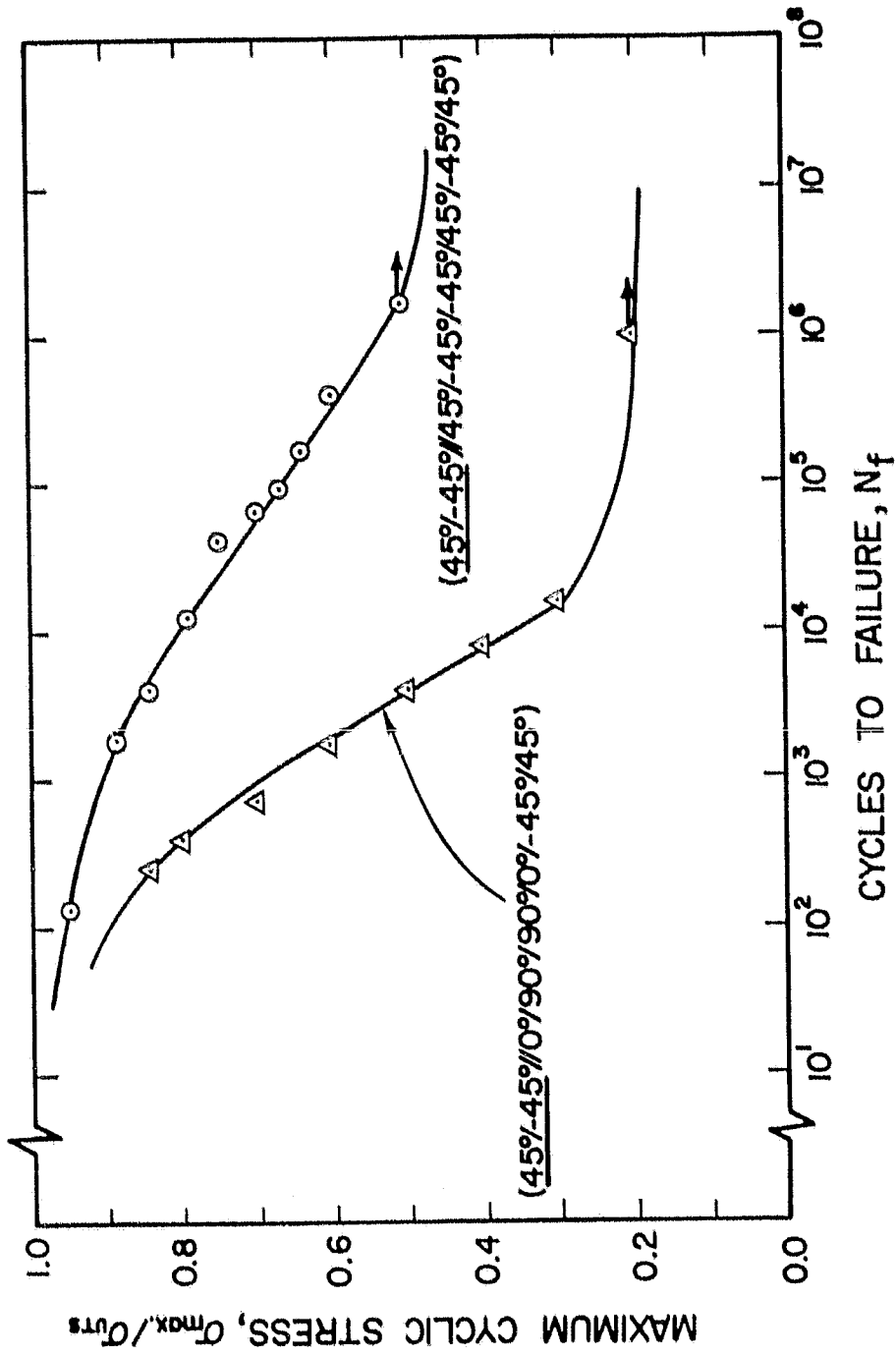

FIG. 7 FATIGUE STRESS vs NUMBER OF CYCLES TO FAILURE FOR GLASS/EPOXY COMPOSITES WITH DIFFERENT LAMINATE CONFIGURATIONS

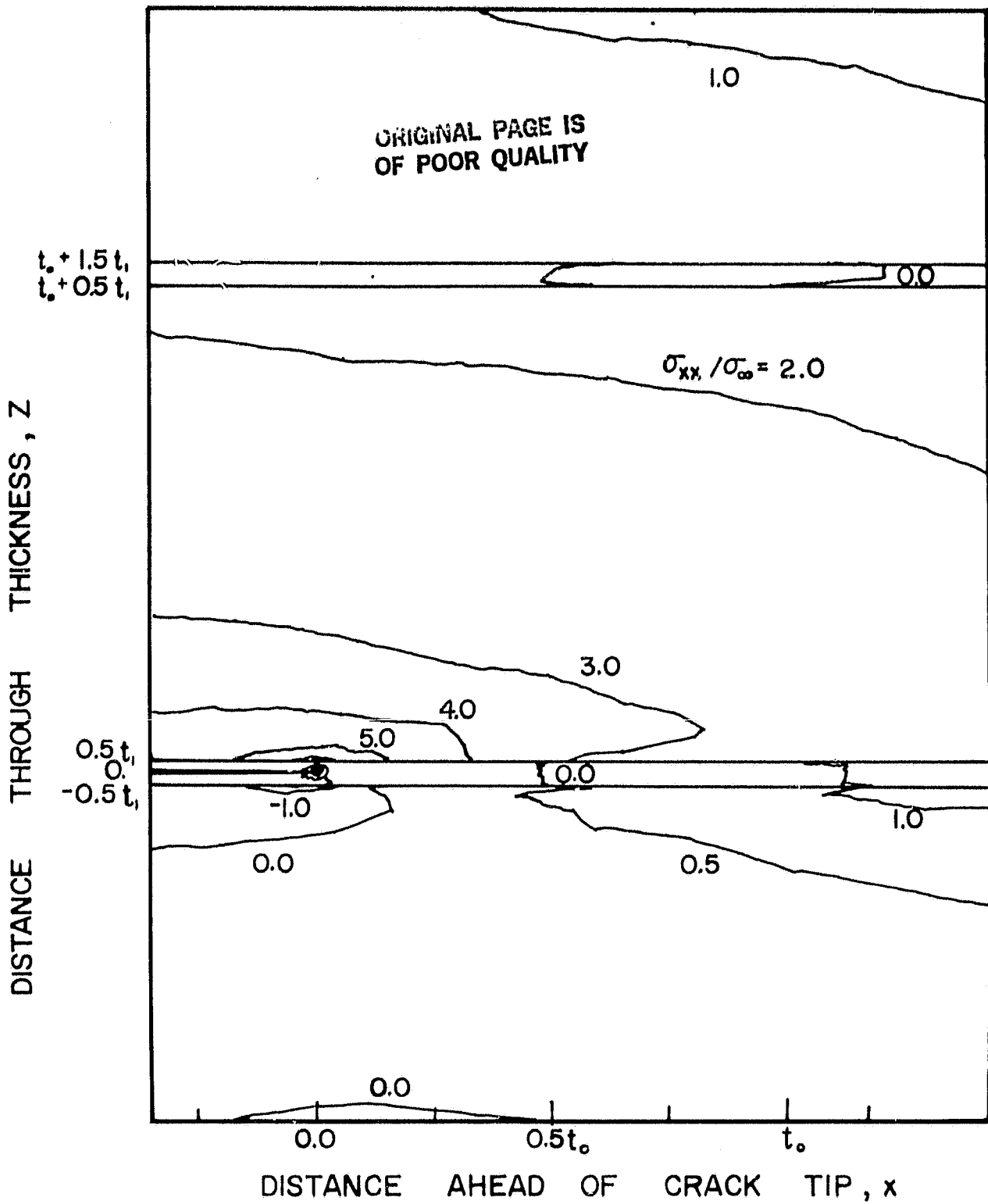

FIG. 8 IN-PLANE LONGITUDINAL STRESS CONTOUR $\sigma_{xx}/\sigma_{\infty}$ NEAR INTERLAMINAR CRACK TIP IN (0°/0°//0°/0°/0°/0°/0°) GLASS/EPOXY

ORIGINAL PAGE IS
OF POOR QUALITY

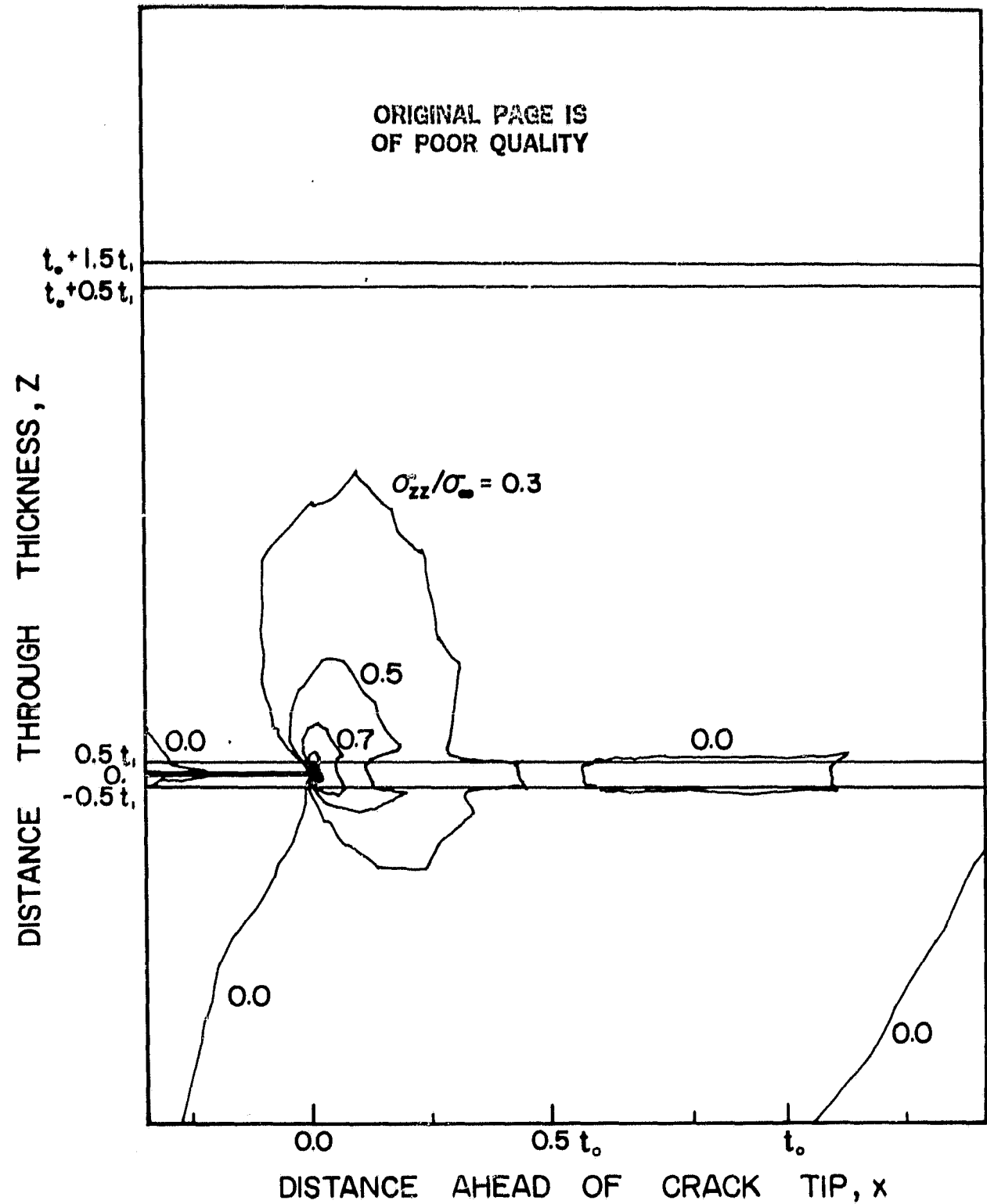

FIG. 9 TRANSVERSE NORMAL STRESS CONTOURS
 $\sigma_{zz}/\sigma_\infty$ NEAR INTERLAMINAR CRACK TIP
IN (0°/0°/0°/0°/0°/0°/0°) GLASS/EPOXY

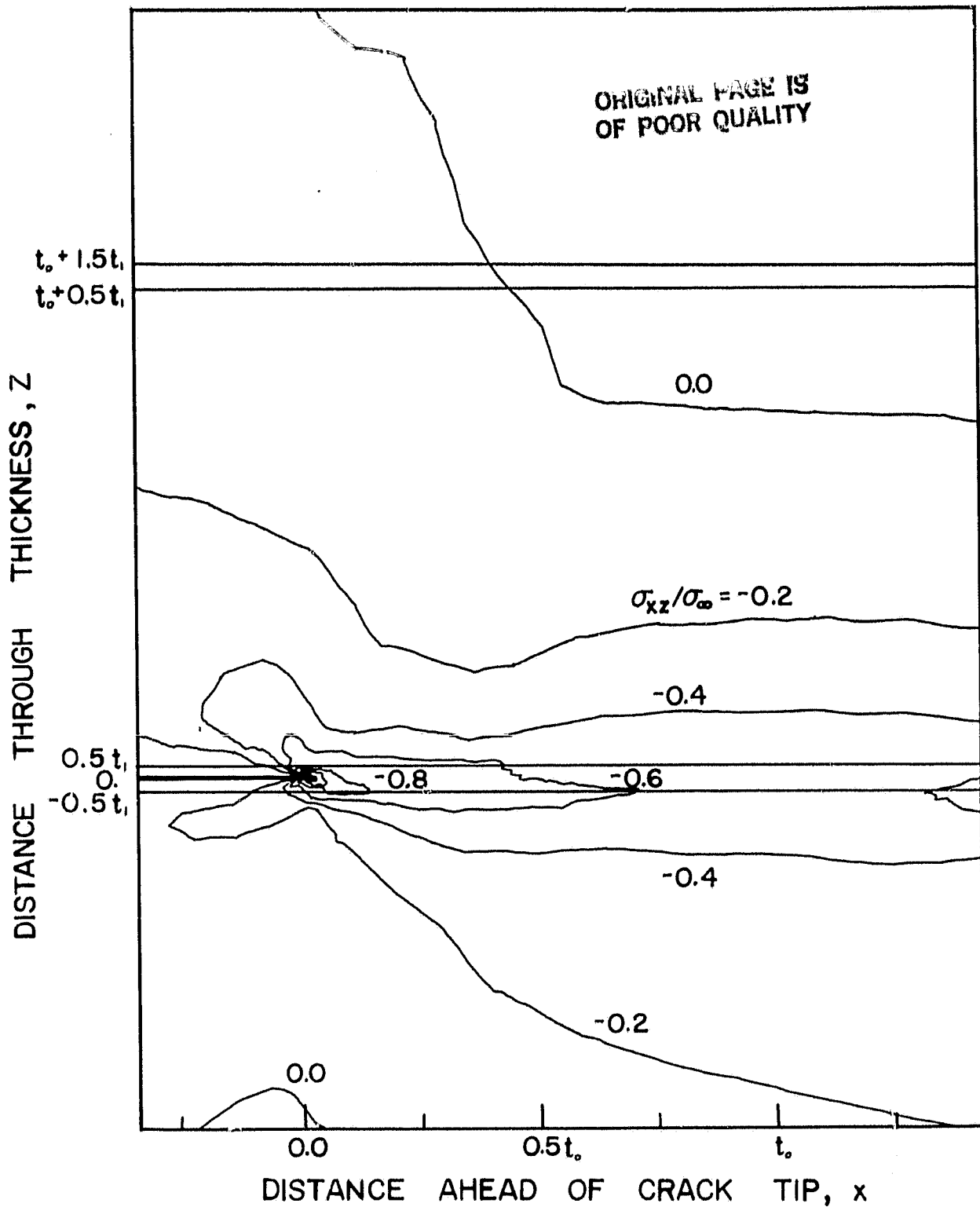

FIG.10 INTERLAMINAR SHEAR STRESS CONTOURS
 $\sigma_{xz}/\sigma_\infty$ NEAR INTERLAMINAR CRACK TIP
 IN (0°/0°/0°/0°/0°/0°) GLASS/EPOXY

ORIGINAL PAGE IS
OF POOR QUALITY

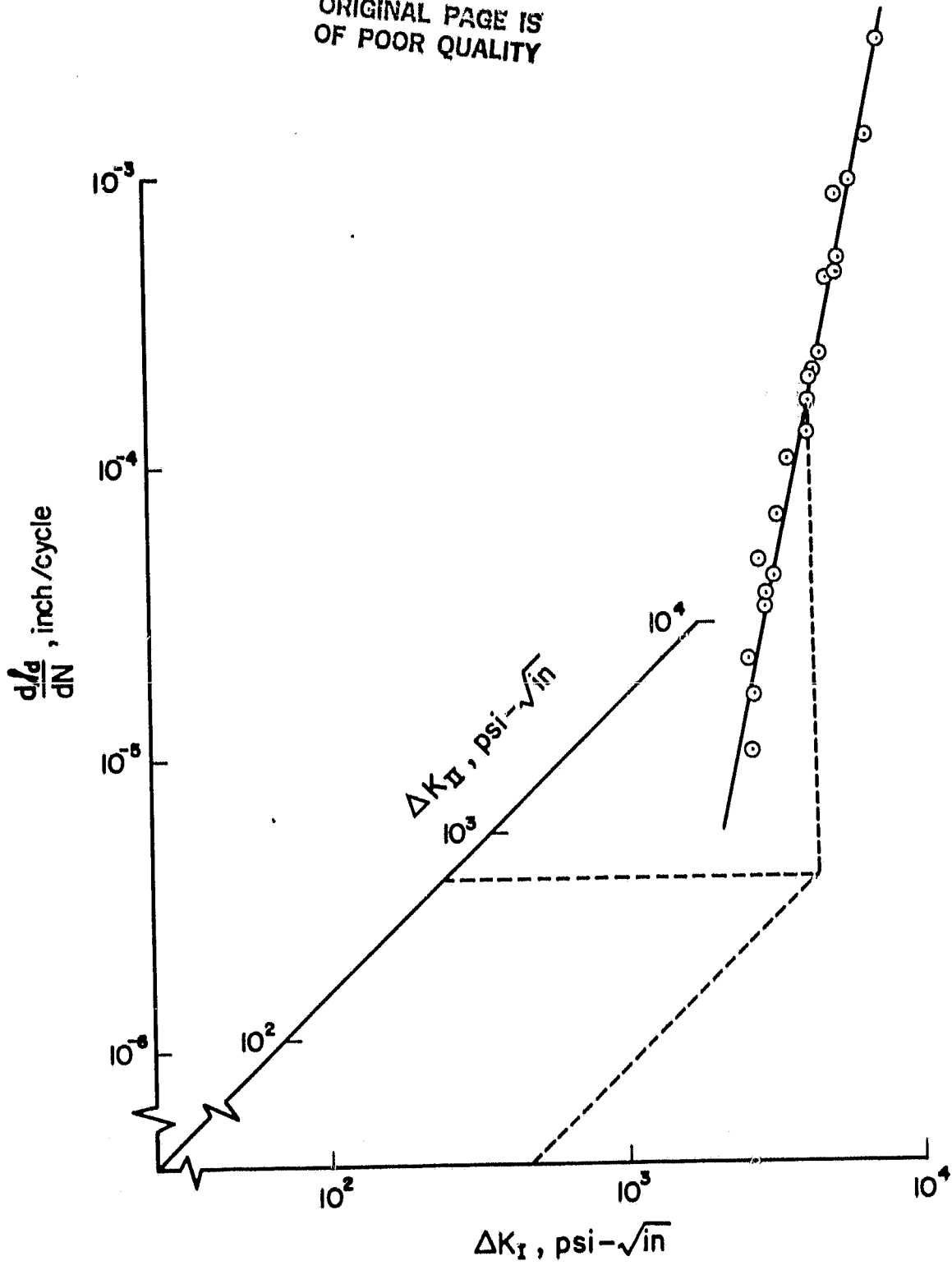

FIG. II INTERLAMINAR CRACK GROWTH RATE $d/d/dN$ AS A FUNCTION OF MIXED-MODE STRESS FACTOR RANGES ΔK_I & ΔK_{II} FOR (0°/0°//0°/0°/0°/0°/0°) GLASS/EPOXY

ORIGINAL PAGE IS
OF POOR QUALITY

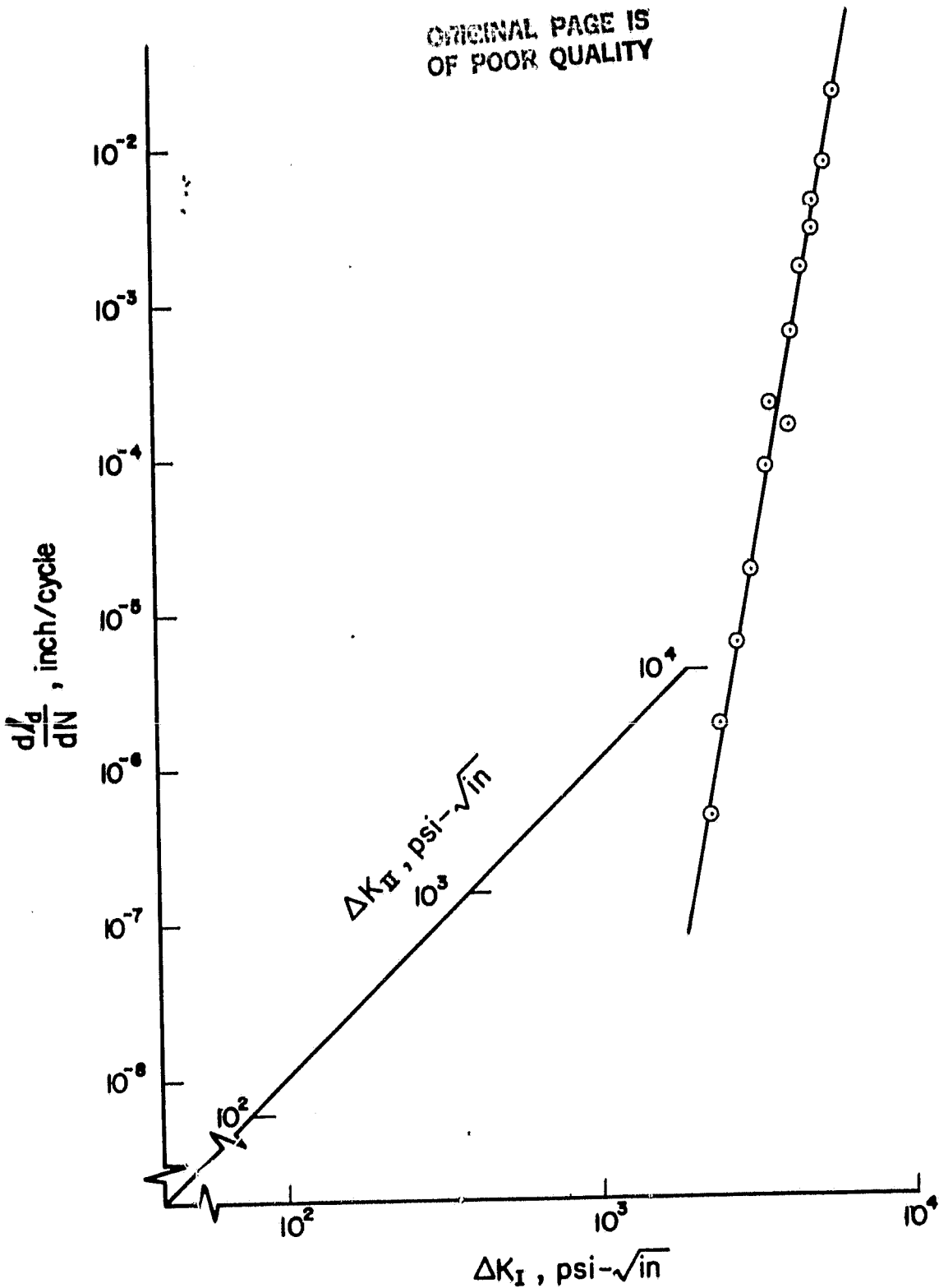

FIG.12 INTERLAMINAR CRACK GROWTH RATE $d/d/dN$ AS A FUNCTION OF RANGES OF MIXED-MODE STRESS INTENSITY FACTORS, ΔK_I & ΔK_{II} FOR (45°-45°/45°-45°-45°/45°-45°/45°) GLASS/EPOXY