

NASA Contractor Report 3572

NASA
CR
3572
c. 1



Analytical and Simulator Study of Advanced Transport Handling Qualities

William H. Levison and William W. Rickard

LOAN COPY: RETURN TO
AECI TECHNICAL LIBRARY
WINDLAND AFB, N.M.

CONTRACT NAS1-16410
JUNE 1982

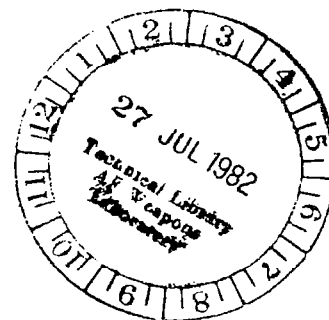



NASA Contractor Report 3572

Analytical and Simulator Study of Advanced Transport Handling Qualities

William H. Levison

*Bolt Beranek and Newman Inc.
Cambridge, Massachusetts*

William W. Rickard

*Douglas Aircraft Company
Long Beach, California*

Prepared for
Langley Research Center
under Contract NAS1-16410



National Aeronautics
and Space Administration

**Scientific and Technical
Information Office**

1982

LIST OF TABLES

1.	Flying Quality Levels of Test Configurations 1-8.	8
2.	Pilot-Related Model Parameters Appropriate to Glideslope Tracking at a 500-foot Altitude	12
3.	Motion Limits	18
4.	Qualities Levels of Test Configurations 1-10.	21
5.	Identification of Test Configurations	24
6.	Subjective Estimates of Attention to Cockpit Instruments for the Glideslope Tracking Task.	29
B1.	Longitudinal Dimensional Stability Derivatives for Rigid Degrees of Freedom.	42
B2.	Longitudinal Dimensional Stability Derivatives for Elastic Degrees of Freedom.	43
B3.	Lateral-Directional Dimensional Stability Derivatives . .	44
B4.	Longitudinal Flying Qualities Parameters.	45
D1.	Turbulence Model Parameters	50
E1.	Pilot Debriefing Form	52-54
F1.	Magnetic Tape Parameter List.	60
G1.	Average Cooper-Harper Pilot Opinion Ratings	65
G2.	Analysis of Pilot Rating Scores: T-Tests of Paired Differences	66
G3.	Averaged Effort Rating Scores	67
G4.	Objective Performance Scores.	68-74

LIST OF FIGURES

1.	Procedures for Predicting Pilot Ratings	3
2.	Predicted Performance/Workload Tradeoffs.	12
3.	Six-Axis Motion Base Simulator.	17
4.	Simulator Cockpit	17
5.	Simulator Control Box	19
6.	Approach Geometry	20
7.	Comparison of Measured and Predicted Criteria	25
8.	Comparison of Predicted and Measured "Error" Variability Scores.	26-27
9.	Effect of Throttle Control on Predicted Performance Index	27

LIST OF FIGURES (cont.)

B1. Augmentation System for Configuration 5.	43
C1. Layout of Motion Base Simulator.	46
C2. Captain's Main Instrument Panel.	47
C3. Center Main Instrument Panel	48
F1. Pilot Comment Card	57
F2. Cooper-Harper Pilot Rating Scale	58
F3. Pilot Rating Form	59
F4. MBS Line Printer Page.	61-62

PREFACE

This report summarizes the work performed for NASA Langley Research Center under Contract No. NAS1-16410 by Bolt Beranek and Newman Inc. (prime contractor) and Douglas Aircraft Company (subcontractor). Dr. William H. Levison was Principal Investigator for Bolt Beranek and Newman, and Mr. William W. Rickard was Project Engineer for Douglas Aircraft Company. Mr. Martin T. Moul and Mr. David B. Middleton served as NASA Technical Monitors.

LIST OF SYMBOLS

A	Relative attention to flight control task
A	Aircraft stability derivative pertaining to elastic mode
B	Aircraft stability derivative pertaining to elastic mode
BW	Bandwidth
F	Control force
g	acceleration of gravity, 32.17 feet/second ²
h	Height error, feet
L	Aircraft stability derivative pertaining to roll axis
M	Aircraft stability derivative pertaining to pitch axis
N	Aircraft stability derivative pertaining to yaw axis
n	normal acceleration, g's
OCM	Optimal Control Model
p	roll rate
q	Pitch rate, degrees/second
R	predicted Cooper-Harper rating
r	yaw rate
s	Laplace frequency variable, radians/second
T	Time constant, seconds
U ₀	Reference airspeed, feet/second
u	incremental aircraft velocity along the longitudinal body axis, feet/second
u _i	Airspeed error relative to moving air mass, feet/second
V	aircraft speed, knots
v	incremental aircraft lateral velocity, feet/second
w	incremental aircraft velocity along the vertical body axis, feet/second
X	Aircraft stability derivative pertaining to longitudinal body axis
Y	Aircraft stability derivative pertaining to lateral body axis
Z	Aircraft stability derivative pertaining to vertical body axis

LIST OF SYMBOLS (Cont.)

α	Angle of attack, radians
γ	vertical flight path angle, degrees
ΔT	thrust deviation from reference, pounds
δ_e	elevator deviation from reference, degrees
δ	generalized control input variable
ζ	damping ratio (dimensionless)
η	Generalized aircraft response variable associated with elastic mode
θ	Pitch error, degrees
σ	standard deviation
ϕ	roll angle
ψ	heading angle
ω	frequency, radians/second

Subscripts

a	aileron control
cc	elevator control
e	elevator control
g	gust input
n	normal acceleration
p	roll rate
p	pilot
ph	aircraft phugoid response mode
q	pitch rate
r	rudder control
RP	rudder control
s	elevator control
sp	aircraft short period response mode
u	X-axis velocity
v	Y-axis velocity
w	aileron control (wheel)
w	Z-axis velocity
α	angle of attack

Conversion Factors

<u>Multiply</u>	<u>by</u>	<u>To Obtain</u>
feet	.3048	meters
inches	.02540	meters
knots	.5148	meters/second
degrees	.01745	radians
pounds	4.448	newtons
pounds	.4536	kilograms

SUMMARY

An analytic methodology, based on the optimal-control pilot model, is demonstrated for assessing longitudinal-axis handling qualities of transport aircraft in final approach. Calibration of the methodology is largely in terms of closed-loop performance requirements, rather than specific vehicle response characteristics, and is based on a combination of published criteria, pilot preferences, physical limitations, and engineering judgment.

Six longitudinal-axis approach configurations were studied covering a range of handling qualities problems, including the presence of flexible aircraft modes. The analytical procedure was used to obtain predictions of (a) Cooper-Harper ratings, (b) a scalar quadratic performance index, and (c) rms excursions of important system variables. A subsequent manned simulation study yielded objective and subjective performance measures that varied across vehicle configurations in the manner predicted by model analysis. In particular, flexible modes for the specific configurations explored in this simulation study were correctly predicted to have no significant effect on handling qualities.

Although performance trends were adequately predicted, experimental error scores were consistently greater than predicted. Therefore, the analytic scheme is recommended for use in obtaining comparative, rather than absolute, handling qualities estimates.

1. INTRODUCTION

1.1 Background

A certain dichotomy is associated with the topic of flying qualities assessment. From the pilot's point of view, the flying qualities of an airplane, in a given task, relates to the degree to which adequate performance can be achieved with reasonable levels of pilot workload [1,2]. Nevertheless, flying qualities specifications are written in terms of open-loop vehicle response characteristics in order to aid the airplane manufacturer in determining compliance with the specifications. Accordingly, considerable effort has been expended, with only partial success, to find the combination of aircraft response parameters that will reliably predict closed-loop performance and pilot workload.

In contrast to open-loop vehicle-centered criteria, pilot/vehicle model analysis allows one to explore issues related to closed-loop performance as well as to workload demands made on the pilot. The effects of external disturbances and control/display parameters, as well as inherent pilot limitations, can be considered. Perhaps most important, predictive schemes based on pilot/vehicle analysis are not constrained to "conventional" dynamics and can therefore be applied to flying qualities studies of aircraft having high-order response characteristics.

Hess [3] and Levison [4,5] have proposed two similar schemes, based on the optimal-control model (OCM) for pilot/vehicle systems [6], for predicting pilot opinion ratings. Levison's scheme was recently tested against data obtained in a previous simulation study of commercial transport handling qualities [5,7]. Results of this test were sufficiently encouraging to warrant the follow-on study that is the subject of this report.

The prediction scheme is based on the following assumptions: (a) pilot rating is a function of the flight task; (b) for a given flight task there exist one or more critical subtasks which serve as the primary determinants of pilot rating; (c) performance requirements are well defined for each critical subtask; (d) pilot opinion is based partly on the degree to which desired performance is achieved and partly on the information-processing workload associated with the task; and (e) a reliable model exists for predicting performance/workload tradeoffs for relevant flight tasks.

These assumptions lead to the procedure diagrammed in Figure 1. In effect, the analytic prediction scheme parallels the procedure that would be followed in performing a well-controlled handling qualities simulation study, the major difference being the use of the optimal control pilot/vehicle model to obtain pilot ratings and other performance measures.

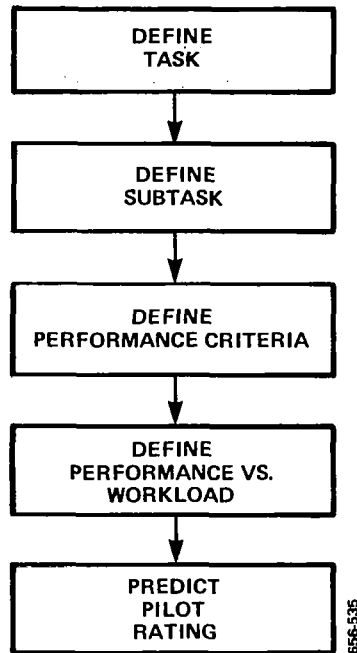

Figure 1. Procedure for Predicting Pilot Rating

The following empirical rating expression was developed in the initial study [4,5] and used in the subsequent effort:

$$R = 10 \left[\frac{\sigma}{\sigma + \sigma_0} + \frac{A}{A + A_0} \right] \quad (1)$$

$$1 < \underline{R} < 10$$

where R is the predicted Cooper-Harper pilot rating, σ is the probability that one or more important system variables will exceed its maximum acceptable value, and A is a measure of the relative attention (i.e., workload) associated with the task. The pilot is assumed to operate on the performance/workload tradeoff curve, predicted by the OCM, so as to minimize R. A good fit to experimental data in the preceding study was found with $\sigma = 0.1$ and $A = 2$.

"Attention" is reflected in the OCM by a signal-to-noise parameter -- one of the independent model parameters that account for the human operator's information processing limitations [8,9]. Since attention is referenced to a level inferred from data obtained in a standardized laboratory tracking task, rather than to some assumed capacity, values greater than unity are possible.

1.2 Objectives

This report summarizes the results of a study by Bolt Beranek and Newman Inc. and Douglas Aircraft Company to provide a rigorous test of the handling-qualities assessment scheme reported previously by Levison [4,5]. Study goals included (a) development of closed-loop performance criteria, (b) a tightly-constrained manned simulation to yield Cooper-Harper opinion ratings with minimal inter-pilot variability, and (c) compilation of a data base of objective performance measures suitable for methodological development. An additional goal was to explore the effects on pilot opinion rating of simulating flexible modes of transport aircraft, and to determine whether or not the analytic scheme would predict these effects.

The study summarized in this report was limited to a single area of application: longitudinal-axis handling qualities of commercial transports in final approach. This particular application was selected to provide a tie to previous results and does not reflect a limitation of the methodology. In theory, the methodology should be equally applicable to lateral-axis handling qualities and to other aircraft types and other flight phases.

Some of the experimental configurations explored in this study were selected to induce specific handling qualities problems and are not representative of aircraft either currently or prospectively operational. The simulation results presented in this report, therefore, are intended as a basis for testing the predictive capabilities of the analytic scheme and not as a definitive study of transport handling qualities.

This study was performed in three sequential phases:

1. Pre-experiment analysis was performed to (a) assist in defining the experimental task, (b) make an initial selection of aircraft configurations to be explored in the manned simulation, (c) define independent parameters of the analytic rating prediction scheme, and (d) predict pilot ratings and objective performance measures. This phase is described in Section 2.
2. A manned simulation was performed with four test pilots to obtain Cooper-Harper pilot opinion ratings for six vehicle configurations. Means and standard deviations were computed for various system variables of interest. The simulator characteristics and the testing procedures are described in Section 3.
3. Post-experiment statistical analysis was performed on both subjective and objective performance measures, and experimental trends were compared to those predicted by the analytic scheme. Experimental results are summarized in Section 4.

Additional details relating to experimental procedures are given in Appendices A-F, and detailed tabulations of experimental results are given in Appendix G. Readers not familiar with the model-based scheme are directed to the literature [4,5] for a review of the methodology that includes both an overview of the optimal control pilot model, and a description of how independent model parameters are selected for this type of application.

2. PRE-EXPERIMENT ANALYSIS

The pre-experiment phase of the study consisted of three major task areas as described below: task definition, preliminary selection of aircraft configurations, and model analysis.

2.1 Task Definition

The flight tasks to be performed by the test pilots were defined, and closed-loop criteria were specified for model analysis. As in the preceding study, the task was that of piloting a simulated large commercial transport aircraft in final approach. Three subtasks were defined: (1) altitude station keeping prior to glideslope capture, (2) glideslope capture, and (3) post-capture tracking of the glideslope. Flare and landing were not considered (and were not performed in the simulation study). For purposes of pre-experiment model analysis, zero-mean turbulence as defined by the Dryden model [1] was assumed, with pitch and yaw rate components omitted. The turbulence model is discussed further in Section 3.1; a complete mathematical description is given in Appendix D.

To ascertain closed-loop requirements, interviews were held with five potential test pilots to determine what they considered to be maximum acceptable values, or "limits", for important system variables in moderate turbulence. (In general, the pilots interpreted a "maximum" value as an excursion indicative of poor approach performance.) Assessments were obtained for each of the flight subtasks, and for various altitudes with respect to the glideslope tracking subtask. The responses presented below are those appropriate to the conditions explored in the pre-experiment model analysis, which consisted of a "frozen-point" (i.e., steady-state) analysis of glideslope tracking at a reference airspeed of 140 knots, a 3 degree descent angle, and a reference altitude of 500 ft.

On the average, the following zero-peak acceptable excursions from trim were specified:

glideslope: 1/2 dot*
sinkrate: 250 ft/min
airspeed: 7.6 kts
pitch: 3.5 degrees
stick: 28% maximum excursion
thrust: 4% aircraft weight

For airspeed and sinkrate excursions, for which the pilots tended to impose asymmetric criteria, the above values reflect 1/2 the distance between upper and lower bounds. The limit on thrust represents a distillation of the pilot responses, which were expressed in different units by different pilots (inches throttle movement, percent N1, change in EPR). The pilots agreed that there was also a subjective limit to pitch rate, but as they could not assign a quantitative value to this parameter, it was excluded from the list of performance requirements.

Although the pilots did not provide subjective limitations to rate-of-change of stick and throttle, "limits" for these quantities were defined partly to satisfy certain mathematical requirements of the optimal control model, and partly to satisfy physical constraints. A stick rate limit of 28% maximum slew rate was assumed, and the limit on rate-of-change of thrust was set equal to 1/2 the limit on thrust deviation to reflect low-bandwidth operation of this control.

To provide the scalar quadratic performance index needed to obtain model solutions, weighting coefficients were defined as the reciprocals of the squares of maximum acceptable values. Thus, an rms derivation of a given system variable equal to its "limit" contributed one unit to the overall "cost".

2.2 Preliminary Selection of Candidate Configurations

The set of vehicle configurations selected for experimental study had to meet two conflicting objectives. First, the set had to be sufficient to allow exploration of a range of handling qualities, including potential problems related to flexible airframe properties. Accordingly, an initial set of configurations was selected to explore effects of relaxed static stability, control augmentation, and structural modes.

* A "dot" is a calibration marking on the glideslope indicator that represented about .35 degrees of path error for the instrument used in the simulation study. At an altitude of 500 feet, one dot corresponded to a height error of about 58 feet.

A second objective of the study was to obtain data suitable for statistical analysis, which dictated that a number of replications of the entire test matrix be obtained for a number of test pilots. In order to keep simulation costs within reasonable bounds, therefore, the number of test configurations was limited.

With these goals in mind, a set of eight potential configurations were initially selected; this set was reduced to six following pre-experiment model analysis.

The longitudinal flying qualities levels of the eight initial configurations, as predicted by existing criteria, are shown in

CONFIG NO.	$\omega_{n_{sp}}$ vs n/α	ζ_{sp}	ζ_{ph} or $T_{2_{ph}}$	STATIC STABILITY	$d\gamma/dV$	-8785 OVERALL	BAND-WIDTH	BW + $d\gamma/dV$
1	1	1	1	STABLE	1	1	1	1
2	1-1/2	1	1	STABLE	WORSE THAN 3	WORSE THAN 3	1	2-1/2
3	WORSE THAN 3	2	WORSE THAN 3	UNSTABLE	1	WORSE THAN 3	3	3
4	WORSE THAN 3	1	WORSE THAN 3	UNSTABLE	3	WORSE THAN 3	3	3
5	2	1	1	STABLE	1	2	1	1
6	3-1/2	2	1	STABLE	1	3-1/2	1	1
7	3	1	1	STABLE	1	3	1	1
8	WORSE THAN 3	1	WORSE THAN 3	UNSTABLE	1	WORSE THAN 3	2	2

81-DP-8397

Table 1. Flying Quality Levels of Test Configurations 1-8

Table 1. There are columns for five -8785B criteria [1]: (1) short period frequency versus acceleration sensitivity ($\omega_{n_{sp}}$ versus ζ_{sp})

n/α , (2) short period damping (ζ_{sp}), (3) phugoid damping (ζ_{ph}) or T_{2sp}), (4) static stability, and (5) flight path stability ($d\gamma/dV$). The pilot, of course, cannot be asked to rate these individual criteria; his rating of longitudinal flying qualities represents their sum. Since the -8785 provides no guidance on how to combine the pieces, one must use his own judgment. The judgment used here was to represent the "-8785 OVERALL" as the worst of the five preceding columns. The next column, labeled "BANDWIDTH", is a flying quality prediction using a frequency domain pilot-in-the-loop criterion [4]. This criterion has been demonstrated reliably to predict pilot opinion of longitudinal maneuvering dynamics. As such, it is not sensitive to $d\gamma/dV$, which is a measure of long-term flight path response. It was shown by Rickard [7] that the combination of the Bandwidth and flight path stability estimates, labeled "BW + $d\gamma/dV$," yields an estimate of longitudinal flying qualities more accurate than the one labeled -8785 OVERALL. The criteria in Table 1 are the tools used to design a matrix of eight configurations.

While there is no officially accepted relation between flying qualities levels and pilot ratings, most practitioners accept the following:

Level	1	2	3	worse than 3
	1-3 1/2	3 1/2 - 6 1/2	6 1/2 - 9 1/2	9 1/2 - 10

Half levels used in Table 1 indicate that a parameter falls too close to a boundary to allow one to reliably determine which level is correct.

Configuration 1, having the closest correspondence to an operational wide-body commercial transport, is considered the baseline condition. Having been explored in the earlier study by Rickard, it provides a useful point of reference. According to the estimates shown in Table 1 (and to Rickard's simulation study), it has Level 1 longitudinal flying qualities. Configurations 8 and 3 explore a progression of increasing static instability, having times to double of 7.7 and 2.4 seconds, respectively. Configuration 2 was chosen to explore the issue of flight path stability, with $d\gamma/dV=0.34$, where 0.24 is the Level 3 limit. Configurations 4 and 5 explore the issue of control augmentation. They are the same airplane, an advanced supersonic transport, without (4) and with (5) a full-state feedback flight control system which was designed using implicit model following. The unaugmented airplane has very poor flying qualities, while the augmented version has fair to good flying qualities, depending on the criteria used.

Configurations 6 and 7 explore the effect of structural dynamics on flying qualities. Both have the same rigid-body equations, with Configuration 7 having two additional second-order modes representing structural dynamics. The criteria indicate that these configurations will be rated the same. The -8785B criteria, which cannot estimate the effect of structural modes, predict Level 3 flying qualities. The short period frequencies are too low and the damping ratio unacceptable or too high. The Bandwidth criteria, which should be able to predict this effect as it makes no assumption about model order, predicts Level 1 flying qualities.

The linearized equations of motion used in modelling vehicle response characteristics are given in Appendix A, and Appendix B contains additional detail characterizing the response of the various configurations explored in this study.

2.3 Model Analysis

Pre-experiment steady-state model analysis was performed for control and display conditions pertaining to glideslope tracking at an altitude of 500 feet, a descent angle of 3 degrees, and a reference airspeed of 140 kts. As recommended by the military handling qualities specifications [1], analysis was performed with a Dryden gust model having longitudinal and vertical rms gust amplitudes of 10 and 6.6 ft/sec, respectively.

Before obtaining model predictions, it was necessary to specify the following independent model parameters relating to the pilot's information processing limitations: (1) "cost" coefficients of the quadratic performance index, (2) time delay, (3) motor noise, and (4) observation noise. A brief review of how these parameters were selected is given below. The reader is referred to documentation of the preceding study [4] for additional methodological details.

As described in Section 2.1, cost weighting coefficients were defined as the reciprocals of the squares of maximum acceptable vehicle and control excursions as determined from pilot interviews. A time delay of 0.29 seconds was adopted to account jointly for pilot and control-actuator delays. The motor noise covariance was set at -50 dB relative to predicted control-rate variance to account for limitations on the pilot's ability to predict perfectly the effects of his control inputs.

Various components of the observation noise were quantified: (1) "threshold" and "residual noise" parameters to account for perceptual resolution limitations, (2) noise/signal parameters were

selected to account for attention-sharing effects, and (3) a baseline noise/signal ratio was treated as an independent parameter of the model analysis to sweep out curves of predicted performance versus attentional workload.

On the basis of previous laboratory tracking studies [10], thresholds of 0.05 degrees visual arc and 0.2 degrees/second visual arc were assumed, respectively, for perception of the displacement and velocity of a given display indicator. Consideration of the eye-to-panel distance, plus the effective display gain (inches of indicator displacement per unit "error"), enabled conversion from visual units to problem units. Additional details on display analysis methodology are contained in [4].

Analysis of the cockpit displays yielded the following perceptual thresholds, in problem units, for an altitude of 500 feet: (a) 4.7 feet height error, (b) 19 ft/sec sinkrate error, (c) 0.43 degrees pitch error, (d) 1.7 degrees/second pitch rate, and (e) 1.9 ft/sec airspeed error. The rather large threshold associated with perception of sinkrate error was a consequence of assuming that the pilot attempts to obtain this information from the velocity of the glideslope indicator.* In addition, a "residual noise" of 0.5 degrees was associated with perception of pitch error to account for the lack of an explicit zero-error reference.

To simplify the analysis, the pilot was assumed to pay equal attention to glideslope, pitch, and airspeed indicators (and was assumed to obtain both displacement and rate information from all but the airspeed indicator). In addition, 34% of the attention was assumed "lost" because of overt scanning requirements. Thus, a relative attention of unity corresponded to relative attentions of 0.22 each to glideslope, pitch, and airspeed variables. As described in the literature, attentional and perceptual factors determined the observation noise variance associated with each perceptual input [6].

Independent model parameters are given in Table 2a, and curves of predicted performance versus relative attention, generated by the optimal control model, are shown in Figure 2a.

* As discussed shortly, this effective threshold was considerably reduced by assuming sinkrate information to be obtained from the vertical velocity instrument.

a) Initial Analysis

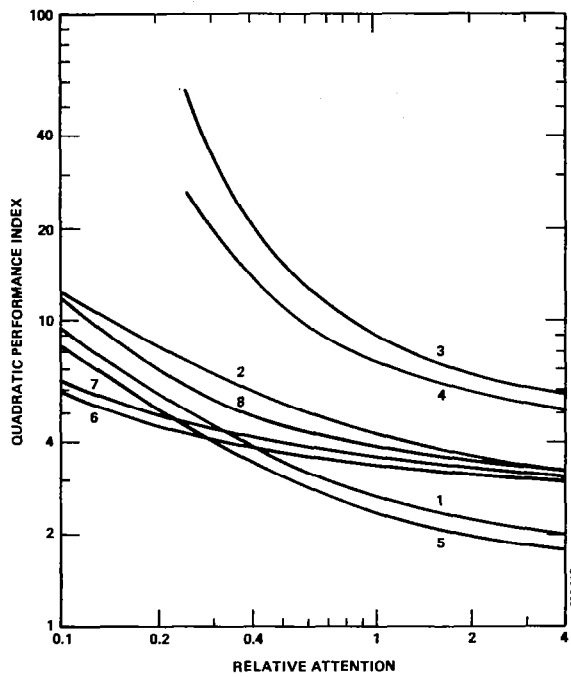

b) Revised Analysis

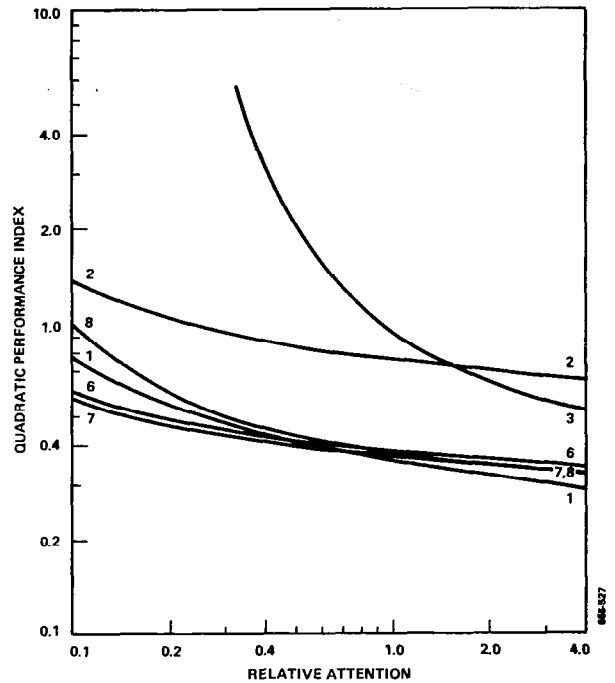

Figure 2. Predicted Performance/Workload Tradeoffs

Figure 2a shows the following trends:

1. Best achievable performance (i.e., lowest cost) with the baseline aircraft (Configuration 1) and the augmented AST (Configuration 5).
2. Worst performance, and greatest sensitivity to attentional workload, with the unstable configurations 3 and 4.
3. Intermediate performance with the configuration having a mild instability (Configuration 8) and the vehicle having adverse $d\gamma/dV$ (Configuration 2).
4. Negligible effects due to simulation of flexible modes (Configurations 6 and 7).

Table 2

Pilot-Related Model Parameters Appropriate to Glideslope Tracking at a 500-foot Altitude

Variable	Config-uration	"Limit"	Cost Coefficient	Perceptual Threshold	Residual Noise	Attention
a) Initial Analysis						
h	all	29.	1.2 E-3	4.7	0	}.22
\dot{h}	all	4.2	5.7 E-2	19.	0	
θ	all	3.5	8.2 E-2	.43	0.5	}.22
q	all	--	--	1.7	0	
u_i	all	13.	5.9 E-3	1.9	0	.22
δ_{ep}	all	22.	2.1 E-3	--	--	
$\dot{\delta}_{ep}$	all	33	9.2 E-4	--	--	
ΔT	1,2,	14,000	5.1 E-9	--	--	--
$\Delta \dot{T}$	3,8	7,000	2.0 E-8	--	--	--
ΔT	6,7	30,000	1.1 E-9	--	--	--
$\Delta \dot{T}$		15,000	4.4 E-9	--	--	--
ΔT	4,5	18,000	3.1 E-9	--	--	--
$\Delta \dot{T}$		9,000	1.2 E-8	--	--	--
b) Subsequent Analysis						
h	all	58	3.0 E-4	4.7	0	.03
\dot{h}	all	4.2	1.8 E-2	0.8	0	.23
θ	all	3.5	8.2 E-2	0.43	0.5	}.15
q	all	--	--	1.7	0	
u_i	all	13	5.9 E-3	1.9	0	.27
δ_{ep}	all	22	2.1 E-3	--	--	--
$\dot{\delta}_{ep}$	all	33	9.2 E-4	--	--	--
ΔT	1,2,	14,000	5.1 E-9	--	--	--
$\Delta \dot{T}$	3,8,	2,800	1.3 E-7	--	--	--
ΔT	6,7	30,000	1.1 E-9	--	--	--
$\Delta \dot{T}$		6,000	2.8 E-8	--	--	--

As noted earlier, the scope of the manned simulation study was limited to six experimental configurations. On the basis of this analysis, Configurations 4 and 5 were dropped from further consideration, as they appeared to be similar in terms of performance/workload tradeoffs to Configurations 3 and 1, respectively.

Application of the rating expression of Equation 1 to the performance/workload predictions shown in Figure 1a yielded unreasonably large Cooper-Harper ratings (e.g., a rating of 8 for the baseline configuration). Partly for this reason, and partly because the Mil Spec backup document [11] indicates that the initial choice of gust intensities represents a low probability (1%) of occurrence, gust intensities were halved for subsequent analysis and experimentation. The reduced levels represent a 50% probability of occurrence.

In addition to the reduction in gust levels, changes in other independent model parameters were modified prior to reanalysis: (1) the allowable performance "window" for glideslope error was increased to ± 1 "dot" to reflect published Category II specifications,* (2) the performance window for sinkrate was increased from around ± 4 ft/sec (240 ft/min) to ± 7.5 ft/sec (450 ft/min) to allow for the fact that, in actual flight, the flare maneuver would substantially reduce sinkrate prior to impact; (3) we assumed that the pilot would obtain sinkrate information from the vertical speed indicator, and we decreased the perceptual threshold to 0.8 ft/sec to reflect assumed visual resolution capabilities with respect to this instrument; (4) the maximum acceptable value for rate of change of thrust was reduced to 1/5 the corresponding limit on thrust deviation to more strongly reflect the pilot's aversion to frequent changes in throttle setting. Finally, the OCM was used to predict the optimal allocation of attention (i.e., the allocation of attention yielding the smallest predicted performance index).

Model parameters used for this subsequent pre-experiment analysis are given in Table 2b. The attentional allocation shown in this table is the average of the optimal allocations predicted for Configurations 1 (baseline) and 3 (unstable); this average allocation was used for subsequent predictions.

The six configurations retained for the simulation study were reanalyzed as described above, and the resulting

* "DC-10 Flight Study Guide", Douglas Aircraft Company, June 1975.

performance/workload tradeoffs are shown in Figure 2b. As is the case with the initial analysis, the penalty for relatively low attention is greatest for Configuration 3, and inclusion of flexible modes has little predicted influence. The predicted performance/workload tradeoff curves are compressed, however, with little separation among the curves for Configurations 1,6,7, and 8 at all but the lower attentional levels. Application of the rating expression of Equation 1 yields predicted ratings (shown later in this report) that range from Level 1 to Level 3 and are consistent with those observed experimentally for Configurations 1 and 3 in the preceding study [4].

3. DESCRIPTION OF EXPERIMENTS

Manned simulations of the approach-to-landing task were performed on a moving-base transport aircraft simulator located at Douglas Aircraft Company. Four test pilots performed multiple trials with each of six vehicle configurations. Simulation characteristics and experimental procedures are described below.

3.1 Simulation Characteristics

The simulation model used with all configurations was a complete airplane. Both longitudinal and lateral-directional degrees of freedom and controls were provided. The controls (column, wheel, and pedals) were DC-10 hardware. Control feel, force gradients, and motion limits were based on the DC-10. A full set of DC-10 instruments was provided. A flight director display was available but not used as this would affect workload and performance and, thus, pilot opinion of flying qualities. Actuator and engine dynamics typical of wide-body aircraft were simulated. Standard linearized equations of motion were used in the simulation. Euler integration of the differential equations was performed at 20 hertz. The actuators and other elements with fast dynamics were simulated using difference equations.

The simulation is Douglas' research and development motion base simulator. The motion platform is shown in Figure 3 and the cab interior in Figure 4. The cab is a DC-10 cockpit with stations for captain, first officer, flight engineer, and observer. Synthetic outside vision is available but was not used in this experiment. Motion limits for the platform are given in Table 3 for a moving mass of 22,000 pounds. The bandwidth for small inputs is 1 hertz, which can be boosted to at least 2 hertz by use of pre-emphasis filters on the motion drive signals. The evaluation pilot sat in the captain's seat and the test engineer in the first officer's seat. The engineer controlled all aspects of the experiment from this position, once the computers were started, using the control box shown in Figure 5. The box has six 3-position toggle switches, six momentary switches and sense lights, and five 16-position thumbwheels with LED readouts above. The box is on an umbilical so that it can be moved around the cab. The software "reads" these switches, performs the commanded functions, and displays the appropriate information on the displays.

In this experiment, only a few switches were used. One of the 3-position switches was used to turn turbulence off or on, one thumbwheel was used to select the configuration, and the pilot

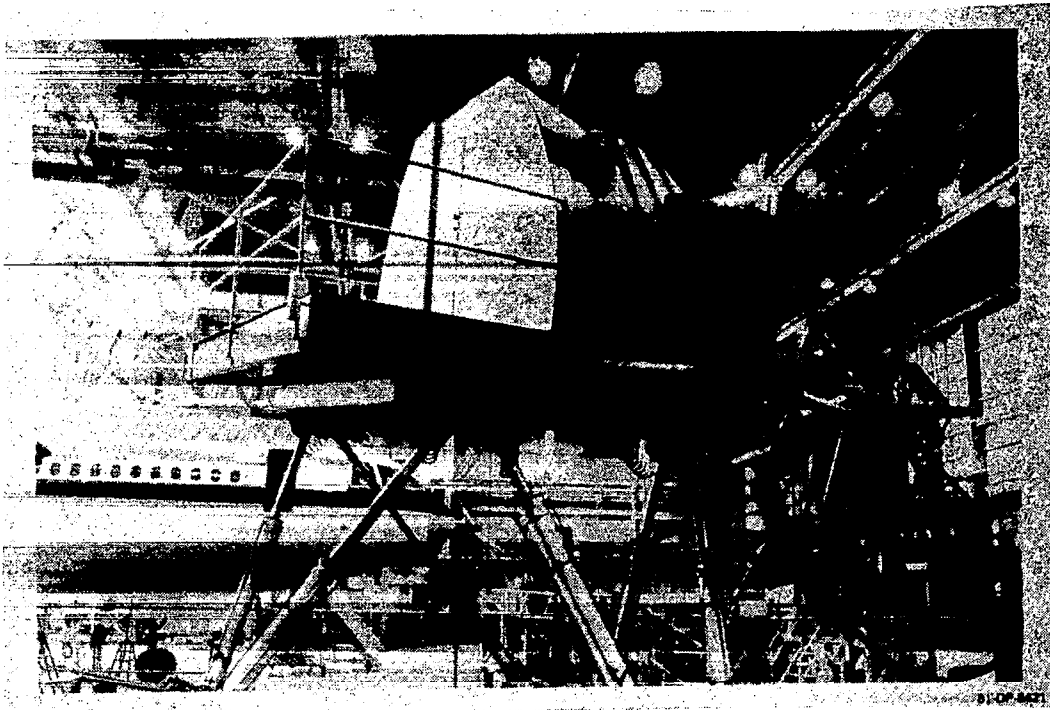

Figure 3. Six-Axis Motion Base Simulator

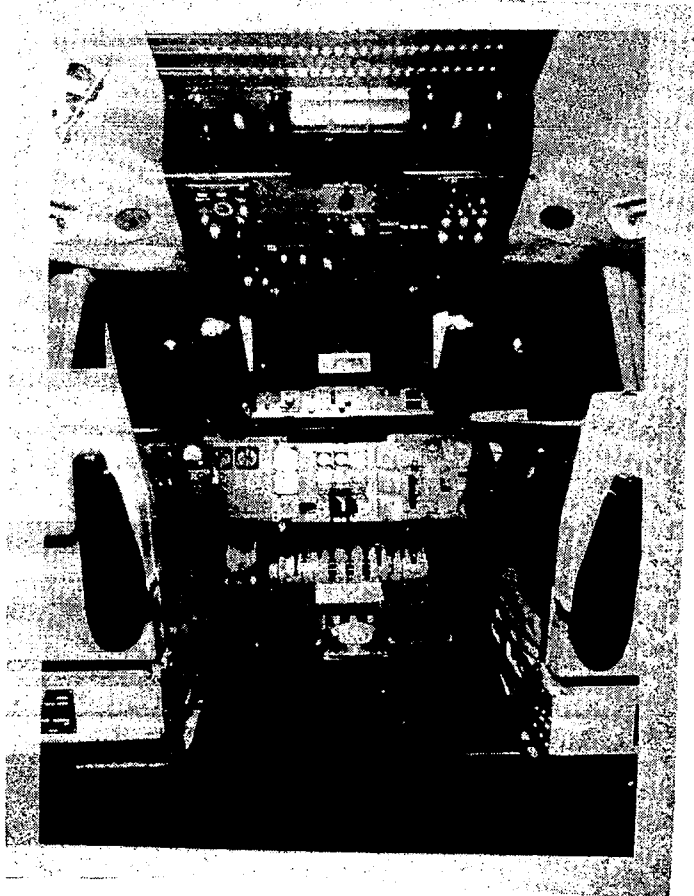

Figure 4. Simulator Cockpit

Table 3. Motion Limits

<u>Axis</u>	<u>Excursion</u>	<u>Velocity</u>	<u>Acceleration</u>
Heave	+ 42 in.	39 in./sec	1.65 g
Sway	+ 67.5 in.	67 in./sec	2.43 g
Surge	+ 65 in.	71 in./sec	1.50 g
Roll	+ 30.7 deg	35.6 deg/sec	447 deg/sec ²
Pitch	+ 33.3 deg	33.6 deg/sec	447 deg/sec ²
Yaw	+ 38.7 deg	36.3 deg/sec	453 deg/sec ²

number was set using another thumbwheel. Three digits of the LED display showed the run number, another showed the pilot number, and another showed the configuration number currently being used by the computer. Another panel contained pushbutton switches to control start, stop, reset, and other operational functions.

The task flown was a manual instrument landing system (ILS) approach using status (rather than director) data. Plan and side views of the approach geometry are shown in Figure 6. The Dryden turbulence model [1] was used, with 50th percentile intensities and scale lengths for an altitude of 500 feet. This model actually varies with airspeed and altitude, but was "frozen" in the experiment to match the steady-state analysis performance with the OCM. A sum-of-sines implementation was used, which concentrates

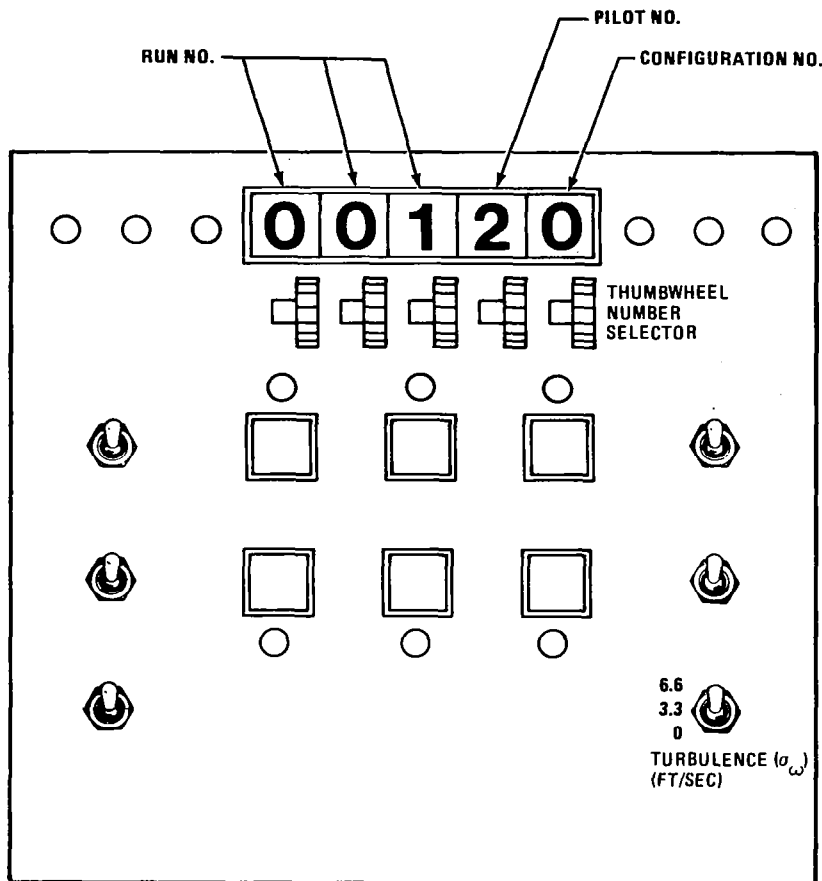
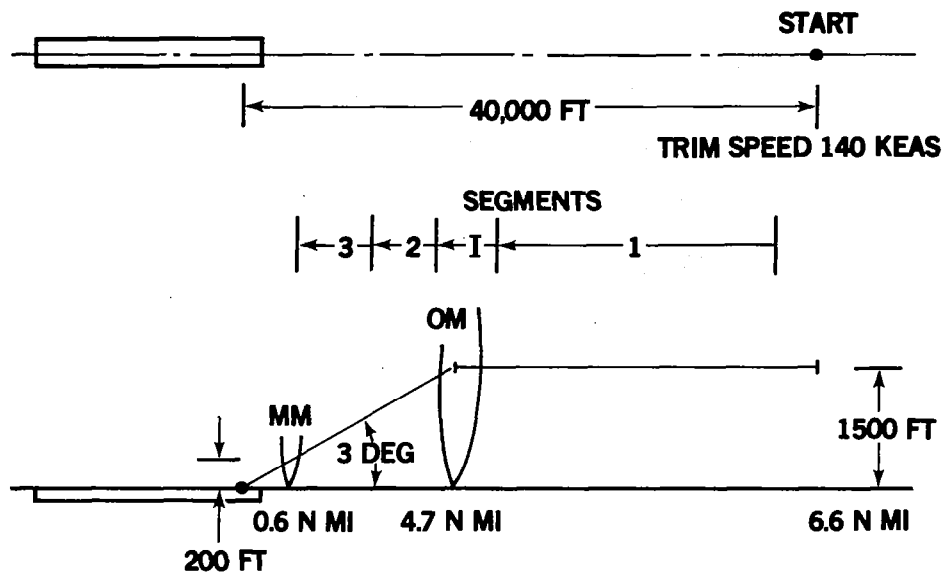

Figure 5. Simulator Control Box

the power at discrete frequencies. Twelve discrete frequencies from 0.0838 to 12.57 radians per second were used. Additional details on the gust simulation are given in Appendix D.

3.2 Experimental Procedures

The evaluations were made by four Douglas test pilots, all of whom had prior experience in motion-base-simulator evaluations of flying qualities. Before the evaluations were begun, a checkout pilot flew the entire test matrix. No discrepancies were found except that, contrary to all predictions, Configurations 6 and 7 were unflyable. The coupling between airspeed and column movement was so tight that loss of control was inevitable if flight-path control was attempted. These were the elastic AST configurations,



81-DP-8420

Figure 6. Approach Geometry

which had an unusually high value of X_g . This had been noticed in the pretest analysis, but was accepted when the flying-quality estimates turned out to be reasonable. Configurations 9 and 10 were developed to replace 6 and 7, respectively, by reducing X_g to a small value and increasing X_u to compensate. The flying quality parameters and estimates (see Table 4) for 9 and 10 were virtually identical to those for 6 and 7, yet 9 and 10 flew quite well.

Of the four pilots involved in the evaluations, two made four replications of the test matrix and two made five. Each session began with a briefing in which the test procedure and performance standards were reviewed. The pilot then flew several approaches to warm up, or get used to, the equipment and procedure. He then flew two approaches with each configuration (turbulence off, then on). The configurations were presented in pseudo-random order, with the order balanced across replications and across pilots. The "turbulence off" runs were flown to allow additional practice, to isolate the turbulence effects, and to gather data for the development of a glideslope capture strategy. The pilots could do whatever maneuvers and experiments they wanted in these runs after the intercept maneuver. In the "turbulence on" runs, however, they were told to track the ILS to the performance standards at all times. A replication of the test matrix took 1-1/2 to 2 hours. A total of 319 approaches were flown for data in the test; 25 more were flown by the checkout pilot. At the end of the test, the pilots were interrogated again about a number of items, including the performance standards they adopted in the test and how they

Table 4. Qualities Levels of Test Configurations 1-10

CONFIG NO.	$\omega_{n_{sp}}$ vs n/α	ζ_{sp}	ζ_{ph} or $T_{2_{ph}}$	STATIC STABILITY	$d\gamma/dV$	-8785 OVERALL	BAND-WIDTH	BW + $d\gamma/dV$
1	1	1	1	STABLE	1	1	1	1
2	1-1/2	1	1	STABLE	WORSE THAN 3	WORSE THAN 3	1	2-1/2
3	WORSE THAN 3	2	WORSE THAN 3	UNSTABLE	1	WORSE THAN 3	3	3
4	WORSE THAN 3	1	WORSE THAN 3	UNSTABLE	3	WORSE THAN 3	3	3
5	2	1	1	STABLE	1	2	1	1
6	3-1/2	2	1	STABLE	1	3-1/2	1	1
7	3	1	1	STABLE	1	3	1	1
8	WORSE THAN 3	1	WORSE THAN 3	UNSTABLE	1	WORSE THAN 3	2	2
9	3	2	1	STABLE	1	3	1	1
10	2	1	1	STABLE	1	1-1/2	1	1

81-DP-8396

allocated their attention. The debriefing form is given in Appendix E.

A great deal of objective and subjective data was taken. Time histories of 50 variables were recorded on digital magnetic tape at 5 hertz for every approach. Stripchart records of 16 variables were made. The mean, root mean square, maximum and minimum values, and standard deviation of 15 variables were computed on-line and output on a line printer at the end of each run. Instantaneous values of 10 variables at 10 points along the approach were also printed out. The printer was also used to record bookkeeping information, such as run start time and date, run number, configuration number, pilot number, etc., to reduce test engineer's workload. The subjective data taken included Cooper-Harper pilot

ratings, effort ratings for the three subtasks and three aspects of control, and pilot comments. The engineer made brief handwritten notes to supplement the complete record made by the cockpit voice recorder.

Data acquisition procedures are described in greater detail in Appendix F.

4. POST-EXPERIMENT ANALYSIS

4.1 Major Results

Statistical analysis was performed on both Cooper-Harper ratings and closed-loop performance metrics. Ratings were first averaged across replications to obtain an average rating per condition per pilot. Population means and across-subject standard deviations were then computed from the individual subject means.

Statistics on system "errors" (deviations from trim) were computed for the three steady-state-like segments of the approach (see Appendix F). Results for the final segment of the glideslope tracking task -- corresponding to descent from approximately 700 to 200 feet altitude -- are reported here. The mean and variability components of each error variable were analyzed separately. Only response variability is reported here, as only that error component can be compared with model predictions for the glideslope tracking task. (Recall, the external disturbances were zero-mean processes.) Mean error is primarily reflective of piloting strategy (e.g., carry excess airspeed, "duck under" the glideslope) and is thus not treated directly by the OCM. In general, the variability component was dominant. A variance score was first computed for each error variable of interest within a given replication. The square root of this measure was then treated as the basic error score. Note that this measure reflects within-trial variability, not run-to-run or pilot-to-pilot variability. Error scores computed in this manner were then subjected to the same statistical analysis as described above for the pilot ratings. Results of the analysis of rating scores and error scores are tabulated in Appendix G.

For the reader's convenience, Table 5 provides a brief identification of the six test configurations explored in the experimental study.

Measured and predicted pilot opinion ratings are presented in Figure 7a. Across-subject standard deviations (designated by vertical bars) were generally less than one rating unit. Thus, the experimental technique yielded rating predictions that were reasonably consistent across pilots.

The trend of the experimental ratings agreed well with pre-experimental model predictions: configurations 1,8,9 and 10 were rated similarly, whereas configurations 2 and 3 received ratings that were appreciably more adverse. The major discrepancy between prediction and experiment was the relative compression of

Table 5. Identification of Test Configurations

No.	Identifier
1	Baseline: closest to wide-body transport
2	Backside of power curve: large positive $\partial\gamma/\partial V$
3	Significant longitudinal static instability
8	Slight longitudinal static instability
9	Rigid-body approximation to flexible AST
10	Flexible AST

the simulation results, with the "better" configurations receiving Level 2 rather than the predicted Level 1 ratings. In addition, configurations 2 and 3 were rated nearly the same on the average, whereas the analytic technique predicted a 2-unit spread on the Cooper-Harper scale.

In a previous study, in which lateral-directional characteristics were considered to reflect Level 1 handling qualities, the "baseline" Configuration 1 received an average pilot rating in the Level 1 range [4,7]. Lateral characteristics were less favorable for the study reported here, receiving rating scores in the Level 2 range. Thus, we suspect that the greater than expected rating scores for Configurations 1,8,9 and 10 reflected, in part, an interaction with the lateral-axis task. (Model predictions were based on the assumption that the lateral-axis task would present no appreciable handling qualities problems.)

Configuration 2 was also explored in the previous study. In that study, as well as in the current one, the rating score obtained in the simulation study was greater than predicted analytically. As discussed shortly, this model/experiment difference may be due in part to a failure of the analytic scheme, as described so far, to consider the adverse effects of requiring loop closures that are not part of the pilot's standard repertoire.

Predicted and experimental measures of the quadratic performance index are compared in Figure 7b. Two sets of model predictions are shown: (a) scores obtained with relative attentions corresponding to minimum ratings, as determined from the

a) Pilot Opinion

b) Performance Index

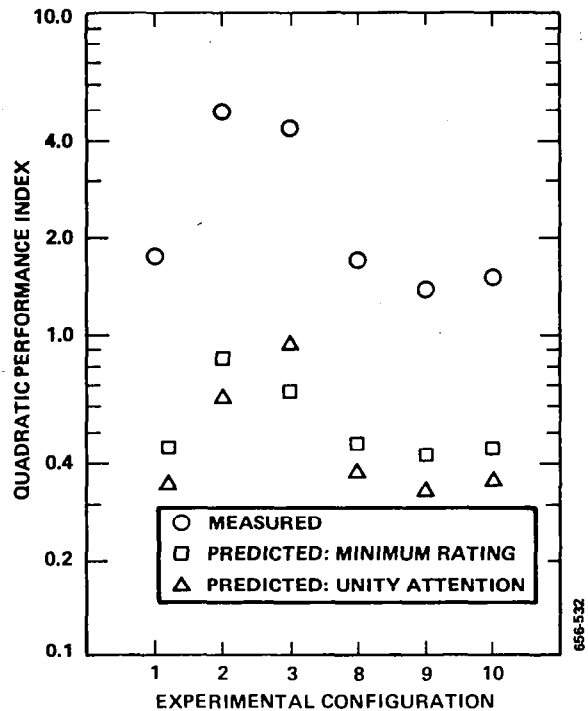
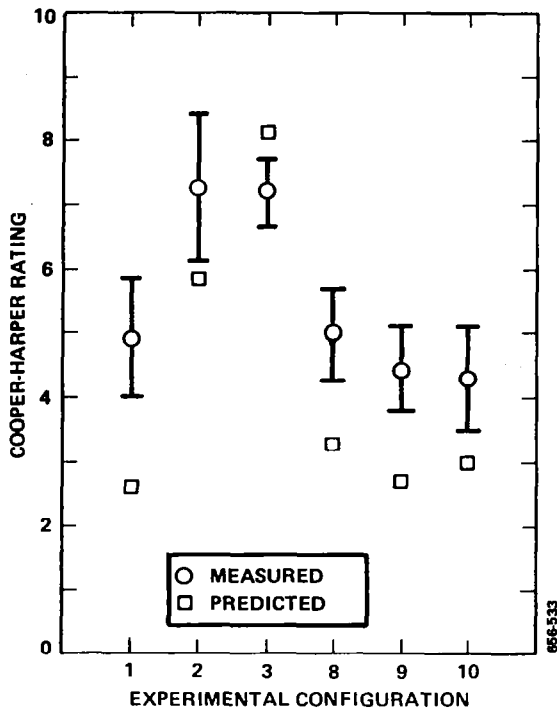

Figure 7. Comparison of Measured and Predicted Criteria

expression of Equation 1, and (b) scores corresponding to a relative attention of unity.

Although scores measured during simulation were considerably greater than predictions, predicted trends were confirmed. As with the rating scores, performance scores for Configurations 1,8,9, and 10 were similar, whereas substantially greater (less favorable) scores were observed for Configurations 2 and 3.

Comparison of predicted and measured "error" variability scores for selected response variables is given in Figure 8. Again, measured scores were greater than analytic predictions, but trends related to effects of vehicle characteristics were generally in agreement. In particular, the analytic procedure correctly

a) Height

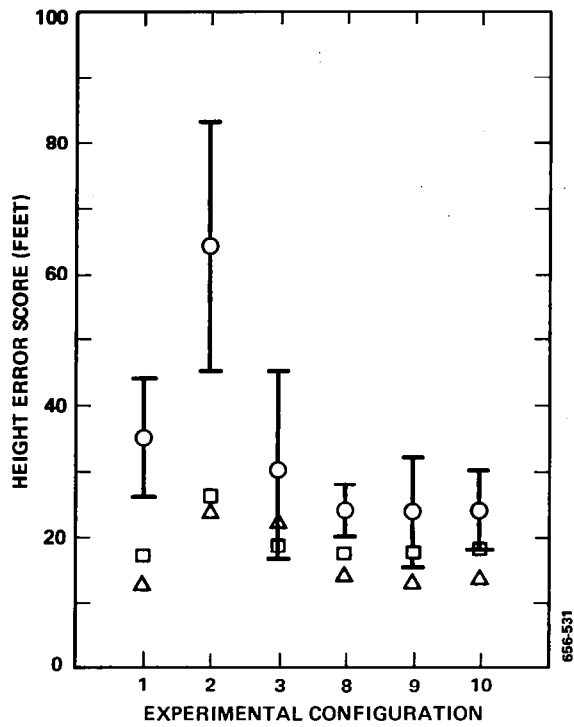

b) Airspeed

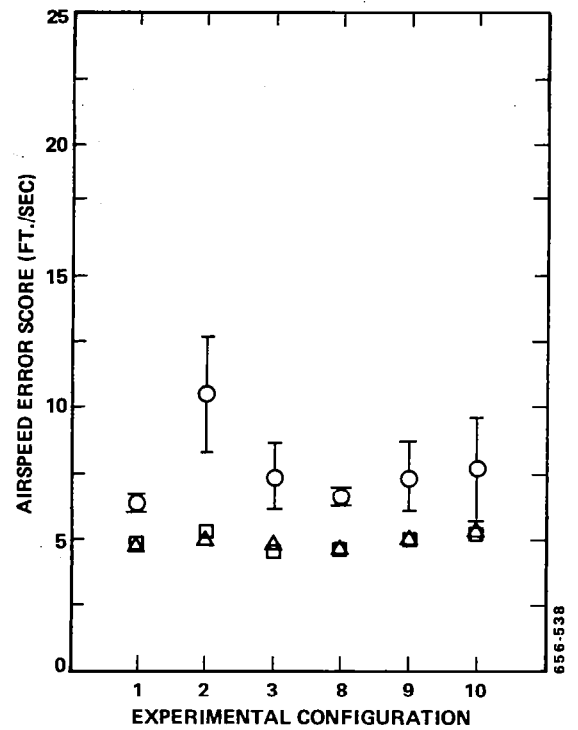

c) Pitch

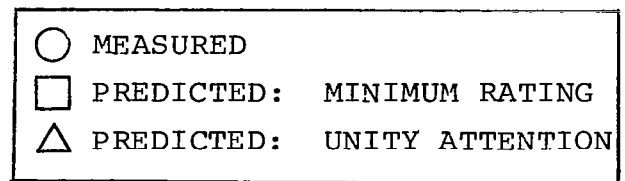
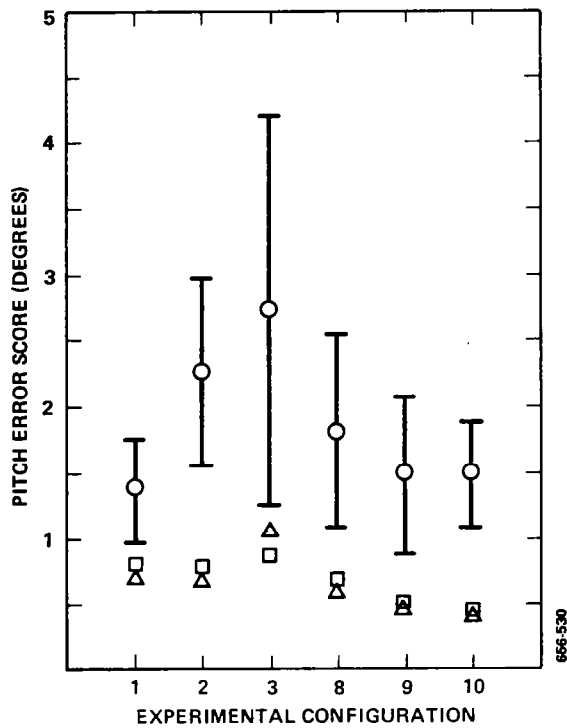
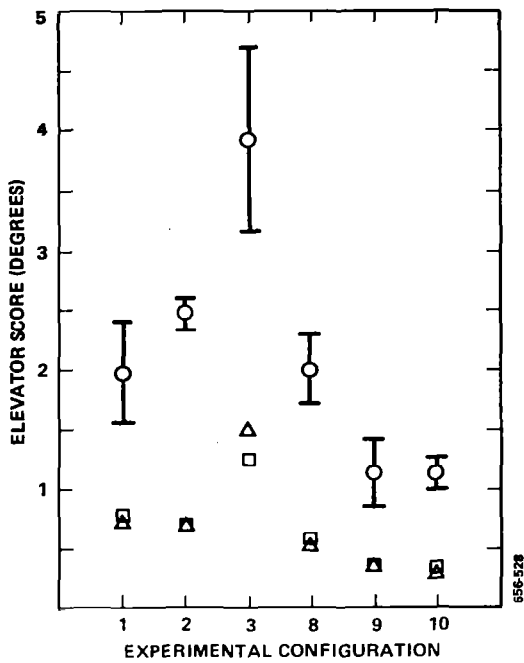

Figure 8. Comparison of Predicted and Measured "Error" Variability Scores

a) Elevator



b) Throttle

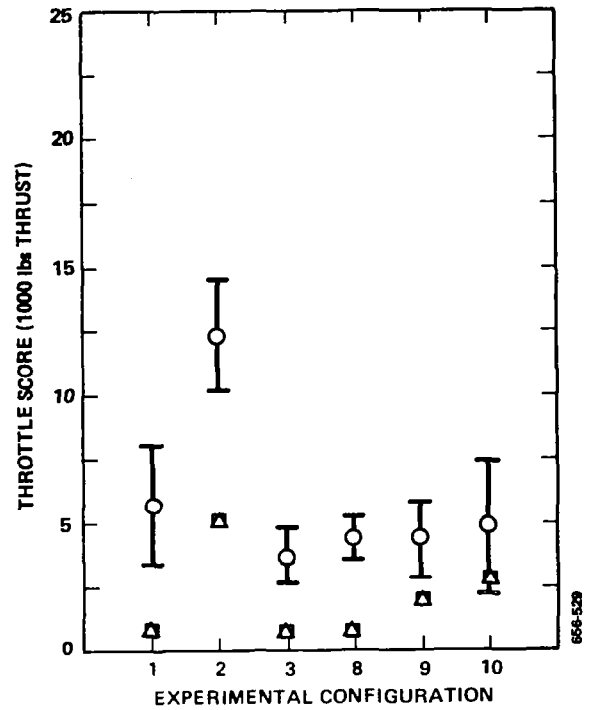

Figure 8 (Concluded). Comparison of Predicted and Measured "Error" Variability Scores

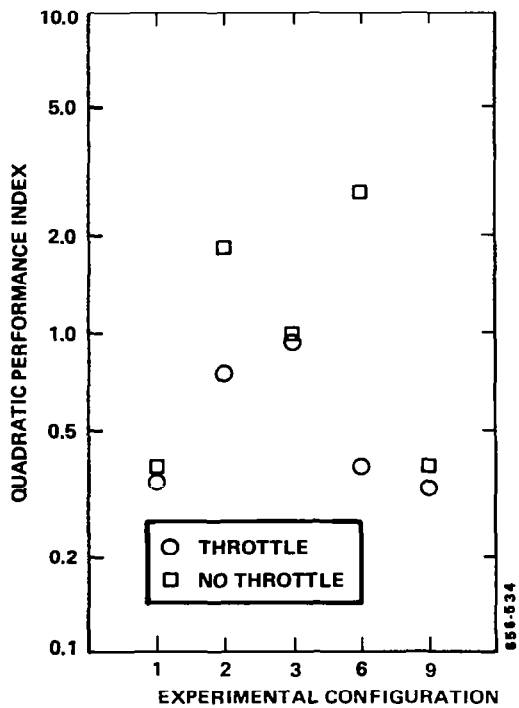

Figure 9. Effect of Throttle Control on Predicted Performance Index

predicted that relatively large elevator deflections would be required for Configuration 3, whereas large thrust changes would be required for Configuration 2. Overall, the two predictions of objective performance scores replicated experimental trends with similar fidelity. The (relatively modest) differences between the two sets of model predictions are discussed in Section 4.2.

Additional model analysis was conducted to determine methods for, first, obtaining a more accurate assessment of the adverse handling qualities associated with Configuration 2, and, second, for predicting the severe controllability problems found experimentally with Configurations 6 and 7. Compared to the baseline configuration, these three configurations required a strategy that relied more heavily on throttle for height control and elevator for speed control: Configuration 2 because of adverse dY/dV characteristics, and Configurations 6 and 7 because of a high pitch-speed coupling. This observation suggested a simple technique for analytically detecting handling qualities problems associated with undesirable throttle activity; specifically, model analysis was performed with and without the throttle control active. To test the discriminability of the procedure, reanalysis was performed also for Configuration 1 (baseline), Configuration 3 (greatest instability), and Configuration 9 (Configuration 6 modified to reduce the pitch-speed coupling). This analysis was performed with the baseline observation noise/signal ratio adjusted to reflect unity relative attention.

Figure 9 shows that this method readily identified handling qualities problems related to throttle activity. The predicted quadratic performance indices for Configurations 1, 3, and 9, while different from each other, were relatively unaffected by the exclusion of throttle control. On the other hand, omission of throttle control caused the performance metric to more than double for Configuration 2 and to increase nearly sevenfold for Configuration 6. Thus, a model comparison of this sort appears to be a simple device for predicting handling qualities difficulties caused by requirements for significant throttle activity.

Results of the pilot debriefing supported the methodology followed in this study. (A sample form is given in Appendix E.) The pilots were first asked to rate the relative importance of the three flight subphases (pre-capture altitude hold, glideslope capture, and glideslope tracking) with regard to determining their Cooper-Harper rating score for the approach. Glideslope tracking was rated most important by three of the four test pilots; the remaining pilot rated GS tracking second in importance. Thus, it

seems reasonable to focus on the glideslope tracking phase for both analytic and experimental determinations of aircraft handling qualities in final approach.

The pilots were also asked to estimate the level of attention paid to various cockpit instruments during the approach as either "high, "moderate", or "little or none". Table 6 shows that, for the glideslope tracking tasks, moderate to high levels of attention were estimated for variables included in the pilot's "display vector" for model analysis, whereas moderate to low levels were estimated for variables not considered during analysis.

Table 6. Subjective Estimates of Attention to Cockpit Instruments for the Glideslope Tracking Task

Instrument	Level of Attention		
	High	Moderate	Little or None
Glideslope	4	--	--
Localizer	4	--	--
Artificial Horizon	2	2	--
Airspeed	1	3	--
Vertical Speed	1	2	1
Altimeter	--	--	4
Engine (N1)	--	1	3

Entries indicate number of responses.

A range of responses was received with regard to maximum allowable "error" associated with adequate performance; these

responses were generally consistent with values used during the model analysis.

4.2 Discussion

The model-based prediction scheme was found to be a good predictor of handling qualities trends across the various configurations. Criteria for which trends were predicted included (1) Cooper-Harper ratings, (2) a performance index providing an overall scalar metric for closed-loop system performance, and (3) standard deviation scores for important variables. As the model results were obtained before the manned simulation was performed, these results are honest predictions.

The analytic prediction scheme differs from most published handling qualities criteria in that it is based primarily on a description of the task being modeled, rather than on specific aircraft response characteristics. "Calibration" of the method is characterized largely by specifications of the external disturbances and of the maximum acceptable excursions for important system variables. The latter are based on a combination of published criteria, pilot preferences (determined from interviews), human response limitations (determined from laboratory experiments), physical limitations of the aircraft control system, and engineering judgement. Ideally, once calibrated for a specific task, the analytic method is capable of rendering valid predictions of handling qualities trends across a variety of aircraft configurations. Additional application will be required to define its range of validity.

Repeatable Cooper-Harper pilot opinion ratings were obtained by following a strict experimental protocol during the simulation. Important aspects of the experiment design and procedure were: (1) use of stationary, zero-mean, pseudo-random inputs to simulate gust disturbances, (2) well-defined subtasks and associated performance standards, and (3) pilot familiarization with the various experimental configurations.

A procedure was developed for using the model-based scheme to reveal low-frequency flight path control problems, including the pitch-speed coupling problem that was not revealed (at least to its fullest extent) by existing handling qualities criteria. This procedure involves a two-step process. First, model predictions are made with the throttle included as a continuous control. Model predictions are then repeated with only the column considered as an operating control. If exclusion of the throttle yields an appreciable degradation in predicted performance, flight path

control problems (and adverse pilot opinion ratings) can be expected.

This particular treatment correctly predicted a substantial improvement in handling qualities resulting from a reduction of the pitch-speed coupling characteristics of test configurations 6 and 7. The published criteria failed to predict this improvement.

The analytic prediction scheme correctly predicted the absence of an influence of structural mode simulation on handling qualities. Additional data are necessary, of course, to determine whether or not this procedure is generally able to quantify the effects of structural modes.

Figure 7 shows that the scalar quadratic performance index mimics the pilot ratings trends. These results confirm the earlier study by Hess [3], in which a monotonic relationship between pilot rating and predicted performance index was demonstrated.

The primary difference between the method applied in this study and that of Hess is in the method for selecting independent model parameters -- especially weightings for the quadratic performance index. Hess has recently proposed a method for selecting weighting coefficients through a rather complex sensitivity analysis using the pilot model [12], whereas the method discussed here relies on task analysis. We suspect that one not thoroughly experienced in the application of the pilot model would find the latter procedure easier to follow.

As described above, model predictions of objective performance measures were obtained in two ways. One prediction scheme simply used the predicted scores corresponding to unity relative attention. The other scheme used predicted performance/workload tradeoffs, along with the pilot rating expression of Equation 1, to find the error score corresponding to minimum predicted pilot rating. Figures 7 and 8 show that for total performance index and for height and pitch excursions, the fixed-attention method predicted lower scores for all configurations except for Configuration 3, in which case the minimum-rating scheme predicted lower scores. These methodological differences are readily explained by noting the "attention" level predicted for minimum pilot rating. In the case of Configuration 3 (which exhibited a significant static instability), minimum rating was predicted for a relative attention greater than unity. (Notice the steep performance/workload relationship predicted for this configuration in Figure 2b). The error score predicted for this configuration by the minimum-rating scheme was therefore less than the score

predicted for the same configuration using unity attention. For all remaining configurations, however, minimum rating was predicted for attentions less than unity (typically around 0.3), and the trend was reversed.

There is some evidence to indicate that pilot opinion ratings were less influenced by attentional demand than was assumed in the application of the rating expression of Equation 1. Figure 7a shows that Configuration 3 is the only configuration for which the Cooper-Harper rating obtained in the simulation study was numerically lower than the predicted rating. Recall that Configuration 3 was also the only Configuration for which a relative attention greater than unity was predicted. Furthermore, Figures 7a and 7b show that Configurations 2 and 3, which yielded nearly identical pilot rating, also yielded nearly the same quadratic performance index. Given the lack of a demonstrated influence of attentional workload, it appears that predictions of relative aircraft handling characteristics can be obtained just as reliably, and with less effort, through model analysis using an assumed constant level attention.

The effort ratings scores, summarized in Table G3 of Appendix G, replicate the trends of the objective performance scores (Figures 7 and 8). The rating scores for the glideslope tracking task as a whole show maximum subjective effort for Configurations 2 and 3 -- the configurations for which the Cooper-Harper rating and scalar performance index were least favorable. The trends of the effort ratings scores for individual control requirements are as follows, with trends of the objective performance measures given in parentheses:

1. Greatest effort for vertical flight path control was required by Configurations 2 and 3 (largest error score for Configuration 2.)
2. Greatest effort for airspeed control was required by Configuration 2 (largest error score for Configuration 2).
3. Greatest effort for pitch control was required by Configuration 3 (largest pitch "error" for Configuration 3).

Thus, the subjective effort rating scores do not appear to contain new information, but tend to confirm the results of the objective performance measurements.

Although performance trends were predicted with reasonable fidelity, actual performance scores were about a factor of two

greater than those predicted by the analytic procedure. Within the constraints imposed by the remaining contractual resources, a number of hypotheses were explored to account for this discrepancy. First, it was noted that prediction errors could not be accounted for by differences in the tradeoff between control effort and system error reduction. If, for example, the pilots were to assign relatively more importance to minimizing control effort than assumed in the model analysis, predicted errors would be greater, but predicted control deviations would be less. As both error and control scores were larger than predicted, we must discard this hypothesis.

Both the time delay and baseline noise/signal ratios were individually increased to reflect attention-sharing penalties beyond those already accounted for in the analysis to account, in part, for the non-negligible workload imposed by the lateral-directional control task. These tests were made for Configuration 1. Decreasing the overall attention (to the longitudinal control axis) to 0.1 did increase predicted error scores, but not sufficiently to match experimental results. Similarly, increasing the time delay parameter from 0.29 seconds (pilot and control-system delay combined) to 1.0 seconds failed to increase predicted scores sufficiently. Thus, reasonable manipulations of these parameters do not appear to account for model mismatch.

A look at time history tracings for the elevator control input (not shown here) reveals a tendency for pulse-like control behavior. Often, the pilots appeared to make one-sided corrections with the elevator, then return the stick to the center position before initiating another corrective response. Such behavior is indicative of non-Gaussian (and nonlinear) response behavior and, as such, violates one of the model assumptions. Further research is needed to determine whether or not this violation is sufficient to explain the large experimental error scores.*

* Pulse-like control behavior does not necessarily rule out application of the pilot model (which assumes that pilot is a linear, but noisy, processor of information). To the extent that the principal effect of this type of nonlinear response is to introduce spectral components beyond the passband of the closed-loop system, aircraft response variables will be largely Gaussian, and the model should give reliable predictions over the frequency band of interest.

Other applications of the pilot model to realistic tasks involving path control (e.g., landing approach, hover) have also found model predictions to be optimistic compared to actual pilot performance. Smit and Wewerinke [13] were able to improve the correspondence between model and data by assigning "indifference thresholds", equal to 1/6 the maximum acceptable excursions, to various display quantities. The rationale was that the pilot's use of perceptual cues was not limited by visual resolution limitations, but rather by the pilot's unwillingness to reduce errors below what is considered good performance.

The notion of indifference thresholds as the limiting factor does not seem reasonable for the data obtained in this study, especially for the more difficult configurations. For example, height and pitch error scores for Configuration 3 were, respectively, about 65 feet (more than 1/2 "dot" GS error at an altitude of 500 feet) and 2.8 degrees. These excursions would appear to be sufficient to avoid complacency. (The subjective impression of both the pilots and the experimenter was that the pilots had to work very hard at this task.)

We cannot rule out entirely the influence of perceptual limitations, however. The values used for visual "thresholds" were based on data obtained in well-controlled laboratory studies using highly trained subjects performing a single-variable, wide-band tracking task. It is possible that effective visual thresholds are greater for the types of instrument cues and signal bandwidths obtained in a more realistic flight situation.

In summary, further methodological development appears necessary to allow more accurate predictions of absolute performance in realistic, high-order flight-control tasks. Nevertheless, accurate predictions of performance trends across task conditions can be achieved. Given the current state of the art, the analytic scheme is recommended for use in obtaining comparative, rather than absolute, handling qualities predictions.

5. CONCLUDING REMARKS

The handling qualities prediction scheme explored in this study has been shown to be a good predictor of handling qualities trends across a variety of longitudinal-axis vehicle response characteristics in the landing approach task. The model correctly predicted the trends of Cooper-Harper pilot ratings, scalar performance indices, error scores for important system response variables, and subjective effort rating scores. Absolute scores, on the other hand, were less well predicted, with experimental error scores being substantially larger than predicted. The prediction scheme is therefore recommended as a tool for comparing handling qualities across candidate configurations.

Because the prediction scheme is based on an analysis of the task structure and task requirements, we feel that it has good potential for identifying handling qualities problems across a wide variety of aircraft configurations, for tasks in which the scheme has been calibrated. At present, calibration is limited to longitudinal-axis control in landing approach.

We conclude with suggestions in the following areas: (1) application of the existing methodology, (2) calibration for additional tasks, and (3) further methodological development.

5.1 Application of the Prediction Scheme

We recommend that the analytic prediction scheme be applied largely as demonstrated in this report, with the addition of a calibration phase. Application to the study of longitudinal-axis handling qualities in final approach should proceed as follows:

1. Obtain linearized mathematical models for the various candidate configurations of interest. These models should include not only basic vehicle response characteristics, but also the dynamical response characteristics of the flight control system, SAS, display dynamics, and any other subsystem that might effect closed-loop control.
2. Analyze the display environment to determine (1) the potentially useful cues available to the pilot for flight control, and (2) the effective perceptual thresholds to be associated with each potential cue. If thresholds cannot be readily determined, then eliminate from the cue set those variables for which the pilot is expected to have difficulty in obtaining useful information (e.g., useful rate information cannot be provided by the motion of glideslope and localizer needles).

3. Assume parameters for the Dryden gust model appropriate to (a) an altitude of 500 feet, (b) the nominal approach speed, and (c) a 50% probability of occurrence.
4. Select weighting coefficients for the scalar performance index based on the following maximum acceptable values: (a) 1 dot glideslope error, (b) 7.5 ft/sec sinkrate error, (c) 3.5 degrees pitch excursion, (d) 7.5 knots airspeed, (e) stick excursion and rate 25% of physical limits, (f) thrust excursion of 4% of aircraft weight, and (g) thrust rate-of-change equal to 0.2 of limit on thrust.
5. Perform preliminary model analysis to determine optimal allocation of attention. This procedure will identify potentially redundant display variables to be eliminated from the task description, and it will allocate attention properly among the useful perceptual cues.
6. Obtain performance/workload tradeoffs for two "calibration" vehicles, one of which is known to have good (Level 1) handling qualities, and one of which is known to have poor (preferably Level 3) handling qualities. If data for such vehicles are not extant, a handling qualities simulation experiment may have to be performed, using the same gust environment and performance requirements adopted for the model analysis.
7. Obtain performance/workload tradeoffs for the candidate configurations by varying the baseline observation noise/signal ratio from 20 dB (relative attention of unity) to -10 dB (relative attention of 10%). Repeat the analysis with the throttle omitted from the control set to identify potential low-frequency path-control problems.
8. Determine relative handling characteristics of the candidate configurations by comparison with the predicted performance/workload curves of the two calibration configurations.

We have omitted the final step of the analysis procedure as originally proposed; namely, the prediction of Cooper-Harper rating via the rating prediction equation of Equation 1. Because we are suggesting that the scheme be used to provide comparisons, rather than absolute predictions, it is not clear that carrying out this additional step yields useful information beyond that contained in the predicted performance/workload tradeoff curves.

5.2 Calibration of the Methodology for Other Tasks

Discussion of the analytic prediction scheme has been limited to longitudinal-axis control in landing approach, because that is the task for which validating data have been obtained. There is no theoretical reason why the method should be limited to longitudinal-axis control, nor to the landing approach task. We feel that the success obtained so far with the method warrants testing in other task situations.

A logical candidate for application is the lateral-directional axis of control in landing approach. The analytic methodology is potentially of greater use in this application, as vehicle-centered handling qualities parameters have been less well defined than for longitudinal-axis control.

Calibration of the methodology should not require a structural modification of the analysis scheme. That is, one should be able to follow the procedure outlined in Section 5.1, using existing computer programs. Rather, calibration should consist primarily of defining maximum allowable values for excursions of system variables important to lateral-directional control, again relying on a mixture of published criteria, pilot preferences, physical limitations, and engineering judgment.

5.3 Methodological Development

Additional development is suggested to improve predictions of absolute performance levels in realistic flight tasks requiring path control. Further exploration of perceptual thresholds is in order to see whether or not a consistent treatment can be found to explain the results obtained for the various configurations explored in this study. As noted above, considerations of the physical environment, plus limits on the degree to which pilots are willing to reduce errors, may lead to parameter values larger than those usually found in laboratory experiments with wide-band tracking tasks.

The presence of apparent nonlinearities in the pilot's control response suggests additional analysis to determine whether or not this type of behavior can be considered responsible for the discrepancy between prediction and experiment. Spectral analysis of the pilot's control response, for example, would allow comparison of measured "remnant" (non-input-correlated response power) with that predicted by the model. Excessive remnant would suggest readjustment of the noise parameters (observation noise, motor noise, or both) to reflect nonlinear (or intermittent) response behavior.

Appendix A

APPENDIX A

EQUATIONS OF MOTION

Linearized, small perturbation equations of motion in stability axes were used in this study. The equations and the notation follow the standard set by the Bureau of Aeronautics Handbooks and can be found in Reference 14. The work was done using dimensions of feet, seconds, and degrees. The longitudinal equations contain two additional degrees of freedom which represent the two elastic modes of motion of Configurations 7 and 10. The equations are given below.

$$\begin{aligned} \dot{u} &= X_u(u-u_g) + X_{\dot{w}}(\dot{w}-\dot{w}_g) + X_w(w-w_g) + X_q q + \left(X_\theta - \frac{g \cos \gamma_o}{57.296} \right) \theta \\ &\quad + X_{\eta_1} \eta_1 + X_{\dot{\eta}_1} \dot{\eta}_1 + X_{\eta_2} \eta_2 + X_{\dot{\eta}_2} \dot{\eta}_2 + X_{\delta_e} \delta_e + X_{i_H} \Delta i_H + X_{\Delta T} \Delta T \\ \dot{w} &= Z_{\dot{u}}(\dot{u}-\dot{u}_g) + Z_u(u-u_g) + Z_w(w-w_g) + \left(\frac{U_o}{57.296} + Z_q \right) q + \left(Z_\theta - \frac{g \sin \gamma_o}{57.296} \right) \theta \\ &\quad + Z_{\eta_1} \eta_1 + Z_{\dot{\eta}_1} \dot{\eta}_1 + Z_{\eta_2} \eta_2 + Z_{\dot{\eta}_2} \dot{\eta}_2 + Z_{\delta_e} \delta_e + Z_{i_H} \Delta i_H + Z_{\Delta T} \Delta T \\ \dot{q} &= M_u(u-u_g) + M_{\dot{w}}(\dot{w}-\dot{w}_g) + M_w(w-w_g) + M_q q \\ &\quad + M_{\eta_1} \eta_1 + M_{\dot{\eta}_1} \dot{\eta}_1 + M_{\eta_2} \eta_2 + M_{\dot{\eta}_2} \dot{\eta}_2 + M_{\delta_e} \delta_e + M_{i_H} \Delta i_H + M_{\Delta T} \Delta T \\ \ddot{\eta}_1 &= A_{\dot{w}}(\dot{w}-\dot{w}_g) + A_w(w-w_g) + A_q q \\ &\quad + A_{\eta_1} \eta_1 + A_{\dot{\eta}_1} \dot{\eta}_1 + A_{\eta_2} \eta_2 + A_{\dot{\eta}_2} \dot{\eta}_2 + A_{\delta_e} \delta_e + A_{i_H} \Delta i_H \\ \ddot{\eta}_2 &= B_{\dot{w}}(\dot{w}-\dot{w}_g) + B_w(w-w_g) + B_q q \\ &\quad + B_{\eta_1} \eta_1 + B_{\dot{\eta}_1} \dot{\eta}_1 + B_{\eta_2} \eta_2 + B_{\dot{\eta}_2} \dot{\eta}_2 + B_{\delta_e} \delta_e + B_{i_H} \Delta i_H \end{aligned}$$

Appendix A

The unusual derivatives, x_{θ} and z_{θ} , have values only for Configurations 6,7,9, and 10, the elastic airplanes. They are artifacts of the way the elastic equations of motion parameters were computed.

The lateral-directional equations of motion contain only the three rigid body degrees of freedom.

$$\begin{aligned} \dot{v} &= Y_v(v-v_g) + Y_p(p-p_g) + \frac{g}{57.296} \phi + Y_r r - \frac{U}{57.296} r + Y_{\delta_a} \delta_a \\ & \quad + Y_{\delta_r} \delta_r \\ \dot{p} &= L_v(v-v_g) + L_p(p-p_g) + L_r r + L_{\delta_a} \delta_a \\ & \quad + L_{\delta_r} \delta_r \\ \dot{r} &= N_v(v-v_g) + N_p(p-p_g) + N_r r + N_{\delta_a} \delta_a \\ & \quad + N_{\delta_r} \delta_r \end{aligned}$$

The transformations to Euler angles are given below. The equation for θ is linear and decoupled to be consistent with the pilot modeling work, while the others are nonlinear for realism.

$$\begin{aligned} \dot{\theta} &= q \\ \dot{\phi} &= p + q \sin\phi \tan\theta + r \cos\phi \tan\theta \\ \dot{\psi} &= (q \sin\phi + r \cos\phi) / \cos\theta \end{aligned}$$

The engine model used was that of a CF6-50A, the engine used in the DC-10-10. To account for differences in airplane weight, the thrust levels were scaled by a factor of 1.286 for Configurations 4 and 5, and a factor of 2.143 for Configurations 6,7,9 and 10. The complex dynamics of engine thrust response to power lever movements were represented by a simple lag as shown below. This approximation is adequate for the purpose of this experiment.

$$\frac{\Delta T}{\Delta T_c} = \frac{2.5}{s+2.5}$$

Appendix A

The responses of control surfaces to pilot force inputs are functions of the feel systems, which were physically present in the simulator, and the actuators, which were simulated. Transfer functions for the combination of feel systems and actuators are given below.

$$\frac{\delta_e}{F_{cc}} = \frac{K_e (850) (50)^2}{(s^2 + 45s + 850) (s + 50)^2} \quad K_e = 0.26 \frac{\text{deg.}}{\text{lb.}}$$

$$\frac{\delta_a}{F_w} = \frac{K_w (10) (50)^2}{(s + 10) (s + 50)^2} \quad K_w = 6.6 \frac{\text{deg.}}{\text{lb.}}$$

$$\frac{\delta_R}{F_{RP}} = \frac{K_R (10) (50)^2}{(s + 10) (s + 50)^2} \quad K_R = 0.164 \frac{\text{deg.}}{\text{lb.}}$$

Appendix B

APPENDIX B

CHARACTERISTICS OF THE CONFIGURATIONS

The longitudinal dimensional stability derivatives of the ten configurations studied are given in Tables B1 and B2 below. Table B1 contains the usual "rigid-body" derivatives, while Table B2 contains the terms due to the elastic degrees of freedom.

These data are the coefficients in the equations of motions of Appendix A. There are ten values (ten columns) in Table B1 for each derivative; these define the ten configurations. There is only one value for each derivative in Table B2; the same values for the elastic terms are used in both Configurations 7 and 10.

The other configurations have no values for these terms; they should be set to zero in the equations of motion. Table B2 is read as follows. The rows are the degrees of freedom (X,Z,M,A,B). The columns are the variables of differentiation (η_1, η_2 , etc.). For example, the variable in row 3(M) and column 4($\dot{\eta}_2$) is $M\dot{\eta}_2$. Its value is -0.07588 and its units are degrees per second. 2

Configuration 5 is an augmented variation of configuration 4. The augmentation system, which was designed using implicit model following and linear optimal control, is shown in Figure B1. The configurations which explore the effects of structural modes on flying qualities (6 vs. 7 and 9 vs. 10) were developed as follows. Let the elastic airplane be represented by a high order, state space model or its equivalent in the frequency domain. The elements of this "state" matrix are not constants: they vary in some unspecified fashion with frequency. A linear low order approximation to this high order, nonlinear system is proposed which has three "rigid" and six elastic degrees of freedom. The low order state matrix has a term for each degree of freedom and its first two derivatives. The elements of the approximate system are computed using a sliding frequency fit. That is, the fit for each element is done at a frequency appropriate to that element. The low order systems developed by this procedure duplicated the dynamics of the high order systems with vanishingly small error from static conditions ($\omega=0$) up to frequencies beyond the highest natural frequency in the low order system. It should be noted that the coefficients of the so-called rigid degrees of freedom contain the low-frequency effects of elasticity.

The two mode (7 and 10) and zero mode (6 and 9) configurations are simply lower order approximations to the six mode configuration. The simplest way to do order reduction is modal

Table Bl. Longitudinal Dimensional Stability Derivatives for Rigid Degrees of Freedom

DERIVATIVE	UNITS	CONFIGURATION									
		1	2	3	4	5	6	7	8	9	10
x_u	1/sec	-.05221	-.05221	-.05332	-.05254	-.05254	-.002838	-.002838	-.05327	-.02129	-.02838
x_w	1/sec	.05479	-.2055	.05712	-.04897	-.04897	.005731	.005731	.05506	.005731	.005731
x_w^*	1	.0	.0	.0	.0	.0	-.03193	-.03193	.0	-.03193	-.03193
x_θ	ft/sec. ² deg.	.0	.0	.0	.0	.0	.0129	.0129	.0	.0129	.0129
x_q	ft/sec.deg.	.0	.0	.0	.0	.0	-5.821	-5.821	.0	-.05821	-.05821
$x_{\delta e}$	ft/sec. ² deg.	.0	.0	.0	-.07566	-.07566	.0	.0	.0	.0	.0
x_{iH}	ft/sec. ² deg.	.0	.0	.0	-.07566	-.07566	.0	.0	.0	.0	.0
$x_{\Delta T}$	1/slug	9.14×10^{-5}	9.14×10^{-5}	9.14×10^{-5}	7.15×10^{-5}	7.15×10^{-5}	4.29×10^{-5}	4.29×10^{-5}	9.14×10^{-5}	4.29×10^{-5}	4.29×10^{-5}
Z_u	1/sec	-.2533	-.2533	-.2610	-.2695	-.2695	-.05489	-.05489	-.2607	-.05489	-.05489
$Z_{\dot{u}}$	1	.0	.0	.0	.0	.0	-.03256	-.03256	.0	-.03256	-.03256
Z_w	1/sec	-.5818	-.5818	-.5664	-.4041	-.4041	-.4129	-.4129	-.5802	-.4129	-.4129
Z_w^*	1	.0	.0	.0	-.00031	-.00031	.0	.0	.0	.0	.0
Z_θ	ft/sec. ² deg.	.0	.0	.0	.0	.0	-.15059	-.15059	.0	-.15059	-.15059
Z_q	ft/sec.deg.	-.2551	-.2551	-.2350	-.3321	-.3321	1.508	1.508	-.2417	1.508	1.508
$Z_{\delta e}$	ft/sec. ² deg.	-.2403	-.2403	-.2403	-.1804	-.1804	-.1229	-.1229	-.2403	-.1229	-.1229
Z_{iH}	ft/sec. ² deg.	-.4121	-.4121	-.4121	-.1804	-.1804	-.2458	-.2458	-.4121	-.2458	-.2458
$Z_{\Delta T}$	1/slug	-2.29×10^{-6}	-2.29×10^{-6}	-2.29×10^{-6}	2.5×10^{-6}	2.5×10^{-6}	1.5×10^{-6}	1.5×10^{-6}	-2.29×10^{-6}	1.5×10^{-6}	1.5×10^{-6}
M_u	deg/ft.sec.	.02136	.02136	.000207	-.001127	-.001127	.0	.0	.000965	.0	.0
M_w	deg/ft.sec.	-.1237	-.1237	.09225	.00172	.00172	-.025	-.025	.02194	-.025	-.025
M_w^*	deg/ft	-.01471	-.01471	-.01056	-.0005104	-.0005104	-.1308	-.1308	-.01176	-.1308	-.1308
M_q	1/sec	-.3989	-.3989	-.2475	-.3109	-.3109	-.5589	-.5589	-.2960	-.5589	-.5589
$M_{\delta e}$	1/sec ²	-.6442	-.6442	-.5275	-.2899	-.2899	-1.208	-1.208	-.5664	-1.208	-1.208
M_{iH}	1/sec ²	-1.039	-1.039	-1.039	-.2899	-.2899	-2.416	-2.416	-1.039	-2.416	-2.416
$M_{\Delta T}$	deg/s.ft.	1.01×10^{-6}	1.01×10^{-6}	1.01×10^{-6}	2.7×10^{-6}	2.7×10^{-6}	1.6×10^{-6}	1.6×10^{-6}	1.01×10^{-6}	1.6×10^{-6}	1.6×10^{-6}

Appendix B

Table B2. Longitudinal Dimensional Derivatives for Elastic Degree of Freedom

		η_1	$\dot{\eta}_1$	η_2	$\dot{\eta}_2$	w	\dot{w}	q	δ_e	i_H
X	units	ft/sec ²	ft/sec	ft/sec ²	ft/sec	*	*	*	*	*
	value	.007971	.0003292	-.01348	-.0007971					
Z	units	ft/sec ²	ft/sec	ft/sec ²	ft/sec	*	*	*	*	*
	value	.3382	.001754	.2498	.01529					
M	units	deg/sec ²	deg/sec	deg/sec ²	deg/sec	*	*	*	*	*
	value	.4381	.05116	-.7804	-.07588					
A	units	1/sec ²	1/sec	1/sec ²	1/sec	1/ft.sec.	1/ft.	1/deg.sec.	1/deg.sec ²	1/deg.sec ²
	value	-36.66	-.3637	-1.621	-.06763	-.3922	.07681	.5861	2.372	4.744
B	units	1/sec ²	1/sec	1/sec ²	1/sec	1/ft.sec.	1/ft.	1/deg.sec.	1/deg.sec ²	1/deg.sec ²
	value	-1.826	-.0002938	-115.9	-1.233	2.581	-.02344	-.4458	-2.987	-5.974

* See Table B1

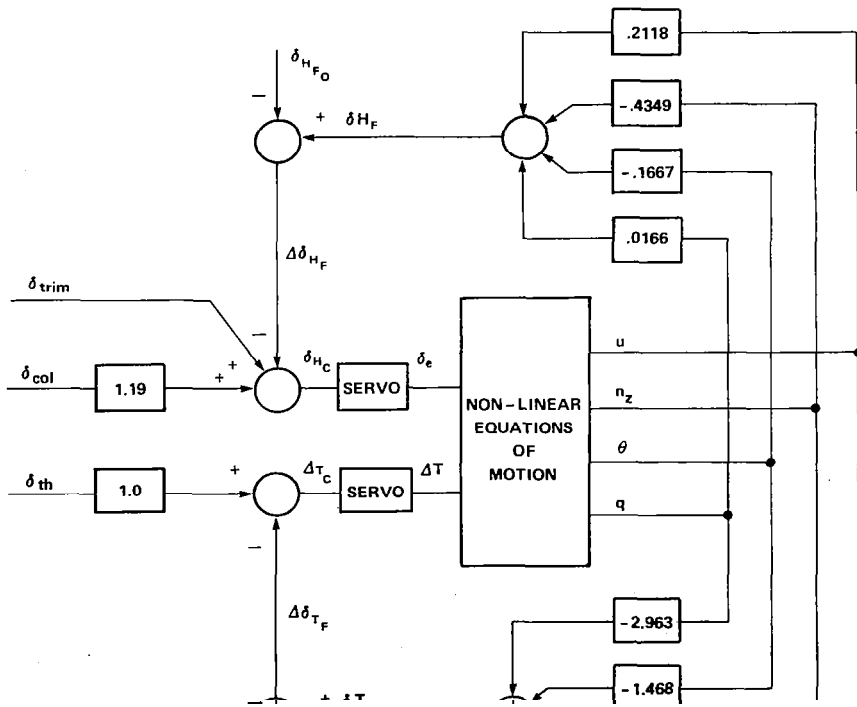

Appendix B

truncation: one simply deletes the equations which define the modes being dropped. This was tried and found to work in the present case. When the higher order modes were dropped, the response of the system changed relatively little across the frequency range of interest.

The dimensional stability derivatives for the lateral-directional rigid-body degrees of freedom are given in Table B3. There are no additional derivatives in the lateral-directional equations due to elastic degrees of freedom. This table is read as was Table B.2. For example, the variable in row 2, column 3, is $L_r = 0.2313 \text{ second}^{-1}$.

Table B3. Lateral-Directional Dimensional Stability Derivatives

	v	p	r	δ_r	δ_a	
Y	units value	1/sec. -.1132	ft/sec.deg. .5130	ft/sec.deg. -4.018	ft/sec. ² deg. .1102	ft/sec. ² deg -.00985
L	units value	deg/ft.sec. -0.3101	1/sec. -1.034	1/sec. .2313	1/sec. ² .2434	1/sec. ² .2696
N	units value	deg/ft.sec. .04724	1/sec. -.1517	1/sec. -0.1636	1/sec. ² -.2300	1/sec. ² .04087

A number of longitudinal flying qualities parameters were computed to permit estimation of flying qualities by criteria other than the optimal control pilot model. The results are shown in Table B4. Note that there is data for the two structural degrees of freedom for the configurations 7 and 10 only. The data are mostly frequencies, damping ratios, and steady state response ratios which can be compared to the criteria of Reference 1. The last two rows, however, are the criteria parameters for the longitudinal maneuvering characteristics of a configuration

Appendix B

Table B4. Longitudinal Flying Qualities Parameters

DERIVATIVE	UNITS	CONFIGURATION									
		1	2	3	4	5	6	7	8	9	10
$\omega_{n_{SP}}$	rad/sec	0.846	0.811	(-1.061)	(-1.057)	0.720	(0.612)	(0.706)	(-0.811)	(0.604)	(0.707)
ζ_{SP}		0.628	0.662	(+0.291)	(+0.285)	0.716	(1.40)	(1.21)	(+0.090)	(1.42)	(1.21)
$\omega_{n_{ph}}$	rad/sec	0.186	0.194	0.210	0.204	0.162	0.045	0.053	0.200	0.043	0.057
ζ_{ph}		0.074	0.041	0.331	0.392	0.902	0.213	0.206	0.636	0.188	0.170
$1/T_{\theta_1}$	rad/sec	-0.084	+0.041	-0.082	-0.0092	-0.229	-0.004	-0.004	-0.082	-0.022	-0.029
$1/T_{\theta_2}$	rad/sec	-0.506	-0.631	-0.583	-0.498	-0.497	-0.414	-0.410	-0.564	-0.414	-0.414
n/α	g/rad	3.80	4.04	4.35	3.81	3.80	4.36	4.32	4.20	3.08	3.06
$d\gamma/dV$	deg/Kt	-0.040	+0.339	-0.057	+0.192	-6.512	0.037	0.037	-0.051	-0.018	-0.041
$\Delta F_s/\Delta V$	lb/kft	-1.52	-1.49	-0.896	-0.896	-5.868	-0.132	0.065	0.189	-0.030	-0.058
$\Delta F_s/\Delta n$	lb/g	112.4	112.4	37.2	-22.1	60.4	29.0	40.5	14.1	29.0	40.5
ω_1	rad/sec	-	-	-	-	-	-	6.04	-	-	5.98
ζ_1		-	-	-	-	-	-	0.030	-	-	0.021
ω_2	rad/sec	-	-	-	-	-	-	10.76	-	-	10.68
ζ_2		-	-	-	-	-	-	0.057	-	-	0.050
$ \theta/\theta_c $	dB	-0.3	-0.4	4.9	3.9	-1.25	0.6	0.0	2.1	0.9	0.3
$\langle \theta/\theta_c \rangle$	deg	40.5	41.6	70.5	62.5	41.5	31.0	28.2	62.3	32.2	29.6

Note: () indicates a root for a first-order mode

Appendix C

APPENDIX C

INSTRUMENT PANEL

The instrument layout of the simulator cab is shown in Figure C1. The pilot flies by reference to instruments located directly in front and just to the right of him. These are referred to as the captain's instrument panel and the center main instrument panel. These panels are shown in more detail in Figures C2 and C3. The primary instruments used in performing the longitudinal portion of the task are the airspeed, pitch, glideslope, altitude and rate of climb indicators on the captain's panel, and the N_1 (reference RPM) indicators on the center main instrument panel.

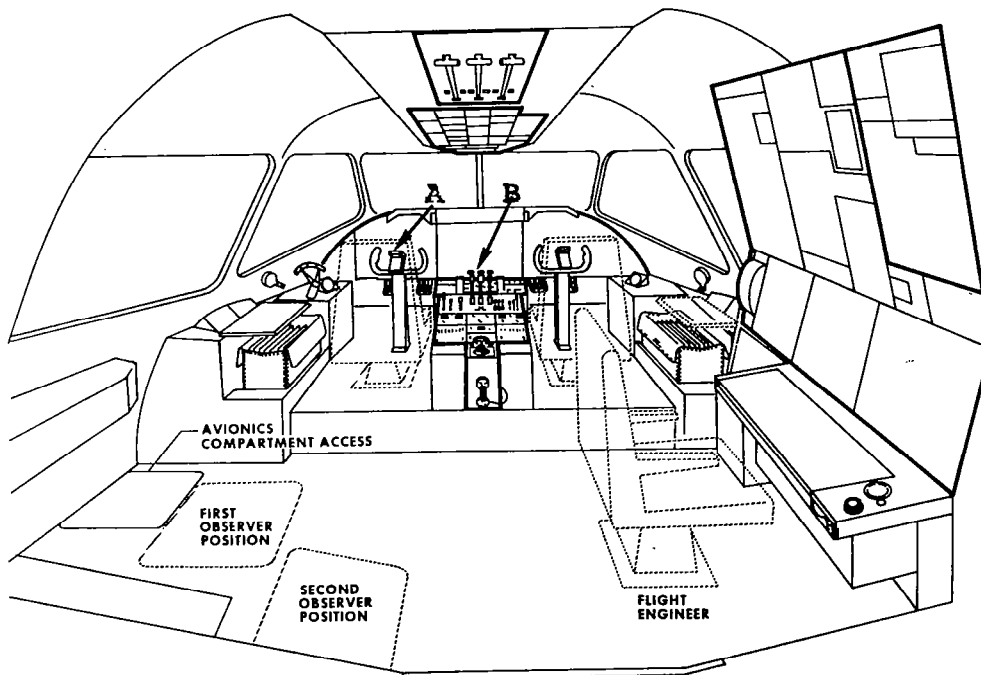

Figure C1. Layout of Motion Base Simulator Cockpit

- A: Captain's Instrument Panel
- B: Center Main Instrument Panel

Appendix C

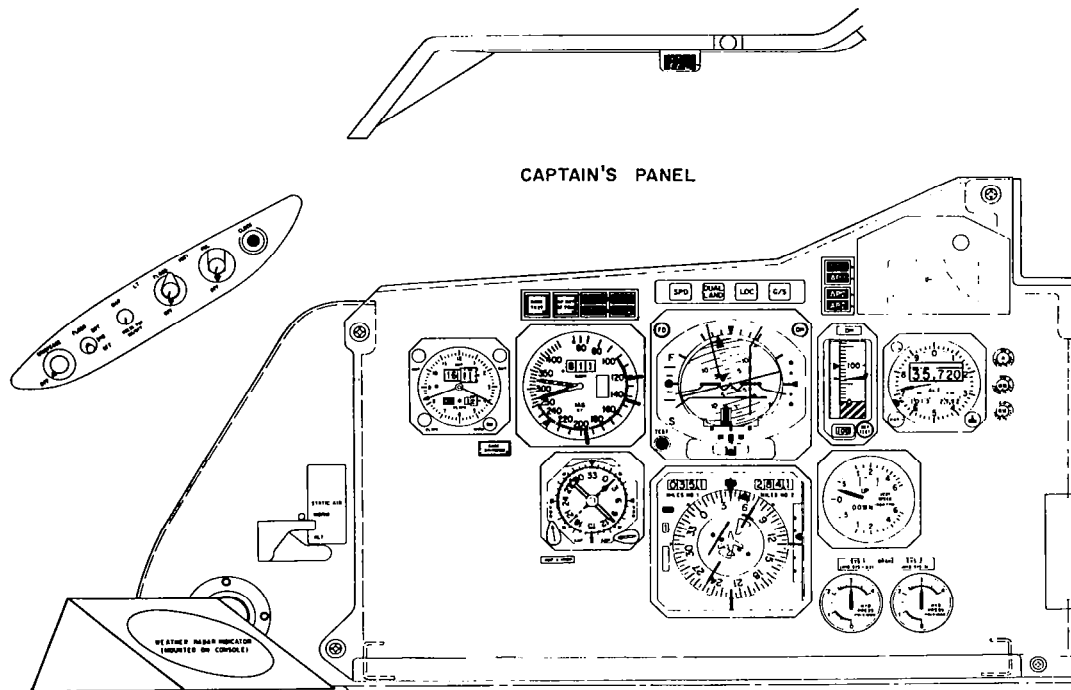

Figure C2. Captain's Main Instrument Panel

Appendix C

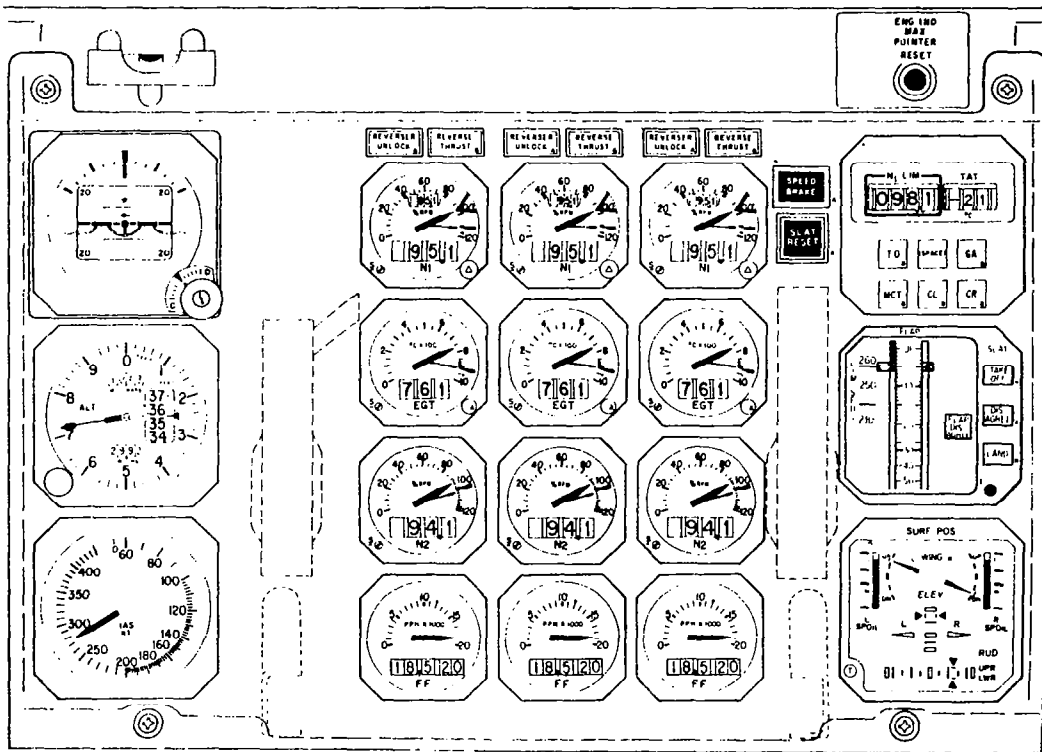

Figure C3. Center Main Instrument Panel

Appendix D

APPENDIX D

TURBULENCE MODELING

Zero-mean random turbulence of the Dryden Form [1] was used as a basis both for model analysis and for the manned simulation. Only four components, u_g, v_g, w_g and p_g were considered; the remaining components, q_g and r_g , were considered to be unimportant. Continuous spectra, corresponding to an altitude of 500 ft and an airspeed of 140 kts, were of the form

$$\frac{u_g}{N_u} = \frac{0.643}{s+0.207} \sigma_{u_g}$$

$$\frac{v_g}{N_v} = \frac{0.788(s+0.119)}{(s+0.207)^2} \sigma_{v_g}$$

$$\frac{w_g}{N_w} = \frac{1.19(s+0.275)}{(s+0.476)^2} \sigma_{w_g}$$

$$\frac{p_g}{N_p} = \frac{1.46}{s+1.06} \sigma_{p_g}$$

where N_u, N_v, N_w , and N_p are white noise processes having unit covariance. The simulation experiment was performed using the following values for rms gust levels:

$$\sigma_{u_g} = 5 \text{ ft/sec}$$

$$\sigma_{v_g} = 3.3 \text{ ft/sec}$$

$$\sigma_{w_g} = 3.3 \text{ ft/sec}$$

$$p_g = 0.58 \text{ deg/sec}$$

It was desired to conduct the simulation in such a manner as to enhance the ability to estimate power spectra and pilot

Appendix D

describing functions, even though there were no plans to obtain such measures during the course of the present study. Accordingly, the analytical models shown above were used as the basis for constructing sum-of-sinusoids inputs for the four gust components simulated in this study. By confining input power to a few frequencies, rather than spreading the power continuously over a wide band, the sum-of-sines format enables one to readily distinguish input-correlated from "remnant"-related signal power, and it improves the signal-to-noise environment for estimating pilot describing functions [15]. Derivatives of the turbulence states, which were needed by the simulation program, were calculated via differentiation of the sum-of-sines inputs.

Each gust component was therefore of the form

$$u_g(t) = \sigma_u \sum_{i=1}^{12} a_{u_i} \cos(k_i \omega_0 t + \phi_{u_i})$$

The fundamental frequency ω_0 was computed as $2\pi/T_0$, where the measurement interval $T_0 = 75$ seconds. Values for component amplitudes are given in Table D1. The initial phase offsets ϕ were chosen randomly from a uniform distribution between 0 and 2π ; phase offsets were randomized from run-to-run and from component-to-component in order to generate random-appearing inputs having a similar statistic but different time histories.

Table D1. Turbulence Model Parameters

VARIABLE	UNITS	INDEX i											
		1	2	3	4	5	6	7	8	9	10	11	12
K_i		1	2	5	7	11	17	23	31	47	67	97	131
a_{u_i}	(ft/sec)	.786	.720	.598	.402	.358	.207	.207	.192	.166	.134	.108	.0872
a_{v_i}	(ft/sec)	.601	.689	.662	.472	.428	.326	.251	.233	.202	.163	.131	.106
a_{w_i}	(ft/sec)	.309	.474	.589	.532	.555	.459	.367	.348	.304	.246	.200	.161
a_{p_i}	(ft/sec)	.368	.425	.511	.478	.543	.490	.414	.407	.365	.299	.244	.198

Appendix E

APPENDIX E

QUESTIONNAIRES USED

A number of questionnaires and forms were used in the subject programs. The first briefing with pilots was held prior to the motion base simulator experiment. An extensive written description of the purposes and methodology of the study was given to the pilots to read prior to the meeting. This was supplemented by an oral briefing at the meeting, followed by a question and answer period. At this point, the pilots knew enough about the program to be able (and motivated) to supply quantitative estimates of tracking performance and workload expectations. These data, which are reported in the Task Definition section of this report, were used in the pre-experiment model analysis. Five pilots, in individual interviews, gave quantitative data on the tracking performance and workload levels expected. Specifically, the pilots were asked for their subjective impressions of maximum acceptable excursions for important system variables in moderate turbulence. Values supplied by the pilots were averaged and then used to set the weighting coefficients in the performance index of the optimal control model and as performance standards for the pilots.

After the experiment was finished, the pilots were asked to fill out the questionnaire which is shown as Table E1 below. This was done for two reasons. First, we felt that they could do a better job of giving quantitative answers after doing a test in which they were constantly reminded to perform to a consistent performance standard. Second, we wanted them to quantify the standards to which they actually worked.

Appendix E

Table E1. Pilot Debriefing Form

You have just completed a simulator study of transport longitudinal-axis handling qualities. You are now asked to fill out this form to provide the experimenters with certain information relating to your piloting strategy and your formulation of Cooper-Harper ratings.

1. Attention Allocation

Check below the relative attentions you paid to the various flight instruments during the runs with turbulence. If you used different scan strategies for different configurations, indicate the strategy most commonly employed during the study. Indicate separately for each of the three flight subphases. (Instruments are listed below alphabetically, not by implied order of importance.)

Relative Attention: H=high, M=moderate, L=little or none

Instrument	Altitude Stationkeeping			Glideslope Capture			Glideslope Tracking		
	H	M	L	H	M	L	H	M	L
	<hr/>								
Altimeter	—	—	—	—	—	—	—	—	—
Attitude-Director Indicator									
Artificial Horizon	—	—	—	—	—	—	—	—	—
Glideslope	—	—	—	—	—	—	—	—	—
Localizer	—	—	—	—	—	—	—	—	—
Engine (N ₁)	—	—	—	—	—	—	—	—	—
Horizontal Situation Indicator									
Compass	—	—	—	—	—	—	—	—	—
Glideslope	—	—	—	—	—	—	—	—	—
Localizer	—	—	—	—	—	—	—	—	—
Indicated Airspeed	—	—	—	—	—	—	—	—	—
Vertical Speed	—	—	—	—	—	—	—	—	—

Appendix E

Table E1. Pilot Debriefing Form (cont.)

Was your attention strategy for any configuration significantly different from that shown above? Yes ___ No ___. If so, state which configuration(s), and indicate how the attention strategy differed.

2. Relative Importance of Subphases

Indicate below the rank ordering of the three flight subphases in terms of their importance to your longitudinal-axis Cooper-Harper rating. Give the rank ordering that applies to most of the configurations. (1 = most important, 3 = least important.)

Altitude Stationkeeping	___
Glideslope Capture	___
Glideslope Tracking	___

Would you order the subphases differently for any configurations? Yes ___ No ___. If so, state which configuration(s), and which order.

3. Performance Requirements

The Cooper-Harper rating scale is defined in terms of performance and workload (i.e., "compensation"). For example, a rating of 6 is defined by the statement "Adequate performance requires extensive pilot compensation". The objective of this question is to find out what you considered to be "adequate performance" when you assigned C-H ratings to the various experimental configurations. Of interest

Appendix E

Table E1. Pilot Debriefing Form (concl.)

here are ratings assigned to longitudinal-axis handling qualities in turbulence. Because the subsequent modeling effort will concentrate on the glide-slope tracking phase, please state performance requirements for that task.

One way to state a performance requirement is to indicate upper and lower bounds, in terms of deviation from trim, and to state the percentage time you feel the airplane should be between these bounds. For example, if we were interested in lateral-axis performance, one might state a lateral-path requirement as being within plus or minus one dot on the localizer 90% of the time. In general, performance requirements should be specified for path, attitude, and control variables.

Please indicate your definitions of "adequate performance" for as many of the following variables as you can. Indicate NA for any variable for which a performance requirement is not applicable or for which you cannot give a quantitative answer. Please specify upper and lower bounds in terms of deviation from trim.

GLIDE SLOPE TRACKING

Variable	Lower Bound	Upper Bound	Percent Time Within Bounds
Glide slope (dots)	—	—	—
Sinkrate (ft/min)	—	—	—
Airspeed (kts)	—	—	—
Pitch (degrees)	—	—	—
Pitch rate (deg/sec)	—	—	—
Column (fraction of available control authority)	— %	— %	—
Throttle (%N1) (Assume trim is 75%)	—	—	—

Appendix F

APPENDIX F

DATA RECORDED

A great deal of subjective and objective data were recorded during the MBS experiment for analysis in this program and in the future. This appendix lists the data recorded. The analysis done on this data is described elsewhere.

Subjective data were recorded in three formats: pilot comments, pilot ratings, and cockpit voice recordings. The pilot comments were recorded by the test engineer during and following each run on the pilot Comment Card, Figure F1. The pilots were encouraged to keep up a running commentary of what they were doing, how the airplane was responding, and their reactions to or impressions of the airplane, the task, and their performance. At the end of each run, the engineer went down the list of eight topics, prompting the pilot for comments and making hand-written notes of the responses. The pilots were then asked to select a Cooper-Harper pilot rating for the longitudinal degrees of freedom and another for the lateral-directional by use of the Cooper-Harper Scale (Figure F2). These numbers were recorded by the engineer on the Pilot Rating Form, Figure F3. The pilot was then asked to rate the mental effort required to perform each of the three subphases and each of three specific control tasks. The pilots did not verbalize responses: they made marks on the eleven point scales on Figure F2 to indicate the required effort. The final type of subjective data recording was made by the cockpit voice recorder. This was not a true cockpit voice recorder, as it was wired into the intercom and thus recorded the sounds in the cockpit plus the voices of the other personnel (computer operator, motion base operator, etc). This was not a problem, as these individuals were only involved in the test when starting and stopping a session or when a problem occurred.

A great deal of objective data were recorded during every run. Fifty channels of time history data were recorded on digital magnetic tape. This was generally done at 5 hertz, with occasional runs recorded at 20 hertz, the simulation update rate. The fifty variables recorded, the units in which they were recorded, and the word number for each variable in the 50-word block are given in Table F1. The format for the remaining objective data, recorded for every run, is shown in Figure F4. It consists of two pages of information computed or stored during each run, then output by the MBS Computer on its line printer. There are three kinds of data: run documentation, instantaneous, and statistical. The first block

of data at the top of the page documents the run number, configuration number, pilot number, time and date, and run starting or reference information. The second block records instantaneous values of nine variables at ten points along the approach. The values are recorded at the instant the airplane passes through the ten range values in the third column. The first two columns show glideslope and actual altitude at the given range. Glideslope altitude at a given range is always the same: it does not vary from run to run. The actual altitude does vary, as do the other eight variables (glideslope deviation, localizer deviation, theta, phi, psi, airspeed, wheel force, and column force). The data labeled "Freeze Point" is meaningless. In prior tests, instantaneous values at touchdown were printed here. In this test, however, there is no touchdown, so there are no data.

The remainder of the page lists statistical data for the following three measurement segments: (1) altitude tracking prior to glideslope capture, (2) glideslope tracking between altitudes of 1200 and 700 feet, and (3) glideslope tracking between altitudes of 700 and 200 feet. The five data columns show mean, root mean square, maximum, minimum, and standard deviation for 15 variables. The data from segment 3 were used in validation of the model.

Appendix F

PILOT COMMENT CARD

OCPM MBS 81

Please comment on the following items. PILOT _____ CONF# _____

Attention: Indicate number of each item. DATE _____ RUN# _____

1. Controller force- and displacement characteristics; control harmony
2. Tendency toward pilot induced oscillation
3. Response to turbulence
4. What is the most positive feature of the configuration
5. What is the most objectionable feature of the configuration
6. Ability to control airspeed
7. Ability to control flight path
8. General comments

Figure F1. Pilot Comment Card

Figure F2. Cooper-Harper Pilot Rating Scale

HANDLING QUALITIES RATING SCALE

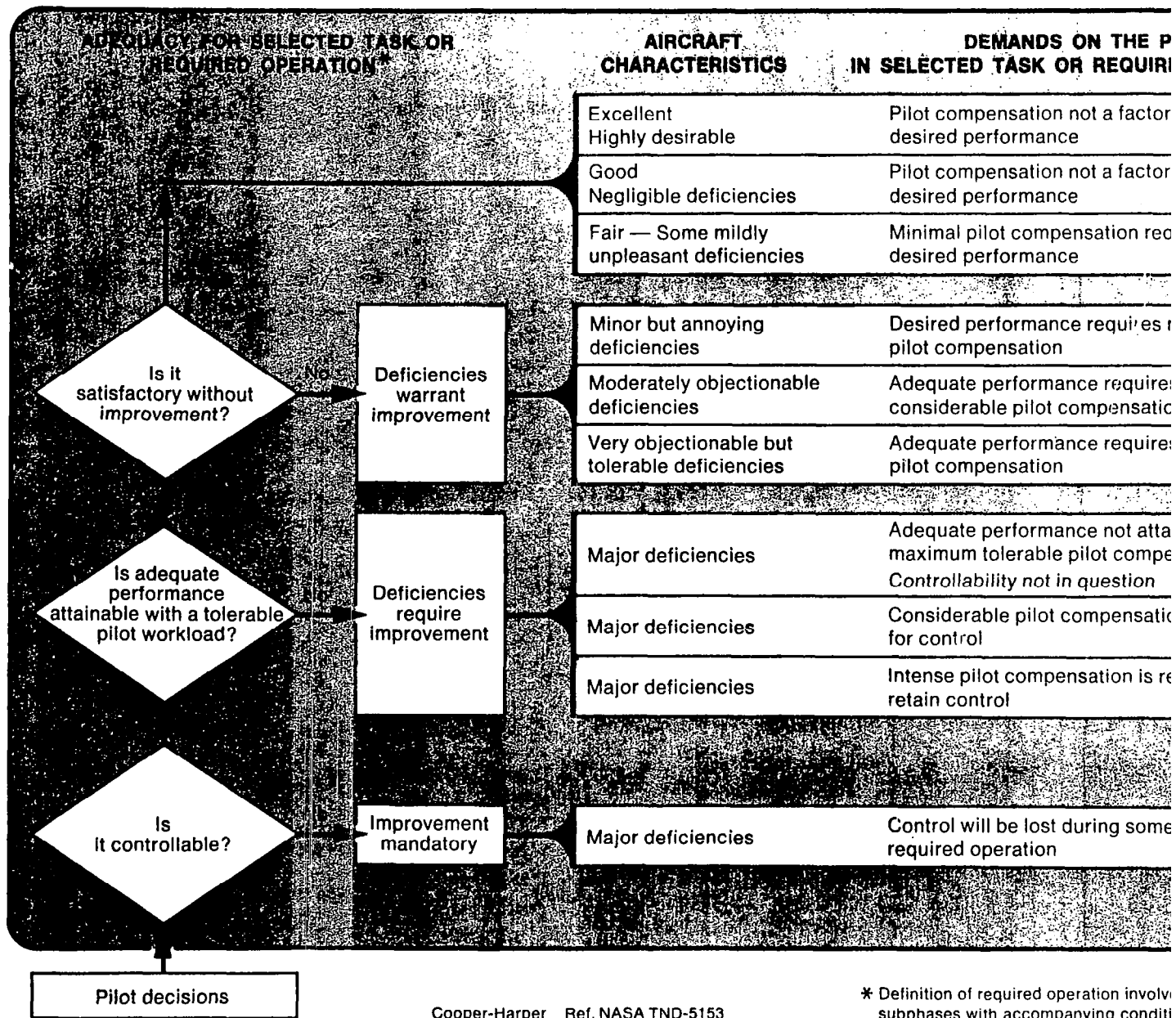

* Definition of required operation involves subphases with accompanying conditions

Appendix F

PILOT RATING FORM

PILOT _____

CONFIG # _____

DATE _____

RUN # _____

Cooper-Harper Handling Quality Rating

Longitudinal

Lateral-Directional

Please indicate level of mental effort and concentration for the following items:

Negligible
Mental
Effort

Extreme
Mental
Effort

Specific Flight Phases

1. Altitude stationkeeping

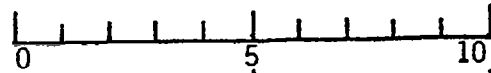

2. Glideslope Capture

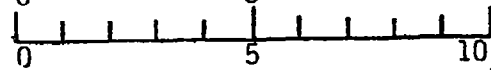

3. Glideslope Tracking

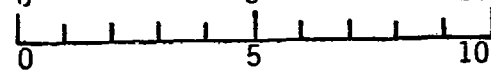

Specific Control Activities

1. Vertical Path Control

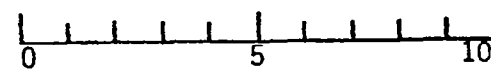

2. Airspeed Control

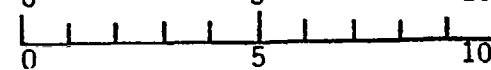

3. Pitch Control

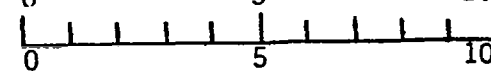

Figure F3. Pilot Rating Form

Appendix F

Table Fl. Magnetic Tape Parameter List

Word #	DESCRIPTION	UNITS	Word #	DESCRIPTION	UNITS
1	Frame Count	(Deg)	26	a _{zps} Airplane Pilot Station Accel.	(Ft/sec ²)
2	θ Euler Angles	(Deg)	27	a _{xCMD} Commanded Cab Pilot Station Accel.	(Ft/sec ²)
3	φ		28	a _{yCMD}	
4	ψ		29	a _{zCMD}	
5	a _x Stability Axis Accelerations	(g)	30	h Altitude	(Ft)
6	a _y		31	G/S Error (.075 volts=1 dot)	(Volts)
7	a _z		32	G/S Error	(Ft)
8	\dot{p}	(Deg/sec ²)	33	n ₁ Structural Mode Coords	
9	\dot{q}		34	\dot{n}_1	
10	\dot{r}		35	n ₂	
11	u _s Stability Axis Velocities	(Ft/sec)	36	\dot{n}_2	
12	v _s		37	Column Force	(lb)
13	w _s		38	Wheel Force	
14	p	(Deg/sec)	39	Rudder Pedal Force	
15	q		40	Column Deflection	(in)
16	r		41	Center Throttle Lever Deflection	(Deg)
17	u _g Stab Axis Gust Velocites	(Ft/sec)	42	Wheel Deflection	(Deg)
18	v _g		43	Rudder Pedal Deflection	(in)
19	w _g		44	δ _e Elevator Position	(Deg)
20	p _g	(Deg/sec)	45	$\dot{\delta}_e$ Elevator Rate	(Deg/sec)
21	α Inertial Wind Angles	(Deg)	46	ΔT Thrust Incr.	(lb)
22	β		47	Loc Error (.075 volts=1 dot)	(Volts)
23	γ Flight Path Angle		48	i _H Stabilizer Position	(Deg)
24	a _{xps} Airplane Pilot Station Accel	(Ft/sec ²)	49	δ _a Aileron Position	
25	a _{yps}		50	δ _r Rudder Position	

Appendix F

OCPM MBS 81
 STABILITY AND CONTRBL TECHNOLOGY
 DOUGLAS AIRCRAFT COMPANY

DATE: 11:29 MAR 24, '81 RUN NO: 138 CONFIG: 9 PILOT#: 1

V(REF): 140 KT THETA (REF): 6/3 DEG ALPHA (REF): 6 DEG
 XI = -5000. FT YI = C. FT ZI = -1500. FT
 TURBULENCE SIGW = 3.3 FT/SEC SIGU = 5.0 FT/SEC

GS ALT (FT)	AIRCRAFT ALT (FT)	RANGE (FT)	G/S DEV (DOTS)	LBC DEV (DOTS)	THETA (DEG)	PHI (DEG)	PSI (DEG)	AIR SPEED (KT)	WHEEL FORCE (LB)	COLUMN FORCE (LB)
1800	1524	-34335	1.3	.2	5.2	1.5	.1	140.2	-23.8	7.4
1650	1463	-31478	.9	.1	5.6	-.1	-1.3	137.3	-23.8	-3.6
1500	1436	-28613	.3	-.0	6.3	.5	1.8	135.7	-23.8	-2.5
1350	1374	-25755	-.2	-.2	2.4	-7.3	2.5	138.7	-23.8	1.0
1200	1164	-22897	.2	-.1	2.3	-1.2	-.8	147.2	-23.8	-12.2
900	908	-17172	-.1	.5	3.1	3.4	-1.4	132.4	-23.8	-5.7
600	568	-11442	.3	-.3	5.3	-3.9	4.4	142.6	-23.8	-9.2
450	471	-8578	-.5	-.7	2.1	-.9	-1.0	145.5	-23.8	-15.3
300	282	-5720	.3	-.2	4.2	-2.6	-.5	141.1	-23.8	-16.1
200	209	-3807	-.6	.5	2.6	.6	-6.6	134.0	-23.8	4.1

FREEZE POINT THE = .C PHI = .0 PSI = .C (DEG)
 VX = .C VY = .C VZ = .C (FPS EARTH)
 AX = .C AY = .C AZ = .C (FT/SEC²)

OVER THE 1 RANGE SEGMENT:

	MEAN	RMS	MAX	MIN	ST DEV
AIRSPEED (KT)	139.120	139.149	144.710	130.314	2.824
RANGE (FT)	-40025.930	40359.852	-31014.605	-48994.352	5181.035
VERT. OFFSET (FT)	-23.434	40.063	49.070	-62.993	32.495
SINK RATE (FT/SEC)	-.428	3.746	7.945	-9.941	3.722
THETA (DEG)	5.915	5.952	7.189	4.603	.666
PITCH RATE (DEG/SEC)	-.012	.230	1.041	-.950	.230
ELEVATOR (DEG)	.000	.425	2.567	-2.717	.425
ELEVATOR RATE (D/S)	.000	1.775	11.448	-11.415	1.775
COLUMN FORCE (LB)	1.189	7.592	22.778	-21.731	7.498
THRUST (LB)	59845.738	59904.375	61681.223	52326.059	2649.969

Figure F4. MBS Line Printer Page

Appendix F

THRUST RATE (LB/SEC)	-33.919	825.647	2051.435	-5282.293	824.950
U GUST (FT/SEC)	.000	5.001	20.141	-12.941	5.001
V GUST (FT/SEC)	.000	4.999	21.320	-14.430	4.999
W GUST (FT/SEC)	.000	3.300	15.262	-12.134	3.300
P GUST (DEG/SEC)	.000	.577	2.739	-2.248	.577

OVER THE 2 RANGE SEGMENT:	DATE:	11:29 MAR 24, '81	RUN NO. 138	750 SAMPLES	
	MEAN	RMS	MAX	MIN	ST DEV
AIRSPED (KT)	139.422	139.505	149.182	127.886	4.818
RANGE (FT)	-18491.535	18668.488	-14080.109	-22994.727	2564.346
VERT. OFFSET (FT)	27.041	35.015	59.882	-8.625	22.246
SINK RATE (FT/SEC)	-12.409	13.066	-5.492	-18.085	4.092
THETA (DEG)	3.429	3.490	4.485	1.965	.650
PITCH RATE (DEG/SEC)	.054	.293	.859	-1.054	.288
ELEVATOR (DEG)	-.118	.493	1.686	-1.732	.479
ELEVATOR RATE (D/S)	.051	1.709	7.702	-7.354	1.708
COLUMN FORCE (LB)	-3.281	8.985	20.728	-19.134	8.364
THRUST (LB)	42346.836	42536.633	48725.863	37903.273	4013.832
THRUST RATE (LB/SEC)	34.566	1049.434	5246.734	-3916.384	1048.865
U GUST (FT/SEC)	.000	5.134	20.141	-10.416	5.134
V GUST (FT/SEC)	.000	5.135	21.320	-11.020	5.135
W GUST (FT/SEC)	.000	3.370	15.262	-8.492	3.370
P GUST (DEG/SEC)	.000	.589	2.739	-1.481	.589

OVER THE 3 RANGE SEGMENT:	DATE:	11:29 MAR 24, '81	RUN NO. 138	750 SAMPLES	
	MEAN	RMS	MAX	MIN	ST DEV
AIRSPED (KT)	141.395	141.421	146.564	136.341	2.723
RANGE (FT)	-9013.340	9376.504	-4577.781	-13498.652	2584.294
VERT. OFFSET (FT)	7.785	27.187	52.608	-22.107	26.049
SINK RATE (FT/SEC)	-11.327	12.224	-3.988	-21.531	4.596
THETA (DEG)	3.587	3.777	5.435	1.416	1.181
PITCH RATE (DEG/SEC)	.004	.508	1.892	-1.674	.508
ELEVATOR (DEG)	-.037	.843	2.905	-3.567	.842
ELEVATOR RATE (D/S)	.001	2.531	8.585	-11.586	2.531
COLUMN FORCE (LB)	.332	9.785	20.683	-26.377	9.780
THRUST (LB)	43175.273	43679.453	54069.398	37077.437	6617.465
THRUST RATE (LB/SEC)	-137.832	1043.157	2024.027	-6657.355	1034.011
U GUST (FT/SEC)	.000	4.164	6.982	-12.941	4.164
V GUST (FT/SEC)	.000	4.244	7.227	-14.430	4.244
W GUST (FT/SEC)	.000	3.019	6.067	-12.134	3.019
P GUST (DEG/SEC)	.000	.538	1.124	-2.248	.538

Figure F4. MBS Line Printer Page (cont.)

Appendix G

APPENDIX G

TABULATION OF PERFORMANCE MEASURES

The following tables contain statistical analysis of pilot opinion ratings and objective performance measures. Average Cooper-Harper ratings for each pilot are given in Table G1, along with means and standard deviations of the individual subject means. Results are given for the longitudinal axis (turbulence on and off) and the lateral axis (turbulence on).

Results of t-tests performed on paired-difference pilot ratings are given in Table G2. With the longitudinal axis, turbulence-on condition taken as a baseline, Table G2a indicates the significance of differences associated with turbulence on or off, and G2b indicates the significance of longitudinal-lateral axis differences in pilot ratings. Entries in this table show the probability that the measured differences can be explained by the null hypothesis (i.e., that apparent differences are due to randomness in the data and not to the experimental conditions). Differences are considered statistically insignificant for probabilities greater than 0.05.

Tables G2c through G2e indicate the significance of rating differences across the vehicle configurations. Since Configuration 1 is taken as the baseline for all comparisons, these tables show no entry in column 1.

Table G3 contains average effort rating scores for each configuration. These scores were obtained from the effort rating form shown in Table F3.

Table G4 contains means and variances for eight longitudinal-axis system variables recorded during the turbulence-on trials. Results are shown for the three quasi-steady-state tracking segments: pre-capture stationkeeping, and post-capture glideslope tracking between 1200 and 700 feet and between 700 and 200 feet. (Measures from the third segment are discussed in the main text.)

Analysis was performed for each variable as follows. First, a within-trial mean and standard deviation was computed from each experimental trial. Within-pilot averaging was performed to yield an average mean score and an average standard-deviation score for each pilot performing each condition. Finally, across-pilot analysis yielded means and standard deviations of these derived measures. Four measures were thereby obtained:

Appendix G

1. the overall mean level of the variable;
2. an across-pilot standard deviation of the mean score (indicating the reliability of the population mean);
3. an average standard deviation score (indicating the average variational component for the four pilots); and
4. an across-pilot standard deviation of the average within-pilot standard deviation scores (indicating the reliability of the averaged standard deviation score).

These four sets of statistical results are presented in order, from top to bottom, in the following tables. The latter two metrics are shown for selected variables in Figure 8 of the main text.

Appendix G

Table G1. Average Cooper-Harper Pilot Opinion Ratings

Pilot	Configuration Number					
	1	2	3	8	9	10
a) Longitudinal Axis, Turbulence Off						
1	3.75	6.00	6.50	4.00	4.25	4.00
2	3.00	4.25	6.00	3.50	2.75	3.00
3	2.25	4.50	5.75	3.88	3.50	2.75
4	4.63	5.75	7.50	5.00	4.50	5.75
Mean	3.41	5.13	6.44	4.10	3.75	3.88
Std. Dev.	1.02	0.88	0.77	0.64	0.79	1.36
b) Longitudinal Axis, Turbulence ON						
1	5.80	8.40	7.00	4.20	5.00	5.05
2	4.00	6.00	7.00	4.88	3.75	3.50
3	4.25	6.63	6.75	5.38	4.00	3.75
4	5.60	8.00	8.00	5.70	5.00	5.00
Mean	4.91	7.26	7.19	5.04	4.44	4.31
Std. Dev.	0.92	1.13	0.55	0.65	0.66	0.80
c) Lateral Axis, Turbulence On						
1	5.00	6.25	5.50	4.25	4.75	5.00
2	5.00	5.38	5.25	5.25	4.63	4.63
3	4.00	4.00	4.00	4.00	4.00	4.25
4	4.75	6.25	5.00	6.75	5.50	5.63
Mean	4.69	5.47	4.94	5.06	4.72	4.88
Std. Dev.	.47	1.06	0.66	1.25	0.67	0.59

Appendix G

Table G2. Analysis of Pilot Rating Scores: T-Tests of Paired Differences

		Configuration					
		1	2	3	8	9	10
a)	Effect of Turbulence, Longitudinal Axis	<.02	<.001	<.02	NS	<.02	NS
b)	Effect of Axis, Turbulence On	NS	<.05	<.01	NS	NS	NS
c)	Effect of Configuration, Long. Axis with Turb.	*	<.001	<.02	NS	<.05	<.01
d)	Effect of Configuration, Long. Axis without Turb.	*	<.02	<.001	NS	NS	NS
e)	Effect of Configuration, Lateral Axis with Turb.	*	NS	NS	NS	NS	NS

NS = not significant (α level of significance $>.05$)

* Reference condition.

Appendix G

Table G3. Averaged Effort Rating Scores

Task	1	2	3	8	9	10
a) Rating by Subtask						
Altitude Stationkeeping	3.8	5.4	5.6	4.2	3.7	3.6
Glideslope Capture	4.2	5.3	5.6	4.2	3.9	3.7
Glideslope Tracking	4.8	6.3	6.5	4.9	4.2	4.0
b) Rating by Control Requirement						
Vertical Path Control	4.5	6.8	6.9	4.8	4.5	4.4
Airspeed Control	4.3	7.0	5.4	4.6	4.5	4.4
Pitch Control	4.9	6.6	7.5	5.3	4.7	4.5

Average of 4 pilots, 4-5 trials/pilot

Appendix G

Table G4. Objective Performance Scores

a) Height Error

OCPM MBS81 TRACKING TASK DATA ENSEMBLE STATISTICS (STD. DEV. AVERAGING) 4-22-81
 LEVEL II: AVERAGES ACROSS PILOTS (ACROSS REPLICATIONS)
 VARIABLE 2: VERT OFFSET (FT)

SEGMENT	(XPIL) MEAN VERT OFFSET (FT)				- TURBULENCE ON	
	1	2	CONFIGURATION		9	10
			3	8		
1	-4.288	-3.296	17.131	-1.646	-3.612	-13.759
2	-35.686	-73.392	6.155	-9.519	5.720	24.653
3	38.428	-73.441	5.900	17.674	7.959	7.106

SEGMENT	(SGXPIL) STANDARD DEVIATION OF XREP ACROSS PILOTS - TURBULENCE ON (A FUNCTION OF XPIL AND XREP**2)				- TURBULENCE ON	
	1	2	CONFIGURATION		9	10
			3	8		
1	28.030	54.019	19.530	11.759	7.947	23.479
2	17.086	56.154	16.533	19.939	18.018	16.356
3	15.837	42.106	9.806	6.697	7.944	7.931

SEGMENT	(SIGPIL) AVERAGE STANDARD DEVIATION - TURBULENCE ON (AVERAGE OF SIGREP VALUES ACROSS PILOTS)				- TURBULENCE ON	
	1	2	CONFIGURATION		9	10
			3	8		
1	43.051	61.245	39.428	29.154	28.643	29.709
2	41.244	59.448	29.414	27.842	31.956	31.771
3	34.780	64.288	30.508	23.976	23.771	24.096

SEGMENT	(SGSGPL) STANDARD DEVIATION OF SIGREP ACROSS PILOTS - TURBULENCE ON (A FUNCTION OF SIGPIL AND SIGREP**2)				- TURBULENCE ON	
	1	2	CONFIGURATION		9	10
			3	8		
1	8.939	17.151	5.413	6.187	6.766	5.907
2	16.241	11.851	4.211	16.757	6.965	10.499
3	8.867	18.866	14.173	3.917	8.321	6.367

Appendix G

Table G4. Objective Performance Scores (cont.)

b) Vertical Velocity

OCPM MBS81 TRACKING TASK DATA ENSEMBLE STATISTICS (STD. DEV. AVERAGING) 4-22-81

LEVEL II: AVERAGES ACROSS PILOTS (ACROSS REPLICATIONS)

VARIABLE 3: SINKRATE (FT/SEC)

SEGMENT	(XPIL) MEAN SINKRATE (FT/SEC)					
	1	2	CONFIGURATION		9	10
			3	8		
1	0.051	-0.284	-0.614	0.049	-0.029	0.070
2	-15.306	-12.868	-12.647	-13.521	-13.204	-12.586
3	-12.682	-12.311	-13.574	-12.459	-12.391	-12.209

SEGMENT	(SGXPIL) STANDARD DEVIATION OF XREP ACROSS PILOTS - TURBULENCE ON (A FUNCTION OF XPIL AND XREP**2)					
	1	2	CONFIGURATION		9	10
			3	8		
1	0.823	1.227	0.695	0.420	0.387	0.454
2	1.059	1.859	0.814	1.193	1.536	0.947
3	0.690	4.358	1.201	0.943	0.867	0.414

SEGMENT	(SIGPIL) AVERAGE STANDARD DEVIATION - TURBULENCE ON (AVERAGE OF SIGREP VALUES ACROSS PILOTS)					
	1	2	CONFIGURATION		9	10
			3	8		
1	5.518	6.556	8.242	5.125	4.330	3.771
2	5.539	7.816	7.813	5.123	5.064	5.223
3	6.127	9.685	9.581	6.567	5.599	5.980

SEGMENT	(SGSGPL) STANDARD DEVIATION OF SIGREP ACROSS PILOTS - TURBULENCE ON (A FUNCTION OF SIGPIL AND SIGREP**2)					
	1	2	CONFIGURATION		9	10
			3	8		
1	0.777	1.638	1.081	0.956	1.034	0.581
2	1.108	2.201	2.428	1.398	0.861	1.899
3	0.640	2.392	5.196	1.870	2.293	1.509

Appendix G

Table G4. Objective Performance Scores (cont.)

c) Pitch Angle

OCPM MBS81 TRACKING TASK DATA ENSEMBLE STATISTICS (STD. DEV. AVERAGING) 4-22-81
 LEVEL II: AVERAGES ACROSS PILOTS (ACROSS REPLICATIONS)
 VARIABLE 4: PITCH ANGLE(DEG)

SEGMENT	(XPIL) MEAN PITCH ANGLE(DEG)				- TURBULENCE ON	
	1	2	3	8	9	10
1	6.160	5.403	5.965	6.081	6.013	6.088
2	1.861	2.528	2.880	2.519	3.018	3.209
3	2.706	3.010	2.732	3.459	3.402	3.313

SEGMENT	(SGXPIL) STANDARD DEVIATION OF XREP ACROSS PILOTS - TURBULENCE ON (A FUNCTION OF XPIL AND XREP**2)				- TURBULENCE ON	
	1	2	3	8	9	10
1	0.165	1.576	0.387	0.139	0.104	0.074
2	0.542	0.761	0.349	0.577	0.493	0.305
3	1.120	1.190	0.739	0.454	0.211	0.097

SEGMENT	(SIGPIL) AVERAGE STANDARD DEVIATION - TURBULENCE ON (AVERAGE OF SIGREP VALUES ACROSS PILOTS)				- TURBULENCE ON	
	1	2	3	8	9	10
1	1.151	1.401	2.324	1.264	0.985	0.859
2	1.177	1.773	2.210	1.191	1.286	1.254
3	1.372	2.250	2.728	1.811	1.484	1.491

SEGMENT	(SGSGPL) STANDARD DEVIATION OF SIGREP ACROSS PILOTS - TURBULENCE ON (A FUNCTION OF SIGPIL AND SIGREP**2)				- TURBULENCE ON	
	1	2	3	8	9	10
1	0.119	0.377	0.367	0.300	0.354	0.138
2	0.248	0.658	0.767	0.255	0.445	0.513
3	0.392	0.714	1.482	0.726	0.600	0.399

Appendix G

Table G4. Objective Performance Scores (cont.)

d) Pitch Rate

OCPM MBS81 TRACKING TASK DATA ENSEMBLE STATISTICS (STD. DEV. AVERAGING) 4-22-81

LEVEL II: AVERAGES ACROSS PILOTS (ACROSS REPLICATIONS)

VARIABLE 5: PITCH RATE (DEG/SEC)

		(XPIL) MEAN PITCH RATE (DEG/SEC)				- TURBULENCE ON	
		CONFIGURATION					
SEGMENT		1	2	3	8	9	10
1		-0.009	-0.021	-0.001	-0.006	-0.008	-0.007
2		-0.005	0.008	0.029	0.016	0.006	0.010
3		0.012	0.015	0.021	0.039	-0.014	-0.024
		(SGXPIL) STANDARD DEVIATION OF XREP ACROSS PILOTS - TURBULENCE ON (A FUNCTION OF XPIL AND XREP**2)					
		CONFIGURATION					
SEGMENT		1	2	3	8	9	10
1		0.020	0.017	0.025	0.008	0.015	0.010
2		0.012	0.041	0.019	0.036	0.016	0.019
3		0.012	0.039	0.056	0.045	0.045	0.091
		(SIGPIL) AVERAGE STANDARD DEVIATION - TURBULENCE ON (AVERAGE OF SIGREP VALUES ACROSS PILOTS)					
		CONFIGURATION					
SEGMENT		1	2	3	8	9	10
1		0.562	0.675	1.288	0.619	0.365	0.347
2		0.640	0.933	1.328	0.672	0.474	0.609
3		0.882	1.249	1.638	1.030	0.743	0.721
		(SGSGPL) STANDARD DEVIATION OF SIGREP ACROSS PILOTS - TURBULENCE ON (A FUNCTION OF SIGPIL AND SIGREP**2)					
		CONFIGURATION					
SEGMENT		1	2	3	8	9	10
1		0.050	0.087	0.255	0.135	0.120	0.027
2		0.046	0.185	0.310	0.078	0.077	0.189
3		0.249	0.199	0.522	0.302	0.250	0.135

Appendix G

Table G4. Objective Performance Scores (cont.)

e) Airspeed

OCPM MBS81 TRACKING TASK DATA ENSEMBLE STATISTICS (STD. DEV. AVERAGING) 4-22-81

LEVEL II: AVERAGES ACROSS PILOTS (ACROSS REPLICATIONS)

VARIABLE 1: AIRSPEED (KT)

SEGMENT	(XPIL) MEAN AIRSPEED (KT)					
	- TURBULENCE ON					
	1	2	CONFIGURATION		9	10
		3	8			
1	139.264	138.958	139.689	139.717	139.385	138.383
2	143.733	144.241	142.499	143.076	144.137	142.423
3	140.902	142.787	143.080	140.215	140.247	140.362

SEGMENT	(SGXPIL) STANDARD DEVIATION OF XREP ACROSS PILOTS - TURBULENCE ON (A FUNCTION OF XPIL AND XREP**2)					
	- TURBULENCE ON					
	1	2	CONFIGURATION		9	10
		3	8			
1	0.456	1.362	1.429	0.707	0.816	0.722
2	1.568	4.274	1.904	2.170	2.041	4.057
3	1.041	2.093	2.784	1.486	0.777	0.433

SEGMENT	(SIGPIL) AVERAGE STANDARD DEVIATION - TURBULENCE ON (AVERAGE OF SIGREP VALUES ACROSS PILOTS)					
	- TURBULENCE ON					
	1	2	CONFIGURATION		9	10
		3	8			
1	3.372	4.277	4.166	3.782	3.846	3.788
2	3.484	5.456	4.154	3.584	4.285	5.381
3	3.765	6.214	4.357	3.955	4.406	4.550

SEGMENT	(SGSGPL) STANDARD DEVIATION OF SIGREP ACROSS PILOTS - TURBULENCE ON (A FUNCTION OF SIGPIL AND SIGREP**2)					
	- TURBULENCE ON					
	1	2	CONFIGURATION		9	10
		3	8			
1	0.200	0.679	0.303	0.258	0.506	0.289
2	0.365	0.996	0.741	0.513	0.649	1.029
3	0.222	1.289	0.738	0.187	0.751	1.161

Appendix G

Table G4. Objective Performance Scores (cont.)

f) Elevator Deflection Angle

OCPM MBS81 TRACKING TASK DATA ENSEMBLE STATISTICS (STD. DEV. AVERAGING) 4-22-81

LEVEL II: AVERAGES ACROSS PILOTS (ACROSS REPLICATIONS)

VARIABLE 6: ELEVATOR DEFLECTION ANGLE (DEG)

(XPIL) MEAN ELEVATOR DEFLECTION ANGLE (DEG) - TURBULENCE ON

SEGMENT	CONFIGURATION					
	1	2	3	8	9	10
1	-0.016	-0.155	0.123	0.053	0.027	0.065
2	0.151	0.330	0.038	0.093	0.102	0.129
3	-0.348	-0.271	-0.019	0.230	0.138	0.169

(SGXPIL) STANDARD DEVIATION OF XREP ACROSS PILOTS - TURBULENCE ON
(A FUNCTION OF XPIL AND XREP**2)

SEGMENT	CONFIGURATION					
	1	2	3	8	9	10
1	0.130	0.273	0.100	0.101	0.036	0.096
2	0.284	0.619	0.436	0.204	0.169	0.180
3	0.374	0.207	0.358	0.298	0.177	0.213

(SIGPIL) AVERAGE STANDARD DEVIATION - TURBULENCE ON
(AVERAGE OF SIGREP VALUES ACROSS PILOTS)

SEGMENT	CONFIGURATION					
	1	2	3	8	9	10
1	1.541	1.372	2.887	1.129	0.555	0.550
2	1.357	1.919	3.356	1.405	0.736	0.813
3	1.966	2.477	3.927	2.008	1.140	1.143

(SGSGPL) STANDARD DEVIATION OF SIGREP ACROSS PILOTS - TURBULENCE ON
(A FUNCTION OF SIGPIL AND SIGREP**2)

SEGMENT	CONFIGURATION					
	1	2	3	8	9	10
1	0.867	0.092	0.562	0.188	0.165	0.030
2	0.165	0.229	0.585	0.220	0.109	0.091
3	0.438	0.121	0.757	0.286	0.281	0.141

Appendix G

Table G4. Objective Performance Scores (concl.)

g) Elevator Deflection Rate

OCPM MBS81 TRACKING TASK DATA ENSEMBLE STATISTICS (STD. DEV. AVERAGING) 4-22-81

LEVEL II: AVERAGES ACROSS PILOTS (ACROSS REPLICATIONS)

VARIABLE 9: THRUST (1000 LB.)

SEGMENT	(XPIL) MEAN THRUST (1000 LB)				- TURBULENCE ON	
	1	2	CONFIGURATION		9	10
			3	8		
1	60.568	61.604	59.886	60.604	60.009	59.851
2	38.424	38.604	43.583	39.853	42.411	41.843
3	40.609	37.877	40.767	41.151	42.359	43.875

SEGMENT	(SGXPIL) STANDARD DEVIATION OF XREP ACROSS PILOTS - TURBULENCE ON (A FUNCTION OF XPIL AND XREP**2)					
	1	2	CONFIGURATION		9	10
			3	8		
1	1.109	2.977	0.816	0.746	0.495	0.897
2	2.408	7.888	2.043	2.529	1.619	1.330
3	2.243	8.862	2.220	1.324	0.848	1.720

SEGMENT	(SIGPIL) AVERAGE STANDARD DEVIATION - TURBULENCE ON (AVERAGE OF SIGREP VALUES ACROSS PILOTS)					
	1	2	CONFIGURATION		9	10
			3	8		
1	4.135	8.603	3.574	4.289	4.450	3.661
2	4.460	11.788	3.442	4.179	4.118	5.773
3	5.765	12.293	3.742	4.397	4.361	4.843

SEGMENT	(SGSGPL) STANDARD DEVIATION OF SIGREP ACROSS PILOTS - TURBULENCE ON (A FUNCTION OF SIGPIL AND SIGREP**2)					
	1	2	CONFIGURATION		9	10
			3	8		
1	0.372	2.497	0.749	0.887	1.004	1.358
2	1.257	1.734	0.549	1.061	1.520	0.993
3	2.317	2.206	1.093	0.767	1.508	2.617

REFERENCES

1. "Flying Qualities of Piloted Airplanes", Military Specification, MIL-F-8785B (ASG), 1969.
2. Cooper, G.E., and Harper, R.P., Jr., "The Use of Pilot Rating in the Evaluation of Aircraft Handling Qualities", NASA TN D-5153, April 1969.
3. Hess, R.A., "Prediction of Pilot Opinion Ratings Using an Optimal Pilot Model", Human Factors, 1977, 19(5), pp. 459-475.
4. Levison, W.H., "A Model-Based Technique for Predicting Pilot Opinion Ratings for Large Commercial Transports", NASA CR-3257, April 1980.
5. Levison, W.H., "A Model-Based Technique for Predicting Pilot Opinion Ratings for Large Commercial Transports", Proc. of the 16th Annual Conference on Manual Control, Cambridge, MA, May 1980, pp. 216-243.
6. Baron, S., and Levison, W.H., "The Optimal Control Model: Status and Future Directions", Proc. of the 1980 International Conf. on Cybernetics and Society, Cambridge, MA, October 1980.
7. Rickard, W.W., "Longitudinal Flying Qualities in the Landing Approach", Proc. of the 12th Annual Conf. on Manual Control, NASA TMX-73, 170, May 1976.
8. Levison, W.H., Elkind, J.I., and Ward, J.L., "Studies of Multi-Variable Manual Control Systems: A Model for Task Interference", NASA CR-1746, May 1971.
9. Levison, W.H., "A Model for Mental Workload in Tasks Requiring Continuous Information Processing", Mental Workload Its Theory and Measurement, Plenum Press, New York and London, 1979.
10. Levison, W.H., "The Effects of Display Gain and Signal Bandwidth on Human Controller Remnant", Wright-Patterson Air Force Base, OH, AMRL-TR-70-93, March 1971.
11. Chalk, C.R., Neal, T.P., Harris, T.M., and Pritchard, F.E., "Background Information and User Guide for MIL-F-8785B (ASG), "Military Specification-Flying Qualities of Piloted Airplanes", AFFDL-TR-69-72, August 1969.

12. Hess, R.A., "A Pilot Modeling Technique for Handling-Qualities Research", J. of Cybernetics and Information Science, Vol. 3, No. 1-4, 1980, pp. 57-97.
13. Smit, J., and Wewerinke, P.H., "An Analysis of Helicopter Pilot Control Behavior and Workload During Instrument Flying Tasks", National Aerospace Laboratory NLR, Publication No. NLR MP 78003 U, May 1978.
14. McRuer, D., Ashkinas, I., and Graham, D., Aircraft Dynamics and Automatic Control, Princeton University Press, 1973.
15. Junker, A.M., and Levison, W.H., "Some Empirical Techniques for Human Operator Performance Measurement", Proceedings of the International Conf. on Cybernetics and Society, Cambridge, MA, October 8-10, 1980.

1. Report No. NASA CR-3572		2. Government Accession No.		3. Recipient's Catalog No.	
4. Title and Subtitle ANALYTICAL AND SIMULATOR STUDY OF ADVANCED TRANSPORT HANDLING QUALITIES				5. Report Date June 1982	
				6. Performing Organization Code	
7. Author(s) William H. Levison and William W. Rickard				8. Performing Organization Report No. 4778	
9. Performing Organization Name and Address Bolt Beranek and Newman Inc. 50 Moulton Street Cambridge, MA 02238 and Douglas Aircraft Company Long Beach, CA 90846				10. Work Unit No.	
				11. Contract or Grant No. NAS1-16410	
12. Sponsoring Agency Name and Address National Aeronautics and Space Administration Washington, D.C. 20546				13. Type of Report and Period Covered Contractor Report	
				14. Sponsoring Agency Code	
15. Supplementary Notes Langley Technical Monitors: Martin T. Moul and David B. Middleton Final Report					
16. Abstract An analytic methodology, based on the optimal-control pilot model, is demonstrated for assessing longitudinal-axis handling qualities of transport aircraft in final approach. Calibration of the methodology is largely in terms of closed-loop performance requirements, rather than specific vehicle response characteristics, and is based on a combination of published criteria, pilot preferences, physical limitations, and engineering judgment. Six longitudinal-axis approach configurations were studied covering a range of handling qualities problems, including the presence of flexible aircraft modes. The analytical procedure was used to obtain predictions of (a) Cooper-Harper ratings, (b) a scalar quadratic performance index, and (c) rms excursions of important system variables. A subsequent manned simulation study yielded objective and subjective performance measures that varied across vehicle configurations in the manner predicted by model analysis. In particular, flexible modes for the specific configurations explored in this simulation study were correctly predicted to have no significant effect on handling qualities.					
17. Key Words (Suggested by Author(s)) Handling Qualities Flexible Modes Pilot Modeling Human Operator Technology			18. Distribution Statement Unclassified - Unlimited Subject Category 08		
19. Security Classif. (of this report) Unclassified		20. Security Classif. (of this page) Unclassified		21. No. of Pages 90	22. Price A05