

## **General Disclaimer**

### **One or more of the Following Statements may affect this Document**

- This document has been reproduced from the best copy furnished by the organizational source. It is being released in the interest of making available as much information as possible.
- This document may contain data, which exceeds the sheet parameters. It was furnished in this condition by the organizational source and is the best copy available.
- This document may contain tone-on-tone or color graphs, charts and/or pictures, which have been reproduced in black and white.
- This document is paginated as submitted by the original source.
- Portions of this document are not fully legible due to the historical nature of some of the material. However, it is the best reproduction available from the original submission.

JPL PUBLICATION 80-38, VOLUME I

(NASA-CR-169787) A SEASAT REPORT. VOLUME  
I: PROGRAM SUMMARY Final Report (Jet  
Propulsion Lab.) 223 p HC .10/MF A01

N83-16829

CSSL 22B

Unclas

G3/43

02593

# Seasat Final Report

## Volume I: Program Summary

Edited by  
E. Pounder



September 15, 1980

National Aeronautics and  
Space Administration

Jet Propulsion Laboratory  
California Institute of Technology  
Pasadena, California

**JPL PUBLICATION 80-38, VOLUME I**

**Seasat Final Report  
Volume I: Program Summary**

**Edited by  
E. Pounder**

**September 15, 1980**

**National Aeronautics and  
Space Administration**

**Jet Propulsion Laboratory  
California Institute of Technology  
Pasadena, California**

**The research described in this publication was carried out by the Jet Propulsion Laboratory, California Institute of Technology, under NASA Contract No. NAS7-100.**

## PREFACE

The Seasat satellite was launched at 01:12:44 GMT on 27 June 1978 from the Western Test Range at Vandenberg Air Force Base, Lompoc, California. The spacecraft was injected into Earth orbit to demonstrate techniques for global monitoring of the dynamics of the air-sea interface and to explore operational applications. To achieve these objectives, a payload of sensors emphasizing all-weather, active and passive, microwave capabilities was carried on the satellite. The mission was prematurely terminated on 10 October 1978 after 106 days of operation by a catastrophic failure in the satellite power subsystem.

Major mission accomplishments were:

- (1) Demonstration of the orbital techniques required to support the mission and sensor operations.
- (2) Demonstration of the simultaneous operation of all sensors for periods of time significant to global monitoring.
- (3) The collection of an important data set for sensor evaluation and scientific use.

The early mission termination precluded:

- (1) Demonstration of the planned operational features of the end-to-end data system.
- (2) Collection of a global data set to meet overall geodetic and seasonal objectives and plans.

This report, in four volumes, includes results of the sensor evaluations and some preliminary scientific results from the initial experiment team activities. Scientific and applications studies will continue through FY 80, and will be included in a separate report.

## ABSTRACT

The Seasat Project was a feasibility demonstration of the use of orbital remote sensing for global ocean observation. The satellite was launched in June of 1978 and was operated successfully until October 1978. At that time, a massive electrical failure occurred in the power system, terminating the mission prematurely.

Volume I summarizes the project and some early results. Included are: (a) program background and experiment objectives, (b) a description of the project organization and interfaces, (c) the mission plan and history, (d) user activities, (e) a brief description of the data system, (f) a financial and manpower summary, and (g) some preliminary results.

Data processing and evaluation continue at JPL under the Seasat Data Utilization Project; final results will be reported as available from that activity.

## CONTENTS

I.	INTRODUCTION -----	1-1
II.	PROGRAM BACKGROUND -----	2-1
A.	PRE-PROJECT PHASE -----	2-1
B.	PROJECT PHASE -----	2-2
C.	PROJECT OBJECTIVES -----	2-4
D.	MISSION OBJECTIVES -----	2-4
E.	EXPERIMENT OBJECTIVES -----	2-5
1.	Altimetry/Precision Orbit Determination Experiment -----	2-5
2.	Scatterometer Experiment -----	2-5
3.	Synthetic Aperture Radar Experiment -----	2-6
4.	Visual and Infrared Radiometer Experiment -----	2-6
5.	Scanning Multichannel Microwave Radiometer Experiment ---	2-6
III.	PROJECT ORGANIZATION -----	3-1
A.	PROJECT ORGANIZATION AND PROGRAM RELATIONSHIPS -----	3-1
1.	Management Objective -----	3-1
2.	Seasat Project Manager -----	3-1
3.	System Managers Relationships -----	3-4
4.	Project Staff -----	3-6
B.	SENSOR MANAGEMENT RESPONSIBILITIES AND SUPPORT REQUIREMENTS ---	3-9
1.	Radar Altimeter -----	3-9
2.	Synthetic Aperture Radar -----	3-10
3.	Scatterometer -----	3-10
4.	Scanning Multichannel Microwave Radiometer -----	3-10
5.	Visual and Infrared Radiometer -----	3-10
6.	Sensor Delivery Requirements -----	3-11
7.	Sensor Coordination Support -----	3-11

C.	PROJECT INTERFACES -----	3-11
D.	SPECIAL BOARDS AND COMMITTEES -----	3-13
	1. Application Steering Committee -----	3-13
	2. Oceanology Advisory Subcommittee -----	3-13
E.	RESOURCES REPORTING -----	3-15
	1. Project Management Report -----	3-15
	2. Work Breakdown Structure -----	3-15
	3. JPL System for Resources Management -----	3-15
	REFERENCES -----	3-15
IV.	MISSION PLAN -----	4-1
A.	INTRODUCTION -----	4-1
B.	TRAJECTORY PLAN -----	4-3
	1. Orbit Selection Criteria -----	4-3
	2. Orbit Maintenance -----	4-9
C.	MISSION PROFILE -----	4-12
V.	MISSION HISTORY -----	5-1
A.	INTRODUCTION -----	5-1
B.	LAUNCH PHASE -----	5-1
C.	INITIAL ORBITAL CRUISE -----	5-5
D.	SENSOR ENGINEERING ASSESSMENT -----	5-5
E.	OBSERVATION PHASE -----	5-6
F.	MANEUVER REDESIGN -----	5-7
G.	MINIMUM POWER PERIOD -----	5-13
H.	POWER SUBSYSTEM FAILURE -----	5-16
I.	MISSION PLANNING SUMMARIES -----	5-17



VI.	SURFACE TRUTH ACTIVITY -----	6-1
A.	GENERAL -----	6-1
B.	PRE-FLIGHT PHASE -----	6-1
C.	MISSION PHASE -----	6-1
1.	Routine Data -----	6-1
2.	Special Experiments -----	6-2
3.	Extreme Conditions -----	6-3
VII.	COMMERICAL USER ACTIVITY -----	7-1
A.	INTRODUCTION -----	7-1
B.	COMMERCIAL USERS -----	7-5
C.	COMMERCIAL DEMONSTRATION PROGRAM -----	7-9
D.	PROGRAM MODIFICATION -----	7-16
VIII.	JOINT NOAA/NASA SOLICITATION -----	8-1
IX.	END-TO-END DATA SYSTEM -----	9-1
A.	INTRODUCTION -----	9-1
B.	THE SEASAT LOW-RATE DATA PROCESSING SYSTEM -----	9-2
1.	Introduction -----	9-2
2.	Satellite On-Board Data Handling -----	9-2
3.	Processing at Goddard Space Flight Center -----	9-7
4.	Processing at JPL -----	9-9
5.	Data Catalogs -----	9-16
C.	LOW-RATE DATA SYSTEM PERFORMANCE -----	9-19
1.	Telemetry Time-Tagging -----	9-20
2.	Data Turn-Around Time -----	9-20
3.	Real-Time User Data Demonstration -----	9-20
4.	Time-Tagging Results -----	9-20

5.	Data Turn-Around Results -----	9-21
6.	Real-Time User Data Demonstration Results -----	9-21
D.	SAR DATA SYSTEM -----	9-21
1.	Introduction -----	9-21
2.	Optical Correlation System Description -----	9-22
3.	Optical Correlation Transfer Functions -----	9-24
4.	Digital Correlator Description -----	9-24
5.	Data Correlation Operations -----	9-30
	REFERENCES -----	9-30
X.	DATA SET DESCRIPTION -----	10-1
A.	LOW-RATE DATA -----	10-1
B.	SAR DATA SET -----	10-1
XI.	SENSOR SUMMARY AND REQUIREMENTS -----	11-1
A.	SUMMARY -----	11-1
B.	SENSOR REQUIREMENTS -----	11-1
1.	Radar Altimeter -----	11-1
2.	Scanning Multichannel Microwave Radiometer -----	11-1
3.	Scatterometer -----	11-2
4.	Synthetic Aperture Radar -----	11-2
5.	Visual and Infrared Radiometer -----	11-3
XII.	PROJECT MANAGEMENT -----	12-1
A.	PURPOSE -----	12-1
B.	BACKGROUND -----	12-1
1.	WFC/APL Baseline Mission (In-house Design) -----	12-2
2.	JPL Alternate Payload (One Satellite System Contractor) -----	12-2
C.	PROJECT IMPLEMENTATION -----	12-5

D.	ESTIMATED COST AT COMPLETION HISTORY -----	12-5
1.	Summary -----	12-5
2.	History -----	12-9
E.	MAJOR INCREASE AREAS -----	12-10
1.	Satellite System -----	12-10
2.	Sensor Development -----	12-16
3.	Mission Operations -----	12-17
4.	Project Management -----	12-17
5.	Launch Vehicle -----	12-17
6.	Network -----	12-18
	REFERENCES -----	12-18
XIII.	PRELIMINARY RESULTS -----	13-1
A.	GENERAL -----	13-1
B.	RADAR ALTIMETER -----	13-1
C.	SCATTEROMETER -----	13-2
D.	SCANNING MULTICHANNEL MICROWAVE RADIOMETER -----	13-4
E.	SYNTHETIC APERTURE RADAR -----	13-6
F.	VISUAL AND INFRARED RADIOMETER -----	13-6
	APPENDIX A - MISSION EVENTS SUMMARY -----	A-1
	APPENDIX B - MISSION PLANNING SUMMARY -----	B-1
	APPENDIX C -- ABBREVIATIONS AND ACRONYMS -----	C-1

## Figures

3-1.	Seasat Program Relationships -----	3-2
3-2.	Seasat Project Relationships -----	3-3
3-3.	Satellite Organizational Structure -----	3-5
3-4.	Project Operations Organizational Structure -----	3-5
3-5.	Ocean Experiments Organizational Structure -----	3-7
3-6.	Mission Engineering Organizational Structure -----	3-8
3-7.	Seasat Project Work Breakdown Structure -----	3-16
4-1.	Seasat Key Mission Events -----	4-2
4-2.	Seasat Launch Window - Launch Day Plot -----	4-5
4-3.	Seasat Orbit Geometry for 18 May 1978 Launch -----	4-6
4-4.	Seasat Launch Profile -----	4-8
4-5.	Heliocentric Geometry -----	4-10
4-6.	Mission Planning Software -----	4-17
4-7.	Seasat Mission Planning Team Sequence Software -----	4-18
4-8.	Typical Planning Week Activities -----	4-19
4-9.	Seasat Early Science Mission Sequence -----	4-26
5-1.	View of Earth From Trajectory N-Pole, 07/07/78 -----	5-2
5-2.	View of Earth From Trajectory N-Pole, 08/01/78 -----	5-2
5-3.	View of Earth From Trajectory N-Pole, 09/01/78 -----	5-3
5-4.	View of Earth From Trajectory N-Pole, 09/25/78 -----	5-3
5-5.	View of Earth From Trajectory N-Pole, 10/10/78 -----	5-4
5-6.	Seasat Launch Orbit Ascending Node Pattern -----	5-8
5-7.	Ground Tracks for Exact 3-Day Repeat Orbit Over Bermuda -----	5-12
7-1.	Seasat Commercial Demonstration Program Origins and Evolution -----	7-3
7-2.	Global Commercial Applications of Seasat Data -----	7-12

7-3.	Seasat Commercial Data Processing and Distribution -----	7-13
7-4.	Commercial Demonstration Program System Configuration -----	7-14
7-5.	Commercial Demonstration System User Locations -----	7-15
7-6.	Commercial Demonstration Program Real-Time User Locations -----	7-21
7-7.	Geographical Distribution of Real-Time Experiments -----	7-22
7-8.	Geographical Distribution of Non-Real-Time Experiments -----	7-23
7-9.	Seasat Commercial Demonstration Program Schedule Summary -----	7-24
8-1.	NOAA Seasat Program -----	8-2
9-1.	Seasat End-To-End Data System -----	9-4
9-2.	Seasat Low-Rate Data System -----	9-5
9-3.	Seasat Project Data Processing System at JPL -----	9-10
9-4.	Seasat Project Data Processing System Functional Diagram -----	9-17
9-5.	Functional Diagram of SAR Data Processing -----	9-23
9-6.	Film Density vs $\sigma^{\circ}$ Calibration Curve -----	9-25
9-7.	Optical Correlation Functional Diagram -----	9-26
9-8.	An FFT Matched Filtering SAR Data Processing Approach -----	9-27
9-9.	Delay and Coherent Registration at SAR Azimuth Spectral Bands -----	9-29
9-10.	Interim Digital SAR Processor Facility Block Diagram -----	9-29
9-11.	Interim Digital SAR Processor Software Block Diagram -----	9-29
9-12.	Seasat SAR Data Converted to Imagery -----	9-31
10-1.	Seasat SAR Coverage: North America -----	10-4
10-2.	Seasat SAR Coverage: Europe -----	10-5
12-1.	Seasat Cost Estimate History (Phase B to Petrone) -----	12-4
13-1.	Altimeter Height Measurement Referenced to the Estimated Geoid -----	13-3
13-2.	Early Wind Field Comparisons -----	13-5
13-3.	SAR Image of Internal Waves in the Gulf of California -----	13-7

**Tables**

2-1.	Consensus of Seasat User Requirements, 30-31 May 1973 -----	2-7
3-1.	System or System-Level Support Interfaces -----	3-12
3-2.	Project Data Support Interfaces -----	3-13
3-3.	Membership Support Interfaces -----	3-14
4-1.	Nominal Orbit Parameters -----	4-4
4-2.	Orbit Insertion Requirements -----	4-7
4-3.	Gross Profile Through Second Orbit Adjust -----	4-9
4-4.	Maneuver Frequency -----	4-11
4-5.	Orbit Parameter Range -----	4-12
4-6.	Pre-launch Mission Planning Summary -----	4-22
5-1.	Nominal Launch Orbit -----	5-5
5-2.	Orbit Definitions -----	5-9
5-3.	Maneuver Timeline -----	5-10
5-4.	Maneuver Performance -----	5-14
7-1.	Summary of Most Likely Range of Benefits for an Operational Seasat Planning Horizon to Year 2000 -----	7-2
7-2.	Potential Investments of Commercial Users Participating in the Industry Demonstration Program -----	7-4
7-3.	Computer Weather Prediction Accuracy, 1950-1976 -----	7-6
7-4.	Computer Weather Prediction Accuracy, 1977-1985 -----	7-7
7-5.	Computer Weather Prediction Projections, 1980-1985 -----	7-7
7-6.	Analysis and Evaluation of Seasat Data by the Commercial Sector -----	7-11
7-7.	Participating Commercial Users Case Studies -----	7-17
9-1.	Elements of Seasat End-to-End-Data System -----	9-3
9-2.	Input Data Characteristics -----	9-22
10-1.	Availability of Sensor Data in MSDR Tapes -----	10-2

10-2.	Seasat SAR Coverage -----	10-3
12-1.	Seasat Estimated Cost at Completion History in Millions of Dollars -----	12-6
12-2.	Cost Growth from Revised Baseline to Final Budget -----	12-10
12-3.	Satellite System Cost Element Breakdown -----	12-11
12-4.	Breakdown of SSE/SM Overrun by Task -----	12-12
12-5.	Breakdown of Bus Overrun by Task -----	12-14
12-6.	SSE/SM Manpower History as of 30 July 1978 -----	12-15
12-7.	Bus Manpower History as of 26 March 1978 -----	12-16

## SECTION I

### INTRODUCTION

The Seasat proof-of-concept mission was the first major step in developing and demonstrating a global ocean dynamics monitoring system using relevant space measurements techniques to provide information to users of the Earth's oceans. Mission objectives included demonstration of techniques for global monitoring of oceanographic and surface meteorological phenomena and features, provision of oceanographic data for both application and scientific users, and the determination of key features of an operational ocean dynamics monitoring system.

The Seasat satellite was launched at 01:12:44 GMT on 27 June 1978 from the Western Test Range at Vandenberg Air Force Base, Lompoc, California, and injected into Earth orbit. To achieve the objectives of the mission, a payload of sensors emphasizing all-weather, active and passive, microwave capabilities was carried on the satellite. However, after 106 days of operation, the mission was prematurely terminated on 10 October 1978 due to a catastrophic failure in the satellite power subsystem.

The Seasat sensor payload package consisted of a precision altimeter, a wind field scatterometer, a synthetic aperture imaging radar, a scanning multi-channel microwave radiometer, and a scanning visible and infrared radiometer. Measurements included wave height, currents, sea surface topography, surface wind speed and direction, wave imaging and directional spectra-yielding wavelengths and direction, ice fields and leads, land imaging, sea surface temperature, and atmospheric water and water vapor content.

This volume summarizes the program background and experiment objectives and provides a description of the organization and interfaces of the project. The mission plan and history are also included as well as user activities and a brief description of the data system. The volume continues with a financial and manpower summary and concludes with some preliminary results of the mission.

Processing and evaluation of data acquired by Seasat continue at JPL under the Seasat Data Utilization Project. Final results are being documented as they become available.

Other activities of this project are documented in separate volumes of this series:

Volume II Flight Systems

Volume III Ground Systems

Volume IV Attitude Determination

Abbreviations and acronyms used in this volume are defined in Appendix C.



## SECTION II

### PROGRAM BACKGROUND

#### A. PRE-PROJECT PHASE

The concept of Seasat evolved over a period of approximately two years, from early 1971 to the spring of 1973. The original idea of an altimetry satellite for geodetic purposes was conceived in the early 1960's, and investigations into the use of active and passive microwave techniques for other environmental measurements came soon after. From 1964 to 1969, the oceanographic science community began to adopt altimetry as a potentially powerful method of observing the global geostrophic circulation with Dr. W. S. von Arx of the Woods Hole Oceanographic Institution as the chief spokesman.

Two important documents were produced which led directly to the inception of Seasat. First, in the summer of 1969, over 50 Earth dynamicists, oceanographers, and instrumentation specialists met at Williamstown, Massachusetts (NASA CR-1579, 1970). That group called for formulation of a broad NASA program using a satellite altimeter capable of 10-cm (4-in.) accuracy for use in ocean circulation research.

Following this, the National Oceanic and Atmospheric Administration (NOAA) and the Atlantic Oceanographic and Meteorological Laboratory (AOML) convened a conference at Key Biscayne, Florida, chaired by Dr. John R. Apel, which generated Sea Surface Topography from Space (NOAA Technical Report ERL 228-AOML 7). At this conference, reports on satellite microwave techniques for measurement of tides, wind fields, sea state, wave heights, and surface wave directional spectra were given in addition to reports relating to geodesy and ocean currents. This was the first collection of documented proceedings which treated most of the eventual Seasat geophysical goals as a group. At the same time, a NASA panel was engaged in planning a comprehensive new program to be structured around the recommendations of the Williamstown summer study. This program had as its major visible elements a strong activity in geopotential and magnetic fields, and a lesser activity in satellite oceanography. The ocean portion called first for GEOS-3, and a future program which proposed Seasat-1 in 1977 and Seasat-2 in 1981. A Seasat sensor complement was suggested, but no attempt was made to specify user requirements. The program document is Earth and Ocean Physics Program (EOPAP), NASA, September 1972.

In late 1972 and early 1973, the (ad hoc) Seasat Users Working Group (UWG) was formed, chaired first by Dr. B. Milwitzky, NASA EOPAP Manager, and later by Dr. Apel of NOAA.\* During the spring of 1973, official user agency and institutional positions on the Seasat requirements were taken and debated. This culminated in the near-final set in May 1973 (see Table 2-1). Those requirements were changed during the following year in detail, but not in substance.

\*In 1975, this group was formalized as the NASA Oceanology Advisory Subcommittee (OAS), and the EOPAP was renamed the Earth and Ocean Applications Program (EOAP).

Dr. Apel, on loan to NASA Headquarters from NOAA, managed the start of the primary Seasat planning efforts in mid-1973. Three Phase A studies were prepared and presented by JPL, Goddard Space Flight Center (GSFC), and the Applied Physics Laboratory (APL) of Johns Hopkins University on July 31, 1973. At this time, the cost of the program was clearly going to exceed an early NASA target of \$40 to \$45 million, and a number of options were carried into the ensuing Phase B studies to determine what steps could be taken to reduce overall costs.

Phase B studies were initiated in late 1973 and were presented in August 1974. For these, the target cost for the program had been set by NASA at \$58.2 million, a figure derived on the basis of the Phase A results. The three Phase B presentations were by JPL, GSFC, and APL/Wallops Flight Center (WFC).

The Phase B results showed that the technology required for all the sensors except the SAR was available from the heritage of Skylab, GEOS, and Nimbus, and that no cost-saving mechanisms were available short of removing a major sensor.

Because the new target cost of \$58.2 million was reached in mid-1973 and had no inflation provisions, by mid-1974 a sensor had to be removed to make up for the national inflation rate alone. The issue was whether the SAR or the Scanning Multichannel Microwave Radiometer (SMMR) should be removed. The SMMR was selected for removal in the fall of 1974 by the UWG, largely on the basis that Nimbus-G was being designed with an identical instrument to fly at the same time.

The ocean scientific community had been largely responsible for the concepts used by Seasat for its environmental measurements, and the document, Seasat-A Scientific Contributions, containing a number of short papers on expected results, was published in July 1974. SMMR sea temperatures were treated as being of high priority.

A Seasat presentation was made on November 19-20, 1974 to the Ocean Science Committee of the Ocean Affairs Board of the NAS, and another shortly thereafter to the Science and Technology Policy Office of the National Science Foundation. One result from those presentations was that the science community pressed NASA for an augmentation of funds to replace the SMMR on Seasat because of the importance of an all-weather ocean surface temperature measurement. This was the eventual result, and by the time of the project implementation start, Seasat had again its complete complement of sensors.

## B. PROJECT PHASE

The Seasat mission was the result of user interest and active involvement from the earliest phases of mission definition through systems development and the next phases entered, experimentation and applications. The users have served as the architects of this "proof-of-concept" mission.

The active involvement of participating Federal agencies, scientific experimenters, both domestic and international, and members of industry with commerce in the marine environment was characteristic of the interest and support for the program within the user community.

The Seasat system was planned to support scientific and applications experiments derived from remotely sensed physical oceanographic data consisting of:

- (1) Surface temperatures, wind speed and direction, wave height, wavelength spectra, and high resolution (25 m (82 ft)) radar images of surface phenomena, including ocean waves.
- (2) Sea ice conditions, including drifting bergs, leads, and polynas, and Arctic ice sheet dynamics.
- (3) Coastal interactions, as well as objects such as ships and offshore platforms.

In addition, atmospheric column water vapor and liquid water measurements were taken to aid in adjusting and interpreting these surface measurements. All but one of the five Seasat sensors were microwave instruments (three active radars and one passive radiometer) capable of cloud-penetrating, day or night, all-weather surface measurements.

The circular orbit at a 108-deg inclination, 796-km (429-nmi) altitude, with a 100-min period provided near global coverage every 36 hours. The spatial and temporal capabilities of the satellite provided global, regional, and local experiments with synoptically valuable data.

The satellite system provided 100 percent duty cycles on all sensors, except the high data rate Synthetic Aperture Radar (SAR). Global data was collected by the NASA Spaceflight and Tracking Data Network (STDN) and transmitted to the U.S. Navy Fleet Numerical Oceanography Center (FNOC) in Monterey, California, in near-real-time (3 to 12 hours after observations) to support weather forecasting and real-time maritime commerce experimenters. Non-real-time data sets were processed at the project processing center at the Jet Propulsion Laboratory (JPL) in Pasadena, California, to support sensor geophysical evaluation, algorithm development, and scientific experiments. These data sets included more accurate orbit and attitude calculations and permitted interactive conversational processing by experimenters. The geophysical data resulting from this process is archived by the Environmental Data Service (EDS) of NOAA, where it can be acquired for a modest reproduction cost by any user. SAR data was collected by specially equipped ground stations (currently three NASA, one Canadian, and one European Space Agency (ESA) stations) when the satellite was within line-of-sight of the receiving site. The NASA-collected SAR data was also placed in the EDS archive.

Several federal groups (NOAA, NASA, Office of Naval Research, U.S. Coast Guard, U.S. Geological Survey, and National Science Foundation) have joined

together in sponsoring and funding selected scientific experiments (through formal solicitation) using Seasat data. These were selected only from domestic non-government scientists and include coastal, open ocean, sea ice, hydrographic, geodetic, and meteorological experiments.

Both NOAA and the Department of Defense (DoD) plan significant internal science and applications programs based on Seasat utilization.

#### C. PROJECT OBJECTIVES

The Seasat project was a proof-of-concept mission whose objectives included the demonstration of techniques for global monitoring of oceanographic phenomena and features, provision of oceanographic data for both application and scientific users, and the determination of key features of an operational ocean dynamics monitoring system.

#### D. MISSION OBJECTIVES

The specific mission objectives were as follows:

- (1) Provide an evaluation of sensor capabilities to measure the following geophysical parameters:
  - (a) Wave heights.
  - (b) Wavelengths and direction.
  - (c) Surface wind speed and direction.
  - (d) Ocean surface temperature.
  - (e) Atmospheric water content (liquid and vapor).
  - (f) Sea ice morphology and dynamics.
  - (g) Icebergs.
- (2) Provide oceanographic data for participating users and, following geophysical evaluation, for distribution to the general user community, including:
  - (a) Predictions of wave height, directional spectra and wind fields for ship routing, ship design, storm damage avoidance, coastal disaster warning, coastal protection and development, and deep-water port development.
  - (b) Maps of current patterns and temperatures for ship routing, fishing, pollution dispersion, and iceberg hazard avoidance.

- (c) Charts of ice fields and leads for navigation and weather prediction.
- (d) Charts of the ocean geoid fine structure.
- (3) Determine key features of an operational ocean dynamics monitoring system, including:
  - (a) Sensor operation.
  - (b) Global sampling.
  - (c) Production of geophysical data records.
  - (d) Near-real time data handling.
  - (e) User operations interaction.
  - (f) Precision orbit determination.
- (4) Demonstrate the economic and social benefits of user agency products.

#### E. EXPERIMENT OBJECTIVES

To achieve the mission objectives, the experiments described in the following paragraphs were performed.

##### 1. Altimetry/Precision Orbit Determination Experiment

The altimetry part of this experiment had two objectives: to measure very precisely the satellite attitude above mean sea level and to measure the significant wave height ( $H_{1/3}$ ) of the ocean surface at the sub-satellite point. The altitude, when combined with accurate orbit determination, gives sea surface topography that can be additionally analyzed to determine the marine geoid and sea surface disturbances due to currents, tides, storm surges, etc. The objective of the Precision Orbit Determination (POD) part of the experiment was to determine the best attainable precision and accuracy of the Seasat ephemeris, to define the associated methodology, and to provide the precision orbit support required to exploit fully the altimeter (ALT) height data for studies of sea surface topography.

##### 2. Scatterometer Experiment

The objective of the scatterometer (SASS) experiment was to provide closely spaced solutions for surface wind speed and direction from which vector wind fields could be derived on a global basis. The principle of measurement was based upon microwave backscatter from small scale waves whose amplitude depends on wind speed.

### 3. Synthetic Aperture Radar Experiment

The primary objective of this experiment with the synthetic aperture radar (SAR) was to obtain radar imagery of ocean waves in deep oceans and coastal regions to derive directional wave spectra in these regions; to obtain radar imagery of sea and freshwater ice and snow cover; to obtain radar imagery of land surfaces; and to demonstrate the environmental monitoring capability of the instrument under day and night and all-weather conditions.

### 4. Visual and Infrared Radiometer Experiment

The objective of this experiment was to provide low resolution images of visual and infrared emissions from ocean, coastal, and atmospheric features that would aid in interpreting the measurements from the microwave instruments. Measurements included cloud position information, clear air sea surface temperatures, and cloud-top brightness temperatures.

### 5. Scanning Multichannel Microwave Radiometer Experiment

The objective of the scanning multichannel microwave radiometer (SMMR) experiment was to obtain all-weather measurements of ocean surface temperature and wind speed. Liquid water and water vapor column content measurements required to obtain accurate sea surface temperatures were also used to provide path loss and atmospheric corrections for the ALT and the SASS.

Table 2-1. Consensus of Seasat User Requirements, 30-31 May 1973

Measurement	Precision or Accuracy	Resolution	Grid Size	Instrument/Sensor Characteristic	Weight (kg)	Power (w)	Sensor Data Rate (bps)	On-Board Processing	Status and Comments
Sea State H <sub>1/3</sub> Wave Ht 1 - 20 m (3 - 66 ft)	±1 m (3 ft) or 25% for DoC ±.5 m (1.64 ft) for DoD	20 km (11 nmi) max	20 km (11 nmi) max	Short Pulse Altimeter	36 kg (80 lb)	125 10 (SB)	10 k	Doppler Processing	● Accurate Verification of Pulse Compression ● 66 cm (26 in.) antenna for 1000 km (540 nm) at 13.9 GHz
All Weather Temperature -2 to +35°C (-35 to +95°F)	±1/2°C	1 - 100 km (.5 - 54 nmi)	50 - 100 km (27 - 54 nmi)	Imaging Radar 2 Frequency Scatterometer	36 kg (80 lb)	125, 2 (SB)	32 k		A/C-200 & 25 cm (79 & 10 in.); 1 m (3 ft) rods & 15 cm (6 in.) cone
Wave Directional Spectrum λ = >50 m (164 ft), θ = 360°	Wave Height ±1/2-1 m (1.64 - 3 ft) or 25% λ ± < 20%, θ ± < 30°	50 m by 50 m (164 ft by 164 ft)	20 km (11 nmi) max	Multi-channel Microwave Radiometer Imaging Radar	68 kg (150 lb) 68 kg (150 lb)	100 180	< 5 k 4 M		● Needs Development Validation ● Antenna 5x3 m (16x10 ft) ● Swath = 150 km (81 nm)
Sea Surface Topography including Marine Geoid	±10 cm (3.39 in.) vertical	<10 km (5.4 nmi)	10 km (11 nmi) along track 100 km (54 nmi) in 25° cross track	2 Frequency Scatterometer BLSA Short Pulse Altimeter	36 kg (80 lb)	125 10 (SB)	< 1 k		Questionable
Integrated Atmospheric Water Vapor	Altimeter error contribution ± 5 cm (2 in.)	10 km (5.4 nmi) desired		Imaging Radar BLSA	36 kg (80 lb) 45 kg (100 lb)	125, 2 (SB) 125	32 k 10 k		1.2 m (3.9 ft) antenna
Electron Density	Temperature ± 1/2° C Relative	100 - 500 m (328 - 1640 ft)	Swath 1200 km (649 nmi)	Topside Sounder Visual and IR Imager (10.5 - 12.5 μ)	14 kg (30 lb) 68 kg (150 lb)	50 75	low 4 M		
Atmospheric and Ocean Features	0 - 50 m/s (164 ft/s) ± 2 m/s (6.6 ft/s) or 25% Direction ± 20°	50 km - 100 km (27 - 54 nmi)	50 km - 100 km (27 - 54 nmi)	Multi-channel Radiometer Scatterometer	79 kg (175 lb)	90	< 5 k < 5 k		102 cm (40 in.) disc at 13.9 GHz

ORIGINAL PAGE IS  
OF POOR QUALITY

## SECTION III

### PROJECT ORGANIZATION

The Seasat Project Office functioned under the programmatic direction of the Earth and Ocean Division of the Office of Space and Terrestrial Applications, National Aeronautics and Space Administration. The Seasat program manager in the Earth and Ocean Division was responsible for overall direction of the Seasat project. Management of the project was the responsibility of the Jet Propulsion Laboratory operated by the California Institute of Technology under a prime contract with NASA.

#### A. PROJECT ORGANIZATION AND PROGRAM RELATIONSHIPS

##### 1. Management Objective

It was the management objective of the project to accomplish the primary objectives of the mission, in the CY 1978 and 1979 time frame, within the cost goal at completion of \$74.70 million. This cost was exclusive of the Surface Truth Program, data analysis (geophysical data processing), OSTDS operations support, and the launch vehicle. The project kept the NASA Office of Space and Terrestrial Applications apprised of the obligational and cost plans via both the program operating plan and its supplements, and the Seasat Obligation Requirements Document. Periodic appraisals of obligation and cost plans versus performance were provided to OSTA.

##### 2. Seasat Project Manager

The project manager was responsible for the direction, organization, and staffing necessary to conduct the Seasat mission, including:

- (1) The control of project funding, resources, and schedules.
- (2) The planning of major project milestones and fiscal expenditures.
- (3) The interfacing of all such matters with NASA and other agencies, as required.

The program relationships, organizational structure, project relationships, and system-management assignments for the project are shown in Figures 3-1 and 3-2. The project staff and system office roles and responsibilities are summarized herein.



ORIGINAL PAGE 13  
OF POOR QUALITY

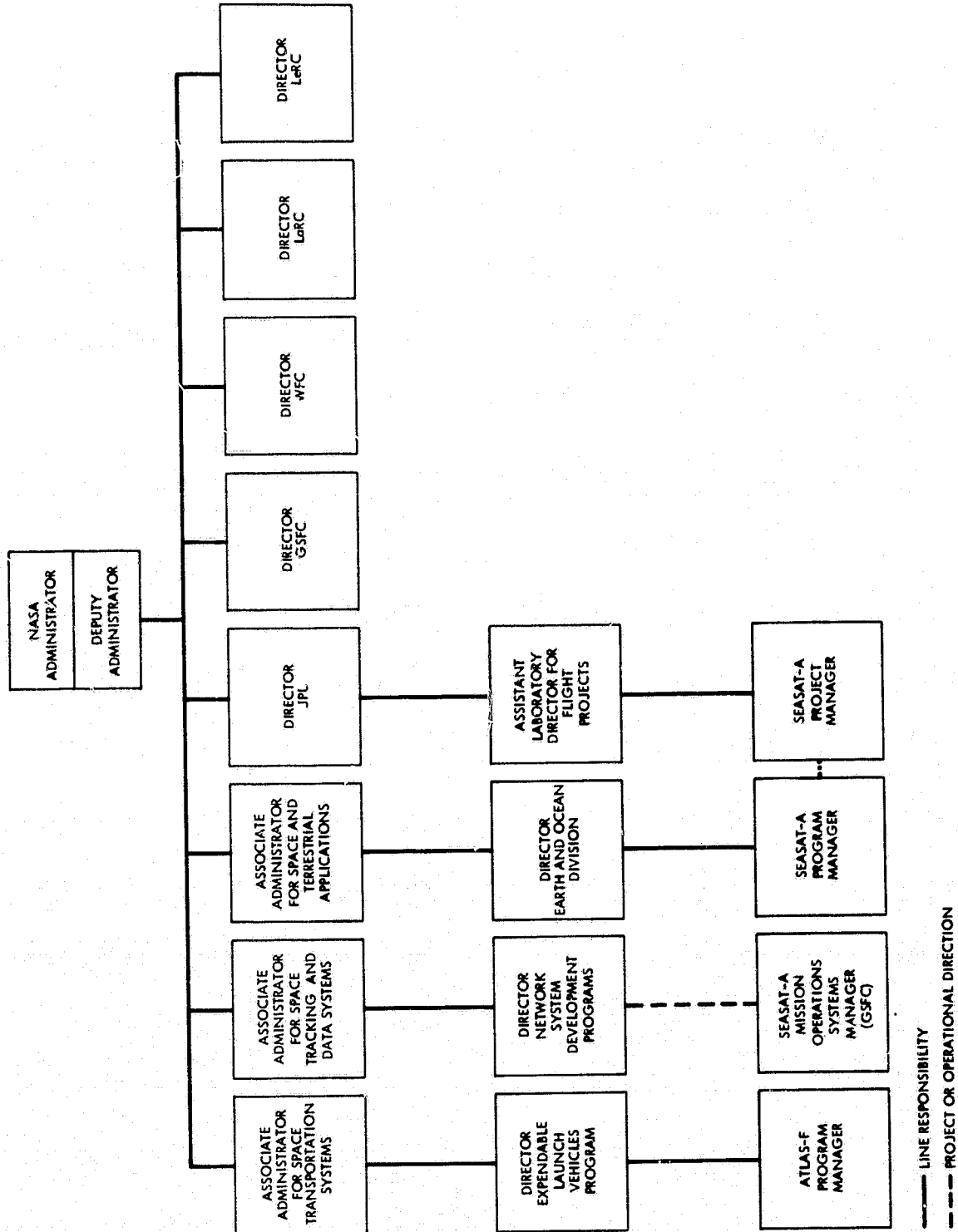

Figure 3-1. Seasat Program Relationships

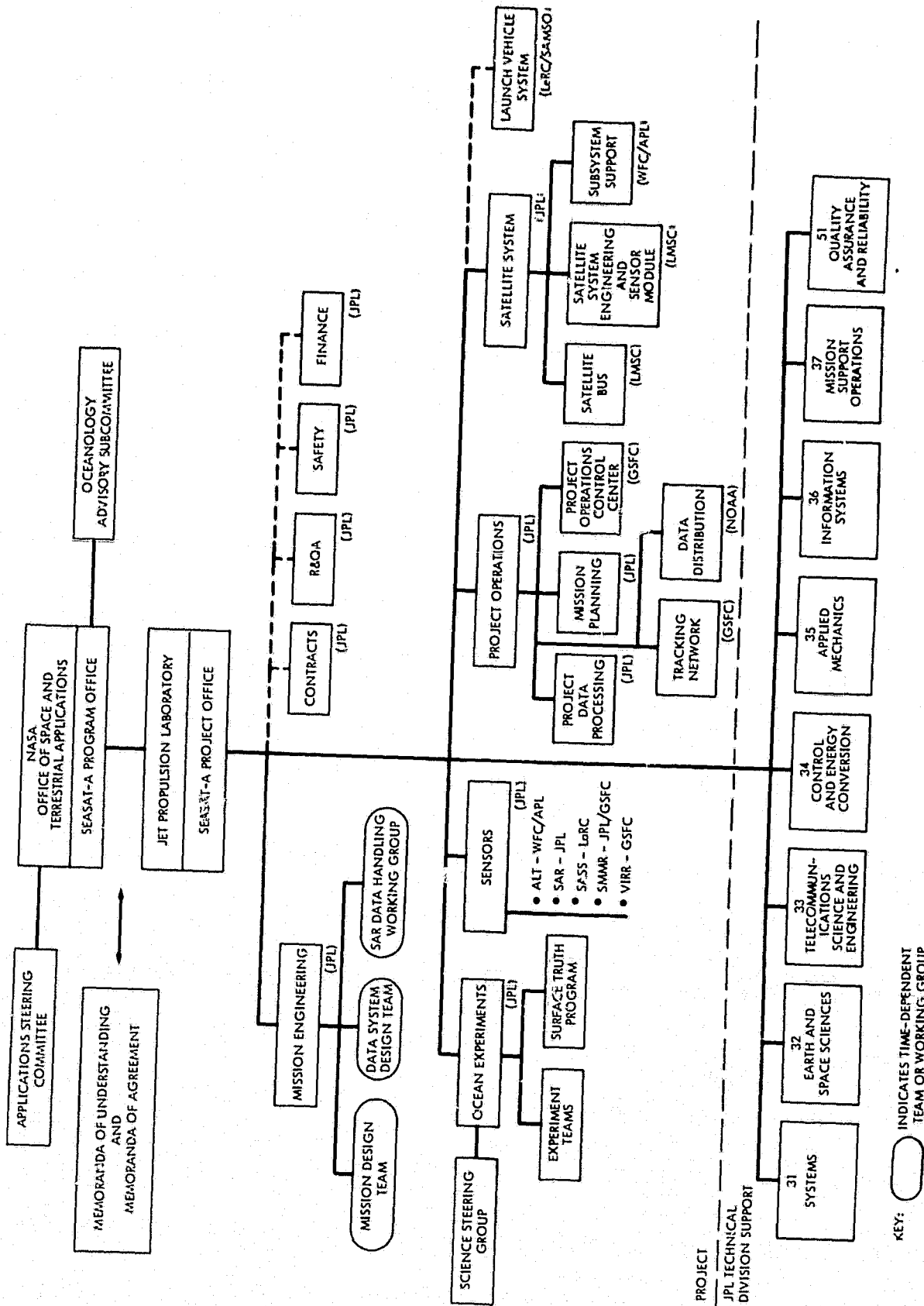

Figure 3-2. Seasat Project Relationships

### 3. System Managers Relationships

The satellite system manager reported administratively to the project manager. The satellite system manager had responsibility for the management of the satellite system, of which the bus and satellite system engineering and sensor module contracts were a major part. The satellite organizational structure is shown in Figure 3-3.

The project operations manager reported administratively to the project manager. He was responsible for the operation of experiment data processing at JPL, mission planning and analysis at JPL, and mission operations and control at GSFC and JPL. The project operations organizational structure is shown in Figure 3-4. The Goddard Space Flight Center provided tracking and data acquisition support and mission control center support to the Seasat project through the Networks Directorate and the Mission and Data Operations Directorate. To manage and coordinate that directorate's support, GSFC designated a support manager in each directorate: the Network Support Manager (NSM) and the Mission Support Manager (MSM). In addition, GSFC designated the MSM as the Mission Operations Systems Manager (MDSM) who was responsible for coordinating GSFC support requirements and commitments with the Seasat Project Operations Manager (POM).

The Launch Vehicle System (LVS) manager was administratively assigned to and located at the Lewis Research Center. He was functionally responsible to the project manager. He was responsible for overall management of the LVS, including all technical, budgetary, procurement, and scheduling activities. He was responsible for supplying to the Seasat project an Atlas F booster, an Interstage Adapter, an appropriate payload fairing, and associated AGE and facilities with all necessary modifications required to meet project requirements and constraints. Included in his responsibilities were the overall LVS integration and the integrity of the flight vehicle. To accomplish these responsibilities, he interfaced with personnel at USAF/SAMSO, Aerospace Corporation, the 6595th Space Test Group, and their contractors, as required.

The USAF was responsible to LeRC to provide the necessary engineering, design, development, procurement, and operation of the Atlas F and interstage adapter as elements of the LVS and to provide launch services.

The USAF/SAMSO was assisted by the Aerospace Corporation in the performance of General Systems Engineering and Technical Direction.

The USAF/6595th Space Test Group, within its assignment of launch operations management, implemented the launch site management role for LeRC and was responsible for meeting LeRC's requirements for launch vehicle operations.

The NASA Office of Space Transportation Systems (OSTS) was the Headquarters management office for the launch vehicle system and provided funds to LeRC for the LVS.

The Ocean Experiments Manager (OEM) was administratively assigned to the project manager and was responsible for the Seasat Science Steering Group (SSG), the five experiment teams (see below), the Surface Truth Program, and the Data Analysis Program. His responsibilities included representing the user's data

ORIGINAL PAGE 13  
OF POOR QUALITY

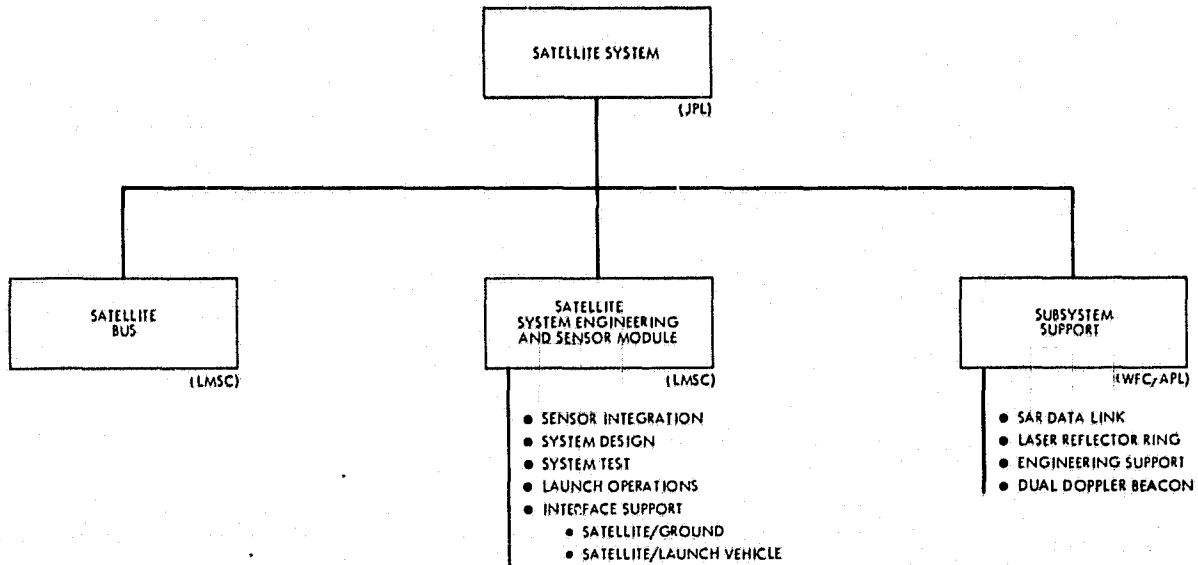

Figure 3-3. Satellite Organizational Structure

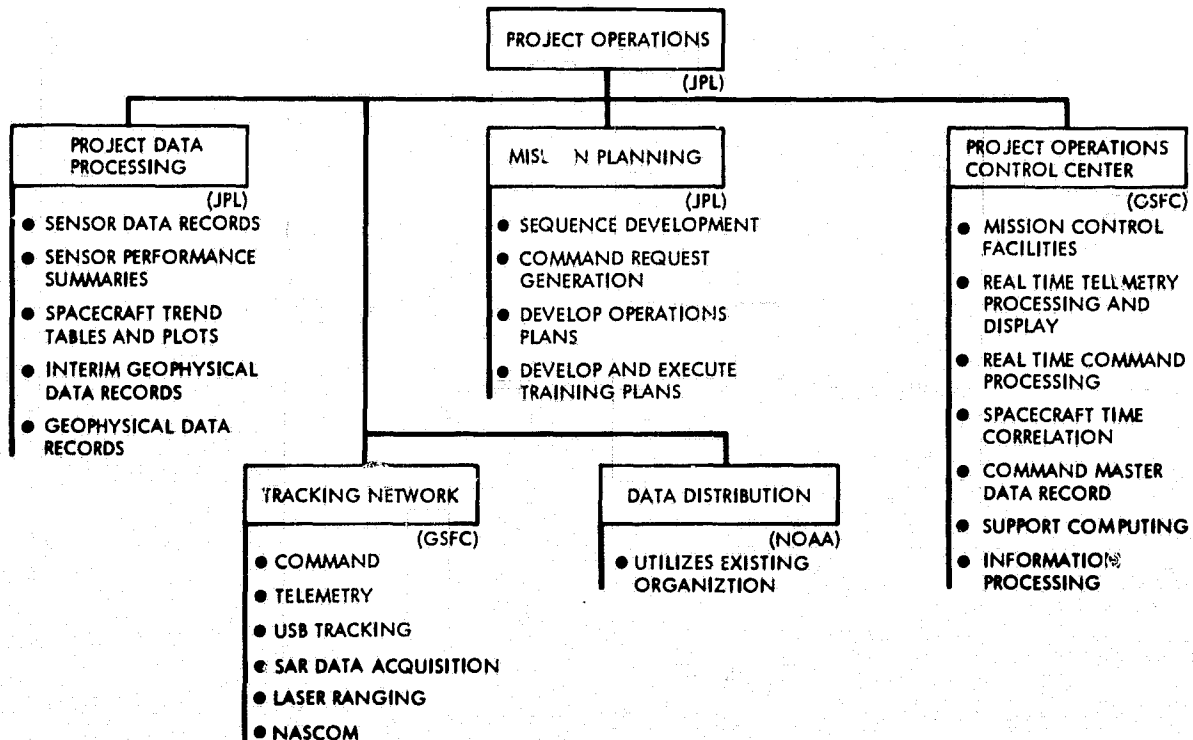

Figure 3-4. Project Operations Organizational Structure

requirements within the project and interpreting project requirements and constraints to the users. The ocean experiments organizational structure is shown in Figure 3-5.

For each of the five Seasat sensors, an experiment team consisting of oceanographic and remote sensing scientists drawn from within NASA, user agencies, and the academic community was formed to provide guidance throughout the sensor design development, implementation, and flight data collection phases. In addition, the teams took the lead in the specification and implementation of both pre- and post-launch surface truth and geophysical evaluation activities, including the definition and evaluation of algorithms required to convert sensor data to geophysical quantities. The conduct of the geophysical evaluation itself was the responsibility of evaluation task groups drawn from the experiment teams, augmented as required by Project personnel and consultants. The post-mission activities of the evaluation task groups were directed by the Geophysical Evaluation Manager.

Prior to launch, the experiment teams provided requirements on the sensor, satellite system, surface truth program, and data system design consistent with the conduct of geophysical evaluation. The SSG was a higher level advisory body, defining requirements in those same areas from an overall science/applications viewpoint. All experiment team leaders were members of the SSG.

The sensor manager was administratively responsible to the project manager for technical and fiscal management of the sensors and for the SAR system design. His responsibilities include representing the project to the sensor offices at each center.

The Mission Engineering Manager (MEM) administratively reported to the project manager, and was assigned responsibility and authority for: mission requirements; mission design; data system design; pre-flight nominal sequences; orbit design and selection; and pre-mission planning. The mission engineering organizational structure is shown in Figure 3-6.

#### 4. Project Staff

The project contracts manager was administratively assigned to the JPL Procurement Division but was functionally responsible to the project manager. He was responsible for the negotiation and the administration of all major project contracts including the satellite bus, and the satellite system engineering and sensor module contracts. Additionally, he was responsible for surveillance of major subcontractor performance. The Procurement Division assigned an analyst to the project contracts manager to assist in the surveillance of contractor and subcontractor resources performance and to provide cost analysis support as appropriate.

The project financial manager was administratively assigned to the JPL Financial Management Division but was functionally responsible to the project manager. He was responsible for project-level financial and manpower planning and control and reporting.

**ORIGINAL PAGE IS  
OF POOR QUALITY**

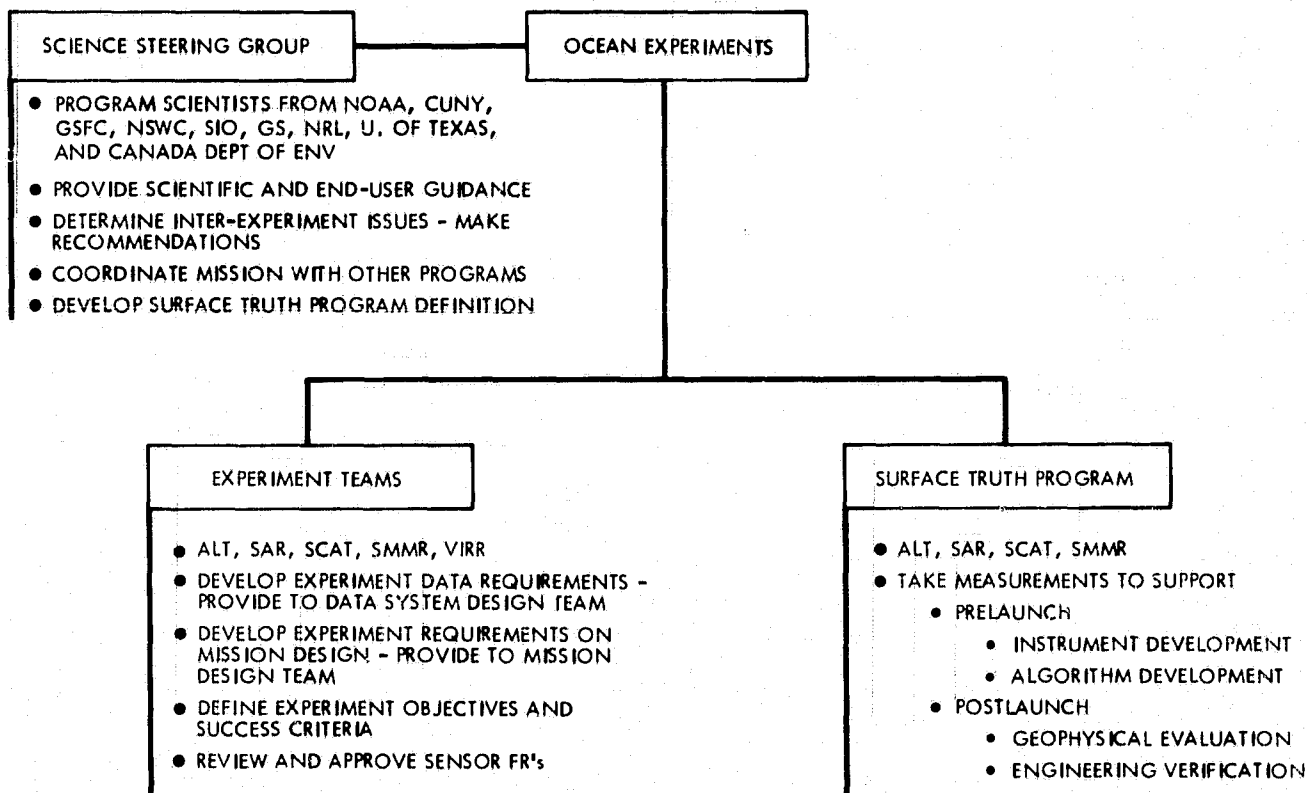

**Figure 3-5. Ocean Experiments Organizational Structure**

ORIGINAL PAGE IS  
OF POOR QUALITY

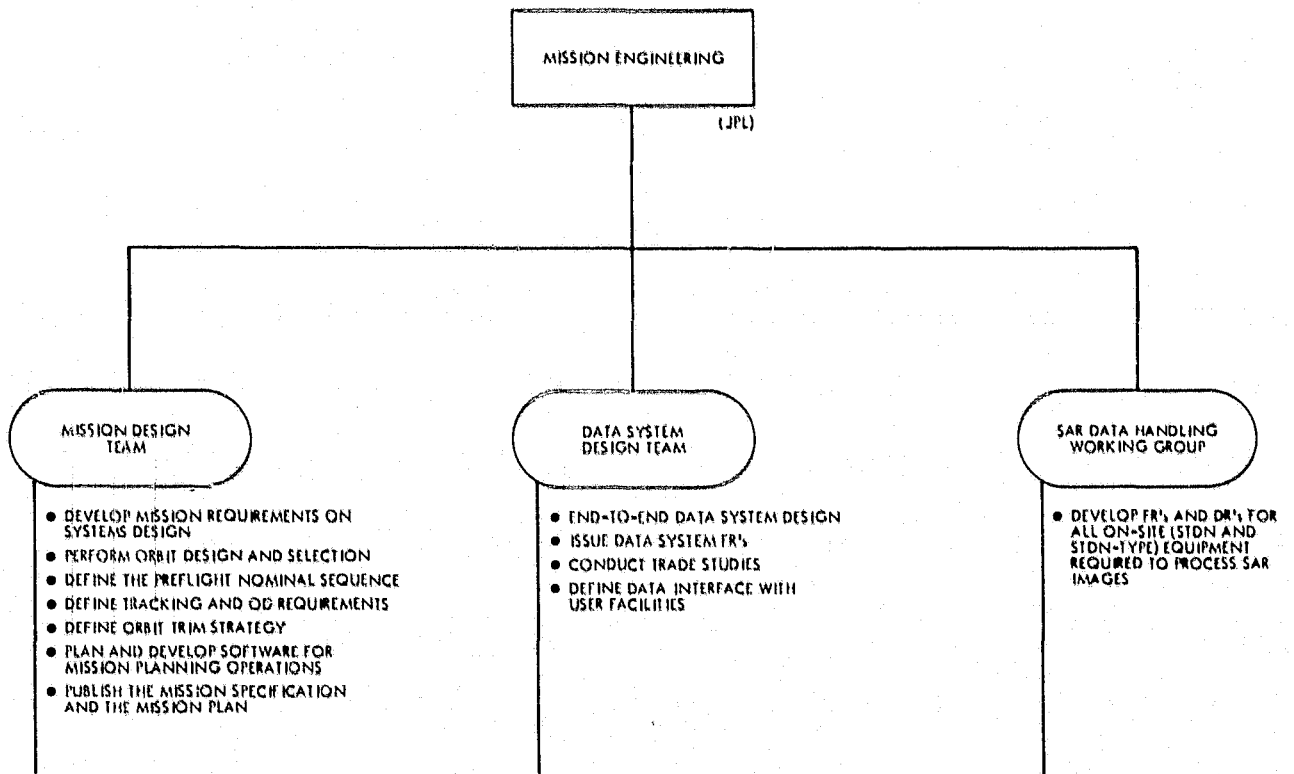

Figure 3-6. Mission Engineering Organizational Structure

The flight project safety engineer was accountable to the assistant laboratory director for flight projects for carrying out his assigned responsibilities. He acted as a project staff specialist for the project and was an ex-officio member of the Safety Steering Committee and Project Review Boards.

The project quality assurance and reliability manager was administratively assigned to the JPL quality assurance and reliability office but was responsible functionally to the project manager. His responsibilities included monitoring, reviewing, and making recommendations within the quality and reliability areas of design, development, fabrication, test, and flight operations. He represented the project reliability activity in liaison with NASA, other government reliability representatives, and industrial organizations.

#### B. SENSOR MANAGEMENT RESPONSIBILITIES AND SUPPORT REQUIREMENTS

Sensor implementors were responsible to the Seasat project sensor manager for sensor design and development within the sensor allocations, including IMS and contingency, as negotiated.

Sensor implementation tasks were managed by JPL pursuant to a Memorandum of Agreement (MOA) between the Seasat project office and WFC for the ALT, LaRC for the SASS, GSFC for the VIRR, the JPL Special Projects Office for the SMMR, and the JPL Telecommunications Science and Engineering Division for the SAR. These sensor implementation tasks included the following:

- (1) Sensor design, development, procurement, fabrication, testing, and pre-launch calibration.
- (2) Support to LMSC's system design, test planning, system test and launch operations, and satellite EMI/RFI analysis and test, with this support to be performed as appropriate at JPL, LMSC, and VAFB.
- (3) Support of sensor experiment team meetings.
- (4) Support of (data processing) algorithm development for system test and mission operations.
- (5) Support of mission operations including real-time operations at GSFC and sensor engineering assessment.

The remainder of this section summarizes, for each sensor, specific responsibilities, support and delivery requirements which were additional to the above tasks.

##### 1. Radar Altimeter

The Wallops Flight Center (WFC) was responsible for the ALT design, procurement, fabrication, subsystem testing, and calibration.



WFC, through an MIPR, subcontracted the sensor with APL. APL has subcontracted the Dispersive Delay Line (DDL) design and breadboard to Anderson Laboratories, the traveling wave tube amplifier (TWTA) to Hughes Aircraft Company, and the upconverter to Zeta Laboratories, with total RF and sensor integration and test at APL. The digital processing units and development of the ground support equipment will be done by APL.

## 2. Synthetic Aperture Radar

The SAR was designed, procured, fabricated, subsystem-tested, and calibrated by the JPL Telecommunications Science and Engineering Division, which was responsible for the SAR end-to-end system design and for specification of the functional requirements of all SAR elements. Major sensor procurements were the transmitter from Westinghouse and the power supply from Martin-Marietta.

Elements and implementation of the SAR experiment, in addition to the sensor, were as follows: LMSC, as the bus contractor, furnished the SAR antenna. APL furnished a dedicated SAR data link. Elements of the SAR data link were furnished by the STDN. Interface agreements were developed by LMSC between the SAR data link and SAR sensor, SAR data link and bus, and SAR data link and STDN. A SAR data-handling working group was responsible for developing the details of the STDN interface agreements. LMSC integrated the SAR antenna, sensor, and data link into the satellite system. System compatibility and end-to-end performance tests were made prior to launch.

## 3. Scatterometer

SASS design, procurement, fabrication, and subsystem test and calibration responsibility was assigned to LaRC. Major subcontracts were between LaRC and the General Electric Company (GE) for the sensor, LaRC and the Hughes Aircraft Company for the transmitter power amplifier (to be furnished to GE for integration), and between LaRC and the Aerojet ElectroSystems Company for the SASS antennas. LMSC integrated the sensor and the antennas into the satellite system.

## 4. Scanning Multichannel Microwave Radiometer

The SMMR was designed, procured, fabricated, subsystem-tested, and calibrated by the JPL Telecommunications Science and Engineering Division. The Seasat SMMR was an add-on to the Nimbus SMMR sensor flight production activity at JPL. The Nimbus SMMR functional design and interfaces were utilized for the Seasat bus and sensor module. Major procurements were the antenna, antenna-scanning motor, and RF subassemblies.

## 5. Visual and Infrared Radiometer

VIRR responsibility was assigned to the Goddard Space Flight Center (GSFC). JPL obtained one ITOS-J SR from the TIROS Project. GSFC certified this unit for flight on Seasat. Upon certification, the designation changed from SR to VIRR.

Santa Barbara Research Center (SBRC), in a support contract with JPL, assisted GSFC in support of instrument retest and recalibration and supported LMSC in instrument integration. The Seasat bus and sensor module utilized the ITOS-J SR functional design and interfaces.

#### 6. Sensor Delivery Requirements

- (1) Each sensor implementor provided one flight model, selected spares, associated documentation, and one set of support equipment and software.
- (2) A SMMR engineering model will be shared between the Seasat and Nimbus projects.
- (3) An additional ITOS-J SR was made available from NOAA for use either in engineering model tests or as a flight spare.

#### 7. Sensor Coordination Support

The JPL Systems Division provided sensor coordination support. The support coordination functions were to:

- (1) Provide assistance in the development of sensor implementation plans and memoranda of agreement between the project and the implementing NASA Center.
- (2) Monitor and review sensor development activities.
- (3) Monitor, review, and coordinate sensor-related bus and sensor module activities:
  - (a) Satellite system design and ICD generation.
  - (b) Satellite system test planning and test operations.
  - (c) Satellite system EMC planning and tests.
  - (d) Launch operations and in-flight sensor engineering assessment.
- (4) Manage SBRC support contract for VIRR integration and test.

#### C. PROJECT INTERFACES

Project interfaces were divided arbitrarily into three categories:

- (1) System or system-level support interfaces.

(2) Data support interfaces.

(3) Membership support.

Basic information regarding these interfaces is displayed in Tables 3-1 through 3-3 respectively.

Table 3-1. System or System-Level Support Interfaces

Center/Agency	Provide	Funding Source
JPL	SAR ground data processor	OSTA
DoD/NRL	Doppler beacon and antenna	DoD/OSTA
GSFC	STDN, NASCOM, POCC, telemetry processing, and support computing	OSTDS
GSFC	Selected SMMR parts	OSTA
GSFC/NOAA	VIRR	OSTA
GSFC/JPL	SMMR sensor with integrated antenna	OSTA
JPL	SAR sensor and system design	OSTA
LaRC	SASS sensor and antennas	OSTA
GSFC/SAO	Laser tracking network and operations (details TBD)	OSTA
LeRC/SAMSO	Launch vehicle system	OSTS Code MV
WFC	ALT sensor with integrated antenna	OSTA
WFC	Subsystem support from APL SAR data link Laser retroreflector ring Engineering support	OSTA

Table 3-2. Project Data Support Interfaces

Center/Agency	Provide	Funding Source
JPL	Processed SAR data to users and to project	OSTA
GSFC/NASCOM	Data link from ULA to FNOC, Monterey, CA	OSTDS
DoD	Support for precision doppler data, station locations, geoid data, Tranet operations	DoD
DoD/FNWC	ULA low rate only telemetry to FNOC; near-real-time processed data from FNWC to NOAA/NMC	DoD
NOAA/EDS	SDRs, IGDRs and GDRs to EDS from PDPS for further processing and distribution within NOAA and to users	NOAA

D. SPECIAL BOARDS AND COMMITTEES

1. Application Steering Committee

The Application Steering Committee is a NASA-sponsored interagency committee composed wholly of government employees to advise and make recommendations on goals and objectives of Application Programs within the Office of Space and Terrestrial Applications (OSTA).

2. Oceanology Advisory Subcommittee

The Oceanology Advisory Subcommittee (OAS) assisted NASA in the definition and conduct of ocean-related programs, such as Seasat, associated with the NASA Ocean Condition Monitoring and Data Utility Program within the Office of Space and Terrestrial Applications. Specific objectives were to:

- (1) Advise and make recommendations on program, mission, and system demonstration planning.
- (2) Present user goals and mission requirements for oceanology programs.

ORIGINAL PAGE IS  
OF POOR QUALITY

Table 3-3. Membership Support Interfaces

AGENCY/ ORGANIZATION	SEASAT-A SCIENCE STEERING GROUP	EXPERIMENT TEAMS				
		ALT-POD	SAR	SASS	SMMR	VIRR
DoC/NOAA	J. APEL - PMEL H.M. BYRNE <sup>b</sup> - PMEL E.P. McCLAIN - NESS D. ROSS - AOML J.W. SHERMAN - NESS J. WILKERSON <sup>b</sup> - NESS	H.M. BYRNE - PMEL B.H. CHOVIK - NOS P. DeLEONIBUS - EMP J.M. DIAMANTE - NOS B. DOUGLAS - NOS L. FEDOR - ERL	F. GONZALEZ - PMEL C. RUFENACH - WPL J.W. SHERMAN - NESS	L. BAER - OEMP P. BLACK - NHEML J. ERNST - NESS G. FLITTNER - NWS	D. ROSS <sup>a</sup> - AOML J. ALISHOUSE - NESS	E.P. McCLAIN <sup>b</sup> - NESS
JPL	J. DUNNE <sup>a</sup>	G. BORN H. HAGAR (POD <sup>c</sup> ) J. LORELL	W. BROWN <sup>c</sup> O. SHERDIN	I. HALBERSTAM	F.T. BARATH E. NJOKU <sup>b</sup> J.M. STACEY <sup>c</sup> J.W. WATERS	
GSFC		J. SIRY D. SMITH F.O. VONBUN J. ZWALLY			P. GLOERSEN T.T. WILHEIT	A.W. McCULLOCH <sup>c</sup>
JSC			K. KRISHEN	K. KRISHEN		
LoRC				W.L. JONES <sup>c</sup> W.L. GRANTHAM	C.T. SWIFT	
WFC		J.T. McGOOGAN C. PURDY W.F. TOWNSEND (ALT <sup>c</sup> )			N.E. HUANG	
DoD/NORDA			P. LaVIOLETTE			
DoD/NSWC	S.L. SMITH, III	S.L. SMITH, III C.J. COHEN R. ANDERLE				
DoD/NRL	V. NOBLE B. YAPLE <sup>b</sup>	B. YAPLE			J.P. HOLLINGER	O. HUH
DOI/GS	P. TELEKI		P. TELEKI <sup>b</sup> W. CAMPBELL		W. CAMPBELL	
DOT/USCG			R. HAYES			
CUNY	W. PIERSON			W. PIERSON <sup>a</sup>	V. CARDONE	
ERIM			R. SHUCHMAN			
JHU/APL			R. BEALE			
SIO	R. STEWART		R. STEWART			R. BERNSTEIN
SAO		E.M. GAPOSCHKIN				
TEXAS A&M			B. BLANCHARD			
UNIVERSITY OF KANSAS				R.K. MOORE		
U. OF TEXAS	B. TAPLEY	B. TAPLEY <sup>a</sup>				
UNIVERSITY OF WASHINGTON					K. KATSAROS	
RESEARCH TRI- ANGLE INSTITUTE						F. VUKOVICH
CANADA DEPT OF ENV	R.O. RAMSEIER		R.O. RAMSEIER	S. PETEHERYCH		

KEY:

- a - CHAIRMAN
- b - ALTERNATE MEMBER
- c - EXPERIMENT REPRESENTATIVE TO TEAM

- (3) Define and clarify measurements and data needs compatible with user requirements and technical capabilities.
- (4) Advise and clarify user interfaces during the design, construction, and tests of space systems.

The OAS was organized into three panels: scientific, agency, and industrial.

#### E. RESOURCES REPORTING

##### 1. Project Management Report

The monthly Project Management Report (PMR) included milestone schedules, resource plans, and narrative analysis as defined in Reference 3-1.

##### 2. Work Breakdown Structure

The project Work Breakdown Structure (WBS) was functionally designed around systems, areas, and activities. The gross project WBS is shown schematically in Figure 3-7. Each contract with LMSC also utilizes a WBS for control and reporting purposes.

##### 3. JPL System for Resources Management

The project utilized the internal JPL System for Resources Management (SRM) to determine the current status of resources. The SRM Resources Status Report (RSR) and supporting detail reports were issued monthly to the project. The RSR reflected information by individual project account code numbers and by various summary levels. The SRM is described in detail in Reference 3-2.

#### REFERENCES

- 3-1. OSSA/OART Project Management Information and Control System (MICS), NHB 2340.2, National Aeronautics and Space Administration, November 1966.
- 3-2. Financial Management Reference Manual, Jet Propulsion Laboratory, Revised January, 1976 (JPL internal document).

ORIGINAL PAGE IS  
OF POOR QUALITY

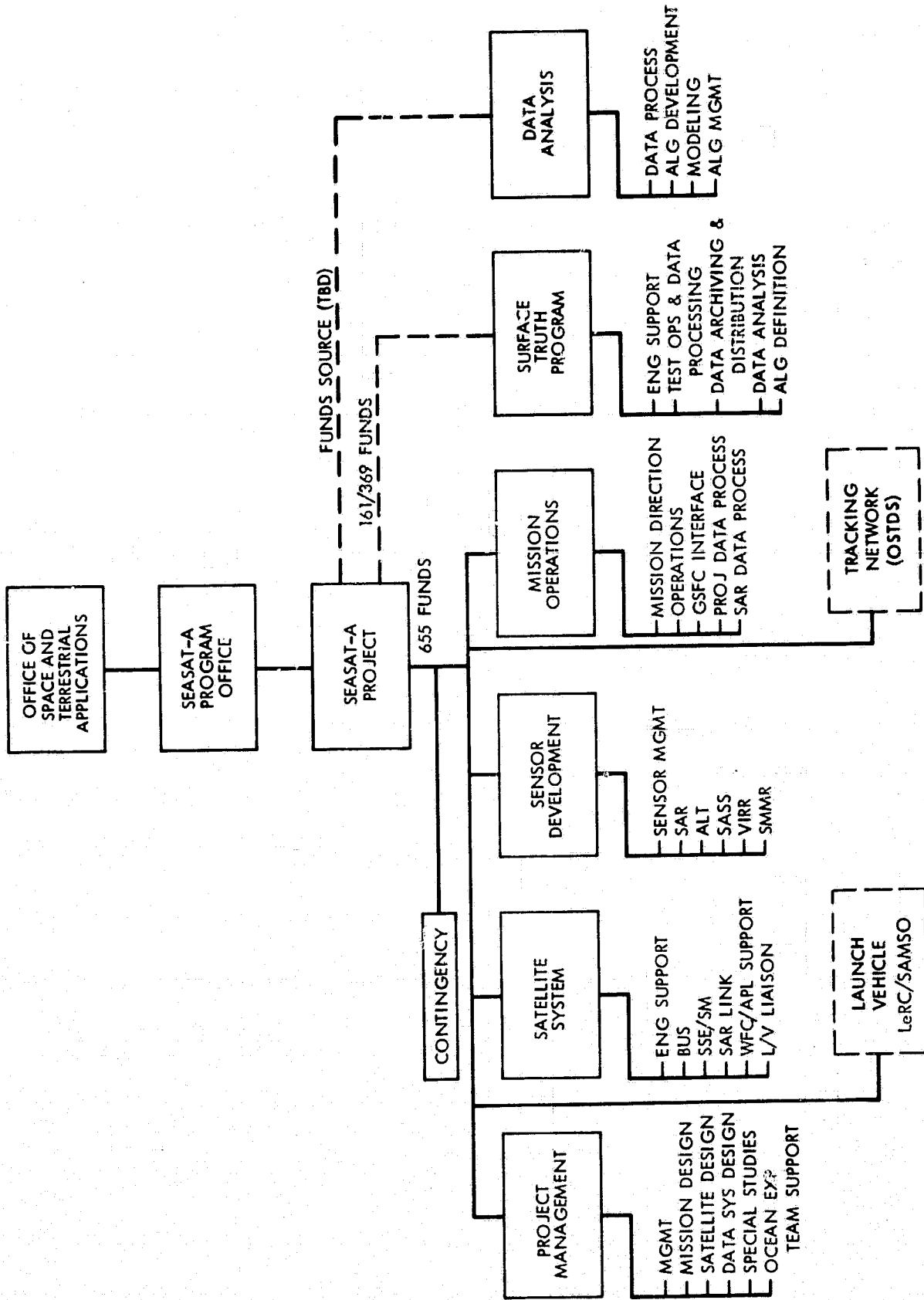

Figure 3-7. Seasat Project Work Breakdown Structure

SECTION IV  
MISSION PLAN

A. INTRODUCTION

A mission plan was developed for Seasat prior to launch which detailed the intended activities of the mission in the areas of mission profile, trajectory design and maintenance, tracking and orbit determination, and attitude determination. The plan called for a nominal launch date of 18 May 1978 and a required mission duration of one year after launch. An additional two-year extended mission was stated as a goal. The overall mission was divided into a number of mission phases, a time period in which a group of related activities were performed to achieve a specific objective. The Seasat mission phases were as follows:

- (1) Pre-launch phase: vehicle erection, mating, and checkout at AFWTR.
- (2) Launch phase: lift-off through satellite system separation from the Atlas booster.
- (3) Orbit insertion phase: satellite system separation through establishment of initial on-orbit satellite configuration. This included both Agena motor burns, fuel and oxidizer dump, and pitch down to on-orbit attitude.
- (4) Initial orbit cruise phase: on-orbit checkout of the engineering subsystems and sensors. Corrective action of any problems encountered. The possibility existed that a trajectory correction might be made in response to an out-of-tolerance injection into orbit.
- (5) Initial calibration phase: a planned 30- to 90-day period for engineering assessment of the sensors in conjunction with correlative sea truth activities.
- (6) Observational phase: normal collection of global low-rate sensor data and selected SAR data.
- (7) Orbit trim phase: periodic interruptions of normal activity to perform thruster burns for orbit maintenance or orbit modification.

During the primary mission the orbit as finally selected would produce several factors that would influence the conduct of the mission, and these were recognized in the pre-launch planning (Figure 4-1). The solar geometry dictated that a power surplus would exist from launch through late June and again from November 1978 through early January 1979. It was expected that the power available would be marginal in July and October 1978 and from mid-January to mid-February 1979. It was expected that there would be a power deficit in



ORIGINAL PAGE IS  
OF POOR QUALITY

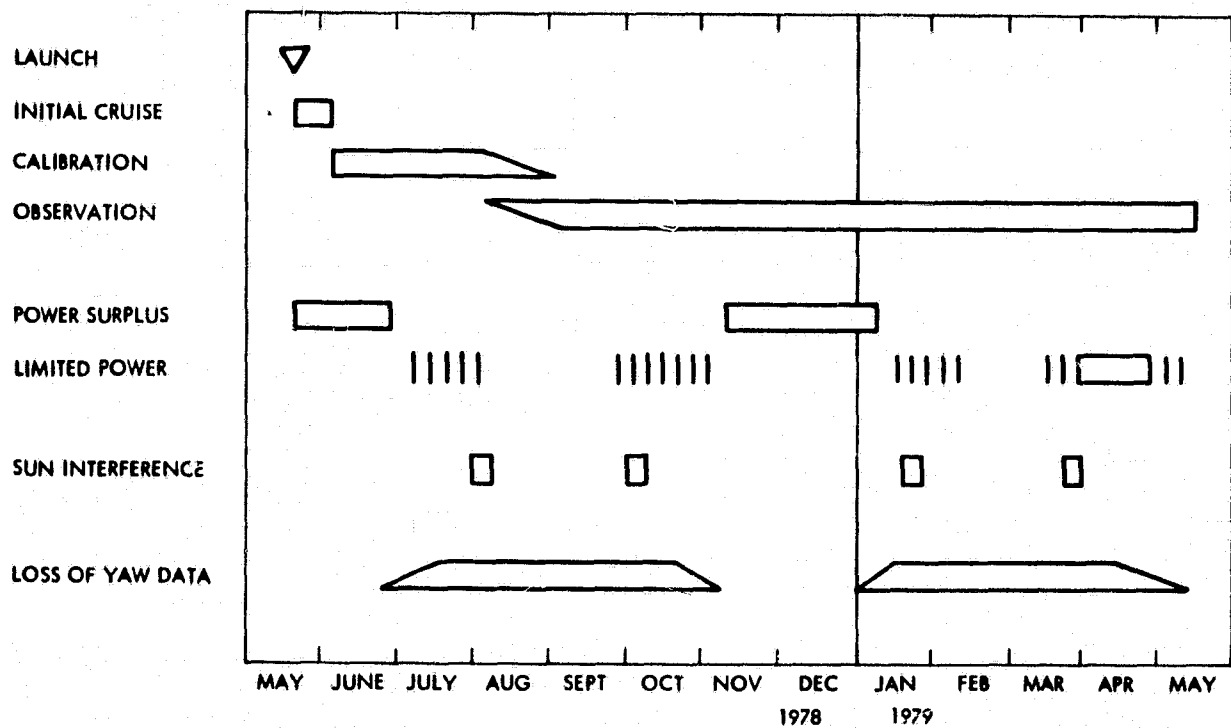

Figure 4-1. Seasat Key Mission Events

April 1979. During the periods of marginal or deficit power availability, it was planned to curtail sensor data acquisition to the extent required based upon flight experience. The most attractive strategy was to curtail SAR imagery completely, then to power the low-rate sensors down over major land masses until acceptable power levels were achieved. Also shown are the expected periods of sun interference which were expected to introduce some bias in attitude control, and the periods during which yaw determination data was expected to be less than continuous. The mission plan recognized that measurements dependent upon either sensor pointing or footprint knowledge might be degraded somewhat during these periods. Such possible measurement degradation was accepted by the project office in view of the satellite system changes and attendant costs required to avoid the problem.

## B. TRAJECTORY PLAN

### 1. Orbit Selection Criteria

The criteria for the selection of the Seasat orbit were developed from the Seasat experiment and sensor requirements. The criteria, developed in the Seasat-A Mission Specification, JPL internal document 622-4, are summarized as follows:

- (1) Altitude between 761 and 835 km (410 and 450 nmi) (active sensor pulse repetition frequencies).
- (2) Ground trace ascending equatorial crossings with an average spacing of 18.5 km (10 nmi) after five months with no spacing greater than 28 km (15 nmi) (geodesy experiment).
- (3) Coverage to  $\pm 72$  deg latitude or greater (SAR).
- (4) Maximization of ground trace intersection angles (deflection of the vertical experiment).
- (5) Minimization of altitude variation (SAR).
- (6) Data collection over any given area of the equator over the entire range of local times corresponding to two diurnal cycles (NOAA users' requirement).
- (7) Ground trace development maximizing local and global coverage over time periods less than one month (SAR).
- (8) Initial full sun orbit (satellite engineering).

The apparent conflicts among these criteria led to analysis of the orbit options and ultimately to the selection of two candidate orbits which best fit the criteria. The first orbit, designated the baseline orbit, was designed to provide a near three-day repeat cycle with the equator crossings each third day migrating an average of 18.5 km (10 nmi) to the eastward. After some five months

of operation the ground trace development would close, providing complete global coverage at an average spacing at the equator of 18.5 km. This orbit had the advantage that areas of interest on the surface would be intensively observed for days or tens of days, but the disadvantage that they would not be observable again for five months. The second orbit, designated the Cambridge orbit, was designed to provide a 25-day near-repeat cycle so that full global coverage would be achieved in 25 days, but with much coarser spacing than the baseline orbit. During subsequent 25-day periods the ground tracing development would shift slightly, so that at the end of five months the required average spacing at the equator of 18.5 km would have been achieved. This orbit had the advantage of increasing the geographic coverage within any given period of weeks, but had the disadvantage that it would require more orbit trim activity to maintain the spacings within specified limits. Orbital parameters for the two candidate orbits are given in Table 4-1. Both orbits used the "frozen orbit" method of controlling the argument of perigee to control altitude over any given point on Earth (Reference E. Cutting, et al., Orbit Analysis for SEASAT-A, J. Astronautical Sciences, Vol. XXVI, No. 4, pp. 315-342, Oct.-Dec. 1978).

Because it was considered prudent to have the satellite in the more easily maintained orbit during satellite checkout and initial orbit operations, the final mission plan which led to the Seasat-A Targeting Specification, JPL internal document 622-70, called for a launch which placed the satellite into the baseline orbit. The requirement for the initial orbits to be in full sun led to the determination of the launch time of day. Figure 4-2 indicates the daily launch window as a function of launch day. For any given day the opening of the window was selected to be the time of day corresponding to the end of occultations. The close of the launch window was arbitrarily defined to be the 30 day-sun contour, i.e., the time at which the launch would result in no sun occultations during the first 30 days of flight. Figure 4-3 depicts the initial orbit

Table 4-1. Nominal Orbit Parameters

Parameter	Orbit 1	Orbit 2
$\bar{a}$	7168.3 km (3863.7 nmi)	7173.4 km (3866.5 nmi)
$\bar{e}$	0.0008	0.0008
$\bar{i}$	108.0 deg	108.0 deg
$\bar{\omega}$	90.0 deg	90.0 deg
$t_p$	00 <sup>h</sup> 46 <sup>m</sup> GMT 5/18/78	Dependent on date of orbit change
$\bar{\Omega}$	298 deg	

ORIGINAL PAGE IS  
OF POOR QUALITY

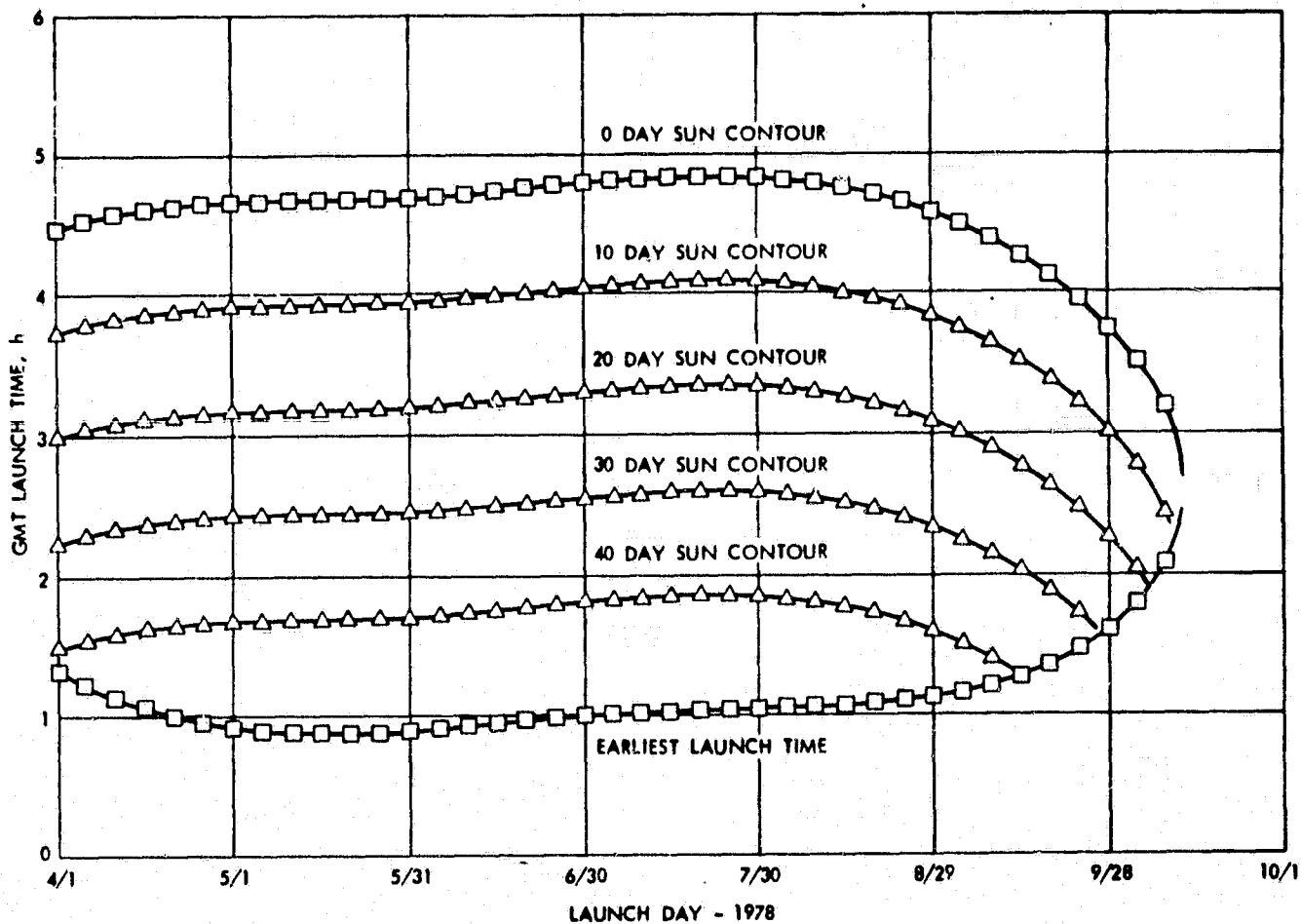

Figure 4-2. Seasat Launch Window - Launch Day Plot

ORIGINAL PAGE IS  
OF POOR QUALITY

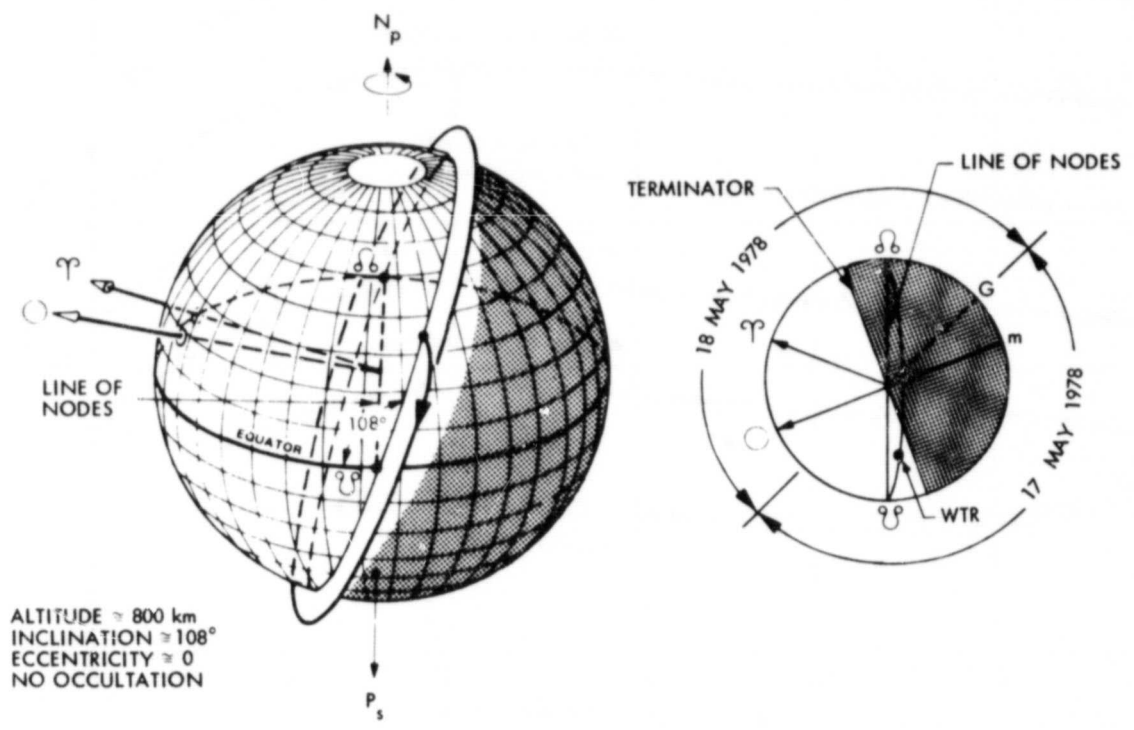

Figure 4-3. Seasat Orbit Geometry for 18 May 1978 Launch

geometry for a projected 18 May 1978 launch day. Table 4-2 lists the orbital elements of the orbit to which the powered flight trajectory was targeted together with the associated uncertainties. Figure 4-4 shows schematically the planned powered flight profile.

As the SAR experiment planning called for a precise target area versus time of year prior to launch to support surface truth and engineering experiments requiring ground support in the target areas, a strategy was adopted for removing any launch errors from the initial injected orbit which also would account for differences in predicted and actual longitudinal positions of the nodes introduced by both the actual launch day and time and the launch errors. This strategy called for the early performance of an orbit adjust maneuver which would introduce a planned bias to the trajectory to cause a longitudinal drift of the ground trace. The bias would be calculated to produce both the proper orbit conditions and longitudinal position at a later time when a second orbit adjust would be performed to achieve the desired baseline orbit. To minimize any execution errors arising from miscalibration of the satellite thrusters, each orbit adjust maneuver was to be preceded by a brief calibration burn in the same direction. Information derived from telemetry and tracking data following these calibration burns would be used in the determination of the durations of the orbit adjust burns. Analysis of this four-burn strategy indicated a negligible fuel penalty for the strategy. Additionally, engineering subsystem checkout was planned to take place prior to the first orbit adjust and sensor power on, and the acquisition of baseline sensor data was planned to take place between the first and second orbit adjusts. The gross plan for this initial period is shown in Table 4-3.

Table 4-2. Orbit Insertion Requirements

	Mean Elements	Osculating Elements	3 $\sigma$ Probability Range, Mean Elements
a (km)	7168.3	7160.0	7160.8 to 7180.6
e	0.0008	0.0006	0.0007 to 0.0046
I (deg)	108.00	108.01	107.8 to 108.5
$\omega$ (deg)	90.0	270.0	18 to 275
M (deg)	0.0	180.0	N.A.

**ORIGINAL PAGE IS  
OF POOR QUALITY**

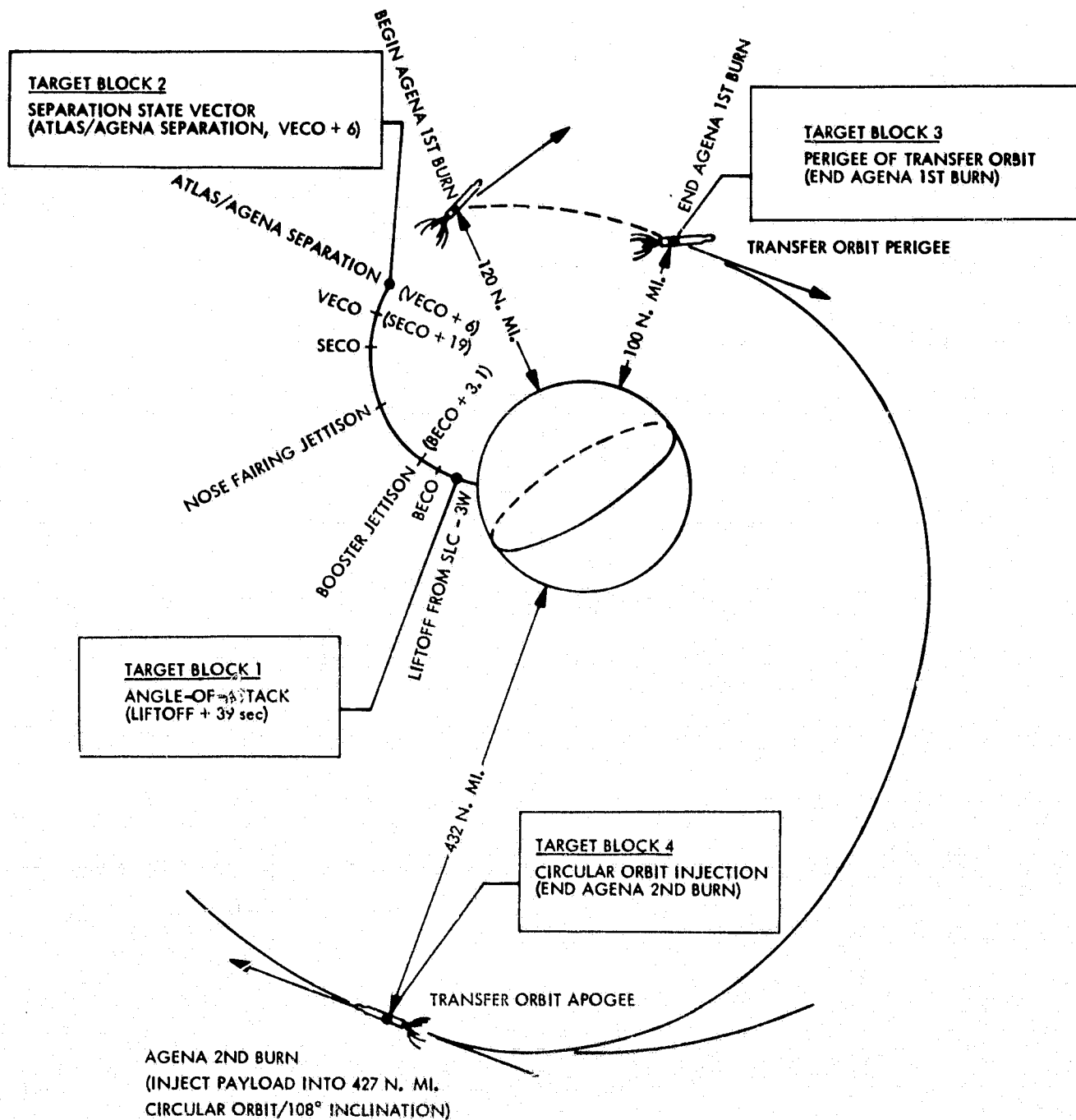

Figure 4-4. Seasat Launch Profile

Table 4-3. Gross Profile Through Second Orbit Adjust

Mission Time	Activity
L = 0	Launch
L + 25 h	Transfer to Orbit Attitude Control Subsystem (OACS)
L + 64 h	Orbit solution and maneuver analysis
L + 3 days	First calibration burn
L + 4 days	Orbit solution and calibration results
L + 5 days	First orbit adjust burn
L + 6 days	Initial sensor turn-ons
L + 9 days	Sensor baseline data acquisition
L + 11 days	Second calibration burn
L + 12 days	Orbit solution and calibration results
L + 13 days	Second orbit adjust burn
L + 14 days	Begin sensor engineering assessment activities

After the second adjust was completed, it was planned to remain in the baseline orbit for the five months necessary for the total ground trace development to provide one global set of geodesy measurements. An interruption of the baseline orbit was to occur in the September 1978 time period when an opportunity would exist to change the orbit to an exact three-day repeat, so that repeated laser and S-band tracking of the satellite as it overflowed the Bermuda station could provide for precise calibration of the ALT. After about thirty days into the exact three-day repeat, a second change maneuver would be performed to return the satellite to the baseline orbit. Upon completion of the baseline geodesy set of measurements, an option existed. A maneuver could be made at that time to transfer from the baseline orbit to the Cambridge orbit to gain more distributed global coverage. The decision on this option was to be made near the end of the five months of baseline operation on the basis of flight experience, data quality and completeness, and maintainability of the orbit. Figure 4-5 shows the heliocentric geometry for the first year of operation based on the originally projected 18 May 1978 launch date.

## 2. Orbit Maintenance

The portion of the maneuver plan dealing with the adjustment of the orbit resulting from injection by the Atlas and Agena to the desired baseline orbit has been discussed in the preceding paragraphs. The balance of the maneuver plan dealt with orbit maintenance (orbit trims) and orbit changes.

A basic problem common to all burns lay in the fact that the thruster centerlines did not pass through the center of gravity of the satellite. This was due in part to the availability of a mounting surface for the thrusters and in part to a decision to rotate the two pitch thrusters 20 deg away from the



ORIGINAL PAGE 13  
OF POOR QUALITY

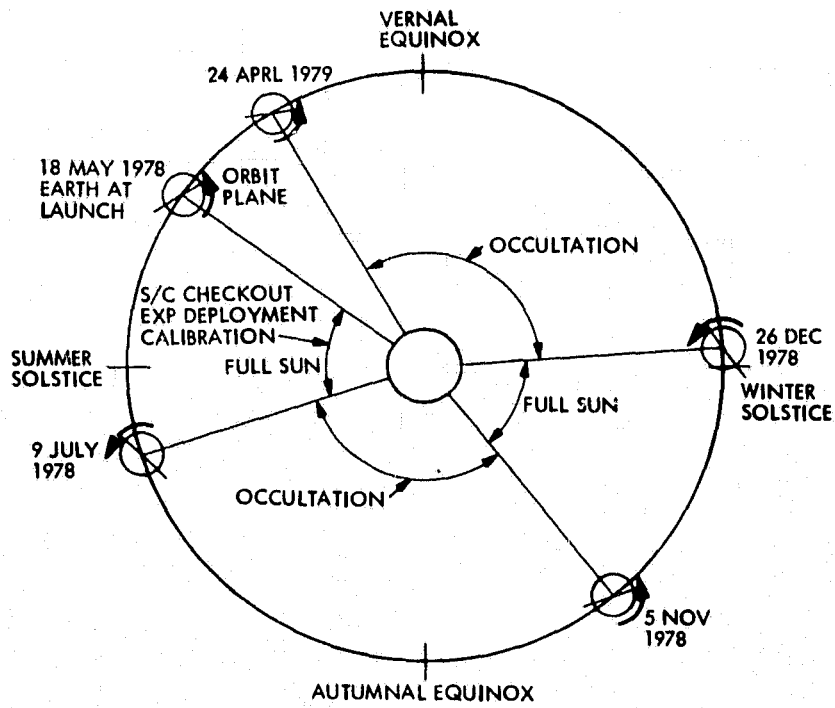

Figure 4-5. Heliocentric Geometry

plane of the solar arrays to reduce plume impingement. The misalignment produced a torque in pitch, which had to be counteracted by the two pitch attitude control thrusters. The rotation away from the plane of the solar arrays produced a torque in roll, which had to be counteracted by the roll attitude control thrusters. Since some plume impingement upon the solar array was still possible, the basic maneuver plan adopted called for feathering the array during burns; that is, rotating the array on the side of the active orbit adjust thruster so that it was parallel to the thruster to minimize the effective impingement area. Uncertainties in the effect of plume impingement, the effect of the attitude control thrusters to counteract the torques produced in pitch and roll, and the actual thruster performance on-orbit led to the decision to perform the calibration burns described above. The rationale was that the additional operational complexity of performing the calibration burns would be outweighed by the reduction in execution errors, which in turn would reduce the number of orbit trims required. This was important both in terms of  $\Delta V$  expenditure and orbital stability for geodesy measurements.

The primary cause of orbit degradation is atmospheric drag, which is a function of the satellite area/mass ratio and atmospheric density. The principal effect of drag is to decrease the semi-major axis of the orbit and, therefore, increase the spacing between ground traces. The strategy adopted was to trim initially to an orbit which yielded spacings on the order of 15 km (8 nmi), then allow the spacing to drift through the desired average value of 18 km (10 nmi), and when the spacing reached about 22 km (12 nmi), retrim back to 15 km. This would result in an average ground trace spacing at the equator of the required 18.5 km. Table 4-4 shows the expected frequency of maneuvers for three levels of solar activity as measured by the 10.7-cm flux level (F). Table 4-5 shows the range of acceptable orbit elements under this orbit trim strategy.

Table 4-4. Maneuver Frequency

Semi-Major Axis Decay	Flux = 100	Flux = 150	Flux = 200
	0.8 m/day	2.5 m/day	7.36 m/day
Semi-major axis range <sup>a</sup> (meters)			
D = 3	276	281	296
D = 25	124	166	287
Days between maneuvers			
D = 3	336	112	40
D = 25	150	66	38
Number maneuvers/152 days			
D = 3	0	1	4
D = 25	1	3	4
<sup>a</sup> D spacing range: D = 3, $\Delta$ = 15-22 km; D = 25, $\Delta$ = 6-28 km			

Table 4-5. Orbit Parameter Range

Parameter	Range
$\bar{a}$ (orbit 1)	7168.139 - 7168.417 km
$\bar{a}$ (orbit 2)	7173.279 - 7173.384 km
$\bar{e}$	0 - 0.002
$\bar{\omega}$	70 - 110 deg

A secondary effect upon the orbit is the inherent instability in the "frozen orbit" caused by drag, higher order harmonics, solar pressure, etc. Since the resulting changes in eccentricity and argument of perigee are slow compared with semi-major axis, it was planned to trim for these values only when semi-major axis adjustments were needed.

A provision was made for orbit changes was made in the  $\Delta V$  allocation. Allocation was made for a change from the baseline orbit to the Cambridge orbit and back again. An additional allocation was made to permit transferring from the baseline orbit to the exact three-day repeat orbit over Bermuda and transferring back to the baseline orbit. These changes were to be made in the same manner as the orbit trims.

### C. MISSION PROFILE

The mission profile planning activity prior to launch was based on the assumption that the profile development process during flight would be an evolutionary process which changed in response to satellite performance in flight and content of the sensor data as analyzed by the various experiment teams. Therefore, the primary profile activity prior to launch was directed toward the establishment of relationships among the operational elements of the project, development of procedures by which the profile would be produced, and the development of the software set required for profile production.

A judgment was made early in the project that, since the Mission Control and Computing Center (MCCC) was to be used only for profile routing but not generation, and since the activity at GSFC would involve the use of institutional facilities to a large extent, the most effective approach would be to design the information interfaces to meet institutional desires, and then to develop a completely new project-peculiar profile subsystem. The intent was to develop an automated system for profile generation and validation with a provision for human intervention at any point. It was felt that this would provide both efficient use of available resources and a high degree of inherent flexibility.

Several things aided in making this possible: (1) the basic satellite design was intended to be flown from the ground with no reprogrammable logic on board; (2) the sensors were body-fixed with no pointing capability; and (3) with the exception of the duty cycle-limited SAR, the sensors were desired to operate continuously throughout the mission to the extent possible. These things meant that an acceptable simulation of the satellite could be accomplished solely by simulating the programmable sequencer on board the satellite, without any concern for the simulation of flight software or scan platform dynamics. Additionally, the provision of a single 25-kb/s low-rate data rate with internally identified block telemetry and the mission requirement that all low-rate telemetry be recorded for subsequent playback reduced any potential problem of data management and data subsystem simulation to a problem of tape recorder management and simulation.

There was some initial misunderstanding on the part of the Mission Planning Team (MPT) as to the level of support to be provided by the Command Memory Management System (CMMS) at GSFC. The early assumption was that some portion of the command generation and validation would be performed within the CMMS using algorithms and guidelines provided by the MPT. This led to an incorrect assessment of the location of the interface between the Mission Planning System (MPS) and CMMS. After it was determined that the only computational services offered by the CMMS were those involved with the translation of a time-ordered set of mnemonics into a command load, the assignment of command memory locations, and the construction of memory masks to allow the Project Operations Control Center (POCC) computer system to verify command loads transmitted, the location of the interface was modified so that the precluded functions were located either within the MPS or the Mission Control Team (MCT) at GSFC. There was initial concern that this might degrade the time resolution of commands based upon orbital geometry because of the age of the ephemeris used to generate the orbit predictions. Analysis showed that worst case (guaranteed) values of along-track timing errors could grow to 20 s with a two-wk data age. This corresponds to an along-track error on the order of 140 km (75 nmi). The point was rendered moot, however, by the discovery that there was no method within the existing system at GSFC to perform a bulk transfer of orbit prediction data of the type required from the orbit determination system to the CMMS.

Examination of the problem showed that for any given 24-h period the relative timing of commands was relatively insensitive to error propagation provided that prediction of any single orbit event was reasonably accurate during the period. This led to the "super trim" concept of time-trimming commands sequences within CMMS to take advantage of the latest possible orbit determination. As implemented, the MPS could elect to have CMMS perform a super trim or not. If the super trim was selected, CMMS determined the difference between the MPT predicted time of first ascending node crossing for each 24-h period and that time predicted at GSFC for the same event. The difference was applied uniformly to all commands requested within the period. Therefore, the more accurate of the two prediction sets could be selected at the nominal set during flight operations.

This concept also had the advantage of placing all of the orbit prediction software within the MPS at JPL. Negotiating and implementing changes to the set of orbit events generated would have been extremely difficult if such changes involved the MPS at JPL and the CMMS and the orbit determination system at GSFC.

With the orbit event predictor internal to the MPS, however, the interfaces were simplified to two standard information interfaces; CMMS received in computer-compatible form the standard set of orbit information to which GSFC operations were accustomed and JPL received from GSFC every two days an updated ephemeris based upon the most recent orbit solution. The ephemeris was used to drive an operational version of JPL's Satellite Mission Design Program (SAMDP). The operational version was designated SAMDPO to distinguish it from the design version, SAMDP3. Program modifications included providing all of the orbit events which might be needed to serve as triggers for automatic command generation and changing computational methods for some orbit events to ensure required accuracy. The output of SAMDPO was a computer file containing a unique set of input information and a time-ordered listing of orbit events including: ascending node crossing, STDN station rise and set events, STDN station elevation angles to the satellite, enter and exit sun occultation, subsatellite point terminator crossings, and boundaries between land and sea.

In fact, there was not a direct interface between the MPS and CMMS in the usual sense. All information exchange between the MPS and CMMS was through the POCC computer system. There was an interface, however, in the sense that the POCC did not operate upon the information it received, but merely buffered and retransmitted it. Therefore, the actual interface between MPS and CMMS concerned the content and syntax of the information, and the use to which the information would be put. With clarification of, and agreement to, the relative roles of the POCC, MCT, MPS, and CMMS, it became possible to define the content and syntax of the information. The basic information exchange in operations was envisioned to be a list of desired spacecraft commands and the desired time of execution going from the MPS to CMMS and a listing of the command load annotated with comments returning from CMMS to the MPS. The latter implied adopting a syntax which would lend itself to human readability if such a listing were to be useful to either the MCT within the POCC or the MPS at JPL. The CMMS personnel proposed the adoption of a syntax which had been used for similar purposes on a previous project, making only those changes necessary to accommodate Seasat special requirements. This proved acceptable to all parties. Subsequent changes were required to the syntax to allow additional CMMS functions to be implemented, but these were trivial except for the CMMS software programming changes required. The changes included the addition of several classes of card image-type designators and the reservation of previously unrestricted portions of comment fields for special instructions. The changes provided special information and instructions to the MCT and CMMS and permitted the operation of an automatic accounting system to ensure congruence between the MPS output and the CMMS input. The accounting system proved especially valuable during operations when it was discovered that a software problem in the MCCC block formatter program was allowing command requests to be lost prior to the transmittal to GSFC.

The content of the information flow from the MPT to CMMS was relatively straightforward. The basic information package was the Command Request Profile (CRP) which contained a set of card images, each of which represented either administrative data to identify the CRP uniquely, configuration data on the MPT software which was used to generate the CRP, ephemeris data identifying the orbit event file used, accounting information, specific requests for stored program commands (SPCs), real time commands (RTCs) and group commands, or comments.

Group command is the nomenclature used at GSFC to designate a specific set of SPC, RTC, and comments to be used with a fixed, specified time relationship to a designated reference time. This is precisely analogous to the spacecraft block as used in JPL planetary programs. It was initially presumed that repetitive command subsequences, such as sensor turn-ons, could be most efficiently identified as group commands and that CMMS, given the group mnemonic and call time, would expand the group and assign the proper times to each entry. Prior to launch, it was realized that this would tend to circumvent the CRP validation process if allowed to occur. Since CRP validation was planned to be done at JPL and not GSFC, use of the group command without expansion would mean that command level validation would not be performed. Conversely, if group command expansion was done and command level validation was performed at JPL, the only way to use groups in CMMS would be for the MPS to take the validated CRP and reconstitute all group commands, a process which would negate the validation. Therefore, there was no intent to make use of the group command capability in CMMS for processing MPS-generated CRP. The capability was not removed from CMMS, however, because it gave the project the option of generating profiles using group commands in the POCC, processing them normally through CMMS, then having the resulting loads hand-validated by the MCT. This was envisioned as the normal mode for maneuver loads when the sensors were cycled.

Two other attendant forms of information were required from the MPT by CMMS. These constituted the CMMS data base for Seasat. The first form of information was a list of command mnemonics, octal codes, and command descriptors, known as the command description table (CDT). The CDT included all commands intended for use via the POCC in flight, and specifically excluded any commands which were used only during Agena-powered flight as being potentially dangerous to the mission. Each command descriptor included a constraint code which informed the CMMS of the risk category for each command, whether or not a command might be time-slipped in case of a time conflict with another command, timing constraints on the loading of the next command, etc. The CDT was formatted in the same syntax as the CRP, so that the same transmission and validation software could be used to process it and included a header to identify it uniquely. The second form of information required from the MPT was the list of approved group commands together with their respective expansions, which was called the group description table (GDT). It included the additional restrictions on group commands as to whether the entire group had to be physically located in the same up-link command load and whether other commands could be interleaved with the group components. Both the CDT and the GDT were under the control of the MPT, and procedures were instituted to ensure that changes to the CMMS data base could not be made except by transmission of the modified data base to CMMS by the MPT.

Transmission between the CMMS and the MPS was to be by high-speed data line with the terminal systems being the MCCC IBM 360-75 computer system at JPL and the POCC Sigma 5 computer system at GSFC. Two factors complicated what otherwise should have been a relatively straightforward matter; first, Seasat would be the first NASA program to use the new 4800-bit NASCOM data block and, second, the MPT software resided in the GPCF Univac 1108 computers. These two factors required the development of the IBM 360-75 computer software which would accept the GPCF Univac 1108 computer-generated CRP, CDT, or GDT, format these data into the 4800-bit NASCOM blocks, and handle the appropriate protocols. Originally

scheduled to be operational by mid-November 1977, completely successful transmissions were not accomplished until the spring of 1978. In the interim, subsystem testing between the MPS and GMMS could only be accomplished through hand-carried tapes.

In addition to the relatively hard interfaces above, there were a set of soft interfaces with the sensor managers and the experiment teams. One concern was that the sensor managers and users might try to circumvent the mission planning process to get last-minute changes into the mission profile. If operations discipline were not maintained, it might become possible for interested parties to input requests directly to the POCC, leading to both a dilution of the limited POCC resources and to the execution in flight of non-validated command sequences. To preclude this, it was agreed within the operations organization that only engineering requests originating either in the Satellite Performance and Analysis Team (SPAT) or at LMSC would be accepted at the POCC, and these requests would require SPAT validation. All sensor command requests would go through the MPS and would be accepted only from a single point of contact designated for each sensor. The form of requests was not specified, because the level of request activity was unknown. It was suggested, however, that if the level of requests was anticipated to be significant (on the order of tens of commands each day), the most appropriate form for the requests would be an 1108-compatible computer file written in the input format of the MPS software. Alternatively, if the frequency of requests was very low (on the order of one or two over a three-month span) but the requests involved a large number of commands which could be generated using the capability of the MPS software, then the most appropriate form would be a written request which could serve as the basis for a modification to the MPS software.

With the interfaces defined, development of the MPS software began. The basic structure of the software (S/W) is shown in Figure 4-6. In a departure from traditional approaches to mission planning software at JPL, full recognition was given to the probability that no matter how carefully the software definition process was conducted, changes in mission strategy or operational capability after launch would mandate changes in the MPS software. Therefore, the software format had to accommodate perhaps major changes while still maintaining its operational capabilities. This philosophy led to a procedure for program modularization using intermediate files with a standard format so that each program could be modified or totally replaced without effect upon the balance of the software. It also had two other advantages: (1) the operator could inspect each intermediate file to determine if there were any problems with the run, and (2) since the programs were independent and the formats standard, the operator could stack the programs in any order. The result was a system with high operator visibility and flexibility of operation. Figure 4-7 depicts the normal operation of the software for a single iteration of a CRP. In actual practice there were often minor corrections to the SAR sequences which dictated iterating the passes through the SAR programs several times before a final merge to form the total CRP.

The mission planning process was designed to be an iterative process for Seasat lasting about four weeks for each week of operation. Therefore, during any week there would be four operational cycles within the MPS (Figure 4-8).

ORIGINAL PAGE 13  
OF POOR QUALITY

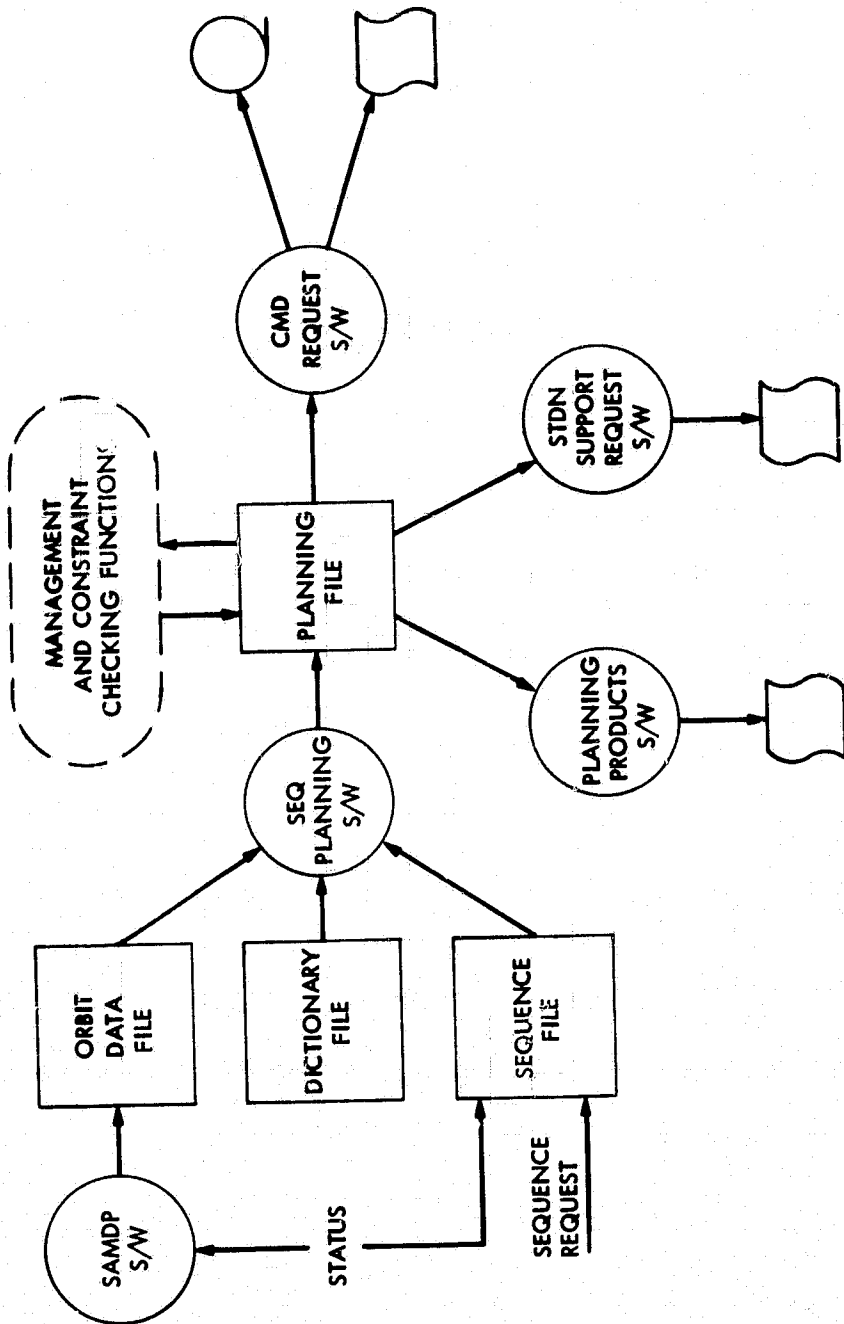

Figure 4-6. Mission Planning Software



ORIGINAL PAGE IS  
OF POOR QUALITY

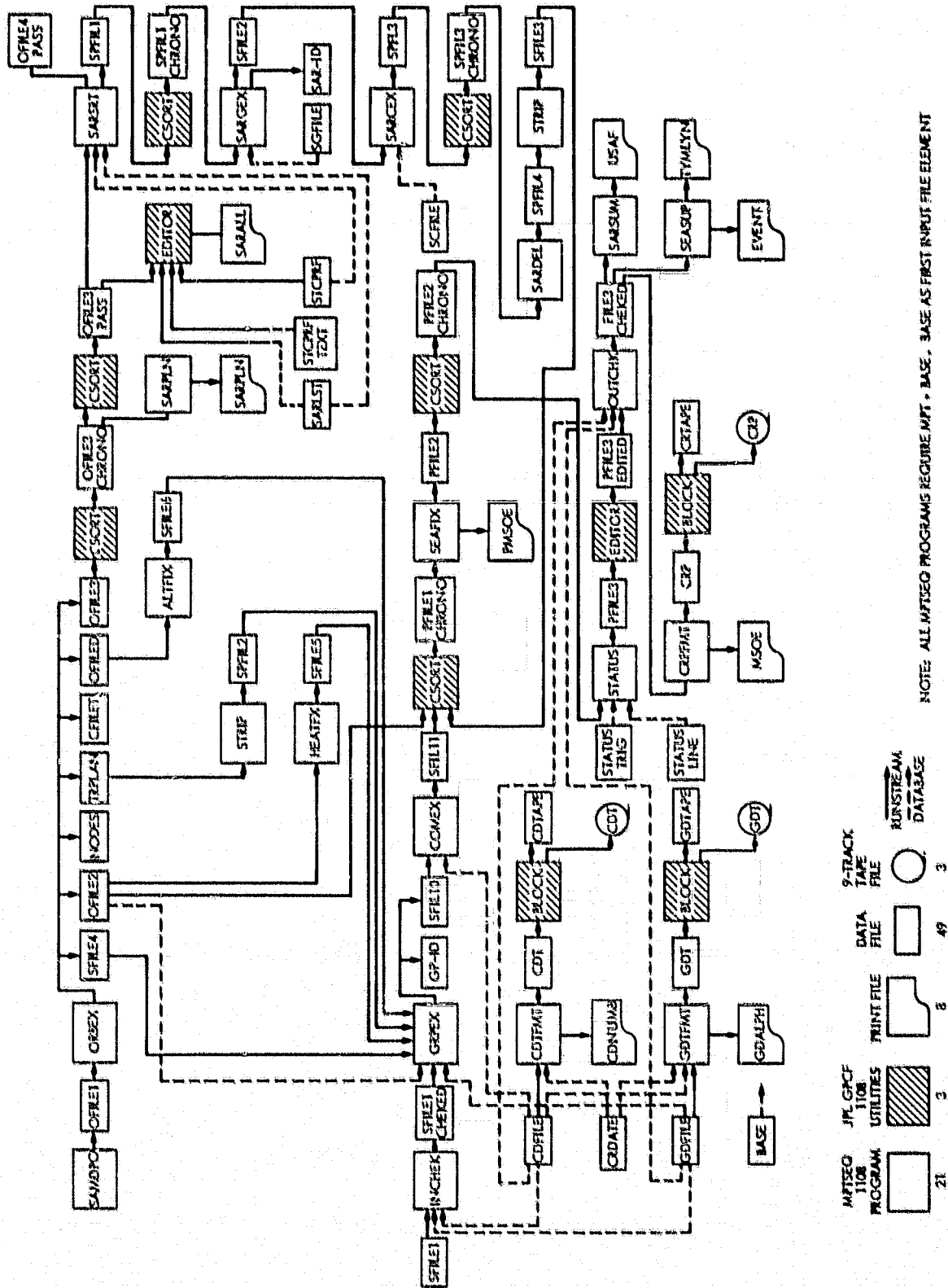
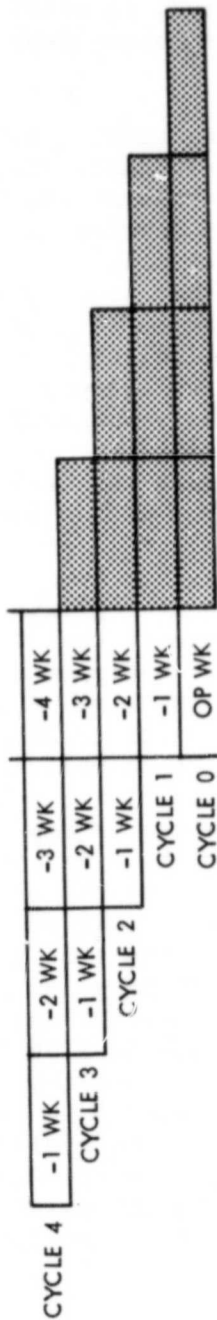

Figure 4-7. Seasat Mission Planning Team Sequence Software



- UPDATE DATA BASE FOR CYCLES 1-4
- MAKE PLANNING FILE FOR CYCLE 4, UPDATE PLANNING FILE FOR CYCLES 1-3
- DO MANAGERMENTS AND CONSTRAINT CHECKS FOR CYCLES 1-3
- DISTRIBUTE PLANNING PRODUCTS FOR CYCLES 1-4
- SEND STDN SUPPORT REQUEST FOR CYCLE 2 TO GSFC (OP WK - 12 DAYS)
- REVIEW PLANNING PRODUCTS FOR CYCLES 1-4
- APPROVE COMMAND REQUEST FILE FOR CYCLE 1
- SEND COMMAND REQUEST FILE FOR CYCLE 1 TO GSFC (OP WK - 4 DAYS)
- REVIEW PLANNING PRODUCTS FOR CYCLES 2-4
- APPROVE FINAL PROFILE FOR CYCLE 2
- APPROVE PRELIMINARY PROFILE FOR CYCLE 3
- PRESENT CAPABILITIES, PROPOSE SEQUENCES FOR CYCLE 4

Figure 4-8. Typical Planning Week Activities

Each cycle in the system would be at a different developmental level; the cycle closest in time to the current week would be in final CRP form, waiting transmission to GSFC, the cycle furthest away would contain only preliminary planning information such as the orbit event file, long range network constraints, and power availability predictions. This implies that some considerable planning effort has to be expended on at least the first four weeks of flight operations prior to launch. The project position was that approved, detailed profiles should exist prior to launch for the entire engineering assessment period (sensor turn-on plus four weeks).

Since this period included the launch, orbit insertion, initial orbit cruise, initial calibration, and maneuver phases as originally defined, the development of the pre-launch profile began with a canvass of the LMSC mission design and SPAT engineers and the sensor managers. In discussions with LMSC personnel, it became apparent that there was a wide difference in operations philosophy between JPL and the LMSC Seasat team. JPL has traditionally maintained that very detailed advance planning to the event level is required for the conduct of a spaceflight mission, not only for the nominal mission but also for principal options and contingencies. The key to this philosophy is the belief that such pre-planning (and pre-decision making) allows the operating system to avoid an absolute reliance upon the availability, correctness, and completeness of ground-processed near-real-time telemetry for analysis and decision. This philosophy has been developed largely through experience with planetary spacecraft where communication times are long compared to the time on station for data acquisition. The LMSC Seasat team experience, however, has been primarily with Earth-orbiting satellites where the communication time is negligible and the time on station is long, offering a change for data recapture if that data is missed at the first opportunity. As a result, the philosophy developed by LMSC is for a small operations team analyzing near-real-time data to serve as the basis for a near-term plan using real-time commands. Therefore, their preferred mode of operation is to develop the pre-planning only to a gross functional level, then, on the basis of telemetered data, to modify the detailed plan, (command load) on a 1- to 24-h time basis. Discussions of these differences in approach yielded agreement that while the Seasat mission was mandated to be a pre-planned mission in the JPL sense, it would be entirely appropriate to adopt the LMSC approach for the period of time which it took to establish the satellite in the normal on-orbit configuration. The initial agreement was that the transition from real-time to planned operations would occur at launch plus 14 days, by which time the satellite clock would have been adjusted to Universal Time (UT) and vernier-trimmed for drift, the ACS would have captured on the momentum wheels and any biases trimmed out, the orbit would have been adjusted to something very close to the observational orbit, and sufficient outgassing would have occurred to reduce any orbit corruption to a level where the sensor data would be usable even though out of specification. At this point initial sensor turn-on could occur. SPAT strongly urged that sensor operation not be scheduled prior to this time because the additional demands upon SPAT and the MCT might introduce some measure of mission risk that was otherwise avoidable.

Among the sensor managers there were the following general agreements:  
(1) sensor turn-on should occur as early in the mission as was both safe and practicable; (2) initial turn-on should occur only in the presence of real-time telemetry with a sensor representative in attendance at GSFC; and (3) that during

some portion of the turn-on activity each sensor should be allowed to acquire data in one or more modes in the absence of any other sensor operation. Beyond these general points, each sensor manager had a preferred sequence of operation which would allow the acquisition of the data set needed for the engineering assessment of the sensors. Some sensor managers, such as those for the ALT and SASS, requested the systematic exercise of a number of operating modes or parameters. The VIRR and SMMR sensor managers requested that their sensors be set to the normal orbit mode and be permitted to remain there. The SAR sensor manager requested the use of special operating parameters in the presence of special ground equipment for calibration.

This basic 6-wk pre-launch plan was carried as long as the scheduled launch date of 18 May 1978 held. With the discovery of the Atlas F boattail heating problem on other Atlas launches, however, it became evident that the Seasat launch date would slip. This created a mission scheduling problem, because extensive surface truth activities had been scheduled as a part of the Joint Air-Sea Interaction Experiment (JASIN) for July 1978. The project office felt that sensor operations would have to begin early enough so that the acquisition of the engineering assessment data and the processing of that data into sensor data records (SDRs) could be completed prior to the start of JASIN. Since this activity was estimated to require on the order of 6 wks, the project decided to advance sensor turn-ons to the period between the first and second orbit adjust maneuvers (Figure 4-9). Based on a projected launch date of 11 June 1978, this plan would permit full support of JASIN, including any response to the engineering assessment data analysis, by the beginning of August 1978.

An additional slip in the Seasat launch date resulted ultimately in a successful launch from Vandenberg Air Force Base on 27 June 1978 (GMT). This additional slip of the launch date caused the engineering assessment activity to overlap the JASIN period. All of the sensors were already into an orbit normal mode of data collection, with the exception of the SASS. The SASS was able to support JASIN with the introduction of selected mode changes in the JASIN area of the North Atlantic Ocean. Therefore, although the engineering assessment analysis activity was incomplete, the data support for JASIN could be accommodated. Engineering assessment activity was planned to essentially cease with satellite rev 487, when the SASS would be commanded to an orbit normal mode. The final pre-launch plan for the first 4 cycles are presented in the Mission Planning Summary (MPS) for cycles 001 through 004 (Table 4-6).

Table 4-6. Pre-launch Mission Planning Summary

CYCLE NO. 4 001  
 Revs 0000 to 0014  
 Days 170 to 176

DAY	DAY	DAY	DAY	DAY	DAY	DAY	DAY								
Monday 19 June 78	Rev Node Time	DAY 170 Monday 20 June 78	Rev Node Time	DAY 171 Tuesday 21 June 78	Rev Node Time	DAY 172 Wednesday 22 June 78	Rev Node Time	DAY 173 Thursday 23 June 78	Rev Node Time	DAY 174 Friday 24 June 78	Rev Node Time	DAY 175 Saturday 25 June 78	Rev Node Time	DAY 176 Sunday 26 June 78	Rev Node Time
															Liftoff 176/0058.12 Deploy antennas, Solar array, Rev 0001 Deploy SAR antenna Revs 0001-0002 Set clock and release, power, zero SMNR Rev 0003 Power subsystem checkout ACS checkout and analysis First 00
															F-1 day preps. Countdown start

Prepared: RA Johnson date 6-12-78  
 Approved: W. J. Johnson date 6-12-78

ORIGINAL PAGE IS  
 OF POOR QUALITY

ORIGINAL PAGE IS  
OF POOR QUALITY

Table 4-6. Pre-launch Mission Planning Summary (Continuation 1)

CYCLE NO. 002  
Revs 0015 to 0114  
Days 177 to 183

DAY	DAY	DAY	DAY	DAY	DAY	DAY
DAY 177 Monday 26 June 78 Rev 0015 Node Time	DAY 178 Tuesday 27 June 78 Rev 0029 Node Time	DAY 179 Wednesday 28 June 78 Rev 0043 Node Time	DAY 180 Thursday 29 June 78 Rev 0057 Node Time	DAY 181 Friday 30 June 78 Rev 0072 Node Time	DAY 182 Saturday 1 July 78 Rev 0086 Node Time	DAY 183 Sunday 2 July 78 Rev 0100 Node Time
Rev 0016 Transfer from RCS to OACS Rev 0021 Begin processing of Full Rev data for ACS Rev 0023 Post injection orbit solution Rev 0025 Load attitude trim commands 1800 GMT Maneuver meeting (Cal burn #1) 2200 GMT Maneuver load to CMS	All day: ACS evaluation 1400 GMT Review maneuver load 1700 GMT Orbit solution 2000 GMT OAMP run	0000 GMT Begin maneuver period Execute Cal burn #1 1200 GMT End maneuver period 1400 GMT Maneuver meeting (OA maneuver #1) 1700 GMT Orbit solution 2000 GMT OAMP run 2200 GMT Maneuver load to CMS	1500 GMT Post-maneuver orbit solution 1800 GMT Final OAMP run 2000 GMT Review and adjust maneuver load 2200 GMT Adjusted maneuver to CMS	0900 GMT Begin maneuver period Execute OA Maneuver #1	1200 GMT End of Maneuver Period (Rev 0092) Rev 0094 Attimeter early T/O #1 (Haw) Rev 0096 Attimeter early T/O #2 (ORR) Rev 0098 Attimeter early T/O #3 (MIL)	Rev 0100 SAR to Operate (GDS) Rev 0102 SMMR T/O #1 (MAD) Attimeter early T/O #4 (HAW) Rev 0103 SAR to Operate (ULA) VIRR T/O #1 (ORR) Rev 0104 SMMR T/O #2 (GMM) Rev 105 SAR SMT (MIL) Rev 0107 SAR XMIT (GDS & ULA: HOTHANDOFF) Rev 0109 SMMR T/O #3 (HAW)

Prepared: R. J. Gibson date 6-12-78  
 Approved: W. B. [Signature] date 6-12-78

Table 4-6. Pre-launch Mission Planning Summary (Continuation 2)

CYCLE NO- 003  
 Revs 0115 to 0214  
 Days 184 to 190

DAY 184 Monday 3 July 78	DAY 185 Tuesday 4 July 78	DAY 186 Wednesday 5 July	DAY 187 Thursday 6 July 78	DAY 188 Friday 7 July 78	DAY 189 Saturday 8 July 78	DAY 190 Sunday 9 July 78
Rev 0115 Node 51.4237 Time 0125.19	Rev 0129 Node 59.7899 Time 0055.46 Rev 0130 Attimeter on, begin quiet time (ULA) Rev 0133 VIRR on, begin quiet time (AGO) Rev 0136 SMRR on, begin quiet time (ULA) Rev 0139 SASS on, begin quiet time (MAD) Rev 0141 SASS HVPS on, Mode 1 (MIL RTC) Rev 0140 GMT Cal burn #2 load to CMS Rev 0140 GMT Select Cal burn #2 sequence Rev 0140 GMT Cal burn #2 load to CMS Rev 0140 GMT Cal burn #2 load to CMS	Rev 0143 Node 68.2153 Time 0626.12 0000 GMT SASS operating, Mode 1 Rev 0143 SMRR on (GDS) Rev 0144 VIRR to operate (GDS) Rev 0145 Attimeter on, Track 1 (ULA) Rev 0150 SAR XMIT (GDS & ULA; HOTHANDOFF) Rev 0160 GMT Approve maneuver load Rev 0170 GMT Orbit Solution Rev 0170 GMT OAMP run 2000 GMT OAMP run	Rev 0158 Node 51.4693 Time 0137.23 0000 GMT Begin maneuver period Execute cal burn #2 1200 GMT End of maneuver period Attimeter on-Track 1, SASS on-Mode 1, VIRR on, SMRR on, SAR normal Opts. 1400 GMT Select OA maneuver #2 sequence 2200 GMT Maneuver load to CMS	Rev 0172 Node 59.8950 Time 0107.50 Rev 0174 SAR XMIT (ULA) Sensors on, satellite quiet day Rev 0177 SAR XMIT (MIL) 1500 GMT Post maneuver solution 1800 GMT Final OAMP run 2100 GMT Predicted post maneuver ephemeris	Rev 0186 Node 68.2617 Time 0038.16 Rev 0186 SAR XMIT (GDS) 0900 GMT Begin maneuver period	Rev 0200 Node 75.0035 Time 0008.24 1200 GMT End of maneuver period Attimeter on-Track 1, SASS on-Mode 1 VIRR on, SMRR on, SAR normal Opts. 1200 GMT (Rev 0207) SAR XMIT (GDS & ULA; HOT HANDOVER) Execute OA maneuver #2

ORIGINAL PAGE IS  
 OF POOR QUALITY

Prepared: RG Wilson date 6-12-78  
 Approved: W. B. Allen date 6-12-78

ORIGINAL PAGE IS  
OF POOR QUALITY

Table 4-6. Pre-launch Mission Planning Summary (Continuation 3)

CYCLE NO. 004  
Revs 0215 to 0300  
Days 191 to 197

DAY 191	DAY 192	DAY 193	DAY 194	DAY 195	DAY 196	DAY 197
Monday 10 July 78 Rev 0215 Node 60.4756 Time 0119.53	Tuesday 11 July 78 Rev 0229 Node 68.9018 Time 0050.20	Wednesday 12 July Rev 0243 Node 77.3279 Time 0020.46	Thursday 13 July 78 Rev 0258 Node 60.6417 Time 0131.57	Friday 14 July 78 Rev 0272 Node 69.0679 Time 0102.23	Saturday 15 July 78 Rev 0286 Node 77.4940 Time 0032.49	Sunday Rev 0300 Node 85.9202 Time 0003.15
Rev 0215 SAR XMIT (GDS) Rev 0220 Altimeter Special Command Test Rev 0221 SAR XMIT (ULA) Rev 0223 Altimeter Track 4 Test, 17 states 1700 GMT Post maneuver orbit solution Rev 0224 Altimeter Track 4 Test, 16 states Rev 0225 Altimeter Track 4 Test, 15 states SASS in Mode 4, Assessment, SMR on, VIRR on, SAR ops. normal Altimeter off	Rev 0229 Altimeter Track 4 Test, 14 states Rev 0230 Altimeter Track 4 Test, 2 states Rev 0232 SAR XMIT (ULA) Rev 0240 Altimeter Whole Rev of Cal II Rev 0241 Altimeter Whole Rev of Test Mode I Rev 0242 Altimeter Begin Whole day of autocar SASS in Mode 4 Assessment, SMR on, VIRR on, SAR ops. normal Altimeter in Track I/Autocal	1200 GMT Maneuver Evaluation complete Rev 0257 End of Altimeter Autocal Altimeter begin orbit normal ops. SASS in Mode 4 Assessment, SMR on, VIRR on, SAR ops. normal Altimeter in Track I	SASS in Mode 4 Assessment, SMR on, VIRR on, SAR ops. normal Altimeter in Track I Rev 0263 SAR XMIT (MIL)	0000 GMT Alt start daily over-land calibrates SASS in Mode 4 Assessment, SMR on, VIRR on, SAR ops. normal Altimeter in Track I	SASS in Mode 4 Assessment, SMR on, VIRR on, SAR ops. normal Altimeter in Track I	Rev 0308 SASS to Mode I SASS in Mode I Assessment, SMR on, VIRR on, SAR ops. normal Altimeter in Track I

Prepared: R. G. Gibson date 6-12-78  
Approved: W. J. Allen date 6-12-78



ORIGINAL PAGE IS  
OF POOR QUALITY

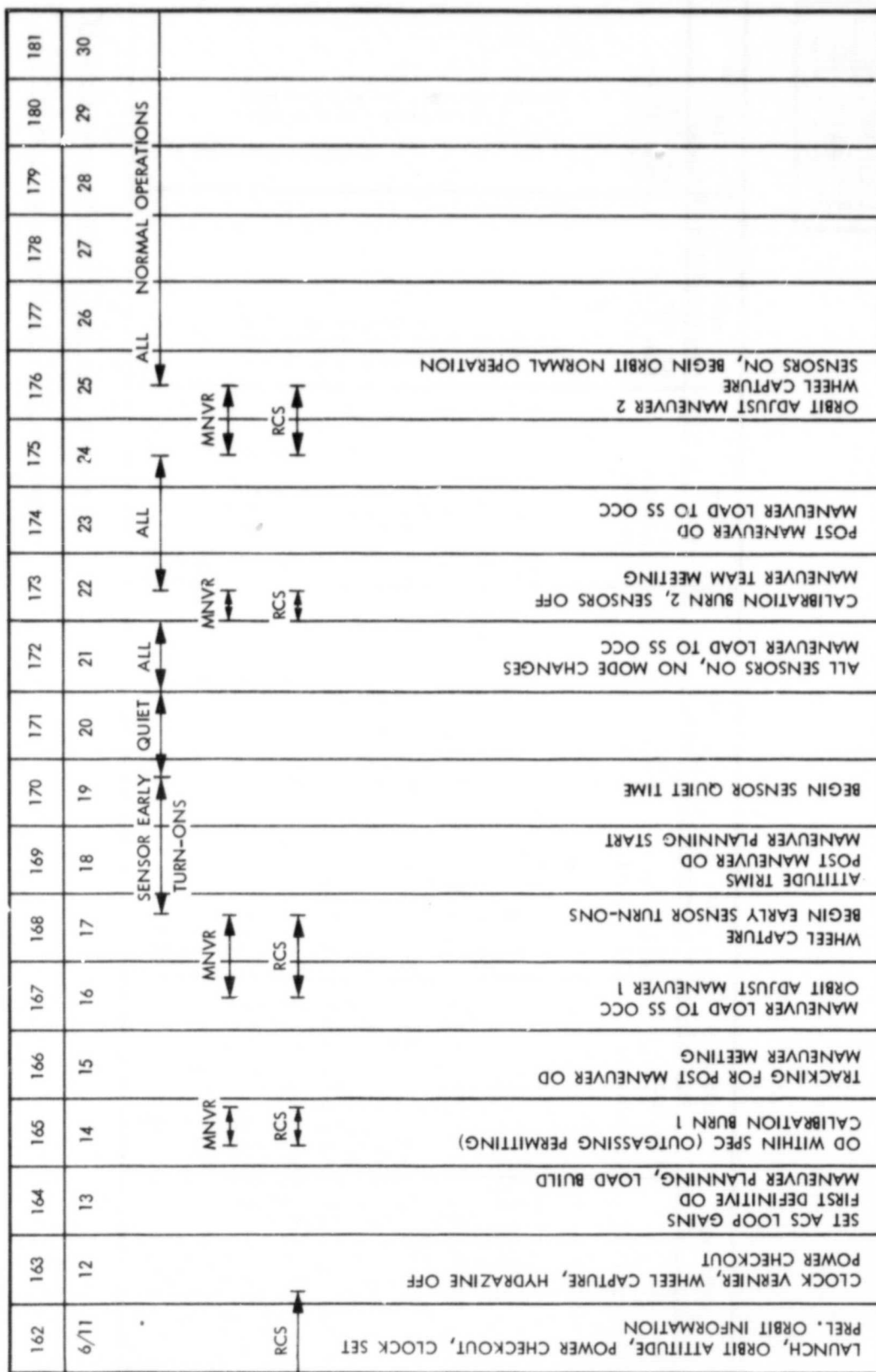

Figure 4-9. Seasat Early Science Mission Sequence

## SECTION V

### MISSION HISTORY

#### A. INTRODUCTION

The planned Seasat mission was modified extensively after launch because of attitude control problems that appeared in the horizon sensor subsystem of the satellite immediately after launch, and which had to be resolved on a higher priority basis. However, the planned JASIN and GOASEX activities were covered by the satellite in a satisfactory manner, and an effective radar altimeter calibration was achieved. Engineering assessments of all sensors were made. A significantly useful global data set was also collected. The mission was terminated prematurely on 10 October 1978 by a massive power failure in the satellite power subsystem.

A detailed history of the actual mission as flown is given in this section. Because of the attitude control difficulties, the attitude history of the satellite is complex. As knowledge of the attitude is fundamental to the geographical location of the sensor data, a detailed analysis of the attitude history and associated error estimates is included in Volume IV of this report. Figures 5-1 through 5-5 show views of the actual satellite orbits as they would appear if viewed from a position above the Earth and at the trajectory north pole (north of the plane of the ecliptic).

Appendix A contains a detailed Launch Events description and an orbital summary for the mission.

#### B. LAUNCH PHASE

The Seasat liftoff from the Air Force Western Test Range on 27 June 1978 (day 178) at 01:12:44 GMT was slightly later than planned because of a brief hold caused by a broken water line in the Space Launch Complex 3W launch pad deluge system. The observed portion of the ascent was well within performance limits. The launch configuration included identical ascent programs stored in both Command Processor and Central Timing Units (CTUs). The CTUs were enabled by an Atlas radio discrete at 01:17:34 GMT in the parallel operating mode for redundancy. The stored ascent sequence included Agena first and second burn events, propellant and oxidizer dump events, attitude commands, and initial equipment deployment commands.

Tape recorder No. 1 was in the record mode at launch, and the intent was to play back the launch and ascent data on the Fairbanks, Alaska (ULA) STDN pass, but ground problems at the STDN site precluded recovery of this data. Usable data was returned by the Advanced Range and Instrumentation Aircraft (ARIA) No. 1 covering the Agena first burn portion of the ascent, but ARIA No. 2, covering the Agena second burn portion of the ascent, did not produce usable telemetry. Final equipment deployments were commanded from the ground during rev 002 and confirmed during the rev 003 ULA pass. At this point Seasat was in its initial orbital cruise mode with all antennas, sensors, and solar panels deployed, nadir-pointed under Reaction Control System (RCS) control, and operating on solar power. The

ORIGINAL PAGE IS  
OF POOR QUALITY

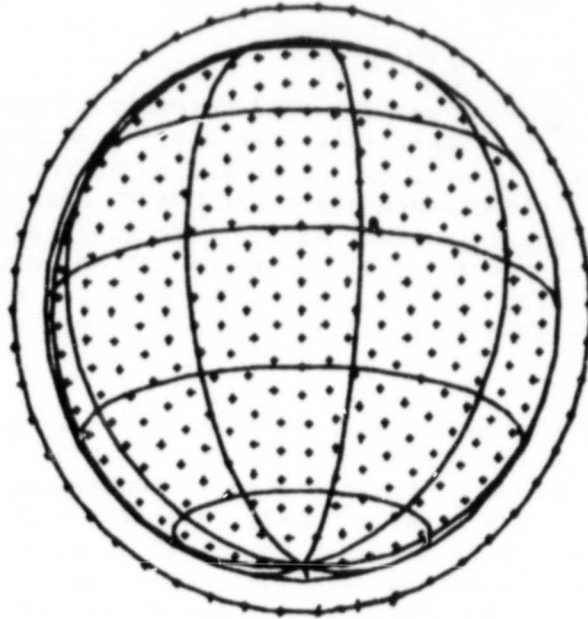

Figure 5-1. View of Earth From Trajectory N-Pole, 07/07/78

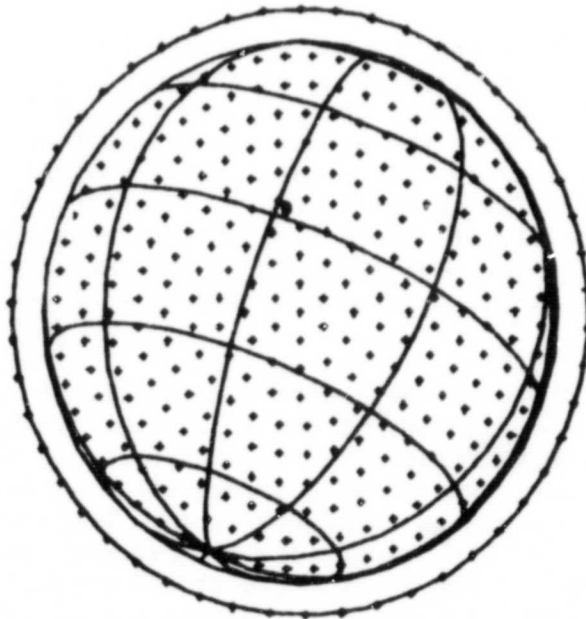

Figure 5-2. View of Earth From Trajectory N-Pole, 08/01/78

ORIGINAL PAGE IS  
OF POOR QUALITY

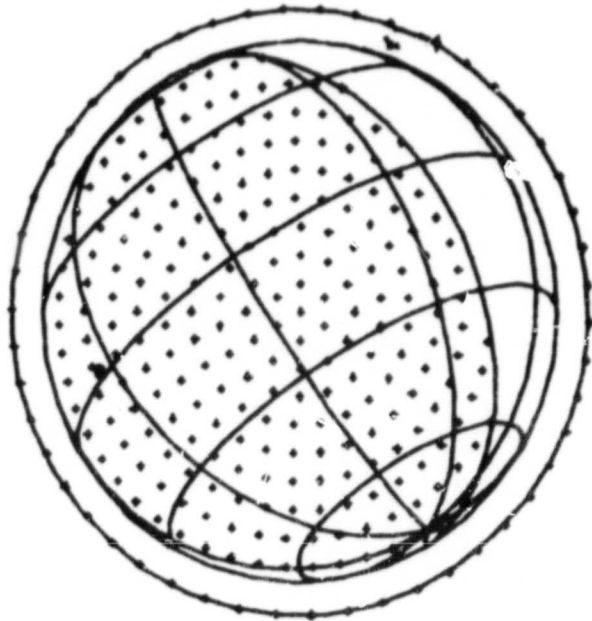

Figure 5-3. View of Earth From Trajectory N-Pole, 09/01/78

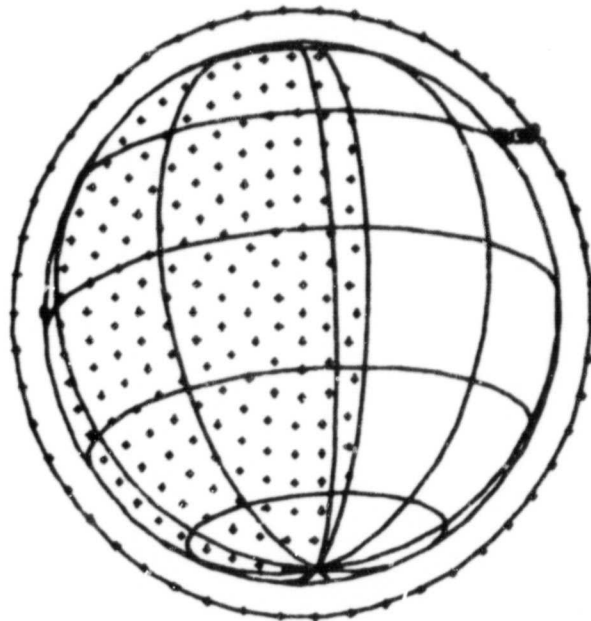

Figure 5-4. View of Earth From Trajectory N-Pole, 09/25/78

ORIGINAL PAGE IS  
OF POOR QUALITY

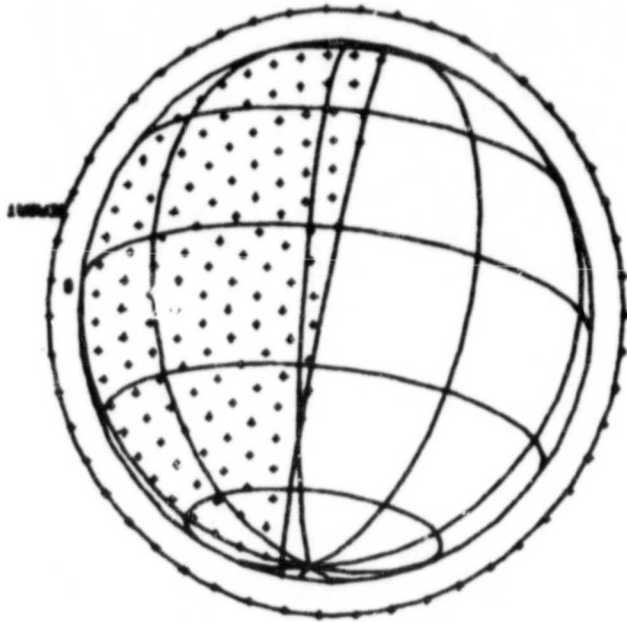

Figure 5-5. View of Earth From Trajectory N-Pole, 10/10/78

Launch orbit achieved was well within specification, although somewhat different than targeted values (Table 5-1). The velocity required to correct to the planned operational orbit would have been 6.3 m/s as compared to the nominal value of 4.4 m/s or the 99 percent probability level of 11 m/s.

### C. INITIAL ORBITAL CRUISE

One day after launch the attitude control system was switched from the RCS, which used gyros and hydrazine jets, to the On-Orbit Attitude Control System (OACS), which used horizon sensors and momentum wheels. After the switch large attitude transients were observed in roll and yaw and the spacecraft was returned to RCS control. Subsequent studies showed that these disturbances occurred at specific points in each orbit revolution. It has been hypothesized that the anomaly was due to direct or reflected sunlight (from some part of the spacecraft) entering the field of view of the horizon sensors. The attitude control system functioned normally under RCS control, but the hydrazine consumption was about 0.045 kg (0.1 lb) per day, which would have reduced the mission duration if continued. To alleviate this problem, the momentum wheels were deactivated, reducing the hydrazine consumption to about 0.045 kg (0.1 lb) per week. On 5 July the satellite was returned to OACS control using the right scanwheel only and momentum wheels. There was no repetition of the anomaly, and it is hypothesized that the sun geometry had changed sufficiently due to orbit precession so that the sun no longer entered the field of view of the horizon sensors. Further details on the attitude anomaly are given in Volume II of this report. All initial maneuver plans were cancelled pending resolution of the attitude problems. By late July the JPL and LMSC operations personnel were confident that the attitude control problems could be circumvented by disconnecting the horizon scanner signal processor output from the roll control system during times of predicted sun interference and permission was given to begin the initial maneuver series on 15 August 1978.

### D. SENSOR ENGINEERING ASSESSMENT

During the period of the attitude anomaly investigation, sensor power was applied as planned, and the sensors were checked out in a systematic manner, both individually and together. Engineering telemetry indicated that all sensors

Table 5-1. Nominal Launch Orbit

Semimajor axis (km)	7168.3
Eccentricity	0.00008
Inclination (deg)	108.0
Argument of perigee (deg)	90.0
Time of perigee (nominal launch rate) (h:min GMT)	00:46 (27 June)
Ascending node (deg)	298

were operating properly, so on 3 July 1978 the engineering assessment portion of the mission was begun. The engineering assessment activity for each sensor was designed to systematically acquire sensor data in each of the operating modes of the sensor and over a representative sample of the adjustable parameter ranges for each sensor. These activities were supported as appropriate by special ground calibration activities and were performed in combination with selected surface truth.

One sensor, the SAR, was unable to proceed according to pre-launch plans. SAR engineering assessment had been predicated upon the node control feature of the maneuver plan, and SAR targets were selected accordingly. With the delay of any maneuver activity until completion of the attitude anomaly analysis, the SAR targets selected prior to launch were unavailable due to the nature of the launch orbit ground trace development. This necessitated replanning the SAR engineering assessment and science acquisition completely. While the replanning was accomplished without material impact to the mission, the difficulties involved in selecting targets manually dictated that an automated targeting technique be developed, so that the SAR planners could more properly devote their time to targeting review rather than implementation. To lend emphasis to this need, on 6 July 1978 the project office was notified of the development of the first of several tropical storms in the Pacific Ocean just inside the coverage afforded by the Goldstone, California SAR-equipped STDN site. The early occurrence of such a unique chance for remote observation of a target of opportunity underscored the importance of flexibility in the SAR operation.

#### E. OBSERVATION PHASE

On 1 July 1978, mission controllers at GSFC had noted indications in the engineering telemetry that the thermostat which controlled the sensor module heaters was cycling on and off much more rapidly than had been anticipated. While this was not of immediate concern, it was an anomaly that put the satellite analysts on notice that special monitoring of the thermostat behavior and of the sensor temperatures was required. Thermostat monitoring was complicated by the fact that most of the satellite data available to the controllers was in the form of snapshots of the real-time data; that is, a limited set of time-sampled cross sections of the telemetry acquired when the satellite was in view of a tracking STDN site. With only one pass normally scheduled each satellite revolution, and with only a few snapshots taken for any particular telemetry channel during a pass lasting about 10 min, it was not possible to characterize any duty cycle with a period less than approximately 20 min. The thermal response in the sensor module, however, was very much slower, so the primary monitoring points were the various sensor temperature monitoring points.

On 16 July 1978 the altimeter +Y base plate temperature sensor exceeded its maximum operating limit, indicating that the nearby heater was on all or almost all of the time. Discussions with the sensor manager determined that a new maximum limit could be used. At 17:02 GMT on day 198 (17 July 1978) controllers observed that the altimeter base plate had exceeded the new upper temperature operating limit. By agreement with the altimeter sensor manager, immediate steps

were taken to turn the altimeter off. At this point of the mission the altimeter was scheduled to conduct a special series of engineering assessment tests in the altimeter's Track 4 operating mode. Track 4 allowed the ground selection of different timing parameters to optimize sensor operation. The complete Track 4 test was lost during the altimeter down time, but was subsequently rescheduled after resumption of altimeter operation.

Evaluation of the problem indicated that there was a possibility that the sensors might be able to operate within temperature limits with the heater bus disabled completely, given the current solar geometry. Accordingly, on day 205, (24 July 1978) the heater bus was commanded off, and the altimeter operation was resumed. Within a few revolutions, it became apparent to the controllers that altimeter operation was not possible, as the SAR data link and SASS temperatures were decreasing toward their respective minimum limits. On day 206 (25 July 1978) the altimeter was again disabled and the heater bus operation restored. A special project review of the problem at IMSC concluded that the only way to maintain full operation of the low-rate sensors was to undertake ground control of the sensor module heater bus. The strategy adopted was to enable the heater bus for that portion of each satellite revolution which would maintain all sensor temperatures at an acceptable level and to disable the bus for the balance of the revolution. This plan was successfully implemented on day 207 and continued for the remainder of the mission.

#### F. MANEUVER REDESIGN

In parallel with the attitude anomaly investigation, the engineering assessment activities, the thermostat anomaly investigation, and routine operations, the trajectory design and maneuver specialists were reviewing the mission impact of remaining in the launch orbit for an extended period of time and preparing a revised maneuver strategy.

The coverage from the launch orbit is plotted in a dot diagram in Figure 5-6. The dots show the Earth-fixed longitudes of ascending nodes plotted against time. The abscissa shows a typical equator segment with the plotted pattern being repeated around the equator. Two major patterns are evident: (1) a long-term 17-day near-repeat pattern with a small miss distance of 0-30 km (0-16 nmi), and (2) a short-term 3-day near-repeat pattern with a larger miss distance of 160 km (86 nmi). The curvature in the 17-day near-repeat pattern was due to drag effects on the semi-major axis which changed the nodal precession rate, which in turn affected coverage. Note that the 17-day pattern did not exactly repeat itself, but missed to the west. However, the stepping pattern could be maintained with maneuvers. The 17-day pattern was advantageous in that it provided nearly 18-km (10 nmi) spacing between adjacent ground traces, and this corresponded to the altimeter long-term mapping requirement. A disadvantage of the launch orbit was that the 3-day pattern had a miss distance that was about 50 percent larger than the SAR swath width of 100 km (54 nmi). Therefore, the SAR and instruments with smaller coverage swaths did not have contiguous coverage for long periods of time. Since both the baseline and Cambridge orbits (Table 5-2) were designed to provide overlap coverage consistent with instrument swaths, it was decided not to stay in the launch orbit, but to comply with the initial maneuver objectives.



ORIGINAL PAGE IS  
OF POOR QUALITY

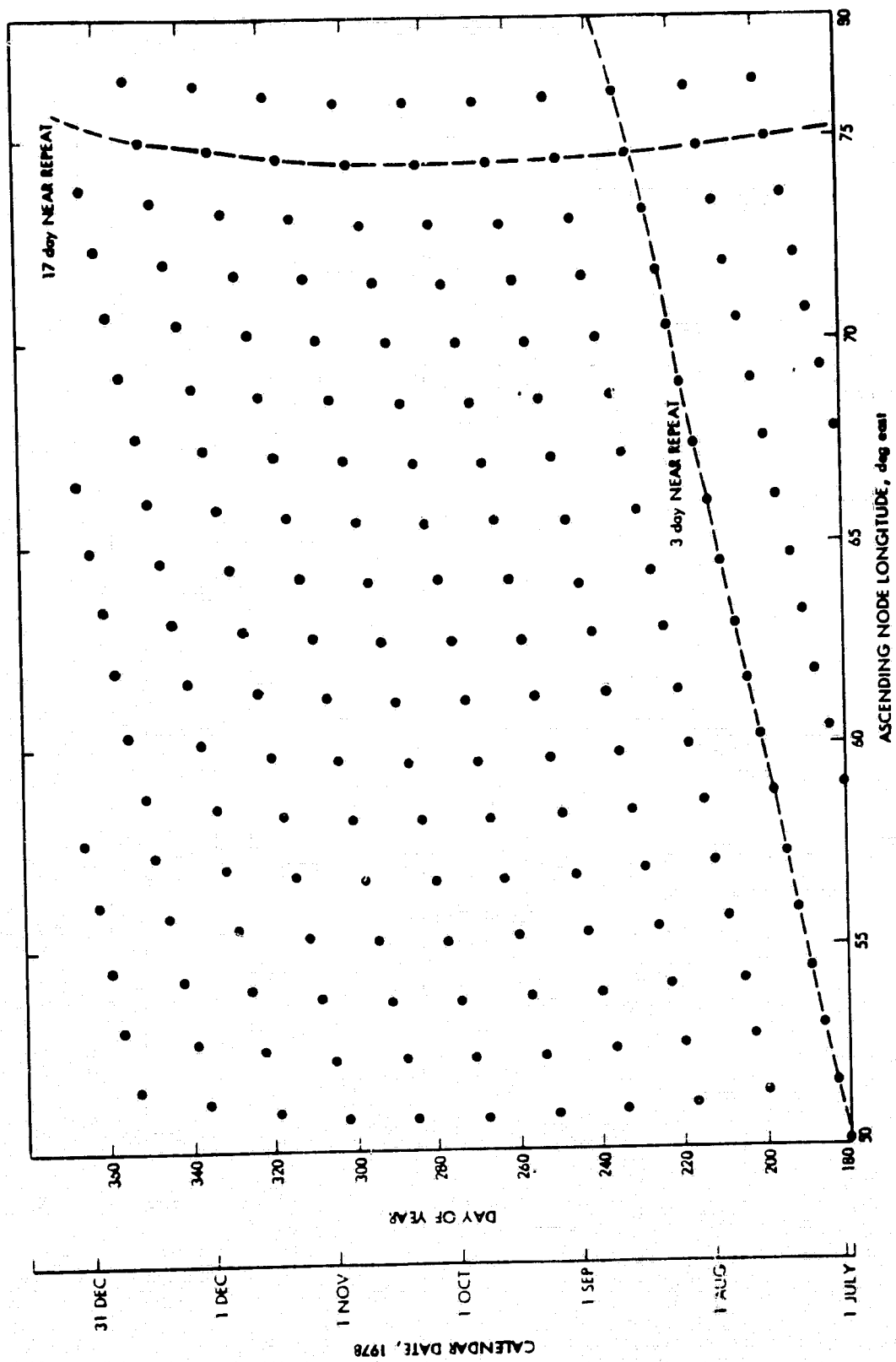

Figure 5-6. Seasat Launch Orbit Ascending Node Pattern

Table 5-2. Orbit Definitions

---

Baseline orbit	A 3-day near repeat orbit which moves 18.5 km (10 nmi) to the East every 3-days. Has advantages of multiple coverage of fixed locations and good orbit stability with respect to drag.
Cambridge orbit	A 25-day near repeat orbit which moves 18.5 km (10 nmi) to the East every 25-days. Has advantage of fast global coverage and optimum SAR swathing.
Exact 3-day repeat orbit	A 3-day exact repeat orbit which provides near-zenith, descending node passes over BDA every 3 days. Has advantages for ALT calibration.
Launch orbit	The orbit actually achieved by the Atlas Agena on June 27. This orbit has identifiable 3-day and 17-day cycle components, see Figure 5-6. The orbit spacing changes with time due to drag (i.e., no maintenance maneuvers).
17-day near-repeat orbit	17-day near-repeat orbit which is close to the launch orbit. Moves 18.5 km (10 nmi) to the West every 17 days (other spacings are possible).
Node control condition	The condition which exists when the node control maneuver synchronizes the ascending node longitudes and times to the pre-flight plan.
Frozen orbit condition	The condition which exists when the orbit adjust maneuver achieves orbital elements which freeze perigee at the maximum North latitude excursion, thereby minimizing altitude and altitude rate variations in Northern hemisphere (desirable for the SAR).

---

The revised strategy called for the following sequence of orbits. First, the baseline orbit was to be established with the frozen orbit condition by August 26. Node control for the baseline orbit was to be such that a descending pass occurred directly over Bermuda Island on 8 September. The satellite was then to be maneuvered into an exact 3-day repeat orbit which passed over Bermuda every third day. This orbit was to be utilized for approximately one month, and then a new orbit established which provided a gradually shifting coverage pattern. The Seasat Science Steering Group voted in late September to follow the exact 3-day repeat with the baseline orbit starting in October 1978. The revised maneuver schedule is shown in Table 5-3.

Table 5-3. Maneuver Timeline

Date	Maneuver	Description
15 August	Calibration No. 1	Calibrate - $\Delta V$ thruster 60-s burn $\Delta a = -1$ km
18 August	Orbit adjust No. 1	Orbit adjust No. 1 changed nodal precession rate. Post-maneuver orbit: $\bar{a} = 7160.1$ $e = 0.00143$ $\omega = 146.27$ $i = 108.023$ $\Omega = 87.7$
23 August	Calibration No. 2	Calibrate + $\Delta V$ thruster 60-s burn $\Delta a = +1$ km
26 August	Orbit adjust No. 2	Orbit adjust No. 2 achieved the nominal pre-flight nodes. The orbit was a baseline ground trace with about 11-km spacing (east) and a near-frozen orbit. Post-maneuver orbit: $\bar{a} = 7168.6$ $e = 0.0008$ $\omega = 95$ $i = 108.023$ $\Omega = 104.3$
1 September	Trim No. 1	Trim No. 1 corrected any execution error resulting from orbit adjust No. 2. This maneuver ensured that the Bermuda overflight would occur on 10 Sept., $\pm 1$ day.
8 September	Orbit Change No. 1	Orbit change No. 1 achieved the 3-day exact-repeat, which is a descending leg over Bermuda Island. Post-maneuver orbit: $\bar{a} = 7169.0$ $e = 0.0008$ $\omega = 90.0$ $i = 108.023$ $\Omega = 126.7$

There were a number of reasons for establishing the 3-day exact-repeat orbit in September. The major reason was that this orbit provided the best coverage of a number of oceanographic activities which could provide surface truth data to validate the Seasat data. These oceanographic activities included the delayed GOASEX in the Gulf of Alaska (9/6/78 - 9/24/78) and JASIN in the Rockall Island, North Atlantic area (7/15/78 - 9/15/78). The altimeter/precision orbit determination team planned surface truth laser ranging and calibration activity in the Bermuda area. There were also a number of other experiments planned which relied on near-repeat coverage of a fixed location at 3-day intervals. Another advantage of this orbit strategy was that once the frozen orbit conditions were achieved, the orbit altitude variations would be minimized in the Northern Hemisphere, thereby optimizing SAR and SMMR operation. Also, the baseline orbit provided a relatively stable orbit pattern with respect to drag effects in case further maneuvers were not advisable (i.e., attitude anomalies were to recur).

Figure 5-7 shows the ground trace pattern for the 3-day exact-repeat orbit. It is seen that one descending trace passed directly over Bermuda Island. For purposes of the ALT/POD experiment, it was desired that the overflight be within  $\pm 5$  km (2.7 nmi) for 30 days.

Achieving the pre-launch ascending nodes meant that the Bermuda overflight would occur on 2 September. However, due to the busy maneuver schedule, this data was rescheduled to 8 September. The new plan called for changing the nodal precession on 18 August so that the actual and nominal ascending nodes would match on 26 August. A maneuver would then match the actual and nominal nodal precession rates so the nodes would remain matched in time. Perfect maneuver execution would cause a descending pass to occur directly over Bermuda Island about 8 September. Corrections to eccentricity and argument of perigee, to achieve the frozen orbit condition, were made during the node control maneuvers by specifying the burn locations. However, errors in thrust levels, during node control maneuvers, could cause the first overflight date to be shifted by up to 30 days. Therefore, a trim maneuver was tentatively scheduled one week after the node synchronization orbit adjust maneuver to remove primarily semi-major axis errors. If the errors after the node control maneuvers were small, the trim maneuver would be cancelled. Using this strategy would ensure that the Bermuda overflight would occur on 8 September  $\pm 1$  day.

The second phase of the revised maneuver strategy was to maneuver into the 3-day exact-repeat (every 43rd rev exactly repeats). The overflight requirement was to pass directly over the laser site within  $\pm 5$  km, and stay within this tolerance for one month. It was estimated that drag would cause the ground trace to shift about 160 m/day eastward due to semi-major axis decay (period increase). If the initial orbit repeated in exactly 43 revs, the orbit would shift due to drag from an exact Bermuda overflight to a 5 km miss (east) after 30 days, given a solar flux of 150. This error could be reduced by targeting to an orbit which had a 3-day repeat which drifted slightly to the west. Then, drag would slow and stop the westward drift and the drift east back over the target. This strategy was designed to limit the drag induced error to less than  $\pm 2$  km.

ORIGINAL PAGE 13  
OF POOR QUALITY

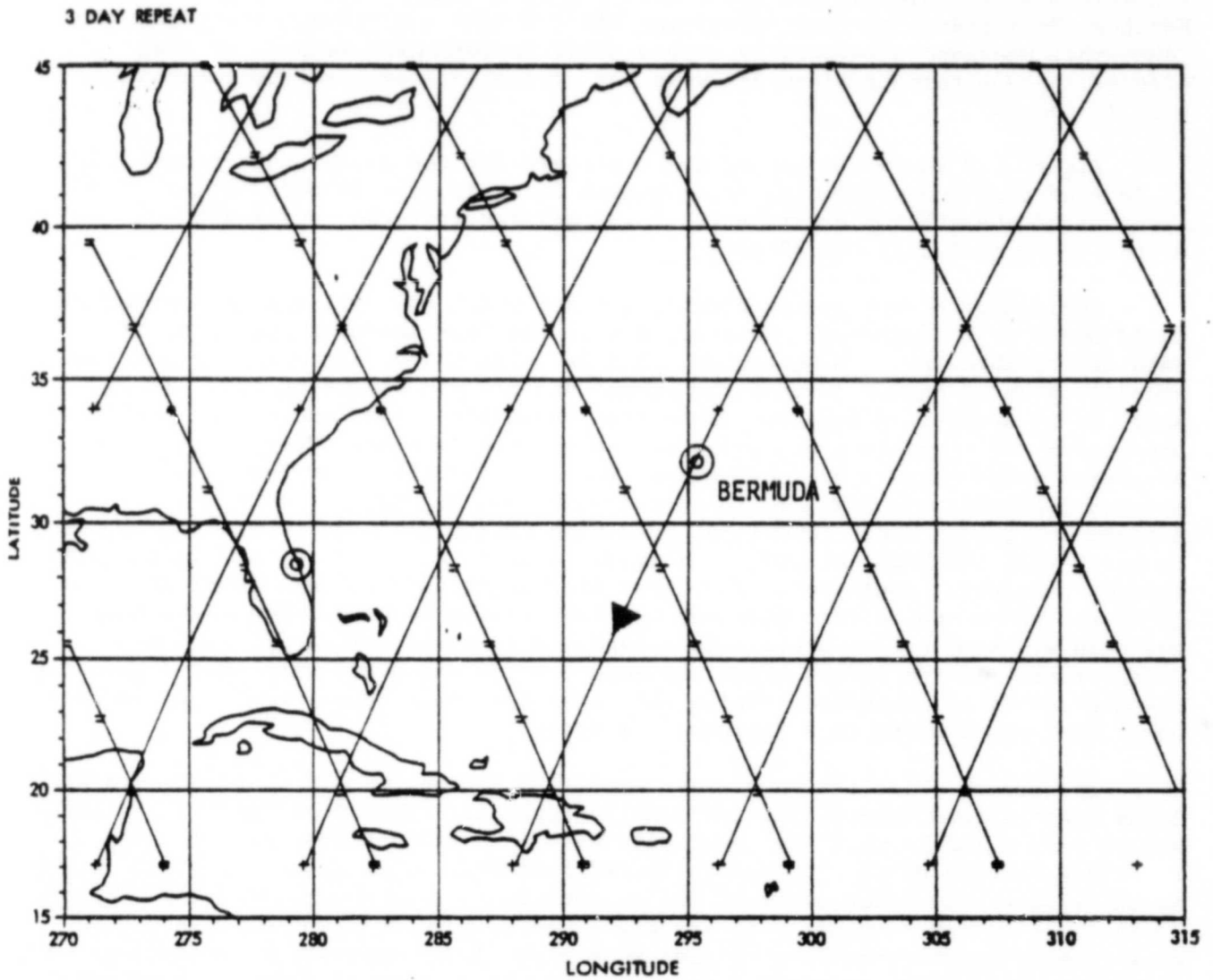

Figure 5-7. Ground Tracks for Exact 3-Day Repeat Orbit Over Bermuda

The Seasat maneuvers were all executed successfully with very good results. All maneuver objectives were met and no abnormalities occurred. The first Seasat Orbit Adjust Thruster (OAT) firing was at 07:41 GMT on 15 August 1978. The purpose of this maneuver was to calibrate the  $-\Delta V$  thruster (i.e., reduce uncertainty about actual specific impulse and thrust levels relative to pre-launch test firings, which were at constant pressure). The performance results for all of the maneuvers are summarized in Table 5-4. It can be seen that after the calibration burns the thrust levels were predictable to 1 percent or better. This fact greatly aided the maneuver success and led directly to the cancellation of the trim originally scheduled for 1 September 1978.

Each maneuver after this first calibration burn was modified slightly from the nominal values to adjust for errors in the previous burn and also to correct for small drag prediction errors. The execution errors from maneuver 4, if uncorrected, could cause the Bermuda Island overflight to slip from 8 September to 10 September 01<sup>h</sup>. This slip was acceptable to the mission planning and altimeter teams, and so the corrective trim on 1 September was cancelled. The maneuver to an exact 3-day repeat orbit with Bermuda overflight was made on 10 September, and the satellite was still in that orbit on 10 October when the power failure occurred which ended the nominal mission.

Additional information on the details of the maneuver execution and satellite performance are available for reference<sup>1</sup>.

#### G. MINIMUM POWER PERIOD

With the onset of satellite occultation (predicted to begin during the middle of cycle 008), mission planners began to become concerned about the availability of power during occultation. One concern was that there was some uncertainty about actual power demand based upon the difference in performance of the heater thermostats in flight compared with pre-launch system test. Another concern lay in the fact that the pre-launch demand based upon analysis did not agree with the measured values. Accordingly, a strategy was developed for systematically reducing loads during the minimum power period expected near the early September time period. Initially, the SAR operation would be curtailed from the nominal 60 min per 24-h period during full-sun portions of the mission to a minimum of 10 min per 24-h period at power minimum. If telemetry and analysis indicated that a further reduction in loads was warranted, then major power consumers among the low-rate sensors would be cycled off during long over-land periods. In addition, priorities would be associated with each of the SAR passes scheduled, so that mission controllers could scrub low priority SAR passes in near-real time if the power situation appeared critical. The restrictions upon SAR operation extended from cycle 009 through cycle 014.

On rev 891, day 240 (28 August 1978) at the beginning of a normal status pass over the Hawaii STDN site (HAW), the data indicated that the VIRR mirror had ceased to scan at some time since the prior status pass. This was a sensor failure which had been anticipated prior to launch, since on previous flights

---

<sup>1</sup>Frautnick, J. C., "Seasat-A Maneuver Strategy," Engineering Memorandum No. 312/78-75, 13 November 1978 (JPL internal document).

Table 5-4. Maneuver Performance

	1	2	3	4	5	6	
Purpose	Calibration (-ΔV)	Change Ω	Calibration (+ΔV)	Launch Error Correction	Trim	Exact 3-Day Repeat	Cambridge Orbit
Date	8/15/78	8/10/78	8/23/78	8/26/78	9/1/78	9/10/78	10/26/78
Rev No.	705	748	820	863		1073	
Start Time (h:min:s GMT)	07:41:08	07:46:58	09:20:36	09:22:08	Cancelled	01:10:22	Power Failure Precluded Execution
Burn Duration (s)	60	84	60	439		28	
Predicted Δa (km)	-1.137	-1.531	+1.111	+7.426		+0.441	
Predicted Δe (x 10 <sup>-3</sup> )	-0.155	-0.205	-0.132	-0.645		+0.025	
Predicted Δω (deg)	-1.066	-2.261	-3.189	-43.648		+4.081	
Actual Δa (km)	-1.120	-1.515	+1.078	+7.483		+0.438	
Actual Δe (x 10 <sup>-3</sup> )	-0.154	-0.203	-0.127	-0.629		+0.025	
Actual Δω (deg)	-0.981	-2.163	-3.199	-45.367		+4.014	
Fuel Consumed (kg (lbm))	0.65 (1.43)	0.78 (1.92)	0.62 (1.36)	3.42 (9.52)		0.25 (0.55)	
Thrust Correction Factor (%)	-1.5 (-ΔV)	-1.0 (-ΔV)	-3.1 (+ΔV)	+0.8 (+ΔV)		-0.7 (+ΔV)	

of the VIRR the same failure had been experienced. As a protection against this failure mode, the VIRR launch configuration had been with the VIRR scan motor enabled and the scan mirror rotating. The plan was to maintain scan mirror motion throughout the flight whether or not the VIRR electronics were powered. Upon observance of the malfunction, the VIRR sensor manager was notified, and a contingency plan to restart the stopped mirror put into effect. The plan involved a sequence of rapidly executed motor start and stop commands which were intended to produce torques sufficiently high enough to free the frozen mirror drive train.

Coincidentally, on the same revolution the altimeter transmitter ceased operating. Four revolutions later the altimeter was turned off, pending analysis. Initially this was thought to be a sensor malfunction, but analysis showed that the transmitter had shut down normally in response to a low voltage on the satellite +28-V regulated bus. A complete analysis of the power situation indicated that the depth of discharge on the satellite batteries during sun occultation was much greater than anticipated. On rev 891 the batteries had dropped so close to total depletion that the battery voltage had dropped below the voltage regulator's capability to maintain regulation. Of the satellite equipment, only the altimeter had undervoltage protection and went into an automatic shutdown. This reduction in satellite loads was very probably essential to the recovery of the power system. Several problems led directly to the onset of the power problem: first, the satellite loads had been underestimated by some 50 W; second, the percentage charge on the batteries at automatic cessation of charging was over-estimated by about 30 percent (a fact which was not realized or reflected in the operations documentation until after mission termination); and, third, nearly all of the status passes available were in the northern hemisphere where Seasat was in sunlight. There was no opportunity to observe the satellite power subsystem performance during occultation.

By day 244 (1 September 1978) the power problem was sufficiently well understood so that the altimeter could be tested to determine if any permanent damage had occurred during the undervoltage period. The sequence used placed the altimeter in standby for one revolution, then transferred to the Track 1 mode as a test of the altimeter TWTA for about 8 min, then placed the altimeter back in standby. Analysis of the data indicated normal operation of the altimeter; thus, as the power situation eased on day 249 (6 September 1978), the altimeter was returned to operation on a 50-percent duty cycle which was increased to 60 percent the following day. On this day, during one of the status passes, the altimeter was observed to drop out momentarily in the real-time data. Again faced with apparently anomalous behavior of the sensor, mission controllers and the sensor manager elected to return the sensor to the standby state. In an effort to understand the problem, sensor engineers at WFC obtained a 78-h block of data from the Seasat tape recorders, and discovered 12 similar dropouts, all out of sight of the STDN sites scheduled to track Seasat. The fact that all were within the same northern latitude band and all were over land led the analysts to believe that this behavior was a normal instrument response to an observing condition. Further analysis together with ground tests performed upon the altimeter engineering model verified that the problem only occurred above a critical altitude over land when the altimeter would sometimes lose lock and go into a reacquire mode for the return signal. The ground tests further disclosed that there was some potential for damage to the instrument if the logic reset caused any of the transmitted pulse to enter the receiver.



The initial project decision was to preclude any altimeter operation except over the ocean on the Bermuda overflight revolutions. These were begun on rev 1074, day 253 (10 September 1978).

Attempts to restart the VIRR scan mirror had been periodically undertaken since the scan motor failure on rev 891. On rev 1099 on day 254 at 20:08:30 GMT (11 September 1978), the first measure of success was achieved; the motor drove the mirror for about 10 s, then stalled again. A repeat of the sequence on the next revolution produced the same results. On rev 1105 a similar sequence succeeded in restarting the motor, and it continued to operate through most of the day. At the beginning of the Orroal, Australia (ORR) status pass, however, the mirror had again stopped. Although efforts to restart the mirror continued, it did not run for more than 20 to 30 s at a time, and ultimately the restart efforts were abandoned.

By day 258 (15 September 1978) sufficient understanding had been gained about the altimeter performance and potential problems that the project was willing to accept the risks of returning to full-time operation of the sensor. The strategy adopted was to operate in the normal Track 1 mode over the oceans, but to switch to Test Mode 1, a CW mode, over major land masses to preclude the potential time race problems given loss of lock over land. Operation in this mode, together with further ground testing, suggested that testing of the flight sensor in Track 4 with a special set of parameters was warranted. These Track 4 tests were conducted with Seasat on day 265 (22 September 1978), and indicated that there was a Track 4 mode which was very close to normal Track 1 operation which would effectively preclude recurrence of the dropouts. The benefit of adopting this strategy was underscored by the observance of a dropout during the ULA status pass on rev 1284 on day 267 at 19:02 GMT (24 September 1978). The revised strategy, which called for Track 4 with the modified parameter set over the oceans, and Test Mode 1 over major land masses, was placed into operation at the beginning of the next operational cycle, cycle 014, beginning shortly after midnight, GMT, on day 268 (25 September 1978). This strategy was successfully employed throughout the remainder of the mission.

On day 272 (29 September 1978) indications in the SMMR telemetry were observed which were interpreted as signaling an incipient failure of sensor encoder A. As a precautionary measure, the ground command to select SMMR encoder B was sent to the satellite on rev 1372 on day 273 at 22:37:34 GMT (30 September 1978). Subsequent analysis indicated that the encoder A performance was normal after all, but the sensor manager decided that there was no advantage in transferring back to encoder A, so the selected encoder for the SMMR remained encoder B for the remainder of the mission.

#### H. POWER SUBSYSTEM FAILURE

Upon satellite acquisition during the status pass at Santiago, Chile (AGO) on rev 1503, mission controllers noted highly abnormal and apparently contradictory indications in the telemetry. The initial suspicion was a fault in the GSFC ground computer system. As a precaution, however, emergency tracking coverage by the next possible STDN station (ORR) was requested. A post-pass reprocessing of the AGO data indicated that the telemetry data observed was valid, and

not a computer artifact. This was verified upon contact of the satellite with ORR, where extremely low battery voltages and high discharge rates were confirmed. Downlink contact with Seasat was lost during the ORR rev 1503 pass on day 283 at 04:08:27 GMT, and never subsequently reestablished.

In an effort to pinpoint the problems which the satellite might have encountered, data was requested from one of the international tracking sites cooperating with the Seasat project, the station at Oakhanger, United Kingdom (UKO). Fortunately, UKO had tracked on rev 1503 just prior to the AGO pass. Processing of the UKO data upon receipt at GSFC showed that a massive power fault had occurred on day 283 at 03:12:01 GMT which resulted in depletion of the satellite batteries and termination of the mission.

After repeated attempts to reestablish ground communications with Seasat, the mission was officially terminated on 10 November 1978.

#### I. MISSION PLANNING SUMMARIES

The mission planning summary sheets, which represent the mission as flown from launch through loss of contact with the satellite, are presented in Appendix B.

## SECTION VI

### SURFACE TRUTH ACTIVITY

#### A. GENERAL

The surface truth program proved during the course of the Seasat project can be grouped into two principal phases; the pre-flight phase and the mission phase. These two phases of surface truth activity are discussed in the following paragraphs.

#### B. PRE-FLIGHT PHASE

The acquisition of surface observations coincident with measurements by aircraft-mounted Seasat prototypical instruments was required to complete instrument design specifications and to characterize the functional dependence of radar observables on geophysical parameters. The latter task provided the basis for the initial geophysical processing algorithms.

Several surface experiments, carefully designed to provide the necessary design and geophysical algorithm information, were conducted prior to launch, starting in CY 1975. Previous aircraft and, in some cases, satellite programs had provided the basic information upon which the feasibility and functional design of the instruments had been established.

Aircraft and associated surface truth data were collected in support of each of the Seasat sensors, and the objectives of the pre-launch phase were met. Two of the experiments, one each on the east and west coasts of the United States, turned out to be multi-institutional in nature, providing scientific data on near-shore wave, wind, and current processes.

Another task of the pre-launch phase was the development and calibration of under-flight sensors for the ALT ( $H_1/3$ ), SASS, and SMMR. Under-flight sensors were used in the mission phase as either secondary standards or radar-observable calibration systems.

#### C. MISSION PHASE

During the flight of Seasat, surface truth data were collected in a variety of ways. In addition to the aircraft under-flight sensor calibrations, data was acquired in the following three categories: routine data, special experiments, and extreme conditions. These three categories are described in the following paragraphs.

##### 1. Routine Data

The U.S. Navy's Fleet Numerical Oceanography Center (FNOC) supported the Seasat data analysis activity by providing all surface reports and selected field

data in the form of a computer-compatible tape called the Auxiliary Data Record (ADR). This invaluable data base included hundreds of wind, sea state, and sea and air temperature reports daily for the mission period. NOAA's National Environmental Satellite Service (NESS), in addition to coordinating special experiments, provided important support in two other areas. First, there was the cooperative vessel program, in which dozens of vessels provided surface observations at satellite over-passage times, using a printed log and an accompanying satellite position calculator. This package was designed and distributed by NESS with the support of the Seasat project. A second important additional data type provided by this service was a complete set of daily meteorological satellite visible and infrared imagery for the Seasat operational period. This imagery, produced by the Geostationary Satellites (GOESs) East and West, is particularly valuable in identifying and locating satellite observation of extreme conditions.

## 2. Special Experiments

As had long been planned, the project cooperated in and conducted, respectively, two major surface experiments during August and September. The first of these experiments was the multi-national Joint Air-Sea Interaction Experiment (JASIN), which was conducted in the eastern Atlantic Ocean near Scotland. An intensive study of the marine boundary layer and air-sea energy transfer was planned and conducted by a group of European and American scientists. JASIN provided a source of high quality surface truth data, much of which will be acquired for Seasat experimenters by way of data exchange agreements. A lead role in obtaining these agreements has been played by a group of European investigators with an interest in Seasat data (the Seasat Users Research Group in Europe (SURGE) headed by Dr. Tom Allen of the Institute of Oceanographic Sciences, Wormley, United Kingdom). Some 200 Seasat passes were obtained over the JASIN area during the experiment period. A NASA C-130 aircraft, equipped with a Seasat under-flight scatterometer built by the Langley Research Center (LaRc), participated along with several European and American research aircraft.

A Seasat-dedicated experiment was conducted in September in the Gulf of Alaska. Termed the Gulf of Alaska Seasat Experiment (GOASEX), this activity was planned and conducted by the National Oceanic and Atmospheric Administration (NOAA), including the Pacific Marine Environmental Laboratory (PMEL), NESS, the Atlantic Oceanographic and Meteorological Laboratory (AOML), the Wave Propagation Laboratory (WPL), and the National Data Buoy Office (NDBO). The principal research facility deployed during GOASEX was NOAA's Class 1 research vessel Oceanographer. The Canadian weather ships Quadra and Vancouver, alternating at ocean weather station PAPA, also obtained special data at satellite over-pass times.

Participating aircraft included the Ames Research Center's CV-990 equipped with an airborne version of the SMMR, the Johnson Space Center's MC-130B with the Seasat under-flight scatterometer, the Naval Research Laboratory's RP-3A equipped with meteorological and microwave radiometer instrumentation, and the Canadian CV-580A aircraft carrying the Environmental Research Institute of

Michigan's synthetic aperture radar system. A very comprehensive data set was collected, corresponding to some 60 satellite passes, including more than a dozen SAR passes. An intensive, coordinated study of this data set was planned as a key element in the early evaluation activity.

### 3. Extreme Conditions

The observation of high wind and sea state conditions require collecting data in several storms. It is fortunate that Seasat data was obtained over dozens of hurricanes, typhoons, and tropical storms in the Atlantic and Pacific Oceans and the Gulf of Mexico. Further, many of these conditions were observed simultaneously, or nearly so, by aircraft, surface vessels, and meteorological satellites. An example of Seasat surface truth data obtained on a hurricane is the data set collected on hurricane Fico during July. During the interval 7-20 July, this storm was observed repeatedly, as it moved to the west from the longitude of Baja California to a region west of Hawaii. SAR images obtained over the central region of the storm on 7 July have yielded sea surface and wave imagery in regions undetectable using visual or infrared sensors, and should provide an otherwise unobtainable data set useful to a study of wave generation and propagation in cyclonic storms.

The hurricane was observed by the scatterometer some three weeks later near Hawaii. A good surface truth data set is available for this observation in the form of meteorological aircraft and ship reports, as well as cloud motion measurements using meteorological satellite imagery. The comparisons made to data between the surface truth data and the SASS-derived winds show a good correlation for this storm. Fico also yielded extreme condition observations for the SMMR, ALT, and VIRR. SMMR data will provide a comparison to SASS winds and, more importantly, a well-documented test case for SASS path attenuation and ALT refraction corrections. For the ALT, Fico and similar intense storms will provide data on significant wave height ( $H_{1/3}$ ) for the upper end of the measurement range.

## SECTION VII

### COMMERCIAL USER ACTIVITY

#### A. INTRODUCTION

Within the Seasat program a set of user-oriented activities on data utilization were planned and are being conducted. One activity involved the use of the data by the commercial ocean community in a set of modest, cooperative experiments or demonstrations involving representative segments of that community. The posture of this commercial user demonstration was necessarily modified following the early termination of the mission to maximize the use of the Seasat data without the benefit of real-time observations from the satellite. This section describes the commercial program as it was originally planned, as well as the structure and plans in its modified form.

Seasat was a product of user interest. A community of users established the concept of Seasat and, beginning early in 1973, guided the program from the early phases of requirements definition through the processes required to establish Seasat as a "new start" in 1975. These users continue to be the architects of a program intended to serve the agencies, institutions, and private concerns that are the projected users of Seasat data and other missions that may stem from Seasat. Their participation has ensured that user needs match the types and quantities of data to flow from the Seasat satellite and ground system.

A Seasat benefits assessment, completed in 1975, identified substantial potential benefits from the use of operational Seasat data. The majority of these potential benefits, summarized in Table 7-1, were identified to be within the commercial ocean community, in areas such as marine transportation, ocean fishing, and off-shore oil and natural gas exploration and development. Commercial activities in the Arctic regions showed particular potential for realizing economic benefits from improved ocean condition data.

The benefit estimates made in the Seasat economic assessment are largely based upon empirical evidence and best estimates of the expected impact of operational Seasat data in the areas of maritime activity which were considered in the assessment. The launch of Seasat and the subsequent analysis of its data will provide the first opportunity to obtain experimental evidence of the effects of Seasat data on the economic performance of selected areas of maritime activity.

As a result of specific proposals presented to NASA by a group of commercial users, NASA implemented a demonstration program to assess the utility of Seasat data in the commercial sector. The origin and evolution of this group of commercial users is shown in Figure 7-1. Seasat data transferred to Fleet Numerical Oceanographic Center (FNOC) for real-time processing was to be used to support industrial users. NASA provides for some additional processing of FNOC information to meet experiment participants' needs. The assimilation and operational use of the data will be accomplished using the participants' resources.

Table 7-1. Summary of Most Likely Range of Benefits for an Operational Seasat Planning Horizon to Year 2000

Industry or Sector	Factors	Integrated Benefit (\$ 1975 Millions) <sup>a</sup>
Off-shore oil and natural gas	Ocean condition forecasts: loss avoidance-labor cost, accident reduction. Platform load factors	214-344
Coastal zones	Improved prediction (landfall) capability: economic loss avoidance	3-81
Arctic operations	Optimum routing of ice-breaking tankers	96-288
Marine transportation	Improved ocean condition forecasts, improved weather routing, improved ship designs, reduced insurance rates	215-525
Ocean fishing	Improved ocean condition forecasts, adverse weather avoidance, improved fisheries management	274-1432
Ports and harbors	Improved precipitation forecasts, improved longshore labor utilization	0.5
	TOTAL	802-2670

<sup>a</sup>10% discount rate

Industry users offered the use of approximately \$20M of their capital equipment and approximately \$1M of operating capital and personnel services for data analysis, industrial distribution, and civil sector assessment. The cost to NASA to undertake this important industrial assessment is approximately \$3M. The elements of this cost-sharing arrangement are shown in Table 7-2.

Through the use of Seasat data in a series of carefully designed experiments or demonstrations, it should be possible to obtain information which will begin to qualify the validity of the earlier benefit studies. In addition, it will be useful in guiding the design of future oceanographic satellite systems to emphasize those characteristics that are of economic importance to the civilian

ORIGINAL PAGE 13  
OF POOR QUALITY

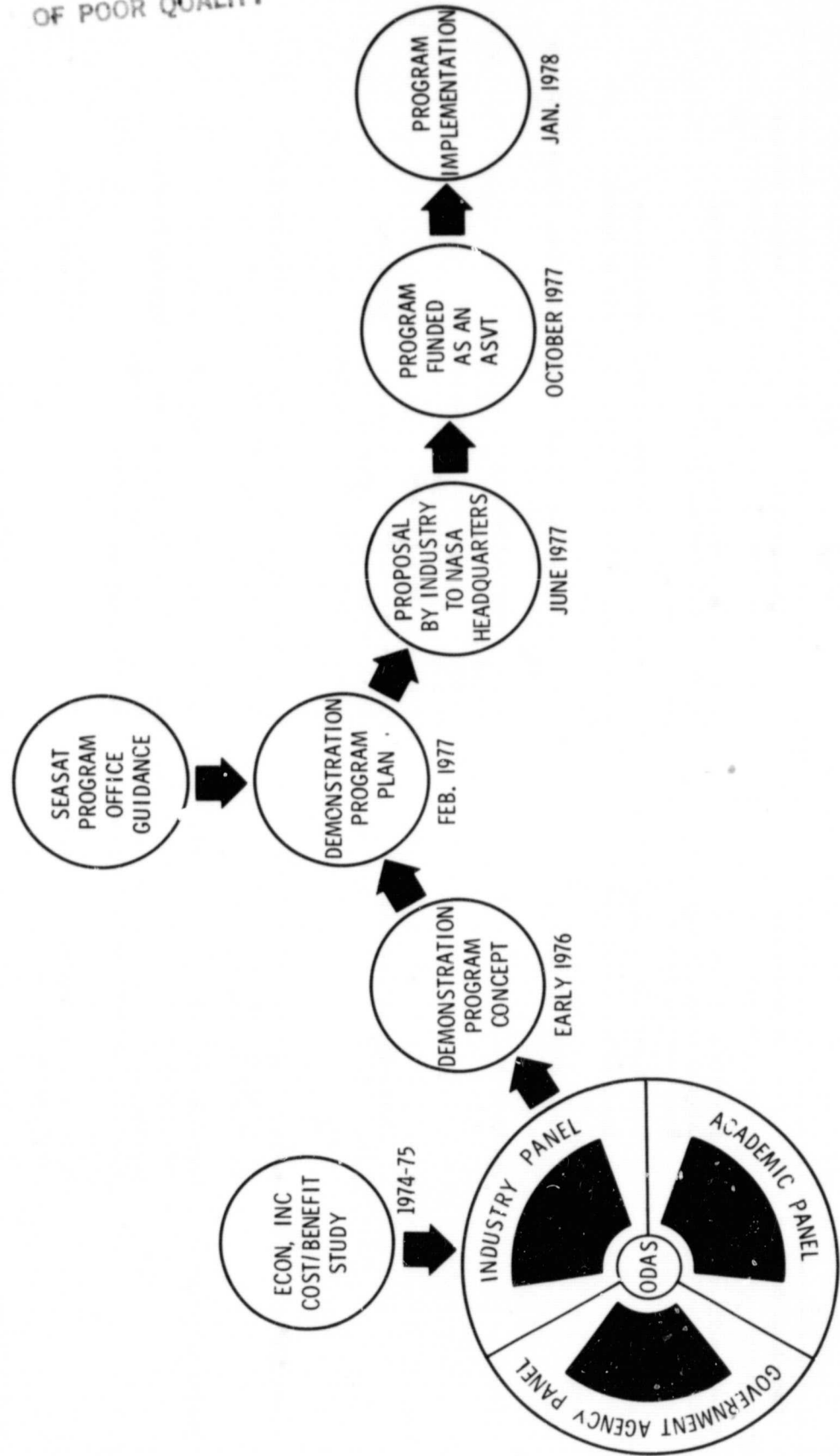

Figure 7-1. Seasat Commercial Demonstration Program Origins and Evolution



Table 7-2. Potential Investments of Commercial Users Participating in the Industry Demonstration Program

Commercial Sector	Organizations	Application	Area of Interest
Off-shore Oil and Gas	1. Gulf Oil of Canada Ltd. Canadian Marine Drilling Ltd. Esso Resources Canada Ltd.	Improve oil and gas exploration in the ice-infested waters of the Beaufort Sea.	Beaufort Sea
	2. Total Eastcan Exploration Ltd.	Monitor sea ice in the Labrador Sea	Labrador Sea
	3. American Gas Association	Detect storm development in the Gulf of Mexico.	Gulf of Mexico
	4. Continental Oil Co.	Detect storms and hurricanes in the Northeastern Atlantic.	North Sea, Baltimore Canyon
	5. Getty Oil Co.	Detect storms and hurricanes in the following locations: Off-shore West Africa, U.S. East Coast, Northwest Australia, Curacao, Argentina, Tunisia, Norway, and Spain.	
	6. Alaska Oil and Gas Assoc.	Evaluate the utility of SAR data in off-shore petroleum operations in the ice-covered areas in the Bering Sea.	Bering Sea
Ocean Mining	Deepsea Ventures, Inc. Kennecott Exploration, Inc. Lockheed Ocean Laboratory	Access SAR data for ocean mining, design, and exploration operations.	Tropical Pacific
Marine Fisheries	North Pacific Fishing Vessel Owners Assoc. (Alaska Crab Fishery)	Ice observations in the Bering Sea.	Bering Sea
	National Marine Fisheries Service/NOAA - (Coordinating 20-30 tuna and albacore vessels).	Study ocean conditions (wave and storm patterns) in the Pacific tuna and salmon fishing regions.	Tropical Pacific
Marine Safety	Marine Advisory Service - (Coordinating 10-15 salmon vessels) International Ice Patrol (USCG)	Survey icebergs and sea ice in the North Atlantic. Study drift properties of icebergs.	U.S. west coast Baffin Bay, Labrador Sea, North Atlantic
Marine Transportation	Oceanroutes Sun Shipbuilding and Drydock Co.	Operational forecasting for World's oceans.	Global

ORIGINAL PAGE IS  
OF POOR QUALITY

sector and commercial users. A third purpose of these demonstrations will be to bring the process of technology transfer from NASA to the expected user of an operational Seasat system.

## B. COMMERCIAL USERS

It is generally believed that the commercial ocean community is still suffering from inadequate scan weather data. This fact directly results in annual economic losses in the tens of millions of dollars and in the significant loss of life.

Even with the technological advances achieved following the launch of the first U.S. meteorological satellite in April 1960, the present global weather data base is still seriously deficient. While the advent of computers has produced some gains in the accuracy of weather and ocean condition predictions, continued improvements are hampered by the lack of observations over the ocean areas.

Satellite-derived cloud cover and infrared temperature data, while valuable in their own right, in general lack correlation with wind and wave information and often do not penetrate cloud cover to measure ocean surface conditions.

Long-range weather forecasting for both continental and ocean areas is dependent upon a space and time dense initialization of wind, temperature, and pressure data. It is estimated that observations of ocean conditions in about the same frequency and spatial density as available now for the continents will be required for one week-weather forecasting.

To illustrate the current situation for the commercial ocean community, it is useful to review several segments of this community in terms of their specific operating deficiencies, and the improvements they anticipate as a result of the data to be supplied by Seasat and future Seasat-type spacecraft.

Consider first the ocean forecast industry itself, including those industries providing optimum weather routing and environmental forecasting services to the marine transportation and off-shore oil industries. As previously mentioned, the use of computers has produced a gain in the accuracy of weather predictions, beginning in the mid-1950's, as illustrated in Table 7-3. This steady increase in utility has been tempered because the absolute level of skill is still low. Since about 1970, the lack of observations over the ocean areas has become one of the dominant conditions inhibiting progress. It is expected that Seasat, by improving the now sparse ocean observations, particularly in regions where weather is generated, will be a major advance in this critical area.

The steps necessary for moving the skill of weather prediction past the threshold of usefulness are:

- (1) Increased observations over the oceans on a regular basis to support analysis on a grid as fine as 60 nautical miles (111 km).

Table 7-3. Computer Weather Prediction Accuracy, 1950-1976

Year	Percent		Comments
	Surface	500 MBS	
1950-1955	10	10	Manual Procedures; Extrapolation
1956-1959	12	15	Simple Computer Model; One Level
1959-1962	14	27	Improved Theory; One Level (Still)
1963-1966	25	30	Three Computational Levels
1967-1970	35	45	Complex (PE) Model; Six Levels
1971-1972	47	58	Improved Physics, Best Year
1973-1976	40	47	Computer and Numerical Model Testing

0 - No Skill  
 100 - Perfect Forecast

- (2) Increased computer power to handle the necessary volume of computations in realistic time (30-60 million floating point operations a second).
- (3) Improved model physics and mathematics, including boundary layer and initial state specification.

Step 1 will be attainable in the early 1980's through such programs as Seasat. The computers with the capacity required for step 2 will be available to weather prediction groups in the same time frame. The research specified in step 3 can then proceed.

Table 7-4 shows the increase in weather prediction skill over North America achieved in the past two decades. Table 7-5 projects the state of the art attainable for the years 1980-1985.

The modest gains shown here are of much greater relative economic importance because a threshold will have been attained and passed. The attainable accuracy for 1985 would result in a remarkable reduction in weather losses suffered by

Table 7-4. Computer Weather Prediction Accuracy, 1977-1985

Year	Percent		Comments
	Surface	500 MBS	
1977-1979	52	62	Medium Resolution Models. Improved Data Communications
1980-1982	50	74	Better Data Coverage Due to First Global GARP Experiment and Seasat
1982-1985	65	80	Adequate Computers, Satellite Data Base, Improved Data Assimilation, and Boundary-Layer Physics

0 - No Skill  
100 - Perfect Forecast

Table 7-5. Computer Weather Prediction Projections, 1980-1985

Year	Reports Daily
1976	
Surface Land Reports	18,000
Ship Reports	2,600
Upper-Air Soundings (Radiosondes)	1,200
Aircraft Reports	1,900
Bathythermograph Reports	150
(Satellite) Upper-Level Wind Vectors	150
(Satellite) Temperature Profiles	1,200

Table 7-5. Computer Weather Prediction Projections,  
1980-1985 (Continuation 1)

Year	Reports Daily
1980-1985	
Satellite Measurements	
Temperature/Humidity Profiles	20,000
Marine Wind Vectors	300,000
Spectral Sea-State Reports	15,000
Sea Surface Temperatures	50,000

sensitive ocean industries. The impact of using Seasat data on the weather routing services industry, as reflected through improved forecasts to the marine transportation community, will cause a reduction in time underway, a reduction in hull and cargo damage, a reduction in fuel consumption, and an increase in ship utilization.

The marine transportation industry operating in the North Atlantic regions is frequently required to follow longer more southerly routes to avoid icebergs. Increases in transit time of several days can result from these more southerly routes. The U.S. Coast Guard International Ice Patrol (IIP) sets the iceberg limits which constrain the courses that vessels must follow on North Atlantic crossings. The IIP established the iceberg limits on the basis of several factors, including aircraft observations of icebergs and knowledge of winds, ocean currents, and sea surface temperatures which serve as inputs to computerized iceberg drift and deterioration models. Prolonged periods of fog and limited aircraft endurance frequently limit visual observations from aircraft, and sparse measurements of winds, currents, and temperatures in the regions of interest create inaccuracies in drift and deterioration model forecasts. As a consequence, the IIP may often set iceberg limits conservatively to the south to ensure vessel safety. Seasat can improve IIP predictions through its all-weather capability to observe ice features and to provide wind, sea slope, and sea surface temperature measurements on a frequent, spatially dense basis. The result should be more efficient IIP surveillance operations which will directly shorten transatlantic shipping times.

Recent increases in the costs of both natural gas and oil, coupled with its growing scarcity in the more accessible regions of the world have given the off-shore oil and gas industry incentives to explore in the more severe and

remote environments. It has proven difficult and expensive to acquire environmental data, including ocean condition data, in these areas. Environmental data is essential to the exploration and production of hydrocarbons. Economic and safety considerations include vessel selection and routing, weather forecasting to set weather windows for seismic exploration and drilling, platform towout and construction activities, and forecasts to enable maximum, safe, day-to-day operating schedules. Additionally, this industry has need for higher quality continuous historical data to refine platform design criteria. The cost of acquiring environmental data on an in situ basis is high. Basic conventional instrumentation programs can easily exceed \$200,000 to \$400,000 a year for each station and the often severe environments contribute to a high failure rate in instrumentation. It is anticipated that Seasat can impact the off-shore oil and gas industry by providing ocean condition measurements such as winds, waves and surface temperatures to ensure higher quality continuous historical data. Use of this data should contribute to improved ocean forecasts, thereby reducing exploration, construction, and production time spent waiting on weather conditions.

Commercial marine fisheries interests in the United States have particular need for accurate ocean condition information, since weather affects all aspects of their operations. Wind and wave conditions affect such factors as the ability of vessels to safely leave and return to port, to deploy and recover fishing gear, to minimize the travel time between the fishing grounds and processing facilities, to reduce "dead loss" of live crabs, and to avoid hull, fishing gear, and other structural damage. Wind conditions in coastal regions can create up-welling phenomena, producing nutrient rich waters where many fish species can be efficiently caught in commercial quantities. Ocean temperatures often delineate narrow boundaries within which certain species travel in productive quantities. Such is the case for several species of tuna and salmon. Ocean temperatures often affect the quality of "tanked" crabs, which require a narrow range of water temperatures to maintain their vitality. The Alaskan Crab Fishery, because of fall and winter operations, experiences excessive gear losses each year due to pack ice movements. Weather forecast information available to most fishing vessels has often been unreliable and radio transmissions, particularly in Arctic regions, are often weak. Data from Seasat, particularly those data sets used in analysis and forecast products, offer the commercial fisherman an opportunity to use more reliable and timely ocean condition information to improve the overall efficiency and safety of his enterprise. Fuel costs can be minimized by reducing search and transit times, gear losses can be minimized by permitting recovery operations to begin with adequate lead time, catch statistics can be improved by identifying potential areas of up-welling and optimum temperatures, and casualty rates of men and vessels can be lowered by avoiding regions with adverse ocean and ice conditions.

#### C. COMMERCIAL DEMONSTRATION PROGRAM

The potential benefits that Seasat and future Seasat satellites can provide to the commercial ocean community are potentially large. The economic assessment performed early in the Seasat program affirmed this fact.

The concept embodied by the Commercial Demonstration Program is quite straightforward. The program consists of a series of demonstrations in several

major areas of ocean commerce, including offshore oil and gas exploration and development, marine transportation, marine fisheries, and maritime safety. The experimental concept covering each of the candidate demonstrations required NASA to provide for the transfer of Seasat data to FNOC for real-time processing and assimilation into forecast products. These FNWC products are "tailored" to each user's needs and are delivered to each participating user. The assimilation and use of these products are both the financial and technical responsibility of the participating users, who were to use these products in their commerce for the duration of the two-year demonstration period, at which time they each would prepare a report describing the degree to which the Seasat data had an impact upon their enterprise.

A key element in the Commercial Demonstration Program concept is that, as a pilot evaluation, it has a definite end point. Assuming experimental success, however, the commercial use of the data from both Seasat and follow-on Seasat systems could be expected to continue. However, such continuation would be under the auspices of operational government agencies. These government agencies (NOAA and others) will supply the data needs of the users, who will either bear or share the costs of using the ocean data products.

Based, in part, upon both the commitment from private industry and the ability of the Seasat-derived data to meet the experimental need, a group of candidate experiments have been organized within the demonstration program. Table 7-6 identifies these candidate demonstrations, as originally planned and some of the key commercial interests involved in them. As illustrated in Figure 7-2, the demonstration program tends to be global in nature, although there are some experiment concentrations in the Arctic regions and the coastal zones of North America.

In contrast to most scientific users, whose data needs can be generally fulfilled on a non-real-time basis, commercial users must be furnished data products on a real or near-real-time basis. The data processing and distribution system devised for the Commercial Demonstration Program provides for the near-real-time distribution of data products to each participating user. In addition, the system allows for timely user feedback to modify products for improved assimilation and use. Such feedback provides essential data to aid in defining the characteristics of a ground processing and distribution system suitable for use with future operational Seasat systems. Figure 7-3 also illustrates the basic processing and distribution flow to be used in the Seasat commercial program. As shown in Figure 7-3, the global data (which excludes the SAR data) was transmitted to NASA ground stations and immediately retransmitted to FNOC by a commercial communication satellite (selected stations required the use of land line transmission). At FNOC, the Seasat data was to be used in the preparation of forecast products. Unclassified forecast products were to be transferred at roughly six-hour intervals to each participating user. The method for transferring products varies as a function of the user's needs and operational areas. Some users choose to receive products through a terminal which accesses the NASA computer at FNOC. Other users, particularly participating vessels, receive products at sea by facsimile broadcasts. This capability is illustrated in Figure 7-4. The locations of the original users participating in the Commercial Demonstration Program is shown in Figure 7-5.

Table 7-6. Analysis and Evaluation of Seasat Data by the Commercial Sector

User Category	User	Resource Available to NASA		Incremental Cost to Participate in Program (\$, Thousands)
		Description	Estimated Value (\$, Thousand)	
Offshore Oil, Gas and Mining	CONOCO	Instrumentation at eight EXP locations	9,000 to 12,000	480 to 600
	Union Oil API Getty Oil AOGA Exxon EPOA APOA Kennecot	Labor for data analysis (40 to 60 mm/year) ships, platforms, buoys, aircraft	320 to 520 --	
Ship Routing	Sun Ship	Two RO/RO vessels	--	40
		Instrumentation Labor and computer usage	150 800	
Marine Fisheries	Ocean Routes, Inc.	Software, computer usage and labor	70	72
		IATTIC	55 Tuna fishing vessels with FAX receivers Data collection and access to IATTA data base	
Ice Operations	Salmon and Albacore Fisheries	12 Fishing vessels and crews (vessel cost \$38,000 to \$50,000)	--	15
		Alaskan Crab Fisheries	10 Fishing vessels and crews (Charter cost \$1,500 to \$2,000 per day)	
Offshore Environmental Forecasting	Sun Ship	Ship design software and computer usage	--	33
		Ocean Routes, Inc.	Five semi-submersible rigs Instrumentation Data collection and reduction (labor)	
Ice Reconnaissance	International Ice Patrol	Oceanographic research vessel (46 ship days) HC 130B aircraft (186 flight hours) Data collection and reduction	-- --	87 100

ORIGINAL PAGE IS  
OF POOR QUALITY



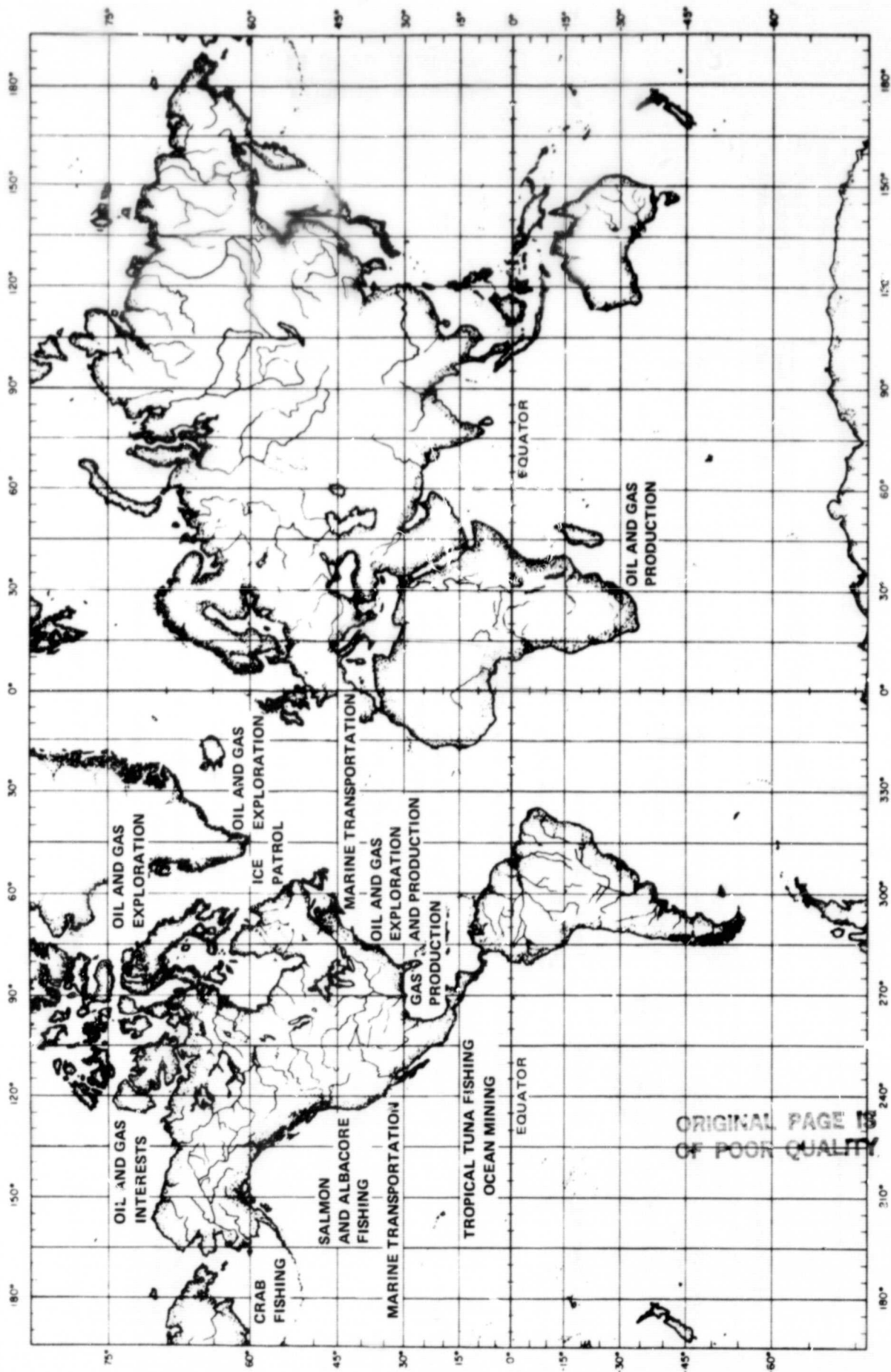

Figure 7-2. Global Commercial Applications of Seasat Data

ORIGINAL PAGE IS  
OF POOR QUALITY

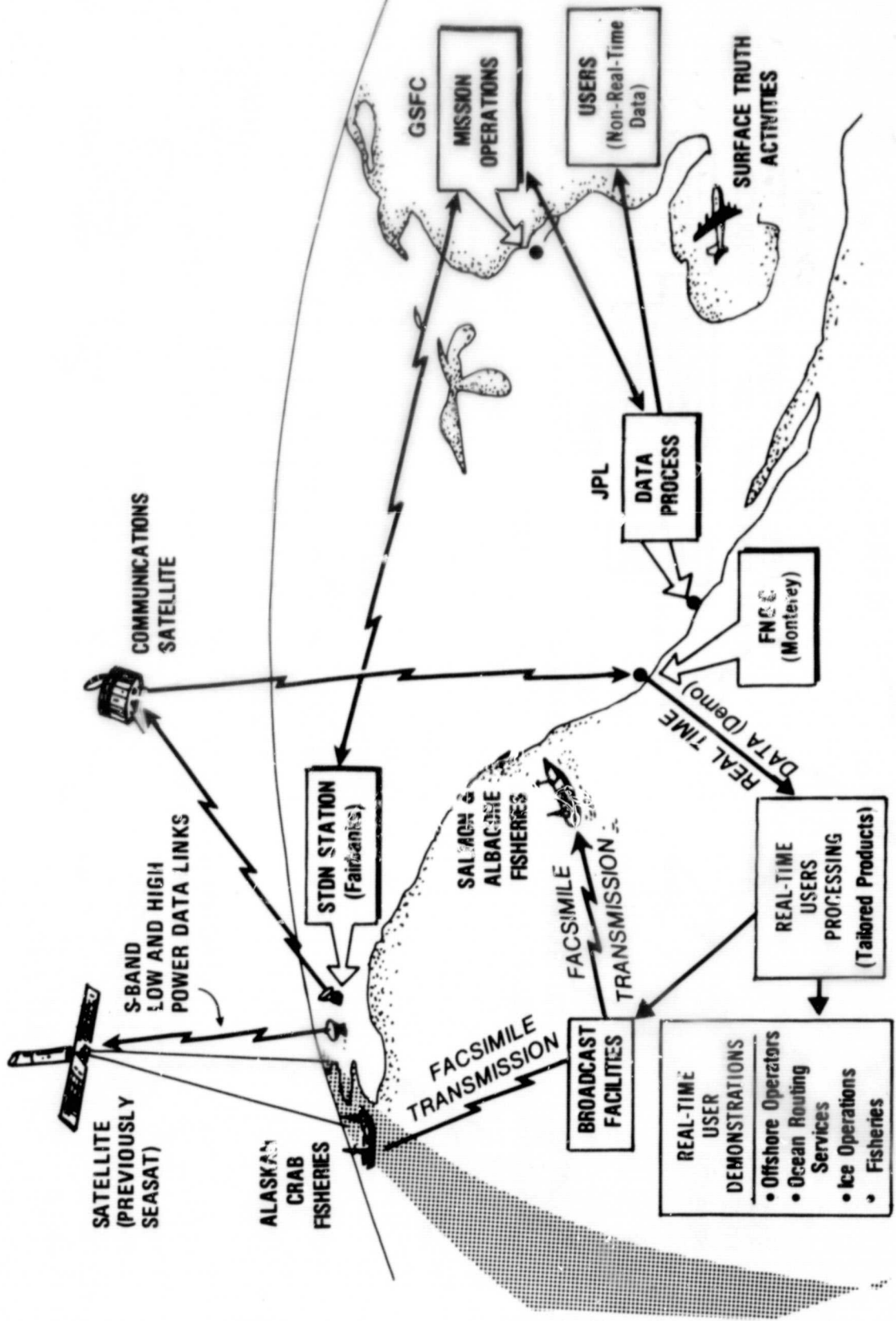

Figure 7-3. Seasat Commercial Data Processing and Distribution

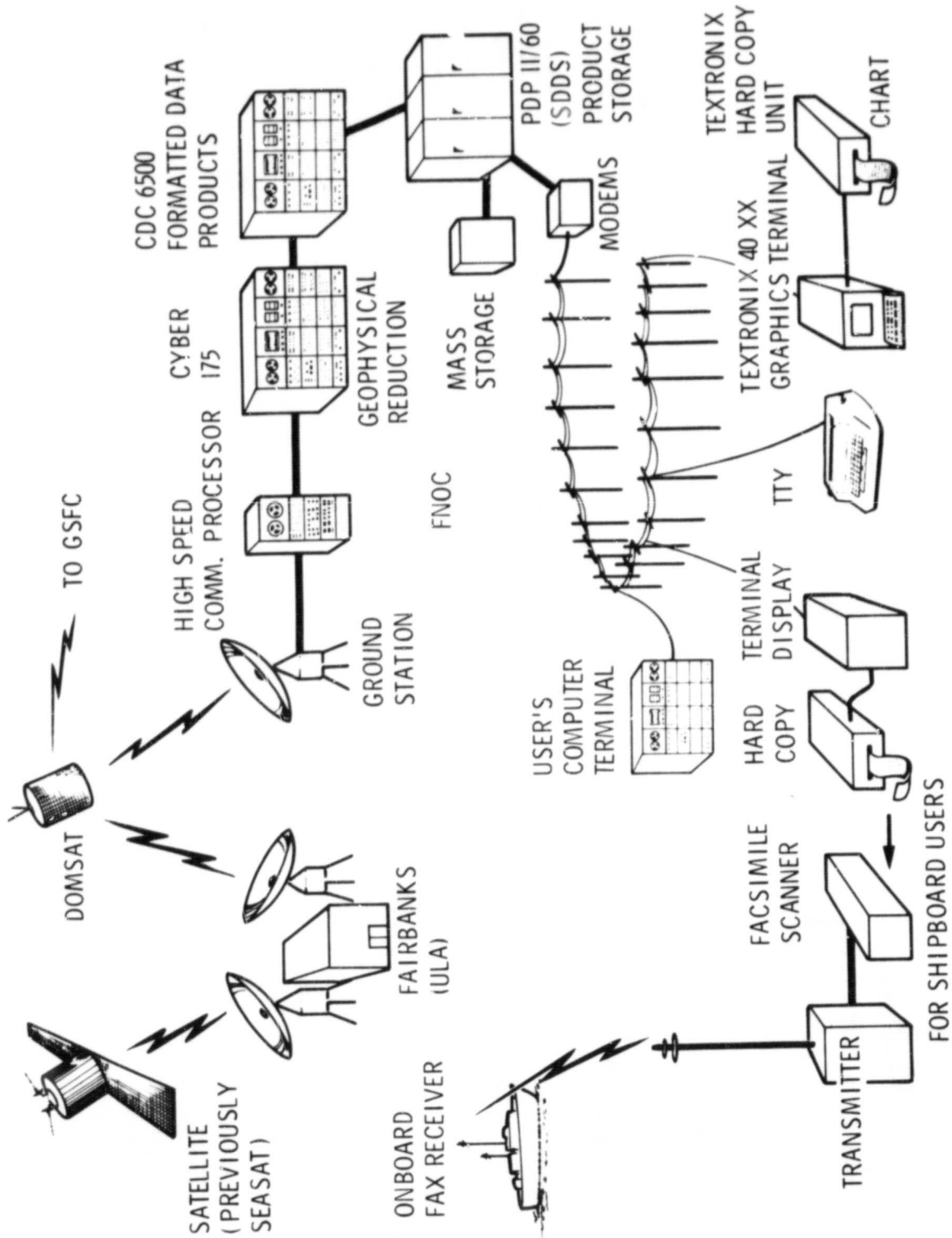

Figure 7-4. Commercial Demonstration Program System Configuration

C-2

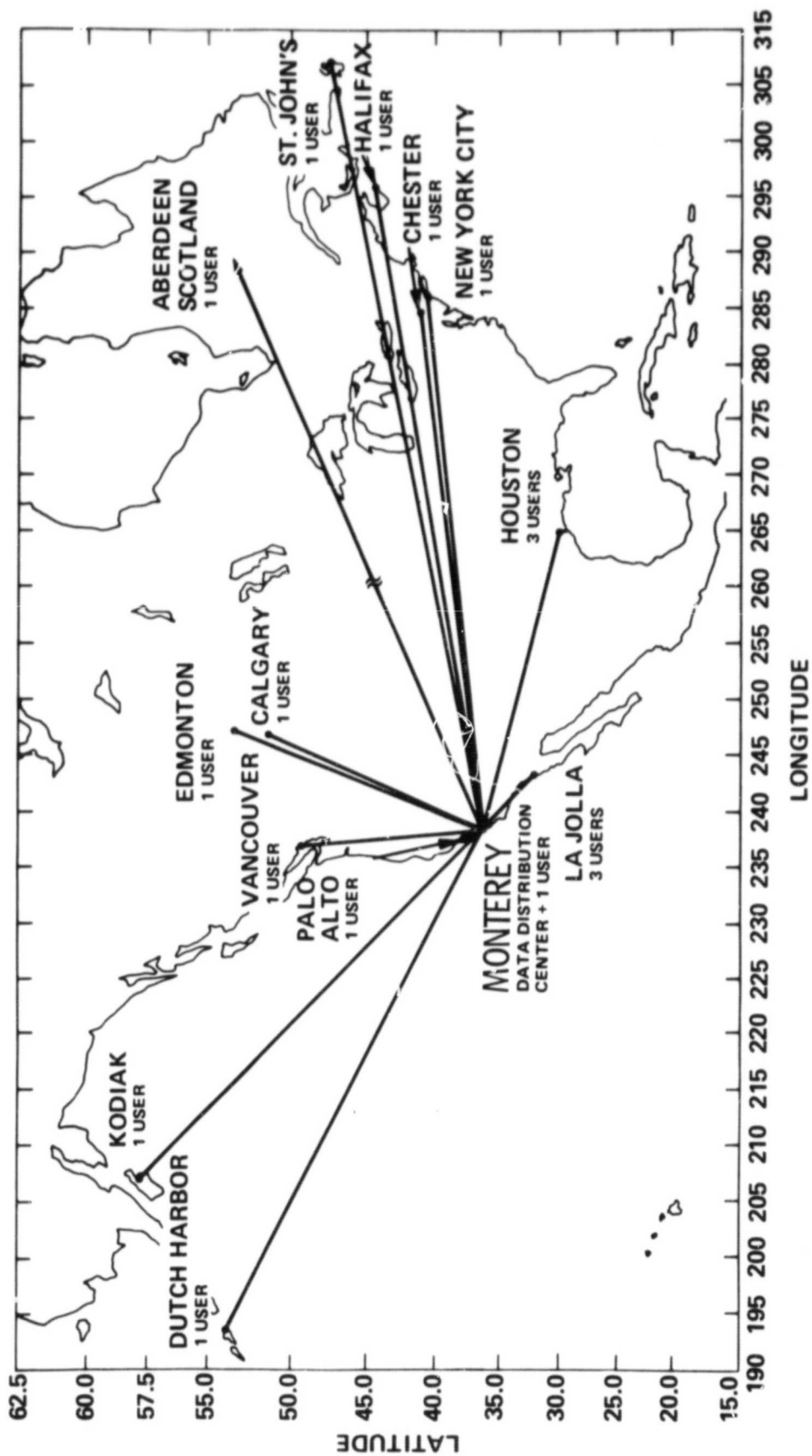

Figure 7-5. Commercial Demonstration System User Locations

#### D. PROGRAM MODIFICATION

The early termination of satellite data acquisition has required the modification of the Commercial Demonstration Program since its principal structure required real-time data delivery. A restructuring of the Commercial Demonstration Program in response to the use of the real-time satellite data stream was accomplished as the result of a users' workshop held on 30 October 1978. With the exception of one or two users whose original demonstrations had key seasonal dependencies, all commercial organizations in the original program elected to continue their participation and support of the program under the terms of the original agreement. In the absence of real-time satellite data, many of the original program objectives had to be achieved using non-real-time Seasat data, combined with suitable analysis and simulation. To complement the use of the non-real-time data analysis, a limited operational demonstration was implemented which used the system capability developed with FNOC for the processing and distribution of real-time ocean products. The determination of key features of the elements of an operational system is possible through this demonstration with the commercial users.

The modified or restructured program, therefore, included three main elements: (1) case studies, using non-real-time Seasat data; (2) a real-time demonstration, involving the FNOC and its standard ocean forecast products; and (3) a user transfer activity directed at achieving an alignment of the Seasat commercial users with the agency or agencies (NOAA and others) who will have responsibility to some commercial users with ocean products from operational oceanographic satellites.

Some 13 commercial users representing a full cross-section of the commercial ocean community will carry out case studies with Seasat data and with user-derived surface truth data and historical data bases. Fifteen of the commercial users will participate in the real-time demonstration, receiving ocean condition (winds, wave lengths, and sea surface temperature) products from FNOC on a daily basis for application in their operational and decision-making activities. Four commercial firms of Canada will participate on a cooperative basis in the program through the auspices of the Canadian Surveillance Satellite Project (SURSAT). The Canadian users will participate in both the case study activities and the real-time demonstration, with each user bearing the costs associated with the transmission of the data from FNOC to their respective locations. Table 7-7 summarizes the demonstration activities (using non-real time and real-time data) of the participating users. Figure 7-6 shows the locations of those users participating in the modified real-time demonstration, while Figures 7-7 and 7-8 illustrate the geographical regions in which each of the user's demonstrations, both real- and non-real-time, are to be conducted.

The Commercial Demonstration Program is planned as a three-year effort with the last two years devoted to utilizing the data products, analyzing the results obtained from their use, and reporting these results to NASA. A summary schedule is shown in Figure 7-9, which depicts the schedule associated with the key events in the program. Present plans call for the completion of the program in FY 80.

Table 7-7. Participating Commercial Users Case Studies

Demonstration Title	Participating Organizations	Nature of Demonstration
*1 Beaufort Sea, oil, gas, and arctic operations	Canadian Marine Drilling, Ltd., ESSO Resources, Ltd., Gulf Oil of Canada	Comparison of Seasat and other radar data against surface truth. Evaluate ability of satellite data to benefit oil and gas operations in Beaufort Sea
*2 Labrador Sea oil, gas, and sea ice	ESSO Resources, Ltd., Total Eastcan Exploration, Ltd.	Comparison of Seasat wind, wave, and ice data against surface truth data. Evaluate utility of data for aiding off-shore facilities design and production operations in Labrador Sea
*3 Gulf of Mexico pipelines	American Gas Assn	Evaluate ability of Seasat data to improve storm prediction capability for determining ocean bottom conditions as they affect subsurface pipelines
*4 U.S. east coast off-shore oil and gas	Continental Oil Co.	Comparison of Seasat data against surface truth data from instrumented platforms. Develop data base for improved structural design and production operations
*5 Worldwide off-shore drilling and production operations	Getty Oil Co.	Develop data base to aid in operations planning. Comparison of Seasat data against surface truth data to determine benefits to offshore drilling and production operations
*6 East Pacific ocean mining	Deepsea Ventures, Inc., Kennecott Exploration, Inc., Lockheed Ocean	Evaluate ability of Seasat data to improve prediction accuracy of severe storms in tropical Pacific to aid deep sea mining operations.

Table 7-7. Participating Commercial Users Case Studies (Continuation 1)

Demonstration Title	Participating Organizations	Nature of Demonstration
*7 Bering Sea ice project	Alaska Oil and Gas Assn, Arctic Research Subcommittee	Assess ability of SAR data to identify ice characteristics in Bering Sea to aid in determining ice loads on off-shore drilling and production structure
8 North Sea oil and gas	Union Oil Co., Continental Oil Co.	Use of Seasat data to develop improved design load data for off-shore drilling and production structures
*9 Marine environmental forecasting in Gulf of Alaska	Ocean Routes, Inc.	Use of Seasat data in generating improved ocean condition forecasts in North Sea to aid off-shore oil and gas drilling and production operations
*10 Ocean thermal energy conversion	Ocean Data Systems, Inc.	Use of Seasat to aid in evaluation and selection of plant sites for ocean thermal energy conversion facilities
11 Ice monitoring for tanker design	Sun Shipbuilding and Dry Dock Co. (Withdrawn from program)	Use Seasat SAR data to evaluate structural changes in ice pressure ridges as a means of selecting optimum routes and defining optimum power design for ice breaking tankers
*12 Ship navigation and simulation	Sun Shipbuilding and Dry Dock Co. (Withdrawn from program)	Integrate Seasat data into routing model to determine fuel consumption versatility and ship performance optimization as a function of trade routes
13 International ice patrol northern survey	U.S. Coast Guard	Demonstrate feasibility and benefits of conducting pre-season survey of icebergs and sea ice in Labrador and Baffin Island coasts using Seasat SAR data in place of aircraft reconnaissance

Table 7-7. Participating Commercial Users Case Studies (Continuation 2)

Demonstration Title	Participating Organizations	Nature of Demonstration
Drift analysis	U.S. Coast Guard	Use of SAR data to observe repetitive iceberg drifts for use in ice drift model. Improve reliability of ice limits in north Atlantic shipping lanes
*Environmental data	U.S. Coast Guard	Evaluate use of Seasat wind and SST data in drift model to improve knowledge of iceberg position and deterioration
*14 Optimum ship routing	Ocean Routes, Inc.	Use of Seasat data to improve forecasts used in developing optimum ship routing information for various marine transportation operators
*15 Alaskan crab fisheries - Dutch Harbor	North Pacific Fishing Vessel Owners Assn	Use of ocean condition forecasts incorporating Seasat data to aid in improved planning and executing crab fishing operations in Bering Sea
*16 Alaskan crab fisheries - Kodiak (marginal participation)	University of Alaska	Use of ocean condition forecasts incorporating Seasat data to aid in improved planning and execution of crab fishing operations in Bering Sea and along Aleutian Island chain
*17 Tropical and temperate tuna fisheries	National Marine Fisheries Service, Southwest Fisheries Laboratory	Use of ocean condition data from Seasat to aid in possible improvement of planning and executing tuna and albacore fishing operations in Pacific regions



Table 7-7. Participating Commercial Users Case Studies (Continuation 3)

Demonstration Title	Participating Organizations	Nature of Demonstration
*18 Pacific salmon fishery	Oregon State University/Marine Advisory Program and Humbolt State University/Marine Advisory Service (participating vessel)	Use of ocean condition forecasts incorporating Seasat data to improve planning and fishing operations of salmon vessels operating along U.S. Pacific coast
°19 North American goose nesting habitat (marginal participation)	Department of Interior, U.S. Fish and Wildlife Service	Assess utility of SAR data to observe ice conditions in Yukon-Kuskokwim delta to determine state of nesting conditions of arctic geese as a means of determining fledgling population and subsequent hunting regulations
*20 Improved real-time weather forecasting	Atmospheric Environmental Service (Canada)	Use of Seasat data as synoptic observations in preparation of ocean and weather analyses and forecasts. Determine what improvements in forecasts may result

\*Real-time data product users.  
°Non-real-time data product users.

ORIGINAL PAGE IS  
OF POOR QUALITY

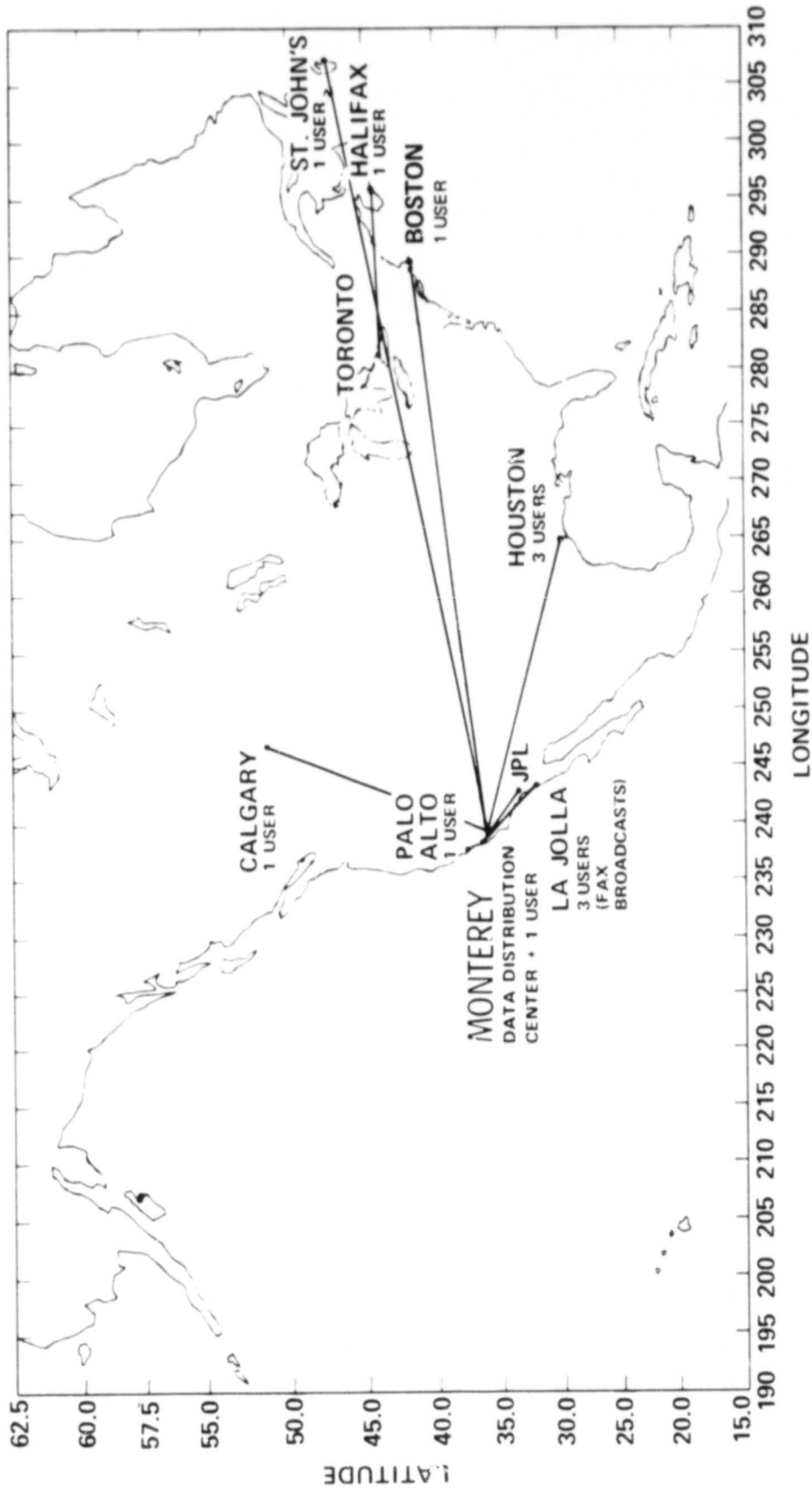

Figure 7-6. Commercial Demonstration Program Real-Time User Locations



ORIGINAL PAGE IS  
OF POOR QUALITY

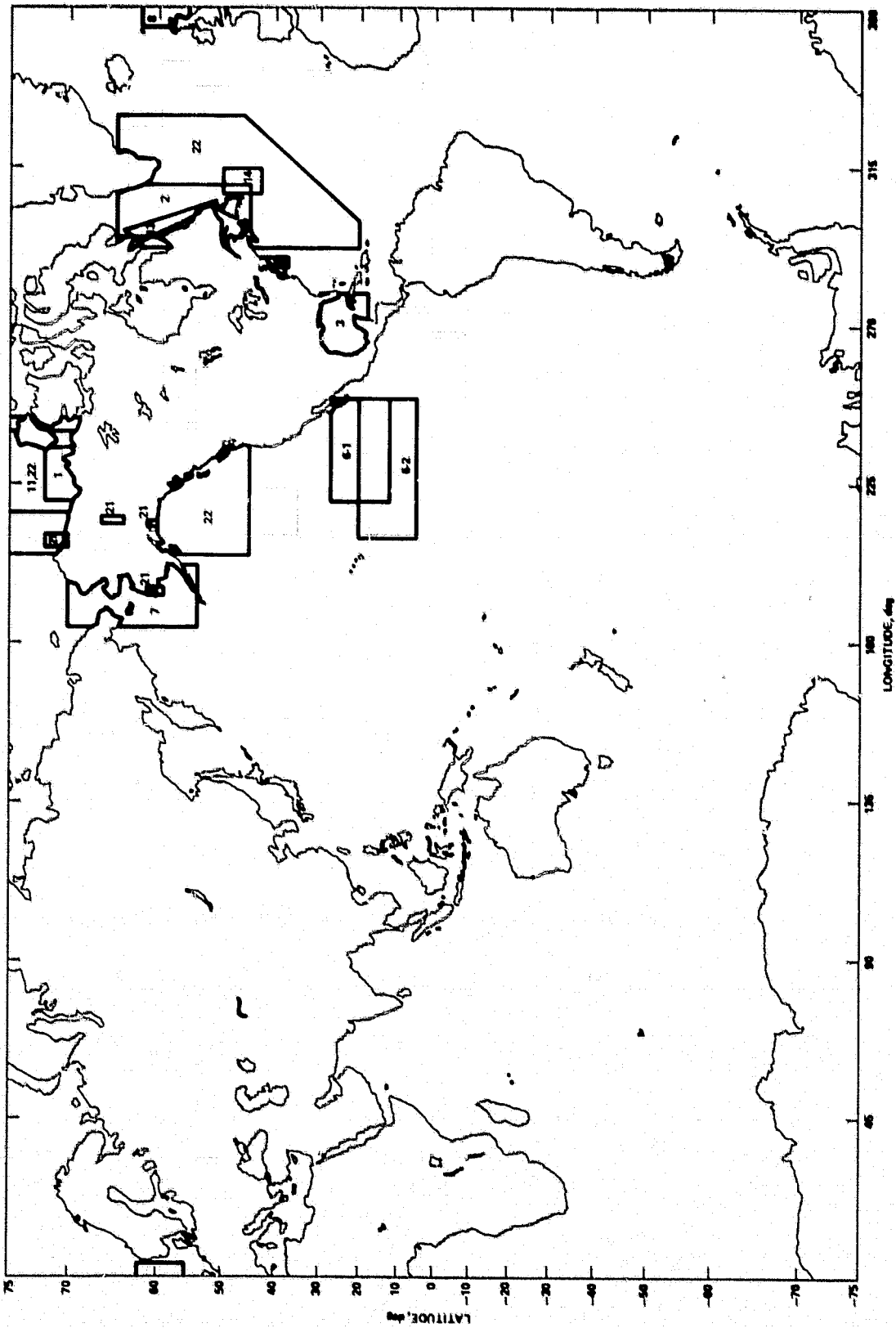

Figure 7-8. Geographical Distribution of Non-Real-Time Experiments



## SECTION VIII

### JOINT NOAA/NASA SOLICITATION

The mission of the National Oceanic and Atmospheric Administration (NOAA) is to:

- (1) Explore, map, and chart the global ocean and its living resources.
- (2) Manage, use, and conserve those resources.
- (3) Describe, monitor, and predict conditions in the atmosphere, ocean, sun, and space environment.
- (4) Issue warnings against impending destructive natural events.
- (5) Develop beneficial methods of environmental modification.
- (6) Assess the consequences of inadvertent environmental modification over a period of time.

Because the application of Seasat technology encompassed a major portion of the marine mission of NOAA, this organization was an early participant with NASA and JPL in planning the Seasat program. Additionally, NOAA prepared its own research and applications program which significantly supported the overall Seasat mission.<sup>1</sup> The objectives of the NOAA Seasat program are to:

- (1) Establish those environmental measurements and acquisition techniques that can be made from an operational system with efficiency and economy.
- (2) Determine the geoid to the accuracy needed to serve as a reference surface for sea-surface topography.
- (3) Continue to improve the understanding of the complex dynamic behavior of the ocean and the sea-air interface.
- (4) Contribute to major on-going international, national, and NOAA programs with synoptic environmental data.

The failure of the Seasat satellite most severely impacted objectives 2 and 4. Support to geodesy and major international programs, such as the global weather experiment, was curtailed significantly, while only the discipline of sea and lake ice was impacted within the group of environmental indices being studied.

The NOAA Seasat program is depicted in the block diagram of Figure 8-1. The basic Seasat activities of NOAA are designated by the heavily outlined boxes

---

<sup>1</sup> NOAA Program Development Plan for Seasat-A Research and Applications, Washington, D.C., March 1977.

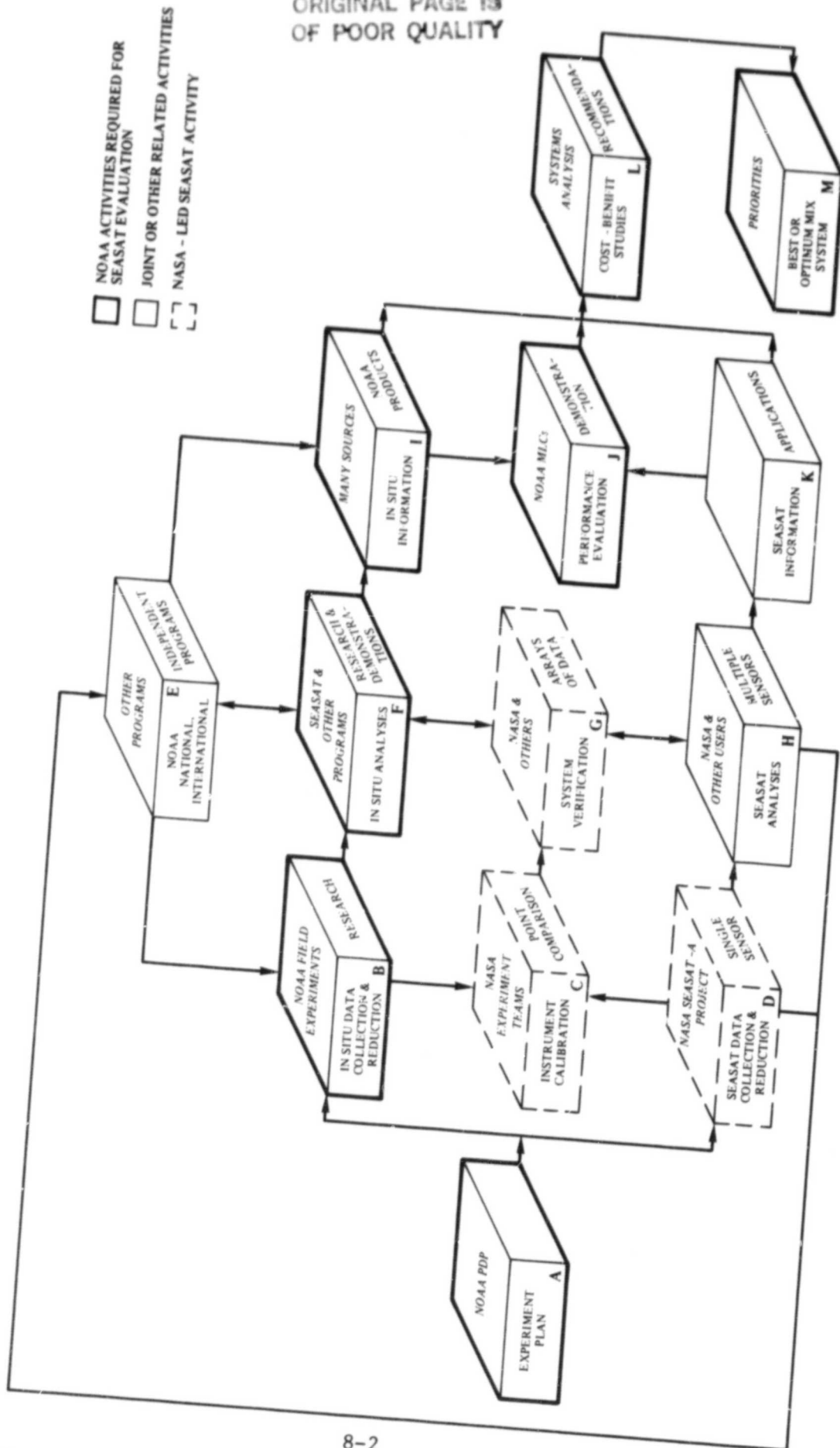

Figure 8-1. NOAA Seasat Program

of the figure, while the NASA-conducted Seasat activities relevant to the NOAA program are denoted by the dashed-line boxes with the remaining boxes representing other marine joint-agency or related activities. From the viewpoint of the NASA Seasat program, elements included in boxes B, C, and F will be discussed here.

These elements can be grouped into major components as follows:

- (1) The NOAA in situ observation program.
- (2) The research program, including both internal and external investigations.
- (3) The demonstration program.
- (4) The NOAA support to the NASA experiment teams.

Elements 1 and 4 are discussed in Sections 4 and 6, respectively. Because the NOAA demonstration studies have been phased into the research activities since the spacecraft failure, only the internal and external research elements are described here.

The overall research program of NOAA is composed of the following studies: shallow water waves and shoals; internal waves; storm surge/setup; near-shore winds and circulation; oil spills; wave spectra; surface winds and wind stress; surface temperature; ocean currents; atmospheric water and water vapor; deep sea tides; geoid determination and precise satellite ephemeris; ice dynamics, mapping, and statistics; global atmospheric wind modeling and boundary layer analysis; wave forecasting; and surface layer transport. Additionally, limited studies related to hydrology, including snow areal extent, snow depth and properties, flood mapping, and soil moisture, are being conducted. These studies include all five Seasat sensors, with emphasis on the microwave sensors, and the SMMR on Nimbus-7.

The NOAA internal program includes approximately 20 NOAA scientists and managers participating in these Seasat studies, while the external program includes 30 scientists in the academic and industrial research communities conducting investigations under the joint NOAA/NASA Announcement of Opportunity (AO). These 30 investigations were selected by competitive review from approximately 150 proposed studies from U. S. nongovernment institutions. The review process included not only NASA and NOAA scientists and remote-sensing experts, but cognizant representatives from the National Science Foundation, Office of Naval Research and other Naval elements, Department of Interior, and Department of Transportation.

Most of these 30 scientists collected unique surface observations during the 106-day life of Seasat. Several studies have been modified because of the failure, and six studies have been terminated or withdrawn (originally 36 studies were selected under the AO). These surface observations and the dedicated NOAA research vessel, Oceanographer, with its complement of NOAA investigators, compose the primary data set for the overall assessment of Seasat validation and performance.



A major priority in the NOAA program to support its mission is to develop global data sets for surface winds, waves, and temperatures, and for the geodetic data set during the lifetime of Seasat. The overall strategy is that while Seasat data extended slightly over one season, essentially all seasons were covered, since the winter and fall seasons were occurring in the southern hemisphere while the summer and fall seasons, including major hurricanes and typhoons, were occurring in the northern hemisphere. This strategy will be used to validate and extend Seasat data into the data-sparse southern hemisphere. It is important to note the NOAA Seasat program will not be completed until full global analyses of winds, waves, temperatures, and topographies are completed.

## SECTION IX

### END-TO-END DATA SYSTEM

#### A. INTRODUCTION

Seasat was a proof of concept mission designed to demonstrate techniques for the global monitoring of oceanographic phenomena by satellite remote sensing. Included in the techniques to be demonstrated were the ability to develop and verify algorithms to produce geophysically useful measurements from the satellite data, and to distribute data to users in a timely manner.

The concept developed to respond to these objectives has two elements which are of great importance to the demonstration and were introduced to the Space Program for the first time. These elements are: (1) the concept of timely geophysical evaluation of remotely sensed data, and (2) an end-to-end data system.

The data products from Seasat have been used by commercial, government, and scientific users for both real-time and nonreal-time purposes. In order for the data to have been useful to these people, the products had to be in geophysical terms with a known accuracy.

Seasat planned and implemented a series of evaluation activities (GOASEX, JASIN participation, and repeat orbit set over Bermuda) to demonstrate the geophysical concept. Because of the early satellite failure, the full range of desired parameter values was not collected. However, the data obtained was evaluated by the scientific teams organized for that purpose, and a set of algorithms was developed, which are now being employed in making a final data record. The geophysical evaluation principle was clearly demonstrated.

The end-to-end data system concept was introduced to make practical the operation of the spacecraft and the evaluation, processing, and distribution of the data collected. Telemetry from the low-rate sensors was captured by the STDN stations. Data overlaps were removed and the data formatted on magnetic tape by GSFC. The calibration, Earth location, and time-tagging of the telemetry were performed by the Instrument Data Processing System (IDPS) at JPL. Also, data gap identification and other verifications were performed on the received telemetry data. The ground data system for the low-rate sensors (that is, excluding the Synthetic Aperture Radar) included the subsystems for the acquisition and preprocessing of telemetry; calculation of orbit and attitude data; decommutation, engineering unit conversion, and Earth location of the measurements; instrument calibration; calculation of geophysical observables; data cataloging; and data distribution.

The low-rate system is very flexible and produces a modular data package. Four modules are included: a Project Master Data File (PMDF), a Sensor Data Record (SDR), an Intermediate Geophysical Data Record (IGDR), and a Geophysical Data Record (GDR). Each of these was designed as a stand-alone process with a controlled interface with the rest of the data system.

The flexibility and modularity allowed an efficient approach: to process verifications (does the system work the way it is supposed to?), to processing

verifications (are the data records correct and free of error?), and to geophysical evaluation (what is the correct physical interpretation of the data?). The geophysical evaluation involved the creation of an Algorithm Development Facility, an auxiliary system, which provided a capability to compare in situ and remotely sensed data in a systematic manner.

The principal elements and participants in the end-to-end data system are listed in Table 9-1 along with the principal function that each performed. Figure 9-1 is a block diagram that shows the interrelationships between elements for purposes of data flow.

The parts of the system involved in satellite operation are described elsewhere (see Volumes II and III). The data processing parts are discussed here in some detail. Two parts are described: the low-rate data system and the SAR data system.

## B. THE SEASAT LOW-RATE DATA PROCESSING SYSTEM

### 1. Introduction

The Seasat low-rate data system (Figure 9-2) is an end-to-end data processing and data distribution system for the four low-rate sensors [radar altimeter (ALT), Seasat-A Scatterometer System (SASS), Scanning Multichannel Microwave Radiometer (SMMR), and Visible and Infrared Radiometer (VIRR)]. The low-rate telemetry frames were continuously recorded on two satellite tape recorders, which alternated between record and playback. The data were transmitted by the satellite in a packet format that included an accurate (200- $\mu$ s) time tag. The data were frame-synchronized at the receiving stations and, with the doppler tracking data, sent over communication lines to the Telemetry Online Processing System (TELOPS) at Goddard Space Flight Center (GSFC). The TELOPS and the Telemetry Processing System (TPS) performed initial quality checks of the data and created time-ordered files which were merged into a daily Project Master Data File (PMDF). The daily telemetry file was provided to the attitude determination system, where the satellite attitude history was generated from the raw telemetry by means of an attitude control system model. The orbit determination system utilized the doppler tracking data to create a "definitive" orbit on a daily basis. These attitude, orbit, and telemetry data were written on magnetic tape and shipped to the Instrument Data Processing System (IDPS) at the Jet Propulsion Laboratory (JPL). The IDPS processed all data to create the Earth-located, time-ordered Master Sensor Data Record (MSDR) and the accompanying data catalog. The Algorithm Development Facility (ADF) (a remote terminal oriented, interactive development facility) then processed a subset of these data into the Interim Geophysical Data Record (IGDR) sensor files and geophysical files. The IGDRs were then made available to the project science teams for geophysical evaluation. After the algorithms and programs were approved by the science teams, the ADF was used to produce a final and complete set of Geophysical Data Records.

### 2. Satellite On-Board Data Handling

A decision to incorporate the concept of block or "packet" telemetry as part of the Seasat "proof of concept" objective was made early in the life of the project. In Seasat implementation block telemetry means that data from each source (each sensor, or satellite engineering data) is inserted into its own

Table 9-1. Elements of Seasat End-to-End-Data System

Name	Abbreviation	Location (Responsibility)	Principal Function
Sea Satellite	Seasat	Space (JPL, LMSC)	Data generation
Mission Planning System	MPS	JPL (JPL, LMSC)	Mission planning
Command Management System	CMS	GSFC (GSFC)	Produce command memory loads from desired sequences
Spaceflight and Tracking Data Network	STDN	Worldwide (GSFC)	Data acquisition
NASA Communications Network	NASCOM	Worldwide (GSFC)	Ground data transmission
Project Operations Control Center	POCC	GSFC (GSFC, LMSC, JPL)	Satellite monitoring and control
Orbit Determination System	ODS	GSFC (GSFC)	Orbit determination
Attitude Determination System	ADS	GSFC (GSFC)	Attitude determination
Information Processing Division	IPD	GSFC (GSFC)	Global data recovery
Instrument Data Processing System	IDPS	JPL (JPL)	Sensor data processing and SDR production
Algorithm Development Facility	ADF	JPL (JPL)	Adaptive algorithm development and interim geophysical data records (IGDR) production
Algorithm Development Facility	ADF	JPL (JPL)	Geophysical Data Record production using GDR "build" software
Fleet Numerical Oceanographic Center	FNOC	FNOC, Monterey, CA (U.S. Navy)	Near-real-time operational data demonstration

ORIGINAL PAGE IS  
OF POOR QUALITY

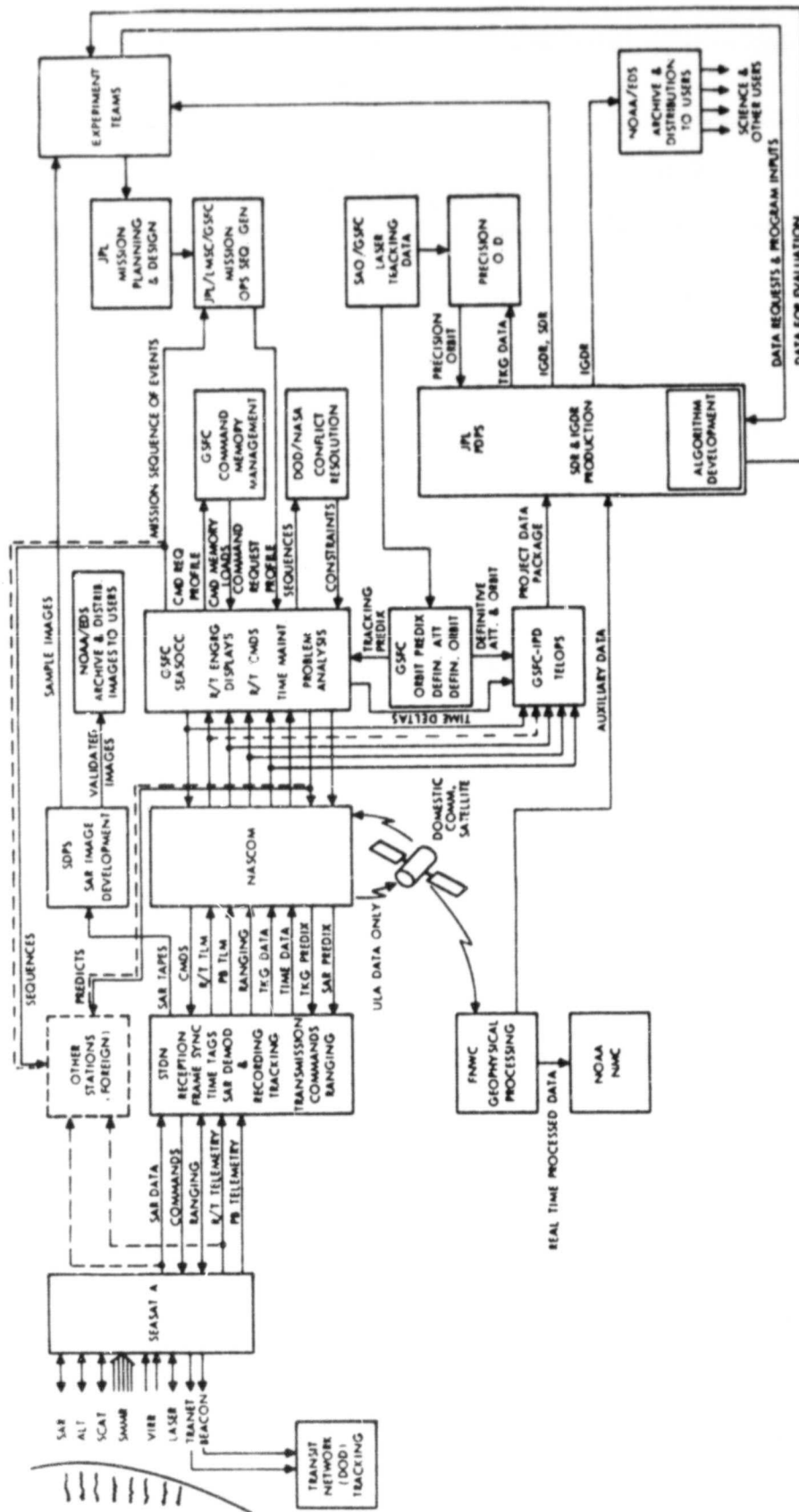

Figure 9-1. Seasat End-To-End Data System

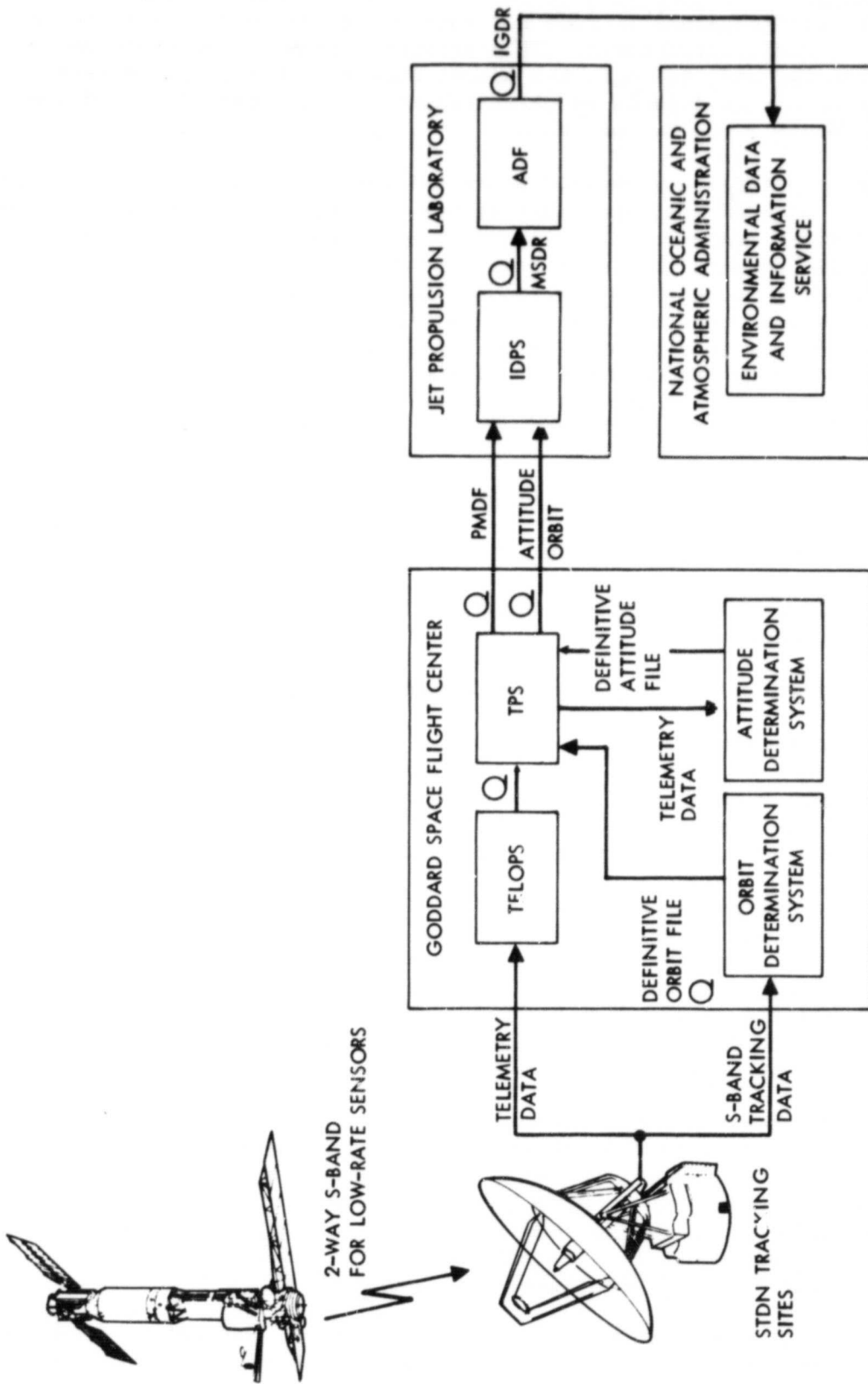

Figure 9-2. Seasat Low-Rate Data System

standard-length, uniquely identified block, and this block is handled throughout the spacecraft and ground telemetry systems as an entity without being further broken down. The self-contained ID code for each block allows each word to be decommutated and uniquely interpreted. This interpretation is not dependent on the sequence of blocks, and, in fact, the blocks appear on the output stream in a pseudo-random sequence that depends on which sensors are in operation, and when in their cycle they are ready to dump data.

The concept of satellite-generated block telemetry was desirable for several reasons. First, it allowed complete independence of data formats and bit assignments among the various sensors. This independence streamlined the negotiation of format changes for sensors that were being developed along with the satellite -- a significant cost driver of previous missions. Second, it provided a method of improved ground accountability for missing blocks. Third, ground sorting and reconstruction of sensor data frames was somewhat simplified because most of the sorting was done on the spacecraft and then kept intact, allowing processing to be done in relatively large chunks (blocks) rather than bits. The telemetry block was examined and minimum decommutation and time correlation were performed.

Seasat block telemetry has the following characteristics:

- (1) Each block has a standard length of 1024 bits.
- (2) Data from each source is assigned its own block, insofar as practicable.
- (3) Each block contains its own identification.
- (4) Each block contains its own time tag.
- (5) The sequence of blocks, as seen on the transmitted telemetry stream, may appear pseudo-random, as it is responsive to sensor data generation which is asynchronous.

Seasat science and engineering data were converted from analog to digital form, where necessary, and buffered and formatted by a part of the satellite data system called the Telemeter and Sensor Interface Unit (TSU). Since the TSU was nearly all new design, it was thought to be most cost effective if each sensor could be accommodated by a customized interface in the TSU. In this manner, most of the necessary changes took place in the TSU, causing minimum impact on the sensor designs, some of which were frozen at the start of the project.

In Seasat implementation, each sensor operated on its own internal cycle, asynchronously with the data system and with the other sensors. In some cases, the sensors provided a continuous stream of data to the telemeter, while other sensors stored data in their own intermediate buffers and burst it across to the telemeter at a specific point in the sensor's cycle. The TSU further buffered this burst of data, queueing it for transmission. One sensor (VIRR) provided an analog output that was filtered, digitized, and buffered by the TSU.

Four blocks of buffering (4096 bits) were provided in the TSU for each sensor source. The transmitted sequence of blocks was established by polling these

buffers in order of priority. Full buffers were fed to the output telemetry stream, while incomplete buffers were bypassed and the next lower priority buffer was checked. If no buffers were ready, the TSU outputted fill blocks (lowest priority) to maintain a constant 25-kbps downlink rate. Instead of sending a useless fill pattern, these fill blocks were designed to sequence routinely through the command memory, providing an image of it on the ground for comparison and verification. This was done without any additional satellite buffering.

The on-board GMT feature of Seasat utilized a stable, adjustable, on-board clock to time tag each block of sensor data as it arrived at the TSU, directly in GMT. Time tags were generated for a specific point in each sensor's cycle and, therefore, represented the time the data was actually taken, not the time it was transmitted to the ground or stored on the tape recorders. Correct knowledge of time is absolutely necessary in a system where precision timing is required (for example, the Seasat Altimeter time tag had to be accurate to within 200 microseconds of GMT) and where random-delay buffering is taking place before transmission to the ground. With on-board GMT each block contains the correct time, and it is not necessary to refer to tables of predicted times during data processing to which an arbitrary spacecraft count corresponds.

The demanding clock accuracy was obtained by tapping off a signal from the Seasat TRANET Beacon oscillator. The TRANET Beacon is a stable, on-board, dual-frequency doppler beacon that is used for precision tracking by the DoD. Stability on the order of five parts in  $10^{10}$  or better was expected, which translates into a worst-case drift of 43  $\mu$ s per day.

The stability of the TRANET oscillator in the Seasat environment was an order of magnitude better than expected. However, in practice it was found that the most severe limitation to achieving high accuracy was the ability to obtain comparably accurate range predictions. Frequent computer runs using the most recent tracking data were necessary in order to maintain the clock to this accuracy. The 200- $\mu$ s accuracy was achieved after the first few weeks of operation. After three months of satellite operation, commands to alter the clock drift compensation rate were necessary only 2 or 3 times a week. The concept of an on-board GMT clock is definitely feasible, but the cost depends greatly on the accuracy required for ground support.

The complete time tag word which appeared in every telemetry block was 40 bits long. It consisted of 26 bits of binary seconds and 14 bits of binary sub-seconds, where the value of the least significant bit was about 61  $\mu$ s. There were sufficient bits to provide an unambiguous time word for a period of two years. Seasat defined its clock as starting with an all-zero count at midnight GMT, January 1, 1978. Knowing this one data point, all time tags for the mission can be calculated easily for any time desired.

### 3. Processing at Goddard Space Flight Center

Telemetry data frames, played back from the spacecraft tape recorders in reverse order, were transmitted to a global network of ground tracking stations managed by the Goddard Space Flight Center (GSFC). The tracking stations received, frame-synchronized, formatted, stored, and later transmitted the telemetry data to data processing facilities at GSFC. The tracking stations also recorded tracking data in real time during Seasat passes. Tracking data parameters include



S-band doppler, range, range rate, antenna pointing angles and time. After each pass, the stations formatted and transmitted the tracking data to GSFC.

Seasat telemetry data was captured at GSFC by TELOPS, a large multimission and multicomputer data system (Refs. 9-1 and 9-2). The system consisted of two parallel IBM 370/145 computers and a mass storage facility operating in a real-time mode. After capture, the telemetry data from a given station pass was continuity checked and reversed. Recall procedures were used to fill any data gaps caused by station-to-GSFC ground communications equipment failures. When complete, a pass of telemetry data was passed to the Telemetry Processing System (TPS, Ref. 9-3), where Seasat-unique processors operated in a batch mode on a Univac 1108 computer. The TPS processors merged telemetry data from different station passes, removed overlap data, appended data quality information, and packaged telemetry data into 24-h (daily) files. The daily telemetry data package was called the Project Master Data File (PMDF) and was recorded on eight 1600-bpi magnetic tapes. Each tape contained 3 h of telemetry data.

Definitive orbit computations were performed on an IBM 360 computer using an orbit support system developed by GSFC. Definitive Orbit Files (DOF) were generated for each satellite data day, which started at zero hours GMT and ended at zero hours GMT of the next day. Each data point in the DOF contained a time, a set of three components of the satellite position vector, and a set of three components of the satellite velocity vector. These vectors are defined in a geocentric inertial coordinate system where X is the true of date vernal equinox, Z is the true of date Earth rotation axis, and Y completes the right-hand system. The frequency of the orbit points was one point per minute with points provided on the even minute marks. The accuracy of the DOF position vector was better than 50 m in the along-track direction and 30 m in both cross-track and radial directions.

Using the Definitive Orbit File and parameters extracted from the spacecraft telemetry data stream, the Definitive Attitude File (DAF) was computed. Definitive attitude processing was performed on an IBM 360 computer using an attitude control system model developed by GSFC. The model provided a continuous pitch and roll history for all times that telemetry information was present, and yaw attitude for all times that sun data was available. Yaw attitude results for all other times were provided using a JPL algorithm. A file of definitive attitude data was generated for each satellite data day, beginning at zero hours GMT and ending at zero hours GMT of the next day. Each data point in the DAF contained a time and a set of Euler angle rotations that correspond to satellite yaw, roll, and pitch. The frequency of the attitude points was 5 s with the attitude point times being subsynchronous with the DOF data point times.

The Definitive Orbit and Definitive Attitude files were received by the 1108 Seasat processors, where these files were combined to produce the A/O tape. A satellite data day consisting of one A/O tape and the accompanying eight PMDF tapes was then shipped to JPL. At JPL the satellite data was processed by the Project Data Processing System to produce geophysical parameters.

#### 4. Processing at JPL

One of the fundamental assumptions used throughout the design of the Project Data Processing System (PDPS) was that algorithms required for processing spacecraft data into final geophysical products would necessarily evolve throughout the duration of the mission. It was assumed that a year-long period of "Geophysical Evaluation" would begin shortly after launch, during which processing algorithms would be evaluated and refined until the overall accuracy goals were met. During this time software would be modified frequently, and small, carefully selected subsets of the data would be examined carefully and reprocessed frequently.

On the other hand, it was assumed that a portion of the processing could be pre-defined and used in a production mode to process the data to a complete archival-quality data set, which would serve as the basis for evaluation and early data distribution. The resulting system design consists of a relatively stable part, optimized for high volume routine production (IDPS), and a part intended for frequent modification by users (ADF). Figure 9-3 provides an overview of the PDPS.

a. Instrument Data Processing System. The GSFC-produced data package was first processed at JPL by the Instrument Data Processing System (IDPS) resident on an IBM 360/75 computer. The IDPS processed all data to create the Earth-located, time-ordered Master Sensor Data Record (MSDR) and accompanying data catalog. The IDPS processors operated in a production environment, where efficiency and ease of operation were key design considerations.

IDPS processing began with the extraction of spacecraft telemetry frames from the PMDF tapes. Validity checks ensured that any data blocks having a bad sync code, a parity error, an invalid block identifier or a bad time tag were detected and discarded. Correcting telemetry blocks known to be in error was not attempted because the cost of implementing and verifying error correcting algorithms far outweighed the anticipated return. In practice less than one-half of one percent of the total data set was lost because of the IDPS validation processing.

Telemetry data blocks that passed the validation tests were used to construct telemetry frames. A frame is a time-tagged information package produced by one of the satellite sensors or engineering system. For engineering data and the SASS and ALT, one minor frame was stored in one telemetry block, making the minor frame construction for these data streams simple. However, for VIRR and SMMR, five and nine telemetry blocks, respectively, were needed to construct one frame. For these sensors telemetry blocks were buffered until a complete frame was available. If one or more blocks in a sequence were lost or discarded because of an error, then an entire multiblock frame was dropped; i.e., a single missing VIRR or SMMR block resulted in an effective outage of five or nine blocks, respectively.

Data channels or measurements were packed (commutated) within a telemetry frame as efficiently as possible to reduce the volume of data transmitted by the satellite to ground stations. A table-driven decommutation (DECOM) procedure was used to extract sensor measurements from the satellite telemetry data frames.

ORIGINAL PAGE IS  
OF POOR QUALITY

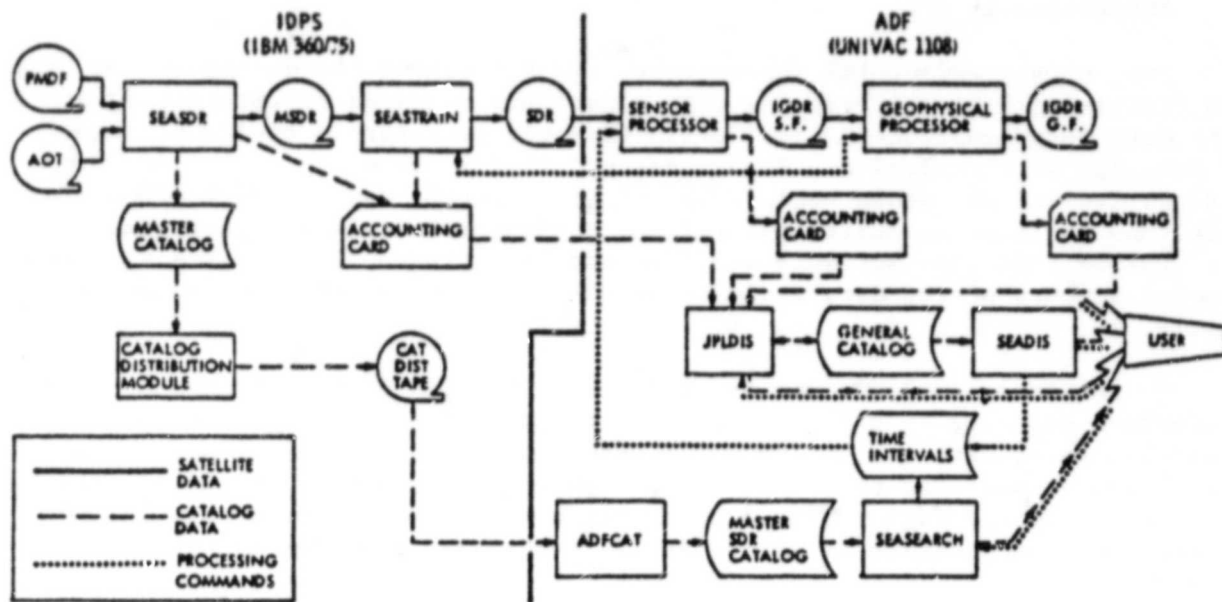

Figure 9-3. Seasat Project Data Processing System at JPL

Maps describing the telemetry frames were constructed for each sensor and engineering data type. Using these maps the DECOM processor, operating on one channel at a time, located the channel in the input frame and moved it to a new output frame. Channels in the new frame were byte aligned for the convenience of further computer processing.

The IDPS converted selected measurements from data numbers (DN) to engineering units (EU), i.e., volts, degrees Celsius, amps, etc. The EU conversion was done as part of the DECOM processing. When a channel to be converted to engineering units was extracted from the input frame, the DECOM processor sent the measurement to the EU routine for conversion. The following standard EU conversion techniques were used:

- (1) Polynomial conversion:

$$EU = A_0 + A_1(DN) + A_2(DN)^2 + \dots + A_n(DN)^n$$

where n could be 1 to 10.

- (2) Table lookup conversion:

$$EU = EU_1 + \frac{EU_{i+1} - EU_1}{DN_{i+1} - DN_1} (DN - DN_1)$$

where  $EU_1$ ,  $EU_{i+1}$ ,  $DN_{i+1}$  were the appropriate values from the lookup table which bracketed the DN value being converted. A table could contain up to 20 DN vs EU pairs.

- (3) If a channel's DN/EU relationship was a function of another channel, then a multicurve conversion technique was employed. DN/EU polynomial curves were defined for several values of the second variable. Two DN/EU curves were then chosen such that they bracketed the current value of the second variable. EU values for the two curves were calculated using the channel's DN value. Then, using the following relationship, the final EU value was computed:

$$EU = CEU_1 + \frac{CEU_{i+1} - CEU_1}{V_{i+1} - V_1} (V - V_1)$$

where  $CEU_1$  and  $CEU_{i+1}$  were the computer EU values for curves  $i$  and  $i + 1$ , respectively, and  $V_1$  and  $V_{i+1}$  were the corresponding values of the second independent variable.  $V$  was the value of the second independent variable and had a value between  $V_1$  and  $V_{i+1}$ .

Polynomial coefficients and table lookup entries used by the EU conversion routines were derived during prelaunch calibration tests.

Most EU conversions were done using one of these standard techniques, but a small number of measurements required special "own code" routines to do the conversions. Each own code routine had code specifically designed to accomplish a unique EU conversion requirement. Less than 10 percent of the measurements that were converted to EU required own code routines.

The IDPS calculated footprint locations and other location-related parameters for each sensor telemetry frame. A sensor footprint is the area on the surface of the Earth scanned by a single instrument measurement. Locations consist of Earth-fixed latitude and longitude for the center of a given footprint. Not every footprint had a location calculated, but enough footprints were located so that the remaining footprints could be located to the required accuracy by linear interpolation.

The time tag for a given telemetry data frame was passed to the IDPS location processor. Footprint time tags were generated using the frame time and tables that defined for each sensor the offset times for each footprint. Thus, a set of footprint time tags was computed for each telemetry data frame. Using the first footprint time, a pair of bracketing satellite attitude points were chosen from the DAF. Then two orbit points that bracketed the attitude points were selected from the DOF. Using a quintic spline interpolation, the satellite

position and velocity vectors were calculated at the times of the attitude points. Footprint location parameters were then calculated for the bracketing attitude times.

Boresight directions for each sensor were expressed in terms of satellite-fixed cone and clock angles. Some instruments were represented by a single boresight, others by as many as 30. The SASS boresight directions were functions of the relative velocity of the spacecraft and the Earth's surface, and of temperature distributions along the antennas. Sensor boresight directions were rotated from body-fixed satellite coordinates into an Earth-centered satellite system. This results in an array of attitude-corrected sensor boresight directions at each of the bracketing attitude times. Sensor look directions were then calculated at each attitude time. The intersection of a look direction with the Earth's surface resulted in a footprint location. Thus, footprint locations and related information peculiar to each sensor were calculated at the bracketing attitude times.

The calculation of location parameters for a given footprint was then accomplished by interpolating the location parameters computed at the bracketing attitude times to the time of the footprint. Footprint location parameters continued to be calculated by interpolation until their time moved outside the interpolation interval. Then the next-to-follow attitude point was selected and the interpolation interval stepped forward. If a telemetry data gap that exceeded one interpolation interval was encountered, then two new attitude points were found, and both sides of the interpolation interval were recomputed. A gap in either the DOF or the DAF greater than one minute resulted in no location parameters being computed for any telemetry frame falling within the gap. All unlocated data products were flagged accordingly.

The footprint positions computed by the location processor have been verified using two techniques. First, the location processor nadir points were compared with nadir points computed using a GSFC precision orbit system. Differences on the order of 20 m were observed, well within the accuracy of the Seasat definitive orbit. Secondly, sensor data were used to detect land/sea boundaries. The known position of a land/sea boundary was then compared by the location processor. Differences were less than sensor footprint resolution sizes.

The location data and other related information were used for several different purposes. The first was to identify the location of the footprint on the surface of the Earth, allowing sensor measurements to be compared to other sensor measurements or to conventional surface data. Another use was the calculation of geophysical parameters by the Algorithm Development Facility. These calculations needed the relative locations of different measurements in order to combine them or they required the footprint location or associated data as algorithm inputs.

Earth-located, EU-converted frames from a given sensor were grouped together to form blocked records. Completed records were then recorded on magnetic tape. The magnetic tape file containing data records for all sensors is the Master Sensor Data Record, which is the Seasat archival data base. This data base is recorded on approximately 1200 magnetic tape reels.

b. Algorithm Development Facility. The Algorithm Development Facility, as its name implies, was intended primarily as a tool to support the development of algorithms after launch. Because it was designed as a development facility rather than as a production facility, the primary design goals were ease of modification, ease of use, and capability to support remote, interactive users. Additional goals were automatic identification of output products with information about their ancestry (such things as processing history, software version, and values of constants used to produce them), portability of algorithm code, and easy access to the total data base. Run-time efficiency was explicitly excluded as a design goal, and was generally sacrificed whenever necessary to meet one of the other goals, especially in early versions. Substantial optimization has been done on later versions.

ADF capabilities fall into four major categories:

- (1) Data base access (providing by two on-line catalogs of available data, and associated catalog search capabilities).
- (2) "Host System" functions (I/O, operating system interface, command interpreters, product identification, catalog entry generation, algorithm drivers).
- (3) Processing algorithms (subroutines that perform engineering or science processing of the data).
- (4) Assorted utilities and analysis support tools.

The primary output products of the ADF are called Interim Geophysical Data Records (IGDR). These may contain partially processed data (IGDR "Sensor Files") or fully processed data (IGDR "Geophysical Files"). Products produced by "unofficial" private versions of ADF programs (see "Custom ADF Programs," below) are called "Evaluation Geophysical Data Records" (EGDR). These products are normally available on nine-track magnetic tape. EGDR products may also be produced on disk or seven-track tape for more convenient use within the local environment of the ADF. As of late 1979, processing of all the data through mature algorithms has begun, producing final Geophysical Data Records (GDR). As used in the remainder of this report, "GDR" refers to any of the above.

Because the ADF software was intended for frequent modification by a large, diverse, and geographically dispersed set of users, special attention was given to the philosophy behind its design and implementation. Some of the broad design goals are stated above. Details are published in References 9-4 and 9-5. Some important guidelines were:

- (1) All input/output is done by the host system (as opposed to the processing algorithms).
- (2) Processing algorithms interface only with the host system algorithm driver (not with each other); the interfaces are strictly controlled.
- (3) Processing algorithms are implemented as subroutines, with well-defined interfaces.

- (4) Algorithm code must be well-structured, clearly expressed, and adequately commented and documented, to facilitate maintenance and modification by persons other than the original programmer.

c. The ADF Sensor Processors. The first step in processing data beyond the SDR level is performed by the ADF sensor processors. These are variants of a single program, and all behave essentially identically. The sensor processors accept an MSDR or SDR tape as input, select data based on user-specified time interval(s) and sensor, apply "Sensor Algorithms" to the data, and produce as output GDR "Sensor Files." Sensor algorithms perform instrument-specific calibrations and corrections, producing as outputs physical observables which are essentially independent of the specific hardware implementation of the instrument. Sensor algorithms require input data only from the sensor being processed.

The primary measurements available in the sensor files are height (the range from the center of mass of the spacecraft to the mean ocean surface), significant wave height, and radar backscatter coefficient for the altimeter; radar backscatter coefficient, noise estimate, and cell geometry for the SASS; antenna temperatures (radiometric measurement) and brightness temperatures (corrected for antenna sidelobes, ionospheric Faraday rotation, and other effects) for the SMMR; and visible radiance and infrared temperature for the VIRR.

In addition to the measurements of interest, the sensor file generally contains the timing and Earth location of the measurements, assorted warning flags indicating potential instrument or data processing problems, the values of all corrections made to the measurements, and instrument mode indicators. Each sensor has algorithms for detecting and flagging "blunder points" in the data. These may be caused by bit errors arising from various sources between the spacecraft and the ground processing system. The error rate may be quite high in some parts of the data. Each sensor file (and geophysical file) also contains text information describing how it was produced, identifying algorithm versions, and giving values of all constants and tables used by the algorithms.

d. The ADF Geophysical Processors. The final step in processing the data to geophysical observables is performed by the geophysical processors. There is a separate geophysical processor for each of ALT, SASS, and SMMR. Each accepts as input the GDR sensor file for the respective sensor, plus additional inputs such as GDR Sensor or Geophysical Files for other sensors. Geophysical processing algorithms transform the physical observables of the sensor file to geophysical observables (e.g., sea surface temperature, wind velocity, wave height, etc.), using whatever additional data are available to correct for atmospheric or other external effects. The output of a geophysical processor is a GDR geophysical file.

The altimeter geophysical algorithms provide corrections for refraction caused by the ionosphere and by air and water in the atmosphere, and for modeled ocean surface effects such as tides (ocean and solid earth), atmospheric pressure loading, and the geoid. In addition, one algorithm converts radar backscatter to wind speed and another replaces the medium-accuracy (30 m) location information by precision orbit information (2 to 3 m) calculated from the best available tracking data.

The SASS geophysical algorithms use microwave brightness measurements from SMMR to correct the SASS backscatter measurements for the effect of atmospheric attenuation, and then convert radar backscatter measurements to wind vectors by combining measurements made in orthogonal directions and applying a model to the measurements. Because of the form of the functional relationship between wind vectors and backscatter measurements, the wind vector algorithms yield multiple solutions called "aliases." Work on an algorithm to select the correct solution from the aliases, typically four in number, is still in a preliminary stage. Currently available data products contain up to four wind solutions at each measurement point.

The SMMR geophysical algorithms are derived from models of ocean surface emissivity and atmospheric emission and absorption. These models are effectively inverted to derive estimates of ocean surface temperature, wind speed, and atmospheric water content (liquid and vapor). In addition, an estimate of the integrated water column is converted to a refractive path length correction for the altimeter.

A special processor exists to perform the SMMR antenna pattern correction (APC). Although this is conceptually part of the sensor algorithms, it resides in a specialized geophysical processor host environment, since its input is a GDR rather than an SDR. The APC processor takes as input GDR "SMMR Supplemental Sensor Records," which are produced by the SMMR sensor processor. These contain radiometrically calibrated antenna temperatures organized on the basis of SMMR minor frames. The output is GDR "SMMR Basic Sensor Records" containing microwave brightness temperatures, organized on regular 600-km square grids each representing about 90 s (about 22 minor frames) of data.

A typical flow chart for the algorithms involved in this processing is shown in Figure 9-4.

e. Standard ADF Programs. The sensor processors perform the functions of: (1) processing user commands, (2) opening files, (3) reading the input SDR header and algorithm data tables, variables, etc., (4) initializing output tapes, and (5) processing data through the SDR input routines, algorithm routines, and GDR output routines.

One of the key concepts of the ADF is that algorithm routines should be independent subroutines which can be modified easily by any user who understands the underlying algorithm and has a basic ability to read and write FORTRAN programs. In order to facilitate this, the algorithms interface with the host system in a standard, well-controlled way. Algorithm drivers are part of the host environment, and contain all the logic and data manipulation functions required to sequence the execution of algorithm routines and move data among them. Processing algorithms are required to interface only with their respective driver, with their subsidiary routines, and with standard mathematical library functions. Thus, a user can replace any algorithm routine with a different version (as long as the same interfaces are maintained) without having detailed knowledge about the functioning of other algorithms or system routines.

The structure and function of the geophysical processor is analogous to that of the sensor processor described above. Initialization functions are essentially the same as for the sensor processor. Algorithm interfacing techniques are also similar, except that additional input capabilities are provided for reading and merging data from a variety of sources (other sensor's GDR, world maps, etc.).



f. Custom ADF Programs. To facilitate the development of algorithms, the ADF was designed so that users could modify algorithm code themselves, and process spacecraft data through the modified code, without affecting other users or the project's data processing activities. This is done as follows.

Source code for all subroutines used in the ADF processors is maintained on the ADF, under configuration control. The subroutines are also available in compiled form. A typical modification would be made by following these steps:

- (1) Determine which algorithm to modify by examining the algorithm specifications and functional block diagrams.
- (2) Copy the source code for that algorithm from the ADF source file to a private file.
- (3) Modify the code as required, without changing interface.
- (4) Compile the modified code.
- (5) Copy the linker control statements for the appropriate processor into a private file, and modify to link in the modified version of the algorithm code instead of the ADF version.
- (6) Use the modified control statements to produce an executable program in a private file.
- (7) Execute the new program in the same way as a standard ADF processor.

Detailed instructions for performing these operations are contained in the ADF User's Guide (Ref. 9-6).

Advanced ADF users who have a thorough understanding of the content of SDR tapes can modify the sensor processor to create special-purpose programs which have full SDR input processing capability and the same operational characteristics as standard ADF programs. For example, several SDR dump programs have been produced in this way. Modifications are made at the level of the algorithm drivers rather than the algorithm subroutines, so additional knowledge of ADF internals is required. Special programs requiring GDR input capability can be constructed in the same way as SDR-reading programs, except that the modification base would be a geophysical or utility processor.

Data tables, constants, and initial values for some variables used by the processing algorithms are read from text files at run initialization time. These files can be modified easily by making a copy into a private file, editing to make the desired changes, and specifying the name of the resulting file for the processor to use in place of its standard file. The file actually used is copied to the output GDR, so that the actual constants used to produce any data product can always be determined.

## 5. Data Catalogs

To provide access to the Seasat data base a catalog system is provided. Catalog Abstract Records (CARs) were produced in the course of production of the

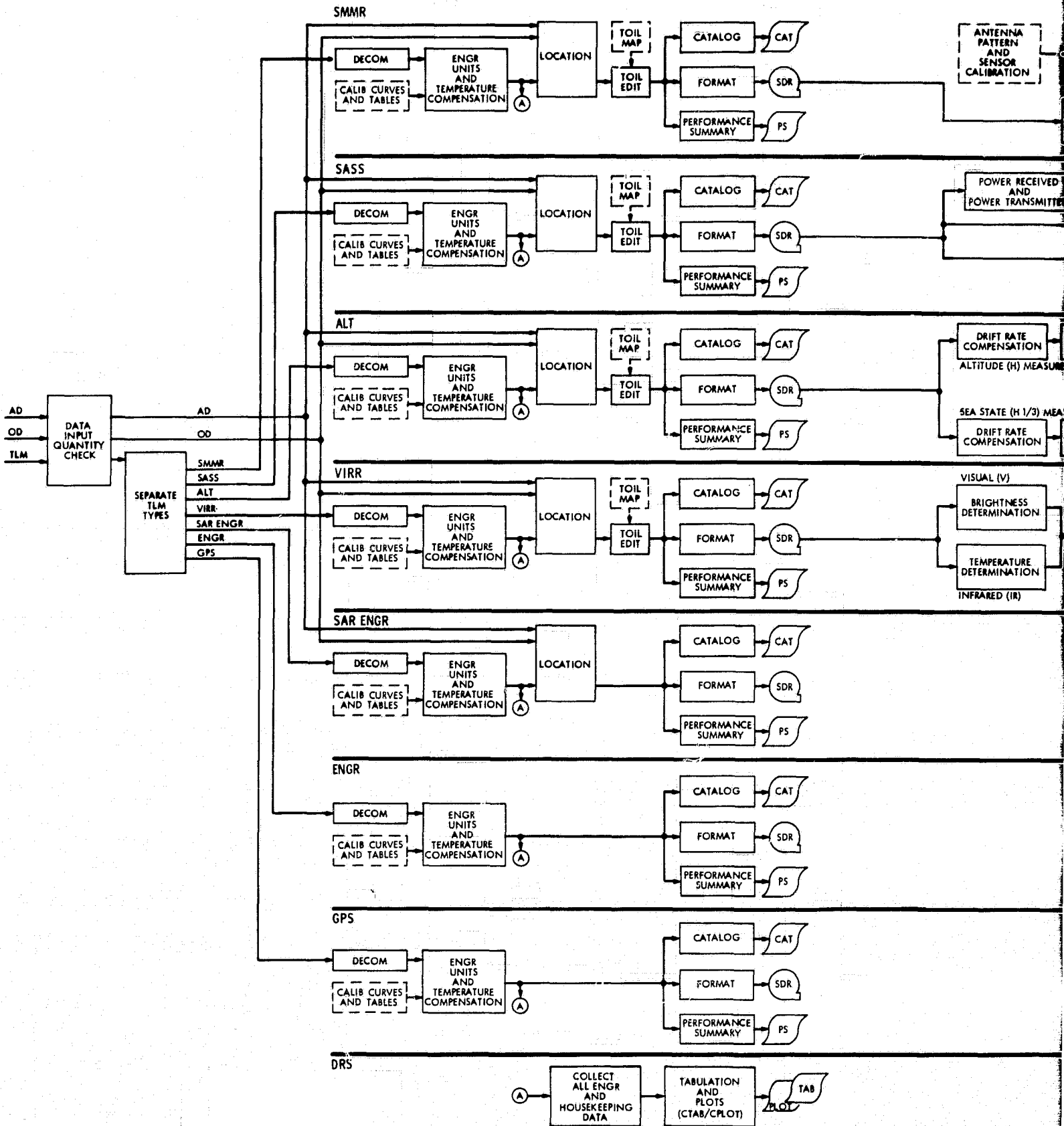

ORIGINAL PAGE 13  
OF POOR QUALITY

EOLDOUT FRAME

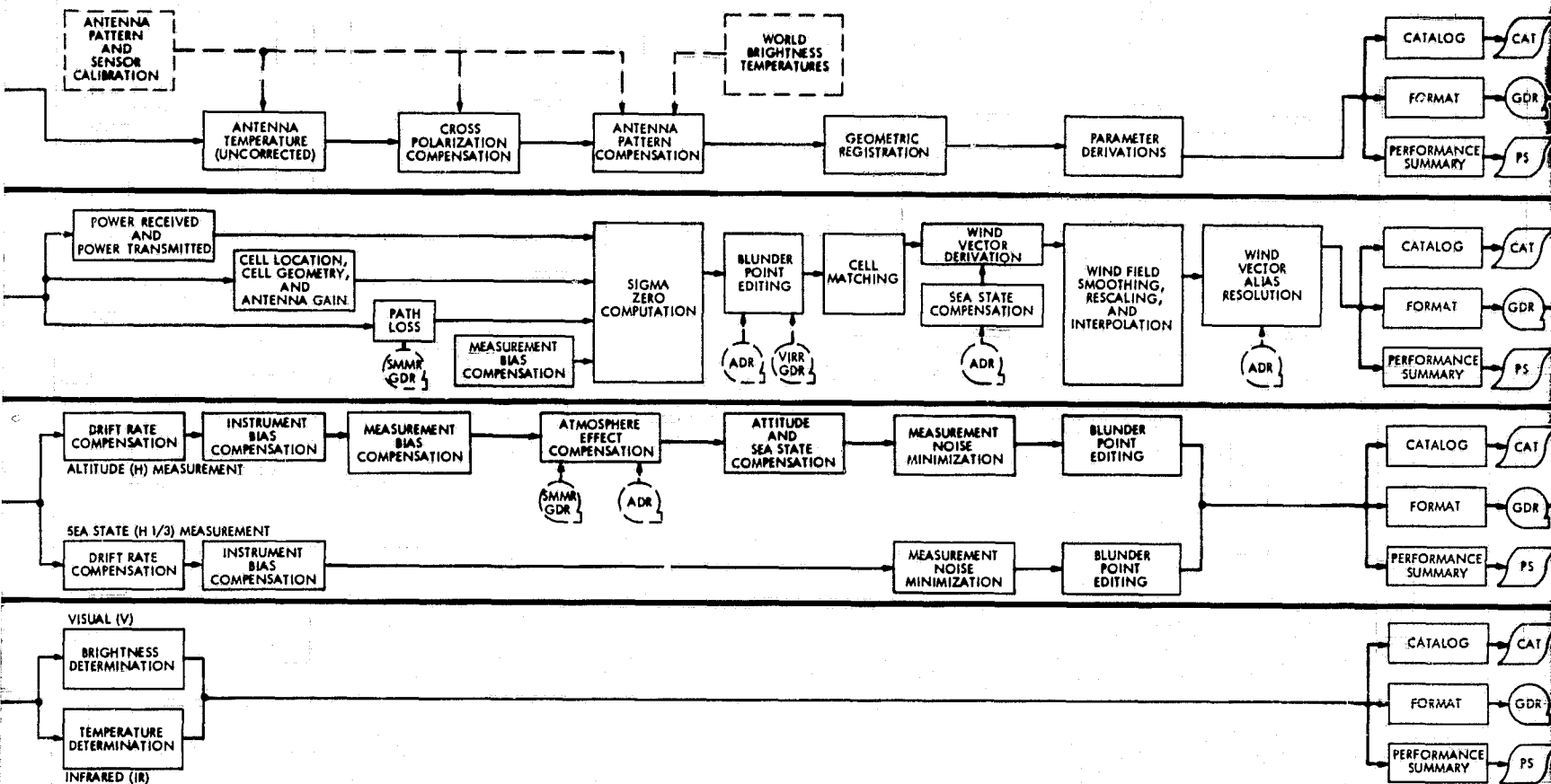

(A) BOX ENTRY  
 AD ATTITUDE D  
 ADR AUXILIARY  
 ALT ALTIMETER  
 CAT CATALOG  
 CPLOT COMPUTER  
 CTAB COMPUTER  
 DECOM DECOMMUT  
 DIS DISPLAY  
 DRS DATA RECO  
 ENGR ENGINEER  
 GDR GEOPHYSIC  
 GPS GLOBAL PO  
 OD ORBIT DETE  
 PS PERFORMAN  
 SAR SYNTHETIC  
 SASS SEASAT-A S  
 SDR SENSOR DA  
 SMMR SCANNING  
 RADIOMETE  
 TLM TELEMETRY  
 TOIL TIMED OCE  
 VIRR VISIBLE AN

ORIGINAL PAGE IS  
OF POOR QUALITY

Figure 9-4. Seasat Project Data Processing System

EOLDOUT FRAME 2

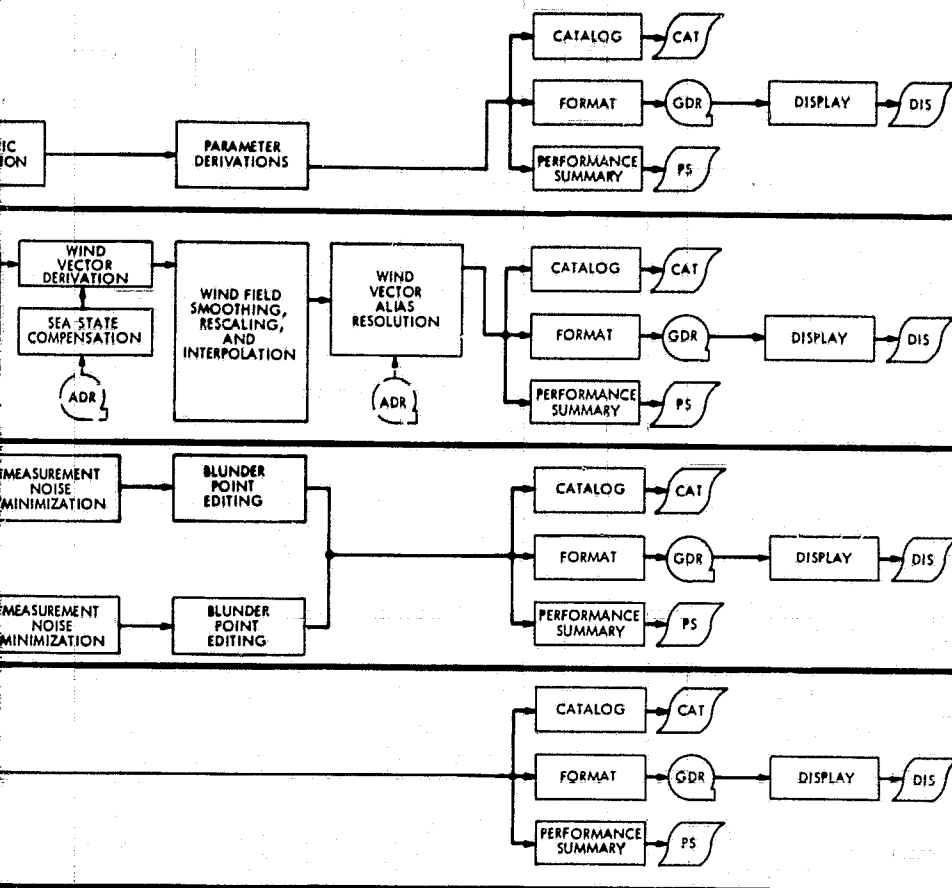

- Ⓐ BOX ENTRY IDENTIFICATION FOR CTAB/CPLOT
- AD ATTITUDE DETERMINATION
  - ADR AUXILIARY DATA RECORD
  - ALT ALTIMETER
  - CAT CATALOG
  - CPLOT COMPUTER PLOT
  - CTAB COMPUTER TABULATION
  - DECOM DECOMMUTATION
  - DIS DISPLAY
  - DRS DATA RECORD SYSTEM
  - ENGR ENGINEERING
  - GDR GEOPHYSICAL DATA RECORD
  - GPS GLOBAL POSITIONING SATELLITE DATA
  - OD ORBIT DETERMINATION
  - PS PERFORMANCE SUMMARY
  - SAR SYNTHETIC APERTURE RADAR
  - SASS SEASAT-A SATELLITE SCATTEROMETER
  - SDR SENSOR DATA RECORD
  - SMMR SCANNING MULTICHANNEL MICROWAVE RADIOMETER
  - TLM TELEMETRY
  - TOIL TIMED OCEAN, ICE, LAND
  - VIRR VISIBLE AND INFRARED RADIOMETER

ORIGINAL PAGE 13  
OF POOR QUALITY

MSDR volumes. A CAR contains an abstract of the sensor and engineering data recorded on an MSDR volume. At the end of a sequence of MSDR production runs, a catalog processing step was executed to introduce all newly produced CARs into the MSDR Master Catalog. MSDR catalog maintenance processors automatically removed any overlap or duplication caused by rerunning MSDR production jobs.

The Master SDR Catalog (Figure 9-3) is the primary entry point to the Seasat data base. The catalog is an on-line, random-access file on the ADF. Access to the catalog is provided by the program SEASEARCH. This program provides the user with a list of MSDR volumes and time intervals that satisfy a set of user-specified criteria, usually including such things as geographic area, instrument modes, and minimum time interval size. This list of intervals ("hits") is normally presented on the user's terminal, but can also be saved in a file for later use as input to other programs.

Note that while the Master SDR Catalog contains information only about MSDR tapes, it implies a great deal of information about all other forms of data as well. For instance, the information supplied about availability of MSDR data satisfying some set of criteria serves as an upper limit on the availability of SDR or GDR data satisfying the same criteria. Also, the relationship between time and such parameters as geography, instrument mode, etc., reported for MSDR data applies equally well to any other data covering the same interval(s). Thus, the only catalog outputs which are specific to MSDR tapes are the tape reel numbers and the implication that all outputs reported actually exist on some tape. Information in these latter categories for SDR and GDR tapes is contained in the general catalog.

The second catalog in the ADF is called the General Catalog. This catalog is primarily a cross reference between time and tape number for all Seasat data tapes. It contains an entry for each MSDR and SDR tape, and an entry for each distinct file on each GDR tape. This catalog is implemented using the "JPL Data-Management and Information System" (JPLDIS), which is a powerful, general-purpose system for creation, maintenance, and searching of data bases having relatively simple structure. Entries in the general catalog are provided by "accounting cards" produced by all programs which produce tape products, as well as manual inputs provided by the ADF operations team. For ADF products, the cards have been replaced by semi-automatic file update procedures. The catalog file can be searched on any logical combination of time interval, tape type, tape reel number, software system version, and -- for GDR tapes -- creation date, file number, and record types contained on the tape. The most general search capabilities, including user-defined report formats and arbitrary sorts, are provided by JPLDIS. Subset capabilities using pre-defined report formats are provided by a specialized program call SEADIS. The latter supports most catalog search needs at reduced cost. Like SEASEARCH, JPLDIS and SEADIS can produce outputs in a file which can be used to provide time interval commands to other ADF programs.

### C. LOW-RATE DATA SYSTEM PERFORMANCE

The basic requirements of the end-to-end data system are given in Seasat-A Mission Specification, JPL internal document 622-4. These requirements are described briefly in the following paragraphs.

## 1. Telemetry Time-Tagging

Sensor telemetry data had to be time-tagged so that the end-to-end accuracy relative to Universal Time Corrected (UTC) was as follows:

- (1) Altimeter data burst gate:  $\pm 200 \mu\text{s}$ .
- (2) Other data:  $\pm 100 \text{ ms}$ .

## 2. Data Turn-Around Time

Processed data had to be forwarded to the experiment teams from JPL within 10 days after acquisition by an STDN station.

## 3. Real-Time User Data Demonstration

Low-rate sensor data received at Fairbanks, Alaska STDN station (ULA) had to be forwarded to the Fleet Numerical Oceanographic Center (FNOC) within 3 h of acquisition by that station.

## 4. Time-Tagging Results

The performance of the end-to-end data system, in terms of meeting the specified requirements, is summarized in the following paragraphs.

The ALT time-tag accuracy requirement of  $\pm 200 \mu\text{s}$  of absolute GMT required pushing the state-of-the-art at both the satellite and the ground stations. The error budget allotted was  $150 \mu\text{s}$  to satellite sources and  $50 \mu\text{s}$  to ground sources.

After the satellite clock was set to GMT on 27 June 1978, a period of monitoring and frequent adjustment followed. During this time errors were discovered caused by the start-up drift of the on-board stable oscillator. It was also found that certain STDN sites had hardware difficulties introducing errors only in time-tag accuracies at the microsecond level. These sites were dropped from the time calibration effort.

But by far the problem that caused the greatest difficulty was the use of extrapolated range predicts for the calibration passes. Range delay varied from 3 to 10 ms and was the longest delay that was accounted for in the calibration process. The error budget allocated  $25 \mu\text{s}$  to range errors, and this value was usually held at the start of a predict. Several days later in the predict, however, it was evident that unpredictable pressure variations acting on the large and low-flying satellite due to drag and unpredictable solar flares caused the accuracy to deteriorate further in the predict. It took some time to identify what was happening; the solution was to request more frequent tracking passes as well as more frequently updated range predicts.

A detailed analysis of the time tag performance was not made for the first few weeks; however, it was generally conceded that after 50 days in orbit the initial difficulties had been solved and the satellite time tags were consistently

maintained within the allocated error budget.

## 5. Data Turn-Around Results

This requirement was not met at the time of satellite failure. A major problem was the delay in receiving data from the Goddard Space Flight Center's TELOPS system. In some instances, this amounted to 50 days from receipt at the STDN station to receipt at JPL. There were only two days out of the mission in which telemetry was received in less than 10 days at JPL from GSFC. Figure 2-21 in Volume III, Ground Systems, of the Seasat Final Report shows the overall delay during the mission in telemetry data in terms of the Project Master Data File (PMDF) tapes. As can be seen in the figure, there was a backlog of approximately 50 days at the time of spacecraft failure.

An additional problem occurred after failure. All PMDF tapes were returned to GSFC about the middle of January 1979 after several serious time regressions were discovered that had to be corrected by GSFC before JPL processing could proceed. The last of these regressed PMDF tapes was received by May 16, 1979.

If the mission had continued, these problems would have continued to receive priority attention until solved. After the failure, the decision was made to proceed directly to the validation of algorithms with the data set obtained, and no further attempt was made to demonstrate a 10-day turn-around capability as such.

## 6. Real-Time User Data Demonstration Results

At the time of satellite failure, FNOC was still in the process of debugging the "front end" of their satellite data processor system. However, the receive-only link between Fairbanks and Monterey was working well and had been demonstrated several times. Therefore, the system requirement to transfer data was met adequately.

Details of the activity at FNOC are discussed in depth in Section VII of this report.

### D. SAR DATA SYSTEM

#### 1. Introduction

The purpose of the SAR data processing system is to convert the data from the digital range-doppler format, as recorded on magnetic tape at the STDN stations, to a range-along track image of the surface. Two systems were developed: an optical correlator and a digital correlator. The optical correlator system evolved from the research aircraft radar correlator; the digital system utilized a minicomputer and an array processor. The development of the optical system required a special lens to compensate for change in target range across the real aperture. Processing rates of the optical system are between 20 to 40 min of data per week or 8000 to 16,000 km of 100-km swath width. The processing rate for digital correlation is 300 km per week of 100-km swath width. The optically correlated data resolution is 45 m in range and 12 m along track. Digitally

correlated resolution is about 25 by 25 m; the pixel size is slightly smaller. Both systems are currently operational.

The input data to both of these systems is in digital form on magnetic tape as recorded by a Martin-Marietta Honeywell High Density Tape Recorder (HDDR). The principal characteristics are given in Table 9-2.

Table 9-2. Input Data Characteristics

---

Magnetic Tape	9600 feet, 1 inch Ampex #79A Format - digital Record speed - 150 ips nominal Data tracks - 39 Housekeeping tracks - 2 (Track 39 not used)  Record rate - $117.5 \times 10^6$ bps nominal Record period - 12 min maximum Record mode - NRZL Maximum skew - <u>+128</u> bits
Record Format	Word length - 7 bits + parity Frame length - 63 bytes Sync - first 3 bytes
Data Format	Major frame - 13,680 samples over a 300.46- $\mu$ s window Quantization - 5 bits Rate - $117.5 \times 10^6$ bps PRF - 1647 pps Minor frame - 1180 bits Major frame - 60 minor frames

---

## 2. Optical Correlation System Description

A functional diagram of the data flow is given in Figure 9-5. The first step is the conversion from digital data on magnetic tape to analog data on film via the optical recorder, a modified Apollo 17 SAR recorder. The data is played back at one-fourth real time, and one-fourth of the swath is recorded on film. The process is repeated four times to cover the 100-km swath. In this mode, the optical recorder system has a modulation transfer function that limits the resolution of the image to about 20 m in slant range (50 m on surface) and 10 m along track (azimuth). The spacecraft radar resolutions are 8 m in slant range and 5 m along track. The optical recorder performance results in a degraded processing resolution limit.

During the transfer of data to film, the amplitude calibration sequence is recorded on the film. The procedure is to use the receiver noise as a reference. This noise varies with each quarter-section of the 100-km swath being processed in accordance with the instantaneous gain (STC) of the receiver which was originally designed to compensate for the change in system gain caused by the antenna



ORIGINAL PAGE IS  
OF POOR QUALITY

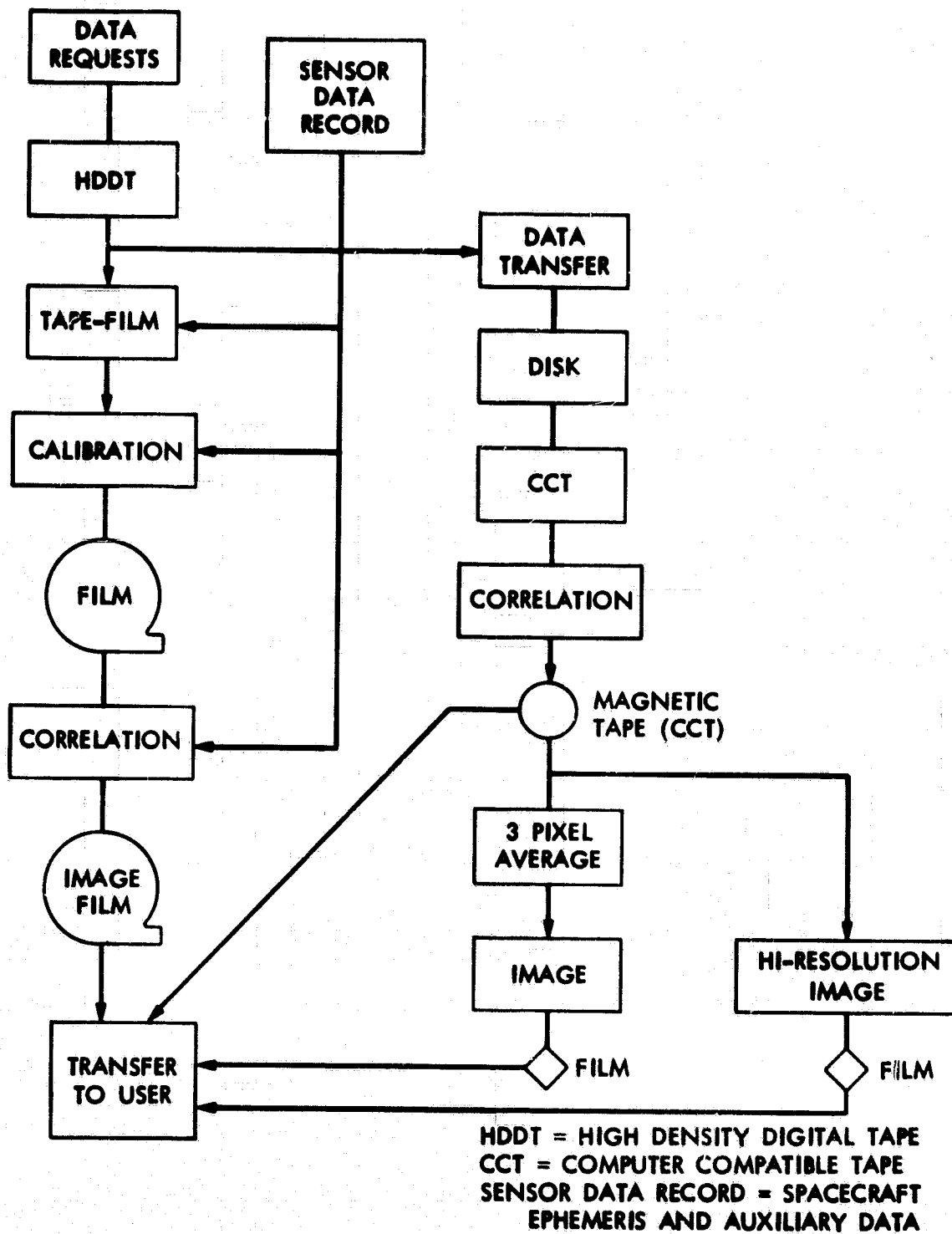

Figure 9-5. Functional Diagram of SAR Data Processing

pattern. However, an error in the command sequence caused the location of the STC relative to the echo to be misplaced, and nearly all the data has a system gain variation of 6 to 12 dB across the swath. All optical data have a noise step wedge at the beginning of each quarter-swath. The steps are: (1) reference 1 (for setting laser intensity in correlator), it varies for each quarter-swath as a function of STC and antenna gain variation, and is used to maintain approximately the same density for the same radar cross-section across the four quarter-swaths; (2) reference 2, 13 dB above receive-only noise as measured for that particular quarter-swath; Steps (3) through (8) are -3 dB steps relative to the level in reference 2 and provide a transfer function relating film density to radar cross-section.

An example of a film density to radar cross-section curve is given in Figure 9-6.

### 3. Optical Correlation Transfer Functions

A functional block diagram of the optical processing system used for Seasat SAR data processing is shown in Figure 9-7. The data recorded digitally on high density magnetic tape is played back on a High Density Digital Recorder (HDDR) and converted to analog video and digital time signals and recorded on photographic film by a CRT recording system. The film is developed and loaded on the input film drive of the optical correlator where it is illuminated by a plane wave from an expanded laser beam. The first lens presents a two-dimensional Fourier transform of the data at its back focal plane. Here the range migration (curvature and walk) correction and frequency filtering are performed. A second lens retransforms the data back to image space where the azimuth telescope achieves unity aspect ratio and brings the azimuth phase histories into focus. A relay lens performs two-dimensional scaling of the image which can be recorded digitally or optically.

### 4. Digital Correlator Description

The development of a digital correlator was initiated in April 1978, supported by the NASA Office of Advanced Science and Technology. The processing began one year later with a throughput rate of three 100 x 100-km scenes per week.

A functional diagram of an approach is shown in Figure 9-8. The raw data are first range-correlated to compress the phase-coded pulse into a much narrower pulse. The range-processed data blocks are stored, and then retrieved along the direction of azimuth correlation. The transfer function of the azimuth filtering needs to be constantly updated for targets at different range,  $r_0$ . This is because the waveform of the reference function changes with respect to  $r_0$ . Because the azimuth reference function is target range-dependent, optimal processing requires range correlation be performed prior to the azimuth correlation.

The algorithm implemented in the software SAR processing system is a slight deviation of the exact hybrid algorithm described above. The particular method was originally described in Ref. 9-9. It assumes a quadratic azimuth phase history, which has a linear frequency-time relationship. Signal samples taken

ORIGINAL PAGE IS  
OF POOR QUALITY

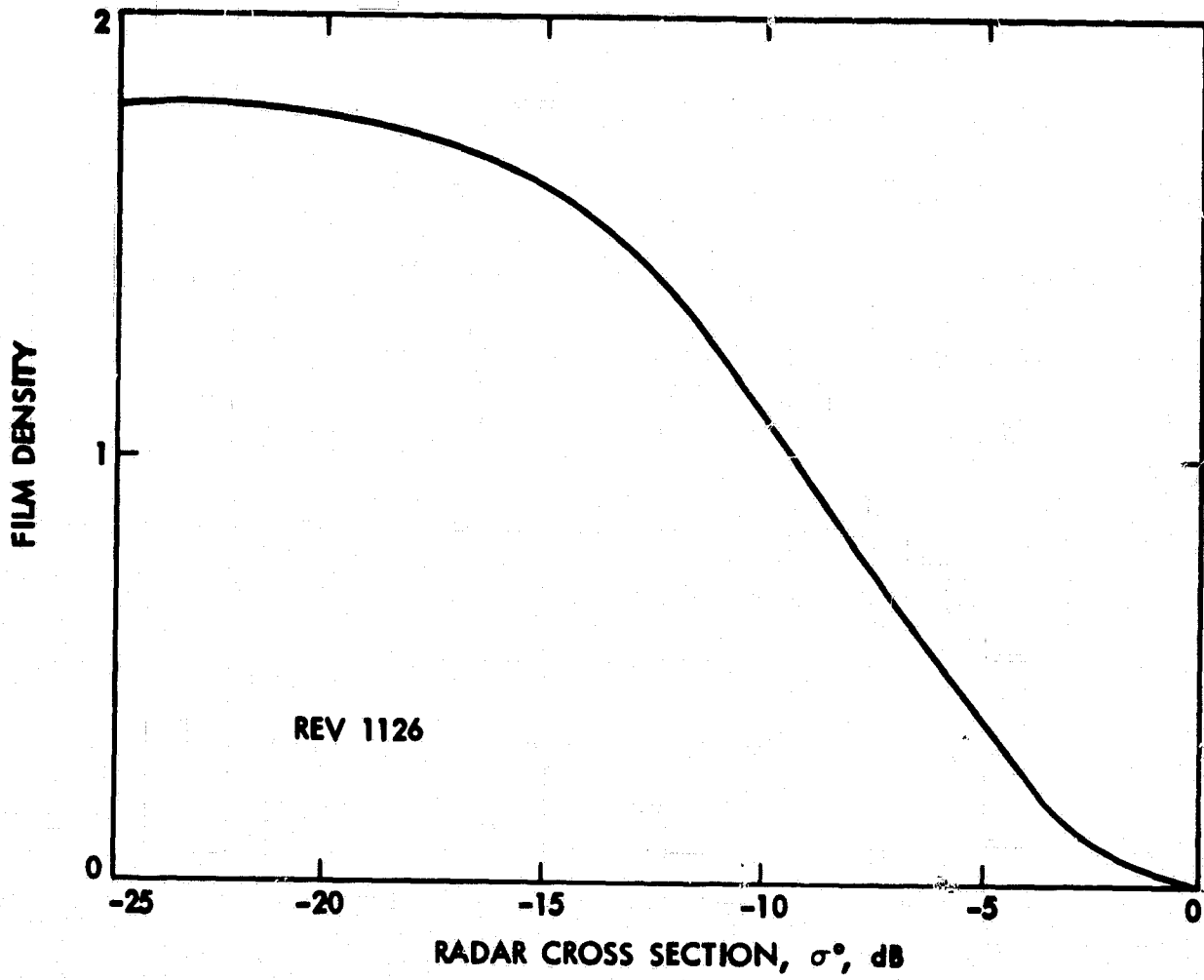

Figure 9-6. Film Density vs  $\sigma^\circ$  Calibration Curve

ORIGINAL PAGE IS  
OF POOR QUALITY

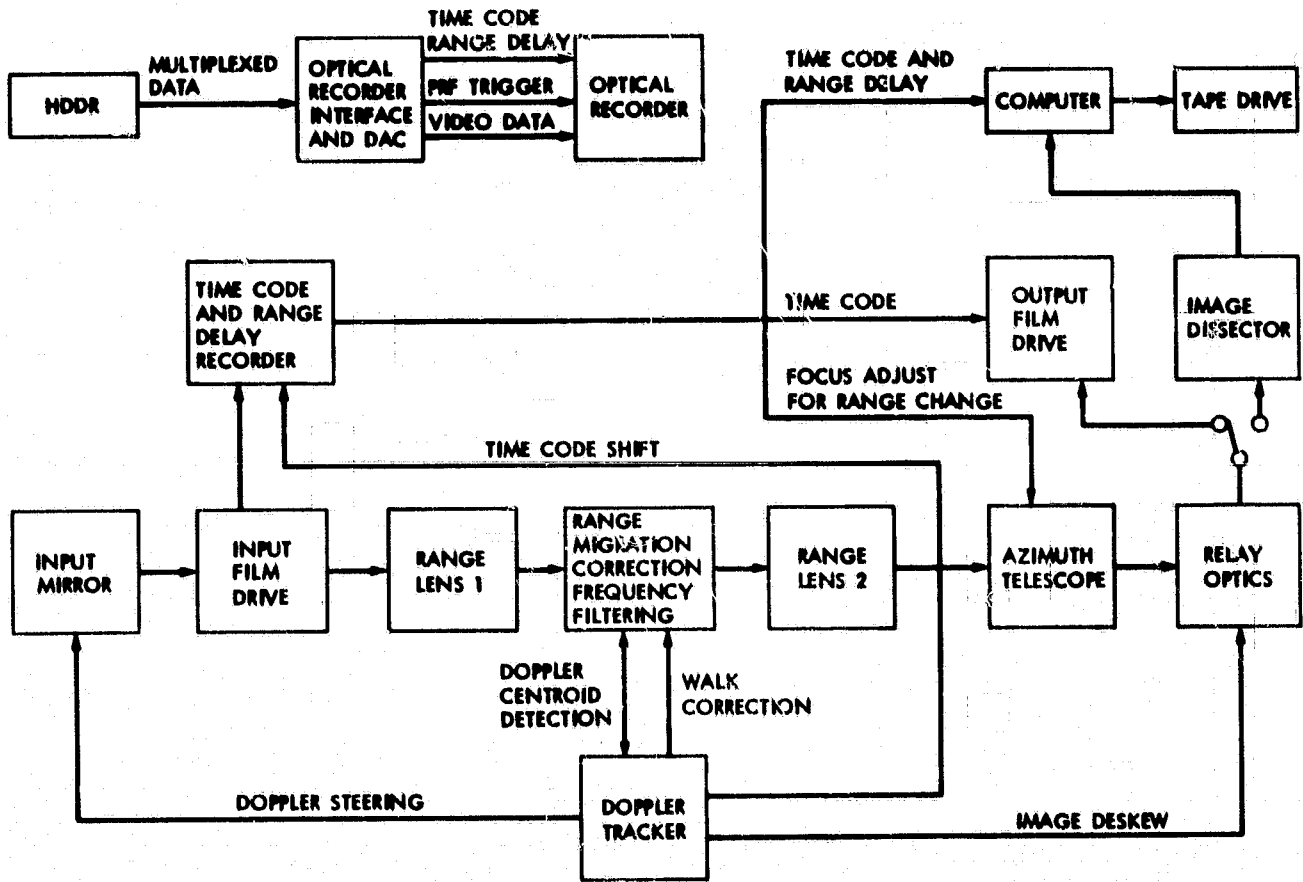

Figure 9-7. Optical Correlation Functional Diagram

ORIGINAL PAGE IS  
OF POOR QUALITY

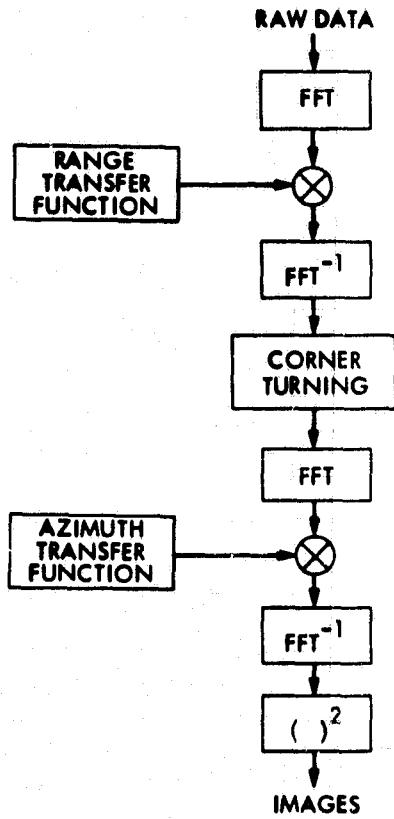

Figure 9-8. An FFT Matched Filtering SAR Data Processing Approach

along a segment of the azimuth response thus occupy a distinct frequency band in the azimuth Fourier transform domain. The correspondence to the hybrid algorithm is that each transfer function has its relatively independent band of spectral response. The hybrid algorithm calls for a linear superposition of the filtered data spectra into a one-dimensional spectrum. The approximation made here is to select a set of nonoverlapping spectral bands and to superimpose them into a composite spectrum. A graphical illustration of the procedure is shown in Figure 9-9. The upper part of the figure is an example of the curved locus of a point target. To compensate for the range curvature effect, radar echo data are range-correlated first. The composite spectrum of an image line is obtained by assembling the appropriate segments from the spectra of several azimuth lines. This is shown in the lower part of Figure 9-9. Note that the spectral segments presented in the figure are mutually independent. This represents a noninterpolative nearest neighbor selection of signal samples from a rectangular grid. For a quadratic phase response function, signal response on the spectral domain resembles that in the time domain because of the linear frequency and time relationship of the quadratic phase function. This nearest-neighbor sampling in azimuth correlation results in a higher side-lobe response than the exact approach as described by the hybrid correlation algorithm.

This digital SAR processing algorithm performs the range and azimuth correlation over one-dimensional block. The block diagram shown in Figure 9-8 is still a valid representation. Memory access in corner turn and range curvature compensation functions presents the main control complexity. In general, the process is straightforward and is capable of providing an order of magnitude gain in arithmetic efficiency relative to a time domain convolutional approach.

The computer used in the implementation is a SEL 32/55 minicomputer. Its core memory was expanded to 96K words (32-bit word) to provide some buffer space for corner turn and range curvature correction functions. The computer was further augmented by an AP-120B floating point array processor to enhance its computational capability. A 300-Mbyte disk drive was incorporated to store the amount of raw data for a 100-km x 100-km Seasat SAR image frame. Another 80-Mbyte disk is also used as an intermediate data storage device. A block diagram of the processing facility is shown in Figure 9-10. The system also features a fiber optics data communication link and interface to transfer data directly from the Seasat High Density Digital Recorder (HDDR) to the 300-Mbyte disk storage. Other elements include a computer tape drive to store the processed digital imagery, and a Dicomed image recorder device for coarse image and data display.

Software implementation is very much constrained by the available memory space in core and disks for intermediate data storage. Each of the major processing function is implemented by a program module. A block diagram of the software modules is shown in Figure 9-11.

After the raw data are loaded onto the 300-Mbyte storage disk, the pre-processing program performs the needed clutterlock and autofocusing functions to refine the SAR processing parameter estimates -- doppler center frequency and frequency rate values -- to produce accurate synthetic aperture phase response history. Operator interaction to examine the spectral energy distribution (for clutterlock) and the quantitative measure of focusing over a small piece of processed imagery is currently required. Based on the refined parameters, a set

ORIGINAL PAGE IS  
OF POOR QUALITY

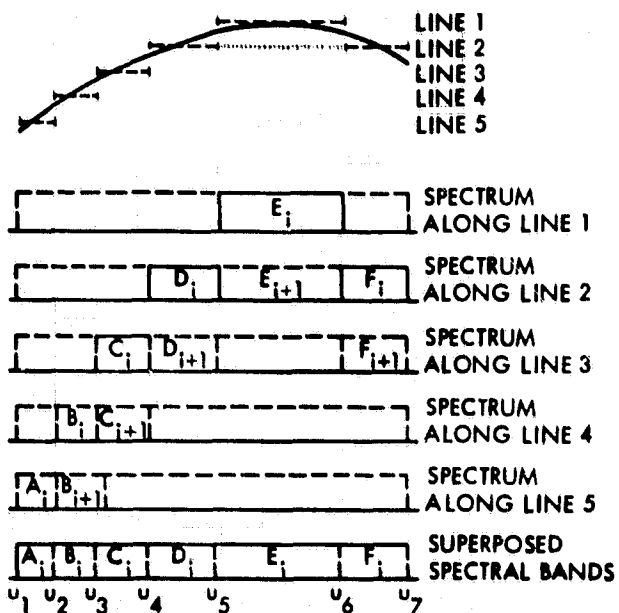

Figure 9-9. Delay and Coherent Registration at SAR Azimuth Spectral Bands

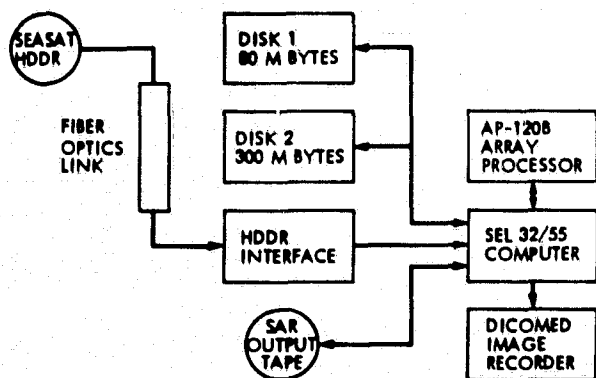

Figure 9-10. Interim Digital SAR Processor Facility Block Diagram

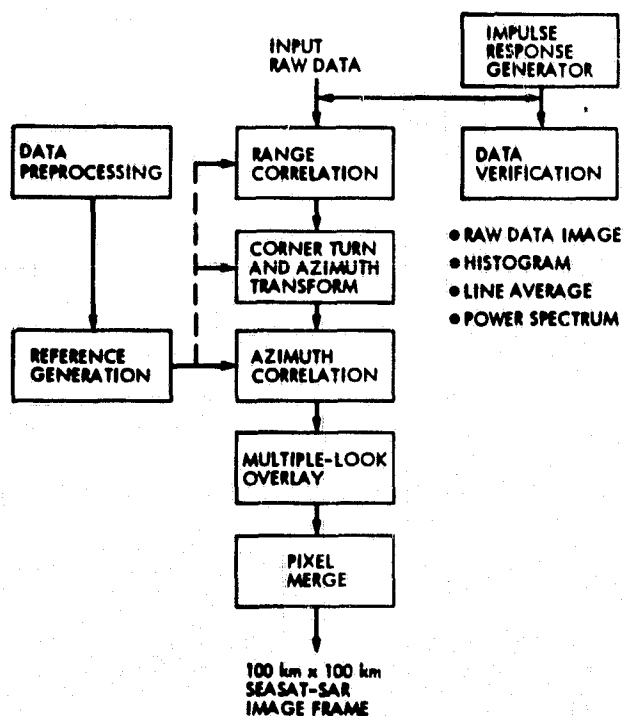

Figure 9-11. Interim Digital SAR Processor Software Block Diagram

of azimuth reference functions is generated and stored on the disk for subsequent correlation processing. The doppler frequency parameter will also be used in range correlation, where a sliding of starting range samples is incorporated to compensate for the excessive range walk effect which result from the near uniform target motion due to Earth rotation during Seasat SAR imaging.

The correlation function in Seasat SAR processing to produce multiple-look SAR imagery comprises four main software modules in this implementation. They are the range correlation, the corner turn and azimuth forward transform, the azimuth correlation, and the multiple-look overlay. The software design reflects an effort to balance the computation time and data transferring time between various hardware elements to improve on system efficiency. The FFT block size was chosen to be 2048 both in the range correlation and azimuth forward transform.

The azimuth inverse transform block is of 512 elements because each single-look Seasat SAR processing requires only one quarter of the available azimuth bandwidth. Delay and overlay of four single-look imagery of the same area is applied to produce a four-look SAR imagery. The finite transform block size and intermediate data storage space limit the size of the output imagery after one loop of correlation processing to be approximately 20 km x 33 km. An executive program controls a total of 15 loops of processing to produce a final 100 km x 100 km Seasat SAR frame which has approximately 36 million pixels. The current throughput speed is one image frame per approximately 9.5 h of processing time.

Other software programs developed for this task include a point target response generator to test the correlation processing, and several other programs to verify the quality of input raw data and output SAR imagery.

## 5. Data Correlation Operations

The purpose of the optical correlation was to provide a survey of all data acquired; resolution and overall quality were secondary. The purpose of the digitally correlated data was to provide a small amount of controlled imagery. The progress in data processing is shown in Figure 9-12. All of this data has been sent to NOAA EDIS for dissemination to the users. All of the digital data and most of the optical imagery were processed at the request of experimenters or users. Currently, all new requests are being handled through NOAA EDIS.

## REFERENCES

- 9-1. Levy, H. H., "Telemetry On-Line Processing System (TELOPS) Interface Control Document," Goddard Space Flight Center Document X-564-76-210, Sept. 1976.
- 9-2. Durkin, J. F., and Cunningham, G. W., "Taking the Measure of Space," Datamation, p. 127, Sept. 1979.



ORIGINAL PAGE IS  
OF POOR QUALITY

- 9-3. "Sea Satellite-A (SEASAT-A) Telemetry Processing System (TPS) Detail Design," prepared for NASA Goddard Space Flight Center by Computer Science Corporation under Contract NAS5-24300, Task Assignment 653, Nov. 1977.
- 9-4. Myers, W., ed., "Studying the Ocean from Space," Computer, pp. 68-75, Aug. 1978.
- 9-5. Brown, J. W., Seasat-A ADF Programming Standards, JPL Internal Document 622-35, Rev. A, Apr. 1978.
- 9-6. Brown, J. W., Seasat-A Algorithm Development Facility User's Guide, JPL Internal Document 622-62, Apr. 1980.
- 9-7. Reeyces, J. L., Meeting of the Optical Society of America, October 1973, Vol. 63, No. 10, p. 1307, 1973.
- 9-8. Bicknell, T., Redmann, G. H., and Brown, W. E., Jr., A Study to Determine the Feasibility of Using Radar Techniques for Public Land Surveying, JPL Internal Document 1200-214, May 20, 1975.
- 9-9. Wu, C., "A Digital System to Produce Imagery from SAR Data," Proceedings of the AIAA Systems Design Driven by Sensors Conference, Paper No. 76-968, Pasadena, California, Oct. 1976.

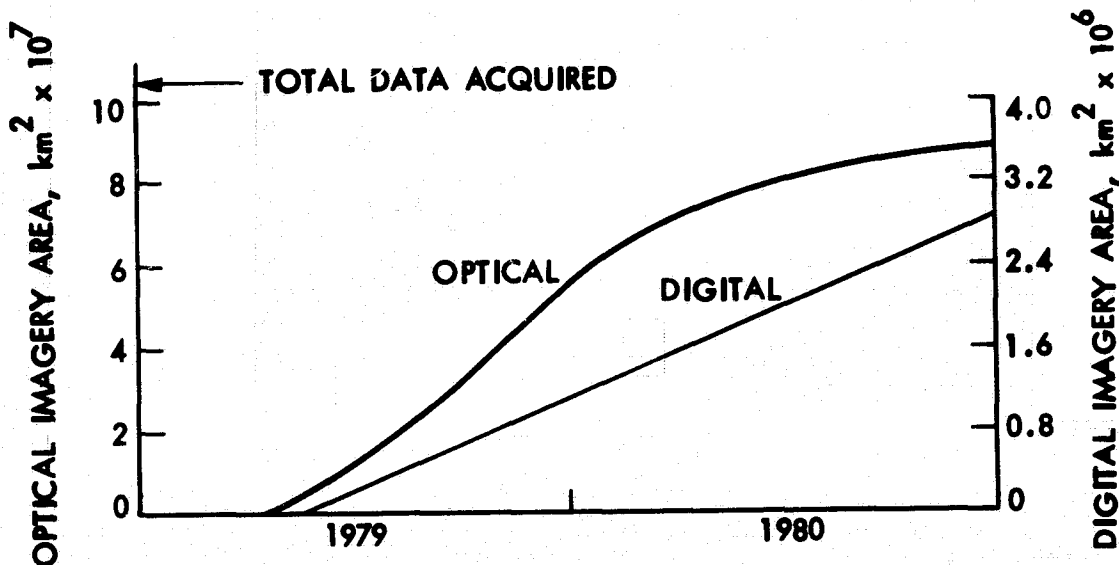

Figure 9-12. Seasat SAR Data Converted to Imagery

## SECTION X

### DATA SET DESCRIPTION

#### A. LOW-RATE DATA

The Instrument Data Processing System (IDPS) processed all data to create the Earth-located, time-ordered Master Sensor Data Record (MSDR) and the accompanying data catalog. The generation of the MSDRs by the IDPS began with the extraction of telemetry data frames from the project master data file. Data channels or measurements were packed (commutated) within a telemetry frame as efficiently as possible to reduce the volume of data transmitted by the satellite. A process called decommutation and engineering unit conversion was used to extract sensor measurements from the satellite telemetry frame and convert them from telemetered numbers to engineering units (volts, degrees, or other units).

These converted channels were positioned in a new data record called the Sensor Data Record (SDR), a record formatted for the convenience of further computer processing. Required auxiliary engineering data channels were similarly processed and added to the SDR. The latitude and longitude of each sensor field-of-view footprint (boresight) and the spacecraft altitude were computed using the telemetered time tag and the satellite attitude and orbit files. Special sensor-dependent Earth-location parameters needed in the geophysical data reduction were also computed. These location parameters were then appended to the SDR. The magnetic tape file containing data records from all sensors is the MSDR, which is the Seasat archival data base. The SDR tape files, containing data from only one sensor, can be extracted from the archival data base as needed.

Two catalogs of the Seasat data, the MSDR catalog and the general catalog, are available to provide convenient access to data of specific interest among the thousands of reels of tape.

The MSDR catalog is a detailed summary of all of the MSDR tapes, and can be searched for data satisfying any desired combination of geography, instrument mode, and time span. Search results include tape reel numbers and other access information and specific time intervals within each tape reel which contain data satisfying all user-specified criteria. The general catalog is essentially a cross-reference between time and tape reel number for all types of data tapes. Both catalogs are on-line and can be searched interactively by users with remote terminals.

Geophysical Data Records (GDRs) are being processed by the Seasat Data Utilization Project and will be described later.

The quantity of data in this set is shown in Table 10-1 for each sensor.

#### B. SAR DATA SET

The amount of data obtained from the five SAR receiving stations is shown in Table 10-2. These data in original form are on high density digital tapes, and are being retained at JPL as raw data records. NOAA-EDIS is archiving three products:

ORIGINAL PAGE IS  
OF POOR QUALITY

Table 10-1. Availability of Sensor Data in MSDR Tapes

Mission Duration = 104 days, 6 h, 52 min, 2 s

Sensor	First Data Date (yr:day:h:min:s)	First Good Science Date (yr:day:h:min:s)	Available Days <sup>a</sup> (day:h:min:s)	Data Gaps in Mission <sup>b</sup> (day:h:min:s)
Engineering (ENG)	78:178:19:38:34	78:178:19:38:34	99:10:44:53 (8,592,293 s)	04:20:07:09 (418,029 s)
Altimeter (ALT)	78:184:14:13:52	78:188:04:21:44	63:11:11:18 (5,483,478 s)	40:17:57:51 (3,526,864 s)
Scatterometer (SASS)	78:187:18:19:50	78:187:18:19:50	90:22:56:17 (7,858,577 s)	13:07:55:45 (1,151,745 s)
Scanning Multi- channel Radio- meter (SMMR)	78:185:05:27:11	78:185:05:27:11	94:04:24:41 (8,137,481 s)	10:02:27:21 (872,841 s)
Visible and Infrared Radio- meter (VIRR)	78:187:09:09:11	78:187:09:09:11	48:00:50:59 (4,150,259 s)	56:06:01:03 (4,860,063 s)

<sup>a</sup> Amount of data at JPL from First Good Science Date to End of Mission.

<sup>b</sup> The sum of all missing or special category data (i.e., standby) from First Data Date to End of Mission. Any data before the First Science Date was regarded as special category data and, therefore, summed in the data gap value.

- (1) 70-mm film strips covering each observational pass, made on the JPL optical correlator.
- (2) Computer compatible digital tapes (CCTs) of selected scenes of greatest interest, made from the original data records.
- (3) Images made from the CCTs.

The geographical coverage is shown in Figures 10-1 and 10-2.

Table 10-2. Seasat SAR Coverage

Station Locations	Coverage Time, min
Fairbanks, Alaska (ULA)	1055
Goldstone, California (GDS)	726
Merritt Island, Florida (MIL)	548
Oakhanger, England (UKO)	182
Shoe Cove, Canada (SNF)	<u>52</u>
Total	2563

ORIGINAL PAGE 19  
OF POOR QUALITY



Figure 10-1. Seasat SAR Coverage: North America

ORIGINAL PAGE 13  
OF POOR QUALITY

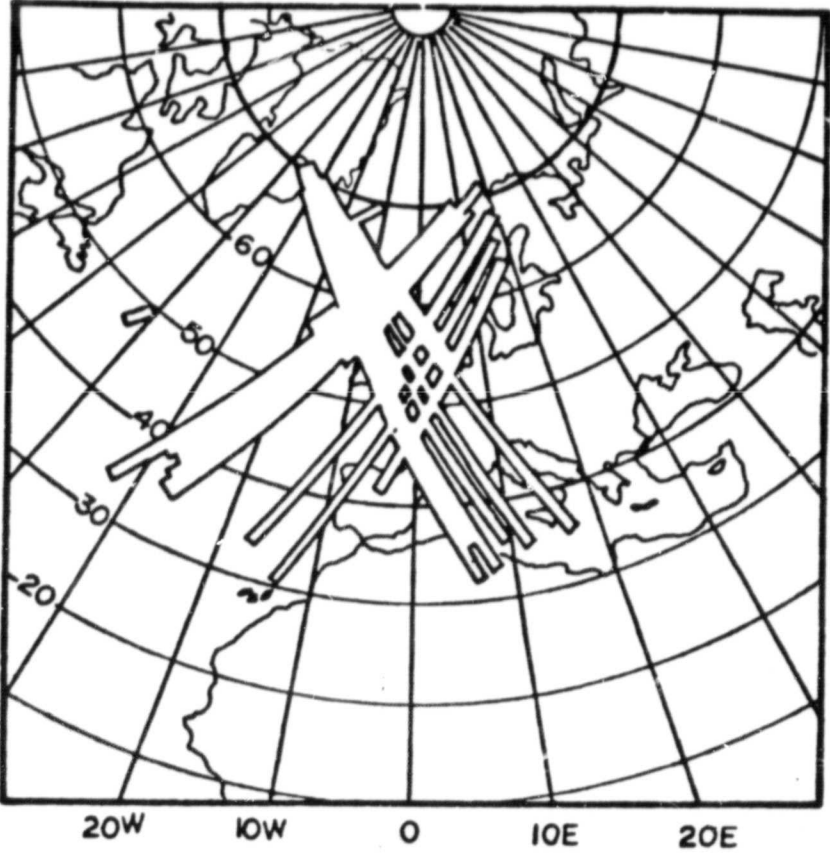

Figure 10-2. Seasat SAR Coverage: Europe

## SECTION XI

### SENSOR SUMMARY AND REQUIREMENTS

#### A. SUMMARY

The Seasat spacecraft carried the following five sensors: Radar Altimeter (ALT); Scanning Multichannel Microwave Radiometer (SMRR); Scatterometer (SASS); Synthetic Aperture Radar (SAR); and Visual and Infrared Radiometer (VIRR). The ALT, SASS, and SAR were active radiators, and the SMRR and VIRR were passive receivers. Each sensor had different coverage characteristics, depending on its pointing, field-of-view, data handling, and, for the SASS, the doppler velocity between the spacecraft and ground points. The sensors were all secured to the spacecraft so that the only change in coverage was due to a change in either or both the spacecraft position and altitude. The only exception was the ALT, which sensed conditions at the sub-spacecraft point normal to the surface and independent of nominal spacecraft oscillations.

#### B. SENSOR REQUIREMENTS

##### 1. Radar Altimeter

The ALT measured average wave height to within 10 percent over a range of 2 to 20 m (6 to 66 ft) and measured the height of the spacecraft above the ocean to a precision of 10 cm (4 in.). The height measurements allowed determination of sea-surface topographic features that corresponded to ocean tides, storm surges, and currents. The ALT generated a 13.56-GHz chirp signal at 2-kW peak power. The signal was radiated to Earth through a 1-m (39-in.) antenna directed at the sub-spacecraft point. The reflected signal, when received at the spacecraft, was amplified, converted from analog to digital form, and processed digitally in the ALT. That processing included the following:

- (1) Acquisition and tracking of the returned signal.
- (2) Development of estimates of altitude and wave state.
- (3) Relaying the on-board measurements and other data for transmission to Earth for additional processing.

The ALT power consumption was 177 W, and the unit weighed 93.8 kg (206.8 lb).

##### 2. Scanning Multichannel Microwave Radiometer

The SMRR data was used to derive sea-surface temperatures, wind speed, and atmospheric water content. It also measured the absolute levels and relative variations in the microwave radiation received from the surface. The SMRR measured: surface temperatures with a precision of 1.5 to 2°C (2.7 to 3.6°F); wind speeds up to 50 m/s (164 ft/s) and provided atmospheric correction data to other instruments by measuring water-vapor content in the atmosphere. The instrument covered an area beneath the satellite 650 km (350 nmi) wide. The SMRR used a

scanning 42-deg-offset parabolic antenna to receive signals from Earth. It measured horizontal and vertical polarization components of microwave radiation at 6.6, 10.69, 18.0, 21.0, and 37.0 GHz. The signal was converted from analog to digital form in the instrument, and then integrated into the satellite telemetry data stream to Earth for final processing. The SMMR power consumption was 59.66 W. The unit weighed 53.9 kg (118.83 lb).

### 3. Scatterometer

The SASS measured fine-scale ocean-surface roughness caused by surface winds. The measurements could be converted directly into wind speed and direction. The SASS measured wind speeds from 4 m/s (13 ft/s) to 48 m/s (154 ft/s) to an accuracy to 10 percent or 2 m/s (6 ft/s), whichever was greater, and wind directions to 20 percent. The instrument measured wind speed and direction in two surface swaths on each side of the spacecraft, each 500 km (270 nmi) wide. The SASS could measure wind speed only for an additional 250 km (135 nmi) on each side of the main swaths. The instrument generated a 14.6-GHz signal at 100-W peak power that was radiated to Earth through four fan-beam antennas that had vertical and horizontal polarization. The reflected signal was received, amplified, and converted from analog to digital form in the sensor. It was then routed to the satellite data system for transmission to Earth for final processing. The unit electronics assembly weighed 59 kg (130 lb), and each antenna weighed 11 kg (24.25 lb) for a total weight of 103 kg (227 lb).

### 4. Synthetic Aperture Radar

The SAR provided all-weather pictures of ocean waves, ice fields, ice leads, (linear openings in ice), fresh-water ice, land, snow cover, and coastal conditions. It also provided ocean-wave spectra, including wave direction. The instrument produced images with resolution of 25 m (80 ft) over a swath of 100 km (54 nmi) wide. A typical pass with the instrument lasted 10 min. The SAR was the first NASA radar system of its kind designed to study ocean-wave patterns from orbit. The system consisted of a deployable radar antenna 2.1 m (7 ft) by 10.7 m (35 ft); a SAR sensor, including a solid-state transmitter, low-noise receiver, and digital controller; and a data link to transmit the radar signal to Earth for processing. The sensor generated a 1.275-GHz chirp signal at 1000-W peak power that was radiated to Earth by the radar antenna. The reflected signal was received on the spacecraft where it was amplified by the sensor, converted to 2.265 GHz, and transmitted to Earth in analog form by the SAR data link. The signal was digitized and stored on tape at the tracking station. The signal was processed into radar images at JPL's Radar Imaging Processing Facility. Because of the high data rate of the radar imagery (equivalent to 110 million b/s), the SAR, with its special ground equipment, operated only within line-of-sight of specific tracking stations equipped to receive the data. Those tracking stations were located at Goldstone, California (GDS), Merritt Island, Florida (MIL), and Fairbanks, Alaska (ULA). The SAR weighed 147 kg (324.5 lb), and consumed 216 W of power.



## 5. Visual and Infrared Radiometer

The VIRR, which was not a microwave instrument, provided supporting data for the four microwave sensor experiments. The VIRR measured the energy received at  $0.72 \mu\text{m}$  (visible) and  $11.5 \mu\text{m}$  (infrared). The instrument scanned at 48 rpm across the sub-satellite point in a plane normal to the orbit plane. The total Earth scan angle from horizon to horizon was 125 deg. The instantaneous field of view for the visible channel was  $2.8 \pm 0.3$  milliradians, and for the IR channel was  $5.3 \pm 0.5-1.1$  milliradians. The VIRR was an existing sensor of the type (ITOS-J SR) used on other NOAA environmental satellites. The performance requirements for the VIRR stated that the data output with appropriate ground processing should result in:

- (1) The determination of ocean surface temperature  $\pm 1.5^\circ\text{C}$  at  $273^\circ\text{C}$ .
- (2) A cell resolution (instantaneous field of view) for the visible channel of 2 km by 2 km (1 nmi by 1 nmi), and for the IR channel of 4 km by 4 km (2 nmi by 2 nmi).
- (3) A grid resolution (from scanning) of 9 km by 9 km (5 nmi by 5 nmi) for both channels.
- (4) Cloud, coastline, or ocean thermal feature location to within 6 km (3 nmi).

The VIRR, consisting of an electronics module and a scanner, weighed 8.1 kg (17.85 lb), and consumed 7.3 W of power.

## SECTION XII

### PROJECT MANAGEMENT

#### A. PURPOSE

Included in this section is a brief historical summary of the financial and manpower resources used by the Seasat project and some insights into the development history of the estimates and the activities and events that resulted in the final resources requirements.

#### B. BACKGROUND

The Seasat project was first proposed within NASA based on the concept that a fixed price mainframe could be procured from industry, a complement of ocean-condition sensors could be evolved from previous satellite and aircraft programs, and the system would be operated within the existing capabilities of the NASA Spaceflight Tracking and Data Network (STDN). Early estimates ranged from \$30 million to \$40 million for this effort.

In September 1973, a Phase A report was provided to the administrator that projected a \$58.2 million run-out cost for Seasat, including the cost of STDN support and a Delta 2910 launch vehicle. The parts at that time were: Office of Applications (OA), \$45.0 million; Office of Tracking and Data Acquisition (OTDA), \$7.9 million; and OSF, \$5.3 million (for the Delta launch vehicle). The \$45.0 million estimate was the Phase A baseline target goal for a satellite system with a five-sensor complement (Reference 12-1).

In December 1973, a not-to-exceed cost ceiling of \$58.2 million was imposed by the Deputy Administrator of NASA upon the Office of Applications for the Seasat project. This ceiling was maintained throughout the Phase B studies. Cost projections that exceeded that amount were cut back by a combination of scope reductions and general trimming so as to remain within the ceiling.

Phase B studies were started with two payloads and approaches defined (Reference 12-2). Wallops Flight Center (WFC) and the Applied Physics Laboratory (APL) of Johns Hopkins University were given the baseline mission with an in-house design approach. The baseline payload included the following sensor complement:

- (1) Radar Altimeter (ALT):  $\pm 10$ -cm precision, pulse compression.
- (2) Scatterometer (SASS): 4- to 30-m/s wind speeds with a dual-frequency mode.
- (3) Synthetic Aperture Radar (SAR): dual swaths, two quantization modes, high-resolution and wide swath imaging modes, and a checkerboard mode; 25-m imagery.

- (4) Nimbus-G five-frequency Scanning Multichannel Microwave Radiometer (SMMR): 7- to 50-m/s wind speeds,  $\pm 1.5^{\circ}\text{C}$  sea surface temperature, low-resolution ice imagery, and provision for a water vapor path length correction for the ALT.
- (5) ITOS-D Visual and Infrared Radiometer (VIRR): clear weather feature identification.

The JPL Phase B study was a system contractor mode with an alternate payload (the same sensor complement as the WFC/APL baseline payload, but excluding the SAR). Four study contracts were negotiated with industry (Boeing, General Electric, LMSC, and TRW), and the results used in developing the JPL cost estimates.

The Phase B mid-term reports (9-10 May 1974) provided the following cost estimates:

1. WFC/APL Baseline Mission (In-house Design)

(1) Bus and launch vehicle	17.3
(2) Sensors	17.3
(3) Sensor module	10.9
(4) Integrated system checkout and launch	1.5
(5) Ground data system, including OTDA	14.4
(6) Spares and 18-month backup	4.3
(7) Program management	- -
	<hr/>
Subtotal	\$65.7 million
IMS and KTR services	1.6
Inflation	6.85
APA	11.05
	<hr/>
Total	\$85.2 million

2. JPL Alternate Payload (One Satellite System Contractor)

(1) Bus and launch vehicle	18.0
(2) Sensors	14.7
(3) Sensor system	6.9
(4) Pre-launch Operations, including \$2.4 million for backup	5.3

(5) Project and OTDA mission operations	8.6
(6) Project management	1.4
	<hr/>
Subtotal	\$54.9 million
Inflation at 5 percent/yr	5.5
APA at 10 percent	5.5
	<hr/>
Total	\$65.9 million

The mid-term review cost estimates demonstrated that the \$58.2 million estimated in the Phase A feasibility studies was not achievable with the program as defined.

NASA headquarters, following the mid-term review, established a design-to-cost program guideline (including contingency and inflation) of \$58.2 million.

The WFC/APL approach was to reduce program requirements until costs were within the guideline. The first step was to return to an experimental SAR with the primary objective of retaining the 25-m resolution and 100-km swath measurement capabilities. Eliminated were the high-speed, high-capacity on-board tape recorder, spacecraft computer, dual-resolution, dual-swath and special ground station interfaces and digital image processor. The SAR demonstration was modified to reduce the volume of data.

The next step was to drop the Nimbus-G microwave radiometer and replace it with the Nimbus-E 2-frequency NEMS radiometer. A further recommendation was that the maximum likelihood processor for the ALT be dropped due to elimination of the data processor requirements for SAR.

These steps resulted in a reduced mission with full implementation by APL for a total cost (including inflation and APA) of \$62.1 million. Since this amount still exceeded the guideline, a program approach minimizing costs proposed building a combined SASS/ALT which would result in a cost savings of \$2.3 million, have JPL provide the SAR (-\$0.6 million), and reduce the spares program by \$0.7 million. These reductions, and other minor adjustments, resulted in a total project cost estimate of \$58.2 million.

At the joint management meeting in August 1974 with APL, JPL, and WFC, a total reduced baseline payload was developed. The sensor module as defined at that time did not include the SASS antennas, S-band transponder, SAR data transmitter and modulator, or the tape recorders. The project total was \$65.4 million and the sensor module was \$12.9 million, including APA. Reductions from this estimate of \$7.2 million were made to develop a project total of \$58.2 million. The amount removed from the sensor module was \$1.8 million (0.9 million module reduction and 0.9 million APL and WFC management). This joint action resulted in a cost estimate of \$10.1 million plus \$1.0 million APA for the sensor module. These were the amounts reported in the 16 August 1974 meeting with Petrone.

Figure 12-1 recaps Seasat's cost estimate history from the start of Phase B to the presentation meeting with Petrone.

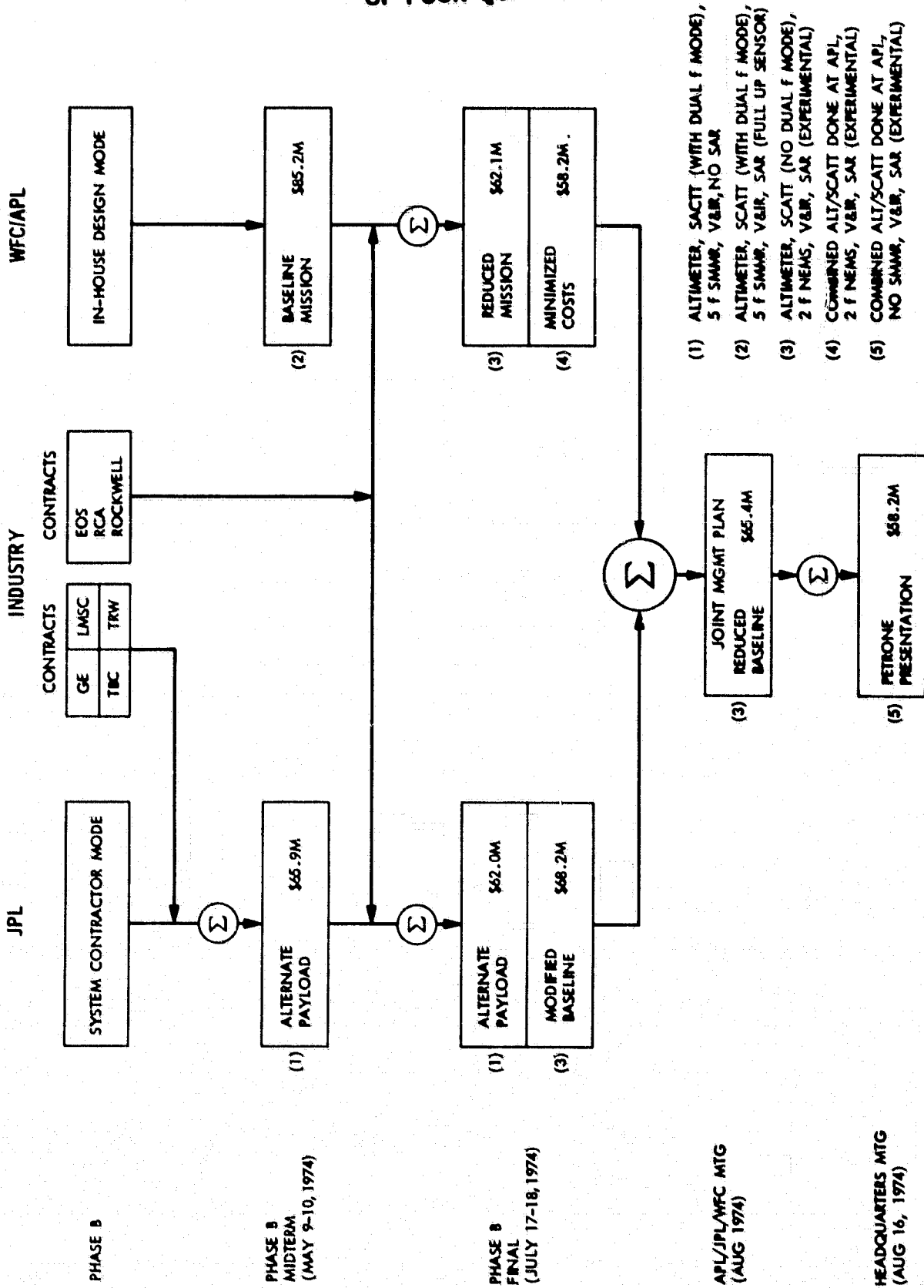

Figure 12-1. Seasat Cost Estimate History (Phase B to Petrone)

## C. PROJECT IMPLEMENTATION

JPL was selected to manage the project in late summer of 1974. A project office was established, and implementation plans were developed. Performance, schedule, and cost goals were established. These goals provided management with a reference point for evaluation of the risks which faced the project.

The overall environment was one of austerity. Phase A and B studies had shown a much higher potential cost at completion. The inflation factor of 5 percent was felt to be quite low. The implementation mode which had been developed within the Phase B studies provided for procurement of a fixed price bus by JPL and sensor module development and sensor integration by WFC/APL. This plan was modified so that the bus contractor would do the entire job in a more traditional system contract type mode. This approach cleared up a large part of the interface problems which could result and was also intended to reduce the total cost of implementation.

Requests for Proposals (RFPs) for the satellite system were released in January and September 1975. The first RFP was still locked to the Phase B approach, and the second RFP was a reflection of the change in implementation approach. The request provided for the total effort to be divided into two contracts, one Fixed Price Incentive (FPI) contract for the satellite bus and a Cost Plus Award Fee (CPAF) contract for satellite system engineering and sensor module development.

In July 1975, a new baseline project was established with OA management, at a new cost at completion total of \$74.7 million. The major changes from the \$58.2 million estimate included: an adjustment for inflation from 5 to 7 percent, addition of the SMMR and upgrading of the ALT based on the strong recommendation of the Seasat Science Steering Group (SSG), and a revision to the basic implementation estimate. Reserves were pared from 11 to 7 percent of the OA portion and no APA was established by Headquarters.

The Lockheed Missile and Space Company (LMSC) of Sunnyvale, California, was selected from two proposals received by JPL. The contracts were negotiated in the winter of 1975 with contract start on 12 February 1976.

The sensors and some selected subsystem elements were provided as GFE to LMSC by JPL and three NASA centers.

## D. ESTIMATED COST AT COMPLETION HISTORY

### 1. Summary

Table 12-1 provides an overview analysis of the changes in estimated cost at completion by the major elements of the project. The following major budgetary milestones were selected: Patrone meeting, \$58.2 million; POP 75-2 (baseline), \$74.7 million; allocation of reserves, \$74.7 million; scope changes, \$78.8 million; pre-launch POP 78-2, \$94.0 million; and the final budget POP 79-2, \$94.0 million.

ORIGINAL PAGE IS  
OF POOR QUALITY

Table 12-1. Seasat Estimated Cost at Completion History  
in Millions of Dollars

Milestone	OA	OSF	OTDA	Total
1) Petrone Meeting (16 August 1974)	49.84	4.84	3.52	58.2
<u>Elements</u>				
Satellite system	23.96			
Sensor development	12.01			
Mission operations	4.66			
Project management	4.41			
Reserves (11%)	4.80			
Launch vehicle		4.84		
STDN network			3.52	
2) POP 75-2 (July 1975) Baseline	65.70	5.00	4.00	74.70
<u>Major Changes from \$58.2 Million</u>				
Inflation adjustment				+6.6
Addition of SMMR				+6.2
Upgrade altimeter				+1.7
Implementation revision				+2.0
Total				+16.5
<u>Elements</u>				
Satellite system	34.25			
Sensor development	16.24			
Mission operations	5.53			
Project management	5.47			
Reserves (7%)	4.21			
Launch vehicle		5.00		
STDN network			4.00	
3) Allocation of Reserves to Baseline in POP 75-2	65.70	5.00	4.00	74.70
<u>Elements</u>				
Satellite system	36.59			
Sensor development	17.35			
Mission operations	5.91			
Project management	5.85			
Launch vehicle		5.00		
STDN network			4.00	
(As a percent of POP elements)				

Table 12-1. Seasat Estimated Cost at Completion History  
in Millions of Dollars (Continuation 1)

Milestone	OA	OSF	OTDA	Total
4) Directed Scope Changes to Revised Baseline	67.20	7.60	4.00	78.8
<u>Elements</u>				
Satellite system	37.39			
Sensor development	17.65			
Mission operations	6.31			
Project management	5.85			
Launch vehicle		7.60		
STDN network			4.00	
<u>Major Changes<sup>a</sup></u>				
SMMR 5th Ch. Elect.	0.30			
GPS Integ/Removal	0.60			
STD Tape Recorder	0.20			
Digital SDPS	0.40			
120" fairing				
		2.60		
		2.60		
Total	1.50			
5) POP 78-2 (June 1978) Pre-launch	77.18	12.60	4.20	93.98
<u>Elements</u>				
Satellite system	43.68			
Sensor development	19.76			
Mission operations	7.28			
Project management	6.46			
Launch vehicle		12.60		
STDN network			4.20	
Percentage Change (overrun) from Revised Baseline				
by Office	15%	66%	5%	

<sup>a</sup>These scope changes were directed by NASA Headquarters. The amounts were the direct cost effects of the changes and do not reflect the total cost/schedule impacts which resulted. In some cases the amounts shown are original estimates and do not reflect final costs.



Table 12-1. Seasat Estimated Cost at Completion History  
in Millions of Dollars (Continuation 2)

Milestone	OA	OSF	OTDA	Total	% <sup>b</sup>
6) POP 79-2 (July 1979) Final Budget	77.16	12.60	4.20	93.96	19
<u>Elements</u>					
Satellite system	43.73				17
Sensor development	19.82				12
Mission operations	7.19				14
Project management	6.42				10
Launch vehicle		12.60			66
STDN network			4.20		5
Percent Change from Revised Baseline by Office	15%	66%	5%		

<sup>b</sup>Percent change by project element from revised baseline.

## 2. History

Phase A studies for the Seasat Mission were initiated early in 1973 culminating in a September 1973 estimate of approximately \$58.2 million for the so-called 5-Sensor System.

Phase B studies conducted in late 1973 through mid-1974 resulted in cost estimates ranging from approximately \$65-85 million. A significantly descoped mission, with a design-to-cost goal of \$58.2 million, was selected by NASA HQ in late 1974.

By mid-1975, following receipt of industry proposals, the strong recommendation of the Seasat Science Steering Group for an augmented science instrument complement, the revised mission baseline was established by NASA HQ at \$74.7 million (in FY74 dollars). The final budget estimate submitted as part of POP 79-2 in July 1979 was \$93.96 million, an increase of \$19.26 million.

The following is a recap of the changes from baseline through the final estimate:

	<u>Baseline</u> (July 1975)	<u>POP 79-2</u> (July 1979)	<u>Percent</u> <u>Change</u>
Satellite System	34.25	43.73	27.7
Sensor Development	16.24	19.82	22
Mission Operations	5.53	7.19	30
Project Management	5.47	6.42	17.4
Reserves	4.21	0	<100>
Launch Vehicle	5.00	12.60	152
STDN Network	4.00	4.20	26
	\$74.7M	\$93.96M	26%

Of the \$19.26 million increase approximately 66 percent was incurred by the Office of Space Flight (launch vehicle), 5 percent by the Office of Tracking and Data Acquisition, and 15 percent by the Office of Applications.

## E. MAJOR INCREASE AREAS

Some brief comments on areas of cost increase are made in this section.

### 1. Satellite System

Financial information on the satellite system follows. Table 12-2 shows cost growth from the revised baseline to the final budget. Table 12-3 is a cost element breakdown. Tables 12-4 and 12-5 detail contract cost history for the LMSC contracts. Tables 12-6 and 12-7 show the corresponding LMSC manpower figures.

The cost growth within the satellite system was a mixture of overruns, scope changes, fee reductions, and usage of project contingency. To provide an understanding of the major factors which resulted in the total cost growth, the major areas and items which increased or decreased are listed in Table 12-2. The amounts shown are ROM estimates to derive the net change of \$6.34 million (17%).

Table 12-2. Cost Growth From Revised Baseline to Final Budget

---

LMSC strike/schedule recovery	\$1.20 million
Launch vehicle problem (launch schedule delay)	1.00
SAR antenna development	1.00
SPAT scope increase	0.70
LMSC overhead and APC increases	1.80
Sensor module manufacturing	0.90
SAR data link	0.90
CATS overrun	0.75
Power subsystem overrun	0.70
Attitude control overrun	0.15
Space technology overrun	0.30
Quality assurance overrun	0.20
AGE overrun	0.10
Award fee loss (SSE/SM)	(1.90)
Weight reduction efforts	0.30
Sensor delivery schedule	0.20
RFI testing of sensors	0.75
Delete one Odetics tape recorder	(0.10)
Delete SM STM	(0.20)
GFE thermal control	(0.10)
Delete spare battery	(0.05)
Project contingency	(2.34)
Miscellaneous net changes	0.08
Total	\$6.34 million

---

Table 12-3. Satellite System Cost Element Breakdown in Millions of Dollars

Bus contract costs (Contract No. 954433)	13.038 <sup>a</sup>
SSE/SM contract costs (Contract No. 954434)	<u>21.235<sup>b</sup></u>
Total LMSC costs	34.273
In-flight performance fee (SSE/SM contract)	0.311
Fixed fee (SSE/SM contract)	0.004
Award Fee (SSE/SM contract)	<u>0</u>
Total LMSC	34.588
Less: OSF funded 120 in. fairing and 90° roll	<u>(1.075)</u>
OSTA funded LMSC total	33.513
JPL general burden	<u>3.180</u>
OSTA funded contracts total	36.693
JPL in-house support	3.051
JPL GFE (Std transponder, CDU, thermal control louvers)	0.621
JPL procured items (propellants, etc.)	<u>0.169</u>
OSTA funded JPL total	40.534
WFC/APL GFE (SAR data link, etc.) and support	3.161
GSFC LRA analysis and test	<u>0.030</u>
Satellite system total (POP 79-2)	43.725

<sup>a</sup>Detailed in Table 12-4.

<sup>b</sup>Detailed in Table 12-5.

Contract No. 954434, a cost reimbursement contract for Satellite System Engineering and the Sensor Module (SSE/SM) was awarded 12 February 1976 at a total estimated cost of \$8,100,000. The SAR antenna and mission operations were excluded pending further study of requirements. During the course of the contract, 48 changes were made which increased the target cost to \$15,237,461. The total estimated cost of the contract exceeded the target cost by \$6,085,564, making the total estimated cost \$21,323,115. Factors contributing to the overrun were: extremely close pricing of the basic contract; cost associated with satellite weight reduction; complexity of the thermal protection; the SAR antenna subcontract; problems with the LMSC computer-assisted test facility; a 20 percent increase in overhead rates; and a substantial increase in the cost of common technical services allocated to all contracts on the basis of direct labor dollars.

Fifty-three percent of the total cost overrun was for direct labor, 16 percent for the SAR antenna, 16 percent for increased indirect expense rates, 11 percent for other direct cost, and 4 percent for material and related burden.

The contract had an award fee pool of \$1,897,833.00 and an in-flight performance pool of \$580,000. Although the contractor had excellent technical, schedule, and administrative performance, scoring 16.4 out of a possible 20, no award fee payments were made because of the 40 percent overrun of costs.

For in-flight performance, \$311,344.00 was awarded for the 105 days of the mission. This is 97.6 percent of the fee available for that period. The remainder of the \$580,000 was forfeited when the satellite failed.

Table 12-4 shows the target cost and cost variance by Work Breakdown Structure (WBS) tasks. The corresponding manpower figures are given in Table 12-6.

Table 12-4. Breakdown of SSE/SM Overrun by Task in Thousands of Dollars

WBS Task	Actual	Target Cost	Cost Variance
1.0 Program management	\$ 826	\$ 846	\$ (20)
2.0 Satellite system design	1420	1438	(18)
3.0 Test and ground operations requirements	344	338	6
4.0 Space technology support	1175	807	368
5.0 SAR antenna	3617	2198	1419
6.0 Sensor module/sensor module support structure	2349	1057	1292
7.0 Sensor module development test	703	493	210
8.0 Data system	1992	1123	869

9.0	Satellite system assembly and test	1850	1527	323
10.0	Launch operations	525	603	(78)
11.0	Mission engineering	140	131	9
12.0	Software	500	545	(45)
13.0	Quality and reliability assurance	806	599	207
14.0	Electromagnetic control	124	166	(42)
15.0	Aerospace ground equipment	664	436	228
16.0	Level-of-effort support	94	116	14
17.0	Allocated prime cost/other direct cost	2396	1464	1151
18.0	SAR enable/disable	101	23	78
19.0	Global positioning satellite	63	33	30
20.0	Mission operations support	1270	970	300
	304.8-cm (120-in.) fairing	276	236	40
	Total Cost:	\$21235	\$15149	\$6086

Contract No. 954433, a fixed price incentive contract for the satellite bus, was also awarded on 12 February 1976 with a target price of \$11,750,000 and a ceiling price of \$13,688,750. During the course of the contract, 21 changes were issued which resulted in a net reduction of the target price to \$11,191,000 and the ceiling price to \$13,037,515, which was negotiated as the final price. An audit made pursuant to the incentive provisions of the contract indicated the contractor incurred a total cost of \$13,200,000. The reasons the contractor exceeded the target price are very similar to the reasons cited for the SSE/SM contract. The contract was closely priced, weight and power problems increased labor costs, subcontracts exceeded estimates, burden rates and the allocated cost of common technical services increased. Thirty-nine percent of the \$1,846,515 difference between the target price and ceiling was caused by increased direct labor cost, 38 percent for increased indirect expense rates, 13 percent for other direct costs, and 10 percent for subcontracts and related burden.

Table 12-5 shows the cost variance (up to ceiling price) by WBS task. The corresponding manpower figures are given in Table 12-7.

Table 12-3. Breakdown of Bus Overrun by Task in Thousands of Dollars

WBS Task	Actual	Target Cost	Cost Variance
1.0 Structure and mechanics	\$ 1447	\$ 1185	\$ 262
2.0 Power	3060	2180	880
3.0 Attitude control	3256	3131	125
4.0 Unified S-band telecommunications	158	150	8
5.0 Data storage	512	546	(34)
6.0 Orbit insertion propulsion	1012	1054	(42)
7.0 Bus assembly and test	1007	806	201
8.0 Aerospace ground equipment	554	845	(291)
9.0 Quality control	444	247	197
10.0 Allocated prime cost/other direct cost	1588	1047	541
Total Cost:	\$13038	\$11191	\$1847

Table 12-6. SSE/SM Manpower History as of 30 July 1978

WBS Task	Equivalent Manyears*		
	1976	1977	1978
1.0 Program Management	6.7	7.5	2.7
2.0 System Design	15.2	11.0	2.8
3.0 Test and Ground Operations Requirements	4.4	2.8	0.1
4.0 Space Technology Support	12.3	8.0	2.2
5.0 SAR Antenna	5.4	8.0	2.6
6.0 SM/SMSS	9.0	32.2	2.7
7.0 SM Development Test	2.0	12.2	0.6
8.0 Data System	12.0	23.6	0.5
9.0 System Assembly and Test	0.8	5.1	29.4
10.0 Launch Operations	---	0.4	12.8
11.0 Mission Engineering	0.8	1.8	---
12.0 Software	2.4	6.8	1.2
13.0 Quality and Reliability Assurance	5.3	9.8	1.3
14.0 Electromagnetic Control	2.0	0.6	0.1
15.0 Aerospace Ground Equipment	1.7	6.9	2.0
16.0 Level of Effort Support	0.7	1.0	0.1
17.0 Allocated Prime Cost/Other Direct Cost	6.2	17.2	4.4
18.0 SAR Enable/Disable	0.5	1.4	---
19.0 Global Positioning Satellite	---	1.2	---
20.0 Mission Operations Support	---	1.2	13.5
304.8-cm (120-in.) fairing	---	4.7	---
Total	87.4	163.4	78.9

\*Equivalent Manyear = 1817.7 hours.



Table 12-7, Bus Manpower History as of 26 March 1978

WBS Task	Equivalent Manyears*		
	1976	1977	1978
1.0 Structure and Mechanics	9.5	16.2	0.3
2.0 Power	19.3	29.0	0.7
3.0 Attitude Control	10.7	10.2	---
4.0 Unified B-Band Telecommunications	1.5	1.5	0.1
5.0 Data Storage	0.7	1.3	---
6.0 Orbit Insertion Propulsion	1.6	0.5	---
7.0 Bus Assembly and Test	3.0	15.3	0.9
8.0 Aerospace Ground Equipment	0.1	6.9	5.9
9.0 Quality Control	3.6	6.1	---
10.0 Allocated Prime Cost/Other Direct Cost	6.9	16.3	0.4
Total	56.9	103.3	7.4

\*Equivalent Manyear = 1817.7 hours.

## 2. Sensor Development

The cost growth (\$2.17 million; 12 percent) within the sensors resulted from the cost impact associated with a weight reduction effort that was instituted as a result of growth in the satellite system; normal development and problems associated with active radar systems; efforts to reduce RFI potentials; delay in hardware development; and minor interface and parts problems during systems test. Modification to the schedule and upgrade of the engineering units to flight levels helped limit the cost growth. The baseline budget was also exceeded due to the need for JPL support to the project office in handling ICDs and monitoring sensor implementors. The following breakdown shows the changes in cost at completion, estimating from the revised baseline to POP 79-2:

Cost (\$ Million)				
Sensor	Revised Baseline	POP 79-2	Change	% Change
SAR	4.92	5.59	+0.67	+ 14
SASS	4.32	6.04	+1.72	+ 40
VIRR	0.53	0.34	-0.19	- 36
ALT	4.91	5.27	+0.36	+ 7
SMMR	2.97	2.06	-0.91	- 31
JPL support	<u>0</u>	<u>0.52</u>	<u>+0.52</u>	<u>+100</u>
	17.65	19.82	+2.17	+ 12

### 3. Mission Operations

These increases (\$0.88 million; 14 percent) resulted from an expansion of pre-launch Ground System training activities, extended plans for mission planning activities and supporting mission design--particularly in the area of maneuver analysis and planning--and cost increases associated with the remote location (to JPL) of the operations center.

### 4. Project Management

The major cause of the cost growth in the project management area (\$0.57 million; 10 percent) was an increase in the SAR management element. The complexity of the SAR system design, in particular the number of subsystems and interfaces which were involved in the development of the SAR as a total system, required increases in this element.

### 5. Launch Vehicle

Initial pre-project cost estimates provided by SAMSO were based on a simplified application of the Atlas F and did not include many of the mission-peculiar modifications and refurbishments required to adapt the launch vehicle to the Seasat mission. As the understanding of the requirements improved at all agencies, the inadequacy of the earlier estimates became evident. The following were some of the factors that required additional funding:

- (1) Reliability improvement involved the removal and replacement of out-moded and low reliability components. These included a new autopilot, command destruct receiver, and propellant utilization and control unit.

- (2) Modifications to the Atlas weapons system to adapt it to Seasat requirements, such as the removal of the forward section, including the conical end, and the fabrication and installation of a new hemispherical front end.

There were changes required to the launch vehicle configuration as a result of required improvements in performance and uncertainties in the aerodynamic characteristics. This resulted in the incorporation of a 304.8-cm (120-in.) diameter fairing that required:

- (1) Fairing refurbishment.
- (2) Additional aerodynamic studies.
- (3) Additional structural analysis.
- (4) Major modifications to the SLC-3 launch complex at VAFB.

There were additional factors, initially not anticipated, that increased costs. These involved:

- (1) Removal and replacement of stress and corrosion prone vernier rocket assemblies.
- (2) Removal and replacement of Thor retrorockets with Titan retrorockets.
- (3) An Atlas boattail heating problem.
- (4) Ninety-degree roll orientation difference between the Atlas and Agena.

The above factors contributed to a total cost increase of \$5 million (66 percent).

## 6. Network

Cost increase was small in both total amount (\$0.2 million) and percent increase (5 percent). The specific cause is related to the developmental nature of some of the equipment used for the data handling between the stations and the control center.

## REFERENCES

- 12-1. Seasat Study Task Team Report and Appendix, October 1973
- 12-2. Program Plan, Revision I, November 1973

## SECTION XIII

### PRELIMINARY RESULTS

#### A. GENERAL

The evaluation of sensor geophysical performance is well underway. As planned, the initial phase of this activity relies heavily upon the data collected during the mission phase of the surface truth program.

The approach is to compare satellite data with corresponding surface observations in a "workshop" mode; i.e., a brief, intensive working meeting involving sensor teams and surface truth analysis. The Gulf of Alaska Seasat Experiment (GOASEX) was the focus of the first of these workshops.

The first GOASEX workshop was conducted at JPL from 22-26 January 1979, comparing for the first time sensor data collected by Seasat to surface truth data derived from ships, aircraft, and buoys during GOASEX.\* The workshop was composed of experiment teams for each of the sensors whose task was to provide a preliminary first-order evaluation of the quality of the Seasat geophysically processed data. Each experiment team had approximately seven members. The basis for the evaluation was modeled field of surface winds, waves, temperature, and atmosphere generated from National Weather Service and Fleet Numerical Weather Central information, supplemented by spot observations from the ships, buoys, and aircraft which collected surface truth data at times of satellite passage. These fields were prepared for a selected number of orbits at NOAA's Pacific Marine Environmental Laboratory in Seattle, WA, Ocean Weather, Inc., White Plains NY, and at the Department of Atmospheric Science at UCLA.

#### B. RADAR ALTIMETER

The ALT performance was found to be consistent with the design specifications for height precision ( $\pm 10$  cm) and significant wave height accuracy (0.5 m or 10 percent, whichever was greater) for sea states less than 4 m. The ALT backscatter coefficient values agreed with corresponding SASS values to within 1 dB for similar sea states. Higher sea states were not encountered during GOASEX, so that the evaluation of sensor performance under these conditions as well as the effects of ionospheric refraction errors remains to be addressed.

Based on analysis of ALT and tracking data from four Seasat passes over Bermuda, it was found that a constant height bias of  $0.50 \pm 0.11$  m provides consistency with the sea and ground truth in the form of measured ocean surface levels from the Bermuda tide gage and geodetic leveling data between the tide gage and laser station. The uncertainty is based on the best estimate at this time of measurement errors, geoid errors, environmental errors, and uncertainties inherent in the analysis technique. The determination and separation of

---

\*Born et al., 1979.

the instrument timing bias, a significant element in the height bias, remains to be accomplished. The conclusions are valid for night-time low sea-state conditions ( $H_{1/3} < 4$  m) which existed at the time of each over-flight.

An example of the ALT height measurement, as well as geodetic and oceanographic features detected, is shown in Figure 13-1, which depicts an ascending pass beginning off the coast of Venezuela, crossing the Puerto Rico trench, and making landfall in the vicinity of New York. The difference between the ALT sea surface height and the geoid calculated by the Goddard Space Flight Center is shown. The designation "GEM 10B" means Goddard Earth Model number 10B. Fine scale geoidal features such as the Puerto Rico trench are clearly evident in the figure since GEM 10B is a 5-deg by 5-deg geoid, and features of this wavelength or less are highly smoothed.

The traverse of the ALT over the Gulf Stream is clearly visible, and its location has been corroborated with satellite infrared imaging. The signature of several short wavelength geoidal features is combined with that of the Gulf Stream in Figure 13-1. However, comparison of the ALT data to a high resolution mean sea surface developed by using the GEOS-3 altimeter data\* shows an amplitude change in the surface of 70 cm over 90 km across the Gulf Stream. Preliminary analysis has also identified slopes corresponding to warm and cold water eddies associated with the Gulf Stream in the North Atlantic and the Kuroshio current in the western Pacific.

The present analysis indicates clearly that the ALT, having undergone development through three separate Earth-orbit missions (Skylab, GEOS-3, Seasat), has reached a level of precision and accuracy that now permits the use of the data for important quantitative oceanographic investigations and practical applications.

### C. SCATTEROMETER

The SASS data were compared to surface truth consisting of wind fields generated from meteorological analyses as well as spot observations from well-calibrated meteorological buoys and oceanographic research vessels. Statistics for the scalar differences between the SASS and surface truth wind speed and direction were compiled for various categories of radar parameters (polarization, incidence angle) and surface conditions (wind speed, latitude and longitude location). Further, these statistics were weighted by the quality of the surface truth (estimated wind speed and direction accuracy) and the atmospheric transmissibility (derived from satellite infrared and visible cloud imagery). Results of this comparison indicated that the SASS processing algorithm (based on aircraft scatterometer data collected years prior to the mission) was biased high by approximately 30 percent compared to surface truth wind speeds, and that the standard deviations about this bias were on the order of 2 m/s. For wind direction, biases for SASS were less than 10 deg with standard deviations about this mean of approximately 20 percent. The results of this limited investigation

---

\*Marsh and Martin et al., 1979.

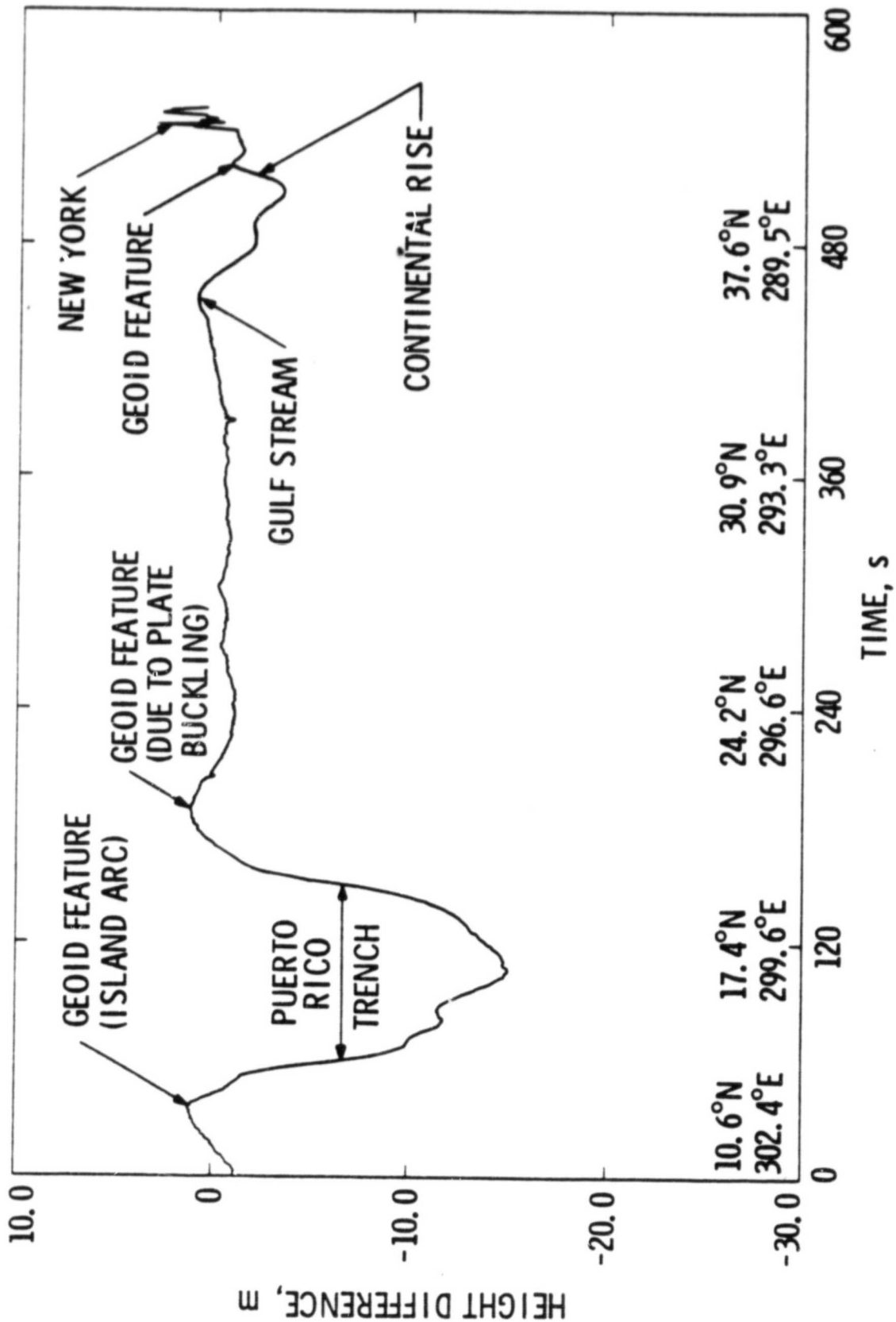

Figure 13-1. Altimeter Height Measurement Referenced to the Estimated Geoid

indicate that, after refinement of the geophysical algorithms, the SASS will meet its pre-launch specifications of  $\pm 2$  m/s or 10 percent (whichever is greater) in wind magnitude and  $\pm 20$  deg in direction. See Figure 13-2.

#### D. SCANNING MULTICHANNEL MICROWAVE RADIOMETER

The results for the SMMR from the workshop are quite encouraging, especially when the immaturity of all the data processing algorithms is considered. Specifically, for open ocean cells of highest quality surface truth, in which no rain is indicated, wind determinations exhibit standard deviations of about 3 m/s about a bias near 1.5 m/s. Highest quality surface truth estimates are probably accurate to  $\pm 2$  m/s. This strongly suggests that the Seasat SMMR design goal of  $\pm 2$  m/s wind speed measurement accuracy can be reached. The sea surface temperature determination had cold biases of 3 to 5°C and standard deviations about the bias of approximately 1.5°C. The stability of the SMMR temperature estimates over the nine-day period (16-25 September 1978) investigated in the workshop provides encouraging evidence that the instrument operates well under a variety of changing meteorological conditions. Furthermore, the initial estimates on the amount of rain (5 mm/h) that would invalidate sea surface temperature determination because of attenuation and scattering appear somewhat conservative. The SMMR-determined integrated atmospheric water vapor, ALT path length corrections, and SASS attenuation estimates are quite consistent with the limited surface truth provided by a set of five radiosonde ascents over weather station PAPA and research vessel Oceanographer. The rain rate determinations were consistent with the observed weather.

Figure 13-2 presents a comparison of surface truth and sensor wind magnitudes for the ALT, SASS, and SMMR during a south to north pass across the Gulf of Alaska. Note that in the areas of highest confidence in surface truth and where there is no rainfall, all sensor and surface truth winds exhibit similar trends. The major discrepancy between all results is basically a bias which varies from approximately 50 percent of the wind magnitude for the ALT to 30 percent for the SASS. These results are based on preliminary algorithms which have not been adjusted to remove the effects of instrument biases. This will occur after the biases have been better defined by processing a data set with a broad spectrum of surface weather conditions. Figure 13-2 also illustrates one of the major problems associated with evaluating remote sensing data; namely, the determination of actual surface conditions from in situ observations to an accuracy compatible with mission specifications. Shown in Figure 13-2 are wind speeds from two wind field analyses. One field is based on surface pressure analysis by J. Overland of NOAA's Pacific Marine Environmental Laboratory and another based on a kinematic analysis incorporating actual surface wind observations by V. Cardone of Oceanweather, Inc. The 2- to 3-m/s difference in wind magnitude between the two analyses, while perhaps due primarily to differences inherent in the analysis techniques, is indicative of the accuracy of surface observation available for sensor and algorithm evaluation.

ORIGINAL PAGE IS  
OF POOR QUALITY

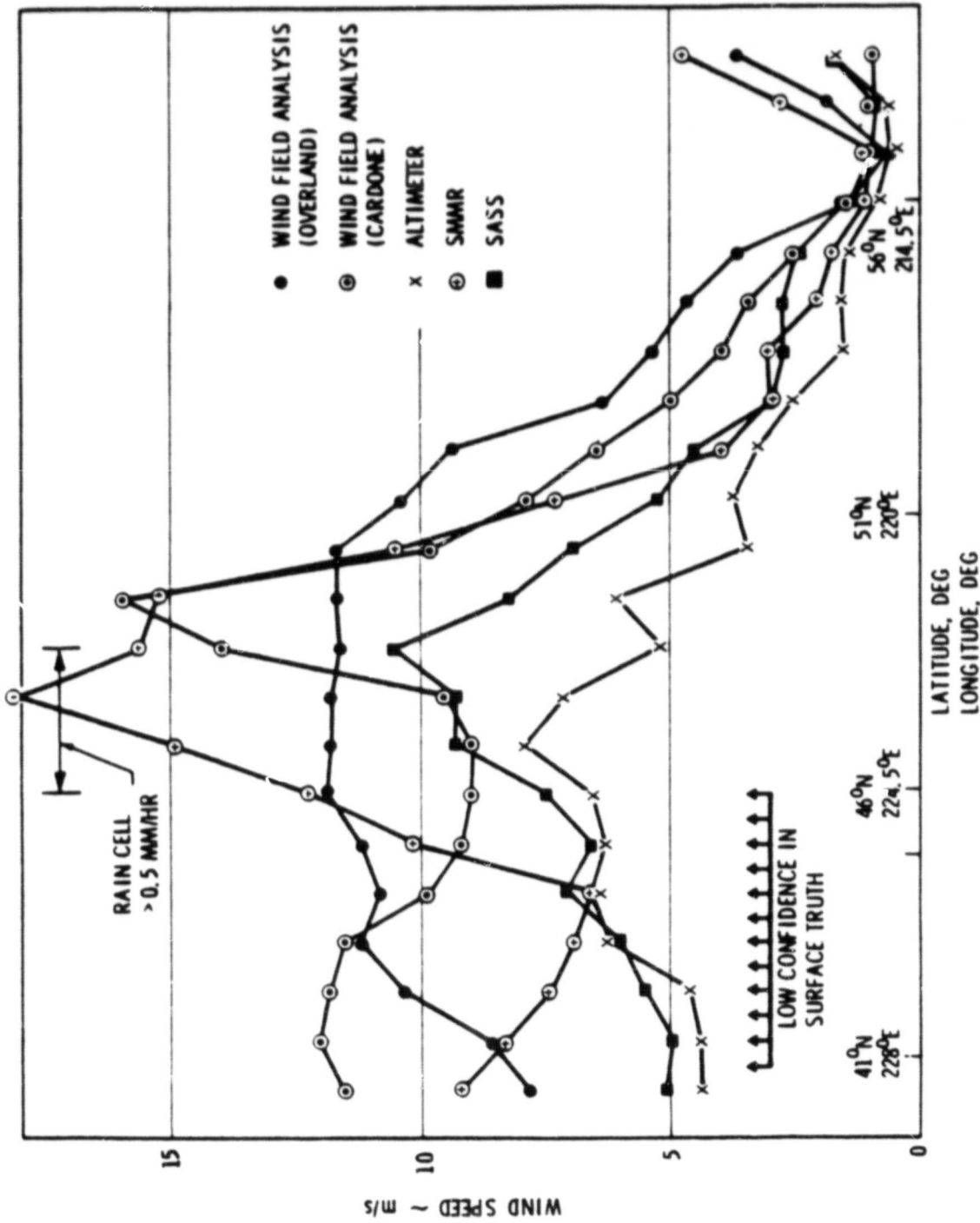

Figure 13-2. Early Wind Field Comparisons



#### E. SYNTHETIC APERTURE RADAR

For the SAR, the objective of the workshop analysis was to determine if SAR data could be used to measure ocean wavelength and direction and determine the range over which ocean waves can be detected. Five SAR passes were examined and compared with surface truth measurements of wavelength and direction. This data set yielded agreement to about  $\pm 10$  percent and  $\pm 20$  deg for wavelength and wave direction, respectively. The threshold at which the SAR could detect ocean waves appears to be between 1.1- and 2.5-m significant wave heights in the range of wind speeds over which the observations were made (5-15 m/s).

In addition to the detection of surface waves, the SAR provided valuable data set on tide- and current-generated internal waves, wave motions at density discontinuities which occur at depths of dozens of meters whose surface expression are alternating smooth and rough bands on a centimeter scale. An example of internal wave imagery is given in Figure 13-3. This image was obtained on 17 September 1978 in the Gulf of California. The island of Angel de la Guarda appears near the middle of the image, and a portion of Isla Tiburon is visible to the southeast. The mainland of Baja California is on the western (left) side of the image. The area covered is 100 km by 280 km.

#### F. VISUAL AND INFRARED RADIOMETER

Although the VIRR was only operative for the first 52 days of the Seasat sensor lifetime of 99 days, the quality of the measurements collected generally appears to be very good. The gridded visual and thermal infrared images are quite adequate for cloud, land, and water feature identification, and a number of scene-specific enhancement options can be exercised.

The noise levels in the VIRR data appear to be comparable to the digitization resolution (about  $0.5^{\circ}\text{C}$  for the infrared measurements). Statistical analysis of a sample of 139 points in a large cloud-free region of the western North Atlantic on 7 July 1978 yielded a mean difference of  $0.8^{\circ}\text{C}$ , a root-mean-square difference of  $1.7^{\circ}\text{C}$ , and a linear correlation coefficient of  $0.84^{\circ}\text{C}$  between VIRR sea surface temperature estimates and those interpolated from a NOAA analysis based on ship, buoy, and expendable bathythermograph observations for the period 5-10 July 1978. This is a very good agreement in view of the uncertainties in the atmospheric correlation to the VIRR brightness temperatures and those in the smoothed NOAA field.



Figure 13-3. SAR Image of Internal Waves in the Gulf of California

**APPENDIX A**  
**MISSION EVENTS SUMMARY**

## SEASAT MISSION EVENTS SUMMARY

### ASCENT SEQUENCE

<u>GMT</u> <u>DOY/HH:MM:SS</u>	<u>EVENT</u> <u>DESCRIPTION</u>
178/01:12:44	Liftoff.
01:16:05	Fairing Separation.
01:17:34	Start Satellite Central Timing Unit (CTU) clocks.
01:17:44	Enable Uncage Satellite Gyros Signal. VECO enable.
01:17:47	Uncage Satellite Gyros. Arm Satellite separation.
01:17:53	Fire Separation Detonator.
01:17:54	Switch Transponder No. 1 from booster adapter antenna to Bus antenna.
01:17:56	Activate High Mode Thrusters. Connect Horizon Sensor Assembly (HSA) roll signal to Roll Gyro Torquer.
01:18:05	Start +150 deg/min. roll rate.
01:18:41	Stop +150 deg/min. roll rate.
01:18:42	Select pitch, roll, and yaw torquing rate polarity.
01:18:51	Start -112.4 deg/min. pitch rate.
01:18:53	Stop -112.4 deg/min. pitch rate. Start -2.9 deg/min. pitch rate. Connect HSA pitch signal to Pitch Gyro Torquer.
01:19:08	Enable Velocity Meter.
01:19:10	Apply First Burn start signal. Deactivate Pitch and Yaw Thruster Circuits and enable Hydraulic Integral Circuits.
01:19:11	Open Propellant Pressurant (Helium) Valves.
01:22:51	Enable Velocity Meter Shutdown Relay.
01:23:01	Velocity Meter command engine shutdown. Activate Pitch and Yaw Thruster Circuits and disable Hydraulic Integral Circuits.

GMT  
DOY/HH:MM:SS

EVENT  
DESCRIPTION

178/01:23:13	Select zero alpha angle. Stop -2.9 deg/min. pitch rate. Start -3.8 deg/min. pitch rate.
01:23:17	Close fuel and oxidizer Propellant Isolation Valves.
01:23:21	Disable Velocity Meter.
01:23:31	Transfer Second Burn number. Disable Velocity Meter Shutdown Relay.
01:23:35	Transfer to low coupling gains and start gyro-compassing.
01:31:02	Close oxidizer Isolation Valve (Helium). Coast for 2315 seconds.
02:09:37	Transfer to high coupling gains and stop gyro-compassing.
02:09:56	Enable Velocity Meter.
02:09:58	Open fuel and oxidizer Propellant Isolation Valves.
02:10:00	Apply Second Burn Start signal. Deactivate pitch and yaw Thruster Circuits and enable Hydraulic Integral Circuits.
02:10:04	Enable Velocity Meter Shutdown Relay.
02:10:06	Velocity Meter command Engine Shutdown.
02:10:09	Open Oxidizer Dump Valve.
02:10:29	Transfer to low coupling gains and start gyro-compassing.
02:10:30	Stop -3.8 deg/min. pitch rate. Start -3.6 deg/min. pitch rate.
02:11:03	Disable Velocity Meter.
02:11:08	Remove Velocity Meter and Hydraulic Power.
02:28:35	Deploy Orbit Antenna No. 1.
02:37:51	Open Fuel Dump Valve.
02:44:33	Stop gyro-compassing. Disconnect HSA Pitch and Roll signals.

GMT  
DOY/HH:MM:SS

EVENT  
DESCRIPTION

178/02:44:43	Stop -3.6 deg/min. pitch rate and start pitch down maneuver (-120 deg/min. pitch rate). Remove Horizon Sensor Assembly power.
02:45:29	Stop -120 deg/min. pitch rate.
02:45:32	Return Tape Recorder No. 2 to Beginning of Tape (Command T/R 2 Read Out).
02:45:34	Select -pitch, -roll, +yaw rates.
02:45:39	Start orbital yaw maneuver (torque Roll Gyro at +120 deg/min. rate).
02:46:24	Stop +120 deg/min. orbital yaw rate.
02:46:25	Select 3.6 deg/min. Orbit Rate.
02:46:34	Start Orbit Pitch Rate (torque Yaw Gyro at -3.6 deg/min. rate).
02:46:39	Connect Scanwheel pitch and roll control to Augmented Electronic Assembly (AEA) and disconnect Horizon Sensor Assembly (HSA) control. Start forward Low Gain Orbital Mode gyro-compassing.
02:46:44	Deploy Solar Arrays.
02:56:03	Deploy SAR Data Link Antenna.
02:56:13	Deploy SASS Antennas 1 and 3.
02:56:27	Enable Transponder 2 Ranging.
02:56:31	Command Tape Recorder 2 Read In.
02:56:38	Deploy SASS Antennas 2 and 4.
02:57:03	Disable Transponder 2 Ranging.
02:57:12	Command Tape Recorder 1 Stop/Standby.
02:57:17	Command Tape Recorder 1 Read Out.
02:57:53	Deploy VIRR. Deploy Tranet Beacon Antenna/Orbit Antenna No. 2.
02:59:23	Release SAR Antenna Restraint.
02:59:33	Command SAR Antenna 90° Pitch-out.

GMT  
DOY/HH:MM:SS

EVENT  
DESCRIPTION

178/03:05:37	Command Tape Recorder 1 Stop/Standby.
03:05:42	Enable Transponder 2 Ranging.
03:05:43	Select low range Gyro Reference Assembly (GRA) telemetry.
03:05:54	NoOp Command: end of pre-launch-programmed ascent sequence.

ORBITAL SEQUENCE

BEGIN EARLY ORBIT PHASE

<u>REV.#</u>	<u>STA.</u>	<u>GMT</u>	<u>EVENT</u>
2	ULA	178/04:25~	Rotate SAR Antenna 90°.
2	HAW	178/04:33~	Extend SAR Antenna.
3	ULA	178/06:05~	Activate Pitch Momentum Wheel (PMW). Select Transponder 1 Normal Deviation.
4	GWM	178/08:00~	Activate Roll Reaction Wheel (RRW).
5	AGO	178/10:25~	Preset CTU Clock to GMT.
8	ULA	178/14:16:00	Command DC-DC Converter 1 Off.
10	GWM	178/17:26:03	Select DC-DC Converter 1 orbit configuration.
16	MAD	179/03:31:00	Transfer from Reaction Control System (RCS) to Orbit Attitude Control System (OACS).
16	ULA	179/03:55:00	Excessive attitude excursions; transfer from OACS to RCS.
16	ACN	179/05:01:00	Transfer from RCS to OACS, after trimming attitude control parameters.
17	ORR	179/05:55:00	Excessive attitude excursions: transfer from OACS to RCS.
19	AGO	179/09:52:32	Command CTU Clock Fine Adjust.
27	MIL	179/22:37:30	Adjust Roll Reaction Wheel bias.
30	MAD	180/03:00:00	Transfer from RCS to OACS (ACS trims).
30	HAW	180/03:40:00	Transfer from OACS to RCS.
42	MIL	180/23:40~	Stop Pitch Momentum Wheel. Reset Roll Reaction Wheel. Turn off magnetic desaturation.



<u>REV.#</u>	<u>STA.</u>	<u>GMT</u>	<u>EVENT</u>
44	MAD	181/02:30	Disable Right Scan Wheel Assembly output.
52	HAW	181/15:50	Turn off High Mode Reaction Control Cluster (HMRCC) Heater.
55	MIL	181/21:36	Turn on Pitch Momentum Wheel.
55	AGO	181/21:48	Select CTU Clock Offset (count rate). Command CTU Clock Fine Adjust.
56	MIL	181/23:08	Command CTU Clock Fine Adjust (set clock to within 50 microseconds of GMT).
59	HAW	182/03:41:00	Transfer from RCS to OACS (ACS trims).
59	ACN	182/05:08:00	Transfer from OACS to RCS.
60	ULA	182/05:38:00	Turn off Right Scan Wheel Assembly (RSWA) Signal Processor.
60	ACN	182/06:45:00	Turn off Pitch Momentum Wheel.
67	ACN	182/17:51	Turn off Control Logic Assembly (CLA) Power Supply 2.
69	AGO	182/21:15~	Observed rapid cycling of ALT Heater.
71	GDS	183/00:17:03	Turn on Pitch Momentum Wheel. Turn off CLA power to Magnetic Control Assembly (MCA).
73	MAD	183/03:09:00	Transfer from RCS to OACS (RCS desaturation).
74	HAW	183/05:23:00	Transfer from OACS TO RCS.
74	ACN	183/06:15:00	Turn off Pitch Momentum Wheel.
76	ULA	183/08:25:00	Disable magnetic desaturation mode.
86	GDS	184/01:26:00	Turn on Gyro for attitude control test.
87	MAD	184/02:43:04	Disconnect Left Scanwheel output.

<u>REV.#</u>	<u>STA.</u>	<u>GMT</u>	<u>EVENT</u>
88	MAD	184/04:16:01	Reconnect Left Scanwheel. Disconnect Right Scanwheel.
88	ORR	184/05:10:00	Enable Scanwheel Pitch and Roll outputs. Start forward gyro- compassing.
<b><u>BEGIN INITIAL SENSOR ACTIVATION</u></b>			
94	HAW	184/14:13:51 14:29:10	Turn ALT on #1, station telemetry down, no real time data acquired. Turn ALT off #1.
95	ACN	184/16:43:06 16:51:27	Turn ALT on #1. Turn ALT off #1.
96/97	GWM	184/19:12:49 19:25:13	Turn ALT on #2. Turn ALT off #2.
98	MIL	184/21:33:47 21:45:14	Turn ALT on #3. Turn ALT off #3.
99	-	184/23:06:53	Enable SAR.
99	MIL	184/23:11:53 23:12:10 23:15:28 23:17:20 23:23:00	SAR operate power on #1. Spikes on link 1 (SAR); station could not lock up. Station set PRF switch to posi- tion 4 and achieved lock-up. Station set PRF switch to Remote. SAR operate power off #1.
100	GDS	185/00:52:02 01:01:41	SAR operate power on #2. SAR operate power off #2.
102	MAD	185/03:44:33 03:56:34	Turn SMMR on #1. Turn on failed due to improper SMMR mode. Turn SMMR off #1.
102	HAW	185/04:14:17 04:29:16	Turn ALT on #4. Turn ALT off #4.
103	MAD	185/05:27:00 05:31:00	Turn SMMR on #1. Turn SMMR off #1.
103	ULA	185/05:42:47 05:53:51	SAR operate power on #3. SAR operate power off #3.
103	ORR	185/06:16:48 06:22:26	Turn VIRR Electronics on. Turn VIRR Electronics off.

<u>REV.#</u>	<u>STA.</u>	<u>GMT</u>	<u>EVENT</u>
104	GWM	185/07:41:35 07:50:40	Turn SMMR on #2. Turn SMMR off #2.
105	MIL	185/08:44:36 08:45:22 08:53:28	SAR operate power on #4. SAR Transmitter on. SAR operate power off #4.
107	GDS	185/12:05:29 12:06:22	SAR operate power on #5. SAR Transmitter on.
107	ULA	185/12:24:35	SAR operate power off #5.
109	HAW	185/15:22:40 15:34:25	Turn SMMR on #3. Turn SMMR off #3.

END INITIAL SENSOR ACTIVATION

114	GDS	186/00:23:00 00:23:01 00:23:31 00:25:00	Turn on Control Logic Assembly (CLA) power. Turn off Left Scanwheel Signal Processor. Turn off CLA Power Supply 2. Start Pitch Momentum wheel.
116	ACN	186/04:45:00	Transfer from RCS to OACS; wheel capture succesful.
124	MAD	186/17:14:00	Turn on magnetic desaturation.

BEGIN SENSOR "QUIET TIME"

130	GDS	187/03:09:51 03:14:02	Turn ALT on. Select ALT Track 1 Mode.
131	ULA	187/04:45:24	Select ALT Track 2 Mode.
132	ULA	187/06:23:52	Select ALT Track 3 Mode.
133	ULA	187/08:02:25	Select ALT Track 4 Mode.
133	GWM	187/08:21:26	Turn ALT off.
133	AGC	187/09:09:09	Turn off VIRR Electronics.
136	ULA	187/12:57:02 12:59:02	Turn off VIRR Electronics. Turn SMRR on.
139	MAD	187/18:17:03 18:19:48	Turn SMMR off. Enable SASS.

<u>REV.#</u>	<u>STA.</u>	<u>GMT</u>	<u>EVENT</u>
141	MIL	187/21:44:02 21:47:22	Turn on SASS High Voltage. Select SASS Mode 4.
<u>END SENSOR "QUIET TIME"</u>			
<u>BEGIN ALL SENSORS OPERATIONS</u>			
143	MIL	188/01:03:11	Turn SMMR on.
144	HAW	188/02:41:49	Turn on VIRR Electronics.
145	ULA	188/04:17:23	Turn ALT on.
150	GDS	188/12:13:27	SAR Target of Opportunity (Hurricane FICO).
153	ACN	188/18:01:33	Connect Solar Arrays Panels 9 and 10.
159	MAD	189/03:23~ 03:24:00 03:24:05	Turn on Left Scanwheel Processor. Turn on Control Logic Assembly (CLA) Power. Turn off CLA Power Supply 2.
160	MAD	189/05:09:00	Turn off Left Scanwheel Signal Processor.
199	MIL	191/23:01:00	Turn off Orbit Adjust telemetry. Turn on Orbit Normal telemetry.
200	MIL	192/00:39:15	Turn on High Mode Reaction Con- trol Cluster (HMRCC) heaters.
203	ULA	192/05:28:00	Execute attitude and magnetic trim sequence.
207	GDS	192/11:55:08	Turn off HMRCC heaters.
238	HAW	194/15:48:00	Trim attitude; adjust Roll Reaction Wheel to final bias setting.
281	HAW	197/16:01:02	ALT +Y Baseplate temperature exceeds high limit.
296	HAW	198/17:02:34 17:05:56	Command ALT to Standby. Turn ALT off.
392	MIL	205/10:06:22 10:07:34	Turn off Heater Bus. Turn ALT on.

<u>REV.#</u>	<u>STA.</u>	<u>GMT</u>	<u>EVENT</u>
398	MAD	205/20:40	SASS temperature below low limit.
398	ORR	205/21:27:30	SAR Data Link temperature below low limit.
401	ETC	206/01:41:19 01:46:00	Turn on Heater Bus. Turn off ALT.
416	GDS	207/02:54:26	Turn on ALT. Initiate 10% Heater Bus duty cycle.
423	ULA	207/14:22:30	Initiate 15% Heater Bus duty cycle.
426	-	207/19:20:00	Initiate 20% Heater Bus duty cycle.
605	ACN	220/08:54~	Pitch and Roll attitude excursions observed due to Sun interference with Scanwheels.

INITIATE ATTITUDE CONTROL MODE 12

607	AGO	220/12:06:01	Switch from Right to Left Scanwheel Signal Processor through period of expected sun interference.
608	MIL	220/12:21:32	Switch from Left to Right Scanwheel Processor.
608	AGO	220/13:42:01 13:42:02	Switch from Right to Left Scanwheel Processor. Disconnect CLA Power Supply 1.
609	-	220/15:22:00 15:22:01	Reconnect CLA Power Supply 1. Turn off Right Scanwheel Signal Processor.
610	GDS	220/15:42:01 15:42:03	Turn on Right Scanwheel Signal Processor. Turn off Left Scanwheel Signal Processor.

STOP A/C MODE 12 AND START A/C MODE 5

613	ORR	220/22:05:00	Disconnect Roll attitude signal through period of sun interference.
-----	-----	--------------	---

<u>REV.#</u>	<u>STA.</u>	<u>GMT</u>	<u>EVENT</u>
614	AGO	220/23:23:00	Reconnect Roll attitude signal.
620	MAD	221/08:34:32	Turn off CLA power.
620	ACN	221/09:51:00 10:01:00	Disconnect Roll attitude signal. Reconnect Roll attitude signal.
621	AGO	221/11:31:00	Disconnect Roll attitude signal.
622	MIL	221/11:49:00	Reconnect Roll attitude signal.
622	AGO	221/13:13:00	Disconnect Roll attitude signal.
623	GDS	221/13:35:00	Reconnect Roll attitude signal.
641	MAD	222/20:20:07	Turn off VIRR Electronics (approaching Detector upper temperature limit).
681	GDS	225/14:51:33	Turn on VIRR Electronics.
681	ULA	225/15:05:30	Turn off CLA Power Supply 1. Turn on Right Scanwheel Signal Processor. Turn on CLA Power Supply 2.

BEGIN +X THRUSTER CALIBRATION MANEUVER

701	AGO	227/01:10:00 01:10:30 01:11:30 01:15:31	Command SASS Standby. Turn SASS off. Select ALT Calibrate. Turn ALT off.
702	MIL	227/02:30:18	Transfer from OACS to RCS.
704	MAD	227/05:30:07	Reposition Solar Arrays for maneuver.
705	HAW	227/07:41:08 07:42:08	+X Orbit Adjust Thruster (OAT) on. +X Orbit Adjust Thruster off.
705	ORR	227/08:01:03	Switch Solar Arrays to Auto- track.
705	ACN	227/08:32:12	Transfer from RCS to OACS.
707	ACN	227/08:20:12	Turn ALT on.
707	ETC	227/10:29:02 10:33:22	Enable SASS High Voltage Power Supply. Select SASS Operate Mode 1.

<u>REV.#</u>	<u>STA.</u>	<u>GMT</u>	<u>EVENT</u>
--------------	-------------	------------	--------------

END +X THRUSTER CALIBRATION MANEUVER

712	-	227/20:00:00	Resume Attitude Control Mode 5.
713	ACN	227/21:09:48	First Sun occultation observed.

BEGIN FIRST ORBIT ADJUST MANEUVER

744	QUI	230/01:08:00 01:08:30 01:09:30 01:13:31	Command SASS Standby. Turn SASS off. Select ALT Calibrate. Turn ALT off.
745	ETC	230/02:38:31	Transfer from OACS to RCS.
747	MAD	230/05:38:00	Reposition Solar Arrays for maneuver.
748	HAW	230/07:46:58 07:48:22	+X Orbit Adjust Thruster on. +X Orbit Adjust Thruster off.
748	ACN	230/08:42:25	Switch Solar Arrays to auto-track.
749	ULA	230/09:10:10	Transfer from RCS to OACS.
749	GWM	230/09:29:12	Turn ALT on.
749	ORR	230/09:39:32 09:42:52	Enable SASS High Voltage Power Supply. Select SASS Operate Mode 1.

END FIRST ORBIT ADJUST MANEUVER

801	AGO	234/00:50:34 00:51:08 00:51:44	Turn off Gyro Reference Assembly (GRA). Turn off AEA and RCS Power. Enable GRA Heater.
-----	-----	--------------------------------------	--

BEGIN -X THRUSTER CALIBRATION MANEUVER

818	-	235/04:43:36	Turn on Gyro Reference Assembly.
819	GDS	235/06:39:17	Transfer from OACS to RCS.
820	MAD	235/07:50:46	Reposition Solar Arrays for maneuver.

Note: SASS Remained on during this maneuver.

<u>REV.#</u>	<u>STA.</u>	<u>GMT</u>	<u>EVENT</u>
820	ACN	235/09:16:18 09:20:36 09:21:36 09:32:46	Command ALT Standby. -X Orbit Adjust Thruster on. -X Orbit Adjust Thruster Off. Switch Solar Arrays to auto-track.
821	GWM	235/10:12:11	Transfer from RCS to OACS.
821	ORR	235/10:23:03 10:24:03	Turn Gyro Reference Assembly (GRA) off. Turn GRA Heater on.
823	MIL	235/12:50:42 12:54:03	Select ALT Calibrate mode. Select ALT Track 1 mode.

END -X THRUSTER CALIBRATION MANEUVER

BEGIN SECOND ORBIT ADJUST MANEUVER

861	-	238/06:00:36	Turn on Gyro Reference Assembly.
862	-	238/07:05:00	Switch ALT to Standby.
863	-	238/08:10:26	Transfer from OACS to RCS.
863	ULA	238/08:19:07 08:20:08 08:22:00	Select SASS Standby. Turn SASS off. Reposition Solar Arrays.
863	ACN	238/09:22:22 09:29:21	-X Orbit Adjust Thruster on. -X Orbit Adjust Thruster off.
864	MAD	238/09:40:03	Switch Solar Arrays to autotrack.
864	ULA	238/10:00:11	Transfer from RCS to OACS.
864	ACN	238/11:04:19 11:07:49	Enable SASS High Voltage Power Supply. Select SASS Operate Mode 1.
865	-	238/11:17:10	Switch ALT to Track 1 mode.

END SECOND ORBIT ADJUST MANEUVER

891	-	240/07:23:25	VIRR Scan Motor Drive failed.
891	-	240/08:10:00	ALT Transmitter shut down automatically due to low spacecraft Unregulated Bus voltage.



<u>REV.#</u>	<u>STA.</u>	<u>GMT</u>	<u>EVENT</u>
895	MIL	240/13:40:32 13:43:38 13:43:39 13:44:08	Select ALT Standby/Initialize Turn ALT Low Voltage Power Supply off. Turn ALT off. Initiate Heater Bus 60% duty cycle.
897	-	240/17:17:00	Begin Heater Bus 40% duty cycle.
898	ULA	240/18:52:00	Attempt VIRR restart - failed.
898	-	240/19:16:12	Begin Heater Bus 12% duty cycle.
917	-	242/02:45:00	Begin Heater Bus 20% duty cycle.
933	-	243/07:03:00	Begin Heater Bus 25% duty cycle.
937	AGO	243/13:38:44	Begin Heater Bus 30% duty cycle.
940	-	243/18:39:17	Begin Heater Bus 35% duty cycle.
946	MIL	244/03:56:38	Begin Heater Bus 40% duty cycle.
953	MIL	244/15:03:06	Command ALT Standby.
954	GDS	244/16:47:04	Turn on ALT Track 1 mode (TWT checkout).
954	ULA	244/16:55:00	Select ALT Standby.
972	GWM	245/22:56:43	Begin Heater Bus 15% duty cycle.
997	-	247/17:17:34	Begin attitude control mode 5B.
997	-	247/17:55:00	Begin attitude control mode 5A.
1000	GWM	247/21:57:15	Begin 20% Heater Bus duty cycle.
1015	GWM	248/23:08:15	Begin 10% Heater Bus duty cycle.
1016	-	249/01:55:02	Select ALT Track 1 mode, 50% duty cycle.
1029	ORR	250/00:05:32	Begin 60% ALT duty cycle.
1043	MAD	250/22:40:00	Select ALT Standby.
1044	GWM	250/23:50:45	Begin 20% Heater Bus duty cycle.

<u>REV.#</u>	<u>STA.</u>	<u>GMT</u>	<u>EVENT</u>
<u>BEGIN ORBIT ADJUST MANEUVER (BERMUDA 3-DAY REPEAT)</u>			
1072	MAD	252/23:25:31	Transfer from OACS to RCS.
1073	MAD	253/01:03:13	Reposition Solar Arrays.
1073	-	253/01:07:30	Select SASS Standby.
		01:08:00	Turn SASS off.
		01:10:22	-X Orbit Adjust Thruster on.
		01:10:53	-X Orbit Adjust Thruster off.
		01:20:00	Switch Solar Arrays to auto-track.
		01:20:10	Enable SASS High Voltage Power Supply.
1073	AGO	253/01:23:30	Select SASS Operate Mode 1.
1073	ORR	253/01:53:10	Transfer from RCS to OACS.
		01:54:34	Turn off Gyro Reference Assembly (GRA).
		01:59:10	Turn off RCS Power.
		01:59:43	Enable GRA Heaters.
<u>END ORBIT ADJUST MANEUVER</u>			
1074	-	253/02:30:30	Switch ALT to Track Mode (first BDA overflight).
1075	-	253/03:54:00	Select ALT Standby.
1084	-	253/19:25:45	Begin attitude control Mode 5.
1097	ULA	254/17:00:49	Begin attitude control Modes 5A and 5B.
1099	HAW	254/20:08:30	Restart VIRR Scan Motor - ran for 10 seconds.
1100	MAD	254/22:22:00	Restart VIRR Scan Motor - ran for 10 seconds.
1103	MIL	255/03:28:00	Begin Scanwheel test. Turn Control Logic Assembly on (both Scanwheels on).
		03:28:02	Turn off Right Scanwheel Signal Processor.
		03:37:02	Turn on Control Logic Assembly.
		03:37:04	Turn off Left Scanwheel Signal Processor.
1105	GDS	255/06:54:44	Restart VIRR Scan Motor - kept running.

<u>REV.#</u>	<u>STA.</u>	<u>GMT</u>	<u>EVENT</u>
1114	HAW	255/21:20:05	Switch from Sun Sensor 1 to Sun Sensor 3.
1115	ORR	256/00:25:35 00:28:50	VIRR Scan Motor stopped. Restart VIRR Scan Motor - unsuccessful.
1117	-	256/02:42:20 02:43:30	Select ALT Calibrate mode. Switch ALT to Track mode (second BDA overflight).
1117	AGO	256/03:15:10	Repeat Scanwheel test.
1118	-	256/04:07:00	Switch ALT to Standby.
1126	GDS	256/17:38:10	Switch ALT to Track mode (GOASEX overflight).
1126	ULA	256/17:46:00	Switch ALT to Standby.
1144	-	258/00:05:24	Begin ALT Track 1 operations over oceans, Test Mode 1 over major land areas.
1154	ULA	258/16:45:00	Restart VIRR Scan Motor - ran 20 seconds.
1170	HAW	259/19:24:00	Restart VIRR Scan Motor - ran 30 seconds.
1229	GWM	264/00:07:23	Begin 10% Heater Bus duty cycle.
1252	GWM	265/13:46:00 13:54:00	Start ALT Track 4 test. Resume ALT Track 1 mode.
1255	GDS	265/18:13:00	Start ALT Track 4 test.
1255	ULA	265/18:21:10	Resume ALT Track 1 mode.
1284	ULA	267/19:02 ~	ALT Transmitter dropped out for 5 secs.
1287	-	268/00:15:09	Begin ALT Test Mode 1 operation over major land masses, Track 4 elsewhere with modified acquisition parameters.
1372	HAW	273/22:37:34	Select SMMR Encoder B.
1503	UKO	283/03:12:01	Short circuit in Electrical Power Subsystem.

<u>REV.#</u>	<u>STA.</u>	<u>GMT</u>	<u>EVENT</u>
1503	ORR	283/04:08:27	Last radio contact with spacecraft.

C-3

APPENDIX B  
MISSION PLANNING SUMMARY

ORIGINAL PAGE IS  
OF POOR QUALITY.

CYCLE NO. 001  
Revs 0000 to 0085  
Days 177 to 183

MISSION PLANNING SUMMARY

DAY 177 Monday 26 June 78	DAY 178 Tuesday 27 June 78	DAY 179 Wednesday 28 June	DAY 180 Thursday 29 June	DAY 181 Friday 30 June 78	DAY 182 Saturday 1 July 78	DAY 183 Sunday 2 July 78
Rev 0001 Node 32.3748 E Time 0206.52	Rev 0015 Node 40.7982 Time 0137.19	Rev 0029 Node 49.2216 Time 0107.46	Rev 0043 Node 57.6450 Time 0038.12	Rev 0057 Node 66.0684 Time 0008.39	Rev 0072 Node 49.3792 Time 0119.51	Rev 0072 Node 49.3792 Time 0119.51
F-1 day preps. Countdown start	Deploy antennas, solar array, Rev 0001 Lift-off 178/0105/00 Deploy SAR antenna Revs 0001-0002 Set clock and release, power, zero SMR Rev 0003 Power subsystem checkout ACS checkout and analysis First OD	Rev 0016 Transfer from RCS to OACS Rev 0021 Begin processing of full Rev data for ACS Rev 0023 Post injection orbit solution Rev 0025 Load attitude trim commands 1800 GMT Maneuver meeting (Cal burn #1) 2200 GMT Maneuver load to CMS	All day: ACS evaluation 1400 GMT Review maneuver load 1700 GMT Orbit solution 2000 GMT OAMP run	0000 GMT Begin maneuver period Execute Cal burn #1 1200 GMT End maneuver period 1400 GMT Maneuver meeting (OA maneuver #1) 1700 GMT Orbit solution 2000 GMT OAMP run 2200 GMT Maneuver load to CMS	1500 GMT Post maneuver orbit solution 1800 GMT Final OAMP run 2000 GMT Review and adjust maneuver load 2200 GMT Adjusted maneuver to CMS	0900 GMT Begin maneuver period Execute OA Maneuver #1

Prepared: *RL Nelson* date 20 June 1978

Approved: *[Signature]* date 20 Jun 78

ORIGINAL PAGE IS  
OF POOR QUALITY

CYCLE NO. 002  
Revs 0086 to 0172  
Days 184 to 190

MISSION PLANNING SUMMARY

DAY	DAY 184	DAY 185	DAY 186	DAY 187	DAY 188	DAY 189	DAY 190
Monday 3 July 78	Rev 0086 Node 59.9607 Time 0050.18	Rev 0100 Node 68.3841 Time 0020.45	Rev 0115 Node 51.6949 Time 0131.57	Rev 0129 Node 60.1183 Time 0102.24	Rev 0143 Node 68.5417 Time 0032.51	Rev 0157 Node 76.9650 Time 0003.18	Rev 0172 Node 60.2752 Time 0114.29
1200 GMT End of Maneuver Period (Rev 0092)	Rev 0094 Altimeter early T/O #1 (Haw) Rev 0096 Altimeter early T/O #2 (ORR)	Rev 0098 Altimeter early T/O #3 (MIL)	Rev 0100 SAR to Operate (GDS) Rev 0102 SMNR T/O #1 (MAD) Altimeter early T/O #4 (Haw) Rev 0103 SAR to Operate (ULA) VIRR T/O #1 (ORR) Rev 0104 SMNR T/O #2 (GMM) Rev 0105 SAR SMIT (MIL) Rev 0107 SAR XMIT (GDS & ULA: HOTHANDOFF) Rev 0109 SMNR T/O #3 (Haw)	Rev 0130 Altimeter on, begin quiet time (ULA) Rev 0133 VIRR on, begin quiet time (ABO) Rev 0136 SMNR on, begin quiet time (ULA) Rev 0139 SASS on, begin quiet time (MAD) Rev 0141 SASS HVPs on, Mode 4 (MIL RTC) 2200 GMT Cal burn #2 load to CMS 1400 GMT Select: Cal burn #2 sequence 2200 GMT Cal burn #2 load to CMS	Rev 0143 SMNR on (GDS) Rev 0144 VIRR to operate (GDS) Rev 0145 Altimeter on, Track 1 (ULA) Rev 0150 SAR XMIT (GDS & ULA: HOTHANDOFF) 1600 GMT Approve maneuver load 1700 GMT Orbit Solution 2000 GMT OAMP run	0000 GMT Begin maneuver period Execute cal burn #2 1200 GMT End of maneuver period Altimeter on-Track 1, SASS on-Mode 4, VIRR on, SMNR on, SAR normal Opts. 1400 GMT Select OA maneuver #2 sequence 2200 GMT Maneuver load to CMS	Rev 0174 SAR XMIT (ULA) Sensors on, satellite quiet day Rev 0177 SAR XMIT (MIL) 1500 GMT Post maneuver solution 1800 GMT Final OAMP run 2100 GMT Predicted post maneuver ephemeris

Prepared: *R. A. Nelson* date 20 June 1978  
Approved: *[Signature]* date 20 Jun 78

ORIGINAL PAGE IS  
OF POOR QUALITY

CYCLE NO. 0003  
Revs 0186 to 0285  
Days 191 to 197

MISSION PLANNING SUMMARY

DAY 191 Monday 10 July 78 Rev 0186 Node 68.6992 Time 0044.56	DAY 192 Tuesday 11 July 78 Rev 0200 Node 77.1226 Time 0016.23	DAY 193 Wednesday 12 July Rev 0215 Node 60.4334 Time 0126.35	DAY 194 Thursday 13 July 78 Rev 0229 Node 68.8567 Time 0057.02	DAY 195 Friday 14 July 78 Rev 0243 Node 77.2801 Time 0027.29	DAY 196 Saturday 15 July 78 Rev 0258 Node 60.5909 Time 0138.41	DAY 197 Sunday 16 July 78 Rev 0272 Node 69.0143 Time 0109.07
0900 GMT Begin maneuver period Rev 0186 SAR XMIT (GDS)	1200 GMT End of maneuver period Aitmeter on-Track 1, SASS on-Mode 4 VIRR on, SMR on, SAR normal opns Rev 0207 SAR XMIT (GDS & ULA: HOT HANDOVER)	Rev 0215 SAR XMIT (GDS) Rev 0220 Aitmeter Special Command Test Rev 0221 SAR XMIT (ULA) Rev 0223 Aitmeter Track 4 Test, 17 states 1700 GMT Post maneuver orbit solution Rev 0224 Aitmeter Track 4 Test, 16 states Rev 0225 Aitmeter Track 4 Test, 15 states SASS in Mode 4, Assessment, SMR on, VIRR on, SAR opns, normal Aitmeter off	Rev 0229 Aitmeter Track 4 Test, 14 states Rev 0230 Aitmeter Track 4 Test, 2 states Rev 0232 SAR XMIT (ULA) Rev 0240 Aitmeter Whole Rev of Cal II Rev 0241 Aitmeter Whole Rev of Test Mode I Rev 0242 Aitmeter Begin Whole day of autocal SASS in Mode 4 Assessment SMR on, VIRR on, SAR opns, normal Aitmeter in Track I/Autocal	1200 GMT Maneuver Evaluation complete Rev 0257 End of Aitmeter Autocal Aitmeter begin orbit normal opns. SASS in Mode 4 Assessment, SMR on, VIRR on, SAR opns, normal Aitmeter in Track I	SASS in Mode 4 Assessment, SMR on, VIRR on, SAR opns, normal Aitmeter in Track I Rev 0263 SAR XMIT (MIL)	0000 GMT Ait start daily over-land calibrates SASS in Mode 4 Assessment, SMR on, VIRR on, SAR opns, normal Aitmeter in Track I Rev 0279 SAR XMIT (GDS & ULA)

Prepared: *R. A. Heiber* date 20 June 1978  
Approved: *[Signature]* date 20 July 78



ORIGINAL PAGE IS  
OF POOR QUALITY

CYCLE NO. 023  
Revs 986 to 0285  
Days 191 to 197

MISSION PLANNING SUMMARY

Modified for actual orbit with no maneuvers

DAY	DAY	DAY	DAY	DAY	DAY	DAY
DAY 191 Monday July 10, 78 Rev 0186 Node 72.1305 Time 0030.44	DAY 192 Tuesday July 11, 78 Rev 0201 Node 55.8899 Time 0140.09	DAY 193 Wednesday July 12 Rev 0215 Node 64.7319 Time 0108.57	DAY 194 Thursday July 13, 78 Rev 0229 Node 73.5741 Time 0337.45	DAY 195 Friday July 14, 78 Rev 0243 Node 82.4163 Time 0006.33	DAY 196 Saturday July 15 Rev 0258 Node 66.1761 Time 0115.59	DAY 197 Sunday July 16, 78 Rev 0272 Node 75.0185 Time 0044.47
Rev 0186 SAR Assessment (GDS) Rev 0187 SAR Gonzales (GDS) Rev 0191 SAR Ice Pack Dynamics (ULA) Rev 0193 SAR Death Valley Cal. (GDS)	Rev 0205 SAR Ice Pack Dynamics (ULA) Rev 0207 SAR Assessment (GDS & ULA)	Rev 0215 SAR Assessment (GDS) Rev 0219 AIT Special CMD Test Rev 0219 AIT Calib, Track 1 Rev 0221 AIT Track 4 Test (14 Sets) Rev 0221 SAR Assessment (MIL & ULA) Rev 0222 AIT Track 4 Test (1: Sets) Rev 0222 AIT Track 4 Test (1: Sets) Rev 0223 AIT Track 4 Test (1: Sets) Rev 0224 AIT Track 4 Test (1: Sets) Rev 0227 AIT Track 4 Test (8 Sets) Rev 0228 AIT Track 4 Test (6 Sets)	Rev 0230 SAR Gonzales (GDS) Rev 0232 SAR Assessment (MIL) Rev 0234 SAR Ice Pack Dynamics (ULA) Rev 0236 SAR Gonzales (GDS) Rev 0240 AIT One Rev Cal II Rev 0241 AIT One Rev Test Mode 2 Rev 0242 AIT Start 15 Revs Autocal Rev 0242 SAR Assessment (MIL)	Rev 0248 SAR Ice Pack Dynamics Rev 0250 SAS to Mode I Rev 0257 AIT End 15 Revs Autocal Rev 0257 AIT Calib, Track 1	Rev 0259 SASS Mode 3 (JASIN) Rev 0259 AIT Calib, Track 2 Rev 0260 SASS Mode 4 (JASIN) Rev 0263 SAR Assessment, Ice Pack (MIL & ULA) Rev 0269 SASS Mode 4 (JASIN) Rev 0270 SASS Mode 3 (JASIN)	Rev 0273 SASS Mode 3 (JASIN) Rev 0273 SAR Gonzales (GDS) Rev 0274 AIT Calib, Track 1 Rev 0274 SASS Mode 4 (JASIN) Rev 0277 SAR Ice Pack Dynamics Rev 0277 SAR Ice Pack Dynamics (ULA) Rev 0279 SAR Assessment, Bartick (GDS, ULA) Rev 0283 SASS Mode 4 (JASIN) Rev 0284 SASS Mode 3 (JASIN)

Alt in Track 1, SASS in Mode 4, SMRP on  
VIR on, SAR in Standby, Satellite on heels,  
Mag Desat.

Prepared: LA Nelson date 7-5-78

Approved: \_\_\_\_\_ date \_\_\_\_\_

ORIGINAL PAGE IS  
OF POOR QUALITY

CYCLE NO. 004  
Revs 0286 to 0386  
Days 209 to 204

MISSION PLANNING SUMMARY

DAY	DAY	DAY	DAY	DAY	DAY	DAY	DAY
DAY 198 Monday July 17, 78 Rev 0286 Node 83.8533 Time 0013:37	DAY 199 Tuesday July 18, 78 Rev 0301 Node 67.6134 Time 0123:02	DAY 200 Wednesday July 19 Rev 0315 Node 76.4560 Time 0051:50	DAY 201 Thursday July 20 Rev 0329 Node 85.2990 Time 0020:38	DAY 202 Friday July 21, 78 Rev 0344 Node 69.0592 Time 0130:03	DAY 203 Saturday July 22, 78 Rev 0358 Node 77.9024 Time 0058:51	DAY 204 Sunday July 23, 78 Rev 0372 Node 86.7455 Time 0027:39	
Rev 0288 SASS Mode 3 (JASIN) Ait Calib, Track 1 Rev 0289 SASS Mode 4 (JASIN) SAR Bartick (ULA) Rev 0292 SAR Assessment (MIL) SAR Ice Pack Dynamics (ULA) Rev 0298 SASS Mode 4 (JASIN) SASS Mode 3 (JASIN) Rev 0299 SASS Mode 3 (JASIN) Revs 0294-0295 Ait Over/Land Test	Rev 0301 SAR Assessment (GDS) Ait Calib, Track 1 Rev 0302 SASS Mode 3 (JASIN) SASS Mode 4 (JASIN) Rev 0303 (SASS Mode 4 (JASIN) SAR Assessment (ULA) Rev 0304 SAR Assessment (ULA) Rev 0308 SAR Calib. Coast (GDS) Rev 0312 SASS Mode 4 (JASIN) Rev 0313 SASS Mode 3 (JASIN) Revs 0307-0309 Ait Over/Land Test	Rev 0316 Ait Calib, Track 1 Rev 0317 SASS Mode 3 (JASIN) SAR Ice Pack Dynamics (ULA) Rev 0320 SAR Assessment (GDS & ULA) Rev 0322 SAR Assessment (GDS & ULA) Rev 0323 SAR Bartick (ULA) Rev 0327 SASS Mode 3 (JASIN) Revs 0321-0324 Ait Over/Land Test	Rev 0329 Ait Over/Land Test Rev 0331 Ait Calib, Track 1 Rev 0332 SASS Mode 3 (JASIN) SASS Mode 4 (JASIN) Rev 0335 SAR Assessment (MIL) Rev 0337 SAR Assessment (ULA) Rev 0341 SASS Mode 4 (JASIN) Rev 0342 SASS Mode 3 (JASIN) Revs 0336-0338 Ait Over/Land Test	Rev 0343 Ait Calib, Track 1 Rev 0344 SAR Assessment (GDS) Rev 0345 SASS Mode 3 (JASIN) Rev 0346 SASS Mode 4 (JASIN) Rev 0349 SAR Assessment (ULA) SAR Ice Pack Dynamics (ULA) Rev 0350 SAR Assessment (ULA) Rev 0351 SAR Pacific Coast (GDS & ULA), Ait Over Land Rev 0355 SASS Mode 4 (JASIN) Rev 0356 SASS Mode 3 (JASIN)	Rev 0358 Ait Calib, Track 1 Rev 0360 SAR Assessment (GDS) SASS Mode 3 (JASIN) Rev 0360 SASS Mode 3 (JASIN) Rev 0365 SAR Assessment (GDS & ULA) Rev 0370 SASS Mode 3 (JASIN) Rev 0371 SAR Assessment (MIL) Rev 0378 SAR Assessment (MIL) Rev 0363 SAR Operate (MIL) Transmit (ULA)	Rev 0374 SASS Mode 3 (JASIN) Rev 0375 SASS Mode 4 (JASIN) Rev 0377 Ait Calib, Track 1 Rev 0378 SAR Assessment, Ice Pack (GDS & ULA) Rev 0380 SAR Assessment (ULA) Rev 0384 SASS Mode 4 (JASIN) Rev 0385 SASS Mode 3 (JASIN)	

Ait in Track 1, SASS in Mode 1, SMR on,  
VIR on, SAR in Standby, Satellite on Wheels, Mag Desat.

Prepared: R. A. Deibon date 7-11-78  
Approved: [Signature] date 7-11-78

ORIGINAL PAGE IS  
OF POOR QUALITY

CYCLE NO. 4 505 A  
Revs 0386 to 0488  
Days 205 to 211

MISSION PLANNING SUMMARY

DAY 205	DAY 206	DAY 207	DAY 208	DAY 209	DAY 210	DAY 211
Monday 24 July 78 Rev 0387 Node 70.5063 Time 0137.05	Tuesday 25 July 78 Rev 0401 Node 79.3496 Time 0105.52	Wednesday 26 July 78 Rev 0415 Node 88.1931 Time 0034.40	Thursday 27 July 78 Rev 0429 Node 97.0369 Time 0003.28	Friday 28 July 78 Rev 0444 Node 80.7980 Time 0112.53	Saturday 29 July 78 Rev 0458 Node 89.6421 Time 0041.41	Sunday 30 July 78 Rev 0472 Node 98.4861 Time 0010.2P
Rev 0387 SAR Storm, Sunset Crater (GDS) SASS Mode 3 (JASIN) SAR Gonzales (GDS) SASS Mode 4 (JASIN) SAR Ice Dynamics (ULA) SAR Mississipp Delta (MIL) SAR Death Valley, Gonzales (GDS) SASS Mode 2 (Assessment)(OLA) SASS Mode 4 (JASIN) SAR East Coast (MIL)	Rev 0401 Ait Catib, Track 1 SASS Mode 3 (JASIN) SAR Ice Dynamics (ULA) SAR Eastern Storm Track (MIL) SAR Pacific Storm Track (GDS) SASS Mode 3 (JASIN) SASS to Mode 3 (Assessment)(ORR)	Rev 0415 SAR Gain Calibrations (GDS) Rev 0417 Ait Catib, Track 1 SASS Mode 4 (JASIN) Rev 0418 SASS Mode 4 (JASIN) Rev 0422 SAR Gulf of Mexico (MIL) Rev 0423 Pac Storm (GDS) Rev 0427 SASS Mode 4 (JASIN)	Rev 0430 SAR Storm Track (GDS) Rev 0431 SASS to Mode 5 (Assessment) SAR Gonzales (GDS) Rev 0432 SASS Mode 4 (JASIN) Rev 0435 SAR Ice Dynamics (ULA) Rev 0437 SAR Death Valley, Gonzales (GDS) Rev 0441 SASS Mode 4 (JASIN) Rev 0442 SASS Mode 3 (JASIN) Rev 0443 SAR East Coast (MIL)	Rev 0444 Ait Catib, Track 1 Rev 0446 SASS Mode 3 (JASIN) Rev 0449 SAR Ice Dynamics (ULA) SASS to Mode 7 (Assessment)(ULA) Rev 0450 SAR Gulf Stream, Great Lakes (MIL) Rev 0456 SASS Mode 3 (JASIN)	Rev 0460 SASS Mode 3 (JASIN) Ait Catib Track 1 Rev 0461 SASS Mode 4 (JASIN) Rev 0464 SAR Ice Dynamics (ULA) Rev 0465 SAR Guatemala (MIL) Rev 0466 SAR Storm Track (GDS) Rev 0467 SASS to Mode 8 (Assessment)(ULA) Rev 0470 SASS Mode 4 (JASIN) Rev 0471 SASS Mode 3 (JASIN)	Rev 0472 SAR Guatemala (MIL) Rev 0473 Ait Catib, Track 1 SAR Storm Track (GDS) Rev 0474 SASS Mode 3 (JASIN) Rev 0475 SASS Mode 4 (JASIN) Rev 0478 SAR Ice Dynamics (ULA) Rev 0480 SAR Gonzales (GDS) Rev 0484 SASS Mode 4 (JASIN) Rev 0485 SASS Mode 3 (JASIN)

ALT IN TRACK 1, SASS IN MODE 6, SMR ON, VIRR  
ON, SAR IN STBY, SATELLITE ON WHEELS, MAG DESAT.

Revised R. G. Johnson Date 7-18-78 Prepared: R. G. Johnson date 7-13-78  
Approved: [Signature] Date 7-19-78 Approved: [Signature] Date 7-19-78

ORIGINAL PAGE 13  
OF POOR QUALITY

CYCLE NO. 1 008  
Rev 0487 to 0586  
Days 212 to 218

MISSION PLANNING SUMMARY

DAY	DAY	DAY	DAY	DAY	DAY	DAY	DAY
DAY 212 Monday July 31, 78	DAY 213 Tuesday Aug 1, 78	DAY 214 Wednesday Aug 2	DAY 215 Thursday Aug 3, 78	DAY 216 Friday Aug 4, 78	DAY 217 Saturday Aug 5, 78	DAY 218 Sunday Aug 6, 78	
Rev 0487 Node 82.2256 Time 0120:00	Rev 0501 Node 91.0688 Time 0048:48	Rev 0515 Node 99.9121 Time 0017:36	Rev 0530 Node 83.6732 Time 0127:01	Rev 0544 Node 92.5167 Time 0055:49	Rev 0558 Node 101.3607 Time 0024:37	Rev 0573 Node 85.1219 Time 0134:02	
Rev 0487 Alt Catib, Track 1 SASS Orbit Normal Test SAR Assessment (GDS) SAR Ice Dynamics (ULA) SAR Gulf Stream (MIL) SAR Pacific Storm (GDS)	Rev 0502 SAR Algodones (GDS) Alt Catib, Track 1 SAR Ice Dynamics (ULA) SAR Gulf of Mexico (MIL) SAR Pacific Storm (GDS)	Rev 0515 SAR Guatemala (GDS) Alt Catib, Track 1 SAR Gonzales (GDS) SAR Ice Dynamics (ULA) SAR Gulf of Mexico (MIL) SAR Assessment (GDS) SAR Atlantic Coast (MIL)	Rev 0530 Alt Catib, Track 1 SAR Assessment (GDS) SAR Ice Dynamics (ULA) SAR Eastern Storm (MIL) SAR (GDS)	Rev 0545 SAR (GDS) Alt Catib, Track 1 SAR (ULA) SAR Ice Dynamics (ULA) SAR (MIL) SAR (GDS & ULA)	Rev 0558 SAR Assessment (MIL) Alt Catib, Track 1 SAR Blanchard (GDS) SAR Ice Dynamics (ULA) SAR Assessment (MIL) SAR (GDS)	Rev 0572 Alt Catib, Track 1 End SASS Orbit Normal Test, Start Observation Phase SAR Assessment (GDS) SAR Ice Dynamics (ULA) SAR Blanchard (GDS) SAR Pacific Storm (GDS)	

Prepared: R. A. Reiber date 7-18-78  
Approved: W. E. Allen date 7-19-78

Alt in Track 1, SASS in Mode 8, VIRK on, SMNR on, SAR Sdbdy Satellite on Wheels, Mag Desat.

CYCLE NO. 007  
 Revs 0587 to 0686  
 Days 219 to 225

MISSION PLANNING SUMMARY

DAY	DAY	DAY	DAY	DAY	DAY	DAY	DAY
Monday 7 Aug 78	Tuesday 8 Aug 78	Wednesday 9 Aug 78	Thursday 10 Aug 78	Friday 11 Aug 78	Saturday 12 Aug 78	Sunday 13 Aug 78	DAY 225
Rev 0587 Node 092,863 Time 0102:47	Rev 0601 Node 102,808 Time 0031:34	Rev 0615 Node 111,551 Time 0006:27	Rev 0630 Node 092,514 Time 0152:57	Rev 0644 Node 104,262 Time 0532:34	Rev 0658 Node 113,107 Time 0007:21	Rev 0673 Node 096,870 Time 0116:46	Rev 0673 Node 096,870 Time 0116:46
ALT CALIB, TRACK 1 SAR S.P. CRATER (GDS) SAR JASIN (UKO) SAR ICE DYNAMICS MONITOR (ULA) SAR WEST COAST (GDS) SAR WEST COAST (GDS) SAR JASIN (UKO) REV 0587 REV 0588 REV 0589 REV 0590 REV 0591 REV 0592 REV 0593 REV 0594 REV 0595 REV 0596 REV 0597	ALT CALIB, TRACK 1 SAR MILA STATION PASS (MIL) SAR ULA STATION PASS (ULA) SAR ICE DYNAMICS MONITOR (ULA) SAR ASSESSMENT (MIL) SAR CRATER FIELD (GDS) REV 0601 REV 0602 REV 0603 REV 0604 REV 0605 REV 0606 REV 0607 REV 0608 REV 0609	ALT CALIB, TRACK 1 SAR DEATH VALLEY (GDS) SAR DEATH VALLEY (GDS) SAR ICE DYNAMICS MONITOR (ULA) SAR T.S. (DOUBLE HOT HANDOVER) MIL, GDS, AND ULA) SAR PACIFIC STORM TRACK (GDS) REV 0615 REV 0616 REV 0617 REV 0618 REV 0619 REV 0620 REV 0621 REV 0622 REV 0623 REV 0624	ALT CALIB, TRACK 1 SAR SYSTEM (GDS) SAR JASIN (UKO) SAR ICE DYNAMICS MONITOR (ULA) SAR MISSISSIPPI DELTA (MIL) SAR SYSTEM (GDS) SAR JASIN (UKO) REV 0630 REV 0631 REV 0632 REV 0633 REV 0634 REV 0635 REV 0636 REV 0637 REV 0638 REV 0639 REV 0640	ALT CALIB, TRACK 1 SAR ULA ANTENNA (ULA) SAR ICE DYNAMICS (ULA) SAR CONTINUATION R-163 (MIL) SAR SYSTEM (GDS) REV 0644 REV 0645 REV 0646 REV 0647 REV 0648 REV 0649 REV 0650 REV 0651 REV 0652	ALT CALIB, TRACK 1 SAR INTERSECTION OF R-163 (MIL) SAR DEATH VALLEY (GDS) SAR ICE DYNAMICS (ULA) SAR DOUBLE HOT HANDOVER (MIL, GDS, AND ULA) REV 0658 REV 0659 REV 0660 REV 0661 REV 0662 REV 0663 REV 0664 REV 0665 REV 0666	ALT CALIB, TRACK 1 SAR SYSTEM (GDS) SAR ICE DYNAMICS (ULA) SAR DEATH VALLEY, GLACIERS (GDS AND ULA) REV 0673 REV 0674 REV 0675 REV 0676 REV 0677 REV 0678 REV 0679 REV 0680 REV 0681	ALT CALIB, TRACK 1 SAR SYSTEM (GDS) SAR ICE DYNAMICS (ULA) SAR DEATH VALLEY, GLACIERS (GDS AND ULA) REV 0673 REV 0674 REV 0675 REV 0676 REV 0677 REV 0678 REV 0679 REV 0680 REV 0681

HEATER BUS ON 20:  
 ALT IN TRACK 1, SASS IN ORBIT NORMAL, WIRN ON, SMMR ON,  
 SAR IN STANDBY, SATELLITE ON WHEELS, MAGNETIC DESATURATION

ORIGINAL PAGE IS  
 OF POOR QUALITY

Prepared: *R. A. Neish* date 7-26-78  
 Approved: *[Signature]* date 7-26-78

ORIGINAL PAGE 12  
OF POOR QUALITY.

CYCLE NO. 007  
Revs 0587 to 0686  
Days 219 to 225

MISSION PLANNING SUMMARY  
As modified by mini-loads

DAY	DAY	DAY	DAY	DAY	DAY	DAY	DAY	DAY					
219	220	221	222	223	224	225	224	225					
Monday	Tuesday	Wednesday	Thursday	Friday	Saturday	Sunday	Saturday	Sunday					
7 Aug 78	8 Aug 78	9 Aug 78	10 Aug 78	11 Aug 78	12 Aug 78	13 Aug 78	12 Aug 78	13 Aug 78					
Rev 0587 Node 093,963 Time 0102:47 ALT CALIB, TRACK 1 SAR S.P. CRATER (GDS) SAR JASIN (UKO) SAR ICE DYNAMICS MONITOR (ULA) SAR WEST COAST (GDS) SAR JASIN (UKO) SAR 0590 SAR 0593 SAR 0595 SAR 0599	Rev 0601 Node 102,808 Time 0031:34 ALT CALIB, TRACK 1 SAR MILA STATION PASS (MIL) SAR ULA STATION PASS (ULA) SAR ICE DYNAMICS MONITOR (ULA) SAR ASSESSMENT (MIL) SAR CRATER FIELD (GDS) REV 0605 REV 0607 REV 0608 REV 0609	Rev 0615 Node 111,653 Time 0000:22 ALT CALIB, TRACK 1 SAR DEATH VALLEY (GDS) SAR ICE DYNAMICS MONITOR (ULA) SAR U.S. (DOUBLE HOT HANDOVER) (MIL, GDS, AND ULA) SAR PACIFIC STORM TRACK (GDS) REV 0615 REV 0617 REV 0622 REV 0623 REV 0624	Rev 0630 Node 095,416 Time 0109:47 ALT CALIB, TRACK 1 SAR SYSTEM (GDS) SAR JASIN (UKO) SAR ICE DYNAMICS MONITOR (ULA) SAR MISSISSIPPI DELTA (MIL) SAR SYSTEM (GDS) SAR 0631 REV 0633 REV 0636 REV 0637 REV 0642	Rev 0644 Node 084,862 Time 0038:34 ALT CALIB, TRACK 1 SAR ULA ANTENNA (ULA) SAR ICE DYNAMICS (ULA) SAR CONTINUATION R-163 (MIL) SAR SYSTEM (GDS) SAR 0650 REV 0651 REV 0652 REV 0655 REV 0658	Rev 0658 Node 113,107 Time 0007:21 ALT CALIB, TRACK 1 SAR INTERSECTION OF R-163 (MIL) SAR DEATH VALLEY (GDS) SAR ICE DYNAMICS (ULA) SAR DOUBLE HOT HANDOVER (MIL, GDS, AND ULA) SAR HURRICANE CORA SAR NO. CAR. SEA TRUTH (MIL) REV 0660 REV 0665 REV 0666	Rev 0673 Node 096,870 Time 0116:46 ALT CALIB, TRACK 1 SAR CALIB, TRACK 1 SAR SYSTEM (GDS) SAR ICE DYNAMICS (ULA) SAR DEATH VALLEY, GLACIERS (GDS AND ULA) REV 0673 REV 0674 REV 0679 REV 0681	Rev 0587 Node 093,963 Time 0102:47 ALT CALIB, TRACK 1 SAR S.P. CRATER (GDS) SAR JASIN (UKO) SAR ICE DYNAMICS MONITOR (ULA) SAR WEST COAST (GDS) SAR JASIN (UKO) SAR 0590 SAR 0593 SAR 0595 SAR 0599	Rev 0601 Node 102,808 Time 0031:34 ALT CALIB, TRACK 1 SAR MILA STATION PASS (MIL) SAR ULA STATION PASS (ULA) SAR ICE DYNAMICS MONITOR (ULA) SAR ASSESSMENT (MIL) SAR CRATER FIELD (GDS) REV 0605 REV 0607 REV 0608 REV 0609	Rev 0615 Node 111,653 Time 0000:22 ALT CALIB, TRACK 1 SAR DEATH VALLEY (GDS) SAR ICE DYNAMICS MONITOR (ULA) SAR U.S. (DOUBLE HOT HANDOVER) (MIL, GDS, AND ULA) SAR PACIFIC STORM TRACK (GDS) REV 0615 REV 0617 REV 0622 REV 0623 REV 0624	Rev 0630 Node 095,416 Time 0109:47 ALT CALIB, TRACK 1 SAR SYSTEM (GDS) SAR JASIN (UKO) SAR ICE DYNAMICS MONITOR (ULA) SAR MISSISSIPPI DELTA (MIL) SAR SYSTEM (GDS) SAR 0631 REV 0633 REV 0636 REV 0637 REV 0642	Rev 0644 Node 084,862 Time 0038:34 ALT CALIB, TRACK 1 SAR ULA ANTENNA (ULA) SAR ICE DYNAMICS (ULA) SAR CONTINUATION R-163 (MIL) SAR SYSTEM (GDS) SAR 0650 REV 0651 REV 0652 REV 0655 REV 0658	Rev 0658 Node 113,107 Time 0007:21 ALT CALIB, TRACK 1 SAR INTERSECTION OF R-163 (MIL) SAR DEATH VALLEY (GDS) SAR ICE DYNAMICS (ULA) SAR DOUBLE HOT HANDOVER (MIL, GDS, AND ULA) SAR HURRICANE CORA SAR NO. CAR. SEA TRUTH (MIL) REV 0660 REV 0665 REV 0666	Rev 0673 Node 096,870 Time 0116:46 ALT CALIB, TRACK 1 SAR CALIB, TRACK 1 SAR SYSTEM (GDS) SAR ICE DYNAMICS (ULA) SAR DEATH VALLEY, GLACIERS (GDS AND ULA) REV 0673 REV 0674 REV 0679 REV 0681

HEATER BUS ON 20%  
ALT IN TRACK 1, SASS IN ORBIT NORMAL, VIRR ON, SMMR ON  
SAR IN STANDBY, SATELLITE ON WHEELS, MAGNETIC DESATURATION

Prepared: *R. D. Nelson* date 7-26-78

Approved: *[Signature]* date 7-26-78

ORIGINAL PAGE IS  
OF POOR QUALITY

CYCLE NO. 008  
Revs. 0687 to 0785  
Days 226 to 232

MISSION PLANNING SUMMARY

DAY 226 Monday 14 Aug 78 Rev 0687 Node 105.72 Time 0045:34	DAY 227 Tuesday 15 Aug 78 Rev 0701 Node 114.57 Time 0014:21	DAY 228 Wednesday 16 Aug 78 Rev 0716 Node 98.40 Time 0123:29	DAY 229 Thursday 17 Aug 78 Rev 0730 Node 107.34 Time 0051:55	DAY 230 Friday 18 Aug 78 Rev 0744 Node 116.27 Time 0020:22	DAY 231 Saturday 19 Aug 78 Rev 0759 Node 100.22 Time 0129:02	DAY 232 Sunday 20 Aug 78 Rev 0773 Node 109.26 Time 0057:04
REV 0687 ALT CALIB, TRACK 1 SAR EAST COAST (MIL) SAR NORTHERN COASTLINE (ULA) REV 0691 SAR ICE DYNAMICS MONITOR (ULA) REV 0693 SAR ICE DYNAMICS MONITOR (ULA) SAR GULF STREAM (MIL) SAR M. TEXAS (GOETZ) AND SYSTEM (GDS AND ULA) REV 0695 SAR M. TEXAS (GOETZ) AND REV 0696 SAR GULF STREAM (MIL) REV 0697, 0688, 0690, 0695 ALT TRACK 4 LAND TEST	REV 0700 ALT CALIB, TRACK 1 0100 GMT START MANEUVER PERIOD EXECUTE CAL BURN #1 1300 GMT END OF MANEUVER PERIOD REV 0710 SAR PACIFIC STORM (GDS) REV 0714 SAR JASIN (UKO)	REV 0716 ALT CALIB, TRACK 1 SAR GULF OF MEXICO (MIL) REV 0719 SAR JASIN (UKO) SAR ALASKA MASK (ULA) REV 0720 SAR ICE DYNAMICS MONITOR (ULA) REV 0722 SAR ICE DYNAMICS MONITOR (ULA) SAR GULF OF MEXICO (MIL) REV 0724 SAR SEATTLE (ULA) REV 0723 SAR GULF OF MEXICO (MIL) REV 0728 START SUN OCCULTATION	REV 0730 ALT CALIB, TRACK 1 REV 0731 SAR BLANCHARD (GDS) REV 0736 SAR ICE DYNAMICS MONITOR (ULA) REV 0737 SAR ATLANTIC STORM TRACK (MIL) REV 0738 SAR GDS MASK & NORTH COAST (GDS AND ULA - HH) REV 0739 SAR PACIFIC STORM TRACK (GDS) REV 0738, 0739 ALT TRACK & LAND TEST 1800 GMT BEGIN MANEUVER PERIOD	ORBIT ADJUST MWR #1 1800 GMT END OF MANEUVER PERIOD REV 0757 SAR JASIN (UKO)	REV 0758 ALT CALIB, TRACK 1 REV 0759 SAR GULF OF MEXICO (MIL) REV 0761 SAR GUN LAKE (GDS) REV 0762 SAR ENGLAND AND EAST (UKO) REV 0765 SAR ICE DYNAMICS MONITOR (ULA) REV 0766 SAR GULF SHELF (MIL) REV 0768 SAR BERING STRAIT (ULA) REV 0766, 0767 ALT TRACK 4 LAND TEST	REV 0773 ALT CALIB, TRACK 1 REV 0774 SAR BLANCHARD (MIL) REV 0780, SAR ICE DYNAMICS MONITOR (ULA) REV 0781 SAR GDS MASK & NORTH COAST (GDS AND ULA - HH) REV 0782 SAR PACIFIC STORM (GDS) SAR JASIN (UKO) REV 0785 SAR JASIN (UKO) REV 0781, 0782 ALT TRACK 4 LAND TEST

Prepared: R. G. Leibon date 9 Aug 1978  
Approved: A. P. Johnson date 9 Aug 78

ALT ON TRACK 1, SASS ORBIT NORMAL, WIRN ON, SMWR ON, SAR OFF,  
SATELLITE ON WHEELS, MAG DESAT., HEATERS ON 20%

ORIGINAL PAGE IS  
OF POOR QUALITY

CYCLE NO. 009  
Revs 0787 to 0886  
Days 233 to 239

MISSION PLANNING SUMMARY

DAY 233 Monday 21 AUG 78	DAY 234 Tuesday 22 AUG 78	DAY 235 Wednesday 23 AUG 78	DAY 236 Thursday 24 AUG 78	DAY 237 Friday 25 AUG 78	DAY 238 Saturday 26 AUG 78	DAY 239 Sunday 27 AUG 78
REV 0787 ALT CALIB, TRACK 1 REV 0788 SAR KRISHEN (6m05 MIL) REV 0789 SAR S.P. CRATER (6m15 GDS) REV 0791 SAR JASIN (12m085 UKO) REV 0793 SAR LABRADOR (11m195 SNF) REV 0794 SAR ICE DYNAMICS (7m05ULA) REV 0795 SAR KRISHEN (6m05 MIL)	REV 0801 ALT CALIB, TRACK 1 REV 0802 SAR CHESAPEAKE BAY (6m455 MIL) REV 0806 SAR NORTH COAST (6m045 ULA) REV 0808 SAR ICE DYNAMICS (6m025 ULA) REV 0809 SAR GULF & FLA (9m575 MIL) REV 0810 SAR GDS MASK (6m335 GDS) REV 0811 SAR GULF OF ALASKA (6m 125 ULA)	0100 GMT BEGIN MANEUVER PERIOD 0920 GMT EXECUTE CAL #2 BURN 1300 GMT END OF MANEUVER PERIOD REV 0824 SAR GDS MASK (6m155 GDS) REV 0825 SAR PACIFIC STORM (6m 335 GDS)	REV 0830 ALT CALIB, TRACK 1 REV 0830 SAR ZENITH PASS (6m165 SNF) REV 0832 SAR GDS MASK (6m265 GDS) REV 0834 SAR JASIN (7m165 UKO) REV 0835 SAR GREENLAND (6m085 SNF) REV 0837 SAR ICE DYNAMICS (6m155 ULA) REV 0838 SAR MISSISSIPPI DELTA (4m575 MIL)	REV 0845 ALT CALIB, TRACK 1 REV 0845 SAR BEALE (5m035 MIL) REV 0849 SAR W. COAST (7m585 ULA) REV 0851 SAR ICE DYNAMICS (4m505 ULA) REV 0852 SAR MIL MASK (7m365 MIL) REV 0853 SAR GDS MASK (4m005 GDS) REV 0853 SAR ULA MASK (4m305 ULA)	1815 GMT BEGIN MANEUVER PERIOD 1815 GMT EXECUTE OR #2 MNYRS 1815 GMT END OF MANEUVER PERIOD	REV 0873 ALT CALIB, TRACK 1 REV 0874 SAR 22L MASK (10m365 MIL) REV 0875 SAR GDS MASK (7m435 GDS) REV 0879 SAR LABRADOR COAST (7m005 SNF) REV 0880 SAR WOODS HOLE (4m005 MIL) REV 0880 SAR ICE DYNAMICS (5m005 ULA) REV 0882 SAR RADAR TEST (4m005 GDS)

Prepared: *R. J. Nelson* date 8-16-78  
 Approved: *U. T. Peterson* date 8-17-78

ALT ON, TRACK1, SASS ORBIT NORMAL, SMR ON, VIRR ON.  
 SAR STANDBY, HTR BUS 15% DUTY, ACS MODE 5



ORIGINAL PAGE IS  
OF POOR QUALITY

CYCLE NO. 010-H  
Revs 0887 to 0986  
Days 240 to 246

MISSION PLANNING SUMMARY  
WITH TRIM MANEUVER

DAY	DAY	DAY	DAY	DAY	DAY	DAY
Monday 28 Aug 78 Rev 0887 Node 123.012 Time 0007.54	Tuesday 29 Aug 78 Rev 0902 Node 113.305 Time 0119.10	Wednesday 30 Aug Rev 0916 Node 121.712 Time 0049.42	Thursday 31 Aug Rev 0930 Node 130.119 Time 0020.13	Friday 1 Sept 78 Rev 0945 Node 113.413 Time 0131.30	Saturday 2 Sept 78 Rev 0959 Node 121.921 Time 0102.01	Sunday 3 Sept 78 Rev 0973 Node 130.228 Time 0032.32
REV 0887 ALT CALIB, TRACK 1 SAR G. BANKS (2mos SNF) 4 SAR NEW BRUNSWICK/BEALE (6mos SNF & MIL) 1/2 SAR W. TEXAS (4mos GDS) 3 SAR N. SEA (5mos UKO) 6 SAR ICE DYNAMICS (5mos ULA) 5	REV 0901 ALT CALIB, TRACK 1 SAR DEATH VALLEY (4mos GDS) 1 SAR ICE DYNAMICS (3mos ULA) 5 SAR BEALE (2mos MIL) 3 SAR ENG. CHANNEL (3mos UKO) 4 SAR JASIN (3mos UKO) 2	REV 0915 ALT CALIB, TRACK 1 SAR JASIN (2mos UKO) 3 SAR LASIN (2mos UKO) 3 SAR LABRADOR (2mos SNF) 4 SAR CAPE COD (2mos MIL) 5 SAR ICE DYNAMICS (2mos ULA) 6 SAR DEATH VALLEY CALIB/PUGET SOUND (2mos, 2mos GDS) 2/1	REV 0930 ALT CALIB, TRACK 1 HEATER BUS TO 10% SAR G. BANK (1mos SNF) 4 SAR NEW BRUNSWICK/BEALE (5mos SHF/MIL) 1/2 SAR ICE DYNAMICS (2mos ULA) 3 SAR ARIZONA (2mos GDS) 5	0000 GMT BEGIN MANEUVER PERIOD  EXECUTE TRIM MANEUVER  2359 GMT END OF MANEUVER PERIOD	REV 0958 ALT CALIB, TRACK 1 SAR PANAMA CITY (2mos MIL) 3 SAR UK (2mos UKO) 5 SAR ICE DYNAMICS (2mos ULA) 4 SAR DEATH VALLEY (PUGET SOUND 2mos, 2mos GDS) 2/1	REV 0973 ALT CALIB, TRACK 1 SAR G. BANKS (1mos SNF) 3 SAR NEW BRUNSWICK/BEALE REV 0974 (5mos SNF/MIL) 2/1 SAR NORTH SEA (2mos UKO) 5 SAR ICE DYNAMICS (2mos ULA) 4

ALT ON-TRACK 1, SASS ORBIT NORMAL, SMR ON, VIRR ON  
SAR STANDBY, HEATER BUS 12 % DUTY, ACS MODE 5

Prepared: *R. J. Ziebar* date 8-22-78  
Approved: *J. Shepherd* date 8-22-78

ORIGINAL PAGE IS  
OF POOR QUALITY

CYCLE NO- 010-N  
Revs 0887 to 0986  
Days 240 to 246

MISSION PLANNING SUMMARY

WITHOUT TRIM MANEUVER

DAY	DAY	DAY	DAY	DAY	DAY	DAY
Monday 28 Aug 78	Tuesday 29 Aug 78	Wednesday 30 Aug	Thursday 31 Aug	Friday 1 Sept 78	Saturday 2 Sept 78	Sunday 3 Sept. 78
Rev 0887 Node 130.012 Time 0007.54	Rev 0902 Node 113.305 Time 0119.10	Rev 0916 Node 121.712 Time 0049.42	Rev 0930 Node 130.119 Time 0020.13	Rev 0945 Node 113.413 Time 0131.30	Rev 0959 Node 121.821 Time 0102.01	Rev 0973 Node 130.228 Time 0032.32
ALT CALIB, TRACK 1 SAR G. BANKS (2mos SNF) 4 SAR NEW BRUNSWICK/BEALE (6mos SNF & MIL) 1/2 SAR M. TEXAS (4mos GDS) 3 SAR N. SEA (5mos UKO) 6 SAR ICE DYNAMICS (5mos ULA) 5 REV 0887 SAR ICE DYNAMICS (5mos ULA) 5	ALT CALIB, TRACK 1 SAR DEATH VALLEY (4mos GDS) 1 SAR ICE DYNAMICS (3mos ULA) 5 SAR BEALE (2mos MIL) 3 SAR ENG. CHANNEL (3mos UKO) 4 SAR JASIN (3mos UKO) 2 REV 0915 SAR JASIN (3mos UKO) 2	ALT CALIB, TRACK 1 SAR JASIN (2mos UKO) 3 SAR LABRADOR (2mos SNF) 4 SAR CAPE COD (2mos MIL) 5 SAR ICE DYNAMICS (2mos ULA) 6 SAR DEATH VALLEY CALIB/PUGET SOUND (2mos, 2mos GDS) 2/1 REV 0925 SAR DEATH VALLEY CALIB/PUGET SOUND	ALT CALIB, TRACK 1 HEATER BUS TO 10% SAR G. BANKS (1mos SNF) 4 SAR NEW BRUNSWICK/BEALE (5mos SNF/MIL) 1/2 SAR ICE DYNAMICS (2mos ULA) 3 SAR ARIZONE (2mos GDS) 5 REV 0939 SAR ARIZONE (2mos GDS) 5	ALT CALIB, TRACK 1 SAR DEATH VALLEY CALIB (3mos GDS) SAR BEALE (3mos MIL) 4 SAR 0952 SAR GUATAMALA (2mos MIL) 5 SAR DUTCH (2mos UKO) 3 SAR JASIN (2mos UKL) 2 REV 0958 SAR JASIN (2mos UKL) 2	ALT CALIB, TRACK 1 SAR PANAMA CITY (2mos MIL) 3 SAR UK (2mos UKO) 5 SAR ICE DYNAMICS (2mos ULA) 4 SAR DEATH VALLEY (PUGET SOUND 2mos, 2mos GDS) 2/1 REV 0968 SAR DEATH VALLEY (PUGET SOUND 2mos, 2mos GDS) 2/1	ALT CALIB, TRACK 1 SAR G. BANKS (1mos SNF) 3 SAR NEW BRUNSWICK/BEALE (5mos SNF/MIL) 2/1 SAR NORTH SEA (2mos UKO) 5 SAR ICE DYNAMICS (2mos ULA) 4 REV 0974 SAR ICE DYNAMICS (2mos ULA) 4

ALT ON-TRACK 1, SASS ORBIT NORMAL, SMR ON, VIRR ON  
SAR STANDBY, HEATER BUS 12% DUTY, ACS MODE 5

Prepared: *RG Nelson* date 8-22-78  
 Approved: *J. Shepherd* date 8-29-78

ORIGINAL PAGE IS  
OF POOR QUALITY

CYCLE NO. 011  
Revs 0987 to 1087  
Days 247 to 253

MISSION PLANNING SUMMARY  
WITH BERMUDA REPEAT MANEUVER

DAY	DAY 247	DAY 248	DAY 249	DAY 250	DAY 251	DAY 252	DAY 253
Monday 4 Sep 78	Tuesday 5 Sep 78	Wednesday 6 Sep 78	Thursday 7 Sep 78	Friday 8 Sep 78	Saturday 9 Sep 78	Saturday 9 Sep 78	Sunday 10 Sep 78
Rev 0987 Node 138.636 Time 0003:03	Rev 1002 Node 121.930 Time 0114:20	Rev 1016 Node 130.339 Time 0044:51	Rev 1030 Node 38.748 Time 0015:22	Rev 1045 Node 122.043 Time 0126:38	Rev 1059 Node 130.452 Time 0057:09	Rev 1072 Node 138.861 Time 0027:40	
REV 0987 ALT CALIB, TRACK 1 SAR GOLDSTONE (2mos GDS) 5 SAR GOASEX (2mos GDS) 2 SAR BEAL (1mos MIL) 4 SAR ICE DYNAMICS (2mos ULA) 6 SAR GOASEX (1mos GDS) 3 SAR JASIN (1mos UKO) 1	REV 1001 ALT CALIB, TRACK 1 SAR GOASEX (2mos GDS) 2 SAR JASIN (2mos UKO) 1 SAR ICE DYNAMICS (2mos ULA) 5 SAR DEATH VALLEY (2mos GDS) 4 SAR GOASEX (2mos GDS) 3	REV 1016 ALT CALIB, TRACK 1 SAR CAPE COD (2mos MIL) 3 SAR GOASEX (2mos GDS) 1 SAR BANKS IS. (2mos ULA) 4 SAR GULF STORM (2mos MIL) 5 SAR GOASEX (2mos GDS) 2	REV 1030 ALT CALIB, TRACK 1 SAR GULF STORM (2mos GDS) 5 SAR GOASEX (1mos GDS) 2 SAR BEAL (1mos MIL) 4 SAR ICE DYNAMICS (3mos ULA) 6 SAR GOASEX (1mos GDS) 3 SAR JASIN (2mos UKO) 1	REV 1044 ALT CALIB, TRACK 1 SAR GOASEX (2mos GDS) 2 SAR JASIN (2mos UKO) 1 SAR ICE DYNAMICS (2mos) 4 SAR DEATH VALLEY (2mos) 3	REV 1059 ALT CALIB, TRACK 1 SAR GOASEX (2mos GDS) 1 1200 GMT BEGIN MANEUVER PERIOD	0000 GMT EXECUTE MANEUVER 1200 GMT END OF MANEUVER PERIOD SAR BANKS IS. (2mos) 5 SAR BEAL (1mos MIL) 4 SAR ICE DYNAMICS (2mos ULA) 6 SAR GOASEX (2mos GDS) 3 SAR JASIN (2mos UKO) 1	

Prepared: *R. J. Wilson* date 8-28-78  
Approved: *J. G. [Signature]* date 8-30-78

ALT UNKNOWN, VIRR UNKNOWN, SASS ORBIT NORMAL, SMNR ON  
SAR STANBY, HEATER BUS UNDER POCG CONTROL, ACS MODE 5

ORIGINAL PAGE NO  
OF POOR QUALITY

CYCLE NO. 4, 011  
Revs 0887 to 1087  
Days 247 to 253

MISSION PLANNING SUMMARY  
WITHOUT BERMUDA REPEAT MANEUVER

DAY 247 Monday 4 Sep 78	DAY 248 Tuesday 5 Sep 78	DAY 249 Wednesday 6 Sep 78	DAY 250 Thursday 7 Sep 78	DAY 251 Friday 8 Sep 78	DAY 252 Saturday 9 Sep 78	DAY 253 Sunday 10 Sep 78
Rev 0987 Node 138.636 Time 0003:03 ALT CALIB, TRACK 1 REV 0987 SAR GOLDSTONE (2mos GDS) 5 REV 0991 SAR GOASEX (2mos GDS) 2 REV 0995 SAR BEAL (2mos MIL) 4 REV 0996 SAR ICE DYNAMICS (2mos ULA) 6 REV 0997 SAR GOASEX (1mos GDS) 3 REV 1001 SAR JASIN (1mos UKO) 1	Rev 1001 Node 121.930 Time 0114:20 ALT CALIB, TRACK 1 REV 1001 SAR CALIB, TRACK 1 REV 1017 SAR CAPE COD (2mos MIL) 3 REV 1020 SAR GOASEX (2mos GDS) 1 REV 1023 SAR BANKS IS. (2mos ULA) 4 REV 1024 SAR GULF STORM (2mos MIL) 5 REV 1026 SAR GOASEX (2mos GDS) 2	Rev 1030 Node 138.748 Time 0015:22 ALT CALIB, TRACK 1 REV 1030 SAR CALIB, TRACK 1 REV 1033 SAR GULF STORM (2mos GDS) 5 REV 1034 SAR GOASEX (1mos GDS) 2 REV 1038 SAR BEAL (1mos MIL) 4 REV 1039 SAR ICE DYNAMICS (3mos ULA) 6 REV 1040 SAR GOASEX (1mos GDS) 3 REV 1044 SAR JASIN (2mos UKO) 1	Rev 1044 Node 122.043 Time 0126:38 ALT CALIB, TRACK 1 REV 1044 SAR CALIB, TRACK 1 REV 1048 SAR GOASEX (2mos GDS) 2 REV 1049 SAR JASIN (2mos UKO) 1 REV 1052 SAR ICE DYNAMICS (2mos) 4 REV 1054 SAR DEATH VALLEY (2mos) 3	Rev 1059 Node 130.452 Time 0057:09 ALT CALIB, TRACK 1 REV 1059 SAR CALIB, TRACK 1 REV 1063 SAR GOASEX (2mos GDS) 1 REV 1066 SAR BANKS ISL. (2mos ULA) 3 REV 1067 SAR CHICAGO (2mos MIL) 5 REV 1068 SAR CRATER (2mos GDS) 4 REV 1069 SAR GOASEX (2mos GDS) 2	Rev 1072 Node 138.861 Time 0027:40 ALT CALIB, TRACK 1 REV 1072 SAR CALIB, TRACK 1 REV 1077 SAR GOASEX (1mos) 2 REV 1080 SAR BANKS IS. (2mos) 5 REV 1081 SAR BEAL (1mos MIL) 4 REV 1087 SAR ICE DYNAMICS (2mos ULA) 6 REV 1083 SAR GOASEX (2mos GDS) 3 REV 1087 SAR JASIN (2mos UKO) 1	

Prepared: *Ed Nelson* date 8-29-78  
Approved: *J. J. ...* date 8-30-78

ALT UNKNOWN, VIRR UNKNOWN, SASS ORBIT NORMAL, SMR ON  
SAR STANDBY, HEATER BUS UNDER POCG CONTROL, ACS MODE 5

ORIGINAL PAGE IS  
OF POOR QUALITY

CYCLE NO- 012  
Revs 1088 to 1187  
Days 254 to 260

MISSION PLANNING SUMMARY

DAY 254 Monday 11 Sep 78	DAY 255 Tuesday 12 Sep 78	DAY 256 Wednesday 13 Sep 78	DAY 257 Thursday 14 Sep 78	DAY 258 Friday 15 Sep 78	DAY 259 Saturday 16 Sep 78	DAY 260 Sunday 17 Sep 78
REV 1087 ALT CALIB, TRACK 1 SAR JASIN (2ms UKO) 3 (DAY 253) SAR JASIN (2ms UKO) 1 SAR ICE DYNAMICS (2ms ULA) 5 SAR LCOA (2ms MIL) 3 SAR D.V./GOASEX (2ms/2ms, GDS) 4/2 REV 1096 SAR LCOA (2ms MIL) 3 REV 1097 SAR D.V./GOASEX (2ms/2ms, GDS) 4/2	REV 1102 ALT CALIB, TRACK 1 SAR TEST (4ms ULA) 3 SAR GULF STREAM (6ms MIL) 2 SAR GOASEX (2ms GDS) 1 REV 1110 SAR GULF STREAM (6ms MIL) 2 REV 1112 SAR GOASEX (2ms GDS) 1	REV 1116 ALT CALIB, TRACK 1 SAR ALASKA (2ms ULA) 4 SAR BEAL (3ms MIL) 2 SAR ICE DYNAMICS (4ms ULA) 3 SAR GOASEX HOT HANDOVER (6ms GDS/ULA) 1 REV 1126 SAR GOASEX HOT HANDOVER (6ms GDS/ULA) 1 REV 1124 SAR ICE DYNAMICS (4ms ULA) 3 REV 1124 SAR BEAL (3ms MIL) 2 REV 1124 SAR ICE DYNAMICS (4ms ULA) 3	REV 1130 ALT CALIB, TRACK 1 REV 1135 SAR JASIN (2ms UKO) 1 REV 1138 SAR ICE DYNAMICS (3ms ULA) 4 REV 1139 SAR LCOA (3ms MIL) 3 REV 1140 SAR D.V./GOASEX (10ms) 2	REV 1145 ALT CALIB, TRACK 1 REV 1149 SAR JASIN (10ms UKO) 1 REV 1153 SAR GULF STREAM (4ms, MIL) 3 REV 1155 SAR GOASEX (7ms GDS) 2	REV 1159 ALT CALIB, TRACK 1 REV 1163 SAR GOASEX (3ms GDS) 2 REV 1167 SAR BEAL (5ms MIL) 3 REV 1167 SAR ICE DYNAMICS (8ms ULA) 4 REV 1169 SAR GOASEX (4ms) 1	REV 1173 ALT CALIB, TRACK 1 REV 1177 SAR GOASEX (4ms GDS) 2 REV 1181 SAR ICE DYNAMICS (5ms ULA) 3 REV 1181 SAR SHOE COVE (2ms SNF) 4 REV 1182 SAR LCOA (5ms MIL) 5 REV 1183 SAR GOASEX (10ms, GDS) 1

ALT ON, TRACK 1; SASS ORBIT NORMAL; SMAR ON; VIRR OFF.  
SAR STANDBY, HTR BUS UNDER PCCC CONTROL, ACS MODE 5

Prepared: *F. Peterson* date 9-6-78  
Approved: *F. Peterson* date 9-6-78

ORIGINAL PAGE IS  
OF POOR QUALITY

CYCLE NO. 013  
Revised to 1287  
Days 261 to 267

MISSION PLANNING SUMMARY

DAY 261 Monday 18 SEP 78	DAY 262 Tuesday 19 SEP 78	DAY 263 Wednesday 20 SEP	DAY 264 Thursday 21 SEP 78	DAY 265 Friday 22 SEP 78	DAY 266 Saturday 23 SEP 78	DAY 267 Sunday 24 SEP 78
Rev 1188 Node 130.472 Time 0135:16 REV 1188 ALT CALIBRATE, TEST MODE 1 REV 1193 SAR NORTH SLOPE (4m30s, ULA) 3 REV 1195 SAR ICE DYNAM (2m30s, ULA) 2 REV 1196 SAR ROSS/HURRICANE (3m30s, MIL) 4 REV 1197 SAR EL PASO (9m00s, GDS) 5 REV 1198 SAR GOSEX (2m00s, GDS) 1 REV 1201 SAR UKO PASS (2m00s, UKO) 6	Rev 1202 Node 138.848 Time 0105:55 REV 1202 ALT CALIBRATE, TEST MODE 1 REV 1204 SAR U.S. TO GULF (10m00s, MIL) 8 REV 1205 SAR CALIBRATE (2m30s, GDS) 4 REV 1206 SAR UKO PASS (2m00s, UKO) 5 REV 1209 SAR CANADA (4m00s, SNF) 3 REV 1210 SAR BEAL/HURRICANE (3m00s, MIL) 2 REV 1211 SAR GUATANALA (3m00s, MIL) 7 REV 1212 SAR GOSEX (2m00s, GDS) 1	Rev 1216 Node 147.223 Time 0036:34 REV 1216 ALT CALIBRATE, TEST MODE 1 REV 1218 SAR CANADA (3m00s, SNF) 4 REV 1220 SAR GOSEX (2m00s, GDS) 1 REV 1224 SAR ICE DYNAMICS (2m30s, ULA) 3 REV 1225 SAR GULF/HURRICANE (3m00s, MIL) 6 REV 1226 SAR CALIBRATION (9m00s, GDS) 2	Rev 1230 Node 155.599 Time 0007:13 REV 1230 SAR UKO JASIN (2m00s, UKO) 9 REV 1231 ALT CALIBRATE, TEST MODE 1 REV 1232 SAR CANADA (10m00s, SNF/MIL HH) 2/3 REV 1235 SAR UKO PASS (2m00s, UKO) 5 REV 1236 SAR ICE/CALIBRATE (4m00s, ULA) 7 REV 1238 SAR CANADA (4m00s, SNF) 6 REV 1239 SAR ROSS/GULF STR/HURR (3m30s, MIL) 8 REV 1241 SAR GOSEX (2m00s, ULA) 4	Rev 1245 Node 138.858 Time 0118:37 REV 1244 SAR UKO PASS (2m00s, UKO) 6 REV 1248 SAR CALIBRATE (2m00s) 4 REV 1249 SAR UKO PASS (2m00s, UKO) 5 REV 1252 SAR CANADA (5m00s, SNF) 7 REV 1253 SAR BEAL/HURRICANE (8m00s, MIL) 2 REV 1254 SAR ICE DYNAMICS (2m00s, ULA) 8 REV 1254 SAR GULF-U.S. SMATH (10m00s, MIL/GDS HH) 10 REV 1255 SAR GOSEX (3m00s, GDS) 1	Rev 1259 Node 147.235 Time 0049:16 9/6 REV 1259 SAR JASIN AREA (2m00s, UKO) 8 REV 1261 SAR CANADA (3m00s, SNF) 7 REV 1263 SAR GOSEX (2m00s, GDS) 1 REV 1265 SAR GREENLAND (2m30s, SNF) 4 REV 1267 SAR BERMUDA/HURR (4m00s, MIL) 2 REV 1269 SAR ICE DYNAMICS (2m00s, ULA) 3 REV 1269 SAR CAL/JUAN DE FUCA (10m00s, GDS/ULA HH) 9/6	Rev 1273 Node 155.611 Time 0019:55 REV 1273 SAR JASIN AREA (2m00s, UKO) 7 REV 1274 ALT CALIBRATE, TEST MODE 1 REV 1275 SAR ICELAND (2m00s, UKO) 6 REV 1278 SAR UKO PASS (2m00s, UKO) 3 REV 1279 SAR CALIBRATE (4m00s, ULA) 5 REV 1281 SAR CANADA (4m00s, SNF) 9 REV 1282 SAR ICE DYNAMICS (2m00s, ULA) 1 REV 1282 SAR GULF STR/HURRICANE (8m00s, MIL) 8 REV 1283 SAR EL PASO SMATH (7m00s, GDS) 11 REV 1284 SAR COOK MOUNT (2m00s, ULA) 10

Prepared: RA Jackson date 9-15-78  
Approved: W.D. Johnson date 9-14-78

ALT ON (TRACK 1/TEST MODE 1); SASS ORBIT NORMAL; SMR ON; VIRR OFF;  
SAR STANDBY; HTR BUS UNDER POCG CONTROL; ACS NORMAL

ORIGINAL PAGE IS  
OF POOR QUALITY

CYCLE NO- 014  
Revs 1288 to 1387  
Days 268 to 274

MISSION PLANNING: SUMMARY

DAY 268	DAY 269	DAY 270	DAY 271	DAY 272	DAY 273	DAY 274
Monday 25 Sep 1978 Rev 1288 Node 138.799 Time 0131:33	Tuesday 26 Sep 78 Rev 1302 Node 147.173 Time 0102:13	Wednesday 27 Sep Rev 1316 Node 155.547 Time 0032:52	Thursday 28 Sep Rev 1330 Node 163.922 Time 0003:31	Friday 29 Sept 1978 Rev 1345 Node 147.180 Time 0114:56	Saturday 30 Sept 78 Rev 1359 Node 155.555 Time 0045:55	Sunday 1 Oct 78 Rev 1373 Node 163.930 Time 0016:14
REV 1288 ALT CALIBRATE/TEST MODE 1 REV 1287 SAR UKO (2MOS) 12 REV 1290 SAR MIL (WHIT, 2MOS) 6 REV 1291 SAR GDS (ENGA, 7M59S) 4 REV 1292 SAR ULA/GDS (SOLC, GOA2, CAMB, 7M08S) 7.2, 8 REV 1296 SAR MIL (BL, 4MOS) 3, ULA (ICEL, 4MOS) 5 REV 1297 SAR GDS (BL 1, 2MOS) 9 REV 1298 SAR GDS (GOA2, 4MOS) 1 REV 1299 SAR ULA (305A, 2MOS) 10 REV 1301 SAR UKO (SUR3, 2MOS) 11	REV 1302 ALT CALIBRATE/TEST MODE 1 REV 1306 SAR GDS (GOA3, 4MOS) 1 REV 1307 SAR UKO (D 5, 2MOS) 3 REV 1309 SAR SNF (303C, LABC, 5MOS) 4 REV 1310 SAR ULA (CAMB, ICE1, 5M59S) 8.5 REV 1311 SAR ULA (607S, 304A, 5M39S) 7.6 REV 1312 SAR GDS (DVAL, ENGA, 7M59S) 2	REV 1316 SAR UKO (D 1B, D 2, 4MOS) 4 REV 1317 ALT CALIBRATE/TEST MODE 1 REV 1318 SAR SNF (GBNK, 4MOS) 5 REV 1318 SAR SNF (SOLA, PORT, BOST, LOND, 4MOS) 8, 3 REV 1321 SAR GDS (GOA1, 4MOS) 2 REV 1322 SAR ULA (ICE2, 4MOS) 7 REV 1324 SAR SNF (HALX, 2MOS) 9 REV 1325 SAR MIL (GSTM, 4MOS) 6 REV 1327 SAR GDS (GOA1, 4MOS) 1	REV 1331 ALT CALIBRATE/TEST MODE 1 REV 1333 SAR MIL (WHIT, 2MOS) 7 REV 1334 SAR GDS (ENGA, 7M59S) 4 REV 1335 SAR ULA/GDS (CAMB, 501C, GOA2, 7MBS) 2 REV 1339 SAR MIL (BELI, 4MOS) 5 REV 1340 SAR GDS (BL 1, 4MOS) 5 REV 1341 SAR GDS (GOA2, 4MOS) 1 REV 1342 SAR ULA (305A, 2MOS) 9	REV 1344 SAR UKO (SUR3, 2MOS) 8 REV 1349 SAR GDS (GOA3, 4MOS) 1 REV 1350 SAR UKO (D 5, 4MOS) 2 REV 1352 SAR SNF (303C, LABC, 5MOS) 3 REV 1353 SAR ULA (ICE1, 4MOS) 4 REV 1354 SAR ULA (607S, 304A, 5M39S) 7 REV 1355 SAR GDS (DVAL, ENGA, 5MOS) 6	REV 1359 SAR UKO (D 1B, D 2, 4MOS) 4 REV 1360 SAR SNF (GBNK, 4MOS) 5 REV 1361 ALT CALIBRATE/TEST MODE 1 REV 1361 SAR SNF (SOLA, PORT, BOST, LOND, 4M37S) 8, 3 REV 1364 SAR GDS (GOA1, 4MOS) 2 REV 1365 SAR ULA (ICE2, 4MOS) 7 REV 1367 SAR SNF (HALX, 2MOS) 9 REV 1368 SAR MIL (GSTM, 4MOS) 6 REV 1370 SAR GDS (GOA1, 4MOS) 1	REV 1374 ALT CALIBRATE/TEST MODE 1 REV 1376 SAR MIL (WHIT, 2MOS) 7 REV 1377 SAR GDS (ENGA, 4MOS) 4 REV 1378 SAR ULA/GDS (CAMB, 501C, GOA2, 7M7S) 2 REV 1382 SAR MIL (BELI, 4MOS) 3, ULA (ICEL, 2MOS) 6 REV 1383 SAR GDS (BL 1, 4MOS) 5 REV 1384 SAR GDS (GOA2, 4MOS) 1 REV 1385 SAR ULA (305A, 2MOS) 9

Prepared: *R. J. Eikon* date 9-21-78  
Approved: *W. J. Eikon* date 9-22-78

ALT ON, TRACK 4/TEST MODE 1 (PARAMETERS 40,5,73,122); SASS NORMAL; SMR ON; VIRR OFF; SAR STANDBY; HTR BUS UNDER POCG CONTROL; ACS NORMAL.

ORIGINAL PAGE 13  
OF POOR QUALITY

CYCLE NO. 015  
Revs 1388 to 1487  
Days 275 to 281

MISSION PLANNING SUMMARY

DAY	DAY 275	DAY 276	DAY 277	DAY 278	DAY 279	DAY 280	DAY 281
Monday Oct 2 1978	Tuesday Oct 3 78	Wednesday Oct 4	Thursday Oct 5 78	Friday Oct 6 1978	Saturday Oct 7 78	Sunday Oct 8 1978	
Rev 1388 Node 147.161 Time 0127:43	Rev 1402 Node 155.536 Time 0058:22	Rev 1416 Node 163.910 Time 0029:01	Rev 1430 Node 147.169 Time 0140:25	Rev 1445 Node 155.544 Time 0111:04	Rev 1458 Node 163.921 Time 0041:43	Rev 1473 Node 172.296 Time 0012:22	
REV 1387 SAR SUR3 (2ms, UKO) 8 REV 1388 ALT CALIBRATE/TEST MODE 1 REV 1391 SAR SIER (4ms, GDS) EQUAL PRIORITIES FROM THIS POINT ON ON SAR PASSES REV 1395 SAR 303C,LABC (11m25s, SNF) ICE1 (10m23s, ULA) REV 1396 SAR CAMB, ICE1 (8m25s, ULA) REV 1397 SAR CAMB (4ms, MIL); 304A (9m12s, ULA) REV 1398 SAR ENGA (7m59s, GDS)	REV 1403 ALT CLIBRATE/TEST MODE 1 SAR GBNK (6ms, SNF) SAR HH SNF/MIL 501A, GSTM (14m59s, SNF/MIL) REV 1404 SAR MLAS (4ms, GDS) REV 1406 SAR IC2 (5m48s, ULA) REV 1408 SAR IC2 (5m58s, ULA) REV 1409 SAR IC2 (5m58s, ULA) REV 1411 SAR GSTM (6ms, MIL); ICE2 (6ms, ULA) REV 1412 SAR GE02 (6ms, GDS)	REV 1417 ALT CALIBRATE/TEST MODE 1 REV 1419 SAR WHIT (5m54s, MIL) REV 1420 SAR DVAL, ENGA (7m04s, GDS) REV 1421 SAR CAMB, 501C (5m05s, ULA) REV 1425 SAR BELI (6ms, MIL); ICE1 (8m14s, ULA) REV 1426 SAR BL 1 (6ms, GDS) REV 1428 SAR 305A (6ms, ULA)	REV 1430 SAR SUR3 (6ms, UKO) REV 1431 ALT CALIBRATE/TEST MODE 1 REV 1434 SAR SIER (4ms, GDS) REV 1438 SAR 303C (11m25s, SNF); ICE1 (10m23s, ULA) REV 1439 SAR CAMB, ICE1 (8m25s, ULA) REV 1440 SAR CAMB (4ms, MIL); 304A (9m12s, ULA) REV 1441 SAR DVAL, P15G, ENGA (8m09s, GDS)	SAR GBNK (6ms, SNF) REV 1446 ALT CALIBRATE/TEST MODE 1 REV 1447 SAR HH 501A, GSTM (15ms, SNF/MIL) REV 1449 SAR MLAS (4ms, GDS) REV 1451 SAR IC2 (5m47s, ULA) REV 1452 SAR IC2 (5m56s, ULA) REV 1454 SAR GSTM (6ms, MIL); ICE2 (6ms, ULA) REV 1455 SAR GE02 (6ms, GDS)	REV 1460 ALT CALIBRATE/TEST MODE 1 REV 1462 SAR WHIT (5m53s, MIL) REV 1463 SAR DVAL, ENGA (9m03s, GDS) REV 1464 SAR CAMB, 501C (5m05s, ULA) REV 1468 SAR BELI (6ms, MIL); ICE1 (8m14s, ULA) REV 1469 SAR BL 1 (6ms, GDS) REV 1471 SAR 305A (6ms, ULA)	REV 1473 SAR SUR3 (6ms, UKO) REV 1474 ALT CALIBRATE/TEST MODE 1 REV 1477 SAR SIER (4ms, GDS) REV 1481 SAR 303C (11m 25s, SNF); ICE1 (10m23s, ULA) REV 1482 SAR CAMB, ICE1 (8m25s, ULA) REV 1483 SAR CAMB (4ms, MIL); 304A (9m12s, ULA) REV 1484 SAR DVAL, P15G, ENGA (11m20s, GDS)	

ALT ON, TRACK 4/TEST MODE 1 (PARAMETERS 40.5,73,122); SASS NORMAL; SMHR ON  
VIRR OFF; SAR STANDBY; HTR BUS UNDER POCG CONTROL; ACS NORMAL;  
T/R READ-INS ADJUSTED TO AVOID BDA OVERFLIGHTS

Prepared: *R. J. Gibson* date 9-27-78  
Approved: *W. J. Liberson* date 9-28-78



ORIGINAL PAGE IS  
OF POOR QUALITY

CYCLE NO- 016  
Revs 1488 to 1587  
Days 282 to 286

MISSION PLANNING SUMMARY

DAY 282 Monday 8 OCT 1978	DAY 283 Tuesday 9 OCT 78	DAY 284 Wednesday 10 OCT	DAY 285 Thursday 11 OCT 78	DAY 286 Friday 12 OCT 1978	DAY 287 Saturday 13 OCT 78	DAY 288 Sunday 14 OCT 78
Rev 1488 Node 155.537 Time 0123:49 REV 1489 ALT CALIBRATE/TEST MODE 1 SAR GBNK (2ms, SNF) REV 1490 SAR 501A, G5TM (18m29s, SNF/MIL) HH REV 1492 SAR LASS (5ms, GDS) REV 1493 SAR DUCO (2ms, UKO) REV 1494 SAR ICE2 (8ms, ULA) REV 1496 SAR OILS, HALX (8m29s, MIL/SNF) HH SAR ICE1 (9m20s, ULA) REV 1497 SAR G5TM (1m59s, MIL) REV 1498 SAR GE02 (2ms, GDS) REV 1499 SAR ALAS (6m30s, UL)	Rev 1502 Node 163.916 Time 0054:27 REV 1502 SAR NTOW (1m26s, UKO) REV 1503 ALT CALIBRATE/TEST MODE 1 REV 1504 SAR GNLD (8ms, UKO) REV 1505 SAR WHIT (2ms, MIL) REV 1506 SAR DVAL, ENGA (3ms, GDS) REV 1507 SAR 501C, CAMB (2ms, ULA) REV 1508 SAR SURI (6ms, UKO) REV 1511 SAR BELI, MISS (7ms, MIL/SNF) HH, ICE1 (2ms, ULA) REV 1512 SAR GUAT, BL 1 (7ms, MIL/GDS) HH REV 1513 SAR GOA1 (6ms, ULA) REV 1514 SAR 305A (2ms, ULA)	Rev 1515 Node 172.290 Time 0025:06 REV 1516 SAR SUR3 (6ms, UKO) REV 1517 ALT CALIBRATE/TEST MODE 1 REV 1519 SAR PCIT, GUAT (7m5s, MIL) REV 1520 SAR SIER (2ms, GDS) REV 1522 SAR HASK (1m22s, UKO) REV 1524 SAR LABC (3ms, SNF); ICE1 (2ms, ULA) REV 1525 SAR CAMB (5ms, ULA) REV 1526 SAR CAME (2ms, MIL); 607S (5ms, ULA) REV 1527 SAR DVAL, ENGA (1m20s, GDS) REV 1528 SAR ALAS (6ms, ULA)	Rev 1530 Node 155.550 Time 0136:30 REV 1530 SAR BALT (6ms, UKO) REV 1531 SAR NSEA (8m1s, UKO) REV 1532 ALT CALIB/TM 1: SAR GBNK (7ms, SNF) REV 1533 SAR 501A, G5TM (7ms, SNF/MIL) HH REV 1535 SAR LASS (2ms, GDS) REV 1536 SAR DUCO (7ms, UKO) REV 1537 SAR ICE1 (9ms, ULA) REV 1538 SAR ICE1 (7m4s, ULA) REV 1539 SAR HALX (2m1s, SNF); ICE1 (3m30s, ULA) REV 1540 SAR G5TM (2ms, MIL); ICE2 (2ms, ULA)	Rev 1545 Node 163.927 Time 0107:09 REV 1545 SAR NTOW (4ms, UKO) REV 1547 ALT CALIB/TM 1: SAR ASTO (11ms, SNF/MIL) HH REV 1548 SAR WHIT (9ms, MIL) REV 1549 SAR DVAL, ENGA (4ms, GDS) REV 1551 SAR UMAS (6ms, ULA) REV 1554 SAR BELI, MISS (7ms, MIL/SNF) HH, SAR ICE1 (2ms, ULA) REV 1555 SAR BL 1 (2ms, MIL); NCOA (6ms, ULA) REV 1557 SAR 305A (2ms, ULA)	Rev 1559 Node 172.305 Time 0037:47 REV 1559 SAR SUR3 (6ms, UKO) REV 1560 ALT CALIB/TM 1: SAR GBNK (2ms, SNF) REV 1562 SAR PCIT, GUAT (6ms, MIL) REV 1563 SAR SIER (9m59s, GDS) REV 1565 SAR HASK (8m33s, UKO) REV 1566 SAR ALAS (7ms, ULA) REV 1567 SAR LABC (6m1s, SNF) REV 1568 SAR CAMB, ICE1 (6ms, ULA) REV 1569 SAR 304A, 607S (5ms, ULA) REV 1570 SAR DVAL, ENGA (5m30s, GDS)	Rev 1573 Node 180.682 Time 0005:25 REV 1573 SAR BALT (5m30s, UKO) REV 1576 SAR 501A, G5TM (13ms, SNF/MIL) HH REV 1578 SAR LASS (2m10s, GDS) REV 1579 SAR DUCO (4ms, UKO) REV 1580 SAR ICE2 (2ms, ULA) REV 1581 SAR ICE1 (7m30s, ULA) REV 1582 SAR HALX (2ms, SNF) REV 1583 SAR G5TM (4ms, MIL); ICE2 (2ms, ULA) REV 1584 SAR GE02, ALAS (15ms, GDS/ULA) HH

REV 1541 SAR GE02 (2ms, GDS)  
 Prepared: RA Johnson date 10-5-78  
 Approved: W.D. Johnson date 10-5-78

ALT ON, TRACK4/TEST MODE 1 (PARAMETERS 40,5 73,122); SASS NORMAL; SMWR ON  
 VIRR OFF; SAR STANDBY; HTR BUS UNDER POCG CONTROL; ACS NORMAL;  
 T/R READ-INS ADJUSTED TO AVOID BDA OVERFLIGHTS

APPENDIX C  
ABBREVIATIONS AND ACRONYMS

## APPENDIX C

### ABBREVIATIONS AND ACRONYMS

ACS	Attitude Control System
ADR	Auxiliary Data Record
AFWTR	Air Force Western Test Range (VAFB)
AGE	Aerospace Ground Equipment
AGO	STDN Station at Santiago, Chile
ALT	Radar Altimeter
AO	Announcement of Opportunity
AOML	Atlantic Oceanographic and Meteorological Laboratory (NOAA)
APL	Applied Physics Laboratory of Johns Hopkins University
ARIA	Advanced Range and Instrumentation Aircraft
CAIS	Computer Aided Test System
CDT	Command Description Table
CMMS	Command Memory Management System (GSFC)
CMS	Command Management System
CPAF	Cost Plus Award Fee
CRP	Command Request Profile
CTU	Central Timing Unit
CUNY	City University of New York
CY	Calendar Year
DDL	Dispersive Delay Line
DoD	Department of Defense
DOT	Department of Transportation
DR	Design Requirement
EDS	Environmental Data Service (NOAA)

ENC	Electromagnetic Compatibility
EMI	Electromagnetic Interference
EMP	Environmental Monitoring and Prediction Service (NOAA)
EOAP	Earth and Ocean Applications Program
EOM	End of Mission
EOPAP	Earth and Ocean Physics Application Program
ERIM	Environmental Research Institute of Michigan
ERL	Environmental Research Laboratories (NOAA)
ESA	European Space Agency
FNOC	Fleet Numerical Oceanography Center (U. S. Navy), Monterey, CA (formerly Fleet Numerical Weather Control)
FOV	Field of View
FPI	Fixed Price Incentive
FY	Fiscal Year
GDS	Geophysical Data Record
GDS	STDN Station at Goldstone, CA
GDT	Ground Description Table
GE	General Electric
GEOS	Geodetic Earth-Orbiting Satellite
GFE	Government Furnished Equipment
GMT	Greenwich Mean Time (Zulu Time)
GOASEX	Gulf of Alaska Seasat Experiment
GOES	Geostationary Operational Environmental Satellite
GS	Geological Survey
GSFC	Goddard Space Flight Center
HAW	STDN Station at Kauai, HA

HVPS	High Voltage Power Supply
ICD	Interface Control Document
IDPS	Instrument Data Processing System
IGDR	Interim Geophysical Data Record
IIP	International Ice Patrol
IMS	Institutional Management System
ITOS	Improved Tiros Operational Satellite (NOAA)
JASIN	Joint Air-Sea Interaction Experiment
JHU/APL	Johns Hopkins University/Applied Physics Laboratory, Baltimore, MD
JPL	Jet Propulsion Laboratory
JSC	Johnson Space Center (NASA), Houston TX
LaRC	Langley Research Center (NASA), Hampton VA
LeRC	Lewis Research Center (NASA), Cleveland OH
LMSC	Lockheed Missile and Space Company, Inc., Sunnyvale, CA
L/V	Launch Vehicle
LVS	Launch Vehicle System
MAD	STDN Station at Madrid, Spain
MCCC	Mission Control and Computing Center
MCT	Mission Control Team
MEM	Mission Engineering Manager
MIL	STDN Station at Merritt Island, FL
MOA	Memorandum of Agreement
MOSM	Mission Operations Systems Manager
MPS	Mission Planning System; Mission Planning Summary
MPT	Mission Planning Team

MSDR	Master Sensor Data Record
MSM	Mission Support Manager
NASA	National Aeronautics and Space Administration
NASCOM	NASA Communications Network
NDBO	National Data Buoy Office
NEMS	Nimbus-E (Nimbus-5) Microwave Spectrometer
NESS	National Environmental Satellite Service (NOAA)
NHEML	National Hurricane Environmental and Meteorological Laboratory (NOAA)
NMC	National Meteorological Center (NOAA), Camp Springs, MD
NOAA	National Oceanic and Atmospheric Administration (DOC)
NORDA	Naval Ocean Research and Development Activity (DOD)
NOS	National Ocean Survey (NOAA)
NRL	National Research Laboratory (USN), San Diego, CA
NSM	Network Support Manager
NSWC	National Surface Weapons Center (USN)
NWS	National Weather Service (NOAA)
OA	Orbit Adjust
OACS	Orbital Attitude Control System
OAMP	Orbit Adjust Maneuver Program
OAS	Orbit Adjust System (LMSC); Oceanology Advisory Subcommittee
OAT	Orbit Adjust Thruster
OD	Orbit Determination
OEM	Ocean Experiments Manager
OEMP	Office of Environmental Monitoring and Prediction (NOAA)
ORR	STDN Station at Orroral, Australia

OSTA	Office of Space and Terrestrial Applications (NASA)
OSTDS	Office of Space Tracking and Data Systems (NASA)
OSTS	Office of Space Transportation Systems
OTDA	Office of Tracking and Data Acquisition (NASA)
PAPA	Ocean Weather Station P
PDPS	Project Data Processing System
PMEL	Pacific Marine Environmental Laboratory (NOAA), Seattle, WA
PMR	Project Management Report
POCC	Project Operations Control Center (GSFC)
POD	Precision Orbit Determination
POM	Project Operations Manager
POP	Program Operating Plan
RCS	Reaction Control System (LMSC)
RFI	Radio Frequency Interference
RFP	Request for Proposal
R&QA	Reliability and Quality Assurance
RSR	Resources Status Report
RTC	Real-Time Command
SANDP	Satellite Mission Design Program
SAMSO	Space and Missile Systems Organization (USAF), Los Angeles, CA
SAO	Smithsonian Astrophysical Observatory
SAR	Synthetic Aperture Radar
SASS	Seasat Scatterometer System
SBRG	Santa Barbara Research Center, Goleta, CA
SCAT	Scatterometer

SDR	Sensor Data Record
SIO	Scripps Institute of Oceanography, La Jolla, CA
SM	Sensor Module
SMMR	Scanning Multichannel Microwave Radiometer
SPAT	Satellite Performance and Analysis Team
SPC	Stored Program Command
SR	Scanning Radiometer
SRM	Systems for Resources Management
SSE	Satellite System Engineering
SSG	Science Steering Group (Seasat)
SSM	Sensor Support Module
STDN	Spaceflight Tracking and Data Network (GSFC)
SURGE	Seasat Users Research Group in Europe
SURSAT	Surveillance Satellite Project of the Canadian Government
S/W	Software
TBD	To Be Determined
TIROS	Television Infrared Observation Satellite
TMDF	Telemetry Master Data File
Tranet	Tracking Network
TWT	Travelling Wave Tube
TWTA	Travelling Wave Tube Amplifier
UCLA	University of California at Los Angeles
UKO	STDN Station at Oakhanger, Farnborough, England, UK
ULA	STDN Station at Fairbanks, Alaska
USAF	United States Air Force
USB	Unified S-Band



USCG	United States Coast Guard
USN	United States Navy
UT	Universal Time
UWG	Users Working Group
VAFB	Vandenberg Air Force Base, CA
VIRR	Visual and Infrared Radiometer
WBS	Work Breakdown Structure
WFC	Wallops Flight Center (NASA), Wallops Island, WA
WPL	Wave Propagation Laboratory (NOAA)
XMIT	Transmit