

E83 10189

NASA Conference Publication 2198

CP - 2198

"Made available under NASA sponsorship
in the interest of early and wide dis-
semination of Earth Resources Survey
Program information and without liability
for any use made thereof."

Second Eastern Regional Remote Sensing Applications Conference

A conference held in
Danvers, Massachusetts
March 9-11, 1981

(E83-10189) SECOND EASTERN REGIONAL REMOTE
SENSING APPLICATIONS CONFERENCE (NASA)
398 p HC A17/MP A01

CSCL 05B

N83-19141
THRU
N83-19181
Unclas
00189

G3/43



NASA Conference Publication 2198

**Second
Eastern Regional
Remote Sensing
Applications
Conference**

**Marc L. Imhoff, R. G. Witt, and
Diane Kugelmann, *Editors***

**Goddard Space Flight Center
Greenbelt, Maryland**

NASA

National Aeronautics and
Space Administration

**Scientific and Technical
Information Office**

1981

PREFACE

The Second Eastern Regional Remote Sensing Applications Conference brought together the user community in Earth resources satellite technology within the ERRSAC region. Through technical sessions, forums, and fellowship, participants from state and local government organizations shared experiences in remote sensing applications with one another and with users in the Federal government, universities, and the private sector. The conference brought participants up to date on new remote sensing technology, explored ways to improve state and regional programs, and provided opportunities to learn about services available from the Federal and private sectors.

ERRSAC is responsible for transferring satellite remote sensing technology to public use, primarily to state and local governments in nineteen north-eastern and north central states. Interacting through orientation, training, cooperative projects, and technical assistance, ERRSAC provides opportunities for potential users to discover how to apply Landsat data to meet their resource information needs.

PRECEDING PAGE BLANK NOT FILMED

CONTENTS

	<u>Page</u>
The Heat Capacity Mapping Mission Nicholas M. Short	1
Transferability and Data Access Issues A. Victor Ferreros	7
State Involvement In and Use of Landsat Technology Paul A. Tessar	13
Georgia Resource Assessment Project: Institutionalizing Landsat and Geographic Data Base Techniques Robert R. Pierce, Bruce Q. Rado, and Nicholas L. Faust	19
The Pacific Northwest Remote Sensing Project Wallace E. Hedrick	43
LACIE and AgRISTARS B. H. Moore	47
Biomass Measurement from Landsat—Drought and Energy Applications Eugene L. Maxwell	51
Remote Sensing for Forest Applications in New York: Two Case Studies John A. Stanturf, Warren R. Philipson, Lisa K. Balliett, and Karen L. Jahn	73
Mapping Forest Types in Worcester County, Maryland, Using Landsat Data James Burtis, Jr. and R. G. Witt	81
Extending the Utility of Forest Cover Maps Joseph K. Berry and Aaron Mansbach	89
Use of Landsat for Land Use and Habitat Inventories for the New Jersey Pinelands Celeste Tracy	101
Landsat Landcover Information Applied to Regional Planning Decisions Cheryle M. Dixon	109
Landsat Applications by the Adirondack Park Agency for Land Cover Analyses and Forest Cover Change John S. Banta and Raymond P. Curran	121
ERRSAC Contributions to the Search for Appalachian Hydrocarbons Herbert W. Blodget	125

PRECEDING PAGE BLANK NOT FILMED

CONTENTS (continued)

	<u>Page</u>
Potential Utility of the Thematic Mapper for Surface Mine Monitoring James R. Irons, Henry M. Lachowski, and Chris Peterson	129
Monitoring Land Conversions from Forest/Wetland to Agriculture Mary Louise Dudding	139
Area Estimation of Forestlands in Southwestern Michigan from Landsat Imagery Michael A. Karteris, William R. Enslin, and Jerry Thiede	147
Application of Remote Sensing to Land and Water Resource Planning: The Pocomoke River Basin, Maryland Stan E. Wildesen and Edward P. Phillips	157
Application of Landsat Data to Monitor Land Reclamation Progress in Belmont County, Ohio Hubertus H.L. Bloemer, James Brumfield, William J. Campbell, R.G. Witt, and Belden G. Bly	167
Mapping Sand and Gravel Pits in the Patuxent River Watershed Timothy J. Schmidt and R.G. Witt	191
Recent Developments with the ORSER System George M. Baumer, Brian J. Turner and Wayne L. Myers	201
The Use of Landsat by the States for Water Quality Assessment Elizabeth M. Middleton	211
Statewide Lake Classification Utilizing Landsat Imagery for the State of Wisconsin Ronald H. Martin and Robert W. Merideth, Jr.	219
Ground Water Use Inventory in Minnesota Using Landsat Data Dennis R. Beissel and Arlene Kerber	237
A Prospective Approach to Coastal Geography from Satellite John C. Munday, Jr.	243
Monitoring Wetlands Change Using Landsat Data David L. Hardin	259
Fundamental Procedures of Geographic Information Analysis Joseph K. Berry and C. Dana Tomlin	269
The Integration of a Landsat Analysis Capability with a Geographic Information System Earl A. Nordstrand	283

CONTENTS (continued)

	<u>Page</u>
Application of Geographic Information Systems to Landscape Architecture Charles L. Killpack	289
Remote Sensing at the University of Massachusetts Robert L. Huguenin	303
Implementation of Statewide Landsat Image Processing Capabilities Robert F. Mills	307
Implementation of Landsat Technology in the Commonwealth of Virginia Edward Sahaydak	311
Using Landsat to Update the Schoharie County, New York, Land Cover Inventory Paul R. Baumann	317
The Evaluation of Alternate Methodologies for Land Cover Classification in an Urbanizing Area Robert M. Smekofski	325
Remote Sensing in the Coastal Zone - A Perspective Peter Cornillon	337
Lake Classification in Vermont Virginia Garrison and Nancy Bryant	345
Procedures for Analysis of Spatial Relationships among Ship Survey Data and Sea Surface Temperature Joseph K. Berry and John K. Sailor	353
Chittenden County, Vermont, Land Cover Project Dennis E. Malloy	367
The University of Vermont Remote Sensing Center Gary S. Smith	373
The Michigan Data Needs Questionnaire Richard Hill-Rowley	377
A Land Cover Classification for Vermont Roy A. Whitmore, Jr.	387

CONTENTS (continued)

	<u>Page</u>
FORUM SUMMARIES:	
Summary of Forestry/Agriculture Forum Arlene Kerber and Brian Stone, Chairpersons	395
Summary of Land Cover Analysis and Planning Forum Janette Gervin and Dennis Malloy, Chairpersons	397
Summary of Surface Mining and Energy Forum Ron Witt and Hubertus Bloemer, Chairpersons	399
Summary of Data Processing Forum Marc Imhoff and Brian J. Turner, Chairpersons	401
Summary of Water Quality/Coastal Zone Forum Betsy Middleton and Peter Cornillon, Chairpersons	403
Summary of GIS Forum Bill Campbell and Chuch Killpack, Chairpersons	405
Summary of Joint Forum of User Development Programs and Substate/Local Scott Cox, Nick Keppel, Philip Cressy, and Robert Ragan, Chairpersons	407
List of Attendees	409

N83 19142

Original photography may be purchased
from EOS Data Center
Sioux Falls, SD 57198

THE HEAT CAPACITY MAPPING MISSION

Nicholas M. Short
Geophysics Branch
NASA/Goddard Space Flight Center
Greenbelt, MD 20771

On April 26, 1978, NASA launched the Heat Capacity Mapping (Radiometer) Mission (HCM(R)M) satellite as the first in a low-cost series of Applications Explorer Missions (AEM). This satellite moves in a near-polar sun synchronous retrograde orbit at an altitude of ca. 620 kilometers that leads to mid-latitude crossing times clustered around 1:30 p.m. and 2:30 a.m. Opposing day-night orbital tracks permit coverage of the same ground areas in a 12-hour interval at latitudes from 0-20° and 35-78° and a 36-hour interval from 20-35°. An orbital track is repeated on a 16-day cycle but adjacent coverage occurs every 5 days.

A 2-channel radiometer collects both reflectance and thermal data over a ground swath of 715 kilometers. One channel measures visible-reflected IR (0.5-1.1 μm) radiation; the second operates in the 10.5-12.5 μm range to sense thermal IR radiation during both day and night passes. The thermal channel has a NEAT (a measure of thermal sensitivity based on signal-to-noise ratio) of 0.3°K at 280°K at a spatial resolution of 600 m. at nadir.

Reflectance data are used to calculate apparent albedo a which affords some indication of solar energy available for surface heating to a depth of a meter or more. The thermal band data relate to day and night radiant (equivalent black-body) temperatures from which a diurnal ΔT value can be determined. These parameters are inputs to the function: Apparent Thermal Inertia (ATI) = $NC(1 - a)/\Delta T$, where N is a variable scaling factor and C is a constant related to the solar flux. ATI is, in turn, related to the quantity P , thermal inertia, defined as $P = \sqrt{K\rho c}$, where K = thermal conductivity, ρ = density, and c = specific heat. Each of those variables is a property of materials. Both inorganic and organic materials have characteristic values of K , ρ , and c , and hence P itself can be diagnostic of given substances (rocks, soil, soil moisture, vegetation) at the Earth's surface.

HCMM therefore is designed to evaluate the utility of thermal inertia (related to heat capacity) and other thermal and reflectance data for (1) discriminating bedrock and unconsolidated regolith types, (2) mapping soil moisture, (3) measuring plant canopy temperatures, (4) examining thermal circulation in large water bodies, and (5) monitoring urban heat island effects. Determination of absolute values for either radiant or kinetic temperatures is usually difficult because of such interfering or indeterminate factors as (1) materials emissivities, (2) latent and sensible heat changes, (3) thermal contributions from the atmosphere, (4) surface wind and other meteorological influences, and (5) effects of topography. Nevertheless, relative differences in albedo or temperature, as evidenced by gray level (tonal) variations in imagery representing the sensed surface, can often be correlated with specific materials. For instance:

	DAY VIS	DAY IR	NIGHT IR	T	ATI
"Pure Water"	D	D-MD	VL	D	VL
Vegetated Surfaces	MD-M	MD-L	M-L	MD-L	L-MD
Damp Soil	MD-M	M-L	MD	M-L	ML-D
Basalt	D	L	M-L	MD	L-VL
Granite	M-L	M	L-M	MD-M	M-L
Desert Sand	L-VL	L-D	MD-L	M-L	M-MD

Level: D = Dark; MD = Medium Dark; M = Medium; L = Light; VL = Very Light (these qualitative tonal values are relative such that dissimilar levels can correspond to similar temperatures, i.e., the levels of D and VL for water expresses the condition (small absolute T) that shows up as relatively cooler and warmer Day and Night IR water signatures with respect to land temperatures.)

Of particular significance, dominantly dark or light tonal patterns in the Day VIS imagery, usually representing similar surface materials, often show considerable gray level variation in day and/or night IR images, generally indicative of changes in density, water content, or composition. These and other patterns may persist when multitemporal scenes are examined, but commonly the patterns vary considerably. This suggests either a variable response to heat input and cooling at different seasons, or frequently their association with ephemeral factors such as local or changing meteorological conditions including irregular air masses or isolated rainfall effects.

A characteristic set of HCMM images is shown in Figure 1. The first three (A-C) have been computer-enhanced, specifically through contrast-stretching and bandpass filtering. Figures 1A and 1B show the states of New York and Pennsylvania as imaged by the Day VIS and Day IR channels on August 19, 1980. Notable in the Day VIS scene are the lenticular dark areas right and below center that correspond to anthracite coal wastes spread along valley floors; the dark tones in and around Philadelphia and New York City (lower right), Pittsburgh (left edge), and Rochester (center top); and the lighter tones in the Catskills (center right) and Atlantic Coast Plains (lower right). In the Day IR scene, the anthracite valleys stand out as light toned (warm) owing to increased temperatures (from the blackbody effect) and the cities also are bright toned (heat island effect). Areas of dense forests tend to be dark toned (quite cool, in part from the evapotranspiration effect); the lobate pattern near upper center further reveals the influence of wooded areas concentrated on synclinal mountains while the zig-zag dark band effect below it is controlled by forests along folded mountain ridges. Note also the thermal patterns in the Great Lakes, especially the band of warmer water (lighter toned) along the south shore of Lake Ontario, as localized by a thermal barrier (darker tones) of cooler and deeper water. Clouds (upper left) appear as very dark tones.

In Figure 1C, the scene is a Night IR image taken that same summer (exact date of overpass not available) over much the same region as the previous two images. Most of the Allegheny Plateau, the Catskills, and glaciated terrain to the north are rendered in dark tones. The areas to the south, including the Valley and Ridge and Coastal Plains physiographic provinces, are warmer as indicated by the medium gray tones. The forested ridges are delineated by even lighter tones (warmer; leaf insulation effect?). Neither the coal waste surfaces nor the cities stand out as warm in this night scene. The most striking difference in the Night IR image is the very light (relatively, warmest) tones that mark both lake and river waters. Once more, the cool clouds show up in dark tones.

Figure 1D is an early experimental version of an ATI image made from May and June 1978 images. Dark tones represent low and light tones higher ATI values respectively. This image, the only one made as yet for this region, is difficult to interpret because of errors in the expression of ATI. Water should appear as light tones, for example, as it does along the Susquehanna River, but doesn't in the Atlantic Ocean and large lakes.

A second set of examples is presented in Figures 2A-D. The sequence A (Day VIS), B (Day IR), and C (Night IR) shows the arid lands of eastern Algeria as imaged in the fall of 1978. The desert dune fields of the Grand Erg Oriental (upper center) are conspicuous. Outcrops (lower part of image), consisting of low reflectance (metamorphic and/or basalt) Cretaceous rocks, are particularly warm at night. The image in Figure 2D contains much of California and adjacent Nevada as seen in a Night IR rendition obtained on July 17, 1978. The Great Valley is conspicuously warmer (because of brown grasses (straw insulation effect)?). The Sierra Nevada Mountains are cool (exposed rock and conifers). The block fault mountain ranges of Nevada tend to be fringed by light tones (reason uncertain). The famous San Andreas fault zone shows up as a dark (cooler because of moisture?) line in the lower center. Thermal eddies are evident in the ocean.

The HCMM investigators program is drawing to a close and final reports are now beginning to define the utility of day/night thermal data. Already it has been demonstrated that, under favorable circumstances, some major rock types can be identified, soil moisture in extensive agricultural and alluvial terrains can be detected and at least semi-quantitatively assessed, and circulation of currents in large water bodies followed by noting their thermal patterns.

ORIGINAL PAGE
BLACK AND WHITE PHOTOGRAPH



B

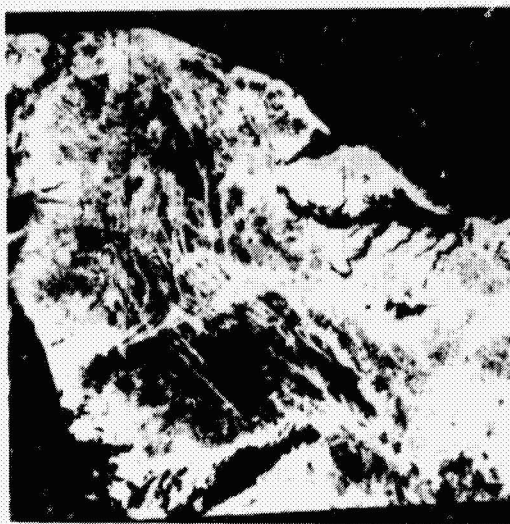

D



A



C

Figure 1

ORIGINAL PAGE
BLACK AND WHITE PHOTOGRAPH



Figure 2

N83 19143

D2

TRANSFERABILITY AND DATA ACCESS ISSUES

A. Victor Ferreros
The Council of State Governments

INTRODUCTION

I would like to briefly discuss the evolution of the DIDS system, the DIDS project in South Carolina, and some of the progress and issues that have emerged from this NASA-sponsored project. The issues emanating from the DIDS project relate to concerns that I believe are shared by the panel members.

DIDS is an acronym that originally stood for Domestic Information Display System. Since then, it has been re-named the Decision Information Display System. Its current official federal title is the Inter-agency Decision Information Display System. Now DIDS is in its second generation. Soon its caretakers will be talking of DIDS in terms of third and fourth generation DIDS systems.

The DIDS- (Decision Information Display System)--is a minicomputer-based system designed to display federal statistical data for a variety of geographic areas in the form of choropleth maps. These statistical maps are then displayed using an interactive full-color high resolution display terminal.

DIDS was a spin-off of satellite technology developed by NASA at the request of the White House. Initially, it was a simple concept. What was perceived as needed at the time was a system that displayed statistical information on a geographic basis for national policymakers. Consequently, the impact of issues could then be studied in terms of the geographic distribution of statistical information across different political jurisdictions.

DIDS is now in an operational mode. Consider the differences between the first and second generations of DIDS. DIDS originally was developed from the Atmospheric and Oceanic Information Processing System (AOIPS), an image processing system developed at NASA's Goddard Space Flight Center.

DIDS originally shared time with other applications on a DEC PDP 11/70 computer. Map displays were generated on a Hazeltine image analysis terminal (IAC-2) tailor-made to NASA specifications and hardwired to the 11/70. System geography, statistics, operating system and software were stored on three different disk drives. The DIDS prototype system originally used a data base containing information from the County and City Databook of the United States, geocoded to individual counties.

When demonstrations at the White House and Capitol Hill were conducted, specially balanced video lines had to be employed to transmit the high resolution video picture image from the Hazeltine terminal at Goddard to a downtown slave monitor. Telecommunication costs per demonstration were prohibitive at about \$40,000. Because of this, most demonstrations were held on-site at Goddard.

The initial demonstrations of DIDS in 1978 led to a one-year period of testing and demonstration by a group of 15 federal agencies. In 1979, smaller and cheaper lines were used to convey video imagery of reasonable quality from the terminal at Goddard to a slave terminal in the downtown Commerce building.

DIDS TODAY

The second generation DIDS system now has its full time hardware base--a DEC VAX 11/780 computer, associated peripherals, a Conrac color monitor, a DeAnza 5512 color image display terminal, an 8 by 10 and 35-mm still camera, and a xerox color copier. DIDS also now has two remote terminal systems: one in the basement of the Old Executive Office Building in Washington, D.C., and one recently installed in Columbia, South Carolina. The \$80,000 remote terminal system consists of a DEC LSI 11/23 minicomputer, 3 disk drives, a VT 100 alphanumeric operating terminal, a DeAnza color 5512 display terminal, and a communications interface.

The second generation DIDS system also provides single-point access to over 5,000 socio-economic and environmental data elements from 22 different agency data bases. In the current system, SMSA, county, congressional district and state statistics primarily from federal agencies are interactively displayed against digitized census geographical boundaries. DIDS today also has a polygon-based world map capability and even has a limited world data set. Outputs from DIDS are represented via CRT display, 35-mm slides, color print, xerox and polaroid photo displays. Currently, 27 federal and non-federal agencies participate and provide funding support to the DIDS program.

HOW DIDS WORKS

DIDS is designed as a user-friendly system. By means of hierarchical menu selection, the user first selects his geography of interest (i.e., U.S. by county, US CD, state by county, metro area by census tract, world map).

The user then selects the data to be color-classified and displayed for the geographic area. This process is done through menus. The user map selects one or two variable map displays. Further data manipulation can be done by changing data classification intervals, changing colors (DIDS has 4096), highlighting intervals, calculating indices, zooming or magnifying subregions of a map to increase resolution, time lapse display of chronological data series and histogram and scatterplot representations. One of its most useful capabilities is that of using a cursor to interactively identify an individual county, and display its data value. DIDS is among many things a system that should revolutionize choropleth map production. It could generate entire statistical atlases in hours rather than months.

Some of the limitations of DIDS technology have been discussed elsewhere and I shall not dwell on this here. Technological enhancements that address

these limitations are on the drawing board of the DIDS program office and are scheduled for implementation in the next few years.

THE SOUTH CAROLINA PROJECT

The Council of State Governments is presently coordinating a DIDS demonstration project in South Carolina sponsored by NASA. The Council has had a history of involvement in natural resource information system projects and has worked with CSPA and NCSL in these areas for some time.

The project represents an attempt to transfer DIDS to a state government environment. The general goal of the project is to evaluate DIDS in terms of its use in a state government setting, to identify ways by which state governments could benefit from DIDS technology and to develop recommendations for system modifications to more effectively address state needs.

After some delay in equipment delivery, the remote terminal system was installed in South Carolina in late December, making it the only other DIDS remote system in the county. It is currently housed in the Social and Behavioral Sciences Lab in the University and scheduled to be moved to the Senate chambers of the South Carolina legislature in late March.

Working with Dave Cowen of the University and Andy Laurent, Fred Vang and other officials in the Division of Research and Statistics, we have identified programmatic areas of state government that could potentially benefit from DIDS utilization. Personnel in these agencies are already preparing county level data in machine readable form for entry into DIDS. The system, with NASA's help, is now fully operational and the communications line to the host is now up and running. A South Carolina data base consisting of over 800 variables from the South Carolina abstract is currently being edited and entered on the host. The South Carolina staff has already been trained for system use and a number of successful demonstrations with state officials have already been held.

The South Carolina evaluation process will include a number of surveys and experimental mechanisms. The user survey will cover actual use, ease of use, utility and specific application issues, and will solicit recommendations for system modification. A series of quasi-experiments will evaluate other alternatives to DIDS--such as a university mainframe solution using standard statistical packages linked to computer mapping software. South Carolina would also like to use DIDS to build a file for Columbia, South Carolina census tracts, and to digitize a more detailed South Carolina county file than that resident on DIDS.

TRANSFERABILITY

An important focus of the evaluation will center on system transferability. In South Carolina, the DIDS remote systems has the same basic user

capabilities as the host computer. The processing of some DIDS functions such as zooming takes longer at the remote site. The major difference is in the amount of disk storage for immediate access. The host has sufficient disk storage so that all DIDS geographic base files and statistical data are available upon user request. The remote has an on-line capacity for only about 300 variables. Similarly, the remote is restricted in the number of geographic base files that can be put on-line for immediate display.

The LSI/11/23 remote system exemplifies a prototype self-contained hardware configuration that already exists in some states. A number of states have acquired hardware with capabilities similar to this system (i.e., Minnesota, New Jersey, Oklahoma, etc.). These are stand-alone data access, retrieval and display systems used in conjunction with GIS and LANDSAT processing applications.

There are some constraints in terms of comparability. DIDS via the DeAnza 5512 hardware has a raster scanning display capability. Furthermore, the raster-encoded polygon data structure of the system enables map images to be created in four to six seconds. The DIDS system also uses DEC equipment. The DIDS program office people roughly estimate that even with a DEC system, four man-years of software conversion would be required to replicate the system elsewhere. Despite these considerations, the point is that parallel technology has also been developed at the state level, and technology does not appear to be an insurmountable barrier in system transferability. Some states could even lay claim to having more cost-effective DIDS-type systems carrying hardware price tags of less than \$10-15 thousand.

Assuming that DIDS-type capabilities already exist on the state level, interest would seem to naturally converge on access to DIDS data bases. This issue is bound to loom clearly as the most important issue of concern to state and local government interest in DIDS.

DATA ACCESS

In its role as coordinator of the South Carolina project, The Council has sat as a member of the DIDS Steering Committee in Washington for the past year and has been in a position to observe some of the more current developments in the evolution of DIDS over the past year. The Steering Committee is chaired by the Director of the Office of Federal Statistical Policy and Standards (that houses the DIDS program). The 22 agencies that fund DIDS and other participants sit on the committee. These federal officials have articulated a role for DIDS as a vehicle for implementing improvements in federal data systems with policies that govern these systems. The benefits are obvious. DIDS forces a common format on federal data bases. It integrates a number of diverse federal data sources into a common standardized single file structure. It has integrated both socio-economic and environmental data into a common base. It may eventually, as its caretakers would like, affect redesign of major federal data programs, and provide a focal point for assessing user needs of all federal data.

The management plan for DIDS in FY 81 and a draft FY 81-82 policy issues statement:

- Does not properly recognize state and local government as governmental organizations.
- Restricts direct program participation in DIDS to the federal community.
- Recommends that DIDS be operated by a private-for-profit firm that would be the only means by which non-federal users could access DIDS products and services.

Such issues, I suspect, are not specific to the nature of the DIDS beast, but most likely mirror the direction of future federal policy towards data access and distribution. It is unfortunate, for these policies ignore:

- State needs for access to federal data, much of which they provide themselves;
- That a data pricing policy should properly distinguish between state and local government users, and private firms;
- That states, by virtue of their experience with similar systems, their resources and technological skills could potentially contribute to DIDS system development;
- That states should be treated as equal partners within the inter-governmental data community.

3

EN83 19144

STATE INVOLVEMENT IN AND USE OF LANDSAT TECHNOLOGY

Paul A. Tessar
National Conference of State Legislatures
Denver, Colorado

I. OVERVIEW

The states have been active participants in the Landsat program over the last five years. My presentation today will first discuss some background on state involvement in Landsat systems planning, will review the status of state Landsat use, overview major state recommendations on the Landsat system and related programs, and lay out future plans of the federal government regarding the Landsat system as reflected in the Fiscal Year 1982 budget process.

II. BACKGROUND ON STATE INVOLVEMENT IN LANDSAT SYSTEMS PLANNING

In 1976, NCSL (The National Conference of State Legislatures) initiated a Remote Sensing Project. Along with this project, a Remote Sensing Task Force composed of state legislators, legislative staff, and state agency staff was formed. This task force conducted a number of user requirement studies. In the last several years a new task force was formed called the NRIS, or Natural Resource Information Systems Task Force. There are a number of members of this task force in this region. Representative Tom Anderson of Michigan is Chairman, Bob Hansen of Minnesota is Vice-Chairman, Representative Dale Locker of Ohio is a member of the committee, as are Delegate Judith Toth of Maryland, Senator Jerome Van Sistine of Wisconsin, and Representative Monroe Flinn of Illinois.

NCSL, through its several Landsat-related task forces, has been very active in making recommendations to the federal government on the configuration of the Landsat system and the types of support activities required by state and local governments to utilize these capabilities. A number of technical recommendations were made on Landsat-D. A Landsat-D support campaign was initiated. Many letters were sent to NASA and OMB and the Congress; and the result of these letters and other support was the approval of the Landsat-D program as currently planned by NASA. NCSL has also made many recommendations on the need for technology transfer assistance. These NCSL recommendations, in combination with the General Accounting Office Report suggesting that NASA needed to more actively see that their technologies were utilized, resulted in the formation of the NASA Regional Applications Program.

Over the last two years, the NRIS Task Force has also been active in making a number of recommendations on the operational Landsat system as proposed by NOAA and the National Earth Satellite Service, or NESS. Over the years NCSL has been involved in a number of user awareness activities such as committee

briefings and workshops and has produced a number of publications such as our NRIS newsletter, Legislator's Guide to Landsat and Legislator's Guide to Natural Resource Information Systems, data requirements surveys, and so on.

In late 1978, the National Governors' Association, through the Council of State Planning Agencies, initiated the Earth Resources Data Project which is an executive counterpart to the Natural Resource Information Systems Project at NCSL. The Earth Resources Data Council is a group within the Council of State Planning Agencies that has provided continuing recommendations on the operational systems and technology transfer activities--many of their recommendations made in conjunction with the NCSL Task Force described previously. CSPA has also been involved in various user awareness activities in conjunction with NCSL and the NASA regional centers.

In 1978, the Intergovernmental Science, Engineering and Technology Advisory Panel, or ISETAP, conducted a study on the state and local government needs for an operational Landsat system. There were many recommendations on the need for an operational system, the form it should take, and the need for related technology transfer assistance. One portion of the ISETAP study was a state Landsat application survey. This survey is currently being updated by NCSL and CSPA.

Over the years, the states have also supported a number of Congressional initiatives directed at operationalizing the Landsat program. These would include the Moss bill, the Ford bill, the Stevenson bill, the Schmitt bill, and, in the future will include additional legislation by Senator Harrison Schmitt of New Mexico and Representative Don Fuqua of Florida. It is anticipated that the Senate will have a bill out by this summer which will deal with the short- and long-term issues related to institutionalization of the Landsat program.

III. STATUS OF LANDSAT USE

Over the last several years there has been a dramatic increase in state usage of Landsat data. By July 1976, there were four states that had analysis and applications capabilities: Texas, Georgia, South Dakota, and Mississippi. At that time, there were also stirrings of interest from a number of other states. As of July, 1978, two more states with analysis and applications capabilities were on line: New Jersey and North Dakota. At that time 20 states were beginning involvement with the NASA Regional Applications Program.

As of today, there are 16 states with digital Landsat capabilities including Georgia, Idaho, Iowa, Kansas, Louisiana, Maryland, Maine, Minnesota, New Jersey, Oklahoma, Oregon, South Carolina, South Dakota, Texas, Vermont and Washington. There are 10 states at this time planning to develop capabilities including Alaska, Arizona, Florida, Kentucky, Michigan, Mississippi, Montana, New Mexico, North Carolina, and Virginia. These estimates are conservative. Other states may be moving ahead. Still, by July 1982, at a minimum, half the states will be routine Landsat users.

IV. MAJOR NCSL/CSPA RECOMMENDATIONS

The NCSL/NRIS Task Force and the CSPA Earth Resources Data Council have, over the last several years, spent a great deal of time studying Landsat-related issues. A number of major recommendations have been developed including:

- Data continuity-- These recommendations have dealt with a need for an operational system and the need to build a third and fourth Landsat-D to ensure continuity through the 1980's.
- Frequency and pattern of observation-- These recommendations have highlighted the need for a two-satellite system for potential eight-day coverage, and the use of inventory rather than skip orbits.
- State representation in program management-- These recommendations have dealt with the need to have NCSL and NGA seats on the federal Landsat Program Board and the need to have actual state agency users on NOAA's User Advisory Committee.
- Fully operational system-- These recommendations have dealt with the bands and resolution required in a fully operational system, and the need for pointable sensors.
- Data processing system-- A number of recommendations have been made in this area including:
 - routine delivery of standard products in seven to fourteen days;
 - emergency delivery in twenty-four to forty-eight hours;
 - retrospective orders in fourteen days;
 - all digital data processing system;
 - nearest neighbor or cubic convolution resampling; and
 - the need for a variety of map projections.
- Data pricing-- These recommendations have dealt with the need for phased incremental price increases and the need for adequate notice of such major price increases to state users. Many states use biennial budget processes, and these two-year budgets are prepared as much as nine months in advance of their implementation. Therefore, three years are required for some state users to have adequate notice of price increases. These recommendations have also made the point that state and local users of Landsat are significant users from a public policy standpoint, and it is not in the public interest to price these users out of the market.
- Data copyright-- This recommendation has dealt with the need for an exemption from the copyright laws for state and local governments for internal usage of Landsat data.

- Data archival-- These recommendations have discussed the need to save all usable data indefinitely. The desire for federal archiving policies to be clear and consistent and for adequate notice to be provided to users of any changes to these archival policies has also been expressed.
- Technology transfer-- The states have provided strong support for NASA Landsat technology transfer efforts -- the Regional Applications Program, the User Requirements Program, and the University Affairs Program. The states feel that there are a number of program elements required for successful technology transfer including orientation, training, demonstration, involvement of policy makers, system development assistance, and a geographically focused program.

V. FUTURE PLANS FOR THE LANDSAT SYSTEM

The best case scenario for the future of the Landsat system was, in my opinion, the Carter budget. This budget recommended that NOAA proceed to build Landsat-D3 and -D4 to assure data continuity through the 1980's, that the ground segments be improved so that there would be an operational data system at Goddard, and that a quick-look capability be available. The Carter budget also provided adequate funding for a third segment of the Landsat system, the user application segment. The NASA Landsat Technology Transfer Programs for state and local governments were to be continued, and a NOAA market development program to work with other user sectors was to be initiated.

Next I would like to discuss the worst case scenario. There is much speculation and rumor in the air. Rather than contribute to the rumor mill, I would like to go at this question from the angle of "what is it that we have to lose? What are potential and likely budget cuts, given the current climate in Washington?"

The Administration and/or Congress will probably examine the commitment of the previous Administration to an operational system. It appears that the transition from the private sector will be accelerated and that we may continue with a quasi-operational system for the near term. Landsat-D1 and -D2, currently under construction, are probably too far along to stop. NOAA's suggested appropriations for \$100 million-plus to build Landsat-D3 and -D4 would appear to be questionable given massive non-military budget cuts. If these expenditures are eliminated, the prospects for data continuity through the decade are not as bright.

Enhancements to the ground data processing system proposed by NOAA are likely to be considered duplicative of the EROS facility and are likely to be cut. In fact, these enhancements fell victim to the first round of Reagan budget cuts. Finally, the administration appears to be eliminating technology transfer across the board, and NASA and NOAA activities in this area could be terminated.

These potential cuts are of great concern to state and local governments. There are many reasons why an operational Landsat system is needed. The new emphasis of the new Administration appears to be a shifting of resource

planning and management to the states. These types of planning and management efforts can be materially aided by the use of Landsat data. At the same time, federal aid to the states is being cut, and many state budgets are in jeopardy due to declining revenues. In these times of tight state budgets, the states have to do more with less. Landsat is a cost-effective tool and can enable smaller staffs to do more work with smaller budgets. The Landsat system and technology was developed by the federal government at an investment of \$1 billion. The states and the people of this country should benefit from this \$1 billion research and development investment.

There are many national policy implications also involved in this question of whether or not there will be an operational Landsat system. The French government is developing a system which may compete with Landsat-D called SPOT. The Japanese are also competing. Perhaps some day we will be using data from their system if the U.S. abandons its plans for an operational system. In short, the users of Landsat data need the continuity and reliability of service that will allow them to confidently make investments which will enable them to utilize Landsat data effectively.

There is a crucial need for technology transfer assistance in general, and in the NASA Landsat Technology Transfer Program in particular. The space segment and the ground segment are only a part of the overall system. We need to recognize and service the user application segment as well. For about \$6 million a year, the federal government could assure that state and local government and public sector users benefit from this \$1 billion federal investment. It would be quite "penny wise and pound foolish" to proceed without such a technology transfer program.

The private sector will not do technology transfer on its own. It is in their interest to sell services and products, not to develop self-sufficient users. Technology Transfer Programs in NASA, in fact, help to develop a market that this private sector can serve. Unfortunately, most private sector firms have not recognized this fact. Technology transfer is relatively cheap, perhaps as cheap as the tile on the space shuttle, and the benefits of this assistance are quite large. The NASA Charter does require the widest practical dissemination of R & D results, and without technology transfer we cannot be assured that the users will benefit from our nation's \$1 billion investment.

Our state governments are very conservative in developing new programs. States simply do not take many risks. As far as new technologies are concerned, our Governors and Legislators are all "from Missouri". Clear benefits need to be demonstrated before they are willing to invest. I'm not sure how many states would be willing to come up with \$50 to \$100 thousand for a Landsat demonstration project, training and technical assistance. They simply would not take advantage of the opportunities and capabilities available from Landsat were they required to invest up front. Given a low-cost, low-risk opportunity to evaluate Landsat, most states have decided to invest in it. Without these demonstrations, however, most would not even have investigated the technology, much less invested in it.

A final point regarding the need for federal technology transfer regards the way the private sector would operate a technology transfer program. The private sector would serve the largest users and let the small ones go. In terms of dollar volumes, the states are rather small users of Landsat. They represent only 6 to 8 percent of the market. In terms of the public policy significance of their usage, however, the states are extremely important users. It is the states that by and large manage our nation's resources and provide stewardship to see that these resources are used without being abused.

The above speculations on the worst case scenario are based on what I feel may come to pass in the Reagan budget recommendations. Perhaps I'm overstating the case, and perhaps not. The budget is currently executive confidential. NASA and NOAA officials cannot speak on the budget until it is released later this week. You may want to listen very carefully on Thursday to NOAA and NASA presentations to see how the programs and hardware discussed earlier have fared.

VI. CONGRESSIONAL APPROPRIATIONS PROCESS IN BRIEF

The Administration budget will be out in the next few days. As we all know, however, the President proposes and Congress disposes. Congress will determine the FY 82 budget. There are many channels open to influence the Congressional process. Those who are concerned will make their feelings and recommendations known to appropriate authorities.

In the next few months, authorizations, appropriations, and budget committees in both houses of the U.S. Congress will be very busy. They will be holding hearings, examining agencies and programs, accepting input from government officials, commercial firms, and private citizens and determining what they feel is a proper funding level for each and every agency and program in the federal government. The FY 82 budget will be the output of this process. It is my hope that this budget will include sufficient funding for a credible Landsat system and Technology Transfer Program. If the Administration and Congress agree with our collective recommendations, it will.

N83 19145 ²⁴

**ORIGINAL PAGE IS
OF POOR QUALITY**

**GEORGIA RESOURCE ASSESSMENT PROJECT: INSTITUTIONALIZING LANDSAT
AND GEOGRAPHIC DATA BASE TECHNIQUES**

**Robert R. Pierce and Bruce Q. Rado
Department of Natural Resources
Environmental Protection Division**

**Nicholas L. Faust
Georgia Institute of Technology**

Original photographs can be purchased
from EPOS Data Center
Sioux Falls, SD 57108

ABSTRACT

The Department of Natural Resources, Environmental Protection Division has been involved in a project for computer mapping and analysis for approximately four years. The initial efforts include the processing of Landsat digital data for each 1.1-acre cell in Georgia and subsequently categorizing the land cover conditions. The project has included the completion of several test cases as well as the establishment of an operational hardware and software processing capability at the Georgia Institute of Technology. Following the completion of the test cases, the operational capability was developed to process the entire state (60,000 sq. miles and 14 Landsat scenes) in a cooperative project between eleven divisions and agencies at the regional, state, and federal levels. Products have been developed for agencies such as the Corps of Engineers, Game and Fish Division, Georgia Forestry Commission, and several other agencies in both mapped and statistical formats.

The project has further involved the development and use of a computerized geographical data base for management programs. To a large extent the applications of the data base have evolved as users of Landsat information requested that other data (i.e., soils, slope, land use, etc.) be made compatible with Landsat for management programs. To date, geographic data bases incorporating Landsat and other spatial data have been constructed to deal with elements of P.L. 92-500 sec. 208, the municipal solid waste management program, and reservoir management for the Corps of Engineers. In addition, Landsat data are being used for applications in wetland, wildlife, and forestry management. While a great deal of technical improvements to the system have occurred, the success of the Georgia project lies with the understanding of and the ability to deal with the institutional needs and user requirements for management programs.

BACKGROUND

Over the past several years, the Department of Natural Resources (DNR) and several other state agencies have expressed the need for an efficient means of collecting, storing, graphically displaying, and interpreting natural

resource information. In addition, several federal agencies with planning and regulatory responsibility for Georgia also expressed the need for an efficient data handling system. Given this demand for more efficient data handling procedures, DNR began to look for an alternative to traditional manual mapping methods.

Beginning in late 1974, the State of Georgia was offered the opportunity to visit the Earth Resources Laboratory of NASA. During the visit, NASA personnel explained the processing procedure for the Landsat data. In addition, several case studies were discussed and as a demonstration NASA processed one Landsat tape using ground truth information collected prior to the visit.

The results of the visit were of sufficient interest to several program managers that a formal request for technology transfer was submitted from Georgia to NASA. NASA agreed to initiate a technology transfer consisting of two phases. Phase I would determine the feasibility of using Landsat for management applications in Georgia utilizing NASA hardware and software essentially cost free to the State, and Phase II would transfer the software and application knowledge provided the State secure the necessary hardware capability.

With the availability of satellite images from Landsat, the gathering of 1.1-acre land cover information became possible within a reasonable budget and time frame. Although very useful, Landsat data alone has only limited application to the wide range of technical and management programs that agencies such as DNR have to administer. Therefore, in order to achieve maximum utilization of the Landsat data, it has become necessary to combine it with other types of mapped data to create a usable and cost effective system for data management. Over the last several years, DNR's ability to generate land cover data (i.e., maps and statistics) from Landsat has increased to an operational system capable of integrating other geographic files.

SYSTEM CONFIGURATION

Hardware

The Resource Assessment Unit of DNR uses the State of Georgia's UNIVAC 1100/82 with an EXEC 8 operating system. Communication with the large mainframe is accomplished primarily through "dial-up" terminals. Computer usage requiring large or special (overprinting at 8 LPI) printouts is done batch while data base updating, correcting and statistical reporting are accomplished in an interactive mode.

All Landsat processing was accomplished at the Georgia Institute of Technology which is also located in downtown Atlanta. Concurrent with the Statewide Landsat Classification Project, Georgia Tech purchased a mini-computer system which was equipped with two disk packs, each with 2 1/2 megabytes of storage, two dual density 9-track tape drivers, a 20" electrostatic printer/plotter, a dumb terminal, and a color image processor. The color image processor has been modified by Tech personnel to enable its use in

either a 256x256x3 plane format or a 512x512x1 plane format, both with 8-bit planes. The sophisticated raster image processor enabled field personnel to directly enter training samples by previewing raw Landsat data so the reflectances resembled a color infrared photograph. The raw data capability, plus the high cost of CPU time on large mainframes such as the UNIVAC, required that all Landsat processing occur on the mini-computer system at Tech.

Construction of the computer data bases including 1) acquisition of data, 2) field checking, 3) encoding, 4) data entry and storage, 5) editing, and 6) data retrieval and display was a state effort conducted by the Resource Assessment Unit. These data bases were built and are maintained by DNR personnel on the State's UNIVAC.

Communication of data between the 36-BIT UNIVAC and the 16-BIT mini-computer was accomplished with some degree of difficulty using data tapes written in binary. The transfer of Landsat data to the State-maintained data bases permitted interactive use of current Landsat information through the already established data base software. The transfer of the verified and corrected data base information to Tech's mini-computer system allowed for color graphic display and for efficient creation of graphic presentation materials on 35-mm slides. All 35-mm slides were photographed directly from the color image processor.

Software

With DNR contracting portions of the project to Georgia Tech, the scenario was created whereby two different computer systems with divergent institutional direction and differing staff disciplines were being employed. This caused a large variety of software to be developed, converted, and implemented.

The primary software used on the State's Univac was CONGRID/DBMANG developed by Richard Hokans at the School of Forest Resources, University of Georgia. The CONGRID (conversational GRID) program is a FORTRAN program developed from (as so many of the Grid-oriented data base programs are) the GRID computer mapping program originally developed by Sinton and Steinitz at Harvard. The program used by Resource Assessment has a format-free verbal command language enabling intersection, union, and linear combination of data variables and generation of associated line printer gray-scale maps. The DBMANG (Data Base Manager) program also uses a verbal command language and is used interactively to build, edit, and maintain the data files and to generate new variables such as soil-associated characteristics from existing soils data.

The software utilized at Georgia Tech for the data base projects is a highly modified mini-computer version of IMGRID. This version is modularized, interactive, and raster oriented. In addition, there are a wide variety of computer programs developed at Georgia Tech to handle all aspects of Landsat processing including geometric rectification and image display on the mini-computer system.

LANDSAT Background

Phase I of the Landsat project surveyed existing programs within the Department of Natural Resources to determine which of these might require data which Landsat could provide. Several Landsat-derived products were produced, including the processing of two Landsat scenes, one for coastal Georgia and one for the northern portion of the State. The land cover categories consisting of water, high and low density urban, pastures, cultivated lands, bare ground, deciduous and coniferous forest, and wetlands were displayed on the products and determined to be of interest to several regional, state, and federal programs. The data were produced in formats specified by the user ranging from geographically mapped products at various scales to tables of statistics by water quality management units (watersheds) and counties. At the completion of Phase I in 1976, it became apparent that Landsat digital processing could provide relatively detailed and accurate data on a repetitive basis covering the entire state, a capability which had never before existed. Since many of our programs require statewide data and analysis over time, Landsat's type of coverage and data production became most attractive.

Institutional Approach

The current Phase II effort is a good example of how regional, state, and federal agencies in Georgia are working together with a common data source for specific applications. DNR has been coordinating a state-wide Landsat digital processing effort which was recently completed. The role of DRN in this project has been to establish a structure for joint participation in the effort, the development of product criteria vis-a-vis legislative requirements of the participating agencies, initiating a cost-sharing plan to insure affordable products with minimum duplication of effort, and to provide data for natural resource management programs as an extension of DNR's technical assistance role.

The following are some of the regional, state, and federal agencies which participated in the Georgia Landsat effort (Figure 1).

The Environmental Protection Division of DNR: For Section 208 and 303e of PL 92-500, regarding non-point source pollution and water quality plans for river basins. The computer-compatible Landsat data allow summarization of the acreage of various land cover conditions within a watershed related to agriculture, forestry, construction, or mining elements that may be potential non-point sources of pollution. From this summary and supplemental information a comparative ranking of the potential of watersheds within the State to emit non-point source pollution was developed. Best management practices were then formulated for those watersheds with the highest pollution potential.

Soil Conservation Service of the U.S. Department of Agriculture: For the Conservation Needs Inventory, regarding the extent and areas of change in

specific types of agriculture, the location of potential areas of gross erosion, and the resulting effects on water quality. Specific land cover conditions which are derived from the Landsat data include location of pasture, bare ground, and crops. The Landsat information allows land cover trend identification, which should facilitate more effective allocation of field personnel. Also, the vegetation cover and water relationships (e.g., wetland conditions) identified by Landsat are useful for environmental assessment in water resource projects.

U.S. Army Corps of Engineers: For Section 404 of PL 92-500 regarding dredge and fill permits, including location of wetlands and spoil areas. In order for the Corps of Engineers to effectively implement the permitting program, they first need to be aware of the wetland locations. Landsat data provide this information. Also, the repetitive nature of Landsat allows monitoring of wetland conditions over time.

Game and Fish Division of DNR: For the Wood Duck Habitat Study under the Pittman-Robertson Act. Landsat is well suited for determining different types of vegetation. This is valuable information for wildlife biologists in studying habitat areas.

Department of Community Affairs: For making land use inferences from land cover categories for comprehensive development plans under HUD 701 planning requirements. Several Area Planning and Development Commissions have expressed an equal interest in this technique and are participating in the project.

U.S. Army, Fort Benning, Georgia: For analysis of forestry and wildlife management areas on the base as a part of the Environmental Impact Statement process.

The challenge to the program during Phase II was to provide a quality of information and support that warranted continuing use of Landsat data. It is expected that future uses will emphasize iterative applications such as the land cover data used by SCS in their Conservation Needs Inventory or by the Environmental Protection Division in their continuing water quality planning process.

Procedure for Landsat Mapping

As the Phase II project began, the participating agencies expressed their genuine desire to the use of Landsat data and furnish substantial field support and cost-sharing for the products. The Department of Natural Resources staff trained over 50 people from regional, state, and federal agencies in the process of correlating the Landsat reflectances to actual ground conditions. The training sessions were designed so field personnel would have an adequate understanding of what data were required while in the field. Listed below are the steps required for the Phase II effort.

-Selection of Management Applications: Legally mandated management programs such as solid waste management, erosion and sediment control, P.L. 92-500 sec. 208, etc. were reviewed to determine which of the State's management efforts might effectively utilize the Landsat data.

-Design Statewide Landcover Classification Scheme and Ground Truth Data Collection Forms: A three-level land cover classification scheme was designed to encompass all possible ground conditions. This task also covered the design of the ground truth forms which were used by the field personnel to record actual land cover conditions.

-Designate Project Personnel: This task included designation of agency personnel and their responsibilities to the Landsat project effort.

-Training Sessions: Instructions were given to the field investigators on how to complete ground truth forms and in the selection of ground truth samples (i.e., an area specifically chosen for validation purposes). The ground truth samples have homogeneous land cover conditions and were used to "train" the computer during the classification process.

-Preview Dates of Satellite Coverage: This task included selection of recent cloud-free coverage dates which had the proper seasonal conditions.

-Collect Information for Ground Truth: Acquire aerial photography, photomaps, base maps, and topographic quadrangles which are used to locate the ground truth samples.

-Collect Ground Truth Data: Field investigators collected ground truth data of uniform areas (i.e., homogeneous stands of pine, marsh grasses, pastures, etc., or impervious surfaces such as paving or exposed rock).

-Enter Ground Truth Data into Georgia Tech System: Ground truth data were entered into the computer in the form of training samples. The training samples in turn were the validation procedure for the classification of the data.

-Statistical Evaluation of Data for Uniformity: Computer histograms were run to test the uniformity of the selected training samples.

-Classification of Landsat Data: This task includes the classification of the raw data using the training samples collected for each of the Landsat scenes. (Figure 2 shows the arrangement of the Landsat scenes for Georgia.)

-Evaluation of Classified Data: The classified data were checked for the correct placement of land features such as lakes, forest, towns, beaches, etc.

-Digitized County and Water Quality Management Units (WQMU) Boundaries: County and WQMU boundaries were digitized using the latitude/longitude coordinate systems. This digitized information was then converted to pixel coordinates to be compatible with the Landsat data.

-Transformation matrices: Latitude and longitude coordinates were assigned to each of the Landsat 1.1-acre cells.

-Combine Digitized Water Quality Management Units (WQMU) and County Data with Landsat Data: The digitized WQMU and county boundaries were superimposed over the Landsat data, and statistics were collected for each of the land cover categories within each of the boundaries.

-Statistical Analysis of Acreage: To further document the Landsat data, the total area of the digitized county data was compared to published acreage statistics, and the digitized WQMU data were compared to statistics derived from planimetry of the WQMU's.

-Preparation for Printing: Data were written in a specified format onto a computer tape which was used to produce both negative and positive film recordings.

-Distribution of Products: Products were distributed to agencies who cooperated in the Landsat project. The complete listing of products is shown in Figure 2.

Landsat Results

Although no exhaustive efforts were made to establish the precise level of accuracy for the Landsat information, there were preliminary efforts to this end. These efforts included the review of literature which dealt with anticipated results in the eastern U.S., superimposing or "flashing" raw data over the classified data, and consultation with personnel from the various field agencies.

Results of these informal efforts confirmed the conclusion that the Landsat products were of very high levels of accuracy for most categories. The ranking of the land cover conditions according to the accuracy of determination, going from the high to low were: water, wetlands, forest conditions, pastures and grass areas, exposed earth, high-density urban and then low-density urban areas. Further, it should be stated that temporal conditions and physiographic regions were at least partly responsible for our varying degrees of success. Further analysis showed that the degree of difficulty in classifying an area was directly related to the amount of experience the individual in the field had collecting training samples and the time in the field relative to the time of satellite passover. The conditions which caused the greatest concern were snow and bare ground. The snow occurred only in the highest elevations of North Georgia and under most conditions is not a factor at Georgia's latitude. However, the bare ground conditions caused by recently cleared agriculture areas in the South Georgia region caused some signatures to be confused with urban areas of similar reflectance. Proper temporal consideration should lessen these difficulties in future efforts.

The results of the Phase II effort supported the earlier premise that satellite data could be used to effectively categorize land cover conditions statewide. The project produced maps covering all 60,000 square miles of the State along with statistics for each of the 198 WQMU's and 159 counties. The challenge to the future will be to increase the awareness within the agencies of Landsat's total abilities, to increase the technical ability to perform tasks, and to broaden the operational system.

DATA BASE Background

With the availability of satellite images from Landsat, the gathering of land cover information for 1.1-acre cells became possible within a reasonable budget and time frame. Although very useful, Landsat data alone have only limited application to the wide range of technical and management programs that agencies such as the Department of Natural Resources have to administer. Therefore, in order to achieve maximum utilization of the Landsat data, it was necessary to combine it with other types of resource data. The objective of merging a number of different types of mapped information is to create a single computerized entity for maximum user interface and for cost-effective data manipulations.

As a means of assessing the advantages of developing and using a computerized data base to catalog, map, and analyze resource information, a demonstration project was initiated by the Department of Natural Resources in north Fulton County. The North Fulton Demonstration Project included digitizing 23 data variables (eventually expanded to 35) over a 200-sq. mi. study area. Although the North Fulton County Project was not brought to completion (it was suspended for lack of personnel time), sufficient testing and preliminary analyses clearly demonstrated how a computerized data base could be useful in evaluating municipal solid waste management sites and in evaluating non-point source pollution as well as erosion potential of sites in water quality management units (WQMU). In summary, the North Fulton County Project demonstrated that resource data could be organized into a readily usable computerized data base and successfully employed for land and water resource management.

As a result of the success of the North Fulton Demonstration Project, the Department of Natural Resources contracted with the U.S. Army Corps of Engineers to prepare a computerized data base for two existing reservoirs in Georgia (Clark Hill and West Point) and one proposed reservoir (Richard B. Russell) and the adjacent lands (see Figure 3). The Resource Assessment Unit was to compile the most current natural and cultural resource data and store the information in a geographically referenced computerized data base. The data base in turn would be used by the Corps in the updating of the master plans. In the case of the Russell Project, the data base was to be used to create an initial Master Plan for the reservoir lands.

Institutional Approach

The complexity of the issues surrounding resource management has increased significantly over the past 10 to 15 years. A particularly valid example of this is the planning of a Corps of Engineers reservoir. These changes have occurred as a result of (1) the advent of more formal rules and regulations pertaining to reservoir projects, (2) the increase in public participation, and (3) the need for a comprehensive design which takes into account accessibility, supply and demand for recreational activities, and the impact of recreational activities on the resource base. In most cases the solution requires a complete natural and cultural resource analysis in concert with a demand/feasibility study. As the public demands greater access to reservoirs, managers are often faced with an array of issues and requirements which must be understood and fulfilled. A successful management system must balance the often conflicting concerns of environmental quality, recreation, budget restrictions, and regulations. Because of this increase in complexity the management techniques of a decade ago are no longer adequate. Therefore, the need arose to test computer methods for designing a master plan.

The computer data bases which this paper describes were employed by the Georgia DNR for the Clark Hill, Richard B. Russell, and West Point projects. Essentially, the method involved the use of computer data base programs for the display and analysis of natural and cultural resource data (Figures 4-10). The data base was designed specifically to address the concerns of the legislation which the Corps of Engineers is mandated to consider, namely:

- (1) National Environmental Policy Act of 1969
- (2) Federal Water Project Recreation Act of 1965
- (3) U.S. Fish and Wildlife Coordination Act of 1965, as amended
- (4) Historic Preservation Act of 1966, as amended
- (5) Executive Order 11593 on Historic Preservation
- (6) Clear Water Act of 1977
- (7) Endangered Species Act of 1973, as amended
- (8) U.S. Army Corps of Engineers Regulation 1130-2-406

The use of a data base for the management of lands adjacent to a reservoir project is a technique aimed toward total and comprehensive land management. When the data base is properly constructed, this approach can be utilized to handle the accounting of all natural and cultural resource information that might be required in the planning process. The data were then used independently and in concert with other data sets to evaluate areas of the reservoir sites which were considered appropriate and inappropriate (as defined by Corps criteria) for land use activities.

In review: the data base approach has displayed several advantages over traditional planning methods. Both manual and computer approaches assumed that the data are available or that the data can be generated from existing information. Although both manual and computer methods require data gathering efforts, data collection for the data base approach proved to be less expensive for the Georgia DNR because of the systematic approach employed. In addition, mass producing computer driven information in map form is considerably less expensive than traditional techniques. Over time, the data base information will be updated and edited as the Corps requires or as new data are developed. All possible economic efficiency is almost certain to be realized if data are updated on a repetitive basis, rather than expending funds for an entirely new data collection effort every 5 years as Georgia has done in the past.

For analysis, the computer data bases were designed to integrate archived computer data in a manner that gives flexibility to a wide variety of map users. The programs are able to be used in conversational language and are designed for maximum flexibility as they contain several routines which perform various types of analyses. Further, once the data base exists, the analyses can be generated for a fraction of the cost of manual analysis and in considerably less time. Analysis maps can be generated for specific issues and tailored to the needs of the user. This approach allows maximum input in a planning process for all interest groups with each having the ability to test the impacts on their particular concerns. The automated approach therefore assisted in a more objective and economical means of data collection, analysis, and public participation and in certain cases may result in quicker regulatory approval and project implementation.

Future Landsat and Data Base Efforts

At present, there is no formally established interdepartmental effort in Georgia government responsible for providing data base and Landsat products to the prospective user. The reason is that the user community is content with the present arrangement for products and services (typically contractual) and also because most organizations have been unable to fund efforts other than on a project-by-project basis. At first glance the latter comment might cause concern as to the ability of the state to design and implement an operational data base system. However, a more detailed analysis of Georgia's institutional arrangement might yield further insight into understanding the present course of action.

To date, program managers have been most receptive to exploring new techniques for data acquisition and analysis. The primary reason for this receptivity is the increased responsibility placed on state resource managers by federally mandated legislation. These federally mandated programs often require massive data collection efforts and tight deadlines. Therefore, federally imposed deadlines, in concert with existing management programs, have created the need for a product-oriented state information system which is able to perform a diverse group of technical tasks within relatively short periods of time. The challenge to the technical staff has been to aggregate several isolated efforts into a state framework for land management.

The challenge facing the effort for a state system in the immediate future will be one of institutional rather than technical concerns. Although an operational Landsat and data base capability exists, the system is designed as a "pay-as-you-go" arrangement. Therefore, potential users have difficulty utilizing the system unless funding is available to cover the anticipated costs of a project for data collection, analysis, and dissemination. Unfortunately, funding is often unavailable or inadequate to meet the costs for certain projects. This scenario can result in potential data base and Landsat projects resorting to traditional manual methods because of the inability to access the system. Therefore, the questions which were addressed in 1976 in establishing the system (such as financing, location, and system configuration and objective.) will all require new thinking for the 1980's.

SUMMARY

The practical applications for these Landsat and data base techniques are almost limitless for an agency such as the Department of Natural Resources which continually makes decisions for which the best and most current information is needed.

To date, data base and Landsat activities conducted by the Department of Natural Resources have demonstrated how data variables such as land cover, soils, slope, and wetland information can be integrated and analyzed for management programs. Further, the 40m data from Landsat C and the proposed 30m Thematic mapper data from Landsat D or D' will allow considerably greater opportunities to map land cover conditions and boundaries of wetlands and to derive better statistical accuracy.

A strong argument can be made for the incorporation of Landsat information with other resource information to form a data base of natural and cultural information for state resource management programs. The data base has demonstrated how large volumes of mapped or statistical information can be easily accessible in a format for decision making. Further, the data base approach will allow managers and technical staff to maintain a "quick look" capability so existing and potential areas of difficulty can be evaluated and monitored over time.

The quick look capability can readily access county, watershed, and wildlife management area data which could be immediately displayed and compared with other maps, aerial photographs, and permit related information. This capability has the advantage of allowing the most recent and comprehensive information to be readily available for the decision-making process. Further, the data can be updated while allowing change detection and other management oriented analysis to occur. As an example, change detection can be employed if a project manager wanted to know the extent of land cover changes in a watershed over a period of time. This might include the change in the amount of acres of impervious surface in a watershed over a period of time and where the changes have occurred.

Perhaps the most valuable aspect of the data base process is the ability of program managers to look quickly at various alternative sites and plans. The data base process enables a program manager to change the data variables and criteria of an analysis to view other possible plan alternatives. Using the data base, the plan alternatives can be evaluated and updated with greater ease than with traditional methods.

The three reservoir projects which the Department of Natural Resources has completed using the data base techniques have proven to be cost efficient and effective from the C.O.E. technical and management perspective. Perhaps even more important, a process has been instituted that will permit updating of existing data and the addition of new data into a computer format that is easily accessible to all users. In the long run, the data base approach is the only solution that will allow information to be efficiently housed in one location and yet be accessible to all public agencies concerned with Georgia.

ACKNOWLEDGEMENTS

The authors wish to thank Mr. Nick Faust and his staff at Georgia Tech for their technical assistance over the past several years. Also, we wish to acknowledge the efforts of Mr. Lawrie Jordan, formerly of Georgia Tech, who spent many a late evening to insure project success, and Wayne Prosser and Herb DeRigo of the U.S. Army Corps of Engineers for their support and faith in our efforts. In addition, we would like to thank those people from the many state and federal agencies who have worked with us and gave resources to assist the effort. Wayne Mooneyhan, Roy Estess, Armond Joyce, and Tom Austin of NASA, ERL provided much energy in assisting us in the early going. Finally, we wish to thank our program managers for their administrative and institutional support.

BIBLIOGRAPHY

- Baxter, F.P., G.W. Smart, E.E. Howard, E.B. Rowland, "Tennessee Valley Authority Land Analysis System". Resource Management Symposium, Purdue University, 1976.
- Faust, N., "Georgia Operational Landsat Processing System". Conference on Machine Processing of Remotely Sensed Data, Purdue University, June, 1979.
- Faust, N., "Design of a Low Cost Automated Landsat Data Analysis System". The 14th Annual International Symposium on Remote Sensing of Earth Resources, University of Michigan, 1979.
- Jordan, L.E., Testimony before the U.S. Senate Subcommittee of Science, Technology, and Space on Senate Bill 657. June 14, 1977. Washington, D.C.
- Jordan, L.E., Testimony before U.S. House of Representatives Subcommittee on Space Science and Applications. June 22, 1977, Washington, D.C.
- Killpack, C.L., "The Role of Computer Mapping and Landsat Data in a Model Implementation Project". The Second Annual International Users Conference on Computer Mapping, Hardware, and Software, Harvard University, July 1979.
- Knapp, E.M., M.R. Szczer, "Spatial Data Integration Requirements for Earth Resources Applications". The Second Annual International Users Conference on Computer Mapping, Hardware, Software and Data Bases, Harvard University, July, 1979.
- Pierce, R.R., D.D. Barile, "Land Use and Land Cover Mapping-City of Palm Bay, Florida". NASA Applications Branch, Kennedy Space Center, 1977.
- Pierce, R.R., B.Q. Rado, "A Case Study of the Clark Hill, Richard B. Russell and West Point Data Base Projects". Georgia Geological Survey, Open-File Report 80-7, Atlanta, Georgia, 1980.
- Rado, B.Q., "Landsat Applications in Georgia: A successful example of Technology Transfer between NASA and State Government." Sixteenth Space Congress Proceedings, Cocoa Beach, Florida, April, 1979.
- Rado, B.Q., Testimony before U.S. House of Representatives, Committee on Science and Technology. June, 1980, Washington, D.C.
- Rado, B.Q., Testimony before U.S. Senate Committee on Commerce, Science and Technology. April, 1979, Washington, D.C.

Steinitz, C. et. al., "The Interaction Between Urbanization and Land: Quality and Quantity in Environmental Planning and Design". Harvard University, 1973.

Steinitz, C., P. Parker, L. Jordan, "Hand-Drawn Overlays: Their History and Prospective Uses". Landscape Architecture, Sept. 1976.

<u>AGENCY</u>	<u>PROJECT OUTPUTS</u>	<u>PROGRAM USE</u>
Ga. DNR - EPD	Statistics of landcover categories for each of 198 WQMUs	P.L. 92-500 sec. 208 & 303e
Ga. DNR - Game & Fish	Statistics of landcover categories for each of 159 counties and 35mm slides for certain counties	Wood Duck Habitat Study and other wetland related programs
Ga. Dept. of Community Affairs	Statistics of landcover categories for each of 159 counties and 1:250,000 maps of the state	HUD-701 natural resource element
Ga. Forestry Commission	Statistics of landcover categories for each of 159 counties & 1:250,000 maps of the state	Statistics to assist in site location studies for forest products industries
Ga. Office Planning & Budget	Statistics of landcover categories for the 159 counties plus 1:250,000 maps	HUD-701 natural resource element, State Development Plan
U.S. Soil Conservation Service	Statistics of landcover categories for each of 159 counties & 1:250,000 maps of the state & 35mm slides for each of 159 counties	Conservation Needs Inventory, Land Inventory Monitoring Program
U.S. Army Corps of Eng.	Statistics of landcover categories for each of 198 WQMUs and 1:250,000 maps of the state	Urban Studies, Wetland Identification (ie. 404), Lakeshore Management Studies
U.S. Army - Fort Benning	Statistics of landcover categories for the fort's 11 management areas plus a 1:50,000 map	Base Master Plan and Environmental Impact Statements
North Georgia Area Planning & Development Commission	Statistics for 6 counties, statistics for 100+ census enumeration districts plus county maps at 1" = 1 mile	HUD-701 natural resource element
Coosa Valley Area Planning & Development Commission	Statistics for 10 counties plus county maps at 1" = 1 mile	HUD-701 natural resource element

ORIGINAL PAGE IS
OF POOR QUALITY

Figure 1. Statewide Landsat Project

ORIGINAL PAGE IS
OF POOR QUALITY

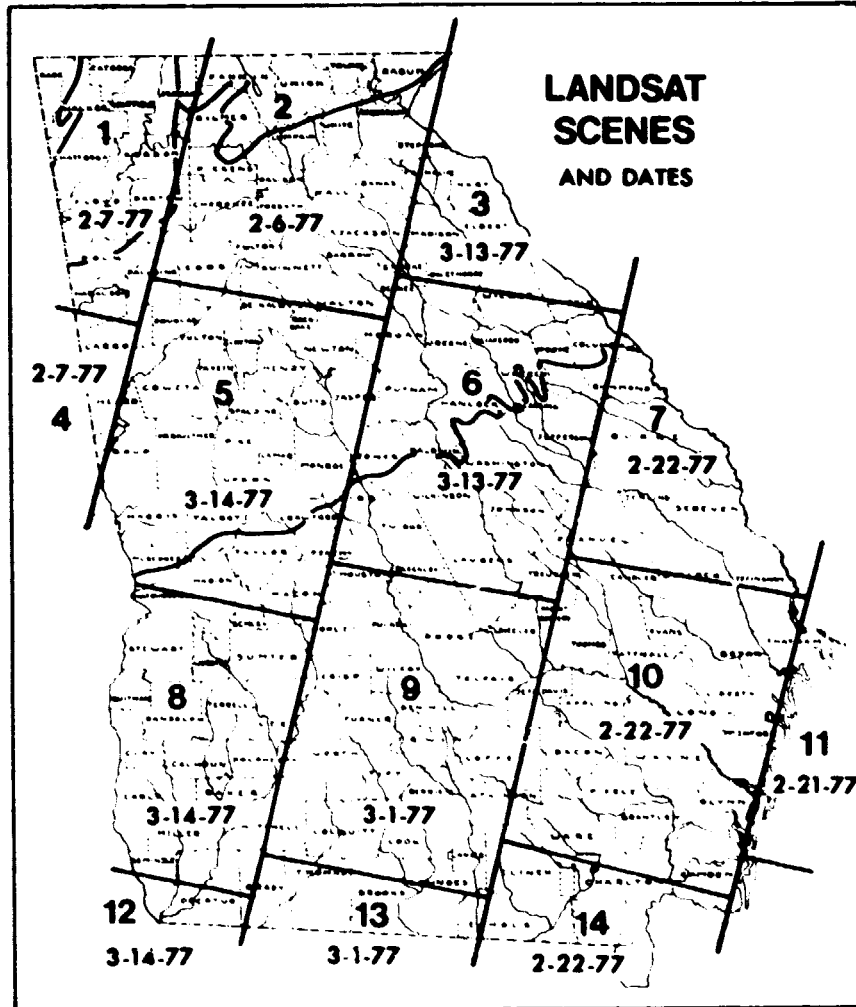

LANDSAT PRODUCTS

- * Classified Landsat data for each of the above scenes
- * 1:250,000 Statewide Maps for each of the above scenes
- * 35 mm slides of each of the 159 counties in Ga.
- * Statistics by county for each of the 159 counties
- * Statistics by water quality management unit for all 198 units
- * Selected products at 1:50,000 and 1:24,000

Figure 2. Landsat Scenes, Dates and Products

ORIGINAL PAGE IS
OF POOR QUALITY



Figure 3. Location Map of Data Base Projects

ORIGINAL PAGE IS
OF POOR QUALITY

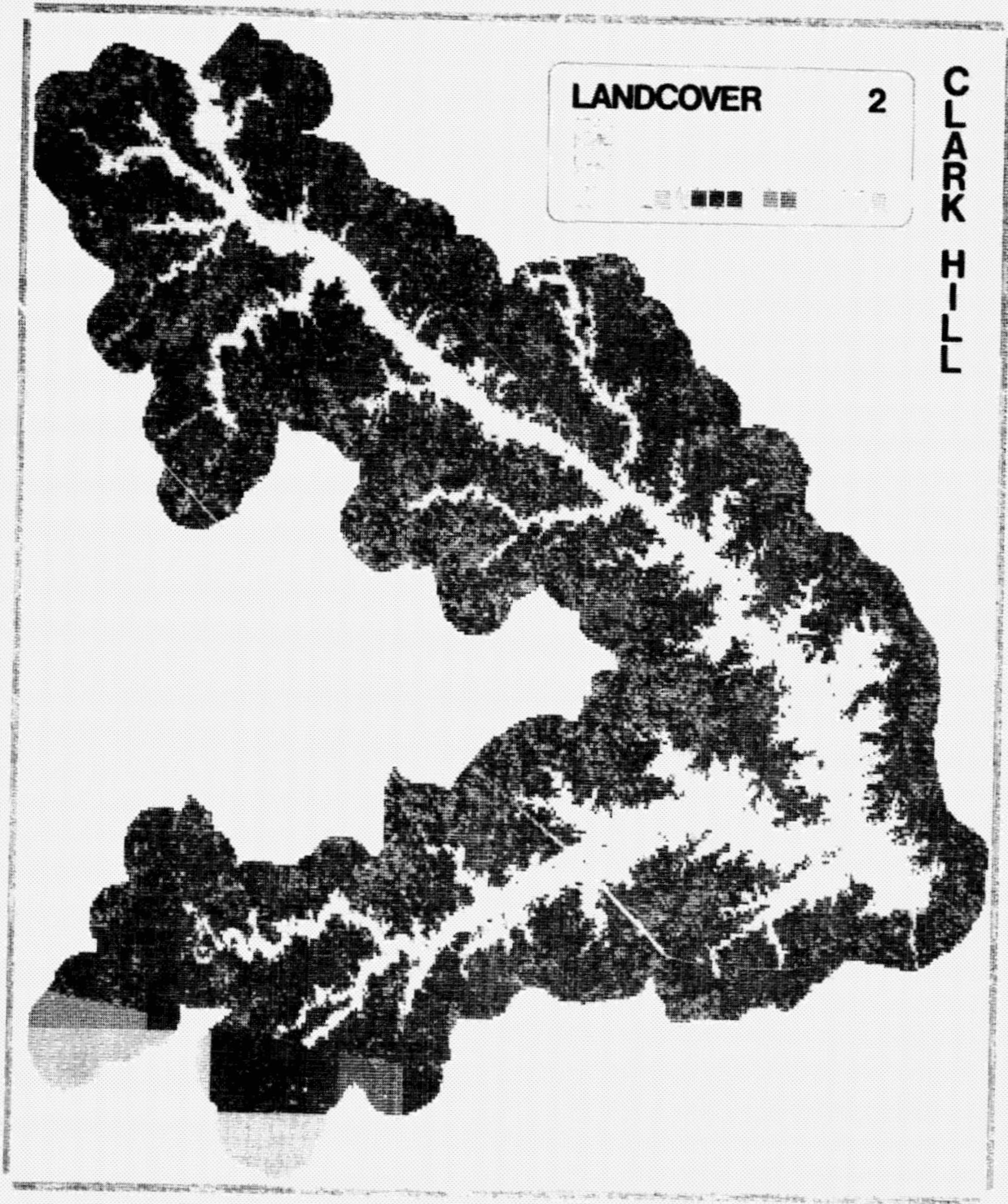

Figure 4. Landsat Land Cover Map of Clark Hill Reservoir. Data are resampled to 4.89-acre cells (scene boundary apparent at bottom of study area).

ORIGINAL PAGE 13
OF POOR QUALITY

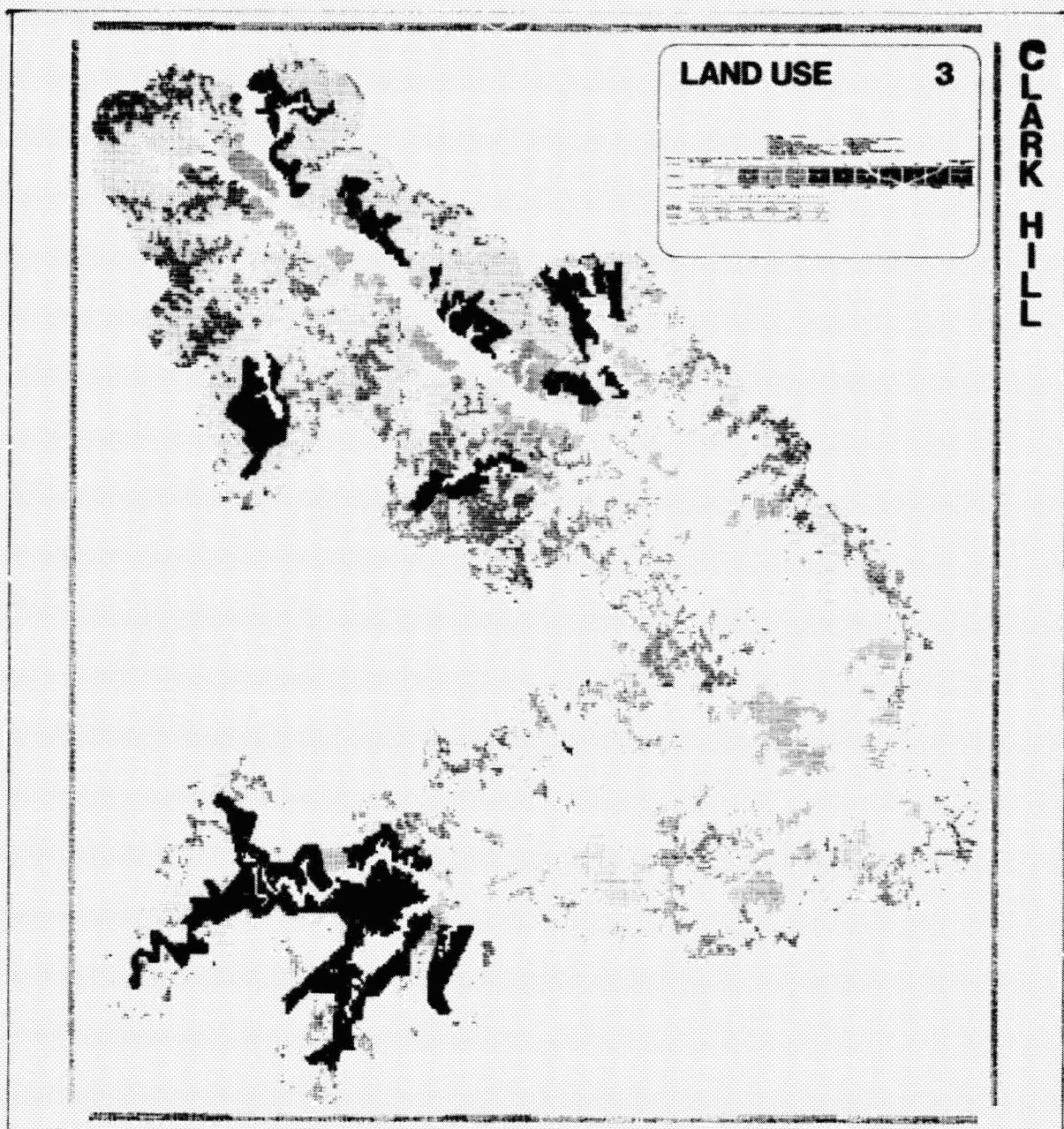

Figure 5. Land Use Map of Clark Hill Reservoir

ORIGINAL PAGE IS
OF POOR QUALITY

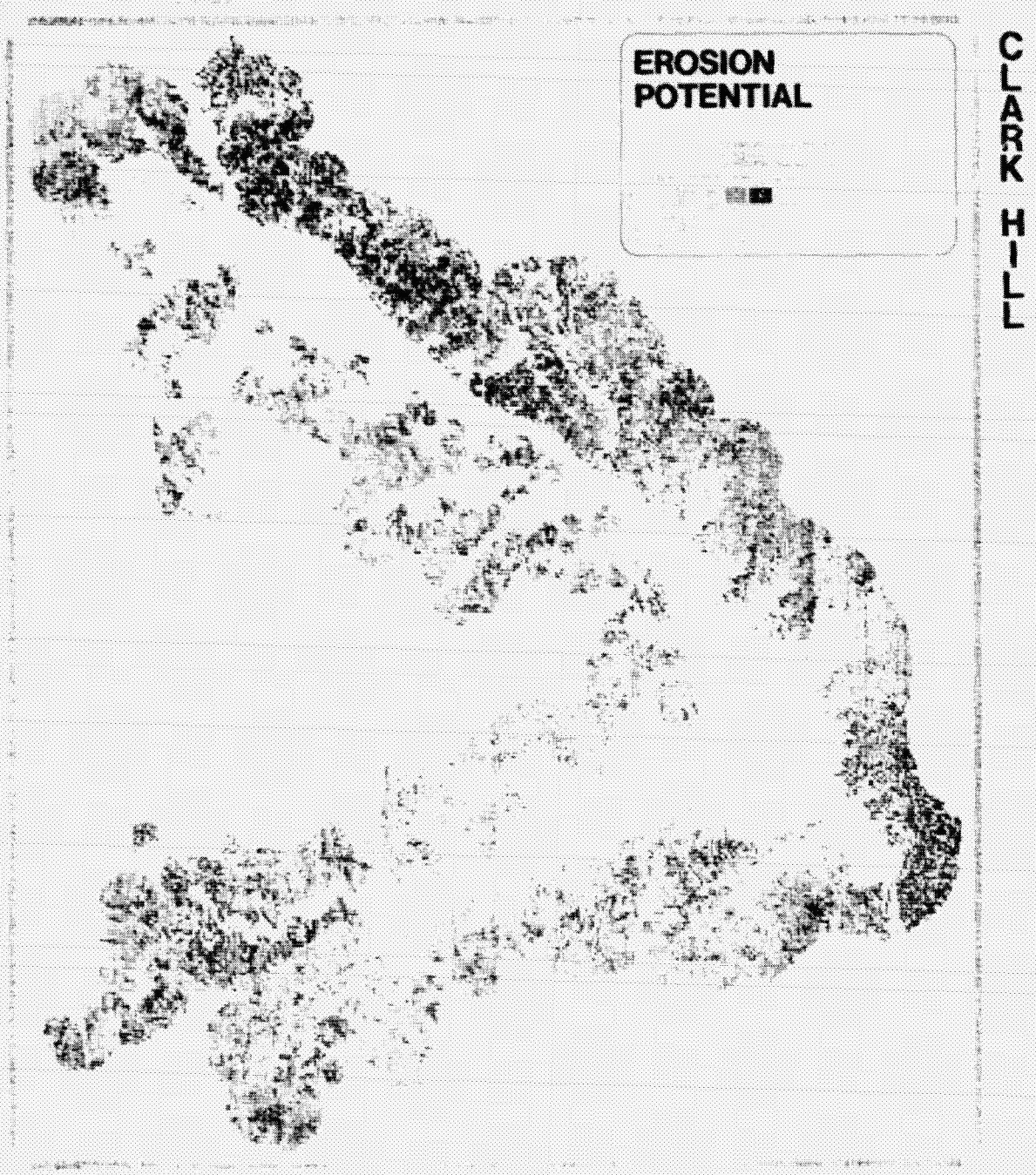

Figure 6. Erosion Potential Map of Clark Hill Reservoir

ORIGINAL PAGE IS
OF POOR QUALITY

**PERMEABILITY
LAYER 3**

14



RICHARD B. RUSSELL



Figure 7. Soil Permeability at 4.89 Acres

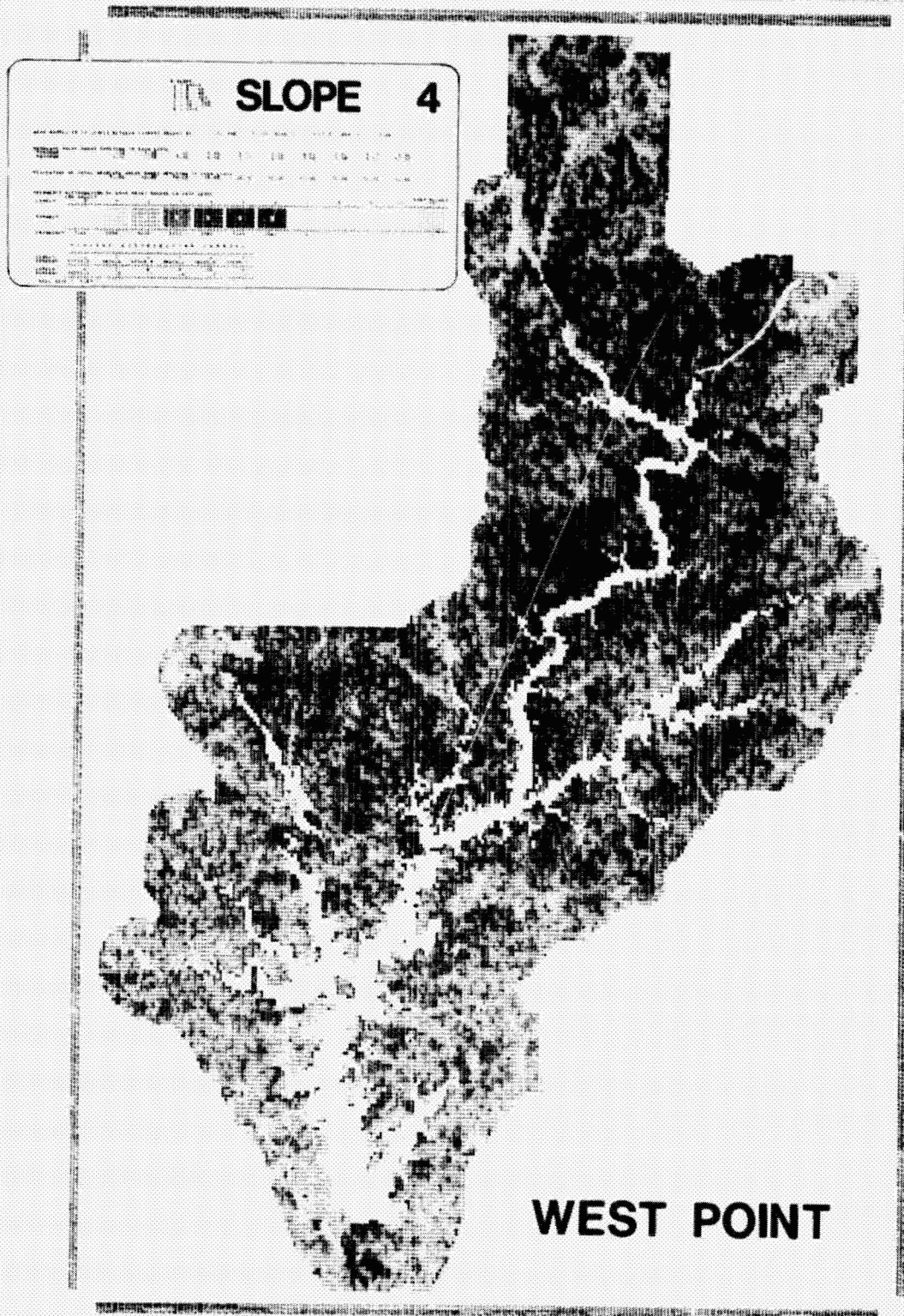

Figure 8. Slope at 4.89 Acres

ORIGINAL PAGE IS
OF POOR QUALITY

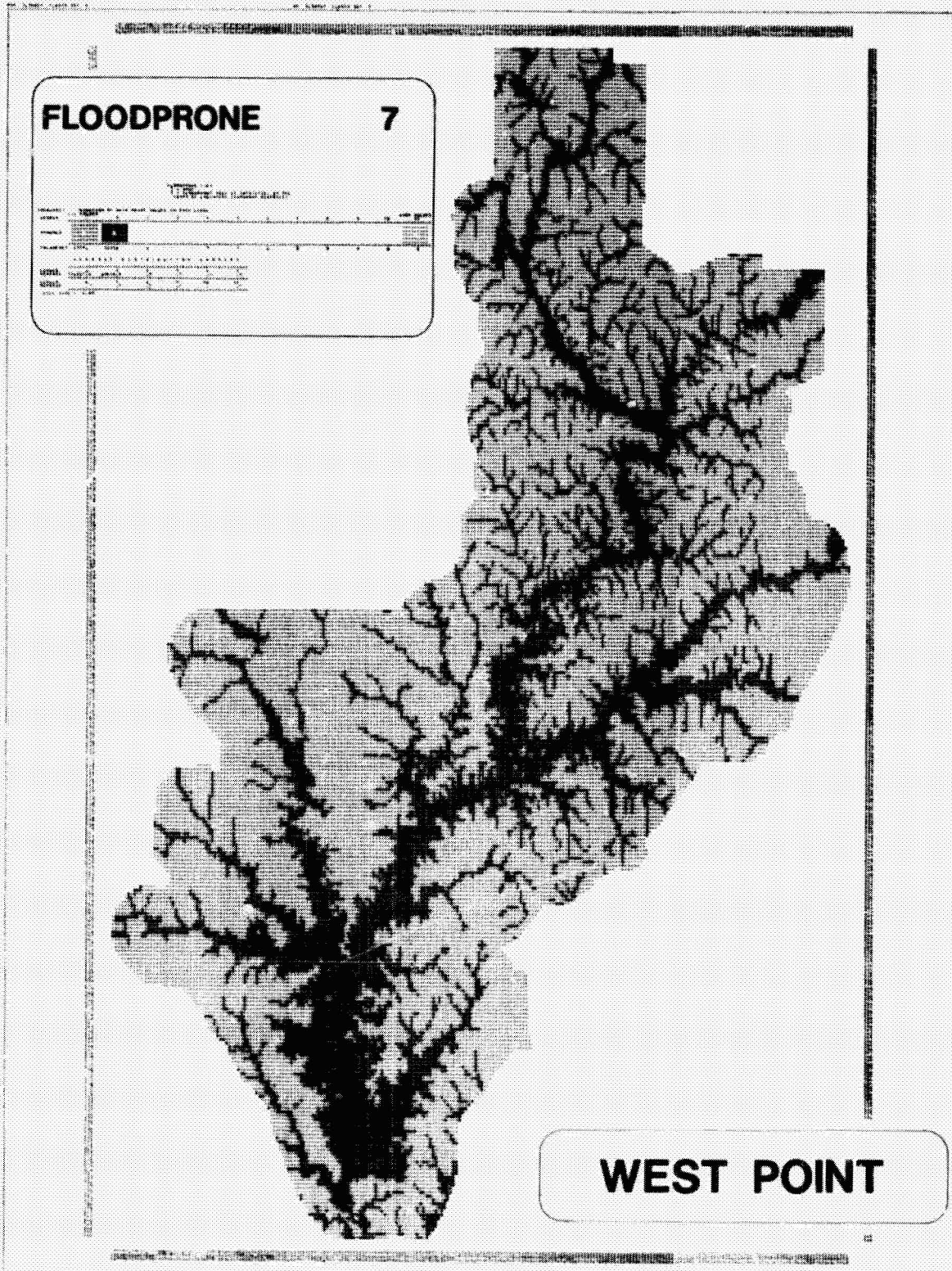

Figure 9. Estimated and Verified Flood-Prone Areas

N83 19146^{D4}

THE PACIFIC NORTHWEST REMOTE SENSING PROJECT

Wallace E. Hedrick
Resources Northwest, Inc.

ABSTRACT

In February 1978, the Pacific Northwest Regional Commission (PNRC), made up of the Governors of Idaho, Oregon, Washington, and a federal co-chairman appointed by the President, approved a three-year effort entitled the Landsat Applications Program (LAP) aimed at establishing operational capabilities in the Pacific Northwest to analyze Landsat digital imagery and apply the results to natural resource management programs.

It all started in the fall of 1974, when the PNRC established the "Land Resources Inventory Task Force" (later changed to "Technology Transfer Task Force") with the charge of investigating the potential application of Landsat technology to state and local problems. The Task Force, with representatives from Idaho, Oregon, Washington and a project director proposed the establishment of the Land Resources Inventory Demonstration Project (LRIDP). The project was designed to demonstrate to state and local agencies methods for extracting and using information derived from satellite remote sensing technology. The Task Force proposed that state and local agencies obtain assistance from organizations that had the required technical expertise and analytical capability in the remote sensing field. The Task Force requested and received this assistance from the National Aeronautics and Space Administration (NASA) and the U.S. Geological Survey (through the EROS and the Geography Programs). During the LRIDP, the Task Force and its two federal partners assembled 45 state and local agencies as participants in 23 individual demonstration projects. These projects were in the discipline areas of forestry, agriculture, rangeland, urban, coastal zone, noxious weeds and surface mining. The results of the LRIDP encouraged the Commission to embark on the Landsat Application Program in 1978 which had as its stated objective.... "to establish in-state capability for the use and application of Landsat data by state and local agencies in their decision making and resource management processes." This objective has been achieved by establishing operational analysis facilities in each of the three states. Idaho and Washington have installed Landsat digital analysis systems in Boise and Olympia to augment analysis programs already in place within those states. Oregon, meanwhile, has enhanced existing capabilities at Oregon State University in Corvallis. Currently, a number of agencies are conducting operational application projects utilizing the new data analysis facilities and Landsat derived data are now being used by these agencies in their day-to-day operations.

IDAHO

Governor John V. Evans issued Executive Order 80-4 on April 11, 1980, establishing an Idaho Image Analysis Facility (IIAF). The facility is operated by the Idaho Department of Water Resources which has been the state's lead agency during the Landsat Application Program. The executive order was the formalization of a long-term effort to establish operational Landsat digital analysis capability in the "Gem State". Governor Evans' order provides a framework for insuring management, coordination, maintenance and technical support of the image analysis facility. The Idaho Image Analysis Facility, while housed and maintained by IDWR, is accessible to other state, federal and local agencies and private interests. IDWR will provide the use of this equipment to agencies in conducting Landsat digital analysis projects. The primary components of the Idaho facility are the VICAR/IBIS image analysis software on the State Auditor's IBM 370-168 and an interactive digital image display device -- STC Model 70 Display and System 511 software -- which operates on IDWR's PDP 11/34 computer. The facility also maintains interpretation equipment for Landsat imagery and aerial photographs.

The establishment of the IIAF is the first step of operational utilization of Landsat data within the state. Faced with very limited budgets and increasing data requirements for improved planning and decision making, the resource managers and policy makers in Idaho will be demanding a level of production capability from this technology which will far overshadow the efforts to date.

OREGON

Oregon was the only state with an existing Landsat processing capability. The Environmental Remote Sensing Laboratory at Oregon State University was already established with support from the University Affairs Office of NASA. The state, therefore, elected to enhance these facilities as its approach to developing operational use of Landsat and designated ERSAL as the operational facility for Oregon.

ERSAL is not limited to Landsat, but provides a full range of services including: sample design for resource inventory and map accuracy assessment; interpretation of large and small scale aerial photographs; analysis of multi-date imagery; and geoscience applications of sidelooking radar imagery. The Landsat processing at ERSAL is done on a Cyber 73 at the OSU Computer Center which provides for bulk processing and remote access from ERSAL.

The Landsat analysis software used is PIXSYS, which started from computer programs developed at Purdue University. This software has been significantly expanded and adapted for Oregon's use over the past 10 years by ERSAL's staff.

WASHINGTON

Washington State did not start from an established base. Like Idaho, Washington was concerned with establishing an operational capability to service state users in a cost effective way. An analysis of existing state hardware showed that Washington State University had a computer with sufficient capacity to efficiently process Landsat data covering large areas.

The Washington State University Computing Service Center actively sought to be designated the repository of processing capability. The availability of the AMDAHL V-6 offered a new generation computer capable of rapidly processing large amounts of data. The state agencies felt that the addition of interactive image processing equipment would make it possible to effectively work with Landsat data.

The operational capability in Washington consists of VICAR/IBIS software on the AMDAHL V-6 computer in Pullman and an Interactive Image Processing Laboratory (IIPL) on the Capitol Campus in Olympia. The IIPL operated by WSU/CSC contains (as in Idaho) the STC Model 70 Display and System 511 earth resources processing software which operates on a PDP 11/34 computer. The AMDAHL V-6 is linked to the IIPL via dedicated telephone lines. Discipline expertise comes from within individual agencies or through cooperative agreements among participating agencies.

Operational capability is achieved by melding the capability of established state expertise and equipment with a modest stimulus of new technology. Together, this combination provides an additional tool to those concerned with natural resource planning and management in Washington State.

PARTICIPATING STATE AND LOCAL AGENCIES

1. Idaho
 - a. Department of Water Resources
 - b. Division of Economic and Community Affairs
 - c. Department of Fish & Game
 - d. University of Idaho
 - e. Bureau of Mines and Geology
2. Oregon
 - a. Department of Land Conservation and Development
 - b. Oregon State University

- c. Department of Fish & Wildlife
 - d. Deschutes County
 - e. Department of Environmental Quality
 - f. Department of Water Resources
3. Washington
- a. City of Tacoma
 - b. Spokane County
 - c. Department of Game
 - d. University of Washington
 - e. Washington State University
 - f. Department of Ecology
 - g. Planning and Community Affairs
 - h. Department of Revenue
 - i. Department of Natural Resources
 - j. Western Washington University

LACIE AND AgRISTARS

B. H. Moore
Lockheed Engineering and Management Services Company, Inc.
Houston, Texas

The USDA has been actively engaged in developing and using remote sensing in support of major departmental missions since the 1940's. Until the past decade, remote sensing efforts primarily involved the use of aerial cameras mounted in fixed-wing aircraft to obtain photographs of the country's land area. In July 1972, the first Earth Resources Technology Satellite (ERTS), now called Landsat 1, was successfully orbited. Since then, it has been demonstrated that digital products as well as image products derived from the data collected by the Multispectral Scanner (MSS) on Landsat, combined with appropriate analysis techniques, can provide useful information to those engaged in monitoring and planning the development and conservation of the Earth's resources.

In 1974, NASA, NOAA, and USDA began the Large Area Crop Inventory Experiment (LACIE) to research, develop, apply, and test a technology which was designed to estimate wheat production worldwide, with a goal of achieving improved accuracy and timeliness over current global estimates. Wheat area estimates were based on analysis of Landsat data, and weather effects models were used to estimate wheat yield. LACIE, completed in 1978, demonstrated that this technology met the established goal (90 percent accuracy with a 90 percent confidence level at harvest) in the U.S. Great Plains and the USSR for two consecutive years. In addition, the LACIE results indicated that technology improvements are needed in certain other important wheat growing regions, primarily where field size is close to present satellite resolution limits and where spring wheat is difficult to separate from other small grains such as spring barley.

Following several years of a small-scale research effort, the Statistical Reporting Service (now part of the Economics, Statistics, and Cooperatives Service of USDA) completed an experiment in 1977 for using Landsat digital data to improve crop acreage estimates for all major spring-planted crops in Illinois. This experiment, using full frame classification combined with ground data collected from a probability sample, demonstrated the usefulness of remote sensing data for estimating domestic crop acreages and for supporting land use estimation activities.

The encouraging results of the above-mentioned two experiments (LACIE and Illinois Crop Acreage Experiment) have led government planners to support additional exploration of the possibilities for extending applications of remote sensing to other domestic uses, as well as to additional crops in other countries.

In 1978, the Secretary of USDA proposed a cooperative effort to carry out a mutually beneficial earth resources-related aerospace research, development, and testing program.* Seven information requirements were identified.

1. Early warning of change affecting production and quality of commodities and renewable resources;
2. commodity production forecasts;
3. land use classification and measurement;
4. renewable resources inventory and assessment;
5. land productivity estimates;
6. conservation practices assessment; and,
7. pollution detection and impact evaluation.

(While all seven are important to the USDA, the first two - early warning and commodity production forecasting - have been given emphasis because of the immediate need for better and more timely information on crop conditions and expected production.)

In response to the USDA Secretary's Initiative, the AgRISTARS (Agriculture and Resources Inventory Surveys Through Aerospace Remote Sensing) Program was established. AgRISTARS is a six-year program of research, development, evaluation, and application of aerospace remote sensing for agricultural resources beginning in Fiscal Year (FY) 1980. The program is a cooperative effort of the USDA, NASA, USDC, USDI, and AID.

The goal of the program is to determine the usefulness, cost, and extent to which aerospace remote sensing data can be integrated into existing or future USDA systems to improve the objectivity, reliability, timeliness, and adequacy of information required to carry out USDA missions. The overall approach is comprised of a balanced program of remote sensing research, development, and testing which addresses domestic resource management, as well as commodity production information needs.

The Technical Program is structured into eight major projects as follow:

1. Early Warning/Crop Condition Assessment (EW/CCA);
2. Foreign Commodity Production Forecasting (FCPF);

*Joint Program of Research and Development of Users of Aerospace Technology for Agricultural Programs, February 1978.

3. Yield Model Development (YMD);
4. Supporting Research (SR);
5. Soil Moisture (SM);
6. Domestic Crops and Land Cover (DC/LC);
7. Renewable Resources Inventory (RRI); and,
8. Conservation and Pollution (C/P).

These elements are interrelated through research, exploratory experiments, pilot experiments, USDA user evaluations, and large-scale application tests.

The EW/CCA research effort is designed to develop and test the basic techniques required to support the operational Crop Condition Assessment Division (CCAD) of the Foreign Agricultural Service in USDA. The EW/CCA addresses 20 crop/region combinations in the U.S. and seven foreign countries (USSR, Argentina, Brazil, Canada, People's Republic of China, Mexico, and Australia) for six major commodities (wheat, barley, corn, soybeans, rice, and cotton).^{*} It is assumed that the techniques utilized for early warning are largely crop dependent and country independent.

The Foreign Commodity Production Forecasting (FCPF) activity addresses 12 crop/region combinations in the U.S. and six foreign countries (USSR, India, Argentina, Brazil, Canada, and Australia) for five major commodities (wheat, barley, corn, soybeans, and rice). This project will develop and test procedures for using aerospace remote sensing technology to provide more objective, timely, and reliable crop production forecasts several times during the growing season and improved preharvest estimates for the crop/regions of interest. The FCPF activity builds upon the existing remote sensing technology base and extends this technology to additional crops and regions. Large Scale Applications Testing (LSAT) of candidate technology for making estimates of production in foreign countries will be conducted by USDA.

The Yield Model Development (YMD) will support USDA crop production forecasting and estimation by (1) testing, evaluating and selecting crop yield models for application testing; (2) identifying areas of feasible research for improvement of model usefulness; and (3) conducting research to modify existing models and to develop new crop yield assessment methods.

^{*}These crops and regions may change in response to USDA information needs.

The Supporting Research (SR) project covers research, development, and testing of new and/or improved remote sensing technology. Research will be conducted in the following areas, as related to applications of remote sensing technology: area estimation, crop development stage estimation, spectral crop appearance in yield estimation, crop stress, and soils.

Soil Moisture (SM) research is directed toward development of the measurement of soil moisture (in-situ and remotely) for potential use in other applications, such as early warning uses, crop yield estimation, watershed runoff, and vegetative stress assessments.

Domestic Crops and Land Cover (DC/LC) objectives are directed at automatic classification and estimation of land cover with emphasis on major crops. Landsat and advanced sensor data will be used in conjunction with ground data to improve the precision of estimation and classification procedures at the substate level and to investigate change monitoring techniques.

The Renewable Resources Inventory (RRI) Project involves requirements in seven major problem areas: Regional and Large Area Inventories; Current Technology Assessment; New Technology Development; Detection, Classification and Measurement of Disturbances; Classification, Modeling and Measurement of Renewable Resources; Determination of Site Suitability and Land Management Planning; and Analytical and Cartographic Support to the Resource Information Display System.

The Conservation Assessment portion of the Conservation and Pollution (C/P) Project addresses applications in three areas: inventory of conservation practices; estimation of water runoff using hydrologic models; and determination of physical characteristics of snowpacks.

The Pollution portion of the C/P Project will provide an assessment of conservation practices through use of remote sensing techniques to quantitatively assess sediment runoff, to detect gaseous and particulate air pollutants, and to assess their impacts on agricultural and forestry resources.

Availability of Thematic Mapper (TM) data from the Landsat D series of satellites may cause the original AgRISTARS schedule to be modified.

N83 19148

D6

ORIGINAL PAGE IS
OF POOR QUALITY

Original photography may be purchased
from EROS Data Center
Sioux Falls, SD 57198

BIOMASS MEASUREMENT FROM LANDSAT-

DROUGHT AND ENERGY APPLICATIONS

Eugene L. Maxwell
Solar Energy Research Institute

ABSTRACT

The theory supporting the use of vegetation indices derived from Landsat data for the direct measurement of biomass is briefly reviewed. The use of multispectral data to measure biomass is a natural and viable application since the photosynthetic production of biomass gives vegetation its unique spectral properties. Vegetation indices also perform a normalization function which tends to make them insensitive to atmospheric and soil color variations. Optical and digital Landsat products are discussed relative to the use of vegetation indices to monitor drought impact. Based on results obtained in Colorado, operational use of Landsat to monitor drought is cost effective, practical and ready for implementation today. The direct measurement of biomass energy resources may also benefit from Landsat technology. Measurement of total biomass and annual primary production may be feasible. Identification of that component of biomass resources available for energy use will require other sources of information, however.

BACKGROUND

Some of the most widespread and universal problems facing the people of this earth have to do with the condition and availability of the vegetation covering the surface. Food, fiber and fuel are provided by the vegetation, as well as products for constructing shelters. Vegetation is also vital for the maintenance of a habitable environment since it has a dominant effect on the oxygen and carbon dioxide in our environment. Natural disasters have always been a factor in man's survival, especially the famines which accompany drought. Such problems are compounded today by overpopulation of the planet which has placed many regions on the edge of disaster, where even a small perturbation below expected food production can result in starvation. Furthermore, with our declining fossil fuel reserves, we can foresee the time when the availability of energy could become a more general survival factor. This concern has resulted in an increase in the use of wood for fuel, which in some regions of the world has resulted in extensive deforestation.

The measurement of standing crop biomass (the quantity of vegetative biomass in place at a given point in time) and the annual production of biomass has therefore taken on worldwide importance. Because of the global nature of the problem, satellite remote sensing is an obvious candidate for the measurement

system. The current Landsat system has the potential for such global monitoring, using vegetation indices derived from the multispectral scanner data.

The theoretical basis for biomass measurement is briefly reviewed and several vegetation indices are compared. Two topical applications, drought monitoring and biomass energy resource assessment, are used to illustrate the potential value of biomass measurement from satellite remote sensing systems. Many other related applications such as monitoring of desertification and deforestation will also benefit from this space-age technology, but none are of more universal concern than drought and energy.

DIRECT VS INDIRECT REMOTE MEASUREMENT

Remote sensing could be used to measure or estimate the quantity of standing crop biomass using direct or indirect methods. The indirect method would use remote sensing to identify and map the characteristics of the vegetation covering the earth's surface. These characteristics would then be used to compute biomass values. For instance, in forested regions the indirect method employs regression equations which relate biomass to species type, size and density. Direct measurement of biomass using remote sensing refers to methods which extract biomass values directly from spectroradiance measurements. The direct method employs regression equations which relate biomass to radiance values. Up to the present time, the direct measurement of biomass using remote sensing has been applied primarily to the assessment of rangeland and cropland condition. There is a considerable volume of literature which addresses the measurement of standing crop biomass using remotely sensed vegetation indices (combinations of radiance values from selected spectral bands). Some of the more available references include Jordan (1969); Maxwell (1976); Pearson, Tucker & Miller (1976); Thompson (1979); and Tucker (1979). A recent report by Maxwell et al., (1980) considered the use of Landsat to monitor drought impact. Key results of that research project are briefly summarized in the application sections of this paper.

VEGETATION INDICES

By definition, a vegetation index should be a variable which is deterministically related to the vegetation characteristic or characteristics of interest. In this instance, our concern and the concern of others is the measurement of standing crop biomass and/or the measurement of biomass production.

EM INTERACTIONS WITH VEGETATION

The density variations observed in a photograph or the variations in the digital numbers recorded by Landsat result from the varying interactions which take place between surface materials and the incident electromagnetic (EM) energy. The use of EM remote sensing methods to measure vegetation characteristics is unique because the measurement of the reflected energy from vegetation is directly related to the biological functioning of that vegetation. This is one

of the few instances in which the extraction of information from remotely sensed data is not dependent on some secondary or tertiary relationship.

The interactive mechanisms of a green leaf can be explained with reference to the leaf cross section shown in Fig. 1 (after Salisbury and Parke, 1970). The light entering the leaf passes through the epidermal cells into the palisade region where most of the chlorophyll content of the leaf exists. The allowed energy states of the chlorophyll results in strong absorption in the red and blue wavelengths. Light which is not absorbed will reach the spongy parenchyma section of the leaf which is characterized by irregular cells separated by air spaces or voids partially filled with water. The different refractive indices of the water and cellulose results in refraction and reflection of the light rays passing through the leaf. This causes a considerable increase in the effective path length of the light rays, thereby increasing the probability that the light will be absorbed. For near IR wavelengths (not absorbed by the leaf pigments) the multiple reflections within the leaf increases the probability that the rays will ultimately exit from the top of the leaf as reflected energy. These phenomena result in spectroreflectance characteristics for green vegetation such as that shown in Fig. 2. The strong pigment absorption processes result in very low reflectance in the visible portion of the spectrum, whereas near IR wavelengths exhibit very strong reflectance. The reflectance characteristics of a typical soil (brown silty loam) is shown in Fig. 2 for comparison.

Position in Spectral Space

From Fig. 2 one notes that as the vegetation covering the soil increases from 0 to 100% canopy cover the reflectance in the visible part of the spectrum will decrease whereas the reflectance in the near IR will increase. Therefore, in agricultural or heavily vegetated areas a pattern of reflectances for individual fields such as that shown in Fig. 3 is often observed. These data were obtained from the Landsat multispectral scanner (MSS) system. Band 5 is in the red portion of the spectrum between 600 and 700 nanometers and band 7 is in the near infrared region between 800 and 1100 nanometers. The individual ellipses shown on this figure represent the distribution of the radiance characteristics of individual fields or locations, i.e., they represent the spectral space occupied by a particular field or location. Fields which contain no green vegetative cover will be found to lie along the soil brightness line in this spectral space plot. During the growing season, as the vegetative cover of the field increases, the field position in spectral space will move up along the greenness curve. The exact path followed will be determined in part by the spectral characteristics of the soil. The soils in northeastern Colorado, where these data were obtained, ranged from dark brown loams to light sandy loams. The reflectance of a lake in this region is also shown.

The use of multispectral data to identify or classify vegetation types is inherently ambiguous because of their movement in spectral space during the growing season and during their life cycle. However, this movement within spectral space which tends to thwart the use of multispectral data for vegetation classification is directly relatable to biomass production and the quantity of vegetation covering the underlying soil. This illustrates the statement previously

made that the measurement of the spectrorreflectance characteristics of vegetation is directly related to the growth processes of the vegetation. We should note that the significance of the pattern shown in Fig. 3 was first recognized by Kauth and Thomas (1976) who dubbed it the tasseled cap (our stocking cap lost its tassel).

Landsat Indices

Some of the most common indices generated from Landsat bands are listed and defined in Table 1. The relative usefulness of these indices for measuring biomass is indicated by the F-values (ratios of variances) given in Table 2. Data sets from rangeland, crops, crops plus range and irrigated hay were used to evaluate the indices. Although the normalized difference index using bands 7 and 5 has a considerably higher mean ranking than the other indices, the most significant observation is the similarity of the F-values. The variations in ranking for the different data sets may in part be an artifact of those sets as are F-value differences between sets. All in all one must conclude that any of these six indices will provide a useful direct measurement of vegetative biomass, which is consistent with the results obtained by Tucker (1979).

Narrow Band Indices

From the reflectance curves shown in Fig. 2, one might conclude that the use of almost any part of the infrared spectrum would be equally useful in forming a vegetation index. Remote sensing systems, however, do not measure reflectance. Rather, they measure the radiance from the scene which is a function of the irradiance, surface reflectance, atmospheric transmittance, and atmospheric radiance variables. This functional relationship can be expressed in a form similar to that shown in Eq. (1), which also shows the functional dependence on wavelength, solar elevation angle and the observation or look angle:

$$L = \frac{1}{\pi} \int_{\lambda_1}^{\lambda_2} E(\lambda) [\rho(\lambda, \theta, \phi) T_o(\lambda, \theta) T_u(\lambda, \phi) \sin \theta + \rho_A(\lambda)] d\lambda \quad (1)$$

where

- I = surface radiance in the band from λ_1 to λ_2 ,
- $E(\lambda)$ = solar spectral irradiance at the top of the atmosphere,
- $\rho(\lambda, \theta, \phi)$ = surface reflectance,
- $T_o(\lambda, \theta)$ = downward atmospheric transmittance,
- $T_u(\lambda, \phi)$ = upward atmospheric transmittance,
- $\rho_A(\lambda)$ = atmospheric upward scattering coefficient,
- λ = wavelength,
- θ = solar elevation angle,
- ϕ = downward look angle from the aircraft or satellite.

The effect of the atmosphere on radiance measurements is observed in the narrow band radiance data from Ungar, et al. (1977), which are shown in Fig. 4. Several major absorption bands as well as many minor atmospheric scattering and absorption phenomena are noted. The Landsat-D Thematic Mapper system has been designed with bands from 630 to 690 nanometers and 760 to 900 nanometers so as to avoid the oxygen and water absorption bands noted on Fig. 4. This should significantly improve the performance of vegetation indices used for the direct measurement of biomass. Landsat-D is scheduled for launch in the 1983 timeframe.

NORMALIZING EFFECTS OF INDICES

The vegetation indices defined in Table 1 are not only sensitive to biomass variations, but they are also relatively insensitive to variations in soil background reflectance and atmospheric absorption and scattering effects. In other words, the ratios and differences used in forming the indices tend to normalize radiance changes lacking spectral structure. For instance, the raising or lowering of the soil curve in Fig. 2, such as might result from soil moisture changes, will be normalized by ratioing any two bands. Complete normalization is not expected since most soil and atmospheric changes exhibit some spectral variations.

Several bare fields having different soil color were used to evaluate the original Landsat bands and the vegetation indices as soil discriminators. The F-statistics for each of these variables when used to discriminate among the soil types are shown in Table 3. These statistics indicate that Landsat bands 4 and 7 are most sensitive to soil color variations, whereas the vegetation indices are relatively insensitive. Data were not available to evaluate atmospheric normalization, but there is good reason to expect that such an effect exists. Further research on the normalizing effects of vegetation indices is underway at SERI and will be reported at a later date.

DROUGHT APPLICATION

A project directed at the development of methods for monitoring drought impact using Landsat data was undertaken with NASA sponsorship during 1978 and 1979. Planning for this project was initiated during 1976 and 1977 because of the severe drought in Colorado and many other western states. Although the severity of the drought was recognized, there were only limited means for comparing the drought impact from one year to the next or one region to the next. Landsat was considered a potential source for such comparative information on the basis that the water deficiencies resulting from drought affect the earth's vegetative cover, which could be monitored using vegetation indices derived from Landsat multispectral data.

The framework within which Landsat might function for monitoring drought impact was defined by the Colorado Department of Agriculture and the Colorado Drought Council as shown in Fig. 5. The potential for data inputs from Landsat are indicated by those parameters marked with a "bullet". For this paper we will

limit consideration to the use of Landsat to monitor rangeland and cropland condition by the direct measurement of biomass.

TEMPORAL AND COST CONSIDERATIONS

If Landsat data are to be used as indicators of drought severity, then the images must be made available in a timely fashion at a reasonable cost for state agency use. In general, it will be necessary to make comparative measurements from year to year and two or three times during the growing season to obtain a reliable measurement of drought impact. These factors tend to magnify cost considerations.

The need for several measurements during the growing season is indicated by the green-up and senescent cycle for rangeland in several Colorado counties during 1978 (see Fig. 6). One should note that during the spring the rangelands tend to green up at most locations, even under drought conditions. Certainly there would be differences in total biomass in one county versus another, but these differences exist in part as a natural consequence of different climate and soil conditions. Supporting evidence of drought impact is obtained, therefore, by monitoring the onset of senescence. For instance, note that the upper curve for Conejos County was taken from an irrigated pasture which was not suffering from drought. Compare this curve with those counties experiencing the most severe drought conditions (Albert, Huerfano, Phillips and Lincoln). Larimer County was in relatively good condition and the sites measured in El Paso County benefited from the 2.6-inch rainfall noted on Fig. 6. It is also interesting to note that Routt County was experiencing drought conditions, but at the higher elevations of that mountainous county the senescent cycle develops at a later date.

These temporal considerations pointed to the need for an inexpensive product and process to be used for frequent monitoring of vegetative biomass for the entire state. It was recognized early on that this could most likely be accomplished with black and white or color optical products generated from Landsat data. The optical products were photointerpreted on a comparative basis to identify those regions suffering the greatest impact. Once critical areas were identified, computer compatible tapes (CCT's) were used to provide a more precise and quantified measure of drought impact.

OPTICAL VEGETATION INDEX (OVI)

Initially it was assumed that false color composite prints for the Landsat data would be used to provide a statewide drought monitoring capability. After a great deal of research and evaluation, however, it was concluded that standard color products suffered from a lack of quality control and that contrast enhanced products of the quality required would be almost as expensive as the cost of performing a full computer analysis of the digital data. The use of color products was therefore rejected for this application, where comparisons from one date to the next are required for drought assessment.

As an alternative optical product, an optical vegetation index (OVI) was generated by forming a sandwich of a band 7 positive transparency and a band 5 negative transparency. The photographic density of this product can be mathematically defined as:

$$D = \log(DN_5/DN_7) + C$$

where

DN₅ = Landsat digital number for band 5,
DN₇ = Digital number for band 7, and
C = Constant.

An example of the OVI is shown in Fig. 7 where a comparison between band 7 and band 5 images can be made. Note for example, the difference in vegetation conditions in the San Luis Valley (west of the mountains) and the eastern plains. This difference is much more evident on the OVI product than on either band 5 or 7 and reflects the difference between an annual precipitation of 8 inches in that part of the San Luis Valley versus annual precipitation of 12 to 14 inches east of the mountains. Note also the dark volcanic cones in the upper left-hand corner of each image. These cones are very sparsely vegetated and their dark appearance on both bands 5 and 7 results from the dark basaltic rocks of which they are comprised. The heavy vegetation in the irrigated agricultural fields in the San Luis Valley and in the bottom of the drainages from the mountains is indicated by the dark tone on the OVI product.

Although these initial results for the OVI product were very encouraging, subsequent analysis has shown that variations in the density of the standard black and white products produced by the EROS Data Center can produce a false indication of changes in vegetation condition. Therefore, caution must be exercised when using these products. In many instances such problems can be identified by examining locations of known land cover conditions, such as irrigated croplands, barren lands, and lakes and reservoirs.

The direct generation of OVI products using computer-generated digital index values and a film writer would eliminate most of the quality control problems and at the same time produce an inexpensive product for use in surveying large areas. A recommendation to provide such a product has been submitted to the EROS Data Center.

DIGITAL INDEX CALIBRATION

Biomass values from ground measurements were needed in order to calibrate the vegetation index values derived from Landsat. Volunteer field personnel from the state extension service, the Colorado State Forest Service and the Colorado Agricultural Experiment Station were used to record vegetation data throughout Colorado during the summer of 1978. The field data obtained were used to establish graphical relationships between vegetation indices and biomass as shown in Fig. 8 for the normalized difference index. The difference between the row crops and rangeland data is probably related to plant structure. The initial growth of

row crops does not produce much canopy cover. Therefore, even though this predominantly vertical growth produces a significant quantity of biomass in the fields, the field reflectance is still dominated by the soil.

Ultimately, when the leaf area index becomes so high that all of the incident light is either absorbed or reflected from the vegetation canopy, the vegetation index will no longer be sensitive to changes in biomass. It is likely the rangeland data will asymptote around 10,000 kilograms per hectare. The asymptote for row crops will occur at a much higher biomass. It is important to recognize that once these asymptotic values are reached, or once maximum growth of any given vegetation type has been achieved, further variations in vegetation index values will be related only to changes in crop vigor. This also serves to remind us that the vegetation indices will always be a function of both biomass and vegetation vigor.

The assessment of drought impact was to be based primarily on an evaluation of change from one date to the next at the same location. Therefore, a decision was made to establish the "universal" nonasymptotic vegetation index/biomass relationship of Fig. 8, spanning the rangeland and row crop data. The dashed lines were visually fit around the mean so as to encompass 90% of the data points (excluding the row crop data below 10,000 kilograms per hectare). These lines were used to bracket nonoverlapping biomass ranges. These results seem to indicate that 2 to 1 changes in biomass can be accurately monitored.

Analytical Procedure

A regression equation could have been fit to the greater portion of the curve in Fig. 8 such that a biomass value could be computed for each pixel. However, a simpler analytical technique making use of the entire curve was selected. The index values for each of the biomass ranges were used in connection with a level slicing or graymapping routine. This procedure is very inexpensive and produces biomass maps as well as statistical summaries (by summing the number of pixels falling within each of the biomass ranges).

Typical Results

Figure 9 compares the results obtained using the graymapping procedure for 1973 (a wet year) and 1976 (a drought year) for a portion of the Earl quadrangle in southcentral Colorado. The effect of the drought on the rangeland and irrigated hay fields of this region is apparent. A more quantitative evaluation of the drought impact is available from the biomass totals for 1973, 1976 and 1978 which are given in Table 4. The accuracy of these total biomass numbers was not evaluated. Since a universal vegetation index curve was being used for a variety of vegetation types, it is not to be expected that the absolute accuracy was especially good. However, since the image dates in each of the three years corresponded to the same point in the growing season, the relative magnitude of change for each of these three regions should be valid.

ENERGY APPLICATIONS

With the supply and cost of fossil fuels becoming a greater concern for the entire world, there is a growing interest in the use of biomass as a renewable energy resource. The inventory of biomass resources, therefore, has taken on new dimensions which suggest a reassessment of inventory objectives and methods.

Current land cover classification schemes use cover type for the first levels of classification. For example, the first level may establish such broad classes as forest, rangeland, shrubland, etc. The second level separates forest into coniferous, deciduous and mixed, and the third level establishes species or ecosystem types such as ponderosa pine, lodgepole pine, spruce-fir, et al. Further characterization of the forest often takes the form of statistics on stand density, species mix and tree heights and diameters. From these statistics and accompanying area estimates, the volume of merchantable timber is calculated. These same statistics could and probably will be used to estimate total biomass (the Forest Service initiated efforts to do so nationwide in 1980).

However, for energy assessment purposes one can conceive of an inventory system which measures total vegetation biomass as the first level of information. Higher levels would then subdivide the biomass into use categories (lumber, poles, plywood, energy, et al.) and ultimately energy content categories could be established. This leads to the interesting concept of using remote sensing for the direct measurement of total vegetative biomass, thereby establishing the first level of information. This will be explored relative to forest resources. At the present time we have no operational experience in using remote sensing in this way. Thus, we can only suggest possible procedures and potential problems, based on research results.

FOREST BIOMASS RESOURCES

Direct measurement of forest biomass energy resources presents more difficult problems than crop residues. Vegetation indices are responsive primarily to the foliage of the tree, not the branches or stem. Hence, direct biomass measurements would actually measure only the smallest component of the total tree biomass (see Table 5 from Saucier, 1979). Also note that the proportion of total tree biomass represented by the foliage will be a function of stand structure, tree size and species. Hence, unless stand, species and size data were available, the measurement of foliage biomass could not be used to estimate total biomass. To further complicate the problem, the biomass of the merchantable stem must be subtracted from the total, since it will be used for higher value products such as saw timber, poles, plywood, etc. Furthermore, the proportion of the total biomass represented by the merchantable stem can vary from as little as 40% to as much as 90%. This is a function of the species, size, location and intended use. The branching habits of hardwoods are particularly significant in this regard. Species exhibiting decurrent branching (lateral branches grow as rapidly as the stem) do not have a large stem. Clark (1978) has found that on the average only 48% of a 40.6 cm Quercus rubra (red oak) is harvested. In general, the proportion of the total biomass which will be available for energy use is highly variable.

In addition to slash left in the field after harvesting, the thinning of stands (especially hardwoods) to improve forest productivity is considered a prime source of fuel wood. One should also consider the removal of dead and diseased trees and trees downed by wind or snow. The complex nature of fuel wood availability obviously requires more than a measurement of total biomass to effectively characterize this resource.

Nevertheless, mapping of total biomass within forest boundaries will provide information not available today. Furthermore, the usefulness of sample plot data collected by the Forest Service might be extended such that estimates could be made on a county or regional basis. Forest Service sampling techniques for state or national inventories are designed to provide accurate data for statistical summaries. They are not meant to provide data for managing a specific forest or stand or for delineating the spatial distribution of the forests within the state. Landsat data and aerial photography may be of special value for mapping the location of total forest biomass.

The use of Landsat to update biomass inventories also appears promising. It is a reasonable hypothesis that vegetation indices are most closely related to the rate of primary production of biomass at the time of measurement. And of course, the rate of production must be strongly correlated to the in-place green biomass wherein the photosynthesis process takes place. Given this hypothesis, it is reasonable to assume that vegetation index data from Landsat, combined with an appropriate growth model and weather data, could be used to estimate annual changes in biomass. In other words, once a reasonably accurate inventory of forest biomass resources exists for a region, Landsat might become a device to monitor change. Landsat could provide an annual update of value to all users of the forest products.

It is apparent that we are not ready to initiate operational use of Landsat for direct measurement of forest biomass resources. Much research and development remains to be done.

SUMMARY AND CONCLUSIONS

The direct measurement of green biomass is one of the most natural applications of multispectral remote sensing systems such as Landsat. Optical vegetation index products can be used to monitor large areas at low cost. Computer processing of the digital data, although more costly, will provide a quantitative assessment of biomass conditions. Due consideration must be given to the movement of vegetation through spectral space, during the growing season and during the life cycle of the plant, if accurate information on biomass quantity and condition is to be obtained.

Monitoring of drought impact and measurement of total biomass resources appear to be feasible applications of this technology. Use in forested areas requires some basic research to address the problem of relating foliage biomass to total biomass. Nevertheless, Landsat used in concert with other sources of information could greatly improve our knowledge of biomass as a renewable energy resource.

REFERENCES

- Clark, A., 1978. Total Tree and its Utilization in the Southern United States. For. Prod. Jour. 24(6), p. 47-52.
- Jordan, C. F., 1969. Derivation of Leaf Area Index from Quality of Light on the Forest Floor. Ecology, 50: 663-666.
- Kauth, R. J. and G. S. Thomas, 1976. The Tasseled Cap--A graphic description of the spectral-temporal development of agricultural crops as seen by Landsat. Proc. Symp. on Machine Proc. of Rem. Sens. Data, West Lafayette, IN, 4B: 41-51.
- Maxwell, E. L., 1976. A Remote Rangeland Analysis System. J. Range Mgt, 29: 66-73.
- Maxwell, E. L., R. M. Aherron, D. Fitz, G. Gross, J. Grunblatt and A. Morse, 1980. Monitoring Drought Impact from Landsat. Report No. 195i, NASA Contract No. NAS 5-25081, Colo. State Univ., Ft. Collins, CO.
- Pearson, R. L., C. J. Tucker and L. D. Miller, 1976. Spectral Mapping of Short-grass Prairie Biomass. Photog. Engr. & R. S., 42: 317-323.
- Salisbury, F. B., and R. V. Parke, 1970. Vascular Plants: Form and Function. 2nd Ed. Wadsworth Pub. Co., Belmont, CA.
- Saucier, Joseph R., 1979. Estimation of Biomass Production and Removal. Proc. of Symp. on Impact of Intensive Harvesting on Forest Nutrient Cycling, SUNY, Syracuse, NY.
- Thompson, D. R., and O. A. Wehmanen, 1979. Using Landsat Digital Data to Detect Moisture Stress. Photog. Eng. & R. S., 45: 201-207.
- Tucker, C. J., 1979. Red and Photographic Infrared Linear Combinations for Monitoring Vegetation. Rem. Sens. of Envir., 8: 127-150.
- Ungar, S. G., W. Collins, J. Coiner, et al., 1977. Atlas of Selected Crop Spectra. Imperial Valley, CA. NASA/GSFC, Greenbelt, MD.

**ORIGINAL PAGE IS
OF POOR QUALITY**

Table 1. SELECTED VEGETATION INDICES

Symbol	Name	Computation
7/5	7/5 Ratio	$(DN_7/DN_5) \times 30$
ND	Normalized Difference	$[(DN_7 - DN_5)/(DN_7 + DN_5) + 1] \times 125$
RND	Root Norm. Diff.	$[(DN_7 - DN_5)/(DN_7 + DN_5) + 1]^{1/2} \times 30$
6/5	6/5 Ratio	$(DN_6/DN_5) \times 30$
ND-6	Normalized Diff.-6	$[(DN_6 - DN_5)/(DN_6 + DN_5) + 1] \times 125$
RND-6	Root Norm. Diff.-6	$[(DN_6 - DN_5)/(DN_6 + DN_5) + 1]^{1/2} \times 30$

Notes: (1) DN stands for the digital number recorded by Landsat.
 (2) Band 5 --- 600-700 nm; Band 6 --- 700-800 nm;
 Band 7 --- 800-1100 nm.

**Table 2. COMPARISON OF INITIAL F-VALUES FOR THE VEGETATION INDICES FOR
FOUR DATA SETS (RANKED FOR EACH SET)**

Index	F-Values Rangeland	F-Values Crops	F-Values Crops & Range	F-Values Irrig. Hay	Mean Rank
7/5	614 (2)	1272 (5)	1930 (4)	220 (6)	4.25
ND	627 (1)	2314 (1)	1961 (3)	495 (2)	1.75
RND	540 (4)	1877 (3)	1998 (2)	368 (4)	3.25
ND-6	525 (5)	1769 (4)	1807 (5)	385 (3)	4.25
RND-6	606 (3)	2026 (2)	1699 (6)	554 (1)	3.00
6/5	517 (6)	1238 (6)	2036 (1)	204 (5)	4.50

**ORIGINAL PAGE 13
OF POOR QUALITY**

Table 3. AN F-STATISTIC EVALUATION OF THE SENSITIVITY OF THE ORIGINAL LANDSAT BANDS AND THE VEGETATION INDICES TO VARIATIONS IN SOIL COLOR

Variable	F-statistic
band 4	291.0
band 7	136.0
RND	15.6
RND-6	15.6
band 5	14.0
ND	13.9
7/5 ratio	13.5
6/5 ratio	9.4
ND-6	9.2
band 6	7.0

Table 4. ESTIMATES OF BIOMASS, USING THE ND INDEX, FOR PORTIONS OF THREE QUADRANGLES IN COLORADO

(All Values are in Kilograms)

Year	Earl ^a	Julesburg ^b	Weston ^c
1973	57,100,000	6,340,000	4,480,000
1976	16,500,000	1,720,000	2,520,000
1978	43,500,000	5,910,000	6,610,000

^a5,420 hectares of rangeland and irrigated hay.

^b1,960 hectares of rangeland.

^c1,020 hectares of mountain shrubland.

ORIGINAL PAGE IS
OF POOR QUALITY

**Table 5. COMPONENT DISTRIBUTION OF COMPLETE TREE ABOVE
GROUND FOR COMMERCIAL SIZED SOUTHERN PINES
GROWING IN NATURAL STANDS**

D. b. h. (cm)	Complete Tree Above-Ground Dry Weight (kg)	Proportion of Complete Tree Above Ground (%)		
		Stem	Branches	Foliage
15.2	83	75	20	5
20.3	175	78	17	5
25.4	319	81	15	4
30.5	497	82	14	4
35.6	729	83	13	4
40.6	1,022	84	12	4
45.7	1,382	85	12	3
50.8	1,817	87	10	3

ORIGINAL PAGE IS
OF POOR QUALITY

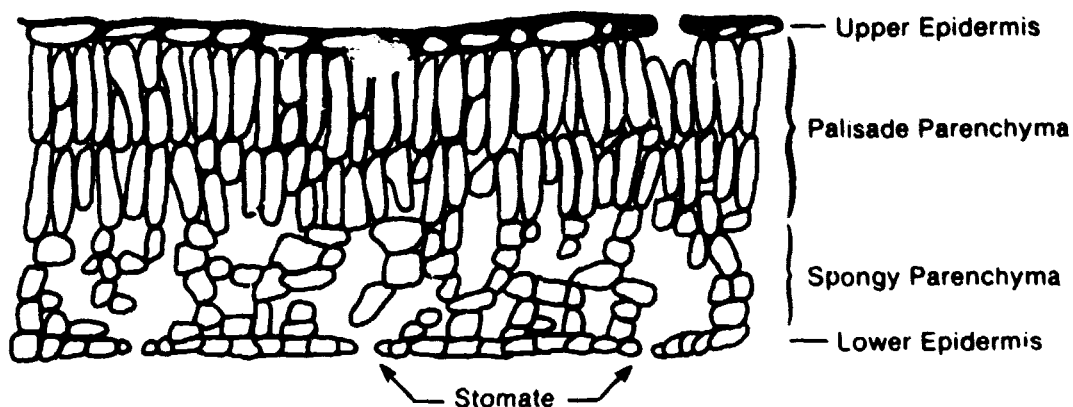

Figure 1. Typical Cross Section of a Leaf Indicating Internal Structure

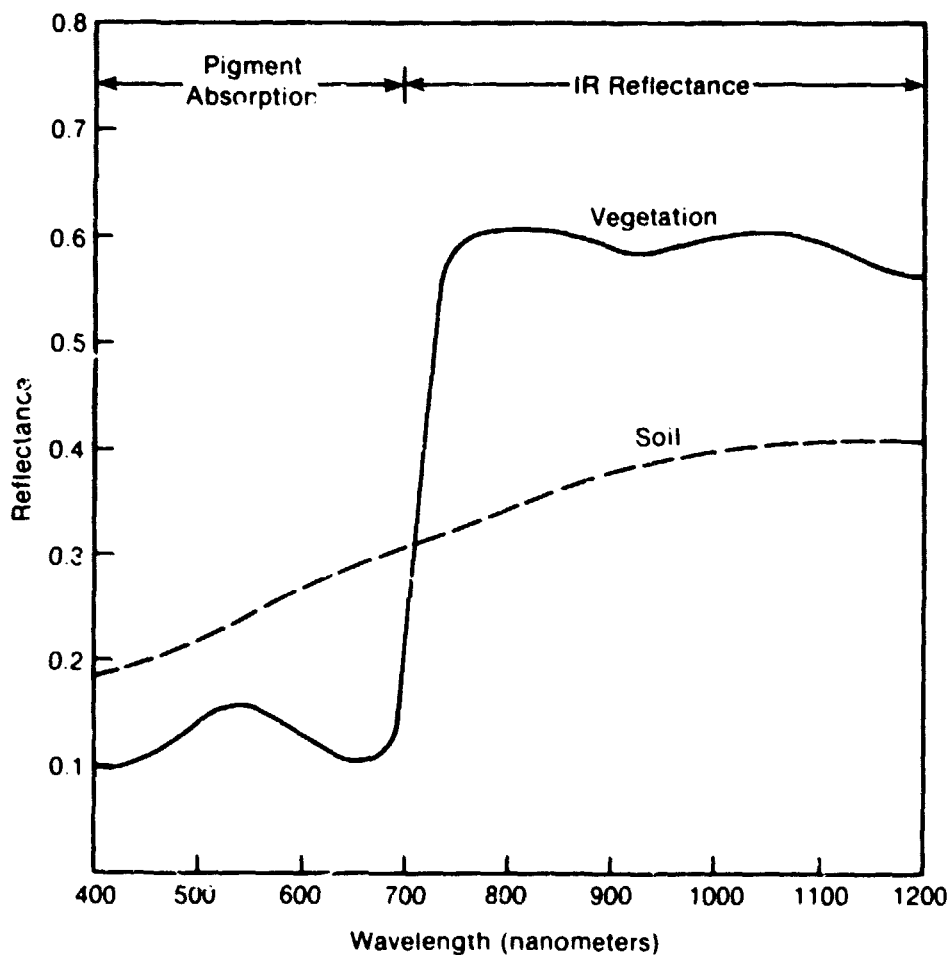

Figure 2. Typical Spectroreflectance Characteristics of Green Vegetation and Brown Silty Loam Soil. Note the chlorophyll absorption bands in the blue (400 - 500 nm) and red (600 - 700 nm) portions of the spectrum.

ORIGINAL PAGE IS
OF POOR QUALITY

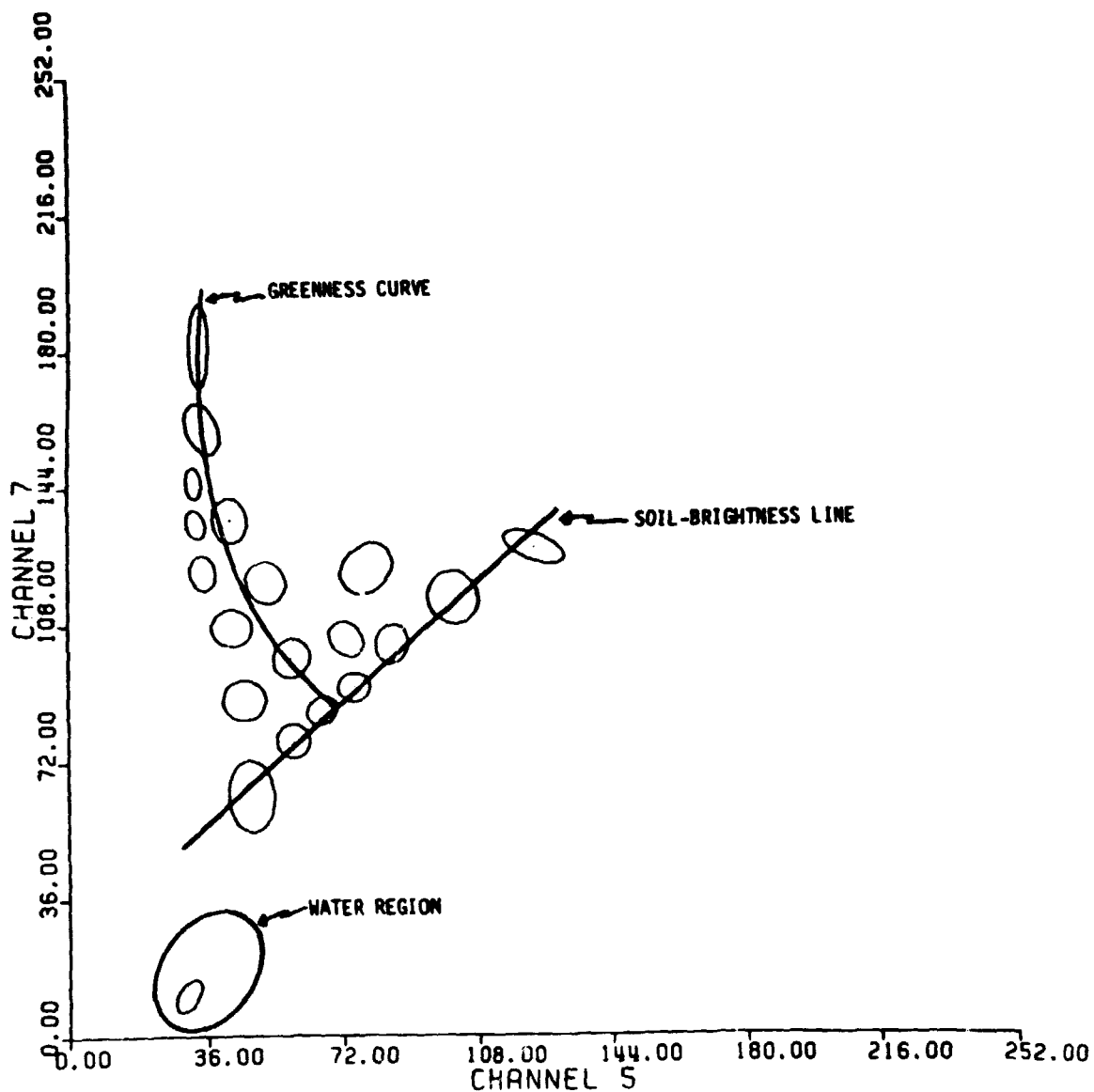

Figure 3. Spectral Clustering of Ground Cover in the Orchard, Colorado Quadrangle on August 16, 1978. See text for discussion.

ORIGINAL PAGE IS
OF POOR QUALITY

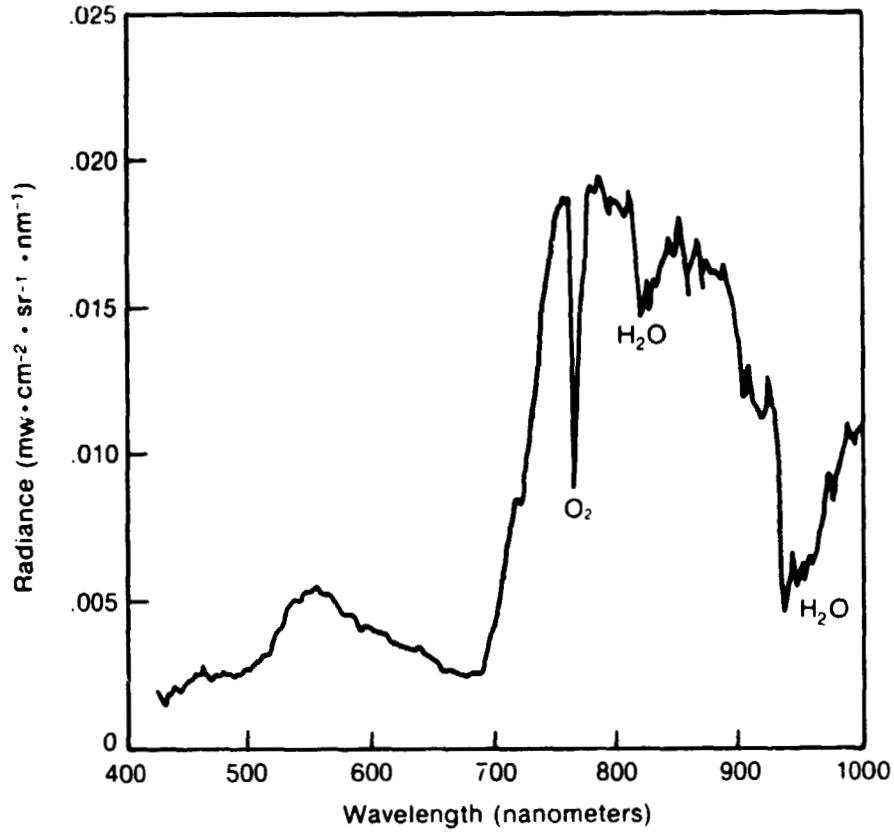
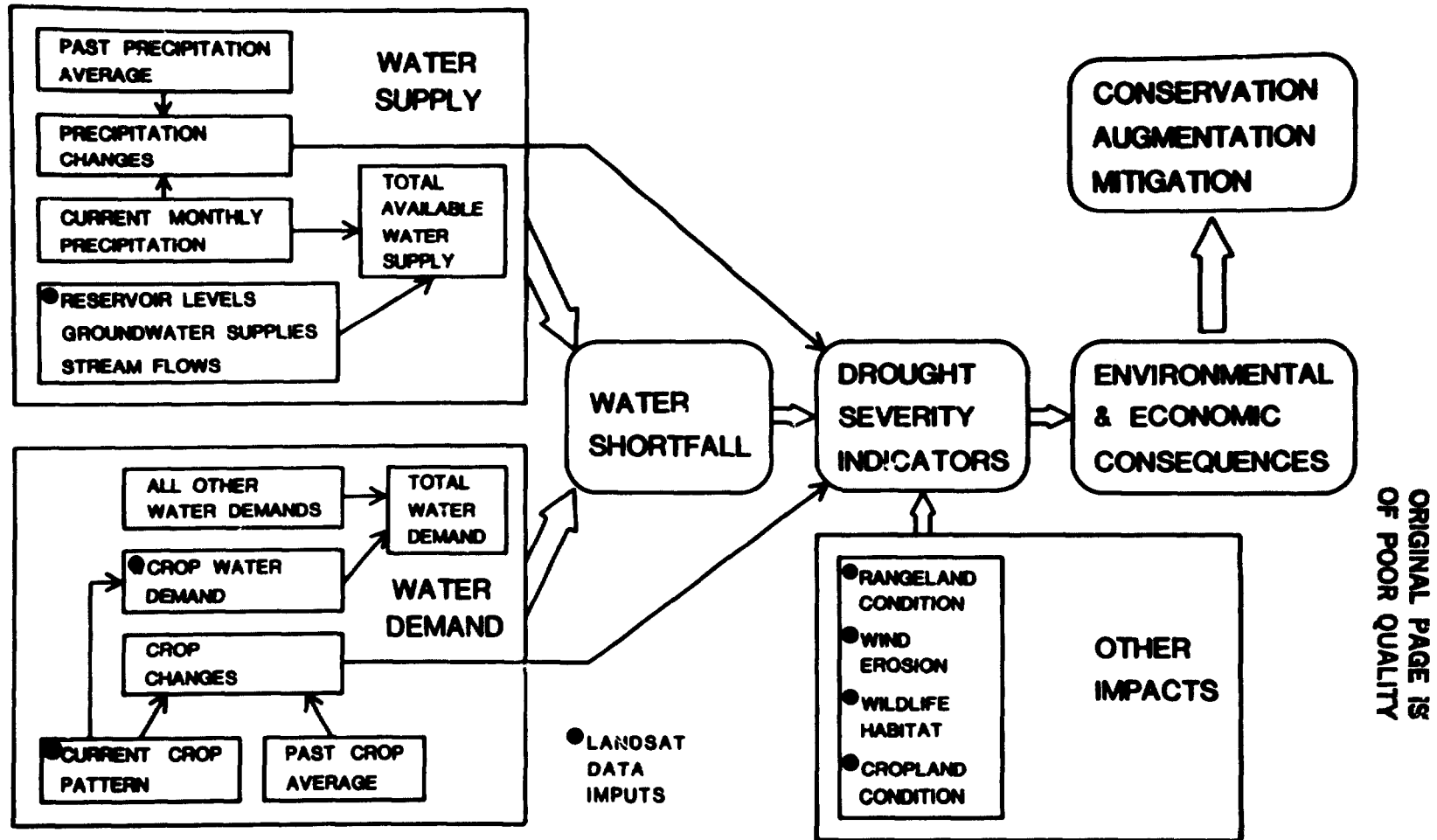

Figure 4. Spectral Radiance Characteristics of Sugar Beet Field in the Imperial Valley, California on May 15, 1975. (From Ungar, et al, 1977, annotations added.)



ORIGINAL PAGE IS
OF POOR QUALITY

Figure 5. Drought Assessment Framework Prepared by the Colorado Department of Agriculture and the Colorado Drought Council - 1977.

ORIGINAL PAGE IS
OF POOR QUALITY

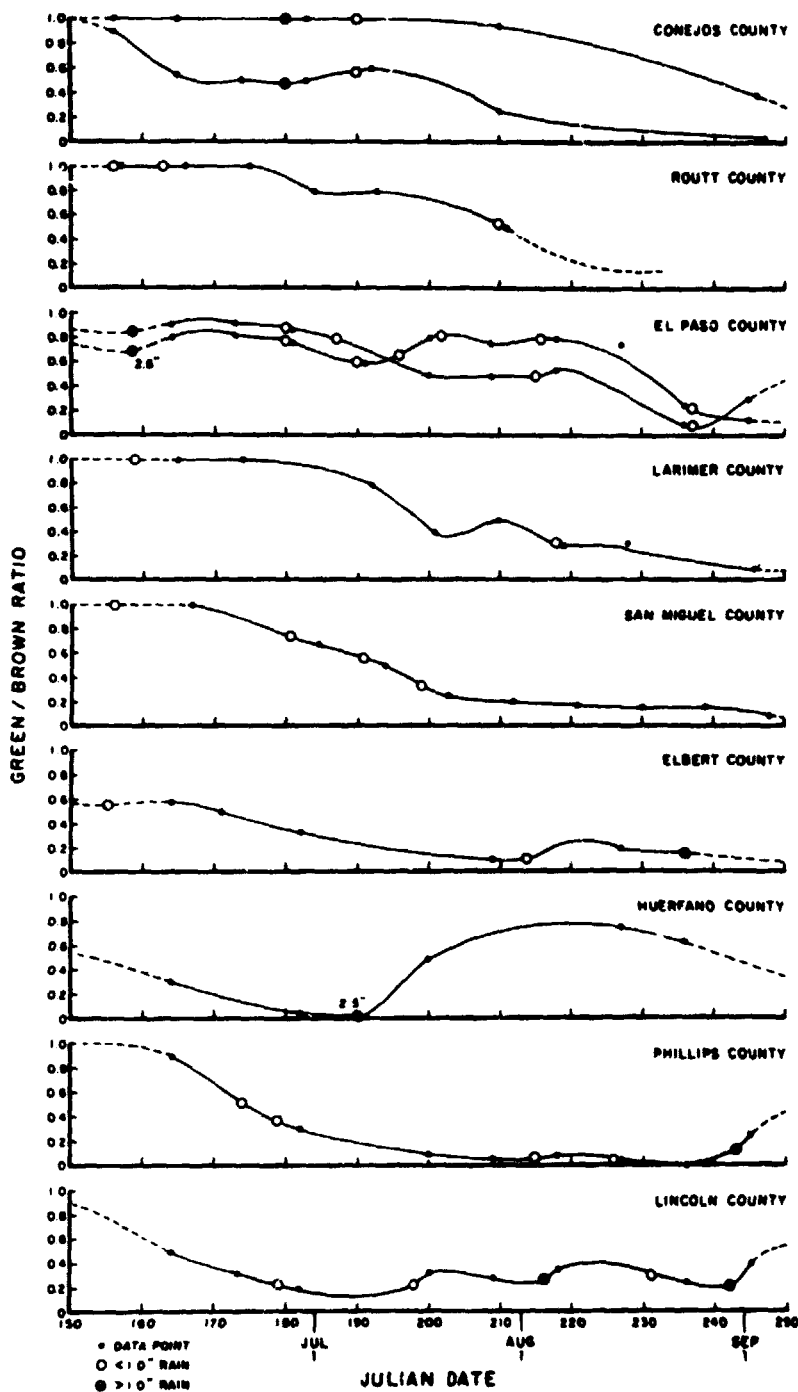
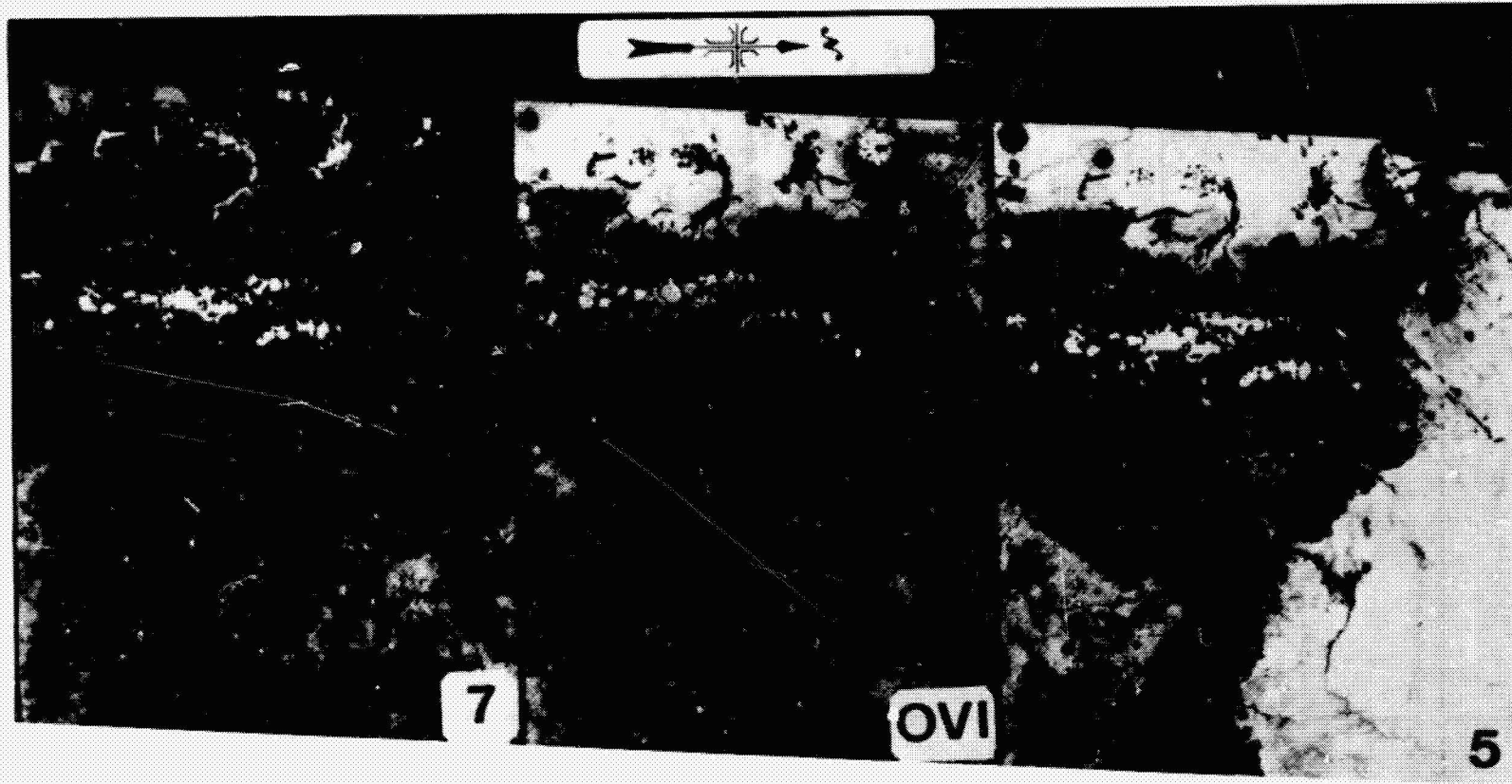

Figure 6. The Green-up and Senescent Cycle for Rangeland in Several Colorado Counties. Data from ocular estimates of field observers. The upper curve for Conejos County is from an irrigated pasture. All data from 1978; rainfall events were regional, not measured at observation fields.



ORIGINAL PAGE IS
OF POOR QUALITY

Figure 7. Positive Print from Landsat Bands 5 and 7 and an Optical Vegetation Index (OVI) Printed from a Sandwich of a Band 7 Positive and a Band 5 Negative. The image is centered on Trinidad in southcentral Colorado on August 6, 1978.

ORIGINAL PAGE IS
OF POOR QUALITY

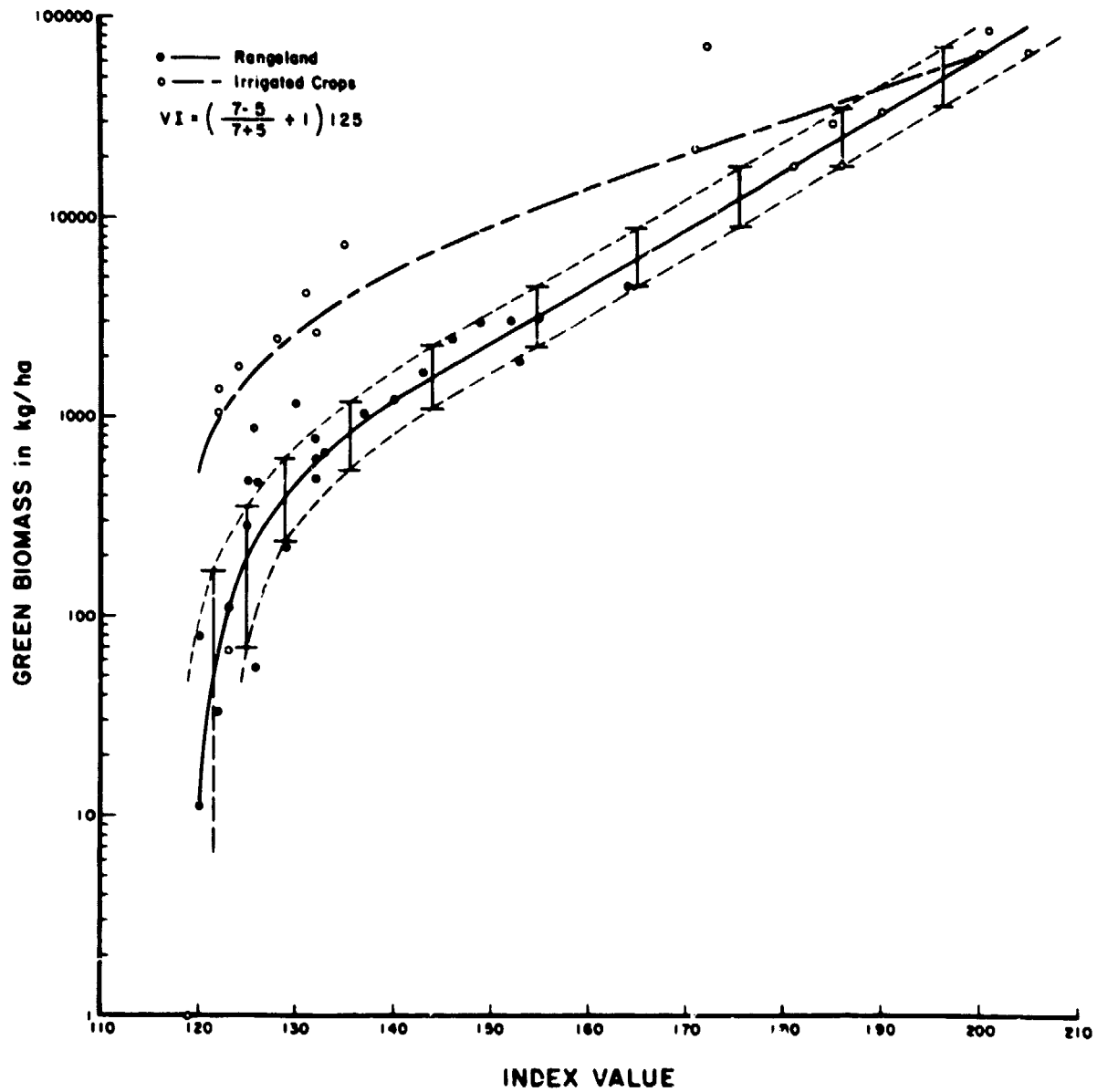

Figure 8. Green Biomass Versus the Normalized Difference (ND) Index. Data are from numerous fields in eastern Colorado and several image dates in 1973 and 1978. This composite "universal" curve ignores known differences of vegetation types. This will limit the absolute accuracy of biomass measurements.

ORIGINAL PAGE IS
OF POOR QUALITY

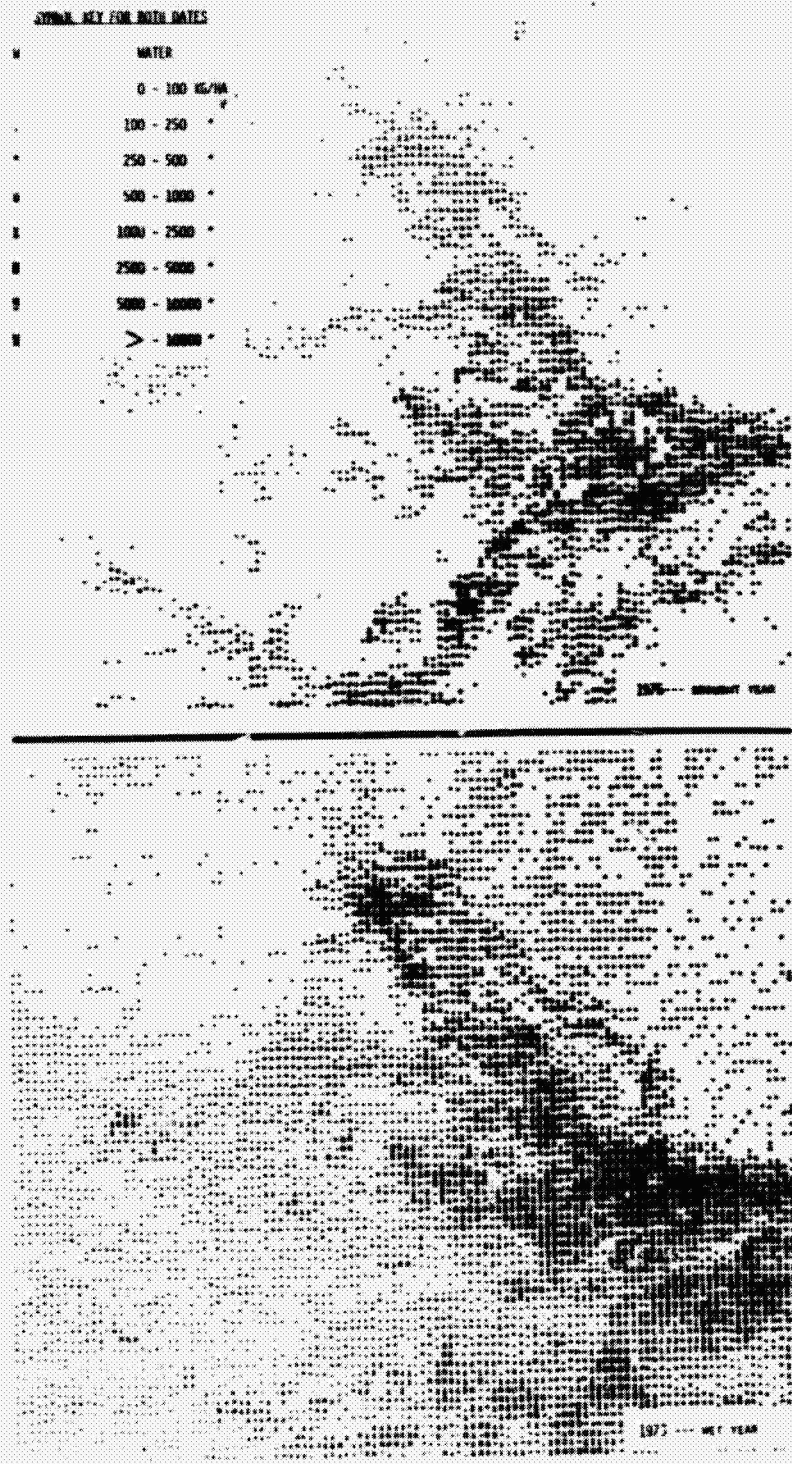

Figure 9. Computer-generated Graymaps of Nine Levels of Biomass in the Earl Quadrangle Near Trinidad, Colorado. Biomass ranges were based on universal curve shown in Figure 8. Highest biomass areas were irrigated hay fields.

N83 19149

27

REMOTE SENSING FOR FOREST APPLICATIONS

IN NEW YORK: TWO CASE STUDIES*

John A. Stanturf, Warren R. Philipson,
Lisa K. Balliett, and Karen L. Jahn
Cornell University

ABSTRACT

Under-utilized forest resources in the Northeast can supply fiber to new markets. Information on forest resources, however, is often too aggregated to estimate available woody material with sufficient detail for planning specific projects. Over the past year, staff of Cornell University's Remote Sensing Program, under a grant from NASA, assisted New York State agency personnel by assessing available woody material for two potential development projects, a wood-fired power plant and a particle board manufacturing plant. These feasibility studies are reviewed, illustrating how information derived from high-altitude aircraft photographs, Landsat imagery, and available supporting data were integrated to arrive at estimates of woody material.

INTRODUCTION

Cornell University's Remote Sensing Program is funded primarily by a grant from the National Aeronautics and Space Administration to the School of Civil and Environmental Engineering. Since the Program's inception in 1972, its staff has endeavored to strengthen instruction and perform research in remote sensing, building upon Cornell's thirty years of experience in aerial photographic studies. A primary activity of the Program is applied research. User-oriented projects are conducted at no charge to the user if the project involves a unique action- or benefit-producing application of aircraft or satellite remote sensing in New York or the Northeast.

Under-utilized forest resources in the Northeast, including New York where annual growth exceeds annual removal, can supply fiber to new markets without adversely affecting conventional timber markets. Over the past year, Program staff assisted New York State agency personnel with assessments of woody material for two projects, a wood-fired power plant in the Adirondack region and a particle board plant in the Southern Tier region. These projects are reviewed in this paper, illustrating how Program staff used remotely sensed and other data to meet the information needs of the users.

* The work described in this paper was supported by NASA Grant NGL 33-010-171.

ORIGINAL PAGE IS
OF POOR QUALITY

STUDY 1. WOOD-FIRED POWER PLANT

Uncertainty in petroleum cost and supply has prompted interest in alternative energy sources such as wood. In New York, the State Energy Office is considering the development of a ten-megawatt (MW) wood-fired power plant in the Adirondack region (Figure 1). One primary consideration is the availability of sufficient woody material. At the request of the State Energy Office, a study was undertaken to assess the potentially available woody material within an economic haul distance of Tupper Lake, New York.

PROBLEM AND APPROACH TO SOLUTION

Available information on forest resources is aggregated and dated. The smallest unit for which data are reported is a county, and at the time of the study, the most recent published inventory data were over ten years old. In order to estimate potential fuelwood stocks, it was necessary to (1) classify land as to its potential availability, using existing remote sensing data and supporting information; (2) identify, map, and measure area of forest cover types on the available land, using remote sensing data; and (3) derive fuelwood estimates in each cover type, using published mensuration data.

MATERIAL AND METHODS

Sources of Information

The available remotely sensed and supplemental data included several dates of high altitude, color infrared aerial photography, two Landsat color composite images, two land use maps of the Adirondack State Park, maps of industry-owned land, and 1:62,500 scale U.S. Geological Survey topographic maps (Table 1).

The Forest Survey of New York (1) was the primary source of available mensuration data. Average volume data for each county were calculated by forest type and used, along with an estimate of annual removals for the Northern Region. Estimates of gross annual growth, mortality, and cull percentage were obtained from a study of timber growth rates of natural stands in New York (2). The weight of branch material from tree tops was also estimated (3).

Land Classification Process

A land classification was established to exclude areas where whole-tree harvesting would be difficult because of legal or physical limitations. Land was excluded if it was nonforested, state-owned, wetland, or steeper than 15%. Industry-owned land was not excluded but assessed separately. Forest cover types were delineated as "dominantly coniferous," "dominantly deciduous," or "mixed coniferous-deciduous" on all potentially available (nonexcluded) land, including that belonging to industry.

The base map consisted of several 1:62,500-scale U.S. Geological Survey topographic maps. A circle of 30-kilometer (km) radius was drawn with the Village of Tupper Lake at the center. The 30-km radius was an arbitrary distance which was considered to be well within an economic haul distance. The total area within the circle was 282,600 hectares (ha).

Aerial photographic interpretation of four land cover types--wetlands, water bodies, forest, and nonforest, was done on acetate using the high altitude, color infrared aerial photographs. Boundaries were transferred to the base map using a Zoom Transfer Scope. Ownership maps were projected to the scale of the base map using an opaque projector, and boundaries were delineated on acetate. Slopes steeper than 15% were also traced onto sheets from the topographic base maps. Potentially available land was then determined by overlaying the different acetate sheets. Further interpretation of the aerial photographs and Landsat images allowed forest types to be separated and their areas subsequently measured with a grid.

Methodology of Fuelwood Estimation

The present growing stock volume and annual growth of the forest cover types was estimated by applying average per hectare values to the land base for growing stock volume and annual removals from the Forest Survey (1), and with data from other studies (2,3). The ability of the available wood resource to supply the power plant under different management schemes was then assessed, assuming average energy and moisture content.

Weighted averages were used in estimating gross volume from the Forest Survey (1) data. The Forest Survey data are recorded for entire counties or the region, while the study area included portions of four counties, and the Forest Survey data are reported by forest types more specific than the three general classes interpreted from the aerial photographs.

RESULTS AND DISCUSSION

Land Area Estimates

Thirty-seven percent of the land within 30 km of Tupper Lake, or approximately 1060 km², is forested land potentially available to supply wood to a power plant. Analysis of high-altitude color infrared photographs and Landsat images found this area to be composed of 51% mixed, 39% deciduous, and 10% coniferous forests.

Available Fuelwood Estimate

The amount of fuelwood potentially available was estimated several ways. The most conservative estimate assumed the availability of only "waste" wood--cull material and mortality. This was estimated to be 72,300 metric tons per year. Assuming suffi-

cient additional top and stump residue from sawlog harvests, there would be sufficient fuelwood within 30 km of Tupper Lake to supply a 10-MW plant without disrupting conventional timber markets. Detailed information on these estimates is available elsewhere (4).

STUDY 2. PARTICLE BOARD FACTORY

PROBLEM AND APPROACH TO SOLUTION

A particle board manufacturing firm is considering the development of a new factory near Bath, N.Y. A primary factor affecting the feasibility is the supply of conifers and low-density hardwoods. Available information on forest resources is aggregated (the smallest unit for which data are reported is a county) and dated (New York, 1970; Pennsylvania, 1965).

At the request of a special consultant to the New York State Commerce Department, Program staff undertook a project to estimate land area supporting conifers. This was done through interpretation of high altitude, color infrared aerial photographs and Landsat satellite images. The delineation of low-density hardwoods (e.g., red maple, aspen, and basswood) was not attempted as this would have required larger scale data, more ground data, or both.

MATERIALS AND METHODS

Sources of Information

A study area was defined as a circle with a radius of 30 km around Bath, N.Y. (Figure 1). Several dates of NASA high altitude, color infrared aerial photographs (scale approximately 1:120,000) were available for the northern half of the study area (Table 2). High altitude photographs were available for only a small portion of the southern half of the study area; however, several dates of Landsat images were on file. A winter and a summer Landsat scene were examined, and these not only covered the area of interest but overlapped the area imaged by the high-altitude photographs.

Procedure

Land areas in conifers were interpreted from the aerial photographs using a zoom stereoscope and tracing directly onto acetate overlays. Areas were tallied using a grid. The overlap of the aerial photographs and Landsat images was beneficial for developing spectral keys for interpreting the Landsat images.

For mapping conifers in the part of the study area covered only by Landsat, photographically enlarged positive transparencies of Landsat bands 5, 6, and 7 were placed in a color additive viewer and registered to provide a composite image at a scale of approximately 1:184,500. The color additive viewer allows blue, green, red, and white light to be shown through each of the transparencies

separately by the use of filters. The resulting false-color image displayed on a viewing screen can be interpreted in a fashion similar to the interpretation of the high-altitude photographs. Choice of colors, however, is arbitrary. The best discrimination of conifers was obtained with the winter scene lacking significant snow. When a green filter was used on band 5, blue on band 6, and red on band 7, conifers appeared as dark, reddish-purple. Acreage was tallied using a grid.

RESULTS

The total area in conifer stands within 80 km of Bath, N.Y., was approximately 71,250 ha. Thirty-eight percent, or 27,000 ha, are located in Pennsylvania.

COMPARISON OF THE STUDIES

The "user" in these studies, state agency personnel, had similar information requirements: location-specific, up-to-date estimates of forest resources for less than entire counties. These needs could not be met by existing forest inventory information. In other ways, however, the information requirements were dissimilar, as were the available data.

In the power plant study detailed information on the potential availability of forest stands was needed. Specific constraints, such as land ownership and slope, had to be considered and required that supplemental information be utilized. Although growth and yield data from published sources were used to estimate the fuelwood volumes, remote sensing methods could also have been applied if appropriate aerial volume keys were available.

In the particle board study, the only information requirement concerned the presence of particular tree species, specifically, conifers and low-density hardwoods. Because of their spectral properties, it was relatively easy to separate conifers (as a class) from deciduous vegetation, even at the small scale of Landsat.

The two studies differed also in the data available. High altitude aircraft photographs were available for almost the entire power plant study area but only for a portion of the particle board study area. Landsat data were available for both studies and were used to supplement the aircraft data on the power plant project but served as the primary data for the particle board study.

REFERENCES

1. Ferguson, R.H.; and Mayer, C.E.: The Timber Resources of New York. USDA Forest Service Resource Bulletin NE-20, 1970. Northeastern Forest Experiment Station, Upper Darby, Pa.
2. Ferree, M.J.; and Hagar, R.K.: Timber Growth Rates For Natural Stands In New York State. SUNY College of Forestry Tech. Publ. 78, 1956. Syracuse, New York.
3. Monteith, D.B.: Whole Tree Weight Tables For New York. AFRI Rept. No. 40, 1979. SUNY College Environmental Science and Forestry, Syracuse, New York.
4. Stanturf, J.A.; Philipson, W.R.; Balliett, L.K.; and Jahn, K.L.: Fuelwood Availability For a Ten Megawatt Power Plant In Tupper Lake, N.Y., Based On Remotely Sensed and Other Data. Remote Sensing Program, Cornell University, 1980. Ithaca, New York.

Table 1. Information Sources For the Power Plant Study

Date/Type/Source/Scale	Land Cover	Slope	Ownership
25 June 1979/Color Infrared Airphoto/NASA/ 1:118,000	X		
20 May 1974/Color Infrared Airphoto/NASA/ 1:116,000	X		
30 April 1973/Landsat Color Composite/NASA/ 1:1,000,000	X		
8 January 1973/Landsat Color Composite/NASA/ 1:1,000,000	X		
April 1979/Adirondack Park Map/ Adirondack Park Agency/ 1:175,000			X
September 1974/Adirondack Park State Land Master Plan/Adirondack Park Agency/ 1:268,000			X
1975-1976/International Paper Co. Forest Survey Maps/International Paper Co./ 1:65,500			X
1953-1955/15 Minute Topographic Maps/US Geological Survey/ 1:62,500	X	X	
1966-1970/7 1/2 Minute Topographic Maps/US Geological Survey/ 1:24,000	X	X	

**ORIGINAL PAGE IS
OF POOR QUALITY**

Table 2. Information Sources For the Particle Board Plant Study

<u>Date/Type/Source/Scale</u>	<u>Conifers</u>	<u>Location</u>
18 August 1978/Color Infrared Airphoto/NASA/ 1:116,000	X	
19 September 1973/Color Infrared Airphoto/NASA/ 1:130,000	X	
25 October 1973/Landsat B&W Positive Transparencies, Bands 5,6 and 7/NASA/Photographically Enlarged to 1:184,500	X	
1950/Army Map Service Topographic Maps/US Geological Survey/ 1:250,000		X

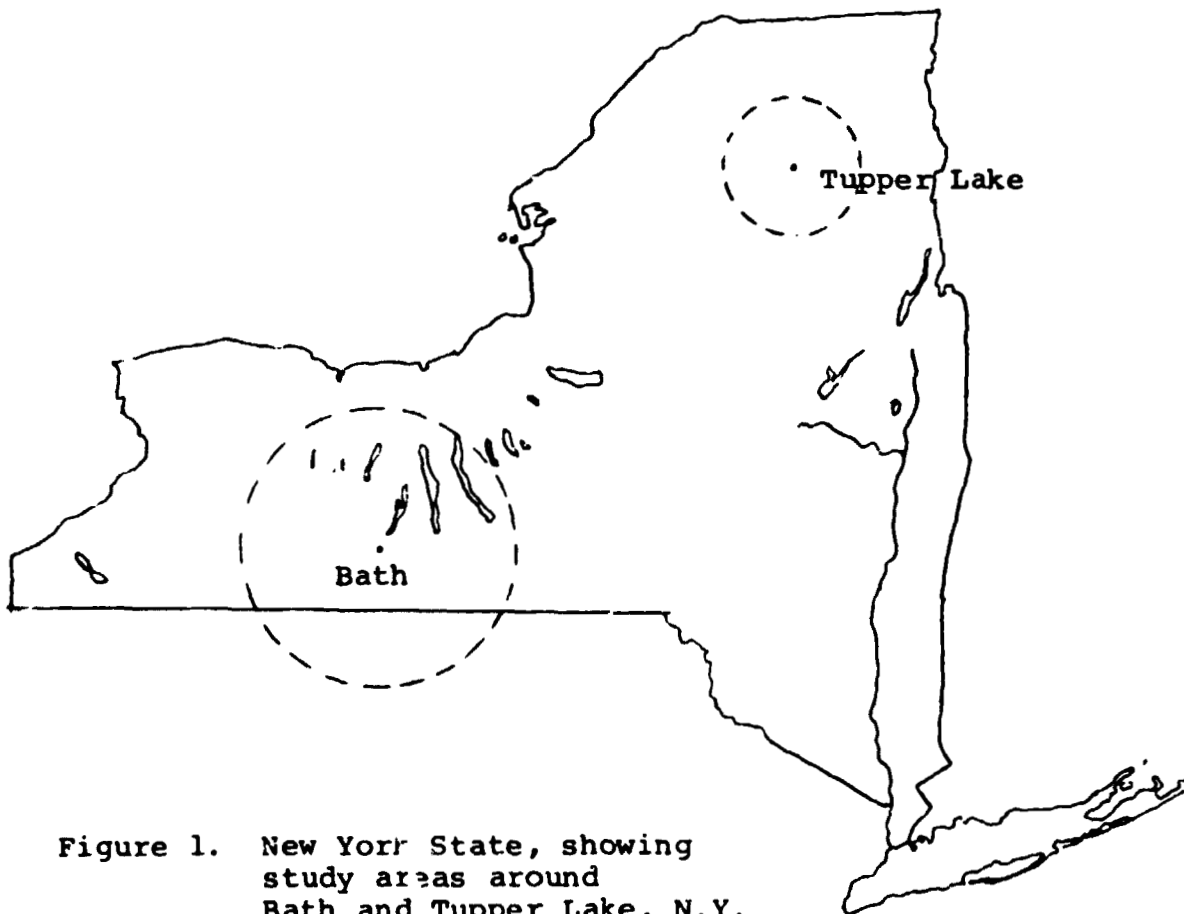

Figure 1. New York State, showing study areas around Bath and Tupper Lake, N.Y.

28
N83 19150

MAPPING FOREST TYPES IN WORCESTER COUNTY, MARYLAND, USING LANDSAT DATA

James Burtis, Jr. and R. G. Witt

ABSTRACT

The Worcester County, Maryland Forest Mapping Study was a cooperative demonstration project conducted by the Eastern Regional Remote Sensing Applications Center (ERRSAC), the Maryland Forest Service and Salisbury State College. The feasibility of mapping Level II forest cover types for a county-sized area on Maryland's Eastern Shore was demonstrated. A Level I land use/land cover classification was carried out for all of Worcester County as well. A June 1978 Landsat scene was utilized in a classification which employed two software packages on different computers (IDIMS on an HP 3000 and ASTEP-II on a Univac 1108).

A twelve category classification scheme was devised for the study area. Resulting products include black and white line printer maps, final color-coded classification maps, digitally enhanced color imagery and tabulated acreage statistics for all land use and land cover types.

INTRODUCTION AND BACKGROUND

The application of satellite data to forestry mapping and related management problems has been well documented in recent years. Historically, aerial photography has been the standard means of mapping and to some degree measuring forest resources. Satellite data have increasingly been employed in recent years to inventory large areas on a repetitive basis. Both public and private entities have undertaken forest inventories through digital processing of remotely sensed data. At least three states have conducted statewide surveys demonstrating the utility of Landsat data applied to forest resource mapping.

After reviewing some of the great variety of inventory studies in the literature, the consensus among most authors is that digital Landsat data provide good mappings (80% to 90% accurate) of broad forest types or Level II categories in most cases. Some factors cited as favorable in use of Landsat data are:

- availability of synoptic data for large areas
- relative objectivity of computer classification vs. air photo interpretation
- the possibility of using multirate imagery to improve single classifications

DATA SOURCES

A subset of one Landsat scene (June 11, 1978) was used in the digital processing and consisted of approximately 1100^2 pixels after preprocessing. High altitude color infrared photography from April 11, 1977 was used as one form of field information. A series of 1:24,000 topographic maps was also used for this purpose, as well as for digitizing the county boundary and ground control points. Further data were collected during field visits and additional information relating to recently harvested sites was encoded on maps by the Maryland Forest Service.

PROCEDURES

This forest cover classification project was executed in large part using the software package ASTEP-II (Algorithm Simulation Test and Evaluation Program, version II) on the Univac 1108 computer at the University of Maryland and at Salisbury State College. Most of the preprocessing (geometric correction) and post-processing (generation of final products) were done using the Interactive Digital Image Manipulation System (IDIMS) on the Hewlett-Packard 3000 computer at ERRSAC. All of the essential classification work, however, was carried out with the ASTEP-II software at the University of Maryland. Thus, the project demonstrates the use of an existing in-place data processing system available to Maryland state personnel.

DATA PREPROCESSING

The first step in preprocessing the digital data was to subset the county study area from the entire scene.

Geometric correction involved picking similar pairs of ground control points on both the image and the topographic maps, and thus relating image points to UTM coordinates. This is done by running a series of three programs after picking all points: ALLCOORD, which accesses the map points from a GIS file and locates them on a UTM grid with specified cell size (50 m. sq.); TRNSFM, which generates transformation equations relating map points to image points up to a third order, and allows manipulation of the points input; and REGISTER, which performs the actual image-to-map registration (rubber sheet stretch) according to the transformation equations.

Following the registration process, a transfer tape containing the geo-corrected data was prepared (IDIMS function TRNSFR) and taken to the University of Maryland Computer Center, where the bulk of processing was done.

DATA PROCESSING AND INTERPRETATION

Data processing was the most time-consuming stage because of the

number of steps involved and the importance of developing correct signatures used to map (classify) all land use and cover types. The following discussion explains the classification process, including details of the programs used in each step.

Selection of Intensive Study Areas/Windows

Areas within the subscene were selected for intensive study and copied from the transfer tape as disk files using DATDEF. At this point, substantive processing began. The program FACTOR was run on each window in order to obtain histograms of the data in each band. Once the histograms were examined and the data were divided into an appropriate number of classes, QUANTZ proved valuable both for locating intensive study areas and in developing initial statistics for the forest type categories.

Signature Development and Extraction

A number of methods were utilized to gain signatures for the final data classification. The simplest method was by adaptive clustering, an unsupervised classification routine. Examples of signatures developed are urban, extractive and shallow water though the urban signature underwent significant refinement.

A second method used to develop signatures was by FACTORing the results from a QUANTZ run band 5 grayscale map, which revealed patterns relating to the coniferous, deciduous and mixed forest types. This method led to a set of means for the forest types.

The third method used in extracting signatures was the polygon sequence of programs. This series of routines allows the user to derive training statistics from input polygons and to manipulate the polygons and the statistics which can be saved in separate files. This procedure was used to derive signatures such as bare fields, vegetated fields, and "other." It was also used to refine some of the signatures in the classification.

Once the set of representative signatures had been derived, a supervised classification DCLASS (minimum distance) was run for the intensive study areas. These were then evaluated, field-checked and refined before proceeding on to a classification of the entire study area.

Field Evaluation

The primary day-to-day source for correlative data was the high altitude, color IR air photography from April 11, 1977 or approximately one year and two months before the Landsat image data. Information derived from field visits was the other main source of ground truth data. The Maryland Forest Service county forester supplied a list of 44 timber sites with specific information on woodlot size, general composition and when

(if) the sites had been cut over. This information was added in the final stages of the classification to correct and refine certain signatures.

Overall Classification

The classification scheme includes twelve categories for the Worcester County study area. Three of these directly represent the forest land base within the study area. Coniferous forest cover is denoted as dark green. Deciduous and mixed forest covers are shown as light green and olive respectively. Vegetated fields are brown while bare fields are tan. Urban land and "other" are red and dark gray in color while nonwooded wetlands show as yellow. Three categories of water have been combined into two, one of which is deep water shown as dark blue. Light blue represents shallow and medium depth waters.

RESULTS

FINAL STATISTICS

Current published statistical data is normally used for comparison and in this project a recent publication entitled, "The Forest Resources of Maryland" 1980 (USDA Forest Service, Resource Bulletin-61) provides forest acreage figures by county. Worcester County forested acreage in this publication is 160,600 acres with a plus/minus sampling error of four percent. The results from this project when totaling the three forest categories in the classification show the forest acreage to be 175,000 acres. Several possibilities exist for the approximately 15,000 acre difference. Definitions are suspect, as well as basic sampling methodologies, and the difference in date of samples. No reliable countywide data on the amounts of pine, hardwoods and mixed forest types exist, but additional verification should give some indication of the accuracy of the acreage results obtained.

FINAL PRODUCTS

- Radiometrically enhanced and geometrically corrected false color images offering a view of the entire study area prior to and for use in the classification work.
- Thematic maps in the form of mylar overlays for 1:24,000 topographic quad maps, depicting all land cover and forest types.
- Tabular data relating project statistics to the U.S. Forest Service figures on hardwood/softwood/mixed acreages and also documenting status changes having occurred in timber harvest areas as of the image date.

C-2

VERIFICATION

The Maryland Forest Service will conduct systematic field evaluations of classification accuracy. This will entail utilizing thematic overlay maps at the topographic quad map scale of 1:24,000 which depict each of the categories in the classification. This representative sampling procedure will be carried out over the entire study area. Any discrepancies here will be investigated thoroughly to improve the classification for use in any follow-on projects.

CONCLUSIONS

It is apparent the project objectives have been met and the utility of the products will be most helpful in conducting forest resource planning and management functions at the county level. The validity of the data appears to be at acceptable levels, but final field verifications must be conducted as a proof.

Utilizing the repetitive nature of LANDSAT data and the classification system developed in this project study the future utility is more than promising. Monitoring forest and land use/land cover changes over time at the county level with resulting products as described above is a high priority need for the Maryland Forest Service. This cooperative demonstration project with ERRSAC is a major step towards that end.

REFERENCES

1. Beaubien, Jean. 1979. Forest type mapping from Landsat digital data. Photogrammetric Engineering and Remote Sensing, 45 (8) = 1135 - 44.
2. Bryant, Emily, Dodge, A.G., and M.J.E. Eger, 1979. Small forest cuttings mapped with Landsat digital data. 13th International Symposium on Remote Sensing of Environment, Proceedings, Vol. II 971 - 81.
3. Fox, Lawrence and K.E. Mayer. 1979. Using guided clustering techniques to analyze Landsat data for mapping forest land cover in northern California. 1979. Symposium on Machine Processing of Remotely Sensed Data, Proceedings - 364 - 7.
4. Hawley, D. L. 1979. Forest inventory of clearcuts utilizing remote sensing techniques. 13th International Symposium on Remote Sensing of Environment, Proceedings, Vol. III: 1385 - 1407.
5. Hoffer, R.M. and M.D. Fleming. 1978. Mapping vegetative cover by computer-aided analysis of satellite data. LARS Technical Report 011178, p. 11
6. Kalensky, Z. and L.R. Scherk. 1975. Accuracy of forest mapping from Landsat computer compatible tapes. 10th International Symposium on Remote Sensing of Environment, Proceedings, Vol. II - 1159 - 67.
7. Walsh, S. J. 1980. Coniferous tree species mapping using Landsat data. Remote Sensing of Environment, 9 = 11-26.
8. Williams, D. L. and L. D. Miller. 1979. Monitoring forest canopy alteration around the world with digital analysis of Landsat imagery. NASA Goddard Space Flight Center Report, p. 45.

ORIGINAL PAGE IS
OF POOR QUALITY

N83 19151

D9

EXTENDING THE UTILITY OF FOREST COVER MAPS

Joseph K. Berry and Aaron Mansbach
Yale University
School of Forestry and Environmental Studies

ABSTRACT

A computer-assisted map analysis system is discussed that characterizes timber supply in terms of standing timber; accessibility considering various harvesting factors; and availability as affected by ownership patterns of timberlands. Factors affecting harvesting include proximity to existing roads and consideration of terrain characteristics. Availability considerations include size of ownership, housing density and excluded areas. The model is demonstrated for a seventy square mile tract in western Massachusetts.

INTRODUCTION

The demand for timber stumpage throughout the United States has been increasing in recent years. This increased demand has stimulated new technologies such as whole tree chipping and special chip recovery operations during milling. Significant growth in the pulp and particle board industries has occurred and the potential use of chips to generate base load electricity may cause the demand to accelerate over the next decade.

The growing demand for wood chips necessitates the development of a new methodology for assessing roundwood supply. In the past, wood chip supplies have been dependent upon mill-oriented activities or self-sufficient pulping operations on large ownerships. Whole-tree chipping on diverse ownerships is the most likely source of additional supplies. Under these new demand conditions, it is important to identify sources of roundwood according to their spatial distribution throughout the supply area. One approach, identified by Berry and Tomlin (1980), assesses forest cover, harvesting accessibility and ownership characteristics so that timber inventory, harvesting costs, and owners' willingness to sell stumpage are integrated into an overall supply schedule. This paper describes the structure of a computer-oriented model for assessing stumpage availability based on this approach. The model spatially characterizes a supply

**ORIGINAL PAGE IS
OF POOR QUALITY**

curve in terms of:

inventory of standing timber;
accessibility considering various harvesting factors; and,
availability as affected by ownership of timber lands.

The model is demonstrated for a seventy square mile tract of land surrounding Petersham, Massachusetts. More extensive evaluations and model refinements are currently under way.

FUNDAMENTAL CONSIDERATIONS

Information on the extent and location of timber resources serves as primary input. This information can be extracted from several sources, such as existing forest cover type maps, color-infrared aerial photography or Landsat satellite imagery. Inventory information alone, however, may not yield accurate estimates of actual supply as affected by physical considerations. Many forested areas, for example, may be too remote from existing access routes for effective harvesting. Some areas may have highly erodible soils or steep slopes that would likewise make certain harvesting techniques inappropriate (Dykstra and Riggs, 1977). Such areas must be eliminated from consideration or the estimated supply will be too high. Social factors must also be considered before an adequate estimate can be made. Some extensively forested areas, such as park lands, may be legally excluded from harvesting. Of the remaining potentially harvestable areas, ownership characteristics, such as parcel size and housing density, can be used to determine propensity of owners to sell stumpage (Binkley, 1979).

SPATIAL DATA BASE

Data encoding, analysis, and display capabilities for this study were provided through the use of software developed at Yale University as part of the Map Analysis Package (Tomlin, in preparation). Information on the biological, physical and cultural features of a given geographic area is encoded to correspond with a grid cell data structure. Each grid cell is assigned a value which represents one member of a set of mutually exclusive categories (e.g., dry land, stream, pond, lake) (Tomlin and Berry, 1979). This process results in a series of computer-generated base maps, each depicting an individual characteristic with values displayed as unique symbols.

**ORIGINAL PAGE IS
OF POOR QUALITY**

Information used in this study is part of a general purpose data base being developed for the Harvard Forest vicinity. Each map represents 45,312 acres as 60 columns and 118 rows (6.4 acres per cell). The base maps for the model include: vegetation cover types, elevation, roads, ownership parcels and existing major structures.

CARTOGRAPHIC MODEL

Figure 1 is a flow chart of the supply model. It presents a logical sequence of Map Analysis Package operations represented as arrows which transform maps that are represented as boxes.

The model consists of three major submodels: inventory, access, and availability. The "inventory submodel" for this study transforms a vegetation cover map into a map of merchantable forested areas. The "access submodel" uses topographic slope and proximity to existing roads to develop a map of the areas accessible for harvesting. A map of topographic slope is generated from an encoded map of elevation. Areas of steep slope are recognized as adversely affecting harvestability. These slopes are considered by developing a map of weighted proximity to existing roads that treats steeply sloped areas as being "farther away."

The "availability submodel" considers ownership patterns in characterizing the propensity of owners to sell stumpage. The size of each parcel is determined from a map of ownerships and then ranked according to their overall acreage. Areas in large parcels are ranked as being "likely" to be available for harvesting. Similarly, areas with a relatively low housing density, as determined from the map of existing map or standards, are ranked as having a strong likelihood of being available. The submodel also eliminates from consideration any areas which prohibit harvesting.

The maps of harvesting potential and owners' propensity to sell stumpage are then combined with the map of forested areas to characterize the forest resource in terms of effective supply. Tabular summaries, as well as maps, can be generated to identify areal extent of all combinations of relative accessibility and availability of the various categories of merchantable forests.

INVENTORY CONSIDERATIONS

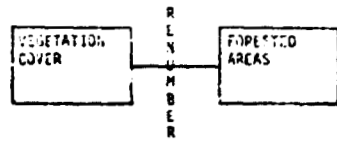

ACCESSIBILITY CONSIDERATIONS

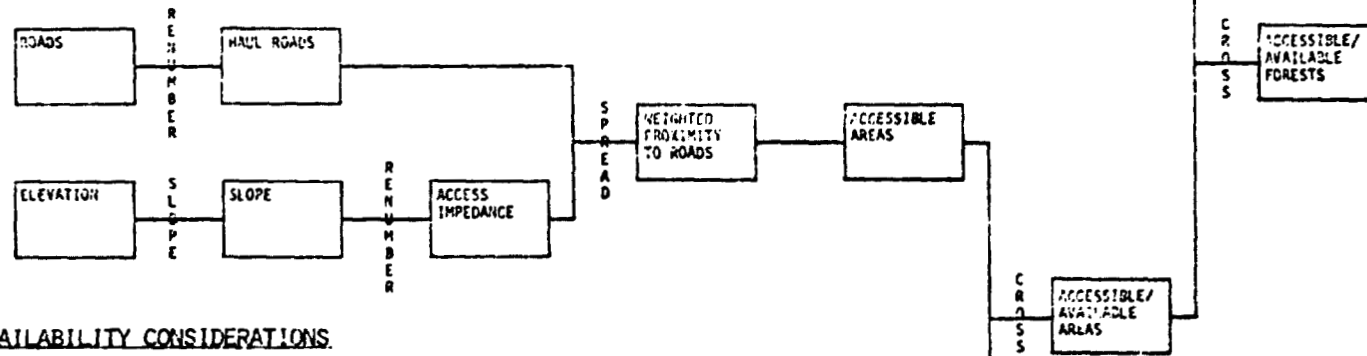

AVAILABILITY CONSIDERATIONS

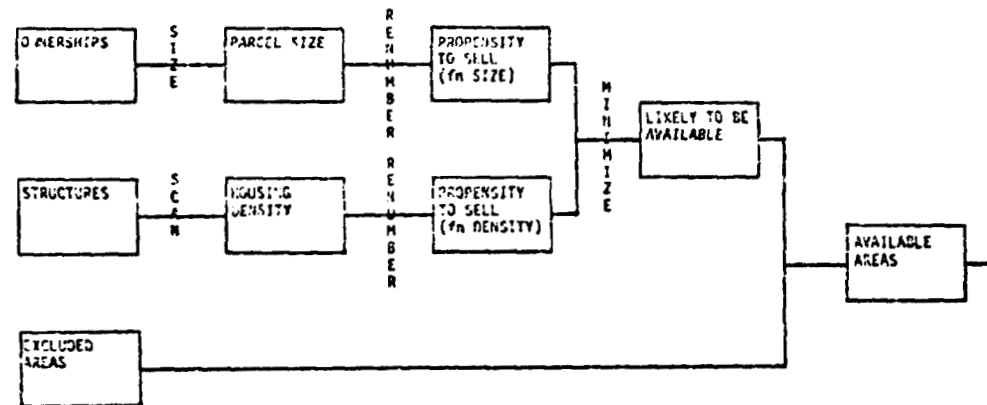

ORIGINAL PAGE IS
OF POOR QUALITY

FIGURE 1. FLOWCHART OF SUPPLY MODEL. The cartographic model of effective timber supply modifies Inventory maps in terms of harvesting access and the likelihood of being available as stumpage. In this flowchart encoded and derived maps are shown as boxes with fundamental map analysis operations indicated as lines.

DEMONSTRATION RESULTS

ORIGINAL PAGE IS
OF POOR QUALITY

The thirty-four vegetation types occurring in the Petersham area were collapsed to nine classes of merchantable forests (Figure 2). These areas comprise 83.6% (37,882 acres) of the study area. However, a large portion of these areas are inaccessible and/or unavailable under current engineering and economic considerations.

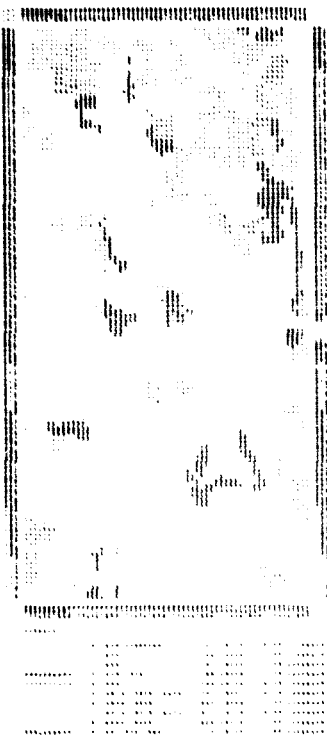

FIGURE 2. FORESTED AREAS. A map of vegetation cover was encoded and reclassified into nine categories of merchantable timber. These areas comprise all but 16.4% (7,430 acres) of the study area as noted in the summary statistics accompanying the map.

Figure 3 represents the important intermediate maps associated with the access submodel. Note the adverse effect of steep slopes in assessing weighted proximity to roads. In determining effective proximity, slopes of 11-15% were treated as moderately limiting, while slopes of more than 16% were treated as severely limiting harvesting accessibility. This analysis reveals that only 47.3% (21,446 acres) of the study area is within easy access of the existing road network.

Figure 4 shows the maps of the availability submodel. Ownership parcels of more than 480 acres comprise 37.4% (16,940

ORIGINAL PAGE IS
OF POOR QUALITY

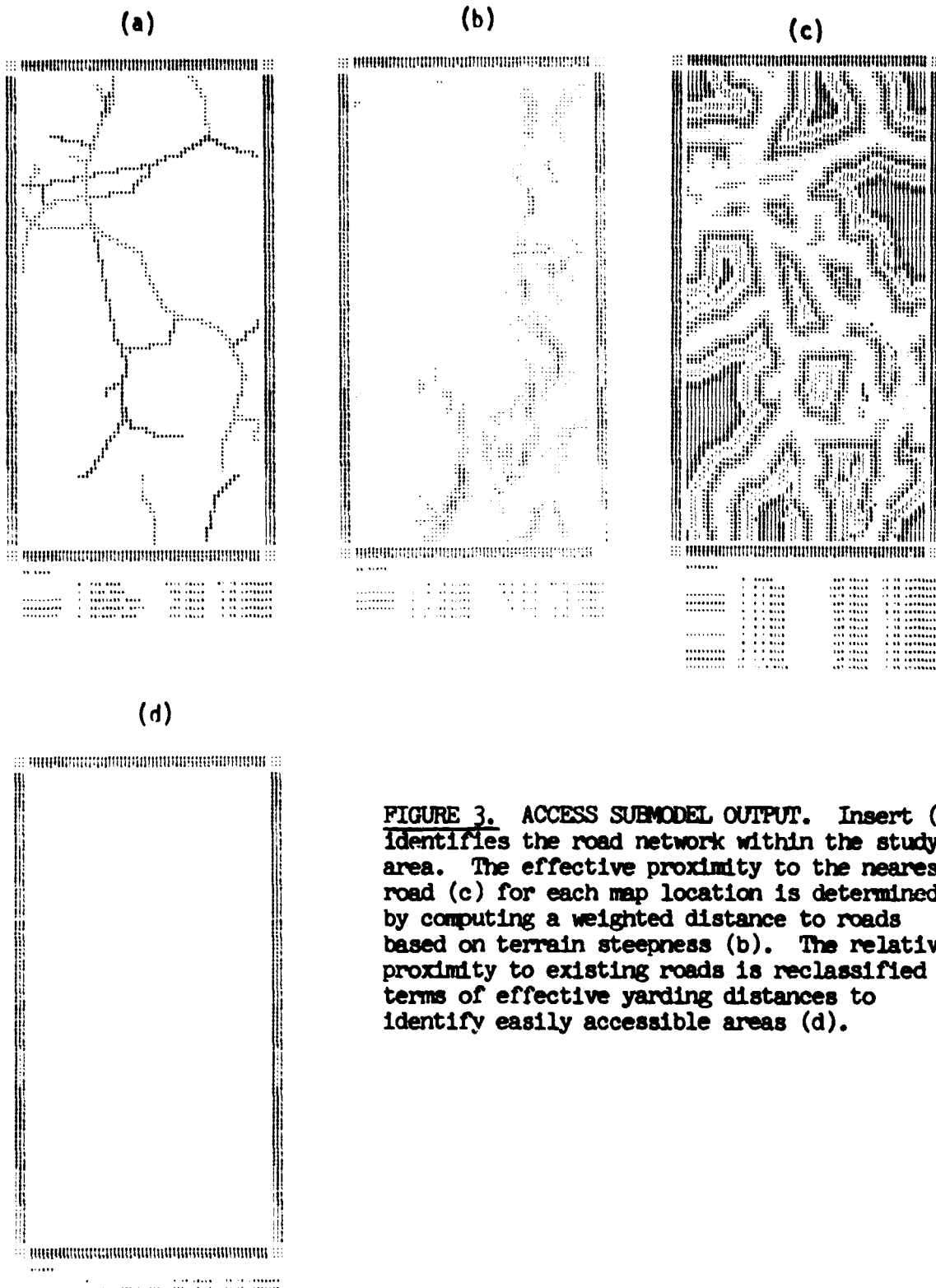

FIGURE 3. ACCESS SUBMODEL OUTPUT. Insert (a) identifies the road network within the study area. The effective proximity to the nearest road (c) for each map location is determined by computing a weighted distance to roads based on terrain steepness (b). The relative proximity to existing roads is reclassified in terms of effective yarding distances to identify easily accessible areas (d).

ORIGINAL PAGE IS
OF POOR QUALITY

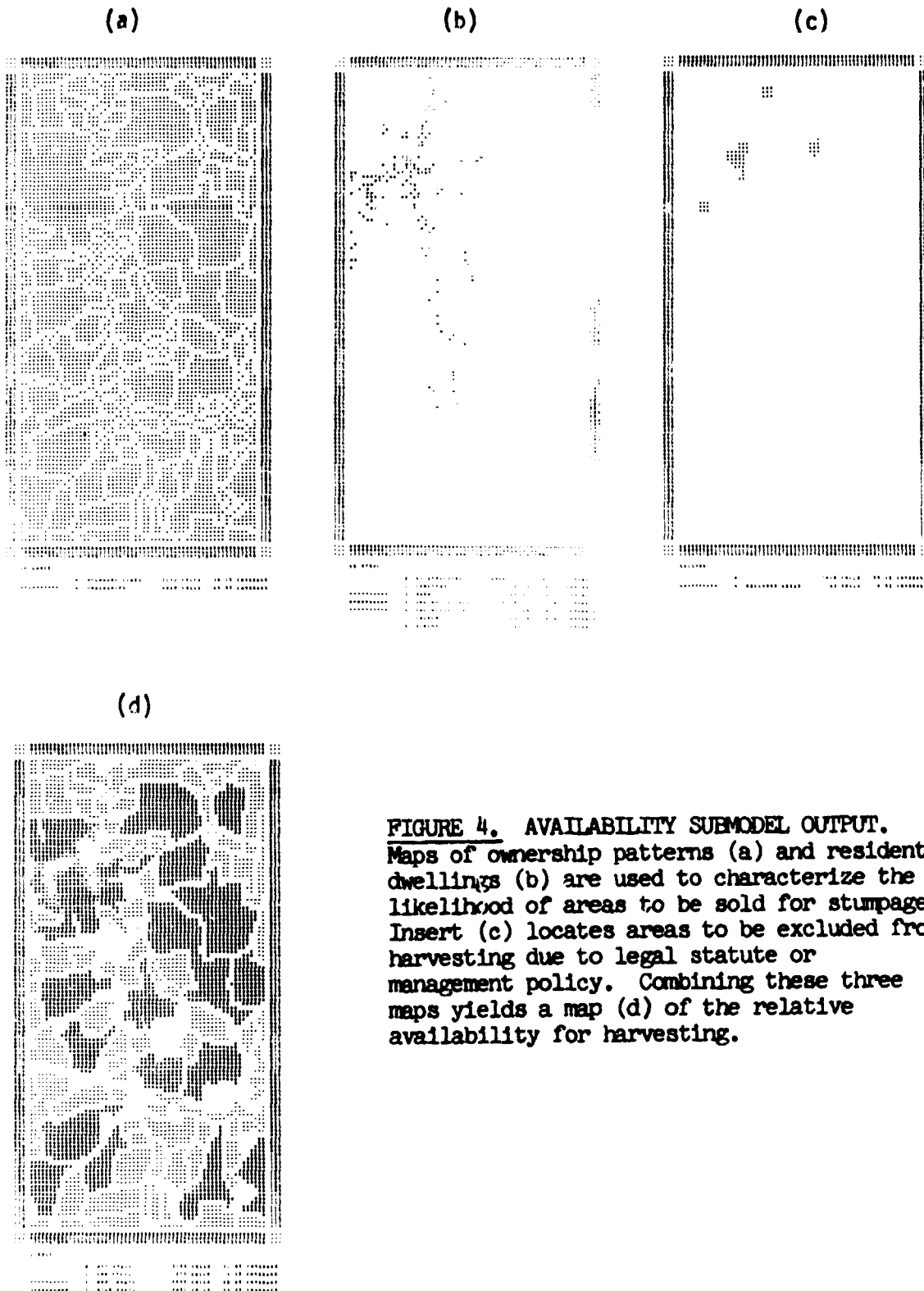

FIGURE 4. AVAILABILITY SUBMODEL OUTPUT.
Maps of ownership patterns (a) and residential dwellings (b) are used to characterize the likelihood of areas to be sold for stumpage. Insert (c) locates areas to be excluded from harvesting due to legal statute or management policy. Combining these three maps yields a map (d) of the relative availability for harvesting.

**ORIGINAL PAGE IS
OF POOR QUALITY**

acres) of the study area. These larger parcels can be considered as having a high probability of being sold for stumpage. Similarly areas of less than five structures per 0.2 square mile (approximately one house per 25 acres) are considered as being likely for sale. These relatively unpopulated areas comprise 97.0% (43,936 acres) of the study area. Combining these two maps creates a map of overall availability. This map identifies 35.2% (15,942 acres) of the study area as being likely to be available for stumpage. However some of these areas may actually be unavailable due to legal statute or management policy. In this demonstration areas to be excluded from harvesting include institutional areas (e.g., schools churches, etc.) and park lands. These comprise only 9% (396 acres) and are spatially coincident with populated areas in most instances. As a result the consideration of excluded areas only slightly decreases the "likely to be available" areas to 35.1% (15,916 acres).

The final phase of the model combines the information on access and availability for the merchantable forested areas. Figure 5 locates the forested areas that have good access and are likely to be available. Of the 37,882 acres of merchantable forests only 5,145 acres are in this desirable category. In addition, with the exception of a few tracts, most of these areas are well dispersed and relatively small. Table 1 summarizes the access/availability information for all of the forested areas. Maps similar to the one in Figure 5 can be displayed for any of the various combinations of accessibility and availability of the forested areas. The total amount of forested area which meets the minimum requirements of this analysis is 24,595 acres. The purely physical inventory of timberlands greatly overstated this acreage and offered no information as to the relative desirability and spatial distribution of the remaining land.

An advantage of computer-assisted map analysis is that once a model is developed and the appropriate data encoded, repeated simulation of the model using different calibration coefficients yields insight into the unique character of an area. For example, if effective skidding distance is extended from 0.5 miles to 0.8 miles and parcel size reduced from 480 acres to 250 acres, the highly desirable forested acreage increases from 5,145 to 8,326 acres. This method of sensitivity analysis can be used to identify the more important considerations as well as give a range of expected supply under various engineering and economic environments.

ORIGINAL PAGE IS
OF POOR QUALITY

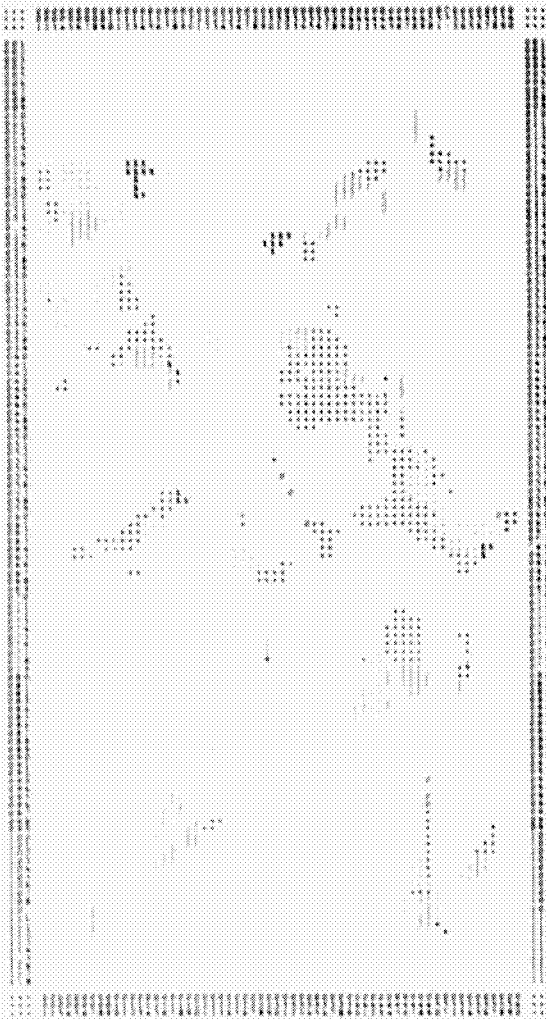

FIGURE 5. TIMBER SUPPLY. This map depicts the forested areas that are likely to be available (PRP-H) and easily accessible (PRX-E) by forest cover classes 1 - 9 (see Table 1). Although 84.6% of the study area has forest cover, this analysis shows that only 11.4% is in the most desirable category.

CLASS	PRP-H	PRX-E	AREA	PERCENT
1	PRP-H	PRX-E	10	0.46
2	PRP-H	PRX-E	10	0.46
3	PRP-H	PRX-E	10	0.46
4	PRP-H	PRX-E	10	0.46
5	PRP-H	PRX-E	10	0.46
6	PRP-H	PRX-E	10	0.46
7	PRP-H	PRX-E	10	0.46
8	PRP-H	PRX-E	10	0.46
9	PRP-H	PRX-E	10	0.46

TABLE 1. FORESTED AREAS BY ACCESSIBILITY
AND AVAILABILITY CLASSES

FORESTED AREAS**	TOTAL ACRES	ACCESSIBILITY/AVAILABILITY* (acres)									
		0	1/1	1/2	1/3	2/1	2/2	2/3	3/1	3/2	3/3
CLASS 1	678	147	0	134	0	0	128	77	0	0	186
CLASS 2	582	179	0	45	0	0	141	58	19	134	0
CLASS 3	1,203	733	0	6	154	0	26	115	64	70	45
CLASS 4	1,964	544	19	70	256	19	154	468	13	288	115
CLASS 5	1,869	736	13	70	90	0	122	269	58	115	390
CLASS 6	6,035	2,131	13	371	474	77	493	908	173	595	800
CLASS 7	11,974	3,648	19	602	576	147	1,062	1,933	352	1,152	2,483
CLASS 8	12,218	4,570	32	838	1,274	70	884	1,683	429	1,491	947
CLASS 9	1,376	608	19	51	6	0	256	13	96	154	173
TOTAL	37,891	13,286	115	2,187	2,830	319	3,266	5,524	1,204	4,005	5,145

* 0 - not accessible and/or available
 1 - low accessibility or availability
 2 - moderate accessibility or availability
 3 - high accessibility or availability
 for example, "1/3" means areas of low
 accessibility and high availability

** CLASS 1 - hardwoods; 41-60 ft.; 81-100% closure
 CLASS 2 - hardwoods; 61-80 ft.; 81-100% closure
 CLASS 3 - softwoods; 21-60 ft.; 30-80% closure
 CLASS 4 - softwoods; 61-80 ft.; 81-100% closure
 CLASS 5 - mixedwoods (S/H); 21-60 ft.; 30-80% closure
 CLASS 6 - mixedwoods (S/E); 61-80 ft.; 30-80% closure
 CLASS 7 - mixedwoods (H/S); 21-60 ft.; 30-80% closure
 CLASS 8 - mixedwoods (H/S); 61-80 ft.; 30-80% closure
 CLASS 9 - mixedwoods (uneven-aged)

ORIGINAL PAGE IS
OF POOR QUALITY

**ORIGINAL PAGE IS
OF POOR QUALITY**

CONCLUSION

The model serves as an excellent strategic planning tool. It locates general areas of likely accessible and available forests and provides insight into the significant factors affecting potential supply. The analysis, however, is not intended to provide output useful to the harvesting crew. Rather it is intended to better indicate actual timber supply than conventional inventory-driven procedures.

ACKNOWLEDGEMENTS

The research described in this paper was supported by grants from the General Services Foundation and the Northwest Area Foundation.

REFERENCES

- Berry, J.K. and C.D. Tomlin: A Cartographic Model for Assessing Roundwood Availability. In WOODPOWER: New Perspective in Forest Usage, Pergamon Press, 1981.
- Binkley, C.S.: Timber Supply from Private Non-Industrial Forests: An Economic Analysis of Landowner Behavior. Doctoral dissertation Yale University School of Forestry, New Haven, Connecticut, 127 pp, 1979.
- Dykstra, D.P. and J.L. Riggs: An Application of Facilities Location Theory to the Design of Forest Harvesting Areas. Transactions of the American Institute of Industrial Engineers 9(3): 270-277, 1977.
- Tomlin, C.D.: Digital Cartographic Modeling Techniques in environmental planning. Doctoral dissertation, Yale School of Forestry, New Haven, Connecticut, in preparation.
- Tomlin, C.D. and J.K. Berry: A Mathematical Structure for Cartographic Modeling in Environmental Analysis. Proceedings of the American Congress on Surveying and Mapping, 39th meeting, pp. 269-283, 1979.

D10

N83 19152

ORIGINAL PAGE IS
OF POOR QUALITY

USE OF LANDSAT FOR LAND USE AND HABITAT
INVENTORIES FOR THE NEW JERSEY PINELANDS

Celeste Tracy
Office of Green Acres
New Jersey Department of Environmental Protection
Trenton, New Jersey

With a need for providing natural and cultural resource information of the state, the New Jersey Heritage Program surveyed available mapping information on landcover and vegetative communities. Most commonly used sources, such as local land use maps and aerial photographs, were seen as being useful for individual sites, but either varied in their classifications or could not be used over extensive areas.

While the Heritage Program was in its formative stages, early in 1979, we decided that the program embark on a demonstration project using Landsat satellite information for the Great Egg Harbor Watershed.

The Landsat demonstration project was initiated with the goals of application (providing an inventory of vegetative communities and land use); flexibility (providing a method of collecting data which can be updated or modified in the future); and efficiency (allowing for an acceptable cost level by having staff undertake the project and avoid more costly methods from air photo interpretation or on-site surveying).

STUDY AREA

The Great Egg Harbor/Tuckahoe Watersheds were chosen as the study area for two reasons. First, the New Jersey Wild and Scenic Rivers Program was going to examine that area for its consideration in the Program. The river or sections of the river would need to be classified as wild, scenic, recreational, or developed recreational. To do that, it needed landcover information. Secondly, the New Jersey Pinelands Planning Commission and the Pinelands National Reserve both required the identification of critical natural areas. Even though these two programs were conducting inventories, it was felt that a demonstration project could provide additional information on some areas, and at the same time, those programs would provide data that could serve as accuracy checks for the demonstration project on other areas. In the long run this double checking proved to be very useful for all the programs.

The area of the Great Egg Harbor Watershed, including that of the Tuckahoe, encompasses approximately 450 square miles in southern New Jersey between Philadelphia and Atlantic City (Figure 1). Located in the Atlantic Outer Coastal Plain Physiographic Province, the topography is flat to gently rolling. Ecologically part of the Pine Barrens, vegetative communities include mostly salt and freshwater marshes, swamp hardwoods, cedar bogs, pine dominant, and oak dominant forests. Fire due to both natural and man-made causes has greatly influenced the vegetation of the area. Because the dominant pitch and short leaf pines are very tolerant to fire, they have remained in many forested areas which might otherwise have been destroyed.

100

**ORIGINAL PAGE IS
OF POOR QUALITY**

The Great Egg Harbor and Tuckahoe Rivers, both draining into Great Egg Harbor Bay on the Atlantic Coast are the major surface water systems. Looking at any U.S.G.S. topographic quadrangles one notices a high degree of wetlands in the watershed. These wetlands are primarily classed as palustrine because of the dominance of swamp hardwoods (e.g., trident red maple, black gum), pitch pine, and to a much lesser extent Atlantic White Cedar.

PROCEDURE

The final classification used was not in all cases what was first worked with. During the course of the project, cover types were added or eliminated depending on the ability of the scanned data to pick out certain covers. Despite shifts in class definition, any changes made still reflected a principal need of habitat and surrounding land use delineation. Forest cover types were classed so that they would be consistent with those used by the Pinelands Commission. The final classification consisted of the following cover types:

1. Agriculture - consisting primarily of row crops, orchards, and blueberry farms. The most characteristic feature was the perception of distinct rows.
2. Field/Pasture - primarily agriculture for dairy and horse farms, but also including abandoned fields, golf courses and large lawns.
3. Developed - urban and suburban areas, major roads, railroads, and developed clusters such as for farms or public buildings.
4. Bare Soil - included to distinguish sand and gravel pits.
5. Pitch Pine Lowlands - The class was a catch-all for areas in which pines form a dense canopy.
6. Pine-Oak Forests - forests in which pines are dominant with some oaks or noticeable oaks in the understory. The Pine-Oak Class also covers recently burned areas in which pitch pines have mostly remained with lesser regeneration of oaks.
7. Oak-Pine Forests - Mixed oak dominant forest, found with these oak dominant communities are pitch pines.
8. Hardwood Swamp Forest - as indicated by the name, this is a lowland forest type, distinguishable by trident red maples, sweet gum and black gum.
9. Wetlands - nonforested wetlands, either tidal or fresh
10. Tidal Marsh - a catch-all classification for wet areas which are, predominantly tidal.

**ORIGINAL PAGE IS
OF POOR QUALITY**

With a one-week training session at Goddard, initial classification work was started with ORSER on determining general groupings of spectral values. We worked with three potential scenes from 1978 to see if one or more was suitable for giving a relatively accurate cover classification. A November scene did not produce easily defined "classes" and was not used. An early April scene produced much more clearly defined images for forested areas. A mid-June scene appeared suitable for some developed areas. After working with ORSER and finding out which of three scenes was suitable for our purposes, we switched to using IDIMS with the help of NASA, concentrating first on the April scene, and finally to a combined data set from April and June.

Besides combining our data sets, we also used a combined supervised and unsupervised classification. For our total twelve categories we relied on 45 separate isoclasses which each exemplified particular subgroupings of a category, or were just good examples of what we thought were a category. For example, for the agriculture category, we selected eleven different sample areas which were either orchards, or in blueberry, grain, and truck farming production. Several modifications to our classification map were made as we encountered problems along the way and were doing some spot checking of areas which appeared to be blatant errors or at least questionable. For example, we knew of one large blueberry field of approximately 600 acres which we had assumed to be all fields. Our initial classification for the area showed some developed pixels. Knowing that there have been problems distinguishing between fields and developed areas in other studies, we assumed those pixels to be incorrect and changed them. However, once we went down to that area, we found that the developed classification was correct as there were several barns and storage areas within the field itself. We then had to go back to the original classification which was correct in the first place.

NASA supplied us with our final products which consisted of large color prints of the whole study area and also a series of three overlays of cover for the ten U.S.G.S. 1:24000 quadrangles which covered the Great Egg Harbor Watershed and surrounding areas. Geometrically corrected, these overlays proved to be very useful for determining cover types and locating cover types in relation to other features noted on a quad.

Once we were fairly satisfied with what we had, we then assessed certain areas to get a more definitive degree of accuracy besides just good, o.k., or bad. We chose six sample areas to concentrate on, ranging in size from $\frac{1}{4}$ square mile to two miles. These were chosen with the help of the Remote Sensing Class of Mr. Ray Mueller at Stockton State College who performed detailed on-site inspections of all of them. The sites were chosen because they were largely representative of certain categories, combinations of several categories, or anomalies. One of these anomalies included a forested area which had been burned only a few years before our 1978 scenes. We were curious to see how accurate forest statistics were for this area as compared to healthy stands. Besides the Stockton students' surveys we also checked the areas against 1972 U.S.G.S. quadrangles; The Pinelands Commission Vegetation Maps which relied mostly on an interpretation of aerial photos from 1979, but

in some cases from 1963; and 1:35000 false color infrared photos from 1977. For the accuracy assessment, we developed "confusion matrices" of all six sample areas, and using the ground truth sources, compared every pixel to the corresponding cover type. Although, this was an extremely tedious process, the tables were very useful for showing not just correctness or errors, but also where mistakes were made for one cover type against every other one, and also for showing errors of commission and omission.

RESULTS

The project area of approximately 525 square miles showed that 61 percent of the total area was forested. Of that, Oak/Pine Forest was the most dominant cover type, being located in upland areas. In the absence of fire, this forest cover is considered to be a climax cover type. Hardwood swamps can easily be sighted along stream corridors, or are otherwise found in areas which have high water tables.

Of all the developed categories, agriculture is the most dominant use and has mostly been located either on the upland or borders of the watershed; or in the northern part, closer to the Philadelphia metropolitan area. In most cases, row crop agriculture near lakes was the result of cranberry bogs being filled in for blueberry cultivation. Agriculture also appears to be a landcover in which fields are largely concentrated together with other agricultural lands. There are very few examples of tracts scattered through forested areas or located along roadways. Field and pasture areas, however, follow roads and show a fairly random distribution throughout the watershed. Through site inspections it was found that several fields were actually abandoned agricultural lands, since grown over.

Although much of the study area is lowland, only five percent was actually identified as being wetland areas and almost nine percent water. These particular areas were distinguished from other wet areas, such as the hardwood swamps, by either being marsh areas which are partially flooded, bogs, or flooded forest areas which were clear cut or burned. Much of the study area included in the water grouping was in the Great Egg Harbor Estuary.

CONCLUSIONS

Analysis of these results provided a mixed bag of conclusions about the accuracy of our classification maps, but on the whole, the results were positive.

In meeting our goal of providing an inventory of vegetative communities and land use we had specific problems which related either to a problem of a cover type, the area, or the scene. Misidentification is probably the first problem noted and we had several, although they related back to the specific areas or the scene. Water is generally identified with a great deal of accuracy, although for one of our areas, the accuracy rate was only 52 percent. What appeared to happen was that in the absence of a cloud shadow class, low spectral values which would have been assigned to shadow were grouped into the next best thing, in this case being water.

As I had mentioned before, some of our sample areas for ground truthing were chosen because they were anomalies. One of these included the Atlantic City Race Track and a surrounding forest. Except for the lawn and pond in the middle of the track, the entire track, grandstand, and stable area were classed as agriculture. The only reason we could think of as to why this happened was that the whole pattern of landcover was that of alternating rows of light and dark reflectance, similar to that of row crops, but on a much larger scale. Our other anomalous area was that of a burned area of approximately 1.5 acres. Looking at our infrared photos, we saw very clearly where the roads on five sides acted as fire breaks, with surrounding forest covers as deciduous (predominantly oak-pine), but with the interior area noticeably coniferous. The Landsat classed image, when ground truthed to the infrared photos showed a high error rate for all forest categories. Where a normal or accurate contingency table would have a diagonal line, indicating that the Landsat classification matched the ground truthed sources, this table literally showed a confusion of pixel counts being spread throughout all classes except wetlands and water. Major categories of cover (forests, developed, aquatic) were grouped correctly, but when looking at hardwood forests or pine/oak forests, the correctness was very low for this area. The quality of the stands themselves was very low, reflecting an ecosystem recuperating from a fire which destroyed much of the vegetation. Because of the fire, a normal forest growth pattern did not exist. What trees remained as canopy were largely the pines, but over the last few years, hardwoods and oaks were beginning to fill in the shrub layer in some parts. In other parts which were burnt but not undergoing a great deal of shrub growth, the classes were largely correct and the error was less than nine percent.

The April scene could have been a major problem because of clouds. There was a large cloud which was accounted for, but there were also much smaller clouds in the scene that were not easily identified in the study area. This did account for some errors in classification, largely mixing clouds with agriculture for some areas, and shadow with water, as I noted before.

The one cover type that we wanted but couldn't get was Atlantic White Cedar Bogs. For using Landsat to identify critical areas they posed as a classic Catch-22 example: they are largely diminishing in the state and therefore considered a critical natural category. But because they are so small, they could not be safely identified in our study area. What resulted was that those we knew of were grouped in either with wetlands or pitch pine lowland categories.

In the long run, the positive results outweighed the negative, and even those had ramifications for better results in the future. For one thing, there are new acreage figures for landcover in the watershed. A big advantage of having data in a pixel or rectangular format is that it is easy to tabulate. If we want to use Landsat for change detection in the future, we will have a numerical base to show just how many changes occur in the area, assuming the same level of accuracy for both.

Use of several scenes during different times of the year can be beneficial depending upon the types of landcover desired. In this particular case agricultural areas, which change their cover in summer, were differentiated from development, which have much less change. The spectral values and the pattern of spectral values are very different in spring and summer for the two.

A combined supervised and unsupervised approach was beneficial and is recommended for future Landsat mapping. Using existing ground truth sources aided in selecting sample areas for training in the supervised approach; these sources also helped in identifying the locations of particular cover types, given their different spectral values. An unsupervised training proved to be useful because classification was made on the basis of reflectance, consequently reducing the possibility of making errors by either assuming a cover type or making a supervised classification on the basis of questionable or scant information.

The problems with not being able to classify cedar bogs and burned areas actually turned out to be clouds with silver linings. The very fact that cedar bogs were so small that they could not be identified, only strengthened the fact that they are a critical habitat and in danger of being eliminated. With the burned area, we at least realized that similar areas warrant a special classification because of differences in the textures in the scene due to regeneration.

Only by directly working on a demonstration project could we have realized the potential use of Landsat. We feel that we have met the goals that we had originally set out to meet and then some. By working directly on the project we got a product, but also a working knowledge of Landsat in realizing what it can and cannot do. When we continue to do future work with Landsat, we will be able to look for classes which are more reflective of a habitat with its various vegetative layers. Multi-temporal data sets will be used in the future for distinguishing spectral values for covers which show a noticeable change in any one season and those covers which are permanent. Particular attention paid to the red and infrared bands can help make that distinction.

Based on the fact that we did make several changes in our classifications over a relatively short period of time, we feel that a Landsat-derived inventory is extremely flexible. Changes made in a matter of days or weeks with Landsat would have required months with most other conventional techniques. We felt that we were not always locked into a prescribed set of classes - if we wanted to add some, we could; if we wanted to delete some, we could; and if we wanted to switch category labels from one isoclass signature to another, we could.

Certainly all these features are not new revelations to many. Several other projects will prove the same thing. Even so, it's important to reiterate them because it is just these features which can improve our knowledge of environmental characteristics and thereby make better decisions on resource conservation.

ORIGINAL PAGE IS
OF POOR QUALITY

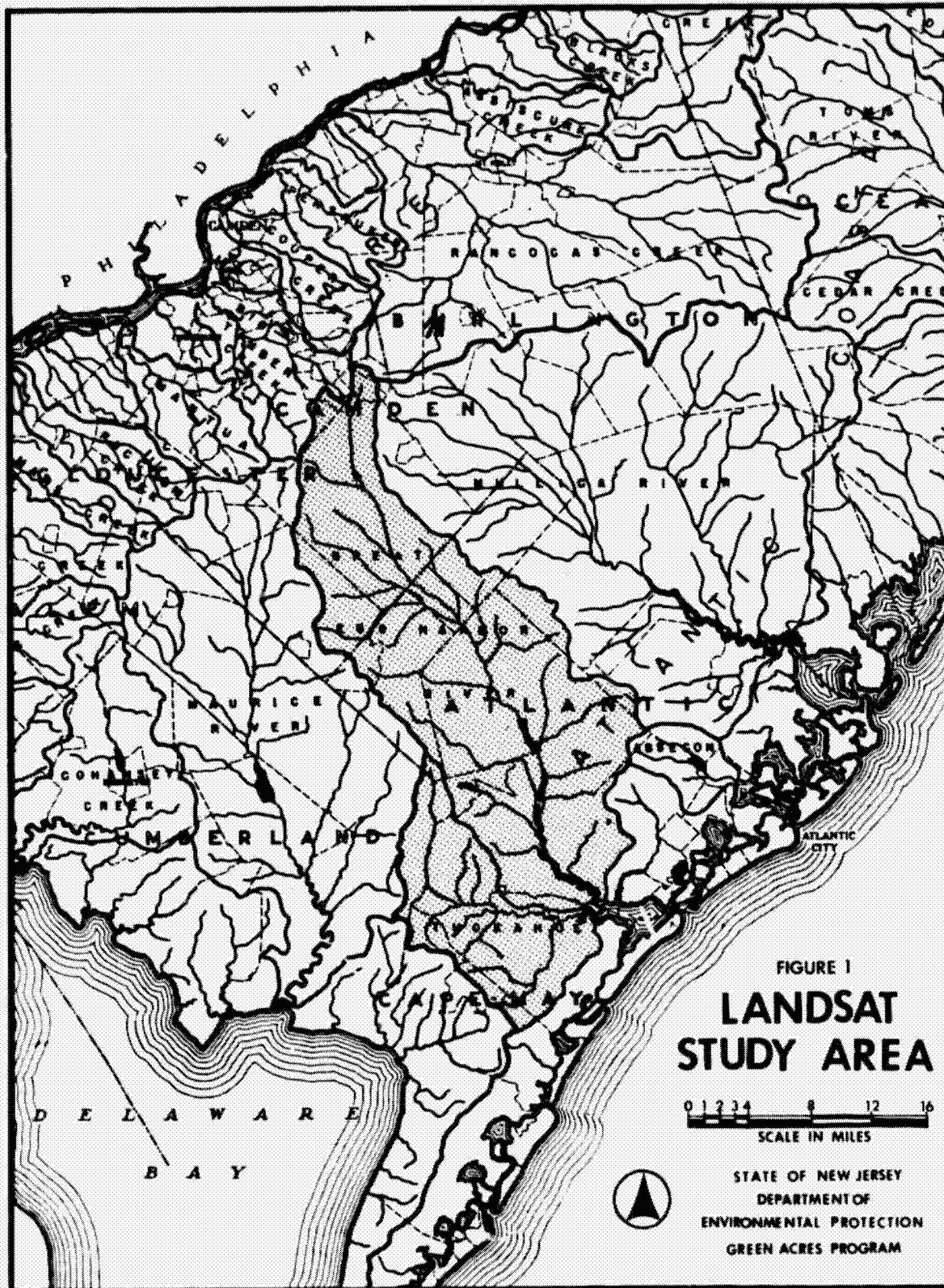

Figure 1. Great Egg Harbor/Tackahoe River Study Area

ORIGINAL PAGE IS
OF POOR QUALITY

Table 1

GREAT EGG HARBOR/TUCKAHOE WATERSHED AREA

Landsat Derived Landcover

<u>Landcover</u>	<u>Pixels</u>	<u>Acres</u>	<u>%</u>
Hardwood	70,014	43,268	15.9
Oak Pine	130,783	80,823	29.7
Pine Oak	58,727	36,293	13.3
Pitch Pine Lowland	10,894	6,732	2.5
Agriculture	40,141	24,807	9.1
Field/Pasture	38,955	24,074	8.8
Bare Soil	2,912	1,799	.7
Developed	25,197	15,571	5.7
Wetlands	8,738	5,400	2.0
Tidal Marsh	13,473	8,326	3.1
Water	39,315	24,296	8.9
Cloud	1,219	753	.3
TOTAL	440,359	272,142	100.0

TOTAL SQUARE MILES 425

N83 19153

D11

LANDSAT LANDCOVER INFORMATION APPLIED TO
REGIONAL PLANNING DECISIONS

Cheryle M. Dixon
Piedmont Planning District Commission
(804) 542-4220

ABSTRACT

A level one land cover classification map is being produced with nine categories utilizing Landsat information. Acreages for each of the nine categories will be tabulated. An accuracy assessment will be performed on the resulting data. Various uses of the Landsat data have been investigated for influencing regional planning decisions. A cost/benefit study will be performed upon completion of the project.

INTRODUCTION

Landsat land cover information is being utilized by Piedmont Planning District Commission located in the State of Virginia. The Commission is a sub-state planning organization serving seven counties and eleven small towns. It is one of twenty-two Planning District Commissions in the state. Piedmont Planning District is basically rural with an average population density of 29 people per square mile.

Piedmont Planning District Commission is presently using the Landsat information to classify, in nine categories, the land cover of the entire District for inclusion in the District Land Use Plan. To accomplish this, the centrally located county of the District, Prince Edward, will be classified first. Because of its central location and diversified land cover, Prince Edward is representative of the entire District. Once the land cover mapping of this central county is complete, with acreages tabulated and an acceptable accuracy level obtained, the same spectral signatures will be used to develop land cover maps and acreages for the remaining six counties within the District.

This paper presents the project progress to date. The nine categories of classification are defined. The computer-compatible tape selection is presented. Two unsupervised classifications have been done, with 50 and 70 classes respectively. Twenty-eight spectral classes have been developed using the supervised technique, employing actual ground truth training sites.

The accuracy of the unsupervised classifications are estimated through comparison with local county statistics and with an actual pixel count of Landsat information compared to ground truth.

Various uses of the Landsat information have been explored and listed. Many other local and state agencies were consulted on this matter.

SELECTION OF CATEGORIES OF CLASSIFICATION

It was decided that a level one classification would be sufficient for use in the District Land Use Plan. Therefore the following nine categories of land cover were selected.

WATER

This category includes rivers, lakes, farm ponds, creeks and sewage lagoons. In some cases the water will be overhung by trees, etc. in which case the area will be classified as that which can be seen from above.

NONFORESTED WETLAND

This category includes marshes, swamps and some pasture/grassland which normally floods along creeks or rivers during a period of average rainfall.

FORESTED WETLAND

This category includes marshes, swamps and wet areas that have trees or small bushes as vegetative cover.

CONIFER FORESTS

This category includes evergreens, most likely in Virginia to be cedar and pine. The pine includes natural Virginia pine, black pine and an abundance of planted loblolly pines. Some white pines occur; however, these are mostly ornamental.

DECIDUOUS FORESTS

This category includes a wide variety of native hardwoods, predominantly oaks, hickory, poplar, gum and maple. Also included in this classification category are cutover/brush areas where hardwoods have been harvested and those areas of natural regeneration of hardwoods.

MIXED FORESTS

This category includes a mixture of the conifer and deciduous areas. The ratios of the mix may vary; therefore, any area that cannot be identified homogeneously as conifer or deciduous will fall into the mixed category.

PASTURE/GRASSLAND

This category includes a variety of grasses that remain as grass for an extended period of time, i.e. for longer than one growing season.

CROPLAND/ROADS

This category includes any land which is cultivated and replanted from year to year. Roads appear in this category due to the timing of the information. In early spring the cropland is just being plowed or planted with no vegetation appearing. Roads are a mixture of the pavement and grass/bare ground to the sides; therefore, the spectral signatures of the roads and cropland are similar.

DEVELOPED

This category includes industrial, commercial and residential areas. It should be noted that this classification category is the most difficult to establish due to the mix of things that will appear in one pixel of 1.1 acres. Small towns should be identified, but individual buildings out in the counties will be included in other categories due to their small size.

SELECTION OF COMPUTER-COMPATIBLE TAPES

A computer-compatible tape set was ordered from EROS Data Center near Sioux Falls, South Dakota dated April 28, 1978. This was a relatively clear date with low cloud cover. Being early spring, there was little foliage on deciduous trees making them more easily distinguishable from coniferous trees. Cropland at this time would either be freshly plowed or freshly planted with no visible vegetative cover, with the exception of winter crops such as wheat. This would, for the most part, make the cropland easily distinguishable from the pasture/grassland.

One other factor greatly influencing the use of the April 1978 tapes was the level of moisture. This particular date was a high water period in Piedmont Planning District; therefore, some flooding appears in the classification.

UNSUPERVISED CLASSIFICATION

An unsupervised classification is done by allowing the computer to select the classes with no reference to actual ground truth. A 50-category classification was done for Prince Edward County. These 50 categories were then grouped, according to their mean values, into the nine classes selected for the project. Those categories with the closest mean values were combined into one class.

The county boundaries were then digitized and statistics tabulated for each class in Prince Edward County.

Table I. - PRINCE EDWARD COUNTY ACREAGES

UNSUPERVISED WITH 50 CLASSES

Water	1,581 acres
Nonforested Wetland	1,836
Forested Wetland	24,682
Coniferous Forests	43,971
Deciduous Forests	53,531
Mixed Forests	23,138
Pasture/Grassland	32,514
Cropland/Roads	35,310
Developed	558
	<hr/>
Total	217,121 acres

In order to take a closer look at the county classification, a blow-up of the Farmville area was done. The same unsupervised technique with the 50 categories was applied to the Farmville area. This area was then scaled to approximate an aerial photograph of the same area dated March 1979. A grid was prepared for the Landsat map and the aerial photo. Specific points were compared on each to determine if the Landsat mapping generally agreed with the aerial photograph. Many of the points on the aerial photograph were visited to be certain of the ground cover.

During the comparisons of the Landsat mapping and the aerial photograph, several problem areas were detected. For example, there was too much coniferous forest appearing on the Landsat map, an area of flooded pastureland was showing up as a developed area and some cropland was identified as forests. Because of these problems, another unsupervised classification was run with 70 categories selected by the computer. It was hoped that the additional categories would separate some of these identified problem areas. The specific problem areas did not improve; however, the overall classification acreages did change. The most significant changes from the 50 classes to 70 classes included a decrease in water, coniferous forests and an increase in cropland.

Table II. - COMPARISON OF FARMVILLE AREA
ACREAGES IN 50 AND 70 CATEGORIES

CLASS	50 CATEGORIES	70 CATEGORIES	% CHANGE
Water	1,071	522	-51%
Nonforested Wetland	1,431	1,574	10%
Forested Wetland	14,364	14,172	1%
Coniferous Forests	20,826	14,056	-33%
Deciduous Forests	18,021	17,296	4%
Mixed Forests	10,670	11,459	7%
Pasture/Grassland	14,276	13,920	- 2%
Cropland/Roads	17,776	25,373	43%
Developed	446	378	15%
		unclassified 131	
	<hr/>	<hr/>	
Total	98,881	98,881	

SUPERVISED CLASSIFICATION

A supervised classification involves the selection of training sites, classifying them and "training" the computer to find all similar areas. Using an aerial photograph or a topographical map, training sites are mapped from actual ground truth. The training sites should be at least 5 acres. The larger the area the better. The most uniform areas are preferably selected for training sites.

Once the training sites are selected and located in the Landsat image, a statistical analysis is then run on each site. The spectral signatures of the most uniform training sites are then keyed into the computer. The computer then identifies all other areas of the same spectral signature or those areas with spectral signatures within a given critical distance. For example, a 10-acre block of deciduous forests is identified with a spectral signature in the four Landsat channels of:

Channel	1	2	3	4
Signature	20.00	22.58	49.33	51.00

The computer is told to classify all areas with this signature or within a critical distance of X from this signature as deciduous forests.

To date, 28 categories have been identified in the Farmville area with ground truth. Approximately 20 percent of the area still remains to be classified.

Table III. - FARMVILLE AREA CLASSIFICATION
SUPERVISED with 28 CATEGORIES

<u>CLASS</u>	<u>ACREAGES</u>
Water	323
Nonforested Wetland	1,055
Forested Wetland	13,319
Coniferous Forests	2,399
Deciduous Forests	28,039
Mixed Forests	11,607
Pasture/Grassland	4,911
Cropland/Roads	15,841
Developed	1,867
Unclassified	19,525
Total	<u>98,886</u>

ACCURACY ASSESSMENT

Although the classification of Prince Edward County is not yet final, this section will discuss the accuracy of the preliminary mapping and tabulations. Two methods of assessment are discussed: 1) comparison of acreages with printed local County statistics, and 2) an actual pixel count from Landsat compared to a ground truth source.

The pixel count method is presented for the Farmville area classification using both the 50 and 70 categories. Note that this paper

presents only an example of this method with a sample of 400 pixels. When the final classification map is obtained, a more comprehensive count of pixels will be undertaken to provide a statistically valid test.

COMPARISON WITH LOCAL STATISTICS FOR PRINCE EDWARD COUNTY

Local county statistics were available for total acreage and only three separate classifications in Prince Edward County. There is some discrepancy in total acreage for the county. This is possibly due to digitizing the county boundary.

According to the Department of Highways and Transportation, Prince Edward County has 225,977.6 acres. Landsat mapped 217,121 acres which is 96.1 percent of the actual.

For individual classifications, statistics are available for cropland, pastureland and forests. According to the 1974 Census of Agriculture there were 39,012 acres of cropland compared to 35,310 acres in the preliminary Landsat classification with 50 categories. This is a difference of 9 percent. Pastureland covered 29,984 acres in 1974 according to the Census of Agriculture. Preliminary Landsat figures indicated there were 32,514 acres of pasture/grassland. This is a difference of 8 percent.

According to the Division of Forestry there were 163,327 acres of forest land in Prince Edward County in 1976. Preliminary Landsat figures show 145,322 acres of forest land. This is a difference of 11 percent.

COMPARISON WITH LOCAL STATISTICS FOR VAUGHAN'S CREEK AND FISHPOND CREEK WATERSHEDS

In 1976, Soil Conservation Service estimated land use acreages for the watersheds of Vaughan's Creek and Fishpond Creek. These figures are to be used in an Environmental Impact Statement for the Upper Appomattox Watershed application. These same boundaries were digitized on the Landsat image. Again the total acreage differs from county figures. This could be due to the digitizing process or an inaccurate estimate by the county. The nine classifications of Landsat data were grouped into 4 general categories to match the SCS classes. When tabulated, Landsat indicated an increase in cropland/grassland and a decrease in woodland.

Table IV. - WATERSHED STATISTICS FROM SOIL CONSERVATION
SERVICE COMPARED TO LANDSAT STATISTICS

VAUGHAN'S CREEK WATERSHED

<u>CLASS</u>	<u>Landsat Acreage</u>	<u>% of Total</u>	<u>SCS County Acreage</u>	<u>% of Total</u>
Cropland	2,455	14.8	2,102	12.5
Grassland	3,940	23.7	3,278	19.5
Woodland	9,923	59.7	10,592	63
Miscellaneous	293	1.8	841	5
	<u>16,611</u>	<u>100%</u>	<u>16,813</u>	<u>100%</u>

FISHPOND CREEK WATERSHED

<u>CLASS</u>	<u>Landsat Acreage</u>	<u>% of Total</u>	<u>SCS County Acreage</u>	<u>% of Total</u>
Cropland	1,283	15	707	8
Grassland	1,010	11	480	5
Woodland	6,371	72	7,741	85
Miscellaneous	138	2	136	2
	<u>8,802</u>	<u>100%</u>	<u>9,064</u>	<u>100%</u>

PIXEL COUNT METHOD

For purposes of demonstrating this method, a 20 pixel by 20 pixel area was selected on the Farmville Area image from both the 50 and 70 category unsupervised classifications. This sample block of 400 pixels contains some of all the nine classes selected for the project. The sample block was located on the aerial photograph and visited to determine actual land cover.

The results of counting the actual pixels mapped correctly and incorrectly showed an overall mapping accuracy of 56 percent for the unsupervised classification with 50 categories of the Farmville area. The unsupervised classification with 70 categories showed 54 percent accuracy.

This method of accuracy assessment takes into consideration those pixels in each class that were identified correctly, those that were omitted from the correct class and those pixels that were committed to an incorrect class. This is shown in the form of a Confusion Table.

USES OF LANDSAT LAND COVER INFORMATION IN REGIONAL PLANNING

LOCAL PLANNING DOCUMENTS

The land cover maps will be used in many local planning documents such as the District Land Use Plan and County Comprehensive Plans. Prior to the use of Landsat mapping, a local land use map involved a map with actual structures, i.e. houses, businesses and industries located throughout the area. These data were obtained through a windshield survey. The largest part of an area was most often left blank and labeled agricultural and forested land. This area is where Landsat information is most beneficial.

WATERSHED PROJECTS

Again, the land cover maps are useful in watershed projects as the Soil Conservation Service compiles their Environmental Impact Statements. One project in particular, Bush River Watershed, had been approved by all agencies required except the Environmental Protection Agency (EPA). EPA was holding up approval on the premise that too many acres of wetlands would be destroyed by the project. Landsat figures could verify the wetland acreages and over time show the wetland variations in other watershed projects.

STUDY OF SILTATION PROBLEMS IN LAKE CHESDIN

Lake Chesdin, when originally built in 1967, was planned to last for 49 years. At the present rate of siltation going on in the lake, it is now estimated to last only 24 years. Landsat could map the land cover and monitor problem areas, such as cutover forest land, which may be contributing to the shortened life of the Lake.

STUDY OF CROPLAND ACREAGES AND DISEASED CROP AREAS

Tobacco is one of the main cash crops in the Piedmont Planning District. Several diseases are present in the area which affect tobacco such as blue mold and black root. In some cases, special treatment of the soil is needed to prevent the disease from recurring or spreading. Landsat land cover mapping could monitor the diseased areas over a period of years. This project is of particular interest to the State Extension Service and the Southern Piedmont Research Station which studies these diseases.

LOCATION OF GEOLOGIC FORMATIONS

The Division of Mineral Resources is particularly interested in the land cover mapping since vegetative cover is often a key to what geologic formations are below the surface. Geologic mapping is very limited within the District; therefore, this possibility for Landsat would be an asset to planning in the area.

USEFUL IN ZONING AND GROWTH CORRIDOR STUDIES

Prince Edward County is studying the possibility of zoning the entire county for the first time. Prime agricultural zoning is being considered. Landsat land cover mapping would show the county exactly where its agricultural land is located.

A Growth Corridor Study is now being done in the Farmville Area. Land use is a major consideration which Landsat can provide. Over a period of years Landsat could also show the direction that actual growth has taken.

FORESTRY SURVEY

The forest industry provides a large percentage of Piedmont Planning District's base employment. With approximately 70 percent of the District in forest land, this is a resource which needs to be managed.

Another Planning District is interested in studying its forest resources as a possible energy source in the future. Landsat land cover information could be utilized in these efforts.

CONCLUDING REMARKS

Piedmont Planning District Commission, in the course of its Demonstration Project, has consulted many other state and local agencies in the use of the Landsat information. All are in agreement about the great potential for use of the Landsat land cover information, especially the comparisons that can be made over a period of years. Landsat land cover information is viewed not as an all-encompassing answer, but as a tool for regional planning and resource management.

Table V. - Confusion Table - Farmville Area
Unsupervised Classification with 50 Classes

	Water	Non-forested wetland	Developed	Conifer	Forested wetland	Cropland/Road	Pastureland/Grassland	Deciduous	Mixed Forests	Total Possible	Omissions	Commissions	Mapping Accuracy
Water	<u>45</u>	0	4	5	0	12	0	0	0	66	$\frac{21}{66} = 32\%$	$\frac{39}{66} = 59\%$	$\frac{45}{45 + 21 + 39} = 43\%$
Nonforested Wetland	7	<u>15</u>	2	0	2	0	0	0	0	26	$\frac{11}{26} = 42\%$	$\frac{15}{26} = 58\%$	$\frac{15}{15 + 11 + 15} = 37\%$
Developed	0	0	<u>8</u>	0	0	6	0	0	0	14	$\frac{6}{14} = 43\%$	$\frac{22}{14} = 157\%$	$\frac{8}{8 + 6 + 22} = 22\%$
Conifers	8	0	1	<u>33</u>	8	10	0	0	0	60	$\frac{27}{60} = 45\%$	$\frac{14}{60} = 23\%$	$\frac{33}{33 + 27 + 14} = 46\%$
Forested Wetland	0	3	0	9	<u>41</u>	1	1	0	0	55	$\frac{14}{55} = 25\%$	$\frac{20}{55} = 36\%$	$\frac{41}{41 + 14 + 20} = 55\%$
Cropland/Road	0	0	0	0	3	<u>31</u>	3	0	0	37	$\frac{6}{37} = 16\%$	$\frac{50}{37} = 135\%$	$\frac{31}{31 + 6 + 50} = 36\%$
Pastureland/Grassland	8	2	4	1	2	16	<u>8</u>	0	0	41	$\frac{22}{41} = 54\%$	$\frac{6}{41} = 15\%$	$\frac{8}{8 + 22 + 6} = 22\%$
Deciduous	15	6	11	4	5	4	2	<u>21</u>	0	68	$\frac{47}{68} = 69\%$	$\frac{0}{68} = 0$	$\frac{21}{21 + 47} = 31\%$
Mixed Forests	1	4	0	4	0	1	0	0	<u>23</u>	33	$\frac{10}{33} = 30\%$	$\frac{0}{33} = 0$	$\frac{23}{23 + 10} = 70\%$
Total	84	30	30	56	61	81	14	21	23	<u>400</u>			
Overall Mapping Accuracy											$\frac{45 + 15 + 8 + 33 + 41 + 31 + 8 + 21 + 23}{400} = \frac{225}{400} = 56\%$		

119

ORIGINAL PAGE IS
OF POOR QUALITY

Table VI. - Confusion Table - Farmville Area
Unsupervised Classification with 70 Classes

	Water	Non-forested wetland	Developed	Conifer	Forested wetland	Cropland/Road	Pastureland/Grassland	Deciduous	Mixed Forests	Total Possible	Omissions	Commissions	Mapping Accuracy
Water	<u>55</u>	5	4	5	2	9	0	0	0	80	$\frac{25}{80} = 31\%$	$\frac{18}{80} = 23\%$	$\frac{55}{55 + 25 + 18} = 56\%$
Nonforested Wetland	5	<u>18</u>	0	0	5	0	0	0	0	28	$\frac{10}{28} = 36\%$	$\frac{34}{28} = 121\%$	$\frac{18}{18 + 10 + 34} = 29\%$
Developed	0	0	<u>8</u>	0	0	6	0	0	0	14	$\frac{6}{14} = 43\%$	$\frac{13}{14} = 93\%$	$\frac{8}{8 + 6 + 13} = 30\%$
Conifers	5	5	2	<u>22</u>	9	5	2	0	0	50	$\frac{28}{50} = 56\%$	$\frac{21}{50} = 42\%$	$\frac{22}{22 + 28 + 21} = 31\%$
Forested Wetland	0	1	0	4	<u>40</u>	0	0	0	2	47	$\frac{7}{47} = 15\%$	$\frac{32}{47} = 68\%$	$\frac{40}{40 + 7 + 32} = 51\%$
Cropland/Road	0	0	0	0	0	<u>36</u>	0	0	0	36	$\frac{0}{36} = 0$	$\frac{53}{36} = 147\%$	$\frac{36}{36 + 53} = 40\%$
Pastureland/Grassland	0	8	0	0	2	23	<u>5</u>	0	0	38	$\frac{33}{38} = 87\%$	$\frac{8}{38} = 21\%$	$\frac{5}{5 + 33 + 8} = 11\%$
Deciduous	3	12	4	6	13	9	1	<u>20</u>	0	68	$\frac{48}{68} = 71\%$	$\frac{2}{68} = 3\%$	$\frac{20}{20 + 48 + 2} = 29\%$
Mixed Forests	5	3	3	6	1	1	5	2	<u>13</u>	39	$\frac{26}{39} = 67\%$	$\frac{2}{39} = 5\%$	$\frac{13}{13 + 26 + 2} = 32\%$
Total	73	52	21	43	72	89	13	22	15	<u>400</u>			
Overall Mapping Accuracy = $\frac{55 + 18 + 8 + 22 + 40 + 36 + 5 + 20 + 13}{400} = \frac{217}{400} = 54\%$													

ORIGINAL PAGE IS
OF POOR QUALITY

N83 19154

D/2

LANDSAT APPLICATIONS BY THE ADIRONDACK PARK AGENCY FOR LAND COVER
ANALYSES AND FOREST COVER CHANGE

John S. Banta, Director of Planning
Adirondack Park Agency

Raymond P. Curran, Supervisor, Resource Analysis Unit
Adirondack Park Agency

ABSTRACT

The New York State Adirondack Park Agency is using Landsat imagery to provide current, consistent parkwide data on forest cover, forest change and other land cover characteristics for the Adirondack Park, an area of 9,375 sq. miles (24,280 km²). Such data are not available from conventional sources. Land cover characteristics will be presented in both tabular and visual formats to facilitate Agency planning functions; including both a detailed joint Government-Industry analysis of Intensive Timber Harvesting in the Adirondack Park; and the installation of a Geographic Information System to assist in economic and natural resource information, storage, retrieval and analysis by the Adirondack Park Agency. This work is in progress and preliminary products are expected in the spring of 1981. The project will be completed by December 31, 1981.

INTRODUCTION

In October 1979 the Adirondack Park Agency initiated a study of intensive harvest practices in order to clarify its jurisdiction over "clearcutting" in the private forests of the Adirondacks. The cooperation of government, industry, professional foresters, and other interested groups was solicited to advise and guide the work. The study was prompted by concerns that increasing demands for wood and wood products could lead to harvest activities that would have an adverse effect on the long-term economic health and environmental quality of the region. Based on the results of the study, the Adirondack Park Agency expects to revise its rules and regulations regarding the use of clearcutting and similar forest practices in the Park. The involvement of the NYS Department of Environmental Conservation and other public and private interests concerned with forest management in the Park will also contribute to the New York State Forest Resources Planning Program conducted by the Department of Environmental Conservation.

SURVEY PURPOSES

A survey of forest cover identifying basic characteristics will give a quantitative assessment and geographically referenced analysis of several planning and operational issues before the Adirondack Park Agency including:

- 1) Distribution and scale of intensive timber harvesting activity;
- 2) Distribution and scale of special interest areas (principally forested wetlands and unique habitat areas);
- 3) Baseline information for future reference of large-scale intensive timber harvesting within the Park.

The survey of the Park using Landsat data is in addition to a ground survey of randomly selected ITH/clearcut sites within the Park and statistical analysis of the USFS forest survey for the Northern New York region.

SURVEY TECHNIQUES

The choice of useable Landsat data was limited by climatic conditions for successive days over the relatively large study area since the satellite does not cover the entire Park on a single pass. The Adirondack Park is roughly 9,725 square miles in size. Cloud-free data were available for October, 1972 (a dormant vegetative period) and August, 1978. Data were provided to a consultant who has undertaken the technical analyses for the Agency.

Prior to performing an initial classification of the data, boundaries of the study area were digitized, data enhanced, and finally the data were geographically rectified.

Considering the goals of the ITH Study, a classification system was devised which emphasized the basic land cover types of the Park -- hardwoods, spruce-fir, pine, wet conifer, brushland, grassland, agricultural areas, exposed earth, "urban" areas, and water bodies. To increase the level of information available for comparison of successive Landsat data elements, cover type classifications for disturbed forest land were also chosen -- cut hardwoods, regenerating hardwoods, and cut spruce fir.

Training samples for initial classification of the 1978 data utilized approximately 36 training sample sites with good ground survey information relevant to the 1978 data set.

Field verification of the 1978 classification has revealed an accurate differentiation of forest types within types and between nonforested/forested areas. The classification accurately detects forest land disturbances; however, it is not always descriptive of the level of disturbance. For example, the "cut hardwoods" classification includes areas of low stocking of hardwoods, irrespective of windthrow, disease, or cutting; the "pasture" classification included in addition to pastured areas, areas of very heavy cutting, and openings in forestland.

Wet conifer and pine areas were found to be very reliable; however, because of dry soils in August 1978, nonforested wetlands tended to be classified on the basis of the emergent vegetation rather than on wet soil.

Another problem is the identification of "water" classifications on steep slopes, possibly caused by blowdowns in areas of great relief and/or bedrock, or shadow.

These problems are presently being rectified and a second set of training samples defined for use in classifying the 1972 data.

APPLICATIONS

The primary application of this work in progress will be in support of the Intensive Timber Harvest Study described above. The Landsat data interpretations are also expected to be of value for: 1) a quantitative assessment of wetlands within the Adirondack Park; 2) resource analysis in local planning within the Park; and, 3) review and evaluation of the Adirondack Park Land Use and Development Plan and Map. For additional information as the study progresses contact: Adirondack Park Agency, P. O. Box 99, Ray Brook, New York 12977.

N83 19155 ^{D/3}

ERRSAC CONTRIBUTIONS TO THE SEARCH FOR APPALACHIAN HYDROCARBONS

Herbert W. Blodget
Eastern Regional Remote Sensing Applications Center (ERRSAC)
NASA/Goddard Space Flight Center
Greenbelt, MD 20771

ABSTRACT

An investigation to assess the application of enhanced Landsat imagery for hydrocarbon exploration in Appalachia was carried out jointly by ERRSAC, the Appalachian Regional Commission, and geologists from seven Appalachian states. The primary objective was to determine the utility of lineaments identified on Landsat imagery as an exploration tool in the search for hydrocarbons within three Appalachian test sites.

The study was conducted in two stages. The initial stage was designed to identify the optimum Landsat imagery enhancement technique for displaying lineaments. The second stage was an analysis of the Landsat lineament data and correlation of the results with oil and gas field information for each of three test sites. Good correlations were found for several states. Successful techniques can be incorporated into a broader exploration model.

INTRODUCTION

In early 1977 NASA embarked on a pilot study to determine the applicability of enhanced Landsat imagery for oil and gas exploration in Appalachia. This project was conducted jointly by ERRSAC, the Appalachian Regional Commission, and geologists from three Appalachian states. The immediate objective was to determine if lineaments identified on Landsat imagery could be used as a tool in petroleum exploration. In particular, it was sought to determine if the fracture zones which commonly form reservoirs for Devonian Shale-gas production are manifest at ground level and visible from Landsat altitudes.

Lineaments, as defined here, are linear or sub-linear traces seen on Landsat imagery. Research has shown that they frequently reflect subsurface geological fractures, the most common of which are joints and faults. Such faults may improve reservoir characteristics and can also be important in the formation of certain classes of structural hydrocarbon traps (Levorsen, 1967, p. 267, and Kostura and Ravenscroft, 1977). Promising results from the pilot study conducted at the 5-county, Kentucky-Ohio-West Virginia test site (Figure 1) led to the initiation of a more comprehensive study that included two additional test sites and geologists from four more states.

METHODOLOGY-RESULTS

The expanded investigation was accomplished in two stages; the first was designed to identify the specific Landsat imagery enhancement best suited for

124

displaying lineaments; the second consisted of plotting lineaments and making an analysis of the lineament trends in respect to both local geological structure and regional tectonics. This included correlation of the lineament data with oil and gas field production information.

In the first phase, each of the state teams of geologists was provided with 12 images of its test site(s). The set included four differently enhanced images for each of three seasons--spring, summer, and fall (Wescott and Smith, 1979). Even though there were wide differences in the training and background of the interpreters, and no collaboration among teams, there was almost unanimous agreement in the conclusions. In particular, it was indicated that winter or "leaves-off" imagery provided the best seasonal data. The sun was at its lowest angle in respect to the earth, and the increased shadow length improved recognition of topographic lineaments. In addition, it was almost unanimously agreed that a simple digital linear stretch provided optimum tonal contrast for all three test sites. In areas of highly dissected topography, as was characteristic in the two southern sites, edge enhancement further improved lineament display, and the Laplacian (3 x 3 filter) algorithm was generally preferred. In the flatter terrain of the New York-Pennsylvania test site, however, edge enhancement tended to emphasize field boundary lines and other cultural features in detriment to geology-related lineaments. Printing on Cibachrome film consistently produced a tonal and textural sharpness not attainable on paper prints. The detailed results of the image analysis were compiled by Smith and Miller (1980). "Standard" enhanced Landsat imagery which incorporated these enhancement procedures is now available from several commercial vendors.

During the second phase of the study, lineaments were plotted on Landsat overlays at 1:250,000 scale for each of the test sites. These data were correlated with published geologic maps, and checked in the field where significant new information appeared to be indicated. A thorough review of Devonian Shale-gas production data for the three test sites revealed that there is presently insufficient subsurface well information available upon which to base conclusive results. Many of the long-lived, low volume Shale-gas wells were drilled in the first third of the century, prior to the advent of down-hole logging procedures. While drillers' logs may have been recorded, very few appear to have been preserved; even precise well location data are scarce. Analysis of the limited data suggests some interesting geologic relationships, and further study is warranted when more information from recently drilled wells becomes available.

Although this one major objective of the study was not fully met, the comparison of lineaments with hydrocarbon production showed some interesting correlations. In New York, Ohio, and Virginia, for example, it was found that some Landsat lineaments coincided with portions of the reservoir margins of certain oil and gas fields that produce from sandstone formations. These correlations could be significant in exploring for hydrocarbons, especially if it can be shown that these lineaments reflect the faults forming the reservoir trap. A schematic of this relationship is shown in Figure 2.

In Allegany County, New York (Figure 3), for example, Landsat lineaments plotted by A. Van Tyne and T. Wickerham of the New York Geological Survey appear to truncate the hydrocarbon production on at least one margin of 13 oil or gas

fields. These lineaments have been broadened in Figure 3 for emphasis. Nine of these significant lineaments trend in a northeasterly direction, suggesting a genetic relationship among these lineaments, regional geologic structure and the associated reservoirs. In particular, this trend parallels the folded Appalachian Mountains to the southeast. In the same county, 13 additional similarly trending lineaments have been identified which are not associated with known petroleum accumulation. For display purposes, these lineaments are shown as broad dashes. Because of the apparent significance of this lineament directional trend, the undrilled areas around these 13 lineaments are considered highly attractive petroleum prospects. These areas should now be examined in detail using traditional geophysical exploration techniques in order to obtain a detailed definition of the subsurface geology. Thus, while there is generally insufficient detailed geological information on Landsat imagery to pinpoint hydrocarbon accumulations, development of a better understanding of the regional geology permits optimum utilization of more expensive geophysical techniques.

CONCLUSIONS

Specific digital and optical image enhancement techniques can be applied to winter (low sun angle) Landsat data to significantly facilitate lineament discrimination in three Appalachian test sites. The linear stretch was found to provide the best tonal contrast, while edge enhancements should only be applied when the test site exhibits strong relief. Printing on a Cibachrome-like base provides added tonal "sharpness" and contrast.

Insufficient subsurface geological data were available from Devonian Shale-gas wells to confirm any definite relationship between Landsat lineaments and gas production. Further small-area studies are warranted when log data from recently drilled wells become available.

The close relationship between lineaments identified on Landsat imagery and known oil and gas reservoirs in three widely separated, geologically diverse Appalachian test sites strongly suggests that lineaments can be related to the structural control of oil and gas reservoirs throughout Appalachia. These relationships should be exploited in developing all reconnaissance exploration programs. Geologic interpretation of Landsat imagery is essential to developing the most complete understanding of regional geology and must be used as one of the guides for the application of more costly, definitive geophysical techniques.

REFERENCES

1. Levorsen, A. I., 1967, *Geology of Petroleum*, second ed.: W. H. Freeman and Company, San Francisco, California, 724 p.
2. Kostura, J. R. and J. H. Ravenscroft, 1977, *Fracture-Controlled Production: AAPG Reprint Series No. 21*, The American Association of Petroleum Geologists, Tulsa, Oklahoma, 221 p.
3. Wescott, T. F. and Smith, A. F., 1979, *Digital Image Processing and Enhancement of Landsat Data for Lineament Mapping and Natural Gas Exploration in Appalachian Region*: in Barlow, H. (ed.), *Proceedings of Third Eastern Gas Shales Symposium*, p. 39-49, Morgantown, West Virginia, October 1-3.
4. Smith, A. F. and J. E. Miller, 1980, *Evaluation of Computer Enhanced Landsat Imagery for Lineament Analysis and Other Geological Applications*: General Electric Company Phase 1 report for NASA contract NAS 5-25364.
5. Van Tyne, A. M. and J. C. Peterson, 1979, *Oil and Gas Fields in New York--as of July 1978*: Morgantown Energy Technology Center METC/EGSP series 102, scale 1:250,000.
6. Blodget, H. W. (ed.), 1979, *Summary of Proceedings, Appalachian Lineament Analysis Workshop*, NASA, Goddard Space Flight Center, October 29-30, 41 p.

N88 19156

D14

POTENTIAL UTILITY OF THE THEMATIC MAPPER FOR SURFACE MINE MONITORING

James R. Irons
Earth Resources Branch
NASA/Goddard Space Flight Center

Henry M. Lachowski* and Chris Peterson
Space Division
General Electric Company

ABSTRACT

One of the many potential applications of the Thematic Mapper (TM) is surface mine monitoring. To assess this potential, data acquired by an aircraft multispectral scanner over Pennsylvania surface mines were preprocessed to simulate the anticipated spectral, spatial, and radiometric characteristics of TM data. False color imagery and thematic maps were derived from the simulated data and compared to imagery and maps derived from Landsat Multispectral Scanner Subsystems (MSS) data. On the basis of this comparison, TM data will increase the detail and accuracy of remotely acquired surface mine information and may enable the remote determination of compliance with reclamation regulations. Further research will investigate effective TM data analysis techniques and evaluate the relative utility of the TM spectral bands for surface mine monitoring.

INTRODUCTION

One of the many possible applications of the Thematic Mapper (TM) multispectral scanner planned for the Landsat-D satellite series is the inventory, inspection, and monitoring of coal surface mines. The ability to identify and inventory surface mines using data from the Multispectral Scanner Subsystems (MSS) of the first three Landsat satellites has been demonstrated in several investigations, but investigators have been unable to consistently extract from MSS data the detailed information required to determine compliance with mining regulations. The TM will offer advantages over the MSS with respect to spectral, spatial, and radiometric characteristics. These improvements will potentially lead to enhanced capabilities for remote surface mine inspection.

To assess the potential benefits accruing from TM improvements, simulated TM data were acquired by an aircraft multispectral scanner over heavily mined areas in central Pennsylvania. The data were used to image, identify, map, and mensurate the area covered by detailed surface mine categories. Results derived from the simulated TM data were compared to similar information extracted from Landsat MSS data.

BACKGROUND

The increased demand and use of coal has created a conflict over the need for energy and the desire to maintain environmental quality. At present, about

*Presently with the Forest Service, U.S. Department of Agriculture

ORIGINAL PAGE IS OF POOR QUALITY

60% of national coal production comes from surface mines and this extraction method has disturbed millions of acres across the United States. Insufficient mine reclamation has left unsightly landscape, ruined previously productive land, increased susceptibility to flooding, and caused air and water pollution.

Recent federal energy policies emphasize increased utilization and mining of coal with stricter control of environmental, health, and safety costs. The Federal Surface Mine Control and Reclamation Act (Public Law 95-87) establishes uniform national standards for surface coal mine reclamation in order to change mining practices which generate severe environmental degradation. The federal act recognizes mining regulation as primarily the responsibility of state government, but requires federal approval of state reclamation programs. In addition, the surface mine act establishes a fund for the reclamation of abandoned mines.

More than 30 states have enacted laws regulating surface mining and reclamation. The Office of Surface Mining with the Department of the Interior reviews all state reclamation programs to determine acceptability under the federal surface mine act. The scope of existing and proposed laws varies among states according to mining conditions, availability of coal, economics, and pressure from environmentalists.

Both federal and state laws require surface mine inventory and inspection to determine compliance with regulations. Inventories involve the identification, mapping, and mensuration of areas disturbed by mining. Mine inspection requires a closer look within the mines to assess activities such as grading, topsoil replacement, and revegetation.

The use of Landsat MSS data to reduce the expense, time, and inaccuracies associated with mine inventories and inspections has been extensively investigated. Accurate inventories have been produced using both the manual interpretation of MSS imagery (references 1 and 2) and the computer-aided analysis of digital MSS data (references 3, 4, and 5). MSS data, however, have not proven to be as useful for mine inspection. The level of detail and spatial resolution of MSS-derived information was often found inadequate for ascertaining compliance with surface mine operation and reclamation regulations (references 6 and 7).

The improvements offered by the TM will potentially enhance the utility of remotely sensed data acquired at satellite altitudes. The TM will provide a finer spatial resolution, additional spectral bands, and more data quantization levels than the MSS. The TM spectral bands were carefully chosen to increase the information content of the data with respect to vegetation and geologic parameters. The characteristics of the TM and the MSS are compared in more detail within Table I. The study reported here addressed the impact of the TM improvements on remote surface mine inspection.

DATA ACQUISITION

STUDY AREAS

The data for this study were acquired for three areas located in Cambria, Centre, and Clarion Counties, Pennsylvania. All the areas are within the Main

ORIGINAL PAGE IS OF POOR QUALITY

Bituminous Coal Field of the Appalachian Plateau Physiographic Province. The areas are heavily forested and are characterized by rolling topography with moderate relief. Geologically, the areas are underlain by horizontal to gently dipping sedimentary strata of the Allegheny Group formed during the Pennsylvanian geologic period. Extensive portions of the areas have been disturbed by contour, hilltop-removal, and area surface coal mining which provided an excellent cross section of active, reclaimed, and abandoned mines for the investigation.

Twenty mine sites within the study areas were selected for intensive study; ten sites were located within Clarion Co. and five sites were within each of the other two study areas. Each mine site covered a square area of 150 hectares. Measurements of the areal extent of detailed land cover categories within the mine sites formed the basis for the evaluation of the simulated TM data.

GROUND REFERENCE DATA

The ground reference data consisted of photointerpreted, low-altitude aerial photography. Color and color-infrared photographs were acquired over the study areas on September 29, 1978 with a Zeiss RMKA 15/23 camera with a 152 mm. lens. The photographs were provided at a scale of 1:12,000 and photointerpretation resulted in a series of transparent acetate overlays showing slope classes, soil surface colors, vegetative species and percent cover, and land cover categories within each of the 20 intensively studied mine sites. The area covered by each land cover category was measured with a planimeter, and these measurements served as ground "truth" for the quantitative accuracy assessment of thematic maps derived from the simulated TM data.

DIGITAL IMAGE DATA

The Landsat-3 MSS and the NS001 aircraft multispectral scanner acquired the digital image data analyzed in this study. The MSS data were acquired on September 29 and 30, 1978 and each study area corresponded to a 500 pixels-by-500 scan lines subset of a Landsat scene. The NS001 scanner was flown over the study areas aboard a C-130 aircraft on June 14, 1979. The NS001 (ref. 8) has been dubbed the "Thematic Mapper Simulator" because it obtains data for spectral bands identical to those planned for the TM. Unfortunately, the data channels corresponding to TM bands six (2.08-2.35 μm) and the thermal band (TM band seven, 10.4-12.5 μm) were not operating during the flights over the study areas. The atmosphere above the areas was clear during all the data acquisition dates. Additional information pertaining to the digital image data is presented in Table II.

DATA ANALYSES AND RESULTS

CLASSIFICATION SCHEME

A critical aspect of the analyses was the specification of a useful land cover classification scheme. A hierarchical scheme based on the Anderson classification system (reference 9) was devised, and surface mines were elevated to a Level I category (Table III). The more detailed Level II and III categories under surface mines were chosen to emphasize land cover types which seemed both useful for surface mine inspection and amenable to recognition via the digital

**ORIGINAL PAGE IS
OF POOR QUALITY**

analyses of the multispectral data. This scheme was applied to the interpretation of the aerial photography and the generation of thematic maps.

DIGITAL ANALYSIS SYSTEM

Most of the digital analyses were performed using General Electric Company's IMAGE-100 interactive image analysis system. The system enables quick color display of multispectral image data on a cathode ray tube and provides image enhancement and classification capabilities in both interactive and batch modes. Several preprocessing tasks were conducted using software of the SMIPS/VICAR Image Processing System.

PREPROCESSING

Geometric rectification was performed on both the aircraft scanner data and the Landsat MSS data. The aircraft scanner data were resampled to the 30 m. resolution expected from TM data and were corrected for the foreshortening (scan angle) effect caused by the instrument's wide scan angle ($+50^{\circ}$). A bilinear transformation mapped the pixel locations of the original data to the appropriate locations within the corrected image, and the gray levels of the corrected image were computed by bilinear interpolation. The Landsat MSS data were geometrically corrected for a skew caused by the Earth's rotation under the satellite.

FALSE COLOR IMAGES

False color images were derived from both the Landsat MSS data and the simulated TM data. The MSS images were generated using MSS bands four, five, and seven (blue, green, and red), and the simulated TM images were derived from the data channels corresponding to TM bands three, four and five (blue, red, and green). All of these data were linearly contrast stretched to enhance the imagery. The images were displayed at a scale of 1:75,000.

A visual comparison of the imagery revealed potential benefits of TM data. Surface mines were evident in the MSS imagery, but the mine boundaries were more distinct in simulated TM imagery. Discrimination between bare agricultural fields and surface mines was easier in the simulated TM images due to a better definition of field shapes. Overall, the simulated TM images presented more detail and were easier to interpret than the MSS images.

THEMATIC MAPS

Thematic maps were also derived from both the MSS data and the simulated TM data. The maps were generated via supervised training of category statistics followed by the use of a parallelepiped classifier. Due to limitations of the image analysis system, only four of the simulated TM data channels (TM bands two, three, four, and five) were applied to the thematic mapping.

The surface mine categories of the classification scheme proved difficult to map. Surface mines appeared spectrally heterogeneous and spatially complex within both the MSS digital images and the simulated TM digital data. In the analyses of both data types, several spectral classes were associated with each surface mine category in order to account for the spectral heterogeneity.

**ORIGINAL PAGE IS
OF POOR QUALITY**

The detailed Level III mine categories could not be reliably identified via the analysis of the MSS data. Locating suitable training areas for these categories was difficult at the 80 m. MSS resolution. Also, the low resolution of the data combined with the spatial complexity of the mined surfaces limited the number of pure pixels for the detailed categories. This result is consistent with past investigations in which MSS data were found inadequate for mine inspection.

The Level III surface mine categories were accurately identified and mapped via the analysis of the simulated TM data. Training areas could be located within the 30 m. resolution data and the categories were spectrally separable. The pixels classified into each category were counted within the 20 intensively studied mine sites. The pixel summations were then converted to units of area (hectares) and compared to the ground reference data. As shown in Table IV, the areal extent of each detailed surface mine category was accurately mensurated.

CONCLUSIONS

Surface mines present complex targets for remote sensing instruments. The composition, color, and texture of the mine spoil varied widely among and within the mines of the Pennsylvania study areas. The spoil was distributed on slopes ranging from near level to 30 degrees at all aspects. The percent ground cover on revegetated areas varied from near zero to 100 percent, and the cover consisted of a variety of grass, forb, legume, and tree species. Surface mines are topographically irregular, spatially complex, and spectrally heterogeneous.

Despite these factors the potential utility of TM data for surface mine inspection was demonstrated. Thematic information which reliably characterized mine complexities could not be extracted from Landsat MSS data, but detailed land cover categories within mines were identified, mapped, and accurately mensurated via the digital analysis of simulated TM data. Information of this sort will enable mine inspectors to evaluate reclamation activities and ascertain compliance with regulations. Thus, the launch of the Thematic Mapper should enhance our present capabilities for surface mine inspection.

FURTHER RESEARCH

Many questions remain regarding the potential utility of TM data. Needed research includes more rigorous evaluations of results derived from TM simulator data, identification or development of analysis techniques which take full advantage of TM data improvements, and determination of which TM data characteristics—spatial, spectral, or radiometric—are most responsible for increases in extracted information. Such research will continue with the TM simulator data used in this study.

Additional preprocessing will be performed on the TM simulator data. Efforts are underway to compensate for radiometric distortions resulting from the NS001 scanner's wide scan angle. The data will also be registered to the Universal Transverse Mercator cartographic projection. Following preprocessing, evaluations will determine how closely the data correspond to the anticipated characteristics of TM data.

**ORIGINAL PAGE IS
OF POOR QUALITY**

More sophisticated analysis techniques will be applied to the TM simulator data. The use of unsupervised training, maximum likelihood classifiers, and spatial information will be investigated. The application of TM data transformations such as band ratios and principal components to surface mine inspection will be studied. Digitized ground reference data will be registered to the TM simulator data to allow the assessment of results with respect to the proportion of pixels correctly classified as well as area mensuration.

Efforts will also be made to isolate the effects of the individual TM improvements: finer spatial resolution, additional spectral bands, and greater quantization levels. Separate data sets will be generated by resampling the TM simulator data to an 80 m. resolution, by degrading the eight-bit data to six bits, and by eliminating the data corresponding to the TM's middle infrared spectral band. The accuracy of thematic maps derived from each of the altered data sets will be compared to the accuracy of thematic maps derived from the unaltered TM simulator data.

The launch of the Thematic Mapper aboard Landsat-D presents exciting possibilities for the remote sensing community. Research has indicated that an enhancement of remote sensing capabilities will result. Further research with simulated TM data is required to prepare the user community for the analysis and full utilization of the actual data.

REFERENCES

1. Chase, P.E.; and Pettyjohn, W.: ERTS-1 Investigation of Ecological Effects of Strip Mining in Eastern Ohio. Symp. on Significant Results Obtained From the Earth Resources Technology Satellite-1, Vol. 1, section A. Goddard Space Flight Center, Greenbelt, MD, 1973, pp. 561-568.
2. Sweet, D.C.; et al.: Significant Application of ERTS-1 Data to Resource Management Activities at the State Level in Ohio. Third Earth Resources Technology Satellite-1 Symp., Vol. 1, section B. Goddard Space Flight Center, Greenbelt, MD, 1973, pp. 1533-1557.
3. Alexander, S.S.; Dein, J.; and Gold, D.P.: The Use of ERTS-1 MSS Data for Mapping Strip Mines and Acid Mine Drainage in Pennsylvania. Symp. on Significant Results Obtained From the Earth Resources Technology Satellite-1, Vol. 1, section A. Goddard Space Flight Center, Greenbelt, MD, 1973, pp. 569-575.
4. Anderson, A.T.; et al.: Landsat Imagery for Surface Mine Inventory. Photogrammetric Engineering and Remote Sensing, vol. 43, no. 8. Aug. 1977, pp. 1027-1036.
5. Rogers, R.H.; and Pettyjohn, W.A.: Determine Utility of ERTS-1 to Detect and Monitor Area Strip Mining and Reclamation. Final Report Prepared for National Aeronautics and Space Administration, Goddard Space Flight Center, Greenbelt, MD. 1975.

**ORIGINAL PAGE IS
OF POOR QUALITY**

6. Russell, O.R. Application of Landsat 2 Data to the Implementation and Enforcement of the Pennsylvania Surface Mining Conservation and Reclamation Act. Final Report Prepared for National Aeronautics and Space Administration, Goddard Space Flight Center, Greenbelt, MD. N77 28551. 1977.
7. Fish, B.R.: A Feasibility Analysis of the Employment of Satellite Imagery to Monitor and Inspect Surface Mine Operations in Western Kentucky. Final Report Prepared for National Aeronautics and Space Administration, Goddard Space Flight Center, Greenbelt, MD. 1977.
8. Richard, R.R.; Merkel, R.F.; and Meeks, G.R.; NS001MS-Landsat-D Thematic Mapper Band Aircraft Scanner. Twelfth Int. Symp. on Remote Sensing of Environment, Manila, Philippines, April 20-26, 1978.
9. Anderson, J.R.; Hardy, E.E.; and Roach, J.T.: A Land Use Classification System for Use with Remote Sensing Data. U.S. Geologic Survey Circular 671. U.S. Government Printing Office. Washington, DC. 1976.
10. Williams, D.L.; and Stauffer, D.L.: What Can the Forest Community Expect From Landsat-D Thematic Mapper Data. presented at Remote Sensing of Natural Resources, Moscow, Idaho, University of Idaho, Sept. 10-14, 1979.

Table I. Sensor Characteristics Planned for the Landsat-D
TM and MSS (Ref. 10).

SPECTRAL BAND	THEMATIC MAPPER (TM)			MULTISPECTRAL SCANNER SUBSYSTEM (MSS)		
	MICROMETERS		RADIOMETRIC SENSITIVITY ($NE\Delta\rho$)	MICROMETERS		RADIOMETRIC SENSITIVITY ($NE\Delta\rho$)
1	0.45	0.52	0.8%	0.5	0.6	0.57%
2	0.52	0.60	0.5%	0.6	0.7	0.57%
3	0.63	0.69	0.5%	0.7	0.8	0.65%
4	0.76	0.90	0.5%	0.8	1.1	0.70%
5	1.55	1.75	1.0%			
6	2.08	2.35	2.4%			
7	10.40	12.50	0.5K ($NE\Delta T$)			
RFOV			30M (Bands 1-6) 120M(Band 7)	82M (Bands 1-4)		
DATA RATE			85 MB/S	15 MB/S		
QUANTIZATION LEVELS			256	64		

**ORIGINAL PAGE IS
OF POOR QUALITY**

Table II. MSS and TM Simulator Data Acquisition Information

	Landsat-3 Multispectral Scanner Subsystem (MSS)	Thematic Mapper Simulator (NS001)
Acquisition Date	September 29 and 30, 1978	June 14, 1979
Altitude (Km)	919	6.1
RFOV (m)	82	15 (at nadir)
Quantization levels	6 bit	8 bit
Scan Angle	<u>+5.78</u> ⁰	<u>+50</u> ⁰

Table III. Classification Scheme

<u>Level I</u>	<u>Level II</u>	<u>Level III</u>
1. Urban		
2. Agriculture	2.1 Row Crops 2.2 Bare Soil 2.3 Pasture	
3. Forest	3.1 Deciduous 3.2 Coniferous 3.3 Mixed	
4. Water		
5. Wetland		
6. Surface Mines	6.1 Barren 6.2 Revegetated	6.11 Graded 6.12 Ungraded 6.21 Grass 6.22 Trees

Table IV. Accuracy of Level II and Level III Surface Mine Category Area Measurements

Category		Accuracy* of Measurement from TM Simulator Data	Ground Reference (hectares)
Level II	Level III		
Barren		0.95	776.8
	Graded	0.89	413.9
	Ungraded	0.88	362.9
Revegetated		0.93	758.7
	Grass	0.84	380.0
	Trees	0.71	378.7

$$*Accuracy = 1 - \frac{\text{Measurement} - \text{Ground Reference}}{\text{Ground Reference}}$$

ORIGINAL PAGE IS
OF POOR QUALITY

ORIGINAL PAGE IS
OF POOR QUALITY

N83 19157 D15

MONITORING LAND CONVERSIONS FROM FOREST, WETLAND TO AGRICULTURE

Mary Louise Dudding
Land Management Information Center
Minnesota State Planning Agency

Original photography may be purchased
from EOS Data Center
Sioux Falls, SD 57198

ABSTRACT

This project investigated the utility of Landsat data in monitoring large-scale land clearance and drainage activities in a forest/wetland environment in northern Minnesota. Landsat tapes from 1973, 1978 and 1980 were used in a multi-temporal unsupervised land cover classification of the 9 x 15 mile site. Results showed quite clearly and in a cost-effective manner where the greatest activity had occurred. It was also possible to integrate the Landsat data with other data available through the Land Management Information Center's (LMIC) geographic information system.

BACKGROUND

Nationwide, there is serious concern that the United States is losing significant amounts of agricultural land. In the area described in this case study, the reverse is occurring--new agricultural land is being created out of forest and peat bogs--but this process, too, is causing concern to state and federal agencies.

The site under examination is in Aitkin County in the northeastern part of Minnesota, an area of 1,828 square miles and 11,169,920 acres (Figure 1). The land cover is predominantly forest, both upland and lowland, and wetlands/bogs interspersed with lakes. The area is sparsely populated. The climate, with its short growing season, is a constraint on many kinds of commercial agriculture, and parts of the county are laced with unused drainage ditches built during the early part of the century in a largely unsuccessful attempt to bring agricultural activity to this part of the state. The area does support some agricultural enterprises in forage crops and small grains with some recent developments in man-made wild rice paddies.

Into this setting several years ago came a land developer who bought up land in the county until he had amassed more than 50,000 acres, or about 10% of the privately held land. Eventually, it became known that he intended to clear and drain about 25,000 acres to be resold for various agricultural purposes. The remainder would be left in its natural condition to be sold as recreational land. By late 1980, it was estimated that he had already cleared and drained between 7-10,000 acres, reopened some abandoned drainage ditches and dug many new ones.

The Aitkin County Commissioners have enthusiastically supported this drainage project which is, however, in violation of several state and federal laws. In Minnesota, it is illegal to drain a wetland over 10 acres in size without obtaining a permit from the Minnesota Department of Natural Resources (DNR) and agreeing to put an equal number of acres back into public wetlands.

**ORIGINAL PAGE IS
OF POOR QUALITY**

To date, the developer has ignored requests from the DNR to go through the permitting process.

The U.S. Army Corps of Engineers says that the developer is in violation of Section 301 of the Clean Water Act for discharge of dredged material into several area lakes and rivers. Upon completion of an environmental assessment the Corps issued several cease and desist orders which the developer has ignored. In addition, complaints have been made by several of the area's wild rice farmers that the new drainage has lowered the water table sufficiently so that the paddies no longer hold the required water.

In late 1980, the Minnesota Environmental Quality Board and the Environmental Review Section of the Minnesota Department of Natural Resources contacted the Land Management Information Center (LMIC) to explore possible ways of monitoring these changes. Shortly thereafter, the Soil Conservation Service agent in Aitkin County also contacted LMIC, citing his concerns over the extensive changes in his area. LMIC offered to demonstrate the capability of Landsat to monitor this type of change in Aitkin County.

METHODOLOGY

HARDWARE

LMIC utilizes a Prime 550 mini-computer with a 1024kb memory. Landsat classifications are done at a DeAnza IP5524 image processing station which includes an image array processor with 756kb refresh memory and a 512 x 512 high-resolution color monitor.

SOFTWARE

LMIC has developed its own Landsat classification software called EPP.CLASS. It can be integrated with the standard Minnesota Land Management Information System (LMIS) Environmental Planning Programming Language (EPPL) software for a variety of analyses and graphic displays. For this project, an unsupervised classification was used. The EPP.CLASS technique develops training sets based on searching for areas of homogeneity of at least five pixels in size. Between 30 and 50 individual cover types are ordinarily identified by this process and these training sets form the basis for the classification scheme. A maximum likelihood classifier was used for this project.

LMIC software is also used to transform the Landsat data into a standard UTM grid cell format. This step becomes the basis for integrating Landsat data with other data in the system such as land use, soil type or forest cover type.

ORIGINAL PAGE IS
OF POOR QUALITY

LANDSAT DATA

Landsat tapes were acquired for three dates: May 1973, May 1978 and July 1980. The size of the pilot area was determined by concentration of drainage activity and by areas of cloud cover in the 1980 scene. The 1980 tape was in the EDIPS format.

CLASSIFICATION PROCESS

The image was first windowed to avoid the cloud-covered areas. The pilot area was approximately 9 x 15 miles with the Mississippi River running from northeast to southwest diagonally through the site.

To correct the images geometrically and to register them to one another, 20 ground control points were digitized from five USGS 7.5-minute topographic maps. After several attempts at registration and the addition of several more ground control points, the scenes were resampled to a 50-meter UTM grid using the nearest neighbor technique.

The first unsupervised classification utilized EPP.CLASS to do a 3 pixel by 3 pixel "moving window" analysis to locate areas of homogeneity. Fifteen cover classes resulted. It was felt that better separation of spectral classes would improve the results so the scenes were reclassified into 29-31 categories.

RESULTS

For each scene, the 29-31 spectral classes were aggregated into seven cover types: (1) lakes and open water, (2) rice paddies with standing water, (3) other rice paddies and bogs, (4) open land, pasture, forage crops and grassy sloughs, (5) low trees and scrub vegetation, (6) forest, and (7) bare ground.

Ground truth used included USGS topographic quads (1973) and 1:24,000 blue-line prints made from 1:90,000 black and white air photos (1977). Persons knowledgeable about the area were queried but a shortage of time did not permit actual field checking of cover types.

It was not practical to reproduce the full color classifications in this paper. Figures 2, 3 and 4 show a black-and-white summary of the unsupervised classifications. Water, wild rice paddies and the major areas of land clearance and drainage are shown in gray tones. The remainder of the classes have been suppressed to present more clearly the significant cover types.

In 1973, (Figure 2) the locations of a few wild rice paddies are clearly shown. By 1978, (Figure 3) some of these paddies have been expanded but no major clearance or drainage projects are evident. Figure 4, however, shows a significant amount of land conversion. The large dark gray block in the upper right-hand corner represents an area of about 5,000 acres which has been converted into potential agricultural land. Moreover, several of the rice paddies which had been closest to this drained area no longer appear in the 1980 scene. This

**ORIGINAL PAGE IS
OF POOR QUALITY**

disappearance might lend support to the contention that the lowering of the water table had adversely affected some wild rice growers.

Landsat data were also integrated with several sets of data from the MLMIS Geographic Information System. The site was overlaid with township lines, section lines and 40-acre parcel boundaries. A digital terrain tape for this area from the National Cartographic Information Center was also processed and integrated with the Landsat data. It expressed the topography of the area in one-foot contours. Land use/cover data from 1967 air photos, originally coded by 40-acre parcels, were resampled to a 50-meter UTM cell so that it could be more easily compared with the Landsat classification.

CONCLUSIONS

The unsupervised classifications used here satisfactorily show areas of large-scale clearance and drainage for agriculture purposes. This kind of monitoring could be done annually by training on large areas of bare ground.

No attempt has yet been made to quantify overall accuracy for each land cover type. The classifications presented here must be considered as preliminary since no field verification was attempted, and there is no doubt that further ground truth would result in improved accuracy.

Even with the limited amount of ground truth available and the relatively short amount of time spent on this project, it appears that Landsat technology does represent a satisfactory method of regularly monitoring large-scale changes in forest/wetland areas which are being converted to agriculture. Perhaps more significant, this technology allows for the easy integration of monitoring data with other data such as soil type, forest cover or watershed boundaries available in an ongoing geographic information system.

ORIGINAL PAGE IS
OF POOR QUALITY

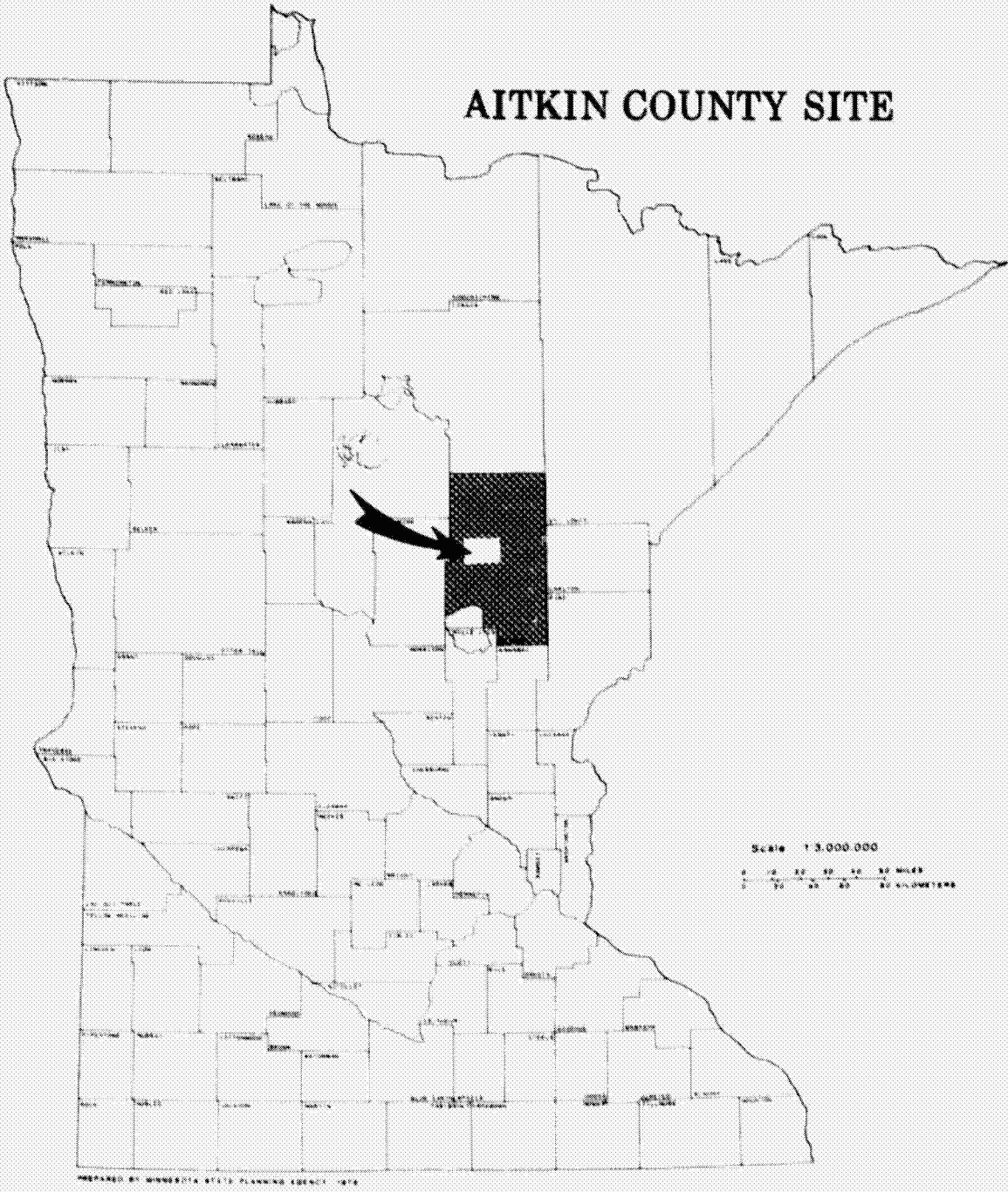
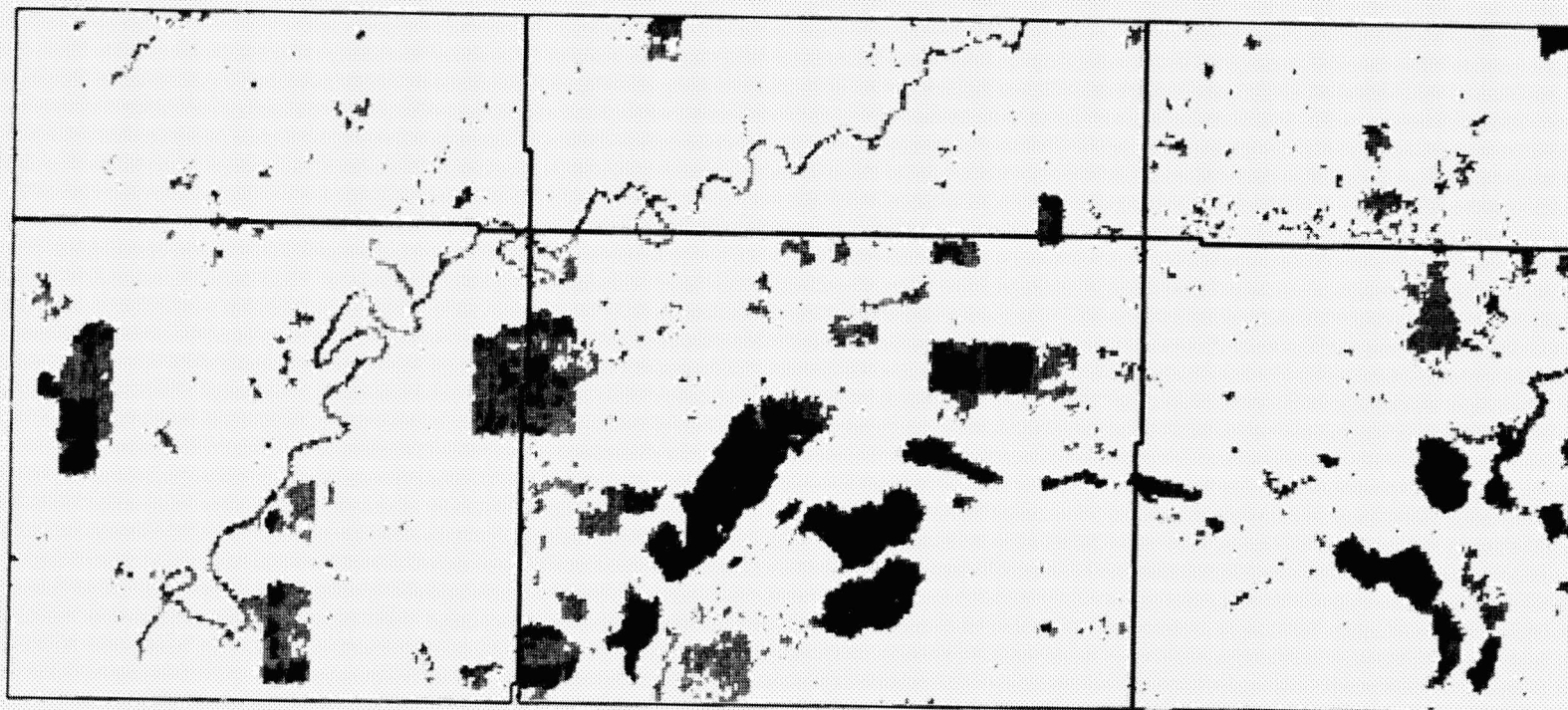

Figure 1

RITKIN COUNTY SITE 1973
LAND COVER TYPES



ORIGINAL PAGE IS
OF POOR QUALITY

144

SYMBOL	COUNT	PERCENT	ACRES	LEGEND	
■	1	4497	4.1	179880.0	WATER, STANDING WATER IN WILD RICE PADDIES
■	2	9317	8.6	372880.0	BOG, WET RICE PADDIES
■	3	98360	87.3	3814400.0	OTHER

Figure 2

AITKIN COUNTY SITE 1978
LAND COVER TYPES

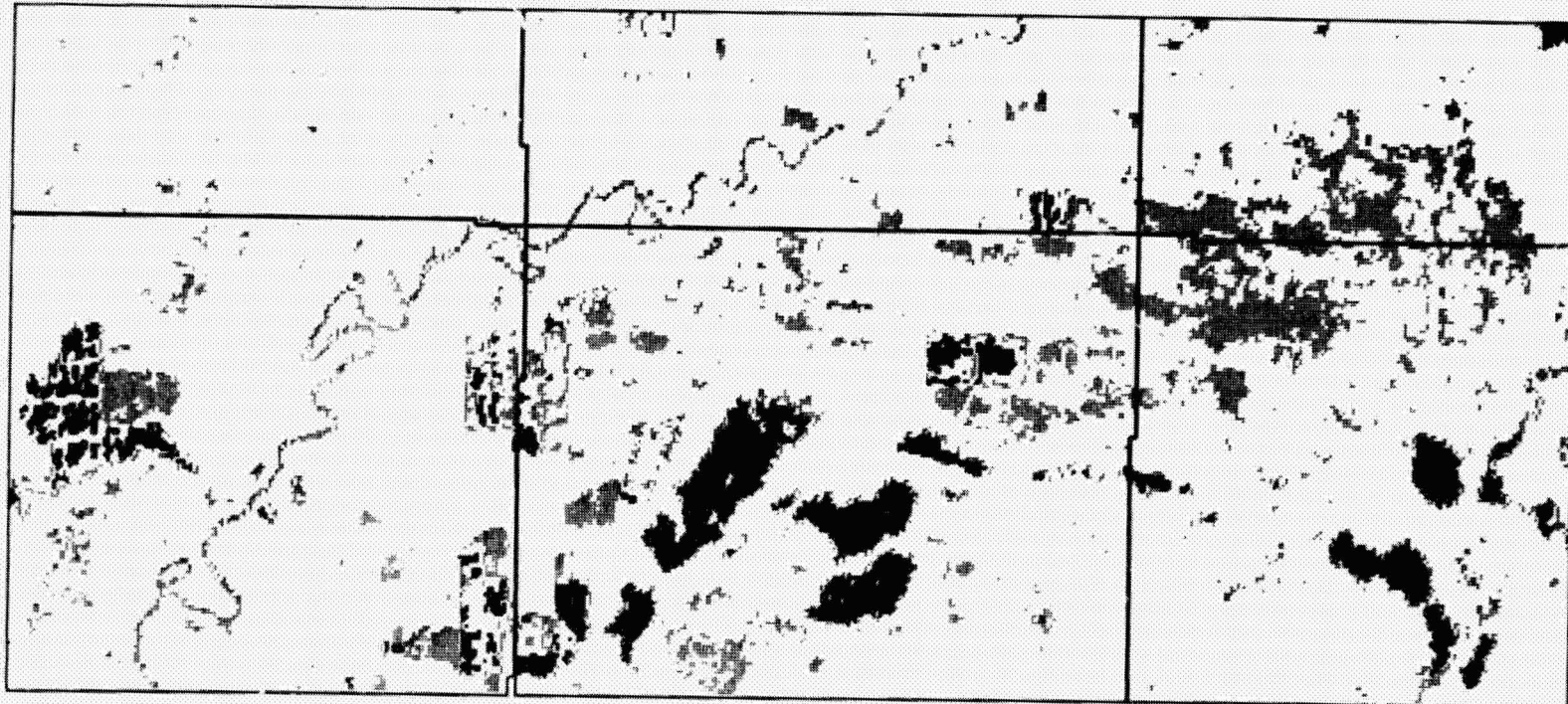

SYMBOL	COUNT	PERCENT	ACRES	LEGEND
1	4427	4.1	177080.0	WATER, SOME WET RICE PADDIES
2	10391	9.8	418840.0	ESS. WET RICE PADDIES
3	94388	88.4	3774240.0	OTHER

Figure 3

AITKIN COUNTY SITE 1988
LAND COVER TYPES

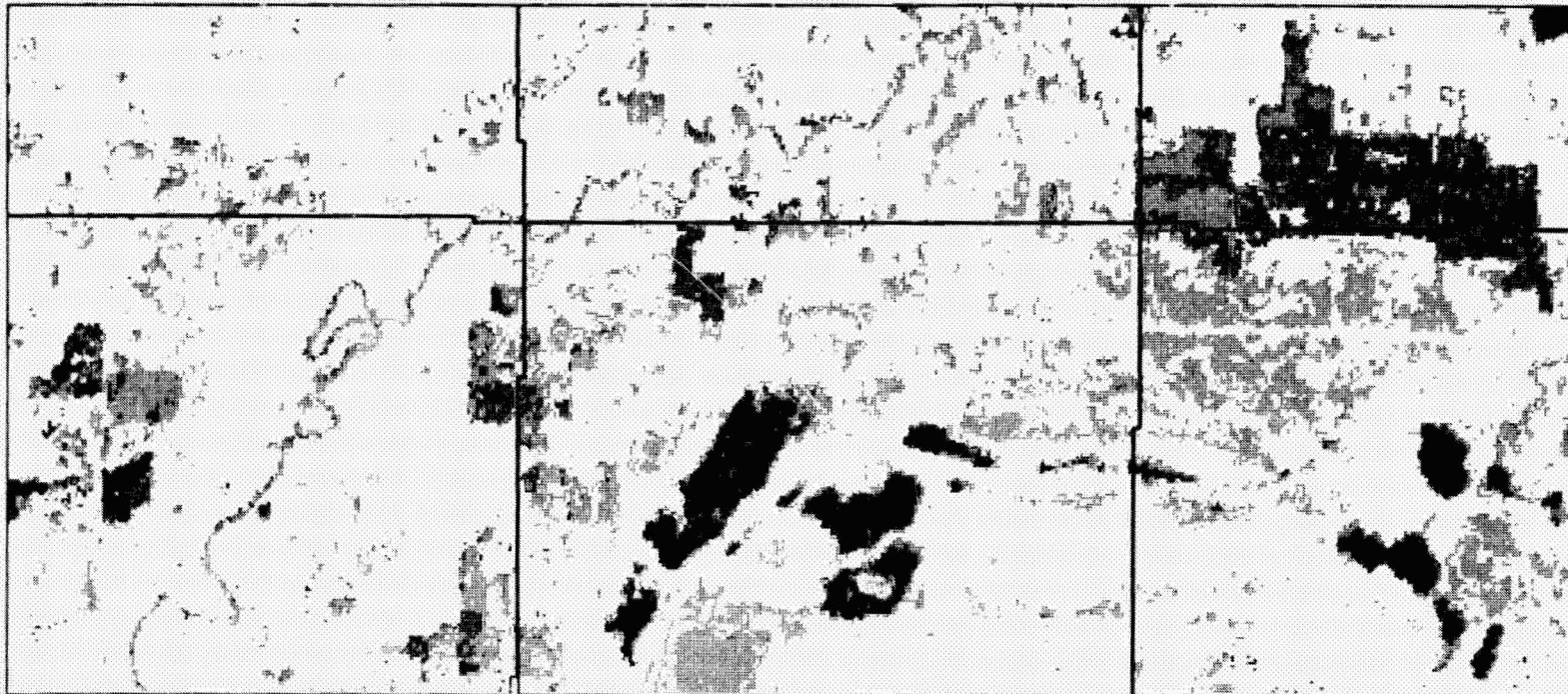

146

ORIGINAL PAGE IS
OF POOR QUALITY

	SYMBOL	COUNT	PERCENT	ACRES	LEGEND
■	1	3119	2.9	124760.0	WATER
■	2	15994	14.7	639760.0	BGG. WET RICE PADDIES
■	3	8451	5.0	218440.0	BARE GROUND, CULTIVATED
	4	84600	77.5	3384000.0	OTHER

Figure 4

N83 19158

D16

AREA ESTIMATION OF FORESTLANDS IN SOUTHWESTERN MICHIGAN
FROM LANDSAT IMAGERY*

Michael A. Karteris and William R. Enslin
Center for Remote Sensing
Michigan State University
East Lansing, Michigan

Jerry Thiede
Forest Management Division
Michigan Department of Natural Resources
Lansing, Michigan

ABSTRACT

This study evaluated the accuracy of mapping and estimating the area of forestlands in southwestern Michigan from winter and fall Landsat images. All omission and commission errors in the Landsat forest maps were identified and mapped through comparison with an existing detailed forest cover type map. Accuracies ranged from 74.0 to 98.5 percent and were higher for the winter imagery. Most errors (85%) occurred along the perimeter of forestlands and were less than 4 hectares (10 acres) in size. Other factors affecting interpretation are reported as well as time and image availability considerations.

INTRODUCTION

The Forest Management Division of the Michigan Department of Natural Resources (MDNR) needs a simple, inexpensive and reliable method for providing up-to-date county-level forest resources information. Presently, forest data are gathered periodically through the cooperative efforts of the MDNR, the U.S. Forest Service and the forest industry in Michigan. The major forest inventory of the entire state is the Michigan Forest Survey. However, the survey is conducted only every 10 to 15 years, it is not site-specific and it is statistically reliable only on a multi-county basis. The Forest Management Division is interested in whether accurate forest information on a county basis can be derived cost effectively from Landsat data.

Studies have been conducted to investigate, evaluate and demonstrate the use of Landsat data in mapping forest resources (refs. 1,2,3,4,5,6). This paper summarizes the results of a one-year study that assessed the accuracy of mapping and estimating the area of scattered forestlands in southwestern Michigan from Landsat imagery (ref. 7). Scattered small forestlands were of interest because the ratio of their perimeter length to areal extent is higher than those of extensive contiguous forests. In terms of image interpretation and

*This research was supported by NASA Grant NGL 23-004-083 and the Michigan Department of Natural Resources, Forest Management Division.

mapping, an interpreter has to identify and delineate many more forest units and boundaries which increases the probability of committing identification and boundary errors.

The objectives of this study were: 1) to map forests using different Landsat image products from two seasons; 2) identify and map all errors by comparing the Landsat-derived forest maps with a detailed forest cover type map; 3) assess the accuracy of interpretation; 4) analyze the factors contributing to error; and 5) evaluate time, cost and image availability considerations.

STUDY AREA

Barry County in southwestern Michigan was selected as the study area because a detailed forest cover type map and recent aerial photography were available. This county contains many scattered forested areas of various sizes and shapes within its land area of 144,780 hectares (357,751 acres). Over 26 percent of the county is covered by forests which consist of many of the forest cover types found in Michigan. Of these forestlands, 99.2 percent are capable of producing commercial timber and two-thirds of them are in private ownership.

Agriculture is the major land use (55%) in the county and includes farming, livestock, dairy and poultry production. Principal crops are corn, wheat, oats, soybeans and dry beans.

Terrain varies from level in the eastern townships to gently rolling in the west. There are numerous wetlands although well drained soils (loams and sandy loams) predominate throughout the county.

DATA SOURCES

It was decided that the optimal Landsat image may be a cloudless winter scene with snow cover on the ground but not on the trees. Under this condition, the tonal contrast between forested areas and other land cover types is very high. For comparative purposes, an additional Landsat scene taken during the growing season would be used.

A Landsat scene from February 26, 1979 (E-30358-15475) and one from September 12, 1979 (E-30556-15460) were selected from available scenes produced on the EDIPS (EROS Digital Image Processing System) equipment. EDIPS imagery was preferred because the system has improved Landsat image quality by employing processing routines for radiometric and geometric corrections, haze removal and edge enhancement.

Two image products of each Landsat scene were selected for interpretation: a Band 5 positive and a false-color composite of the winter scene, and a false-color composite and a diazo-enhanced color composite of the fall scene. All of the images were 185mm x 185mm (7.3 in. x 7.3 in.) transparencies.

The diazo color composite was produced to enhance (contrast stretch) forested areas using a density-specified process (refs. 8,9). Film exposure for each band was determined through densitometric analysis of forest areas clearly

depicted on all black-and-white band positives and use of characteristic density (sensitometric) curves for each diazo film. The false-color composite consisted of one yellow diazo copy of Band 4, three magenta copies of Band 5 and one cyan copy of Band 7.

The primary source of reference (ground truth) data was a recently completed forest cover type map of the county (ref. 10). The map was prepared from photointerpretation of 1:30,680 scale color infrared (CIR) photography taken in 1974. In cases where discrepancies between the Landsat forest maps and this map were found, available 1:24,000 scale CIR photography acquired in 1978 was used to resolve differences.

METHODOLOGY

Separate forest maps and area estimates for the county were derived from visual interpretation of the four Landsat images. Forest areas as small as one hectare (2.5 acres) were delineated from these images onto 1:50,000 scale county base maps using a precision rear projection system.

The interpretation entailed the identification and delineation of the boundaries of all forest areas without considering forest type or condition, and was performed by one interpreter. Prior to interpretation, the interpreter trained himself to recognize the appearances of forestlands on each image through analysis of a test area. To minimize bias in interpretation decisions due to experience gained from a previous interpretation, the sequence of interpretation alternated between winter and fall scenes with a one-week break between scenes. An interpretation overlay showing the boundaries of forestlands was prepared from each Landsat image.

The existence of the forest cover type map of the county permitted a complete assessment of the accuracy of interpretation. All errors in each Landsat forest map were identified and delineated onto separate overlays (fig. 1) through comparing each map superimposed on top of the forest cover type map. Registration was done on an individual forest tract basis since the geometric projections of the Landsat imagery (Hotine Oblique Mercator) and the reference map (polyconic) were different.

Omission errors were classified into forest type, stand size and density classes and commission errors were divided into seven land cover/use categories (table I). The omission and commission errors were further separated into boundary or identification errors. Boundary errors are areal differences in the perimeter (size and shape) of individual forestlands between the Landsat maps and reference map. Errors due to misinterpreting an entire forest tract or identifying a non-forest cover area as forest were considered identification errors. Identification errors are the most serious because individual parcels of land of a certain class are absolutely lost by assigning them to another class.

Another category was identified but not included in the accuracy assessment because it did not represent Landsat classification error. This category consisted of individual forestlands that were correctly interpreted on the

Landsat images but were not shown on the forest type map. These lands, verified on recent aerial photography, were considered "overlooked forests" on the reference maps. Forested areas which had been harvested since the compilation of the forest cover type map were also included in this category.

The frequency and areal extent of each type of error was determined for each Landsat map. Areas were estimated using a cell grid having a 0.25 hectare (0.625 acre) cell size. All values were rounded off to one decimal place.

RESULTS AND DISCUSSION

Three types of agreement or accuracy were calculated: interpretation, classification and mapping. Interpretation agreement expresses the relative proportion of the total forest area mapped from Landsat to the total reference (actual) forest area of the county without considering errors of omission or commission. This type of accuracy is non-site specific and, therefore, is useful only if total area estimates are needed. Classification agreement expresses the relative proportion of the actual forest area that was correctly mapped as forest from Landsat taking into account only the omission errors. As such, it indicates how accurately individual forest tracts were identified without considering the misinterpretation of non-forested areas as forests (i.e., commission errors). Mapping agreement provides a measure of the locational or positional accuracy of the interpretation maps (ref. 11). It expresses the relative proportion of the actual forest area that was correctly mapped as forest, taking into account both errors of omission and commission.

The accuracies achieved with each type of Landsat image are given in table II. Overall, the accuracies ranged from 74.0 to 98.5 percent and were higher for the winter scene than the fall scene. Mapping accuracy (which has the greatest validity) was the highest for the winter false-color composite (88.3 percent), whereas the diazo enhancement of the fall scene improved the mapping accuracy over the fall false-color composite. Considering all types of accuracy, the winter false-color composite image provided the most accurate forest map of the county, although a diazo-enhanced image of the winter scene may even further improve accuracy.

An investigation was made of the major factors affecting interpretation errors. A summary of the various interpretation errors by type of Landsat image is presented in table III. Over 83 percent of all commission and omission errors were boundary errors. The accuracy of identifying individual forest tracts from Landsat imagery (not considering their area) would, therefore, be substantially higher than those presented in table II.

An analysis of the size of the error units showed that most areas were less than 4 hectares (10 acres) in size. Thus, if one is interested only in mapping forestlands larger than 4 hectares, the accuracy achievable may be improved.

Evaluation of the commission errors indicated that agricultural land was the major component of error, followed by treed bogs, brushland and urban trees. This was expected because of the high percent of boundary error and agriculture

being the major land use in the county. However, accuracy may be improved if treed bogs and brushlands are considered forested areas.

The frequency and area of misinterpreted forest cover type categories (omission errors) were proportional to their occurrence in the county. Both stocking level (density) and stand size affected the interpretability of all forest cover types. Forest stands of lower stocking level and small stand size were more often misinterpreted; however, stocking level contributed more to omission error than stand size.

The amount of time spent on interpreting each Landsat image, including registration, training and interpretation, was recorded. The total time required to map the forests of the county ranged from about 13 hours for the winter color composite to 21 hours for the fall color composite.

Another factor considered was the availability of Landsat images for a given season. All available Landsat images of the county taken between 1972 and 1980 were classified according to frequency and percent cloud cover. A total of 186 Landsat images have been taken since 1972 and, of these, only 13 images (7 percent) have no cloud cover. Over 64 percent of all images and over 93 percent of the winter scenes have a cloud cover of more than 40 percent. The availability of cloud-free winter images is definitely much lower than clear fall images.

CONCLUSION

This study found that accurate acreage estimates of forestlands can be derived from Landsat imagery. The total forested area in Barry County was estimated to be within 3 percent of reference data, although site-specific accuracies of the Landsat images ranged from 74.0% to 88.3%. The false-color composite of the winter Landsat scene (with snow cover) provided the most accurate forest map and diazo enhancement improved the accuracy achievable from the fall Landsat scene.

In light of the accuracy levels achieved, and considering the relative efficiency and availability of the technology, the Forest Management Division, Michigan Department of Natural Resources, believes that Landsat-derived forest statistics can provide a valuable supplement to current forest resources data. It is also likely that Landsat can provide the first level forest area statistics in the periodic forest surveys and be used to update some of those statistics.

REFERENCES

1. Beaubien, J. 1979. Forest type mapping from Landsat digital data. *Photogrammetric Engineering and Remote Sensing*. 45(8):1135-1144.
2. Bryant, E.; A.G. Dodge, Jr. and S.D. Warren. 1980. Landsat for practical forest type mapping: a test case. *Photogrammetric Engineering and Remote Sensing*. 46(12):1575-1584.
3. Dodge, A.G. and E.S. Bryant. 1976. Forest type mapping with satellite data. *Journal of Forestry*. 74(8):526-531.
4. Hoffer, R.M.; S.C. Noyer and R.P. Mroczynski. 1978. A comparison of Landsat and forest survey estimates of forest cover. *Proceedings of the Fall Convention of the American Society of Photogrammetry*, Albuquerque, New Mexico, pp. 221-231.
5. Kan, E.P. 1978. Nationwide forestry application program. A literature review of major remote sensing projects mapping forest land in the U.S., using satellite data and automatic data processing. Lockheed Electronics Company, Inc., Final Report LEC-12131, Houston, Texas, 65 p.
6. Mead, R.A. and M.P. Meyer. 1977. Landsat digital data application to forest vegetation and land use classification in Minnesota. *Proceedings of the Fourth Annual Symposium on Machine Processing of Remotely Sensed Data*, Laboratory for Application of Remote Sensing, Purdue University, West Lafayette, Indiana, pp. 270-279.
7. Karteris, M.A. 1980. An evaluation of satellite data for estimating the area of small forestlands in the southern Lower Peninsula of Michigan. Ph.D. Dissertation, Michigan State University, East Lansing, Michigan, 184 p.
8. Lusch, D.P. 1981. Diazo processing of Landsat imagery: a low-cost instructional technique. Paper presented at the Conference on Remote Sensing Education, Purdue University, West Lafayette, Indiana.
9. Malan, O.G. 1976. How to use transparent diazo colour film for interpretation of Landsat images. *COSPAR, Technique Manual Series No. 6*, Paris, France, 37 p.
10. Tatem, L. 1978. Barry County forest resources. A.S.C.S., Hastings, Michigan, 43 p. (Mimeographed).
11. Kalensky, Z. and L.R. Scherk. 1975. Accuracy of forest mapping from Landsat computer compatible tapes. *Proceedings of the Tenth International Symposium on Remote Sensing of Environment*, ERIM, Ann Arbor, Michigan, pp. 1159-1167.

ORIGINAL PAGE IS
OF POOR QUALITY

Table I
Forest Type and Land Cover/Use Classification System

Error Class	Category	Symbol	Description
Omission	Pine	P ₀ ...P ₉	Stands ranging from re-generation to full stocking sawtimber
	Oak-Hickory	O ₀ ...O ₉	"
	Northern Hardwoods	M ₀ ...M ₉	"
	Aspen	A ₀ ...A ₉	"
	Lowland Hardwoods	E ₀ ...E ₉	"
	Mixed Hardwoods	K ₀ ...K ₉	"
	Conifer Swamps	Q ₀ ...Q ₉	"
	Spruce-Fir	S ₀ ...S ₉	"
Locust	B ₀ ...B ₉	"	
Commission	Agriculture	A	Areas supporting agricultural crops
	Treed Bog	B ₀	Adverse sites supporting trees with more than 10% crown cover
	Upland, Lowland Brush	B ₁ ...B ₄	Areas with brush of variable maturity and stocking and trees of less than 10% crown cover
	Scattered Trees	T	Areas supporting trees with less than 10% crown cover
	Urban	U	Urban areas without trees or other brush vegetation
	Urban-Trees	UT	Urban areas with tree vegetation
	Water-Marsh	W	Areas permanently or periodically covered by standing water

ORIGINAL PAGE IS
OF POOR QUALITY

Table II
Classification, Interpretation and Mapping Agreement by Type of Landsat Image

TYPE OF LANDSAT IMAGE									
Agreement	Black-and-White Winter		Color Fall		Color Winter		Diaz Fall		Total Forested Acreage
	Acreage	%	Acreage	%	Acreage	%	Acreage	%	
Classification	56879.0	95.0	51513.2	86.0	55613.7	92.8	53571.9	89.5	59876
Interpretation	66161.5	89.5	61265.7	97.7	58720.5	98.1	60751.9	98.5	
Mapping	56879.0	82.2	51513.2	74.0	55613.7	88.3	53571.9	79.9	

Table III
Errors of Interpretation Performance by Type of Landsat Image¹
for Barry County, Michigan

TYPE OF LANDSAT IMAGE																	
Error		Black-and-White Winter		Color Fall		Color Winter		Diaz Fall									
		Frequency	Acreage ²	Frequency	Acreage	Frequency	Acreage	Frequency	Acreage								
		Abs.	%	Abs.	%	Abs.	%	Abs.	%								
Commission	Boundary	1255	88.8	7988.9	86.1	1191	92.2	9113.9	93.4	482	87.6	2603.0	83.8	1127	96.1	6957.4	96.9
	Identification	150	11.2	1293.6	13.9	95	7.8	638.6	6.6	68	12.4	503.0	16.2	46	3.9	222.6	3.1
	Total	1413	100.0	9282.5	100.0	1291	100.0	9752.5	100.0	550	100.0	3106.0	100.0	1173	100.0	7180.0	100.0
Omission	Boundary	591	90.8	2670.8	89.1	1017	85.6	7294.4	87.2	878	91.1	3796.8	89.1	936	86.0	5465.1	86.7
	Identification	60	9.2	326.2	10.9	172	14.4	1068.4	12.8	86	8.9	465.5	10.9	152	14.0	839.0	13.3
	Total	651	100.0	2997.0	100.0	1189	100.0	8362.8	100.0	964	100.0	4262.3	100.0	1088	100.0	6304.1	100.0

¹Total forest acreage: 59,876 acres.

²The acreage values represent the number of acres incorrectly interpreted. They are expressed in acres in all subsequent tables and graphs.

ORIGINAL PAGE IS
OF POOR QUALITY

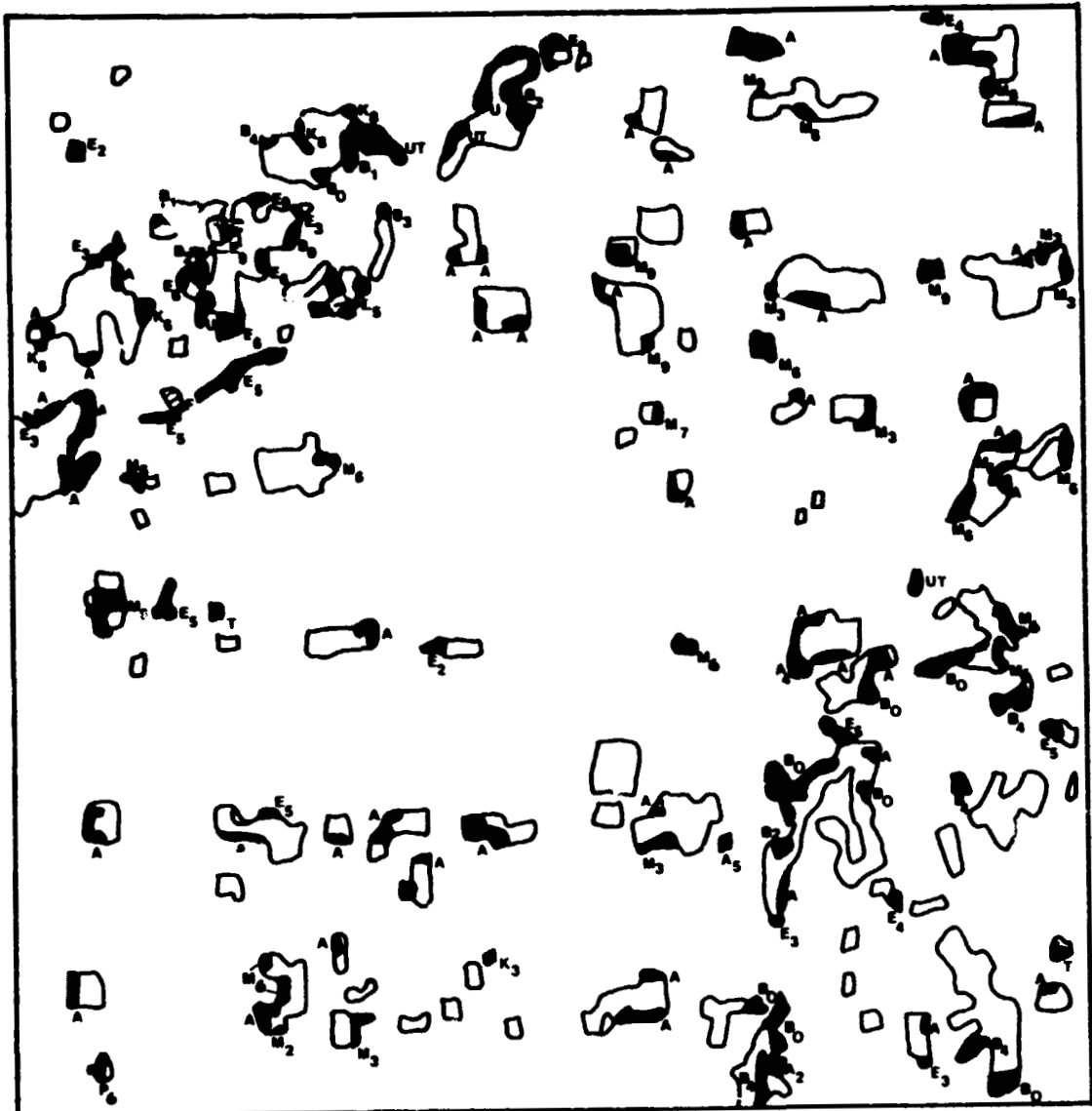

- | | |
|--|---|
|  Forests Correctly Identified |  Overlooked Forests |
|  Commission Errors |  Omission Errors |

Figure 1. Forest Interpretation Map from the Color Fall Image of Woodland Township, Barry County, Showing Commission and Omission Errors. See Table I for explanation of codes.

N83 19159^{D17}

ORIGINAL PAGE IS
OF POOR QUALITY

APPLICATION OF REMOTE SENSING TO
LAND AND WATER RESOURCE PLANNING:
THE POCOMOKE RIVER BASIN, MARYLAND

Stan E. Wildesen, Planning Engineer, Soil Conservation Service
Salisbury, Maryland

Edward P. Phillips, Chairman, Pocomoke River Advisory
Committee, Berlin, Maryland

ABSTRACT

The Pocomoke River Advisory Committee (PRAC) in conjunction with the Soil Conservation Service (SCS), United States Department of Agriculture, conducted a study of the Pocomoke River Basin, Maryland to develop a comprehensive resource management plan that provides for the management and protection of the natural resources of the river.

Because of the size of the river basin, the inaccessibility of certain areas and study time constraints, several remote sensing techniques were used to collect base information. This information provided an adequate understanding of the environment and its resources, thus enabling effective management options to be designed.

The remote sensing techniques used for assessment included manual analysis of high altitude color-infrared (IR) photography, computer-assisted analysis (ORSER) of Landsat-II imagery, and the application of Airborne Oceanographic Lidar (AOL) for topographic mapping.

Results show that each technique was valuable in providing the needed base data necessary for resource planning.

INTRODUCTION

The Pocomoke River Advisory Committee requested a special river basin study to be initiated by the Soil Conservation Service, USDA. This study focused on the upper portion of the river between Snow Hill, Maryland and the Delaware State Line. Historically, this section of

PRECEDING PAGE BLANK NOT FILMED

PAGE 156 INTENTIONALLY BLANK

the river has been maintained by dredging. In recent years the dredged channel has become inefficient because of sedimentation, windfalls and debris. This has caused severe drainage problems especially during periods of high rainfall. This study concentrated on the management and balance of agricultural drainage demands with environmental and recreational concerns. The latter group is concerned with the preservation of natural flora and fauna indigenous to the swamp ecosystem flanking both sides of the river. The solutions involved a considerable amount of data acquisition for a multitude of parameters. Perhaps the most important of these inputs necessary to predict potential impacts of any action was the hydraulic and hydrologic conditions of these ecosystems. Through the use of remote sensing base data were obtained to analyze these conditions.

Major examination centered on the river corridor, a 23.2 km. (14.4 mi.) channel and a 1.2 km. (0.75 mile) wooded floodplain. This corridor still contains the old river bed, its oxbows, the dredged channel of 24.3 m. (80 feet) top width and 1.5 m. (5 feet) high spoil piles. During the channel construction in the 1940's continuous spoil piles were placed on both sides of the river resulting in individual vegetational patterns.

High altitude color infrared (IR) photography was used to highlight unique areas in the corridor and throughout the basin. It was the purpose of Landsat-II MSS analysis to document these present patterns, compare with color IR results and use as follow-up for future assessment after the implementation of several management schemes.

Airborne Oceanographic Lidar (AOL) application for topographic mapping was used with available ground survey data to document the available floodwater storage and model the hydrologic conditions that can occur.

HIGH ALTITUDE PHOTOGRAPHY

IMAGERY SELECTION

High altitude 18240 m. (60,000 ft.) color infrared (IR) photography, NASA mission 74-039, dated March 13, 1974, was chosen for analysis. This flight represented the most promising for wetland interpretation because of high water and defoliated condition. This condition revealed definitive boundary lines that allowed separation of wetland forest.

Color infrared 91 cm. X 91 cm. (36 in. X 36 in.) paper photos were chosen because of the inexpensive cost. At a cost of \$250,00, five (5)

frames provided more than complete coverage of the basin. The under-flight photography was chosen for wetland identification and as the primary source for data collection.

This method has proven successful in other studies. This scale, approximately 1:29,000, needed to show enough detail for small wetland units but still provide enough information for total environmental and agricultural considerations.

CLASSIFICATION AND IDENTIFICATION

The five frames, 91 cm. X 91 cm. (36 in. X 36 in.) paper photos, were covered with .0127 cm. (0.005 in.) frosted mylar drafting film overlay. The frames were then quartered to enable a convenient use for field checking. Suspected areas of wet forest were delineated on the mylar with No. 2 pencil.

Field investigation performed to identify areas by wetland vegetation types was based on the United States Department of Interior, Fish and Wildlife Service, Circular 39.

IMAGERY INTERPRETATION AND DELINEATION

Interpretations of infrared photography showed two major locations of the wetlands. There were (1) depressions found on upland flats that were dispersed and isolated, and (2) systematic wetlands located along the riverine systems. In the upland the photography helped locate the sites and likely access routes. It also determined the general shape and geometry of the areas. At riverine systems, the alignment, shape, location and dimensions were provided. On-site inspection of the sample areas perfected interpretation of these photos. With knowledge of on-site conditions and the color, texture and position on the photos, field review site priorities were made.

Visual analysis of the color infrared (IR) photographs ascertained wetlands as small as 6 m. (20 ft.) in diameter and showed a linear alignment of drainage ditches down to 1.2 m (4 ft.) width.

Detail and accuracy were greater than the use of conventional methods. Approximately 90 percent of the wetland mapping was accomplished by use of these photos. Only 10 percent of the conventional field time was needed for IR photo verification. Total field and office time required 60 days, approximately 1/10 the time of conventional method.

LANDSAT IMAGERY

IMAGERY SELECTION

A four-band Landsat-II scene, scanned on April 9, 1978 was obtained on computer-compatible tape. Selection of this scene was based on a defoliated forest condition, bare cropland condition, and a high water condition in the floodplain. The single selection of this scene was proposed to demonstrate (1) the ability of Landsat analysis to perform similarly to the high-altitude color infrared photography for identification of wetland and forest patterns, and (2) examine the potential ability of Landsat analysis to delineate wet and dry cropland soils.

WETLAND AND FORESTLAND ANALYSIS

Classification and Identification

The Landsat scene was analyzed using the ORSER System (software package of the Office of Remote Sensing of Earth's Resources, The Pennsylvania State University).^{*} Using the Landsat scene, the spectral signatures of a 40,000-acre test area were evaluated in hopes of detecting and classifying characteristic plan expressions. The vegetative areas had unique patterns associated with them. These patterns were indicators of the vegetation, wetness, and biological condition. Though land use and cover types are normally associated with ground condition, aspect, and vegetation, aspect was not a major consideration.

The topography of the area is relatively flat with less than 1 percent slope except in floodplain-upland breaks. The mean sea level elevations are less than 7.6 m. (25 ft.) causing negligible aspects.

An initial map was generated to verify general location and orientation. These maps were then compared with SCS aerial photos, USGS 7½ minute quadrangles and SCS soil surveys for the surrounding counties. Training sites were selected from these data bases.

^{*}Irish, Richard R.; Luce, Frederick C., 1980, Identification of Ecological Response Units by Computer Classification of Landsat MSS Data (Unpublished).

Various ORSER programs were iterated to refine the land classification maps. The resulting signatures and locations were compared to a color infrared high-altitude photo mission number 73-197, dated December 1, 1973. Ground truthing was not used. After successive use of these ORSER programs a final classification map was produced and compared to the high-altitude photos.

Verification

Transects were taken on the final computer-generated classification map and compared to transects on the high altitude color infrared photographs dated March 13, 1974. The floodplain sampling area was 606 ha. (1500 ac.). Transects were made every 760 m. (2500 ft.). Sampling points on the transect were taken every 304 m. (1000 ft.) giving approximately four sampling points for every transect.

The wetland type at each of the sampling points was examined within each population. The individual examination of each point was referenced as an event. If the wetland type at a point was the same for both the delineated overlay and the ground point, a value of 1 was assigned to that event. If the forest types were not the same a value of 0 was assigned to that event.*

The number of correctly identified sampling points, stated as a percentage, were computed using the following equation.

$$\text{Percentage of points identified correctly} = \frac{\text{Total value of events}}{\text{Total number of events}} \times 100$$

The percentage of correctly identified sampling points was an estimate of the accuracy of the Landsat classification.

Results

Upon completion of the program reiterations, a total of 22 specific signatures were identified. Comparison of the final computer map with aerial photos revealed eight general categories of the 22 signatures. Four categories were analyzed for wetland analysis.

*deSteiguer, J. E., Forest Type Mapping of the Atchafalaya River Basin from Satellite and Aircraft Imagery.

These categories were significantly similar to the previously mentioned manual analysis of wetlands on color infrared photographs:

- (1) Water (#) 51 ha. (127 ac.)
- (2) Wetland vegetation (.) 162 ha. (400 ac.)
- (3) Deciduous forestland (X) 1366 ha. (3381 ac.)
- (4) Unknown forestland (+) 2036 ha. (5039 ac.)

The first category was representative of open canopy areas of the river or existing milldams. In one area a dying and inundated swamp was represented. Wetland conditions of this category and others varied with upland drainage or channel overflow.

Category No. 2 and Category No. 3 represented a type 7 swamp. These areas paralleled the main dredged channel and reflected the overflow from the main channel and entrapment of upland drainage. The boundary with the next classification showed the extent of high water encroachment.

The location of Category No. 4 along the periphery of type 7 confirmed by ground truthing to be a type 1 situation. These areas were different by wetness, distance from channel overflow, and general elevation increase.

Though the classifications were formulated without ground truthing the computer generated classification map provided an 87 percent accuracy. Ground truthing is always necessary to assess the plant species composition but this demonstration showed that use of Landsat remote sensing data can complement, improve or reduce field work. This process maximized the use of digital data and minimized field work.

Results indicate that if manual analysis of high-altitude IR photos reduce conventional methods by 90 percent, Landsat imagery analysis using computer assistance may further reduce the work load and time. Landsat may be used either as a preliminary analysis synoptic coverage of the entire basin or for selection of specific areas for a more detailed analysis.

IDENTIFICATION OF WET CROPLAND

Introduction

Inadequate surface and subsurface drainage of agricultural crops

and pasture land can be a severe problem to the agricultural economy. This drainage problem is caused by seasonally high water tables and a lack of adequate drainage outlets. A particular visual measure as to the effectiveness of surface drainage is soil moisture retention and wet field conditions.

Attempts were made to identify cropland areas of varying wetness (relative surface soil moisture content) throughout the test area to assess the effectiveness and need for agricultural drainage channels.

This test site in the Pocomoke River Basin was selected to assess the utility of Landsat MSS data for mapping and monitoring cropland soil wetness for assessment, planning, and management of major agricultural drainage construction projects. Using the ORSER computer program package, an April 9th, 1978 Landsat scene was analyzed. The upland segment of the Pocomoke was identified and tested.

Classification and Identification

The composite brightness and uniformity map was generated first to verify the study location and provide easier selection and identification of sample areas. These areas were of known relative wetness.

Initially one band 7 was analyzed to display the water reflective ability. Successive use of various ORSER subprograms revealed unique areas of spring planting and/or winter crops but classification was difficult to complete.

Analysis with four (4) bands did not significantly improve classification results. The comparison of the classification maps with the high-altitude color infrared photographs showed partial recognition of some unique cropland patterns but general discernible accuracy did not exist. No uniformity in wet and dry soil areas seemed to exist.

Results

Identification of unique spectral signatures for wet and dry cropland was difficult to ascertain. The final classification map revealed minimal identification of the sample areas. Further review suggests soil moisture for the particular Landsat scene was not at a desired optimum. Winter cover crop complicated the analysis due to the spectral response of the vegetation. cursory analysis negated further investigation of other programs for refinement.

AIRBORNE LASER TECHNOLOGY FOR TOPOGRAPHIC MAPPING

INTRODUCTION

The Airborne Oceanographic Lidar (AOL) is a state-of-the-art pulsed laser system designed primarily for field demonstration and technology transfer experiments for user agencies that need new technology in the areas of (1) airborne bathymetry and (2) laser induced fluorescence. Since the AOL system must perform as a high-precision laser altimeter for these two areas, it allowed use for topographic mapping.

The AOL can also be utilized for the determination of tree heights. In the bathymetry mode a short laser pulse is transmitted to the ground. The pulse is partially reflected back by the tree canopy to the aircraft receiver while the other part of the pulse penetrates the canopy to the ground surface and returns also. The separation in the two returns provides a measurement of tree heights, and the sum of the initial range and the tree height yields an accurate measurement to ground level.

TECHNIQUES

AOL was applied in the profiling mode over the river floodplain. Typical flight lines were 1 to 3 km. in length. Beginning and ending flight lines were marked with tethered red and/or white balloons. Altitudes were between 165 and 300 m. (500 and 1000 ft.). The aircraft speed was 75 to 100 meters/second (150 to 200 knots). The flightline was covered with a tolerance of 30 meters cross-track at the beginning and ending of the line.

GROUND SUPPORT

The ground survey team correlated their activities with the aircraft information. Field data were collected and identified with photographic records of the flight lines. Survey lines were cut and mean sea level elevations were verified at necessary test points. Elevations were determined for at least three identifiable points of photographic records to compare and correlate U.S.G.S. Coast and Geodetic Survey markers with lidar application data.

The ground team acquired permission to establish navigation guides and markers on private lands and access for additional survey.

AIRCRAFT POSITIONING

Presently positional data as well as altitude data (pitch, roll and heading) can be determined for aircraft. However these data are usable for a short term due to gyro drifts. The use of vertical accelerometer removes vertical aircraft motion for the data. Though drifts occur, errors are removed by knowing three easily accessible survey points in the flight line.

Additional positioning was made available to the proximity with NASA Wallops Island Flight Center. During flights precision tracking C-band radars were used.

MAPPING CAPABILITIES

In the profiling mode data were provided every 20 cm. of length at 434 km. (270 mi./hr.). Precision has been shown in previous demonstrations to be 2 cm. on a static target and 6 cm. over smooth ground.

RESULTS

Laser transects have several advantages over present survey techniques used for planning. They are:

- a. The AOL system can collect data within 30 seconds compared to several days for a ground survey team.
- b. Many more data points are supplied along the line by laser than conventional methods.
- c. The AOL system demonstrated potential for rapid and detailed mapping for logistical difficult profile lines.
- d. Laser raw data are collected in digital form, allowing for immediate computer processing.
- e. The AOL system demonstrated the ability to measure tree heights and also measure to ground level in foliage covered terrain - a task difficult to impossible for photogrammetry.

SUMMARY

The use of remote sensing techniques for the Pocomoke River Basin Study acquired needed data.

The use of high altitude color infrared photography for wetland identification was faster and less expensive than the conventional methods. Analysis of Landsat MSS data showed 87 percent accuracy in identifying wetland and forest patterns. Because of this accuracy present patterns are documented and available for future assessment when management options are applied. Aerial application for topographic mapping provides information for planning purposes.

Results show that each technique is in the state of the art. Use of these techniques can be used in land and water resource planning.

REFERENCES

- Turner, B. J., D. N. Applegate, and E. F. Merembeck, Satellite and Aircraft Multispectral Scanner Digital Data User Manual, ORSER Tech. Rept. S-78, 1979.
- U.S.D.A., Pocomoke River Advisory Committee, Plan of Work for the Pocomoke River Special Study, 1979.
- U.S.D.A., Soil Conservation Service, Soil Survey: Wicomico County, Maryland, 1970.
- U.S.D.A., Soil Conservation Service, Soil Survey: Worcester County, Maryland, 1973.

N83 19160 ^{D/B}

ORIGINAL PAGE IS
OF POOR QUALITY

APPLICATION OF LANDSAT DATA TO MONITOR
LAND RECLAMATION PROGRESS IN BELMONT COUNTY, OHIO

Hubertus H.L. Bloemer
Ohio University, *Adena*

James Brumfield
Marshall University, *Huntington, W. Va.*

William J. Campbell
NASA/Goddard

Original photography may be purchased
from EOS Data Center
Sioux Falls, SD 57198

R.G. Witt
NASA/Goddard

Belden G. Bly
Computer Sciences Corporation/Goddard

Surface mining for coal has become an increasingly important response to the nation's demand for domestic energy supplies. East-central Ohio (Fig. 1) today is among the country's largest suppliers of coal. The area has been disrupted by coal mining since the early 1800s. Belmont County (Fig. 2) has become almost synonymous with strip mining. A major part of the county has been churned over since the introduction of strip mining to the county in 1918.

Belmont County has several layers of coal throughout its area. Some of the seams are extracted through deep mining but most of the coal is surface mined. Surface mining, for the most part, is classified as either contour or area strip mining. Generally speaking, area strip mining (Fig. 3) is practiced on flat terrain. This process consists of the removal of vegetation cover, the cutting of a trench to expose the coal seam, the removal of the coal and repetition of the operation.

In the contour method, (Fig. 4) a bench is cut into a coal seam that crops out along a valley. Earth removal continues into and around the hill until the amount of overburden makes further mining economically impractical. The spoil stripped from above the seam is dumped 180° from the cut, tending to fill the adjacent valley. The spoil may thus occur in rows. Most of the strip mining operations in Belmont County use the contour method.

After the coal mining procedures are terminated, the area is characterized by a steep uncut face, the highwall, a relatively flat bench that follows the contour of the hill, and an adjacent spoil pile consisting of previously removed overburden. Lakes or ponds form frequently on the bench between the spoil and the highwall. The scene left behind is at best undesirable.

ORIGINAL PAGE IS
OF POOR QUALITY

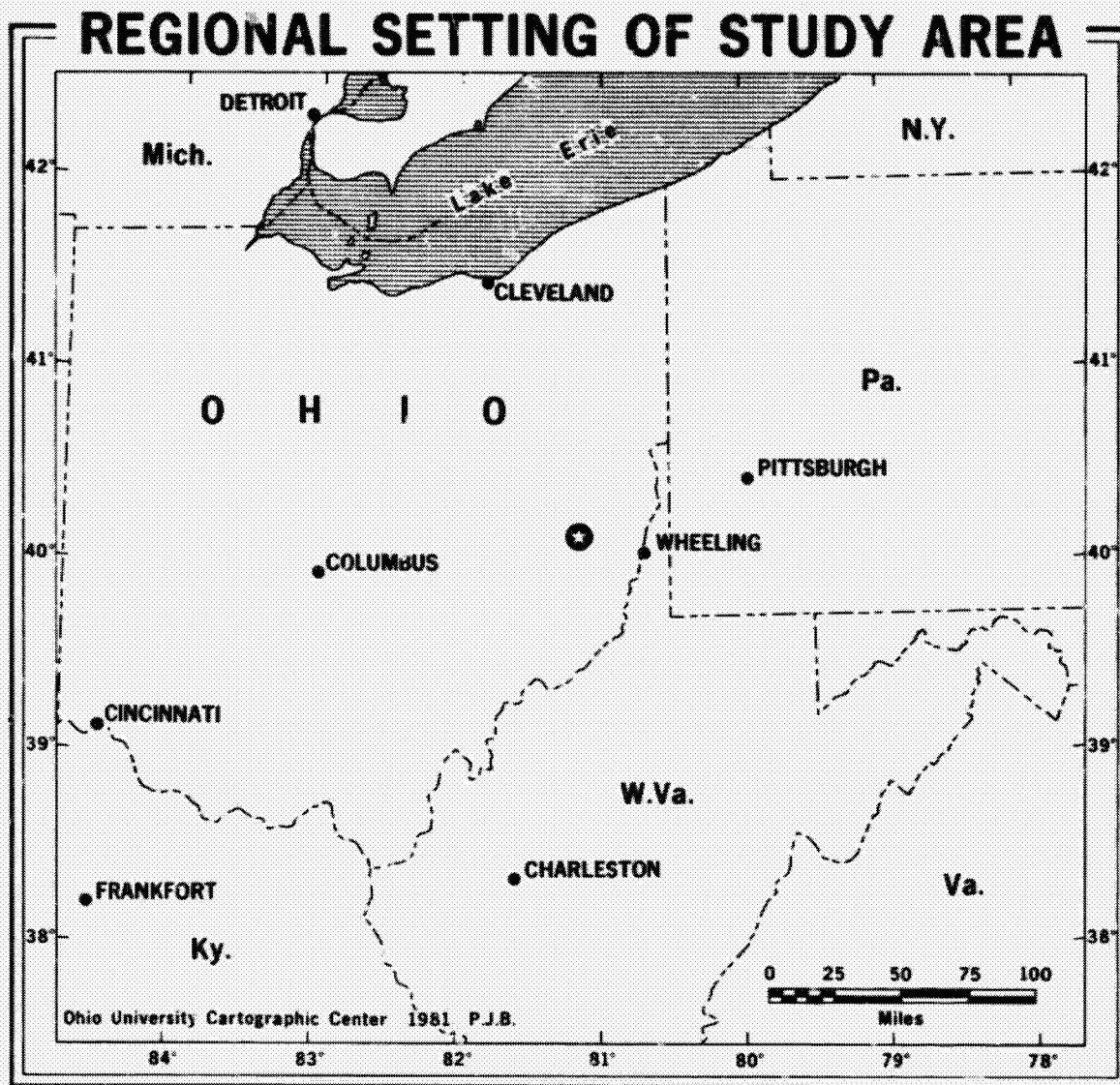
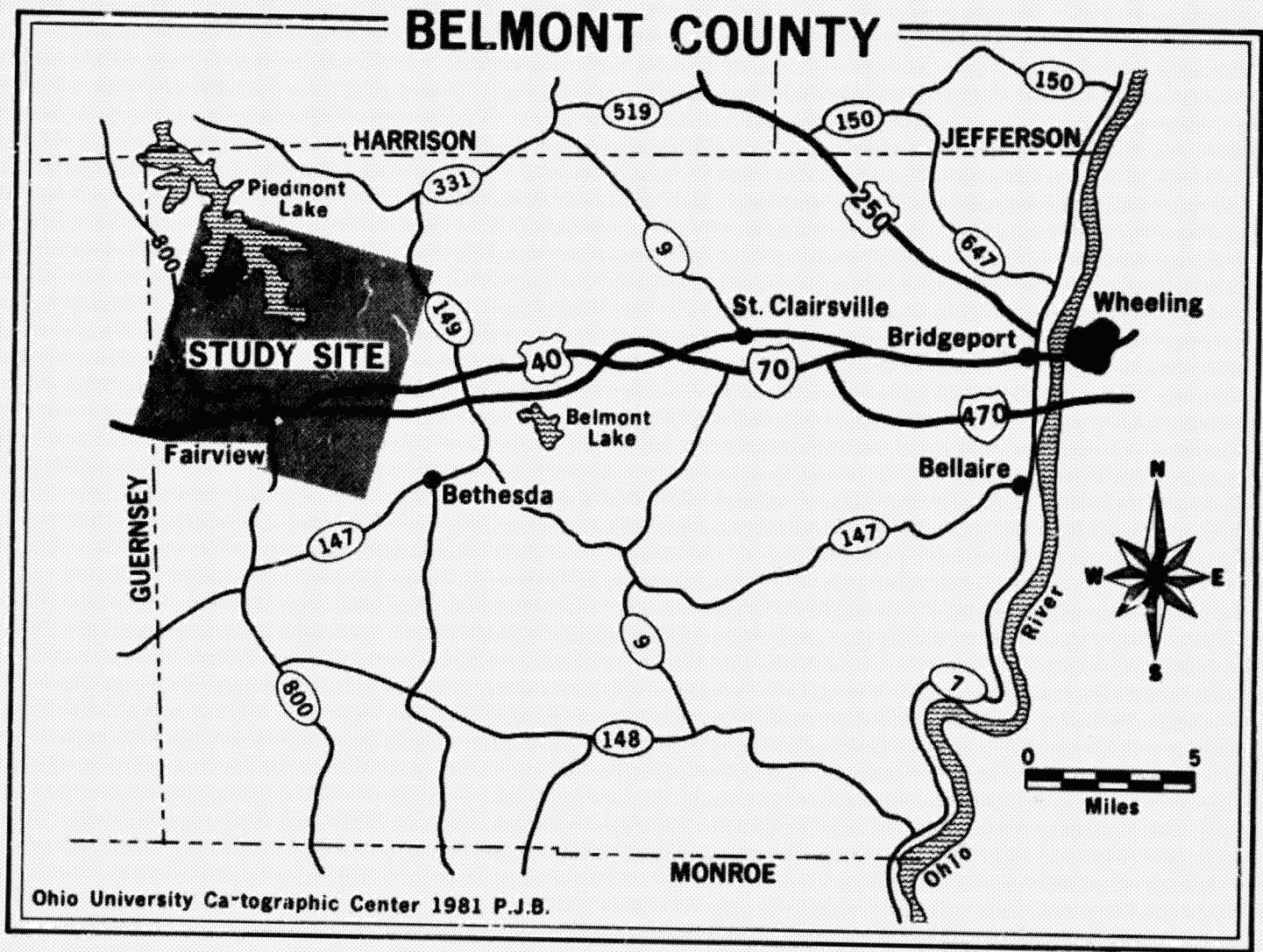

Figure 1

From the early days of strip mining until about 1948 little concern was expressed or heard regarding the detrimental effects of surface coal mining to the environment. The Ohio legislature passed a law in 1948 which required restoration of the mined surface. However, these reclamation requirements resulted only in some grading and, to varying degrees, planting of trees and ground cover on spoil banks. With the Ohio legislature's 1972 passage of stricter reclamation laws, including provisions for the enforcement of the more rigid requirements, it has become increasingly necessary for state government agencies to be able to monitor reclamation of land disturbed by surface mining. Traditional means of monitoring strip mine operations and subsequent



ORIGINAL PAGE IS
OF POOR QUALITY

Figure 2

ORIGINAL PAGE IS
OF POOR QUALITY

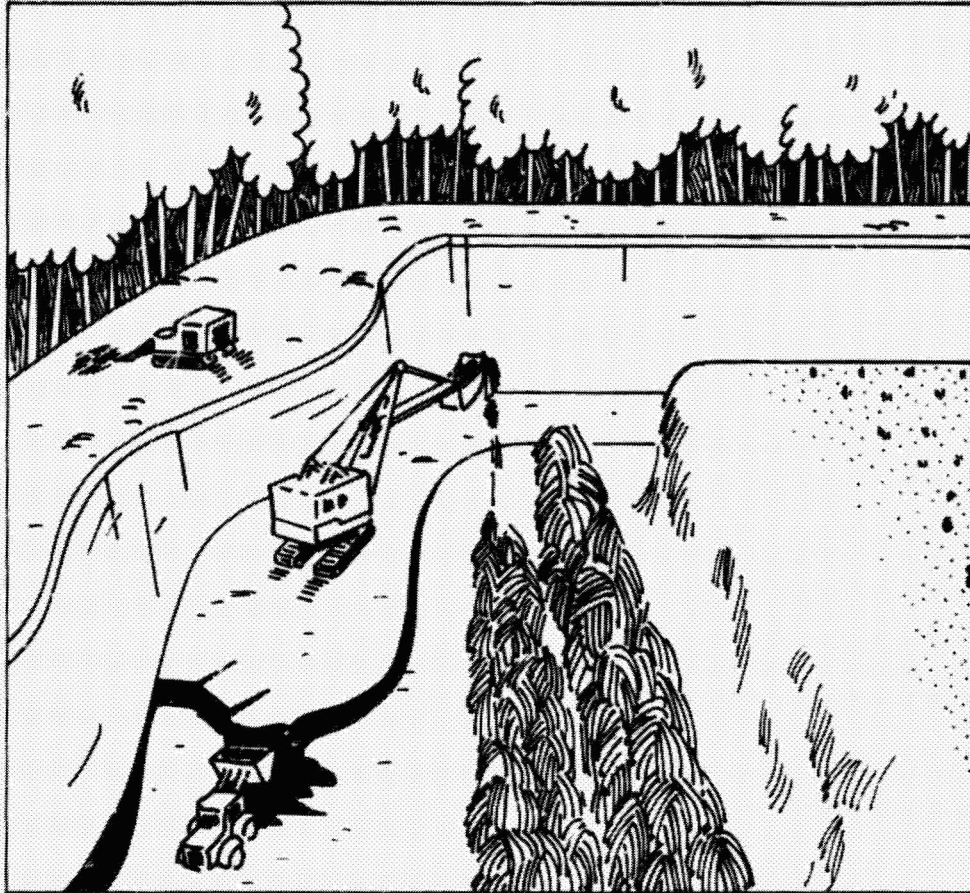

Figure 3. Area Strip Mining

reclamation efforts include the use of both aerial photography and on-site inspections. These techniques are time consuming and expensive, especially where repetitive coverage is needed over extensive areas.

The availability of Landsat 1 data provided an opportunity to investigate the application of new techniques to the old problem of surface mining and related reclamation progress. Several studies have been conducted to determine the applicability of Landsat data and associated digital image processing techniques to the surficial problems associated with mining operations.

This study addresses itself specifically to the application of a non-traditional unsupervised classification approach to multispectral data. This approach is designed to render increased classification separability in land cover analysis of surface mined areas. At the same time it reduces the dimensionality of the data and requires only minimal analytical skills in digital data processing.

ORIGINAL PAGE IS
OF POOR QUALITY

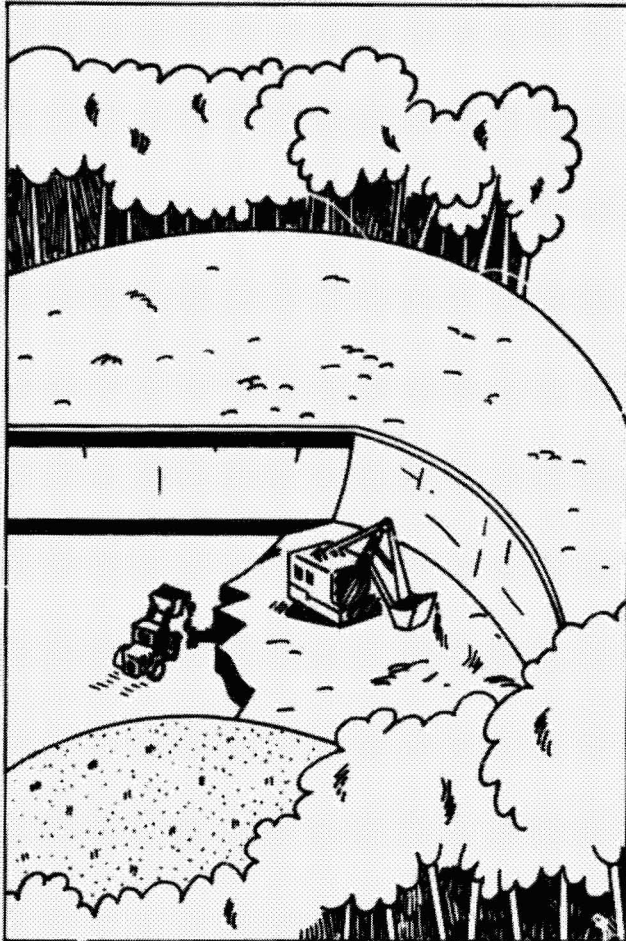

Figure 4. Contour Strip Mining

LITERATURE REVIEW

An early study - "Relevance of ERTS-1 data to the State of Ohio" (Sweet, David C., et al., 1974) - examined the application of Landsat data to mapping strip mines, but only using image enhancement and not computer processing of digital data. Band 5 and 7 images obtained during the growing season were found to be most useful in delineating mined areas. Another early study entitled "Automatic Mapping of Strip Mine Operations From Spacecraft Data" (Rogers, et al., 1974) consisted of a dual-temporal classification of three county study areas in Ohio. The authors produced overlays and pixel counts for a generalized scheme of categories including stripped land, reclaimed land, natural vegetation, and water. They concluded that the resulting classifications were 90%+ accurate, at one-tenth the cost of traditional mapping techniques.

Anderson, et al., (1977) conducted a significant study on surface mine mapping in the two western-most counties in Maryland. In "LANDSAT Imagery for Surface Mine Inventory," a band-ratio method was applied to map and measure disturbed surface areas which the authors found to be both geographically and temporally extendable. Three dates between September 1972 and July 1974 were used in the study. When classified, the ratioed band 5/6 data proved more than

**ORIGINAL PAGE IS
OF POOR QUALITY**

90% accurate in delineating surface mines over 30 acres in size. Anderson et al., (1975) suggest that such a multi-level sampling approach (with correlative air photo data) is "an effective, rapid, and accurate means of monitoring the surface mining cycle" with immediate cost benefits.

In "Remote Sensing of Surface Mines: A Comparative Study of Sensor Systems" (Irons, et al., 1980), the authors compared Landsat MSS, an airborne MSS, the airborne Thematic Mapper Simulator (TMS), and high altitude color and color infrared photography. Data were collected for study areas in spring and autumn within three counties of the bituminous coal mining region of Pennsylvania. Most of the digital processing, including successful application of band ratioing (5/6 again), was executed using General Electric's Digital Image Analysis Laboratory (DIAL). The authors' main conclusions were that "Landsat data (are) . . . most suitable for a synoptic inventory of mines on a regional basis," while "high altitude aerial photography (is) . . . the best source of the detailed information required for reclamation monitoring" (Irons, et al., 1980).

Spisz and Dooley conducted a similar study entitled "Assessment of Satellite and Aircraft Multispectral Scanner Data for Strip Mine Monitoring" in 1980. The authors compared Landsat MSS, aircraft 11-band MSS, and infrared air photos with ground survey information obtained for a surface mine test site in eastern Kentucky. The Landsat data were from several dates over a five-year period, and were used to produce classified maps of the study area showing changes in the extent of the strip-mining zone. Band 5/6 ratioed data provided a qualitative (level I) separation of categories, but a highly supervised approach was recommended for greater discrimination within mine and reclamation areas.

Thus the literature is in agreement on the fact that Landsat data can be used to map strip-mined areas with a high degree of success, but also that a greater degree of detail is needed to break down the progressive stages of mining and reclamation efforts. This study explores both new and traditional techniques with such a goal in mind.

TRADITIONAL APPROACHES USED FOR SURFACE MINE ANALYSIS

Landsat imagery has been used by a number of researchers to identify and measure the areal extent of surface mines. In multi-spectral sensor (MSS) band 5 the light gray tones associated with mines stand out against the darker forest tones. Mine identification is best in the summer months because of the high contrast between barren mine areas and fully vegetated forest cover. Mines containing standing water and exposed carbonaceous deposits are best identified by MSS 7 because they are very absorptive in the near-infrared region. This channel has also been used to identify older reclaimed surface mines because their less dense vegetation can be distinguished from the surrounding vegetation (Sweet et al., 1973). While Landsat imagery can be used to map the location of larger surface mines, most studies have concluded that the resolution of the imagery alone is inadequate for identifying submine features. Therefore the manual interpretation of Landsat imagery is not recommended for monitoring compliance with mine operation and reclamation regulations (Russell, 1977; Fish, 1977).

ORIGINAL PAGE IS
OF POOR QUALITY

Although digital analysis is more complex than the manual interpretation of Landsat imagery, it has the advantages of increased spectral and spatial resolution, automated data handling, and the ability to readily calculate acreages for any given category in a classification. A wide variety of classifiers and digital techniques have been used to identify surface mines. While minimum distance and parallelepiped classification algorithms have been used in several studies, the maximum-likelihood is apparently the most popular classifier. Both supervised and unsupervised classification techniques have been successfully used in surface mine studies. Other approaches used in surface mine analysis include density slicing, band ratioing, and canonical analysis.

Cluster analysis groups spectrally similar pixels into clusters, each of which has a characteristic spectral response. Most studies have found cluster analysis to be appropriate only for sites where there is limited knowledge about the area. One study suggests that cluster analysis has been successfully used in large spectrally uniform areas but is less accurate in complex sites with varied surface features. Spectrally complex sites produce border clusters, composed of mixed pixels, which may introduce confusion into the final classification (Spisz and Dooley, 1980). Conversely, a Pennsylvania State University study found that cluster analysis provided good definition of stripped areas as well as backfills, trenched areas, and areas cleared for future stripping operations (Alexander et al., 1973). Cluster analysis has also been used in areas where mines were so narrow and serpentine in shape that supervised training polygons could not be drawn without including unwanted surface cover (Middleton and Bly, 1979; Schall, personal communication, 1980).

In supervised analysis certain user defined training areas are specified to the computer as containing a specific surface cover. The computer is then instructed to analyze the magnitude and variance of the spectral responses from each training site and then identify all pixels in the rest of the image with similar characteristics. The selection of training sites can be hampered by several factors. Submine features may be narrow and complex in shape, making training site selection difficult. This is particularly true of reclaimed areas which may be scattered throughout the mine site and may contain varying percentages of vegetative cover. Many investigators have observed a wide variation in the spectral responses recorded within and between mines. The influence of slope and aspect are responsible for much of this variation. Slope at some sites may range from near level to in excess of 30 degrees, and vary greatly in aspect. In some mining areas the composition, color, and texture of surface soil can vary greatly. All these spectral variations must be accounted for, requiring individual signatures for each situation. Because of this spectral variability several training areas are usually selected for each class. In some cases where mines have been extremely small, investigators have chosen to select training areas outside of the general study area (Spisz and Dooley, 1980). Studies using digital methods have typically been able to classify mine sites into active, inactive, graded, and reclaimed categories. Several investigators have encountered difficulty in developing signatures for several levels of reclaimed vegetation. Irons et al., (1980) had difficulty in identifying re-

**ORIGINAL PAGE IS
OF POOR QUALITY**

claimed areas in Pennsylvania when the reclaimed site had more than 60 percent vegetation cover. Anderson and Schubert (1976) had problems in distinguishing mature grass from recently seeded areas.

Most studies have encountered difficulty in extending signatures beyond the immediate mine site. In an EPA study separate signatures were developed for each mine (EPA, 1975). Density slicing of band-ratioed data has been shown to be a successful technique for reducing temporal and geographical differences. The MSS 5/6 ratio has been found to minimize topographical relief effects (Holben and Justice, 1979). Using this ratio Anderson was able to extend signatures between adjacent scenes and to other dates. However, the extension of mine signatures produced confusion with urban and built-up areas (Anderson et al., 1975; Irons et al., 1980). The ratio of these two channels also enhances the contrast between barren or partially revegetated surface mine spoil and the surrounding vegetation (Anderson et al., 1977; Irons et al., 1980). The same type of boundary pixel/partially revegetated pixel confusion, as existed in the 4-band classification, was also experienced with the ratioed data (Anderson et al., 1979).

Middleton and Bly (1980) merged a MSS 5/6 ratioed band with the four Landsat bands. These data were then classified using a hybrid signature file developed using supervised and unsupervised clustering techniques. These signatures were successfully extended over a 2500 square mile region in Virginia, but the same urban/mine misclassification experienced in previous studies was encountered.

SUPERVISED VS. UNSUPERVISED APPROACHES USED FOR SURFACE MINE ANALYSIS

Several approaches have been applied to ascertain land cover types and extent of surface mining/reclamation by digital image processing (Irons et al., 1980; Spisz and Dooley, 1980; and Rogers et al., 1974). In a hybrid-type classification approach Tanner (1979) found favorable results in applying a sequential clustering algorithm to aircraft multi-spectral scanner data for initial determination of spectral groupings of surface mined areas. Classified image results were used to facilitate identification of spectrally uniform regions to select training sites for additional classification approaches. He also determined four-band channel selection by canonical analysis from an 11-channel data set. In another study on surface mining and reclamation, Irons et al., (1980) employed a supervised classification procedure. Data from three multi-spectral scanner sensor systems were evaluated, including the four Landsat MSS bands. With the use of linear discriminant analysis they were able to reduce the dimensionality of the aircraft scanner data and optimize category separability for application on the Digital Image Analysis Laboratory (DIAL) system by General Electric.

Given the availability of such a variety of procedural approaches, the question arises concerning just how to select the best method for analysis. Spisz and Dooley (1980) found that a comparison of classification results by both supervised and unsupervised computer analysis procedures provided overall excellent agreement of classification categories. The successful application of supervised classification approaches are, however, generally dependent on

ORIGINAL PAGE IS
OF POOR QUALITY

the skills of the analyst, capability and versatility of the available computer hardware/software system, and the computer time available for analyst's usage. Conversely, unsupervised techniques are generally data dependent rather than analyst dependent for land cover categories (Spisz and Dooley, 1980).

THE NON-TRADITIONAL UNSUPERVISED CLASSIFICATION PROCEDURE

An unsupervised classification procedure, utilizing the cluster algorithm and maximum likelihood classifier of Electromagnetic Systems Laboratory's (E.S.L.) Interactive Digital Image Manipulation System (IDIMS) (See ESL Technical Manual 1978) and a NASA modification of the Office of Remote Sensing of Environmental Resources (ORSER) system's canonical analysis algorithm (Turner, 1978) was implemented on the HP 3000 Computer System at NASA/ERRSAC, Goddard Space Flight Center in Greenbelt, Maryland. This provided the basis for comparison of a traditional clustering/maximum likelihood algorithm sequence with a non-traditional algorithm sequence (Flow Chart I). The non-traditional sequence re-

FLOW CHART 1

PROCEDURE
Algorithm Flow Chart I
NASA/GSFC/ERRSAC IDIMS
Procedural Application
Algorithm Sequence

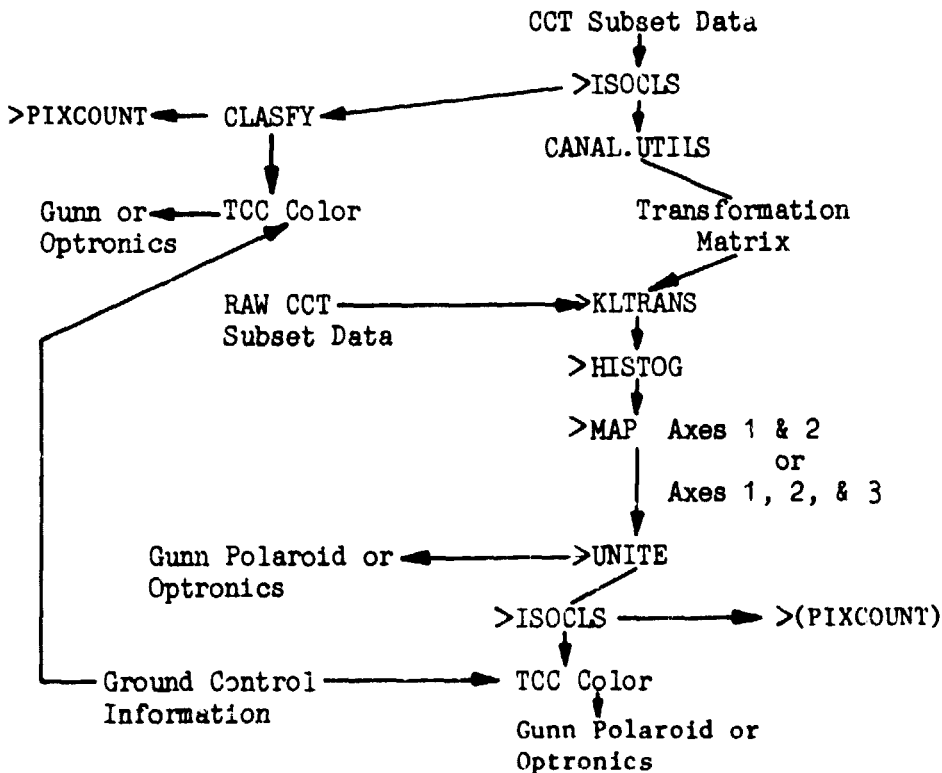

ORIGINAL PAGE IS
OF POOR QUALITY

sulted in cluster generated categories which were canonically transformed to maximize among-category separability and to reduce the dimensionality of the data for the classification procedure (Merembeck et al., 1977). The canonical analysis algorithm translates, rotates and rescales the data based on the within-category and the among-categories group variability, which hierarchically diminishes along with each additional transformed axis, thus maximizing among-categories separability (Merembeck, 1977, Lachowski and Borden, 1973). The transformed MSS data sets were then presented as enhanced images for visual image interpretation. They were also subjected to a cluster analysis of the first two axes to develop new mean category signatures for the transformed images.

The traditional procedure consists of:

1. Clustering of the sub-set data into 30 categories.
2. The 30 cluster category means and covariance matrices are input to the maximum likelihood classifier.
3. Finally, the categories from the maximum likelihood classifiers are grouped on the basis of ground control information.

The non-traditional procedure is as follows:

1. Clustering of the sub-set data into 30 categories.
2. Input the 30 cluster category means and covariance matrices into canonical analysis to develop transformation matrix.
3. The canonical transformation matrix is multiplied by the original data subset.
4. The canonically transformed data sub-set is clustered into 30 categories.
5. Finally, clusters are grouped on the basis of ground control information.

The two classification sequences were then compared using Landsat MSS data sub-sets from computer compatible tapes (CCTs) for September 1973, August 1976, and September 1979 for the study area near Piedmont Lake in Belmont County, Ohio. (See Figure 2.) The above dates were selected because they coincide with available ground truth information from the Ohio Department of Natural Resources and the United States Geological Survey. The uniform time interval was also part of the above consideration. The late summer scenes were selected since they provide maximum information regarding vegetated and barren areas which is of particular interest in the monitoring of land reclamation progress.

COMPUTER ANALYSIS

Both the traditional and non-traditional supervised classification algorithm sequences were based on the initial clustering algorithm applied to the original image data sub-sets for which thirty clusters were developed. No attempt was made at that point to identify category separability or relevance to land cover categories. All stipulated parameters controlling the cluster algorithm were held constant throughout their application in developing spectral groupings in the various image data sub-sets. In the traditional approach the statistics file containing the mean and covariance matrices for each of the

**ORIGINAL PAGE IS
OF POOR QUALITY**

data sets which was then input to a maximum likelihood classifier algorithm to develop classification categories. Each category was interactively identified according to probable land cover type through interpretation of medium altitude black-and-white panchromatic aerial photographs. The non-traditional approach input the same cluster generated statistics files into the modified canonical algorithm to generate the transformation matrix which was then applied to the original data sub-sets for each year.

The parameters (see ESL Technical Manual, 1978) controlling the cluster algorithms were held constant for both the original data application and the first two canonically transformed axes. These axes contained approximately 98% of the among-category variability for each data set. Each category was interactively identified to determine the land cover type it represented.

DISCUSSION AND RESULTS

The literature review substantiated that Landsat data can effectively be utilized to help monitor surface mining areas and subsequent reclamation progress. This study does not duplicate the obvious, but rather shows that the data manipulation procedure can enhance a great deal of subtle information within the data illustrated by linear contrast stretching of the data sets (Figures 5, 6 and 7). The subtleties will show not only the difference between mined and unmined areas, or reclaimed versus unreclaimed land, but furthermore determine the difference between various stages of reclamation progress.

Through the previously described procedures, the canonically transformed data sets were presented as enhanced images. Three different color composites, consisting of the first two or three transformed axes, were generated. One composite was presented as red, green, and blue for axes 1, 2, and 3. The second was presented as red, green, and blue for axes 1, 2 and (4=0) (Figures 8, 9 and 10), while the third was presented as red, green, and blue for axes 2, 1 and 3 (Figures 11, 12 and 13). Canonical enhancement of Landsat imagery was interpreted with the aid of transparent overlays for spatial variations and groupings of color tones (Figures 14, 15 and 16) and compared with NASA U-2 color IR photos at a scale of 1:125,000 (Figures 17 and 18). Stages of reclamation were delineated for active mining/ungraded, graded barren, recently revegetated, more mature vegetated, and poorly reclaimed areas, as well as small bodies of water and inherent sediment patterns in Lake Piedmont. The periphery of the surface mined area was mapped along with road surfaces, all of which was distinguishable through enhancement procedures. The above procedures appear to provide a pseudo-unsupervised classification of the MSS data. This application appears to be particularly adaptable to heterogeneous MSS image data.

TRADITIONAL UNSUPERVISED CLASSIFICATION COMPARED TO NON-TRADITIONAL APPROACH

This portion compares the traditional cluster/maximum likelihood algorithm sequence with the non-traditional cluster/canonical transformation/cluster algorithm sequence (clustered classification, Figures 19, 20 and 21; maximum like-

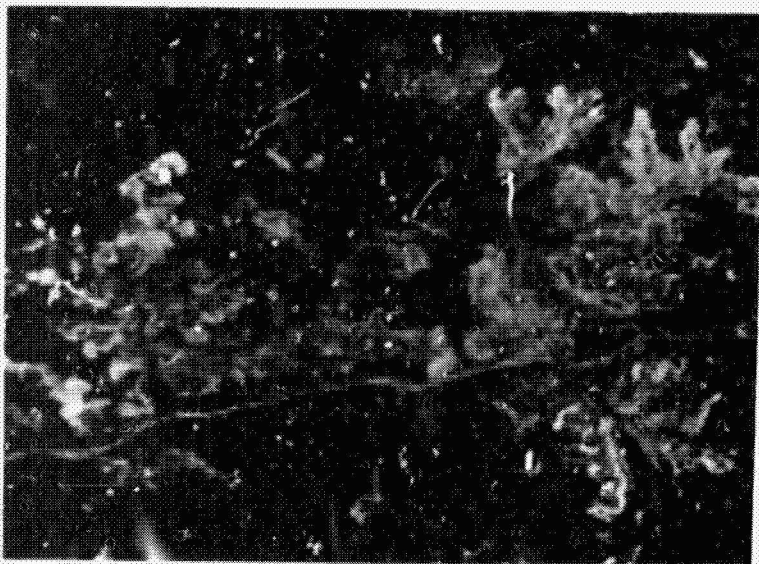

Figure 5. Sept. '73

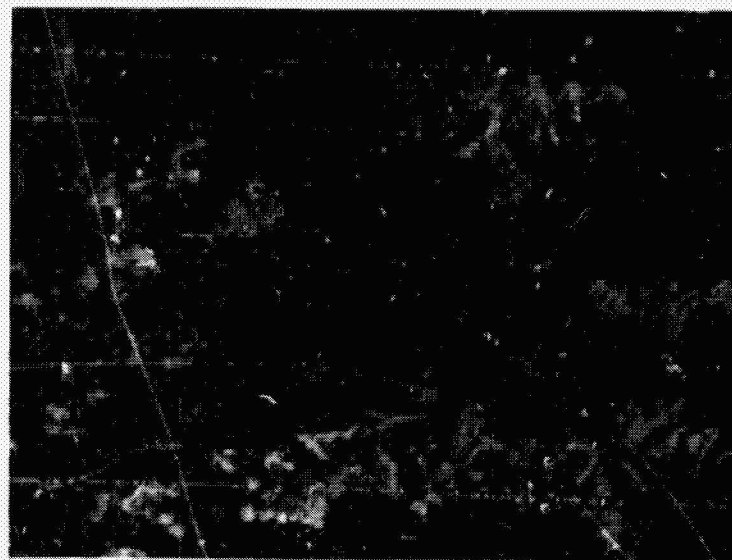

Figure 6. Aug. '76

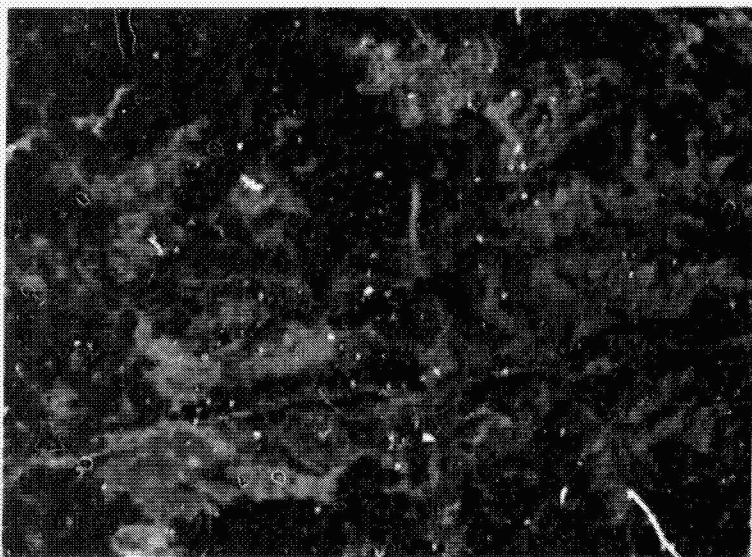

Figure 7. Sept. '79

LINEAR CONTRAST STRETCHED ENHANCEMENT

ORIGINAL PAGE IS
OF POOR QUALITY

ORIGINAL PAGE IS
OF POOR QUALITY

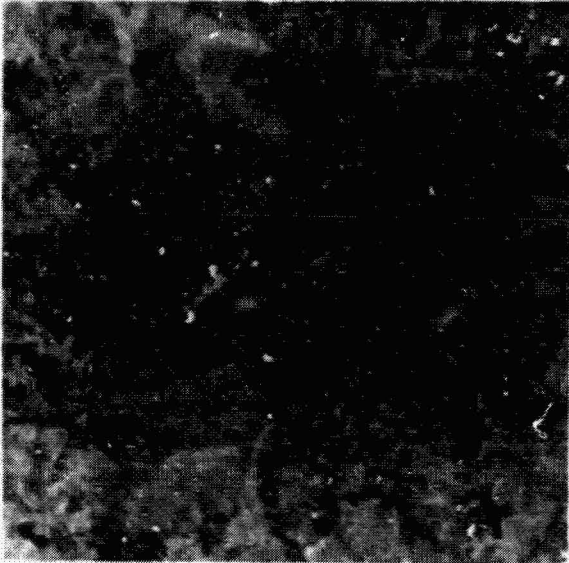

Figure 8. Sept. '73

Figure 9. Aug. '76

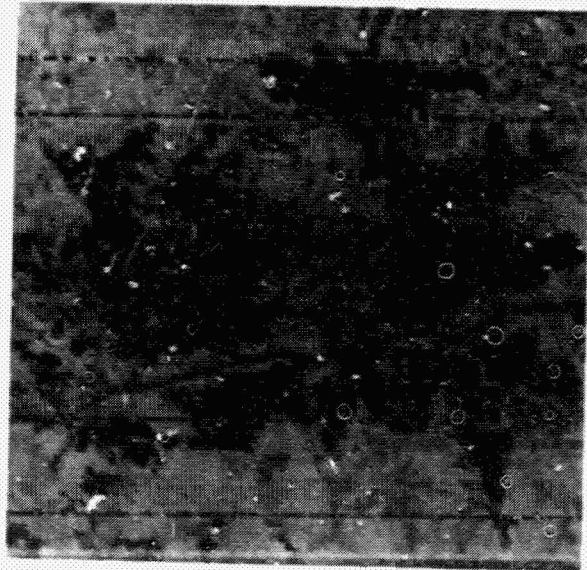
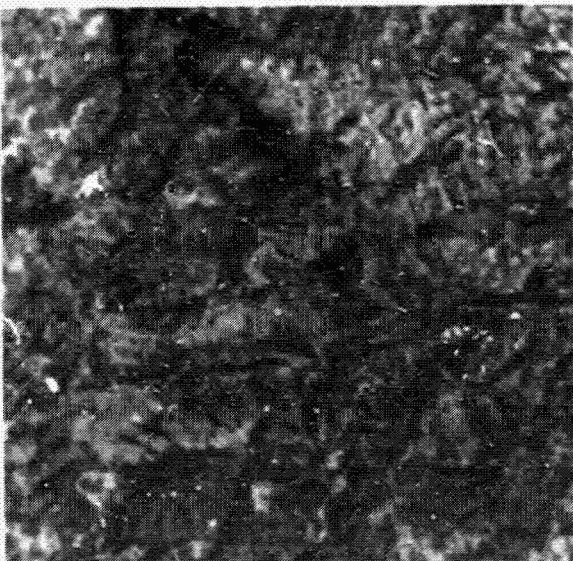

Figure 10. Sept. '79



CANONICALLY TRANSFORMED ENHANCEMENT
WITH AXES 1, 2, ($\lambda=0$) as R, G, B.

ORIGINAL PAGE IS
OF POOR QUALITY

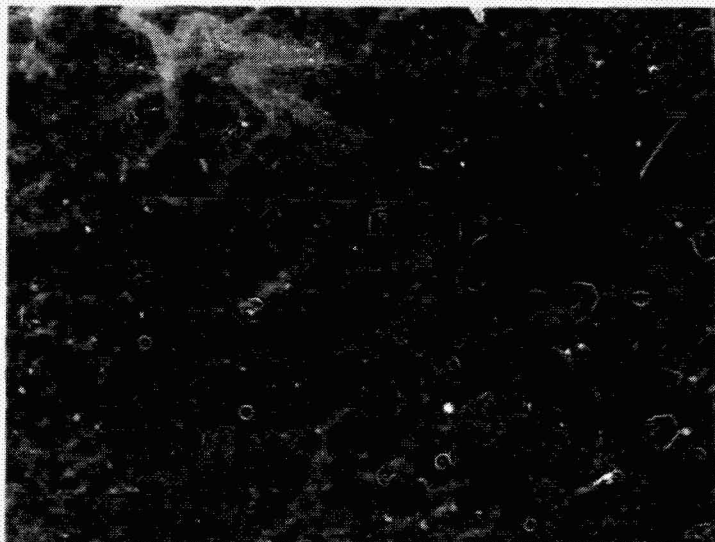

Figure 11. Sept. '73

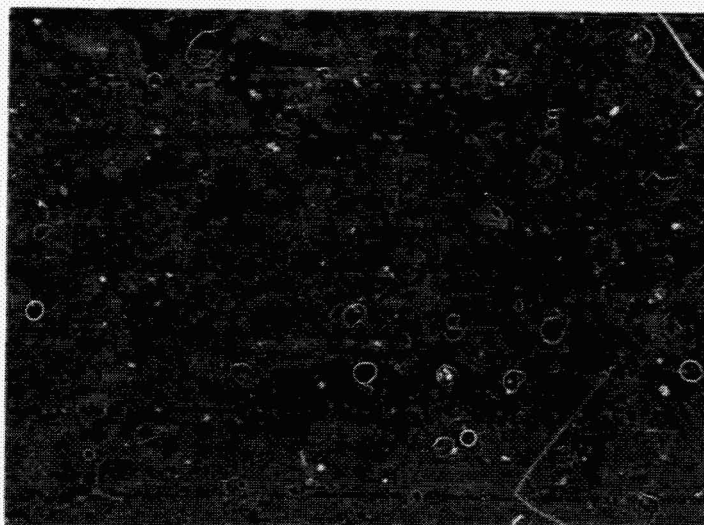

Figure 13. Sept. '79

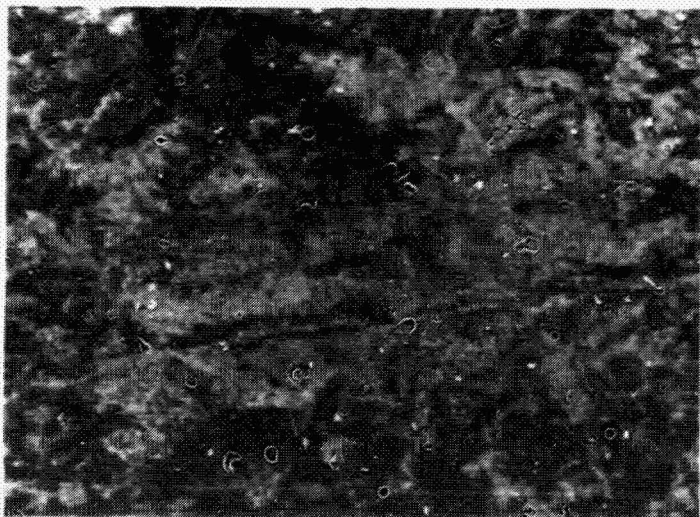
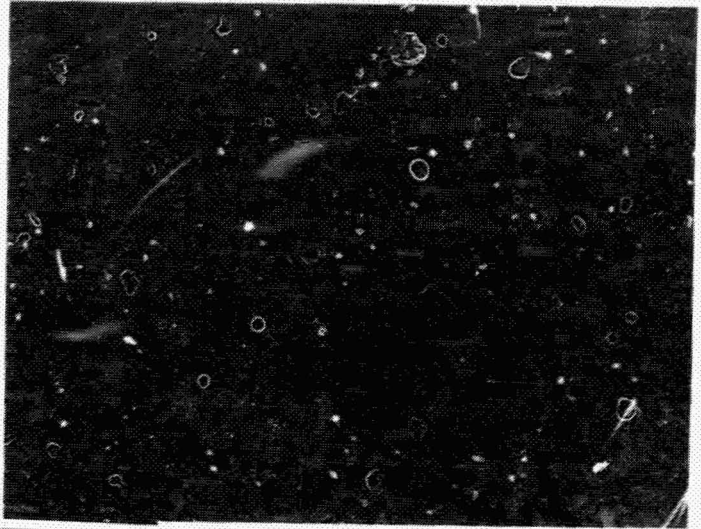

Figure 12. Aug. '76

CANONICALLY TRANSFORMED ENHANCE-
MENTS WITH AXES 2, 1, 3 AS RED,
GREEN, BLUE.



CANONICAL TRANSFORMED IMAGES WITH
TRANSPARENT OVERLAYS.

Figure 15. Sept. 179

Figure 16. Sept. 179

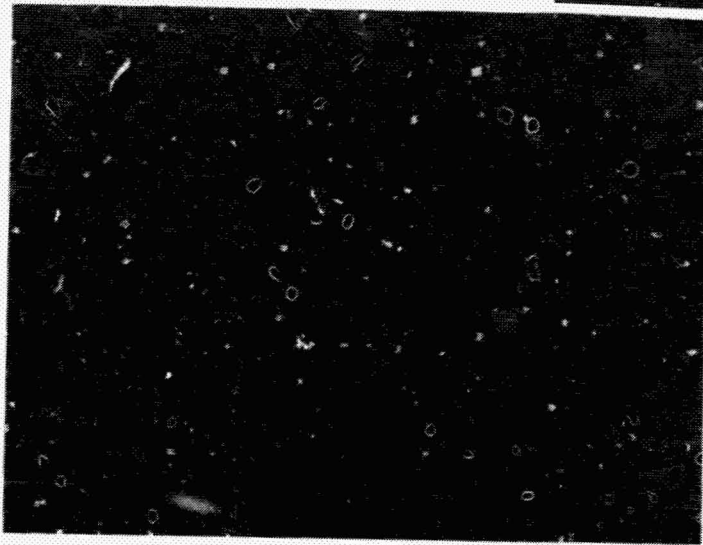
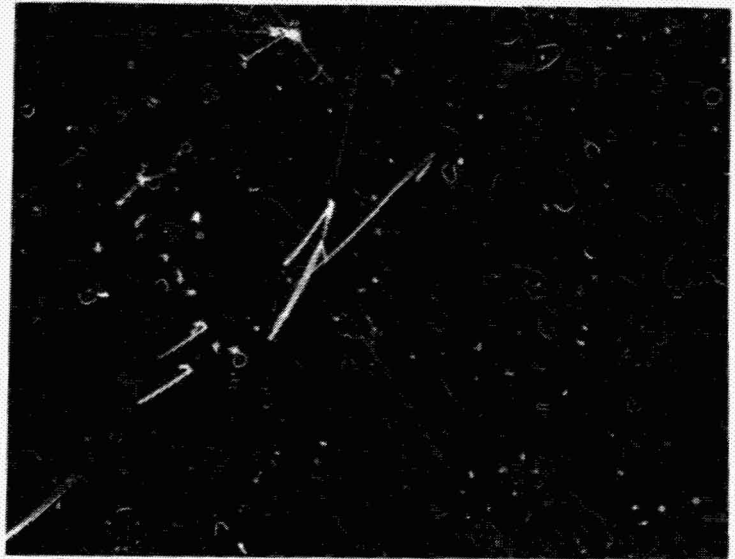

Figure 14. Sept. 173



ORIGINAL PAGE IS
OF POOR QUALITY

ORIGINAL PAGE IS
OF POOR QUALITY

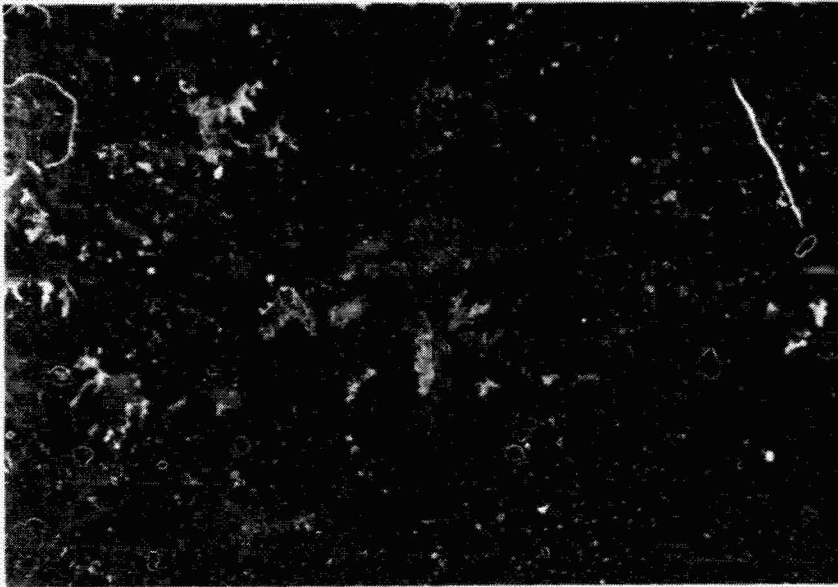

Figure 17. Summer '76

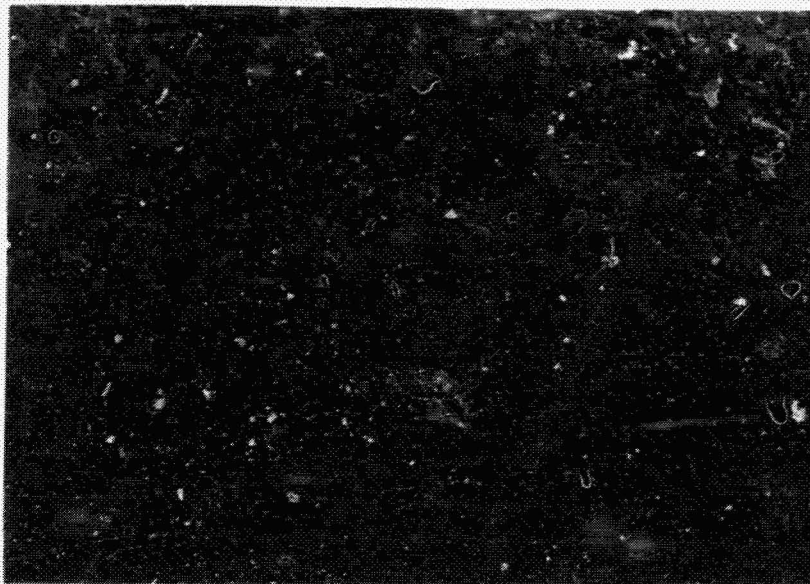

Figure 18. Summer '79

NASA U2 C.I.R. 1:125,000 AERIAL PHOTOGRAPHY.

ORIGINAL PAGE IS
OF POOR QUALITY

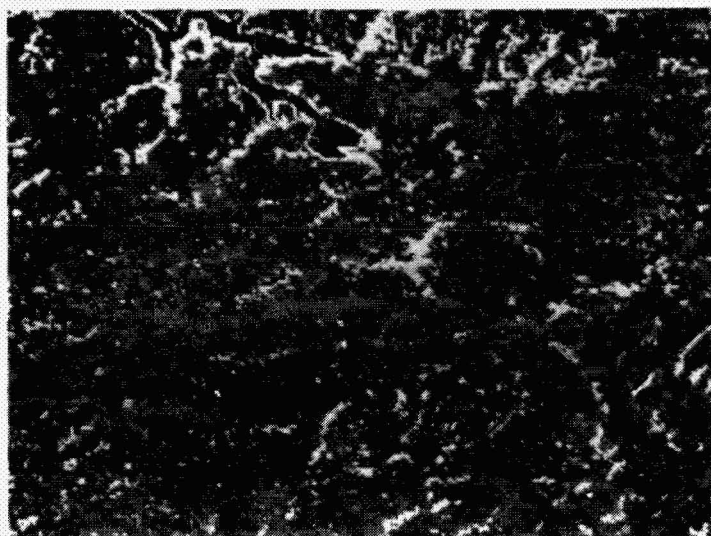

Figure 19. Sept. '73



Figure 20. Aug. '76

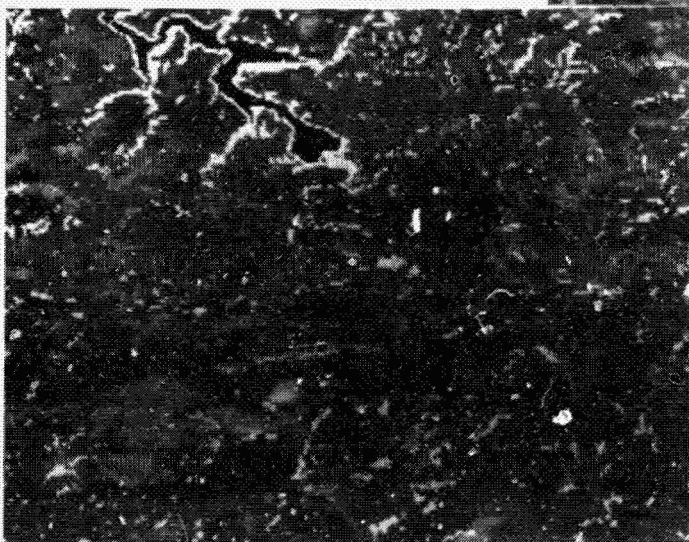

Figure 21. Sept. '79

CLUSTER CLASSIFICATION.

likelihood classification, Figures 22, 23 and 24; non-traditional classification, Figure 25, 26 and 27). It serves to determine the reliability and repeatability of results for multi-temporal data sets to distinguish subtle differences in non-homogeneous data as a result of land cover variability. As can be seen in Table I, pixel count groupings based on initial categories demonstrate that the transformed classified data sets include separable water categories not evident in either the direct cluster or the application of the maximum likelihood classifier algorithm.

The classification involving the canonically transformed data clearly depicts the shallow/sediment laden water and shows its spatial distribution throughout the three images. Most of the impoundments are associated with mining/reclamation activities as verified by U-2 color IR photography.

ENHANCEMENT RESULTS

Outlining tonal variations in the canonically enhanced imagery sets the pattern of land cover categories which were then merged with ancillary information and reference data to produce land use categories for the final classification results. Some land cover categories developed from the enhanced imagery were combined in terms of land use information. An example of this is illustrated by the contour earth backfill patterns in active mining or inactive mining in reclaimed land use categories as seen in the 1973 enhanced imagery (see Figures 8 and 11).

For this study, the red and black color combination in the final classification was maintained separately to highlight those land use categories for visual interpretation (see Figures 14, 15 and 16). The spatial extent of the mining/reclamation areas, outlined by the categories in Table I and illustrated in Figures 11, 12 and 13 were found to fit very well. Further comparison shows the classified transformed data to have less of a salt-and-pepper appearance than the traditional classification. A comparison of the above with appropriate aerial photographs shows better agreement with land cover classes than the traditional classifications. A more detailed classification of the categories was not attempted at the time of interactive computer analysis. This was due to lack of appropriate ground truth at the time.

CONCLUSION

The analysis of the data clearly establishes that the non-traditional unsupervised classification approach accomplishes the goal set forth in this study. Increased separability of land cover categories is achieved along with reduction of the dimensionality of the data. The application of the non-traditional classification procedure is well suited for nearly automated digital data processing.

The application of the non-traditional classification procedure requires minimal interaction with the computer processing until the final phase, when the categories are related to land cover classes. Otherwise, the non-tradition-

ORIGINAL PAGE IS
OF POOR QUALITY

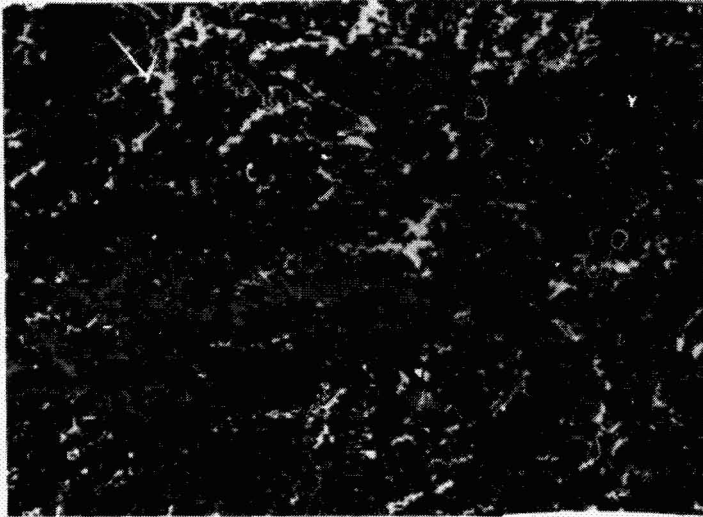

Figure 22. Sept. '73

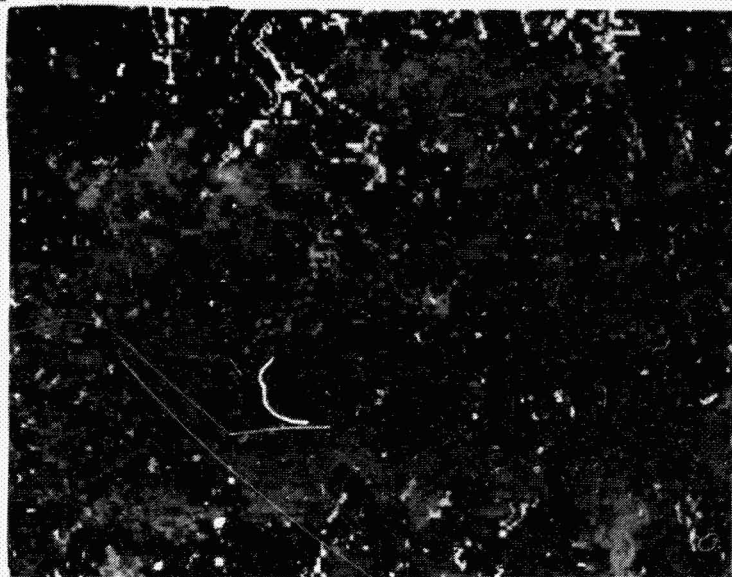

Figure 24. Sept. '79

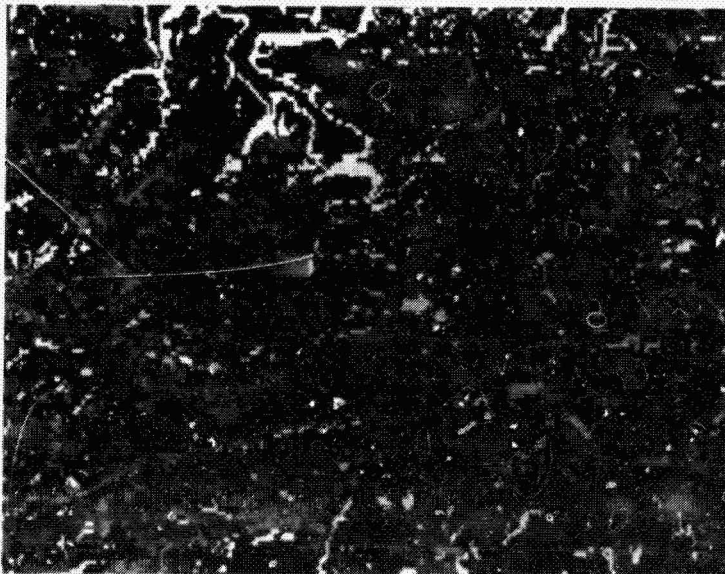

Figure 23. Aug. '76

MAXIMUM LIKELIHOOD CLASSIFICA-
TION.

ORIGINAL PAGE IS
OF POOR QUALITY

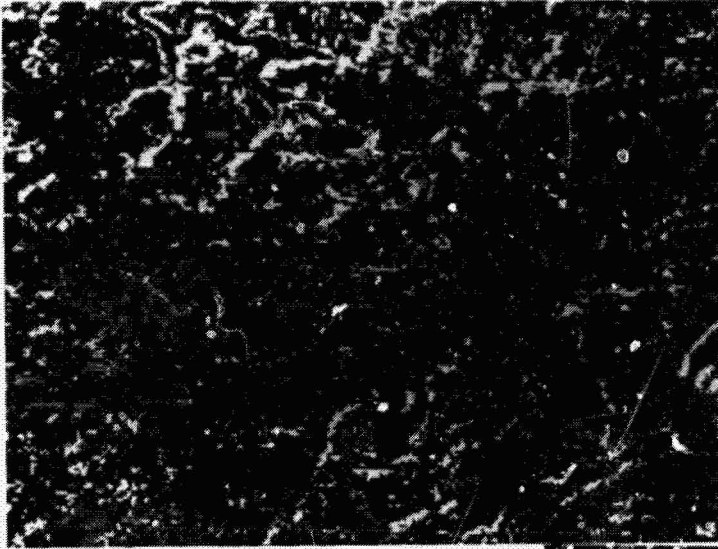

Figure 25. Sept. '73

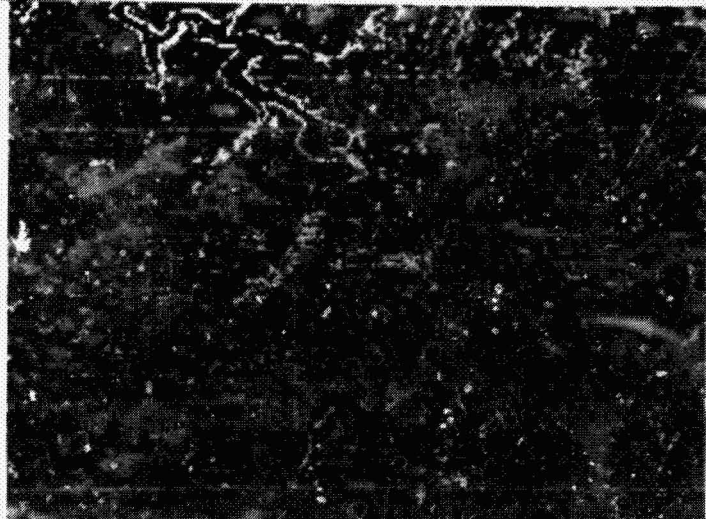

Figure 26. Aug. '76

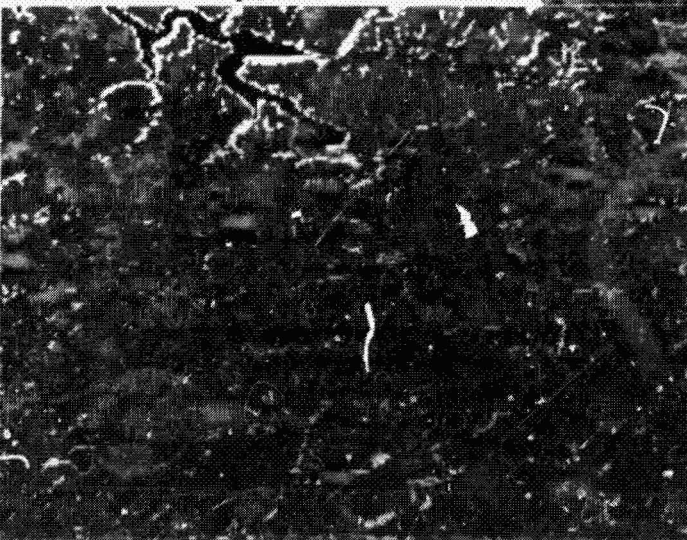

Figure 27. Sept. '79

NONTRADITIONAL CLASSIFICATIONS.

al approach is a fully automated one. It accomplishes all the above without the heavy dependence on a highly skilled analyst that is inherent in the supervised classification procedure.

Further research is currently under way to illustrate finer land cover categories through image analysis and classification with additional ground truth. Application of this non-traditional procedure to Thematic Mapper Simulated Data to reduce the dimensionality of the data set while maintaining classification accuracy is anticipated.

Table I

<u>CATEGORY DESCRIPTION</u>	<u>COLOR</u>	<u>47864 CLS73</u>	<u>47864 MAX73</u>	<u>47864 TRANS073</u>	<u>46360 CLS76</u>	<u>46360 MAX76</u>	<u>46360 TRANS076</u>	<u>46413 CLS79</u>	<u>46413 MAX79</u>	<u>46413 TRANS079</u>
Water	Blue	959	925	813	1,002	993	791	758	727	818
Sediment/shallow water	Lt. Blue	none	none	108	none	none	370	none	none	612
Active mining	Black	768	825	713	476	624	823	none	none	none
Barren inactive mining/ ungraded	Red	1,064	1,009	1,493	none	none	none	none	none	none
Barren partially reclaimed	Purple	2,029	2,094	840	2,177	2,240	1,928	920	1,003	1,242
Sparsely vegetated/ partially reclaimed	Yellow	3,502	3,477	4,052	4,414	4,522	6,036	2,386	2,369	2,242
Drainage pattern shallow/ vegetated partially reclaimed highwall	Sand	3,753	3,954	4,111	1,387	2,086	2,056	2,838	2,891	1,928
Mask/forest-agri./ to emphasize mining/ reclamation	Olive/ brown	24,841	22,474	26,145	20,463	21,865	21,794	16,057	17,552	22,263
Vegetated reclaimed	Orange	9,196	13,106	11,088	15,871	15,026	13,948	21,183	21,871	17,308

ORIGINAL PAGE IS
OF POOR QUALITY

ORIGINAL PAGE IS
OF POOR QUALITY

REFERENCES

- Alexander, S. S., Dein, J. and Gold, D. P. 1973. "The Use of ERTS-1 MSS Data for Mapping Strip Mines and Acid Mine Drainage in Pennsylvania," Symposium on Significant Results Obtained From Earth Resource Technology Satellite-1, Vol. 1, Section A. Goddard Space Flight Center, Greenbelt, Maryland: 569-575.
- Anderson, A. T., Schultz, D., Burchman, N. and Nock, H. M. 1977. "Landsat Imagery for Surface Mine Inventory," P.E.R.S., 43 (8), pp. 1927-36.
- Anderson, A. T., Schultz, D. and Burchman, N. 1975. "Landsat Inventory of Surface-mined Areas Using Extendable Digital Techniques," NASA Technical Report X-900-75-165 (preprint), Goddard Space Flight Center, 21 p.
- Chase, P. E. and Pettyjohn, W. 1973. "ERTS-1 Investigation of Ecological Effects of Strip Mining in Eastern Ohio," Symposium on Significant Results Obtained from ERTS-1, Vol. 1A, pp. 561-68.
- E.P.A. 1975. "An Application of ERTS Technology to the Evaluation of Coal Strip Mining and Reclamation in the Northern Great Plains," EPA 330/3-75-001, National Technical Information Service, Springfield, Virginia.
- ESL Technical Manual, Interactive Digital Image Manipulation System Reference Manual, Palo Alto, California. 1978.
- Holben, B. N. and Justice, C. O. June 1979. "Evaluation and Modeling of Topographic Effects on the Spectral Response from Nadir Point Sensors," NASA-TM-80305.
- Irons, J. R., Lachowski, H. and Peterson, C. 1980. "Remote Sensing of Surface Mines: A Comparative Study of Sensor Systems," The 14th International Symposium on Remote Sensing of Environment, San Jose, Costa Rica, May 1980.
- Lachowski, H. M. and Borden, F. Y. 1973. "Classification of ERTS-1 MSS Data by Canonical Analysis," NASA SP-327-1, AO, NASA/GSFC, Greenbelt, Maryland, pp. 1243-1251.
- Merembeck, F., Borden, F. Y., Podwysocki, M. H. and Applegate, D. N. 1977. "Application of Canonical Analysis to Multispectral Scanner Data," 14th Annual Symposium on the Application of Computers in Mine and Industry, University Park.
- Middleton, E. M. and Ely, B. G. 1981. "Virginia Strip Mine Project: A Landsat Survey of Wise County," ERRSAC Project Report No. 81-X, Goddard Space Flight Center, Greenbelt, Maryland.
- Podwysocki, H., Gunther, F. J. and Blodget, H. W. January 1977. "Discrimination of Rock and Soil Types by Digital Analysis of Landsat Data," NASA Technical Report X-923-77-17 (preprint), Technical Information and Administration Support Division, NASA/GSFC, Greenbelt, Maryland.

ORIGINAL PAGE IS
OF POOR QUALITY

- Rogers, R. H., Pettyjohn, W. A. and Reed, L. E. 1974. "Automatic Mapping of Strip Mine Operations from Spacecraft Data," NASA Technical Memorandum 79268, 19 p.
- Russell, O. R. 1977. "Application of Landsat 2 Data to the Implementation and Enforcement of the Pennsylvania Surface Mining Conservation and Reclamation Act." Final Report Prepared for National Aeronautic and Space Administration, Goddard Space Flight Center, Greenbelt, Maryland.
- Schall, Gary. 1980. Personal communication.
- Spisz, E. W. and Dooley, J. T. 1980. "Assessment of Satellite and Aircraft Multispectral Scanner Data for Strip Mine Monitoring." NASA Technical Memorandum 79268. 19 p.
- Sweet, D. C., Pincura, P. G., Meir, C. J., Garret, B. B., Herd, L., Wukelic, G. E., Stephen, J. G. and Small, H. E. 1973. "Significant Applications of ERTS-1 Data to Resource Management Activities at the State Level in Ohio," Third Earth Resources Technology Satellite-1 Symposium. Washington, D. C.
- Tanner, C. E. 1979. "Computer Processing of Multispectral Scanner Data Over Coal Strip Mines," EPA-600/7-79-080, Interagency, Energy/Environment R & D Program Report, Las Vegas, Nevada.
- Turner, B. et al. 1978. Satellite and Aircraft Multispectral Scanner Digital Data Users Manual, Office for Remote Sensing of Earth Resources, The Pennsylvania State University, University Park.

N83 19161

D19

MAPPING SAND AND GRAVEL PITS IN THE PATUXENT RIVER WATERSHED

Timothy J. Schmidt
State of Maryland, Department of Natural Resources

R. G. Witt
Goddard Space Flight Center

ABSTRACT

Landsat data from July 1973 and June 1978 for the Patuxent River Watershed of Maryland were processed in an effort to devise an economical method of monitoring the reclamation of sand and gravel pits. ASTEP-II and IDIMS software were utilized to derive signatures for sand and gravel pits and other land use/land cover types. Both unsupervised and supervised classifications of the two data sets were produced. Resultant statistics and color output products were compared in order to determine the extent of reclamation and expansion of sand and gravel pits over the five-year time span and to check the locations of more recent sand and gravel pits. Preliminary results indicate that, for a selected northern sub-acre, signatures derived for sand and gravel pits were nearly 90 percent accurate.

INTRODUCTION

The Maryland Surface Mines Project was initiated in November of 1979 as a cooperative demonstration project between ERRSAC (Eastern Regional Remote Sensing Applications Center) and the State of Maryland Department of Natural Resources, Water Resources Administration, Surface Mining Division as part of the state technology transfer program sponsored by the Maryland Department of State Planning. The aim of the project was to map sand and gravel pits within the Patuxent River Watershed in order to monitor the reclamation of sand and gravel pits. Two Landsat digital data sets for July 1973 and June 1978 and aerial photographs from similar dates were utilized for the analysis. The satellite data were pre-processed using the Interactive Digital Image Manipulation System (IDIMS) at ERRSAC. Further processing was done by means of ASTEP-II software on the University of Maryland's Univac 1108 computer system. Starting with small portions and then extrapolating to the overall study area, spectral signatures for various land use/land cover types were developed. Both unsupervised and supervised classifications were executed in order to categorize the data as one of the following: gravel pits, grass, forest, urban, or water. This process was accomplished for both image dates and compared with ground truth information - including air photos, topographic maps, and field observations. Using further field data gathered by the Water Resources Administration, an accuracy assessment was undertaken. Final products such as color thematic maps and a change detection map depicting mine, urban, and vegetational changes

will be generated. A cost-benefit study demonstrating the advantages of using satellite data in such an investigation is also to be conducted.

PURPOSE OF STUDY

Satellite remote sensing is being used for a wide variety of land use and land cover mapping tasks. One application has been the inventory of surface mining operations, such as coal strip mines and gravel pits, to map the extent of mining activities within a county or region. Reclamation efforts, natural revegetation, and mine expansion can be monitored by comparison of classified Landsat data derived from different dates.

The Surface Mining Division of the Water Resources Administration became a part of the project in an effort to find an economical method of monitoring the reclamation of non-fuel surface mines. The Surface Mining Division is responsible for the regulation of non-fuel surface mines and accordingly is responsible to insure reclamation of surface mines. Surface mine operators, as part of their permit requirements, are required to reclaim areas disturbed by mining and its associated activities. In addition, the Water Resources Administration itself will be reclaiming abandoned surface mine areas. Rather than make repeated follow-up inspections to determine the success of reclamation, which would be time consuming and costly, the Water Resources Administration decided to examine the feasibility of utilizing Landsat data to monitor reclamation.

In order to monitor the surface mine reclamation it is necessary to have image data available on an as-needed basis. Image data are available from other sources but not with the frequency of Landsat. Imagery other than Landsat is most often flown during the winter months when foliage is at a minimum, but imagery is needed showing the successful revegetation of reclaimed sites. In addition, the ASTEP-II software will perform all necessary area calculations saving many man-hours of time needed to planimeter air photos, the usual alternative to Landsat.

In conducting the project it was necessary to choose a representative area. The Patuxent River Watershed contains a large number of sand and gravel pits. These pits are active and abandoned, reclaimed and unreclaimed. The watershed also contains a good mix of land cover/land use types. It was decided not to include stone quarries in the study since by their very nature they are much slower in their progression toward mining completion, and will generally be reclaimed by allowing them to fill with water, rather than be revegetated to any great extent.

PROJECT DESCRIPTION

OBJECTIVE

The main objectives of the project were to map surface mining operations within the study area for two different dates, and to visually compare the changes in these extractive sites that occurred over the 5-year time span. Final products portray both the locations and the total extent of the mining operations for the two dates. Also, a general (Level 1) land use/land cover classification was developed for the entire study area. This inventory was conducted in order to facilitate current mine reclamation efforts and to provide a method to monitor reclamation of pits.

STUDY AREAS

The study area as depicted in the chosen Landsat images was the Patuxent River Watershed. The Patuxent River is one of nine designated Wild and Scenic Rivers in the state and is contained within the Coastal Plain and Piedmont provinces. The watershed has a drainage area of 930 square miles and includes seven counties: Montgomery, Howard, Prince George's, Anne Arundel, Calvert, Charles, and St. Mary's. The watershed within Montgomery, Howard, and part of Prince George's Counties features the rolling topography and predominant agricultural land use characteristic of the Piedmont Province. The remaining counties are within the Coastal Plain Province. The Coastal Plain province in the Patuxent River Watershed of Prince George's and Anne Arundel Counties is predominately forested with local high residential densities interspersed with agriculture and surface mining. The watershed in Calvert, Charles, and St. Mary's Counties features low residential densities with river margin forests and somewhat less extensive agricultural land use than in the upper portion of the watershed.

As defined for the project, the proposed study area was the portion of the watershed extending from the town of Laurel in the north to the town of Eagle Harbor in the south. To the west lies the drainage system of the Potomac and Anacostia Rivers; to the east that of the Chesapeake Bay. Initially, it was planned to divide this portion of the watershed into two study areas. The two study areas, one in the northern section of the scene, the other in the southern section, both contain a large number of sand and gravel operations. However, time constraints restricted the project to sand and gravel operations in the northern section. It should be noted that the northern section contains high density residential/commercial land use as well as forest and grass land, thus providing a variety of land use/land cover types to differentiate from the sand and gravel pits.

DATA SOURCES

Various sources of data and information were used for the project. These sources are:

- ° Landsat digital data computer-compatible tapes (CCT's) for 8 July 1973 and 30 June 1978;
- ° High-altitude color IR aerial photography for 12 April 1977 with a scale of 1:130,000;
- ° Low-altitude black and white aerial photography for April 1972 and May 1978 with a scale of 1:400;
- ° High-altitude black and white photography for 12 April 1977 with a scale of 1:200,000;
- ° Topographic maps at the following scales:
 - 1:24,000 sheets for Laurel, Beltsville, Anacostia, Bowie, Bristol, Upper Marlboro, Lower Marlboro, Brandywine, and Piscataway quadrangles;
 - 1:62,500 sheets for Anne Arundel and Prince George's counties;
- ° Ground truth information came from direct observations in the field, with supplementary information provided by Water Resources Administration personnel.

PROCEDURE

The analysis of surface mine reclamation was performed by a dual-temporal digital classification of the Landsat data. Following is a detailed discussion of the two separate classifications.

DATA PROCESSING

Once the Landsat computer-compatible tapes (CCT's) were available, the study area (Laurel to Eagle Harbor) was subset from each of the two scenes and a rough geocorrection of each was performed by means of the IDIMS functions "Control" and "Register." The subsets for the two dates were precisely matched by locating similar ground coordinates. Transfer tapes were then prepared in a format that is compatible with existing software at the University of Maryland. The data were then processed on the Univac 1108 computer there, using the ASTEP-II (Algorithm Simulation Test and Evaluation Program, version II) software

package. This software had been installed at the University of Maryland as part of the overall ERRSAC technology transfer program for the State.

DATA ANALYSIS STEPS

- ° Study sub-areas were selected for in-depth analysis and signature extraction by means of the ASTEP-II DATDEF (data definition) function. They were as follows: a small but intensively mined section along I-95 southwest of Laurel; a larger window including Laurel in the north of the study area; and two similar windows in the southern portion of the study area. Each of these would be used in the process of developing signatures.
- ° The following ASTEP-II programs were run: FACTOR to acquire histograms, QUANTZ to perform density slices, and IMAGES to produce gray-scale maps in all four bands for the small I-95 window.
- ° ITRCLU (iterative clustering), an unsupervised classification was run on the intensively mined I-95 window. Typical mine signatures were then identified and saved in a file.
- ° ISOCLS (an IDIMS function), an unsupervised classification, was executed on the larger northern (Laurel) window for both dates to produce land use/land cover signatures for other categories such as residential/commercial, forest, grass and water.
- ° After extensive testing with both groups of signatures, the best mine signatures from ITRCLU and other land use/cover type signatures from ISOCLS were combined in MAXLIK (maximum likelihood) and DCLASS (minimum distance) supervised classifications of the larger northern window.
- ° Resulting classification maps were field checked for accuracy, using air photos and on-sight inspection. Signatures producing the best results were retained.
- ° Preliminary final products for the Laurel area were generated using MINDSTG and the IDIMS (MINDSTG is the IDIMS function equivalent to DCLASS in ASTEP-II)
- ° The ADPCLU (adaptive clustering) unsupervised classification was run for the southern windows to develop mine and agricultural signatures unique to the rural setting.

- ° These signatures were input into a DCLASS (minimum distance) classification for the southern windows, and the accuracy of this mapping was checked.
- ° The ADPCLU signatures will be combined with the preselected ITRCLU and ISOCLS signatures in a DCLASS (minimum distance) supervised classification of the entire study area. Both ADPCLU and DCLASS were adopted in the later stages of the project because they were approximately one-fifth as costly to run as ITRCLU and MAXLIK, while producing very similar results.
- ° Extensive field checking was then performed to verify the results of the DCLASS classification maps of the study area, including use of aerial photos and topographic maps.
- ° Portions of the study area that were grossly misclassified were corrected by reclassification.
- ° Acreage statistics (# pixels x 1.1) were obtained for all classification categories from the IDIMS system.
- ° All of the previous steps executed for the June 1978 image data are being repeated for the earlier (July 1973) data set.
- ° Final hardcopy output products will be generated for both dates, and a change detection (DIFIMG) map produced.
- ° Cost/benefit analysis is also to be undertaken by the Water Resources Administration personnel.

VALIDATION

Validation of classified data was accomplished by comparing the resultant DCLASS images with the previously mentioned data sources: 1:24,000 quad maps, 1:62,500 county maps, aerial photography, and direct field observations. Additional information was supplied by topographic drawings submitted by surface mine operators to the Water Resources Administration as a requirement to obtain a surface mining permit. These drawings provided especially accurate acreage figures for active sand and gravel pits in the Laurel vicinity. The 1978 scene corresponds closely to the time period that surface mine operators were obtaining the permits.

RESULTS

The following categories were distinguished as part of the classification:

- ° Sand and gravel pits
 - ° Grass - includes open fields, agriculture, and golf courses
 - ° Forest - includes deciduous, coniferous, and marsh
 - ° Residential
 - ° Residential/Commercial
 - ° Commercial
 - ° Water
- } Urban (combined as)

Listed in Table 1 are the ISOCLS signatures derived from IDIMS and the ITRCLU signatures derived from ASTEP-II for 1978 for the Laurel vicinity. This table also lists the ISOCLS signatures derived from IDIMS for 1973. Due to constraints in the ASTEP-II software it is possible to derive and classify with a maximum of only twenty signatures, whereas the IDIMS has the capability to produce more than 50 signatures. All signatures are derived from MSS channels 4, 5, 6, and 7.

Analysis of the images produced from the ISOCLS and ITRCLU functions revealed that neither was the best process to utilize for the Laurel area. Since the ITRCLU function resulted in outstanding sand and gravel pit signatures and the ISOCLS provided better signatures for the other land use/land cover types, these signatures were combined into one file. This combination produced an image whereby it was possible to detect the location of sand and gravel pits with nearly 90 percent accuracy. Accuracy for pit size was approximately 80 percent.

The accuracy of pit location as depicted by the image product was checked by comparison with maps and air photos and field work. Actively mined sites were particularly noticeable as anticipated. But it was not expected that sites just a few acres in size and no longer active would be depicted with the frequency shown in the image.

Pit size was less accurate due to several reasons. Typically, the pits in the Laurel area are near urban zones where the signatures of the two land uses may be confused. Those pits that are not near urban zones are surrounded by forest, which can reduce the pit size in an image. They also may contain shallow ponds, refuse dumped in the pit area, or scrub vegetation. All of these contribute to confusion in the Landsat data.

**ORIGINAL PAGE IS
OF POOR QUALITY**

Initial attempts to analyze sand and gravel pits in the southern section of the Landsat image did not provide the same success as that of the Laurel area. DCLASS images for the southern section failed to depict several large sand and gravel pits. The exact reason for this is unknown but it is probably a result of geology. Sand and gravel pits in the Laurel area are found in the Potomac Group, a Lower Cretaceous formation of a white, buff, or red-brown color. The pits in the southern section are found in the Upland Deposits and are tan, orange, or reddish brown in color.

An attempt was made to analyze 1973 data for the Laurel area in order to detect temporal changes in the sand and gravel pits. The initial results of this analysis were not as successful as with the 1978 image. The number of pixels classified as pits for 1973 was greater than that of 1978, which was not to be expected. Instead, there should have been a greater number of pixels classified as pits in 1978 for several reasons: 1) there was little reclamation of sand and gravel pits during the five-year span; 2) there was expansion of some existing pits; and 3) there were new pits opened during the years following 1973. The main reason for this discrepancy is the expansion of the urban and commercial areas. The DCLASS and MINDSTG (an IDIMS function) image products show that there are pixels within or immediately adjacent to urban and commercial areas which are classified as sand and gravel pits. By checking the air photos and topographic maps it was possible to determine that these pixels designate bare soil where construction sites were located. Once these "construction" pixels are eliminated from the sand and gravel classification the number of pixels for pit signatures is more meaningful.

CONCLUSIONS

It has been shown that it is possible to use Landsat imagery to monitor sand and gravel pits. Combining the 1978 ITRCLU pit signatures and ISOCLS signatures for grass, forest, urban, commercial, and water in the Laurel vicinity produced satisfactory results. Results were not as satisfactory in the southern section but this is probably due to the geology of the area. With some further refinement it is likely that results approximating the accuracy of those derived in the Laurel vicinity will be achieved. Attempts to measure temporal changes in the Laurel vicinity were not highly accurate but this is due to the large amount of construction activity being detected as sand and gravel. Another reason may be that the 1973 data were imaged by Landsat 1 while the 1978 data were imaged by Landsat 2, causing radiometric differences in the signatures produced. This would not be a problem once the correct signatures are obtained and entered into a file. The purpose of using Landsat is not the detection of new pits but to monitor the reclamation of existing pits. The ASTEP-II change detection map (DIFIMG) will serve this function. It is expected that once proper signatures are derived, sand and gravel pits throughout the entire Coastal Plain can be monitored for reclamation.

Table I

MSS Band	IDIMS 1973 (Laurel window ISOCLS sigs.)				IDIMS 1978				ITRCLU 1978 (I-95 window)				
	4	5	6	7	4	5	6	7	4	5	6	7	
Sand & Gravel	64.83	80.26	84.55	71.57	44.87	70.37	79.88	66.63	54.21	89.57	94.89	76.21	
	47.94	49.94	66.82	63.39	32.21	42.63	64.32	62.05	31.25	40.59	64.96	64.06	
	56.29	64.60	73.22	64.85	39.71	57.15	67.18	58.12	39.91	59.46	72.98	63.51	
	56.16	56.79	62.82	54.81					44.95	64.04	76.96	64.63	
									40.69	57.75	62.82	51.71	
								48.75	77.17	83.57	67.59		
								32.38	42.74	58.26	53.67		
								35.58	50.53	68.36	62.60		
								51.93	82.11	90.37	73.19		
No. Pixels	485				475				743				
Grass	34.88	23.69	62.64	71.13	20.56	15.56	64.34	77.23	21.66	17.64	61.07	71.18	
	36.37	26.97	58.69	64.05	26.79	28.96	59.09	62.47	22.50	20.38	55.48	62.14	
	34.57	24.75	50.60	54.33	21.75	19.17	52.26	58.46	22.87	29.16	59.91	63.28	
					23.54	21.97	56.73	62.82	23.48	22.70	50.75	54.98	
					21.68	18.08	60.26	69.45					
No. Pixels	3613				4530				157				
Forest	31.20	20.08	48.72	55.08	18.69	13.48	48.96	58.50	19.19	14.10	53.38	67.25	
	31.27	20.00	51.34	58.83	18.45	12.65	52.78	63.99	19.51	15.13	49.46	57.93	
	31.37	20.27	45.53	49.13	18.63	13.36	44.89	52.46	19.49	15.41	41.22	46.40	
	30.92	19.45	52.87	62.96	18.58	12.85	56.65	69.33					
	31.54	20.73	41.05	41.75	18.98	14.25	39.57	44.73					
	33.66	22.88	53.96	60.27	20.33	16.47	54.62	63.79					
	32.41	20.96	56.82	66.09									
No. Pixels	16970				15747				934				

ORIGINAL PAGE IS
OF POOR QUALITY

Table I (cont.)

MSS Band	IDIMS 1973 (Laurel window ISOCLS sigs.)				IDIMS 1978				ITRCLU 1978 (I-95 window)				
	4	5	6	7	4	5	6	7	4	5	6	7	
Res/Com	39.56	33.41	56.28	57.56	30.41	35.71	55.95	54.56	27.52	30.74	53.47	54.08	
	42.07	38.16	61.64	62.00	25.03	24.61	52.46	56.04	35.68	45.22	51.12	43.36	
	36.67	27.58	53.93	57.61	35.59	46.12	56.67	50.11	26.05	28.25	46.39	46.48	
	39.55	32.70	46.10	43.48	29.87	33.74	49.07	47.09	30.59	36.28	45.80	41.45	
	36.15	27.16	47.76	48.86	25.50	25.61	47.12	49.27					
	39.63	32.67	51.79	51.99	27.65	29.88	51.87	52.83					
	48.56	46.96	52.67	45.81	21.76	19.28	47.13	52.61					
	43.58	38.26	41.59	33.69	33.14	40.28	47.71	41.85					
	44.86	43.67	58.09	54.55	31.04	34.63	38.68	33.20					
	43.61	38.67	50.92	47.48	27.35	29.23	43.30	42.00					
No. Pixels		6820				7325				669			
Water No. Pixels	34.04	22.92	27.06	21.61	18.94	12.73	17.10	15.37					
		108				63							

200

ORIGINAL PAGE IS
OF POOR QUALITY

N88 19162 ²⁰

RECENT DEVELOPMENTS WITH THE ORSER SYSTEM

George M. Baumer, Brian J. Turner and Wayne L. Myers

Office for Remote Sensing of Earth Resources
The Pennsylvania State University

ABSTRACT

The ORSER system is a continually evolving remote sensing data analysis package. During the last few years, major additions have been made to the Preprocessing and Data Analysis sub-systems and minor changes to the Display sub-system. Ongoing developments are also described.

INTRODUCTION

The ORSER system has changed significantly in the past few years. The directions of change have been motivated by a number of factors, including the rapid change in technology and the needs of users in a wide spectrum of areas. By no means is every new enhancement of the ORSER system described in this paper, but an effort has been made to stress the significant improvements.

The ORSER system is fully documented in the "User Manual" (ref. 1). A new version of the User Manual should be available by June 1981. Earlier versions of the system have been described by Borden (ref. 2) and McMurtry et al. (ref. 3). An excellent introduction to the system has been prepared by ERRSAC (ref. 4). Since many ORSER users have gained their familiarity with the system through ERRSAC training sessions, we have used the version of ORSER used by ERRSAC in association with their OCCULT front-end system as a base for this discussion of recent developments.

THE ORSER SYSTEM PHILOSOPHY

The ORSER package now consists of about 35 individual programs that can be grouped into three general types. These types are as follows:

1. Preprocessing sub-system--The main function of these programs is to read data that are in one of a large variety of formats and convert that data into the 'ORSER raw data' format. This data set can then be read and processed by the Data Analysis programs. Also included in this group are programs that allow merging (overlying) of data, windowing, spanning adjacent data, data transformations, bounding of irregular areas and geometric correction. (See figure 1.)

2. Data analysis sub-system—Once the data are in the 'ORSER raw data' format, any one of the analysis programs may be run on this data set. (See figure 2.) Most of these programs produce a character map which can be stored on disk in the 'ORSER compressed map' format for later display, or printed on a line printer. A number of supervised and unsupervised classifiers are available. Most of these programs have default values for the parameters that allow a first look at the data with very little needed input from the user. A detailed explanation of each program, the algorithm used and the default values are given in the ORSER User Manual (ref. 1).
3. Display sub-system—Data in the 'ORSER compressed map' format can be displayed on a number of different devices. A correction program is available that allows the map to be corrected for differences in the output device itself as well as scale changes and geometric correction. Line printer maps are generated by each data analysis program and are therefore used extensively for most intermediate work. (See figure 3.)

EXTENSIONS TO THE ORSER SOFTWARE SYSTEM

PREPROCESSING SUB-SYSTEM

Additional Data Formats

One of the real strengths of the ORSER system is its ability to handle a number of different data types from different scanners on different platforms in ever-changing formats. To keep this strength and to accommodate the need to overlay different data types, the following programs were developed (or modified). A brief description of the function of each program is listed:

SUBAIR translates data from aircraft scanners into the 'ORSER raw data' format.

REFORMAT reads data in a number of 'band sequential' formats including VICAR and IDIMS.

RFMIDTT reformats 'DIGITAL TERRAIN DATA' from the NCIC into ORSER format.

SUBSET has been expanded to include the new formats for LANDSAT data generated after February 1979.

A program is currently underway to read the HCMM data tapes.

Data Management Programs

Programs that allow data to be overlaid for the purpose of temporal analysis or improved classification were seen as a necessity. Also needed

was a method of looking at an irregular area such as a county or watershed. The following programs were developed to answer these needs.

MERGE merges registered Landsat or other data from two overpasses of the same area. Data are usually geometrically corrected and rotated using SUBGM before being registered.

SPAN spans data from two adjacent panels of the same Landsat scene, or concatenates data from two consecutive Landsat scenes of the same pass.

SUBBOUND subsets an irregularly bounded area from an ORSER or Landsat tape into ORSER format. It is otherwise the same as the SUBSET program, which operates only on rectangular areas called blocks.

Data Transformation Programs

Programs that read 'raw data' and transform it have been found to be useful by users in different disciplines. The transformed data can then be used by any of the ORSER data analysis programs. There are five programs that provide the means for doing a number of transformations, including principal components and canonical analysis. The first three programs (CANAL, RSCOR, and ROTATE) provide the means to actually transform the data.

CANAL uses the techniques of canonical analysis to derive a set of orthogonal, linear transformations that maximize category separability on as few axes as possible. The analysis is based on the mean vectors (or signatures) and their corresponding variance-covariance matrices for input categories. The resulting transformation matrix can be input to other programs to transform the data and category signatures.

RSCOR computes partial and multiple correlations from a variance-covariance matrix.

ROTATE, given the variance-covariance matrix of a population, finds the principal components axes of the population and rotates selected axes to have equal variance over other selected axes. Equal variance rotation is sometimes useful for data display on film recorders.

Geometric Correction Programs

Geometric correction of data is necessary for three main reasons. First, if two data sets are to be merged, they must be registered before being merged. This can be a difficult job, especially if the data types vary greatly. Second, often a researcher has the need for a map that will physically overlay another map for ground-truthing. Third, often a display device will not have the same pixel dimensions as the data and this must be corrected or the data will be stretched in one direction or the other. The ORSER system provides for correction of either 'raw data' or already classified data. It also

provides for corrections of known parameters (e.g., scale, pixel shape) and 'rubber sheet stretching.' The latter is a method of correction where ground control points are used to define a transformation from an image reference system to a map reference system. The following three programs provide the above features.

EZLS reads in a set of ground control points and produces regression output of the functions needed by SUBGM or DISPGM to do the actual stretch. This program is needed only for the 'rubber sheet stretch' option.

SUBGM can either correct the data using certain known parameters such as the scale or pixel configuration desired, or can perform the actual stretch given the functions from EZLS. This program works on 'raw data' only.

DISPGM does what SUBGM does but only on data that have already been classified.

DATA ANALYSIS SUB-SYSTEM

Enhancements to data analysis techniques include a maximum likelihood classifier (MAXCLASS) and a new version of the STATS program (USTATS) which makes delineation of training areas easier and allows for detection of 'outlier' points. Another new program, STCLASS was written for use with the CLUS program. A brief description of each of these programs follows.

MAXCLASS classifies data by the maximum likelihood method given the mean vectors and variance-covariance matrices produced by the STATS or USTATS programs.

USTATS is a version of STATS that computes statistics for elements within a training area that exhibit a certain level of local spectral uniformity. The appropriate level of uniformity is determined from UMAP output. The motivations for developing USTATS were to simplify the procedure for delineating training areas and to reduce the number of outlier elements included in the computations.

STCLASS produces a classification map based on the algorithm used in the CLASS program, and simultaneously generates statistics for selected input signatures. The sample for each signature consists of the pixels classified in the category defined by that signature. The statistics are the same as those generated by the STATS program. STCLASS was written primarily to obtain statistics for signatures output from the CLUS program, since CLUS only generates spectral signatures for each category.

CHANGE DETECTION TECHNIQUES

Two different ways of looking at change are currently available and a third is being developed. Change can be detected in two different classified

maps by using the MAPCOMP program described below. Alternatively, raw data can be merged using the MERGE program and the resulting data set used with any of the data analysis programs.

MAPCOMP compares two character maps, element by element, and outputs a comparison map and associated summary tables. Comparison categories are defined by specifying the input maps' symbol pair and a corresponding output map symbol.

MERGE merges registered Landsat or other data from two overpasses of the same area. Data are usually geometrically corrected and rotated using SUBGM before being registered.

DISPLAY SUB-SYSTEM

The LMAP program which formerly was used to produce line boundary and shaded classification maps on a Calcomp plotter has been adapted to plot on a variety of devices including Tektronix's 4010 CRT terminal and 4662 plotter.

UNDER DEVELOPMENT

Listed briefly below are projects that are currently underway.

- Expansion of the system to handle larger data sets. The maximum line length of a data line in the ORSER format is being expanded from 3696 bytes to 18410 bytes. This will allow 'full-scene' capability on a 5-channel data set. It will also make the system more flexible in handling merged data sets. This version of the programs will be available in June 1981.
- In an effort to make the programs easier to install on a wider variety of computers, an all-FORTRAN version of the ORSER system will also be available in June 1981.
- A system of programs that will handle polygon data is currently being developed. They will perform such operations as: polygon to grid format conversion, editing of digitizer data, overlaying of polygon data onto grid data for display purposes, and calculation of area statistics.
- A method to visually evaluate a particular set of geometric correction functions before the transformation is actually done is being developed to enhance our correction process.
- A front-end system similar to ERRSAC's OCCULT is being developed using Penn State's Interact editing system to set up the JCL program stems. This front-end is user-oriented and eliminates many of the job control errors with which RJE users had to contend. The current version is set up for about half of the ORSER programs. It is hoped that by the end of this year, the entire system will be built into this framework.

- MASK, a program that will allow the overlay of raw data with a classified map to eliminate certain categories, is being written. This program is being developed to implement an algorithm that will be used by NASA/GSFC and the Pennsylvania Bureau of Forestry Division of Forest Pest Management to classify levels of gypsy moth defoliation in forests over the entire state of Pennsylvania.
- A ZONAL system is being written. A common deficiency of most systems for processing Landsat data is lack of provision for incorporating classification results with information derived from other sources. The ZONAL system will provide the ability to aggregate classification results over externally defined geographic referencing units such as grid cells or polygons. Output will be a listing (file) of aggregated data by geounit. Such a file can be readily formatted for direct entry as an additional layer in a host information system where non-remote sensing information resides.

CONCLUDING REMARKS

The ORSER system is highly dynamic. In the past we have relied on informal communication and such opportunities as this to keep users informed on the latest developments. With the large number of versions now being used, this is no longer possible. Furthermore, users are beginning to adapt the system to their own needs. Although we generally hear of this, such information often doesn't get to other users who may well benefit from it.

To act as a medium for this kind of exchange, some users have recently suggested the formation of an ORSER Users' Group, a thought that we have had for some time. ORSER is willing to sponsor this, with shared financial responsibility by users. Our immediate goal would be to establish a (quarterly?) newsletter with material solicited and compiled by an ORSER staff member. Hopefully, this will provide an avenue for suggestions as to what else the 'Users Group' might do.

REFERENCES

1. Turner, B. J.; Applegate, D. N.; and Merembeck, B. F.: Satellite and Aircraft Multispectral Scanner Digital Data User Manual. ORSER Tech. Rept. 9-78. The Pennsylvania State Univ., 1978.
2. Borden, F. Y.: A Digital Processing and Analysis System for Multispectral Scanner and Similar Data. In Shahroki, F. (Ed.): Remote Sensing of Earth Resources, Vol. I. Univ. of Tennessee Space Inst., 1972, pp. 481-507.
3. McMurtry, G. J.; Borden, F. Y.; Weeden, H. A.; and Petersen, G. W.: The Penn State ORSER System for Processing and Analyzing ERTS and other MSS data. In Shahroki, F. (Ed.): Remote Sensing of Earth Resources, Vol. III. Univ. of Tennessee Space Inst., 1974, pp. 721-740.
4. National Aeronautics and Space Administration: ORSER 'Hands-On' Training Manual. ERRSAC, NASA Goddard Space Flight Center, 1980.

ORIGINAL PAGE 13
OF POOR QUALITY

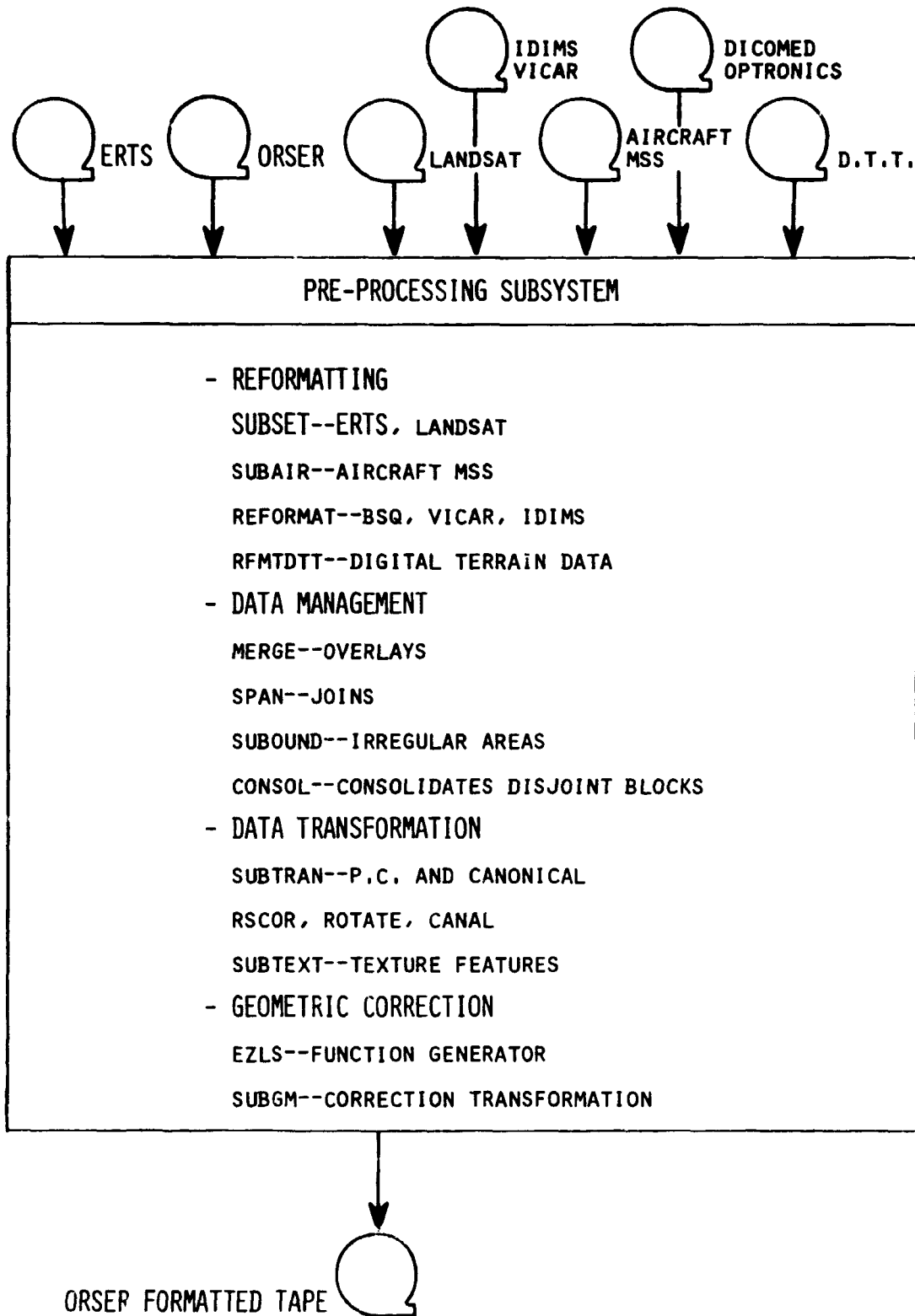

Figure 1. Components of Preprocessing Subsystem

ORIGINAL PAGE IS
OF POOR QUALITY

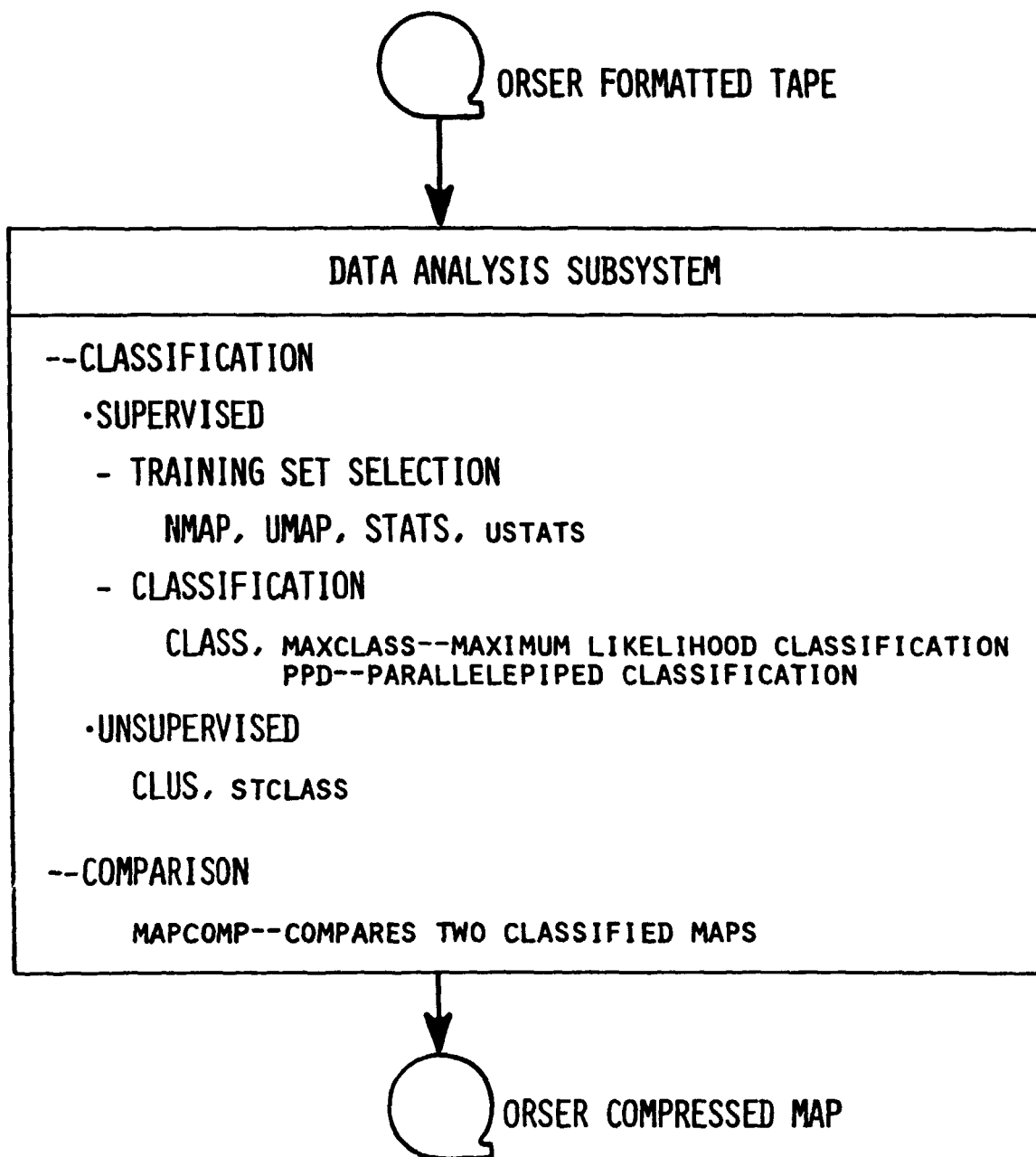
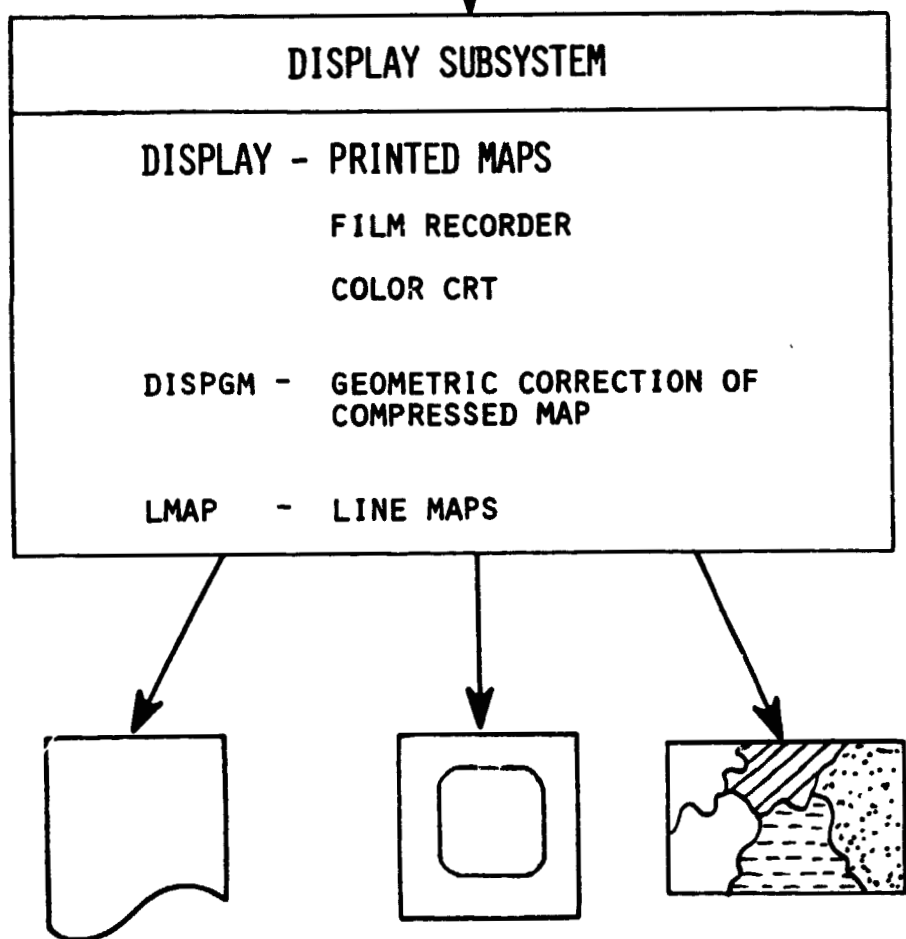

Figure 2. Components of Analysis Subsystem

ORIGINAL PAGE IS
OF POOR QUALITY

ORDER COMPRESSED MAP



FINAL OUTPUT PRODUCTS

Figure 3. Components of Display Subsystem

D21

N83 19163

THE USE OF LANDSAT BY THE STATES FOR WATER QUALITY ASSESSMENT

Elizabeth M. Middleton
ERRSAC
Goddard Space Flight Center
Greenbelt, MD 20771

ABSTRACT

The use of Landsat for water resources applications in U.S. state demonstration projects is reviewed. The most common single application undertaken between 1976 and 1981 was found to be water condition assessment. The majority of projects, however, fell into the general category of watershed hydrology. Some of the states in ERRSAC's 19-state region are attempting to use Landsat data in an operational mode for water quality assessment. Two of these state projects from Vermont and Wisconsin are described in brief. The basic information requirements of Section 314 of the U.S. Pollution Control Act are given with the type of input Landsat data could potentially provide toward those requirements. Surveys were performed by ERRSAC to determine (a) how its states were responding in 1980-1981 to the federal and state water quality laws; and (b) the status of Landsat analysis capabilities of each state.

INTRODUCTION

In recent years, Landsat has been utilized for input to an impressive variety of projects for water resources applications. As diverse as they appear, they can for the sake of simplicity, be placed in two general categories--watershed hydrology and water body condition studies as shown in Figure 1. For the former, maps locating the surface extent of snow cover, land cover types, and surface water are produced from Landsat data in conjunction with supporting ground truth. Acreages for these cover types are input, along with other resource data, into the appropriate hydrologic model for predicting or estimating water supply, erosion potential, or water quality (in terms of turbidity) related to erosion. For water condition assessment, maps of the distribution patterns of water parameters, especially those related to turbidity, can be produced from high quality Landsat data. The estimated values of these parameters are used as input, with supporting surface truth data, to models which estimate or predict the general water quality of a water body.

THE USE OF LANDSAT BY THE STATES FOR WATER RESOURCES

According to information available through the NASA Regional Applications Program and the 1978 "ISETAP" document prepared by the Intergovernmental Science, Engineering and Technical Advisory Panel for the Executive Office of the President of the United States, the majority of the state Landsat demonstration projects in water resources have been in the general category of watershed applications. However, the single application with the greatest interest as evidenced by numbers of projects was water body condition assessment. Twenty-nine projects for

**ORIGINAL PAGE IS
OF POOR QUALITY**

this application were reported out of the approximately 120 Landsat water resource projects involving 39 states in the U.S. up through the 1980 calendar year. The next most common application was land cover mapping for erosion potential assessment (19), followed by surface water inventories (15), flood plain mapping (13), and general planning and management (11). Other less common applications included basin studies, irrigation management, shoreline delineation, snowcover mapping, and reservoir volume estimation, as shown in Table I. The proportional representation of each application area is presented in the pie chart in Figure 2.

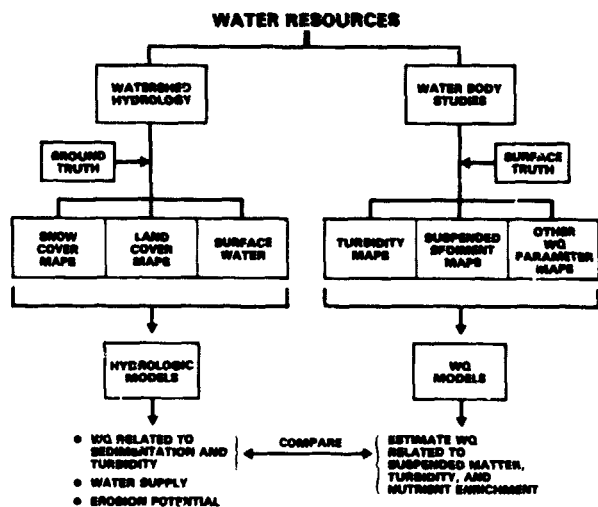

Figure 1. A schematic representation of the use of Landsat data for water resource applications

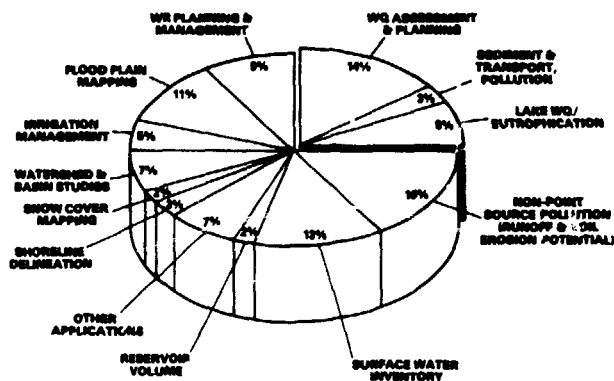

Figure 2. The percentage break-out of state Landsat water resources projects, 1976-1981

An interesting trend in the adoption of operational uses of Landsat data based on the results of demonstration projects emerged from the above information and is represented in histogram form in Figure 3. While states participated in from one to eight water resource projects each (in most cases, in addition to other applications such as agriculture, forestry, and geology), those states with three or more water resources projects were more likely than others to designate at least one of these projects an operational application within that state. Furthermore, while few states participated in more than five different water resources projects, those that did reported all of these to represent operational applications in their resource management programs. Apparently, demonstrated success within a state requires several successes in water resources applications before any application is adopted as operational, but these successes increase confidence in Landsat and facilitate the adoption of related applications. The exception is where a single project in a state leads to its operational status almost immediately as was the case with watershed applications in four states.

ORIGINAL PAGE 13
OF POOR QUALITY

WATER RESOURCES APPLICATION	NO. OF PROJECTS	NO. OF STATES	NO. OF STATES WITH OPERATIONAL CAPABILITY
WATER CONDITION ASSESSMENT	28	28	18
LANDCOVER FOR EROSION POTENTIAL	18	17	16
SURFACE WATER INVENTORY	16	16	7
FLOOD PLAIN & RELATED STUDIES	13	12	8
PLANNING & MANAGEMENT	11	11	2
WATERSHED OR BASIN STUDIES	8	8	2
IRRIGATION MANAGEMENT	8	8	2
SHORELINE DELINEATION	4	4	2
SNOWCOVER MAPPING	3	3	1
RESERVOIR VOLUME	2	2	0
OTHER	8	7	3
	118		

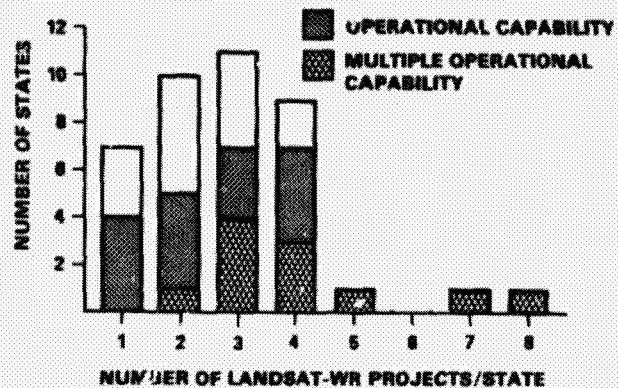

Table I. State Utilization of Landsat Technology for Water Resources

Figure 3. State involvement with Landsat--water resources projects

LANDSAT AND STATE WATER QUALITY PROGRAMS

Consistent with the national focus, the water resources applications of most interest for state Landsat demonstration projects and NASA-funded research in ERRSAC's region have been in water/water body condition assessment, generally referred to as water quality assessment. In the absence of an endorsed approach by NASA, the states desiring to use Landsat data for water quality assessment have proceeded, out of necessity, on their own. The techniques used have varied from state to state and include single and multiple parameter regression analyses, ratio techniques, principal components analysis, cluster analysis employed in conjunction with spectral classification techniques, and the use of indices for combining data for average conditions. Each of these techniques is appropriate for particular kinds of information needs. And the states, with differing water quality problems, have consequently employed a variety of different approaches to data analysis.

Two state projects undertaken by Vermont and Wisconsin exemplify different approaches to the use of Landsat data for a water resource problem concerning water quality. In Vermont, the Department of Water Resources was interested in correlating the routine samples of Secchi disc depth, chlorophyll *a* and phosphorus taken in lakes as part of the state key monitoring program with Landsat data acquired on the same day. Of particular interest were measurements of the sediment and nutrient load associated with spring runoff. These measurements have been good predictors in Vermont of water clarity, as indicated by Secchi depth, in the summer months. Numerical estimates of turbidity-related water parameters and maps showing their distribution patterns constituted the primary information need for Vermont. These data were used to classify lakes and to supplement the field data in unsampled areas and provide distribution maps of patterns not apparent with point samples. To accomplish this in-house, the DNR has made plans to use the state Landsat analysis software, an advanced version of the ORSER system developed at Pennsylvania State University which resides at the University of Vermont and is available to user agencies. An overview of the

ORIGINAL PAGE IS
OF POOR QUALITY

data analysis procedures worked out for Vermont by ERRSAC to accomplish their goals using the ORSER system is shown in Figure 4.

The Wisconsin DNR's goals to accomplish lake classification according to trophic state are very different. Here the emphasis is on determining average water conditions within a lake, especially those related to turbidity, in order to evaluate trophic status. Field samples taken the same day as the Landsat overpass are obtained as often as possible and input to a model developed by the University of Wisconsin-Madison. The methods to accomplish this set of requirements with Landsat data are summarized in Figure 5.

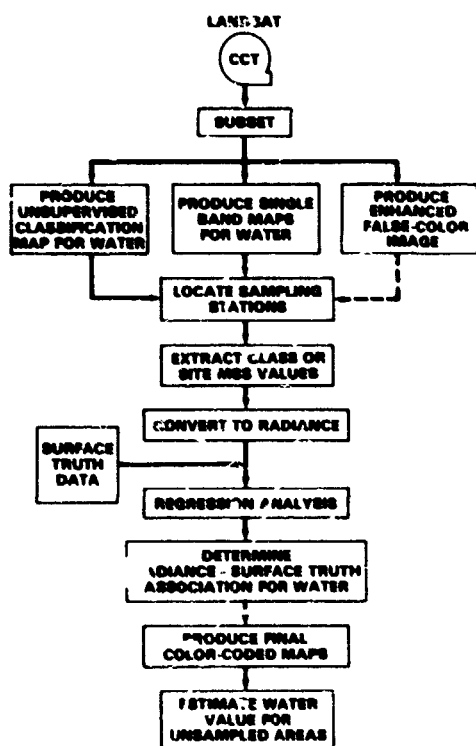

Figure 4. The Vermont Landsat data analysis methods for the state Lake Study, an out-growth of the Lake Champlain study

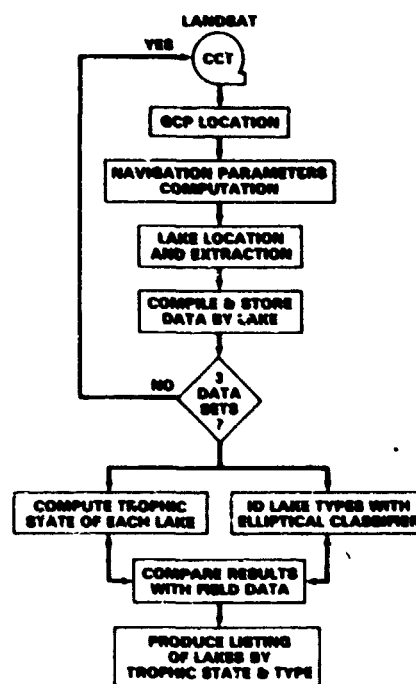

Figure 5. The Wisconsin Landsat data analysis methods for the statewide Lake Classification Study

MOTIVATING FACTORS FOR STATE WATER QUALITY MONITORING PROGRAMS

In order to provide technical guidance to our states as requested, ERRSAC became involved in the evaluation of Landsat data as a transferable technology for water quality studies. The emphasis of this evaluation has been to (a) determine the user requirements for water quality assessment; (b) identify the Landsat analysis techniques in use; (c) compare methodologies of these techniques; (d) compare the information derived using these techniques; and (e) identify techniques for further study and/or development.

Although the particular water quality information needs of a state may vary, they originate from a common source. Resource management's concern for maintaining water quality standards and for understanding the impact of cultural activities on water quality have provided a common driver in all the states for acquiring water quality information. More importantly, though, state and federal legislation mandates the acquisition and reporting of certain types of water quality information. These resource management needs and legislative requirements can in part be supplied by Landsat data, especially in those states which support a geo-based data base for natural resources.

The most important legislation addressing water quality is the Federal Water Pollution Control Act of 1972 (Public Law 92-507), commonly referred to as the Clean Water Act, which is regulated by the U.S. Environmental Protection Agency (EPA). The portion of this law which creates the most burdensome demands on states is Section 314 which requires that EPA assist the states in controlling sources of pollution which affect the quality of freshwater lakes and assist in the restoration of lakes which have been degraded. A primary goal identified for the program for the 1980-1985 time period is to ensure that at least one water body within 25 miles of every major Standard Metropolitan Statistical Area (SMSA as defined by the U.S. Bureau of the Census) is suitable for contact recreation. This is to be accomplished by either protecting an existing lake with acceptable water quality or by restoring a degraded lake to an acceptable condition. EPA has also established five specific objectives for this time period: (1) to select projects which maximize public benefits; (2) to integrate The Clean Lakes Program (as it was defined by EPA prior to 1980) with other environmental and water quality programs; (3) to emphasize watershed management; (4) to develop active state involvement and maintain federal/state partnerships; and (5) to conduct continuous programs and project evaluations.

Section 314 is composed of three major parts, each of which has its own specific requirements. These are:

1. The Lake Classification Survey, which requires each state to identify and classify all publicly owned freshwater lakes in the state according to eutrophic conditions;

2. The Phase 1 Study, which involves deriving procedures, processes, and methods (including land use requirements) to control sources of pollution of these lakes; and

3. The Phase 2 Study, which includes developing methods and procedures in conjunction with appropriate federal, state and local agencies, to restore the quality of these water bodies.

Each year, beginning in 1981, the states will prepare and submit a report to EPA containing information required in these three sections.

It was the comprehensive requirements of this legislation which encouraged states like Wisconsin and Vermont to examine Landsat as a means of acquiring information

**ORIGINAL PAGE IS
OF POOR QUALITY**

that could not otherwise be obtained practically. The basic information requirements of this act and the type of input Landsat data could potentially provide toward those requirements are listed in Table II.

INFORMATION REQUIRED	REQUIREMENT FOR		POTENTIAL DATA ACQUISITION				
	LAKE CLASS	PHASE I OR II	L	L - MAP	L - FIELD	L - OTHER	NO L
WATER BODY - GENERAL							
LOCATION, SURFACE AREA	•	•	•				
ALTERNATE SITES		•	•				
HYDROLOGIC RELATIONSHIPS		•	•	•			
POLLUTION	•	•	•				•
TROPIC CLASSIFICATION	•	•	•		•		
SCIOLOGY, PUBLIC ACCESS, RESIDENT POPULATION		•					•
WATER BODY - SPECIFIC							
SIZE, SHAPE, SURFACES, SOLIDS, EFFLUENTS, CHLOROPHYLL A	•	•			•		
ALGAL BLOOMS, MACROPHYTES		•			•		
WATERSHED							
AREA, TOPOGRAPHY		•		•			
SCIOLOGY	•	•					•
LAND USE		•					•
RELATED OR ASSOCIATED		•			•		•
OTHER							
LAKE SPECIFIC SCIOLOGY, SCIOLOGY & CHEMISTRY, WATER USES, etc.							•

Table II. Critical Elements of the Clean Water Act, Section 314

SUMMARY OF INFORMATION COMPLETED	STATES SURVEYED									
	FEDERAL REGION I		FEDERAL REGION II		FEDERAL REGION III		FEDERAL REGION V			
	ME	VT	NJ	NY	DE	VA	DC	MD	PA	WV
L.C. FOR USE COMPLETED	•	•	•	•	•	•	•	•	•	•
L.C. SURVEY IN PROGRESS	•	•	•	•	•	•	•	•	•	•
APPROVED PHASE I PROJECTS	•	•	•	•	•	•	•	•	•	•
APPROVED PHASE II PROJECTS	•	•	•	•	•	•	•	•	•	•
L.C. DATA COMPARABLE TO PHASE I REQUIREMENTS	•	•	•	•	•	•	•	•	•	•
ACTIVE LAY MONITORING PROGRAMS	•	•	(1)	(1)		(1)	•	•	•	•
STATE WATER QUALITY LAWS	•	•	•	•	•	•	•	•	•	•
LANDSAT USES FOR WATER QUALITY MONITORING	•	•	•	•	•	•	•	•	•	•
SHOULD WELCOME LANDSAT HELP IN WATER QUALITY MONITORING	•	•	•	•	•	•	•	•	•	•

L.C. - LAKE CLASSIFICATION

Table III. Results of the Telephone Survey to Determine How ERRSAC's States are Responding to Legislative Requirements for Water Quality

ERRSAC'S STATES

The states in ERRSAC's region have been actively involved in water quality monitoring and assessment programs. This was borne out by a telephone survey performed by ERRSAC of the water resource agencies in its states, which found that 11 of the 19 states were currently involved in water quality programs (see Table III). EPA requirements provided impetus for most of the state programs although all but one of these states also had state water quality laws similar to the federal requirements governing maintenance of standards. Most of these states were in the midst of approved Phase I and II projects, and the majority had already acquired either lake classification data comparable to Phase I requirements or had already completed their lake classification survey for 1982. Half of the states contacted by phone have used Landsat in some way for water quality surveys. Every state contacted would use Landsat data in water quality monitoring if the data could be obtained on a reliable basis. Also, assistance with this technology would be welcomed. A complete state-by-state survey revealed that nine states in ERRSAC's region (see Table IV) have participated in a water quality monitoring program using Landsat digital data.

In order for a state to use Landsat data in an operational mode for water quality monitoring and assessment, it must have access to a Landsat analysis capability. This is especially important in the early phases of incorporation of Landsat data into a state program when the agency attempting to use new technology must understand how to tailor the data for their particular needs.

**ORIGINAL PAGE IS
OF POOR QUALITY**

Contracting out is feasible at an advanced stage of the process when the benefits and limitations of the data are well understood and the preferred methodologies are well established. To ascertain the status of state Landsat capabilities in ERRSAC's region as an indicator of the readiness of states to directly engage in the examination of this technology, the information available from the state technology transfer programs initiated and managed through ERRSAC was pooled. The regional profile which emerged is presented in Table IV. This survey shows that 17 states have a digital analysis capability. This capability typically resides with a state university but may be state-agency based or developed cooperatively between the state agency and the university. However, only four states are presently considered operational or near operational in Landsat technology.

LANDSAT STATUS	STATES IN ERRSAC'S REGION																		
	FEDERAL REGION I						FED REG II		FEDERAL REGION III				FEDERAL REGION V						
	CT	ME ^X	MA	NH	RI	VT ^X	NJ ^X	NY ^X	DE ^X	MD	PA	VA ^X	WV	IL ^X	IN	MI ^X	MO ^X	OH ^X	WI ^X
INACTIVE	•		•		•						•		•		•				
STATE/ERRSAC PROGRAM		••		(•)		•	•	•	••	•		•		••		•	•	•	••
UNIVERSITY DIGITAL CAPABILITY		•	•	•		••		•	•	••	•	•	•	•	•	•	•	•	•
UNIVERSITY-STATE COOPERATIVE EFFORT		(•)				•			(•)	•		•				•		•	
STATE AGENCY BASED DIGITAL CAPABILITY							•					•					•		
OPERATIONAL						•	•					(•)					•		
WATER QUALITY MONITORING STUDY				•		•			•	•		•		•			•	•	•

- NEW ERRSAC PROGRAM, FY 1981
- Δ REMOTE SENSING PROGRAM DIRECTED TOWARDS COASTAL ZONE ANALYSIS AND OCEANOGRAPHY
- AT LEAST ONE UNIVERSITY IN THE STATE HAS AN ADVANCED LANDSAT ANALYSIS CAPABILITY
- () UNKNOWN
- X STATES CONTACTED IN THE TELEPHONE SURVEY

Table IV. The Status of State Landsat Capabilities in ERRSAC's Region

CONCLUSIONS

From this brief review of state needs for meeting requirements in water quality, it is apparent that Landsat data can be a valuable addition to traditional means of data acquisition. The states, at least in ERRSAC's region, have the technological expertise to use Landsat data. In fact, Landsat data are being used successfully by some states to meet EPA Section 314 requirements. Other states and organizations are interested in using Landsat for water condition assessment. But the appropriate methodologies for using these data for water quality work must be more firmly defined. This is because the technology is currently limited to states with acknowledged expertise. Development of endorsed methodologies will simplify the process for new users, thereby increasing its appeal and transferability. To that end, NASA and EPA are both in the process of evaluating the state-of-the-art remote sensing lake classification technology.

BIBLIOGRAPHY

- "Clean Lakes Program Guidance Manual." U.S. Environmental Protection Agency, Office of Water Regulation and Standards. September 1980. 320 pp.
- "Clean Lakes Program Strategy." U.S. Environmental Protection Agency, Office of Water Regulations and Standards. EPA-440/5-80-014 August 1980. 22 pp.
- Intergovernmental Science, Engineering and Technology Advisory Panel (ISETAP). State and Local Government Perspectives on a Landsat Information System, Office of Science and Technical Policy, Executive Office of the President, 1978. Washington, DC., 325 pp.
- E. M. Middleton and R. F. Marcell. An ERRSAC User Requirements Study for Water Quality of Inland Water Bodies. An Eastern Regional Remote Sensing Applications Center document in preparation (1981).
- E. M. Middleton and J. C. Munday, Jr. Landsat--What is Operational in Water Resources? Proceedings of the Sixth Canadian Symposium on Remote Sensing, Halifax, Nova Scotia, Canada, 1980, 19 pp.
- "Our Nation's Lakes." U.S. Environmental Protection Agency, Office of Water Regulations and Standards. EPA-440/5-80-009 July 1980. 58 pp.
- "State of the States: Water Resources Planning and Management." U.S. Water Resources Council. April 1980. 183 pp.
- "Your Lake--And the Clean Lakes Program." U.S. Environmental Protection Agency, Office of Water Regulations and Standards. EPA-440/5-80-010 1980. 11 pp.

N83 19164

D22

STATEWIDE LAKE CLASSIFICATION
UTILIZING LANDSAT IMAGERY FOR THE
STATE OF WISCONSIN

Ronald H. Martin
Wisconsin Department of Natural Resources

and

Robert W. Merideth, Jr.
Environmental Remote Sensing Center
University of Wisconsin-Madison

ABSTRACT

A cooperative program between the Wisconsin Department of Natural Resources (DNR) and the University of Wisconsin-Madison (UW-MSN) has resulted in the assessment of the trophic condition of approximately 3,000 significant inland lakes in Wisconsin. The project has investigated the feasibility of using both photographic and digital representations of Landsat multispectral scanner (MSS) data for lake classification. The result of the project has been the development of a nearly automated system which, with minimal human interaction, locates and extracts the lake data, then corrects the data for atmospheric effects, and finally classifies all the significant lakes in the state as to trophic condition.

INTRODUCTION

Wisconsin is rich in lakes. There are about 15,000 lakes in the state totalling almost 1,000,000 acres. In addition, the portions of Lake Michigan and Lake Superior lying within Wisconsin boundaries total 6,439,700 acres. As a result, lakes are a very important natural resource to Wisconsin with recreational use of the lakes forming a significant part of the state's economy. As the trend continues towards ever increasing recreational use of Wisconsin's inland lakes, so has the rate of eutrophication. At the same time, though, Wisconsin has increased its awareness of the importance of protecting lakes as a resource. Efforts have been directed toward lake trophic classification as well as lake management, protection, and rehabilitation. Both Federal legislation (PL-92-500 of the Federal Water Pollution Control Act Amendments) and state legislation (Wisconsin's Lake Protection and Rehabilitation Law) require the Department of Natural Resources (DNR) to monitor and classify all the significant lakes in the state.

BACKGROUND

Initial efforts by the DNR to respond to PL 92-500 were to classify by conventional field methods about 1100 lakes over 100 acres in size. A Lake Condition Index (LCI) based on Secchi disk depth, hypolimnetic dissolved oxygen, and winter fish kill was used to classify lakes. Because this method proved to be very costly in terms of collecting the lake data, the Wisconsin DNR in 1974 initiated a project to investigate the feasibility of using Landsat satellite imagery to monitor inland lake water quality. The DNR contracted with the Institute for Environmental Studies (IES) at the University of Wisconsin - Madison to conduct the research project. The goal of the research was to develop a nearly automated system which, with minimal human interaction, would locate, extract, and correct the satellite data and then would classify each lake in the state at a minimal cost.

INITIAL INVESTIGATIONS

The analysis program was designed around an interactive graphics terminal and The Madison Academic Computing Center's UNIVAC 1110 computer. Landsat MSS brightness values for particular lakes were obtained from images of Landsat digital data displayed on cathode ray tube (CRT) screens. Using digital data derived from 37 lakes, lakes were classified using the relationship between Band 5 scene brightness and Secchi disk depth. (Figure 1). Much of the scatter around the regression line can be explained by the interval between the field sampling date and the Landsat overpass date.

Since Secchi disk depth is a somewhat arbitrary water quality parameter, turbidity was also measured in 27 lakes. Landsat Band 5 data were correlated with the turbidity measurements. The correlation between measured turbidity (field data) and predicted turbidity from the satellite was quite good (Figure 2).

Since determining the trophic state of a water body should be more than just looking at Secchi disk depth or turbidity at one point in time, a multi-date analysis was conducted. Satellite data variation over an entire season from spring to fall was evaluated. The condition of lakes investigated ranged from oligotrophic to eutrophic. For almost all lakes, as the algal turbidity levels increased during the summer months, the brightness values in Band 5 increased. Figure 3 illustrates the difference in Band 5 reflectance on August 3, 1975 and September 26, 1975. It became apparent from this that just one date of Landsat MSS data would be inadequate to monitor something as dynamic as a water body.

Also, it was found, after careful examination of satellite imagery, that light atmospheric haze significantly increased reflectance values. Figure 4 shows the difference in lake reflectance from one day to the next due primarily to atmospheric effects. The need for atmospheric correction was apparent.

As a result of initial investigations it was concluded that: (1) the Landsat multispectral scanner was capable of monitoring lake trophic conditions; (2) multi-temporal data were necessary, and (3) corrections for atmospheric effects on data needed to be made.

PRESENT METHODOLOGY

SEMI-AUTOMATIC TECHNIQUES

After the initial investigations in 1974-75, the DNR and the University of Wisconsin - Madison embarked on a joint project to classify lakes utilizing 1976 Landsat multispectral scanner data. EPA and NASA supplied the funding for this project. All lakes greater than 20 acres in size and deeper than 8 feet were included in the study. It was decided by DNR limnologists that a minimum of three dates of Landsat data would be necessary for classification. This necessitated the development of a highly sophisticated and versatile computer program package for the navigation and extraction of digital satellite data. Details of these programs are documented elsewhere (References 1, 2, and 3). Only a short description of the data extraction procedures will be related here.

Each lake is located on a USGS topographic map and the coordinates of its bounding polygon are digitized and stored on a computer file (Figure 5). In addition, control points corresponding to easily recognized points on satellite imagery are digitized, and their latitude/longitude coordinates are placed on computer files. Figure 6 shows a typical control point character map for Pewaukee Lake in Waukesha County.

Each Landsat computer-compatible tape (CCT) is navigated by an affine transformation program using the digitized control points. Each lake is then located in the scene and the lake pixels within the polygons are extracted. From these extracted pixels, the lake's spectral values for Bands 4, 5, and 6 and the means and variances of those band values are stored for classification. Usually the only interpretive assistance necessary in this process is in the satellite navigation procedure and in the inspection of the extracted output to confirm that the navigation was accurate.

After the data are extracted and just prior to classification, an atmospheric correction of the satellite data is performed. The recorded signal from the satellite is corrected for the effects of scattering and absorption in the atmosphere. All dates of data are normalized to the clearest day. Figure 7 is a block diagram showing the procedure for the Wisconsin Lake Classification Programs.

CATEGORIZATION SCHEME

It was determined that the desired product for this lake classification system would be a numerical designation for each classified lake indicating the severity of any water quality problem. With this in mind, DNR limnologists developed a lake categorization scheme (Table 1) utilizing ground sampling data and personal experience to classify 45 lakes. Organic nitrogen, total phosphorus, turbidity, and Secchi disk depth measurements were used to validate their conclusions about the lakes' classification.

EXPERIMENTAL RESULTS USING 1976 LANDSAT DATA

Landsat data values were extracted from 1976 scenes and the data were corrected for atmospheric effects. A nine-parameter regression equation was used to correlate the Landsat data with the DNR categorization for the 45 sampled lakes. A trophic class number was predicted by the regression equation and rounded to the nearest integer. To check on the model's reliability to predict trophic classes, the observed trophic class numbers (compiled by DNR limnologists) were plotted against the numbers predicted by the regression equations. As Figure 8 shows, the observed values differed from predicted values by more than one in a number of cases. Ideally the predicted trophic class numbers would be within one of the observed trophic class numbers. A certain amount of subjectivity was involved in determining the observed trophic class numbers which accounts in part for some of the variability between observed and predicted trophic class numbers. Some subjectivity is desirable in a classification system because eutrophication in the public's view involves different standards of acceptability.

Although the model was considered by DNR limnologist to be less than desirable as a predictive tool for lake classification, the regression model was used to classify the remainder of the lakes throughout the state to fulfill the requirements of a grant agreement. The final output listed each lake by county and classified them by trophic state with the number of dates used for each classification also included. Table 3 depicts a typical representation of the lake classification output for Waukesha County, Wisconsin. Reference 4 contains the results of a demonstration project using 1976 Landsat data, and reference 5 contains the complete lake classification utilizing 1976 Landsat data.

In addition to classification as to trophic condition, lakes were also classified as to type. The different type classes included: clear, humic, algae, silt, or macrophyte, depending on the most distinctive lake characteristic. Type classes are not mutually exclusive and thus it is difficult to delineate lakes by type.

The type classification procedure, like the trophic classification, depends on the spectral characteristics of Bands 4, 5, and 6. A three-dimensional plot is made using the signal values of each of the three bands. In principle, the spectral data of lakes of different type classes should separate into unique ellipses. Figure 9 shows the distribution of data points for a clear and algae lake plotted for two dimensions (Bands 4 and 5). However, DNR limnologists were not entirely satisfied with the type classification because of overlapping type spectral characteristics. This was due in part to the limited amount of field data that were available in 1976.

EXPERIMENTAL RESULTS UTILIZING 1979 AND 1980 LANDSAT DATA

The 1976 demonstration project showed that an operational method for statewide lake classification could be developed using Landsat data. As a result, interest from both the State of Wisconsin and EPA generated continued funds. A grant of \$100,000 was committed by EPA in 1979 to continue this project utilizing 1979 and 1980 Landsat data for lake classification.

Data were extracted in 1979 and 1980 from the CCTs in the same manner as the 1976 data (except for slight program modification for the new Band Sequential Format). However, because the regression model used in the earlier lake classification scheme (Table 1) was less reliable, it was replaced with Carlson's trophic state index (TSI) (Reference 6). A numerical scale from 0-100, was used in the Carlson TSI. This is in direct contrast to the lake categorization method developed by DNR limnologists that had a scale from one to seven. As opposed to the more subjective lake classification scheme, the Carlson index can be calculated from any of several parameters, including Secchi disk transparency, chlorophyll, and total phosphorus. Table 4 shows the relationship between the Carlson TSI numbers and associated parameter values based on data from Wisconsin lakes. Each major division (10, 20, 30, etc.) represents a doubling in algal biomass and a halving of Secchi disk transparency. The lake trophic classification methodology is based on the ability of Landsat to predict field sampled parameters and then to incorporate these values into Carlson's TSI scheme.

Lake sampling corresponding to satellite overpasses was done in the summer of 1979 and 1980 and will continue in 1981. A number of regression analyses were performed between various transformations and combinations of lake field parameters (Secchi disk depth, color, turbidity, and chlorophyll-a concentration) and satellite data values (Reference 7). These correlations utilized field measurements and extracted Landsat data from 80 lakes. The field measurements were taken within four days of a corresponding Landsat overpass. Of the regression analyses run, the best relationship was between the ratio of Band 4 to Band 5 and chlorophyll-a concentration. Natural logarithms were taken of both the chlorophyll-a data and the ratios of Bands 4 and 5. Figure 8 shows a plot of the natural logarithms of chlorophyll-a concentration and the ratios of Bands 4 and 5 on a subset of data from 26 southern Wisconsin lakes. The following equation shows the relationship of the data plotted in Figure 10.

$$\ln \text{Chl-a} = 4.04 - 2.38 \ln \text{B4/B5} \quad r^2 = 75.3 \quad (1)$$

Using the chlorophyll-a concentration derived from this regression equation and Carlson's relationship for incorporating chlorophyll-a concentration into his index scheme (Equation 2), a predicted TSI was calculated for the data set on 26 southern Wisconsin lakes. $\text{TSI}(\text{chl-a}) = 10 \left(6 - \frac{0.715 - .468 \ln \text{Chl-a}}{\ln 2} \right)$ (2)

Table 5 compares the predicted TSI with measured (or field calculated) TSI numbers. The predicted and measured TSI values compared favorably.

Because the lakes in northern and southern Wisconsin are chemically different, regression analyses were run separately for each group of lakes. Due to these morphological differences in lakes, several regional predictive models will be used to classify lakes rather than having a single statewide model.

The ability of Landsat to predict levels of chlorophyll-a in lakes makes it easy to incorporate into Carlson's index. As additional ground truth data become available, investigations will continue to predict color and levels of

turbidity from satellite data. If color and turbidity can be predicted from satellite data, then it would be possible to correct for the effect of color and turbidity on Secchi disk depth. The corrected Secchi disk depth would be an additional tool to determine the lake's trophic state using Carlson's index.

The current lake classification efforts are scheduled to be completed by January 1, 1982. A report will be submitted to EPA detailing the results of the classification.

DISCUSSION AND CONCLUSIONS

The results of the regression analyses between certain Landsat parameter values and ground truth information are very good. Nearly all lakes with good ground calibration were classified correctly within DNR criteria. Review of the preliminary 1979-80 results has been favorable from DNR field personnel.

The computer and personnel costs for executing the lake classification programs are very modest. Considering cost for computer time and data acquisition, lakes in one scene with three dates of satellite data can also be classified for approximately \$1,400 plus four weeks of personnel time. Ten or eleven Landsat scenes include most of the lakes in Wisconsin. The estimated cost of classifying the lakes in the State of Wisconsin for 1976 was approximately \$16,000 plus twelve months of personnel time. This project has demonstrated that Landsat digital data is a cost-effective approach for assessing lake water quality.

An important aspect of this lake classification program is its flexibility. Different regression models can also be developed and used for different regions based on the water quality of that particular region. This approach to lake classification is reasonable since public standards and concepts of eutrophication differ between regions within a state.

The Landsat satellite multispectral scanner data can be used to monitor trophic changes in lakes over time. Short-range goals are to classify all significant lakes in the state by Carlson's trophic state index using 1979-80 Landsat data. The 1976 data will then be reclassified using Carlson's TSI and compared to the 1979-80 results. The changes in the lakes over the three- to four-year period can then be monitored. The long range goals are to reclassify lakes in Wisconsin over an eight- to ten-year period to monitor trophic changes over a longer time period.

Further research is still needed to develop better atmospheric correction models and to study further the relationships between Landsat spectral values and measured water quality parameters. The lake classification program utilizing Landsat is regarded as a successful operational project in Wisconsin. This success is due to the close cooperation between DNR and University personnel from the inception of the project, as well as continued funding from NASA and EPA. Techniques developed in Wisconsin for lake classification could quite feasibly be extended to other states.

REFERENCES

1. Fisher, L. T., F. L. Scarpance, and R. G. Thompsen: Multidate Landsat Lake Quality Monitoring Program. Photogrammetric Engineering and Remote Sensing, Vol. 45, No. 4, April 1979, pp. 519-527.
2. Holmquist, Kenneth W.: The Landsat Lake Eutrophication Study. Unpublished UW-MSN Masters Degree Report, December, 1977.
3. Scarpance, F. L., K. Holmquist, and L. T. Fisher: Landsat Analysis of Lake Quality. Photogrammetric Engineering and Remote Sensing, Vol. 45, No. 5, May 1979, pp. 623-633.
4. Martin, Ronald H. and K. Holmquist: Remote Sensing as a Mechanism for Classification of Wisconsin Lakes by Trophic Condition. Wisconsin Department of Natural Resources, April 1979.
5. Scarpance, Frank L.: Demonstration Project to Evaluate the Opportunities for Operational Application of Landsat Data in Wisconsin. NASA Grant NAS 5-25505, University of Wisconsin, November 1980.
6. Carlson, Robert E.: A Trophic State Index for Lakes. Limnology and Oceanography, V. 22(2), March 1977.
7. Yeadon, Robert J.: Statewide Lake Classification using Landsat Satellite Imagery. Master of Science Report, University of Wisconsin-Madison, November 1980.

TABLE I. LAKE CATEGORIZATION SCHEME

Class	Class #
Oligotrophic - O	1
Om	2
Mo	3
Mesotrophic - M	4
Me	5
Em	6
Eutrophic - E	7

Table II. FORTY FIVE CONTROL LAKES WITH OBSERVED AND PREDICTED TROPHIC CLASS NUMBERS

Lake Name	County	Observed Trophic Class Numbers	Predicted Trophic Class Numbers	Difference Observed between and Predicted
Upper Nemahbin	Waukesha	3	2.0	1.0
Mason	Adams	6	4.3	1.7
Oconomowoc	Waukesha	3	1.8	1.2
Rock	Jefferson	3	3.6	- 0.6
Ripley	Jefferson	4	3.7	0.3
Nagawicka	Waukesha	4	3.2	0.8
Castle Rock	Juneau	6	3.9	2.1
Monona	Dane	5	3.3	1.7
Beaver Dam	Dodge	6	6.5	- 0.5
Waubesa	Dane	5	4.8	0.2
Fox	Dodge	6	7.1	- 1.1
Kegonsa	Dane	5	5.6	- 0.6
Metonga	Forest	2	3.2	- 1.2
Stevens	Forest	6	4.0	2.0
Roberts	Forest	4	3.4	0.6
Pickere1	Forest	6	3.9	2.1
Enterprise	Langlade	5	4.0	1.0
Greater Bass	Langlade	4	3.0	1.0
Rollingstone	Langlade	6	4.0	2.0
Crystal	Lincoln	1	3.1	- 2.1
Long	Lincoln	3	3.8	- 0.8
Archibald	Oconto	2	3.3	- 1.3
Tomahawk	Oneida	2	2.8	- 0.8
Two Sisters	Oneida	2	2.7	- 0.7
North Nokomis	Oneida	3	3.3	- 0.3
Clear	Oneida	1	2.4	- 1.4
Little Tomahawk	Oneida	2	2.8	- 0.8
Muskellunge	Oneida	4	4.8	- 0.8
Oneida	Oneida	6	5.0	1.0
Katherine	Oneida	1	2.8	- 1.8
Bearskin	Oneida	4	4.6	- 0.6
Minocqua	Oneida	3	3.3	- 0.3
Pelican	Oneida	4	4.2	- 0.2
George	Oneida	5	5.1	- 0.1
Crescent	Oneida	4	3.7	0.3
Horsehead	Oneida	7	7.2	- 0.2
Big Crooked	Vilas	1	2.5	- 1.5
Black Oak	Vilas	1	2.4	- 1.4
North Twin	Vilas	3	3.3	- 0.3
Big Muskellunge	Vilas	3	2.4	0.6
Catfish	Vilas	4	5.1	- 1.1
Pickere1	Vilas	5	5.1	- 0.1
Little St. Germain	Vilas	4	4.6	- 0.6
Big Bass	Vilas	4	2.6	1.4
Muskeilunge	Vilas	7	5.3	1.7

TABLE III. LAKE CLASSIFICATION OUTPUT FOR WAUKESHA COUNTY, WISCONSIN

Lake No.	Lake Name	Class	Type	Dates
1	Ashippun	4	Algae	3
2	Beaver	3	Algae	3
3	Big Muskego	7	Algae	3
4	Cornell	6	Algae	3
5	Crooked	5	Macrophyte	3
6	Denoon	5	Algae	3
7	Dutchman	4	Algae	3
8	Eagle Spring	5	Algae	3
9	Forest	4	Macrophyte	3
10	Fowler	4	Algae	3
11	Golden	5	Algae	3
12	Hunters	5	Algae	3
13	Keesus	4	Algae	3
14	Lac LaBelle	4	Algae	3
15	Little Muskego	5	Algae	3
16	Lower Genesee	4	Algae	3
17	Lower Nashotah	3	Algae	3
18	Lower Nemahbin	4	Algae	3
19	Lower Phantom	5	Algae	3
20	Merton Millpond	5	Algae	3
21	Mid Genesee	3	Algae	3
22	Monterey Millpond	4	Algae	3
23	Moose	4	Algae	3
24	Nagawicka	4	Algae	3
25	North	3	Algae	3
26	Oconomowoc	2	Algae	3
28	Ottawa	6	Algae	3
29	Pewaukee	4	Algae	3
30	Pine	4	Algae	3
31	Pretty	3	Algae	3
32	Rainbow Springs	5	Algae	3
33	School Section	6	Algae	3
34	Silver	3	Algae	3
35	Spring	7	Algae	3
36	UN S23,14T8R17	5	Algae	3
37	Upper Genesee	5	Algae	3
38	Upper Nashotah	3	Algae	3
39	Upper Nemahbin	3	Algae	3
40	Upper Oconomowoc	6	Algae	3
41	Upper Phantom	5	Algae	3
42	Waterville Millpond	5	Algae	3
43	Wood	5	Algae	3

TABLE IV. RELATIONSHIP BETWEEN CARLSON TSI NUMBERS AND ASSOCIATED WATER QUALITY PARAMETERS ON WISCONSIN LAKES

TSI	Secchi Disc (meters)	Surface Phosphorus ($\mu\text{g}/\text{l}$)	Surface Chlorophyll ($\mu\text{g}/\text{l}$)
0	64	.10	.005
10	32	.21	.02
20	16	.42	.09
30	8	.84	.40
40	4	1.7	1.7
50	2	3.4	7.7
60	1	6.8	33.7
70	0.5	13.5	148
80	0.25	27	650
90	0.12	54	2,870
100	0.06	108	12,600

TABLE V. SOUTHERN WISCONSIN LAKES CLASSIFIED BY CARLSON'S TSI

Lake Name	B4/B5	Estimated Ln Chl a	Predicted TSI	Measured Ln Chl a	Measured TSI
George	1.15	3.70	64	3.50	65
Pit	2.04	2.34	53	1.79	48
Unnamed (46-023)	1.22	3.56	65	3.22	62
Browns	2.54	1.82	48	2.20	52
Amy Bell	2.77	1.62	46	1.79	48
Bark	1.62	2.89	59	2.56	56
Green	1.73	2.74	57	1.79	48
Wallace	1.68	2.81	58	1.61	46
Lower Phantom	2.68	1.69	47	0.69	37
Upper Phantom	1.79	2.65	57	2.08	51
Pretty	2.11	2.27	53	1.61	46
School Section	1.84	2.59	56	2.08	51
Okauchee	2.63	1.74	48	1.79	48
Ashippan	2.86	1.54	46	2.20	52
Keesus	3.00	1.42	45	1.94	50
Merton Pond	3.42	1.12	42	1.38	44
Moose	4.76	0.33	34	1.38	44
Upper Nemhabin	3.19	1.28	43	1.79	48
Pine	4.29	0.57	36	0.69	37
Silver	3.16	1.30	43	1.10	41
Sinissippi	0.98	4.10	71	5.46	84
Leota	0.75	4.72	77	6.11	90
Decatur	0.93	4.21	72	5.10	81
Waubesa	1.30	3.42	64	2.94	59
Kegonsa	1.19	3.62	66	3.69	67
Albany Pond	0.81	4.53	75	4.03	70

ORIGINAL PAGE IS
OF POOR QUALITY

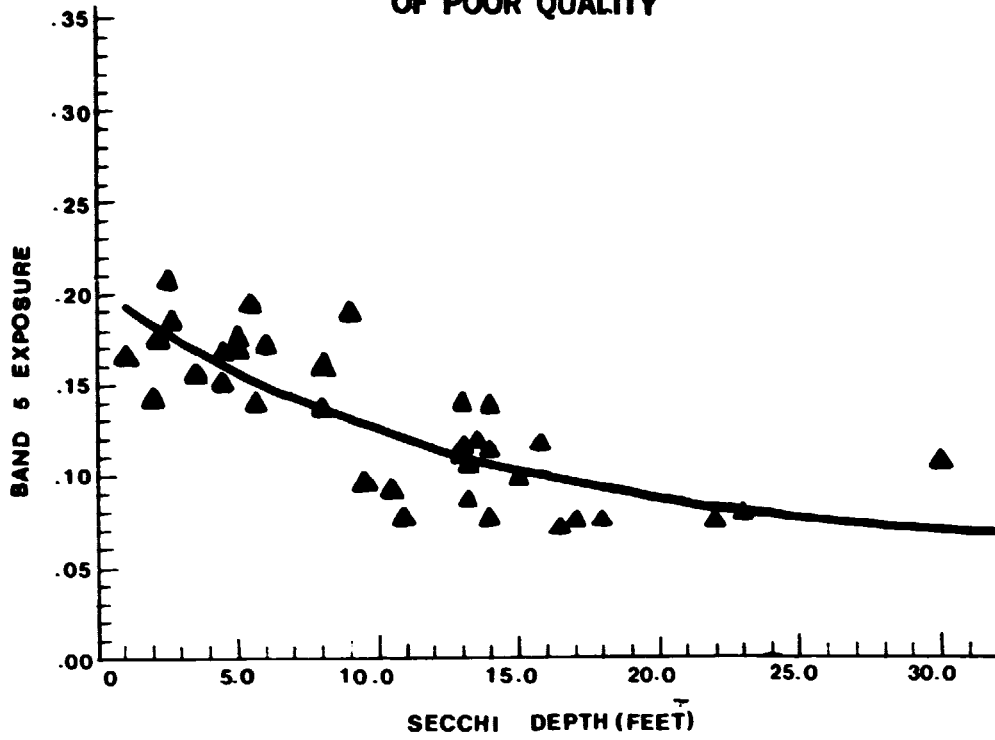

Figure 1. Secchi Disc Versus Band 5 Exposure. Exponential Regression Represented by the Solid Line.

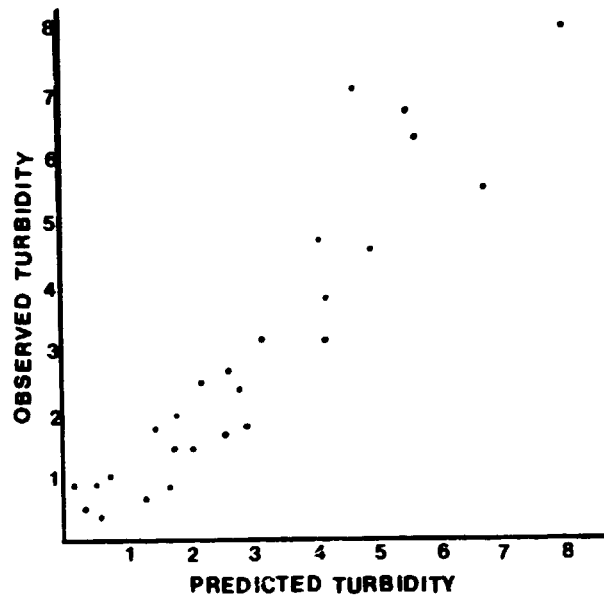
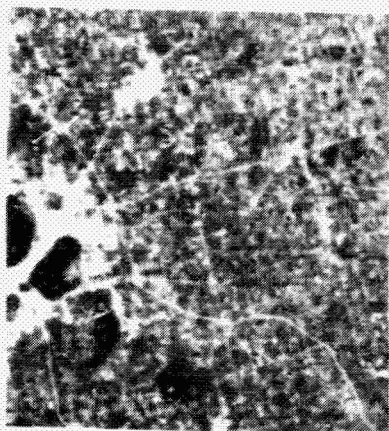
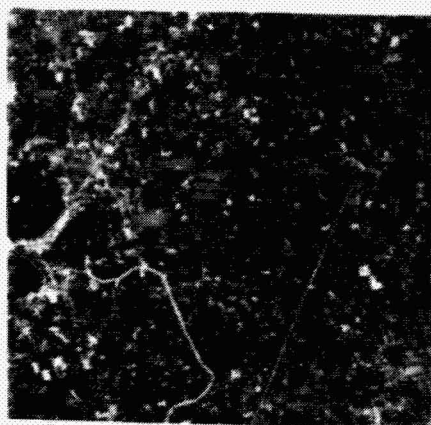

Figure 2. Plot of Observed (Measured) Versus Predicted Turbidity

ORIGINAL PAGE IS
OF POOR QUALITY



3 AUG 75



26 SEPT 75

Figure 3. Band 5 Reflectance Difference During the Growing Season (Spring to Fall)

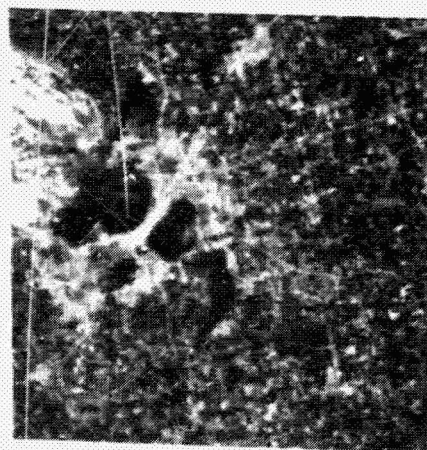

17 JULY 75

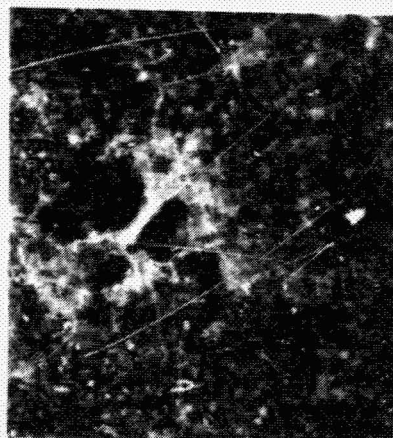

16 JULY 75

Figure 4. Difference in Lake Reflectance Due to Atmospheric Effects

ORIGINAL PAGE IS
OF POOR QUALITY

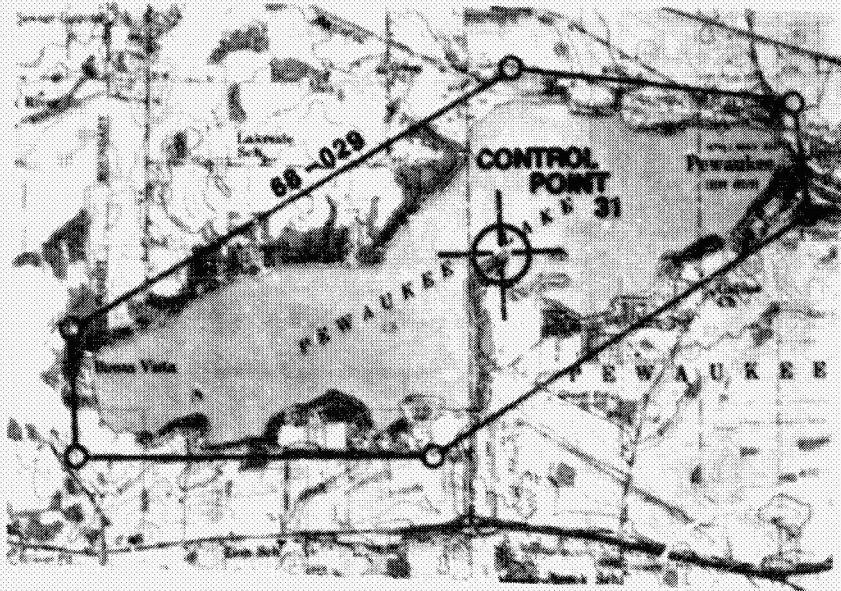

Figure 5. Topographic Map of Pewaukee Lake Showing the Bounding Polygon

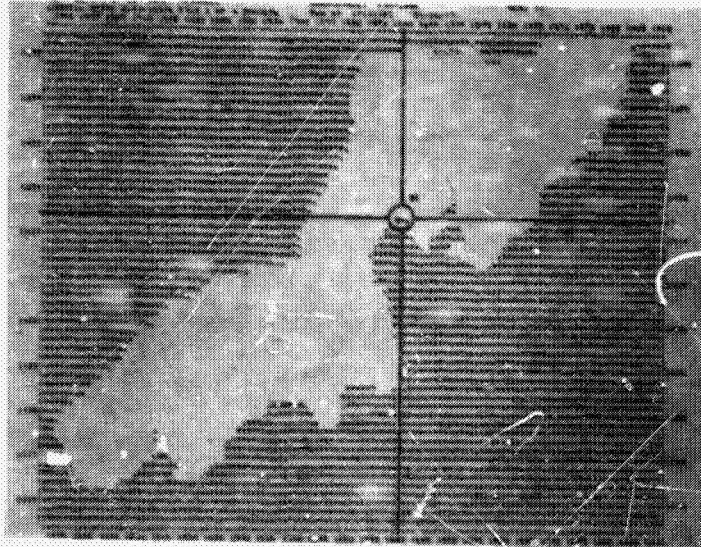

Figure 6. Control Point Map of Pewaukee Lake

ORIGINAL PAGE IS
OF POOR QUALITY

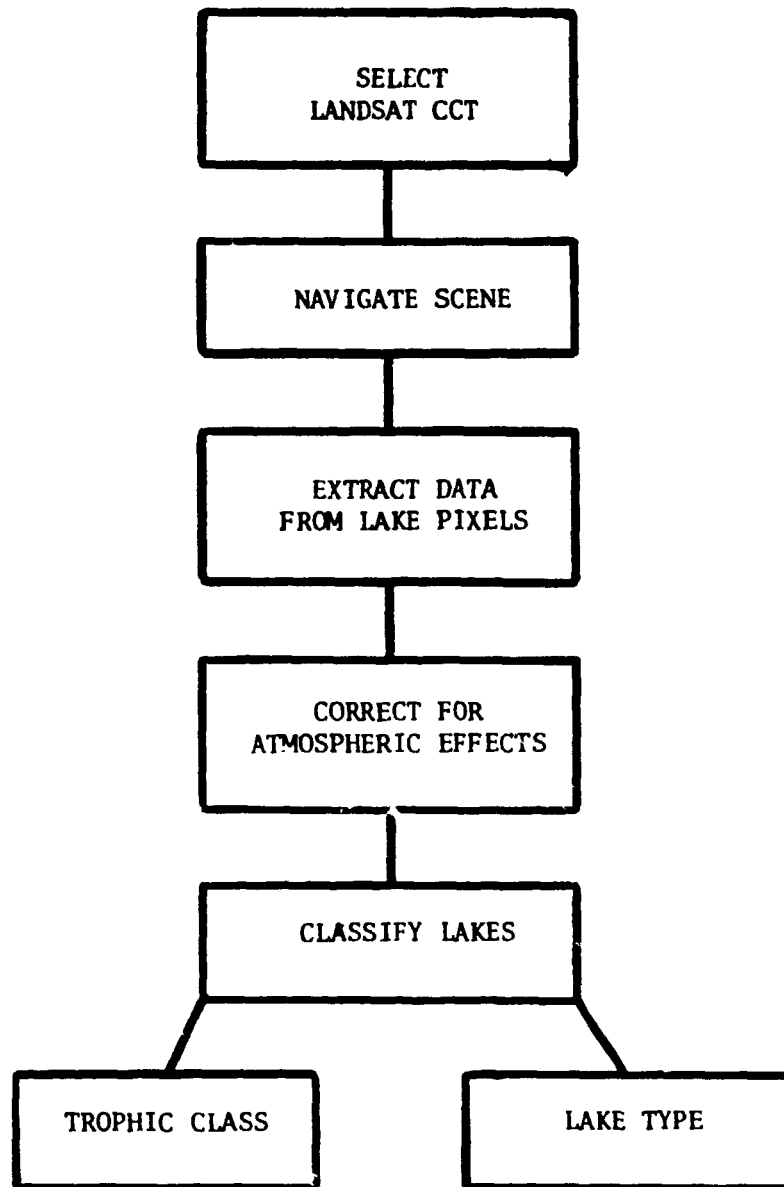

Figure 7. Block Diagram of Lake Classification Program

ORIGINAL PAGE IS
OF POOR QUALITY

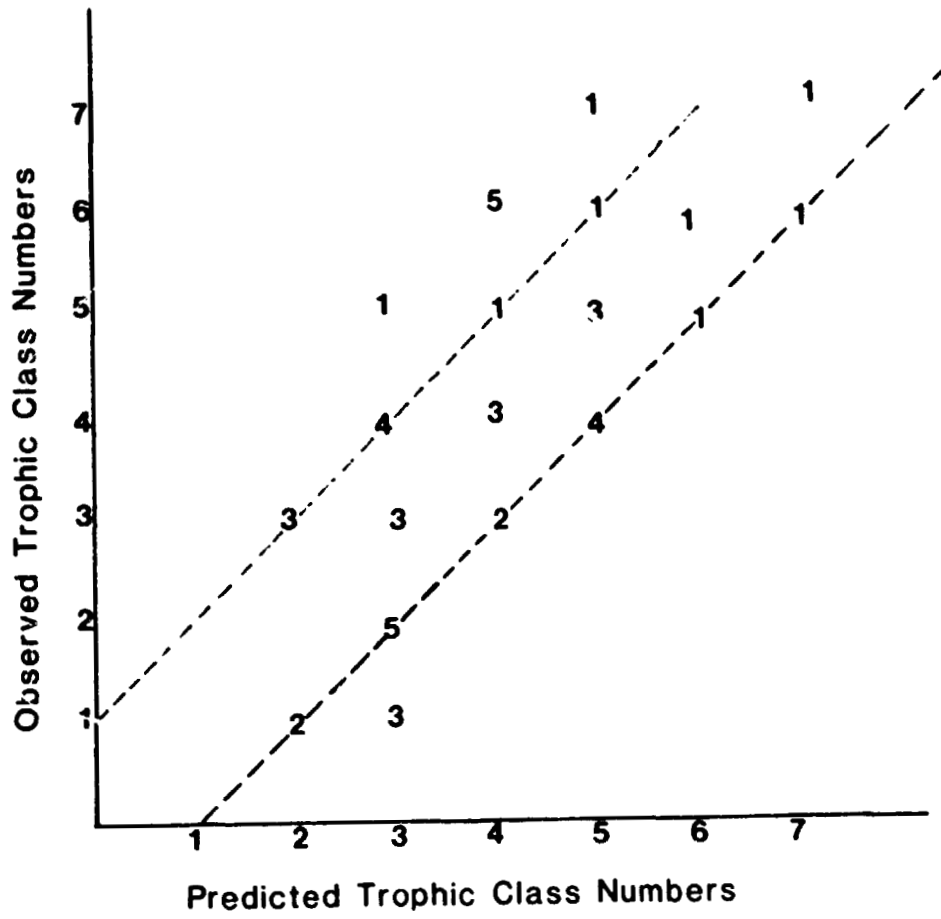

Figure 8. Plot of Observed Versus Predicted Trophic Class Numbers. The Numbers Indicate the Number of Occurrences with Those Values.

ORIGINAL PAGE IS
OF POOR QUALITY

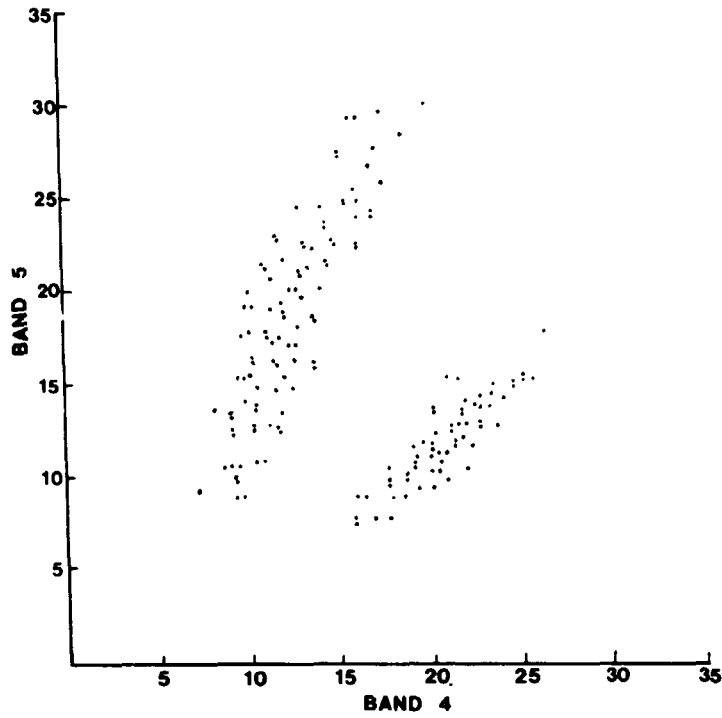

Figure 9. Scatter Diagram of the Elliptical Classifier Depicting the Distribution of Data Points for a Clear and Algae Lake

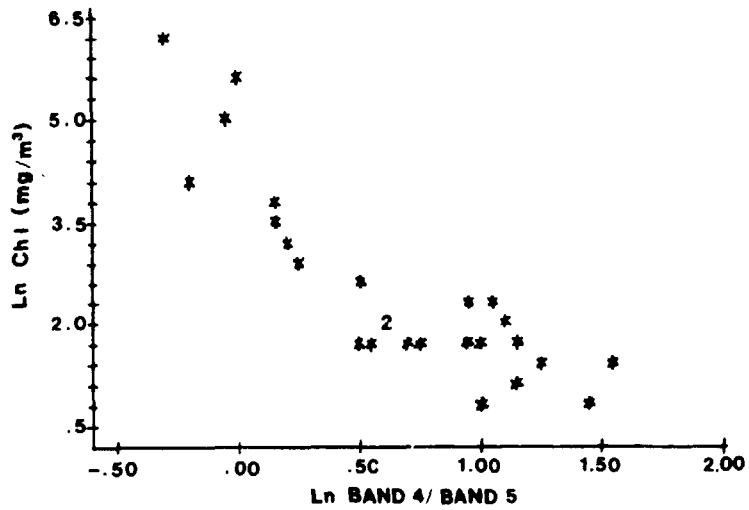

Figure 10. Ln Chlorophyll a Versus Ln Band 4/ Band 5 for 26 Southern Lakes

N83 19165 D23

ORIGINAL PAGE IS
OF POOR QUALITY

GROUND WATER USE INVENTORY
IN MINNESOTA USING LANDSAT DATA

Dennis R. Beissel
Minnesota Department of Natural Resources

Arlene Kerber
ERRSAC/NASA-Goddard SFC

ABSTRACT

An irrigation ground water use inventory in Sherburne County, Minnesota, was attempted by indirectly locating irrigation wells by determining the location of irrigated lands. Digital classification of Landsat MSS imagery was employed using the IDIMS at Goddard Space Flight Center. Single-date classification proved moderately successful after accurate ground truth data were obtained. A combination of supervised and unsupervised classification was used. Multitemporal analysis using August 10 and May 21, 1978 imagery was also attempted. This unsupervised classification proved most successful in identifying crops and irrigated fields.

INTRODUCTION

The Minnesota Department of Natural Resources, Division of Waters, has a water resource management responsibility which includes the mandate to regulate and document statewide water use and to issue water appropriation permits. To help meet this responsibility the Department is completing an inventory of high capacity wells in the state. Most of these wells in rural areas are used for agricultural irrigation or municipal water supplies. By spring of 1981 there were about 3,000 permitted irrigation wells in Minnesota, the majority of which were drilled since 1976.

It was recognized that the Department needed a means of locating non-permitted irrigation wells and confirming the location of permitted wells. Field checking is the most accurate means of well locating, but it is very manpower intensive and time consuming. It was decided that the best approach to the problem would be to locate irrigated lands, and then correlate these with known well locations. The presence of irrigated land not located near a permitted well would suggest the existence of an unpermitted well which should then be investigated. The project was designed to test the use of Landsat imagery for irrigated land identification. Photointerpretation of standard Landsat images has been used successfully to locate and inventory irrigated lands in several areas. However, digitally processed Landsat data, using various classification or ratioing algorithms has also been exploited to enhance separability of irrigated lands from non-irrigated lands. Our primary long term interest is to develop accurate estimates of water use.

PROJECT DESCRIPTION

OBJECTIVES

The primary purpose of the project was to provide the necessary information to aid the Division of Waters in determining the location of irrigation wells for which there were no records. The availability of such information would result in a considerable savings in personnel time and money. The second objective of this study was to obtain regional water use data for water budget model input.

SITE DESCRIPTION

A portion of Sherburne County, located along the Mississippi River northwest of Minneapolis-St. Paul, was chosen as the demonstration site. The regional setting is shown in Figure 1. Sherburne County, a largely agricultural region, contains some of the most heavily irrigated areas in Minnesota. Agricultural acreage in 1974 accounted for 56,600 hectares (139,870 acres) out of a total 113,400 hectares (280,320 acres) that make up the county. The average size of the farms, based on a 667-farm statistical sample, is 85 hectares (210 acres). The major crops are corn, potatoes, hay, oats, and wheat. The soil type of this area is basically a sandy soil that has very good drainage. Soils of this type are more severely affected by drought conditions than other soils with greater water-retention capabilities. As of March 1980, there were 197 permitted irrigation wells located in the county.

CLASSIFICATION PROCEDURE

SINGLE DATE ANALYSIS

The August 10, 1978 Landsat scene was chosen for evaluation because it was created during the irrigation season and had little cloud cover. The project area was initially classified using training fields plotted on the 1:24,000 orthophoto maps. This classification was then refined using an iterative process of addition, combination, and elimination of appropriate training fields. Even when the best possible classification had been achieved, some irrigated fields had not yet been identified in their entirety, while others had been misclassified.

In order to improve the results, an unsupervised classification using the IDIMS program ISOCLS was developed. The 25 spectral classes derived were analyzed using the orthophoto maps and ground truth knowledge provided by the state participants, and wherever possible, the correct land cover type of each spectral class was identified. Some of the original 25 spectral classes were subsequently eliminated because they represented mixed classes that were developed along the margins of different cover types, while others were removed because they were so small in areal extent that they were difficult to locate with certainty, and therefore impossible to identify as specific land cover classes.

Both the supervised and unsupervised approaches yielded classification results that were good for certain specific categories while not as accurate for others. It was thus necessary to combine the optimum class signatures developed independently by the separate techniques. This was accomplished by aggregating the signatures from both the unsupervised and supervised approaches into a single spectral signature set. In order to further improve the classification accuracy, and in particular to decrease the amount of land being classified incorrectly as irrigated, thresholding of the data was employed. Setting the threshold at 20 percent generally yielded the overall best results for the pertinent classes in the study area.

Using this optimum classification, it was possible to identify irrigated corn, irrigated potatoes, and other mixed crops. However, additional analysis showed that some available ground truth information - crop type, land use (plowed vs. undisturbed land), and soil moisture data (irrigated/non-irrigated) - was not adequate for optimum training area selection. In particular, an insufficient number of training fields had been validated by field check, and there was a need for better geographical distribution of training fields within the test site. Some of the initial ground truth and training field information had been derived from reports rather than actual field surveys, and these in some cases, proved inaccurate or misleading. To rectify this shortcoming, additional ground truth was collected and initial ground truth rechecked before any further digital processing was done.

The final classification was far superior to initial effects because of improved training field selection.

Irrigated corn, irrigated potatoes and mixed irrigated crops could be discriminated one from the other; however, some small grains such as wheat were not separable from grasses (hay, open areas, etc.). As a result, the latter were combined into a single class designated as "other." This also included roads and disturbed areas. Rye fields were discriminated with enough accuracy to keep them as a separate category. Irrigated versus non-irrigated small grains and grasses could not be separated.

MULTITEMPORAL ANALYSIS

Another analysis conducted during the demonstration process included the creation of a multitemporal Landsat data set from the August 10 and May 21, 1978 scenes; the two data sets were registered and combined to form a single 8-band data set - four bands from each date. The IDIMS clustering program (ISOCLS) was then run on this two-date data set. This unsupervised classification algorithm developed 16 spectral classes. Using the ground truth collected earlier, water classes were combined together as well as non-agriculture classes (trees, brush, etc.); each was assigned a distinctive color and incorporated into the classification map image. These were of no immediate interest to the analysts and served only for locational purposes. The remaining unidentified agriculture spectral classes of interest were each

given a distinguishing color to aid in the determination of land cover type. After the completion of the analysis of all 16 multitemporal spectral classes, they were grouped into appropriate land cover categories and each category was assigned a final color and incorporated into a final classification map.

RESULTS

The May 21, 1978 data provided the greatest contrast between plowed and non-plowed fields. The August 10, 1978 scene, however, exhibited soil moisture and vegetative cover differences best, especially where these differences were associated with irrigation/non-irrigation conditions.

The overall gain in classification accuracy achieved by using the two-date data set was accomplished by taking advantage of temporal differences in reflectance values for selected irrigated crops. This incorporation of information inherent in the local crop calendar greatly improved the vegetation class separability over what could be obtained using only the single-date data.

Discrimination among the different agriculture classes was much more complete, and most fields could be uniformly classified with little or no misclassification occurring within the specific field. In addition, two-date data permitted the irrigated land classes to be delineated with improved accuracy. This was probably due to the fact that the additional information on land surface conditions (plowed or unplowed) provided by the May data set contributed to a better understanding of the areal distribution and state of the agricultural land. Some irrigated land could not have been identified from the August data alone if the fields had not been watered for a week or so and did not exhibit adequate contrast to the contiguous non-irrigated vegetation.

As of 1978, there were 195 known irrigation wells in Sherburne County. Visual interpretation of the two-date classification revealed about 50 irrigated fields covering a total area of about 10 square miles which could not be readily matched with permitted, high capacity well locations. It is likely that not all of this irrigated acreage is supplied by a ground water source, and that some of the fields may be misclassified. However, by using the classified imagery as a guide, field inspection of these 50 scattered sites can be accomplished in about one-third or less the time than would be required for inspection of the entire county. This is a very significant savings in both time, personnel and material resources, and at the same time, assures that all the major irrigated areas have been surveyed.

CONCLUSIONS

- (1) Multitemporal unsupervised classification based on Landsat data provided a reliable delineation of certain specific crop types and irrigated/non-irrigated lands in Sherburne County.
- (2) A supervised Landsat classification procedure could have been more successful if more ground truth was available and it had been verified prior to training area selection.

- (3) Single date Landsat image classification should not be discounted for use in mapping irrigated fields in Minnesota. Accurate ground truth collected at sites with adequate areal distribution would help assure optimum training area selection and more accurate classification.

ADDITIONAL STUDY

The University of Minnesota Remote Sensing Laboratory, which had funds for small research projects, agreed to work with the Minnesota Department of Natural Resources, Division of Waters on an experimental project to test the use of small scale, small format areal photography to identify irrigated fields in Sherburne County.

A test strip was flown in July, 1980 to compare color infrared and color photography. Color infrared produced the greatest contrast between irrigated and non-irrigated fields so the entire county was flown using color-IR.

The photographs were taken with a 35-mm camera with a 28-mm lens mounted in the belly hole of a small aircraft. The area was flown at an altitude of approximately 12,000 feet above sea level. It took about three hours of flight time to produce 16 photo strips covering the 113,400 hectares (280,320 acres) in Sherburne County. Twelve rolls of film were needed to produce 300 prints.

Selecting irrigated fields by visual interpretation took an experienced photo-analyst eight man-hours to complete. Field checking irrigated fields in the entire county was accomplished by one person in three days (30 man-hours). The field work did not involve locating wells or complete crop identification, both very man-power intensive tasks. The cost of obtaining the photographs, not including salary, was approximately \$350.00. Interpretation of the new photos is currently being done by the Remote Sensing Laboratory and results will be forthcoming later in 1981.

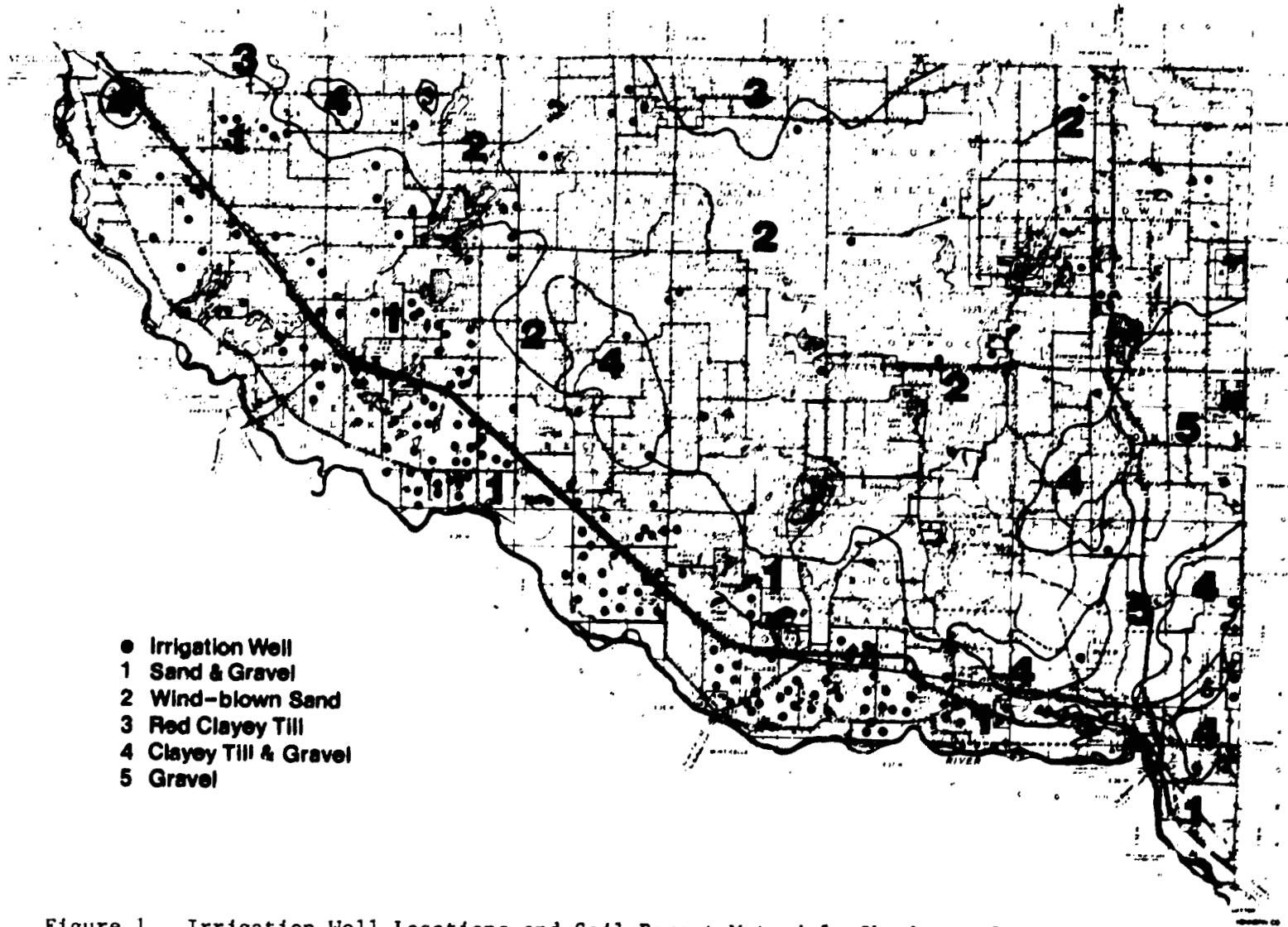

ORIGINAL PAGE IS
OF POOR QUALITY

Figure 1. Irrigation Well Locations and Soil Parent Material, Sherburne County, Minnesota

N83 19166

D24

A PROSPECTIVE APPROACH
TO COASTAL GEOGRAPHY FROM SATELLITE*

John C. Munday Jr.
Virginia Institute of Marine Science
College of William and Mary
Gloucester Point, Virginia 23062

ABSTRACT

A forecasting protocol termed the Prospective Approach has been used to examine probable futures relative to coastal applications of satellite data. Significant variables include the energy situation, the national economy, national earth satellite programs, and coastal zone research, commercial activity, and regulatory activity. Alternative scenarios for the period until 1986 are presented. Possible responses by state/local remote sensing centers include operational applications for users, input to geo-base information systems (GIS), development of decision-making algorithms using GIS data, and long term research programs for coastal management using merged satellite and traditional data.

INTRODUCTION

Nearly a decade has passed since the launch of Landsat 1, an era when Landsat was described as "the Complete Geographer" (Falconer, 1974). Looking backward, most will agree that Landsat applications have reached a remarkable level, a view only slightly muted by reminders that the potential was oversold at first. Now, in looking forward, we seek a "prospective" for future use of satellite data, including data from new sensor systems to be tested during the coming decade.

The present time has certainly developed into a juncture. For geographers and resource managers, geo-base information systems are rapidly being implemented by federal and state agencies. Remote sensing has won a port of entry

*Partially supported by the Department of Taxation, Richmond, Virginia.
Virginia Institute of Marine Science Contributor Number 1000.

to such systems, due in large measure to successful Landsat mapping of forests, agricultural resources, and land cover. Responsibility for an operational land satellite system has been assigned to NOAA, and new sensors are being readied by NASA for orbital testing. Contrariwise, the federal budget is being severely cut in response to economic and political changes. Regional planners and resource specialists might therefore assess the "prospective" for satellite geography in view of funding constraints and program redefinition at the federal level.

Several contexts are appropriate for developing such a "prospective." The context here is a mission-oriented program of geographic research and applications for state and local government in the mid-Atlantic coastal zone. The coastal zone is targeted because of its high population density, multiple conflicting uses, and highly charged environmental issues. Recognizing its uniqueness, Congress in 1972 enacted the Coastal Zone Management Act (Public Law 89-454) to provide financial and administrative assistance to coastal states endeavoring to plan and manage coastal areas. Nearly half the states have federally-approved coastal zone management programs and are receiving federal grants. Other states have developed coastal programs independently of federal support (Higgins, 1979).

Improved coastal management will require ongoing research. Coastal studies, perhaps more than other fields of study, involve questions that are both basic (to an understanding of coastal processes, whether physical, biological, or cultural), and important to planners/managers and the general public. Questions with these two attributes should command high priority in the distribution of federal research funds.

Landsat was viewed early as having potential applications in the coastal zone (ERTS Conferences, 1973a, b). Although some geographers and coastal managers disdained its potential because of the limited spatial resolution of the multispectral scanner, Landsat projects have proven that many coastal applications are cost effective (NCSL, 1977). Also, satellites provide uniformity in data formats, measurable accuracy and precision of data and analysis products, and a synoptic view from orbit which is unsurpassed. Under the impact of budget constraints during the 1980's, these features will become more attractive because of data needs for geographic information systems.

How then can expanded and more effective coastal application of satellite data be achieved? There are two groups who will have differing perspectives in answering this question. The first is comprised of federal personnel charged with budget and national program responsibility. The second group, of interest in this paper, includes satellite data users at the state and local level. Planning for better satellite data utilization by this group is somewhat more hazardous, because of the necessity of dealing with uncertainties at both the federal and state/local level. The severe impact of loss of state support has been illustrated in North Dakota (NCSL, 1979) which lost the Resources and Environmental Assessment Program (REAP).

To assist coastal groups toward more effective use of satellite data, this paper explores alternative circumstances which might prevail in the mid-1980's, and then delineates alternative strategies for promoting applications given the

various circumstances. To explore possible futures in the mid-1980's, a forecasting methodology has been employed called the "Prospective Approach" (Godet, 1978).

THE PROSPECTIVE APPROACH

Perfect knowledge of the future would permit devising a perfect strategy for maximizing satellite applications to coastal geography. Although perfect prediction is unattainable, we can plan effectively with the help of forecasting techniques. Quantitative methods of forecasting include dynamic systems modeling, and probability and cross-impact techniques, while non-quantitative methods include the Delphi technique and scenario analysis. All forecasting methods have defects and all are based ultimately upon subjective opinion; therefore, it is expected that forecasts may fail in major ways from time to time.

The Prospective Approach seeks to minimize forecasting errors by use of a combination of mathematical and non-mathematical methods. Initially, one defines essential system variables and the immediate effects (or cross-impacts) between variables. The long-term indirect effects flowing from the cross-impacts are elucidated using matrix methods. From the results, significant hypotheses about future events are formulated. These are assigned individual and joint (pairwise) probabilities of occurrence. Mathematical methods are then used to determine the probabilities of different combinations of possible future events.

Subsequently, the desired future (wish-fulfillment) is introduced (hence the uniqueness of this forecasting method, and its appellation "Prospective"): combinations of probable and desired futures are used to construct scenarios of future states and of the developmental processes leading to them, and strategies are developed for ensuring the occurrence of the desired future. In outline form, the Prospective Approach has four phases: probable futures, desired future, scenarios, and strategies.

SCOPE

In the application of forecasting methods, it is normal to use a large panel of experts at each stage. This ensures that appropriate diversity of opinion is incorporated. Here, because of limited resources, only three sets of opinions were included. The purpose in using a set protocol of forecasting methods was to help clarify and sharpen thinking about options. In this the outcome has been judged successful.

The time period under primary consideration is 5 years (1981-1986), and to a lesser extent the 1980s as a whole. Nationally, major changes in budgets and programs can occur after each Presidential election, every 4 years. Satellite

planning, construction, and launch require at least 8 years; thus, the satellite options which could be available in 1986, including domestic and foreign satellites, have already been determined. For periods beyond 8 years, technological advances can occur which could significantly alter the picture. The late 1980's when multiple linear array sensors become available, are just at the limit for affecting most state/local coastal planning.

APPLICATION

Essential Variables and System Structure

From the holistic standpoint, the system of concern is that complex of agents, programs, processes, and events which will determine the scope of opportunities for satellite data users in coastal geography. Essential variables of the system are those necessary components whose states can be defined at different times (Ashby, 1963); the variables need not be quantifiable; they need not be of the same type. One essential variable will be the local group immediately concerned with implementing desirable strategies to meet the future; in our case, the group is the Remote Sensing Center (RSC).

To define the rest of the "system," it will be helpful to sketch the present circumstances. Certainly state and local variables are important. However, the impact of the national economy on the 1980 Presidential election is without question, and one consequence is federal budget reductions, which have directly caused cancellation of follow-on Landsats D3 and D4, originally due for launch in 1985 and 1986. Thus, national affairs in the broad context affect coastal users. Likewise, international events have a major impact on coastal affairs. Recently, a Coast Guard representative in marine safety remarked that OPEC was more responsible than any other factor in reducing oil pollution—a 1000-barrel spill now costs \$40,000. Coastal transportation and recreation planning must now account for declining auto use due to escalating gasoline prices. The U.S. fleet of oceanographic research vessels has contracted substantially because of high fuel costs, while offshore drilling has increased. Development of geographic information systems may be stimulated slightly by high fuel costs, via demands for greater efficiency in resource management. Finally, a major uncertainty is the possibility of international conflict over petroleum resources and monetary imbalance involving petro-dollars; many public figures have openly proclaimed that the period through 1985 is one of maximum danger internationally.

In Virginia, planning district commissions are using Landsat data for land cover mapping. The state is developing an integrated data base of econometric and resource data called the Commonwealth Data Base (CDB). Landsat data processing is partially supported by CDB.

From such considerations, essential variables for the system were selected as listed in Table 1. The number was held to 15 to limit the effort required in subsequent analysis. Studies of this type sometimes employ up to 100 essential variables (Godet, 1978).

TABLE 1
Cross-Impact Variables

	<u>International Variables</u>
TRADE	1 International trade; export/import flows of monetary capital, resources, and industrial output.
PEACE	2 Degree of international peace; level of belligerency between major powers and blocs.
ENERGY	3 Energy resource availability and cost; multi-national flows of petroleum.
	<u>National Variables</u>
ECONOMY	4 Economic activity; gross domestic product; inflation rate.
DEFENSE	5 Defense spending; level of military preparedness.
SATELLITE	6 Earth satellite applications program, especially Landsat.
	<u>Coastal Geography</u>
RESEARCH	7 Coastal zone research (environmental/economic/industrial/urban) in universities, institutes, and government.
COMMERCIAL	8 Commercial sector engineering and economic activity.
REGULATORY	9 CZM monitoring, and regulatory activity by government.
	<u>Commonwealth of Virginia Variables</u>
BUDGET	10 State economic activity; revenues and budget.
CDB	11 Commonwealth Data Base; econometric model, geobase information system (GIS), data collection including remote sensing.
	<u>Regional and County Variables</u>
PLANNING	12 Level of activity by planning commissions.
METHODS	13 Flexibility toward new methods including remote sensing.
	<u>Institutional Variables</u>
MISSION	14 Mission of the institute; program allocations among basic research, applications, and advisory services.
CENTER	15 Remote Sensing Center activities; federal, CDB, and internal components.

**ORIGINAL PAGE IS
OF POOR QUALITY**

The next step was to prepare a cross-impact matrix, which presents the static structure of the system (Gordon and Hayward, 1968; McLean and Shepherd, 1976). The matrix has essential variables as both row and column labels; each matrix element is filled with a one if (a zero if not) the row variable has a direct influence (immediate effect; immediate impact) on the column variable. Diagonal elements are set to zero.

To produce a single finalized matrix from those produced by the participants, the entries for each matrix element are combined by a majority rule, or by a summation. The latter procedure in effect weights each interaction on a scale whose maximum is the number of participants. The resulting matrix in this study is shown in Table 2. Driver and follower variables in a static sense are revealed by the row and column sums.

TABLE 2
Cross-Impact Matrix

Influence On																Row Sum	Row %	Driver Variables
	Trade	Peace	Energy	Economy	Defense	Satellite	Research	Commercial	Regulatory	Budget	CDB	Planning	Methods	Mission	Center			
Of	1	2	3	4	5	6	7	8	9	0	1	2	3	4	5			
Trade	1	2	3	3	3	2	0	2	1	3	0	1	0	1	0	21	5.8	
Peace	2	3	3	3	3	1	2	1	2	1	1	1	1	1	1	24	6.6	
Energy	3	3	3	3	3	2	3	2	2	3	2	2	2	2	2	34	9.3	*
Economy	4	3	2	3	2	3	3	3	2	3	2	1	2	2	2	33	9.0	*
Defense	5	2	3	3	3	2	3	2	1	2	0	1	0	0	0	22	6.0	
Satellite	6	2	0	3	1	1	3	2	2	1	3	1	3	2	3	27	7.4	
Research	7	2	0	3	2	0	2	2	3	1	2	2	3	3	3	28	7.7	
Commercial	8	3	0	3	3	0	1	3	3	3	3	3	3	3	2	33	9.0	*
Regulatory	9	1	0	2	2	1	2	3	3	2	3	2	3	3	3	30	8.2	*
Budget	10	1	0	1	3	0	1	2	1	3	3	2	2	3	3	25	6.8	
CDB	11	0	0	0	0	0	3	2	2	2	0	1	3	2	3	18	4.9	
Planning	12	0	0	0	0	0	1	1	2	2	0	3	3	2	3	17	4.7	
Methods	13	0	0	0	0	0	2	2	1	1	2	2	2	2	3	17	4.7	
Mission	14	0	0	1	0	0	2	3	0	3	1	2	2	2	3	19	5.2	
Center	15	0	0	0	0	0	2	3	0	1	0	3	2	3	3	17	4.7	
Column Sum		20	10	25	23	13	26	33	23	28	22	29	24	29	31	365		
Column %		6.5	2.7	6.8	6.3	3.6	7.1	9.0	6.3	7.7	6.1	8.0	6.6	8.0	8.5			
Follower Variables								*										*

Dynamic Behavior

Raising the matrix to successively higher powers is used to reveal long-term (indirect) dynamic interactions. Squaring a matrix containing zeroes and ones shows the number of feedback loops of two steps; raising to the power n shows the number of loops of length n (including repeated cycles of shorter lengths). By the power $n = 6$, the order of variables ranked according to the greatest number of feedback loops is stabilized. The rank order based on results from the diagonal shows the pivotal variables for the system; results from the last column show the variables with most impact on the Center. The two sets of results obtained for $n = 6$ are shown in Table 3.

Significant Hypotheses

The results in Table 3 indicate that the pivotal variables are Energy, Economy, and Satellite, and the trio Research, Commercial, and Regulatory. Significant hypotheses concerning future events should be formulated around these variables. Although the variable CDB did not rank higher than eighth, the participants decided to add CDB as a seventh pivotal variable because of its immediate importance to Center activities. In formulating hypotheses for subsequent analysis, it is best to limit the number to five or six. The close relationship among the trio of coastal zone variables suggested a merger into a single variable called coastal zone management (CZM). The list of variables then numbered five. The hypotheses formulated around these variables are shown in Table 4. It is easier for the participants in the next step if each hypothesis involves not a

TABLE 3

Dynamic Rank Order Results

<u>System Pivotal Variables</u>	<u>Variables With Impact on the Center</u>
1. Research	1. Energy
2. Regulatory	2. Economy
3. Energy	3. Commercial
4. Commercial	4. Regulatory
5. Satellite	5. Research
6. Economy	6. Peace
7. Mission	7. Satellite
8. CDB	8. Defense
9. Center	9. Trade
10. Methods	10. Budget
11. Budget	11. Mission
12. Trade	12. CDB
13. Planning	13. Methods
14. Defense	14. Planning
15. Peace	15. Center

process but an event whose occurrence or lack of occurrence could be easily judged in the future, such as "By 1986, there will occur a gap in Landsat coverage of at least 12 months." The hypotheses in Table 4 are generally more process-oriented than this example.

TABLE 4
Scenario Hypotheses for 1986

<u>Variable</u>	<u>Hypothesis</u>
1 Energy	Energy supplies, especially petroleum, will be plentiful at reasonable cost.
2 Economy	The national economy will persist as at present (moderate growth; 10% inflation); stagflation will be avoided.
3 Satellite	Civilian earth satellite programs (beside meteorological satellites) will be very active; the Landsat program will provide data continuously.
4 CZM	Coastal zone geography, regional planning, management, and research activity will be vigorous locally.
5 CDB	The state GIS program will be fully funded and staffed as projected in planning documents.

Probability of Events

Participants were then asked to assign to each event a probability of occurrence, and to each pair of events a joint probability of occurrence. It is difficult to assign probabilities to higher orders of joint occurrence, hence the resort in scenario generation to mathematical solutions. It was first suggested in the literature that conditional probabilities be assigned to pairs of events ($P_{i/j}$ = probability of event i if event j occurs), but answers from each participant are then found to be self-inconsistent from the viewpoint of classical probability theory, necessitating adjustment procedures to produce a consistent set of probabilities (Duperrin and Godet, 1975; Godet, 1976a). The ensuing debate has generated several alternative procedures for generating scenarios from probabilities (Mitchell and Tydeman, 1976a; Godet, 1976b; Mitchell and Tydeman, 1976b; Kelly, 1976; McLean, 1976; Bloom, 1977; Kaya, Ishikawa, and Mori, 1979), as well as a discussion of the misunderstanding involved in applying Bayes' probability theorem to a causative cross-impact analysis (Enzer and Alter, 1978). At this stage in the debate the mathematical problems are simplified by having participants assign not conditional probabilities but joint probabilities (Mitchell, Tydeman, and Curnow, 1977), which in effect requires participants to judge the eventual outcome of the dynamic interactions between pairs of variables.

**ORIGINAL PAGE IS
OF POOR QUALITY**

The results from the participants are obtained in the form of an event interaction matrix. Obtaining joint rather than conditional probabilities renders the matrix symmetric. Matrices from the participants were combined by averaging the results for each matrix element. Table 5 shows the finished matrix.

TABLE 5
Event Interaction Probability Matrix

	Energy	Economy	Satellite	CZM	CDB	
	1	2	3	4	5	
Energy	1	57				
Economy	2	44	72			
Satellite	3	32	40	47		
CZM	4	40	45	38	60	
CDB	5	37	46	40	47	65

Scenario Generation and Most Probable Futures

For a system with m events, there are $r = 2^m$ situation scenarios (combinations of events) E_k ($k = 1, \dots, r$). Each scenario has an unknown probability Π_k . Let e_i represent the i th event, with event probability P_i and joint probability P_{ij} . Then let

$$a_{ik} = \begin{cases} 1 & \text{if } e_i \text{ occurs in } E_k, \\ 0 & \text{if otherwise;} \end{cases}$$

$$b_{ijk} = \begin{cases} 1 & \text{if } e_i \text{ and } e_j \text{ occur in } E_k, \\ 0 & \text{if otherwise.} \end{cases}$$

The value of a selected Π_{k^*} can be found by using the revised simplex linear programming method for the equation set

$$\sum_{k=1}^r a_{ik} \Pi_k = P_i \quad \text{for } i = 1, 2, \dots, m;$$

$$\sum_{k=1}^r b_{ijk} \Pi_k = P_{ij} \quad \text{for } i = 1, 2, \dots, m-1, i < j \leq m;$$

$$\sum_{k=1}^r \Pi_k = 1; \quad \Pi_k > 0 \text{ for all } k;$$

**ORIGINAL PAGE IS
OF POOR QUALITY**

where the objective function is to maximize the chosen Π_k^* . The value of Π_k^* obtained is a unique maximum, but because there are 2^m variables in only $1+m*(m+1)/2$ equations (ignoring the non-negativity conditions), the accompanying Π_k values are not unique. By 2^m runs of the linear program the maximum values for all Π_k can be obtained (Mitchell, Tydeman, and Curnow, 1977). The results are shown in Table 6. Maximization for each Π_k separately produces $\sum \Pi_k = 3.234$.

The ten most probable situation scenarios comprising 48% of the total probability are extracted from Table 6 and shown in order in Table 7.

TABLE 6
Scenario Probabilities and Rankings

Number(k)	e ₁	e ₂	e ₃	e ₄	e ₅	Π_k	kank*
1	0	0	0	0	0	0.09	16
2	0	0	0	0	1	0.13	6
3	0	0	0	1	0	0.07	24
4	0	0	0	1	1	0.123	8
5	0	0	1	0	0	0.05	31
6	0	0	1	0	1	0.07	20
7	0	0	1	1	0	0.05	32
8	0	0	1	1	1	0.07	26
9	0	1	0	0	0	0.15	4
10	0	1	0	0	1	0.13	5
11	0	1	0	1	0	0.10	12
12	0	1	0	1	1	0.115	11
13	0	1	1	0	0	0.07	25
14	0	1	1	0	1	0.09	19
15	0	1	1	1	0	0.07	21
16	0	1	1	1	1	0.15	3
17	1	0	0	0	0	0.09	17
18	1	0	0	0	1	0.09	18
19	1	0	0	1	0	0.09	14
20	1	0	0	1	1	0.12	9
21	1	0	1	0	0	0.056	30
22	1	0	1	0	1	0.063	29
23	1	0	1	1	0	0.063	28
24	1	0	1	1	1	0.07	22
25	1	1	0	0	0	0.17	2
26	1	1	0	0	1	0.093	13
27	1	1	0	1	0	0.13	7
28	1	1	0	1	1	0.12	10
29	1	1	1	0	0	0.07	23
30	1	1	1	0	1	0.09	15
31	1	1	1	1	0	0.07	27
32	1	1	1	1	1	0.32	1

* Ties eliminated by details of the simplex solutions.

Desired Future

**ORIGINAL PAGE IS
OF POOR QUALITY**

The goal restated is to achieve expanded and more effective application of satellite data to coastal zone research and management. Specific objectives within that goal may be identified as the following:

1. Maintain statewide user services for Landsat data processing;
2. Make Landsat services more cost efficient; expand capabilities via additional software and hardware;
3. Broaden capabilities for processing and applying other sensor and satellite data (e.g., Thematic Mapper, Seasat SAR, Nimbus-7 Coastal Zone Color Scanner, Heat Capacity Mapping Mission);
4. Publicize capabilities and potential applications;
5. Investigate new applications, test their feasibility, and establish operational capability for new feasible applications; and
6. Facilitate the implementation of operational capabilities in user agencies.

TABLE 7
First 10 Scenarios in Rank Order

Rank	Scenario					Π_k	% of Total	
	k	e ₁	e ₂	e ₃	e ₄			e ₅
I	32	1	1	1	1	1	0.32	9.9
II	25	1	1	0	0	0	0.17	5.3
III	16	0	1	1	1	1	0.15	4.6
IV	9	0	1	0	0	0	0.15	4.6
V	10	0	1	0	0	1	0.13	4.0
VI	2	0	0	0	0	1	0.13	4.0
VII	27	1	1	0	1	0	0.13	4.0
VIII	4	0	0	0	1	1	0.123	3.8
IX	20	1	0	0	1	1	0.12	3.7
X	28	1	1	0	1	1	0.12	3.7
Totals (Yes/No)		5/5	7/3	2/8	6/4	7/3	1.543	47.6

These goals imply the necessity for permanent employees, facilities, and continuous funding. The goals are transformed into a statement similar in form to the earlier events e_1 . An appropriate size for the facility is indicated (Munday, 1980):

e_6 : A regional remote sensing facility will be situated in a coastal university providing research and advisory services; personnel -- two permanent scientists with strong ties to state/local government, two permanent assistants including a computer specialist, two graduate student assistants, and a secretary.

Scenarios and Strategies

The last two stages of the Prospective Approach will be combined in this analysis. Scenarios I through X are linked one at a time with e_6 , to form mixture scenarios of probable + desired futures. Each scenario is given a literary description. Then a response is shown containing appropriate strategies for ensuring e_6 throughout the desired period ending in 1986. Four of the ten scenarios are shown as examples.

Scenario I + e_6 : Most likely scenario:

Description: "Despite the economic and budgetary impact of minor fuel scarcity and rising prices, the Landsat program retains strong support from the federal government, due in part to continued attention given to coastal environmental affairs and to the economic/industrial impact on coastal resources. As well, states continue in their development of resource data bases, spurred by energy costs to make more efficient use of available data. Landsat is seen as one significant source of data. The continuity of Landsats in orbit, and availability of both historical and new data, have had a favorable impact on state, regional, and coastal applications of the data. State facilities for Landsat data processing are expanding at a moderate rate, their use is steady, and the market for services continues to broaden."

Response: Maximize attention on operational applications, such as provision of services to planning districts; emphasize public relations aspects; broaden capabilities in response to the demand for services; as time permits, conduct research into potential applications and use of new satellite data sources.

Scenario II + e_6 :

Description: "The international energy situation and the national economy are reasonably healthy, with fuel supplies and prices within workable limits. However, the Landsat program is suffering from federal program cutbacks, and there are long periods of loss of data continuity because of failure in old satellites. Other satellite programs have been delayed indefinitely. Coastal zone activities are diminished due to de-emphasis on environmental protection, and state programs are minimally funded due to conservative state budgets. The market for Landsat services is therefore depressed."

Response: Broaden and diversify research in marine and coastal science beyond coastal zone satellite applications; prepare for future data needs by purchases of archived satellite data; develop research programs into new applications of satellite data to resource management; de-emphasize satellite applications to coastal environmental pollution.

Scenario III + e₆:

Description: "Energy supplies are scarce and fuel costs are markedly higher. Although the national economy is not greatly affected in general, particular circumstances with great dependence on fuel supplies are adversely affected. Automobile use is markedly decreased; recreational travel is hard hit; coastal resort industries are suffering; traditional and newly-emerging communications industries are booming. Environmental impacts are decreasing due to diminished fuel usage. Satellite programs enjoy strong support, along with coastal resource management activities and state GIS programs, as governments move to implement efficient mechanisms for resource management in the face of a fuel-deficient future."

Response: Emphasize additions to GIS data storage; develop capabilities for long-line communications transfer of Landsat data products; improve algorithms for resource management using merged satellite and traditional data; develop research programs into new applications of satellite data to resource management; de-emphasize satellite applications to coastal environmental pollution.

Scenario VI + e₆: Contrasting scenario:

Description: "International events have seriously disrupted energy supplies and shaken the national economy. Fuel prices have increased dramatically as the cost of oil has reached \$90 per barrel on the spot market. The economy is in recession and the inflation rate is 22%. Federal satellite programs are stagnant, the national commitment to an operational Landsat program has been delayed until 1995, and no Landsat has been functional for 15 months. Due to reduced revenues at all levels of government, coastal zone activities in research, monitoring and consulting have decreased. The market for Landsat services is nil, and states have reduced their commitment to in-state Landsat data processing capabilities. The one bright spot is that the state GIS is well-funded because legislators believe that comprehensive resource planning with data bases is imperative under the adverse economic conditions."

Response: Emphasize additions to GIS data storage; prepare additional Landsat products from old Landsat data; prepare for future data needs by purchases of archived satellite data; conduct low-budget coastal research which can ultimately benefit GIS applications.

SUMMARY

The use of a forecasting protocol has clarified possible future circumstances which have high potential for affecting coastal applications of satellite data. Responses to the most probable alternative futures have been suggested for coastal remote sensing centers serving state/local users of satellite data. If the user market expands, centers may emphasize operational applications. If the national satellite program contracts while state GIS programs expand, centers may emphasize GIS data input, and algorithms for decision-making using GIS banks of satellite and traditional data. If both satellite programs and GIS programs contract, centers may again focus on coastal management using merged satellite and traditional data, but with the emphasis on long-term exploratory research programs.

REFERENCES

- Ashby, W.R. 1963. An introduction to cybernetics. John Wiley, New York, 295 p.
- Bloom, M.F. 1977. Time-dependent event cross-impact analysis: results from a new model. Technol. Forecast. Soc. Change 10:181-201.
- Duperrin, J.C. and M. Godet. 1975. SMIC 74 - A method for constructing and ranking scenarios. Futures 7(4):302-312.
- Enzer, E. and S. Alter. 1978. Cross-impact analysis and classical probability. Futures 10(3):227-239.
- ERTS Conferences. 1973. Symposium Significant Results from ERTS-1, March 5-9; Third ERTS-1 Symp., December 10-14. NASA Goddard SFC. Greenbelt, Maryland.
- Falconer, A. 1974. ERTS - The complete geographer. Second Canadian Symp. on Remote Sensing, Guelph, Ontario, Dept. Energy, Mines and Resources, Ottawa, p. 650-651.
- Godet, M. 1976a. Scenarios of air transport development to 1990 by SMIC 74 - A new cross-impact method. Technol. Forecast. Soc. Change 9:279-288.
- Godet, M. 1976b. SMIC 74: A reply from the authors. Futures 8(4):336-340.
- Godet, M. 1979. The crisis in forecasting and the emergence of the "prospective" approach. Pergamon Press, New York, 134 p.

- Gordon, T.J. and H. Hayward. 1968. Initial experiments with the cross-impact matrix method of forecasting. *Futures* 1(2):100-116.
- Higgins, H.W. 1979. CZM - The states' response: an assessment of state coastal zone management programs. National Conference of State Legislatures, Denver, Colorado, 90 p.
- Kaya, Y., M. Ishikawa, and S. Mori. 1979. A revised cross-impact method and its applications to the forecast of urban transportation technology. *Technol. Forecast. Soc. Change* 14:243-257.
- Kelley, P. 1976. Further comments on cross-impact analysis. *Futures* 8(4): 341-345.
- McLean, M. 1976. Does cross-impact analysis have a future? *Futures* 8(4): 345-349.
- McLean, M. and P. Shepherd. 1976. The importance of model structure. *Futures* 8(1):40-51.
- Mitchell, R.B. and J. Tydeman. 1976a. A note on SMIC 74. *Futures* 8(1):64-67.
- Mitchell, R.B. and J. Tydeman. 1976b. A further comment on SMIC 74. *Futures* 8(4):340-341.
- Mitchell, R.B., J. Tydeman, and R. Curnow. 1977. Scenario generation: limitations and developments in cross-impact analysis. *Futures* 9(3): 205-215.
- Munday, J.C., Jr. 1980. Organization of remote sensing capability for data needs in marine resource management. Presented at the COSTED-COSPAR Workshop on Applications of Space Observations to Marine Resources in Developing Countries, NOAA/NESS, Camp Springs, Maryland, Submitted, 17 p.
- National Conference of State Legislatures. 1977. Summary and highlights: Legislative workshop on state uses of satellite remote sensing #5. Denver, Colorado, 123 p.
- National Conference of State Legislatures. 1979. North Dakota REAP appropriation bill vetoed. *NCSL Remote Sensing* (Denver, Colorado) 3(3):1-2.

N83 19167^{D25}

MONITORING WETLANDS CHANGE USING LANDSAT DATA

David L. Hardin
Delaware Department of Natural Resources
and Environmental Control

ABSTRACT

A wetlands monitoring study has been initiated as part of Delaware's Landsat applications demonstration project. Classifications of digital data are being conducted in an effort to determine the location and acreage of wetlands loss or gain, species conversion, and application for the inventory and typing of freshwater wetlands. A multi-seasonal approach is being employed to compare data from two different years. At present, unsupervised classifications have been conducted to Level I and, to some extent, Level II for two of the four dates being examined. Initial results indicate the multi-seasonal approach will allow much better separation of wetland types for both tidal and non-tidal wetlands than will either season alone. Change detection will be possible but will generally miss the small acreages now impacted by man.

INTRODUCTION

Remote sensing of wetlands has become commonplace in recent years with aerial photography, primarily natural color and color infrared, now considered the standard method for wetlands mapping and inventory programs. Tidal marshes are particularly well-suited for remote sensing techniques as they have relatively low species diversities yet high biomass production. This generally results in large homogeneous stands of vegetation that are easy to distinguish visually from adjacent uplands and other marsh species. These characteristics have also resulted in successful digital analysis of multispectral data from both airborne and satellite sensors.

Much of the remote sensing work in wetlands has resulted from a flurry of legislative activity in the late 1960's and early 1970's on the part of various states concerned with the dramatic loss of their wetlands. The State of Delaware passed a wetlands act in 1976, requiring a permit for most potentially destructive activities in all tidal wetlands and inland wetlands larger than 400 acres. The law also required that these same wetlands be mapped and that these maps, when accepted after a public review process, would then legally designate those wetlands under state jurisdiction. Photomaps showing the wetlands boundaries and vegetation types were compiled, using 1973 aerial photography, and adopted in 1976.

In 1979, the Wetlands Section, which administers the act, decided that due to man-induced activities and natural processes, the maps needed to be updated.

New aerial photography was obtained and the maps were revised. Recently completed, this project indicates that relatively large-scale changes have taken place in Delaware's wetlands due to erosion, accretion and species replacement.

During this project, the state entered into a cooperative agreement with the NASA-Eastern Regional Remote Sensing Applications Center (ERRSAC) at Goddard Space Flight Center, Greenbelt, Maryland to conduct a Landsat applications demonstration project in Delaware. The Wetlands Section felt that this same process would be a good test of Landsat and, if successful, would provide a faster, more economical method of monitoring wetlands change, although not at the resolution required for regulatory work. Therefore, a wetlands change detection study was proposed and accepted as part of the demonstration project. Specific objectives we hope to achieve include locating and quantifying losses and gains in tidal wetlands, mapping the conversion of other marsh types to reed grass (Phragmites communis), and identifying and classifying freshwater wetlands.

A body of remote sensing expertise and experience with satellite imagery already exists in the state at the University of Delaware. Faculty and graduate students have conducted a number of Landsat studies, some directly or indirectly related to wetlands. Wetlands-related studies have included wetlands mapping, species identification, wetlands productivity, and water quality. Studies on wetlands assessment, including detection of stressed wetlands, are currently underway.

WETLAND TYPES

Wetlands in Delaware can be grouped by salinity, degree of tidal influence or vegetation type. Most of the tidal wetlands consist of salt marsh although tidal-fresh or near-freshwater marshes and swamps are present. Inland or non-tidal wetlands are strictly freshwater and include marshes, wet meadows, swamps and open water. Marshes and wet meadows contain grasses and herbaceous vegetation and swamps contain woody vegetation.

TIDAL WETLANDS

Low Marsh

Low marsh is occupied primarily by saltmarsh cordgrass (Spartina alterniflora), an emergent, robust grass occurring in several growth forms ranging from 0.5 to 2 meters. Low marsh is flooded twice daily on each high tide and provides most of the detrital material that serves as the energy source to the estuary.

High Marsh

High marsh is dominated by salt hay (Spartina patens) and spike grass (Distichlis spicata). These are narrow, densely growing grasses less than one meter in length. A weakened section of the stem causes them to fall over about mid-summer, giving the marsh a swirled appearance. High marsh is flooded only by spring (monthly high tides) and storm tides. High marsh depressions are the breeding grounds for the salt marsh mosquito (Aedes sollicitans).

Salt Bush

Salt bush is a collective term for two species of salt-tolerant shrubs, marsh elder (Iva frutescens) and groundsel-bush (Baccharis halimifolia). These are low-growing shrubs, usually less than 2 meters in height, that occur on elevated portions of marsh, such as old dredge spoil disposal sites and near the upland border. Salt bush usually has a dense undergrowth of salt hay and spike grass.

Transition Marsh

Transition marsh is a term for low, brackish marshes containing a mixture of salt-tolerant and freshwater species. There are no true dominants, but commonly occurring species include saltmarsh cordgrass, big cordgrass (Spartina cynosuroides), cattails (Typha spp.), threesquares (Scirpus spp.), smartweeds (Polygonum spp.), tidemarth waterhemp (Acnida cannabina) and others. These areas are valuable as wildlife habitat, especially for waterfowl.

Reed Grass

Reed grass (Phragmites communis) is a tall, extremely robust grass that forms dense stands and rapidly invades disturbed areas of marsh. It has spread over large areas of low-salinity wetlands, replacing high value wildlife food plants. Most colonies have become established within the last 10-20 years; the dominance exhibited in many areas by the species has apparently developed within the very recent past (ref. 1).

Freshwater Marsh (Tidal)

Freshwater tidal marsh species are determined by the elevation in relation to the tide. Higher areas are occupied by cattails, threesquares, smartweeds, and others. The lower, more extensive, tidal flats are occupied by arrow-arum (Peltandra virginica) and pickeral weed (Pontederia cordata). The latter are broad-leaved emergents that rapidly break down and disappear in the fall.

Swamp (Tidal)

Tidal swamp occurs in the upper reaches of some of the tidal rivers and creeks. Deciduous and coniferous types are present, dominated by red maple (Acer rubrum) and Atlantic white cedar (Chamaecyparis thyoides), respectively.

INLAND (NON-TIDAL) WETLANDS

Marsh

Inland marsh is dominated by many of the same species found in tidal freshwater marshes. Areas tend to be smaller, but species often occur in distinct stands. Species diversity is higher than in tidal marshes. Inland marshes may occur separately in lowland depressions or in association with lakes, rivers and streams.

Wet Meadow

Wet meadows normally contain standing water only in the spring although the soil is saturated within a few inches of the surface throughout most of the growing season. Characteristic vegetation includes grasses such as red top (Agrostis spp.), manna grass (Gyneria spp.), sedges (Carex spp.) and rushes (Juncus spp.).

Swamp

Swamps occur adjacent to lakes, ponds and streams and in lowland depressions. Standing water is common and the soil is always saturated. Common species include red maple, blackgum (Nyssa sylvatica), sweetgum (Liquidambar styraciflua), water oak (Quercus nigra), and, in the southern part of the state, bald cypress (Taxodium distichum).

Open Water

This type consists of small shallow ponds, usually less than 3 meters in depth. A fringe of emergent vegetation is generally present along the shoreline. Submerged and floating aquatic plants such as waterlillies (Nymphaea spp.), pondweeds (Potamogeton spp.), spatterdock, (Nuphar luteum), and coontail (Ceratophyllum sp.) are common.

STUDY AREA

Sussex County, the southernmost of Delaware's three counties, is the study area (fig. 1). It was chosen for two reasons: most of the filling of wetlands for development has occurred there in areas adjacent to the small bays, and it has the widest range of wetland types in the state.

Five training sites have been selected: these include two sites (1 and 2) along the coast that have salt marshes, two inland sites (3 and 4) containing freshwater wetlands, and one site (5) containing tidal freshwater wetlands.

LANDSAT DATA

Landsat MSS data for both spring and summer from two separate years was selected, April 3 and July 20, 1974, and March 17 and July 3, 1979. A multi-seasonal approach was chosen as it has been highly successful in identifying freshwater wetlands from aerial photography (ref. 2, 3, 4). The purpose is to have a date during high water before leaves come out and a date during or just after the growing season when vegetation is well-developed. The spring date allows relatively easy location of areas with standing water, while the summer date allows identification and separation of the major vegetation types. It is therefore possible to separate permanent swamps from bottomland hardwoods that are flooded only briefly during periods of high water, or to separate marsh from open water.

RESULTS AND DISCUSSION

Unsupervised classifications to Level I have been largely completed for April, 1974 and July, 1979 (Table I). Forest cover has been classified to Level II for April, 1974 and wetlands to Level II for July, 1979.

April data appear to have a high potential for separating freshwater wetlands. Wooded areas can be divided into several categories by what seems to be soil moisture differences. Wooded swamps and bottomland hardwoods have been tentatively separated from uplands. Multi-seasonal analysis should make it possible to separate these types and even to classify by dominant species associations, especially unique areas such as cypress swamps or tidal cedar swamps.

However, April data are less successful when examined for tidal marshes. Two major types, high marsh and reed grass, are indistinguishable from upland fields and croplands. Past work by the University of Delaware indicates these types should be separable on the July imagery (ref. 5), and initial work with the July, 1979 data appears to separate salt hay from the agriculture category

fairly well. Much of the marsh the computer classified as shallow water for the April, 1974 date appears as low marsh on aerial photography. Strong winds from the south on this date kept much of the water from high tide in Delaware Bay and probably increased the level of water on the marsh. Winter tides have removed much of the dead marsh vegetation by April, leaving large amounts of exposed mud. This serves to lower the reflectance value of these flooded areas, giving them a signature different from the water of the Bay and creeks. This appears to be a situation unique to this date.

July data appear to be more useful in separating salt marshes from agricultural lands than the April data. Known areas of high marsh that were classified agricultural using the April data were correctly included in the salt marsh category when July data were used. Some of the low marsh areas (tidal marsh classification) have been separated from the other tidal marsh types by the July data. Further effort should result in the ability to distinguish high marsh and reed grass types.

However, July, 1979 data also resulted in some agricultural lands being classified as salt marsh. While this also occurred with the April data, much more of this confusion existed with the July data. The summer of 1979 was unusually wet, and flooded or poorly drained fields having low-growing vegetation or stubble probably had signatures similar to that of salt marsh.

Freshwater wetlands are not distinguishable using July data. Swamps are not separable from other forest cover types because of leaf cover. Freshwater marshes and wet meadows are probably classified as agricultural cover or salt marsh. No attempt has yet been made to separate freshwater wetlands into different types.

Forested cover is also not as well classified by July data as by April data. Forested cover, especially deciduous types, is confused with agricultural cover when using the July data. Most of those areas that are classified as forest cover are categorized as coniferous cover, including many areas of deciduous cover. Swamps, which are largely deciduous, are also classified as coniferous cover or agricultural cover. Other studies have used summer Landsat data for forest cover categorization and have achieved high accuracies for Level II classifications.

Coniferous forest is distinguished from deciduous forest using the April data. However, a striping problem exists in the categorization of these two cover types that could result in a large number of pixels being misclassified.

CONCLUDING REMARKS

At present, it is too early to tell how successful Landsat data will be in meeting the stated objectives. Although problems exist, we feel many of these will disappear with further analysis. The potential for separation of fresh-water wetlands appears better than we hoped would be possible. One area of concern is the small wetlands less than 2.5 hectares which are below the resolution capabilities of the current satellites. The improved resolution of Landsat-D will result in a significant increase in the number of these small areas that can be identified and increased accuracy in wetlands classification.

Although we have not progressed far enough with the analysis to adequately test Landsat data for monitoring wetlands changes, some changes have been observed between the two dates worked with so far. Successful monitoring of tidal wetlands by Landsat would provide a fast, economical way to periodically examine these wetlands and to determine the most cost-effective time to re-fly our aerial photography and update our regulatory maps. Also, past and current research at the University of Delaware is providing groundwork that could permit tidal wetlands to be classified on the basis of productivity or overall condition. This kind of information would be highly beneficial during the permit evaluation process on large proposed projects.

REFERENCES

1. Tyranski, J.M.: A Study of the Common Reed Grass (Phragmites communis Trin.) in the Coastal Zone of Delaware. M.S. Thesis, University of Delaware. 1977.
2. Carter, V.; Malone, D.L.; and Burbank, J.H.: Wetland Classification and Mapping in Western Tennessee. Photogramm. Eng. and Remote Sensing, Vol. 45, No. 3, Mar. 1979, pp. 273-284.
3. Colwell, J.E.; Gilmer, D.S.; Work, E.A.; Rebel, D.L.; and Roller, N.E.G.: Use of Landsat to Assess Waterfowl Habitat Quality. Final Report prepared for NASA, Greenbelt, Maryland, 1978.
4. Cowardin, L.M.; and Myers, V.I.: Remote Sensing for Identification and Classification of Wetland Vegetation. J. Wildl. Manage., Vol. 38, No. 2, July 1974, pp. 308-314.
5. Klemas, V.; Bartlett, D.; Rogers, R.; and Reed, L.: Inventories of Delaware's Coastal Vegetation and Land Use Utilizing Digital Processing of ERTS-1 Imagery. Proceedings of the Ninth International Symposium on Remote Sensing of the Environment, April 15-19, 1974, pp. 139-1410.

ORIGINAL PAGE IS
OF POOR QUALITY

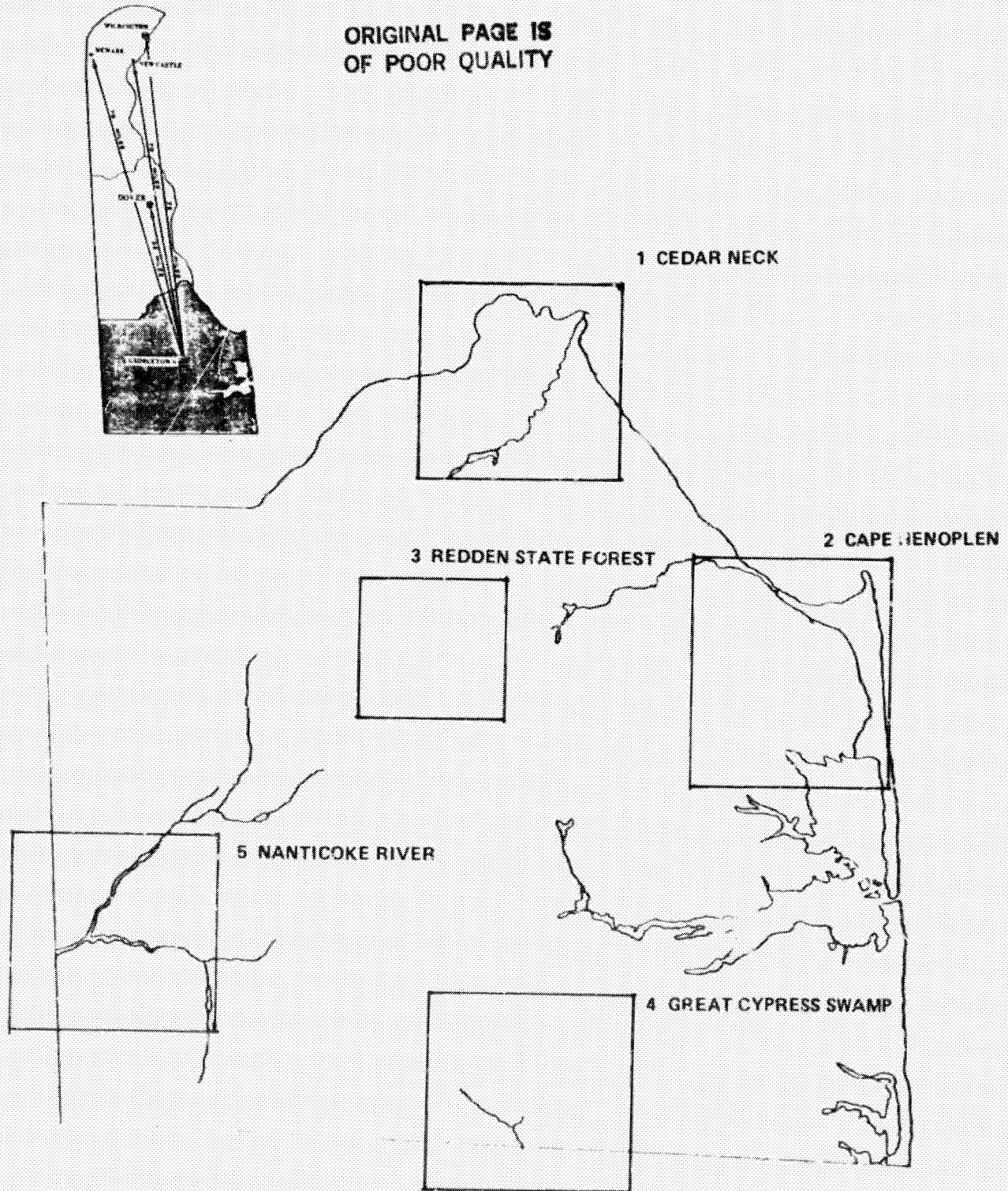

Figure 1. Sussex County, Delaware Study Area and the Five Training Sites Used for the Unsupervised Classification

**ORIGINAL PAGE IS
OF POOR QUALITY**

**TABLE I. - INITIAL LAND COVER CLASSES ASSIGNED FOR
APRIL, 1974 AND JULY, 1979 DATA**

April 1974 classification

Sand
Water
Mud flats
Salt marsh
Coniferous forest
Deciduous forest
Freshwater swamp
Agriculture
Urban

July 1979 classification

Sand/clouds
Water
Mud flats
Tidal marsh
Salt marsh
Coniferous forest/swamp
Deciduous forest
Agriculture
Urban

0-4

N83 19168

D26

FUNDAMENTAL PROCEDURES OF
GEOGRAPHIC INFORMATION ANALYSIS

Joseph K. Berry
Yale University
School of Forestry and Environmental Studies

C. Dana Tomlin
Harvard University
Graduate School of Design

ABSTRACT

Analytical procedures common to most computer-oriented geographic information systems are composed of fundamental map processing operations. This paper develops a conceptual framework for such procedures and describes basic operations common to a broad range of applications. Among the major classes of primitive operations identified are those associated with:

- reclassifying map categories as a function of the initial classification, the shape, the position, or the size of the spatial configuration associated with each category;
- overlaying maps on a point-by-point, a category-wide, or a map-wide basis;
- measuring distance;
- establishing visual or optimal path connectivity; and,
- characterizing cartographic neighborhoods based on the thematic or spatial attributes of the data values within each neighborhood.

By organizing such operations in a coherent manner, the basis for a generalized cartographic modeling structure can be developed which accommodates a variety of needs in a common, flexible and intuitive manner. None of the procedures identified is specific to a particular application. The use of each is limited only by the general thematic and spatial nature of the data to which it is applied. Most of the techniques described have been implemented as part of the Map Analysis Package (MAP) developed at the Yale School of Forestry and Environmental Studies.

INTRODUCTION

Information relating specifically to the spatial characteristics of natural resources has been difficult to incorporate into environmental planning. Manual

ORIGINAL PAGE IS
OF POOR QUALITY

techniques methodologies have proven to be both tedious and analytically limited. Computer-assisted geographic information systems, on the other hand, hold promise in providing capabilities clearly needed for effective planning. This need has caused the developing science of spatial information analysis to be somewhat prematurely cast into operational contexts. The result has been a growing number of special purpose systems designed for more or less unique applications. Recent efforts, however, have attempted to recognize the processing similarities among such systems in order to develop more general capabilities.

Most computer-oriented, geographic information systems include processing capabilities that relate to the encoding, storage, analysis, and/or display of spatial data. This paper describes a series of techniques that relate specifically to the analysis of mapped data and to the needs of environmental planning in particular. It identifies fundamental map processing operations common to a broad range of applications. Most of the operations are part of one or more of the many geographic information systems currently in use (Calkins and Marble, 1980). Among the major classes of primitive operations identified are those which:

- reclassify map categories;
- overlay maps on a point-by-point category-wide or map-wide basis;
- measure distance;
- establish visual or optimal path connectivity;
- and,
- characterize the thematic or spatial attributes of cartographic neighborhoods.

By organizing primitive operations in a logical manner, a generalized cartographic modeling approach can be developed (Tomlin and Berry, 1979).

This fundamental approach can be conceptualized as a "map algebra" in which entire maps are treated as variables. In this context primitive map analysis operations can be seen as analagous to traditional mathematical operations. The sequencing of map operations is thus similar to the algebraic solution of equations to find unknowns. In this case, however, the unknowns represent entire maps. This approach has proven to be particularly effective in presenting spatial analysis techniques to individuals with limited experience in geographic information processing (Berry and Tomlin, 1980).

RECLASSIFYING

The first, and in many ways the most fundamental class of analytical operations involves the reclassification of map categories. Figure 1 shows the result of reclassifying a map as a function of its initial thematic values. The

ORIGINAL PAGE IS
OF POOR QUALITY

thematic attributes of a map are simply its legend categories expressed as a list of names and/or numbers. For display, a unique graphic symbol is associated with each thematic value. In Figure 1, the COVERTYPE map has categories of LAKE, MEADOW and FOREST. These are stored as thematic values of 1, 2 and 3 and displayed as the symbols "-", "=", "0", respectively. A binary map that isolates the meadow can be created by simply assigning to the lake and forest areas a value of a graphic symbol " " (blank).

A similar reclassification operation might involve the ranking or weighting of qualitative map categories to generate a new map with quantitative values. A map of soil types for example, might be assigned values that indicate the relative suitability of each soil type for residential development. Quantitative values may also be reclassified to yield new quantitative values. This might simply involve a specified reordering of map categories as described above (e.g., given a map of soil moisture content, generate a map of suitability levels for plant growth). Or, it could involve the application of a generalized reclassifying function such as "level-slicing" which splits a continuous range of map category values into discrete intervals (e.g., derivation of a contour map from a map of topographic elevation values).

Reclassification operations can also relate to "locational," as opposed to purely thematic attributes associated with a map. One such characteristic is position. A map category represented by a single point location, for example, might be reclassified according to its latitude and longitude. Similarly, a line segment or polygon could be reassigned values indicating its center of gravity or orientation.

Another locationally based characteristic is size. In the case of map categories associated with linear features or point locations, overall length or number of points might be used as the basis for reclassifying those categories. Similarly, a map category associated with a planar area might be reclassified according to its total acreage or the length of its perimeter. For example, a map of surface water might be reassigned values to indicate the areal extent of lakes or the length of streams. The same sort of technique might also be used to deal with volume. Given a map of depth to bottom for a group of lakes for example, each might be assigned a value indicating total water volume based on the areal extent of each depth category.

In addition to reclassifying maps based on thematic value, position or size shape characteristics can also be used. Shape characteristics associated with linear forms identify the patterns formed by multiple line segments (e.g., dendritic stream patterns). The primary shape characteristics associated with areal forms include boundary convexity and topological genius. Convexity relates to the overall "regularity" of the perimeter of an area, while topological genius characterizes its "spatial integrity." A map of forest stands for example, might be reclassified such that each stand is characterized according to the relative amount of forest edge with respect to total acreage and the frequency of interior

ORIGINAL PAGE IS OF POOR QUALITY

forest canopy gaps. Those stands with a large proportion of edges and a high frequency of gaps will generally indicate better wildlife habitat.

OVERLAYING

Operations for overlaying maps begin to relate to the uniquely spatial, as well as to the thematic nature of cartographic information. Overlay operations can be characterized according to whether they combine map values on a point-by-point or on a category-wide basis. The former approach involves creation of new maps such that the thematic value assigned to every point location is computed as a function of the values associated with that location on two or more maps. Figure 2 shows an example of this type of operation. Here, maps of cover type and topographic slope are combined to create a new map in which each location is characterized by a thematic value identifying its particular cover/slope combination.

In this example, qualitative data (cover type) was combined with quantitative data (terrain slope) to yield qualitative values identifying cross-tabulated map categories. Consideration of the type of data of course dictates the appropriateness of the adding, subtracting, multiplying, dividing, exponentizing, maximizing, minimizing, masking, etc. on a point-by-point overlay basis.

Another approach to overlaying maps involves category-wide summarization of values. Rather than combining information on a location-specific basis, this group of operations summarizes the spatial coincidence of entire categories of two or more maps. Figure 3 contains an example of a category-wide overlay operation using the same input maps (COVER and slope) as those in Figure 2. In this example, the categories of the cover type map are used to define areas over which the values of the slope maps are averaged. The computed values of average slope are then used to reclassify each of the cover type categories. Summary statistics which can be used in this way include the total, average, maximum, minimum, median, mode, or minority value; the standard deviation, variance, or diversity of values; and the correlation, deviation, or uniqueness of particular value combinations. For example, a map indicating the proportion of undeveloped land within each of several counties could be generated by superimposing a map of county boundaries on a map of land use and computing the ratio of undeveloped land to the total land area for each county. As with cell-by-cell overlay techniques, data types must be consistent with the summary statistic used.

MEASURING DISTANCE

The third class of analytic operations relates primarily to the locational nature of cartographic information. Operations in this group generally involve the measurement of distance between locations on a map. One of the simplest of

ORIGINAL PAGE IS
OF POOR QUALITY

these operations involves the creation of a map in which the value assigned to each location indicates the shortest distance "as the crow flies" between that location and a specified "target" area. Insert (a) of Figure 4 is an example of a map that indicates the shortest distance from a ranch to all other locations. The result is a series of concentric, equidistant zones around the ranch.

In other contexts, however, the "shortest" route between two points may not always be the straight line of the crow. And even if it is straight, the Euclidean length of that line may not always reflect a meaningful measure of distance. A distance of two miles "as the crow flies," for example, may become six miles "as the hiker walks." Furthermore, differences in the speed of travel between the crow and the hiker may make travel time a more appropriate measure of "distance." From this perspective, distance may be defined in terms of relative ease of movement and expressed in such units as time, cost or energy. Insert (b) of Figure 4 shows a map of hiking time zones around the ranch. It was generated by characterizing the various cover/slope categories of the map in Figure 2 as in terms of their relative suitability for hiking. In the example, two types of "barriers" are identified. The lake presents an absolute barrier which completely restricts hiking. The land areas, on the other hand, represent relative barriers to hiking which indicate varied impedance to movement.

The use of barriers in directing movement can be used in several ways. Given a map of topographic elevation, the watershed of any location can be characterized by treating all "downhill" areas as absolute barriers, then determining the simple distance to all "uphill" locations. Another example involves the use of a map of relative geographic barriers to all terrain vehicle travel (e.g., highway speed limits, topographic slope, cover type) to generate a map of concentric time zones around a forest fire station.

ESTABLISHING CONNECTIVITY

Another distance related class of operations is concerned with the nature of connectivity among locations on a map. One technique traces the steepest downhill path from a specified location over a three-dimensional surface. If the map represents a non-porous topographic surface, the path will identify the route of surficial runoff. For a surface represented by a travel time map, the steepest downhill path traces the quickest route. Insert (a) of Figure 5 contains a map of the optimal path between the cabin and the ranch in terms of hiking time. Similarly, maps indicating the best routing of a powerline or highway corridor can be generated by considering more complex accumulated cost surfaces based on engineering and/or social constraints.

The process of establishing visual connectivity can also be regarded as an extension of distance measurement. Here however, distance is measured only over

ORIGINAL PAGE IS
OF POOR QUALITY

straight lines or rays emanating from a target area. The intervening topographic relief and land cover serve as visual barriers between locations. Insert (b) of Figure 5 shows a map of the "viewshed" of the ranch.

NEIGHBORHOOD CHARACTERIZATION

The final class of analytical operations involves the creation of new maps in which the value assigned to each location is a function of the values of its surrounding locations or neighborhood. Among the simplest operations in this group are those which involve the calculation of summary statistics characterizing neighborhoods. Depending on the type of map being analyzed, these statistics might include the maximum land value, the average number of houses per hectare, or the proportion of softwoods. Insert (a) of Figure 6 shows a map that characterizes cover type diversity. Other neighborhood summary operations can be used for spatial interpolation, map smoothing, assessing narrowness, or parceling categories into contiguous groups.

A second group of neighborhood operations involves characterizing three-dimensional surfaces. Slope and aspect maps can be generated from a map of topographic elevation by a "least squares" fit of a plane to a neighborhood defined by adjoining elevation values. This technique is analogous to the fitting of a linear regression line to data points, except that a plane is fitted. The slope and orientation of the plane determines the values for maps of slope and aspect. Insert (b) of Figure 6 shows a map of aspect based on a map of elevation values. This technique is not limited to land form analysis. It might also be used to measure rates of change (i.e., slope) over non-topographic surfaces such as maps of travel time or accumulated cost. Consider, for example, the generation of a new slope map from an existing slope map (i.e., second derivative of an elevation map) to indicate topographic roughness.

CARTOGRAPHIC MODELING

As an example of some of the ways in which fundamental map processing operations might be combined to perform more complex analyses, consider the cartographic model outlined in Figure 7. Given maps of topographic elevation and land use categories, the model allocates a minimum-cost highway alignment between two predetermined termini. Relative cost is measured in terms of locational criteria rather than dollars. For this example, these criteria include only avoidance of steep slopes and minimization of visual exposure to residential areas. The model uses operations from each of the fundamental classes outlined above.

**ORIGINAL PAGE IS
OF POOR QUALITY**

Several natural resources related models have been developed at the Yale School of Forestry and Environmental Studies using this approach as embodied in Map Analysis Package software (Tomlin, in preparation). These include models for:

- assessing deer habitat quality as a function of weighted proximity to natural and anthropogenic factors;
- mapping outdoor recreation opportunity as determined by an area's remoteness, size, and physical and social attributes;
- predicting storm runoff from small watersheds by spatially evaluating the standard SCS model;
- assessing the spatial ramifications of the comprehensive plan of a small town; and,
- characterizing timberlands in terms of predicted felling breakage, effective timber supply, and optimal timing of harvesting.

CONCLUSION

A broad range of fundamental map analysis operations can be identified and grouped according to generalized characteristics. This organization establishes a framework for understanding of the analytic potential of computer-assisted map analysis. By logically ordering these fundamental operations, a cartographic modeling language can be developed which accommodates a variety of applications in a common, flexible and intuitive manner.

REFERENCES

1. Calkins, H. and Marble, D. F.: Computer Software for Spatial Data Handling. International Geographical Union, Ottawa, Ontario, 1980.
2. Berry, J. K. and Tomlin, C. D.: Cartographic Modeling in the Classroom-- A Fundamental Approach to Computer Assisted Map Analysis. Amer. Congress on Surveying and Mapping, 40th Symposium Proc., 227-241, 1980.
3. Tomlin, C. D.: Cartographic Modeling Techniques in Environmental Planning. Doctoral dissertation, Yale School of Forestry, New Haven, Connecticut, in preparation.
4. Tomlin, C. D. and Berry, J. K.: A Mathematical Structure for Cartographic Modeling in Environmental Analysis, Amer. Congress on Surveying and Mapping, 39th Symp. Proc., 269-283, 1979.

ORIGINAL PAGE IS
OF POOR QUALITY

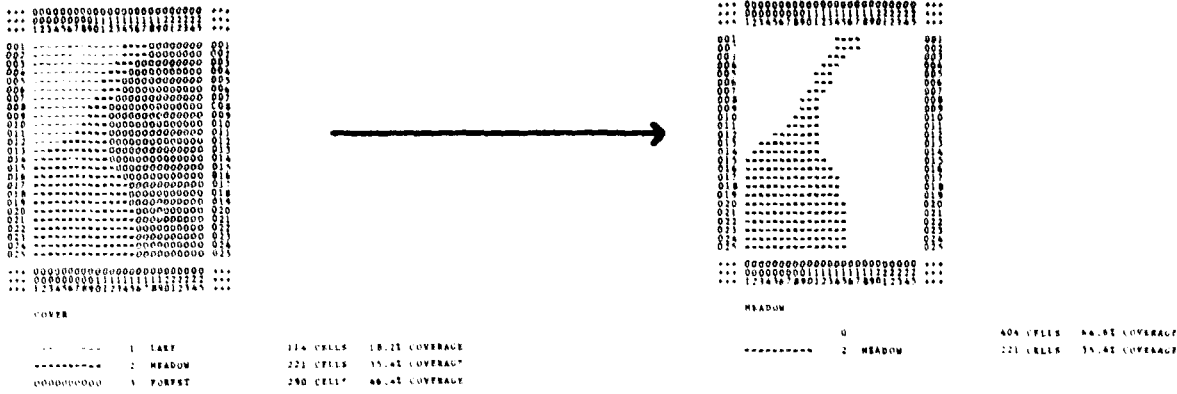

FIGURE 1. RECLASSIFYING MAPS. Reclassification can be based on initial thematic value as in this example. The cover types of LAKE and FOREST are renumbered to the value zero and displayed as blanks. The resulting map isolates the MEADOW area.

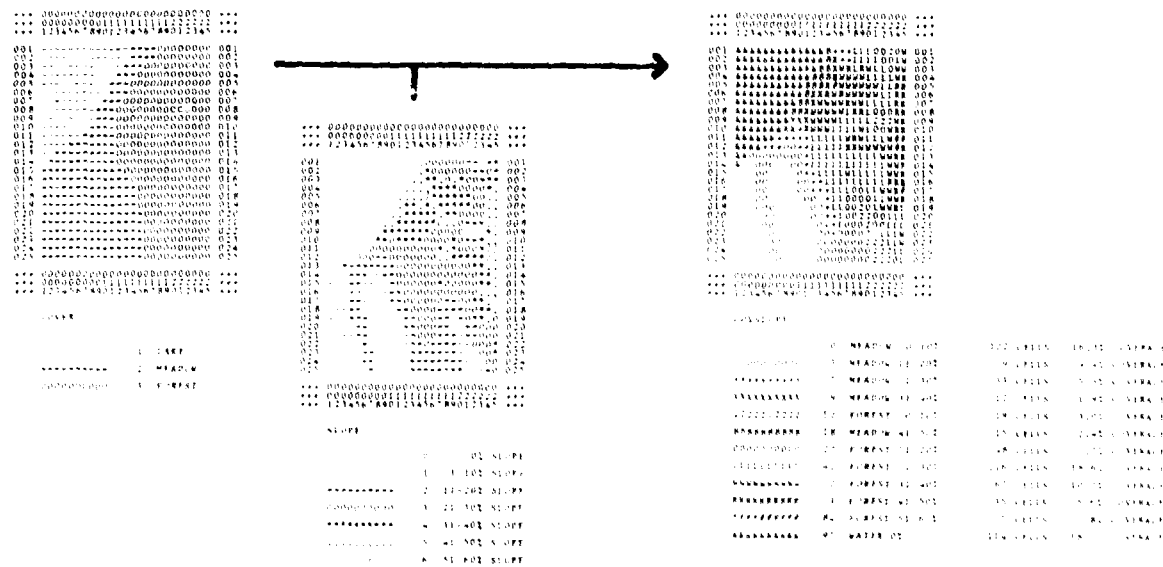

FIGURE 2. CELL-BY-CELL OVERLAY. Cell-by-cell overlays are location specific. In this example each map location is assigned a unique value identifying the cover type and slope combination.

ORIGINAL PAGE IS
OF POOR QUALITY

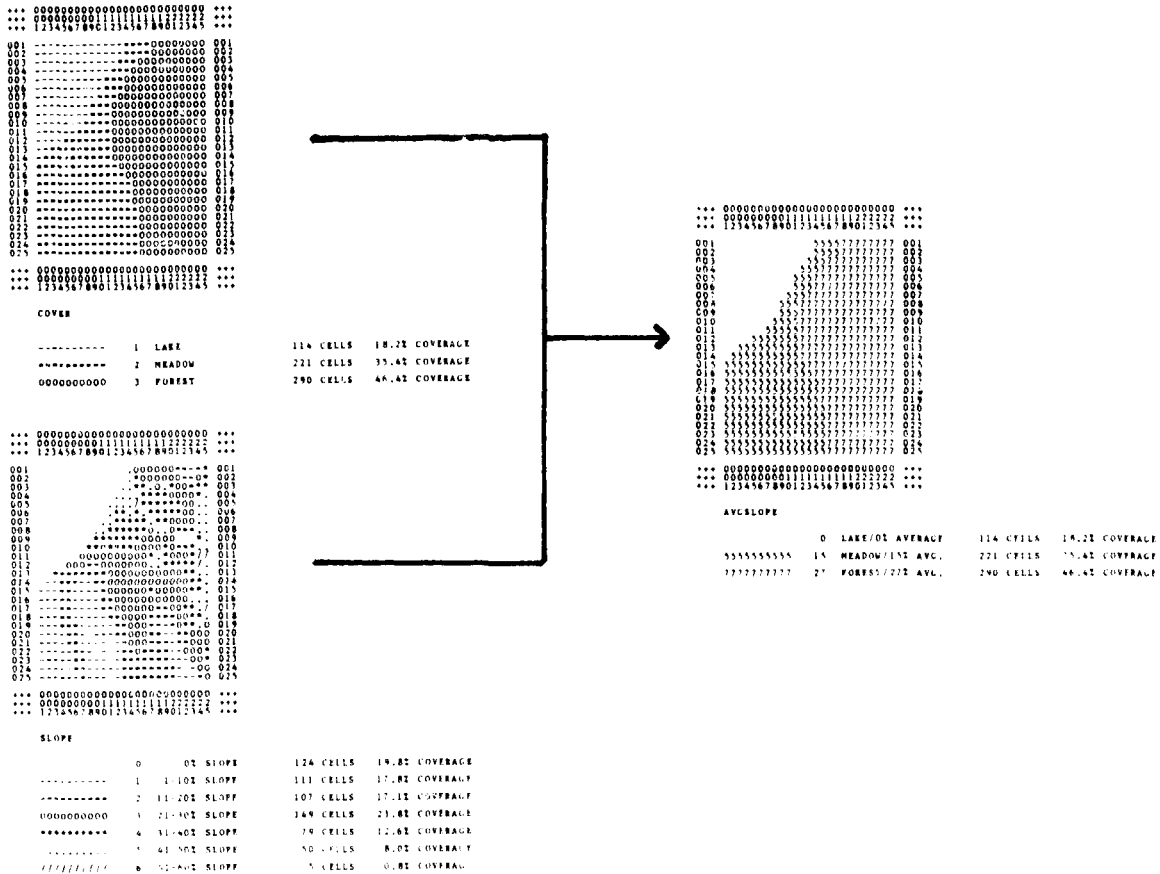

FIGURE 3. CATEGORY-WIDE OVERLAY. Category-wide overlays summarize the spatial coincidence of areal features. In this example each of the three cover types are assigned a value equal to their average slopes. In computing these averages the slope values occurring within each cover type boundary is averaged separately.

ORIGINAL PAGE IS
OF POOR QUALITY

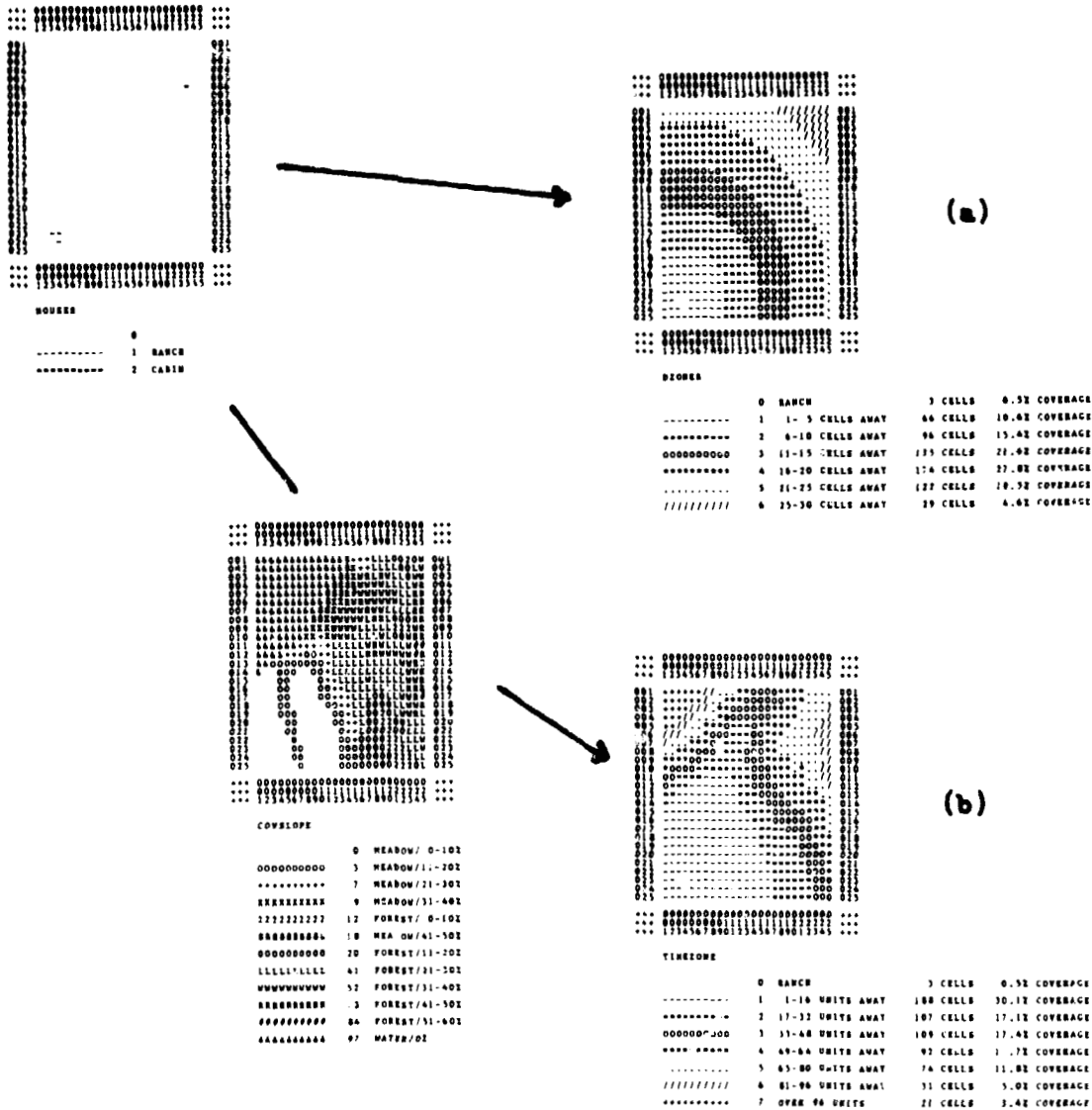

FIGURE 4. MEASURING DISTANCE. Distance between points can be determined as Euclidean length or as a function of absolute or relative barriers. In this example, insert (a) identifies equidistant zones around the ranch. Insert (b) is a time-weighted distance map identifying timezones of hiking from the ranch. It was generated by considering the relative ease of travel through each cover type.

ORIGINAL PAGE IS
OF POOR QUALITY

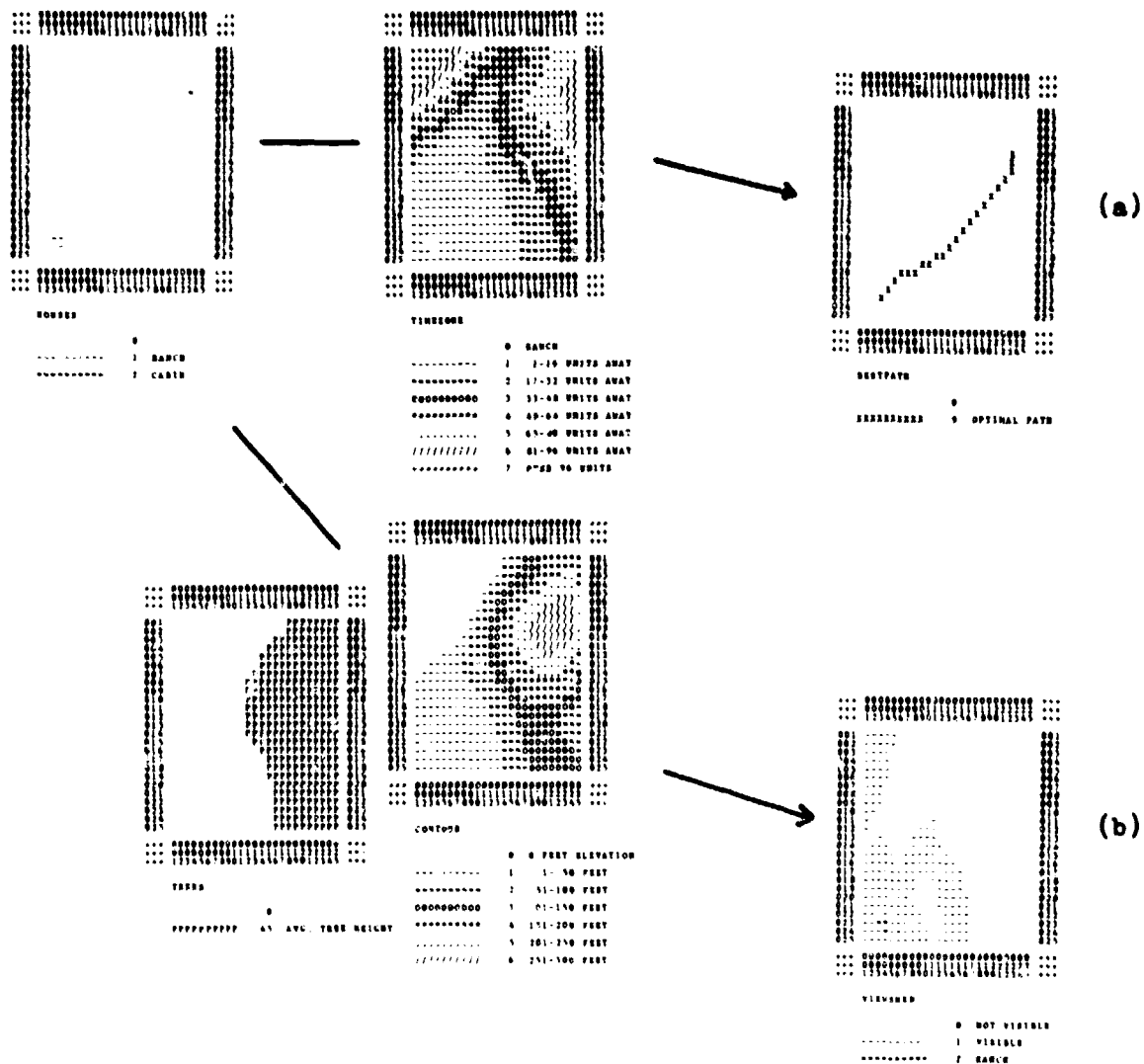

FIGURE 5. ESTABLISHING CONNECTIVITY. Connectivity operations characterize the nature of the spatial linkages between points. Insert (a) delineates the shortest (i.e. quickest) hiking route between the cabin and the ranch. The route traces the steepest downhill path along a cumulative hiking-time surface. Insert (b) identifies the viewshed of the ranch. Topographic relief and forest cover act as visual barriers when establishing connectivity.

ORIGINAL PAGE IS
OF POOR QUALITY

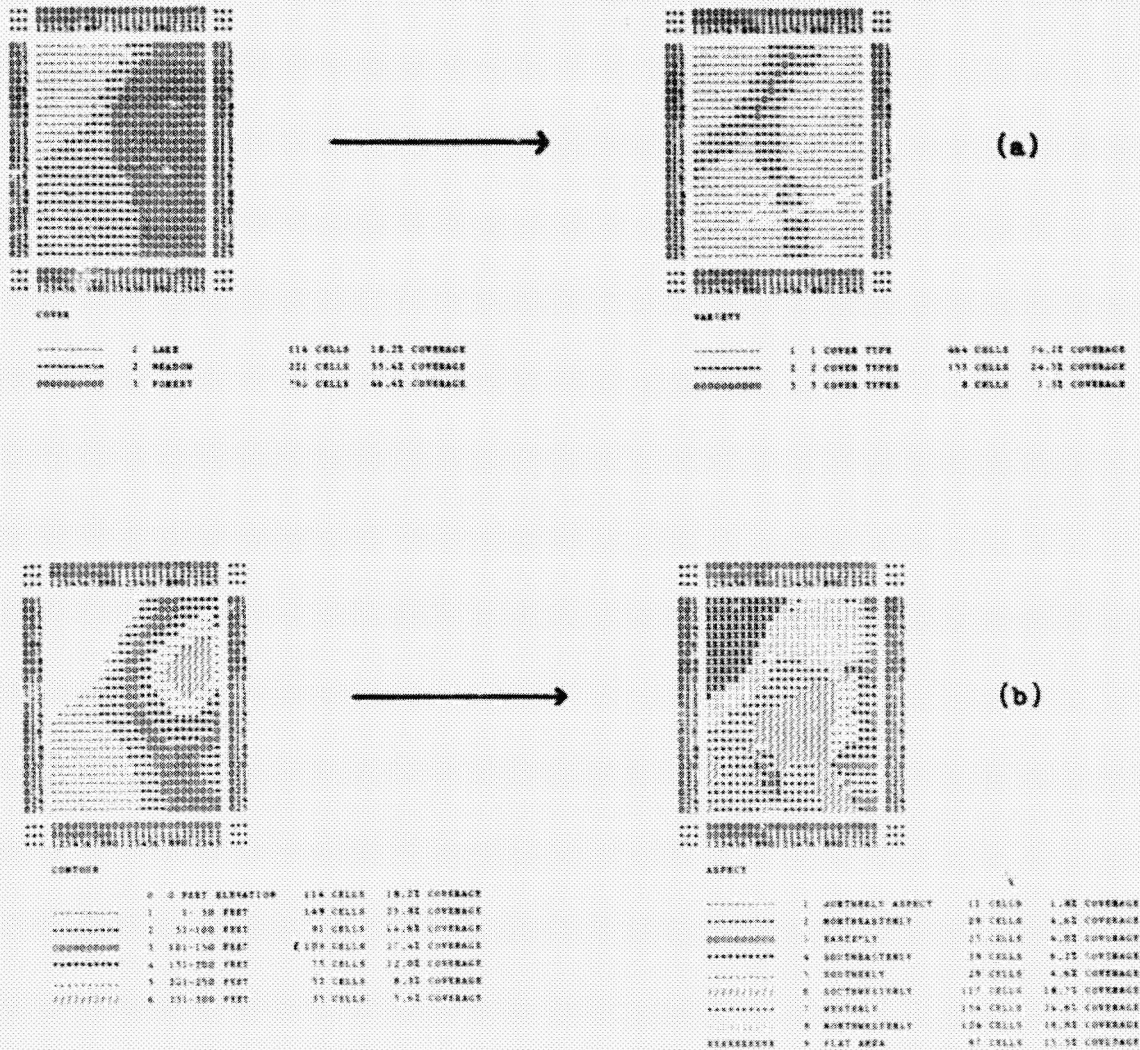

FIGURE 6. CHARACTERIZING CARTOGRAPHIC NEIGHBORHOODS. Neighborhood operations characterize map locations by summarizing the attributes of their surrounding locations. Insert (a) is a map of cover type diversity generated by computing the number of different cover types in the immediate vicinity of each map location. Insert (b) is a map of topographic aspect. It was generated by successively fitting a plane to neighborhoods of adjoining elevation values.

ORIGINAL PAGE IS
OF POOR QUALITY

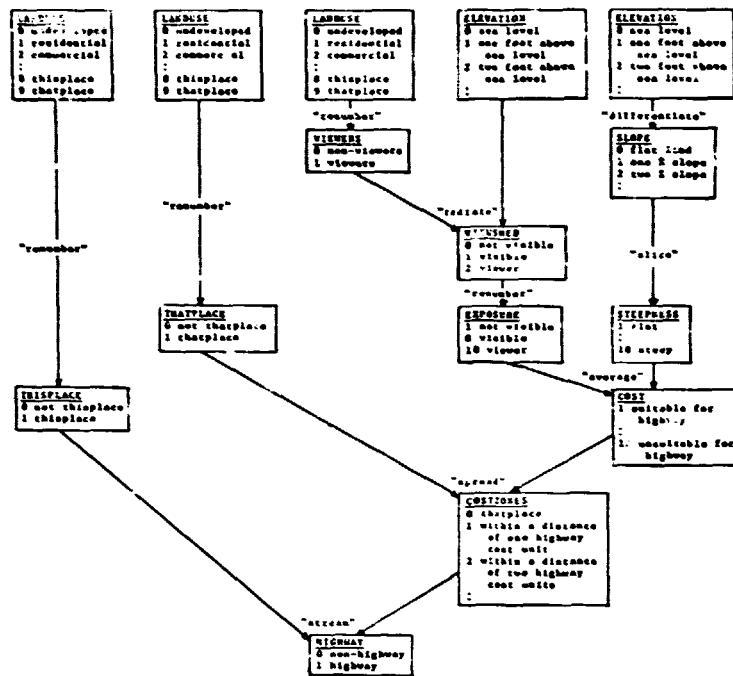

FIGURE 7. CARTOGRAPHIC MODELING. Cartographic modeling is analogous to conventional algebraic evaluation in which primitive mathematical operations are sequentially ordered to solve complex expressions. This example uses a series of map operations (indicated by arrows) to derive intermediate maps (indicated as boxes) leading to a final map that identifies the optimal corridor for a highway.

N83 19169

D27

THE INTEGRATION OF A LANDSAT ANALYSIS CAPABILITY
WITH A GEOGRAPHIC INFORMATION SYSTEM

Earl A. Nordstrand
Land Management Information Center
Minnesota State Planning Agency

ABSTRACT

Geographic information systems process data relative to location. An effective geographic information system must be able to integrate all types of locational information including Landsat. The two primary problems in handling Landsat data are data registration and selection of appropriate information. Minnesota has integrated Landsat data by developing a flexible, compatible analysis tool and using an existing data base to select the usable data from a Landsat analysis.

INTRODUCTION

Location, though not always recorded, is inherent to all types of information. In most cases, location affects or influences the form of information. Geographers use maps to understand information and its relationship to location. Map interpretation and correlation is a difficult task in normal circumstances, but a geographic information system simplifies the task. The Geographic Information System (GIS) is used to integrate all types of information that can be identified by location.

Location is not a simple concept, however, because of differing accuracy needs and the problem of dealing with spherical geometry. Survey and coordinate systems have been developed to identify locations of the Earth, but often these systems are too complex and man resorts to administrative units or descriptors that make exact location impossible. An effective geographic information system must have techniques or computer processes to handle all types of locational references. Additionally, a geographic information system must establish an accessible data base, innovatively use available equipment and most importantly, provide the link between technical capabilities and user needs; "to tell people what will work."

Remote sensing is a valuable tool to learn about geographic information. Remote sensing products are a form of map information, although more detailed and including more information than a typical thematic map. Landsat, although not a traditional remote sensing methodology, is a digital form of information that can be easily integrated with a geographic information system. The Landsat resolution and spectral sensitivity are scheduled to improve with Landsat D. Geographic information systems can integrate Landsat data to improve the data base at a reasonable cost and the technology exists to use the data now.

Minnesota has developed an integrated approach to geographic data including Landsat and is finding that planners and decision makers welcome this information because it can be quantified and presented in an interpretable form. Minnesota's

approach to location, data base, system capabilities and integration of Landsat data into a geographic information system may be useful to others as expanded use of geographic information system capabilities develops.

LOCATION

The location of an item of information can most easily be described by its distance in two directions from a known point. The distance can be measured in any unit and is usually referred to as x and y. In a raster or grid system the distance can be measured in rows and columns. In a polygonal data base, information can be about a point, line or polygon which is described by one or more pairs of x,y coordinates. Grid data cannot normally be as accurate as polygon data, thus the polygon is often preferred. An effective geographic information system has to be able to handle any of these location descriptions and be able to use data in any of these forms.

Although these location descriptors are the building blocks of a geographic information system, many complications arise because of alternative coordinate schemes, distortion in maps and aerial photos and the variety of map projections that data can be displayed on or captured from. Reasonably accurate results require that all data be converted to a common coordinate system. In addition, GIS should have routines to compensate for distortions or compute alternative projections. Minnesota has decided to use the Universal Transverse Mercator projection coordinates as the common element between all data sets. In addition, programs to do bilinear and affine transformations are used as well as programs to calculate state plane, universal transverse mercator or Lambert polyconic conformal coordinates from latitude-longitude coordinates.

Even if a system is able to handle all kinds of coordinate systems, a large volume of information may be missed. This information is referenced by an administrative unit which has geographic extent. Most economic, demographic or social information is collected in this way as is information such as ownership. An important part of building a geographic information system with wide applicability is to include polygonal or grid cell references for these administrative units. Minnesota has included Public Land Survey units to the quarter section, Census units to block detail, school districts, and watersheds through which other data can be integrated into the data base.

Landsat has its own georeferencing system based upon the orbit of the satellite and the resolution of the sensors. In order to make Landsat data compatible with other data, it is resampled into UTM coordinates using either nearest neighbor or cubic convolution and an affine transformation. Once this resampling is accomplished, Landsat looks much like other map data and the reflectance can then be compared to other data in the system.

DATA BASE

Landsat data alone are of minimal value to many types of environmental analyses or the applications of a GIS. Landsat at best is land cover information

of limited resolution that needs an analyst's interpretation. The availability of recurrent coverage and the fact that Landsat is collecting data even if the data have not been requested gives it utility when a land cover phenomena needs evaluation. If other information already exists in a geographic information system, it can be very important to the acceptance of Landsat data as part of a geographic information system application.

A variety of data is necessary to enable a GIS to address environmental problems. Minnesota originally collected the best available statewide data, computerized it in a public land survey grid and made it available for use. The data included soils associations, land use/cover, forest type, water features, roads, public ownership and Census Minor Civil Divisions. These data are used in many regional and statewide environmental analyses. It is not extremely accurate or detailed but does provide the overview capabilities. As Minnesota has matured in its use of a GIS, many new and more detailed sources of information have become available and are being integrated into the data base.

Data uncovered over the past two to four years includes some in digital form, some on published maps and some as scribe lines or photo interpretation lines on air photos. These include:

- 1) Detailed water information found in the Environmental Protection Agency river mile files. These data include all rivers, streams and lakes as digitized lines.
- 2) The digital elevation model data from the National Cartographic Information Center have provided elevation, slope and aspect information.
- 3) The National Wetlands Inventory, although not funded through completion, is defining wetlands on air photo overlays down to 1/2 acre in size. Minnesota is developing a process to digitize these data as they become available.
- 4) Forest plots will be digitized by the Minnesota Department of Natural Resources as part of a timber management system.
- 5) An evaluation of technologies for capturing detailed soils surveys will develop a methodology to digitize the soils maps.
- 6) Landsat processing capability has been added to incorporate these digital files into the data base.

Using advanced geographic information system techniques, these data can be stored in its most detailed form and used at resolutions appropriate for the analyses. The complication is that Landsat needs more interpretation to become a usable product and requires flexible software so that the data can be used selectively. Minnesota has developed a software capability that is flexible and efficient for handling Landsat data in conjunction with other information in the system.

SYSTEM CAPABILITIES

The Landsat analysis capability in Minnesota has been integrated with all other GIS capabilities by insuring file compatibility and developing flexible analysis routines. Minnesota has traditionally processed grid cell data with a software package called the Environmental Planning and Programming Language (EPPL). This software has a very sophisticated set of commands to allow manipulation of grid cell data plus the flexibility to allow the user to include FORTRAN statements for special functions. Using this combination of capabilities the user can classify a Landsat image and then selectively merge the results with other data that may exist for the area under study.

In addition to use of the general purpose software, Landsat processing requires interpretation by the analyst. This interpretation is best accomplished by providing interactive tools such as image processing equipment to aid in the process. By allowing the analyst to examine a full color image of the area being analyzed, the analyst can use judgement in acceptance of a classified result.

A final necessity to the acceptance of Landsat and GIS data by decision makers is the ability to produce meaningful output. A variety of plotting capabilities are necessary to allow flexibility in map composition. Minnesota has developed software that allows shading or boundary plotting with specially designed symbols. This software also allows up to three overlays and text to be added to plots. A typical plot may have several gray shades for different land cover classes with township section lines overlaid (Figure 1). This creates a map that has orientation references. This software also drives a color plotter for cases where color will aid the interpretation.

Flexible capabilities and integrated facilities allow the analyst to be creative and develop the most from his data. Landsat data can be filtered through other information and composited to create a usable land use/land cover map. An approach used in Minnesota to the compositing of this information will be discussed next.

LANDSAT INTEGRATION

Landsat includes a tremendous amount of information about the landscape. Depending upon weather conditions, it is relatively easy to obtain information by season for every year since the first Landsat was launched. If all of the Landsat data were acquired for one location, the sheer volume of the information would overwhelm most environmental planners. Using a GIS capability the analyst can select the information meaningful to the specific environmental issue.

The initial problems with Landsat data are to resolve the location questions and to reduce the volume of data that needs to be handled. The location problems are usually handled by the aforementioned resampling techniques which transform the Landsat data into a known map projection grid. After this resampling is accomplished, the Landsat image can be directly compared to other data

in the information system. Additionally, the volume of data needs to be reduced and this is usually accomplished by an unsupervised classification.

An effective unsupervised classification requires a good technique to develop the training sets or areas which are identified as features that are representative of land cover types. The technique used in Minnesota searches for areas of homogeneity of at least five pixels in size. These areas then become foci for the classifier to find other similar areas. The result of the process identifies from 30 to 50 individual cover types from the original 63 possible types.

The next step is to compare these 30 to 50 categories to known information in the data base. Within the Minnesota Land Management Information System, information such as soil types, land use, forest cover type or elevation could be used to refine the classification. This is done by accepting the Landsat classification only if it occurs within certain categories of these other variables. Because of the difference between the 40-acre resolution of the MLMIS data and the .625 or 2.5 acre resolution of resampled Landsat data, the Landsat classification can be used as an improvement of the resolution of the original data base.

In addition to the above technique for refining land cover information, Landsat can also be used to monitor land cover change that is either seasonal or occurs over several years. Abrupt changes in cover of two to five acres in size or larger are relatively easy to identify with Landsat and should become a very important part of the monitoring of change in our environment.

CONCLUSION

Landsat data should become a part of a GIS but cannot be the backbone. When Landsat data are integrated with other information, it can provide valuable information to the analyst or decision maker put in a usable form. GIS technology will allow Landsat data to be used effectively. If Landsat resolution and spectral sensitivity are improved, the users of GIS technology will surely increase their dependence on Landsat data.

AITKIN COUNTY SITE 1988
LAND COVER TYPES

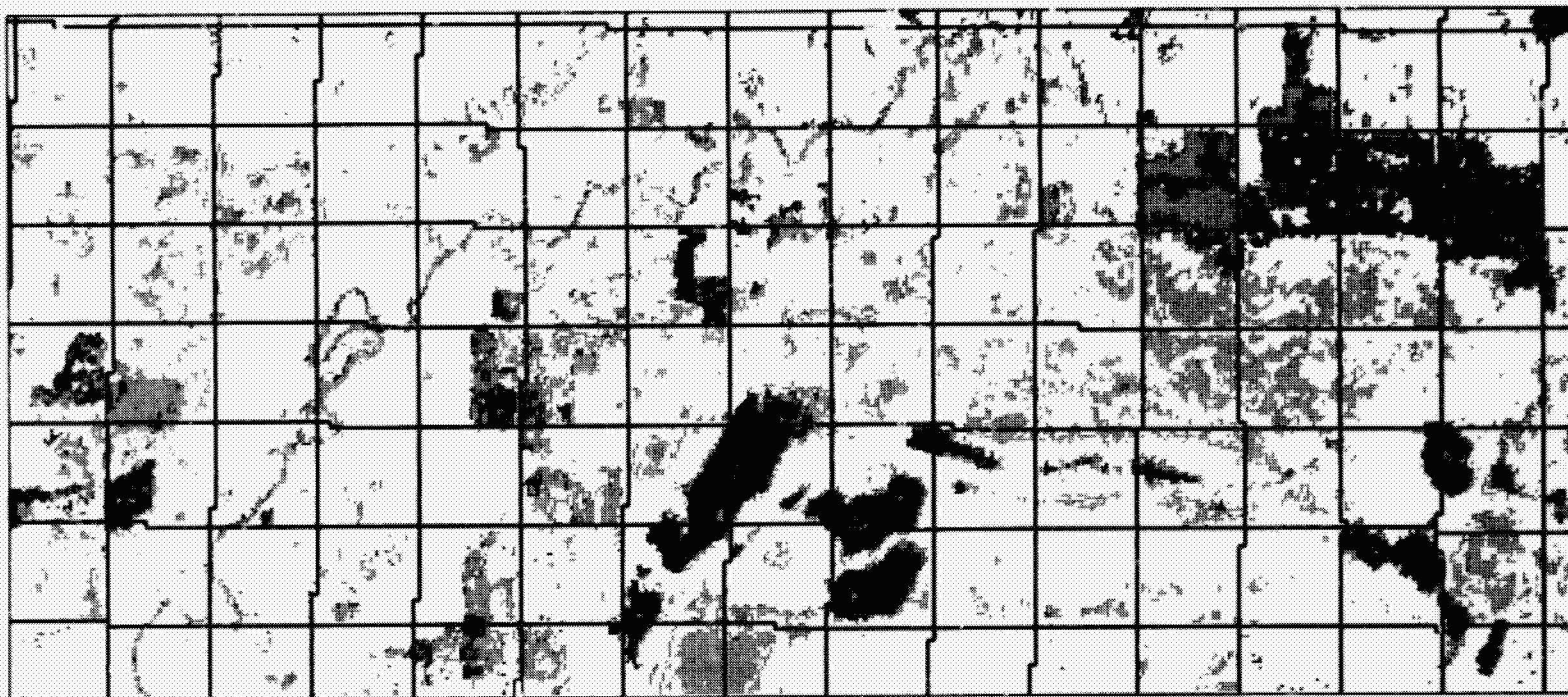

ORIGINAL PAGE IS
OF POOR QUALITY

	SYMBOL	COUNT	PERCENT	ACRES	LEGEND
■	1	3119	2.8	124780.0	WATER
■	2	15994	14.7	629780.0	WET RICE PADDIES
■	3	5481	5.0	218440.0	BARE GROUND, CULTIVATED
	4	84800	77.5	3364000.0	OTHER

Figure 1

APPLICATION OF GEOGRAPHIC INFORMATION SYSTEMS TO LANDSCAPE ARCHITECTURE

Charles L. Killpack
Utah State University

ABSTRACT

This paper describes the dilemma of the application of Geographic Information Systems to landscape architecture. The paper covers the evolution of Geographic Information Systems (GIS) and how the emphasis on either data capture or spatial analysis has caused problems in their ultimate use in regional landscape assessment. The future looks good for new applications once systems can handle complex modeling and the routine day-to-day activities of landscape architectural and planning firms.

INTRODUCTION

The history and use of GIS in landscape architecture reflects upon the actual evolution of GIS. This evolution produced a dilemma for landscape architects and planners that to some extent exists even today. This dilemma is especially troublesome for landscape architects practicing regional landscape assessment. To understand this dilemma, one must review the evolution of GIS.

The purpose of this paper is to briefly discuss the development of GIS and the influences of landscape architecture on this development and the influences of the systems on landscape architecture. The evolution of the systems can be categorized into two main areas of development: Those professionals interested in (1) capturing, storing, mapping and displaying spatial data; and (2) manipulating, analyzing, modeling and simulating with spatial data. The one group included, among many others, cartographers, geographers, engineers, architects; and the second group included planners, geographers, foresters, ecologists, and, of course, landscape architects. The groups are divided into the two extremes of an artificial continuum (at the real risk of distorting the inferences drawn). The far left side is residence to those interested in representing the original data as accurately as possible, while the far right is occupied by those most interested in duplicating the traditional methods of data combination used by planners (see Figure 1). This first group spent their time trying to develop systems to capture and represent spatial phenomena as accurately as a cartographer or draftsman, while the second group was more interested in generalizing or abstracting the data in order to visualize relationships between various data sets or, probably more importantly, mimic existing spatial data combination procedures.

This initial period was one of typical research and development where many different ideas and techniques were tried. Particularly in landscape architecture there was GRID and IMGRID, METLAND and PERMITS being developed by Harvard, University of Massachusetts, and University of Wisconsin, respectively

(ref. 1, 2, 3, 4). These systems were being tested and used by groups such as the Corps of Engineers, Forest Service, and Bonneville Power Administration. Figure 2 reflects the two research/development groups with each having a unique interest, either automated mapping or modeling. The interface with the computer and its awkward peripheral equipment was elementary and focused on making the equipment replicate existing procedures. Although there were some important attempts in landscape architecture to utilize the computer's graphic and especially its number-crunching ability through statistical data analysis, most uses were simple combinations of nominal and ordinal data. A few projects were unique, and they included the clustering procedure used by Wisconsin (ref. 5, 6, 7), the impact evaluation based upon hierarchical non-linear combination of data (ref. 8), weighted composites (ref. 9, 10), and visual analysis of large areas (ref. 11). There is also a larger diverse group outside landscape architecture dealing with gaming, simulation, and probabilistic and stochastic modeling (ref. 12, 13, 14). Also, cartographers and geographers were involved in map production and research into the theoretical aspects of representing a three-dimensional phenomenon with a spatial data structure (ref. 15, 16).

The landscape architectural users during this period were a small diverse group scattered throughout areas of interest, and most had little to lose by trying the results of a research product, especially when it was subsidized. User groups include states like New York and Minnesota; power companies like BPA and TVA; towns like North Logan; regions such as Indiana Heartland; and agencies such as the Corps of Engineers and the Forest Service. Also, this period saw large grants appear focused around the implementation of these systems to practical problems. In the area of modeling, the Ford Foundation's Regional Environmental Management programs and NSF's RANN programs greatly contributed to the research and development (ref. 17). In the area of mapping and automated cartography, groups such as USGS, Canadian Geographic Information System, and research activities at the Harvard Lab for Computer Graphics and Spatial Analysis led the way in application and research (ref. 18).

THE DILEMMA

This development is what caused the dilemma in landscape architecture. The problem seemed to be one of using a GIS, or perhaps more accurately stated as a Land Information System. The available system had two major characteristics: the ability to capture and map data accurately or manipulate and model with the data. These frustrations were found by the landscape architect during the storage and analysis phase of the modeling activities; for example, the overlaying of original data (polygon) took incredible amounts of computer time (ref. 19). A major problem rested in the input procedures. The abstracted grid cell techniques were labor intensive and costly to update and edit, while the polygon files were in most cases double digitized; many hours were spent correcting and editing "slivers" (ref. 20). Because of these problems many applications suffered losses. For example, the LUNR project in New York did not have the equipment or administrative procedures to handle the data at the scale appropriate to the types of issues being faced by the local planning groups. On the other hand, the Canadian Geographic Information System (CGIS) tried to utilize the most sophisticated equipment for data capture but was unable to produce usable output. (Recent upgrades of the CGIS have made it an operational system.)

There were probably even more examples of computer data bases collected at the wrong scale and resolution mostly in a grid cell format that couldn't provide the user enough "detailed" data for decision making. An important concept that was overlooked by many user groups, especially landscape architects, is that of making land information systems routine. Many frustrations and disappointments would have been less important if the user and the developer would have realized that many single purpose or limited systems could not respond to the routine or everyday activities of the users' organizations. One good example is the application of a land information system to predict loss of agricultural land in the Indianapolis area.

AN EXAMPLE CASE STUDY

This project was completed at the Holcomb Research Institute in cooperation with the Indiana Heartland Coordinating Commission, the Regional Planning Agency for Indianapolis/Marian County and the seven adjacent counties. The project had four steps which included defining prime farmland, determining existing farmland, projecting a new pattern of land use, analyzing the loss of prime farmland, and evaluating the impact of projecting prime farmland. The project described here used Landsat to produce an accurate, up-to-date inventory of farmland which was combined with other computer data files that had been collected by the Indiana Heartland Coordinating Commission (IHCC) for their 208 Water Quality project. The data were collected on a 500 x 500 meter grid (approximately 62 acres). The data base included political boundaries, water, institutions, housing, transportation, recreation, railroads, soils, commerce, rivers and agriculture. This information was then augmented by Landsat data which was transferred to the 62-acre cells in order to match the existing data base.

The prime soils had to be identified through the use of the criteria developed by the USDA. In general, this includes well drained, flat, no rocks, moderate Ph, and good nutrient content. In Indiana where much of the soil is prime, it required the computer to sort through the 66 soil associations and determine its prime "ranking." Figure 3 shows the general soil associations grouped into four shades which illustrate that the lower left-hand corner is where the landscape escaped the effects of the last glacier, and the soils are more diverse, rocky, and in general, less suitable for farming. In Figure 4 the dark areas show the cells that contain over 50 percent prime soil.

Landsat data were used to delineate current farmland. The reasons Landsat was chosen over other conventional sources include:

- available for the dates required
- already in a computer-compatible form
- cheaper than paying air photo interpretation (about \$200 to be processed)
- uniform coverage for 2 million acres
- had infrared capabilities to aid in distinguishing crop type

- appropriate for regional scale work
- the software and hardware required were available

The Landsat data were then classified using ground truth and conventional air photos. Figure 5 shows the current prime farmland. This map is produced by combining the prime soils map with a map that contains bare and fallow soil, corn fields, pasture, and soybeans. The resultant dark areas are those that are both prime soils and current farmland. This map is then used to determine the amount of prime farmland available. The prime farmland map was overlaid with the results of a land use allocation model that allocated the appropriate number of cells of new land uses. The model analyzed the relationship between existing land use and land available for development. The model analyzes the existing spatial pattern and projects that pattern and its characteristics into the future. Figure 6 shows the dark areas as being the new land uses projected and the gray areas being the existing land use patterns. The map of projected land uses (Figure 6) was then overlaid with the prime farmland map (Figure 4) to produce Figure 7. Figure 7 illustrates the estimated loss of prime farmland by the projected land use patterns. The dark areas are those areas that were prime farmland and will be removed by the projected development. The gray area is the existing land use pattern.

The next step was to use the current prime farmland map (Figure 4) as a constraint on the land use allocation model. This meant that the model could not allocate on prime farmland; therefore, it had to find the next-best cells. The resultant map (Figure 8) shows the projected pattern resulting from preserving prime farmland. The pattern is much the same as Figure 6 except there are many changes that meant certain communities would suffer a loss in development, while other communities with similar prime areas for development, but less prime farmland, would gain in land use development.

This study was very useful to the agency, but it is difficult to incorporate the data and software as an important part of their routine work. The frustration is a result of these systems not being able to perform day-to-day tasks with the type of data and resolution required.

THE FUTURE

The future of GIS for landscape architecture and planning is directly related to operational GIS that can respond to both single-purpose studies and the day-to-day routine tasks. Today we see a swell of activity in private companies developing operational GIS. This is a direct result of the demanding systems that can handle detailed data input for most types of data and provide special modeling capabilities for special purpose studies. This demand has spurred the development of a GIS that can respond to three major user groups: inexpensive, expensive, and very expensive (see Figure 9). Since most new development of GIS technology is going to occur in the private sector, they will focus on the user groups in two ways. The first, which is an option open only to the larger companies, is by providing a small micro-system, a mid-size system, and a full-blown system. The second approach will be for smaller companies to focus on one of the markets. For example, ERDAS (ref. 21) is producing small systems to

handle relatively small data bases with abstracted data capturing techniques all for 30 to 50 thousand dollars. The ERDAS company is a small company focusing on the inexpensive market. Also, larger companies such as the APPLE system are now producing spatial analysis software.

Another approach by medium-sized companies is to produce a scaled-down version of their larger system, such as COMARC (ref. 22). The final approach would be one similar to Intergraph (ref. 23), where they pursue larger users who can afford the total system.

The inherent problem is the important concept of routine. There will be no problem in systems for paper companies, oil companies, federal agencies, and large cities due to the capital and manpower inherent in these groups. They will be able to purchase the large GIS for one-half million dollars plus. But where does that leave the other two groups? The medium group is still in pretty good shape. This group would include medium-sized cities, regional agencies and landscape architectural consulting companies that handle project-by-project jobs. These groups can use the systems almost routinely given that the data are input by polygon and analyzed in conjunction with the other types of data. Finally, where does this leave the small user? My guess is that for the near future they are stuck without enough money to get what they need. For example, if a vendor can reduce the cost of the system to 30 to 40 thousand dollars, something must be sacrificed. In most cases, it's the data input; that means going from a polygon file to a raster or grid. This causes a major conflict, again using the idea of "routine." The small user will probably be a community or a consultant working with small communities or small-scale projects. The major use of a system for a small town is the parcel or ownership boundaries. But most small systems lack the resolution to handle the polygon file. While some systems handle the polygon file, the attribute system is too limited to make it operate on a routine basis. The future will see this problem become less severe as technology develops new disc access systems and more processing power becomes cheaper.

The use of GIS for landscape architecture relates to the cost of developing systems that can handle both small-scale routine projects and larger, single-purpose studies. One major factor in the use of GIS technology is the potential availability of raw data in a computer-compatible form. Let's say that a consultant gets a contract to assess the impacts of the MX missile system on a large area in Nevada and Utah. The first step is to get the DMA topographic tapes, which through simple mathematical transformation give the consultant aspect, slope, drainage patterns, and elevation. The next step is to get the GBF/Dime Files, which provide all the social economic parameters required. The third step is to obtain a classified Landsat scene which provides the land cover data, and finally, the consultant can obtain from the SCS the digitized soil data for the region. And if they are lucky, they will find a property boundary file from the state or local tax organizations. A final problem in the complete utilization of GIS for landscape architects is related to the inherent utility of computer systems. The research in the application of computer mapping and spatial analysis is tied directly to the ability of the user to understand the inherent utility of the computer system. Perhaps a similar situation occurred around the 1900's with the tractor and farming. "The escape of the tractor from its identity with the horse occurred when its design and use were related to the inherent utility it offered and not to replacement or substitution . . ." (ref. 24).

ORIGINAL PAGE IS
OF POOR QUALITY

REFERENCES

1. Sinton, David and Carl Steinitz: GRID, Laboratory for Computer Graphics and Spatial Analysis, Harvard University, Cambridge, MA.
2. Sinton, David F. 1976. "I.M.G.R.I.D., An Information Manipulation System for Grid Cell Data Structures." Harvard University, Cambridge, MA.
3. Fabos, et al. 1973. "Model for Landscape Resource Assessment, Part I of the Metropolitan Landscape Planning Model (Metland)." Department of Landscape Architecture and Regional Planning, University of Massachusetts, Amherst, MA.
4. Niemann, B. J. 1972. PERMITS, Landscape Limited/Bonneville Power Administration, Portland, OR.
5. Niemann, B. J. 1975. Rural Landscape Assessment: A Comparative Evaluation to High Platform Remote Sensors. Madison, WI: University of Wisconsin.
6. McCarthy, M. M. Complexity and Valued Landscapes. Paper presented at "Our National Landscape," Incline Village, NV, 1979.
7. Killpack, C., and R. Hyde. 1978. "Applying Landsat Data in a Geographic Information System to Delineate Prime Farmlands and Evaluate their Loss to Urban Expansion." Published in papers from the Fourteenth Annual Conference of the Urban and Regional Information Systems Association, August 29-September 2, Atlanta, GA. Chicago: URISA.
8. Steinitz, Carl, Brown, H. J., and Goodale, P. et al. 1978. Managing Suburban Growth: A Modeling Approach. Grant ENV-72-03372-A06. Research Applied to National Needs (RANN) Program, National Science Foundation, Washington, D.C., Cambridge, MA: Harvard University, Landscape Architecture, Research Office, Graduate School of Design.
9. Joyner, S. A., et al. 1979. "Computer Mapping for Landscape Planning," Paper read at the Harvard Computer Graphics Week, July 1979, Cambridge, MA.
10. Murry, B. H., and B. J. Niemann. 1975. "A Landscape Assessment-Optimization Procedure for Electric-Energy Corridor Selection." In Landscape Assessment, eds. E. Zube, R. Bush, and J. Fabos. Scroudsburg, Penn: Dowden, Hutchinson, and Ross, Inc.
11. Paulson, M. S. 1979. "The Visual Information System." Proceeding for the National Conference on Applied Techniques for Analysis and Management of the Visual Resource, Incline Village, Nevada.
12. Brown, J. H., et al. 1972. Empirical Models of Urban Land Use: Suggestions on Research Objectives and Organizations. Washington, D.C.: National Bureau of Economic Research.

13. Duke, R. D. 1964. Gaming/Simulation in Urban Research. East Lansing, Michigan: Institute of Community Development and Services, Michigan State University.
14. Dueker, K. J. 1979. "Land Resource Information Systems: A Review of Fifteen Years Experience." Geo-processing, 1: 105-128.
15. Peucker, T. and N. Chrisman. 1975. Cartographic Data Structures. The American Cartography, 1.
16. Tomlinson, R. F. 1972. Geographical Data Handling. Vol. 1. Symposium Edition. A publication of the International Geographical Union Commission on geographical data sensing and processing for the UNESCO/IGU Second Symposium on geographic information system, Ottawa, August.
17. National Science Foundation/ENV. Regional Environmental Systems, Assessment of RANN Projects. NSF/ENV 76-04273. Washington, D.C.: University of Washington, Department of Civil Engineering.
18. Teicholz, E. D. 1977. "Computer Applications in Planning, Design and Construction." Harvard Graduate School of Design, Publication Series in Architecture, Harvard University, Cambridge, MA.
19. Comprehensive Planning Organization of the San Diego Region, 1974. PIOS-II, General Systems Description, San Diego, CA.
20. Dangermond, J. 1976. Integrated Terrain Unit Mapping (ITUM) - an Approach for Automation of Polygon Natural Resource Information. Redlands, CA: Environmental Systems Research Institute.
21. ERDAS, 999 McMillan St. N.W., Atlanta, GA.
22. COMARC Design Systems, San Francisco, CA.
23. InterGraph (M & S Computing), Huntsville, AL
24. Zube, E. H., and M. J. Zube, eds. 1977. Changing Rural Landscapes. Amherst: University of Massachusetts Press. (Includes paper by Jackson p. 34.)

**ORIGINAL PAGE IS
OF POOR QUALITY**

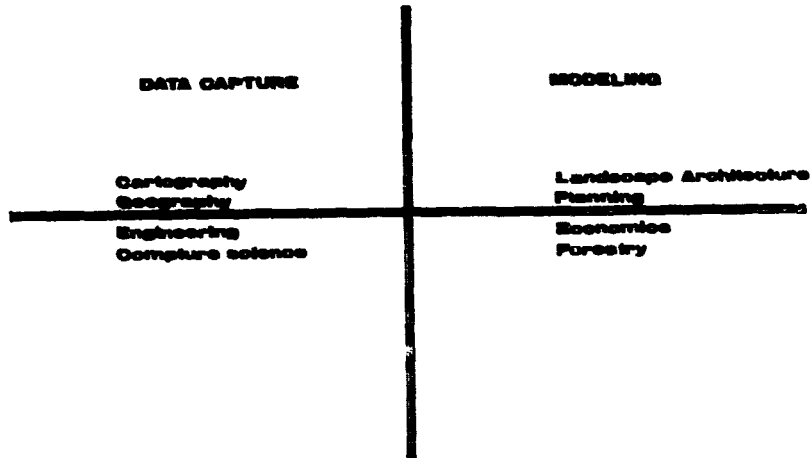

Figure 1. The distinction between the development groups was one of data capture and modeling. Because of the discipline's background, each had its own need for an initial Geographic Information System.

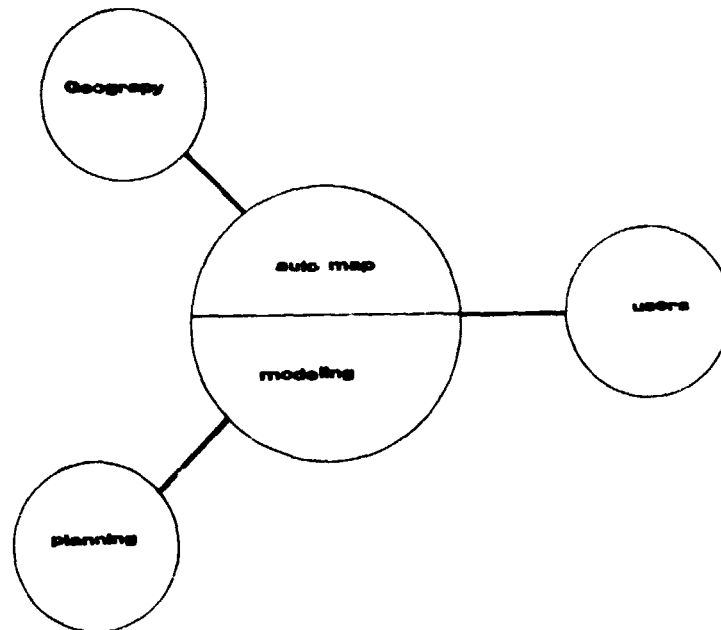

Figure 2. The two major groups involved in the development of information systems had two separate objectives; one group was striving for perfect map production and data capture, while the other was more interested in large visual relationship between spatial data.

ORIGINAL PAGE IS
OF POOR QUALITY



Figure 3. Generalized soil association map for the study region; 66 soil associations are represented by four shades of gray for graphic purposes.

ORIGINAL PAGE IS
OF POOR QUALITY



1982-1983
■

Figure 4. Prime soils map as identified by USDA Soil Conservation Service criteria. Of the 56 soil associations measured for this region, 24 are considered prime farmland soils.

ORIGINAL PAGE IS
OF POOR QUALITY



Figure 5. Current prime farmland distribution. By removing land cover other than agricultural (by Landsat data) with an overlay subtraction routine, the current prime farmland areas were delineated.

ORIGINAL PAGE IS
OF POOR QUALITY

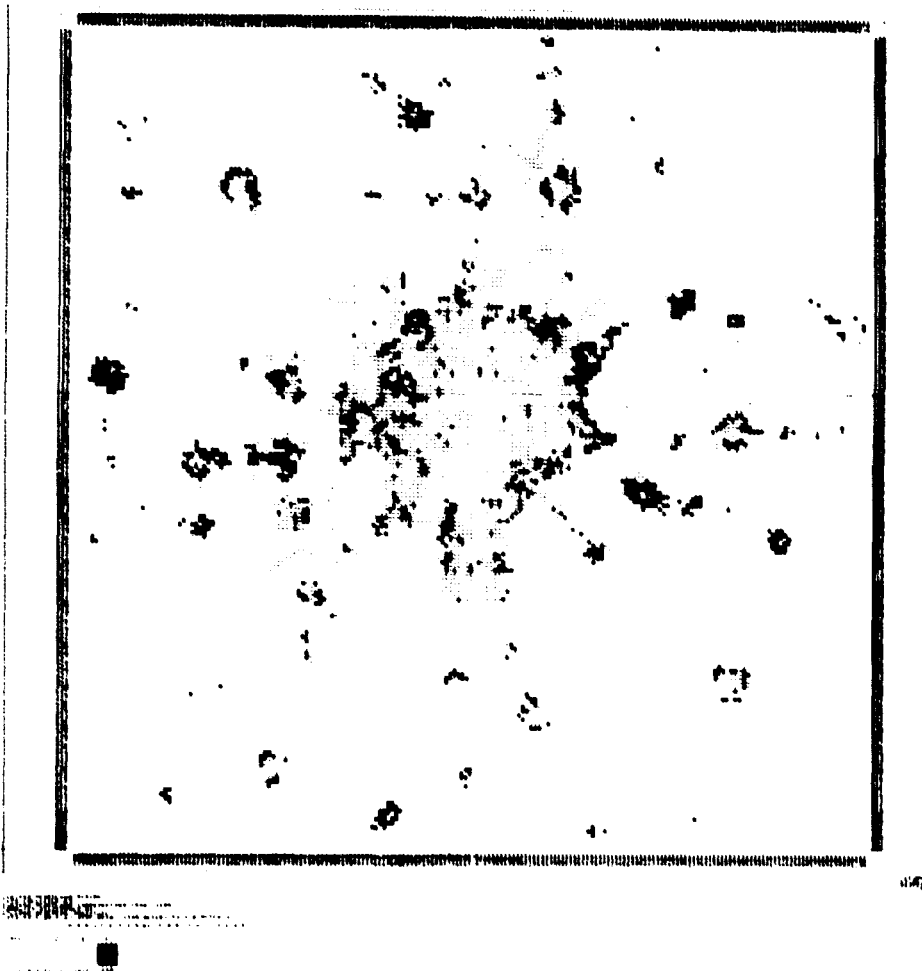

Figure 6. Projections of development for low-, medium- and high-density housing for the year 2000 (dar symbol). Current urban development is symbolized by a dash. No constraints are used and some prime farmlands become developed. A total of 81,890 acres (1320 cells) are projected to be developed at the current rate of development.

ORIGINAL PAGE IS
OF POOR QUALITY



Figure 7. Loss of prime farmlands. By the year 2000, 30,030 acres of prime farmland will have been lost to urban expansion. The average farm size in Indiana is 191 acres, which is equivalent to losing 157 farms.

ORIGINAL PAGE IS
OF POOR QUALITY

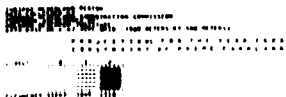
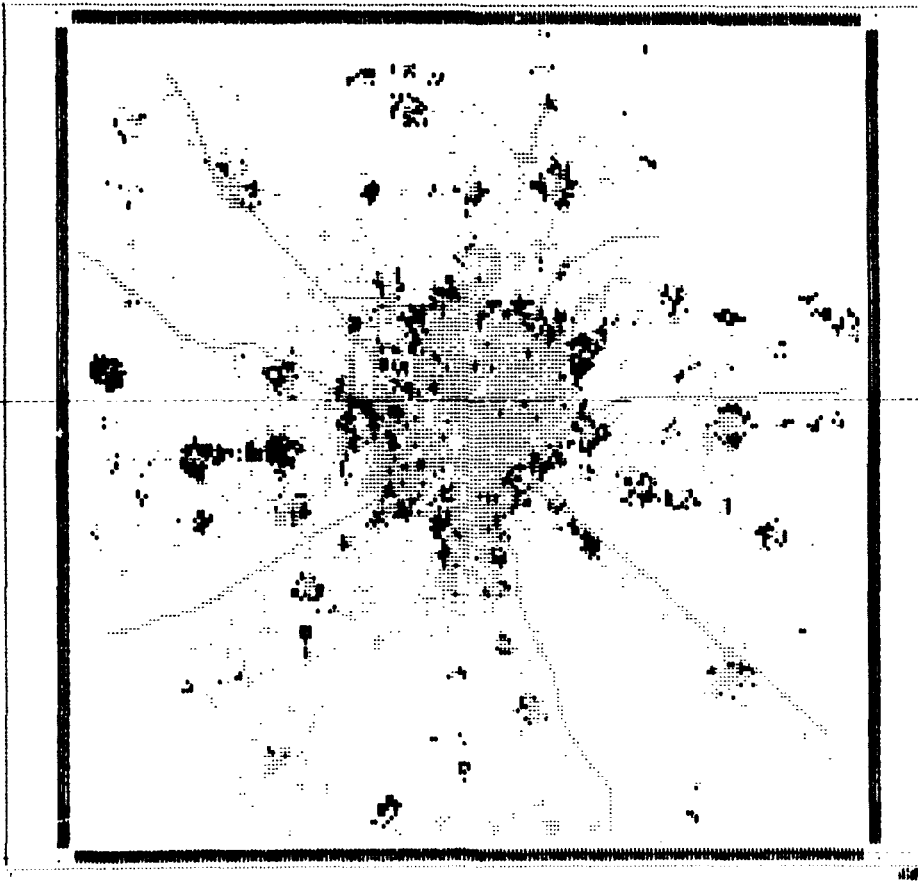

Figure 8. By preventing the projected development upon prime farmland, a total of 81,840 acres are still allocated for new development, but the development is forced to occur on areas other than the prime farmland.

N83 19170 D28

REMOTE SENSING AT THE UNIVERSITY OF MASSACHUSETTS

Robert L. Huguenin
Remote Sensing Center - Hasbrouck
University of Massachusetts
Amherst, MA 01003

Over thirty faculty are actively engaged in remote sensing projects at the University of Massachusetts, and we are now attempting to pool that talent through joint courses, cooperative projects, and the development of new common-use facilities. Expertise currently spans from Astronomy and the Planetary Sciences, through Geology and Geography, Electrical and Computer Engineering, Civil Engineering, Computer Information Sciences, Computer Art, Forestry and Wildlife Management, to Landscape Architecture and Regional Planning.

An Image Processing Laboratory has been established. Currently we are using the University Computing Center's large CYBER 175 computer with extended memory, a large dedicated disc drive, Ramtek 9400 high-resolution 1280 x 1024 color display with a PDP 1133 interface to the CYBER, a dedicated Gould 5200 electrostatic printer/plotter, and three major image processing software systems. Two of the software systems are interactive and one is batch. INTERSYS 103, developed by the Control Data Corporation, allows interactive viewing of data (up to 60 bits per pixel), provides display commands including one that controls the Ramtek, and it permits interactive creation and debugging of new display functions. XPLOR is an image processing applications library through which INTERSYS performs its image processing functions (data conditioning, image enhancement, image registration, multispectral analysis, mosaicking, terrain presentation, digital filtering, and I/O utility routines). XPLOR is ideal for large images and image mosaicks and it operates in background batch mode, while INTERSYS remains interactive. TIPS, developed by our Assitant Director for Image Processing while at UHawaii, is a more interactive system for smaller images or image segments. It performs many of the same functions as XPLOR, but it is designed to be used interactively on a dedicated minicomputer. TIPS also operates in floating point format for detailed quantitative analysis (XPLOR operates in integer format). Both XPLOR and TIPS are being upgraded with new subroutines to expand their versatility. Ultimately the user will work with TIPS to interactively develop a processing procedure on small (1024 x 1024) segments of a full scene, and then process the full scene or scenes with the identical procedure in batch mode using enhanced XPLOR. A fourth somewhat less-robust image processing software system has also been made operational on the CYBER primarily for instructional and training use, by a faculty member within the Department of Forestry and Wildlife Management. The Landscape Architecture and Regional Planning Department's METLAND Project operates a computerized geobased information system. In addition the Engineering Computer Station within the Department of Electrical and Computer Engineering is developing a special image processing research and development program using a VAX-based system.

The University has strong image processing, graphics, and artificial intelligence/pattern recognition expertise within the Computing Center, Department of Computer Information Sciences, Department of Electrical and Computer Engineering, and the Computer Art Program; capabilities are rapidly expanding through our efforts to pool that expertise and promote interactions within the applications personnel. Future plans call for several additional image processing capabilities to be added pending funding, including a scanning image digitizer/hardcopy writer unit, additional terminals, and a dedicated production photolab. The University also plans to expand its current library of Landsat and CZCS tapes, airphotos, and maps, with the eventual establishment of an Archival Service to assist users in the rapid acquisition and quality evaluation of retrospective data from national archives (EROS, EDIC, etc.) and private collections.

Associated with this effort, we are attempting to develop a unique real-time Automated Data Acquisition and Processing System (ADAPS) for direct reception and processing of satellite image data. This project is being planned as a component of the University's Five College Radio Astronomy Observatory. The FCRAO is an operational mode facility that routinely acquires, processes, and displays up to 40 Mbit/sec data for the user in real time. The facility operates the largest and most sensitive millimeter wave telescope in the world, and its meter wave facility has been used to discover over half of the pulsars recorded to date. The latter facility has been fully automated and it can uniquely operate unattended. The FCRAO staff of 62 people represents the kind of expertise necessary to develop ADAPS, and through a cooperative effort with the Image Processing Lab personnel we are trying to transfer the radio astronomy technology to the problem of timely data acquisition. ADAPS software will process the data in floating point as part of an effort to introduce new quantitative processing routines from the Astronomy and Planetary Science fields to Earth satellite data.

As part of this technology transfer effort, the University's Planetary Chemistry Laboratory within the Department of Physics and Astronomy is developing an Applications Spectroscopy Laboratory to transfer Planetary Science spectrophotometry and spectral imagery techniques to earth applications. This is a state-of-the-art facility operating a new Perkin Elmer model 330 microprocessor controlled UV/VIS/NIR (0.185 - 2.5 μm) spectrophotometer with reflectance sphere and a Perkin Elmer model 283B IR (2.5 - 50 μm) spectrophotometer. These instruments are fully controlled and the data are processed by a multi-mainframe computer system, consisting of a Perkin Elmer model 3500 Data Station, a Hewlett Packard model HP 9845C color vector graphics minicomputer with a .5 Mbyte accessible RAM, an HP 9845B B/W vector graphics minicomputer with .2 Mbyte RAM, an HP 3497A Data Acquisition/Control mainframe, HP 3437A digital system voltmeter, HP 3456A digital voltmeter, and HP 6002A Programmable power supply. Peripherals include an HP 9895A flexible disc memory, HP 9874A high resolution digitizer, and HP 9872A 4-color plotter. We are currently adding a Tektronix 7854 400 MHz digital storage waveform processing oscilloscope interfaced to the computer system and a new Gamma Scientific

telespectroradiometer system, which will initially be used with a pulsed UV source. The spectroradiometer will also be used for field measurements, with upgrading planned during Summer 1981 to provide field portability and wavelength extension from the current .2 - .8 μm range into the infrared. Working in conjunction with the spectroscopy equipment are Orion microprocessor-controlled model 811 and model 601A pH/Eh meters, which will also be upgraded for field geochemistry applications. There is a Perkin Elmer model TSG-2 thermogravimetric system and a Varian Vista 4600 Gas Chromatograph with a VISTA CDS 401 data station controller. The Laboratory is currently involved in mineral and petroleum exploration development applications, based on vegetal stress and mineral spectroscopy and field geochemistry techniques, including participation in the NASA/GEOSAT Test Site Program.

Another technology transfer program that is developing as part of the remote sensing effort is the Visual Discrimination Laboratory. The VDL is studying problems of visual attention and multidimensional display and interpretation techniques, using primarily an HP 9845C color vector graphics minicomputer equipped with a touch screen digitizer and associated peripherals. Problems are being approached by a psychologist who has specialized in studies of selective attention and attentional deficits. This laboratory has plans to establish a special User Training Facility, developing highly reinforcing programmed learning software packages which are aimed at overcoming current barriers to image processing training. A major emphasis will be placed on developing new approaches to training potential users who have stayed away from what they feel to be a 'high-technology skill' that they would not be able to learn. Emphasis will also be placed on developing new techniques for creating and interpreting more quantitative multidimensional data sets for those users who have stayed away from what they feel to be a nonquantitative 'pretty-picture' approach to remote sensing.

The University is expanding its curriculum in remote sensing technology, applications, and interpretation theory, and it is attempting to develop several state and substate cooperative projects in conjunction with NASA Goddard/ERRSAC and the New England Innovation Group. We are trying to develop and expand cooperative programs with the private sector, primarily in the areas of exploration, data processing, and user training software development, and millimeter wave sensor development.

N83 19171

D29

IMPLEMENTATION OF STATEWIDE LANDSAT IMAGE PROCESSING CAPABILITIES

Robert F. Mills
New Jersey Department of Environmental Protection

I'd like to talk about something that is slightly different from what's described on the agenda as "a Landsat statewide image processing capability." Instead, let's consider the general process of how you should go about establishing such a thing. Rather than discuss our successes in New Jersey, we'll talk more about our mistakes, and how those mistakes might benefit those of you who are beginning the development of a state Landsat capability. There are enough mistakes to be made in this business that we all ought to economize a bit on our mistake budgets.

Throughout my remarks I'll use an analogy which some people have found effective. It's one of comparing remote sensing processing systems to automobiles. There are a lot of different ways to categorize the universe, but if we break the automotive industry down into a trichotomy, if there is such a word, one way to stereotype cars is to compare the Pinto approach with the Mercedes approach, and in between is what you might call a pickup truck approach. In most cases, you don't want the Pinto approach, because the thing doesn't cost too much, but it doesn't go very fast either, so you get hit behind and it blows up. On the other hand, maybe you can't afford a Mercedes, and despite what they say about European engineering and craftsmanship, the thing is so elaborate that it's going to be in the garage most of the time, so you don't want to take that approach. What you probably want is the pickup truck; something that will get the job done, and is going to be versatile and flexible. This is true with regard to hardware, software, and to a lesser extent, data.

In terms of the kind of hardware that you need for a statewide system, the most important factor is the one of cost. Costs in this field are changing radically, and will continue to change radically for a while, but there are some broad guidelines you can use in deciding what your costs are going to be, and what kind of cost is appropriate for what you are trying to do. The first thing that you must decide is: do you need image processing capability, or are you really producing maps from image data? It is a very significant cost difference between the types of hardware that you need to do those two kinds of things. If you are a massive regional center, you need pretty flexible full power image processing capability: you need an IDIMS type of system that can crunch a lot of information through, because you are dealing with a lot of tapes. Most of us don't deal with that kind of data volume, and if we get a few tapes a year, it's a lot. What we are generally looking at is the map result from that, that is our end product. We may use image processing techniques to try to see what is going on in the data, to help us get a map out, but generally a lot of us are interested in maps per se, not images.

The performance difference of image processing vs. mapping is going to be one of number of colors that the hardware can handle. If you need to handle only mapping, you only need a few colors. If you need image processing capability, you need a lot more colors, and that translates into certain hardware components (chiefly memory) that are going to drive your costs way up.

What are typical costs on these systems today? If you are looking for a general image display capability, you are going to pay somewhere in the neighborhood of forty to fifty thousand 1981 dollars. That's not including a lot of analysis software along with it, that's just the hardware to display general imagery in a flexible way. If you are talking about strictly displaying mapped information (categorized from the imagery), then you are looking at much lower price levels. Three years ago, we put in a system that can do most of the things I've seen here this week in terms of map display (not in terms of analysis), for seven thousand dollars. Since then, the prices have come down considerably, and today you can get the same type of device, with more whistles and bells, for about \$3,500, adequate to do color mapping. That means more than an order of magnitude cost difference between these two approaches, imaging versus mapping.

Another thing to consider is the trade-off in utility of what you are doing, and that's translated into (a) product quality, how good a product you're going to get, and is it going to be satisfactory for your needs; (b) how much staff time you're going to put in to get out a useful product. One of those \$3,500 units might be adequate to display your data once, but if you are located remotely from a central computer that it relies on, you may wait 10 or 15 minutes for the display to come up on the screen. That will repeatedly cost you certain amount of staff and computer time, and mistakes. If you get something that has a little stand-alone capability, it's going to cost you dramatically less to operate than one of the real cheap terminals I mentioned above (the Pinto approach that relies on the mainframe for processing).

The final point to keep in mind with regard to hardware is flexibility. One of the key points I want to make here is with reference to the discussion of the DIDS project a few days ago. That whole project was a spin-off from image processing technology, and somebody just deciding that it ought to work for demographic data, as well. If you plan things right, you can end up with a capability that's going to help you a lot with remote sensing imagery, but it will also, and very importantly, be of use to you in other contexts, like demographic mapping. Getting the attention of your commissioners and governors and legislators to that kind of thing could be a key factor in your overall successful implementation of the image processing system. That kind

of data can be more important to them directly than images from Landsat, but it may also help them to see the importance of image processing and the technology that is associated with it.

With regard to software, we can again make the analogy with cars, especially in the context of flexibility. Everyone seems to take the approach that they need to build the brick three-holer outhouse with software. The kind of flexibility you get from designing a complete system like that is desirable, but you must consider the cost you are incurring, the cost of maintaining it, the length of time it takes to develop it, and whether or not anybody is ever going to use all of the flexibility. I am not arguing for a piecemeal or organic approach, resulting in things sticking out of a system all over the place as needed, but again, unless you are a regional center that needs a general flexible capability to support anyone who walks in the door, too much flexibility may be a bad thing. You must trade that off with available programming staff and complexity of operating the system. If your particular operating context doesn't allow you to flexibly allow for new programming, then perhaps you must get it all done up front.

The third component of any system to deal with information in an automated form is the data itself: the information that you are processing. Here again you are talking about two very different approaches, depending on whether you consider image processing only, or geographic information systems.

With regard to image processing, you really need to be geocorrecting and archiving raw data. You don't want to categorize maps from 13 different tapes and then try to pull them all together and use that in GIS. You need to archive the raw data, because then you have a much more flexible data source to operate from, for modeling for example. Going hand in hand with this approach is the requirement that you cross-reference from the start with the other data you will be using. Don't make the mistake of creating a huge data base, whether it's raw or categorized, and not geo-referencing it to something else. The earlier on you do this, the better off you are. If you do it with the raw data, for example, you can very easily compare the raw data with ground truth.

With regard to natural resource data in a geographic information system, our analogy with automobiles breaks down. Spare absolutely no expense to make sure you have good data in your system, because the first time a mistake appears publicly in that data, your program is going to go right down the tubes. Since that kind of approach demands that what you are going to do is going to cost a little money, I would caution you to question a data assumption that a lot of us make with regard to natural resource information

systems. Maybe you don't need a twenty-layer pancake data base for your entire state. You may need it for certain important regions in the state, but you should consider (1) what it is going to cost you to do it, (2) what real returns you are going to get from whatever data you put in the system and (3) what it's going to cost you long term to capture and maintain that data. Decide what you really need to get from the system, and what key things are going to make that system successful, before you put data into it. That may vary a great deal depending on the size of your state, and the kind of issues that you are facing. Our situation in New Jersey is not a typical one; we have a very small state, land values are extraordinarily high, population density is the highest in the U.S. We've had to consider all these factors in deciding what data to acquire for our geographic information system, and what kinds of remote sensing data are appropriate to our image processing system. Those kinds of factors are going to make all the difference in what data you collect and how you are going to use it.

Finally, the fourth component of any type of system like this is the people involved. You must make sure that the people you are working with have an environment conducive to productive work. You can't take the typical computer data center approach of having a big glass outhouse to show off the equipment, then you put in the tape library, keypunches, et cetera, and then oh yeah, here's where we can stick the people working on the system, behind this pile of cardboard boxes. That's not the way to deal with people with any kind of computerized system. It's certainly not appropriate when what you are trying to create is a hybrid man-machine intelligence, composed of skilled people who can interact with machines to help understand our environment.

N83 19172 230

IMPLEMENTATION OF LANDSAT TECHNOLOGY
IN THE COMMONWEALTH OF VIRGINIA

Ed Sahaydak
Commonwealth Data Base Task Force
Richmond, Virginia

ABSTRACT

Virginia initiated implementation of Landsat technology under the Commonwealth Data Base on the first day of July 1980. Historical events which led up to this implementation will help to explain activities that created the Commonwealth Data Base (CDB) concept. The CDB concept has enveloped Landsat technology into an integrated organization of two components: Virginia Resource Information System and the Econometric Model of Virginia. But demonstrations of Landsat technology in Virginia were actually the catalyst that created the Commonwealth Data Base concept.

INTRODUCTION

This paper describes a brief history of events which led to the formal implementation of Landsat technology in Virginia. It also explains the concept of the Commonwealth Data Base as it is perceived by the users and the systems development task force. Furthermore, it covers the CDB organization which has been established to implement the CDB concept in Virginia. It does not include the technical aspects of the systems development for the CDB.

HISTORY OF CDB AND LANDSAT IMPLEMENTATION

Separate series of activities evolved in Virginia before the formal organization was established for systems development of the CDB. Those separate series of activities were events that evolved into remote sensing applications for natural resources, remote sensing demonstration projects in Virginia, and econometric modeling of Virginia.

First, a recapitulation of significant events that led to formal organization for remote sensing applications follows. Prior to 1974 there were numerous state agencies and universities that cooperated with NASA and other federal departments in programs which utilized remote sensing data from Landsat satellites and aircraft. In early 1974 the Division of State Planning and Community Affairs defined a statewide resources information system, but in July of 1976 a reorganization of the state government discontinued these efforts. Subsequently in 1976 and until 1978 numerous meetings were held to bring remote sensing into Virginia, but no single formal organization took place until 1978. In 1978 the General Assembly created a Joint Subcommittee to study development of a Virginia Resource Information System (VARIS). On May 9, 1978 the Secretary of Commerce and Resources and Warren Hypes of NASA organized an Executive Branch Task Force on the Virginia Resources Information System.

Second, an objectives listing of remote sensing demonstration projects that were initiated to transfer remote sensing technology to the Commonwealth of Virginia are as follows:

Thermal Plume Detection and Quantification - objective was to demonstrate remote sensing for routine monitoring of the thermal structure of a large section of a river;

Forest Classification Using Landsat - objective was a Level II forest classification of an entire county;

Coniferous Biomass Assessment - objective was to produce vegetative classification inventory especially of coniferous vegetation of a regional area by use of Landsat remote sensing;

Watershed Change Detection - objective is to produce via Landsat a Level I land cover map and data for a watershed which is to be combined with soils and other descriptive data for predicting threats to water quality;

Land Use/Land Cover Classifications - objectives are a Level I land cover map of two counties, a Level II land cover map of forest and agriculture classification for selected areas, and an accuracy assessment of Landsat classification compared to aircraft remote sensing classifications;

Mined Land Reclamation Assessment - objective was to produce from Landsat data separate land cover maps from 1974 and 1978 data on two study areas, followed by a change detection map for the two study areas showing land cover changes;

Integration of Landsat Data and Geo-Based Information System - objective was to demonstrate automated integration of Landsat data and other geo-based data.

The third series of activities relating to the CDB and specifically to the econometric modeling of Virginia are summarized as follows. On May 2, 1978 the Commissioner of Taxation submitted a position paper to the Secretary of Administration and Finance proposing to build an Econometric Model of Virginia. In June 1978 the Cabinet recommended the Econometric Model to the Governor. On July 11, 1978 the Governor charged the Secretary of Administration and Finance to implement the Econometric Model of Virginia. In July 1978 a task force was formed. It completed the study of an econometric model and selected a vendor to build a model in November 1979.

The last significant series of events merged the Econometric Model concept and VARIS concept into a single project. These events took place in the following chronological sequence. On December 12, 1979 the Secretary of Administration and Finance suggested that the Econometric Model had need for resources information and that a single effort of the two concepts be considered. In March 1980 the General Assembly approved funds for the Econometric Model and the VARIS project in the Department of Taxation Budget for

the biennium 1980-1982. In May 1980 the Secretary of Administration and Finance gave the authority and responsibility to the Commissioner of Taxation to proceed with the project. On June 2, 1980 the Commonwealth Data Base Task Force was organized by the Commissioner of Taxation and given a charter to proceed with Phase I (Problem Definition) of systems development for the CDB.

CDB CONCEPT

There are two distinct CDB concepts. The users perceive it as a ready source of natural resource, economic, and demographic information presented via images, graphics, or statistics with some data needs. In contrast, the systems development task force concept is a set of notions which must be analyzed, designed, and implemented cohesively to satisfy the users' concept and requirements with the dollar and time constraints set by management.

First, the user concept must be turned into requirements to be met if the CDB project is to be successful. The requirements vary among the users. Although the users are addressed collectively as a generic user, they must also be recognized as three distinct types. These types include agencies, planning district commissions, and localities. Localities are counties and those cities which have a separate government from that of the county in which they reside.

The scope of user informational requirements has been constrained to natural resources, economic, and demographics. However, the form in which this information will be produced varies from images to statistics, which represent measurements of some phenomenon usually over time or in comparison to some other recognized phenomenon or artificial intelligence. Likewise, the mediums on which the informational requirements are to be delivered to the user include: hard copies of statistics, images, graphics, maps, cathode ray tube (CRT) on line, or just a magnetic tape for subsequent processing or modeling.

An additional user requirement is data which include spatial references such as Landsat, other remote sensing data, digitized geo-based and geo-political data, and also descriptive statistics. Sources of data from Landsat origin have been clearly defined, but the other sources are being determined in Phase III (Requirements Definition) of the CDB systems development cycle.

Next, the systems development concept initially consists of numerous and distinct notions which must be analyzed and designed into an orderly concept based on user requirements, availability of systems technology and/or data, plus budgetary and temporal constraints. Each notion will be dealt with separately and collectively during the systems development life cycle. A formal methodology for this systems development will be utilized.

This methodology breaks down the CDB systems development process into ten distinct phases and within each phase describes the tasks which must be completed. At the end of each phase, the facts are compiled, a formal document published of the phase findings and recommendations, and then distributed to the user and Steering Committee (SC) for review. After the SC is satisfied with the results, a staff copy of the phase document is sent to the Management

Review Committee for approval/disapproval. In the meantime, the task force plans for and starts a subsequent phase, while the users and Steering Committee review the published phase document.

Within the above concepts, history, and mandate, the Commonwealth has organized itself (CDB Organization) to accommodate carrying out the systems development life cycle of the CDB and to implement the use of Landsat technology to meet the needs of the user. It must be pointed out here that the concept of the user is not limited to government but includes the private sector.

CDB ORGANIZATION

Organization of a task force and a control group initiated the systems development effort of the CDB which include Landsat technology as an integral part of CDB. Initially, members assigned to the task force organized all participants for systems development and users into a formal organization. Next a control group was created to give overall guidance for the project, user representation, and technical assistance to the task force.

The control group consists of a Management Review Committee (MRC), a Steering Committee (SC), and Technical Review Group (TRG). The CDB Task Force provides administrative and coordinating support to the committees of this control group.

The MRC consists of representatives from two cabinet secretaries: the Secretary of Administration and Finance and the Secretary of Commerce and Resources. The chairman of the MRC is the Commissioner of the Department of Taxation. Legislative representatives from the House Agriculture, Senate Agriculture, and House Appropriations Committees serve in a legislative liaison capacity to the MRC.

The chartered mission of the MRC is to provide overall project control and directions for the CDB project. Some of its specific responsibilities are approval/disapproval of all systems development phase documents, initiations of the Steering Committee and the Technical Review Group, and also approval/disapproval of contracts with vendors and other state agencies.

The Steering Committee (SC) of the control group consists of user representatives of all potential CDB users. Like the MRC, the SC has legislative liaison members assigned from the staff of the Senate Finance Committee and House Appropriations Committee.

The SC is the primary interface between the task force and users of the CDB. An at-large user representative selected by the MRC serves as the SC chairman. In addition, the SC makes recommendations to the MRC for member replacements as positions are vacated. Its mission is to represent the CDB user community, review all systems development phase documents presented by the CDB task force, and present the reviewed phase documents to the MRC for approval.

The third unit of the control group is the Technical Review Group (TRG). It is the technical assistance group for the CDB project and consists of technical experts. In addition to economic, scientific, and systems expertise, legal

counsel is made available by the TRG. Their specific responsibilities include: review of all state and vendor proposals from a technical viewpoint, review systems development phase documents, review CDB contracts, and provide technical consultation whenever required.

The CDB Task Force is part of the total CDB organization and interfaces with the control group. It is responsible for staffing each phase of the CDB project. CDB Task Force control and appointment of the Task Force members resides with the Department of Taxation. The Commonwealth Tax Commissioner appoints members to the Task Force depending upon staffing needs of each phase, continuity of the project as a whole, and budgetary constraints.

N83 19173

D31

USING LANDSAT TO UPDATE THE SCHOHARIE COUNTY,
NEW YORK, LAND COVER INVENTORY*

Paul R. Baumann

State University of New York College at Oneonta

ABSTRACT

This demonstration project examines the utility of Landsat at the county and local government level. More precisely, this project deals with the updating of the New York State Land Use and Natural Resources (LUNR) maps, valuable planning and development tools utilized by county governments. Both the feasibility of producing these maps and the transferability of them to the county government level are evaluated in this interim report. The study area is Schoharie County, New York.

INTRODUCTION

This demonstration project is designed to evaluate the utility of operational applications of Landsat to county and local governments. More specifically, this project explores the potential use of Landsat for updating the New York State Land Use and Natural Resources maps, valuable planning and development tools frequently used by county governments. If successful results are obtained, the updated maps may pave the path for regular use of Landsat technology at the county level in New York State. The project centers on Schoharie County which is situated in the Catskills. Work on the project is being conducted principally by the Department of Geography, SUNY College at Oneonta. This paper is an interim report on this project outlining its background, progress, and potential success.

BACKGROUND

In 1966, the late Governor Nelson Rockefeller directed the New York State Office of Planning Coordination to develop a comprehensive land use and natural resource inventory of the entire state. (ref. 1) This inventory was given the acronym, LUNR. Data for the LUNR inventory were based on aerial photography taken in 1967 and 1968 of upstate New York and in 1969 and 1970 of Long Island and New York City. From these photographs, land uses were mapped on transparent film overlays, using the standard U.S. Geological Survey 7½ minute quadrangle as the base. The land use overlay maps were made at the scale of 1:24000.

*Project is being supported by a contract (NAS5-25967) from NASA Eastern Regional Remote Sensing Applications Center.

Land use data for the inventory were divided into two types: area and point data. Two overlay maps, one for area and the other for point data, were made to correspond in coverage and scale to each of the 7½ minute USGS maps within the state. Area land use maps delineated all the land within the state according to 51 categories, with boundaries defined by use. Point land use maps designated by symbol the specific location of 68 different types of land use. At the county level, the area land use maps have proven to be much more usable than the point maps because they have provided information not readily available. Point information has been easily obtainable from other sources.

From the information on these maps a computerized geo-data base was constructed for the state. The data base was structured on the Universal Transverse Mercator (UTM) grid with a cell resolution size of one square kilometer or 247.1 acres. Land use data were recorded either as a percentage of the total cell area or as the number of occurrences within a cell. Two computer programs were designed to analyze and to display information from the data base. This data base has been used primarily at the state government level rather than the county or local level. At the local government level the cell size has been too large for most applications. Also, the one program requires a knowledge of how to formulate sophisticated, quantitative models, a subject about which few county officials have any familiarity.

In 1972, the Temporary State Commission to Study the Catskills was established by the state legislature. One of the charges of this commission was to analyze land use conditions in the seven-county area designated as the Catskills. Schoharie County was included as part of the seven-county area. Based on aerial photographs taken in 1973, updated LUNR maps were made of the region. Thus, the Commission was able to compare the 1968 and 1973 maps, a five-year interval. The geo-data base was not updated. In 1976, the Commission was dissolved with no plans for updating LUNR maps in the future.

Even though many local governments have expressed a desire to have new LUNR maps and many state agencies have stated a strong need for an updated geo-data base, the high costs of acquiring aerial imagery for the entire state, of interpreting the photography, and of manually drafting the maps and entering information into the geo-data base make it impossible to maintain the LUNR system. Consequently, one of the major objectives of this demonstration project is to determine the effectiveness of Landsat in updating the LUNR system, in particular the maps because of their utility at the county government level.

In 1975 the Schoharie County Planning and Development Agency and the Department of Geography at SUNY College at Oneonta entered into a cooperative arrangement called the Schoharie County Cooperative Program (SCCP). Under this program several major projects have been undertaken by the Department of Geography for the county. One major project was the development of a county-wide automated geographic information system. (ref. 2) This information system contains terrain, soil, cultural, and land use data by UTM 1/16km² grid cells. Land use data were obtained from the 1973 LUNR maps. This geo-data base is very similar in structure to the LUNR data base but it has a smaller cell size and additional variables. Land use information generated from this demonstration project will be used to update the Schoharie County geo-data base making it possible to evaluate Landsat for such a task.

PROGRESS

The first step under this project was to select an appropriate Landsat scene. Since the LUNR inventories were conducted in 1968 and 1973, county officials expressed a desire to maintain the five-year interval between inventories which made it necessary to acquire a 1978 scene. Like much of the Northeast, Schoharie County is located in a hilly-mountainous region where considerable cloud cover exists throughout most of the year. This condition makes it extremely difficult to find a workable scene. A November 2nd scene was selected initially because it was the only cloud-free data set with high quality ratings in all four bands. However, at that time of the year the sun angle was low creating shadow conditions on west facing slopes and high reflectance areas on east facing slopes. A variety of ratioing techniques were employed in an attempt to rectify this situation but little success was obtained. In addition, the time of year was not the best for detecting agricultural patterns. Later, two other scenes were acquired, one for August 22 and the other for September 9. The August scene had ratings of "8" in all four bands but some small clouds existed in the upland areas of the county. The September scene was cloud free but had only average ratings in two bands. At present, work is concentrated mainly on the August scene. The small clouds are being cosmetically removed at the classification stage.

After a scene has been selected, the processing stage is started. The Department of Geography at SUNY College at Oneonta has developed its own computer system for analyzing multispectral data. Known as the Landsat Analysis Package (LAP), the system has been developed by combining a variety of methods employed in other systems and by creating some new techniques. (ref. 3) The initial step under the LAP system is to strip and reformat a scene. Frequently, special software must be written to remove unusual data irregularities. Once the data have been rectified and reorganized, a modified version of the technique known as SEARCH is used to create training fields. This technique was originally developed by NASA's Earth Resources Laboratory. (ref. 4) SEARCH is unsupervised in approach to the extent that training fields are automatically selected but the statistics generated are based on the supervised approach. Statistically similar training fields are merged to form spectral classes. The spectral classes are used in conjunction with the maximum likelihood classification technique to classify each pixel within the study area. Each pixel is assigned to a spectral class and each spectral class is related to a land cover class. Several spectral classes may be grouped together to form one land cover class.

With this project the difficult task has been to develop land cover classes which correspond to the land use classes used under the LUNR inventories. The LUNR land use definitions are based mainly on air photo techniques; thus, the same techniques are being utilized to assign land cover classes to spectral classes. Aerial photographs of selected areas within the county are being used to identify land use conditions based on the LUNR definitions. These land use patterns are then compared to the spectral classes to determine the land cover classes. Surprisingly, the spectral classes generated with the August scene have produced good land cover classes in terms of corresponding to the LUNR

classes. However, some LUNR classes relate to topographic conditions such as hill farm land versus valley farm land. These conditions are not easily differentiated using Landsat spectral data. To overcome this problem, terrain data from the Schoharie County geo-data base are being merged with the spectral data to form a seven-channel data set. Hopefully, this new data set will generate more divergent spectral classes. Work is presently being done on developing the merging techniques.

Once an acceptable classification has been developed, the subscene covering Schoharie County will be geometrically corrected and rescaled to relate to the 7½ minute USGS quadrangle maps. Employing a digital plotter, land cover maps will be plotted onto a mylar surface. These maps will be similar to the LUNR maps in appearance. Mylar, a durable mapping surface, is a transparent film making it possible to overlay the land cover maps on the county's topographic and soil maps. This overlay ability will allow county officials to note spatial relationships between terrain, soil, and land cover. Also, the mylar will permit excellent blue print copies of the land cover maps to be made. The blue print copies will be used as work maps for a variety of purposes. These land cover maps will be different from the LUNR maps in two ways. First, due to the size and shape of the pixels the land cover patterns on the maps will be block-like in appearance. Second, because point data are impossible to detect with the Landsat resolution, only area data are being classified and mapped. Consequently, one land cover map will be developed for each 7½ minute USGS quad rather than two maps which was the case under the LUNR inventories. The elimination of the point data maps is not perceived as a major problem. As previously indicated, the county government officials are much more interested in the area land use information than point information.

POTENTIAL SUCCESS

A considerable amount of effort has been directed towards transferring Landsat technology to state and multi-state governments. Such effort is only now beginning to appear with respect to local governments. No question exists about the need for up-to-date land use information by local governments. The real questions are: "Can Landsat fulfill this need?" and if so, "How can this technology be transferred to a local government?" The products generated under this project will help answer the first question. The second question, however, will be harder to answer since transferability will be determined more by financial and human considerations than by technical results.

Except for urban fringe areas most large cities have up-to-date geo-data bases which can be used to create more accurate and better detailed land use maps than can be produced from existing Landsat systems. Landsat's greatest potential at the local government level is in the rural areas where large tracks of homogeneous land use exist and where spectral data truly reflect actual land cover rather than indicate it by inference. Although Landsat has much to offer rural, local governments, a couple of major issues must be examined before measuring the success of the technology transfer.

First, limited financial and human resources at the local government level make it difficult to install and maintain the needed systems to analyze and

display Landsat imagery. True, the costs of hardware and software are decreasing, and low-cost computer systems designed specifically for analyzing Landsat data are being developed. However, a five or ten thousand dollar investment is still a large commitment for a rural, county government and most low-cost systems are built on the black box concept of allowing a user to put data in and get new data out but never to explain how the data are analyzed in the box. In addition, to acquiring a system the local government faces the problem of hiring a remote sensing specialist and of keeping this person trained in this rapidly changing field. Such costs are not feasible for most local governments.

Thus, to utilize Landsat technology, most county governments will find it necessary to obtain outside help. Such help can come from several sources. One source might be a state agency which has developed the required remote sensing capabilities. Local and state agencies might work together but frequently such relationships are antagonistic. Often these strained relationships exist because local governments are forced to meet regulations mandated by the state government. Many times the regulations relate to the utilization of rural land. Also, state agencies generally must view issues from a larger scale than local agencies resulting at times in regulations considered irrelevant at a county level. In fact, many rural local governments might not ever collect land use data if such data were not required for various state and federal programs. Another source of remote sensing assistance for local governments would be the universities. However, large universities usually emphasize research over public service work and small universities commonly do not possess the resources to perform the work. Finally, a local government might pay a private company to do the work. This option is oftentimes too expensive for a local government. Each of these sources of remote sensing help has certain benefits and certain liabilities from the local government's perspective. Each local government needs to have the option of selecting the help it wants and no state or federal model should be imposed.

In this demonstration project the county and the college have a long and good working relationship. Products generated through this relationship under various projects have been reviewed by three other counties in the region and these counties are now exploring ways to have similar products produced for them. Hopefully, this diffusion process will involve the land use maps created under this project. Also, Schoharie County is considering updating its land use inventory again in 1983 based on the success of Landsat D and D'. Consequently, the potential success of transferring this technology looks good as long as success is measured by the use of Landsat and not by the installation of sophisticated systems to analyze the data.

A second issue related to technology transfer deals with getting local government officials and decision makers to accept the idea that multispectral data from a satellite can be used to determine accurately land cover conditions. In terms of the traditional aerial photo interpretation methods, many people can look at an aerial photograph and inherently grasp how land use information might be extrapolated from it. However, such inherent understanding generally does not exist with satellite multispectral data especially when used in conjunction with sophisticated computer and quantitative techniques. People are curious and mystified by all the Buck Rogers type technology but they are not sure if they trust the results from it. Understanding and appreciating this

issue is very important to the success of transferring Landsat technology to the local government level. In rural counties many of the officials and decision makers are people of the land. Thus, they are reluctant about making any decisions concerning the land based on technology which they do not fully understand, especially decisions relating to land evaluation, and thereby, possible control and taxation. Since many of the decisions which they must make relate to state and federal regulations, they are particularly skeptical about utilizing any new, unknown technology. They already view many of the state and federal regulations as benefitting the urban areas at the expense of the rural land. In one respect they perceive themselves in an ongoing struggle with the forces of urbanization, and computers and satellites are considered weapons produced by the urban landscape. Thus, one must be sensitive to these feelings when trying to introduce Landsat technology into the decision-making realm of the rural environment.

In terms of this demonstration project, the county planner and personnel from his office have been given several one-day courses on how multispectral data are analyzed and satellite imagery is obtained. The purpose of these courses is not to make remote sensing specialists or even general analysts out of these people but to provide them with a level of understanding so that they are comfortable with products generated using Landsat technology and are able to recognize both the assets and liabilities of the system. These individuals will become a human interface between the specialists at the college and other local government officials. Both the planner and the assistant planner have farms in the county making them people of the land. Local officials and decision makers are more likely to use products created by Landsat if they sense that some of their own people have some understanding about it. Specialists, especially those from a university environment, will be viewed frequently as outsiders, and although they would receive due consideration by a town zoning board or the county board of representatives for their effort in creating land cover maps, their products may see little actual use. The approach outlined here for introducing Landsat technology at the county government level has worked well in the past on other projects between the college and the county and appears to be working successfully on this project. Only time will determine how successful this approach has been.

SUMMARY

This interim report has described the background, progress, and potential success of this local government demonstration project. This project is attempting, with a new technology, to continue an existing land inventory, a difficult task. The land cover maps and the county geo-data base should be updated by the end of the year. The potential success of this project will be determined by how the generated products are accepted and used. Although at this time a high probability of a successful project exists, only time, as previously stated, will determine the overall success of the project.

REFERENCES

1. Swanson, Roger A.: The Land Use and Natural Resource Inventory of New York State. New York State Office of Planning Coordination. 1969.
2. Baumann, Paul R.: The Schoharie County Cooperative Program: A Case Study in Applied Geography. Proceedings of the Middle State Division Association of American Geographers, Vol. II, 1977, pp. 81-84.
3. Baumann, Paul R.: Remote Sensing Technology & Applications: User's Reference Manual. Department of Geography, SUNY - Oneonta. 1980.

N83 19174

D32

**ORIGINAL PAGE IS
OF POOR QUALITY**

THE EVALUATION OF ALTERNATE METHODOLOGIES FOR LAND COVER
CLASSIFICATION IN AN URBANIZING AREA

Robert M. Smekofski
Land Management Information Center
Minnesota State Planning Agency

ABSTRACT

The Minnesota State Planning Agency (MSPA) is interested in the usefulness of Landsat in classifying land cover and in identifying and classifying land use change. A pilot study was undertaken using an urbanizing area as the study area. The question of what was the best technique for classification became a primary focus of the study. The study, a cooperative effort between EROS Data Center, the University of Minnesota, and MSPA, evaluated the many computer-assisted techniques available to analyze Landsat data. Techniques of statistical training (polygons from CRT, unsupervised clustering, polygons from digitizer and binary masks) were tested with minimum distance to the mean, maximum likelihood and canonical analysis with minimum distance to the mean classifiers. The twelve output images were compared to photo interpreted samples, ground verified samples and the current land use data base at MSPA. Results of this study indicate that for a reconnaissance inventory, the unsupervised training with canonical analysis-minimum distance classifier is the most efficient. If more detailed ground truth and ground verification is available, the polygons from the digitizer training with the canonical analysis minimum distance is more accurate.

INTRODUCTION

BACKGROUND

A major concern in testing various techniques of classifying land cover using Landsat data was to evaluate what importance Landsat data could have in the updating of land use/cover information in the Minnesota Land Management Information System (MLMIS). MLMIS is a part of the Minnesota State Planning Agency's Land Management Information Center (LMIC). The system was developed in an attempt to centralize and analyze data on Minnesota's resources. It is both a depository of geographically-based information and a computer analysis system.

MLMIS data include cultural, resource and political boundary information. Information is stored on computer files by 40-acre parcel for every parcel in the state. It is organized by region, county, and township and can be accessed for mapping or statistical analysis.

PRECEDING PAGE BLANK NOT FILMED

The MLMIS land use/cover data variable was produced using interpretation of high-altitude photography of the state obtained in the spring of 1968 and 1969. For each 40-acre data cell a determination was made of the dominant land use within the cell. The nine classes of land use were chosen so interpreters could determine land use from aerial photos, consulting a minimum of other data sources.

The updating of these data is desirable for a number of reasons. Most important is the need for more current data. Data resolution is also a concern. For many studies the 40-acre resolution is too crude and a smaller cell size of accurate data is necessary. This consideration, coupled with LMIC's recent acquisition of new hardware and software providing polygon data capture capabilities, is a strong incentive to update these data at a resolution smaller than 40-acre parcel. The costs of recording land use/cover data for an entire state using aerial photo interpretation is prohibitive and alternatives need to be explored.

OBJECTIVES

With the need to update the MLMIS, and the availability of Landsat computer-compatible tape (CCT) data, a study was initiated to assess current methods of training and use of pattern recognition (classification) algorithms.

Four methods of training set selection were used in this study:

- (1) Supervised polygon selection on a CRT
- (2) Unsupervised clustering
- (3) Polygons digitized from interpretations of color infrared aerial photography
- (4) Binary masks developed from MLMIS land use data.

The results of the four training methods were used as input to three classification techniques:

- (1) Minimum distance to the mean
- (2) Maximum likelihood
- (3) Minimum distance to the mean after canonical transformation

This resulted in twelve different land cover classifications which are studied in this analysis.

STUDY AREA

A study area exhibiting suburban and exurban growth characteristics was chosen because of the State Planning Agency's desire to assess methods for monitoring urban growth. They are contained within four USGS 7.5-minute quadrangles--Centerville, Hugo, White Bear East, and White Bear West. These quadrangles cover the northeast suburban portion of the Twin Cities, with White Bear Lake approximately in the center of the area.

Within the study area boundaries there is a transition from an older high density suburban area to rural farmland. Included in this spectrum is new and expanding suburban and exurban growth on the fringes of the urbanized area of the Twin Cities. Especially in this northeastern section of the Twin Cities metropolitan area, the distance between the various stages of urban development is at a minimum. The study area contains numerous lakes, wetlands, and forested areas. The variety of land cover in this area offered the chance to assess the practicality and/or difficulty of using Landsat digital data to classify the various land cover types.

The subscene representing this study area was selected from the latest available data at the time of the study which was a scene of May 24, 1979. The subscene was destriped and registered to a 50-meter Universal Transverse Mercator (UTM) grid using a cubic convolution resampling technique.

TECHNIQUES

The training set selection and the application of their statistics to various classification algorithms was done at the EROS Data Center using the Interactive Digital Image Manipulation System (IDIMS).

Training set data collection was done primarily by staff from the Remote Sensing Laboratory at the University of Minnesota's College of Forestry and MSPA staff. The collection of training set information and the classifications were completed in the autumn of 1979.

TRAINING SET SELECTION

Four methods of statistical training of classifiers were used: supervised polygon selection from CRT screen, unsupervised clustering, air photo-based supervised/cluster training, and training from the existing MLMIS land cover data base. The coincidence of base information and Landsat scene data is not ideal. The color infrared photography used dates from 1977; the MLMIS land use/cover data is based on 1969 aerial photography, and the field observations were done in autumn of 1979.

Supervised Polygon Selection From CRT Screen

Polygons were selected on a color CRT from enlarged subscenes by an analyst familiar with remote sensing but not the study area. Reference was made to 7.5-minute quadrangles to assist in the selection of areas of the desired classes. The polygons were not made so small as to be homogeneous training fields but were of a size to contain five to ten spectral classes of land cover within the designated land use. Several polygons for each land use were selected. A clustering algorithm was run on pixels within the polygons which resulted in one file of 43 clusters after the deletion of clusters which overlapped.

Unsupervised Clustering

Unsupervised clustering was done on the study area subscene. The clustering algorithm grouped the data into 64 clusters which were consolidated using a separability algorithm to 60 clusters.

Air Photo-Based Supervised/Cluster Training

Polygons were entered by digitizing from 1:24,000 scale color infrared aerial photographs which had been interpreted by analysts familiar with the area and who had done some field verification. The polygons were used as masks of the data and clustering was done with the same parameters as the previous techniques. Sixty cluster groups resulted from this process.

Training From Existing MLMIS Land Use Data

Data were extracted from the multispectral information by creating binary masks for each land use class from the existing MLMIS digital land use data. These data had been converted from an original 40-acre grid to the 50-meter cells used in this study. The resulting masked data were then clustered with the same parameters as the previous techniques. The initial results of 238 clusters were consolidated to 58.

In all of the above training set selection techniques, except the unsupervised technique, there are varying degrees of gaps in spectral space between clusters and, when compared in two dimensions, considerable overlap of clusters.

CLASSIFICATION ALGORITHMS

The training set clusters extracted by the four techniques were applied to the data by three different classification algorithms, minimum distance to the mean, maximum likelihood, and canonical transformation with minimum distance to the mean.

Minimum Distance to the Mean

This algorithm is the "simplest" of the three used in terms of complexity and speed of processing. The multispectral vector of the data is tested against the mean vector in the training statistics and assigns the pixel to the cluster which is at a minimum distance. A threshold using a maximum distance parameter is employed to exclude from classification pixels which are not within a reasonable distance of the mean. The same distance threshold was used for the application of the minimum distance to mean classifier with each training technique.

Maximum Likelihood

The maximum likelihood classifier computes a likelihood value for each pixel based on the mean and covariance of each cluster and assigns the pixel to the cluster which has the maximum likelihood value. A threshold value of five percent was used for the four interpretations of the algorithm.

Canonical Transformation With Minimum Distance to the Mean

This technique uses a linear transformation of the data to make the minimum distance classifier more accurate. A canonical analysis transformation employs the technique of rotating the axis(es) of a spectral group(s) to increase the separability of clusters while minimizing the differences occurring within each cluster. Canonical analysis transformation can allow for classification with fewer bands, but this was not done in this study.

CLUSTER ASSIGNMENTS

Following the classification by the three algorithms the resulting clusters were grouped to approximate as closely as possible MLMIS land use classes. This grouping was done on the CRT with the assistance of maps, aerial photographs and knowledge of the area. Because the Landsat classification yielded land cover classifications and MLMIS data are a combination of land use and land cover, these groupings were not in direct correlation. Residential areas with a relatively high density of trees had to be assigned to the forested category to avoid the confusion of classifying forested areas as residential. One of the reasons this problem arose in all of the classifications was the date of the image. By late May trees had more leaves than would be desirable for a Landsat land cover classification. The decision to use such a late date was governed by the problem of procuring a cloud free image for spring of that year.

COMPARISON OF ACCURACY OF THE CLASSIFICATIONS

The determination of accuracy in a Landsat classification is always difficult and care was taken to verify by a number of different means. These included comparison with MLMIS land use/cover data, comparison with photo-interpreted reference data, and comparison with ground verification points. In all of these cases the verification information was put into the same 50-meter UTM registration as the image allowing the use of automated contingency tables.

MLMIS DATA FOR VERIFICATION

There exists in MLMIS a land use/land cover variable which records a dominant land use for every 40-acre parcel in Minnesota. The primary information source was 1:90,000 scale black and white air photos. The nine land use/cover classes are:

- Forested
- Cultivated
- Water
- Marsh
- Urban Residential
- Extractive
- Pasture and Open
- Urban Non-Residential or Mixed Residential
- Transportation

The Landsat classification was matched to seven of the nine classes. The excluded classes were transportation and extractive uses because these uses cover such small areas.

The results of the contingency table comparisons with the MLMIS data and the twelve classifications are shown in Table 1. The average agreement of all categories ranged from approximately 23% to 30%. The relatively low correlation can partially be explained by the comparison of 40-acre data to 50-meter cell information. The correlations between water and forest were the highest (80%) and the urban category correlation the lowest (approximately 10-15%). The range in accuracy among the various land cover classes was found to be approximately the same no matter which classification scheme was used.

Table 1
 Accuracy of Techniques Compared with MLMIS Data
 (values in percent agreement)

		Classification Method		
		<u>Minimum Distance</u>	<u>Maximum Likelihood</u>	<u>Canonical Analysis With Minimum Distance</u>
Training Set	Supervised	26.7	23.0	29.7
Selection	Unsupervised	28.6	27.9	28.0
	Digitized polygons from air photos	27.9	26.4	30.4
	Binary Masks from MLMIS Data	26.6	26.4	26.4

To eliminate the problem of comparing 50-meter cells to 40-acre data in 50-meter format, an attempt was made to reclassify the 50-meter data to an equivalent of 40-acre resolution by use of a smoothing operation which uses a most-populous-member technique. A window of 7 lines by 7 rows was run through the classified image and the majority value found in the window was assigned to the center cell. The comparison of the smoothed classification to MLMIS data is shown in Table 2 and the improvement in correlation can be seen.

Table 2

Accuracy of Techniques (after smoothing program) Compared with MLMIS Data
(values in percent agreement)

		Classification Method		
		<u>Minimum Distance</u>	<u>Maximum Likelihood</u>	<u>Canonical Analysis With Minimum Distance</u>
Training Set Selection	Supervised	33.4	21.6	34.4
	Unsupervised	32.6	32.3	31.7
	Digitized polygons from air photos	33.6	33.1	34.0
	Binary Masks from MLMIS Data	31.4	31.7	30.1

AIR PHOTO DATA FOR VERIFICATION

Color infrared aerial photography was flown for the Twin Cities area in July and August of 1977 in support of wetlands mapping. The photos are at a scale of 1:24,000 and six scenes covering approximately 30% of the study area were selected for analysis. These were photo-interpreted into 18 land cover classes which were later put into the nine land use/cover categories. A minimum mapping unit of one acre was used in the determination of classes on the aerial photo polygons. Table 3 shows the comparison of the classifications to the aerial photo polygons.

Table 3

Accuracy of Techniques Compared with Photo Interpreted Data
(values in percent agreement)

		Classification Method		
		<u>Minimum Distance</u>	<u>Maximum Likelihood</u>	<u>Canonical Analysis With Minimum Distance</u>
Training Set Selection	Supervised	28.9	25.3	34.1
	Unsupervised	33.0	32.3	33.0
	Digitized polygons from air photos	33.6	31.7	37.6
	Binary Masks from MLMS Data	31.3	31.1	32.3

OBSERVATIONS ON ACCURACY VERIFICATION

The use of a variety of information sources for accuracy verification produces some differences in the results of the contingency tables. More important than the differences in the percentage of agreement between the verification and classification data is the similarity in the rankings in each of the tables. Comparison was also done by using 30 ground points randomly selected within the seven classification classes. Accuracy verification using these points produced similar rankings as the other verifications.

Besides the use of quantitative methods for accuracy verification there was also visual assessment of the classifications by MSPA staff. The advantage of visual assessment is that certain key features of special concern can be checked to see if they have been correctly classified. Visual assessment was done initially using the color CRT at EROS Data Center, with color and black/white hard copy, and later on a color CRT at the LMIC. The rankings of agreement from contingency tables did not differ appreciably from the judgements of visual assessment.

CONCLUSIONS

USEFULNESS OF LANDSAT CLASSIFICATIONS

The usefulness of Landsat data for the updating of MLMS land use/land cover data is dependent on the land cover types desired from a classification.

The primary interest of the MSPA in Landsat cover analysis was the classification of low density urban development. This was the category judged to contain more confusion with other cover types when visual assessment of the classifications was done by MSPA staff. This is due partly to the date of the image being used and also to the nature of urban development in the Twin Cities suburban area. The low density of the development makes confusion with pasture/open land cover a problem. The late spring date of the image makes it difficult, if not impossible, to separate forest areas from forested residential areas. Confusion also occurs between low density development and pasture and open land. The pasture land in the study area (and in much of Minnesota) tends not to be homogeneous but a very mixed area of brush, grasses, bare soil, and trees. This combination appears to cause very similar spectral responses to areas of known low density residential development.

Agricultural lands had to be divided initially into bare ground (tilled) and cultivated (already green) categories. When these were combined later into one category, confusion resulted between the bare ground agriculture and lands being cleared for construction. The agricultural lands already green tended to be confused with land uses associated with the urban setting - parks, golf courses, and cemeteries.

Utilizing the MLMIS analysis capabilities can help in differentiating cover types in areas with similar spectral signatures. Conversion of the Landsat classification to MLMIS data format and resampling of MLMIS 40-acre resolution data to 50-meter resolution enables the analyst to compare Landsat classifications. An example of this process is the comparison of MLMIS public ownership data with a land cover classification to separate "green" agricultural lands from parks. The modifications can be carried out by computer using a multivariate conversion process.

ADVANTAGE OF CLASSIFICATION TECHNIQUES

The amount of personnel time involved in using the various training set selection methods varies greatly. The amount of computer processing time needed for computation of the three classification algorithms also varies.

The least personnel time was used in the unsupervised training set selection process because the analyst has only to assign the clusters to the final land cover categories. The clusters resulting from unsupervised training set selection appear to be superior to most other methods because of the lack of overlap and large distances between spectral clusters. The only drawback appears to be that of missing unique spectral classes which represent certain cover types. This problem can be alleviated by adding analyst-chosen training sets to the clusters selected by unsupervised machine training. The method of using polygons digitized from interpreted air photos consumed the most personnel time. The photo interpretation took 12 hours and the digitizing added an equal amount of time. The advantage in using this method was that it produced superior training sets. It is recommended that the investment of time be made only if the ground verification information is of high quality such as the 1:24,000 scale color infrared photography used in this study.

The computer processing time for the three different algorithms varied greatly but was not affected by the training method used. The maximum likelihood classifications took about three times as much processing time as the minimum distance and canonical transformation with minimum distance classifying algorithms.

The best combination of accuracy, personnel time, and computer processing time seemed to be reached when the canonical transformation (with minimum distance algorithm) classifier was used with unsupervised training sets. The difference in results and accuracy between the unsupervised and the air photo training sets was not great enough to outweigh the savings in human and computer facility resources.

REFERENCES

1. Nelson, Charles A.; Meisner, Douglas E.; Smekofski, Robert E.;
Techniques to Update a Land Management Information System With
Landsat Data 1980. (soon to be published).

REMOTE SENSING IN THE COASTAL ZONE - A PERSPECTIVE

Peter Cornillon
University of Rhode Island

This presentation is an attempt to put some of the problems associated with remote sensing of the coastal zone in perspective. The conclusion which I draw from these arguments is that at least for the foreseeable future remote sensing of the coastal region will be more appropriately performed with aircraft. There will be, of course, exceptions to the following discussions, hence to the conclusions, cases for which satellites are more appropriate.

The problems alluded to above shall be introduced by reviewing the differences between remote sensing of terrestrial regions and remote sensing of open ocean areas. First we present briefly the electromagnetic spectrum (figure 1). The important regions to consider are the visible portion .5-.7 μm , the near infrared portion .8-1.5 μm , the thermal infrared portion 9 to 12 μm and the microwave portion 1 mm to 10 m. These are, of course, approximate ranges. Figure 2 shows the visible to thermal IR portion in greater detail.

With this brief background we shall now look at some scales associated with phenomena of interest in the terrestrial and oceanographic regions. In figure 3 several typical examples are given of quantities of interest in the two regions along with the associated range of time scales. One immediately observes in this figure the relatively slower rate of change of terrestrial features as compared to oceanographic ones. In the oceans the time scales of interest range from hours to hundreds of hours while on land they range from tens of hours to thousands of hours. Next consider the spatial scales of interest. From figure 4 it is apparent that in general terrestrial scales are smaller, tens of meters to kilometers, than those of the ocean, kilometers to hundreds of kilometers. Figure 5 compares the spectral and radiometric resolution of the two regions. The columns under the heading of "spectral" list the wavelength parameters of interest. The first column is for visible light, the second, near infrared, the third, thermal infrared and the fourth, microwave. It becomes immediately apparent that in both the oceans and on land the visible and the microwave regions are of interest. The difference appears in the near infrared and the thermal infrared. The latter is of great importance for the oceans while the former is critical for vegetation on land. The column under the heading "reflectance" applies to the visible portion of the spectrum. Reflectance from terrestrial regions is about an order of magnitude larger than for the oceans. This means that a sensor sensitive to the oceans saturates over land while one sensitive to terrestrial parameters sees little or no variability in the oceans.

Figures 3 to 5 are summarized in figure 6. From this list it becomes apparent why the Multispectral Scanner (MSS) of Landsat is designed with 80-meter resolution as compared to the 800-meter resolution of the Coastal Zone

Color Scanner (CZCS) on Nimbus-7. It is also clear why the CZCS is so much more sensitive than the MSS and why Landsat gives repeat coverage once every 18 days as compared to the near daily coverage of Nimbus-7.

With this in mind we now consider the coastal zone. First the spatial scales of interest are in general closer to the terrestrial scales discussed above, while the time scales are closer to the oceanographic ones (maybe even somewhat shorter). The required spectral and radiometric sensitivity is also much closer to that required of the ocean than the land, when considering the wet part of the coastal zone, the reflectivity being approximately that of the open ocean.

At this time there is no satellite that meets these requirements and none is planned. Airborne sensors do exist and tailor-made missions can be flown to satisfy many or most of the scale constraints listed above. Finally, it must be stressed that these arguments are quite general in nature and therefore certainly do not encompass all possible scenarios. They do, however, apply in most cases, and must be kept in mind when approaching a problem dealing with remote sensing of the coastal region.

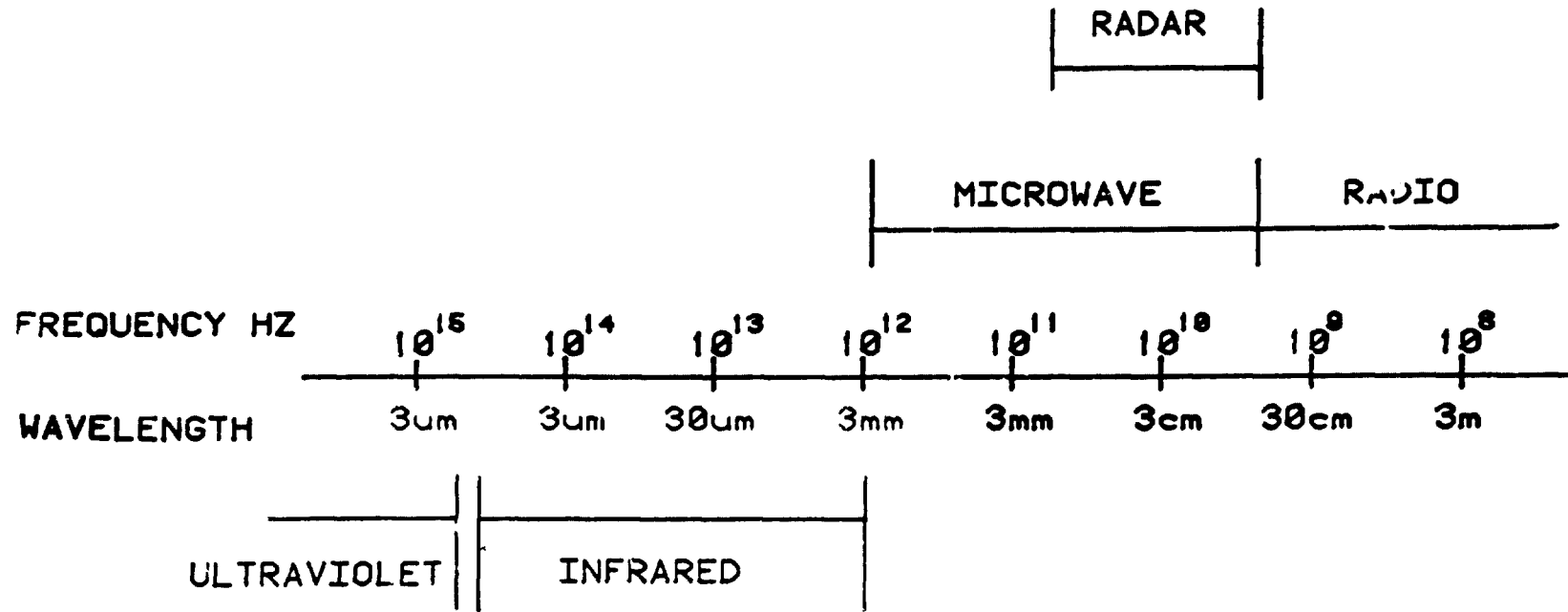

ORIGINAL PAGE IS
OF POOR QUALITY

SYMBOL	MEANING	MAGNITUDE
Å	ANGSTROM	10^{-10} METERS
nm	NANOMETERS	10^{-9} METERS
µm	MICROMETERS	10^{-6} METERS
mm	MILLIMETERS	10^{-3} METERS
cm	CENTIMETERS	10^{-2} METERS

Figure 1. Electromagnetic Spectrum

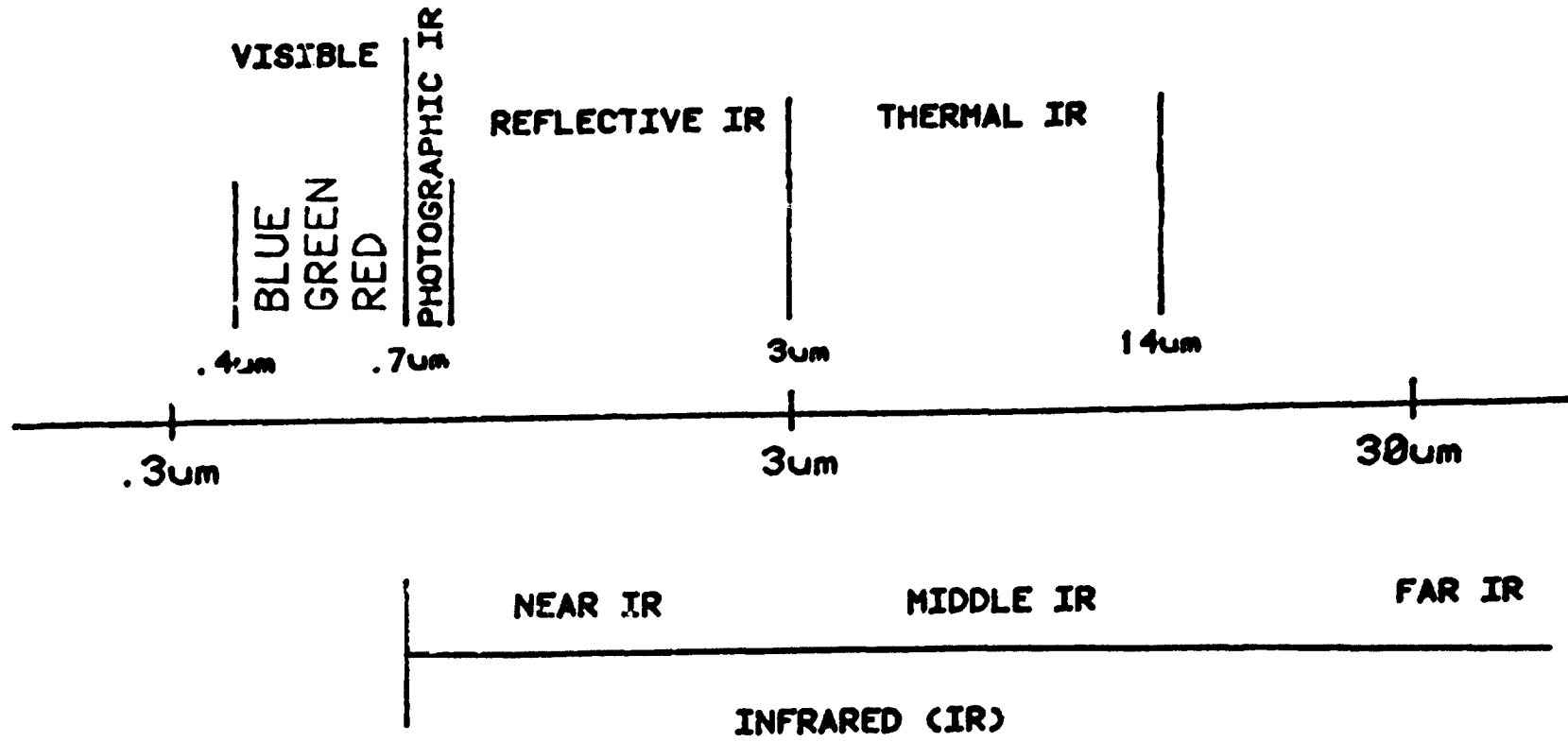

ORIGINAL PAGE IS
OF POOR QUALITY

Figure 2. Visible and Infrared Portion of the Electromagnetic Spectrum

ORIGINAL PAGE IS
OF POOR QUALITY

DAY ~ 10^1 HRS
WEEK ~ 10^2 HRS
MONTH ~ 10^3 HRS
YEAR ~ 10^4 HRS

TERRESTRIAL OBSERVABLES

TIME (HRS)

VEGETATIVE COVER
URBANIZATION
SOIL MOISTURE
GEOLOGICAL FORM

10^1 - 10^3
 10^3 - 10^4
 10^2 - 10^3
 10^4 - 10^7

OCEANOGRAPHIC OBSERVABLES

TIME (HRS)

PLANKTONIC BLOOM
WATER MASS DELINEATION
LARGE SCALE CURRENTS
RINGS/EDDIES
FISHERIES
WAVES
TIDES

10^0 - 10^2
 10^1 - 10^2
 10^0 - 10^2
 10^2 - 10^3
 10^0 - 10^4
 10^1 - 10^1
 10^1 - 10^3

Figure 3. Temporal Comparison

ORIGINAL PAGE IS
OF POOR QUALITY

TERRESTRIAL OBSERVABLES

VEGETATIVE COVER
URBANIZATION
SOIL MOISTURE
GEOLOGICAL FORM
VERTICAL ROUGHNESS

DISTANCE (METERS)

10^1 - 10^4
 10^1 - 10^4
 10^1 - 10^4
 10^1 - 10^4
 10^0 - 10^3

OCEANOGRAPHIC OBSERVABLES

PLANKTONIC BLOOM
WATER MASS DELINEATION
LARGE SCALE CURRENTS
RINGS/EDDIES
FISHERIES
WAVES
TIDES
VERTICAL ROUGHNESS

DISTANCE (METERS)

10^1 - 10^4
 10^2 - 10^4
 10^3 - 10^4
 10^3 - 10^4
 10^1 - 10^4
 10^0 - 10^2
 10^3 - 10^5
 10^{-3} - 10^2

Figure 4. Spatial Comparison

ORIGINAL PAGE IS
OF POOR QUALITY

VISIBLE ~ .4 TO .7 μm ~ 10^{-5} CM
 NEAR IR ~ .7 TO 2 μm ~ 10^{-4} CM
 THERMAL IR ~ 9 TO 12 μm ~ 10^{-3} CM
 MICROWAVE ~ .1 TO 100 μm ~ 10^1 CM

<u>TERRESTRIAL OBSERVABLES</u>	<u>SPECTRAL</u>		<u>REFLECTANCE</u>
VEGETATIVE COVER			
URBANIZATION	10^{-5}	10^{-4}	10^1
SOIL MOISTURE	10^{-5}		10^1
GEOLOGICAL FORM	10^{-5}	10^{-3}	10^1
	10^{-5}	10^1	10^1
			30 : 20X
			30 : 10X
			: 10X

<u>OCEANOGRAPHIC OBSERVABLES</u>	<u>SPECTRAL</u>		<u>REFLECTANCE</u>
PLANKTONIC BLOOM	10^{-5}		10^1
WATER MASS DELINEATION	10^{-5}	10^{-3}	10^1
LARGE SCALE CURRENTS	10^{-5}	10^{-3}	10^1
RINGS/EDDIES	10^{-5}	10^{-3}	10^1
FISHERIES	10^{-5}	10^{-3}	10^1
WAVES	10^{-5}		10^1
TIDES	10^{-5}		10^1
			5 : 2X
			5 : 2X
			5 : 2X
			5 : 2X
			5 : 2X

Figure 5. Spectral/Radiometric Comparison

ORIGINAL PAGE IS
OF POOR QUALITY

<u>QUANTITY</u>	<u>TERRESTRIAL</u>	<u>OCEANOGRAPHIC</u>
TEMPORAL	DAYS	HOURS
SPATIAL	METERS	KILOMETERS
RADIOMETRIC		
REFLECTANCE MEAN	30%	5%
REFLECTANCE VARIANCE	20%	2%
SPECTRAL	VISIBLE NEAR IR —— MICROWAVE	VISIBLE —— THERMAL MICROWAVE

Figure 6. Comparison Summary

LAKE CLASSIFICATION IN VERMONT

Virginia Garrison and Nancy Bryant
Vermont Department of Water Resources

ABSTRACT

Section 314 of the Federal Clean Water Act requires each state to classify all of the publicly owned freshwater lakes in the State according to trophic state. In order to comply with this Act and, in so doing, develop a procedure to periodically update the classification, the State of Vermont evaluated the ability of Landsat to detect general water quality and specific water quality parameters in Vermont lakes. Unsupervised and supervised classifications as well as regression analyses were used to examine Landsat data from Lake Champlain and from four small nearby lakes. Unsupervised and supervised classifications were found to be of somewhat limited value. Regression analyses revealed a good correlation between depth-integrated total phosphorus concentrations and Landsat Band 4 data ($r^2 = 0.92$) and between Secchi disk transparencies and Landsat Band 4 data ($r^2 = 0.85$). No correlation was found between depth-integrated chlorophyll-a samples and Landsat data. Vermont is now expanding this Landsat evaluation to include the remaining lakes in the state greater than twenty acres and steps are being taken to incorporate Landsat into the state's ongoing water quality monitoring programs.

INTRODUCTION

In December 1978, the Vermont Department of Water Resources received a grant from the U.S. Environmental Protection Agency, in part, to classify lakes in the state greater than twenty acres according to trophic state. At that time, existing manpower and equipment resources were insufficient to allow the Department to collect water samples from each of the lakes involved, and therefore a more economically feasible alternative was sought. Preliminary information gathered from studies conducted in other states (1,2) indicated that Landsat could be used in Vermont's Lake Classification Program. Landsat had the added advantage of providing a means by which trophic classifications could be updated periodically without requiring massive field sampling programs.

The decision was made to test the ability of Landsat to detect water quality in Vermont lakes by using the single Landsat scene that encompasses all of Lake Champlain and several smaller lakes in the western part of the state (scene 15/29). The water quality of the lakes in this scene is representative of the range of lake water quality found in Vermont. A suitable flyover of scene 15/29 was obtained on July 21, 1979, and surface truth (water quality data) was collected through Vermont's Volunteer Lay Monitoring Program and other existing Department sampling programs. The U.S. Environmental Protection Agency's Environmental Monitoring Systems Laboratory in Las Vegas, Nevada (EMSL-LV) was

contracted to perform three methods of analysis of the Landsat data - an unsupervised classification; a supervised classification; and regression analyses of surface truth and Landsat data (Figure 1).

UNSUPERVISED CLASSIFICATION

The Environmental Monitoring Systems Laboratory used the classifier SEARCH/MLR431, a clustering and maximum likelihood procedure, to initially classify the Landsat scene. The nine water classes that were distinguished through this approach could be grouped and related to clear water, turbid water, and water containing detectable amounts of chlorophyll. The unsupervised classification thus provided some general qualitative water quality information on the lakes in the scene without requiring a large amount of surface truth data. General knowledge of the water bodies was sufficient to interpret the classification. However, no quantitative water quality parameter values could be assigned to the classes due to the general nature of the classification. No attempt was made to determine whether some type of Trophic State Index would correlate with the nine classes.

SUPERVISED CLASSIFICATION

The next approach to the data analysis was a supervised classification using the MAXL4 classifier. Twenty-three sampling sites on Lake Champlain and one site on each of four smaller lakes were used as training sites for the classification. The resulting classified image was very helpful in the Department's evaluation of monitoring coverage of Lake Champlain and nearby lakes. However, again no quantitative parameter values could be assigned to the water classes since the classification was based on training sites characterized by a variety of water quality parameters and not based on a single water quality parameter. The Department has used the classified image to determine which sampling sites on the lakes are repetitive and therefore can be eliminated, and where new sites are needed (unclassified areas on the image indicate that the water quality in those areas is unlike that found at any existing sampling site). In addition, as new lakes are brought into sampling programs, the number and location of sampling sites on these lakes are chosen on the basis of information obtained from the supervised classified image.

REGRESSION ANALYSES

At this point in the evaluation of the Landsat scene, the State of Vermont and EMSL-LV requested the assistance of the Eastern Regional Remote Sensing Application Center (ERRSAC) in Greenbelt, Maryland, in developing a procedure whereby Landsat data could be correlated quantitatively with certain water quality parameters such as Secchi disk transparency, total phosphorus concentration and chlorophyll-a concentration. Twenty-six of the sampling sites used in the supervised classification were used in this procedure. Landsat data (MSS values for Bands 4, 5 and 6) were extracted from the area around the sampling sites on the tape, converted to radiance values and compared to water quality data collected at the sites near the time of the flyover, within one week of July 21, 1979

(Table 1). ERRSAC then performed regression analyses to determine whether correlations existed between the Landsat data and the water quality sampling data. A good logarithmic correlation was found between Secchi disk transparencies and Band 4 radiance values (Figure 2):

$$(\text{radiance}) = 0.52 - 0.07 \ln (\text{Secchi disk transparency}); r^2 = 0.85.$$

A good linear correlation was found between depth-integrated total phosphorus concentrations and Band 4 radiance values (Figure 3):

$$(\text{radiance}) = 0.31 + 0.008 (\text{total phosphorus}); r^2 = 0.92.$$

No correlation was found between Landsat data and depth-integrated chlorophyll-a concentrations, apparently due to the fact that Landsat sensors can only detect near-surface chlorophyll. The chlorophyll-a samples used for ground truth were collected by means of a hose lowered to a depth of twice the Secchi disk transparency.

Following the regression analyses, radiance values were assigned to ranges in total phosphorus concentrations, and Secchi disk transparencies and maps of the lakes were developed which depicted these ranges in water quality data. These maps have been helpful in characterizing the water quality of Lake Champlain in areas where no sampling sites exist and the information obtained from the maps has been used in several Department programs.

FUTURE INVESTIGATIONS

The results of Vermont's initial test of Landsat's ability to detect lake water quality has encouraged the state to continue working with Landsat to monitor lake water quality. EMSL-LV is presently analyzing Landsat data from two scenes taken over Vermont on July 14, 1980 (scenes 14/29 and 14/30) in order to determine the water quality of the remaining lakes in the State greater than twenty acres. In addition, preliminary steps are now being taken to develop a process through which Landsat information can be used on a frequent basis to monitor water quality in Vermont. Water quality data for ground truth, specifically Secchi disk transparency, total phosphorus and chlorophyll-a, will be collected through Vermont's Volunteer Lay Monitoring Program. Attempts to correlate Landsat radiance values with surface chlorophyll-a concentrations will begin in 1981. The major problem now facing Vermont's use of Landsat to periodically monitor lake water quality is the scarcity of relatively cloud-free flyovers over the state during the open-water season, April to November.

REFERENCES

1. Blackwell, Richard J. and Dale H.P. Boland: Trophic Classification of Selected Colorado Lakes. EPA 600/4-79-005, January, 1979.
2. Scarpace, D. Frank L; Kenneth W. Holmquist; and Dr. Lawrence T. Fisher: Landsat Analysis of Lake Quality. Photogrammetric Engineering and Remote Sensing, Vol. 45, No. 5, May 1979, pp. 623-633.

ORIGINAL PAGE IS
OF POOR QUALITY

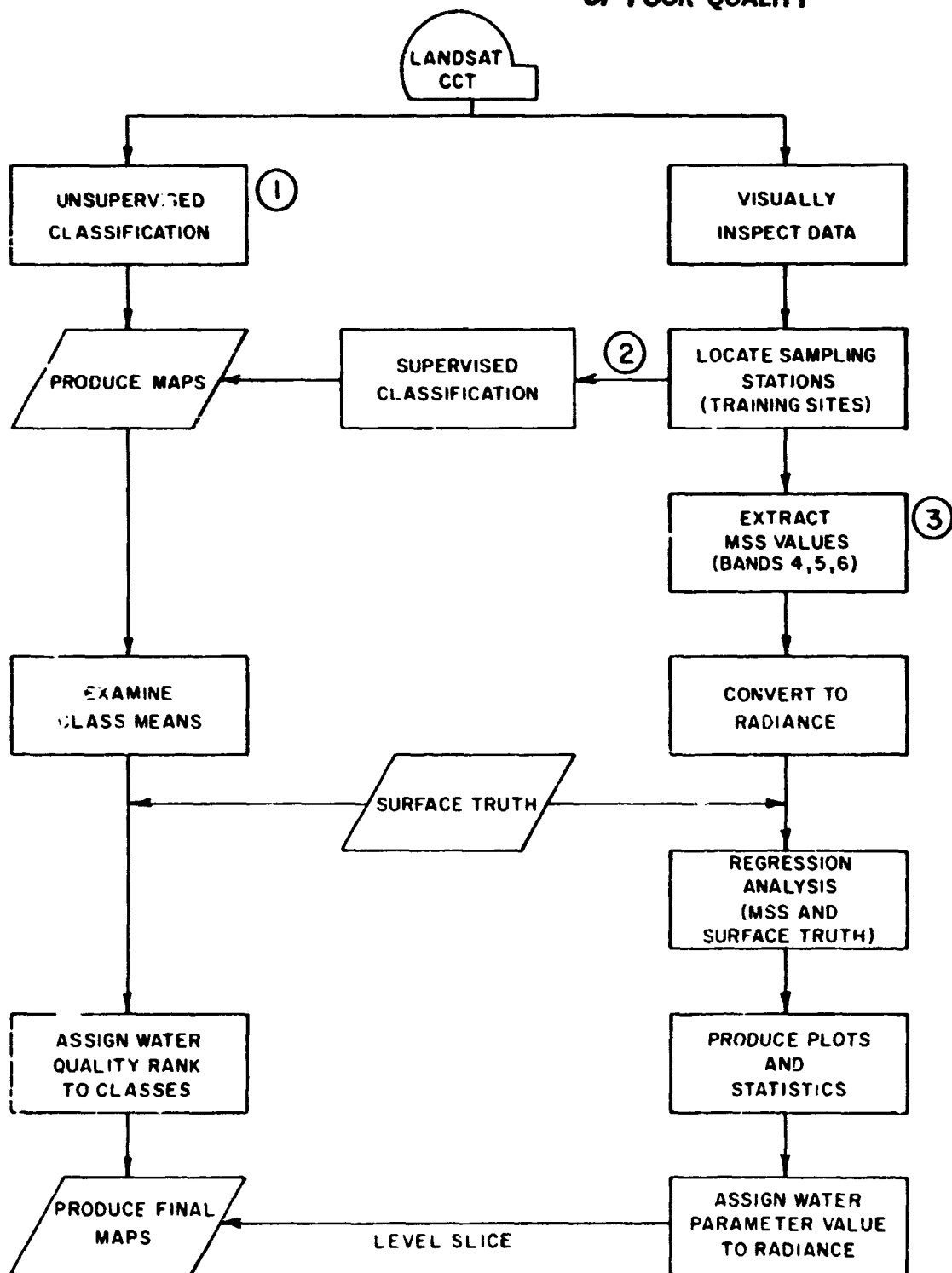

Figure 1. Procedures for Determining Water Quality Using Landsat

ORIGINAL PAGE IS
OF POOR QUALITY

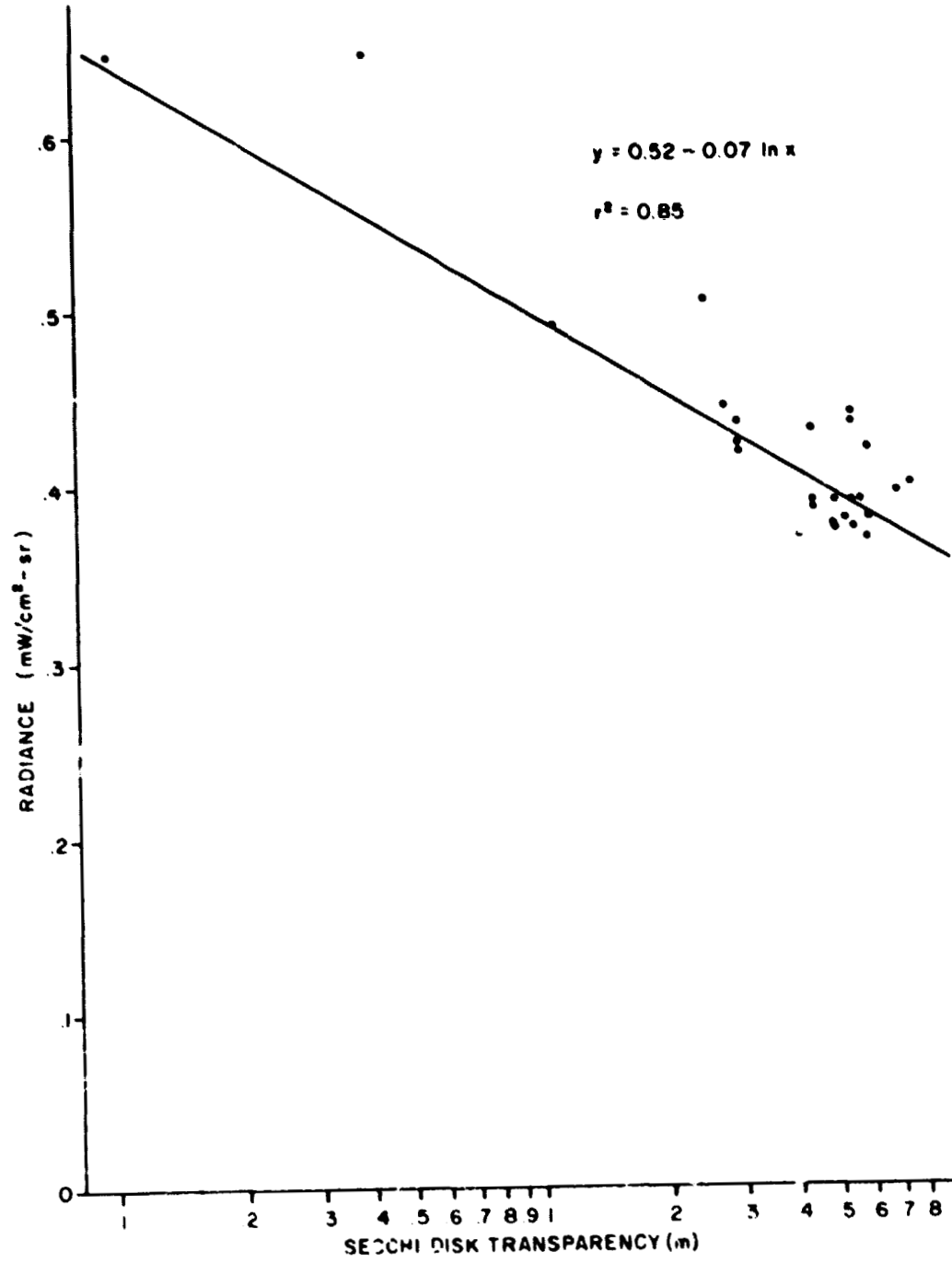

Figure 2. Secchi Disk Transparency Versus Band 4 Radiance

ORIGINAL PAGE IS
OF POOR QUALITY

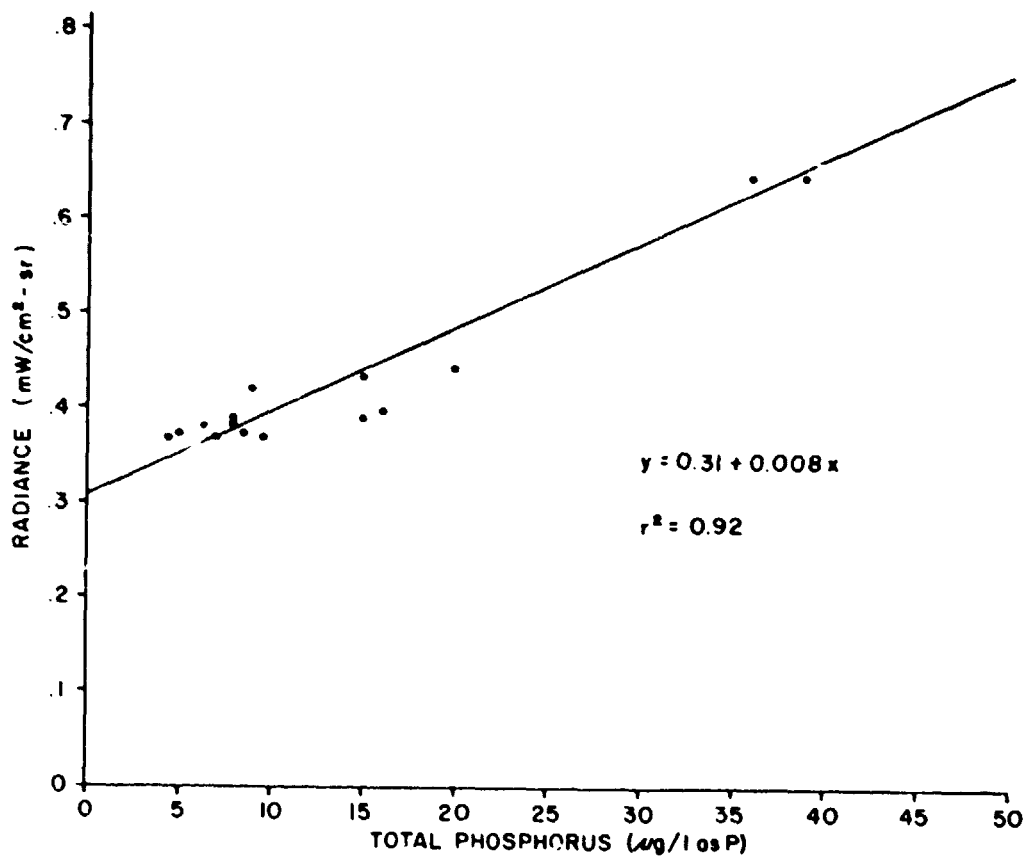

Figure 3. Total Phosphorus Versus Band 4 Radiance

**ORIGINAL PAGE IS
OF POOR QUALITY**

Table 1 - LAKE CHAMPLAIN SURFACE WATER QUALITY AND LANDSAT DATA

Station No.	July 14, 1979			Radiance (MW/cm ² -sr)		
	Surface Truth			4'	5'	6'
	(m) Secchi	(µg/l) Chl-a	(µg/l) T-Phos.			
02	0.1	7.2	39	.646	.408	.233
03	0.4	9.2	36	.646	.402	.221
05	4.5	4.2	8	.386	.201	.138
06/11	4.1	6.0	9.5	.370	.201	.138
10	5.0	3.4	5	.376	.194	.135
9	5.5	4.0	8.5	.376	.201	.135
07/8	5.5	3.1	8	.390	.211	.135
08	5.7	4.4	—	.390	.218	.146
1	5.5	3.6	15	.390	.207	.135
7	6.0	4.0	6.5	.380	.214	.144
09	4.5	2.1	—	.390	.225	.150
10/6	6.0	3.9	4.5	.370	.201	.138
11/3	5.3	4.6	7	.370	.214	.144
5	7.5	6.5	16	.400	.225	.150
12	7.0	—	—	.396	.225	.150
21	4.5	—	—	.430	.178	.161
14	5.5	3.6	—	.436	.178	.161
15	3.0	—	—	.420	.167	.152
16	5.0	—	—	.400	.214	.144
17	3.0	3.9	15	.436	.191	.173
18	6.0	4.0	9	.420	.181	.164
19	5.5	2.2	—	.440	.187	.169
20	2.8	3.4	20	.444	.197	.177
Carmi	1.1	24.	—	.490	.221	.198
Iroquois	3.0	6.0	—	.446	.207	.187
Fairfield	2.5	16.	—	.506	.258	.230
	n=26	n=22	n=15			

N83 19177 ^{D35}

ORIGINAL PAGE IS
OF POOR QUALITY

PROCEDURES FOR ANALYSIS OF SPATIAL
RELATIONSHIPS AMONG SHIP
SURVEY DATA AND SEA
SURFACE TEMPERATURE

Joseph K. Berry and John K. Sailor
Yale University
School of Forestry and Environmental Studies

ABSTRACT

Remote sensing and computer-assisted map analysis techniques hold promise for providing many of the capabilities needed for effective oceanographic research and management. The expansive spatial nature of most oceanographic issues makes them particularly appropriate for these new techniques. However, contemporary methods of analysis of ship survey data rarely involve a rigorous consideration of spatial factors other than the simple spatial distributions assumed by traditional statistical techniques. In addition this historical approach severely limits the integrated use of remotely sensed data. This paper describes a study designed to establish a limited spatial data base for the U.S. eastern seaboard vicinity and to demonstrate computer-assisted analysis techniques for investigating spatial patterns and relationships among ship survey data and remotely sensed sea surface temperature. Ship survey variables included concentrations of two zooplankton, two ichthyoplankton, and two fish species, in addition to physical data of depth to bottom and surface and bottom water temperatures. Continuous spatial distributions of these data were created by both weighted nearest neighbor and iterative smoothing interpolation techniques. Maps of surface water temperature were created by digitizing GOES satellite images. All mapped data were spatially registered by conversion of latitude and longitude coordinates to rotated Lambert conic conformal rectilinear coordinates and stored in grid format of approximately one hundred square kilometers per cell. The analysis of these data include the generation of statistical summaries and maps describing the joint occurrence among variables.

INTRODUCTION

Advances in remote sensing techniques are providing researchers with data on oceanographic variables in continuous distributions

PRECEDING PAGE BLANK NOT FILMED

ORIGINAL PAGE IS OF POOR QUALITY

over large areas. To be most useful, these data will have to be used in concert with the ship survey measurements that have and will continue to be taken in oceanographic studies. Computer-assisted map analysis techniques hold promise for linking remotely and proximally sensed oceanographic data and for extending existing capabilities for analyzing the spatial relationships among these measurements.

Prior to analysis, geocoded data must be put in a form that allows comparison and manipulation at a common scale and projection. If a geographic information system is to be used, the data must be in a computer-compatible form. The objectives of this study were to establish a limited spatial data base for the eastern seaboard vicinity and to demonstrate the use of computer-assisted map analysis techniques for investigating spatial patterns and relationships among ship survey data and surface water temperature data.

ESTABLISHING THE SPATIAL DATA BASE

Creation of a spatial data base involves three steps: encoding and editing the data; registering the data by performing scale and projection manipulation; and, where necessary, creating continuous spatial distributions from point measurements. Data for this study were provided by the National Marine Fisheries Service, Northeast Fisheries Center. Ship survey measurements of eleven variables were provided on cards and magnetic tape. These included surface chlorophyll concentration, Calanus sp abundance, Centropages sp abundance, Ammodytes sp abundance, Yellowtail weight, Yellowtail number, Haddock weight, Haddock number, surface temperature, bottom temperature, and depth to bottom. A total of 540 stations were included in the data, but not all parameters were measured at each station. Latitude and longitude coordinates were provided either directly or through a station identifier. These data were placed in a common format in an online disk dataset, for further processing.

Registration of the data was performed using a Lambert conic conformal projection. For this study, all ship survey data were spatially registered by conversion of recorded latitude and longitude coordinates to rotated Lambert conic conformal rectilinear coordinates and stored in grid format of approximately one hundred square kilometers per cell. Figure 1 schematically identifies the steps in this process.

Remote sensing data of sea surface temperature were provided by two GOS satellite images. A zoom transfer scope was used to

ORIGINAL PAGE IS
OF POOR QUALITY

optically register the imagery to a computer-generated plot of converted latitude and longitude coordinates and to transcribe the thermal delineations. These images were rendered into computer-compatible form using an electronic digitizing tablet. Land areas were encoded from a map in a similar fashion.

CREATING CONTINUOUS SPATIAL DISTRIBUTIONS

In order to compare the spatial relationships with remotely sensed sea surface temperature data, continuous spatial distributions derived from the sea survey data are required. Without such distributions, no further spatial insight is gained in the analysis than would be available if the data were compared in a scalar fashion. There are two approaches to generating continuous spatial distributions from point stations: map interpolation, and map generalization.

Interpolation refers to a process similar to that used in simple bivariate statistics involving the estimation of values in continuous or even spacings from unevenly spaced data. In interpolation, no functional form is assumed by the analyst. Examples of this process in map analysis are nearest neighbor interpolation, weighted distance interpolation, and iterative smoothing interpolation.

In contrast, map generalization refers to the expression of map values using a mathematical function. In this process the analyst imposes a functional form upon the observations, and the entire map is expressed based on this mathematical relationship. Examples of map generalization are surface fitting techniques such as trend analysis of Fourier series or harmonic regression (Basset 1972).

Figure 2 illustrates the concepts of interpolation and generalization techniques used in this study. Iterative smoothing interpolation involves scanning a map with a "moving window," that gives the cell at the center of the "window" the average of all stations occurring within the radius of the "window." In this way, the technique is analogous to a spatial moving average. By performing this technique over the map several times in succession, a smooth surface is generated. Nearest neighbor interpolation gives any point on the map the value of the nearest station measurement. Weighted distance interpolation is similar to the nearest neighbor technique; however, it gives each point on the map a value based on the distance weighted average of a specified number of the nearest stations (Davis 1973).

ORIGINAL PAGE IS
OF POOR QUALITY

In the map generalization technique of trend surface analysis, polynomial surfaces of specified degrees are fitted to spatial data using regression techniques (Davis 1973). Trend surface analysis is used to separate regional "trends" embodied in the polynomial surface fitted to the data, for local anomalies. The anomalies are found as areas with high residuals, where the observation differs widely from the trend surface value at that point. Trend surface analysis has some methodological considerations to which the user should be alert. First, it is not often possible to know what functional form a mapped variable should take. Thus, in many cases, the form imposed on the data is arbitrary. Also the density, distribution, and degree of clustering of the data points have a pronounced effect on the results of the regression.

RESULTS AND DISCUSSION

As a means of comparing the techniques of map interpolation and map generalization, four techniques were performed on the data for the Yellowtail. A map of the raw data stations is shown in Figure 3a. Figure 3b illustrates the result of using the iterative smoothing process on the Yellowtail number data. A "smoother" surface would have been obtained with further iterations of the process. Figure 3c shows the nearest neighbor interpolation of the same point data, while Figure 3d shows the weighted average interpolation. The trend surface maps in Figure 4 illustrate the imposition of mathematical relationships on the Yellowtail data. Both a first order (plane) and second order surface were fitted to the data.

All interpolations are estimations of the true spatial distribution of a variable. Therefore, no one of the techniques can be said to be consistently more accurate than any others. However, generalizations can be made about the resulting distributions and their effect on subsequent analyses. The iterative smoothing technique tends to result in symmetrical patterns resulting from the scanning "window" of constant radius. The nearest neighbor technique creates "islands" of constant value which may be intuitively troubling with well mixed parameters as are found in oceanography. The weighted distance method creates the most intuitively pleasing surfaces. Because each cell is derived from the distance weighted average of several nearby stations, it may make use of the spatial relationships in the data to the greatest degree. However, the process does tend to average out small scale variability.

**ORIGINAL PAGE IS
OF POOR QUALITY**

The plane trend surface is obviously a gross oversimplification of the data. Nevertheless, it illustrates a decreasing trend in Yellowtail number to the south. The second order trend surface is more sophisticated. However, it is clearly influenced by the linear sampling pattern of the data stations. This is especially true at the edges of the map, where extreme trend surface values are found in areas where no sampling occurred. These effects are documented in the structural geology literature where trend surface analysis has been widely used (Davis 1973).

For the demonstrations reported in this paper, weighted distance interpolation was used for all maps. With a complete data base a broad range of analytical operations are possible using the Map Analysis Package (MAP) software system recently developed at Yale (Tomlin, in preparation). Four major classes of fundamental map operations can be identified. These involve reclassifying map categories, overlaying maps, measuring cartographic distances, and characterizing cartographic neighborhoods. Each of these classes has several primitive operations. By logically organizing these primitive operations, the basis for a generalized cartographic modeling structure can be formed which accommodates a variety of complex applications (Tomlin and Berry 1979).

SPATIAL RELATIONSHIPS

As a means of demonstrating the use of the geocoded data base to link proximally sensed data with remotely sensed data, analyses were performed on the surface chlorophyll data and the GOES temperature data. First, an overlay process was used to extract the GOES temperature value for certain stations (Figure 5a). A cartographic distance operation was used to find those stations within the vicinity of Georges Bank. The resulting map was then used in an overlay process to find the GOES temperature value for each of these stations.

Second, a map of joint coincidence of GOES thermal data and interpolated surface chlorophyll concentrations was prepared (Figure 5b). This map was generated by assigning a unique thematic value to selected combinations of the categories of both maps. For this example, the combining was designed such that the map locates combinations of lower surface temperatures and higher chlorophyll concentrations. In addition, statistical summaries of the joint occurrence of these same data can be prepared (Table 1). The upper portion of the table contains "cross-tab" information on the simple and weighted frequency of joint coincidence. The lower portion reports the "spatial overlap" between the two maps. The

**ORIGINAL PAGE IS
OF POOR QUALITY**

"100% overlap" for the land categories of both maps implies perfect spatial coincidence, as would be expected. The "27.53% overlap" (101-200 mg/m³ and 5-9 degrees Centigrade) indicates only a small spatial coincidence.

Complicated modeling procedures can be performed on both the proximally sensed and remotely sensed data using the computerized data base created in this study. This process was demonstrated by creating a cartographic model to estimate the spatial aspects of energy transfer efficiency in the Georges Bank ecosystem. Simplifying assumptions were made that the standing crop of primary producers and herbivores was equivalent to production. Maps of surface chlorophyll and *Calanus sp.* were multiplied by their respective factors to create maps of primary and secondary standing carbon. The maps were then overlaid to determine the herbivore transfer efficiency. The resulting map of energy transfer efficiency was compared to the remotely sensed map of surface temperature. A cross tabulation indicated that the more efficient energy transfer occurred in the 5-8 degrees Centigrade range (Table 2). Further refinement of both the data and the analytical technique are required to use this result for research purposes. However, the process clearly demonstrates the utility of computerized spatial analysis in complicated oceanographic questions.

CONCLUSION

This study was designed to demonstrate the more important considerations of establishing a spatial data base and the potential analysis of that data. Geographic information processing facilitates both mapping and map analysis. Once in a computerized form, the spatial relationships among and within maps can be readily assessed. Maps that identify joint coincidence, relative distances, and summary statistics can be generated. Extended analyses for describing flows or exchanges within oceanographic systems can be accomplished by developing cartographic models. The capabilities of geographic information processing are well suited to providing the link between proximally sensed ship survey data and remotely sensed data.

The study illustrates the important considerations for spatial analysis of oceanographic data and linking proximally and remotely sensed ocean measurements in spatial analyses. With further development, these techniques hold potential for enabling more effective oceanographic research.

ORIGINAL PAGE IS
OF POOR QUALITY

ACKNOWLEDGEMENTS

The research described in this paper was supported under NOAA-NMFS contract Number NA-81-FA-C-00006, issued by the National Marine Fisheries Service, Northeast Fisheries Center, Woods Hole, MA. Dr. Julien Goulet was the technical monitor of the project.

REFERENCES

Basset, Keith: Numerical Methods for Map Analysis. In Progress in Geography, Volume 4, 1972.

Davis, John C: Statistics and Data Analysis in Geology. John Wiley and Sons, Inc., New York, pp. 298-407, 1973.

Tomlin, C.D.: Cartographic Modeling Techniques in Environmental Planning. Doctoral dissertation, Yale School of Forestry, New Haven, Connecticut, in preparation.

Tomlin, C.D., Berry, J.K.: A Mathematical Structure for Cartographic Modeling in Environmental Analysis. American Congress on Surveying and Mapping, 39th Symp. Proc., 269-283, 1979.

ORIGINAL PAGE IS
OF POOR QUALITY

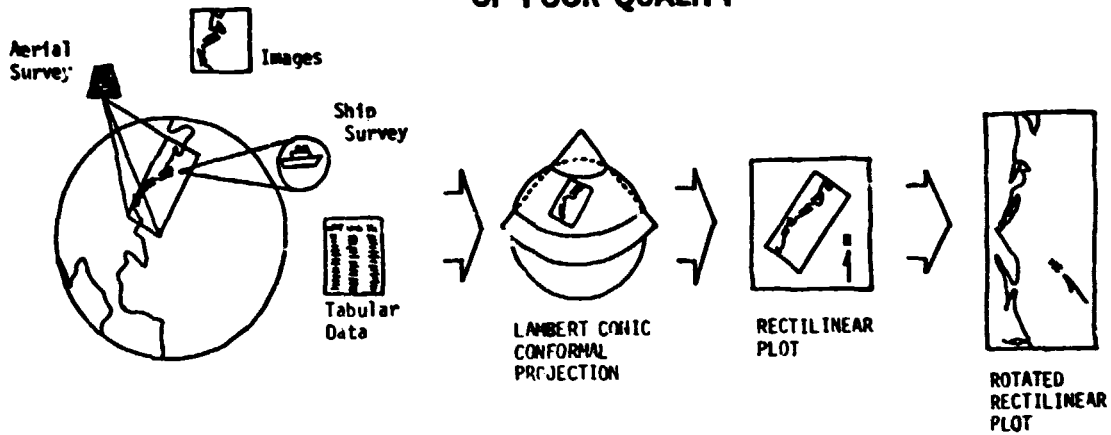

FIGURE 1. GEOGRAPHIC REFERENCING SYSTEM. Latitude/Longitude coordinates of both ship survey and image data are first converted to coordinates of a Lambert conic conformal projection. These coordinates are then converted to rectilinear X, Y coordinates which in turn are rotated to express the maximum rectangular sea surface area along the Eastern coast.

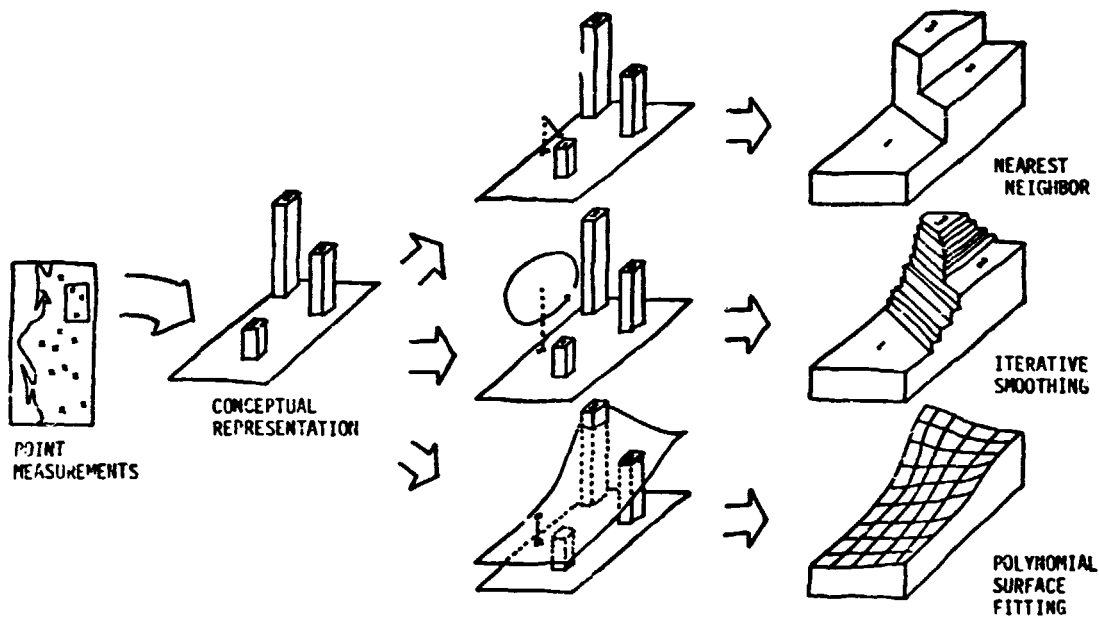

FIGURE 2. APPROXIMATION OF CONTINUOUS SPATIAL DISTRIBUTIONS. Three fundamental approaches to create continuous spatial distribution include nearest neighbor, iterative smoothing and polynomial surface fitting. Nearest neighbor routines assign a value to an unsampled area based on its nearest neighboring measured point (or weighted average of several neighbors). Iterative smoothing averages values within a "roving window" that is successively scanned across the map. Polynomial surface fitting determines interpolated values from a "best-fitted" mathematical surface that is prescribed by the user.

C-5

ORIGINAL PAGE IS
OF POOR QUALITY

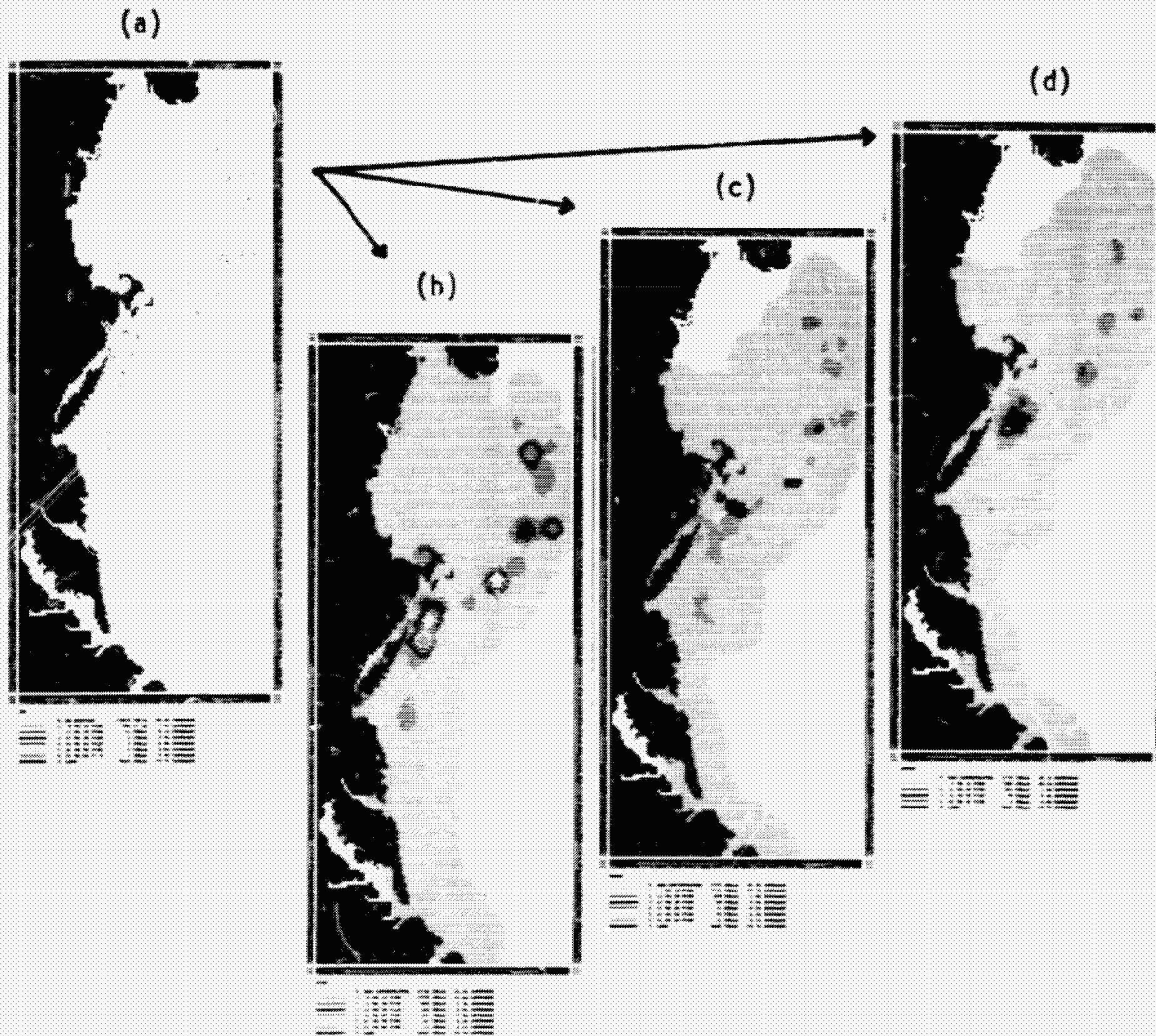

FIGURE 3. SPATIAL INTERPOLATION OF SHIP SURVEY DATA. Insert (a) locates ship survey measurement points; insert (b) is an iteratively smoothed map of numbers of Yellowtail; insert (c) is a map based on nearest neighbor interpolation; insert (d) is a map based on the weighted average of several neighboring measurements.

ORIGINAL PAGE IS
OF POOR QUALITY

(a)

(b)



FIGURE 4. TREND SURFACE FITTING OF SHIP SURVEY DATA. Insert (a) shows a first degree polynomial surface (plane) fit of the number of Yellowtail data. Insert (b) is a second degree surface fit.

ORIGINAL PAGE IS
OF POOR QUALITY

(a)

(b)

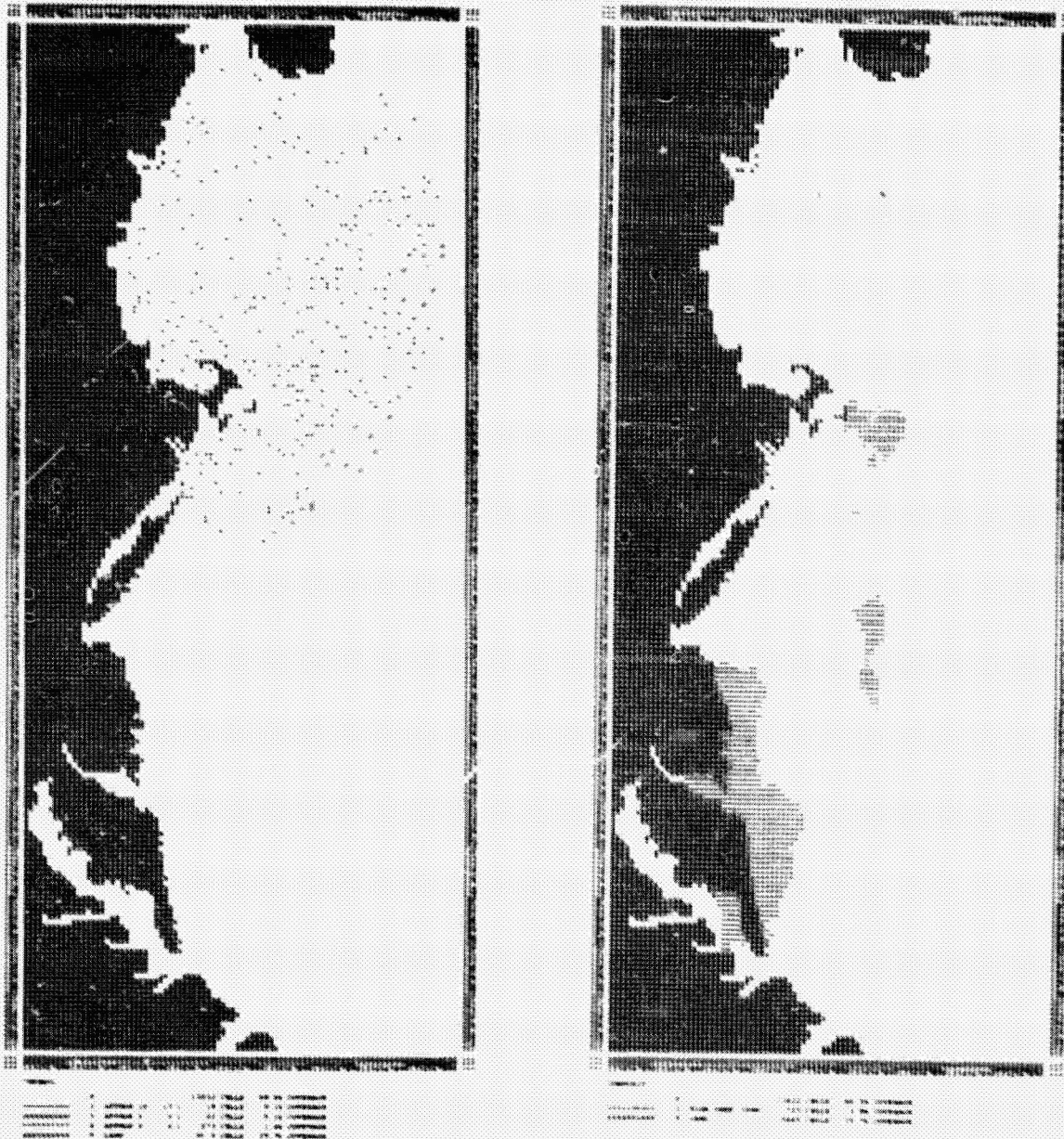

FIGURE 5. SPATIAL RELATIONSHIP AMONG SHIP SURVEY DATA AND SEA SURFACE TEMPERATURE. Insert (a) assigns satellite measured temperature values to each ship survey station within Georges Bank. The map was created by first identifying stations within Georges Bank vicinity, then assigning satellite temperature values to these locations. Note the relatively warmer stations at the lower right portion as would be expected. Insert (b) identifies areas of low surface temperature and high chlorophyll concentrations. This map was created by comparing a satellite temperature map and a surface chlorophyll map. Note the somewhat unique joint occurrence off the coast of New Jersey.

ORIGINAL PAGE IS
OF POOR QUALITY

TABLE 1. SURFACE CHLOROPHYLL CONCENTRATION BY SURFACE TEMPERATURE

MAP	MAP CATEGORIES	# OF CELLS	% OF TOTAL AREA	SCORE	% OF TOTAL SCORE	AVERAGE SCORE
SZONES	0 LAND	5645	49.7	0	0.0	0.0
SZONES	1 0 - 100 MG/M3	2511	22.1	9676	43.9	3.85
SZONES	2 101 - 200 MG/M3	2484	21.9	9471	43.0	3.81
SZONES	3 201 - 300 MG/M3	501	4.4	2004	9.1	4.00
SZONES	4 301 - 400 MG/M3	210	1.8	840	3.8	4.00
SZONES	5 401 - 500 MG/M3	7	0.1	28	0.1	4.00
SZONES	6 501 - 560 MG/M3	5	0.0	20	0.1	4.00
	TOTAL PER MAP	11363		22039		1.94

MAP	MAP CATEGORIES	# OF CELLS	% OF TOTAL AREA	SCORE	% OF TOTAL SCORE	AVERAGE SCORE
23MAR	0 LAND	5645	49.7	0	0.0	0.0
23MAR	1 APPROX > 13 C	14	0.1	14	0.1	1.00
23MAR	2 APPROX 10 - 13 C	103	0.9	206	2.1	2.00
23MAR	3 APPROX 5 - 9 C	585	5.1	844	8.5	1.44
23MAR	4 APPROX 0 TO 4 C	5016	44.1	8823	89.2	1.76
	TOTAL PER MAP	11363		9887		0.87

MAJOR MAP CATEGORIES	MINOR MAP CATEGORIES	# OF CELLS	% OF TOTAL AREA	% OF MAJOR AREA	% OF MINOR AREA	% OVERLAP
0 LAND	0 LAND	5645	49.7	100.0	100.0	100.00
1 0 - 100 MG/M3	1 APPROX > 13 C	14	0.1	0.6	100.0	50.28
1 0 - 100 MG/M3	3 APPROX 5 - 9 C	326	2.9	13.0	55.7	24.35
1 0 - 100 MG/M3	4 APPROX 0 TO 4 C	2171	19.1	86.5	43.3	64.87
2 101 - 200 MG/M3	2 APPROX 10 - 13 C	103	0.9	4.1	100.0	52.07
2 101 - 200 MG/M3	3 APPROX 5 - 9 C	259	2.3	10.4	44.3	27.35
2 101 - 200 MG/M3	4 APPROX 0 TO 4 C	2122	18.7	85.4	42.3	63.87
3 201 - 300 MG/M3	4 APPROX 0 TO 4 C	501	4.4	100.0	10.0	54.99
4 301 - 400 MG/M3	4 APPROX 0 TO 4 C	210	1.8	100.0	4.2	52.09
5 401 - 500 MG/M3	4 APPROX 0 TO 4 C	7	0.1	100.0	0.1	50.07
6 501 - 560 MG/M3	4 APPROX 0 TO 4 C	5	0.0	100.0	0.1	50.05

ORIGINAL PAGE IS
OF POOR QUALITY

TABLE 2. TRANSFER EFFICIENCY BY SURFACE TEMPERATURE

MAP	MAP CATEGORIES	# OF CELLS	% OF TOTAL AREA	SCORE	% OF TOTAL SCORE	AVERAGE SCORE
GBTEMP	0 NOT GEORGES	9853	51.9	0	0.0	0.0
GBTEMP	2 10-13 C	329	1.7	106	0.2	0.32
GBTEMP	3 5 - 9 C	570	3.0	577	1.1	1.01
GBTEMP	4 0 - 9 C	2593	13.7	1464	2.8	0.56
GBTEMP	9 LAND	5645	29.7	50805	95.9	9.00
	-----	-----		-----		-----
	TOTAL PER MAP	18990		52952		2.79

MAP	MAP CATEGORIES	# OF CELLS	% OF TOTAL AREA	SCORE	% OF TOTAL SCORE	AVERAGE SCORE
EFFICIENCY	0	11888	62.6	7337	11.5	0.62
EFFICIENCY	1 1% EFFICIENCY	1031	5.4	3887	6.1	3.77
EFFICIENCY	2 2% EFFICIENCY	250	1.3	900	1.4	3.60
EFFICIENCY	3 3% EFFICIENCY	124	0.7	460	0.7	3.71
EFFICIENCY	4 4% EFFICIENCY	16	0.1	48	0.1	3.00
EFFICIENCY	5 5% OR GREATER	36	0.2	108	0.2	3.00
EFFICIENCY	9 LAND	5645	29.7	50805	80.0	9.00
	-----	-----		-----		-----
	TOTAL PER MAP	18990		63545		3.35

MAJOR MAP CATEGORIES	MINOR MAP CATEGORIES	# OF CELLS	% OF TOTAL AREA	% OF MAJOR AREA	% OF MINOR AREA	% OVERLAP
0 NOT GEORGES	0	9853	51.9	100.0	82.9	91.44
2 10-13 C	0	226	1.2	68.7	1.9	35.30
2 10-13 C	1 1% EFFICIENCY	100	0.5	30.4	9.7	20.05
2 10-13 C	2 2% EFFICIENCY	3	0.0	0.9	1.2	1.06
3 5 - 9 C	0	351	1.8	61.6	3.0	32.27
3 5 - 9 C	1 1% EFFICIENCY	37	0.2	6.5	3.6	5.04
3 5 - 9 C	2 2% EFFICIENCY	94	0.5	16.5	37.6	27.05
3 5 - 9 C	3 3% EFFICIENCY	36	0.2	6.3	29.0	17.67
3 5 - 9 C	4 4% EFFICIENCY	16	0.1	2.8	100.0	51.40
3 5 - 9 C	5 5% OR GREATER	36	0.2	6.3	100.0	53.16
4 0 - 9 C	0	1458	7.7	56.2	12.3	34.25
4 0 - 9 C	1 1% EFFICIENCY	894	4.7	34.5	86.7	60.59
4 0 - 9 C	2 2% EFFICIENCY	153	0.8	5.9	61.2	33.55
4 0 - 9 C	3 3% EFFICIENCY	88	0.5	3.4	71.0	37.18
9 LAND	9 LAND	5645	29.7	100.0	100.0	100.00

D36

N83 19178

**ORIGINAL PAGE IS
OF POOR QUALITY**

CHITTENDEN COUNTY, VERMONT
LAND COVER PROJECT

Dennis E. Malloy
Vermont State Planning Office

ABSTRACT

Vermont needs the kind of data on its natural resource base and development trends that Landsat has the potential to provide. This paper describes the testing of Landsat applicability to urban and agricultural land use analysis at the substate level. It finds that the Landsat system has a place in Vermont and places like it, but that the present operation is inadequate and the need for technology transfer and excellent communication between the producers and users is fundamental to the future of the system and for the realization of benefit from the investment.

INTRODUCTION

This project was initiated in June 1979 to determine whether Landsat data are useful in detecting urban and agricultural land use patterns in Vermont. Further, we wished to find out how well Landsat can assist us in detecting change in these categories over time. We focused the study on Chittenden County, Vermont for two reasons. First, it contains the City of Burlington and its suburbs, which comprise the fastest growing, as well as the largest urban area in Vermont.

Second, the County also has great diversity. It is on the shore of Lake Champlain, contains significant agricultural activity in the lowlands of the lake basin, extensive forest resources in the uplands and considerable variation in terrain as the county extends from the Lake to the main ridge of the Green Mountains. We are concerned about the retention of our agricultural and forest resources, and about the rate and course of urban development in Vermont. Landsat is a tool that we wished to evaluate in relation to these concerns, and felt that we had a test for it that was typical of not only Vermont, but much of New England in terms of difficulty: small, diverse land use patterns, steep terrain and lots of clouds.

This project was undertaken by the Vermont State Planning Office, with the assistance of the Chittenden County Regional Planning Commission and the invaluable support of the staff at NASA's Eastern Regional Remote Sensing Application Center (ERRSAC) at Goddard Space Flight Center. The project is not completed and this represents a progress report.

PROJECT SCOPE AND STRATEGY

This project was designed jointly by the staffs of the Vermont State Planning Office and ERRSAC. Our strategy was to obtain Landsat images of Chittenden County with less than 10 percent cloud cover from several seasons in the early 1970's and similar coverage from the late 1970's.

We then intended to determine which scene in each year provided the best delineation of urban land cover and which the best delineation of agricultural land, and compare the scenes from the early 1970's with those from the late 1970's to evaluate Landsat's utility for detecting land use change in Vermont.

We first reviewed Landsat scenes of Vermont and found that an October 1974 scene was the only usable image from the early 1970's. We selected Landsat data sets from May 6, August 22, and November 2, 1978 as representative of the late 1970's.

After selecting these scenes, we obtained ground truth for 1974 and 1978 through the Chittenden County Regional Planning Commission, using 1974 black and white photography, late 1977 color infrared imagery and the Regional Commission's own thorough knowledge of the area. We collected this ground truth for each of the Anderson¹ Level II land use/land cover classes that were likely to be found in Vermont.

METHODOLOGY

Our first processing step was to determine which of the three 1978 Landsat data sets would provide the best urban and agricultural classifications. We extracted a 512 by 512 pixel subset covering the city of Burlington and the surrounding area for the May, August and November dates. We then developed an unsupervised classification of each subset using the IDIMS program ISOCLS, at Goddard.

Using this clustering program, 25 spectral classes were derived from the August data set, 25 from the May data set and 6 from the November data set. We then analyzed the spectral classes for each date to determine the proper land cover classification using the predetermined ground truth and high-altitude color infrared photography (scale = 1:80,000) over the study area, that we had in hand.

After we determined the land cover type for each spectral class, we color-coded them and displayed the results on the CRT screen. Color polaroids were made for each date and these products were enlarged by a factor of three for easier interpretation by Vermont personnel. The ERRSAC staff sent these initial products to the Vermont State Planning Office to be used for accuracy assessment by Chittenden County Regional Planning Commission staff and municipal officials.

It was readily apparent after this analysis that the August 1978 Landsat data provided the best data set for this analysis. The November data set was too late in the season. Hardwood trees had lost their leaves. Pasture and grass/open land had lost the characteristically green color of the growing season and consisted of dead or dying vegetation. Thus the reflectance response was not appreciably different for several different land covers and therefore not separable. The November data also resulted in a lower sun angle which caused more of a shadow effect in the mountainous terrain of this region and would have presented a problem in classifying these areas.

The May scene was taken before vegetation was fully vibrant and after many agricultural fields had been plowed. This resulted in insufficient distinction between some types of agricultural land uses but, more important, it caused mixed radiant classes containing plowed fields, some urban land uses and areas under construction. With further analysis and more discrete ground truth, imagery from this time of year could be quite useful in monitoring agricultural and urban activity.

The next step was to analyze the August data to determine misclassification and pinpoint problem classes. The analysis of the spectral classes yielded both a predominantly industrial category as well as a predominantly commercial category. The residential class, because of its heterogeneity, did not break out as well. Three spectral classes were defined as residential but also classified other areas such as the airport. Initially two of the residential classes were defined as older and newer residential as a result of ground truth knowledge of state personnel.

Another problem that occurred was the misclassification of some agricultural fields along the river as forested. To help improve this classification several training fields were selected in these fields. The signatures from these fields were added to the original spectral signatures derived from the unsupervised approach, and the data were reclassified. The classification was then rechecked for accuracy. Two of the five training fields were eliminated

as unacceptable but three were retained. These signatures added to the accuracy of the agricultural areas.

EVALUATION OF CLASSIFICATION ACCURACY

ERRSAC provided enlarged polaroid products from the corrected classification of the August data set which the State Planning Office staff evaluated for classification accuracy with substantial assistance from the regional planning commission. To do so, a common grid reference system was applied to both the August Landsat classification and a mosaic of the color infrared photography. Grid-cell size was approximately 25 acres. The planning commission then randomly selected 30% of the grid-cells for the Town of Colchester and compared the actual land use/land cover with the Landsat classification. The analysis that they did was essential in preparing us to make final corrections to the classification.

On returning to Goddard, Vermont State Planning Office and ERRSAC personnel examined the cells that appeared to be misclassified. These cells were then located on the 1:80,000 color infrared photography and on the Landsat data displayed and enlarged on the CRT screen. After examining some of these misclassified cells it was discovered that most discrepancies were the result of typical problems encountered in Landsat classification. Some areas in the wetland areas classified as either agriculture/open or as forested. The August data were taken during a time of low water and drier conditions which resulted in this classification. Because this was an urban land cover project, the agriculture/forest/wetland misclassification was not of primary consideration and was not dealt with. (The May 1978 data set taken at a time of higher water level in the wetlands discriminated the wetland class very well.) Landsat geometric distortion, color IR photographic distortion, and grid reference inaccuracy accounted for many of the differences.

After analysis of misclassified cells, all of the 28 spectral classes were again reanalyzed and reinterpreted to determine the most accurate land cover class. The original analysis of the classes was upheld although the categorization of the land cover classes was altered to more closely represent the actual cover types the satellite was imaging rather than more arbitrary urban classes. For example, previously we had defined class 18 as older residential and class 22 as newer residential. On further examination we found that both classes were probably medium density residential with the difference that one class had fewer trees and wider spaces than the other residential class. These classes could have been combined but we felt that keeping them separate could provide useful information for planners since one of the classes defined certain subdivisions and neighborhoods.

The industrial category consisting of classes 10 and 25 was changed to industrial/commercial because these classes, in fact, contained some commercial land uses. Along the same lines, the commercial category was more accurately defined as commercial/residential since some high density residential was included.

Because of some of the problems in the earlier classification, the agricultural fields along the Winooski River were checked very closely. In general the classification was good, although a few small areas in two of these fields classified as forest. The reason for this has not been determined. Perhaps dark or wet soil or bare spots in these corn fields might have caused the problem.

PROGRESS TO DATE

We are now at the point of presenting this corrected and rectified classification to regional planning and municipal officials for a final critique. This is but a first step. I suspect that there is a little room for further refinement in the classification of urban land cover. There is certainly room for further analysis of the agricultural land classes.

Beyond that, the next step should be a similar analysis of the 1974 image and an attempt at change detection. I will make no prediction of the degree of success that this effort will bring.

RESULTS AND CONCLUSIONS

Results are only intermediate at present. We may be typical of a state that is making its first foray into Landsat. We have learned much, but it has taken time. We have relied heavily on the staff of the Eastern Regional Remote Sensing Applications Center (ERRSAC) at Goddard Space Flight Center. Without their assistance this project would not have happened, a useful application of Landsat would have been missed or deferred, and we would be the poorer for it.

The present Landsat system has serious shortcomings for state or substate applications in Vermont and similar places. Frequency of coverage with a one-satellite system is totally inadequate, when cloud cover and other atmospheric interference is taken into consideration.

Still, Landsat data are valuable to us for several applications, as part of a cohesive geographic information system that should emerge here in the next several years. To see this realized in an efficient manner, we need a continuation of the kind of support that we have received from the NASA regional applications center. We need the technical support as both personnel and systems change and we need the continued communication among the producers and users throughout the country.

N83 19179

D37

THE UNIVERSITY OF VERMONT REMOTE SENSING CENTER

**Gary S. Smith
University of Vermont
School of Natural Resources**

ABSTRACT

The University of Vermont's Remote Sensing Applications Program is a NASA funded center that has been in existence since June 1978. System capabilities include digital image processing and conventional photographic interpretation. Its expressed purpose is the identification of practical applications of remotely sensed data and its encouraged use in earth resource management.

BACKGROUND AND OBJECTIVES

The Remote Sensing Applications Program at the University of Vermont was established in June 1978. Its creation was made possible by a grant (NSG 7453) from The National Aeronautics and Space Administration's Office of University Affairs. The initial funding covered a period of three years. Subsequent funding from NASA has been awarded through May 1984.

The expressed purpose of the Remote Sensing Applications Program is to investigate and encourage the practical application of remotely sensed data to a variety of earth resource problems. The primary objectives have been:

1. To test and evaluate the applicability of remote sensing technology to the solution of specific problems faced by resource managers and decision makers at the local, town, county and state levels.
2. To identify mechanisms and implement procedures for the transfer of applicable technology to appropriate user groups and for user groups to transmit needs to individuals competent in remote sensing technology.
3. To enhance the comprehensive education and research programs of the University of Vermont by the presence of resident expertise in remote sensing technology and the development and acquisition of this technology.

PRECEDING PAGE BLANK NOT FILMED

DISCUSSION

At the inception of the project, remote sensing capabilities at the School were limited to traditional photographic interpretation techniques. With the grant from NASA, the opportunity to expand into digital image processing was realized. Initial evaluation of available software packages, capable of processing digital data, such as Landsat were identified. Ultimately, the ORSER software package developed at the Pennsylvania State University was selected for installation on the University of Vermont's IBM 3031 computer. This decision was based on the program's compatibility with existing computer equipment coupled with the fact that it could be purchased at a reasonable price.

To assure the rapid installation of the software package, the School retained the services of the principal programmer for ORSER at Penn State. This consultant, working with local personnel, was able to bring up about 80 percent of the ORSER package in four days. The remaining programs were more specialized in nature, and the decision was made to incorporate them as needed.

As the local user community became familiar with the capabilities of the ORSER programs, modifications were made in the programs to suit local needs. One particular time-saving addition was the interfacing of the School's digitizer with the "SUBBOUND" program. This allows the user to directly input line and pixel elements, defining the boundary of an irregularly shaped area. This has proven to be of considerable value in the analysis of lake and river watersheds.

Use of Vermont's ORSER installation has not been limited to individuals associated with the University. The system is currently being accessed remotely by the State's Department of Forests and Parks and the Department of Water Resources.

In addition to the development of a digital image processing capability, steps have been undertaken to improve the photographic interpretation capabilities within the School. This was considered vital to the overall success of the program, since several of the projects undertaken were not appropriate for Landsat data alone. These improved capabilities include the addition of two Bausch and Lomb Stereo Zoom Transfer Scopes and two Bausch and Lomb Stereo Interpretation Systems.

One major project undertaken by the program has been the creation of a remote sensing information system containing descriptive information on all aerial imagery recorded over the State of Vermont. An exhaustive search of all possible sources revealed that over 200 separate photo missions have been conducted over the state. Initial plans had called for the publication of these data in a booklet format. The data will now be entered into the computer so that they can be selectively withdrawn to meet specific user requirements. This format will also allow the staff to maintain and distribute a current listing of all available photography at all times. Upon receipt of an inquiry, a search will be made through the computer files to identify all

suitable imagery. Coverage can be requested by a specific town, county or for the entire state. Additional constraints, such as film type, scale or range of scales, year and season can be placed on the sea. h. For example, an individual could request all of the coverage recorded over Burlington between 1953 and 1957 utilizing black and white panchromatic film at a nominal scale of 1:20,000. At the completion of the search, a listing of all available photography will be sent to the requester. Included with this list will be information explaining how to obtain copies of the photography and who currently holds examples of it in the state.

To notify all potential users of the existence of the data bank, a brief pamphlet is being prepared describing the system. Because many of the potential users have had little experience in the use of remotely sensed data, a brief discussion of remote sensing, photo scale, film types and suggested uses for the imagery is included. This material was added with the intent of attracting new users, such as town officials, to the idea of using remotely sensed data.

In addition to faculty involvement, the Remote Sensing Applications Program currently employs two full-time salaried personnel, specifically trained in remote sensing techniques. Additional hourly employees are added as project needs dictate. The program has also assisted several graduate students with their research work. To date the program has been involved in fifteen separate projects addressing such topics as cover-type mapping, water quality analysis, forest insect defoliation and land-use change analysis. Data sources have included satellite imagery, aircraft multispectral scanner tapes and conventional aerial photography. Other data sources expected to see use in the near future are digitized aerial photos and the digital RBV data.

To aid in technology transfer the Remote Sensing Applications Program has conducted a series of one-day short courses designed to acquaint state personnel with the capabilities of color infrared photography and Landsat digital data analysis. In addition to numerous tours and demonstrations staff members have been called upon to make numerous presentations both within and outside Vermont.

Future plans of The School of Natural Resources call for the creation of a total information center, designed around a geographic information system or GIS. The school is currently awaiting delivery of a Digital Equipment Corporation's VAX 11/750 minicomputer that will house this system. This machine will also house an image processing system. It is the intent of the school to interface the capabilities of the GIS with the features of the image processing system.

CONCLUSION

During the nearly three-year existence of the Remote Sensing Applications Program all three major objectives have been actively addressed. The success

of the program is due to several factors. The first and most obvious is the continued funding from NASA. Other contributing factors include the strong support of the University of Vermont, the invaluable assistance of ERRSAC personnel and an excellent working relationship between the program and state government officials. We would welcome the opportunity to share our experiences with other organizations and to learn from their developments.

N83 19180

D38

THE MICHIGAN DATA NEEDS QUESTIONNAIRE*

Richard Hill-Rowley
Center for Remote Sensing
Michigan State University
East Lansing, Michigan

ABSTRACT

The Michigan Resource Inventory Act (Public Act 204, 1979) is currently being implemented by the Division of Land Resource Programs, Michigan Department of Natural Resources. Provisions of the Act include the establishment of an Inventory Advisory Committee, the development of a current use inventory, assembling a land resource inventory and establishing a technical assistance program. The data needs questionnaire is an element in the project design study for the Act and is aimed at gathering information on what inventory information is required by land use planners throughout the state. Analysis of questionnaire responses is still in progress; however, some information on current use categories has already been tabulated. The respondents selected a broad range of categories at all levels of detail. Those most frequently indicated were urban categories.

EVOLUTION OF THE MICHIGAN RESOURCE INVENTORY ACT

Significant environmental and land use legislation was passed in Michigan during the 1970's to protect shorelands, farmland, and open space, and to prevent practices which lead to soil erosion. Attempts to formalize more comprehensive land use legislation failed. It was clear, however, that the need for a new and complete inventory of the land resource base in Michigan had been recognized by both supporters and opponents of comprehensive land use legislation. In January 1979 a bipartisan group of three legislators established a 30-member land use task force with representatives from concerned parties to assist in drafting a politically acceptable bill incorporating this inventory idea. The task force identified the need for: i) comprehensive information on land resources and land use activities and ii) better cooperation between state and local authorities in land resource management efforts. These suggestions formed the basis of the Michigan Resource Inventory Act (Public Act 204) which was passed in December 1979, signed by the Governor in January 1980 and assigned to the Department of Natural Resources (DNR) for implementation.

The Act has four main components:

1. An Inventory Advisory Committee (IAC) was established and given the task of assisting the DNR in completing its responsibilities under the Act. The

*This research was supported by the Division of Land Resource Programs, Michigan Department of Natural Resources and the Department of Resource Development, Michigan State University. Logistical support was provided by the Center for Remote Sensing, Michigan State University.

IAC is composed of 20 members from across Michigan representing local government associations, soil conservation districts, land resource based industries, state and federal agencies, environmental groups and the universities. The committee is involved with major policy decisions, the review of important technical decisions made by DNR staff and reporting to the Governor and legislature both issues and solutions identified during the inventory program.

2. A Current Use Inventory is to be completed for Michigan every five years. This inventory can be conducted by local government or regional agencies with up to a 75% cost reimbursement. Some of the inventory work will be completed by DNR staff where local agencies are not sufficiently prepared to undertake the work. Categories to be delineated will fall into such general groups as urban, agriculture, forests, wetlands and mining. Specific category descriptions have to be finalized and will be addressed later in the paper.

3. A Land Resource Inventory will also be prepared. This inventory will identify lands especially suited for farming, forestry and mineral extraction. Much land resource data that are currently available, such as soils and geologic information, will be reformatted so that all sets are consistent and, through the use of a data management system, can be accessed by users to assist them in their planning and resource management efforts.

4. A Technical Assistance Program. The Act requires the DNR to establish a thorough technical assistance program. This will involve publishing and distributing inventories to local governments, conducting workshops and seminars, the preparation of problem solving manuals and direct professional assistance to local governments with unique or difficult problems. With this type of program, PA 204 will provide information and analytical techniques to local agencies which will allow them to make more informed decisions, rather than drawing that authority away and investing it in a state land use committee. This is the critical feature because it makes PA 204 politically acceptable where previous land use proposals were not.

Prior to implementing the provisions of the Act, a project design study to define both the specific categories and methods which will be used in the inventory process and the specifications of the data management system has been initiated.

METHODOLOGY

Identification of inventory categories that are useful to the widest spectrum of users in the state is important. An integral part of this selection involves not only category selection but also technical characteristics. The right category with poor or inappropriate technical specifications has little utility and will cause frustration and disillusionment in the user community, thus jeopardizing the whole inventory process. In order to obtain direct information on category preference from the user community, it was decided that a detailed survey of user needs should be a part of the project design study.

A questionnaire was designed to elicit responses from professional planners, resource managers and other interested groups or individuals concerning

their data needs with respect to PA 204. The general categories listed in the Act were recast as potential data elements and divided into four sections.

RESOURCE INFORMATION CATEGORIES

1. Current Use Inventory. The categories listed in the Act are broad, general groups rather than specific working land use categories. In fact, users may require land use categories in several different forms, broken down into specific components or levels of detail. This requires the use of a comprehensive land use classification system so that clearly defined, mutually exclusive categories can be identified and understood by producers and users alike.

The Michigan Land Cover/Use Classification System (1975) was put together by a group of concerned professionals under the sponsorship of the Department of Natural Resources. It incorporates Level I and II categories from the system developed for use in the U.S. Geological Survey mapping program (Anderson, 1976). Level III and Level IV categories are also defined in this system with particular reference to the Michigan environment. The system has been used extensively for land use inventory in the state.

Levels I, II and III have been used in the data needs questionnaire as the group of categories from which respondents can choose when defining their requirements for land use information. Level IV information has been left out except for six categories which further specify "Utilities" (#146) and have, in the past, proved to be important for regional planners. As a general rule, Level IV categories are so specific and numerous that they are not included on land use maps or in their related information systems. The land cover/use categories in the questionnaire are listed in Table 1. A number of categories from Level III were omitted or combined with others because they were not often used, or could easily be combined with other categories. Clearly it was anticipated that any individual respondent would not identify a need for all of the categories and the questionnaire instructions illustrated a possible response for categories in the "urban" grouping. The general extent of urban land including all sub-categories may be an item of importance, although within the boundaries of this area the more specific categories of Residential and Industrial from Level II and Mobile Home Parks and Strip (commercial) Development from Level III might be indicated. This is a selection of five categories out of a possible forty-five that are considered to be needed by the agency.

2. Special Lands. In the language of PA 204 some functionally defined lands are included under the rubric of current use. They refer specifically to lands reserved or designated under other land resource related Michigan legislation.

Lands enrolled in the Farmland and Open Space Preservation Act and the Commercial Forest Reserves Act are mentioned specifically. These groupings differ from the current use categories in that they are not necessarily homogeneous and often consist of several land cover types. In a practical sense this means that the methodologies used to inventory these types of lands are different from those used with current use and they are often difficult to fit into a neat classification scheme. There are other categories of information important in a comprehensive resource inventory that are similar to areas subject to legisla-

tive mandates such as flood plains and recreation areas that, together, make up a group loosely defined as special lands (Table 2). The list is not comprehensive and the respondent can add other categories that are considered important.

3. Land Resource Data. This group of categories refers to the major natural resources of an area which are important in most resource management decisions (Table 3). Again, the list is not comprehensive but it does attempt to make more specific the general categories indicated in the land resources language of PA 204. Four groups are indicated: geology, soils, hydrology and climate.

4. Composite Indicators. Assessing the capacity of an area for some future land use or to evaluate whether its current use is best, given a set of criteria, often involves the consideration of several land attributes simultaneously. Data management systems with large geographic data bases allow resource managers to overlay and factor several variables in order to come up with limitations for certain types of development and suitability indicators for others (Table 2). A number of suitability indicators were suggested in the language of PA 204 and others have been added to this list. The next logical step would be to enquire as to the component data elements considered important in making up the composite indicator, but such a complicated task is beyond the scope of the questionnaire.

INVENTORY CHARACTERISTICS

As mentioned earlier, category selection is only the first part of the data needs identification process. Equally as important are a number of decisions on what can broadly be defined as the format of those data. The questionnaire identifies nine format components which a user should consider on choosing a particular information category. Several options are indicated for each of the nine components and it is only through an evaluation of these options that a producer can decide how best to collect and present the inventory information selected. The nine components are: coverage, resolution, accuracy, scale, level of aggregation for tabular data, application areas, importance, frequency of use and up-dating cycle (Table 3). Each of these components is applicable to the four groups of categories but they are of most critical importance to the current use categories as these data will be gathered from primary sources while most of the other data are assembled from other documentary sources. With documentary sources the format allows the provider to select, combine and possibly modify or reject data that might be used incorrectly to support decision making. Using this information to direct primary data acquisition allows critical decisions on data source and methodology to be made in the clearest possible manner.

THE QUESTIONNAIRE DOCUMENT

Drafts of the questionnaire composed of the author's initial choices and wording for the Resources Information Categories and Information Characteristics were prepared for review and comment by staff within the Division of Land Resource Programs responsible for implementation of PA 204. Copies of this document were also reviewed by staff of the Center for Remote Sensing and the Department of Geography at Michigan State University. Modifications to both

sections were incorporated in a revised document that was prepared in the single sheet format chosen for distribution. The questionnaire was then reviewed a second time with particular attention being paid to layout and the explanatory text that had been completely re-written from the initial draft. The review process at this stage went through several iterations with changes being made in the questionnaire layout and in the explanatory text. A final draft was eventually agreed upon and type-set for reproduction and testing by individuals likely to respond to the questionnaire in its final form. This pre-test stage had to be accomplished quickly because of agency constraints and, as a consequence, only two responses were gathered. The pre-test responses confirmed the substance of the questionnaire but indicated some mechanical problems in the layout and text type sizes. These were corrected by graphic highlighting, re-setting some of the type and the preparation of a step-by-step instruction sheet to lead the respondent through the explanatory text.

The questionnaire was put together in a matrix format similar to that employed in a survey of data needs administered to Oregon State government officials (Brooks, 1980). Respondents were asked to enter and/or select their category choices from the list on the left side of matrix boxes. If other choices were more appropriate, alternative selections could be written in or explained in a comments section. Once the categories were selected, the respondent then indicated one of the options from each of the information characteristic components. Again, new options in these components could be added or completely new components could be used if this was deemed necessary.

RESULTS

Analysis of the questionnaires is still in progress, and consequently this section will only report on the overall response and preliminary results from the current use inventory section.

Questionnaires were mailed to six groups. Emphasis was placed on professional planners, particularly those at the county level. However, planners in the cities, at the township level and county commissioners in counties without planning departments were also included. Table 4 contains the full tabulation of responses. Overall response was 46% of the total questionnaires mailed (86 returns from 186 mailed). A substantially better response rate was achieved from the major target groups of regional and county planners. Responses were obtained from 66% of county planners and 79% of regional planners. The distribution of these responses within Michigan was also of interest. The regional agency responses, because of their larger percentage return, have the most comprehensive areal coverage but the county agency responses (planners and commissioners combined) are also well distributed throughout the state. This is important because the results of tabulation from this group of responses can be considered to be without substantial regional bias.

As indicated earlier in the paper, two types of information were required from the questionnaire. First, which group of categories would serve the greatest number of users in Michigan; second, for these categories, which technical characteristics are required for effective utilization of the information.

Initial tabulations show that a wide range of categories are considered to be important but that only five categories were selected by over 50% of the total respondents (Table 5). These categories are from Levels II and III and are all Urban types. If the threshold level is reduced to categories that are selected by over 45% of all respondents, the number of categories selected more than doubles (13 categories). More categories are added in Level II and Level III; all from the Urban group with the exception of Streams which can really be considered as a base map category. Level I categories of Agriculture, Water and Wetland are included at the 45% threshold, throwing into even clearer perspective the respondents' overall need for detailed urban information and only very general information from the other major land use categories. Dropping the threshold level to 40% has little additional effect; Forest is added in Level I and Lakes in Level II, plus two other Level II urban categories.

It is anticipated that the major users of the inventory information will be the county and regional planners and PA 204 is very much oriented to the needs of this group. Combining the responses of county and regional planners with those of the county commissioners creates a sub-group which is probably more representative of actual needs than the full set of returns. The category selections of this sub-group are more focused than the total returns and are less oriented to Level III urban categories as might be expected with the responses from cities excluded (Table 6). Categories from the urban grouping do, nevertheless, dominate those in the 50% or above threshold group. Orchards is the sole Level II agricultural category although the four major non-urban categories are included in the Level I group at the 50% threshold. Moving through the 45% threshold adds two agricultural categories to Level II. At the 40% threshold, the Level II agricultural group is completed, Level II wetlands are added as are the other Level II categories and three additional detailed urban categories. This last group seems to be the mix of categories that can serve as a base from which to make final decisions on categories to be included in the inventory. It has a good range between levels and seems to meet a substantial proportion of user needs. Further work with the response data will be done, however, before a set of recommended categories is submitted to the Department of Natural Resources.

The second task, that of tabulating the technical characteristics of the categories selected by the respondents, is still in progress. Responses tabulated for Level I Urban suggest that this, too, will be a fairly complicated pattern. For this category the total and sub-total responses are essentially similar, varying only by degree. With each characteristic the majority choice is usually clear, however, secondary choices are also indicated. Individual township coverage is chosen with a ten-acre resolution and 90% accuracy. A scale of 1:24,000 is indicated but strong representation for 1:10,000 is also recorded. Aggregation by township is just barely the majority choice with section aggregation the only other choice. The category is considered very important and would be applied in the general planning and management of urban development areas on a weekly basis. An update cycle of every two years is deemed most appropriate. Interpretation of this information will be facilitated by considering groups of categories and making inter-group comparisons.

CONCLUSION

Work in the next months will allow recommendations on the current use inventory categories and the other information categories to be finalized for presentation to the Department of Natural Resources. Final decisions in this area will be made by the Inventory Advisory Committee. Inventory work is scheduled to commence in October 1981 and the data source to be used will be 1:24,000 color infrared imagery acquired for all of Michigan in 1978 and 1979. Other work is also in progress to define which of the selected categories can be updated accurately using Landsat and to develop operational procedures for implementing this strategy.

A copy of the questionnaire and complete tabulations of the responses are available from the author.

REFERENCES

1. Anderson, James. R., et al. 1976. A Land Use and Land Cover Classification System for Use with Remote Sensor Data. U.S. Geological Survey Professional Paper 964, Washington, D.C.
2. Brooks, Kristina M. 1980. Requirements for a Statewide Geographic Information System: A Survey of Agency Data and Analytical Needs. Oregon State Department of Forestry.
3. Michigan Land Use Classification and Referencing Committee. 1975. Michigan Land Cover/Use Classification System. Division of Land Resource Programs, Department of Natural Resources, Lansing, Michigan.

ORIGINAL PAGE IS
OF POOR QUALITY

TABLE 1. CURRENT USE INVENTORY CATEGORIES INCLUDED IN THE MICHIGAN DATA NEEDS QUESTIONNAIRE.

CURRENT USE INVENTORY			CURRENT USE INVENTORY			
Level I	Level II	Level III	Level I	Level II	Level III	
1 Urban	11 Residential	111 Multi-family residential	2 Agriculture	21 Cropland, meadow and permanent pasture	211 Cultivated cropland	
		112 Single-family residential			212 Agr. research and permanent pasture	
		113 Other residential		22 Woods, shrublands, temporary and semi-cropland	221 Total woods	
	114 Mobile home parks	222 Shrublands and vineyards				
	115 Other (please specify)	223 Pastures and meadows				
	12 Commercial, Services, Institutions	121 Primary/central business district		23 Improved pasture	231 Pasture	
		122 Shopping centers			232 Pasture	
		123 Office business district			24 Non-agricultural land	241 Parkland
		124 Secondary business district				242 Other (please specify)
	13 Industrial	131 Primary metal production		3 Amusement	31 Amusement	
		132 Petrochemical			4 Forest Land	41 Deciduous forest
		133 Primary metal smelting				411 Hardwood
		134 Paper, pulp, glass				412 Softwood
		135 Chemical processing				42 Coniferous forest
136 Other (please specify)		421 Spruce				
14 Transportation, Communication and Utilities		141 Air transportation	5 Other			51 Parks and recreation
	142 Rail transportation	52 Lakes				
	143 Water transportation	53 Structures				
	144 Communication	54 Great Lakes				
	145 Road transportation	6 Wetland		61 Forested wetlands		
	146 Utilities			62 Nonforested wetlands		
	15 Mixed Urban Land Use			151 Electrical generation and transmission	7 Open	71 Open water
				152 Solid waste disposal and storage		72 Open water
		153 Sewer treatment and transmission		73 Open water		
		154 Other (please specify)		74 Open water		
16 Recreation		161 Open pit	8 Wetland	81 Forested wetlands		
		162 Beach		82 Nonforested wetlands		
		163 Other		83 Open water		
17 Open Area		171 Open water	9 Open	91 Open water		
		172 Open water		92 Open water		
		173 Open water		93 Open water		
	174 Open water	94 Open water				

TABLE 2. RESOURCE INFORMATION CATEGORIES INCLUDED IN THE MICHIGAN DATA NEEDS QUESTIONNAIRE.

Special Lands

1. Ownership
2. Recreation
3. Historic and Archeological Sites
4. Wildlife Preserves
5. Floodplains
6. Farmland and Open Space
7. Commercial Forest Reserves
8. Shorelands
9. Wilderness and Natural Areas
10. Natural Rivers
11. Other Reserved Lands

Land Resource Data

- Geology:
1. Bedrock Geology
 2. Glacial Geology
 3. Depth to Bedrock
- Soils:
4. Texture
 5. Drainage Characteristics
 6. Permeability
 7. Slope
- Hydrology:
8. Ground Water Availability
 9. Floodplains
- Climate:
10. Normal Values
 11. Variability

Composite Indicators

- Limitations:
1. Residential Development
 2. Commercial Development
 3. Industrial Development
 4. Solid Waste Disposal
 5. Septic Tanks
 6. Mining Activity
 7. Roads and Parking Lots
 8. Erosion Hazards and Subsistence
- Suitability:
9. Agriculture
 10. Forestry
 11. Recreation
 12. Mineral Extraction
 13. Wildlife Habitat

ORIGINAL PAGE IS
OF POOR QUALITY

TABLE 3. INFORMATION CHARACTERISTICS OPTIONS INCLUDED IN THE MICHIGAN DATA NEEDS QUESTIONNAIRE.

A COVERAGE What geographic coverage is required?

- 1 Individual township
- 2 County
- 3 Multi-county area
- 4 Tailored coverage with emphasis on lands with particular resources
- 5 Specific regions, e.g., watershed, recreation area, etc. (please specify)
- 6 Other (please specify)

B RESOLUTION What is the most appropriate land size minimum sized unit to be mapped for the inventory?

- 1 Less than 1 acre
- 2 1 acre
- 3 2.5 acres
- 4 10 acres
- 5 60 acres (1/4 section)
- 6 100 acres (1/2 section)
- 7 600 acres (one township or 1 section)
- 8 Other (please specify)

C ACCURACY What level of accuracy is required? Accuracy levels and costs are directly related. Higher accuracy levels generally go along with progressively higher costs. Please indicate the best accuracy level available for your project needs.

- 1 90%
- 2 80%
- 3 70%
- 4 60%
- 5 Other (please specify)

D SCALE If map products are required, indicate the most appropriate scale.

- 1 1:10,000 (1" = 653 feet)
- 2 1:15,000 (1" = 1,120 feet or 6" = 1 mile)
- 3 1:20,000 (1" = 1,600 feet)
- 4 1:24,000 (1" = 2,000 feet or same as USGS 1:24,000)
- 5 1:31,000 (1" = 2,840 feet or same as USGS 1:31,000)
- 6 1:50,000 (1" = 4,167 feet)
- 7 1:62,500 (1" = 5,200 feet or same as USGS 1:62,500)
- 8 1:81,000 (1" = 7 mile)
- 9 1:100,000
- 10 1:250,000
- 11 Other (please specify)

E NON-MAP FORMATS If tabular data are required, please indicate appropriate level of aggregation.

- 1 Section
- 2 Township
- 3 County
- 4 Township unit
- 5 Management unit
- 6 Watershed
- 7 River Basin
- 8 Other (please specify)

F APPLICATION

- 1 Farmland and open space preservation program
- 2 Forest management
- 3 Wildlife habitat management and protection
- 4 State planning and development planning (zoning, subdivision regulations, etc.)
- 5 Tax apportionment
- 6 Management of urban development
- 7 Siting decisions for industrial development
- 8 Siting decisions for commercial development
- 9 Siting decisions for recreational development
- 10 Siting decisions for recreational development
- 11 Right-of-way corridor decisions
- 12 Implementation of the National Flood Insurance Act
- 13 Environmental impact analysis
- 14 Other (please specify)

G IMPORTANCE How important is the resource category to the activities of your unit?

Not very important 1 2 3 4 5 critical?

H FREQUENCY USE How frequently would this data variable be used?

- 1 Several times daily
- 2 Daily
- 3 Several times weekly
- 4 Weekly
- 5 Several times monthly
- 6 Monthly
- 7 Quarterly
- 8 Several times annually
- 9 Annually
- 10 Bi-annually
- 11 At least every 3-4 years
- 12 At least once every 10 years
- 13 Other (please specify)

I UPDATING CYCLE How long are the data available before updating is needed?

- 1 Less than 1 year
- 2 Each year
- 3 Every 2 years
- 4 Every 3 years
- 5 Every 10 years
- 6 Other (please specify)

TABLE 4. RATE OF RESPONSE TO THE MICHIGAN DATA NEEDS QUESTIONNAIRE.

	Total Mailed	Responses	Percent Return
Regions	14	11	79
County Planners	53	45	86
County Commissioners	10	7	70
Cities and Towns	37	23	62
Townships	20	6	30
Others	12	10	83
TOTAL	126	86	68

ORIGINAL PAGE IS
OF POOR QUALITY

TABLE 5. CATEGORIES SELECTED BY QUESTIONNAIRE RESPONDENTS:
THE TOTAL RESPONSE GROUP.

<u>Over 50% of Respondents</u>		
I	II	III
	Commercial, Services and Institutional Industrial Open Space	Multi-Family Residential Single Family Residential (5 categories)
<u>Over 45% of Respondents</u>		
I	II	III
Agriculture Water Wetlands	Residential Transportation, Communications and Utilities Streams	Mobile Home Parks Strip Development (8 categories plus previous 5 for cumulative total of 13 categories)
<u>Over 40% of Respondents</u>		
I	II	III
Forest	Lakes	Shopping Centers Road Transportation (4 categories plus previous 13 for a cumulative total of 17 categories)

TABLE 6. CATEGORIES SELECTED BY QUESTIONNAIRE RESPONDENTS:
THE PLANNER SUB-GROUP.

<u>Over 50% of Respondents</u>		
I	II	III
Agriculture Forest Water Wetlands	Residential Commercial, Services and Institutional Industrial Transportation, Communications and Utilities Extractive Open Space Orchards Streams Lakes	Multi-Family Residential Single Family Residential Mobile Home Parks (16 categories)
<u>Over 45% of Respondents</u>		
I	II	III
	Confined Feeding Other Agriculture	 (2 categories plus previous 16 for a cumulative total of 18 categories)
<u>Over 40% of Respondents</u>		
I	II	III
Range Barren	Cropland, Rotation and Permanent Pasture Forested Wetlands Non-Forested Wetlands	Central Business District Rail Transportation Solid Waste Disposal (8 categories plus previous 18 for a cumulative total of 26 categories)

N83 19181

39

A LAND COVER CLASSIFICATION FOR VERMONT

Roy A. Whitmore, Jr.
Professor of Forestry
School of Natural Resources
University of Vermont
Burlington, VT 05405

INTRODUCTION

Rapid changes in land use are presently occurring in Vermont. These changes include clearing of agricultural and forest land for urban and industrial development and the reversion of agricultural land to forest. Vermont is a small state covering some 24,887 square kilometers (9609 square miles). Of this 833 square kilometers (322 square miles) are state waters of Lake Champlain and 857 square kilometers (331 square miles) are inland waters. According to the last forest survey conducted by the U.S. Forest Service, 1,792,767 hectares (4,430,000 acres) or 76 percent of the area is classified as forest. Information about this forest area is needed for the development of management plans, to monitor and regulate forest practices and to promote and encourage the development of forest production to meet growing wood needs.

THE STUDY

The current project grew out of earlier cooperative efforts by the Vermont Department of Forests and Parks, the University of Vermont, and the Eastern Regional Remote Sensing Applications Center to detect and assess the extent of defoliation caused by forest tent caterpillar. That effort was not successful but did result in reasonably good forest cover classifications of the test areas. Products developed from these efforts were shown to state and university personnel who saw the usefulness of such data. From these beginnings, the current project developed as a cooperative effort by the three agencies. The University's effort is being conducted under the auspices of an applications grant from the Office of University Affairs of the National Aeronautics and Space Administration (NASA Grant NSG-7453).

This project has three objectives: (1) demonstrate the feasibility of using Landsat data for resource management; (2) establish projects and meet state needs for specific resource information; and (3) assist state personnel in obtaining technical expertise in the processing and analysis of Landsat data.

Two projects were initially developed involving land cover classification. The first of these involved statewide forest cover classification while the second involved an inventory of lakes and ponds with areas greater than 20 acres and classification of land use within their respective watersheds. Subsequent investigation showed that the objectives of both of these projects could be met through a single effort.

STUDY METHODS AND PROCEDURES

During the developmental stages of the project, it was decided to carry out all data processing on the Interactive Digital Image Manipulation System (IDIMS) at Goddard. At this time the ORSER program package was operational at Vermont but was not used because of the limited areas that can be processed at a single time. All classification would be by the "supervised" approach in which specific types of ground cover are identified and located prior to the classification process.

LANDSAT DATA

A prerequisite to the success of this project was the identification and acquisition of suitable Landsat scenes and data tapes. To completely cover the state required the classification and merging of portions of four Landsat scenes. With Vermont's chronic cloud cover, the selection of suitable data tapes was difficult. The decision was finally made to utilize two scenes recorded on September 26, 1978 (#30205-14555 and 30205-14561) for the eastern half of the state and another two scenes from August 22, 1978 (#30170-15011 and 30170-15014) for the western portion of Vermont. All four of these scenes were cloud free and had four good bands of data.

GROUND TRUTH AND TRAINING FIELDS

State and University personnel collected ground truth information for a series of test areas across the state within each of the four selected scenes. Training fields within the test areas had to meet three criteria: (1) the areas themselves must contain only one cover type; (2) the cover of the training areas had to be positively identified by photointerpretations; and (3) the training fields had to represent the variation present within a particular cover type.

The data for these training fields were interpreted from 1:80,000 color infrared and 1:20,000 black and white panchromatic aerial photos flown in 1977 and 1974 respectively. As many forest and other cover types as possible were located with the intention of producing a very detailed cover type map. This task proved to be a very formidable one. It was compounded by the fact that the fall color change had begun to occur at the time the September 26 scenes were recorded. It became apparent that a more general map would have to be produced with a smaller number of cover classifications. Training field coordinates recorded as Landsat scan lines and pixels were selected and registered to the ground truth training sites. Statistical data were computed for each training site. Histograms of reflectance values from each of the four bands were analyzed in terms of distribution. Those approaching normal distribution were accepted. Samples representing each of the major cover types were clustered in order to define subclasses or spectral classes within the major cover types. Statistics were calculated for each spectral class and the separability of classes was tested. The final statistics were used to classify the pixels in each major study area.

Classified map products were produced for several 500 pixel by 500 pixel study areas throughout the state. They were brought back to Vermont and checked against ground truth for classification accuracy and correction where necessary.

This work continued through the summer and fall of 1979 and involved some adjustment in classification signatures.

CLASSIFICATION

The extensive checking and subsequent adjustments produced a finalized signature set for a particular type of land cover in each of the four scenes. These signature files were utilized by the computer to classify each of the pixels within the useable portion of each scene. The final classification tapes contained data coded pixel by pixel into eight land cover classes as determined by the signature inputs. Digitized boundary data were used to subset the four areas of the state from their respective Landsat scenes. The four pieces were merged to form a composite classified map of Vermont. Resulting products included a digital tape of the composite scene and a film recorder negative used to produce the photographic product shown in Figure 1. This depicts the cover classification using every other pixel within every other scan line.

ACCURACY DETERMINATION

In order to test the accuracy of the classification, a procedure based upon a systematic random sampling method was applied to the Landsat data. Percentages of land cover were compared by a check of randomly selected areas that were photointerpreted. Such accuracy checks should accomplish two things: (1) overall classification accuracy and (2) spatial accuracy of the classification. Both of these can be achieved using the same photointerpreted cells.

Vermont has a statewide plane coordinate system in both English and metric units. The metric system uses 1,000 meter grids. A state orthophoto mapping project uses 4,000 meter grids and has produced orthophoto prints of these cells at a scale of 1:5000. Each grid cell contains 1600 hectares (3954 acres). The orthophoto maps could not be used for accuracy checking because they are only available for two-thirds of the state and because they have been developed over a 10-year period. However, the grid system could be used.

A 10 percent random sample of 167 cells was drawn and the coordinates transferred to 1:63,360 scale state highway maps. The locations of these are shown in Figure 2. Land cover within each of these sample cells was interpreted from 1977 1:80,000 scale color infrared photography and transferred to the base maps with a Bausch and Lomb Stereo Zoom Transfer Scope. The resulting maps were digitized to obtain area data by land cover class.

RESULTS

The results of this comparison are shown in Table 1. Many of the apparent differences found to date are due to inherent differences between the definitions used by an interpreter and the more rigid assignment of computer classification. For example, Landsat classified 79 percent of the area as forest cover whereas 75 percent was so classified by photointerpretation. More detailed examination of smaller cover features would cause the interpreter to call many Landsat classified forest areas as either urban or untilled agricultural lands.

Further tests of accuracy are planned for smaller areas to be subset from the larger classification.

A major benefit derived from this demonstration project was the "jelling" of a general cooperative remote sensing effort within the state. With image processing capabilities available within the state and a general understanding of Landsat's capabilities held by many state officials, additional cooperative efforts have been initiated and more are anticipated.

CONCLUSIONS

The synoptic view of Landsat provides an opportunity to obtain reasonably accurate land cover information over large areas such as states, counties or watersheds provided that the classification is held to level one. Once large areas have been classified using computer processing techniques it is possible to produce classifications for smaller areas by subsetting, through use of a digitizer, from the larger classified area. These capabilities which combine satellite, sensor, and computer make a large area land cover classification system possible.

ORIGINAL PAGE IS
OF POOR QUALITY

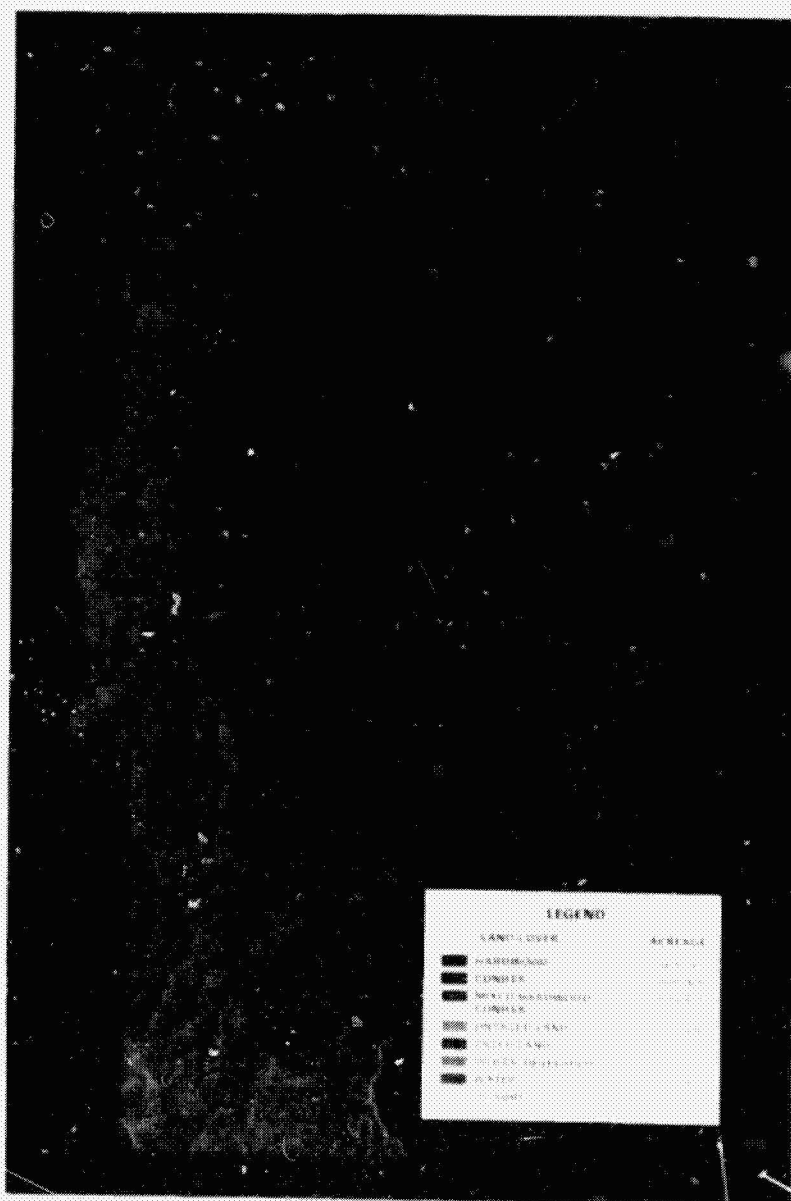

Figure 1. Land cover classification of the State of Vermont derived from the computer analysis of digital data of four Landsat scenes.

ORIGINAL PAGE IS
OF POOR QUALITY

SAMPLING UNIT LOCATIONS

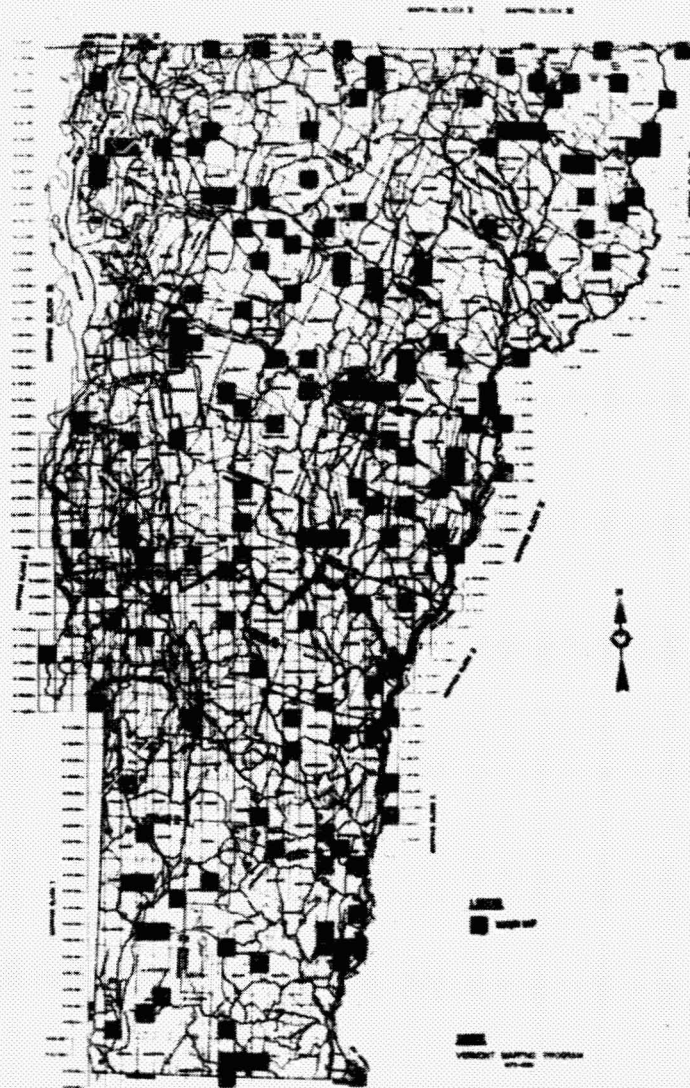

Figure 2. Location of 167 randomly selected sample grid cells for photointerpretation test of accuracy of Landsat land cover classification.

**ORIGINAL PAGE IS
OF POOR QUALITY**

Table 1. Comparison of land cover area estimates by photointerpretation and computer classification of Landsat digital data in Vermont.

<u>Land Cover</u>	<u>Photo Derived</u>	<u>Landsat</u>	<u>Difference</u>
		-----Percent-----	
FOREST	75.3 ± 1.4	79	+3.7
Hardwood	36.3 ± 2.0	54	+17.7
Conifer	21.1 ± 1.1	15	-6.1
Mixed	17.9 ± 1.0	10	-7.9
AGRICULTURE	19.5 ± 1.0	16	-3.5
Tilled	2.5 ± .4	4	+1.5
Untilled	17.0 ± 1.3	12	-5.0
URBAN	2.4 ± .7	1	-1.4
WATER	2.7 ± .9	4	-0.1
BARREN	0.1 ± .02	(0.01)	-0.1

OMIT
70
END

SUMMARY OF FORESTRY/AGRICULTURE FORUM

Chairpersons: Arlene Kerber, ERRSAC
Brian Stone, Vermont Department of Forests, Parks,
and Recreation

The forestry/agriculture forum began with two presentations: "Monitoring Forest to Agriculture Land Conversion" by Mary Louise Dudding of the Minnesota State Planning Agency, and "Michigan Small Forest Woodlot Survey" by William Enslin of Michigan State University. Following these presentations there was much concern about the proposed FY82 budget cut of the Regional Applications Program. Discussion focused on program impacts, the present Administration's policy, and misunderstandings about technology transfer. Everyone was encouraged to write to their Congressmen and Senators about two serious issues which would affect state needs:

(1) Loss of application potential--States need the low-risk, low-cost opportunity that presently exists to apply the technology and see how it works before they are willing to make an investment.

(2) Loss of continuity of data (due to postponement or cancellation of new satellite launches or change in operational system status, a data gap could occur).

The next topic of discussion was the use of Landsat data in the U.S. Forest Service Forest Survey. It was emphasized that Landsat can be used as a first-cut stratification for the Survey, as a cross-check for existing forest statistics, as well as an inexpensive means to update statistics between surveys on a regular basis. In addition, Landsat can be used by planners as a guide to spatial distribution of statistical data of the Forest Survey.

The need for forest type maps which Landsat can provide was emphasized. Some states find forest statistics without any map product not very useful. Two major problems were mentioned--the Survey does not provide maps along with the statistics so the statistics do not make sense to planners. Secondly, some states such as Indiana, Illinois, and Ohio may have to wait as long as 17-19 years between Forest Surveys.

It was pointed out, however, that the Forest Survey's purpose is determining timber resource statistics to answer the national question of how much wood there is--it is not a mapping function. The Forest Service is adding data such as wildlife and biomass which will be useful to the states. If states work in conjunction with them, they are more responsive and the Survey will be more successful within a state. There is a need for more communication.

PRECEDING PAGE BLANK NOT FILMED

394

Maine, where the Forest Service is presently working on the Survey, is attempting to digitize all photo plots which will give good geographic location for statistical data. The need for the states to take the lead in initiation of inputs (e.g., digitization, specific state needs, available state information) to the Survey was emphasized.

The use of Landsat to update the Survey was emphasized as an important role. There is a real need, at least every 5 years, perhaps more often, for a relatively inexpensive way to update forest maps and statistics between surveys. Landsat data from 1978 were able to update 1972 Forest Survey statistics for Vermont by showing an increase of about 5 percent in the total forested land over this 6-year period. Photointerpretation of aerial photography over smaller areas have verified the overall results.

The accuracy assessment of the Vermont Landsat-derived land cover map showed that a Level I classification was very good. The Level II classification was not as accurate due to: Landsat's 1.1-acre resolution versus aerial photography not being photointerpreted to that fine a level, the subjective nature of photointerpretation, and the confusion created by the lack of a clear definition of what is considered forest cover and what is mixed forestland.

Different ways of using Landsat data with Forest Survey statistics were also discussed. The suggestion was made to think in terms of a statistical surface by using Landsat to guide a spatial interpolation of statistical data to come up with an approximation of a map. In North Carolina, another way of using Landsat data and Forest Survey statistics was to include them into a land information system which relates statistics as well as other data to a specific area.

Another problem expressed during the forum was Landsat's difficulty in monitoring slow change in forestry applications. While Landsat does show changes as the result of fire, forest pests, e.g., spruce budworm, and clearcutting, forest succession is difficult to detect. It is important to delineate between clearcut and stages of forest growth. The northeast states, particularly Maine, New Hampshire, and Vermont need at least a 5-year interval to monitor change with Landsat.

The forum concluded with a brief discussion on wildlife applications, specifically the location of hemlock for the monitoring and inventorying of deer yards. The point was made that the seasonal time of year is a critical factor in delineating specific species associations, especially in the east with its mixed forest.

SUMMARY OF
LAND COVER ANALYSIS AND PLANNING FORUM

Co-chairpersons: Janette Gervin, ERRSAC
Dennis Malloy, Vermont State Planning Office

The forum began with a presentation by Edward J. Philips of the Pocomoke River Advisory Committee of his paper "Application of Landsat Data for Land and Water Research Planning, the Pocomoke River Basin, MD." Following this, Ms. Gervin opened up the discussion by asking the group what specific needs planners wished to see addressed in future Landsat systems. Several group members mentioned the resolution necessary to differentiate low density residential areas. The improved resolution of the TM was also expected to aid in categorization of wetlands.

The next topic mentioned was the possible problems associated with the increased data volume of the TM data rate, production, availability, user handling, and compatibility with the smaller computers that many state users tend to use. Ms. Gervin indicated that these problems might persist in the short run since Landsat-D like its predecessors would be administered by NASA as a research, not an operational, system with improvement anticipated when the series becomes operational.

Assuming the Carter Administration Plan to operationalize the Landsat system would be affected in some form, Ms. Gervin asked the group what institutional and technical problems planners could foresee. They cited the uncertainty of plans and lack of information flow from NASA-NOAA to the states, making it difficult for them to even know which computer system to invest in. There was a brief discussion on the availability of data and operational history of past, present, and future Landsat satellites. Next, Mr. Malloy asked how satisfactory a frequency of 1 every 18 day coverage was for their objectives. While noting the importance of cloud cover, a member pointed out that the 4 passes necessary for water quality work required more than one satellite. The launch time for Landsat-2 was not known.

The group was then asked its preferred patterns of coverage, turnaround time, and reliability. Response was very mixed, depending on the users need; some users required a month turnaround, others gave more importance to price, and some were using 3-year-old Landsat data for current classifications.

Mr. Malloy addressed the group members who had used Landsat data as to their institutional problems, and how they would operate if budget cutting stopped NASA support. The responses were that some states would simply stop using/or not start using Landsat data, that others would have to rely more on universities and experienced state and local government organizations. There was mixed enthusiasm for dealing with the private sector as local governments are frequently required to deal with the lowest bidder, and frequently aren't experienced.

SUMMARY OF SURFACE MINING AND ENERGY FORUM

Co-chairpersons: Ron Witt, ERRSAC
Dr. Hubertus Bloemer, Ohio University

The surface mining forum began with two very different papers, both of which dealt with the monitoring of surface mines. Tim Schmid of the Maryland Department of Natural Resources Water Resources Administration, discussed his cooperative project with ERRSAC that involves mapping sand and gravel pits in the Patuxent River Watershed. The classifications were developed from Landsat MSS digital data acquired on two dates over a 5-year time span. Hugh Bloemer, assistant professor at the Department of Geography, Ohio University, provided a detailed description of several processing techniques, and concluded with a discussion of his work on multi-temporal monitoring of strip mines in eastern Ohio. The text of these presentations is included elsewhere in this volume. Both papers provided an introduction and background for the discussion which followed. In addition, several questions which were identified in advance provided further focus for the forum:

- What is "state of the art" in remote sensing of surface mines?
- What is the best time of year from which to select the imagery to delineate surface mines?
- What new techniques are being applied or are anticipated?
- What categories of mines are mappable at current satellite resolution levels?

The first question was addressed by Jim Irons' paper in the plenary session and discussed in further detail in Bloemer's presentation. In summary, Landsat is ideally suited for monitoring surface-mined areas on a regional basis, both to determine the areal extent of mines and to look at sequential change. Detailed inspection of individual mines, however, is better left to interpretation of low-altitude aerial photography. For example, Landsat data have been used to monitor large strip-mined areas in Ohio, West Virginia, Pennsylvania, Maryland, and Kentucky. Furthermore, Maryland and Michigan currently have programs to map surface mines on a statewide basis and anticipate using Landsat data to accomplish their objectives.

Because of the distinctive contrast in reflection between healthy vegetation and barren areas, the optimal Landsat data for surface mine mapping is imaged during the summer months when the vegetative cover is most fully developed. The more dense and vigorous is the vegetation surrounding mined sites; the greater is the contrast between the two. Thus the extent of surface mining activity potentially can be mapped more accurately late in the growing season.

Little was said in regard to new techniques development, except that the higher spatial resolution (30 meters) and more selective spectral range of the thematic mapper would significantly improve the surface mine mapping capability from orbital altitudes.

In addition to the discussion on remote sensing of surface mines, an Ohio delegate outlined a project using Landsat data to select potential and alternative ethynol (gasohol) plant sites in his state.

SUMMARY OF DATA PROCESSING FORUM

Co-chairpersons: Marc Imhoff, ERRSAC
Brian J. Turner, ORSER, Pennsylvania State University

The data processing forum began with a presentation prepared by Dr. Brian Turner, director of the Office for Remote Sensing of Earth Resources of the Pennsylvania State University, entitled "Recent Developments with the ORSER System." This presentation dealt with an overview of the capabilities of the Office for Remote Sensing of Earth Resources (ORSER) digital image processing system and described in detail most of the major alterations and amendments to this system. A few of the major changes either recently installed or in the process of being developed are: the addition of a user-friendly front end to the software system designed to streamline program stem editing, expansion of the system to handle larger data sets, an all-FORTRAN version of the ORSER system to make the programs easier to install on a wider variety of computers, a system of programs designed to handle polygon data as well as editing of digitizer data and calculation of area statistics, and a variety of data management program improvements. The text for this presentation can be found elsewhere in this volume. With the ORSER system presentation as an introduction, the forum discussion as a whole tended to revolve around the ORSER system and ORSER users.

Dr. Brian Turner proposed that an ORSER users group be formed and supported in part by the user community. Within this proposal a newsletter will be published by the group which could be used to keep the user community up to date on alterations and amendments as well as provide a means for users to voice present and future requirements and discuss problems. To date there are 25 U.S. and eight foreign ORSER users.

Several users expressed a desire to see some kind of atmospheric correction or haze correction program input to the system. It was agreed that such a program would be useful, although very few such algorithms are currently operational. Other suggestions focused upon such proposed system additions as the inclusion of NASA STATS to the ORSER system, and the installation of an algorithm within the STATS program that would provide a histogram of the distance of each pixel vector from the various class means in order to more accurately determine an optimal critical distance.

Image Processing Systems other than ORSER were also discussed as they might be compared to ORSER. Interactive systems were described as being considerably more powerful in terms of processing time, convenience and display capability. The point was also made that interactive systems are much more expensive and require a technician educated in digital processing. ORSER on the other hand is very inexpensive, and is an excellent system with which to train people in digital processing techniques due to its step-by-step batch type mode of operation.

Discussion continued in comparing the virtues of the ORSER system and interactive systems such as ESL's IDIMS.

In general, it was agreed that the ORSER system has a wide range of processing capabilities, but that some kind of interactive mode of processing for image display, image enhancement, ground control point selection, and training site selection would be helpful.

SUMMARY OF WATER QUALITY/COASTAL ZONE FORUM

Chairpersons: Betsy Middleton, ERRSAC
Peter Cornillon, University of Rhode Island

The water quality/coastal zone forum dedicated a large portion of time to the following four presentations: "Remote Sensing in the Coastal Zone--A Perspective" by Peter Cornillon of the University of Rhode Island, "Lake Classification in Vermont" by Nancy Bryant of the Vermont Department of Water Resources, "Thermal Infrared Imagery, Cape Cod, Massachusetts" by Barbara Ryan of the U.S. Department of the Interior, and "New Jersey Long Shore Protection" by Susan Halsey of the New Jersey Geological Survey. Following these presentations, the forum participants were divided into two discussion groups, one devoted to coastal zone issues and the other geared specifically to water quality topics.

In the coastal zone group, Dr. Cornillon addressed the question of why remote sensing has been used so little in the coastal zone regions to date. Discussions that followed focused on the problems and impediments which had been experienced. The need for in situ information relative to color changes in sand, type of sediment load transport, etc. was emphasized if Light Detection and Ranging (LIDAR) or other remote sensing devices are to be used. Dr. Cornillon cautioned the group not to be too optimistic about the degree of information available from remote sensing alone, noting that it was oversold to the oceanographic community for physical oceanographic offshore research in 1968. In the intervening 10 years until 1978, when TIROS-N satellite was launched, little progress was made leaving oceanographers pessimistic about the utilization of remote sensing as a useful research tool.

However, the point was made that satellite data have been very useful in Gulf Stream studies, both in positioning and defining the dynamics of ring formation and more recently in relating Gulf Stream west wall undulations to tidal flow input. Attempts are being made to use this technique to estimate Stream velocity.

Further discussion emphasized the benefits of multispectral sensing from high altitude aircraft in coastal zone assessments. However, complications relating to aircraft position and motion that can be predictably computed for satellites must be measured and input to correct aircraft data. The suggestion was made that, for the price of one satellite launch, many dedicated aircraft sweeps of coastal regions could be made and with joint scheduling of aircraft for multi-state use, perhaps cost-effective operations could be obtained. In general, it was agreed that aircraft photos probably would be a valuable addition to Landsat data.

The water quality group began their discussion pinpointing the problems associated with observing chlorophyll measurements using remote sensing techniques. It was pointed out that a bright reflective bottom surface facilitates the

detection of chlorophyll algae. The point was made that experimental data more recent than the Purdue/LARS research are available regarding backscattering and environmental factors controlling chlorophyll measurements.

The next topic discussed was the growing concern on trophic status. Making a trophic state assessment is difficult due to regional problems. There is a need to take into consideration public perception of what water quality standards should be in the region and what individual program needs exist within the state. It was further expressed that a big problem in water quality assessment is the difficulty in acquiring adequate quantities of repetitive data in a timely fashion.

SUMMARY OF GIS FORUM

Co-Chairpersons: Bill Campbell, ERRSAC
Chuck Killpack, Utah State University

A wide variety of issues relating to development and applications of geographic information systems (GIS) were discussed in this forum. Participation came from a diverse audience whose experience with GIS ranged from systems development to first-time exposure. Most of the questions focused on what types of systems (levels of sophistication) to invest in, and when it would be appropriate for a state agency or private company to do so. The forum began with Robert Mills explaining the development of a New Jersey statewide GIS and some of the ways that it has been utilized. This introductory talk led to a number of questions and generated a discussion based on the following issues, which were highlighted at the start of the forum:

- 1 a low-cost GIS
- 2 GIS data sources
- 3 applications of GIS's
- 4 administration of GIS
- 5 the future in GIS's

Some of the questions that were raised are listed below as a means of summarizing the discussion.

- How does one decide on a minimum resolution level for mapping when different data resolution levels are involved; and how detailed and reliable should such data be?
- What types and levels of data are needed and at what point (volume and scale) should one go with an automated GIS system? How many staff with what kinds of backgrounds are necessary to get a GIS system underway?
- To what extent are GIS systems a qualitative, new tool?
- Who sells GIS systems, and what GIS systems are available commercially?
- Once installed, will a GIS system make it possible to reduce staff?
- How does one go about integrating digital terrain data with Landsat MSS data?

- What are the possibilities of decision making using a GIS, for site-specific evaluations or predictions?

Perhaps the salient conclusion of the forum for those who are thinking of setting up a geographic information system was the advice to start small and learn by making your own mistakes, but gear the solution (system) to fit your needs. Most of all, get your feet wet by starting at some point, because the state of the art is constantly changing. The key is to focus information where it is most needed. And lastly, whenever and as early as possible, get the applications people talking with the computer people to insure that system development meets the needs of the user.

SUMMARY OF
JOINT FORUM OF USER DEVELOPMENT PROGRAMS AND SUBSTATE/LOCAL

Chairpersons: Scott Cox, ERRSAC/GSFC
Nick Keppel, New England Innovation Group
Philip Cressy, ERRSAC/GSFC
Robert Ragan, University of Maryland

The session combined two forum groups originally scheduled separately. The bulk of the forum's time was given to its three speakers' presentations and the discussions which followed were abbreviated. The three presentations were: "Chittenden County, Vermont Land Cover Project" by Dennis Malloy of the Vermont State Planning Office, Montpelier, VT; "The University of Vermont Remote Sensing Center" by Gary Smith of the University of Vermont, Burlington, VT; and "The Michigan Data Needs Questionnaire" by Richard Hill-Rowley of Michigan State University, East Lansing, MI.

The chair questioned whether new county use of Landsat data would be stimulated by the example of other counties who are now users, and would the new budget constraints prevent this? The consensus was that the desire for data would be present, but that local governments were constrained by their own legislative and budget cycles, and it was hoped that universities would be able to give some help.

Asked if any of the audience had been consulted regarding what bands to include on Landsat-D and whether or not to have an MSS aboard, one person replied that he had been a member of an advisory board which recommended having an MSS and a thermal band on the TM. Dr. Cressy stated that the inclusion of the MSS was a response to the user's request for continuous, reliable data of a type with which they were familiar.

The chair asked if local governments are sufficiently interested and willing to use remote sensing to justify continuation of the program by the federal government. Answers were mixed and reflected various local needs and problems with paying for the data/service. The chair noted the use of remote sensing is now well established in planning models for water resources and suggested that research should be applied to such key uses. The audience noted the need for a replacement for ERRSAC, such as universities, if its program was discontinued. It was felt that the states could pay for these services if the local government couldn't. One member commented that his state would pay much more for an older, proven technology like aerial photography. Members commented on their different projects' time constraints and expressed concern about USGS's photo-mapping inability to fill their data gaps.

The chair summarized the roles of all parties, stated that without ERRSAC there'd still be a need for federal participation.

Suggestions were made concerning contacting Congress to show support for ERFAC's program. Dr. Cressy finished by stressing the importance of the development of partnerships among the state and local users in the event of lack of a federal program.

ERRSAC/NOAA Conference Attendees
March 9-12, 1981

Minoru Akiyama
LARS/Purdue University
1220 Potter Drive
W. Lafayette, IN 47906
(317) 463-0128

Linda Alverson
Diamond International Corp.
New England Land & Timber
Jameson Street
Old Town, ME 04468
(207) 827-7711 x463

Roger B. Arend
Photographic Interpretation
Corporation
Box 868
Hanover, NH 03755
(603) 643-2268

Phillip Augusta
Institute of Natural and
Environmental Resources
James Hall 402
University of New Hampshire
Durham, NH 03824
(603) 862-1700

John S. Banta, Esq.
Director of Planning
Adirondack Park Agency
P.O. Box 99
Ray Brook, NY 12977
(518) 891-4050

G. Robinson Barker
Southern Paperworks Division
St. Regis Paper Company
32218 Clark Road, Suite 411
Jacksonville, FL

Paul Baumann
Department of Geography
State University of NY
Oneonta, NY 13820
(607) 431-3150

George Baumer
ORSER, Penn State University
206 Ferguson Building
University Park, PA 16802
(814) 865-7554

Klaus J. Bayr
Keene State College
Keene, NH 03431
(603) 352-1909 x480

Lewis S. Beers
General Electric Company
P.O. Box 8555
Philadelphia, PA 19101
(215) 962-4158

Dennis R. Beissel
Minnesota Department of
Natural Resources
3rd Floor Space Center
444 Lafayette Road
St. Paul, MN 55103
(612) 296-0430

Joseph K. Berry
Sage Hall
205 Prospect Street
Yale University
New Haven, CT 06511
(203) 436-4729

Frank E. Bibbins
NASA Aerospace Research
Applications Center
1201 E. 38th Street
Indianapolis, IN 46205
(317) 264-4646

David Block
Department of Geography and
Regional Planning
Salisbury State College
Salisbury, MD 21801
(301) 546-3261

Herb Blodget
Code 902.1
Goddard Space Flight Center
Greenbelt, MD 20771
(301) 344-8997

Hubertus L. Bloemer
Ohio University
Department of Geography
Athens, OH 45701
(614) 594-6841

Paul Bock
University of Connecticut
C.E. Department
Storrs, CT 06268
(203) 486-4016

Ron Bonfilio
U.S. General Accounting Office
551 G Street, NW
Washington, D.C. 20548
(202) 275-3192

Francis P. Bowles
Ecosystems Center
Marine Biological Lab.
Woods Hole, MA 02543
(617) 548-3705 or 3772

Miles G. Boylan
Center for Remote Sensing
Michigan State University
East Lansing, MI 48824
(517) 353-9226

Murray Brace
5 Auburn Street
Nashua, NH 03060
(603) 883-6344

Alexander Brown
Data General Corporation
Rte. 9, MSB-211
Westborough, MA 01581
(617) 366-8911 x5242

Joel Brown
54 Creighton Street
Cambridge, MA 02140
(617) 864-6791

James O. Brumfield
Remote Sensing Group
Marshall University
Huntington, WV 25701
(304) 696-6738

Nancy Bryant
Vermont Department of
Water Resources
State Office Building
Montpelier, VT 05602
(802) 828-2761

Jay Buckley
General Electric Company
P.O. Box 8555
Philadelphia, PA 19101
(215) 962-3262

Jim Burtis
Forest Service
Tawes State Office Building
Annapolis, MD 21401
(301) 269-3776

Gary L. Bye
Commonwealth of Massachusetts
Dept. of Environmental Mgmt.
100 Cambridge Street
Boston, MA 02202
(617) 727-3174

Lynell Cameron
LogEtronics, Inc.
7001 Loisdale Road
Springfield, VA 22042
(703) 971-1400 x242

Bill Campbell
Code 902.1
Goddard Space Flight Center
Greenbelt, MD 20771
(301) 344-8909

Alejandro Candelario
Commonwealth of Puerto Rico
Dept. of Natural Resources
P.O. Box 5887
San Juan, PR 00906
(809) 722-3571

Bill Carey
Greenhorne & O'Mara, Inc.
6715 Kenilworth Avenue
Riverdale, MD 20737
(301) 277-2121

Rick Carlson
Dept. of Environmental Resources
P.O. Box 2357
Harrisburg, PA 17120
(717) 783-8727

Angy Castro
Commonwealth of Puerto Rico
P.O. Box 41109
San Juan, PR 00940
(809) 726-5440

Roger Caves
Division of Parks, Recreation
and Technical Services
DNREC
Box 1401, Tatnall Bldg.
Dover, DE 19901
(302) 736-5284

J. M. Chaisson
Maine State Planning Office
Mail Station #38
State House
Augusta, ME 04333
(207) 289-3154

Eber, Chesebrough
MA Division of Water
Pollution Control
Lyman School, Rt. 9
Westborough, MA 01581
(617) 366-9181

Duncan M. Chesley
Remote Sensing Center
320 Hasbrouck Lab.
University of Massachusetts
Amherst, MA 01002
(413) 545-2510

Daniel L. Civco
University of Connecticut
U-87 Natural Resources Dept.
Storrs, CT 06268
(203) 486-2840

Douglas G. Clark
Indiana Department of
Natural Resources
Division of Water
Rm. 605, State Office Bldg.
Indianapolis, IN 46204
(317) 232-4160

Charles P. Comeau
Optronics International, Inc.
7 Stuart Road
Chelmsford, MA 01824
(617) 246-4511

James F. Connors
Land Use Regulation Commission
State House Station 22
Augusta, ME 04333
(207) 289-2631

William J. Conroy
General Electric Company
4701 Forbes Blvd.
Lanham, MD 20801
(301) 459-2900

Daniel Cooper
Greenhorne & O'Mara, Inc.
6715 Kenilworth Avenue
Riverdale, MD 20737
(301) 277-2121 x227

Kristine Corey
Division of Fisheries
and Wildlife
Field Headquarters
Westborough, MA 01581

Peter Cornillon
Department of Ocean
Engineering
University of RI
Kingston, RI 02881
(401) 792-2189

Dan Cotter
6508 Bowie Drive
Springfield, VA 22150
(202) 377-1250

Scott Cox
Code 902.1
Goddard Space Flight Center
Greenbelt, MD 20771
(301) 344-8909

Nancy Cranker
Massachusetts Department of
Environmental Quality Engr.
1 Winter Street
Boston, MA 02110
(617) 727-7436

Phil Cressy
Code 902.1
Goddard Space Flight Center
Greenbelt, MD 20771
(301) 344-7658

Raymond Curran
Box 99
Adirondack Park Agency
Raybrook, NY 12977

Kathleen Dailey
18B Totman Drive
Woburn, MA 01901
(617) 935-4493

Bill Dallam
General Electric Company
4701 Forbes Road
Lanham, MD 20801
(301) 457-2000 x458

Peter Descamps
Commonwealth of Massachusetts
Dept. of Environmental Mgt.
100 Cambridge Street
Boston, MA 02202
(617) 727-3184

Robert Dezmelyk
Laboratory Computer
Systems, Inc.
139 Main Street
Cambridge, MA 02142
(617) 547-4738

Cheryle Dixon
Piedmont Planning District
Commission
Box P, 10 1/2 High Street
Farmville, VA 23901
(804) 542-4220

Pauline F. Doroshenko
Aero-Marine Surveys, Inc.
Drawer 1230
New London, CT 06320
(203) 447-3047

Benjamin Drake
Department of Geophysical
Sciences
Technology Building
Old Dominion University
Norfolk, VA 23508
(804) 440-4301

Mary Louise Dudding
Minnesota Land/Mgt. Info.
Center
State Planning Agency
LL45, Metro Square Bldg.
St. Paul, MN 55101
(612) 296-2720

Edward F. Dyer
Grinele Systems
419 N. Chapelgate Lane
P.O. Box 2946
Baltimore, MD 21229
(301) 945-2922

Robert L. Edwards
Northeast Fisheries Center
Woods Hole, MA 02543
(617) 548-5123

William Enslin
Michigan State University
Center for Remote Sensing
201 UPLA Building
East Lansing, MI 48824
(517) 353-7195

Nick Faust
17 Roanoke Avenue
Atlanta, GA 30305
(404) 266-2062

Frank Fels
RCA American Communications,
Incorporated
400 College Road East
Princeton, NJ 08540
(609) 734-4010

Victor Ferreros
Council of State Governments
P.O. Box 11910
Lexington, KY 40578
(606) 252-2291

John T. Finn
Dept. of Forestry & Wildlife
Holdsworth Hall
University of Massachusetts
Amherst, MA 01003
(413) 545-2538

Bruce Firsching
Institute of Natural and
Environmental Resources
University of New Hampshire
102 Hertzell Hall
Durham, NH 03824
(603) 447-3047

Timothy L. Flynn
Aero-Marine Surveys, Inc.
Drawer 1230
New London, CT 06320
(203) 447-3047

Robert E. Frost
UAS Engr. Topo. Lab.
Ft. Belvoir, VA 22060
(703) 664-3621

Sheila Frye
10249 Prince Place
Upper Marlboro, MD 20870
(301) 377-1250

Robert W. Fuller
206 Hills Building
University of Vermont
Burlington, VT 05405
(802) 656-2620

Lester E. Garvin
Charles T. Main, Inc.
101 Huntington Ave.
Boston, MA 02199
(617) 262-3200

Janette Gervin
Code 902.1
Goddard Space Flight Center
Greenbelt, MD 20771
(301) 344-7061

Julien Goulet
Natural Marine Fisheries
Service
Rural Route 7
Narragansett, RI 02882
(401) 789-9326

James Griffin
Graduate School of Oceanography
University of Rhode Island
Kingston, RI 02881
(401) 792-6110

Baron N. Guetti
New York State Department of
Environmental Conservation
50 Wolf Road, Room 532
Albany, NY 12233
(518) 457-3431

Fred Gunther
Computer Sciences Corp.
8728 Colesville Road
Silver Spring, MD 20910
(301) 344-5155

Sue Halsey
NJ Dept. of Environmental
Protection/NJ Geo. Survey
Box 1390
Trenton, NJ 08625
(609) 984-6526

David L. Hardin
Delaware Dept. of Natural
Resources & Environmental
Control
DNREC - Wetlands Section
Room 203, Blue Hen Mall
Dover, DE 19901
(302) 736-4691

Peggy Harwood
Council of State Planning
Agencies
444 N. Capitol Street, NW
Washington, D.C. 20001
(202) 624-7727

Wallace Hedrick
Resources NW, Inc.
775 North 8th Street
Boise, ID 83702
(208) 345-0640

Fred Henderson
Geosat Committee, Inc.
153 Kearny St., Suite 209
San Francisco, CA 94108
(415) 981-6265

Janet Hess
Northeast Fisheries Center
South Ferry Road
Narragansett, RI 02882
(401) 789-9326

Kenneth Hicks
RCA Astro Electronics
M.S. 56, P.O. Box 800
Princeton, NJ 08540
(609) 448-3400 x2333

Cyrol G. Hide
S.A. Science Office
2555 M Street, NW
Washington, D.C. 20037
(202) 833-3860

Richard Hill-Rowley
Center for Remote Sensing
201 UPLA Building
Michigan State University
East Lansing, MI 48824
(517) 353-7195

Marida Hines
Computer Sciences Corp.
8728 Colesville Road
Silver Spring, MD 20910
(301) 589-1545

Nancy J. Hooper
Metrics, Inc.
290 Interstate North, Suite 116
Atlanta, GA 30339
(404) 955-1975

William G. Howland
Dept. of Geography
McGill University
805 Sherbrooke St., West
Montreal, P.Q. H3A2K6
CANADA

Robert Huguenin
University of Massachusetts
Remote Sensing Center
Amherst, MA 01003
(413) 545-2570

Dorothy S. Hunnewell
DEQE, Division of Hazardous
Waste
1 Winter Street
Boston, MA 02110
(617) 727-0774

Warren Hypes
SR1, Box 129-E
Toano, VA 23165
(804) 564-3666

Marc Imhoff
Goddard Space Flight Center
Code 902.1
Greenbelt, MD 20771
(301) 344-5240

Tadahico Inada
National Space Development
Agency of Japan
Embassy of Japan, Science Section
900 Watergate
600 New Hampshire Ave., NW
Washington, D.C. 20037
(202) 234-2266

Jim Irons
Code 923
Goddard Space Flight Center
Greenbelt, MD 20771
(301) 344-5240

David F. Janes
Commonwealth of Massachusetts
Dept. of Environmental Mgt.
100 Cambridge Street
Boston, MA 02202
(617) 727-0247

Arthur W. Johnson
System Development Corporation
7929 Westpark Drive
McLean, VA 22102
(703) 790-9850

David S. Johnson
Asst. Admin. for Satellites
National Oceanic & Atmospheric
Administration
Washington, D.C. 20230
(202) 763-7190

Gene O. Johnson
R&D - Ohio Dept. of Energy
30 East Broad Street
34th Floor
Columbus, OH 43215
(614) 466-8277

Lawrence N. Jolma, Jr.
Planning Research Corp.
7600 Old Springhouse Road
McLean, VA 22102
(703) 893-1800 x2453

Judy Jones
New Jersey Dept. of
Environmental Protection
88 East State Street
Trenton, NJ 08625
(609) 984-7755

Robert Kasvinsky
New England River Basins
Commission
141 Milk Street, 3rd Floor
Boston, MA 02109
(617) 223-6314

William Keefe
Chief, Comprehensive Planning
for Loudoun County
18 North King Street
Administrative Building
Leesburg, VA 22075
(703) 777-0252

Linda M. Kelley
GSA/ADTS
J. W. McCormack PO & CH
Boston, MA 02109
(617) 223-6277

William C. Kennard
Natural Resources
Conservation Department
U-87
University of Connecticut
Storrs, CT 06268
(203) 486-2839

William D. Kenney
Goddard Space Flight Center
Code 415.8
Greenbelt, MD 20771
(301) 344-7745

Nick Kepple
New England Innovation Group
12F North Main Street
Providence, RI 02903
(401) 272-3437

Arlene Kerber
5376 Mad River Lane
Columbia, MD 21044
(301) 730-0845

Charles Killpack
Dept. of Landscape and
Environmental Planning
Utah State University
Logan, UT 84322
(801) 750-3476

Hobart King
Box 879
Morgantown, WV 26505
(304) 292-6331 x227

Hans Klundor Associates
Hanover, NH 03755
(603) 649-1131

Greg T. Koeln
Dept. of Fisheries and
Wildlife
School of Forestry and
Wildlife Resources
VPI and State University
Blacksburg, VA 24061
(703) 961-5320

Diane Kugelmann
Code 902.1
Goddard Space Flight Center
Greenbelt, MD 20771
(301) 344-8146

E. J. Langham
National Hydrology Research
Institute
Environment Canada
351 St. Joseph Boulevard
Hull P.O.
K1A 0E7
CANADA
(613) 997-2385

Wendy Larson
Institute of Natural and
Environmental Resources
University of New Hampshire
Durham, NH 03824
(603) 862-1700

Ming T. Lee
Illinois State Water Survey
P.O. Box 5050, Station A
Champaign, IL 61820
(217) 333-4960

Gail Leighton
NH Div. of Forest & Lands
Box 856
Concord, NH 03301
(603) 271-3456

Laurence Leone, Jr.
26 Porter Street
East Boston, MA 02128
(617) 569-4787

Aulis Lind
Dept. of Geography
University of Vermont
Burlington, VT 05401
(802) 656-3060

David T. Lindgren
Dept. of Geography
Dartmouth College
Hanover, NH 03755
(603) 646-3379

Taylor H. Loop
Geological Sciences
New England College
Henniker, NH 03278
(603) 428-2354

Manuel A. Lopez
Environmental Research
Inst. of Michigan
1501 Wilson Blvd., Suite 90
Arlington, VA 22209
(703) 528-5250

John Lukens
94 University Avenue
Providence, RI 02906
(401) 272-8269

Jack McCarthy
School of Natural Resources
University of Vermont
16 Colchester Avenue
Burlington, VT 05401
(802) 656-2684

Marty McClure
University of Rhode Island
Graduate School of
Oceanography
Southferr Road
Narragansett, RI 02882
(401) 792-6265

Chet McCord
Massachusetts Division of
Fisheries and Wildlife
Field Headquarters
Westborough, MA 01581
(617) 366-4479

E. Bruce MacDougall
Department Head
Dept. of Landscape Architecture
and Regional Planning
University of Massachusetts
Amherst, MA 01003
(413) 545-2255

James McLaughlin
Office of State Planning
2 1/2 Beacon Street
Concord, NH 03301
(603) 271-2155

Alden McLellan, IV
CN 402
Trenton, NH 08625
(609) 292-2906

Philip D. McLellan
Commonwealth of Massachusetts
Dept. of Environmental Mgt.
100 Cambridge Street
Boston, MA 02202
(617) 727-4704

Norman MacLeod
P.O. Box 9984
Chevy Chase, MD 20015
(301) 654-8856

Robert T. Macomber
AeroEco
3 Wilelinor Drive
Annapolis, MD 21037
(301) 261-8448

Joseph Mahone
GSA/ADTS
J. W. McCormack PO & CH
Boston, MA 02109
(617) 223-6277

Dennis Malloy
Vermont State Planning Office
Pavilion Office Bldg.
Montpelier, VT 05602
(802) 828-3326

Christopher Martin
University of Massachusetts
Marine Station
Box 128, Lanesville Station
Gloucester, MA 01930
(617) 281-1930

Ron Martin
Box 7921
Dept. of Natural Resources
GEF-2 Building
Madison, WI 53702
(608) 266-9270

Robert J. Mathieu
Dept. of Geography
Slippery Rock State
Slippery Rock, PA 06057
(412) 794-7169

Eugene Maxwell
Solar Energy Institute
1617 Cole Blvd.
Golden, CO 80401
(303) 231-7988

Alexander Melendez
Commonwealth of Puerto Rico
P.O. Box 7066
Barrio Obrero Station
Santurce, PR 00916
(809) 754-3184

Robert W. Merideth, Jr.
Environmental Remote
Sensing Center
Univ. of Wisconsin - Madison
1253 Meteorology Bldg.
Madison, WI 53706
(608) 263-4578

Charles Messina
W. Va. Geological/
Econ. Survey
Box 879
Morgantown, WV 26505

Betsy Middleton
Code 902.1
Bldg. 22, Room G56
Goddard Space Flight Center
Greenbelt, MD 20771
(301) 344-8403

Robert Mills
Dept. 190
W. State Street
Trenton, NJ 08625

Barry Moore
Lockheed/EMSCO
1830 NASA Rd., #1
Houston, TX 77058
(713) 483-4623

Stephen J. Moore
Essex Agricultural and
Technical Institute
Hathorne, MA 01937
(617) 774-0050

Pat Mulligan
Code 902.1
Goddard Space Flight Center
Greenbelt, MD 20771
(301) 344-8146

John C. Munday, Jr.
Head, Remote Sensing Center
Va. Institute of Marine Sciences
Gloucester Point, VA 23062
(804) 642-2111 x254

Helen Mustafa
Northeast Fisheries Center
Woods Hole, MA 02543
(617) 548-5123

Susann Doris Nachmann
6 Central Avenue
Burlington, MA 01903
(617) 272-5499

Bob Nelson
Dept. of Environmental
Resources/Pennsylvania
P.O. Box 2357
Harrisburg, PA 17120
(717) 783-8727

Charles H. Nixon
COMS, URI
19 Upper College Road
Kingston, RI 02881
(401) 789-1374

Earl A. Nordstrand
Land Management Information
Center
Minnesota State Planning Agency

Sue Norman
NASA/ARC
Moffett Field, CA

Howard Nowell
NH Fish and Game Dept.
34 Bridge Street
Concord, NH 03301
(603) 271-2462

Kurt N. Olson
INER, James Hall
University of New Hampshire
Durham, NH 03824
(603) 862-1020

Linea Olson
18 Roosevelt Avenue
Apt. 6
Hudson, NH
(603) 880-8693

Bryant Pake
New England Innovation Gp.
251 Main Street
Berlin, NH 03570
(401) 272-3437

Ted Paludan
University of Tennessee
Space Institute
Tullahoma, TN 37388
(615) 455-0631

D. G. Park
The Geosat Committee, Inc.
153 Kearny, Suite 209
San Francisco, CA 94108
(415) 891-6265

J. Thomas Parr
TASC
1 Jacob Way
Reading, MA 01867
(617) 944-0863

Alan Patterson
33 Willow Avenue
Somerville, MA 02144
(617) 623-1163

Al Patunoff
Dept. of Forests, Parks
and Recreation
Heritage II Building
79 River Street
Montpelier, VT 05602
(802) 828-3471

Joseph E. Pelczarski
Coastal Zone Mgt.
100 Cambridge Street
Boston, MA 02202
(617) 727-9530

Edward P. Phillips
Pocomoke River Advisory
Committee
Decatur Farm
Route 3, P.O. Box 236
Berlin, MD 21811
(301) 641-0328

John Quimby
Dept. of Environmental
Resources
P.O. Box 2357
Harrisburg, PA 17120
(717) 783-8727

R. M. Ragan
Department of Civil
Engineering
University of Maryland
College Park, MD 20740
(301) 454-6617

William P. Raney
5946 Wilton Road
Alexandria, VA
(703) 960-9034

Phillip Reynolds
Columbia Gas System
20 Montchanin Road
Wilmington, DE 19807
(302) 429-9935

Kevin Richardson
50 Cottage Street
Amherst, MA 01002
(413) 594-6512

Noel Ring
Earth Sciences Department
University of Lowell
Lowell, MA 01854
(617) 452-5000 x2541

Robert Rogers
ERIM
P.O. Box 8618
Ann Arbor, MI 48107
(319) 994-1200

Barbara J. Ryan
U.S. Geological Survey
150 Causeway Street
Suite 1001
Boston, MA 02114
(617) 223-2822

Edward Sahaydak
Commonwealth Data Base
Commonweaalth of Virginia
Taxation Department
Richmond, VA 23383
(804) 257-8064

John Sailor
44 Cherry Street, #4
Somerville, MA 02144
(617) 666-5116

John Salop
Va. State Air Pollution Board
Penbroke 4
Penbroke Park, Suite 409
Virginia Beach, VA 23462

Angelito R. Sandoval
Connell Commodities, Inc.
45 Cardinal Drive
Westfield, NJ 07092
(201) 233-0700

Peter Saunders
Dept. of Forestry
and Wildlife
Univ. of Massachusetts
Amherst, MA 01003
(413) 545-2011

Timothy J. Schmidt
Surface Mining Division
State of Maryland
Dept. of Natural Resources
Tawes State Office Bldg.
(D-3)
Annapolis, MD 21401
(301) 269-2265

Len Sedney
Envirosphere Company
2 World Trade Center
New York, NY 10048
(212) 839-1129

Becky Sherer
Mass. Division of Water
Pollution Control
Lyman School, Rt. 9
Westborough, MA 01581
(617) 366-9181

Nick Short
Code 902.1
Goddard Space Flight Center
Greenbelt, MD 20771
(301) 344-5515

Lou Slee
General Electric Company
P.O. Box 8555
Philadelphia, PA 19101
(215) 962-1079

Robert Smekofski
Minnesota Land Mgt/
Information Center
State Planning Agency
LL45, Metro Square Bldg.
St. Paul, MN 55101
(612) 296-1204

Gary Smith
16 Cochester Avenue
University of Vermont
Burlington, VT 05405
(802) 656-2684

Arthur Socolow
Pennsylvania Geological Survey
914 Executive House
Harrisburg, PA 17101
(717) 787-2169

Cheng-jyi Song
Modeling & Engineering Section
Indiana State Board of Health
1330 West Michigan Street
Indianapolis, IN 46206
(317) 633-0729

G. William Spann
Metrics, Inc.
290 Interstate North
Suite 116
Atlanta, GA 30339
(404) 955-1975

Bob Spivey
Dept. of Conservation
Bureau of Public Lands
Augusta, ME 04333
(207) 289-3061

Lynn Sprague
Division of Soil/Water
Conservation
DNREC
Box 1401, Tatnall Bldg.
Dover, DE 19901
(302) 736-4411

John A. Stanturf
Cornell University
Remote Sensing Program
464 Hollister-Cornell
Ithaca, NY 14853
(607) 256-4330

Jan Stetson
Mass. Dept. of Environmental
Quality Engineering
Office of Planning &
Program Management
1 Winter Street
Boston, MA 02110
(617) 727-0774

Brian Stone
Dept. of Forests, Parks
and Recreation
Heritage II Bldg.
79 River Street
Montpelier, VT 05602
(802) 828-3471

Dick Stoneslifer
Code 902
Goddard Space Flight Center
Greenbelt, MD 20771
(301) 344-7856

Alan J. Stratton
TASC
1 Jacob Way
Reading, MA 01867
(617) 944-6850

Nevin Strock
Commonwealth of Pennsylvania
Dept. of Environmental Resources
P.O. Box 2063
Harrisburg, PA 17120
(717) 783-8845

Laurie H. Suda
ESSO & Agr. & Technical Institute
Hathorne, MA 01933
(617) 774-0050 x78

Dennis J. Swartwout
Univ. of Massachusetts
Dept. of Wildlife Mgt.
Holdsworth Hall
Amherst, MA 01003
(413) 545-2666

Paul A. Tessar
National Conference of
State Legislatures
1125 17th Street, Suite 1500
Denver, CO 80202
(303) 623-6600

Andrews L. Tolman
Maine Geological Survey
Station 22
Augusta, ME 04333
(207) 289-2801

Julio A. Toro
Commonwealth of Puerto Rico
Dept. of Natural Resources
P.O. Box 5887
San Juan, PR 00906
(809) 723-8774 x294

Celeste Tracy
New Jersey Department of
Environmental Protection
Heritage Program/
Office Green Acres
1301 Parkside Avenue
Trenton, NJ 08638
(609) 292-2455

Brian J. Turner
ORSER, Penn State University
208 Ferguson Building
University Park, PA 16802
(814) 865-1602

Alex Tuyahov
NASA Headquarters
600 Independence Ave., SW
Washington, D.C. 20546
(202) 755-8653

David E. Ulmer
ORI, Inc.
1400 Spring Street
Silver Spring, MD 20910
(301) 588-6180

James S. Vandergraft
Automated Sciences Group
700 Roeder Road
Silver Spring, MD 20910
(301) 587-8750 x301

Randy Vereen
Illinois Bureau of the Budget
State House Room 2 1/2
Springfield, IL 62706
(217) 782-3548

Joe Vitale
NASA Headquarters
600 Independence Avenue, SW
Washington, D.C. 20546
(202) 755-7450

Jimmy Weber
5376 Mad River Lane
Columbia, MD 21044
(301) 730-0845

Richard Weinstein
NASA Headquarters
Code GTS-6
Washington, D.C. 20546
(202) 755-7450

Gary Westerman
Maine Dept. of Environmental
Protection
Water Bureau/Planning Div.
State House Station #17
Augusta, ME 04333
(207) 289-2591

James A. Wheaton
Laboratory Computer
Systems, Inc.
139 Main Street
Cambridge, MA 02142
(617) 547-4738

James White
Photo Science, Inc.
7840 Airpark Road
Gaithersburg, MD 20760
(301) 948-8550

Roy Whitmore
Department of Forestry
217 Hill Building
University of Vermont
Burlington, VT 05405
(802) 656-2620

Mark Wilkins
Science and Technology Dept.
British Embassy
3100 Massachusetts Ave., NW
Washington, D.C. 20008
(202) 462-1340

Ron Witt
Code 902.1
Goddard Space Flight Center
Greenbelt, MD 20771
(301) 344-5042

Dave J. Wright
Manager, Adv. Systems Marketing
General Electric Company
Valley Forge Space Center
P.O. Box 8555
Philadelphia, PA 19101
(215) 962-3409

Robert D. Yaro
Commonwealth of Massachusetts
Dept. of Environmental Mgt.
100 Cambridge Street
Boston, MA 02202
(617) 727-8893

Clarice M. Yentsch
Bigelow Laboratory
McKown Point
West Boothbay Harbor, ME 04575
(207) 633-2173

David Zumeta
Indiana State Planning
Services Agency
143 W. Market Street, Suite 300
Indianapolis, IN 46227
(317) 232-1500