

General Disclaimer

One or more of the Following Statements may affect this Document

- This document has been reproduced from the best copy furnished by the organizational source. It is being released in the interest of making available as much information as possible.
- This document may contain data, which exceeds the sheet parameters. It was furnished in this condition by the organizational source and is the best copy available.
- This document may contain tone-on-tone or color graphs, charts and/or pictures, which have been reproduced in black and white.
- This document is paginated as submitted by the original source.
- Portions of this document are not fully legible due to the historical nature of some of the material. However, it is the best reproduction available from the original submission.

NASA-CR-168129



TRW Space & Technology Group

Requirements for a Mobile Communications Satellite System

Volume 2 - Technical Report

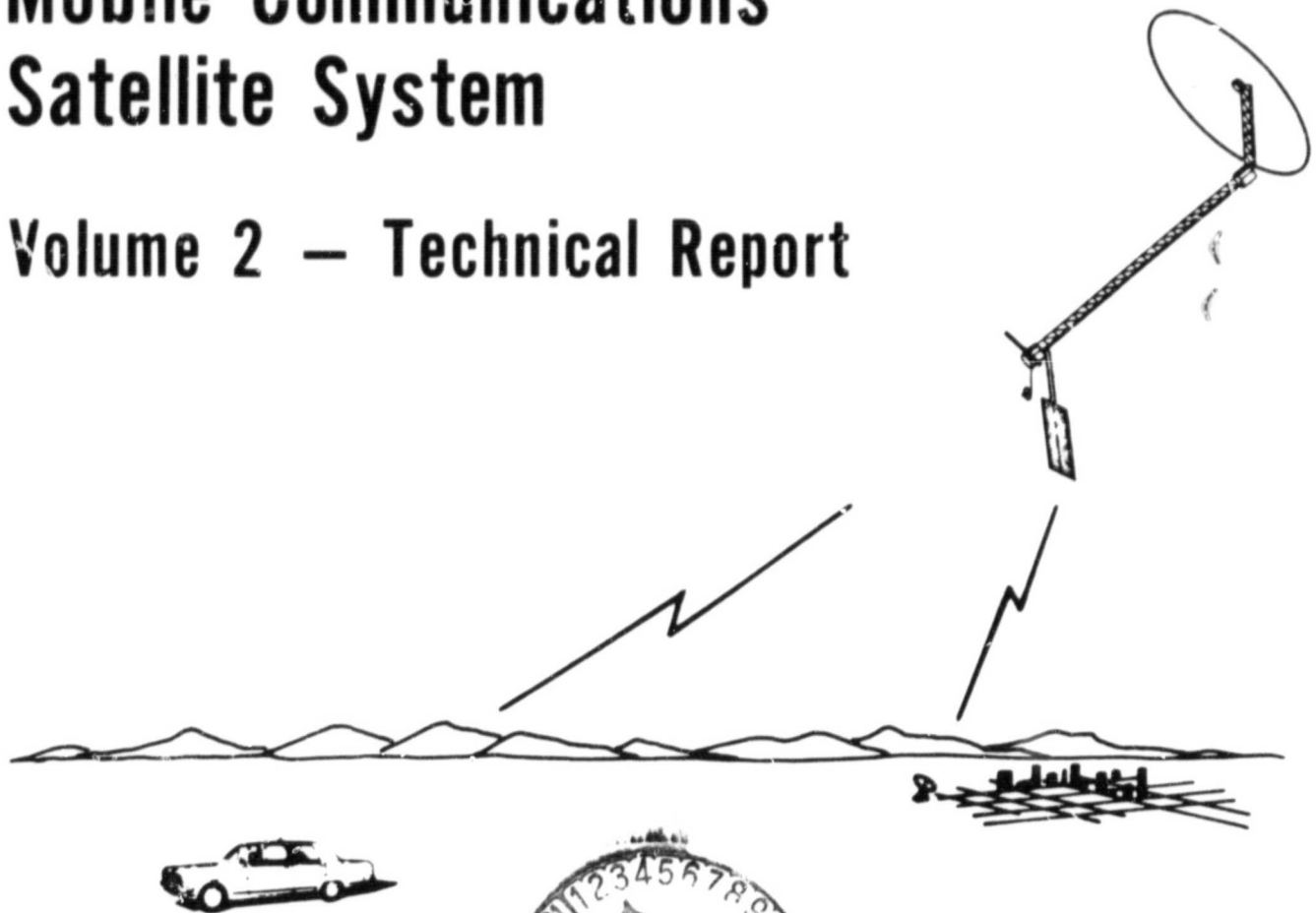

April 11, 1983

Prepared for:
NASA
Lewis Research Center

(NASA-CR-168129) REQUIREMENTS FOR A MOBILE COMMUNICATIONS SATELLITE SYSTEM. VOLUME 2: TECHNICAL REPORT Final Report, 15 Dec. 1981 - 31 Mar. 1983 (TRW, Inc., Redondo Beach, Calif.) 382 p HC A17/MP AC1

N83-23498

Unclas
03481

CSC1 17B G3/32

1. Report No. CR 168129	2. Government Accession No.	3. Recipient's Catalog No.	
4. Title and Subtitle Requirements for a Mobile Communications Satellite System Volume II Technical Report		5. Report Date 4-11-83	
		6. Performing Organization Code	
7. Author(s) Dr. Michael Horstein		8. Performing Organization Report No.	
		10. Work Unit No.	
9. Performing Organization Name and Address TRW Inc. One Space Park. Redondo Beach, CA 90278		11. Contract or Grant No. NAS3-23257	
		13. Type of Report and Period Covered Contractor Report 12-15-81 through 3-31-83	
12. Sponsoring Agency Name and Address NASA Lewis Research Center Cleveland, OH 44135		14. Sponsoring Agency Code 643-10-02	
		15. Supplementary Notes Final Report Technical Monitor - Charles Provencher, Jr. NASA/Lewis Research Center	
16. Abstract <p>Three types of satellite-aided mobile communications are considered for users in areas not served by (terrestrial) cellular radio systems. In System 1, mobile units are provided a direct satellite link to a gateway station, which serves as the interface to the terrestrial toll network. In System 2, a terrestrial radio link similar to those in cellular systems connects the mobile unit to a translator station; each translator relays the traffic from mobile units in its vicinity, via satellite, to the regional gateway. It is not feasible for System 2 to provide ubiquitous coverage. Therefore, System 3 is introduced, in which the small percentage of users not within range of a translator are provided a direct satellite link as in System 1.</p> <p>While System 2 can operate with leased satellite capacity, Systems 1 and 3 require a dedicated satellite. A major portion of this study is concerned with the design of a satellite for System 1. A weight limit of 10,000 lbs, corresponding to the projected 1990 STS capability, is imposed on the design. Frequency re-use of the allocated spectrum, through multiple satellite beams, is employed to generate the specified system capacity. Both offset-fed and center-fed reflectors are considered. For an assumed 10-MHz allocation and a population of 350,000 subscribers, a two-satellite system is required. The reflector diameters corresponding to offset-fed and center-fed geometries are 46 m and 62 m, respectively. Thus, large-space-structure technology is inherent to the implementation of System 1.</p> <p>In addition to establishing the technical requirements for the three types of satellite systems, the monthly service charge needed to provide a specified return on invested capital is computed. A net present value analysis is used for this purpose.</p>			
17. Key Words (Suggested by Author(s)) Land-mobile satellite service Cellular radio Multiple-beam antennas Beamformer networks Large space structures		18. Distribution Statement Unclassified - Unlimited	
19. Security Classif. (of this report) Unclassified	20. Security Classif. (of this page) Unclassified	21. No. of Pages 378	22. Price*

* For sale by the National Technical Information Service, Springfield, Virginia 22161



TRW Space & Technology
Group

Requirements for a
**Mobile Communications
Satellite System**

Volume 2 — Technical Report

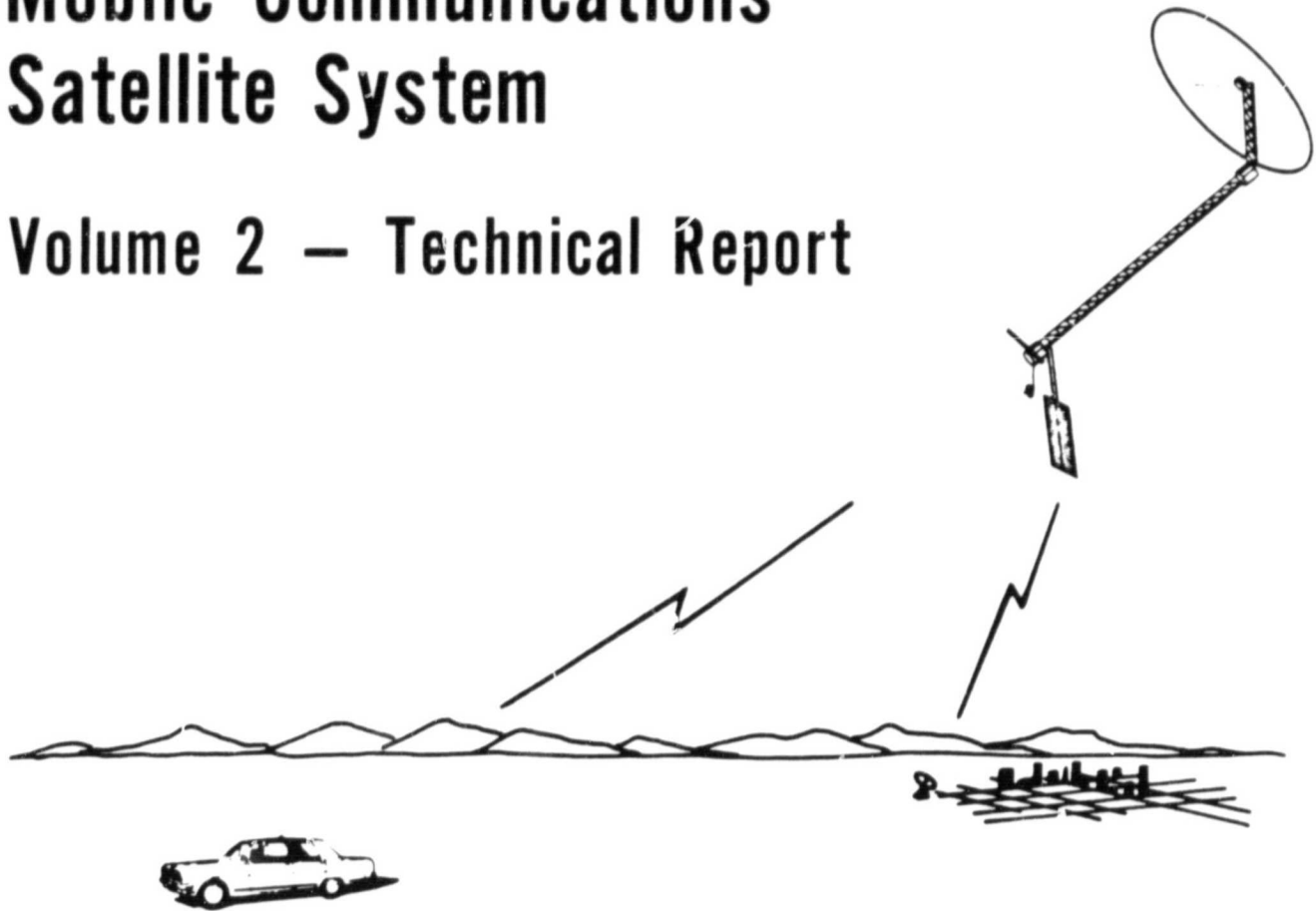

April 11, 1983

Prepared for:
NASA
Lewis Research Center

TRW Space &
Technology Group
One Space Park
Redondo Beach, CA 90278



Requirements for a Mobile Communications Satellite System

Volume 2 — Technical Report

Contract No. NAS3-23257

Document No. D39061-017

April 11, 1983

Prepared for:
NASA
Lewis Research Center
21000 Brookpark Road
Cleveland, Ohio 44135

Approved:

A handwritten signature in cursive script, appearing to read 'M. Hörstein', is written over a horizontal line.

M. Hörstein
Project Manager

A handwritten signature in cursive script, appearing to read 'H. D. Culver', is written over a horizontal line.

H. D. Culver
Manager, Systems Definition and Analysis

PREFACE

This document is the final report of a 14-month study conducted by TRW Space and Technology Group for the NASA Lewis Research Center to determine the technical feasibility and economic viability of a mobile communications satellite system.

The report comprises three volumes. Volume 1 is an Executive Summary for Volume 2, which contains the principal technical results of the study. Volume 3 is the final report of a Large Space Structures Measurement Study, which was conducted as an add-on to the original contract.

CONTRIBUTORS

Major technical contributions were made by the following individuals in the areas indicated:

Mr. W. Akle	Satellite Configurations Control Dynamics Structural Analysis
Mr. M. A. Cantor	Satellite Subsystems
Mr. J. A. Dryden	Satellite Costing Monthly Service Charge Computation
Dr. M. Horstein	Communication System Design
Mr. E. R. Pacheco	Satellite Antenna Design User Antenna Design

Motorola, as subcontractor to TRW, contributed to the design of the ground segment in areas requiring cellular-radio type of equipment. Additionally, they addressed the question of cellular-system compatibility and provided an understanding of propagation phenomena in systems where mobile-unit transmissions traverse a terrestrial path prior to the satellite link. Motorola's technical efforts were coordinated by Dr. J. J. Mikulski, while equipment cost data were supplied by Mr. J. P. Caile.

The technical contract monitors for NASA LeRC were Mr. B. E. LeRoy and Mr. C. E. Provencher.

CONTENTS

	Page
1. INTRODUCTION	1-1
2. SYSTEM 1	2-1
2.1 Introduction	2-1
2.2 Single-Satellite, Cellular-Compatible System	2-8
2.2.1 Requirements	2-8
2.2.2 Cellular-System Compatibility	2-10
2.2.3 System Sizing	2-12
2.2.4 Carrier Assignment	2-16
2.2.5 Satellite/Gateway Links	2-18
2.2.6 Satellite Link Design	2-21
2.2.7 Satellite Description	2-24
2.2.8 Gateway Description	2-27
2.2.9 Mobile Unit Modifications	2-33
2.2.10 Monthly Service Charge	2-37
2.2.11 System Assessment	2-38
2.3 Alternate System Configurations	2-41
2.3.1 Non-Cellular-Compatible Modulation	2-41
2.3.2 Multiple-Satellite Systems	2-43
2.3.3 Shared-Allocation Systems	2-43
2.3.4 System Comparison	2-48
2.3.5 Baseline System Development	2-53
2.3.6 Monthly Service Charge	2-59
2.4 Alternate Traffic Patterns	2-63
2.4.1 Non-uniform Geographic Distribution	2-63
2.4.2 Alternate Traffic Scenarios	2-70
2.4.3 Satellite Requirements	2-74
2.4.4 Monthly Service Charge	2-74
2.4.5 Ground Spare Strategy	2-78
2.4.6 Two- vs. Three-Satellite System	2-80
2.5 Baseline System Description	2-84
2.5.1 Offset-Fed vs. Center-Fed Satellite Design	2-84
2.5.2 System Sizing	2-89
2.5.3 Feed-Cluster Approach to Beam Formation	2-91
2.5.4 Repeater Block Diagram	2-95
2.5.5 Satellite Power Requirements	2-95
2.5.6 Satellite Weight Summary	2-101
2.5.7 Monthly Service Charge	2-101
2.6 Satellite Antenna Subsystem	2-105

CONTENTS (Continued)

	Page
2.6.1 Requirements	2-105
2.6.2 4-Frequency-Set, Offset-Fed Baseline	2-107
2.6.3 7-Frequency-Set, Center-Fed Baseline	2-123
2.7 Satellite Configurations and Control Dynamics	2-133
2.7.1 Satellite Configurations	2-133
2.7.2 Control Dynamics	2-138
3. SYSTEM 2	3-1
3.1 Introduction	3-1
3.2 System Description	3-2
3.2.1 Translator Coverage Area	3-2
3.2.2 Translator/Gateway Transmission	3-5
3.2.3 Gateway Description	3-9
3.2.4 Translator Description	3-11
3.3 Monthly Service Charge	3-20
4. SYSTEM 3	4-1
4.1 Introduction	4-1
4.2 Satellite Requirements	4-2
4.2.1 Baseline Subscriber Scenario	4-2
4.2.2 Alternate Traffic Scenarios	4-3
4.3 Monthly Service Charge	4-4
5. CRITICAL TECHNOLOGY IDENTIFICATION	5-1
5.1 Introduction	5-1
5.2 Large Space Structure	5-2
5.2.1 Configuration Technology	5-2
5.2.2 Structures Technology	5-4
5.2.3 Attitude Control System (ACS) Technology	5-9
5.3 Antenna Feed System	5-12
5.4 UHF Solid-State Amplifiers	5-16
5.5 Other Subsystems	5-20

CONTENTS (Continued)

	Page
5.6 Summary	5-20
5.7 Prioritization of Critical Technology	5-20
6. TECHNOLOGY DEVELOPMENT PLAN	6-1
6.1 Introduction	6-1
6.2 Large Space Structure	6-1
6.2.1 Reflector	6-1
6.2.2 Mast	6-6
6.2.3 Attitude Control Subsystem (ACS)	6-10
6.2.4 Measurement System	6-13
6.3 UHF Antenna	6-15
6.3.1 Feed/Beamformer Network	6-18
6.3.2 Mast (Center-Fed Design)	6-20
7. CONCLUSIONS	7-1

APPENDICES

A MONTHLY SERVICE CHARGE COMPUTATION	A-1
B INTERFERENCE IN SHARED-ALLOCATION SYSTEM	B-1
C USER ANTENNA REQUIREMENTS	C-1
D SCENARIO C SYSTEM DESIGN	D-1
E LINK ANALYSIS FOR BASELINE SYSTEMS	E-1
F SATELLITE ANTENNA STRUCTURAL DESIGN	F-1
G SATELLITE SUBSYSTEM WEIGHT ANALYSIS	G-1
H TECHNOLOGY DEVELOPMENT PLAN COST ESTIMATES	H-1

ILLUSTRATIONS

	Page	
1-1	System 1 Configuration	1-3
1-2	System 2 Configuration	1-6
1-3	System 3 Configuration	1-8
2-1	Frequency Allocations	2-9
2-2	System Sizing Methodology	2-13
2-3	4-Frequency-Set Beam Pattern	2-14
2-4	Typical CONUS-Coverage Beam Pattern	2-15
2-5	Carrier Frequency Assignments	2-17
2-6	Gateway Ku-Band Frequency Plan	2-20
2-7	Offset-Fed Satellite Configuration	2-26
2-8	Gateway Block Diagram	2-28
2-9	Gateway RF-to-4-Wire Subsystem	2-29
2-10	User Antenna Concept	2-57
2-11	Satellite and Gateway Deployment Schedule for 2-Satellite System	2-60
2-12	Case 7 -- MSC Cost Sensitivity	2-61
2-13	Geographic Subscriber Distribution	2-65
2-14	Subscriber Exclusion vs. System Capacity	2-69
2-15	Case 7 -- MSC for Non-uniform Subscriber Distribution	2-71
2-16	Traffic Scenarios	2-72
2-17	MSC for Different Subscriber Scenarios	2-79
2-18	Direct Offset-Fed Satellite Configuration	2-85
2-19	Center-Fed Satellite Configuration	2-86
2-20	7-Frequency-Set Beam Pattern	2-88

ILLUSTRATIONS (Continued)

		Page
2-21	Frequency Borrowing Between Beams	2-90
2-22	Feed-Cluster Approach to Beam Formation	2-93
2-23	Overlapping Feed Clusters for Adjacent Beams	2-94
2-24	Satellite Repeater Block Diagram (Offset-Fed Design, 3x2 Redundancy)	2-96
2-25	MSC for Baseline Configuration	2-103
2-26	Cumulative Discounted Cash Flow for Offset-Fed Design	2-104
2-27	4-Frequency Set Beam Pattern	2-108
2-28	Co-channel Beam Gain Patterns for Center-Fed Antenna with 4-Frequency Sets	2-109
2-29	Co-channel-Beam Gain Patterns for Offset-Fed Antenna with 4-Frequency Sets	2-111
2-30	Offset-Fed Antenna Schematic	2-112
2-31	Feed Approaches for Offset-Fed Reflector	2-113
2-32	Co-channel Feed Clusters for 4-Frequency-Set Beam Pattern	2-114
2-33	Single-Feed-Per-Beam Approaches for Offset-Fed Reflector	2-116
2-34	Backfire Feed Design for Offset-Fed Reflector	2-117
2-35	Single-Feed-Per-Beam Helical Array for Offset-Fed Reflector	2-118
2-36	Short-Backfire Element	2-119
2-37	Short-Backfire 4-Element Cluster for Offset-Fed Reflector	2-120
2-38	Typical Illumination Pattern for 4-Feed Cluster	2-121
2-39	Transmit Beamformer Schematic for 4-Feed Cluster	2-124
2-40	7-Frequency-Set Beam Pattern	2-125
2-41	Co-channel-Beam Gain Patterns for Center-Fed Antenna with 7-Frequency Sets	2-126
2-42	Center-Fed Antenna Schematic	2-128

ILLUSTRATIONS (Continued)

	Page	
2-43	Feed Approaches for Center-Fed Reflector	2-129
2-44	4-Element Cluster for Center-Fed Reflector	2-130
2-45	7-Element Cluster for Center-Fed Reflector	2-131
2-46	Integral Propulsion System (IPS) Weight and Length in STS Cargo Bay	2-134
2-47	Center-Fed Satellite Configuration	2-135
2-48	Center-Fed Satellite Stowed in STS Cargo Bay	2-136
2-49	Direct Offset-Fed Satellite Configuration	2-137
2-50	Direct Offset-Fed Satellite Stowed in STS Cargo Bay	2-139
2-51	Satellite Deployment Concept for Offset-Fed Configuration	2-140
2-52	Satellite Structural and Control Error Budget (Typical Values for Offset-Fed Configuration)	2-141
2-53	System Stiffness Requirements for Offset-Fed Configuration	2-142
2-54	Pointing Control Alternatives for Offset-Fed Configuration	2-143
2-55	Satellite Attitude Control Subsystem (ACS)	2-145
3-1	Gateway Block Diagram	3-10
3-2	Translator Block Diagram	3-16
3-3	Gateway/Translator Deployment Schedule for Baseline Subscriber Scenario	3-19
3-4	Monthly Service Charge Sensitivity to Coverage Variations	3-23
3-5	MSC Sensitivity to Cost Variations	3-25
3-6	System 2 Traffic Scenarios	3-26
3-7	MSC for Different Traffic Scenarios	3-27
4-1	Transportable vs. Mobile MSC	4-6
4-2	MSC Sensitivity to Modulation Format	4-7
4-3	MSC Sensitivity to Cost Variations	4-9

ILLUSTRATIONS (Continued)

	Page	
4-4	MSC for Different Subscriber Scenarios	4-10
4-5	MSC Reduction from Lease of Unused Transponders	4-12
5-1	Alternative Mast Concepts for Center-Fed Design	5-15
5-2	Alternative Offset-Fed Mast Concept	5-17
6-1	Reflector Development Plan	6-3
6-2	15-Meter Scale Reflector Ground Testing	6-4
6-3	Reflector and Mast Flight Verification Testing	6-7
6-4	Structures and Control Technology Development Schedule	6-8
6-5	Mast Technology Development Plan	6-11
6-6	23-Meter Mast Ground Testing	6-12
6-7	ACS Controller Technology Development Plan	6-14
6-8	Global Sensor Arrangement	6-16
6-9	Satellite Antenna Development	6-17
7-1	MSC System Comparison	7-3

TABLES

		Page
2-1	Link Noise Allocation	2-23
2-2	Gateway Cost Elements	2-31
2-3	Gateway RF/IF Section Costs (\$)	2-32
2-4	Gateway Channel Requirements	2-34
2-5	System 1 Gateway Costs (\$K)	2-35
2-6	Sample MSC Calculation	2-39
2-7	System 1 Alternate Configurations	2-42
2-8	Intersystem Interference for Shared Frequency Allocation	2-46
2-9	Weight/Power Summary for System 1 Options	2-49
2-10	MSC for System 1 Options	2-51
2-11	Selected System 1 Configurations	2-52
2-12	User/Satellite Geometry for 3-Satellite System (Deg)	2-55
2-13	User/Satellite Geometry for 2-Satellite System (Deg)	2-56
2-14	Subscriber Density	2-64
2-15	Relative Beam Areas for Satellite at 110° W. Longitude	2-66
2-16	Per-Beam Subscriber Density	2-67
2-17	Satellite Antenna Requirements	2-75
2-18	Satellite Weight (lb) for Different Subscriber Scenarios	2-76
2-19	Satellite Deployment Schedule	2-77
2-20	MSC Sensitivity to Ground Spare Strategy	2-81
2-21	Baseline System Sizing	2-92
2-22	Link Power Budget for Satellite-to-Mobile Transmission	2-97
2-23	Satellite RF Power Requirements	2-99
2-24	Satellite DC Power Requirements	2-100

TABLES

		Page
2-25	Satellite Weight Summary	2-102
2-26	Baseline Antenna Configurations	2-106
2-27	Summary Comparison of Feed Approaches for Offset-Fed Reflector	2-122
2-28	Summary Comparison of Feed Approaches for Center-Fed Reflector	2-132
3-1	Transponder Requirements for Baseline Subscriber Scenario	3-7
3-2	Gateway Cost Elements	3-12
3-3	Gateway and Translator RF/IF Section Costs (\$)	3-13
3-4	Gateway Costs (\$K) for Baseline Subscriber Scenario	3-14
3-5	Translator Cost Elements	3-15
3-6	Translator Channel Requirements for Baseline Subscriber Scenario	3-18
3-7	Translator Costs (\$K) for Baseline Subscriber Scenario	3-21
3-8	System 2 Expenditures (\$M) for Baseline Subscriber Scenario	3-22
5-1	State-of-the-Art Projection for Configuration Technology	5-21
5-2	State-of-the-Art Projection for Structures Technology	5-22
5-3	State-of-the-Art Projection for Attitude Control System Technology	5-24
5-4	State-of-the-Art Projection for Antenna Feed System Technology	5-25
5-5	State-of-the-Art Projection for Other Satellite Technologies	5-26
6-1	Reflector Testing Limitations	6-5

1. INTRODUCTION

Current mobile radio-telephone service in the United States is extremely poor, primarily because of the limited amount of frequency spectrum allocated to this service. As a consequence, there are long waiting lists in metropolitan areas for service. Furthermore, mobile users typically experience long delays in placing calls. Finally, even where the grade of service is acceptable, the quality of reception may be unsatisfactory.

In an attempt to alleviate this situation, the Federal Communications Commission (FCC) has allocated a pair of 20-MHz UHF bands to a new type of mobile radio-telephone service, referred to as "cellular" radio. More specifically, 825-845 MHz is reserved for mobile transmit and 870-890 MHz for mobile receive. Frequency re-use of the indicated bands is made possible by (1) subdivision of each area served into cells, and (2) subdivision of the set of carrier frequencies available from the 20-MHz allocation into several subsets. By restricting communication within each cell to a single frequency subset and limiting transmit power levels, use of the same frequency subset in a number of different cells is made possible. In this way, a substantially higher system capacity than is suggested by the 20-MHz allocation can be achieved.

At present, two pilot cellular systems are in operation: one operated by Illinois Bell in the Chicago area, and the other by American Radio Telephone Service, with Motorola as implementation contractor, in the Baltimore/Washington area. A description of Bell's Advanced Mobile Phone Service (AMPS) is provided by Reference 1-1.

The economic viability of cellular radio in a particular area depends on the size of the subscriber population. By FCC decree, two entities will operate competitively in each Standard Metropolitan Statistical Area (SMSA): the existing wire-line carrier and an entry selected from the radio common carriers (RCCs). It is estimated that the SMSAs served by cellular radio will constitute 10 percent of the land area of the U.S.; the inhabitants thereof, 60 percent of the population (Reference 1-2). This would leave 90 percent of the land mass and 40 percent of the population unprovided for.

This deficiency can be remedied through implementation of a satellite system that serves mobile users in rural areas and beyond, where a cellular system is not practical. The 1979 World Administrative Radio Conference (WARC) allocated the 806-890 MHz band to land-mobile satellite service (LMSS). Should the FCC decide to allocate a portion of this band to LMSS within the U.S., substantial capacity could be generated through a system of frequency re-use analogous to that used in cellular systems.

The transmission links for LMSS are depicted in Figure 1-1. The mobile vehicle communicates, by satellite relay, with a gateway station that provides the interface with the switched telephone network (STN). The remainder of the circuit between the mobile vehicle and a "land user" (i.e., a non-mobile user) is completed via an appropriate path through the STN. It is anticipated that a number of gateways will provide different points of entry to the STN. Since the base stations (cell sites in AMPS terminology) found in cellular systems are eliminated when a direct user/gateway satellite link is provided, the gateway must perform the normal base-station functions.

Through use of a large satellite antenna, multiple spot-beam coverage of the contiguous U.S. (CONUS) can be provided. If the full complement of carrier frequencies is divided into subsets, with each beam restricted to use of a single subset, a system of frequency re-use is established. The beam pattern can be thought of as providing an extension of the SMSA cell systems throughout the remainder of CONUS. The radius of the land area covered by one of the satellite beams is typically an order of magnitude (or more) greater than the largest cell radius. There is at least a 2-order-of-magnitude disparity, therefore, between beam and cell areas.

While the preponderance of calls is expected to take place between a mobile user and a land user, a certain number of calls will be of the mobile-to-mobile variety. It is not anticipated that the satellite will be provided with a switching capability. Accordingly, each mobile user will be able to access the STN only through the gateway associated with the UHF beam in which the user lies. If the two mobiles involved in a call are provided connections to the same gateway, the circuit can be turned around

ORIGINAL PAGE IS
OF POOR QUALITY

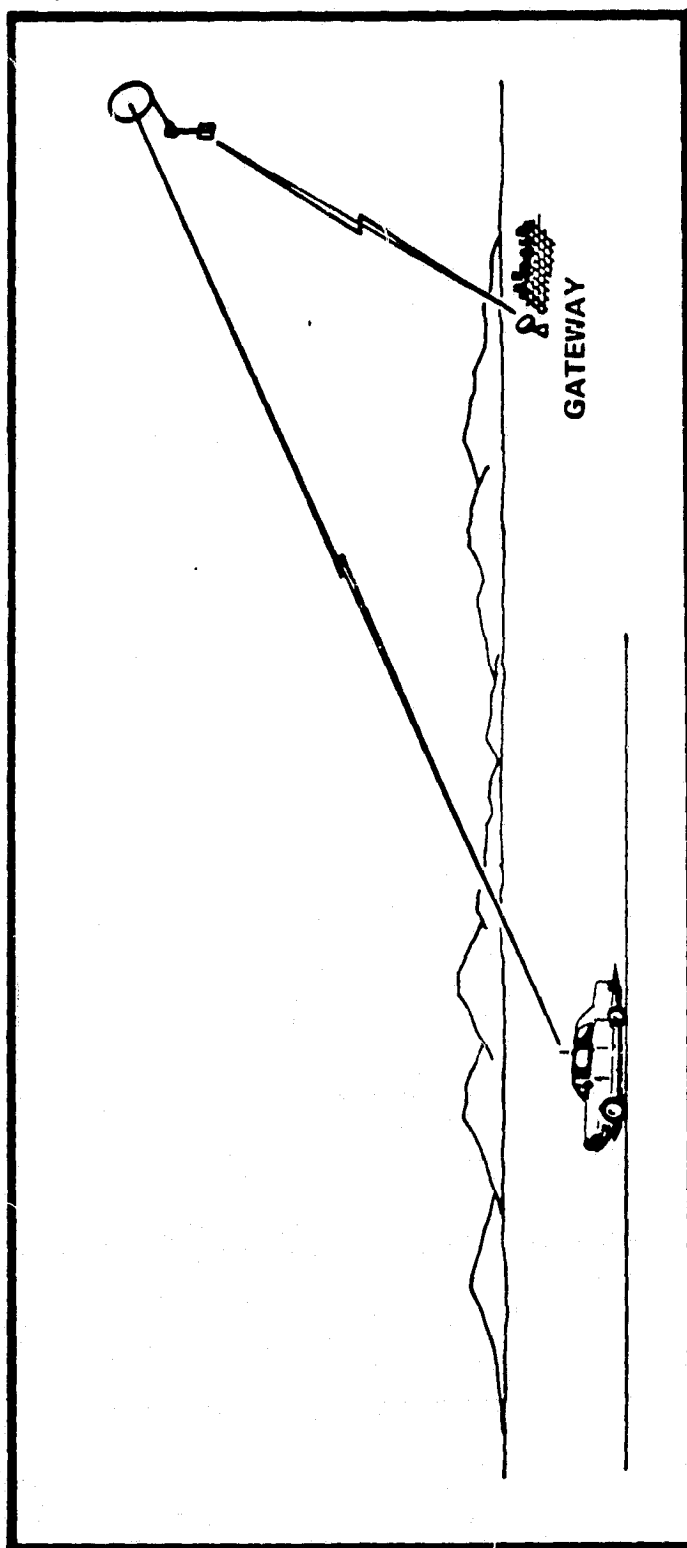

Figure 1-1. System 1 Configuration

in the gateway and need never enter the STN. If the mobiles are served by different gateways, the circuit must include a terrestrial portion between the two gateways.

In most calls that involve only a single mobile vehicle, only one satellite hop will take place — that between mobile and gateway. However, the possibility of two satellite hops does exist. On a mobile-originated call, this possibility can be avoided by "tagging" the call at the gateway so that a second satellite hop is not introduced in the portion of the circuit between the gateway and the land user. While this capability does not presently exist, it should be available once telephone switching is all-digital.

On a mobile-completed call, however, there is no way for the originating toll office (the one associated with the land user) to determine that the call will eventually be routed, via gateway, to a mobile user. If the land-user/gateway distance is sufficiently great (as in a transcontinental call), there is the possibility that a satellite link will be inserted between land user and gateway.

Of course, a double satellite hop is unavoidable (in the absence of satellite switching) on calls between two mobile vehicles.

It is desirable that the mobile transceiver used in a land-mobile satellite system (i.e., with an MSAT) be compatible with cellular-system mobile units. This would allow a user to communicate via the cellular system while in one of the larger SMSAs, and via MSAT otherwise. In all likelihood, it would be necessary for such a user to subscribe separately to cellular and satellite services. However, compatibility of a single mobile unit with both systems would greatly reduce the cost of the mobile equipment. (Even with a compatible mobile transceiver, however, it would be necessary to employ separate antennas for cellular and MSAT use.)

The feasibility of maintaining cellular compatibility hinges on the required system capacity in relation to the bandwidth of the LMSS frequency allocation. The larger the capacity, or the narrower the allocation, the larger is the required frequency re-use factor for a given carrier spacing. A larger re-use factor implies a heavier and more costly satellite.

The cellular system uses 30-kHz carrier spacing, while a maximum LMSS frequency allocation of 10 MHz is considered in this study. Initially, an end-of-life (EOL) population of 180,000 subscribers was specified by NASA; this was later increased to 350,000 through introduction of alternate subscriber scenarios.

It is found that a satellite sized to support the smaller population, with 30-kHz carrier spacing and a 10-MHz allocation, exceeds the projected capability of the Space Transportation System (STS). A similar conclusion is reached for each satellite of a multiple (i.e., 2 or 3) satellite system designed to support the larger population. An important conclusion of this study, therefore, is that narrower forms of modulation than that used by cellular systems need to be considered.

The type of system discussed thus far, in which the user is provided a direct satellite transmission link, is referred to as System 1. Exploration of conceptual system designs for accomplishing this objective, together with technological implications, constitutes the major portion of this study.

Two other distinct system configurations were examined, however. In the first, referred to as System 2, mobile-unit transmissions follow a terrestrial path to a "translator" station (Figure 1-2). The translator concentrates the traffic from mobile units in its coverage area and relays this traffic through a satellite to a gateway station.

Transmission between mobile unit and translator is virtually identical to that between mobile unit and base station in a cellular system. In fact, the coverage areas of individual translators can be viewed as direct extensions of the SMSA cell systems. Thus, the mobile units would use the same pair of 20-MHz allocations currently allocated to cellular use.

The distinction between System 2 and cellular systems lies in the translator/gateway link. The cellular systems use land lines to establish this connection. Land lines would be impractical for the distances encountered in a system covering much of CONUS. For example, with a dozen gateway stations, the typical translator/gateway distance is several hundred miles. Satellite links are therefore used for translator/gateway transmission.

ORIGINAL PAGE IS
OF POOR QUALITY

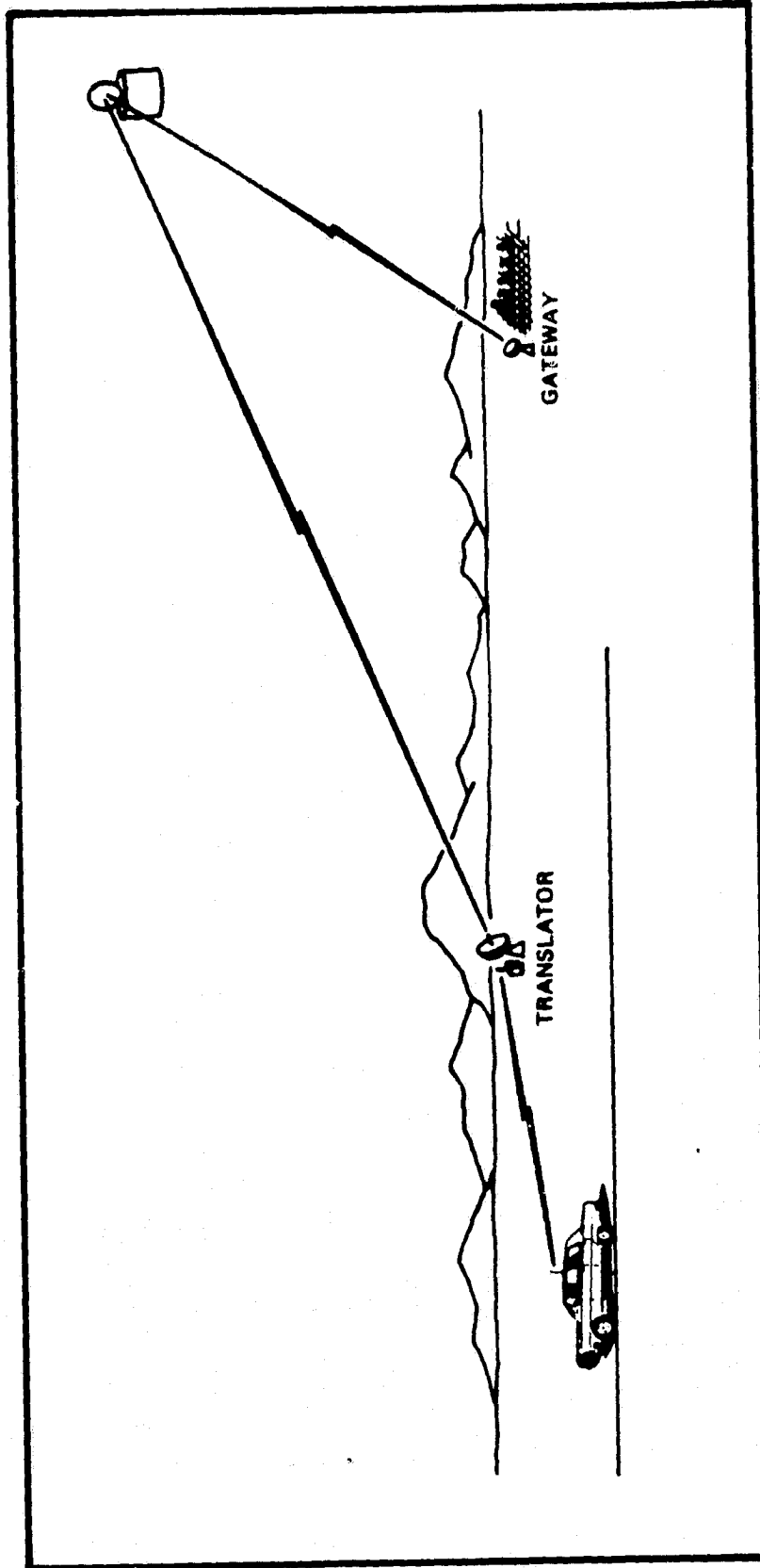

Figure 1-2. System 2 Configuration

Transmission in the gateway-to-translator direction is of the point-to-multipoint type. This transmission can be conducted at any of the "fixed-satellite" frequency allocations. Moreover, since standard domestic satellites can be used for this purpose, leased capacity can be used in place of a dedicated satellite. As a result, most of the System 2 cost is in the ground segment. This is in contrast to System 1, where the space segment cost is dominant.

The attractiveness of System 2 depends on the portion of CONUS that can be profitably covered by translator stations. (System 1 coverage, by contrast, is universal.) Profitable coverage of a region by a set of translators depends on the range of an individual translator, because of the large fixed (i.e., channel-independent) component of translator cost. Much of this fixed cost lies in the tower, which is assumed to have a height of 500 feet, and in the satellite-related RF hardware.

A number of assumptions have been made in the analysis of System 2. First, because of the extremely high cost of a free-standing tower, it is assumed that an advantageous location can be found for each translator, which permits a guyed tower to be erected. Secondly, a coverage area corresponding to a 40-mile transmission range has been assumed for all translators. This is a reasonable figure for open areas, provided the mobile units and translators are equipped with more sensitive receivers than are employed in cellular systems.

Finally, a common monthly service charge (MSC) has been assumed for users in all areas served by System 2. Clearly, a higher MSC is required in regions where the subscriber density is lower than the nationwide average. Assumption of a common MSC leads, therefore, to an optimistic conclusion regarding the portion of CONUS that can profitably be served.

Because System 2 cannot be expected to provide complete CONUS coverage, a variant of this configuration, called System 3, is introduced. This is a hybrid system, in which System 2 service is supplemented by direct satellite links to subscribers in the uncovered portions of CONUS (Figure 1-3). Because of the latter group of subscribers, a dedicated satellite is required.

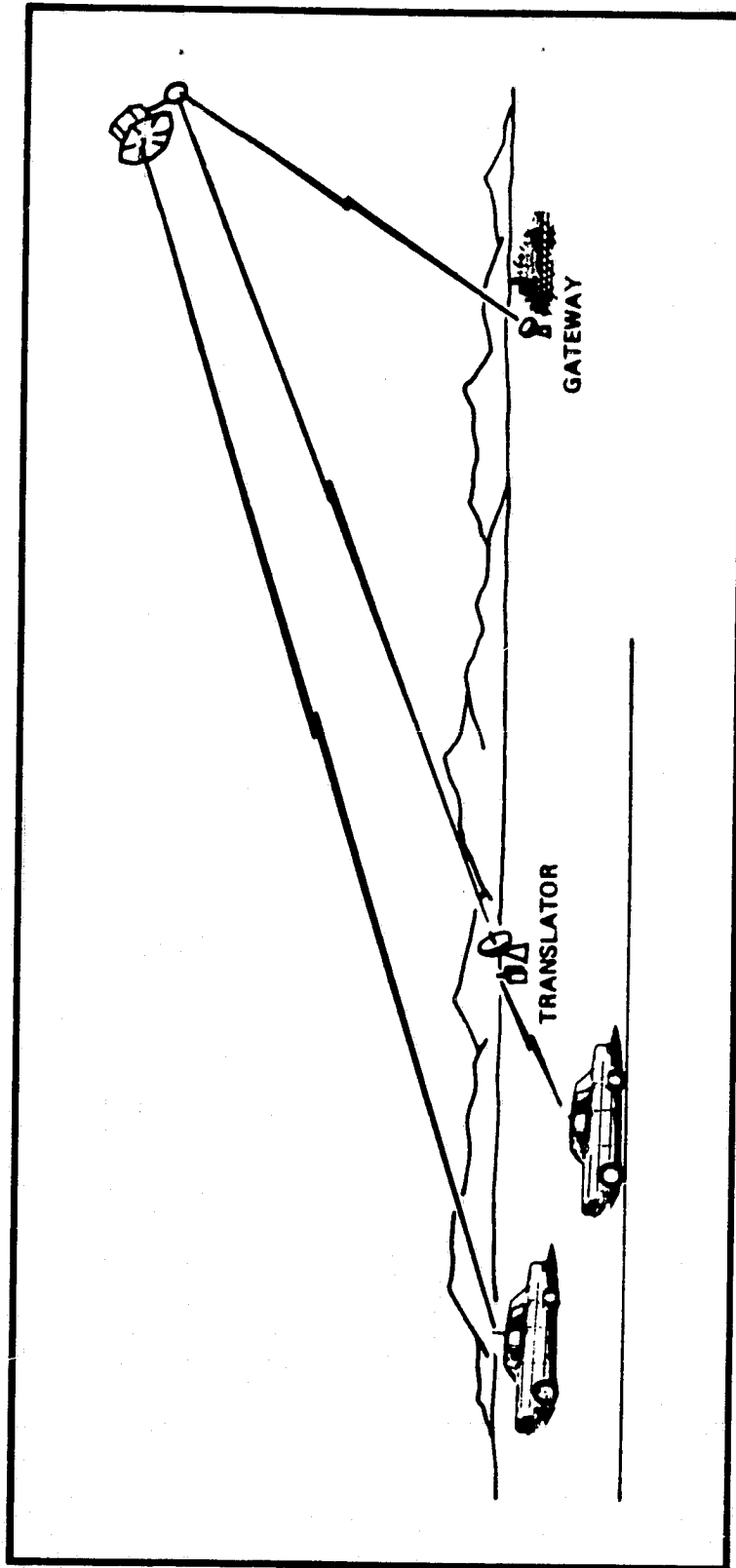

Figure 1-3. System 3 Configuration

To minimize the satellite requirements, these additional users, while mobile in nature, communicate only while at rest. (The associated equipment is referred to as a transportable unit, rather than a mobile unit.) This restriction allows the user to set up for transmission by deploying an antenna that would not be suitable for a moving vehicle. The added gain thereby achieved reduces the required satellite effective-isotropic-radiated-power (EIRP).

The dedicated satellite of System 3 greatly increases the space-segment cost over that associated with System 2. Moreover, the number of transportable users is expected to be a small fraction of the number of mobile users. Were the transportable users to bear the full brunt of this added cost (by fixing the MSC for mobile users at the value found for System 2), the MSC for the transportable users would be prohibitive.

The alternative is to raise the mobile-user MSC and use the surcharge to subsidize the transportable service. In the extreme, if the same MSC is imposed on both classes of user, the mobile-user charge will be more than 50 percent greater than the MSC for System 2. The benefits derived from the ubiquitous service provided by System 3 must be weighed against the additional charge that must be borne by mobile users.

During the course of this study, systems were configured to accommodate half a dozen different subscriber scenarios postulated by NASA. (These scenarios are, to a large degree, the product of a parallel study by General Electric Company to determine the potential market for LMSS.) In each case, an MSC was computed to provide a specified rate of return on invested capital. In an operational system, the size of subscriber population will vary in an inverse manner with the MSC imposed. In the absence of information regarding market sensitivity to the rate charged, it is not possible to establish the degree of consistency of a postulated subscriber base and the derived MSC.

In addition to the MSC, a subscriber to any of the three systems must bear two additional costs. The first of these is the per-call charge to establish the circuit portion between the gateway and the toll office nearest the land user. With eight gateways (the number in one of the two System 1 baselines), the length of this terrestrial link is typically

400 miles. For a subscriber that incurs charges for an average of 10 minutes a day,* 20 days a month, at an assumed rate of 40 cents per minute, the monthly STN charge would be \$80.

An attempt to reduce this charge by a proliferation of gateway stations is not likely to prove fruitful. It is estimated that, if this process were carried to the extreme of locating a gateway within the area illuminated by each UHF beam in System 1 (which number 61 in the above-referenced system), the gateway costs for the system would increase by not more than 100 percent. Since the gateway costs are a small fraction of the total system cost, the MSC would be increased by a relatively small percentage.

On the other hand, the length of a typical terrestrial link between gateway and land user would still be about 150 miles. For most users, therefore, a toll charge would still be incurred on most calls. Furthermore, the portion of the satellite payload connected with the satellite/gateway links would be considerably complicated by a large increase in the number of gateways.

It may be concluded that a significant, unavoidable charge will be associated with the gateway/land-user portion of the circuit established with any of the three system configurations considered in this study. Although the economic aspects of LMSS discussed in this report focus on the MSC, this additional charge should not be lost sight of.

The final cost to the user is that associated with the mobile unit. This equipment may be either purchased or leased. In the latter event, the lease charge may be incorporated in the MSC. It should be emphasized that, as defined in this study, the MSC does not include the cost of the mobile unit.

It is hard to predict the cost of a mobile unit in the time period envisioned for LMSS. (Initial operation is projected for 1995.) Currently, mobile units for cellular systems can be made to sell for \$2500 to

* A market survey performed by Arthur D. Little, Inc. indicates that, for cellular radio, the average number of calls expected per day is 5.7. The average call duration is expected to be 2.5-3.0 minutes, although the average for current mobile radio is only 1.6 minutes (Reference 1-3).

\$3000.* With current market projections for these systems, a substantial reduction in unit price can be expected in future years. A mobile unit designed for MSAT use would benefit substantially from the "learning curve" for cellular units to the extent that there is commonality of design. However, if cellular compatibility should be abandoned, a separate learning curve would have to be applied to MSAT mobiles.

In deriving the gateway and translator station costs, considerable help was provided by Motorola, which was a subcontractor to TRW in this study. Motorola's input in this regard was confined to those elements commonly found in cellular-system base stations and switching offices. These include UHF radio equipment, transmission tower and antenna, base-site controller, channel banks, and switching equipment.

Motorola also contributed to an understanding of propagation phenomena and their effect on translator-station coverage area. In addition, they analyzed cellular mobile-unit designs to determine the extent to which compatibility is possible for cellular and MSAT operation.

The basic assumptions regarding translator and gateway cost elements for System 2 are clearly delineated in Section 3.2. In addition, an example is given showing how the time profile of ground-segment costs is constructed from the basic cost elements for a particular traffic scenario. From this example, the persistent reader should be able to construct a similar profile for any of the other traffic scenarios considered in this study. Because System 2 can operate with leased satellite capacity, the ground segment cost is the principal determinant of the MSC.

Estimated costs of the dedicated satellites for Systems 1 and 3 are omitted for proprietary reasons.

While this study deals only with mobile radio-telephone, it is well recognized that other market segments exist for mobile radio service in non-urban areas. The previously mentioned GE study identifies three distinct market segments: mobile radio-telephone, commercial and public radio, and new services. In the latter category, two important

*Private communication from Mr. Jim Caile of Motorola.

sub-segments are the oil and gas industry and the inter-city trucking industry. Public radio includes a number of "dispatch" applications. Further discussion of these markets can be found in Reference 1-4.

A satellite designed for LMSS would be transparent to the specific service provided. To determine the economic viability of a land-mobile satellite system intended to service a variety of market segments, the non-telephone traffic and associated revenue must be taken into account.

It is reasonable to assume that a higher tariff per-minute-of-channel-occupancy would be imposed on non-telephone services than on telephony. Depending on the traffic ratio for these two categories, a significantly lower MSC for radio-telephone users could result from inclusion of non-telephone traffic. Thus, the MSCs computed in this study should be regarded as upper limits on the rate that would have to be charged in a mixed-traffic system.

The principal previous study dealing with LMSS system design was performed by JPL (Reference 1-5). That study concentrated on the technology required for a System 1 type of configuration. A satellite point design was provided as a focus for the technologies involved.

By contrast, the present study analyzes the different technologies only to the extent needed to select a preferred design, and to estimate satellite weight and cost. The prime objective is to establish technical feasibility and economic viability of satellite-aided mobile communications.

In addition to the subject matter outlined above, a large space structure (LSS) measurement study was conducted as an add-on to the present contract. The measurements are to be made, initially, in a series of ground and STS-tended tests of a scale model, which is designed to validate scalability of analytical tools used in LSS development. In addition, the measurement system will become an integral part of the satellite attitude control subsystem. The results of the measurement study are being submitted as Volume 3 of this report.

References

- 1-1 The Bell System Technical Journal, Volume 58, No. 1, January 1979.
- 1-2 P. A. Castruccio, C. S. Marantz, and J. Freibaum, "Need for, and Financial Feasibility of, Satellite-Aided Land Mobile Communications," Proc. Int. Conference on Communications, Philadelphia, 13-17 June 1982, Paper 7H.1.
- 1-3 C. A. Bean, "Cellular — Who Will Use It?," Telocator, January 1982, pp. 14-15.
- 1-4 G. H. Knouse and P. A. Castruccio, "The Concept of an Integrated Terrestrial/Land Mobile Satellite System," Proc. Int. Conference on Communications, Seattle, 8-12 June 1980.
- 1-5 F. Naderi (Editor), Land Mobile Satellite Service (LMSS), JPL Publication 82-19, 15 February 1982.

2. SYSTEM 1

2.1 INTRODUCTION

The System 1 architecture is strongly dependent on the subscriber scenario. In particular, the satellite(s) must be designed to accommodate the number of subscribers at the end of system life. This requirement determines the number of satellites and their design specifications. By contrast, the rate of subscriber buildup affects only the time(s) at which additional satellites must be launched, in the context of a multiple-satellite system.

In addition, however, the rate at which subscribers are added to the system determines the revenue profile for a given MSC. In combination with the profiles of capital expenditures and operating expenses, the subscriber profile fixes the MSC that must be imposed by the system operator.

Because of the limited directivity that can be realized from practical mobile-unit antennas, high-quality transmission between user and satellite requires large satellite EIRP and G/T values. Both requirements are satisfied through use of a multibeam satellite antenna. At UHF frequencies in the 806-890 MHz range (the band allocated for land-mobile satellite use at the 1979 WARC), an extremely large reflector is needed to provide the required antenna gain.

An equally compelling reason for the use of large satellite antennas is the need to generate capacity, from a bandwidth standpoint, sufficient to support the projected subscriber population. NASA originally requested that the FCC allocate a pair of 10-MHz bands (one for uplink transmission and the other for the downlink) for land-mobile satellite communications within the U.S.* This would permit a maximum of 333 voice circuits to be established through a single use of the allocated spectrum, with the 30-kHz carrier spacing used in cellular systems. Frequency re-use is made possible by employing a multibeam antenna configuration. The number of

* In a more recent petition for rulemaking, the requested allocation has been reduced to a pair of 4-MHz bands.

frequency re-uses needed to provide the requisite voice-channel capacity determines the size of the satellite antenna.

It is not possible to re-use the entire spectral allocation in each beam. To do so would result in unacceptable co-channel interference levels. It is necessary, therefore, to divide the set of voice channels available from the allocated band into disjoint subsets, with users in each beam assigned frequencies from one of these subsets. Creation of a larger number of frequency subsets increases the minimum distance between co-channel beams (i.e., beams assigned the same frequency subset), resulting in a lower level of co-channel interference. However, a larger number of subsets also reduces the number of voice channels per beam, thereby necessitating an increased number of beams to support a given subscriber population.

The System 1 baseline designs were derived in an evolutionary manner, regarding the population to be served as well as the satellite and user requirements for a given population. Initially, an EOL subscriber population of 180,000 users was postulated by NASA. With an assumed traffic contribution of 0.026 erlang/user during the busy hour (which is assumed coincident for all users), the corresponding peak traffic load is 4680 erlangs.

Because of the desire for cellular-system compatibility, 30-kHz channel spacing was taken as a requirement for the initial system design. In addition, the satellites were sized so that a single satellite can handle the full 4680-erlang, busy-hour traffic load. This allows the user antenna to be near-omnidirectional, a simplifying feature, albeit at the expense of a higher-powered satellite. This approach is consistent with the oftexpressed philosophy that, in a many-user system, as much of the design burden as possible should be placed on the satellite.

Conceptual design of a system as just outlined is developed in Section 2.2. The issue of cellular compatibility is explored in some detail, and it is shown that the major modification to the cellular mobile transceiver needed for satellite operation is an improved receiver front-end. The system sizing methodology developed for this "single-satellite" case (the outcome of which is the required number of beams or, equivalently, the

satellite antenna size) is equally applicable to the "multiple-satellite" systems examined in Section 2.3.

The MSC needed to support a system of this kind is computed as a function of the required internal rate of return (IRR) on invested capital. A net present value (NPV) analysis is used to determine this charge. A description of the NPV computation is given in Appendix A.

In sizing the satellite, a uniform geographic distribution of subscribers was initially assumed. Since the satellite antenna must grow (i.e., the beams must narrow) with an increase in the maximum subscriber density found anywhere in the coverage area, this is a most optimistic assumption. Nevertheless, a satellite of sufficient size to support the postulated EOL population is estimated to weigh about 10,000 pounds, with no contingency factor included. This is roughly equal to the maximum STS geosynchronous capability with the orbital transfer vehicles projected to be available by 1990. Moreover, the MSC for a 10 percent IRR is found to be \$215, growing to \$320 for a 15 percent IRR, and to \$420 for a 20 percent IRR. (All IRR values are real rates of return; the MSC is stated in 1982 dollars.)

The estimate of satellite weight and the profile of required MSC for a single-satellite system were both regarded as unacceptably high. (In addition to the optimistic assumption regarding the geographic subscriber distribution, weight estimates for several satellite subsystems were later judged to be on the optimistic side as well.)

During this initial design phase, NASA and its contractors were in the process of deriving alternate subscriber scenarios. These typically suggested larger EOL populations than originally assumed. It became evident that if these larger populations were coupled with a more realistic geographic distribution, much larger space-segment capacity would be needed. This could only be accomplished by a radical departure in system architecture.

To this end, non-cellular-compatible forms of modulation were introduced. Among the more promising candidates is FM with 5-kHz peak deviation, which requires a channel spacing of only 12 kHz. For a given frequency allocation, this results in a factor-of-2.5 increase in channel capacity.

The narrower-bandwidth FM is in use today with non-cellular terrestrial mobile radio. The carrier spacing in these systems is 25 kHz. This relatively large spacing is needed to avoid adjacent-channel interference, which can arise from a large disparity in received signal strength on adjacent channels. By contrast, propagation conditions are much more uniform in satellite transmission. Received carrier levels will therefore differ by a relatively small amount. This permits the use of the narrower, 12-kHz carrier spacing.

Additionally, multiple-satellite systems were considered. By allocating the capacity requirements between 2 or more satellites, each of the satellites can be reduced considerably in size. This approach does require, however, that the user be able to discriminate between co-channel signals transmitted by different satellites. This requirement has significant implications for the design of the mobile-unit antenna.

An EOL population of 180,000 users was again assumed, together with a uniform geographic distribution.

In addition to the previously assumed 10-MHz allocation, system designs were developed for a 4-MHz allocation. This was done because of the diminishing probability that a 10-MHz contiguous allocation, which requires a shift in the band already allocated for cellular-system operation, would be granted by the FCC. Obviously, such a reduced allocation greatly increases the difficulty of designing a satellite system to accommodate the projected subscriber population.

Because of uncertainties surrounding an exclusive allocation of any size for land-mobile satellite use, systems were also designed to share the 20-MHz cellular allocation. The technical feasibility of this approach depends on interleaving the carrier frequencies of the satellite system with those of the cellular system. Thus, 30-kHz carrier spacing is also required in the satellite system, although the carrier noise bandwidth in the latter system may be much smaller than 30 kHz.

An analysis of the compatibility of satellite and cellular systems sharing a common allocation is presented in Appendix B. If 5-kHz peak-deviation FM is used in the satellite system, intersystem interference is unacceptably high, especially from the terrestrial (i.e., cellular) mobiles

into the satellite. More advanced digital modulation formats such as linear predictive coding (LPC) offer the promise of compatible operation, however.

Based on a comparison of satellite weight and MSC, systems incorporating 5-kHz peak-deviation FM and multiple satellites were selected for further investigation. A mobile antenna suitable for use in a multiple-satellite system is described in Section 2.3.5. The performance of such an antenna is derived in Appendix C.

Alternate traffic patterns are introduced in Section 2.4. First, a more realistic geographic distribution of subscribers is considered. This distribution is based on the non-SMSA population within CONUS. It is shown that, to accommodate such a distribution, the satellite must be designed as if the user subscriber population were uniformly distributed but twice its actual size.

Four alternate traffic scenarios, specified by NASA, are then considered. System designs are developed for these scenarios using the non-uniform geographic distribution referred to above. It is found that satellites designed for 2-satellite, as well as 3-satellite, systems can be accommodated by the STS for EOL subscriber populations as large as 350,000 (i.e., twice that previously assumed). The MSC for either system is about \$130 for a 10 percent IRR, as compared with \$215 for the initial system design.

The above analysis of multiple-satellite systems is based on the assumption that each satellite provides an equal share of the system capacity. However, the satellites must be spaced in orbit by 30 degrees or more to avoid excessive intersatellite interference. Because of heavy subscriber concentration in the eastern half of CONUS, satellites positioned at corresponding longitudes will contribute more heavily to the system capacity than those at more westerly longitudes. Thus, each satellite of a 2-satellite system can be used more effectively than the most westerly satellite in a 3-satellite system. For this reason, the baseline system consists of 2 satellites, biased in an easterly direction with respect to the range of longitudes spanned by CONUS.

A pair of baseline system designs is developed in Section 2.5. The feature distinguishing the two systems is the satellite feed/reflector geometry. In one case an offset-fed reflector is used. (Satellite weight estimates for all previously referred-to designs are based on this geometry.) This has generally been the preferred approach to multibeam satellite antenna design, because improved sidelobe performance can be realized in the absence of reflector blockage by the feed assembly.

The second baseline design is based on a center-fed reflector. While sidelobe levels are generally higher than with the offset-fed reflector, adequate system performance can be achieved by employing a larger number of frequency subsets, and hence a larger number of UHF beams. The great advantage of the center-fed antenna geometry is the structural stiffness that results from the symmetry of the design.

The satellites for the baseline systems are sized for a user population of 350,000 or, equivalently, a busy-hour traffic load of 9000 erlangs. They are designed for a 7-year life. The frequency re-use factor in each case is based on availability of a 10-MHz exclusive frequency allocation and selection of 5-kHz peak-deviation FM. The designs would be little changed for a 20-MHz shared allocation. The principal difference would be a satellite weight penalty of at most 10 percent, resulting from the 25-percent greater frequency re-use factor required with a shared allocation.

The salient features of the satellite antenna feed system for both baseline designs are derived in Section 2.6. The main problem associated with the feed design is that the gain required for proper reflector illumination is incompatible with the area-per-beam available on the feed assembly surface. The solution is to form each beam through excitation of a cluster of feeds, with the clusters for adjacent beams sharing feed elements. Proper excitation of the feed elements is accomplished through a relatively complex beamformer network.

Stowed, as well as deployed, configurations of the baseline satellite designs are shown in Section 2.7. Placement of the satellites in geosynchronous orbit is based on an integral-propulsion type of upper stage. The weight and STS cargo-bay length occupied by this upper stage are shown as a function of payload weight.

Section 2.7 also contains a discussion of possible approaches to the attitude control problem. The baseline approach (for the offset-fed geometry) is described and a typical error budget indicated.

A parametric analysis of the satellite reflector and mast system, in terms of reflector diameter, is presented in Appendix F. This analysis is intended to be very broad in scope, including several reflector types and feed/reflector geometries. Thus, while major attention is given to the Lockheed (LMSC) wrap-rib reflector design, the Harris hoop-column is also considered. In addition to direct offset-fed and center-fed geometries, a Cassegrain configuration is examined. The latter is rejected, however, because of excessive weight.

2.2 SINGLE-SATELLITE, CELLULAR-COMPATIBLE SYSTEM

In this system, the mobile unit must be capable of interoperability with either MSAT or the cellular system. In one possible scenario, the user would initially attempt to access the local cellular net. If unsuccessful, he would have the option of completing the call via satellite, which might involve a higher charge than a terrestrially completed call. The satellite attempt would take place, or not, depending on a user-selected switch position on the mobile unit. It is intended that the entire signaling process take place automatically, as is the case in the cellular system.

2.2.1 Requirements

The current frequency allocation for cellular-system operation is shown in Figure 2-1. The mobile transmit band extends from 825-845 MHz, while the receive band runs from 870-890 MHz. The 10-MHz exclusive allocation for satellite transmission would extend from 821-831 MHz for mobile transmit, and from 866-876 MHz for mobile receive. Allocation of these bands is predicated on a 6-MHz shift in the previously allocated cellular-system bands.

The satellites are designed for a 7-year life, with initial operating capability (IOC) scheduled for 1995. Satellite technology must be available by 1990.

The subscriber population is assumed to be 50,000 at IOC and to grow at a 20 percent annual rate. At the end of 7 years, there are 180,000 users. With an assumed 0.026-erlang busy-hour traffic contribution per user, the EOL traffic load is 4680 erlangs.

For purposes of system sizing, the relevant geographic subscriber distribution is stated on a per-beam basis. In general, satellite beams cover more area the more northerly the latitude and the larger the longitudinal displacement from the satellite. The assumption of a uniform geographic distribution will be interpreted to mean uniformity on a per-beam basis. Note that this is more favorable, in the sense of requiring a smaller satellite, than uniformity on a per-square-mile basis. In fact, it presumes a subscriber density per-square-mile that varies inversely with beam area.

ORIGINAL PAGE IS
OF POOR QUALITY

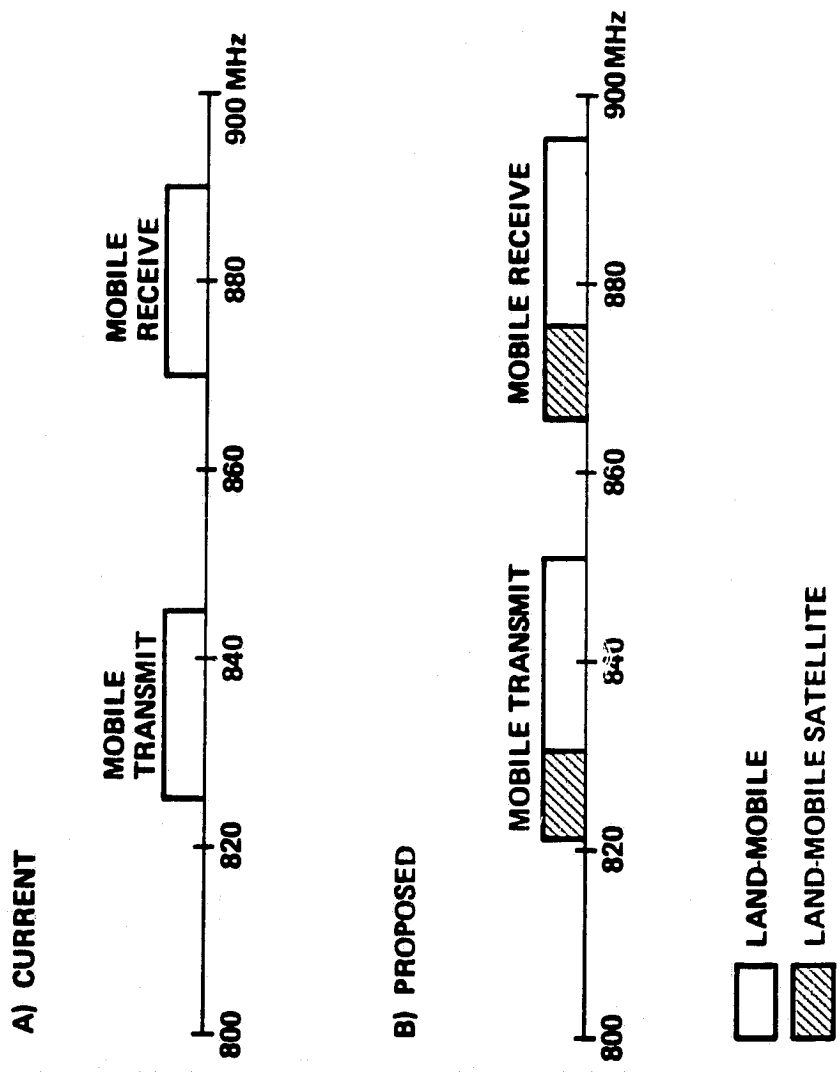

Figure 2-1. Frequency Allocations

The weight of MSAT is constrained by the STS launch capability, in combination with the orbital transfer vehicle (OTV) geosynchronous capability. Continued STS development should result in 65,000-pound launch capability by the latter part of this decade. A new OTV development is required to place MSAT in geosynchronous orbit. Proposed designs include the relatively high-g wide-body Centaur and the low-thrust integral propulsion system (IPS) under study at TRW. Both designs can support geosynchronous payloads slightly in excess of 10,000 pounds.

The stowed satellite dimensions are constrained by the STS cargo-bay width of 15 feet and the length not occupied by the OTV. The so-called Centaur G design (Reference 2-1), which has a payload capability of 10,600 pounds, is currently under development by NASA. This Centaur version is 20 feet long, which leaves 40 feet of STS bay length for the payload, or 36 feet after allowing 4 feet for extra-vehicular activity (EVA).

By comparison, the IPS allows 42 feet for the payload. Satellite weight in this study will be constrained by the estimated IPS payload capability of 10,400 pounds.

2.2.2 Cellular-System Compatibility

The mobile-unit antenna for cellular-system operation is designed for maximum gain near the horizon. For a single-satellite system, the range of elevation angles encountered within CONUS is 20 to 60 degrees. (This assumes the user vehicle is on level ground.) Consequently, the mobile unit should be equipped with an antenna designed to maximize the minimum gain over this range.

Such an antenna has been described in a JPL report (Reference 2-2) and will be adopted for this study. It consists of a pair of crossed drooping dipoles, which can be set either 10.7 or 15.9 centimeters above the surface of the user vehicle. The position selected would be a semi-permanent adjustment dependent on the user location. The minimum gain for this 2-position antenna design, between elevation angles of 20 and 60 degrees, is 4 dB.

In cellular systems, the mobile units and the base stations are typically equipped with 9-dB noise-figure receivers. This is done primarily for reasons of cost. Considerably lower noise figures are needed

for the MSAT mobiles, to minimize the satellite power requirements. For combined cellular/MSAT operations, for which the transmit and receive bands are separated by only 15 MHz (see Figure 2-1), the minimum practical noise figure is about 3 dB.

The signaling procedure adopted in cellular systems uses a "busy/idle" transition, in a continuous bit stream transmitted by the base station, to avoid "collisions" between 2 or more users trying to access the system simultaneously. When there are no call setups in progress, the busy/idle bit, which is transmitted periodically, assumes a particular value (either zero or one). A user attempting to initiate a call first sends a brief burst indicating this desire. He then listens for a transition in the busy/idle bit. If received within 0.1 second, he assumes it is in response to his call attempt, and call setup proceeds. If the transition is not detected within this interval, a re-try is initiated after waiting a random interval of time. In this way, the probability of call-setup collisions is minimized.

A modified procedure could be followed for satellite transmission, which would allow for the round-trip propagation delay between mobile and gateway stations of about 0.5 second. To lessen the probability of collision and thereby increase channel utilization, the transition interval would be replaced by a transition "window". The window opening would follow the initial transmission by a delay equal to the minimum round-trip propagation time. It would remain open for perhaps 0.1-0.2 second.

It can be shown, however, that for the amount of traffic anticipated on a single satellite beam, a simpler procedure can be followed in which the entire call-setup message is transmitted on a random-access basis. Because the messages are variable in length, a procedure of the unslotted-ALOHA type would be followed (Reference 2-3). With 100 channels/beam, which is larger than any case considered here, the erlang load of a signaling channel used in this manner would be less than 0.1, even if all messages were of maximum length. This is well below the saturation value of 0.18 for unslotted ALOHA. A single signaling channel suffices, therefore, for an entire beam.

The cellular system uses narrowband FM with a 2:1 companding ratio. The carrier noise bandwidth is 27.5 kHz, while the carrier spacing is 30 kHz. Of the several functional elements in the present AMPS mobile transceiver, the logic unit and the data transmission rate are critically linked to the channel bandwidth. The 10-kHz data rate and Manchester encoding require a 26-kHz IF bandwidth. Thus, an increase in channel capacity achieved by adopting a narrower form of modulation would also require a new data format. This would amount to complete abandonment of cellular compatibility.

2.2.3 System Sizing

The satellite must be sized to support the EOL busy-hour traffic of 4680 erlangs. The procedure used to determine the required antenna diameter and the associated number of beams is diagramed in Figure 2-2. At a spacing of 30 kHz, a total of 333 carriers is available from the 10-MHz UHF allocation.

With an offset-fed reflector, it is necessary to employ 4 frequency subsets to maintain adequate control of co-channel interference (see discussion in Section 2.6.2). A 4-frequency-set beam pattern is illustrated in Figure 2-3. Each beam in this pattern is assigned $333/4 \approx 83$ channels. It will be assumed that 2 channels are reserved for signaling, so that 81 channels remain for voice traffic. For a 0.02 grade of service, 70.5 erlangs of traffic can be supported in each beam.

Nominally, the number of beams required is found by dividing the total traffic by the beam capacity; i.e., $4680/70.5 = 66.4$ beams. However, not all beams are wholly contained within the boundaries of CONUS. Under the assumption of a uniform geographic subscriber distribution (on a per-beam basis), the number of users in a beam only partially within CONUS is given by the appropriate fraction times the number of users in a beam which lies entirely within CONUS. The sum of the number of beams contained in CONUS, including fractional beams, will be termed the number of beam equivalents. It is this quantity, then, that must be equal to 66.4.

A beam pattern (as seen from geosynchronous orbit) providing CONUS coverage, with about 66.4 beam equivalents contained within CONUS, is shown in Figure 2-4. There are 83 beams in all, each with a half-power

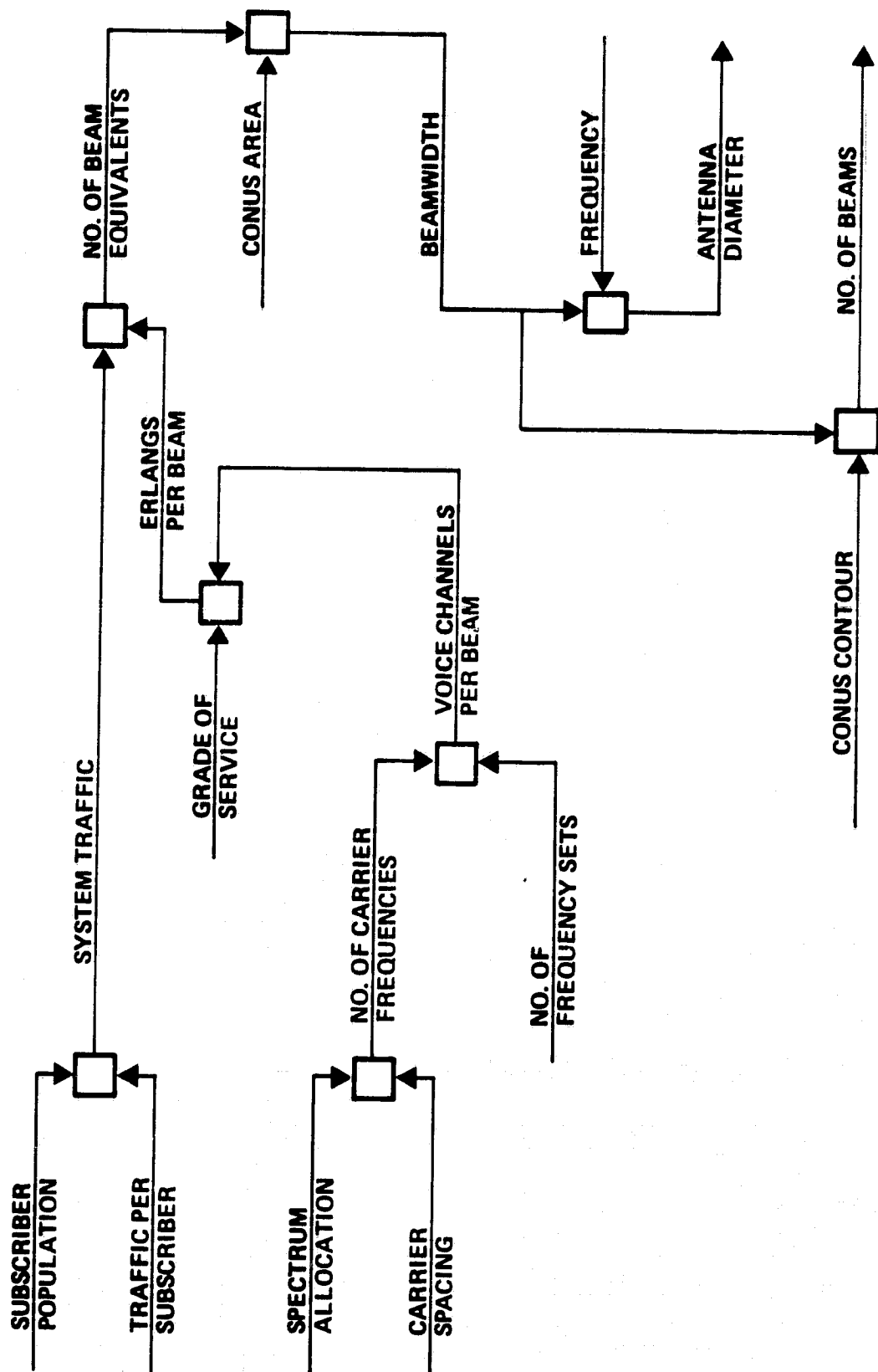

Figure 2-2. System Sizing Methodology

ORIGINAL PAGE 13
OF POOR QUALITY

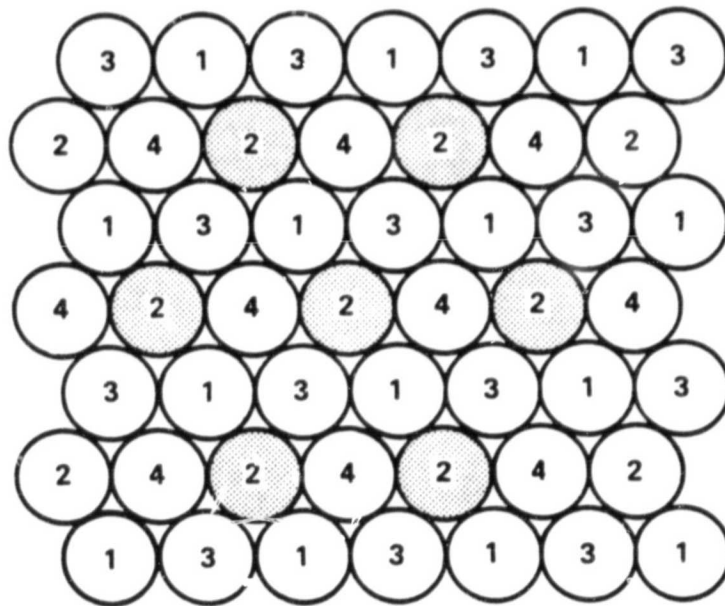

Figure 2-3. 4-Frequency-Set Beam Pattern

ORIGINAL PAGE IS
OF POOR QUALITY

0.48-DEG HPBW

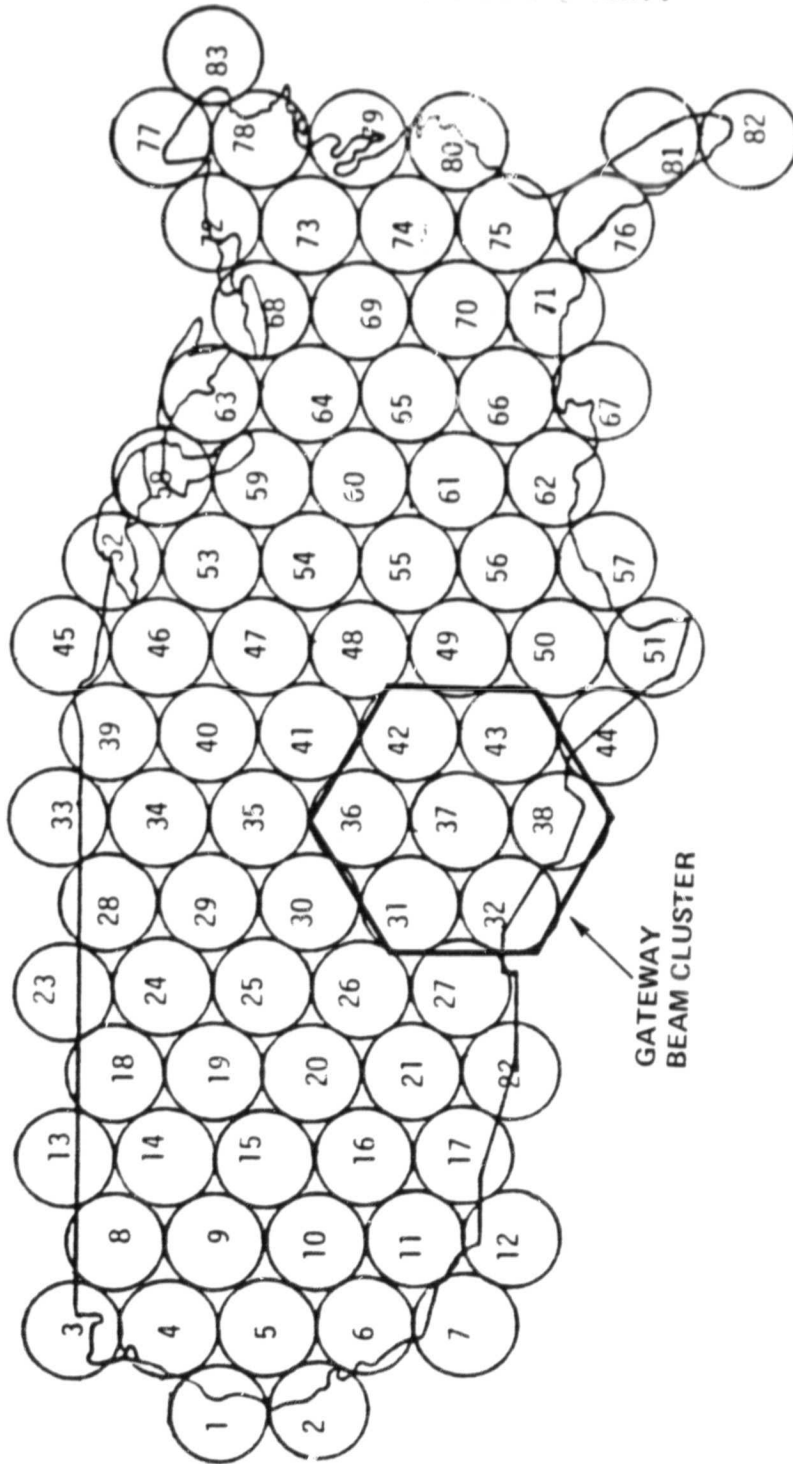

Figure 2-4. Typical CONUS-Coverage Beam Pattern

beamwidth (HPBW) of 0.48 degree. At the midpoint of the mobile transmit band, 826 MHz, the antenna diameter required to produce this beam size is about 52 meters. The exact size depends on the reflector illumination, which must be designed to produce adequate sidelobe performance.

2.2.4 Carrier Assignment

Division of the full complement of carrier frequencies into 4 subsets can be done in several ways. For example, the carriers in each subset may be uniformly spaced and interleaved with those of any other set (Figure 2-5a). This is the procedure followed in cellular systems, in which 7 frequency sets are used. The virtue in this arrangement is that adjacent-channel interference between carriers in the same subset is non-existent. This is especially significant in a terrestrial system, because there can be very large differences in received signal strength between carriers.

Propagation differences are much smaller on satellite links; consequently, it may not be necessary to preclude assignment of adjacent frequencies to the same beam. If a frequency subset is permitted to contain adjacent frequencies, the "close-packed" arrangement of Figure 2-5b may be considered. This format has the advantage of reducing the bandwidth required on the satellite/gateway links, as will become evident in Section 2.2.5.

In both of the above methods of carrier assignment, the carrier frequencies in each subset are uniformly spaced. It will initially be assumed that there is a one-to-one correspondence between feeds and beams; i.e., the input to each final amplifier consists solely of carriers from a single subset. Then, all of the intermodulation (IM) products generated in each amplifier will fall directly on frequencies of that subset (or on uniformly spaced extensions of the frequencies in that subset).

The carrier-to-IM power ratio (C/IM) at the amplifier output can be greatly improved by assigning carrier frequencies to subsets in a random manner. While the total IM power generated is unchanged, it is now distributed over all frequencies, rather than just those of carriers input to the amplifier. Thus, for the case of 4 frequency subsets, C/IM is increased by 6 dB.

ORIGINAL PAGE IS
OF POOR QUALITY

A) UNIFORM SPACING, WITH BEAM INTERLEAVING

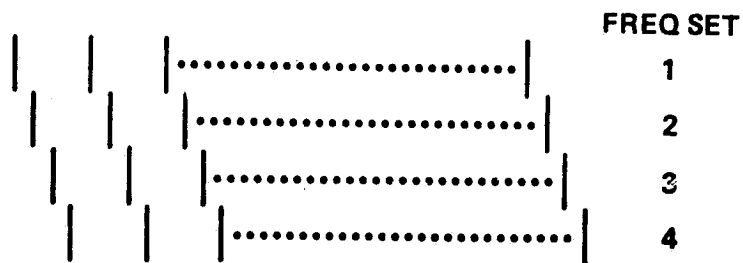

B) UNIFORM SPACING, CLOSE-PACKED

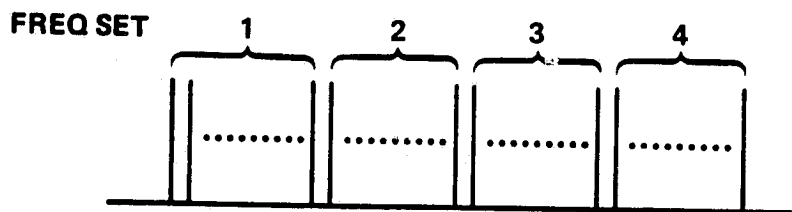

Figure 2-5. Carrier Frequency Assignments

This argument is overly simplistic, however. With a random carrier assignment, the IM spectrum is identical at the output of each amplifier. Users in a given beam will therefore be subjected to IM products generated in amplifiers associated with each of the 6 surrounding beams, although at lower levels of EIRP. This effect can be appreciated by considering a user located at a beam "crossover" point. Combined IM power from the 2 beams in question will be twice that emanating from the amplifier generating the carrier intended for the user.

The situation is complicated by the fact that a given beam is actually generated by multiple feeds (see Section 2.5.3). Consequently, an individual carrier is fed, with appropriate amplitude and phase, to the different amplifiers associated with those feeds. A C/IM analysis for the actual signal distribution is beyond the scope of this study. Nevertheless, it appears probable that some C/IM improvement results from assigning carriers to subsets in a random manner. Moreover, this improvement should increase as the number of frequency subsets is increased.

No specific choice of frequency assignment method will be made at this point. The uncertainty in C/IM (the determination of which requires a knowledge of the final amplifier characteristic and mode of operation) is resolved, for purposes of system design, through allocation of a portion of the total link noise budget to IM noise power (see Section 2.2.6).

2.2.5 Satellite/Gateway Links

The gateway stations serve as the interface between the satellite links and the STN. It is envisioned that each gateway station will be connected to either a No. 4 or a No. 5 telephone office. In principal, a single gateway could be used for the entire satellite network. Apart from the load presented to the associated telephone office, this arrangement is undesirable because of the long terrestrial links that would be needed to reach the land user. If the gateway were centrally located, these links could extend to 1500 miles.

As the number of gateways is increased, the average length of the terrestrial links decreases. In the limiting case, each UHF beam would be assigned to a separate gateway. Based on gateway costs exhibited in Section 2.2.8, this would perhaps double the cost of the ground segment.

Although the MSC would increase by a relatively small amount, toll charges would still be incurred for most gateway/land-user connections. Moreover, the satellite/gateway link design would be considerably complicated.

As suggested in Figure 2-4, a compromise was made in which a gateway typically services users in a 7-beam UHF cluster. Therefore, 12 gateways are required for the 83 beams. The geographic configuration of the UHF beams served by a common gateway is not particularly important. What does matter is that some minimum angular separation (as seen from the satellite) is maintained between gateways. Assume, for example, that the 7-beam cluster centered on beam 21 is served by a second gateway; and furthermore, that the two gateways are restricted in location to beams 37 to 21, respectively. By choosing the size of the satellite antenna for the gateway links so that the beams to the gateways are the same size as the UHF beams, it is possible to fully re-use the assigned frequency band on all satellite/gateway links.

The bandwidth requirements for satellite/gateway transmission can be understood from examination of Figure 2-6. The satellite acts as a frequency-translation repeater. No attempt is made to filter out individual carriers. Instead, the entire band of carriers transmitted by users in a given beam is repeated, as a unit, down to the gateway. A similar process takes place in the reverse direction. Therefore, for either the interleaved or randomly chosen carrier sets, satellite/gateway transmissions corresponding to a given UHF beam span 10 MHz of bandwidth. If a gateway controls 7 UHF beams, 7 such 10-MHz bands must be transmitted in either direction between satellite and gateway. Including guard bands, roughly 100 MHz must be assigned to these links.

In the case of closely packed carriers (see Figure 2-5), each UHF beam requires only one-fourth the bandwidth associated with either of the other two methods of carrier assignment. Therefore, for a 7-beam UHF cluster, approximately 25 MHz must be assigned to the gateway links.

Whether the required bandwidth is 25 MHz or 100 MHz, the same band is used to all gateways. As indicated previously, co-channel interference on the gateway links is limited by the combination of gateway separation and narrow satellite beams.

ORIGINAL PAGE IS
OF POOR QUALITY

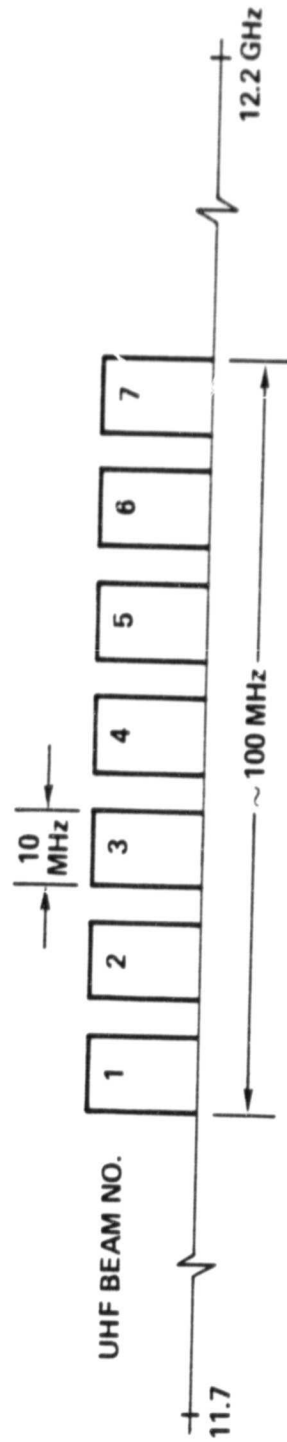

- EACH 10-MHz BAND CONTAINS UP TO 81 ASSIGNED VOICE CHANNELS AND 1 OR 2 CALL-SETUP CHANNELS

- A COMMON SET OF CHANNEL ASSIGNMENTS COULD BE SHARED BY:

- A) BEAMS 2 AND 5
- B) BEAMS 3 AND 6
- C) BEAMS 4 AND 7

Figure 2-6. Gateway Ku-Band Frequency Plan

Candidate frequencies for the gateway links include the "fixed-satellite" allocations at S-band (2655-2690 MHz up, and 2500-2690 MHz down), Ku-band (14/12 GHz), and Ka-band (30/20 GHz). The allocation at C-band (6/4 GHz) was not considered because of overcrowding of the geostationary arc at these frequencies. S-band was ruled out because the 35-MHz uplink allocation is inadequate unless the frequency sets are chosen to be close-packed. Ka-band was rejected because rain attenuation is sufficiently great that the power required for transmission to the gateways could be a non-negligible fraction of that required for the UHF downlinks. This leaves Ku-band, at which the allocation (500 MHz) is ample and the rain attenuation is relatively modest.

At Ku-band, a satellite antenna about 3 meters in diameter is required to produce beams of the desired size.

2.2.6 Satellite Link Design

Because the satellite acts as a frequency translation repeater, uplink and downlink noise contributions are additive in both the forward (gateway-to-mobile) and return (mobile-to-gateway) directions. A noise budget allocation is most readily accomplished in terms of the corresponding carrier-to-noise components. A composite carrier-to-noise ratio (C/N) of at least 10 dB is required, as this is the threshold value for demodulation of an FM carrier.

A common set of C/N component ratios can be defined for the forward and return transmission paths. These are listed below:

C/N_{tu} = carrier-to-uplink thermal noise ratio

C/N_{td} = carrier-to-downlink thermal noise ratio

C/I_{cu} = carrier-to-uplink co-channel interference ratio

C/I_{cd} = carrier-to-downlink co-channel interference ratio

C/IM = carrier-to-IM ratio

With respect to the forward link, C/N_{td} is the critical component since the downlink carrier power is the prime determinant of the required satellite power. The selected value of C/N_{td} should be as small as possible, consistent with achieving a resultant C/N of 10 dB. To this end, C/N_{td} has been fixed at 12.5 dB.

Next in importance is C/I_{cd} , as stringent sidelobe requirements on the UHF links place a considerable burden on the antenna subsystem design. (These requirements may, in fact, result in reduced system capacity for a given antenna size, if they can be realized only by resorting to a larger number of frequency sets.) A specification of 17 dB will be placed on C/I_{cd} . Realization of this system value, which represents the combined effect of co-channel interferers from several beams, is discussed in Section 2.6.

Intermodulation products in the forward direction are generated in the UHF power amplifiers. As explained in Section 2.2.4, evaluation of C/IM involves a complex analysis as well as a detailed understanding of the amplifier characteristics. For purposes of this study, a C/IM value of 20 dB will be assumed. (Attainment of this value would be aided, to an undetermined extent, by a random set of carrier assignments).

There is no question that a C/IM value of 20 dB can be achieved. To do so, however, requires that the amplifiers be "backed off" from saturation to operate in a sufficiently linear region. In general, DC/RF conversion efficiency decreases with the amount of backoff. From a system point of view, the backoff required to achieve a 20-dB C/IM value may result in unacceptably low DC/RF efficiency. Should this occur, it would be necessary to decrease the downlink thermal noise allocation. For example, a value of $C/IM = 16$ dB could be tolerated if C/N_{td} were increased from 12.5 to 13.9 dB.

A value of $C/I_{cu} = 20$ dB should be readily achievable. With the satellite Ku-band antenna selected to produce beams identical in size to the UHF beams, the minimum separation between Ku-band beams is 2.65 HPBW. Sidelobe control resulting in $C/I_{cu} \geq 20$ dB is not difficult with this configuration.

The remaining C/N component, C/N_{tu} , must be at least 24.2 dB to yield a composite C/N of 10 dB. This value is readily achieved since the Ku-band link is presumed to include a 5-meter earth station.

A summary of the C/N component values in the forward direction, as well as those in the return direction, is given in Table 2-1.

ORIGINAL PAGE IS
OF POOR QUALITY

Table 2-1. Link Noise Allocation

REQUIREMENT: COMPOSITE-LINK C/N = 10 dB

GATEWAY-TO-MOBILE DIRECTION	MOBILE-TO-GATEWAY DIRECTION
$C/N_{tu} = 24.2 \text{ dB}$	$C/N_{tu} = 17.9 \text{ dB}$
$C/N_{td} = 12.5 \text{ dB}$	$C/N_{td} = 16.2 \text{ dB}$
$C/I_{cu} = 20.0 \text{ dB}$	$C/I_{cu} = 14.0 \text{ dB}$
$C/I_{cd} = 17.0 \text{ dB}$	$C/I_{cd} = 20.0 \text{ dB}$
$C/IM = 20.0 \text{ dB}$	$C/IM = 20.0 \text{ dB}$

- C/N_{tu} = UPLINK CARRIER-TO-THERMAL NOISE RATIO
- C/N_{td} = DOWNLINK CARRIER-TO-THERMAL NOISE RATIO
- C/I_{cu} = UPLINK CARRIER-TO-COCHANNEL INTERFERENCE RATIO
- C/I_{cd} = DOWNLINK CARRIER-TO-COCHANNEL INTERFERENCE RATIO
- C/IM = CARRIER-TO-INTERMODULATION NOISE RATIO

In the return direction, C/N_{tu} is determined by the available transmitter power in the mobile units. The assumed value of 3 watts is based on cost considerations, as well as the desire for compatibility with cellular-system mobile radios. The Motorola mobile units, which operate into base-station sector antennas, require only 1 watt of transmitter power. Bell System mobile units are designed to work with base-station antennas providing 360-degree azimuthal coverage and consequently have 3-watt transmitters. Larger transmit power in the MSAT mobile units, which would be quite costly, is not needed because a C/N_{tu} of 17.9 dB can be realized with 3 watts of transmit power. (Link budgets corresponding to the baseline set of system parameters can be found in Appendix E.)

The effective co-channel interference power on the UHF uplink is determined by considerations similar to those affecting co-channel interference on the UHF downlink, with one exception. Whereas both desired and interfering signals are affected similarly by multipath on the downlink, uplink multipath effects are independent. Thus, C/I_{cu} for a user subject to a sizable fade due to multipath could be significantly reduced. To allow for this possibility, C/I_{cu} will be taken as 14 dB.

The values of C/I_{cd} (which is analogous to C/I_{cu} in the forward direction) and C/IM are both taken as 20 dB. The remaining C/N component, C/N_{td} , must be at least 16.2 dB to achieve a composite C/N of 10 dB. This requires a Ku-band transmit power of only 5 milliwatts per carrier.

By contrast, the downlink to the mobile units requires 0.85 watt per carrier. The average number of active carriers is given by the product of the total system traffic (4680 erlangs) and the voice activity factor (assumed to be 0.4). Therefore, the total satellite RF power requirement is $0.4(4680)(0.85) = 1700$ watts.

2.2.7 Satellite Description

As previously described, the UHF reflector for this initial satellite design is assumed to be offset-fed. The reflector design is of the wrap-rib type, which has been developed at Lockheed (LMSC). This construction is relatively lightweight, has a small stowed length, and deploys rather simply.

The mast system for the offset-fed design consists of two parts, arranged in an L-shaped configuration (Figure 2-7). The shorter portion begins at the rear of the reflector hub and extends beyond the reflector edge. The longer segment attaches to the main bus and feed assembly, and ensures that the latter is at the required distance from the reflector. The mast is of an articulated design, with rigid longerons; the canisters are located at the elbow of the "L".

The length of the main mast is determined by the f/D required for satisfactory sidelobe performance (f is the focal length of the reflector and D is its diameter). The JPL design parameters were followed in this regard (see Reference 2-2). Accordingly, f/D is taken as 1.5. Thus, for a 52-meter reflector (see Section 2.2.3), a 78-meter main mast is required. The ratio f/D_p , where D_p is the diameter of the parent paraboloid, is 0.67.

All of the subsystems with the exception of the reaction control system (RCS) are located in the main bus. The RCS has thrusters located both at the main bus and behind the reflector. This distributed control maximizes the moment arm for attitude control, thereby minimizing the amount of fuel required.

The solar panel is attached to the main bus by an Astromast. The latter must be long enough to avoid shadowing of the solar array by the reflector.

The Ku-band antenna, which provides communications to the gateway stations, is colocated with the main bus.

The amount of fuel required for east-west stationkeeping is rather small. By contrast, a large amount of fuel would be needed for north-south stationkeeping. More than 1000 pounds of satellite weight can be saved by dispensing with north-south stationkeeping. Instead, north-south drift is compensated for by "nodding" the satellite to maintain the proper antenna pointing direction.

Several assumptions made to obtain a preliminary satellite weight estimate were on the optimistic side. Among these are: 1) a single-feed-per-beam approach to the UHF antenna design, and 2) 40 percent efficient UHF solid-state amplifiers. The first assumption, which significantly reduces the dimensions of the feed assembly and the number of

ORIGINAL PAGE IS
OF POOR QUALITY

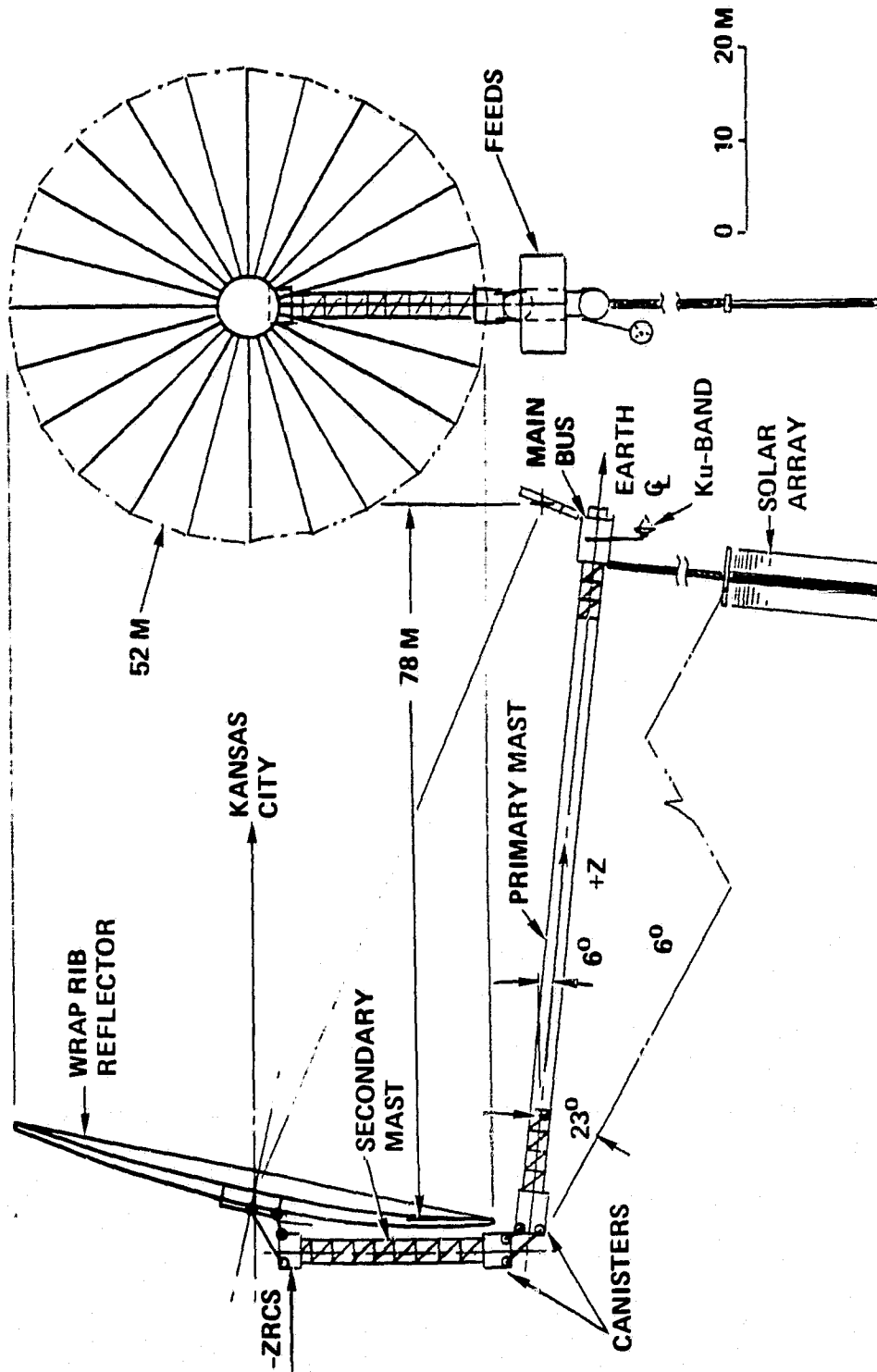

Figure 2-7. Offset-Fed Satellite Configuration

electronic components, is not necessarily unrealistic. However, it is considered a high-risk approach and is replaced in the baseline designs by a feed-cluster approach to beam formation (see Section 2-6).

Even with these assumptions, a single satellite sized to accommodate the 180,000 EOL users was estimated to weigh 10,000 pounds with no contingency factor included. A larger and heavier satellite would be required if the same user population were assumed to follow a non-uniform geographic distribution.

2.2.8 Gateway Description

The basic elements of the gateway stations are shown in Figure 2-8. The gateway performs the combined functions of the base stations (or cell sites) and mobile telecommunications switching office (MTSO) found in cellular systems. Thus, for System 1, the base-site controller, which processes signals for transmission to and after reception from the mobile units, is found at the gateway.

The RF-to-4-wire subsystem converts the 30-kHz-wide user transmissions, as relayed by the satellite, to the audio 4-wire level. On transmission, this subsystem converts the signals that normally would be transmitted by the base stations in a cellular system into the proper format for satellite transmission. An expanded view of this subsystem is shown in Figure 2-9.

The satellite transmissions are grouped by UHF beam, as depicted in Figure 2-6. The initial demultiplexing process indicated in Figure 2-9 isolates the signals in an individual UHF beam prior to downconversion to 70 MHz. The 81 voice carriers in each beam, if uniformly spaced across the 10-MHz band, are separated by 120 kHz (i.e., 4 times the 30-kHz carrier bandwidth). The modems in the RF-to-4-wire subsystem reduce the various carriers to a 0-10 kHz audio channel, which contains both voice and signaling information.

In the forward direction, the 81 voice channels in an individual UHF beam are combined through frequency-division multiplexing (FDM). For a gateway that controls 7 UHF beams, 7 such composite signals are combined in the manner of Figure 2-6 (i.e., by a second tier of FDM). The output of the latter process is upconverted prior to final amplification.

ORIGINAL PAGE IS
OF POOR QUALITY

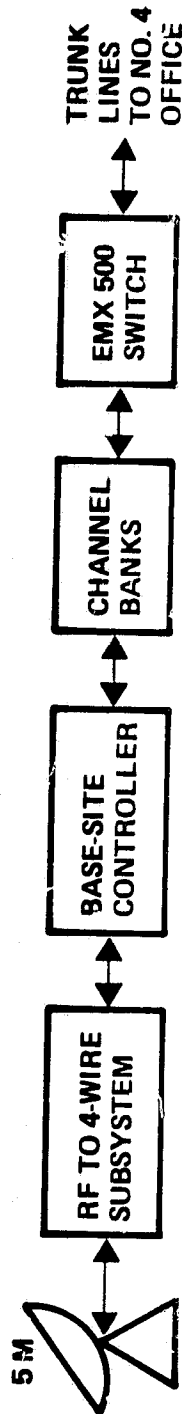

Figure 2-8. Gateway Block Diagram

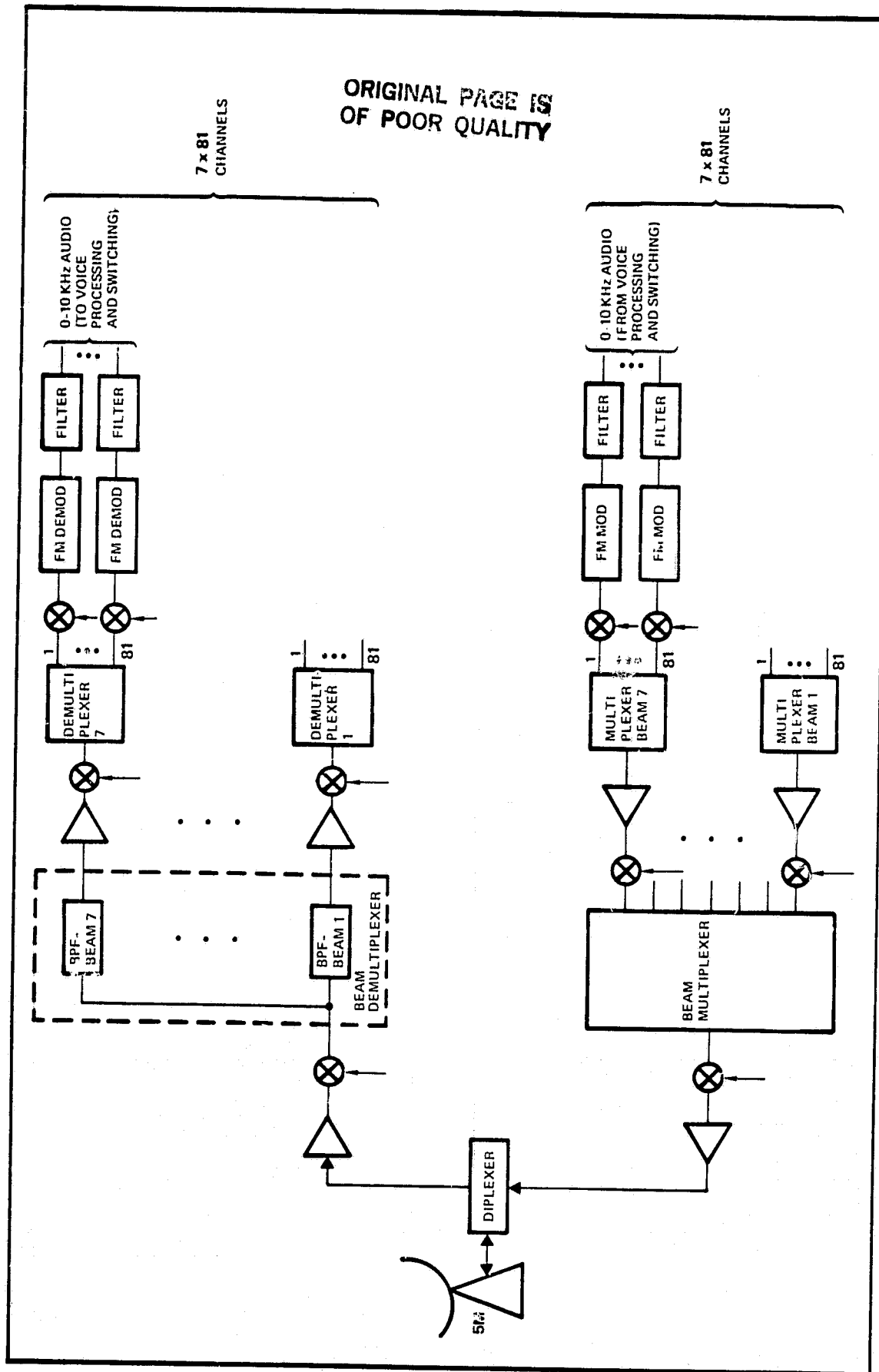

Figure 2-9. Gateway RF-to-4-Wire Subsystem

The remaining gateway equipment is fairly standard in terms of the functions performed in a cellular radio system. The base-site controller contains the control equipment normally found in a cellular-system base station. This unit is responsible for call setup, supervision, and termination functions, as well as syllabic companding to improve the signal-to-noise ratio for received speech. It is microprocessor based.

The output of the controller for each voice channel is an analog audio signal. These analog signals are digitized by the channel banks in a standard PCM format and multiplexed to form T1-carrier inputs to the EMX 500 switch. The latter is a Motorola designation for a switch similar in nature to the Bell System ESS 1/1A switch.

The switch consists of processors, memory, switching network, trunk circuits, and miscellaneous service circuits. In addition to providing a termination for trunk lines to a No. 4 toll office (or possibly a No. 5 local office), the switch performs billing and, in the case of a mobile-to-mobile call, provides the necessary connection so that the call does not have to be processed by the STN.

The modem section of the RF-to-4-wire subsystem, as well as the base-site controller, is modular in terms of the number of voice channels supported. In addition, the channel banks and the switch can be augmented on an individual channel basis. The voice channels are segregated on a per-beam basis and this separation is maintained throughout the gateway hardware. Therefore, the relevant channel requirements are those computed on a per-beam basis.

The cost of the gateway station elements is shown in Table 2-2. Although Ku-band has been chosen for satellite/gateway transmission, the cost of the RF/IF section is based on current C-band technology, in the expectation that Ku-band hardware will reach a similar state of maturity by 1990. A breakdown of the RF/IF section costs is given in Table 2-3. The modem costs are rough estimates, since these units represent a new hardware development.

The base-site controller costs are representative of current prices. For the gateway as depicted in Figure 2-9, with 81 channels/beam, three blocks would be required by the end of the 7-year system life.

Table 2-2. Gateway Cost Elements

<u>ELEMENT</u>	<u>COST</u>
● RF TO 4-WIRE SUBSYSTEM	
● RF/IF SECTION	● \$170K
● MODEMS	● \$15K PER 12-CHANNEL BLOCK
● BASE-SITE CONTROLLER	
● 32 CHANNELS/BLOCK	● \$36K PER 32-CHANNEL FRAME PLUS \$1K PER CHANNEL
● UP TO 3 BLOCKS/BEAM	
● 7 BEAMS/GATEWAY	
● CHANNEL BANK (A/D)	● \$500 PER CHANNEL
● EMX 500 SWITCH	● \$1.1M FOR FRAME PLUS \$1250 PER CHANNEL
● BLDG., POWER, A/C	● \$100K

Table 2-3. Gateway RF/IF Section Costs (\$)

	<u>QTY.</u>	<u>UNIT COST</u>	<u>REDUNDANT</u>	<u>COST PER GATEWAY</u>
ANTENNA	1	20,000		20,000
<u>DOWNLINK</u>				
LNA	1	2,000	X	7,000
DOWNCONVERTER (12 GHz--700 MHz)	1	11,000	X	25,000
BEAM DEMULTIPLEXER	1	4,000		4,000
IF AMPLIFIER	7	1,000	X	14,000
DOWNCONVERTER (700 MHz--70 MHz)	7	500	X	7,000
<u>UPLINK</u>				
IF AMPLIFIER	7	1,000	X	14,000
UPCONVERTER (70 MHz--700 MHz)	7	500	X	7,000
BEAM MULTIPLEXER	1	5,000		5,000
UPCONVERTER (700 MHz--14 GHz)	1	12,000	X	27,000
HPA	1	20,000	X	40,000
TOTAL				170,000

The EMX 500 switch can handle about 700 voice channels. It is adequate, therefore, for the gateway complement of $7 \times 81 = 567$ channels.

In deriving an MSC, it is necessary to determine the ground-segment expenditures over the life of the system. The first step in this process is to calculate the channel requirements as a function of time. This is done in Table 2-4 for 0.02 call blockage. The reference point for the time scale ($T=0$) corresponds to the IOC, at which point there are 50,000 subscribers.

Expenditures corresponding to the channel requirements in Table 2-4 are given in Table 2-5. The costs shown have been compiled using the basic cost elements in Table 2-2. It is assumed that, at the start of each year, adequate channel equipment is installed to handle the subscriber traffic through the end of the year. For example, the final equipment required for a 7-year life is installed during the sixth year following IOC.

In addition to its normal STN interface functions, one of the gateway stations would be designated to provide the usual satellite control functions. By analogy with other satellite subsystem designs, the additional ground segment cost attributable to this function has been taken as \$18 million.

2.2.9 Mobile Unit Modifications

Several necessary modifications were mentioned in Section 2.2.2 in the discussion of cellular-system compatibility. One of these relates to the unsuitability of the protocol based on busy/idle bit transition for satellite transmission. Provision already exists in the AMPS system control specification for ignoring the busy/idle bit. Thus, if no aspects of the signaling format are changed, the impact on logic unit cost is minimal.

Another important change affecting the logic unit concerns the use of voice-actuated transmission (VOX) in both the forward and return directions. This is especially important in the forward direction to conserve satellite power. In cellular systems, provision for VOX exists in the return direction to accommodate the power needs of portables. There is no corresponding provision in the forward direction, however.

In fact, the current cellular system design depends on continuous transmission by the base station of a SAT tone (5970 to 6030 Hz) over the

Table 2-4. Gateway Channel Requirements

<u>TIME (T)</u>	<u>SUBSCRIBERS</u>	<u>ERLANGS PER UHF BEAM</u>	<u>CHANNELS PER UHF BEAM*</u>
0	50,000	19.6	28
1	60,000	23.4	32
2	72,000	28.2	37
3	86,400	33.8	43
4	103,680	40.6	51
5	124,416	48.7	59
6	149,300	58.5	69
7	179,160	70.2	81

***0.02 CALL BLOCKAGE**

ORIGINAL PAGE IS
OF POOR QUALITY

Table 2-5. System 1 Gateway Costs (\$K)

<u>TIME (YRS)</u>	<u>RF TO 4-WIRE SUBSYSTEM</u>	<u>BASE-SITE CONTROLLER</u>	<u>CHANNEL BANKS</u>	<u>EMX 500 SWITCH</u>	<u>TOTAL COST PER GATEWAY*</u>
0	535	728**	112	1380	3737***
1	105	287	18	44	599
2		42	21	53	153
3	105	56	28	70	342
4		56	28	70	203
5	105	322	35	88	726
6	105	84	42	105	444

*INCLUDES 20% PROGRAM-LEVEL COST AND 10% INTEGRATOR FEE (32% COMBINED)

**INCLUDES REDUNDANT FRAME FOR EACH UHF BEAM

***INCLUDES \$100K FOR BLDG., POWER, A/C

NOTE: NONRECURRING COST ASSUMED TO BE \$7M

voice channel. This tone is continuously transponded by the mobile, as long as the voice channel is maintained. Mobiles constantly monitor SAT tone to determine fades, loss of signal from base station, or capture of signal from the wrong base station.

The use of VOX for satellite transmission makes it impossible for the mobile to differentiate loss of signal from a lull in conversation. The significance of this capability in a satellite setting, where large signal fades can result only from direct blockage, needs to be assessed. If necessary, alternate means of providing this capability must be found.

There are other, minor changes required in the logic circuitry. For example, it might be desirable to permit a finer range of power control than the 4-dB steps available in cellular systems. None of the digital logic changes implies a significant increase in mobile unit cost, however. The major cost impact of satellite operation is in the transceiver analog circuitry.

Two factors can be identified as critical in creating an MSAT/AMPS compatible mobile radiotelephone: 1) an increase in the mobile transmit and receive bands to 30 MHz in accordance with Figure 2-1b, and 2) a radical reduction in the receiver noise figure. The latter is made difficult because of the small (15 MHz) separation between the transmit and receive bands.

The noise figure can be considered to consist of two parts: 1) the noise figure as measured at the preamplifier input, and 2) degradation due to insertion loss of the filter preceding the preamplifier. The best commercially available preamplifiers have noise figures in the range from 0.9 to 1.2 dB. This value will be degraded by noise contributions from succeeding stages, by an amount that depends on the preamplifier gain. When practical constraints on the preamplifier gain are taken into account, realistic noise figures at the preamplifier input of 1.5 to 1.8 dB can be expected.

Enough selectivity must be provided ahead of the first receiver stage to prevent it from being overloaded or desensitized by the transmit carrier. (Additional selectivity may also be required after the first stage and before the mixer to prevent a similar desensitization of the

mixer.) Satisfactory preamplifier performance requires about 66 dB of transmit carrier attenuation by the receive filter. For a single-front-end design, this attenuation must be realized only 15 MHz below the lower edge of the receive band.

The insertion loss can be held to 1.6 dB through use of a 10- or 12-pole filter with an unloaded Q of 1500. Alternatively, an unloaded Q of 2000 would produce an insertion loss of 1.2 dB. Reasonable filter volumes would be achieved in both cases by using a high-Q ceramic dielectric material. In the first case, the receiver noise figure would be 3.1 to 3.4 dB; in the second case, 2.7 to 3 dB. For the various system designs considered in this report, a receiver noise figure of 3 dB has been assumed.

It is also possible to design a dual-front-end receiver, with separate filters for the 866-876 MHz satellite band and the 876-896 MHz terrestrial band. The filter for the satellite band must now provide 66 dB of selectivity 35 MHz below the lower edge of the 10-MHz receive band. A 4-pole filter is adequate for this purpose. A filter with sections having an unloaded Q of 1500 would provide an insertion loss of 1.1 dB in this case, and a receiver noise figure of 2.6 to 2.9 dB.

The (recurring) cost of modifying a cellular-system transceiver to produce a 3-dB noise figure is about \$700, irrespective of whether a single- or dual-front-end design is employed. This should be compared with the typical cost of a cellular-system mobile unit, which is currently about \$3000. Considerably lower figures have been predicted, however, with the proliferation of cellular systems.

2.2.10 Monthly Service Charge

From a financial standpoint, the MSAT project may be regarded as a sequence of cash flows, starting with the initial R&D expenditures and concluding at the end of planned system operations. The cash flows are of several types: capital expenditures, revenues, operating expenses, and taxes. The MSC, which determines the revenue flow for the assumed subscriber scenario, is chosen to provide a specified return on invested capital.

The adopted measure of "return on invested capital" is the internal rate of return (IRR), which is defined as the "discount rate which equates the present value of expected cash outflows with the present value of expected cash inflows. Conceptually, IRR can be thought of as the compound annual interest rate that would balance the project cash inflows and outflows if they were, respectively, deposits to and withdrawals from a bank savings account" (Reference 2-4).

The required IRR for a project is related to its riskiness; a higher degree of risk implies the need for a higher IRR. The degree of risk involved in a project, as well as the association of a required IRR, is a subjective matter. To allow for a wide range of subjectivity, IRR values from 10 to 25 percent are considered in this study.

The MSC corresponding to a specified IRR is computed in an iterative manner. The result of the final iteration of such a calculation, for a 10 percent IRR, is shown in Table 2-6. The project spans 12 years, with operations (and hence revenues) starting in year 6. The net cash flow for each year is given in the next-to-last line. Discounting of the cash flows to a common time (in this case, to year 0) is accomplished through multiplication by e^{-rt} , where r is the IRR (i.e., 0.1) and t is the year in which the cash flow occurs. The exponential factor implies continuous, rather than discrete, compounding.

The discounted or present value of the cash flow appears in the last line. When the MSC is properly chosen, the sum of the discounted cash flows (i.e., the net present value or NPV of the project) is zero, as indicated by the entry in the first column.

2.2.11 System Assessment

As previously indicated, the estimated weight of a satellite sized to accommodate 180,000 uniformly distributed subscribers is roughly 10,000 pounds (without contingency).* A larger subscriber population, coupled

*Because the weight estimates for several subsystems were relatively crude at this point in the study, a detailed weight breakdown is deferred to Section 2.5, in which the baseline designs are described.

Table 2-6. Sample MSC Calculation

\$218 MONTHLY CHARGE FOR 10% RATE OF RETURN

	TOTAL \$M-81	YEARS																								
		1	2	3	4	5	6	7	8	9	10	11	12													
FINANCING																										
ACQUISITION	800	108	209	179	165	91	25	2	4	2	4	2	9	5	0											
OPERATIONS	21	0	0	0	0	0	3	3	3	3	3	3	3	4	4											
TOTAL FINANCING	821	108	209	179	165	91	28	4	7	5	7	5	12	9	4											
TAXES																										
SUBSCRIBERS (000)	710	0	0	0	0	0	55	66	79	95	79	85	114	137	164											
REVENUE AT \$218 PER MONTH	1861	0	0	0	0	0	144	173	207	249	207	249	299	359	430											
SALVAGE	92	0	0	0	0	0	0	0	0	0	0	0	0	0	92											
TOTAL REVENUE	1953	0	0	0	0	0	144	173	207	249	207	249	299	359	522											
EXPENSES																										
OPERATIONS	21	0	0	0	0	0	3	3	3	3	3	3	3	4	4											
DEPRECIATION	708	0	0	0	0	0	63	112	112	105	112	105	105	105	105											
TOTAL EXPENSES	729	0	0	0	0	0	66	115	115	108	115	108	108	109	109											
TAXABLE PROFIT	1225	0	0	0	0	0	79	58	92	141	92	141	190	250	413											
TAXES AT 46%	-563	0	0	0	0	0	-36	-27	-42	-65	-42	-65	-88	-115	-190											
CASH FLOW																										
REVENUE	1861	0	0	0	0	0	144	173	207	249	207	249	299	359	430											
TOTAL FINANCING	-821	-108	-209	-179	-165	-91	-28	-4	-7	-5	-7	-5	-12	-9	-4											
TAXES	-563	0	0	0	0	0	-36	-27	-42	-65	-42	-65	-88	-115	-190											
INVESTMENT TAX CREDIT	80	11	21	18	17	9	3	0	0	0	0	0	1	1	0											
NET CASH FLOW	649	-97	-188	-161	-149	-82	83	142	158	179	142	158	200	236	328											
PRESENT VALUE AT 10%	0	-88	-154	-120	-100	-50	45	70	71	73	70	71	74	78	99											

with a more realistic (i.e., a non-uniform) geographic distribution, would result in a satellite considerably heavier than the project STS capability. It is concluded, at this point, that a single-satellite system with cellular-compatible mobile units is too limited in capacity to be considered further.

In addition, the MSC for the system described is quite high. For example, at a 10 percent IRR, it exceeds \$200.* User costs also include terrestrial toll charges for circuit completion to the land user and the equivalent rental charge for the mobile unit.

The high MSC results, in part, from the relatively small subscriber population. In addition to the operational satellite, an on-orbit spare must be provided and, in all likelihood, a ground spare as well. Thus, 3 satellites must be built, and 2 launched, to support a single operational satellite. While a population twice as large would require 2 operational satellites at EOL, only 4 satellites would be needed in all.

The constraint of cellular compatibility also contributes significantly to the MSC. Were it permissible to use a narrower carrier spacing than 30 kHz, a smaller frequency re-use factor would suffice. The satellite antenna, in turn, would be reduced in size, resulting in less satellite weight and a lower MSC.

*As in the weight estimate, significant changes were made in the MSC calculation following this initial system sizing exercise. Consequently, detailed MSC data are omitted at this point.

2.3 ALTERNATE SYSTEM CONFIGURATIONS

In an effort to configure a system that would accommodate a larger number of subscribers at a lower per-subscriber charge, several major modifications were made in various combinations. The cases considered are listed in Table 2-7. The three dimensions of the problem indicated in the table are discussed in Sections 2.3.1 to 2.3.3.

The reason for considering a 4-MHz exclusive allocation is that reserve bands of this size exist below the transmit and receive bands allocated to cellular-system use. Thus, it would be possible to dedicate a pair of 4-MHz bands to a land-mobile satellite system without the need to shift the cellular-system allocations. Of course, the problems already encountered with a pair of 10-MHz exclusive allocations would be exacerbated if only 4 MHz were available.

2.3.1 Non-Cellular-Compatible Modulation

The modulation format selected is narrowband FM, as in cellular systems, but with a peak deviation of 5 kHz rather than 12 kHz. This permits a carrier spacing of 12 kHz instead of the cellular-system spacing of 30 kHz. A factor-of-2.5 increase in capacity from each re-use of the allocated frequency band is thereby achieved. Since the FM threshold is essentially the same for both systems, the increase in capacity is gained at no increase in satellite transmit power.

The 5-kHz peak-deviation modulation format is characteristic of current (i.e., non-cellular) terrestrial mobile systems. The rather large carrier spacing of 25 kHz used in these systems (relative to the 5-kHz peak deviation) is chosen to avoid adjacent-channel interference, since there is no geographic restriction on the assignment of carrier frequencies, as exists in cellular systems. The same degree of adjacent-channel protection is not required in a satellite system, because there is little variation in the received strength of different carriers, either at a given user location or at the satellite.

Table 2-7. System 1 Alternate Configurations

CASE	CELLULAR-COMPATIBLE MODULATION	FREQUENCY REUSE BY SATELLITE	FREQUENCY ALLOCATION (MHz)
1.	YES	NO	10 EXCLUSIVE
2.	YES	NO	4 EXCLUSIVE
3.	YES	YES	10 EXCLUSIVE
4.	YES	YES	4 EXCLUSIVE
5.	NO	NO	10 EXCLUSIVE
6.	NO	NO	4 EXCLUSIVE
7.	NO	YES	10 EXCLUSIVE
8.	NO	YES	4 EXCLUSIVE
9.	NO	NO	20 SHARED
10.	NO	YES	20 SHARED

2.3.2 Multiple-Satellite Systems

In the systems envisioned, 2 or more satellites provide the EOL system capacity. Each satellite, however, affords complete CONUS coverage. By this means, the satellite antenna size required for a given system capacity is minimized.

For example, in a 2-satellite system, each satellite generates half as many beams as would be required of a single satellite. The beams cover twice the area of (have a beamwidth $\sqrt{2}$ times as large as) those in a single-satellite system. As a result, the satellite antenna diameter is reduced by a factor of $\sqrt{2}$.

The choice of satellite, as well as the frequency assignment, on a particular call is made by a master control station. The user will generally be subjected to co-channel interference from one or more signals from the other satellite(s). The number and strength of these interfering signals depend on the beam patterns (and, consequently, the locations) of the different satellites.

To ensure that intersatellite co-channel interference is held to a manageable value, the mobile unit must include an antenna capable of discriminating between signals from the various satellites. This is possible with an antenna of modest proportions only if the satellites are adequately separated in longitude. The capability to reject co-channel signals from unwanted satellites is generally accompanied by an increase in gain toward the desired satellite, relative to the near-omnidirectional pattern of an antenna suitable for use in a single-satellite system.

The reduction in satellite antenna gain that accompanies the use of multiple satellites is exactly offset by the decrease in the number of carriers transmitted by each satellite. The result is that the total RF power required of each satellite is less than that for a single-satellite system by the increase in user antenna gain.

2.3.3 Shared-Allocation Systems

Because of the uncertainty in obtaining an exclusive allocation for land-mobile satellite use, the possibility of sharing the cellular allocation was explored. The feasibility of this approach depends on

interleaving the MSAT carriers with those of the cellular system and making them narrow enough to avoid excessive mutual interference. Thus, the MSAT carriers would also be spaced by 30 kHz, regardless of their noise bandwidth. The capacity available from each re-use of the 20-MHz frequency allocation is the same as that for the cellular system - namely, 666 carriers. The number of carriers in each beam is equal to 666 divided by the number of frequency sets employed.

There are 4 different interference mechanisms in a shared-allocation system. If the mobile transmit and receive bands are the same for both systems, the interference modes are:

- 1) Satellite mobile into terrestrial base station.
- 2) Terrestrial base station into satellite mobile.
- 3) Satellite into terrestrial mobile.
- 4) Terrestrial mobile into satellite.

To avoid overwhelming mutual interference between satellite mobile and terrestrial base station, it is assumed that the satellite mode of operation is not attempted while the mobile is within the normal operating range of the base station. Accordingly, the first 2 interference modes apply only to mobiles within a relatively narrow band, starting at a distance from the base station where satisfactory cellular operation is no longer possible and extending to that distance where the interference becomes negligible.

By contrast, the last 2 modes apply uniformly to all terrestrial mobiles. There are only minor differences, depending on propagation factors, between interfering signals received by, or from, different terrestrial mobiles.

There is one important distinction, however, between the last 2 interference modes. While there can be only 1 significant co-channel interferer transmitted by the satellite, a number of terrestrial mobiles can interfere with the transmission received from a satellite mobile. This number is a function of the size of the satellite beams and the density of the terrestrial subscriber population. Because of the small-scale cellular

structure of the terrestrial system, as compared with the much larger beam structure of the satellite system, a single SMSA can contribute several co-channel interferers to a satellite beam. Moreover, a beam in northeast CONUS may contain several SMSAs.

An analysis of all 4 interference modes is given in Appendix B. The results are summarized in Table 2-8 in terms of the worst-case C/I, where C is the power in the desired carrier and I is the power in the interfering signal(s).

These results will be evaluated, first, for the case where the satellite system uses 5-kHz peak-deviation FM carriers. The maximum tolerable C/I depends on which system is being interfered with. If it is the terrestrial system, the interference is "slightly perceptible" at C/I = 3 dB. In the opposite direction, the interference is "slightly perceptible" at C/I = 0 dB.* In establishing these values, it is assumed that no other source of noise or interference is present.

For interference into a terrestrial base station, the C/I deficiency is 6.7 dB; for interference into a satellite mobile, it is 6 dB. These deficiencies can be erased by an increase in the mobile/base station separation of 47 percent in the first case and 41 percent in the second case. (These values are based on a propagation loss proportional to the fourth power of distance). The cell radius in a cellular system is typically 8 miles (prior to cell subdivision). Therefore, only those satellite mobiles in a band from 8 to 12 miles distant from a base station will tend to suffer interference from, or inject interference into, the terrestrial system.

The C/I deficiency for the case of satellite interference with a terrestrial mobile is 3.5 dB. This is a worst-case value, which can improve if the mobile is not near the peak of the satellite beam or if the level of the interfering signal is reduced by multipath. Nevertheless, a sufficient number of terrestrial mobiles will be adversely affected as to render the situation unsatisfactory.

* Both of these figures are based on subjective tests made by Motorola's Corporate Research Group at Schaumburg, Illinois.

Table 2-8. Intersystem Interference for Shared Frequency Allocation

<u>INTERFERENCE MODE</u>	<u>C/I FOR SLIGHTLY PERCEPTIBLE NOISE</u>	<u>WORST-CASE C/I</u>	<u>MARGIN</u>
SAT. MOBILE INTO BASE STATION	3 dB	-3.7 dB	-6.7 dB
BASE STATION INTO SAT. MOBILE	0	-6.0	-6.0
SATELLITE INTO TERRESTRIAL MOBILE	3	-0.5	-3.5
TERRESTRIAL MOBILE INTO SATELLITE	0	-6.0	-6.0

The final interference mode, from terrestrial mobile into the satellite, is the most difficult one to quantify because of uncertainty regarding the number of interferers. It is also potentially the most damaging. It is assumed, for purposes of this analysis, that cellular systems within CONUS will eventually capture 0.5 percent of the total population.* Additionally, it is assumed that, in the northeast corridor of CONUS, as much as 10 percent of the subscriber population (about 125,000 users) could lie within a single satellite beam. Based on these figures, it is estimated that there will typically be at least 5 terrestrial mobiles interfering with the signal received from a satellite mobile. The corresponding C/I deficiency for this interference mode is 6 dB.

It is concluded from this analysis that a shared allocation with cellular systems is not feasible, if the satellite system uses 5-kHz peak-deviation FM as a modulation format.

Digital modulation formats offer more promise, however. In a paper by Carney and Linder (Reference 2-5), test results are reported for a mobile radio that transmits digitized voice signals in a 2.4-kb/s linear predictive coding (LPC) format. With frequency-shift-keyed (FSK) modulation, the required channel spacing is only 5-6 kHz.

To obtain an estimate of the tolerable interference from a neighboring cellular-system carrier, note that the (unmodulated) interferer is separated from the satellite carrier by 15 kHz. At the maximum deviation of 12 kHz, corresponding to speech peaks, the terrestrial carrier will be only 3 kHz removed from the satellite carrier. It is reasonable to assess the interfering effect of the terrestrial carrier on the basis of this extreme frequency position.**

It is shown in Figure 2-10 of Reference 2-5 that the protection ratio for an LPC carrier with respect to an interfering carrier offset by 3 kHz is approximately 25 dB. In other words, the interfering carrier must be 25 dB stronger than the desired carrier to have an objectionable effect.

* Suggested by Mr. Jim Caile of Motorola. Higher estimates from other competitors in the field have been quoted in the press.

** Private communication from Dr. J.J. Mikulski of Motorola.

This should be compared with the 0-dB C/I criterion when the desired signal is a 5-kHz peak-deviation FM carrier.

While data relating to interference from an LPC carrier into a cellular-system carrier are not available, the narrow bandwidth of the former suggests that the effect should be substantially less than that from a 5-kHz peak-deviation FM carrier. It may be anticipated, therefore, that cellular and satellite systems can operate compatibly in a shared-frequency band, provided the satellite system uses a narrowband (i.e., 5-6 kHz) digitally modulated carrier.

2.3.4 System Comparison

A summary of the satellite weight and power requirements of the various alternatives to a single-satellite/cellular-compatible/10-MHz system is given in Table 2-9. The cases are numbered to correspond to those in Table 2-7. In all cases, a population of 180,000 uniformly distributed subscribers was assumed. Consideration of larger populations and/or a non-uniform geographic distribution is deferred to Section 2.4. The object at this point was to narrow the range of alternatives to a small number capable of substantial population growth. The weights shown do not include a contingency factor.

In all cases but the second, it is possible to design a satellite that can be placed in geosynchronous orbit by an STS in combination with an upper stage such as the TRW integral propulsion system. In round numbers, this implies a satellite no longer than 40 feet and weighing not more than 10,000 pounds. In Case 2, a single satellite providing sufficient EOL capacity to accommodate 180,000 users would require an 85-meter antenna. For this particular case, an alternate satellite configuration was selected that just meets the assumed STS capability; the user population that can be supported is only 68,000.

Two system variations were examined for Case 3, one in which 3 satellites provide the EOL capacity and a second in which only 2 satellites are used. For a 33-degree satellite spacing (see Section 2.3.5), a minimum satellite elevation angle of 21 degrees can be realized with a 2-satellite system, as compared with 10 degrees for a 3-satellite system. In addition,

Table 2-9. Weight/Power Summary for System 1 Options

CASE	2*	3A	3B	4	5	6	7	8	9	10
S/C ANTENNA DIAMETER (METERS)	52	30	37	49	31	51	22	36	35	24
RF POWER (WATTS)	680	750	750	525	1550	700	775	350	1210	660
DC POWER (WATTS)**	3175	3180	3250	2630	5860	3230	3180	1910	4760	2820
S/C WEIGHT (LBS)***	8700	6110	6985	6985	7560	8750	5215	6250	7550	5340
NO. OF S/C	1	3	2	3	1	1	2	2	1	2

*PROVIDES ONLY 40% OF REQUIRED CAPACITY

**30% DC → RF CONVERSION EFFICIENCY

***OFFSET-FED ANTENNA, SINGLE FEED PER BEAM

the satellite weight in a 2-satellite system is well below the 10,000-pound upper limit. Therefore, only a 2-satellite configuration was investigated for Cases 7, 8, and 10. In Case 4, 3 satellites are required because of the 4-MHz allocation.

In Cases 9 and 10, 5-kHz peak-deviation FM was assumed for the satellite system, despite the (subsequent) finding that this modulation format is not compatible with the cellular-system modulation in a shared-frequency allocation. The principal effect of substituting a narrower, digitally modulated carrier in the satellite system would be a reduction in the required RF power.

With the exception of Cases 2 and 6, the satellites are well below 10,000 pounds. (For the baseline designs, however, a cluster-feed approach to beam formation is adopted, which leads to a larger and heavier feed assembly.) Clearly, the configurations offering the greatest growth potential are those of Cases 7 and 10. This is not surprising, since both employ multiple satellites and the narrower FM format.

The MSC for the various configurations is shown in Table 2-10 for IRRs varying from 10 to 25 percent. As expected, the IRR is lowest for Cases 7 and 10. Note that an STS cost (without upper stage) of \$40 million was assumed; this was raised to \$60 million, by NASA direction, in later analyses. Both an on-orbit spare and a ground spare were included in all systems. It was assumed that a satellite failure in fact occurred, necessitating launch of the ground spare (at a time when the on-orbit spare was operational, so that no revenue was lost). For simplicity, the satellites were assumed to be launched in consecutive years. In all subsequent analyses, the satellite launch schedule was based on subscriber population growth. The effect of different strategies regarding use of a ground spare, as well as different eventualities regarding satellite failures, is examined in Section 2.4.5.

Based on considerations of satellite weight and MSC, Cases 7 and 10 were selected for further investigation. The salient features of these two systems are restated in Table 2-11. The question of the optimum number of satellites remains open at this point, to be answered in light of alternate traffic scenarios (see Section 2.4.2).

Table 2-10. MSC for System 1 Options

RATE OF RETURN	CASE									
	2	3A	3B	4	5	6	7	8	9	10
10%	748	260	266	324	241	282	210	256	245	215
15%	1118	377	392	471	359	421	309	376	366	316
20%	1613	530	557	663	517	607	439	534	527	450
25%	2272	728	774	914	727	855	609	741	740	625

NOTES:

1. BASELINE SUBSCRIBER SCENARIO
2. \$40M STS COST
3. SATELLITES, INCLUDING GROUND SPARE, LAUNCHED IN CONSECUTIVE YEARS

ORIGINAL PAGE 19
OF POOR QUALITY

Table 2-11. Selected System 1 Configurations

● **CASE 7**

- 10 MHz EXCLUSIVE FREQUENCY ALLOCATION
- 5 kHz PEAK FREQUENCY DEVIATION
- 12 kHz CHANNEL SPACING
- TWO- OR THREE-SATELLITE SYSTEM

● **CASE 10**

- 20 MHz SHARED FREQUENCY ALLOCATION
- 5 kHz PEAK FREQUENCY DEVIATION
- 30 kHz CHANNEL SPACING
- TWO- OR THREE-SATELLITE SYSTEM

While the exclusive- vs. shared-allocation aspect of Cases 7 and 10 makes these systems appear very different, operationally they are quite similar. The only difference is the set of frequencies from which a carrier pair is drawn in response to a call request.

More significantly, the satellite weights for Cases 7 and 10 differ only slightly, with Case 10 being the heavier. The explanation lies in the channel capacity afforded by each re-use of the allocated frequency band. While the allocation for Case 10 is twice as large, the carrier spacing is larger by a factor of 2.5. Therefore, the per-beam capacity of Case 10 is only 0.8 times that of Case 7. To generate an equivalent system capacity, the satellite antenna diameter for Case 10 must be 1.12 times that for Case 7. This gives rise to a satellite weight that is at most 10 percent greater than that for Case 7.

In addition, the MSC for Case 10 has been found to be at most 6 percent larger than the MSC for Case 7. Because of these small differences, baseline system development will be described in terms of the Case 7 requirements.

2.3.5 Baseline System Development

Certain characteristics of the baseline systems can be specified at this point, irrespective of the population size and distribution on which the designs are based. These include satellite spacing and user antenna requirements.

It has been taken as a system requirement that the minimum satellite elevation angle from any point in CONUS shall be no smaller than 10 degrees. This restricts the satellite longitude to the range from 64 to 130 degrees. For a 3-satellite system, maximum spacing is achieved with the satellites at 64, 97, and 130 degrees. For a 2-satellite system, the minimum satellite elevation angle is maximized at 21 degrees by positioning the satellites at 80 and 113 degrees. (There are reasons for doing otherwise, however, as will be seen in Section 2.4.6.) It will be assumed that, regardless of the satellite positions chosen in a 2-satellite system, the longitudinal spacing will be no smaller than 33 degrees. This additional constraint is needed to avoid placing excessively stringent requirements on the user antenna.

The latter requirements are derived by considering the user/satellite geometry for 5 extreme locations in CONUS. The pertinent relationships are shown in Tables 2-12 and 2-13 for 2- and 3-satellite systems. The line-of-sight angular separation for a pair of adjacent satellites in a 3-satellite system varies from 35 to 38 degrees. This is also the separation range for a 2-satellite system, provided the satellite longitudes differ by exactly 33 degrees. For the extreme satellites in a 3-satellite system, the angular separation is at least 71 degrees.

The user antenna must provide adequate rejection of co-channel signals from unwanted satellites over the indicated line-of-sight ranges. In the link noise allocation, the carrier-to-intersatellite co-channel interference, $(C/I)_{CS}$, has been assigned a value of 17 dB. Since 2 different propagation paths are involved in computing this ratio, a value for $(C/I)_{CS}$ of at least 20 dB is desirable when propagation factors are ignored.

An antenna which has the potential for satisfying this requirement is depicted in Figure 2-10. It is essentially a linear array of 4 microstrip patches, which can be rotated through 360 degrees. The patches are fed in phase. Consequently, when the line-of-sight to the wanted satellite is normal to the line through the patch centers, the gain toward the satellite of the 4-patch combination is 6 dB higher than that of a single patch.

A means must be provided to initially rotate the antenna to the desired orientation. This can be done in several ways. Information for this control function would be transmitted to the mobile unit as part of the call-setup procedure.

The desired orientation is maintained, in the face of a change in user direction, through a monopulse tracking system. The patches are divided into pairs for this purpose, with the combined output from each pair fed into a 180-degree hybrid. The output of the hybrid, which is the difference between the two inputs, provides the activating signal for the tracking system.

The normal to the plane of the antenna is tilted away from vertical so that, when the antenna is rotated to the proper azimuth, the maximum elevation-angle difference between the satellite and the antenna boresight

ORIGINAL PAGE IS
OF POOR QUALITY.

Table 2-12. User/Satellite Geometry for 3-Satellite System (Deg)

USER LOCATION			LINE-OF-SIGHT COORDINATES									LINE-OF-SIGHT ANGULAR DIFFERENCE		
STATE	LAT.	LONG.	SATellite LONGITUDE						SATellite LONGITUDES					
			64°		97°		130°		64°, 97°	97°, 130°	64°, 130°			
			AZ	EL	AZ	EL	AZ	EL	AZ	EL				
MAINE	47°	68°	175	36	217	39	249	10	37	36	72			
FLORIDA	26°	81°	145	54	213	55	249	28	37	37	74			
TEXAS	26°	98°	123	42	178	60	235	43	38	38	76			
CALIFORNIA	33°	117°	112	22	146	46	203	49	37	37	74			
WASHINGTON	48°	124°	113	11	146	29	188	35	35	36	71			

ORIGINAL PAGE IS
OF POOR QUALITY

Table 2-13. User/Satellite Geometry for 2-Satellite System (Deg)

USER LOCATION			LINE-OF-SIGHT COORDINATES				LINE-OF-SIGHT ANGULAR DIFFERENCE
STATE	LAT.	LONG.	SATELLITE LONGITUDE				
			80°		113°		
			AZ	EL	AZ	EL	
MAINE	47°	68°	196	35	234	21	36
FLORIDA	26°	81°	178	60	235	43	38
TEXAS	26°	98°	143	54	211	55	38
CALIFORNIA	33°	117°	126	35	173	51	37
WASHINGTON	48°	124°	128	21	165	34	35

ORIGINAL PAGE 13
OF POOR QUALITY

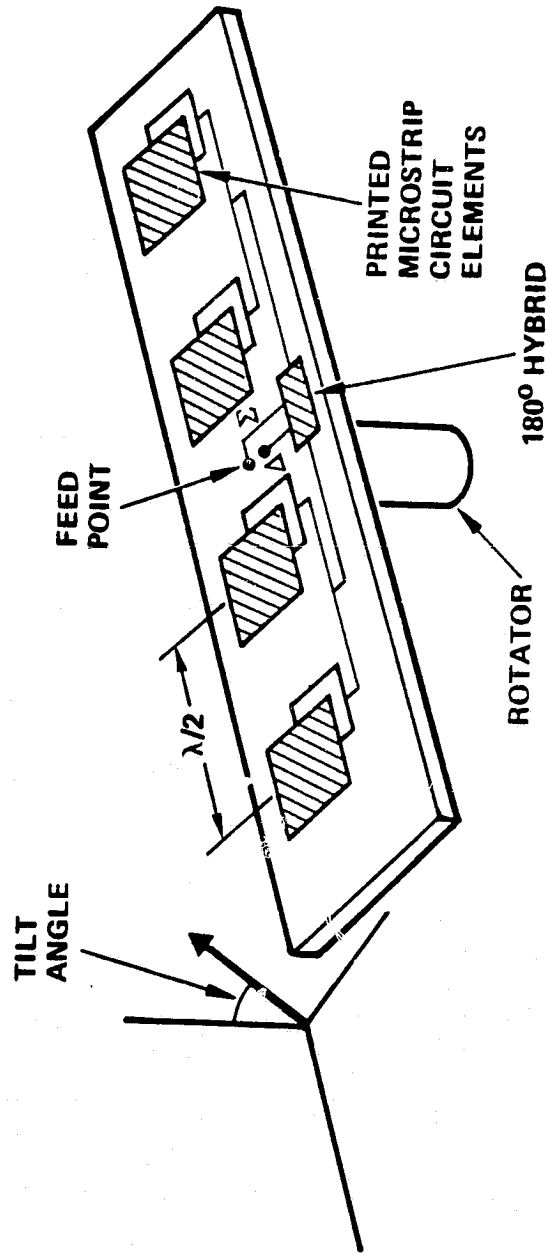

Figure 2-10. User Antenna Concept

will tend to be minimized. To hold the loss-of-gain from boresight to 1 dB, the elevation-angle difference should be less than 25 degrees. Thus, a pair of (semi-permanent) user-selectable, tilt-angle settings of (say) 45 and 60 degrees would be appropriate. A choice between these values, which correspond to boresight elevation angles of 45 and 30 degrees, respectively, would be made on the basis of user location.

The ability of the described antenna to reject signals from unwanted satellites is analyzed in Appendix C. The results will be summarized here. First, in a 3-satellite system, only the interference between adjacent satellites is significant. The worst-case interference arises for the Florida location cited in Table 2-12. For a boresight elevation angle of 45 degrees and the wanted satellite at 130° longitude, there is only 10-dB rejection with respect to the satellite at 97 degrees. For the Texas location indicated in Table 2-12 and the wanted satellite at either 64 or 130 degrees, the rejection is 15 dB with respect to the satellite at 97 degrees. These are extreme cases, however. For most locations within CONUS, the goal of 20-dB rejection is realized.

Discrimination between satellites in a 2-satellite system is generally better than in a 3-satellite system, because the difference in longitude between user location and wanted satellite does not become so extreme.

Rejection of intersatellite co-channel interference can be considerably enhanced by using the opposite polarization sense in adjacent satellites. This would require, as part of the call-setup procedure, a command to the user to switch to the polarization sense that corresponds to the assigned satellite. For the antenna design in Figure 2-10, the polarization sense is fixed, through use of 2 feed lines to each patch differing in length by 1/4 wavelength. To make the polarization sense switchable, a 90-degree hybrid would be inserted at the feed junction for each patch and the pair of feed lines emanating therefrom equalized in length. A pair of signals would be fed to all 4 90-degree hybrids, with the relative phasing of the signals determining the polarization sense.

The additional discrimination that results from employing both senses of circular polarization on the satellite links depends on the ellipticity

of the satellite and user antennas. In all circumstances, however, the additional discrimination is at least 10 dB. Therefore, the 20-dB goal for $(C/I)_{CS}$ will be realized, even for the most disadvantageous user location.

Use of the 4-patch mobile-unit antenna, in place of the single crossed dipole associated with a single-satellite system, reduces the satellite RF power requirement. The difference in minimum gain between the two antennas is about 5 dB (9 dB vs. 4 dB). However, the allocation for one or more link-noise components must be reduced to allow for intersatellite co-channel interference. The most likely candidate, in the forward direction, is the downlink thermal noise, because of its large value in the single-satellite system design. (As shown in Table 2-1, $(C/N)_{td} = 12.5$ dB, while the next smallest ratio is 17 dB.) To allow for a value of $(C/I)_{CS}$ equal to 17 dB, $(C/N)_{td}$ must be increased to 14.4 dB. Thus, the reduction in required satellite power is only about 3 dB.

2.3.6 Monthly Service Charge

In developing the MSC for a multiple-satellite system, the following ground rules were observed:

- 1) No more than 1 satellite launched in any year.
- 2) On-orbit spare launched during initial year of operations.
- 3) Additional satellites launched during year in which capacity of on-orbit satellites (excepting the spare) is first exceeded.
- 4) Ground spare launched in first open year.
- 5) No loss of revenue due to satellite failure.

The satellite and gateway deployment schedule for a 2-satellite system is shown in Figure 2-11. The resulting MSC is given by the solid curve in Figure 2-12.

The gateway costs used to derive the MSC are those described in Section 2.2.8. No attempt was made to account for the added RF equipment needed to communicate with more than one satellite. As can be seen from Figure 2-12, even adding 50 percent to the gateway costs has little effect on the MSC, as most of the cost is in the space segment. Thus, a 50 percent increase in the satellite cost increases the MSC by nearly 50 percent. In performing this variation, the STS cost was held fixed at \$60 million.

ORIGINAL PAGE IS
OF POOR QUALITY

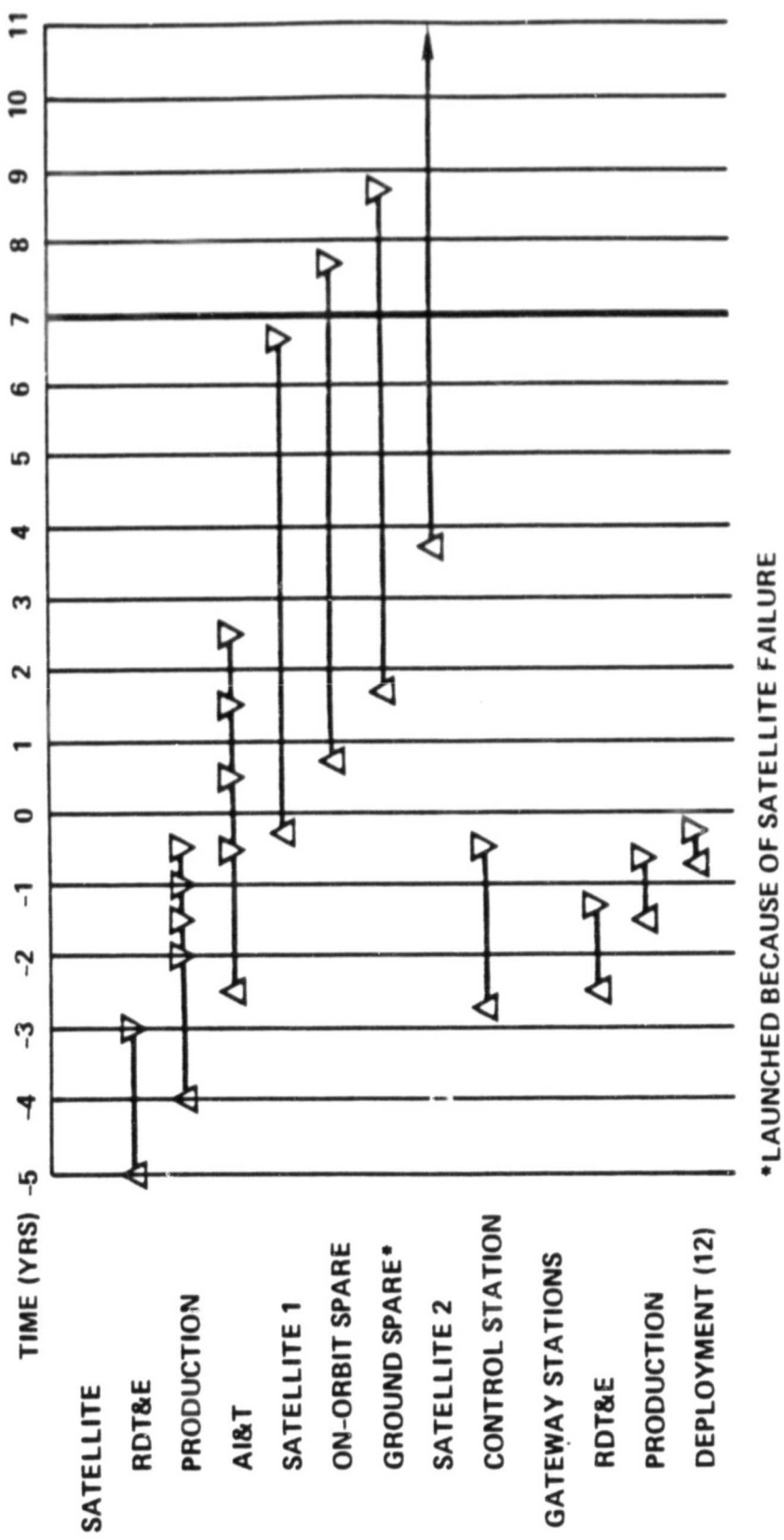

Figure 2-11. Satellite and Gateway Deployment Schedule for 2-Satellite System

ORIGINAL PAGE 13
OF POOR QUALITY

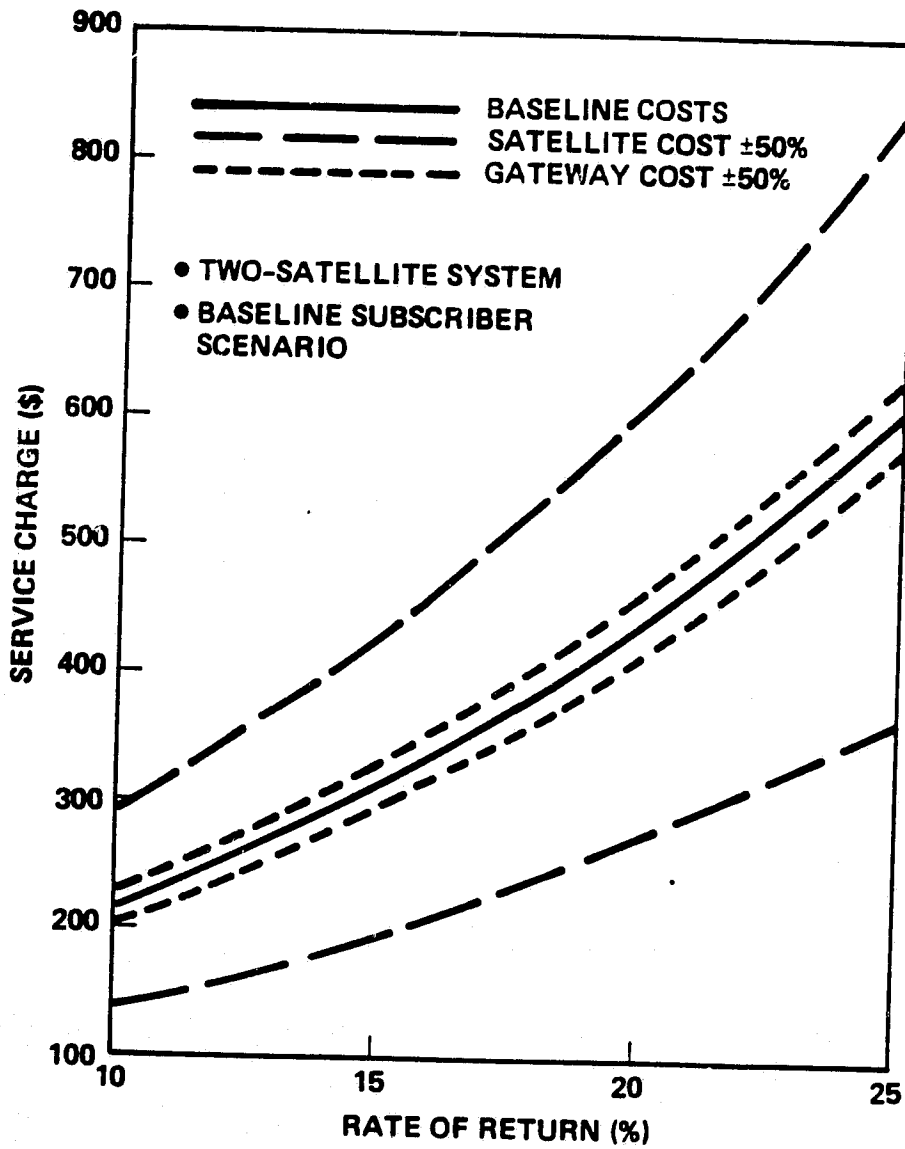

Figure 2-12. Case 7 -- MSC Cost Sensitivity

The baseline subscriber scenario referred to in Figure 2-12 has an EOL population of 180,000 users, as previously discussed. It is assumed to grow, during the 7-year period of operations, at a 20-percent annual rate. The population at the start of operations, therefore, numbers 50,000 users.

The term baseline, as applied to this scenario, is attributable to its being the initial scenario examined. This scenario should not be associated with the "baseline" system designs developed in Section 2.5, which are based on a different subscriber scenario. The latter is designated as Scenario B and is among 5 alternate subscriber scenarios supplied by NASA.

2.4 ALTERNATE TRAFFIC PATTERNS

In this section, the effect on both satellite design and MSC of departures from the baseline subscriber scenario are investigated. Two types of variations affect the satellite design: EOL population and geographic distribution. The MSC is additionally affected by the rate of subscriber buildup.

2.4.1 Non-uniform Geographic Distribution

A non-uniform or skewed geographic distribution of subscribers has a profound effect on the satellite design. The important quantity is the number of subscribers per beam, which is found by multiplying the population density per square-mile by the beam area in square miles. The first factor, normalized to the total subscriber population, is displayed on a state-by-state basis in Table 2-14. The same distribution is shown pictorially in Figure 2-13. This distribution is based on a population distribution which appears in Reference 2-6.

The latter distribution is derived by subtracting the SMSA population from the total state population, and adjusting the difference by a satellite system "use factor" that accounts for the statewide pattern of terrestrial-system availability. The use factor accounts for the decreasing probability that the population is served by a terrestrial system as the population density decreases.

The beam areas, which are displayed by state in Table 2-15, are derived from a typical beam pattern and associated beam areas.* The typical beam area in each state, which is normalized to the area of the smallest beam, corresponds to a satellite located at 110° west longitude. (More will be said later about the significance of the satellite location.)

If each entry in Table 2-14 is multiplied by the corresponding entry in Table 2-15 and the product divided by the average product over CONUS, the entries in the first column of Table 2-16 result. Also shown in Table 2-16 is the percentage of the total subscriber population on a state-by-state basis.

* Provided by Dr. F. Naderi of JPL.

ORIGINAL PAGE 10
OF POOR QUALITY

Table 2-14. Subscriber Density

STATE	DENSITY*	STATE	DENSITY*	STATE	DENSITY*
ARIZONA	86	MAINE	485	OHIO	667
ALABAMA	306	MARYLAND	85	OKLAHOMA	372
ARKANSAS	305	MASSACHUSETTS	0	OREGON	184
CALIFORNIA	276	MICHIGAN	601	PENNSYLVANIA	505
COLORADO	149	MINNESOTA	369	RHODE ISLAND	0
CONNECTICUT	0	MISSISSIPPI	581	SO. CAROLINA	650
DELEWARE	0	MISSOURI	443	SO. DAKOTA	179
FLORIDA	575	MONTANA	101	TENNESSEE	608
GEORGIA	592	NEBRASKA	242	TEXAS	333
IDAHO	176	NEVADA	35	UTAH	125
ILLINOIS	656	NEW HAMPSHIRE	645	VERMONT	614
INDIANA	645	NEW JERSEY	0	VIRGINIA	661
IOWA	608	NEW MEXICO	122	WASHINGTON	349
KANSAS	154	NEW YORK	633	WEST VIRGINIA	645
KENTUCKY	644	NO. CAROLINA	667	WISCONSIN	598
LOUISIANA	598	NO. DAKOTA	178	WYOMING	71

* X 10⁻⁹ SUBSCRIBERS/SQ. MI
TOTAL SUBSCRIBERS

ORIGINAL PAGE 19
OF POOR QUALITY

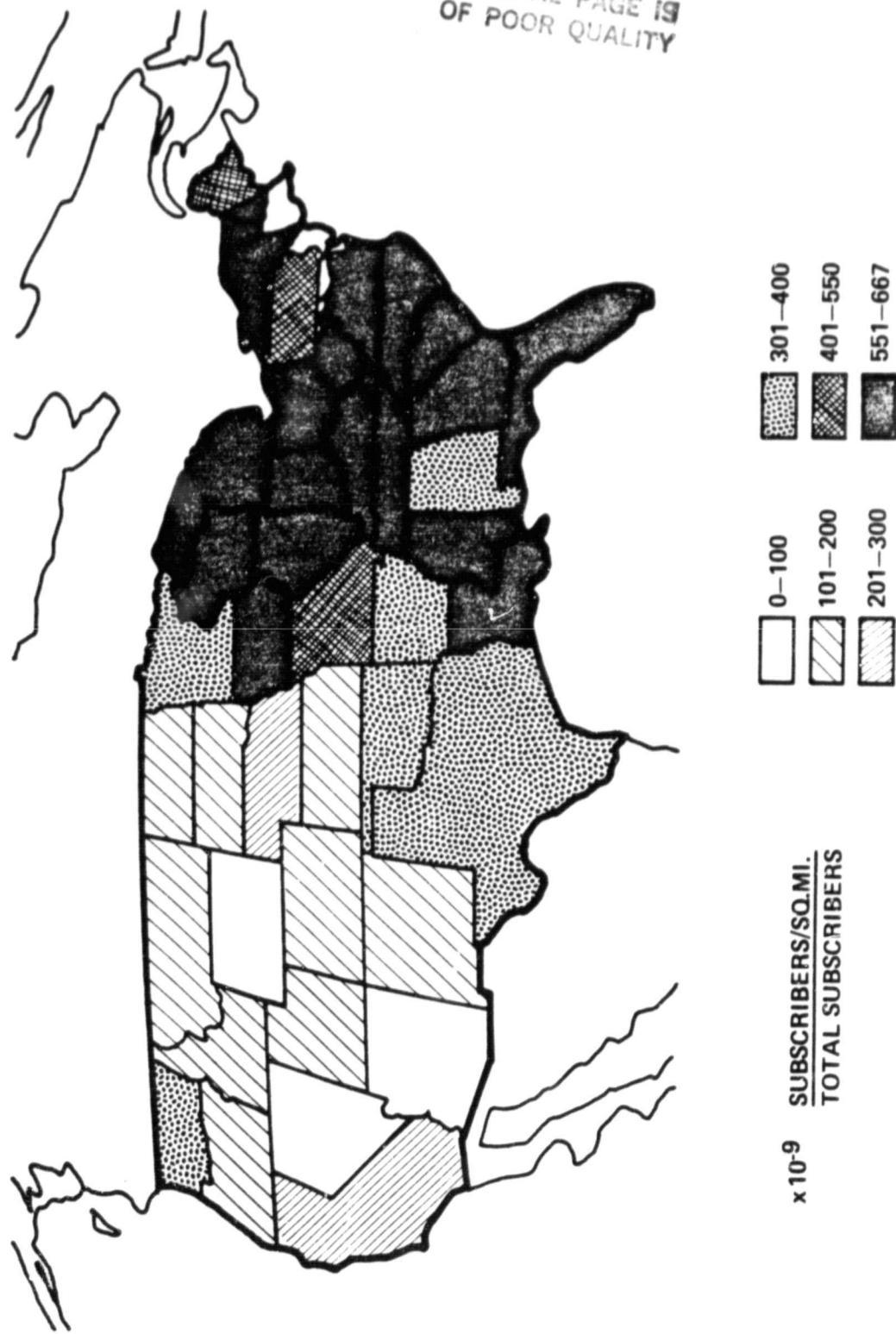

Figure 2-13. Geographic Subscriber Distribution

Table 2-15. Relative Beam Areas for
Satellite at 1100 W. Longitude

STATE	BEAM AREA	STATE	BEAM AREA	STATE	BEAM AREA
ARIZONA	1.15	MAINE	2.58	OHIO	1.57
ALABAMA	1.26	MARYLAND	1.65	OKLAHOMA	1.17
ARKANSAS	1.24	MASSACHUSETTS	1.96	OREGON	1.50
CALIFORNIA	1.23	MICHIGAN	1.66	PENNSYLVANIA	1.73
COLORADO	1.24	MINNESOTA	1.67	RHODE ISLAND	1.96
CONNECTICUT	1.96	MISSISSIPPI	1.22	SO. CAROLINA	1.44
DELAWARE	1.65	MISSOURI	1.29	SO. DAKOTA	1.40
FLORIDA	1.29	MONTANA	1.46	TENNESSEE	1.32
GEORGIA	1.34	NEBRASKA	1.31	TEXAS	1.08
IDAHO	1.41	NEVADA	1.28	UTAH	1.30
ILLINOIS	1.36	NEW HAMPSHIRE	2.20	VERMONT	2.12
INDIANA	1.45	NEW JERSEY	1.65	VIRGINIA	1.65
IOWA	1.36	NEW MEXICO	1.12	WASHINGTON	1.55
KANSAS	1.24	NEW YORK	1.85	WEST VIRGINIA	1.49
KENTUCKY	1.38	NO. CAROLINA	1.50	WISCONSIN	1.54
LOUISIANA	1.14	NO. DAKOTA	1.58	WYOMING	1.38

ORIGINAL PAGE 13
OF POOR QUALITY

Table 2-16. Per-Beam Subscriber Density

STATE	PER-BEAM SUBSCRIBER DENSITY	PERCENTAGE OF TOTAL U.S. SUBSCRIBERS	STATE	PER-BEAM SUBSCRIBER DENSITY	PERCENTAGE OF TOTAL U.S. SUBSCRIBERS
NEW HAMPSHIRE	3.23	0.60	OKLAHOMA	0.99	2.60
VERMONT	2.97	0.59	ALABAMA	0.88	1.58
MAINE	2.85	1.61	ARKANSAS	0.86	1.62
NEW YORK	2.67	3.14	TEXAS	0.82	8.91
VIRGINIA	2.49	2.70	CALIFORNIA	0.77	4.38
OHIO	2.39	2.75	NEBRASKA	0.72	1.87
NO. CAROLINA	2.28	3.51	NO. DAKOTA	0.64	1.26
MICHIGAN	2.27	3.50	OREGON	0.63	1.78
WEST VIRGINIA	2.19	1.56	SO. DAKOTA	0.57	1.38
SO. CAROLINA	2.13	2.02	IDAHO	0.56	1.47
INDIANA	2.13	2.34	KANSAS	0.43	1.27
WISCONSIN	2.10	3.36	COLORADO	0.42	1.55
ILLINOIS	2.03	3.70	UTAH	0.37	1.06
KENTUCKY	2.02	2.60	MONTANA	0.34	1.48
PENNSYLVANIA	1.99	2.29	MARYLAND	0.32	0.09
IOWA	1.88	3.42	NEW MEXICO	0.31	1.48
TENNESSEE	1.83	2.57	ARIZONA	0.23	0.98
GEORGIA	1.81	3.49	WYOMING	0.22	0.70
FLORIDA	1.69	3.37	NEVADA	0.10	0.39
MISSISSIPPI	1.62	2.77	CONNECTICUT	0	0
LOUISIANA	1.55	2.90	DELAWARE	0	0
MINNESOTA	1.40	3.10	MASSACHUSETTS	0	0
MISSOURI	1.30	3.09	NEW JERSEY	0	0
WASHINGTON	1.23	2.38	RHODE ISLAND	0	0

ORIGINAL PAGE IS
OF POOR QUALITY

An entry of unity in the first column of Table 2-16 means that the population density is the same as it would be for a uniform subscriber distribution (on a per-beam basis). If it is desired to accommodate all subscribers with some minimum grade of service, it would appear necessary (from the first entry in Table 2-16) to provide a system capacity 3.2 times that required for a uniform subscriber distribution. Actually, the system capacities implied by subscriber densities for New Hampshire and Vermont, and probably for Maine as well, are unrealistically high because the beams covering those states will extend considerably beyond the boundary of CONUS. Consequently, the average subscriber density over those beams will be less than that for the land areas they include. However, the system capacity still has to be 2.7 times that for a uniform distribution, corresponding to the subscriber density in New York.

If the system capacity were sized to the New York subscriber density, a number of beams would be severely under-utilized. The total number of beams, and hence the system cost, can be reduced by undersizing the system with respect to the areas of greatest subscriber density. The system operator in these areas would then have to choose between two alternatives: 1) refuse service to new applicants once the capacity at the prescribed grade of service is fully utilized, or 2) continue to accept new subscribers, with a degradation in the grade of service provided. With the latter alternative, the grade of service varies from beam to beam; consequently, the quality of service on a system-wide basis is difficult to quantify. For this reason, the first alternative will be used to estimate the desired system capacity.

The consequences of selecting a maximum subscriber density at which to provide service is shown in Figure 2-14. If this level is set at 2.5 times the CONUS average, for example, only New York is affected, and the subscribers excluded amount to less than 1 percent of the nationwide total. A reduction in the "system capacity factor" to 1.8 increases the fraction of the population excluded to 7.5 percent.

While this might be an acceptable percentage if the excluded users were distributed over all CONUS, they will, in fact, be concentrated in relatively few states. In New York, for example, $(2.67-1.8)/2.67 = 0.33$

ORIGINAL PAGE IS
OF POOR QUALITY

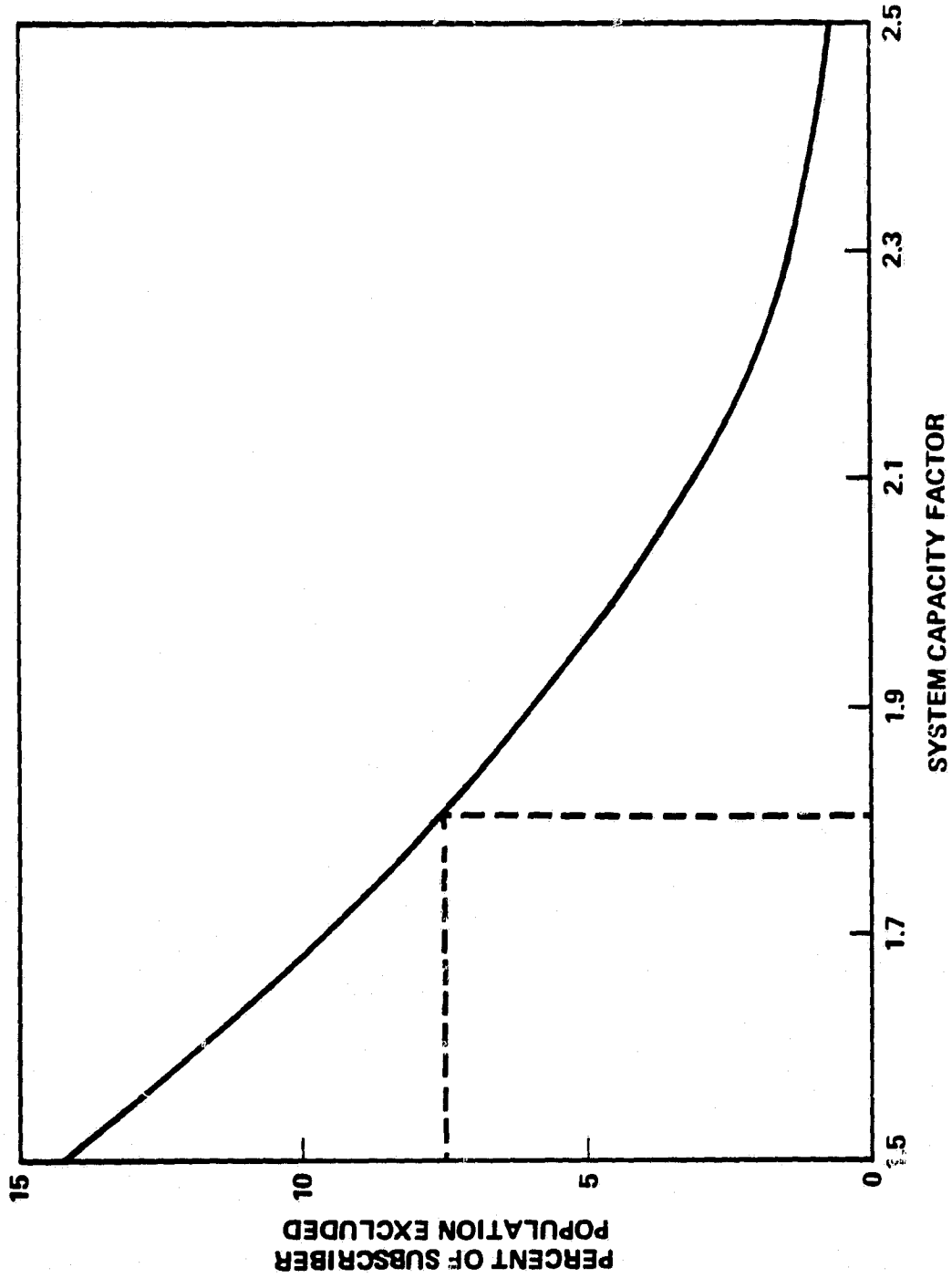

Figure 2-14. Subscriber Exclusion Vs. System Capacity

of the user population would be excluded. It is apparent that the system capacity factor must be based on a more localized examination of population density. This is done in Section 2.5.2, where satellite sizing is done for the baseline system designs.

To illustrate the effect of a skewed geographic distribution, a system capacity factor of 1.8 is assumed. The resulting MSC is shown in Figure 2-15 as a function of IRR.

2.4.2 Alternate Traffic Scenarios

Five alternate traffic scenarios were prescribed by NASA. All but one were for a 7-year period of operations, the exception being for 10 years. All but one were voice only; the other was a combination of voice and data. The EOL traffic volume in three of the all-voice cases is about twice that for the baseline traffic scenario; in the fourth all-voice case, it is 4 times as large.

The rate of traffic buildup in all cases is governed by a Gompertz curve. The general form of this curve is

$$y = CA^{B^t}$$

where y is the size of the population at time t , C is the asymptotic value of the population (i.e., the value at $t = \infty$), and A is the fraction of the asymptotic value at $t = 0$. The constant B is related to the time at which the curve reaches some percentage of the final value. For example, $B = (\log 0.9 / \log A)^{1/N}$, where N is the year in which the curve reaches 90 percent of the final value.

The 5 cases considered are listed below, with the traffic buildup for each shown in Figure 2-16. The time $t=0$ is assumed to correspond to the year 1995. For all scenarios except C, the users are assumed to be distributed geographically according to Table 2-14.

C-2

ORIGINAL PAGE 19
OF POOR QUALITY

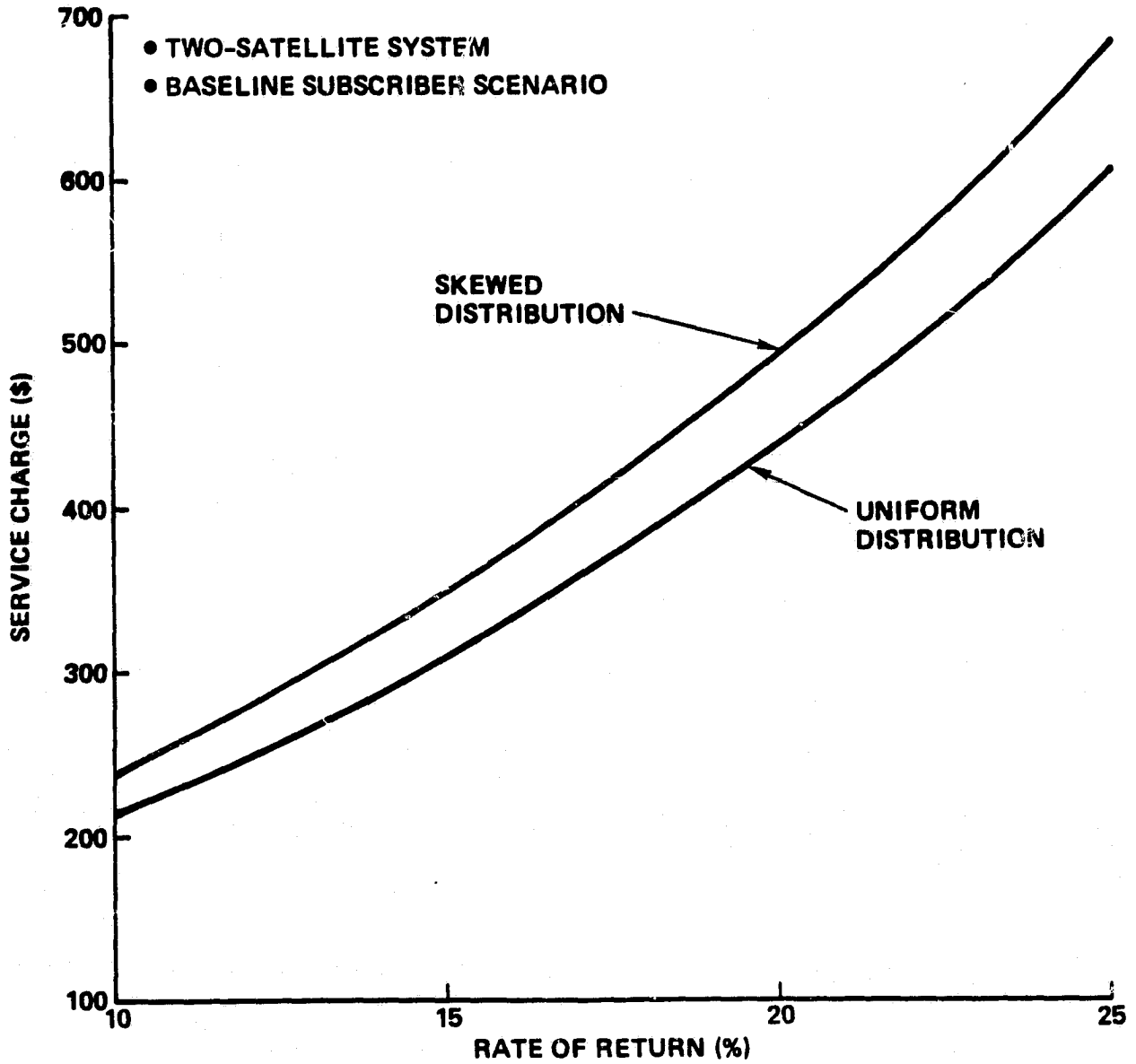

Figure 2-15. Case 7 -- MSC for Nonuniform Subscriber Distribution

ORIGINAL PAGE IS
OF POOR QUALITY

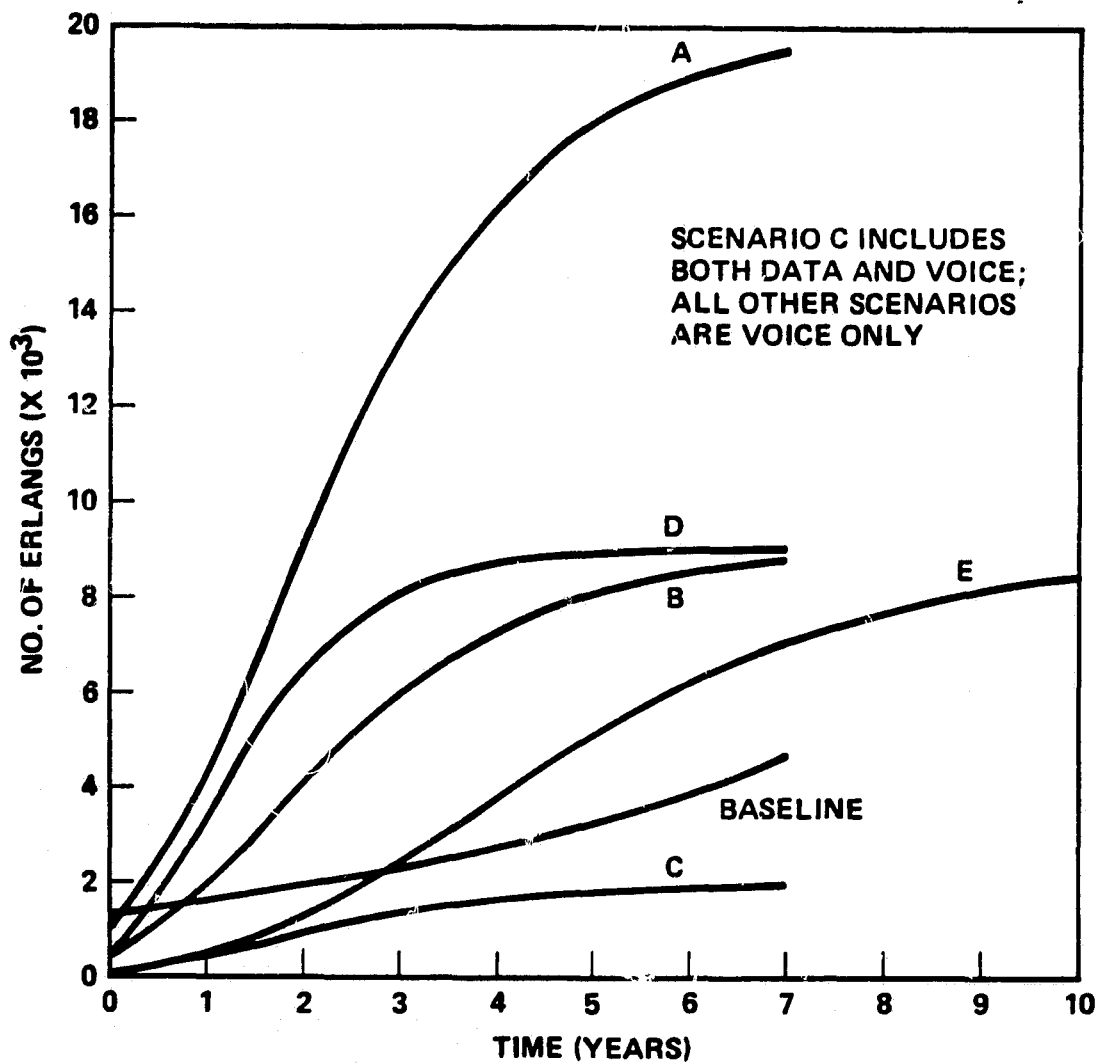

Figure 2-16. Traffic Scenarios

<u>Scenario</u>	<u>Traffic Parameter</u>		
	<u>C</u>	<u>A</u>	<u>B</u>
A	20,000	.05	.512
B	9,000	.05	.512
C	2,000	.05	.512
D	9,000	.05	.328
E	9,000	.01	.657

Since scenarios B, D, and E have approximately the same EOL population, they require the same satellite antenna size. Of these 3 scenarios, D results in the lowest subscriber charge and E the highest, because of differences in the rate of traffic buildup. Scenario E requires a heavier satellite than B or D because of the 10-year satellite life. Scenario A cannot be accommodated by a 2-satellite system and, even in a 3-satellite configuration, results in satellites that are probably too heavy for the STS.

Scenario C, unlike the other 4 alternate scenarios, is postulated to comprise equal voice and data components, measured in erlangs. The 1000 erlangs of data are prescribed to be at a rate of 56 kb/s. Consequently, the transmission bandwidth per erlang of data traffic is substantially greater than the corresponding quantity for voice. In addition, each erlang of data results in continuous transmission in both forward and return directions. With voice, on the other hand, use of VOX reduces the number of active carriers, and therefore the average power consumed, by 60 percent.

Because of its different bandwidth and power requirements, scenario C is analyzed separately in Appendix D. Two systems are developed, corresponding to 10-MHz and 4-MHz allocations. No a priori assumptions are made regarding the number of satellites or the type of user antenna needed. In contrast to the other scenarios, a uniform geographic distribution is assumed.

It is found that, with a 10-MHz allocation, a single satellite suffices if the user is provided with an antenna gain of a magnitude previously associated with a multiple-satellite system. With a 4-MHz

allocation, 2 satellites are probably required, as the weight of a single satellite designed to support the entire system traffic leaves no margin with respect to booster capability.

2.4.3 Satellite Requirements

The satellite antenna requirements associated with the different traffic scenarios are shown in Table 2-17 for 2- and 3-satellite systems. Requirements for both Case 7 and Case 10 are indicated. The traffic listed is at EOL and is therefore slightly less than the asymptotic value (20,000 erlangs for scenario A and 9000 erlangs otherwise). The relative capacity factor gives the maximum beam capacity relative to that for the baseline subscriber scenario. It accounts for both the increased EOL population and the non-uniform geographic distribution (with a capacity factor of 1.8).

The estimated satellite weight (without contingency) for the various cases depicted in Table 2-17 is shown in Table 2-18. It is seen that scenarios B and D can readily be accommodated in a 2-satellite configuration for both Case 7 and Case 10. For scenario E, addition of a 20 percent contingency factor to the 2-satellite, Case 10 weight places the satellite above the nominal, 10,000-pound design goal; consequently, a 3-satellite system might be necessary in this instance. Finally, it is seen that, even for Case 7 and a 3-satellite system, the satellites for scenario A are too heavy to be considered further.

2.4.4 Monthly Service Charge

Monthly service charges are developed for scenarios B, D, and E. Since virtually identical satellites are required for scenarios B and D, MSC differences result primarily from different rates of subscriber buildup. MSC differences arising from launch schedule variations are relatively minor.

Scheduled satellite deployment for the 3 subscriber scenarios is shown in Table 2-19. A ground spare, in addition to an on-orbit spare, is assumed to be required in all cases. Therefore, a total of 4 satellites is needed in a 2-satellite system; a total of 5 for a 3-satellite system.

No more than 1 satellite is launched in a single year. The spare for the first operational satellite is launched during the initial year of operations. Additional satellites are launched during the first year that

ORIGINAL PAGE IS
OF POOR QUALITY

Table 2-17. Satellite Antenna Requirements

SUBSCRIBER SCENARIO	TRAFFIC (ERLANGS)	BEAM EQUIVALENTS		NO. OF BEAMS		ANTENNA DIAM (M)		
		RELATIVE CAPACITY	CASE 7	CASE 10	CASE 7	CASE 10	CASE 7	CASE 10
A	19,455	7.52	88.0	110.5	107	128	65.1	73.0
B	8,755	3.38	39.5	49.7	53	64	43.6	48.9
D	8,989	3.47	40.6	51.0	54	66	44.2	49.6
E	8,400	3.25	38.0	47.8	51	62	42.8	48.0
TWO-SATELLITE SYSTEM								
THREE-SATELLITE SYSTEM								
			58.7	73.7	74	91	53.2	59.6
			26.3	33.1	38	45	35.6	39.9
			27.1	34.0	39	46	36.1	40.5
			25.3	31.9	37	44	34.9	39.2

ORIGINAL PAGE IS
OF POOR QUALITY.

Table 2-18. Satellite Weight (lb) for Different
Subscriber Scenarios

SCENARIO	CASE 7		CASE 10	
	2 S/C	3 S/C	2 S/C	3 S/C
A		9520		10960
B,D	7460	6240	8200	6570
E	8280	7000	9080	7330

*OFFSET-FED ANTENNA DESIGN,
SINGLE FEED PER BEAM

Table 2-19. Satellite Deployment Schedule

SATELLITE NO.	TWO-SATELLITE SYSTEM			THREE-SATELLITE SYSTEM		
	B	D	E	B	D	E
1	0	0	0	0	0	0
2	1	1	1	1	1	1
3	3	2	5	2	2**	4
4				3	3**	6

*ON-ORBIT AVAILABILITY, MEASURED IN YEARS FROM DATE OF INITIAL OPERATING CAPABILITY, ASSUMING NO SATELLITE FAILURES

**ONE YEAR LATER THAN REQUIRED BY SUBSCRIBER SCENARIO

the capacity of all previously launched satellites (excepting the on-orbit spare) is exceeded, with the following exception. Observance of this rule for scenario D would violate the 1-launch-per-year restriction. Consequently, the third and fourth satellites are presumed to be launched, as shown in Table 2-19, one year later than needed. The effect on the MSC is minimal, however, since it only involves deferring the launch costs of these 2 satellites for one year.

The MSC for scenarios B, D, and E, as well as for the baseline scenario, is shown in Figure 2-17. Three factors account for the variation in MSC with traffic scenario:

- 1) The smaller ratio of satellites built-to-satellites producing revenue at EOL in a multisatellite system.
- 2) The rate of traffic buildup.
- 3) Geographic subscriber distribution.

The last factor favors the baseline scenario, for which the geographic distribution is uniform. However, the first 2 factors more than compensate for this effect, producing a lower MSC for each of the 3 alternate scenarios.

From the standpoint of the MSC, there is little to choose between a 2-satellite and a 3-satellite system. In other words, the cost of the additional satellite in a 3-satellite system is offset by the higher per-satellite cost in a 2-satellite system.

In computing the MSC, it was assumed that it became necessary to launch the ground spare in the first "open" year. For scenario B and the 2-satellite system, this is year 2 (see Table 2-19). For scenario D and a 2-satellite system, on the other hand, the first open year is the third year of operations. Alternate assumptions regarding the ground spare are considered in the next section.

2.4.5 Ground Spare Strategy

The MSC needed to provide a specified IRR on invested capital depends on the strategy adopted regarding a ground spare. It also depends, to a lesser extent, on the need to place the ground spare (if purchased) in orbit as the result of a satellite failure.

ORIGINAL PAGE IS
OF POOR QUALITY

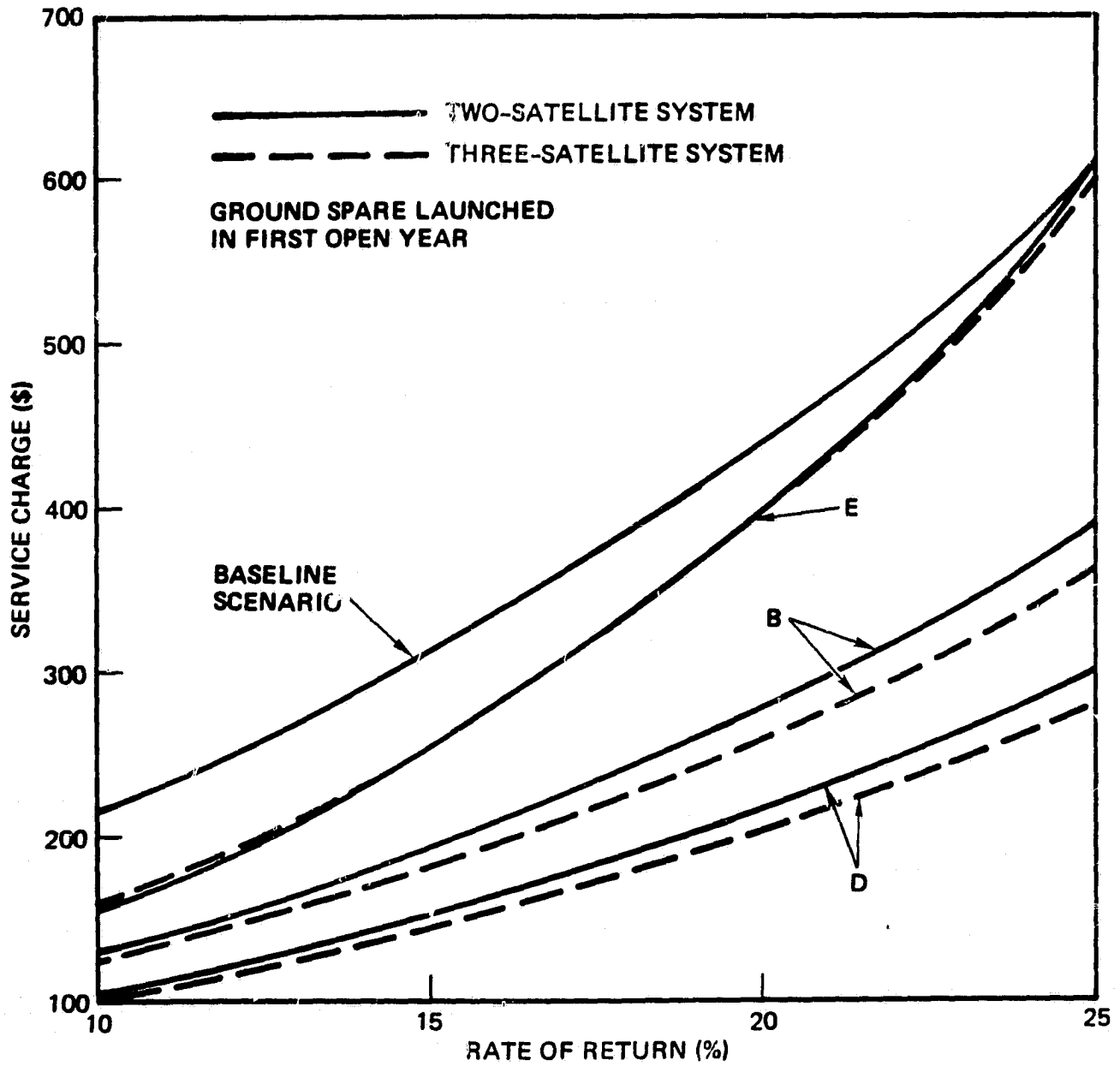

Figure 2-17. MSC for Different Subscriber Scenarios

Five different sets of assumptions regarding the ground spare, together with the resulting MSC, are shown in Table 2-20. The MSC corresponds to a 10 percent IRR. The reference case is based on the baseline subscriber scenario and a 2-satellite system. The need to launch the ground spare in year 3 is predicated on a failure of the on-orbit spare. The MSC would be unchanged if the first satellite should fail instead, provided the on-orbit spare is already in position so that no revenue loss is incurred.

In the first alternative scenario, a satellite failure does not occur until year 7. (The symbol F indicates which satellite has failed, by year of deployment, rather than by year of failure.) The \$4 MSC reduction is a measure of the time-value-of-money associated with the launch costs, which are expended in year 7 instead of year 3.

In the second alternative, no satellite failure occurs within the 7-year period of operations (i.e., the launch costs for the ground spare are deferred indefinitely).

An MSC of \$194 is required with a policy in which no ground spare is purchased. No revenue will be lost with this policy as long as not more than 1 satellite experiences a failure (and, in that event, if the on-orbit spare is already in position). The MSC of \$194 represents a reduction of either \$13 or about \$20 over the case where a ground spare is bought, depending on whether or not the spare is eventually launched.

Finally, should the first satellite fail prior to the start of operations, a full year's revenue would be lost. To compensate for such a loss, the MSC would have to be set substantially higher than in any of the cases where no revenue loss is incurred. It should be pointed out, however, that the first year's revenue with the baseline subscriber scenario is proportionately much higher than it is for the other scenarios (see Figure 2-16). If the more gradual buildup of scenarios B, D, and E is taken as representative of the rate of adoption of the new technology, loss of the first year's revenue is much less significant than is implied by Table 2-20.

2.4.6 Two- vs. Three-Satellite System

It was shown in Section 2.4.4 that there is little difference in MSC between a 2-satellite and a 3-satellite system. For simplicity, satellite

ORIGINAL PAGE IS
OF POOR QUALITY

Table 2-20. MSC Sensitivity to Ground Spare Strategy

CASE	SERVICE CHARGE (\$)	YEAR OF OPERATION							COMMENTS	
		1	2	3	4	5	6	7		
REFERENCE	215	Δ	F	G/S		Δ				
ALT 1	211	Δ	Δ			F				G/S
ALT 2	207	Δ	Δ			Δ				SPARE BOUGHT
ALT 3	194	Δ	Δ			Δ				SPARE NOT BOUGHT
ALT 4	242	F	Δ	G/S		Δ				LAUNCH FAILURE

*CASE 7, TWO-SATELLITE SYSTEM, BASELINE SUBSCRIBER SCENARIO, 10% RATE OF RETURN

Δ = SUCCESSFUL SATELLITE

F = SATELLITE FAILURE

G/S = GROUND SPARE

sizing for these 2 systems was based on the assumption that all satellites of a given system generate equal capacity. This is clearly not the case, since the beam areas in a given geographic region are a function of satellite longitude. The beam areas on which sizing has been based are those for a satellite at 100° west longitude.

The significance of the actual satellite locations can best be understood by assuming that the satellites in a 2-satellite system have the same longitudes as the easternmost satellite pair in a 3-satellite system — namely, 64 and 97 degrees. The beam areas over the densely populated northeast portion of CONUS are only slightly larger for the 97-degree location than they are as seen from 64 degrees. Therefore, the 2 satellites contribute about equally to the system capacity in this critical region.

The northeast beams for a satellite located at 130° west longitude, on the other hand, are considerably larger than those for the other two locations. Consequently, a satellite so located contributes considerably less to the system capacity in this region. The conclusion to be drawn is that a 3-satellite system sized according to Table 2-17 provides less capacity than the indicated 2-satellite system. Alternatively, to obtain equal system capacity, the satellite size for the 3-satellite system would have to be increased significantly.

The relative MSC for a 3-satellite system properly sized to provide the required capacity in the northeast part of CONUS would therefore be somewhat higher than indicated in Figure 2-17. A 3-satellite system has the further disadvantage of producing satellite elevation angles as low as 10 degrees in the northeast and northwest corners of CONUS. This is undesirable from the standpoints of user antenna design, multipath loss, and the possibility of line-of-sight blockage. It may be concluded that a 2-satellite system is the preferred configuration.

Satellite longitudes in a two-satellite system need not be 64 and 97 degrees. A satellite located at 64° longitude would result in undesirably low satellite elevation angles in northwest CONUS. The more westerly satellite could be positioned as far west as 110° longitude and still generate the capacity implied by the relative capacity factor in

Table 2-17. The more easterly satellite, if positioned at 77° longitude, would maintain the 33-degree separation needed for control of inter-satellite co-channel interference. With this pair of locations, the minimum satellite elevation angle would be 19 degrees.

The preceding discussion is based on providing CONUS coverage only. A requirement to add Hawaii coverage would not affect the conclusions reached. However, inclusion of Alaska coverage would make a 3-satellite system a necessity. Consider the relatively extreme Alaska coordinates of 160° longitude and 70° latitude. To maintain a satellite elevation angle of 10°, the satellite serving Alaska would have to be located at 134° longitude. On the other hand, a pair of much more easterly satellites is required for coverage of Northeastern CONUS. Thus, a total of 3 satellites in all is needed.

ORIGINAL PAGE IS
OF POOR QUALITY

2.5 BASELINE SYSTEM DESCRIPTION

Based on the various system configurations examined, a 2-satellite system with narrowband (5-kHz peak deviation) FM has been selected as the most promising from the standpoint of providing adequate capacity at relatively low MSC. An exclusive 10-MHz allocation is assumed, although the satellite design would be little changed with a 20-MHz shared allocation.

All of the satellite sizing and weight estimation to this point has been based on an offset-fed antenna design. It is shown in Section 2.6.3 that a center-fed design offers considerable promise. This alternate feed/reflector geometry forms the basis of a second baseline system.

Additionally, the feed assembly weight has been estimated on the assumption that each beam is generated from a single feed. While such an approach is possible, it constitutes a high technical risk. Instead, a feed-cluster approach to beam formation is adopted in the baseline designs. It is found that different clustering arrangements are appropriate with the center-fed and offset-fed designs.

System sizing is based on an EOL population of 350,000 subscribers or, equivalently, 9000 erlangs of traffic. This corresponds roughly to scenario B or D, both of which span 7 years. (Scenario E, which spans 10 years, is not considered in developing the baseline designs.) The more conservative rate of traffic buildup corresponding to scenario B will be adopted for the purpose of computing the MSC.

2.5.1 Offset-Fed vs. Center-Fed Satellite Design

The satellite configurations for offset-fed and center-fed feed/reflector geometries are shown in Figures 2-18 and 2-19. The feed assembly contains all of the UHF electronics, including the beamformer network but excluding the upconverters and downconverters (see Figure 2-24). It is especially important that the UHF HPAs and LNAs be colocated with the feed elements to minimize transmit losses in the first instance and receiver noise figure in the second.

The solar array for either design is located at the end of a mast of sufficient length to prevent excessive shadowing by the reflector. In the center-fed design, cabling from the solar array runs through the reflector hub and along the main mast to the bus, to provide power to the various

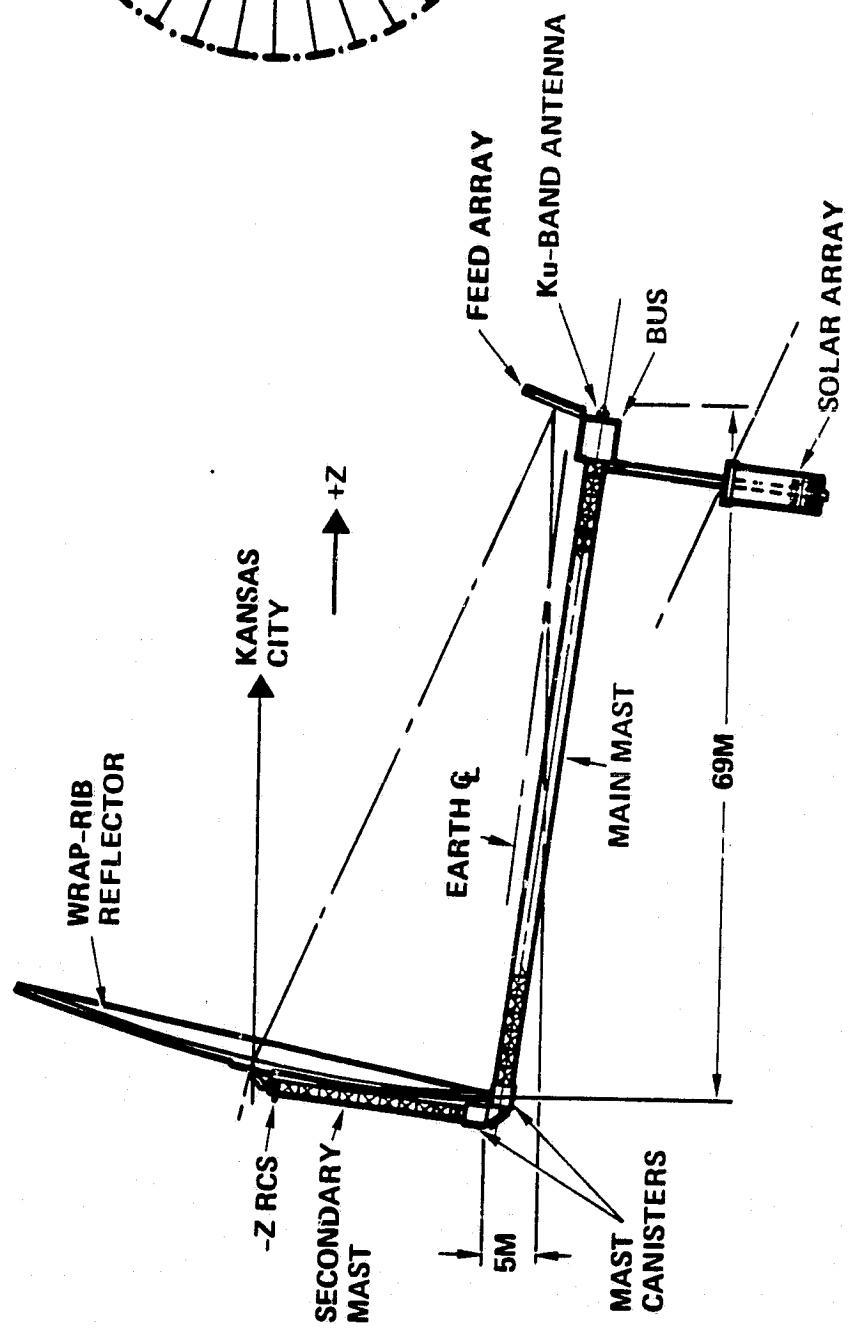
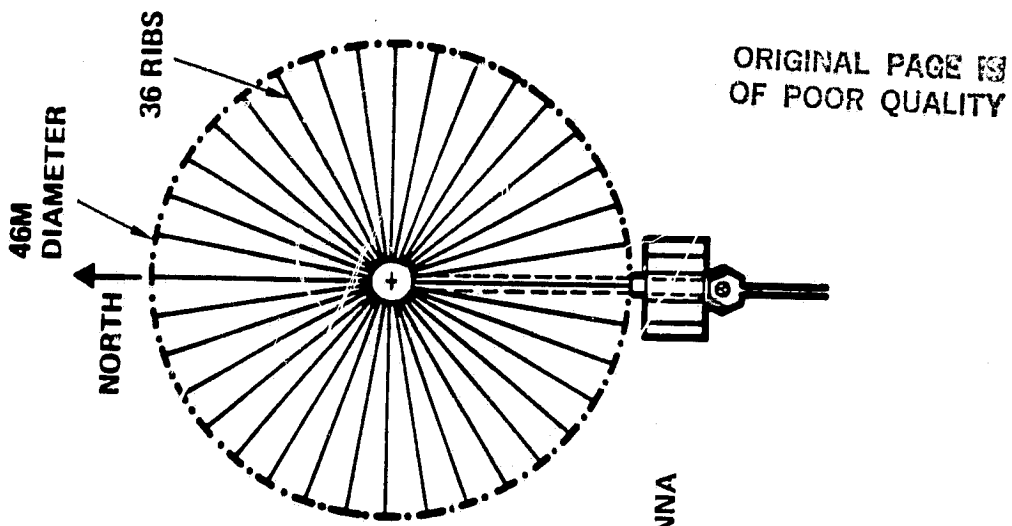

Figure 2-18. Direct Offset-Fed Satellite Configuration

ORIGINAL PAGE IS
OF POOR QUALITY

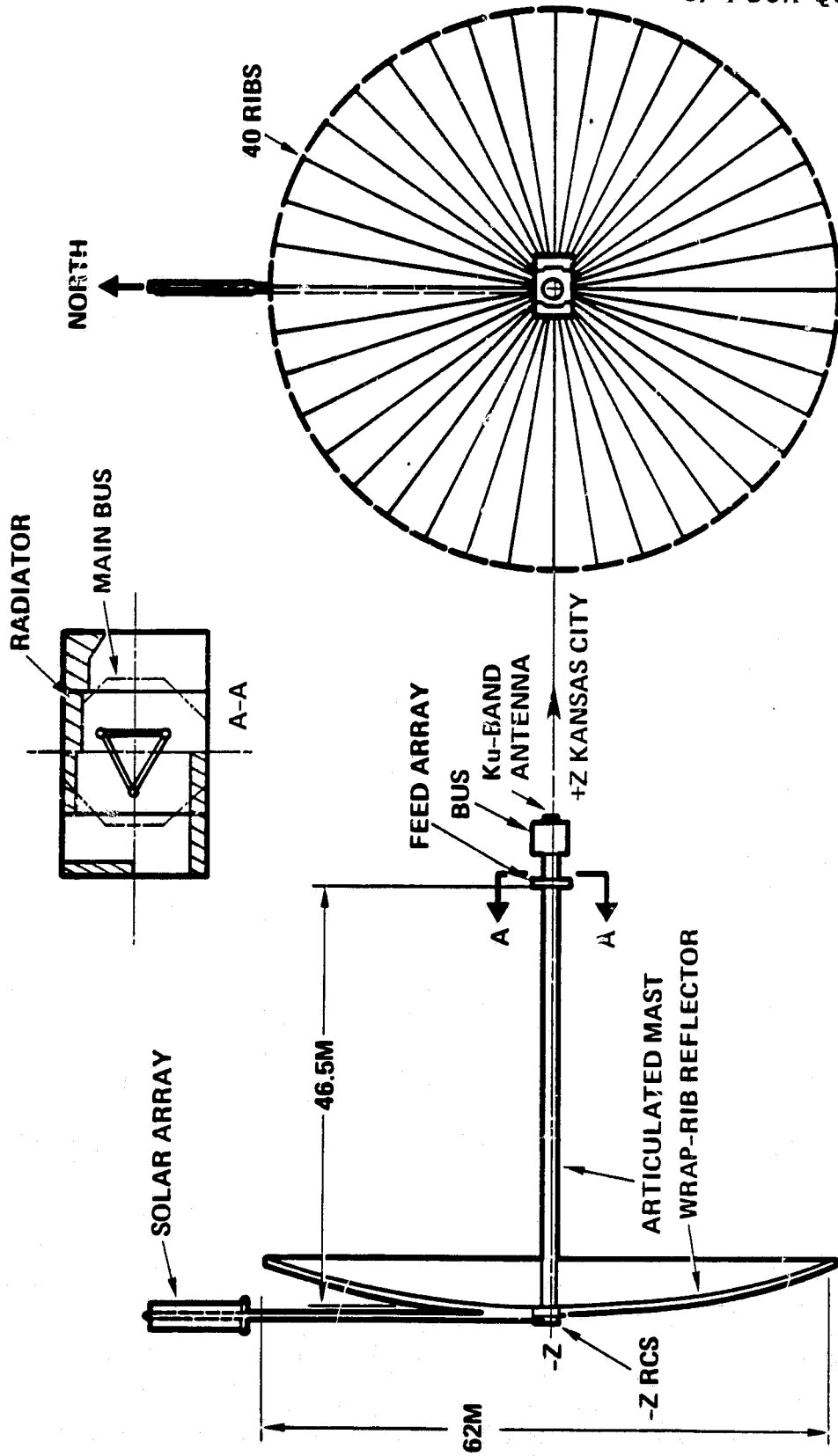

Figure 2-19. Center-Fed Satellite Configuration

subsystems. With the exception of the reaction control subsystem (RCS), which is divided between the bus and the reflector hub, the subsystems are all concentrated in the bus.

The indicated dimensions for the two designs are the result of a sizing exercise outlined in Section 2.5.2. The required number of ribs in the reflector is based on the surface accuracy needed for sidelobe control. The underlying structural analysis is presented in Appendix F.

The smaller reflector of the offset-fed design results from the use of 4 frequency sets, arranged as in Figure 2-3. It is shown in Section 2.6.2 that this frequency arrangement leads to acceptable levels of co-channel interference from mainlobes as well as sidelobes of neighboring beams. The undesirable aspect of the offset-fed design is its low structural rigidity. This results from the L-shaped mast structure and, in particular, the 69-meter length of the main mast. The mast length is the result of the selected f/D of 1.5, which is required to maintain a low sidelobe profile.

The center-fed design offers the prospect of a much more rigid structure. However, blockage of the reflector by the feed assembly precludes the use of only 4 frequency sets. Were this attempted, high comalobe levels (i.e., the level of the first inboard sidelobe) would produce unacceptable co-channel interference, especially for beams substantially off boresight (see Figure 2-28). A larger number of frequency sets is therefore required.

A 7-frequency-set beam pattern, for use with a center-fed design, is shown in Figure 2-20. The minimum spacing between co-channel beams is 2.65 HPBW, as compared with 2 HPBW in the offset-fed design. This increased spacing is sufficient to avoid comalobe interference. Co-channel interference from other sidelobes is shown in Section 2.6.3 to be acceptable from a system point of view. This analysis, however, does not account for the effect of the mast and cabling. Consequently, further investigation is needed to validate this concept.

The size of each frequency set with the proposed center-fed design is 4/7 as large as each set in the offset-fed system concept. Consequently, 7/4 as many beams are required to generate the same system capacity.

ORIGINAL PAGE IS
OF POOR QUALITY

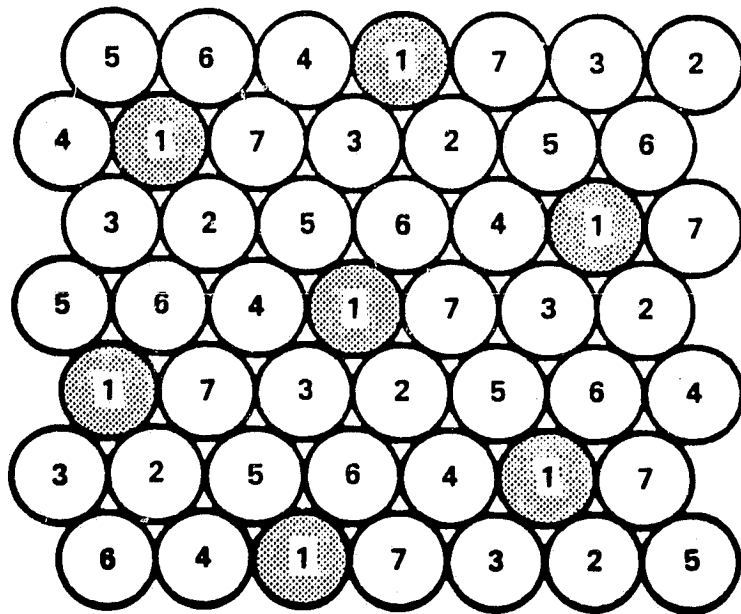

Figure 2-20. 7-Frequency-Set Beam Pattern

The antenna diameter in the center-fed design must therefore be larger, by a factor of $\sqrt{7/4}$, than the antenna in an offset-fed design.

The 46.5-meter mast length in the center-fed design reflects the lower f/D of 0.75 that suffices with this geometry. Thus, despite the larger reflector, the mast for this design is shorter than in the offset-fed case.

2.5.2 System Sizing

System sizing depends on the maximum per-beam subscriber density that must be accommodated. The per-beam subscriber density was presented on a state-by-state basis in Table 2-16. These densities are expressed relative to the density for a uniform geographic distribution. They account for variations in both beam area and subscriber density.

Comparison of the entries in Table 2-16 with a typical CONUS-coverage beam pattern leads to the conclusion that the maximum per-beam subscriber density is about 2.4. If a 0.1 grade of service (rather than 0.05) is permitted in the most densely populated beam, the corresponding traffic increase is 9 percent with 4 frequency sets and 10 percent with 7 frequency sets. This reduces the effective subscriber density to $2.4/1.09 = 2.2$.

Additionally, it is possible to "borrow" unused frequencies from nearby beams to stretch the capacity of a given beam. This procedure is illustrated in Figure 2-21. In part A, the shaded beam assigned frequency set #2 is assumed to saturate first. Suppose, for example, that all four shaded beams assigned frequency set #3 have a common unused group of frequencies. These frequencies can be used in the saturated beam, since all other beams assigned set #3 are more than 2 HPBW removed from the saturated beam. Similarly, frequencies from set #1 or set #4 can be borrowed from neighboring beams, in addition to those from set #3.

In part B of Figure 2-21, the shaded beams assigned frequency set #3 can lend any commonly unused frequencies to the shaded beam assigned frequency set #1. This is permissible because all other beams assigned frequency set #3 are more than 2.65 HPBW removed from the saturated beam. In this case, frequencies may be simultaneously borrowed from any of the 6 sets not assigned to the beam that has saturated.

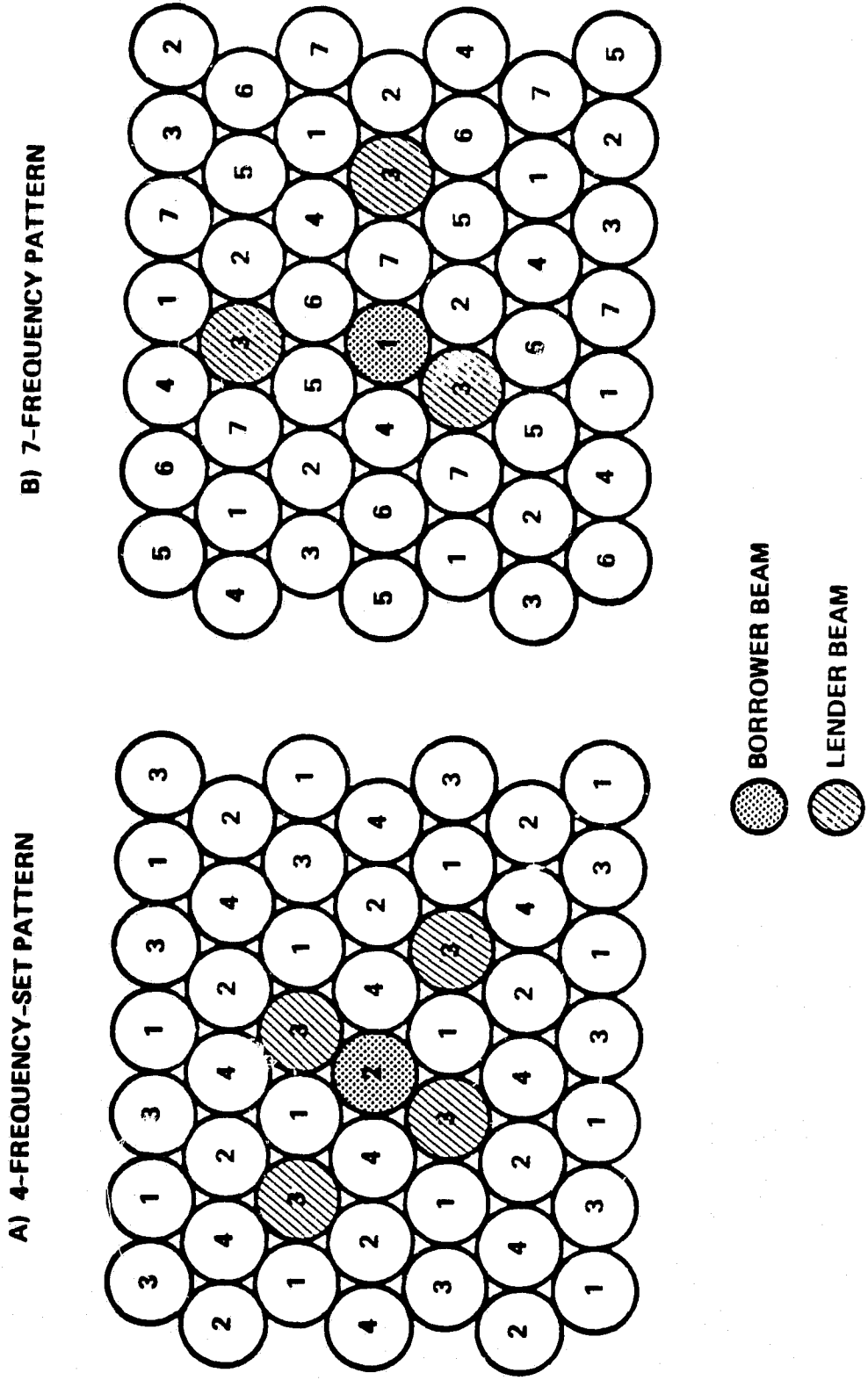

Figure 2-21. Frequency Borrowing Between Beams

The frequency-borrowing process requires coordination among the gateways controlling the affected beams. Moreover, to maximize the number of frequencies available to be borrowed, frequencies in a given set should be assigned in the same order in all beams using that set.

It will arbitrarily be assumed that the available number of carriers per beam can be increased by 10 percent through frequency borrowing. The effective subscriber density is thereby further reduced to $2.2/1.1 = 2.0$. Thus, to accommodate subscribers in the densest beam, the satellite antenna must be sized for a uniformly distributed subscriber population that is twice as large as the anticipated skewed population.

System sizing for the two baseline designs is illustrated in Table 2-21. In a 2-satellite system designed to handle an EOL traffic of 9000 erlangs, each satellite must support 4500 erlangs. The required antenna diameter is 46 meters for the offset-fed design and 62 meters for the center-fed design. The associated number of beams is 61 or 101, respectively; the half-power beamwidth, 0.57 degree or 0.42 degree.

2.5.3 Feed-Cluster Approach to Beam Formation

Generation of a set of contiguous beams with 3-dB crossovers places a maximum value on the feed-assembly area that can be devoted to each beam. On the other hand, good sidelobe control implies a highly tapered reflector illumination; this, in turn, requires a certain minimum feed area per beam. Unfortunately, the minimum area of the latter requirement generally exceeds the maximum area of the former requirement.

Additional feed-element gain (i.e., greater illumination taper) can be realized by utilizing the dimension normal to the plane of the feed assembly. In this way, the feed-assembly area that must be devoted to each beam is reduced. An endfire element is illustrative of this concept. However, the increased likelihood of electromagnetic coupling between elements, which would degrade the sidelobe pattern, makes this a high-risk approach.

The alternative is to generate each beam from a cluster of feeds, with a given feed generally contributing to more than one beam (Figure 2-22). The overlapping nature of the feed clusters is illustrated in Figure 2-23.

ORIGINAL PAGE IS
OF POOR QUALITY

Table 2-21. Baseline System Sizing

REQUIREMENT: 4,500 ERLANGS/SATELLITE

	<u>OFFSET-FED</u>	<u>CENTER-FED</u>
FREQUENCY SETS	4	7
CHANNELS/BEAM	208	119
ERLANGS/BEAM (UNIFORM)*	200	111
BEAM EQUIVALENTS (UNIFORM)	22.5	40.5
BEAM EQUIVALENTS (SKEWED)	45	81
BEAMS	61	101
HALF-POWER BEAMWIDTH	0.57°	0.42°
ANTENNA DIAMETER	46 m	62 m

***0.05 GRADE OF SERVICE**

ORIGINAL PROBLEM
OF POOR QUALITY

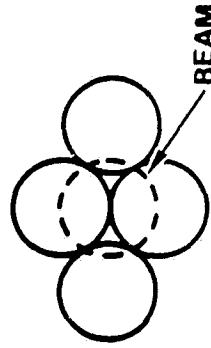
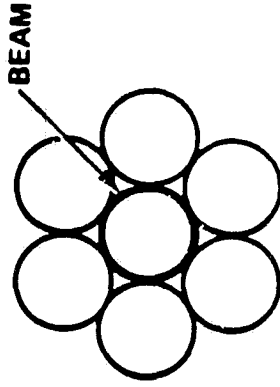

• CENTER-FED DESIGN

- OVERLAPPING 7-FEED CLUSTERS PROVIDE REQUIRED DIRECTIVITY
- 152 FEEDS REQUIRED TO FORM 101 BEAMS

• OFFSET-FED DESIGN

- OVERLAPPING 4-FEED CLUSTERS PROVIDE REQUIRED DIRECTIVITY
- WITH CLUSTER IN ORIENTATION SHOWN, 84 FEEDS REQUIRED TO FORM 61 BEAMS

Figure 2-22. Feed-Cluster Approach to Beam Formation

With the center-fed design, a 7-feed cluster generates each beam. If the feed layout is regarded as a mapping of the coverage area, each cluster generates a beam which is coincident with the center feed. A peripheral layer of feeds is required to complete the clusters for the outermost beams. A total of 152 feeds is required for 101 beams.

A 4-feed cluster suffices for the offset-fed design. The beam in this case is centrally located with respect to the 4 feeds, as shown in Figure 2-22. With the cluster oriented as indicated (i.e., the feeds that are tangent at the beam center are aligned north-south), only half a peripheral layer of feeds is needed along the north and south boundaries of CUNUS. This minimizes the number of feeds required, 84 being needed to form 61 beams.

2.5.4 Repeater Block Diagram

A block diagram of the satellite repeater is shown in Figure 2-24 for the offset-fed design. Three-for-two redundancy is assumed. Accordingly, each of the UHF receiver, downconverter, upconverter, and transmitter units handles a pair of channels. Similar redundant units are provided at Ku-band. The beamformer network operates at RF frequencies. On the receive side, it immediately follows the LNAs; on the transmit side, it immediately precedes the HPAs.

As indicated previously, the beamformer network is located on the feed array. This is not essential. However, it does reduce the number of cables between the feed assembly and the bus to the number of beams rather than the number of feeds.

Note that 7 distinct local oscillator frequencies are required for downconversion of the UHF signals, and 7 additional frequencies for the upconversion process. This corresponds to the (typical) assignment of 7 UHF beams to a gateway station, as depicted by the frequency plan in Figure 2-6.

2.5.5 Satellite Power Requirements

The satellite power required to support the mobile links is determined by the power budget of Table 2-22. (Power budgets for the other system links are provided in Appendix E.) While the EIRP/channel is identical for

ORIGINAL PAGE IS
OF POOR QUALITY

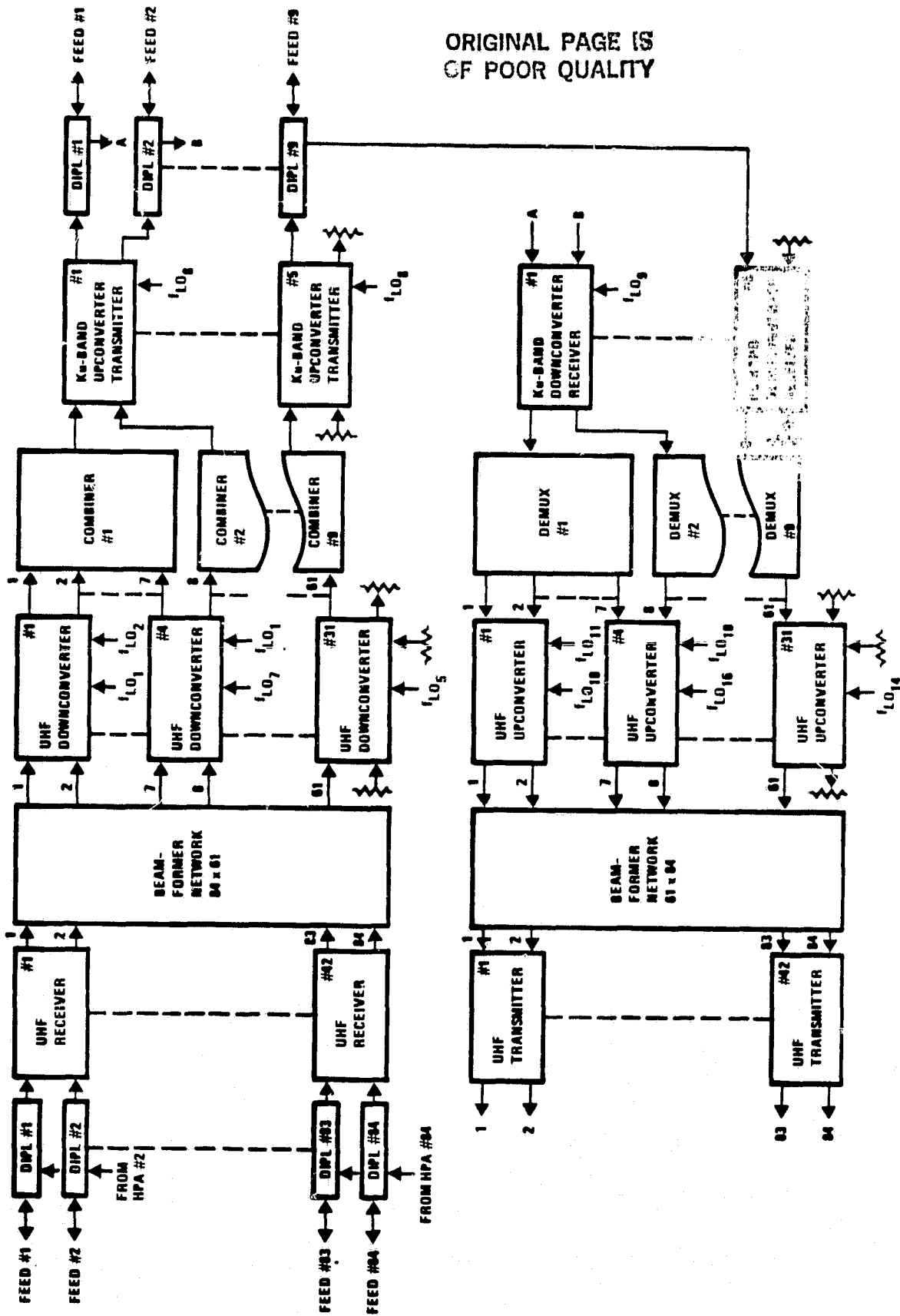

Figure 2-24. Satellite Repeater Block Diagram
(Offset-Fed Design, 3x2 Redundancy)

Table 2-22. Link Power Budget for
Satellite-to-Mobile Transmission

	<u>OFFSET-FED</u>	<u>CENTER-FED</u>
TRANSMIT POWER/CHANNEL, dBW	-7.7 (0.17 W)	-10.0 (0.10 W)
CIRCUIT LOSS, dB	-1.0	-1.0
TRANSMIT ANTENNA GAIN, dB	48.1	50.4
EIRP, dBW	<u>39.4</u>	<u>39.4</u>
POINTING LOSS, dB	-4.0	
BEAM JITTER LOSS, dB	-1.0	
PATH LOSS, dB	-183.0	
MULTIPATH LOSS, dB	-5.0	
POLARIZATION LOSS, dB	-0.5	
RECEIVE ANTENNA GAIN, dB	9.0	
LINE LOSS, dB	<u>-1.0</u>	
RECEIVED CARRIER POWER, dBW	<u>-146.1</u>	
RECEIVE SYSTEM NOISE TEMPERATURE, dB-K	27.6	
BOLTZMANN'S CONSTANT, W/K-Hz	-228.6	
CARRIER NOISE BANDWIDTH, dB-Hz	<u>40.4</u>	
RECEIVED NOISE POWER, dBW	<u>-160.6</u>	
C/N, dB	14.5	

ORIGINAL PAGE IS
OF POOR QUALITY

the two designs, the transmit power differs because of the difference in antenna size. For the offset-fed design, the transmit power per channel is 0.17 watt; for the center-fed design, 0.10 watt.

The satellite RF power requirements are developed in Table 2-23 for the most densely populated beam. It is assumed that the normal complement of frequencies assigned to each beam is augmented by frequency borrowing. The carriers are voice-activated, except for the signaling channels (4 per beam with 4 frequency sets, 2 per beam with 7 frequency sets). For the offset-fed design, each UHF HPA must be capable of transmitting 16 watts of RF power in a sufficiently linear mode to control the magnitude of the IM products generated. For the center-fed design, the corresponding requirement is 5.4 watts.

The DC satellite power needed to support the mobile links can only be approximated without considerably further investigation. In general, the maximum anticipated RF power in an individual beam will be less than that for a fully loaded beam. If all beams are provided with the same size HPA, the efficiency decreases with a reduction in the amount of RF power supplied. On the other hand, beams known in advance to support a relatively small fraction of the maximum traffic can be provided with a lower-rated amplifier, thereby improving the DC/RF efficiency.

DC/RF efficiency for solid-state power amplifiers developed by RCA for use in (C-band) Advanced Satcoms is claimed to be 33 percent (Reference 2-7). This efficiency is available, however, only for single-carrier operation close to saturation.* It is estimated that the efficiency at a backoff sufficient to produce a C/IM value of 20 dB with many-carrier operation (see Table 2-1) would be about 20 percent. In general, higher efficiency is achievable at lower frequencies. For the present analysis, therefore, an efficiency of 25 percent is assumed.

Accordingly, a fully loaded beam requires 64 watts of DC power for the offset-fed design and 22 watts for the center-fed design (Table 2-24). Although the DC/RF efficiency decreases with reduced beam loading, the

* Private communication with Dr. Jack Kiegler of RCA.

ORIGINAL PAGE IS
OF POOR QUALITY

Table 2-23. Satellite RF Power Requirements

	<u>OFFSET-FED</u>	<u>CENTER-FED</u>
TRANSMIT POWER/CARRIER	0.15 W	0.085 W
EIRP/CARRIER	39 dBW	39 dBW
VOICE CHANNELS/BEAM (10% BORROWED)	224	129
VOICE-ACTIVATED CARRIERS/BEAM	90	52
TOTAL ACTIVE CARRIERS/BEAM	94	54
TRANSMIT POWER/BEAM	14 W	4.6 W

Table 2-24. Satellite DC Power Requirements

● UHF AMPLIFIER EFFICIENCY FOR FULLY LOADED BEAM: 25%

	<u>OFFSET-FED</u>	<u>CENTER-FED</u>
● DC POWER FOR FULLY LOADED BEAM	64 W	22 W
● NO. OF BEAM EQUIVALENTS	45	81
● ESTIMATE OF TOTAL DC POWER	2880 W	1780 W
● LOWER BOUND ON DC POWER	1225 W	720 W

$$\left[\frac{\text{RF POWER/CARRIER} \times \text{NO. OF ACTIVE CARRIERS}}{\text{UHF AMPL EFF FOR FULLY LOADED BEAM}} \right]$$

ORIGINAL PAGE IS
OF POOR QUALITY

absolute value of DC power required also decreases. It will conservatively be assumed that the total DC power requirement is given by the product of the power required for a fully loaded beam and the number of beam equivalents needed to cover CONUS.

A lower bound on the required DC power can be computed by assuming that all carriers are generated at the DC-to-RF efficiency characteristic of a fully loaded beam. It is seen from Table 2-24 that the lower bound is only 40-43 percent of the previous estimate.

2.5.6 Satellite Weight Summary

A satellite weight breakdown by subsystem is given in Table 2-25. Analysis supporting the subsystem weight estimates can be found in Appendix G. Both satellite designs, including a 20 percent contingency factor, are well under the projected STS/IPS capability of 10,400 pounds.

2.5.7 Monthly Service Charge

The required MSC for the two baseline system designs is shown as a function of IRR in Figure 2-25. The MSC difference between the two systems is small enough to be ignored. Preference for one system over the other should therefore be based on considerations of satellite weight and technological risk.

It is of interest to examine the time variation of cumulative discounted cash flow (CDCF), which is shown in Figure 2-26 for the offset-fed design. It is inherent to the MSC calculation that the CDCF is zero at the defined end of system life.

Regardless of the IRR, capital expenditures, expressed in present-value terms, are fairly uniform over the 5-year period preceding the start of operations. In all cases, a positive cash flow is first experienced in the seventh year of the project, which is the second year of operations. Since all cash flows are referred (i.e., discounted) to the start of the project, the maximum negative CDCF decreases with increasing IRR. If a 15 percent IRR is taken as representative of the project risk, the CDCF reaches a peak negative value of \$500 million.

Table 2-25. Satellite Weight Summary

<u>ITEM</u>	<u>CENTER-FED</u>	<u>WEIGHT (LB)</u>	<u>OFFSET-FED</u>
REFLECTOR	1050		800
MASTS	260		510
COMM & DATA (INCL. Ku-BAND)	360		360
FEED ASSEMBLY	1630		2115
RADIATING ELEMENTS	70	125	
ELECTRONICS	560	455	
BEAM-FORMING NETWORK	150	335	
RF & DC CABLING	350	250	
THERMAL CONTROL	270	440	
STRUCTURE	230	510	
ATTITUDE CONTROL	430		830
REACTION CONTROL	1400		1160
DRY	310	255	
PROPELLANT	1090	905	
THERMAL CONTROL (BODY)	100		100
ELECTRICAL POWER	540		530
DC CABLING	540		480
STRUCTURE & INTEGRATION	690		760
TOTAL	7000		7645
CONTINGENCY (20%)	1400		1530
BOOSTER CAPABILITY (IPS)	10400		10400
MARGIN	2000 (24%)		1225 (13%)

ORIGINAL PAGE IS
OF POOR QUALITY.

ORIGINAL PAGE IS
OF POOR QUALITY

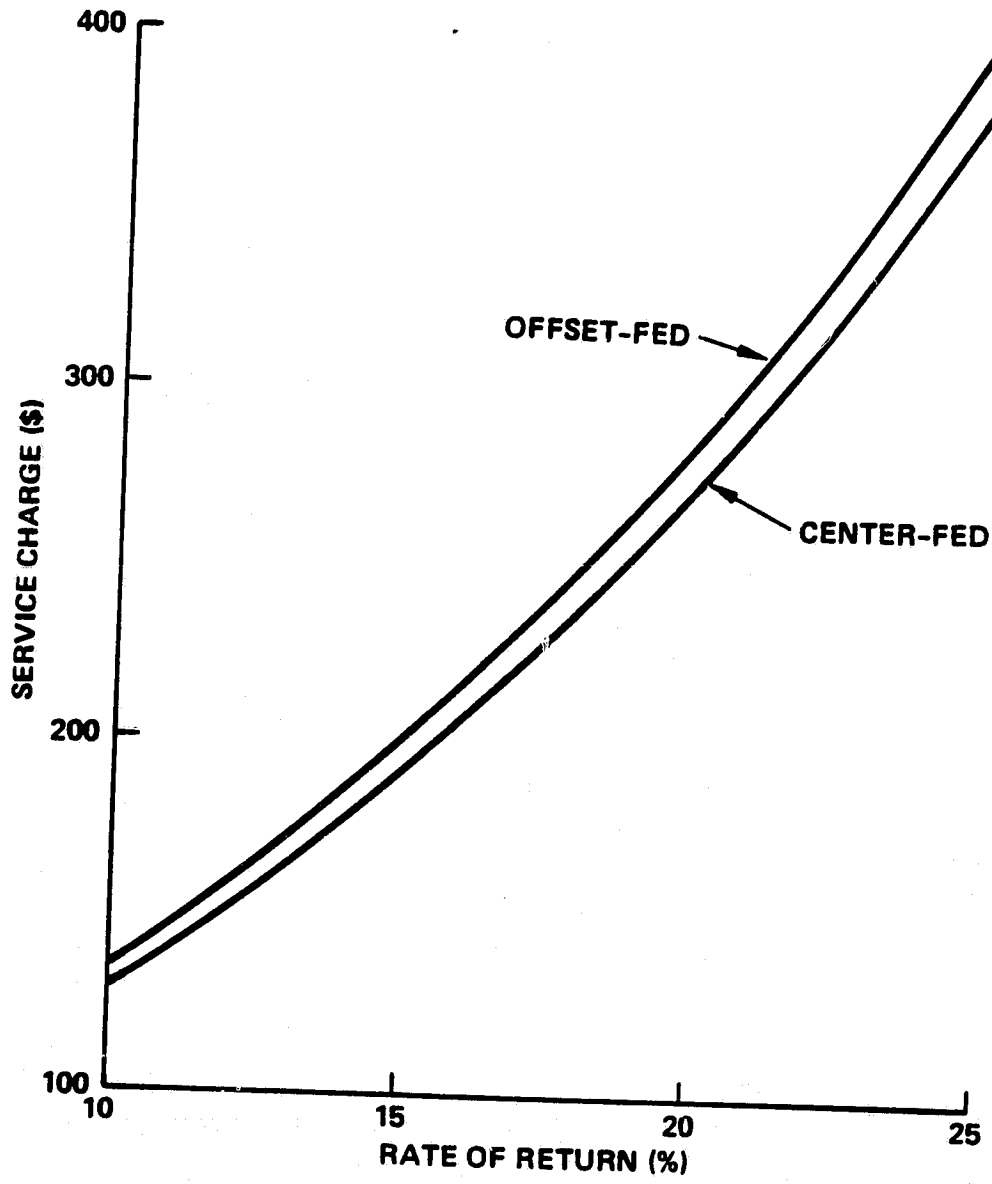

Figure 2-25. MSC for Baseline Configurations

ORIGINAL PAGE IS
OF POOR QUALITY

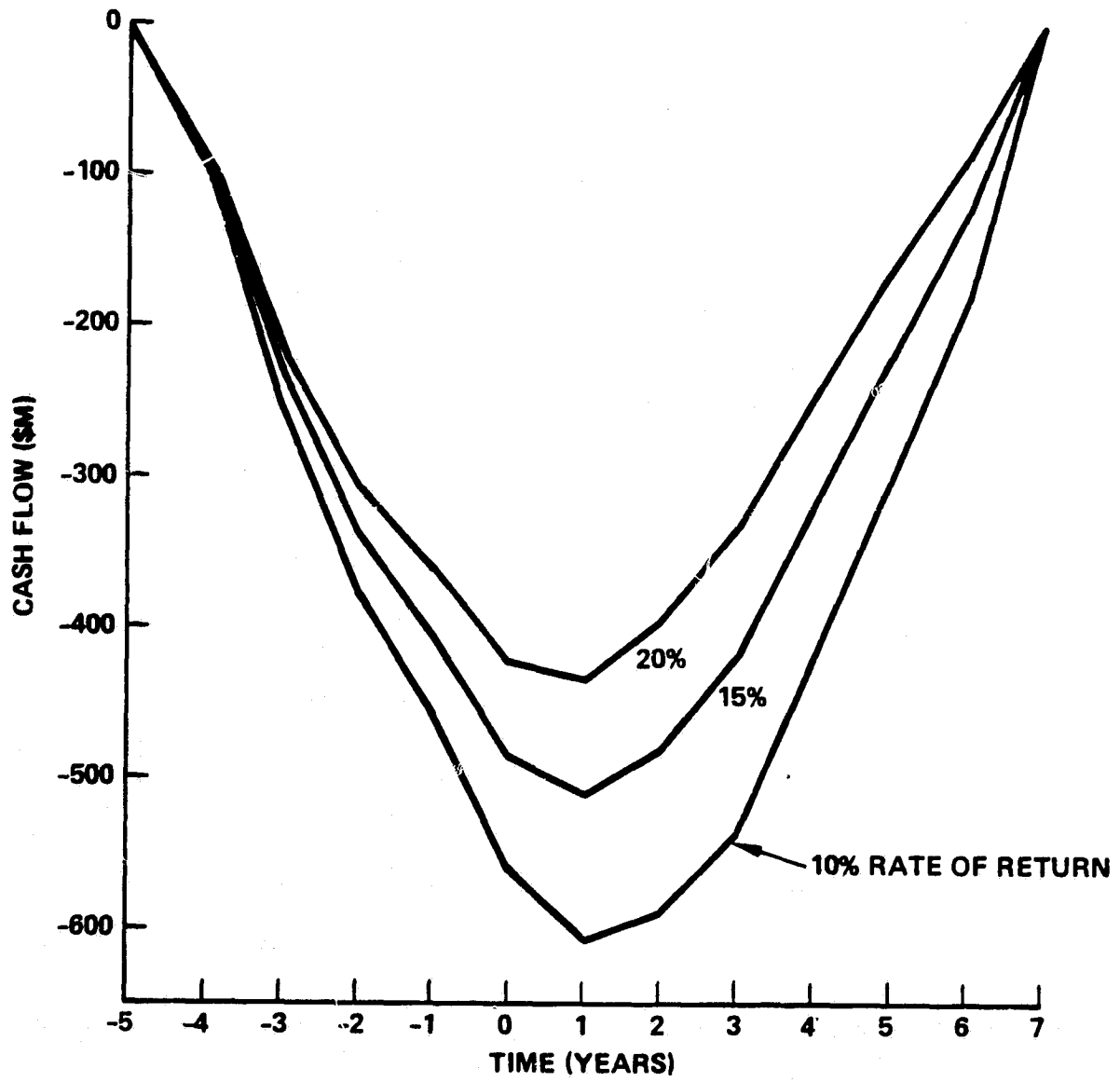

Figure 2-26. Cumulative Discounted Cash Flow for Offset-Fed Design

2.6 SATELLITE ANTENNA SUBSYSTEM

The antenna subsystem design is characterized by the feed/reflector geometry and the number of distinct frequency sets into which the frequency allocation is divided. The four combinations that were initially considered, as well as the two baseline choices, are indicated in Table 2-26.

The reflector size is a direct consequence of the number of frequency sets. The 4-frequency-set choice is preferable, therefore, whenever permitted by the RF properties of the resulting design. This is the case for the offset-fed design, as will be demonstrated shortly. Consequently, there would be no reason to consider the use of 7 frequency sets, even if the resulting satellite weight were within the STS capability. For the center-fed design, it will be seen that co-channel interference precludes the use of 4 frequency sets.

2.6.1 Requirements

The driving requirements on the antenna design are:

- 1) Contiguous beams providing CONUS coverage.
- 2) 3-dB beam crossovers.
- 3) Co-channel-beam spatial isolation ≥ 30 dB.

The latter criterion represents a theoretical value that applies to a single co-channel interferer. The combined effect of the 6 closest co-channel beams is typically to increase the interference level due to the dominant co-channel beam by 3 to 5 dB. On the other hand, the allowance made for co-channel interference in the system design is -17 dB relative to the level of the desired carrier. Consequently, there is ample margin for conditions that depart from theoretical if a single-interferer isolation of 30 dB is achieved for a mathematical model of the antenna subsystem.

Co-channel-beam interference can result either from the mainlobe or from sidelobes. The offset-fed reflector system inherently has the lowest possible sidelobe levels. This results from the absence of aperture blockage. The center-fed design suffers from blockage by the feed array. Nevertheless, it has several attractive features which tend to make it the preferred choice if it can be made to meet the RF design goals. The

Table 2-26. Baseline Antenna Configurations

	OFFSET-FED	CENTER-FED
4 FREQUENCY SETS	BASILINE SELECTION 46-m REFLECTOR	EXCESSIVE CO-CHANNEL-BEAM INTERFERENCE
7 FREQUENCY SETS	WEIGHT EXCEEDS STS CAPABILITY	BASILINE SELECTION 62-m REFLECTOR

advantages of a center-fed reflector include: a shorter mast, a much smaller feed system, a more symmetric satellite configuration, and a more mature deployment technique.

To compare the 2 reflector approaches from an RF standpoint, it is necessary to define appropriate f/D ratios. With the selected reflector sizes, beam scan angles of 6 HPBW (for the offset-fed design) to 8 HPBW (for the center-fed design) arise. This means that relatively large f/D values are required for both configurations for sidelobe (in particular, comalobe) control.

The offset-fed reflector design parameters were studied extensively by JPL for this application (Reference 2-2). The JPL-selected quantities were an f/D of 1.5, or a parent parabola f/D_p of 0.67. These same values were selected for the offset-fed baseline approach in the present study.

For the center-fed design, f/D values of 0.5, 0.75, and 1.0 were examined. As noted previously, higher f/D values produce lower sidelobe levels. Hence, purely on this basis, an f/D of 1.0 or higher would be the choice. However, for a scanned antenna system, aperture blockage increases with f/D . For the considered f/D values, the blockage ratios are 7, 10, and 12.5 percent, respectively. The effect of aperture blockage is to increase the sidelobe levels. Hence, as a compromise which tends to produce the lowest sidelobes, an f/D of 0.75 was selected.

2.6.2 4-Frequency-Set, Offset-Fed Baseline

A CONUS-coverage beam pattern with 0.48-degree beams is shown in Figure 2-27.* Selection of a 4-frequency-set baseline is based on co-channel interference experienced among the shaded frequency-set #4 beams. This particular pattern cut was selected because co-channel-beam interference is at a maximum in this plane.

Gain patterns in the plane of interest for the 4 shaded beams are shown, first, in Figure 2-28 for a center-fed reflector. There are 2

*The appropriate HPBW for a 4-frequency-set system design, whether based on an offset-fed or center-fed reflector, is 0.57 degree. Thus, interference calculations based on the beam pattern of Figure 2-27 will be somewhat conservative.

ORIGINAL PAGE IS
OF POOR QUALITY

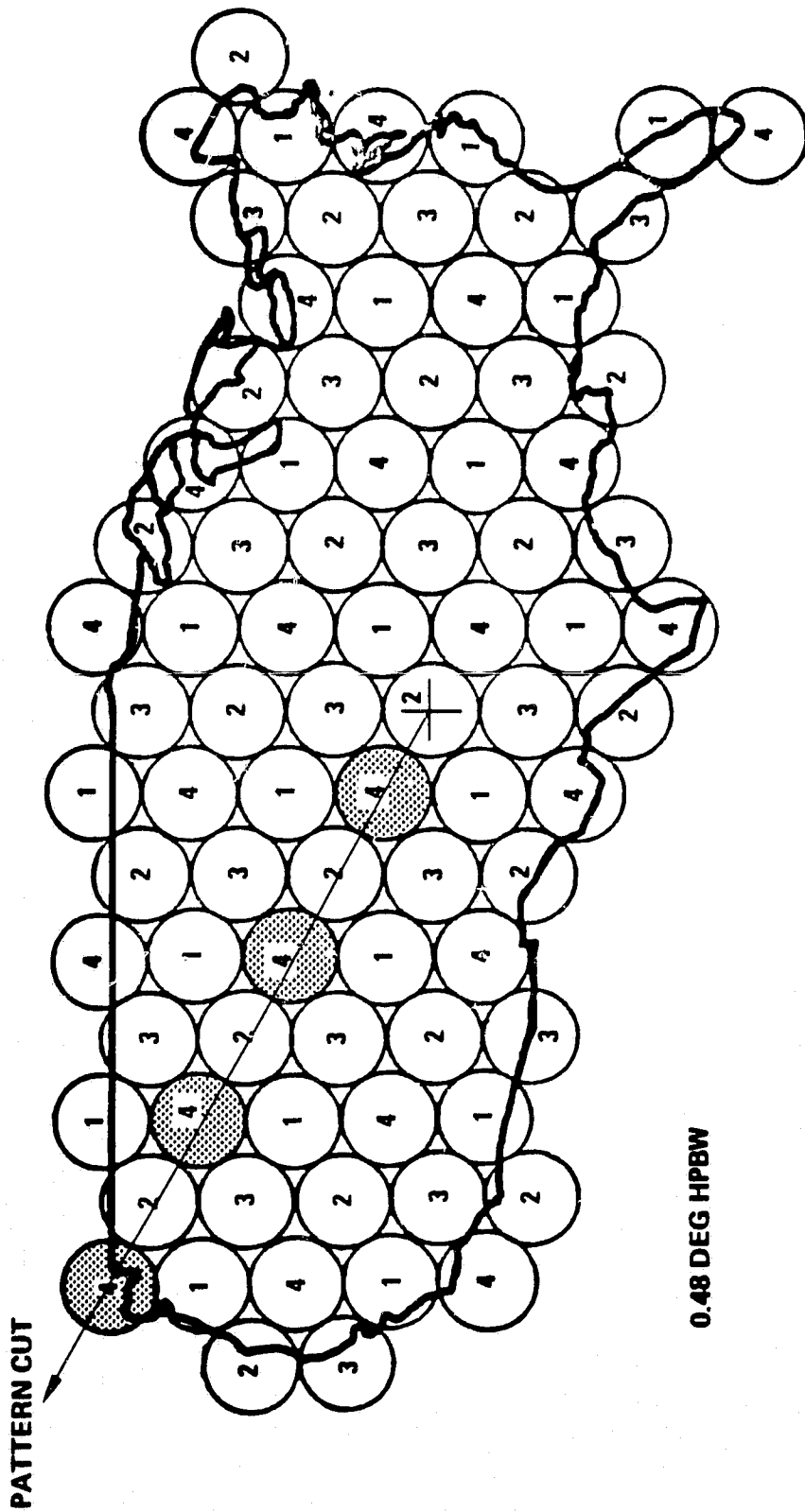

Figure 2-27. 4-Frequency Set Beam Pattern

ORIGINAL PAGE 13
OF POOR QUALITY

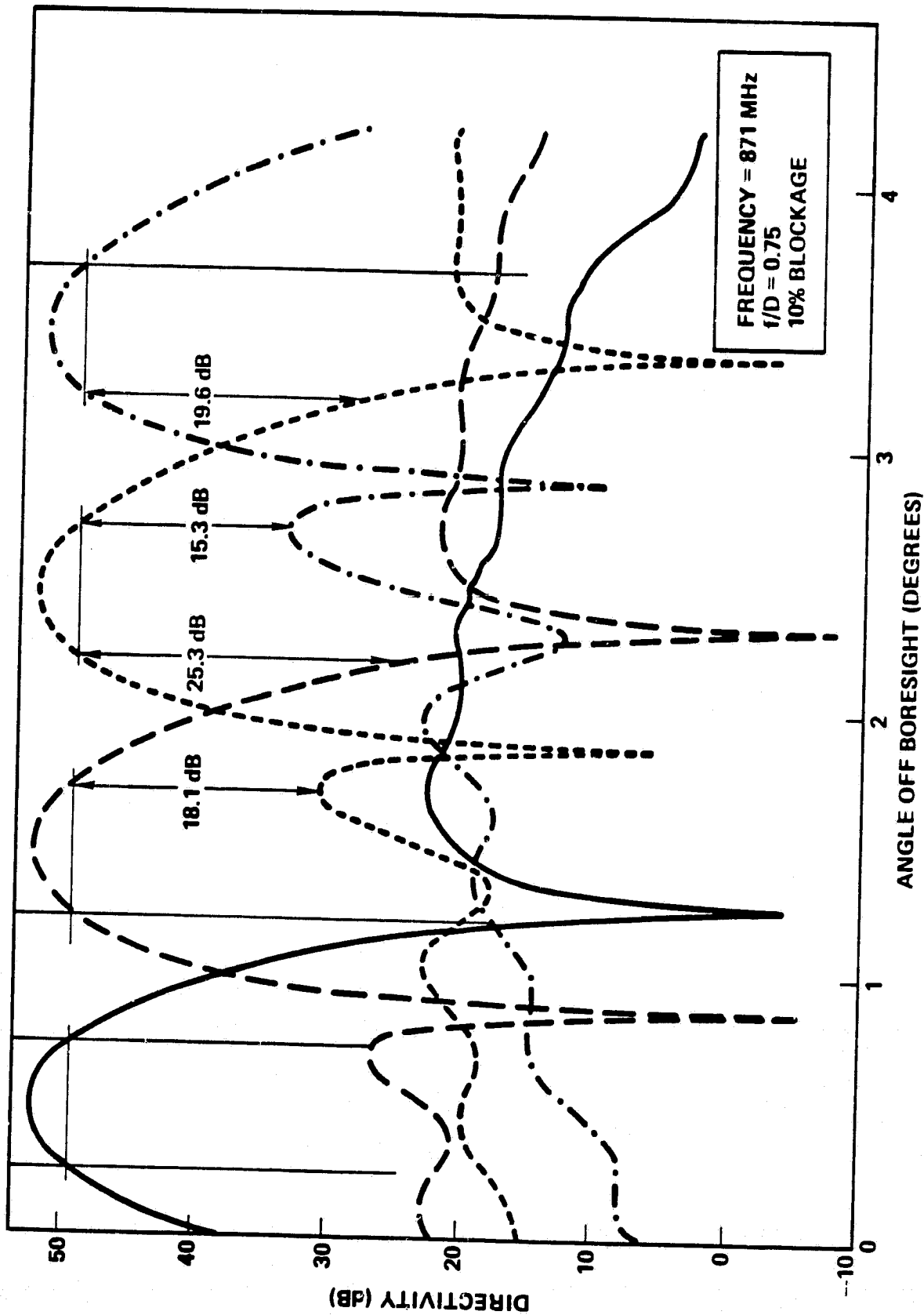

Figure 2-28. Co-channel Beam Gain Patterns for Center-Fed Antenna With 4-Frequency Sets

interference modes. The first is produced by the sidelobes, of which the comalobe is the main interferer. In fact, the comalobes peak at the worst possible location, namely, at the 3-dB point of the inboard adjacent co-channel beam. The second type of interference is a mainlobe-to-mainlobe effect. Both types of interference increase with greater scan angles.

The mainlobe interference can be alleviated by increasing the f/D beyond 0.75. To do so, however, would increase the blockage, thereby increasing the comalobe levels. With the interference levels indicated in Figure 2-28, it may be concluded that a 4-frequency-set beam pattern is not suitable for a center-fed design.

A set of co-channel-beam gain patterns, also in a radially directed cut from boresight, is shown in Figure 2-29 for an offset-fed reflector. In this case, the beamwidth of 0.60 degree is just slightly larger than the baseline value of 0.57 degree corresponding to a 46-meter reflector. In the absence of feed blockage, the sidelobes are nearly 40 dB below the peak mainlobe gain. Although the level of the outboard mainlobe skirt increases with scan angle, it is at least 34 dB below the desired signal level at all user locations. The 4-frequency-set/offset-fed reflector combination therefore meets the design goal of providing more than 30 dB of co-channel-beam isolation.

Figure 2-30 contains a schematic of the offset-fed baseline antenna. Note that adjacent feeds are spaced by 2λ , whereas an effective feed size of 4λ is required to achieve the necessary sidelobe levels. Options to meet the feed-size criterion include a single-feed-per-beam approach and the more conservative overlapping-feed-cluster approach, as shown in Figure 2-31. Several feed-cluster configurations may be considered. These range from a triad solution to a 7-feed cluster arrangement.

Feed clusters for neighboring co-channel beams in a 4-frequency-set beam pattern are shown in Figure 2-32. Co-channel 7-feed clusters have a feed element in common. As a result, user transmissions intended for one of the beams inject interference into co-channel transmissions intended for the second beam. Six potential co-channel interferers exist for each user transmission, one interferer being associated with each outer element of

ORIGINAL PAGE IS
OF POOR QUALITY

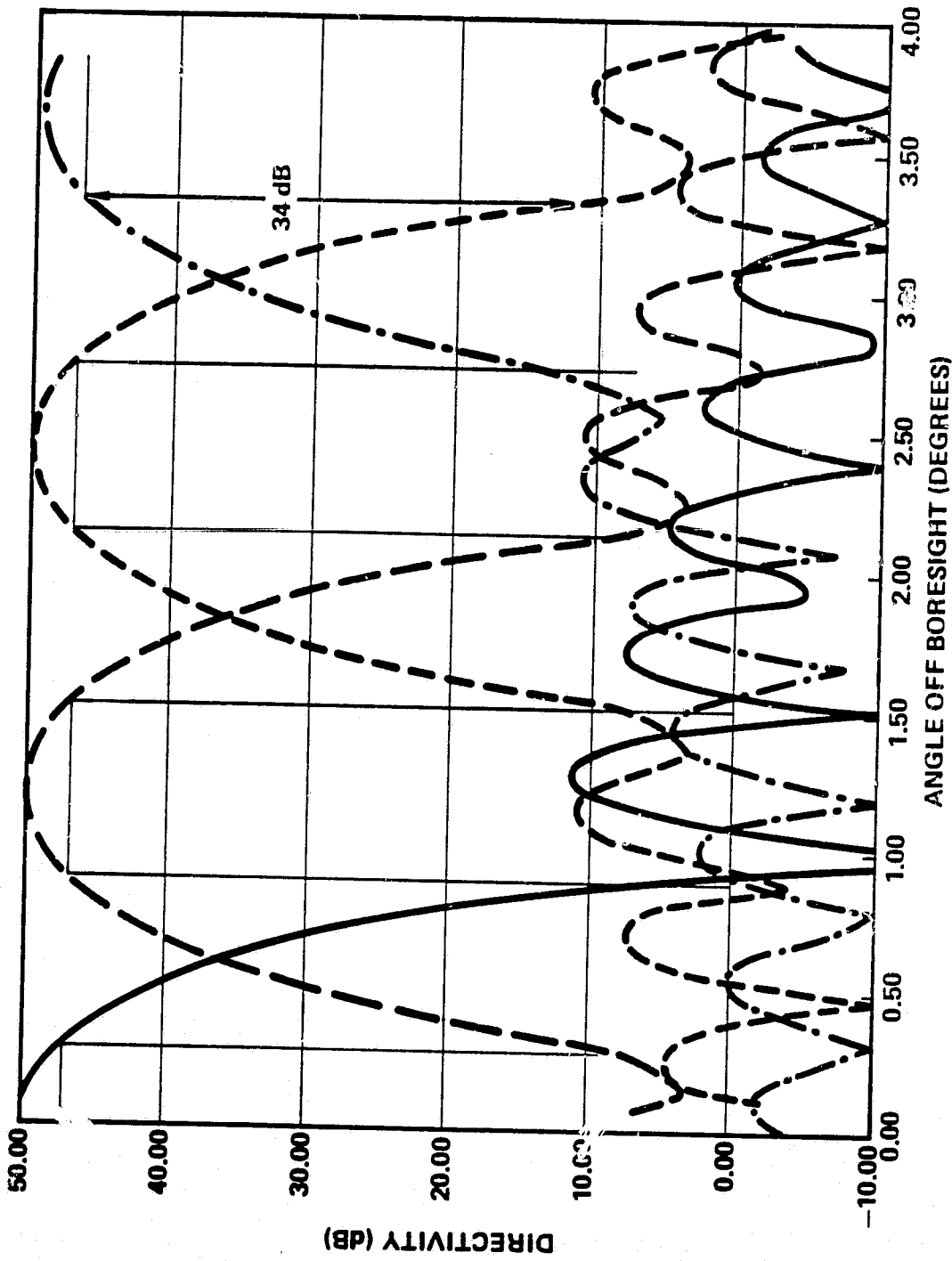
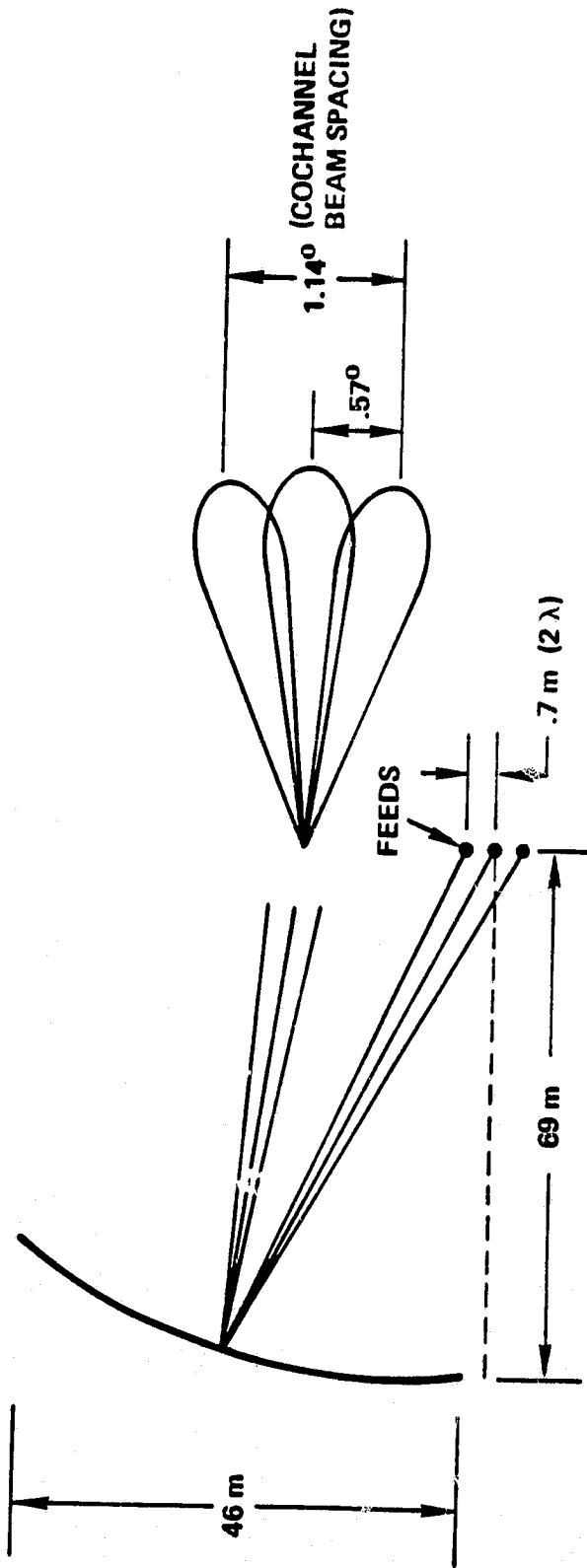

Figure 2-29. Co-channel 1-Beam Gain Patterns for Offset-Fed Antenna with 4-Frequency Sets

(4 FREQUENCY SETS)



ORIGINAL PAGE IS
OF POOR QUALITY

- LOW SIDELobe LEVELS REQUIRE A RELATIVELY HIGH-DIRECTIVITY FEED SYSTEM
- EDGE TAPER GREATER THAN 18 dB
- EFFECTIVE FEED DIMENSION GREATER THAN 4λ

Figure 2-30. Offset-Fed Antenna Schematic

ORIGINAL PAGE IS
OF POOR QUALITY

(A) SINGLE FEED PER BEAM

(B) OVERLAPPING FEED CLUSTERS

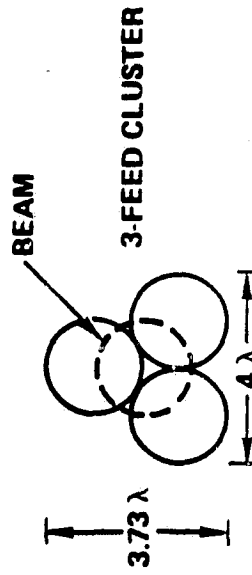
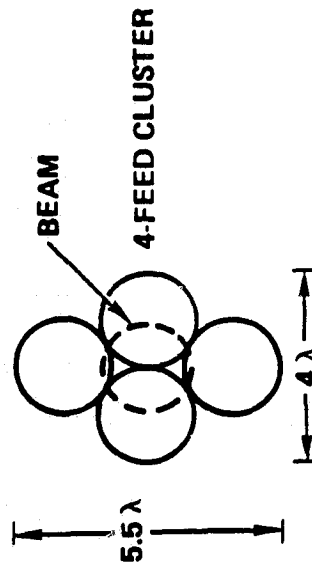
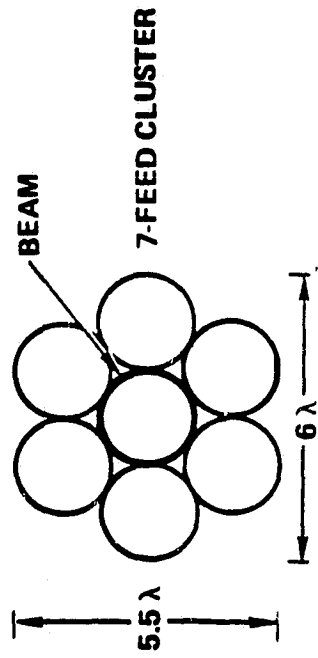
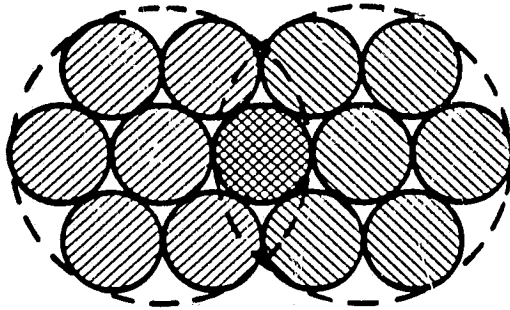

Figure 2-31. Feed Approaches for Offset-Fed Reflector

ORIGINAL PAGE IS
OF POOR QUALITY

(A) 7-FEED CLUSTER



CLUSTERS OVERLAP; CANNOT BE
USED WITH 4 FREQUENCY SETS

(B) 4-FEED CLUSTER

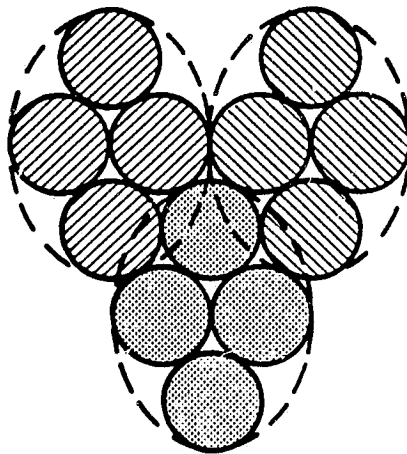

CLUSTERS DO NOT OVERLAP;
OK WITH 4 FREQUENCY SETS

Figure 2-32. Co-channel Feed Clusters for
4-Frequency-Set Beam Pattern

the cluster. Because of this interference, the 7-feed arrangement has been rejected for use with a 4-frequency-set system.

On the other hand, 4-feed clusters corresponding to co-channel beams have no elements in common. The same is true of 3-feed clusters. Consequently, both of these beamforming techniques are viable approaches.

Several single-feed-per-beam approaches can be considered, as shown in Figure 2-33. A drawback to the conventional endfire element is its required length of 8λ . The backfire antenna permits this length to be halved. This is truly a volume-antenna concept. As shown in Figure 2-34, 18-dBi directivity is attributable to the 4λ length of the endfire element. By cupping the design with a 2λ groundplane dimension, additional gain of 4 to 4.5 dB is generated.

The third single-feed-per-beam approach illustrated in Figure 2-33 assumes the form of an array. The array is self-contained in that no other beams share any of the elements. Further detail on one possible approach to the array concept is given in Figure 2-35. Note that the center element has a higher gain than the surrounding elements. This choice is predicated on reducing, to the extent possible, coupling between adjacent beams.

There are many antenna feed elements which could be used with the cluster formats. The most attractive choice, because of its versatility and efficiency, is the short backfire element (Figure 2-36). The short-backfire is essentially a dipole placed within a resonant cup. If additional gain is required, a passive director element can be added.

Presented in Figure 2-37 is the arrangement of backfire feeds in a 4-feed cluster. To determine RF acceptability of the concept, the feed patterns of Figure 2-38 were generated. It was found necessary to taper the power of the B elements and to add a small amount of phasing between the A and B elements. The result is a 24-dB illumination taper in curve 1 and a comparably effective taper in curve 2.

Use of a 3-feed cluster with an offset-fed reflector would require endfire gain. Pattern control would also be more difficult in this case than with the 4-feed cluster.

A qualitative comparison of the feed concepts is presented in Table 2-27. The various single-feed-per-beam approaches have the highest risk

ORIGINAL PAGE IS
OF POOR QUALITY

• CONVENTIONAL ENDFIRE-ANTENNA FEED

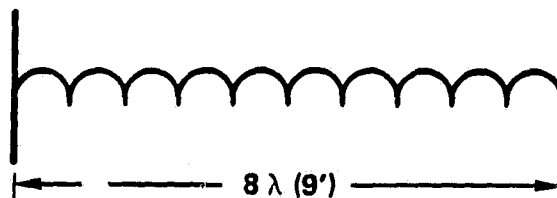

• BACKFIRE-ANTENNA FEED

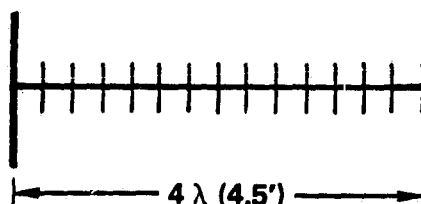

• ARRAY FEED

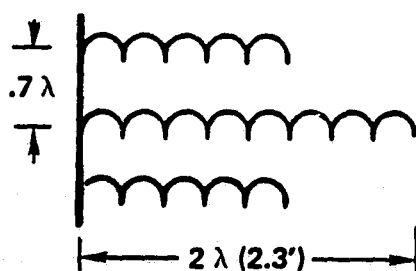
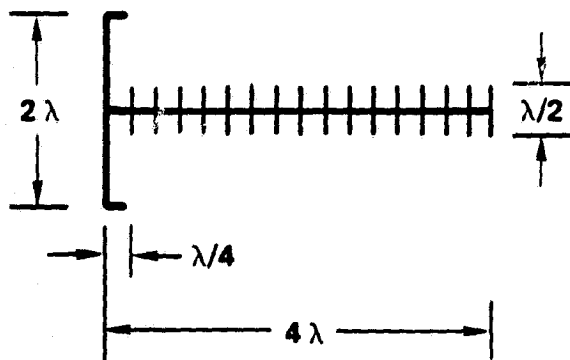

Figure 2-33. Single-Feed-Per-Beam Approaches
for Offset-Fed Reflector

ORIGINAL PAGE IS
OF POOR QUALITY



- BACKFIRE-ANTENNA YAGI CONFIGURATION
- DIRECTIVITY ~ 22 dBi
- INDIVIDUAL YAGI 18 dBi + BACKFIRE INCREASE OF 4 dB

Figure 2-34. Backfire Feed Design for Offset-Fed Reflector

ORIGINAL PAGE IS
OF POOR QUALITY.

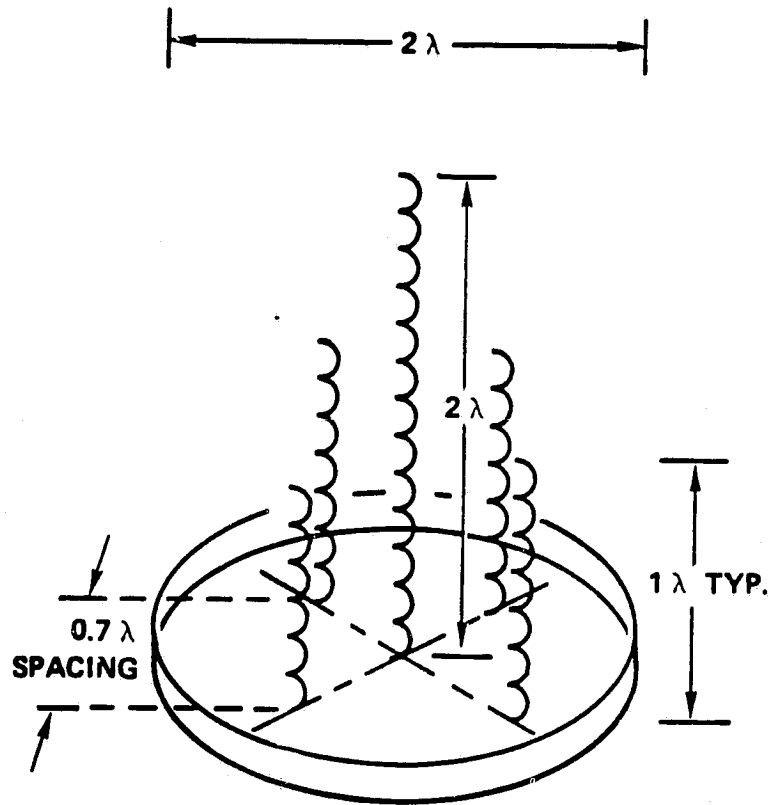

5 ELEMENT HELICAL ARRAY

DIRECTIVITY ~ 22 dBi

Figure 2-35. Single-Feed-Per-Beam Helical Array
for Offset-Fed Reflector

ORIGINAL PAGE IS
OF POOR QUALITY

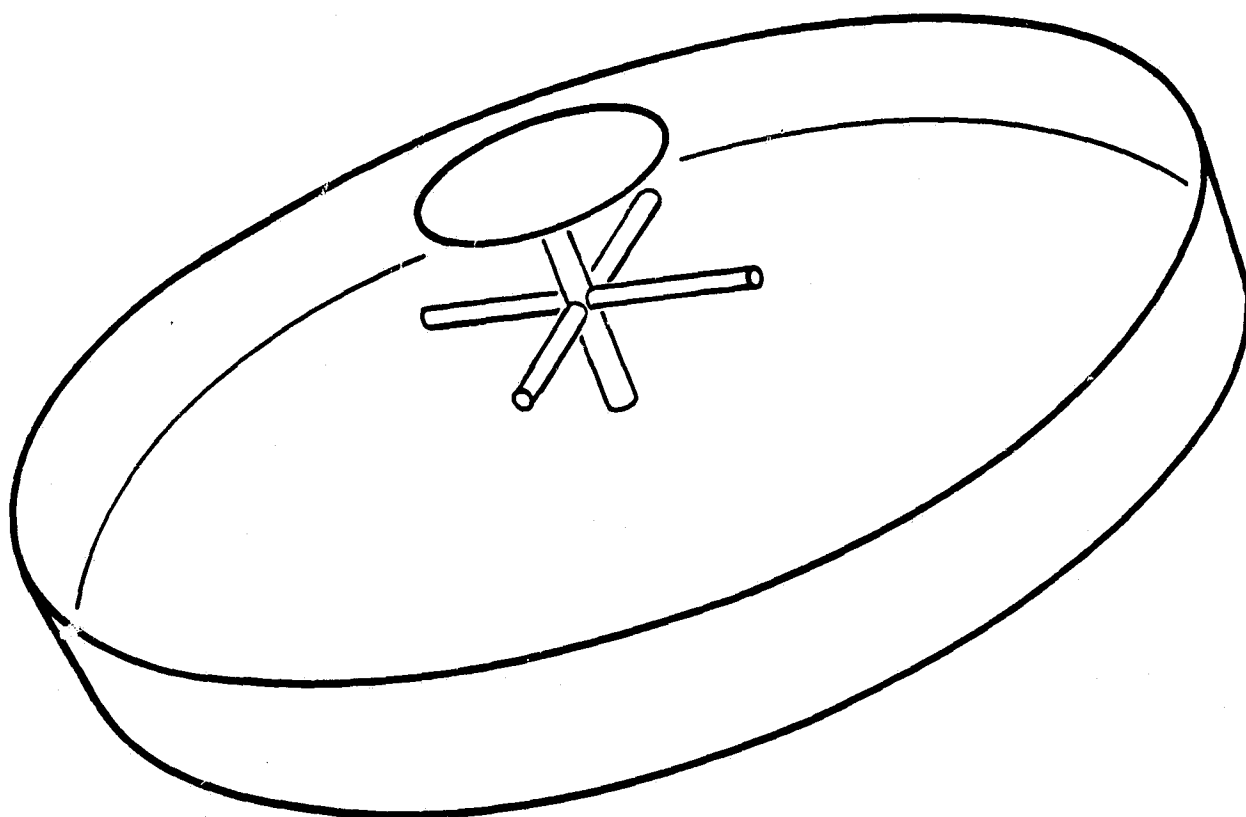

Figure 2-36. Short-Backfire Element

ORIGINAL PAGE IS
OF POOR QUALITY

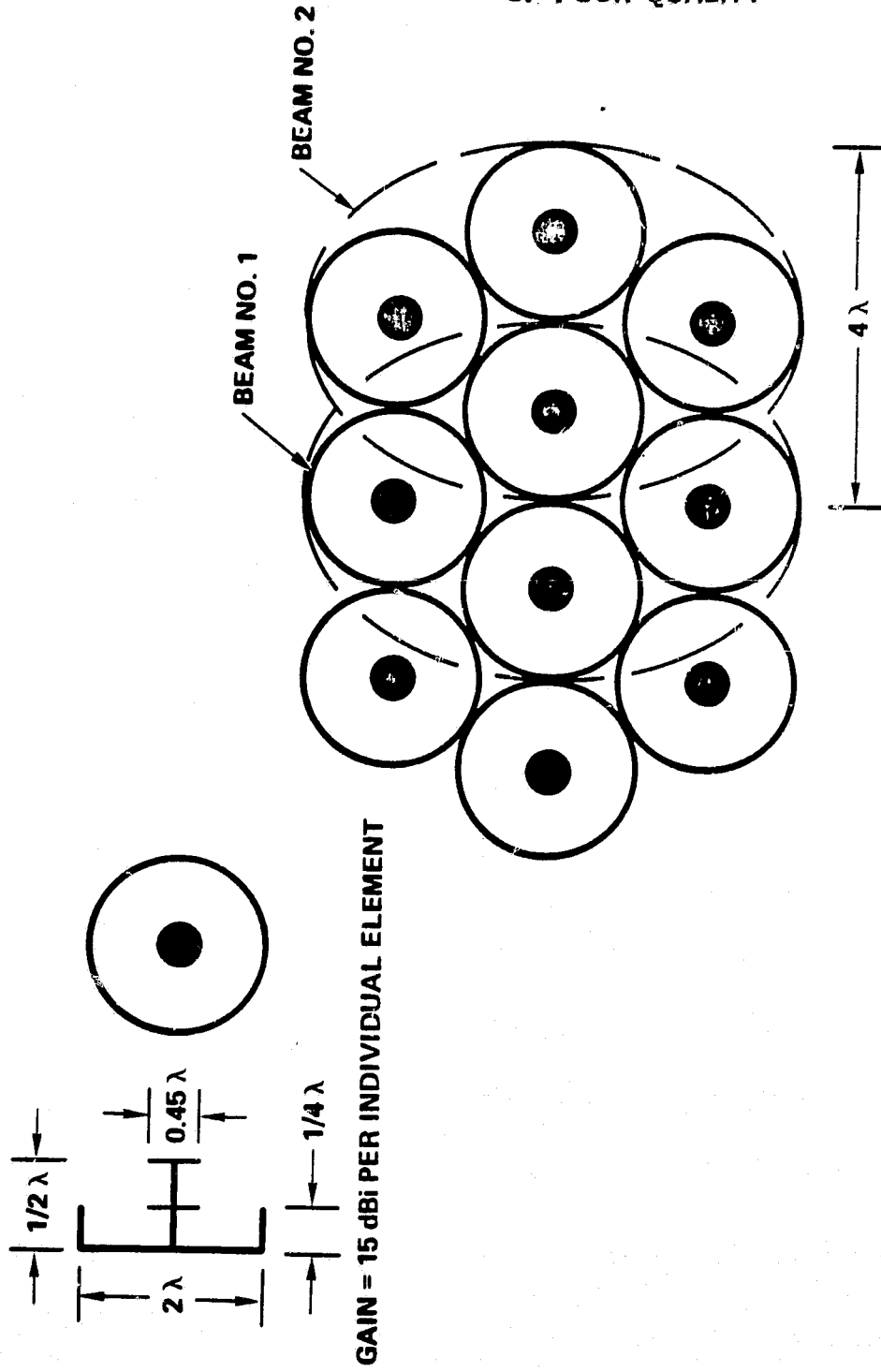
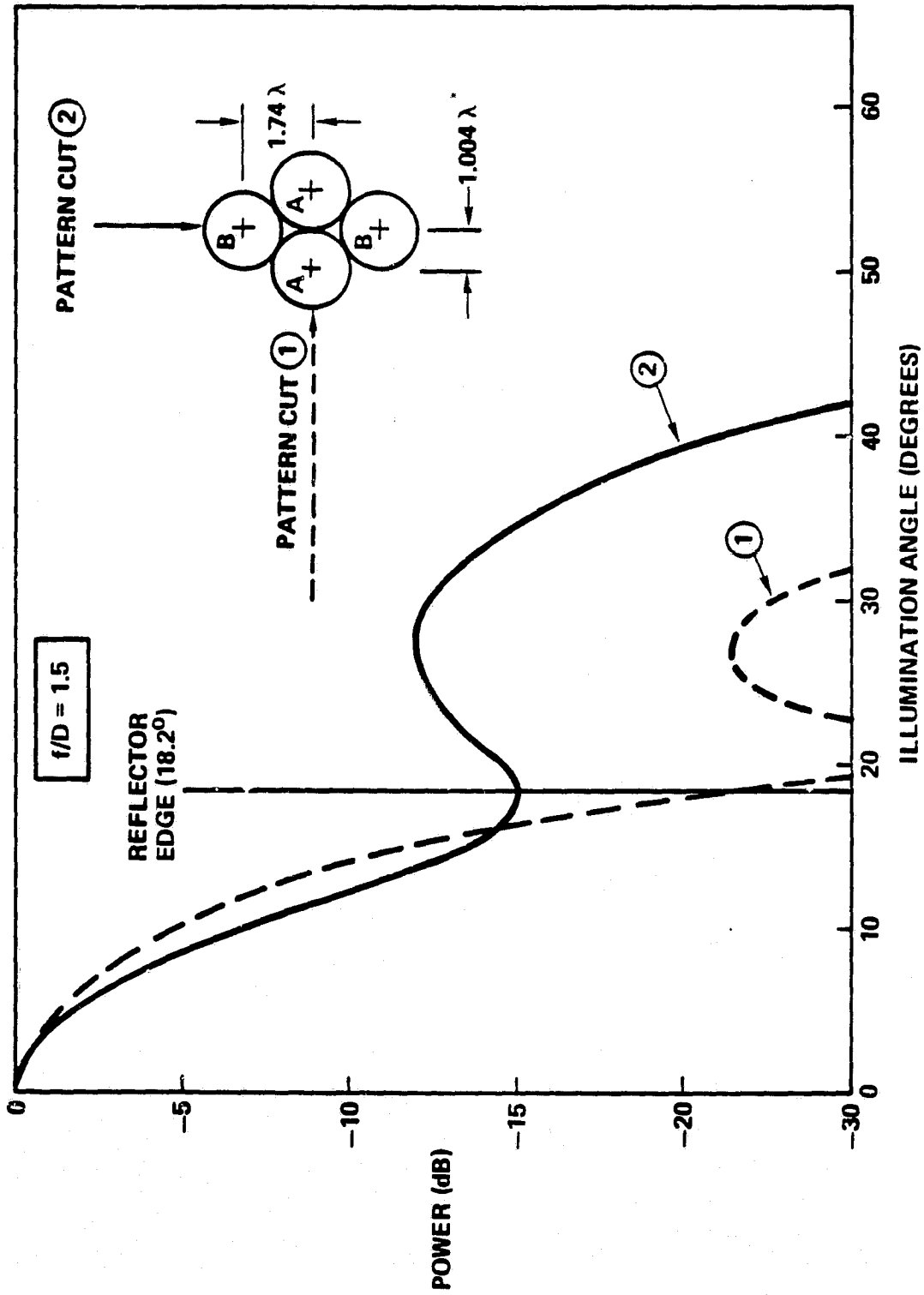

Figure 2-37. Short-Backfire 4-Element Cluster
for Offset-Fed Reflector



NOTE: RELATIVE FEED EXCITATIONS ARE $E_A=1$, $E_B=0.6$ /10°

Figure 2-38. Typical Illumination Pattern
for 4-Feed Cluster

Table 2-27. Summary Comparison of Feed Approaches for Offset-Fed Reflector

	<u>RISK ASSESSMENT</u>	<u>COMMENT</u>
<ul style="list-style-type: none"> ● SINGLE FEED PER BEAM <ul style="list-style-type: none"> — ENDFIRE FEED — BACKFIRE FEED — ARRAY FEED 	<p>HIGHEST</p> <p>HIGH</p> <p>HIGH</p>	<p>MUTUAL-COUPLING EFFECT ON SIDELOBES</p>
<ul style="list-style-type: none"> ● CLUSTERED FEED <ul style="list-style-type: none"> — SHORT-BACKFIRE, 4-FEED CLUSTER — 3-FEED CLUSTER 	<p>LOW</p> <p>MEDIUM</p>	
<ul style="list-style-type: none"> ● SELECTED APPROACH: SHORT-BACKFIRE, 4-FEED CLUSTER 		

ORIGINAL PAGE 19
OF POOR QUALITY

from the standpoint of sidelobe control. The lowest risk is associated with the 4-feed cluster. Therefore, this configuration was selected for the 4-frequency-set, offset-fed baseline. The transmit beamformer schematic associated with the 4-feed cluster is shown in Figure 2-39.

2.6.3 7-Frequency-Set, Center-Fed Baseline

A CONUS-coverage, 7-frequency-set beam pattern is presented in Figure 2-40. In this case, the 0.48-degree HPBW is larger than the 0.42 degree HPBW associated with a 62-meter reflector. To model the baseline situation more accurately, a fictitious fourth beam assigned frequency set #1 has been added along the indicated pattern cut. Consideration of this last beam is equivalent to a reduction in HPBW.

Gain patterns for the shaded co-channel beams in Figure 2-40 are shown in Figure 2-41 for a center-fed antenna system. The first observation is that comalobe interference is not a factor. This is the result of the 2.65-HPBW spacing rather than the 2-HPBW spacing in the 4-frequency-set case. The increased beam spacing also eliminates mainlobe interference. Thus, only the ambient sidelobe levels are of concern. In all cases, individual interferers are at least 27 dB below the desired signal.

While this single-interferer level does not quite meet the 30-dB design goal, an argument can be made that the system interference allocation of -17 dB with respect to the desired signal will still be satisfied. It can be seen from Figure 2-41 that the two neighboring co-channel beams produce comparable amounts of interference. Thus, from the radial pattern cut alone, the interference can be as high as 24 dB below the desired signal. There are four other neighboring co-channel beams lying outside the plane of this cut. Even if the latter beams make equal interference contributions at the user locations in Figure 2-41 where the interference is a maximum, the desired signal at these locations would be 19 dB above the combined interference level.

Although this calculation indicates a margin of only 2 dB against departures from the mathematical model, note that 6 equal interferers were assumed. This, in itself, is pessimistic. If 5 of the interferers should assume the maximum theoretical value, the sixth could increase by 7 dB without causing the system allocation to be exceeded. Alternatively,

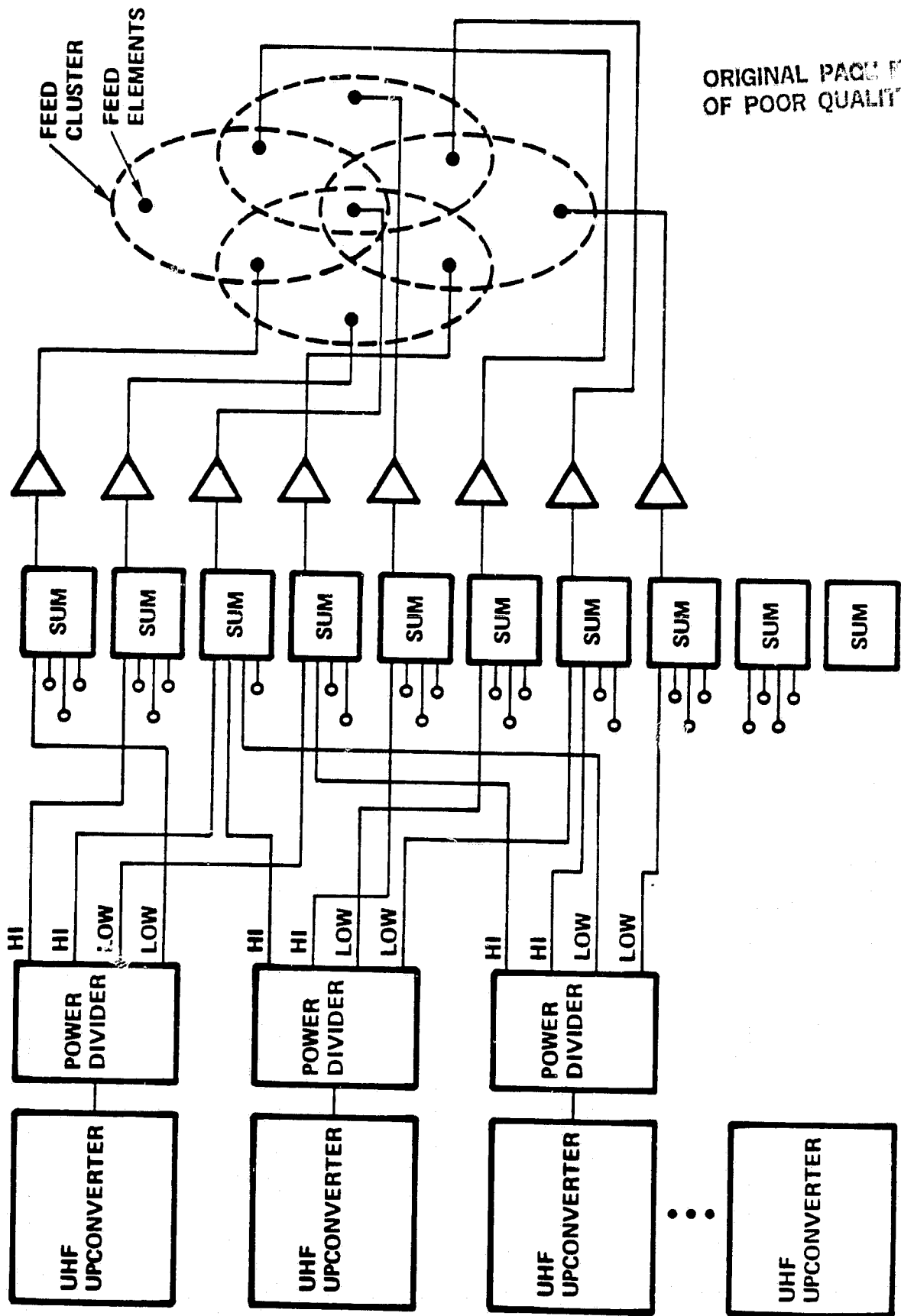
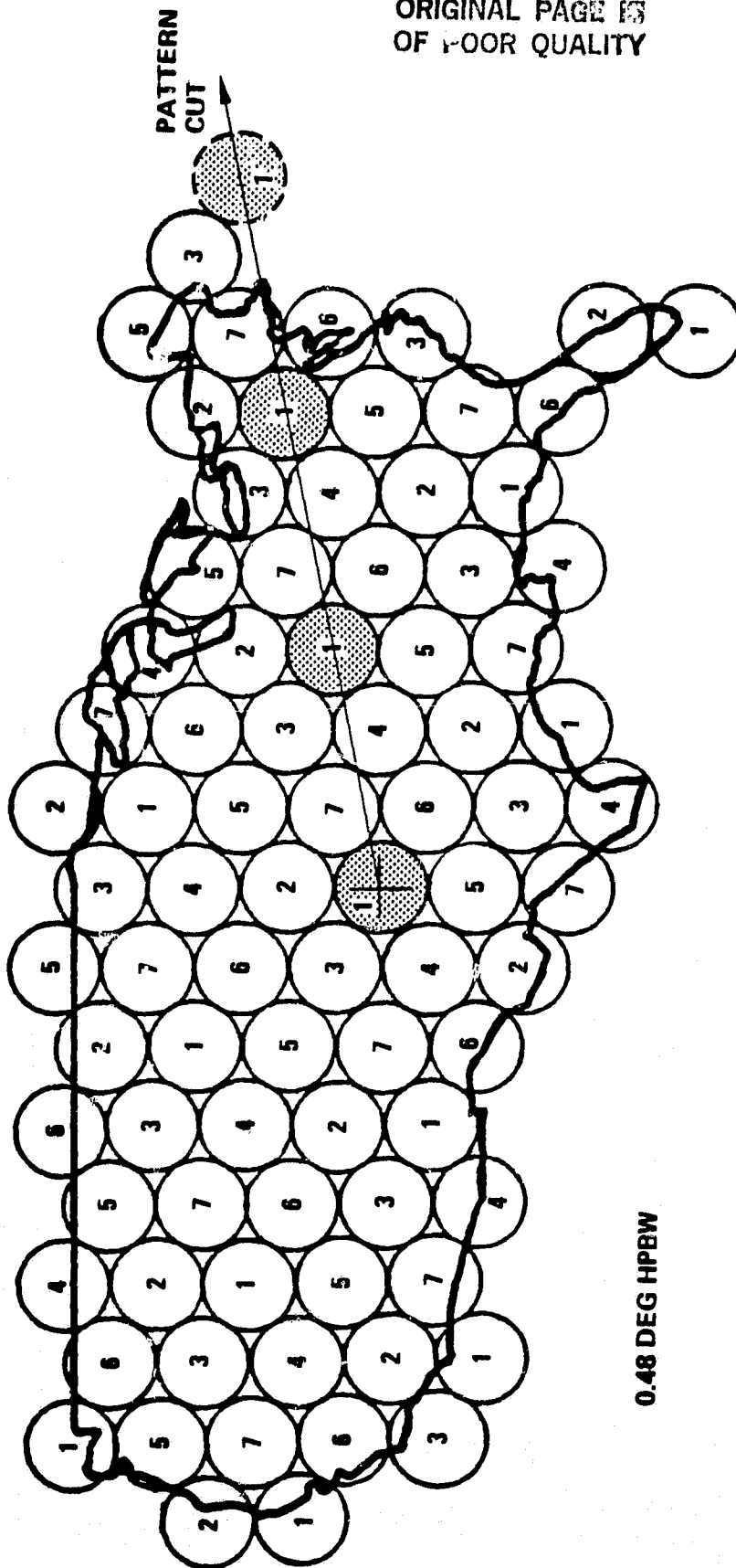

Figure 2-39. Transmit Beamformer Schematic for 4-Feed Cluster

ORIGINAL PAGE IS
OF POOR QUALITY



0.48 DEG HPBW

Figure 2-40. 7-Frequency-Set Beam Pattern

ORIGINAL PAGE IS
OF POOR QUALITY

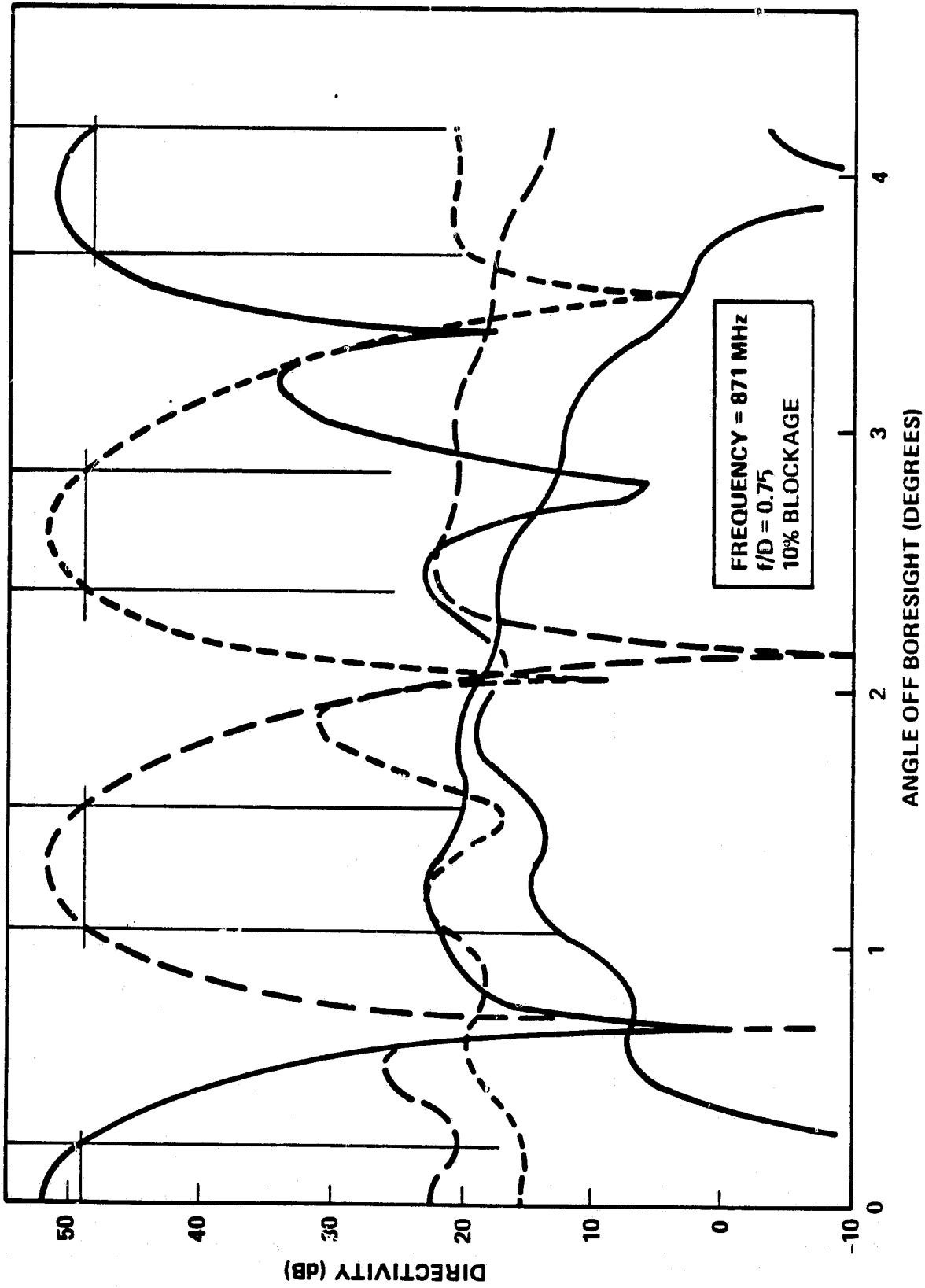

Figure 2-41. Co-channel-Beam Gain Patterns for
Center-Fed Antenna with 7-Frequency Sets

if 4 of the interference levels are fixed at this value, a 5-dB increase in each of the remaining 2 is acceptable, etc. Thus, there is good reason to believe that a 7-frequency-set, center-fed design will prove workable.

The center-fed antenna design schematic is shown in Figure 2-42. The feed-element spacing for contiguous HPBW beams is λ . As before, however, a larger feed dimension is required for sidelobe control, in this case 2λ . Feed approaches for the center-fed design are shown in Figure 2-43. For a single-feed-per-beam approach using an endfire element, an element length of 3λ is required. A backfire feed would require a 2λ -diameter groundplane and is therefore not suitable for this application. The other configurations considered are the 4-feed cluster and the 7-feed cluster.

A typical 4-feed cluster approach is shown in Figure 2-44. To achieve good illumination-pattern control, it is necessary to lower the power to the top and bottom feeds. When this is done, it is discovered that slightly more individual-element gain is needed to provide the required illumination taper. The additional gain is provided by the helices shown in the figure.

A 7-feed cluster design is presented in Figure 2-45. The design contains the microstrip antenna patch elements made by Ball Aerospace and suggested by JPL for use in 4-patch combinations (Reference 2-2). By controlling the amplitude of the excitation to the patch elements, the desired illumination taper can be achieved.

A qualitative comparison of the different approaches to the feed design problem is presented in Table 2-28. A single-feed-per-beam approach is very risky in terms of sidelobe control. Both of the clustered feed approaches are workable. The 4-feed cluster has a much simpler beamformer than the 7-feed cluster. However, inasmuch as some endfire gain is necessary in the 4-feed approach, the mechanical implementation is more difficult than with the microstrip design. Primarily because of the mechanical feed considerations and the illumination control versatility offered by the 7-feed design, the latter approach was selected.

(7 FREQUENCY SETS)

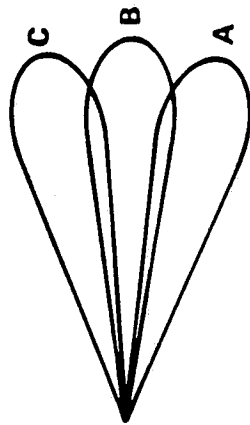
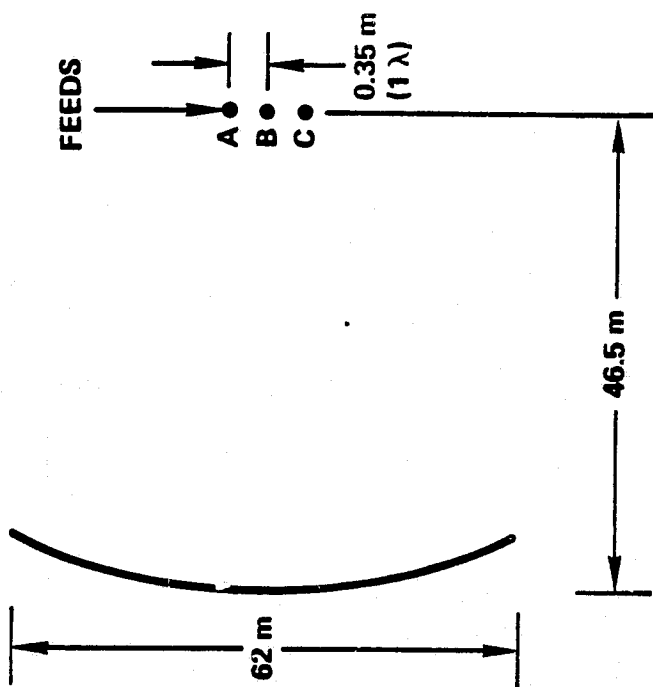

ORIGINAL PAGE IS
OF POOR QUALITY

- LOW SIDELobe LEVELS REQUIRE A RELATIVELY HIGH-DIRECTIVITY FEED SYSTEM
- EDGE TAPER GREATER THAN 18 dB
- EFFECTIVE FEED DIMENSION GREATER THAN 2λ

Figure 2-42. Center-Fed Antenna Schematic

ORIGINAL PAGE IS
OF POOR QUALITY

(A) SINGLE-FEED-PER-BEAM, ENDFIRE ANTENNA



(B) OVERLAPPING FEED CLUSTERS

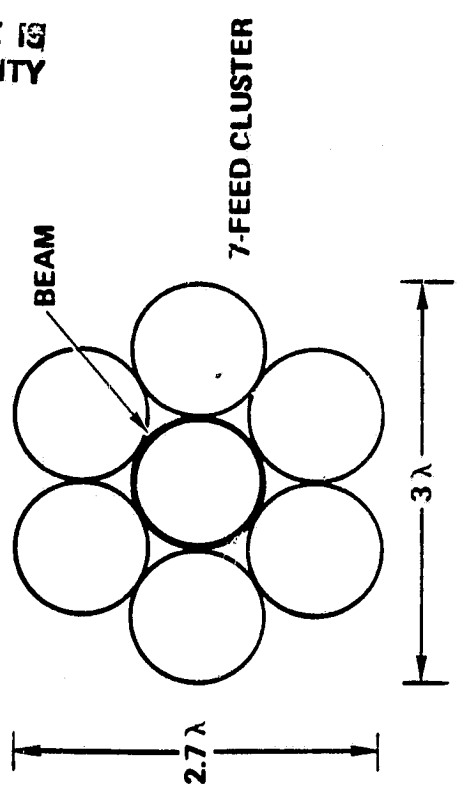
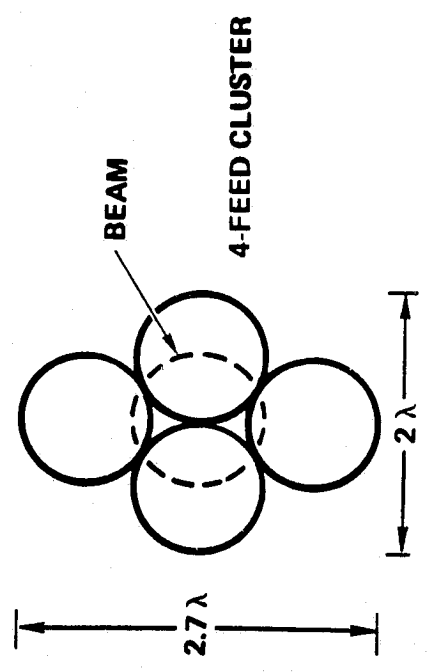
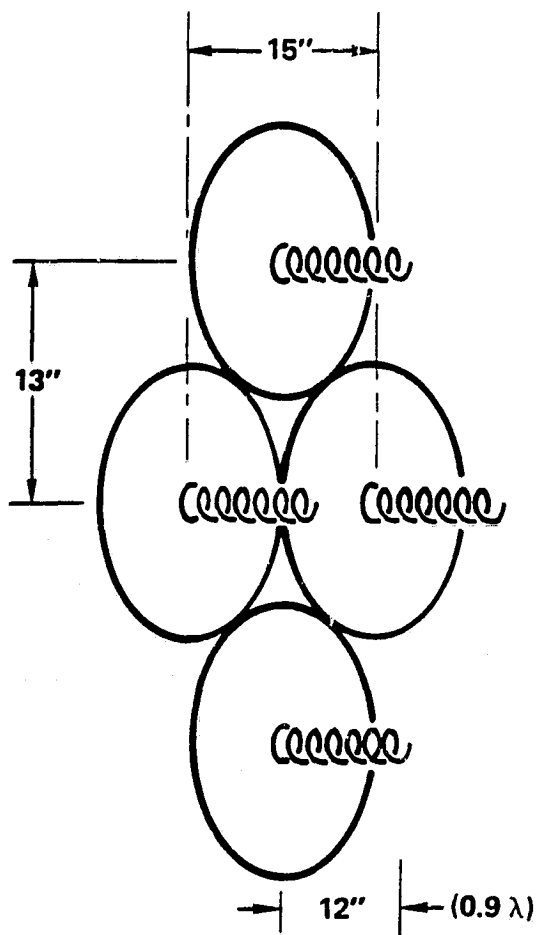

Figure 2-43. Feed Approaches for Center-Fed Reflector

ORIGINAL PAGE IS
OF POOR QUALITY



- ADDITIONAL ELEMENT GAINS, UTILIZING THIRD DIMENSION, ARE REQUIRED TO ACHIEVE THE NECESSARY TAPER

Figure 2-44. 4-Element Cluster for Center-Fed Reflector

ORIGINAL PAGE IS
OF POOR QUALITY

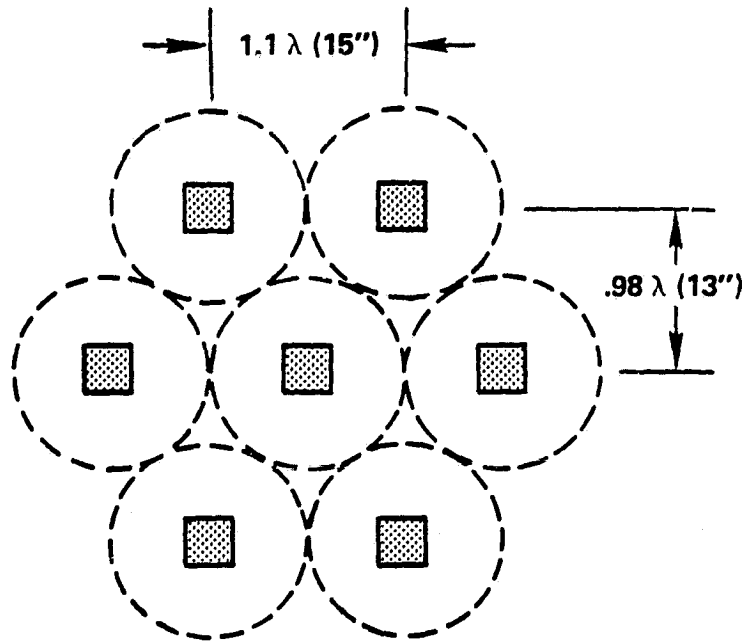

- MICROSTRIP ELEMENTS
- 7 INDIVIDUAL ELEMENTS PER BEAM
- CENTER ELEMENT RECEIVES 79% OF POWER
- EACH OUTER ELEMENT RECEIVES 3.5% OF POWER
- ALL ELEMENTS FED IN PHASE

} JPL

Figure 2-45. 7-Element Cluster for Center-Fed Reflector

Table 2-28. Summary Comparison of Feed Approaches for Center-Fed Reflector

- SINGLE FEED PER BEAM

ANTENNA FEED-ELEMENT LENGTH AND SPACING MAKE MUTUAL COUPLING A HIGH RISK FACTOR IN MAINTAINING GOOD SIDELobe CONTROL

- CLUSTERED-FEED APPROACHES

- 4-ELEMENT HELICAL ARRAY

- WORKABLE SOLUTION
- LESS COMPLEX BEAMFORMER
- MORE DIFFICULT MECHANICAL IMPLEMENTATION

- 7-ELEMENT MICROSTRIP ARRAY

- WORKABLE SOLUTION
- MOST COMPLEX BEAMFORMER
- LESS DIFFICULT MECHANICAL IMPLEMENTATION

- SELECTED APPROACH: 7-ELEMENT MICROSTRIP ARRAY

2.7 SATELLITE CONFIGURATIONS AND CONTROL DYNAMICS

The STS bay length available to the satellite depends on the OTV dimensions. The baseline configurations are based on use of an IPS-type of OTV. The weight and length of an IPS upper-stage are shown in Figure 2-46. Based on the projected STS lift capability of 65,000 pounds, the maximum payload weight is 10,400 pounds. The IPS length for this maximum payload is 12.5 feet.

Deployed and stowed configurations for the baseline satellite designs are displayed in this section, together with stages in the deployment sequence.

An error budget for satellite attitude control is developed for the offset-fed configuration, which presents the more difficult design problem. Various methods of controlling satellite pointing to the required accuracy are presented, and the baseline preference indicated.

2.7.1 Satellite Configurations

The center-fed satellite configuration is shown in Figure 2-47. The bus is separated from the feed assembly by about 5 feet to allow for feed-panel stowage and heat dissipation. A 3-meter Ku-band antenna is located in front of the bus. The solar-array mast is chosen long enough to avoid reflector sun obscuration. A single solar array (rather than a balanced pair) was chosen to bias the satellite principal inertia axis toward the desired pointing direction, typically taken as Kansas City. By this means, the gravity gradient imbalance is reduced to 3 degrees from the 6 degrees that would result from a balanced design. The RCS thrusters/propellants are the only other items not in the main bus.

Stowage of the center-fed configuration in the STS cargo bay is shown in Figure 2-48. A margin of 9 feet is realized, after allowing for a 13-foot OTV (IPS). As shown, the antenna stows in a linear manner, with 2 folds in the feed. Deployment is accomplished, therefore, simply by extending the mast and unfurling the reflector.

The offset-fed satellite configuration is shown in Figure 2-49. There exists a 16-degree gravity-gradient imbalance of the principal inertia axis. This imbalance has been minimized by shortening the solar-array mast relative to the length required to avoid shadowing by the reflector. The

ORIGINAL PAGE IS
OF POOR QUALITY

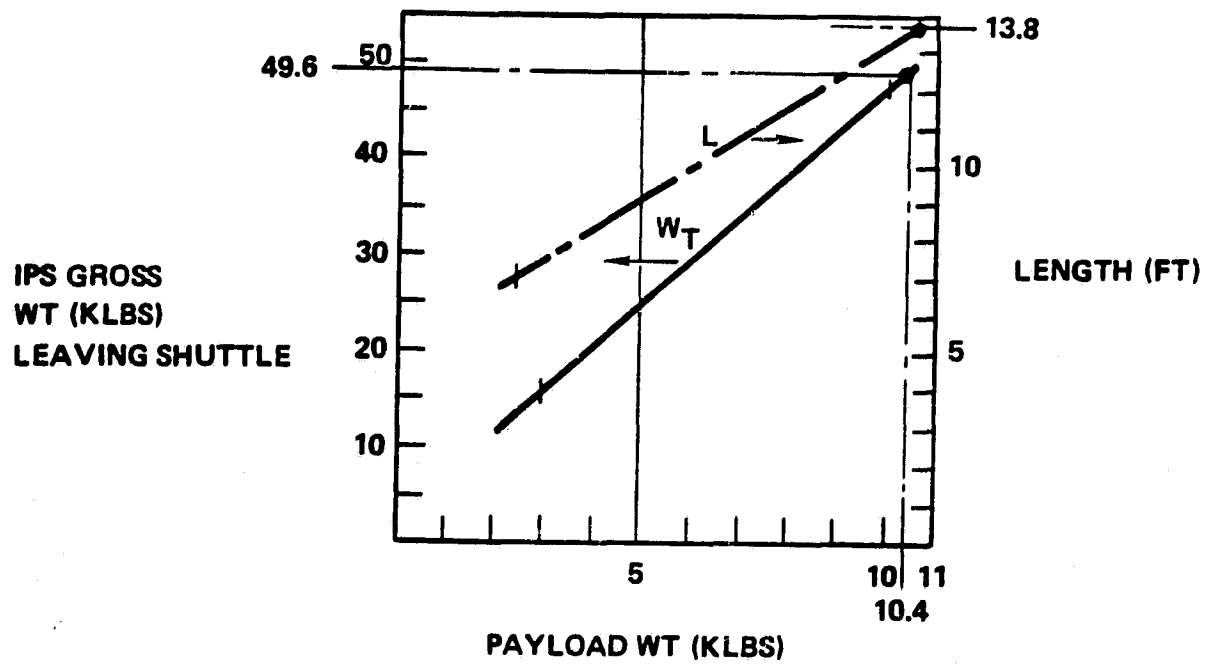

- NOTES: - 65,000 LBS STS LIFT CAPABILITY
- 5,000 LBS ASE AND RESERVES

Figure 2-46. Integral Propulsion System (IPS)
Weight and Length in STS Cargo Bay

ORIGINAL PAGE IS
OF POOR QUALITY

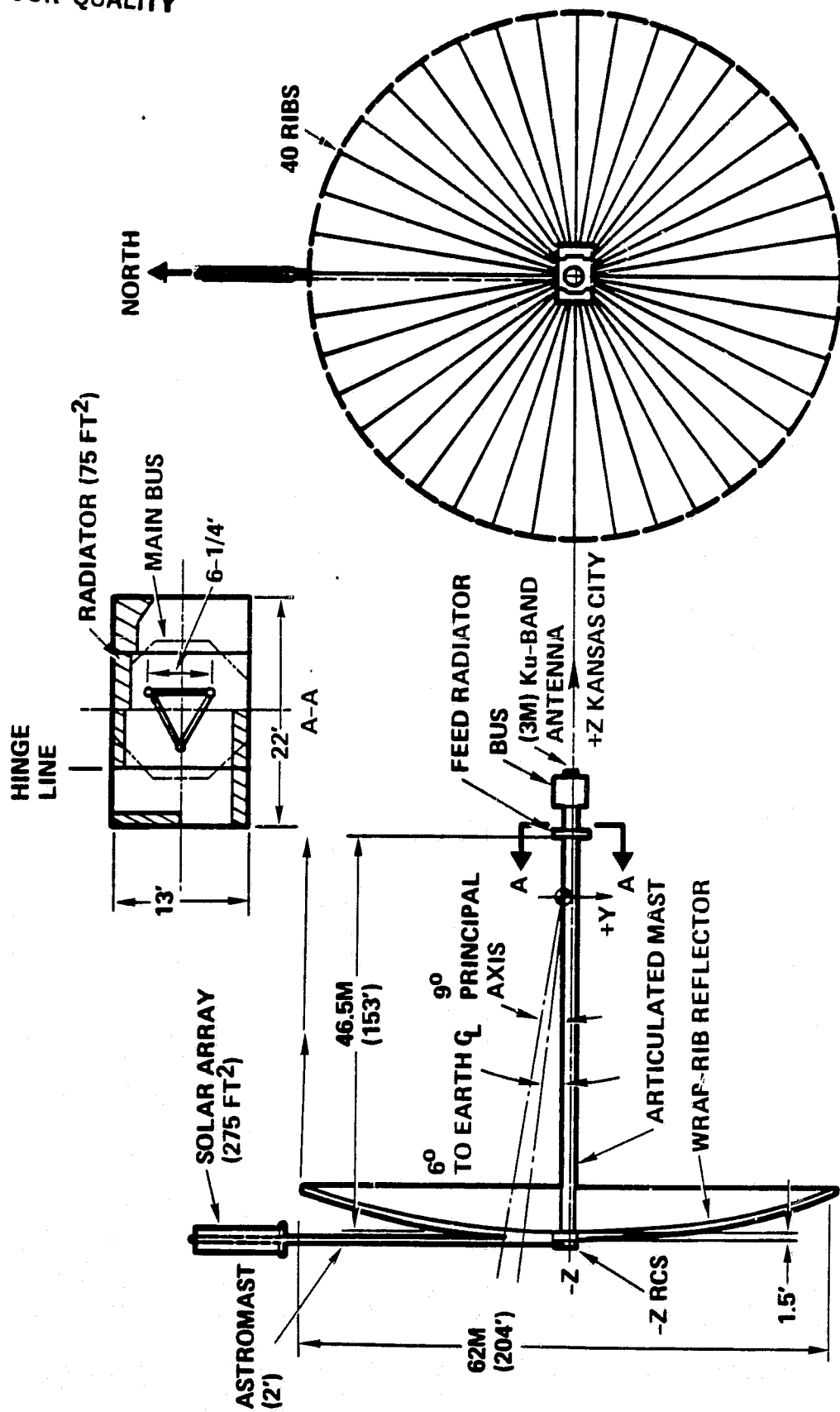

Figure 2-47. Center-Fed Satellite Configuration

ORIGINAL PAGE IS
OF POOR QUALITY

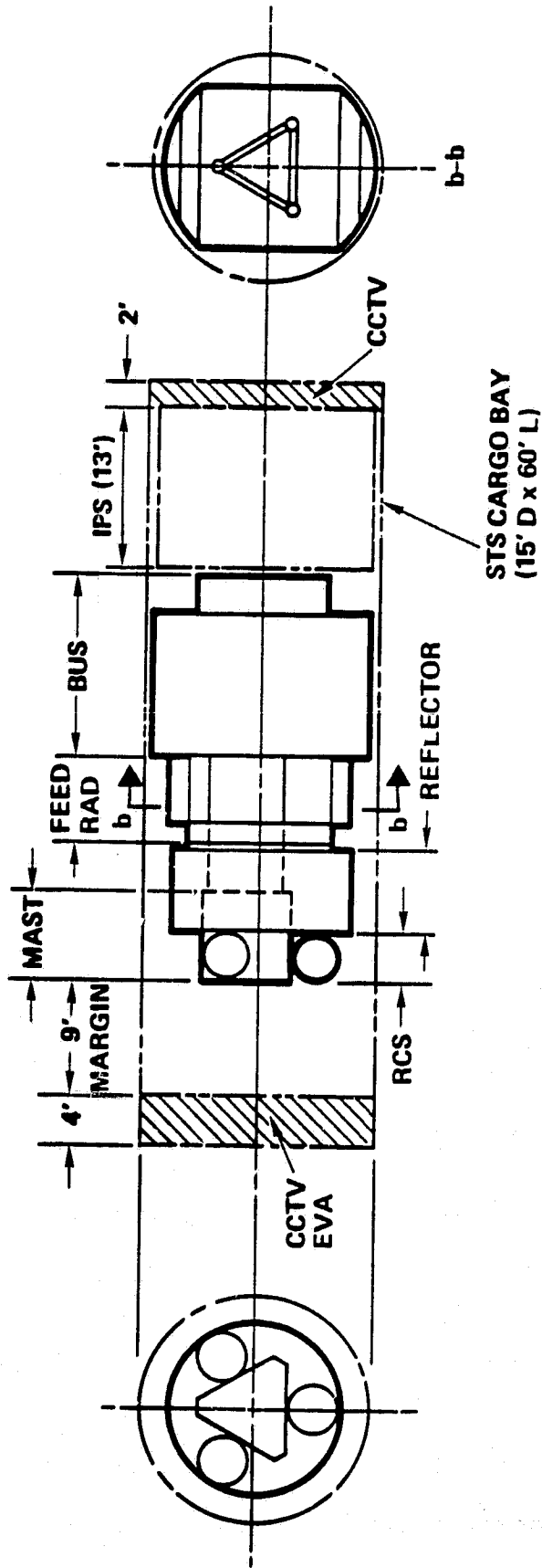

Figure 2-48. Center-Fed Satellite Stowed in STS Cargo Bay

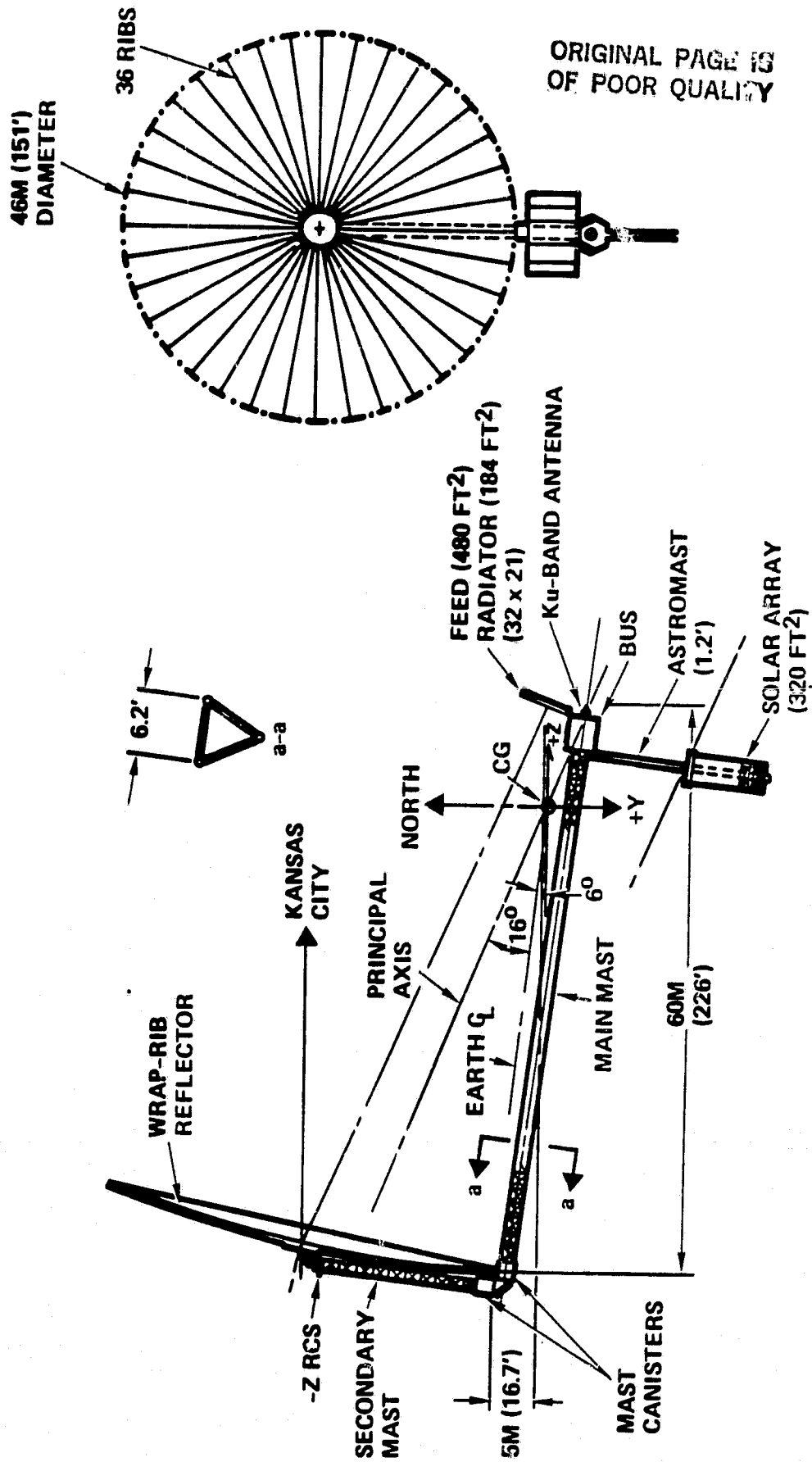

Figure 2-49. Direct Offset-Fed Satellite Configuration

resulting shadowing is compensated by the eclipse capability designed into the electrical power system.

Stowage and deployment concepts for the offset-fed design are depicted in Figures 2-50 and 2-51. By coincidence, the 9-foot cargo-bay margin is identical to that previously found for the center-fed design.

2.7.2 Control Dynamics

Factors affecting satellite pointing accuracy and RF properties of the transmissions are listed in Figure 2-52, together with the error budgeted for each one. The allowances for defocusing and reflector surface distortions are stated as fractions of a wavelength. Corresponding losses in directivity are indicated. However, the significant RF effect of these distortions is measured by the change in sidelobe level. It is believed that the sidelobe effects associated with the stated directivity losses will prove acceptable. Nevertheless, further investigation is required to verify this fact.

The remainder of this discussion will focus on the pointing requirements. The pointing error budget of 0.12 degree corresponds to slightly more than 1/5-HPBW shift of the beam pattern for the offset-fed baseline antenna design. This allowance is not unduly stringent for current LSST active controls technology.

The satellite's first dynamic mode is torsional. Distortions of this type lead to a decentering effect between feed and reflector. For the disturbances shown in Figure 2-53, decentering amounts to approximately 0.2 degree. With the addition of manufacturing and thermal effects, total decentering is about 0.4 degree. This is more than three times the allowed pointing error. Additionally, static and dynamic angular distortions, if uncorrected, would contribute 0.2 degree to the pointing error.

ACS approaches to offset these distortions range from an overall satellite pointing correction to various feed/reflector gimbal concepts, as indicated in Figure 2-54. Choice of the former as the baseline approach is based on the satellite torsional frequency response (expected to lie in the range from 0.05 to 0.1 Hz) being significantly higher than the frequency of the disturbance. This leads to long-term decentering forces, somewhat

ORIGINAL PAGE 19
OF FOUR QUALITY

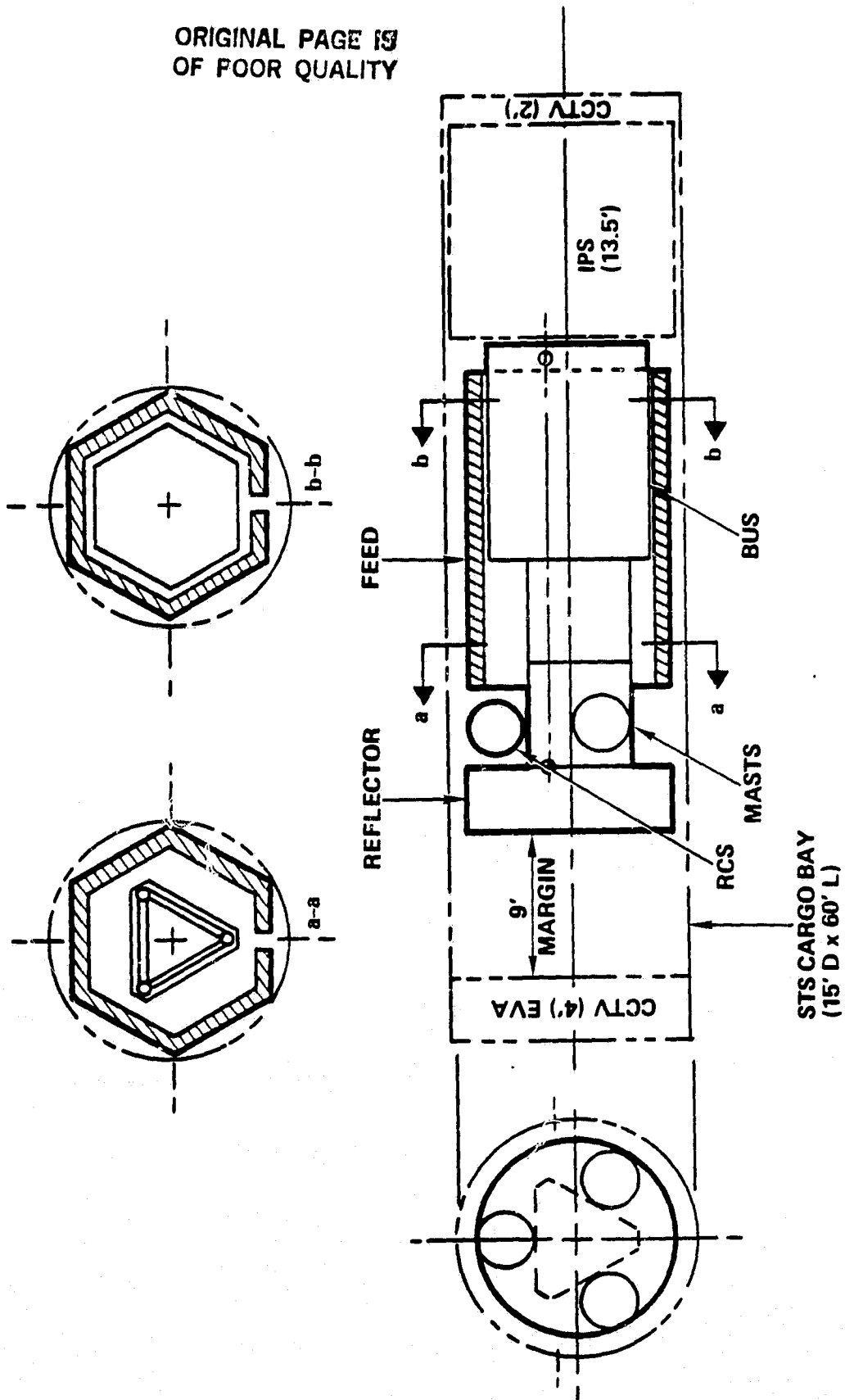

Figure 2-50. Direct Offset-Fed Satellite
Stowed in STS Cargo Bay

ORIGINAL PAGE IS
OF POOR QUALITY

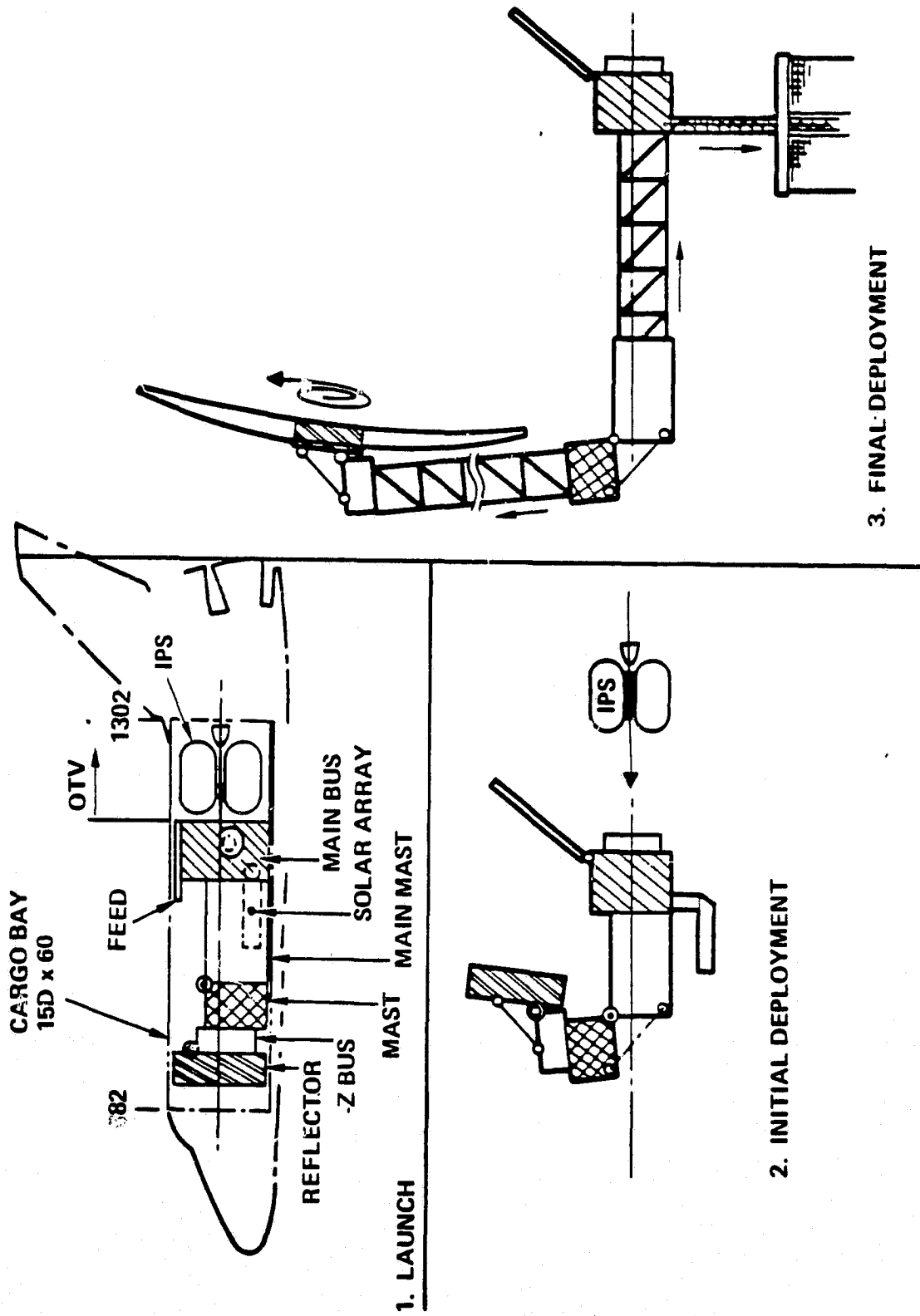
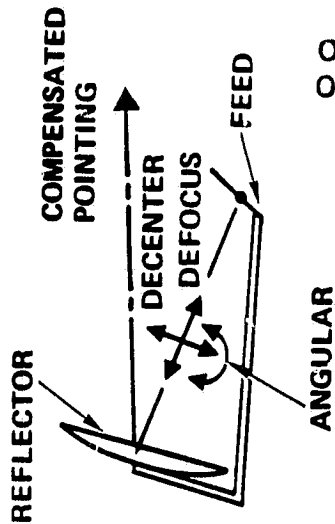

Figure 2-51. Satellite Deployment Concept for Offset-Fed Configuration

	NET BUDGET	ALLOCATION		
		MFG, THERMAL	DYNAMIC	ACS
<ul style="list-style-type: none"> • POINTING <ul style="list-style-type: none"> - ACS • CONTROL • STABILITY - DECENTER (LATERAL) - ANGULAR 	0.12 ^{dB}	-	-	0.09° 0.03°
<ul style="list-style-type: none"> • DEFOCUS (LONGITUDINAL) 	$\lambda/2 = 6.5$ IN. (0.15 ϵ^2 GAIN LOSS)	*0.2° $\lambda/3 = 4.5$ IN.	*0.2° $\lambda/3 = 4.5$ IN.	-
<ul style="list-style-type: none"> • SURFACE ACCURACY 	$\lambda/8 = 1.6$ IN. (0.20 dB GAIN LOSS)	*0.1° $\lambda/10 = 1.3$ IN.	*0.1° $\lambda/12 = 1$ IN.	-

(*COMPENSATED BY ATTITUDE CONTROL SUBSYSTEM (ACS) RESOLVER)



ORIGINAL PAGE IS OF POOR QUALITY

Figure 2-52. Satellite Structural and Control Error Budget (Typical Values for Offset-Fed Configuration)

ORIGINAL PAGE IS
OF POOR QUALITY

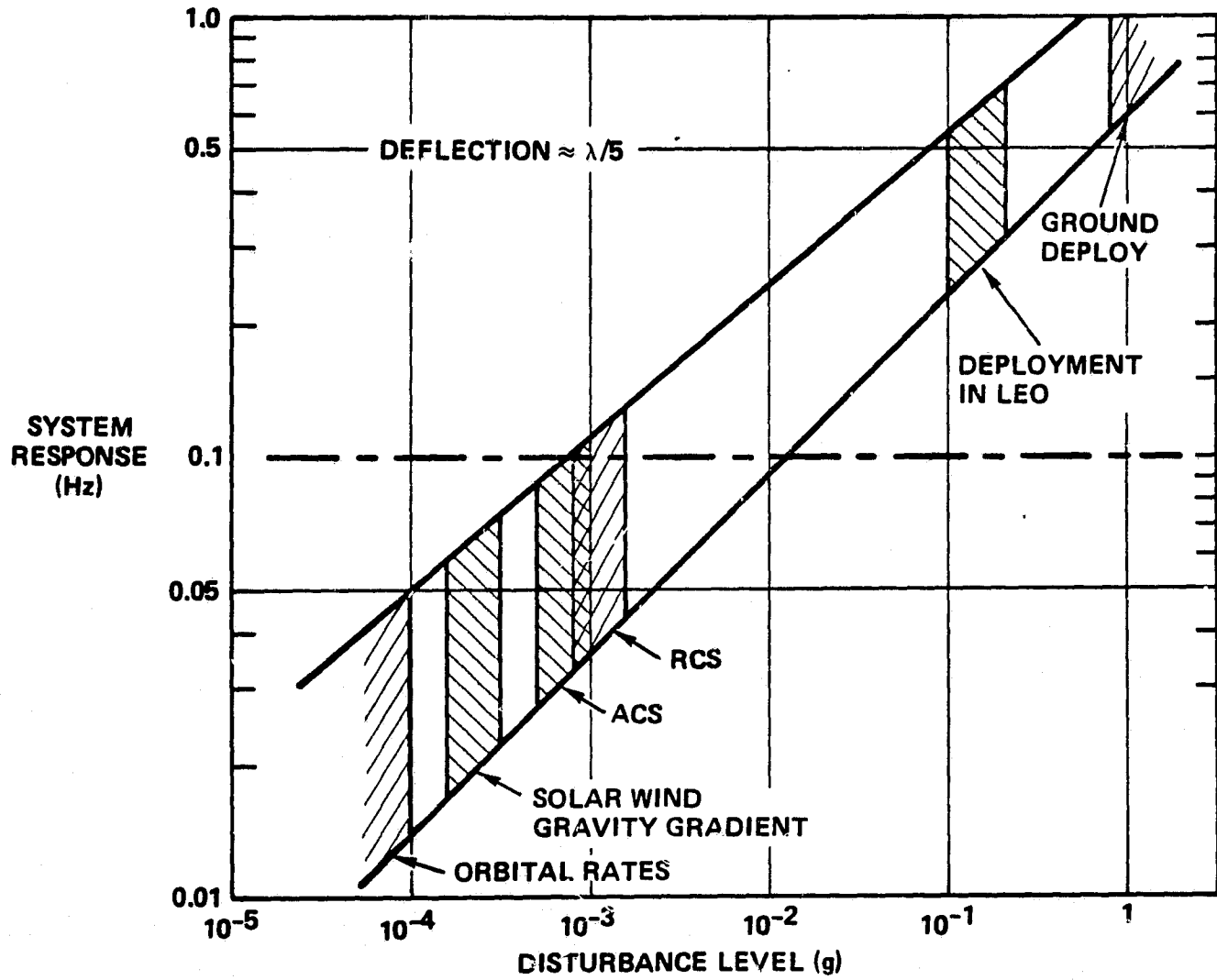
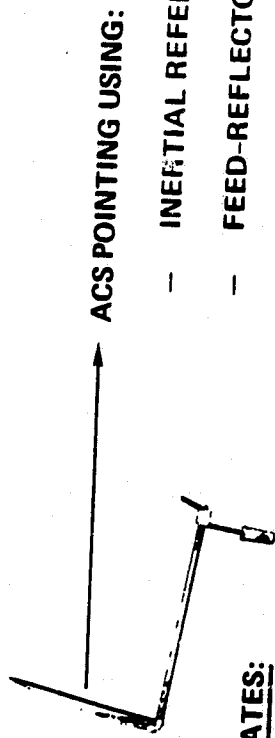

Figure 2-53. System Stiffness Requirements for Offset-Fed Configuration

BASELINE:



COMMENTS

SIMPLIFIED SYSTEM.
MAY BE TRACKING LIMITED

ALTERNATES:

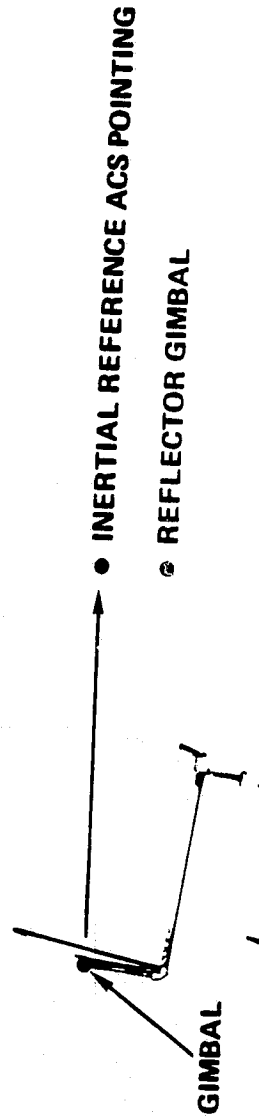

UNFAVORABLE REFLECTOR TO
MASS MASS

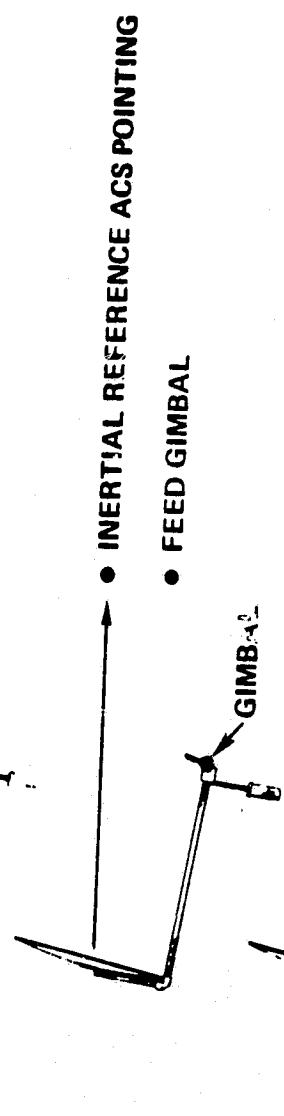

LOW CORRECTION EFFICIENCY

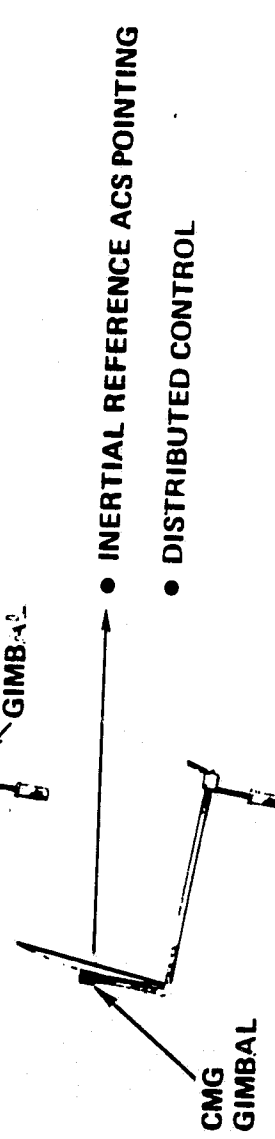

EFFICIENT - REQUIRES ADDED
HARDWARE

Figure 2-54. Pointing Control Alternatives
for Offset-Fed Configuration

decoupled from the structural response period, which may be offset by proper satellite pointing without the use of gimbals or active mechanical devices.

To accomplish satellite pointing to the necessary accuracy, 2 feedback systems are used: 1) monopulse sensing of a reference gateway station, allowing the ACS to track the desired target, and 2) a laser-diode feed/reflector position sensing system, as detailed in Figure 2-55. The necessary ACS hardware consists of a position/rate sensing system (SAMS, SPLRS) and pointing resolver capability, together with required software. These techniques make maximum use of on-going technology development in LSST controls, thereby minimizing the technical risk to a successful satellite design.

Of the total uncorrected pointing error of 0.12 degree, 0.09 degree is a relatively long-term component based on the ACS capability. The primary effect of this component is to necessitate generation of a few extra satellite beams to guarantee continuous coverage of CONUS boundaries.

The remaining pointing-error component of 0.03 degree, which represents short-term instabilities or jitter, can lead to a reduction in received signal level during the course of a call. This is especially significant for a user located at the relative null between beams at the time of call origination. To account for this possibility, a loss factor of 1 dB has been included in the UHF link budgets.

ORIGINAL PAGE IS
OF POOR QUALITY

ORIGINAL PAGE IS
OF POOR QUALITY

- CENTER-FED: STANDARD ACS IN BUS
- OFFSET-FED: STANDARD ACS PLUS
 - POSITION/RATE SENSING
 - POINTING RESOLVER

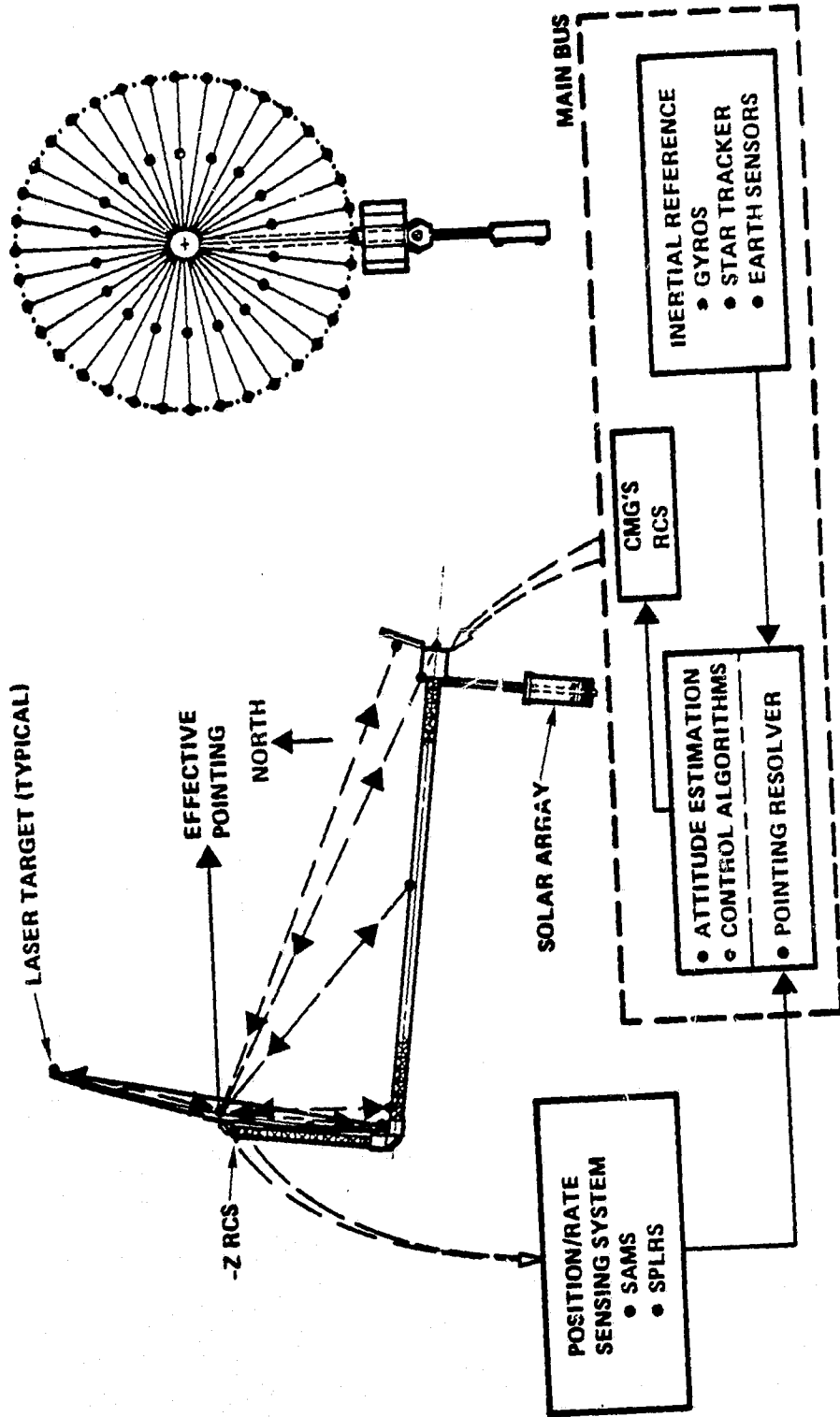

SAMS: SURFACE ACCURACY MEASUREMENT SYSTEM
SPLRS: SELF-PULSED LASER RANGING SYSTEM

Figure 2-55. Satellite Attitude Control Subsystem (ACS)

REFERENCES

- 2-1 W. F. Rector III, "Centaur Capabilities for Communications Satellite Launches," Proc. AIAA 9th Communication Satellite Systems Conference, 8 March 1982, paper 82-0558.
- 2-2 F. Naderi (Editor), Land Mobile Satellite Service (LMSS), JPL Publication 82-19, 15 February 1982.
- 2-3 N. Abramson, "The ALOHA System - Another Alternative for Computer Communication," Proc. AFIPS 1970 Fall Joint Computer Conf., Vol 37, pp 281-285.
- 2-4 P. A. Castruccio, C. S. Marantz, and J. Freibaum, "Need For, and Financial Feasibility of, Satellite-Aided Land Mobile Communications," Proc. Int. Conf. on Communications, Philadelphia, 13-17 June 1982, paper 7H.1.
- 2-5 S. Carney and D. Linder, "A Digital Mobile Radio for 5-6 Kilohertz Channels," Proc. Int. Conf. on Communications, Philadelphia, 13-17 June 1982, paper 5B.3.
- 2-6 R. E. Anderson and R. T. Milton, Satellite-Aided Mobile Radio Concepts Study, General Electric Co. Document No. 79SDS4240, June 1979.
- 2-7 B. Manz, "RCA Begins Final Countdown for Solid-State Satcom," Microwaves, October 1982, pp. 25-31.

3. SYSTEM 2

3.1 INTRODUCTION

The System 2 configuration is similar to that of current cellular systems in the sense that translator stations exercise control over mobile units in their respective areas and provide a point of concentration for the corresponding voice channels. It differs from the cellular systems by providing satellite, rather than land-line, connections between the translator and gateway stations.

System 2 requires no new frequency allocations, as the mobile units can use the bands currently allocated to land-mobile services. There are two such 20-MHz bands, one for the outbound (translator-to-mobile) direction and the other for the inbound (mobile-to-translator) direction. By FCC ruling with regard to cellular systems, the land-mobile allocation is to be shared equally in each metropolitan area by the existing wireline carrier and an applicant to be selected from the radio common carriers (RCCs). The competitive marketplace will then determine the number of subscribers captured by each of the two carriers.

Whether a similar degree of competition would be imposed on systems of the type under study here (which can be regarded as cellular extensions into rural areas) is not clear. A major factor in any future FCC ruling on this matter would be the joint commercial viability of a pair of carriers operating competitively outside the urban and suburban areas. For present purposes, it is assumed that a single operating entity will serve the entire subscriber population within reach of a given translator station. This assumption is reflected both in the system costs and in the resulting subscriber charge.

In a system of translator stations covering a major portion of CONUS, there will be considerable variability in the number of subscribers captured by individual translators. Since the cost of a translator station has a large fixed component, the MSC that must be charged by a regional system operator depends on the number of translators in the system and the total number of subscribers captured. Clearly, the MSC will be lower in a region with higher average population density.

**ORIGINAL PAGE IS
OF POOR QUALITY**

MSC variations due to different population densities are ignored in this study. In fact, the MSC is computed as if there were but a single operating entity for all of CONUS.

On the other hand, it is recognized that, in the current regulatory climate, it is unlikely that a carrier would be required to provide coverage of areas where this cannot be done profitably. Therefore, MSC sensitivity to the total area served will be examined. In so doing, the total number of subscribers is not varied. This eliminates the need to make any assumption regarding the geographic distribution of subscribers. The rationale for this simplification is that the number of potential subscribers eliminated by less-than-complete CONUS coverage will in all cases be small compared with the number of subscribers actually served.

3.2 SYSTEM DESCRIPTION

In contrast to System 1, where most of the capital expenditures are related to the space segment, the dominant costs for System 2 are in the ground segment. This is attributable to the large number of translators required for CONUS coverage, coupled with the relatively low space-segment cost to provide communication links between the translator and gateway stations. Because of the large fixed component of translator-station cost, the number of translators is a key parameter in determining total system cost. For a fixed total coverage area, the required number of translators varies inversely with the square of the radius-of-coverage of an individual translator station.

3.2.1 Translator Coverage Area

The coverage area of a translator station depends on the antenna tower height and the EIRP employed. Even with these parameters fixed, however, the coverage area will vary considerably depending on the elevation of the station and local propagation conditions. To simplify the analysis, a uniform coverage area, corresponding to open terrain, will be assumed. This assumption tends to maximize the coverage area and is therefore optimistic for undulating terrain in which translator/mobile communications is not possible from many locations.

Of course, extremely variable terrain, as in mountainous areas, is typically associated with low population density. Such areas would be excluded from attempted coverage by the criterion of economic viability.

The question of coverage is treated statistically. An area is defined to be covered if 90 percent of the locations in the area are covered. In general, for an area that just meets this criterion, locations close to the translator station are more likely to be covered than those farther away.

An antenna tower height of 500 feet has been selected as the maximum value that can be justified economically. It is assumed that the site selected permits a guyed tower to be erected, as the cost for such a tower is much lower than that for a free-standing tower.

Translator ERP is assumed to be in the range of 115 to 145 watts (equivalent EIRP is 2.3 dB higher). This is somewhat in excess of the current FCC 100-watt ERP limitation placed on cellular systems. The mobile ERP is assumed to be 4 watts (which is based on use of a 3-watt transmitter). Both mobile and base station are assumed to be equipped with 4.5-dB noise-figure receivers. It can be shown that this combination of parameters leads to balanced transmission — i.e., comparable inbound and outbound received signal quality. The common transmission range is estimated to be 40 miles.

The estimated 40-mile range can be substantiated by comparison with the achievable range in cellular systems. In urban areas, these systems typically realize a transmission distance of 10 miles with a 500-foot tower and 80-100 watts ERP. Curves of Okumura (Reference 3-1), reproduced in Reference 3-2, indicate that a 32-dB increase in propagation loss is incurred, for urban-like areas, in extending the transmission range from 10 to 40 miles at 900 MHz. On the other hand, Hata (Reference 3-2) shows that the propagation loss is reduced by 28 dB, at 900 MHz, in going from urban to open areas. Therefore, to realize a 40-mile range in open areas, it is only necessary to provide an effective power 4 dB higher than is found in cellular systems.

Consider transmission in the outbound direction. The needed 4-dB improvement is provided by the lower noise figure assumed for the mobile receiver. The prevailing noise figure of 9 dB in cellular systems is based

on a mixer front-end. Reduction to the previously indicated 4.5 dB is possible through inclusion of a low-noise pre-amplifier. Additionally, about 1.5 dB greater power has been assumed for the base-station transmitter than is found in cellular systems.

Because of balanced transmission in the inbound and outbound directions, the desired range is achieved in the inbound direction as well.

If the translator coverage areas form a pattern like that in Figure 2-4, achievement of a 40-mile transmission range results in a 34.6-mile radius for each circle in the terrestrial pattern. The corresponding circular area is 3770 square miles. Since the area of CONUS is 3 million square miles, about 800 translators would be required for complete CONUS coverage.

It will initially be assumed that System 2 service is economically viable over 50 percent of CONUS. A total of 400 translators is therefore required. If the cellular systems in place by the mid-1990s are presumed to cover 10 percent of CONUS, 60 percent of CONUS will be covered by one type of system or the other.

Transmission between mobile units and translator stations is assumed to follow standard cellular practice, with one variation. It has been found that, by judiciously assigning frequencies according to user location within a cell, excessive interference between cells can be avoided with as few as 4 frequency subsets (rather than 7).^{*} Accordingly, for the 20-MHz land-mobile allocation, 166 30-kHz channels are available in each cell, of which two would be reserved for call setup.

The same set of subscriber scenarios will be considered for System 2 as was previously considered for System 1. To judge the adequacy of 164 channels to handle the postulated voice traffic, consider scenario B, which was the basis for the two System 1 baseline designs. The EOL traffic for scenario B is approximately 9000 erlangs, or an average of 22.5 erlangs per translator station. At a 0.05 grade of service, 28 circuits are required to handle 22.5 erlangs of traffic.

^{*}Private communication from Dr. J. J. Mikulski of Motorola.

The traffic load per translator will vary according to subscriber density. To warrant the full complement of 164 circuits, the traffic load would have to be 160 erlangs. Thus, there is sufficient capacity per translator to handle $160/22.5 \approx 7$ times the average traffic load with 4 frequency sets.

With 7 frequency sets, on the other hand, 95 30-kHz channels are available from a 20-MHz allocation. If two channels are reserved for call setup, the traffic capacity per translator is 88 erlangs at a 0.05 grade of service. In this case, there is sufficient capacity to accommodate $88/22.5 \approx 4$ times the average translator traffic. If a greater amount of traffic were offered, the coverage area would have to be reduced, much as the cell size is reduced with increasing traffic in cellular systems.

3.2.2 Translator/Gateway Transmission

The instantaneous traffic requirements at the translator stations are relatively small and quite dynamic, reflecting the random nature of call arrival times. A time-division-multiple-access (TDMA) transmission format is assumed for the translator/gateway links. This permits aggregation of the traffic from a large number of translator stations on a single carrier, thereby minimizing the satellite capacity requirements. In fact, depending on the maximum carrier bandwidth and the traffic offered, it may be possible for all translators controlled by a given gateway to share a common carrier.

The specific transmission parameters adopted are those associated with Digital Communication Corporation's DYNAC terminal: 8.8-Mb/s maximum bit rate, 30-msec frame, 4-phase-PSK modulation, 380-symbol reference burst (for each of two such bursts), and 150-symbol preamble per terminal. When used for voice transmission, 32-kb/s delta modulation encoding is employed.

Design of the translator/gateway links is based on leased satellite capacity rather than a dedicated satellite. One reason for this choice is that standard earth terminals, insofar as the RF components are concerned, can be employed at both the translator and the gateway sites in conjunction with satellites similar to those in commercial service today. Additionally, the capacity requirements, especially in the early years of operation, are far less than those available from a typical commercial

satellite. Therefore, cash flow requirements can be considerably reduced through leasing.

For the baseline subscriber scenario, for example, only 3 transponders of the current C-band variety are required at the start of operations. This number grows to 7 transponders at the end of 7 years (see below). By contrast, current C-band satellites provide 24 40-MHz transponders. (Polarization diversity permits re-use of the 500-MHz C-band allocation.) While scenario B requires 15 transponders at EOL, only 2 are needed in the first year because of the slow initial rate of subscriber buildup.

Of the "fixed-satellite" frequency allocations, either C-band (6/4 GHz) or Ku-band (14/11 GHz) would be suitable for the translator/gateway links. C-band has been selected for the purpose of developing satellite lease charges and earth-station equipment costs because of the relatively mature state of satellite service at these frequencies.

In particular, S-band was not considered (for a dedicated satellite) because of the limited uplink allocation of 35 MHz. To supply the needed capacity while providing complete CONUS coverage, a multibeam satellite antenna with approximately 30 beams would be required for the baseline subscriber scenario. The corresponding reflector diameter is about 40 feet. Inclusion of such a satellite would defeat the primary purpose of System 2, which is to eliminate the need for a complex space structure. Such a satellite would significantly increase the cost of the space segment.

While the translator/gateway links could also be considered as a customer-premise-service (CPS) application in a 30/20 GHz system, the existence of such a system in the U.S. during the 1990s is uncertain.

For consistency with the System 1 design, 12 CONUS gateways are assumed for System 2. Once again, however, the gateway costs are relatively insignificant as far as the MSC is concerned.

The transponder requirements for the baseline subscriber scenario are derived in Table 3-1. It is assumed that all 400 translator stations will be installed by the nominal start of operations, which corresponds to $T = 0$ (see also Figure 2-16). A maximum rate of translator installation equal to

ORIGINAL PAGE 19
OF POOR QUALITY

Table 3-1. Transponder Requirements for
Baseline Subscriber Scenario

TIME, T (YRS)	VOICE CHANNELS PER GATEWAY*	TRANSMISSION RATE PER GATEWAY (Mb/s)**	SYSTEM TRANSMISSION RATE (Mb/s)**	REQUIRED NO. OF TRANSPONDERS
-3	33	1.20	14.4	1
-2	67	2.39	28.7	2
-1	108	3.80	45.5	3
0	159	5.47	65.6	3
1	182	6.20	74.4	4
2	209	7.07	84.8	4
3	241	8.09	97.1	5
4	280	9.39	112.1	6
5	326	10.86	130.3	6
6	380	12.59	151.5	7
7	447	14.73	176.8	8

*0.01 CALL BLOCKAGE

**IN EACH DIRECTION; MUST BE DOUBLED TO OBTAIN TRANSPONDER LOADING

100/year has been assumed. Therefore, 100 translators will be in place at $T = -3$, 200 at $T = -2$, etc.

Rather than allow these translators to stand idle prior to $T = 0$, system operation is assumed to begin once the first 100 translators have been installed. (This requires, of course, that all 12 gateways be operational at this point.) The number of potential subscribers in these early years is found by extrapolating backward from $T = 0$ at the 20 percent annual growth rate that prevails subsequent to $T = 0$. The fraction captured is equal to the fractional number of translators installed.

The number of voice channels per gateway shown in Table 3-1 corresponds to 1/12 of the total system traffic, as there is a total of 12 gateways. Since traffic is aggregated by gateway for the proposed TDMA transmission, each voice channel required at one of the gateways corresponds to a distinct voice channel at the satellite. This relatively high degree of traffic aggregation permits a small value of call blockage, namely 0.01, to be assigned to the gateways with little impact on the amount of gateway equipment or satellite capacity required. The grade of service (exclusive of call blockage in the STN) is essentially equal to the sum of the call blockage values associated with the gateway and translator stations.

The instantaneous channel needs of a translator station fluctuate with the random call arrivals. In each TDMA frame, a translator is assigned a time slot which contains one voice channel more than it currently requires. In this way, a newly originated call can be serviced immediately. As soon as the gateway learns that the reserve channel is in use, a replacement channel is assigned to the translator. Similarly, the channel complement assigned to a translator is reduced by 1 when a call is terminated.

A set of reserve channels does not affect the amount of equipment required at a translator. It does, however, affect the equipment required at the gateways and the satellite capacity requirement. These additional needs are reflected in the entries of Table 3-1.

The transmission rate per gateway is based on a voice-channel bit rate of 32 kb/s. The assumed 8.8-Mb/s capacity of a TDMA carrier is exceeded at each gateway during the fourth year of service. Subsequent to this time,

two TDMA carriers per gateway are required; however, the carrier transmission rates are adjusted so that no excess satellite capacity is utilized.

The composite transmission rate for the system, equal to 12 times the transmission rate per gateway, determines the required number of satellite transponders. The indicated transponder requirements are based on the sharing of each transponder by five 8.8-Mb/s carriers (or by any larger number of carriers with the same total bit rate). The bandwidth spanned by 5 such carriers is 31.5 MHz.

The number of satellite transponders required at EOL is roughly proportional to the system traffic at that time. The transponder requirements for the other traffic scenarios considered are given in the table below.

Traffic Scenario	No. of Transponders
BASELINE	8
A	30
B	15
D	15
E	14

3.2.3 Gateway Description

A top-level block diagram of a gateway station is shown in Figure 3-1. There are two principal differences between this gateway and the configuration for System 1 (see Figure 2-8). First, the base-site controller has been removed and relocated in the translator, where it functions just as it would in a cellular system. Secondly, the array of FM modems used in System 1 is replaced by a single (digital) TDMA modem. In addition, a central processor (i.e., minicomputer) provides overall network control, including assignment of voice-channel capacity to individual translators.

The RF/IF section filters the TDMA carrier of interest from the other carriers in the transponder and converts it to a 70-MHz IF frequency. The TDMA equipment demodulates the digital stream and, through voice cards, produces individual voice channels at the 4-wire level.

ORIGINAL PAGE 19
OF POOR QUALITY

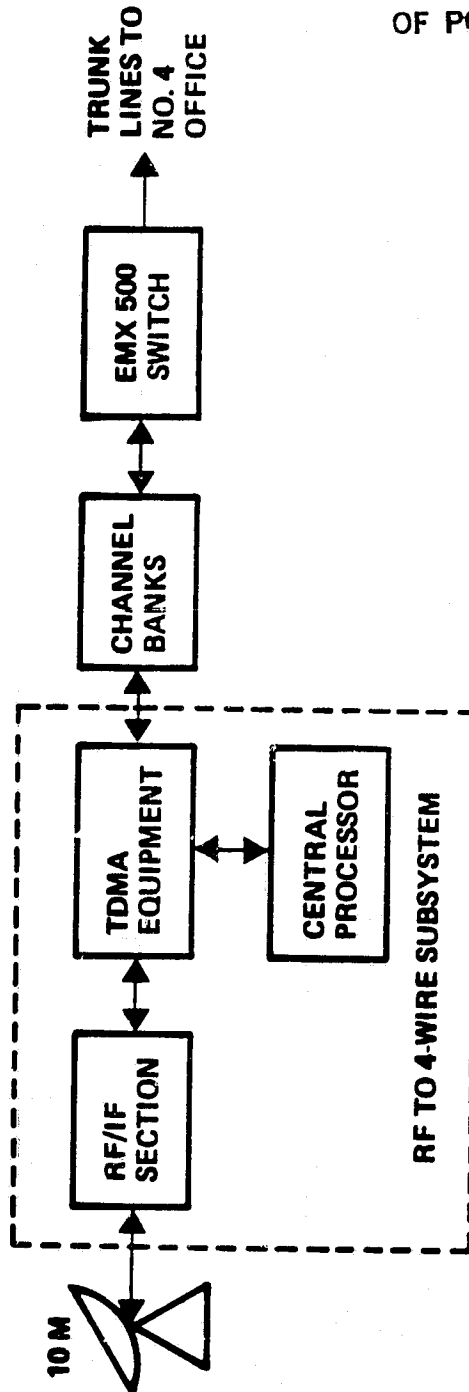

Figure 3-1. Gateway Block Diagram

The analog outputs of the TDMA equipment are digitized by the channel banks, as in System 1, and then fed to the EMX 500 switch. The combination of D/A conversion in the TDMA equipment, followed by A/D conversion in the channel banks, is necessary because the switch requires a T1 carrier as input. Since a T1 carrier comprises multiple PCM-encoded voice channels, and transmission over the satellite link employs delta modulation (which is necessary to conserve satellite capacity), the two digital formats are not compatible with one another.

The cost elements of a typical gateway station are shown in Table 3-2. Cost of the RF/IF section is further broken down in Table 3-3. It is assumed that, if more than one carrier is required to handle the traffic at a gateway, the multiple carriers operate through the same transponder so that only a single upconverter/downconverter combination is required.

The gateway channel equipment requirements in Table 3-1 have been combined with the cost elements in Table 3-2 to produce the gateway costs shown in Table 3-4 for the baseline subscriber scenario. The costs in each row represent incremental expenditures for equipment that must be in place by the time indicated. These equipment requirements guarantee that sufficient capacity will be available to handle the offered traffic throughout the following year. The total gateway cost is obtained by (sequentially) adding 20 percent program-level cost and 10 percent profit to the sum of the major element costs.

3.2.4 Translator Description

The major elements of a translator station are shown in Figure 3-2. The cost of these elements is given in Table 3-5. The UHF-to-4-wire subsystem includes both the UHF radio and the base-site controller. The channelized outputs of this subsystem are combined in a TDM format and transmitted, in periodic bursts, in the time slot assigned by the gateway station. The RF/IF section is identical to that of the gateway. In fact, with a 10-meter antenna used at both the translator and the gateway, the transmission parameters are the same in both directions.

The RF components of the translator and gateway terminals are chosen to produce a bit error rate of 10^{-3} for voice transmission with the transponder loading described in Section 3.2.2 (i.e., 5 8.8-Mb/s carriers).

ORIGINAL PAGE IS
OF POOR QUALITY

Table 3-2. Gateway Cost Elements

<u>ELEMENT</u>	<u>COST</u>
● RF TO 4-WIRE SUBSYSTEM	
● RF/IF SECTION	● \$149K
● TDMA EQUIPMENT	● \$60K FOR COMMON EQUIPMENT (REDUNDANT) PLUS \$1500 PER VOICE CARD
● CENTRAL PROCESSOR	● \$100K (REDUNDANT)
● CHANNEL BANKS (A/D)	● \$500 PER CHANNEL
● EMX 500 SWITCH	● \$1.1M FOR FRAME PLUS \$1250 PER CHANNEL
● BLDG., POWER, A/C	● \$100K

ORIGINAL PAGE 19
OF POOR QUALITY

Table 3-3. Gateway and Translator RF/IF Section Costs

<u>ITEM</u>	<u>UNIT COST</u>	<u>REDUNDANT</u>	<u>COST PER STATION</u>
ANTENNA (10 M)	68,000		68,000
LNA (90° K GaAs FET)	1,500	X	6,000
HPA (25 W SOLID-STATE)	11,000	X	23,000
DOWNCONVERTER	11,000	X	25,000
UPCONVERTER	12,000	X	27,000
TOTAL			149,000

ORIGINAL PAGE 19
OF POOR QUALITY

Table 3-4. Gateway Costs (\$K) for
Baseline Subscriber Scenario

<u>TIME, T (YRS)</u>	<u>RF TO 4-WIRE SUBSYSTEM</u>	<u>CHANNEL BANKS</u>	<u>EMX 500 SWITCH</u>	<u>TOTAL COST PER GATEWAY*</u>
-3	410	34	1184	2249**
-2	62	21	52	178
-1	77	26	64	220
0	35	12	29	100
1	41	14	34	118
2	48	16	40	137
3	119	20	49	248
4	69	23	58	198
5	81	27	68	232
6	101	34	84	289

*INCLUDES PROGRAM LEVEL COSTS @ 20% AND INTEGRATOR PROFIT @ 10%

**INCLUDES \$100K FOR BLDG., POWER, A/C

ORIGINAL PAGE IS
OF POOR QUALITY

Table 3-5. Translator Cost Elements

<u>ELEMENT</u>	<u>COST</u>
● 500-FT. TOWER (INCL. SITE PREP.), BLDG., POWER, A/C	● \$100K
● CABLE (8 RUNS)	● \$40K
● ANTENNA (6-SECTOR)	● \$7K
● UHF TO 4-WIRE SUBSYSTEM	● \$145K PER 16-CHANNEL FRAME PLUS \$12K PER CHANNEL
● TDMA EQUIPMENT	● \$60K FOR COMMON EQUIPMENT (REDUNDANT) PLUS \$1500 PER VOICE CARD
● RF/IF SECTION	● \$149K

ORIGINAL PAGE IS
OF POOR QUALITY

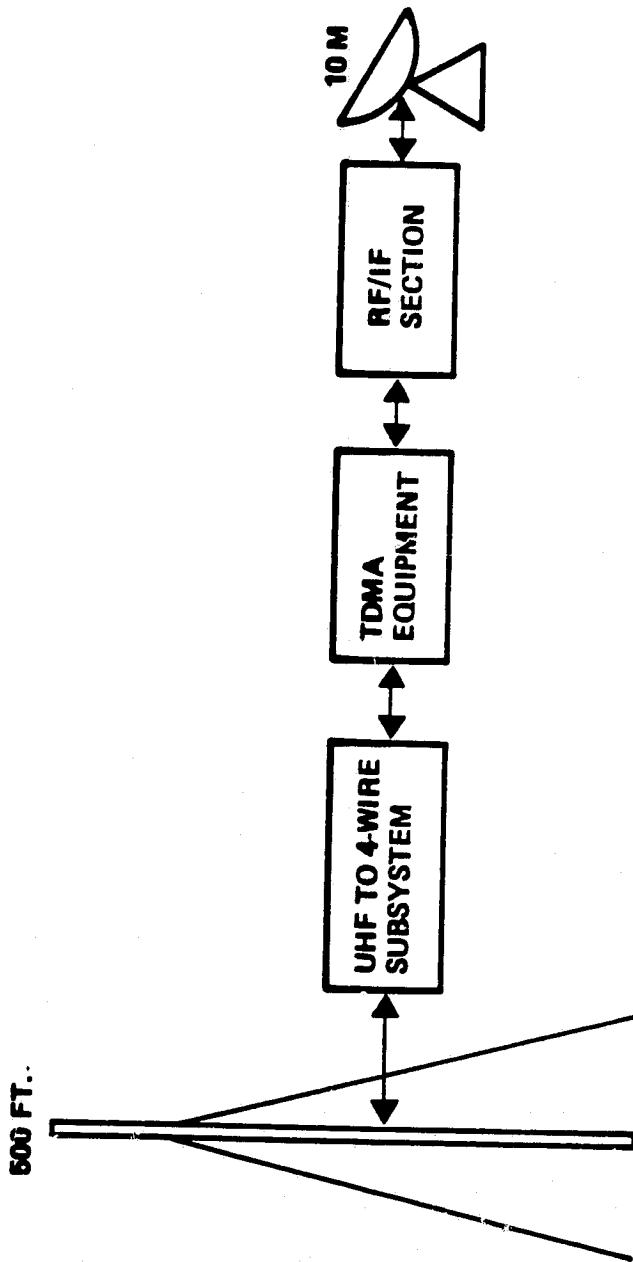

Figure 3-2. Translator Block Diagram

This is accomplished through use of a 10-meter antenna, a GaAs FET LNA which results in a G/T of 29.7 dB/K, and an HPA rated at 20 watts. (The transmit power per carrier at the maximum 8.8-Mb/s rate is about 5 watts.) C-band solid-state amplifiers of this size should be readily available in the 1990 time frame. A somewhat larger HPA will be needed at the gateways when the single-carrier capacity is exceeded.

Link power budgets corresponding to multicarrier transponder operation can be found in Appendix E.

Channel requirements for an individual translator station are shown in Table 3-6 for the baseline traffic scenario and 0.05 call blockage. (The associated grade of service, with a gateway call blockage of 0.01, is 0.06.) This set of channel requirements corresponds to a translator that is among the first 100 installed. The deployment schedule for the translator and gateways is shown in Figure 3-3. A translator that is among the second 100 installed has no channel requirements at $T = -3$. One that is among the third group of 100 has no channel requirements at either $T = -3$ or $T = -2$. Finally, the fourth group of translators has no channel requirements before $T = 0$.

The number of subscribers (and hence the traffic) per translator in Table 3-6 is found by dividing the total for the system by 400, which is the number of translators at EOL. In effect, a uniform geographic distribution of subscribers has been assumed. This is clearly not the case. As has been observed from Figure 2-13, the subscriber distribution is highly non-uniform. However, in contrast with System 1, this distribution (within the 50 percent of CONUS covered) does not have a significant effect on the MSC.

The cost associated with the translators can be divided into fixed and variable components. The total fixed cost depends only on the number of translators. While the variable cost for a particular translator depends on the number of subscribers served, a modified subscriber distribution merely shifts the variable costs among the translators without changing the total. Therefore, as long as all 400 translators belong to a system for which a single MSC is computed, the subscriber distribution is immaterial. For simplicity, a uniform geographic distribution has been assumed.

Table 3-6. Translator Channel Requirements
for Baseline Subscriber Scenario

<u>TIME, T (YRS)</u>	<u>SUBSCRIBERS/ TRANSLATOR</u>	<u>ERLANGS/ TRANSLATOR</u>	<u>CHANNELS/ TRANSLATOR*</u>
-3	72	1.9	5
-2	87	2.3	6
-1	104	2.7	6
0	125	3.3	7
1	150	3.9	8
2	180	4.7	9
3	216	5.6	10
4	259	6.7	11
5	311	8.1	13
6	373	9.7	14
7	447	11.6	17

*0.05 CALL BLOCKAGE

ORIGINAL PAGE IS
OF POOR QUALITY

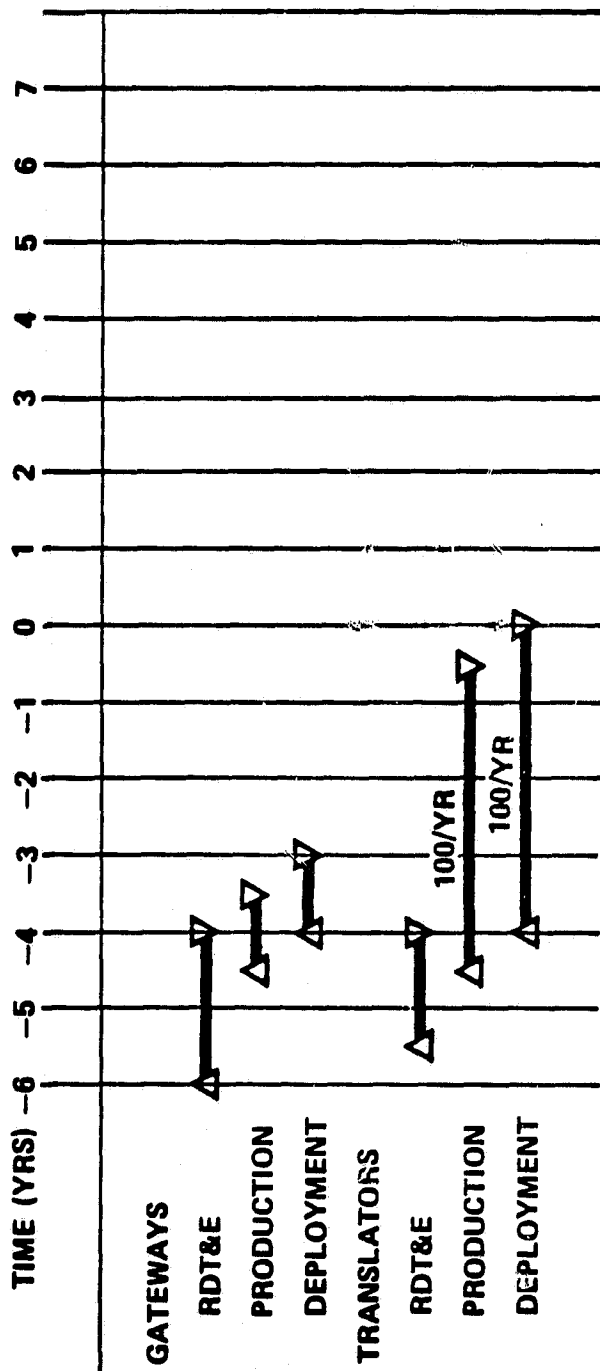

Figure 3-3. Gateway/Translator Deployment Schedule for Baseline Subscriber Scenario

Equipment costs corresponding to the channel requirements in Table 3-6 are given in Table 3-7. The total cost per translator is obtained by adding a 20 percent program level cost and a 10 percent integration profit to the sum of the individual element costs.

3.3 MONTHLY SERVICE CHARGE

The total cost of deploying the earth segment is shown in Table 3-8. The entries for the gateways were obtained by multiplying the entries in the last column of Table 3-4 by 12, the number of gateways. The expenditure profile for the translators is the sum of four separate expenditure profiles, one for each group of 100 translators.

Note the time period designated for each gateway and translator entry in Table 3-8. In previous tables, equipment requirements were specified according to the time at which the hardware had to be in place. The specified times ranged from $T = -3$ to $T = 7$ and included $T = 0$, the nominal start of operations and the point at which there are 50,000 subscribers in the baseline scenario.

In Table 3-8 it is assumed that expenditures for equipment required at a particular time are made during the preceding year. Accordingly, the first-column entries for which there are earth-segment expenditures range from year -4 to year 6, with all years referenced to $T = 0$.

The satellite lease charges, on the other hand, are assumed to be paid in the year in which service is received. Therefore, the corresponding entries in the first column of Table 3-8 range from -3 to 7. The assumed lease charge is \$2 million/year, which is approximately the current rate for a "backed-up" C-band transponder. The amount of capacity leased during a particular year is based on the year-end requirement. In year 1, for example, 4 transponders are reserved, corresponding to the capacity requirement at $T = 1$ in Table 3-1.

The MSC required with the baseline subscriber scenario is given by the lower curve in Figure 3-4. Sensitivity of the MSC to variations either in total coverage or in single-translator coverage is illustrated by the upper curve. By the first interpretation of this curve, 70 percent of CONUS is covered, with each translator again capable of communicating with mobiles 40 miles distant. A total of 560 translators is required in this case.

ORIGINAL PAGE IS
OF POOR QUALITY

Table 3-7. Translator Costs (\$K) for
Baseline Subscriber Scenario

<u>TIME, T</u> <u>(YRS)</u>	<u>TOWER</u> <u>ETC</u>	<u>UHF TO 4-WIRE</u> <u>SUBSYSTEM</u>	<u>TDMA</u> <u>EQUIPMENT</u>	<u>RF/IF</u> <u>SECTION</u>	<u>TOTAL COST</u> <u>PER TRANSLATER*</u>
-3	147	253**	75	149	824
-2		0			0
-1		12			16
0		12			16
1		12			16
2		12			16
3		12	11		30
4		24			32
5		12			16
6		181			239

*INCLUDES PROGRAM LEVEL COST @ 20% AND INTEGRATOR PROFIT @ 10%

**INCLUDES REDUNDANT CONTROLLER (\$36K)

ORIGINAL PAGE 13
OF POOR QUALITY

Table 3-8. System 2 Expenditures (\$M)
for Baseline Subscriber Scenario

<u>YEAR</u>	<u>S/C LEASE CHARGES</u>	<u>GATEWAY EXPEND</u>	<u>TRANSLATOR EXPEND</u>	<u>EARTH-SEGMENT EXPEND</u>
-4		27.3	82.4	109.7
-3	4	2.1	82.4	84.5
-2	6	2.6	87.1	84.8
-1	6	1.2	90.3	91.5
1	8	1.5	6.3	7.8
2	8	1.6	6.3	7.9
3	10	3.0	12.1	15.2
4	12	2.4	12.7	15.1
5	12	2.8	6.3	9.3
6	14	3.4	95.6	99.0
7	16			

ORIGINAL PAGE 19
OF POOR QUALITY

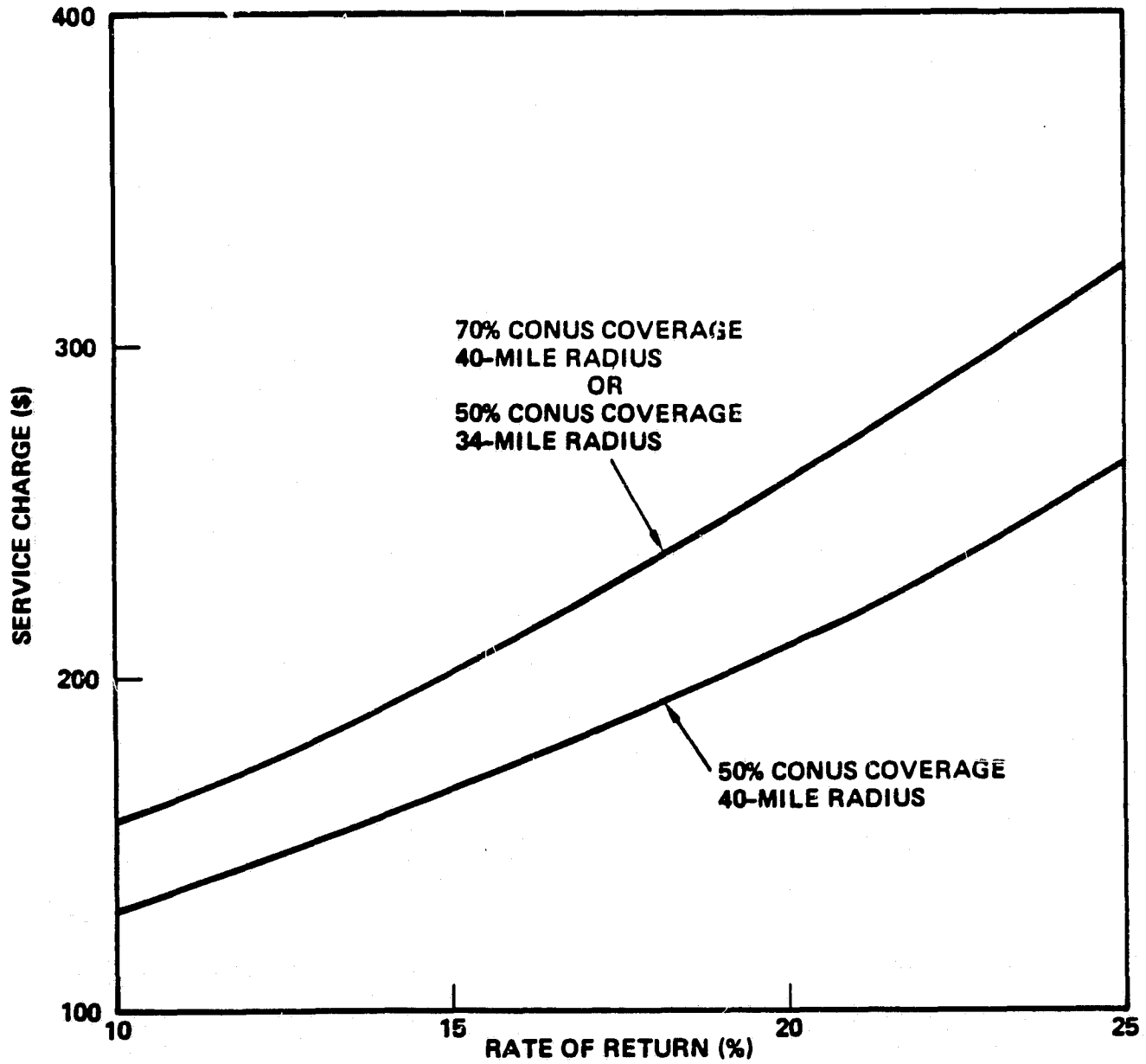

Figure 3-4. MSC Sensitivity to Coverage Variations

If, instead, the translator radius of coverage is reduced to 34 miles, 560 translators are needed to provide the original 50-percent CONUS coverage. The number of subscribers captured is assumed to be the same as in the previous case, since the subscriber density can be expected to diminish rapidly once the most profitable 50 percent of CONUS has been covered. With an identical subscriber scenario, as well as identical equipment costs, the MSC is the same for the two cases.

The complement of 560 translators represents an increase of 40 percent over the original 400 translators. Yet the MSC increase is only 20 percent for a 10-percent IRR, increasing to 23 percent for a 25-percent IRR. The smaller percentage increase in MSC is attributable to the sizable variable cost component of an individual translator station. This component depends on the number of subscribers supported by the translator. Since the total subscriber population is assumed invariant to the number of translators, the system-wide total of the variable cost components is the same for all cases considered.

MSC sensitivity to cost variations in the different system segments is shown in Figure 3-5. The translators are clearly the dominant cost factor in the system. The satellite lease charges constitute the least significant factor.

The alternate traffic scenarios previously considered for System 1 are repeated in Figure 3-6. Earth-segment costs for these scenarios were computed in a similar manner to those for the baseline scenario, with one exception. Because the traffic at $T = 0$ is such a small fraction of the EOL traffic, it was assumed that no revenue is derived prior to $T = 0$. As a consequence, satellite capacity is leased beginning at $T = 0$.

The MSC profiles for the alternate traffic scenarios are shown in Figure 3-7. Because the revenue stream for scenario E stretches over 10 years, the MSC in this case increases more rapidly with increasing IRR.

Reference

- 3-1 Y. Okumura et al., "Field Strength and Its Variability in VHF and UHF Land-Mobile Radio Service," Review of the Electrical Communication Laboratory, Nippon Telegraph and Telephone Corporation, Vol. 16, September-October 1968.

ORIGINAL PAGE IS
OF POOR QUALITY

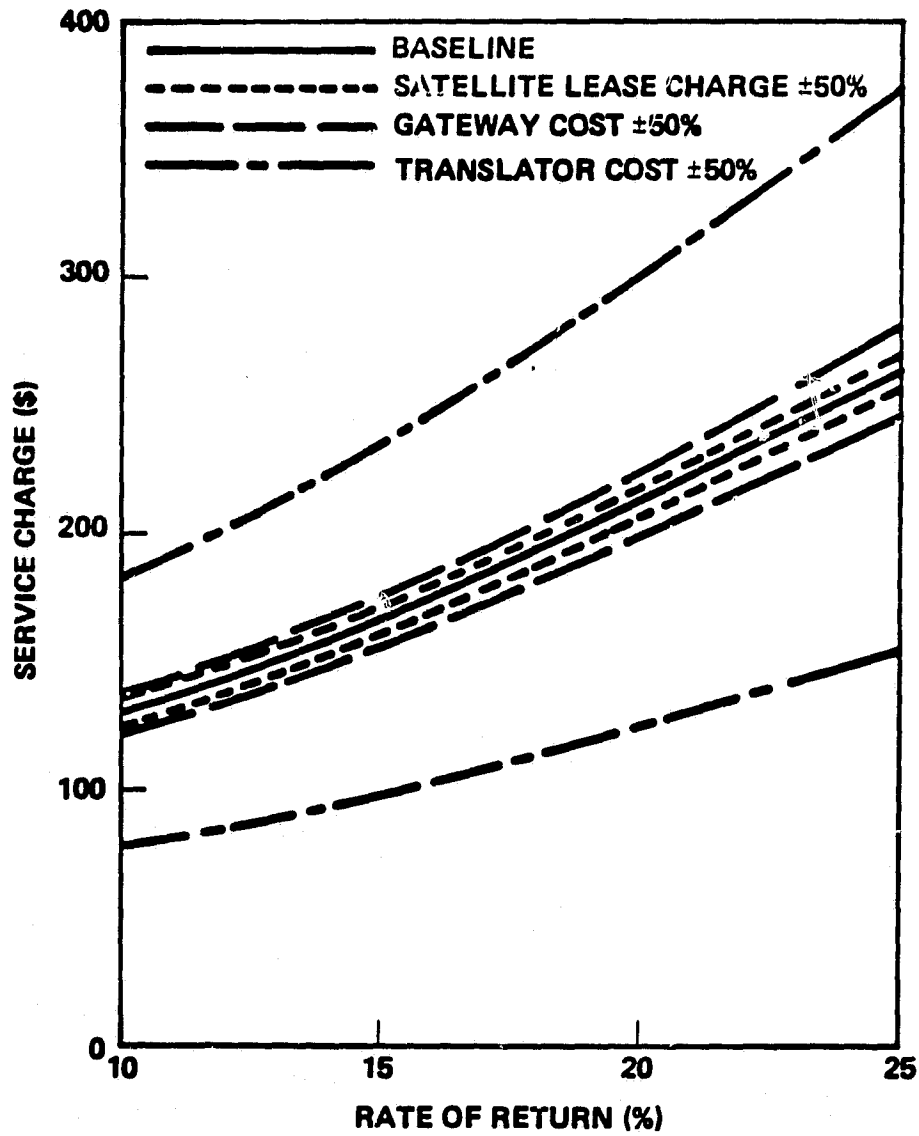

Figure 3-5. MSC Sensitivity to Cost Variations

ORIGINAL PAGE IS
OF POOR QUALITY,

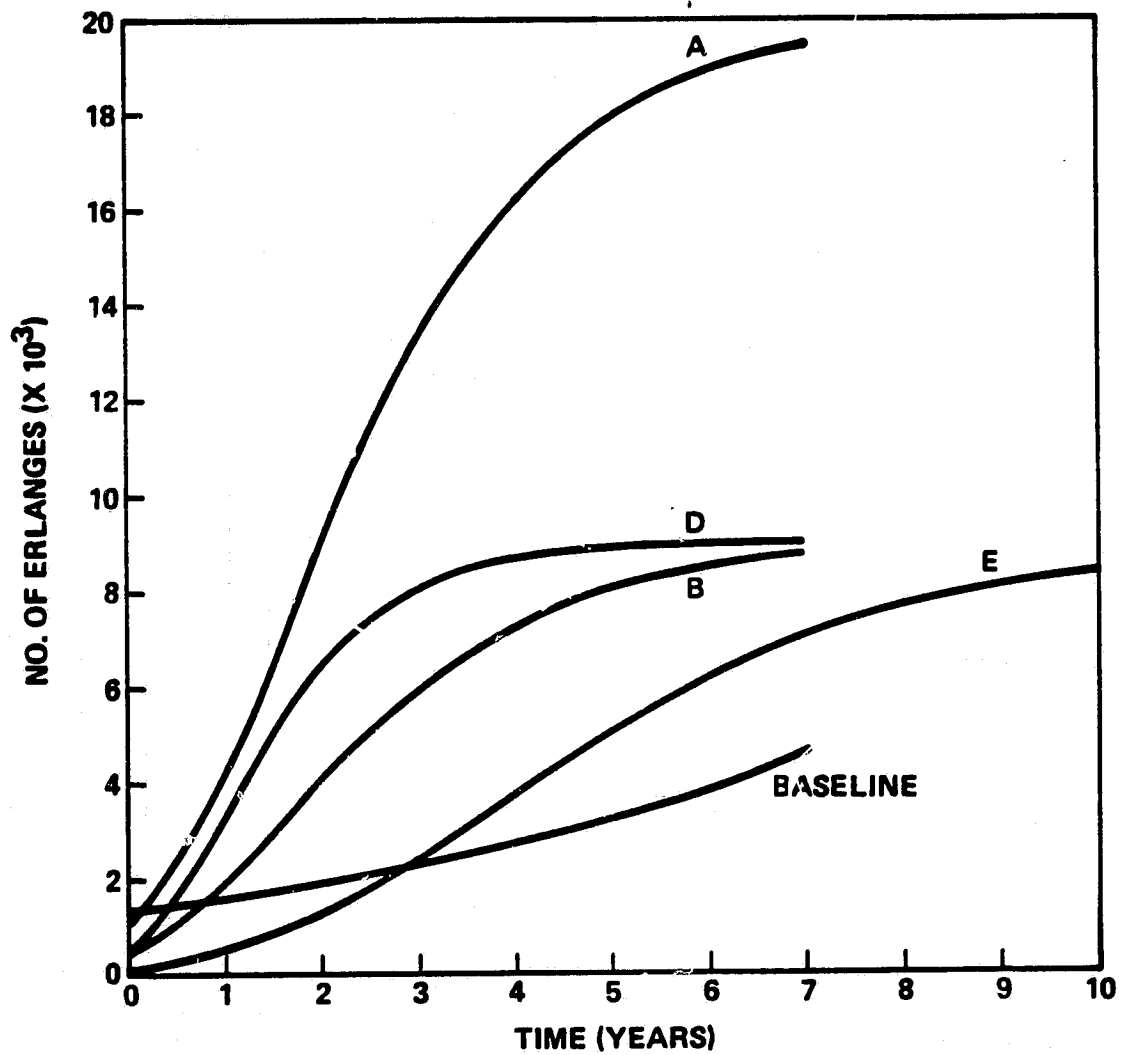

Figure 3-6. System 2 Traffic Scenarios

ORIGINAL PAGE IS
OF POOR QUALITY

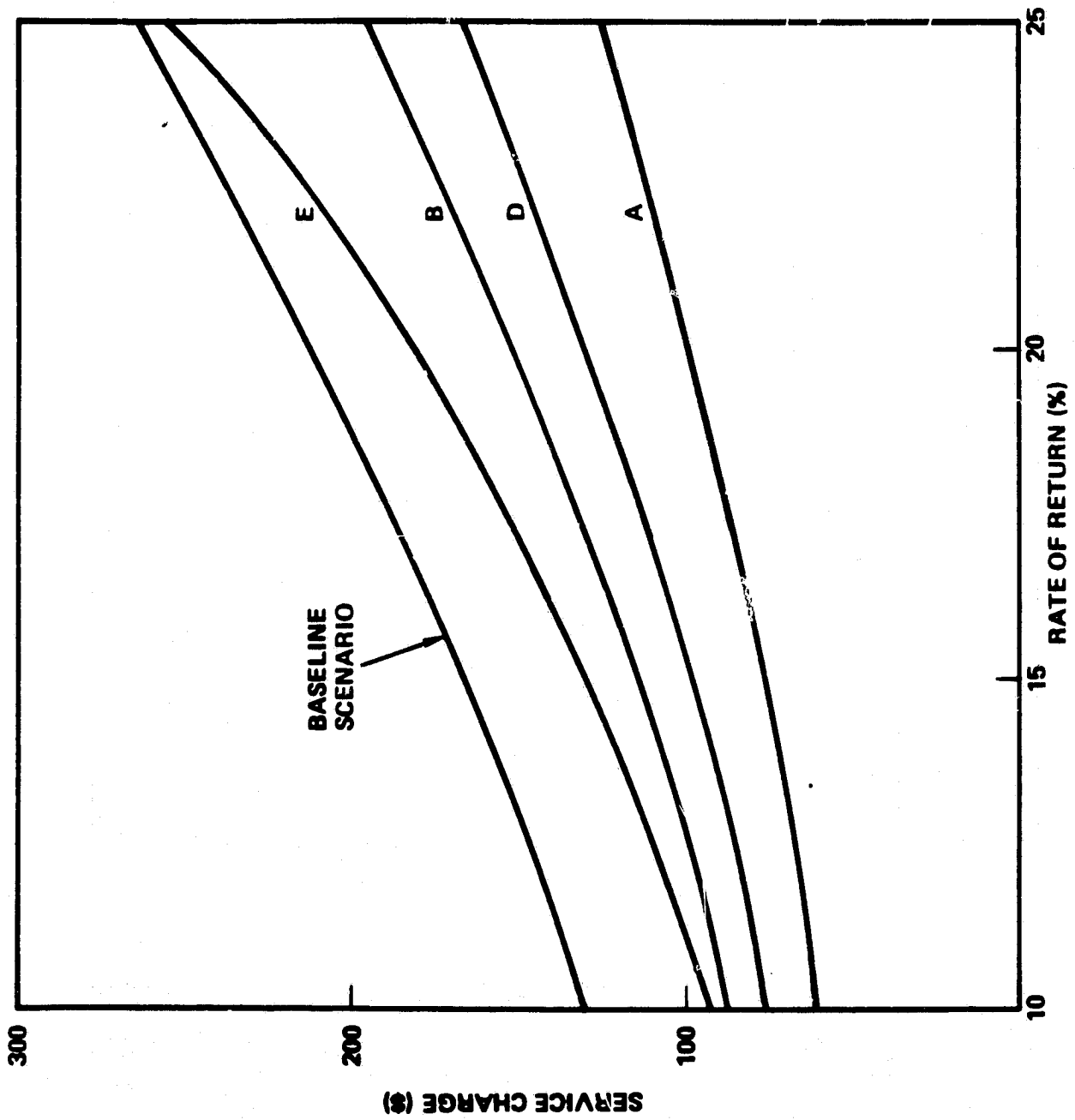

Figure 3-7. MSC for Different Traffic Scenarios

- 3-2. M. Hata, "Empirical Formula for Propagation Loss in Land Mobile Radio Services," IEEE Transactions on Vehicular Technology, Vol. 29, August 1980, pp. 317-325.

4. SYSTEM 3

4.1 INTRODUCTION

System 3 is a hybrid system. From a user point of view, it operates in the same manner as System 2 in those areas serviced by translator stations. Outside these areas, users communicate directly through the satellite, in much the same manner as in System 1. For reasons that will become clear shortly, the equipment used by the latter group of subscribers will be referred to as "transportable" units. This is in contrast to the "mobile" equipment of the former group of subscribers.

A dedicated satellite is required to service the transportable units. This group is anticipated to be small in number. Consequently, the satellite should be made as simple as possible to minimize the per-unit space-segment cost attributable to the transportables.* One way to accomplish this is to provide complete CONUS coverage with a single satellite beam. Although a single beam may provide adequate capacity for the transportable population, the reduced satellite antenna gain implies large per-carrier transmit power for both the satellite and the transportable unit. These power levels can be kept manageable only by increasing the transportable-unit antenna gain.

The achievable antenna gain, for a practical installation that has to operate while the user vehicle is in motion, is limited. (For example, a gain of about 8 dB can be realized over an elevation-angle range of 20 to 60 degrees with a 3 x 3 phased array which is 18 inches on a side.) For this reason, the antenna for the transportable units is required to operate only while the vehicle is at rest. However, it must be capable of rapid deployment and stowage; hence the term "transportable".

The antenna selected for the transportable units is a collapsible helix. When extended, it has a length of 3.5 feet. A means must be

*The space-segment costs attributable to the transportable units can be found by subtracting, from the cost of a dedicated space segment designed to serve both transportable and mobile users, the System 2 lease charges for the mobile user alone.

provided to point this antenna in the direction of the satellite while the vehicle is at rest. A boresight gain of about 15 dB is achievable with an antenna of this type.

4.2 SATELLITE REQUIREMENTS

The satellite requirements are obtained by associating with each of the System 2 traffic scenarios for the mobile users a traffic scenario for the transportable users.

4.2.1 Baseline Subscriber Scenario

The baseline mobile population comprises 180,000 users at EOL. In the System 2 configuration, mobile units communicate with the translator stations using the standard cellular-system transmission format. In particular, the carrier spacing is 30 kHz.

The EOL transportable traffic associated with the baseline mobile scenario is the maximum amount compatible with single-beam CONUS coverage. This number depends on the carrier spacing assumed for transportable transmission. At the point in the study when this question was first addressed, alternate modulation formats to the cellular format had not yet been considered. Consequently, the carrier spacing was taken as 30 kHz.

The frequency band specified for transportable transmission is 821-825 MHz. The complementary band for the satellite transmission is 866-870 MHz. This spectrum allocation permits 133 carriers at a spacing of 30 kHz. After allowances for signaling channels and call blockage, the satellite capacity is approximately 120 erlangs of voice traffic. This is only 2.6 percent of the EOL baseline traffic postulated for the mobile users.

As derived in Section 3.2.2, the mobile traffic can be handled by 8 transponders of the current C-band variety. The dedicated satellite designed for System 3 operation would include a payload of this type for the mobile users. Initial operating capability for this satellite is scheduled for 1995, the time at which the mobile population reaches 50,000. Prior to that time, translators already deployed would operate through leased satellite capacity. By this means, the revenue profile for the System 3 mobiles is maintained identical to that for System 2.

Despite the much larger volume of mobile traffic, the satellite power requirements are dominated by the transportable traffic. (The power requirements are derived in Appendix E.) This can be attributed to the large antenna gain of the translator stations compared with that of the transportable units (50.5 dB versus 15 dB). It is shown in Appendix E that the FLEETSAT bus is well matched to the baseline-scenario power requirements. FLEETSAT has a 12-foot antenna that provides (single-beam) CONUS coverage.

4.2.2 Alternate Traffic Scenarios

A common transportable traffic scenario (specified by NASA) is associated with mobile scenarios B, D, and E. This is a voice/data mix comprising 120 erlangs of voice and 120 erlangs of data. The data are constituted as follows: 40 percent at 56 kb/s and 60 percent at 9.6 kb/s.

The voice carriers are assumed to be spaced by 12 kHz (corresponding to 5-kHz peak-deviation FM), while the data-carrier spacing is 40 kHz or 8 kHz, respectively, corresponding to QSPK transmission. It is readily verified that these values lead to a total bandwidth occupancy of 4 MHz, so that frequency re-use is not required. (For simplicity, erlangs and channels are considered synonymous.)

A non-cellular-compatible modulation format for transportable voice transmissions is not nearly so objectionable as a noncompatible format for mobile users. In the remote areas where transportable units are expected to operate, cellular compatibility may have little significance.

The transportable traffic corresponding to scenario A (also specified by NASA) is a voice/data mix comprising 300 erlangs of voice and 300 erlangs of data. The data are divided, as in the previous case, between 56-kb/s and 9.6-kb/s carriers. Since a single-beam is just adequate for the transportable traffic associated with mobile scenarios B, D, and E, the transportable traffic associated with mobile scenario A requires a 2.5-fold re-use of the 4-MHz allocation. This is accomplished through use of 4 frequency sets and a beam pattern that places 10 beam equivalents within the boundaries of CONUS. (A uniform geographic distribution of transportable units is assumed.) A total of 17 beams is needed in all. These are generated by a 20-meter satellite antenna.

Thus, the System 3 satellite for scenario A could be made similar to the offset-fed baseline for System 1, except that the number of beams is much smaller. The satellite would also contain a sufficient number of C-band transponders for the mobile traffic.

At EOL, the mobile traffic in scenario A would fill 30 transponders; for scenarios B and D, 15 transponders; and for scenario E, 14 transponders (see Section 3.2.2).

As is the case with the baseline scenario, the satellite power requirements for scenarios B, D, and E are dominated by the transportable traffic. The required power is virtually identical in these three cases and about 65 percent higher than that for the baseline scenario. The TDRS bus is a suitable vehicle for these scenarios. It uses a pair of 16-foot antennas, symmetrically illuminated, for eastern and western CONUS coverage. The minimum gain over CONUS is 2.5 dB greater than that achieved with the 12-foot FLEETSAT antenna and is comparable to the performance realizable with a single shaped beam covering CONUS. The latter approach would require a 25-foot antenna at the frequencies of interest.

Because of the multibeam configuration proposed for scenario A, the satellite antenna has considerably more gain than the single-beam antennas suggested for the other scenarios. As a result, the power needed to support the transportable traffic is only half that for the baseline scenario, despite the four-fold increase in traffic level. However, substantially more power is needed for the mobile traffic, in accordance with the larger required number of transponders. The net result is that the total satellite power required for scenario A is about equal to that for the baseline scenario and 2/3 that for scenarios B, D, and E. Full details can be found in Appendix E.

4.3 MONTHLY SERVICE CHARGE

Two extreme approaches are possible in computing an appropriate MSC for a mix of mobile and transportable subscribers:

1. Keep the mobile MSC the same as in System 2 by making the transportable users bear the burden of all space-segment costs over and above the satellite lease charges for the System 2 mobile users.
2. Impose a common MSC on mobile and transportable users.

These approaches are represented by the end points of the solid curve in Figure 4-1, which shows the trade-off between mobile and transportable MSCs for the baseline subscriber scenario and a 10 percent IRR. All points on this curve produce identical total revenues in each year of system operation. (The mobile and transportable populations are assumed to grow at the same 20-percent annual rate.) Because of the preponderance of mobile users and the large System 3 space-segment costs in comparison with the System 2 satellite lease charges, a prohibitive MSC results from making the transportable users pay for the cost differential.

The dashed curve in Figure 4-1 results from narrowing the carrier spacing to 12 kHz (i.e., from using 5-kHz peak-deviation FM). The number of transportable users that can be accommodated in a 4-MHz allocation is increased by a factor of 2.5 by this means. However, the transportable MSC is still far too large to be supportable, if the mobile users are required to pay no more than in System 2.

On the other hand, a common MSC for the two user types would be set at \$210 for a carrier spacing of 30 kHz, and \$204 for a carrier spacing of 12 kHz. The latter figure represents an increase of 57 percent over the System 2 MSC of \$130.

While any point on the curves in Figure 4-1 could be used as the basis for MSC selection, it is not possible to significantly reduce the mobile MSC without greatly increasing the transportable MSC. Therefore, a common MSC has been adopted as a ground rule, both for the baseline scenario and for the alternate scenarios.

The MSC for the baseline scenario is shown as a function of IRR in Figure 4-2. The three curves correspond to different spacings for the transportable carriers. In addition to the two FM cases, linear predictive coding (LPC) is represented. This is a relatively recent digital development. It has been shown (Reference 4-1) that satisfactory transmission can be accomplished in only 5-6 kHz of bandwidth using 2.4-kb/s voice encoding. It remains to assess the quality of the reconstructed voice signal versus that for FM transmission.

Because of the relatively small transportable population, even with LPC, not much reduction in the MSC is possible. The principal benefit of

ORIGINAL PAGE IS
OF POOR QUALITY

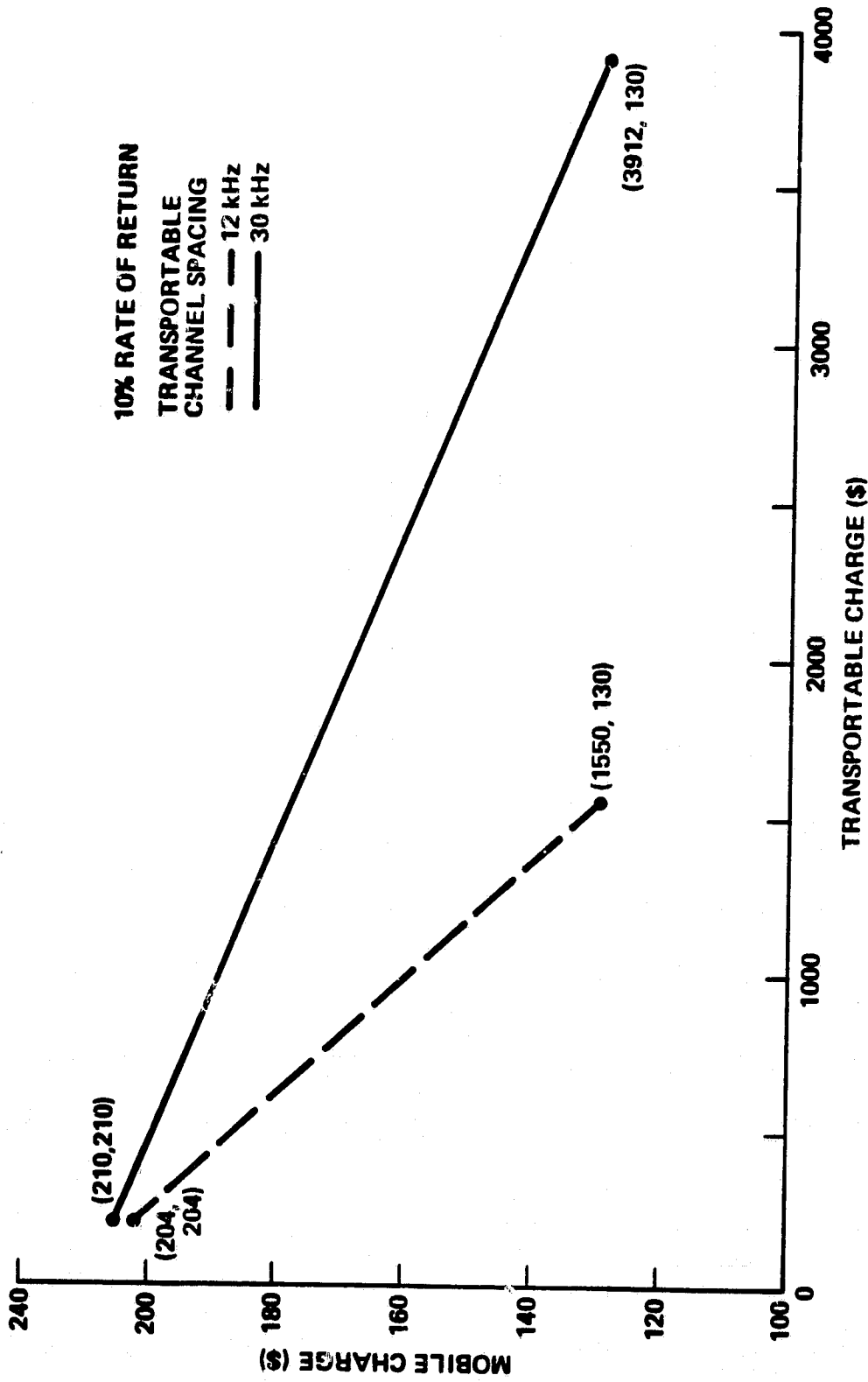

Figure 4-1. Transportable Vs. Mobile MSC

ORIGINAL PAGE 19
OF POOR QUALITY

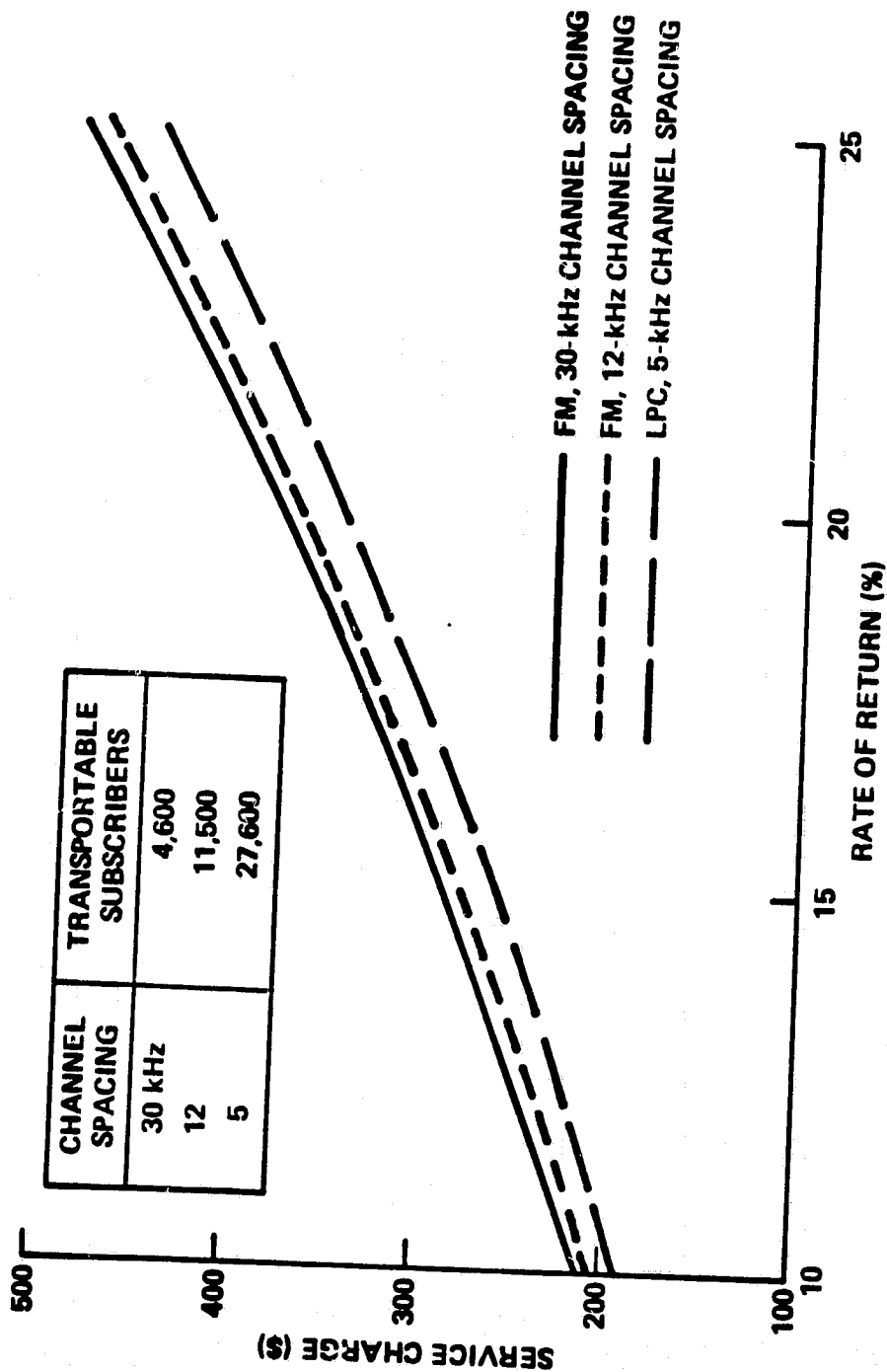

Figure 4-2. MSC Sensitivity to Modulation Format

introducing a narrower modulation format is, simply, that a larger population can be supported in the postulated 4 MHz allocation.

The effect on the MSC of varying the cost of the different system segments by ± 50 percent is shown in Figure 4-3. As in System 2, the translators represent the largest capital investment. However, the satellite cost is a close second in this case. This is consistent with the 57-percent increase in MSC for System 3 over that for System 2.

In deriving the MSC for alternate traffic scenarios, the same charge per-unit-bandwidth was established for data as for voice. In all cases, however, the MSC is presented for a voice subscriber (i.e., a subscriber that contributes 0.026 erlang to the busy-hour traffic load). The MSC for full-time use of a 9.6-kb/s data channel (by transportable users) would be $(8/12)/0.026 = 25.6$ times the MSC for a voice subscriber. The first factor is the bandwidth ratio for the two channels.

The transportable-traffic annual growth rate for the alternate scenarios was taken as 20 percent. This is different from the mobile-traffic growth rate for these scenarios (see Figure 3-6).

The MSC for traffic scenarios A, B, D, and E are shown in Figure 4-4. The charge for scenario A bears approximately the same relation to the charges for the other scenarios as was the case for System 2. This is noteworthy inasmuch as a different satellite approach was required for scenario A because of the frequency re-use factor.

It was previously indicated that the FLEETSAT bus suffices for the baseline scenario, while the TDRS bus is required for scenarios B, D, and E. There is not a significant cost difference between the two satellite derivatives, however. Therefore, the estimated cost of the TDRS derivative was used for the baseline scenario as well as scenarios B, D, and E.

The satellite for scenarios B, D, or E requires about 15 transponders for the EOL mobile traffic. On the other hand, there is sufficient bandwidth for 24 40-MHz transponders in the 500-MHz allocation at either C-band or Ku-band (with polarization diversity). The possibility of including 24 transponders and leasing those not needed for mobile communications has not been considered to this point.

ORIGINAL PAGE IS
OF POOR QUALITY

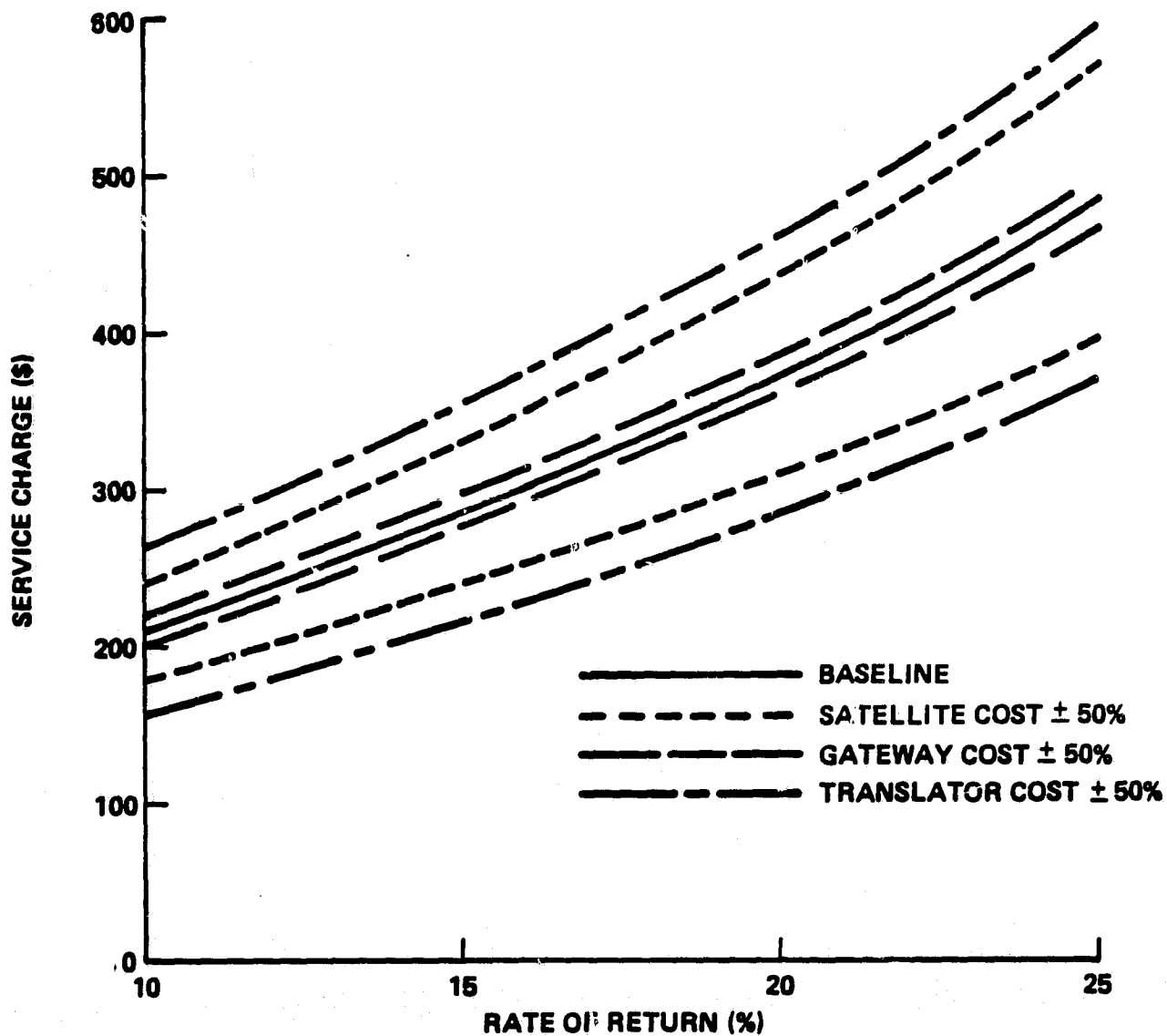

Figure 4-3. MSC Sensitivity to Cost Variations

ORIGINAL PAGE 19
OF POOR QUALITY

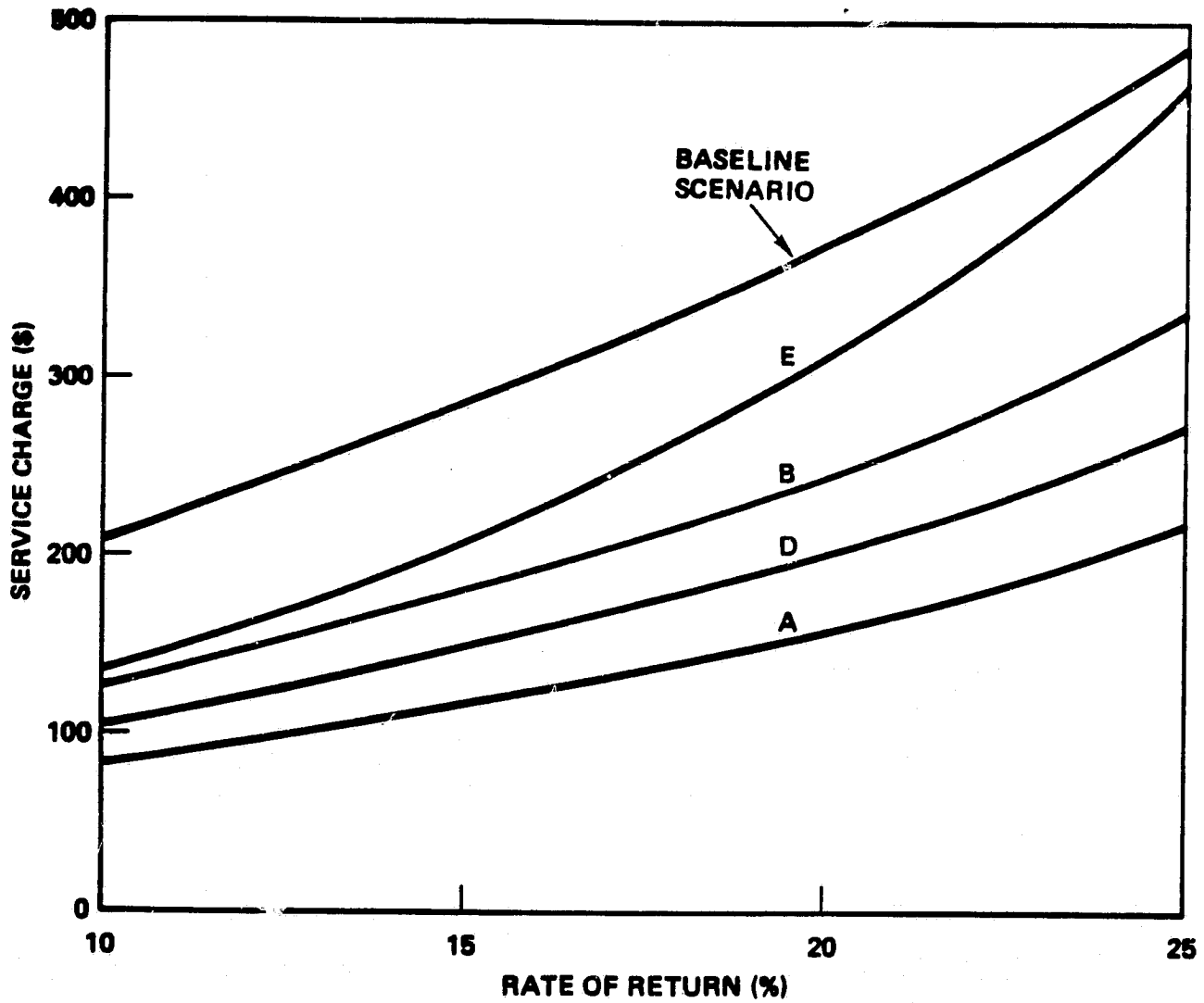

Figure 4-4. MSC for Different Subscriber Scenarios

Financial arrangements for the lease of extra transponders are indicated in Figure 4-5. The 9 transponders that would be available for the 7-year satellite life are shown at \$2 million/year, which is approximately the current C-band lease rate. The lease charge for the remaining transponders is assumed to be \$1 million/year, for as many years as they are available. As can be seen from the figure, the MSC is reduced only slightly by transponder leasing.

Reference

- 4-1. S. Carney and D. Linder, "A Digital Mobile Radio for 5-6 Kiloherz Channels," Proc. Int. Conf. on Communications, Philadelphia, 13-17 June 1982, paper 5B.3.

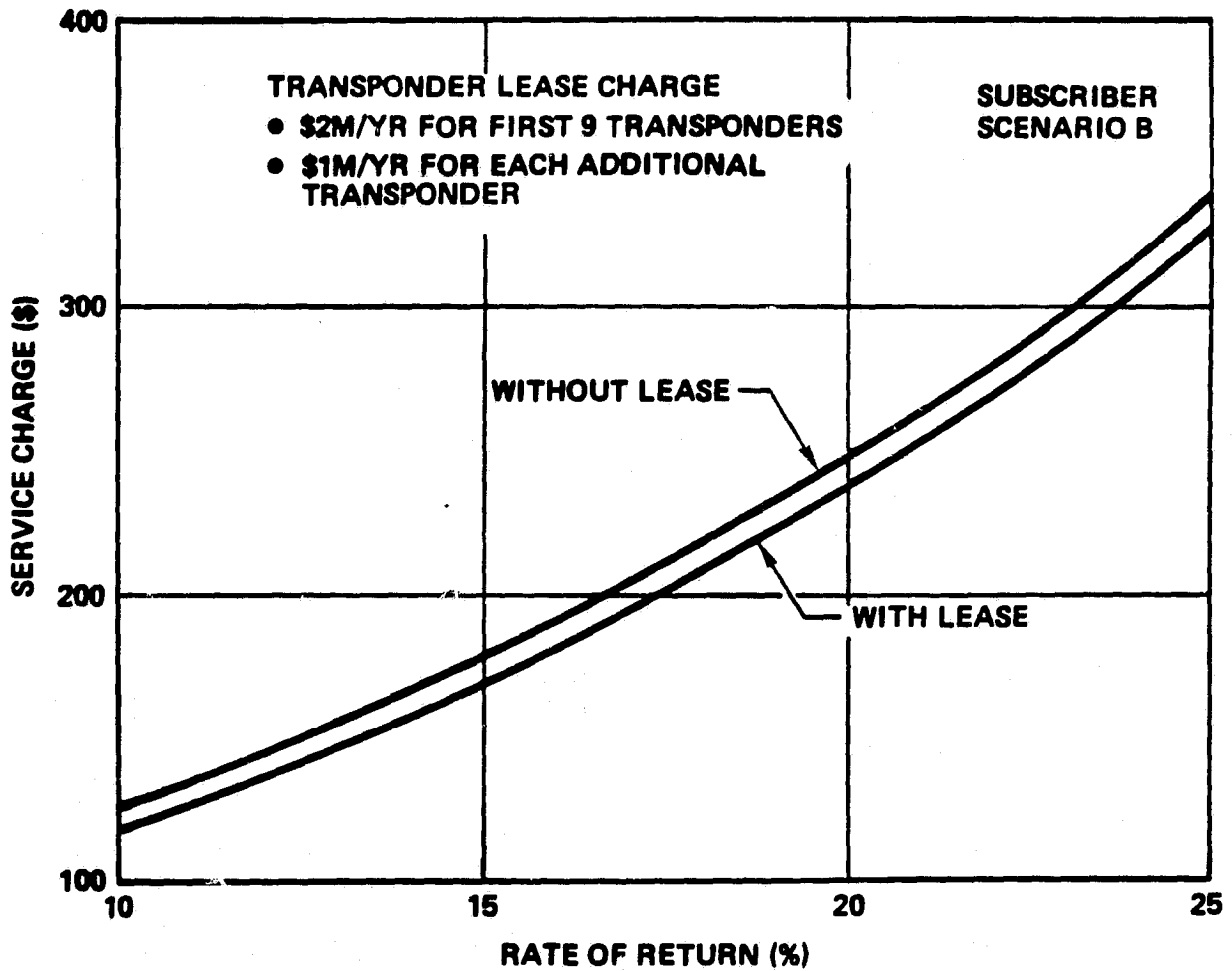

Figure 4-5. MSC Reduction From Lease of Unused Transponders

5. CRITICAL TECHNOLOGY IDENTIFICATION

5.1 INTRODUCTION

Of the three system configurations considered in this report, only the space segment of System 1 incorporates technology that is not expected to exist in 1990 in the absence of LMSS. System 2 requires leased satellite capacity, while the TDRS bus can handle the System 3 traffic for scenarios B, D, and E. (The baseline scenario and scenario A will not be considered further.)

Additionally, a modem development is required for the gateway stations in System 1.

A new mobile unit is required for the baseline System 1 configurations, and also for the transportable users in System 3. The System 1 mobile unit utilizes 5-kHz peak-deviation FM, while the characteristics of the System 3 modem depend on the modulation format selected.

This section of the report will focus on the satellite technology for System 1. The major portion of the critical technology is associated with the large space structure (LSS) aspect of the satellite design. This technology is conveniently divided into three major subdivisions:

1. Configuration - relates to launch vehicle, orbital transfer vehicle (OTV), and possible manned participation.
2. Structures - involves determination of environmental parameters, reflector and mast requirements, materials requirements, analytical modeling, and testing.
3. Attitude Control - includes active and adaptive controls, and the required measurement system.

The other significant area requiring technology development is the antenna feed system. From an RF standpoint, this includes the mast design as well as the feed/beamformer combination.

The remaining subsystems use presently available or near-term technology. Although the UHF solid-state amplifiers play a key role in the system design, the technology is mature; consequently, tailoring of existing technology to the application at hand, rather than new technology development, is involved.

5.2 LARGE SPACE STRUCTURE

5.2.1 Configuration Technology

The dominant configuration technology drivers for the selected baseline designs (offset-fed and center-fed, wrap-rib reflector) result from use of the STS as the launch vehicle. Three STS-associated technology issues, and their probable development by the late 1980s, will be discussed in this section: (a) STS launch vehicle capability, (b) orbital transfer vehicle, and (c) possible use of STS manned capability.

STS Launch Vehicle

MSAT is configured to "fit" in the orbiter cargo bay, together with its OTV, in a single launch to low-earth-orbit (LEO). A 9-foot margin in cargo-bay length exists for each of the baseline designs. Weight estimates for these designs are:

	<u>Center-Fed</u>	<u>Offset-Fed</u>
Satellite (Incl. 20 percent contingency)	8,340	9,035
IPS (OTV)	40,000	43,200
Airborne Support Equipment (ASE)	5,000	5,000
Total Lift-Off Weight	53,340	57,235 (1b)

With the on-going STS modifications, in excess of 60,000 pounds (65,000-pound target) is allowed at launch. The previously imposed satellite weight limit of 10,400 pounds corresponds to an STS capability of 65,000 pounds.

It may be concluded that neither cargo-bay volume nor launch weight is critical, except for OTV capability, which is discussed separately. Historical growth of complex satellite systems suggests that the satellite weight margin with respect to the assumed STS capability may not be excessive, especially for the offset-fed design.

Future national space programs require STS derivative vehicles with increased weight and size capability. This increased payload capability would ease MSAT weight targets and allow less costly component selection in

weight-sensitive systems such as structures and power. Boeing/NASA STS (unmanned) studies project up to 125,000-pound capability in LEO in the early 1990s.

Martin-Marietta/NASA designs, based on a cargo fairing located aft of the external tank, increase the allowable cargo diameter from 15 feet to over 30 feet. This increase would have a dramatic impact on feasible antenna deployment and stowage concepts. Simpler configurations, such as the TDRS antenna, or even highly efficient, rigid-surface (sunflower) reflectors could be considered.

Such STS improvements are still in the feasibility stage. Some of these improvements should materialize by the end of the decade, and should be monitored because of their potential impact on the MSAT design.

Orbital Transfer Vehicle (OTV)

Presently approved, STS-compatible OTVs are not adequate for MSAT. The satellite baseline designs are based on the availability of either a wide-body Centaur or an integral propulsion system (IPS) OTV. Ongoing NASA/DoD studies of high-energy upper stages for STS tend toward IPS technology. Also, IPS is competitive in weight and length with Centaur. Availability of an IPS, or equivalent, OTV is critical to MSAT development. With present national needs, such an OTV should be available by the late 1980s.

Another OTV issue relates to a low-thrust transfer from LEO to geosynchronous orbit (GEO), allowing deployment and checkout of MSAT in LEO. The benefits would be risk minimization, cost reduction (less redundancy), and satellite retrieval and refurbishment. IPS is close to meeting the low acceleration levels required. Consideration should therefore be given to making this capability a requirement.

Unmanned OTVs with remote manipulator capability, such as Teleoperator, may be available in GEO in the 1990s. This technology would make it possible to replace failed modules or upgrade satellite performance. Multi-Mission Spacecraft (MMS) type modular designs to take advantage of teleoperators are state-of-the-art and would reduce satellite risk and cost.

Manned Participation

The MSAT configuration is based on a self-deploying satellite in GEO. NASA/DoD interest in a manned OTV (MOTV) or sortie vehicle may result in such a system by the 1990s. Alternatively, with an unmanned low-thrust OTV, MSAT can be deployed in LEO, close to the STS. In either case (manned OTV or STS support), the MSAT configuration is enhanced by manned presence. For example, deployment mechanisms can be "backed-up" or even fully activated by man, failed modules can be replaced, the system can be upgraded, and critical reflector surface control implemented.

Taking man's participation even further leads to active assembly of MSAT in space. Very large box-truss members can then be efficiently used, increasing dynamic stiffness to the point where state-of-the-art ACS systems are feasible.

At this time, there are no clear results indicating a choice between automated or manned orbital operations in future systems. As STS matures and NASA/DoD develop additional STS elements (Teleoperator, Space Station, MOTV, low-thrust OTV), this issue will be resolved.

5.2.2 Structures Technology

Large space structure technology (LSST) affects the satellite design in the following respects: structural design criteria, deployable structures, materials characterization, dynamic analysis, and testing. These topics will be discussed in turn.

Structural Design Criteria

Experience is quite limited in dealing with the types of disturbances that will affect a large space system such as MSAT. From ground testing through space operations, the structural design criteria (loads, stiffness, and environmental effects) are unique.

On the ground, 1g gravity, air currents, and temperature gradients, even within an enclosed building, constitute major disturbances to the structure. Special handling and orientation criteria must be developed for the various system elements.

STS integration and launch loads, for either test flights or operational launch, must be understood for "folded," highly flexible

structural elements (cabling, mesh) to prevent snags or undue settling of the stowed reflector.

STS-attached testing may impose orbital loads that are a magnitude higher than operational loads. This results from STS thruster activation (limit cycling, attitude control) or crew motion while in orbit.

While operational in GEO, gravity-gradient and solar-wind disturbances, which are minor in their effect on existing satellites, will induce structural torques and possibly produce dynamic coupling with MSAT. Thermal gradients will distort MSAT sufficiently to be of concern; understanding sun shadowing and thermal behavior of multimaterial masts and reflectors is required to predict satellite response.

ACS operation (CMGs, thrusters) induce loads and frequencies which, although of secondary importance in present satellite structures, are critical for MSAT. Combined ACS/structures criteria must be developed to ensure decoupling of the two subsystems.

In summary, technology development is required to classify and quantify the various ground, testing, and orbital loads, disturbances, and environmental factors to generate a comprehensive set of MSAT structural design criteria.

Deployable Structures

NASA and industry technology programs related to deployable lightweight structures have been in progress for several years. The areas of present interest are deployable reflectors (46 and 62 meters) and masts which are compatible with launch of MSAT in a single STS flight.

LMSC's wrap-rib reflector, 10 meters in diameter, was flown in the early 1970s on ATS-6. Present technology development effort is directed at scaling up this design, increasing its stiffness by material and shape selection, and dynamically modeling the larger reflector. A 15-meter reflector development is planned. Fabrication of full-size scale ribs was completed in 1981. Demonstration of the wrap-rib reflector on an STS flight experiment will establish the proof-of-concept required prior to starting full-scale MSAT development in 1990.

The principal reflector development issues are surface accuracy and analytical modeling. To achieve the surface accuracy goal, the ribs must be stable and must deploy consistently, and the mesh supports and preloads must be managed to produce the desired effect when deployed. Unlike the ATS-6 10-meter reflector, MSAT cannot be readily tested in the 1g ground environment.

High-stiffness deployable mast technology is paralleling reflector development. Articulated and telescoping designs, to achieve rigid longerons, have been demonstrated on short masts. STS testing is being planned to acquire zero-g dynamic response data. Present state-of-the-art for coilable mast technology (as exemplified by Astromasts, which are in use in several programs) is fully mature; however, coilable masts have diameter and stiffness limitations that preclude their use on MSAT, other than for appendages (solar arrays).

Rigid longeron mast concepts are not new developments, but the size and dynamic stability required for MSAT are technologically challenging. The mast complexity results from the longeron multiple pinned joints and unpredictability of the stabilizing tension in diagonal members. Joint hysteresis (free-play), precise deployment and consistent preload of diagonal cables, and scalability of ground test data in a 1g environment are problems to be resolved in the next few years.

Materials Characterization

Materials technology requirements relate to the need for low weight and a high degree of stiffness. In addition, the MSAT application requires that the materials be used in unique ways.

Cabling is used for the mast diagonals and for reflector surface control. These cables may be up to 100 meters in length, with constant preload required throughout system life. They have to bend or reel for stowage, probably for a long period. Cabling materials must be dimensionally stable (thermal, preload) and lightweight, and must not unduly block the RF field. Cable performance, reliability, and predictability are essential.

Present technology efforts for cabling are concentrated on graphite and quartz. Materials properties are being derived, but the issues of size and stability remain to be investigated.

For the reflector ribs and the mast columns and battens, graphite-epoxy (GR-E) is the leading candidate. GR-E is in wide use, but further development is needed to achieve the minimum possible gauges and improve properties predictability.

The satellite weight is sensitive to the number of GR-E layers in structural elements. Three or more layers are required to provide structural/thermal stability in multiple directions. Further, layups tend to show properties scatter in inverse proportion to the number of layers used. For the present application, a minimum of three layers will be used for tubes (longeron) or ribs.

In addition to the problems of cabling and thin layups, materials development for RF compatibility is required. For example, in the center-fed configuration, mast blockage must be considered. Fiberglass has been suggested as a replacement for GR-E. This material selection issue could be of critical importance for the center-fed design.

Joining techniques (bonding, mechanical) must be examined to automate, as much as possible, the assembly operations. This is desirable because of the large number of elements and the need to reduce properties scatter in a repeatable manner.

Structural/Dynamic Modeling

Inability to full-scale test the satellite structure on the ground places a premium on analytical modeling to predict the dynamic response of the system. None of the analysis techniques available today meets the stringent requirements imposed by MSAT or other large space structures.

The analytical capability that must be developed relates to: (1) the large computer program required and the need to resolve it into smaller component parts, and (2) dynamic modeling of nonlinear, large deflections. Solution of the first problem depends on improved modal analysis and integration of multiple structural models (masts, reflector/ribs/mesh, main bus, appendages, etc.). The second problem requires the ability to account for the nonlinear behavior of joints and tension cabling.

In present satellite systems, these problems are resolved by analytical approximation (if full solution is not practical), followed by test correlation and parameter adjustment. For convenience, the damping

constant of the structure is usually the model parameter adjusted. For MSAT, damping may be a dominant aspect of system behavior (because of mesh behavior and the number of mast joints involved) and must be known accurately. Testing prior to flight may be impractical. To minimize ACS requirements to stabilize the satellite, therefore, accurate analytical modeling is required.

The analytical model must also incorporate the effect of the various disturbances in a distributed manner to accurately predict the satellite response.

Testing

Ground testing of MSAT is limited by the 1g environment to either scale tests or tethered full-scale tests. Scalability of the test data is severely limited by the damping and preload characteristics induced by gravity and tethers, if used. Scaling a structure dynamically requires compromises regarding the scaling parameter to be used. Issues to be considered include balancing of extensional (area) versus flexural (bending) stiffness, joint sizing, and cabling and mesh preload selection.

The ground environment results in drag effects on the moving structure and excitation by air currents. The test model must accurately predict these effects if vacuum dynamic testing is not feasible. In systems that have multiple responses in a narrow band, as does MSAT, these ground effects may mask the desired system response.

Once the ground test is complete, a LEO test of the same test specimen will produce the required correlation between zero-g and 1g environments. The STS is a natural vehicle for this test, and plans exist to test-fly masts and reflectors in the mid-1980s. In performing STS testing, consideration must be given to Orbiter-induced disturbances (ACS, thrusters) and their isolation.

Use of STS for deployment and dynamic testing requires added test hardware for manned flight safety. This could lead to a test specimen design that is more rigid than is required for a free-flyer. Also, it is desirable to bring the test specimen back to earth. Re-stowing a large reflector would pose a much more complex mechanical problem than deployment. This results from the requirements to: (1) automatically re-stow

the mesh, and (2) provide all locking joints (masts, hoops, rib roots) with an unlock capability.

Careful analysis of the ground and STS-supported test requirements must be made early in the development cycle. Design goals include scalability of the data and the determination of structural requirements imposed by either 1g ground tests or STS safety, loads, and re-stowage requirements.

5.2.3 Attitude Control System (ACS) Technology

Many operational satellite systems incorporate flexible appendages, but the appendage mass is relatively small when compared to that of the satellite. Also, in present satellites, the payload (antennas, optics) is rigidly mounted or gimballed to the bus. Control technology for these systems is mature. Large space structures require new technology or improvements over current performance levels. For MSAT, this is because of the long flexible mast that connects the feed and the reflector, and which leads to large relative motions between them.

The satellite baselines do not use active gimbals or feed/reflector alignment. Rather, they are based on the ability of the ACS to sense the required pointing (RF signal), the present state of the structure (measurements), and to predict the near-term modal response of the satellite (algorithms). With this capability, the ACS steers the dynamically excited structure to maximize the RF signal.

Four control technology areas are covered in this section: active controls, adaptive or robust controls, impulse and momentum devices, and feedback measurement systems. This breakdown was chosen to describe MSAT-peculiar controls implementation. For the most part, mature ACS functional aspects are not discussed here.

Active Controls

Active control implies a feedback system (RF signal, position sensors) that provides data to an ACS controller, which in turn commands mechanical devices to alter the position of the controlled element. Various feedback-controlled active mechanical pivots, gimbals, and tension control cables are discussed below. In addition, active structural damping or stiffness enhancement is addressed.

The satellite baselines do not use gimbals, since the satellite is controlled as a single unit to provide the required pointing. Inasmuch as this technology is not yet proven, alternate ACS approaches may be required. Thus, gimbals may be needed at either the feed or the reflector hub for proper pointing. With the exception of the required feedback sensors (discussed later), this technology already exists if the driven mass is smaller than the gimbal support base. An example is the feed (lower mass), which is gimbaled off the main bus (higher mass). On the other hand, the reflector mass is larger than that of its supporting mast. Use of a gimbal between them could result in instability unless a complex, reactionless gimbal system is employed.

Active controls can also be used to enhance structural stiffness and natural damping. On the mast, the diagonal cabling tension can be controlled to damp out excitation modes. On the wrap-rib reflector, mechanical components (dampers, motors) can be used to alter the rib response. These mechanisms must be controlled by the ACS from measurement feedback. Implementing this technology would make the satellite response "stiffer" and lead to rapid damping of disturbances. Small-scale feasibility ground tests (plate tests) have been conducted, and NASA/DoD plans exist for an STS flight-test experiment incorporating adaptive-control and measurement technologies (discussed below).

Adaptive Controls

MSAT flexible body control dynamics require that: (1) the ACS controller be updatable in orbit, and (2) it be possible to resolve the satellite complex response modes, through ground processing, to maintain control authority over attitude. The need for this adaptive capability results from inability to fully characterize the modal response in ground testing because of earth gravity effects.

Technology development (NASA/DoD) is proceeding to: (1) enhance bandwidth capability and adaptability of the controller (robust systems), and (2) characterize orbital disturbances and structural modal response using a satellite measurements system coupled with ground data reduction algorithms. Several methods have been proposed and plans are proceeding to test such a concept on the STS.

Adaptive controls must be demonstrated prior to commitment to MSAT development in the late 1980s. Areas of development should include:

1. Stability-ensuring design methodology, which maintains system stability in spite of system modal uncertainties. A design which is robust in a stability sense may nevertheless have poor pointing accuracy. As system knowledge improves, through analysis and/or test, control system design can be enhanced to provide more accurate pointing.
2. On-orbit system identification. Because the satellite cannot be tested on the ground in its fully deployed form, a method of estimating system parameters from on-orbit experimental data is needed.
3. Control system/structure tradeoff. Attitude control can be achieved either by means of additional software, resulting in a lighter structure, or with less software and a heavier structure.

Impulse and Momentum Devices

The ACS controller provides commands to the MSAT reaction wheels (RW), control moment gyros (CMG), and reaction control subsystem (RCS), which together form the controlling authority to torque or displace the satellite as desired. Other devices that may be used include magnetic torquers, ion thrusters, etc.

RCS technology is mature. What is required is a tailoring of the thruster pulse-shape and amplitude to decouple the output from the satellite dynamic response. This is critical since the thrusters constitute, by an order of magnitude, the major orbital disturbance to the satellite. Low thrust, smooth on-off slopes are required. Development of other control devices will also benefit attitude control. Such devices may include mass proof actuators (linear momentum exchange), active/passive dampers, position/rate sensors, etc.

Measurement Systems

A unique feature of an LSS system such as MSAT is the requirement to measure the shape (position) and rates of motion of the entire satellite, over distances up to 100 meters. These data are provided to the ACS controller to close the feedback loop and result in corrective commands. The measurement system consists of (a) a monopulse pickup antenna that tracks an earth signal (pointing direction), (b) a feed/reflector distance

and angular-position measurement system, (c) a reflector-surface measurement system, and (d) accelerometers and strain gauges, distributed over the structure to provide modal response information (initialization).

Monopulse tracking and modal response instrumentation technology is mature. Range and angular measurement sensors are being developed by NASA based on pulsed laser technology.

Angular sensor concepts such as the TRW surface accuracy measurement system (SAMS) have been proven on the ground. Range measurement, such as the JPL self-pulsed laser ranging system, lags the SAMS only slightly in development. For MSAT, these two systems, or their equivalent, will be required in the mid-1980s as part of the required STS flight demonstration tests.

Location of the accelerometers and strain gauges is critical for the data to be useful. Selection of instrumentation locations depends on accuracy of the analytical model. As discussed above under Structures Technology, LSS analysis will only yield approximate results required for instrumentation definition. Modal synthesis testing techniques will be used to define the instrumentation.

5.3 ANTENNA FEED SYSTEM

The antenna feed system for MSAT is unique in several respects. Requirements for multibeam antenna systems exist for a number of satellites, such as the INTELSAT series and the proposed Advanced Communications Technology Satellite (ACTS), the latter to operate at 30/20 GHz. However, each of these systems operates at higher frequencies and with significantly smaller antennas. The MSAT multibeam antenna involves low-frequency antenna feed technology, in which physical size, weight, and deployment capability (in addition to RF performance) are important design considerations. Presently configured multibeam antennas at higher frequencies employ waveguide technology with no requirement for feed subsystem deployment.

It is not anticipated that other satellite systems requiring similar large multibeam antennas will be developed in this decade. If this technology is to be available by 1990, therefore, it will likely be only through expenditure of funds for this specific application.

Technology development is required in two key areas: the RF feed/beamformer combination and the mast that connects feed and reflector. The mast has been dealt with extensively from a structural point of view. It is no less important, however, that the mast configuration and materials be selected such that RF performance is not significantly impaired. Nominally, this is a problem only for the center-fed design. However, it may be desirable, to avoid structural difficulties associated with the L-shaped mast in the offset-fed design, to consider mast configurations that could result in some degree of reflector blockage.

Feed/Beamformer Network

From an RF standpoint, low secondary sidelobe levels imply good feed illumination pattern control. This control can be guaranteed only by hardware verification. Among the parameters to be determined are the feed-element spacings required to produce the desired secondary beam placements. Element spacing will vary with scan angle, to account for variations in beam deviation factor. It must also account for the effect of mutual coupling between feed elements.

In addition, appropriate excitation (amplitude and phase) for the elements of each feed cluster must be determined. There is a nominal set of excitations associated, say, with a cluster located on boresight. This set of excitations has to be perturbed, as a function of scan angle, to compensate for the variable element spacing referred to above.

Finally, the beamformer design must be relatively insensitive to the effects of mutual coupling, thermal changes, and stress variations.

In addition to RF considerations, the feed/beamformer combination must be designed with deployment in mind. There are two beamformer networks associated with the feed system, corresponding to the transmit and receive functions. The beamformers are mated to the feed system through diplexers at each of the feed elements. With the large number of feed elements in both baseline designs, numerous interconnects are required. (The power amplifiers must also be situated close to the diplexers and therefore will be mounted on the beamformer substrate.) Because of the RF circuitry complexity, mechanical implementation is of critical concern. Means of folding and deploying the feed/beamformer network must be devised to ensure

RF integrity. Additional, environmental constraints must be built into the design to ensure that both thermal and stress forces can be controlled for RF integrity.

Because each beam is generated from an array feed cluster, the amplitude, phase, and voltage standing wave ratio for each antenna element must be preserved. If these parameters are not preserved to some predetermined set of values, the sidelobe levels will degrade. Variations in any of these parameters will affect mutual coupling mechanisms and impact adjacent feed elements as well.

Mast Design

In the center-fed design, the mast joins the reflector apex to the feed assembly. The mast is an open triangular truss, presumably fabricated from a nonmetallic material, which intersects the feed system at three points. DC power cables are routed from the solar array through the truss structure.

A number of issues must be addressed with this concept. First, what is the effect of the open truss structure on sidelobe performance? Is it more advantageous to use a nonmetallic structure such as fiberglass, or a lossy RF material such as the graphite-epoxy layups; or might a metallic truss be the best choice? Several RF mechanisms are at play which must be understood. These include the concern that the mast might be excited by the feed structure and act as a surface-wave carrier, in addition to the possibility that the truss structure might simply be a predictable aperture blockage.

The DC power cables are the next issue. Insight into the effect of cabling can be gained through investigation of the mast effect. Cabling produces a thin metallic line blockage between feed and reflector. This, by itself, should not be a serious concern. However, the effect of cabling in the context of the mast truss structure must be understood.

It is possible to alleviate the RF problems associated with the mast structure at the cost of introducing a degree of mechanical complexity. Two possibilities, in addition to the baseline arrangement, are shown in Figure 5-1.

ORIGINAL PAGE IS
OF POOR QUALITY

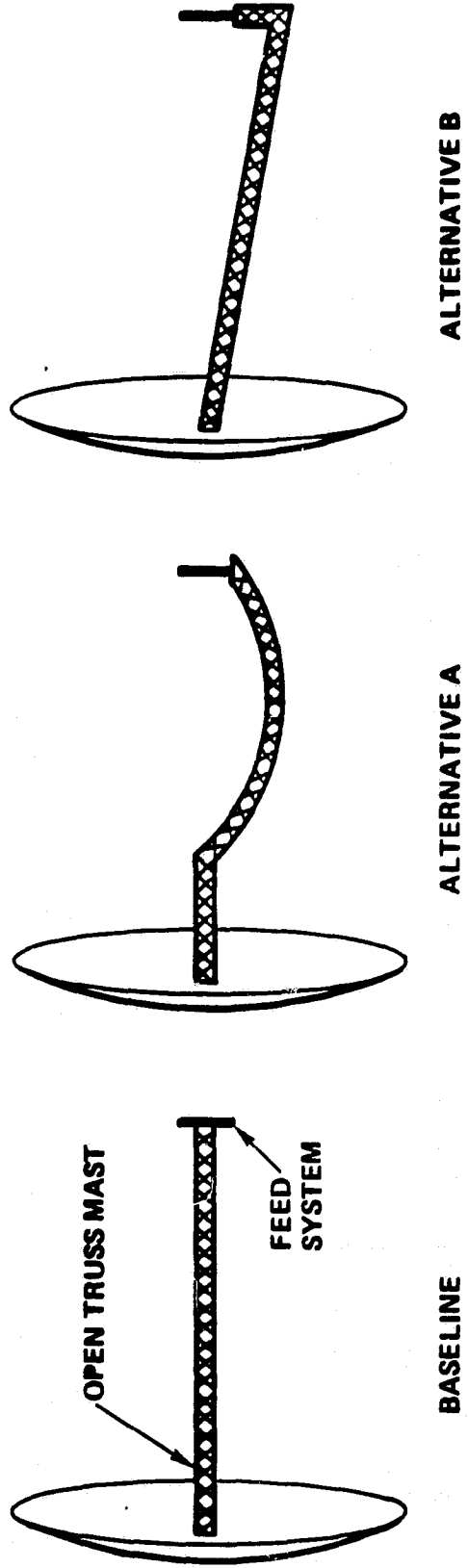

Figure 5-1. Alternative Mast Concepts for Center-Fed Design

The baseline offset-fed reflector design contains an "L" shaped mast composed of two sections. The first section starts at the back of the reflector centroid and extends for approximately 75 feet. The second section is about 250 feet long, extending to the focal point of the reflector system, where it intersects the payload compartment and the feed array. This mast assembly is complex because of its length, elbow joint, structural rigidity requirements, and need to be deployable.

One possible means of easing the mechanical difficulties associated with the mast is depicted in Figure 5-2. This concept calls for the most direct mast path between the reflector centroid and the payload/feed systems. This mast configuration greatly alleviates structural and ACS problems by reducing length, eliminating the elbow joint, and allowing the use of more mature deployment techniques. The mast in this configuration would constitute an RF blockage to the antenna system. The effect of this blockage on sidelobe performance would have to be determined. Of particular interest is whether comalobe levels would permit the use of only four frequency sets, as is the case for the L-shaped mast.

5.4 UHF SOLID-STATE AMPLIFIERS

Capability of the satellite UHF amplifiers affects system design and performance in two important respects: (1) the allocation that must be made for intermodulation (IM) noise, and (2) the DC power needed to support the UHF downlinks. The required RF power, and consequently the DC power, varies inversely with the downlink thermal noise allocation in the link noise/interference power budget. Thus, improved IM performance, which permits an increase in thermal noise allocation, serves to reduce the required DC power, for a fixed DC/RF conversion efficiency.

On the other hand, improved IM performance is achieved by increasing amplifier linearity, which generally implies reduced DC/RF conversion efficiency. In the present baseline satellite designs, DC/RF efficiency varies from beam to beam (i.e., from amplifier to amplifier). It is generally highest in a fully loaded beam and decreases with reduced beam loading. (This variability can be reduced somewhat by using lower-rated amplifiers or beams with lower anticipated traffic requirements.) It is not clear, therefore, to what extent a reduced IM allocation decreases the required DC power.

ORIGINAL PAGE IS
OF POOR QUALITY

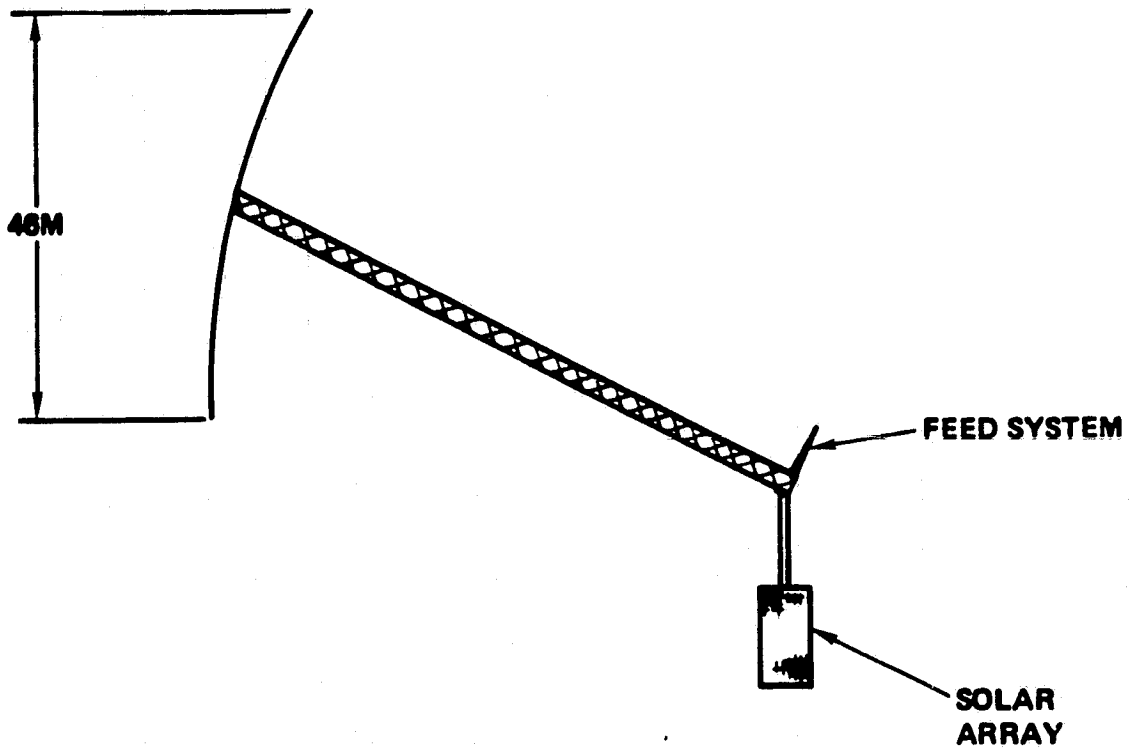

Figure 5-2. Alternative Offset-Fed Mast Concept

The problem is further complicated by the dependence of the IM power affecting a given carrier on the specific frequency plan adopted. Assume, for the moment, that each beam is generated from a single feed. If the carriers in each frequency set (i.e., in each beam) are uniformly spaced, all IM products within the carrier band will fall on assigned carrier frequencies. By contrast, if the frequency sets are chosen in a random manner, only $(1/N)$ th of the IM power generated by a given amplifier will fall on frequencies found at the amplifier input. Here, N is the number of frequency sets. For the offset-fed baseline design, where $N=4$, a 6-dB reduction in effective IM power results. For the center-fed baseline, where $N=7$, the reduction is 8.5 dB.

This argument overstates the IM reduction due to a random frequency assignment. A given carrier can be affected not only by IM products in its own beam, but also by IM products in the six neighboring beams. For uniformly spaced frequencies, the IM products generated in the surrounding beams are not co-channel with the carrier of interest. With a random set of frequency assignments, however, all beams contain the same IM power at any specified frequency. The total IM power affecting a carrier, therefore, depends on the satellite antenna gain for each of the surrounding beams at the location of the user to which the carrier is assigned.

For a single-feed-per-beam antenna design, the received IM power, like the received carrier power, is 3 dB below the peak value at the beam crossover points. Where each beam is formed by a cluster of feeds, however, the 3-dB IM contour lies outside the 3-dB carrier contour, because of the lack of coherence between IM products generated in different amplifiers. This factor reduces the apparent IM advantage resulting from a random set of frequency assignments over a wide range of user positions.

It is evident from the foregoing discussion that optimum UHF amplifier design and operation depends on a thorough communications system analysis. A key input to this analysis is the tradeoff between IM performance with a multicarrier input and DC/RF conversion efficiency, for a solid-state amplifier operating between 800 and 900 MHz. Solid-state amplifier design, particularly at these frequencies, is a mature technology. Moreover, the specific design problem posed above is not uncommon. A technology breakthrough that would significantly improve performance cannot be anticipated,

therefore. What is needed is a fine tuning of existing amplifier design techniques, with the measure of performance carefully chosen to reflect the system implications of a particular amplifier design.

It is relevant to ask, at this point, whether achievable amplifier performance has been properly reflected in the baseline system designs. Three assumptions have been made with respect to performance:

1. Carrier-to-IM power ratio of 20 dB
2. DC/RF conversion efficiency of 25 percent
3. Total DC power computed as the product of
 - a. DC power for fully loaded beam, and
 - b. Number of beam equivalents.

Assumption 3 is felt to be conservative, although it becomes less so as the amplifier is operated more linearly to improve IM performance.

The first assumption may turn out to be optimistic. It was based on the choice of a random set of frequency assignments. As explained above, the advantage of this technique is reduced by IM products generated in neighboring beams, particularly with a feed-cluster approach to beam formation.

A possible increase in IM allocation can best be accommodated by reduction in a pair of allocations:

1. Intersatellite co-channel interference
2. UHF downlink thermal noise.

Because of the conservative nature of assumption 3 above, a limited reduction in thermal noise allocation can probably be accommodated with no increase in required DC power.

Finally, it should be noted that the electrical power and (feed-assembly) thermal-control subsystems for the two baseline designs are of modest proportions, as determined from the satellite weight breakdown. Therefore, a moderate increase in DC power requirements, if necessitated by an increase in the IM allocation, can readily be accommodated.

In summary, the state-of-the-art in UHF solid-state amplifier design is not likely to improve significantly in the future. However, the amplifier requirements based on the baseline designs can be satisfied with at most a slight adjustment of the link noise/interference allocations. Thus, the amplifier technology is not critical to a successful system design.

5.5 OTHER SUBSYSTEMS

The principal subsystems not already covered include: electrical power, thermal control (for feed assembly), and reaction control. Technology for the latter two subsystems is mature. The electrical power subsystem envisioned for the baseline satellite designs includes NiH₂ batteries and GaAs solar cells. Both of these technologies are in a developmental stage. They are currently available only in small quantities. By 1990, however, the two technologies should be mature.

5.6 SUMMARY

The various technologies required for implementation of the baseline satellite designs are summarized in Tables 5-1 to 5-5. In Table 5-1, dealing with Configuration Technology, the added benefits that would derive from enhancement of the STS capability or manned participation at LEO or GEO are pointed out. In this chart, only the 65,000-pound STS capability and the MSAT-compatible OTV are essential for the baseline designs. In the remaining charts, all cited technologies are needed, except for certain active controls items in Table 5-3.

5.7 PRIORITIZATION OF CRITICAL TECHNOLOGY

Certain technology items, such as the STS and the OTV, are obviously essential to a successful MSAT mission. However, their development is not dependent on the desire to implement MSAT. Moreover, at the present time, adequate STS and OTV capability by 1990 seems reasonably assured. Consequently, launch and orbital-transfer vehicles will not be considered among the critical technology items.

Instead, attention will be focused on technologies for which there do not exist compelling applications. In these cases, technology development hinges to a substantial degree on MSAT motivation. This is not to say that such technologies will not be undertaken in the absence of MSAT development. In fact, large-space-structure technology has been in the

ORIGINAL PAGE
OF POOR QUALITY

Table 5-1. State-of-the-Art Projection
for Configuration Technology

TECHNOLOGY	IMPACT	AVAILABILITY
STS LAUNCH CAPABILITY	65,000 LB CAPABILITY REQUIRED	MID TO LATE '80s
STS DERIVATIVES LAUNCH WEIGHT INCREASE SIZE INCREASE	LESS COST/RISK IN SATELLITE/OTV COMPONENT SELECTION MAY AFFECT DEPLOYMENT/ STOWAGE CONCEPTS	FEASIBILITY STUDIES ONLY FEASIBILITY STUDIES ONLY
ORBITAL TRANSFER VEHICLE MSAT-COMPATIBLE OTV LOW-THRUST OTV	DEVELOPMENT REQUIRED FOR 1995 LAUNCH DEPLOYMENT AND CHECKOUT IN LEO MINIMIZES RISK AND COST	NASA/DoD DEVELOPMENT SCHED- ULED FOR COMPLETION BY LATE '80s ABOVE OTV DEVELOPMENT MAY ASSUME THIS FORM
MANNED PARTICIPATION MSAT ASSEMBLY MOTV	DYNAMICALLY MORE STABLE CONFIGURATION REPAIR/REFURBISHMENT IN GEO	MID '80s, REQUIRES LOW-THRUST OTV POSSIBLY IN MID '90s

Table 5-2. State-of-the-Art Projection
for Structures Technology

TECHNOLOGY	IMPACT	AVAILABILITY
<p>STRUCTURAL DESIGN CRITERIA</p> <p>DYNAMIC LOADS</p> <p>THERMAL</p> <p>ORBITAL</p>	<p>} NECESSARY TO SPECIFY STRUCTURAL REQUIREMENTS, PREDICT SATELLITE DYNAMIC RESPONSE</p>	<p>ANALYTICAL MODELING CAPABILITY LIKELY BY LATE '80s</p>
<p>REFLECTOR</p> <p>MESH MANAGEMENT</p> <p>WRAP-RIB DESIGN</p> <p>STOWAGE/DEPLOYMENT</p>	<p>UNCERTAINTY IN STOWAGE, SURFACE ACCURACY PREDICTIONS</p> <p>ADDED TORSIONAL STIFFNESS SIMPLIFIES ACS SYSTEM</p> <p>MICRO-FAILURES CAN BE INDUCED IN MATERIALS</p>	<p>ORBITAL STS SCALE TEST LIKELY IN MID '80s</p> <p>NO NEW CONCEPTS BEING DEVELOPED</p> <p>ONGOING TESTS LIKELY TO RESOLVE ISSUE BY MID '80s</p>
<p>MASTS</p> <p>RIGIDITY</p> <p>STABILITY</p> <p>PREDICTABILITY</p>	<p>STRAIGHT LONGERON TECHNOLOGY REQUIRED</p> <p>JOINT HYSTERESIS CONTROL REQUIRED WITHOUT DEGRADING DEPLOYMENT RELIABILITY</p> <p>CONTROLLED PRELOAD IN DIAGONAL CABLING MUST BE PROVED</p>	<p>TESTS PLANNED IN MID '80s</p> <p>ANALYTICAL TOOLS AND TEST RESULTS LIKELY IN MID '80s</p> <p>SAME AS ABOVE</p>

Table 5-2. State-of-the-Art Projection
for Structures Technology (Continued)

TECHNOLOGY	IMPACT	AVAILABILITY
<p>MATERIALS CABLING</p> <p>RIBS AND LONGERONS</p> <p>JOINING TECHNIQUES</p> <p>RF PERFORMANCE</p>	<p>MUST DEVELOP LONG CABLES WITH STABLE, PREDICTABLE PROPERTIES</p> <p>CONSISTENT LAYOUT TECHNIQUES REQUIRED TO REDUCE MATERIAL PROPERTIES SCATTER</p> <p>STABLE, REPEATABLE TECHNIQUES MUST BE DEVELOPED</p> <p>SUITABLE MATERIALS NEEDED TO MINIMIZE MAST EFFECTS IN CENTER-FED DESIGN</p>	<p>MATERIALS TESTS PLANNED; LIKELY RESOLUTION IN MID-TO-LATE '80s</p> <p>SAME AS ABOVE</p> <p>SAME AS ABOVE</p> <p>SAME AS ABOVE</p>
<p>ANALYTICAL MODELING</p>	<p>IN ABSENCE OF GROUND TEST DATA CORRELATION, MORE ACCURATE PREDICTION TECHNIQUES REQUIRED</p>	<p>CAPABILITY LIKELY BY LATE '80s</p>
<p>TESTING</p> <p>GROUND TESTING OF SCALE MODEL</p> <p>STS TESTING</p>	<p>INTEGRAL PART OF DESIGN PROCESS; REQUIRED TO QUALIFY FOR STS TESTING</p> <p>ESSENTIAL TO CHARACTERIZE ZERO-G BEHAVIOR</p>	<p>LIKELY COMPLETION BY MID '80s</p> <p>LIKELY IN MID '80s</p>

Table 5-3. State-of-the-Art Projection
for Attitude Control System Technology

TECHNOLOGY	IMPACT	AVAILABILITY
<p>ACTIVE CONTROLS FEED GIMBALS DAMPING MAST CABLING</p>	<p>ALTERNATE POINTING MODE PROVIDES STIFFER RESPONSE MAY BE REQUIRED IF STIFFNESS GOALS NOT MET</p>	<p>TECHNOLOGY IS AVAILABLE ACTIVE DAMPERS SUITABLE FOR MSAT LIKELY IN LATE '80s CONTROL TECHNOLOGY LIKELY TO BE AVAILABLE IN LATE '80s</p>
<p>ADAPTIVE CONTROLS CONTROLLER MODAL CHARACTERIZATION</p>	<p>HARDWARE/SOFTWARE DEVELOPMENT REQUIRED REQUIRE ON-ORBIT MEASUREMENT SYSTEM, COUPLED WITH ANALYTIC METHODS FOR GROUND PROCESSING</p>	<p>ONGOING RESEARCH; LIKELY AVAILABILITY BY MID-TO-LATE '80s SAME AS ABOVE</p>
<p>IMPULSE AND MOMENTUM DEVICES</p>	<p>POTENTIAL SATELLITE DISTURBANCE</p>	<p>TECHNOLOGY IS AVAILABLE</p>
<p>MEASUREMENT SYSTEMS MONOPULSE TRACKING FEED/REFLECTOR RANGE AND ANGULAR POSITION SENSORS REFLECTOR SURFACE MEASUREMENT DISTRIBUTED ACCELEROM- ETERS AND STRAIN GAUGES</p>	<p>NEEDED FOR INITIAL MODAL RESPONSE, ONGOING ATTITUDE DETERMINATION</p>	<p>TECHNOLOGY IS AVAILABLE, EXCEPT FOR RANGE AND ANGU- LAR SENSORS, WHICH ARE LIKELY BY MID '80s</p>

Table 5-4. State-of-the-Art Projection
for Antenna Feed System Technology

TECHNOLOGY	IMPACT	AVAILABILITY
<p>FEED/BEAMFORMER NETWORK</p> <p>FEED-ELEMENT SPACING, EXCITATION</p> <p>BEAMFORMER NETWORK DESIGN</p> <p>RF IMPACT OF STOWAGE, DEPLOYMENT, THERMAL EFFECTS</p>	<p>BEAM PLACEMENTS, SIDELOBE PERFORMANCE</p> <p>SIDELOBE PERFORMANCE</p> <p>RF INTEGRITY</p>	<p>NOT BY '90</p> <p>NOT BY '90</p> <p>NOT BY '90</p>
<p>MAST DESIGN</p> <p>CONFIGURATION FOR CENTER-FED AND OFFSET-FED DESIGNS</p> <p>MATERIALS</p> <p>CABLING</p>	<p>BLOCKAGE, INDUCED CURRENTS AFFECTING SIDELobe PERFORMANCE</p>	<p>NOT BY '90</p> <p>NOT BY '90</p> <p>NOT BY '90</p>

Table 5-5. State-of-the-Art Projection
for Other Satellite Technologies

TECHNOLOGY	IMPACT	AVAILABILITY
UHF SOLID-STATE AMPLIFIERS IM CHARACTERISTIC DC/RF EFFICIENCY	SYSTEM NOISE ALLOCATION DC POWER REQUIREMENTS	} MATURE TECHNOLOGY
ELECTRICAL POWER NiH ₂ BATTERIES GaAs SOLAR CELLS	} REDUCED SATELLITE WEIGHT	TECHNOLOGY SHOULD BE MATURE BY '90
HEAT PIPES FOR FEED ASSEMBLY	ESSENTIAL FOR THERMAL CONTROL	MATURE TECHNOLOGY
REACTION CONTROL SUBSYSTEM	REQUIRED FOR ATTITUDE STABILIZATION	MATURE TECHNOLOGY

development stage for a number of years under NASA sponsorship. However, continued funding is not assured in the absence of strongly desired applications. For these technologies, MSAT can help to provide the necessary motivation.

In this vein, technology prioritization will be based on the absence of current development efforts, as well as the importance of the technology to a successful MSAT mission. By these criteria, the following ordering has been established, with the most critical item heading the list.

1. Feed Assembly/Beamformer Network. No plans to develop this technology presently exist. Control of co-channel interference, in particular, must be established to validate the frequency re-use plan adopted.
2. Mast Configuration - RF Properties. No plans exist for the development of this technology either. It may be crucial to the feasibility of a center-fed design or, for that matter, to any alternative to the L-shaped mast of the offset-fed design.
3. Analytical Modeling/Testing. Analytical modeling, in combination with ground testing of scale models, is an essential prerequisite to zero-g STS testing. Continued funding must be provided.
4. Adaptive Attitude Control. This involves development of a controller and the capability for modal characterization. It is primarily a software development. Continued funding is necessary.
5. Reflector/Mast Development. The critical reflector development is in the area of mesh management. All aspects of mast development listed in Table 5-2 require attention. Funding must be continued.

In this listing, the subject of active controls has been omitted, as it is not incorporated in the baseline designs as currently envisioned. If active damping and/or mast cabling should prove necessary, these would rank just below adaptive attitude control in priority.

Finally, the range and angular sensors included in the attitude control measurement system, structural materials, and the structural design criteria have not been listed as critical items. While some additional development is needed in these areas, the effort required is considerably less than that for the listed technologies.

6. TECHNOLOGY DEVELOPMENT PLAN

6.1 INTRODUCTION

The critical technology needed for the MSAT system was identified in Section 5. In this section, plans will be described for the development of these technologies. Task schedules are provided in this section, while estimated development costs are deferred to Appendix H. Technology development should be completed in 1990 to enable launch of an experimental MSAT in the 1995 time frame.

Each of the subsystems involved will be examined to determine the need for flight verification. If required, flight testing will be an integral part of the development program to be completed by 1990.

Development plans presented here are confined to satellite-associated technology for System 1. As pointed out previously, special-purpose modems have to be developed for use in the gateways of System 1. In addition, a new mobile-unit is required for the System 1 baselines, as well as for the transportable units in System 3.

6.2 LARGE SPACE STRUCTURE

In Section 5, the technologies discussed typically apply to more than one structural element. Structural development will be described in terms of the two principal elements, reflector and mast. The attitude control system and the measurement system will be discussed separately.

6.2.1 Reflector

A wrap-rib reflector has been selected for both the 46-meter offset-fed antenna and the 62-meter center-fed design. Although a 10-meter wrap-rib reflector was flown on ATS-6, little of the experience gained from the experiment is applicable to MSAT. The larger MSAT reflectors are very flexible and are unable to support their own weight in a 1g ground-test environment. In addition, the MSAT reflector's dynamic characteristics cause it to have a much greater influence on the spacecraft than the much smaller ATS-6 reflector.

The objectives of the wrap-rib reflector development program are to: (1) verify that analytical modeling has the capability to accurately predict the reflector's structural response, and (2) verify, through orbital flight test, the capability of the reflector to deploy successfully.

The development approach is to combine structural response characterization and deployment verification objectives into a single plan. Elements of the development plan are illustrated in Figure 6-1. Low-key wrap-rib reflector development is taking place at LMSC. Full-scale ground deployment tests on four ribs (three gores) have been performed. In addition, analytical dynamic/control models are being developed for various large space systems (LSS) applications. As shown in Figure 6-1, this effort leads into a 1985 start for MSAT reflector development.

Ground testing of a scale model of the reflector is recommended for the following reasons:

- 1) The size of the facility required to house the reflector makes ground testing of a full-scale model impractical. Note that the facility must tether the reflector, as well as closely control air currents and thermal environment.
- 2) A scaled reflector up to 15 meters in diameter may be tested ideally in existing vacuum chambers. This would allow thermal as well as dynamic tests.
- 3) The MSAT reflector is part of a larger family of LSS structures, rather than an isolated development. Confidence acquired in the ability to predict full-scale behavior from tests performed on scale models would benefit all LSS applications.
- 4) Recent computer developments (and storage capacity in particular) make possible the sophisticated analysis tools needed for MSAT structural, thermal, and control models. These tools, which are very cost effective once developed, permit the prediction of full-scale performance from test results of scaled-down models.

Ground testing of the reflector is illustrated in Figure 6-2. There are aspects of the ground environment, however, that make it necessary to supplement ground tests with flight tests. These are listed in Table 6-1. It is seen that, except for the scale-model requirement, the ground limitations are eliminated in the zero-g, vacuum conditions of space.

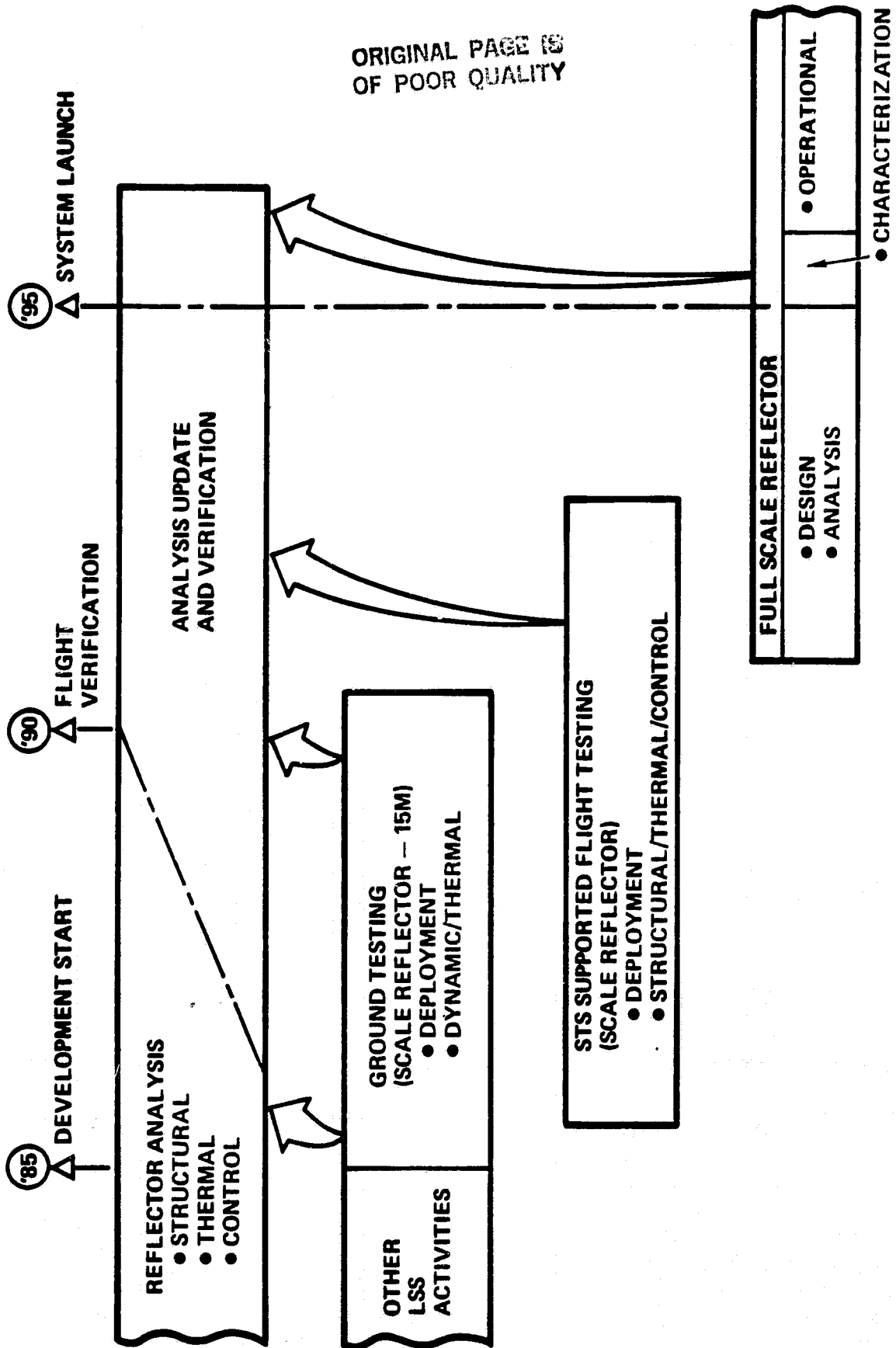
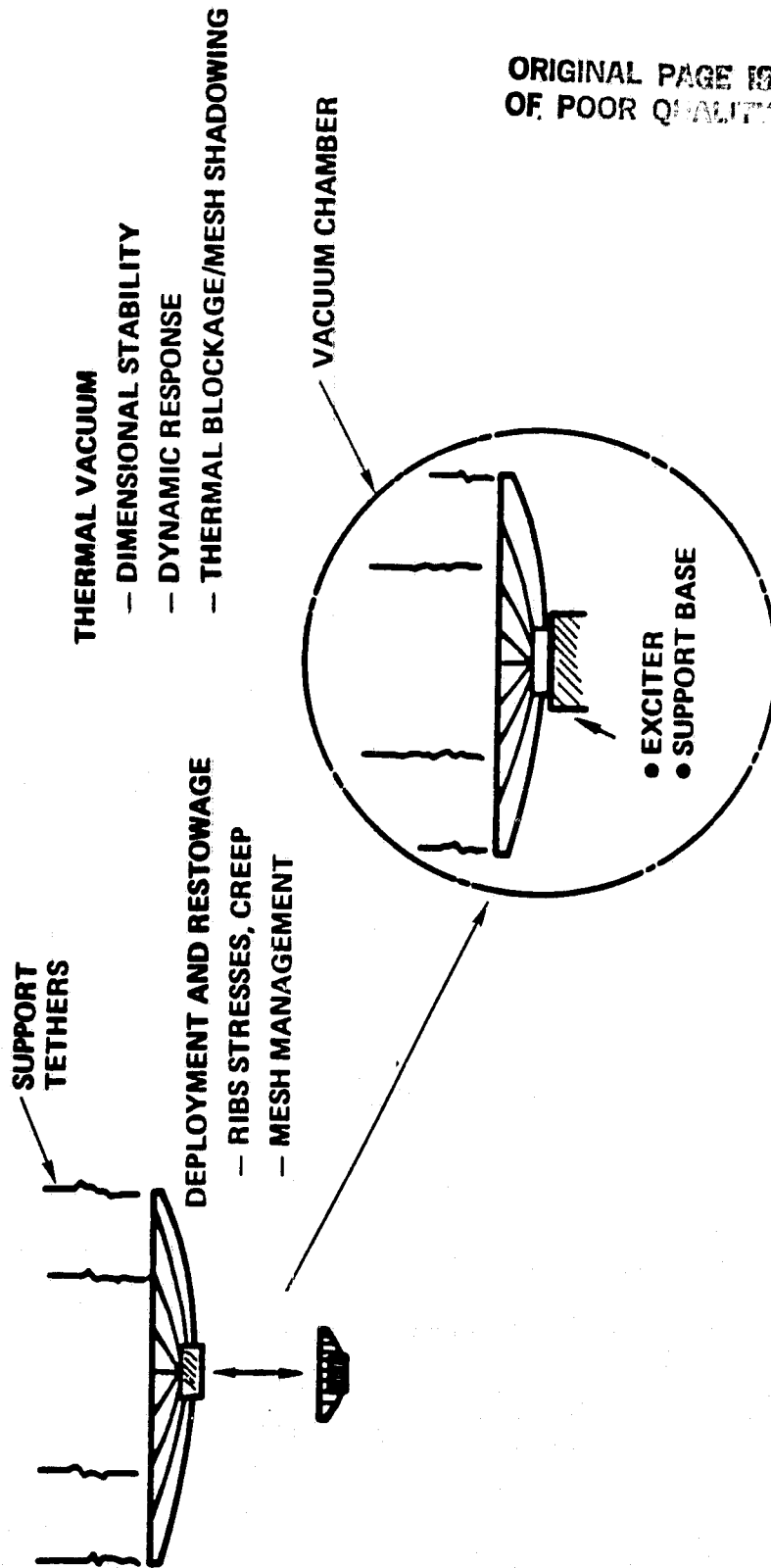

Figure 6-1. Reflector Development Plan



ORIGINAL PAGE IS
OF POOR QUALITY

Figure 6-2. 15M Scale Reflector Ground Testing

Table 6-1. Reflector Testing Limitations

	REQUIREMENT
<p>● GROUND TESTING LIMITATIONS</p> <ul style="list-style-type: none"> ● PENDULUM EFFECT ALTERS DEFLECTION RESPONSE ● AIR RESISTANCE PROVIDES UNWANTED DAMPING ● 1g GRAVITY LOAD ON JOINTS AND STRUCTURE AFFECTS DAMPING ● LSS SIZE WILL NOT FIT TEST FACILITIES ● LSS IS NOT ABLE TO SUPPORT 1g GRAVITY 	<p>ZERO-g VACUUM ZERO-g SCALING ZERO-g</p>
<p>● STS TESTING LIMITATIONS</p> <ul style="list-style-type: none"> ● STS DISTURBANCE LEVELS ● STS LIMIT CYCLING ● COST ● TIMELINES ● SAFETY ● TEST SPECIMEN RETRIEVAL 	<p>DRIFT FLIGHT DRIFT FLIGHT SIZE LIMITATION TEST PREDICTABILITY PROVEN CONCEPT RESTOW CAPABILITY</p>

ORIGINAL PAGE IS
OF POOR QUALITY

Conversely, the concern for safety in STS testing is satisfied by using the same 15-meter model that has previously undergone ground testing. This procedure also contributes to test predictability and tends to minimize development costs. The remaining limitations of STS testing are overcome through performing the tests in drift flight.

Use of the same reflector for ground and flight testing also makes possible direct correlation of test results. Hopefully, with increased experience, it will be possible to perform a greater portion of the needed tests on the ground.

Use of the STS for flight test of a large deployable reflector was originally proposed by JPL in the late 1970s. Alternately, TRW and other aerospace firms have suggested that the Space Station could be employed to develop large space antennas for application to communications and scientific missions. Space Station would permit much more extensive testing of the MSAT antenna than is possible while attached to the STS. However, it is anticipated that, with suitable prior ground testing, STS testing over a period of 6 to 12 hours will provide the needed empirical data. Also, it is worth pointing out that the projected 1990 launch data for Space Station coincides with the point at which MSAT development should be completed.

With an STS-attached test, full retrieval capability is proposed. More detailed analysis is required to show that this choice is clearly more effective than a non-retrievable free-flyer experiment. The combined reflector and mast flight test is illustrated in Figure 6-3.

The reflector development schedule is shown in Figure 6-4.

6.2.2 Mast

Coilable masts, such as the Astromast, and other types of mechanical deployable structures have seen extensive use in space. The MSAT mast application is unique from two standpoints:

- 1) Stowage and stiffness requirements have resulted in mast designs with large diameters (up to 3 meters), with many articulations (joints) needed to maintain a straight, rigid longeron after deployment.

ORIGINAL PAGE IS
OF POOR QUALITY

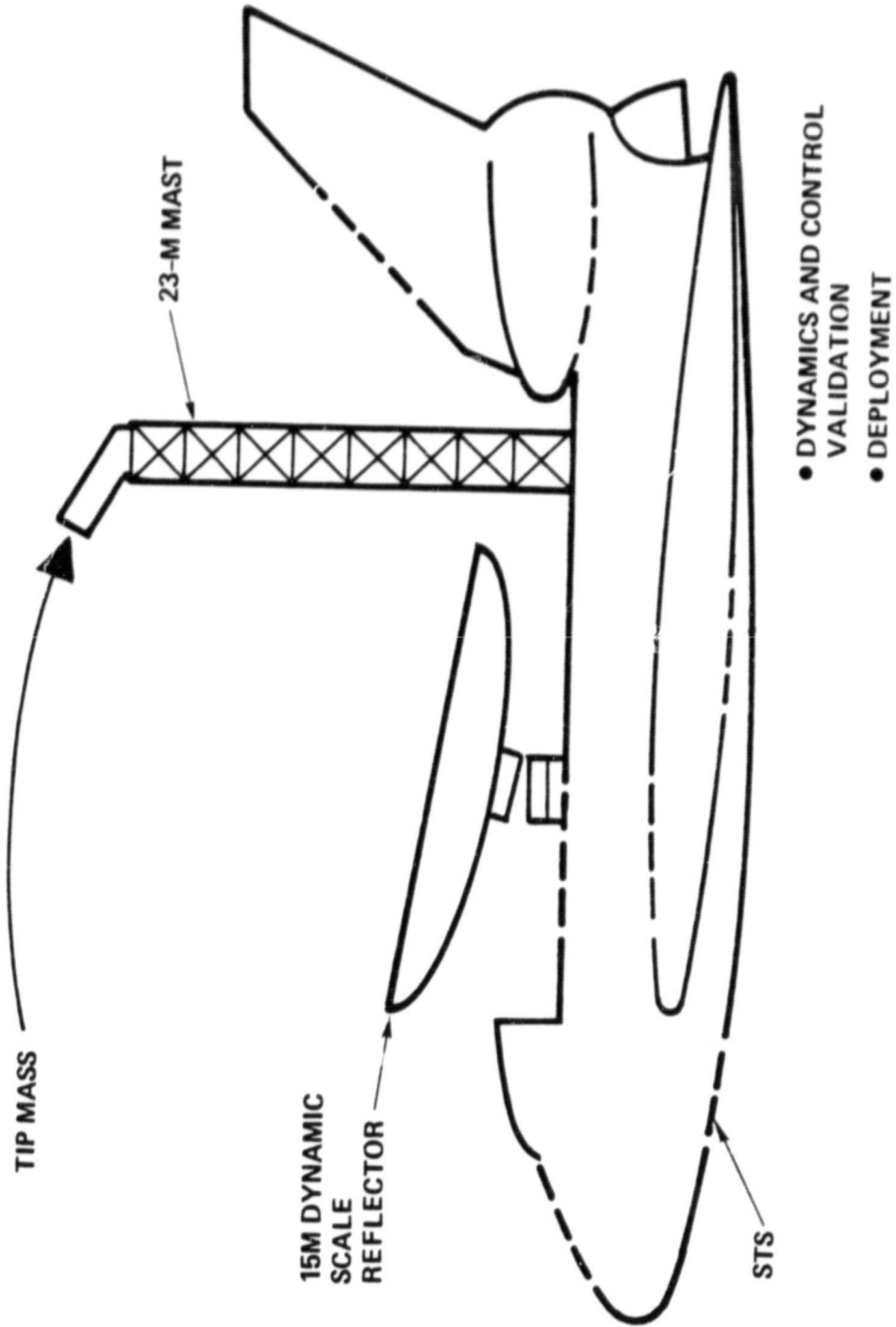

Figure 6-3. Reflector and Mast Flight Verification Testing

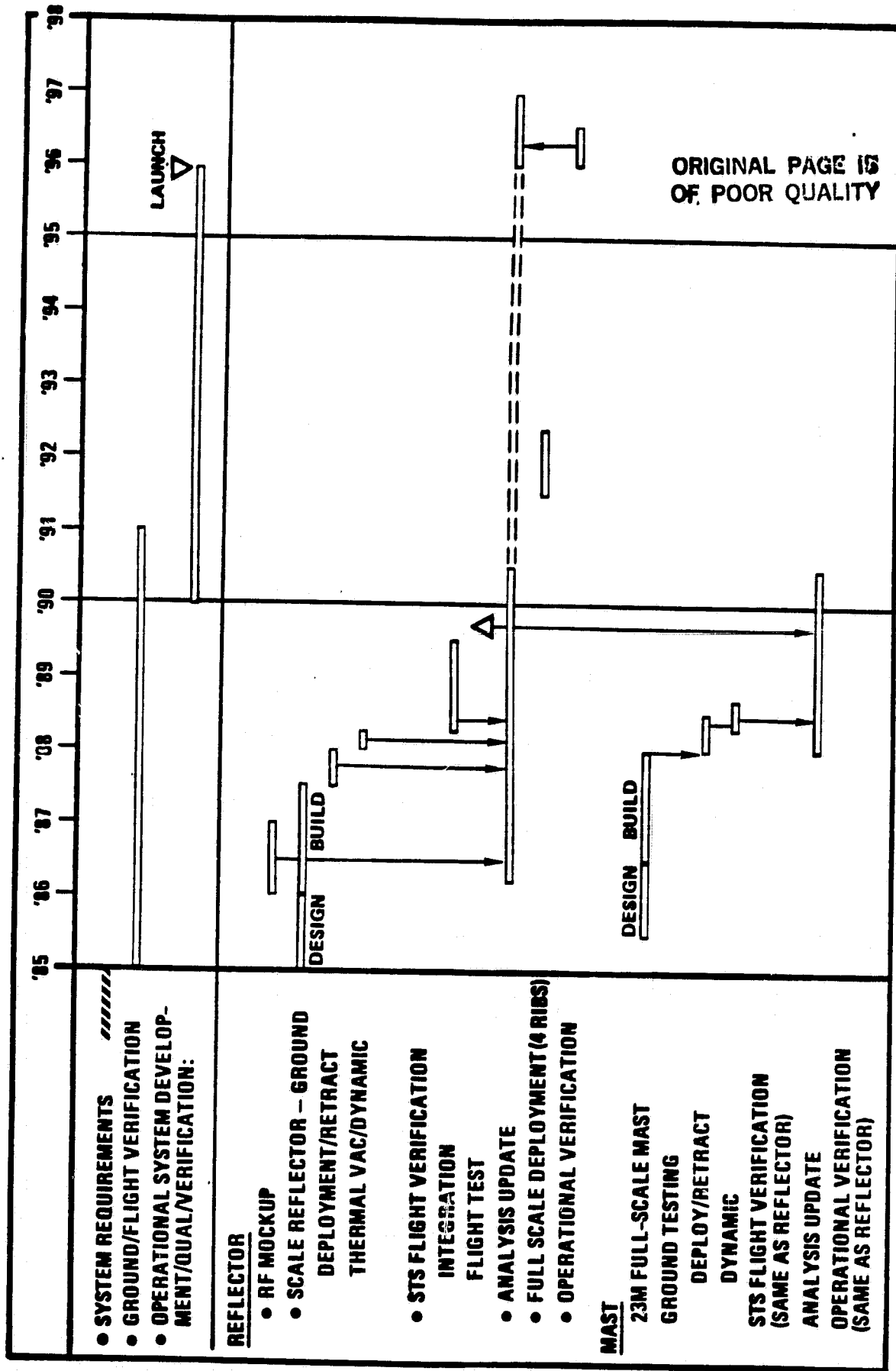

Figure 6-4. Structures and Control Technology Development Schedule

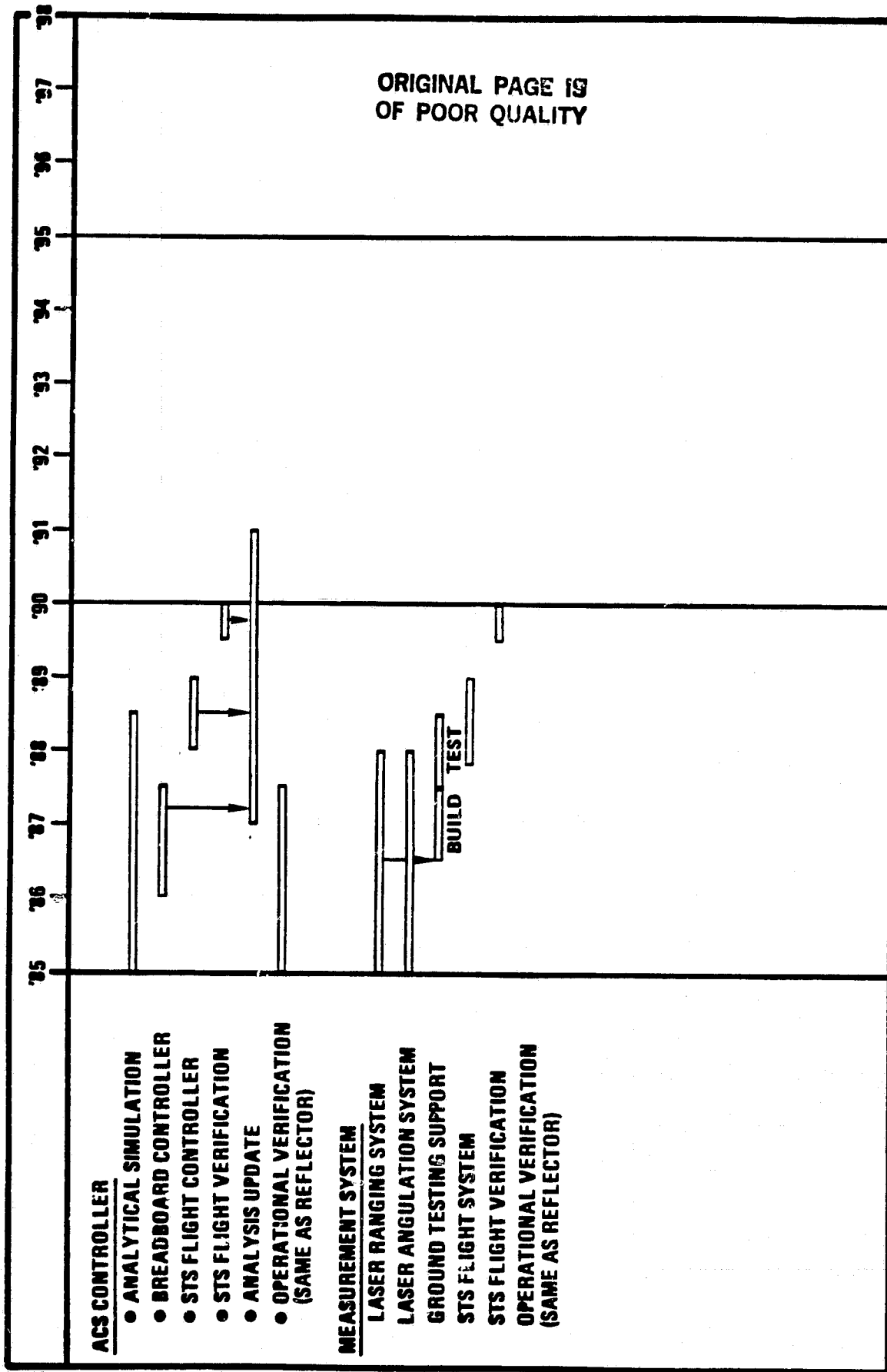

Figure 6-4. Structures and Control Technology Development Schedule (Continued)

- 2) Unlike previous spacecraft, the MSAT mast couples two major masses, namely, the main bus/feed and the reflector. Dynamic response of the satellite is critically dependent on structural characterization of the mast.

The objective of this development plan is to verify the deployment, thermal, and structural-response characteristics of the articulated masts, and to develop the analytical tools required to support these activities.

Of the two baseline satellite designs, the offset-fed is the more critical because of the L-shaped mast configuration. The mast connecting to the reflector and that attaching to the bus are 23 meters and 69 meters long, respectively. The development plan is based on this configuration.

The overall approach is given in Figure 6-5. Development rationale is the same as stated previously for the reflector. The "short-leg," 23-meter full-scale mast is selected for development. This size will not allow for thermal vacuum testing. Dynamic and deployment/retraction tests are accomplished on an air-bearing surface, or with the mast suspended from a test fixture. This arrangement is illustrated in Figure 6-6.

The STS verification flight uses the 23-meter mast in conjunction with the 15-meter reflector and feed system to provide a low-cost flight test of all MSAT critical systems, as shown in Figure 6-3.

6.2.3 Attitude Control Subsystem (ACS)

The MSAT size and structural flexibility require that the ACS be able to control satellite pointing without full knowledge of the structure response characteristics. Some of the critical first modes will be within the ACS control bandwidth, and the ACS must remain stable in their presence. Once the system is deployed, a measurement system will help to define the response modes, but a degree of uncertainty will remain. The ACS controller is updated on the basis of the measured response, so that eventually more accurate operational pointing is achieved. This procedure is unlike that for other spacecraft programs, where ACS and dynamic response are decoupled, with verification achieved on the ground prior to flight.

The objective of the ACS controller/processor technology development plan is to design a stable, low-bandwidth, reconfigurable control system, in support of an MSAT go-ahead decision in 1990.

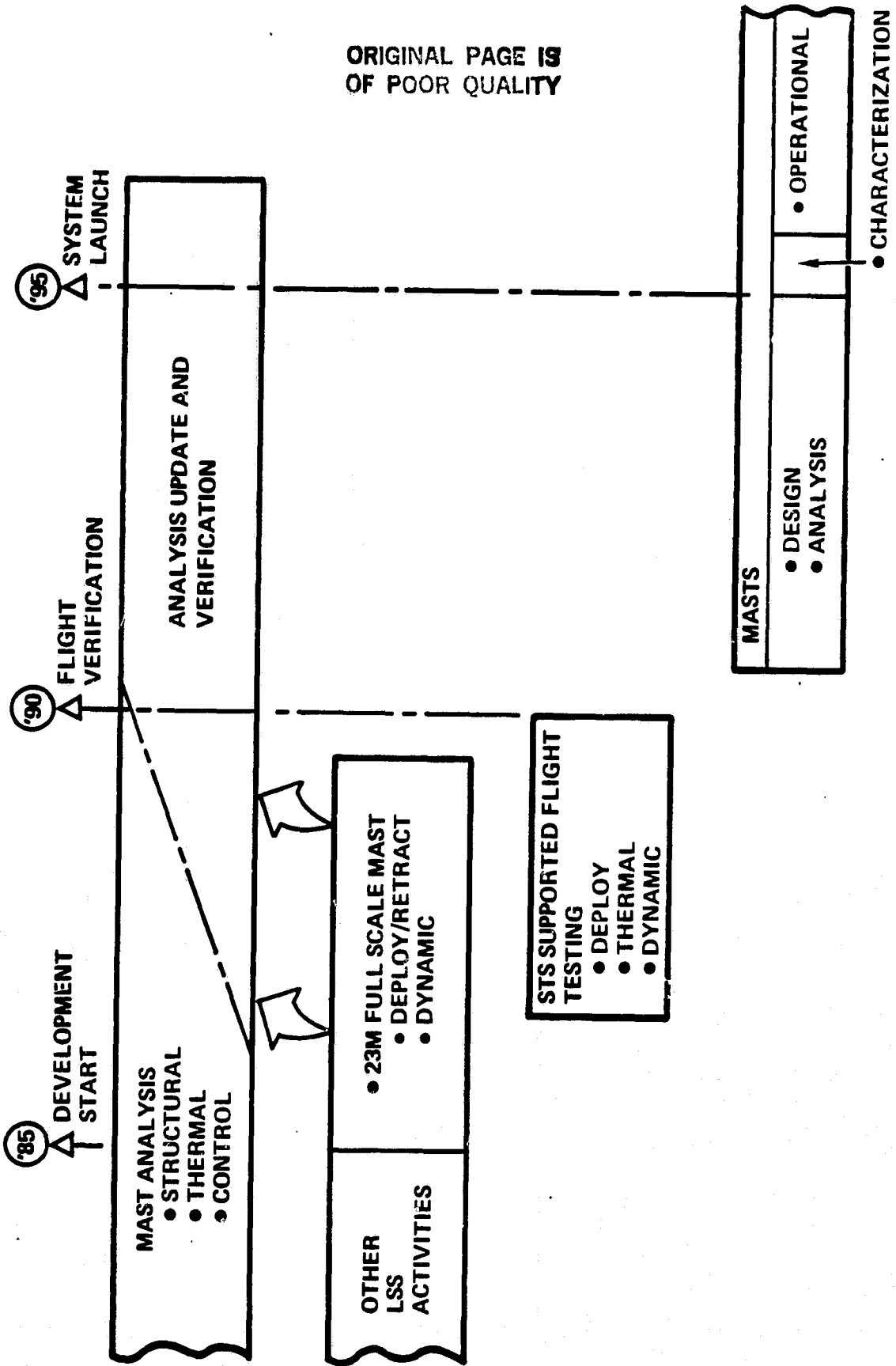
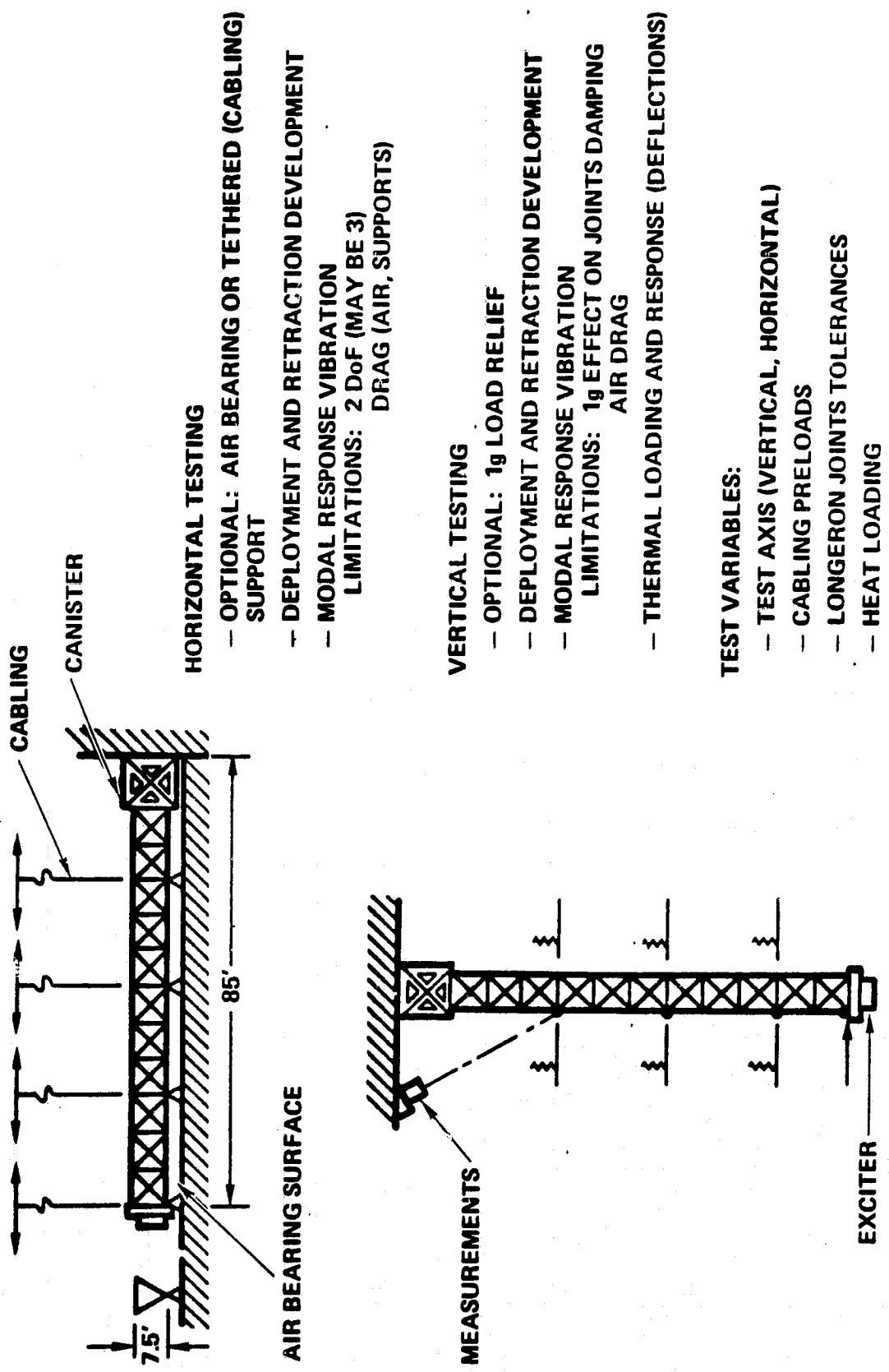

Figure 6-5. Mast Technology Development Plan



HORIZONTAL TESTING

- OPTIONAL: AIR BEARING OR TETHERED (CABLING) SUPPORT
- DEPLOYMENT AND RETRACTION DEVELOPMENT
- MODAL RESPONSE VIBRATION
- LIMITATIONS: 2 DoF (MAY BE 3)
- DRAG (AIR, SUPPORTS)

VERTICAL TESTING

- OPTIONAL: 1g LOAD RELIEF
- DEPLOYMENT AND RETRACTION DEVELOPMENT
- MODAL RESPONSE VIBRATION
- LIMITATIONS: 1g EFFECT ON JOINTS DAMPING
- AIR DRAG
- THERMAL LOADING AND RESPONSE (DEFLECTIONS)

TEST VARIABLES:

- TEST AXIS (VERTICAL, HORIZONTAL)
- CABLING PRELOADS
- LONGERON JOINTS TOLERANCES
- HEAT LOADING

Figure 6-6. 23-Meter Mast Ground Testing

An overview of controller development is shown in Figure 6-7. The critical step is to select a controller configuration based on on-going LSS technology effort. TRW has in-house efforts underway, and NASA has supported numerous controller studies with industry under its LSS program. Factors affecting the selection of controller configuration include:

- Degree of dynamic structural identification
- Expected scatter in structural damping knowledge
- Scale-test correlation to full-scale ACS
- Control-law stability and adaptability

Once the controller configuration has been selected, its dynamic characteristics must be defined through the following types of tests:

- Open-loop response - linearity with increased input signal
- Closed-loop response - phase and gain margins
- Disturbance rejection, tuning
- Adaptability to system malfunction

With the controller characteristics defined, a test program can be undertaken in conjunction with the reflector and mast development. This would include both ground and flight tests. The test program would be designed to verify:

- Stability during deployment
- Pointing performance before and after reconfiguration (i.e., structural characterization)
- Stability during disturbances (e.g., solar pressure, thermal changes)
- Compatibility with Orbiter disturbances (e.g., jet firings)

The schedule for the controller development is shown in Figure 6-4. This plan parallels the structural development and uses structural tests to develop and verify controller performance.

6.2.4 Measurement System

The measurement system must provide real-time position data of structural elements to aid in characterization and control of structural

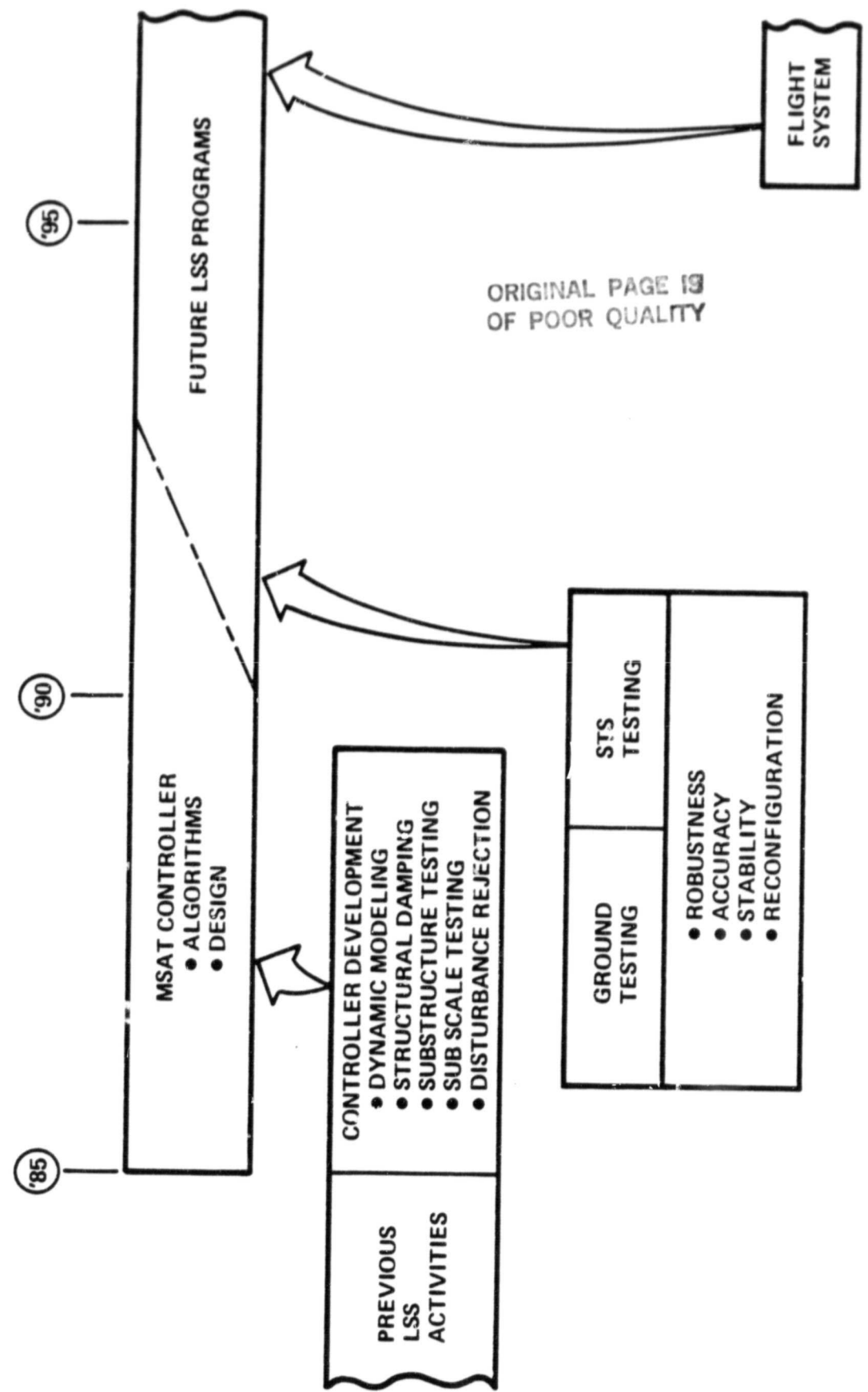

Figure 6-7. ACS Controller Technology Development Plan

response. This system must perform to an accuracy measured in millimeters, at ranges approaching 100 meters. It must perform this function without influencing the structural response of the system.

Conceptual design of an MSAT measurement system has been developed as part of this study and is described in a separate report. A typical measurement configuration, as applied to the reflector, is shown in Figure 6-8.

The key technology drivers in the development of a measurement system are:

- Data rates and data-reduction techniques to provide adequate model response characterization
- Size and weight of telescope sensors
- Discrimination capability against star background or sun

The measurement system development schedule to support other MSAT development is shown in Figure 6-4.

6.3 UHF ANTENNA

The antenna development is concerned primarily with the feed/beamformer combination. In addition, however, a mast structure must be devised which leads to acceptable RF performance while minimizing structural aspects of the attitude control problem. Reflector development has been considered in Section 6.2, under the Large Space Structure heading. Satisfactory RF performance of the reflector can be guaranteed by satisfaction of structural and thermal specifications.

Two baseline satellite designs were presented for System 1, one offset-fed and the other center-fed. The center-fed option is the preferred configuration, provided satisfactory RF performance can be achieved. Some RF degradation will result from mast effects. It is suggested, therefore, that mast tests precede feed/beamformer development. Otherwise, parallel center-fed and offset-fed developments would be required. This may be necessary to a limited extent anyway, to avoid having the schedule jeopardized by possible rejection of the center-fed option.

The development schedule for the antenna subsystem is shown in Figure 6-9. It is important to note that there is no requirement for flight testing in any of the tasks.

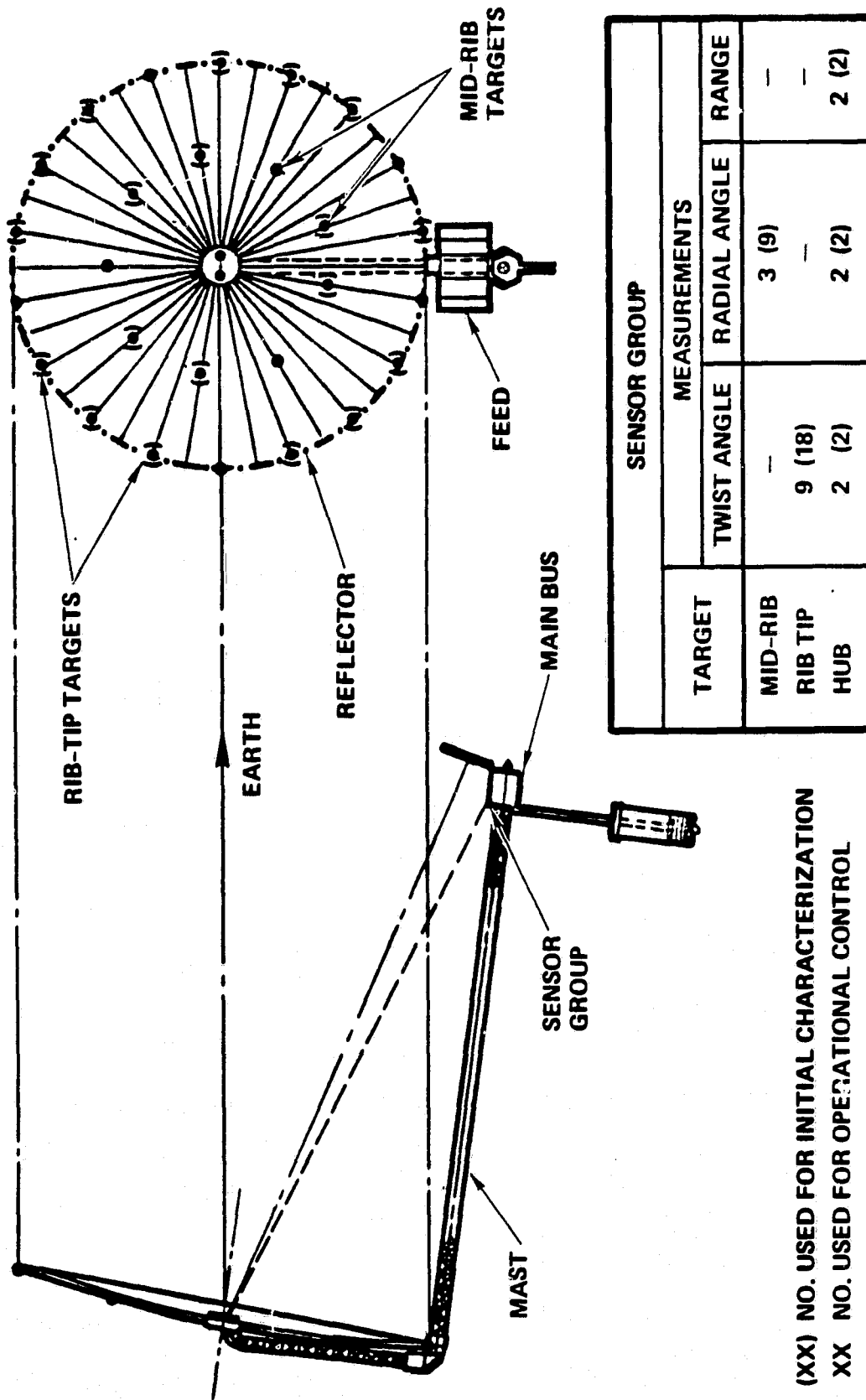

(XX) NO. USED FOR INITIAL CHARACTERIZATION
XX NO. USED FOR OPERATIONAL CONTROL

Figure 6-8. Global Sensor Arrangement

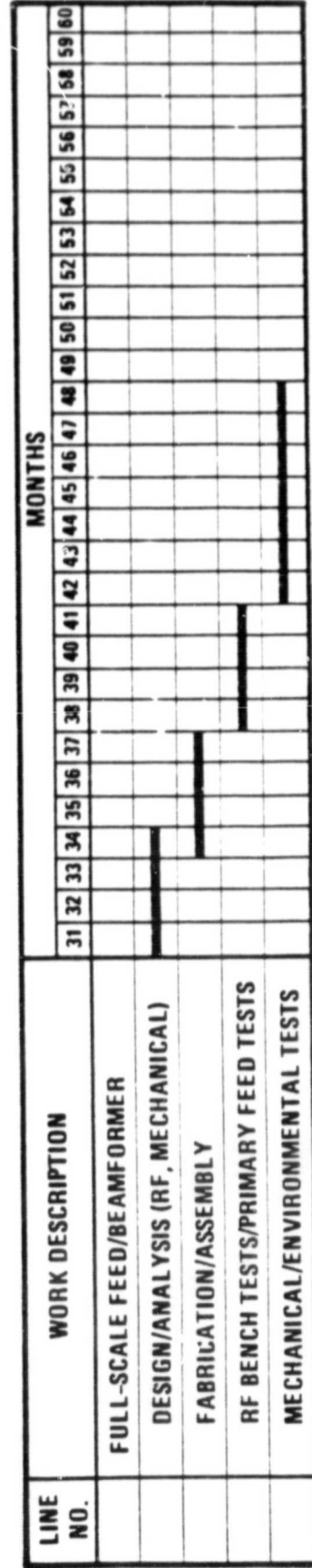
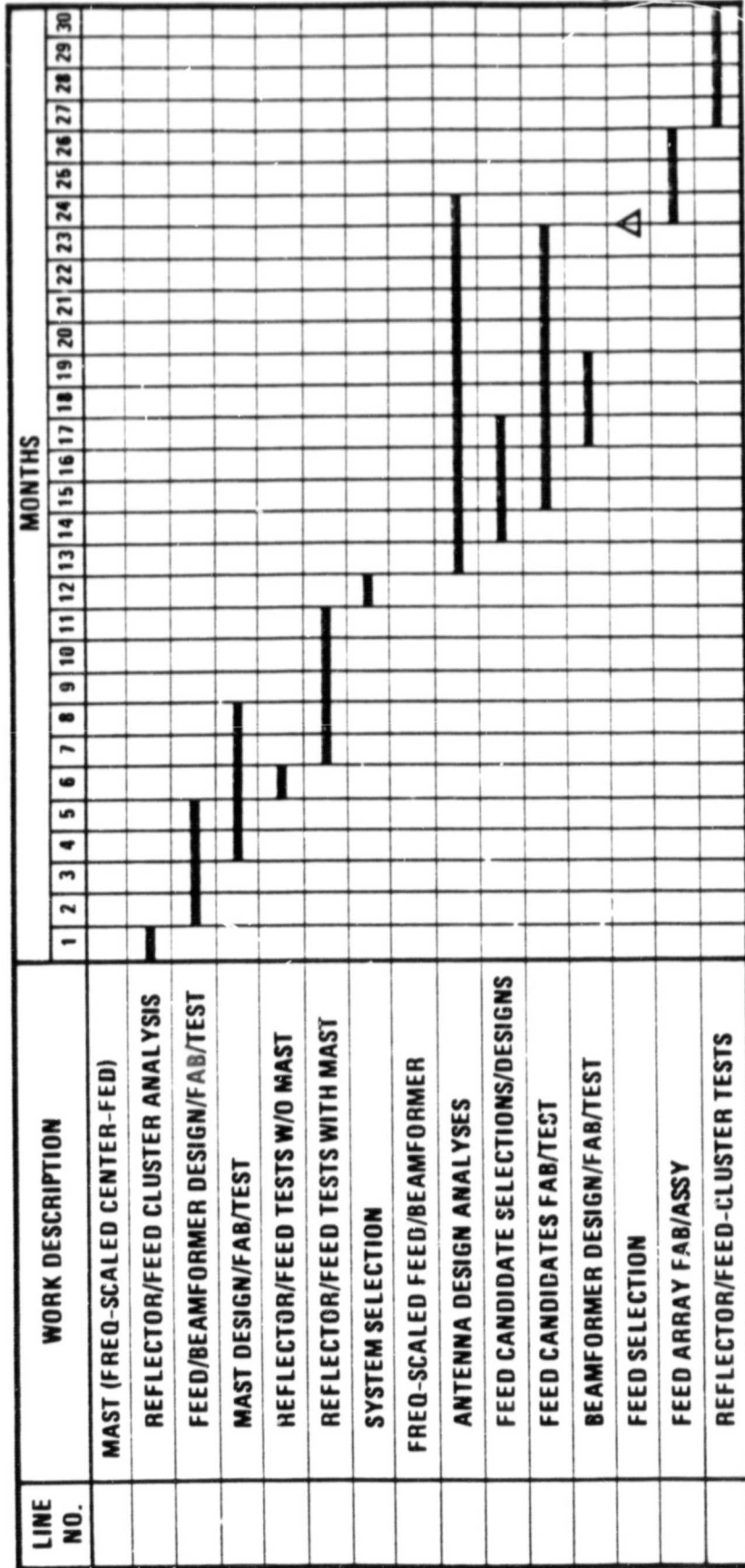

Figure 6-9. Satellite Antenna Development Schedule

6.3.1 Feed/Beamformer Network

The major goals of the feed/beamformer development are:

- Co-channel beam isolation greater than 25 dB
- Beam peak-gain efficiency greater than 40 percent
- Beam scan capability of 8 HPBW
- Configuration beam spacings (i.e., crossovers) at the HPBW contour

Completion of the development plan will result in the following design information: reflector shape parameters, recommended feed-element type, feed-cluster arrangement, feed-element placements, beamformer configuration, beamformer phase and amplitude distribution per beam location, beamformer performance, and antenna performance.

RF performance of the multibeam antenna system is substantiated by a combination of analysis, hardware design, and measurement. Analytical modeling is used to determine the reflector parameters and all pertinent feed parameters. Hardware design, fabrication, and test is employed to develop a breadboard scale-frequency model based on the analytical model. Hardware verification is essential because of the high co-channel beam isolation requirement and the inability of analysis to accurately predict sidelobe levels.

The farthest scanned beam locations provide the most difficulty in meeting the combined gain and beam-isolation requirements. Therefore, essentially the full feed system needs to be modeled for test purposes. A full-scale breadboard feed/beamformer development will verify the electrical and mechanical design based on the scale-frequency development. One objective is to demonstrate the capability of folding and deploying the feed array, transmit beamformer, receive beamformer, and diplexer combination, while preserving electrical integrity.

The feed parameters determined through analysis include required feed-element radiation patterns, feed spacing, number of elements in each cluster, and power and phase distribution as a function of scanned beam location. With these parameters defined, several candidate feed elements can be identified. A convenient scale frequency needs to be selected so

that each candidate feed system can be easily tested and secondary tests run. To test a feed system, a beamformer model needs to be designed, fabricated, and tested. (This beamformer is used for test purposes only.) The scale-frequency beamformer can be as simple as a set of coaxial lines cut to specified electrical lengths, combined with power dividers or hybrids, and possibly coaxial attenuators. Another test-beamformer approach is to simulate the full-scale design to ascertain if undefined problems are present and to gain insight into beamformer performance capabilities.

The candidate feeds must be tested as individual elements and also in a clustered arrangement. The purpose of these tests is to determine the effect of mutual coupling between feeds. Next, the candidate feed clusters, together with the test beamformer, need to be examined for pattern and gain characteristics. (The arraying of individual elements in a cluster tends to negate the effect of mutual cross-coupling.) The feed-cluster data obtained from the latter measurements are then input to the theoretical models for feed-element selection. After feed-element selection, it is necessary to fabricate nearly the entire feed-element array for testing with a reflector.

Secondary pattern and gain tests with a reflector constitute the final feasibility demonstration. Performance contour data are required on one-half of the beam array to correctly define co-channel beam isolation for an offset-fed reflector. The reason is that the offset-fed reflector exhibits different performance characteristics when a beam is scanned upward, as opposed to downward, in elevation. For a center-fed reflector system, which is symmetric in all directions, only a quarter of the beams need to be tested to determine the full performance. Final co-channel beam isolation is obtained by reflecting the measured beam performance about the boresight and reducing the sidelobe data.

Packaging of the transmit and receive beamformers, together with the associated diplexors and RF amplifiers, constitutes a difficult design task. As presently configured, these units are physically attached to the feed-element structure and must withstand extreme environmental temperature changes, in addition to surviving the deployment process. The approach required to demonstrate performance and mechanical integrity involves the design, fabrication, and test of a full-scale feed/beamformer system.

Beamformer development begins with the selection of candidate concepts. Possible approaches will be influenced by selection of the feed-element type and cluster arrangement. Therefore, beamformer development should be delayed until the feed system has been defined.

The next step is to develop detailed designs of one or two of the concepts. Analysis of the candidate designs will lead to a selected concept. At this time, it must be determined how much of the feed/beamformer system needs to be modeled for verification purposes. Once this decision is made, fabrication of the unit will disclose any manufacturing or assembly problems.

The full-scale breadboard beamformer unit should be tested for the RF parameters of VSWR, loss, amplitude distribution, and phase distribution. Mechanical tests of folding and unfolding the feed assembly will ensure RF integrity under deployment conditions. The unit should also be subjected to environmental conditions to determine if the materials can withstand thermal-cycle stresses.

6.3.2 Mast(Center-Fed Design)

The offset-fed satellite design, with its L-shaped mast, does not present an RF design problem. An alternate, single-mast design, which provides a direct connection between the reflector apex and the offset feed location, has been suggested as a means of alleviating the structural problems of an offset feed/reflector geometry. To assess this possibility, the RF effect of such a mast must be determined.

The feasibility of the center-fed satellite design, by comparison, depends on developing a mast configuration that degrades RF performance only minimally. Sidelobe performance of a center-fed antenna depends on feed blockage, feed/mast coupling, and reflector/mast coupling.

To minimize feed/mast interaction, the preferred mast design is a triangular open truss configuration. A suitable tie-in to the multiple-feed system must be chosen. One approach is to have the tie-ins terminate in truss tubes which are positioned orthogonally to the feed assembly. The length and diameter of the tubes, as well as the truss diameter and

material, must be chosen to minimize RF coupling effects. A key question to be answered is: must the truss material be RF transparent (e.g., fiberglass), or can it be a graphite-epoxy layup or perhaps aluminum?

Understanding of the mast configuration must be obtained by test. Theoretical analysis has not progressed to the point where coupling effects can be modeled with sufficient accuracy to verify the low sidelobe levels required. Scale-frequency model tests are the most reliable for selection of an appropriate mast design. It is reasonably simple to design a mechanically acceptable feed/reflector test system that can handle a variety of interchangeable mast configurations. The reflector size, in terms of wavelength, need not be as large as that anticipated for MSAT. Mast effects measured on an electrically smaller reflector can be used to predict performance on an electrically larger design.

To test a series of mast configurations, test feed systems and beamformers must be devised. A cursory analytical trade is needed to determine a test feed-cluster configuration in terms of element spacings, number of feed elements, and the required amplitude and phase excitations. Low sidelobe performance should be the principal criterion in this selection. With this approach, the far-lobe region can be monitored for RF effects. Therefore, the selected test feed system need not produce the close-in low sidelobe levels. The least risky approach would be to use the suggested 7-element array of microstrip elements. This cluster arrangement could be used to test variants of the offset-fed mast as well as center-fed mast candidates.

Once the theoretical reflector/feed-cluster trades for the test system are complete, the feed elements must be fabricated and tested individually. A relatively large number of elements is needed to provide for off-axis beam tests and to ensure validity of coupling effects. The test beamformer would be constructed from coaxial lines, coax attenuators, controlled line lengths, and power dividers.

Reflector/feed-cluster tests without a center mast need to be made to establish a baseline set of contour patterns. Different beams locations from boresight to the farthest scan beam location need to be characterized.

Measurement of sidelobe performance with various mast configurations is the last task. The initial configuration is the open triangular truss configuration described above. Other approaches are possible if difficulties arise with the baseline mast configuration. The other approaches involve configurations that intersect the feed system from the back side.

7. CONCLUSIONS

The technical feasibility of LMSS depends on the size of the subscriber population and the geosynchronous payload capability of the launch vehicle. The system concepts investigated in this study will be assessed in terms of scenario B, which projects a subscriber population of 350,000 at the end of a 7-year system life (corresponding to the year 2002). The satellite designs are based on a 10,000-pound payload capability.

System 1 will be considered first. Two distinct regulatory environments were examined: one in which a pair of 10-MHz exclusive allocations is granted for LMSS, and a second in which LMSS shares the two 20-MHz cellular bands. For the latter case, it was concluded that compatibility cannot be achieved using 5-KHz peak-deviation FM (PDFM), the narrowband alternative to the 12-kHz PDFM employed in cellular systems. However, digital techniques such as LPC offer the promise that compatible operation could become a reality.

With a 10-MHz exclusive allocation, it was found necessary to: (1) abandon cellular compatibility in favor of the narrower FM format, and (2) employ multiple satellites, to accommodate 350,000 subscribers geographically distributed in accordance with the non-SMSA population of CONUS. The requirement for multiple satellites forces the user to employ an antenna designed for satellite discrimination. A preliminary analysis indicates that a phased array of reasonable proportions is not suitable for this purpose. However, satisfactory discrimination can be realized with a mechanically steerable antenna, about 2 feet in length, which maintains the desired pointing direction through a monopulse tracking system.

This relatively complex user antenna can be avoided by adopting a digital format such as LPC. The latter requires 6-kHz carrier spacing as compared with 12-kHz for 5-kHz PDFM. Halving the carrier spacing permits the EOL system traffic to be carried on a single satellite, rather than the pair of satellites envisioned for FM transmission. In a single-satellite system, the user antenna need only provide sufficient gain, at elevation angles greater than 20 degrees, to hold the required satellite power to a manageable level.

With a shared frequency allocation, the required frequency re-use factor is independent of the modulation format, because 30-kHz carrier spacing is needed for frequency interleaving with the cellular system. Thus, despite the use of LPC, 2 satellites are required to accommodate 350,000 subscribers. In fact, the satellite design is similar to that for the baseline, exclusive-allocation system, which employs 5-kHz PDFM.

One distinction should be observed, however. A mobile unit in a shared-allocation satellite system must be prevented from operating in this mode whenever it is within the range of a cellular-system base station. If the user also subscribes to the cellular service, the unit may be switched to base-station control at these times.

With an exclusive LMSS allocation, on the other hand, there is no possibility of interference between the two systems. Thus, a satellite mobile can continue to communicate through the satellite regardless of its location. It will be limited only by propagation factors such as shadowing, which can be extremely severe in an urban environment (Reference 7-1).

Two different satellite designs were developed for a 2-satellite system based on 5-kHz PDFM and a 10-MHz exclusive allocation. One employs an offset-fed reflector, and the other a center-fed reflector. The reflector diameters are 46 meters and 62 meters, respectively; the corresponding main-mast lengths are 69 meters and 46.5 meters. Both designs are based on use of a wrap-rib reflector.

The offset-fed design has very little structural stiffness. Consequently, maintaining the proper feed/reflector geometry is a difficult technical problem. Considerable large-space structure technology development is required in this area.

The center-fed design, by contrast, is relatively rigid. However, its sidelobe properties for multibeam operation are inferior to those of the offset-fed design. Further investigation is required to substantiate this aspect of performance.

Finally, a sizable development effort is required to design the feed array and associated beamformer network for either satellite configuration.

The MSC for the baseline System 1 configurations is shown in Figure 7-1. The specific curve shown corresponds to the center-fed design; however,

ORIGINAL PAGE IS
OF POOR QUALITY

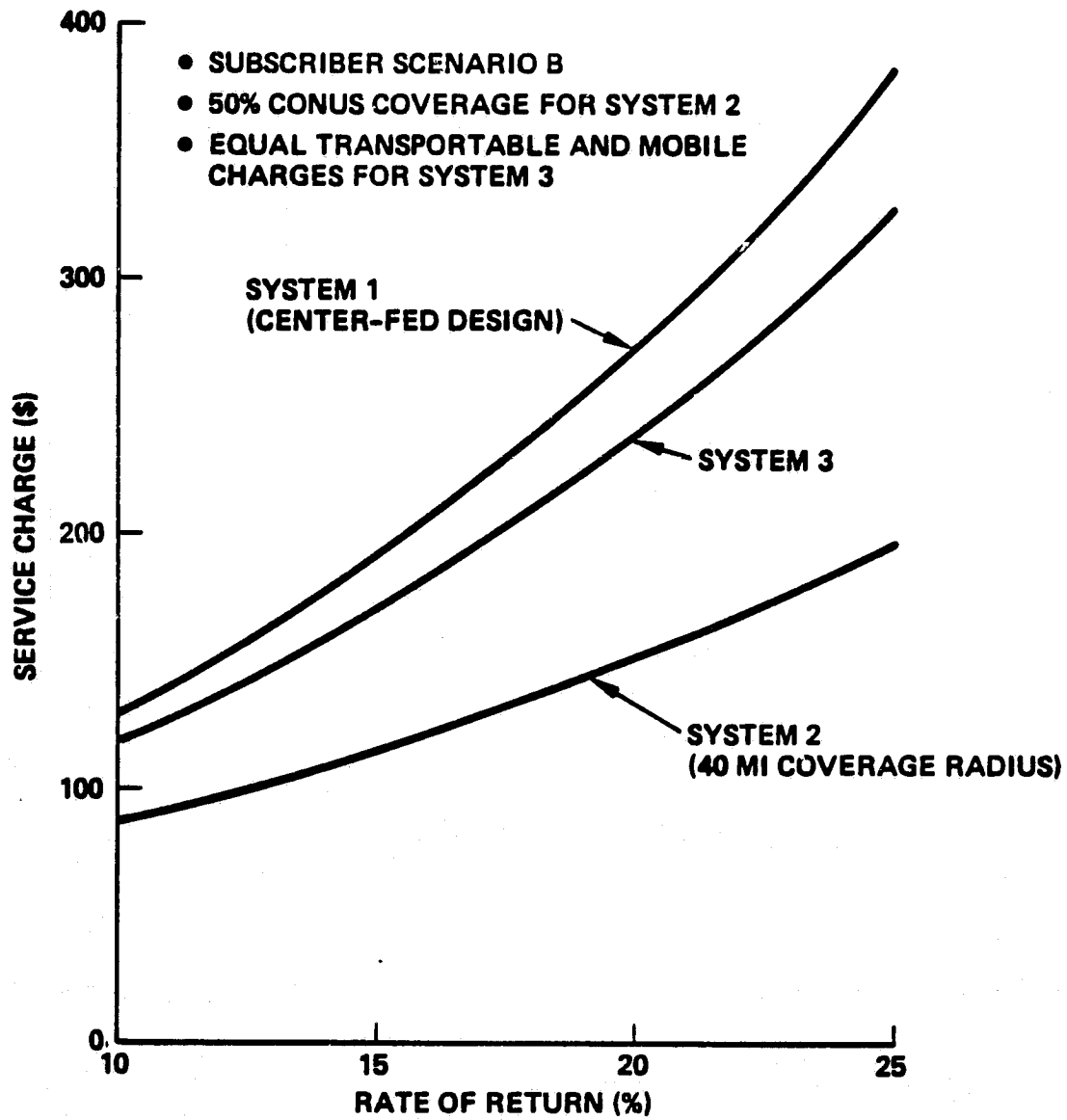

Figure 7-1. MSC System Comparison

there is little difference between this curve and the one for the offset-fed design. In addition to the MSC, an LMSS subscriber incurs a per-call charge for the gateway/land-user portion of the circuit. It is estimated that the latter charge will typically add \$80 to a user's monthly bill. It should be emphasized that the MSC depicted in Figure 7-1 does not include the cost of leasing the mobile unit.

In light of the recent NASA petition to the FCC requesting a pair of 4-MHz exclusive allocations for LMSS, it is appropriate to assess the implications of such a bandwidth constraint. The factor-of-2.5 reduction in bandwidth necessitates a similar increase in the frequency re-use factor for the system, if it is to serve the same EOL population. Whereas 2 satellites are needed for a 10-MHz allocation with 5-kHz PDFM, 4 satellites would nominally suffice with a 4-MHz allocation, because of the weight margin in the baseline designs. However, because of the high subscriber density in Eastern CONUS and the need to maintain a large longitudinal separation between satellites for user discrimination, the desired capacity would not in fact be achieved.

The scenario B EOL population can be accommodated in a 4-MHz allocation by adopting the narrower-bandwidth LPC format. Two satellites would be required in this case, necessitating the more complex form of user antenna.

A single-satellite system, permitting use of a simple user antenna, would be appropriate with a 4-MHz allocation only if the EOL subscriber population is substantially reduced. The problem with such a system design is the relatively high associated MSC. This can be appreciated by considering the total space-segment cost, which includes a substantial non-recurring component, as well as both ground and on-orbit spares. In reducing the number of operational satellites from 2 to 1, the total space segment cost is only reduced by 18 percent, while the revenue stream is halved (assuming that the number of subscribers in each year is half that for a 2-satellite system).

Regardless of the frequency allocation that may ultimately be made for LMSS, the advantages of minimizing the carrier spacing are obvious. LPC, in combination with FSK modulation, has been suggested as an embodiment of a narrower transmission format. The specific development referred to

(Reference 7-2) uses a voice-encoding bit rate of 2.4 kb/s. The reconstructed voice quality must be assessed in comparison with that resulting from FM transmission.

Further development of narrowband digital techniques can be expected in coming years, since bandwidth efficiency will be a prime requirement for non-telephonic applications of land-mobile radio. It is quite possible, therefore, that corresponding mobile-unit development will have progressed to the point where only relatively minor modifications are needed for LMSS.

The space-segment costs required to extend radio-telephone service beyond the areas served by cellular systems can be greatly reduced by utilizing translator stations to concentrate the mobile-unit traffic in the manner of System 2. Based on a 40-mile-coverage radius and a system of translators that covers 50 percent of CONUS, the required MSC is substantially reduced from the MSC associated with System 1 (see Figure 7-1).

There are uncertainties associated with the propagation aspects of System 2, however. A closer look at the coverage area attainable with a 500-foot tower (and reasonable EIRP values for the translator and mobile units) in the less remote, rural regions is needed to substantiate the MSC values. If, for example, the translator density must be increased by 40 percent (corresponding to a coverage radius of 34 miles), the MSC increases by slightly more than 20 percent.

On the other hand, a higher density of translators in certain rural areas might be accompanied by a greater-than-average subscriber density. This combination would tend to reduce the required MSC in these areas.

The increase in space segment cost occasioned by provision of LMSS to (transportable) users outside the regions that can profitably be served by System 2 has a significant impact on the MSC (see Figure 7-1). It is assumed that the "transportable" service is subsidized by the System 2 subscribers, to the extent that a common MSC is imposed on both user classes. Otherwise, the charge for transportable service would be prohibitive for the great majority of prospective subscribers.

Two comments are in order regarding the use of Figure 7-1 to compare the economics of the three systems considered. First, the MSC for each system should correspond to an IRR that reflects the risk inherent in the

project. It might reasonably be argued that the large space structure in System 1 represents a larger technological risk than is found in System 2, and that System 3 falls somewhere in between from a risk standpoint. It follows that the actual MSC disparity between systems is larger than that obtained by consideration of a fixed IRR.

Secondly, the MSC depends on the subscriber scenario. If the annual percentage growth of the subscriber population is assumed to be the same for all three systems, the subscriber scenario may be characterized by the EOL population. Identical EOL populations were assumed for all three systems (namely, that corresponding to scenario B). Clearly, however, the actual number of subscribers will vary inversely with the MSC imposed. Therefore, a difference in MSC between systems can only be accentuated by taking into account the demand elasticity for land-mobile satellite communications.

References

- 7-1 G.C. Hess, "Land-Mobile Satellite Excess Path Loss Measurements", IEEE Trans. on Vehicular Technology, Volume VT-29, May 1980, pp. 290-297.
- 7-2 S. Carney and D. Linder, "A Digital Mobile Radio for 5-6 Kilohertz Channels", Proc. Int. Conf. on Communications, Philadelphia, 13-17 June 1982, paper 5B.3.

APPENDIX A - MONTHLY SERVICE CHARGE COMPUTATION

The flow diagram of Figure A-1 shows the method by which the MSC is calculated. This is an iterative process. It is also a comprehensive process in that system traffic, revenue, costs, taxes, and cash flow are assessed against the present value criterion. The correct MSC is obtained when the present value of the system cash flow is zero, when discounted at the required rate of return.

The diagram contains two distinct loops. The primary loop is on the right side (from "Start" to "System Present Value") and represents the accounting and discounting of cash flow. The left side of the diagram is a subordinate process which reflects the calculation of taxes and time-phased costs. Total Revenue is a factor in both processes; thus the loops are interdependent.

The time distribution of revenue, cost, and expenses is denoted by the subscript "t" in the diagram. Time invariant quantities include MSC, system present value, economic life, schedule, and total acquisition cost. The MSC adjustment varies with the degree of closure in the iteration. All other variables are evaluated for each period of time (year) and are subject to the summation loop of the right-side process.

A detailed explanation of the various items required for the MSC calculation is provided below.

Cash Flow Process

Start-Service Charge. An initial guess at the appropriate MSC starts the iterative process.

Traffic. Traffic in year t is taken from the designated traffic scenario and multiplied by the MSC to calculate nominal revenue. Traffic and revenue will be zero during the years of system acquisition prior to operations.

Salvage. This is the residual value of system assets at the end of the system life cycle. It will be equal to depreciable cost minus depreciation taken throughout the life cycle. It is an addition to revenue, representing the sale of the system, occurring in the final year.

Total Revenue. The sum of Traffic times Service Charge, plus Salvage, for year t. An input to the Tax calculation.

ORIGINAL PAGE 19
OF POOR QUALITY

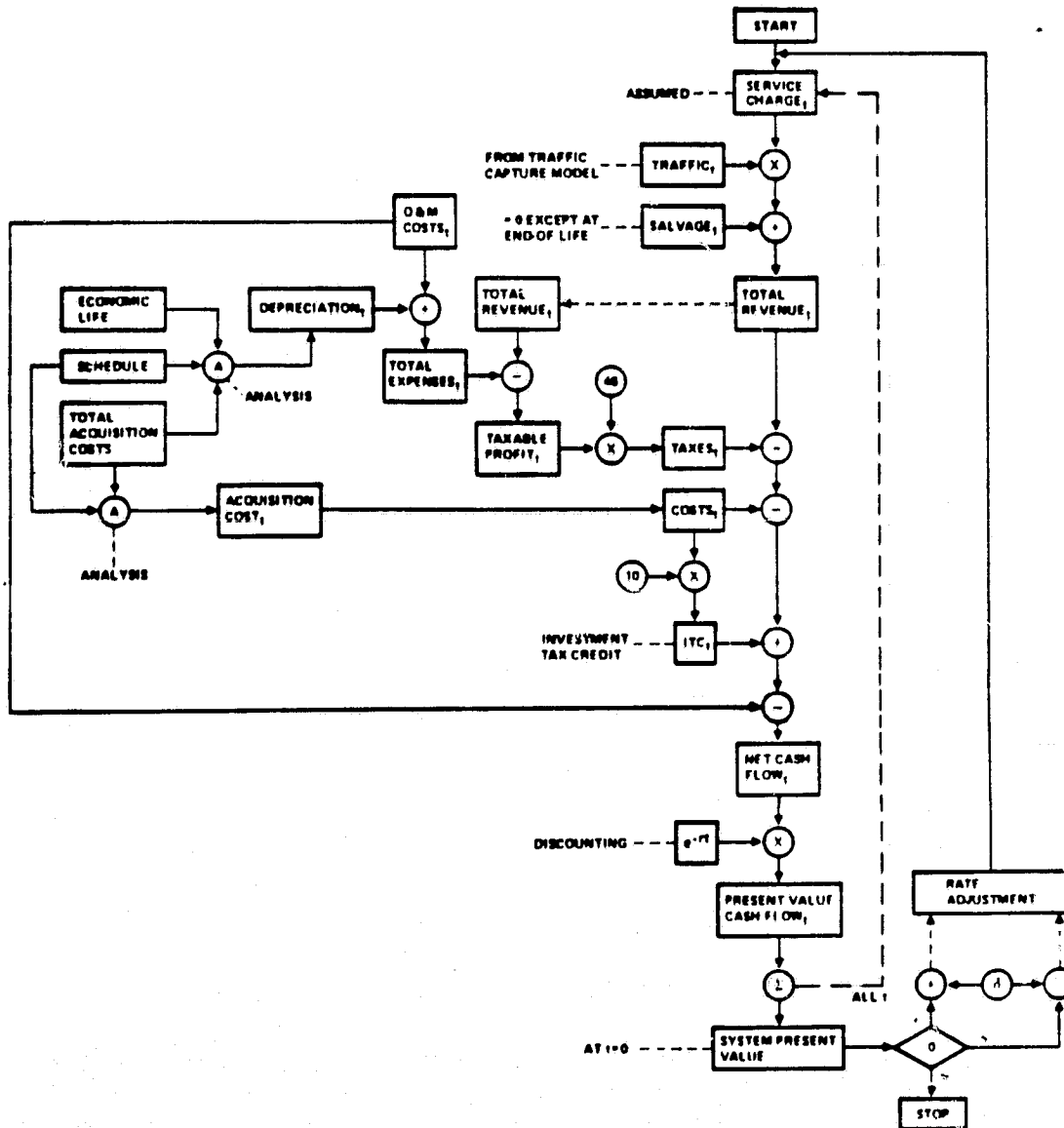

Figure A-1. MSC Calculation - Net Present Value Analysis

ORIGINAL PAGE IS
OF POOR QUALITY

Taxes. Taxes to be paid in year t , based on Revenue minus Expenses (see below).

Costs. Actual costs incurred for development, production, or operations and maintenance in year t .

Investment Tax Credit. 10 percent of the actual investment, taken immediately.

Net Cash Flow. Total Revenue minus Taxes minus Costs plus Investment Tax Credit. The net amount of cash received in year t .

e^{-rt} . The continuous discounting factor which adjusts the Net Cash Flow of year t to present value in year 0. The parameter r is the real rate of return on investment required by the investor.

Present Value Cash Flow. The present value of the year- t cash flow.

System Present Value. Sum of the Present Value Cash Flow for all years t in the system life cycle, leading to the net return on investment. If this value is positive, a return greater than r is being earned and the MSC initial guess was too high; and vice versa. A better estimate of the MSC is made and the process is repeated until the System Present Value is reasonably close to zero.

Tax and Time Phasing Process

O&M Costs. These costs are combined with Depreciation in year t to yield Total Expenses. The latter is subtracted from Total Revenue to yield Taxable Profit, which is multiplied by 0.46 to obtain Taxes in year t .

Depreciation. The result of analyzing Total Acquisition Costs, the Economic Life of the asset, and the Schedule of asset introduction. Straight-line depreciation is assumed.

Acquisition Cost. Results from the time-phasing of Total Acquisition Cost in accordance with the Schedule.

APPENDIX B - INTERFERENCE IN SHARED-ALLOCATION SYSTEM

In the proposed shared-allocation system, both the satellite mobiles and the terrestrial mobiles transmit in the 825-845 MHz band, while the satellite and the base stations transmit in the 870-890 MHz band. Carrier spacing in either system is 30 kHz. However, the carrier frequencies in one system are interleaved with those of the other to provide a minimum spacing of 15 kHz between carriers of the two systems. Additionally, a more narrowband modulation is used in the satellite system, to further reduce interference between the two systems.

For the given frequency allocations, there are four interference modes:

1. Satellite mobile into terrestrial base station
2. Terrestrial base station into satellite mobile
3. Satellite into terrestrial mobile
4. Terrestrial mobile into satellite.

These will be considered in turn. The various quantities that enter into the calculations are defined in Table B-1.

The feasibility of a shared-allocation system will be analyzed for the case where the satellite system uses 5-kHz peak-deviation FM. Tolerable carrier-to-interference (C/I) ratios, based on "slightly perceptible" interference, have been measured for this situation. The following results were obtained:*

1. For interference from the satellite system into the terrestrial system, the minimum acceptable C/I is 3 dB.
2. For interference from the terrestrial system into the satellite system, the minimum acceptable C/I is 0 dB.

In establishing these C/I criteria, the interference was the dominant degradation present; in particular, thermal noise was negligible by comparison.

*Private communication from Dr. James J. Mikulski of Motorola.

Table B-1. List of Symbols

$\left(\frac{I}{N}\right)_{TB}$	= Interference-to-noise ratio for terrestrial base station
$\left(\frac{I}{N}\right)_{TM}$	= Interference-to-noise ratio for terrestrial mobile
$\left(\frac{I}{N}\right)_{SM}$	= Interference-to-noise ratio for satellite mobile
$\left(\frac{C}{I}\right)_{Su}$	= Satellite uplink carrier-to-interference ratio
$\left(\frac{C}{N}\right)_T$	= Minimum carrier-to-noise ratio to access terrestrial system
$\left(\frac{C}{N}\right)_{td}$	= Minimum downlink carrier-to-thermal noise ratio
E_{SB}	= Satellite-mobile EIRP toward base station
E_{TH}	= Terrestrial-mobile EIRP toward horizon
G_{SS}	= Satellite-mobile antenna gain in satellite direction
G_{SB}	= Satellite-mobile antenna gain toward base station
G_{TH}	= Terrestrial-mobile antenna gain toward horizon
G_{TS}	= Terrestrial-mobile antenna gain in satellite direction
NF_S	= Satellite-mobile noise figure
NF_T	= Terrestrial-mobile noise figure
ΔL_p	= Reduction in satellite mobile/base station propagation loss during satellite call
L_{Pg}^T	= Satellite pointing loss for terrestrial mobile
L_{Mu}^T	= Terrestrial-mobile multipath loss with respect to satellite transmission
L_S^T	= Propagation loss due to shadowing of terrestrial mobile

For interference from terrestrial mobiles into the satellite, a C/I estimate is readily calculated. For the other three interference modes listed above, it is more convenient to compute the ratio of interference-to-thermal noise power (I/N). Values of I/N equivalent to the required C/I values are obtained by observing that $I/N = (C/N)/(C/I)$, where C/N is the required carrier-to-thermal noise ratio. The latter quantity will be taken as 12 dB for either system. Accordingly, the maximum acceptable I/N values are:

1. For interference into the terrestrial system, 9 dB
2. For interference into the satellite system, 12 dB.

Since the permissible levels of interference were established with no other significant sources of noise or interference present, the above I/N values must be regarded as optimistic. Furthermore, should the required C/N values exceed 12 dB, the corresponding I/N values would have to be raised accordingly.

Satellite Mobile into Terrestrial Base Station

The term satellite mobile refers to a unit that has the capability to communicate via satellite. It is assumed that such a unit will request a satellite circuit only after having tried and failed to access the terrestrial system. In any event, satellite operation must be precluded when the user is within range of a terrestrial base station. Accordingly, a satellite mobile which is just outside the range of a terrestrial base station presents the greatest interference potential to the terrestrial system.

The interference introduced by a satellite mobile in this situation can be expressed in terms of the maximum carrier-to-noise ratio at the base station for which an access attempt is unsuccessful (or, equivalently, the minimum carrier-to-noise ratio, $(C/N)_T$, that results in a successful access attempt). Since the mobile switches to a different antenna for satellite transmission, the interference power received by the base station differs from the carrier power received during the terrestrial access attempt by the difference in mobile EIRP in the two cases. The mobile EIRP toward the horizon while in the terrestrial mode is assumed independent of azimuth. In the satellite mode, however, the mobile EIRP will generally vary with

azimuth whenever the mobile antenna exhibits significant directivity. The mobile EIRP toward the base station while in the satellite mode is denoted by E_{SB} ; the horizon value in the terrestrial mode, by E_{TH} .

Because of the motion of the mobile, propagation conditions between it and the base station during a satellite call may vary from the conditions prevailing during the unsuccessful attempt to access the terrestrial system. The symbol ΔL_p is used to represent the reduction in propagation loss during this period.

The I/N value corresponding to a satellite mobile just outside the range of a terrestrial base station is:

$$\frac{I}{N}_{TB} = \frac{C}{N}_T - E_{TH} + E_{SB} + \Delta L_p \quad (B-1)$$

No interference reduction is assumed to result from the polarization difference between the two systems (circular for the satellite and linear for the terrestrial) because of the unknown axial ratio of the satellite mobile in the direction of the base station.

The value of E_{SB} is obtained by modifying the uplink EIRP of the satellite mobile for the lower antenna gain in the direction of the base station. The uplink EIRP for the baseline mobile-unit antenna design is 12.8 dBW (see Table E-2). Therefore:

$$E_{SB} = 12.8 - G_{SS} + G_{SB} \quad (B-2)$$

where G_{SS} and G_{SB} are the values of the mobile antenna gain in the direction of the satellite and base station, respectively.

The carrier-to-noise ratio required to access the terrestrial system is approximately 11 dB. Also, for a 3-watt mobile transmitter, E_{TH} is typically 8.2 dBW. Therefore, the interference-to-noise ratio for the base station becomes:

$$\frac{I}{N}_{TB} = 15.6 - G_{SS} + G_{SB} + \Delta L_p \quad (B-3)$$

The difference in mobile-unit antenna gain, $\Delta G = G_{SS} - G_{SB}$, depends on the type of antenna used. For the mechanically steerable antenna suggested in Section 2.3.5 for use with multiple-satellite systems, ΔG varies over a wide range, depending on the azimuth of the base station relative to the azimuth of the wanted satellite. If the two azimuths are the same and the antenna boresight is fixed at an elevation angle of 45 degrees, ΔG can be as small as 2 dB. On the other hand, for a 90-degree difference in azimuth, ΔG is more than 20 dB.

If it is assumed that $\Delta L_p = 0$, it can be seen from equation B-3 that the required 9-dB value of $(I/N)_{TB}$ is met if $\Delta G \geq 6.6$ dB. With the 2-dB worst-case value of ΔG , $(I/N)_{TB}$ is too large by 4.6 dB. A reduction in $(I/N)_{TB}$ by this amount requires an increase in mobile-unit/base-station distance by a factor of 1.3. With a nominal cell radius of 8 miles, satellite mobiles more than 10.4 miles from the base station meet the interference requirement.

Terrestrial Base Station into Satellite Mobile

The interference received by a satellite mobile that has just failed to access the terrestrial system is given by $(C/N)_T - G_{TH} + G_{SB}$, where G_{TH} is the mobile antenna gain toward the horizon when in the terrestrial mode. The terrestrial system is normally designed for balanced transmission between base station and mobile units, based on comparable noise figures at either end. The unsuccessful terrestrial access attempt is therefore presumed to have occurred with the equivalent of a terrestrial-system receiver employed in the satellite mobile. This noise-figure distinction results in greater satellite-mobile sensitivity to base station interference.

The interference-to-noise ratio for the satellite mobile is given by

$$\left(\frac{I}{N}\right)_{SM} = \left(\frac{C}{N}\right)_T - G_{TH} + G_{SB} + NF_T - NF_S + \Delta L_p \quad (B-4)$$

where $\Delta NF = NF_T - NF_S$ is the noise-figure differential between the terrestrial and satellite systems. Typically, $\Delta NF = 9 - 3 = 6$ dB. Consistent with previous assumptions, $G_{TH} = 3.4$ dB. The worst-case (i.e., maximum)

value of G_{SB} is about 7 dB, corresponding to a base station at the same azimuth as the mobile-antenna boresight.

For this worst case, and with $\Delta L_p = 0$, $(I/N)_{SM} = 20.6$ dB. This is 8.6 dB greater than the value corresponding to "slightly perceptible" interference. A reduction in the level of the interfering signal by this amount would result from an increase in mobile-unit/base-station distance from 8 to 13.1 miles.

Satellite into Terrestrial Mobile

The interference presented to a terrestrial mobile can be computed from the design parameters of the satellite downlink. The carrier power received by a satellite mobile depends on its location with respect to the center of the assigned satellite beam (i.e., on the pointing loss) and on the multipath loss encountered. The minimum downlink carrier-to-noise ratio, with these effects accounted for, is represented by $(C/N)_{td}$.

The reduction due to multipath of the interference seen by the terrestrial mobile will be represented by L_{Mu}^T . The interference level is further reduced by any shadowing, L_S^T , of the terrestrial mobile. It is also reduced by 3 dB as a result of the difference in polarization between the satellite and terrestrial systems.

The interference-to-noise ratio for a terrestrial mobile near the center of one of the satellite beams is given by:

$$\left(\frac{I}{N}\right)_{TM} + \left(\frac{C}{N}\right)_{td} - L_{Mu}^T - L_S^T - G_{SS} + G_{TS} + NF_S - NF_T + 7 \quad (B-5)$$

where G_{TS} is the antenna gain of the terrestrial mobile in the direction of the satellite, and the satellite-system maximum pointing loss and multipath allowance are both taken as 5 dB.

The terrestrial mobile antenna has a broad gain pattern. Since the satellite may be at a low elevation angle, G_{TS} will be taken as 3.4 dB, the value previously assumed for the gain toward the horizon.

While shadowing in urban areas can be extremely large (Reference B-1), it is strongly dependent on the line-of-sight direction to the satellite. Shadowing is far less likely in suburban or rural areas. The term L_S is

therefore set equal to zero in estimating the interference into an individual terrestrial mobile. With the aim of computing a worst-case value of $(I/N)_{TM}$, L_{Mu}^T will also be taken as zero.

According to Table E-5, the values of $(C/N)_{td}$ and G_{SS} are 14.5 dB and 9 dB, respectively. The corresponding value of $(I/N)_{TM}$ is 9.9 dB. This is 0.9 dB higher than the value corresponding to slightly perceptible interference. However, since worst-case assumptions were made in several respects, it is likely that noticeable interference would be reported by a relatively small percentage of terrestrial mobiles.

Terrestrial Mobile into Satellite

The final interference mechanism, and the one likely to prove most troublesome, is from the terrestrial mobiles into the satellite. In this case, the interference will be assessed by the uplink carrier-to-interference ratio, $(C/I)_{Su}$.

In general, a number of cells of the terrestrial system will be encompassed by a single satellite beam. Interference can therefore be received simultaneously from several terrestrial mobiles at the same frequency. Moreover, with the carrier frequencies of the satellite system interleaved with those of the terrestrial system, two sets of co-channel carriers (one on either side) contribute to interference experienced by a given satellite-system carrier. Finally, it should be noted that the terrestrial-system carriers are generally not voice activated, so there is no corresponding dilution of the interference power.

The effect of any single interferer can be evaluated by comparing the wanted and unwanted received signal levels at the satellite. The satellite-mobile EIRP in the direction of the satellite is 12.8 dB (see Table E-2). Consistent with previously stated assumptions, the terrestrial-mobile EIRP in the same direction is 8.2 dBW. The satellite pointing loss at the location of the satellite mobile is assumed to be the maximum value of 5 dB. Furthermore, the wanted signal is assumed to undergo a multipath loss equal to the full 5-dB allowance. On the other hand, the unwanted signal undergoes a 3-dB polarization loss. The resulting carrier-to-interference ratio is given by:

$$\left(\frac{C}{I}\right)_{Su} = L_{Pg}^T + L_{Mu}^T + L_S^T - 2.4 \quad (B-6)$$

where L_{Pg}^T is the satellite pointing loss for the terrestrial mobile. It is seen that the carrier-to-interference ratio for a single interferer can be quite variable, depending on the values of the three loss terms.

Up to this point, the terrestrial-mobile EIRP has been treated as a constant, namely 8.2 dBW, corresponding to a 3-watt transmitter. However, the terrestrial base stations have the capability to reduce mobile transmit power with decreasing distance, so as to maintain a more nearly constant received signal level. Within a cell of maximum size, exercise of this capability will reduce the average EIRP by only about 2 dB. However, as the larger cells are subdivided to provide increased system capacity, sizable transmit power reductions can result. Since these power reductions will be occurring as the number of terrestrial subscribers is increasing, the net effect will be to limit (or conceivably reduce) the level of interference seen at the satellite.

For simplicity, each terrestrial mobile will be assumed to transmit either at maximum power or at negligible power. The carrier-to-interference ratio experienced with N effective interferers can be written as:

$$\left(\frac{C}{I}\right)_{Su} = \left(L_{Pg}^T\right)_{AV} + \left(L_{Mu}^T\right)_{AV} - 10 \log N - 2.4 \quad (B-7)$$

where the indicated averages are taken over the N interferers and where shadowing effects are assumed negligible. The average pointing loss is 1-2 dB. It will arbitrarily be assumed that the average multipath loss is 2 dB. It is then approximately true that:

$$\left(\frac{C}{I}\right)_{Su} = 1 - 10 \log N \quad (B-8)$$

The number of effective interferers on a given frequency can be estimated from the anticipated terrestrial subscriber population. On average, the capturable market is estimated to be at least 0.5 percent of

the total population.* The number of subscribers lying within a single satellite beam will be greatest in the northeast part of CONUS. With 20 MHz of spectrum available, about 60 beams are needed in a 2-satellite configuration to provide system capacity corresponding to subscriber scenario B (see Figure 2-15). In the Northeast Corridor, as much as 10 percent of the subscriber population (about 125,000 users) could be captured in a single satellite beam. With each subscriber generating an average of 0.026 erlang of traffic during the busy hour and 666 carrier frequencies available, there will be an average of 5 users per frequency.

Several of these subscribers (e.g., in the New York City area) can be expected to operate in cells of reduced size. If it is assumed that half the subscribers produce negligible interference, there will be only an average of 2.5 effective interferers (i.e., those operating in cells of maximum size) on any frequency.

In the areas covered by most other satellite beams, there will be less need for frequency re-use within a cellular system. Consequently, although the number of subscribers per beam will be smaller than in the Northeast Corridor, there may be a comparable amount of interference in many cases.

Because the proposed set of frequencies for the satellite system is interleaved with that of the terrestrial system, there are 2 frequencies in the latter system that can interfere with each frequency in the former system. In all, therefore, there will be 5 effective interferers with each carrier of the satellite system.

For 5 effective carriers, $(C/I)_{Su} = -6$ dB. This is 6 dB less than the required value. Moreover, if base stations should not exercise power control in the cellular systems, $(C/I)_{Su}$ would be 3 dB lower. Finally, it should be pointed out that some prospective cellular-system operators project the eventual market to be several times higher than the 0.5-percent-of-the-population estimate made here. If these more optimistic projections should materialize, the interference experienced at the satellite would be correspondingly higher.

* Suggested by Mr. Jim Caile of Motorola.

REFERENCE

- B-1. G. C. Hess, "Land-Mobile Satellite Excess Path Loss Measurements," IEEE Transactions on Vehicular Technology, Vol. 29, May 1980, pp. 290-297.

APPENDIX C - USER ANTENNA REQUIREMENTS

The feasibility of the multiple-satellite concept hinges on the protection that can be provided against co-channel signals from other than the assigned satellite. A set of 5 extreme locations within CONUS was selected as a means of testing the adequacy of any proposed user antenna design. These are indicated in Table C-1, along with the satellite/user coordinates for the 3-satellite configuration and the line-of-sight (LOS) separation between pairs of satellites. Similar data for the 2-satellite case are given in Table C-2. The separation between adjacent satellites, as seen by the user, ranges from 35 to 38 degrees, while the angle between the outer satellites in a 3-satellite configuration always exceeds 70 degrees.

The proposed antenna concept is shown in Figure C-1. It consists of a linear array of 4 microstrip patches, which can be rotated through 360 degrees. The patches are fed in phase. Consequently, when the LOS to the wanted satellite is normal to the line through the patch centers, the gain toward the satellite is 6 dB higher than that of a single patch, provided the patches are excited equally. A typical gain pattern for a single patch is shown in Figure C-2.

The normal to the plane of the antenna is tilted away from vertical so that, when the antenna is rotated to the azimuth of the wanted satellite, the maximum elevation-angle difference between the satellite and the antenna boresight will tend to be minimized. To hold the loss of gain from boresight to 1 dB, the elevation-angle difference should be less than 25 degrees. Thus, a pair of (semi-permanent) user-selectable, tilt-angle settings of (say) 45 and 60 degrees might be appropriate. A choice between these values, which correspond to boresight elevation angles of 45 and 30 degrees, would be made on the basis of user location.

The direction of the unwanted satellite with respect to the user/wanted-satellite geometry varies considerably, depending primarily on the difference in longitude between user and wanted satellite. At the very least, good co-channel rejection should be provided in the (azimuthal) plane defined by the LOS to the wanted satellite and the line through the

Table C-1. Satellite/User Geometry for 3-Satellite System (Deg)

USER LOCATION			LINE-OF-SIGHT COORDINATES						LINE-OF-SIGHT ANGULAR DIFFERENCE		
STATE	LAT.	LONG.	SATELLITE LONGITUDE						SATELLITE LONGITUDES		
			64°		97°		130°		64°, 97°	97°, 130°	64°, 130°
			AZ	EL	AZ	EL	AZ	EL			
MAINE	47°	68°	175	36	217	29	249	10	37	35	72
FLORIDA	26°	81°	145	54	213	55	249	28	37	37	74
TEXAS	26°	98°	123	42	178	60	235	43	38	38	75
CALIFORNIA	33°	117°	112	22	146	46	203	49	37	37	74
WASHINGTON	48°	124°	113	11	146	29	188	35	36	36	71

Table C-2. Satellite/User Geometry for 2-Satellite System (Deg)

USER LOCATION			LINE-OF-SIGHT COORDINATES				LINE-OF-SIGHT ANGULAR DIFFERENCE
STATE	LAT.	LONG.	SATELLITE LONGITUDE				
			80°		113°		
			AZ	EL	AZ	EL	
MAINE	47°	68°	196	35	234	21	36
FLORIDA	26°	81°	178	60	235	43	38
TEXAS	26°	98°	143	54	211	55	38
CALIFORNIA	33°	117°	126	35	173	51	37
WASHINGTON	48°	124°	128	21	165	34	35

ORIGINAL PAGE IS
OF POOR QUALITY

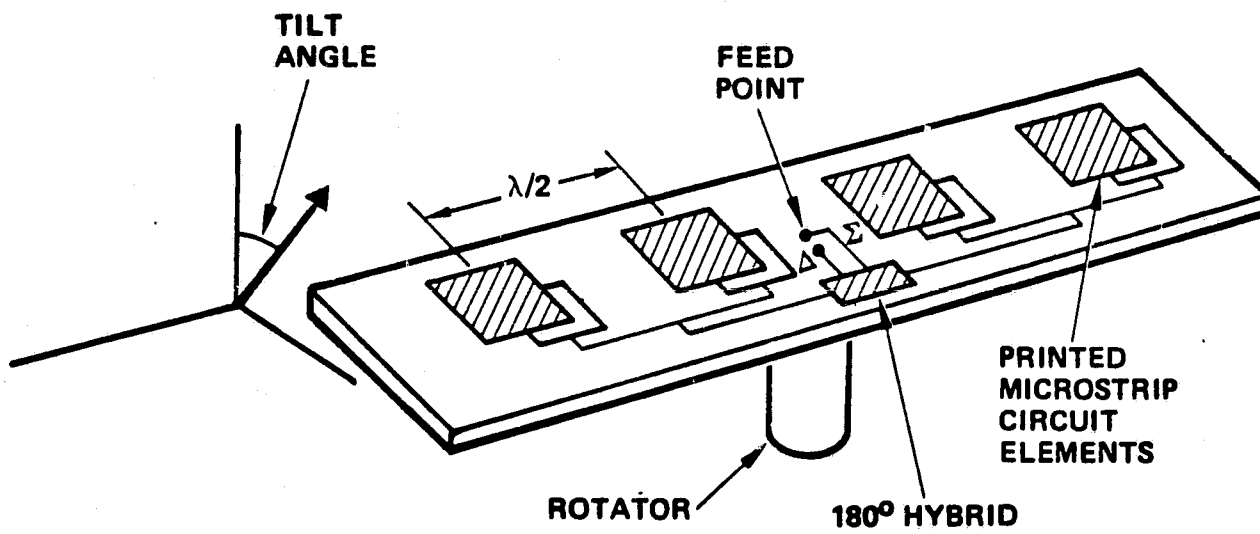
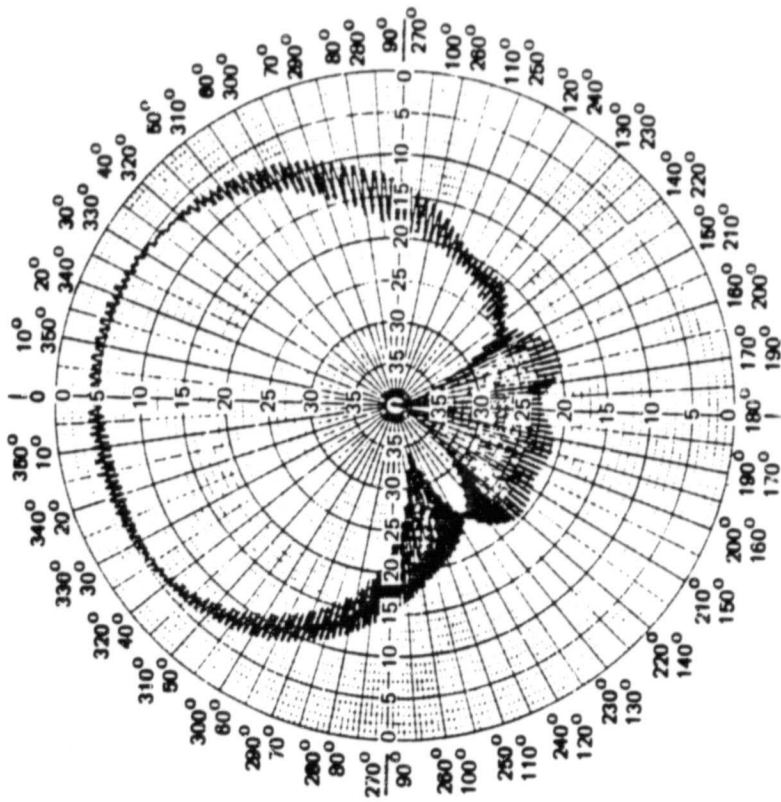
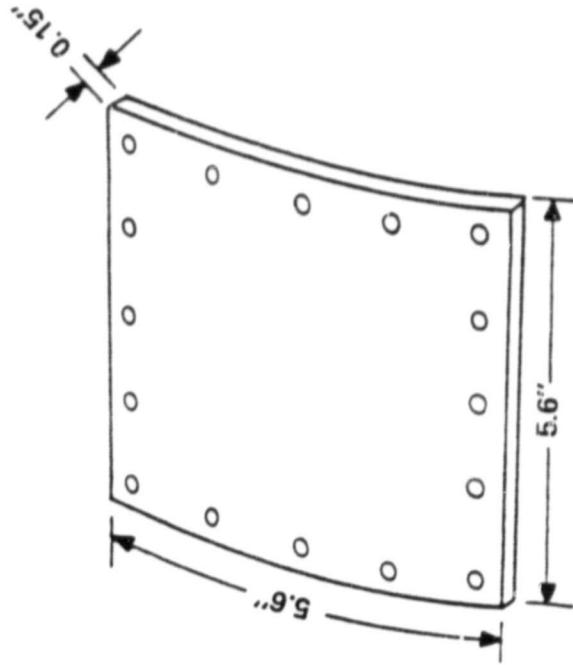

Figure C-1. User Antenna Concept

FREQUENCY: SINGLE FREQUENCY, 850 MHz BAND
 PEAK GAIN: 5.5 dBic
 BEAMWIDTH: 100 DEGREES
 POLARIZATION: CIRCULAR
 AXIAL RATIO: 2 dB ON BROADSIDE

ORIGINAL PAGE IS
 OF POOR QUALITY



TYPICAL RADIATION PATTERN (IN dB)
 ROTATING LINEAR SOURCE

Figure C-2. Ball Aerospace Printed-Circuit Antenna Element

patch centers. The unwanted satellite(s) lie close to this plane when the user and wanted satellite are at the same longitude.

Gain patterns in the indicated plane are shown in Figure C-3 for the case where the LOS to the wanted satellite coincides with the antenna boresight. The four curves shown correspond to different amounts of tapering (i.e., reduced illumination) of the two outer elements. Note that a 5.3-dB decrease in relative sidelobe level can be achieved at the cost of a 1.5-dB reduction in peak gain for a 3-dB taper. The maximum sidelobe gain in this case is -19.5 dB relative to the peak gain, while in the range from 35 to 38 degrees off-axis, the relative gain is no greater than -25.5 dB. Because of this superior spatial isolation, the 3-dB tapered configuration was selected for further study.

The mobile antenna must maintain its orientation (i.e., boresight azimuth) despite any vehicle motion. It is evident from Figure C-3 that a relatively small pointing error can result in a considerable increase in intersatellite interference. The antenna orientation is controlled by a monopulse tracking system that makes use of a 180-degree hybrid as shown in Figure C-1. The output of the hybrid is shown in Figure C-4 as a function of azimuthal error. To hold the pointing error within ± 3 degrees, for example, it is only necessary to maintain the tracking system output within a 13-dB range.

Before the monopulse tracking system can effectively control the antenna orientation, the antenna must be pointed in the general direction of the wanted satellite. Satellite selection is done by the master control station as part of the call-setup procedure. This information is communicated to the user along with the assigned pair of carrier frequencies. To eliminate the need for knowledge of the user-vehicle orientation, a scanning procedure is employed to provide initial satellite acquisition.

Evaluation of the proposed mobile antenna requires examination of an arbitrary user/satellite geometry. The relevant coordinates are defined in Figure C-5, in which the Z-axis coincides with the antenna boresight and the X-axis passes through the centers of the microstrip patches.

ORIGINAL PAGE 13
OF POOR QUALITY

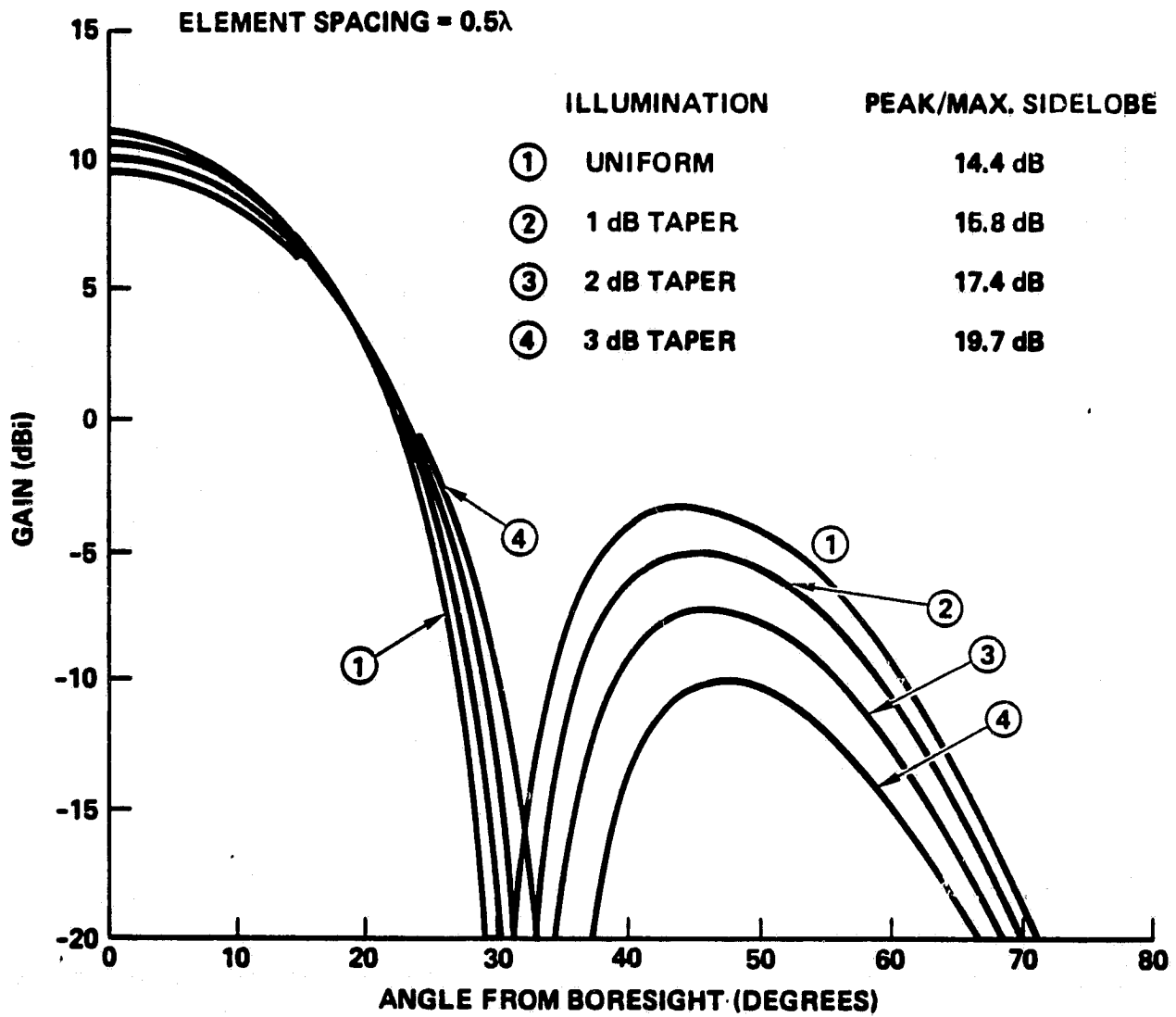

Figure C-3. Azimuthal Pattern for 4-Element Linear Array

ORIGINAL PAGE IS
OF POOR QUALITY

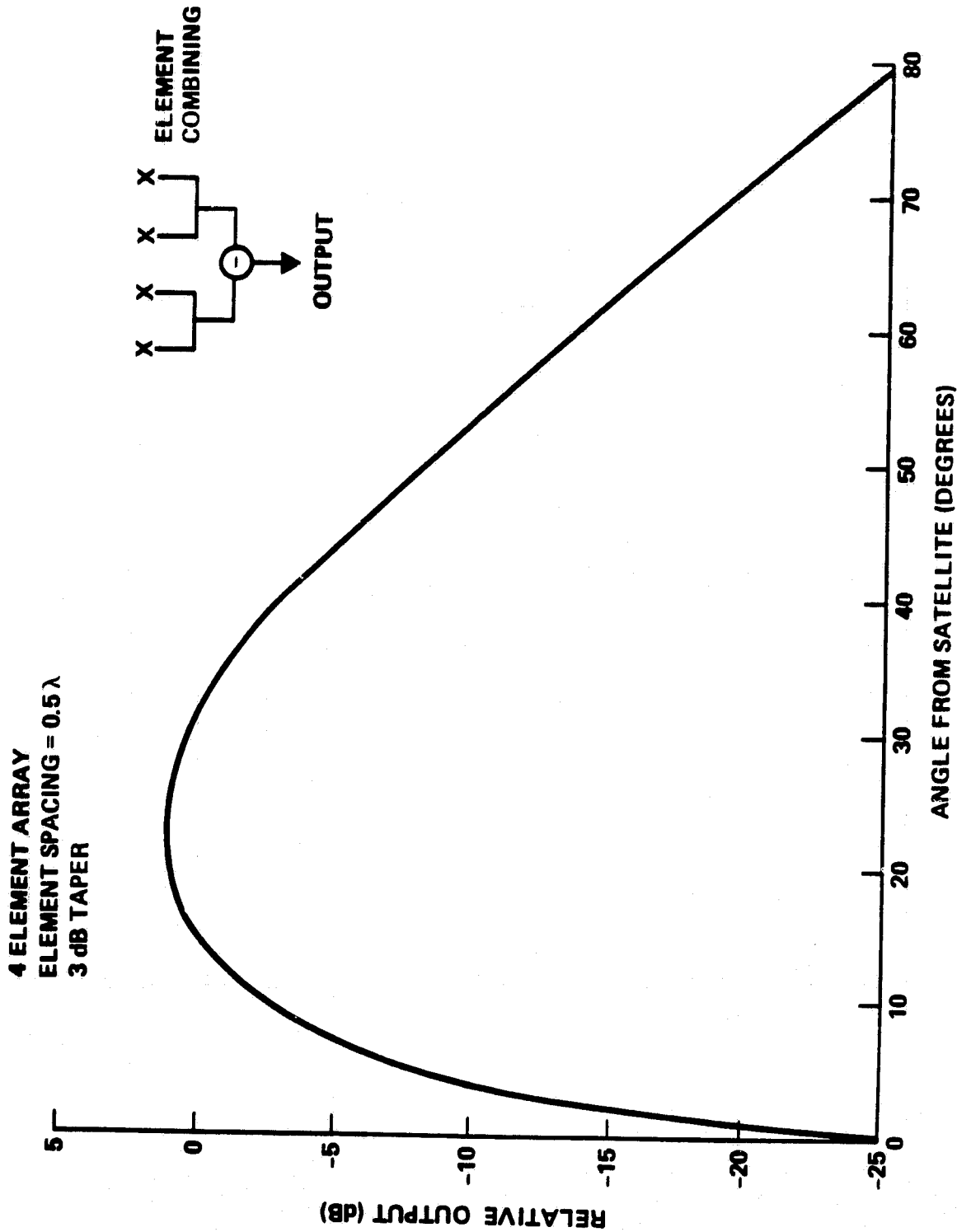

Figure C-4. Monopulse Tracking System Output Signal

ORIGINAL PAGE 13
OF POOR QUALITY

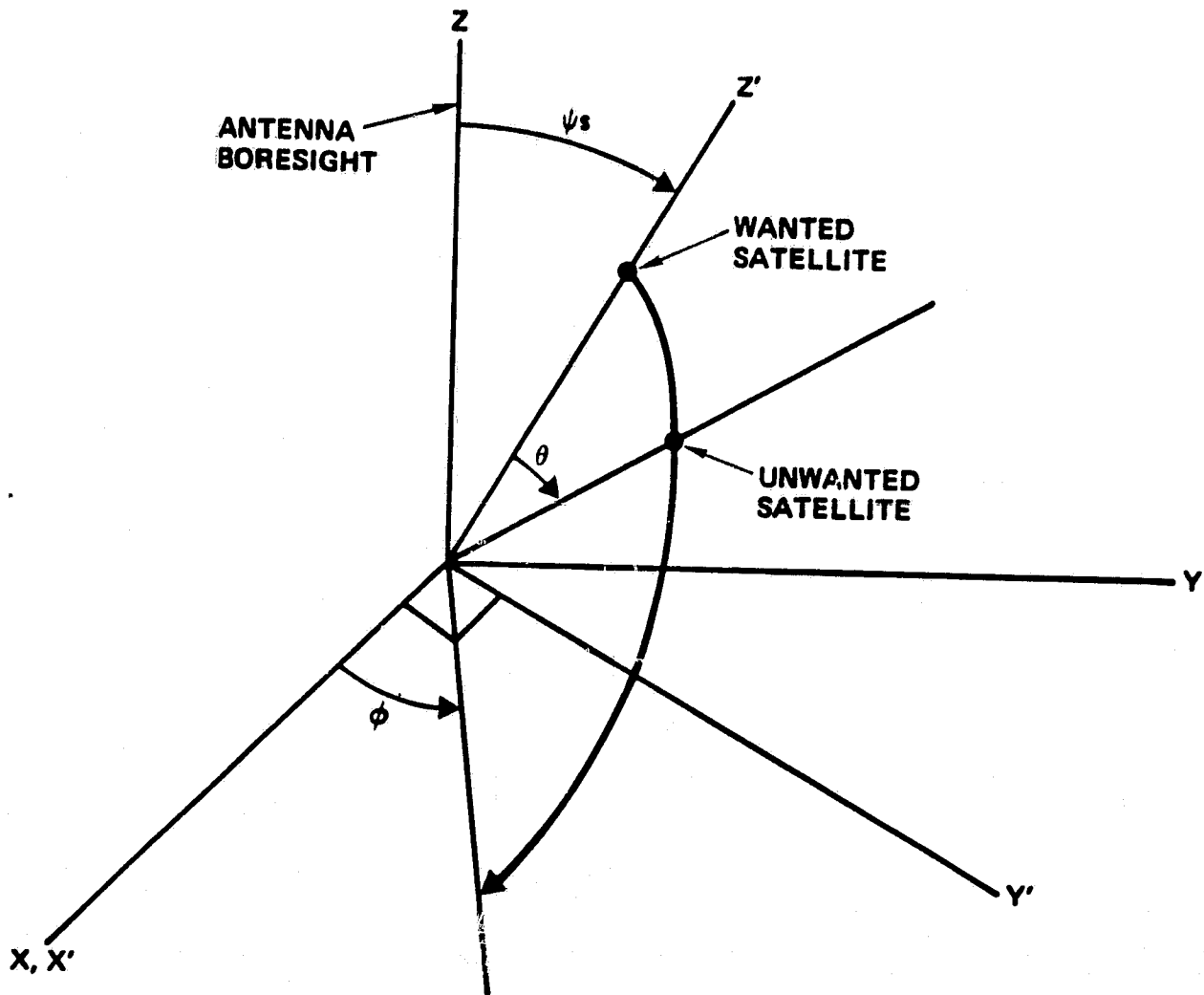

Figure C-5. User Antenna/Satellite Geometry

Gain patterns for the special case where the antenna boresight and the LOS to the wanted satellite coincide are shown in Figure C-6. The $\phi = 90^\circ$ pattern, which corresponds to the elevation plane, gives the reduction in gain toward the wanted satellite that would result from raising or lowering the antenna boresight.

Gain patterns for elevation-angle differences of 20, 40, and 50 degrees between the wanted satellite and the antenna boresight are shown in Figures C-7 to C-9. It can be inferred from Figures C-7 and C-8 that, to maintain a gain of no less than 9 dB toward the wanted satellite, the elevation-angle difference should be held to about 25 degrees. For a 2-satellite system, where the minimum satellite elevation angle is 21 degrees, the antenna boresight should be pointed no higher than 46 degrees. For a 3-satellite system, where the minimum satellite elevation angle is 10 degrees, the boresight should be pointed no higher than 35 degrees.

To determine the user antenna gain toward an unwanted satellite, the θ and ϕ coordinates of the satellite must be established. This is done in Tables C-3 and C-4 for the 3-satellite and 2-satellite cases, respectively. Only three of the five extreme locations selected to illustrate the user/satellite geometry in Tables C-1 and C-2 are repeated in Tables C-3 and C-4, because of the symmetry introduced by the choice of satellite longitudes. While the magnitude of ϕ depends only on the user/satellite geometry, its sign depends on the relative elevation angle between the boresight and the wanted satellite. The values of ϕ given in Tables C-3 and C-4 assume a higher elevation angle for the antenna boresight.

For a lower boresight elevation, the sign of ϕ should be reversed. If the antenna boresight points directly at the satellite, the sign of ϕ is irrelevant because of the symmetry of the gain pattern about the LOS to the satellite.

For the purpose of illustration, assume a 3-satellite system with the antenna elevated at 45 degrees. Consider a user located in Maine communicating through the satellite at 90 degrees. This satellite is seen at an elevation angle of 29 degrees (see Table C-1). The gain patterns of Figure C-7, which correspond to an elevation-angle difference of 20 degrees,

ORIGINAL PAGE 19
OF POOR QUALITY

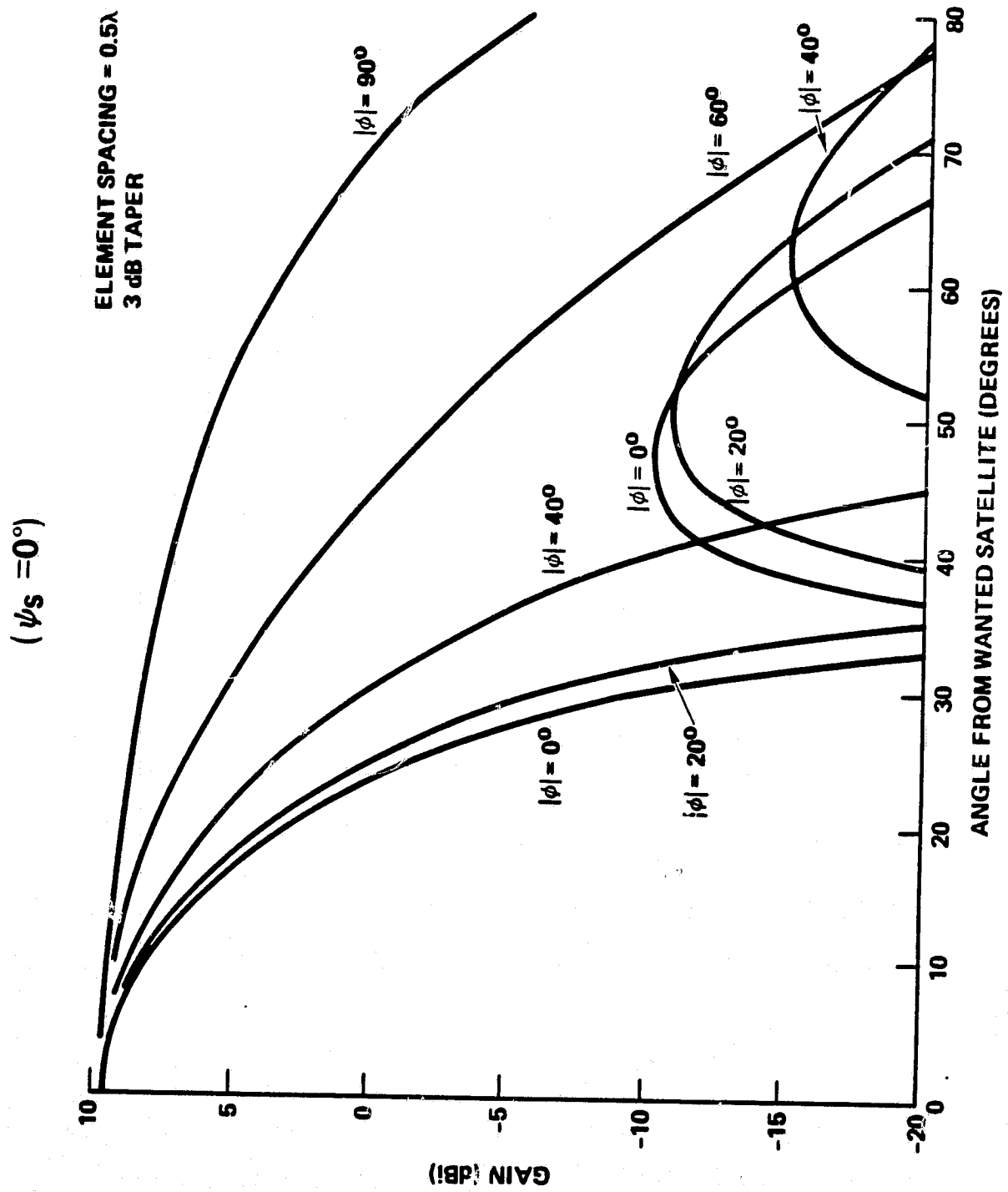

Figure C-6. Gain Pattern for 4-Element Linear Array

ORIGINAL PAGE IS
OF POOR QUALITY

$$(\psi_s = 20^\circ, \phi \geq 0^\circ)$$

ELEMENT SPACING = 0.5λ
3 dB TAPER

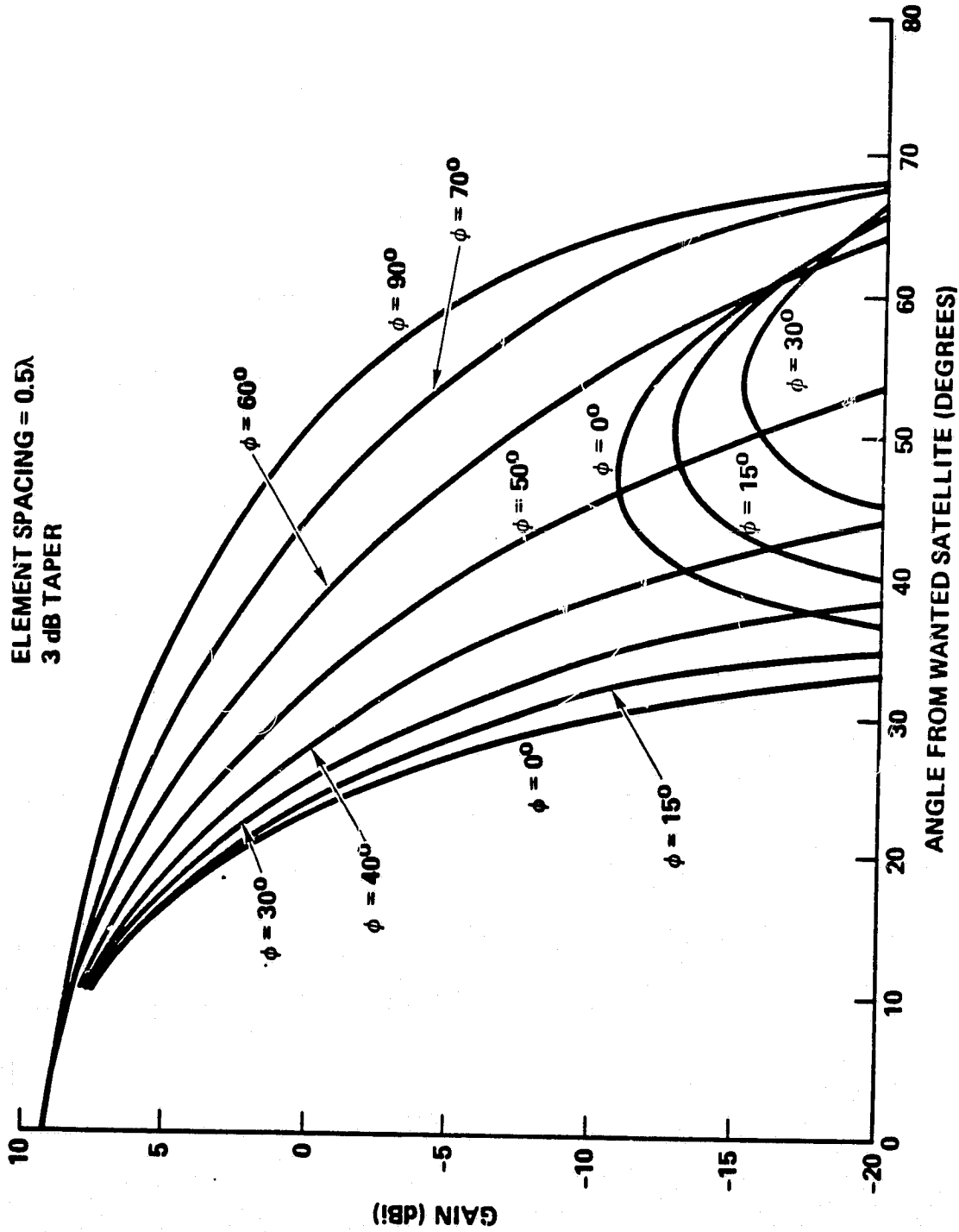

Figure C-7a. Gain Pattern for 4-Element Linear Array

ORIGINAL PAGE IS
OF POOR QUALITY

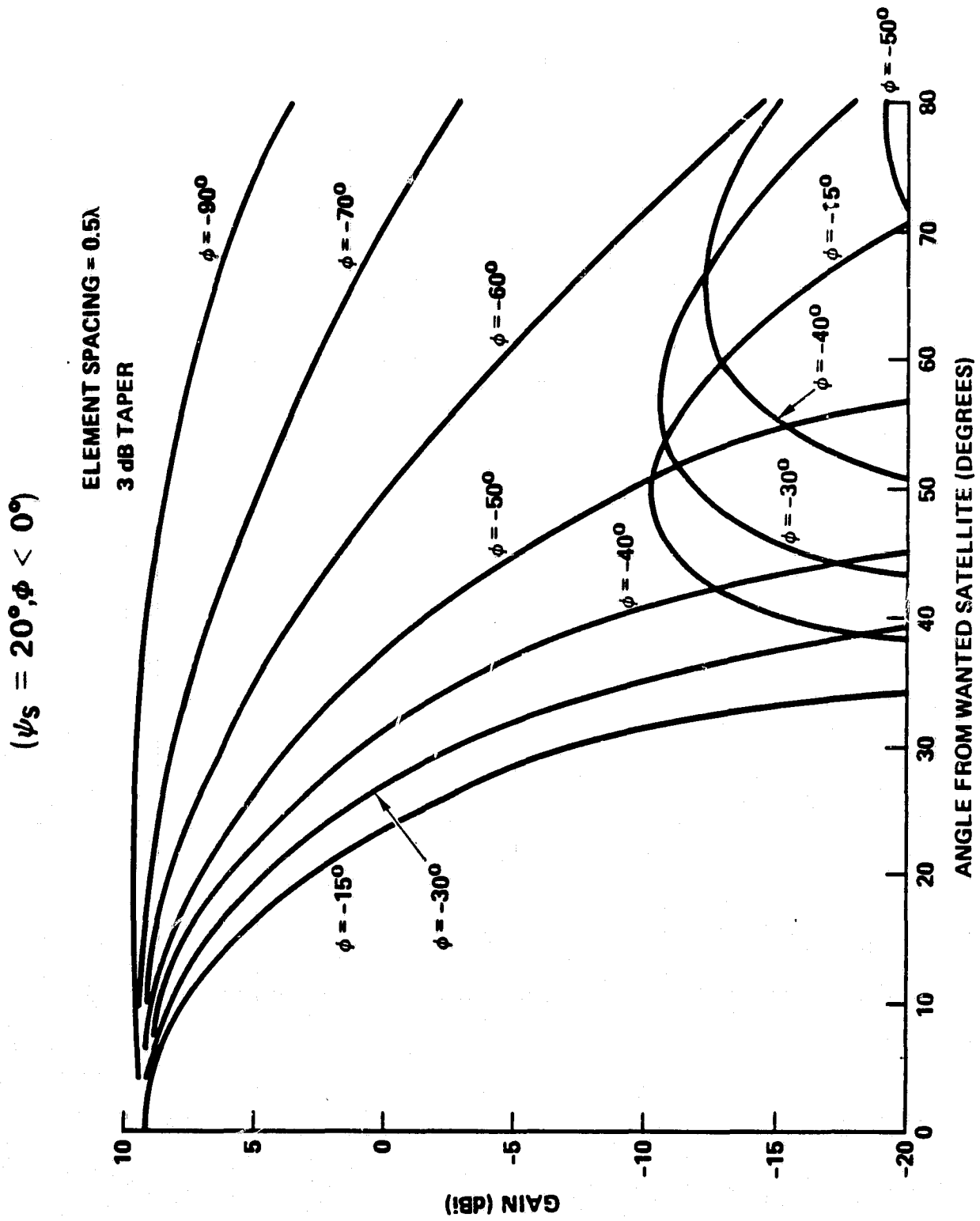

Figure C-7b. Gain Pattern for 4-Element Linear Array

ORIGINAL PAGE IS
OF POOR QUALITY

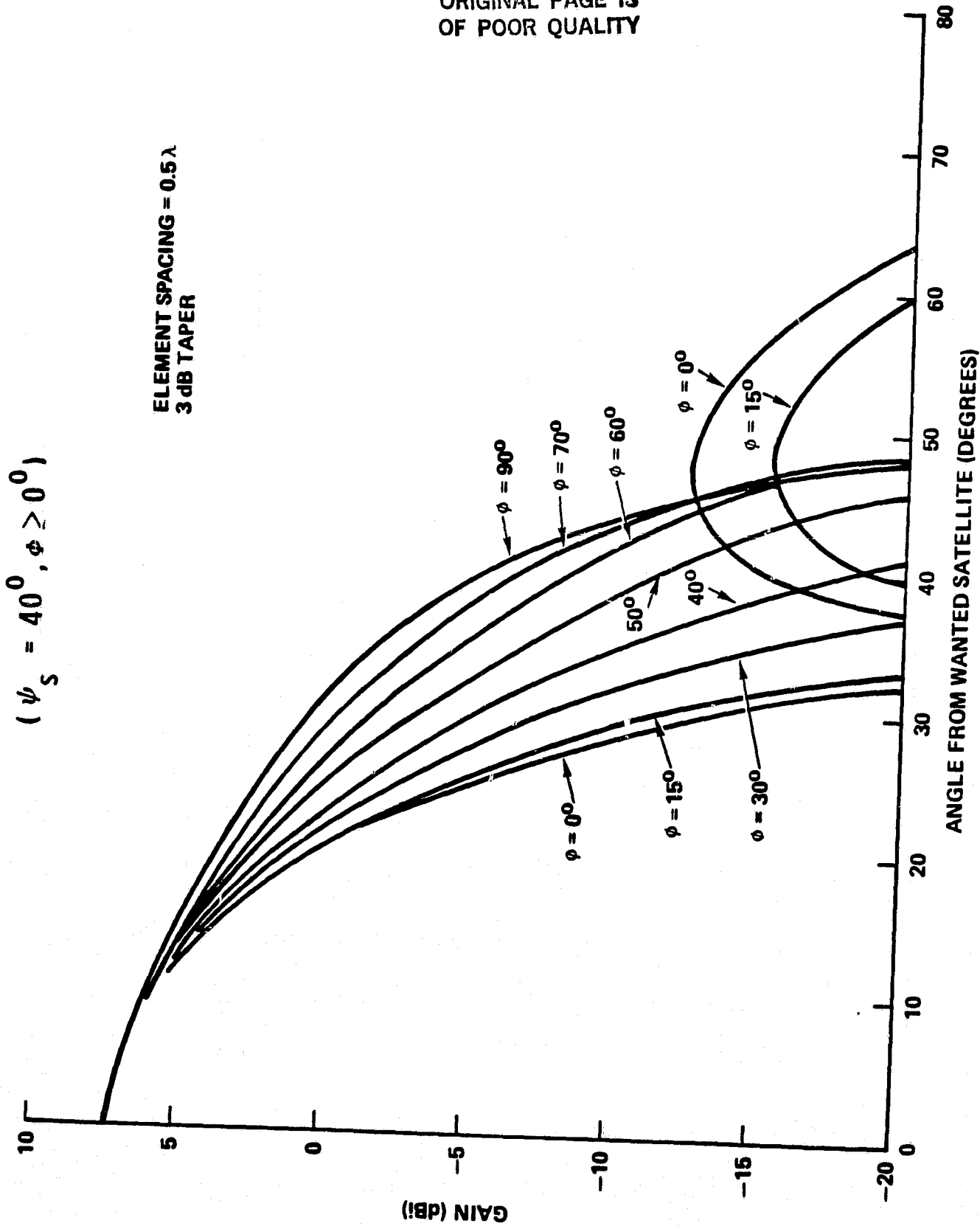

Figure C-8a. Gain Pattern for 4-Element Linear Array

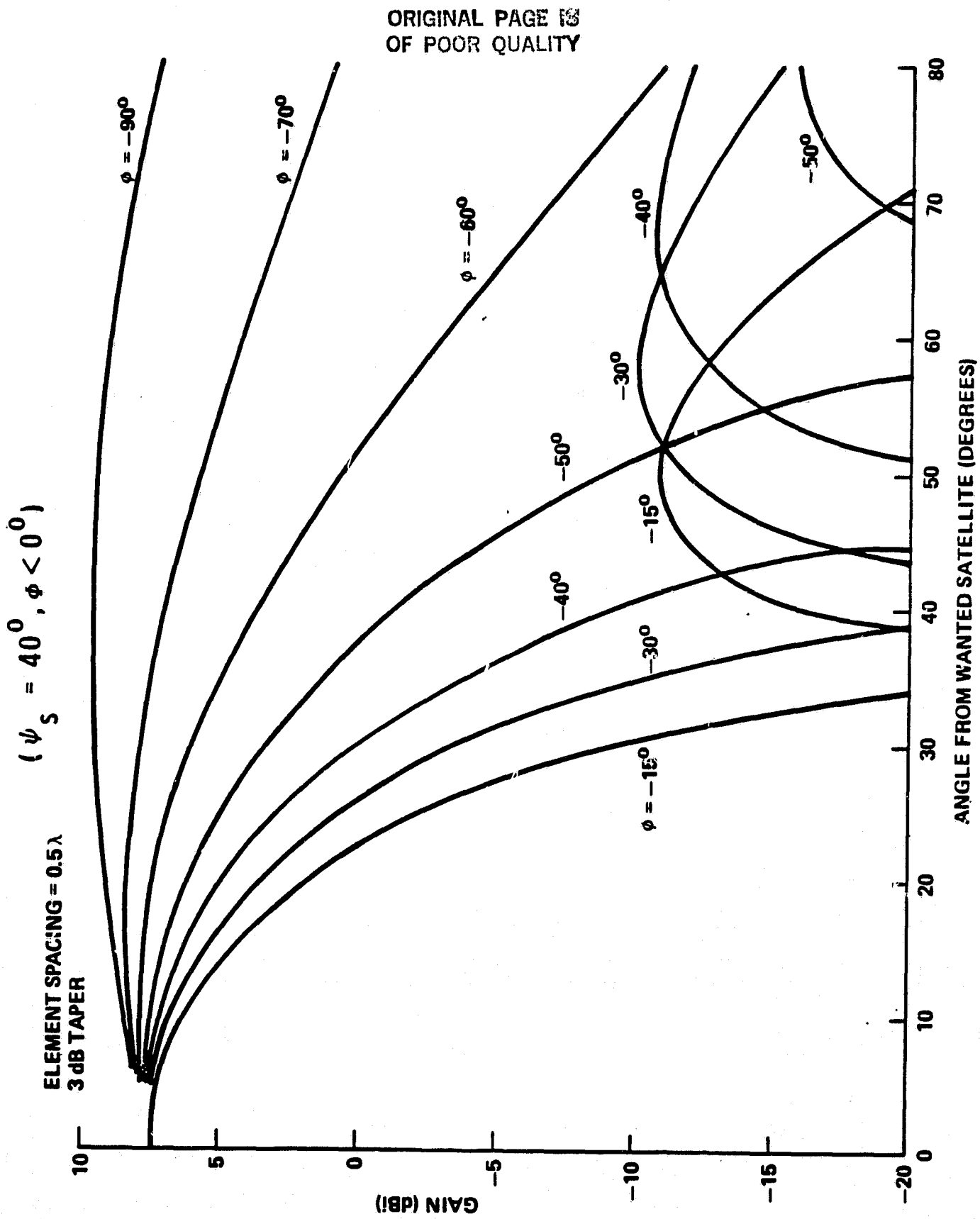

Figure C-8b. Gain Pattern for 4-Element Linear Array

ORIGINAL PAGE 19
OF POOR QUALITY

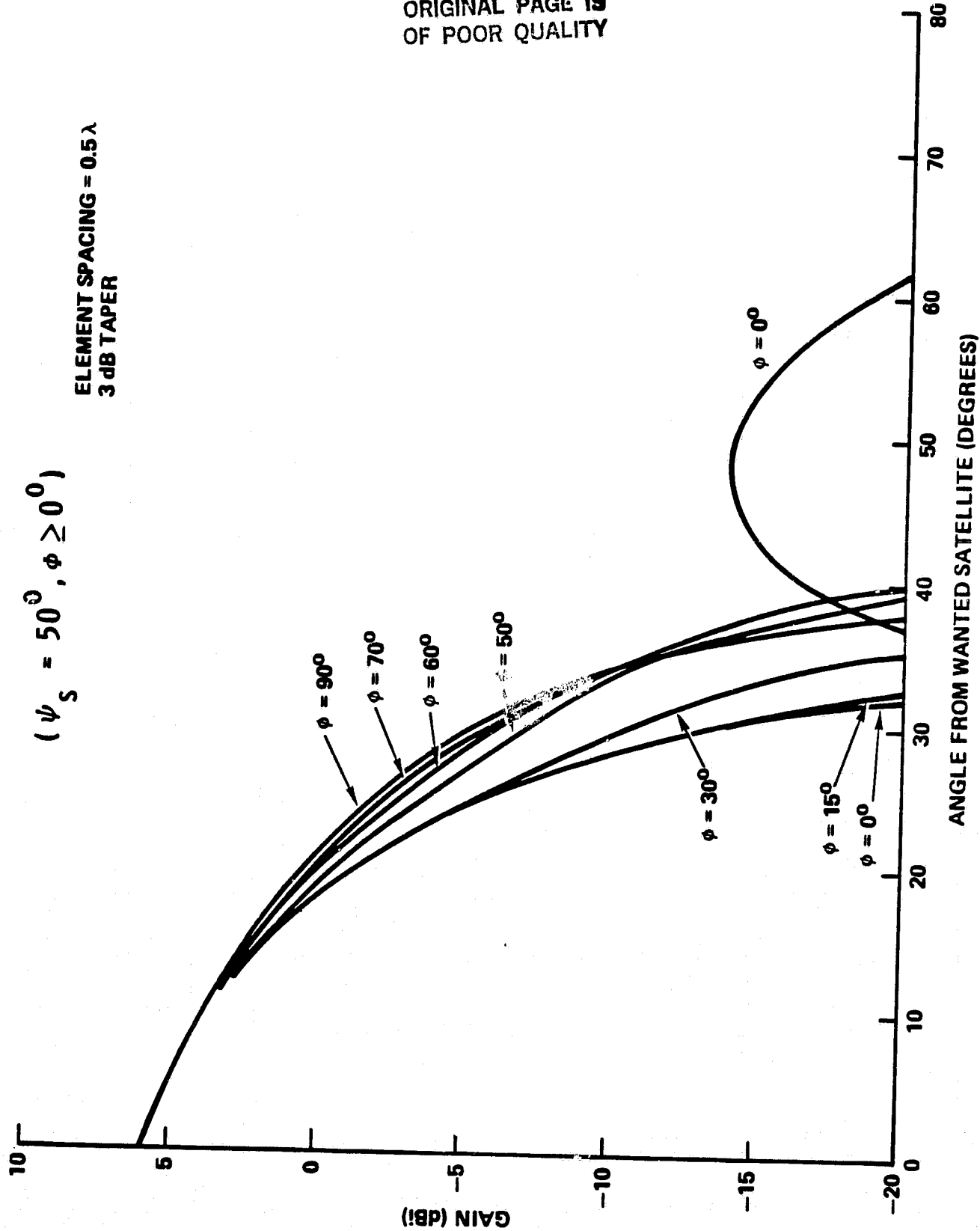

Figure C-9a. Gain Pattern for 4-Element Linear Array

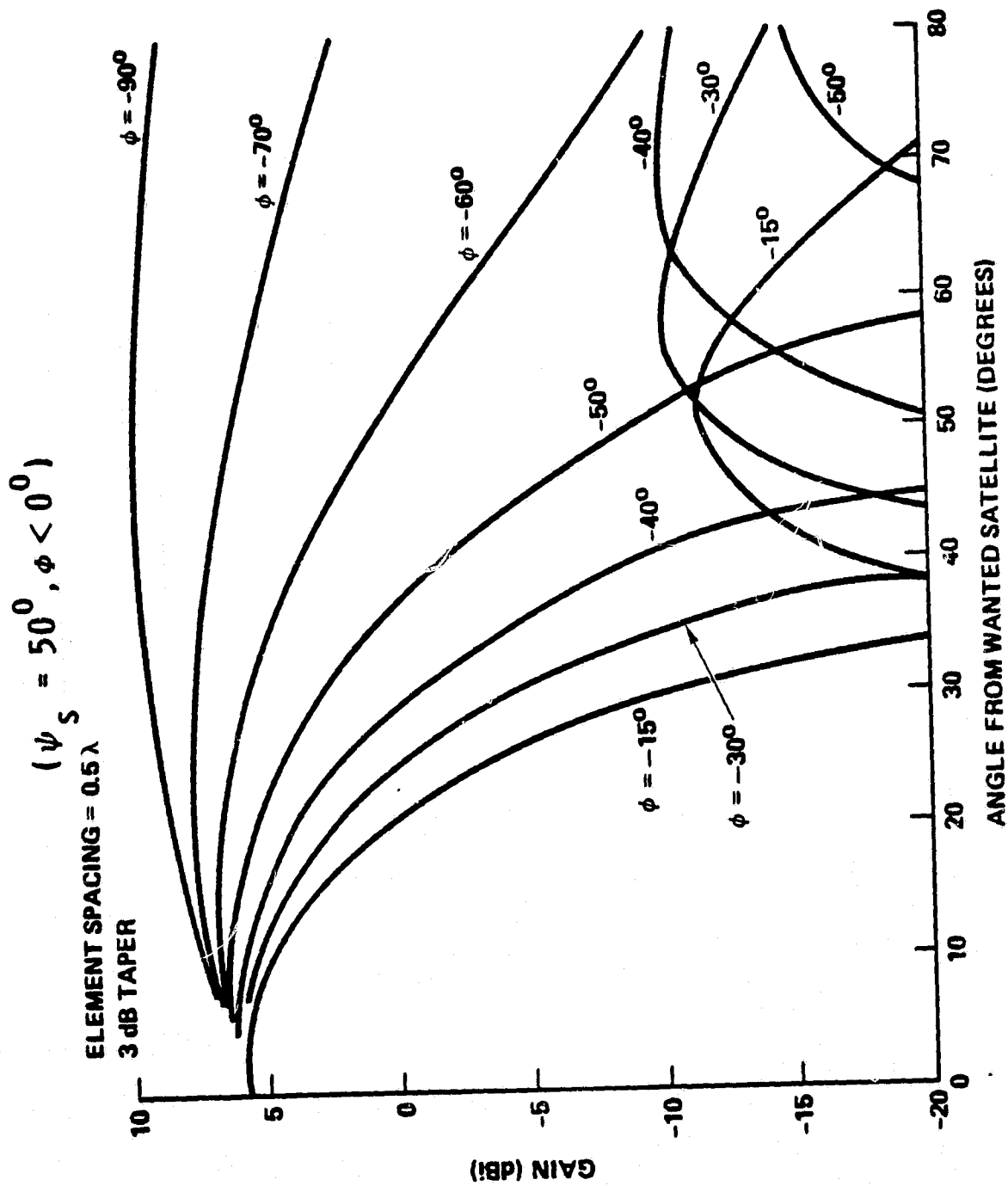

Figure C-9b. Gain Pattern for 4-Element Linear Array

Table C-3. Relative Position ($\phi, \theta \sim \text{Deg}$) of Interfering Satellite
(3-Satellite System)

USER LOCATION			SATELLITE LONGITUDES (WANTED, UNWANTED)					
STATE	LAT.	LONG.	64°, 97°	97°, 64°	64°, 130°	130°, 64°	97°, 130°	130°, 97°
MAINE	47°	68°	~ 0, 37	-22, 37	~ 0, 71	-36, 71	24, 35	-26, 35
FLORIDA	26°	81°	-30, 37	-30, 37	-28, 74	-43, 74	31, 37	-46, 37
TEXAS	26°	98°	-47, 38	~ 0, 38	-46, 75	-46, 75	~ 0, 38	-47, 38

Table C-4. Relative Position ($\phi, \delta \sim$ Deg) of Interfering Satellite
(2-Satellite System)

USER LOCATION			SATELLITE LONGITUDES (WANTED, UNWANTED)	
STATE	LAT.	LONG.	80°, 113°	113°, 80°
MAINE	47°	68°	11, 36	-31, 36
FLORIDA	26°	81°	0, 38	-46, 38
TEXAS	26°	98°	-31, 38	-27, 38

provide a good approximation to the patterns for the actual difference of 16 degrees. For an unwanted satellite at a longitude of 64 degrees, $\phi = 22^\circ$ and $\theta = 37^\circ$ (see Table C-3). From Figure C-7b, the isolation in the direction of this satellite is close to 30 dB. On the other hand, an unwanted satellite at 130 degrees has coordinates $\phi = 24^\circ$ and $\theta = 35^\circ$. The isolation for this satellite (from Figure C-7a) is 22.5 dB.

More generally, it can be seen that the potential for significant co-channel interference is greater the larger the magnitude of ϕ . Furthermore, the interference generated by a satellite can be significant only with respect to the adjacent satellite (i.e., in a 3-satellite system, interference between the satellites at 64 and 130 degrees is insignificant). Of the (ϕ, θ) combinations shown in Table C-3, therefore, the greatest interference occurs for a user in Florida and a satellite combination of $(130^\circ, 97^\circ)$. The next highest level of interference occurs for a user in Texas and satellite combinations of $(64^\circ, 97^\circ)$ and $(130^\circ, 97^\circ)$.

Consider a user in Florida, with an antenna elevated 45 degrees from the horizon. If the wanted satellite is at 130 degrees, the appropriate gain patterns are well approximated by the curves in Figure C-7. For an unwanted satellite at 97 degrees, the isolation is only 10.5 dB.

For a Texas user communicating through the satellite at either 64 or 130 degrees, an antenna elevated 45 degrees will point almost directly at the satellite. The isolation with respect to a satellite at 97 degrees is about 15 dB.

The inadequate isolation between certain satellite pairs as seen from southern user locations can be alleviated through use of polarization diversity. In a 2-satellite system, right-hand circular polarization is used with one satellite, and left-hand with the other. In a 3-satellite system, the middle satellite uses the opposite sense of polarization from the outer two satellites. The mobile equipment is switched between the two polarization senses according to the identity of the wanted satellite.

The use of both polarization senses will improve the intersatellite isolation by a minimum of 10 dB, depending on the axial ratios of the satellite and user antennas. Thus, even in the worst case, the net isolation will be at least 20 dB.

The analysis presented has assumed nominal positioning of the mobile antenna with respect to the wanted satellite. The azimuth of the antenna boresight will generally differ slightly from that of the satellite, depending on the accuracy of the tracking system. For example, a 3-degree azimuth error can increase the adjacent-satellite interference by 1.5 dB for a Florida user and the (130°,97°) satellite combination, depending on the direction of the error. Nevertheless, it may be concluded that the mobile antenna design presented, in combination with polarization diversity, provides the necessary isolation between satellites.

APPENDIX D - SCENARIO C SYSTEM DESIGN

Four of the five scenarios considered for System 1 (see Figure 2-15) are assumed to be all-voice. The exception is scenario C, which is evenly divided between voice and data, in units of erlangs.

The data channels are all 56 kb/s. The bandwidth occupancy of each such channel is about 40 kHz with QPSK transmission, as compared with 12 kHz for voice. Equally important, the C/N requirements are 4 dB higher for data than they are for voice. In addition, each erlang of data results in continuous transmission in both forward and return directions (as contrasted with voice-activated transmission). Thus, despite the low traffic volume in erlang terms, substantial satellite resources of both power and bandwidth are required to handle the data.

The driving requirement for the satellite design is available bandwidth. Accordingly, two designs are developed, corresponding to 10-MHz and 4-MHz allocations. The latter allocation is the basic assumption underlying the design of System 3 (for "transportable" users), as well as being representative of several alternate System 1 configurations. No a priori assumption is made regarding the type of user antenna (i.e., whether suitable for mobile, or only transportable, users). Therefore, the user requirements determined in the 4-MHz case will establish whether the system is appropriate for a mobile user population.

The problem posed by data transmission is immediately evident from the C/N requirements. For a BER of 10^{-5} and uncoded QPSK transmission, C/N must be at least 14 dB. (This value is 2 dB above "theoretical", a difference that is required for "implementation" margin. No system margin has been included, however.) This contrasts with a C/N requirement of 10 dB for voice.

On the other hand, the nonthermal interference sources assumed in the previous system design work include, for the gateway-to-mobile direction of transmission:

$$\begin{aligned} C/I_{cu} &= \text{uplink carrier-to-co-channel interference ratio} \\ &= 20 \text{ dB} \end{aligned}$$

C/I_{cd} = downlink carrier-to-co-channel interference ratio
= 17 dB

C/IM = carrier-to-intermodulation noise ratio
= 20 dB

The combined carrier-to-interference ratio for these three interference sources is 14 dB. With uncoded QPSK transmission, therefore, the noise budget is fully allocated, with no allowance for thermal effects.

Two strategies are available to reduce the C/N requirement: 1) use BPSK in place of QPSK, or 2) use coded, rather than uncoded, QPSK. The first option, which reduces the required C/N by 3 dB but doubles the required frequency re-use factor, is the preferred choice with a 10-MHz allocation. It also has the advantage of not requiring a codec (i.e., coding and decoding equipment) as part of the mobile unit.

A single satellite consistent with the STS/IPS capability can handle the scenario C traffic with BPSK transmission and a 10-MHz allocation. An offset-fed reflector is assumed, so that only 4 frequency sets are needed. A satellite antenna diameter of 42 meters provides the necessary frequency re-use factor. It is found, however, that a more directional user antenna than has previously been associated with a single-satellite system is required to hold the satellite power to a manageable value.

For this reason, a user antenna gain of 9 dB has been assumed. This is the value associated with the mechanically steerable antenna proposed for multisatellite systems. It is not necessary, of course, that this type of antenna be used in the present instance, since discrimination against co-channel transmissions from other satellites is not a requirement. In fact, comparable gain can be realized from a 3x3 electronically phased array with 0.5λ spacing between elements.

A weight breakdown, by subsystem, for a satellite with the features just described is given in Table D-1. The total weight of 9700 pounds, including 20 percent contingency, leaves a margin of 8 percent with respect to the STS/ITS capability of 10,400 pounds.

With a 4-MHz allocation, more bandwidth-efficient modulation than BPSK is required for a single-satellite system. The use of rate 3/4 convolutional coding with Viterbi decoding, in conjunction with QPSK transmission,

Table D-1. Satellite Weight Summary for Scenario C

ITEM	10-MHz ALLOCATION		4-MHz ALLOCATION	
	UNCODED BPSK	CODED QPSK	UNCODED BPSK	CODED QPSK
REFLECTOR				
MASTS	750	1050	850	
COMM & DATA (INCL Ku-BAND)	470	550	500	
FEED ASSEMBLY	360	360	360	
	2230	2490	1860	
RADIATING ELEMENTS	110	160	120	
ELECTRONICS	390	560	390	
BEAM-FORMING NETWORK	290	430	310	
RF & DC CABLING	220	320	230	
THERMAL CONTROL	760	310	310	
STRUCTURE	460	710	500	
ATTITUDE CONTROL				
REACTION CONTROL	780	1030	830	
DRY	240	1650	1250	
PROPELLANT	830	370	250	
THERMAL CONTROL (BODY)		1280	1000	
ELECTRICAL POWER	100	100	100	
DC CABLING	850	400	400	
STRUCTURE & INTEGRATION	630	335	330	
	800	875	710	
TOTAL	8040	8840	7190	
CONTINGENCY (20%)	1660	1770	1440	
BOOSTER CAPABILITY (IPS)	10400	10400	10400	
MARGIN	750 (8%)	-210 (-2%)	1770 (21%)	

significantly reduces the C/N requirement (to 8.8 dB) while expanding the bandwidth only modestly (by a factor of 4/3). This approach requires, however, that a codec be incorporated in the user equipment.

A single satellite designed to accommodate the scenario C traffic in a 4-MHz allocation requires a 56-meter antenna. If the user is again equipped with a 9-dB-gain antenna, the satellite RF power requirement is only 40 percent of that for the design based on a 10-MHz allocation. This power reduction results from the larger satellite antenna, coupled with the lower C/N requirement.

From the weight breakdown in Table D-1, it is seen that the satellite weight (including contingency) slightly exceeds the STS/IPS capability. It was therefore decided to explore a 2-satellite solution to the problem of a 4-MHz allocation.

Since each satellite must now provide only half the system capacity, it is possible to consider using uncoded BPSK, for which the C/N requirement is 11 dB. With more than one satellite, however, an additional interference term must be considered, namely, intersatellite co-channel interference. In previous work, C/I for this source of interference was assigned a value of 17 dB. In combination with the other, previously mentioned interference sources, this leaves 17.1 dB for the carrier-to-thermal noise ratio in the forward direction.

Because of this rather meager thermal-noise allocation, the satellite RF power requirement would be undesirably high if the user antenna gain were unchanged from the 9-dB value assumed in the previous cases. For this reason, the 15-dB antenna gain previously associated with a transportable user has been assumed in the present case. It is seen from Table D-1 that the resulting weight of each satellite in a 2-satellite system is well below the STS/IPS capability.

Scenario C link budgets are presented in Tables D-2 and D-3. As explained above, the satellite RF power requirements are largely those associated with the data traffic. Consequently, a single link budget for voice transmission, shown in Table D-2 for the 10-MHz allocation case, is

Table D-2. UHF Downlink Power Budget (10 MHz Allocation)

10-MHz ALLOCATION		
	VOICE	DATA
TRANSMIT POWER/CHANNEL, dBW	-8.9 (0.13 W)	0.3 (1.07 W)
CIRCUIT LOSS, dB	-1.0	-1.0
TRANSMIT ANTENNA GAIN, dB	47.3	47.3
EIRP, dBW	<u>37.4</u>	<u>46.5</u>
POINTING LOSS, dB	-4.0	
BEAM JITTER LOSS, dB	-1.0	
PATH LOSS, dB	-183.0	
MULTIPATH LOSS, dB	-5.0	
POLARIZATION LOSS, dB	-0.5	
RECEIVE ANTENNA GAIN, dB	9.0	
LINE LOSS, dB	-1.0	
RECEIVED CARRIER POWER, dBW	<u>-148.1</u>	<u>-138.9</u>
RECEIVE SYSTEM NOISE TEMPERATURE, dB-K	27.6	27.6
BOLTZMANN'S CONSTANT, W/K-Hz	-228.6	-228.6
CARRIER NOISE BANDWIDTH, dB-Hz	40.4	48.1
RECEIVED NOISE POWER, dBW	<u>-160.6</u>	<u>-152.9</u>
C/N, dB	12.5	14.0

Table D-3. UHF Downlink Power Budget (4 MHz Allocation)

	4-MHz ALLOCATION	
	CODED QPSK	UNCODED BPSK
TRANSMIT POWER/CHANNEL, dBW	-7.3 (0.19 W)	-3.5 (0.45 W)
CIRCUIT LOSS, dB	-1.0	-1.0
TRANSMIT ANTENNA GAIN, dB	49.8	48.3
EIRP, dBW	<u>41.5</u>	<u>43.8</u>
POINTING LOSS, dB	-4.0	-4.0
BEAM JITTER LOSS, dB	-1.3	-1.0
PATH LOSS, dB	-183.0	-183.0
MULTIPATH LOSS, dB	-5.0	-5.0
POLARIZATION LOSS, dB	-0.5	-0.5
RECEIVE ANTENNA GAIN, dB	9.0	15.0
LINE LOSS, dB	-1.0	-1.0
RECEIVED CARRIER POWER, dBW	<u>-144.3</u>	<u>-135.7</u>
RECEIVE SYSTEM NOISE TEMPERATURE, dB-K	27.6	27.6
BOLTZMANN'S CONSTANT, W/K-Hz	-228.6	-228.6
CARRIER NOISE BANDWIDTH, dB-Hz	46.3	48.1
RECEIVED NOISE POWER, dBW	<u>-154.7</u>	<u>-152.9</u>
C/N, dB	10.4	17.2

ORIGINAL PAGE 19
OF POOR QUALITY

provided for reference purposes. A data link budget for the same case is also given in Table D-2, while data link budgets for the two 4-MHz cases are shown in Table D-3.

The total RF power requirements for both voice and data are presented in Table D-4. Since there are 1000 erlangs each of voice and data, the total power is obtained by multiplying the per-carrier power by 1000 in the case of data and by 400 for voice, corresponding to a voice activation factor of 0.4.

To compute an MSC for the different system designs, it is assumed that the charge per-unit-bandwidth is the same for both voice and data. Thus, an equivalent number of voice subscribers is computed, as if the total bandwidth required for both voice and data were occupied exclusively by voice traffic. The resulting charge per voice subscriber is shown in Figure D-1 as a function of the required rate of return on invested capital.

The charge for full-time use of a 56-kb/s data channel is found by multiplying the service charge for a voice subscriber by $(80/12)/0.026 = 256$ for uncoded BPSK, and by $(53.3/12)/0.026 = 171$ for coded QPSK. The first factor is the bandwidth ratio for a data channel vs. that for a voice channel. The second factor is the busy-hour traffic of (i.e., fractional channel use by) a voice subscriber. For a 10-percent IRR, the MSC would be \$36.4K or \$38.7K for uncoded BPSK, according to the frequency allocation; for coded QPSK, \$29.9K.

The charge to a user requiring only fractional channel occupancy would depend on the data traffic statistics. If a data channel were shared by the same number of users as a voice channel, the average monthly rate would be 80/12 or 53.3/12 times that for a voice subscriber for uncoded BPSK and coded QPSK, respectively.

Table D-4. Satellite RF Power Requirements

	10-MHz ALLOCATION		4-MHz ALLOCATION	
	UNCODED BPSK	UNCODED BPSK	CODED QPSK	UNCODED BPSK
VOICE	51 W	31 W	16 W	
DATA	1072 W	186 W	447 W	
TOTAL	1123 W	217 W	463 W	

(ORIGINAL PAGE IS
OF POOR QUALITY

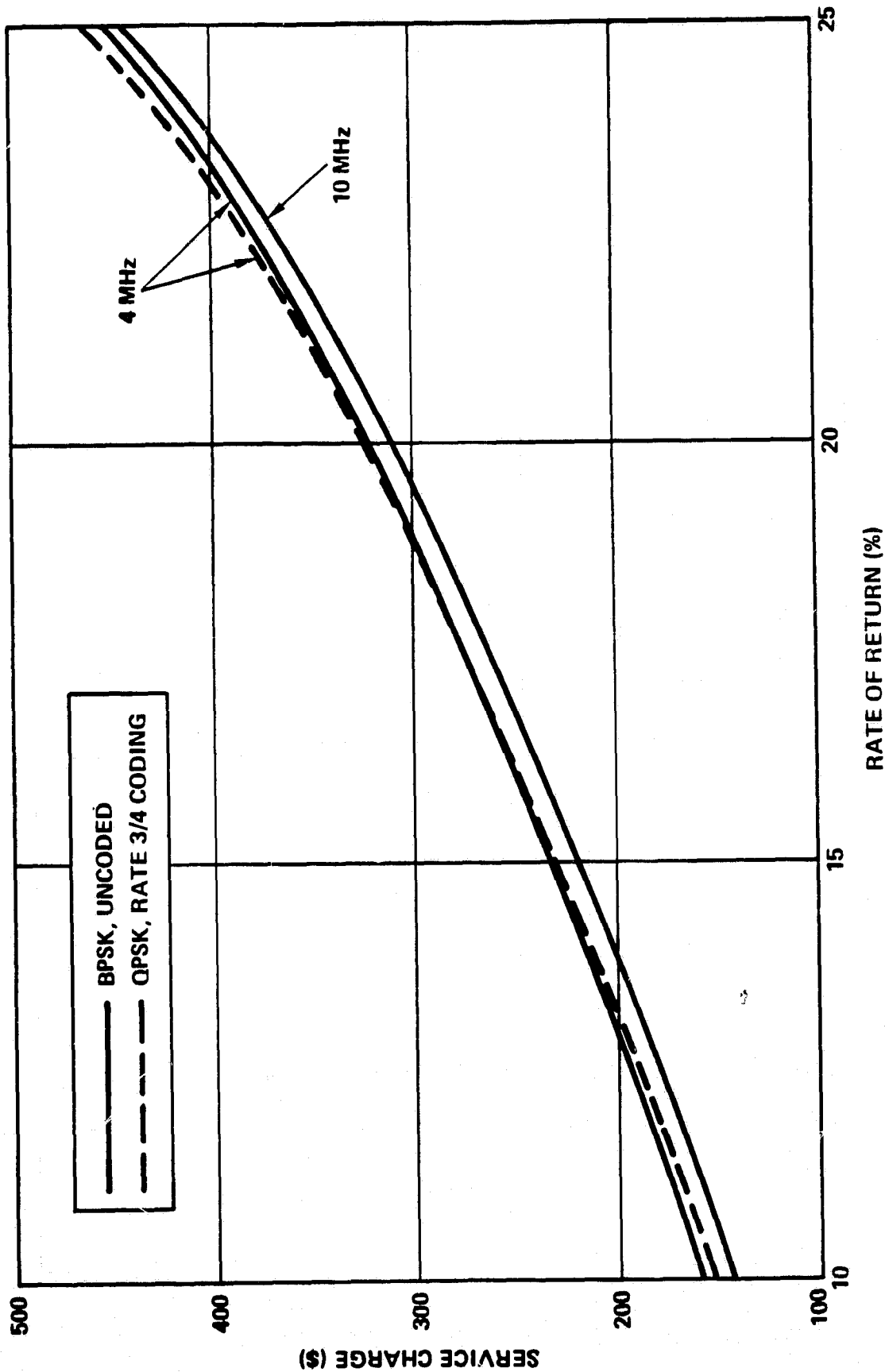

Figure D-1. MSC for Scenario C

APPENDIX E - LINK ANALYSIS FOR BASELINE SYSTEMS

System 1

Link budgets for the two baseline configurations are given in Tables E-1 to E-5. The link noise allocation, shown in Table E-1, provides a set of requirements on the various carrier-to-thermal noise ratios. In the gateway-to-mobile direction, a C/N_{td} value of 14.5 dB is the smallest compatible with the assumed levels of co-channel interference (both intra-satellite and intersatellite) and intermodulation noise. The value of C/N_{tu} , namely 23.2 dB, is the remaining allocation needed to yield a composite link C/N of 10 dB.

In the mobile-to-gateway direction, a 3-watt mobile transmitter results in $C/N_{tu} = 27.8$ dB for the offset design, as shown in Table E-2. This allows $C/N_{td} = 17.2$ dB, after the co-channel interference and intermodulation terms are accounted for. In the center-fed case, the higher C/N_{tu} of 30.1 dB reduces C/N_{td} negligibly, to 17.1 dB; consequently, only a single satellite-to-gateway link budget is shown (Table E-3).

The primary determinant of required satellite power is the mobile downlink. As shown in Table E-5, the required power per carrier is 0.17 watt for the offset-fed design and 0.10 watt for the center-fed design. The beam-jitter loss of 1 dB corresponds to a short-term antenna instability of 0.04 degree for the offset-fed design and 0.03 degree for the center-fed design. The receive-system noise temperature is based on a 3-dB noise-figure receiver and a 290 K noise background.

A detailed accounting of the satellite UHF antenna gain at the downlink frequency of 871 MHz is given in Table E-6. For the 46-meter offset-fed reflector, the efficiency (including the effect of scan loss) is 37 percent. For the 62-meter center-fed reflector, it is 34 percent.

By comparing Tables E-3 and E-5, it is seen that the gateway links require only 1.3 percent of the power needed for the mobile links with the offset-fed design. For the center-fed design, the fraction is 2.2 percent.

System 2

Translators communicating with a common gateway share a carrier in a TDMA mode. Depending on the subscriber scenario, the traffic at a gateway

Table E-1. Link Noise Allocation

REQUIREMENT: COMPOSITE-LINK C/N = 10 dB

GATEWAY-TO-MOBILE DIRECTION

- C/N_{tu} = 23.2 dB
- C/N_{td} = 14.5 dB
- C/I_{cu} = 20.0 dB
- C/I_{cd} = 17.0 dB
- C/IM = 20.0 dB
- C/I_{sd} = 17.0 dB

MOBILE-TO-GATEWAY DIRECTION

- C/N_{tu} = 27.8 dB
- C/N_{td} = 17.2 dB
- C/I_{cu} = 14.0 dB
- C/I_{cd} = 20.0 dB
- C/IM = 20.0 dB
- C/I_{su} = 17.0 dB

C/N_{tu} = UPLINK CARRIER-TO-THERMAL NOISE RATIO

C/N_{td} = DOWNLINK CARRIER-TO-THERMAL NOISE RATIO

C/I_{cu} = UPLINK CARRIER-TO-COCHANNEL INTERFERENCE RATIO

C/I_{cd} = DOWNLINK CARRIER-TO-COCHANNEL INTERFERENCE RATIO

C/IM = CARRIER-TO-INTERMODULATION NOISE RATIO

C/I_{sd} = DOWNLINK CARRIER-TO-INTERSATELLITE INTERFERENCE RATIO

C/I_{su} = UPLINK CARRIER-TO-INTERSATELLITE INTERFERENCE RATIO

ORIGINAL PAGE 19
OF POOR QUALITY

Table E-2. Mobile-to-Satellite Link Budget (826 MHz)

	<u>OFFSET-FED</u>	<u>CENTER-FED</u>
TRANSMIT POWER/CHANNEL, dBW	4.8 (3W)	
LINE LOSS, dB	-1.0	
TRANSMIT ANTENNA GAIN, dB	9.0	
MULTIPATH LOSS, dB	-5.0	
PATH LOSS, dB	-182.6	
POINTING LOSS, dB	-4.0	
BEAM JITTER, dB	-1.0	
POLARIZATION LOSS, dB	-0.5	
RECEIVE ANTENNA GAIN, dB	47.7	49.9
CIRCUIT LOSS, dB	-1.0	
RECEIVED CARRIER POWER, dBW	<u>-133.6</u>	<u>-131.4</u>
RECEIVE SYSTEM NOISE TEMPERATURE, dB-K	26.8	
BOLTZMANN'S CONSTANT, WATTS/K-Hz	-228.6	
CARRIER NOISE BANDWIDTH, dB-Hz	40.4	
RECEIVED NOISE POWER, dBW	<u>-161.4</u>	<u>-161.4</u>
C/N, dB	27.8	30.0

Table E-3. Satellite-to-Gateway Link Budget (12 GHz)

TRANSMIT POWER/CHANNEL, dBW	-26.6 (2.2 mW)
CIRCUIT LOSS, dB	-2.0
TRANSMIT ANTENNA GAIN (3 METERS, 50% EFFICIENCY), dB	48.5
OFF-AXIS SCAN LOSS, dB	-0.4
POINTING LOSS, dB	-3.0
PATH LOSS, dB	-205.8
POLARIZATION LOSS, dB	-0.5
RAIN LOSS, dB	-6.0
RECEIVE ANTENNA GAIN (5 METERS, 65% EFFICIENCY), dB	54.0
POINTING LOSS, dB	-0.4
LINE LOSS, dB	-1.5
RECEIVED CARRIER POWER, dBW	<u>-143.7</u>
RECEIVE SYSTEM NOISE TEMPERATURE, dB-K	27.3
BOLTZMANN'S CONSTANT, WATTS/K-Hz	-228.6
CARRIER NOISE BANDWIDTH, dB-Hz	<u>40.4</u>
RECEIVED NOISE POWER, dBW	<u>-160.9</u>
C/N, dB	17.2

ORIGINAL PAGE IS
OF POOR QUALITY

Table E-4. Gateway-to-Satellite Link Budget (14 GHz)

TRANSMIT POWER/CHANNEL, dBW	-21.7 (6.8 mW)
LINE LOSS, dB	-1.5
TRANSMIT ANTENNA GAIN (5 METERS, 65% EFFICIENCY), dB	55.5
POINTING LOSS, dB	-0.4
PATH LOSS, dB	-207.2
POLARIZATION LOSS, dB	-0.5
RAIN LOSS, dB	-6.0
RECEIVE ANTENNA GAIN (3 METERS, 50% EFFICIENCY), dB	49.8
OFF-AXIS SCAN LOSS, dB	-0.4
POINTING LOSS, dB	-3.0
CIRCUIT LOSS, dB	-2.0
RECEIVED CARRIER POWER, dBW	<u>-137.4</u>
RECEIVE SYSTEM NOISE TEMPERATURE, dB-K	27.6
BOLTZMANN'S CONSTANT, W/K-Hz	-228.6
CARRIER NOISE BANDWIDTH, dB-Hz	<u>40.4</u>
RECEIVED NOISE POWER, dBW	<u>-160.6</u>
C/N, dB	23.2

ORIGINAL PAGE IS
OF POOR QUALITY

Table E-5. Satellite-to-Mobile Link Budget (871 MHz)

	<u>OFFSET-FED</u>	<u>CENTER-FED</u>
TRANSMIT POWER/CHANNEL, dBW	-7.7 (0.17 W)	-10.0 (0.10 W)
CIRCUIT LOSS, dB	-1.0	-1.0
TRANSMIT ANTENNA GAIN, dB	48.1	50.4
EIRP, dBW	39.4	39.4
POINTING LOSS, dB	-4.0	
BEAM JITTER LOSS, dB	-1.0	
PATH LOSS, dB	-183.0	
MULTIPATH LOSS, dB	-5.0	
POLARIZATION LOSS, dB	-0.5	
RECEIVE ANTENNA GAIN, dB	9.0	
LINE LOSS, dB	-1.0	
RECEIVED CARRIER POWER, dBW	-146.1	
RECEIVE SYSTEM NOISE TEMPERATURE, dB-K	27.6	
BOLTZMANN'S CONSTANT, W/K-Hz	-228.6	
CARRIER NOISE BANDWIDTH, dB-Hz	40.4	
RECEIVED NOISE POWER, dBW	-160.6	
C/N, dB	14.5	

ORIGINAL PAGE IS
OF POOR QUALITY

ORIGINAL PAGE IS
OF POOR QUALITY

Table E-6. Satellite UHF Antenna Gain (877 MHz)

	<u>OFFSET-FED</u>	<u>CENTER-FED</u>
GAIN AT 100% EFFICIENCY $(\frac{\pi D}{\lambda})^2$, dBi	52.46 (46 m)	55.05 (62 m)
APERTURE ILLUMINATION, SPILLOVER, FEED BLOCKAGE, dB	-3.22	-3.38
GORE LOSS, dB	-0.1	-0.1
MESH LOSS, dB	-0.05	-0.05
FOCUS, dB	-0.1	-0.1
FEED VSWR, dB	-0.2	-0.2
CROSS POLARIZATION, dB	-0.1	-0.1
REFLECTOR ENVIRONMENTAL DISTORTIONS, FEED/REFLECTOR DISTORTIONS, dB	-0.2	-0.25
STRUT INTERACTION, dB	-0.1	-0.1
BORESIGHT BEAM GAIN, dBi	48.39	50.82
SCAN LOSS AT 3.2°, dB	-0.3	-0.4
GAIN AT 3.2°, dBi	48.09	50.42
EFFICIENCY (%)	36.6	34.4

may build up to the point where the capacity of a single carrier, assumed to be 8.8 Mb/s, is exceeded. In this case, the gateway would have to transmit 2 or more carriers simultaneously. A single transponder on a typical C-band domestic satellite has a capacity of five 8.8-Mb/s carriers, or 44 Mb/s.

The link budgets in Tables E-7 and E-8, which are valid in either direction between translator and gateway, are computed for a carrier operating at the maximum 8.8-Mb/s rate. The single-carrier saturated EIRP of 34 dB on the downlink is typical of current U.S. domestic satellites. The output backoff of 5.7 dB has been optimized to balance thermal and intermodulation noise for the composite translator/satellite/gateway link.

The composite link C/N requirement of 13 dB is based on a QPSK transmission of delta-modulated voice at a BER of 10^{-3} .

System 3

There are 3 distinct traffic scenarios for the transportable units in System 3. The transportable traffic associated with the baseline System 2 subscriber scenario consists of 120 erlangs of voice traffic. This is the maximum amount that can be accommodated in a 4-MHz allocation without frequency re-use, assuming cellular-compatible, 30-kHz carrier spacing.

Associated with scenarios B, D, and E is a voice/data mix comprising 120 erlangs of voice and 120 erlangs of data. The data are constituted as follows: 40 percent at 56 kb/s and 60 percent at 9.6 kb/s. The voice carriers are assumed to be located at 12-kHz centers (corresponding to 5-kHz peak-deviation FM), while the data-carrier spacings are 40 kHz and 8 kHz, respectively. It is readily verified that these values lead to a total bandwidth occupancy of 4 MHz, so that frequency re-use is not required. (For simplicity, erlangs and channels have been treated as if synonymous).

Finally, corresponding to scenario A is a voice/data mix comprising 300 erlangs of voice and 300 erlangs of data. The data are apportioned as in the previous case between 56-kb/s and 9.6-kb/s carriers. A 2.5-fold re-use of the 4-MHz allocation is therefore necessary.

Link analysis will be performed first for the traffic mix corresponding to scenarios B, D, and E: 120 erlangs voice plus 120 erlangs data. A

Table E-7. System 2 Uplink Power Budget (6 GHz)
(8.8 Mb/s Carrier)

TRANSMIT POWER, dBW	8.3
LINE LOSS, dB	-1.0
TRANSMIT ANTENNA GAIN (10 m), dB	54.0
PATH LOSS, dB	-200.0
RECEIVE ANTENNA GAIN, dB	28.0
RECEIVED CARRIER POWER, dBW	-110.8
RECEIVE SYSTEM NOISE TEMP, dB-K	27.0
BOLTZMANN'S CONSTANT, W/K-hz	-228.6
CARRIER NOISE BANDWIDTH, dB-Hz	67.0
RECEIVED NOISE POWER, dBW	-134.6
UPLINK C/N, dB	23.8

Table E-8. System 2 Downlink Power Budget (4 GHz)
(8.8 Mb/s Carrier)

EIRP (SINGLE CARRIER SATURATION), dBW	34.0
OUTPUT BACKOFF, dB	-5.7
MULTICARRIER POWER DIVISION, dB	-7.0
PATH LOSS, dB	-196.5
RECEIVE ANTENNA GAIN (10 m), dB	<u>50.5</u>
RECEIVED CARRIER POWER, dBW	-124.7
RECEIVE SYSTEM NOISE TEMP., dB-K	20.8
BOLTZMANN'S CONSTANT, W/K-Hz	-228.6
CARRIER NOISE BANDWIDTH, dB-Hz	<u>67.0</u>
RECEIVED NOISE POWER, dBW	-140.8
DOWNLINK C/N, dB	16.1
UPLINK C/N, dB	23.8
C/IM, dB	16.6
COMPOSITE-LINK C/N, dB	13.0

power budget for an individual voice channel with 11-kHz noise bandwidth (12-kHz channel spacing) is given in Table E-9. The required downlink C/N has been set at 12.5 dB, which is also the design value for System 1. As there is no co-channel interference (i.e., no frequency re-use) in this case, a lower value than 12.5 dB could be used. However, the power required for the voice carriers is almost insignificant when compared with that needed for data transmission. Consequently, the link budget of Table E-9 serves primarily to establish a reference point for the data requirements.

The satellite antenna gain of 27.5 dB is the minimum value typically associated with a shaped beam covering CONUS. At 871 MHz, a 25-foot diameter would be required if the shaping is to be done with a single antenna. An alternative is to use a pair of 16-foot antennas, with symmetric illumination, for eastern and western CONUS coverage. It happens that TDRS is so equipped; consequently, the power requirements will be compared with TDRS capability.

The user antenna is assumed to be of the endfire type. Specifically, a collapsible helix is envisioned, which extends to a 3.5-foot length when the user vehicle is stopped and the antenna deployed. The antenna gain is taken as 15 dB. Because of the relatively high directivity in this case, the allowance for multipath loss has been reduced to 3 dB.

The satellite transmit power for an individual voice carrier is 0.5 watt. With 120 erlangs of voice traffic, 40 percent activated, the RF power requirement is 24 watts. This traffic can be handled by a single solid-state amplifier.

The power requirements for data transmission will be established in relation to those for the voice case. The total bandwidth occupied by the data carriers is 2.5 MHz. With a carrier-spacing/QPSK-symbol-rate ratio of 1.5 and a carrier-noise-bandwidth/symbol-rate ratio of 1.15, the composite noise bandwidth of the data carrier is 1.92 MHz. This compares with 1.32 MHz for the voice carriers.

Next, it is necessary to establish the data downlink C/N requirement. A BER = 10^{-5} will be assumed. Accounting for QPSK transmission and allowing 2 dB for implementation margin leads to a required C/N of 14 dB in the

Table E-9. Satellite-to-Transportable Link Budget (871 MHz)

TRANSMIT POWER/VOICE CHANNEL, dBW	-2.9
CIRCUIT LOSS, dB	-1.0
TRANSMIT ANTENNA GAIN, dB	27.5
PATH LOSS, dB	-183.0
MULTIPATH LOSS, dB	-3.0
POLARIZATION LOSS, dB	-0.5
RECEIVE ANTENNA GAIN, dB	15.0
LINE LOSS, dB	-1.0
RECEIVED CARRIER POWER, dBW	-148.9
RECEIVE SYSTEM NOISE TEMPERATURE, dB-K	26.8
BOLTZMANN'S CONSTANT, W/K-Hz	-228.6
NOISE BANDWIDTH, dB-Hz	40.4
RECEIVED NOISE POWER, dBW	-161.4
C/N, dB	12.5

ORIGINAL PAGE 15
OF POOR QUALITY

ORIGINAL PAGE IS
OF POOR QUALITY

carrier noise bandwidth. If a carrier-to-intermodulation power ratio of 20 dB is assumed, the downlink C/N requirement becomes 15.3 dB.

The RF power required to support the data carriers can now be computed as follows:

Power for voice carriers (24 watts)	13.8 dBW
Bandwidth ratio (1.92/1.32)	1.6 dB
Difference in C/N requirements (15.3-12.5)	2.8 dB
Absence of voice activation	<u>4.0</u> dB
Power for data carriers	22.2 dBW

Thus, the data carriers require a combined RF power of 166 watts. With the voice carriers included, the power requirement is 190 watts.

The RF power for the baseline scenario is simply computed. Since the traffic is all voice, the power per-unit-bandwidth would be identical to that for the voice traffic in scenarios B, D, and E if the TDRS bus were used. (The fact that the carrier noise bandwidths differ in the two cases is irrelevant.) Because of the lower power requirement associated with voice traffic, the FLEETSAT bus is used in place of TDRS. A single 12-foot antenna provides CONUS coverage; consequently, the antenna gain is lower by 2.5 dB than with TDRS. With the bandwidth allocated to voice equal to 4 MHz rather than 1.44 MHz, the required power is $13.8 + 10 \log (4/1.44) + 2.5 = 20.7$ dBW, or about 120 watts.

The scenario A traffic has the same proportions of voice and data of each type as the traffic for scenarios B, D, and E. A multibeam antenna generating about 17 beams (10 beam equivalents) is needed to accommodate the 600 erlangs of total traffic. Because of the large antenna gain associated with the narrow beams, less satellite power is required for the transportable traffic of scenario A than for the smaller traffic load of the other scenarios. The relevant calculation is as follows:

Power for scenarios B, D, E (240 erlangs)	22.8 dBW
Gain for CONUS-coverage beam	27.5 dB
Peak gain for 20-m antenna (42 percent eff.)	-41.3 dB
Pointing error	4.0 dB
Beam jitter	0.3 dB
Traffic ratio (600/240)	<u>4.0</u> dB
Power for scenario A	17.3 dBW

Thus, scenario A requires a total RF power of 54 watts.

The satellite power requirements for the different subscriber scenarios are summarized in Table E-10. A DC/RF conversion efficiency of 25 percent is assumed for the UHF solid-state amplifiers (i.e., for the transportable traffic). Mobile traffic operates according to the link budgets of Tables E-7 and E-8. On the downlink to the translators, the 34-dBW EIRP corresponding to single-carrier saturation is based on the use of 5-watt final TWTAs. Although considerably less power than 5 watts would be transmitted in a multicarrier mode, the required DC power is assumed to be unchanged from that needed for single-carrier operation at 35 percent DC/RF efficiency.

The DC power shown in the last column of Table E-10 is the regulated power needed in direct support of the satellite links. The required power from the solar panels is developed in Table E-11 for all but scenario A. (The satellite in the latter case was sized using the techniques previously applied in System 1.) The power requirement for the baseline scenario, on the one hand, and that for scenarios B, D, and E, on the other hand, are seen to be within the FLEETSAT and TDRS capabilities, respectively.

A link budget for a single voice channel transmitted by a transportable unit is shown in Table E-12. The uplink C/N is essentially equal to the C/N value for the composite transportable/satellite/gateway link. The value of 20.3 dB, corresponding to a 3-watt transportable transmitter, is well above the nominal 10-dB FM threshold.

Table E-10. Satellite Regulated Power Requirements for System 3

SUBSCRIBER SCENARIO	TRANSPORTABLE TRAFFIC		MOBILE TRAFFIC		TOTAL DC POWER (W)
	RF POWER (W)	DC POWER (W)	NO. OF TRANSPONDERS	DC POWER (W)	
BASELINE	120	480	8	115	595
A	55	220	30	430	650
B	190	760	15	215	975
D	190	760	15	215	975
E	190	760	14	200	960

Table E-11. Satellite Total Power Requirements for System 3

	<u>BASELINE SCENARIO</u>	<u>SCENARIOS B, D, E</u>
● REGULATED POWER (W)	595	975
● UNREGULATED POWER TO SUPPORT SATELLITE LINKS (W)	685	1120
● SUBSYSTEM POWER (W)	345	345
● TOTAL UNREGULATED POWER (W)		
— WITHOUT MARGIN	1030	1465
— INCLUDING 20% MARGIN	1235*	1760**

ORIGINAL PAGE IS
OF POOR QUALITY

*FLEETSAT CAPABILITY: 1585 W AFTER 5 YRS

**TDRS CAPABILITY: 1850 W AFTER 10 YRS

Table E-12. Transportable-to-Satellite Link Budget (826 MHz)

TRANSMIT POWER/VOICE CHANNEL, dBW	4.8
LINE LOSS, dB	-1.0
TRANSMIT ANTENNA GAIN, dB	14.6
MULTIPATH LOSS, dB	-3.0
PATH LOSS, dB	-182.6
POLARIZATION LOSS, dB	-0.5
RECEIVE ANTENNA GAIN, dB	27.1
CIRCUIT LOSS, dB	-1.0
RECEIVED CARRIER POWER, dBW	-141.1
RECEIVE SYSTEM NOISE TEMPERATURE, dB-K	26.8
BOLTZMANN'S CONSTANT, W/K-Hz	-228.6
NOISE BANDWIDTH, dB-Hz	40.4
RECEIVED NOISE POWER, dBW	-161.4
C/N, dB	20.3

ORIGINAL PAGE IS
OF POOR QUALITY

On the other hand, the uplink C/N for a 56-kb/s data carrier (32.2-kHz noise bandwidth) is only 15.6 dB. Moreover, the C/N requirement for data was shown to be 14 dB. Therefore, a 3-watt transmitter is barely sufficient for 56-kb/s transmission.

APPENDIX F - SATELLITE ANTENNA STRUCTURAL DESIGN

The principal satellite antenna elements are the reflector, masts, and feed assembly. Four different antenna configurations are considered, with the following three based on the LMSC wrap-rib reflector design:

1. Direct offset-fed
2. Center-fed
3. Offset-fed Cassegrain.

The fourth configuration is the Harris hoop-column, which can be used in a multiple-aperture (direct offset-fed) or single aperture (center-fed) mode.

The mast analysis is based on articulated, expandable mast concepts for large space structures currently in a developmental stage. These concepts are described in References F-1 to F-3.

All analytical results are presented parametrically, as a function of the reflector diameter. Diameters between 15 meters and 100 meters are considered.

Wrap-Rib Reflector Analysis

The three antenna configurations based on the wrap-rib reflector are shown in Figures F-1 to F-3. The graph insert in each figure shows the feed-assembly dimensions as a function of reflector diameter. For the Cassegrain configuration, the secondary reflector dimensions and the distance between reflectors are also shown. The mast length for the direct offset-fed and center-fed designs is chosen to provide an f/D of 1.5 and 0.75, respectively.

The reflector geometry is depicted in Figure F-4, in which the important parameters are defined. The logic path by which the reflector analysis is performed is shown in Figure F-5. It is assumed that indeterminate twisting of the ribs in stowage is not permitted; the stowed length of the reflector is therefore given by the indicated formula. A constant frequency response is maintained for the entire range of diameters, based on an initial design for a 160-foot reflector. The requirement for constant frequency response, together with the peak allowable surface error, determines the reflector weight.

ORIGINAL PAGE IS
OF POOR QUALITY

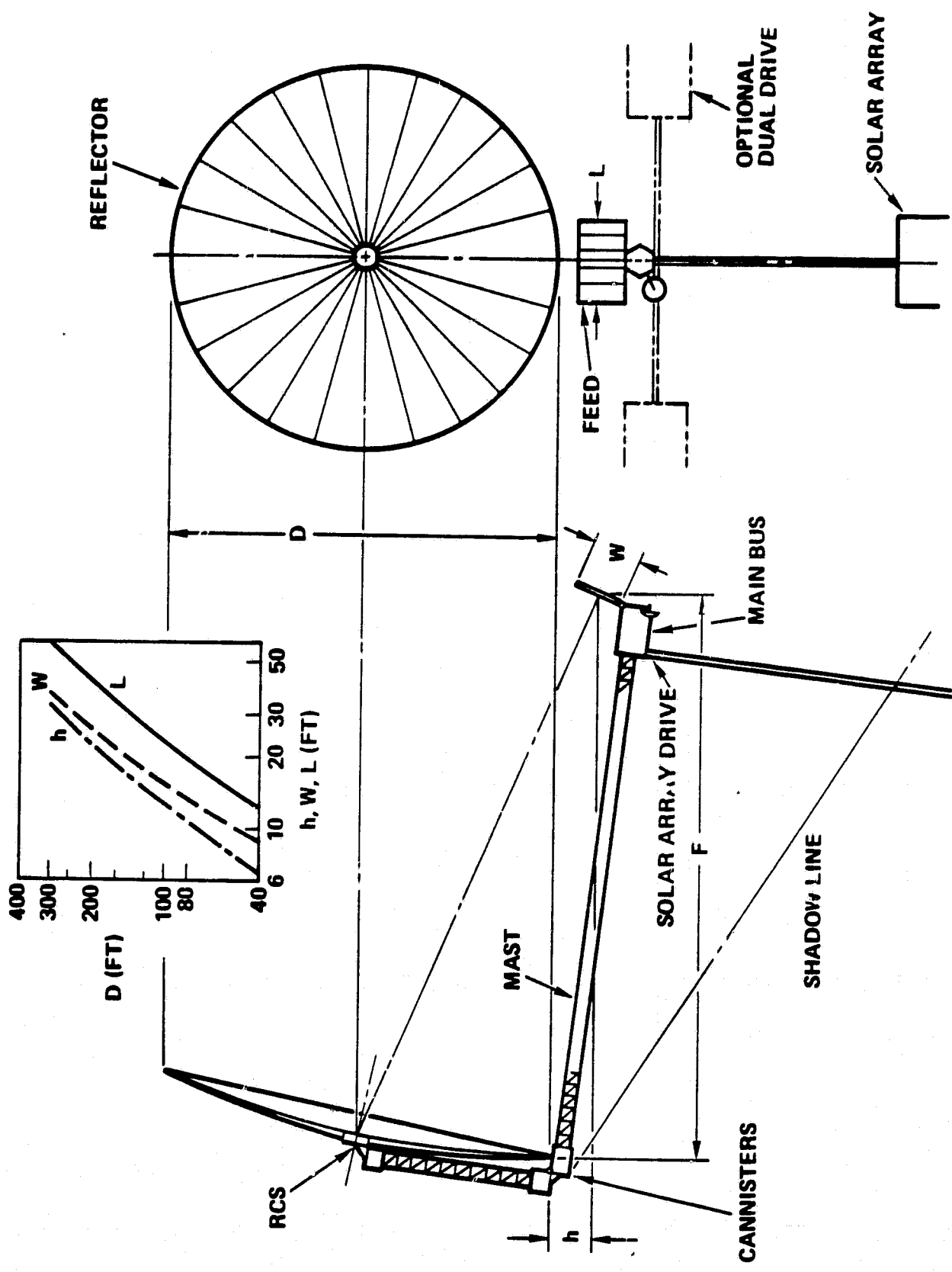

Figure F-1. Direct Offset-Fed Configuration

ORIGINAL PAGE IS
OF POOR QUALITY

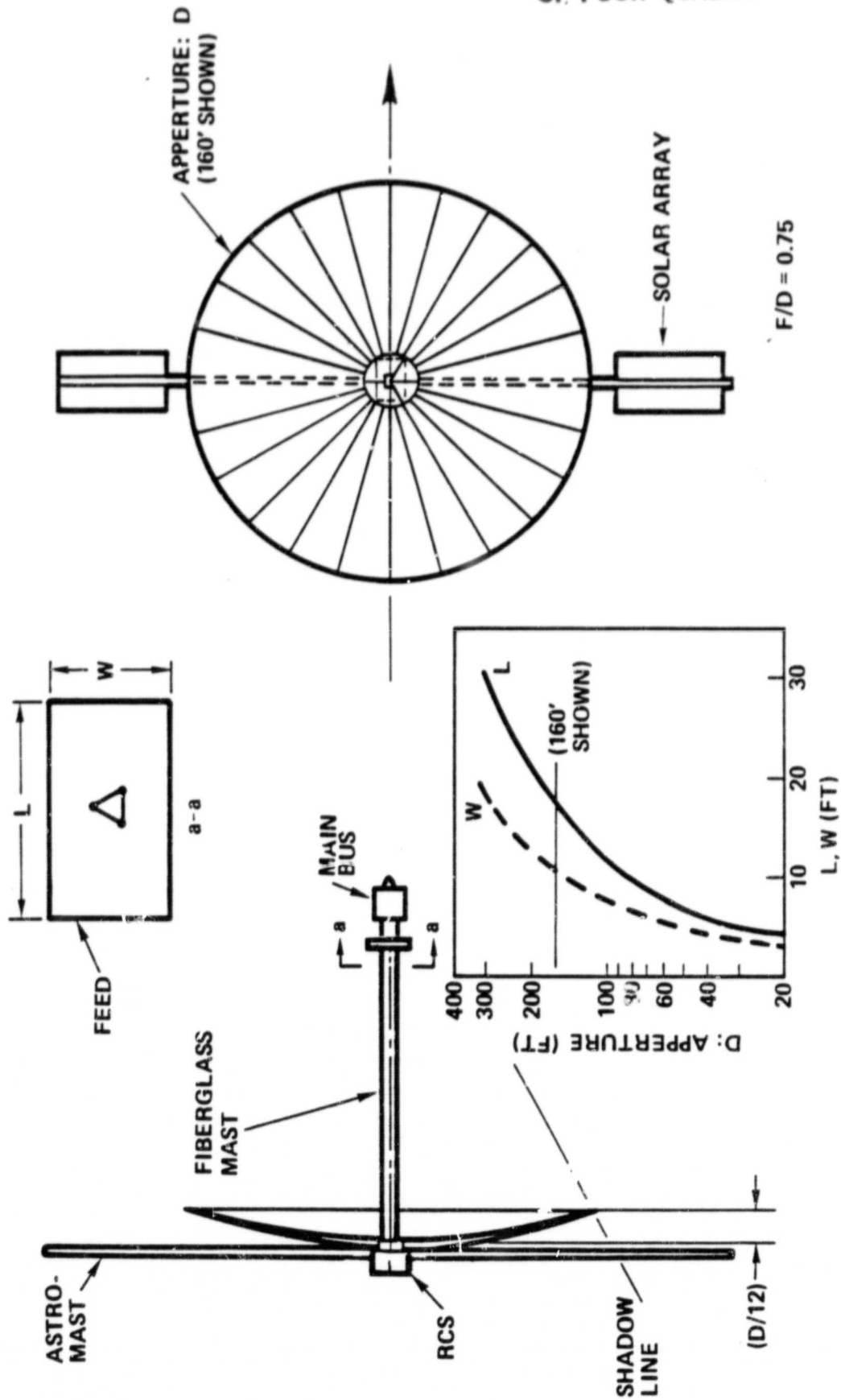

Figure F-2. Center-Fed Configuration

ORIGINAL PAGE IS
OF POOR QUALITY

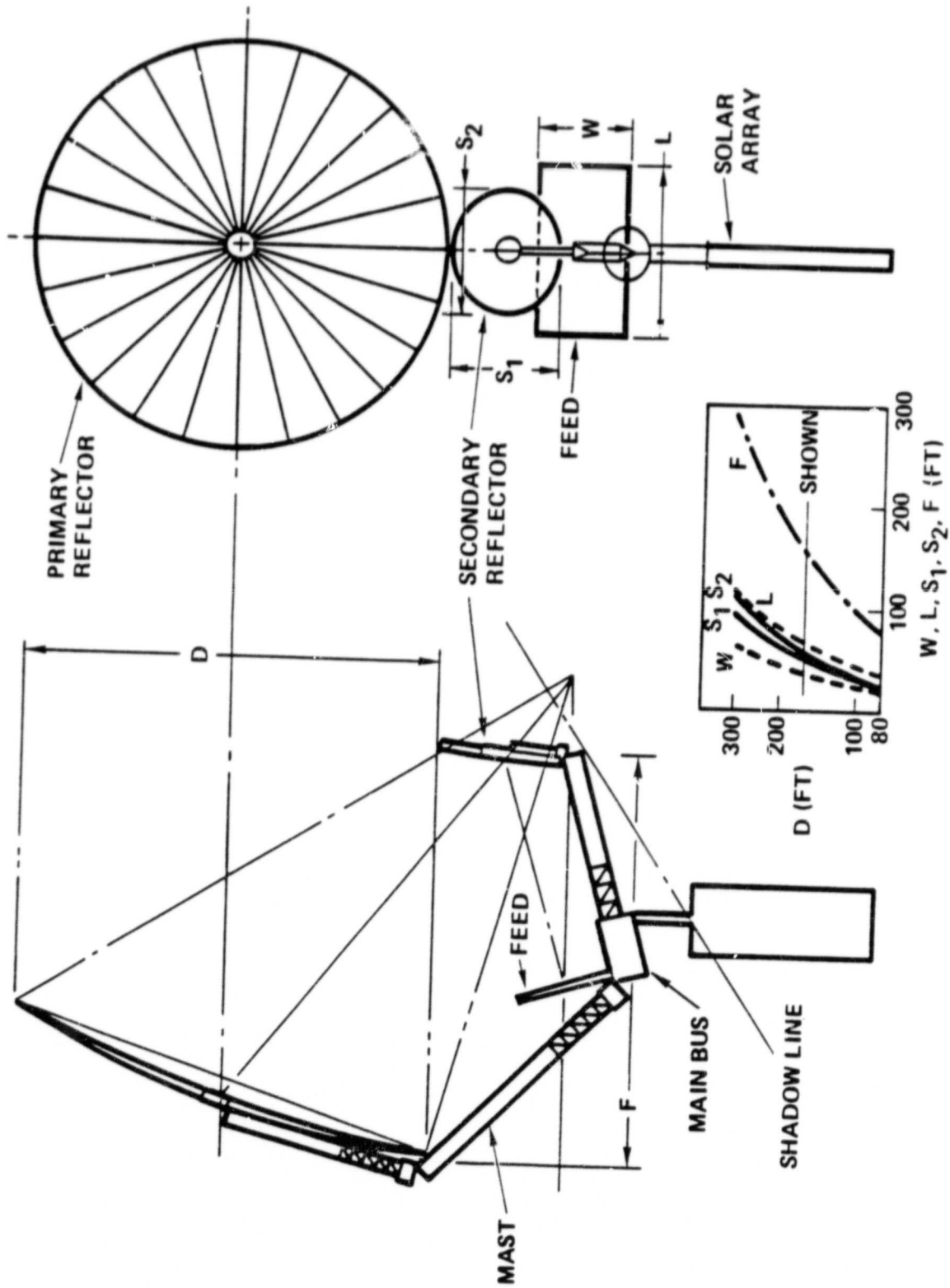
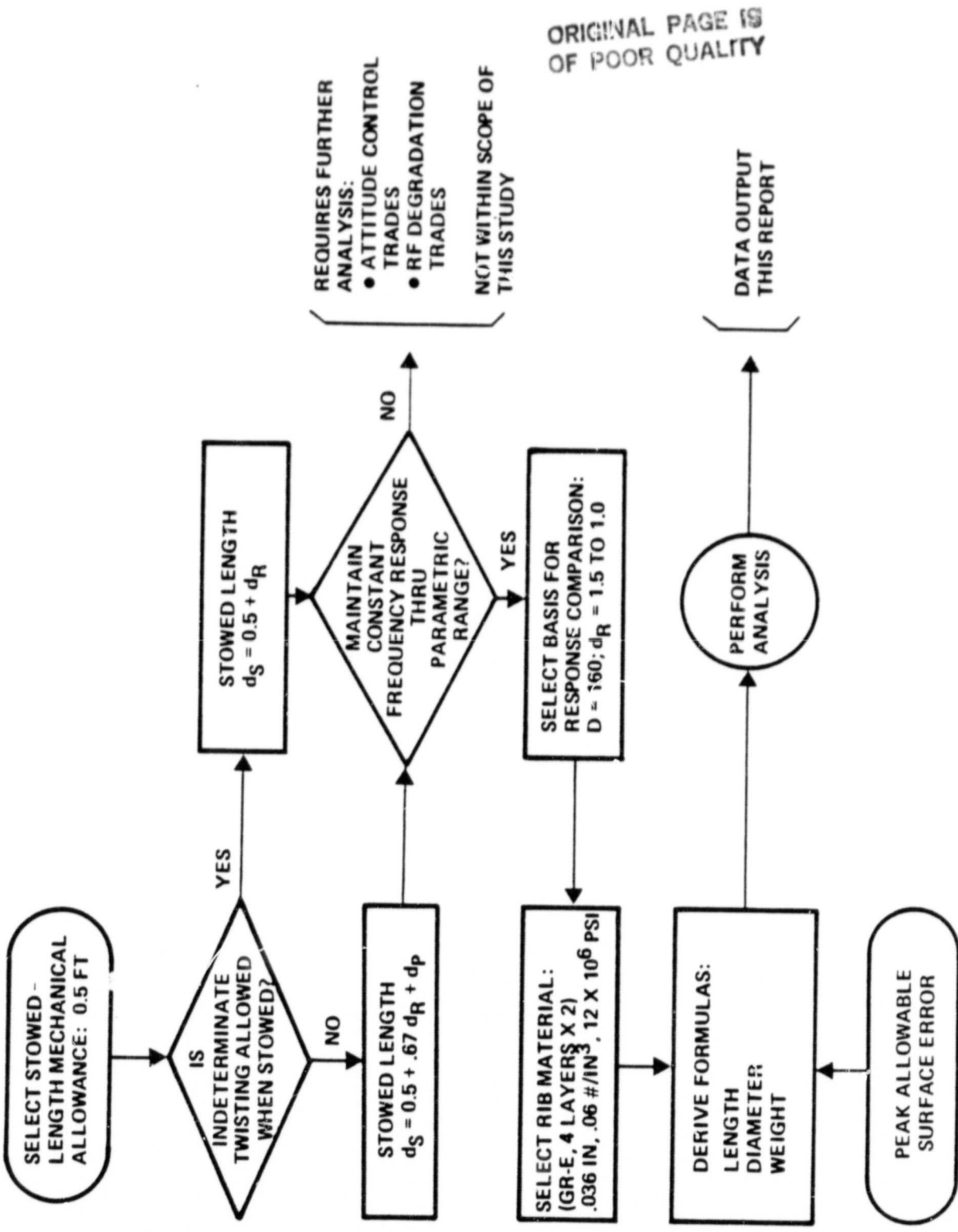

Figure F-3. Offset-Fed Cassegrain Configuration



ORIGINAL PAGE IS OF POOR QUALITY

Figure F-5. Logic Path - Reflector Configuration Parametric Analysis

The reflector weight is a function of the required number of ribs. This number, in turn, depends on the surface accuracy needed to provide the requisite RF performance. The surface accuracy is conveniently specified by the peak surface error, which occurs at the reflector edge. (Note that the tolerable edge error depends on the taper of the feed illumination -- i.e., greater taper permits a larger edge error.) The number of ribs is shown as a function of the antenna aperture, with peak surface error as a parameter, in Figure F-6a. The surface error is expressed as a fraction of the wavelength.

For a given number of ribs, the reflector weight depends on the required structural stiffness. With a constant-dynamic-response ground rule, the weight is as shown in Figure F-6b for a range of peak surface errors. The result of varying the rib root depth is also shown. The fraction of the total reflector weight accounted for by the ribs is shown in Figure F-6c.

The stowed reflector length depends on the amount of "twisting" allowed as the ribs are wound around the hub. LMSC has demonstrated the ability to stow a single rib within its root depth; this is accomplished by twisting the rib to conform to the hub. The present stowage analysis presumes no twisting, because of (1) the susceptibility of graphite epoxy to stress cracking and creep, and (2) the fact that multiple ribs are stowed on top of each other. The stowed length under these conditions is shown in Figure F-6d.

The allowable peak surface error is determined by relating that quantity to the loss in antenna directivity. The directivity loss serves as a proxy for sidelobe performance; it has been found, through experience, that degradation of sidelobe performance is minimal if the loss in directivity is held to 0.1-0.2 dB. From the relationships in Figure F-7, it is seen that the surface accuracy must be maintained to a value between $\lambda/16$ and $\lambda/8$.

LMSC wrap-rib design data are also shown in Figure F-7. About a factor-of-2 discrepancy exists in terms of the required number of ribs relative to the results of the present analysis. There appears to be no simple explanation for this discrepancy. However, the LMSC analysis is based on specification of the rms surface error, rather than the peak surface error.

ORIGINAL PAGE IS
OF POOR QUALITY.

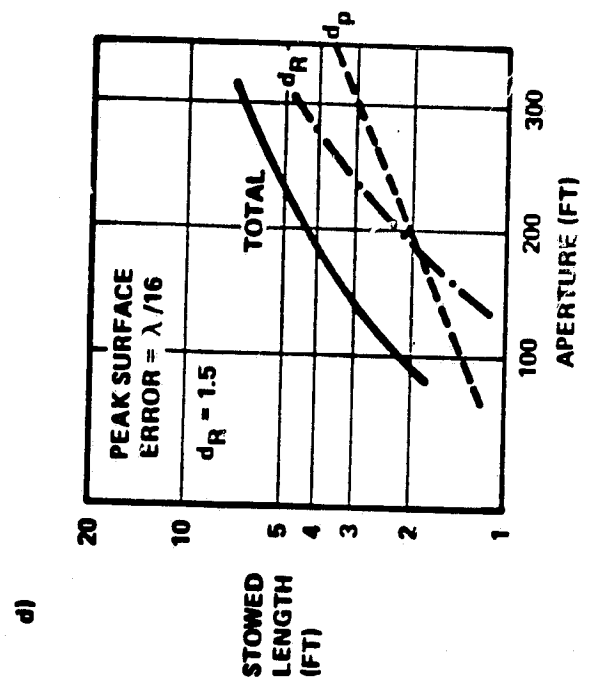
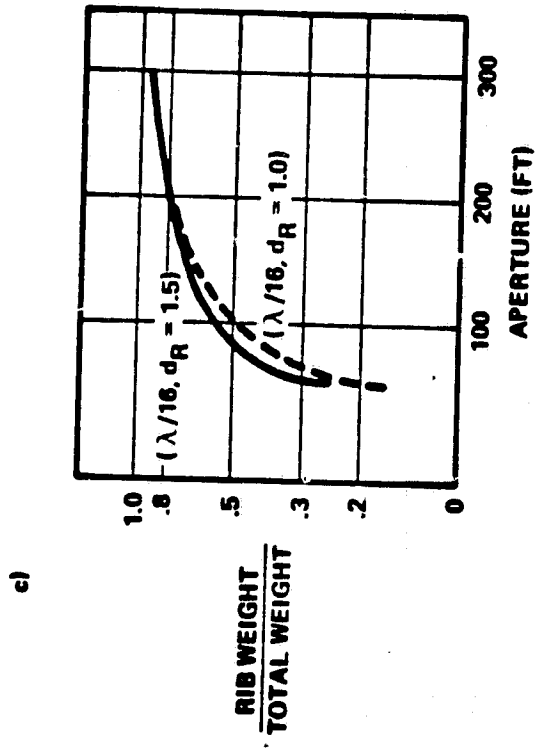
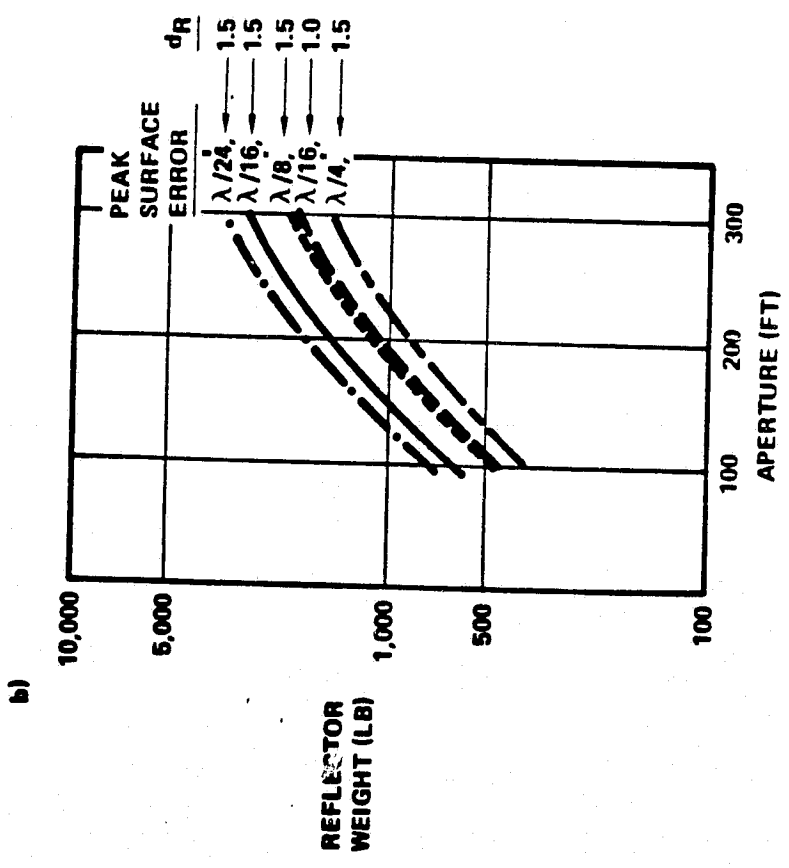
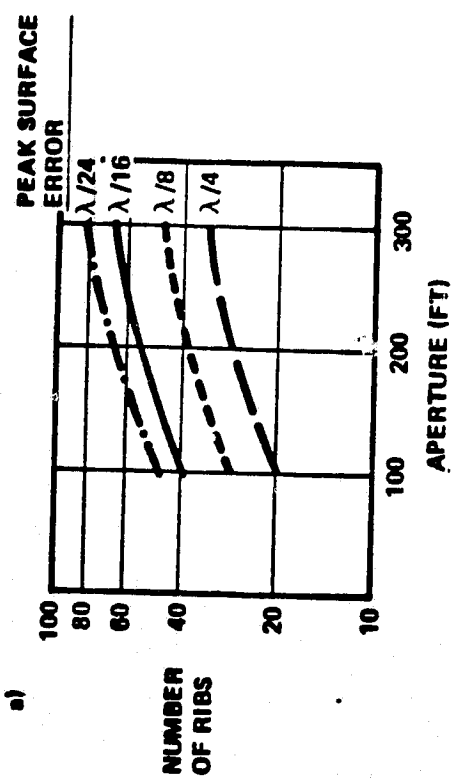

Figure F-6. Offset-Fed Reflector Design Parameters

ORIGINAL PAGE IS
OF POOR QUALITY

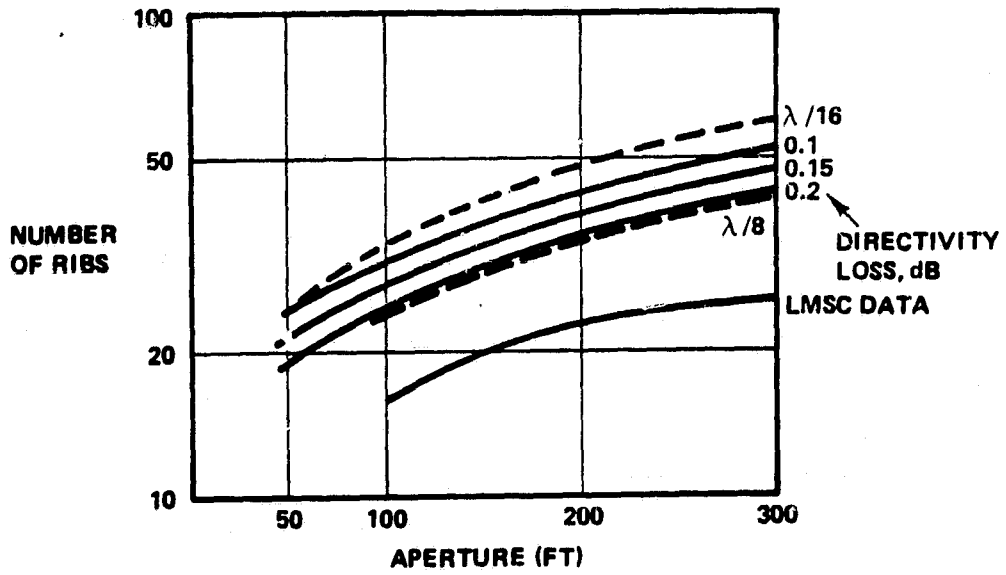

Figure F-7. Peak Surface-Error Tolerance for Center-Fed Configuration

Wrap-rib reflector design parameters for the three antenna configurations under consideration are shown in Figure F-8. The curves are drawn for peak surface errors of $\lambda/16$ and $\lambda/8$, and for a rib root depth of 1.5 feet. The center-fed design affords a modest reduction in number of ribs, and consequently in weight, over a direct offset-fed design for the same reflector diameter. The latter provides a more significant advantage over the offset-fed Cassegrain design.

For a 150-foot diameter, for example, the weight differential between the Cassegrain and the direct offset-fed reflector is about 250 pounds. The differences in stowed length, on the other hand, are small. At the same diameter, the center-fed design requires 1.4 feet more space than the direct offset-fed design; the Cassegrain, 0.5 foot more than the direct offset-fed reflector.

It is seen from Figure F-6c that, for diameters exceeding 100 feet, the ribs account for more than 50 percent of the reflector weight. Possible approaches to minimizing the number of ribs include (1) second-surface mesh shape control and (2) rib "branching" to reduce edge errors. The weight can also be reduced by decreasing rib height and, consequently, stiffness. This would necessitate dynamic control of the reflector surface, however.

Mast Analysis

Two prime considerations in the design of the mast system are weight and stowed dimensions. In addition, the design must meet minimum stiffness requirements.

A larger bay size always results in greater mast stiffness. Minimum stowed length may imply a bay size either larger or smaller than that needed for constant stiffness, depending on the feed/reflector geometry and the reflector diameter. Consequently, the bay size will be computed for both minimum-stowage and constant-stiffness designs and the larger value selected, subject to an upper limit imposed by the STS cargo-bay diameter.

Parameters describing the mast structure, as well as the stowage concept, are defined in Figure F-9. The aspect ratio of the mast bay, which is the ratio of length to width, is chosen to be unity. The common bay dimension is represented by the letter h .

ORIGINAL PAGE IS
OF POOR QUALITY

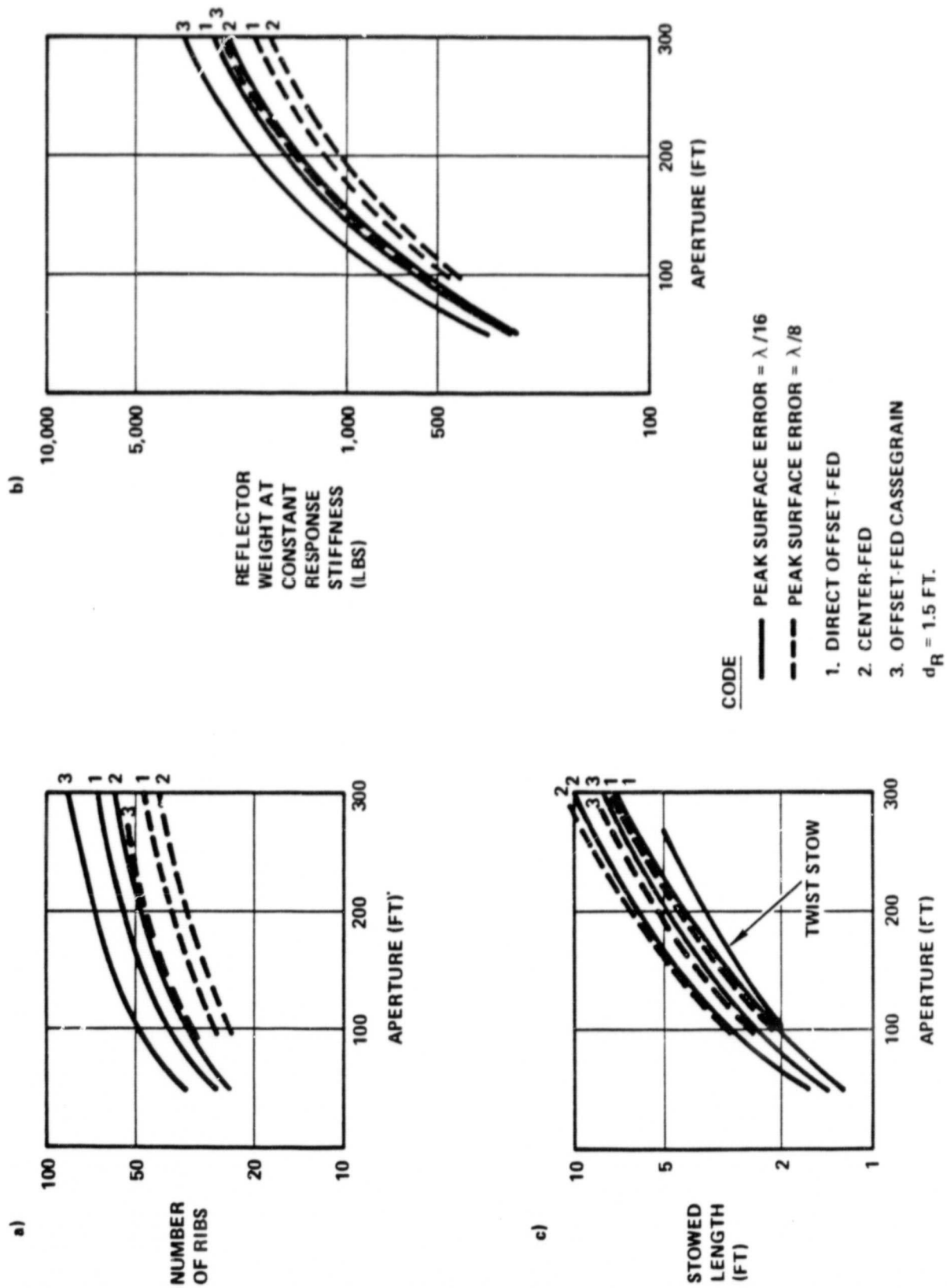
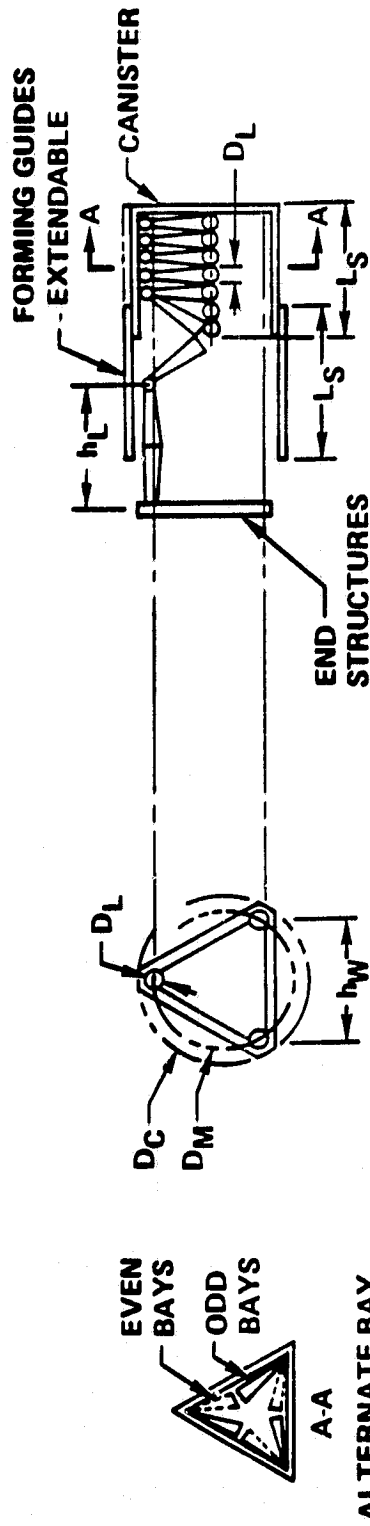

Figure F-8. Reflector Design Parameters

ORIGINAL PAGE IS
OF POOR QUALITY



DEFINITIONS AND RELATIONSHIPS:

- L = MAST DEPLOYED LENGTH (FT)
- D_L = LONGERON DIAMETER (FT)
- h_L = BAY LENGTH (FT)
- h_W = BAY WIDTH (FT)
- AR = ASPECT RATIO = h_L/h_W ; OPTIMUM AT AR = 1, OR $h_W = h_L = h$
- D_M = MAST NOMINAL DIAMETER (FT) = $1.155 h_L$
- D_C = CANISTER INSCRIBED DIAMETER (FT) = $D_M + D_L + 0.1$ MECHANICAL ALLOWANCE
- L_S = MAST STOWED LENGTH (FT) = $[(L/h) D_L + 0.5$ MECHANICAL ALLOWANCE] $\geq (h + 0.5)$

Figure F-9. Articulated-Mast Stowage Concept

The STS places an upper limit on the mast bay size, which is different for the two feed/reflector geometries. The offset-fed design is more constrained because of the stowage requirements of the feed assembly. As can be seen from Figure F-10, the maximum bay sizes are 10 and 11.5 feet for the offset-fed and center-fed designs, respectively. Mast stowage for the Cassegrain antenna is not considered, as it is later shown that the weight of this configuration is excessive.

The mast stowed length is shown as a function of deployed length in Figure F-11, for several values of bay size and two values of longeron diameter. These results are in agreement with Reference F-2, except for the canister constraint on minimum stowed length. An allowance of 0.5 foot is made for drives, guides, and structural/mechanical supports.

It is evident from Figure F-11 that, for given values of mast deployed length and longeron diameter, there is a well-defined minimum stowed length. Moreover, this minimum stowage is achieved only by proper choice of the bay size, h .

This relationship can be understood by observing that, for deployment purposes, each canister (there are two in the offset-fed case) must be no shorter than the bay size plus 0.5 foot. For fixed deployed length, on the other hand, the stack height of the mast decreases with increasing bay size. Minimum stowed mast length is achieved, therefore, when the bay size is chosen so that the mast stacks to a height equal to the minimum canister length (Figure F-12). For stiffness-critical designs (large bay size), the canister is not completely filled. On the other hand, for lightly loaded masts, as in the center-fed antenna, a small bay size results from applying a dynamic response criterion, resulting in "overflow" of the canister.

The latter condition is illustrated in Figure F-13, where, in the center-fed case, the bay size for constant stiffness is less than that required for minimum stowage, for all antenna diameters less than 400 feet. For the offset-fed design, the reverse is true for diameters larger than 140 feet. Maintaining constant dynamic response in the offset-fed case causes the STS constraint on bay size to be reached at an antenna diameter of 190 feet (58 meters). Thicker longeron walls, resulting in a moderate weight penalty, are required to maintain constant stiffness with larger antennas.

ORIGINAL PAGE IS
OF POOR QUALITY

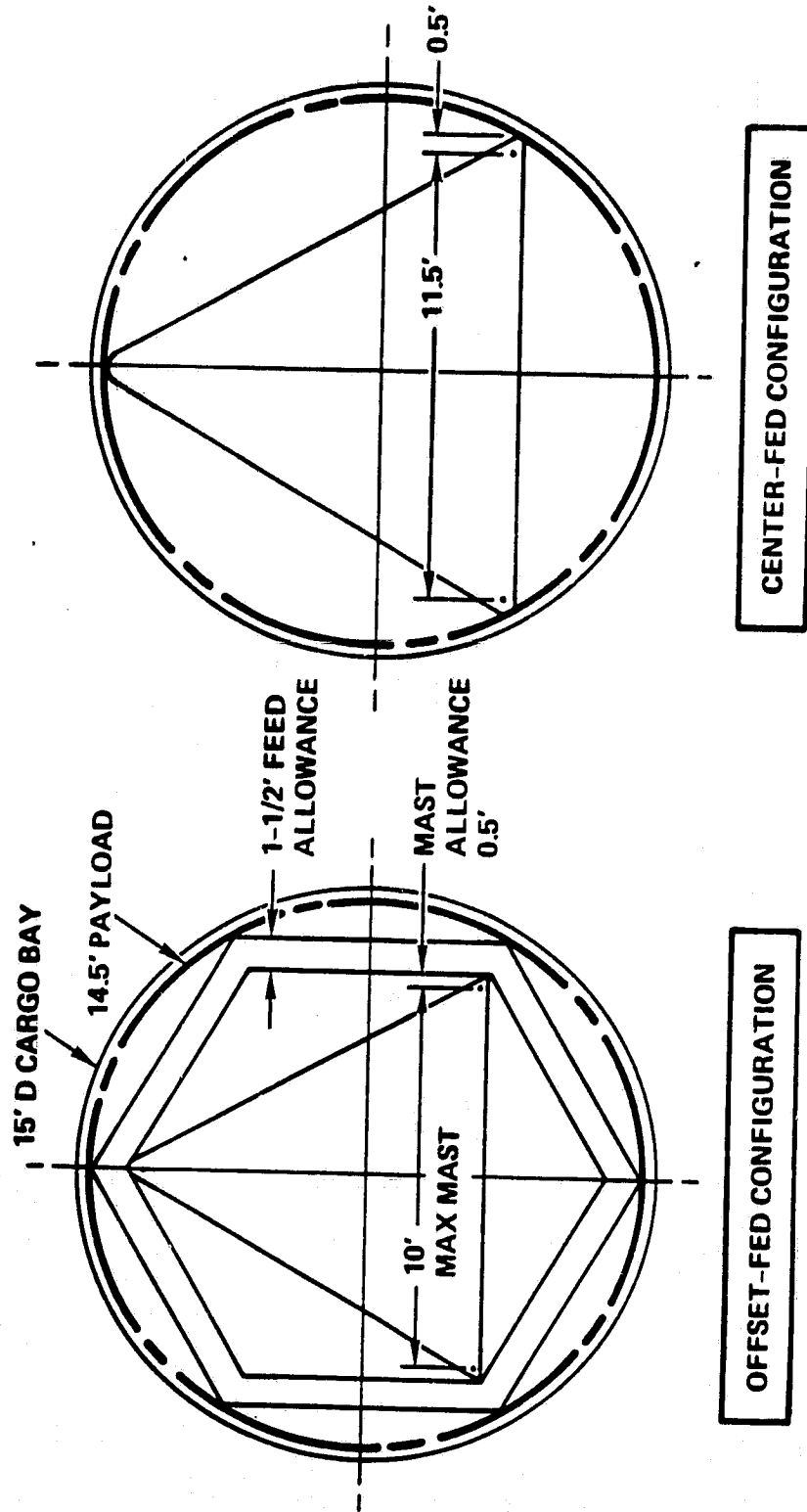

Figure F-10. STS Constraints on Mast Bay Size

ORIGINAL PAGE IS
OF POOR QUALITY

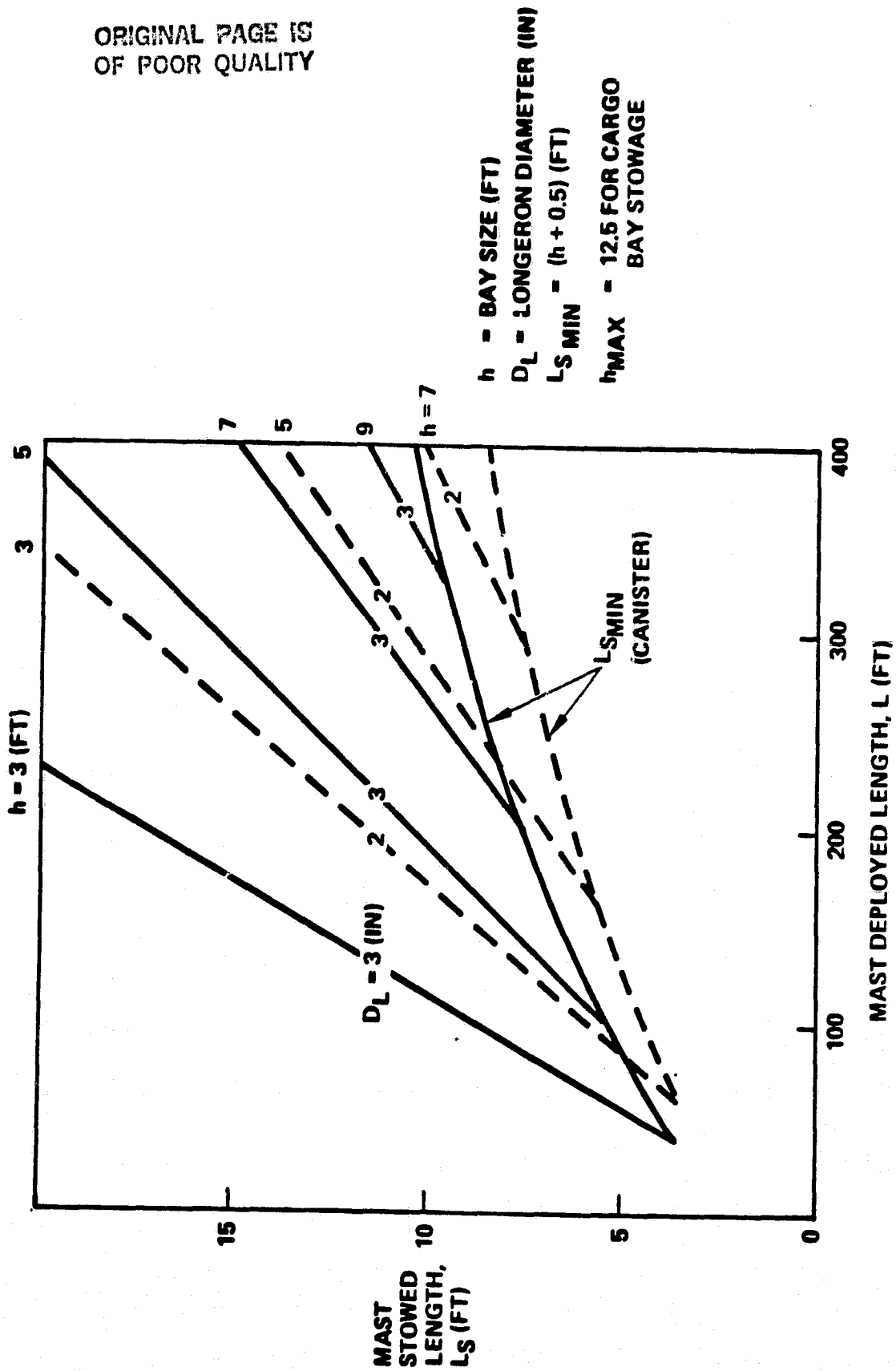

Figure F-11. Articulated-Mast Stowed Length

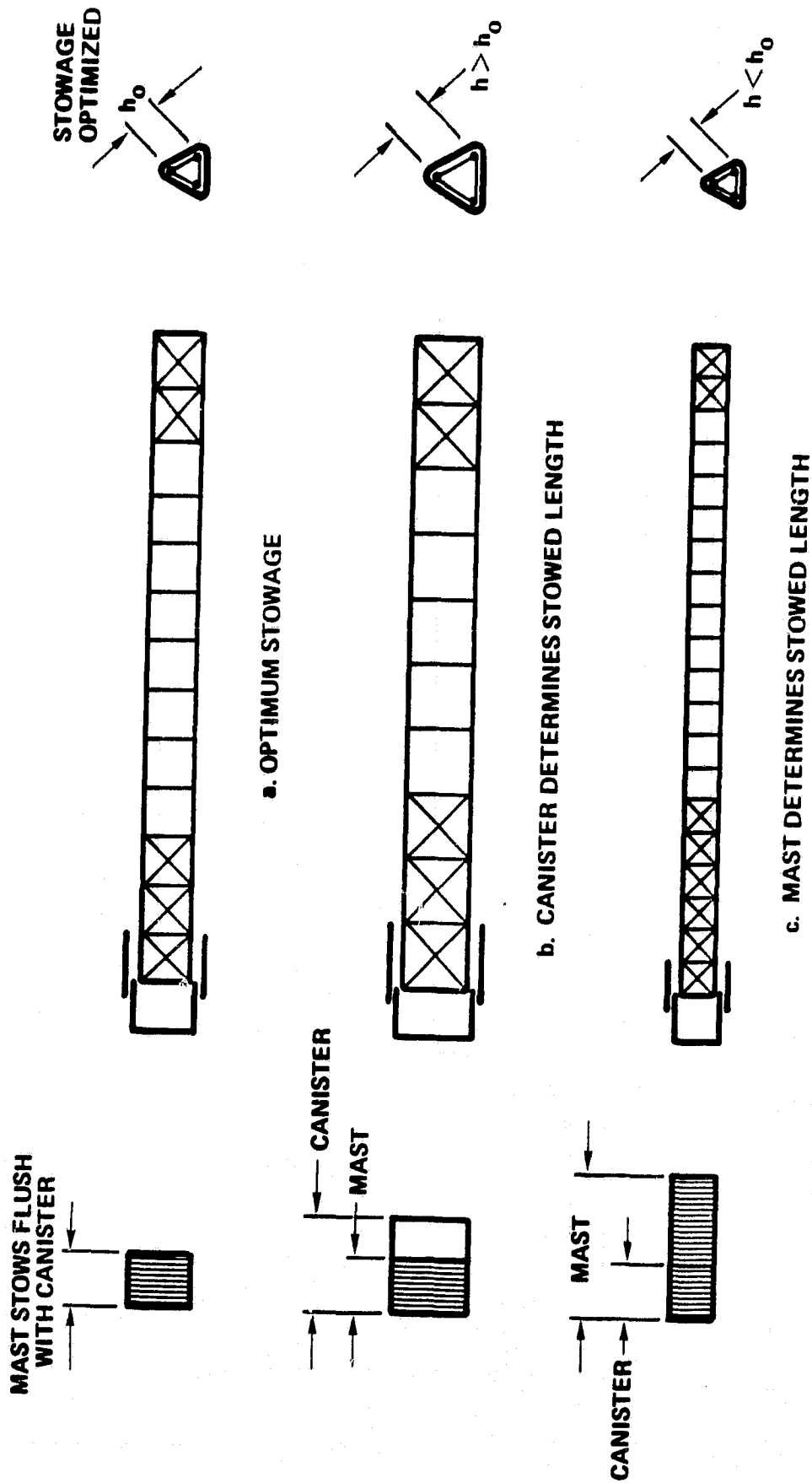

Figure F-12. Bay Size Impact on Mast Stowed Length

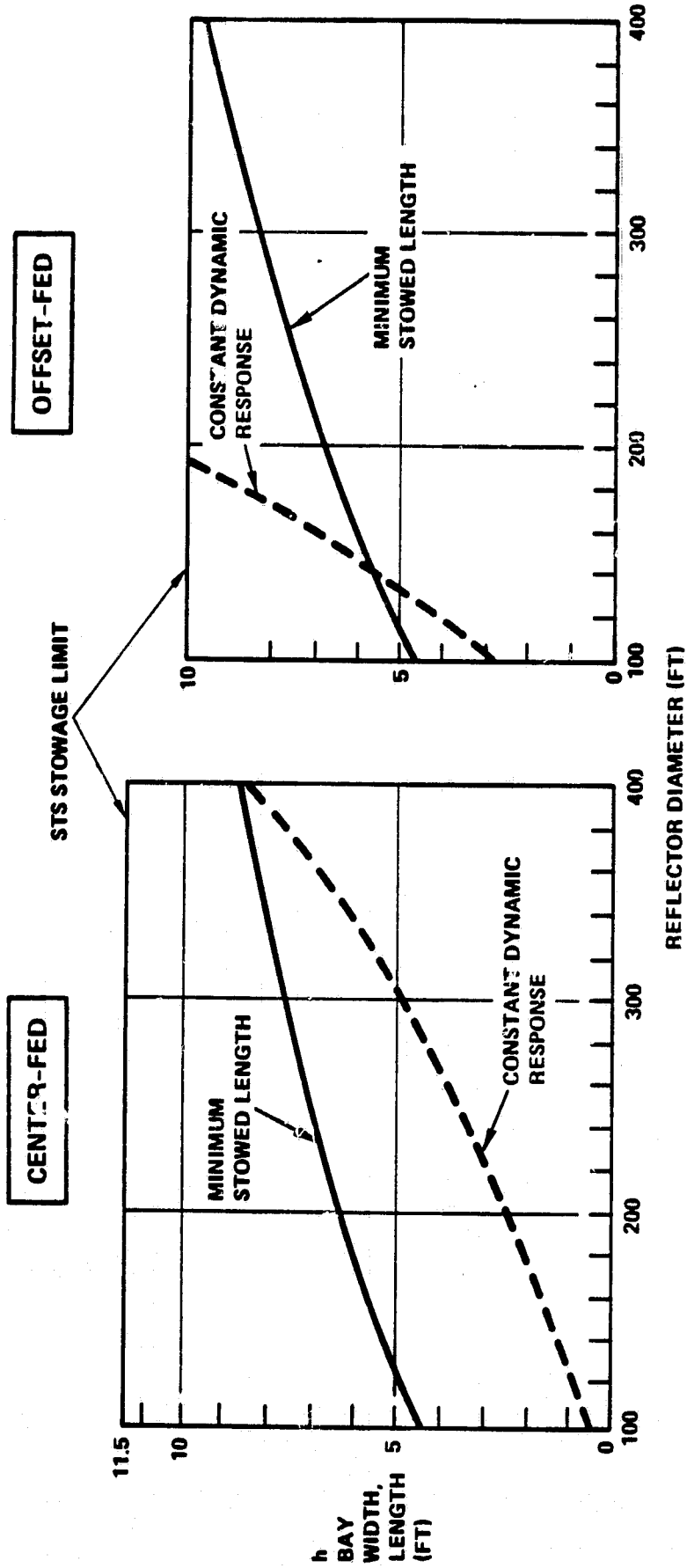

Figure F-13. Mast Bay Size for Minimum Stowed Length

Composite curves showing the minimum stowed mast length for the center-fed and offset-fed design, subject to STS and stiffness constraints, are shown in Figure F-14. Formulas for the stowed length at constant stiffness are given in Figure F-15.

Because of the small weight difference between unconstrained-minimum-stowed-length and constant-response mast designs, the weight of a constant-response mast system will be taken as representative of either design. The weight of the mast system is derived by assuming minimum-gauge (4-layer graphite epoxy) thicknesses for battens and longerons. The longeron diameter is assumed to be 3 inches. With a 5-percent allowance for integration, the weight of the mast/canister combination for the three antenna configurations is given by the formulas in Figure F-15.

The bay size, which is needed to compute the mast system weight, depends on the reflector diameter, total satellite weight, and the distribution of that weight. The assumptions made regarding the weight distribution for the three antenna designs are shown in Figure F-15. The resulting bay size is shown in Figure F-16a for constant system dynamic response. The reference value for the dynamic response is based on the following set of parameter values: $D = 160$ feet, $h = 7$ feet, and $W = 9000$ pounds.

The mast system weight corresponding to the bay size in Figure F-16a is shown in Figure F-16b, for each of the three antenna configurations. Strictly speaking, the two parts of Figure F-16 should be used in an iterative manner, since the satellite weight must be known to compute the mast bay dimension. However, an approximate value for the satellite weight permits the bay size to be computed with reasonable accuracy.

Feed Array

A folded stowage concept has been developed for the feed array, with hinge points at the limit of the cargo bay (Figure F-17). With 3 inches of clearance on each side, the maximum occupied diameter is 14.5 feet. It follows that the maximum developed length for the feed array is 43 feet.

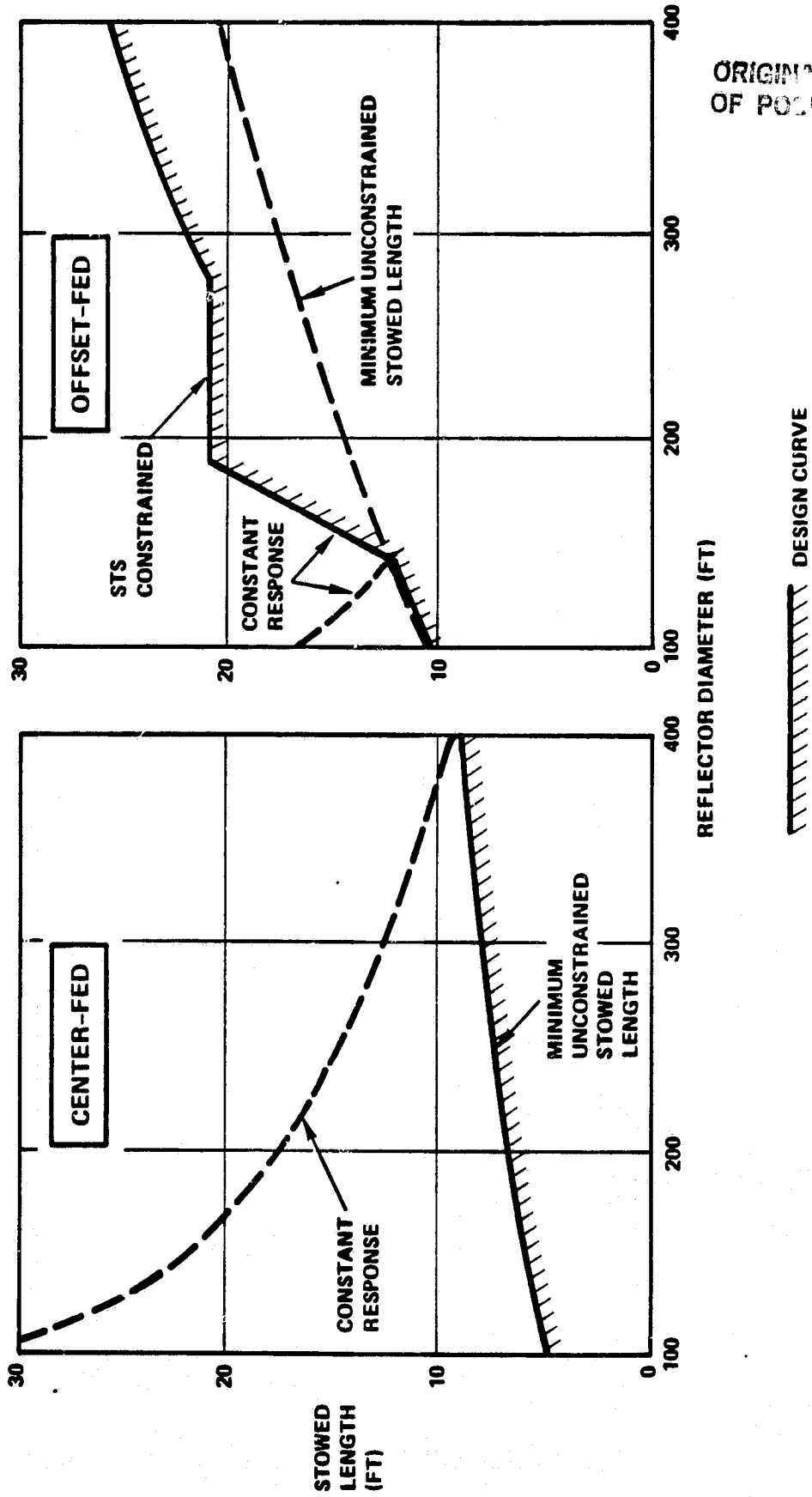

Figure F-14. Minimum Mast-System Stowed Length Consistent With Stiffness and STS Constraints

NOTATION: W = SATELLITE WEIGHT (LB) $AR = 1$
 D = REFLECTOR DIAMETER (FT) $D_L = 3$ IN.
 h = BAY SIZE
 L_S = TOTAL MAST STOWED LENGTH
 W_{MC} = MAST SYSTEM WEIGHT

CONFIGURATION	MAST SIZE, STOWAGE, AND WEIGHT	FLAT-DEVELOPED MASTS
1. DIRECT OFFSET-FED*	$h = 3.65 \times 10^{-5} (WD^3)^{1/2}$ (FT) $L_S = (.47 Dh^{-1} + 0.5) \geq (2h + 1)$ (FT) $W_{MC} = (1.65 + 1.13 h^{-1}) D + 38 h$ (LBS)	
2. CENTER-FED	$h = 8.03 \times 10^{-6} (WD^3)^{1/2}$ $L_S = (.19 dh^{-1} + 0.5) \geq (h + 0.5)$ $W_{MC} = (0.66 + 0.45 h^{-1}) D + 19h$	
3. OFFSET-FED CASSEGRAIN	$h = 1.74 \times 10^{-5} (WD^3)^{1/2}$ $L_S = (.47 Dh^{-1} + 0.5) \geq (3.5 h + 1.75)$ $W_{MC} = (1.65 + 1.13 h^{-1}) D + 56h$	

* L_1 SHOULD BE 1.5D FOR $f/D = 1.5$

Figure F-15. Mast Bay, Stowed Length, and Weight Formulas for Constant System Dynamic Response

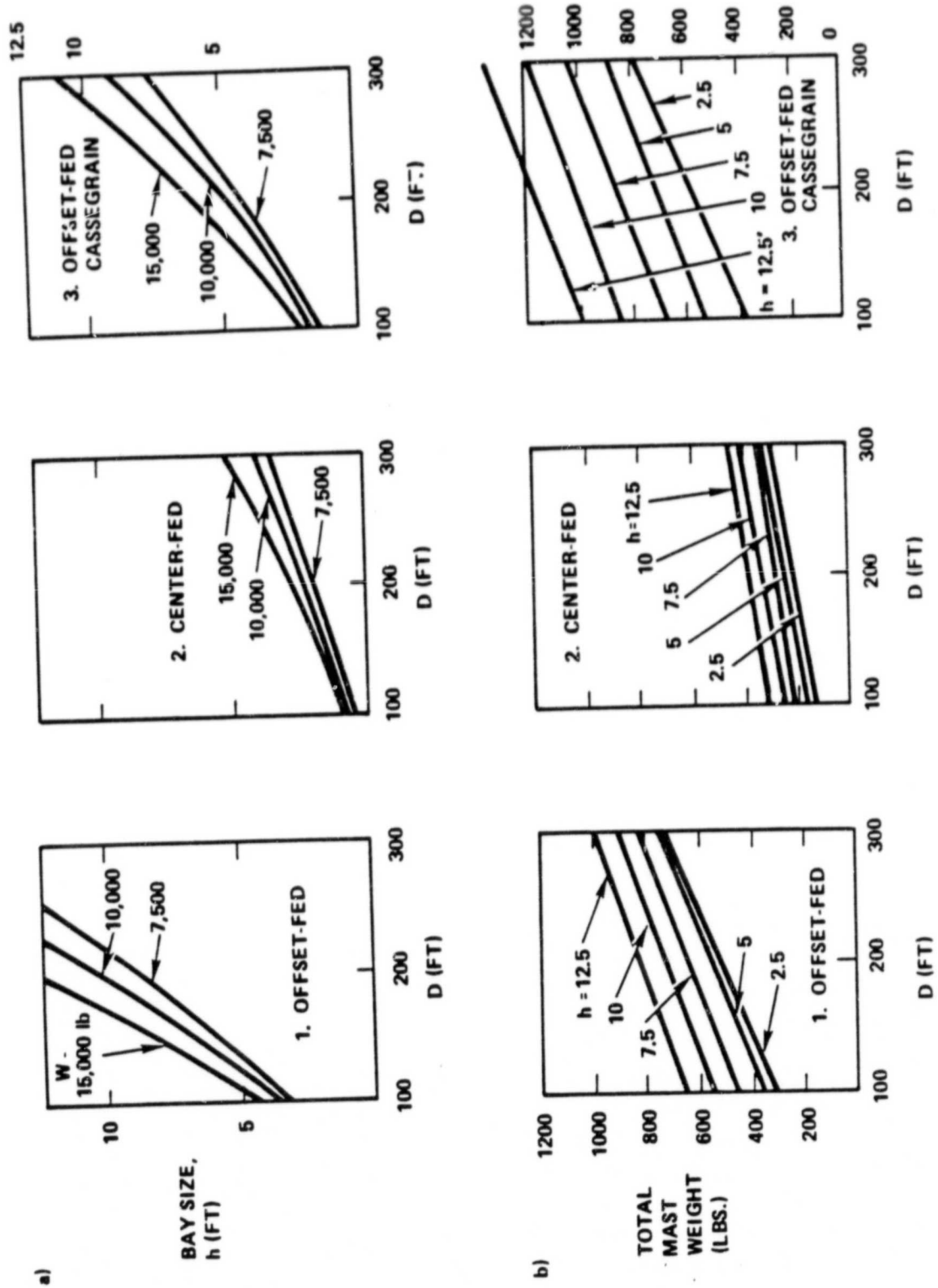
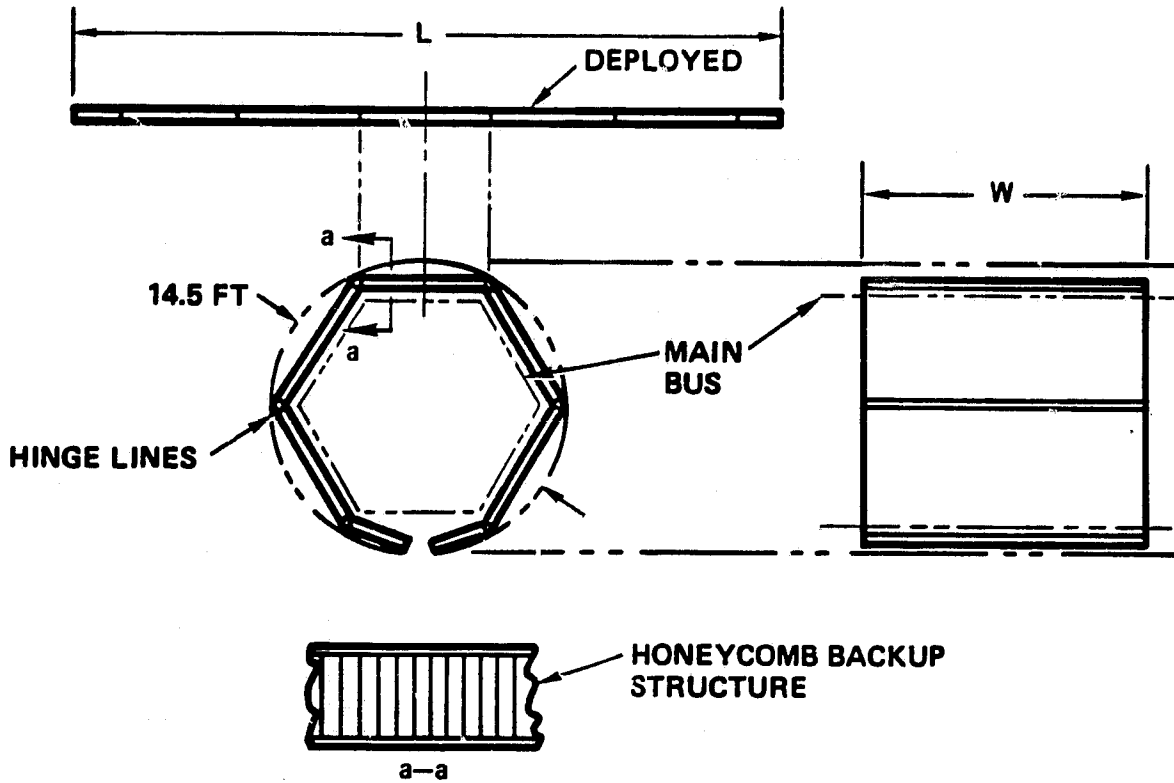

Figure F-16. Bay Size and Mast System Weight for Constant Stiffness

ORIGINAL PAGE 13
OF POOR QUALITY



STRUCTURE-ONLY WEIGHT APPROXIMATION: 1 LB/FT²

Figure F-17. Stowed Feed Array

This places the following restrictions on the reflector diameter that can be used with the different optical configurations:

Direct offset-fed	< 200 feet
Center-fed	< 300+ feet
Offset-fed Cassegrain	< 110 feet

Only the Cassegrain configuration is significantly limited in size by stowage considerations.

The feed assembly is assumed to have a 4-6 inch honeycomb core with fiberglass or graphite epoxy facesheets. The weight of this structure is assumed to be 1 lb/ft². This accounts only for the assembly structure; it does not include the feeds, or any of the attached electronics or thermal-control elements.

Total Antenna System Weight

A weight comparison of the three antenna configurations based on the wrap-rib reflector will be made for a 150-foot antenna diameter, using the data presented above. The results are shown in Table F-1. With an assumed satellite weight limitation on the order of 10,000 pounds, the Cassegrain design is prohibitively heavy. The large weight difference between it and the direct offset-fed design is attributable to the size of the feed array. For a given f/D, the linear dimension of the Cassegrain feed is twice that of the direct offset-fed feed; hence the area, and consequently the weight, is about four times as large.

Hoop-Column Antenna

A satellite configuration based on the hoop-column reflector is shown in Figure F-18. Three separate apertures are fed in an offset manner from the centrally located mast structure. Each aperture provides one-third of the required number of beams. As a result, the available area per feed on each of the corresponding feed assemblies is three times what it would be with a single aperture. Because of this increased feed area, it may not be necessary to cluster feeds to obtain the desired aperture illumination, thereby eliminating the need for a beamformer network.

Offsetting this advantage, however, is the relatively large weight of a hoop-column antenna. Available data on hoop-column LSST designs are

Table F-1. Antenna Subsystem Weight for 150-ft. Reflector

ELEMENT	DIRECT OFFSET-FED	CENTER-FED	OFFSET-FED CASSEGRAIN
REFLECTOR	800	720	1000
MAST	530	175	510
SUBREFLECTOR	-	-	200
FEED	485	155	1795
TOTAL	1815	1050	3505

ORIGINAL PAGE 13
OF POOR QUALITY

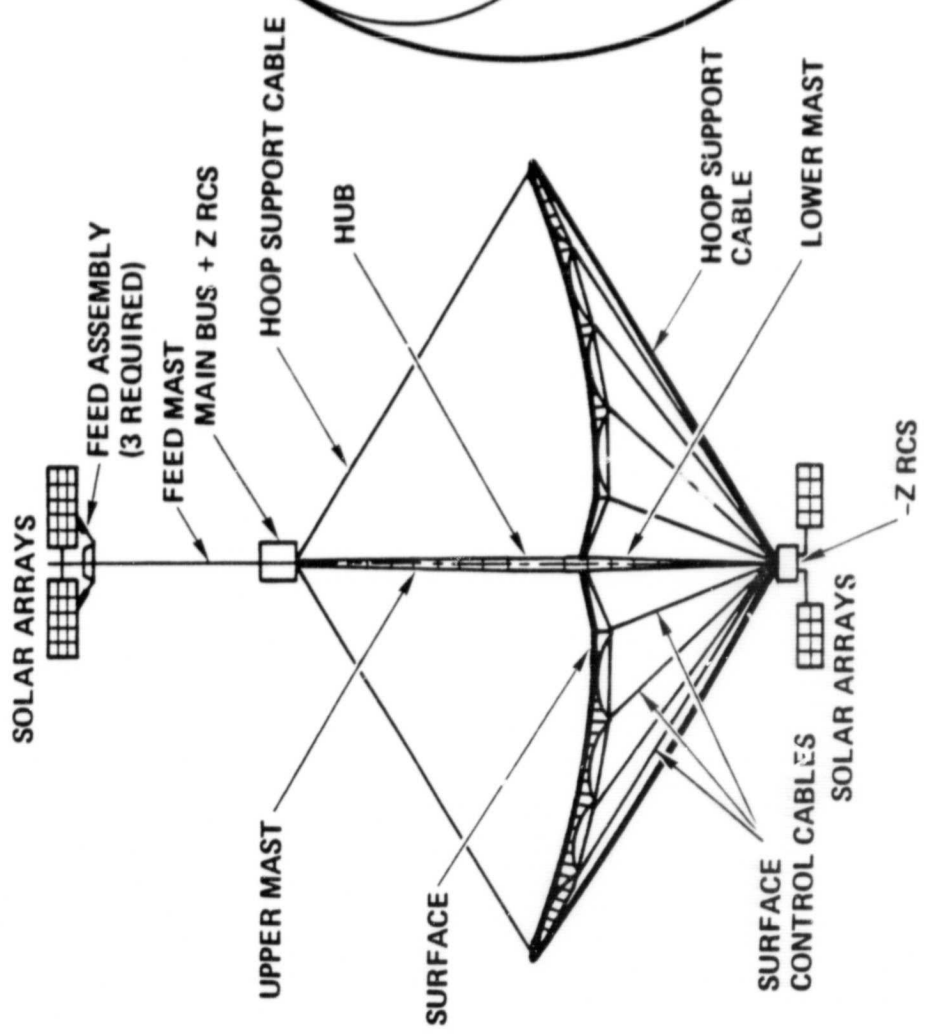
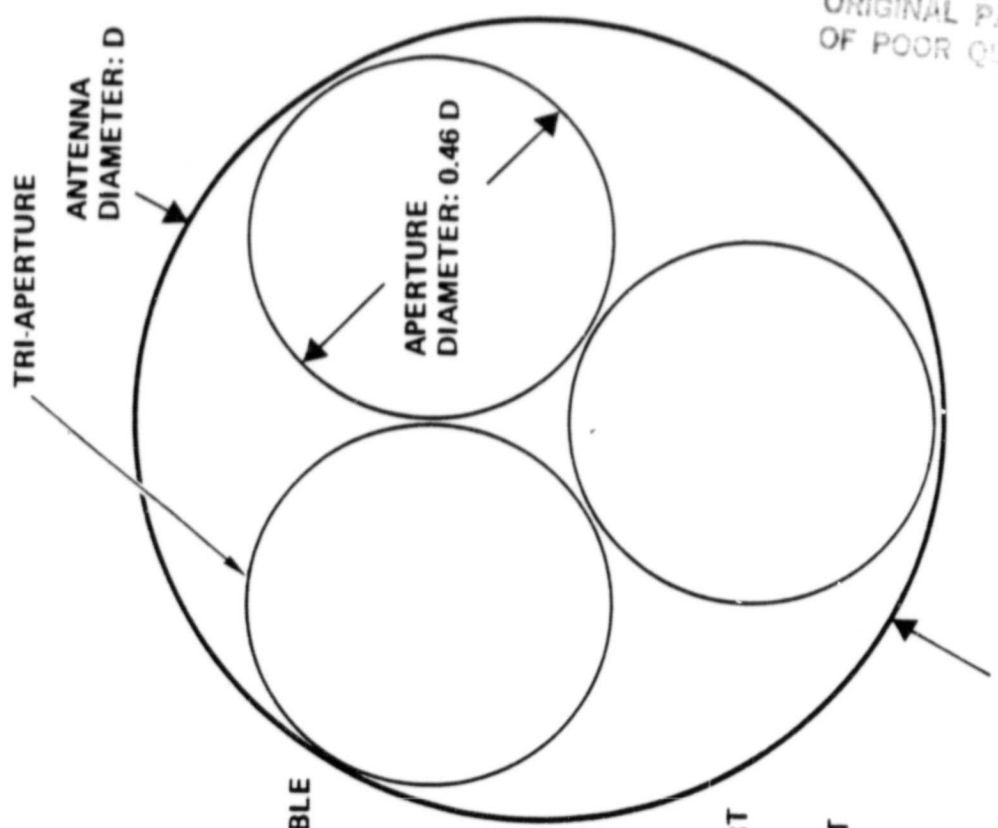

Figure F-18. Hoop-Column System Configuration

summarized in Reference F-4. Data from this report, together with previously published work, were used to generate weight and stowage characteristics. These are shown in Figures F-19 and F-20.

A weight and stowage comparison of a 50-meter wrap-rib antenna with an equivalent tri-aperture hoop-column antenna is shown in Table F-2. LMSC wrap-rib data are included for comparison. The disadvantage of the hoop-column design, from the standpoint of both weight and stowed length, is apparent.

Since the hoop-column antenna can also be used in a single-aperture, center-fed configuration, comparison with a center-fed wrap-rib design is also provided in Table F-2. While the weights are comparable, the stowed length is considerably smaller with the wrap-rib design.

ORIGINAL PAGE 13
OF POOR QUALITY

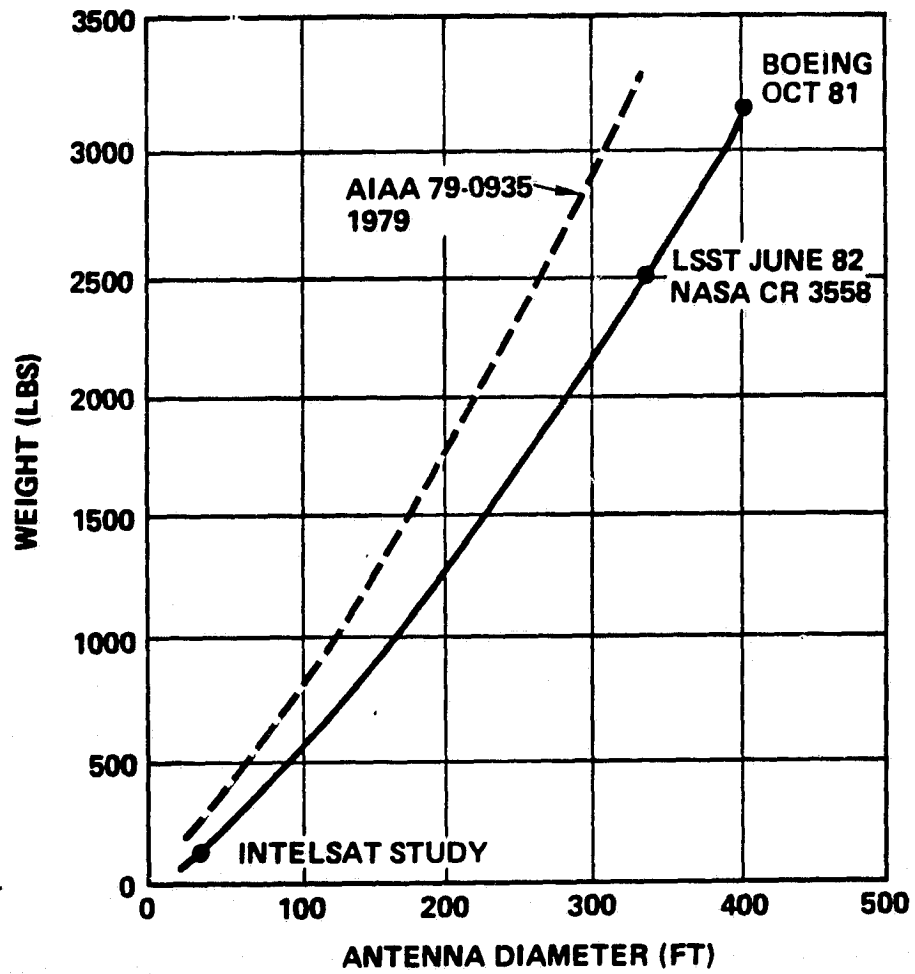

Figure F-19. Hoop-Column Antenna Weight (Excluding Feeds)

ORIGINAL PAGE IS
OF POOR QUALITY

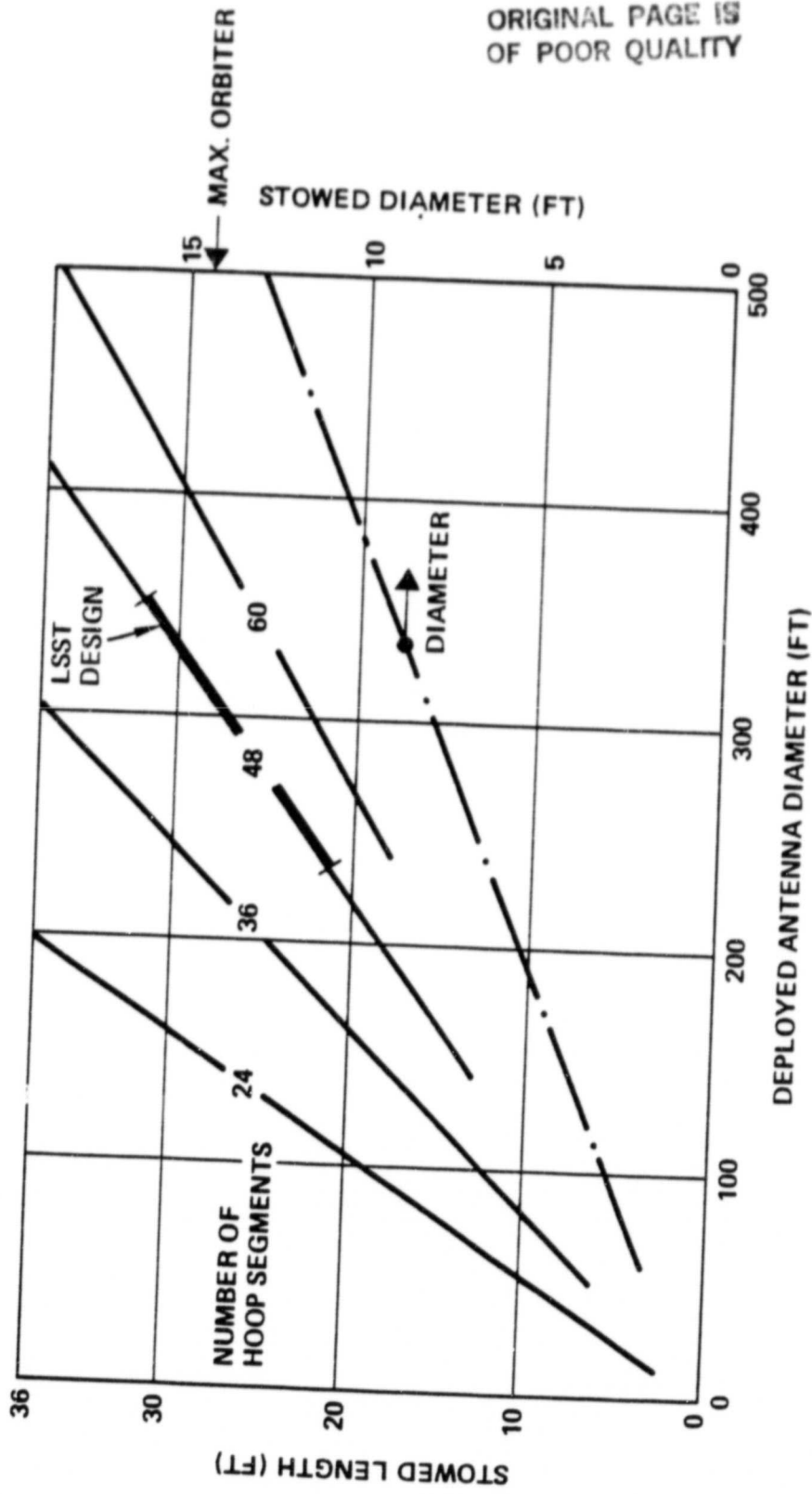

Figure F-20. Hoop-Column Antenna Stowed Dimensions

Table F-2. Comparison of Wrap-Rib and Hoop-Column Antennas

RF SYSTEM	OFFSET-FED		CENTER-FED	
	50 M	110 M TRIAPERTURE	50 M	
ANTENNA CONFIGURATION	WRAP-RIB	HOOP-COLUMN	WRAP-RIB	HOOP-COLUMN
REFLECTOR (LB)	900 740*	800	820	292
MASTS (LB)	600 300*	1294	150	471
HOOP (LB)	- -	706	-	257
TOTAL (LB)	1500 1030*	2800	970	1020
STOWED DIA/LENGTH (FT)	13/21	9.2/31	13/6	4.3/14.2

*LMSC DATA

References:

- F-1. P.R. Preiswerk and J.C. Stammreich, Assessment of Current and Projected Performance Characteristics of Deployable Structural Masts, Astro Research Corp., ARC-TN-1085, 15 April 1980, prepared for NASA-MSFC (NAS8-33712).
- F-2. A.A. Woods, Jr. and N.F. Garcia, "Offset Wrap Rib Antenna Concept Development," NASA Conference Publication 2215, Large Space Systems Technology - 1981.
- F-3. M.R. Sullivan, "Maypole (Hoop/Column) Concept Development Program," NASA Conference Publication 2215, Large Space Systems Technology - 1981.
- F-4. M.R. Sullivan, LSST (Hoop/Column) Maypole Antenna Development Program, Harris Corp., NASA Contractor Report 3558, Part 1, June 1982.

APPENDIX G - SATELLITE SUBSYSTEM WEIGHT ANALYSIS

The various subsystems were developed to a level that enabled satellite costing. This involved identifying subsystem components and estimating their weight and technology level. Four different methods were used for weight estimation:

1. Comparison with subsystems in other TRW designs (Space Platform, TDRS, Defense Satellite Program, MILSTAR, etc.)
2. Parametric studies wherein subsystem (or partial subsystem) weights were calculated for different performance levels or sizes
3. Calculations of unit weight and multiplication by the number of units
4. Direct calculation.

Method 1 was used for electrical power system components except for batteries and solar array, attitude control system except for control moment gyros (CMGs), data handling system, communications other than Ku-band and UHF transmissions, cabling, and propulsion components. Method 2 was used for the reflector, masts, CMGs, thermal-control radiators, feed structure, and propellant. Method 3 was applied to the beamforming network, UHF electronics, and radiating elements, while the solar array and batteries were sized by Method 4.

A breakdown of the satellite weight by subsystem is presented in Table G-1 for the two baseline designs. Each subsystem will be discussed in turn. Note that a contingency factor of 20 percent is included. For an integral propulsion system, which is projected to have a geosynchronous capability of 10,400 pounds, margins of 2000 and 1225 pounds are available for the center-fed and offset-fed designs, respectively.

Reflector and Masts

Reflector and mast weights were taken from Figures F-8 and F-16, for a peak reflector-surface error of $\lambda/8$.

Communication and Data Handling

The communication and data handling system consists of three separate subsystems: an STDN-compatible S-band subsystem used for launch, orbit injection, checkout, on-orbit anomalies, and lost-bird mode; telemetry and

Table G-1. Satellite Weight Summary

<u>ITEM</u>	<u>CENTER-FED</u>	<u>WEIGHT (LB)</u>	<u>OFFSET-FED</u>
REFLECTOR	1050		800
MASTS	260		510
COMM & DATA (INCL. Ku-BAND)	360		360
FEED ASSEMBLY	1630		2115
RADIATING ELEMENTS	70		125
ELECTRONICS	560		455
BEAM-FORMING NETWORK	150		335
RF & DC CABLING	350		250
THERMAL CONTROL	270		440
STRUCTURE	230		510
ATTITUDE CONTROL	430		830
REACTION CONTROL	1400		1160
DRY			
PROPELLANT	310	255	905
1090			
THERMAL CONTROL (BODY)	100		100
ELECTRICAL POWER	540		530
DC CABLING	540		480
STRUCTURE & INTEGRATION	690		760
TOTAL	7000		7645
CONTINGENCY (20%)	1400		1530
BOOSTER CAPABILITY (IPS)	10400		10400
MARGIN	2000 (24%)		1225 (13%)

command subsystem; and the Ku-band subsystem to the gateways. The weight of these subsystems is essentially independent of the antenna diameter and the satellite configuration.

The S-band system is fully redundant, with omnidirectional antennas, and weighs 147 pounds including harness. The data handling system, also redundant, weighs approximately 140 pounds including the Orbiter interface unit. These values were taken from modified Power Station data. The Ku-band electronics were estimated to weigh 53 pounds; the Ku-band antenna, 20 pounds. The total subsystem weight was therefore taken as 360 pounds for both configurations.

UHF Feed Assembly

The feed assembly consists of several subsystems, with their weights shown in Table G-2. The center-fed design has 150 feeds, while the offset-fed design has 84 feeds. These feed arrays generate 101 and 61 beams, respectively.

The radiating elements for the two configurations are shown in Figure G-1. The per-feed dimensions of the microstrip-patch/ground-plane combination (suggested by JPL in conjunction with an offset-fed design) are only half as great (one-quarter the area) as would be required with an offset-fed reflector of the same size and comparable RF performance. Based on this comparison with the JPL published weight data, the per-feed weight of the radiating elements is estimated at 0.46 pound for the center-fed design.

By contrast, the weight of the short-backfire element used in the offset-fed design was found by adding weight estimates for each of its component parts. The total was 1.5 pounds per element.

The repeater block diagram is shown in Figure G-2 for the offset-fed design. (The repeater for the center-fed design differs only in the number of beams generated and the feed-clustering arrangement.) The UHF repeater components will be located on the feed assembly. Note that 3x2 redundancy is used for all active components. The weight breakdown for the UHF electronics is given in Table G-3. The upconverter/transmitter is heavier in the offset-fed design because of the larger power transmitted and, therefore, dissipated.

Table G-2. UHF Feed Assembly Weight Breakdown

	<u>CENTER-FED</u>	<u>OFFSET-FED</u>
• RADIATING ELEMENTS	70 LB	125 LB
• ELECTRONICS (3 FOR 2 REDUNDANCY)	560	455
• BEAMFORMER NETWORK (BASED ON JPL DATA)	150	335
• RF & DC CABLING	350	250
• THERMAL CONTROL	270	440
• STRUCTURE	<u>230</u>	<u>510</u>
• TOTAL	1630 LB	2115 LB

**CENTER-FED
(MICROSTRIP-JPL DIAGRAM)**

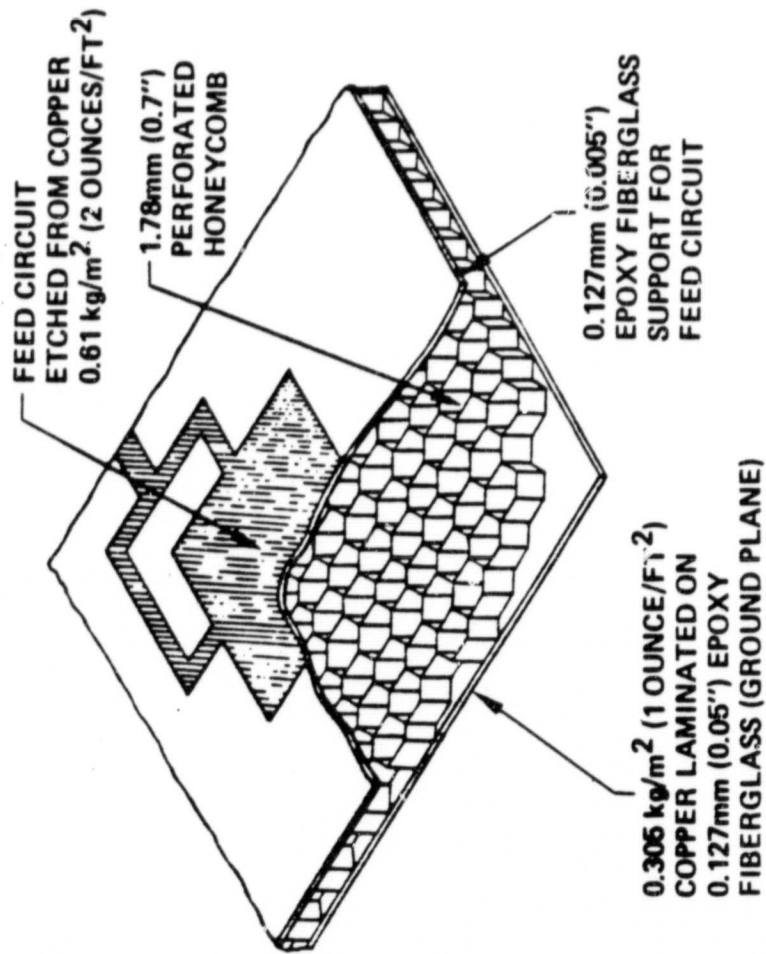

0.46 LB/ELEMENT

**OFFSET-FED
(SHORT-BACKFIRE)**

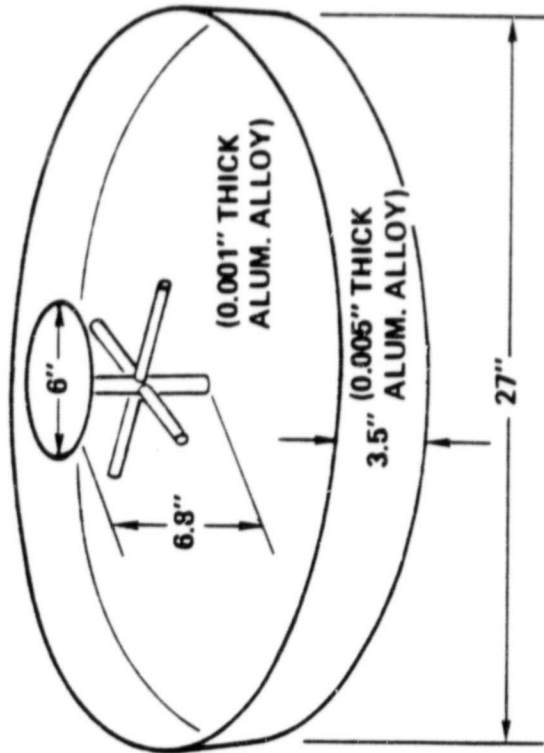

1.5 LB/ELEMENT

ORIGINAL PAGE IS
OF POOR QUALITY

Figure G-1. UHF Radiating Elements

ORIGINAL PAGE IS
OF POOR QUALITY

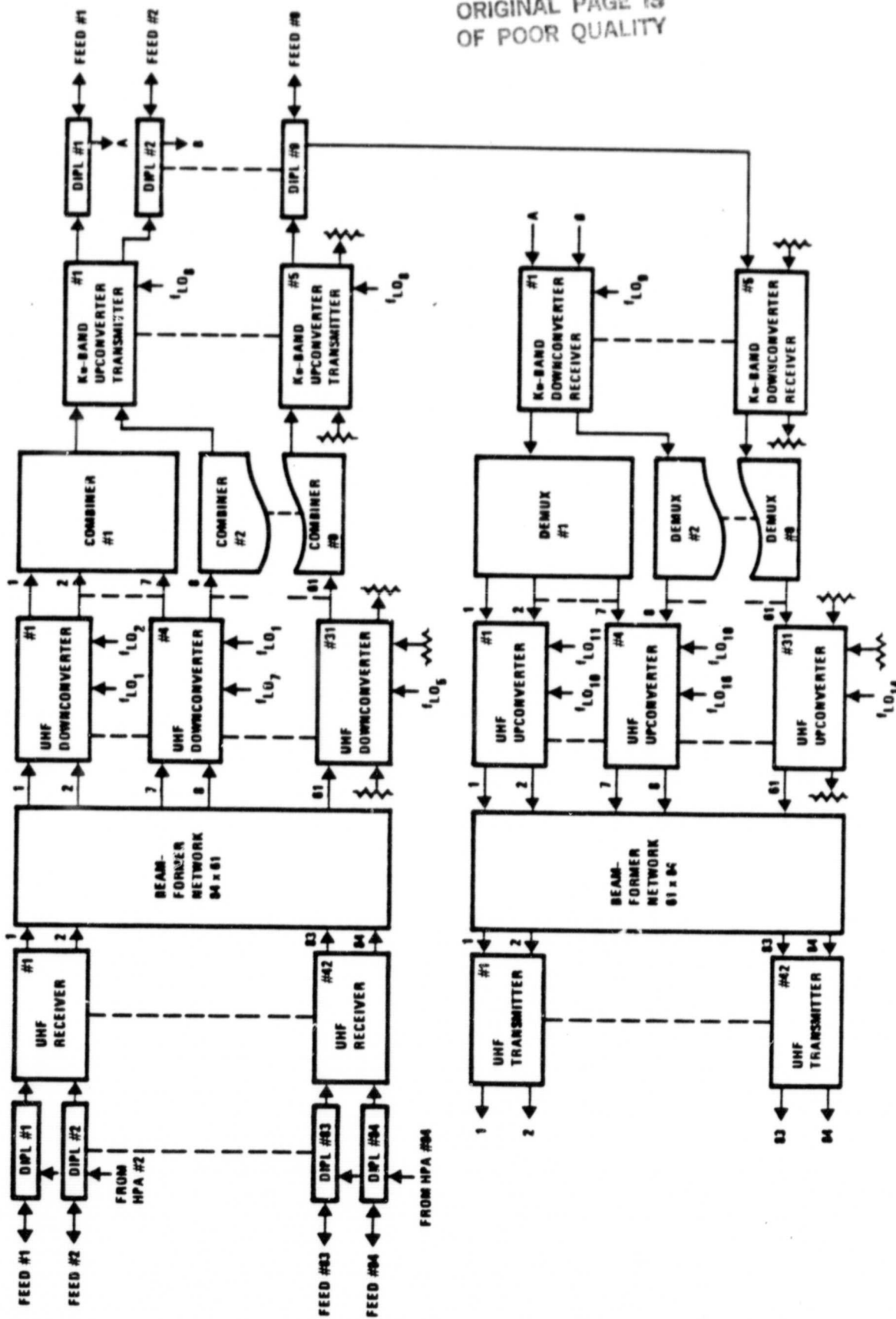

Figure G-2. Satellite Repeater Block Diagram
(Offset-Fed Design, 3x2 Redundancy)

Table G-3. Weight of UHF Electronics

	<u>OFFSET-FED</u>	<u>CENTER-FED</u>
DIPLEXER (PER PAIR OF FEEDS)	2 LB	2 LB
UHF DOWNCONVERTER/RECEIVER (PER 3 x 2 REDUNDANT PAIR)	1	1
UHF UPCONVERTER/TRANSMITTER (PER 3 x 2 REDUNDANT PAIR)	7	4
TOTAL (PER PAIR OF FEEDS)	10	7
NO. OF FEEDS	84	150
UHF ELECTRONICS	420	525
OTHER	<u>35</u>	<u>35</u>
TOTAL	455 LB	560 LB

ORIGINAL PAGE IS
OF POOR QUALITY

The weight of the beamformer network is assumed to be proportional to the structure area. For the offset-fed design, therefore, the JPL weight of 4 lb/feed-element was taken as directly applicable. On the other hand, the feed-array dimensions for a center-fed reflector are only half those for an offset-fed reflector of the same size. In this case, the beamformer network weight was taken as 1 lb/feed-element.

RF and DC cabling was taken as 3 lb/feed-element for the offset-fed design and 2.33 lb/feed-element for the center-fed design. Thus, only a slight area dependence was attributed to these cables.

Thermal control subsystem weight is a function of the heat that must be radiated from the feed assembly. Heat pipes and radiators were selected since a passive system would not suffice. Radiator area and thermal subsystem weight are shown in Figure G-3. Assumptions incorporated into these curves include:

1. Equipment maintained at $25^{\circ} \pm 15^{\circ}\text{C}$
2. Fin efficiency of 0.8 (a compromise between weight and area)
3. Silver teflon radiator surfaces: $\alpha = 0.3$ at EOL, $\epsilon = 0.76$
4. 5°C rise between radiator and equipment
5. Weights include honeycomb, saddles, heat pipes, and skins.

With 25-percent DC/RF transmitter efficiency, the radiators must reject 1230 watts for the center-fed design and 2355 watts for the offset-fed design. The respective radiator areas are 80 ft^2 and 120 ft^2 , while the thermal sub-system weights are 270 and 440 pounds.

The area of the feed structure is a function of the reflector diameter and the f/D ratio. The feed array is irregularly shaped, corresponding to the outline of CONUS. The structure weight is given in Figure G-4, based on a per-unit weight of 1 lb/ft^2 .

Attitude Control System

The attitude control system (ACS) must determine and control satellite attitude and position. It must nod the satellite to compensate for the absence of north-south stationkeeping, maintain beam pointing within 1/4 beamwidth (approximately 0.1 degree), and store momentum due to solar

ORIGINAL PAGE IS
OF POOR QUALITY

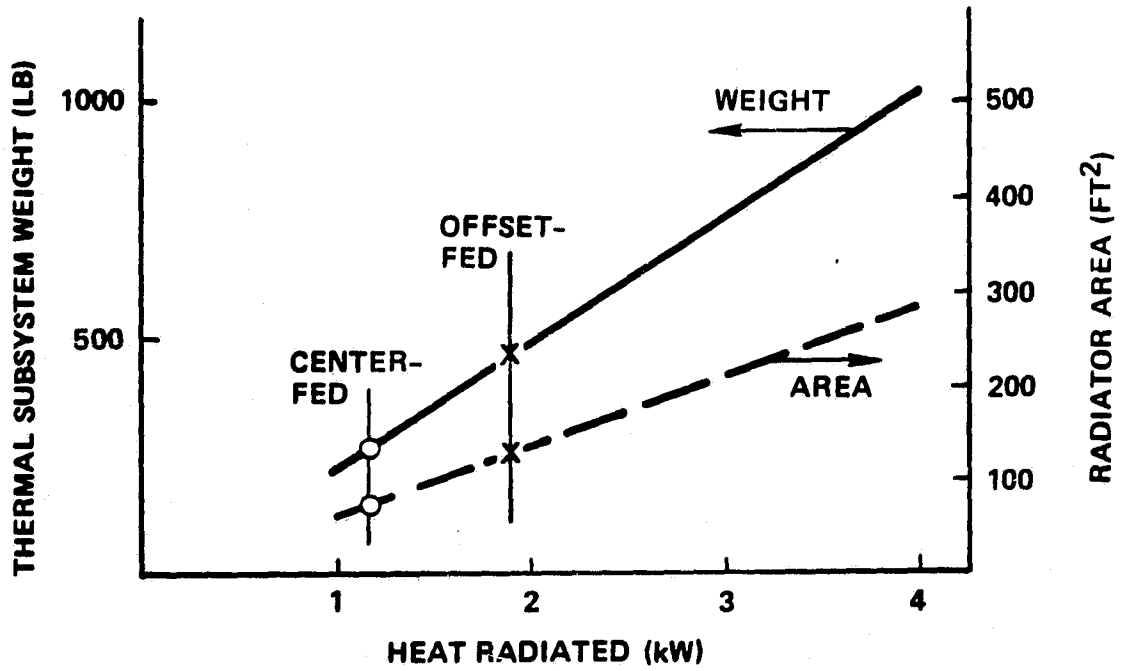

Figure G-3. Thermal Control of UHF Feed Assembly

ORIGINAL PAGE IS
OF POOR QUALITY

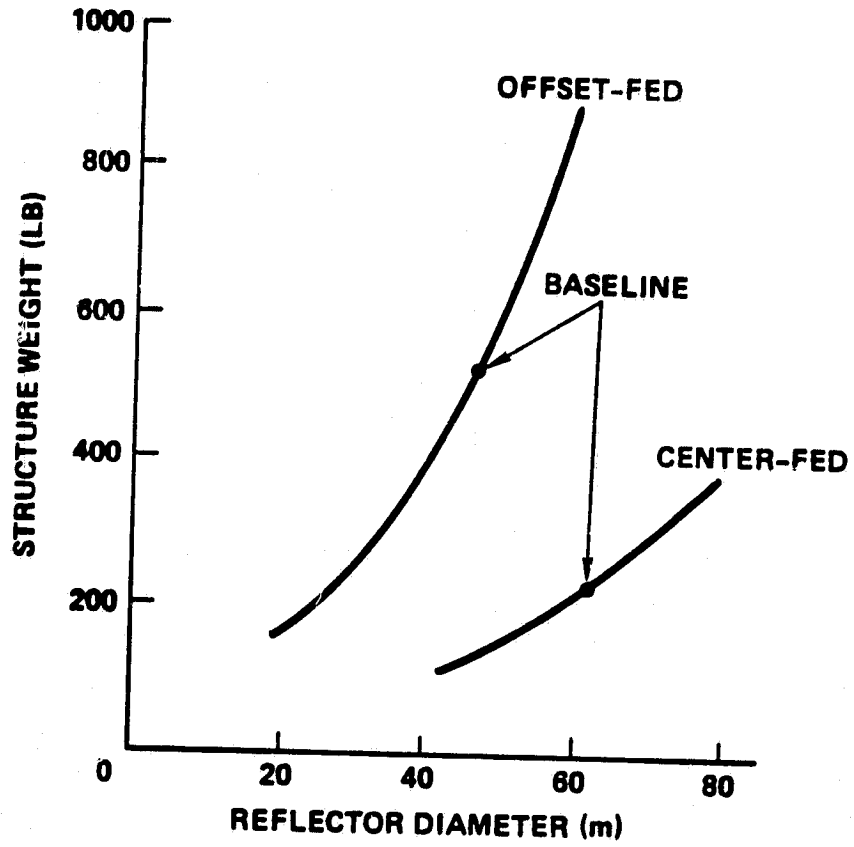

Figure G-4. UHF Feed-Assembly Structure Weight

pressure, gravity gradient, and other sources. Sun sensors, star sensors, rate gyros, and electronics (based on current technology) are used for attitude determination. The solar-array drive is also current technology. These items will be the same for both baseline designs.

Momentum due to satellite disturbances is stored in CMGs, which are unloaded by the reaction control system (RCS) when they become saturated. Figure G-5 shows the baseline weight of the various components (taken from the Space Platform Study) and the CMG weight as a function of reflector diameter. The large difference between the center-fed and offset-fed designs results from the asymmetry of the latter, which produces larger gravity-gradient and solar-pressure torques.

Reaction Control System

The RCS provides the ΔV for initial injection-error correction, collision avoidance, and east-west stationkeeping. The ΔV requirements are independent of satellite configuration and size; consequently, the propellant needed depends only on satellite weight. The RCS also provides the torque for unloading the wheels and for correcting the ellipticity of the orbit caused by solar pressure. The propellant required for these two functions does depend on satellite size and configuration.

Orbit ellipticity due to solar pressure is accentuated by the large UHF antenna area. When the satellite is approaching the sun, the retarding force due to solar pressure slows the satellite, thereby lowering the altitude in the opposite half of the orbit. Conversely, when the satellite is receding from the sun, solar pressure tends to speed up the satellite, thus increasing the altitude in the original half of the orbit. This continued action causes a circular orbit to become elliptical, with the different velocities at apogee and perigee producing an apparent east-west motion that must be corrected.

Figure G-6 shows the weight of the complete RCS system, including the hydrazine, tanks, thrusters, and piping. The hardware weight is assumed to be approximately 22 percent of the total weight.

Thermal Control System (Body)

The body thermal control system must dissipate approximately 600 watts of power. Another 100 watts is allowed for heaters in the cold condition.

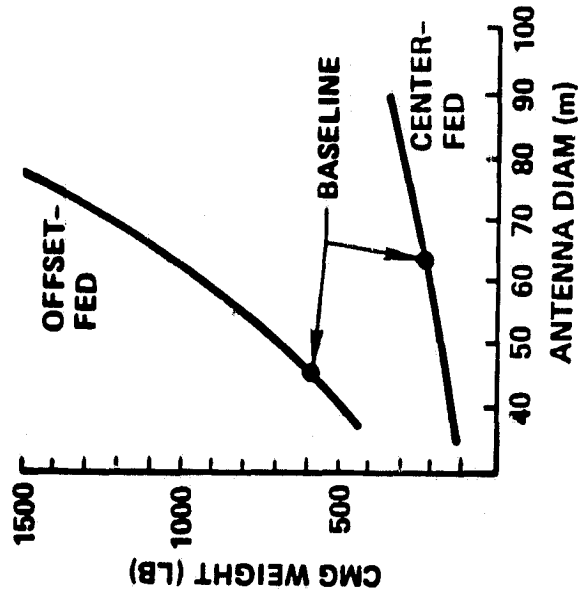

ELEMENT	CENTER-FED	OFFSET-FED
SUN SENSORS, STAR SENSORS, RATE GYROS, ELECTRONICS (CURRENT TECHNOLOGY)	90 LB	90 LB
SOLAR ARRAY DRIVE	70	70
CONTROL MOMENT GYROS (BENDIX SKYLAB)	200	600
SENSOR SYSTEM	70	70
TOTAL	430 LB	830 LB

Figure G-5. Attitude Control Subsystem Weight

ORIGINAL PAGE IS
OF POOR QUALITY

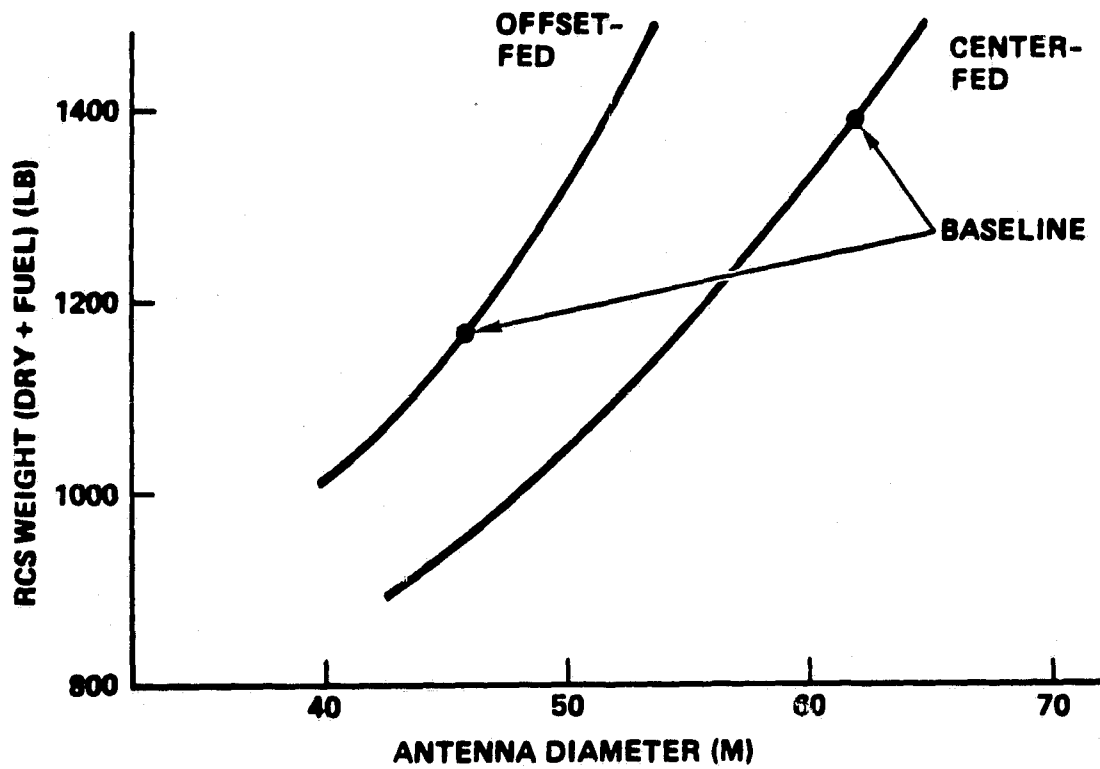

Figure G-6. Reaction Control Subsystem Weight

Thermal control can be done passively with insulation, paint, and conduction paths. A weight of 100 pounds is assumed for these items, including heaters.

Electrical Power

The electrical power subsystem must supply the communications payload and the supporting subsystems with electrical power to operate during daylight and eclipse. Power is generated by solar arrays during daylight and stored in NiH₂ batteries for use during eclipse.

Table G-4 shows the payload power requirements during both the busy hour and eclipse, as well as the power requirements for the various subsystems. (Battery charge and margin are excluded.) The payload power is obtained by applying a DC/RF conversion factor of 0.25 and a regulation factor of 1.15 to the "equivalent" RF power for the satellite as a whole.

The latter quantity is introduced to avoid, at this level of analysis, the difficult question of how the DC power on a per-beam basis varies with beam loading. Equivalent RF power is defined as the product of the RF power for a fully loaded beam (corresponding to maximum subscriber density) and the number of beam equivalents needed to cover CONUS. The equivalent RF power during the busy hour is found to be 440 watts for the center-fed design and 720 watts for the offset-fed design. The corresponding values of payload power are larger by 18 percent and 10 percent, respectively, than those indicated in Table G-4. As a result, the EPS weight is understated by about 50 pounds and 30 pounds in the two cases.

It is assumed that during the 1.2 hours of eclipse, which occurs around midnight, the payload DC power requirement falls to 25 percent of its busy-hour value because of the reduced traffic level.

A computer program was developed to calculate battery and solar array sizes and weights. This program takes account of the battery-charging power requirements and the 10-percent margin. It computes array requirements at both solstice and equinox, and accounts for radiation degradation at geo-synchronous altitude.

Both GaAs and thin silicon cells were considered for the solar array. Thin silicon cells of 15-percent efficiency, as proposed for MILSTAR, were

ORIGINAL PAGE IS
OF POOR QUALITY

Table 6-4. Electrical Power Requirements

	<u>CENTER-FED</u>	<u>OFFSET-FED</u>
● PAYLOAD POWER		
— BUSY HOUR	1700 W	3000 W
— ECLIPSE	425 W	750 W
● SUBSYSTEM POWER		
— DATA HANDLING		150 W
— Ku-BAND ELECTRONICS		150
— ATTITUDE CONTROL		250
— ELECTRICAL POWER		50
— HEATERS		100
— TOTAL		700 W
● TOTAL POWER REQUIREMENT		
— BUSY HOUR*	2400 W	3700 W
— ECLIPSE	1125 W	1450 W

*DOES NOT INCLUDE MARGIN (10%) AND BATTERY CHARGE

selected to reduce cost and risk. An array specific weight of 0.63 lb/ft² was assumed. This is the value on TRW's TDRS array; it results in a specific power of 60 W/kg.

NiH₂ batteries were chosen over NiCd because of the large weight saving and greater temperature tolerance. A battery specific-energy-density of 66 W-H/Kg was used for sizing purposes.

Additional weights associated with the solar array include the interfacing weight (50 pounds) and the mast weight (1 lb/ft).

In addition to the solar array and battery, the power system includes components such as battery charger, power distribution unit, and power control unit. The combined weight of these components was taken as 130 pounds, based on a comparison with Space Platform requirements.

Table G-5 summarizes the electrical power system, showing beginning-of-life (BOL) and 7-year end-of-life (EOL) array capability, array area, number and size of batteries, and system weights. The battery was sized for a depth of discharge (DOD) of 54 percent with all three batteries operating, and for 80 percent with one battery failed. This is within the limits of NiH₂ cells. A 10-percent increase in battery size (≈10 lb) would provide 50- and 75-percent DOD for the 3- and 2-battery conditions, respectively.

Electrical Cabling

Electrical cabling can represent a sizable weight. Cabling weights on several existing satellites were reviewed and a value of approximately 100 lb/kW was obtained. However, these examples do not include cases where the array is located at a distance from the bus or where power must be distributed over a large area like the feed array.

The weight of cabling associated with the feed array has been included with the feed assembly. The specific weight of cables from the array to the bus was taken as 1 lb/ft. The offset-fed configuration has a relatively short distance of 40 feet from the mast to the bus. The center-fed array, which is behind and above the reflector to prevent shadowing, requires 100 feet of cable to reach the antenna hub and another 150 feet to reach the bus, for a total of 250 feet.

Table G-5. Electrical Power System Sizing

	<u>CENTER-FED</u>	<u>OFFSET-FED</u>
TOTAL ARRAY LOAD - BOL	3520 W	5400 W
TOTAL ARRAY LOAD - EOL	2900 W	4390 W
ARRAY AREA*	280 FT ²	320 FT ²
ARRAY WEIGHT*	170 LB	200 LB
INTERFACING WEIGHT	50 LB	50 LB
MAST WEIGHT	100 LB	40 LB
BATTERY SIZE	30 AH	36 AH
NO. OF BATTERIES	3	3
BATTERY WEIGHT	90 LB	110 LB
ARRAY AND BATTERY WEIGHT	410 LB	400 LB
ELECTRICAL EQUIPMENT WEIGHT	130 LB	130 LB
TOTAL EPS WEIGHT	540 LB	530 LB

*25% LOSS ASSUMED FOR CENTER-FED DESIGN DUE TO CABLE LENGTH FROM ARRAY TO BUS

ORIGINAL PAGE IS
OF POOR QUALITY

The EOL array power is a measure of the power that must be distributed to the bus components. Using the values of EOL array power in Table G-5, a total cable weight of 540 pounds is found for the center-fed design and 480 pounds for the offset-fed design.

Structure and Integration

The bus structure involves conventional aluminum construction and, possibly, graphite composites in some areas to reduce weight. The structure and integration requirements were assumed to be 11 percent of the weight of all other components or, equivalently, 10 percent of the total satellite weight.

APPENDIX H
TECHNOLOGY DEVELOPMENT PLAN COST ESTIMATES

Cost estimates for the various phases of the technology development plan are presented in Tables H-1 and H-2. A variety of methods was used to obtain these estimates. The cost of major hardware elements (i.e., reflector and mast) is based on vendor quotes. Other hardware, such as the ACS and measurement system, was costed by a combination of engineering estimates and cost estimating relationships (CER) with other development efforts. Test costs were derived from a bottoms up estimate.

The development of satellite antenna technology was obtained largely by analogy with the 30/20 GHz antenna development performed at TRW. Factors taken into account include similarities between developments (e.g., feed cluster approach to beam formation), physical extent of feed array, and duration of development program.

The following ground rules were observed in developing the cost estimates:

- All costs in 1982 dollars
- No fee included in costs
- Estimates based on wrap-rib design only
- No costs included for the basic ground facility, which is assumed to be available for other large space structure activities in the mid-80s
- No STS pallet costs included.

Development costs for the structures and control technology is presented in a manner that permits integrated development of the four key technology areas, yet still allows for a gradual implementation short of the total flight program. The four technologies are:

- 1) Mast design and assembly, including ground structural and dynamic testing
- 2) Reflector design and assembly, including ground structural, dynamic, and thermal testing

- 3) ACS controller development and assembly of the STS flight experiment controller
- 4) Laser measurement system development and assembly of the STS flight experiment system.

Integrated testing consists of the following two phases:

- 1) Ground integrated testing of the mast, reflector, ACS controller, and measurement system. This qualifies the antenna system for STS flight testing. This test provides the baseline data to be compared with zero-g testing.
- 2) STS integration and flight testing, including all safety, data acquisition, and experiment control electronics and structure.

For the RF technology development, the analysis needed to design the frequency-scaled feed/beamformer is shown as a separate cost item.

Development of the scale model is an iterative process, between analysis and test, which leads to RF validation of the selected concept. The full-scale breadboard development verifies RF integrity of the feed array in an operational environment, including the effects of the deployment process.

**ORIGINAL PAGE IS
OF POOR QUALITY**

Table H-1. Structures and Control Technology Development Plan Cost (\$82M)

● PROGRAM LEVEL	7.4
● MAST (GROUND STRUCT/MECH TESTING)	
– DUMMY MAST	0.2
– FULL-SCALE SHORT MAST	2.1
– AI&T	<u>1.2</u>
TOTAL	3.5
● REFLECTOR (GROUND STRUCT/MECH TESTING)	
– FULL-SCALE 4 RIBS	0.3
– 1/3 SCALE REFLECTOR	7.0
– AI&T	<u>1.2</u>
TOTAL	8.5
● ACS	3.8
● MEASUREMENT SYSTEM	3.8
● GROUND INTEGRATED ANTENNA TEST (AI&T)	1.7
● STS FLIGHT TEST	
– ASE ELECTRONICS	3.4
– ASE STRUCTURE	1.0
– GROUND SUPPORT EQUIPMENT	0.5
– AI&T	<u>1.1</u>
TOTAL	6.0
TOTAL	34.7

Table H-2. RF Technology Development Plan Cost (\$82M)

● PROGRAM LEVEL	1.2
● MAST	0.8
● FEED/BEAMFORMER	
– ANALYSIS/SIMULATION	0.5
– FREQ-SCALED BREADBOARD	1.5
– FULL-SCALE BREADBOARD	<u>2.0</u>
TOTAL	4.0
TOTAL	6.0