

## THE IMAGING SPECTROMETER APPROACH

### Executive Summary

John B. Wellman

Jet Propulsion Laboratory

California Institute of Technology

May 11, 1982

### SUMMARY OF CONCLUSIONS

(1) A need for advanced multispectral capabilities has been defined by a significant segment of the discipline groups. Needs include multiple spectral bands, high spectral resolution, and the ability to tailor the band choices for the research application.

(2) Two important design drivers are the requirement for spatial registration of the spectral components and the implementation of the advanced multispectral capability, including spectral band width, number of bands and programmability.

(3) The dispersive approach, fundamental to the Imaging Spectrometer concept, achieves these capabilities by utilizing a spectrometer to disperse the spectral content while preserving the spatial identity of the information in the cross-track direction. Area array detectors in the spectrometer focal plane detect and store the spatial and multispectral content for each line of the image. The choice of spectral bands, image IFOV and swath width is implemented by programmed readout of the focal plane. These choices in conjunction with data compression are used to match the output data rate with the telemetry link capability.

(4) Progress in the key technologies of optics, focal plane

detector arrays, onboard processing and focal plane cooling supports the viability of the Imaging Spectrometer approach. Continued support of the current technology development activities will permit the implementation of a space flight system in the late 1980's.

### THE NEED FOR ADVANCED MULTISPECTRAL CAPABILITIES

Differing observational requirements of the several discipline groups combine to justify an advanced capability. Several disciplines, which can be individually satisfied with a few spectral bands, require different sets of bands, thereby necessitating a wide variety of bands to choose from. Other measurement goals are optimized by making the spectral bands narrow. The problem of removing atmospheric effects from multispectral data sets may necessitate additional spectral bands to characterize the atmospheric contribution. Finally, there is a need to explore the accessible spectral regions to determine the most useful bands. These needs can be met by a programmable sensor which possesses sufficient granularity in spectral band selection to exploit the known spectral signatures and to explore new spectral characteristics.

### KEY DESIGN DRIVERS

The parameters of IFOV, swath width, radiometric sensitivity (NE $\delta$ R), and data rates determine the system design of land remote sensing systems in general. Spatial registration of the multispectral samples is extremely critical in discriminating among instrument approaches. In critically sampled MLA-type systems a fundamental loss in multispectral information occurs when the misregistration exceeds about 0.3 pixels. In the range from 0.3 to 1.0 pixels, resampling will not produce a significant improvement. For misregistration greater than 1.0 pixel, resampling will improve quality, but not the level of completely registered data.

For advanced multispectral systems with high spectral resolution capability, three considerations are critical -- the spectral band width (or granularity), the number of spectral bands, and the spectral programmability

of the instrument. With the NEdR specification, spectral band width determines the required system aperture, a major determining factor in instrument size and cost. The number of bands directly influences data rate. Programmability implies complexity in the onboard electronics.

### THE DISPERSIVE IMAGING APPROACH

A variety of Imaging Spectrometer instrument concepts are under study ranging from aircraft instruments with limited imaging capability (Airborne Imaging Spectrometer) to free-flying spacecraft-borne systems capable of meeting both research and operational needs. An intermediate design suitable for space shuttle and possible space platform application is described in the attached viewgraphs and paper (Imaging Spectrometer Technologies for Advanced Earth Remote Sensing, Wellman, et al, Paper No. 345-04, Proceedings of the Society of Photo-Optical Instrumentation Engineers, May 6, 1982).

The instrument provides 20 nanometer spectral resolution over the wavelength range from 0.4 to 2.5 micrometers with 10m IFOV in the VNIR and 20m IFOV in the SWIR. A 60 km swath width is obtained from 300 km. Although internal data rates are high, a wide variety of multispectral imaging modes can be commanded within the data rate constraints imposed by the Shuttle and TDRSS.

### PROGRESS IN KEY TECHNOLOGIES

As part of this program the key technologies of optics, focal plane detector arrays, onboard processing and focal plane cooling are being developed.

An optical design concept centered on a multiple-pass Schmidt system has been shown to satisfy the spatial and spectral resolution requirements. Linearization of prism dispersion is accomplished by using a multiple element prism. Breadboarding of critical elements is planned.

Planar hybrid HgCdTe area arrays of 32 by 32 format have been fabricated and tested. Development of 64 by 64 element mosaickable arrays for the 1.0 to 2.5 micrometer region has begun. An alternative technology using InSb has been demonstrated with 128 element linear arrays. The extension to area arrays is planned.

The Block Adaptive Rate Controlled (BARC) data compression algorithm implemented for the Galileo mission to Jupiter has been modified and demonstrated with representative terrestrial scenes. Electronics for the programmable readout of area array detectors and real-time radiometric calibration restoration are being breadboarded for use with the existing HgCdTe SWIR arrays.

A radiative cooler suitable for free-flying missions has been designed and analyzed. A new approach -- the adsorption refrigerator -- has been chosen for study in connection with a shuttle mission. This cooler provides closed cycle cooling over a wide range of temperatures without the concern of limited lifetimes attendant to mechanical compressors.

Progress in these technologies is sufficient to project flight readiness in the late 1980's.

## THE IMAGING SPECTROMETER APPROACH

- o MAJOR CONCLUSIONS
- o THE REGISTRATION ISSUE
- o DESIGN SPACE FOR I. S. SYSTEMS
- o AN EXAMPLE: SHUTTLE IMAGING SPECTROMETER
- o REMARKS ON TECHNOLOGY READINESS

## MAJOR CONCLUSIONS

- o NEEDS FOR ADVANCED MULTISPECTRAL CAPABILITIES NOTED:
  - MULTIPLE BANDS
  - HIGH SPECTRAL RESOLUTION
  - PROGRAMMABILITY
- o SPECTRAL CAPABILITY KEY DESIGN DRIVER
  - REGISTRATION
  - DEFINITION OF SPECTRAL SELECTION FEATURES
- o VIABLE DISPERSIVE IMAGING APPROACH UNDER DEVELOPMENT
- o PROGRESS IN KEY TECHNOLOGIES SUPPORTS THE APPROACH

## ISSUES

### SPATIAL REGISTRATION OF MULTISPECTRAL DATA SETS

QUESTION: BY WHAT AMOUNT CAN SEPARATE SPECTRAL SAMPLES BE MIS-REGISTERED WITHOUT DEGRADING THE INHERENT QUALITY OF THE DATA

SUGGESTED ANSWER:

- (1) FOR MISREGISTRATION LESS THAN 0.1 TO 0.3 PIXELS THE DATA MAY BE USED DIRECTLY FOR CLASSIFICATION WITH LITTLE DEGRADATION FROM 0-PIXEL MISREGISTRATION
- (2) FOR MISREGISTRATION OF THE ORDER 0.3 - 1.0 PIXELS A SIGNIFICANT LOSS IN CLASSIFICATION ACCURACY (10%) WILL OCCUR. RESAMPLING WILL NOT PRODUCE A SIGNIFICANT IMPROVEMENT

ISSUES (CONT)

- (3) FOR MISREGISTRATION GREATER THAN 1 PIXEL, RESAMPLING CAN IMPROVE CLASSIFICATION ACCURACIES TO THE LEVEL INDICATED IN (2), WITHOUT RESAMPLING ERRORS OF 10 TO 30% WILL OCCUR.

REFERENCES:

- (1) SWAIN, P. H., VANDERBILT, V. C., JOBUSCH, C. D., "A QUANTITATIVE APPLICATIONS-ORIENTED EVALUATION OF THEMATIC MAPPER DESIGN SPECIFICATIONS," 1981 INTERNATIONAL GEOSCIENCE AND REMOTE SENSING SYMPOSIUM, WASHINGTON, D.C., JUNE 8-10, 1981, P820.
- (2) ROOT, G. R., "REGISTRATION BETWEEN SPECTRAL BANDS," APPENDIX A, IN APPLICATION OF SOLID STATE ARRAY TECHNOLOGY TO AN OPERATIONAL LAND-OBSERVING SYSTEM, JPL DOCUMENT 715-82, OCT 31, 1980.



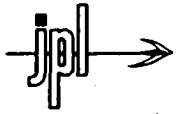

# COMPARISON OF LAND REMOTE SENSING SYSTEMS

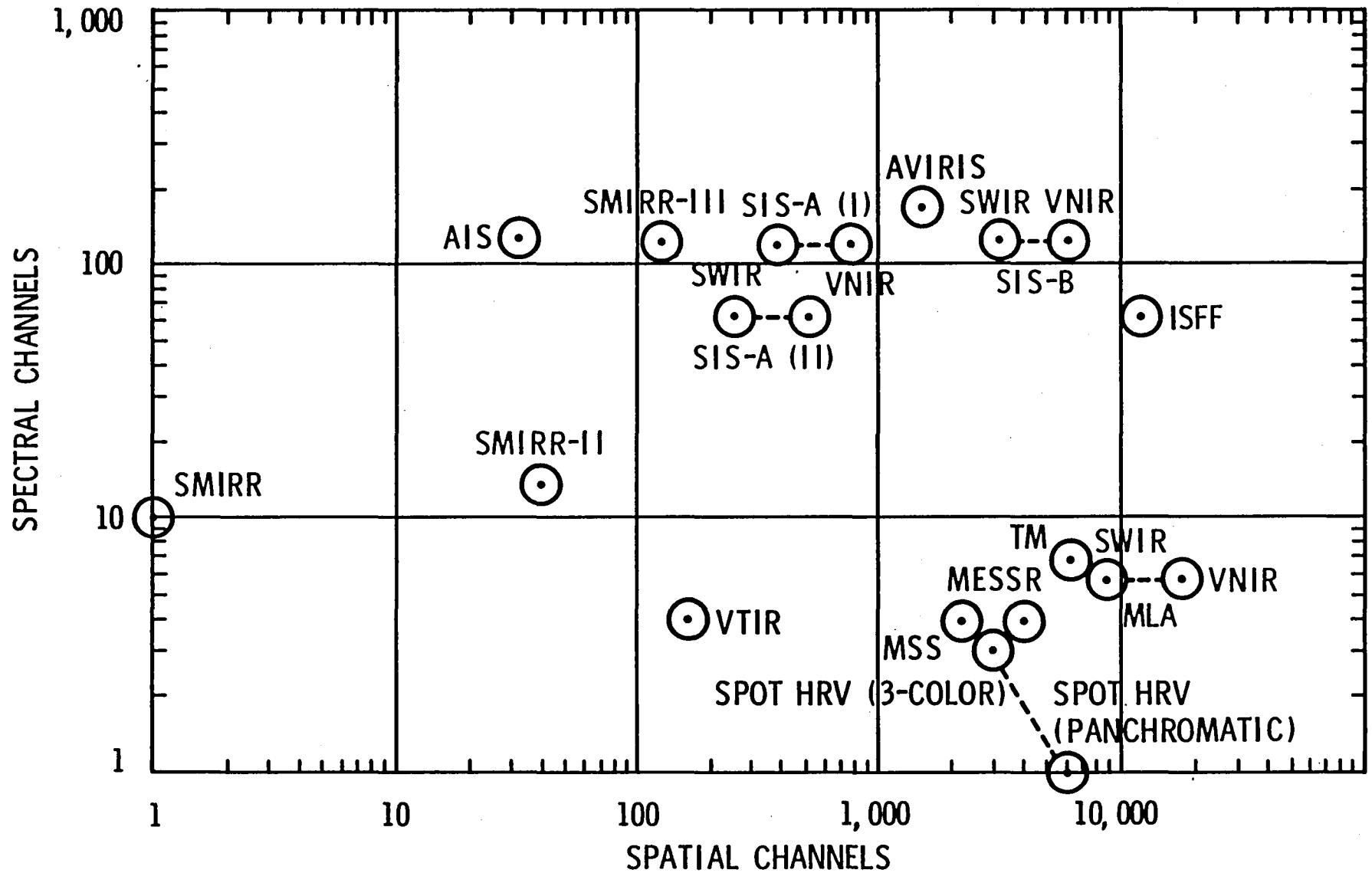



# LAND REMOTE SENSING SYSTEM INDEX

## INSTRUMENTS FLOWN

**MSS** – MULTI-  
SPECTRAL  
SCANNER  
SYSTEM  
(LANDSATS  
1-3)

**SMIRR** – SHUTTLE  
MULTI-  
SPECTRAL  
RADIOMETER  
(SHUTTLE  
OSTA-2)

## INSTRUMENTS UNDER DEVELOPMENT

**TM** – THEMATIC  
MAPPER  
(1982)

**SPOT** – HRV –  
SYSTEME  
PROBATOIRE  
d'OBSERVA-  
TION DE LA  
TERRE (1984)

**MESSR** – MULTI-  
SPECTRAL  
ELECTRONIC  
SELF-SCAN-  
ING RADIO-  
METER  
(1985)

**VTIR** – VISIBLE AND  
THERMAL  
INFRARED  
RADIOMETER  
(1985)

## INSTRUMENT CONCEPTS

**MLA** – MULTI-  
SPECTRAL  
LINEAR  
ARRAY  
(1987-)

**SIS** – SHUTTLE  
IMAGING  
SPECTRO-  
METER  
(A: 1987-)  
(B: 1989-)

**ISFF** – IMAGING  
SPECTRO-  
METER  
FREE-  
FLYER  
(1980-)

**SMIRR** – SHUTTLE  
MULTI-  
SPECTRAL  
INFRARED  
RADIO-  
METER  
(II: 1885-)  
(III: 1887-)

## AIRCRAFT INSTRUMENTS

**AIS** – AIRBORNE  
IMAGING  
SPECTRO-  
METER  
(1982)

**AVIRIS** – ADVANCED  
VISUAL AND  
INFRARED  
IMAGING  
SPECTRO-  
METER  
(1985)

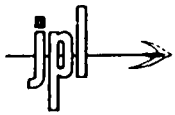

## PERFORMANCE REQUIREMENTS

PARAMETER	VALUE	
	VNIR	SWIR
GROUND IFOV, m	10	20
SPECTRAL RESOLUTION, nm	20	20
SWATH WIDTH, km	60	60
RADIOMETRIC PRECISION, PERCENT	0.5	1.0

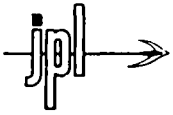

# DISPERSIVE IMAGING TECHNIQUE

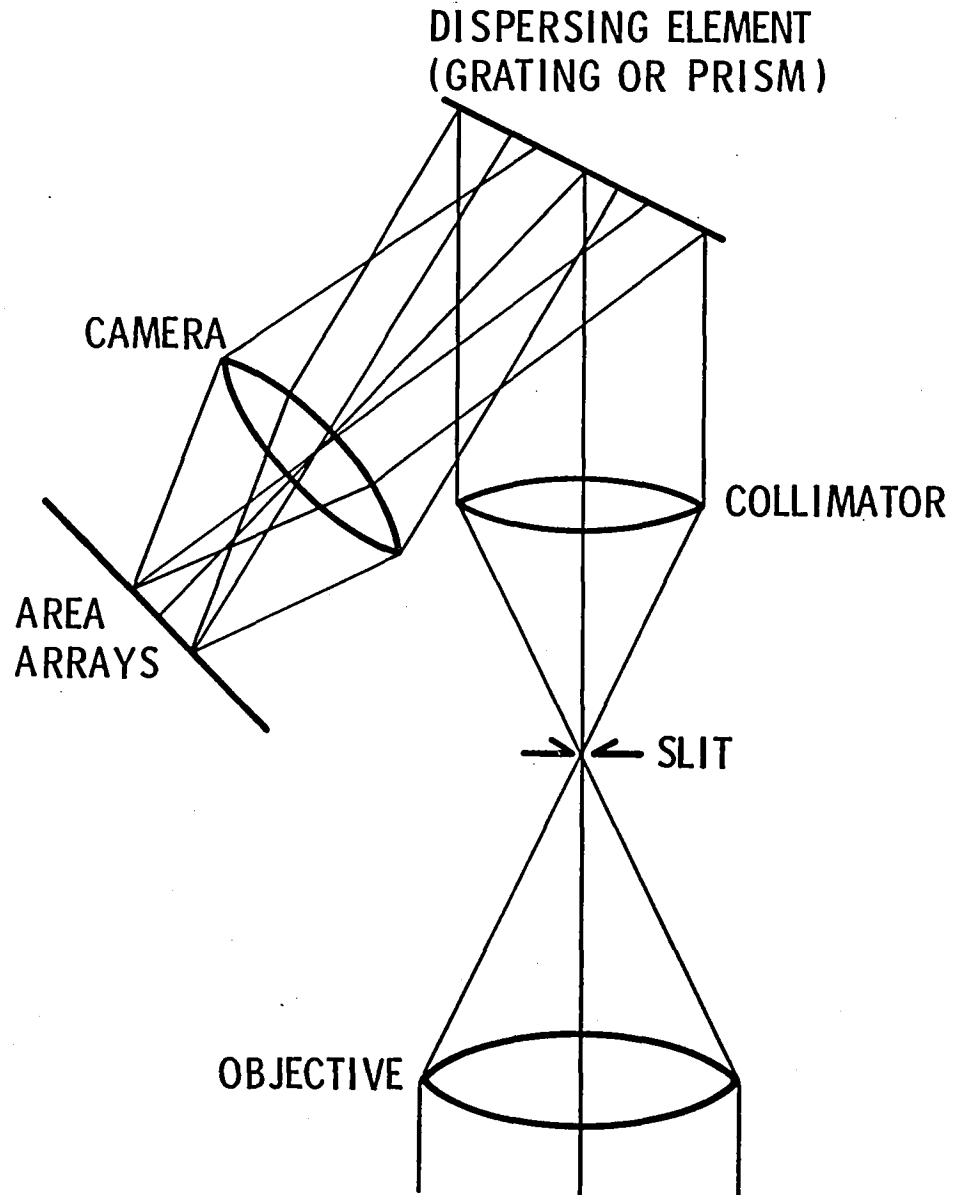

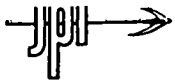

# IMAGING SPECTROMETER CONCEPT



OBJECT SPACE

DURING ONE LINE TIME: ONE LINE OF THE SCENE IS TRANSFORMED INTO MANY LINE IMAGES AT DIFFERING WAVELENGTHS

← SPATIAL INFORMATION →

$x_1, x_2$  -----

-----  $x_n$

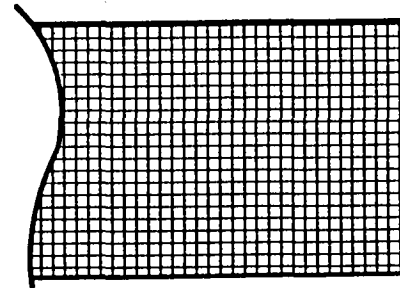
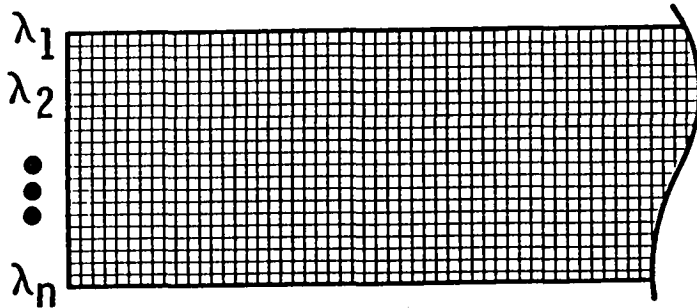

BAND 7

BAND 6



BAND 1

IMAGE SPACE

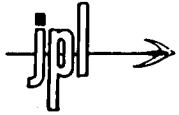

## **IN-FLIGHT FUNCTIONAL CAPABILITIES**

- **SPECTRAL BAND SELECTION**

THE NUMBER, CENTRAL WAVELENGTH AND SPECTRAL BANDWIDTH OF THE CHANNELS MAY BE SELECTED AND VARIED ACCORDING TO USER CHOICES

- **ONBOARD RADIOMETRIC CORRECTION AND REGISTRATION**

DATA COMPRESSION AND ADVANCED INFORMATION PROCESSING CAN BE APPLIED TO THE DATA, PRODUCING INFORMATION-INTENSIVE TELEMETRY

- **SELECTABLE IFOV**

VARIOUS IFOV'S MAY BE COMMANDED TO INVESTIGATE DIFFERING RESOLUTIONS, TO MATCH TELEMETRY CAPABILITIES, OR TO PROVIDE A LOW-RESOLUTION LOW DATA RATE CHANNEL

- **SELECTABLE SWATH WIDTH**

COMBINED WITH SELECTABLE SWATH WIDTH A VARIETY OF TARGET CHOICE AND VIEWING PARAMETER SELECTIONS CAN BE MADE WITHIN A LIMITED TELEMETRY CAPABILITY



# IMAGING SPECTROMETER OPTICAL CONCEPT

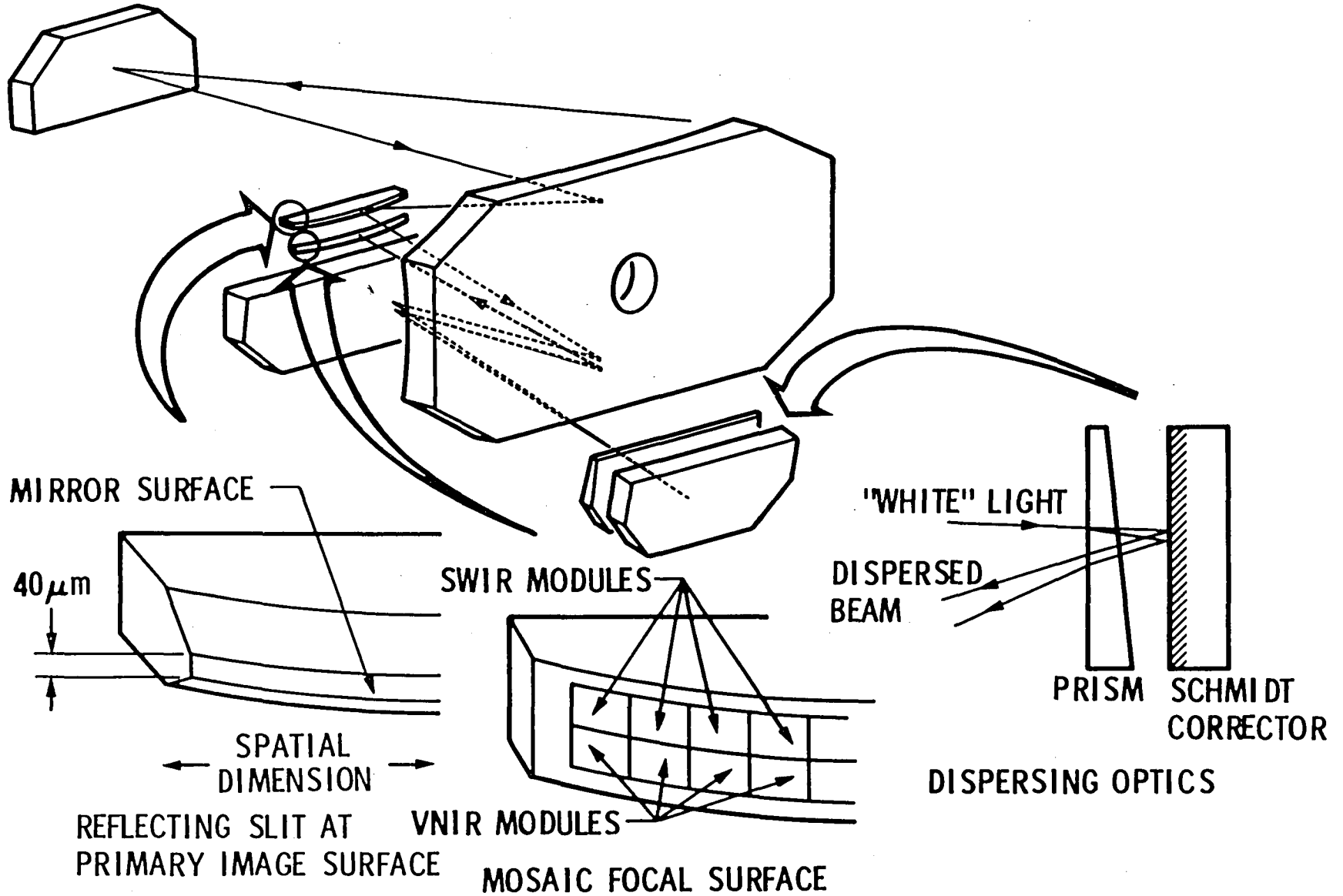

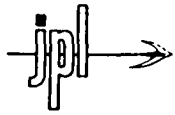

## DESIGN CHARACTERISTICS

PARAMETER	VALUE
EQUIVALENT APERTURE DIAMETER, cm	30
TELESCOPE FOCAL LENGTH, cm	120
PHYSICAL SLIT WIDTH, $\mu\text{m}$	40
GROUND-PROJECTED SLIT WIDTH, m	10
ALTITUDE, km	300
SWATH WIDTH, km	61.44
DETECTOR SIZE (pixel), $\mu\text{m}$	40 x 40
LINE TIME (FOR 10 m IFOV), ms	1.385
ENCODING, bits/pixel	8
RAW DATA RATE (VNIR), bits/s	$2.27 \times 10^9$
(SWIR), bits/s	$0.57 \times 10^9$
(Total), bits/s	$2.84 \times 10^9$



### SAMPLE IMAGING MODES AND DATA RATES

CHANNELS	VNIR		CHANNELS	IFOV (M)	SWATH WIDTH (KM)	DATA RATES (1)	
	IFOV (M)	IFOV (M)				@ 8 BITS/PIXEL (MB/s)	@ 3.2 BITS/PIXEL (2) (MB/s)
1	10	-	-	-	60	35.5	14.2
-	-	1	20	-	60	8.9	3.6
4	10	2	20	-	60	159.8	63.9
3	10	3	20	-	60	133.2	53.3
2	10	4	20	-	60	106.6	42.6
4	10	2	20	-	45	117.4	46.9
6	20	-	-	-	60	53.4	21.4
(3) 12	30	-	-	-	60	47.3	18.9

(1) LIMIT FOR FREE-FLYER WITH TDRSS IS 300 MB/s; FOR SHUTTLE, 50 MB/s

(2) BLOCK ADAPTIVE RATE CONTROLLED (BARC) DATA COMPRESSION OF 2.5:1 ASSUMED

(3) REQUIRES CHANGE TO IMAGING SPECTROMETER BASELINE DEFINITION

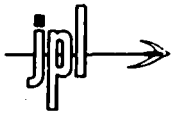

# RADIOMETRIC PERFORMANCE CHARACTERISTICS OF THE SIS

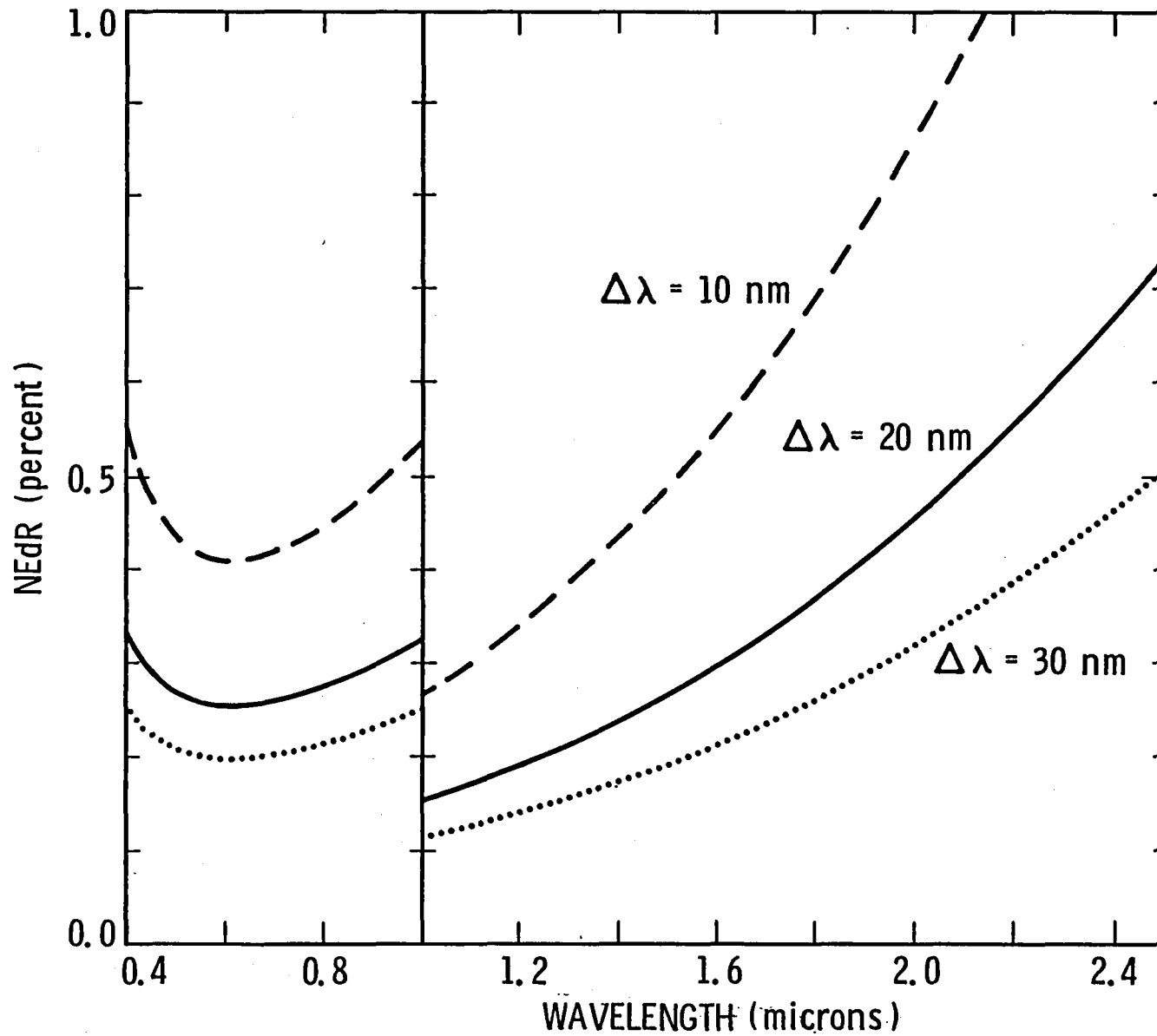

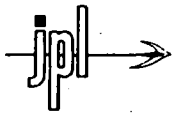

# OPTICAL CONFIGURATION

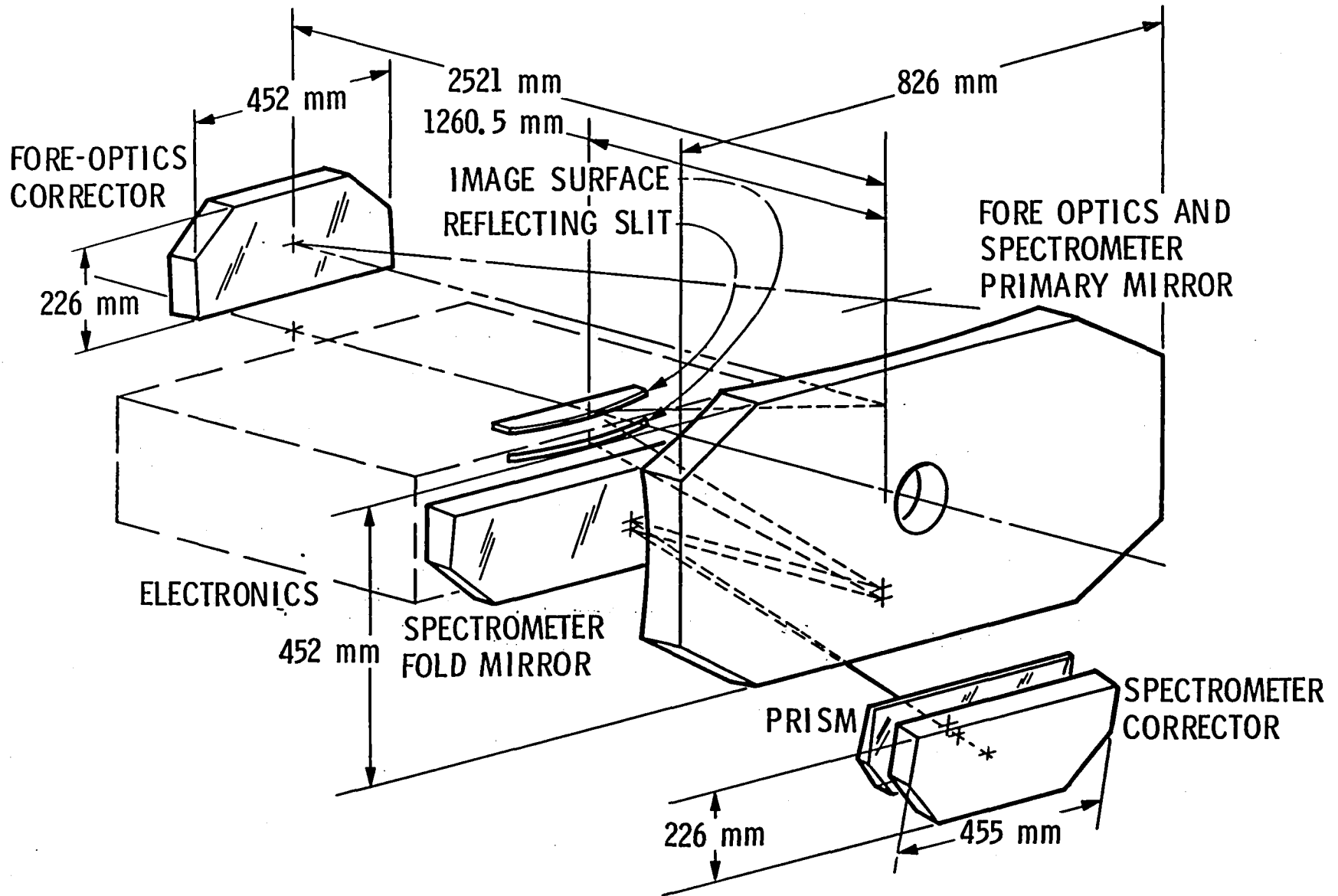

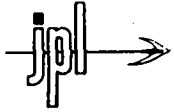

# OPTICAL POINT SPREAD FUNCTIONS

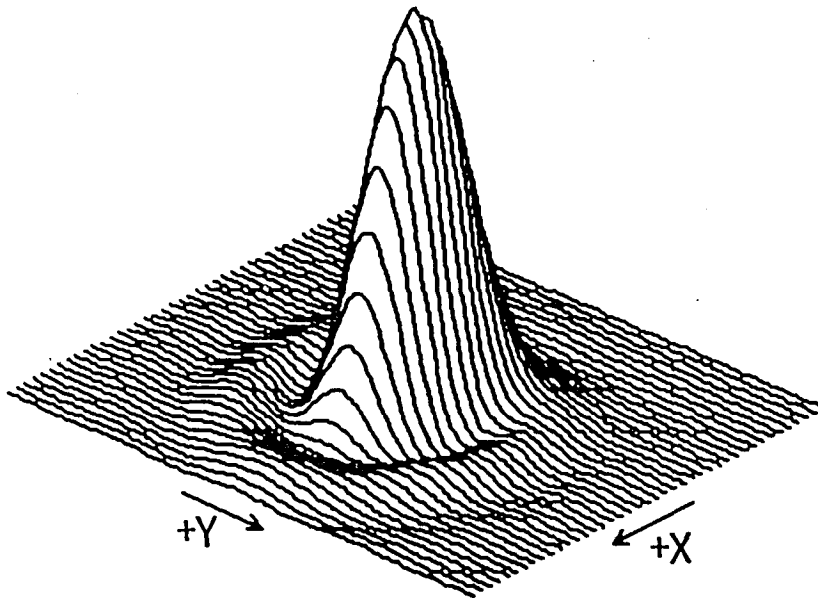

ON AXIS

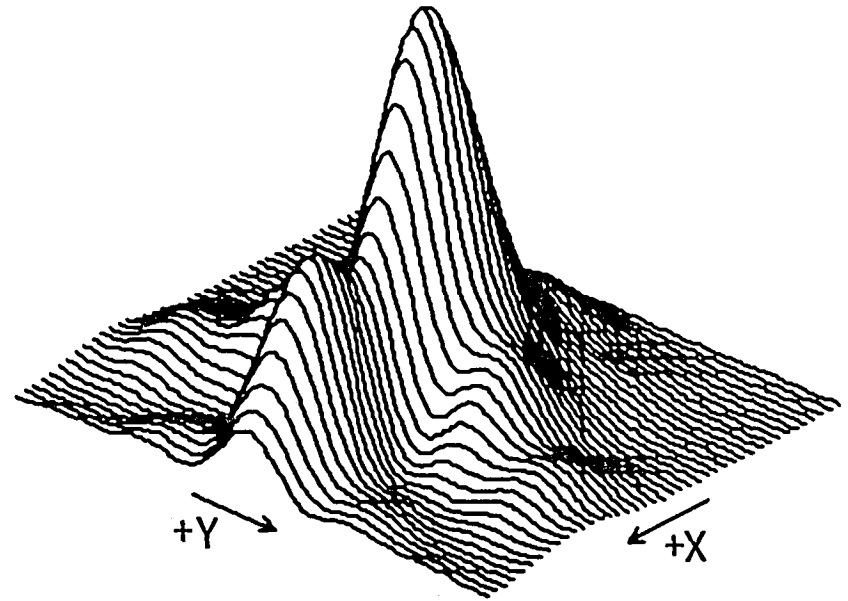

FULL FIELD

X IS THE SPECTRAL DIMENSION

Y IS THE SPATIAL DIMENSION

PLOT BOUNDARIES DEFINE 40 x 40  $\mu\text{m}$  PIXEL

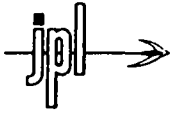

# SHUTTLE IMAGING SPECTROMETER FOCAL PLANE

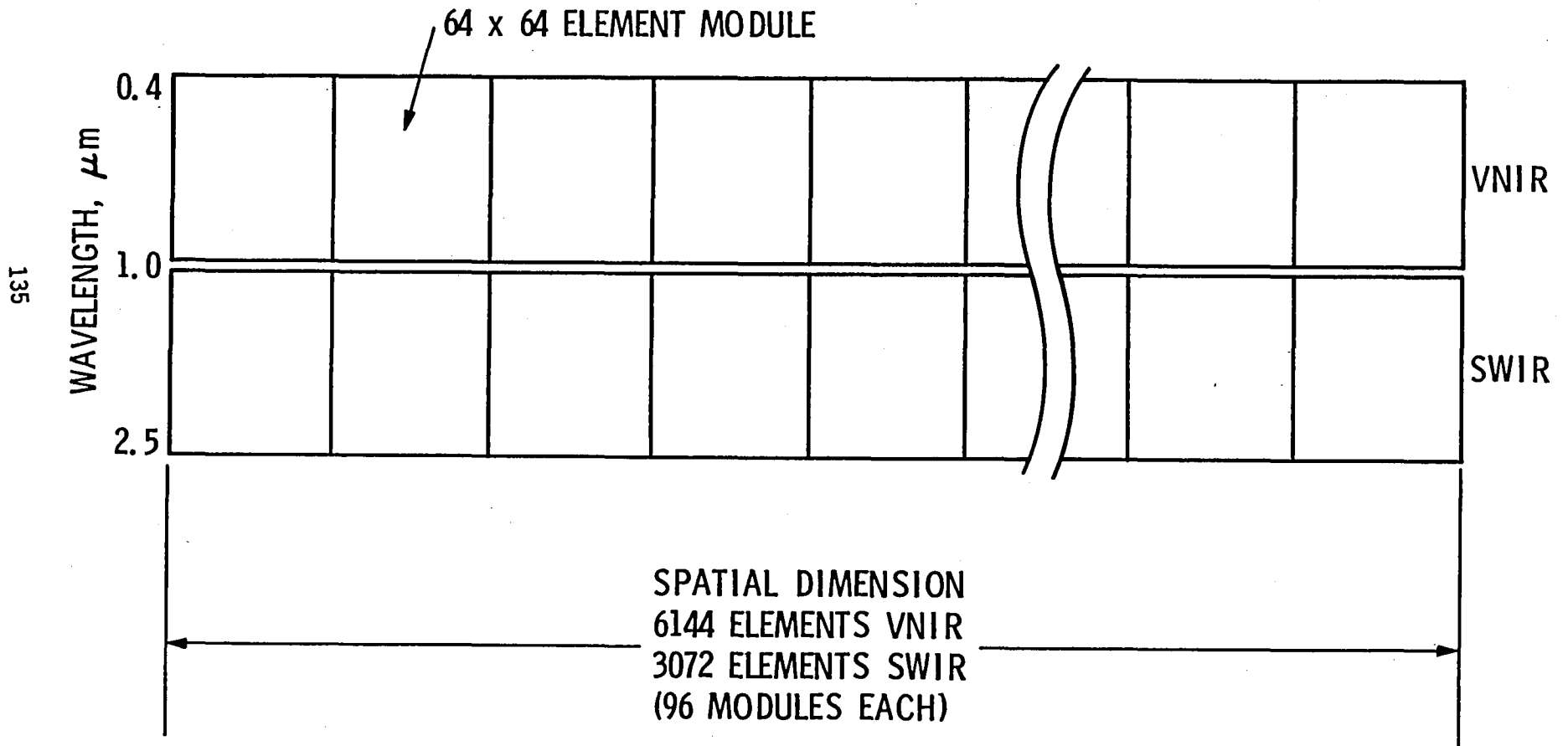

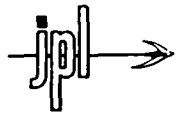

# ADSORPTION REFRIGERATOR BLOCK DIAGRAM

