

General Disclaimer

One or more of the Following Statements may affect this Document

- This document has been reproduced from the best copy furnished by the organizational source. It is being released in the interest of making available as much information as possible.
- This document may contain data, which exceeds the sheet parameters. It was furnished in this condition by the organizational source and is the best copy available.
- This document may contain tone-on-tone or color graphs, charts and/or pictures, which have been reproduced in black and white.
- This document is paginated as submitted by the original source.
- Portions of this document are not fully legible due to the historical nature of some of the material. However, it is the best reproduction available from the original submission.

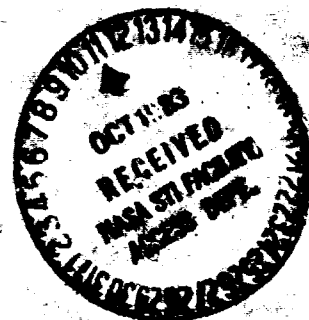

NASA's Advanced Communications Technology Satellite (ACTS)

(NASA-TM-83416) NASA'S ADVANCED
COMMUNICATIONS TECHNOLOGY SATELLITE (ACTS)
(NASA) 13 p HC A02/MF A01 CSCI 17B

N83-35004

Unclas
G3/17 42098

Richard T. Gedney
Lewis Research Center
Cleveland, Ohio

Prepared for the
Ohmcon Electronic Show and Convention
cosponsored by the IEEE, NWPCA, and the ERA
Detroit, Michigan, June 16, 1983

NASA

NASA'S ADVANCED COMMUNICATIONS TECHNOLOGY SATELLITE (ACTS)

Richard T. Gedney
National Aeronautics and Space Administration
Lewis Research Center
Cleveland, Ohio 44135

SUMMARY

E-1104

NASA recently restructured its Space Communications Program to emphasize the development of high risk communication technology useable in multiple frequency bands and to support a wide range of future communication needs. As part of this restructuring, the Advanced Communications Technology Satellite (ACTS) Project will develop and experimentally verify the technology associated with multiple fixed and scanning beam systems which will enable growth in communication satellite capacities and more effective utilization of the radio frequency spectrum. The ACTS requirements and operation as well as the technology significance for future systems are described.

ACTS PROJECT OBJECTIVES

The Advanced Communications Technology Satellite (ACTS) Project is aimed at the development and flight verification of the technology associated with multiple fixed and scanning beam systems (see fig. 1) which will enable growth in communication satellite capacities and more effective utilization of the radio frequency spectrum. The technologies include multiple beam antennas (MBA), on-board switching and processing, RF devices and components and advanced earth stations. The verification of the technology in a flight environment is considered a crucial and necessary step for successful transition from laboratory theory to commercial implementation.

The Project, besides reducing the technical risk for the implementation of the advanced technology in commercial systems envisioned for the future will also assist the U.S. industry in competing in the communications satellite market with foreign sources. The Project has been structured to establish a harmonious Government/industry working relationship and to provide intensive interaction with the industry so that the technology will be transferred smoothly and efficiently and will have a major impact. This process which has already been started with (a) the conduct of system studies for operational services (refs. 1 to 6), (b) the development of laboratory proof-of-concept models for the critical technology systems (ref. 7), and (c) the conduct of system studies to defined experimental systems (refs. 8 to 12), will continue with the ACTS system development and be concluded during a two year experimental period after launch of ACTS in mid 1988 (see fig. 2). During the post launch period, NASA will make the ACTS available to other Government agencies, universities, industry and other organizations for conducting a wide range of experiments to verify that the multiple beam system technologies can provide effective communication services.

ACTS DESCRIPTION

The requirements for the ACTS which were closely coordinated with the communication carrier and supplier industry are given in detail in reference 13.

The type of operational MBA systems for which the ACTS technology is intended is summarized in reference 14. The philosophy taken in setting the requirements for ACTS has been to limit them to just that necessary to prove out the technology in an experimental mode of operation and thus minimize system cost.

Multibeam Antenna

The use of multiple fixed and scanning spot beams is the key for achieving large communications satellite capacities. As shown in figure 3 the antenna for ACTS will employ off-axis feeds and folded optics (although not necessarily the concept shown). A beam is formed by a radiating feed element or group of elements which successively illuminate the subreflector and then the main reflector. In order to form closely spaced beams, a feed crowding problem occurs which can only be solved by combining a cluster of feed elements using a network of power dividers and phase shifters. In general, fixed beams are formed by a cluster of horns combined through a network of phase shifters and power dividers which are fixed prior to launch. Scanning beams are formed by a cluster of horns combined through a network of switches, phase shifters and power dividers controlled by an on-board processor. Amplitude, phase and horn selection are varied to provide the desired beam movement or hopping. The multibeam antenna system for ACTS will operate over a minimum bandwidth of 750 MHz within the uplink operating frequency range of 27.5 to 30.0 GHz and the downlink operating frequency range of 17.7 to 20.2 GHz.

Using a main reflector with a 3 meter diameter, the antenna system for ACTS will produce beamwidths of approximately 0.40° (130 mile diam earth coverage area) with maximum off-axis scan angles of 3.5° . It is expected to deliver fixed and scanning beam gains of, respectively, 52 and 48 dBi with sidelobe levels 40 dB less than the main beam. Isolation between beams at the same frequency and whose centers are two half power beamwidths or greater apart is to be at least 30 dB. The new antenna technology which must be developed to meet these requirements will allow future operational communications satellites to reuse the frequency in separate beams from 5 to 15 times, and therefore significantly increase their capacities over present-day systems.

ACTS will be configured with three fixed beams and two scanning beams. The total coverage for ACTS will be approximately 20 percent of the Continental United States (CONUS), and the actual coverage will be determined to a large extent from experiment requirements.

TDMA

The basic mode of operation for ACTS is Time Division Multiple Access (TDMA) whereby all messages sent to a ground terminal by users are digitized, multiplexed with other messages, compressed in time and transmitted to the spacecraft as bursts of data at bit rates much higher than the information rates. This means of communications is illustrated in figure 4 where the data bursts from two transmitting ground terminals, each in a separate beam, are alternatively sent to two ground terminals also in separate beams. At the receiving terminals, each burst is momentarily stored in a buffer memory before it is demultiplexed and converted back to continuous messages which are sent from the terminal to the users over a terrestrial links at the information rate. For most satellite-switched TDMA multiple beam systems, many ground terminals may exist at each beam location with the need to communicate with each other. The ground terminals must all be coordinated to send and received bursts at the proper time so that data bursts don't interfere with one another

and the spacecraft must route (i.e., switch) each received data burst from each uplink beam to the proper downlink beam. All communications for SS-TDMA system including the scheduling of each data burst and the satellite switching is controlled by a Master Control Station (MCS). TDMA is frequently a more efficient use of satellite capacity and provides for simpler, more flexible earth terminals than that of the traditionally used Frequency Division Multiple Access (FDMA) technique (see ref. 15).

Besides the technology for the MDA, the critical technologies are those associated with the satellite switching of TDMA data bursts from uplink beams to the proper downlink beams. For the ACTS, the satellite switching is accomplished either via an IF switch matrix or a baseband processor (BBP). These two modes of operation can best be understood by following the progress of messages through the system.

IF-Switch Matrix Mode

For the IF-switch matrix mode of operation, each data burst is formed according to destination. The MCS assigns a time slot defining when the burst is to be sent by the transmitting terminal; informs the satellite when the burst is to be received at the satellite and to which downlink beam it should be sent; and informs the receiving terminal when it will receive the bursts. As shown by figure 5 (the transponder shown should only be construed as a possible one since the actual design does not exist) bursts received at the satellite are down converted from 30 GHz to an intermediate frequency (IF) and sent to one of the rows of the switch matrix (one uplink beam per row). The columns of the matrix are connected through up converters (which convert the IF to the downlink frequencies in the 20 GHz band) to the downlink beam feed horn(s). At the intersections of the matrix, switch elements connect upon command the correct rows and columns. The MCS coordinates the transmission of bursts from terminals so that bursts from each uplink beam can pass through the switch matrix simultaneously to separate downlink beams. Although the ACTS will only have a 3x3 switch matrix, the technology used is required to be applicable to operational systems with twenty beams. A 20x20 matrix, which would contain 400 switches, requires new technology so that the matrix weight and power consumption are suitable for spacecraft operation. In order to allow small dead times between data burst (high TDMA efficiency) the switch speed is required to be less than 20 nanoseconds. References 16 and 17 describe NASA sponsored switch matrix developments.

A possible antenna beam coverage for ACTS is shown in figure 6. As previously discussed, ACTS will be configured with three fixed beams and two scanning beams. Since the scanning beams may momentarily be frozen, communications using the IF switch matrix can be accomplished using any combination of fixed and scanning beams. Each scanning beam can be positioned anywhere within its sector as well as at isolated positions outside the sector. The antenna technology for ACTS will be useable for an operational design that would provide 20 0.3 degree beamwidth fixed beams at any location in CONUS. (see ref. 18).

The ACTS has nominally been configured to operate in the IF switch matrix mode with burst rates of 240 MSPS. The terminal characteristics for this mode of operation are given in figure 7. In order to overcome rain fades, the ACTS is being configured to automatically sense rain fades at rates up to 1 dB/sec and then boost the RF power being transmitted in the affected beam by approximately 8 dB on the downlink and 18 dB on the uplink. When rain fades greater than these occur, site diversity can be utilized to maintain acceptable BER performance. Site diversity is accomplished by having two terminals located

apart at a distance greater than 10 km. When heavy rain occurs over one terminal, a terrestrial link is used to switch to the other terminal where rain will be less intense. For operational systems with a large number of beams, power augmentation has the potential to substantially reduce the average dc power required for the spacecraft communication transponders since the probability of simultaneous occurrence of significant rain fade in more than one beam is small. The technology and system designs which are necessary for power augmentation and spatial diversity do not currently exist.

For the ACTS, system experimenters may conduct experiments at burst rates other than 240 MSPS provided a bandwidth greater than 750 MHz is not required. The use of the IF switch matrix mode of operation might very well be used in an operational system where the high-volume traffic for a network of beams connecting metropolitan areas justifies dedicating a complete transponder and fixed antenna beam to each location. When the communication users are widely dispersed and the average traffic volume per node is not large, more efficient use of satellite transponders can be accomplished by sharing each transponder among a number of beam locations (communication nodes). Using TDMA and scanning beams in conjunction with a baseband processor (BBP) is one way which permits the use of an individual transponder for a number of beam locations.

BBP/Scanning Beam Mode

For this mode, a scanning beam system serves a large geographical area by stepping an uplink and downlink spot beam across it in a regular scan pattern. Each spot beam location may contain a large number of ground terminals, and each terminal sends up TDMA bursts containing one or more messages. However contrary to the IF-switch matrix mode of communication, each message within the burst may be destined for a different ground terminal at a different beam location. After transmitting or receiving all messages for a scan pattern, each scanning beam must quickly make the rounds again to maintain message continuity. An advantage of the scanning beam system is the ability to accommodate time varying traffic requirements by changing the time a scanning spot spends at any one location. The ACTS system will employ two scanning spot beams each one of which will be able to scan to any location within a sector and to isolated locations outside the sectors. A possible scan beam coverage for ACTS is shown in figure 6. Each scan sector will be contiguous to the other for a minimum of three beamwidths to test out the feasibility of using the same frequency in each sector without interference. The allowable time it takes a scanning beam to step from one location to any other will be less than one microsecond to minimize the dead time during which no TDMA burst can be transmitted. The implementation of a scanning beam system which can provide complete coverage for a sector requires a major technological advance in the antenna beam forming network (BFN) including the feed elements. The required BFN technology is described in more detail in reference 18. The antenna technology for ACTS will be useable for an operational design that provides six 0.3 degree beamwidth scanning beams over 80 percent of CONUS.

When the TDMA burst are received onboard the spacecraft, they are down converted to an IF frequency as shown in figure 5 and sent to the baseband processor. The baseband processor demodulates each burst; temporarily stores the data in input memories; sorts and groups messages in output memories according to downlink beam and ground terminal destination. When the downlink scanning beam is at the proper location, messages for a particular ground terminal are read out of the output memories as a single TDMA burst, remodulated, up converted to 20 GHz and transmitted to the ground terminal. In this manner,

the BBP provides complete interconnectivity on an individual circuit basis as is possible with the current terrestrial phone system. Therefore, the BBP represents a transfer of the switchboard from earth to the sky. When rain occurs at a particular ground terminal, Forward Error Correction (FEC) coding in conjunction with burst rate reduction will be used to overcome fades as great as 10 dB. In order to incorporate a large capacity baseband processor with reasonable weight and power, Large Scale Integrated (LSI) circuits which operate at high speed, and are able to withstand the space radiation environment must be incorporated for the demodulators, decoders, parallel-to-serial and serial-to-parallel converters, memories and other components. The baseband processor which is described in more detail in reference 19 is a major technology challenge for the ACTS Project. The BBP technology used in ACTS is to permit operational systems that provide interconnectivity between at least six scanning beams with a total throughput of at least 3 GBPS.

Since the ground terminals to be used in the BBP/Scanning Beam mode are to have lower throughput, the system architecture has been designed to minimize the cost of the ground terminal. As a result, the uplink burst rates are less than the downlink burst rates to permit a smaller diameter ground terminal antenna diameter as well as a lower power 30 GHz amplifier. The uplink bursts are nominally either 30 or 120 MSPS while the downlink burst rate is 240 MSPS. In order to handle a variety of ground terminals at any spot beam location, each uplink beam can accept any combination of uplink channel types (30 or 120 MSPS) in a frequency division multiplexed mode provided the sum total instantaneous throughput per single beam does not exceed 240 MBPS and for both beams does not exceed 360 MBPS. The number and types of channels are to be selectable for each ground terminal transmission within a beam dwell period dependent upon traffic demands. Figure 7 presents the nominal ground terminal characteristics for the BBP/Scanning Beam mode of operation. The three meter 30 MSPS Burst Rate ground terminal will be compact and should be readily installed as shown in figure 8.

PROJECT PLANS

As shown by figure 2, the RFP for ACTS has been released and contract award is planned for early 1984 with launch scheduled for mid 1988. NASA intends to procure the spacecraft with communications payload; a single ground station with site diversity capable of communications in both the IF-switch matrix and baseband processor modes; the master control station for operating the spacecraft, conducting ground terminal network operations and conducting experiment operations; and system operations for a two year experiment period.

During the experiment period NASA will make available to the public and private sectors the capabilities of the ACTS system for conducting experiments. A Notice of Intent (reference 20) has been issued to solicit preliminary experiment proposals for ACTS and to determine any special experiment requirements which might affect the ACTS design. An Experiment Opportunity Notice will be issued in 1984 to solicit firm experiments proposals. It is the intent of NASA to accept all experiments which meet the ACTS Project objectives, can be accomplished within the basic ACTS capability and are funded by the experimenters. The conduct of meaningful experiment programs by the public and private sectors will be the concluding phase of this cooperative project for advancing technology and maintaining U.S. preeminence in satellite communications.

REFERENCES

1. Jorasch, R.; et al.: Concepts for 18/30 GHz Satellite Communications Systems Study. (WDL-TR8457, Ford Aerospace and Communications Corp.; NASA Contract NAS3-21362.) NASA CR-159625, Nov. 1979.
2. Bronstein, L. M.: The 18 and 30 GHz Fixed Service Communication Satellite System Study. (HAC-REF-E 1992-1, SCG-90275R, Hughes Aircraft Co.; NASA Contract NAS3-21367.) NASA CR-159627, Sept. 1979.
3. Katz, J. L.; et al.: Application of Advanced On-Board Processing Concepts to Future Satellite Communications Systems. (MTR-3787, Mitre Corp.; Contract F19628-79-C-0001.) NASA CR-159682, June 1979.
4. 30/20 GHz Mixed User Architecture Development Study. NASA CR-159686, Oct. 1979.
5. Customer Premise Service Study for 30/20 GHz Satellite Systems. TRW, Doc. No. 038050-11, Aug. 1982.
6. Milton, R. T.; et al.: Customer Premise Service Study for 30/20 GHz Satellite Systems. (GE-835DS4206, General Electric Co.; NASA Contract NAS3-22890.) NASA CR-167986, Jan. 1983.
7. "Current Status of NASA's Multibeam Communications Technology Program," D. Santarpia and J. Bagwell, NASA, to be presented at EASCON 83, Washington, D.C., September 1983.
8. 30/20 GHz Demonstration System. TRW, Doc. No. 36565-018, May 29, 1981.
9. Bronstein, L.; et al.: 30/20 GHz Flight Experiment System Phase II Final Report. (SCG-8103411R, Hughes Aircraft Co.; NASA Contract NAS3-22340.) NASA CR-165409, July 1981.
10. Jorasch, R. E.; et al.: 30/20 GHz System Configuration Study Final Report. NASA CR-165465, Sept. 1981.
11. 30/20 GHz Demonstration System SSUSD/BSE Final Report. NASA CR-165454, July 1981.
12. 30/20 GHz Demonstration System Using the RCA Satcom Bus. RCA Astro-Electronics, NASA Contract NAS3-22881, July 1981.
13. ACTS Requirements Document (Appendix B) for Advanced Communications Technology Satellite System. NASA Lewis Research Center, Cleveland, Ohio, RFP 3-511907, Mar. 1983
14. Ramler, J. R.; and Salzman, J.A.: Concept for Advanced Satellite Communications and Required Technologies. NTC '82 Systems for the Eighties, IEEE, 1982, pp. A2.1.1-A2.1.5.
15. "A Comparison of FDMA/TDMA Approaches to Satellite Service for Low Data Rate Earth Stations," G. Stevens, NASA Lewis Research Center, Cleveland, Ohio, to be published.

16. Cory, B. J.; et al.: Development of a Microwave 20 x 20 Switch Matrix for 30/20 GHz SS-TDMA Application. NTC '82 Systems for the Eighties, IEEE, 1982, pp. A2.3.1-A2.3.5.
17. "High-Speed Wide Band 20 x 20 Microwave Switch Matrix," E. Coban et al., Ford Aerospace & Communications Co., ICC 83, Boston, Massachusetts, June 1983.
18. "Advanced 30/20 GHz Multiple-Beam Antennas for Communications Satellites," R. Myhre, NASA, ICC 83, Boston, Massachusetts, June 1983.
19. Sabourin, D. J.; and Jirberg, R. J.: Baseband Processor Development for SS-TDMA Communication Systems. International Telemetry Conference, Vol. 17, International Foundation for Telemetry, 1981, pp. 521-529.
20. ACTS Notice of Intent for Experiments. Communications Division, Office of Space Science and Applications, NASA Headquarters, Washington, D.C., Mar. 1983.

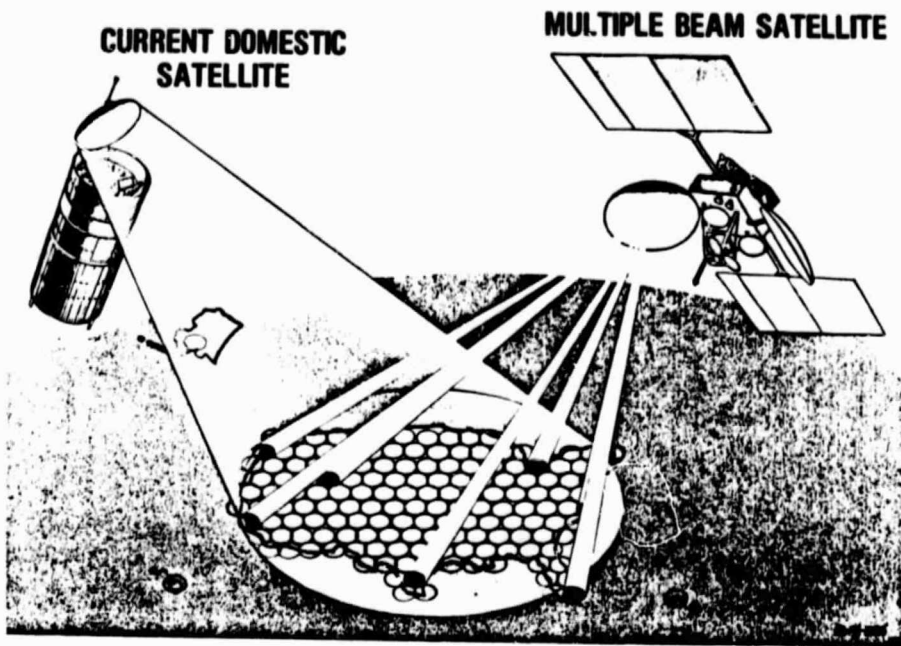

FIGURE 1: INCREASE CAPACITY WITH FREQUENCY REUSE

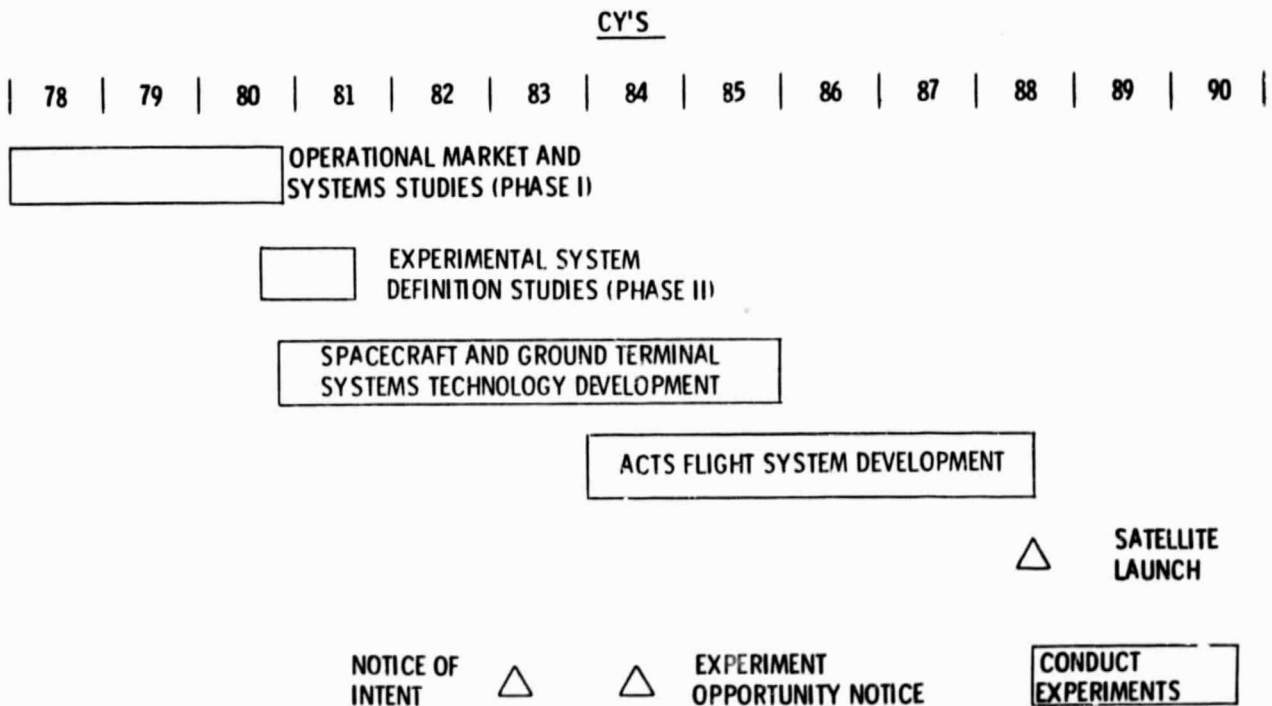

FIGURE 2: ACTS PROGRAM ELEMENTS

ORIGINAL PAGE 19
OF POOR QUALITY

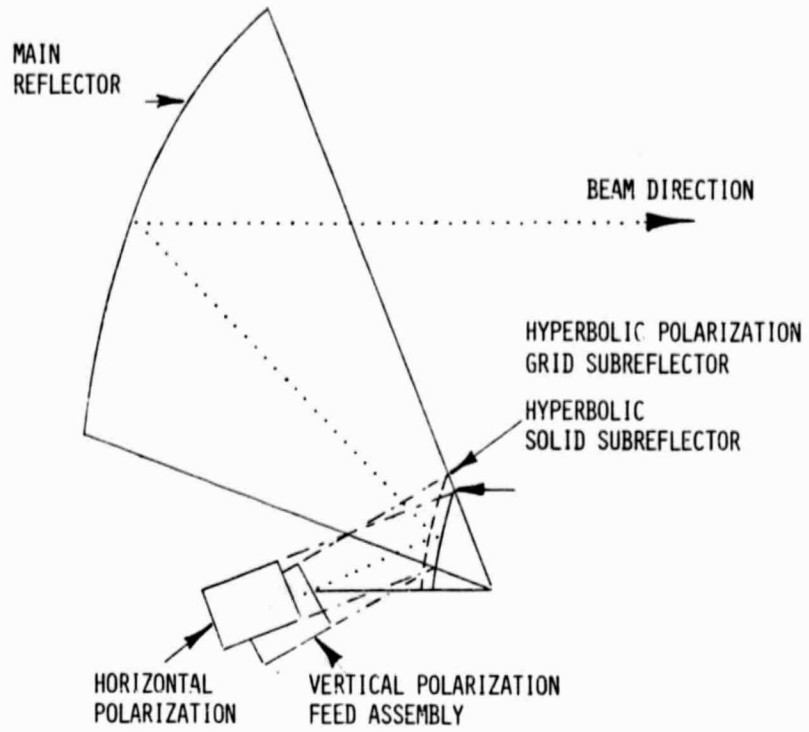

FIGURE 3: ONE POSSIBLE ANTENNA DESIGN FOR 30/20 GHz ANTENNA SYSTEM

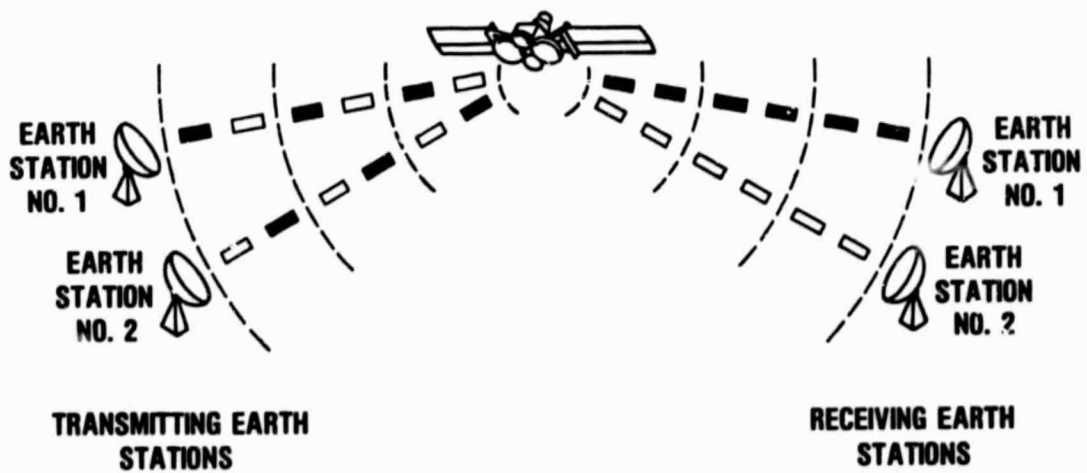

FIGURE 4: SATELLITE-SWITCHED TDMA CONCEPT

ORIGINAL PAGE IS
OF POOR QUALITY

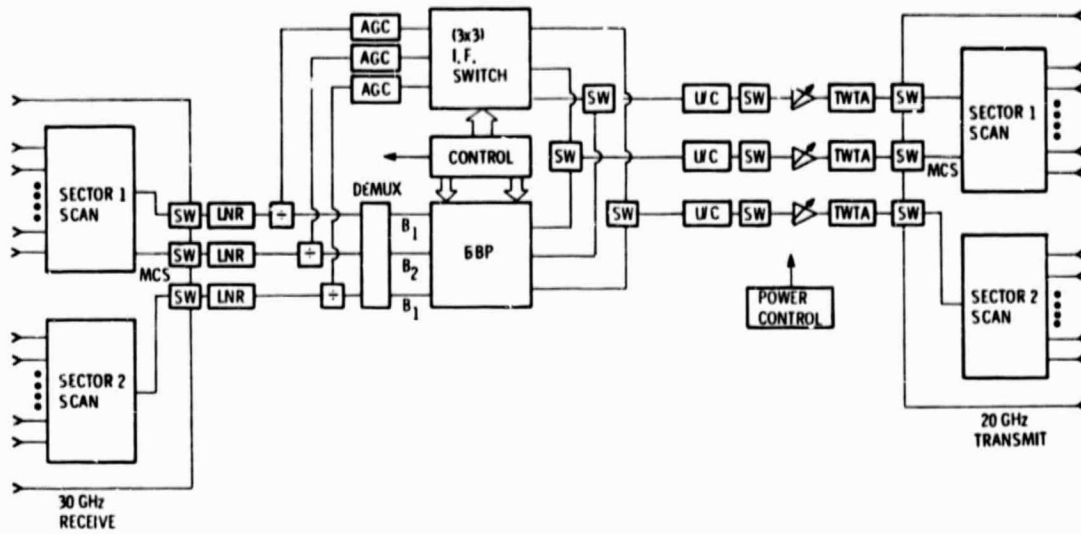

FIGURE 5: POSSIBLE COMMUNICATION PAYLOAD FOR ACTS

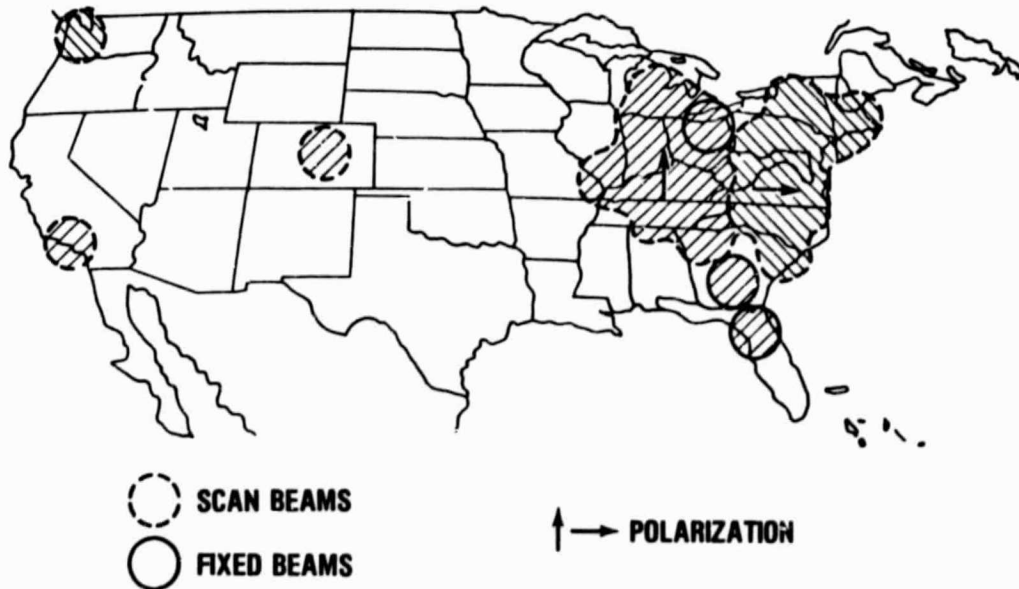

FIGURE 6: ONE POSSIBLE ADVANCED COMMUNICATIONS TECHNOLOGY SATELLITE ANTENNA COVERAGE

PARAMETER	SCANNING BEAM/BBP MODE		IF SWITCH MATRIX MODE
BURST RATE (MSPS)			
UPLINK	30	120	240
DOWNLINK	240	240	240
ANTENNA SIZE (M)	3	5	5
G/T (db/K)	22	27	27
H/PA (WATTS)	20	10	400
NOMINAL BER	10^{-6}		
FADE COMPENSATION	FEC, BURST RATE REDUCTION		POWER AUGMENTATION
FADE (UP/DOWN, DB)	15/6		18/8

FIGURE 7: BASELINE ACTS GROUND TERMINAL CHARACTERISTICS

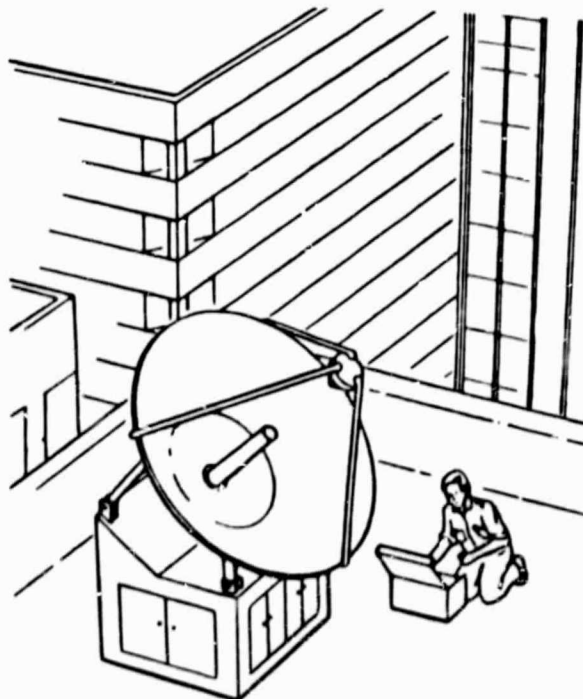

FIGURE 8: LOW BURST RATE TERMINAL