

NASA TM-84391

NASA Technical Memorandum 84391

gJE
✓ Whitham
✓ Bennett

NASA-TM-84391 19840001982

Numerical Calculation of the Transonic Potential Flow Past a Cranked Wing

I-Chung Chang and Michael Tauber

September 1983

LIBRARY COPY

NOV 1 1983

LANGLEY RESEARCH CENTER
LIBRARY, NASA
HAMPTON, VIRGINIA



National Aeronautics and
Space Administration

Numerical Calculation of the Transonic Potential Flow Past a Cranked Wing

I - Chung Chang and Michael Tauber, Ames Research Center, Moffett Field, California 94035



National Aeronautics and
Space Administration

Ames Research Center
Moffett Field, California 94035

N84-10049 #

SUMMARY

The widely used transonic swept-wing code, FLO22, was found to have an error in the transformed flow equation in the computational domain. The revised version of the code correctly accounted for the non-straight-leading-edge geometry and its effect on the pressure distribution.

INTRODUCTION

Transonic flow calculations have been made for many years. Among the wide variety of numerical procedures that are now available, a series of computer programs known as the FLO codes have been developed by Professor Jameson and his coworkers. One of them, the widely used swept wing code, FLO22 (ref. 1), has been known to generate inaccurate results for wings with non-straight-leading-edges. Recently, the code was used to calculate the flow past an ONERA cranked wing model mounted on a wall (ref. 2), and the predictions were found to be very poor in the vicinity of the crank. The reason for the poor predictions was identified as an error associated with the scaling between the physical space and the computational domain. In fact, the FLO22 code is dimensional for wings having non-straight-leading-edges.

ANALYSIS

The governing equations (ref. 1) for steady, inviscid, compressible isentropic flow in Cartesian coordinates (x,y,z) are the potential-flow equation

$$(a^2 - u^2)\phi_{xx} + (a^2 - v^2)\phi_{yy} + (a^2 - w^2)\phi_{zz} - 2uv\phi_{xy} - 2uw\phi_{xz} - 2vw\phi_{yz} = 0 \quad (1)$$

the Bernoulli equation

$$\frac{1}{2} (u^2 + v^2 + w^2) + \frac{a^2}{\gamma - 1} = \text{constant}$$

and the isentropic relation

$$\frac{p}{\rho^\gamma} = \text{constant}$$

Here, ϕ is the velocity potential (defined such that $\nabla\phi = (u,v,w)$ is the velocity vector), a is the speed of sound, γ is 1.4 for air, p is the pressure, and ρ is the density. Let the reduced potential, G , be defined through the relation

$$G = \phi - x \cos \alpha - y \sin \alpha$$

The term G satisfies equation (1), where α is the angle of attack of the wing. (Far-field flow speed and density are taken as unity.)

The flow equation (1) can be written in terms of G and solved in a computational domain generated through a sequence of mappings from the physical space. The first three mappings consist of the first shearing transformation

$$\left. \begin{aligned} \bar{x} &= x - x_s(z) \\ \bar{y} &= y - y_s(z) \\ \bar{z} &= z \end{aligned} \right\} \quad (2)$$

the square-root transformation

$$\begin{aligned} (X_1 + iY_1)^2 &= 2(\bar{x} + i\bar{y}) \\ Z_1 &= \bar{z} \end{aligned}$$

and the second shearing transformation

$$\left. \begin{aligned} X &= X_1 \\ Y &= Y_1 - S(X_1, Z_1) \\ Z &= Z_1 \end{aligned} \right\} \quad (3)$$

where the singular line (the Jacobian vanishes) of the square-root transformation is represented as $x = x_s(z)$, $y = y_s(z)$ and the entire wing surface is described as $Y_1 = S(X_1, Z_1)$.

It is useful to introduce a scaling mapping between the first shearing transformation and the square-root mapping

$$\left. \begin{aligned} \tilde{x} &= \bar{x}/\text{SCAL} \\ \tilde{y} &= \bar{y}/\text{SCAL} \\ \tilde{z} &= \bar{z}/\text{SCALZ} \end{aligned} \right\} \quad (4)$$

that will account for the exact scaling relation between the physical space and the computational domain. The parameters SCAL and SCALZ are real variables that are defined in the subroutine COORD of FLO22, and set up the stretched coordinates (see ref. 1). The square-root transformation becomes

$$\left. \begin{aligned} (X_1 + iY_1)^2 &= 2(\tilde{x} + i\tilde{y}) \\ Z_1 &= \tilde{z} \end{aligned} \right\} \quad (5)$$

The flow equation, in terms of G and using the mappings (2), (3), (4), and (5), becomes an equation of the form

$$AG_{XX} + BG_{YY} + CG_{ZZ} + 2DG_{XY} + 2EG_{XZ} + 2FG_{YZ} + R_1G_X + R_2G_Y = 0 \quad (6)$$

which is equivalent to equation (9) of the original analysis (ref. 1) if the following notations are introduced:

$$\begin{aligned}
 \sigma &= X_{1\tilde{x}} \\
 \mu &= Y_{1\tilde{y}} \\
 \xi &= -(x'_S\sigma + y'_S\mu) \\
 \eta &= x'_S\mu - y'_S\sigma \\
 \alpha &= -(\sigma S_x + \mu) \\
 \beta &= \sigma - \mu S_x \\
 Q &= SCAL/SCALZ \\
 \gamma &= \eta - \xi S_x - QS_z \\
 \chi &= x'_S X_{1\tilde{x}\tilde{x}} + y'_S X_{1\tilde{x}\tilde{y}} \\
 \psi &= -y'_S X_{1\tilde{x}\tilde{x}} + x'_S X_{1\tilde{x}\tilde{y}} \\
 \Lambda &= S_x X_{1\tilde{x}\tilde{x}} + X_{1\tilde{x}\tilde{y}} \\
 \Sigma &= S_x X_{1\tilde{x}\tilde{y}} + X_{1\tilde{x}\tilde{x}} \\
 U &= u\sigma + v\mu + w\xi \\
 \text{and} \quad V &= u\alpha + v\beta + w\gamma
 \end{aligned}$$

Then the coefficients of equation (6) can be written as

$$A = (\sigma^2 + \mu^2 + \xi^2)a^2 - U^2$$

$$B = (\alpha^2 + \beta^2 + \gamma^2)a^2 - V^2$$

$$C = Q^2(a^2 - w^2)$$

$$D = (\sigma\alpha + \mu\beta + \xi\gamma)a^2 - UV$$

$$E = Q(\xi a^2 - Uw)$$

$$F = Q(\gamma a^2 - Vw)$$

$$\begin{aligned}
 R_1 &= -SCAL(a^2 - w^2)(x''_S\sigma + y''_S\mu) + (x'_S\chi + y'_S\psi) - X_{1\tilde{x}\tilde{x}}(u^2 - v^2) - 2uvX_{1\tilde{x}\tilde{y}} + 2uw\chi \\
 &\quad + 2vw\psi
 \end{aligned}$$

$$\begin{aligned}
 \text{and } R_2 &= -SCAL(a^2 - w^2)(x''_S\alpha + y''_S\beta) + U^2S_{xx} + w^2Q^2S_{zz} + 2UwQS_{xz} + (u^2 - v^2)\Lambda + 2uv\Sigma \\
 &\quad - 2uw(S_x\chi + \psi) - 2vw(S_x\psi - \chi) - a^2[(\sigma^2 + \mu^2 + \xi^2)S_{xx} + Q^2S_{zz} + 2\xi QS_{xz}] \\
 &\quad + (a^2 - w^2)[(y'_S\chi - x'_S\psi) - S_x(x'_S\chi + y'_S\psi)]
 \end{aligned}$$

In the original version of the FLO22 code, the real variable SCAL was omitted in the expression for R_1 and R_2 , which is equivalent to setting this variable to unity. This did not have any effect for straight leading-edge geometries, but caused errors for non-straight-leading-edges, or those with curvature.

RESULTS

The flow over the ONERA cranked wing (fig. 1) was calculated at a Mach number of 0.85. The reflection-plate model had an NACA 0012 airfoil and was set at an angle of attack of zero degrees. Comparisons with the ONERA experimental data and the original FLO22 results are shown in figures 2-6. The correction improves the correlation significantly near the leading-edge crank (station #3).

CONCLUSIONS

The widely used transonic swept-wing computer code, FLO22, was found to have an error in the transformed-flow equation in the computational domain. The revised version of the code correctly accounted for the discontinuous leading-edge geometry and its effect on the pressure distribution.

REFERENCES

1. Jameson, A.; and Caughey, D.: Numerical Calculation of the Transonic Flow Past a Swept Wing. ERDA Research and Development Report C00-3077-140, Courant Institute of Mathematical Sciences, New York University, New York, June 1977.
2. Philippe, J.; and Chattot, J.: Experimental and Theoretical Studies on Helicopter Blade Tips at ONERA. Presented at the 6th European Rotorcraft and Powered Lift Aircraft Forum, 1980.

ONERA WING ON WALL

FMACH = 0.85 ALPHA = 0

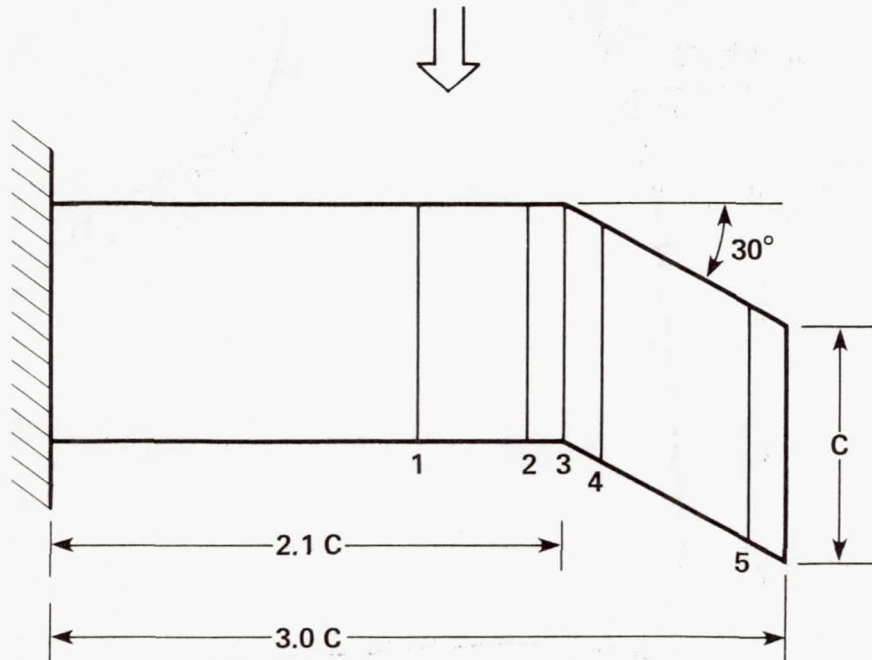
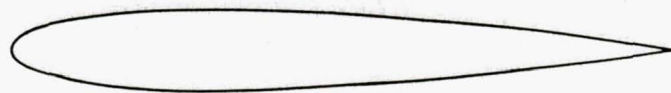
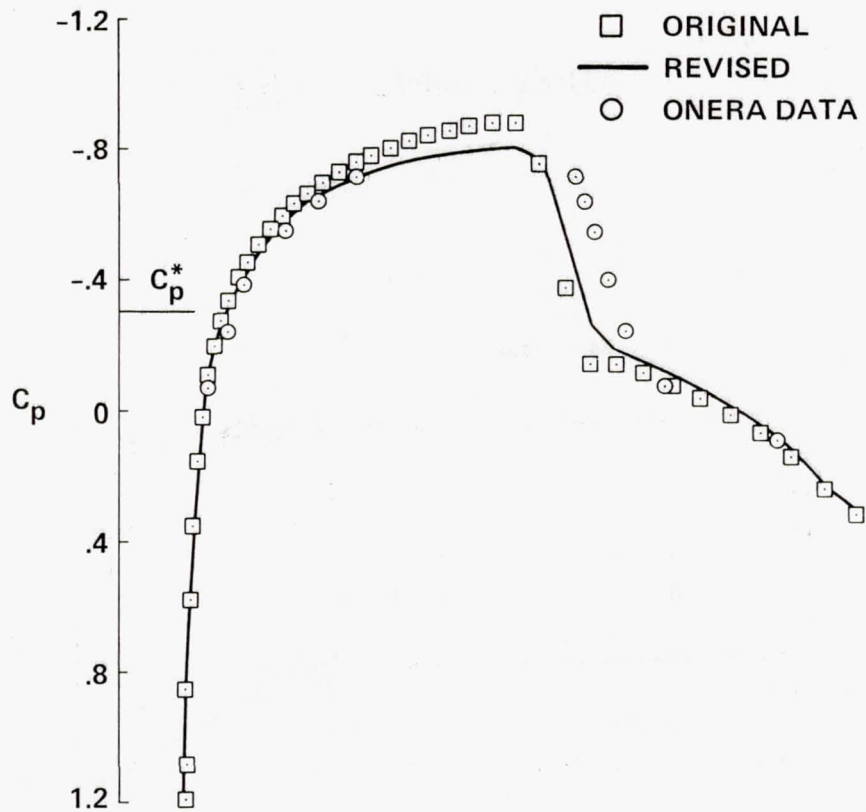
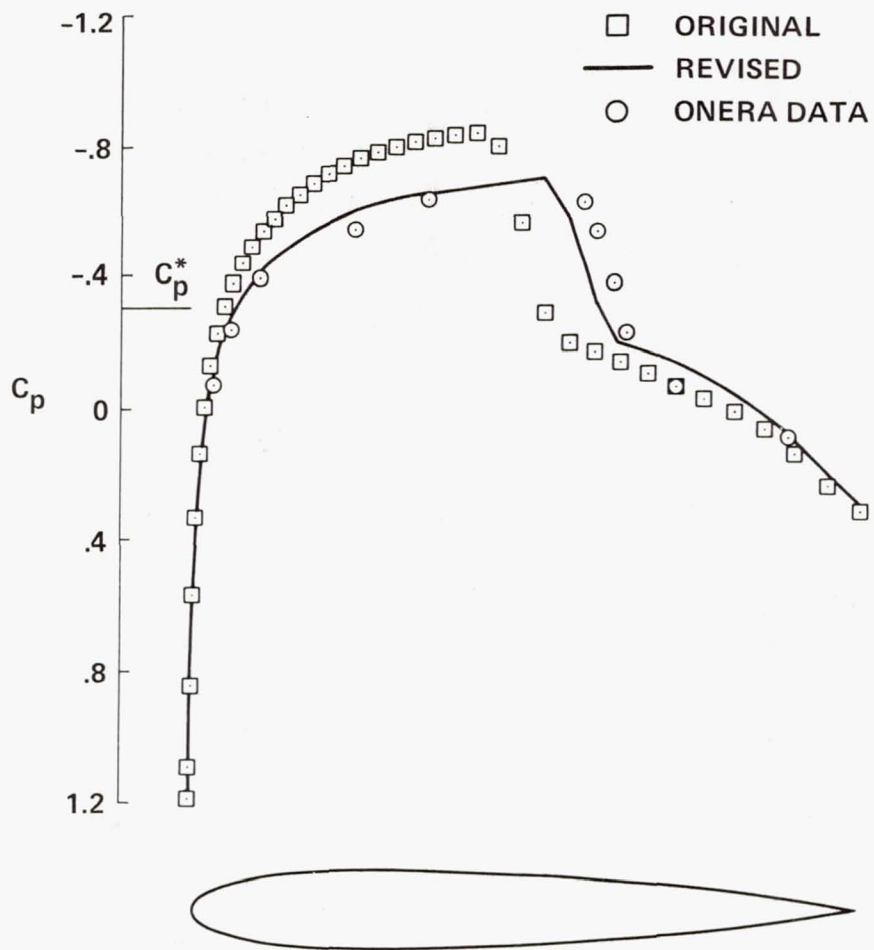

Figure 1.- The ONERA cranked wing on wall.



STATION = 1
 MACH = 0.8500 AL = 0
 CL = 0 CD = 0.0188 CM = 0

Figure 2.- Pressure distribution at span station 1.



STATION = 2
 MACH = 0.8500 AL = 0
 CL = 0 CD = 0.0118 CM = 0

Figure 3.- Pressure distribution at span station 2.

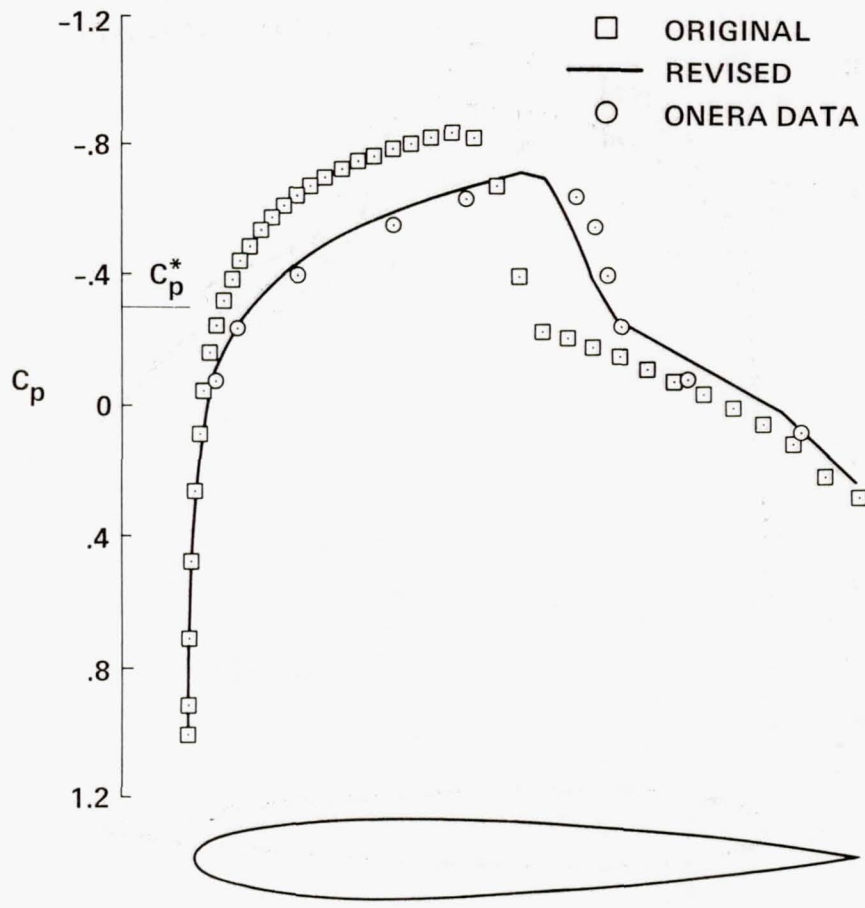

STATION = 3
MACH = 0.8500 AL = 0
CL = 0 CD = 0.0047 CM = 0

Figure 4.- Pressure distribution at span station 3.

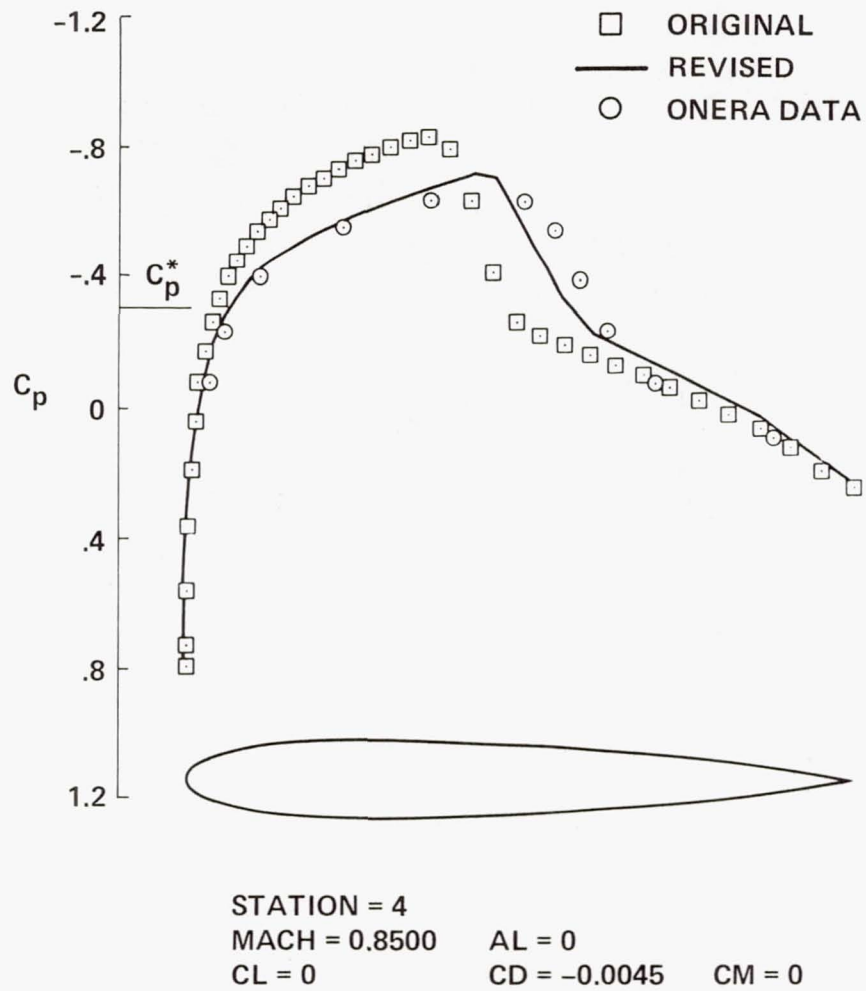

Figure 5.- Pressure distribution at span station 4.

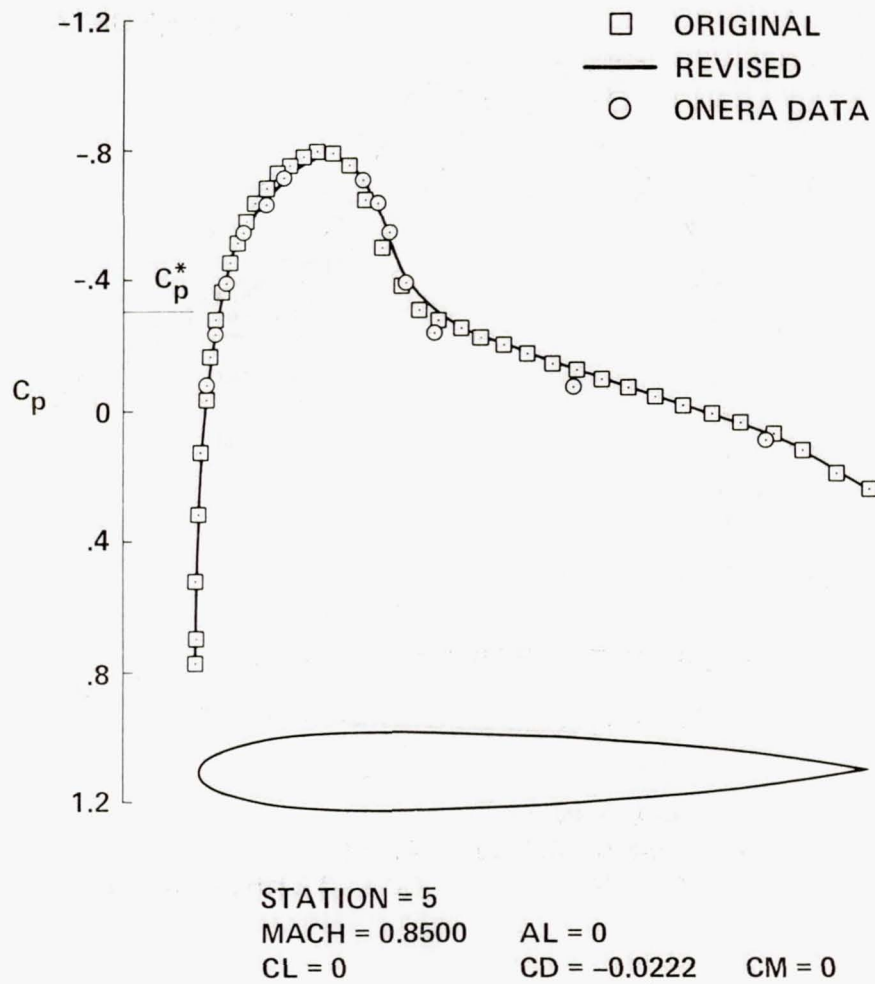

Figure 6.- Pressure distribution at span station 5.

1. Report No. NASA TM-84391	2. Government Accession No.	3. Recipient's Catalog No.	
4. Title and Subtitle NUMERICAL CALCULATION OF THE TRANSONIC POTENTIAL FLOW PAST A CRANKED WING		5. Report Date September 1983	
		6. Performing Organization Code	
7. Author(s) I-Chung Chang and Michael Tauber		8. Performing Organization Report No. A-9452	
9. Performing Organization Name and Address Ames Research Center Moffett Field, California 94035		10. Work Unit No. T-3334Y	
		11. Contract or Grant No.	
12. Sponsoring Agency Name and Address National Aeronautics and Space Administration Washington, D.C. 20546		13. Type of Report and Period Covered Technical Memorandum	
		14. Sponsoring Agency Code 505-31-21	
15. Supplementary Notes Point of Contact: I-Chung Chang, Ames Research Center, M/S 227-8, Moffett Field, California 94035 (415) 965-6396 or FTS 448-6396			
16. Abstract The widely used transonic swept-wing code, FL022, was found to have an error in the transformed flow equation in the computational domain. The revised version of the code correctly accounted for the non-straight-leading-edge geometry and its effect on the pressure distribution.			
17. Key Words (Suggested by Author(s)) Transonic flow Supercritical wing Aerodynamics		18. Distribution Statement Unlimited Subject Category: 05	
19. Security Classif. (of this report) Unclassified	20. Security Classif. (of this page) Unclassified	21. No. of Pages 13	22. Price* A02

3 1176 00511 2363

LANGLEY RESEARCH CENTER



3 1176 00511 2363

