

NASA CR-168,178

NASA CR-168178
DOE/NASA/0189-83/2

NASA-CR-168178
19840006003

Study and Review of Permanent Magnets for Electric Vehicle Propulsion Motors

Karl Strnat
University of Dayton
Electric Engineering Department

September 1983

Prepared for
NATIONAL AERONAUTICS AND SPACE ADMINISTRATION
Lewis Research Center
Under Contract DEN 3-189



LIBRARY COPY

for
U.S. DEPARTMENT OF ENERGY
Conservation and Renewable Energy
Office of Vehicle and Engine R&D

1984
LANGLEY RESEARCH CENTER
LIBRARY NASA
HAMPTON, VIRGINIA

DISCLAIMER

This report was prepared as an account of work sponsored by an agency of the United States Government. Neither the United States Government nor any agency thereof, nor any of their employees, makes any warranty, express or implied, or assumes any legal liability or responsibility for the accuracy, completeness, or usefulness of any information, apparatus, product, or process disclosed, or represents that its use would not infringe privately owned rights. Reference herein to any specific commercial product, process, or service by trade name, trademark, manufacturer, or otherwise, does not necessarily constitute or imply its endorsement, recommendation, or favoring by the United States Government or any agency thereof. The views and opinions of authors expressed herein do not necessarily state or reflect those of the United States Government or any agency thereof.

Printed in the United States of America

Available from

National Technical Information Service
U S Department of Commerce
5285 Port Royal Road
Springfield, VA 22161

NTIS price codes¹

Printed copy A08
Microfiche copy A01

¹Codes are used for pricing all publications. The code is determined by the number of pages in the publication. Information pertaining to the pricing codes can be found in the current issues of the following publications, which are generally available in most libraries: *Energy Research Abstracts (ERA)*, *Government Reports Announcements and Index (GRA and I)*, *Scientific and Technical Abstract Reports (STAR)*, and publication, NTIS-PR-360 available from NTIS at the above address.

Study and Review of Permanent Magnets for Electric Vehicle Propulsion Motors

Karl Strnat
University of Dayton
Electric Engineering Department
Dayton, Ohio 45469

September 1983

Prepared for
National Aeronautics and Space Administration
Lewis Research Center
Cleveland, Ohio 44135
Under Contract DEN 3-189

for
U S DEPARTMENT OF ENERGY
Conservation and Renewable Energy
Office of Vehicle and Engine R&D
Washington, D C 20545
Under Interagency Agreement DE-AI01-77CS51044

This Page Intentionally Left Blank

TABLE OF CONTENTS

SUMMARY	vii
INTRODUCTION	vii
I. <u>PERMANENT MAGNET REQUIREMENTS FOR MOTORS</u>	1-1
A. Purpose, outline and methodology of study	1-1
1. General review of permanent magnet electric motors	1-1
2. The case for PM motors in electric vehicle propulsion	1-3
3. Objectives of the study effort under this contract	1-4
4. Information gathering activities	1-6
5. Analysis of the information obtained	1-8
B. Permanent-magnet motor types designed under the DOE/NASA EHV program	1-11
1. Different design concepts pursued	1-11
2. Summary of PM requirements for the different motor designs	1-17
C. Motor performance and magnet selection	1-18
D. PM material properties relevant to motor design	1-21
1. General comments	1-21
2. Listing of needed or potentially useful design data	1-21
3. Economic factors to be considered	1-23
E. References - Chapter I	1-24
II. <u>REVIEW OF AVAILABLE PERMANENT MAGNET MATERIALS</u>	2-1
A. Magnet types and their relative significance	2-1
1. Definition and general function of a permanent magnet	2-1
2. Available permanent magnet types	2-1
3. Comparison of basic PM properties	2-3
B. Magnet types most useful in propulsion motors	2-6
1. Materials selected by NASA contractors	2-6
2. Discussion of these choices	2-6
3. Potentially useful PM materials in development	2-7

C. Economic information on magnets and raw materials	2-9
1. General considerations, PM quantities required and produced	2-9
2. Magnet prices and price history	2-13
3. Raw materials for PM production and their cost	2-16
4. General raw material supply situation	2-21
5. Cobalt production and utilization	2-26
a. Mining and primary production of cobalt	2-26
b. Cobalt uses and consumption	2-28
6. Production and utilization of the rare earths	2-30
a. General considerations	2-30
b. Rare earths, deposits and individual abundance	2-31
c. Samarium, availability and production	2-34
d. Sufficiency of the Sm supply for REPM production	2-34
e. Use patterns for the rare earths	2-37
D. References - Chapter II	2-40
<u>III. PM CHARACTERIZATION AND INTEGRATION INTO MOTORS</u>	3-1
A. Introduction	3-1
B. Concepts and quantities for describing permanent magnets	3-2
1. Introductory remarks	3-2
2. Static magnetic properties at room temperature	3-2
(a) Major hysteresis loops	3-2
(b) Second-quadrant demagnetization curves and salient quantities	3-3
(c) Static energy product	3-3
3. Initial magnetization, charging	3-5
4. Dynamic operation of magnets	3-7
(a) Recoil lines, recoil permeability, recoil loop fields	3-7
(b) Dynamic energy products	3-9
5. Temperature variation of magnetic properties	3-11
(a) General statements	3-11
(b) Temperature variation of remanence	3-12
(c) Temperature variation of coercivity	3-13
(d) Demagnetization curves at different temperatures	3-15
(e) First-quadrant magnetization and remanence curves	3-15
(f) Irreversible and reversible losses	3-16
(g) The thermal cycling behavior of selected magnet types	3-19
6. Temporal stability of magnetic properties	3-22
(a) Aging behavior and its description	3-22
(b) Physical causes of aging	3-23
(c) Prestabilization measures	3-23

C. Magnetic Circuit Geometry of PM Motors	3-25
1. Survey of basic motor geometries	3-25
2. Factors affecting magnet location in the motor	3-29
D. References - Chapter III	3-31
IV. <u>COMMERCIAL PERMANENT MAGNETS - TYPES, PROPERTIES AND SOURCES</u>	4-1
A. Introductory remarks	4-1
1. Magnets included in listings	4-1
2. Sources of information	4-1
3. Suggested use of information	4-1
B. Summary listings of high-grade PM for electric motors	4-2
1. Material types, generic names (U.S.) and brand names	4-2
2. Manufacturers and magnet types produced by each	4-2
3. Magnet producers included in this survey	4-2
4. Summaries of basic design data for important PM types	4-2
5. Examples of graphic design information	4-24
V. <u>TESTING OF Mn-Al-C MAGNETS</u>	5-1
A. Background information	5-1
B. Material available from Japan	5-1
C. Magnetic data requirements and plan of studies	5-1
D. Experimental procedure and results of magnetic tests	5-3
1. Measuring method	5-3
2. Uniformity of properties in 31 mm extruded bar	5-3
3. Easy and hard axis magnetization curves at several temperatures	5-4
4. Dynamic operation of the magnet	5-5
5. Summary of temperature variation of magnetic properties	5-5
E. Mechanical tests	5-6
1. Machining experience	5-6
2. Bending test for flexural strength	5-6
3. Compressive strength test	5-6
F. Conclusion and summary of results	5-7
G. References - Chapter V	5-10

VI. <u>FEASIBLE MAGNET DEVELOPMENTS</u>	6-1
A. Objective, chapter organization	6-1
B. State-of-the-art summary for the different high-grade magnet materials considered for possible use in EHV propulsion motors.	6-1
1. Commercially available magnet materials	6-1
(a) Alnico magnets	6-2
(b) Iron-chromium-cobalt magnets	6-3
(c) Manganese-aluminum-carbon magnets	6-4
(d) Hard-magnetic ferrites	6-6
(e) Rare earth-cobalt magnets	6-8
2. Experimental new permanent magnet materials	6-13
(a) Heavy rare earth-iron compounds	6-13
(b) Microcrystalline rare earth-iron alloys	6-14
(c) Crystallized amorphous Fe-Ni-base alloys	6-16
(d) Recommendations for NASA	6-16
C. Summary of developments that could impact EHV propulsion motor technology	6-16
D. Specific R&D projects recommended for possible NASA/DOE funding	6-17
E. References - Chapter VI	6-19
VII. <u>CONCLUDING REMARKS</u>	7-1
ACKNOWLEDGMENTS	7-2
APPENDIX A - General Bibliography	A-1
APPENDIX B - Table of Symbols and Abbreviations	B-1

SUMMARY

A study of permanent magnets (PM) was performed in support of the DOE/NASA electric and hybrid vehicle program. PM requirements for electric propulsion motors are analyzed, design principles and relevant properties of magnets are discussed. Available PM types are reviewed. For the needed high-grade magnets, design data, commercial varieties and sources are tabulated, based on a survey of vendors. Economic factors such as raw material availability, production capacity and cost are analyzed, especially for cobalt and the rare earths. Extruded Mn-Al-C magnets from Japan were experimentally characterized. Dynamic magnetic data for the range -50° to $+150^{\circ}\text{C}$ and some mechanical properties are reported. The state of development of the important PM material families is reviewed. Feasible improvements or new developments of magnets for electric vehicle motors are identified.

INTRODUCTION

This report presents the results of a multi-faceted study of permanent magnets and their use in propulsion motors for electric vehicles. It is intended to provide motor designers with technical design data and economic information they need to make an informed choice among magnet materials and to assist them in the most effective utilization of the magnets.

Under the DOE/NASA Electric and Hybrid Vehicle Program, several other contractors designed and developed new permanent magnet motors; also the associated power supplies and electronic controls. Our project was intended to complement their efforts. We had to interact with the motor designers, provide requested information about the magnets they chose to work with, and suggest possible alternatives to use in future PM motor development.

The present report has analytic, encyclopedic, experimental and tutorial aspects. The magnet requirements for electric propulsion motors and the needs for quantitative information are analyzed. Relevant magnetic and other quantities are defined and their value for the motor designer is discussed. Principles of efficient magnetic circuit design using different permanent magnets are qualitatively explained. Commercially available magnetic material types are reviewed and the magnet types most suitable for motor use are identified. With the cooperation of many magnet producers in the USA and other industrial countries, data on the properties and commercial availability of the magnets of potential interest were collected and tabulated. Data for newly developed magnet materials (Mn-Al-C, Fe-Cr-Co, rare earth-cobalt) were collected from the scattered literature, certain properties of Mn-Al-C were measured, and the results are systematically presented. Extensive references to more detailed source material are given.

In view of the fact that electric vehicles might eventually become a major new market for permanent magnets and consume a substantial fraction of magnet production, an analysis of certain economic prospects was undertaken. It takes into account the natural abundance of raw materials,

geographic location of sources, present and projected production capacity of the material and magnet-producing industries, as well as some cost factors and price developments. Of particular interest in this respect are the rare-earth magnets and their principal raw materials, cobalt, samarium and the other rare earths. Potential quantity requirements of different suitable magnet materials for a hypothetical mass production of vehicle motors are analyzed and put in perspective relative to the materials' availability.

Finally, the state of technology and industrial development for the important permanent-magnet families is summarized. The prospects for some new magnet materials now in the research state are discussed. Some feasible improvements of magnets for motors or of manufacturing processes for them are identified.

I. PERMANENT MAGNET REQUIREMENTS FOR MOTORS

A. Purpose, Outline and Methodology of Study

1. General Review of Permanent Magnet Electric Motors.

Permanent magnets (PM's) can be used to replace one set of windings in several types of electric motors: DC motors, synchronous and various hybrid AC machines, stepping motors, actuators. In mechanically commutated DC motors, the magnets are located in the stator, while the rotor has windings that are fed in the usual manner through brushes. With the newer magnet materials of high energy density and high coercive force it is also possible to put the permanent magnets in the rotor, using a so-called "inside out" design (1). This has the advantage that no electric power needs to be supplied to the rotor, which thus remains cooler. However, if mechanical commutation is used with such an inside-out machine, sliding contacts are still necessary; in fact, the commutator structure becomes more complex, requiring additional slip rings (2).

PM motors with magnet rotors could be built even with the low coercive force alnicos, but the designs are awkward, the rotors are large and massive, and they have very high moments of inertia (3). Therefore, such motors found only very limited use. Rotating-magnet machines have become truly practical only with the availability of the modern magnets that combine high intrinsic coercive force with at least moderately high energy density. Particularly the rare earth-cobalt magnets and the best grades of modern ferrites are suitable.

The availability of drastically improved permanent magnet materials in the last decade has made PM motors a much more practical device than they had been in the past. Because of this, their range of applications is now rapidly broadening (4,5). In the past, permanent magnets were used - with very few exceptions - only in miniature motors and in fractional-horsepower machines for battery-powered hand tools. Now, PM machines with ratings of several kW are coming into widespread use in machine tools (6); larger machines with 50 to 200 kW have been successfully developed for specific aircraft and space vehicle applications (7); and design studies for much larger machines - in the MW range - are said to show that these have practical promise for ship propulsion (8).

Such dramatic progress was possible not only because of the development of better magnet materials, but a confluence of new technologies was also required to make the present revolution in motor design and utilization patterns possible. High-power semiconductors, modern amplifier technology and, increasingly, microprocessors are important elements of the modern drive systems built around PM motors. Thus, the conventional mechanical commutator can now be replaced by an electronic commutation system that senses the angular position of the PM rotor and switches the current in the stator windings in synchronism with the shaft rotation. This led to the so-called brushless DC motors (9). Such motors are almost identical with PM synchronous motors as described in the next paragraph. The distinction between a true AC synchronous motor and a brushless DC motor lies in the nature of the associated power and information processing equipment, not in the electromagnetic design of the motor itself.

The second basic kind of motor that can utilize permanent magnets is thus the AC synchronous motor (10). A permanent magnet array in the rotor tends to follow a rotating air-gap field produced by a multi-phase winding, or by the winding of a permanent-split capacitor machine fed from a 1-phase line with the help of a phase-shift capacitor (pseudo 2-phase). PM synchronous motors for many years were also restricted mostly to very low-power devices, such as clocks, appliance timers, etc. Their use has recently been extended to drive functions in small household items such as kitchen blenders, mixers, and electric razors. Now, with the availability of rare earth-cobalt magnets and recent advances in power electronics, they have become practical as torque motors and industrial drives of several kW ratings, aircraft starter motors of 60 and 150 kW, and, of course, they are being considered for use as traction motors in electric automobiles (11,12).

PM synchronous motors operated from a fixed-frequency supply are generally not self-starting, and when a single-phase rotor is brought up to synchronous speed somehow, it will run in either direction. To make a synchronous motor self-starting under these conditions, it is often made into a hybrid motor of some sort. One possibility is to imbed conductors in the rotor in such a manner that the machine can function as an induction motor - however inefficiently - during the start-up (13,14). Or one can also use the self-starting properties of a hysteresis motor by including an element of semihard magnetic steel in the rotor. These features of an induction or hysteresis motor can either be integrated with the synchronous PM rotor structure, or a separate auxiliary induction or hysteresis rotor can be mounted next to the PM rotor on the same shaft. The variation of the reluctance with the rotor position can also be used as a starting aid. For single-phase synchronous motors, the running direction can be uniquely defined by introducing a magnetic unsymmetry in the reluctance of the magnetic flux path of the PM rotor-stator system.

A pure synchronous machine with a PM rotor can, of course, also be operated at variable speeds from a variable-frequency power supply. If the supply frequency begins to build up from zero at a sufficiently slow rate, the motor will be self-starting. Recent advances in semiconductor technology and in the art of power conditioning have made such variable-speed synchronous motor systems a practical and often economic proposition. They are being developed for many applications now. The currents supplied to a permanent magnet motor do not need to be sinusoidal. The motors will run on partial sine waves such as those supplied from SCRs, and a properly designed motor can also be operated with a sequence of square pulses, so that pulse-width and pulse-frequency modulation schemes may be used to control the power and the running speed of PM rotors.

For the sake of completeness it should be mentioned that hysteresis motors are a form of PM motor with magnets in the rotor. The permanent magnet materials used in them are purposely chosen to have coercive forces in the 50 to 200 Oersted range - very low by present PM standards - so that their magnetization can be reversed with only moderate difficulty during the starting. As we mentioned before, such motors are self-starting, even in a fixed frequency rotating field, and they can eventually achieve full synchronism. However, hysteresis motors of a given physical size develop much less torque than other motor types, so their application is restricted

to timers and to certain applications where slip proportional to the load is important (e.g. coil winders). If built to deliver several kW, they would be extremely inefficient and bulky, and so they are entirely unsuited for use in vehicle propulsion.

2. The Case for Permanent Magnet Motors in Electric Vehicle Propulsion.

The DOE/NASA Electric and Hybrid Vehicle (EHV) Program includes projects to develop several alternative motor/controller systems and to explore their utility for vehicle drives. Secunde (11) discussed the types of systems and their prospects for EHV propulsion use as follows.

Presently operating electric cars generally use as their traction motors one of the conventional wire-wound DC motor types. These have been commercially available for a long time in the required range of power rating of about 10 to 30 kW. They can operate from batteries over a wide speed range, and they can be simply and efficiently controlled by changing the field excitation current or the voltage applied to the armature (rotor) terminals. The motor/controller systems are well developed and understood. Still more flexible control is possible with modern solid-state choppers (DC-to-DC converters). However, wire-wound DC motors are expensive to produce, their size and weight for given ratings are relatively large, they have mechanical commutators and brushes that wear, spark, need maintenance, and limit the running speed; and they have a heat removal problem. The need for electric excitation results in lower efficiency (and thus greater battery drain) than can be achieved with some other motor types.

With semiconductor power electronics it has become possible to build vehicle propulsion systems that use AC machines or brushless, PM-type DC motors. The alternatives now under development are brushless motors with permanent-magnet rotors, electronically commutated by three-phase semiconductor inverters; and AC induction motors controlled by polyphase, variable frequency/variable voltage inverters. In both cases, the motor is simpler and thus potentially cheaper to manufacture than a wound-armature motor. The rotor is solid and has no electrical connections, it can therefore run at higher speed, and no power is needed for excitation. Induction motors are, of course, the most common electric motor type and quite cheap. Inverted PM motors are still developmental items and - if samarium-cobalt magnets are used - they are more expensive than wound DC motors, because of the high present cost of the magnets. Both, induction and PM motors, require complex control electronics only now being developed. The inverters use high-current semiconductor elements (thyristors or transistors) which are still quite expensive.

However, the prospects for the availability of much cheaper power semiconductors in the near future are good. The electronic controller provides virtually all needed control functions, and it can be programmed with a microprocessor for optimum system performance over a wide operating range. Thus, the induction and/or the PM motor system may ultimately prove more economical than the brush-type motor drive.

We shall now focus on the permanent magnet motors. Generally speaking, electronically commutated DC or synchronous PM machines offer these advantages: They are simpler in construction than mechanically commutated DC machines, they have no brushes and commutator, the

elimination of coils means reduced losses, thus better electrical efficiency and less heat development. The absence of rotor windings also reduces the risk of insulation failure and thus increases reliability. All the I^2R losses occur in the stator from which it is easier to remove the heat. A properly built PM rotor with a support hoop can safely rotate at speeds several times that of wire wound rotors. As a consequence, the energy density of the machine - which is proportional to the speed - can be considerably higher. In a properly designed permanent magnet machine, these features add up to a substantially smaller motor size and a more efficient machine.

Depending on the magnet material used, the initial cost of the motor may be higher or lower than that of a wound machine. Machines with ferrite, Alnico, Mn-Al-C and rare-earth magnets are under consideration. Parker (5) argued that the use of rare earth-cobalt permanent magnets (REPM) in larger electrical machines should bring economic advantages over electromagnetic excitation, and even over PM motors utilizing ferrites, if one considered the entire energy conversion system and optimizes the design. At the present prices of high-current semiconductor devices, the motor and power converter together are certainly more costly than the conventional motor and controller system. However, it is expected that the electronic package will become considerably cheaper in several years, so that the life cycle cost of the system with an electronically commutated PM motor may well become lower than that of competing systems. For these reasons, DOE/NASA have contracted to develop several PM motor-electronic converter propulsion systems (11). The development of new brushless PM motors under this program was described by Maslowski (12). It has indeed resulted in experimental motors of much higher performance than their wire-wound counterparts. The three participating contractors each chose at least one motor design employing REPM, plus another using cheaper but poorer magnet materials. For details see Section I,B below.

3. Objectives of the Study Effort under this Contract.

The work at the University of Dayton under this contract was to support the further development of these and similar drive systems. It was intended to assist motor designers and production planners by providing detailed information on permanent magnets, their properties, correct use, cost and supply factors, and the prospects for the future of magnet development.

The specific objectives stated in the contract document were

1. To define the requirements that a permanent magnet must meet to be used in propulsion motors for electric vehicles.
2. To identify those permanent magnet types applicable to propulsion motors for electric vehicles and to compile technical, cost and availability data for them.
3. To establish the principles and procedures for integrating suitable permanent magnets into the magnetic circuit design of propulsion motors for electric vehicles.

4. To characterize the properties of available manganese-aluminum-carbon permanent magnets by experimental tests.
5. To recommend improvements to existing permanent magnets and/or new magnets with the potential for overcoming the limitations of existing magnet materials, and identify those for which further development within a reasonable cost and time frame may be feasible.

For the work toward these goals, the following task structure was established:

Task I - Permanent Magnet Requirements for Motors

The literature on propulsion motors and PM motors in general was to be studied, DOE/NASA contractors and motor manufacturers were to be visited for discussions, and from the information gathered, a set of requirements and characteristics was to be defined which PM's must possess to be useful in propulsion motors.

Task II - Review of Permanent Magnets.

Pertinent data on technical properties, magnet availability and cost, and on the materials supply base were to be compiled and tabulated, considering all existing (and proposed new) suitable permanent magnets.

Task III - Permanent Magnet Categorization.

The results of Tasks I and II were to be integrated. The specific suitability (or lack thereof) of the various PM for motor design with the various magnets were to be discussed.

Task IV - Mid-Program Review.

An oral review of progress at the completion of Task III.

Task V - Permanent Magnet Tests.

Information on, and samples of, the new PM material from Japan, Mn-Al-C, were to be obtained. The pertinent magnetic and other physical characteristics were to be measured.

Task VI - Feasible Permanent Magnet Developments.

New PM Materials or potential improvements of existing PM's for propulsion motors were to be identified. Specific recommendations for feasible developments or improvements were to be made.

Task VII - Program Review.

This was a final oral review of progress and results for NASA-Lewis personnel at the completion of Task VI.

4. Information Gathering Activities.

(a) The initial task was to identify and understand the design approaches taken by the different groups working on electric propulsion systems under DOE/NASA contracts. This was accomplished by obtaining and reading their progress reports (which were few and uninformative in the early phases of the work, in 1980/81), and by seeking personal contact with the project managers and engineers. With the assistance of our NASA contract monitor, Mr. F. Gourash, a number of visits to (and by) motor contractors were arranged. K. Strnat made the visits. All contractor personnel were cooperative and helpful. The following contacts were made.

1/1980 - Visit to the University of Dayton (UD) by P. Campbell of the University of Southern California (USC). Dr. Campbell gave a seminar on electric vehicle motors and discussed his group's role in the DOE/NASA project.

4/1980 - Conversations with F. Werner and K. Foster, of the Westinghouse Research Labs., at the INTERMAG Conference in Boston. Discussed their company's motor projects, arranged a later visit to Westinghouse.

5/1980 - Visit to P. Campbell's laboratory at USC, Los Angeles. Discussed projects, saw motors, test stand. K.S. gave seminar lecture on modern magnet materials for USC students and local industry.

5/1980 (Same trip) - Visit to Garrett Airesearch Mfg. Comp. at Torrance, CA. Discussed their NASA EHV-drive project, other PM motor and REPM device development. Met with F.Echolds (project supervisor), A.Druzscza, F.McCarthy, D.Moeller, C.Ramezani, K.Wuertz.

5/1980 - Visit at General Electric Corp. R&D Center, Schenectady, NY. Met with G.Kliman (project supervisor), R.Hunsinger, R.Tompkins regarding NASA project, saw motors, test stands. Also visited motor expert E.Richter in another division. Visited magnetic materials scientists J. Becker, J. Livingston, F.Luborsky, D.L.Martin. Gave seminar lecture.

7/1980 - Visit at University of Dayton by GE R&D Center personnel, G.Kliman and R.Tompkins. Discussed further their magnet material requirements for EHV motors, our work on magnets, showed UD laboratories. Planned Mn-Al-C magnet testing.

8/1980 - Visit to Inland Motor Div., Kollmorgen Corp., Rad. c, VA. Met B.Overton (project engineer) to discuss his DOE/NASA work done in cooperation with VPI. Met with L.Langley, R. Fisher re. other PM motors, with others - on the subject of magnet material requirements for motor applications.

10/1980 - Visit to Westinghouse Research Center, E.Pittsburgh, PA. Met Wm.Jones (project engineer) to discuss NASA EHV project, D.Greene, D.Triezenberg, A.Crapo re. this and other motor developments; F.Werner and K.Foster about magnetic materials testing, saw their laboratory.

(b) The second aspect of the information gathering concerned permanent magnet materials. Data for properties of importance in engineering design were collected for the magnet types useful in EHV motors. Also of interest

were the types and grades which are offered by major commercial manufacturers worldwide; whether magnets are available in the required shapes and large sizes; and their cost. To supplement the information available in our extensive files and in the easily accessible technical literature, we pursued three avenues:

A letter request was mailed in June, 1980 to 36 magnet producers or vendors, 12 of them located in the USA and 24 in other countries. Twenty-eight replies were received. These ranged from letters and relatively superficial product listings to detailed technical brochures, sometimes supplemented with thick packages of scientific articles. We now have an extensive file of recent commercial literature on magnets that is open for inspection on request to interested engineers from other EHV project contractors. The tabulations in Chapter III of this report are an attempt to analyse and summarize this information in ways that should help motor designers in their design calculations, and in selecting and ordering the permanent magnets needed from commercial sources. A draft copy of these tables was submitted to the participating companies with the request to review and, if necessary, correct the pertinent entries.

Some additional visits were made to permanent magnet manufacturers, and some producer representatives visited us. In these conversations we tried to explore topics generally ignored in the technical sales and application literature, i.e., the nature of the raw materials used in magnet production, the materials supply situation, magnet prices and the factors affecting them, production capacities and expansion plans. Understandably, not much useful information was obtained regarding prices and production, even in personal conversations with company executives.

Such personal contacts with magnet manufacturers included.

4/1980 - Raytheon Comp. in Waltham, Mass. (In conjunction with Intermag Conference.) Met D.Hutchens, J.Sklenak, saw REPM production facility, and laboratories; discussed development efforts.

5/1980 - Visit at the University of Dayton by Y. Sakamoto of the Matsushita Electric Industrial Co. of Japan, at present the sole manufacturer of Mn-Al-C magnets. (This followed up a visit by K.Strnat, in 1979, to the Matsushita Research Center in Japan.) We requested samples for testing that were received in due course.

10/1980 - Visit to Colt Industries, Crucible Materials Research Center, at Pittsburgh, PA. Met with Dr. Narasimhan and Mr. Preusch. Discussed Alnico, ferrite and RE-Co magnet production and pricing. Saw pilot line production facilities for REPM made by low-oxygen processing.

6/1981 - Visit at the University of Dayton by T. Shimoda of the Japanese Suwa-Seikosha Comp. Discussed that company's progress in the development of high-energy, epoxy-bonded REPM, production and future plans. (Magnet samples were received by mail later.)

8/1981 - Visit to Hitachi Magnetics Corp. at Edmore, Michigan. Discussed REPM, ferrite and Lodex magnet production and saw parts of plant. Met F.Doser, F.Jones, R.Parker, S.Rashidi and J.Thoe (Engineering Manager).

Another valuable source of information was the 5th International Workshop on Rare Earth-Cobalt Permanent Magnets, held in Roanoke, VA, in June, 1981. R. Secunde reviewed the DOE/NASA program. With view toward the EHV motor requirements, a discussion session on raw materials was held. General reviews of the magnet development in Japan and China were given by invited speakers from these countries (G11).

Finally, inquiries were made and personal conversations took place with representatives of some raw materials suppliers. Companies that responded with information were the Molybdenum Corp., the Research Chemicals Co. and the Ronson Metals Corp. (all U.S. suppliers of rare-earth materials), the French RE manufacturer, Rhone-Poulenc, and the German Th. Goldschmidt Co. On the cobalt supply side, information was obtained from the Canadian company, Sherritt Gordon Mines, Ltd., and recently, from the Cobalt Development Institute in Brussels, Belgium. Information obtained from these sources was used primarily in preparing Section I,D of this report.

5. Analysis of the Information Obtained

(a) From conversations with NASA-Lewis personnel, the visits with motor contractors and background reading, an overall picture emerged of the drive system development program and of the approaches the different contractors were pursuing. The general aspects of this program that are of interest for our own work are outlined in this section. A more detailed discussion of the various design concepts used in the development of permanent magnet motors, and of the specific types and quantities of magnet materials employed, will be found in the following Section B. From conversations with the project engineers, we were also able to formulate a list of the PM material properties that are, or should be, taken into account in the motor design (Section C). Next, we attempted to determine the economic factors that influence the utility of a given permanent magnet material for EHV motors. We accumulated some information on cost factors that influence the finished magnet prices, with emphasis on raw materials, their availability and typical prices (Section D). Finally, we formulated the specific property requirements which the EHV application imposes on the permanent magnets, relating them to different aspects of the motor design. (Section E.)

(b) The design goals for the motor-controller system were given by the NASA program management to the contractors indirectly, in terms of vehicle performance specifications. From these, the specific motor design objectives had to be derived under reasonable assumptions concerning losses in gears and power train, and the behavior of the electric power processing equipment. The guidelines were as follows. (11, 12).

A 3000 pound vehicle is to be operated according to Schedule D of the SAE J227a test standard for urban passenger cars. It has to accelerate from 0 to 45 mph in 28 seconds, be capable of continuous operation at 55 mph for 2 hours, and climb a 10% grade while maintaining 30 mph. The power source would supply 120 V DC and have 0.05 Ohm internal resistance (lead/acid battery pack).

From this information, a preliminary study concluded that the motor should have a minimum power rating of 11 kW continuous and 26 kW peak output. Most contractors designed somewhat more powerful motors. The

design objectives were thus not quite uniform, making it difficult to directly compare the different motors, and thus the quantities of magnet materials needed. Figure 1-1 depicts a typical duty cycle of instantaneous motor power versus time consistent with these vehicle performance specifications (11).

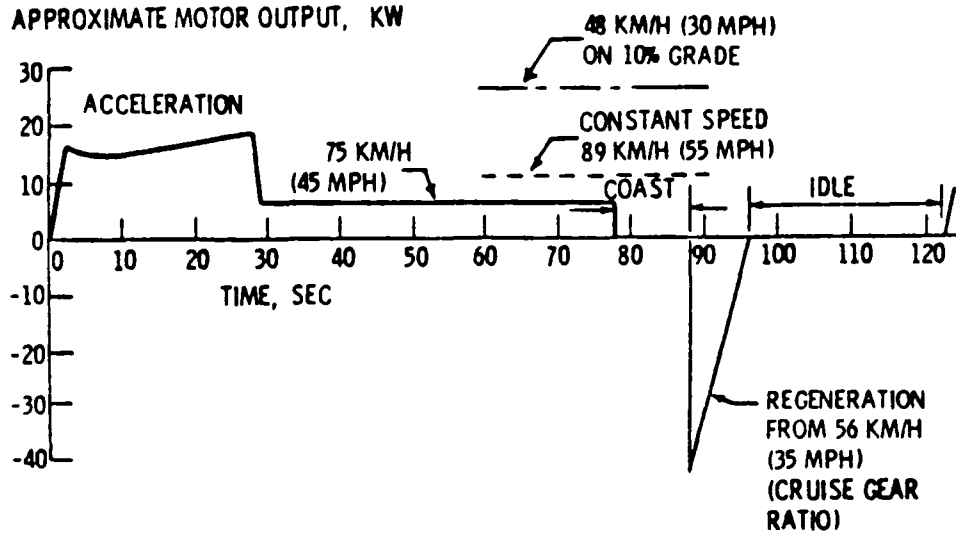

Figure 1-1: Typical motor duty cycle. Instantaneous power required during drive cycle according to Schedule D of SAE J227a test standard (Ref. 11).

(c) Following is a list of the motor contractors involved in this program during the 1978-82 period, with a brief definition of their assignments.

A group in the Electrical Engineering Department of the Virginia Polytechnic Institute and State University (VPI), in cooperation with the Inland Motor Div. of Kollmorgen Corp. (KC), worked on brushless PM motors of drum design (radial gap flux). Their motors have intermediate speed and use the PM materials Sm-Co and strontium ferrite.

The Garrett AiResearch Manufacturing Comp. (GAR) built a high-speed PM drum motor with Sm-Co, and then - as their "advanced design" - a homopolar disk motor (axial gap flux) of moderate speed that also uses a sintered Sm-Co magnet in the rotor.

The General Electric Corporate R&D Center group (GE) chose a low speed brushless motor of disk geometry that was designed to use Mn-Al-C as the PM material. But it was first built with Alnico 8 substituting for the as yet unavailable new magnet alloy. Later the motor was redesigned with Sm-Co.

Each of these contractors began working on a motor based on existing technology, called the "improved design." Then they proceeded to motors based on novel concepts, termed the "advanced design."

The University of Southern California's Electrical Engineering Department (USC) developed methods for the analytical modeling of axial-

field PM motors, calculated the behaviour of several motor types, and verified the results by testing such a machine in the laboratory. Special attention was given to the problems with Alnico designs.

These were the contractors working on permanent magnet machines, whose projects were to be directly supported by our study effort. Some additional companies worked on motors that do not use magnets.

A group at the Westinghouse Research Laboratory develops a wire-wound, brush commutated DC motor of disk geometry that is fed through a high frequency electronic chopper. This is seen as a more economical solution in the short term, until cheaper high-performance magnets and semiconductor devices become available. We understand that in a later version of the same motor, a ferrite magnet may be added to the stator which would supply that portion of the excitation field (30-40%) that does not need to be varied for speed control.

Finally, three more contractors - another General Electric Division, the Gould Corporation, and the Eaton Corporation - all work on drive systems that employ an induction motor driven by a variable frequency/variable voltage/polyphase inverter. These projects were of no particular concern in our present work.

B. Permanent-Magnet Motor Types Designed Under the DOE/NASA EHV Program

1. Different Design Concepts Pursued

In this section we shall discuss in greater detail the design approaches chosen by the three contractors who designed and built PM motors. The emphasis will be on the geometry of the magnetic circuit, the type of the PM materials employed, and the shapes and quantities of the permanent magnets used. All the motors have the PM in the rotor and are thus of the brushless, or synchronous variety.

The first choice of all contractors for the PM material was a rare earth-cobalt magnet; more specifically, sintered SmCo_5 . Of all magnets commercially available when these programs were planned, this was the one with by far the most desirable performance characteristics. (Very high energy product and intrinsic coercive force, straight-line B vs.H demagnetization curve throughout the second quadrant of the hysteresis loop.) During the program period, the so-called "cobalt crisis" occurred. For about three years, cobalt costs - and therefore REPM magnet prices - rose to unreasonable levels, and serious questions about the long-range cobalt supply situation were raised. In view of this adverse development it was logical to look for alternative, cobalt-free magnet materials that could be used. Two of the contractors (VPI/KC and GAR) redesigned their motors with ferrite ceramic magnets, the third (GE) chose the new metallic PM material, Mn-Al-C.

"Continuous" and "peak" power ratings are quoted for each motor in the following discussions. It should be noted that these numbers are difficult to define for the vehicle propulsion motors. The different contractors seem to have used somewhat different test criteria, even relating to different drive-test cycles for the vehicle, and therefore, the kW numbers quoted should not be taken too literally. In terms of thermal load, "continuous" means operation for at least 1 hour (more than the thermal time constant), "peak power" refers to operation for 1 minute without overheating.

(a) Garrett AiResearch Manufacturing Comp. Projects:

Design GAR-1 ("NASA Improved Motor")

This is a drum motor with the basic geometry shown in Fig. 1-2. It is a high-speed machine rated at 26,000 rpm maximum speed, 35 kW peak power, for 1 minute, and 15 kW continuous capability. It weighs 15 kg plus 2.7 kg for a fan required for forced-air cooling (12,15). This extremely low weight is attributable to the very high operating speed. It is estimated that the gearing needed to reduce the shaft speed will add another 2 to 4 kg (11).

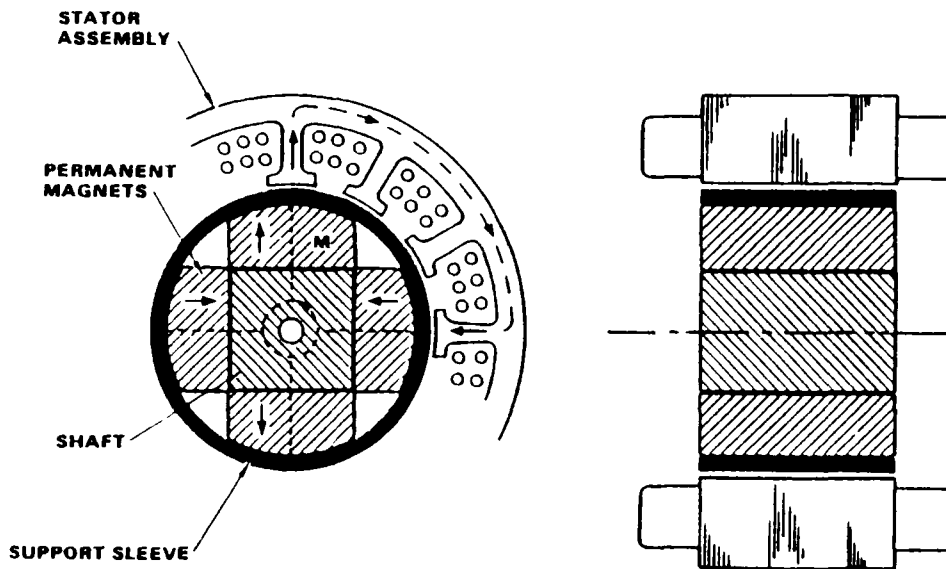

Figure 1-2. Basic geometry of 4-pole drum motor with radially oriented permanent magnets (REPM or Ceramic) in the rotor. (GAR-1 and VPI/KC-1) (Ref. 16).

This motor has a 4-pole rotor with radially oriented magnets bonded onto a magnetic steel core (shaft). In this arrangement, leakage flux is minimized compared to designs in which the magnets do not directly face the air gap. However, the magnets must be constrained against centrifugal forces by a nonmagnetic support sleeve. The thickness of this retainer adds to the effective air-gap length, thus increasing leakage again.

The PM material is sintered SmCo_5 of, nominally, 175 kJ/m^3 (22 MGOe) static energy product. This was the top grade of rare earth-cobalt magnets commercially available in the 1978-79 time period when this motor was designed. The quantity of PM material in the finished motor is 1.4 kg.

Design GAR-2 ("NASA Improved Motor, Low Cost Version")

This is a redesign of GAR-1 with ceramic ferrite magnets instead of Sm-Co (12). Ferrites are relatively low-cost magnets, they contain no cobalt and use very cheap raw materials of unlimited availability, the industry manufacturing PM ferrites is mature and there is excess production capacity in the USA and worldwide.

The geometry of this drum motor is the same as before (see Fig.1-2). Rated speed is 22,000 rpm, peak power is 26 kW. A 6-pole rotor design was chosen. The machine weight is 34 kg, plus 2.7 for the fan, this is 2.3 times the weight of the Sm-Co motor. This motor was designed but not actually built and tested.

The PM material chosen for this design was the Ceramic-8 grade of sintered, anisotropic strontium ferrite. The nominal energy product is 26

kJ/m^3 (3.25 MGOe). Again, this was the best grade of ferrite for the purpose available from U.S. commercial production at the time. It offers an optimum combination of high remanence (hence, energy) and satisfactory intrinsic coercive force. The quantity of ferrite needed per machine is 5.9 kg. This is 4.2 times the mass, or 7 times the volume, of the Sm-Co in GAR-1.

Design GAR-3 ("NASA Advanced Motor")

This motor is radically different from GAR-1 and 2. It is a disk motor of homopolar construction (Fig. 1-3). The ratings are 14,000 rpm maximum speed and 11/26 kW power. The weight is 22 kg (11,16). This machine was actually built. The development was terminated before the design objectives were fully achieved.

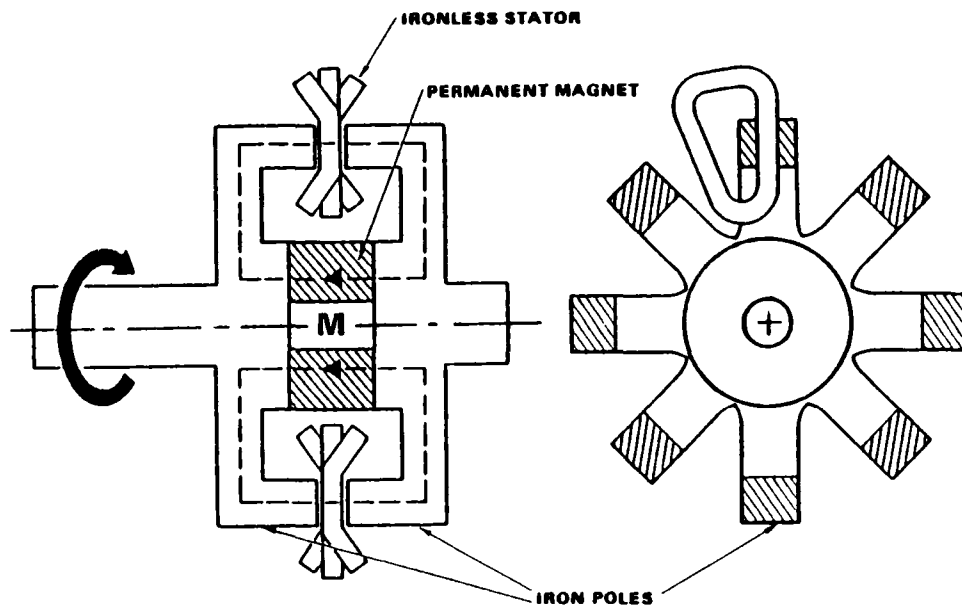

Figure 1-3: Basic geometry of the homopolar disc motor having a single, axially oriented REPM centrally located in the rotor. (GAR-3) (Ref. 16).

The rotor has a single, large, ring-shaped permanent magnet (6 in. OD) that is axially magnetized. The poles are radially extended by solid steel pieces that form 8 identical claws on each side. At the outer rim of the structure, these claws direct the flux axially into an annular interaction volume. In this "washer-shaped" air gap, eight angular channels of high flux alternate with segments of low flux density. The flux is in the same direction throughout the air gap. The ironless stator winding (a sequence of bobbin-wound coils) sees on each side an alternation of stronger and weaker poles of the same sign, a total of 16 such "poles."

The PM material is sintered Sm-Co of a nominal energy product of 120 kJ/m^3 (15 MGOe). The composite ring magnet of 5.957" OD, 0.374" ID and 0.45" axial thickness weighs 1.672 kg. It is radially constrained by a

hoop of nonmagnetic steel (Inconel), which does not add to the air gap in this design.

This motor was intended to be self-cooling through the fan action of the claw structure. Model tests showed that this also caused excessive windage losses (11). These could be avoided by filling in the cutouts in the pole structure. Other disadvantages of this unique design seem to be increased flux leakage between the radial steel arms on opposite sides of the magnet, and the danger of eddy currents in the aluminum housing walls.

(b) Virginia Polytechnic Inst. and Kollmorgen Corp.

Design VPI/KC-1 ("NASA Improved Motor")

This is again a drum motor, very similar to GAR-1 (Fig.1-2), but it is a medium speed machine. The ratings are 7,650 rpm maximum speed, 26kW peak power, 11 kW continuous. The machine weighs 40 kg, all inclusive (11,12,17).

The 4-pole rotor has radially magnetized SmCo_5 sintered magnets restrained by a nonmagnetic steel sleeve. Its overall dimensions are 3" diameter and 6.3" axial length. The magnet material was not the most expensive top grade, but a more conservatively chosen typical production REPM that is now available from many suppliers. The design value of the energy product was 144 kJ/m^3 (18 MGOe). There are 2.4 kg (5.3 lb) Sm-Co in the motor.

Design VPI/KC-2 ("NASA" Improved Motor, Version 2")

The above motor was redesigned as a 6-pole machine to reduce the amount of expensive Sm-Co required. The ratings for this version are: Maximum speed 8,600 rpm, peak power 26 kW, continuous power 11 kW. This motor weighs only 27 kg. (11)

Using the same grade of sintered SmCo_5 (144 kJ/m^3), only 1.47 kg of the magnet are now required, practically the same quantity as for GAR-1.

Design VPI/KC-3 ("NASA Improved Motor, Low Cost Version")

The VPI/KC team, too, redesigned the latter motor (VPI/KC-2) with the cheaper PM material, Ceramic-8. This 6-pole machine has 9,000 rpm top speed, again 26 kW/11 kW power rating. Its weight is 58 kg, or 2.1 times the weight of the equivalent Sm-Co motor. (11)

4.34 kg of Ceramic-8 magnet material with 26 kJ/m^3 energy product is required. This is about three times the weight of SmCo_5 in VPI/KC-2, or 4.9 times the magnet volume.

(c) General Electric Corp. R&D Center

The work of this group was exclusively on disk motors with axial air-gap field. (See Fig.1-4) The permanent magnets are nearly cubic blocks located at the circumference of the single rotor disk. Their magnetization direction is axial. They extend through the thickness of the rotor (no iron pole pieces) and are radially restrained by a thick nonmagnetic hoop.

The double-sided stator has a flat, 3-phase layer winding that necessitates an unusually large air gap. The flux closes on the outside of each stator half through a slotless, spiral-wound, laminated iron return path.

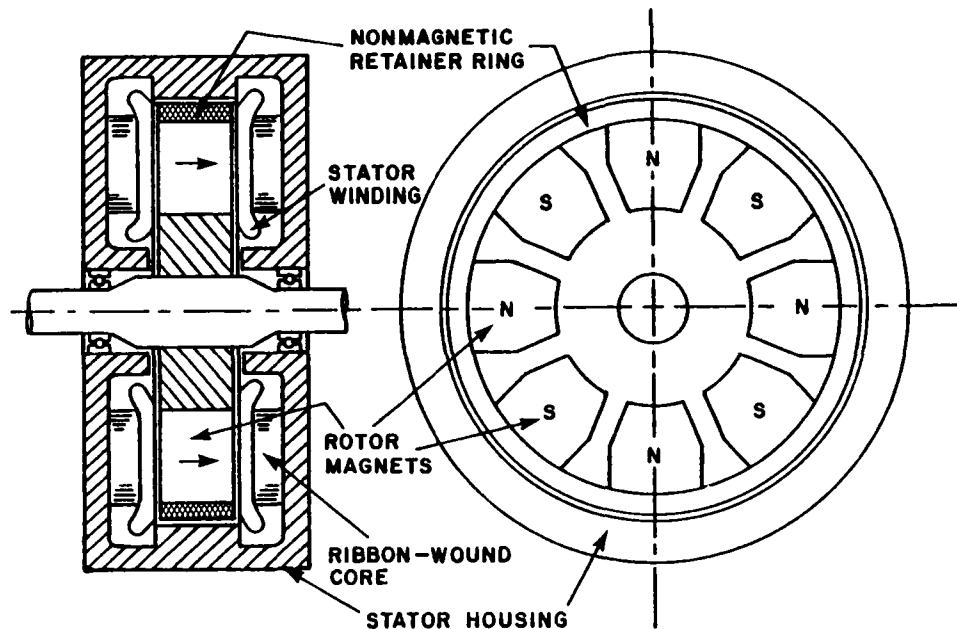

Figure 1-4. Basic geometry of disk motor with eight axially oriented magnets (Mn-Al-C, Alnico 8 HC or REPM) in the rotor. (GE-1,2,3) (Ref. 18)

Design GE-1 ("Proof-of-Principle Motor")

This first version of the new machine type that was built and tested is rated 5.2 kW (7 HP) at 3,600 rpm. It was said to be capable of developing 75 kW peak power for a short time. The total weight is 41.5 kg. (18,19)

The rotor has 8 poles on each side, generated by eight magnets of sintered SmCo_5 . Each magnet is approximately a 1-inch cube, but is assembled from several smaller pieces and trapezoidally tapered. The total weight of Sm-Co used is 7.8 kg - an excessive amount for the low power rating of the motor.

Design GE-2 ("NASA Advanced Motor")

This is a full-scale propulsion motor of the same basic design as GE-1, but for higher-speed operation, and designed to use a less expensive magnet material. It is rated 15 kW continuous at 11,000 rpm, 30 kW for 1 minute. The total weight is 58 kg. (11)

The 8-pole rotor was designed to contain 6.8 kg of the magnet material Mn-Al-C with a nominal energy product of 6 MGOe. However, since not enough of this PM material was available, the machine was built using the same volume of Alnico-8HC in its place. This required 9.9 kg of Alnico having 5.5 MGOe.

TABLE 1-1: MAGNET REQUIREMENTS AND COST FOR THE DIFFERENT MOTORS

DESIGN (Rating, kW)	MAGNET TYPE (BH) _{max}	INDIV MAGNET (Weight, g)	NO.	TOTAL FOR MOTOR	
				(Weight, kg)	(Cost, \$)
GAR-1 (15/35)	SmCo ₅ (22 MGOe)	350	4	1.4	185
GAR-2 (11/26)	Ceramic-8 (3.25 MGOe)	983	6	5.9	11
GAR-3 (11/26)	SmCo ₅ (15 MGOe)	1,672	1	1.67	221
VPI/KC-1 (11/26)	SmCo ₅ (18 MGOe)	60	4	2.4	317
VPI/KC-2 (11/26)	SmCo ₅ (18 MGOe)	245	6	1.47	194
VPI/KC-3 (11/26)	Ceramic-8 (3.5 MGOe)	723	6	4.34	8.12
GE-1 (5.2/75)	SmCo ₅ (18 MGOe)	975	8	7.8	1,030
GE-2 (11/30)	Alnico-8HC (5.5 MGOe)	1,238	8	9.9	240
GE-3 (15/45)	SmCo ₅ (18 MGOe)	870	8	6.96	918

* Cost estimates for magnets in an assumed commercial production of 100,000 motors per year. These are based on the lowest price quotes for magnets in early 1983.

Design GE-3

After difficulties with gradual demagnetization of the PMs were encountered in the operation of GE-2, the motor was redesigned using Sm-Co magnets. (11,20) This motor was successfully tested and was said to be capable of operating continuously at 15 kW without overheating, 30 kW for 4 minutes, and 45 kW for 1 minute.

The 8-pole rotor contained 6.96 kg of sintered SmCo_5 of 18 MGOe nominal energy product.

2. Summary of PM Requirements for the Different Motor Designs.

The listing, in Table 1-1, of magnet material types used and the quantities required for each of the motors is based on the preceding discussion in Section B,1. The abbreviations designating the different designs were introduced there. The cost figures are based on the price analysis detailed later in Chapter II, Section D,1. They are not the prices actually paid by the contractor for the small quantities of magnet material used in the experimental motors, but rather, the estimated cost of the magnets in large production lots, if orders were placed early in 1983.

C. Motor Performance and Magnet Selection

In this section we investigate, in a qualitative way, the relationship between desired motor performance characteristics or specific motor design objectives on the one hand, and the properties of available permanent magnet materials on the other. One purpose of this is to assist the motor designer in analyzing the various factors that influence the decision which magnet material to use. The second intent is to lay the groundwork for a subsequent discussion of the PM materials, of the relevant properties of the magnets, their definition and description in Chapter II.

Selecting the optimum PM for a propulsion motor is not simple. Many considerations enter into the choice, and they often conflict, requiring well thought-out compromises. These considerations include, of course, the best performance of the motor, its weight and size, and its energy efficiency; but also the consequences of these for the entire drive system of which the motor is a part. Various economic factors enter: the direct cost of the magnet material, the effects of the PM choice on the initial cost of the whole motor, of the power electronics package and the battery. The life cycle cost of the drive system is affected by the PM material choice. So is the producibility of the motor, including needed machining methods, tolerances, problems with magnetizing the magnets after assembly or handling them in the premagnetized condition, etc.

The results of our qualitative analysis of some of these relationships are summarized in Table II. We first selected eight motor characteristics, performance or producibility traits which are obviously all either required or highly desirable. The second column in the table lists the motor design parameters, or the cost factors in production or operation, which are most closely related to each specific trait. The third column suggests material choices and design measures that may be taken - especially in the magnetic circuit - to achieve the desired goal. Column 4 names the PM properties that are most relevant to the design subtask at hand. In column 5, semi-quantitative information is given for one salient property. The important PM materials that might be considered by the motor designer are listed in order of decreasing values for that particular quantity. Sometimes it is the highest, sometimes the lowest property value that is most desirable, chapter II should be consulted for details. In the last column, some of the designer's options are mentioned and some consequences of his choice of the PM material are discussed.

TABLE 1-2: CORRELATION OF MOTOR PERFORMANCE CHARACTERISTICS AND
(Part 1) MAGNET MATERIAL CHOICE. PERTINENT DESIGN OPTIONS.

DESIRED MOTOR CHARACTERISTIC OR PERFORMANCE TRAIT	RELATED MOTOR DESIGN OR MANUFACTURING CONSIDERATION	MEASURES BY WHICH DESIRED MOTOR BEHAVIOR MIGHT BE ACHIEVED	MOST RELEVANT PERMANENT MAGNET PROPERTIES	PERMANENT MAGNET MATERIAL SELECTION (Materials listed in order of decreasing relevant property)	MOTOR DESIGNER'S PRINCIPAL OPTIONS. CONSEQUENCES OF PM MATERIAL CHOICE
Compact motor, minimum motor weight	High air gap field, B_g (Designers are used to 7-9 kG) Motor rpm permissible temperature rise	Choice of high-remanence PM material, or flux focussing with iron pole structures High running speed of motor High current loading	Remanence, B_r Induction at typical operating point, B_d	Alnico 5 $B_r=12-13.5$ kG Fe-Cr-Co 8.5-14 Sint RE-Co 7-11 Alnico 8 7-8.8 Bonded RE-Co 5-8.5 Mn-Al-C 5-6 Sint Ferrite 3-4	a) PM at gap $\rightarrow B_g$ limited to 0.5-0.9 B_r Lower $B_g \rightarrow$ larger pole area needed (larger gap volume, machine circumference) b) Fe pole pieces can raise $B_g \rightarrow$ more weight, volume, flux path length in magnetic circuit
High torque at low speed (start, climb, stall conditions)	Good tolerance for high temporary armature reaction or high current surges	Choice of PM material with high resistance to demagnetization Design to take best advantage of the H_k available	Knee field, H_k ($B=0.9B_1$) Intrinsic coercive force, M^H_c Recoil permeability, μ_r Temperature variation of H_k and M^H_c	RECo ₅ $H_k=8-20$ kOe RE ₂ Co ₁₇ 4-10 Ferrites 2-4 Alnico 8 1.3-1.8 Mn-Al-C 1.3-1.5 Alnico 5 0.5-0.7 Fe-Cr-Co 0.3-0.7	a) High $H_k \rightarrow$ little danger of demagnetization \rightarrow freedom in choosing PM position (at gap!), operating point, tolerance of high current peaks b) Low $H_k \rightarrow$ designer must limit stall current and/or protect magnet by placing it far from air gap, using long PM or magnetic circuit length
Smallest absolute quantity of permanent magnet in motor (Decision between different PM materials)	Size, weight of magnet structure Inertia of PM rotor	Choice of high-energy magnet material combined with optimal magnetic circuit design	Energy products Static, $(BH)_{max}$ Dynamic, or useful recoil, $(BH)_u$	$(BH)_{max}$ in MGOe Sint RE ₂ Co ₁₇ 23-30 Sint RECo ₅ 14-26 Bonded RE-Co 6-18 Alnico 5-9 Mn-Al-C, Fe-Cr-Co 5-6.5 Sint Ferrite 3-4	a) Important when PM material expensive (RE-Co) For cheap PM (ferrite) other factors are more important b) Must design for operation near BH_{max} point OK for RE-Co, most ferrites Difficult when H_c low (Alnico)
Minimize fraction of motor volume or weight allotted to PM after a specific magnet material is selected	Size, weight, inertia, (cost) of magnet structure	Design for normal operation near the $(BH)_{max}$ point Minimize stray and leakage flux Optimize recoil behavior	Operating permeance B_d/H_d for $(BH)_{max}$ H_k (or demagnetization curve shape) Recoil loop field	$\sim B_d/H_d$ for $(BH)_{max}$, G/Oe Alnico 5, 5-7, 5COL 16-18 Fe-Cr-Co 15-25 Mn-Al-C 2.2-2.4 Sint RE ₂ Co ₁₇ 1.2-1.4 Sint Ferrite 1.1-1.2 Sint SmCo ₅ 1.0-1.1	a) Especially important when PM material expensive (RE-Co) b) Operation near BH_{max} point OK for RE-Co and most ferrites Difficult when H_c low (e.g. Alnico)

TABLE 1-2: CORRELATION OF MOTOR PERFORMANCE CHARACTERISTICS AND
(Part 2) MAGNET MATERIAL CHOICE. PERTINENT DESIGN OPTIONS.

Constant torque and power over operating temperature range - Or meet minimum performance specs at temperature extremes	Temp variation of air-gap flux density Surge currents at temperature extremes	(a) Use PM with small temperature variation (b) Worst-case design and temperature compensation of flux in circuit (c) Keep motor temperature low	Temperature variation of B_r , M^H_c , H_k Recoil loop fields at the extremes of operating temperature range	Alnicos have best temperature stability Ferrites and Mn-Al-C show strong temperature variation RE-Co types intermediate (allow internal compensation → flux trade-off necessary)	Complex considerations apply trade-offs required See discussion in text and information for individual PM types Note The usually quoted temperature coefficients (of B_r) are quite insufficient as an aid in motor design
Minimum cost of electromagnetic motor components Low motor price	Total materials cost (PM + softmag maerial + copper) Cost of fabrication and assembly	Balance costs of PM, softmag matl, Cu, manu- facturing cost of mag circuit for individual case	Cost per unit energy or gap flux of raw materials and/or finished magnet (Cost factors: raw materials, magnet production, shaping)	Raw material cost \$/kg Ferrites 0.53 Mn-Al-C 1.60 Fe-Cr-Co 4.70 Alnicos 3.50 - 5.00 RE ₂ Co ₁₇ 23 - 30 RECo ₅ 16 - 50	Complex Trade-offs necessary (a) Cheap PM → larger volume and weight, motor bigger other costs rise (b) Expensive RE-Co → very compact design possible (c) High H_c , H_k → larger gap OK, less critical machining tolerances, assembly is easier
Ease and low cost of initial magnetization	Cost of magnetizing fixture Complexity of procedure for magnetizing initially and after repair Energy cost for magnetizing	Know behavior of specific PM chosen Keep options for magnetizing and their cost in mind when designing motor	Applied "saturat," field H_g needed to develop full (or sufficient) B_r , H_c and H_k	DC magnetizing field in closed circuit, H_g [kOe] RECo ₅ (virgin) 10-15 RECo ₅ (remag) 25-50 RE ₂ Co ₁₇ (precip) 10-15 Mn-Al-C 10-12 Ferrites ~ 10 Alnico 8 ~ 8 Alnico 5 ~ 3.5 Fe-Cr-Co 2.5-8	Complex behavior, depends on specific PM type Some additional factors to consider (a) Magnetizing before or after assembly (b) DC vs pulse magnetization (pulse length) (c) geometry of magnetic circuit charging flux path eddy currents (pulse charging) (d) Incorporation of special magnetizing coils in motor (Alnico Fe-Cr-Co may require them)
Energy-efficient motor operation in electric vehicle	High energy efficiency under normal operating or driving conditions	Use of PM instead of wound field Design for high gap flux density Power conditioning system should be considered with motor	B_r , (BH) max B_d at (BH) max	(see above listings)	PM motors have general efficiency advantage over wound-field motor High gap-flux density is favorable PM rotors have low windage loss

D. PM Material Properties Relevant to Motor Design.

1. General Comments

Based on the foregoing discussions we can now compile a list of those physical properties of the magnet material that should be considered in the motor design. Unfortunately, the magnet manufacturers often provide quite insufficient information with their products, so that one has to hunt through textbooks and research papers for data measured on other materials that are presumably similar. This search is time-consuming and frequently yields meager results regarding some of the desired information. Particularly, magnetization curves in transverse applied fields, recoil loop sets, the temperature variation of properties over the operating range of the machine, demagnetization curves for the "third quadrant," and the long-term flux stability at elevated temperatures are often not given or only very incompletely described. In response to the relatively recent insistence on more information by increasingly sophisticated magnet users, such data are now being generated. This is done in part by independent laboratories under U.S. Government sponsorship - such as the characterization work on Mn-Al-C under the present contract - but increasingly also by progressive magnet producers.

The motor designer needs property data about the PM materials in four general categories - magnetic, mechanical, thermal and electrical. More specifically for the passenger vehicle application, there should be data on the temperature variation of many properties in the range of the potential operating temperatures of the motor magnet, from about -50°C to $+150^{\circ}\text{C}$. The temperature may frequently cycle through all or part of this range, and prolonged operation near the upper temperature limit is likely.

Especially the useful magnetic flux often varies in a complex way with temperature. It exhibits irreversible losses on first heating or cooling, nonlinear reversible changes, and finally, aging effects during prolonged heating that may also be influenced by chemicals in the atmosphere. Furthermore, the magnet in a propulsion motor is exposed to strongly varying demagnetizing fields (its operation is "dynamic"), and when the magnet is located at the air gap, the armature reaction currents produce a strong magnetic field component under right angles to the magnetization direction. The worst of these demagnetizing influences - experienced during start, motor stall or steep climb of the vehicle - can occur simultaneously with the temperature extremes. (E.g., starting the car after overnight outdoor parking in severe winter weather, or restarting the engine when it stalled or was turned off at the end of a long climb, particularly on a hot summer day.)

2. Listing of Needed or Potentially Useful Design Data

Magnetic Properties:

- (a) Major hysteresis loop or second-quadrant curves of B and (B-H) vs. H, measured in the easy and hard directions of magnetization.

- (b) Numerical data for B_r , H_k , MH_c , BH_c , $(BH)_{max}$, B_d/H_d at $(BH)_{max}$.
- (c) Second/third-quadrant recoil loop fields.
- (d) Numerical data for B_r , $(B_pH)_m$ or $(BH)_u$, (B_rH_x) , $(B_1H)_m$.
- (e) Temperature variation from -50°C to $+150^\circ\text{C}$ of the quantities B_r , B_d at preferred operating point, H_k , MH_c , μ_r , recoil loops at several temperatures.
- (f) Temporal stability at elevated temperature in air of the quantities B_r , B_d (preferred operating point), H_k , MH_c .
- (g) Initial magnetization curves, first-quadrant minor loops for remagnetization, dependence of second-quadrant properties on the magnetizing field and on magnetic history of the PM.
- (h) Numerical data for the minimum required field for full charging of virgin and of previously magnetized magnets.
- (i) Information regarding initial magnetization/remagnetization at elevated temperatures.

Mechanical Properties

- (a) General physical integrity and fragility of magnets.
- (b) Brittle vs. ductile fracture behavior.
- (c) Tensile, flexural and compressive ultimate strength (statistical data!).
- (d) Elastic and transverse modulus (Young's modulus, Poisson's ratio).
- (e) Hardness data by appropriate method.
- (f) Machinability and recommended shaping methods.

Thermal Properties:

- (a) Heat capacity ($0 - 100^\circ\text{C}$) or specific heat around room temperature.
- (b) Thermal conductivity and its direction dependence (anisotropy).
- (c) Coefficient of thermal expansion and its anisotropy.
- (d) Thermal shock resistance.

Electrical Properties:

- (a) Resistivity (or conductivity) and its anisotropy at room temperature.
- (b) Temperature coefficient of resistivity ($0 - 100^\circ\text{C}$).

In Chapter III some of these concepts and quantities that are not in very common usage, or which have special significance for motor design, will be defined and discussed in some detail. The above listing has also guided our attempt to collect and organize the data on commercial magnets, whose results constitute Chapter III.

3. Economic Factors to be Considered

Again, we shall first merely list the factors of interest in the context of this report. A more detailed discussion of these with quantitative data presented in the form of tables and graphs is given in Section II,C.

In any discussion of such a multi-faceted subject as we are attempting in this report, it is inevitable that terms are sometimes used before they are defined, or data come from systematic tabulations in a later section. Where possible, forward references are made to facilitate the understanding in such cases.

The following topics of a primarily economic nature will be considered in Section II,C:

1. The quantities of PM materials that would be required if one of the motors designed under the NASA/DOE program went into mass production for vehicle use. They will be put into perspective relative to present production levels of the important PM material types.
2. Magnet prices and the factors that influence them. Present prices, price history and future outlook with emphasis on developmental magnet types.
3. Raw materials for magnet production and their cost. Quantities of these raw materials needed for the different magnet types, with emphasis on scarce or expensive constituents.
4. The raw material supply situation. Domestic and global resources, natural abundance; location of the main deposits.
5. Special attention will be given to the availability of cobalt, samarium and the rare earths in general.

E. REFERENCES - CHAPTER I

1. Electric Machines. G.R.Slemon and A. Stroughen, p. 351 (See G6, Genl.Bibliography)
2. "Cobalt-Rare Earth Magnets for DC Machines", S. Noodleman, Goldschmidt informiert, 4/75, No. 35, p. 75 (See G14).
3. "Perm.Magnet Applications", F.G. Tyack. Chap. 7 in D. Hadfield, "Perm. Magnets and Magnetism," p. 345. (See G3).
4. "Future Uses of Permanent Magnet Materials in Electrical Machines." K. J. Binns. 2nd Conf. Advances in Mag. Materials and their Applications, p. 151. (See G15).
5. "Rare Earth Permanent Magnets and Large Electrical Machines." R.J. Parker, 3rd Intl Workshop Rare Earth-Co Perm. Magnets, p. 67. (See G9).
6. "Application of Rare Earth Magnets to DC Machines." S. Noodleman, 2nd Intl. Workshop Rare Earth-Co Perm. Magnets, p. 214. (See G8).
7. "Rare Earth Magnets and 400 Hz Aircraft Power Systems. - An Overview." W. U. Borger, 3rd Intl. Workshop Rare Earth-Co Perm. Magnets, p 88. (See G9).
8. "Rare Earth-Cobalt Perm. Magnets for Electr. Machines of Medium to Large Power Ratings." E. Richter, Goldschmidt informiert, 2/79, No. 48, p. 50. (See G13).
9. "Application of Rare Earth-Cobalt Magnets to Brushless DC Motors." R.L. Fisher, 5th Intl. Workshop Rare Earth-Co Perm. Magnets, p. 41. (See G11).
10. "Synchronous Machine Designs Using Different Types of Perm. Magnets." E. Richter and T.W. Neumann, ibid., p. 1 (G11).
11. "Electric Vehicle Motors and Controllers." R. Secunde, ibid., p. 81 (G11).
12. "Electronically Commutated DC Motors for Electric Vehicles." E.A. Maslowski, SAE Paper No. 810411 (1981), DOE/NASA Report No. 51044-14, NASA TM-81654.
13. "Some Aspects of the Development and Design of a High Performance Perm. Magnet Synch. Motor." K.J. Binns et al., Small Electrical Machines, p 76. (See G7).
14. "The Isosyn Motor, A New Generation of P.M. Synchronous Motors." G. Bermond, J.B. Flynn. Small and Special Electrical Machines, p 119. (See G16).
15. "Garrett Electric Vehicle Capabilities." Company brochure of the Garrett AiResearch Manufacturing Comp. of California. (1980)

16. "Electronically Commutated Motors for Vehicle Applications." E.F. Echolds, SAE Paper No. 800 062 (1980)
17. "Improved Electron.Commutated Brushless DC Motor for Electric Vehicles," N.A. Demerdash, F.C. Lee, T.W. Nehl and B.P. Overton. Proc. DOE E/HV Contractors' Meeting, June 1979.
18. "Advanced Electric Vehicle Motor Development - Documentation of Adv. Motor Concept DEN-76." G.B. Kliman, V.B. Honsinger and R.N. Johnson. Progress report to NASA LeRC, June 1979.
19. "Advanced Motor Development." G. Kliman. Proc. DOE E/HV Contractors' Meeting, June 1979, Section 38-4.
20. Personal communication G. Kliman, GE Comp., (1983).

II. REVIEW OF AVAILABLE PERMANENT MAGNET MATERIALS

A. Magnet Types and their Relative Significance

1. Definition and General Function of a Permanent Magnet

A permanent magnet (PM) is a piece of ferro- or ferrimagnetic material capable of storing magnetic energy. This energy is invested in the PM during the initial process of magnetizing it by means of electric energy ("charging"). The magnet will more or less retain this energy for an indefinite period of time under the adverse influences it may experience in use. These influences can be due to the environment or to the action of other components of the device of which it is a part.

The PM can be used in a device or machine to produce the same effects as an electromagnet excited with DC current, but without the need for continuous electric power input. Generally speaking, the PM generates a magnetic field in a volume of space which can then interact with other magnetizable bodies, electric currents, moving charged particles or electromagnetic waves. More specifically in electric machinery (but also in loudspeakers, etc.) the PM is used as a source of air-gap flux that exerts a force on a current-carrying conductor, or which assists in inducing electric voltage during motion. The PM can also provide a magnetic moment to be acted upon by an external magnetic field, generating mechanical force or torque over a distance without physical contact. This is its primary function in the brushless PM-rotor motors, in modern torquers, linear actuators, etc., but also in magneto-mechanical devices such as couplers or magnetic bearings.

Although in most applications these functions could be - and in the past often have been - provided by electromagnets, with or without cores of softmagnetic materials, PMs are increasingly becoming the preferred choice. The reasons are the dramatic improvements of the properties of modern PM materials, the trend toward miniaturization of devices, and the increasing cost of energy.

While the PM is useful because it stores magnetic energy, this energy is not consumed in the device operation. In motors, e.g., a conversion of external electric energy into mechanical energy takes place, the reverse happens in generators. In this conversion, the PM plays a role comparable to that of a catalyst in a chemical reaction: it is a necessary intermediary, but its energy is not used up. (If the air-gap flux or rotor moment is established by electromagnetic excitation instead of a PM, the excitation field energy is still conserved. However, some energy is then dissipated, namely, the ohmic I^2R losses of the excitation current, I , needed to maintain the gap flux.)

2. Available Permanent Magnet Types

When we speak of a specific permanent magnet we imply a circuit component of a particular size and shape that has a very specific set of physical characteristics - defined by the long list of quantities in

Section I,D,2 or by an appropriate subset. Size and shape are partly design choices, but to a large extent they are determined by the more basic material properties. The material's properties, in turn, depend on the chemical composition, on its metallurgical state; the grain alignment (which determines the magnetic anisotropy), and to a lesser extent on some other aspects of magnet production method and circuit use. Since so many factors must be considered, comparisons between different magnets are by no means straightforward. The proper choice of a magnet that is optimal for a particular application can become quite a complex task. Some of the detailed data needed in making this choice can be found in the tabulations in Chapter III and we will also discuss their significance in motor design.

But first we shall make a more cursory comparison of the available magnets. This is done by grouping them according to their basic chemical makeup. Such a comparison is indeed useful since the groups so defined have important common characteristics. For instance, ferrites are electrical (and thermal) insulators while all other magnets are metallic conductors. Alnicos and Fe-Cr-Co have relatively high remanence and low coercive force, ferrites have low remanence and fairly high coercivity, while both these quantities have high values for the REPM. Economic criteria strengthen the individuality of the basic compositional groups and provide further discrimination between them. Ferrites use very cheap and plentiful raw materials, PtCo by far the most expensive and scarce ones, Alnico and REPM use much cobalt, but with greatly different efficiency, while Mn-Al-C and the ferrites require none at all. For the REPM one must consider a raw material market, namely the rare earths, which has been of no concern for permanent magnets before about 1970. - All these factors are given closer scrutiny in later chapters.

Table 2-1 lists the commercially available PM material types. Those that are now or will probably soon be used in large quantities are underlined. For each magnet category the period of its commercial introduction is stated, although improved subtypes were sometimes developed much later. (See Fig. 2-3.) Brief comments are made concerning the relative commercial significance at the present time and the perceived trend of usage.

TABLE 2-1 IMPORTANT COMMERCIAL PM MATERIALS AND THEIR USES

(MATERIAL TYPE)	(INTRODUCED)	(USE)	(USE TREND)
MARTENSITIC STEELS	1820 - 1930	V SMALL	DECLINING
<u>ALNICO ALLOYS</u>	1930's	LARGE	DECLINING
REMALLOY (Fe-Co-Mo)	1930's	MEDIUM	DECLINING
PtCo	1930's	V SMALL	FAST DECLINING
CUNIFE CUNICO	1930's	SMALL	?
VICALLOY	1940's	V SMALL	?
ESD Fe-Co	1950's	SMALL	?
<u>FERRITES (OXIDES)</u>	1950's	V LARGE	FAST GROWING
<u>RE-Co ALLOYS</u>	1970's	MEDIUM	FAST GROWING
Fe-Cr-Co ALLOYS	LATE 70's	SMALL -	REPLACING REMALLOY ALNICO 5
<u>Mn-Al C ALLOY</u>	LATE 70's	SMALL -	REPLACING SOME ALNICO 5

3. Comparison of Basic PM Properties

An elementary method often used for roughly comparing PM materials with each other is to consider their room-temperature B vs. H demagnetization curves. Fig. 2-1 shows such curves for a selection of the PM materials that are of possible interest for propulsion motor use. These curves are for the best commercial magnets of each type available about 1981. For the large PM families, Alnico and REPM, we show two subtypes in each case - those with the highest remanence and the highest coercivity.

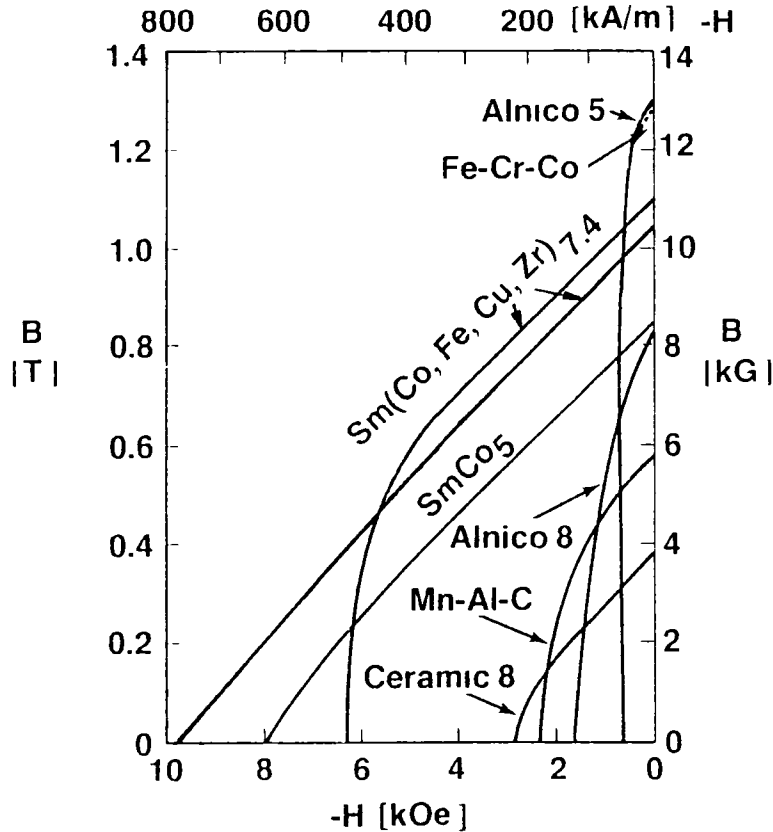

Figure 2-1: Room temperature B,H-demagnetization curves for magnet types of potential importance for PM propulsion motors.

Another simple but very frequently used comparison between magnet types is based on the quantity called static energy product, $(BH)_{\max}$. Figure 2-2 compares energy product values of available magnets. Here we have included all the PM types listed in Table 2-1, and for those of possible utility in EHV motors there is a further breakdown into subcategories. Since each bar represents a family of commercial products, the lower and upper limits of the range of advertised products are indicated. The materials are arranged in the order of increasing best values. All REPM seem superior to all other magnets in this comparison. We see that the sintered "2-17" REPM can store the largest amount of magnetic energy per unit volume, followed by sintered (RE)Co₅ and the matrix-type REPM made from powdered "2-17" alloys. Ferrites have much lower energy products, with Alnico, Mn-Al-C and Fe-Cr-Co being in between these extremes.

Figure 2-3 compares basically the same types of PM materials in still another way, considering three salient room temperature properties, the remanence B_r , energy product $(BH)_{max}$, and the intrinsic coercive force M^H_c . Here, the materials are arranged in the order of decreasing B_r values (the best advertised). Where improvements are yet to be expected, the probable limiting values are indicated by dashed brackets. The most outstanding property of all REPM is their extremely high intrinsic coercive force. Their large energy products are the result of combining this high M^H_c with the also rather high B_r values. But we shall see that, for the propulsion motor application, a high M^H_c is of great importance in its own right.

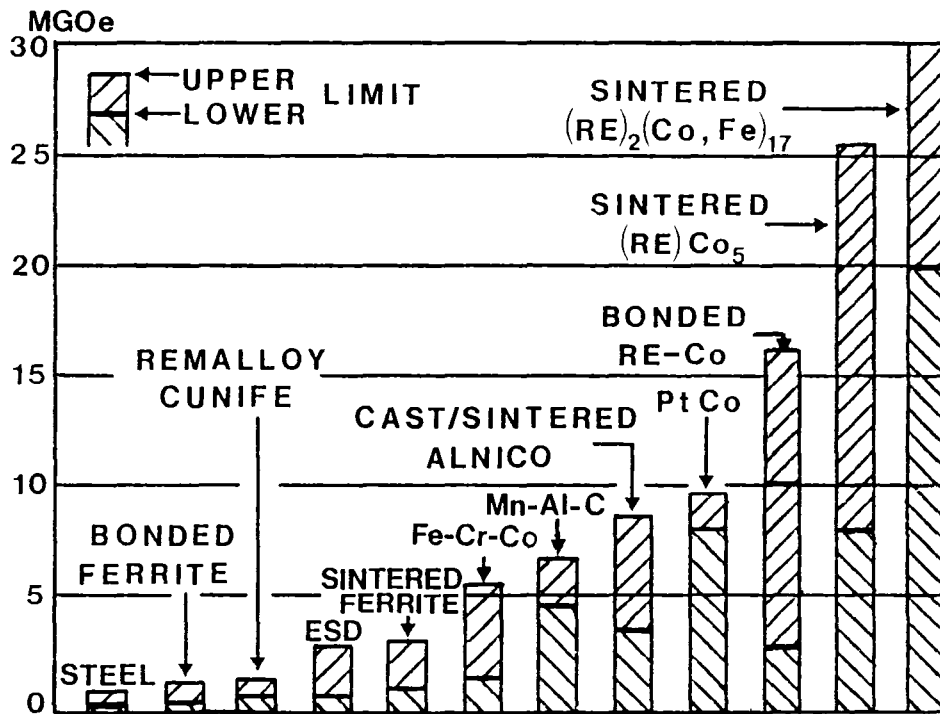

Figure 2-2 Comparison of static energy product values for commercial permanent magnet materials.

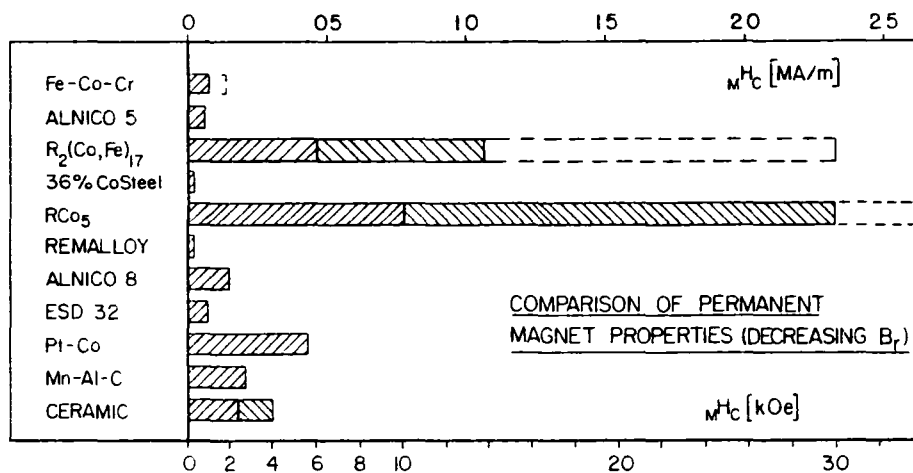
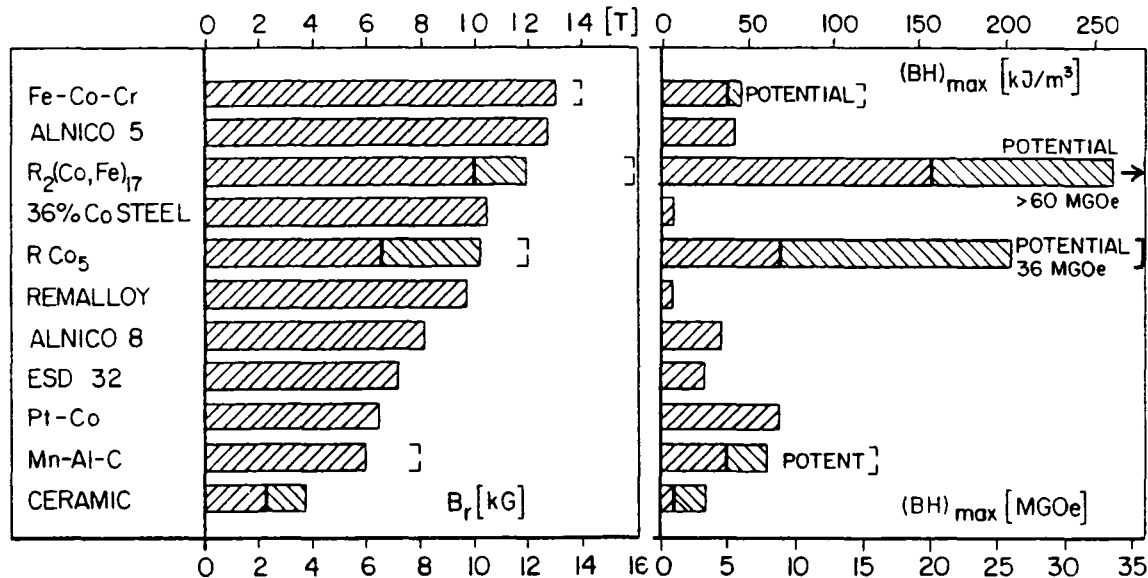

Figure 2-3: Comparison of room-temperature salient properties for permanent magnet materials.

B. Magnet Types Most Useful in Propulsion Motors

1. Materials Selected by NASA Contractors

In Chapter I we stated that the different motor contractors had made the following selections of PM materials for their designs

(1) SmCo_5 was everybody's first choice strictly from a performance point-of view. Its use resulted in excellent motors, but the high price of the magnets and severe temporary supply difficulties with cobalt made it seem an economically indefensible choice in 1979-80.

(2) Ceramic 8 ferrite was finally considered the best low-cost alternative. It is the material that would have to be used unless the cobalt supply problems were satisfactorily resolved and sufficient long-term supplies of Co and Sm at reasonable and stable prices were guaranteed.

(3) Mn-Al-C was seriously considered for awhile, but it was abandoned as lacking in elevated temperature magnetic properties, and because its future availability at low cost is questionable.

(4) Alnico 8 was used in one design, but merely as a placeholder for Mn-Al-C.

2. Discussion of these Choices

Using the property information given in the preceding graphs and in Table 1-1, we can see why these materials were chosen. Disregarding cost factors first and looking only at the room-temperature B,H properties as shown in Fig.2-2, a magnet would be considered best for EHV propulsion motors if it combines high B_r with a straight-line demagnetization curve. The higher coercivity version of the "2-17" REPM labeled $\text{Sm}(\text{Co,Fe,Cu,Zr})_{7.4}$ would thus be the best of the magnets shown, SmCo_5 would be the second choice. However, at the start of these motor projects high-coercivity "2-17" magnets were not yet available, so SmCo_5 was the logical choice.

In view of the high price of the REPM and the developing cobalt crisis, Co-free or low-cobalt alternatives were considered. Low-Co Fe-Cr-Co magnets, while offering attractively high remanence, are disqualified by their low coercive force. (See the requirements specified in Table 1-2.) Alnico 8 is better in this respect, although still not very good, but we shall show later that it makes less efficient use of the cobalt contained, and even at present Co prices - which are low again - it has a higher material cost per unit magnetic energy than Sm-Co. (See Table 2-10.)

The new Mn-Al-C seemed like the next best choice. It has a lower B_r but better H_c than Alnico 8, yet a significantly higher B_r and energy product than any ferrite. Like the latter it contains no cobalt and is made from low-cost raw materials. The detrimental large negative temperature coefficient of MH_c was not known at the time. It was the

reason why the GE group later abandoned Mn-Al-C as unsuited for their motor. Another reason was that Mn-Al-C so far shows no realistic promise of indeed becoming the inexpensive magnet material which one might expect from the low raw material cost.

By contrast, the ferrite PM are indeed inexpensive and the raw materials plentiful. The commercial grade chosen, Ceramic 8, has a coercive force almost as high as its B_r value (if both quantities are measured in Gauss or in Tesla). Its B vs. H demagnetization curve approximates the desirable straight line through most of the second quadrant. In this respect Ceramic 8 is comparable with the REPM. But the ferrite magnets also have by far the lowest remanence and energy product of all materials considered. This has the consequence that considerably more magnet material must be used. The entire motor becomes bigger and heavier, and the magnetic circuit design less efficient.

Comparing motor designs using Ceramic 8 and SmCo_5 , the following general statements can be made. The ferrite's lower remanence means that the volume of the PM material must theoretically be increased at least in proportion to the ratio of the B_r values, i.e., by a factor of about 2.3 to 2.6. (Since remanence times volume is a measure of the approximate magnetic moment of the rotor magnets). Taking into account the different densities of the two PM materials, the ferrite magnets should have to be heavier than the SmCo_5 at least by a factor 1.4 to 1.6. In these comparisons it is assumed that the motor design remains essentially unchanged - same number of poles, rotor diameter and RPM, only the rotor length is to be increased.

Let us now compare the actual magnet weight ratios, Ceramic 8 to SmCo_5 , for the two pairs of motors built and tested by VPI/Kollmorgen and by Garrett AiResearch. (See Section I,B,1 and Table 1-1.) The motor designated VPI/KC-3 actually used a 3 times greater magnet weight than VPI/KC-2, versus a minimum weight-increase factor 1.4 calculated from the remanence ratio. The two VPI/KC motors were indeed quite comparable (6 poles, same rotor diameter, almost the same speed). - For the motor pair GAR-2/GAR-1 the actual magnet mass increased 4.2-fold, versus a minimum factor of 1.6 calculated from the ratio of the remanence values. Of course, the two GAR motors differ more strongly. (4-pole REPM vs. 6-pole ferrite design, 18% lower speed for the ferrite motor.) - In any case, we see that the real magnet weight increase was more than twice that predicted from the ratio of remanence values alone. Here as in many other instances, the volumetric design advantages offered by the REPM go far beyond what the mere consideration of their greater induction or, in other cases, their energy product values would suggest. Some reasons for this will be discussed below and in Chapter IV.

3. Potentially Useful PM Materials in Development.

In the PM family of sintered ferrites, some laboratory developments of the last decade have recently been introduced into commercial production. This development occurred first in Japan and Europe, but U.S. companies are now also introducing these new "supergrades" of ceramic magnets. One type potentially very useful for propulsion motors has $B_r = 3.7$ kG, $MH_c = 4.2$ kOe and 3.25 MGOe energy product (1,2). Yet higher intrinsic coercivities are possible at a sacrifice of remanence, e.g., 3.0 kG at 5.2 kOe (1).

Such magnets might also be advantageous for EHV motors.

Two-component ferrite magnets have recently been developed in Germany (1) for use as radially magnetized stator arcs in automotive starter motors of about 1 kW rating. These have a high- H_c segment at the edge where the demagnetizing effect of the armature reaction is highest, while most of the arc is a lower- H_c /high- B_r material. This principle might be used to make improved ceramic magnets for propulsion motor use, or it might even be employed to make 2-component REPM arcs.

New rare earth-cobalt magnets that will be more suitable for propulsion motors than the sintered $SmCo_5$ used so far are also becoming available. The high-coercivity versions of "2-17" magnets, $Sm(Co,TM)_{7.2-7.4}$, have $B_r = 10$ to 11.5 kG combined with $M_H C = 10 - 12$ kOe and energy products of 24 to 27 MGOe. They have substantially straight-line B vs. H curves in the entire second quadrant (at room temperature) and they need less Co and Sm per unit energy or flux than the $SmCo_5$. New RCo_5 magnets with some of the scarce Sm substituted by Pr are now also commercially produced that have sufficiently high coercivity and up to 27 MGOe energy product. The replacement of a large portion of the Sm in RCo_5 by Ce or mischmetal is feasible - although not now done in large-scale commercial production - if a sacrifice of remanence, energy density and temperature coefficient is accepted as a trade-off for the advantage of cheaper and more plentiful raw materials. These matters are discussed in detail in Section II,C.

Several types of bonded, or "matrix" type REPM are now also available. While present magnets of this kind are not stable enough for the propulsion motor application (3), or their coercivity has not been high enough (4), improvements are now in the laboratory stage which should make the next generation of matrix REPM very attractive for EHV motors. Crucial improvements involve the utilization of high- H_c "2-17" alloys and a soft-metal matrix (4,5).

Microcrystalline rare earth-iron alloys fabricated by rapid quenching of a molten alloy are now under active investigation in several laboratories (6,7,8). Their utility as permanent magnets is yet to be proved, and if a practical magnet material should result, its commercial availability is certainly still many years in the future.

For details about material development efforts, their prospects and possible significance for EHV propulsion motors see Chapter VI.

C. Economic Information on Magnets and Raw Materials.

1. General Considerations, PM Quantities Required and Produced

The economic considerations which will determine the ultimate choice of one specific motor design over another, or even the decision in favor of using a specific PM material, are quite complex. Any serious attempt to discuss them all would far exceed the scope of this report. In the present section, we shall only try to provide factual information on the cost of the magnets, the raw materials from which they are made, and on some of the factors that influence these costs and the supply of the materials. A general discussion is offered first. It is followed by the results of quantitative analysis - presented in the form of tabulations and graphs - with more detailed comments where appropriate.

First, of course, one must know the quantity of magnet material needed per motor. For the motor types designed or tested under the NASA LeRC program this was determined in Chapter I,B. (See Table 1-1.) From this information one can calculate the approximate quantities of PM material and of the principal raw materials, that would be needed annually for a hypothetical production of 100,000 vehicles per year. The PM material requirements are summarized in Table 2-2 and compared with approximate production figures. Table 2-3 gives the amounts of the constituent materials that would be consumed.

TABLE 2-2: ESTIMATED WORLD PRODUCTION AND POTENTIAL EHV REQUIREMENTS FOR SEVERAL PM TYPES
(References 9, 10, 11, 12, 31)

PERM MAGNET MATERIAL TYPE	ESTIMATED WORLD PRODUCTION 1980 (83) [Metric tons/year]**	ESTIM. REQUIREMENT FOR 100,000 EHV MOTORS [Metric tons/year]***	FRACTION OF PRODUCTION REQ'D. [%]
ALL ALNICOS	8,700 (6,000)	990 (ALNICO 8 HC)	11 (16.5)
ALL FERRITES	96,400 (130,000)	434 (CERAMIC 8)	0.45 (0.33)
ALL REPM	175 (650)	140 (SINT. SmCo ₅)	80 (21)
Mn-Al	A few (~100)	300 (MATSUSHITA Type - B)	- (~3 x prod.)

Production figures for 1980 based on information from several sources which agree reasonably well, Mn-Al-C data based on conversation with Y. Sakamoto. Figures for 1983 are author's estimates based on observed trends and predictions contained in references

** Excludes Communist countries which do not publish production figures

** * Based on these motors in Table II requiring the minimum quantity of each PM.

TABLE 2-3 ESTIMATES OF RAW MATERIAL REQUIREMENTS FOR EHV MOTORS
 BASED ON 100,000 UNITS PER YEAR (SEVERAL ALTERNATIVE PM TYPES)

PM TYPE	MAIN CONSTITUENTS (Quantities in Metric Tons/Year)													
	Mn	Fe	Co	Ni	Cu	Al	Sm	Sm ₂ O ₃	Ca	Ti	Zr	Hf	Fe ₂ O ₃	SrCO ₃
ALNICO 8 HC		287	376	149	30	69				79				
CERAMIC 8							*	**	**				388	65
SmCo ₅			92				48	or 56	and 24					
Sm(TM) ₇₋₂		21	71		8.5		36	or 42	and 17		3.5	or 2		
Mn - Al	215			2.5		81								

* Samarium metal used in the melt-metallurgical production of the REPM alloys

** Samarium oxide and calcium (as a reducing agent) used instead of Sm metal in the direct reduction process

Next, the unit selling prices of the magnets - in large quantities and in the required sizes and simple shapes - are of interest. These prices are reasonably well established only for some of the magnets, as is discussed below.

The different grades of Alnico magnets have, of course, long been in large-scale production. Many competitive commercial facilities exist; the manufacturing methods are well developed, and thus, a solid basis for a meaningful cost analysis exists. Nevertheless, the last few years have brought wild price fluctuations due to the "cobalt crisis" of 1978 through 1981. After this period of very high prices, which must be considered a temporary aberration, Alnico prices have now again stabilized at a relatively low level. Present quotes for large quantities can probably be considered realistic estimates for the next decade, except for inflationary increases.

For the ceramic ferrites, the raw material supply has been plentiful and stable, it is essentially unlimited. Raw material costs are lower than for all other magnets, much lower than for most. Large-scale production facilities have been in existence for 20 years. They are now in a period of modernization, automation and expansion. A substantial excess production capacity exists for the standard grades at this time. Better manufacturing methods are being introduced that yield improved "supergrades" which are more desirable for electric motors than the standard Ceramic 8. The present price structure is likely to remain fairly stable, and cost estimates based on current quotes should be realistic for years to come. The ferrite quantities potentially needed for EHV propulsion motors are small compared with present total production (see Table 2-2), and such a new use would not require a major expansion of industrial capacity.

The pricing situation for all the other magnet materials under consideration is less clear. They are all newer products for which true mass production facilities have not yet been established, and for which the technology is still under vigorous development.

The iron-chromium-cobalt based magnet alloys have evolved in the last decade. Their commercialization started seriously only when cobalt became

scarce, and just a few of the many possible grades are now in a limited production. These magnets duplicate Alnico properties, but they have a significantly lower Co content for comparable properties. The raw materials cost slightly less than those of equivalent Alnico. Finished magnets are priced like the equivalent Alnico grades, and this will probably remain so for the foreseeable future. However, if cobalt supply difficulties should again develop, the prices and availability of Fe-Cr-Co need not be as severely affected as those of Alnico. - These magnets are, at present, of no interest for propulsion motors; their best coercive force values are not high enough.

The new Mn-Al-based alloy magnets had been seriously considered for use in propulsion motors, although we shall see that their poor elevated temperature properties probably disqualify them. This magnet material contains no cobalt at all, a fact that made it seem very attractive when Co was scarce, and which has spurred its development. The main constituents, manganese and aluminum, are plentiful and rather inexpensive. The raw material cost for Mn-Al, per unit magnetic energy stored in the magnet, is low - only about twice that of ferrites. However, the only successful manufacturing method known to produce good grain orientation involves a very costly extrusion process. As a consequence, the finished magnets are quite expensive - comparable at present to Alnico 8 - and are likely to remain so for the predictable future.

The rare earth-cobalt magnet alloys (REPM) use by far the most expensive raw materials of all magnets of interest here. They also contain the largest weight proportion of cobalt - 48 to 66%, depending on the subtype. But the total amount of Co required per unit of useful magnetic energy is significantly less than for Alnico. This is true even for static device applications, but more so yet for motors, where one can take advantage of the very high intrinsic coercivity of the REPM. The rare earth elements are not as rare as the name suggests (Table 2-4). In fact, the RE most used in the magnets at present, samarium - although it is one of the rarer of the RE - is more abundant in nature than, e.g., beryllium.

If we compare raw material costs per unit energy again, the REPM are quite competitive with the Alnicos for static applications, and cheaper when the comparison is based on the "intrinsic energy product" often used to measure the relative merit of magnets for motor applications. (See Table 2-5.) - Manufacture and use of the REPM have so far been on a modest scale; the estimated world production in 1980 was only a little more than the potential annual requirement for the EHV application. In 1983, it may be about three times that requirement. (See Table 2-2.) A significant expansion of present production facilities would therefore be required if this automotive application came about. This is particularly true for some newer types that would probably be best for the propulsion motors: $\text{Sm}_2(\text{TM})_{17}$, MMCo_5 and bonded 2-17 magnets. If these were used, it will be necessary to develop more efficient manufacturing methods and build new, larger plants - especially in the USA. The present world production is still 50 to 75% sintered SmCo_5 . - Finished magnet prices are still much higher than the raw material cost, but there is no reason why this should remain so. If automotive or other uses for large quantities of REPM develop, rationalization and increased competition in the magnet, metallurgical and mining industries are likely to bring prices down.

TABLE 2-4: ESTIMATED ABUNDANCE OF VARIOUS ELEMENTS IN *
THE EARTH'S CRUST. (Part per million, or gram per metric ton)

Al	81,300	Cu	70	Pr	5.5
Fe	50,000	Ce	46	<u>Hf</u>	<u>4.5</u>
Ti	4,400	Sn	40	Cd	0.15
Mn	1,000	Y	28	Ag	0.10
Sr	300	Nd	24	Pt	0.005
Ba	250	Co	23	<u>Au</u>	<u>0.005</u>
Zr	220	La	18	RE	133. **
Ni	80	Sm	6.5	LRE	100.

* According to Ref. 14 (1952). Other sources report somewhat different values. Note that more recent estimates claim Ce-60, La-30 and the total rare earth abundance RE-185 (Ref. 15).

** RE = total rare earths, including Y and the heavy lanthanides.

LRE = light rare earths, La + Ce + Pr + Nd + Sm. These can all be used in REPM and, together, constitute mischmetal, MM.

Yttrium, Y, can also be used as a minor addition to Sm in magnets.

2. Magnet Prices and Price History

The prices of permanent magnets are difficult to define in a general way. They depend strongly on the size and complexity of the part, quantities produced, the amount of surface machining to be done, tolerances for properties, dimensions, chips and microcracks, etc. For this reason, manufacturers are hesitant to quote prices per unit weight of any magnet material, but especially for the newer ones. We have nevertheless undertaken it to obtain such prices per pound or kilogram, to use them in determining the cost of a unit of useful magnetic energy stored in the various PM materials.

The price information was obtained in conversations with managers of many magnet producers and a few large-scale users. The basis of the quotes was always the proposition that simple shapes would be needed on a regular basis in the rather large annual quantities defined in Table 2-2. Surface finish and other quality specifications were to conform to MMPA-defined minima. Little or no machining was to be included in the price. The informal and non-binding quotes received are listed as "selling prices" in Table 2-5. We see that they still cover a rather wide range for a given PM type. The lowest value listed for each material category was used as the basis for calculations and comparisons, on the assumption that - in case a large vehicle motor market should develop - the magnets would indeed become available at prices at least as low as the quoted minima. (This ignores inflationary increases and the possibility of another artificial raw material shortage.) This is probably a good assumption for Alnico and Ferrite, while the REPM prices should eventually drop below present minima.

The prices of the magnets which contain significant amounts of cobalt have undergone drastic fluctuations in the last few years. This was a consequence of a temporary disruption of cobalt metal supplies from the principal source of primary cobalt for the Western World, the mines in South-Central Africa. The so-called "cobalt crisis" began in 1977/78 when civil war and insurgency temporarily halted production in Zaire and international speculation in cobalt aggravated the problem. Figure 2-4 illustrates what has happened to cobalt prices since then. The so-called producer price, for long-term quantity contracts, rose fivefold in about two years and was maintained at that prohibitively high level for another two years. In 1981/82, however, the price dropped rapidly again to levels equal to those of 1976. Taking inflation into account, the Co price is now again comparable to that which prevailed virtually unchanged (in "real dollars") for at least two decades preceding the supply crisis.

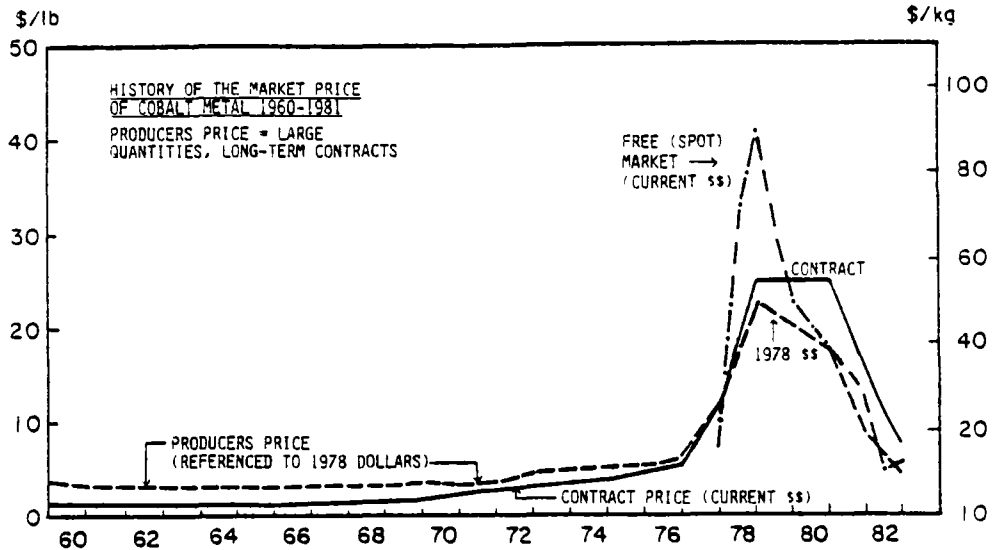

Figure 2-4: Historical Development of the Market Price of Cobalt Metal Since 1960

The supply crisis caused Co users to substitute other materials for Co where possible (ferrites and Fe-Cr-Co for Alnico magnets, Ni-base for Co-base superalloys in jet engines); also to avoid waste and recirculate scrap, and to recover Co from discarded products (engine parts). As a consequence, the U.S. and worldwide cobalt demand dropped significantly while the supply was fully restored. But the substitutions mentioned are largely permanent. It is now widely believed that the present cobalt surplus will last, prices will remain low for many years to come, and no further shortages are expected in the near future.

The magnet prices most affected by the cobalt crisis were those of Alnico and the REPM. Figure 2-5 shows the development of the prices for rare earth-cobalt magnets and raw materials since the invention of the REPM.

The events of the last 5 years are reflected as a 2-1/2 fold temporary rise of the minimum Sm-Co magnet prices. If the Co price holds steady as expected, it seems likely that REPM unit prices will continue to fall as manufacturing methods improve, quantity uses develop, and additional production capacity is installed. The 1975/76 minimum of about \$60/kg for sintered SmCo_5 could well be reached again. In fact, 2-17 magnets of 40% higher energy density than SmCo_5 may become the cheapest REPM. If this happens, the lowest cost per unit energy for REPM would drop to about 1/3 of its present level.

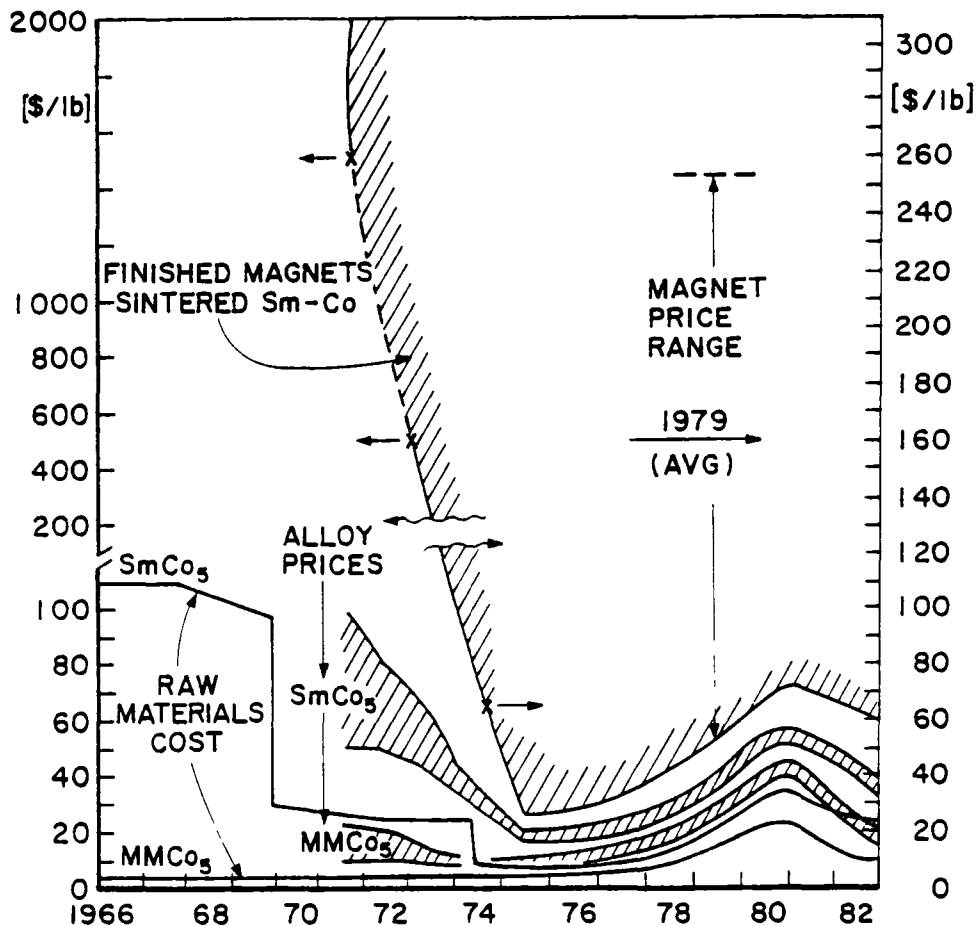

Fig. 2-5 .Development of the prices for rare-earth magnets, alloys and raw materials since the invention of the REPM. The curve marked "finished magnets" represents the lowest quoted prices.

While Alnico and REPM prices rose, hard ferrites became better and slightly cheaper. This is attributable to improved manufacturing methods and increased commercial competition.

In any case, the cost analysis under this contract, first attempted in 1980 when cobalt-magnet prices were at their peak, had to be repeated recently. Up-to-date cost information was obtained by phone-calls to suppliers, and tables and bar graphs were redone.

Table 2-5 includes a price analysis for all commercially available PM types of interest for propulsion motors, with other standard Ceramic and Alnico grades included for comparison. The cost per unit energy, in terms of the usual definition of energy product, was calculated and is given in \$ per Joule. This was done for two different "energy figures of merit," the commonly quoted "static energy product" and the "intrinsic energy

product." Neither measures very directly the performance of the PM in motors of common design, but indeed, there is no single such figure of merit that has general validity. Some motors - at least with the expensive REPM - have been designed so that the PM material works near $(BH)_{\max}$. It can also be argued that the absolute limit of the demagnetizing force to which an REPM or ferrite magnet can be pushed without significantly demagnetizing it is near the knee of the intrinsic curve. At that point the motor would deliver maximum torque (at least for a short time, until it overheats). The operating condition of the magnet is then fairly characterized by the intrinsic energy product, $(B_1 H_d)_{\max}$.

In any case, Table 2-5 compares the lowest magnet costs per unit weight, per Joule for optimum static operation, and per Joule for operation at the knee of the intrinsic demagnetization curve. We see that the unit weight prices vary widely, almost by two orders of magnitude between Ceramic 8 and the best REPM. In the "static \$/J" column this difference is narrowed to a factor 20, and the energy unit in an REPM costs less than twice that of Alnico 8. If the "intrinsic \$/J" are considered, the REPM energy costs less than that provided by any Alnico, and only 10 to 15 times as much as a \$/J in the ferrites. Mn-Al and Fe-Cr-Co cost more per Joule than Alnico 8 in static or intrinsic terms, and even the REPM are cheaper than either in terms of "intrinsic \$/J".

3. Raw Materials for PM Production and their Cost

A similar cost analysis can be performed in terms of the raw materials from which the permanent magnets are produced. In preparation, we first review the chemical composition of the different PM types (Table 2-6). The second input we need is the prices of the metals, oxides and other reagents needed. These are listed in Table 2-7. Note that Alnico, Fe-Cr-Co, Mn-Al and the REPM by one commercial manufacturing process are made by melting together the metallic ingredients. By contrast, the starting materials for the ferrite production are iron oxide and strontium or barium carbonate (and sometimes a little Sr-sulfate). And an increasingly popular alternative method for making the alloys for REPM production, the reduction/diffusion or coreduction process, introduces the rare earth component (usually Sm) and the Zr or Hf or Ti in the form of oxides. These are significantly cheaper than the metals, but the cost difference between the melting and direct reduction methods is narrowed by the requirement for calcium metal as a reducing agent in the latter.

We can now calculate the approximate raw material costs for the different magnet materials of interest. The results are given in Table 2-8. We see again a very wide spread of unit costs, but the differences are not as extreme as those seen in the finished magnet prices. In terms of the \$/Joule (static) figures, the cheapest REPM are now equal to the Alnico 8! There is still no question that the ferrites are - and will remain - by far the cheapest of the magnet materials, in terms of any measure we employ. However, the raw materials for Mn-Al cost only three times as much as the ferrite ingredients, and per unit static energy they are only twice as expensive as Ceramic 8.

TABLE 2-5: SUMMARY OF PRODUCER PRICES AND COST PER ENERGY UNIT FOR PERMANENT MAGNETS (Finished high-grade permanent magnets. Prices quoted 1982-83 for simple shapes in mass production, no or minimal machining.)

PM MATERIAL	(BH) _{max} [MGOe]				APPROX DENSITY d g/cm ³	SELLING PRICES \$/lb	VALUES ASSUMED IN CALCULATIONS*				PRICE PER UNIT OF MAGNETIC ENERGY	
	MMPA STAND	COMMERCIAL RANGE	BEST LAB	THEO LIMIT			MAGNET PRICE (Lowest Quotes)		ENERGY DENSITIES**		Static *** \$/J	Intrinsic \$/J
							\$/lb	\$/kg	(BH) _{max} MGOe	(B ₁ H _d) _{max} MGOe		
Ceramic 5	3 4	3 4 - 4 2	} 4 5	} 5 7	} 5 0	1-2	1 00	2 20	3 8	8 2	0 36	0 17
Ceramic 6	2 45	2 5 - 3 2				1-3	1 00	2 20	3 0	10 0	0 46	0 14
Ceramic 7	2 75	2 75 - 3 5				1-3	1 00	2 20	3 2	12 0	0 43	0 12
Ceramic 8	3 5	3 4 - 4 2				0 85 - 3	0 85	1 87	3 8	10 5	0 31	0 11
"Super" 3 8 x 3 8	-	~3 5				1 50 - 3	1 50	3 30	3 5	16 3	0 59	0 13
Alnico 5 DG	6 5	6 5 - 7 0	} 12	} ?	} 7 3	7-25	7 00	15 40	5 5	5 9	2 56	2 38
Alnico 5 COL	7 55	7 5 - 8 2				10-28	10 00	22 00	8 0	8 5	2 51	2 36
Alnico 8	5 3	5 0 - 6 2				11-30	11 00	24 20	6 0	7 3	3 68	3 03
Alnico 9	9 0	9 0 - 10 5				15-50	15 00	33 00	10 0	11 8	3 01	2 55
SmCo ₅ (Sm, Pr)Co ₅	15 - 18	16 - 22 20 - 27	} 28	~ 30 ~ 36	} 8 2	60-200	60 00	132 00	18 22	80 90	7 52 6 15	1 69 1 50
H _i - H _c	-	22 - 26	} ~33	} ~60	} 8 4	65-200	65 00	143 00	24	80	6 26	1 88
Sm ₂ TM ₁₇ Lo - H _c	-	24 - 30					65 00	143 00	26	47	5 78	3 20
MMCo ₅	12	10 - 14	~16	~20	8 0	50-100	50 00	110 00	14	50	7 86	2 20
Fe-Cr-Co	-	4 - 6	~8	~15	7 7	10-15	10 00	22 00	5	5 3	4 24	4 00
Mn-Al-C	-	5 - 6	~8	~12	5 0	15-20	15 00	33 00	5	8 0	4 16	2 58

For ferrites, Alnico 5 and 8, SmCo₅ and Sm, PrCo₅ these prices would probably be quoted at this time (1983) for a large scale production of propulsion motor magnets on long-term contracts. Other prices are lowest for the present small-scale production. Lower prices (in 1983 dollars) are likely for large, long-term orders. (Except for Alnico 9 and, perhaps, Mn-Al-C.) (BH)_{max} is the usual "static energy product" as measured by the area of the largest rectangle inscribed in the second-quadrant B vs H demagnetization curve. (B₁H_d)_{max} is measured by the largest rectangle inscribed in the intrinsic demagnetization curve, B₁ vs H. "Magnetic energy" is here defined in terms of the above "figures of merit", (BH)_{max} and (B₁H_d)_{max}. The price per unit energy is calculated as (Price x Density)/(Energy Product) = P[\$/lb] x d[g/cm³] x 125 [MGOe cm³/J]/(BH)[MGOe] x 454 [g/lb]

TABLE 2-6: COMPOSITION RANGES OF THE IMPORTANT P. M. TYPES (In Weight %)
 (Principal constituents. Magnetic component only, binder of bonded magnets not included.)

	Cr	Mn	Fe	Co	Ni	Cu	Al	Ti	Zr	Hf	Ba	Sr	Sm	Ce	Pr	ORE	C	O
ALNICO 5,8,9,8HC			$\frac{29}{54}$	$\frac{23}{38}$	$\frac{14}{15}$	$\frac{3}{4}$	$\frac{7}{9}$	$\frac{0}{8}$										
Fe-Cr-Co	$\frac{28}{33}$		$\frac{55}{62}$	$\frac{7}{15}$														
Mn-Al-C		$\frac{70}{73}$			$\frac{0}{0.8}$		$\frac{27}{30}$										$\frac{0.5}{0.7}$	
SmCo ₅				$\frac{63}{66}$									$\frac{34}{37}$					
RE(TM) ₅₋₆			$\frac{11}{8}$	$\frac{48}{52}$		$\frac{10}{12}$		$\frac{(0)}{(1)}$					$\frac{0}{37}$	$\frac{32}{0}$	$\frac{0}{17}$			
RE(TM) _{7-8.3}		$\frac{0}{1}$	$\frac{20}{13}$	$\frac{49}{52}$		$\frac{4}{11}$		$\frac{(0)}{(1)}$	$\frac{1.5}{2.5}$	$\frac{(1.5)}{(2)}$			$\frac{18}{27}$	$\frac{8}{0}$				
Sm ₂ Co ₁₇				$\frac{76}{76}$									$\frac{24}{24}$					
FERRITES			$\frac{59}{63}$								$\frac{12}{14}$	$\frac{8}{10}$						$\frac{27}{29}$
	MAGNETIC 3d-SERIES TRANSITION METALS					NONMAGNETIC METALS						RARE EARTH 5f-TRANSIT. METALS				NON-METALS		

2-18

TABLE 2-7: PRICES OF METALS AND REAGENTS USED IN MAGNET PRODUCTION (Values used in computing raw materials cost given for magnets.)

METAL OR REAGENT	PRICES IN \$/kg *				DATE OF PRICE QUOTE	
	For Metal as Melt Stock (Alnico, etc.)	Powder (REPM by R/D)	For Oxide or Carbonate (Ferrites, or REPM by R/D or KOR)	(Oxide) (Formula) For Metal Contained		
Chromium	9.40				5/81	
Manganese	1.60				5/81	
Iron	0.75	4.25			10/82	
Cobalt	10.00	14.00				
Nickel	3.45	4.50				
Copper	2.00	4.00				
Aluminum	1.60					
Hafnium	220.00		80.00	(HfO ₂)	94.00	5/83
Titanium	9.00	18.00				
Zirconium	33.00					
Lanthanum	48.00***		15.00	(La ₂ O ₃)	17.65	5/83
Cerium	48.00		10.00	(CeO ₂)	11.80	
Praseodymium	88.00		35.00	(Pr ₆ O ₁₁)	41.18	
Neodymium	120.00		8.00	(Nd ₂ O ₃)	9.30	
Samarium	120.00		44.00	(Sm ₂ O ₃)	51.90	
Yttrium	300.00		95.00	(Y ₂ O ₃)	126.70	
Calcium	12.00					
Fe ₂ O ₃			0.44			2/83
BaCO ₃			1.00			
SrCO ₃			1.03			
REPM ALLOY POWDERS made by direct reduction process (R/D or KOR)						
SmCo ₅		66 - 75				2/83
40w/o Sm-Co		73 - 88				
SmTM~7 3		66 - 73				

Generally based on minimum orders of either 100 lbs or 1000 lbs
 Price range for magnet-grade metals. The lower prices are for stock used in the melt-metallurgical production of Alnico, Fe-Cr-Co, Mn-Al or REPM. The higher prices are for the powders required for the production of Sm-TM alloys by the direct reduction methods (R/D or KOR)

*** Of the rare earths in metallic form, only samarium is produced on a large commercial scale today. As markets develop, for magnets or other large-scale uses of the metals, the prices are expected to drop significantly, reflecting the greater availability of these metals compared to Sm.

The information on magnet prices and raw material costs is summarized in the form of two bargraphs, Figures 2-6 and 7. These include not only the lowest present prices but give ranges where a range of prices was quoted to us. Closer inspection shows that the differential between material cost and the lowest prices for finished magnets is much greater for Mn-Al-C and for all the REPM types than for the long-established Alnicos and for the ferrites which are in a true and highly automated mass production. While the extrusion process may keep the processing cost for Mn-Al-C high, it seems there is hope for a reduction of the high processing-cost differential in case of the REPM. Their processing resembles that of the ferrites in many ways, and the latter has become very cheap. (However, the need for exclusion of air complicates the REPM processing.) Bonded versions of the rare-earth magnets (with a polymeric or metallic matrix, see Chapter VI) may ultimately offer the lowest processing cost of any REPM.

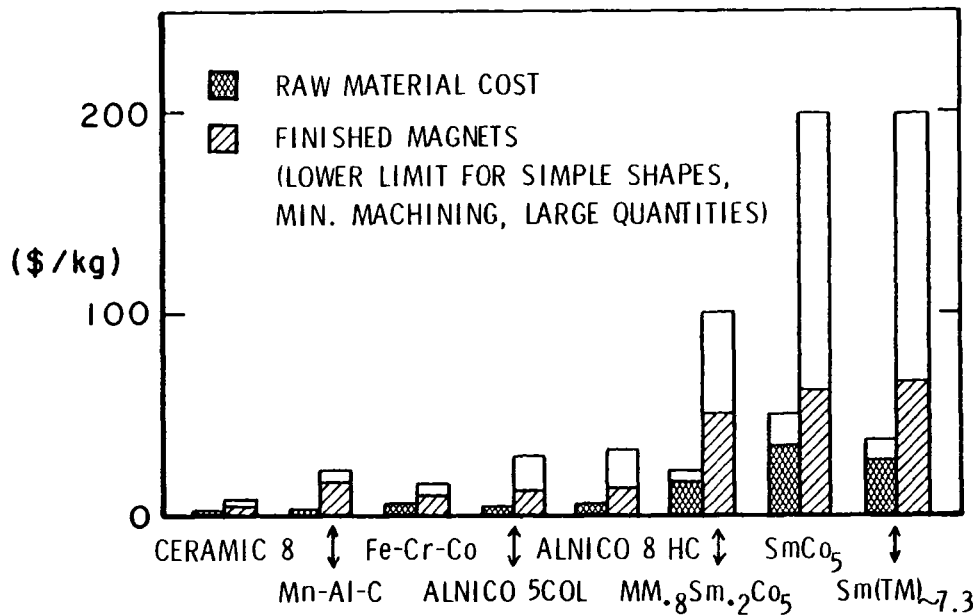

Fig.2-6 : Magnet Cost Estimates (Feb. 1983). Range of price per unit weight, \$/kg, for large quantities of raw materials and finished magnets.

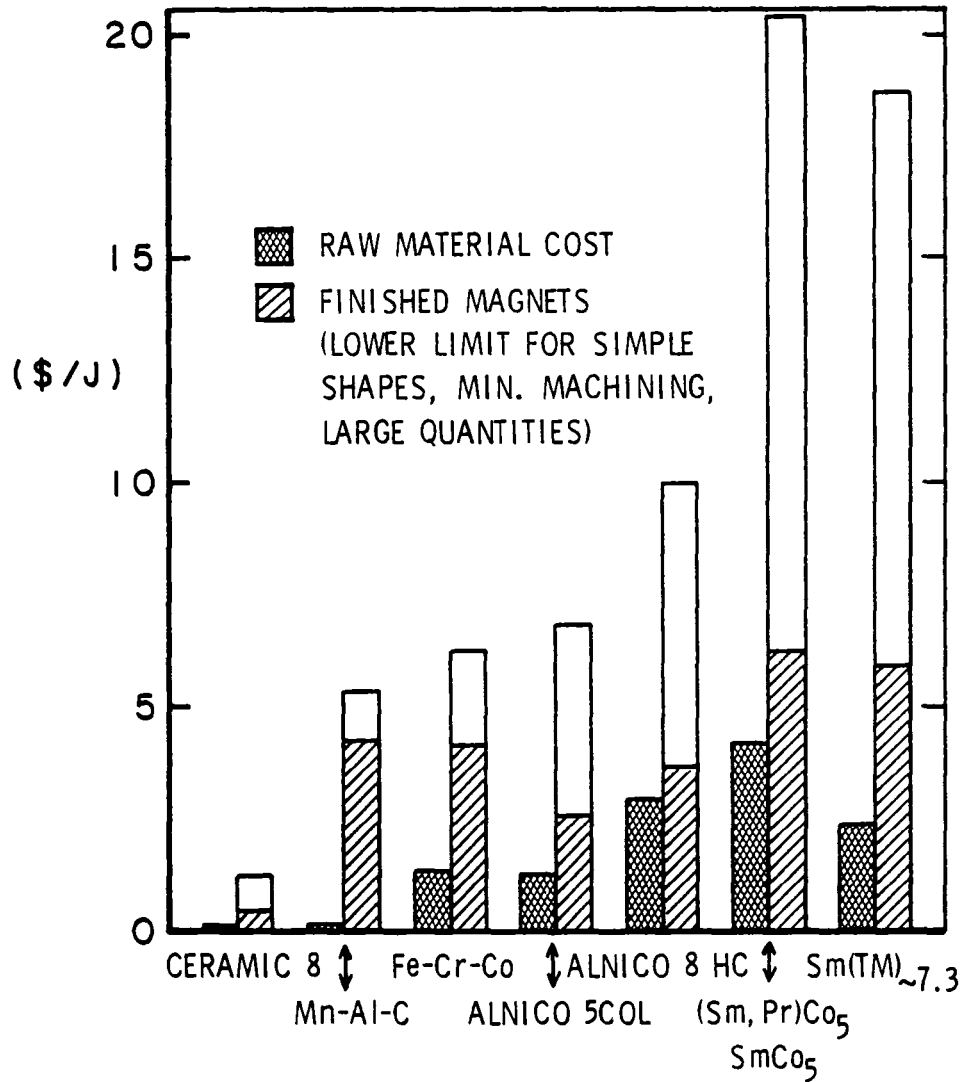

Fig.2-7 : Magnet Cost Estimates (Feb. 1983). Cost per unit energy, \$/Joule, based on typical static energy product, $(BH)_{max}$.

4. General Raw Material Supply Situation

We shall now briefly consider the availability of minerals from which the metals or other starting materials for magnet production are made. Much is written about this topic each year. The figures quoted for production, consumption and, particularly, for estimated total reserves vary considerably. Probably the most reliable statistics and estimates are

TABLE 2-8: COST OF RAW MATERIALS FOR SELECTED HIGH-GRADE MAGNETS (1982/83)

MATERIAL TYPE (COMMERCIAL EXAMPLES)	Assumed $(BH)_{\max}$		Density 10^6 g/m^3	UNIT COST OF RAW MATERIALS			
	MGOe	kJ/m^3		\$/kg		\$/Joule (Static)	
				Melting	Reduction	Melting	Reduction
ALNICO 5 COL (Many Brands)	7.5	60	7.3	3.50	-	0.43	-
ALNICO 8 HC (Many Brands)	5.0	40	7.3	5.00	-	0.91	-
Fe-Cr-Co (INDALLOY V)	5.5	44	7.7	4.70	-	0.82	-
Mn-Al-C-Ni (TYPE-B)	5.5	44	5.0	1.60	-	0.18	-
SmCo ₅ (Many Brands)	18.0	143	8.2	50.00	34.00	2.87	1.95
MMCo ₅ (Several Brands)	12.00	95	8.0	23.80	16.00	2.00	1.35
(Sm, Ce)(TM) ₇ (SEREM - R22)	21.0	167	8.4	32.40	22.80	1.63	1.15
Sm(TM) _{7.4} (REC-30)	27.0	215	8.4	36.30	23.00	1.42	0.90
Sm(TM) _{7.22} (REC-26)	25.0	200	8.4	37.10	26.70	1.56	1.12
Sm(TM) _{7.25} (HICOREX-27)	27.0	215	8.4	38.50	27.20	1.50	1.06
Sm(TM) _{8.35} (SAM-DH) Epoxy-bonded magnet	15.0	119	7.1	34.00	23.80	2.03	1.42
CERAMIC 8 (Many Brands)	4.0	32	5.0	0.53		0.08	

those contained in the annual reviews published by the U.S. Bureau of Mines on specific elements. While the figures given in this chapter are taken mostly from other publications - topical review papers dealing with magnet materials, the "cobalt crisis" or the rare earths - the Bureau of Mines is usually quoted as the primary source of information.

In Table 2-9 are listed most of the elements needed in the production of those permanent magnets which are potentially useful for the EHV motor application. (Trace constituents are ignored.) We can see that, at the present time, a large fraction of the raw materials is imported. The reason for this is often that it has been cheaper to import than to produce in the USA, and not that there are no substantial natural mineral reserve on U.S. territory - there are! There has been a tendency to neglect the development of U.S. mines and refining facilities, or even to close some that were previously operated. This can lead to severe temporary disruptions in our materials supply, with concomitant severe price fluctuations such as those which were recently experienced with cobalt.

TABLE 2-9. IMPORTS OF PM RAW MATERIALS IN 1982
(Refs. 16, 29, 31)

Mineral or Metal	Imports in % of U S. Consumption	Major Foreign Mineral Sources	Used in PM Materials for EHV Motors
Cobalt	98	Zaire, Zambia, Canada	Alnico, FeCrCo, REPM
Iron	23	Canada, Venezuela	Alnico, FeCrCo, REPM
Nickel	73	Canada, Norway	Alnico, Mn-Al
Copper	18	Canada, Peru, Chili	Alnico, REPM
Chromium	91	Zimbabwe, S. Africa, USSR	FeCrCo
Manganese	98	Brazil, Gabon, S Africa	Mn-Al
Aluminum	88	Jamaica, Australia, Canada	Mn-Al, Alnico
Titanium	23*	Canada, Australia	Alnico
Zirconium	75	Australia, S Africa	REPM
Hafnium	75	Australia, S Africa	REPM
Samarium	90	Australia, Brazil, China	REPM
Barium	40	Peru, Ireland, Mexico	Ferrites
Strontium	100	Mexico, Spain	Ferrites

*) For ilmenite The much rarer mineral, rutile, which has been the main raw material for Ti metal production, is 97% imported.

In the following two sections we shall consider in greater detail the supply situation regarding the two materials that are most important for high-performance magnets, cobalt and the rare earths. Among the RE, the samarium supply is of greatest concern.

In addition to ferrite ceramics, the REPM and Alnico 8 are the magnet materials of greatest interest to us here. The raw materials for the ferrites - iron, barium and strontium minerals - are plentiful in this

country, even though all strontium is now imported. For the Alnico and REPM production, cobalt is the most critical material. It was in short supply for a period of several years. This Co supply crisis 1978 to 1981 caused a major shift in magnet use patterns from Alnicos to ferrites; it stimulated the development of the Co-free or low-Co metallic magnet materials, Mn-Al and Fe-Cr-Co; and it brought a steady increase of the use of REPM in high-technology applications. However, the supply difficulties also frightened and discouraged many potential large-scale users of REPM. Companies who had developed motors and other products destined for the automotive market that would use rare earth-cobalt magnets indefinitely postponed the production of these.

The second major constituent of the REPM is samarium. Small quantities of praseodymium and cerium are also used in commercial REPM types. Pr, Ce and some other rare earths will probably find growing applications in commercial magnets as the REPM consumption grows. These metals are relative newcomers to the technological scene. Application engineers and production planners are often still unfamiliar with the economic circumstances surrounding them.

It is instructive to determine the relative quantities of cobalt and, where applicable, samarium that are needed to accomplish the desired device function with different common high-energy magnets. We shall again assume that the magnetic circuit in each case is optimized for use of the minimum volume of PM material (which is often not possible or desirable for other reasons). For five selected Co-containing magnet types, Table 2-10 shows first the weight fractions of Co and Sm. From these and from the stated typical numbers for the static and intrinsic energy products, we can calculate the amounts of these elements required per unit of the stored magnetic energy. Although the two representative REPM have the highest cobalt contents, the picture changes when we reference these figure to energy units. Even in terms of static operation, the "2-17" magnet yields more energy per gram of Co than the other magnet alloys listed. In devices designed to deliver maximum torque, so that $(B_i H_d)_{\max}$ becomes a good figure of merit, both REPM types are by far the most efficient users of cobalt.

TABLE 2-10: Co AND Sm NEEDED PER UNIT MAGNETIC ENERGY
FOR HIGH-ENERGY MAGNETS CONTAINING THESE METALS

MAGNET TYPE (Commercial Example)	Assumed Energy Products [MGOe]		Weight Fraction [g(metal)/g(PM)]		Amount of metal per mag. energy unit			
	Static	Intrinsic	Co	Sm	Static* [g(metal)/Joule]		Intrinsic	
					Co	Sm	Co	Sm
ALNICO 5 COL	8.0	8.5	0.24	-	27.4	-	25.8	-
ALNICO 8 HC	5.5	6.8	0.38	-	63.1	-	51.0	-
Fe-Cr-Co (INDALLOY V)	5.25	5.5	0.15	-	27.5	-	26.3	-
SmCo ₅ , Sintered	18.0	80.	0.65	0.35	37.0	19.9	8.3	4.5
Sm(TM) _{~7.2} (REC-26)	26.0	80.	0.50	0.26	20.2	10.5	6.6	3.4

*Co(Sm) per energy unit [g/J] = 125 × Density [g/cm³] × Weight Fraction [g/g] / Energy Product [MGOe]
For "static" values, the energy product is (BH)_{max}, for "intrinsic" (B_iH_d)_{max}.

5. Cobalt Production and Utilization (See references 17 through 21)

a. Mining and Primary Production of Cobalt

In the ore bodies cobalt is always associated with other metals of the iron group, usually with copper or nickel, or with both. It is almost invariably a minor constituent of the minerals and a co-product of the Cu or Ni production. This puts definite limits on the availability of Co (at reasonable cost) which are independent of the total cobalt reserves, since the processing of ores for their Co content alone has not been justifiable. On the other hand, some large nickel producers have not extracted the Co from the ores processed, but could be equipped to do it. The high price which cobalt commanded a few years ago induced some mining companies to make the necessary investment to provide additional Co from current Cu and Ni production.

The most important single source of the world's cobalt have long been copper mines in south-central Africa, in Zaire and to a lesser extent Zambia. Some of the material is still processed in or traded through Belgium. Zaire still supplies nearly half the new cobalt produced, although its market share is steadily falling as new sources come on stream. Mining companies in Australia, the Philippines, in New Caledonia (French S. Pacific possession), South Africa and Zambia have added processing facilities in recent years and are beginning to produce substantial quantities of additional cobalt. There has been much talk about plans to reopen some old or develop new U.S. mines and Co processing plants. The Blackbird Mine in Idaho (Noranda Comp.), the Madison Mine in Missouri (Anschutz Mining Company) and a new mine for Ni-Co deposits in Northern California (CA Nickel Comp.). The author does not know which of these plans will indeed be realized in view of the recent precipitous cobalt price drop and the present relative Co glut.

The annual world consumption of cobalt in all forms has been around 30,000 metric tons in the last few years (Figure 2-8). An estimated 75% of this is used in the non-communist countries, about 25% in the USA alone.

The total known cobalt reserves of the world in dry land deposits worth mining are fairly large when compared with present production levels. They are summarized in Table 2-11.

It would thus appear that the cobalt reserves could supply the world's industry for between 130 and 300 years at present consumption levels and, presumably, at a fairly steady price. Experience also shows that the world's mineral reserves are still incompletely explored and poorly documented. Estimates such as those in Table 2-11 are usually increased every few years, and deposits that are not now considered rich enough for mining may be reclassified in the future, as mining and chemical technology improve.

TABLE 2-11: ESTIMATED WORLD COBALT RESERVES (Ref. 16,21)

Country or Region	Documented Deposits (Reserves in 1,000 metric tons)	Estimated Additional
Cuba	800	300
Indonesia	565	300
Zaire	450	230
Philippines	425	1750
USA	400	350
New Caledonia	385	450
Zambia	300	50
Canada	220	30
USSR	200	150
Australia	135	165
Est. World Totals (Including minor reserves in other regions not named.)	~4000	~4500

An additional potential future source of cobalt are the seabottom deposits of so-called "manganese nodules." In addition to 14-25% Mn, 0.4-1.3% Ni and 0.15-1.2% Cu they contain 0.25%-0.7% cobalt. (Typically 0.3%.) The total reserves of these nodules are estimated as 10^{17} to 10^{18} tons (Ref.21). This would mean additional potential world reserves which are 10,000 to 100,000 times larger than the most optimistic recent estimates of land based deposits. Commercial deep sea mining will certainly not start before the 1990's. It has been estimated (Ref. 21) that 10 mining sites might process 3 million tons of nodules per year and produce 35,000 t/a of cobalt, thus doubling present production levels, or completely satisfying present consumption.

In any case, there is no reason to conclude from the recent cobalt crisis that the world is about to run out of Co reserves. - However, in the interest of securing an uninterrupted supply of this important material at acceptable prices, it will be necessary to further develop some of the new sources mentioned, including domestic ones. At this time, North America and Europe are still too strongly dependent on the output of two single, remote regions in Africa that may well be subject to more political upheaval and military action in the future, which could again cause another severe supply crisis. - Before a commitment is made to a potentially very large new industrial use of a material that contains much cobalt, such as magnets for automotive propulsion motors, the Co supply should be carefully analyzed and secured. On the other hand, the panic reaction of some companies to the recent shortage seems strongly exaggerated.

b. Cobalt Uses and Consumption

We shall now consider cobalt consumption and compare it with the supply. Figure 2-8 shows that total world consumption substantially exceeded production of new cobalt for most of the last decade. This was possible in part because the United States had accumulated a large stockpile of the metal which it was liquidating in the early 1970's. These government sales were responsible for keeping the selling price low until about 1977, but this also discouraged domestic U.S. production. The beginning of the "cobalt crisis" coincided with the end of stockpile sales following several years of increasing consumption; also with the civil war in Zaire and fights over the control of Shaba province (Katanga). Note, however, that the line marked "Zaire production" in Figure 2-8 shows a steady rise since 1977. The supply interruptions from the former Belgian Congo were thus not primarily due to production stoppages but rather to the destruction of the only rail link, which made normal shipping impossible. Altogether it seems that the production buildup since 1976 simply was initially not rapid enough to keep up with the increasing demand. A general slight Co shortage and the extreme temporary price rises we discussed before (see Figure 2-4) were the result.

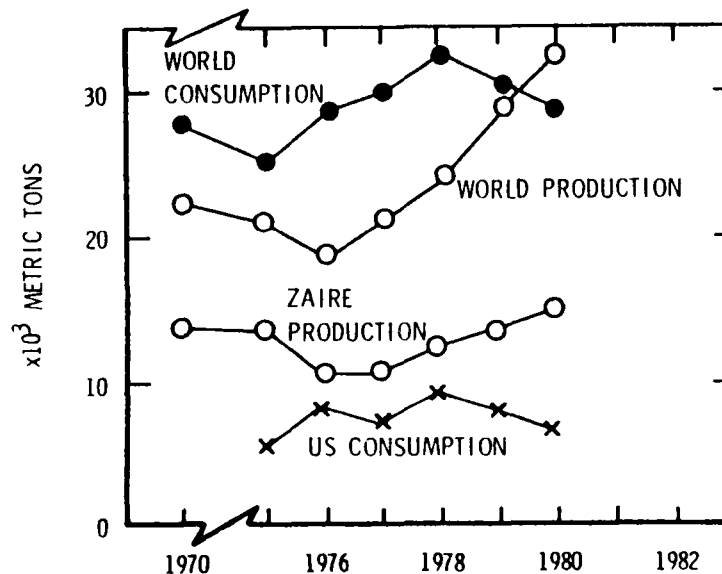

Figure 2-8: Annual Cobalt Production and Consumption. (Ref. 20, 21, 22))

The normalization of shipments from Africa, addition of production capacity elsewhere, widespread Co substitution by users, and finally, stricter conservation and scrap recycling measures have since then created a much more favorable situation for cobalt users again. Since 1980 world production has exceeded demand and cobalt is now cheaper than just before the crisis years.

Since cobalt is indispensable for many industrial uses and plays an important role in airplane engines, the USA and other industrial countries are in the process of rebuilding their strategic Co stockpiles. The existence of these, coupled with the increased production capacity outside Africa, should go far to assure supply and price stability over the long term.

In order to plan for a large new use, one has to know what other major uses for cobalt exist, what share of the supply they consume, and what the development trends are for consumption in the various use categories. We shall therefore briefly review these next.

The U.S. Bureau of Mines categorizes industrial cobalt uses as follows. (1) Magnetic alloys (permanent magnets, soft magnetic Fe-Co-base alloys), (2) Superalloys (for hot stages of gas turbines, etc.), (3) Cutting tools and wear resistant materials (binder in cemented carbides); (4) Other metallic uses (especially in steels), and (5) Chemicals and miscellaneous (coloring of glass and ceramics, catalysts for petroleum processing, plastics and paint production. Figure 2-9 summarizes the U.S. consumption by category through the crisis years from 1977 to 1980. After a 1978 use peak we see a significant drop in all categories except "superalloys." In spite of a slow shift from the use of Co-base to Ni-base high temperature/high strength alloys (which do use Co, but less), the consumption of Co for these has increased rapidly, and this trend is expected to continue. - The shift from Alnico to ferrite magnets and REPM has reduced the Co market share of all magnetic alloys from 21% in '77 to only 15% of the (lower) 1980 total. Magnets will further decrease their share. - The downtrend in category (3) is expected to continue due to new carbide bonding techniques that use less binder and the partial replacement of Co by Ni. - The decreased use of Co catalysts is attributed more to the generally low economic activity than to substitution, so this use is expected to rise again.

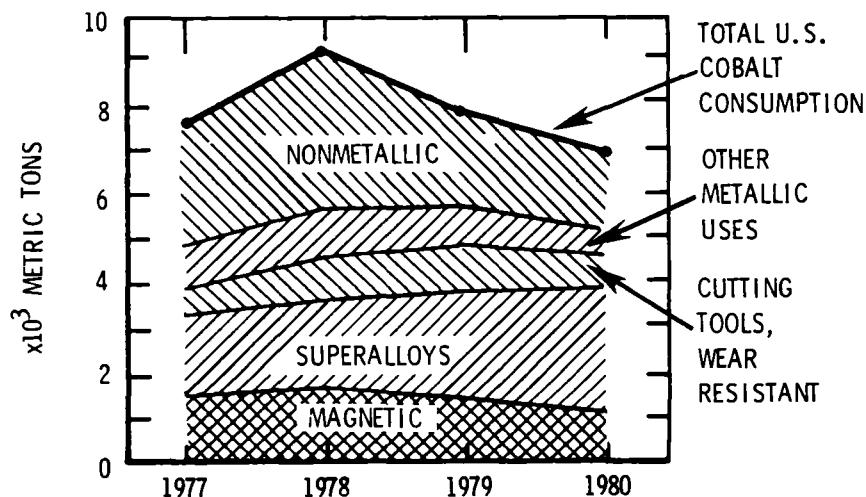

Figure 2-9 U.S. Cobalt Consumption by Use Category. (Ref. 30)

The total U.S. usage of cobalt dropped 23% between 1978 and '80, with much of the reduction believed to be irreversible even in this time of excess production. These shifts should help to keep the price down. We also see that magnetic materials with their share of 15% (and permanent magnets alone with perhaps 10%) are no longer the major user of Co they used to be. (In 1974, the magnetic alloy industry, with a 25% share, was considered the largest single cobalt consumer.)

It is instructive to express as a percentage of cobalt consumption the Co quantities that an annual production of 100,000 electric vehicle propulsion motors would require. (See Table 2-3.) If Alnico 8 HC and the design GE-2 were used, 376 metric tons of Co metal would be needed. This is 5.4% of the total U.S. cobalt consumption in 1980, or 36% of the magnetic materials share. If SmCo₅ in the VPI/KC-3 designs were employed, 92 t/a of Co, i.e., only 1.3% of total U.S. Co consumption, or 8.8% of the magnetic materials share of Co use would be required. Neither is expected to upset the supply or price structure of the Co market; certainly the REPM solution would not.

6. Production and Utilization of the Rare Earths (See references 23-30)

a. General Considerations

The "rare earths" are a family of 15 elements (17 if we include their close chemical relatives, yttrium and scandium) that are chemically very similar. For this reason they always occur together in the minerals from which they are commercially produced. However, they differ strongly in some of their physical properties, including their suitability for use in permanent magnets. Samarium is the most desirable of the RE for this purpose. Other RE metals can be used, singly or combined, but in most cases still with a strong admixture of Sm.

The DOE/NASA motor contractors have so far only considered sintered SmCo₅ in their designs. While this is justifiable during the developmental stage, we shall in this section discuss some compelling economic reasons why in a mass-produced vehicle motor a different REPM type with much lower samarium content should be used. Fortunately the development of the REPM has progressed to a point where several alternative magnet types with useful properties are now or will soon be in production that need less Sm or even none at all. Even if the latter should not be good enough for propulsion motors, their use in other applications will remove some competition for the Sm supplies.

As we saw before, Sm is a relatively scarce element. (Only 1/3 as abundant as Co.) More importantly, though, it constitutes only between 0.5% and 3% of the total RE content of the common rare-earth minerals. During the early stages of processing these, all the RE stay together; later on they must be separated from one another. It would be utterly unreasonable to process large quantities of ores only to extract the samarium content, or any narrow portion of the RE "spectrum." This would raise the price of Sm₂O₃ at least tenfold (Ref. 23), or the Sm metal price to 4-5 times its present level.

Thus it is economically essential that a large portion of the other RE present in the ore can also be sold. The commercial availability of any given RE at acceptable cost is always related to the whole rare earth economy. Such availability can only grow at the rate at which markets for the majority constituents of the minerals grow, i.e., for Ce and/or La, Nd, or their commercial mixtures, including mischmetal. This means that the global supply of samarium will be limited to the Sm content of the total ore quantity processed for other reasons by all the rare-earth producers. Like cobalt, samarium is a co-product, primarily of lanthanum and cerium. However, it is also true that much more of the Sm contained in the

processed ores could be recovered than is at present.

b. Rare Earth Ores, Deposits and Individual Abundance

It is instructive to look again at the estimated abundance of the elements in the earth's crust, this time of the RE relative to each other. (Fig. G 2-10. We see that Y, La, Nd and especially Ce are all much more abundant than Sm, while the "heavier RE" (with higher atomic numbers than Sm) are all rarer. Also, all even-numbered RE are more plentiful than their neighbors. While the composition of the RE ores varies somewhat, it generally reflects these distribution patterns.

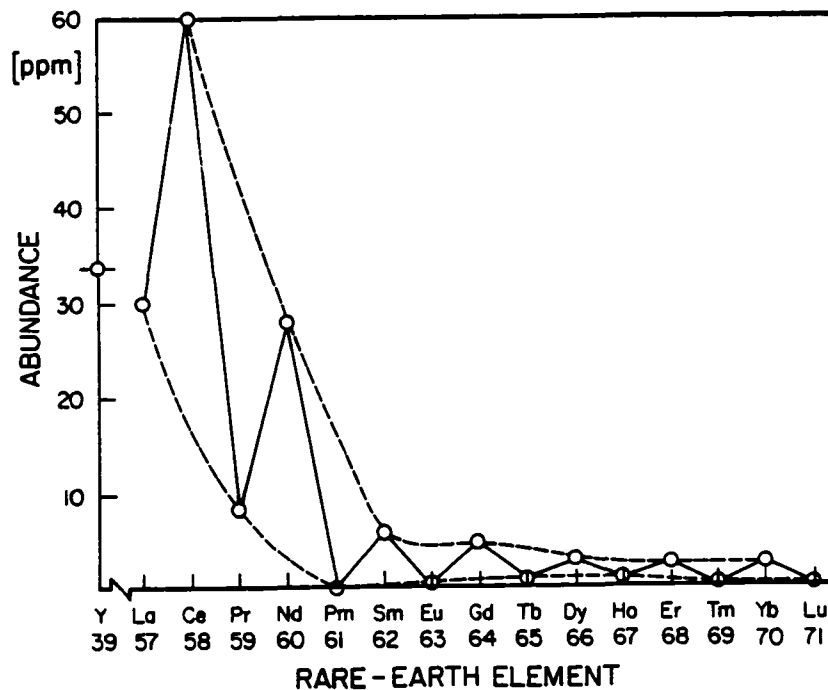

Figure 2-10: Natural Abundance of the Rare-Earth Elements in the Earth's Crust (Ref. 15).

The most important RE-bearing minerals in the common ores are called Monazite, Bastnaesite and Xenotime. The first two are the feed material for the large-scale production of mischmetal and the separated "light RE", and thus also the principal source for Sm. Xenotime is the main source for yttrium and the heavy RE. While it contains more Sm than most Bastnaesites, it is a much rarer mineral and of little importance for the magnet industry. Table 2-12 lists typical chemical compositions for these three mineral types (which often occur mixed in the ores). Also given is

TABLE 2-12: TYPICAL ANALYSES OF IMPORTANT RARE-EARTH MINERALS
(References 15, 24, 27, 30)

MINERAL → Contains % of equivalent ↓	BASTNAESITE (LRE) FCO ₃ (California, USA)	MONAZITE (LRE) PO ₄ (Kerala, India)	BAOTOU MIN'L 2/3 Bast , 1/3 Monaz (Inn Mongolia, China)	XENOTIME (Y, HRE) PO ₄ (Malaysia)
Th ₂ O ₃	< 0.1	9.8	0.3	1.1
TOTAL REO actual (theoret) }	~70 (75)	~59 (70)	~61	~60 (67)
Indiv. REO	Individual contents in % of total REO in mineral			
La ₂ O ₃	33	23	27	0.4
CeO ₂	50	46	50	1.4
Pr ₆ O ₁₁	4	5	5.5	0.5
Nd ₂ O ₃	12	18	15	1.2
Sm ₂ O ₃	0.5	3	1.3	1.1
Eu ₂ O ₃	0.1	0.1	0.2	0.01
Gd ₂ O ₃	0.2	1.8	0.4	4.0
Tb ₂ O ₃	} 0.1	} 1.1	} 0.35	1.2
Dy ₂ O ₃				6.5
Ho ₂ O ₃				2.5
Er ₂ O ₃				6.1
Tm ₂ O ₃				0.9
Yb ₂ O ₃				9.0
Lu ₂ O ₃				0.8
Y ₂ O ₃	0.1	2.0	0.25	64.3
ASSOCIATED WITH OTHER USEFUL MINERALS	Barite (Ba) Celestite (Sr) Calcite (Ca)	Ilmenite, Rutile (Ti) Zircon (Zr) Cassiterite (Sn) [Xenotime (Y, HRE)]	Magnetite (Fe) Hematite (Fe)	Heavy-Metal Minerals [Monazite (LRE)]
TOTAL REO CONTENT IN ORE [wt %]	7-10	1-20	5.5	1-20

an analysis for the Chinese Baotou ore (see below) which contains a mixture of Bastnaesite and Monazite. The contents of individual RE are as usual quoted as weight % of the oxides, rather than the elements.

Table 2-13 states the general location of the world's important known RE ore bodies and the predominant RE minerals found there. It shows first recent estimates of the deposits in terms of total rare-earth oxides (REO), the "resources." Note that there are significant deposits of Bastnaesite in the United States, which is probably the largest supplier of RE concentrates to the industry at this time. In China, near Baotou in Inner Mongolia, is what appears to be the largest deposit of rare earths in the world. It reportedly contains three times as much total REO as all other known reserves combined. It is also noteworthy that the Baotou mineral has about 2-1/2 times as much samarium as the California Bastnaesite, 1.3% vs. 0.5% Sm_2O_3 . - The table also shows the corresponding approximate reserves of Sm_2O_3 and the equivalent samarium metal, since these are of such great importance for the REPM. If we compare the figures in the last column with the projected need for samarium in magnets for EHV propulsion motors at 36-48 t/a, we would judge the total reserves of Sm as virtually inexhaustible. Even the proven U.S. reserves alone could supply the EHV application for over 800 years! However, a realistic assessment has to relate the Sm supply to the annually processed quantity of RE minerals instead. This shall be attempted next.

TABLE 2-13: ASSURED RARE EARTH DEPOSITS AND ESTIMATED SAMARIUM RESERVES OF THE WORLD, IN METRIC TONS. (Ref. 15, 23, 24)

GEOGRAPHIC LOCATION	PREDOMINANT MINERAL TYPES	RESOURCES 10^3 t total REO	EST. SAMARIUM CONTENT*	
			10^3 t Sm_2O_3	10^3 t Sm Metal
Africa and Madagaskar	Monazite	150	4 5	3 9
	Bastnaesite	100	0 5	0 4
Australia	Monazite	500	15	12 9
	Uranium Ore	300	12	10 3
Brazil	Monazite	1,000	30	25 8
Canada	Uranium Ore	150	6	5.2
China (Inner Mongolia) **	Mon /Bast. Mixture	35,000	455	391.3
India	Monazite	3,000	90	77 4
South-East Asia	Monazite	100	3	2 6
USA	Bastnaesite	5,000	25	21 5
	Monazite	700	21	18
ESTIMATED WORLD TOTALS		46,000	662	569

*Estimates based on Sm_2O_3 contents of 3% of total REO for Monazite, 0.5% for Bastnaesite, 1.3% for the Chinese ore and 4% for the uranium by-products. The amount of contained Sm metal is 0.86 times the Sm_2O_3 content of the ore.

** Tailings from an iron-ore mine. These estimates were made after 20 years of production and thus appear quite reliable.

c. Samarium Availability and Production

Table 2-14 contains statistics for the worldwide processing of RE ores in 1977 (24) and an estimate for 1983 (31). The upper limit on the amount of Sm metal that could theoretically have been available in 1977 is about 364 metric tons. This figure assumes that all of the Sm contained in the ore would indeed be separated and that this separation is 100% efficient. This is, of course, not possible. In fact, the industrial capacity for Sm separation in 1977 was quite limited, with one company (Rhone-Poulenc at La Rochelle in France) producing most of the world's supply of Sm_2O_3 . The actual production in '77 was probably less than 50 t equivalent Sm metal. The magnet industry was practically the only user of this Sm.

TABLE 2-14: RE ORES PROCESSED IN 1977 (ESTIMATES FOR 1983) AND THE POTENTIALLY AVAILABLE REO AND SAMARIUM CONTENTS. (Refs. 24, 31)

PRODUCTION fr MINERAL → ↓	MONAZITE	BASTNAESITE	XENOTIME	URANIUM RESIDUE
WORLDWIDE PRODUCTION (Metric tons REO)	(77) 11,000 (83) 14,000	18,400 (18,400)	90 (0)	45 (0)
GRAND TOTAL RARE EARTHS OXIDES	(1977) 29,535 Metric Tons Total REO (1983) (32,400) " " " "			
CONTAINED SAMARIUM OXIDE	(1977) 327 (1983) (416)	92 (92)	2 (0)	2 (0)
GRAND TOTAL SAMARIUM OXIDE	(1977) 423 Metric Tons Sm_2O_3 (1983) (508) " " " "			
GRAND TOTAL CONTAINED ELEMENTAL SAMARIUM	(1977) 364 Metric Tons Sm (1983) (437) " " " "			

Recognizing the rapidly growing demand for Sm, two companies are in the process of greatly expanding their RE separation facilities (solvent extraction plants), and some of the new capacity is already in operation. Rhone-Poulenc has built a new U.S. plant in Freeport, Texas; Union-Molycorp has added separation capacity at Mountain Pass, CA, and it produces Sm metal in Washington, PA. The W. R. Grace Comp. is also considering RE separation facilities. Table 2-15 shows a 1977 estimate of the total annual Sm production capacity that would be installed between 1980 and '82. (24) It also contains approximate production figures for some years past and projections for the near future which J. G. Cannon presented orally at the 6th Workshop on REPM, Sep. 1982.

d. Sufficiency of the Sm Supply for REPM Production

Based on the predictions about Sm availability contained in Table 2-15 we can now define probable upper limits for the availability of rare earth-cobalt permanent magnets. In turn, we can compare these with our estimates of the quantities of magnet alloys (or their constituents) that would be required for an annual production of 100,000 vehicle propulsion motors. (See Tables 2-2 and 2-3.) We shall do this, making several alternative assumptions about the chemical compositions of the REPM used.

TABLE 2-15: SAMARIUM AVAILABILITY BASED ON INDUSTRIAL RARE EARTH SEPARATION
 Estimated production (24, 29, 31), present separation capacity, and future production
 estimates (24, 31). [Metric tons.]

COMMERCIAL PROCESSOR	ESTIMATED Sm PRODUCTION				INSTALLED SEPARATION CAPACITY 1982 (29, 31)	PROJECTED PRODUCTION (31)			
	1975	1977	1979	1980		1983	1985	1990	
Rhone-Poulenc	← In France only →				France, USA	250			
Union-Molycorp	← None →				USA	180			
Others (exclusive of USSR)					Mostly China and Japan	90			
TOTAL Sm ₂ O ₃ CONTAINED Sm	12	47	93	150		520	250	340	500
	10	40	80	129		447	215	290	430

Of many useful compositions now in production or development, we shall select four examples, keeping in mind that high intrinsic coercive force is an essential property for a propulsion-motor magnet. The first is sintered SmCo_5 , which is at present the most-produced of the REPM and was used in all the developmental EHV motors. Next is the prototype of the new, high-coercivity "2-17 magnets" that are now being commercially introduced, with formula $\text{Sm}(\text{Co, TM})_{7.25}$. The third example is $(\text{Sm}_{.8}\text{RE}_{.2})(\text{Co, TM})_{8.35}$ - an alloy that is closer to the ideal 2-17 composition. Sintered magnets of this variety do not yet exist. But based on the use of a high- H_c $\text{Sm}(\text{Co, TM})_{8.35}$ in bonded REPM and the successful partial substitution of Sm by RE = Ce, Pr, Y, Gd or Er in low- H_c "2-17", it seems certain that suitable magnets of this general type will become commercially available in the next few years. Finally, we shall include an often considered "mischmetal-cobalt" magnet of 1-5 stoichiometry in which 20% of the total RE is Sm to assure acceptably high coercive force. Magnets of similar compositions have been in a small-scale commercial production for years, but they have not really been needed since the Sm supply has been ample for the modest-size REPM market.

In Table 2-16 we show availability limits for these four alloy types, calculated from the prior estimates of samarium availability in the years 1983, 1985 and 1990.

TABLE 2-16 : QUANTITIES OF DIFFERENT REPM ALLOYS OBTAINABLE FROM PROJECTED WORLD SAMARIUM PRODUCTION (100% Yield assumed! - USSR not included)

YEAR	1983	1985	1990
Est. Sm Production [met. tons]	215	290	430
ALLOY TYPE	ALLOY QUANTITY [metric tons]		
Sm Co_5	600	810	1,195
$\text{Sm}(\text{Co, TM})_{7.25}$	830	1,120	1,665
$(\text{Sm}_{.8}\text{RE}_{.2})(\text{Co, TM})_{8.35}$	1,165	1,570	2,320
$(\text{MM}_{.8}\text{Sm}_{.2})\text{Co}_5$	3,115	4,205	6,225

If SmCo_5 was to remain the REPM of choice, the Sm supply could barely satisfy the anticipated growth of the REPM market, even without the addition of a new automotive application. The 140 t/a which 100,000 EHV propulsion motors would require are a rather large fraction of the availability limit (23% now, 12% in 1990). A transition to 2-17 magnets would help in two ways: More alloy could be made from the available Sm (example 3 would double the alloy supply); and less magnet material would be needed in the motors since the energy product is higher (22-28 MGOe vs.

18 for average SmCo_5), so that only about 100 t/a might be required for EHV motors. The 1-5 mischmetal magnets of example 4 have lower energy products (12-16 MGOe); thus, more alloy would be needed for the EHV motors, perhaps 180-200 t/a. But compared to the availability projections, this would represent a much smaller fraction, $\sim 6\%$ in 1983 and $\sim 3.2\%$ in 1990.

In reality, of course, the commercial offering of REPM will be a mix of these and other types. It seems likely that various "2-17" magnets will soon replace SmCo_5 as the most-used REPM. Cerium-based REPM with little or no Sm could be used in less demanding applications, freeing Sm for motor magnets. And magnets with a high mischmetal content, similar to example 4, could certainly be produced with properties acceptable for EHV motor use.- It seems that one or more of these alternatives must be introduced in commercial magnet production if EHV propulsion motors and possibly other automotive applications for REPM were to become a reality.

All these speculations have left out of consideration the potentially large additional samarium supplies that could come from China. At this time, the Chinese rare-earth industry has only a small Sm production capacity, and the PRC is not yet a viable supplier of the magnet industry in other countries. However, it appears that the PRC plans to build large new plants for RE separation, samarium, alloy and magnet production, so that its exports of these products may well become a major factor in another decade. This could dramatically raise the limits imposed on the growth of the REPM market by the samarium supply.

e. Use Patterns for the Rare Earths. (References 15, 24, 25, 28, 30)

For the rare earths it is even more important than for cobalt that a potential large-scale user keep informed about the range of other commercial applications and the material requirements for them. There are two aspects to this: On the one hand, we must know which other uses compete with the magnets for the available supplies of the elements needed in REPM production. (Sm; Pr, Ce; the mixture MM; for specialty magnets also some Gd, Dy, Ho or Er; and in the future perhaps Y, Nd and La in combination with Sm.) The other aspect, previously mentioned, is that the RE always occur together in nature, and as a consequence, the availability and cost of the individual elements are strongly dependent on the markets for other rare earths.

The rarer of the RE that are useful in magnets - Sm, Pr, Gd, Dy, Ho, Er - can only be economically produced as a co-product of cerium/lanthanum (or mischmetal) from Bastnaesite and Monazite ores, or as a co-product of Yttrium from Xenotime. The demand for Ce, La, MM and Y at a given time thus fixes the upper limit on their availability, as was discussed in detail for samarium. On the other hand, if one of the dominant RE elements - Ce, La, Nd, Y (or better yet, mischmetal) - were later needed in large quantity for the magnets, it would be quite economical to process more of the appropriate mineral specifically for this purpose. (But there would then be more of the rarer RE available as a by-product looking for a market.) In any case, the rare-earth industry must always attempt to keep in balance their full range of products. In view of the large number of elements involved and the fact that the quantity relations between them are

fixed by nature in fairly narrow limits, this is difficult to do. Potential large-quantity users of rare earths are advised to consult and cooperate closely with the few major RE producers in their development and production planning efforts.

The major industrial applications of RE at the present time are briefly described in the following paragraphs. Most uses are not for the metals but rather for oxides or other inorganic compounds. Also, about two-thirds of the consumption is for broad RE mixtures; one-third is for chemical concentrates of one or two elements; only about 5% of the total production is as pure individual elements (>98%). Applications requiring specific RE elements because of their individual properties are still few and require only small quantities. Among them are the presently produced magnets. It should be mentioned, however, that most large scale, nonspecific applications for mixed rare earths - such as catalysts or additives for iron and steel production - permit the extraction of minor constituents that are wanted for other uses, such as Sm or the heavier RE.

Following is a brief review of the applications:

Petroleum cracking catalysts containing 5-10% Ce-depleted mixed REO are now the largest single use for rare earths. RE catalysts are also used for hydriding, the polymerization of plastics, in converters for car exhausts, (Ce), etc.

Metallurgical uses - mostly for mischmetal - include lighter flints, additives to malleable cast iron (graphite nodularization) and steels (to change sulfide morphology). These are declining rapidly. Individual RE (Pr, Nd, etc.) are used in small quantities in structural magnesium, aluminum, copper and titanium alloys.

The glass and optical industries use large quantities of Ce_2O_3 for polishing. Nd, Pr and Er are used for glass coloring, Ce also for decolorizing, Nd and Er in laser glasses. La, Y and Gd increase the refraction index, with La particularly being used in most camera lenses and optical fibres.

The ceramic industry is a user of REO for tile coloring (Pr, Ce), in enamels (Ce), refractories such as metallurgical crucibles (Y), etc. The U.S. Consumption for these purposes is only 10 - 15 tons per year.

The bright red phosphor in color TV screens contains Y and some Eu. Many other RE are also suitable as phosphors for different colors. The lighting industry increasingly uses Y and Eu in highly efficient fluorescent bulbs and in high-pressure Hg vapor lamps. Mixed RE from monazite have long been used in carbons for high-intensity arc lamps.

In solid state electronics RE are needed in ceramic dielectrics for capacitors (Nd), in garnet orthoferrites for microwave devices and magnetic "bubble" computer memories (primarily Gd), and La in high-emission cathodes. These are generally uses for small quantities of highly pure rare earths and are of no concern as competitors for REPM raw materials.

In nuclear reactors Gd is used in control rods. Eu, Sm and Dy are also suitable. Ceramic radiation shields also employ these elements.

The figures in Table 2-17 give us a feeling for the consumption of RE in the different major market segments. Gschneidner (Ref.30) distinguishes 4 main categories. The first three - metallurgical, chemical and glass/ceramics - each accounted for about one-third of the world's RE consumption in 1978, while the fourth - highly purified separated RE - was only 1%. The iron and steel industry uses natural mischmetal, and the dominant chemical use, catalysts, also employs the natural mix of RE. Together these consume 60% of the RE globally. The content of specific minor elements in the mixtures is immaterial for these applications. This is important for the magnet industry! In the electrolytic MM production, the Sm and Eu are retained in the slag, which is now reprocessed to provide these elements for magnets and TV phosphors, respectively. They are also increasingly removed from the cracking catalysts as the RE industry installs more separation capacity.

Note that in this table the RE used for magnets are included under the heading "metallurgical" and lumped together in a subcategory with flints. We see again that the magnets require only a small fraction of the total rare-earth production (this may now be about 1%), and even rapid growth will not make them a major consumer of RE. The total RE market has shown a fairly steady annual growth of about 10% in the last decade. One can expect this expansion to continue, with the consequence that the potential Sm supply should also grow at this rate.

TABLE 2-17: THE RARE EARTH MARKETS IN 1978. (Ref. 30)

MARKET SEGMENT	CONSUMPTION [METRIC TONS REO]	
	Non-Com. World	USA [% of N. -C. W.]
METALLURGICAL INDUSTRY	(7,850)	
Cast Iron	2,650	67.9 %
Steels	4,000	72.5
Flints, Magnets, etc.	1,200	62.5
CHEMICAL INDUSTRY	(7,800)	
Cracking Catalysts	6,000	80.0
Other Chemical Uses	1,800	77.8
GLASS AND CERAMICS	(8,600)	
Polishing	4,400	36.4
Additives	4,200	45.2
PHOSPHORS, ELECTRONICS	(250)	
(Separated 98% pure REO)	250	60.0
TOTALS	24,500	62.4%

D. References - Chapter II

1. "Choice of PM Materials for Automotive Starter Motors." R. Corbach, paper at NMPA Permanent Magnet Seminar, Jan. 1982, Raleigh, N.C., (Rob. Bosch GmG, Herne, W. Germany).
2. "TDK Anisotropic Ferrite Magnets." Products Catalogue BME9Y-012B, Nov. 1979, TDK Electronics Co., Ltd., Tokyo, Japan.
3. "Air Aging of Rare Earth-Cobalt Matrix Magnets." R.M.W. Strnat, et al., 6th Int'l. Workshop Rare Earth-Co Perm. Magnets (1982), p. 469. (Sec. G18.)
4. "Developments in Magnetic Properties of Resin-Bonded $\text{Sm}_2\text{TM}_{17}$ Type Magnet." T. Shimoda et al., 5th Int'l. Workshop Rare Earth-Co Perm. Magnets (1981), p. 595. (Sec. G11.)
5. "New Solder-Bonded RE-Co Magnets with Improved Energy Density and Stability." R.M.W. Strnat et al., *ibid.*, p. 609. (Sec. G11.)
6. "A New Class of Melt Quenched Amorphous Magnetic Alloys" (Abstract). N.C. Koon, C.M. Williams and B.N. Das, J. Appl. Physics 52 (1981), p. 2535.
7. "Magnetic Hardening of Pr-Fe and Nd-Fe Alloys by Melt Spinning." J.J. Croat, J. Appl. Physics 53 (1982), p. 3161.
8. "Surface Effects on Hysteresis Loop Shapes in High-Coercive-Force Crystallized Amorphous Alloys." J. J. Becker, IEEE Trans. Magnetics, MAG-18 (1982), p. 1451.
9. "The Development of PM Alloys in Japan." Y. Tawara and H. Kaneko, 6th Intl. Workshop Rare Earth-Co Perm. Magnets, p. 499. (See G18.)
10. "European Market and Principal Applications of Rare Earth-Cobalt Magnets." D. Weinmann and F. Gallo, 6th Intl. Workshop REPM p. 285 (See G18.)
11. "Review of Recent Permanent Magnet Developments." Y. Iwama, 5th Intl. Workshop REPM, p. 283. (See G11.)
12. Oral presentations and panel discussions on "Indust. applications of REPM and future aspects" at 6th Intl. Workshop REPM, Baden, Austria (Sep. 1982).
13. Conversations with several representatives of U.S. magnet producing companies and some magnet users.
14. Principles of Geochemistry. Brian Mason. John Wiley & Sons, N.Y. (1952) as quoted in Handbook of Chemistry and Physics (1978).

15. "Seltene Erden." E. Greinacher and K. Reinhardt, in *Chemische Technologie*, Vol. 2, Part I, p. 678. Carl Hanser Verlag, Munich/Vienna (4th ed., 1982).
16. "Functional and Economic Considerations in the Selection of Perm. Magnets." R.J. Parker. Lecture at Eng.Short Course in Dayton, Ohio, 1980. (See G19.)
17. "Impact of Recent Cobalt Supply Situation on Magnetic Materials and Applications." G.Y. Chin, et al. *IEEE Trans.Magnetics*, MAG-15 (1979) p. 1685.
18. "Kobalt-Verbrauch und Ruckführung." C. Voigt, *Metall* 36, p. 1297 (Dec. 1982).
19. "Cobalt," R.F. Pearce. *Eng. & Min. J.*, McGraw Hill Co., 181 (March, 1980) p. 111.
20. "The Availability of Raw Materials for Perm.Magnet Production." H.J. Roorda and R.A. Kuhnel, *Proc. 3rd Europ.Conf. on Hard Magnetic Materials* (1974), p. 17 (See G17.)
21. "Cobalt Utilization and Availability." T.A. Gaspar, *Current Awareness Bulletin No. 106*, Battelle Columbus Laboratories (Dec. 1981).
22. "Kobalt - Steigende Produktion." W. Krajewski. *Metall* 35 (1981) p. 81.
23. "Availability of Rare Earth for the RE-Co Perm.Magnet Market." T. Isozaki, *Proc. 4th Intl. Workshop RE-Co Perm.Magnets*, p. 317. (See G10.)
24. "Availability of Rare Earths for the RE-Co Perm.Magnet Market." J.P. Fort. Company report of Rhone-Poulenc Industries, Paris, and Rhodia, Inc., N.J. (1978). See also Ph.Poirier, *4th Indust. Minerals Int'l. Congress*, Atlanta, GA (1980). Rhone-Poulenc Industries.
25. "New Applications of Rare Earths - Their Impact on the Producer." K.E. Davis. *Proc.Conf. on Advances in the Applications of Rare Earth Materials*, Multi-Science Publishing Co., Ltd., London (1978).
26. "Rare Earths." J.G.Cannon, *Eng. & Min. J.*, McGraw Hill Co., March 1983.
27. "A Survey of China's Rare Earth Industry." Ma Peng-Qi and Xu Lai-Zi, *Final Report 5th Int'l. Workshop Rare Earth-Co. Perm. Magnets*, Univ. of Dayton, Ohio (1981) p. 24.
28. "Rare Earths and Permanent Magnets." A Brambilla, *Metal Powder Report* 37 (Jan. 1982) p. 24.
29. Personal communication, J. G. Cannon, Union Molycorp, June 1983.
30. "Rare Earth Specialty Inorganic Chemicals." K.A. Gschneidner, Jr. Article in book *Specialty Inorganic Chemicals*, R.Thompson, editor. The Royal Soc. of Chemistry, London (1981) p. 403.
31. Personal communication, J. P. Spooner, Rhone-Poulenc Inc., May 1983.

III. PM CHARACTERIZATION AND INTEGRATION INTO MOTORS

A. Introduction

It was originally intended that this report should contain an "exposition on design" of magnetic circuits for PM motors. However, other aspects of the work - collecting and organizing PM property data, economic analysis, the experimental characterization of Mn-Al-C, and analyzing feasible future PM developments - consumed much more than their share of time and funds. So the design method study was de-emphasized. But also, as he learned more about electric motor design, the author felt increasingly inadequate to do this complex job justice. Therefore, no pretense is made that we can teach the motor experts what they know much better. Nor shall we rehash the basic formulas for magnetic circuit design based on the electric circuit analogy, their augmentation by empirical "fudge factors" to account for leakage flux, or by the more precise computerized small-element techniques of flux pattern analysis. Fairly thorough general expositions of these mathematical design aids (as well as applications to specific cases of motor design) may be found in the References G2, G4, G6 through G11, and G16.

Instead we shall attempt two things in this chapter. First we discuss some specific properties and behavior patterns of permanent magnet materials that are of importance for their use in motors, also defining the quantities used to describe them. Then we shall survey pictorially the basic geometries of PM motors, discuss some of the factors which influence the shape and placement of the PM in the machine, and the consequences of different magnet locations.

In the course of doing this here (and also in the earlier review of the specific NASA EHV motors in Chapter I) we accomplish at least in part the objective of developing design tools and rules. The emphasis is on knowing the PM material, its possibilities and limitations, rather than on the mathematics of magnetic circuit design.

B. Concepts and Quantities for Describing Permanent Magnets

1. Introductory Remarks

In Section I,D,2 we had compiled a list of magnet material properties for which the motor designer needs quantitative information or numerical data. The purpose of this was threefold - to guide our data collection effort, to help the motor design engineer in critically using the product literature and communicating with magnet vendors, and to suggest to the PM manufacturer what properties to measure and report to the motor producer. In the following we shall concentrate on the "magnetic properties" listed before, defining some quantities and developing concepts that are particularly important for motors. A familiarity with magnetic properties and units, and a knowledge of the basic description of permanent magnets are assumed. We shall emphasize less well-known concepts and the behavior patterns of those PM materials that were selected for propulsion motors.

2. Static Magnetic Properties at Room Temperature.

(a) Major Hysteresis Loops.

By "major loop" we mean a loop traced in a quasi-static manner with slowly and monotonically changing applied field. It is also implied that the peak field value is sufficient to saturate the material with either polarity. Fig. 3-1 shows such major loops and indicates some commonly used salient properties - remanence, B_r , the two coercive forces, B^H_c ("normal") and M^H_c ("intrinsic"), and the static energy product, $(BH)_{max}$. For modern permanent magnets the distinction between the "normal" B vs. H and the "intrinsic" B-H vs. H curves is very important since they differ strongly from each other, especially for ferrites and the REPl. It must also be noted that for certain REPl (e.g., $SmCo_5$) it is often difficult or impossible to trace a true major loop, as these materials require extremely high field strength to saturate them.

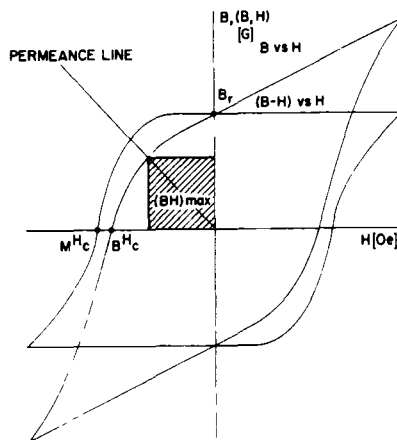

Figure 3-1. Major hysteresis loops and some salient PM properties.

(b) Second Quadrant Demagnetization Curves and Salient Quantities.

Most operating states of a permanent magnet are located in the second quadrant (Q-II) of the hysteresis loop, so usually only that is reported by the magnet manufacturers. Fig. 3-2 shows the normal and the intrinsic Q-II curves for a good sintered SmCo_5 magnet. They are strongly different and both need to be known for propulsion motor design! Under the influence of the extreme armature reaction during startup or stall of a motor, the magnet may experience such a high demagnetizing field that the operating point is driven into the third quadrant of B vs. H and the sign of the flux is indeed reversed. However, as long as the magnetization or intrinsic induction, $B_1 = B - H$, remains essentially constant, the magnet is not demagnetized. In fact, the motor torque increases in proportion to the increasing field applied by the armature current.

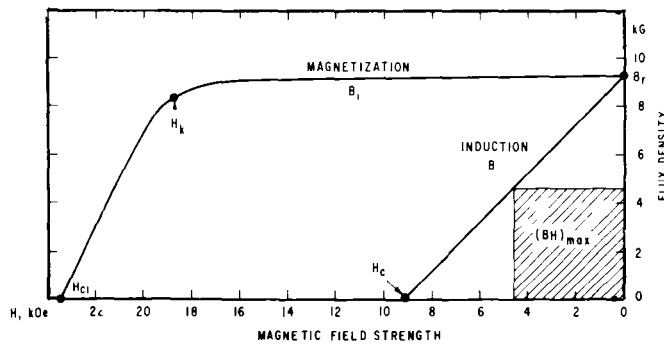

Figure 3-2: Demagnetization curves showing B_r , H_k , $(BH)_{\max}$ and coercive forces.

The magnet can thus operate to the end of the horizontal portion of B_1 vs H , or to the end of the straight-line portion of B vs H , which is (as usual) not shown in Fig. 3-2. It is now common, although not universally accepted, to define this terminal operating point as the one where the intrinsic induction has been reduced by 10%, i.e., $B_1 = 0.9 B_r$. The highest permissible demagnetizing field so defined is called the "knee field," H_k . If it is exceeded in operation, even momentarily, the magnet is usually severely and permanently weakened.

Note that for many low-coercivity magnet materials (steels, most Alnicos, Fe-Cr-Co) the B and the B_1 curves in Q-II are nearly identical. The distinction between them, and between the two coercive forces, is then not important, and often only the B vs. H curve is given. Note also that the B -curve can always be constructed from the B_1 -curve. In principle the reverse is also true, however, if B vs. H is only drawn to the $B H_c$ point, we have insufficient information to construct the left part of B_1 vs. H and to determine H_k . (See Fig. 3-2.)

(c) Static Energy Product

This frequently cited figure of merit, $(BH)_{\max}$, is represented by the area of the largest rectangle that can be inscribed in Q-II between the B vs. H curve and the coordinate axes. It was indicated in the Figures 3-1

and 3-2. (BH) is an energy density per unit magnet volume. It is proportional to the field energy which this PM volume unit can contribute to the useful magnetic field in the air gap of a static device (e.g., a loudspeaker). Thus, a given steady field in a given air-gap volume can be generated with the minimum amount of a specific magnet material if the latter is operated at the point of $(BH)_{\max}$ on the major loop. In turn, when we compare different PM materials, we should need only half the magnet volume of a PM with double the energy product.

This assumes that it is indeed possible to design the device so the PM operates at the permeance line corresponding to $(BH)_{\max}$. However, this is often not the case and other considerations overrule the minimum magnet volume criterion. For instance, for the low-coercivity 2-17 REPM, the Q-II curve looks like Fig. 3-3, the $(BH)_{\max}$ point is practically at the knee. If one designs the magnetic circuit so that the PM operates normally in points P/P' then there is no protection against demagnetization by the high stall or start current in a propulsion motor. The armature reaction field, H_a , would demagnetize the magnet substantially as it approaches the knee field, H_k (points Q/Q'), which is only slightly greater than H_d for the maximum energy product. Therefore, one must design for a higher operating point and use more magnetic material. For the high- B_r ferrite magnets and for Mn-Al-C the demagnetization curves look similar and the same qualitative considerations apply. With Alnico 8 the situation is worse. The "knee" and thus the $(BH)_{\max}$ -point are shifted far up toward the remanence point, and to prevent accidental demagnetization, the operating point may have to be moved even closer to B_r . - For a high-coercivity ferrite magnet, the H_k may be high enough to afford sufficient protection against the armature reaction, but the operating flux density, B_d , at the BH_{\max} -point is very low (1.5 to 2 kG). A higher B_d is usually chosen to increase the air-gap flux, and again more than the minimum magnet volume suggested by the energy product number must be used. - For a good $SmCo_5$ magnet or a high-coercivity 2-17 REPM the situation is as shown in Fig. 3-4. The circuit can generally be designed to operate at $(BH)_{\max}$ under normal circumstances, the very high H_k affords protection against any conceivable demagnetization effects. While the designer might still like to increase the air-gap flux density above the $B_d = 4 - 5$ kG level, the high cost of the magnet material generally demands designing for minimum PM volume.

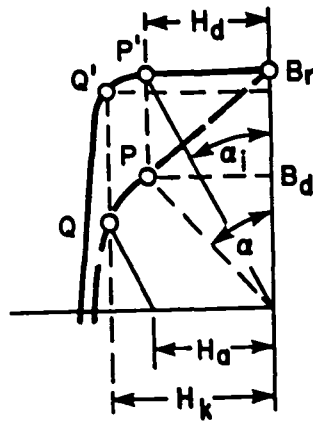

Figure 3-3 Schematic demagnetization curve of low- H_c perm. magnet with optimum static operating point or range.

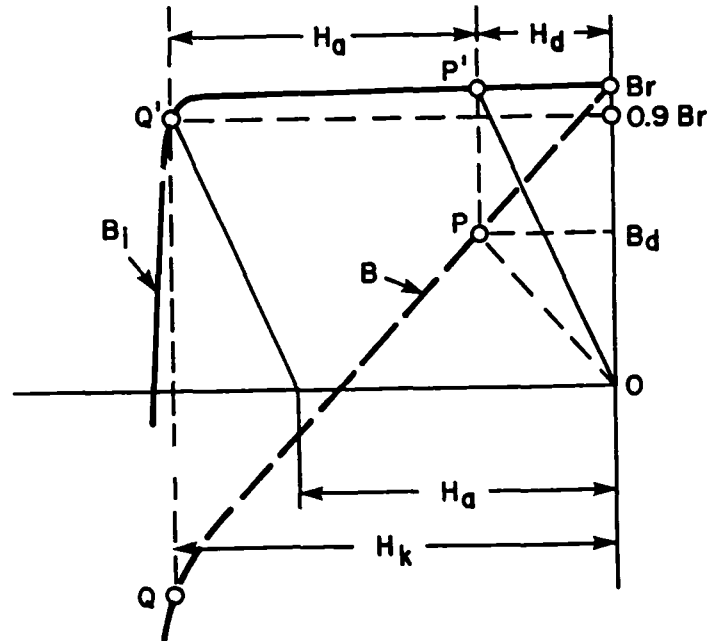

Figure 3-4. Schematic demagnetization curve of a SmCo_5 or high- H_c ferrite magnet.

3. Initial Magnetization, Charging.

In the traditional description of permanent magnets for the application engineer, initial magnetization curves or other B, H -relationships involving the first quadrant are seldom mentioned. This reflects the fact that Alnicos, most ferrites and any of the other older PM having fairly low coercivity can be saturated with rather modest applied fields, and when they are saturated, their Q-II permanent magnetic properties are fully developed. It is generally said that a field at least equal to 3 - 5 times H_c is needed for this, whether the magnet is "virgin"

or has been magnetized before and is to be reversed. This means that about 3 to 8 kOe are sufficient to magnetize or "charge" Alnico and Fe-Cr-Co, 10 to 12 kOe are required for ferrites or Mn-Al-C. Such field strengths are easily achieved with the conventional DC or pulse magnetizers which most device producers have available.

Some of the rare earth-cobalt magnets, however, pose new problems in this respect. They need much higher charging fields to be fully saturated - 35 to over 50 kOe - and if only lower fields are available, the crucial Q-II properties depend in a complex manner on the field strength and the prior magnetic history of the magnet. Unfortunately it is just the high- H_c magnets best suited for propulsion motors that show this undesirable behavior.

The older of the precipitation hardened REPM, including some "1-5", "1-7" and the lower- H_c versions of "2-17", are rather well behaved 12 to 15 kOe will fully charge them. However, the common $SmCo_5$ and similar RCo_5 magnet types show the magnetization behavior illustrated in Fig. 3-5. The initial magnetization curve of the virgin magnet rises steeply and appears to reach saturation at about 10 kOe. However, the second quadrant demagnetization curve is not fully developed by charging the magnet in such a relatively low field. The remanence and, especially, the intrinsic coercive force and knee field (and thus also the energy product) have not reached their best possible values. Much higher charging fields are needed to get the performance quoted by the manufacturer. - If a $SmCo_5$ magnet was previously magnetized (e.g., in an acceptance test) and then field-demagnetized for assembly, it requires an even higher field strength to remagnetize it. - The problem is still greater with the newest, high-coercivity "2-17" magnets. More will be said about this later.

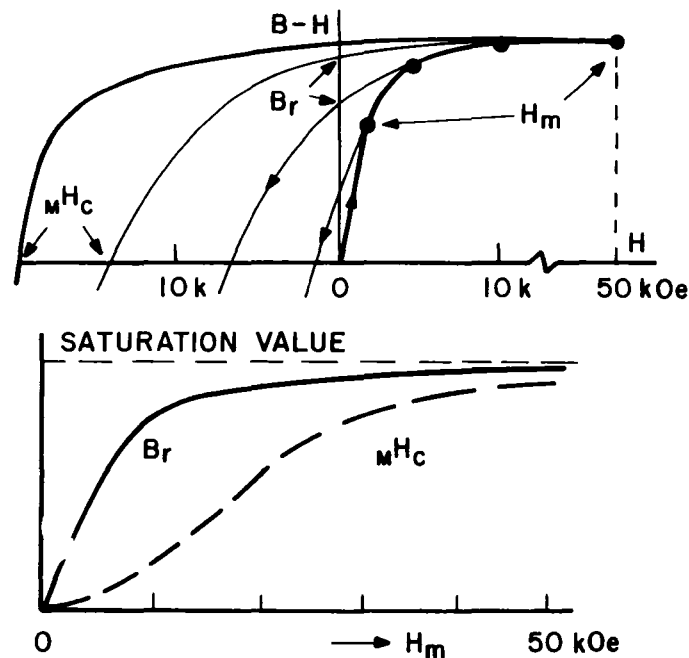

Figure 3-5 Initial magnetization of a $SmCo_5$ magnet.

High coercivity ferrites exhibit a behavior that is qualitatively similar to that of SmCo_5 . But this is of little practical consequence because the absolute level of their coercivity is much lower. The magnets can be fully charged with commonly available magnetizing equipment.

4. Dynamic Operation of Magnets

We mentioned that the function of a permanent magnet in many devices, such as loudspeakers, can be described by an operating point on the second quadrant of the major hysteresis loop. For magnets in most motors, however, this is an inadequate description. A magnet in a motor (and in many other devices, including the simple door latch) is subjected to a varying demagnetizing field. This is called "dynamic operation." The operating point lies no longer on the outer, "major" loop, but it moves in a cyclic fashion along a "minor loop" that lies entirely within the area enclosed by the major hysteresis loop. One consequence is that the flux density is lower than the value of B we read off the major Q-II curve for a given negative field strength. We shall discuss this in some detail. Another effect - a small additional energy loss due to minor-loop hysteresis - is of little consequence, and so we shall ignore it.

(a) Recoil Lines, Recoil Permeability, Recoil Loop Fields

This specific kind of minor hysteresis loop in the second quadrant is called a "recoil loop." Figure 3-6 illustrates such recoil loops in Q-II of the B vs. H plot. The example chosen, although qualitative, reflects most closely the behavior of Alnico 5 DG. If the negative field reaches a largest value H_1 , then decreases to a smaller magnitude, H_2 , and continues to cycle between these two values, the small lancet-shaped minor loop between the points A_1 and A_2 describes the varying magnetization states. If the field is decreased to zero in each cycle, the larger lancet loop A_1-B_0 , with sides C and D , is traversed. We then speak of "complete recoil." Unless otherwise specified, this is meant when we speak of a recoil loop per se. (The small area inside the loop is a measure of the energy dissipated as heat during each cycle.) If later the maximum negative field increases to H_3 the magnet is demagnetized to the point A_3 on the major loop (flux density B_3), and from then on the magnet states cycle between A_3 and B_0' on the lower recoil loop. We see that, once point A_1 is below the knee of the major loop ($H_1 > H_k$), small increases in the peak demagnetizing field (from H_1 to H_3) cause a major reduction of the useful flux density (B_1 to B_3 , or B_0 to B_0').

To simplify design procedures, the recoil loop is usually replaced by its center line (e.g., A_1-B_0), called the "recoil line." In turn, this line is described by its slope, the "recoil permeability," $\mu_r = (B_0 - B_1)/H_1$. This permeability is (incorrectly) used even in calculations involving only partial recoil, such as from point A_1 to A_2 , which is clearly along a flatter line. A further approximation that is commonly made assumes that all recoil lines originating from different points on the major loop have the same slope. In other words, a single value for μ_r is usually attributed to a given magnet material.

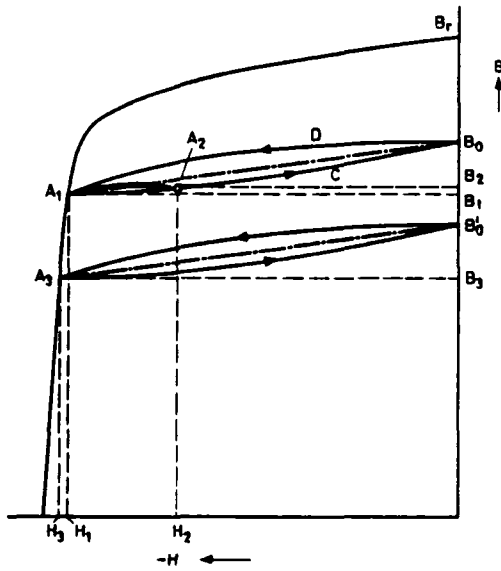

Figure 3-6 Definitions of recoil loops, lines and permeability.

Adopting these simplifications we can now discuss, with the help of Fig. 3-7, the use of such recoil lines in motor design. Assume that the operating point P_1 is defined by the smallest air gap between rotor and stator. The corresponding permeance value is $p = -B_m/H_m$, and the position of the permeance line can also be defined by the angle, α . There are three or four possible effects that will cause the magnet in a motor to operate on a recoil line. We shall discuss them one by one, using one and the same geometric construction in Fig. 3-7, although in reality they will be of different magnitude, and although they can indeed occur simultaneously.

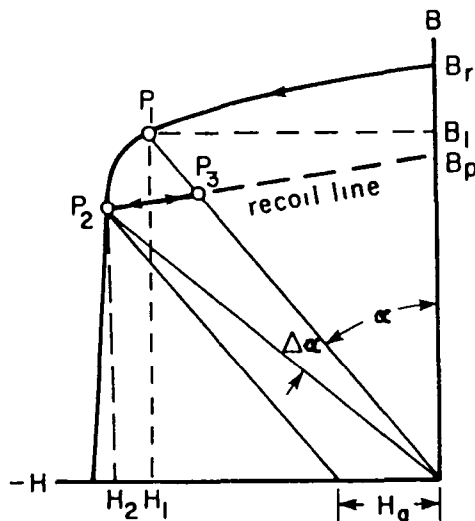

Figure 3-7: Use of recoil lines in magnetic circuit design.

(1) As the motor rotates, the air gap is slightly increased, causing operation in point P_2 on a new permeance line under angle $\alpha + \Delta\alpha$. When the gap is reduced again, the permeance line returns to α , but the magnet will now operate on the recoil line, in point P_3 . In multi-pole motors with many armature slots this is a very small effect.

(2) If the motor is disassembled and the rotor pulled from the stator, this amounts to a very drastic increase of the air gap. Here, too, the operating point will slide down the major loop and then, upon reassembly, recoil to a lower flux state, P_3 , on the recoil line. With magnets of low or medium coercive force (Alnico, etc.) one can and must guard against such self-demagnetization by "keeping," or remagnetize after assembly.

(3) During operation of the motor, and especially under the worst-case conditions of stall or start, an armature reaction field, H_a , will be added to the "self-demagnetizing" field, H_1 . This, too, first lowers the operating point on the major loop, to P_2 , and when the armature reaction ceases, the magnet recoils to P_3 and a lower flux density than it had in P_1 . The corresponding geometric construction is to draw a line parallel to the permeance line $O-P_1$, offset along the H-axis by H_a . This defines P_2 .

(4) Temperature changes - heating or cooling, depending on the magnet type - can also cause the magnet to operate on a minor loop. These flux losses will be discussed below.

For the most complete description of the recoil behavior, families of such minor loops covering the entire second and parts of the third quadrant of B vs. H should be plotted. An example of such a "recoil loop field" is shown in Fig. 5-5, Chapter V. From such detailed information the designer can graphically determine operating points or read the most appropriate slope to use as μ_r in equations.

(b) Dynamic Energy Products

The previously discussed static energy product, $(BH)_{\max}$, is valuable in comparing the volumetric efficiency of different PM materials in devices when there is little or no change of permeance. For electric motors this is only the case when the armature reaction is small. $(BH)_{\max}$ is thus certainly not a good figure of merit for vehicle propulsion motors.

For these and any other devices in which the PM working point moves significantly during the operation, and the magnet operates on a recoil loop, other figures of merit must be used. A number of different energy quantities have been defined that may be collectively called "dynamic energy products." They serve more or less well in rating magnet materials for different dynamic applications. We shall discuss four that have been used by motor designers (1). All take into account that a good motor magnet should have a high remanent flux density (to which the air-gap flux and the magnetic rotor moment, and thus the torque are proportional) and a high resistance to demagnetization by armature reaction. The latter is especially important when the PM directly faces the air gap, as it often does in modern PM motors, but less so when the magnet is buried and iron poles are employed. The four energy quantities used as dynamic figures-of-merit try to give roughly equal weight to these two factors.

J. R. Ireland (2) introduced the quantity $(B_r H_x)$ whose definition is shown in Figure 2-8a. It combines the zero-field remanence, B_r , with the demagnetizing field strength, H_x , which reduces the intrinsic induction or magnetization intensity to 80% of its remanent value. This H_x is somewhat arbitrarily defined highest permissible value for the armature reaction field during stall or start. One might with equal justification allow only a reduction of B to $0.9 B_r$ under the worst circumstances. The corresponding energy product would then be $(B_r H_k)$ where as before, $H_k = H$ at $0.9 B_r$.

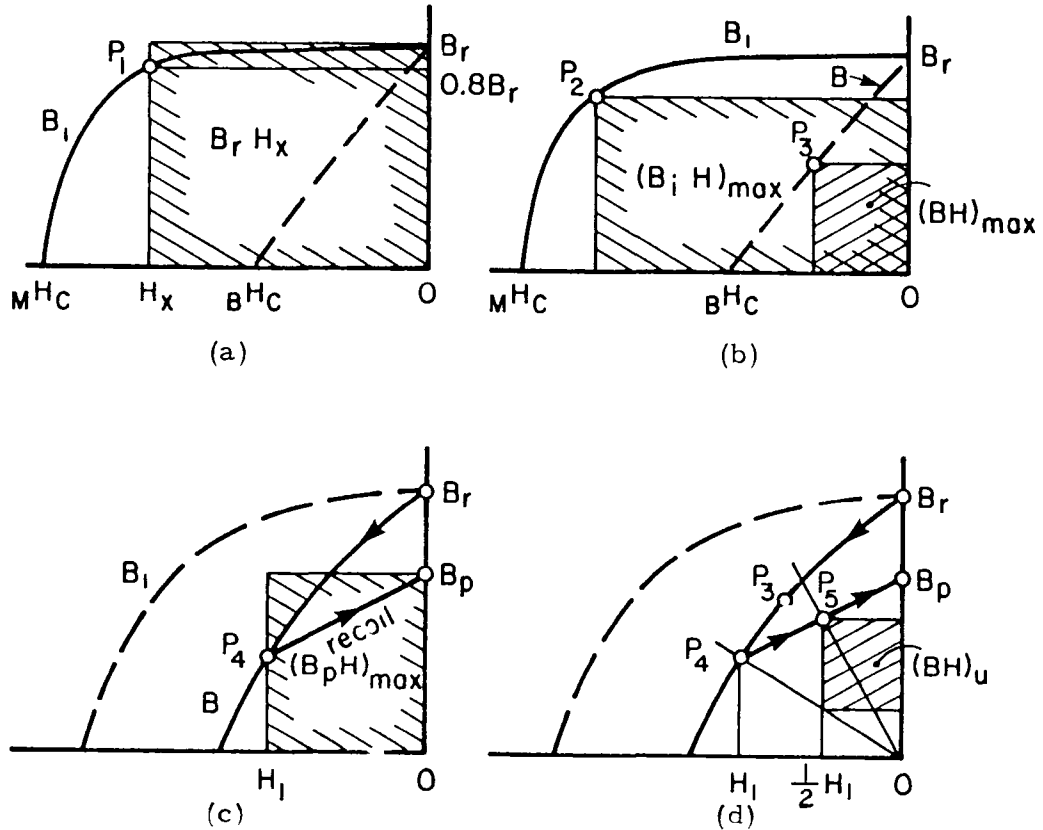

Figure 3-8 Definitions of different "energy products."

In a more direct analogy to the static energy product, one can define an "intrinsic energy product" (3). This $(B_1 H)_{\max}$ is measured by the area of the largest rectangle that can be inscribed in the intrinsic demagnetization curve, Fig. 3-8b. For square-loop magnets it is numerically close to $B_r H_x$. For low- H_c magnets like Alnico 5 it is also not much different from $(BH)_{\max}$, but it becomes many times larger than the static energy product for high-coercivity ferrites and, especially, SmCo_5 . This is the example chosen in the figure.

Figure 3-8c helps us define the quantity $(B_p H)_{\max}$. (See G-4, Parker and Studders, p. 121 ff.) B_p is the "permanent induction" at $H=0$ after full recoil from the lowest working point, P_4 . As P_4 is moved along the major loop, the magnitude of $B_p H_1$ changes. The highest value, $(B_p H)_{\max}$, is a unique characteristic of the magnet material. Note that this maximum may occur for recoil from a point P_4 in the third quadrant of B vs. H . This is

the case for high-coercivity, square loop REPM or ferrites, where the quantity $(B_p H)_{\max}$ can again be close to the values $(B_r H_x)$ and $(B_1 H)_{\max}$, and much larger than $(BH)_{\max}$. Our illustration is more characteristic of a magnet like Mn-Al-C where the maximum occurs in Q-II.

Finally we should mention the "useful recoil energy product" which E. Schwabe (4) first introduced as a quantity meaningful in the design of pulling-and-holding magnets and of PM couplings. Its definition is illustrated in Fig. 3-8d. We take again areas in the B,H-plane as a measure of energy quantities per unit PM volume. If the air gap in a device changes and, as a consequence, the magnet operates between the two permeance lines shown (or between points P_4 and P_5), the shaded rectangle represents the energy available for the work of pulling. For a given recoil line, this area is largest when P_5 is the midpoint between P_4 and B_p . Again, if P_4 is allowed to slide along the major loop, the area and its corresponding energy, $(BH)_u$, will have a highest value, $(BH)_u$. This recoil energy product then is exactly one quarter of the previously defined $(B_p H)_{\max}$. Therefore, these two quantities are equivalent as figures of merit for magnets. $(BH)_u$ -values have frequently been published. The recoil energy is always smaller than the static energy product, but for high-coercivity, square loop ferrites or REPM it can become nearly equal to $(BH)_{\max}$. This indicates the superiority of such magnets over Alnico, etc., for dynamic applications.

The two latter quantities, $(B_p H)_{\max}$ and the equivalent $(BH)_u$, can also be directly and quantitatively related to the energy converted in a DC permanent magnet electrical machine (5).

Temperature Variation of Magnetic Properties

(a) General Statements

Variations of temperature bring about a variety of changes in the PM properties that are complex and therefore difficult to describe. Certainly any attempt to discuss the temperature effects in a concise manner, such as the present one, will always leave much to be desired. Published information is sometimes confusing, even with regard to nomenclature and definitions of the quantities used. The different classes of PM materials react very differently to temperature change; for a given material the location of the operating point plays a role (this is often overlooked!), and there are strong thermal hysteresis effects when the temperature is cycled. For a demanding magnet user it is therefore important to critically study the published information for each specific magnet material considered. The designer is also advised to consult knowledgeable technical personnel of the magnet manufacturer.

Although we discuss here the temperature dependence of PM properties and their temporal variation under two different headings, it should be noted that they can often not be clearly separated. This is especially true for thermal cycling to and the long-term aging effects at elevated temperatures. (See II,C,6).

Here we can only give a very general review of the temperature/time related phenomena and their description, illustrating our comments with a few examples. Some more details for specific selected magnets can be found

in Section IV. For general treatises of temperature effects on PM, the reader is directed, e.g., to Refs. (6) and G1 through G4. They also contain much specific information on the behavior of older magnet types, especially Alnico.

(b) Temperature Variation of Remanence

The most basic and well-known thermo-magnetic effect is the temperature variation of the spontaneous magnetization, M_s , or somewhat imprecisely, of the "saturation." Usually, M_s (or the saturation intrinsic induction, B_{1s} or B_s) decreases monotonically with increasing absolute temperature, toward zero at the Curie point, T_C . The rate of drop increases as T_C is approached. All the PM materials considered for propulsion motors act this way. The upper curve in Fig. 3-9, for SmCo_5 , may be taken as qualitatively typical for them. But note that Curie points vary widely, from about 570 K for Mn-Al-C, through 720 K for the ferrites, 900 - 1100 K for the different REPM, to 1120 K for Alnico 8. The slope of the curve around room temperature is greater when T_C is lower.

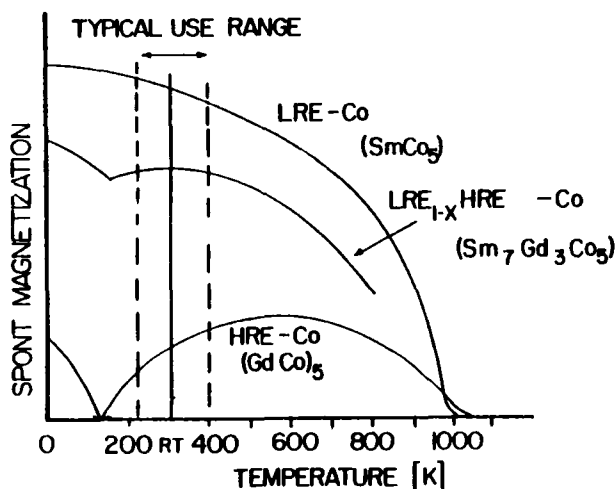

Figure 3-9: Temperature variation of spontaneous or saturation magnetization

For good, square-loop PM, the reversible temperature function of the remanence, B_r , closely follows that of B_s . In the operating temperature range of motors, perhaps 225 K to 400 or 450 K (about -50 to +125 or 175°C), it is common to approximate the temperature variation of B_s and B_r by a straight line and to quote its slope as the "temperature coefficient." This is obviously more justifiable for magnets with high Curie points (Alnico, REPM, Fe-Cr-Co) than for the ferrites or Mn-Al which have low T_C , although it is also done for the latter. When such a temperature coefficient is used in design, it is important to know how it is defined: at a fixed temperature or for a range? What is the range? What is the reference temperature? (Usually room temperature.)

It should be noted here that some high-coercivity alloys of heavy rare earths (HRE) have a very different temperature function of B_r , as is illustrated for $GdCo_5$ by the lowest of the curves in Fig. 3-9. Such alloys have a positive instead of the usual negative temperature coefficient in the use range around room temperature. This can be exploited for making magnets that have a fairly flat temperature function of B_s , as shown by the middle curve in Fig. 3-9. It is done by mixing in a HRE with the light rare earth (LRE). Gadolinium substituted $SmCo_5$ magnets (7) are now in use for microwave tubes, and other temperature compensated magnets of this kind are under development (8). They may later become of interest for motor applications.

(c) Temperature Variation of Coercivity

We saw that the lowest expected value of the intrinsic coercive force is an important design parameter for PM propulsion motors. Therefore, the variation of M^H_C over the operating temperature range is of crucial interest. The M^H_C vs. T function shows much greater variety than B_s vs. T . The two seem rather unrelated. (The physical factors controlling the coercivity are complex and still poorly understood.) Fig. 3-10 shows important examples of the M^H_C vs. T dependence for some EHV motor magnets.

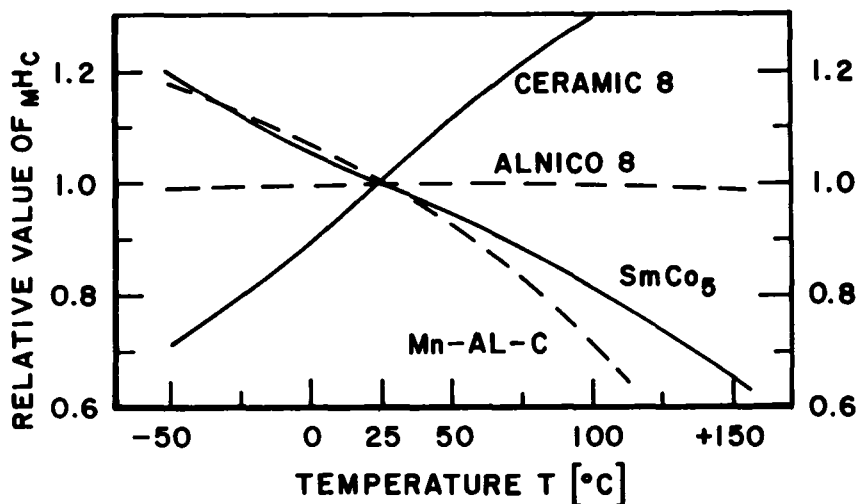
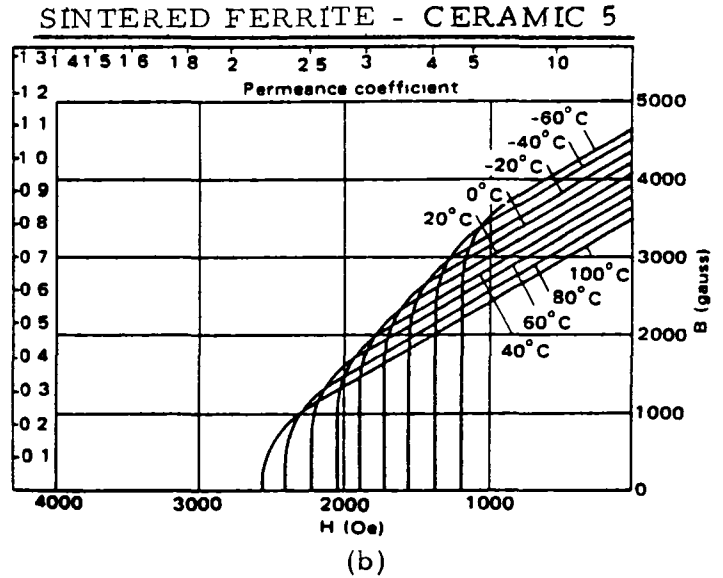
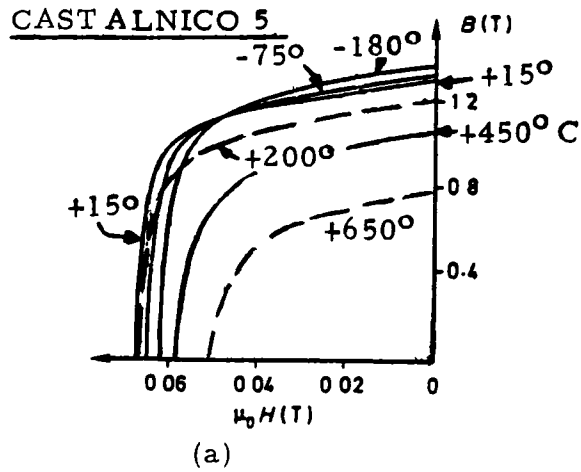
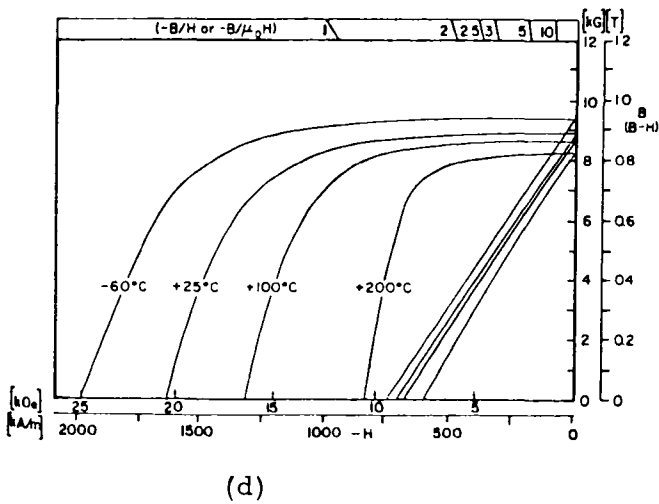

Figure 3-10. Temperature dependence of M^H_C for representative magnets of importance for propulsion motors.

If the intrinsic coercivity is low (as for Alnico, Fe-Cr-Co, Mn-Al-C and some ferrites), the induction coercive force, B^H_C , is determined by M^H_C and closely follows its temperature variation. If M^H_C is very high and the hysteresis loop "square" ($SmCo_5$, high H_C versions of ferrites and 2-17 REPM), then B^H_C is determined primarily by the remanence and its temperature variation follows closely the B_r vs. T .



SINTERED SmCo_5



EXTRUDED Mn-Al-C

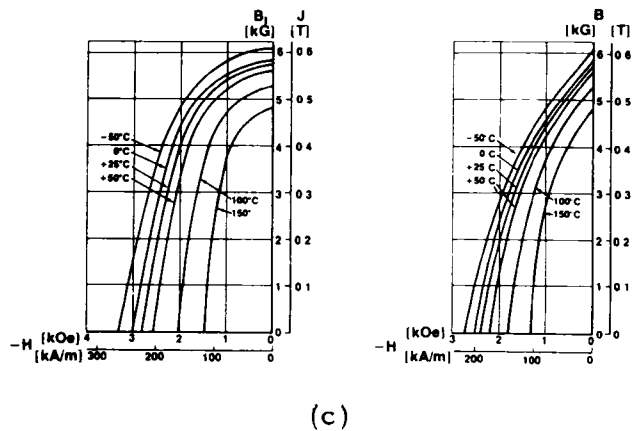

Figure 3-11. B, H demagnetization curves of several magnet materials measured at different temperatures. (a) Cast Alnico 5, (b) Sintered Ceramic 5, (c) Extruded Mn-Al-C, (d) Sintered SmCo_5 .

(d) Demagnetization Curves at Different Temperatures

There are very important borderline cases (some ferrites and 2-17 REPM) where the temperature dependence of $B_r^H C$ follows that of $M^H C$ in one part of the temperature range of interest, B_r in another, and neither very closely. At least in these cases additional information is needed. Also, for many magnets the demagnetization curve is not very well defined just by its end points, B_r and H_c . Important subtle changes in the curve shape, and thus in the operating flux levels for realistic working points, can only be seen from sets of demagnetization curves measured at different temperatures in reasonably close intervals.

Fig. 3-11 shows such families of major-loop second quadrant curves for four types of magnet materials. They are selected to illustrate the great variety of behavior. For the highly coercive materials it is important that both, the "intrinsic" and "normal" curves are known. For lower- H_c magnets, which have a "knee" in the second quadrant of B vs. H at all temperatures, a set of the normal demagnetization curves is sufficient for the purposes of the design engineer.

Note the unique behavior of the ceramic ferrite magnets for which $M^H C$ has a positive temperature coefficient, while the coefficient for the remanence is negative. For the other magnets the coefficients for both, B_r and H_c , are negative, although the two can have very different numerical values. Alnico 5 has also a negative temperature coefficient of H_c , but only at cryogenic temperatures, this is out of the operating range for EHV motors.

(e) First-Quadrant Magnetization and Remanence Curves

Like the Q-II demagnetization curve shape, the initial magnetization curve of a virgin magnet is also temperature dependent. This fact has been of little practical consequence for device design and fabrication, and it has therefore received virtually no attention in the engineering literature. Q-I magnetization curves usually have design significance only in relation to the ease of "charging" the magnet. When such a curve is shown, it is normally for room temperature only, and it is usually a plot of zero-field remanence as a function of the peak magnetizing field, rather than the virgin magnetization curve per se. This B_r vs H_m is easier to measure and more useful to the engineer than B (or B_1) vs. H in Q-I.

For all older magnet types, including the alnicos and ferrites, the field strength needed to fully magnetize them at room temperature (RT) - before or after incorporation in a motor or subassembly - is within the range of common pulse or DC chargers. (See Section III,B,3). The situation is different for the new rare-earth magnets, though. For $SmCo_5$ magnets one needs a 50 kOe or higher charging field at RT to develop the optimal Q-II curve shape. Charging at elevated temperatures would reduce the field requirement. But room-temperature magnetizing is much more convenient. And since 15 to 20 kOe at RT yields compromise values that are acceptable for most applications - e.g., 80 to 85% of $(B_1 H)_{max}$ - elevated temperature charging is generally not employed.

The newest commercial REPM type though (and potentially the most valuable propulsion motor magnet), the high H_c 2-17, does indeed need about 50 kOe charging field at room temperature. Just slightly lower fields will yield significantly poorer Q-II properties. This can be seen from the 25° C-curve in Fig. 3-12 which shows the remanence values that can be achieved with different peak magnetizing fields (11). W. Ervens also measured such B_r vs. H_m curves at 200 and 400°C. It can be seen that at 400°C a more reasonable charging field of 15 to 20 kOe suffices. For these magnets, elevated-temperature charging may have to become a commercial production technique. This also implies that charging after device assembly may often be impossible, and that the magnets will have to be handled in premagnetized form.

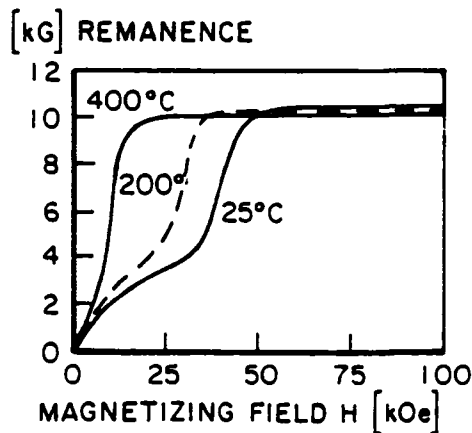

Figure 3-12. Effects of temperature variations on the operating-point induction (Schematic) Definitions of reversible and material effects.

(f) Irreversible and Reversible Losses

The most common way of describing the temperature variation of PM properties in the application literature is in terms of "losses." By this term we mean a reduction of the flux-density value, B_d , at a specified operating point on the major loop Q-II (with unit permeance, p) by a short-term temperature excursion from room temperature (usually heating). This is expressed as a percentage of the initial RT value. More useful than numerical values for these "losses" are curves of B_d (at $B_d/H_d=p$) vs. temperature showing one or more full heating-cooling cycles. Fig. 3-13, after R. Tenzer (12), shows examples of such curves. These are schematic and meant to facilitate a general discussion of the heat-cycle effects, but they describe qualitatively the behavior of Alnico 8, $SmCo_5$ and Mn-Al-C.

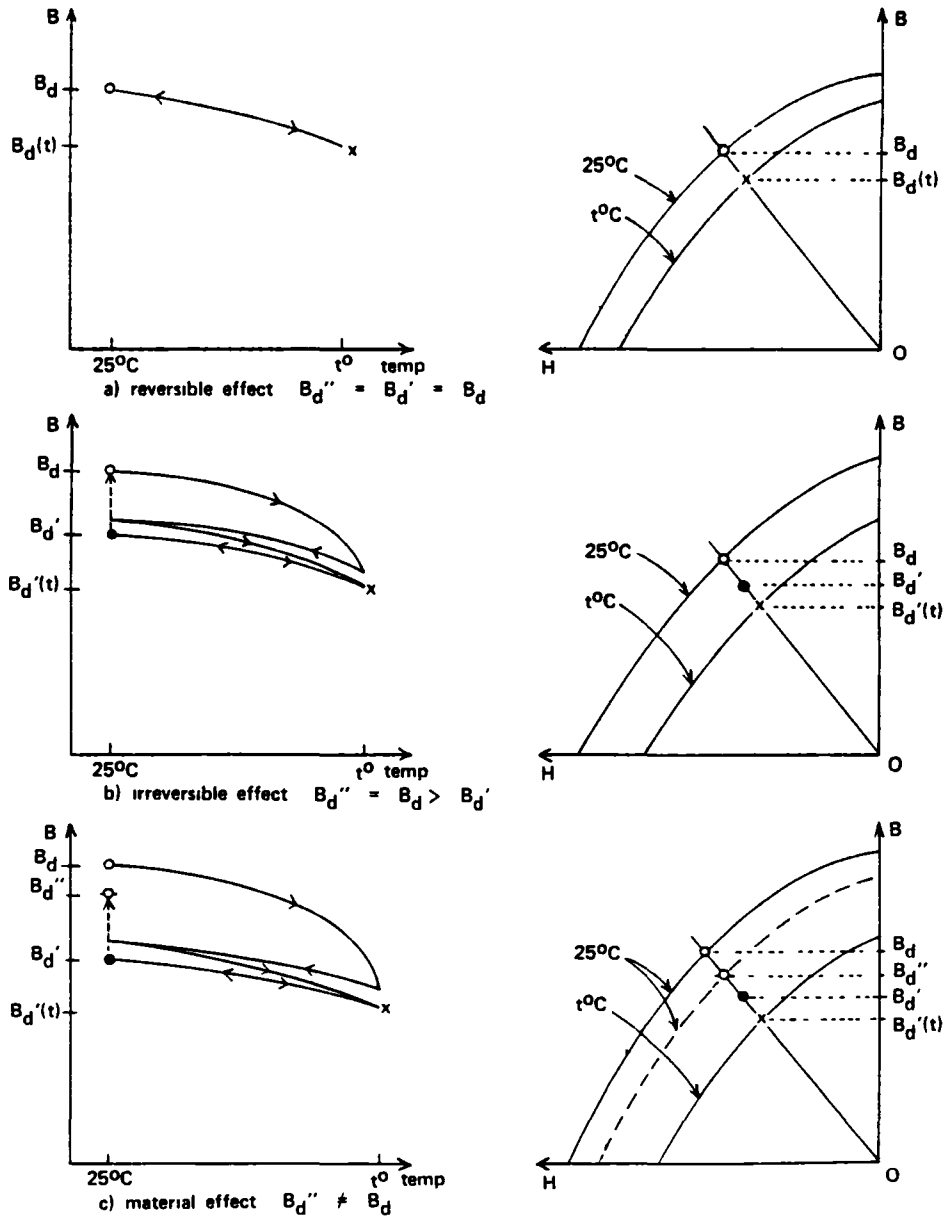

Figure 3-13: Change of operating point induction during elevated-temperature aging. (Schematic.)

Curve a) in Fig. 3-13 applies only to small temperature excursions. The induction changes reversibly along a slightly bowed line that represents the B-coordinates of intercepts of a chosen permeance line with the major loops for different temperatures. If a set of such Q-II demagnetization curves is available, B_d vs. t curves can be constructed for any permeance value. The quantity $B_d(25^\circ) - B_d(T)$ is called the "reversible loss." This reduction of the useful flux density on heating is fully recovered simply by returning the magnet to room temperature. - For larger temperature excursions, case b), only a part of the B-change will be recovered on cooling, $B_d' - B_d(T)$. The other part, $B_d - B_d'$, is permanent as far as passive device operation is concerned. It can only be recovered by

recharging the magnet. This is called the "irreversible loss." - Finally, when the temperature exceeds several hundred °C (with the exact value depending on the material, but also on the time of exposure), changes in the microstructure of the magnet, surface oxidation, etc., can cause an additional loss which can no longer be recovered by recharging in a field. This quantity, $B_d - B_d''$ in Fig. 3-13 c, is often called the "permanent loss."

The pictures indicate that on repeated cycling small additional irreversible losses are incurred. A stable reversible curve is reached only after several cycles (3 to 10). If constant or repeatable flux values are needed in device operation, the magnet must be stabilized by preheating it to the highest anticipated use temperature and cycling several times.

The reversible B_d vs. T behavior closely reflects the temperature variation of spontaneous magnetization and remanence. It is commonly approximated by a straight line and characterized by a "temperature coefficient" (see III,B,b). This is convenient but obviously imprecise, and it can be very misleading, as we shall see below.

By contrast, the irreversible loss depends strongly on the shape of the demagnetization curve of the individual magnet, and thus on metallurgical parameters such as heat treatment, grain size and porosity, and on its magnetic history (e.g., the peak magnetizing field). As an example we consider a set of loss measurements by D. L. Martin (13) on sintered SmCo_5 magnets, Fig. 3-14. We see that the loss is low and constant when the intrinsic Q-II demagnetization curve is square (H_k is high), but that it shoots up when the knee field becomes too low. As H_k sometimes varies drastically in the commercial production of certain magnet types, so do the irreversible losses (14).

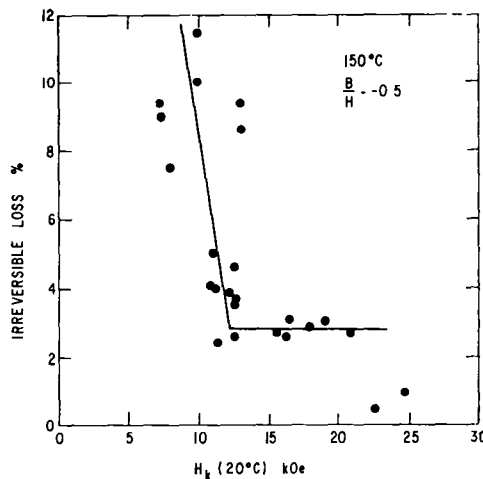

Figure 3-14. Dependence of irreversible loss on heating to 150°C on knee field, H_k , for sintered SmCo_5 . (Ref. 13)

(g) The Thermal Cycling Behavior of Selected Magnet Types

The actual behavior of specific magnets can be significantly more complex than that shown schematically in Fig. 3-13. For magnets which have low H_k values and a knee in the Q-II of the B vs. H curve, the shape of the B_d vs. T curves depends strongly on the permeance, $p=B/H$. As a still relatively simple case we show first, in Fig. 3-15, a set of curves for a 2-17 REPM of the low-coercivity variety, REC-30 of the TDK Corp. (15). This set of B vs. H curves is much like the schematic one in Fig. 3-13: as the temperature increases B_r and H_c decrease and the whole curve moves inward toward the origin. For a high permeance, where the operating point remains clearly above the knee at all temperatures, B_d vs. T is almost linear and reversible. But for the lowest B/H values, the operating point drops below the knee at higher temperatures and the irreversible losses increase dramatically.

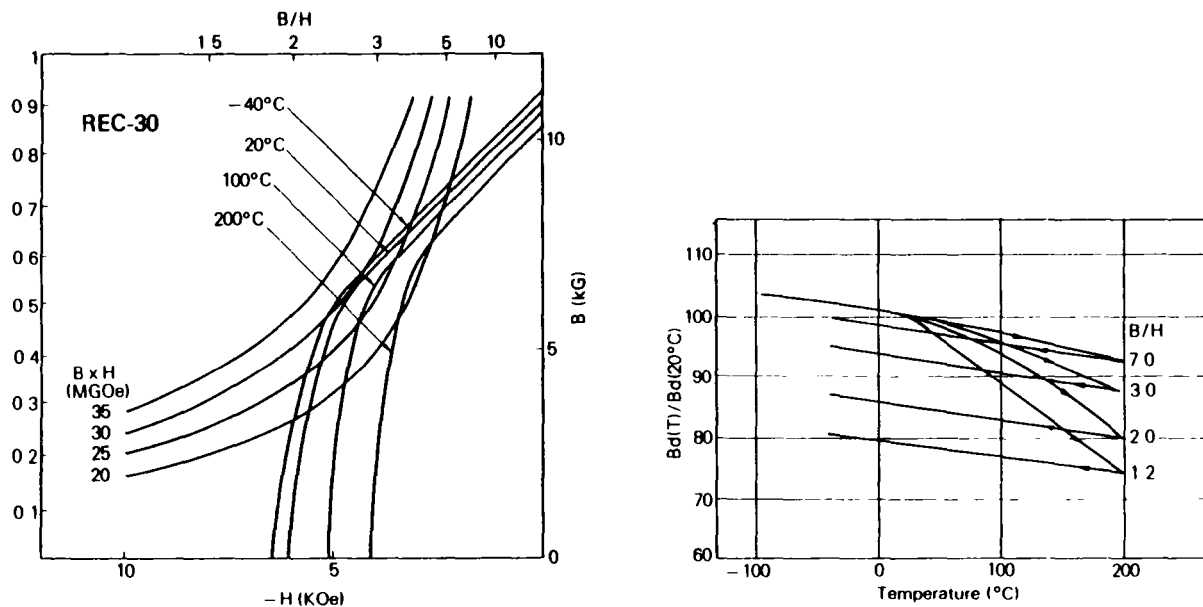

Figure 3-15: Demagnetization curves, and temperature cycling behavior of a 2-17 REPM, low- R_c version. (Ref. 15)

For Alnico 5 (Fig.3-16) the B vs. H curves change relatively little with temperature, but they cross over. At high permeance (curve a) the curve shifts resemble those for the REPM, and B_d vs T is reversible and linear. But for operating points below the knee (curves b and c), there is a large irreversible loss on cooling, as well as the expected loss on heating. In addition, the reversible curves traced during subsequent cycles are strongly nonlinear and even show maxima. This has to do with the fact that the operating point does not remain on the major Q-II loop but ends up on a recoil curve. This is more clearly seen in the next set of curves, for a ferrite.

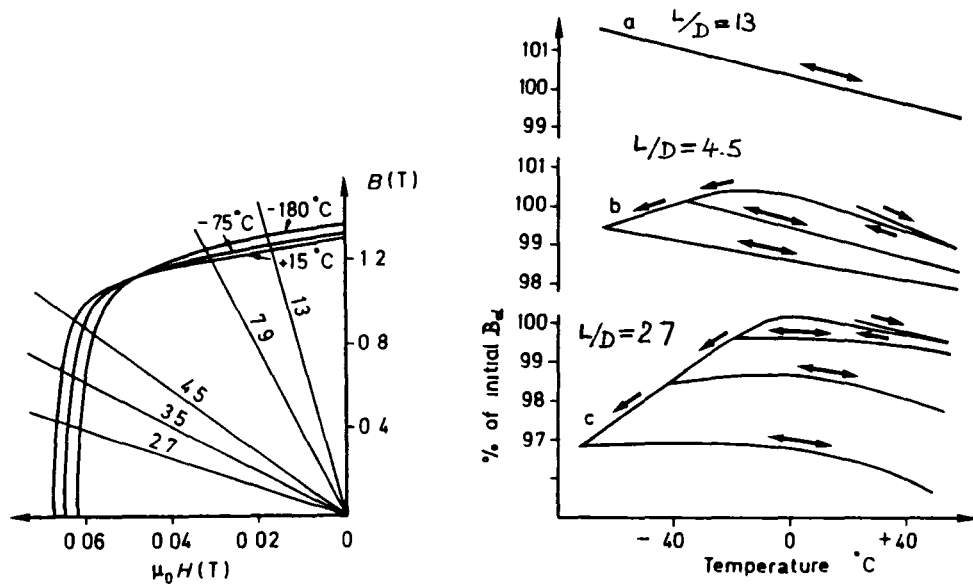
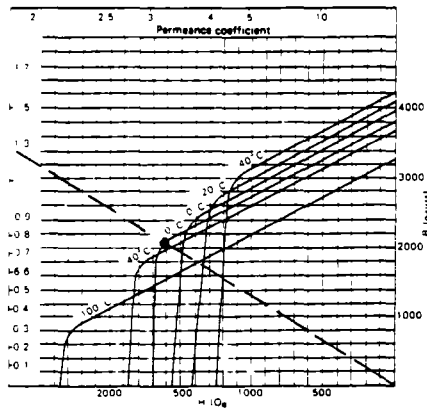

Figure 3-16: Demagnetization curves and temperature cycling behavior of Alnico 5. (Ref. G1)

Figure 3-17 shows a measured set of demagnetization curves at different temperatures for a ferrite with high remanence and relatively low coercive force, and a correlated set of B_d vs. T thermal cycling curves (15). On the right hand side of the page is a set of similar, but schematic, curves showing permeance lines and three operating points - above, at and below the well developed knee (16). When the temperature changes, the permeance line remains the same (a static device is assumed!), while the demagnetization curves move relative to it. If the room-temperature operating point is at the knee (case b), heating will lower the flux (P_1 to P_2), but the point will remain on the reversible top part of the hysteresis loop. On cooling below RT, however, it will slide down the steep flank of the shifting curve (P_1 to P_3) thus lowering the flux again. On rewarming to room temperature, the operating point will now move onto a recoil loop which itself will sink down as the temperature increases. The operating point will consequently move still lower, to P_4 . This process is reversible - either on recooling or on further heating - as long as the operation continues on a recoil line.

In analyzing the expected performance of a ferrite magnet in a motor, constructions like these must be combined with those discussed in III,B,4 above. In addition to the temperature variations of the hysteresis loops, movements of the operating point due to changing permeance (motor rotation) and demagnetizing fields (armature reaction) must be taken into account.

MEASURED DATA (TDK)



Low temperature demagnetization characteristic of FB_2

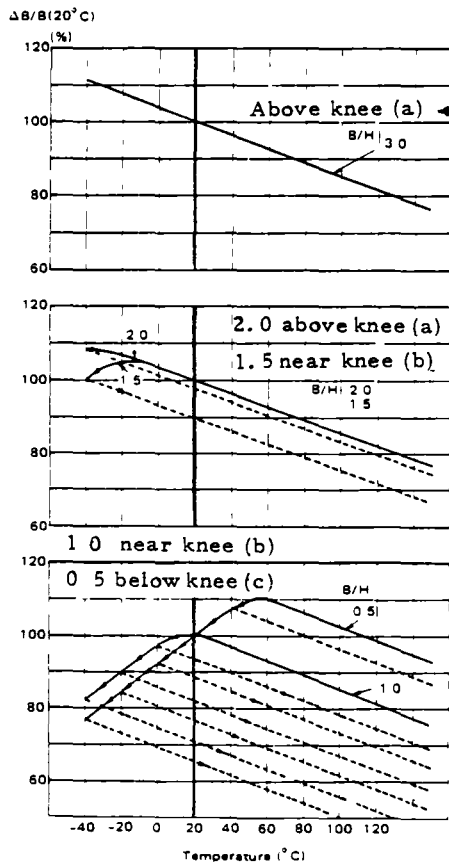

SCHEMATIC EXPLANATION

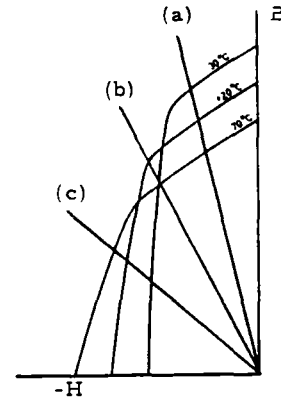

Location of operating point (permeance coeff. $\rightarrow B/H$) relative to knee at room temperature (a) above knee (b) at knee (c) below knee

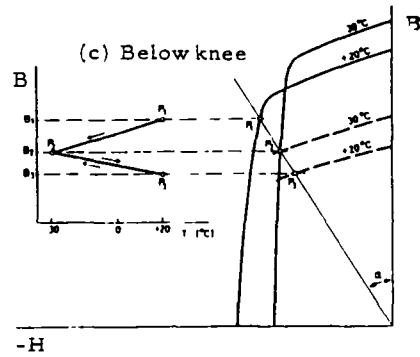
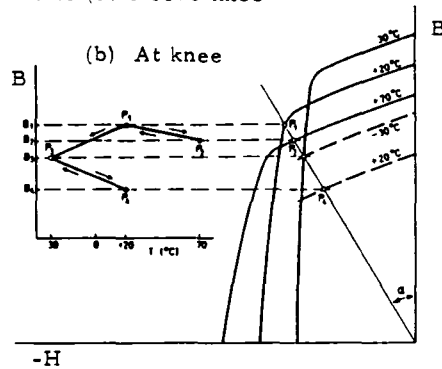

Figure 3-17. Temperature variation of the operating-point flux for a ferrite. (Ref. 15)

6. Temporal Stability of Magnetic Properties

(a) General Comments on Stability

The permanence of a permanent magnet is relative. The flux it delivers into the magnetic circuit of a device changes with time under environmental influences. Early steel magnets showed poor stability against such influences. This was due largely to their low coercivity. Modern magnets, which have several ten to hundred times higher H_{ic} and H_k values, show indeed a very high degree of flux stability. Aging effects at or near room temperature are usually of concern only for delicate meter movements or electronic instruments. However, even in some of the new magnet materials, flux losses on the order of several percent - and more in some PM types - can occur when they are used at elevated temperatures (say, 100 to 200°C). This is particularly true if the heating is combined with other adverse external influences. The temporal stability of the magnet materials we intend to use in EkV propulsion motors must therefore be of interest to us.

In the case of the propulsion motors, important factors that can affect the flux stability are: (1) steady magnetic fields, including self-demagnetizing fields due to the air gap, (2) alternating magnetic fields generated by currents in the armature and by reluctance changes during rotation, (3) heat-elevated operating temperatures of 100°C or more may occur for long periods of time, and (4) mechanical stresses - steady (due to restraining or centrifugal forces) and alternating (changing magnetic attraction by the stator teeth).

Of course, these will always occur combined. As far as purely magnetic changes are concerned (flux changes by domain-wall relaxation) each of the above influences may bring about the same effects in time. The resulting flux change will thus be due to several causes. For the purpose of experimental study and description, however, it is necessary to isolate the various influences from each other. In the following we shall restrict our discussion mostly to the relatively high-coercivity/high energy magnets we have considered for this motor application.

Mechanical influences (steady stress or shocks) did affect the magnetization of the early steel magnets, but they have been shown to have negligibly small effects on the flux stability of alnicos, ceramic ferrites, REPM and Mn-Al-C. (See, e.g., G1, G2, G4). Many of the best magnets are, of course, brittle and may break when subjected to mechanical shock.

The influence of demagnetizing H-fields has been discussed above. There are time-dependent effects associated with this, variously called magnetic aftereffect, magnetic viscosity and relaxation. Especially when H_d approaches or exceeds H_k , there may be a prolonged slow change of B_d , measurable for a period of several minutes.

Alternating fields (or cyclic DC fields) can activate the same domain-wall relaxation phenomena. This leads to a small position change of the recoil loop, which will stabilize only after several cycles. Figure 3-18

illustrates this effect for two cases. a change of the applied field (armature reaction) and of the self-demagnetizing field (permeance change due to a varying air gap.

The adverse effects of temperature changes on the flux stability were discussed in detail in the previous section. Note that temperature cycling always takes time, even in laboratory tests. And in motor operation the magnet will certainly be exposed to elevated temperatures for varying periods. It is thus clear that the effects of temperature cycling (irreversible losses) and of long-term exposure (aging) can not be clearly separated. Nevertheless it is common to distinguish between temperature effects (short time) and aging effects (long time). - Thus, we come to the special topic of this section, the temporal stability of magnets.

(b) Temporal Stability of Magnet Properties.

When a magnet is newly charged and its flux (or its operating-point induction, or the magnetic moment) is observed for a long period of time, a slow decay is found to occur. It usually follows a time function such as that depicted in Figure 3-19, at least at higher temperatures. First there is a relatively severe and fast-occurring initial loss. (The irreversible loss in a heating-cooling cycle is a major part of this!) This is followed by a long period of increasing stability, marked the "plateau," during which there is often a constant loss per logarithmic time cycle (i.e., the \ln/\log plot is a straight line). At higher temperatures and for some magnets, the flux decline will later accelerate and sometimes become catastrophic. This was observed for steel magnets, but also for the very high-coercivity SmCo_5 above 200-250°C (14), polymer bonded REPM at 50-100°C (17), and high- H_c 2-17 REPM above 350°C (11). The example of Fig. 3-19 is for sintered SmCo_5 , $B/H=-1$, aged at 250°C. Like the irreversible losses on temperature cycling, the aging losses depend on the operating point permeance. The lower the B/H value the more severe are the aging losses.

Corresponding to the three more or less distinct segments of the aging curve, we distinguish three kinds of aging losses. An initial loss (in the first several hours at temperature), a long-term aging loss that is thought due purely to magnetic effects and is recoverable by recharging, and - at least in some materials - a permanent aging loss. The latter is attributed to changes in the metallurgical microstructure or to oxidation effects (or to other corrosion). In bonded magnets it may also be due to a softening of the matrix.

(c) Prestabilization Measures

The initial loss can be anticipated by heating the magnet for 1 to 4 hours to a temperature slightly above the future operating temperature. The flux is thereby reduced by the initial loss and in device use, immediately enters the relatively stable "plateau." It is also possible to "knock down" and prestabilize the flux of a magnet by exposure to a DC demagnetizing field at RT or at a moderately elevated temperature, or by AC field cycling according to Fig. 3-18. In either case, the later thermal aging losses are reduced. The exact conditions needed for such prestabilization are a matter of trial and error, and the user should consult the magnet manufacturer about effective procedures.

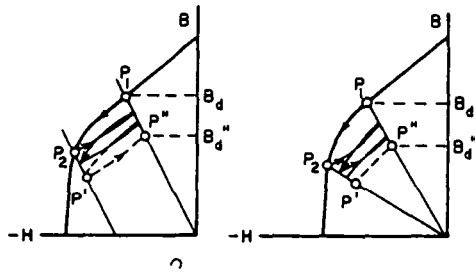

Figure 3-18: Effects of Varying Applied Field or Air-Gap Reluctance on Flux Stability.

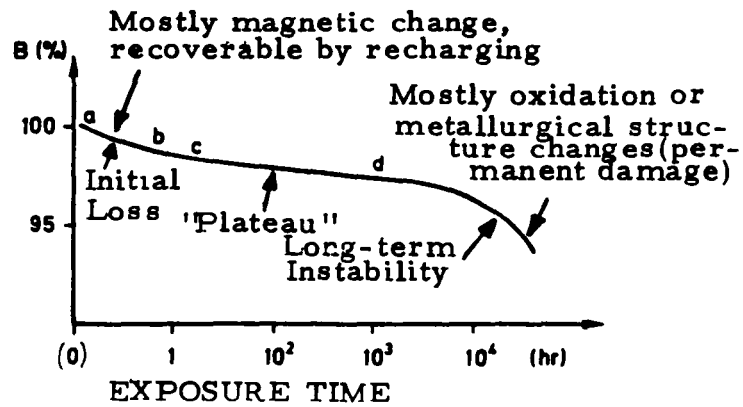

Figure 3-19: Long-Term Aging of Magnets, Schematic (Example: SmCo_5 , $B/H = -1$, 250°C).

C. Magnet Circuit Geometry of PM Motors

1. Survey of Basic Motor Geometries.

In Chapter I we discussed the geometry of several PM motors which NASA/DOE contractors considered or built for potential EHV propulsion use. To put these in perspective relative to other earlier or recent work on PM motors, we present here a number of schematic cross sections of motors. This is not meant to be an exhaustive collection, but it will indicate the basic magnetic circuit geometries that have been devised.

Figure 3-20 shows several classical arrangements of motors that use magnet materials with relatively low coercive force. In all cases the air gap flux is (at least mostly) radial. On the left are a 2-pole and a 4-pole motor with the PM located in the stator. This common geometry has unrestricted room for the PM, which is necessary when energy product is low and a large magnet volume is needed. Also, iron flux conductors and pole pieces are used here. These have a two-fold function: They raise the PM operating permeance high above the knee, which is necessary to prevent self-demagnetization of the low- H_c magnet. They also protect the PM from demagnetization by the armature reaction by placing the magnet far from the air gap.

In the center and right of the picture are early designs with the magnet in the rotor. For the reasons discussed - the need for a long flux path and protection of the magnet from armature reaction by removing it from the gap - the magnets themselves are long and steel pole pieces are used again. These rotors become very massive because of the fairly low useful energy density of the PM materials. Also, the leakage flux losses are quite large, requiring the use of even more PM volume. The imbricated-pole designs shown yield more compact and thus mechanically preferable rotors; but most of the PM flux is wasted as leakage flux between the fingers of the pole structures.

In figure 3-21 we have radial-flux geometries that are appropriate to the modern high- H_c magnet materials. The high coercivity makes the magnet immune to demagnetization by the armature reaction and allows one to place the magnet directly at the air gap. The PM arcs should be short in the flux direction. On the left are two examples of common designs with the PM in the stator. They require mechanical commutators and brushes. The 2-pole motor on top is proper for ferrite. Because of the low remanence, a large magnet cross section is needed to produce enough pole flux. Multipole designs such as the one below it are more suited to REPM which have high remanence as well as high H_c .

Because of their very high energy density, the REPM can also conveniently be put in the rotor. Examples of this are shown in the center column. These are suitable rotors for brushless DC or synchronous motors. SmCo_5 or 2-17 REPM have high enough remanence to place them directly at the air gap, without pole pieces, and yet use 4, 6 or 8-pole designs. SmCo_5 and the new high- H_c 2-17 magnets also have an intrinsic coercive force so high that armature reaction, even at start or stall, is no threat to them.

A great advantage of magnets that face the air gap is the extremely small leakage flux. This, in turn, helps minimize the PM volume. If one

MAGNET LOCATION IN MOTORS – MOSTLY RADIAL FLUX

LOW TO MEDIUM COERCIVITY MAGNETS – ALNICO 5, Fe-Cr-Co

3-26

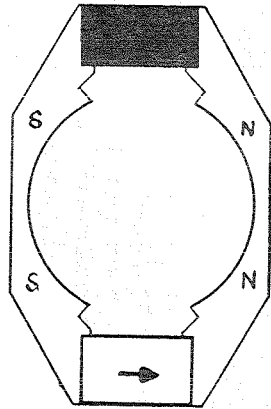

P.M. IN STATOR (D.C. MOTOR)

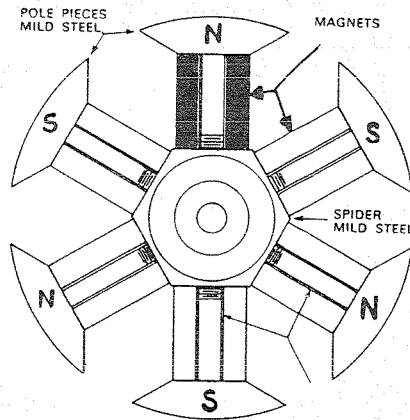

SALIENT POLES

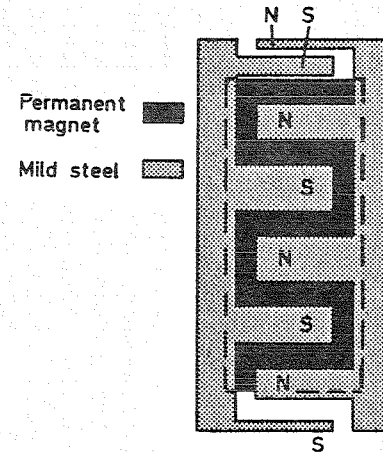

IMBRICATED POLES

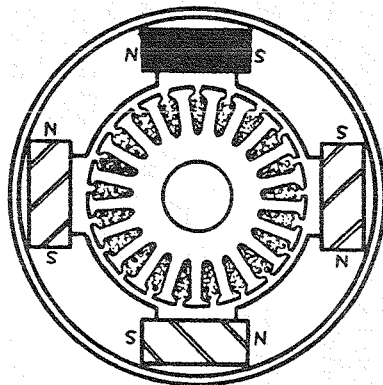

LUNDELL ROTOR (IMBRICATED)

P.M. IN ROTOR (A.C. OR BRUSHLESS D.C.)

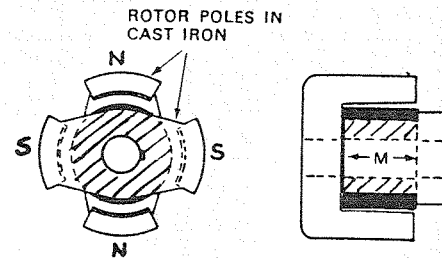
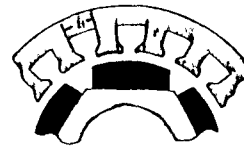
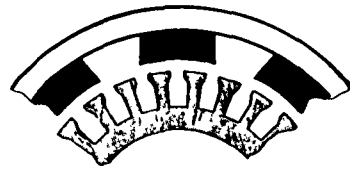
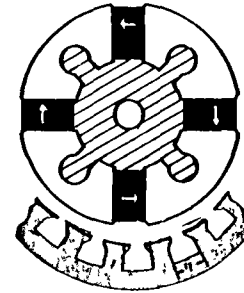
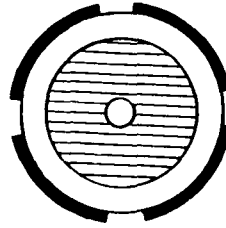
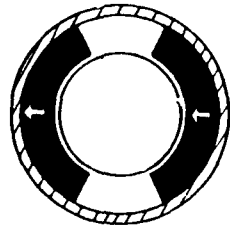

Figure 3-20: Magnet Location in Motors I (Mostly Radial Flux).

MAGNET LOCATION IN MOTORS - RADIAL FLUX

HIGH COERCIVITY MAGNETS - FERRITE, REPM



LOW SPEED MOTORS
P.M. IN ROTOR (A.C.
OR BRUSHLESS D.C.)

P.M. IN STATOR
(COMMUTATED D.C. MOTOR)

HIGH SPEED MOTORS
P.M. IN ROTOR WITH
RETAINING RING
(A.C. OR BRUSHLESS D.C.)

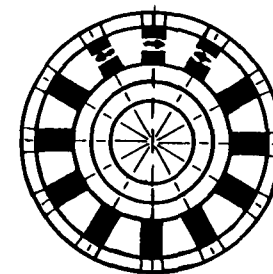
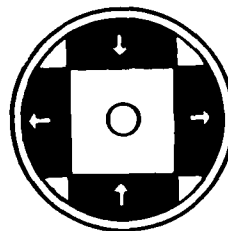

Figure 3-21: Magnet Location in Motors II (Radial Flux).

MAGNET LOCATION IN MOTORS - AXIAL FLUX

HIGH TO VERY HIGH COERCIVITY MAGNETS - Mn-Al-C, FERRITE, REPM

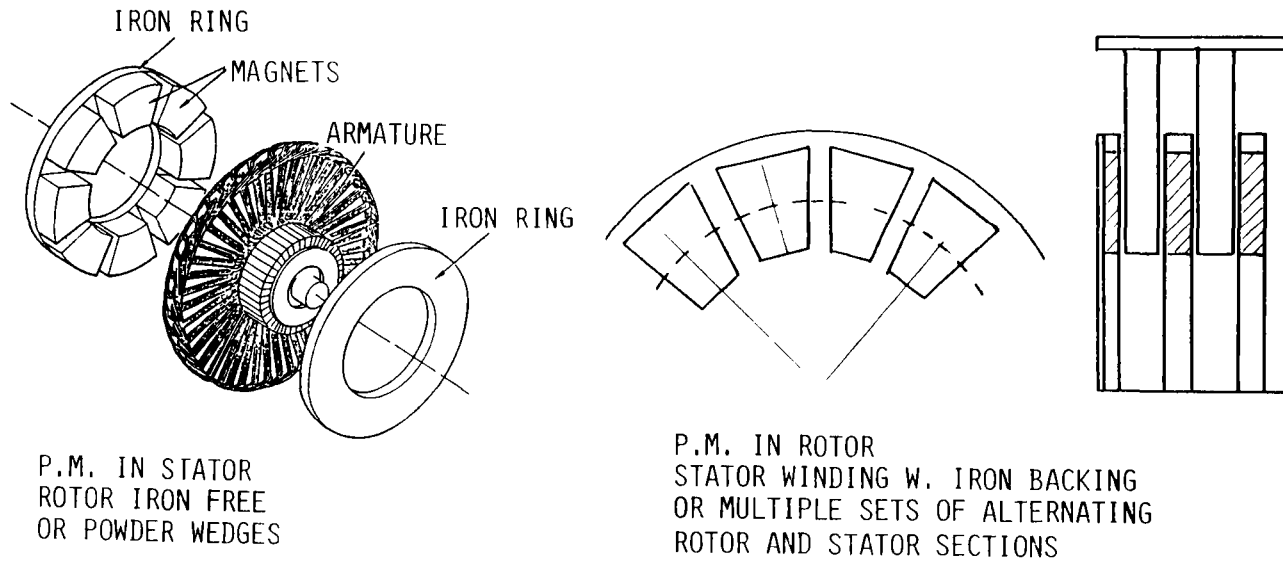

Figure 3-22. Magnet Location in Motors III (Axial Flux).

can, in addition, design for a normal operating point near $(BH)_{\max}$, the absolute minimum amount of magnet material is used.

The pictures on the right show an alternative which removes the magnets from the air gap. It uses iron pole pieces and a flux-focusing principle. This permits one to increase the gap-flux density above the magnet induction value, B_d . However, it also creates new leakage paths and thus reduces the efficiency of magnet utilization.

The upper designs, right and center, use magnets that are usually cemented to the rotor core. Such motors are limited in their running speed since the centrifugal force wants to throw off the magnets. In high-speed motors one must therefore use a retaining ring. If this ring is nonmagnetic it increases the effective airgap. Thus it reduces the useful gap flux and increases the flux leakage around the sides of the magnets. An ingenious solution uses a composite ring with alternating magnetic and nonmagnetic steel segments (1B), but this is expensive to fabricate.

Finally, in Figure 3-22, we show schematically two axial-field designs (19,20). These, too, are best suited for use with high-coercivity magnets such as ferrites, REPM or Mn-Al-C. The PM can be stationary (left), combined with an ironless rotor and commutator, or the PM can be placed in the rotor (right picture).

3. Factors Affecting Magnet Location in the Motor

Summarizing the above discussion, we can make the following statements about the relationship between the characteristics of the PM and its proper location in the motor.

(a) PM Energy Density: When the intrinsic energy density $(B_1H)_{\max}$ is very high, it is easy to place the magnet in the rotor. Lower-energy magnets, such as ferrites, require a very long rotor.

(b) Remanence: If the remanence and thus the operating flux density are low, iron poles and flux-focusing techniques should be employed. This is a desirable approach for ferrite motors, but usually not required for the REPM.

(c) Stray Flux Considerations. Placing a short magnet directly at the air gap (in rotor or stator) minimizes flux leakage. It is possible to do this with ferrites and REPM. It is certainly the most material-efficient design for the latter. Alnicos and Fe-Cr-Co are inefficient motor magnets. Their low coercivity dictates long path lengths which cause large leakage flux losses.

(d) Armature Reaction The A.R. is particularly severe in vehicle propulsion motors. Only SmCo₅ the high- H_c 2-17 REPM, or high-coercivity ferrites can be used directly at the gap, where the exposure is highest. Alnico and Fe-Cr-Co magnets must be placed away from the gap, in the stator, separated from it by Fe poles, to protect them from being demagnetized. Even Alnico 8 and Mn-Al-C are probably endangered if placed at the gap.

(e) Heating: Magnets with a low Curie temperature, such as Mn-Al-C, must be located where they will not become too hot. This would again speak for placing the magnet in the stator, away from the winding, and in a place where it is effectively cooled.

C. References - Chapter III

1. "Dauermagnete für Elektromotoren." R. Ebeling and K. Stablein, *Elektro-Anzeiger* 30 (1977), p. 23.
2. "New Figure of Merit for Ceramic PM Material Intended for DC Motor Applications." J.R. Ireland, *J. Appl. Physics* 38 (1967), p. 1011.
3. "The Place of Magnets in Modern Industry." L. Moreau, *IEEE Trans Magnetics*, MAG-6 (1970), p. 255.
4. "Berechnungsgrundlagen für dauermagnetische Haftsysteme." E. Schwabe, *Ber. Arbeitsgen. Ferrromagnetismus*, Stuttgart (1959), p. 74.
5. "Kenngrößen von Alnico-Werkstoffen für dynamische Anwendungen." K. Stablein, *Tech. Mitteilungen Krupp* 26 (1968), p. 1. Company journal of the F. Krupp GmbH, Essen W. Germany.
6. "Temperature Effects on Permanent Magnets." *Applied Magnetics*, Vol. 16, No. 1, Company journal of the Indiana General Div., EL&K Corp., Valparaiso, Indiana (1969).
7. "Low Temperature Coefficient Cobalt-Rare Earth Magnets." F. G. Jones and H. Tokunaga, *IEEE Trans. Magnetics*, MAG-12 (1976), p. 968.
8. "High Coercive Force 2-17 Type $\text{Sm}_{1-x}\text{Er}_x(\text{Co}_{.69}\text{Cu}_{.08}\text{Fe}_{.22}\text{Zr}_{.02})_{7.22}$ Magnets With Low Temperature Coefficient." H. F. Mildrum et al., Paper No. 0-1, 16th Rare Earth Research Conf., Tallahassee, Florida, April 1983. (Proc. to be published by J. Less-Com. Metals, 1983).
9. "Permanent Magnet Properties of Mn-Al-C Between -50° and $+150^\circ\text{C}$." Z. Abdelnour, H. Mildrum and K. Strnat, *IEEE Trans. Magnetics*, MAG-17 (1981), p. 2651.
10. "Properties of Various Sintered RE-Co Perm. Magnets Between -60°C and $+200^\circ\text{C}$." Z. Abdelnour, H. Mildrum and K. Strnat, *IEEE Trans. Magnetics*, MAG-16 (1980), p. 994.
11. "Koermax. Samarium-Cobalt-Dauermagnete höchster Güte und Stabilität." W. Ervens, *Tech. Mitt. Krupp*, v. 4C (1932), p. 99.
12. R. Tenzer, in loc. cit. 6.
13. "Permanent Magnet Characterization Measurements." D. L. Martin, 5th Int'l. Workshop Rare Earth-Co Perm. Magnets, p. 371, (See G11).
14. "Stability and Temperature Cycling Behavior of R-Co Magnets." H. F. Mildrum and K.M.D. Wong, 2nd Int'l. Workshop Rare Earth-Co Perm. Magnets, p. 35, (See. G8.).

15. "Magnets - Ferrites/Rare Earth Cobalt Magnets." Comp. brochure DME94-001B of the TDK Electronics Co., Ltd. (1979).
16. "DC Motors with Ferroxdure Magnets." Philips Application Book, N. V Philips Gloeilampenfabrieken, Eindhoven, The Netherlands (1974).
17. "Thermal Stability and Temp. Coefficients of Four Rare Earth-Cobalt Matrix Magnets Heated in Dry Air." R.M.W. Strnat et al., J. Appl. Physics, 53 (1982), p. 2380.
18. "High-Speed PM Generator of the 200 kVA Rating Class Utilizing RE-Co Magnets." L.J. Bailey and E. Richter, 2nd Workshop Rare Earth-Co Perm. Magnets (1976), p. 235. (See G8.)
19. "Principles of PM Axial-Field DC Machine." P. Campbell, Proc. IEE 121 (1974) p. 1489.
20. "Inverter-Fed Disc Rotor Synchronous Machines with PM Excitation " H. Weh et al., ICEM 1982, Budapest.

IV. COMMERCIAL PERMANENT MAGNETS - TYPES, PROPERTIES AND SOURCES

A. Introductory Remarks

1. Magnets Included in Listings

This chapter is a summary of information on selected commercial PM materials, their typical properties, important manufacturers and the brand names used by them. The information has been arranged mostly in the form of tables. (Some of it in alternative ways.) It is hoped that this will assist motor designers in quickly selecting candidate magnet materials for any given design alternative considered, and in locating several potential commercial sources for them.

The magnet types selected for these listings are the "high grade materials" which might conceivably be used in propulsion motors for electric vehicles. This includes all the PM's that NASA contractors have indeed used or seriously considered in their designs, but also some of the newer rare-earth magnet materials, and some conventional PM's that are technically less well suited but may have a cost advantage. Particularly, all Alnico types - cast and sintered - of grade 5 or "better" (in the sense of having higher energy product or coercivity) are listed; also their new Fe-Cr-Co counterparts, Ceramic 5 and better ferrites; and extruded Mn-Al-C. Almost all commercial REPM, including most polymer-bonded varieties, would qualify in principle for EHV motor use and are thus included.

2. Sources of Information

The tabulations are based in large part on the product information sent us by 28 magnet producers in response to our solicitation in 1980. (See Section I, A, 4). In addition, we used reference books as well as product and application literature in our files. A first draft of the tables was sent to the participating magnet manufacturers in 1981 for a review of our description of their products. Comments and corrections received were taken into account. Because of the long delay in publishing this report, we made an attempt to update, late in 1982, the listing of product types and commercial sources, but this was not as systematic as the initial collection effort.

No claim is made as to the completeness of our listings of companies and their products. There are certainly additional manufacturers not included here, especially outside the USA. And in the newer and still developmental magnet categories, some additional products may have recently been introduced or specifications changed.

3. Suggested Use of Information

The information given in this chapter should be taken as illustrative rather than exhaustive. It is impossible to offer, in a report such as this, a comprehensive collection of design data for all the PM types of possible interest. The motor engineer is admonished to use the information given here only to familiarize himself with the basic properties and

behavior patterns of the different PM types available, and perhaps as a guide in making the basic decision which type to use. For the quantitative design, it is absolutely necessary to obtain detailed product information from the prospective vendor for his specific product. The selected property tabulations and graphs given in this chapter, and the general discussions in the preceding chapters should only be considered examples. They might suggest which type of information is important and should be obtained from the magnet supplier.

B. Summary Listing of High-Grade PM's for Electric Motors

1. Material Types, Generic Names (U.S.) and Brand Names

In Table 4-1 (seven pages) the magnets are arranged by major subtypes that are distinguished by different processing and different magnetic properties. In addition to the approximate (nominal) composition and salient permanent magnet properties at room temperature, the table gives the names and locations of manufacturers of equivalent products and the brand names they use.

2. Manufacturers and Magnet Types Produced by Each

Table 4-2 (eight pages) lists the various participating magnet manufacturers in alphabetical order. It tells us the basic types of magnets they sell and identifies subtypes by their brand names. These can be correlated to their approximate generic (U.S.-MMPA) equivalent as given in the table heading.

3. Magnet Producers Included in this Summary

Table 4-3 lists the addresses of company headquarters or principal plant locations where additional product information may be obtained or orders placed. For foreign manufacturers, the address of the U.S. sales representative is given where known to us.

4. Summaries of Basic Design Data for Important PM Types

The following three tables, 4-4, 4-5, and 4-6, summarize the numerical design data most needed by motor designers for high-grade magnets of the three most important magnet families: cast Alnicos, Ferrites and REPM's. Given are ranges or average values for salient magnetic, physical and mechanical strength properties at room temperature.

TABLE 4-1: COMMERCIAL HIGH-GRADE PERMANENT MAGNETS (BY MATERIAL TYPES) Page 1 of 7

STANDARD TYPE NAME (US-MMPA)	NOMINAL COMPOSITION WEIGHT %	NOMINAL PERMANENT MAGNET PROPERTIES (SALIENT SECOND QUADRANT QUANTITIES)								MANUFACTURES NAME	COUNTRY	BRAND NAMES OF EQUIVALENT OR SIMILAR PRODUCTS
		B_r		B^H_c		M^H_c		$(BH)_{max}$				
		kG	T	kOe	MA/m	kOe	MA/m	MGOe	kJ/m ³			
CAST ALNICO 5	8Al, 14Ni, 24Co, 3Cu, 51Fe	12.8	1.28	0.64	0.051			5.5	43.8	AIMANTS UGIMAG ARNOLD ENGINEERING COLT INDUSTRIES DURA MAGNETICS FIRTH VICKERS FOUNDRY HITACHI MAGNETICS CORP HITACHI METALS LTD INDIANA GENERAL DIV EM&M JAMES NEILL (NAPIER STREET) LTD KRUPP WIDIA MITSUBISHI STEEL MAGNETICS LTD MAGNETFABR'K BONN GMBH PHILIPS PREFORMATIONS LTD SUMITOMO SPECIAL METALS LTD THOMAS AND SKINNER INC. TOHOKU METALS IND LTD WARABI SPECIAL STEEL CO, LTD	FRANCE U S A U S A U S A ENGLAND U S A JAPAN U S A ENGLAND GERMANY JAPAN GERMANY HOLLAND ENGLAND JAPAN U S A JAPAN JAPAN	ALNICO 600, 700 ALNICO 5 ALNICO 5 ALNICO 5 ALCOMAX II, III ALNICO 5 YCM-1B ALNICO 5 ALCOMAX II, III KOERZIT 500 MK-5 ALNICO 500 TICONAL 500 MAGLOY 1 NKS-500 ALNICO 5 TMK-1B WM-7
CAST ALNICO 5DG	8Al, 14Ni, 24Co, 3Cu, 51Fe	13.3	1.33	0.67	0.053			6.5	51.7	AIMANTS UGIMAG ARNOLD ENGINEERING COLT INDUSTRIES HITACHI MAGNETICS CORP HITACHI METALS LTD INDIANA GENERAL DIV EM&M KRUPP WIDIA MAGNETFABRIK BONN GMBH MITSUBISHI STEEL MAGNETICS LTD PHILIPS PREFORMATIONS LTD SUMITOMO SPECIAL STEEL CO, LTD THOMAS AND SKINNER INC TOHOKU METALS IND LTD WARABI SPECIAL STEEL CO, LTD	FRANCE U S A U S A U S A JAPAN U S A GERMANY GERMANY JAPAN HOLLAND ENGLAND JAPAN U S A JAPAN JAPAN	ALNICO 600 UGIMAX ALNICO 5cc ALNICO 5DG ALNICO 5DG YCM-1D ALNICO 5DG KOERZIT 600 ALNICO 580 MK-5DG, -5SDG TICONAL 550, 600 MAGLOY 10 NKS 600 ALNICO -5DG TMK-1BG WM-7D

4-3

TABLE 4-1: COMMERCIAL HIGH-GRADE PERMANENT MAGNETS (BY MATERIAL TYPES) Page 2 of 7

STANDARD TYPE NAME (US-MMPA)	NOMINAL COMPOSITION WEIGHT %	NOMINAL PERMANENT MAGNET PROPERTIES (SALIENT SECOND QUADRANT QUANTITIES)								MANUFACTURES NAME	COUNTRY	BRAND NAMES OF EQUIVALENT OR SIMILAR PRODUCTS
		B _r		B ^H _c		M ^H _c		(BH) _{max}				
		kG	T	kOe	MA/m	kOe	MA/m	MGOe	kJ/m ³			
CAST ALNICO-5COL (ALNICO 5-7)	8Al, 14Ni, 24Co, 3Cu, 51Fe	13.5	1.35	0.74	0.059			7.55	60.1	AIMANTS UGIMAG ARNOLD ENGINEERING COLT INDUSTRIES DURA MAGNETICS INC HITACHI MAGNETICS CORP HITACHI METALS INC INDIANA GENERAL DIV EM&M KRUPP WIDIA MAGNETFABRIK BONN GMBH MITSUBISHI STEEL MFG CO, LTD PREFORMATIONS LTD SUMITOMO SPECIAL METAL LTD THOMAS AND SKINNER INC TOHOKU METALS IND LTD	FRANCE U S A U S A U S A U S A U S A U S A GERMANY GERMANY JAPAN U S A GERMANY GERMANY JAPAN ENGLAND JAPAN U S A JAPAN	ALNICO 600 Super Ugimax ARKOMAX 800 ALNICO 5-7 ALNICO 5-7 ALNICO 5-7 HIMAG ALNICO 5-7 KOERZIT 700 ALNICO 700 MK-100CG MAGLOY 100 NKS-750 ALNICO 5 COL TMK-1FG
CAST ALNICO 8	7Al, 15Ni, 35Co, 4Cu, 5Ti, 34Fe	8.2	0.82	1.65	0.131			5.3	42.2	AIMANTS UGIMAG ARNOLD ENGINEERING COLT INDUSTRIES DURA MAGNETICS FIRTH VICKERS FOUNDRY INC HITACHI MAGNETICS CORP HITACHI METALS LTD INDIANA GENERAL DIV EM&M KRUPP WIDIA MAGNETFABRIK BONN GMBH MITSUBISHI STEEL MAGNETICS LTD PHILIPS PREFORMATIONS LTD SUMITOMO SPECIAL METALS LTD THOMAS AND SKINNER INC TOHOKU METALS IND LTD	FRANCE U S A U S A U S A ENGLAND U S A JAPAN U S A GERMANY GERMANY JAPAN HOLLAND ENGLAND JAPAN U S A JAPAN	ALNICO 1500 ALNICO 8B ALNICO 8 ALNICO 8 HYCOMAX II ALNICO 8A YCM-8C ALNICO 8H KOERZIT 450 ALNICO 40/12 MK-8B TICONAL 550 MAGLOY 8B NKS-550H ALNICO 8C TMK-5
CAST ALNICO 8HC	8Al, 14Ni, 38Co, 3Cu, 8Ti, 29Fe	7.2	0.72	1.9	0.15			5.0	39.8	AIMANTS UGIMAG ARNOLD ENGINEERING HITACHI MAGNETICS CORP HITACHI METALS LTD KRUPP WIDIA MITSUBISHI STEEL MFG CO LTD PREFORMATIONS LTD THOMAS AND SKINNER INC TOHOKU METALS IND CORP	FRANCE U S A U S A JAPAN GERMANY JAPAN ENGLAND U S A JAPAN	ALNICO 2000 ALNICO 8H ALNICO 8B YCM-8E KOERZIT 1800 MK-6B MAGLOY 8H ALNICO 8HC TMK-5B

4-4

TABLE 4-1: COMMERCIAL HIGH-GRADE PERMANENT MAGNETS (BY MATERIAL TYPES) Page 3 of 7

STANDARD TYPE NAME (US-MMPA)	NOMINAL COMPOSITION WEIGHT %	NOMINAL PERMANENT MAGNET PROPERTIES (SALIENT SECOND QUADRANT QUANTITIES)								MANUFACTURES NAME	COUNTRY	BRAND NAMES OF EQUIVALENT OR SIMILAR PRODUCTS
		B_r		B^H_c		M^H_c		$(BH)_{max}$				
		kG	T	kOe	MA/m	kOe	MA/m	MGOe	kJ/m^3			
CAST ALNICO 8HE	8Al, 14Ni, 38Co, 3Cu, 7Ti, 31Fe	8.8	0.88	1.8	0.14			6.75	53.7	AIMANTS UGIMAG ARNOLD ENGINEERING HITACHI MAGNETICS CORP INDIANA GENERAL DIV EM&M THOMAS AND SKINNER INC TOHOKU METALS IND CORP	FRANCE U S A U S A U S A U S A JAPAN	ALNICO 2000 ALNICO 8HE ALNICO 8C ALNICO 8HE ALNICO 8HE TMK-5A
CAST ALNICO 9	7Al, 15Ni, 35Co, 4Cu, 5Ti, 34Fe	10.5	1.05	1.5	0.12			9.0	71.6	AIMANTS UGIMAG ARNOLD ENGINEERING HITACHI MAGNETICS CORP HITACHI METALS LTD INDIANA GENERAL DIV EM&M JAMES NEILL (NAPIER STREET) LTD MITSUBISHI STEEL MAGNET'CS LTD PHILIPS SUMITOMO SPECIAL METALS LTD THOMAS AND SKINNER INC TOHOKU METALS IND LTD	FRANCE U S A U S A JAPAN U S A ENGLAND JAPAN HOLLAND JAPAN U S A JAPAN	Alnico 1500 Super Ugimax ALNICO 9 ALNICO 9 YCM-9B ALNICO 9 MODIFIED HYCOMAX MK-N9 TICONAL 900 NKS-1000 ALNICO 9 TMK-5D
SINTERED ALNICO 8	7Al, 15Ni, 35Co, 4Cu, 5Ti, 34Fe	7.4	0.74	1.5	0.12			4.0	31.8	ARNOLD ENGINEERING HITACHI MAGNETICS CORP INDIANA GENERAL DIV EM&M KRUPP WIDIA SUMITOMO SPECIAL METALS LTD THOMAS AND SKINNER INC THYSSEN EDELSTAHLWERKE TOHOKU METALS IND LTD	U S A U S A U S A GERMANY JAPAN U S A GERMANY JAPAN	SINT ALNICO 8B SINT ALNICO 8A SINT ALNICO 8H KOERZIT 450 NKSP-450H ALNICO 8C OERSTIT 450K Q-6
SINTERED ALNICO 8HC	7Al, 14Ni, 38Co, 3Cu, 8Ti, 30Fe	6.7	0.67	1.8	0.14			4.5	35.8	ARNOLD ENGINEERING HITACHI MAGNETICS CORP INDIANA GENERAL DIV EM&M KRUPP WIDIA THYSSEN EDELSTAHLWERKE TOHOKU METALS IND LTD	U S A U S A U S A GERMANY GERMANY JAPAN	SINT ALNICO 8H SINT ALNICO 8B SINT ALNICO 8 KOERZIT 1800 OERSTIT 450kk SR-1
SINTERED ALNICO 8HE	7Al, 14Ni, 38Co, 3Cu, 6Ti, 32Fe	8.6	0.86	1.5	0.12	1.57	0.13	5.5	43.8	INDIANA GENERAL DIV EM&M TOHOKU METALS IND LTD	U S A JAPAN	SINT ALNICO 8HE SR-2

4-5

TABLE 4-1: COMMERCIAL HIGH-GRADE PERMANENT MAGNETS (BY MATERIAL TYPES) Page 4 of 7

STANDARD TYPE NAME (US-MMPA)	NOMINAL COMPOSITION WEIGHT %	NOMINAL PERMANENT MAGNET PROPERTIES (SALIENT SECOND QUADRANT QUANTITIES)								MANUFACTURES NAME	COUNTRY	BRAND NAMES OF EQUIVALENT OR SIMILAR PRODUCTS
		B_r		B^H_c		M^H_c		$(BH)_{max}$				
		kG	T	kOe	MA/m	kOe	MA/m	MGOe	kJ/m ³			
SINTERED FERRITE CERAMIC 5	MO·6Fe ₂ O ₃ (M=Ba, Sr) 60 Fe, 13 Ba, or/and Sr, 27O ₂ (%)	3 8	0 38	2 4	0 19			3 4	27 0	AIMANTS UGIMAG ALLEN-BRADLEY Ferrite Division ARNOLD ENGINEERING COLT INDUSTRIES DURA MAGNETICS HITACHI MAGNETICS CORP HITACHI METALS LTD KRUPP WIDIA MAGNETFABRIK BONN GMBH PHILIPS PREFORMATIONS LTD STACKPOLE CORP SUMITOMO SPECIAL METALS LTD TDK ELECTRONICS CORP THYSSEN EDELSTAHLWERKE	FRANCE U S A U S A U S A U S A U S A JAPAN GERMANY GERMANY HOLLAND ENGLAND U S A JAPAN JAPAN GERMANY	SPINALOR 3B M5 ARNOX 5 FERRIMAG 5 DURAMAX-5 CERAMIC 5 YBM-1BB KOERZIT 300 360 OX 380 FXD 360 FEROBA 2 STACKPOLE 5 FXD-380(4) FB4A, 4C OXIT 380R
SINTERED FERRITE CERAMIC 7	MO·6Fe ₂ O ₃ (M=Sr, Ba) (see above)	3 4	0 34	3 25	0 26	4 0	0 32	2 75	21 9	AIMANTS UGIMAG ALLEN-BRADLEY, Ferrite Division ARNOLD ENGINEERING COLT INDUSTRIES HITACHI MAGNETICS CORP HITACHI METALS LTD KRUPP WIDIA MAGNETFABRIK BONN GMBH PHILIPS STACKPOLE CORP SUMITOMO SPECIAL METALS LTD TDK ELECTRONICS CORP THYSSEN EDELSTAHLWERKE	FRANCE U S A U S A U S A U S A JAPAN GERMANY GERMANY HOLLAND U S A JAPAN JAPAN GERMANY	SPINALOR 4F M7 ARNOX 7 FERRIMAG 7 CERAMIC 7 YBM-2BC KOERZIT 330K OX 330 FXD 270 STACKPOLE 7 SSR-320H FB4H OXIT 310
SINTERED FERRITE CERAMIC 8	MO·6Fe ₂ O ₃ (M=Sr, Ba) (see above)	3 85	0 385	2 95	0 23	3 05	0 24	3 5	27 9	AIMANTS UGIMAG ALLEN-BRADLEY, Ferrite Division ARNOLD ENGINEERING COLT INDUSTRIES HITACHI MAGNETICS CORP HITACHI METALS LTD KRUPP WIDIA MAGNETFABRIK BONN GMBH PHILIPS PREFORMATIONS LTD STACKPOLE CORP SUMITOMO SPECIAL METALS LTD TDK ELECTRONICS CORP THYSSEN EDELSTAHLWERKE	FRANCE U S A U S A U S A U S A JAPAN GERMANY GERMANY HOLLAND ENGLAND U S A JAPAN JAPAN GERMANY	SPINALOR 4H M8 ARNOX 8 FERRIMAG 8 CERAMIC 8 YBM-2B KOERZIT 380 OX 400 FXD 370 FEROBA 3 STACKPOLE 8 SSR-360H FB4B, 4X OXIT 410

4-6

TABLE 4-1: COMMERCIAL HIGH-GRADE PERMANENT MAGNETS (BY MATERIAL TYPES) Page 5 of 7

STANDARD TYPE NAME (US-MMPA)	NOMINAL COMPOSITION WEIGHT %	NOMINAL PERMANENT MAGNET PROPERTIES (SALIENT SECOND QUADRANT QUANTITIES)								MANUFACTURES NAME	COUNTRY	BRAND NAMES OF EQUIVALENT OR SIMILAR PRODUCTS
		B _r		B _c ^H		M _c ^H		(BH) _{max}				
		kG	T	kOe	MA/m	kOe	MA/m	MGOe	kJ/m ³			
Mn-Al-C	71.5Mn, 27Al, 0.7C, 0.8Ni	5.2-6.2	0.52-0.62	2.0-2.6	0.159-0.207	2.4-3.0	0.191-0.239	5.0-6.5	39.8-51.7	Matsushita Electrical Ind Co, Ltd	JAPAN	Mn-Al-C
Fe-Cr-Co	EXAMPLES 46Fe, 31Cr, 23Co or 55Fe, 33Cr, 12Co or 61Fe, 28Cr, 11Co	8.5-14	0.85-1.4	0.5-0.73	0.04-0.058			2.0-6.0	15.9-47.7	ARNOLD ENGINEERING HITACHI METALS LTD INDIANA GENERAL DIV EM&M MITSUBISHI STEEL MAGNETICS LTD PREFORMATIONS LTD SUMITOMO SPECIAL METALS LTD TOHOKU METALS IND LTD VACUUMSCHMELZE GMBH WARABI SPECIAL STEEL CO, LTD WESTERN ELECTRIC CO, INC (Bell System)	U S A JAPAN U S A JAPAN ENGLAND JAPAN JAPAN GERMANY JAPAN U S A	ARNOKROME-I KHJ INDALLOY 5 KM-5 CROFECO I CKS-500 K-1, K-2 CROVAC-23/500, 23/250, 15/400, 15/150, 10/380, 10/130 WK-200, 400, 480 CHROMINDUR IIB, IIH, III, IV
POLYMER BONDED RE-Co ("1-5")	EXAMPLES 64Co, 36Sm or 64Co, 27Sm, 9Ce-MM Plus different organic binders	5.0	0.5	4.0	0.32	7.0	0.56	6	48	MAGNETFABRIK BONN GMBH	GERMANY	SECO 50/60p
		4.4-7.5	0.44-0.75	2.7-6.0	0.22-0.48			4.9	32-72	MITSUBISHI STEEL MFG CO, LTD	JAPAN	MP 5L, 5H, 7L, 7H, 9L, 9H
		4.9-5.4	0.49-0.54	4.3-4.4	0.34-0.35	6.9-13.8	0.55-1.1	5.6-6.6	46-53	PHILIPS	HOLLAND	REM 50/60
		4.0-5.0	0.40-0.50	3.0-4.0	0.24-0.32	9.0	0.72	4.6	32-48	POLYMAG INC	U S A	POLYCORE 60
		5.5-5.9	0.55-0.59	4.5-5.2	0.36-0.41	10.0	0.80	7.8	56-64	PREFORMATIONS LTD	ENGLAND	SUPERMAGLOY B2, B3
		6.0-6.4	0.60-0.64	5.5-6.0	0.44-0.48	15-20	1.2-1.6	9-10	72-80	RECOMA INC	U S A	RECOMA 10
		6.4-7.0	0.64-0.70	5.3-5.7	0.42-0.45			10-12	80-95	SUWA SEIKOSHA CO, LTD	JAPAN	SAM-D
		6.4-6.9	0.64-0.69	5.2-5.9	0.41-0.47			9.3-10.7	74-85	TOHOKU METAL INDUSTRIES, LTD	JAPAN	LANTHANET LM-10
		6.0-6.4	0.60-0.64	5.5-6.0	0.44-0.48	15-20	1.2-1.6	9-10	72-80	UGIMAG-RECOMA	Switzerland	RECOMA 10
		5.5-6.4	0.55-0.64	5.3-6.3	0.42-0.50	18.8	1.5	7.5-10	60-80	VACUUMSCHMELZE GMBH	GERMANY	VACOMAX 65K
POLYMER BONDED RE-Co ("2-17")	51Co, 16Fe, 7Cu, 3Zr, 23Sm	7.8-8.1	0.78-0.81	6.3-6.7	0.5-0.54	10-11	0.80-0.88	13-15	104-120	SUWA SEIKOSHA CO, LTD	JAPAN	SAM-15 (SAM DH) SAM-17 (SAM FX)
		8.6-8.9	0.86-0.89	6.5-7.0	0.52-0.56	10-12	0.80-0.96	16-17	128-136			

TABLE 4-1: COMMERCIAL HIGH-GRADE PERMANENT MAGNETS (BY MATERIAL TYPES) Page 6 of 7

STANDARD TYPE NAME (US-MMPA)	NOMINAL COMPOSITION WEIGHT %	NOMINAL PERMANENT MAGNET PROPERTIES (SALIENT SECOND QUADRANT QUANTITIES)								MANUFACTURES NAME	COUNTRY	BRAND NAMES OF EQUIVALENT OR SIMILAR PRODUCTS
		B _r		B _c ^H		M _c ^H		(BH) _{max}				
		kG	T	kOe	MA/m	kOe	MA/m	MGOe	kJ/m ³			
SINTERED RE-Co ("1-5")	EXAMPLES	8 3-8 7	0 83- -0 87	8 0-8 4	0 64- -0 67	15	1 2	16-19	135-150	AIMANTS UGIMAG	FRANCE	CORAMAG
	64 Co, 36 Sm or 49Co, 9 Fe, 11 Cu, 31 Ce or 52 Co, 8 Fe 11 Cu, 28 Ce 1 Ti	6 5-8 5	0 65- -0 85	5 6-8 0	0 45- -0 64	10-16	0 80- -1 27	10-20	80-160	COLT INDUSTRIES	U S A.	CRUCORE 10,12,15,18,20
		8 0-8 5	0 80- -0 85	7 5-8 3	0 60- -0 66	16-20	1 27- -1 60	16-18	127-145	ELECTRON ENGERGY CORPORATION	U S A	REMCO 16,18
		8 2-9 4	0 82- -0 94	7 5-8 8	0 60- -0 70	15	1 19	16-21	127-171	HITACHI MAGNETICS CORP	U S A	HICOREX 90A,B,96A, B
		7 8-10 5	0 78- -1 05	7 0-10	0 56- -0 80	7-20	0 56- -1 60	15-27	119-215	HITACHI METALS LTD	JAPAN	HICOREX 18A, B, C, 22A, B 21B, 25, 26A
		8 1-9 4	0 81- -0 94	7 9-8 3	0 63- -0 66	10-16	0 80- -1 27	16-21	127-167	INDIANA GENERAL DIV EM&M	U S A	INCOR 16, 18, 21
		7 5-9 0	0 75- -0 90	6 53- -8 55	0 52- -0 68	12 6	1 0	14-20	111-160	KRUPP WIDIA	GERMANY	KOERMAX 130, 160
		8 0-8 5	0 80- -0 85	7 0-8 0	0 56- -0 64	12-15	1 0- -1 2	15-18	120-140	MAGNETFABRIK BONN GMBH	GERMANY	SECO 120, 140
		6 7-9 9	0 67- -0 99	5 0-7 5	0 40- -0 60	11-15	0 88- -1 2	12-21	95-167	MITSUBISHI STEEL MAGNETICS CO	JAPAN	MRC 1, 2, 3
		8 1	0 81	7 5	0 60	16 3	1 3	16	128	PHILIPS	HOLLAND	RES160
		8 8	0 88	7 5-8 5	0 60- -0 68	18	1 44	17-18	136-145	PREFORMATIONS LTD	ENGLAND	SUPERMAGLOY
		8 3-9 6	0 83- -0 96	8 0-9 5	0 64- -0 76	15-18	1 2- -1 43	16-23	128-183	RAYTHEON COMPANY	U S A	RAECO 16, 20, 23
		7 5-9 0	0 75- -0 90	7 0-8 5	0 56- -0 68	9-15	0 72- -1 2	16-20	127-160	RECOMA INC	U S A	RECOMA 18,20,22
		7 3-8 6	0 73- -0 86	3 0-5 4	0 24- -0 43	3 3-5 8	0 26- -0 46	11 5-16	92-127	SHIN-ETSU CHEMICAL CO , LTD	JAPAN	SEREM R9HA,R10H,R12 R10A,R14,R16
		7 0-9 8	0 70- -0 98	5 5-8 3	0 44- -0 66			10-23	80-183	SUMITOMO SPECIAL METALS	JAPAN	CORMAX-1300,1800,2300
		7 3-9 2	0 73- -0 92	6 5-9 0	0 52- -0 72	7 5-16	0 60- -1 27	13-21	103-167	TDK ELECTRONICS CORP	JAPAN	REC 14,16,18,20
		8 0-9 0	0 80- -0 90	7 5-8 5	0 60- -0 68	14	1 12	16-20	127-160	THOMAS AND SKINNER INC.	U S A	RE-Co
		9 2	0 92	9 05	0 72	20	1 6	20	160	THYSSEN EDELSTAHLWERKE	GERMANY	SECOLIT
		7 8-9 6	0 78- -0 96	7 6-9 4	0 61- -0 75			15-23	119-183	TOHOKU METALS IND , LTD	JAPAN	LANTHANET LM-16,19, 22
		6 8-7 2	0 68- -0 72	4 5-5 0	0 36- -0 40	4 7-5 5	0 37- -0 44	10-12	80-95	TOSHIBA CORPORATION	JAPAN	TOSREX-11
		7 5	0 75	7 0	0 56	9	0 72	16	127	UGIMAG-RECOMA	Switzerland	RECOMA 14
		8 2	0 82	7 7	0 61	17-28	1 4-2 2	14-20	111-160	VARIAN TWT DIVISION	U S A	Samarium Cobalt
		8 0-10	0 80- -1 05	6 9-10	0 55- -0 80	19-31	1 5-2 5	15 5-27	125-220	VACUUMSCHMELZE GMBH	GERMANY	VACOMAX-140, 145, 170, 200
	9 0-9 8	0 90- -0 98	7 8-8 5	0 67- -0 68			20-21 5	160-178	CENTRAL IRON & STEEL 'NSTIT	CHINA	RF 100, 110	

TABLE 4-1: COMMERCIAL HIGH-GRADE PERMANENT MAGNETS (BY MATERIAL TYPES) Page 7 of 7

STANDARD TYPE NAME (US-MMPA)	NOMINAL COMPOSITION WEIGHT %	NOMINAL PERMANENT MAGNET PROPERTIES (SALIENT SECOND QUADRANT QUANTITIES)								MANUFACTURES NAME	COUNTRY	BRAND NAMES OF EQUIVALENT OR SIMILAR PRODUCTS
		B_r		B_c^H		M_c^H		$(BH)_{max}$				
		kG	T	kOe	MA/m	kOe	MA/m	MGOe	kJ/m^3			
SINTERED RE-Co ("2-17")	EXAMPLES 50 Co, 15 Fe, 8 Cu, 1.5 Zr, 25.5 Sm or 49 Co, 13.5 Fe, 10.5 Cu, 1 Zr, 26 Sm or 51 Co, 13 Fe, 8 Cu, 1 Mn, 27 Sm	9.2-11	0.92- -1.1	5.5-7.0	0.44- -0.56	6.0	0.48	20-30	159-238	HITACHI METALS LTD	U S A	HICOREX-99A, B, C
		8.5-11.5	0.85- -1.15	4.5-7.0	0.36- -0.56	4.7-8.0	0.37- -0.64	18-31	143-247	NAMIKI PRECISION JEWEL CO., LTD	JAPAN	KM-20, 23, 26, 30
		8.0-11.0	0.80- -1.10	7.0-7.5	0.56- -0.60	7.5	0.60	18-26	143-207	RECOMA INC	U S A	RECOMA-26
		7.8-10.3	0.78- -1.03	5.0-8.5	0.40- -0.68	5.5-11	0.44- -0.88	15-28	119-223	SHIN-ETSU CHEMICAL CO., LTD	JAPAN	SEREM R18A, R18H, R22, R28
		9.2-11.2	0.92- -1.12	7.0-10	0.56- -0.80	6.2-10	0.50- -0.80	20-31	159-246	TDK ELECTRONICS CORPORATION	JAPAN	REC-22, 24B, 25, 26, 30
		8.3-9.6	0.83- -0.96	6.5-8.0	0.52- -0.64	6.0-9.0	0.48- -0.72	17-23	135-183	TOSHIBA CORPORATION	JAPAN	TOSREX-18, 22
		8.0-11.0	0.80- -1.10	7.0-7.5	0.56- -0.60	7.5	0.60	18-30	143-240	UGIMAG-RECOMA	Switzerland	RECOMA 20, 25
		11.0	1.10	6.7	0.54			29.0	232	CENTRAL IRON & STEEL INSTIT	CHINA	RE 130
Temperature Compensated SINTERED RE-Co ("1-5")	EXAMPLES 66 Co, 27 Sm, 7 Ho or 66 Co, 20 Sm, 14 Gd									AIMANTS UGIMAG	FRANCE	CORASTAB
		6.0-7.5	0.60- -0.75	5.5-6.0	0.44- -0.48	2.0	1.6	9-14	71-111	HITACHI METALS LTD	U S A JAPAN	HICOREX-92, 93 HICOREX-10S, 13S
		7.2	0.72	5.6	0.45			14	111	CENTRAL IRON & STEEL	CHINA	RE 120 ("1-5")
		9.9	0.99	5.8	0.47			22.6	178	CENTRAL IRON & STEEL	CHINA	RE 140 ("2-17")

TABLE 4-2: COMMERCIAL HIGH-GRADE PERMANENT MAGNETS (BY PRODUCER) Page 1 of 8

MANUFACTURER		CAST ALNICO		SINTERED ALNICO	SINTERED FERRITE	MANGANESE-ALUMINUM-CARBON (ANISOTROPIC)	IRON-CHROMIUM-COBALT (ANISOTROPIC)	POLYMER BONDED RARE-EARTH COBALT (ANISOTROPIC)	SINTERED RE-COBALT (ANISOTROPIC)
COMPANY	COUNTRY	ALNICO 5	ALNICO 8	ALNICO 8	CERAMIC 5				RC ₅ (Cu)
		ALNICO 5DG	ALNICO 8HC	ALNICO 8HC	CERAMIC 7	RC ₅ (Cu)			
		ALNICO 5COL (5-7)	ALNICO 8HE	ALNICO 8HE	CERAMIC 8	R ₂ Co ₁₇ (Cu)			
									TEMP COMP
AIMANTS UGIMAG	FRANCE	ALNICO 600 ALNICO 700	ALNICO 1500		SPINALOR 3B				CORAMAG
		ALNICO 600 UGIMAX	ALNICO 2000		SPINALOR 4F				
		ALNICO 600 SUPER UGIMAX	ALNICO 1500 SUPER UGIMAX		SPINALOR 4H				CORASTAB
ALLEN-BRADLEY FERRITE DIVISION	U S A				M5				
					M7				
					M8				
ARNOLD ENGINEERING	U S A	ALNICO 5	ALNICO 8B	ALNICO 8B	ARNOX 5		ARNOKROME-I		
		ALNICO 5cc	ALNICO 8H	ALNICO 8H	ARNOX 7				
		ARKOMAX 800	ALNICO 9		ARNOX 8				
** COLT INDUSTRIES, CRUCIBLE MAGNETICS	U S A	ALNICO 5	ALNICO 8		FERRIMAG 5	(UNDER-DEVELOPEMENT)	(UNDER-DEVELOPEMENT)		CRUCORE 10, 12, 15, 18, 20
		ALNICO 5DG			FERRIMAG 7				
		ALNICO 5-7			FERRIMAG 8				(DEVELOPING)
DURA MAGNETICS INC	U S A	ALNICO 5	ALNICO 8		DURAMAX-5				
		ALNICO 5-7							

** Central Iron and Steel Res Instit (China) Listed in back

4-10

TABLE 4-2: COMMERCIAL HIGH-GRADE PERMANENT MAGNETS (BY PRODUCER) Page 2 of 8

MANUFACTURER		CAST ALNICO		SINTERED ALNICO	SINTERED FERRITE	MANGANESE-ALUMINUM-CARBON (ANISOTROPIC)	IRON-CHROMIUM-COBALT (ANISOTROPIC)	POLYMER BONDED RARE-EARTH COBALT (ANISOTROPIC) RCo ₅ (Cu) R ₂ Co ₁₇ (Cu)	SINTERED RE-COBALT (ANISOTROPIC)
COMPANY	COUNTRY	ALNICO 5	ALNICO 8	ALNICO 8	CERAMIC 5				RCO ₅ (Cu)
		ALNICO 5DG	ALNICO 8HC	ALNICO 8HC	CERAMIC 7				R ₂ Co ₁₇ (Cu)
		ALNICO 5COL (5-7)	ALNICO 9	ALNICO 8HE	CERAMIC 8			TEMP COMP	
ELECTRON ENERGY CORPORATION	U S A								REMCO 16, 18
									(DEVELOPING)
FIRTH VICKERS FOUNDRY LTD	ENGLAND	ALCOMAX II, III	HYCOMAX II						
HITACHI MAGNETICS CORP	U S A	ALNICO 5	ALNICO 8A	ALNICO 8A	CERAMIC 5				HICOREX 90A, B 96A, B
		ALNICO 5DG	ALNICO 8B	ALNICO 8B	CERAMIC 7				HICOREX 99A, B, C
		ALNICO 5-7	ALNICO 8C		CERAMIC 8				HICOREX 92, 93
			ALNICO 9						
HITACHI METALS LTD	JAPAN	YCM-1B	YCM-8C		YBM-1BB				Hicorex 18A, B, C 21B, 22A, B 25, 26A
		YCM-1D	YCM-8E		YBM-2BC		KHJ		HICOREX 23, 25, 27
		HIMAG	YCM-9B		YBM-2B				HICOREX 10S, 13S
INDIANA GENERAL DIV EM&M	U S A	ALNICO 5	ALNICO 8H	ALNICO 8H					INCOR 16, 18, 21
		ALNICO 5DG		ALNICO 8			INDALLOY 5		
		ALNICO 5-7	ALNICO 8HE						
		ALNICO 9	ALNICO 8HE						

TABLE 4-2: COMMERCIAL HIGH-GRADE PERMANENT MAGNETS (BY PRODUCER) Page 3 of 8

MANUFACTURER		CAST ALNICO		SINTERED ALNICO	SINTERED FERRITE	MANGANESE-ALUMINUM-CARBON (ANISOTROPIC)	IRON-CHROMIUM-COBALT (ANISOTROPIC)	POLYMER BONDED RARE-EARTH COBALT (ANISOTROPIC)	SINTERED RE-COBALT (ANISOTROPIC)
COMPANY	COUNTRY	ALNICO 5	ALNICO 8	ALNICO 8	CERAMIC 5			RC ₅ (Cu)	RC ₅ (Cu)
		ALNICO 5DG	ALNICO 8HC	ALNICO 8HC	CERAMIC 7				TEMP COMP
		ALNICO 5COL (5-7)	ALNICO 8HE	ALNICO 8HE	CERAMIC 8			R ₂ Co ₁₇ (Cu)	
			ALNICO 9						
JAMES NEILL (NAPIER ST) LTD	ENGLAND	ALCOMAX II, III							
			MODIFIED HYCOMAX						
KRUPP WIDIA	WEST GERMANY	KOERZIT 500	KOERZIT 450	KOERZIT 450	KOERZIT 300, 360				KOERMAX 130, 160
		KOERZIT 600	KOERZIT 1800	KOERZIT 1800	KOERZIT 330K				
		KOERZIT 700			KOERZIT 380				
MAGNETFABRIK BONN GMBH	WEST GERMANY	ALNICO 500	ALNICO 40/12		OX 380			SECO 50/60p	SECO 120, 140
		ALNICO 580			OX 330				
		ALNICO 700			OX 400				
MATSUSHITA ELECTRIC INDUSTRIAL CO , LTD	JAPAN					M ₁ -Al-C			
MITSUBISHI STEEL MAGNETICS CO , LTD	JAPAN	MK-5	MK-8B					MP-5L, 5H, 7L, 7H, 9L, 9H	MRC 1, 2, 3
		MK-5DG MK-5SDG					KM-5		
		MK-100CG	MK-N9						

4-12

TABLE 4-2: COMMERCIAL HIGH-GRADE PERMANENT MAGNETS (BY PRODUCER) Page 4 of 8

MANUFACTURER		CAST ALNICO		SINTERED ALNICO	SINTERED FERRITE	MANGANESE-ALUMINUM-CARBON (ANISOTROPIC)	IRON-CHROMIUM-COBALT (ANISOTROPIC)	POLYMER BONDED RARE-EARTH COBALT (ANISOTROPIC)	SINTERED RE-COBALT (ANISOTROPIC)
COMPANY	COUNTRY	ALNICO 5	ALNICO 8	ALNICO 8	CERAMIC 5				RC ₅ (Cu)
		ALNICO 5DG	ALNICO 8HC	ALNICO 8HC	CERAMIC 7	R ₂ Co ₁₇ (Cu)			
		ALNICO 5COL (5-7)	ALNICO 8HE	ALNICO 8HE	CERAMIC 8	TEMP COMP			
NAMIKI PRECISION JEWEL CO., LTD	JAPAN								KM 20, 23, 26, 30
PHILIPS (ELCOMA DIV)	Netherlands	TICONAL 500	TICONAL 550		FXD-360			REM 50 REM 60	RES 160
		TICONAL 550, 600			FXD-270				
			TICONAL 900		FXD-370				
POLYMAG INC	U S A							POLYCORE PM-60	
PREFORMATIONS LTD	ENGLAND	MAGLOY 1	MAGLOY 8B		FERROBA 1		CROFECO 1	SUPERMAGLOY B2, B3	SUPERMAGLOY S1, S2
		MAGLOY 10	MAGLOY 8H		FERROBA 2				
		MAGLOY 100			FERROBA 3				
RAYTHEON	U S A								RAECO 16, 19, 21

4-13

TABLE 4-2: COMMERCIAL HIGH-GRADE PERMANENT MAGNETS (BY PRODUCER) Page 5 of 8

MANUFACTURER		CAST ALNICO		SINTERED ALNICO	SINTERED FERRITE	MANGANESE-ALUMINUM-CARBON (ANISOTROPIC)	IRON-CHROMIUM-COBALT (ANISOTROPIC)	POLYMER BONDED RARE-EARTH COBALT (ANISOTROPIC)	SINTERED RE-COBALT (ANISOTROPIC)
COMPANY	COUNTRY	ALNICO 5	ALNICO 8	ALNICO 8	CERAMIC 5				RCo ₅ (Cu)
		ALNICO 5DG	ALNICO 8HC	ALNICO 8HC	CERAMIC 7				R ₂ Co ₁₇ (Cu)
		ALNICO 5COL (5-7)	ALNICO 8HE	ALNICO 8HE	CERAMIC 8	TEMP COMP			
RECOMA INC	U S A							RECOMA 10	RECOMA 18,22,20
									RECOMA 26
SHINETSU CHEMICAL IND CORP LTD	JAPAN								SEREM R9HA, R10H, R10A, R12, R14
									SEREM R16, R18A, R18H, R22, R28
STACKPOLE INC	U S A				STACKPOLE 5				
					STACKPOLE 7				
					STACKPOLE 8				
SUMITOMO SPECIAL METALS CO, LTD	JAPAN	NKS-500	NKS-550H	NKSP-450H	FXD-380(4)		CKS-500		CORMAX- 1300, 1800, 2300
		NKS-600			SSR -320H				
		NKS-750	NKS-1000		SSR -360II				
SUWA SEIKOSHA CO, LTD	JAPAN							SAM-D	
								SAM-DH	

4-14

TABLE 4-2: COMMERCIAL HIGH-GRADE PERMANENT MAGNETS (BY PRODUCER) Page 6 of 8

MANUFACTURER		CAST ALNICO		SINTERED ALNICO	SINTERED FERRITE	MANGANESE-ALUMINUM-CARBON (ANISOTROPIC)	IRON-CHROMIUM-COBALT (ANISOTROPIC)	POLYMER BONDED RARE-EARTH COBALT (ANISOTROPIC)	SINTERED RE-COBALT (ANISOTROPIC)
COMPANY	COUNTRY	ALNICO 5	ALNICO 8	ALNICO 8	CERAMIC 5				RCo ₅ (Cu)
		ALNICO 5DG	ALNICO 8HC	ALNICO 8HC	CERAMIC 7	R ₂ Co ₁₇ (Cu)			
		ALNICO 5COL (5-7)	ALNICO 8HE	ALNICO 8HE	CERAMIC 8	TEMP COMP			
TDK ELECTRONICS CORPORATION	JAPAN				FB4A, 4C			REC 14,16,18,20	
					FB4H			REC 22,24B,26,30	
					FB4B, 4X				
THOMAS & SKINNER INC	U S A	ALNICO 5	ALNICO 8C					RE-Co	
		ALNICO 5DG	ALNICO 8HC					(DEVELOPING)	
		ALNICO 5COL	ALNICO 8HE						
THYSSEN EDELSTAHLWERKE	WEST GERMANY			OERSTIT 450k	OXIT 380R			SECOLIT	
				OERSTIT 450kk	OXIT 310				
					OXIT 410				
TOHOKU METALS INDUSTRIES LTD	JAPAN	TMK-1B	TMK-5	Q-6			K-1 K-2	LANTHANET LM-10	
		TMK-1BG	TMK-5B	SR-1					
		TMK-1FG	TMK-5A	SR-2					
TOSHIBA CORPORATION	JAPAN							TOSREX-11	
								TOSREX-18, 22	

4-15

TABLE 4-2: COMMERCIAL HIGH-GRADE PERMANENT MAGNETS (BY PRODUCER) Page 7 of 8

MANUFACTURER		CAST ALNICO		SINTERED ALNICO	SINTERED FERRITE	MANGANESE-ALUMINUM-CARBON (ANISOTROPIC)	IRON-CHROMIUM-COBALT (ANISOTROPIC)	POLYMER BONDED RARE-EARTH COBALT (ANISOTROPIC)	SINTERED RE-COBALT (ANISOTROPIC)	
COMPANY	COUNTRY	ALNICO 5	ALNICO 8	ALNICO 8	CERAMIC 5			RCo ₅ (Cu)	R ₂ Co ₁₇ (Cu)	TEMP COMP
		ALNICO 5DG	ALNICO 8HC	ALNICO 8HC	CERAMIC 7					
		ALNICO 5COL (5-7)	ALNICO 8HE	ALNICO 8HE	CERAMIC 8					
VACUUMSCHMELZE GMBH	WEST GERMANY						CROVAX-23/500 15/400 10/380	VACOMAX 65K	VACOMAX 140, 145, 170, 200	
VARIAN TWT DIVISION	U S A								SAMARIUM-COBALT	
UGIMAG RECOMA	Switzerland							RECOMA 10	RECOMA 14 RECOMA 20, 25	
WARABI SPECIAL STEEL CO, LTD	JAPAN	WM-7					WK-200 WK-400 WK-480			
WESTERN ELECTRIC CO, INC (Bell System)	U S A	WM-7D					CHROMINDUR II B, II H, III III C, IV			

4-16

TABLE 4-2: COMMERCIAL HIGH-GRADE PERMANENT MAGNETS (BY PRODUCER) Page 8 of 8

MANUFACTURER		CAST ALNICO		SINTERED ALNICO	SINTERED FERRITE	MANGANESE-ALUMINUM-CARBON (ANISOTROPIC)	IRON-CHROMIUM-COBALT (ANISOTROPIC)	POLYMER BONDED RARE-EARTH COBALT (ANISOTROPIC) RCo ₅ (Cu) R ₂ Co ₁₇ (Cu)	SINTERED RE-COBALT (ANISOTROPIC)
COMPANY	COUNTRY	ALNICO 5	ALNICO 8	ALNICO 8	CERAMIC 5				RCo ₅ (Cu)
		ALNICO 5DG	ALNICO 8HC	ALNICO 8HC	CERAMIC 7			R ₂ Co ₁₇ (Cu)	
		ALNICO 5COL (5-7)	ALNICO 8HE	ALNICO 8HE	CERAMIC 8			TEMP. COMP.	
Central Iron and Steel Research Institut Peking University	CHINA							RE 100, 110	
								RE 130	
								RE 120 ("1-5") RE 140 ("2-17")	

4-17

TABLE 4-3: ADDRESSES OF MAGNET MANUFACTURERS
 INCLUDED IN THE NASA/DOE SURVEY (p. 1 of 3 pages)

<u>Address of Plant or Principal Business Office</u>	<u>Address of U.S. Sales Representative for Foreign Manufacturers</u>
Aimants Ugimag S. A 34, rue de Mironmesnil 75008 Paris FRANCE	RECOMA, Inc. 2 Stewart Place Fairfield, NJ 07006
Magnetics Div., Allen Bradley Co. 1201 S. Second Street Milwaukee, Wisconsin 53204	
Arnold Engineering Co. P. O. Box G Marengo, Illinois 60152	
RECOMA, Inc. 2 Stewart Place Fairfield, New Jersey 07006	
Central Iron & Steel Research Institute Peking (Beijing) CHINA, People's Republic of	LDJ Electronics, Inc P. O. Box 219 1280 E. Big Beaver Rd. Troy, Michigan 48099
Colt Industries, Colt Inc. Magnetics Division RFD #2 Elizabethtown, KY 42701	
Dura Magnetic, Inc. Pyle Drive Sylvania, Ohio 43560	
Electron Energy Corp. 329 Main St. Landisville, PA 17538	
Firth Vickers Foundry Ltd. Garter St., P. O. Box 160 Sheffield S4 7QY ENGLAND, U. K.	
Hitachi Magnetics Corp. Edmore Michigan 48829	
Hitachi Metals, Ltd. 1-2, 2-chome, Marunouchi Chiyoda-ku, Tokyo, JAPAN	Hitachi Magnetics Corp. Edmore Michigan 48829
Indiana General Div. of EMM Corp. 405 Elm Street Valparaiso, Indiana 46383	
Industria Ossidi Sinterizzati, S. R. L. 21023 Malgesso (Varese), ITALY	

<u>Address of Plant or Principal Business Office</u>	<u>Address of U.S. Sales Representative for Foreign Manufacturers</u>
Fried Krupp GmbH KRUPP WIDIA Munchener Str. 90 Postfach 102161 4300 Essen 1 WEST GERMANY Magnetic Products James Neill (Napier Street) Ltd. Napier Street, Sheffield S11 8 HB ENGLAND, U. K.	Krupp International, Inc 550 Mamaroneck Avenue Harrison, NY 10528
Magnetfabrik Bonn GmbH Postfach 2005 Dorotheenstrasse 215 D-5300 Bonn 1, WEST GERMANY (BRD)	Electro-Physik Inc. 5700 Thurston Ave., Suite 224 Virginia Beach, VA 23455
Matsushita Electric Industrial Co., Ltd. Kadoma, Osaka 571, JAPAN	
Mitsubishi Steel Magnetics Co., Ltd. 9-31 Shinonome 1-chome, Koto-ku Tokyo, JAPAN	Mitsubishi Steel Mfg. Co., Ltd. 227 Park Avenue New York, N. Y. 10017
Namiki Precision Jewel Co., Ltd. 22-8, 3-chome, Shinden Adachi-ku, Tokyo, JAPAN	Namiki Precision Jewel Co., Ltd. 15 Essex Road Paramus, New Jersey 07652
N. V. Philips Gloeilampenfabrieken Electric Components and Materials Div. Eindhoven, THE NETHERLANDS	
POLYMAG, Inc. Horseblock and Yapank-Patchogue Roads Yaphank, NY 11980	
Preformations, Ltd. Cheney Manor, Swindon Wiltshire SN2 2PX ENGLAND, U. K.	
Raytheon Corporation 190 Willow Street Waltham, Massachusetts 02154	
Shin-Etsu Chemical Co., Ltd 2-Chome, Ohtemachi Chiyoda, Tokyo JAPAN	
The Stackpole Corporation Magnet Division 700 Elk Avenue Kane, Pennsylvania 16735	
Sumitomo Special Metals Co., Ltd. 22 Kitahama, 5-Chome, Higashi-ku Osaka, JAPAN	

Address of Plant or
Principal Business Office

Suwa Seikosha Co., Ltd.
3-3-5 Owa, Suwa-Shi
Nagano-Ken 392, JAPAN

TDK Electronic Corp.
13-1, 1-chome
Nihonbash, chou-ku
Tokyo 103
JAPAN

Thomas & Skinner, Inc.
1120 East 23rd Street
Indianapolis, IN 46205

Thyssen Edelstahlwerke
Magnetfabrik Dortmund
Ostkirchenstrasse 177
4600 Dortmund
WEST GERMANY (BRD)

Tohoku Metal Ind., Ltd.
13-10, 7-chome, Ginza
Chuo-ku
Tokyo, JAPAN

Toshiba Corporation
Metal Products Division
26-5 Toranomom 1-Chome
Minato-Ku, Tokyo 105, JAPAN

UGIMAG-RECOMA AG
Hardstrasse 5
5600 Lenzberg
SWITZERLAND

Varian, TWT Div.
611 Hansen Way
Palo Alto, California 94303

Vacuumschmelze GmbH
Postfach 2253
D-6450 Hanau
WEST GERMANY (BRD)

Warabi Special Steel Co., Ltd.
1-16-1, Chuo, Warabi-shi
Saitoma, JAPAN

Western Electric Co., Inc.
Send inquiries to
Bell Laboratories
Murray Hill, NJ 07974

Address of U.S. Sales Representative
for Foreign Manufacturers

TDK Corporation of America
2041 Rosecrans Ave., Suite 365
El Segundo, California 90245

RECOMA, Inc.
2 Stewart Place
Fairfield, New Jersey 07006

Vacuumschmelze
c/o Siemens Corp.
186 Wood Avenue South
Iselin, NJ 08830

TABLE 4-4: COMMERCIAL HIGH-COERCIVITY CAST ALNICOS - SUMMARY OF PROPERTY DATA
(Property values at 25°C except as noted.)

MMPA DESIGNATION (USA).			ALNICO 8		ALNICO 8 HE		ALNICO 8 H(HC)		ALNICO 9	
MAGNETIC PROPERTIES			MMPA MIN	COMMERCIAL RANGE	MMPA MIN	COMMERCIAL RANGE	MMPA MIN	COMMERCIAL RANGE	MMPA MIN	COMMERCIAL RANGE
Residual Induction	B_r	kG	8.2	8.0 - 8.3		9.2 - 9.4	7.2	7.2 - 7.8	10.5	10.5 - 11.5
Coercive Force	BH_c	kOe	1.65	1.6 - 1.7		1.5 - 1.6	1.9	1.9 - 2.0	1.5	1.5 - 1.6
Intrinsic Coercive Force	MH_c	kOe		1.65 - 1.76		2.0 - 2.3		2.05 - 2.2		1.5 - 1.7
Knee Field ($B_d = 0.9 B_r$)	H_k	kOe		0.5 - 0.6		0.5 - 0.6		0.7 - 0.8		1.2 - 1.3
Static Energy Product	$(BH)_{max}$	MGOe	5.3	5.0 - 5.5		5.8 - 6.2	5.0	5.0 - 5.8	9.0	8.5 - 10.5
Intrinsic Energy Product	$(B_i H)_{max}$	MGOe		6.5 - 7.2		7.0 - 7.5		6.6 - 7.8		10.2 - 12.3
Recoil Energy Product	$(BH)_u$	MGOe		1.6 - 2.1		—		2.3 - 2.5		2.6 - 3
Recoil Permeability	μ_r	G/Oe		2 - 3		~ 2		~ 2		1.3 - 1.5
Temperature Coefficient of Residual Induction	$\delta = \frac{100 \times B_r}{B_r \times \Delta T}$	% per °C	About - 0.015 (0-100°C, for B_r only Temp variation of B_d depends strongly on B_d/H_d')							
Curie Temperature	T_c	°C	~ 850°C							
PHYSICAL PROPERTIES										
Mass Density	d		~ 7.3 g/cm ³							
Thermal Expansion Coefficient (0-100°C)	$\alpha = \frac{100 \times \Delta L}{L \times \Delta T}$		(10 - 12) x 10 ⁻⁶ % per °C (no direction specified, average?)							
Specific Heat	C_p		~ 0.11 cal/g °C ≈ 460 J/kg.°C ≈ 0.11 BTU/lb °F							
Thermal Conductivity	K									
Electrical Resistivity			(50 - 62) x 10 ⁻⁶ Ω cm							
MECHANICAL PROPERTIES (Real fracture strength is determined by cracks Magnets should not carry load)										
Tensile Strength	σ_t		5 - 30 kgf/mm ² ≈ 50 - 300 MPa ≈ (7 - 43) x 10 ³ psi							
Compressive Strength	σ_c									
Flexural Strength	σ_f									
Modulus of Elasticity	E									
Poisson's Ratio	ν									
Rockwell Hardness	H_c		C 56 - 58							

TABLE 4-5: COMMERCIAL HIGH-GRADE SINTERED P.M. FERRITES - SUMMARY OF PROPERTY DATA
(Property Values at 25°C except as noted.)

MMPA DESIGNATION (USA)		CERAMIC 5		CERAMIC 6		CERAMIC 7		CERAMIC 8		NEW "SUPERGRADES"(Examples)	
		MMPA MIN	COMMERCIAL RANGE	MMPA MIN	COMMERCIAL RANGE	MMPA MIN	COMMERCIAL RANGE	MMPA MIN	COMMERCIAL RANGE	TDK FB4X	BOSCH HC400
MAGNETIC PROPERTIES											
Residual Induction	B_r kG	3.8	3.8 - 4.2	3.2	3.2 - 3.7	3.4	3.4 - 3.8	3.85	3.85 - 4.1	4.1 - 4.3	3.75
Coercive Force	B_H kOe	2.4	2.0 - 2.5	2.82	2.8 - 3.3	3.25	3.25 - 3.6	2.95	2.95 - 3.4	2.8 - 3.1	~3.6
Intrinsic Coercive Force	M_H kOe		2.02 - 2.6	3.3	3.1 - 3.6	4.0	4.0 - 4.4	3.05	3.0 - 3.55	2.8 - 3.2	4.8
Knee Field ($B_d=0.9B_r$)	H_k kOe		1.9 - 2.4		2.5 - 3.1		3.7 - 4.2		2.8 - 3.4	2.7 - 3.1	
Static Energy Product	$(BH)_{max}$ MGOe	3.4	3.3 - 4.2	2.45	2.5 - 3.2	2.75	2.75 - 3.5	3.5	3.4 - 4.1	4.0 - 4.2	~3.5
Intrinsic Energy Product	$(B_iH)_{max}$ MGOe		8.0 - 8.5		9.0 - 10.7		11 - 13		9.3 - 11.5	10 - 11	~16.3
Recoil Energy Product	$(BH)_u$ MGOe		1.5 - 1.8		2.0 - 2.3		2.5 - 2.8		2.4 - 2.9		
Recoil Permeability	μ_r G/Oe		1.1 - 1.2		1.1 - 1.2		1.05 - 1.1		1.05 - 1.1	1.05 - 1.1	
Revers Temp Coefficient of Residual Induction	$\int = \frac{100 \times B_r}{B_r \Delta T}$ % per °C	-0.18 to -0.20 reported (average value 0 to 100°C, or at 25°C, but often not identified)									
Curie Temperature	T_C °C	~450°C (440 - 460° reported Upper limit for strontium ferrite)									
PHYSICAL PROPERTIES											
Mass Density	d g/cm ³	4.8 - 5.1		4.6 - 4.9		4.7 - 4.9		4.8 - 4.9		4.9 - 5.0	
Thermal Expansion Coefficient (0-100°C)	$\alpha = \frac{100 \times \Delta L}{L \times \Delta T}$ [10 ⁻⁶ % per °C]	14		14		15		15		15	
Specific Heat	C_p	9.5		9.0		10		10		10	
Thermal Conductivity	K	0.16 - 0.2 cal/g °C ≈ 670 - 840 J/kg °C ≈ 0.16 - 0.2 BTU/lb °F									
Electrical Resistivity		0.005 - 0.01 cal/cm s °C ≈ 2.1 - 4.2 W/m °C ≈ 1.2 - 2.4 BTU/ft hr °F									
2x10 ⁵ - 1x10 ⁶ Ω cm (semiconductors resistivity reduced upon heating)											
MECHANICAL PROPERTIES (Real fracture strength depends on cracks that are always present Magnets should not carry load)											
Tensile Strength	σ_t	2 - 6 kgf/mm ²		≈ 20 - 60 MPa		≈ (2.9 - 8.7) x 10 ³		psi			
Compressive Strength	σ_c	40 - 150 kgf/mm ²		≈ 400 - 1500 MPa		≈ (58 - 220) x 10 ³		psi			
Flexural Strength	σ_f	5 - 9 kgf/mm ²		≈ 50 - 90 MPa		≈ (7.2 - 13) x 10 ³		psi			
Modulus of Elasticity	E_f	(14 - 20) x 10 ³ kgf/mm ²		≈ (140 - 200) x 10 ³ M Pa		≈ (20 - 30) x 10 ⁶		psi			
Poisson's Ratio	ν	~0.28									

TABLE 4-6: COMMERCIAL HIGH-GRADE RARE EARTH-TRANSITION METAL MAGNETS - SUMMARY OF PROPERTY DATA (Property values at 25°C except as noted.)

MAGNETIC PROPERTIES		SINTERED Sm-Co ₅	SINTERED (Sm,Pr)Co ₅	SINTERED Sm ₂ (Co, Fe, Cu, TM) ₁₇ Low-H _c High-H _c		SINTERED (MM 8Sm ₂)Co ₅	SINTERED (Ce 85Sm 15) (Co, TM) ₆	EPOXY-BONDED Sm ₂ (Co, Fe, Cu, Zr) ₁₇
Residual Induction	B _r kG	7 8 - 9 8	9 2 - 10 5	9 2 - 11 2	9 2 - 10 8	7 0 - 8 5	8 0 - 8 6	7 8 - 8 9
Coercive Force	B _H ^H _c kOe	7 5 - 9 5	8 5 - 10 2	6 0 - 6 8	7 0 - 10 0	6 - 7 8	4 4 - 5 4	6 3 - 7 0
Intrinsic Coercive Force	M _H ^H _c kOe	12 - >25	≥10	6 2 - 7 0	10 - 12	7 - 10	4 8 - 6 0	10 - 12
Knee Field (B _d =0.9 B _r)	H _k kOe	5 - 20	7 - 9	5 2 - 5 4	7 5 - 9	6 - 7 5	4 - 5	
Static Energy Product	(BH) _{max} MGOe	16 - 23	20 - 27	22 - 31	20 - 27	12 - 16	14 - 17	13 - 17
Intrinsic Energy Product	(B _i H) _{max} MGOe	40 - >120	50 - 80	45 - 50	60 - 90	40 - 60	30 - 40	
Recoil Energy Product	(BH) _u MGOe	14 - >20						
Recoil Permeability	μ _r	1 0 - 1 05	1 0 - 1 05	1 0 - 1 05		1 05 - 1 1	1 01	
Revers Temp Coefficient of Residual Induction	$\beta = \frac{100 \times B_r}{B_r \times \Delta T}$ % per °C	-0.045 to -0.04	-0.05	-0.03		-0.06	-0.09	-0.06 (-20 to +80°C)
Curie Temperature	T _C °C	700 - 750	700 - 750	800 - 850		~520		~850
PHYSICAL PROPERTIES								
Mass Density	d g/cm ³	8 1 - 8 3	8 0 - 8 1	8 3 - 8 5		8 0 - 8 1	8 3	7 0 - 7 2
Thermal Expansion Coefficient (0 - 100°C)	$\alpha = \frac{100 \times \Delta L}{L \times \Delta T}$ {10 ⁻⁶ % } /LM	6 0	6 1	8 0		4		
Specific Heat	C _p cal/g °C	13 0	12 5	11 0		12		
Thermal Conductivity	K 10 ⁻³ cal/cm s °C	0 09	—	0 08		0 09		
Electrical Resistivity	ρ 10 ⁻⁶ Ω cm	25 - 30	26 - 29	28		25		
		48 - 53	—	86		65		0 03 - 0 1 cm
MECHANICAL PROPERTIES (Real fracture strength determined by presence of cracks Magnets should not carry load)								
Tensile Strength	σ _t kgf/mm ²	3 5 - 4 1		3 6		~ 3 5		
Compressive Strength	σ _c kgf/mm ²	25 - 105		50 - 82		~130		
Flexural Strength	σ _f kgf/mm ²	7 - 18		12 - 15		12 - 16		8 - 12
Modulus of Elasticity	E 10 ³ kgf/mm	16 - 18		12 - 15		~ 18		
Poisson's Ratio	ν	—		—		—		
Hardness Rockwell C	R _C	C50 - 55		—		52		
Hardness Vickers	H _v	450 - 520		500 - 600		550		80 - 120

5. Examples of Graphic Design Information

We shall now consider some selected examples of graphic data presentation. In the author's opinion, these show very useful ways of summarizing generally needed design information for a given type of permanent magnet material. The emphasis here is on the mode of presentation. While the graphs do also convey useful design data, no attempt was made to be comprehensive either with regard to PM material types or their manufacturers. Specific commercial products are chosen merely as examples, not because they are unique or their use is recommended over other, similar products.

First we shall consider a graphic method that is convenient for orienting oneself about the salient room-temperature properties available in a given family of PM materials. Fig. 4-1 demonstrates a nice way of summarizing a given manufacturer's offering of PM ferrites. The example is taken from the TDK Corporation's commercial application literature. In a plot of remanence versus intrinsic coercive force, typical properties of specific ferrite grades and their nominal production tolerances are indicated as rectangles. Primary grade designations are in the company's code, which is not familiar to most U.S. users. Approximate equivalents to the grades standardized by the U.S. Magnet Materials Producers' Association (MMPA) are written into the rectangles. These correspondences are suggested by TDK. The author has also put circles into the figure that represent the MMPA minimum values for these older standard grades.

This graph illustrates fairly well the range of ferrite properties now being offered by an increasing number of manufacturers. Note that modern ceramic magnets often significantly exceed the minimum values of the traditional standards, particularly with regard to the remanence. This is due to the introduction of improved wet-pressing procedures in recent years which produce improved particle alignment.

Next we take a look at commercial offerings of rare earth-cobalt magnets. Fig. 4-2 again shows a graph as published by TDK, with dots put in by the author representing MMPA standard grades. Fig. 4-3 is an equivalent graph, composed by the author, summarizing the REPM production program of the Hitachi Magnetics Corp. Both summaries correspond to the status of 1981. Several other major magnet producers in different countries offer a substantially equivalent set of magnet grades.

In these graphs, the remanence values are plotted versus the induction coercive force (or "normal" H_c). This is done as a matter of convenience, since the intrinsic coercive force covers a very wide range that cannot be easily plotted. For some REPM types $M H_c$ is very high, and it also varies more in production than $B H_c$. Since $M H_c$ and H_k are very important quantities for the design of certain motors and other devices, these graphs present only a part of the information needed for making even basis decisions on material selection.

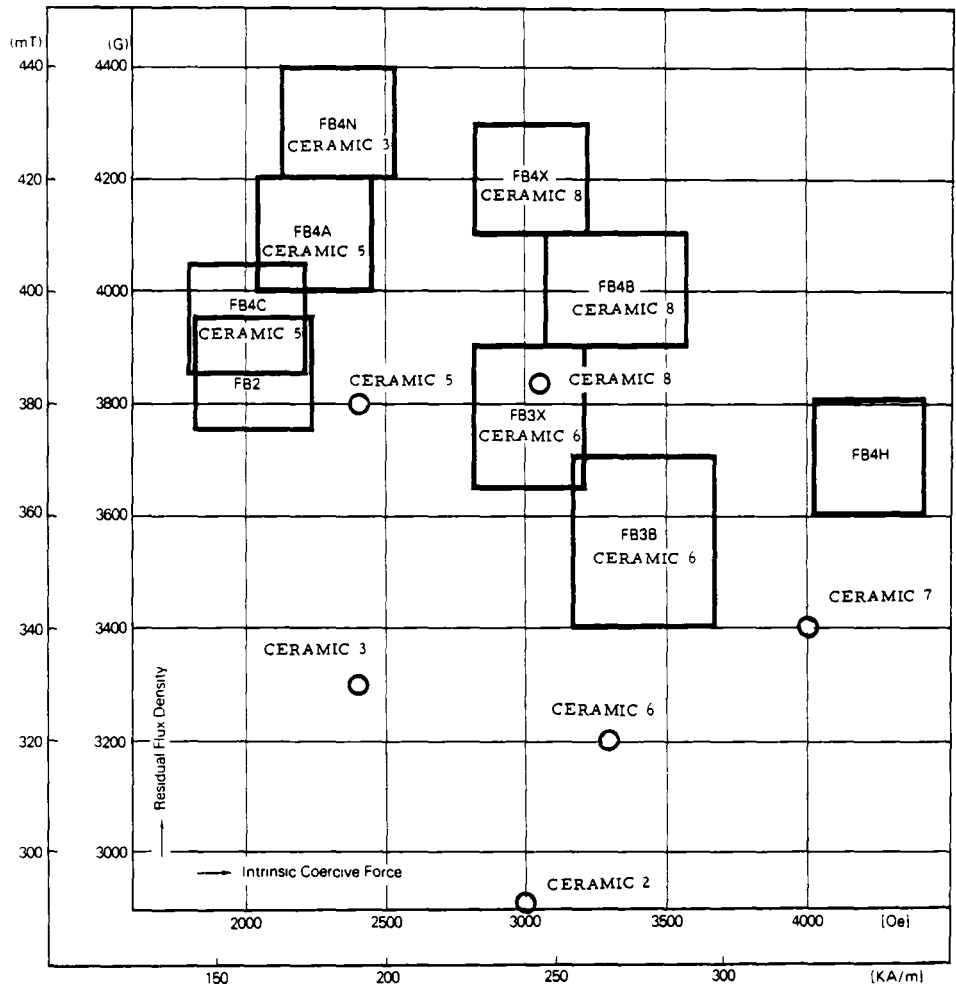

THE DOTS INDICATE "TYPICAL" GRADE PROPERTIES PER US-MMPA SPECIFICATION NO 0100 THE "CERAMIC NO " DESIGNATION IN EACH BLOCK INDICATES EQUIVALENCE AS SUGGESTED BY TDK NOTE THAT B_r VALUES SIGNIFICANTLY EXCEED MINIMA.

Figure 4-1. Modern Commercial Ceramic Ferrite Magnets (Example: TDK Production of Anisotropic Ferrites)

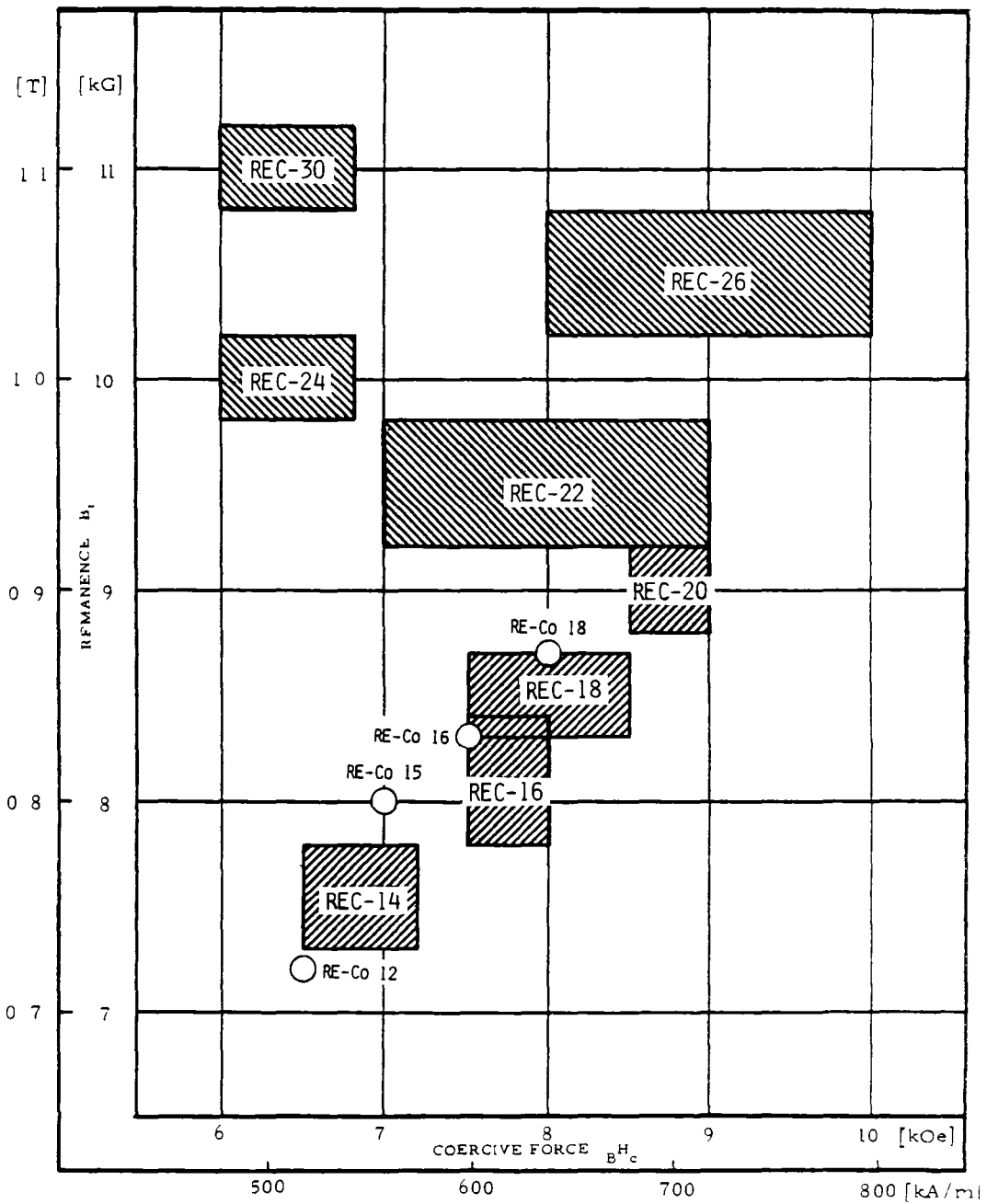

THE DOTS INDICATE "TYPICAL" GRADE PROPERTIES PER US-MMPA SPECIFICATION NO. 0100

Figure 4-2. Commercial Production of Rare Earth-Cobalt Magnets-I (Example: TDK Production Program Sintered REPM)

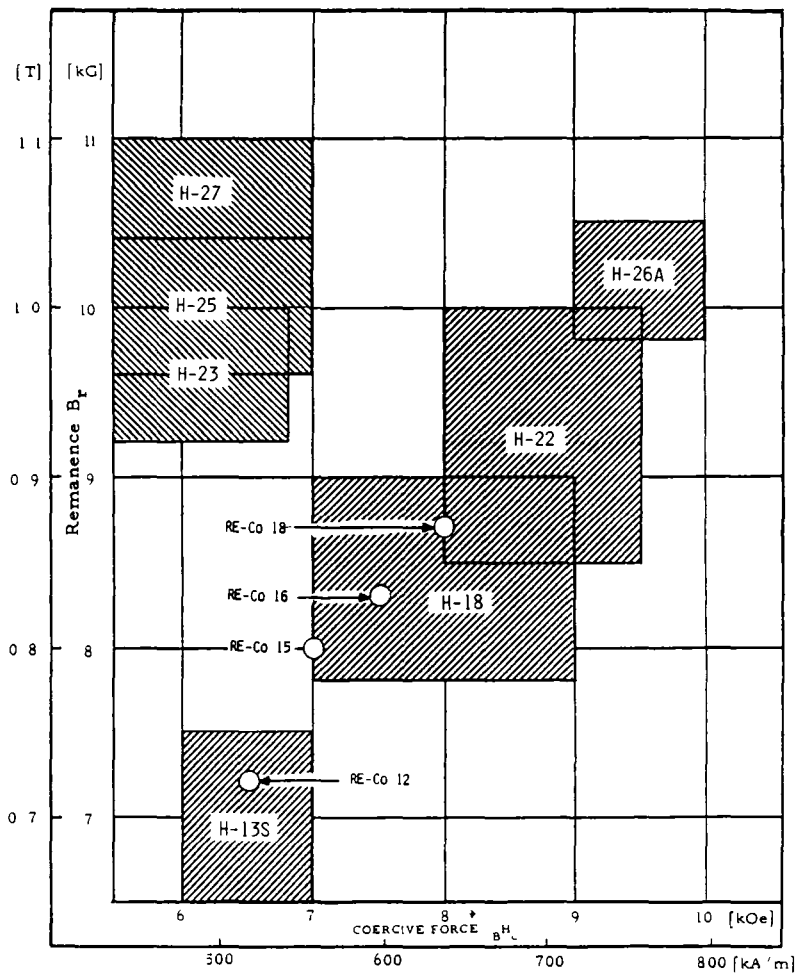

*THE DOTS INDICATE "TYPICAL" GRADE PROPERTIES PER US-MMPA SPECIFICATION NO 0100

Figure4-3: Commercial Production of Rare Earth-Cobalt Magnets-II (Example: Hitachi Magnetics Corp.)

Note also that these graphs and company grade designations do not specify the chemical and metallurgical nature of the magnets. For ferrites, the variation in this respect is not so great. In the REPM family of magnets, however - as was previously discussed - a large variety of compositions and heat-treating methods is possible. This leads to strong variations in magnetic and some other physical properties, which are already represented in today's commercial production, and the variety keeps growing. The Figures 4-2 and 3 include 1-5 and 2-17 magnets, nucleation and pinning controlled types, compositions with Pr, Ce and mischmetal substitutions for Sm, and even magnets with heavy-RE substitutions for temperature compensation. (The two companies chosen as examples do not yet manufacture bonded REPM types, but other vendors who do might include such matrix magnets in the same graph.) Note that this kind of summary by itself does not allow this important distinction to be made.

In the following figures we show examples of how property summaries for specific subtypes of magnets can be presented that do give the designer more information on the magnetic behavior while still being simple and fairly general. While we do identify some specific products that were tested, the information given in the composite graphs is characteristic of generic magnet types that are now available from different vendors. (See Tables 4-1 and 4-2.)

We begin with important rare-earth magnet types. Figures 4-4 and 5 show the results of tests on sintered SmCo_5 magnets obtained from several commercial sources. (See references 10 and 14, Chapter III.) The intrinsic room-temperature demagnetization curves fall within the broad shaded band. Note that the B vs. H curves alone do not reveal this production variation; they are practically all identical. The temperature variation of the second-quadrant, major-loop shape in a hypothetical extreme motor operating range, -60 to $+200^\circ\text{C}$, is shown for one of the magnets tested, namely that with the lowest $M^H H_c$. The temperature dependence of its salient numerical quantities, B_r , $B^H H_c$ and $(BH)_{\max}$, is derived from these curves and plotted separately. The description of long-term "stability" is represented by curves that show the relative change of the open-circuit flux as a function of exposure time in air at 150°C . These curves show the aging from a prestabilized state achieved by briefly heating the magnets to 150° (for 15 minutes). The permeance values $B/H = 1$ and 0.25 correspond to operation near the $(BH)_{\max}$ -point and fairly close to the intrinsic coercive force point. Note that the aging losses vary with the permeance, and that aging curves (or temperature cycling curves) for B_r (at $H=0$) that are often reported are not a good description of the actual behaviour of the magnet. Magnets are always used at a lower operating point in the device or machine. For propulsion motor design, the recoil behavior of the magnet is of importance. Fig. 4-5 shows sets of recoil curves for another good sintered SmCo_5 magnet, measured at 25°C and elevated temperatures to 200°C . Three B vs. H plots show lines for recoil from several points in the second quadrant. They almost coincide with the major loop, even at 200°C . This behavior is typical of well-made, square-loop REPM and ceramic ferrites. (But certainly not of the other, lower- H_c materials.) When the demagnetizing field exceeds the knee field, significant flux losses occur during field cycling even for SmCo_5 . The second-quadrant (B-H) plot shows recoil curves describing this situation at 25° and 200°C .

RANGE OF DEMAG. CURVES 25°C

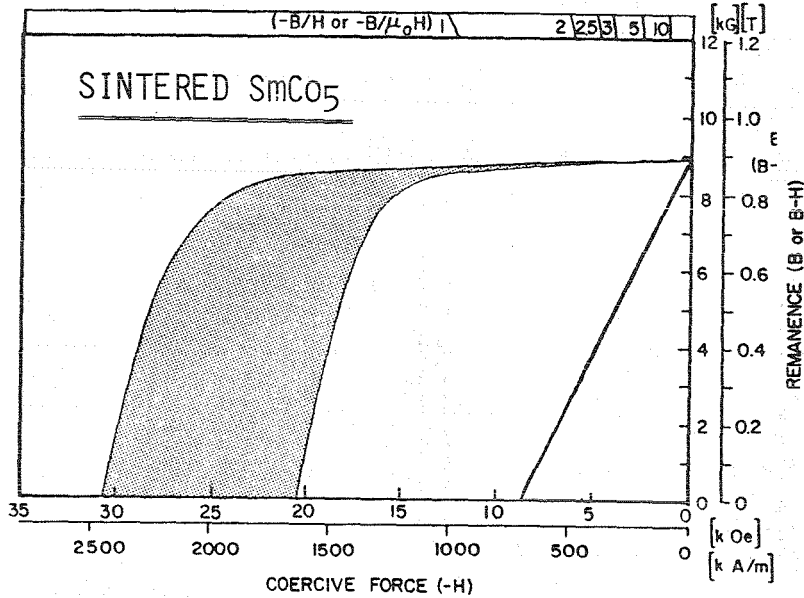

DEMAG. CURVES AT DIFFERENT TEMPERATURES

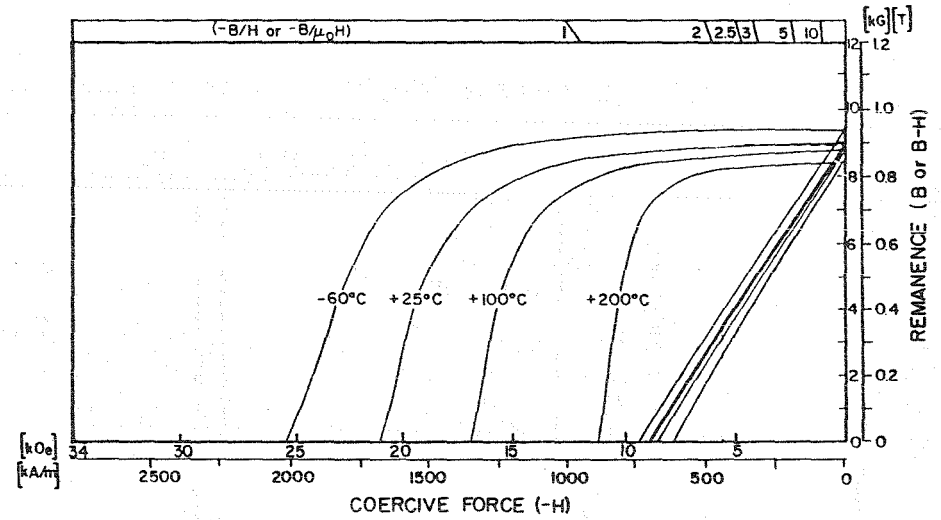

4-29

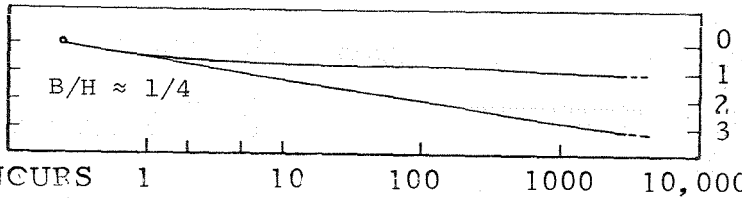
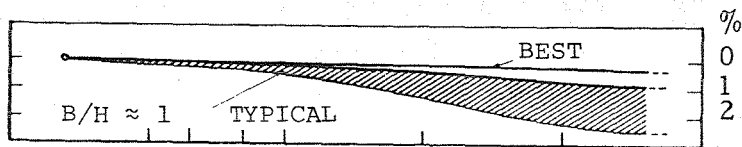

SmCo5 AGING AT 150°C

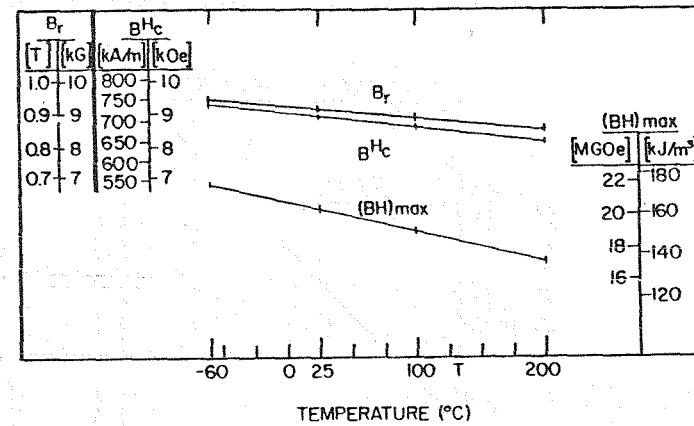

TEMP. CHARACTERISTICS SmCo5

Figure 4-4: Test Results on Commercial Sintered SmCo5 Magnets-I. Production scatter, temperature effects, at 150°C. (Ref. 3-10, 14)

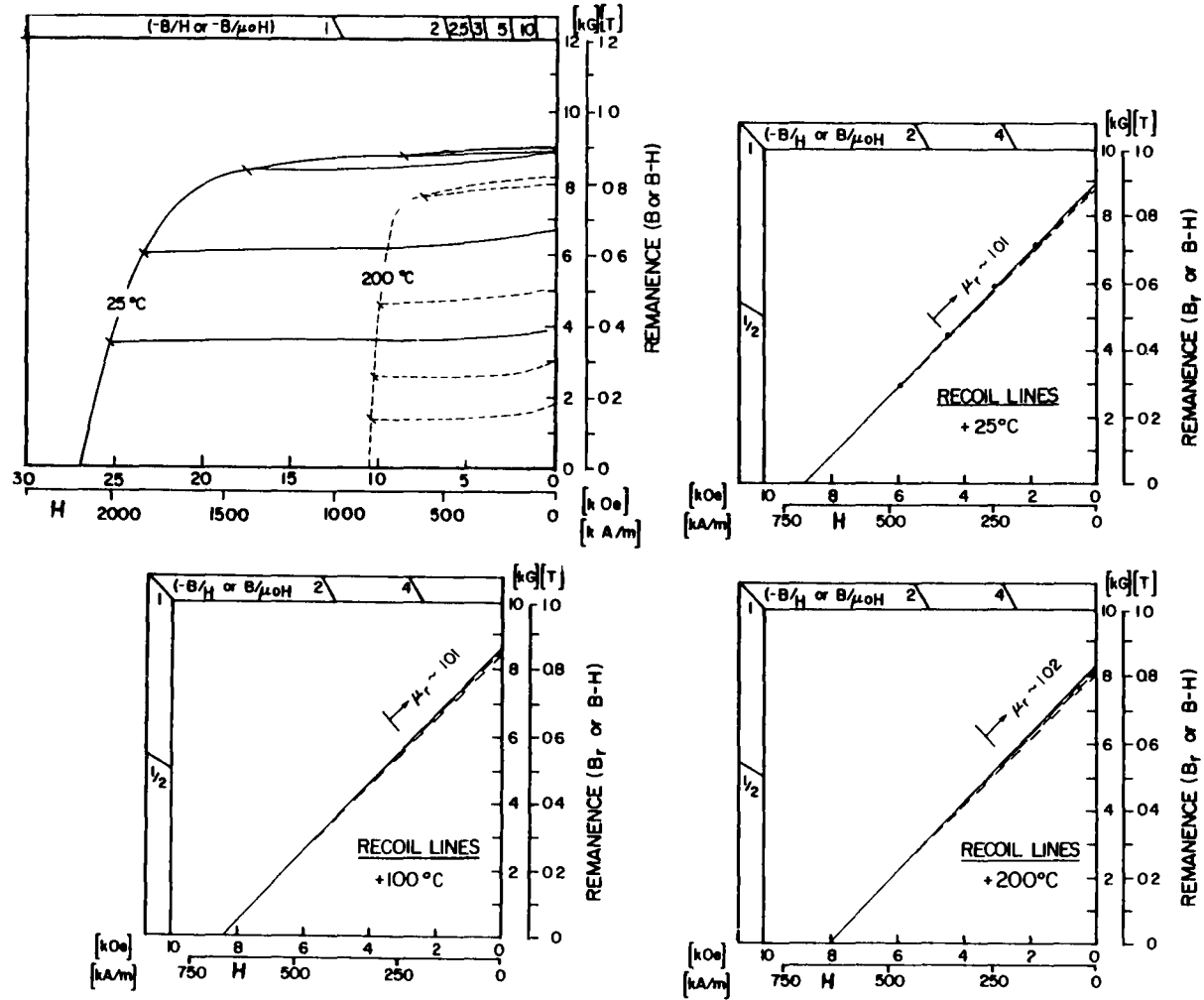

Figure 4-5. Test Results on Commercial Sintered SmCo₅ Magnets-II
 Dynamic behavior, recoil lines at 25^o, 100^o, 200^o C. (Ref. 3-10, 14)

The next figure, 4-6, is a similar set of curves for a "2-17" REPM of the relatively low- H_C variety. Most of the measurements were made on TDK's grade REC-30. This is a material of the approximate composition $\text{Sm}(\text{Co,Fe,Cu,Zr})_{7.3}$ that has been sintered and optimally heat treated. Several other companies are now offering similar products that have similar magnetic properties. However, it should be noted that the addition of Mn or Cr, and the partial substitution of Sm by other RE (particularly Ce or a heavy RE) will result in a significantly different temperature variation of the magnetic properties. We want to emphasize again that it is important for the critical user to demand that the magnet manufacturer identify the magnet type by composition and provide very specific test data of the kind shown here by example.

The remaining figures in this chapter show similar magnetic property summaries, particularly temperature variation and stability information where available, for other new magnet types. Fig. 4-7 is for Mn-Al-C. More details, including recoil curves, can be found in Chapter V and in an earlier report issued under this contract, Ref. 5-1. In Fig. 4-8, similar information is shown for one kind of Fe-Cr-Co alloy magnet that is now in commercial production at several companies. We have not been able to find aging data but it can be assumed that the behavior is similar to Alnico 5.

While this collection of data sheets is quite incomplete and the selection somewhat arbitrary, it may make the intended point that the motor designer needs much more information than a set of numbers describing static magnet operation at room temperature. Magnet manufacturers and their contract laboratories are increasingly aware of this need and are generating data of the kind shown above. It is hoped that this discussion will help to increase the awareness of both, user and producer, and stimulate efforts to evolve a somewhat standardized format for presenting the design information in graphic form. Certainly, as new PM types are developed, data on the dynamic magnetic behavior, temperature variation and temporal stability of properties should be generated early on under conditions meaningful for electric machine operation and should be presented in ways most useful for the design engineer. The graphs shown here may serve as useful examples.

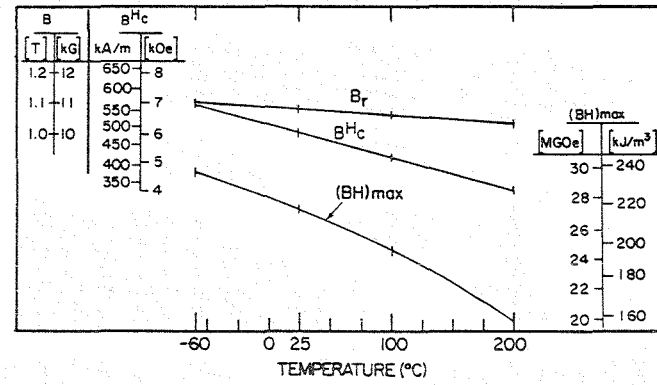
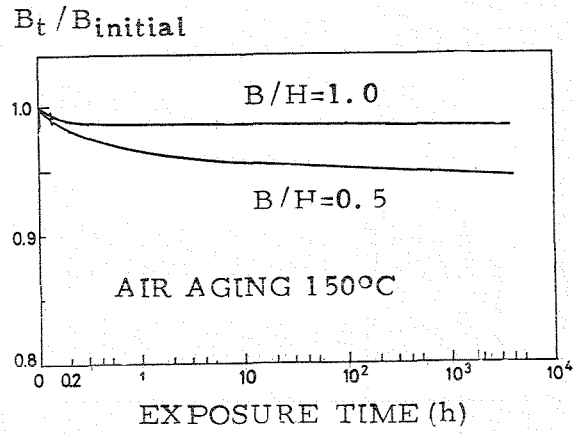
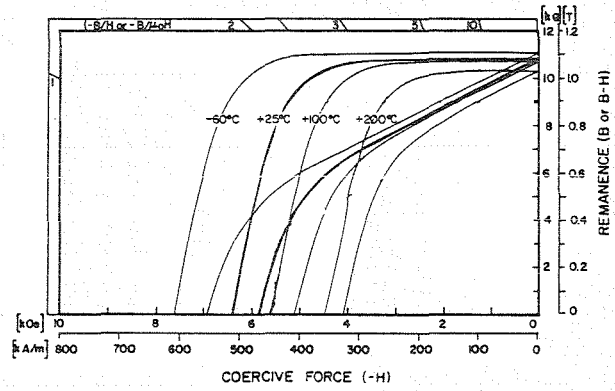
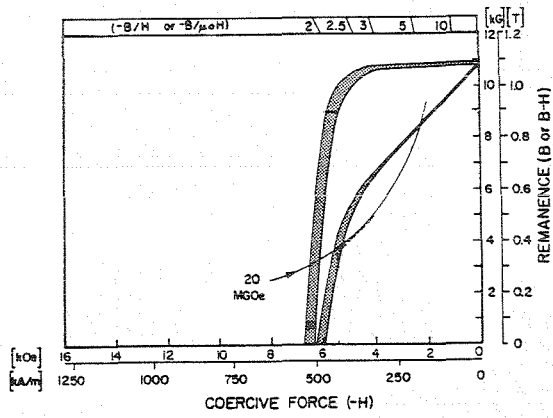
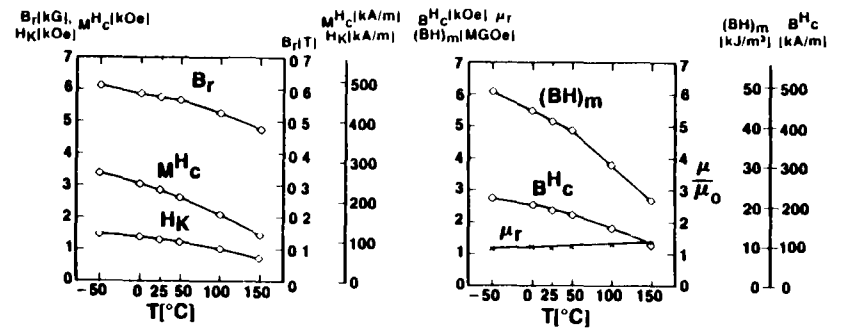
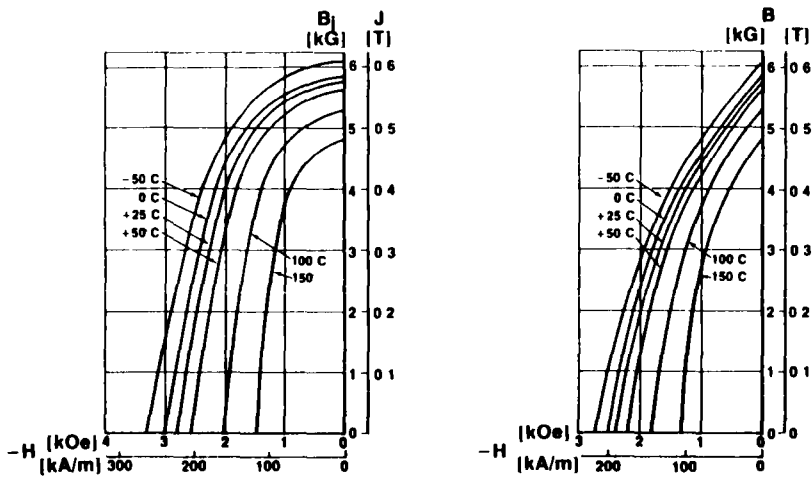

Figure 4-6: Test Results on Typical Sintered "2-17" Magnets of Low- H_c Type, Composition $Sm(Co, Cu, Fe, Zr)_{7.3}$ (References 3-10, 14) Production scatter, temperature variation.



Magnetic Properties vs. Temperature

Intrinsic and Normal Demagnetization Curves

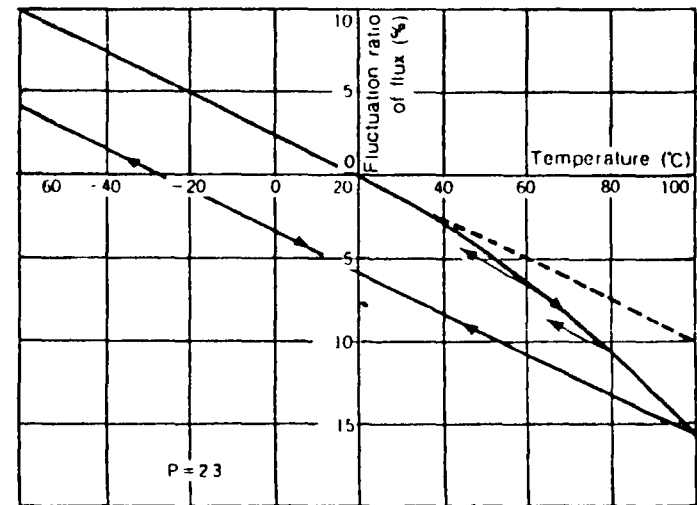
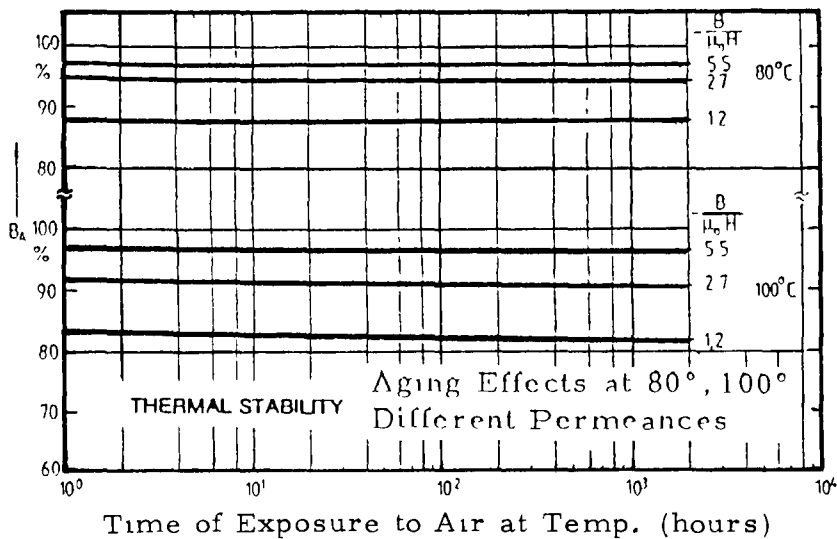
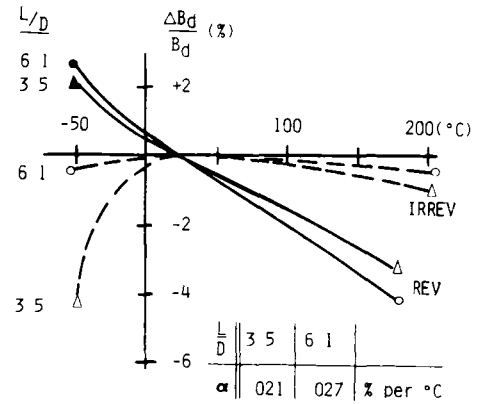
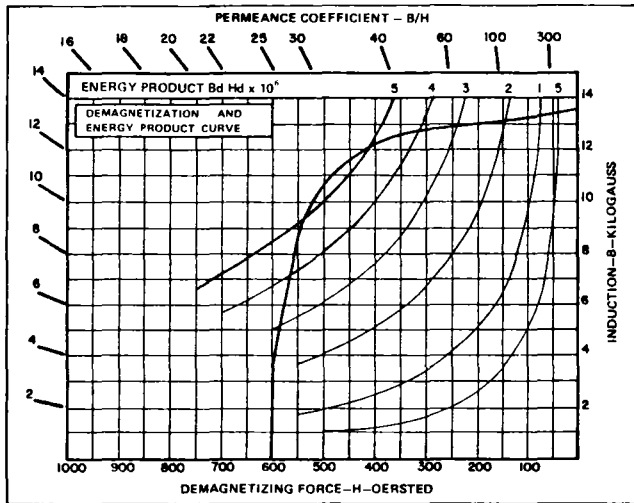

Figure 4-7: Test Results on Commercial Mn-Al-C Magnets. Temperature variation and stability, (Ref. 3-9, 11)



IRREVERSIBLE AND REVERSIBLE LOSSES FOR 58 Fe, 22 Cr, 15 Co, 4 V

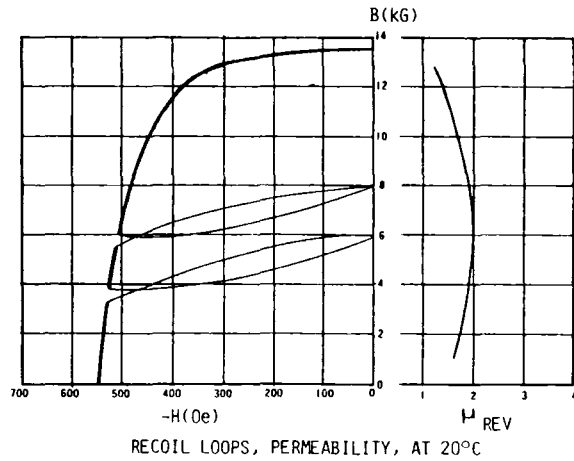
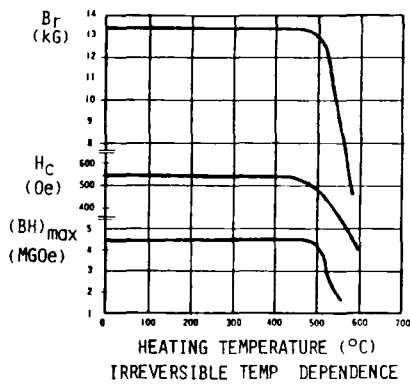

Figure 4-8: Properties of a Commercial Fe-Cr-Co Magnet (Source: Product literature of Indiana General and Hitachi Magnetics Companies)

V. TESTING OF Mn-Al-C MAGNETS

A. Background Information:

An experimental characterization of the magnetic and some of the mechanical properties of the new permanent magnet material, Mn-Al-C, was called for as part of this contract. The principal purpose was to evaluate its suitability for use in EHV propulsion motors. Since the General Electric R&D Center group had designed a disk motor that would use this magnet (Design GE-2, see Section I-B,1), we communicated with Drs. Kliman and Thompson there about the data needed and planned the tests accordingly. This task was completed in 1981 and a detailed separate report was prepared (1). Some of the results have been published in a journal (2). Therefore, only a short review is included here, highlighting the work plan and the results.

In the last ten years the Matsushita Electric Industrial Co. in Japan has developed to commercial maturity this permanent magnet material, which is based on a manganese-aluminum intermetallic phase (3,4). In terms of their room temperature magnetic properties, the best magnets of this kind (as described in Matsushita publications) combine moderately high remanence values ($B_r \approx 6$ kG), approaching those of Alnico 8 HC, with a coercive force ($H_c \approx 2.7$ kOe) in the range of that of high-energy hard ferrites.

B. Material Available from Japan

The only commercial source for Mn-Al-C magnets at the present time is the Matsushita Company. Magnets produced in Japan are now available in the USA from the Panasonic Company, Inc. In earlier laboratory pilot production, Matsushita produced a variety of rods of circular cross section, ranging from about 4 mm to 31 mm diameter. Some of these sizes are now going into a larger-scale commercial production (including 4 mm, 6.5 mm and 31 mm rods). Engineering samples of sufficient quantity for the evaluation in motors were not available in the U.S. until 1981, but we were given samples from several sizes of bar stock for this evaluation program by Mr. Y. Sakamoto of the Matsushita Research Center at Osaka, Japan. The commercial version of the magnet grade we tested is now called Type-B.

C. Magnetic Data Requirements and Plan of Studies

1. For the contemplated use of Mn-Al-C magnets in the rotors of traction motors, it would be desirable to have a high air-gap flux density of about 6 kG. However, if the magnet is placed directly at the gap, as in the GE axial-field, "advanced motor" design, B_{gap} is only about 3 to 4 kG if the material is used close to its maximum volumetric efficiency. The high motor currents possible during vehicle climb or in a stall/start condition, and the self-demagnetizing fields due to the air gaps, require that the magnet have a high resistance to demagnetization. The coercive force of Mn-Al-C, ~ 2700 Oe at room temperature, is relatively favorable in this respect compared to the values for Alnico grades (600-1900 Oe).

2. The flux direction in the magnet is not always or in every volume element parallel to the easy axis of magnetization (the extrusion axis in Mn-Al-C). Attempts to take this fact quantitatively into account in the design of machines require a detailed knowledge of the magnetization characteristics of the permanent magnet, not only for the easy-axis magnetization direction for which they are usually published by the manufacturer, but for three mutually perpendicular directions. We undertook it to describe the magnetic anisotropy by measuring major hysteresis loops for the extrusion axis, the radial and the circumferential ("transverse") directions of the 31 mm extruded bar. This was done at several temperatures, and at room temperature for two locations on the bar cross section.

3. The vehicle traction motor was designed to operate at winding temperatures of about 150°C. Peak temperatures of 180°C to 200°C might be tolerable from the point of view of electrical insulation and structural integrity. Although the magnets will generally be cooler, they certainly could get as hot as about 150°C unless special provisions are made for cooling them. Because of its low Curie temperature, Mn-Al-C shows fairly severe flux losses on heating. While the generally reported temperature coefficient of $B_r(H=0)$ is moderate (-0.12% per °C, average between 0 and 100°C), the intrinsic coercive force and hysteresis loop shape deteriorate much more rapidly on heating than does the zero-field remanence. As a consequence, the temperature coefficient of the useful flux density, B_d at a realistic operating point of perhaps $B_d/H_d = -2.3$ to -2.5 , is going to be much less favorable. Also, the losses above ~100°C will rise at an increasing rate. The severe loss of $M H_c$ on heating means a poor resistance to demagnetization under the combined influence of motor overheating and large currents during a prolonged steep climb, an operating condition that must be expected on occasion. The designer, who must protect the magnet against demagnetization under worst-case conditions, thus needs detailed information about the temperature dependence of the hysteresis curves and recoil loops. While low temperatures do not pose a threat to the stability of Mn-Al-C magnets, their characteristics down to the lowest expected environmental temperatures should also be known. With these requirements in mind, we measured demagnetization curves B vs. H and $(B-H)$ vs. H over the range from -50°C to +150°C.

4. The variable effective air gap during motor operation, current surges occurring for any reason, or partial disassembly of the motor cause the magnet material to "recoil" and work on a minor hysteresis loop in the second quadrant of $(B-H)$ vs. H . We have measured recoil loop fields (full recoil to $H=0$) at several different temperatures in order to allow designers to accurately assess the effects of such operating point changes.

For some samples (at room temperature only) an extended minor-loop field was plotted with the recoil lines continuing through the first quadrant to the full original forward magnetizing field. These curves will be useful in determining how to initially charge the magnets in the fully or partially assembled motor, or how to remagnetize them

after accidental demagnetization, or in similar operations. Minor loop fields were plotted only for the extrusion axis, i.e., the normal magnetization direction.

D. Experimental Procedure and Results of Magnetic Tests

1. Measuring Method:

Intrinsic hysteresis loops and demagnetization curves were measured in a closed circuit, using the quasi-steady field of an iron-core electromagnet. The peak field was ~24 kOe. The instrument was an integrating hysteresis graph which utilizes inductive B and H sensing and electronic (B-H) signal formation. (B-H) vs. H loops were traced and B,H curves constructed from them.

2. Uniformity of Properties in 31 mm Extruded Bar:

Two 6.35 mm cylinders were cored out, by electric discharge machining, from the edge and the center of a 6 mm thick disk. Full hysteresis loops were plotted for each of the two samples at room temperature. They are shown in Figure 5-1. The remanence near the edge of the disk is slightly better than at the center, while the intrinsic coercive force is the same. The higher B_r is thought to be due to better crystal orientation. It is likely that the greater shear stresses near the die wall during the extrusion process favor the formation of the desired crystal texture. This can be correlated to the results of another set of measurements on cylindrical samples of different extrusion diameter. (See Table 5-1.) The smaller the extrusion diameter, the higher are remanence and energy product. It seems that the material in the smaller bars is subjected to a higher average shear stress during extrusion and therefore better oriented.

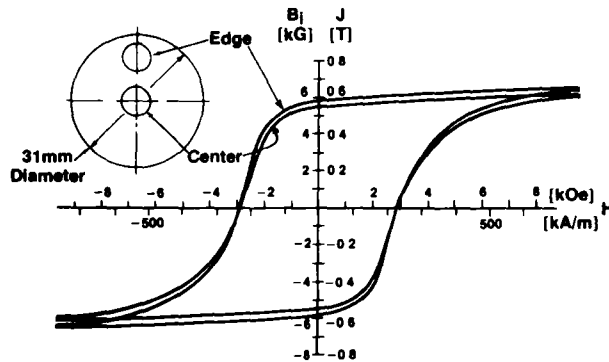

Figure 5-1: Non-Uniformity of Properties in the 31 mm Extruded Rod.

TABLE 5-1: ROOM-TEMPERATURE PROPERTIES AS A FUNCTION OF EXTRUSION DIAMETER

ROD DIAMETER [mm]	B_r [kG]	M^{H_c} [kOe]	B^{H_c} [kOe]	$(BH)_m$ [MGoe]
6.5	5.95	2.63	2.42	6.0
24	5.45	3.30	2.75	5.4
31	5.45	3.15	2.55	5.0

3. Easy and Hard Axis Magnetization Curves at Several Temperatures

Using an 8.2 mm cube cut near the edge of another 31 mm disk, measurements were performed at -50°C , 0°C , 50°C , 100°C and 150°C . For these measurements, a special temperature-compensated fixture provides a controlled temperature environment for sample, coils, and electromagnet pole piece extensions.

Major hysteresis loops were plotted for the easy axis and the two hardest axes of magnetization at all temperatures. An example of typical intrinsic loops is shown in Figure 5-2. (The radial and transverse hard-axis loops are almost identical and represented by a single trace.)

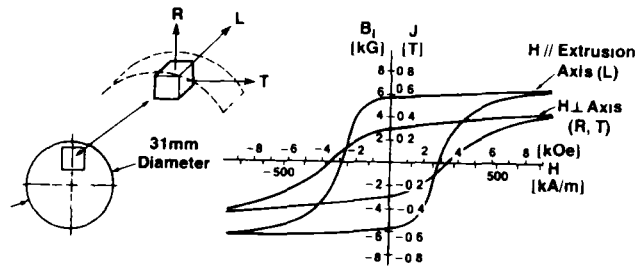

Figure 5-2: Easy Axis & Hard Axis Curves At 25°C .

A composite of easy and hard axis intrinsic demagnetization loops with temperature as the parameter is shown in Figure 5-3. All of the major intrinsic and normal easy-axis demagnetization curves at the various temperatures were replotted on a single chart to reflect the magnetic property variations with temperature. One can see from Figure 5-4 that B_r retains a respectable value of ~ 4.7 kG ($\sim 0.47\text{T}$) at $+150^{\circ}\text{C}$, but $M_H C$ drops drastically from ~ 2.8 kOe (~ 223 kA/m) at $+25^{\circ}\text{C}$ to ~ 1.5 kOe (~ 120 kA/m) at $+150^{\circ}\text{C}$.

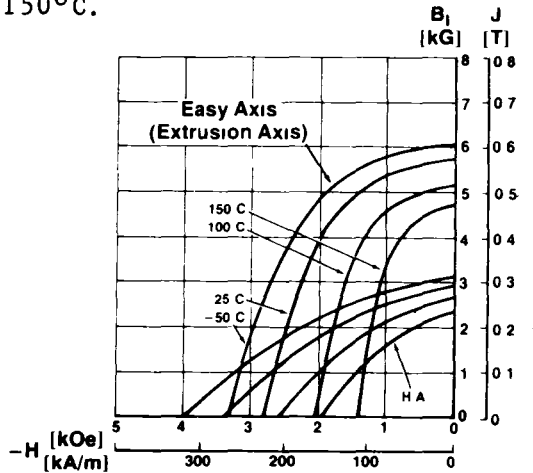

Figure 5-3: Easy and Hard Axis Curves at Selected Temperatures.

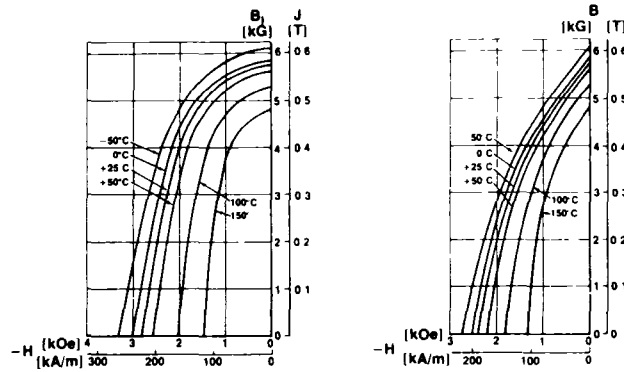

Figure 5-4: Intrinsic and Normal Demagnetization Curves.

4. Dynamic Operation of the Magnet.

Recoil loop fields were measured at all the temperatures. Figure 5-5 is an example for room temperature. In order to be able to describe numerically the recoil loops, we used the quantity μ_r , a recoil permeability that we defined as the slope of the line connecting the two tips of the minor loop for complete recoil from the optimum magnet operating point at $B/H = -2.5 \text{ G/Oe}$ ($B/\mu_0 H = -2.5$).

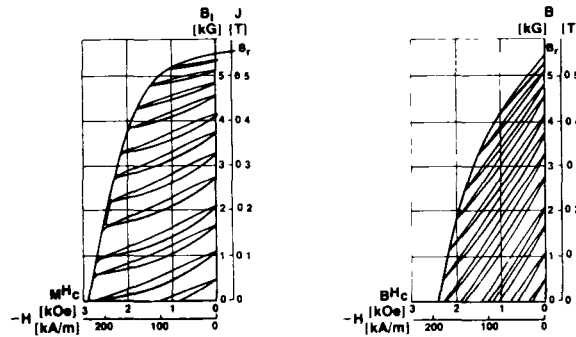

Figure 5-5: Second Quadrant Recoil Loops at 25°C

5. Summary of Temperature Variation of Magnetic Properties

The best way to summarize all of the numerical data is to plot the principal magnetic property values as a function of temperature. This was done in Figure 5-6. From such a graph, one can calculate temperature coefficients for the various properties at various temperatures or temperature spans following methods described in detail in many published articles (5).

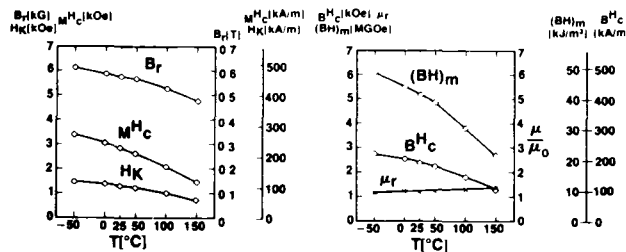

Figure 5-6: Magnetic Properties vs Temperature.

E. Mechanical Tests

1. Machining Experience

During the machining of test samples it became obvious that the extruded Mn-Al-C (Ni) alloy is not really ductile at room temperature. While it can certainly be machined with carbide tools according to Matsushita's instruction, the workpiece chipped severely during drilling on the exit side. In spark-erosion machining (EDM), too, a piece broke off the corner of one cube. The latter fracture may have started at a flaw that was present in the 31 mm disc from the extrusion process. The fracture surfaces look like those of ceramics and are indicative of brittle fracture.

2. Bending Test for Flexural Strength

Room-temperature bending tests were performed on two specimens cut from a 31 mm disc. However, only the ultimate strength was determined. The samples were too small to instrument them for elastic modulus and Poisson's ratio measurements, as was originally intended.

The flexural tests were performed on prismatic bar specimens of 3 x 3 x ~26 mm (0.13 x 0.13 x ~1 in) size, with the load applied parallel and perpendicular to the magnetization // extrusion direction. The long direction of the bar was essentially along a diameter of the 31 mm disc, i.e., a magnetically hard axis. The samples were magnetized. Four-point flexure testing was used in preference to a uniaxial tension test.

From the machining experience described above we had reasons to suspect that the material is indeed relatively brittle. The fracture mode of the flexure test bars confirmed this. The broken surfaces look like those of the machining fractures, and there is no evidence of plastic deformation before failure of the bars.

TABLE 5-2: RESULTS OF THE FLEXURE TESTS:

Specimen Type	Dimensions		Load [kgf]	Ultimate Strength		
	b[mm]	d[mm]		[MPa]	[kgf/mm ²]	[kpsi]
F // M	3.23	3.24	27.3	150.8	14.8	21.9
F ⊥ M	3.34	3.21	31.0	171.0	16.8	24.8

3. Compressive Strength Test:

A cube cut from the 31 mm diameter stock was subjected to a compressive strength test. An Instron Universal Tester with self-alignment fixture and load pacer was used in this compressive strength test. The sample was loaded in the compression fixture with the force

parallel to the extrusion direction // magnetic easy axis // thickness of the cylindrical disc. A stress-strain curve was recorded. (See Ref. 1) Numerical values for Young's modulus of elasticity and for ultimate strength were derived from the curve. T-type strain gauges were bonded on the side of the cube thus measuring strain in both the longitudinal and transverse directions for given static loads. A transverse strain vs. longitudinal strain curve was plotted from which Poisson's Ratio was calculated.

TABLE 5-3: RESULTS OF COMPRESSIVE STRENGTH TEST ON CUBE M-1647

DIMENSIONS	b = 8.11 mm = 0.3193 in
	d = 8.01 mm = 0.3153 in
COMPRESSION FAILURE LOAD	= 8550 kgf = 18,800 lbs
ULTIMATE COMPRESSIVE STRENGTH	= 1290 MPa = 131 kgf/mm ² = 186.7 kpsi
YOUNG'S MODULUS, E	= 180,000 MPa = 18,300 kgf/mm ² = 26,000 kpsi
POISSON'S RATIO, ν	= 0.25

F. Conclusion and Summary of Results.

An experimental characterization of selected magnetic and some mechanical properties of the new permanent magnet material, Mn-Al-C, was undertaken. The samples were provided by the only commercial producer, the Japanese Matsushita Electric Industrial Co., Ltd. Pieces of extruded rods of three different diameters (6.5 mm, 24 mm and 31 mm) were tested.

The magnetic results may be highlighted as follows.

- (1) Matsushita reported conservative numbers for the magnetic properties. We measured slightly higher values for remanence, coercivity and energy product. This is unusual. We normally find the claims of vendors exaggerated and measure lower properties than reported by the producers.

- (2) The B_r and $(BH)_{max}$ for the 31 mm rod are poorer than those of the 24 mm or 6.5 mm rod stock. It appears that the smaller the diameter of the extruded bar, the better is the grain orientation achieved, and therefore the remanence, loop squareness and energy product are better. The remanence and energy values for the 24 mm rod stock lie between those of the 6.5 mm rod and those of the 31 mm rod, but closer to the latter.
- (3) There is a radial gradient of the properties, at least in the 31 mm rod. B_r and $(BH)_{max}$ near the rim are about 7% and 18% higher than the respective quantities at the center of the rod. This seems again to be due to better crystal orientation. It is likely that the greater shear stresses near the die wall during the extrusion process favor the formation of the desired crystal texture there. Not enough of the 24 mm material was available to make a similar homogeneity check.
- (4) The hardest axes of magnetization perpendicular to the extrusion direction - in the radial and transverse directions - are practically identical in their magnetic properties.
- (5) As a consequence of the low Curie temperature of Mn-Al-C ($T_c = 275 - 300^\circ\text{C}$), all of the magnetic properties are strongly temperature dependent. They deteriorate very rapidly as the samples are heated to $\sim 150^\circ\text{C}$. Although B_r only drops from 5.78 kG at 25°C to 4.78 kG at 150°C , the quantities M_H and $(BH)_{max}$ fall off much faster. The intrinsic coercive force goes from 2.85 kOe down to 1.46 kOe, and the energy product from 5.2 MGOe to only 2.7 MGOe when the temperature rises from 25°C to 150°C .
- (6) Detailed information was obtained on the recoil behavior of Mn-Al-C at various temperatures between -50° and $+150^\circ\text{C}$. The second-quadrant recoil loop fields reported should be a valuable aid in the proper design of motors. It was found that the intrinsic recoil loops of Mn-Al-C have an unusual sickle shape. This finding is strictly of basic-science interest.

The mechanical tests showed the following results.

- (1) The extruded Mn-Al-C (Ni) alloy is not really ductile at room temperature. While it can be machined with carbide tools according to Matsushita's instructions, the workpiece easily chips and one has to be very careful. In spark erosion machining (EDM), too, a piece broke off. The latter fracture may have started at a flaw that was present in the 31 mm disc from the extrusion process. The fracture surfaces look like those of ceramics and are indicative of brittle fracture.

From the machining experience described above we concluded that the material is indeed relatively brittle. The fracture mode of flexure test bars confirmed this. The broken surfaces again look like those of the machining fractures, and there is no evidence of plastic deformation before failure of the bars.

- (2) The ultimate strength measure during the flexure tests was 150.8 MPa when the force was parallel to the direction of magnetization, and 171.0 MPa when perpendicular.
- (3) In a compression test of a cubic sample, the ultimate compressive strength was 1290 MPa. Young's modulus is 180,000 MPa and Poisson's ratio is 0.25.

In conclusion, it must be said that the Mn-Al-C does not look very attractive for use in automotive propulsion motors because of the severe loss of coercivity on heating above 100°C. At least, the engineers will have to carefully design for the worst-case current load at the highest magnet temperature expected in use. The limited sizes and shapes in which the material is presently available are also a disadvantage. However, there is no question that Mn-Al-C has the potential of replacing Alnico 5 in many other applications where the magnet stays essentially at room temperature and/or the operating point is essentially fixed.

G. REFERENCES - CHAPTER V.

1. Z.Abdelnour, H.Mildrum and K.Strnat, "Testing of the Permanent Magnet Material Mn-Al-C for Potential Use in Propulsion Motors for Electric Vehicles." Report DOE/NASA/0189-81/1 (NASA CR-165291), NASA Lewis Research Center, March 1981.
2. Z.Abdelnour, H.Mildrum and K.Strnat, "Permanent Magnet Properties of Mn-Al-C Between -50°C and $+150^{\circ}\text{C}$." IEEE Trans. Magnetics, MAG-17 (1981) p. 2651.
3. T.Ohtani et al., "Magnetic Properties of Mn-Al-C Permanent Magnet Alloys." IEEE Trans. Magnetics, MAG-13, (1977), p. 1328.
4. T.Kubo et al., "Anisotropic Mn-Al-C Alloy Permanent Magnets can be Machined and Mass Produced." JEE, No. 127 (July 1977), p. 50. (DEMPA Publications, Inc., Tokyo, Japan).
5. Z.Abdelnour, H.Mildrum and K.Strnat, "Properties of Various Sintered Rare Earth-Cobalt Permanent Magnets Between -60° and $+200^{\circ}\text{C}$." IEEE Trans. Magnetics, MAG-16, (1980), p. 994.

VI. FEASIBLE MAGNET DEVELOPMENTS

A. Objective, Chapter Organization

The stated purpose of Task VI was to identify potential new permanent magnets or suggest possible improvements to existing permanent magnets. To be considered were materials which show a high potential for use in propulsion motors for electric or hybrid vehicles (EHV).

This chapter is an attempt to assess relevant findings under the other tasks of this program. The objectives were to define feasible development possibilities in the permanent magnet field, to determine the nature and extent of modifications that might be made to magnets to effect useful improvements, and the impact such improved magnets could have on propulsion motors.

An analysis was performed that included presently available and proposed new permanent-magnet materials. We tried to determine which of them show a potential for substantial improvement in motor performance, or which could reduce certain existing limitations imposed on motor design by the permanent magnet material. This resulted in specific recommendations for development work on new permanent magnets or for improvements on existing magnet types. The recommendations take into account not only technological and presumed economic feasibility, but also the investigator's knowledge of current development work sponsored by industry or U.S. Government agencies. Unnecessary duplication of effort should be avoided and any parallel efforts should be coordinated.

This report on Task VI is organized in the following manner: First we review the present state of development - in laboratory and commercial production - of those magnet materials that are definitely or potentially suitable for motor use. Next, permanent magnet developments which are judged feasible and promise to have substantial impact on the technology of EHV propulsion motors are summarized. Current efforts to achieve such a development as far as they are known to the investigator are considered in this section. Finally, some specific materials development and manufacturing technology projects are suggested which - in the author's opinion - would have particular payoff for EHV propulsion, and which do not seem to be pursued with adequate effort and funds anywhere in the USA. The criterion for "adequate effort" is whether it could make a promising material commercially available in a 2 to 5-year time frame.

B. State-of-the-Art Summary for the Different High-Grade Magnet Materials Considered for Possible Use in EHV Propulsion Motors

1. COMMERCIALY AVAILABLE MAGNET MATERIALS

We shall first consider the commercially available material types which were included in the data collection effort under Task II. These are the magnet types which NASA motor contractors have used in their designs, and others which have sufficiently attractive properties so that they could be considered for propulsion motor use, possibly after some improvements have been made. Subsequently we shall discuss experimental new materials that are now in the early stages of laboratory development. Finally, we

shall speculate on possibilities to develop completely new magnets which could have an impact on propulsion motors in the long run, perhaps after a period of 5-10 years of development work. The selection here is based on a combination of physical properties, and on economic factors as far as they can be assessed at the present time.

(a) ALNICO MAGNETS.

Significance for EHV: NASA/DOE program contractors have used or considered using in their designs only the higher coercive force grades, Alnico 8, 8 HC and 8 HE, and the maximum energy version, Alnico 9. Alnico 5-7 is a more economical and common Alnico variety, however, it is much less well suited for the electric propulsion motors because of its low coercive force.

State of Development. The invention of the precursors of today's Alnico alloys in the early 1930's was followed by a 30-year period of innovation and steady improvements. A plateau with regard to the useful magnetic properties was reached in the R&D laboratories about 20 years ago. The last gains were made by increasing coercivity to nearly 2000 Oe and developing parallel grain orientation in these high- H_c alloys. The resulting commercial grades - Alnico 8 and 9 - were introduced into commercial production by a limited number of manufacturers in the 1960's. The manufacturing technology for all Alnico grades is now very well developed. However, the production methods for Alnico 8, and even more so those for Alnico 9 which involve sophisticated measures to promote directional solidification from the melt, are quite expensive.

Future Prospects. In the period from 1950 through the mid-1970's the Alnicos in general were by far the most important commercial permanent magnets. In the last decade, however, the hardmagnetic ferrites replaced them in this role, first in Europe and more recently also in the USA and in Japan.

The highest-coercivity/high-energy Alnico grades most useful for propulsion motors contain 35-40% by weight of cobalt. The high Co content makes Alnico magnets in general, and these 8 and 9 grades in particular, economically highly vulnerable to cobalt supply difficulties and the resulting strong cobalt price fluctuations. During the recent cobalt crisis that peaked in the years 1978 through 1980, many former large-quantity users of Alnico switched to ferrites wherever the lower flux density and poor high and low temperature performance of the latter are acceptable. (As they are, e.g., in loudspeakers.) In some other applications, where highest performance and compact device design are more important than magnet cost, the switch was to rare earth-cobalt magnets. The cobalt crisis also accelerated the commercial introduction of the Fe-Cr-Co family of magnets. Fe-Cr-Co magnets have properties so similar to Alnico 5 that they can be directly substituted in existing circuit designs. (See below). It may be reasonably expected that this new magnet type will slowly replace at least the medium Alnico grades in most applications where ferrites cannot be used.

The applicability of Alnico (and Fe-Cr-Co) magnets to EHV propulsion motors is limited by their low to moderate coercive-force values. (<1 kOe for Alnico 5, <2 kOe for Alnico 8.) While it is theoretically still not

well understood why the coercivity should be so limited, the absence of any substantial improvement of H_c during the last 20 years - in spite of some continuing research efforts - suggests that further gains are unlikely.

Work to be done in general. There are interesting research problems still to be resolved. However, no feasible development project is foreseen that would promise significant property gains or cost reductions.

Recommendations for NASA effort: Neither a materials nor a manufacturing method development effort can be recommended. Motor designers should not expect new Alnico varieties with higher energy or coercivity to become available. On the contrary, Alnico 9 production has been abandoned by several manufacturers as economically unjustifiable. One must generally expect that Alnico production will continue to decline in the coming years.

(b) IRON-CHROMIUM-COBALT MAGNETS

Significance for BEV: Different members of the relatively new Fe-Cr-Co-based family of magnets now offer properties equal to those of Alnico 5 and the lower Alnico grades. Fe-Cr-Co alloys may eventually allow duplication in commercial production of Alnico 3 magnets as well. The required cobalt content is only 35 to 50 percent of that of the magnetically equivalent Alnicos. As long as most of the cobalt metal used in the USA has to be imported from South-Central Africa and the supply and price situation remains precarious, this must be considered a very important economic advantage of Fe-Cr-Co over Alnico. Another potential advantage of Fe-Cr-Co, that could lead to lower device production costs, lies in the fact that these alloys can be cold-formed and machined to some degree in an intermediate state of heat treatment. By contrast, the finishing of cast Alnico is strictly limited to grinding, or else to slow and costly techniques such as spark erosion.

State of Development: The best Fe-Cr-Co grades now commercially offered are comparable with Alnico 5 with regard to their magnetic properties. The properties of cast Alnico 5-7 and of sintered Alnico 8 have been nearly equalled in laboratory samples, but the best coercive force is still lower than that of Alnico 8, namely, only about 1.4 kOe. The Fe-Cr-Co production technology is similar to that of Alnico, but at the present time of early commercialization, processing appears to be still more expensive than that of equivalent Alnico grades, thus reducing the raw material price advantage. The need for rapid cooling after the solutionizing heat treatment has so far limited the maximum stock sizes to 10 mm diameter, a definite drawback for BEV motor use.

Future prospects. The presently advertised best remanent values of about 12 kG are still significantly short of the theoretical limit of about 14 kG. As with the Alnicos, it is difficult to say where the ultimate upper limit for the intrinsic coercive force may lie, but it is reasonable to hope for a significant increase over the highest value of about 1.4 kOe reached so far. Maximum energy products of 7 to 8 MGOe in small-piece production in the next few years are a reasonable expectation.

Work to be done in general: The alternative process of deformation aging, presently under active development by Bell Lab scientists (1),

could lead to a cheaper manufacturing process (2). This line of development should certainly be pursued. Different efforts to improve the metallurgical grain alignment and therefore B_r and $(BH)_{max}$, and to cultivate higher coercive force, are in progress in several industrial laboratories around the world. They are likely to bring significant progress in understanding the process parameters which control properties, and they will undoubtedly result in improved and cheaper commercial Fe-Cr-Co magnets in the next few years.

Recommendations for NASA: It does not appear necessary for NASA/DOE (or any other U.S. Government agency) to support R&D work on Fe-Cr-Co magnets at this time. Several of the major U.S. magnet-producing firms are now quite actively developing a domestic manufacturing technology, primarily in competition with some Japanese manufacturers who took the lead several years ago. Their motivation is, of course, the threat that Fe-Cr-Co will increasingly replace the higher quality Alnico grades, and that the Alnico production and sales will continue to decline. As a direct replacement in existing device or machine production lines, Fe-Cr-Co is likely to capture a significant portion of the present Alnico market.

(c) MANGANESE-ALUMINIUM-CARBON MAGNETS

Significance for EMV: This material has room temperature magnetization curves which made it appear quite attractive for use in propulsion motors. It combines a remanence comparable to that of Alnico 8 with an intrinsic coercive force that is up to 50 percent higher than that of Alnico 8 HC. The very low Curie temperature, about 300°C, and the high negative temperature coefficient of coercivity that is a consequence of the low T_c , are severe disadvantages of this alloy in the propulsion motor application.

The material has the very important economic advantage of containing no cobalt at all. The principal alloying constituents, Mn and Al, are very abundant and use low-cost raw materials. It must be noted, though, that practically all the manganese and aluminum (or its parent mineral, bauxite) used in the United States are presently imported. The electrolytic reduction processes used in producing the two metals are very energy intensive, making the formerly quite inexpensive materials sensitive to upward price pressure as energy costs increase. This will partly offset the advantage of cheap and plentiful ores. The finished magnet material Mn-Al-C (-Ni), like the Fe-Cr-Co, is workable to a limited extent with conventional hard-faced cutting tools. This offers a potential manufacturing cost advantage over Alnico in electric motor production.

State of Development: At the present time the material is commercially available from only one source, the Matsushita Corporation of Japan. (Traded under the brand name ALMAX by Panasonic in the USA.) The anisotropic magnets - those which looked promising for propulsion motors - are produced by a sequence of steps that include an extrusion of bars at moderately high temperatures. The need for this extrusion with a large reduction ratio, which produces an orientation of the metallurgical grains along the extrusion axis, severely limits the available shapes and sizes. The rods - generally cylindrical in cross section - are produced with diameters between about 6 and 30 millimeters. Magnets of more complex cross sections have to be machined from the cylindrical rods, and larger

magnets have to be composites of smaller pieces. The cost per unit weight of the extruded bar in its final condition is at present comparable to that of Alnico 5, that is, the use of cheap raw materials has not yet resulted in the initially expected low cost per unit of energy. Since the extrusion equipment presents a very large investment and the process seems inherently expensive, it is quite possible that the prospect of a very inexpensive new magnet may not materialize.

The most severe shortcoming of this material, its low Curie point, is unfortunately an inherent disadvantage associated with the Mn-Al-phase on which the magnets are based. The minor alloying additions made so far for practical reasons - carbon to stabilize the desired metallurgical phase, and nickel to facilitate the extrusion - have only lowered T_c further. There appears to be no prospect for significantly increasing T_c above 300°C. This magnet type relies basically on one single, fairly narrowly defined intermetallic phase of Mn and Al. Mn-Al cannot give rise to a whole family of widely variable compositions, as do Alnico, the Fe-Cr-Co, and the rare-earth magnet alloys. There is very little potential for modifying the chemical composition in a way that promises higher T_c . The development prospects in this important respect are, therefore, quite limited.

Work to be done in general. The most important need is for a cheaper magnet production process that is capable of developing a grain orientation equal to or better than that obtained in the warm extrusion. Alternative methods of plastic deformation may have a chance of success and should be explored. Note, however, that in an earlier phase of development work on Mn-Al about 20 years ago (without C and Ni additions at the time), swaging had been extensively tried. This had only moderate success and was abandoned as an unpromising method for commercial production. Powder metallurgy (pulverizing, pressing, sintering) is another basically different alternative. Matsushita researchers have apparently tried it, with some success, but discarded it as uneconomical for mass production (3). However, there may still be a chance for significant improvement if determined attempts to develop a powder metallurgical alternative were to be made. Of course, the proven warm extrusion method itself should be developed further.

Recommendations for NASA. Based partly on the detailed characterization of Japanese Mn-Al-C samples undertaken as part of the present program (see report on Task V), and also on experiences with the material in a prototype motor built at GE (4), it now appears that Mn-Al-C is much less attractive for use in EHV propulsion motors than was initially assumed. The principal difficulty is with the strong loss of intrinsic coercive force on heating near and above 100°C. In view of this and the apparent absence of hope that the Curie point can be increased, we cannot recommend that NASA/DOE invest in either a material or a process development effort on Mn-Al-C at this time.

The material as it is now produced by Matsushita does have potential applications in devices that operate essentially at room temperature. Since in these, at present, Alnico 5 is used, the magnet industry in the USA and in Europe is now fairly active in trying to duplicate the earlier Japanese accomplishment, and perhaps to improve the economics of manufacturing. The prospect here is for a completely cobalt-free

replacement for the most-used magnet material, so the economic stakes are high. It is almost certain that the industry will, of itself, make a sufficient effort to develop cheaper production processes. If this is successful, a substantial production capacity will undoubtedly be developed rather rapidly, without the need for government subsidies.

(d) HARD-MAGNETIC FERRITES

Significance for EHV: The features that make the hexagonal Ba and Sr oxide ferrites the material of choice in a large and growing number of magnet applications are the very low material costs and the virtually unlimited supply of raw materials. Finished magnet prices depend very much on the quantity in which a particular ferrite grade and magnet shape is produced, and on the needed sophistication of the manufacturing process. Isotropic or poorly oriented sintered ferrites, and polymer-bonded magnets made by injection molding or sheet rolling (which induces a relatively poor, mechanically induced orientation) are indeed very cheap magnets. However, these low grades are of no interest for propulsion motor use. For the EHV motors, only the well oriented, high-coercive force sintered grades classified as Ceramic 5, 7 and 8, or the very recently introduced "superferrites" with even higher remanence and energy product values, can be considered. For these, the processing costs are 2 to 5 times the raw material costs. But the finished magnets are still far less expensive than any of the metallic permanent magnets. In application areas where the magnet constitutes a major portion of the device cost and where a large device volume is not objectionable, ferrites are by far the most economic choice. This fact has led to phenomenal growth in their production and use during the last decade.

However, the best remanence values of ferrites are only between 1/3 and 2/3 of the B_r of the metal magnets discussed here, and this restricts their energy product to between 10 and 40 percent of the latter. This means that (in static-flux devices) between 2-1/2 and 10 times the magnet volume has to be used compared to, say, Mn-Al-C on the one end and $\text{Sm}_2(\text{Co,Fe})_{17}$ on the other extreme of the range of metal magnets. For propulsion motors, additional considerations come into play, as was discussed in the previous task summaries. A ferrite rotor will always have a significantly larger total size for the same power rating than a rotor using Mn-Al-C or an Alnico-8 magnet. A great disadvantage of ferrites is again the strong temperature dependence of their properties. The Curie point is moderately low, about $T_c = 450^\circ\text{C}$, and as a consequence, the B_r decreases fairly rapidly on heating. (High negative temperature coefficient.) More detrimental, however, for propulsion motor use is the fact that the intrinsic coercive force of all ferrites decreases quickly on cooling below room temperature (RT). Although the RT magnetization coercive force ("intrinsic" H_c) of a high-remanence ferrite may be between $H_c = 2,500$ and $3,500$ Oe, one has to design the rotor for the significantly lower value that prevails at the lowest expected use temperature, say at -50°C . This, too, increases the quantity of magnet material needed and thus the overall motor volume and weight, often so significantly that the feasibility of using ferrite magnets in EHV motors is questionable. Some designers have argued that the use of a much more expensive PM material that combines high energy density with high H_c and good temperature behavior can sometimes result in an overall drive system that is cheaper to produce than one using a ferrite

motor. Or at least it may have sufficiently higher performance and lower operating costs, so that the somewhat higher initial system cost due to the added expense of the better magnets is justifiable.

State of Development. It appears that the large amount of laboratory work reported before about 1965 had explored most of the compositional variations possible with the hexagonal ferrites. By about 1970, laboratory methods had been devised for obtaining nearly perfect grain orientation in sintered ferrites, and the preparation parameters had been optimized for desirable combinations of B_r and H_c for various application categories. During the last decade, many of these advances have been introduced into commercial production practice. It appears that by now both, the science of hard ferrites and industrial production technology, have achieved a mature state.

Future Prospects. We may expect that commercial magnets approaching the best laboratory properties of 5 to 10 years ago will become increasingly available in mass production. This commercialization process is farther along in Japanese and European magnet plants than it is in this country. However, the U.S. ferrite industry is now in a state of renewal, with some of the older plants being closed and large new, highly automated mass production facilities being built elsewhere (5). The capability for producing rather large single-piece magnets of several cubic inches volume is also being developed. We can expect best commercial magnets which combine a B_r 4,400 Gauss with an H_c 2,500 Oe on one end of the range of room-temperature properties, and B_r 4,100 G with H_c 3,500 Oe on the other. At an additional sacrifice of remanence, still higher coercive forces (in excess of 4,000 Oe) are now also possible in production.

Work to be done in general: A recent publication indicates that the poor temperature coefficient of remanence can be improved by arsenic substitution in barium ferrite (6). This is an area where additional laboratory research should be done. Otherwise, the trend - and perhaps the primary need - seems to be for changes in the manufacturing process aimed at lowering the production costs without unduly compromising magnetic properties. One interesting project of recent years concerned the preparation of single-piece sintered, arc-shaped magnets in which the coercive force is made to vary along the arc by means of controlled composition variations (7). Such magnets are said to give better performance in starter motors. If an EHV propulsion motor should be designed using arc-shaped magnets facing the air gap, similar magnets with graduated properties might be beneficial. Either a gradual composition variation, or a step-like change achieved by cementing together sections of different materials, could be considered for large motors.

Recommendations for NASA: The only prospect for a significant improvement of ferrite magnet properties of potential importance for EHV motors is the above mentioned lowering of the temperature variation by As additions. It seems questionable, however, that the large-scale handling of highly toxic arsenic compounds in the otherwise rather benign environment of a large ferrite production plant would be acceptable. If it were done, the added expense of the environmental controls might well make the modified ferrite quite expensive.

Otherwise, all desirable material or process modifications now appear

to be in the transition from laboratory to production plant. The magnet industry has ample economic incentive to set up for the production of the best magnets at the lowest possible prices. Encouragement from government agencies should not be needed. Especially, too, the use of fairly large sintered ferrite magnets in electric motors other than propulsion motors is now becoming so important, and is growing so rapidly, that the needed production capacity should be available if and when electric vehicles should require such magnets.

One worthwhile special avenue to explore would be the use of the above-mentioned composite magnets. These could either combine two different ferrite types, or a ferrite plus another, metallic, magnet material. At this time, it would seem to be up to motor design experts to explore whether such magnets would be beneficial for vehicle propulsion motors. If the decision is affirmative, the special manufacturing technology for such composites would have to be developed.

(e) RARE EARTH-COBALT MAGNETS

Significance for EHV: These relatively new magnets (the first prototype went into small-scale production only twelve years ago) have properties that make them almost ideally suited for use in electric motors and generators (2). They have very high energy products (8 to >30 MCOe), which permits their convenient use in the rotor of a machine and, more generally, allows a very compact machine design. Their remanence values (6 to >11 kOe) cover the same range as the Alnico, Fe-Cr-Co or Mn-Al magnets, they are high enough that the magnets can be located directly at the air gap. In addition, the rare-earth permanent magnets (REPM) have by far the highest intrinsic coercive force values of any practical permanent magnet material, namely, $H_c = 5$ to 40 kOe. This means that most REPM (with the exception of a few high- B_r /relatively low- H_c subtypes) are essentially impossible to demagnetize even under the most adverse operating conditions encountered in a motor. No special design consideration needs to be given to self-demagnetization during partial disassembly of the machine or to demagnetization by armature reaction - both of which are serious problems with Alnico and Fe-Cr-Co. With regard to temperature effects, there are no problems encountered in cooling below room temperature - in contrast to the ferrites. The upper limit for long-term stable operation lies between about 125°C and at least 300°C for the different varieties of REPM. With Curie temperatures between 500 and 900°C , the reversible temperature coefficient and the irreversible flux loss on heating to the top use temperature are generally quite small. (With the notable exception of one type of 2-17 magnet and some CeCo_5 -based variants, which should be avoided for the motors.)

On the negative side, the great brittleness of the sintered REPM causes handling problems in device manufacture, and their hardness necessitates grinding or EDM machining as the finishing operations, as with Alnico. Large, single pieces of sintered REPM, and also the thin arc segments desirable in some designs, are difficult to produce. The magnets contain a large proportion of cobalt metal (50 to 66 weight %) and this makes them vulnerable to the cobalt supply difficulties and price increases of the kind recently experienced, again a problem they share with the Alnico magnets. However, the REPM take very much better advantage of the cobalt contained in the alloy than do either Alnico or Fe-Cr-Co, especially

in dynamic applications such as in electrical machinery, so that the total cobalt metal needed for an REPM machine of comparable rating can be less. A significantly smaller magnet volume is needed when REPM are used. This results in savings of structural materials elsewhere in the motor, and the manufacturing costs are lower, with these secondary savings often offsetting the higher cost of the permanent magnet itself.

Several of the NASA/DOE motor contractors have designed and built successful propulsion motors using sintered SmCo_5 magnets. They apparently consider the rare-earth magnets the ideal PM to use and have concluded that the REPM could be economical in this application - even at the present rather high prices for SmCo_5 - if only certain practical problems of magnet manufacture and handling can be overcome. Before a truly large-scale production for electric automobiles begins there should also be assurance that the recent cobalt supply crisis is not likely to be repeated. This is primarily a problem of world politics and will in part depend on the Co stock-piling activities of the U.S. government.

State of Development. The "rare earth-cobalt" magnets (REPM) are potentially a very large family of permanent magnets, differentiated by chemical composition, the basic mechanism of magnetic hardening, and by the production technology employed. The REPM offer a very wide range of magnetic, mechanical and other physical properties. This great variability in properties, composition, alloy cost and raw material availability has no precedent in any other family of permanent magnets. It far surpasses even the possibilities of varying the alnicos and the ferrites. This is due to several circumstances: There are fifteen rare-earth elements, many of which can be used singly or in combination as the RE partner in the REPM alloys. Cobalt is not the only transition metal usable; one has learned to partially substitute the cobalt by other magnetic elements, namely, iron, manganese, chromium, or nickel. Copper and minor amounts of still other transition metals are added for specific effects. The alloys can be made either by melting together the elements or by a direct reduction method from oxide powders. The magnets can be produced from the alloys by powder metallurgy involving sintering, at least in principle also by casting, and one can make matrix magnets with either polymer or metal binders. It is possible to consciously employ either domain nucleation or domain-wall pinning by precipitates as the principal magnetic hardening mechanism. This relates to details of the alloy composition, determines the level of coercive force obtainable, and it has important practical implications for the ease of charging the magnets.

For several years (and in the USA for all practical purposes until now) sintered SmCo_5 was the only REPM material commercially produced in significant quantity. Most present device or machine designs using REPM are based on it. Sintered SrCo_5 offers production values of the energy product between 16 and 22 MGOe, an extremely high coercive force (15 to 40 kOe), and it contains about 66% cobalt and 34% samarium by weight.

Three or four years ago, several Japanese companies introduced sintered products that are based on the "2-17" intermetallic phase (of actual composition in the range $\text{Sm}(\text{Co}, \text{Fe})_{7-8}$). Energy products up to 33 MGOe were reported in the best laboratory samples, about 28 MGOe, at a coercive force of $M_H^C = 5 - 7$ kOe, seems to be consistently achievable in production. These so-called "2-17 magnets" are better and more economical

for the propulsion motor application than SmCo_5 for several reasons. However, their intrinsic coercive force was initially judged somewhat too low for propulsion motors. Very recently, the TDK Corp. of Japan introduced an advanced product of this kind which has about twice the coercive force, 11-12 kOe, and an advertised energy product of 26 MGOe. These properties make it appear as the ideal magnet for motor use. In fact, we can expect that alloys of this kind will replace the sintered SmCo_5 in nearly all its present or potential device applications. However, the needed simultaneous control of several critical process parameters, a long-term heat-treating cycle, and the lack of competition have kept this material, so far, relatively expensive. Its broad-based availability at competitive prices in the USA will require a substantial investment in domestic production facilities and is probably still 3 - 5 years in the future.

The rare-earth element preferentially used in the REPM, samarium, is in relatively limited supply, and it is therefore significantly more expensive than the more abundant elements cerium, lanthanum, praseodymium, neodymium and yttrium. Recognizing this, several industrial laboratories have developed magnets which used little or no Sm, but instead Ce or even Ce-rich mischmetal, or in which at least a significant portion of the Sm is replaced by the elements La, Ce, Pr and Nd or Y. This has so far been done mostly for the alloy type RECo_5 , although similar substitutions are also possible in the "2-17" alloys. Relatively little development work has been done on the latter. It appeared several years ago that the REPMs would soon find large-scale applications in the conventional automobile. For this large-quantity use it would have been absolutely essential to get away from the dependence on samarium. However, the cobalt supply crisis and the quintupling of the cobalt price in less than two years changed the economic realities, at least temporarily. The automobile manufacturers abandoned or postponed most of their plans for using REPMs, and for the limited quantities presently used in non-automotive applications, the Sm supply has so far been adequate. Sm is the preferred rare earth because it takes better advantage than the other RE of the expensive cobalt. Several magnet producers who had advertised Ce- or mischmetal-based 1-5 magnets have withdrawn them from commercial production. Such products that are still available have not found a large market to date.

Matrix magnets based on SmCo_5 with various polymer binders have been commercially available for a number of years. In this type of magnet, one dilutes the magnetic material with a non-magnetic binder. This degrades the magnetic properties. But one gains some important advantages regarding production costs, the ease of handling the magnets in assembly operations, and a degree of machinability. Matrix magnets also offer an easy possibility for producing large, or thin, or fairly complex shapes in a single piece and without excessive machining or material waste, and the production yield can be dramatically improved.

Such matrix magnets, if they use a fine-grained SmCo_5 powder as the magnetic constituent, have room-temperature energy products of 5-12 MGOe. Most of them still qualify as high energy magnets, superior to most other magnet types except the sintered REPM. However, bonded SmCo_5 magnets have the severe disadvantage of aging rapidly when exposed to elevated temperatures (9). Their manufacturers specify highest permissible use temperatures between 60 and 100°C, but even at such relatively low

temperatures, the loss of coercivity and remanence as a function of exposure time is intolerably fast and severe. Recently announced epoxy-bonded magnets using a "2-17" samarium alloy as the magnetic constituent have considerably better initial room-temperature properties, with $(BH)_{\max} = 12-18$ MGOe covering the range of energies that sintered $MMCo_5$ can provide (10). They also exhibit much better long-term stability at $100^\circ C$ (11). According to a representative of the manufacturer, the Suwa Seikosha Company in Japan, the economic production for the best magnets is at this time restricted to small pieces of less than 6 grams (12).

Future Prospects: There is still much room for further development of the REPM. The above mentioned possibility of using different rare earths, or mixtures thereof, allows one to tailor-make alloys to the requirements of different applications (13). The addition of praseodymium and neodymium can increase the energy product and remanence of Sm-Co magnets and broaden the raw material base somewhat (14). Lanthanum, Cerium, the inexpensive mixtures known as mischmetal (MM), (15), and to some extent yttrium, can be used to lower the cost and broaden the availability of the raw materials very significantly. The incorporation of the so-called heavy rare earths, gadolinium, dysprosium, holmium and erbium, can be used to achieve internal temperature compensation. (However, the heavy rare earths are indeed rare and expensive) (16).

In the RCO_5 subgroup of REPM, many of these substitution possibilities have been explored successfully in the laboratory (17); some additional magnet types have been developed to near production maturity, and a few are in a small-scale production (18). This is true for Gd-substituted, temperature compensated magnets which are desirable for microwave devices (19). Cerium- or mischmetal-based RCO_5 were contemplated for use in certain automotive applications, but their low Curie point most likely precludes their use in EHV propulsion motors. Furthermore, $MMCo_5$ will only be economical as compared to the $Sm_2(Co, Fe)_{17}$ alloys if cobalt remains sufficiently cheap.

Sintered "2-17" Sm-alloy magnets will undoubtedly soon be commercially produced by many REPM manufacturers. They should quickly replace $SmCo_5$ in most applications. The use of 2-17 powders with organic and metallic binders will give matrix magnets much more attractive properties, so they should soon find rapidly increasing acceptance and use. These, too, can substitute for sintered $SmCo_5$ in many of its present applications. But they should also be a very attractive replacement for Alnico 8 which they resemble with regard to remanence while offering superior energy product and much higher coercive force.

The manufacturing technology for sintered 2-17 magnets is fairly well developed in Japan, but U.S. companies will have to make an intense effort in the next few years in this field. For polymer-bonded magnets, production techniques using extrusion methods and injection molding appear to be under development by several industrial firms (20). These will yield relatively poor magnetic properties, due to poor particle orientation and high binder content, but they will have the great advantage of low production cost. Whether semi-isotropic magnets produced this way find a true mass market will depend on the future development of the cobalt price and on the degree to which Co can be replaced by iron and other magnetic transition metals in the 2-17 alloys. Flexible magnets with a high content

of a rubber-like binder have been developed in the laboratory. They, too, could find a wide variety of applications - just as flexible ferrite magnets did - provided cobalt prices are sufficiently low and the magnet alloys become significantly cheaper. To reduce the alloy costs, through savings in processing, the direct reduction process of making alloy powders from oxides should be adapted to various types of the precipitation hardened 2-17 magnet alloys. A Chinese laboratory has recently claimed success in doing this (21). The Hitachi Magnetics Corp. has been making a 2-17 alloy powder in the USA by their R/D process for some time but not yet sintered magnets; these are produced by Hitachi in Japan (22).

Work to be done in general: In the area of 2-17 magnet alloy development, the partial or complete substitution of Sm by the more plentiful rare-earth metals Ce, Pr and Nd - or possibly by the Ce + La-rich mixture known as mischmetal - should be vigorously pursued. The maximum practical limits for replacing Co by Fe, possibly in mixture with Mn or Cr, should be explored. Magnets should be developed in which the total transition metal-to-rare earth ratio is as high as possible, close to the stoichiometric ratio 17:2 (8.5) or even higher. Again, the Japanese Suwa Seiksha Company has pointed the way to an excellent solution (23).

The possibilities of internal temperature compensation by the incorporation of heavy rare earths into 2-17 alloys should be developed for electron tubes and other special applications. A recent Chinese publication reported progress in this respect (24).

Bonded magnets using 2-17 alloys - first the Sm variety and later others based on rare-earth blends - should be placed in commercial production rapidly. They seem destined to have broad areas of utility. Their main limitation and physical integrity problems, due to softening of the matrix on heating, embrittlement and shrinkage on cooling, can be alleviated by the use of a soft-metal binder (25). The manufacturing technology for such magnets should also be developed, particularly with the EHV motor applications in mind.

Recommendations for NASA: EHV motor designs evolved by NASA contractors that now incorporate SmCo_5 sintered magnets could all use the newer, high coercive force 2-17 magnets instead, in a very similar way, but with greater material economy. The machines could become still slightly more compact if the design is optimized. On the other hand, the best of 2-17 bonded ("matrix") magnets might be directly substituted for the SmCo_5 . This would result in slightly larger motors. But the corresponding small increases in the cost of the magnet alloy, conductor and structural materials could be more than offset by economies in magnet manufacture and handling in the motor assembly operations. In the GE advanced disk-motor designed for Mn-Al-C magnets, easy-to-manufacture bonded 2-17 REPM of fairly high binder content could be used directly in the place of the Mn-Al-C (or of the Alnico 8 used in the first experimental motor).

The polymer-bonded REPM, especially fine-powder magnets based on SmCo_5 , have the above-mentioned severe temperature restrictions. If bonded magnets are to be used in propulsion motors, the much more stable metal-matrix magnets made with coarse-grained 2-17 alloys would seem the correct choice. Development work on a manufacturing technology for this latter product is therefore recommended. Metal-matrix magnets were prepared in

the laboratory several years ago. Aging tests have shown them to be quite stable up to 150°C (26). However, before the application in EHV propulsion motors became a serious prospect, the magnet industry had no incentive to develop a commercial product of the kind. This appears to be an area where NASA/DOE investment in the development of a manufacturing technology would seem highly beneficial and probably necessary to make prototype magnets for testing in the motors available soon.

More generally, for all the newer types of 2-17 REPM that have potential utility for propulsion motors, there is as yet a definite lack of many of the specific property data which the motor design engineer requires. Information on the dynamic recoil behavior over the range of use temperatures, mechanical strength, the electrical and thermal conductivities and their direction dependence, long-term/elevated temperature stability, etc., may also have to be generated under government contracts. Measurement programs should be undertaken soon if the data is to be available in time for the motor developers to make intelligent design decisions, or to optimize their machines before the start of production runs.

2. EXPERIMENTAL NEW PERMANENT MAGNET MATERIALS

(a) HEAVY RARE EARTH-IRON COMPOUNDS

State of the Art. In the last seven or eight years, another group of rare earth-transition metal intermetallic compounds, the RFe₂ family, has been intensely studied. Some of these compounds have been proposed as potentially useful new permanent magnet alloys (27). Among all rare earth-iron compounds, these have the relatively highest Curie temperatures, with a peak of about 520°C for GdFe₂. RFe₂ compounds exist only with the rare-earth elements Ce, Sm, and the so-called heavy rare earths, Gd through Lu (28). The crystal structure of all the RFe₂ compounds is cubic, not hexagonal as that of the prototype permanent-magnet compounds RCo₅ and R₂Co₁₇. Surprisingly, however, they were found to have a very high magneto-crystalline anisotropy, one of the basic magnetic properties that can qualify a substance as a potential permanent magnet material. Some of the heavy-rare-earth RFe₂ have indeed been discussed in scientific publications in terms of their "permanent magnet properties." A room temp. energy product of ~9 MGOe has been reported for a film of TbFe₂ that was first prepared in amorphous form by rapid sputtering (27) then crystallized by annealing in a magnetic field. These compounds have, however, a number of disadvantages that almost certainly disqualify them as practical permanent magnets. For one, they contain rather large weight percentages of the relatively expensive and scarce heavy rare-earth metals. The compounds with reasonably high saturation, SmFe₂, DyFe₂ and ErFe₂, have marginal Curie temperatures of 300 - 400°C. The RFe₂ are ferri-magnetic, with the Fe and the RE magnetic moments opposing each other and subtracting, rather than adding. This makes the use of the heavy rare earths doubly uneconomical. And terbium, of course, is one of the rarest and most expensive of the RE metals (29). It would not be reasonable to plan on using it in permanent magnets for a mass-technology application.

The crystalline RFe_2 compounds possess an extremely high magnetostriction. For that reason they have been under intense study, with applications in sonic and ultrasonic transducers in mind (30).

(b) Microcrystalline Rare Earth-Iron Alloys

Very recently, a variety of iron-based alloys containing substantial amounts of rare-earth elements, plus small additions of glass formers (B, P, C, Si), have been prepared in amorphous form and investigated for useful magnetic properties. It was found that several of the compositions studied developed a high coercive force during a subsequent annealing heat treatment that converts the alloys to a crystalline state with extremely fine grains. The first such case was probably the above mentioned sputtered $TbFe_2$ film (27). Since then, rapid melt quenching techniques have been successfully employed for preparing rare earth-iron alloys in the amorphous state. Light rare earths (LRE) have been used instead of - or in combination with - heavy rare earths (HRE) because they are more plentiful and cheaper than the HRE, and their magnetic moments couple ferromagnetically with those of the iron atoms. Investigators affiliated with several research laboratories have suggested that such recrystallized amorphous RE-Fe alloys could be useful permanent magnet materials.

N.C. Koon et al. (31) reported for a specific alloy, $(Fe_{.82}B_{.18})_{.9}Tb_{.05}La_{.05}$, that a coercive force of $M_H C = 8$ kOe was achieved. This alloy also has a moderately high room temperature saturation induction of about 8,000 G and thus theoretically a potential energy product of 16 MGOe. But the Curie point is very low, only $230^{\circ}C$, which foreshadows an intolerably severe temperature dependence of the PM properties. The initially reported hysteresis loop is far from the desirable "square" shape, although that can certainly be improved. However, even this alloy still has a rather high content of the very scarce element, terbium, about 15 weight %. The alloy composition is, in fact, not far removed from the composition R_2Fe_{17} . It was long ago concluded (32) that the R_2Fe_{17} intermetallic compounds in crystalline form were not suited as potential permanent magnet materials because of their low Curie temperatures. The addition of a glass-forming element and the preparation in a semi-amorphous state cannot be expected to change T_c much and may even lower it further.

Melt-quenching and similar techniques do, however, allow the preparation - in a homogeneous amorphous state - of alloys which do not exist as single-phase intermetallics in the crystalline state. When such alloys are cautiously annealed, or when the initial quenching rate is not too high, they can exist in a mixed state of an amorphous phase plus one or more crystal phases, and the latter may themselves be metastable. Any structure sensitive property, such as magnetic coercivity or permeability, may be very different in such a sample from what it would be in a fully crystallized condition of metallurgical equilibrium.

This possibility has been exploited by J. J. Croat et al. (33,34). They made metastable $R_{1-x}Fe_x$ alloys (containing some boron and silicon) with $R = Pr$ and Nd in the composition range $x = 0.4$ to 0.7 . No binary crystalline compounds of Pr or Nd with Fe seem to exist in this portion of the phase diagram which includes the 1:1 and 1:2 atomic ratios.

On melt-spun ribbons of these, coercivities up to 8.5 kOe were observed at RT, and at cryogenic temperatures (20 K) up to 60 kOe (!) were measured. For the alloy $Nd_{.4}Fe_{.6}$ hysteresis loops were measured at 22°C which are interpreted by some as promising good permanent magnet behavior. A coercivity of 7.5 kOe, remanence of 40 emu/g, and saturation of ~55 emu/g were reported. Assuming a density of about 8.5 g/cm³ (no value reported), we can estimate the saturation induction as ~8,200 G, which corresponds to a potential energy product of about 17 MGOe. Since samples made by this technique seem to be inherently isotropic, this is not a realistic upper limit. But even if only half that value could be achieved in practice, one would indeed have a useful new magnet. However, the Curie point is again only 500 K (227°C). This means that magnetization and coercive force will drop rapidly with increasing temperature, which is very detrimental behavior for propulsion motor magnets, and indeed for many other applications. (It should be remembered that even the somewhat higher Curie point of Mn-Al-C, 300°C, disqualified that material for the EHV motors.)

With these alloys, again, the use of Sm for the rare earth results in the highest coercive force (35). An $M_H C$ of 24 kOe was achieved with $Sm_{.4}Fe_{.6}$, but at a lower saturation, and the Curie point is still much too low.

G. Hadjipanayis et al. (36) have recently indicated that they have achieved $M_H C = 3-7$ kOe on melt-quenched $Fe(Tb,Pr)_2$ alloys. These alloys have significantly higher Curie points, $T_C = 440°C$ (like ferrite magnets). But they have lower saturation, and they contain again the scarce and expensive rare earth, terbium.

Very recent reports from the Sumitomo Special Metals Co. in Japan indicate that a breakthrough in making Nd-Fe-based magnets may have been achieved there (38). Magnets having 35 MGOe energy product were prepared in the laboratory and a pilot production is said to start late in 1983. Although no details are known as yet, the high $(BH)_{max}$ suggests that this magnet is crystalline, well-oriented and dense. It is not made by melt quenching (39), but apparently by sintering. To obtain the high B_r , it must be based on an Fe-rich composition, perhaps "NdFe₅" stabilized by third-element additions. More information is expected from papers scheduled for conferences in October and November, 1983 (40).

Reviewing these preliminary results, this author concludes that microcrystalline RE-Fe alloys do not look very promising as useful new permanent magnet materials. In addition to the drawbacks mentioned above, one must consider the very high RE content (about 60 weight % for $Nd_{.4}Fe_{.6}$). This partly offsets the professed economic advantages of going from Co to Fe with respect to raw material availability and cost. It could also mean greater chemical and therefore magnetic instability compared with

the RCO_5 or 2-17 alloys. The fact that the semi-amorphous state is itself thermodynamically unstable may also contribute to undesirable magnetic aging effects at elevated temperatures.

A material like Sumitomo's "Neomax" may have greater practical promise. Its utility for motors will strongly depend on temperature variation of the magnetic properties in the 100° to 200°C range. It probably has a fairly low T_c , which is likely to preclude an efficient use of the magnets in EHV propulsion motors.

(c) Crystallized Amorphous Fe-Ni-Base Alloys

Another recent line of research has shown that coercive forces of a few hundred Oersted can be achieved in rapidly quenched Fe-Ni alloys without rare earths. J. J. Becker (37) prepared alloys $(\text{Fe,Ni})_{80}\text{G}_{20}$ in the amorphous state, using for the glass former, G, various combinations of phosphorus, boron and carbon. Crystallizing these during a brief anneal formed a major phase with the structure of cementite (Fe_3C), along with a finely dispersed FCC Ni phase, and coercivities up to 430 Oe were obtained. For a cobalt- and RE-free metallic material, this is a respectable coercive force. With further improvements, such a material might be able to rival Alnico 5.

This work was obviously motivated by the general rush away from cobalt which the Co supply crisis had triggered a few years ago. Too little is published as yet to allow a detailed assessment of the practical potential of such alloys for permanent magnets. But whatever merit a Co-free magnet with less than 500 Oe coercive force may have for other applications, it would not be suitable for EHV propulsion motors because the H_c is too low in absolute terms.

(d) Recommendations for NASA

In summary it can be said that none of the experimental cobalt-free, iron-based alloys discussed in this section promises to become a particularly useful new permanent magnet material for propulsion motors. It is conceivable, however, that the application of the techniques of melt quenching and microcrystallization, when used with alloys containing substantial amounts of cobalt after all, might yield results of practical utility.

No development effort on crystalline RE-Fe or on any melt-quenched material is recommended in support of the EHV motor project. However, the continuation of the above mentioned laboratory studies of metastable alloys made by rapid solidification should be carefully monitored.

C. Summary of Developments that could Impact EHV Propulsion Motor Technology

We shall now briefly summarize the applicable statements made about each material type in Sections A and B of this Chapter. A more detailed discussion can be found in those sections, under the subheadings "Work to be done" and "Recommendations for NASA Effort." Here we shall only consider developments or improvements that appear feasible and could result in better or more economical magnets for PM electric motors.

Fe-Cr-Co magnets would become marginally useful for propulsion motors if the coercive force can be raised to more than 2 kOe, so that magnets with properties at least equivalent to Alnico 8 HC can be made. Methods for producing pieces of larger cross section would then also be needed. Methods of grain alignment and the "deformation aging" process should be improved to allow economic production of an Alnico 9 equivalent. No need for NASA sponsorship of such work is perceived.

Mn-Al-C would need a coercivity of at least 5 to 6 kOe at room temperature, combined with good loop squareness, to offset the large negative temperature coefficient and retain a sufficiently high H_c at 150°C. If this were achieved, a cheaper alternative to hot extrusion as the method of developing good grain orientation must be found. It should be suited for making pieces of larger and other-than-round cross sections. The prospect for achieving all this in a reasonable time frame does not seem good. The restoration of a normal cobalt supply situation and recent low Co price has again removed much of the impetus for a heavy effort to develop the Mn-Al technology.

For sintered ferrites, the prospect of improving the temperature coefficient by arsenic additions - or a possible alternative method for the same purpose - should be explored. Composites of high- B_r /high- H_c materials (Bosch magnets) should be developed in the types and sizes suitable for use in radial-magnet rotors for EHV motors. Possible advantages of applying this concept to combinations involving metal magnets should be explored.

In the rare earth-cobalt family, high- H_c "2-17" magnets should be modified by substituting other light RE elements (Ce, Nd, Pr) and/or yttrium for Sm to the greatest possible extent. The Fe content should be maximized and the alloy composition brought close to stoichiometric 2-17, all while maintaining an RT coercivity in excess of 12 to 15 kOe. Magnetizing methods for the high- H_c 2-17 magnets must be developed that permit in-situ charging after assembly. A combination of moderate long-pulse fields and moderately elevated temperature will probably be most effective. The use of Mg alloying additions to dramatically enhance the H_c of mischmetal-cobalt magnets should be further developed and introduced in commercial production. Bonded magnets based on high-coercivity 2-17 alloys and efficient production methods for them should be further developed, especially the temperature-stable metal matrix versions.

D. Specific R&D Projects Recommended for Possible NASA/DOE Funding

The following are some special topics selected from the above summary list. The selection is based on the perception that such innovation would particularly benefit the development of EHV propulsion motors; also, that they are either not being seriously pursued now, or the effort is not adequately funded to assure sufficiently rapid progress toward commercialization in less than five years.

1. High energy/high H_c ferrites with reduced temperature variation of properties - the suggested arsenic substitution ⁶-should be further developed in laboratory, the feasibility of its use in commercial production should be explored.

2. Composite ferrite arcs, consisting of a high-remanence segment to provide maximum gap flux and a high-coercivity segment at the trailing edge to prevent demagnetization, are now produced by the German Bosch company for new automotive starter motors. Similar ferrite composites, perhaps with continuously varying properties, and optimized for propulsion motors, should be developed in the USA. The possibilities of extending this concept to metallic, high-flux magnets should be investigated. The desirability of such magnets with several possible property combinations should be analyzed by an imaginative motor designer.

3. Bonded REPM with metal matrix. - The method of solder bonding magnetic particles should be applied to the new, high coercivity 2-17 alloys. Preparative metallurgy for optimizing these alloys for bonded-magnet use must be developed. Efficient production methods for alignment, compaction and soldering should be developed. The integration of magnet formation into subassembly production for most economic motor manufacture should be explored. Binder/flux system alternative to Sn-Pb solder should be developed for higher temperature capability and improved creep strength.

4. Magnet characterization efforts: A program should be initiated to fully characterize the newer REPM magnet types specifically for propulsion motor operation. Missing information includes dynamic recoil behavior from -50° to $+150^{\circ}\text{C}$, mechanical strength and thermal property data, effects of transverse field components on the magnetization, long-term property stability at elevated temperature, effective and cost-efficient methods of magnetizing and demagnetizing. Of particular interest are the new high-coercivity 2-17 types based on Sm, the versions with other RE metals substituted for Sm, and bonded magnets made from them.

References - Chapter VI

1. "Deformation-Induced Anisotropic Cr-Co-Fe Permanent Magnet Alloys." S. Jin, IEEE Trans. Magnetics, MAG-15 (1979) p. 1748.
2. "Deformation-Aged Cr-Co-Cu-Fe Permanent Magnet Alloys." S. Jin et al, IEEE Trans. Magnetics, MAG-16 (1980) p. 1050.
3. Oral communication, Y. Sakamoto, May 1980.
4. Oral communication, G.B. Kliman, 1982. Work at GE under NASA/DOE contract DEN3-76.
5. "Increasing Overcapacity Sparks Magnet Shakeout." N. Snyderman, Electronic News, August 31, 1981, p. 27.
6. "As-Substituierte Hartferrite - Neue Ergebnisse." F.J. Esper, G. Kaiser. Proc. 3rd Europ.Conf. Hard Magnetic Materials, p. 94 (See G17).
7. "Choice of PM Materials for Automotive Starter Motors." R.Corbach, Bosch GMBH, Herne, W. Germany. Company preprint of presentation at MMPA seminar, Raleigh, NC (Jan. 1982).
8. See References in Chapter I: 1-4, 1-5, 1-6 and 1-8.
9. "Thermal Stability and Temperature Coefficients of Four Rare Earth-Cobalt Matrix Magnets Heated in Dry Air." R.M.W. Strnat et al., J. Appl. Physics 53 (1982) p. 2380.
10. "New Resin-Bonded Sm-Co Magnet Having High Energy Product." T. Shimoda, et al., 4th Intl. Workshop Rare Earth-Co Perm.Magnets, p. 335. (See G10).
11. "Development of Magnetic Properties in a Resin Bonded Sm₂Co₁₇ Type Magnet." T.Shimoda et al., 5th Intl. Workshop Rare Earth-Co Perm.Magnets, p. 595. (See G11).
12. Oral communication, T.Shimoda, June 1981.
13. "Rare-Earth Magnets in Present Production and Development." K.J.Strnat, J. Magnetism and Mag. Matls. 7 (1978) p. 351.
14. "Evaluation of the Utility of a (Pr,Nd)Co₅ Alloy for Permanent Magnets." J.B.Y. Tsui et al., J. Appl.Physics 42 (1971) p. 1539.
15. "Developments in Mischmetal-Cobalt-5 and Low-Samarium Magnet Materials." M.G.H. Wells and K.S.V.L. Narasimhan, Goldschmidt informiert 2/79, No. 48, p. 15. (See G13).
16. "Low Temperature Coefficient Cobalt-Rare Earth Magnets." F.G. Jones and M. Tokunaga, IEEE Trans. Magnetics, MAG-12 (1976) p. 968.
17. "Low Oxygen Processing of SmCo₅ Magnets." K.S.V.L. Narasimhan, J. Appl. Physics 52 (1981) p. 2512.

18. Hitachi Magnetics Corp., Electron Energy Corp., Colt Industries.
19. "Millimeter Wave/Microwave Device Applications of Rare Earth-Cobalt Magnets." F.Rothwarf et al., 3rd Intl. Workshop Rare Earth-Co Perm.Magnets, p. 255. (See G9).
20. (a) "Developments in the Production of Bonded Rare Earth-Cobalt Magnets." R.E. Johnson, 5th Intl. Workshop Rare Earth-Co Perm. Magnets, p. 555. (See G11).
 (b) "MG Plamag - Plastic Bonded Rare Earth Magnets by Injection Molding." Sales brochure of the Japanese MG Comp. Ltd., (1982).
21. "Reduction-Diffusion Preparation of $\text{Sm}_2(\text{Co,Fe,Cu,Zr})_{17}$ -Type Alloy Powders and Magnets Made from Them." Dong Li et al., 5th Intl. Workshop Rare Earth Perm. Magnets, p. 571. (See G11.)
22. " $\text{Sm}_2(\text{Co,Fe,Cu})_{17}$ Permanent Magnet Alloys with Additive Element Hf." T. Nezu et al., 4th Intl. Workshop Rare Earth-Co Perm.Magnets, p. 437. (See G10).
23. "New Resin-Bonded Sm-Co Magnet Having High Energy Product." T. Shimoda et al., *ibid.*, p. 335. (See G10).
24. "The 2-17 Type $\text{Sm}_{2-x}\text{HRE}_x\text{Co}_{10}\text{Cu}_{1.5}\text{Fe}_{3.2}\text{Zr}_{0.2}$ (HRE=Gd,Tb,Dy,Ho,Er) Magnets With Low Temperature Coefficient." D.Li et al., IEEE Trans. Magnetics, MAG-16 (1980) p. 988.
25. "New Solder-Bonded Rare Earth-Cobalt Magnets With Improved Energy Density and Thermal Stability." R.M.W. Strnat et al., 5th Intl. Workshop Rare Earth-Co Perm.Magnets, p. 609. (See G11).
26. "Air Aging of Rare Earth-Cobalt Magnets." R.M.W.Strnat and S.Liu, 6th Intl. Workshop Rare Earth-Co Perm. Magnets, Paper PIV-10 (See G18).
27. "Effects of Annealing on the Coercivity of Amorphous TbFe_2 ." H.T.Savage et al., IEEE Trans. Magnetics, MAG-10 (1974) p. 807.
28. "Iron-Rare Earth Intermediate Phases." A.E. Ray, Proc. 7th Rare Earth Research Conf., Coronado, CA (1968), p. 473.
29. "Seltene Erden." E. Greinacher and K. Reinhardt, article in *Chemische Technologie*, 4th Ed., Vol. 2, C. Hanser Verlag (1982).
30. "Magnetic and Magneto-Elastic Properties of Highly Magnetostrictive Rare Earth-Iron Laves Phase Compounds." A.E. Clark, AIP Conf. Proc. No. 18, Part 2 (1973) p. 1015. *Am.Inst.Physics*.
31. "Magnetic Properties of Amorphous and Crystallised $(\text{Fe}_{82}\text{B}_{18})_9\text{Tb}_{0.05}\text{La}_{1.5}$." N. C. Koon and B. N. Das, *Appl. Phys. letters* 39 (1981) p. 840.
32. "Magnetic Properties of Rare Earth-Iron Intermetallic Compounds." K. Strnat et al., IEEE Trans. Magnetics, MAG-2 (1966) p. 489.

33. J.J. Croat, J. Magnetism and Mag. Matls. 24 (1978) p. 125.
34. "Magnetic Hardening of Pr-Fe and Nd-Fe Alloys by Melt-Spinning." J. J. Croat, J. Appl. Phys. 53 (1982) p. 3161.
35. "Melt-Spun Rare Earth-Iron Alloys: Dependence of Coercivity on Quench Rate." J. J. Croat and J. F. Herbst, General Motors Research Laboratories, Research Publication GMR-3816, Sep. 1981.
36. "Magnetic Hysteresis in Rapidly Quenched Rare-Earth Alloys." G. C. Hadjipanayis et al., Paper No. AB-1, 1983 INTERMAG Conf. To be published in IEEE Trans. Magnetics, MAG-19 (1983).
37. "Composition Dependence of Coercive Force of Some Crystallized Amorphous Alloys." J. J. Becker, Paper No. AB-3, ibid.
38. "Strongest Magnet Unveiled," Mainichi Daily News, Tokyo, Japan, June 4, 1983.
39. Personal communication from A. Higuchi of Sumitomo Special Metals Co., Ltd., Osaka, Japan.
40. (a) Paper 681 at the 1983 Fall Meeting, Japan Institute of Metals, Oct. 4, 1983, Akita, Japan.

(b) Paper EB-01, M. Sagawa et al, 29th Conf. Magnetism and Magnetic Materials, Pittsburgh, PA, Nov. 4, 1983. To be published in J. Appl. Physics, 1984.

VII. CONCLUDING REMARKS

We have conducted a general review of the requirements - technical and economic - which the use in propulsion motors imposes on permanent magnets. From this we distilled a list of properties for which the motor design engineers need data. Engineering terms not in common use were defined and their significance for magnetic circuit design was discussed. Similarly, some economic requirements were identified, and thus a framework was created for the subsequent discussion of the cost and supply situation for different magnet types.

The commercially available permanent magnet materials were reviewed. Those found applicable to electric vehicle motors - or judged at least potentially useful - were treated in greater detail. Important engineering data and physical properties of concern to the designer, also commercial sources for magnets and brand names, were tabulated. A full characterization of all quantities of interest would far exceed the limitations set for this report. However, at least illustrative examples of graphs and tables were given for the desirable detailed description of behavior such as dynamic recoil, the variation of the magnetic flux with temperature, its dependence on the operating point on the hysteresis loop, the temporal flux stability under various operating conditions, etc. We pointed out gaps in the published information, and we made some suggestions for a better and more unified description of magnetic properties.

If and when electric vehicle motors with permanent magnets go into large-scale production, magnet prices, the supply situation and the cost of the raw materials will become important factors. For some of the newer magnets, especially those containing rare-earth elements and/or cobalt metal, the economic future is as yet rather unclear. Motor designers are often not familiar with the longer-term supply and price situation. With extensive input from magnet and metal producers, and with information provided by mining firms and the National Bureau of Mines, we have attempted to compile information that should assist in a realistic economic planning for future commercial production of PM motors.

For one particular new magnet material, Mn-Al-C, an experimental study was performed to characterize its properties for propulsion motor use. Mn-Al-C became only recently commercially available from a Japanese firm. Its appearance caused much excitement because of the low raw material cost. We reached the conclusion that it was not well suited for this application, primarily because of the fast decrease of the intrinsic coercive force on heating.

Finally, we attempted to analyze the prospects for development work on magnet materials and manufacturing processes that could make better or cheaper magnets for propulsion motors available in a few years. In this analysis we considered commercially available magnets as well as experimental materials now emerging from research laboratories. This discussion was concluded with some recommendations for specific development projects that might be beneficially pursued by DOE and/or NASA.

The study performed had so many different aspects, and so many different materials were discussed, that a concise summary of the specific and quantitative conclusions is nearly impossible. The reader is advised to use the table of contents to find a specific subtopic of interest, and then to look for conclusions at the end of the appropriate chapter.

It is hoped that this report will be of use not only to the designers of vehicle propulsion motors, but to all users of high-energy permanent magnets.

ACKNOWLEDGMENTS

The following persons of the University of Dayton staff have significantly contributed to the project and/or to this report: Mr. Z. A. Abdelnour and Prof. H. F. Mildrum with experimental work on Mn-Al-C magnets; these and Mr. J. B. Krupar with the data collection, review and tabulation; Mrs. N. D. Roche with the report preparation.

The following gentlemen reviewed portions of the report and made valuable suggestions: J. G. Cannon of Union Molycorp., Inc.; M. Clegg and R. Fraser of Sherritt Gordon Mines, Ltd.; M. Doser, F. G. Jones and R. J. Parker of Hitachi Magnetics Corp.; Y. Sakamoto of Matsushita Electric Ind. Comp., Ltd.; B. Overton of the Kollmorgen Corp., and J. P. Spooner of Rhone-Poulenc, Inc. Many others have provided data upon request and critiqued our use of their contributions.

The NASA project monitor, Mr. F. Gourash, remained very kindly helpful throughout the duration of the project in spite of the very long delays in its completion.

The author wants to express his gratitude to all who assisted in bringing the effort to a successful conclusion.

APPENDIX A

GENERAL BIBLIOGRAPHY

Text and reference books, conference proceedings and published collections of papers dedicated specifically to permanent magnets and/or electric motors.

- G1 Permanent Magnets in Theory and Practice. Malcolm McCaig. Halsted Press, Div. of J. Wiley and Sons, Inc., New York, NY (1977).
- G2 Dauermagnete - Werkstoffe and Anwendungen. K. Schüller and K. Brinkman. Springer-Verlag, Berlin-Heidelberg-New York (1970).
- G3 Permanent Magnets and Magnetism. D.Hadfield, editor. Iliffe Books, Ltd., London and J.Wiley and Sons, Inc., New York (1962).
- G4 Permanent Magnets and Their Applications. R.J. Parker and R.J.Studders. J. Wiley and Sons, Inc., New York (1962).
- G5 Introduction to Magnetic Materials. B.D. Cullity. Addison-Wesley Publishing Co., Reading, MA (1972).
- G6 Electric Machines. G.R. Slemon and A. Straughen. Addison-Wesley Publishing Co., Inc., Reading, MA (1980).
- G7 Small Electrical Machines. IEE Conf. Public. No. 136. The Institution of Electrical Engineers, London, UK (1976).
- G8 Proc. 2nd Intl. Workshop Rare Earth-Co Perm. Mag., K.J. Strnat, editor. Univ. of Dayton, Dayton, OH (1976).
- G9 Proc. 3rd Intl. Workshop Rare Earth-Co Perm.Mag., K.J. Strnat, editor. Univ. of Dayton, Dayton, OH (1978).
- G10 Proc. 4th Intl. Workshop Rare Earth-Co. Perm. Mag., H. Kaneko and T. Kurino, editors. The Soc. of Non-Traditional Technology, Tokyo, Japan (1979).
- G11 Proc. 5th Intl. Workshop Rare Earth-Co Perm. Mag., K.J. Strnat, editor. Univ. of Dayton, Dayton, OH (1981).
- G12 Thyssen Techn. Berichte, V.6/1 (June 1980), Dauermagnet-Werkstoffe Secolit. H. Brandis, et al., editors. Special issue of comp. journal, Thyssen Edelstahlwerke, Krefeld, W. Germany.
- G13 Goldschmidt informiert, 2/79, No. 48. K. Kornfeld, editor. Special issue of comp. journal, Th.Goldschmidt AG, Essen, W. Germany.
- G14 Goldschmidt informiert, 4/75, No. 35. K. Kornfeld, editor. Special issue of comp. journal, Th.Goldschmidt AG, Essen, West Germany.
- G15 Second Conf. on Advances in Magnetic Materials and their Applications. IEE Conf. Public. No. 142. The Institution of Electrical Engineers, London, UK (1976).

- G16 Small and Special Electrical Machines. IEE Conf. Public. No. 202. The Institute of Electrical Engineers, London, UK (1981).
- G17 Proc. 3rd European Conf. on Hard Magnetic Materials. H. Zijlstra, editor. Bond voor Materialenkennis, Den Haag, The Netherlands (1974).
- G18 Proc. 6th Intl. Workshop Rare Earth-Co Perm. Magnets. J. Fidler, editor. Tech. University Vienna, Austria (1982).
- G19 Modern Perm. Magnet Materials: Their Potential and Design. (Vol. of course notes.) Engineering short courses in Dayton, Ohio and Cambridge, England (1980). P. Campbell, editor. Univ. of Southern California.
- G20 Ceramic Permanent Magnet Motors. J. R. Ireland. McGraw-Hill Book Comp., New York (1968).
- G21 DC Motors, Speed Controls, Servo Systems. Engineering Handbook by Electro-Craft Corp., Hopkins, MN (1973).

APPENDIX B

TABLE OF SYMBOLS AND ABBREVIATIONS

AC	Alternating current
B	Magnetic flux density (induction)
B_s	Gap flux density in motor
B_i	Intrinsic induction
B_r	Residual flux density, remanence
B_d	Operating-point induction, corresponds to demagnetizing field, H_d , see below.
B_s	Saturation (intrinsic) induction
$(BH)_{max}$	Static maximum energy product
$(BH)_u$	Useful recoil energy product
$(B_i H)_m$	Intrinsic energy product
DC	Direct current
DoE	U.S. Department of Energy
E	Elastic modulus
EDM	Electric discharge machining
EHV	Electric and hybrid vehicles
EV	Electric vehicles
FCC	Face centered cubic (crystal structure)
GAR	Garrett A1Research Manufacturing Corp.
GE	General Electric Company
HMC	Hitachi Magnetics Corp.
HRE	Heavy rare earth (element, metal)
H	Magnetic field strength, general
H_a	Anisotropy field strength
H_c	Magnetic coercive force
H_m	Magnetizing field strength
BH_c	Induction coercive force ("normal" H_c)
MH_c	Magnetization coercive force ("induction- H_c ")
H_d	Operating field strength, "demagnetizing field" in second quadrant of hysteresis loop.
H_v	Vickers hardness
ID	Inner diameter
IEEE	Institute of Electrical and Electronic Engineers
KC	Kollmorgen Corporation
KOR	Coreduction method of alloy production
L/D	Length-to-diameter ratio of cylindrical magnet
LRE	Light rare earth (element, metal)
M	Magnetization intensity (vector)
M_s	Saturation magnetization
MM	Mischmetal (a rare earth mixture)
MMPA	Magnetic Material Producers Association, USA
NASA	National Aeronautics and Space Administration
NASA/LeRC	NASA-Lewis Research Center
OD	Outer diameter
P	Poisson's constant (elasticity theory)
PM	Permanent magnet
PRC	People's Republic of China
Q-2	Second quadrant of hysteresis loop

R_C	Rockwell-C hardness
R&D	Research and development
R/D	Reduction-diffusion method of alloy production
RE	Rare earth (element) metal
REO	Rare-earth oxide
REPM	Rare-earth permanent magnet
rpm	Revolution per minute
RT	Room temperature
SCR	Silicon controlled rectifier
T_C	Magnetic Curie temperature
TDK	TDK Electronics Corp., Japan
TM	Transition metal (3d-element)
UD	University of Dayton, Ohio
USC	University of Southern California
VPI	Virginia Polytechnic Institute and State University
μ	Permeability
μ_0	Permeability of free space
μ_r	Recoil permeability
σ_c	Compressive strength
σ_t	Tensile strength

1 Report No NASA CR-168178		2 Government Accession No		3 Recipient's Catalog No	
4 Title and Subtitle STUDY AND REVIEW OF PERMANENT MAGNETS FOR ELECTRIC VEHICLE PROPULSION MOTORS				5 Report Date September 1983	
				6 Performing Organization Code 778-36-06	
7 Author(s) Karl J Strnat				8 Performing Organization Report No	
9 Performing Organization Name and Address University of Dayton Department of Electrical Engineering KL-365 Magnetics Dayton, Ohio 45469				10 Work Unit No 93732	
				11 Contract or Grant No DEN3-189	
12 Sponsoring Agency Name and Address U.S. Department of Energy Office of Vehicle and Engine R&D Washington, D C 20545				13 Type of Report and Period Covered Contractor Report	
				14 Sponsoring Agency Code DOE/NASA/0189-83/2	
15. Supplementary Notes Final Report • Prepared under Interagency Agreement DEA101-77CS51044 Project Manager, Francis Gourash, Electric and Hybrid Vehicle Project Office, NASA Lewis Research Center, Cleveland, Ohio 44135					
16. Abstract A study of permanent magnets (PM) was performed in support of the DOE/NASA electric and hybrid vehicle program. PM requirements for electric propulsion motors are analyzed, design principles and relevant properties of magnets are discussed. Available PM types are reviewed. For the needed high-grade magnets, design data, commercial varieties and sources are tabulated, based on a survey of vendors. Economic factors such as raw material availability, production capacity and cost are analyzed, especially for cobalt and the rare earths. Extruded Mn-Al-C magnets from Japan were experimentally characterized. Dynamic magnetic data for the range -50° to +150°C and some mechanical properties are reported. The state of development of the important PM material families is reviewed. Feasible improvements or new developments of magnets for electric vehicle motors are identified.					
17 Key Words (Suggested by Author(s)) 1. Propulsion motors, electric vehicles 2. Permanent magnets, properties, sources 3. Magnetic design principles 4. Raw materials, economics			18 Distribution Statement Unclassified - unlimited STAR Category 85 DOE Category UC-96		
19 Security Classif (of this report) Unclassified		20 Security Classif (of this page) Unclassified		21 No of Pages 181	22 Price* A08

* For sale by the National Technical Information Service Springfield Virginia 22161

End of Document