

General Disclaimer

One or more of the Following Statements may affect this Document

- This document has been reproduced from the best copy furnished by the organizational source. It is being released in the interest of making available as much information as possible.
- This document may contain data, which exceeds the sheet parameters. It was furnished in this condition by the organizational source and is the best copy available.
- This document may contain tone-on-tone or color graphs, charts and/or pictures, which have been reproduced in black and white.
- This document is paginated as submitted by the original source.
- Portions of this document are not fully legible due to the historical nature of some of the material. However, it is the best reproduction available from the original submission.



CRINC

(NASA-CR-175354) DETERMINATION OF THE
STATIC PERFORMANCE OF A CUYUNA CC MODEL
UL-430RR ENGINE (Kansas Univ. Center for
Research, Inc.) 101 p HC A05/MF A01

N84-16179

CSCL 21A G3/07

Unclas
00542



THE UNIVERSITY OF KANSAS CENTER FOR RESEARCH, INC.

2291 Irving Hill Drive-Campus West

Lawrence, Kansas 66045

DETERMINATION OF THE
STATIC PERFORMANCE OF A
CUYUNA 430 cc. MODEL UL-430RR ENGINE
KU-FRL-6135-1

Carlos L. Blacklock, Project Manager
Dr. Jan Roskam, Principal Investigator

Prepared under NASA Grant NAG1-345
for
National Aeronautics and Space Administration
Langley Research Center

Flight Research Laboratory
University of Kansas Center for Research, Inc.
Lawrence, Kansas 66045

October 1983

SUMMARY

This report presents results of static performance tests carried out on an ultralight engine. A Cuyuna 430 cc, 2-stroke, 2-cylinder engine (model UL-430RR) was placed on the test stand of the Mel Harned Propulsion Laboratory of the University of Kansas. On the test stand, seven performance parameters were measured:

- Thrust
- Torque
- Propeller RPM
- Fuel Flow
- Cylinder Head Temperature
- Exhaust Gas Temperature
- Change in Pressure through the Propeller.

Measurement of each of the above parameters was taken at specific values of RPM. The propeller RPM's ranged from idle at approximately 750 RPM to a maximum value of 2810 RPM.

The test results were then manipulated to obtain

- Thrust Coefficient
- Power Coefficient
- Shaft Horsepower
- Shaft Specific Fuel Consumption.

A summary of typical data obtained follows:

- Thrust_{SL}: 10-220 lbs
- C_T: Approximately Constant at 0.10
- SHP_{SL}: 0-11.5 HP
- C_p: 0.075-0.175 at high RPM's
- SSFC_{SL}: 1.5-4.0 lbs/Hr-HP at high RPM's
- Fuel Consumption: 0-33.0 lbs/Hr.

TABLE OF CONTENTS

<u>Section</u>	<u>Page</u>
Summary	i
Table of Contents	ii
List of Symbols	iii
List of Figures	v
1. Introduction	1.1
2. Test Apparatus	2.1
2.1 Thrust	2.2
2.2 Torque	2.4
2.3 Propeller RPM.	2.5
2.4 Temperatures (EGT, CHT).	2.8
2.5 Fuel Flow.	2.11
3. Test Results	3.1
4. Discussion of Test Results	4.1
4.1 Thrust	4.1
4.2 Torque	4.2
4.3 Temperatures	4.3
4.4 Fuel Flow.	4.3
5. Conclusions and Recommendations.	5.1
6. References	6.1
7. Appendices	7.1
A. Presentation of Raw Data	Ai
B. Presentation of the Parameter System Accuracies.	Bi
C. Description and Calibrations for all Measuring Systems.	Ci
D. Calculation of Performance Parameters.	Di
E. Recommendations for Obtaining Thrust Using the ΔP Method.	Ei

LIST OF SYMBOLS

<u>symbol</u>	<u>definition</u>	<u>units</u>
ΔP	Change in Pressure through the Prop.	lbs/in ²
Q	Torque	ft-lbs
T	Thrust	lbs.
T _{SL}	Thrust corrected to Standard Sea Level Conditions	lbs.
OAT	Outside Air Temperature	°F
N	Propeller RPM	rev/min
n	Propeller RPM	rev/sec
BP	Barometric Pressure	in of HG
°F	Degrees Farenheight	°F
°C	Degrees Celsius	°C
W ₁	Initial Weight in Fuel Flow measurements	lbs.
W ₂	Final Weight in Fuel Flow Measurements	lbs.
cc	Cubic Centimeters	cm ³
σ	Error in the calculation of a parameter	-
ϵ	Error in the measurement of a parameter	-
DC	Direct Current	-
EGT	Exhaust Gas Temperature	°C
CHT	Cylinder Head Temperature	°C
ρ	Density	slugs/ft ³
ρ_0	Standard Sea Level Density	slugs/ft ³
ρ_w	Density of Water	slugs/ft ³
γ	Specific Gravity	-
ΔH	Change in ΔP calibration tube height	cm
P _a	Atmospheric Pressure	lbs/in ²
P	Pressure	lbs/in ²
R	Universal Gas Constant(1716.5)	ft-lbs/°R
C _T	Coefficient of Thrust = $T/\rho n^2 D^4$	-
D	Propeller Diameter(4.5)	ft.
C _P	Coefficient of Power = $P/\rho n^3 D^5$	-
SHP	Shaft Horsepower	HP
SHP _{SL}	Shaft Horsepower Corrected to Standard Sea Level Conditions	HP
P	Power	ft-lbs/sec

LIST OF SYMBOLS CONT.

<u>symbol</u>	<u>definition</u>	<u>units</u>
σ_C	Error due to propagation of power Coeff.	-
σ_C^P	Error due to propagation of Thrust Coeff.	-
σ_C^T	Error due to propagation of Thrust	lbs.
σ_T	Error due to propagation of Shaft HP	HP
σ_{SHP}	Shaft Specific Fuel Consumption	lbs/Hr-HP
SSFC	Change in fuel weight $W_2 - W_1$	lbs.
ΔW_f	Actuator Disk Area of Propeller	ft ²
A		

LIST OF FIGURES

<u>Number</u>	<u>Title</u>	<u>Page</u>
2.1	Static Test Stand at the Mel Harned Propulsion Laboratory	2.1
2.2	Load Cell Positioned to Sense Thrust	2.2
2.3	DC Power Supply Used to Supply Power to Transducers.	2.3
2.4	Amplifier System Used to Amplify Transducer Signal	2.3
2.5	Strip Chart Recorder Used to Record Measured Signals.	2.4
2.6	Torque System.	2.4
2.7	Torque Load Cell Minus Its Transducer.	2.5
2.8	RPM Measurement System	2.6
2.9	Close-Up of the Hall Effect Transistor	2.7
2.10	Circuit Used to Obtain Instantaneous Values of RPM	2.7
2.11	Circuit Used to Obtain Continuous Values of RPM.	2.8
2.12	Thermocouple Used to Measure the EGT of the Engine	2.9
2.13	Exhaust Gas Temperature Thermocouple Placed in Exhaust Gas Manifold	2.9
2.14(a)	Digital Thermometer Used to Record Temperature	2.10
2.14(b)	Position of the Thermometer in the Control Room of the Propulsion Laboratory	2.10
2.15	Fuel Flow System Set-Up Including Scale and Timer.	2.11
2.16	Timer Used to Obtain Fuel Flow of the Engine	2.12
3.1	Thrust as a Function of RPM for a Cuyuna UL-430RR Engine.	3.2
3.2	Static Thrust Coefficient as a Function of RPM for a Cuyuna UL-430RR Engine	3.3
3.3	Thrust Converted to Sea Level Standard Conditions as a Function of Prop RPM.	3.4
3.4	Torque of a Cuyuna UL-430RR Engine as a Function of Propeller RPM	3.5
3.5	Shaft Horsepower for a Cuyuna UL-430RR Engine as a Function of Propeller RPM.	3.6

LIST OF FIGURES (continued)

<u>Number</u>	<u>Title</u>	<u>Page</u>
3.6	Static Power Coefficient for a Cuyuna UL-430RR Engine as a Function of RPM.	3.7
3.7	Shaft Horsepower Converted to Sea Level Standard Conditions as a Function of Propeller RPM.	3.8
3.8	Exhaust Gas Temperature for a Cuyuna UL-430RR Engine as a Function of RPM.	3.9
3.9	Cylinder Head Temperature for a Cuyuna UL-430RR Engine as a Function of RPM.	3.10
3.10	Fuel Consumption for a Cuyuna UL-430RR Engine as a Function of RPM	3.11
3.11	Shaft Specific Fuel Consumption as a Function of Propeller RPM	3.12
3.12	Shaft Specific Fuel Consumption Converted to Standard Sea Level Conditions as a Function of Propeller RPM	3.13

1. INTRODUCTION

The purpose of this report is to document the static performance characteristics of a typical ultralight engine. Tests were carried out on a Cuyuna 430 cc, 2-stroke, 2-cylinder (model UL-430RR) engine taken from an Airmass Sunburst Ultralight (model C).

Two-stroke engines have a history of having instabilities in the range of operating conditions. These tests were used to obtain a better overall "picture" of problems with this engine. The data would also assure that the engine performance data obtained during flight testing are valid as well as accurate.

Tests were conducted with the help of Grant #NAG1-345 obtained from Langley Research Center, National Aeronautics and Space Administration, Hampton, Virginia. The technical monitors for this project are Lou Williams, Joe Stickle, and Bruce Holmes.

2. TEST APPARATUS INTRODUCTION

The static testing of the ultralight engine took place in the Mel Harned Propulsion Laboratory at the University of Kansas. Figure 2.1 shows the test

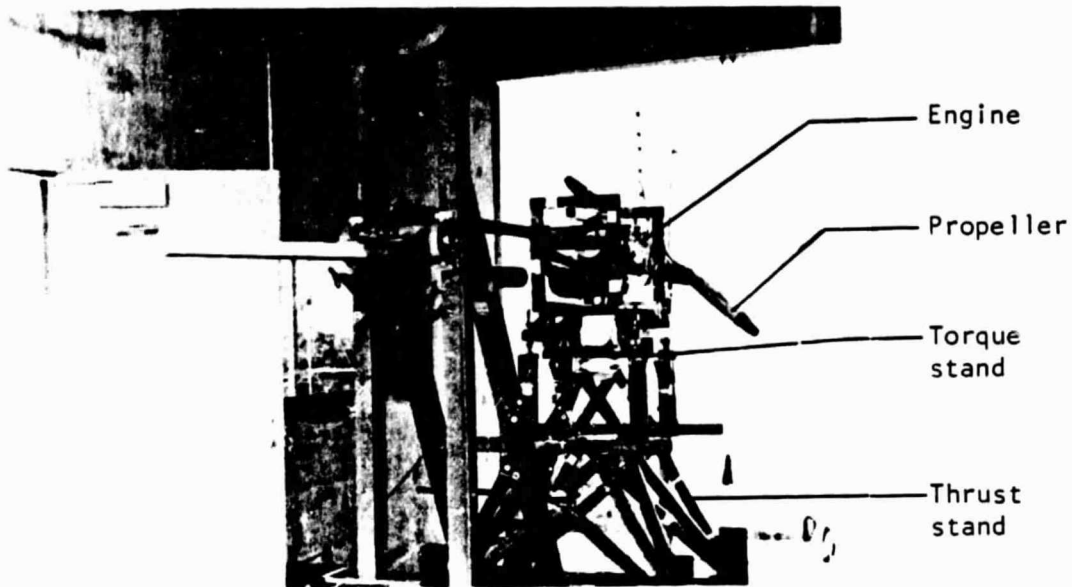

Figure 2.1 - Static Test Stand at the Mel Harned Propulsion Laboratory. (Note: Thrust calibration stand is installed in this figure.)

stand with the ultralight engine installed. Seven basic parameters were measured on the test stand:

- Thrust
- Torque
- Propeller RPM
- Exhaust Gas Temperature
- Cylinder Head Temperature
- Change in Pressure through the Propeller (ΔP)
- Fuel Flow.

The following sections present a detailed description of how each of the parameters was obtained.

2.1 THRUST

ORIGINAL PAGE IS
OF POOR QUALITY

The test stand was constructed in such a manner that the thrust and the torque measuring systems of the stand would be completely uncoupled. The thrust itself was obtained by the translation in the "x" direction of the entire upper portion of the test stand. To reduce friction, the upper structure rests on four leaf springs. The leaf springs were allowed to bend, thus promoting translation due to a thrust load. The thrust was sensed by a load cell connected to the stand as shown in Figure 2.2. The two outer rods were



Figure 2.2 - The Load Cell Positioned to Sense Thrust

used to protect the test stand from extensive damage if there is a load cell flexure failure. The reference voltage is supplied by the Hewlett Packard Dual DC power supply shown in Figure 2.3. The load cell then supplies a return voltage proportional to the thrust of the engine. This voltage was amplified (Figure 2.4) and recorded on an eight-channel Techni-Rite TR-888 Strip Chart Recorder, shown in Figure 2.5. For more details, see Appendix C, Section C2.

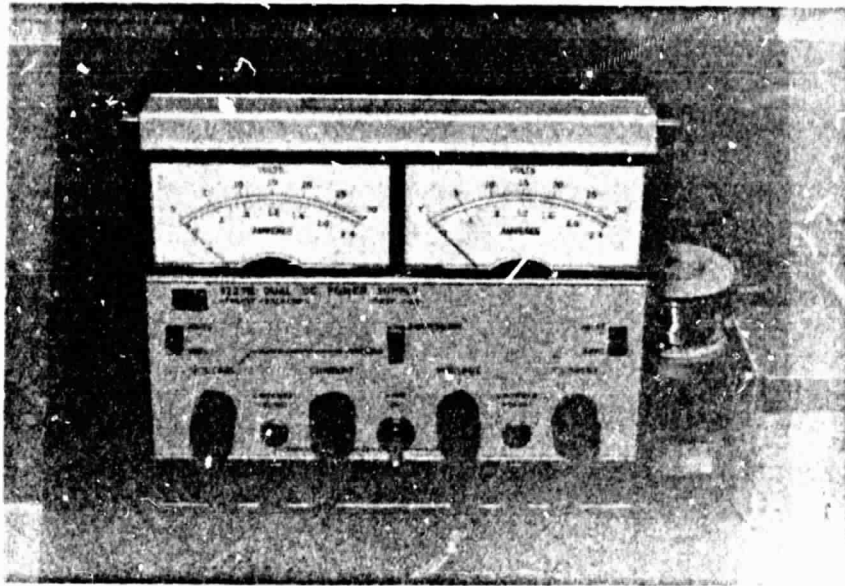

Figure 2.3 - DC Power Supply Used to Supply Power to Transducers

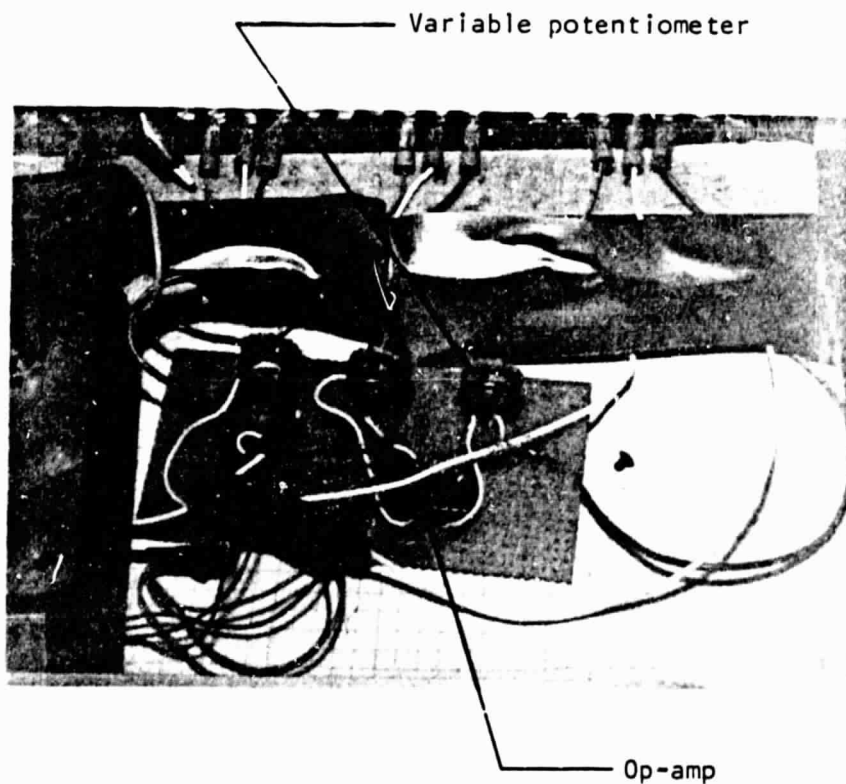

Figure 2.4 - Amplifier System Used to Amplify Transducer Signal

ORIGINAL PAGE IS
OF POOR QUALITY

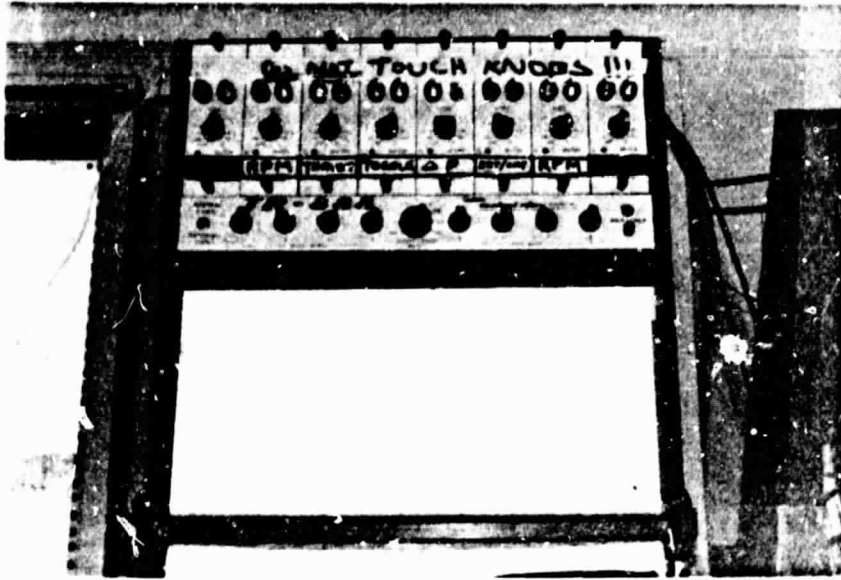

Figure 2.5 - The Strip Chart Recorder Used to Record Measured Signals

2.2 TORQUE

As stated in Section 2.1, the thrust and the torque were uncoupled by the use of two separate systems. The engine and the upper part of the torque stand rest on two stainless steel flexures located as shown in Figure 2.6.

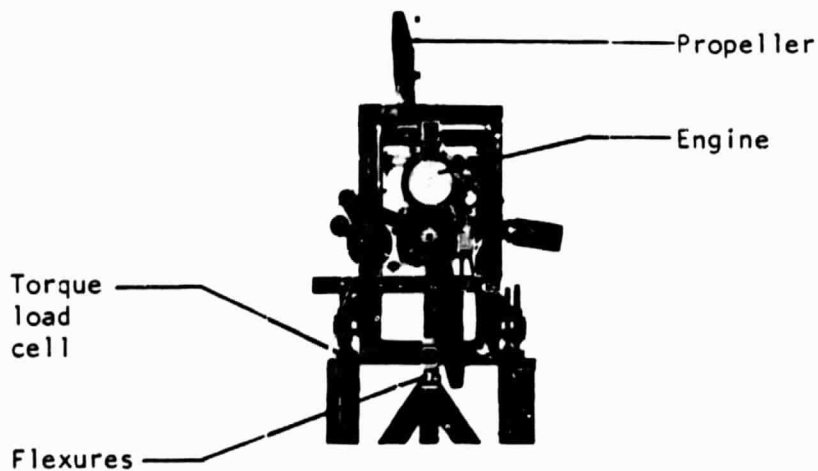

Figure 2.6 - Torque System

As the engine/propeller combination produces a torque about its thrust line, the torque stand deflects about the flexures. The torque was sensed by a load cell, shown in Figure 2.7. The load cell was placed a distance of 10.5 in. from the flexures. The same method of recording the torque load cell signal was used as described for the thrust signal in Section 2.1. For a more detailed description, see Appendix C, Section C3.

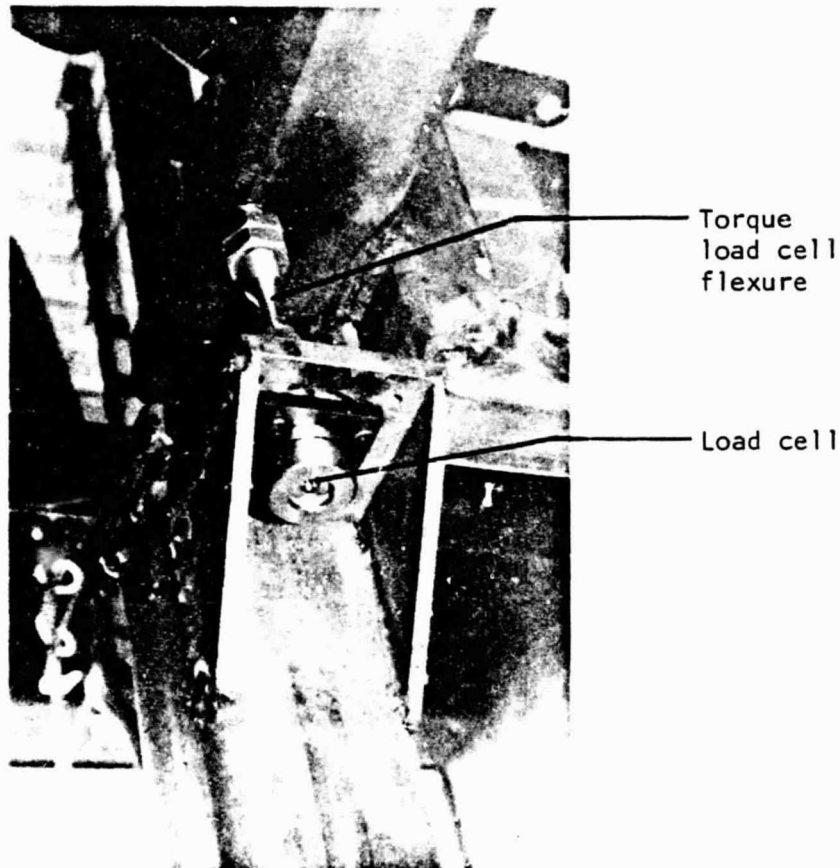

Figure 2.7 - Torque Load Cell Minus Its Transducer

2.3 PROPELLER RPM

Because of the 2-to-1 gear reduction, there had to be a determination of whether the engine RPM or the propeller RPM was easiest to obtain accurately. It was decided that since all of the calculations were based on the

ORIGINAL PAGE IS
OF POOR QUALITY

propeller RPM's, a system should be considered first to measure RPM of the propeller. After careful consideration, it was decided that a system based on the Hall Effect Principle (Appendix C, pg. C1) would be easily adaptable as well as accurate.

The Hall Effect Principle uses a transistor that creates a pulse of voltage whenever the south pole of a magnet passes very close to the transistor. This method being known, a magnet was placed on the propeller hub. To counteract the weight of the magnet, another one was placed just opposite it. This took care of any "out-of-balance" effects due to the magnet spinning a finite distance from the centerline. To make sure that there was only one pulse per revolution, one of the magnets had its south pole showing while the other magnet had its north pole showing. The Hall Effect transistor was attached to the propeller shaft bearing supports, as shown in Figure 2.8.

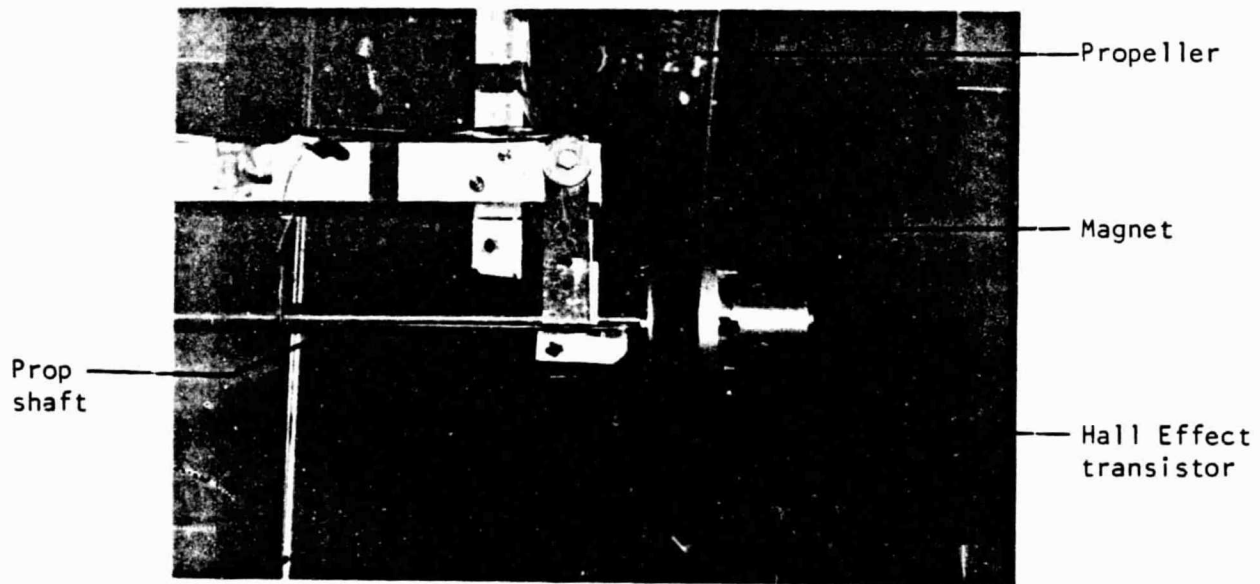

Figure 2.8 - RPM Measurement System

Figure 2.9 shows a close-up of the Hall Effect transistor. It can be seen glued to its support, which extends forward so it would be close enough to the magnets to be in their magnetic field (see Appendix C, pg. C1, for a schematic).

ORIGINAL PAGE IS
OF POOR QUALITY

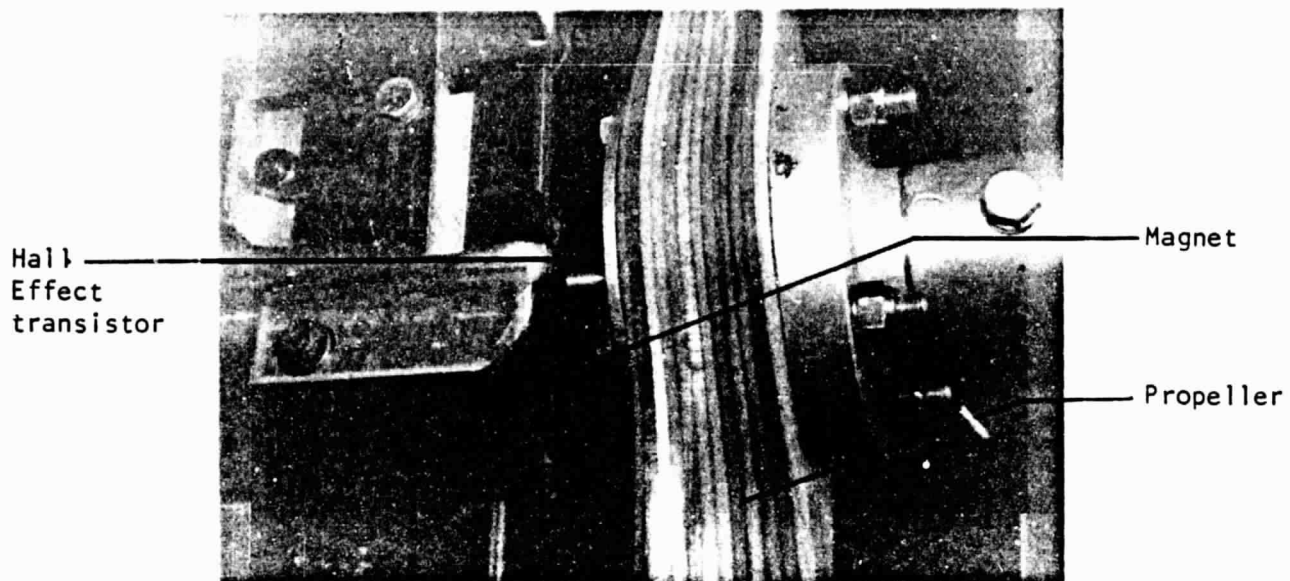

Figure 2.9 - Close-Up of the Hall Effect Transistor

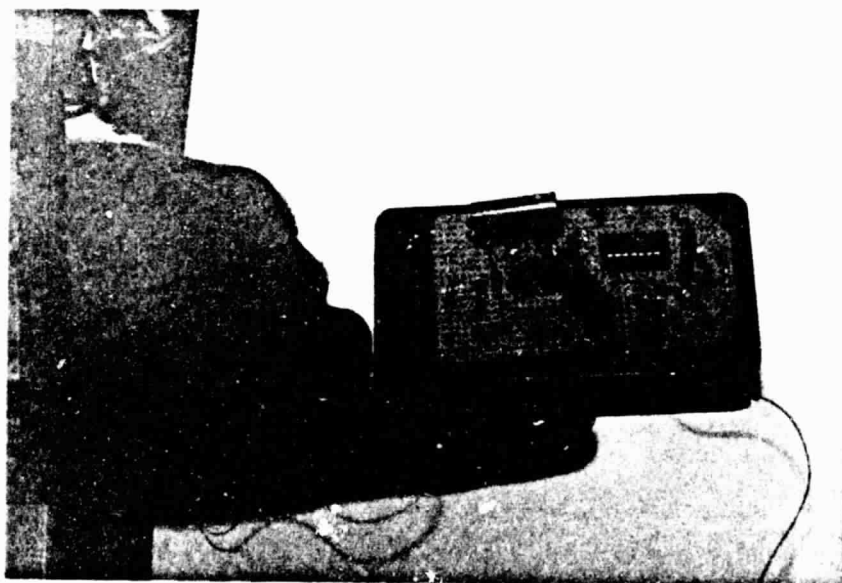

Figure 2.10 - Circuit Used to Obtain the Instantaneous Values of RPM

**ORIGINAL PAGE IS
OF POOR QUALITY**

The transistor itself produces a voltage pulse whose frequency is exactly equal to the propeller RPM. It was decided that during testing, two forms of signals would be needed. The first was an instantaneous signal, while the second signal was a continuous signal. The circuit in Figure 2.10 (Appendix C, pg. C1 for circuit diagram) was first constructed to give the two signals desired; however, after checking, it was found that it would give only an instantaneous value of RPM. A second circuit, shown in Figure 2.11 (Appendix C, pg. C2 for circuit diagram), was then constructed to obtain continuous values of RPM. With this system, the engine could be tested at known values of RPM. The signal was recorded on an eight-channel strip chart recorder, shown in Figure 2.5. For further details, see Appendix C, Section C1.

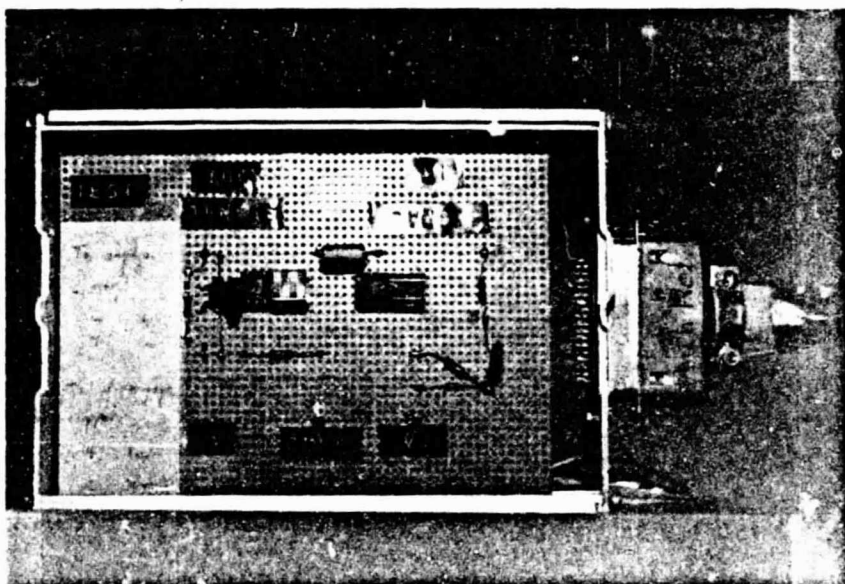

Figure 2.11 - Circuit Used to Obtain Continuous Values of RPM

2.4 TEMPERATURES

There were two temperature readings made:

- A type "K" (chromel-alumel) thermocouple was placed inside the exhaust manifold at the junction of the two pipes coming from each of the two cylinders to measure the exhaust gas temperature. This positioning of the thermocouple was used to make sure the effect of

both cylinders on one thermocouple was recorded. Figure 2.12 shows the thermocouple placed in the exhaust manifold, while Figure 2.13 shows a close-up of the same picture. The thermocouple sensed the EGT, while the value was read out digitally on an Omega Digital

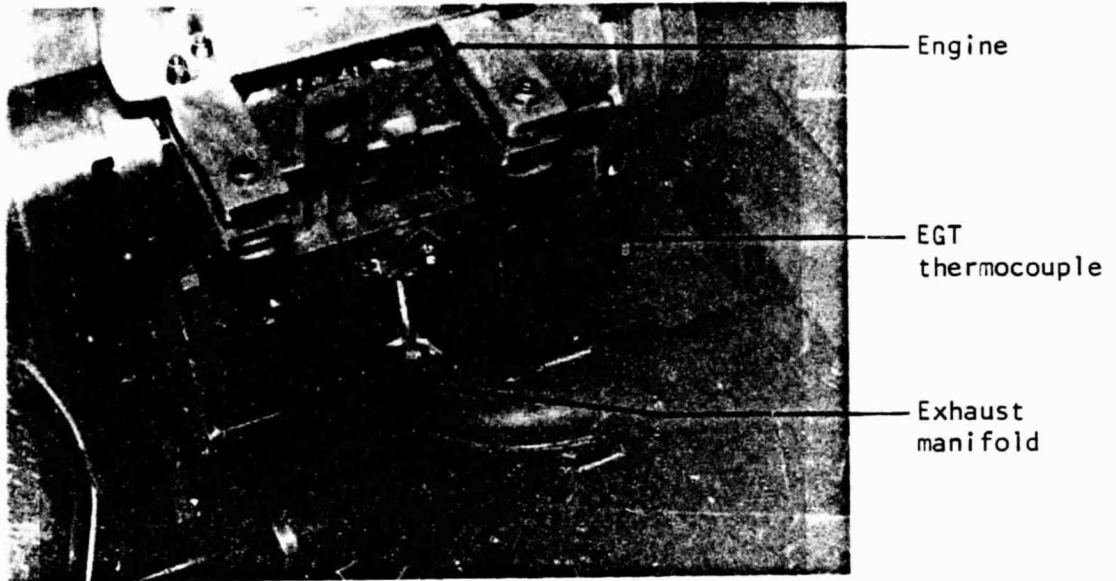

Figure 2.12 - Thermocouple Used to Measure the EGT of the Engine

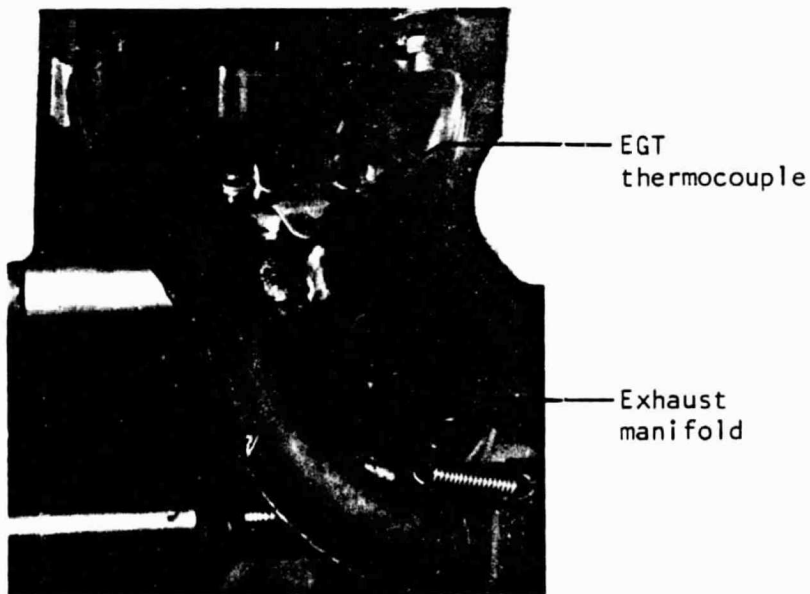

Figure 2.13 - Exhaust Gas Temperature Thermocouple Place in Exhaust Gas Manifold

Thermometer, shown in Figure 2.14(a). Figure 2.14(b) shows the position of the thermometer in the propulsion lab control room. The EGT signal was sent to an eight-channel strip chart recorder (Figure 2.5) by the use of the analog terminal located on the back of the Omega Thermometer.

- The other temperature was the Cylinder Head Temperature, which was obtained by placing a type "K" (chromel-alumel) thermocouple on a head bolt located on the rear cylinder. This was done because the rear cylinder is the hottest exterior portion of the rear cylinder according to the owner of the regional Cuyuna dealership, Kansas City, Missouri. The same method of recording the data was used for CHT, as was described earlier for EGT. This was done by the use of a switch located just to the right of the Omega Thermometer shown in Figure 2.14(a). About halfway through the run at one RPM, the switch was changed, thus changing the place at which the temperature was being measured. For further information, see Appendix C, Section C5.

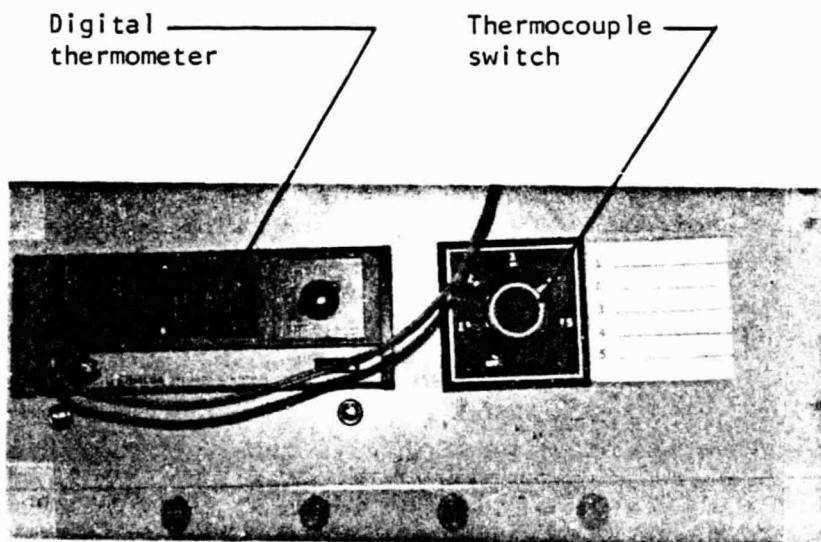

Figure 2.14(a) - Digital Thermometer Used to Record Temperature

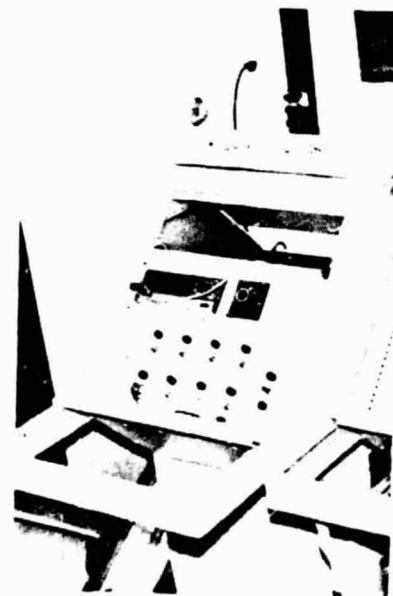

Figure 2.14(b) - Position of the Thermometer in the Control Room of the Propulsion Laboratory

2.5 FUEL FLOW

ORIGINAL PAGE IS
OF POOR QUALITY

The fuel flow of the engine was obtained by the use of a very simple system. It consisted of a scale to measure the weight of the fuel plus a timer to keep track of the Δ time. The system itself was set up as in Figure 2.15. A 2.5 gallon tank would sit on the scale; and once the engine RPM was stabilized, the operator would level out the scale and record the initial weight (W_1). At the same time, a second operator would start the timer.

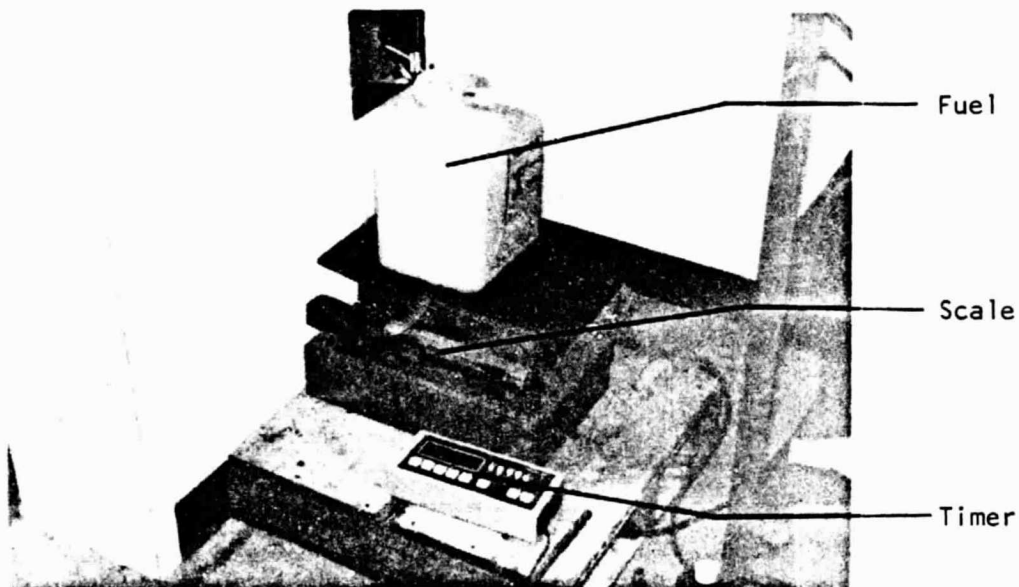

Figure 2.15 - Fuel Flow System Set-Up Including Scale and Timer

The timer used was a Galab 500 Digital Darkroom Timer (Figure 2.16). The timer would be set to a known time, usually 60 or 120 secs, depending on the engine RPM. As the time counted down, the scale operator would try to keep the scale balanced such that when the time "beeped," the final weight (W_2) could be obtained almost instantaneously. With W_1 , W_2 , and Δt , values

of fuel consumption in lbs/Hr could be easily obtained and, from this, the shaft specific fuel consumption. For further details, see Appendix C, Section C6.

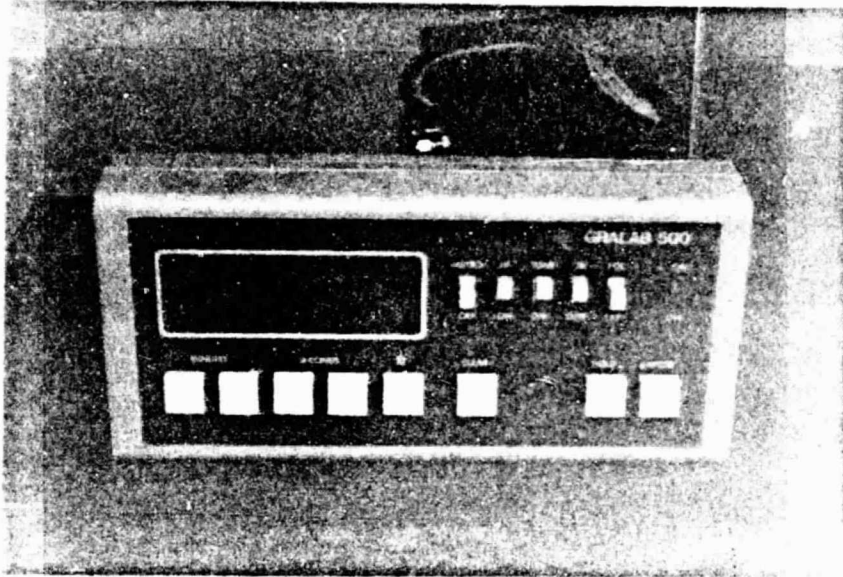

Figure 2.16 - Timer Used to Obtain Fuel Flow of the Engine

3. TEST RESULTS

This section presents graphically the results of the static testing of a Cuyuna 430 cc (model UL-430RR) engine taken from an Airmass Sunburst Ultralight (model C). The following data are presented:

- Thrust vs. Propeller RPM (Figure 3.1)
- C_T vs. Propeller RPM (Figure 3.2)
- T_{SL} vs. Propeller RPM (Figure 3.3)
- Q vs. Propeller RPM (Figure 3.4)
- SHP vs. Propeller RPM (Figure 3.5)
- C_p vs. Propeller RPM (Figure 3.6)
- SHP_{SL} vs. Propeller RPM (Figure 3.7)
- EGT vs. Propeller RPM (Figure 3.8)
- CHT vs. Propeller RPM (Figure 3.9)
- Fuel Consumption vs. Propeller RPM (Figure 3.10)
- SSFC vs. Propeller RPM (Figure 3.11)
- $SSDC_{SL}$ vs. Propeller RPM (Figure 3.12)

For details concerning calculations of the above parameters, see Appendix D. For information dealing with the error bars in the Figures, see Appendix B. A detailed discussion of the above results is presented in Chapter 4.

ORIGINAL PAGE IS
OF POOR QUALITY

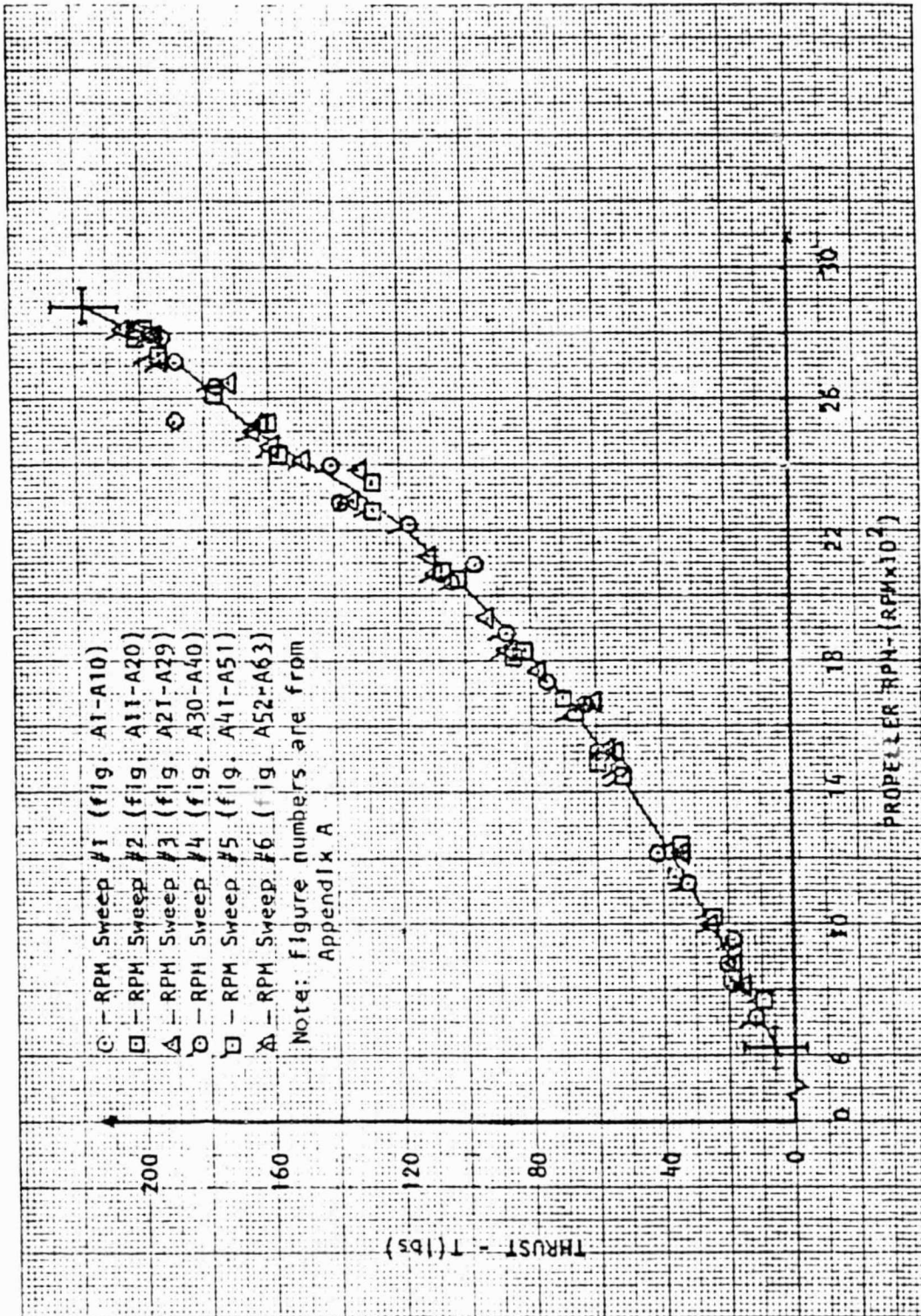

CALC	<i>Blanked</i>	<i>7/18/82</i>	REVISED	DATE
CHECK				
APPO				
APPO				

Figure 3.1 - Thrust as a function of RPM for a Cuyuna UL-430RR engine.

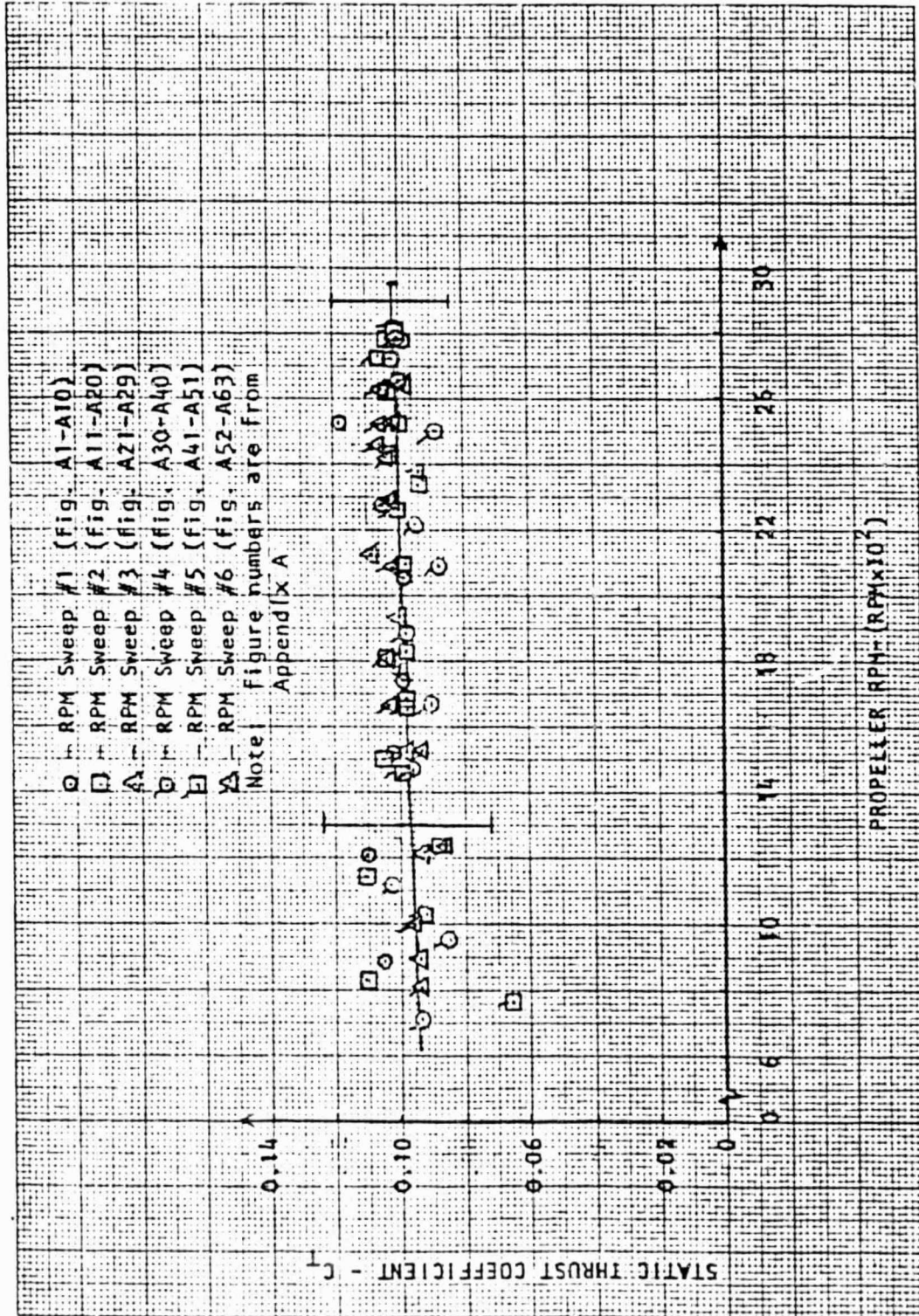

CALC	<i>Blackbird</i>	<i>1/18/83</i>	REVISED	DATE
CHECK				
APPO				
APPO				

Figure 3.2 - Static Thrust Coefficient as a function of RPM for a Cuyuna UL-430RR engine.

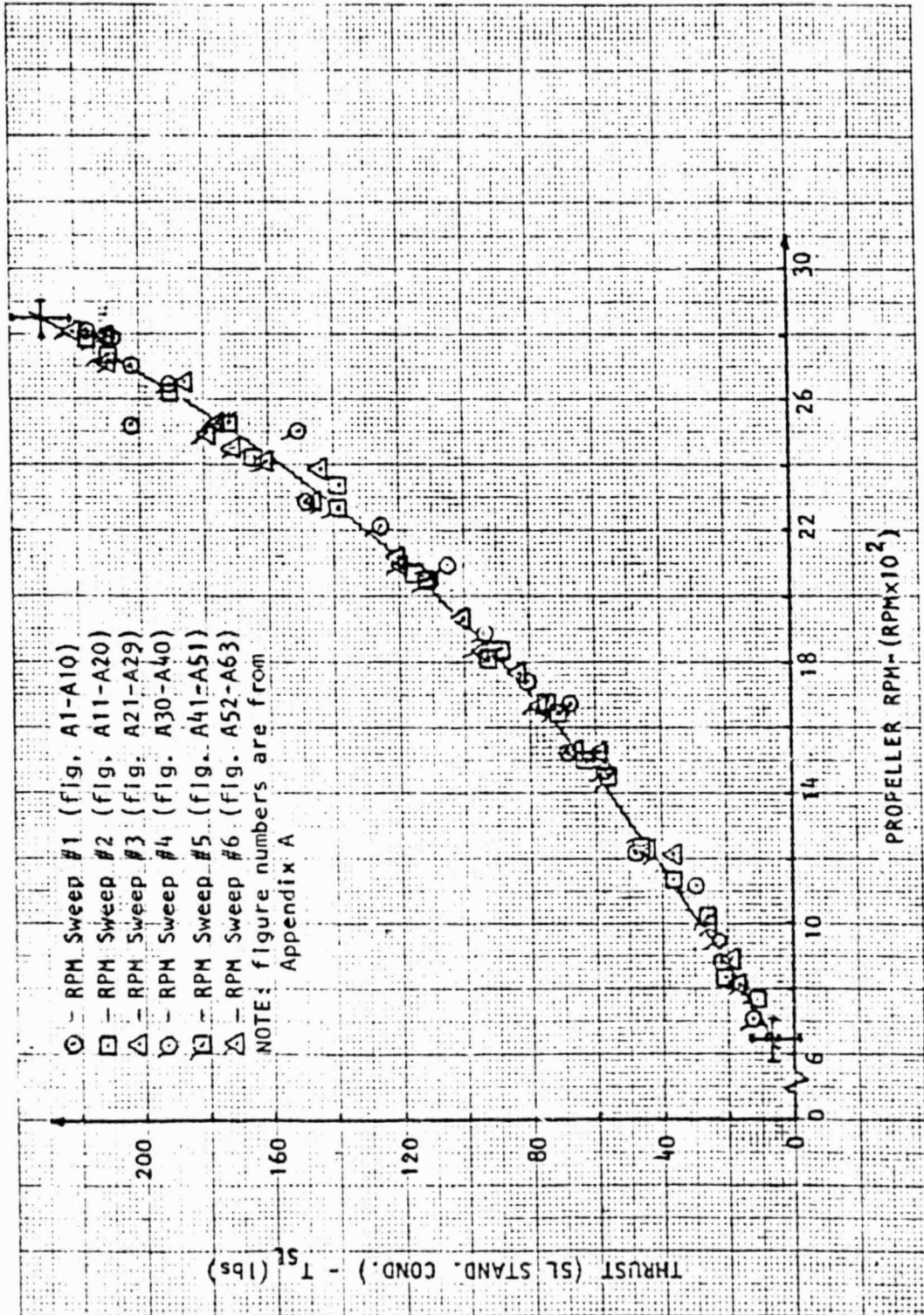

CALC	Blacklock	9/11/53	REVISED	DATE
CHECK				
APPD				
APPD				

Figure 3.3 - Thrust converted to sea level stand. conditions as a function of PROP. RPM

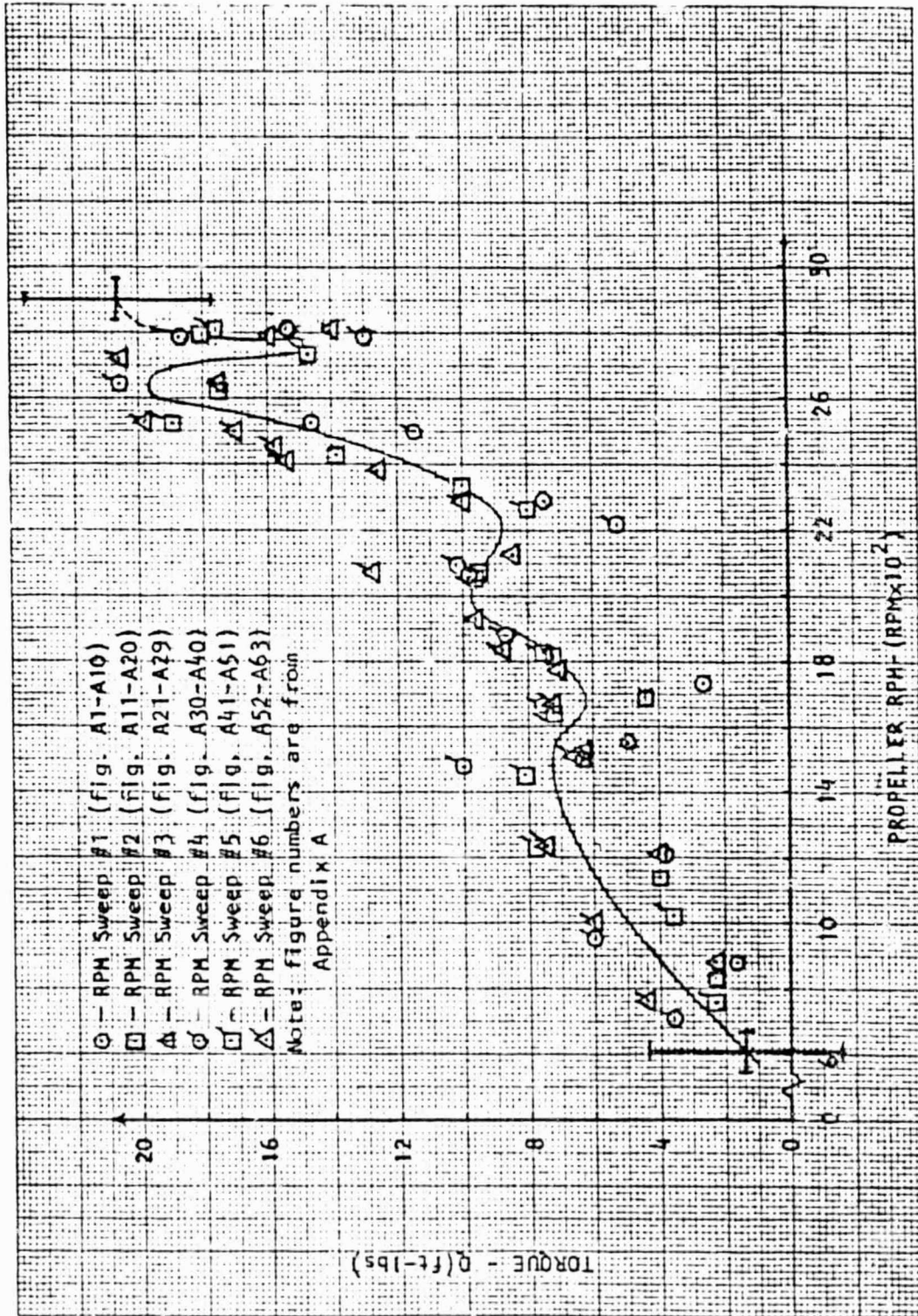

CALC	<i>2/24/83</i>	9/10/83	REVISED	DATE
CHECK				
APPO				
APPO				

Figure 3.4 -
Torque for a Cuyuna UL-430RR
engine as a function of Propeller RPM

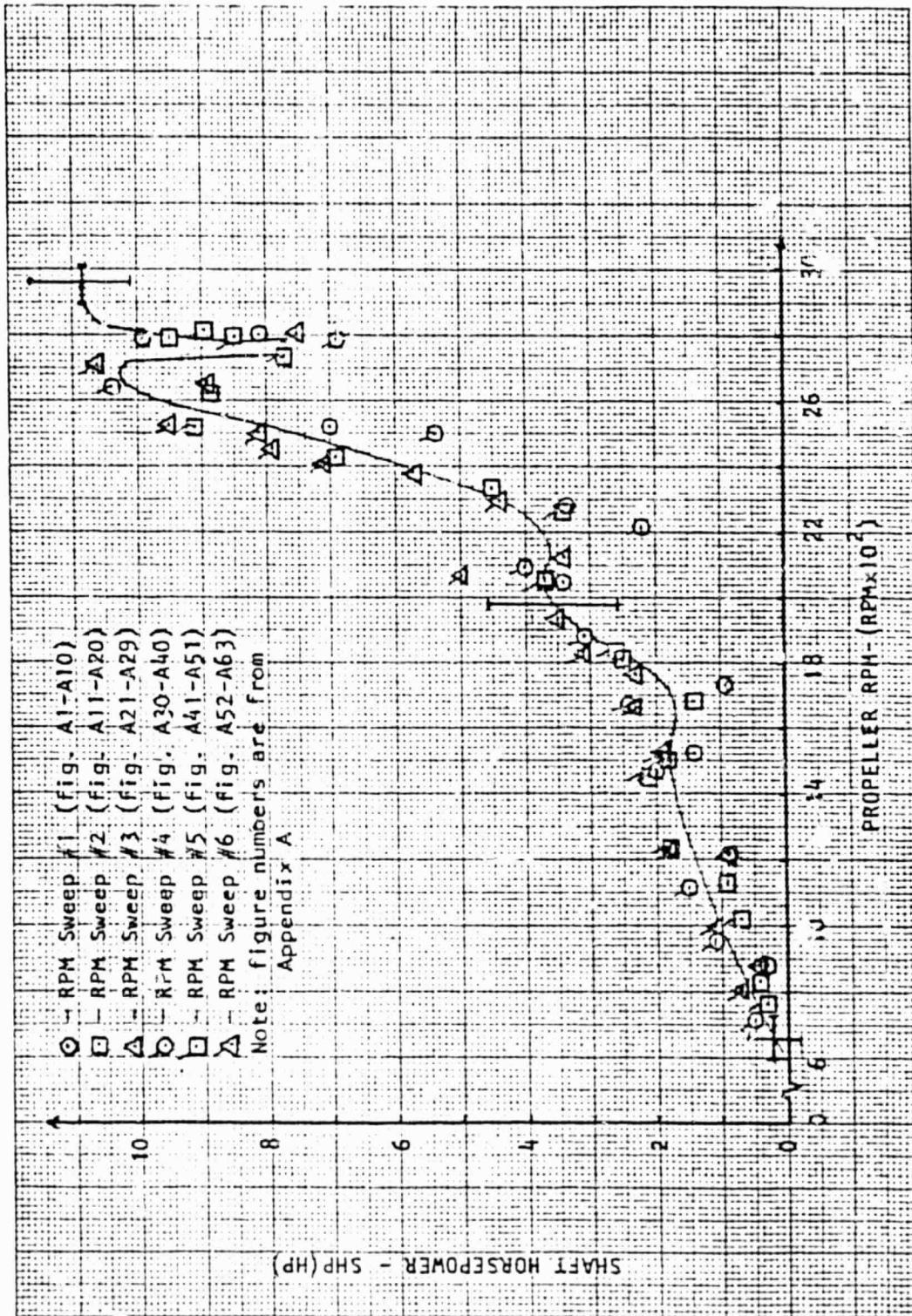

CALC	<i>B. Brinkley</i>	<i>9/18/84</i>	REVISED	DATE
CHECK				
APPD				
APPD				

Figure 3.5 -
Shaft Horsepower for a Cuyuna UL-430RR
Engine as a function of Propeller RPM

ORIGINAL PAGE IS
OF POOR QUALITY

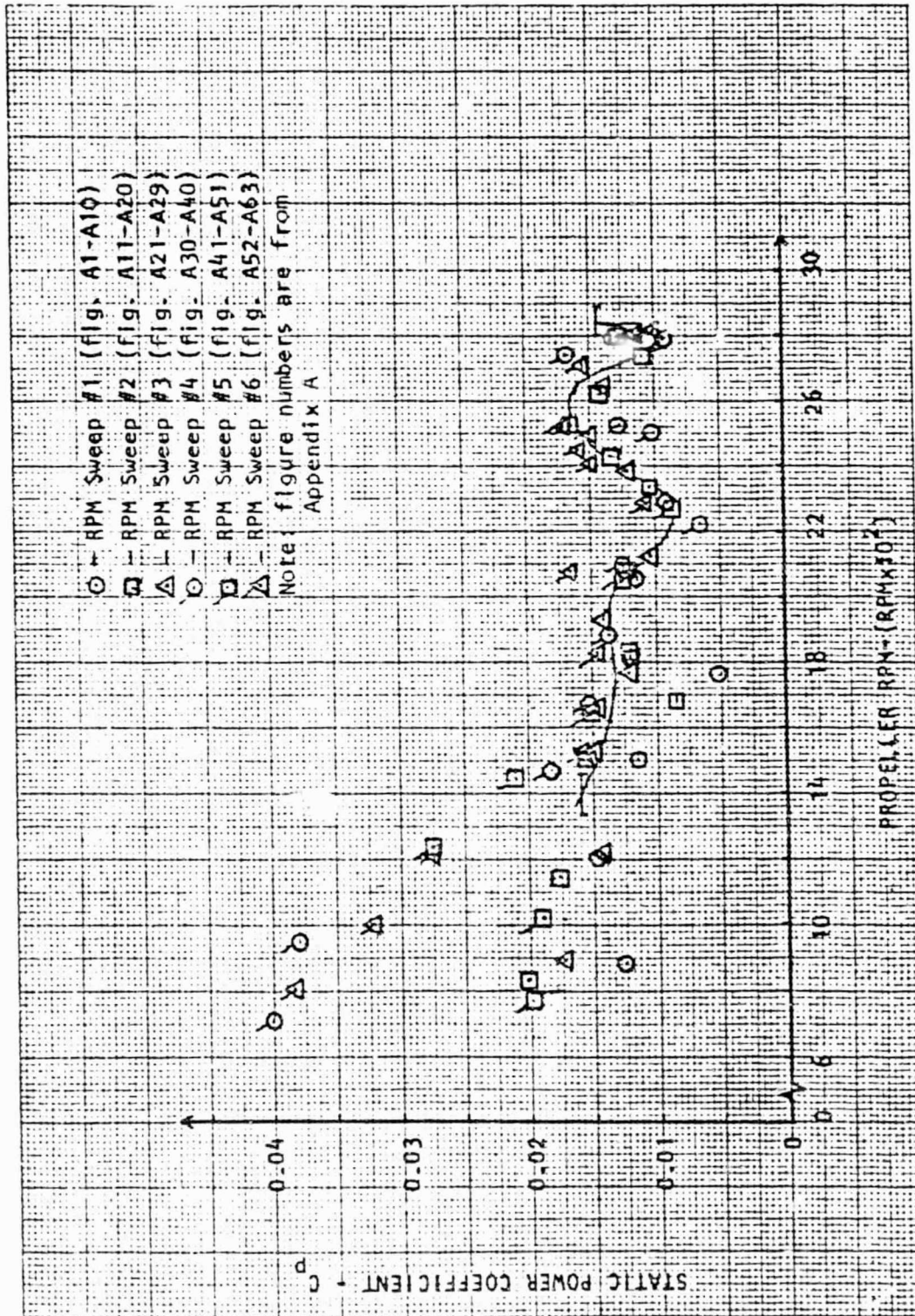

CALC	Blanket	9/10/83	REVISED	DATE	Figure 3.6 - Static Power Coefficient for a Cuyuna UL-430RR Engine as a function of RPM	UNIVERSITY OF KANSAS	PAGE 3.7
CHECK							
APPD							
APPD							

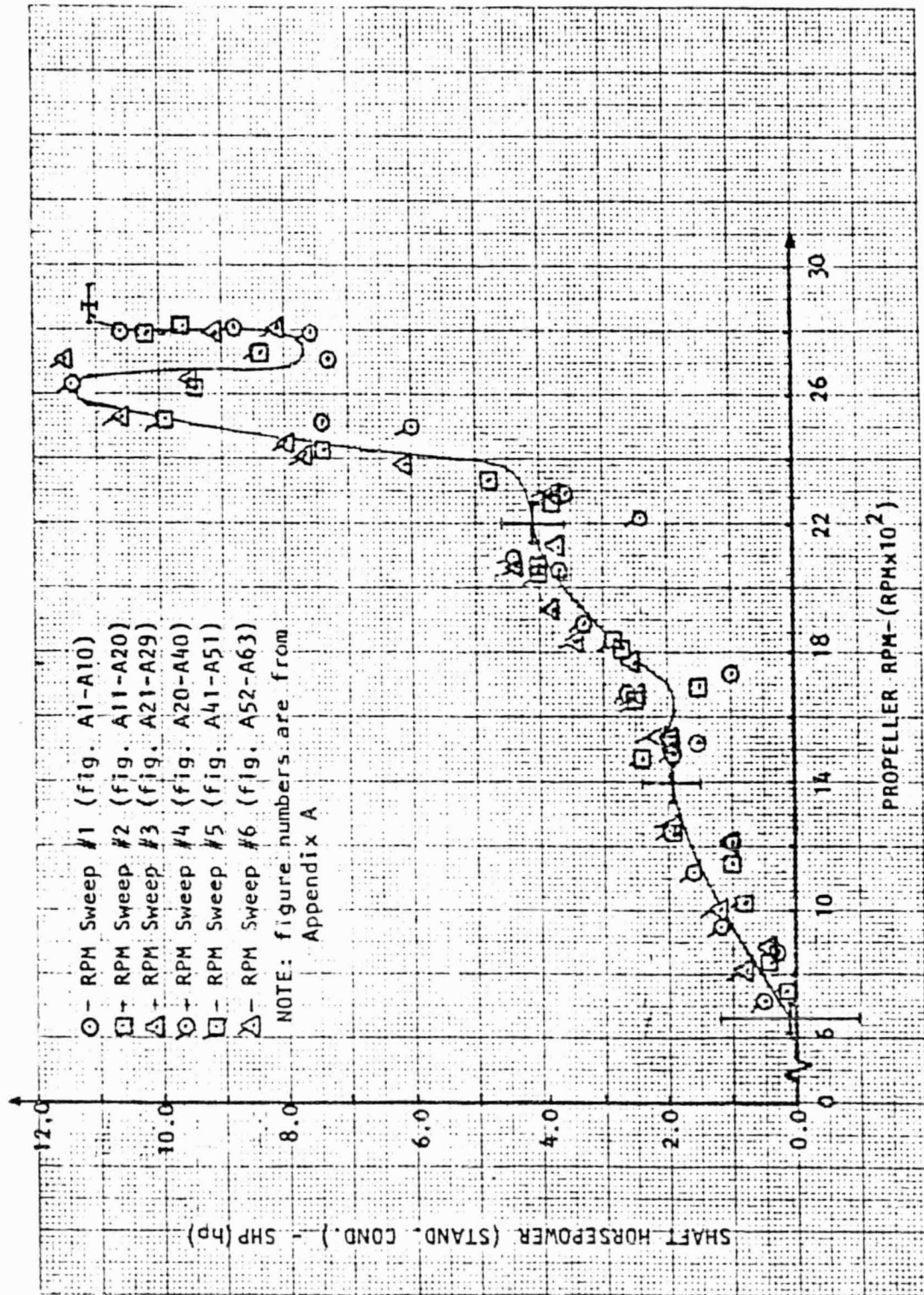

CALC	Blacklock	9/21	REVISED	DATE	<p>Figure 3.7 - Shaft Horsepower converted to standard SL cond. as a function of Prop. RPM</p> <p>UNIVERSITY OF KANSAS</p>
CHECK					
APPD					
APPD					
					PAGE 3.8

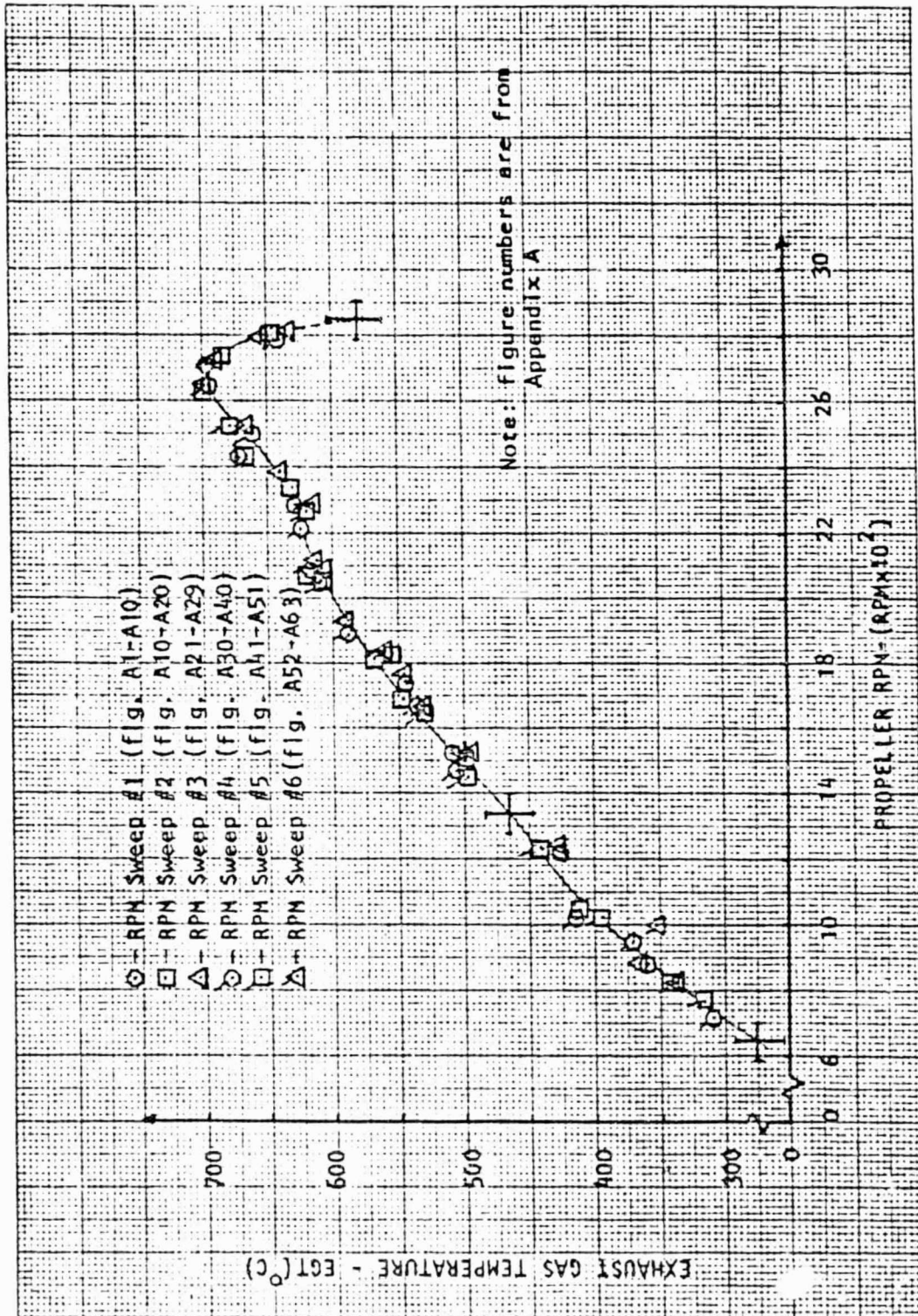

CALC	<i>Blankin</i>	7/11/83	REVISED	DATE	Figure 3.8 -	
CHECK					Exhaust Gas Temperature for a Cuyuna	
APPO					UL-439RR Engine as a function of RPM	
APPO						
UNIVERSITY OF KANSAS						PAGE
						3.9

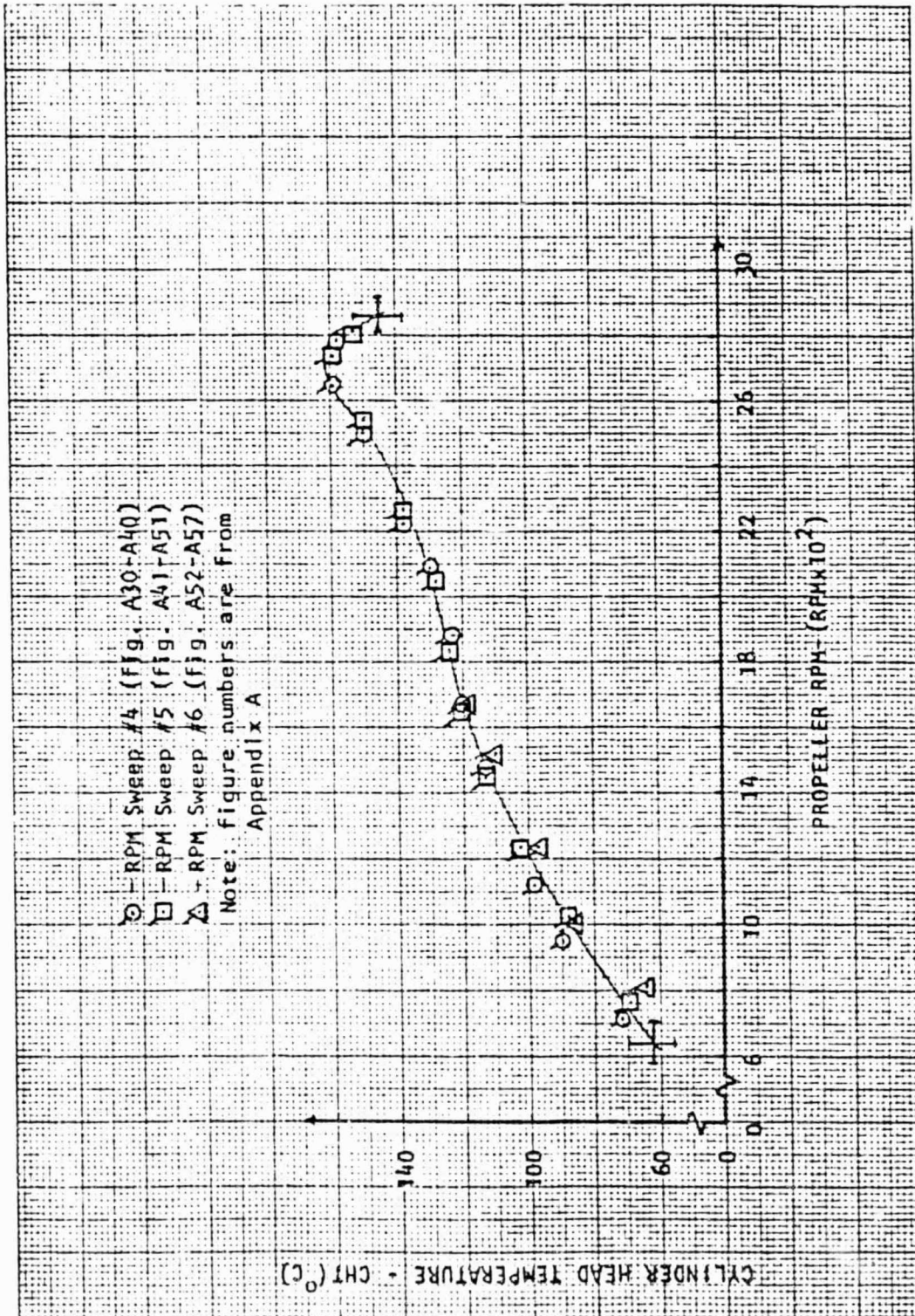

CALC	Blackford	3/19/83	REVISED	DATE
CHECK				
APPO				
APPO				

Figure 3.9 -
Cylinder Head Temperature for a Cuyuna
UL-430RR Engine as a function of RPM

ORIGINAL PAGE IS
OF POOR QUALITY

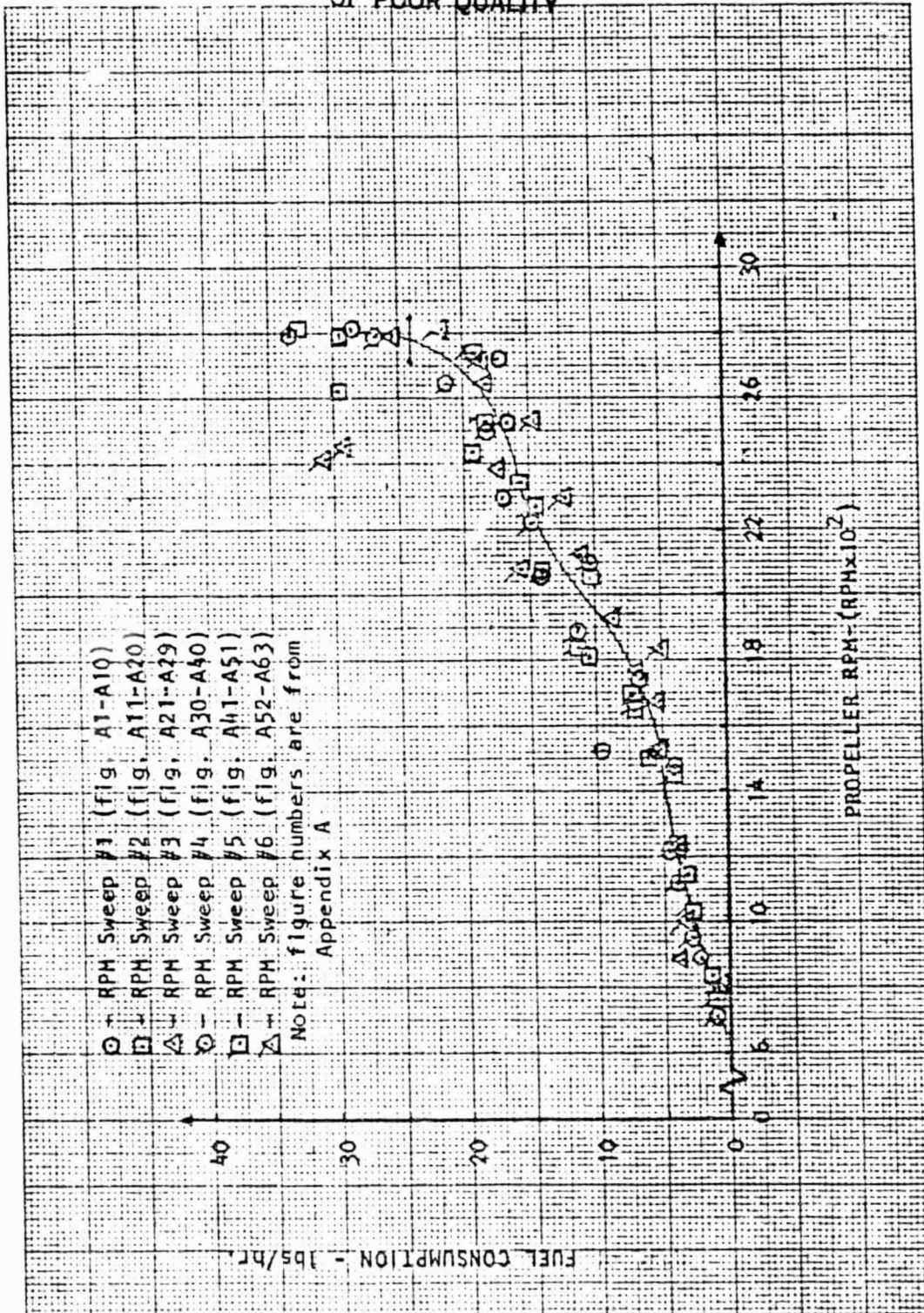

CALC	<i>Blanchard</i>	<i>9/26</i>	REVISED	DATE	Figure 3.10 - Fuel Consumption for a Cuyuna UL-430R engine as a function of Propeller RPM.
CHECK					
APPD					
APPD					
UNIVERSITY OF KANSAS					PAGE 3.11

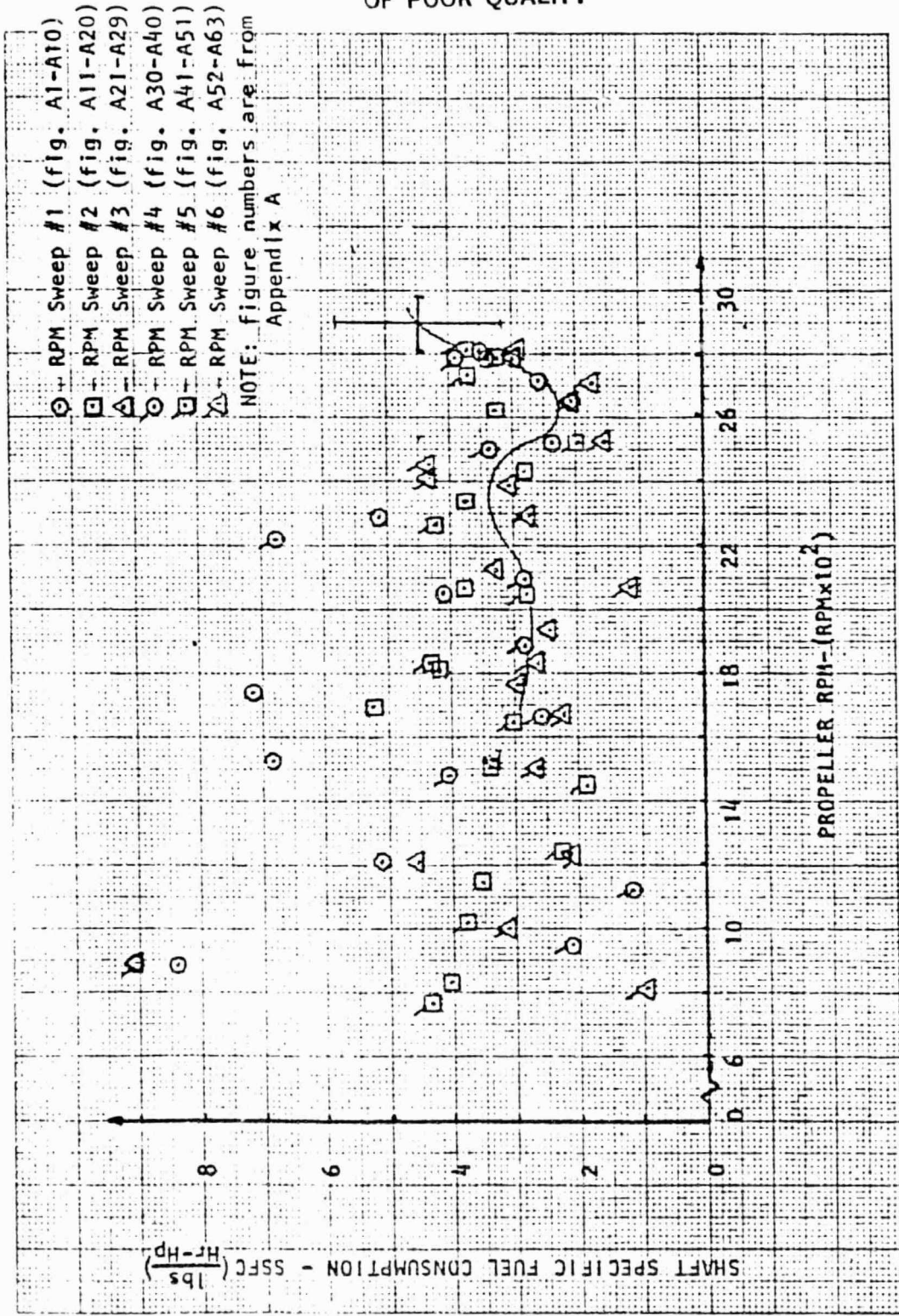

CALC	Bluelial	10/1/83	REVISED	DATE	Figure 3.11 - Shaft Specific Fuel Consumption as a function of Propeller RPM	UNIVERSITY OF KANSAS	PAGE 3.12
CHECK							
APPD							
APPC							

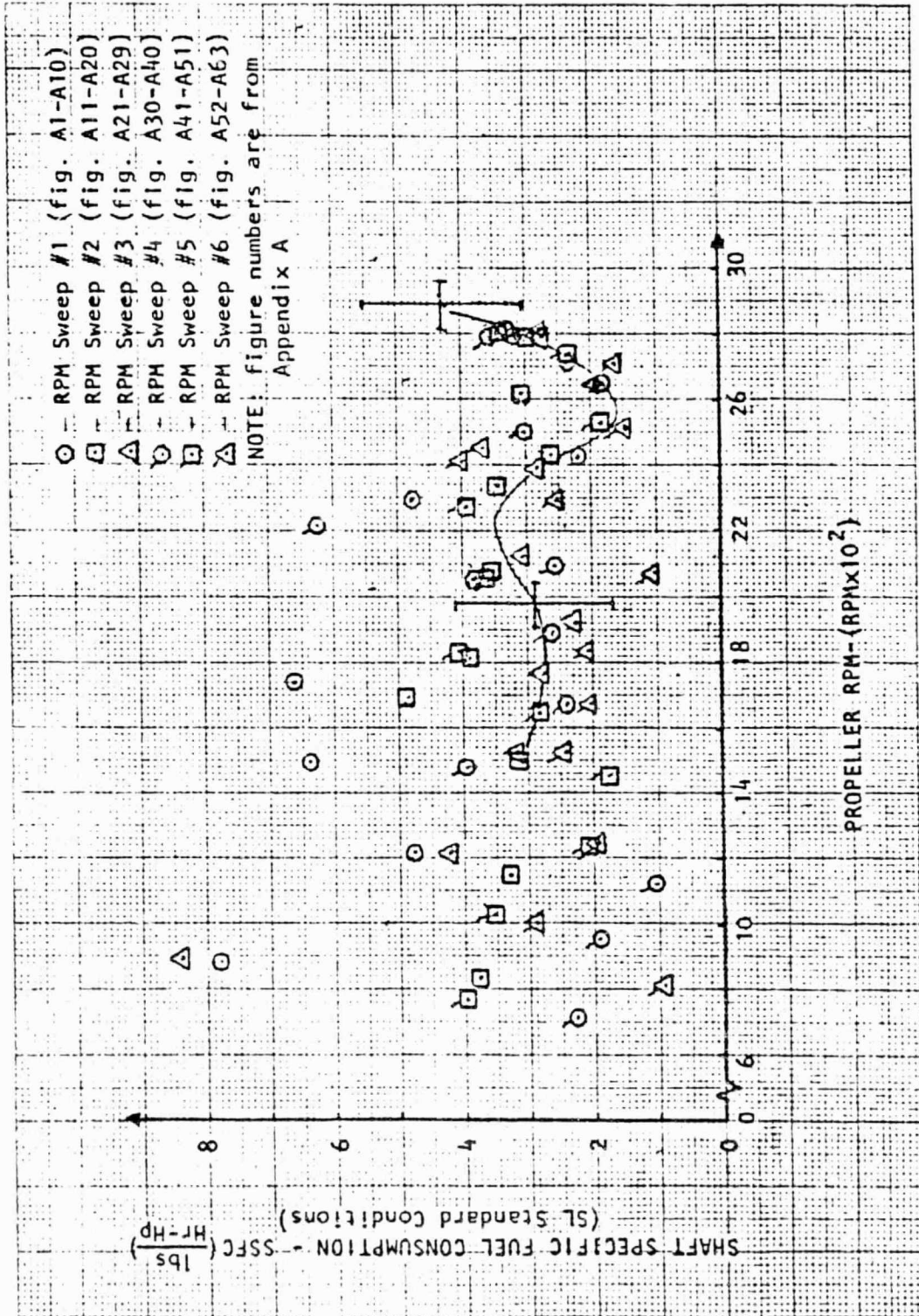

CALC	Blacklock	9/2/83	REVISED	DATE
CHECK				
APPO				
APPO				

Figure 3.12 -
Shaft Specific Fuel Consump. (SL Stand.)
as a function of the Propeller RPM

4. DISCUSSION OF TEST RESULTS

This chapter presents a detailed discussion of the results shown in Chapter 3. Section 4.1 discusses the thrust parameters, while Section 4.2 gives a discussion of the torque parameters. Section 4.3 presents the EGT and CHT discussions, and 4.4 discusses fuel flow parameters.

4.1 THRUST

The thrust parameters-- T , C_T , and T --at SL standard conditions are shown in Figures 3.1-3.3. Using the methods described in Section 2, a very nice thrust curve was obtained. It ranged from 10 lbs at idle (750 RPM) to 208 lbs at the maximum RPM (2810 RPM). It should be noted that even with the fluctuations in SHP, the thrust curve increased at a constant rate. Although the HP does dip, the propeller does seemingly absorb enough power to keep the thrust curve continuous. From the thrust and the test atmospheric conditions, the coefficient of thrust ($C_T = T/\rho n^2 D^4$) was obtained. It was shown to be reasonably constant over the entire RPM range at approximately 0.10. The final thrust parameter was the thrust corrected to standard sea level conditions. By correcting the thrust, the entire curve shifted up approximately 12 lbs at high RPM's and 2-3 lbs at lower RPM's. Note that at an idle condition corresponding to sitting on the ground, there is a finite value of thrust which is approximately 10-15 lbs. This brings up the question: When in this condition, how will the ultralight be able to stay in one place? The problem arises out of the situation that this ultralight has no brakes. The solution is that the ultralight is made such that when it is idling, a person could put his feet down to hold himself in one place.

4.2 TORQUE

The torque parameters are shown in Figures 3.4-3.7. The first one is the torque as a function of RPM. It was seen that three dips occurred in the torque plot. They occurred at 1700, 2200, and 2450 RPM. This could be due to two problems:

- Scavenging effects. After a charge of fuel has been ignited, the cylinder goes down, forcing a new charge of fuel to the top of the cylinder. This new charge, in turn, forces the exhaust gas from the previous charge out of the exhaust port. If this scavenging does not take place exactly at the right instant, a certain portion of the exhaust gas from the previous charge remains to be burnt again. This decreases the scavenging efficiency of the engine and, in turn, decreases its power output.
- Out-of-tune exhaust system. As discussed earlier, the exhaust gas of the engine is pushed out in a pulse. This pulse creates a back pressure that, when the next pulse appears, is pulled out. This kind of thing happens all of the way through the exhaust system. Because of this, the system has to be tuned to obtain the correct back pressure through the entire system. If this is not done, power losses can occur. Note, however, that an exhaust system can be only tuned for one RPM.

The torque ranged from 2.0 ft-lbs at idle to a maximum of 22.0 ft-lbs. From the torque, shaft horsepower can be found. It is seen that the dips in the SHP curve are again obtained as expected. The maximum SHP is a different story, however. From Figure 3.5, the maximum SHP is 10.5 HP. The engine itself was rated at 30 HP. This shows that the Ritz wooden propeller (54 in. diameter, and a 27 in. pitch) does not load up the engine enough to obtain all of its power potential. This is all right, since the thrust obtained was sufficient for this aircraft. From the SHP, the coefficient of power ($C_p = P/\rho n^3 D^5$) was obtained. Due to vibrational problems in the stand from the engine, the lower RPM values had a very high degree of scatter. At high RPM's, values of between 0.075 and 0.175 were obtained for C_p . Again from the coefficient, sea level standard corrections were made to the SHP. At SL, the maximum SHP was 11.5 HP, still nowhere close to the rated HP of the engine.

4.3 TEMPERATURES

There were two temperature measurements made: the exhaust gas temperature and the cylinder head temperature. They are shown plotted against propeller RPM in Figures 3.8 and 3.9. The EGT ranges from 310°C to 700°C over the tested range of RPM's. There is only one interesting thing to note on the EGT curve. At higher RPM's, above 2650 RPM, the fuel consumption increases at a much higher rate than does the RPM of the engine. The effect that this has is to quench or cool the pistons with fuel. The same phenomenon can be seen in the CHT curve. Values of CHT range from 65°C at low RPM's to 160°C at high RPM's. Again, since the pistons cool, the heads of the engine will also cool down.

4.4 FUEL FLOW

The fuel flow parameters are shown in Figures 3.10-3.12. They include the measured values of fuel consumption, the shaft specific fuel consumption, and the SSFC corrected to standard sea level conditions. The fuel consumption ranged from about 1.0 lbs/Hr at idle to 18 lbs/Hr at 2600 RPM and, from there, increased to 35 lbs/Hr at 2810 RPM. These data are consistent with the quenching effects shown in Section 4.3. From the fuel consumption, the SSFC can be calculated. In this curve, the vibration effects are very prevalent at lower RPM's; however, at higher RPM's, the SSFC ranged from 2.0-4.0 lbs/Hr-HP. Correcting the SSFC to standard sea level conditions lowered its magnitude from the above to values ranging from 1.5-3.5 lbs/Hr-HP.

5. CONCLUSIONS AND RECOMMENDATIONS

In conclusion, the performance characteristics of the Cuyuna 430 cc UL-430RR engine were typical for two-stroke engines. The performance characteristics shown graphically in Chapter 3 show that although there were problems in the horsepower output of the engine, the thrust of the engine remained consistent throughout the RPM range.

Some of the performance characteristics exhibited at higher RPM's are due to the use of an RPM limiter. This is to control the exhaust gas temperature so as not to allow it to exceed the maximum temperature allowed, which is approximately 710°C. The tests done on the engine were completed with the mixture adjustment screw set at 1.5 turns from the closed position.

The following shows some recommendations made to obtain the engine performance at different conditions:

- Test the engine with different propellers. This could be done by changing the pitch of the propeller or the number of blades of the propeller. This test would extract more power from the engine, thus using it to its highest potential.
- Test the engine with different exhaust systems. Since the tuning of the exhaust system is a major factor in the performance of the engine, if different exhaust systems were applied, a system could be obtained that would optimize the engine performance.
- Conduct acoustical tests. There is a trade-off between the amount of tuning a person can do to an exhaust system and the noise that the system produces. Therefore, the tests conducted on the different exhaust systems must be coordinated with acoustical tests.

The preceding has been a presentation of the static performance of a Cuyuna UL-430RR engine taken from an Airmass Sunburst Ultralight. For further information regarding the engine performance, see the appendices.

6. REFERENCES

1. Instrumentation Handbook for the University of Kansas Propulsion Laboratory put together by Jerry Hanson, Aerospace Engineering Department Technician, 1983.
2. Eshbach, O.W., "Handbook of Engineering Fundamentals," Wiley Engineering Handbook Series, John Wiley and Sons INC; New York, © 1952.
3. Hamilton Standard: A Division of United Aircraft Corporation; Publication PDB 6101, Revision A, "Static Performance Calculation Procedures", Publication SP 67122, Sept. 27, 1967.
4. Rogowski, A.R.; "Elements of Internal-Combustion Engines"; McGraw-Hill Book Company, New York; © 1953.
5. Lan, C.T., Roskam J.; "Airplane Aerodynamics and Performance"; University of Kansas, Roskam Aviation and Engineering Corporation; © 1980.
6. Blacklock C.L., Davis R.K., Coussa G.; "Final Performance Data Obtained from a FOX 29 Model Airplane Engine", Report written to fulfill the requirements of AE571 (piston engines) at the Universtiy of Kansas, Professor W. Schweikhard, Instructor; 4/30/82.
7. Holman J.P., Gajada W.J.; "Experimental Methods for Engineers"; McGraw-Hill Book Company, New York, © 1978.

APPENDICES

APPENDIX A
PRESENTATION OF THE RAW DATA

TABLE OF CONTENTS

<u>Section</u>	<u>Title</u>	<u>Page</u>
A1.	Torque Calibration Curve	A1
A2.	Thrust Calibration Curve	A2
A3.	ΔP Calibration Curve	A3
A4.	Temperature Calibration Curve	A4
A5.	Propeller Calibration Curve	A5
A6.	Raw static Engine Data	A6
A7.	Raw Fuel Flow Data and Atmospheric Conditions for tests	A69

ORIGINAL PAGE IS
OF POOR QUALITY

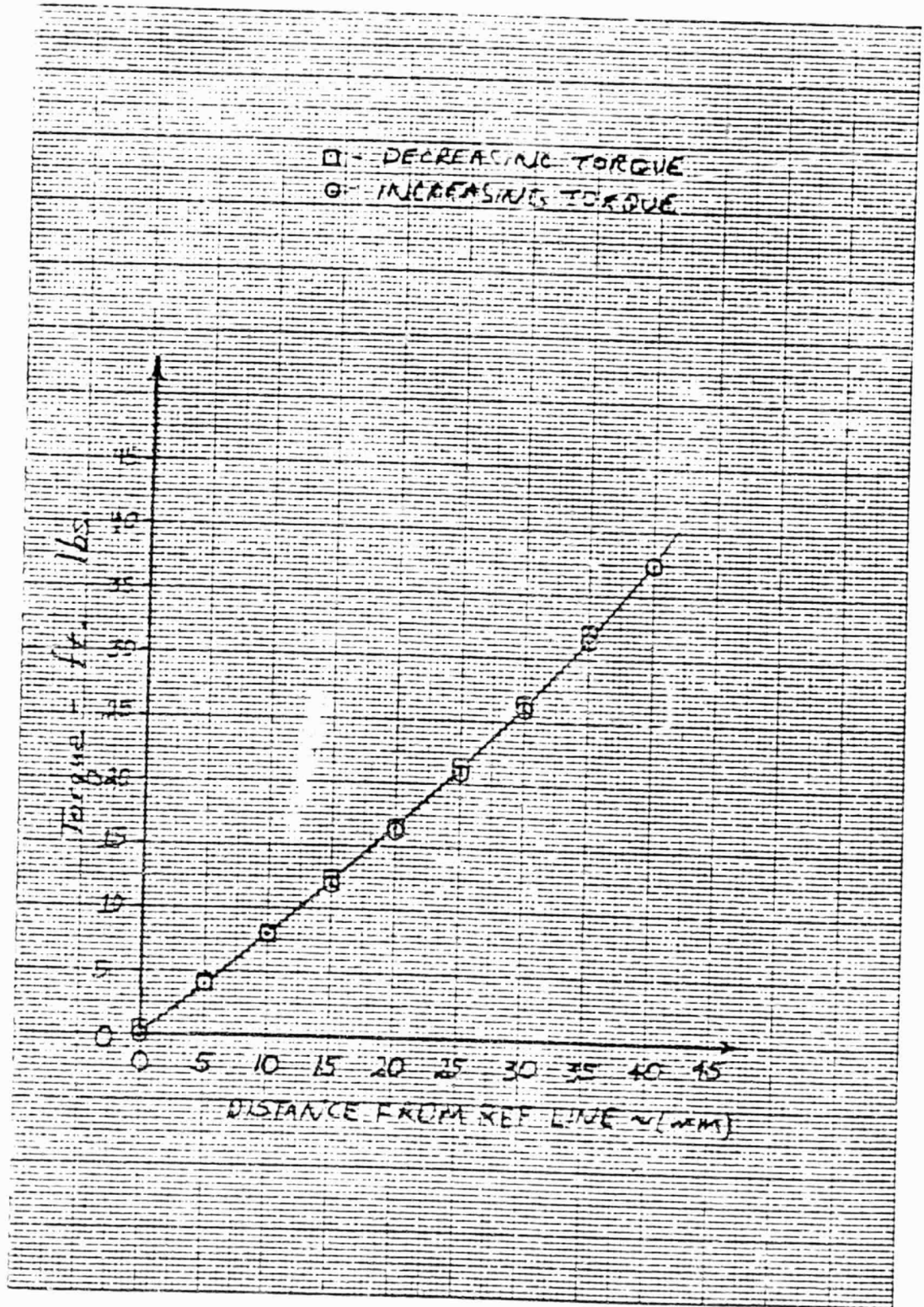

CALC	GLA RLOCK	8/16/83	REVISED	DATE
CHECK				
APPO				
APPO				

Figure 1A - Torque Calibration Curve.

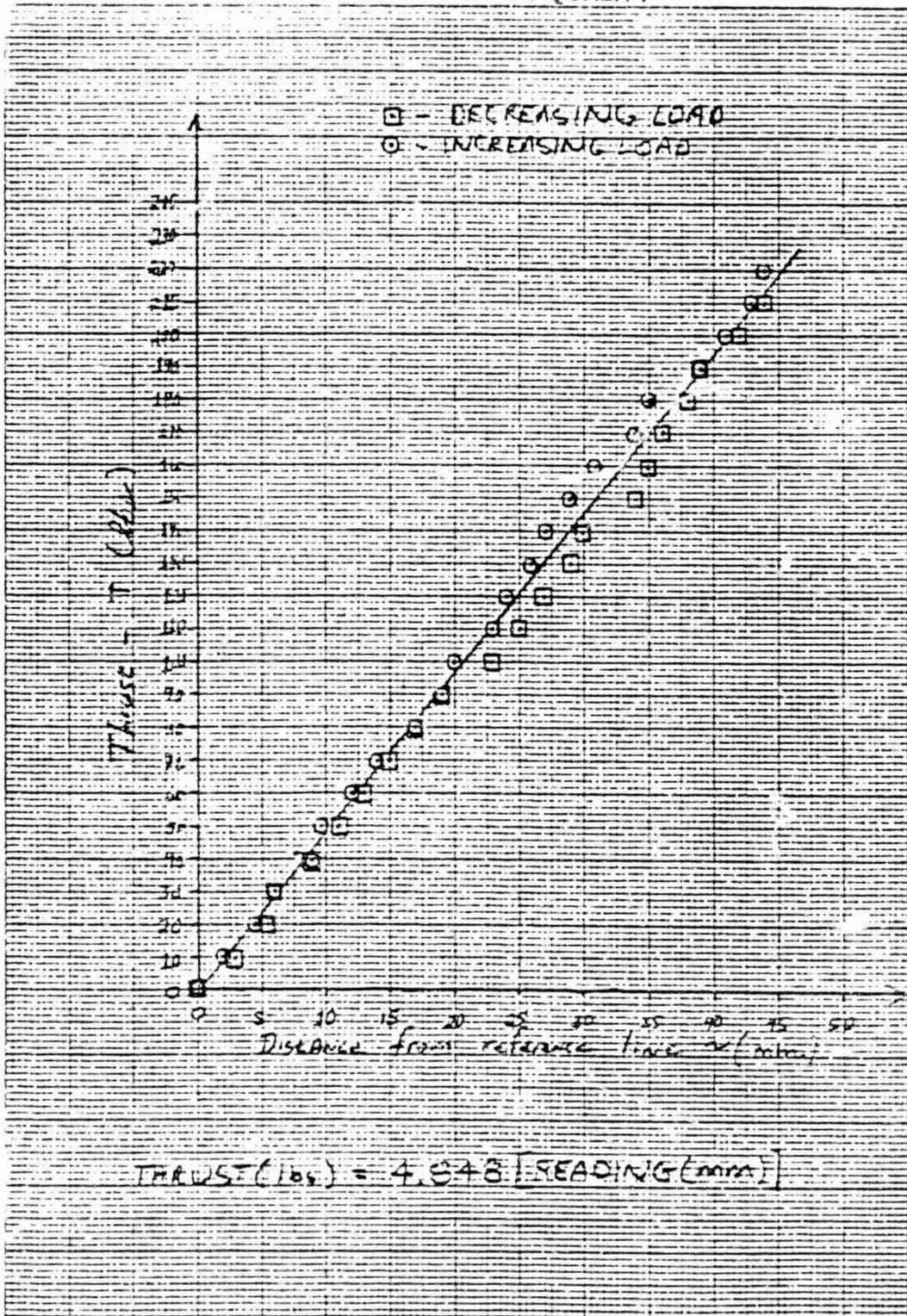

CALC BLACKLOCK 7/17/83	REVISED	DATE	Figure 2A - Thrust Calibration Curve.
CHECK			
APPD			
APPD			
UNIVERSITY OF KANSAS			PAGE A2

ORIGINAL PAGE IS
OF POOR QUALITY

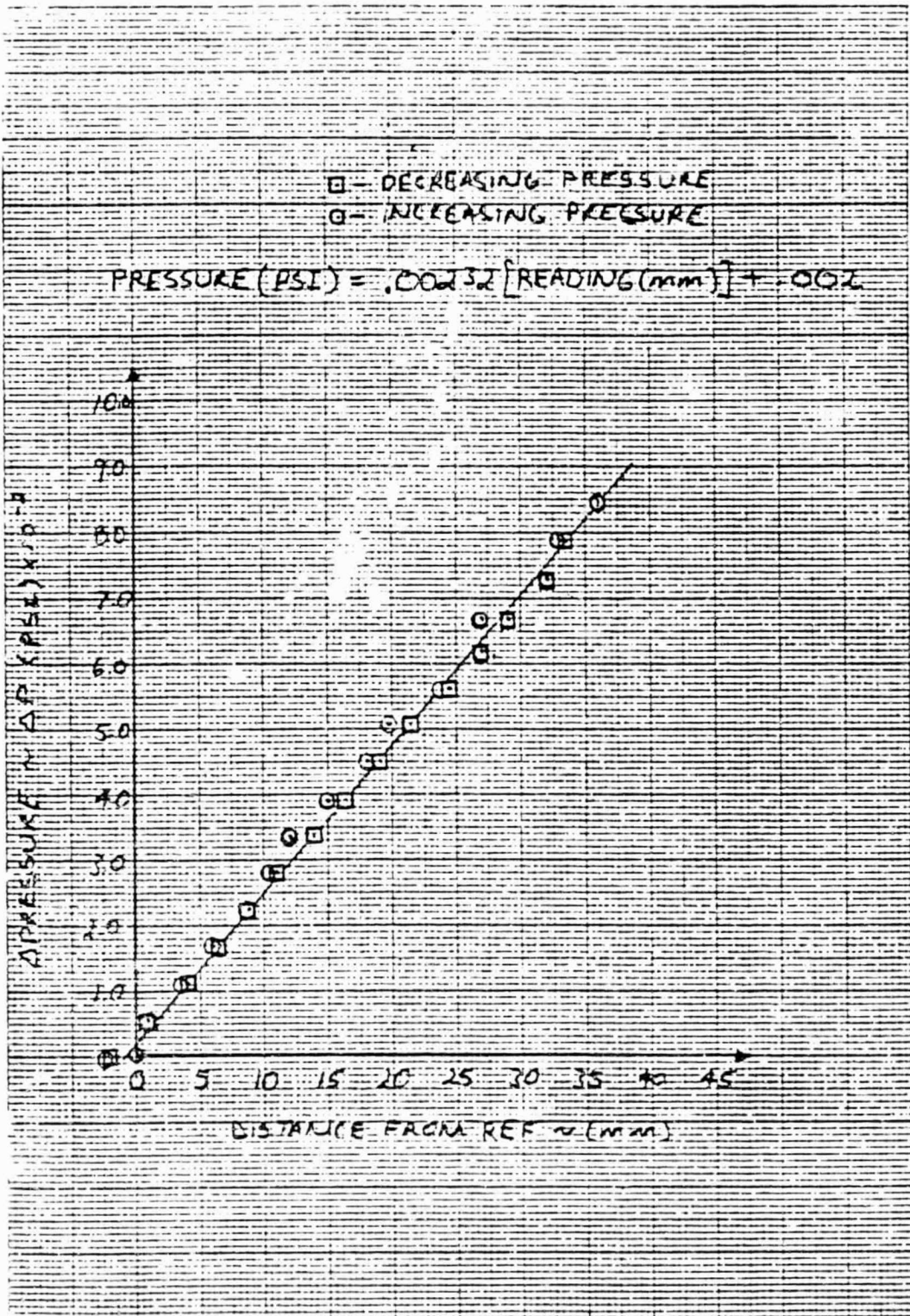

<table border="1"> <tr> <td>CALC</td> <td>BLACKLOCK</td> <td>3/17/53</td> <td>REVISED</td> <td>DATE</td> </tr> <tr> <td>CHECK</td> <td></td> <td></td> <td></td> <td></td> </tr> <tr> <td>APPO</td> <td></td> <td></td> <td></td> <td></td> </tr> <tr> <td>APPO</td> <td></td> <td></td> <td></td> <td></td> </tr> </table>	CALC	BLACKLOCK	3/17/53	REVISED	DATE	CHECK					APPO					APPO					<p>Figure 3A - ΔPressure Calibration Curve.</p>	<p>PAGE A3</p>
CALC	BLACKLOCK	3/17/53	REVISED	DATE																		
CHECK																						
APPO																						
APPO																						
UNIVERSITY OF KANSAS																						

ORIGINAL PAGE 19
OF POOR QUALITY

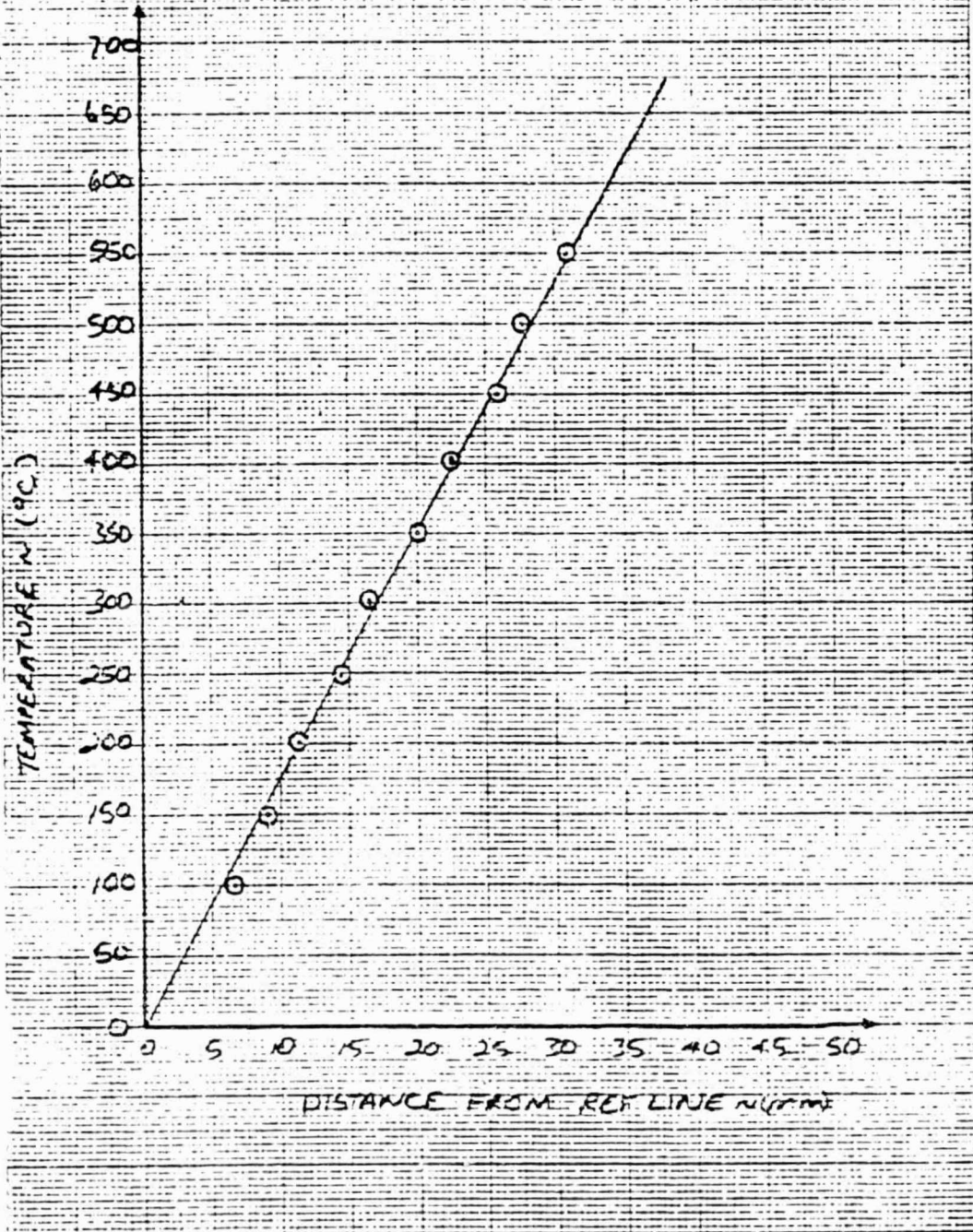

<table border="1"> <tr> <td> <table border="1"> <tr> <td> <table border="1"> <tr> <td> <table border="1"> <tr> <td>CALC</td> <td>Blacklock</td> <td>9/11</td> <td>REVISED</td> <td>DATE</td> </tr> <tr> <td>CHECK</td> <td></td> <td></td> <td></td> <td></td> </tr> <tr> <td>APPD</td> <td></td> <td></td> <td></td> <td></td> </tr> <tr> <td>APPD</td> <td></td> <td></td> <td></td> <td></td> </tr> </table> </td> <td colspan="4"> Figure 4A - Temperature Calibration Curve. </td> </tr> <tr> <td colspan="5" style="text-align: center;"> UNIVERSITY OF KANSAS </td> <td style="text-align: right;"> PAGE A4 </td> </tr> </table> </td> </tr> </table> </td> </tr> </table>	<table border="1"> <tr> <td> <table border="1"> <tr> <td> <table border="1"> <tr> <td>CALC</td> <td>Blacklock</td> <td>9/11</td> <td>REVISED</td> <td>DATE</td> </tr> <tr> <td>CHECK</td> <td></td> <td></td> <td></td> <td></td> </tr> <tr> <td>APPD</td> <td></td> <td></td> <td></td> <td></td> </tr> <tr> <td>APPD</td> <td></td> <td></td> <td></td> <td></td> </tr> </table> </td> <td colspan="4"> Figure 4A - Temperature Calibration Curve. </td> </tr> <tr> <td colspan="5" style="text-align: center;"> UNIVERSITY OF KANSAS </td> <td style="text-align: right;"> PAGE A4 </td> </tr> </table> </td> </tr> </table>	<table border="1"> <tr> <td> <table border="1"> <tr> <td>CALC</td> <td>Blacklock</td> <td>9/11</td> <td>REVISED</td> <td>DATE</td> </tr> <tr> <td>CHECK</td> <td></td> <td></td> <td></td> <td></td> </tr> <tr> <td>APPD</td> <td></td> <td></td> <td></td> <td></td> </tr> <tr> <td>APPD</td> <td></td> <td></td> <td></td> <td></td> </tr> </table> </td> <td colspan="4"> Figure 4A - Temperature Calibration Curve. </td> </tr> <tr> <td colspan="5" style="text-align: center;"> UNIVERSITY OF KANSAS </td> <td style="text-align: right;"> PAGE A4 </td> </tr> </table>	<table border="1"> <tr> <td>CALC</td> <td>Blacklock</td> <td>9/11</td> <td>REVISED</td> <td>DATE</td> </tr> <tr> <td>CHECK</td> <td></td> <td></td> <td></td> <td></td> </tr> <tr> <td>APPD</td> <td></td> <td></td> <td></td> <td></td> </tr> <tr> <td>APPD</td> <td></td> <td></td> <td></td> <td></td> </tr> </table>	CALC	Blacklock	9/11	REVISED	DATE	CHECK					APPD					APPD					Figure 4A - Temperature Calibration Curve.				UNIVERSITY OF KANSAS					PAGE A4
<table border="1"> <tr> <td> <table border="1"> <tr> <td> <table border="1"> <tr> <td>CALC</td> <td>Blacklock</td> <td>9/11</td> <td>REVISED</td> <td>DATE</td> </tr> <tr> <td>CHECK</td> <td></td> <td></td> <td></td> <td></td> </tr> <tr> <td>APPD</td> <td></td> <td></td> <td></td> <td></td> </tr> <tr> <td>APPD</td> <td></td> <td></td> <td></td> <td></td> </tr> </table> </td> <td colspan="4"> Figure 4A - Temperature Calibration Curve. </td> </tr> <tr> <td colspan="5" style="text-align: center;"> UNIVERSITY OF KANSAS </td> <td style="text-align: right;"> PAGE A4 </td> </tr> </table> </td> </tr> </table>	<table border="1"> <tr> <td> <table border="1"> <tr> <td>CALC</td> <td>Blacklock</td> <td>9/11</td> <td>REVISED</td> <td>DATE</td> </tr> <tr> <td>CHECK</td> <td></td> <td></td> <td></td> <td></td> </tr> <tr> <td>APPD</td> <td></td> <td></td> <td></td> <td></td> </tr> <tr> <td>APPD</td> <td></td> <td></td> <td></td> <td></td> </tr> </table> </td> <td colspan="4"> Figure 4A - Temperature Calibration Curve. </td> </tr> <tr> <td colspan="5" style="text-align: center;"> UNIVERSITY OF KANSAS </td> <td style="text-align: right;"> PAGE A4 </td> </tr> </table>	<table border="1"> <tr> <td>CALC</td> <td>Blacklock</td> <td>9/11</td> <td>REVISED</td> <td>DATE</td> </tr> <tr> <td>CHECK</td> <td></td> <td></td> <td></td> <td></td> </tr> <tr> <td>APPD</td> <td></td> <td></td> <td></td> <td></td> </tr> <tr> <td>APPD</td> <td></td> <td></td> <td></td> <td></td> </tr> </table>	CALC	Blacklock	9/11	REVISED	DATE	CHECK					APPD					APPD					Figure 4A - Temperature Calibration Curve.				UNIVERSITY OF KANSAS					PAGE A4	
<table border="1"> <tr> <td> <table border="1"> <tr> <td>CALC</td> <td>Blacklock</td> <td>9/11</td> <td>REVISED</td> <td>DATE</td> </tr> <tr> <td>CHECK</td> <td></td> <td></td> <td></td> <td></td> </tr> <tr> <td>APPD</td> <td></td> <td></td> <td></td> <td></td> </tr> <tr> <td>APPD</td> <td></td> <td></td> <td></td> <td></td> </tr> </table> </td> <td colspan="4"> Figure 4A - Temperature Calibration Curve. </td> </tr> <tr> <td colspan="5" style="text-align: center;"> UNIVERSITY OF KANSAS </td> <td style="text-align: right;"> PAGE A4 </td> </tr> </table>	<table border="1"> <tr> <td>CALC</td> <td>Blacklock</td> <td>9/11</td> <td>REVISED</td> <td>DATE</td> </tr> <tr> <td>CHECK</td> <td></td> <td></td> <td></td> <td></td> </tr> <tr> <td>APPD</td> <td></td> <td></td> <td></td> <td></td> </tr> <tr> <td>APPD</td> <td></td> <td></td> <td></td> <td></td> </tr> </table>	CALC	Blacklock	9/11	REVISED	DATE	CHECK					APPD					APPD					Figure 4A - Temperature Calibration Curve.				UNIVERSITY OF KANSAS					PAGE A4		
<table border="1"> <tr> <td>CALC</td> <td>Blacklock</td> <td>9/11</td> <td>REVISED</td> <td>DATE</td> </tr> <tr> <td>CHECK</td> <td></td> <td></td> <td></td> <td></td> </tr> <tr> <td>APPD</td> <td></td> <td></td> <td></td> <td></td> </tr> <tr> <td>APPD</td> <td></td> <td></td> <td></td> <td></td> </tr> </table>	CALC	Blacklock	9/11	REVISED	DATE	CHECK					APPD					APPD					Figure 4A - Temperature Calibration Curve.												
CALC	Blacklock	9/11	REVISED	DATE																													
CHECK																																	
APPD																																	
APPD																																	
UNIVERSITY OF KANSAS					PAGE A4																												

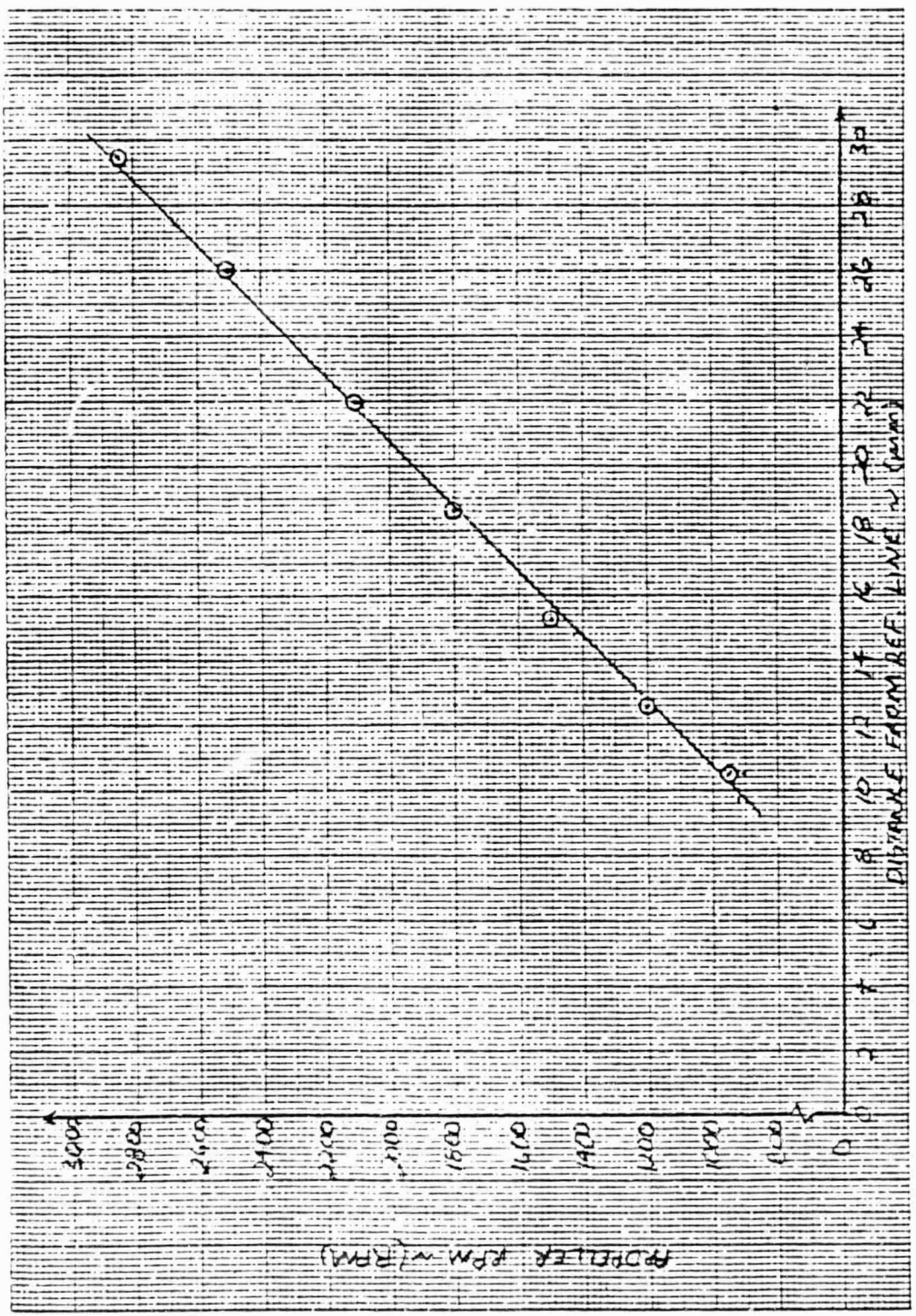

CALC	BLACKLOLV	9/17	REVISED	DATE	Figure 5A - Propeller RPM Calibration Curve	PAGE A5
CHECK						
APPD					UNIVERSITY OF KANSAS	PAGE A5
APPD						

ORIGINAL PAGE IS
OF POOR QUALITY

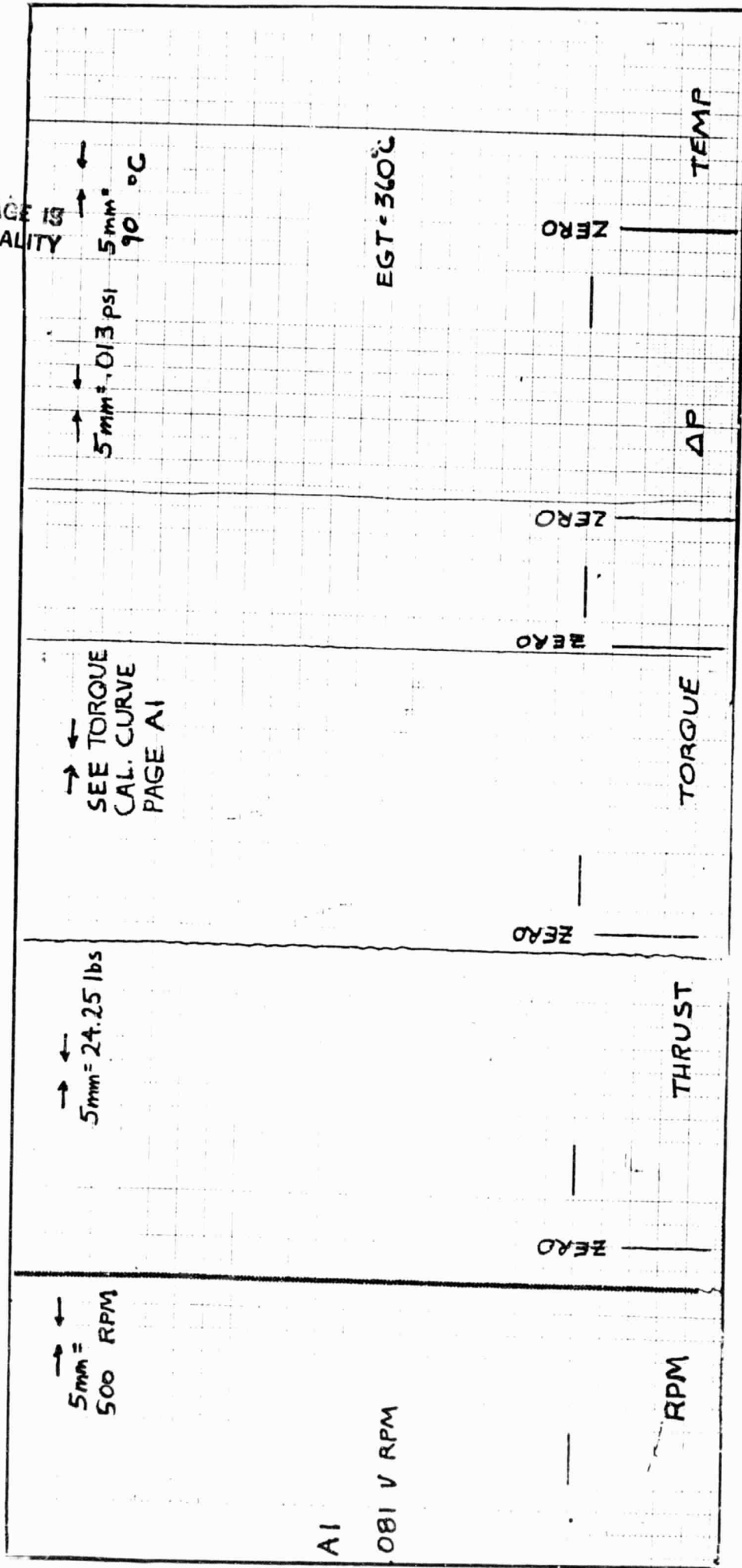

Figure A-1 - Raw static engine data.
RPM= 881, Humidity= 70.0%, OAT= 86°F
Date: 8/29/83, BP= 29.20 in of HG

ORIGINAL PAGE IS
OF POOR QUALITY

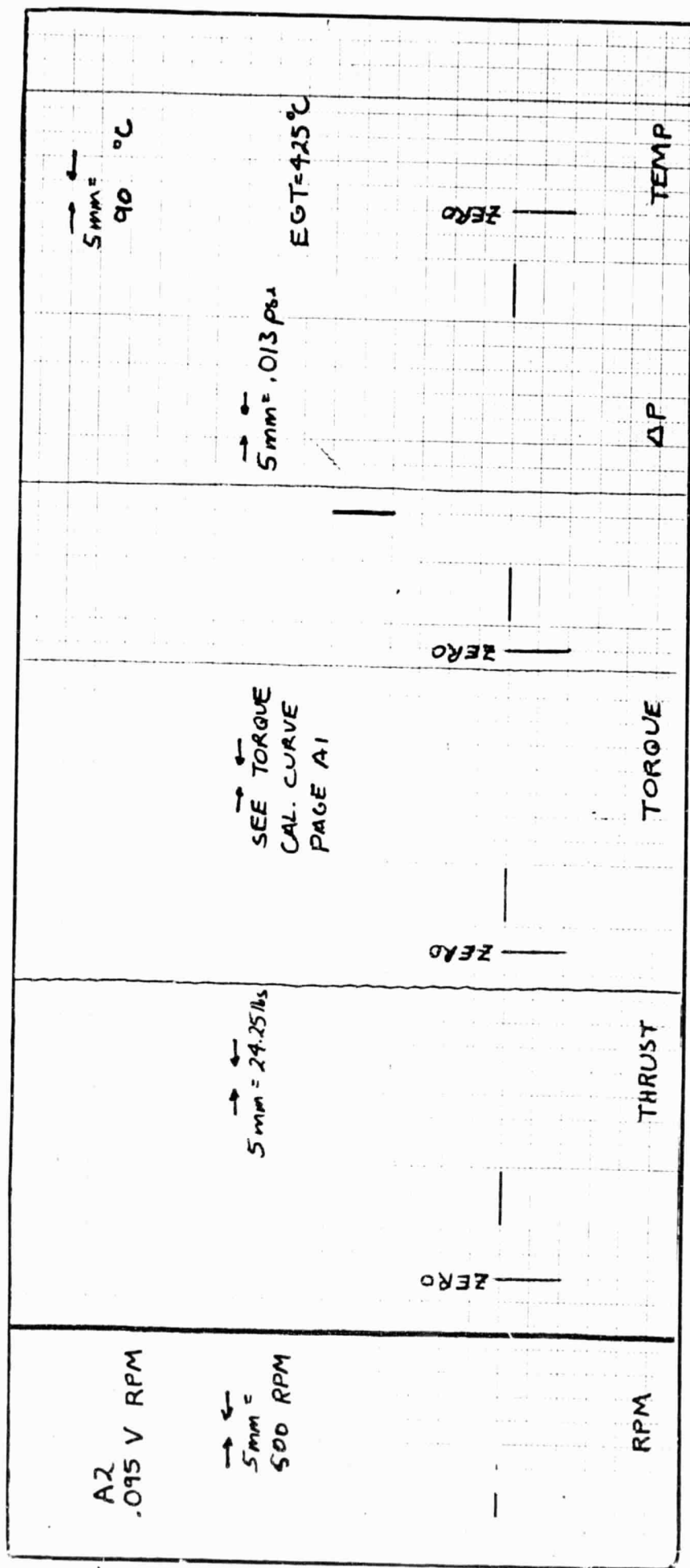

Figure A-2 - Raw static engine data.
RPM= 1214, Humidity=70.0%, OAT= 86 °F
Date: 8/29/83, BP= 29.20 in of HG

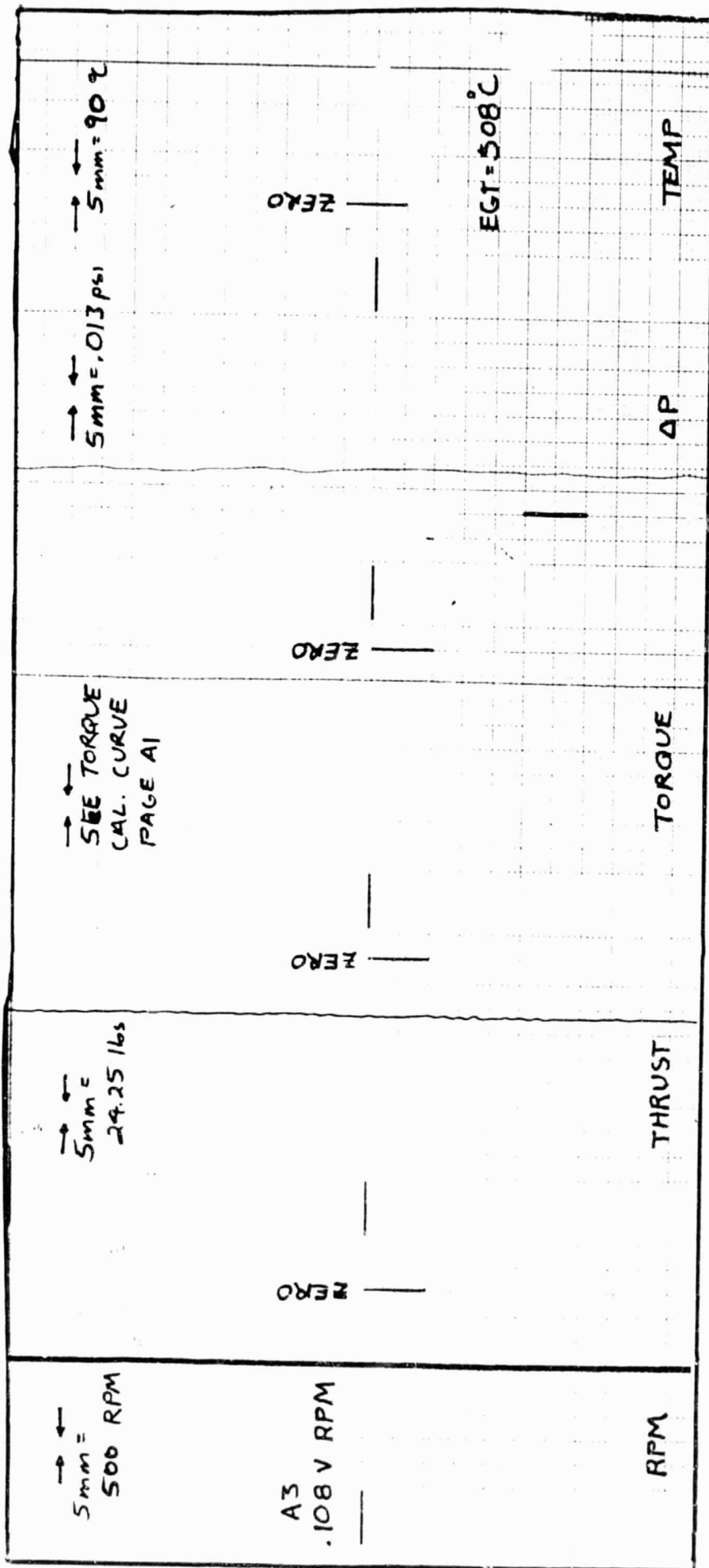
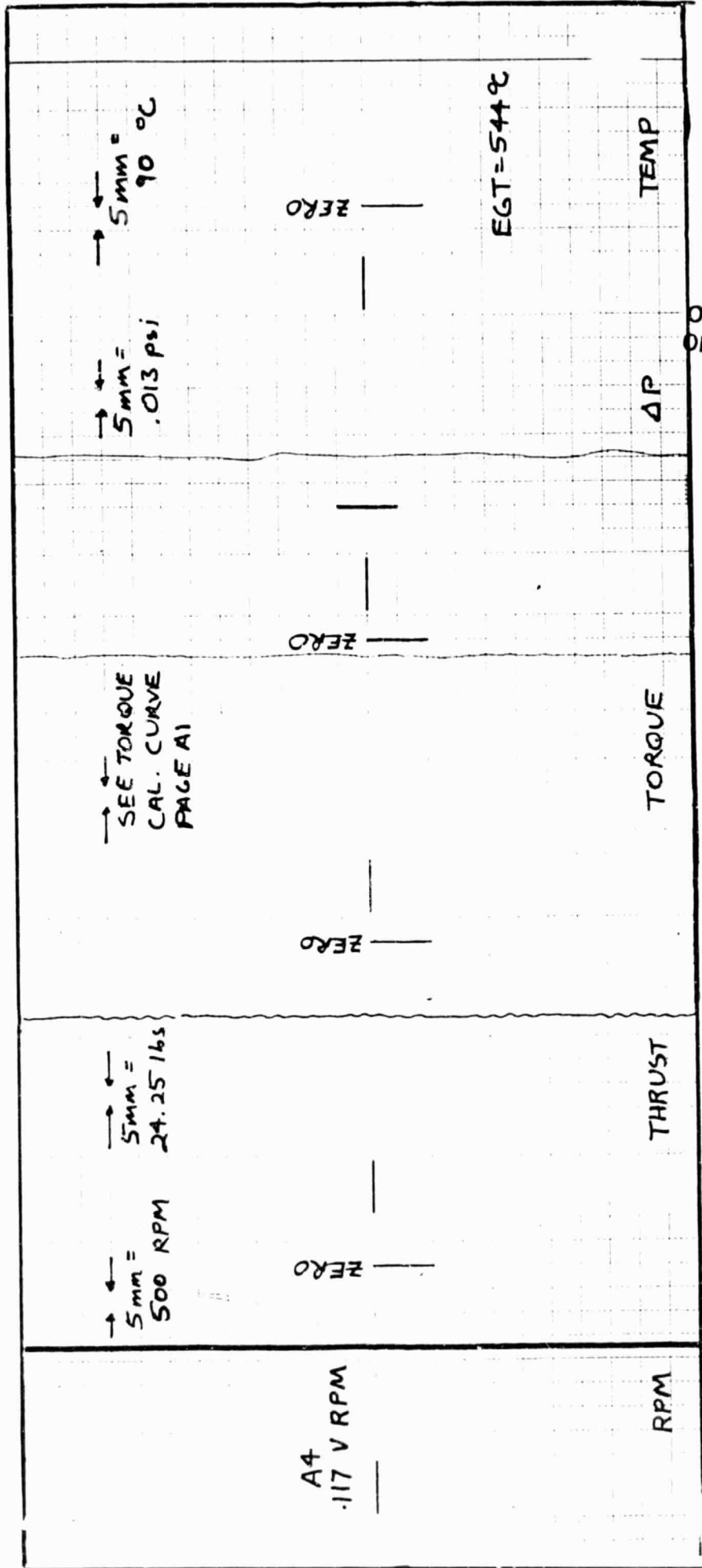

Figure A-3 - Raw static engine data.
 RPM = 1524, Humidity = 71.0% OAT = 86°F
 Date: 8/29/83, BP = 29.20 in of HG

ORIGINAL PAGE 13
 OF POOR QUALITY



ORIGINAL PAGE IS
OF POOR QUALITY

Figure A-4 - Raw static engine data.
RPM= 1738, Humidity= 71.0%, OAT= 86°F
Date: 8/29/83, BP= 29.20 in of HG

ORIGINAL PAGE IS
OF POOR QUALITY

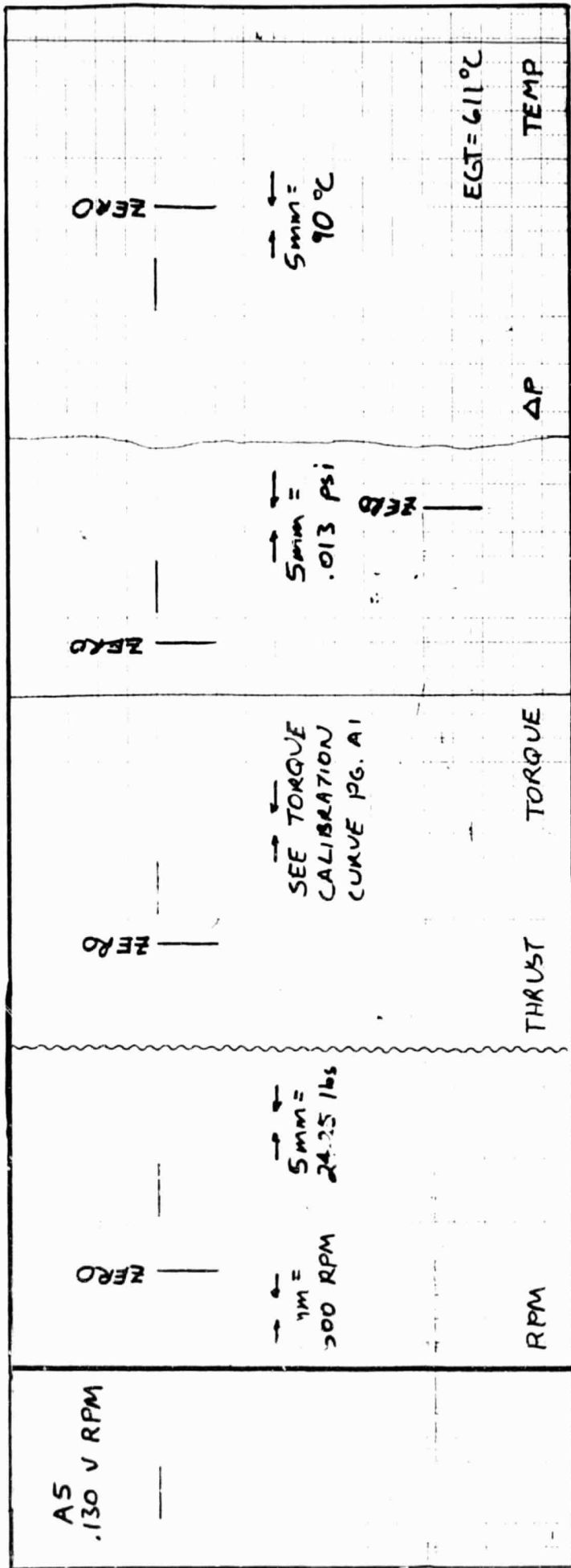

Figure A-5 - Raw static engine data.
RPM= 2048, Humidity= 71.0%, OAT= 86°F
Date: 8/29/83, BP= 29.20 in of HG

ORIGINAL PAGE IS
OF POOR QUALITY

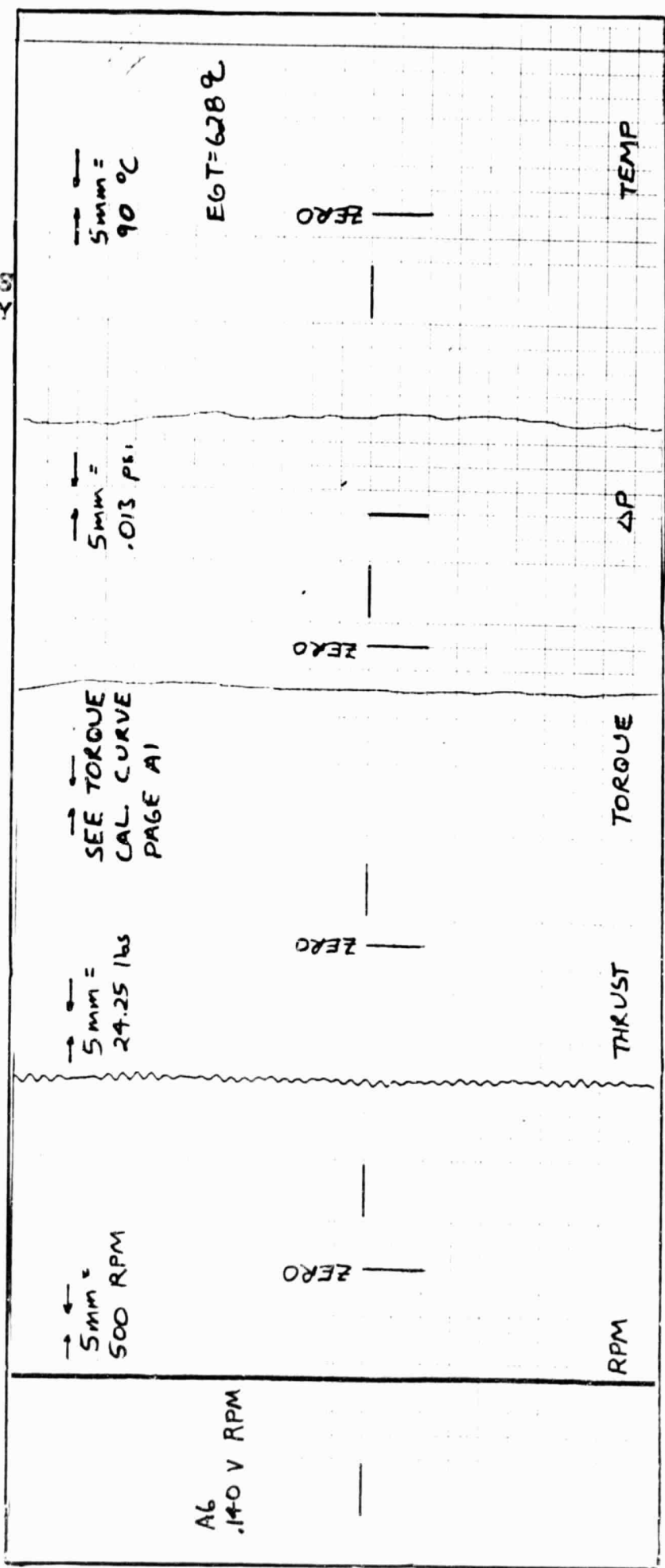

Figure A-6 - Raw static engine data,
RPM= 2286, Humidity= 71.0%, OAT= 86 °F
Date: 8/29/83, BP= 29.20 in of HG

ORIGINAL PAGE IS
OF POOR QUALITY

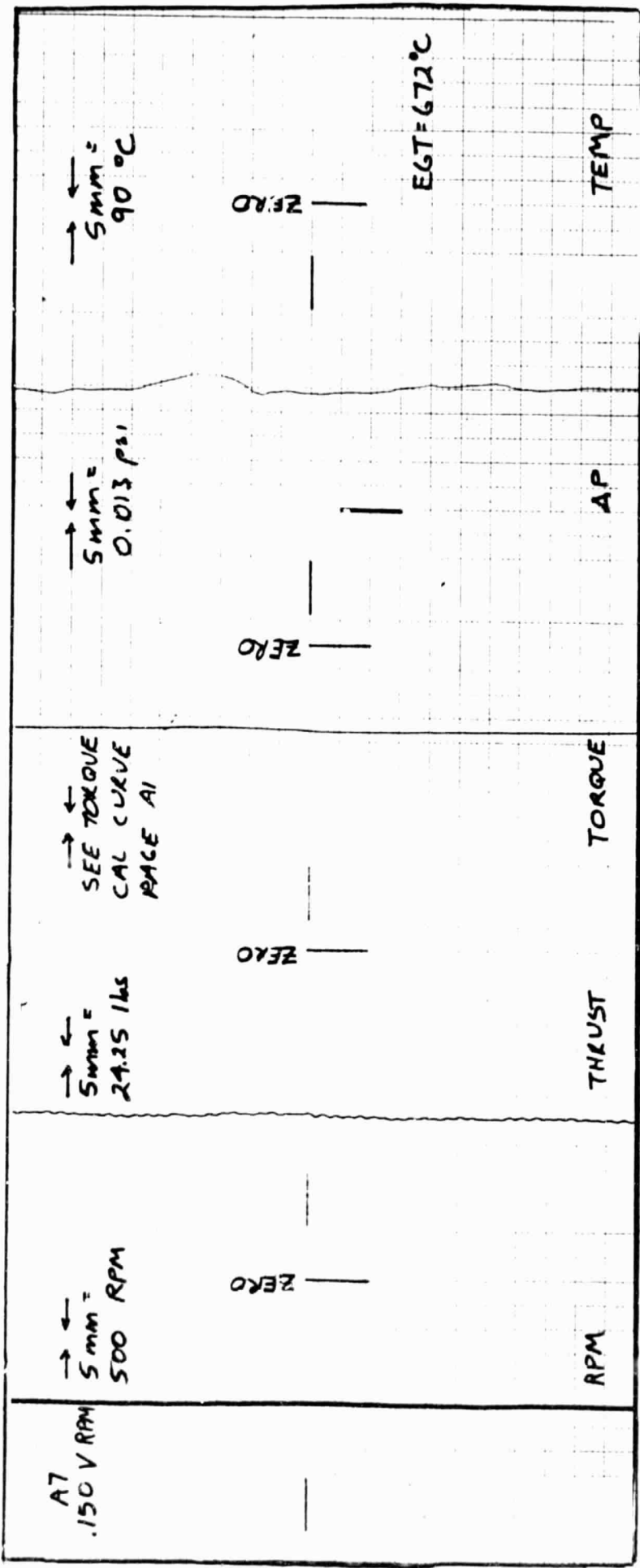
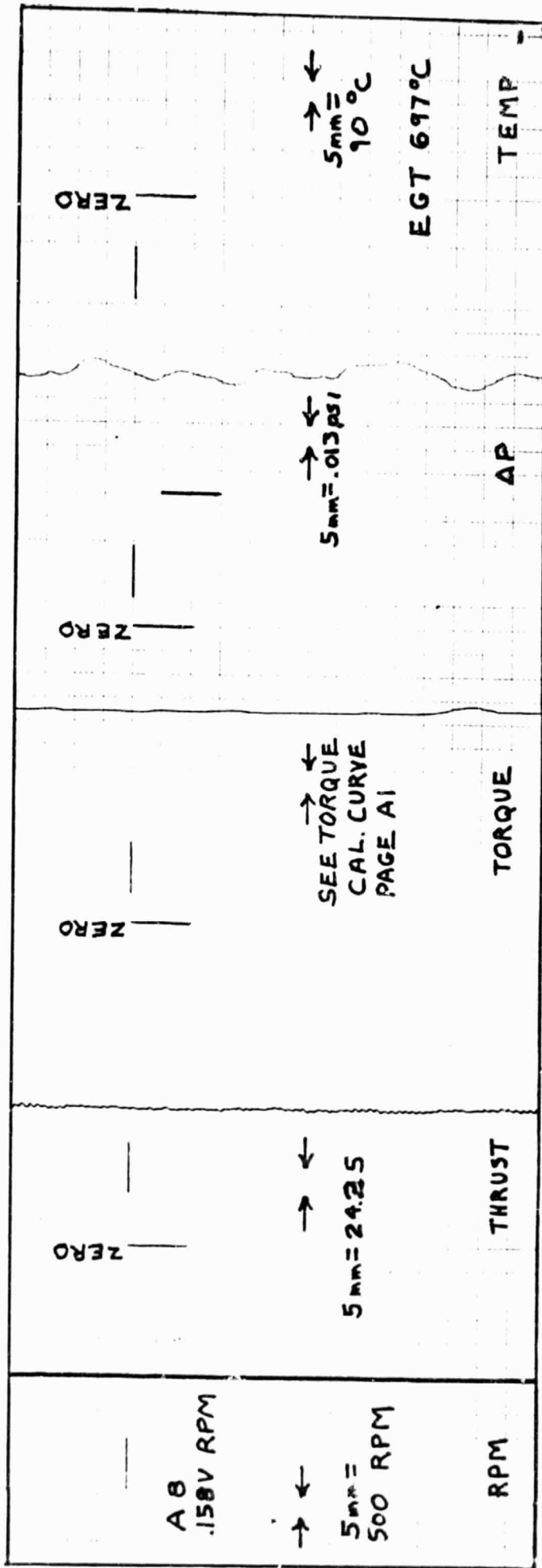

Figure A-7 - Raw static engine data,
RPM = 2524, Humidity = 71.0, CAT = 86°F
Date: 8/29/83, BP = 29.20 in. HG



ORIGINAL PAGE IS
OF POOR QUALITY

Figure A-8 - Raw static engine data,
RPM= 2714, Humidity= 71.0%, OAT= 86°F
Date: 8/29/83, BP= 29.20 in of HG

(A13)

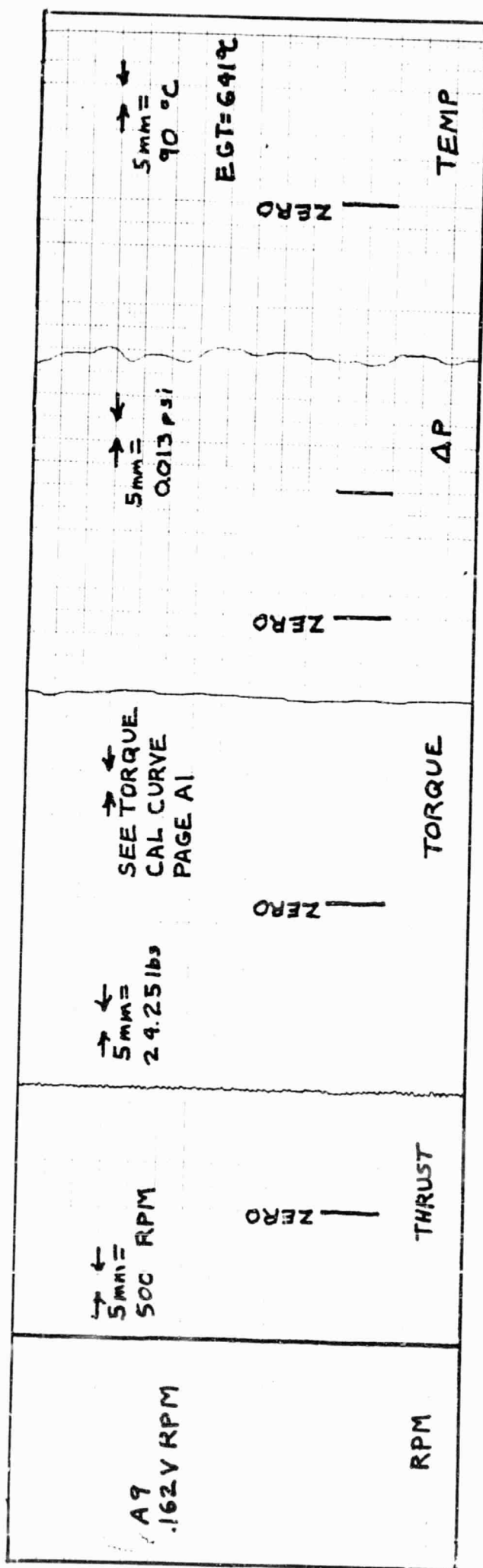

ORIGINAL PAGE IS
OF POOR QUALITY

Figure A-9 - Raw static engine data.
RPM= 2810, Humidity= 71.0%, OAT= 86°F
Date: 8/29/83, BP= 29.20 in of HG

(A14)

ORIGINAL PAGE IS
OF POOR QUALITY

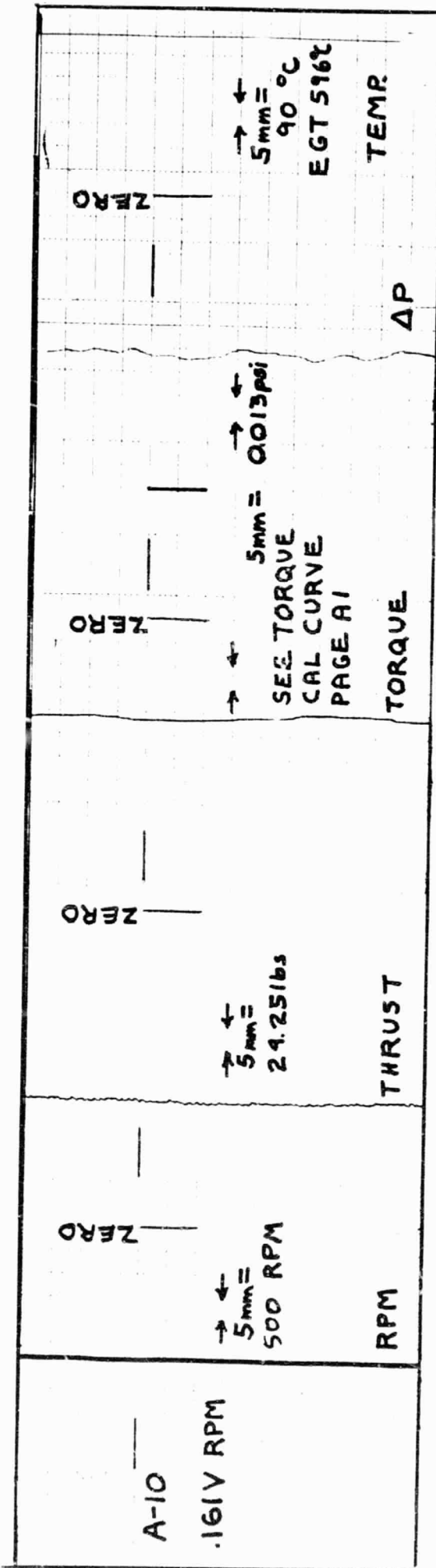

Figure A-10 - Raw static engine data.
RPM= 2786, Humidity= 71.0%, OAT= 86°F
Date: 8/29/83, BP= 29.20 in of HG

ORIGINAL PAGE IS
OF POOR QUALITY

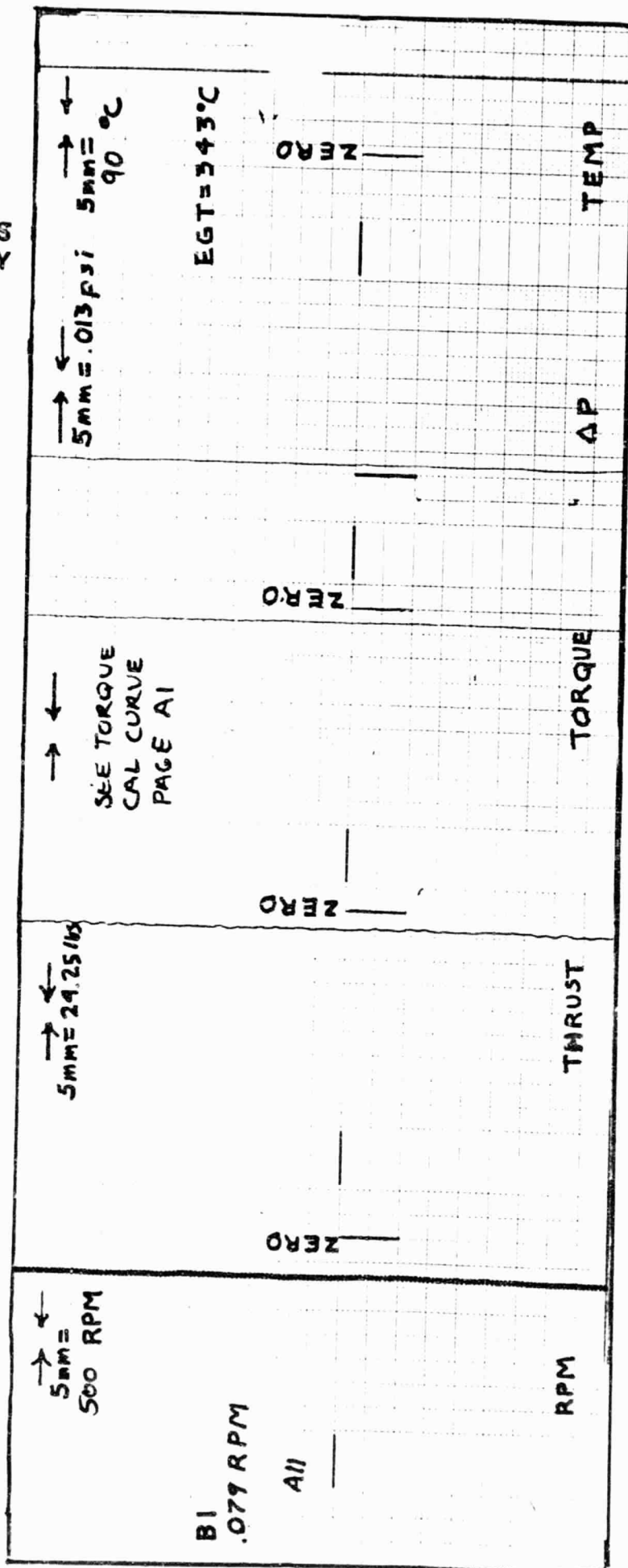

Figure A-11 - Raw static engine data.
RPM= 833, Humidity=69.5%, OAT= 87°F
Date: 8/29/83, BP= 29.26 in of HG

ORIGINAL PAGE IS
OF POOR QUALITY

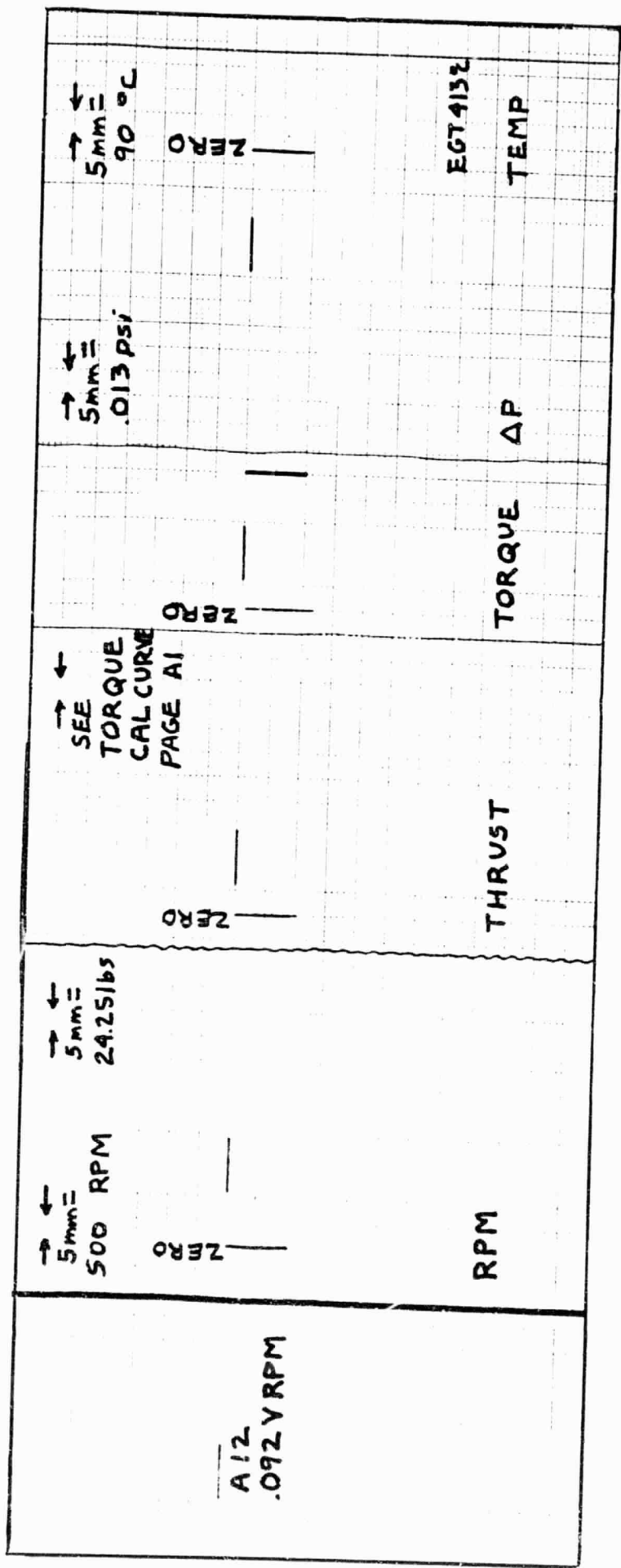

Figure A-12 - Raw Static engine data.
RPM= 1143, Humidity= 69.5%, OAT= 87°F
Date: 8/29/83, BP= 29.2" in of HG

(A17)

ORIGINAL PAGE 13
OF POOR QUALITY

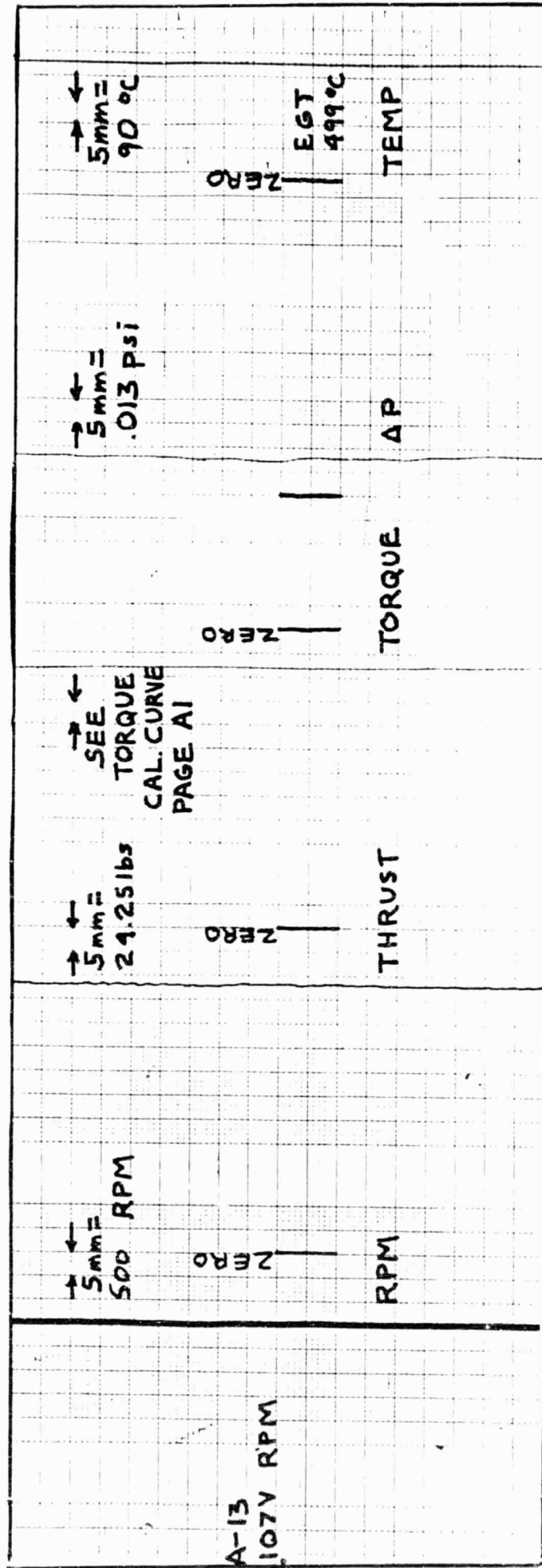

Figure A-13 - Raw static engine data.
RPM=1500, Humidity=69.5%, OAT= 87 F
Date: 8/29/83, BP= 29.24 in of HG

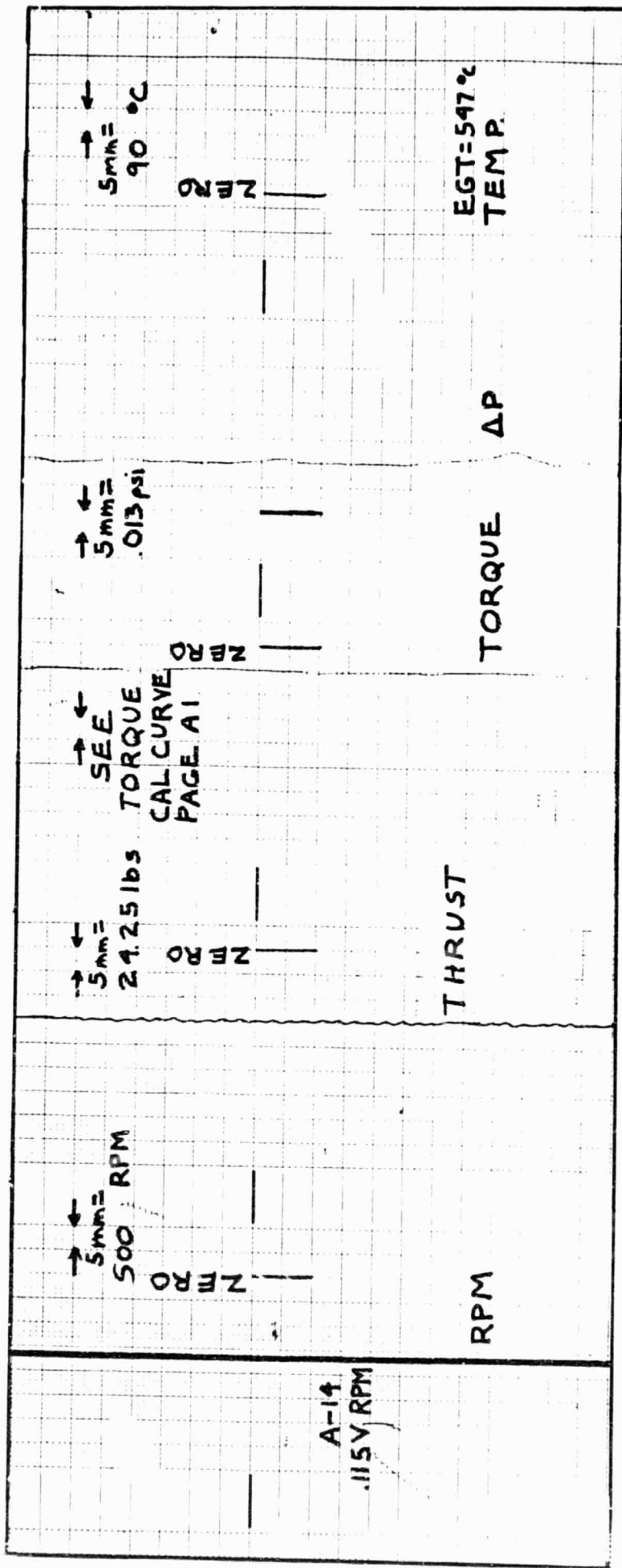

Figure A-14 - Raw static engine data.
 RPM= 1690, Humidity=69.0%, OAT= 87°F
 Date: 8/29/83, BP= 29.24 in of HG

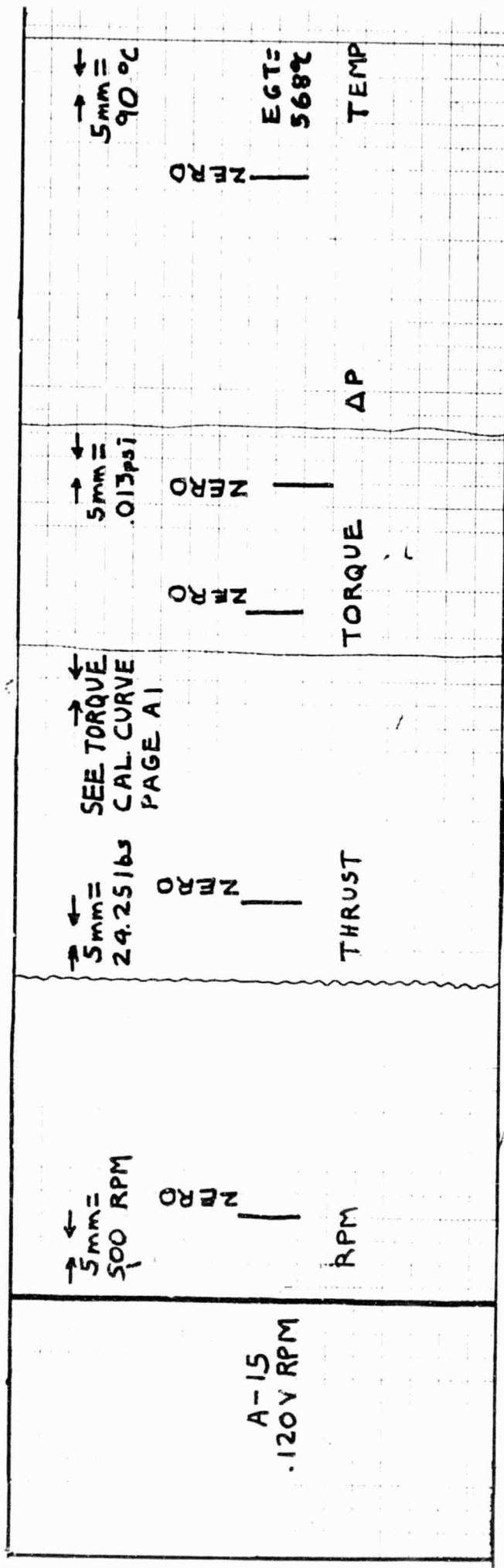

Figure A-15 - Raw static engine data.
 RPM= 1810, Humidity= 69.0%, OAT= 87°F
 Date: 8/29/83, BP= 29.24 in of HG

ORIGINAL PAGE IS
 OF POOR QUALITY

(A20)

ORIGINAL PAGE IS
OF POOR QUALITY

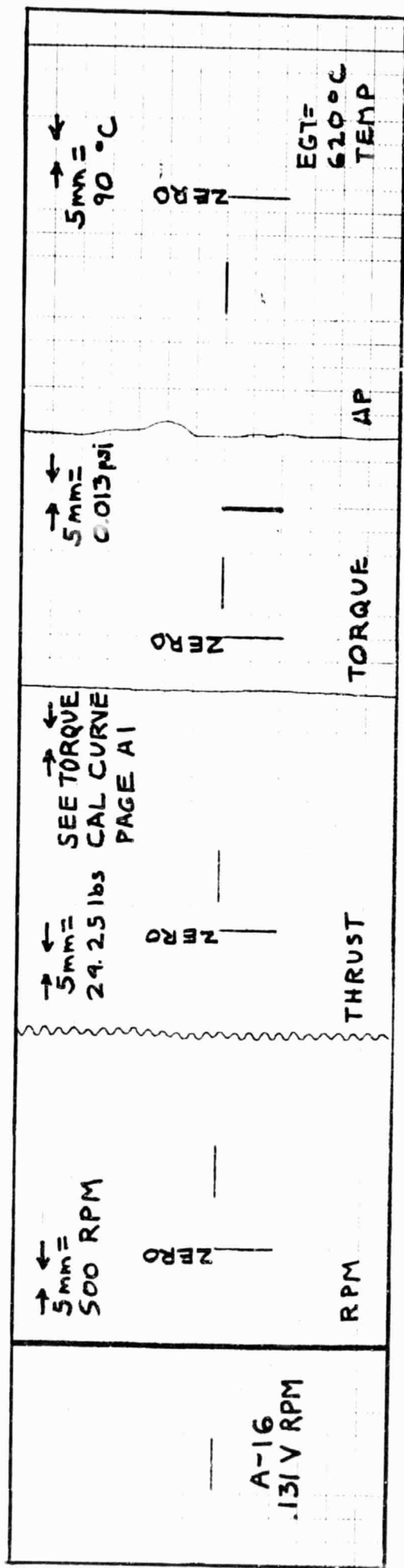

Figure A-16 - Raw static engine data.
RPM= 2071, Humidity= 69.0%, OAT= 87°F
Date: 8/29/83, BP= 29.25 in of HG

ORIGINAL PAGE 15
OF POOR QUALITY

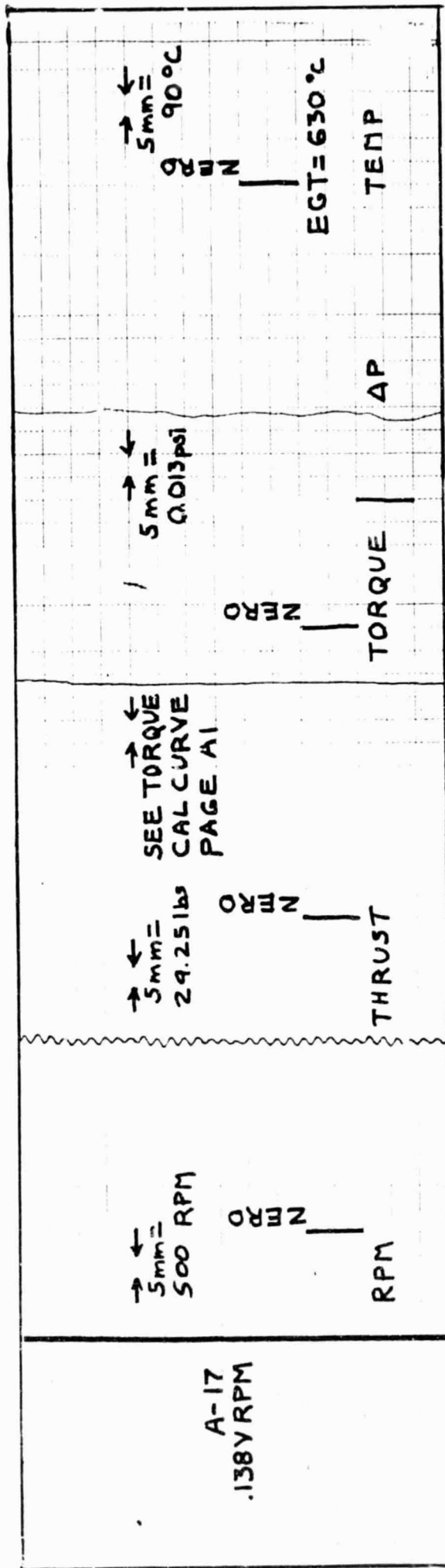
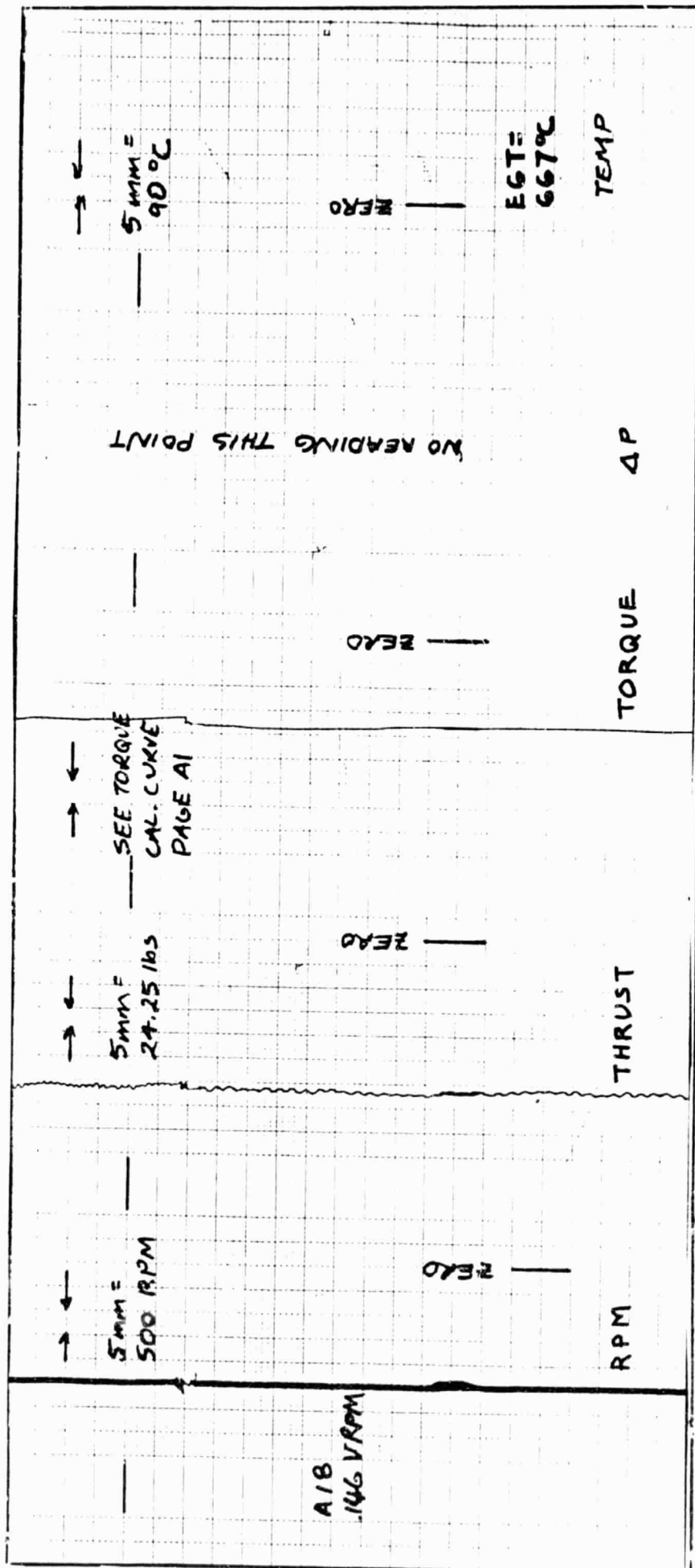

Figure A-17 - Raw static engine data.
RPM = 2338, Humidity = 69.0%, OAT = 87°F
Date: 8/29/83, BP = 29.25 in of HG

(A22)



ORIGINAL PAGE IS
OF POOR QUALITY

Figure A-18 - Raw static engine data.
RPM= 2429, Humidity= 69.0%, OAT= 87°F
Date: 8/29/83, BP= 29.25 in of HG

(A23)

ORIGINAL PAGE IS
OF POOR QUALITY

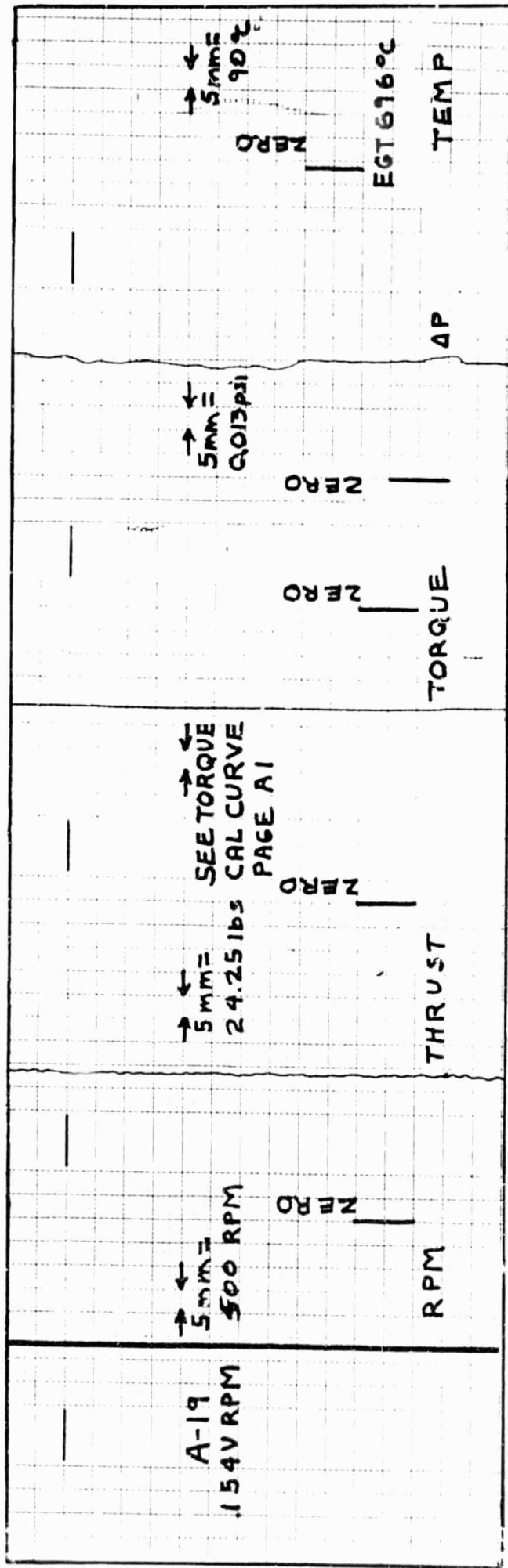

Figure A-19 - Raw static engine data.
RPM= 2619, Humidity= 68.0%, OAT= 87°F
Date: 8/29/83, BP= 29.25 in of HG

ORIGINAL PAGE IS
OF POOR QUALITY

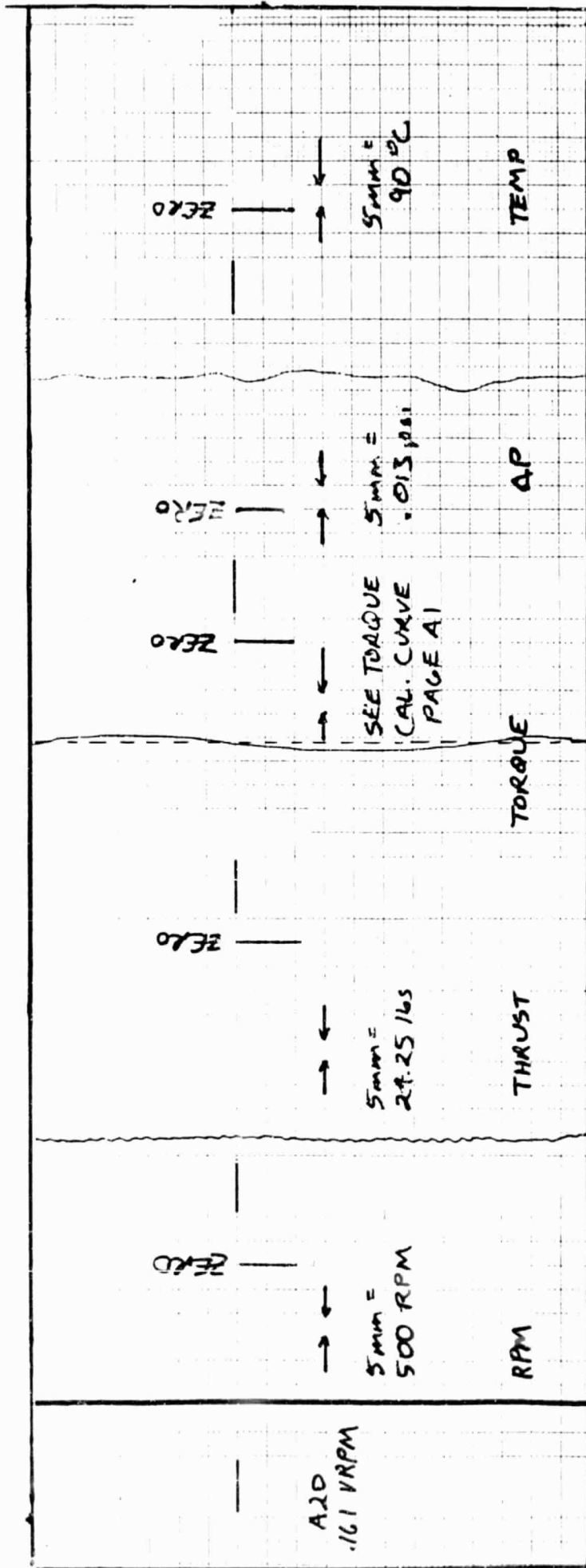
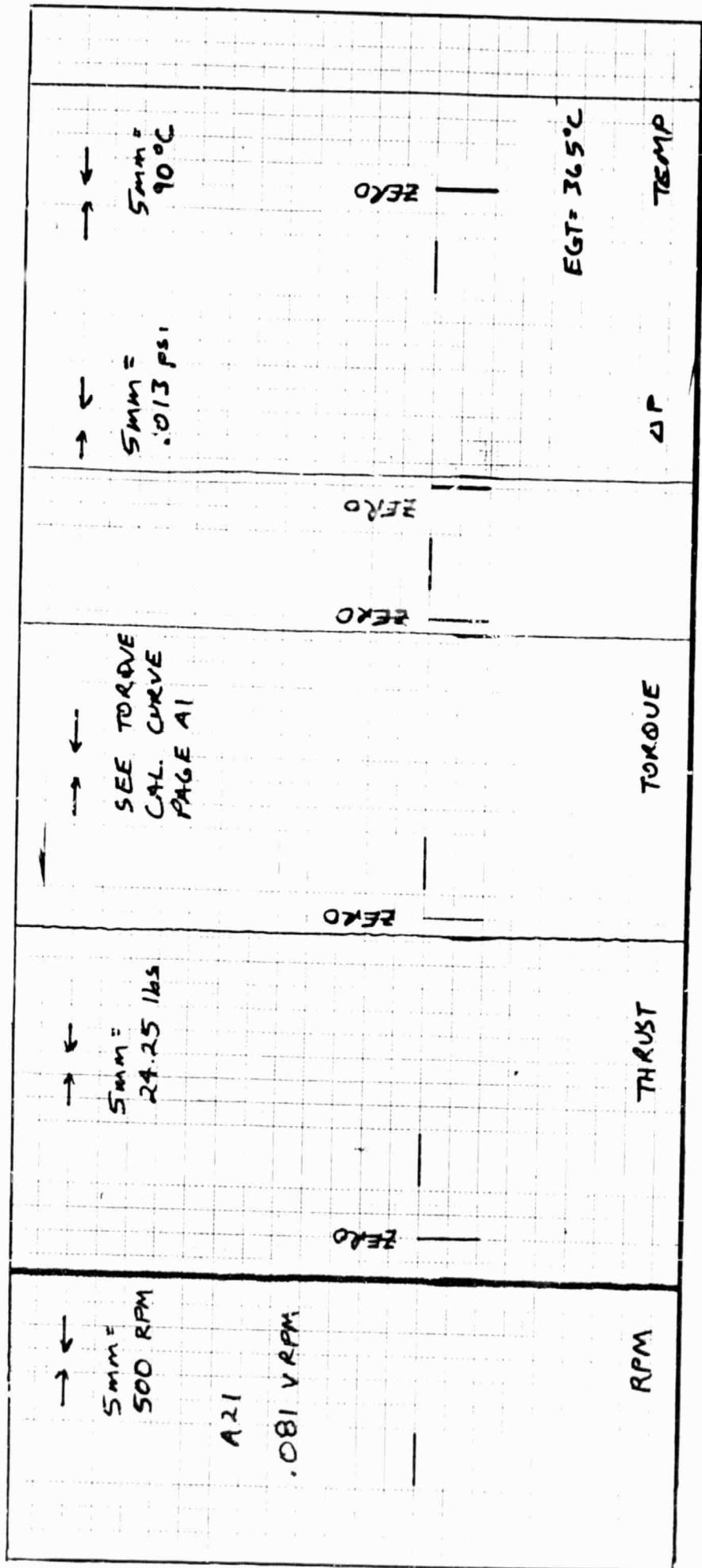
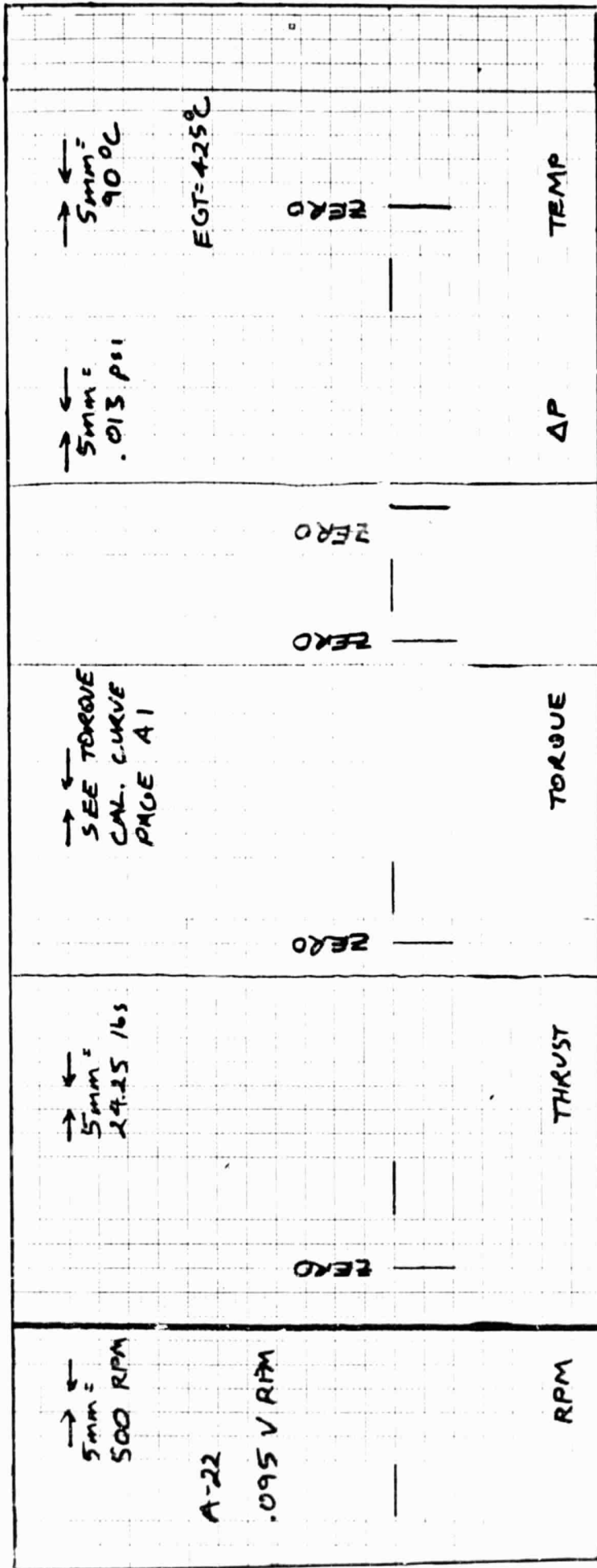

Figure A-20 - Raw static engine data.
RPM= 2786, Humidity= 68.0%, OAT= 88°F
Date: 8/29/83, BP= 29.25 in of HG



ORIGINAL PAGE IS
OF POOR QUALITY

Figure A-21 - Raw static engine data.
 RPM = 881, Humidity = 66.5%, OAT = 87°F
 Date: 8/29/83, BP = 29.25 in of HG



ORIGINAL PAGE IS
OF POOR QUALITY

Figure A-22 - Raw static engine data.
RPM= 1214, Humidity= 67.0%, OAT= 88°F
Date: 8/29/83, BP= 29.25 in of HG

(A27)

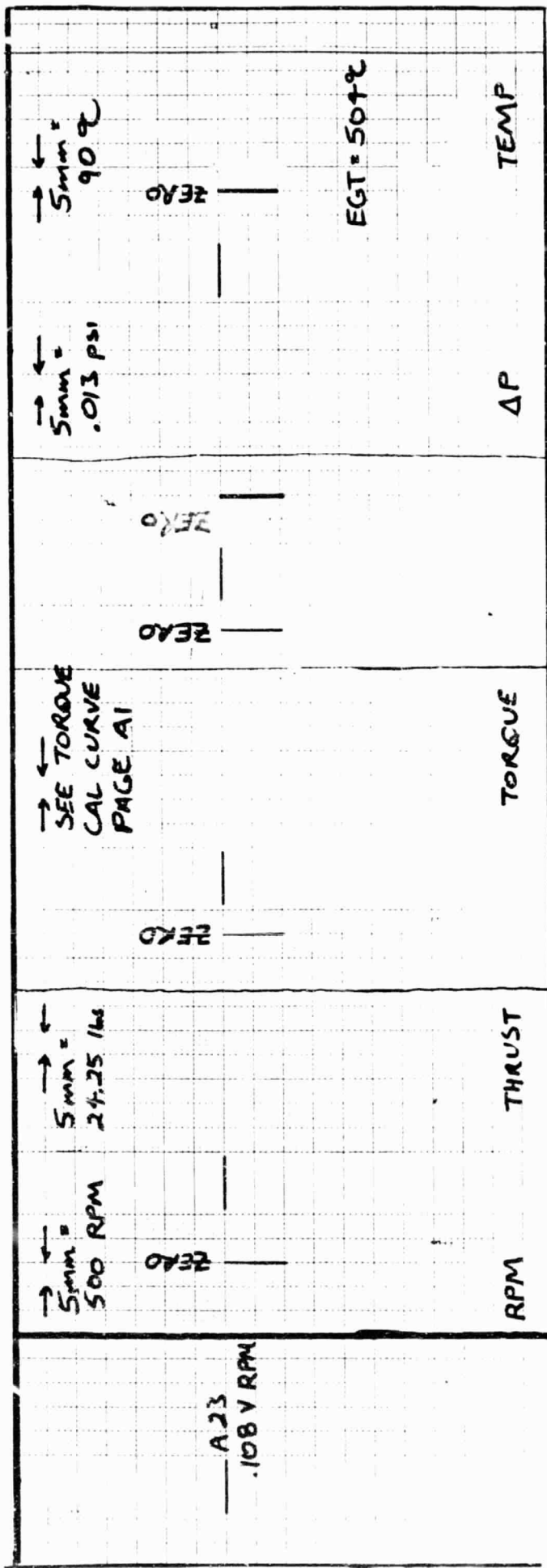

ORIGINAL PAGE 13
OF POOR QUALITY

Figure A-23 - Raw static engine data.
RPM= 1524, Humidity= 67.0%, OAT= 88°F
Date: 8/29/83, BP= 29.25 in of HG

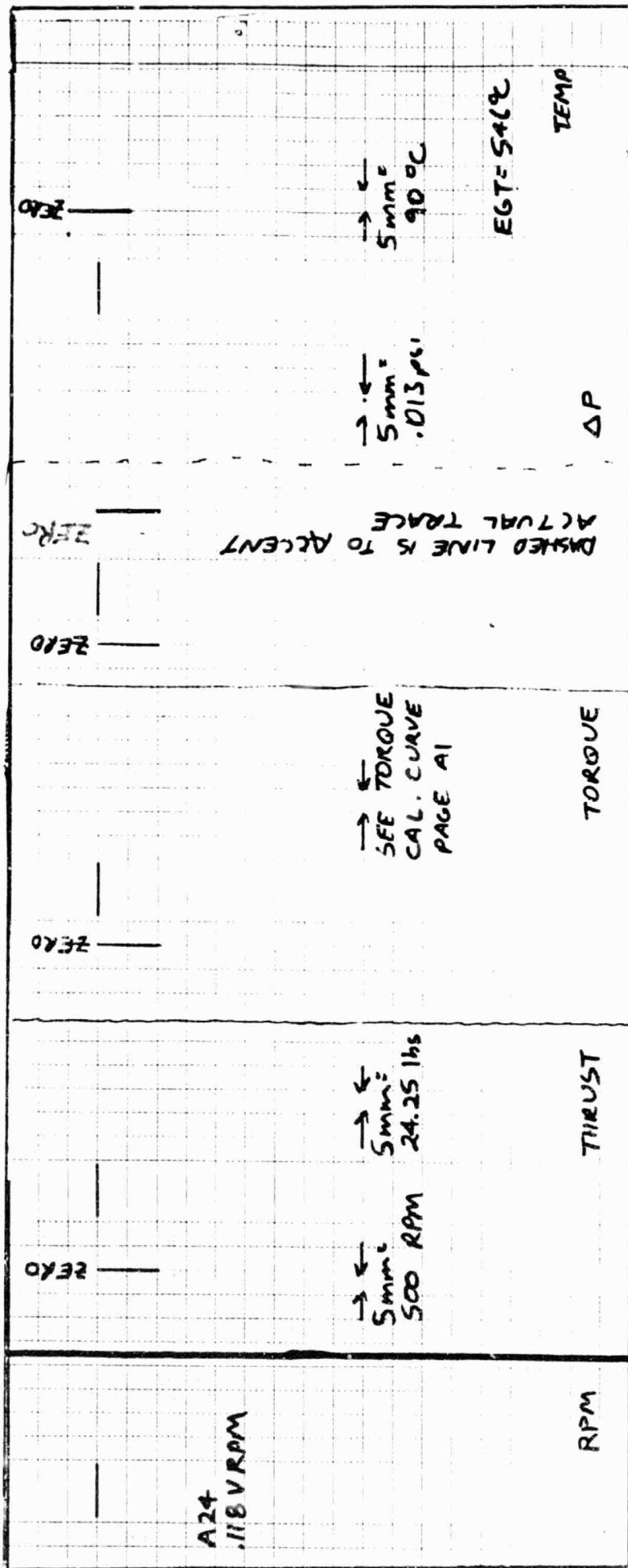

ORIGINAL PAGE IS OF POOR QUALITY

Figure A-24 - Raw static engine data.
 RPM = 1762, Humidity = 66.5%, OAT = 88°F
 Date: 8/29/83, DP = 29.25 in of HG

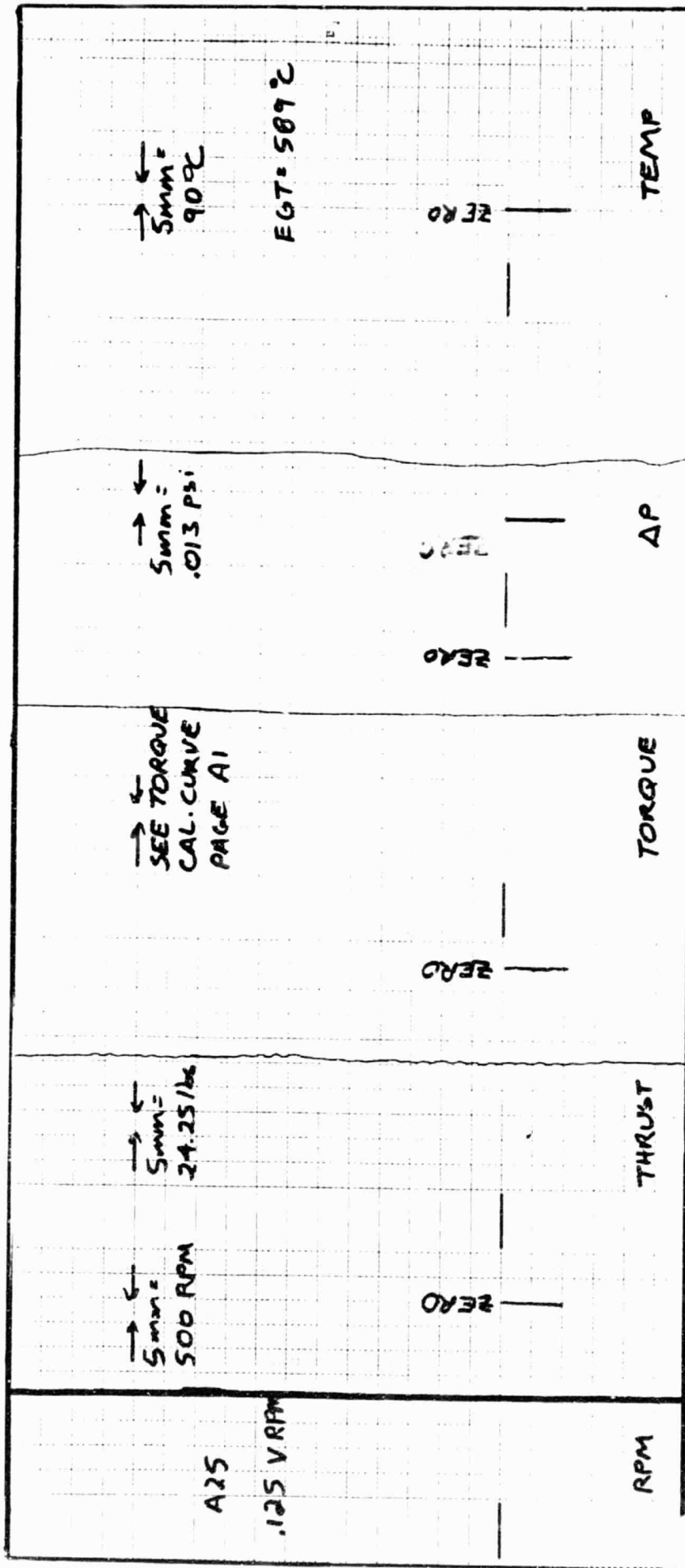

ORIGINAL PAGE IS
OF POOR QUALITY

Figure A-25 - Raw static engine data.
 RPM = 1929, Humidity = 66.0%, OAT = 88°F
 Date: 8/29/83, BP = 29.25 in of HG

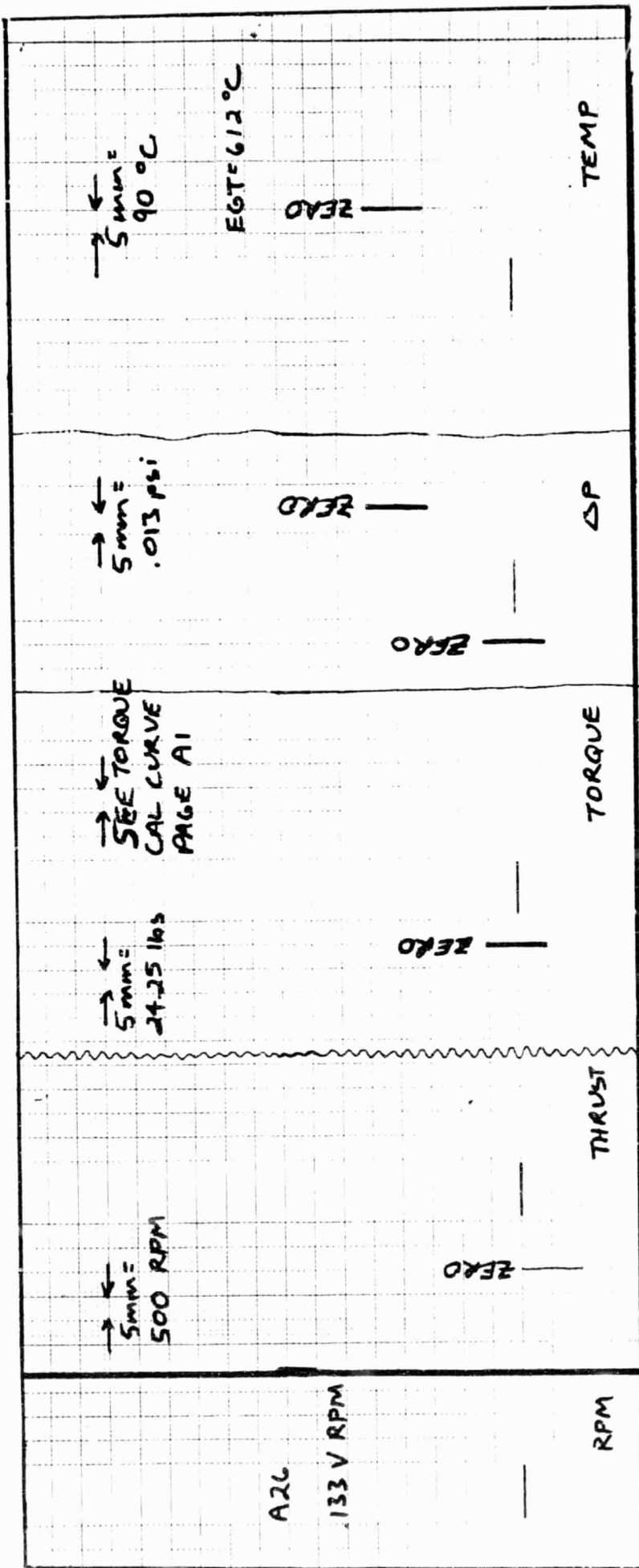

ORIGINAL PAGE IS
OF POOR QUALITY

Figure A-26 - Paw static engine data.
 RPM = 2119, Humidity = 66.0%, OAT = 88°F
 Date: 8/29/83, BP = 29.25 in of HG

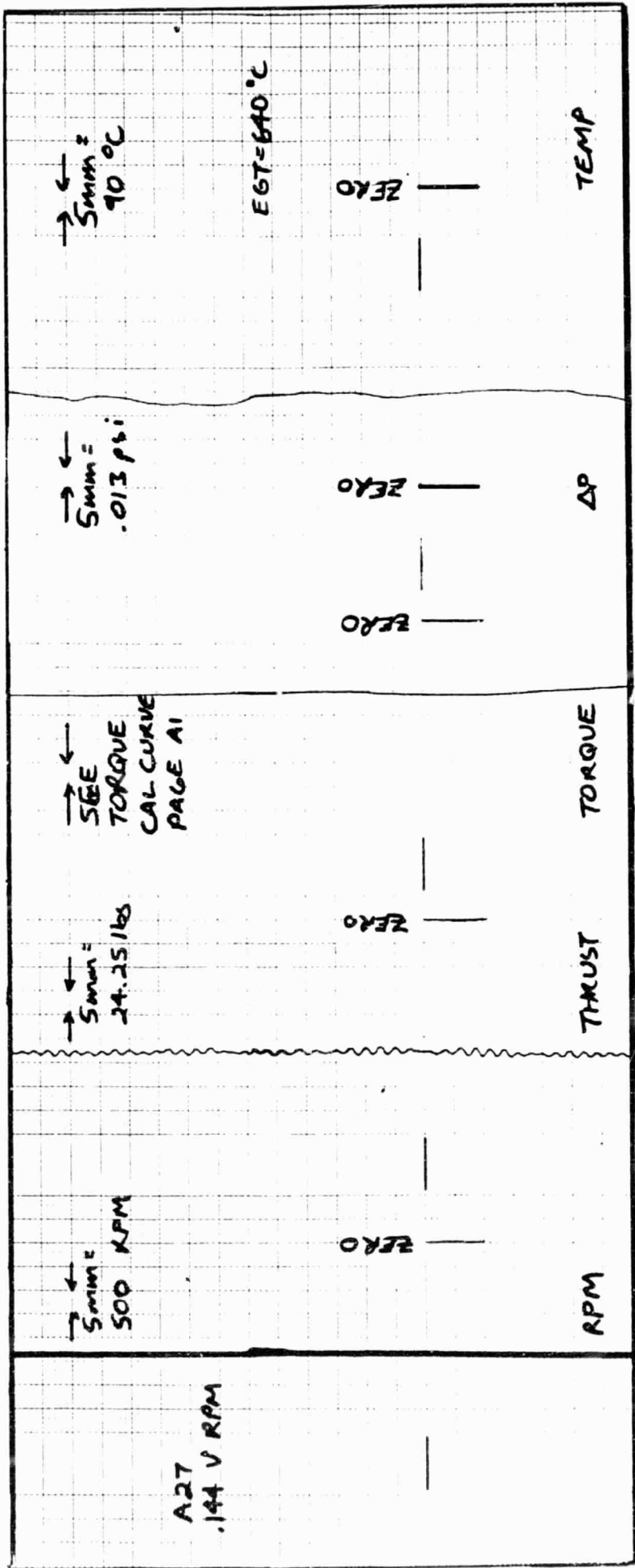

CH 10176 PAGE 13
OF POOR QUALITY

Figure A-27 - Raw static engine data.
RPM= 2381, Humidity= 67.0%, OAT= 88°F
Date: 8/29/83, BP= 29.25 in of HG

(A32)

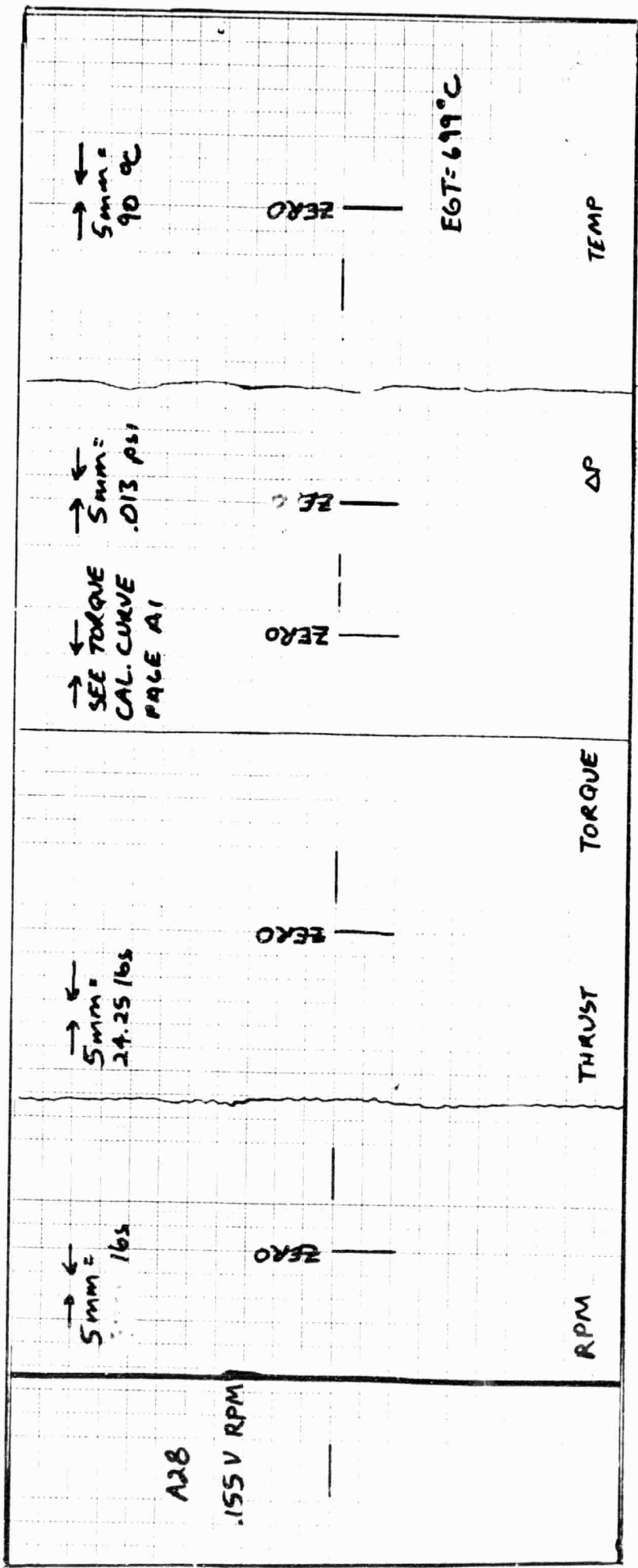

ORIGINAL PAGE IS OF POOR QUALITY

Figure A-28 - Raw static engine data.
 RPM= 2643, Humidity= 66.5%, OAT= 88°F
 Date: 8/29/83, BP= 29.25 in of HG

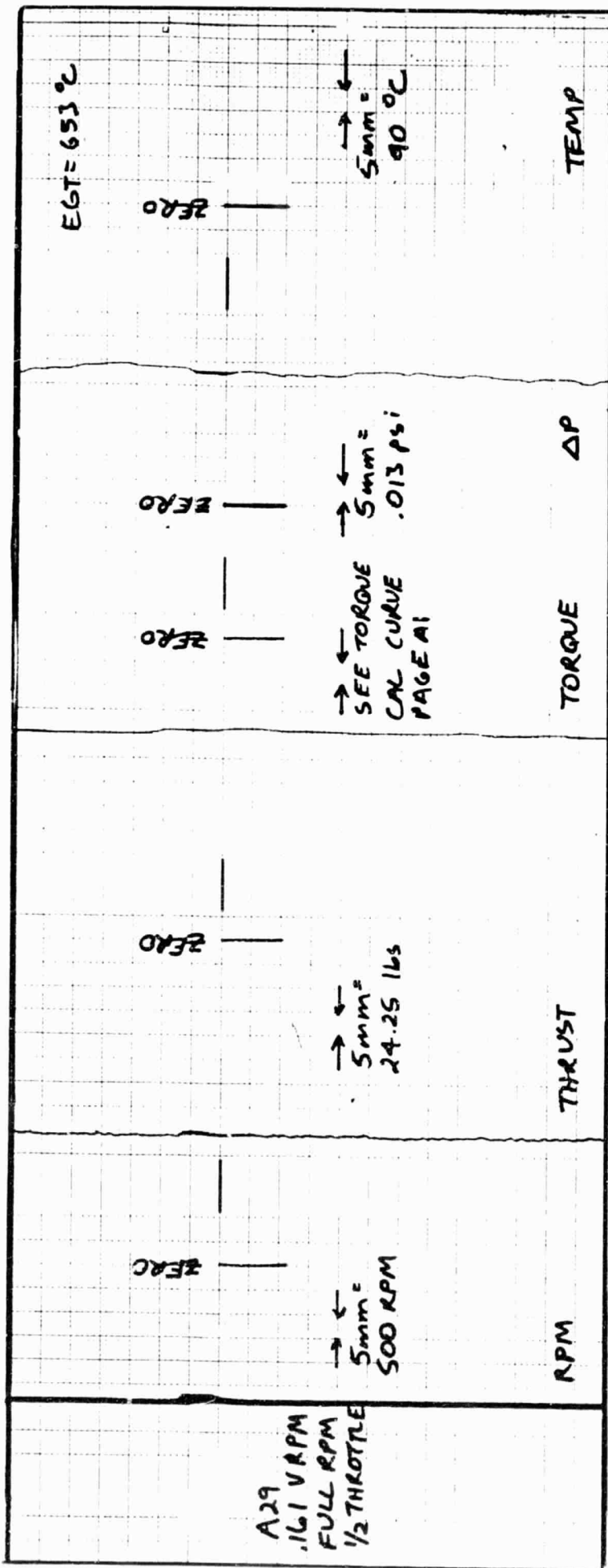

ORIGINAL PAGE IS
OF POOR QUALITY

(A34)

Figure A-29 - Raw static engine data.
 RPM = 2786, Humidity = 66.0%, OAT = 88°F
 Date: 8/29/83, BP = 29.25 in of HG

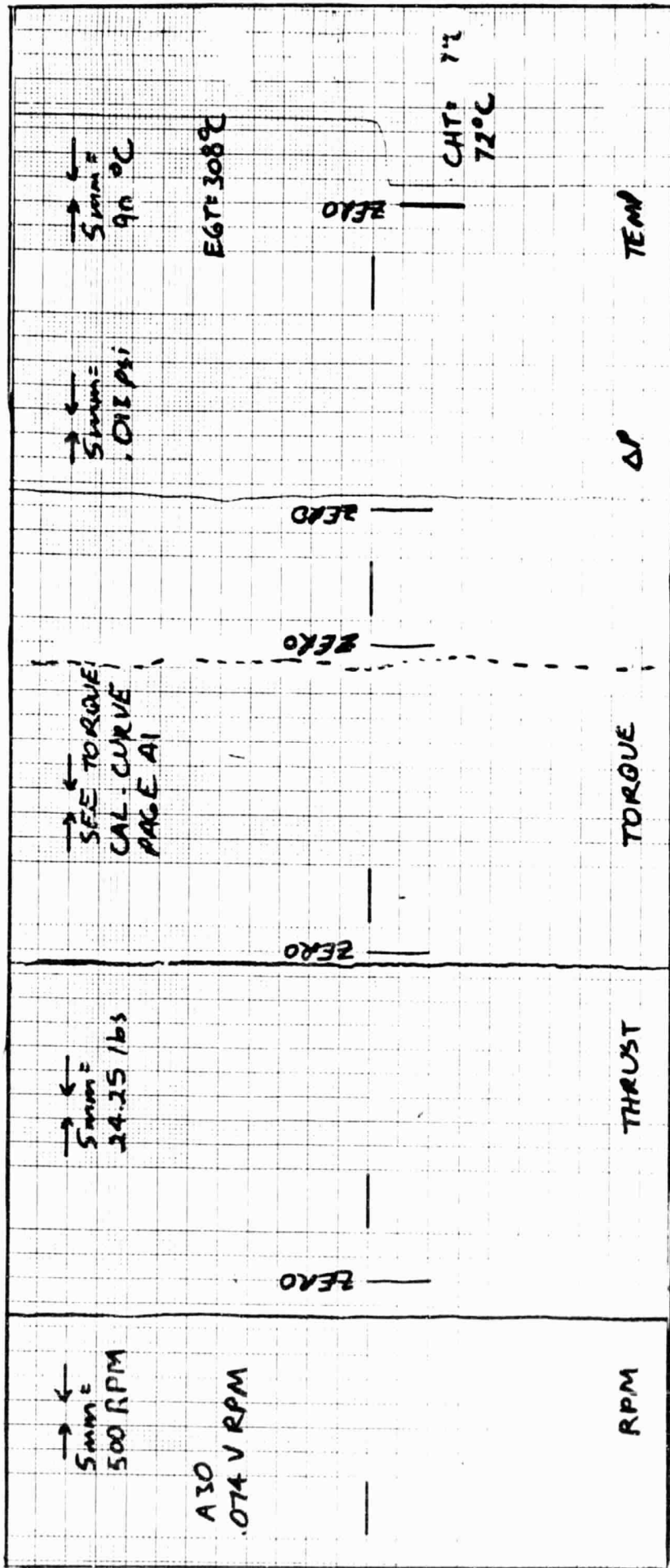

ORIGINAL PAGE IS
OF POOR QUALITY

Figure A-30 - Raw static engine data.
 RPM= 714, Humidity= 72.0%, OAT= 87°F
 Date: 8/23/83, BP= 29.32 in of HG

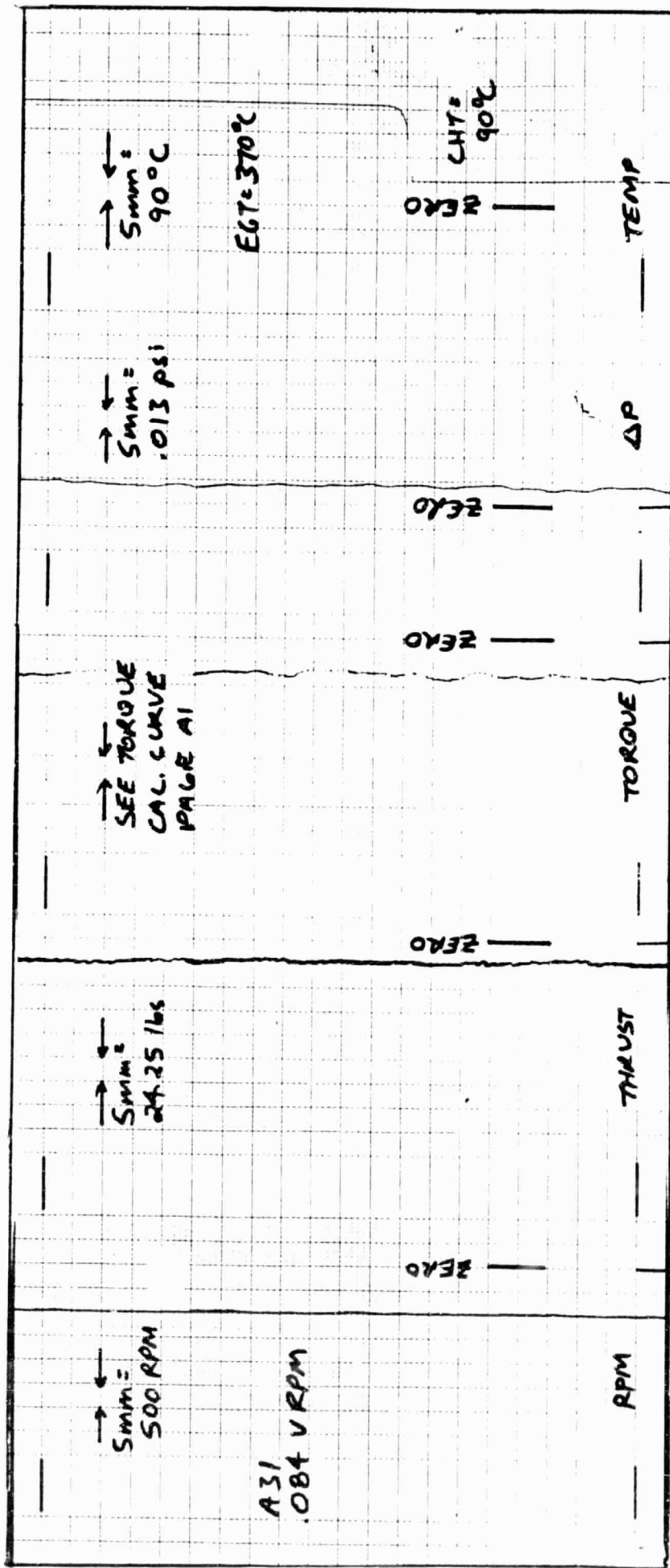

ORIGINAL PAGE IS
OF POOR QUALITY

Figure A-31 - Raw static engine data.
 RPM= 952, Humidity= 71.8%, OAT= 87°F
 Date: 8/23/83, BP= 29.30 in of HG

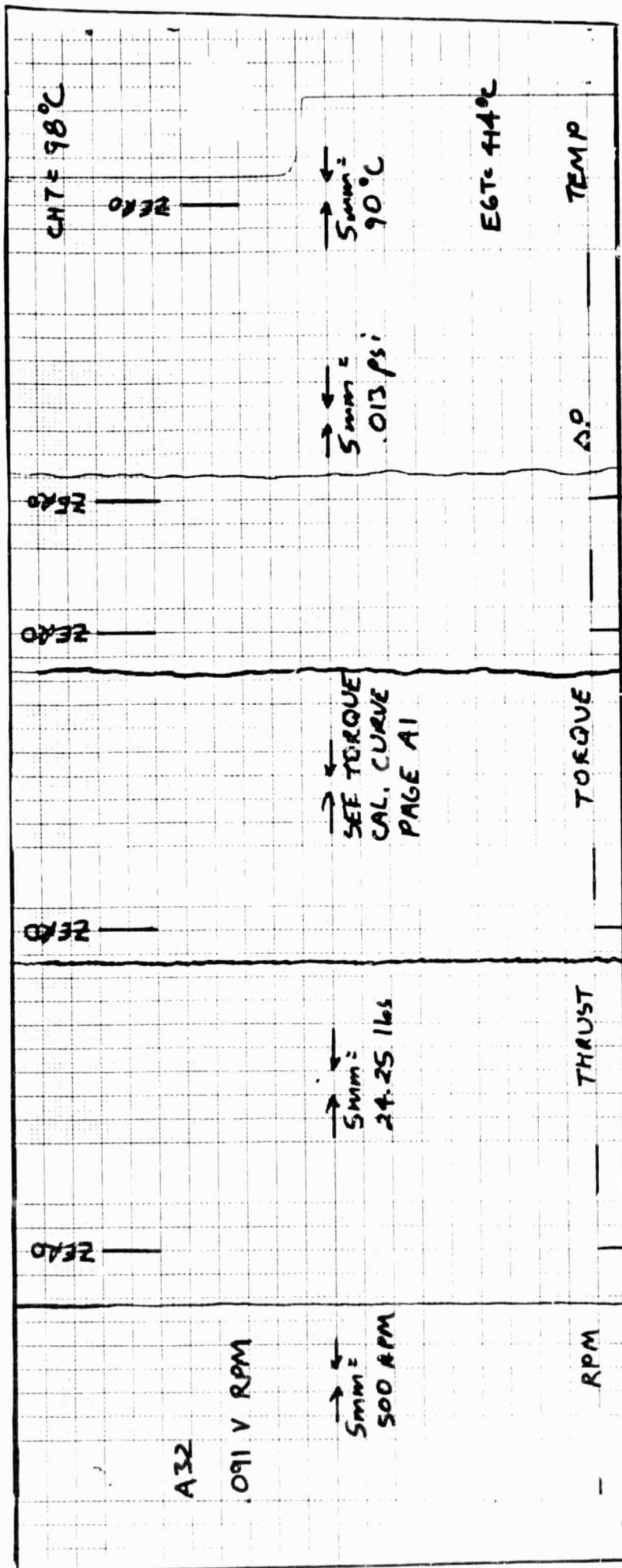

ORIGINAL PAGE IS OF POOR QUALITY

Figure A-32 - Raw static engine data.
 RPM= 1119, Humidity= 71.8%, OAT= 87°F
 Date: 8/23/83, BP= 29.31 in of HG

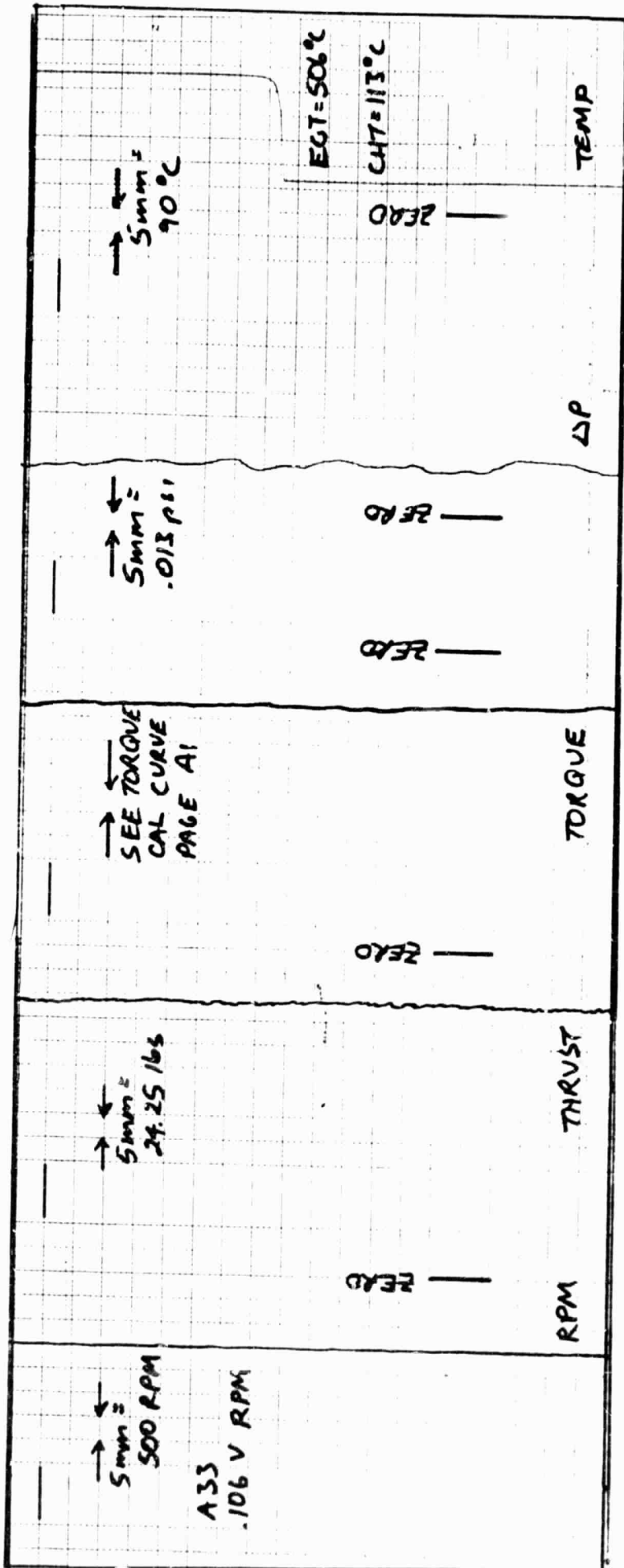

ORIGINAL PAGE IS
OF POOR QUALITY

Figure A-33 - Raw static engine data.
 RPM = 1476, Humidity = 72.2%, OAT = 87°F
 Date: 8/23/83, BP = 29.31 in of HG

(A38)

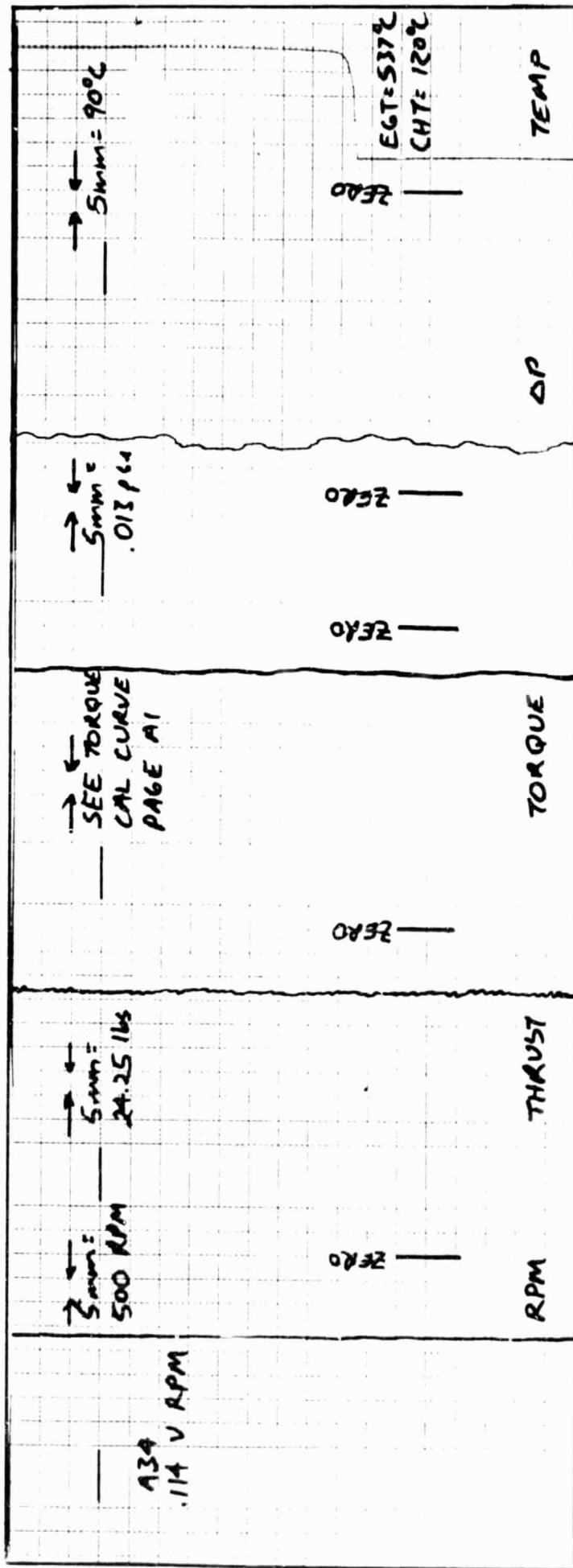

ORIGINAL PAGE IS
OF POOR QUALITY

Figure A-34 - Raw static engine data.
 RPM = 1667, Humidity = 72.2%, OAT = 87°F
 Date: 8/23/83, BP = 29.31 in of HG

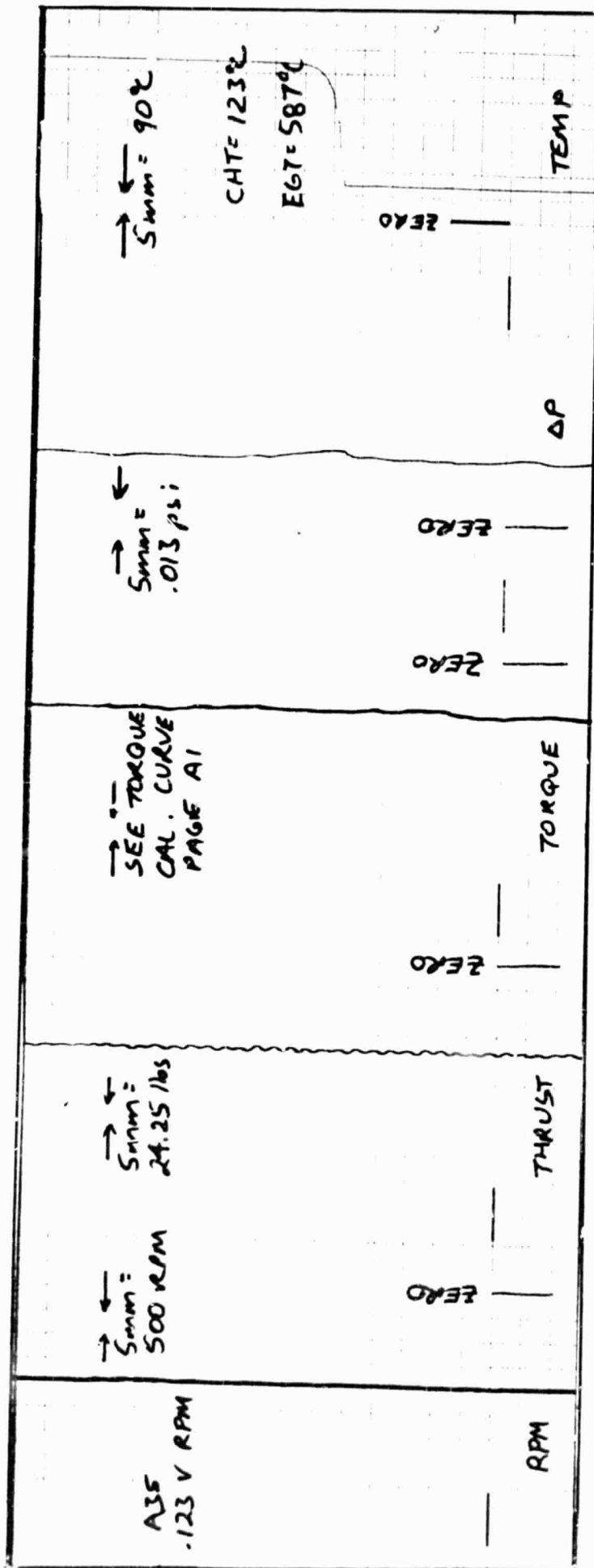

ORIGINAL PAGE IS
OF POOR QUALITY

Figure A-35 - Raw static engine data.
RPM = 1881, Humidity = 72.2%, OAT = 87°F
Date: 8/23/83, BP = 29.31 in of HG

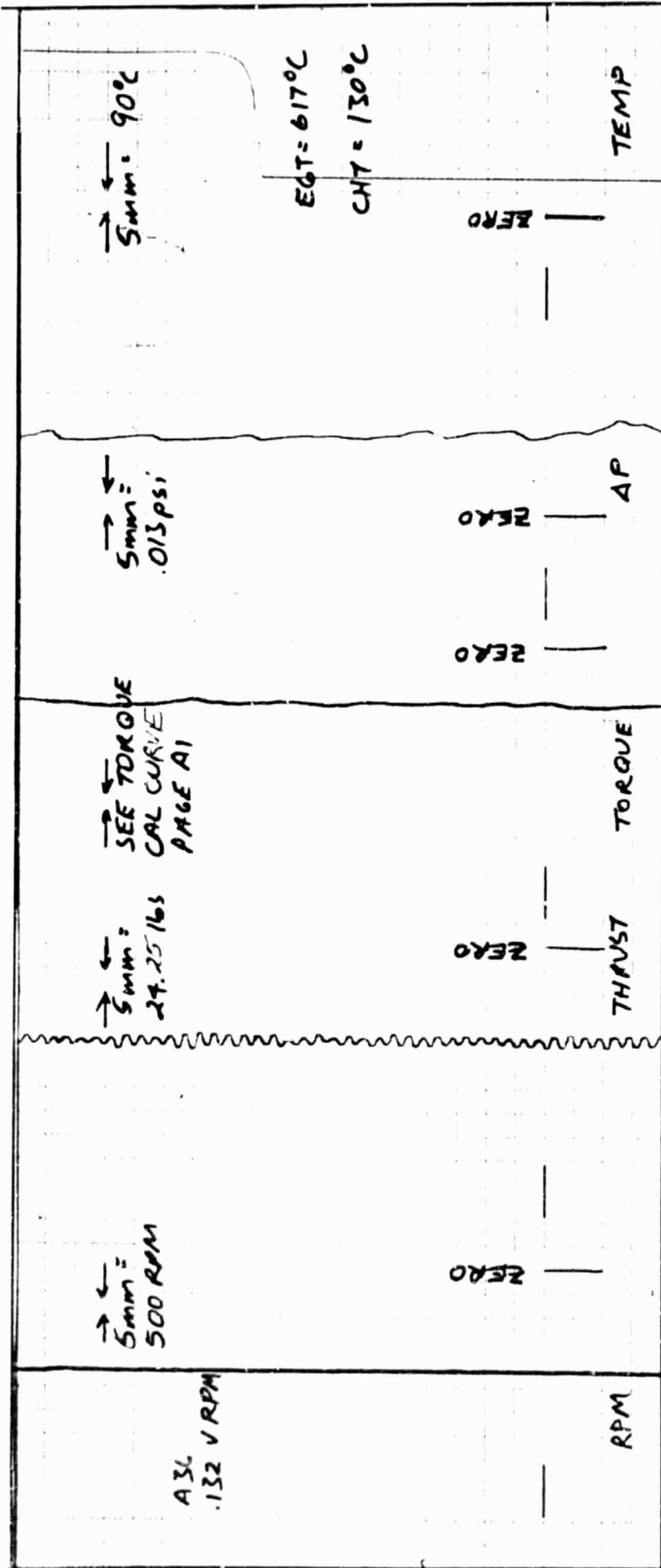

ORIGINAL PAGE IS
OF POOR QUALITY

Figure A-36 - Raw static engine data.
 RPM= 2095, Humidity= 72.2%, OAT= 87°F
 Date: 8/23/83, BP= 29.30 in of HG

(A41)

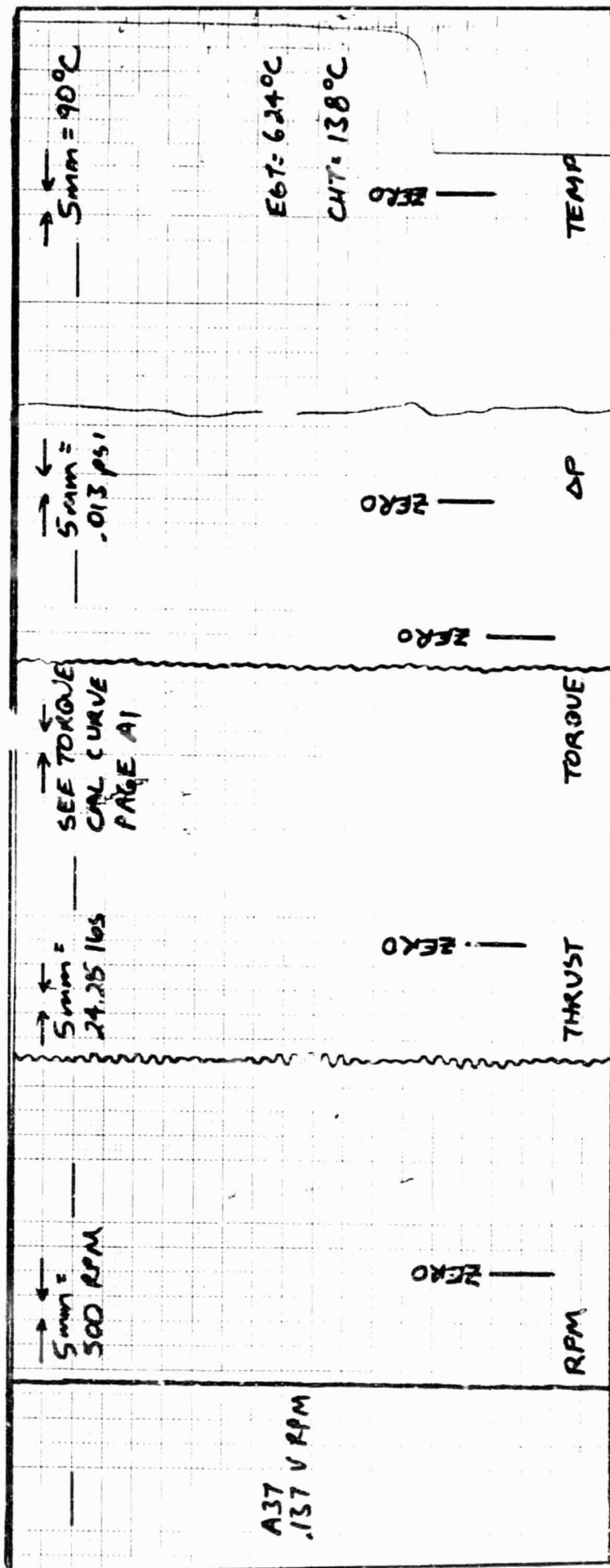

ORIGINAL PAGE IS
OF POOR QUALITY

Figure A-37 - Raw static engine data.
RPM = 2214, Humidity = 71.8%, OAT = 87°F
Date: 8/23/83, BP = 29.30 in of HG

(A42)

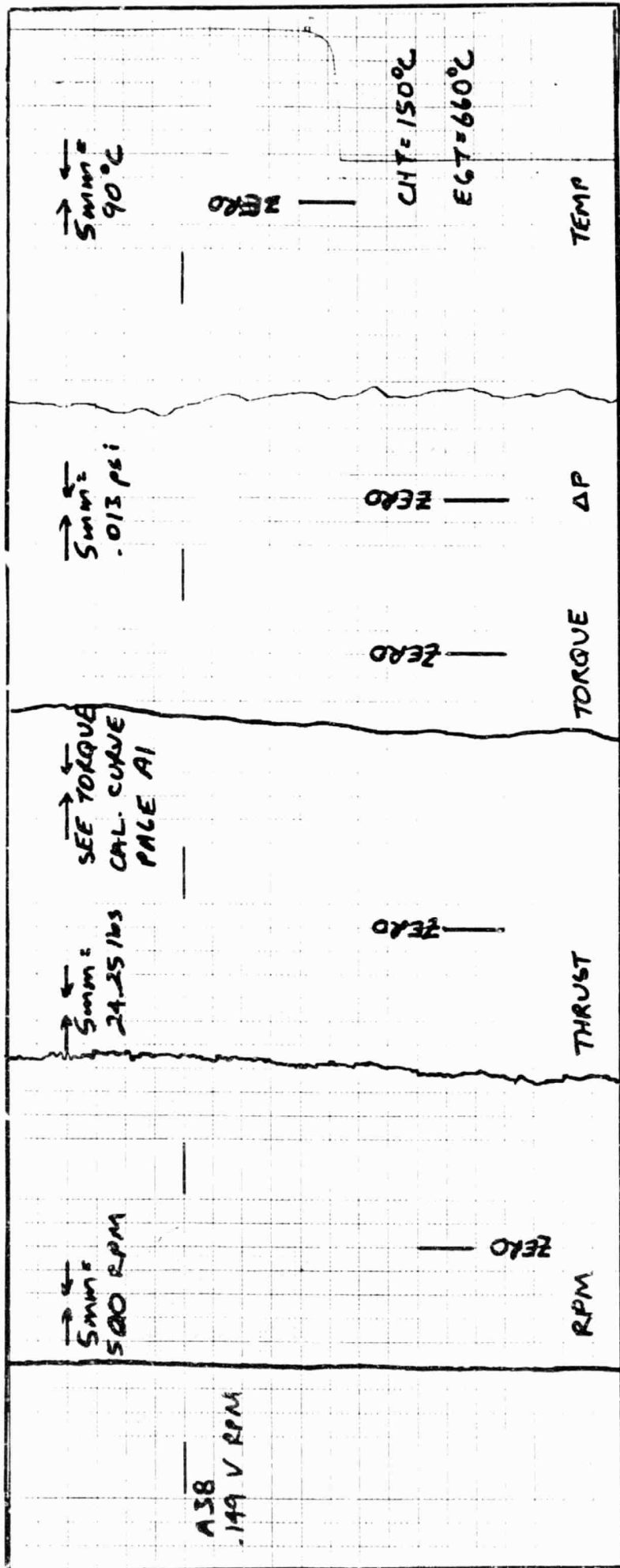

ORIGINAL PAGE IS
OF POOR QUALITY

Figure A-38 - Raw static engine data.
RPM = 2500, Humidity = 72.0%, OAT = 87°F
Date: 8/23/83, BP = 29.30 in of HG

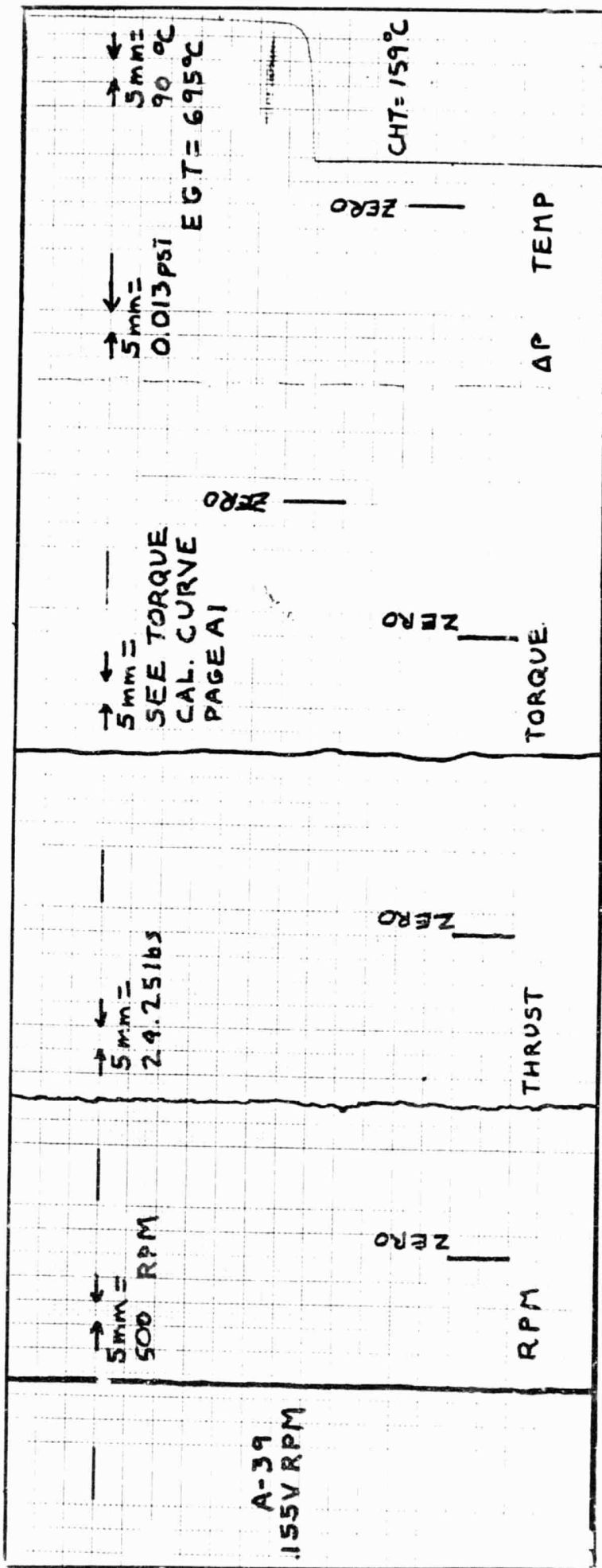

ORIGINAL PAGE IS
OF POOR QUALITY

Figure A-39 - Raw static engine data.
RPM = 2643, Humidity = 71.8%, OAT = 87°F
Date: 8/23/83, BP = 29.30 in of HG

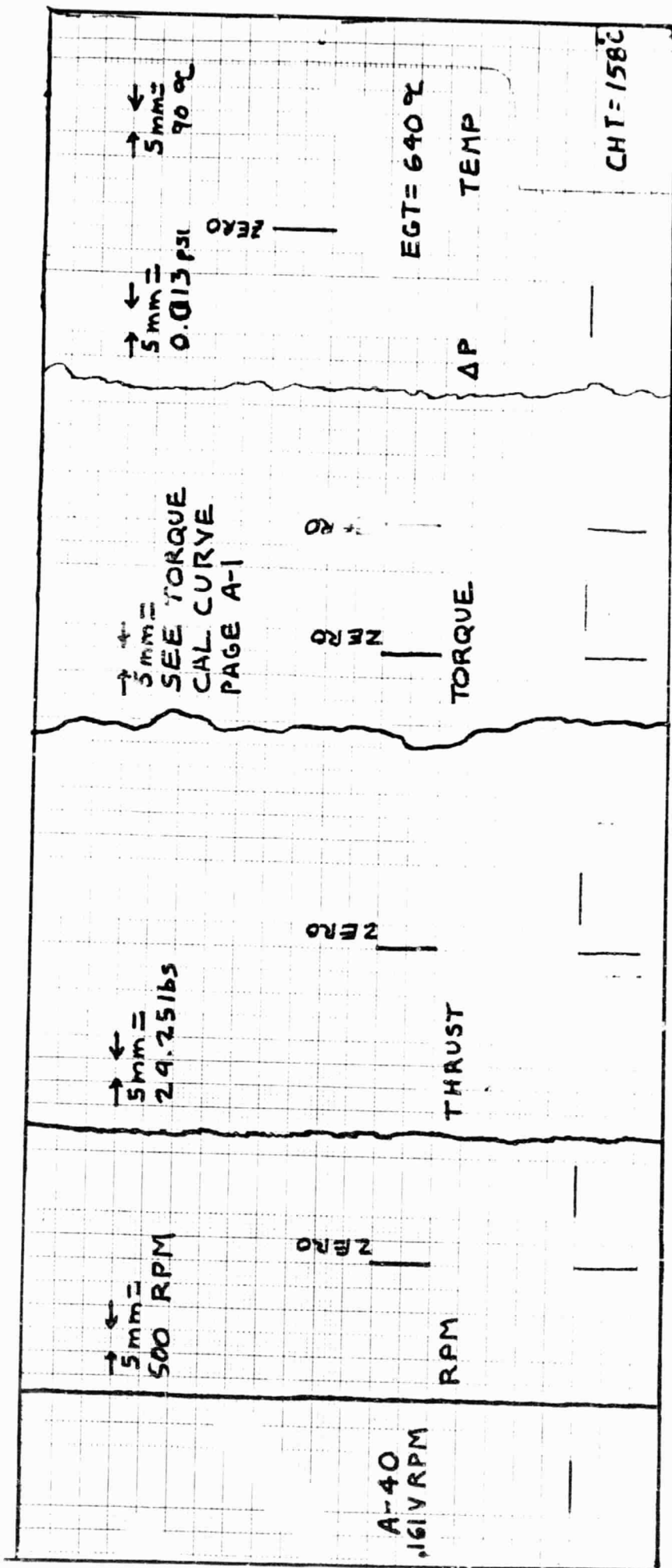

ORIGINAL PAGE IS
OF POOR QUALITY

Figure A-40 - Raw static engine data.
RPM = 2786, Humidity = 71.8%, OAT = 87°F
Date: 8/23/83, BP = 29.30 in of HG

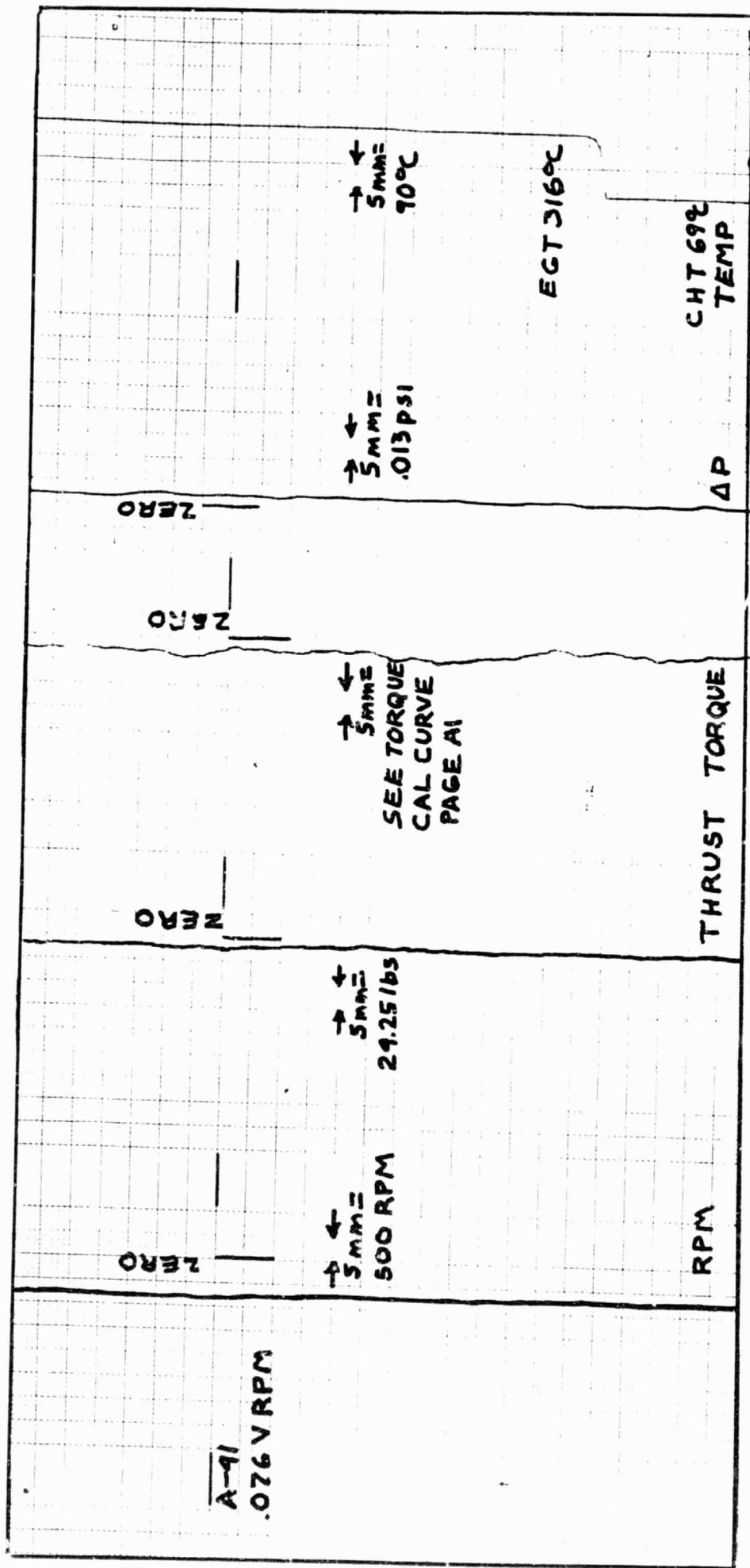

ORIGINAL PAGE IS
OF POOR QUALITY

Figure A-41 - Raw static engine data.
RPM= 762, Humidity= 70.2%, OAT= 87°F
Date: 8/23/83, BP= 29.30 in of HG

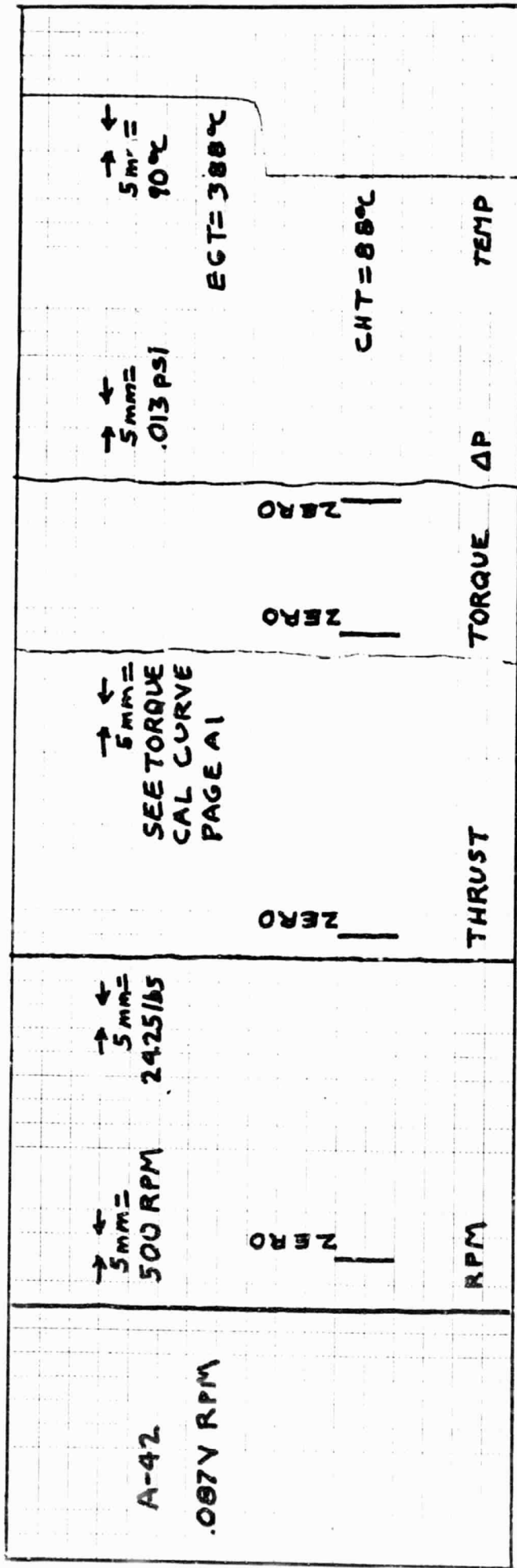

ORIGINAL PAGE IS
OF POOR QUALITY

Figure A-42 - Raw static engine data.
 RPM = 1024, Humidity = 70.2%, OAT = 87°F
 Date: 8/23/83, BP = 29.30 in of HG

(A47)

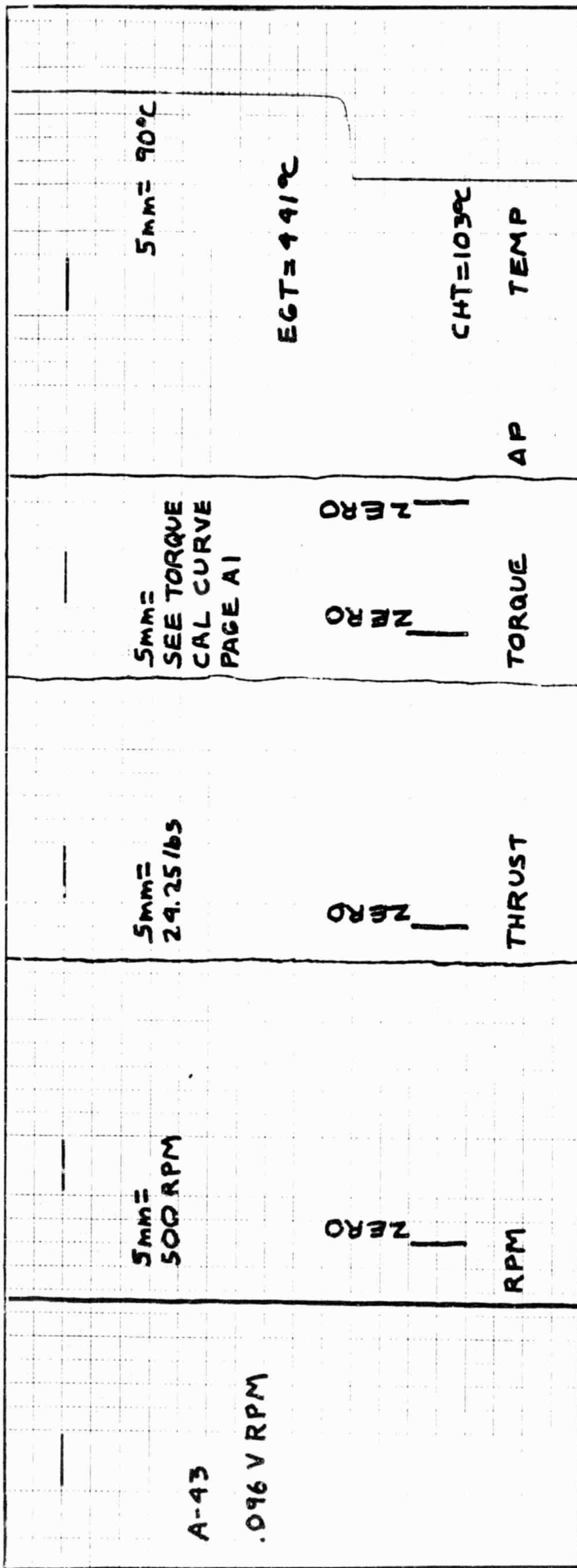

ORIGINAL PAGE IS
OF POOR QUALITY

Figure A-43 - Raw static engine data.
RPM = 1238, Humidity = 70.6%, OAT = 87°F
Date: 8/23/83, BP = 29.30 in of HG

(A48)

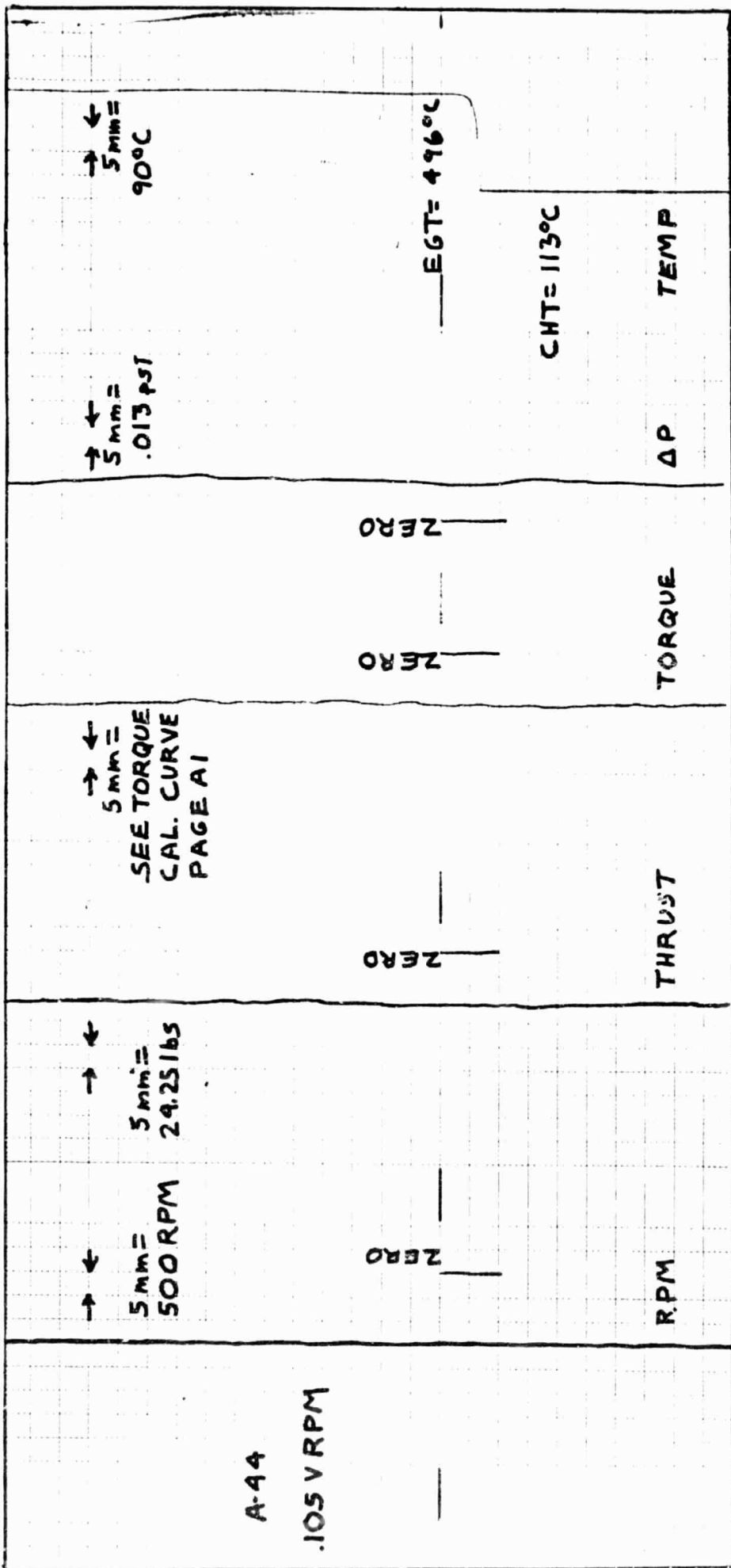

ORIGINAL PAGE IS
OF POOR QUALITY

Figure A-44 - Raw static engine data.
RPM= 1452, Humidity= 70.8%, OAT= 88°F
Date: 8/23/83, BP= 29.30 in of HG

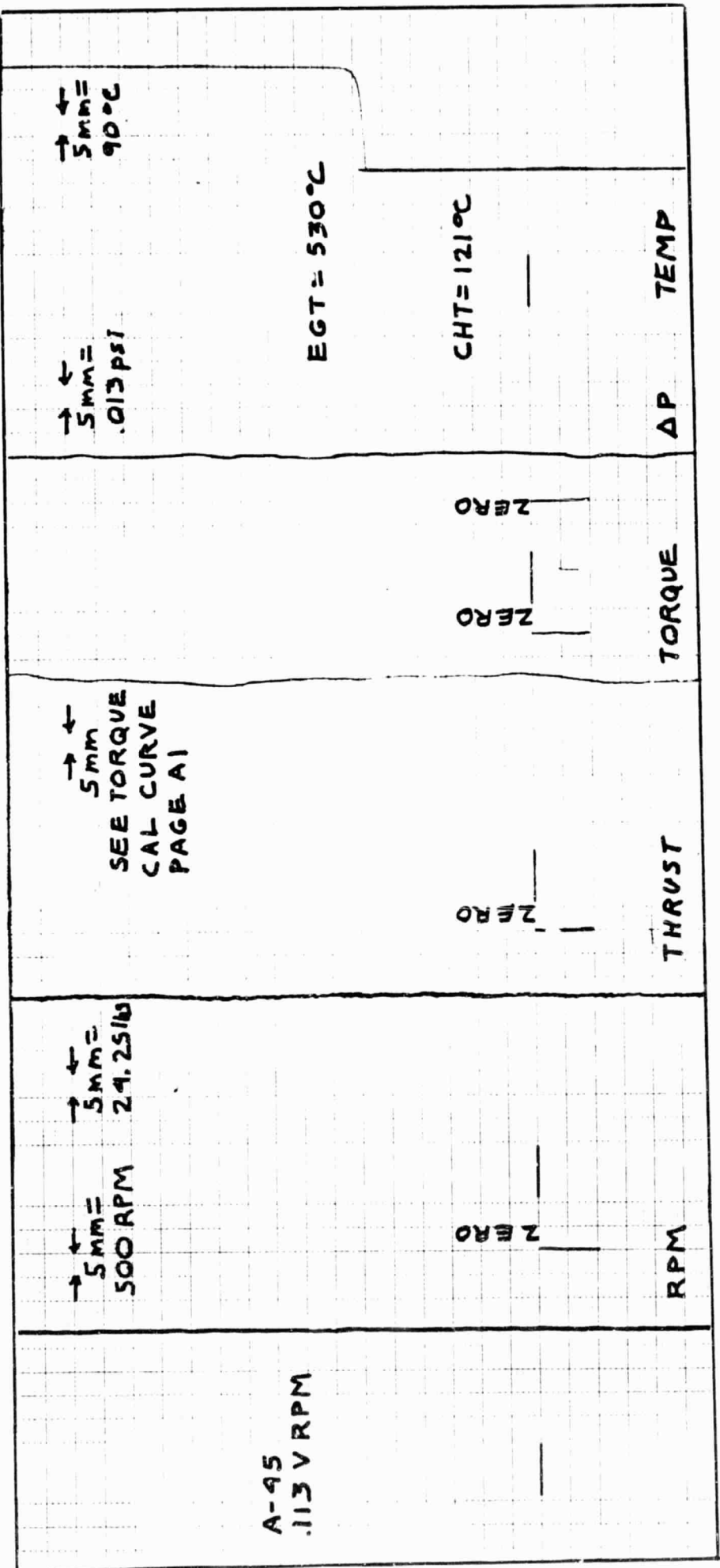

ORIGINAL PAGE IS
OF POOR QUALITY

Figure A-45 - Raw static engine data.
RPM= 1643, Humidity= 69.8%, OAT= 88°F
Date: 8/23/83, BP= 29.30 in of HG

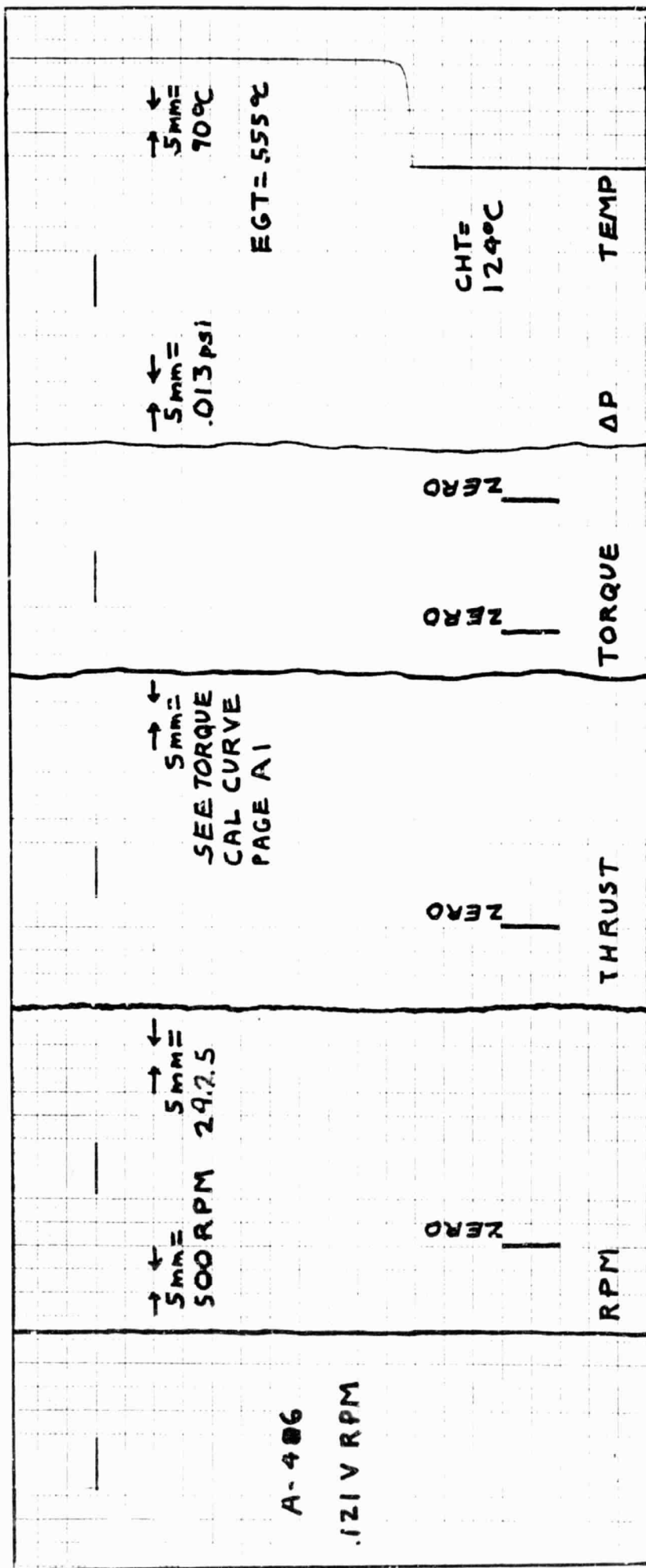

ORIGINAL PAGE IS
OF POOR QUALITY

Figure A-46 - Raw static engine data.
RPM= 1833, Humidity= 69.8%, OAT= 88°F
Date: 8/23/83, BP=29.30 in of HG

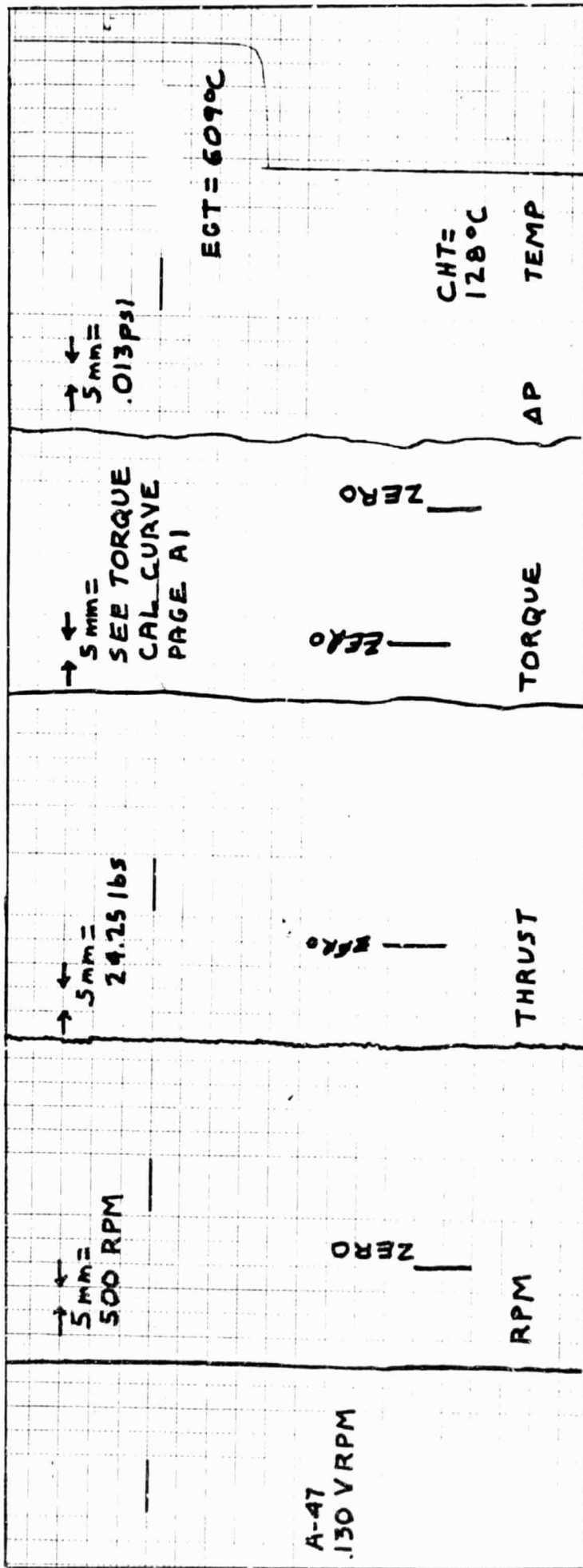

ORIGINAL PAGE IS
POOR QUALITY

Figure A-47 - Raw static engine data.
RPM = 2048. Humidity = 69.8%, OAT = 88°F
Date: 8/23/83, BP = 23.30 in of HG

(A52)

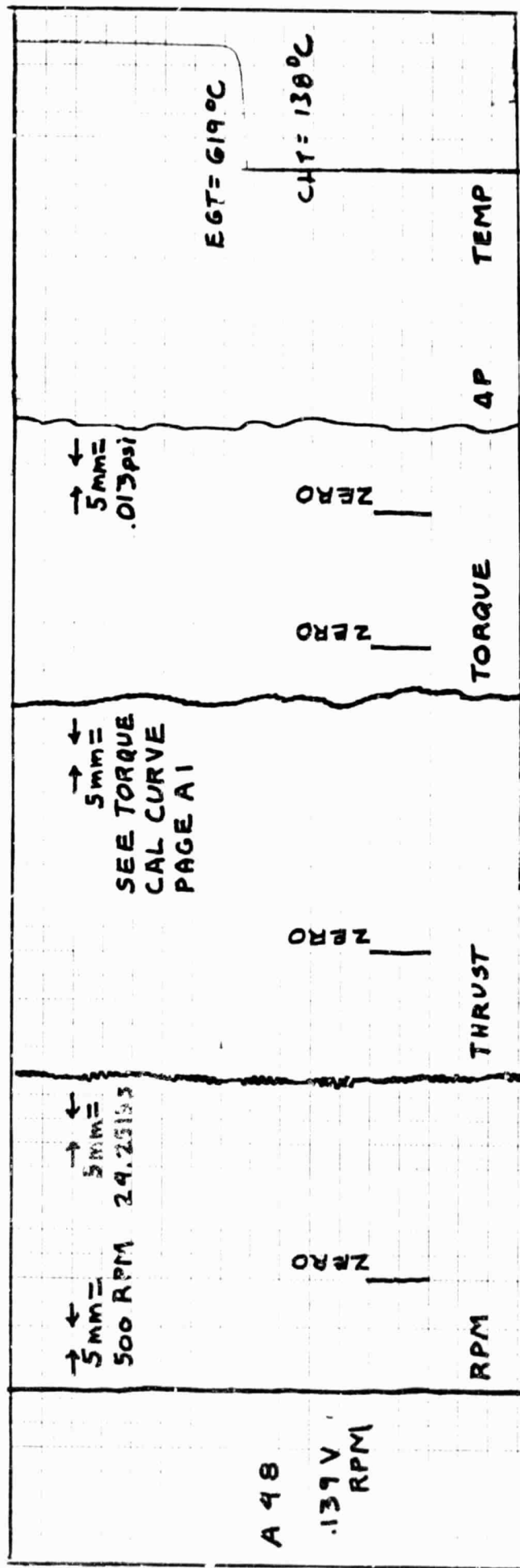

ORIGINAL PAGE IS
OF POOR QUALITY

Figure A-48 - Raw static engine data.
 RPM= 2262, Humidity= 69.8%, OAT= 88°F
 Date: 8/23/83, BP= 29.30 in of HG

(A53)

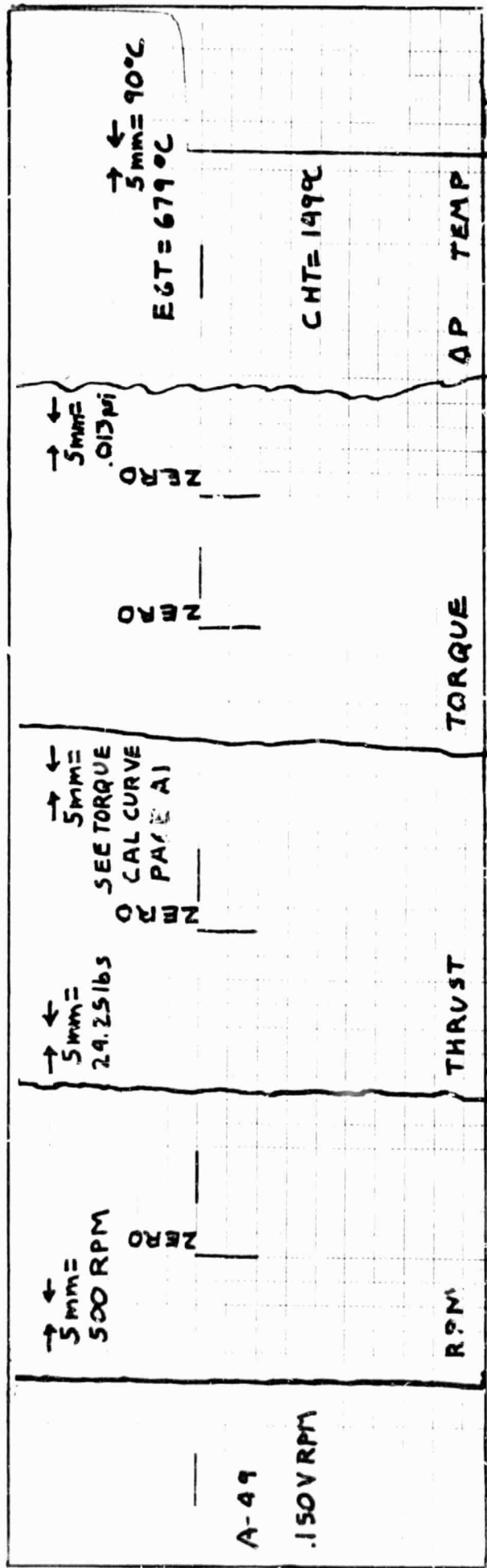

ORIGINAL PAGE IS
OF POOR QUALITY

Figure A-49 - Raw static engine data.
RPM= 2524, Humidity= 69.8%, OAT= 88°F
Date: 8/23/83, BP= 29.30 in of HG

(A54)

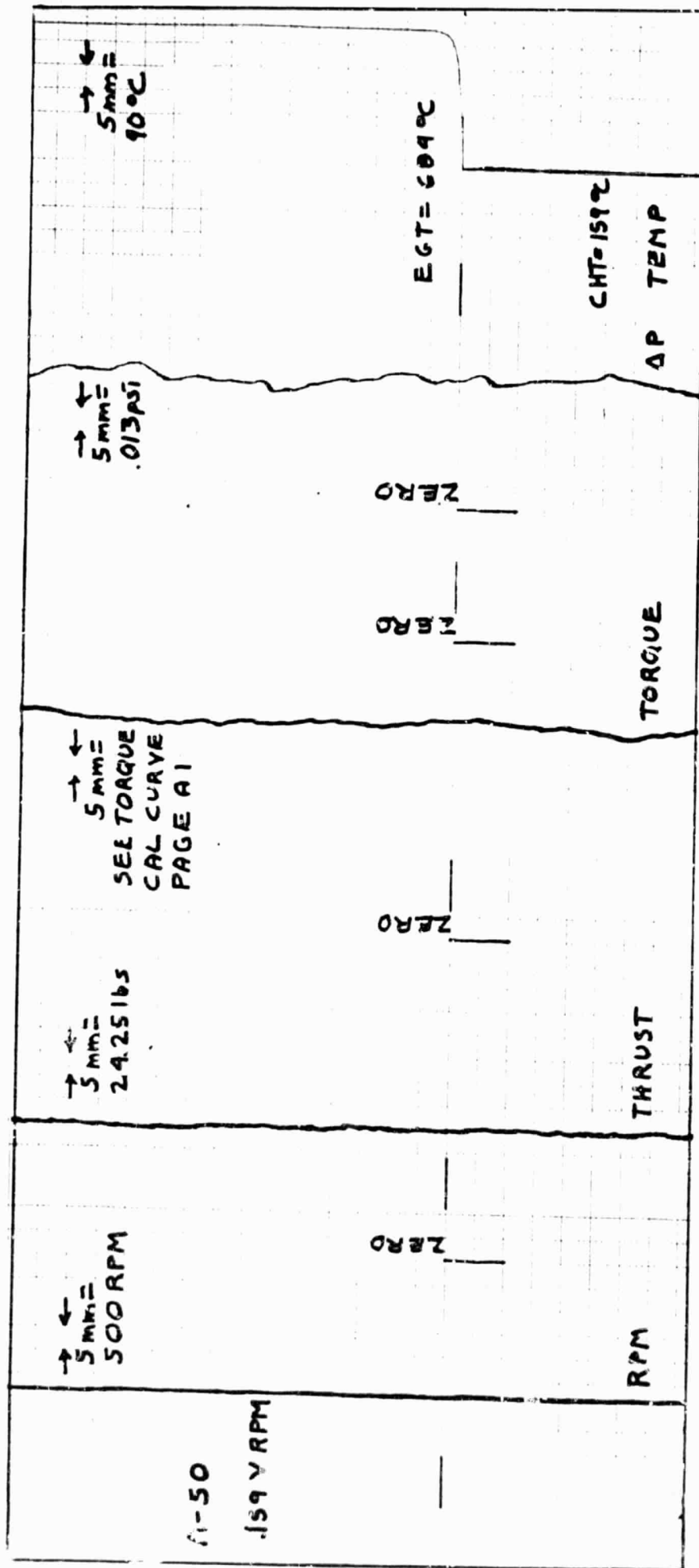

ORIGINAL PAGE 13
OF POOR QUALITY

Figure A-50 - Raw static engine data.
RPM = 2738, Humidity = 69.8%, OAT = 87°F
Date: 8/23/83, BP = 29.30 in of HG

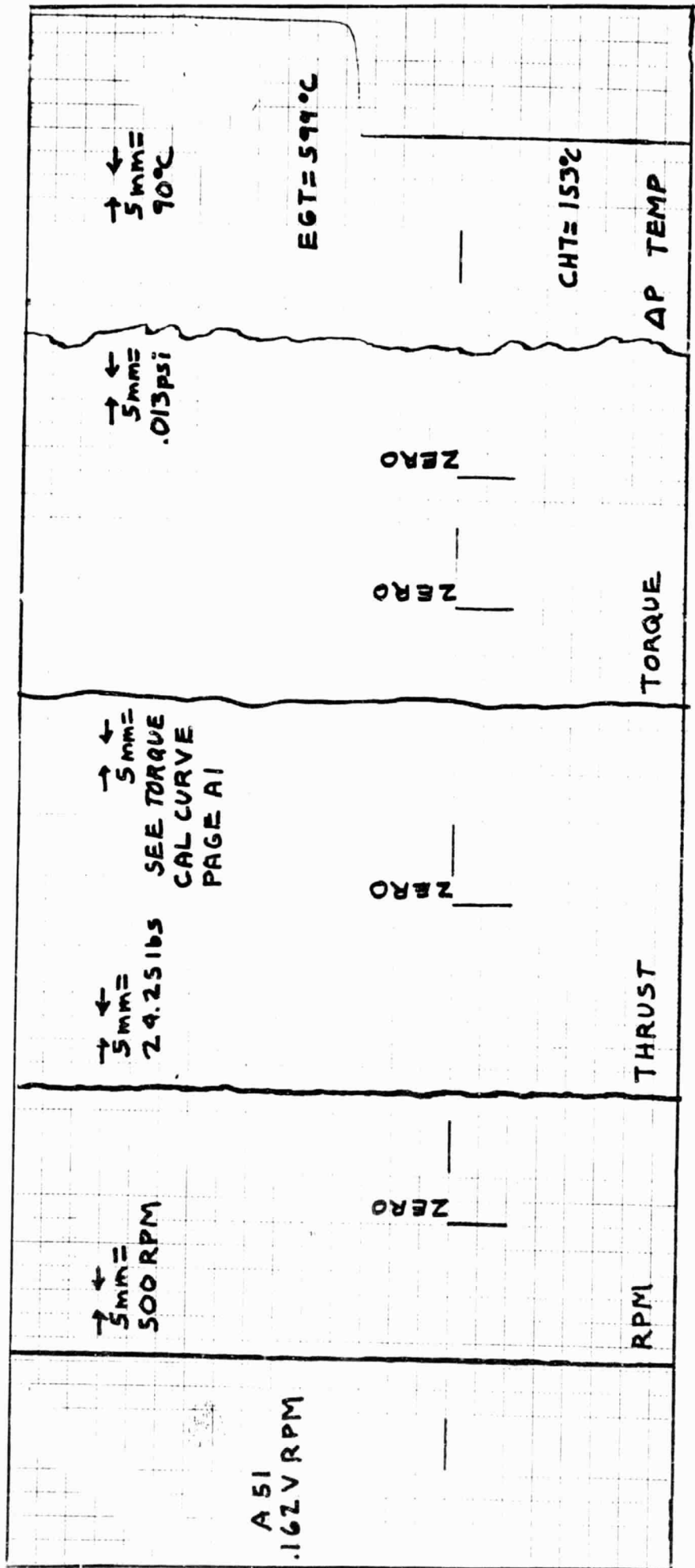

ORIGINAL PAGE IS
OF POOR QUALITY

Figure A-51 - Raw static engine data.
RPM = 2810, Humidity = 69.8%, OAT = 87°F
Date: 8/23/83, BP = 29.30 in of HG

(A56)

C-2

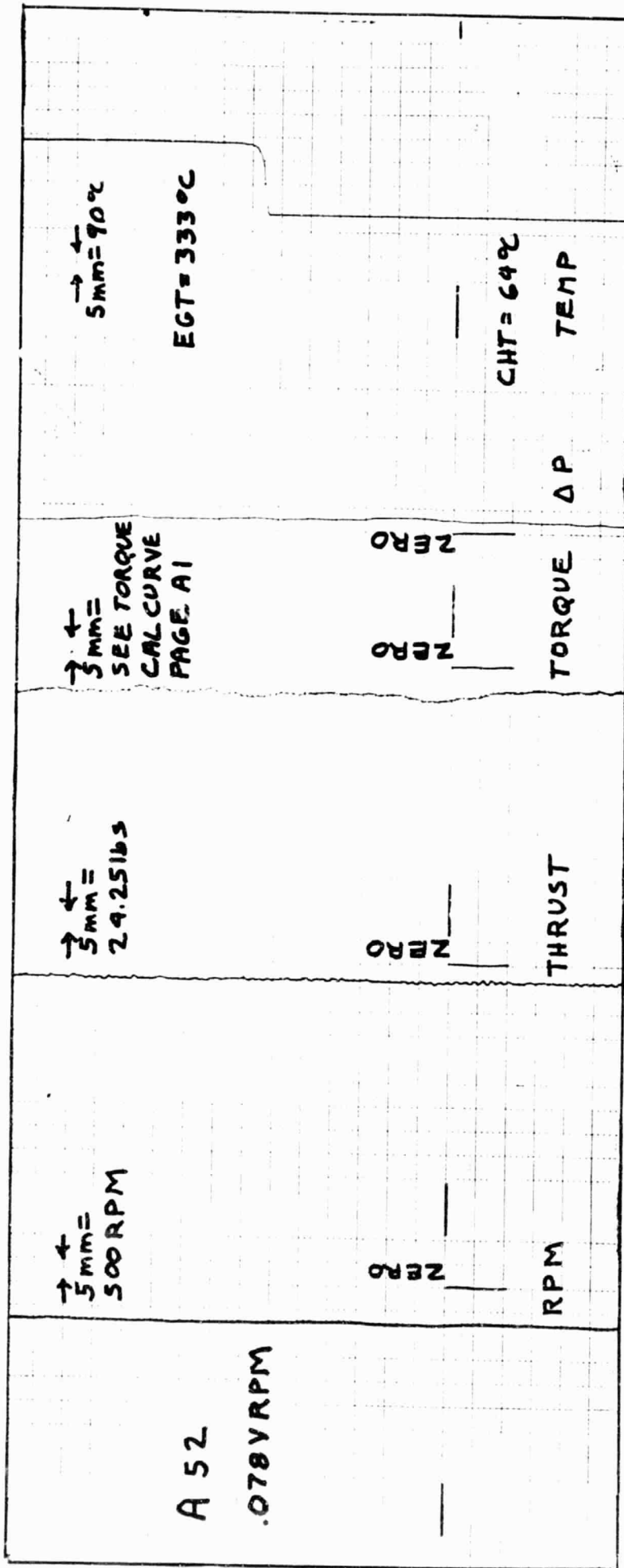

ORIGINAL PAGE IS
OF POOR QUALITY

Figure A-52 - Raw static engine data.
RPM= 810, Humidity= 64.0%, OAT= 89°F
Date: 8/24/83, BP= 29.37 in of HG

(A57)

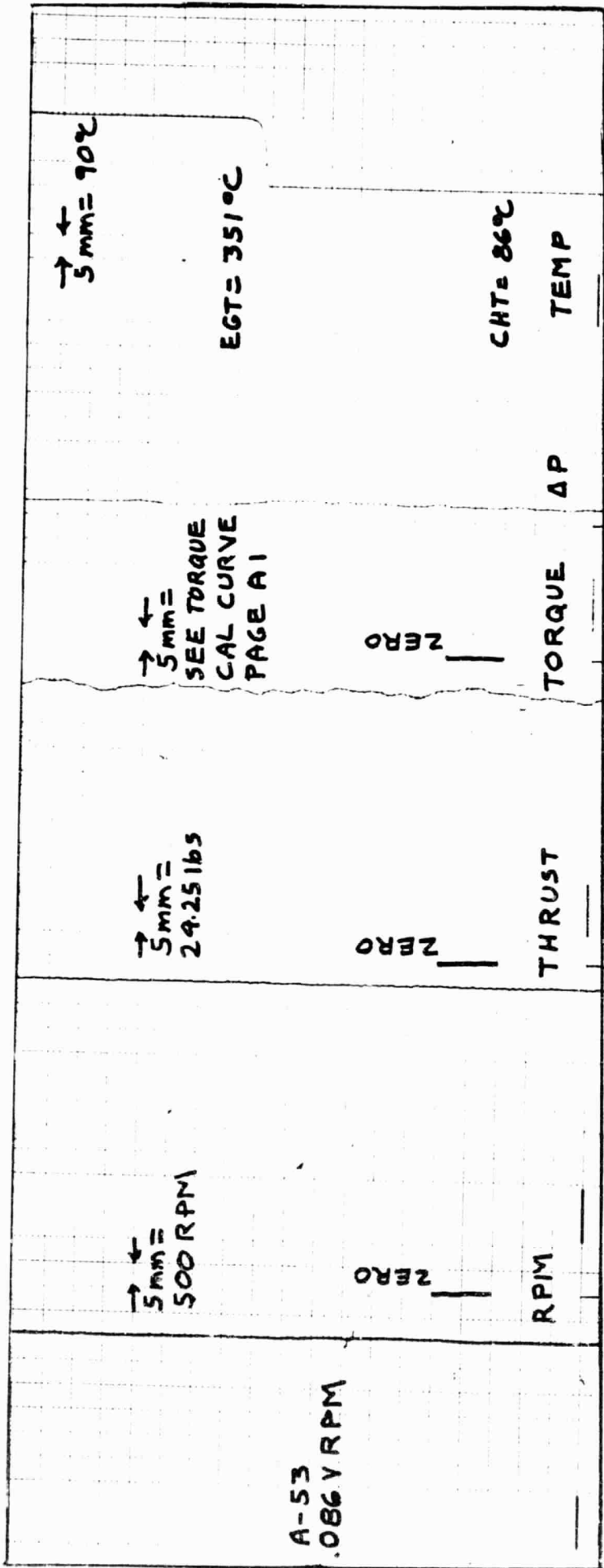

ORIGINAL PAGE IS
OF POOR QUALITY

Figure A-53 - Raw static engine data.
RPM= 1000, Humidity= 64.0%, OAT= 90°F
Date: 8/24/83, BP= 29.37 in of HG

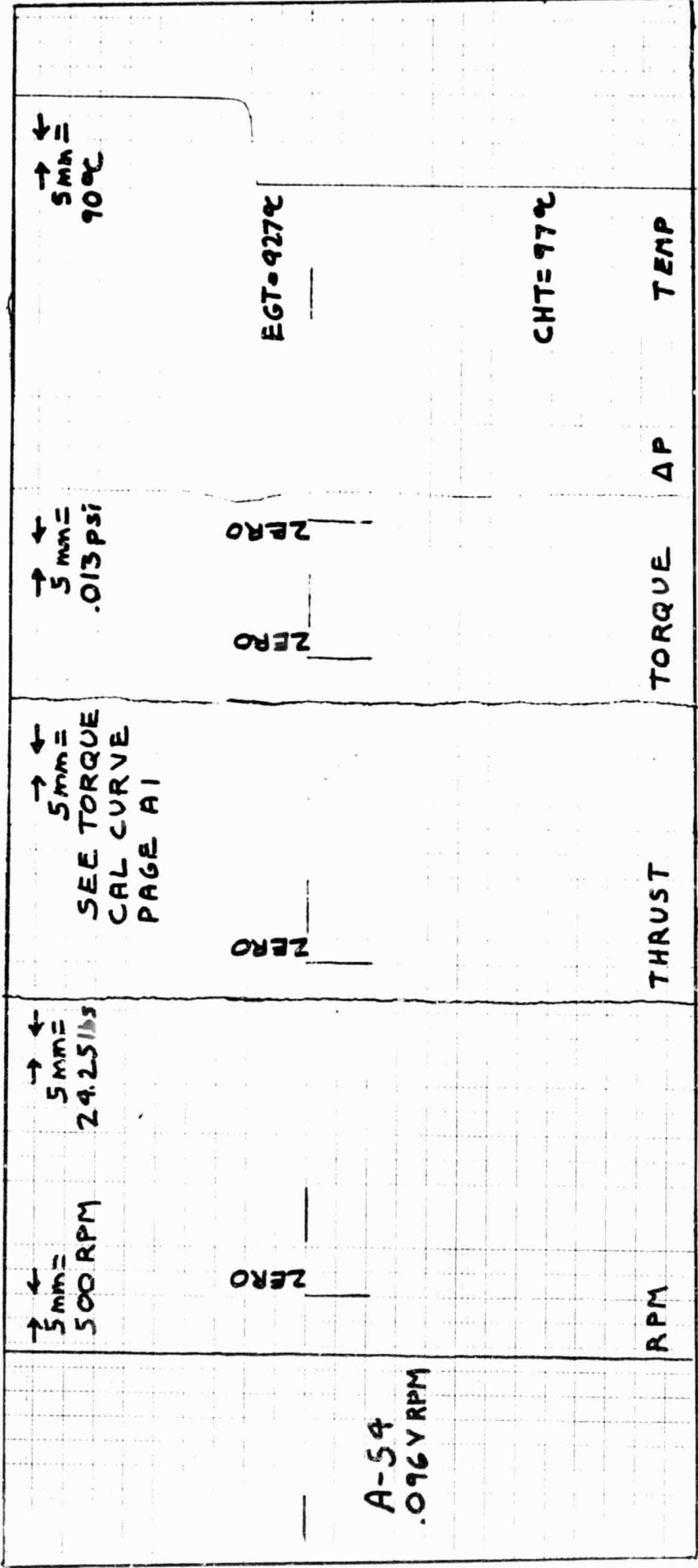

Figure A-54 - Raw static engine data.
RPM= 1238, Humidity= 63.0%, OAT= 90°C F
Date: 8/24/83, BP= 29.37 in of HG

(A59)

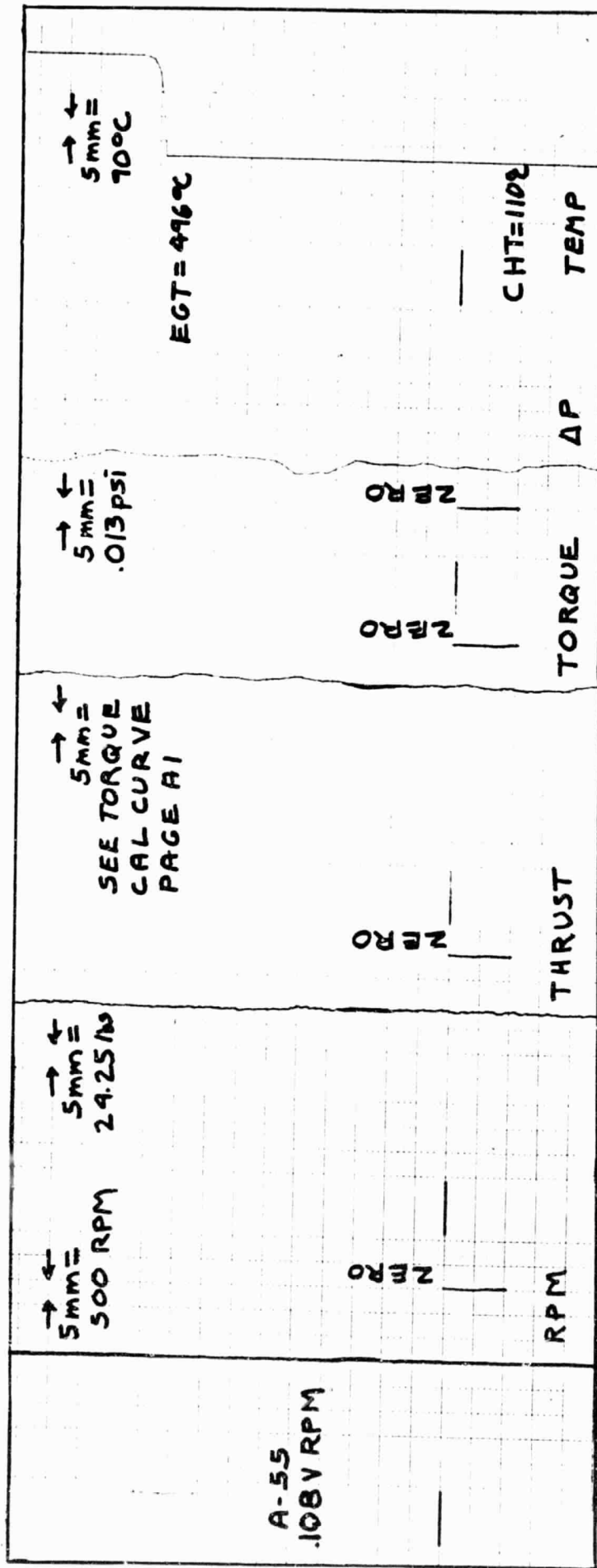
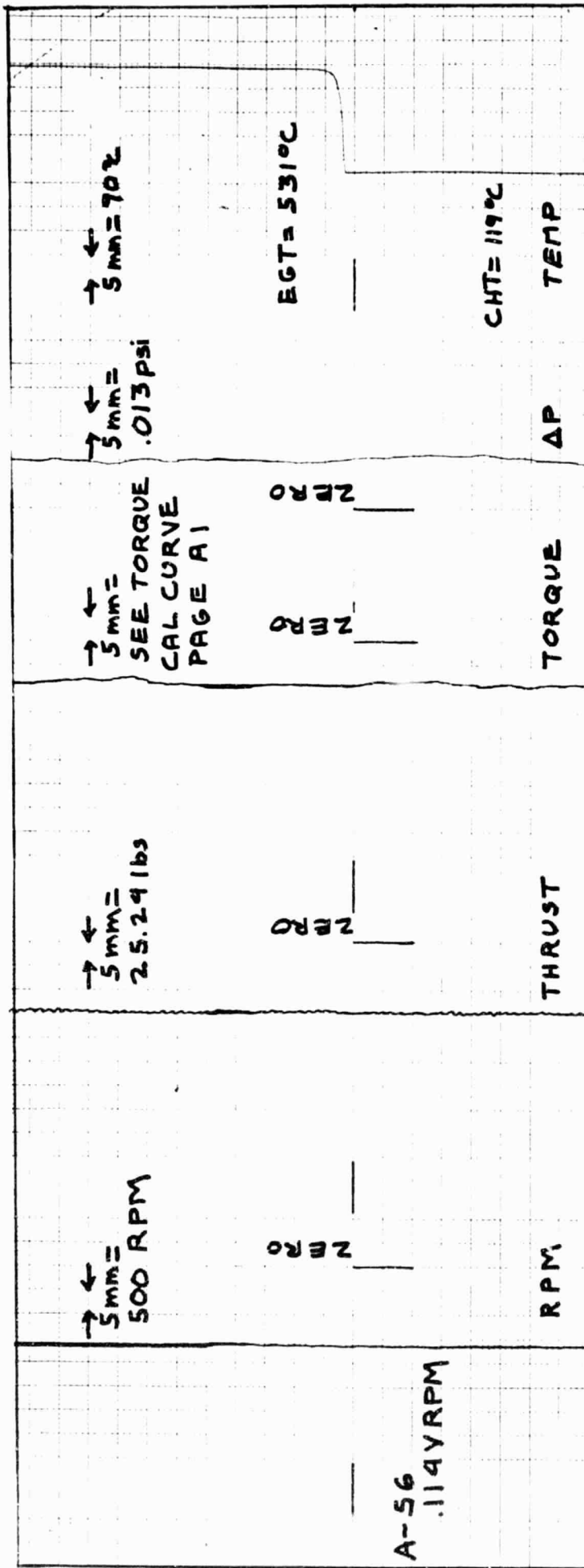

Figure A-55 - Raw static engine data.
 RPM= 1524, Humidity= 62.0%, OAT= 90 F
 Date: 8/24/83, BP= 29.37 in of HG

(A60)



ORIGINAL DATA OF POOR QUALITY

Figure A-56 - Raw static engine data.
RPM= 1667, Humidity= 61.0%, OAT= 91°F
Date: 8/24/83, BP= 29.37 in of HG

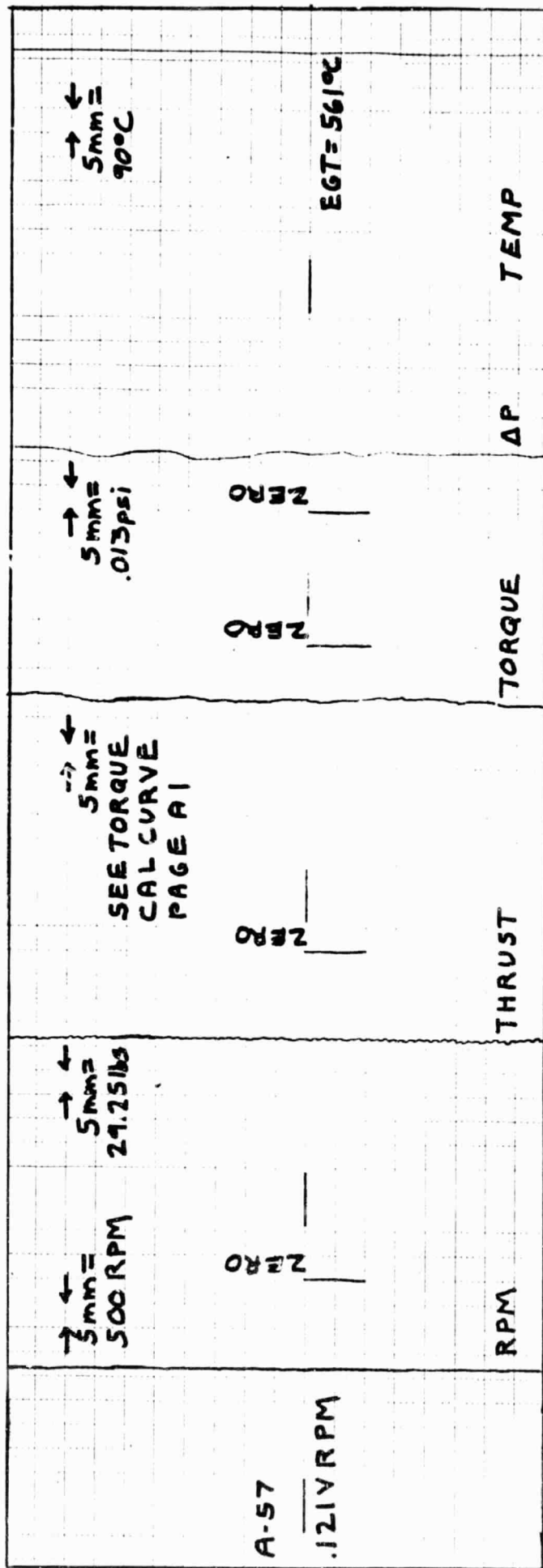

GROUP CALIBRATION
OF POGR QUALITY

Figure A-57 - Raw static engine data.
 RPM= 1833, Humidity= 62.0%, OAT= 91 F
 Date: 8/24/83, BP= 29.37 in of HG

(A62)

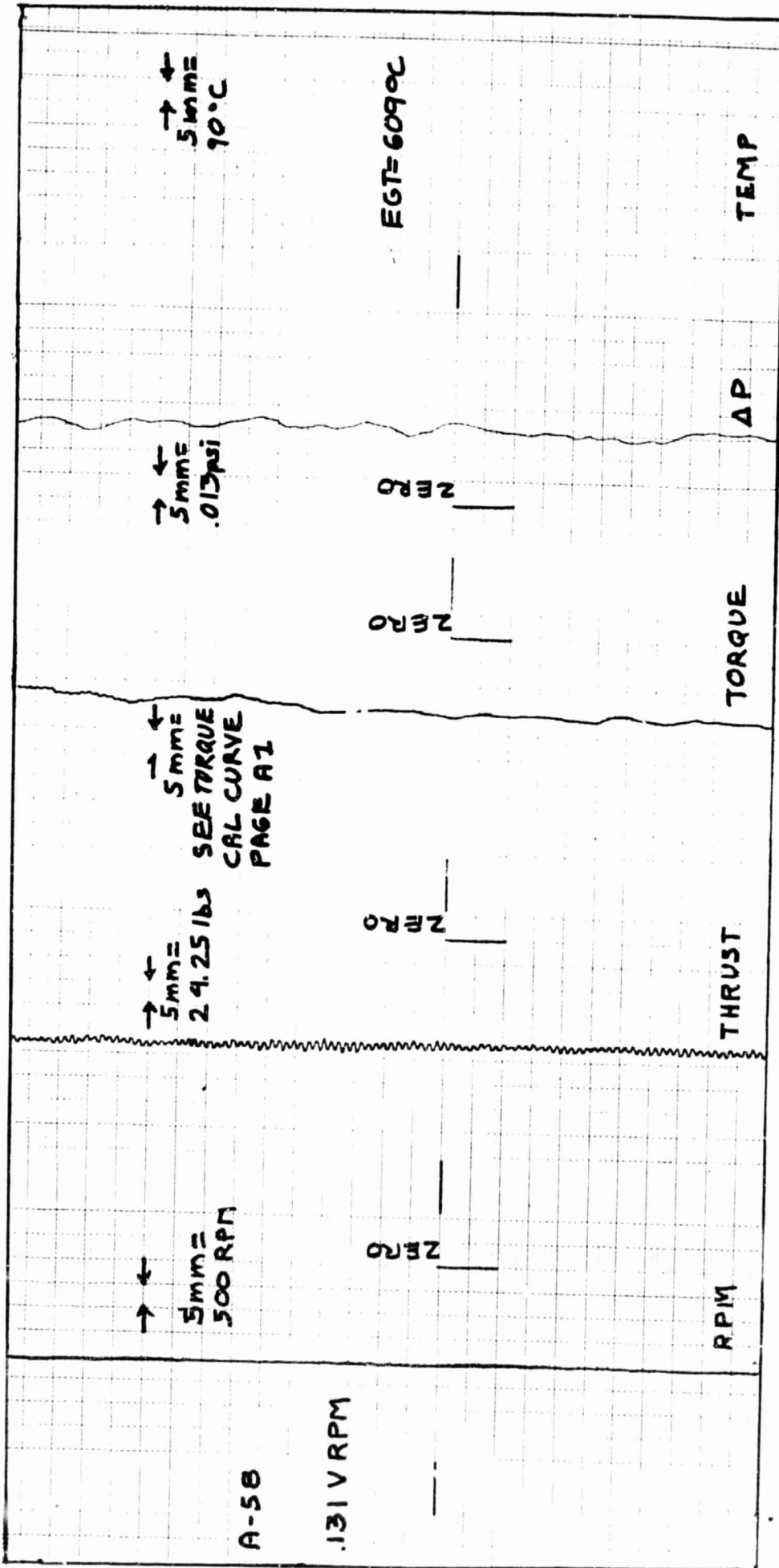
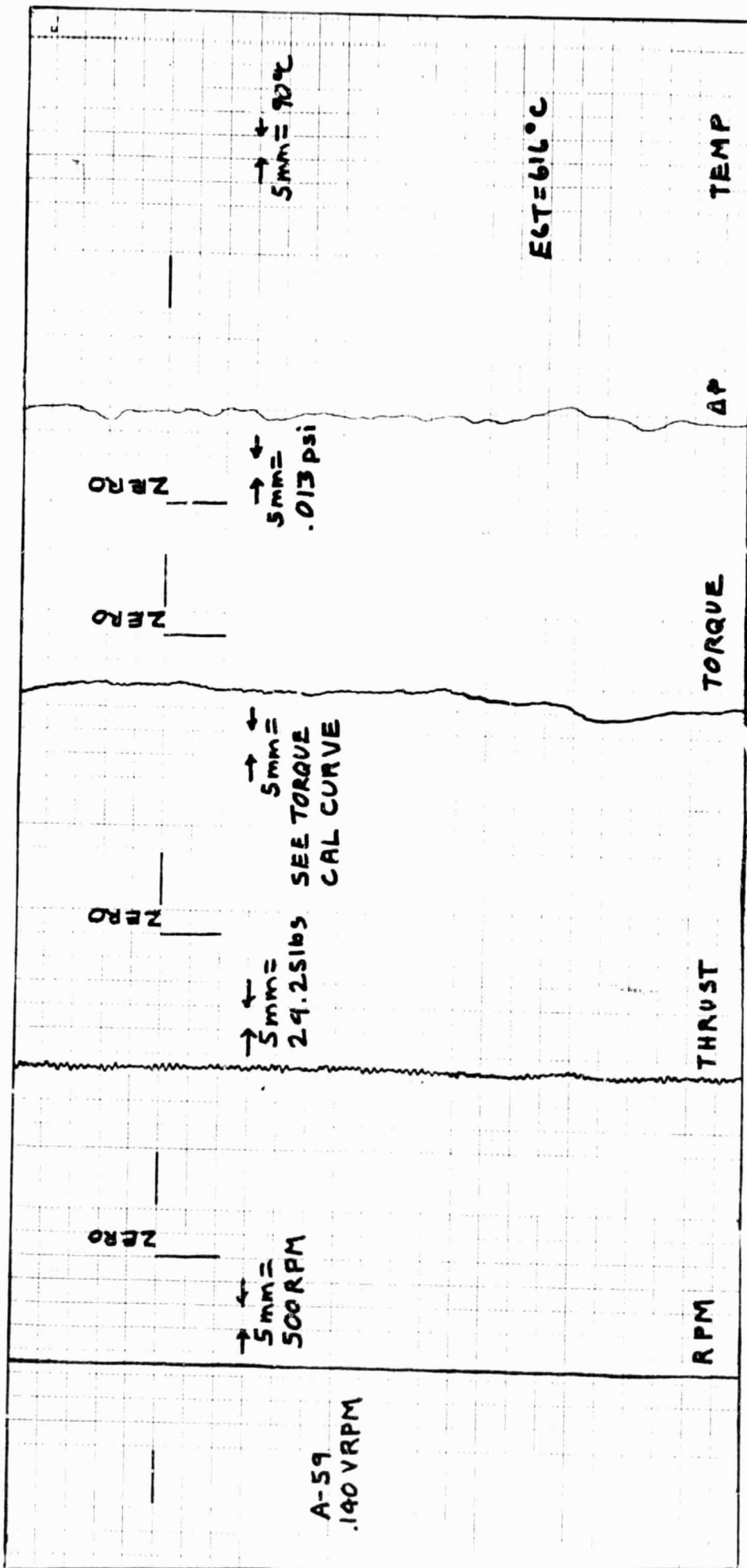

Figure A-58 - Raw static engine data.
 RPM= 2071, Humidity= 61.0%, OAT= 91°F
 Date: 8/24/83, BP= 29.37 in of HG

ORIGINAL PAGE IS
 OF POOR QUALITY



ORIGINAL TRACE IS
OF POOR QUALITY

Figure A-59 - Raw static engine data.
RPM = 2286, Humidity = 60.0%, OAT = 91°F
Date: 8/24/83, BP = 29.37 in of HG

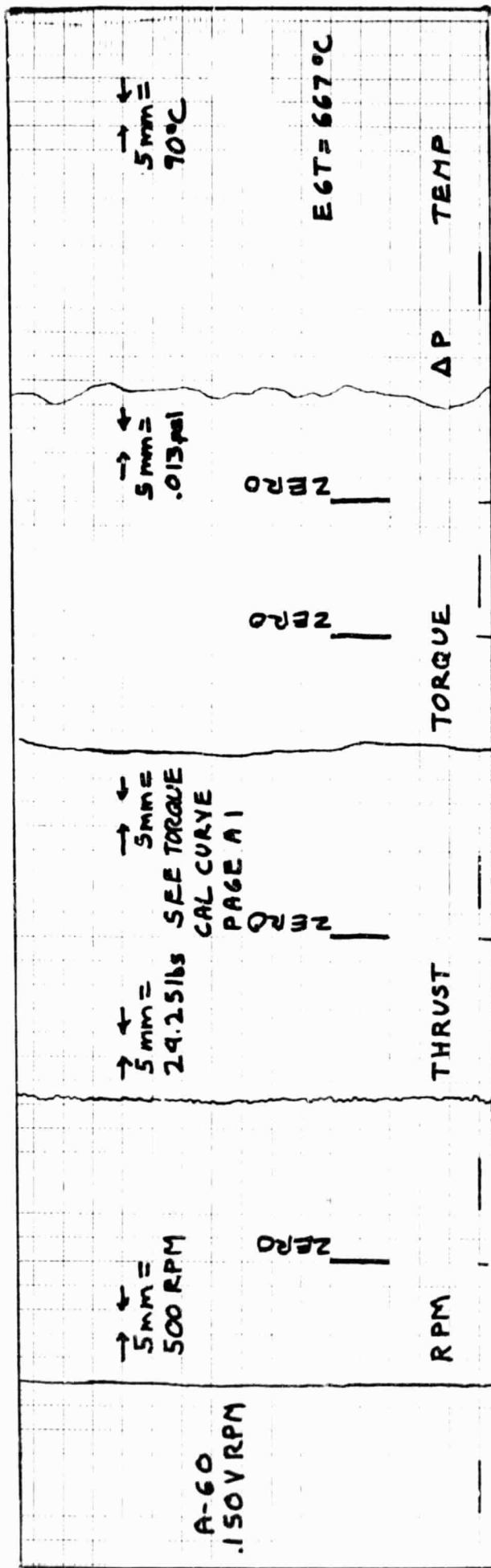
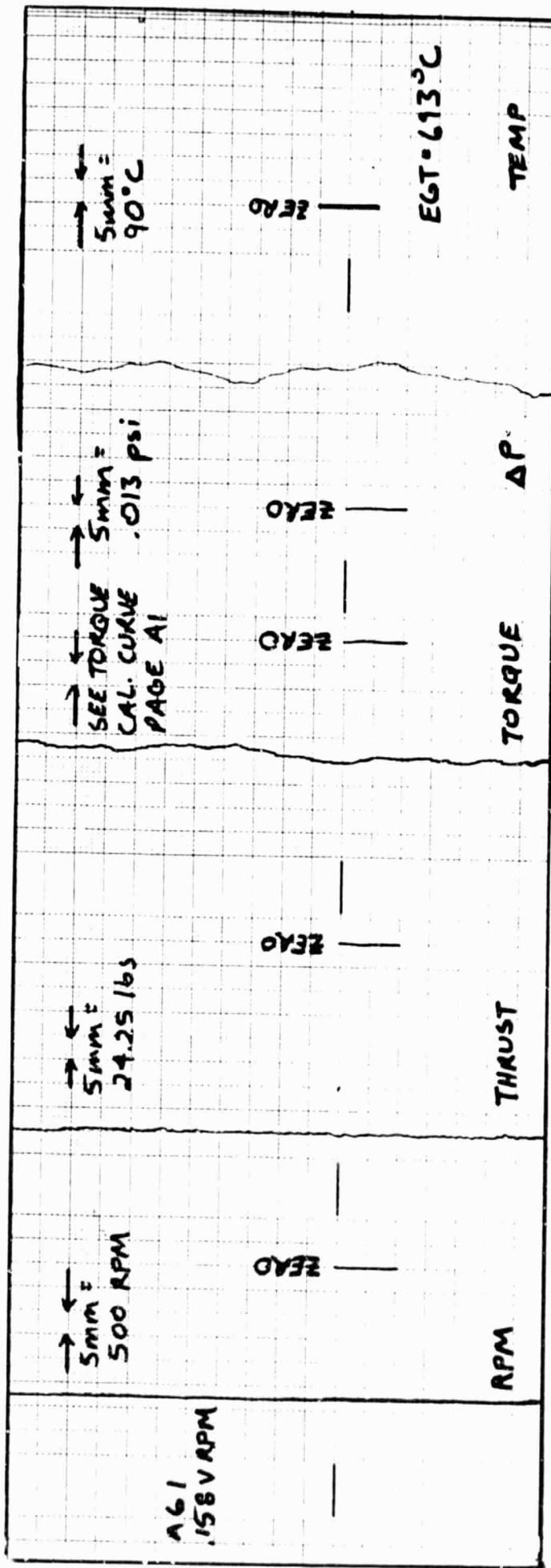

Figure A-60 - Raw static engine data.
 RPM= 2524, Humidity= 62.0%, OAT= 91°F
 Date: 8/24/83, BP= 29.37 in of HG

ORIGINAL PAGE IS
OF POOR QUALITY



ORIGINAL PAGE 17
OF POOR QUALITY

Figure A-61 - Raw static engine data.
RPM= 2714, Humidity= 62.0%, OAT= 91°F
Date: 8/24/83, BP= 29.37 in of HG

(A66)

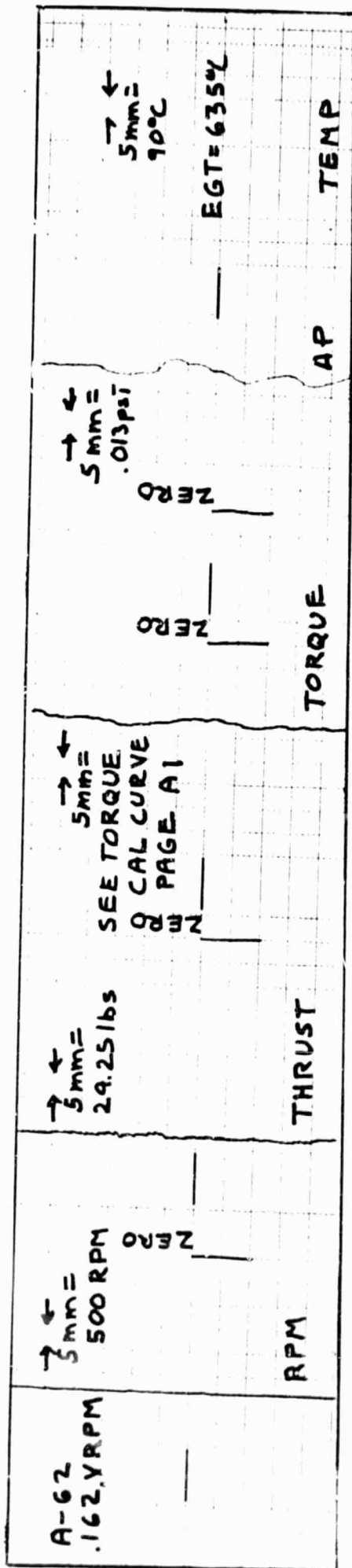

ORIGINAL PAGE IS
OF POOR QUALITY

Figure A-62 - Raw static engine data.
RPM= 2810, Humidity= 62.0%, OAT= 91°F
Date: 8/24/83, BP= 29.37 in of HG

(A67)

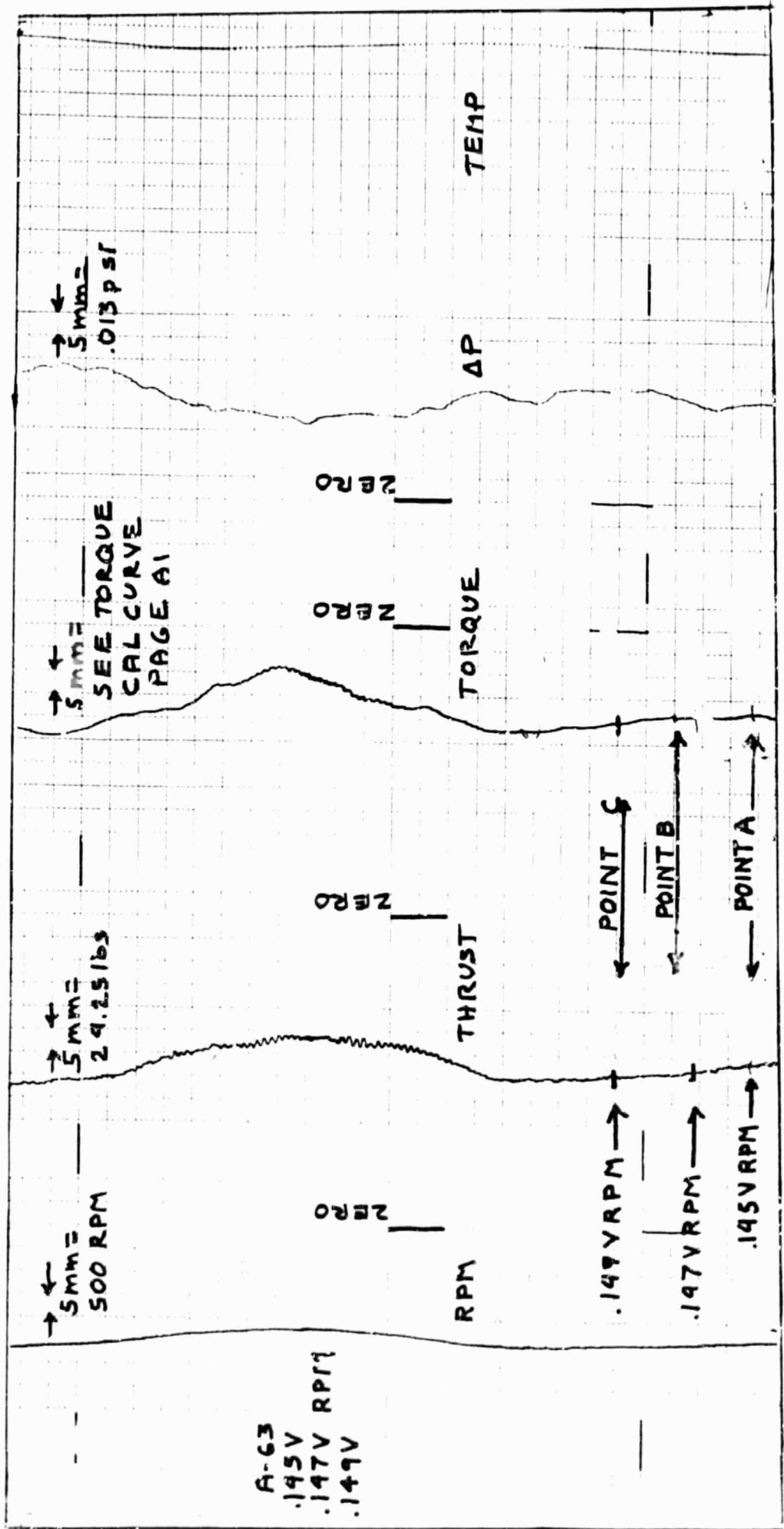

ORIGINAL PAGE IS OF POOR QUALITY

(A68)

Date: 8/24/83, BP= 29.37 in of HG
 pt c: RPM= 2500, Humidity= 62.0 %
 OAT= 91°F, Date: 8/24/83, BP= 29.37
 in of HG.

Figure A-63 - Data taken from unstable
 region of engine. pt a: RPM= 2405,
 Humidity= 62.0%, OAT= 91°F, Date:
 8/24/83, BP= 29.37 in of HG. pt b:
 RPM= 2452, Humidity= 62.0%, OAT= 91°F.

Run#	Figure #	Period sec.	O.A.T. deg. F.	B.P. in. Hg	Humidity %	Date	W ₁ lbs.	W ₂ lbs.	R.P.M.	Time
A1	A- 1	60	86	29.2	70.0	8/29/83	18.000	17.961	881	2:52
A2	A- 2	60	86	29.2	70.0	8/29/83	18.000	17.921	1214	2:56
A3	A- 3	60	86	29.2	71.0	8/29/83	18.000	17.898	1524	2:58
A4	A- 4	60	86	29.2	71.0	8/29/83	18.000	17.889	1738	3:00
A5	A- 5	60	86	29.2	71.0	8/29/83	17.825	17.649	2048	3:01
A6	A- 6	60	86	29.2	71.0	8/29/83	17.482	17.196	2286	3:04
A7	A- 7	60	86	29.2	71.0	8/29/83	16.975	16.700	2524	3:06
A8	A- 8	60	86	29.2	71.0	8/29/83	16.000	15.710	2714	3:08
A9	A- 9	60	86	29.2	71.0	8/29/83	15.000	14.543	2810	3:10
A10	A-10	60	86	29.2	71.0	8/29/83	14.000	13.440	2786	3:12

Period: Elapsed time from W₁ to W₂ weight recordings.

Table A1 - Table of the Raw Fuel Flow data taken, table also shows the testing conditions for each figure number.

Run#	Figure #	Period sec.	O.A.T. deg. F	B.P. in. Hg	Humidity %	Date	W ₁ lbs	W ₂ lbs	R.P.M.	Time
B- 1	A-11	60	87	29.26	69.5	8/29/83	13.000	12.975	833	3:48
B- 2	A-12	60	87	29.24	69.5	8/29/83	12.950	12.895	1143	3:51
B- 3	A-13	60	87	29.24	69.5	8/29/83	13.000	12.900	1500	3:54
B- 4	A-14	60	87	29.26	69.0	8/29/83	13.000	12.878	1690	3:55
B- 5	A-15	60	87	29.26	69.0	8/29/83	12.000	11.825	1810	3:58
B- 6	A-16	60	87	29.26	69.0	8/29/83	12.000	11.756	2071	4:01
B- 7	A-17	60	87	29.26	69.0	8/29/83	11.000	10.722	2338	4:04
B- 9	A-18	60	87	29.26	68.0	8/29/83	10.000	9.678	2429	4:07
B-10	A-19	60	88	29.26	68.0	8/29/83	10.000	9.520	2619	4:10
B-11	A-20	60	88	29.26	68.0	8/29/83	9.000	8.500	2786	4:12

Period: Elapsed time from W₁ to W₂ weight recordings.

Table A2 - Table showing the Raw Fuel Flow Data, this table also shows testing conditions for each figure number.

Run#	Figure #	Period sec.	O.A.T. deg. F	B.P. in. Hg.	Humidity %	Date	W ₁ lbs.	W ₂ lbs.	R.P.M.	Time
C1	A-21	60	87	29.25	66.5	8/29/83	7.897	7.841	881	-----
C2	A-22	60	88	29.25	67.0	8/29/83	8.000	7.930	1214	-----
C3	A-23	60	88	29.25	67.0	8/29/83	7.839	7.740	1524	-----
C4	A-24	60	88	29.25	66.5	8/23/83	7.652	7.538	1762	-----
C5	A-25	60	88	29.25	66.0	8/29/83	6.990	6.848	1929	-----
C6	A-26	60	88	29.25	66.0	8/29/83	6.789	6.601	2119	-----
C7	A-27	60	88	29.25	67.0	8/29/83	6.000	5.712	2381	-----
C8	A-28	60	88	29.25	66.5	8/29/83	5.700	5.396	2643	-----
C9	A-29	60	88	29.25	66.0	8/29/83	5.000	4.579	2786	-----

Period: Elapsed time from W₁ to W₂ weight recordings.

Table A3 - Table showing the Raw Fuel Flow data along with the testing conditions.

Run#	Figure #	Period sec.	O.A.T. deg. F	B.P. in. Hg	Humidity %	Date	W ₁ lbs	W ₂ lbs	R.P.M. Prop.	Time
1	A-30	120	87	29.32	72.0	8/23/83	16.000	15.962	714	3:05
2	A-31	120	87	29.30	71.8	8/23/83	15.913	15.835	952	3:13
3	A-32	120	87	29.30	71.8	8/23/83	15.715	15.658	1119	3:16
4	A-33	120	87	29.31	72.2	8/23/83	15.492	15.252	1476	3:21
5	A-34	120	87	29.31	72.2	8/23/83	14.918	14.713	1667	3:24
6	A-35	120	87	29.31	72.2	8/23/83	13.728	13.440	1881	3:35
7	A-36	120	87	29.30	72.2	8/23/83	13.000	12.621	2045	3:39
8	A-37	120	87	29.30	71.8	8/23/83	12.000	11.552	2214	3:42
9	A-38	120	87	29.30	72.0	8/23/83	11.000	10.388	2500	3:47
10	A-39	120	87	29.30	71.8	8/23/83	10.000	9.283	2643	3:55
11	A-40	60	87	29.30	71.8	8/23/83	9.000	8.475	2786	3:57
13	A-41	60	87	29.30	70.2	8/23/83	18.000	17.980	762	4:25
14	A-42	60	87	29.30	70.2	8/23/83	17.910	17.863	1042	4:27

Period: Elapsed time from W₁ to W₂ weight recordings.

Table A4 - Table showing the Raw Fuel Flow data along with the testing conditions for each figure number.

ORIGINAL PAGE NO
OF POOR QUALITY

Run#	Figure #	Period sec.	O.A.T. deg. F	B.P. in. Hg	Humidity %	Date	W ₁ lbs	W ₂ lbs	R.P.M.	Time
15	A-43	60	87	29.30	70.6	8/23/83	17.780	17.715	1238	4:29
16	A-44	60	88	29.30	70.8	8/23/83	17.500	17.430	1452	4:33
17	A-45	60	88	29.30	69.8	8/23/83	17.000	16.883	1643	4:39
18	A-46	60	88	29.30	69.8	8/23/83	16.600	16.410	1833	4:42
19	A-47	60	88	29.30	69.8	8/23/83	16.000	15.827	2048	4:49
20	A-48	60	88	29.30	69.8	8/23/83	15.720	15.477	2262	4:53
21	A-49	60	88	29.30	69.8	8/23/83	15.000	14.699	2524	4:56
22	A-50	60	88	29.30	69.8	8/23/83	13.835	13.513	2738	4:59
23	A-51	60	88	29.30	69.8	8/23/83	13.000	12.452	2810	5:02
25	A-52	60	89	29.37	64	8/24/83	12.000	11.987	810	4:47
26	A-53	60	89	29.37	64	8/24/83	11.968	11.910	1000	4:49
27	A-54	60	90	29.37	63	8/24/83	11.858	11.795	1238	5:02
28	A-55	60	90	29.37	62	8/24/83	11.637	11.552	1524	5:04
29	A-56	60	91	29.37	61	8/24/83	11.356	11.238	1667	5:07
30	A-57	60	91	29.37	62	8/24/83	10.850	10.755	1833	5:09
31	A-58	60	91	29.37	61	8/24/83	10.373	10.169	2071	5:11

Period: Elapsed time from W₁ to W₂ weight recordings.

Table A5 - Table showing the Raw Fuel Flow data along with the testing conditions for each figure number.

(A73)

Run#	Figure #	Period sec.	O.A.T. deg. F	B.P. in. Hg	Humidity %	Date	W ₁ lbs	W ₂ lbs	R.P.M.	Time
32	A-59	60	91	29.37	60.0	8/24/83	10.000	9.755	2286	5:14
33	A-60	60	91	29.37	62.0	8/24/83	8.000	7.690	2524	5:17
34	A-61	60	91	29.37	62.0	8/24/83	8.000	7.637	2714	5:19
35	A-62	60	91	29.37	62.0	8/24/83	7.000	6.487	2810	5:21
35	A-63	60	91	29.37	62.0	8/24/83	6.000	5.513	2405	5:23

Period: Elapsed time from W₁ to W₂ weight recordings.

ORIGINAL DATA
 QUALITY

Table A6 - Table showing the Raw Fuel Flow data along with the testing conditions for each figure number.

APPENDIX B

PRESENTATION OF THE PARAMETER SYSTEM ACCURACIES

TABLE OF CONTENTS

<u>Section</u>	<u>Title</u>	<u>Page</u>
B.	Determination of Measuring System Accuracies	B1
B1.	Exhaust Gas Temperature	B1
B2.	Propeller RPM	B3
B3.	Torque	B5
B4.	Thrust	B6
B5.	Change in Pressure through the Propeller	B7
B6.	Cylinder Head Temperature	B8
B7.	Fuel Flow	B9

APPENDIX B

B. Determination of the Measuring System's Accuracies

With the instrumentation system in working order, it was then necessary that the accuracies of each of the systems be found. There were seven quantities being measured, they are: RPM, Thrust, Torque, Change in Pressure Through the Propeller, Exhaust Gas Temperature, Cylinder Head Temperature and Fuel Flow. The following is a determination of the accuracies associated with each system.

B1. Exhaust Gas Temperature

The device measuring temperature is an Omega type 2809 Digital Thermometer. This device sends a reference voltage to a thermocouple and receives a voltage proportional to the temperature that the thermocouple is sensing. The digital thermometer then sends a DC voltage to an analog strip chart recorder. To insure to a greater extent, the accuracy of the thermometer, the methods of Reference 1 Section VI page 4 were used to calibrate the Digital Thermometer as well as the thermocouples. The following is a table showing the errors in the system as well as the reason for the error.

Table B-1 - Errors and the reasons for error in the Exhaust Gas Temp. System

*	*	*
<u>Errors</u>		<u>Reason for such error</u>
±0.005 mV		● Zeroing error- one can't zero an HP 2402A Integrating Digital Voltmeter to within 0.005 mV of zero.
±0.001 mV		● The voltmeter described above uses a linear fit to aid it in staying at zero. The 0.001 mV is to account for non-linearities at the top end of the curve.
±0.010 mV		● The actual voltage that the Digital Thermometer refers to was 48.890 mV which corresponds to 1200°C. When reading the scale of the voltmeter, the second decimal could be held const. but the third jumped up and down approx. 0.010 mV.

Table B-1 - Continued

*	*	*
<u>Error</u>		<u>Reason for such error</u>
$\pm 1.0^{\circ}\text{C}$	•	This was the digital reading error after calibration as stated in Ref 1 Sect. VI Page 5. Note that all errors before and including this one are due to the calibration of the instrumentation, the following are inherent.
$\pm 7.0^{\circ}\text{F} = \pm 3.9^{\circ}\text{C}$	•	Reference 1, Section VI, Page 6. inherent for a type 'K' Thermocouple.
$\pm 0.3\%$ of full scale $= \pm 3.6^{\circ}\text{C}$	•	Full scale range of a type 'K' thermocouple is 0°C to 1200°C . This value is due to the use of the analog output on the Digital Thermometer. Reference 1, Section VI, page 6.
$\pm 0.5 \text{ mm}$	•	This is the resolution error on a Technirite 8-channel TS-888 Strip Chart Recorder Reference 1, Section I, page 29.
*	*	*

With the above errors, the total system error for Exhaust Gas Temperature can be obtained. The total is as follows:

$$\epsilon_{\text{EGT}} = \pm 0.016 \text{ mV} \pm 8.5^{\circ}\text{C} \pm 0.5\text{mm}$$

$$\frac{.016 \text{ mV}}{x} = \frac{48.89 \text{ mV}}{1200^{\circ}\text{C}} \quad \text{From this } .016\text{mV} = 0.40^{\circ}\text{C}$$

$$\frac{0.5 \text{ mm}}{x} = \frac{30.0 \text{ mm}}{550^{\circ}\text{C}} \quad \text{From this } 0.5 \text{ mm} = 9.2^{\circ}\text{C}$$

Therefore: $\epsilon_{\text{EGT}} = \pm 0.40^{\circ}\text{C} \pm 8.5^{\circ}\text{C} \pm 9.2^{\circ}\text{C}$

$$\underline{\underline{\epsilon_{\text{EGT}} = \pm 18.1^{\circ}\text{C}}}$$

To obtain the scale factors used above the calibration curves were used. They are located in Appendix C.

B2. Propeller RPM

There were two RPM circuits used in this experiment, both of them used the Hall Effect Principle. The first displayed its output on a Micronta Digital Multimeter (Model #22-197U). The output, displayed as a voltage, was matched to a calibration curve (Figure B1, page B4), and a proportional RPM was extracted. Calibration of the first circuit consisted of applying a function of known frequency by a function generator, and recording the output. To insure that a similar function was obtained for calibration purposes, a dual oscilloscope was used to modify the signal from the function generator. The following is the errors of the first system:

Table B-2 - Errors in the Rpm system and explanation of such error

<u>Error</u>	<u>Reason for such error</u>
± 5.0 RPM	<ul style="list-style-type: none"> ● Error in the calibration curve of the first system.
± 0.5 mV = ± 10.0 RPM	<ul style="list-style-type: none"> ● Error in the above discribed voltmeter.

Therefore the first RPM circuit has a total error of,

$$\epsilon_{\text{RPM}\#1} = \pm 15.0 \text{ RPM}$$

The second system electronics are very accurate. This is because the system does not estimate or integrate the Hall Effect signal, it actually counts the pulses and converts that frequency into a DC voltage. Note that the circuit diagrams are located in Appendix C. Since the circuit does actually count only the following errors will apply.

Table B-3 - Errors in the Rpm system #2

<u>Error</u>	<u>Reason for such error</u>
± 15.0 RPM	<ul style="list-style-type: none"> ● the error as given in table B-2.
± 0.5 mm	<ul style="list-style-type: none"> ● Resolution error in the strip chart recorder.

$$\frac{0.5 \text{ mm}}{x} = \frac{30.0 \text{ mm}}{2850 \text{ RPM}} \quad \text{From this } 0.5 \text{ mm} = 47.5 \text{ RPM}$$

Therefore:

$$\underline{\underline{\epsilon_{\text{RPM}}(\text{total}) = \pm 62.5 \text{ RPM}}}$$

ORIGINAL PAGE 15
OF POOR QUALITY

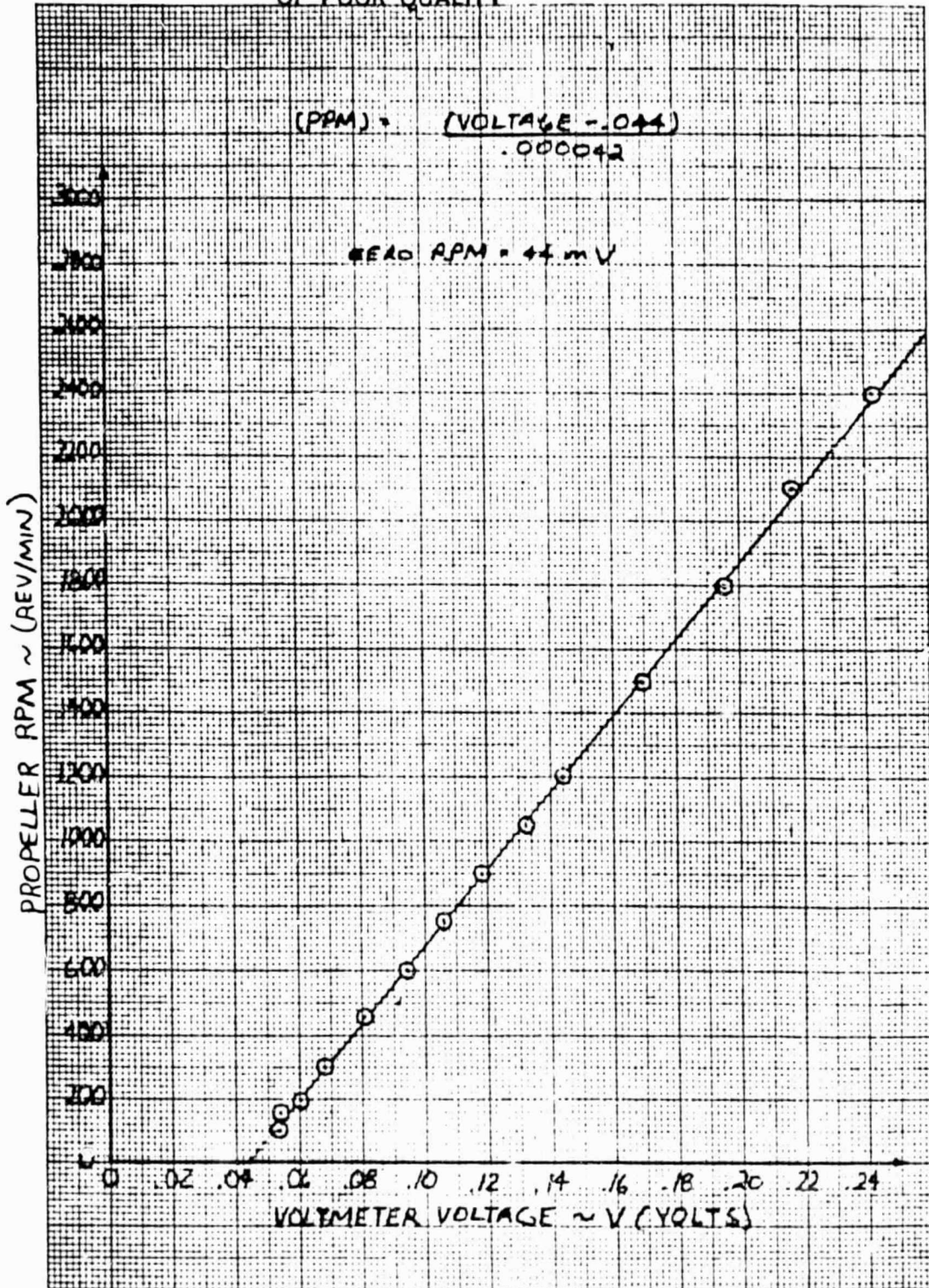

CALC	BROOKE	6/10/83	REVISED	DATE
CHECK			BLACKLOCK	8/23
APPO				
APPO				

Figure B1 - RPM Calibration Curve
System #1 using a digital voltmeter.

01614PL

B3. Torque

The Torque calibration device works by applying a relatively pure moment about the engine center line or the crank shaft. It is done in this manner to give as accurate as possible simulation of the actual torque produced by the engine. Figure B-2 (below) shows a schematic of the torque calibration stand.

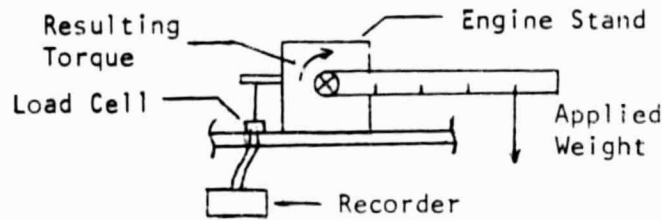

Figure B-2 - Schematic of the Torque Calibration Stand

With the system given, the following shows the errors associated with the Torque Calibration stand:

Table B-4 - Errors on the torque system and the reasons for them

<u>Error</u>	<u>Reason for such error</u>
± 0.5 ft-lbs	• misalignment of the weights to create the proper moment.
± 0.5 mm	• Resolution error in the strip chart recorder used.
± 1.8 mm	• error due to hysteresis inherent in the system.

$$\frac{0.5 \text{ mm}}{x} = \frac{43.0 \text{ mm}}{45.0 \text{ ft-lbs}} \quad \text{From this } 0.5 \text{ mm} = 0.52 \text{ ft-lbs}$$

$$\frac{1.8 \text{ mm}}{x} = \frac{43.0 \text{ mm}}{45.0 \text{ ft-lbs}} \quad \text{From this } 1.8 \text{ mm} = 1.90 \text{ ft-lbs}$$

Therefore: $\epsilon_Q = \pm 0.5 \text{ ft-lbs} \pm 0.52 \text{ ft-lbs} \pm 1.90 \text{ ft-lbs}$

$$\underline{\underline{\epsilon_Q = \pm 2.92 \text{ ft-lbs}}}$$

B4. Thrust

ORIGINAL PAGE IS
OF POOR QUALITY

The thrust calibration is obtained by using what is called a 'Mechanical Advantage' as illustrated below (Figure B3).

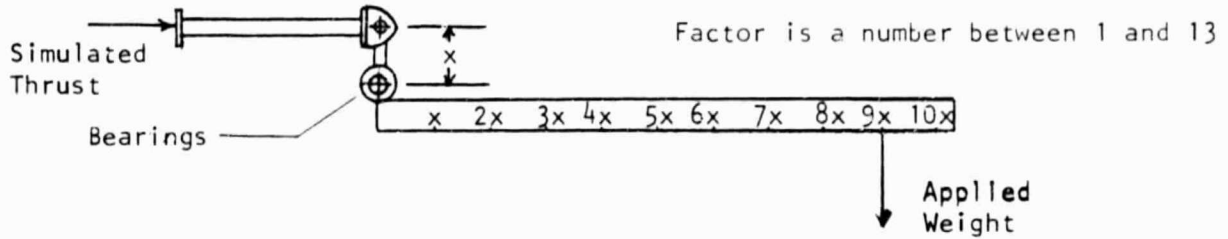

Figure B3 - Schematic of the Operation of the Thrust Calibration Stand

The simulated thrust is obtained at a distance x from the bearings around which a moment is applied. This moment is obtained by applying a known weight at a multiple of x distance (from 1-13) from the bearings. This is proved by the following equation.

$$(x) * (\text{Simulated Thrust}) = (\text{Factor}) * (x) * (\text{Applied Weight})$$

Therefore: $(\text{Simulated Thrust}) = (\text{Factor}) * (\text{Applied Weight})$

The errors associated with this system are as follows (Table B-5):

Table B-5 - Errors in the Thrust System and there reasons

<u>Error</u>	<u>Reason for such error</u>
± 0.25 in.	<ul style="list-style-type: none"> • This error comes about due to the misplacement of the weights on the stand.
± 0.5 mm	<ul style="list-style-type: none"> • Resolution error in the Strip Chart Recorder used
± 1.5 mm	<ul style="list-style-type: none"> • Error due to the inherent Hysteresis in the system

From the previous page:

$$\epsilon = \text{TAN}^{-1} \frac{0.25}{70.25} = 0.20 \text{ deg.}$$

$$W \cos(0.20 \text{ deg}) = \epsilon$$

$$\epsilon = \pm 6.3 \times 10^{-6} (W)$$

From this and an maximum applied weight of 200 lbs., the error ϵ is

$$\epsilon = \pm 0.0016 \text{ lbs.}$$

This error is going to be assumed negligible 0.0163% of the total error in the Thrust system

$$\frac{0.5 \text{ mm}}{x} = \frac{44.0 \text{ mm}}{220 \text{ lbs}} \quad \text{from this } 0.5 \text{ mm} = 2.3 \text{ lbs.}$$

$$\frac{1.5 \text{ mm}}{x} = \frac{44.0 \text{ mm}}{220 \text{ lbs}} \quad \text{from this } 1.5 \text{ mm} = 7.5 \text{ lbs.}$$

Therefore the total error in the thrust system is:

$$\epsilon_{\text{Thrust}} = \pm 2.3 \pm 7.5$$

$$\underline{\underline{\epsilon_{\text{Thrust}} = \pm 9.8 \text{ lbs.}}}$$

B5. Change in Pressure through the Propeller

The ΔP Calibration was done using a 30⁰ slant U-tube filled with Methal Alcohol. With a 20 cc syringe (see appendix c for a more graphic description), known pressures were applied. The actual pressures could be calculated as follows:

$$\text{Pressure(psi)} = \gamma \rho_w \Delta H$$

Where: γ = Specific Gravity of Methal Alcohol

$$\gamma = 0.790 \quad \text{Reference 2}$$

$$\rho_w = 62.40 \text{ lbs/ft}^3 \quad \text{Ref. 2} \quad \rho_w = \text{Density of Water (lbs/ft}^3)$$

ΔH = Change in alcohol height (cm.)

Knowing this the errors in the system were found (Table B-6):

Table B-6 - Error in the ΔP system and there reasons.

<u>Error</u>	<u>Reason for such error</u>
± 1.0 mm	• Error due to the inherent hysteresis in the ΔP system.
± 0.2 cm.*	• Error in the manual reading of the U-tube.
± 0.5 mm	• Resolution error in the Strip Chart Recorder.

With these values, the total error in the ΔP system was found.

$$\epsilon_{\Delta P} = \pm 1.0 \text{ mm} \pm 0.2 \text{ cm}^* \pm 0.5 \text{ mm}$$

$$\frac{0.5 \text{ mm}}{x} = \frac{38.0 \text{ mm}}{15.0 \text{ cm}^*} \quad \text{From this } 0.5 \text{ mm} = 0.2 \text{ cm}^*$$

$$\frac{1.0 \text{ mm}}{x} = \frac{38.0 \text{ mm}}{15.0 \text{ cm}^*} \quad \text{From this } 1.0 \text{ mm} = 0.4 \text{ cm}^*$$

Therefore: $\epsilon_{\Delta P} = \pm 0.8 \text{ cm}^*$

From this,

$$\underline{\underline{\epsilon_{\Delta P} = \pm 3.85 \times 10^{-3} \text{ psi}}}$$

*Note: All values given were the values directly off of the 30° slant height U-tube. The vertical distances would be exactly $\frac{1}{2}$ of the slant values.

B6. Cylinder Head Temperature

The CHT of the engine was obtained in exactly the same manner as EGT. This by using a type 'K' thermocouple and sensing it by a Digital Thermometer (described in sect. B1). Since the two systems (EGT and CHT) are exactly the same, then the errors are exactly the same. From this:

$$\underline{\underline{\epsilon_{\text{CHT}} = \pm 18.1^\circ\text{C}}}$$

B7. Fuel Flow

The fuel flow accuracies are as follows:

Table B-7 - Errors in the fuel flow system and there reasons

<u>Error</u>	<u>Reason for such error</u>
± 0.005 lbs.	● Resolution error in the scales used.
$\pm 0.016\%$ of the range used in secs	● This is the inherent error in the Digital Timer.
± 0.5 lbs	● Lag time when the person sees the time go to zero and then looks up to take down the initial value of weight as well as the final value of weight.

$$(\pm 0.016\%)*(120 \text{ secs.}) = \epsilon_{\text{time}}$$

From this: $\epsilon_{\text{time}} = 0.02 \text{ secs.}$

$$\epsilon_{\text{weight}} = \pm 0.005 \text{ lbs} \pm 0.5 \text{ lbs}$$

From this: $\epsilon_{\text{weight}} = \pm 0.505 \text{ lbs}$

with the values of ϵ_{time} and ϵ_{weight} , the total error in the fuel flow system may be obtained. To do this however, the methods of propagation of error must be used since:

$$\epsilon_{\text{fuel flow}} = \epsilon_{\text{weight}} + \epsilon_{\text{time}}$$

$$\epsilon_{\text{fuel flow}} = (\pm 0.505 \text{ lbs}) / (\pm 0.02 \text{ secs})$$

Note: The methods for determining propagation of error were obtained from the University of Kansas Physics Dept.

APPENDIX C
DESCRIPTION AND CALIBRATIONS
FOR ALL MEASURING SYSTEMS

TABLE OF CONTENTS

<u>Section</u>	<u>Title</u>	<u>Page</u>
C.	System Description and Calibration	C1
C1.	Propeller Rpm	C1
C2.	Thrust	C2
C3.	Torque	C6
C4.	Change in Pressure through the Propeller	C19
C5.	Temperatures (EGT and CHT)	C19
C6.	Fuel Flow	C26

APPENDIX C

C. System Description and Calibration

This section deals with the calibration and description of each system used on the engine test stand. These systems are: RPM, Thrust, Torque, Change in Pressure through the Propeller, Exhaust Gas Temperature, and Cylinder Head Temperature. The following sections show the calibration and description for each of the above systems.

C1. RPM

RPM was obtained by the use of a Hall Effect Transistor. The transistor was positioned as shown in figure C1. Each time the south pole of a magnet passed the transistor, a voltage pulse was produced. The Rpm is directly equal to the number of voltage pulses per second. Two separate circuits were

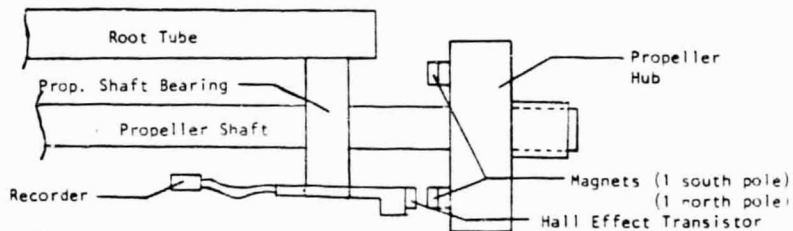

Figure C-1 - Positioning of the Hall Effect Transistor

used for Rpm. The first RPM circuit (Figure C2) took pulses produced by the Hall Effect Transistor and when read by a Micronta Digital Voltmeter (Model #22-197U), produced a proportional voltage. This system was calibrated by

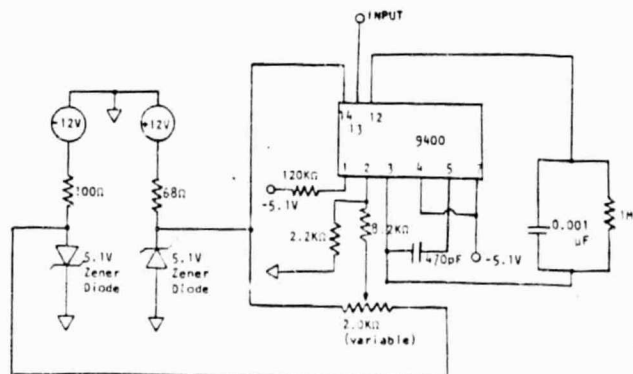
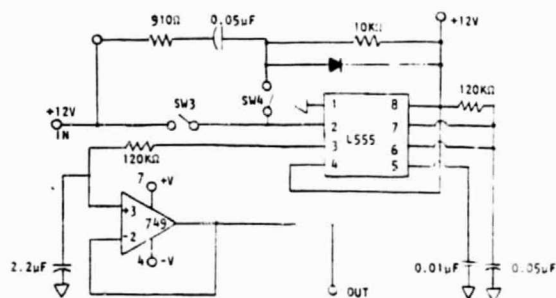

Figure C-2 - First Propeller RPM Circuit

applying a similar pulse from a function generator. With a known applied frequency, a voltage proportional to that frequency was obtained (figure C3). With this curve, instantaneous values of RPM could be obtained at all times.

The second RPM circuit incorporated an L555 timing circuit (figure C4). This method allowed a continuous analog reading of the RPM by a strip



ORIGINAL PAGE IS
OF POOR QUALITY

Figure C-4 - Second Rpm Circuit Diagram

chart recorder. Calibration of this system was done using the instantaneous reading obtained from the first RPM system. The actual calibration strips are shown in figure C6 while figure C5 shows RPM as a function of mm from the reference line or zero line.

C2. Thrust

Values of thrust were obtained by the use of a 500lb load cell in series with a linearly flexible stand (figure C7). The load cell transducers sense

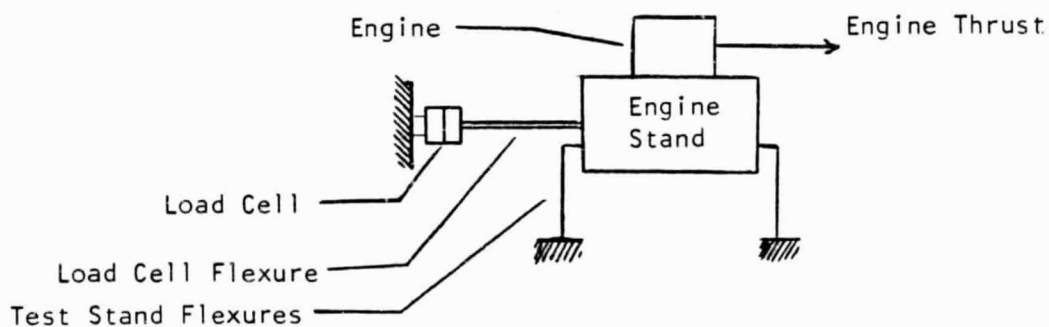
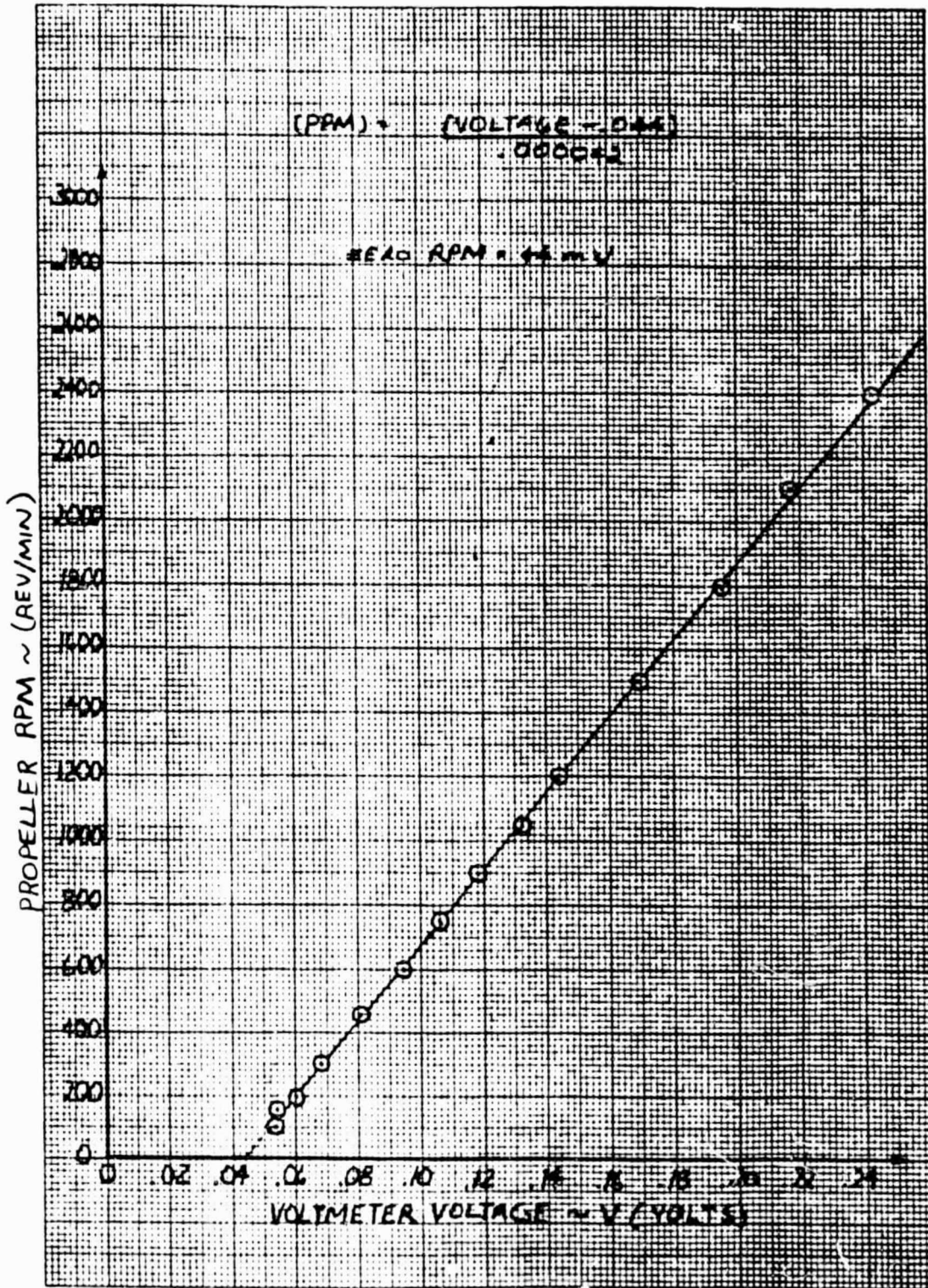

Figure C-7 - Schematic of the method for obtaining thrust

a thrust load and sent a proportional voltage through an amplifying circuit (figure C8) and from the amplifier to an analog strip chart recorder. Figure C12 shows the actual calibration strips while thrust as a function of mm from the



CALC	BROOKE	6/10/83	REVISED	DATE
CHECK			BLACKLOCK	8/83
APPD				
APPD				

Figure C3 - RPM Calibration Curve
System #1 using a Digital voltmeter.

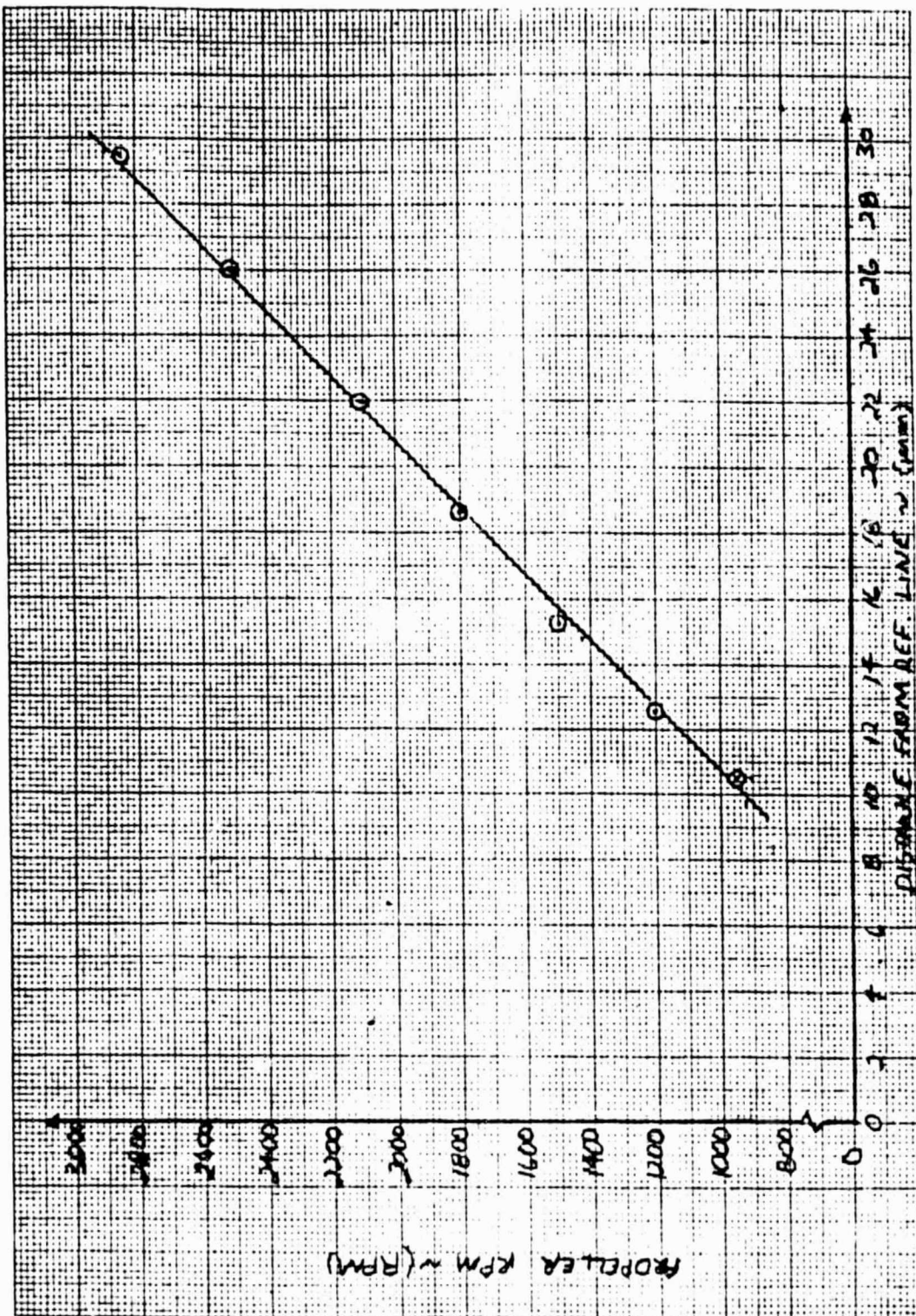

CALC	BLACKLOX	9/11	REVISED	DATE
CHECK				
APPO				
APPO				

Figure C5 - Propeller RPM
Calibration Curve.

ORIGINAL PAGE IS
OF POOR QUALITY

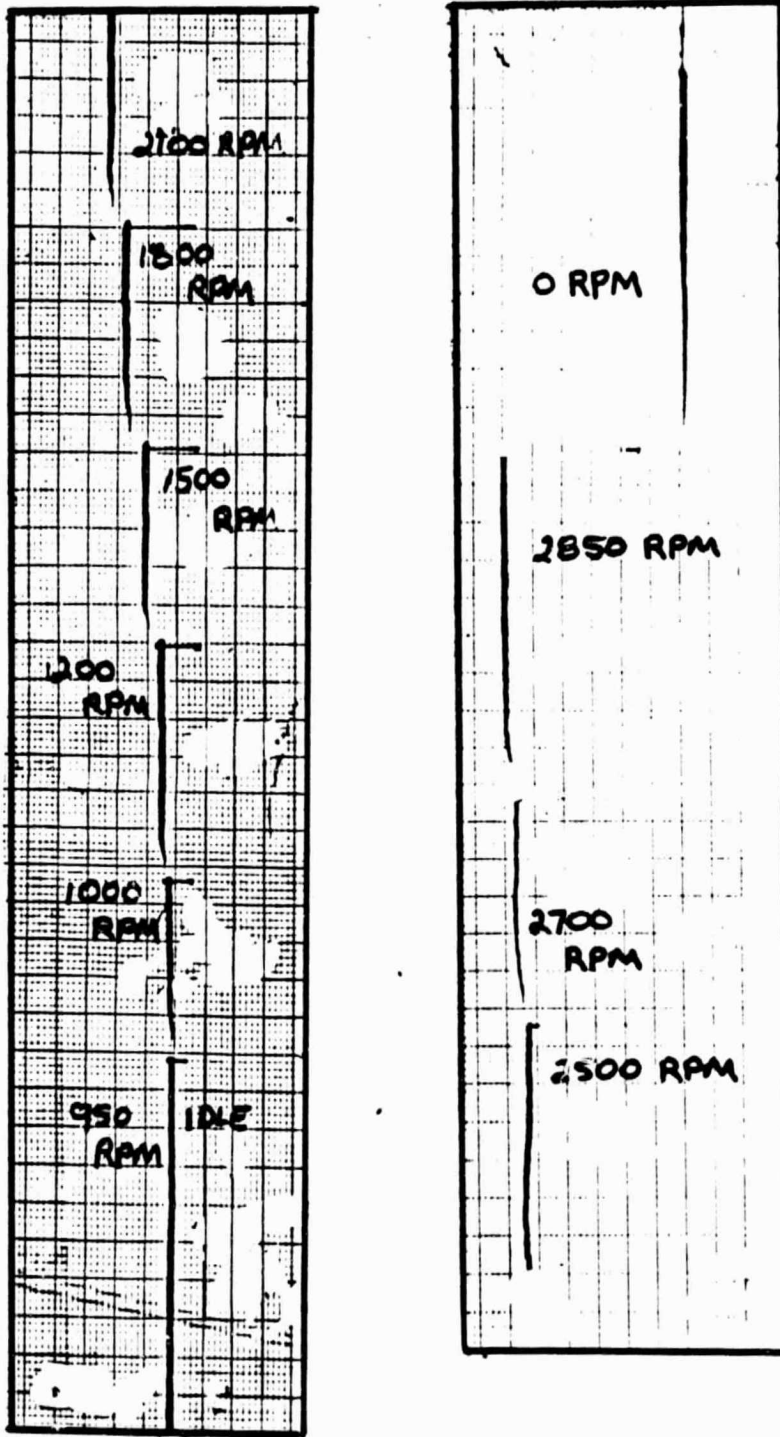

Figure C-6 - Actual Propeller Rpm
Calibration Strips

(C5)

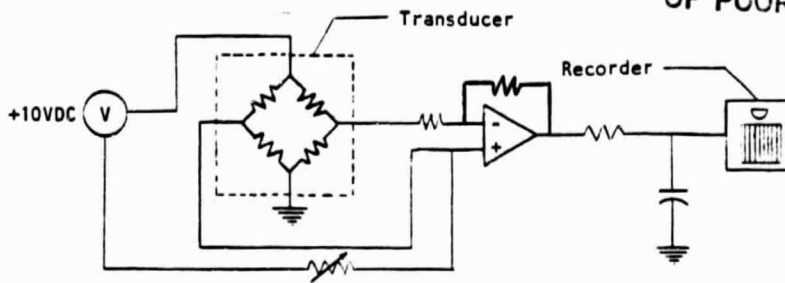

Figure C-8 - Amplification Circuit Diagram

reference line is shown in figure C11. Calibration was done by applying a known thrust using a calibration stand. Figure C9 shows a schematic of the calibration stand while an actual picture of the stand is shown in figure C10.

C3 Torque

Torque was obtained as shown in Figure C1 . As for thrust, the torque load cell transducer produced a voltage proportional to the load seen by the load cell at a distance 'l' from the flexure or torque. Again an amplification circuit (figure C8) was used to boost the signal such that a analog strip

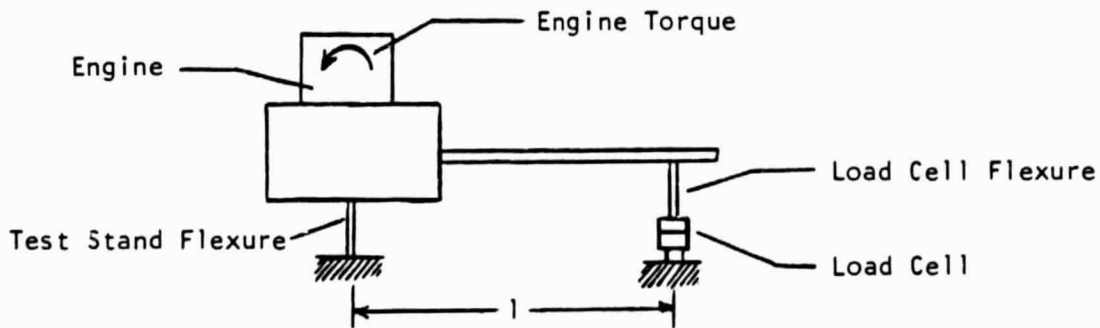

Figure C1 - Schematic for Obtaining Torque

chart recorder could read the signal. Figure C1 shows the actual calibration strips for torque while the curve constructed showing the torque as a function of the distance in mm from the reference line is shown in figure C1 . A schematic of the calibration stand is shown in figure C1 with an actual photo shown in figure C1 .

ORIGINAL PAGE IS
OF POOR QUALITY

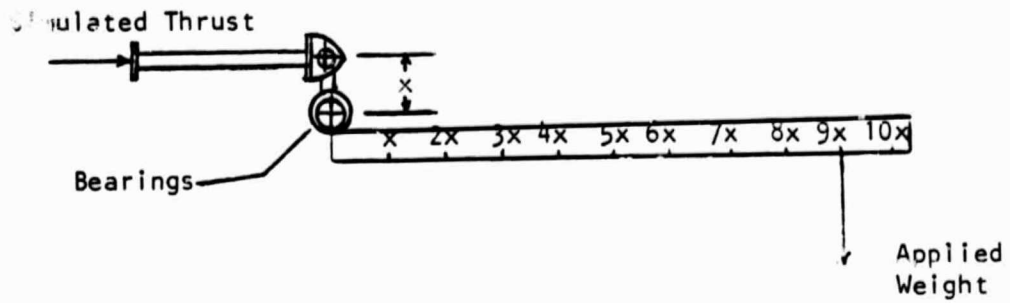

Figure C-9 - Schematic of the Thrust Calibration Stand

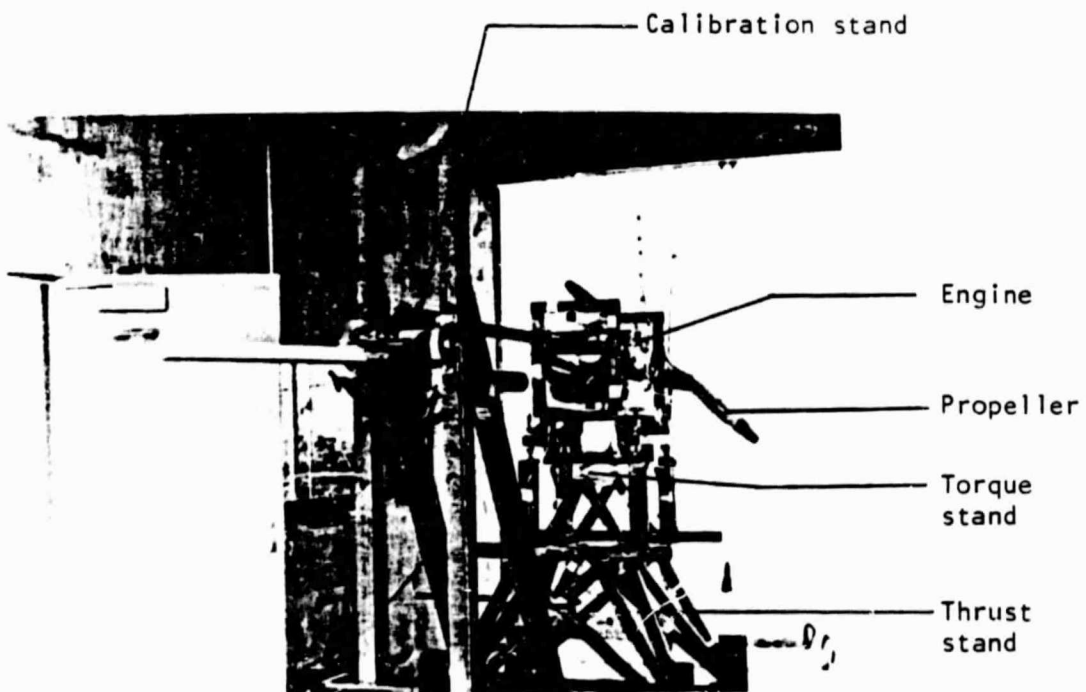
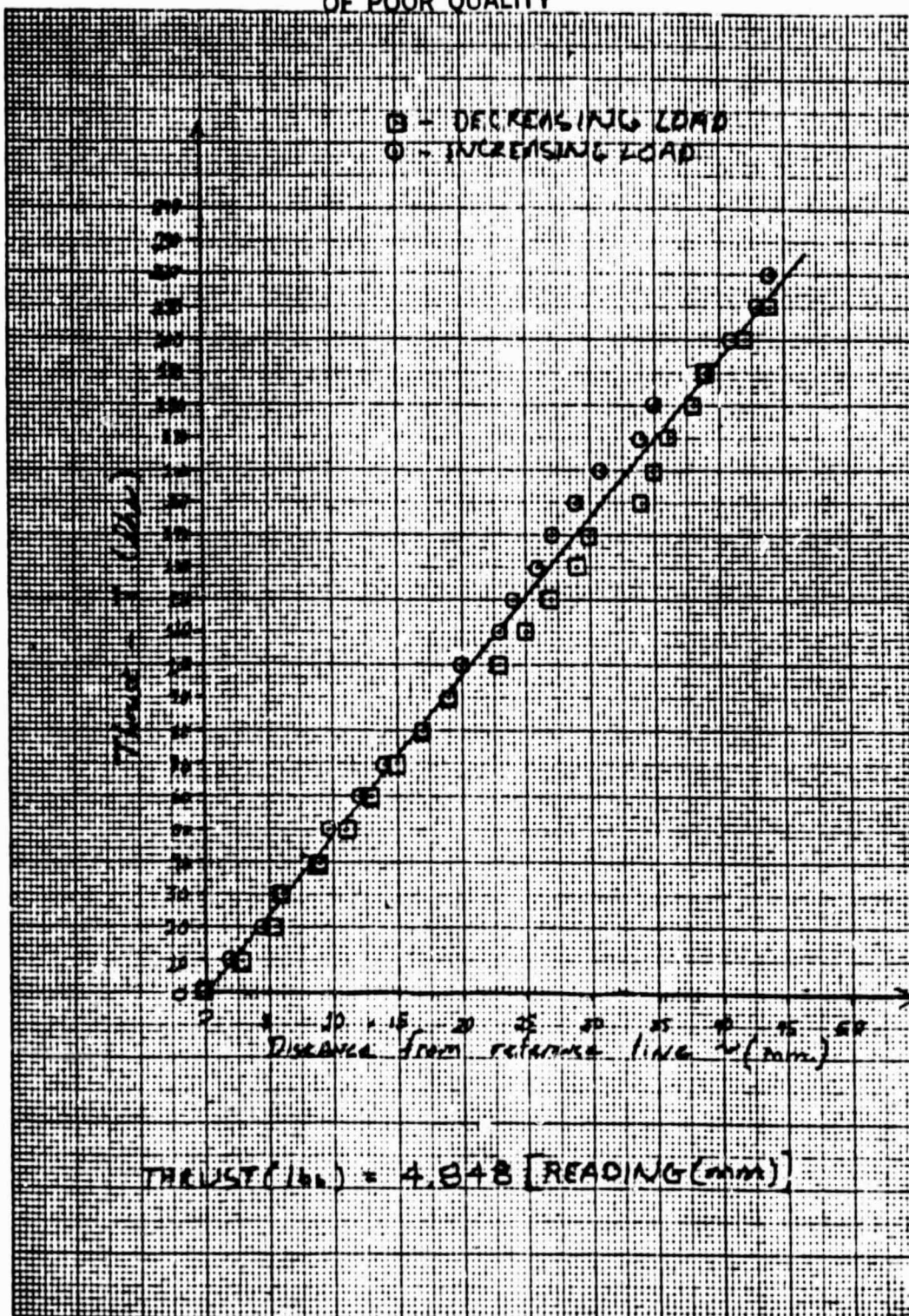

Figure C-10 - Photograph of the Thrust Calibration Stand

ORIGINAL PAGE IS
OF POOR QUALITY



CALC	BLACKWELL 7/7/93	REVISED	DATE	Figure C11 - Thrust Calibration Curve.	PAGE C8
CHECK					
APPO					
APPO					
				UNIVERSITY OF KANSAS	

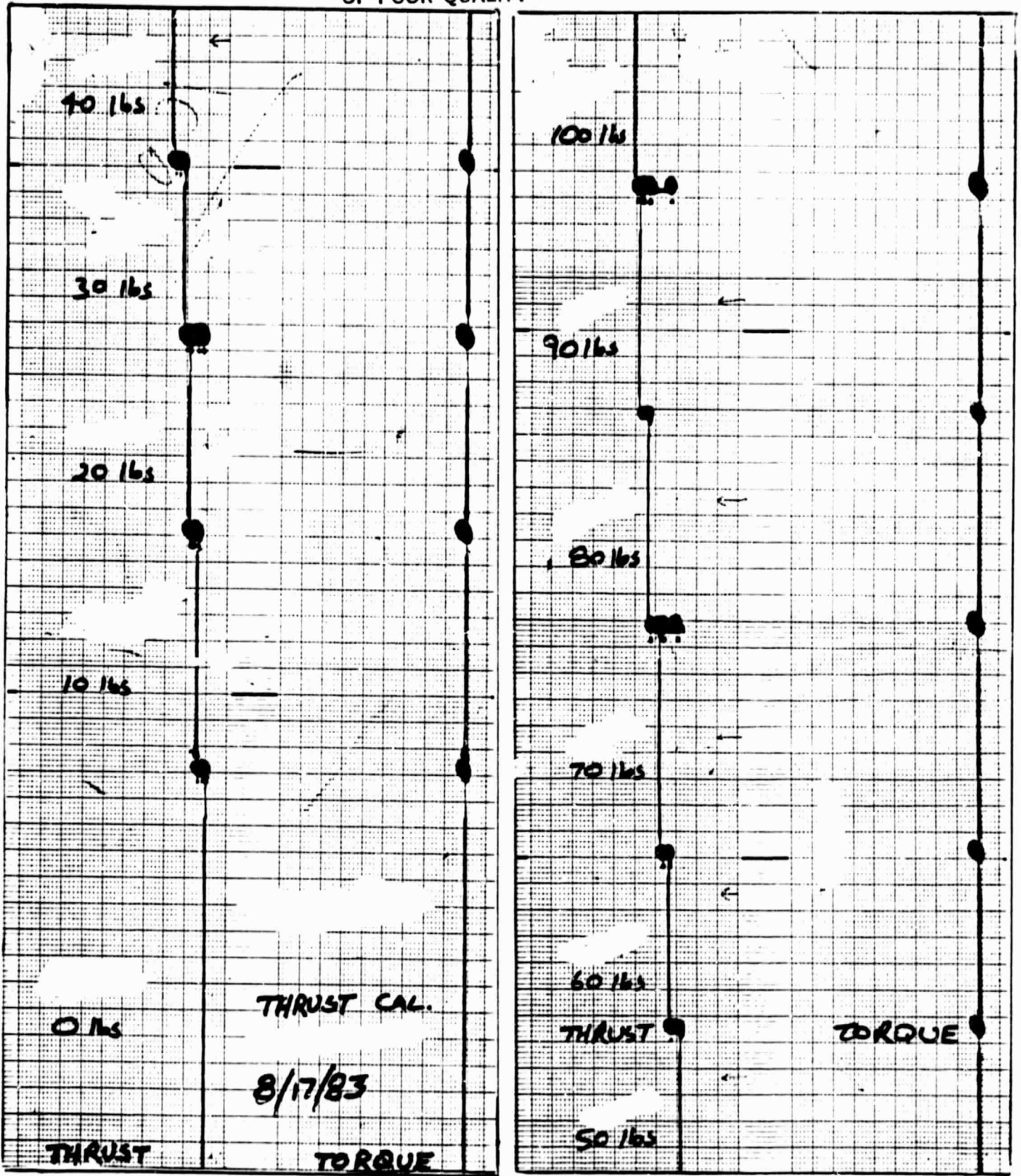
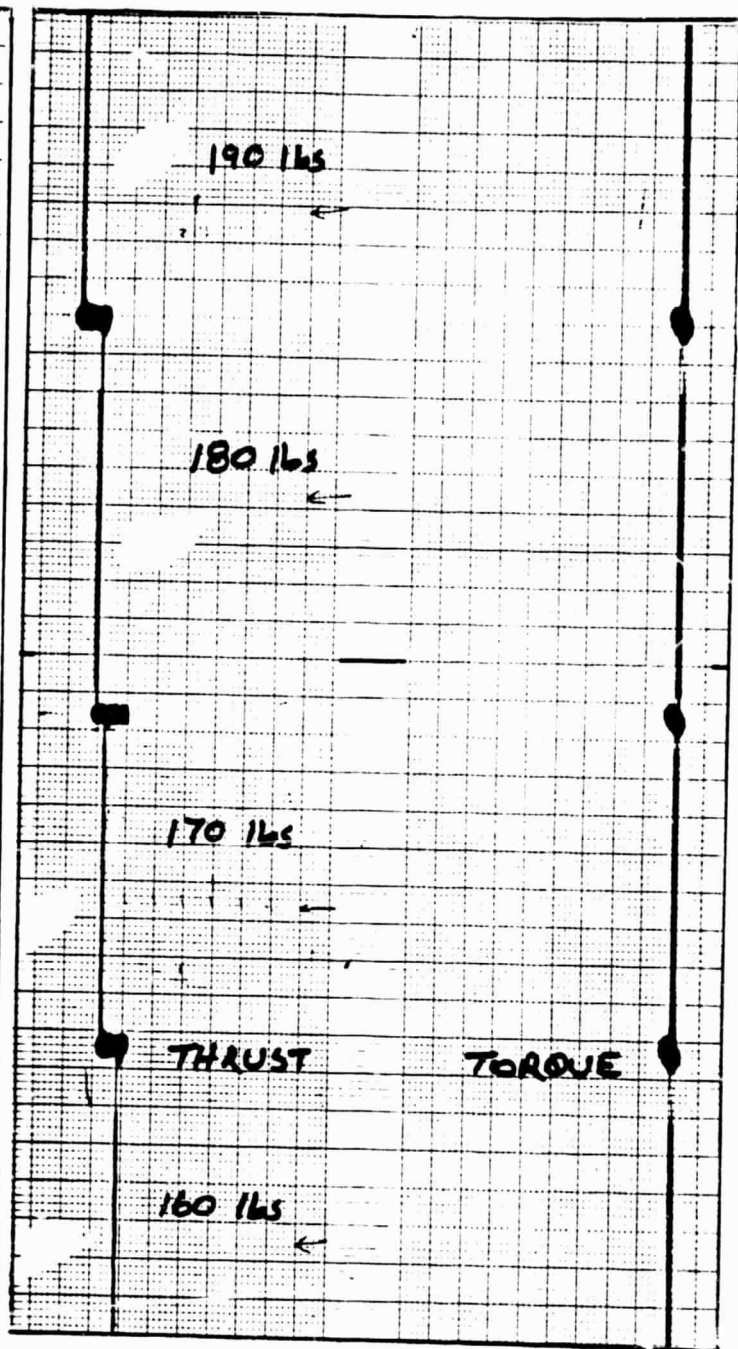
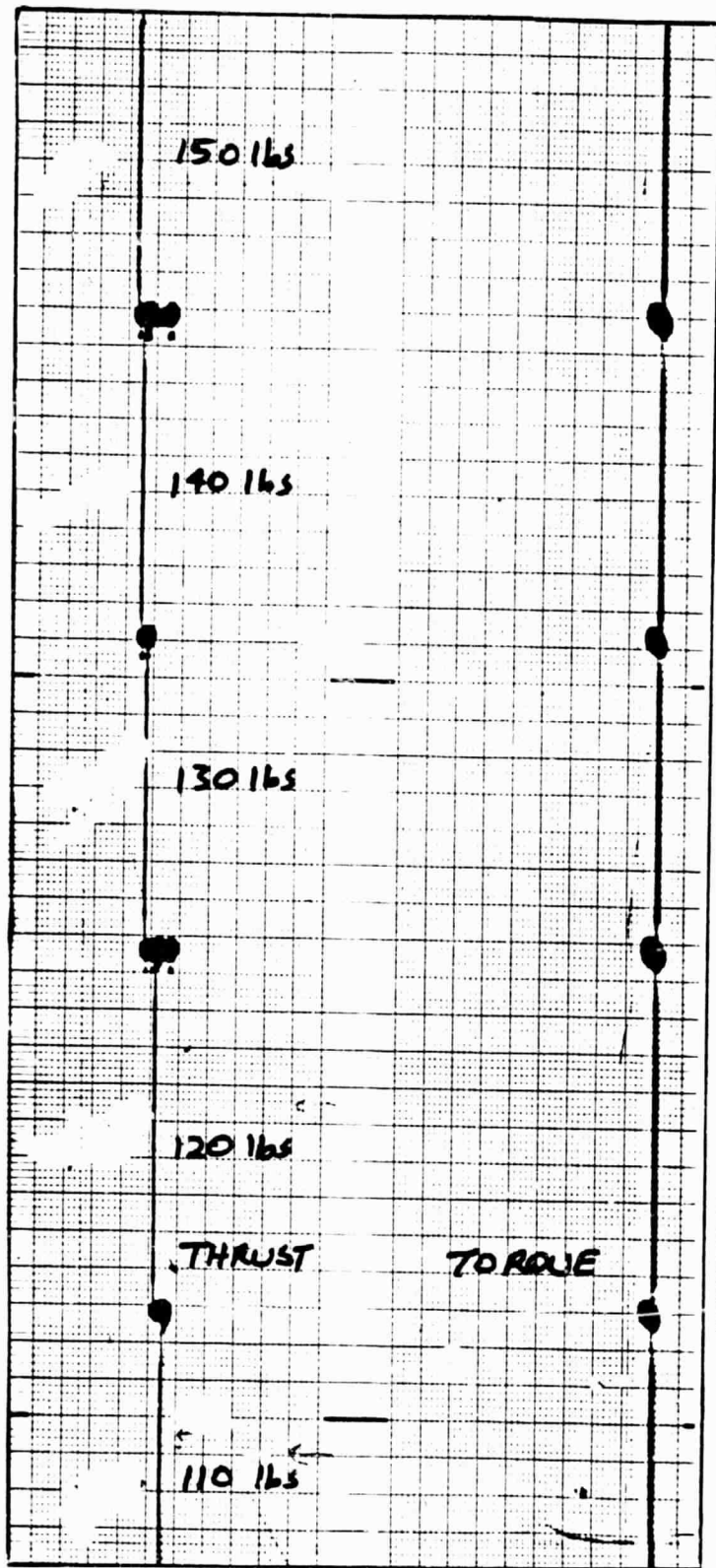

Figure C-12 - Actual Calibration
Strips for the Thrust System.

Date: 8/17/83



ORIGINAL PAGE IS
OF POOR QUALITY

Figure C-12 - Actual Calibration
Strips for the Thrust System.

Date: 8/17/83

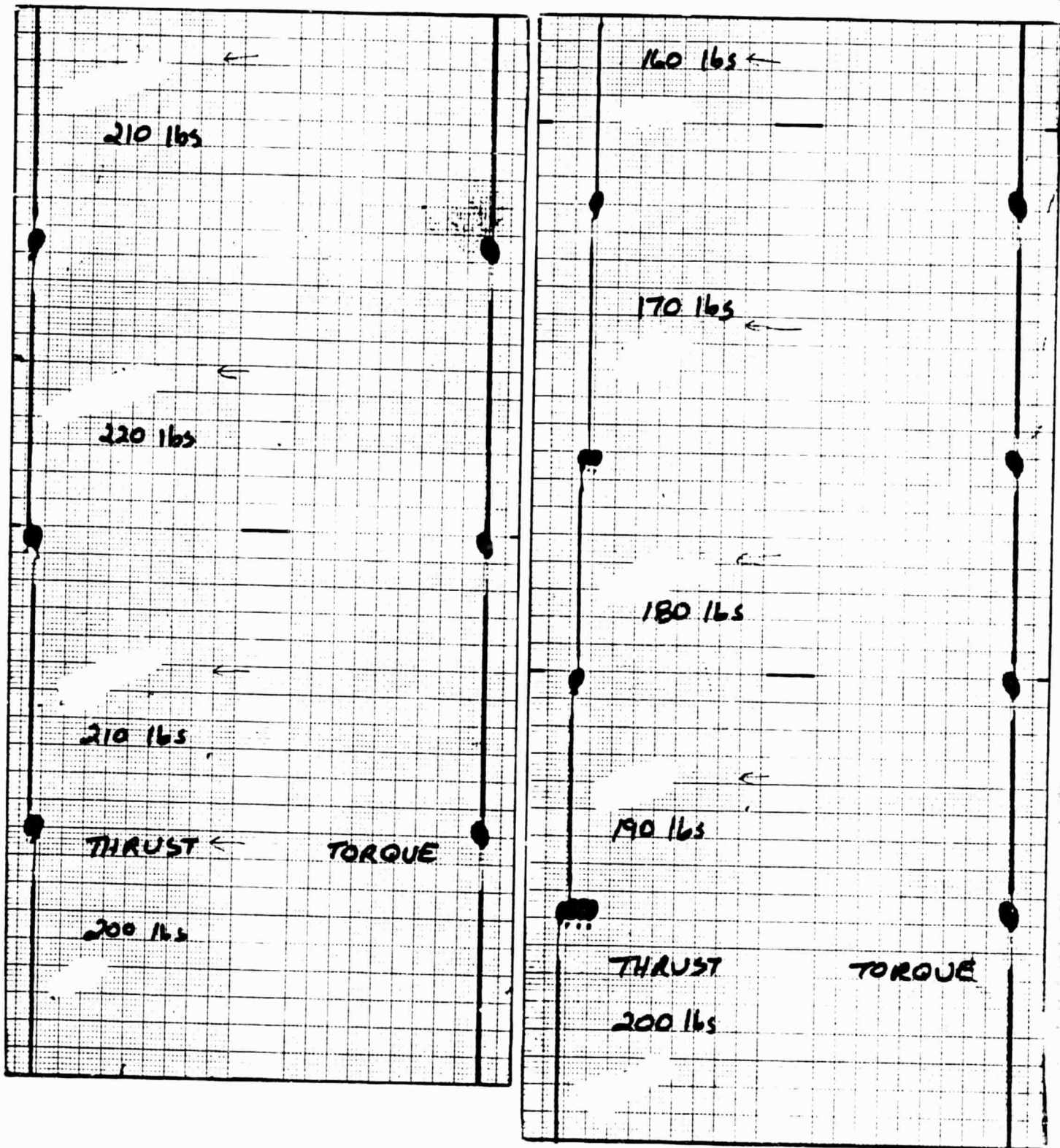
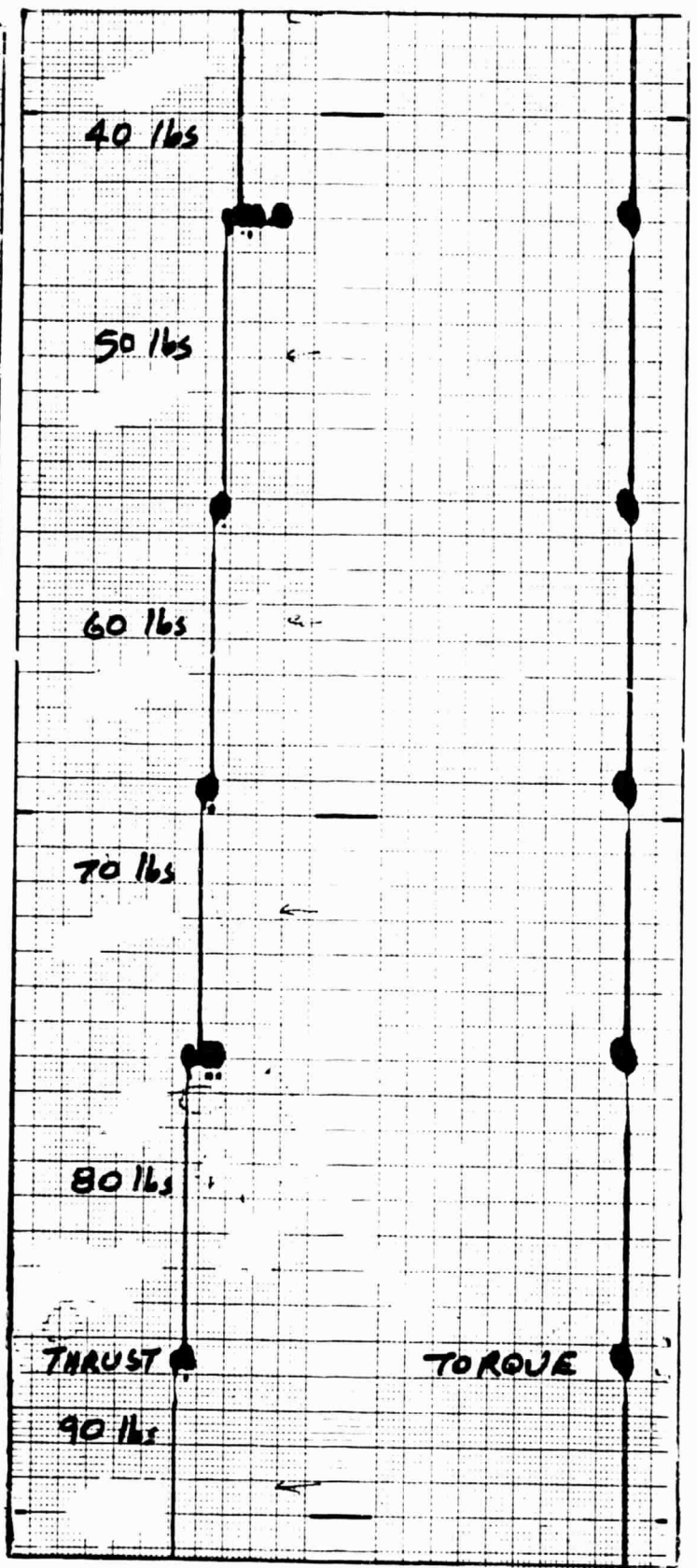
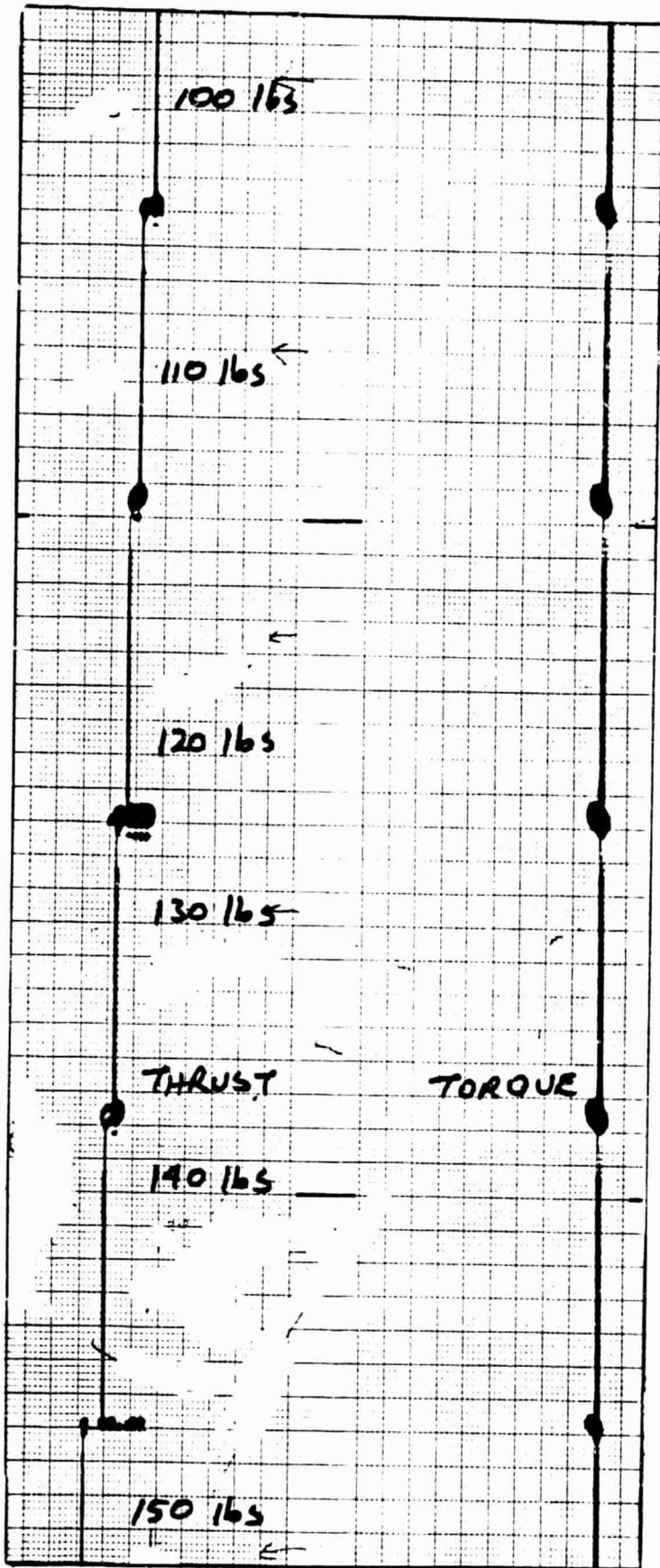

Figure C-12 - Actual Calibration Strips for the Thrust System.

Date: 8/17/83

ORIGINAL PAGE IS OF POOR QUALITY



ORIGINAL PAGE IS
OF POOR QUALITY

Figure C-12 - Actual Calibration
Strips for the Thrust System.

Date: 8/17/83

ORIGINAL PAGE IS
OF POOR QUALITY

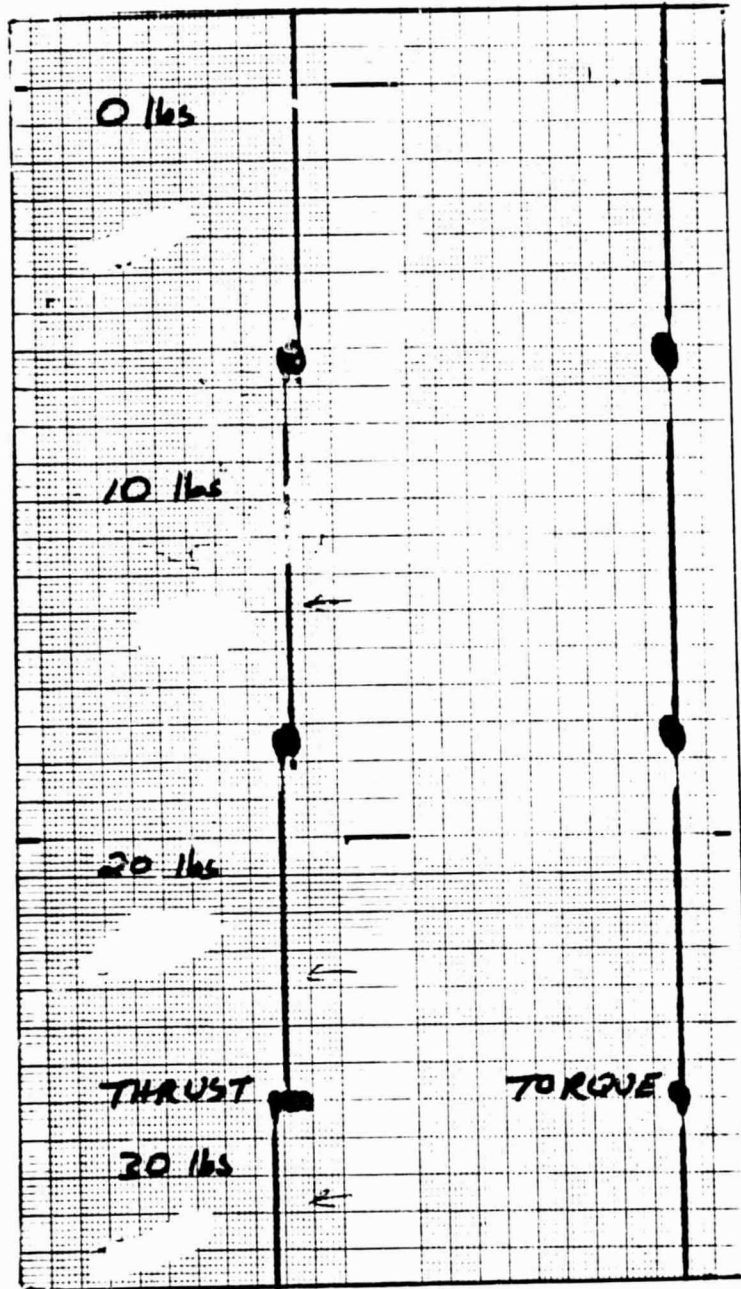

Figure C-12 - Actual Calibration
Strips for the Thrust System.

Date: 8/17/83

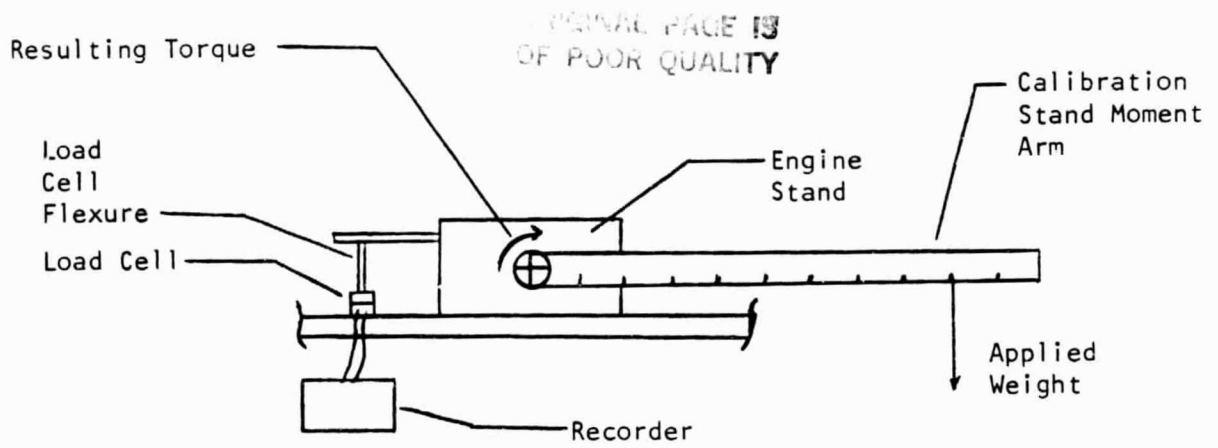

Figure C-14 - Schematic of the Torque Calibration Stand

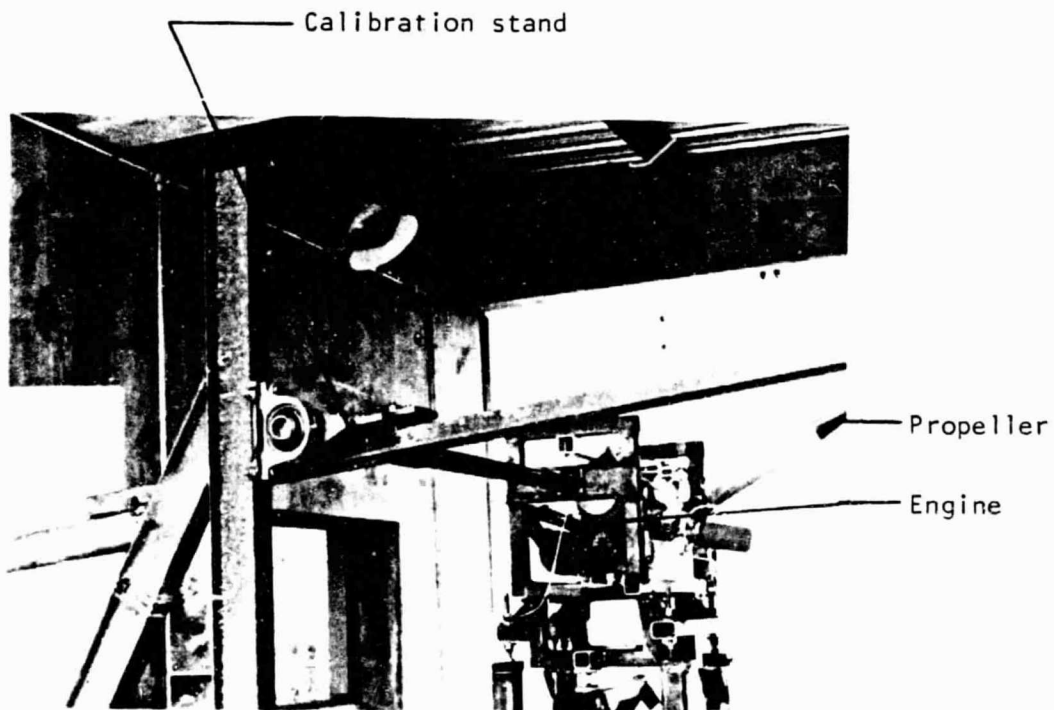
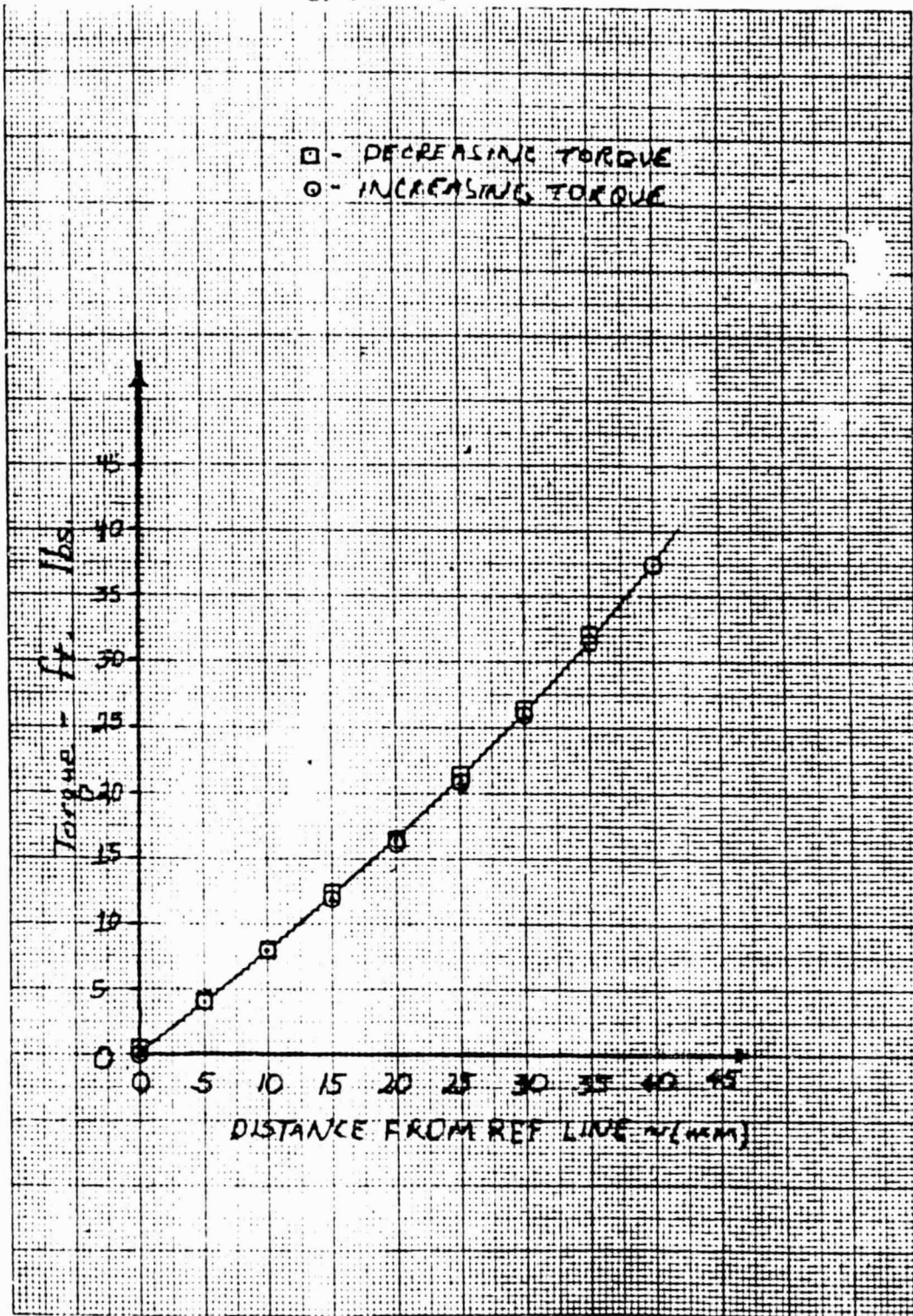

Figure C-15 - Photograph of the Torque Calibration Stand

ORIGINAL PAGE IS
OF POOR QUALITY



CALC	RLA (LOCK)	8/16/83	REVISED	DATE
CHECK				
APPD				
APPD				

Figure C16 - Torque Calibration Curve.

ORIGINAL PAGE IS
OF POOR QUALITY

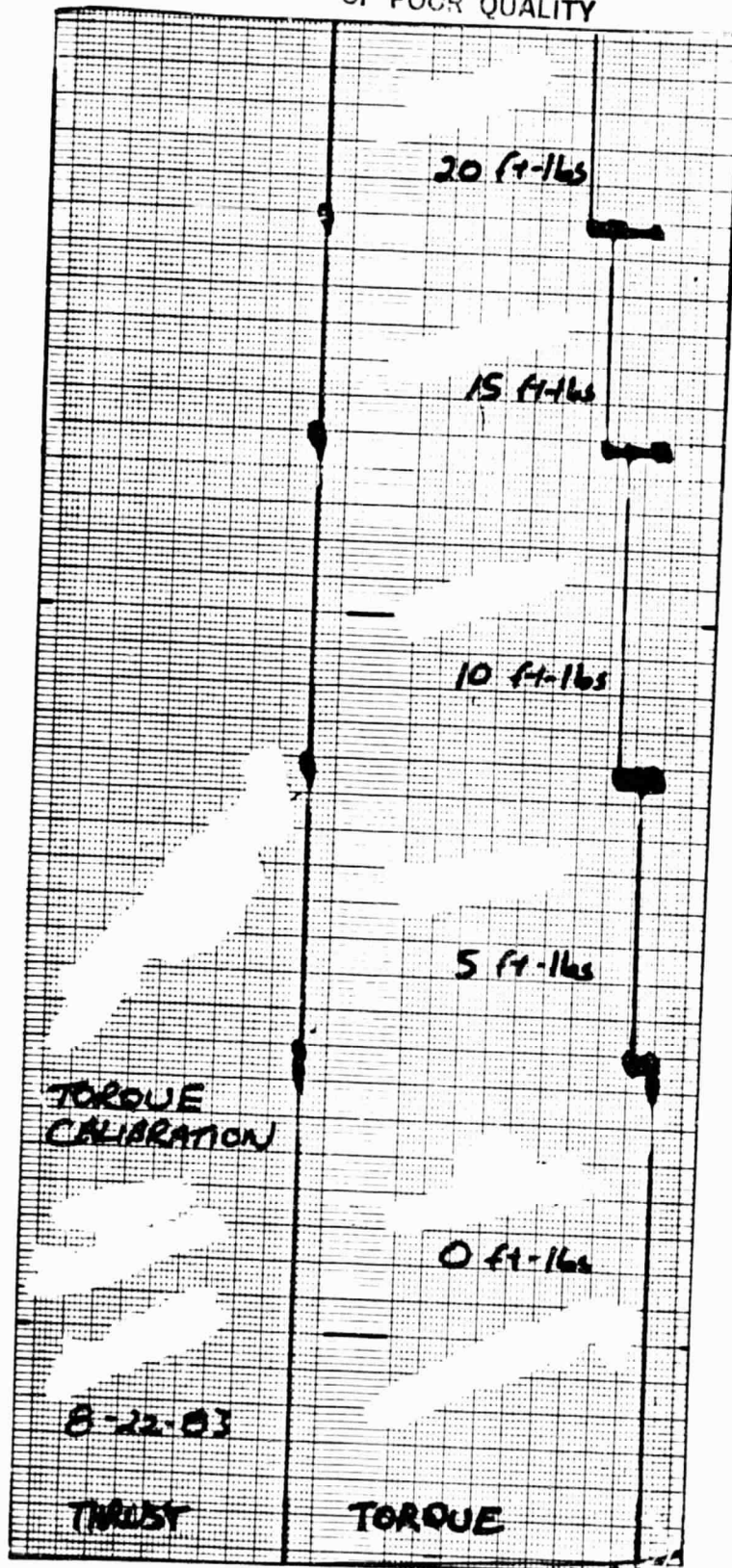

Figure C-17 - Actual Calibration
Strips for the Torque System.

Date: 8/22/83

ORIGINAL PAGE IS
OF POOR QUALITY

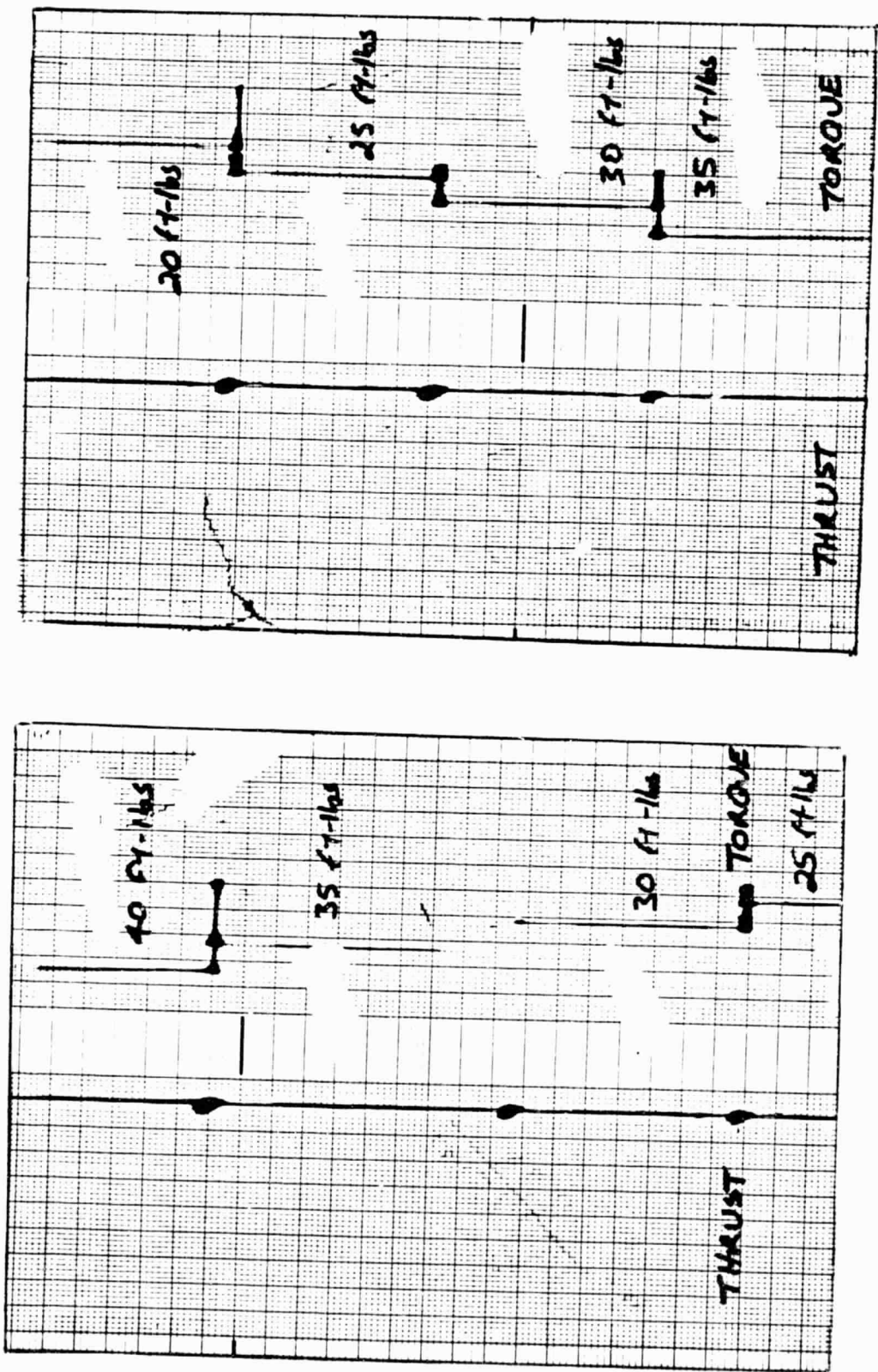

Figure C-17 - Actual Calibration
Strips for the Torque System.

Date: 8/22/83

(C17)

ORIGINAL PAGE IS
OF POOR QUALITY

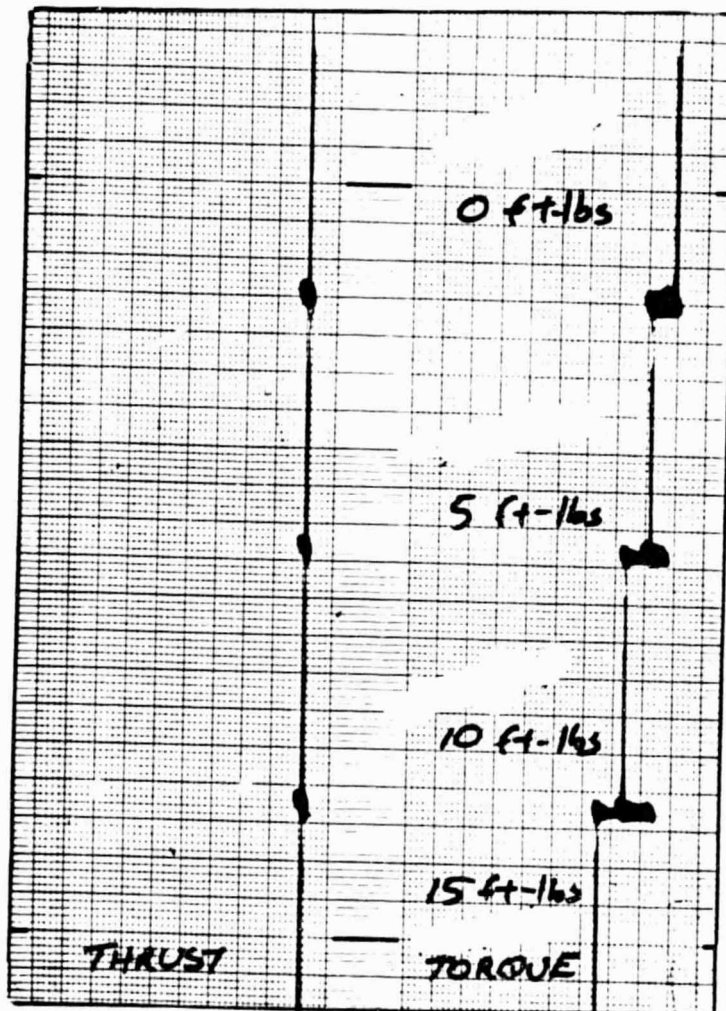

Figure C-17 - Actual Calibration
Strips for the Torque System.

Date: 8/22/83

C4. Change in Pressure Through the Propeller

ΔP Through the propeller was obtained by placing a rake of total pressure tubes in front of and behind the propeller plane as shown in figure C18.

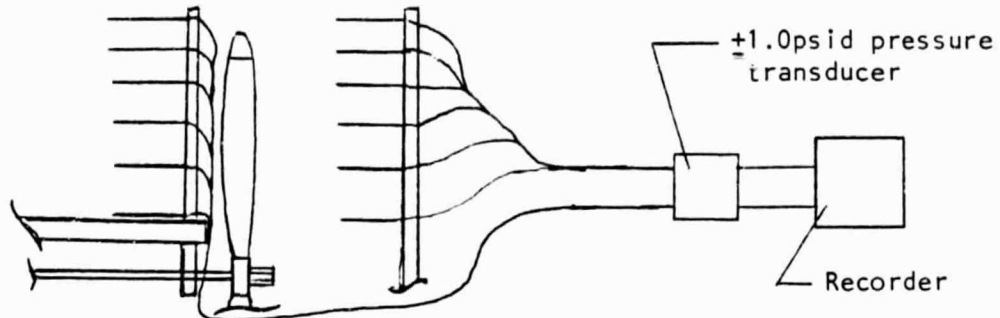

Figure C-18 - Rake Placement to obtain ΔP

All of the tubes on each rake were converged to one tube and connected to a ± 1.0 psi differential pressure transducer. The transducer senses a differential pressure and sends out a proportional voltage. The signal is amplified and filtered as shown in figure C8. Calibration of the ΔP system was done using a glass U-tube positioned on a 30° slant board. A 20 cc syringe was used to control the applied pressure. Figure C19 shows a plot of ΔP in lbs/in^2 as a function of mm from the reference line. Figure C20 shows the strips obtained from calibration. Figure C21 shows a schematic of the ΔP calibration device.

C5. Temperatures (EGT and CHT)

Both the EGT and the CHT of the engine were obtained in exactly the same manner, that of using a digital thermometer. Figure C23 shows a

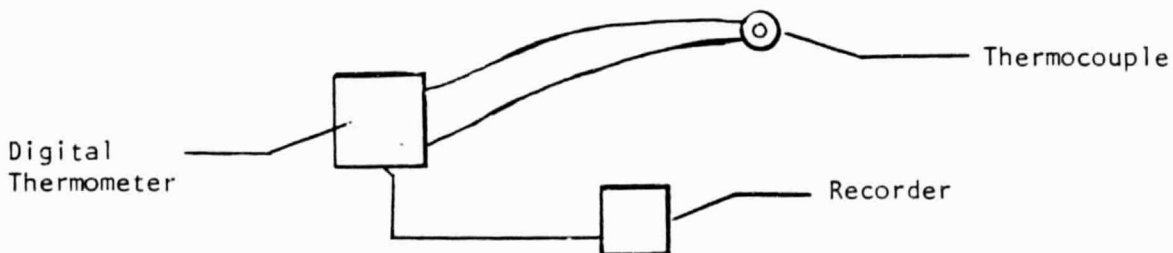

Figure C-23 - Schematic of the Temp. Sensing System

schematic of the temperature system. Calibration was done on the thermometer itself using the methods of reference #1, section VI, page 4. Figure C24 shows the Temp. Cal. curve which is Temp. as a function of mm of distance from the

ORIGINAL PAGE IS
OF POOR QUALITY

□ - DECREASING PRESSURE
○ - INCREASING PRESSURE

$$\text{PRESSURE (PSI)} = .00252 [\text{READING (mm)}] + .002$$

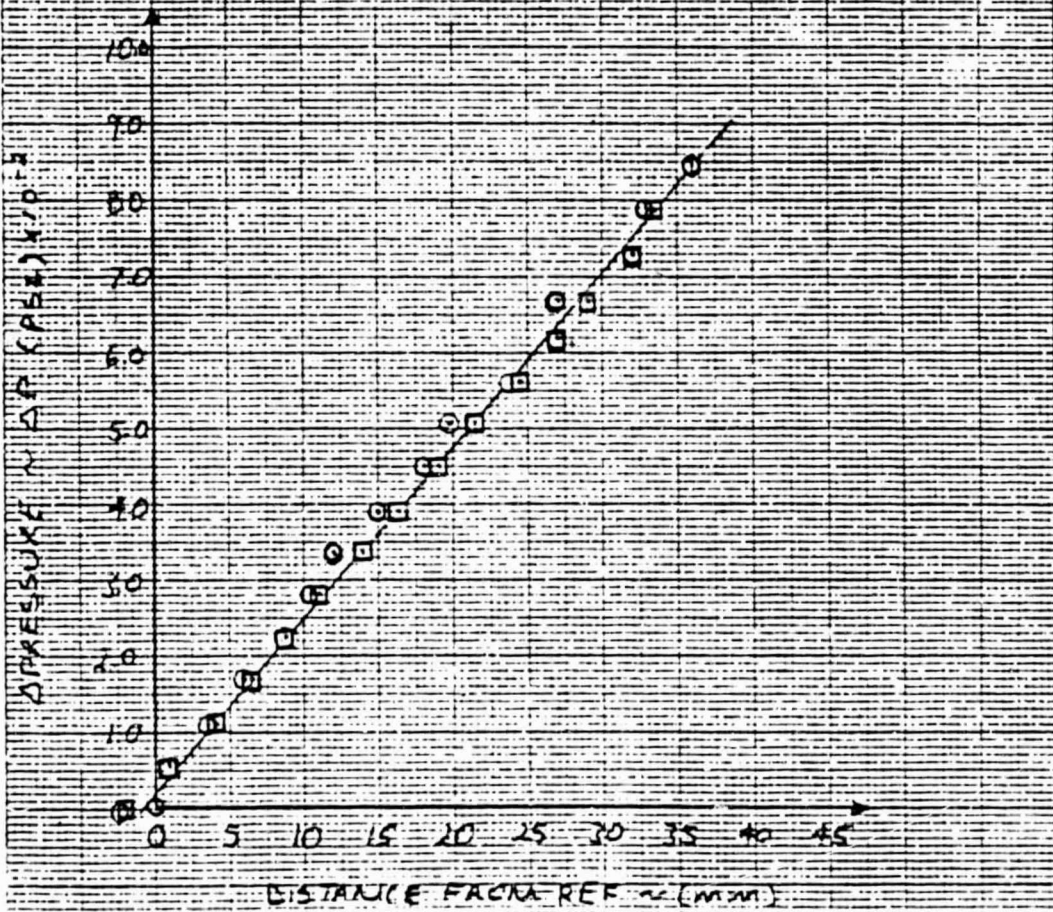

CALC	BLACKLOCK	3/17/73	REVISED	DATE
CHECK				
APPD				
APPD				

Figure C19 - ΔPressure Calibration Curve.

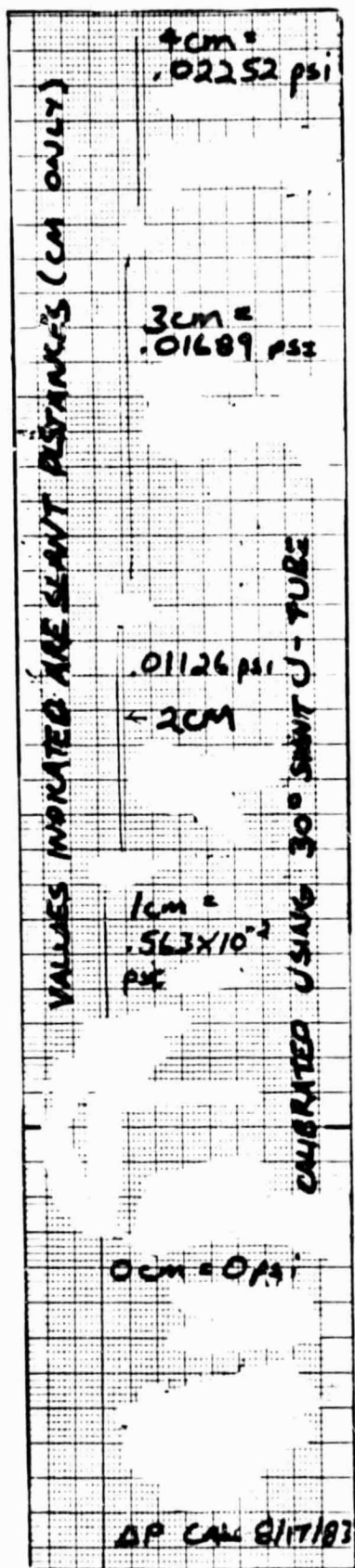

ORIGINAL PAGE IS
OF POOR QUALITY

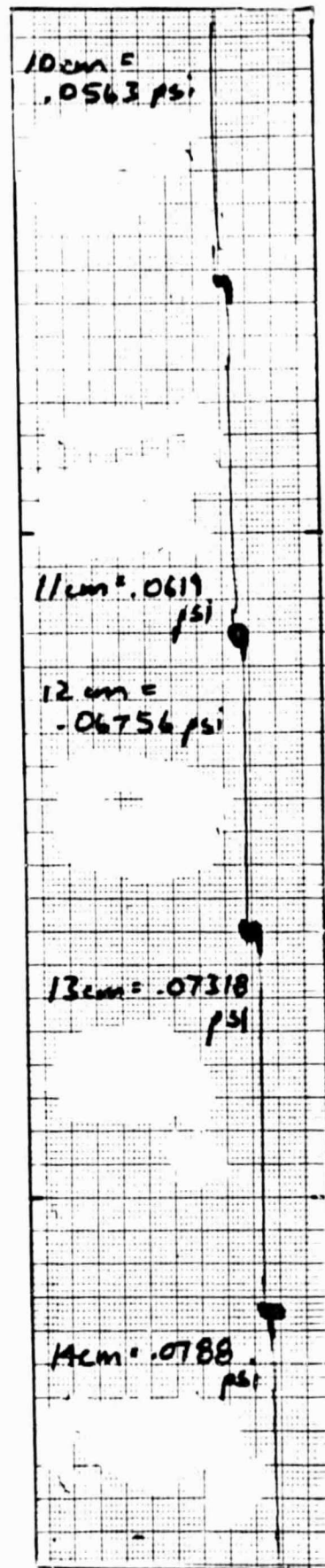
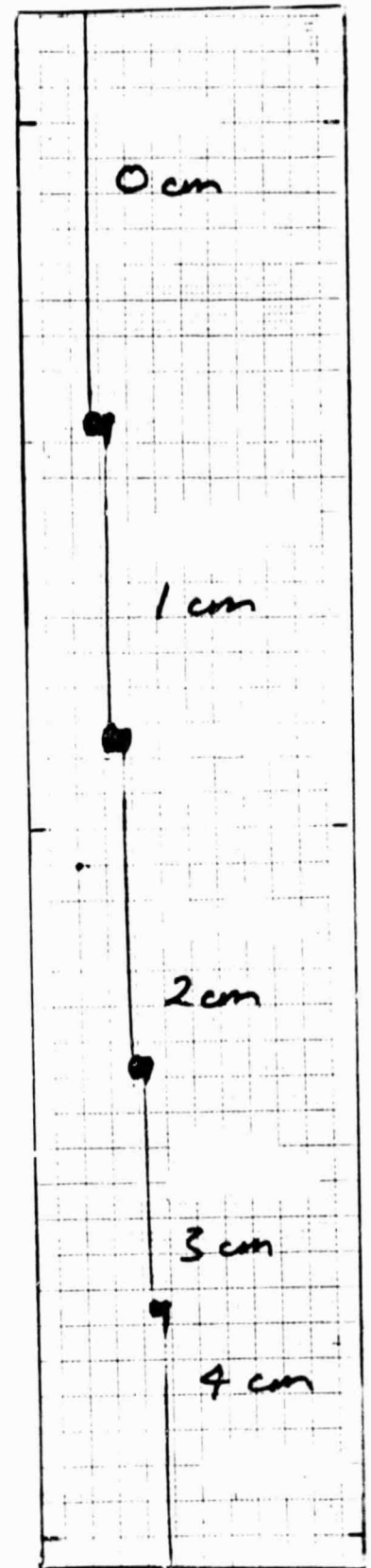
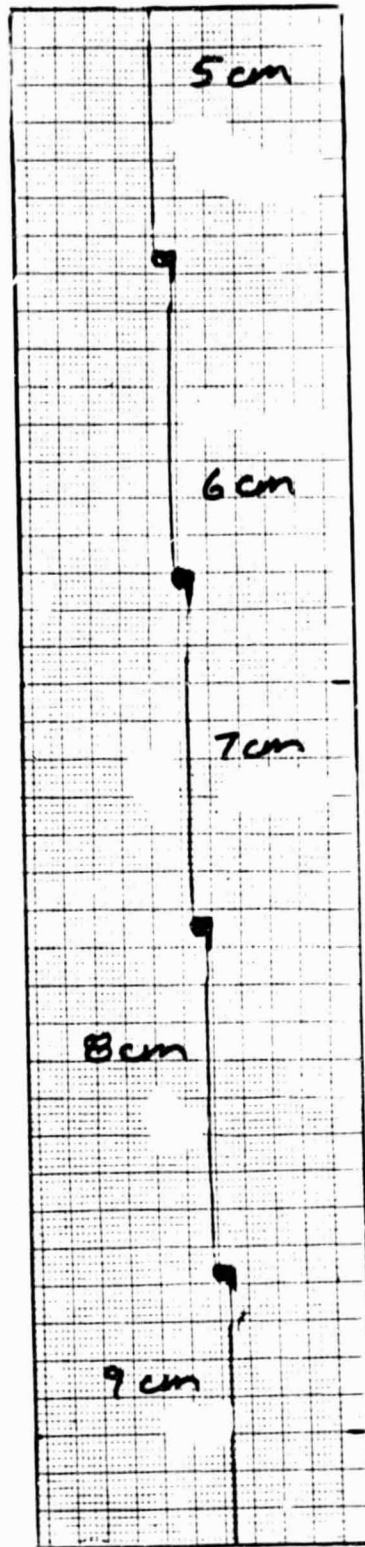
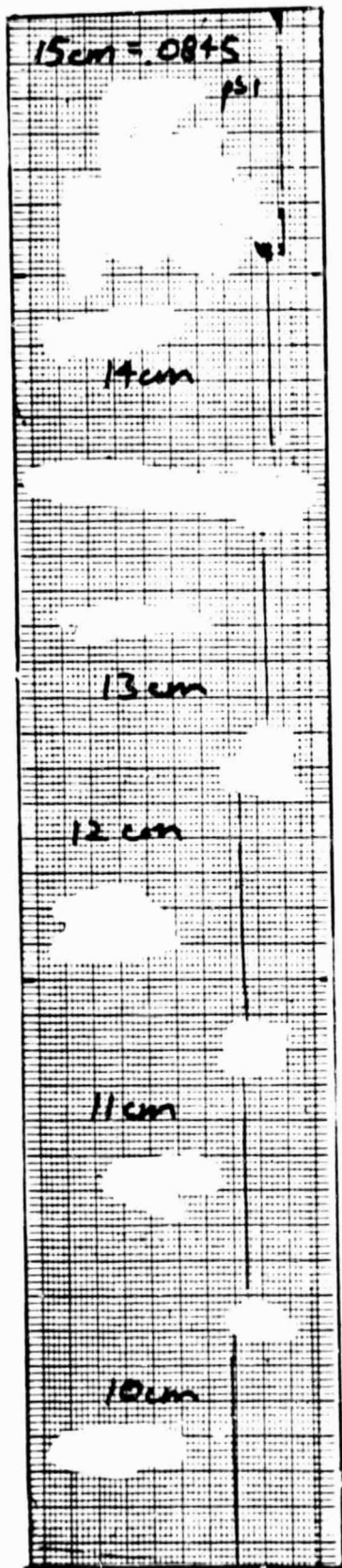

Figure C-20 - Actual Calibration Strips for the ΔP System

Date: 8/17/83



ORIGINAL PAGE IS
OF POOR QUALITY

Figure C-20 - Actual Calibration
Strips for the ΔP System.

Date: 8/17/83

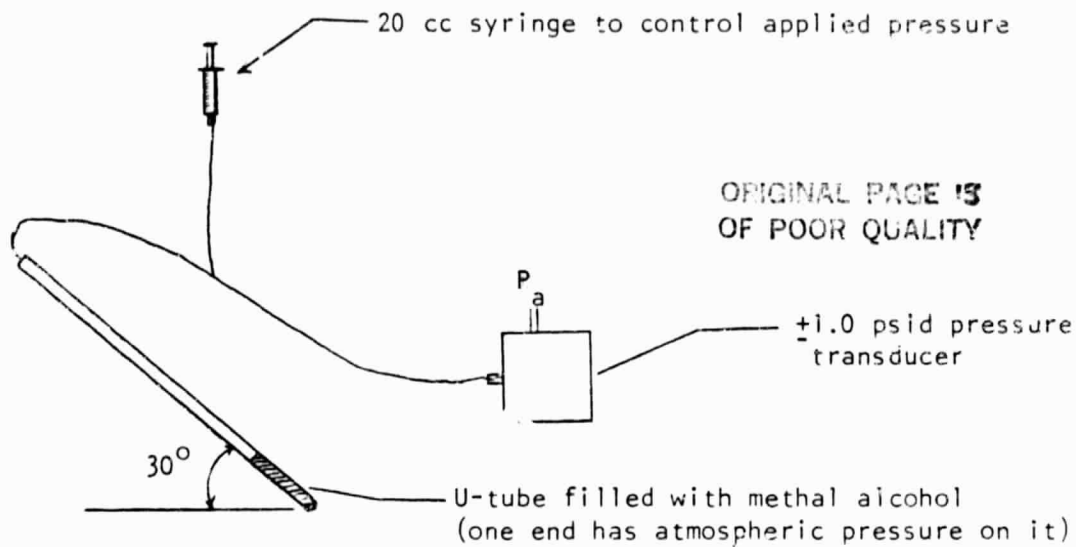

Figure C-21 - Schematic of the ΔP Calibration Device

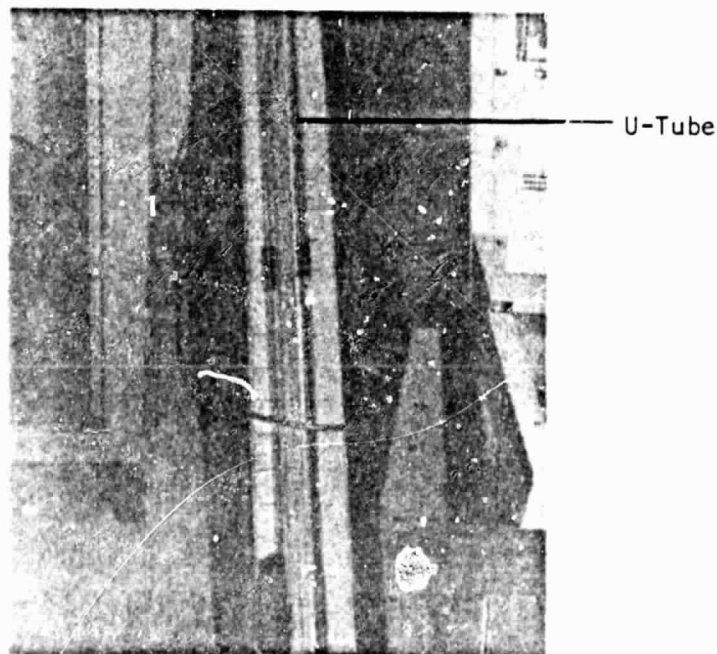
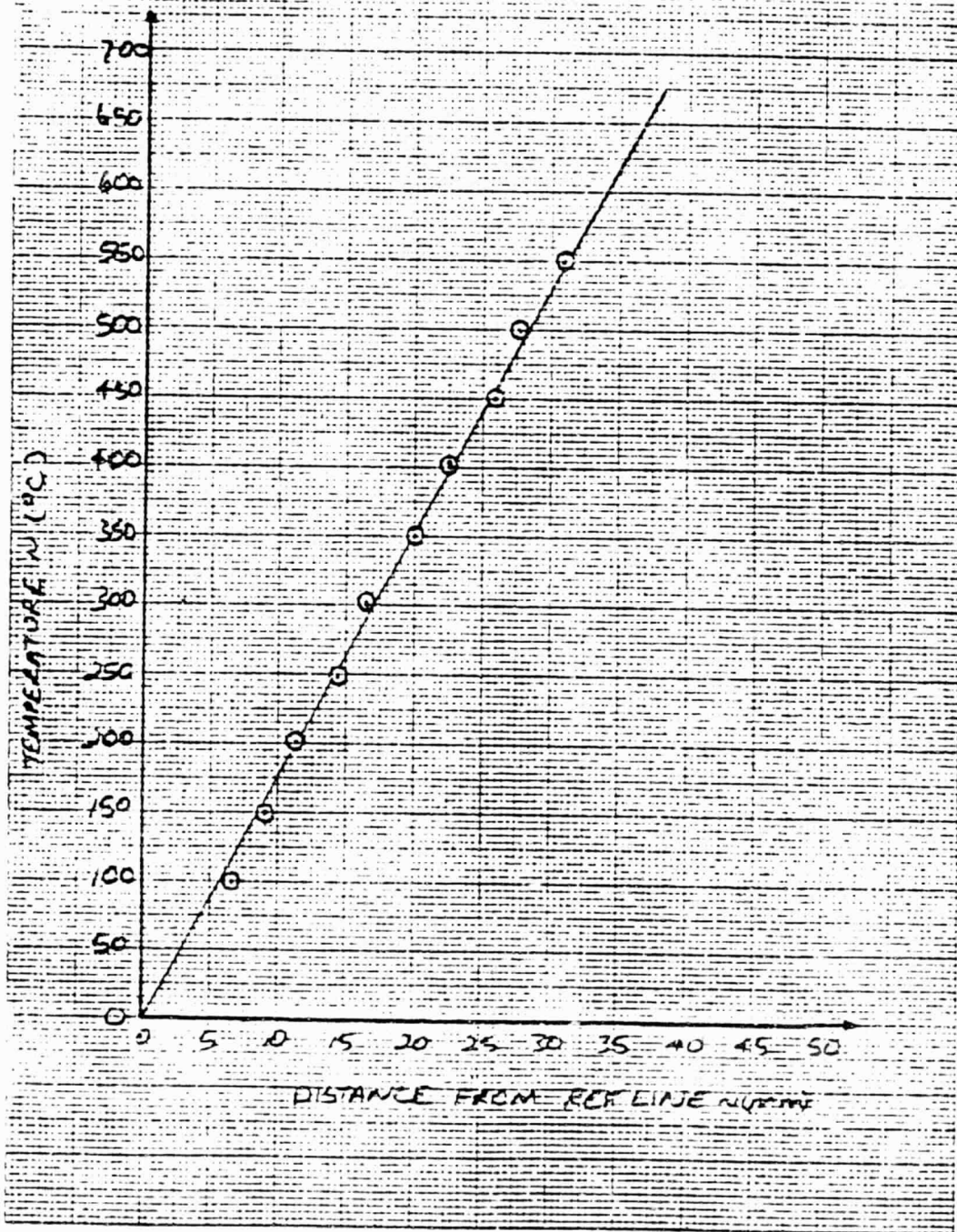

Figure C-22 - Photograph of the ΔP Calibration Device

reference line. Figure C25 shows the actual calibration strips from which Figure C24 was constructed.

Note: Above statement is a continuation of page C19.



<table border="1"> <tr> <td> <table border="1"> <tr> <td>CALC</td> <td>Block</td> <td>9/11</td> <td>REVISED</td> <td>DATE</td> </tr> <tr> <td>CHECK</td> <td></td> <td></td> <td></td> <td></td> </tr> <tr> <td>APPD</td> <td></td> <td></td> <td></td> <td></td> </tr> <tr> <td>APPD</td> <td></td> <td></td> <td></td> <td></td> </tr> </table> </td> <td colspan="4"> Figure C24 - Temperature Calibration Curve. </td> </tr> <tr> <td colspan="5" style="text-align: center;"> UNIVERSITY OF KANSAS </td> <td> PAGE C24 </td> </tr> </table>	<table border="1"> <tr> <td>CALC</td> <td>Block</td> <td>9/11</td> <td>REVISED</td> <td>DATE</td> </tr> <tr> <td>CHECK</td> <td></td> <td></td> <td></td> <td></td> </tr> <tr> <td>APPD</td> <td></td> <td></td> <td></td> <td></td> </tr> <tr> <td>APPD</td> <td></td> <td></td> <td></td> <td></td> </tr> </table>	CALC	Block	9/11	REVISED	DATE	CHECK					APPD					APPD					Figure C24 - Temperature Calibration Curve.				UNIVERSITY OF KANSAS					PAGE C24
<table border="1"> <tr> <td>CALC</td> <td>Block</td> <td>9/11</td> <td>REVISED</td> <td>DATE</td> </tr> <tr> <td>CHECK</td> <td></td> <td></td> <td></td> <td></td> </tr> <tr> <td>APPD</td> <td></td> <td></td> <td></td> <td></td> </tr> <tr> <td>APPD</td> <td></td> <td></td> <td></td> <td></td> </tr> </table>	CALC	Block	9/11	REVISED	DATE	CHECK					APPD					APPD					Figure C24 - Temperature Calibration Curve.										
CALC	Block	9/11	REVISED	DATE																											
CHECK																															
APPD																															
APPD																															
UNIVERSITY OF KANSAS					PAGE C24																										

ORIGINAL PAGE 13
OF POOR QUALITY

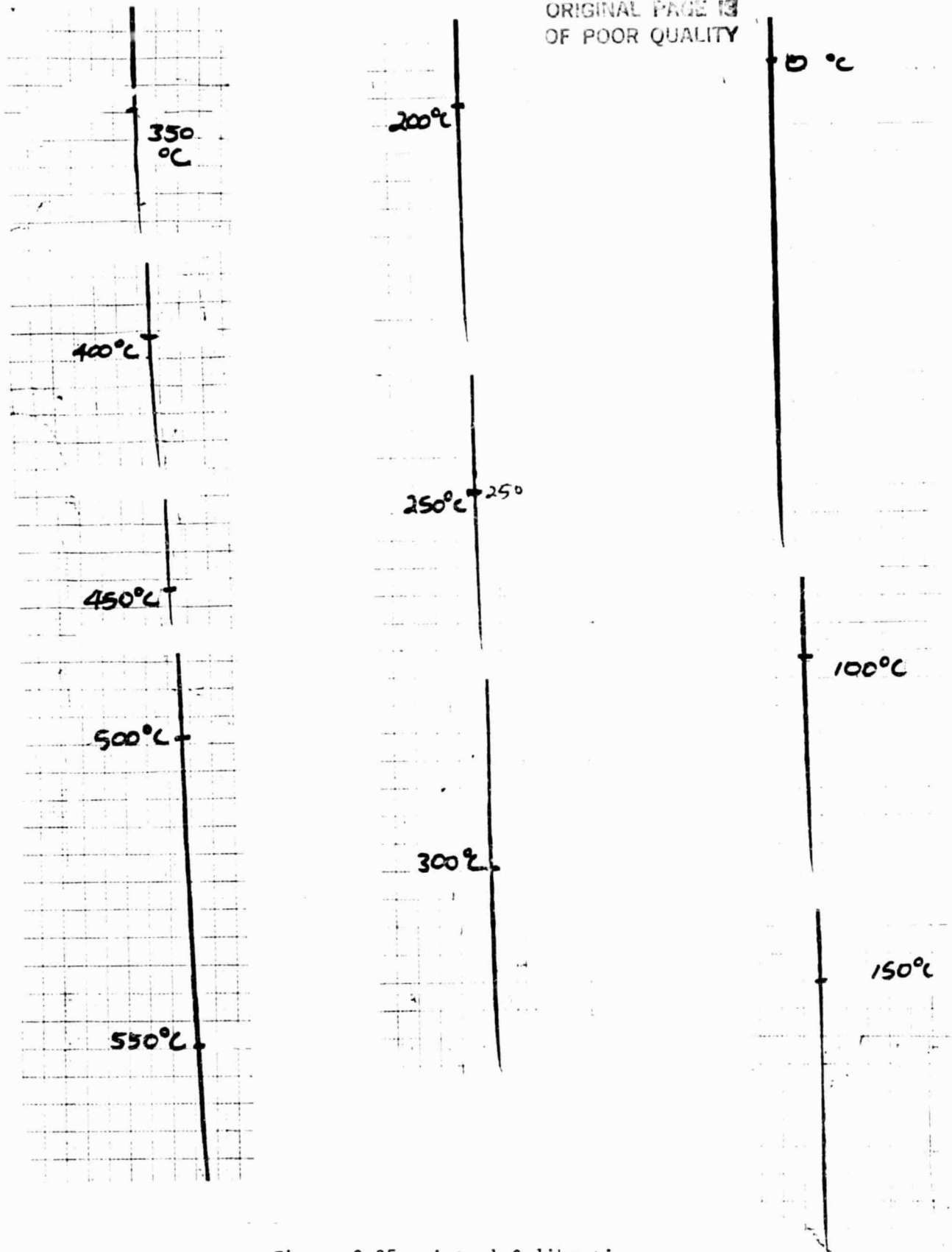
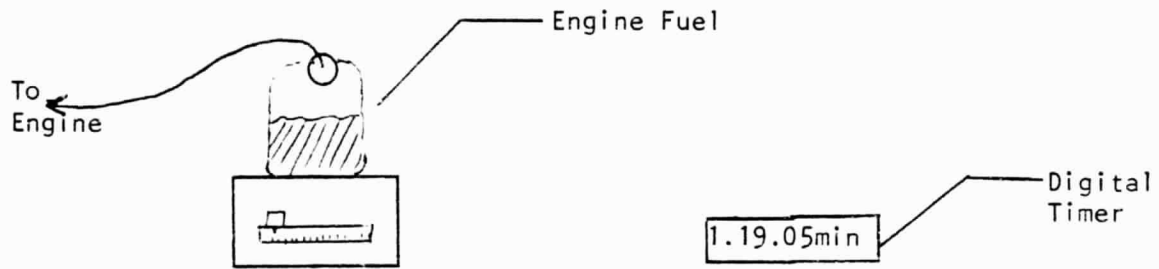

Figure C-25 - Actual Calibration
Strips for the Temperature System

(C25)

C7. Fuel Flow

Fuel Flow was obtained by measuring the change in weight of the fuel in a finite amount of time. No calibration was necessary because the $\Delta\text{Weight}_{\text{fuel}}$ values were determined by using a scale. The time increment was obtained using a Galab 500 LSI Digital Darkroom Timer. Figure C26 shows a schematic of the Fuel Flow measuring system.



$$x \text{ lbs of fuel in } y \text{ secs} = x/y \text{ lbs/sec}$$

Figure C-26 - Schematic of the Fuel Flow System

APPENDIX D
CALCULATION OF PERFORMANCE PARAMETERS

(Di)

TABLE OF CONTENTS

<u>Section</u>	<u>Title</u>	<u>Page</u>
D.	INTRODUCTION To The Calculation of the Engine Performance Parameters	D1
D1.	THRUST Parameters	D-1
D2.	TORQUE Parameters	D-11
D3.	TEMPERATURE Parameters	D-23
D4.	FUEL-FLOW Parameters	D-28

APPENDIX D

D. Calculation of Performance Parameters

From the basic performance measurements made in the propulsion laboratory, secondary parameters can be calculated. These parameters include the coefficient of thrust, sea level thrust, shaft horsepower, the coefficient of power, sea level values of shaft horsepower, shaft specific fuel consumption, and finally, sea level values of shaft specific fuel consumption. With the above list, a complete performance 'picture' can be given of the engine. The following sections deal with the extraction of these parameter from the raw data. Section D1 shows the thrust parameter, section D2 gives the parameter taken from the torque data. Section D3 shows the temperature data while section D4 presents the fuel flow data.

D1 Thrust

The actual values of thrust were taken from Appendix A. Appendix A is split into 6 groups. Each one of the groups corresponds to one sweep of RPM i.e. Taking several values of RPM through a range from idle to max RPM. At each of the data points, the barometric pressure, the outside air temperature, the relative humidity, and an instantaneous value of RPM was read. Tables D1 -D3 show the culmination of all the data that was taken along with the calculated parameters.

From Tables D1 - D3, the density for each data point was calculated. This was done using equation D1.

$$\rho = \frac{P}{RT} \quad (D1)$$

where:

- ρ = Density (Slugs/Ft³)
- P = Barometric Pressure (lbs/Ft²)
- R = Gas Constant (1716.5 Ft²/Sec²°R)
- T = Outside Air Temperature (°R)

Sample Calculation: Density Using Data From A37

$$\begin{aligned} P &= 29.30 \text{ in of Hg} & \rho &= \frac{P}{RT} & D(1) \\ T &= 547.6 \text{ }^\circ\text{R} \\ \rho &= \frac{(29.30)(70.72)}{(171.6.5)(54.7.6)} \\ \rho &= \underline{\underline{.002205 \text{ Slugs/Ft}^3}} \end{aligned}$$

Once the density for each data point was calculated, the actual thrust was obtained in MM from the zero line with the distances, the conversion factor was used to get values of thrust in pounds. The conversion factor is

$$\text{Thrust (lbs)} = 4.848 \text{ (MM from zero line)} \quad (D2)$$

Figure D1 shows thrust of the engine as a function of propeller RPM using the values of thrust. The coefficient of thrust was calculated using equation (D3).

$$C_T = \frac{T}{\rho n^2 D^4} \quad (D3)$$

where: T - Thrust (lbs)
 ρ - Air Density (Slugs/ft³)
N - Propeller RPM (revs/sec)
D - Propeller Diameter (4.5 ft)

Figure D2 shows the coefficient of thrust as a function of propeller RPM.

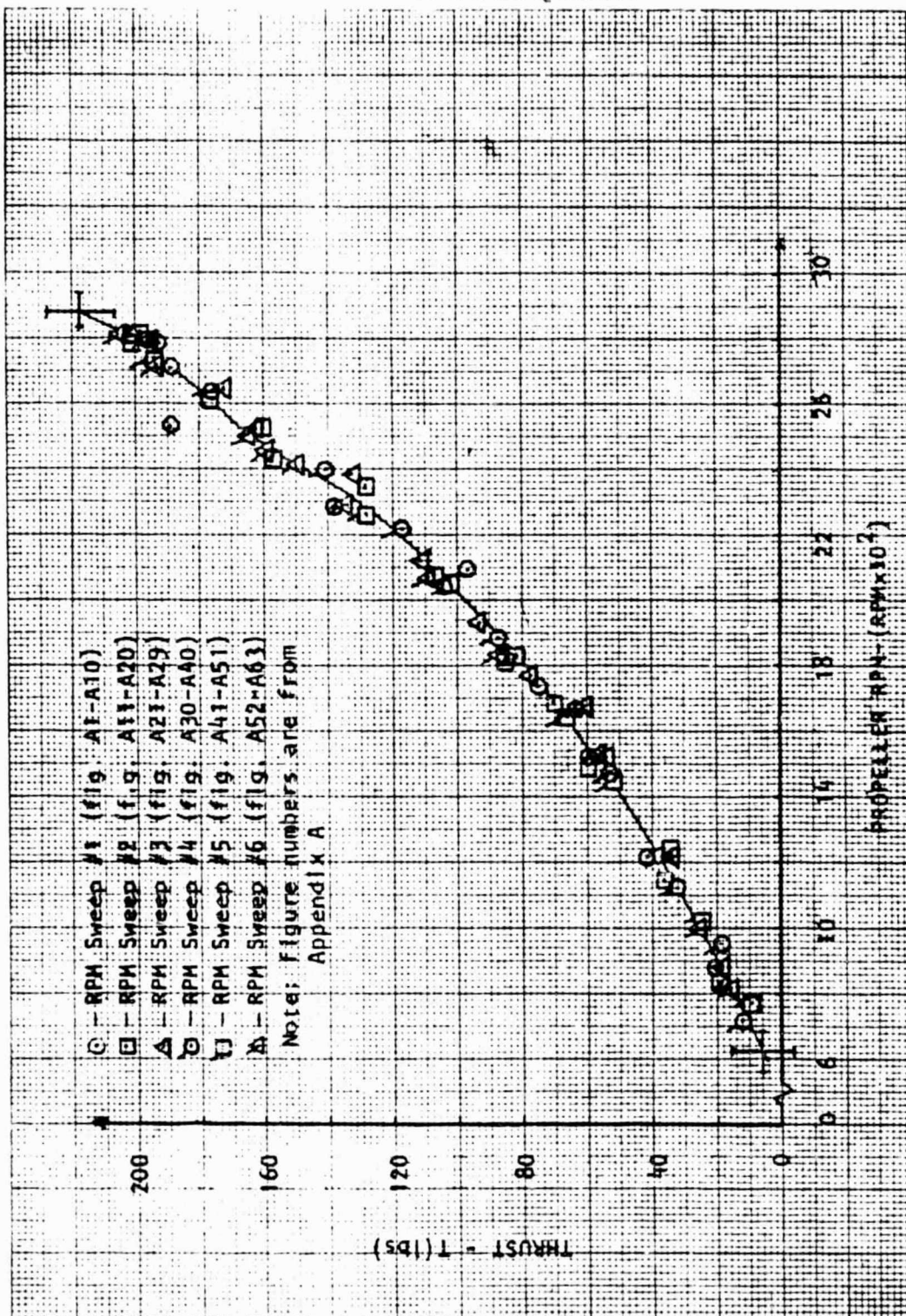

CALC	<i>Blanchard</i>	<i>9/18/87</i>	REVISED	DATE
CHECK				
APPD				
APPD				

Figure D1-
Values of Thrust for a Cuyuna UL-430RR
Engine as a function of Propeller RPM

Sample Calculation: Thrust

Data from Figure A37

$$MM = 24.2 \text{ MM}$$

$$\text{Thrust} = 4.848 \text{ (MM from zero line)} \quad (D2)$$

$$\text{Thrust} = 4.848 \times 24.2$$

$$\underline{\underline{\text{Thrust} = 117.3 \text{ lbs}}}$$

Sample Calculations: Thrust Coefficient

Data from Figure A37

$$C_T = \frac{T}{\rho n^2 D^4} \quad (D3)$$

where: $T = 117.3 \text{ lbs}$

$$\rho = .002205 \text{ slugs/ft}^3$$

$$n = 36.9 \text{ revs/sec}$$

$$D = 4.5 \text{ ft}$$

$$C_T = \frac{117.3}{(.002205) (36.9)^2 (4.5)^4}$$

$$\underline{\underline{C_T = .095}}$$

The final parameter is the values of thrust corrected to standard sea level conditions.

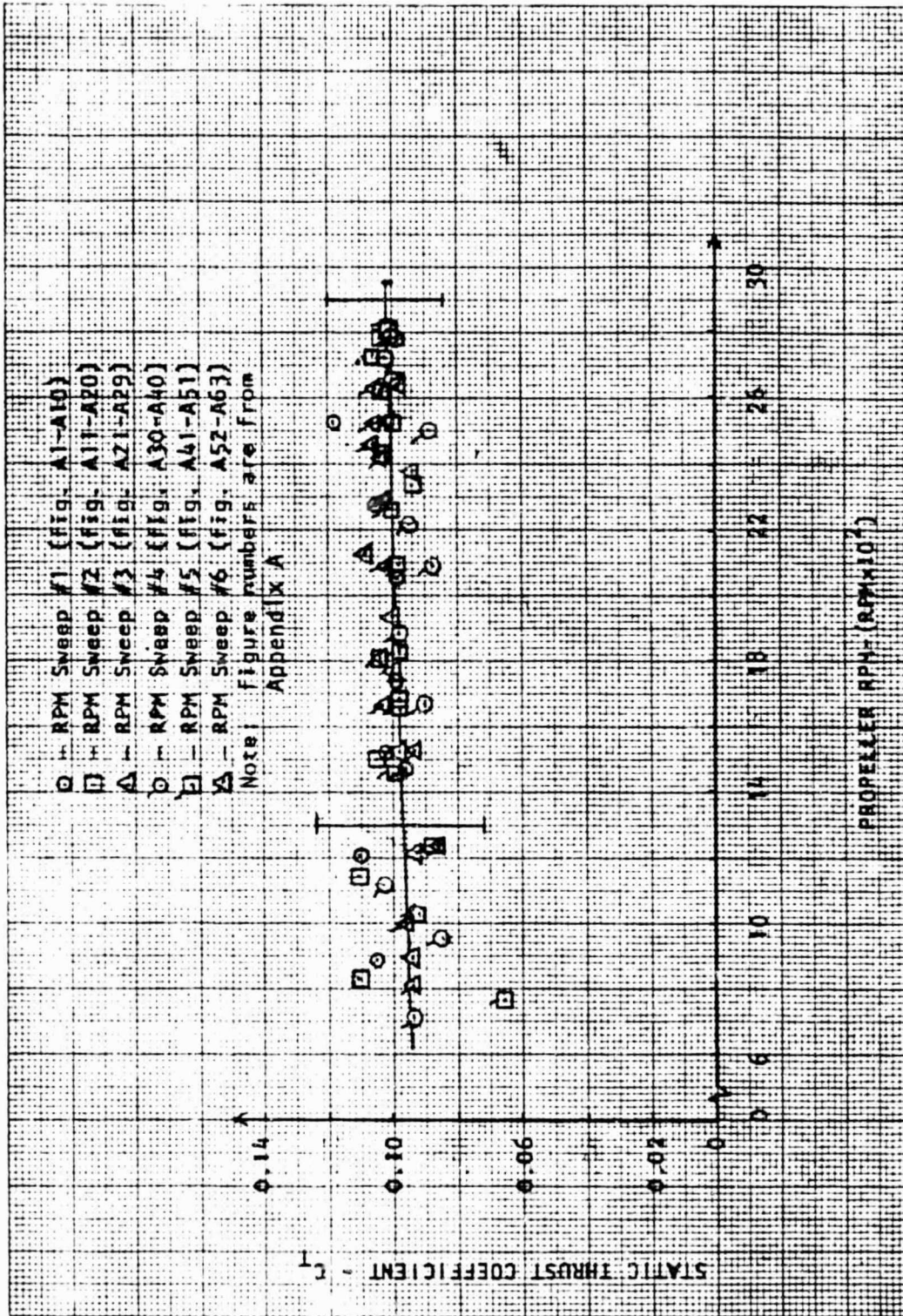

CALC	Blackwell	9/10/03	REVISED	DATE
CHECK				
APPD				
APPD				

Figure D2-
Static Thrust Coefficient for a Cuyuna
UL-430RR Engine as a function of RPM

To obtain these values, the thrust coefficient was assumed constant with altitude. Therefore T_{SL} can be obtained with equation D4

$$T_{SL} = C_T \rho_0 n^2 D^4 \quad (D4)$$

where:

C_T = Thrust Coefficient Calculated Earlier

ρ_0 = Standard Sea Level Air Density
(.0023769 slugs/ft³)

n = Propeller RPM (revs/sec)

D = Propeller Parameter (4.5 ft)

Figure D3 shows a plot of thrust corrected to sea level as a function of propeller RPM. The actual points are given in Tables D1-D6.

The errors in the thrust coefficient and sea level thrust were obtained by using equation (D5) taken from Ref. 7 page 45 equation 3-2.

$$\sigma_f^2 = \sum_{i=1}^N \left(\frac{\partial F}{\partial X_i} \right)^2 \sigma_{X_i}^2 \quad (D5)$$

It was determined that the error in thrust coefficient was negligible while the error in the sea level values of thrust are shown in tables D1-D3 as well as in Figure D3.

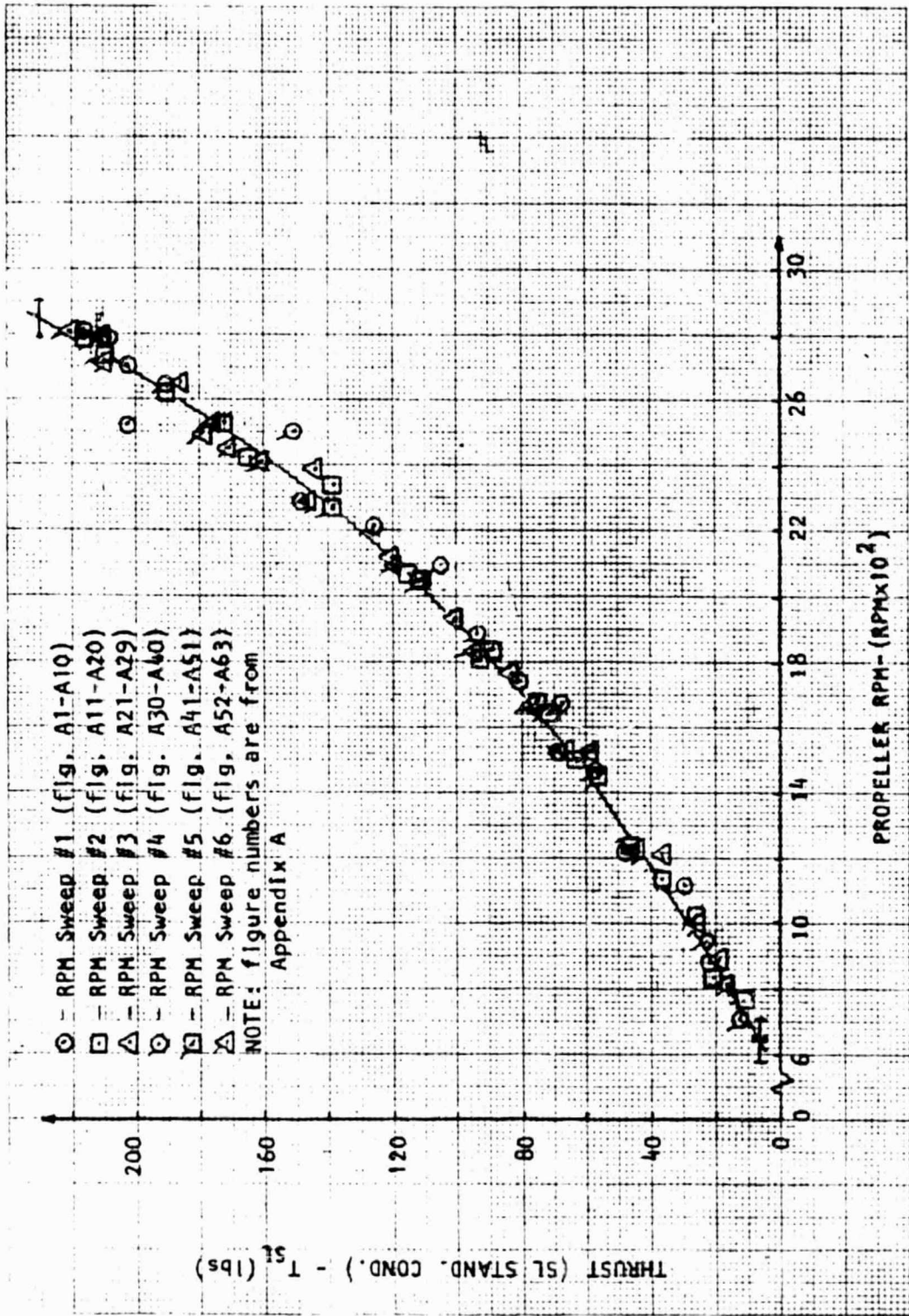

<table border="1"> <tr> <td>CALC</td> <td>Blacklock</td> <td>9/17/60</td> <td>REVISED</td> <td>DATE</td> </tr> <tr> <td>CHECK</td> <td></td> <td></td> <td></td> <td></td> </tr> <tr> <td>APPD</td> <td></td> <td></td> <td></td> <td></td> </tr> <tr> <td>APPD</td> <td></td> <td></td> <td></td> <td></td> </tr> </table>	CALC	Blacklock	9/17/60	REVISED	DATE	CHECK					APPD					APPD					<p>Figure D3- Thrust converted to sea level stand. conditions as a function of PROP. RPM</p>	<p>PAGE 07</p>
CALC	Blacklock	9/17/60	REVISED	DATE																		
CHECK																						
APPD																						
APPD																						
<p>UNIVERSITY OF KANSAS</p>																						

ORIGINAL PAGE IS
OF POOR QUALITY

Run #	Figure #	BP ± .01 In. of Hg	T ± .5°R °C	$\rho \pm 2 \times 10^{-5}$ slugs/ft ³	MM from zero lin	R.P.M. ± 62.5 R.P.M.	T ± 9.8 lbs lbs	C _T ± σ CT	T _{SL} ± σ T _{SL} lbs ±
1	A30	29.32	547.5	.002207	2.5	714	12.1	.094 ± .083	13.0 ± 9.8
2	A31	29.30	547.6	.002205	4.0	952	19.4	.085 ± .051	20.9 ±
3	A32	29.30	547.6	.002205	6.7	1119	32.5	.103 ± .042	34.9 ±
4	A33	29.31	547.6	.002206	11.0	1476	53.3	.097 ± .030	57.4 ±
5	A34	29.31	547.6	.002206	13.0	1667	63.0	.090 ± .025	67.9 ±
6	A35	29.31	547.6	.002206	18.0	1881	87.3	.098 ± .025	94.1 ±
7	A36	29.30	547.6	.002205	20.0	2095	97.0	.088 ± .020	104.6 ±
8	A37	29.30	547.6	.002205	24.2	2214	117.3	.095 ± .021	126.0 ±
9	A38	29.30	547.6	.002205	29.0	2500	140.6	.089 ± .018	150.6 ±
10	A39	29.30	547.6	.002205	36.3	2643	176.0	.100 ± .019	189.1 ±
11	A40	29.30	547.6	.002205	40.5	2786	196.3	.100 ± .019	210.1 ±
13	A41	29.30	547.6	.002205	2.0	762	9.7	.066 ± .070	10.4 ±
14	A42	29.30	546.6	.002209	5.0	1024	24.2	.096 ± .096	26.0 ±
15	A43	29.30	546.6	.002209	7.0	1238	33.3	.088 ± .035	36.5 ±
16	A44	29.30	547.6	.002205	10.8	1452	52.4	.099 ± .031	56.5 ±
17	A45	29.30	547.6	.002205	13.7	1643	66.4	.098 ± .027	71.6 ±
18	A46	29.30	547.6	.002205	17.0	1833	82.4	.098 ± .025	88.8 ±
19	A47	29.30	547.6	.002205	21.2	2048	102.8	.098 ± .022	110.8 ±
20	A48	29.30	547.6	.002205	26.5	2262	128.5	.100 ± .021	138.5 ±
21	A49	29.30	547.6	.002205	33.0	2574	160.0	.100 ± .020	172.5 ±
22	A50	29.30	547.6	.002205	40.2	2738	194.9	.104 ± .019	210.1 ±
23	A51	29.30	547.6	.002205	41.0	2810	198.8	.100 ± .018	214.3 ±

Table D1 - Tabular form showing values of Thrust performance parameters including Thrust, Thrust Coefficient, and Sea Level values of Thrust.

Run #	Figure #	BP ± .01 in. of Hg	T ± .5°R °R	$\rho \pm 2 \times 10^{-6}$ slugs/ft ³	MM from zero lin	R.P.M. ± 62.5 R.P.M.	T ± 9.8 lbs lbs	C _T ± σ C _T	T _{SL} ± σ T _{SL} lbs ±
25	A52	29.37	548.6	.002206	3.2	810	15.5	.094 ± .067	16.7 ± 9.8
26	A53	29.37	548.6	.002206	5.0	1000	24.2	.096 ± .048	26.1 ±
27	A54	29.37	549.6	.002202	6.8	1238	33.0	.086 ± .034	35.6 ±
28	A55	29.37	549.6	.002202	11.2	1524	54.3	.093 ± .028	58.6 ±
29	A56	29.37	550.6	.002198	14.8	1667	71.8	.103 ± .028	77.6 ±
30	A57	29.37	550.6	.002198	18.0	1833	87.3	.104 ± .026	94.4 ±
31	A58	29.37	550.6	.002198	22.5	2071	109.1	.102 ± .023	118.0 ±
32	A59	29.37	550.6	.002198	27.8	2286	134.8	.103 ± .022	147.8 ±
33	A60	29.37	550.6	.002198	33.5	2524	162.4	.102 ± .020	175.6 ±
34	A61	29.37	550.6	.002198	40.0	2714	193.9	.105 ± .020	209.7 ±
35A	A62	29.37	550.6	.002198	42.3	2810	205.1	.104 ± .019	221.8 ±
35B	A63	29.37	550.6	.002198	31.0	2405	150.3	.104 ± .021	162.5 ±
35B	A63	29.37	550.6	.002198	32.8	2452	159.0	.106 ± .020	171.9 ±
35B	A63	29.37	550.6	.002198	34.2	2500	165.8	.106 ± .021	179.3 ±
A1	A1	29.20	545.6	.002206	4.2	881	20.4	.105 ± .060	22.0 ±
A2	A2	29.20	545.6	.002206	8.5	1214	41.2	.111 ± .040	44.4 ±
A3	A3	29.20	545.6	.002206	12.3	1524	59.6	.102 ± .030	64.2 ±
A4	A4	29.20	545.6	.002206	15.5	1738	75.1	.099 ± .026	80.9 ±
A5	A5	29.20	545.6	.002206	21.5	2048	104.2	.099 ± .023	112.3 ±
A6	A6	29.20	545.6	.002206	28.5	2286	138.2	.105 ± .022	148.9 ±
A7	A7	29.20	545.6	.002206	39.0	2524	189.1	.118 ± .023	203.8 ±
A8	A8	29.20	545.6	.002206	39.0	2714	189.1	.102 ± .019	216.8 ±
A9	A9	29.20	545.6	.002206	41.5	2810	201.2	.101 ± .019	216.8 ±
A10	A10	29.20	545.6	.002206	40.0	2786	193.9	.099 ± .018	208.9 ±

Table D2 - Table showing the calculated Thrust performance parameters including the Thrust, Thrust Coefficient, and Sea Level values of Thrust.

Run #	Figure #	BP ± .01 in. of Hg	T ± .5°R °R	$\rho \pm 2 \times 10^{-6}$ slgs/ft ³	HM from zero 11n	R.P.H. ± 62.5 R.P.H.	T ± 9.8 lbs lbs	C _T ± 0 CT	T _{SL} ± 0 T _{SL} lbs ±
B1	A11	29.26	546.6	.002206	4.0	833	19.4	.111 ± .067	20.9 ± 9.8
B2	A12	29.24	546.6	.002205	7.5	1143	36.4	.111 ± .043	39.2 ±
B3	A13	29.24	546.6	.002205	12.2	1500	59.1	.105 ± .031	63.7 ±
B4	A14	29.26	546.6	.002206	15.5	1690	70.3	.098 ± .026	75.7 ±
B5	A15	29.26	546.6	.002206	17.7	1810	85.8	.104 ± .026	92.9 ±
B6	A16	29.26	546.6	.002206	22.0	2071	106.7	.099 ± .022	115.0 ±
B7	A17	29.26	546.6	.002206	26.5	2338	128.5	.094 ± .020	138.5 ±
B8	A18	29.26	546.6	.002206	31.5	2429	152.7	.103 ± .021	164.5 ±
B9	A19	29.26	546.6	.002206	36.5	2619	177.0	.103 ± .020	190.7 ±
B10	A20	29.26	547.6	.002202	41.5	2786	201.2	.103 ± .190	217.2 ±
C1	A21	29.25	546.6	.002205	3.8	881	18.4	.094 ± .058	19.8 ±
C2	A22	29.25	547.6	.002205	7.0	1214	33.9	.092 ± .036	36.5 ±
C3	A23	29.25	547.6	.002205	11.8	1524	57.2	.098 ± .029	61.7 ±
C4	A24	29.25	547.6	.002205	16.0	1762	77.6	.100 ± .026	83.7 ±
C5	A25	29.25	547.6	.002205	19.2	1919	92.1	.100 ± .029	100.4 ±
C6	A26	29.25	547.6	.002201	23.0	2119	111.5	.109 ± .029	120.4 ±
C7	A27	29.25	547.6	.002201	27.5	2381	133.3	.094 ± .019	144.0 ±
C8	A28	29.25	547.6	.002201	35.5	2643	172.1	.098 ± .019	185.9 ±
C9	A29	29.25	547.6	.002201	40.3	2786	195.4	.100 ± .019	211.0 ±

Table D3 - Table showing the calculated Thrust performance parameters including the Thrust, Thrust Coefficient, and Sea Level values of Thrust.

D2 Torque

The torque values of the test were obtained from figures located in Appendix A. Again measured parameters were barometric pressure, outside air temp, and relative humidity. Tables D4-D5 show the values of torque as obtained from Appendix A. Figure D4 shows a plot of torque in ft-lbs as a function of propeller RPM.

As with thrust several parameters can be calculated using torque and RPM. Among them are the shaft horsepower (SHP), the power coefficient (C_p), and from C_p , values of SHP corrected to standard sea level conditions. The first parameter is SHP, shown by Equation D6 below:

$$\text{SHP} = \frac{2\pi NQ}{33000} \quad (\text{HP}) \quad (\text{D6})$$

where:

$$N = \text{Propeller RPM} \left(\frac{\text{revs}}{\text{min}} \right)$$

$$Q = \text{Torque (ft-lbs)}$$

Sample Calculations: Shaft Horsepower

Data From A37

$$\text{SHP} = \frac{2\pi NQ}{33000}$$

where:

$$N = 2214 \text{ RPM}$$

$$A = 5.2 \text{ ft-lbs}$$

$$\text{SHP} = \frac{(2\pi) (2214) (5.2)}{33000}$$

$$\underline{\underline{\text{SHP} = 2.20 \text{ HP}}}$$

Actual values of SHP are shown in Tables D6 -D8.

Again a coefficient is available. The power coefficient defined in Eqn. D7 non-dimensionalizes the SHP of the engine.

$$C_P = \frac{P}{\rho n^3 D^5} \quad (D7)$$

where:

$P = \text{HP (ft-lbs/sec)}$

$\rho = \text{Density (slugs/ft}^3\text{)}$

$n = \text{RPM (revs/sec)}$

$D = \text{Prop Diameter (ft)}$

Tables D6-D8 show the actual values of C_P . From values of C_P where $\rho = \rho_0$ values of SHP corrected to sea level may be obtained. These values are shown in Tables D6-D8. Eqn D8 shows how SHP_{SL} was obtained.

$$\text{SHP}_{\text{SL}} = C_P \rho_0 n^3 D^5 \quad (D8)$$

where:

$C_P = \text{Power Coefficient as obtained from Eqn (D7)}$

$\rho_0 = \text{Sea Level Density}$
(.0023769 slugs/ft³)

$n = \text{RPM (revs/sec)}$

$D = \text{Prop Diameter (4.5 ft)}$

Sample Calculation: Power Coefficient

Data From Figure A37

$$C_P = \frac{P}{\rho n^3 D^5}$$

where: $P = (550) (2.20) \text{ ft-lbs}$

$\rho = .002205 \text{ slugs/ft}^3$

$n = 36.9 \text{ revs/sec}$

$D = 4.5 \text{ ft}$

$$C_P = \frac{(550) (2.20)}{(.02205) (36.9)^3 (4.5)^5}$$

$$\underline{\underline{C_P = 0.0060}}$$

Sample Calculation: Sea Level Horsepower

Data Taken From Figure A37

$$SHP_{SL} = C_p \rho_o n^3 D^5$$

where:

$$C_p = .0060$$

$$\rho_o = .0023769 \text{ slugs/ft}^3$$

$$n = 36.9 \text{ revs/sec}$$

$$D = 4.5 \text{ ft}$$

$$SHP_{SL} = (.0060) (.0023769) (36.9)^3 (4.5)^5$$

$$SHP_{SL} = 1322.22 \text{ ft-lbs/sec}$$

$$\underline{\underline{SHP_{SL} = 2.40 \text{ HP}}}$$

Again values of SHP, C_p , and SHP_{SL} are found in Figures D10-D11.

Figure D5 shows SHP, while Figure D6 shows C_p , and Figure D7 shows SHP_{SL} all as a function of propeller RPM.

The errors for each of the previous parameters were propagated by using Eqn D5 of this section. The values of σ_{HP} are shown in Tables D6 -D8 while the power coefficient errors were assumed negligible ($\sigma_{Cp} = \pm 3 \times 10^{-7}$). The error propagated to sea level SHP is shown in Tables D6 - D8.

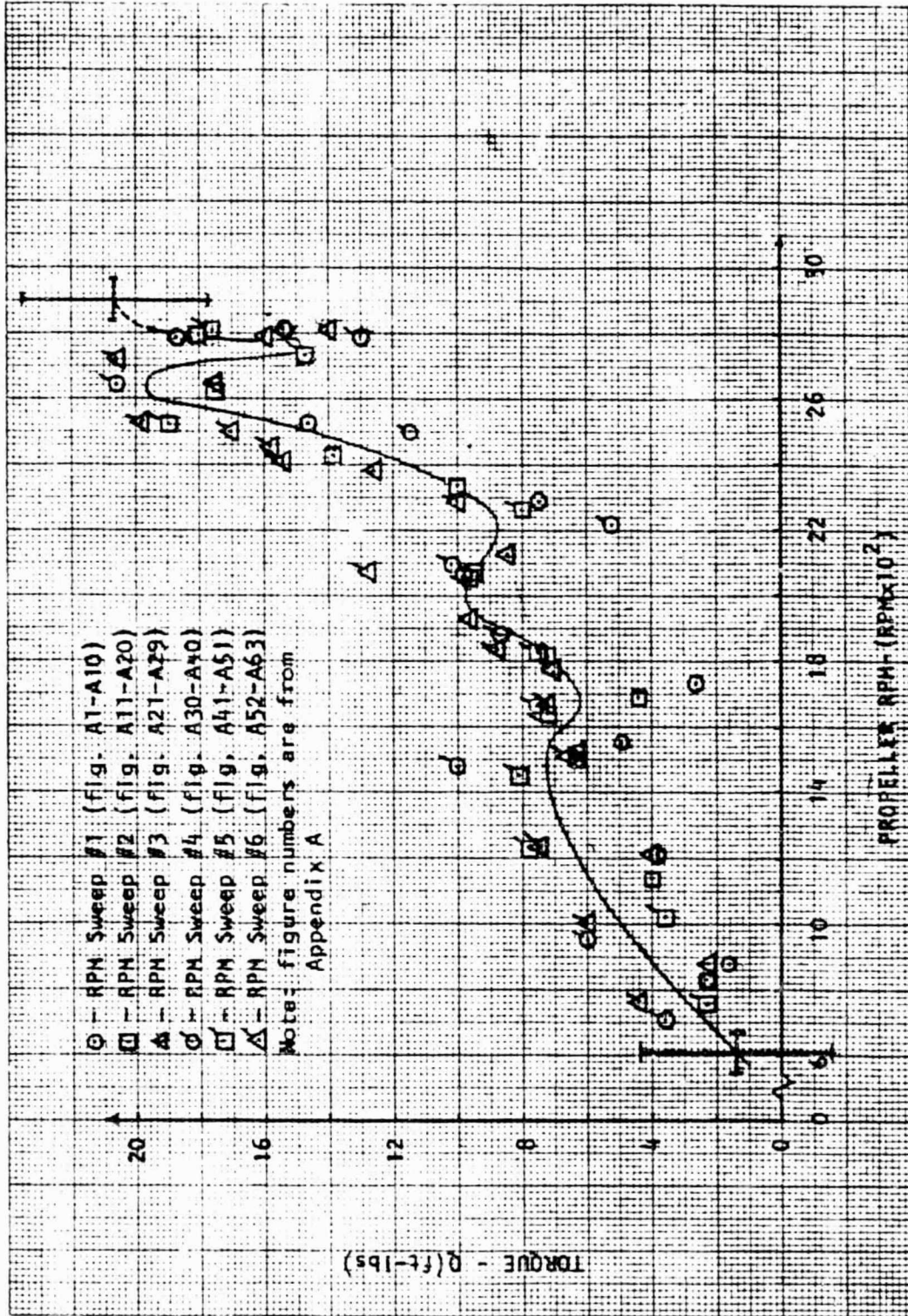

<table border="1"> <tr> <td>CALC</td> <td>Blaugher, C.</td> <td>9/18/83</td> <td>REVISED</td> <td>DATE</td> </tr> <tr> <td>CHECK</td> <td></td> <td></td> <td></td> <td></td> </tr> <tr> <td>APPD</td> <td></td> <td></td> <td></td> <td></td> </tr> <tr> <td>APPD</td> <td></td> <td></td> <td></td> <td></td> </tr> </table>	CALC	Blaugher, C.	9/18/83	REVISED	DATE	CHECK					APPD					APPD					<p>Figure D4 - Values of Torque for a Cuyuna UL-430RR Engine as a function of Propeller RPM</p>	<p>PAGE D14</p>
CALC	Blaugher, C.	9/18/83	REVISED	DATE																		
CHECK																						
APPD																						
APPD																						
<p>UNIVERSITY OF KANSAS</p>																						

ORIGINAL FACE IS
OF POOR QUALITY

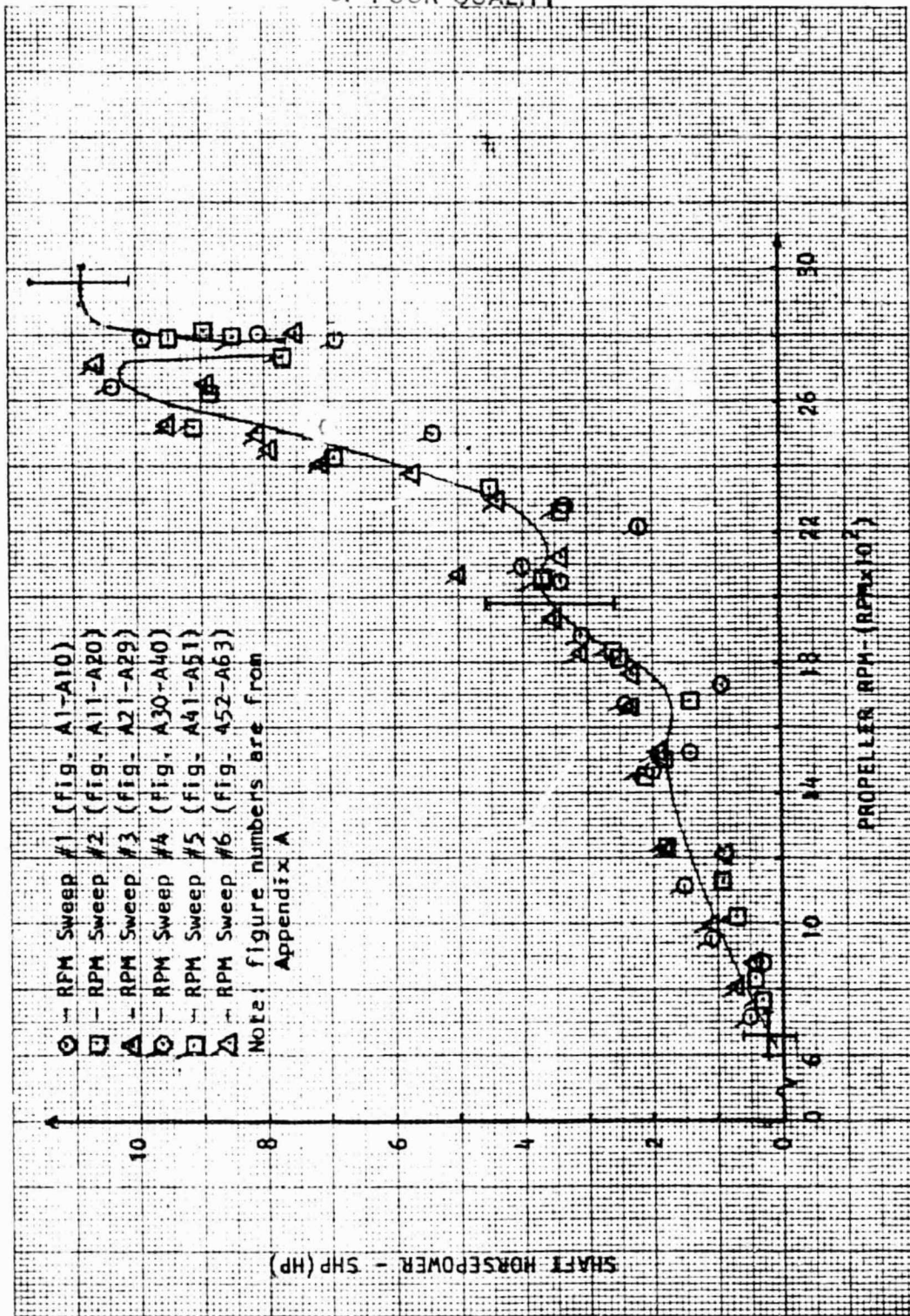

CALC	Blanchard	9/18/82	REVISED	DATE
CHECK				
APPD				
APPD				

Figure D5 -
Shaft Horsepower for a Cuyuna UL-430RR
Engine as a function of Propeller RPM

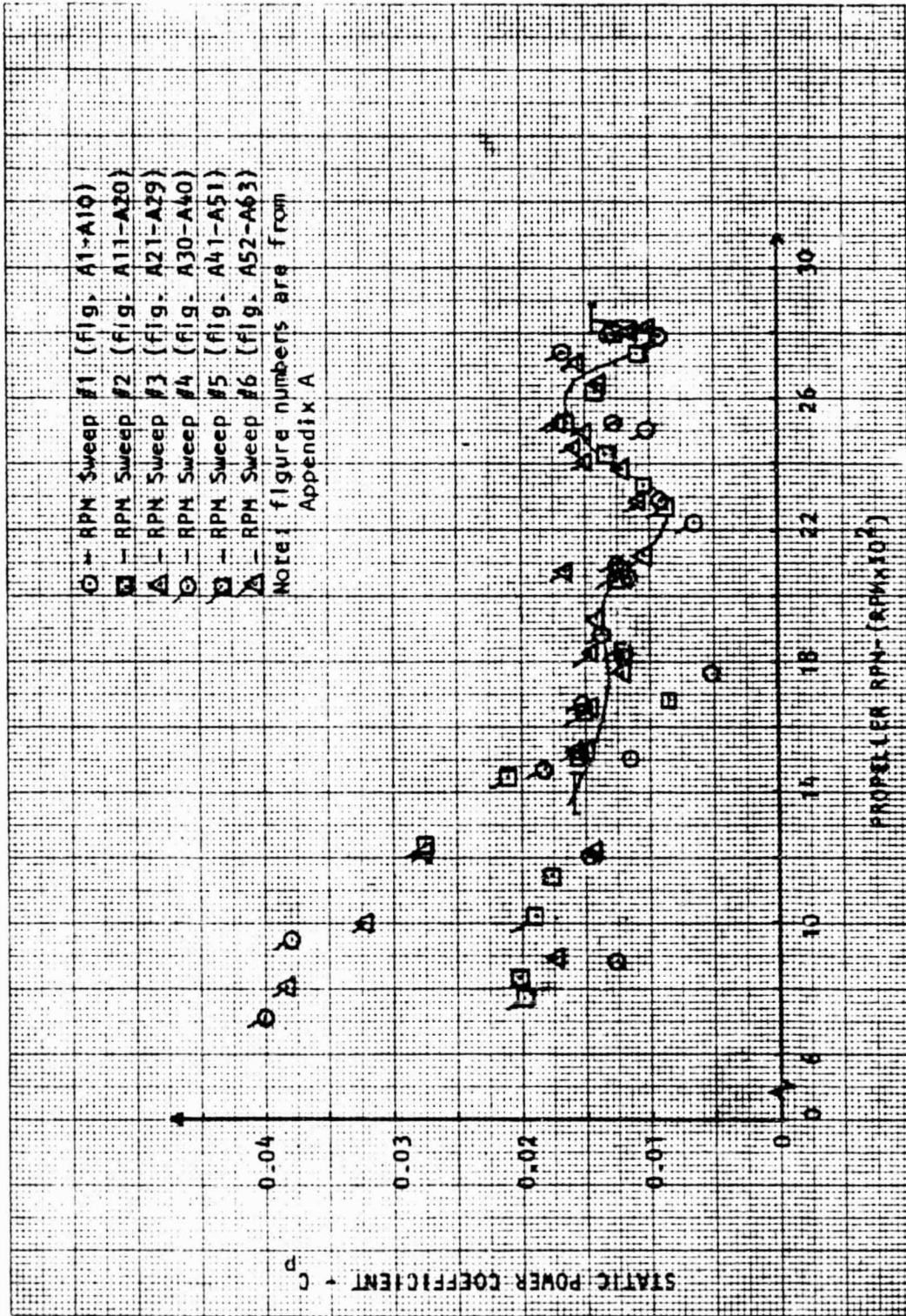

CALC	<i>Blank</i>	<i>9/10/83</i>	REVISED	DATE
CHECK				
APPD				
APPD				

Figure D6 -
Static Power Coefficient for a Cuyuna
UL-430RR Engine as a function of RPM

ORIGINAL FILED IN
OF POOR QUALITY

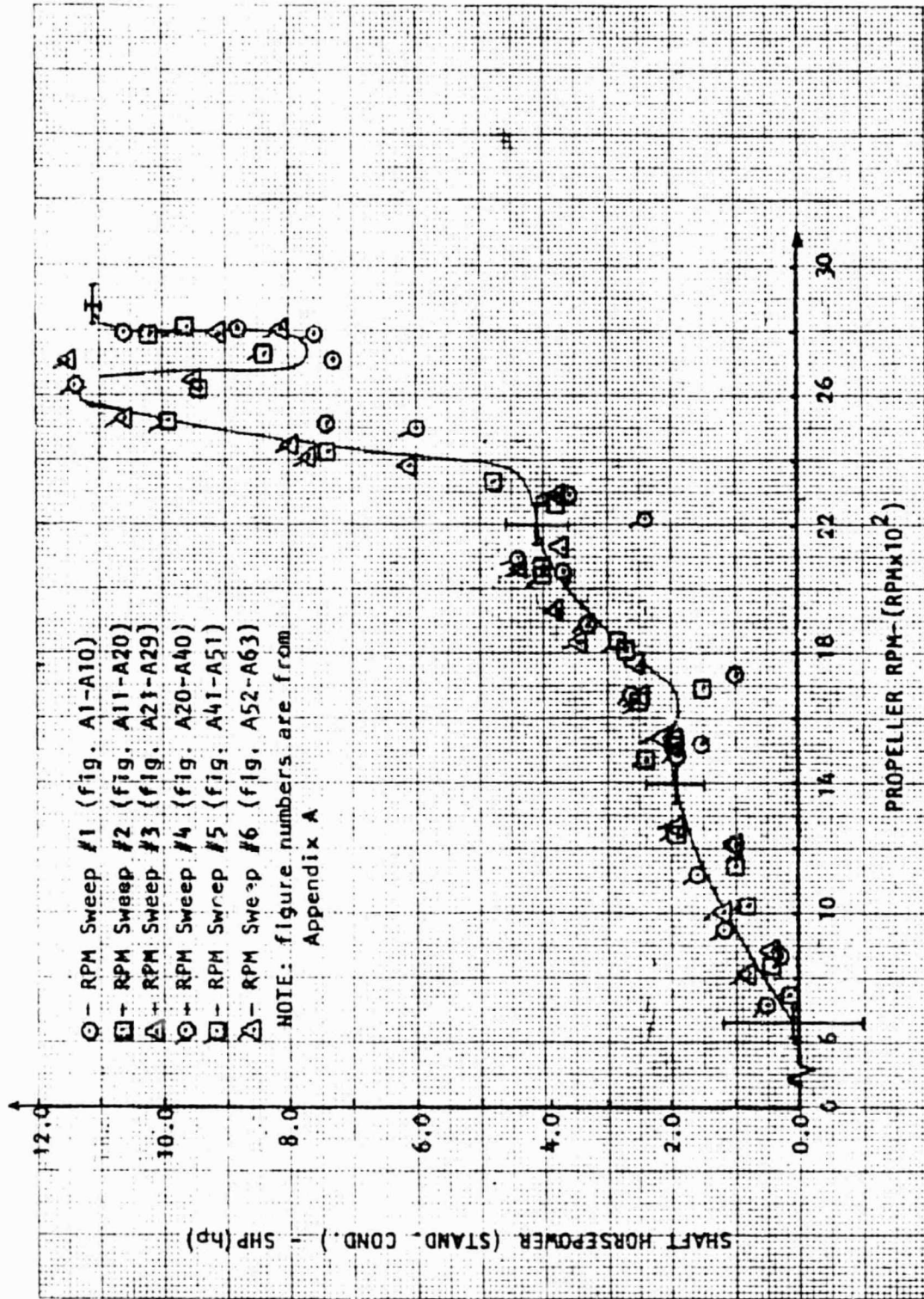

CALC	Blackhawk	9/21	REVISED	DATE	Figure D7 - Shaft Horsepower converted to standard SL cond. as a function of Prop. RPM	UNIVERSITY OF KANSAS	PAGE D17
CHECK							
APPD							
APPD							

I Run #	Fig #	mm For Zero Line	R.P.M. \pm 62.5	Torque \pm 2.92 l Ft.-lbs
A 1	A-1	2.0	881	1.6
A 2	A-2	4.2	1214	3.8
A 3	A-3	6.1	1524	4.9
A 4	A-4	3.5	1738	2.6
A 5	A-5	11.0	2048	8.8
A 6	A-6		2286	7.5
A 7	A-7	17.6	2524	14.6
A 8	A-8	18.0	2714	14.9
A 9	A-9	18.5	2810	15.4
A10	A-10	22.0	2786	18.5
B 1	A-11	3.0	833	2.3
B 2	A-12	5.0	1143	4.0
B 3	A-13	8.0	1500	6.3
B 4	A-14	5.5	1690	4.4
B 5	A-15	9.0	1810	7.2
B 6	A-16	11.8	2071	9.5
B 7	A-17	12.3	2338	10.0
B 8	A-18	18.0	2429	14.9
B 9	A-19	21.0	2619	17.5
B10	A-20	21.5	2786	18.0
C 1	A-21	3.0	881	2.3
C 2	A-22	5.0	1214	4.0
C 3	A-23	8.0	1524	6.3
C 4	A-24	8.8	1762	7.0
C 5	A-25	12.0	1929	9.6
C 6	A-26	10.3	2119	8.4

I Run #	Fig. #	mm For Zero Line	R.P.M. \pm 62.5	Torque \pm 2.92 l Ft.-lbs
C 7	A-27	15.5	2381	12.6
C 8	A-28	21.0	2643	17.5
C 9	A-29	19.5	2786	16.0
1	A-30	4.5	714	3.6
2	A-31	7.5	952	6.0
3	A-32	9.0	1119	7.2
4	A-33	12.3	1476	10.0
5	A-34	9.5	1667	7.5
6	A-35	10.8	1881	8.7
7	A-36	12.7	2095	10.2
8	A-37	6.5	2214	5.2
9	A-38	14.0	2500	11.3

Table D4 - Table of values of Torque taken from Appendix A

I Run #	Fig. #	mm For Zero Line	R.P.M. ± 62.5 R.P.M.	Torque ± 2.92 Ft.-lbs
10	A-39	24.5	2643	20.6
11	A-40	16.0	2786	13.0
13	A-41	3.0	762	2.3
14	A-42	4.5	1024	3.6
15	A-43	9.8	1238	7.8
16	A-44	10.2	1452	8.1
17	A-45	9.0	1643	7.2
18	A-46	9.5	1833	7.5
19	A-47	12.0	2048	9.6
20	A-48	10.0	2262	8.0
21	A-49	22.5	2524	18.9
22	A-50	17.8	2738	14.7
23	A-51	20.0	2810	16.6

I Run #	Fig #	mm For Zero Line	R.P.M. ± 62.5 R.P.M.	Torque ± 2.92 Ft.-lbs.
25	A-52	5.5	810	4.4
26	A-53	7.5	1000	6.0
27	A-54	9.5	1238	7.5
28	A-55	8.3	1524	9.5
29	A-56	9.0	1667	8.3
30	A-57	11.0	1833	8.8
31	A-58	15.8	2071	12.8
32	A-59	12.3	2286	10.0
33	A-60	23.5	2524	19.8
34	A-61	24.5	2714	20.6
35A	A-62	17.0	2810	14.0
35B	A-63-a	18.5	2405	15.4
35B	A-63-b	19.0	2452	15.8
35B	A-63-b	20.5	2500	17.0

Table D5 - Table of the values of Torque taken from Appendix A.

ORIGINAL PAGE IS
OF POOR QUALITY

Figure #	B.P. ± .01 In. of Hg	T ± .5°R	$\rho \pm 2 \times 10^{-6}$ slugs/ft ³	R.P.M. ± 62.5 R.P.M.	Torque ± 2.9 ft/lbs	H.P. ± 0HP H.P.	$C_p \pm \text{ocp}$ $\sigma = \pm 3 \times 10^{-7}$	H.P.S.L. ± 0H.P.S.L.
A1	29.20	545.6	.002206	381	1.6	.3 ± .5	.0128 ±	.3 ± 1.1
A2	29.20	545.6	.002206	1214	3.8	.9 ± .7	.0147 ±	1.0 ± .8
A3	29.20	545.6	.002206	1524	4.9	1.4 ± 1.0	.0115 ±	1.5 ± .7
A4	29.20	545.6	.002206	1738	2.6	.9 ± 1.0	.0050 ±	1.0 ± 1.1
A5	29.20	545.6	.002206	2048	8.8	3.4 ± 1.1	.0115 ±	3.7 ± .3
A6	29.20	545.6	.002206	2286	7.5	3.3 ± 1.3	.0081 ±	3.6 ± .4
A7	29.20	545.6	.002206	2524	14.6	7.0 ± 1.4	.0127 ±	7.5 ± .2
A8	29.20	545.6	.002206	2714	14.9	7.7 ± 1.5	.0112 ±	7.3 ± .2
A9	29.20	545.6	.002206	2810	15.4	8.2 ± 1.6	.0108 ±	8.8 ± .2
A10	29.20	545.6	.002206	2786	18.5	9.8 ± 1.6	.0132 ±	10.6 ± .2
A11	29.26	546.6	.002206	833	2.3	.4 ± .5	.0202 ±	.4 ± 1.3
A12	29.24	546.6	.002205	1143	4.0	.9 ± .7	.0176 ±	1.0 ± .8
A13	29.24	546.6	.002205	1500	6.3	1.8 ± .8	.0156 ±	1.9 ± .4
A14	29.26	546.6	.002206	1690	4.4	1.4 ± .9	.0085 ±	1.5 ± .6
A15	29.26	546.6	.002206	1810	7.2	2.5 ± 1.1	.0123 ±	2.7 ± .4
A16	29.26	546.6	.002206	2071	9.5	3.7 ± 1.2	.0121 ±	4.0 ± .3
A17	29.26	546.6	.002206	2338	10.0	4.5 ± 1.3	.0103 ±	4.8 ± .3
A18	29.26	546.6	.002206	2429	14.9	6.9 ± 1.4	.0140 ±	7.4 ± .2
A19	29.26	546.6	.002206	2619	17.5	8.7 ± 1.5	.0142 ±	9.4 ± .2
A20	29.26	547.6	.002202	2786	18.0	9.5 ± 1.5	.0128 ±	10.2 ± .2
A21	29.25	546.6	.002205	881	2.3	.9 ± .5	.0171 ±	.4 ± 1.3
A22	29.25	547.6	.002205	1214	4.0	.9 ± .7	.0147 ±	1.0 ± .8
A23	29.25	547.6	.002205	1524	6.3	1.8 ± .8	.0149 ±	1.9 ± .9

Table D6 - Table showing the calculated performance parameters using the measured value of Torque.

ORIGINAL PAGE IS
OF POOR QUALITY

Figure #	B.P. ± .01 In of Hg	T ± .5°R	$\rho \pm 2 \times 10^{-6}$ slugs/ft ³	R.P.M. ± 62.5 R.P.M.	Torque ± 2.9 ft/lbs	H.P. ± 0HP H.P.	$C_p \pm \text{ocp}$ $\sigma \pm 13 \times 10^{-7}$	H.P.S.L. ± 0H.P.S.L.
A24	29.25	547.6	.002205	1762	7.0	2.3 ± .9	.0123 ±	2.5 ± .9
A25	29.25	547.6	.002205	1929	9.6	3.5 ± 1.0	.0142 ±	3.8 ± .3
A26	29.25	547.6	.002205	2119	8.4	3.4 ± 1.2	.0104 ±	3.7 ± .3
A27	29.25	547.6	.002205	2381	12.6	5.7 ± 1.3	.0123 ±	6.1 ± .2
A28	29.25	547.6	.002205	2643	17.5	8.8 ± 1.5	.0139 ±	9.5 ± .2
A29	29.25	547.6	.002205	2786	16.0	8.5 ± 1.6	.0115 ±	9.1 ± .2
A30	29.32	547.6	.002207	714	3.6	.5 ± .4	.0400 ±	.5 ± .8
A31	29.30	547.6	.002205	952	6.0	1.1 ± .5	.0380 ±	1.2 ± .5
A32	29.30	547.6	.002205	1119	7.2	1.5 ± .6	.0319 ±	1.6 ± .9
A33	29.31	547.6	.002206	1476	10.0	2.0 ± .6	.0181 ±	1.9 ± .2
A34	29.31	547.6	.002205	1667	7.5	2.4 ± .9	.0151 ±	2.6 ± .4
A35	29.31	547.6	.002206	1881	8.9	3.1 ± 1.0	.0136 ±	3.3 ± .2
A36	29.30	547.6	.002205	2095	10.2	4.0 ± 1.1	.0127 ±	4.4 ± .3
A37	29.30	547.6	.002205	2214	5.2	2.2 ± 1.2	.0060 ±	2.4 ± .5
A38	29.30	547.6	.002205	2500	11.3	5.9 ± 1.4	.0101 ±	6.0 ± .1
A39	29.30	547.6	.002205	2643	20.6	10.4 ± 1.5	.0168 ±	11.4 ± .1
A40	29.30	547.6	.002205	2786	13.0	6.9 ± 1.5	.0093 ±	7.6 ± .2
A41	29.30	547.6	.002205	762	2.3	.3 ± .4	.0198 ±	.3 ± 1.3
A42	29.30	547.6	.002209	1024	3.6	.7 ± .6	.0190 ±	.8 ± .9
A43	29.30	546.6	.002209	1238	7.8	1.8 ± .7	.0276 ±	1.9 ± .4
A44	29.30	547.6	.002205	1452	8.1	2.2 ± .8	.0210 ±	2.4 ± .4
A45	29.30	547.6	.002205	1643	7.2	2.1 ± .9	.0151 ±	2.5 ± .4
A46	29.30	547.6	.002205	1853	7.5	2.6 ± 1.0	.0123 ±	2.8 ± .4
A47	29.30	547.6	.002205	2048	9.6	3.7 ± 1.1	.0126 ±	4.0 ± .3

Table G7 - Table showing the calculated performance parameters using the measured values of Torque.

ORIGINAL TESTS
OF POOR QUALITY

Figure #	B.P. ± .01 in. of Hg	T ± .5°R	$\rho \pm 2 \times 10^{-6}$ slugs/ft ³	R.P.M. ± 62.5 R.P.M.	Torque ± 2.9 ft./lbs	H.P. ± oHP H.P.	$C_p \pm \text{ocp}$ $n=3 \times 10^{-7}$	H.P.S.L. ± oH.P.S.L.
A48	29.30	547.6	.002205	2262	8.0	3.9 ± 1.2	.0086 ±	3.7 ± .3
A49	29.30	547.6	.002205	2524	18.9	9.1 ± 1.4	.0165 ±	9.8 ± .2
A50	29.30	547.6	.002205	2738	14.7	7.7 ± 1.5	.0109 ±	8.3 ± .2
A51	29.30	547.6	.002205	2810	16.6	8.9 ± 1.6	.0117 ±	9.6 ± .2
A52	29.37	548.6	.002206	810	4.4	.7 ± .5	.0384 ±	.8 ± .7
A53	29.37	548.6	.002206	1000	6.0	1.1 ± .5	.0321 ±	1.2 ± .5
A54	29.37	549.6	.002202	1238	7.5	1.8 ± .7	.0277 ±	1.9 ± .9
A55	29.37	549.6	.002202	1524	6.5	1.9 ± .9	.0157 ±	2.1 ± .5
A56	29.37	550.6	.002198	1667	7.2	2.3 ± .9	.0145 ±	2.5 ± .4
A57	29.37	550.6	.002198	1833	8.8	3.1 ± 1.0	.0147 ±	3.4 ± .3
A58	29.37	550.6	.002198	2071	12.8	5.0 ± 1.1	.0165 ±	5.4 ± .2
A59	29.37	550.6	.002198	2286	10.0	9.4 ± 1.3	.0108 ±	4.8 ± .3
A60	29.37	550.6	.002198	2524	19.8	9.5 ± 1.4	.0173 ±	10.3 ± .1
A61	29.37	550.6	.002198	2714	10.6	10.6 ± 1.5	.0155 ±	11.5 ± .1
A62	29.37	550.6	.002198	2810	14.0	7.5 ± 1.6	.0100 ±	8.1 ± .2
A63	29.37	550.6	.002198	2405	15.4	7.1 ± 1.3	.0150 ±	8.0 ± .2
A63	29.37	550.6	.002198	2452	15.8	7.9 ± 1.4	.0157 ±	8.0 ± .2
A63	29.37	550.6	.002198	2500	17.0	8.1 ± 1.4	.0152 ±	-

Table D8 - Table showing the calculated performance parameters using the measured values of Torque.

D3. Temperature

Temperature readings were taken in two different locations. The first was the exhaust gas temperature which was obtained by a thermocouple placed in the intersection of the exhaust manifold. Values of EGT as shown in table D9 were taken directly from Appendix A. Figure D8 shows a plot of EGT as a function of propeller RPM.

The second of the temperatures was cylinder head temperature. Figure D9 shows CHT as a function of propeller RPM. The values used are shown in Table D10.

ORIGINAL PAGE IS
OF POOR QUALITY

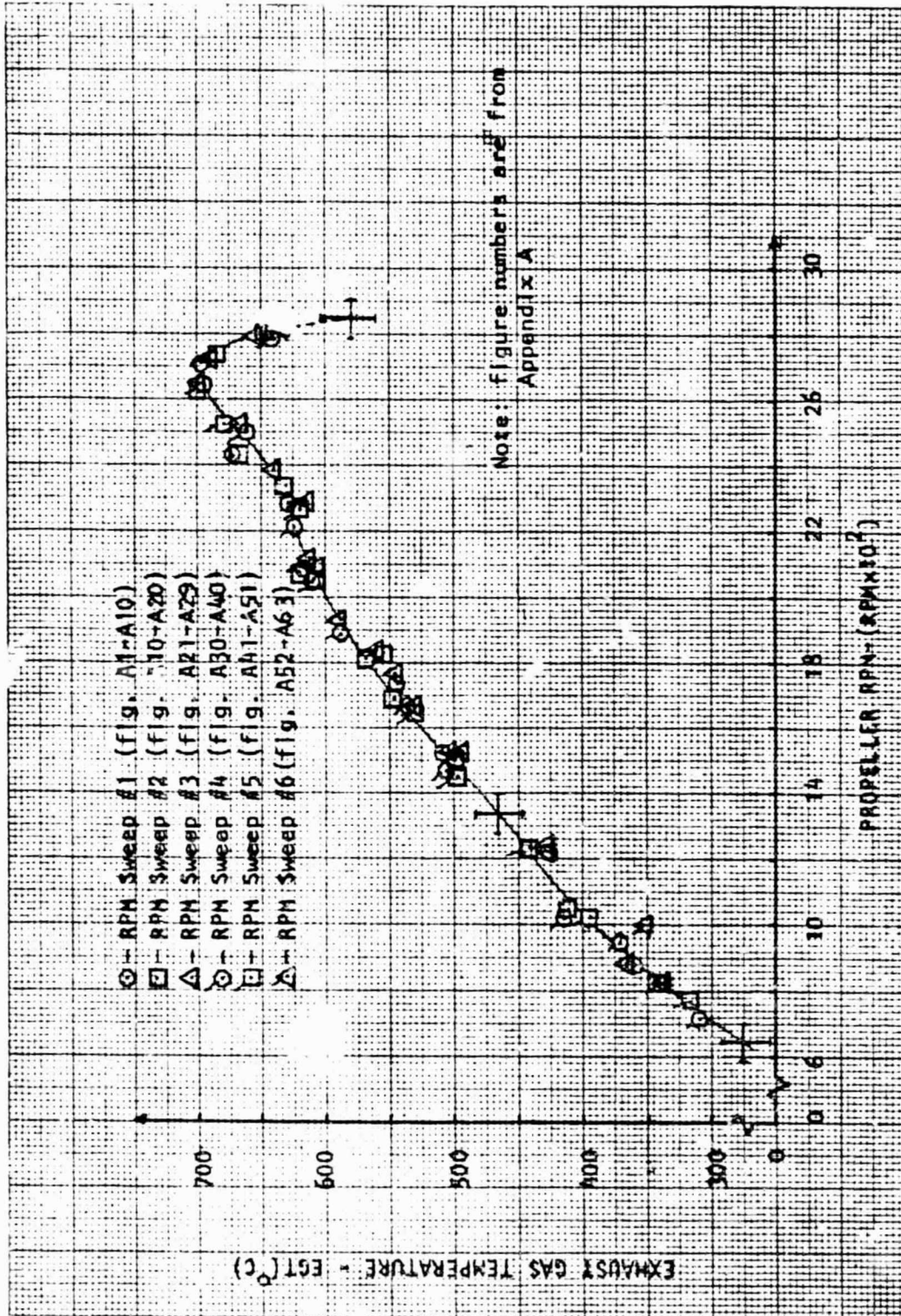

CALC	<i>Blanchard</i>	<i>7/19/83</i>	REVISED	DATE	<p>Figure D8 - Exhaust Gas Temperature for a Cuyuna UL-439RR Engine as a function of RPM</p> <p>UNIVERSITY OF KANSAS</p>	PAGE
CHECK						D24
APPD						
APPD						

I Run #	Fig. #	R.P.M.	E.G.T. °C
25	A-52	810	333
26	A-53	1000	351
27	A-54	1238	427
28	A-55	1524	496
29	A-56	1667	531
30	A-57	1833	561
31	A-58	2071	609
32	A-59	2286	616
33	A-60	2524	667
34	A-61	2714	693
35	A-62	2810	635

I Run #	Fig. #	R.P.M.	E.G.T. °C
C 6	A-26	2119	612
C 7	A-27	2381	640
C 8	A-28	2643	699
C 9	A-29	2786	653
1	A-30	714	308
2	A-31	952	370
3	A-32	1119	414
4	A-33	1478	506
5	A-34	1667	537
6	A-35	1987	587
7	A-36	2095	617
8	A-37	2214	617
9	A-38	2500	660
10	A-39	2643	695
11	A-40	2786	640
13	A-41	762	316
14	A-42	1024	388
15	A-43	1238	441
16	A-44	1452	496
17	A-45	1643	530
18	A-46	1833	555
19	A-47	2048	609
20	A-48	2262	619
21	A-49	2524	679
22	A-50	2738	684
23	A-51	2810	599

I Run #	Fig. #	R.P.M.	E.G.T. °C
A 1	A-1	881	360
A 2	A-2	1214	425
A 3	A-3	1524	508
A 4	A-4	1738	544
A 5	A-5	2048	611
A 6	A-6	2286	628
A 7	A-7	2524	672
A 8	A-8	2714	657
A 9	A-9	2810	641
A10	A-10	2706	596
B 1	A-11	833	343
B 2	A-12	1143	413
B 3	A-13	1500	449
B 4	A-14	1690	547
B 5	A-15	1810	568
B 6	A-16	2071	620
B 7	A-17	2338	630
B 8	A-18	2429	667
B 9	A-19	261	696
B10	A-20	2786	---
C 1	A-21	881	365
C 2	A-22	1214	425
C 3	A-23	1524	504
C 4	A-24	1762	546
C 5	A-25	1929	589

Table D9 - Table showing the measured values of Exhaust Gas Temperature.

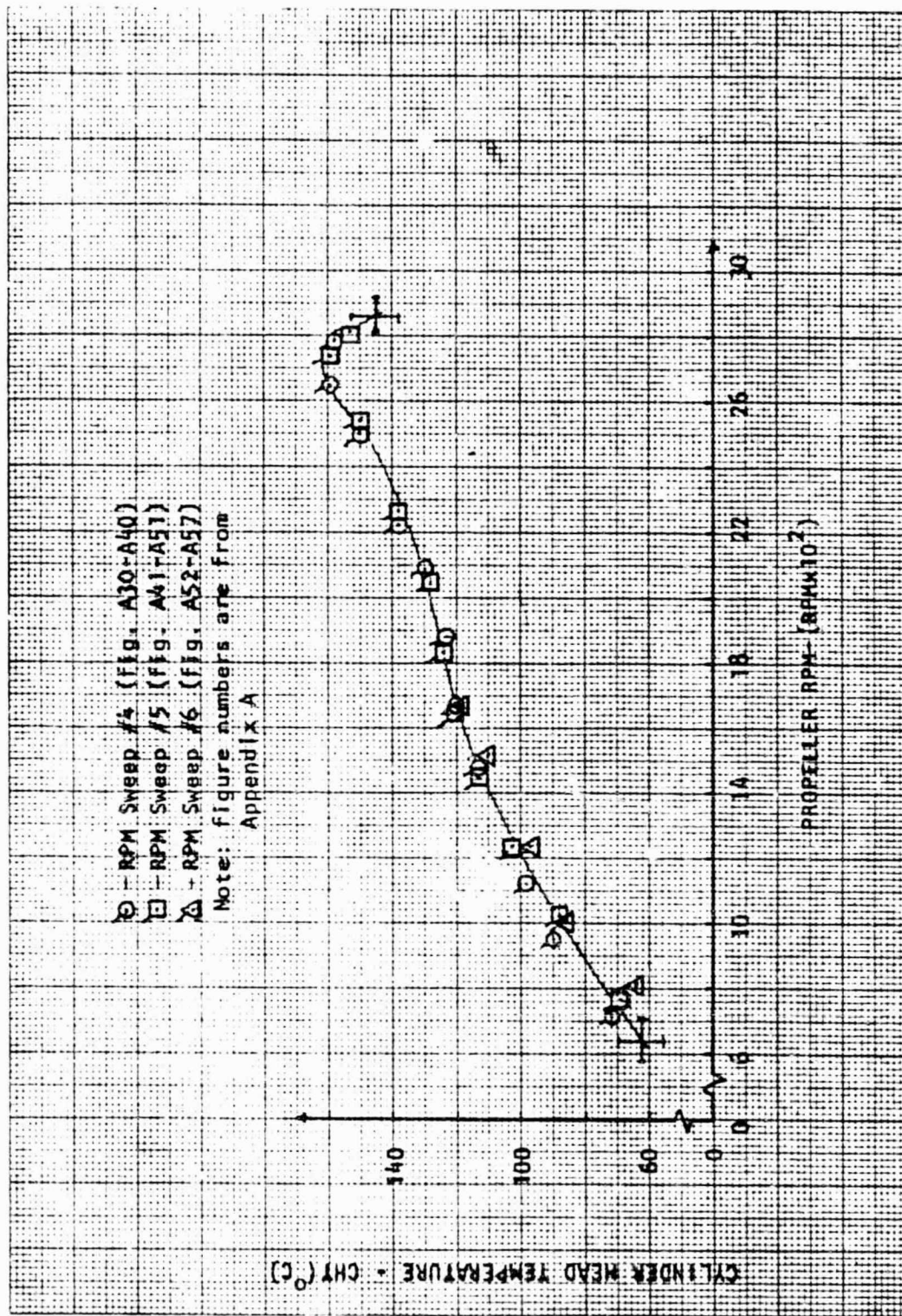

CALC	<i>Blackburn</i>	9/19/83	REVISED	DATE
CHECK				
APPD				
APPD				

Figure D9 -
Cylinder Head Temperature for a Cuyuna
UL-430RR Engine as a function of RPM

ORIGINAL PAGE IS
OF POOR QUALITY

Run #	Fig. #	R.P.M.	C.H.T. °C
1	A-30	714	72
2	A-31	952	90
3	A-32	1119	98
4	A-33	1476	113
5	A-34	1667	120
6	A-35	1881	123
7	A-36	2095	130
8	A-37	2214	138
9	A-38	2500	150
10	A-39	2643	159
11	A-40	2786	158
13	A-41	762	69
14	A-42	1024	88
15	A-43	1238	103
16	A-44	1452	113
17	A-45	1643	121
18	A-46	1833	124
19	A-47	2048	128
20	A-48	2262	138
21	A-49	2524	149
22	A-50	2738	159
23	A-51	2810	153
24	A-52	810	64
25	A-53	1000	86
26	A-54	1238	97
27	A-55	1524	110

Run #	Fig. #	R.P.M.	C.H.T. °C
28	A-56	1667	119
29	A-57	-----	---
30	A-58	-----	---
31	A-59	-----	---
32	A-60	-----	---
33	A-61	-----	---
34	A-62	-----	---
35	A-63	-----	---

Table D10 - Table showing the measured values of
Cylinder Head Temperature.

D4. Fuel Flow Parameters

The fuel flow values are shown in the table in the back of Appendix A (Tables A1-A6). With the measured quantities, a value of shaft specific fuel consumption in lbs/Hr-HP could be calculated using eqn. D9.

$$SSFC = \frac{\text{Fuel Flow}}{\text{SHP}} \quad (D9)$$

Where: Fuel Flow = $\Delta W_f / \Delta t$ (lbs/Hr)
SHP = Shaft Horsepower (HP) from sect. D2

Sample Calculation: SSFC

Data is from Figure A37

$$SSFC = \frac{\text{Fuel Flow}}{\text{SHP}}$$

Where: Fuel Flow = 14.95 lbs/hr.
SHP = 2.2 HP

$$SSFC = \frac{14.95}{2.2} \quad \underline{\underline{SSFC = 6.79 \text{ lbs/HR-HP}}}$$

values of Fuel flow and SSFC are shown in table D11 and D12, while Figure D10 shows SSFC as a function of Propeller RPM. To further clarify the curve, figure D12 shows the rate of fuel consumption also as a function of propeller RPM.

The sea level values are shown in tables D13 and D14 and are plotted as a function of propeller RPM in figure D11. Their respective errors are also shown in the previous tables and where calculated using eqn. D5.

ORIGINAL PAGE IS
OF POOR QUALITY

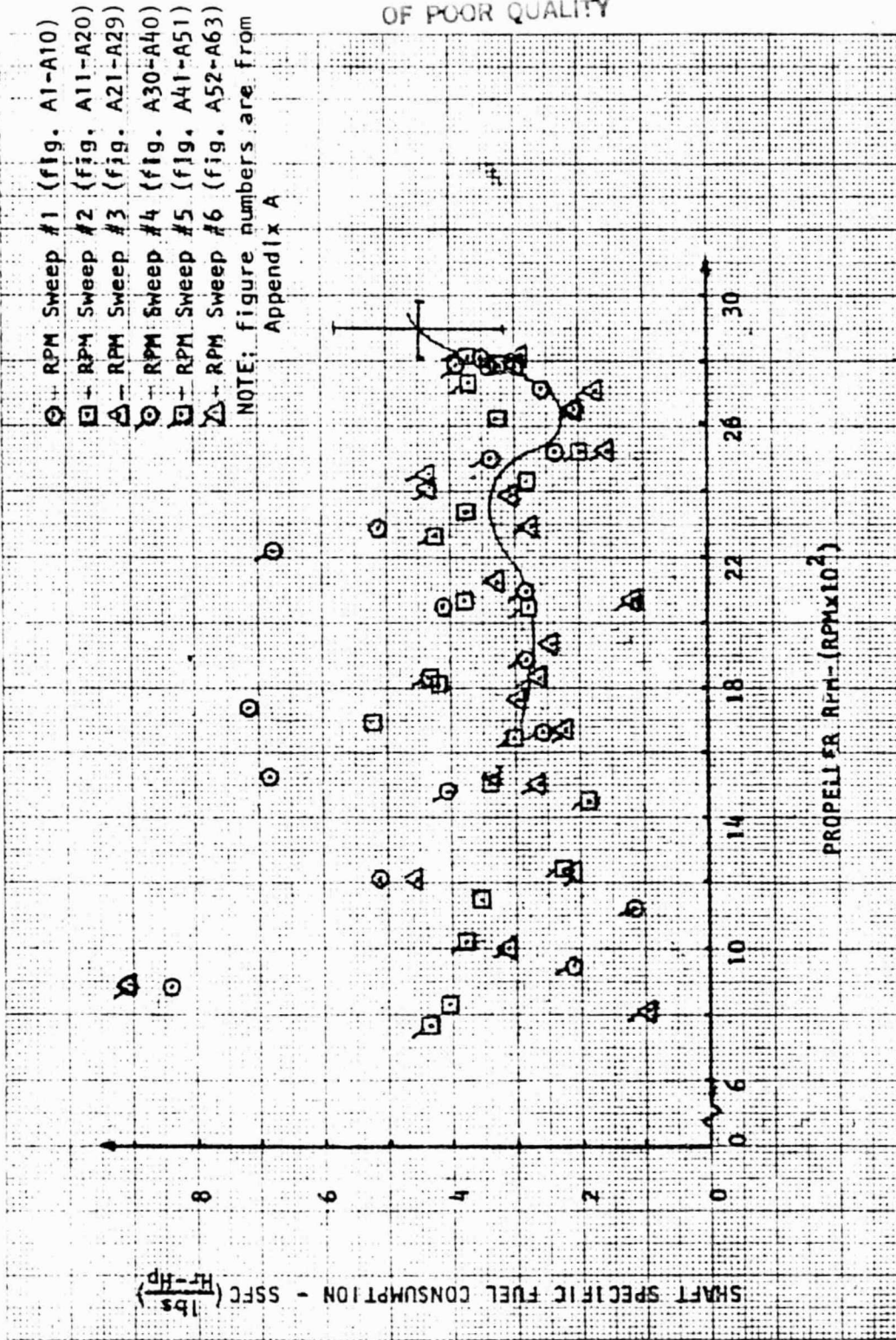

CALC	Blanchard	10/6/83	REVISED	DATE
CHECK				
APPD				
APPD				

Figure D10 -
Shaft Specific Fuel Consumption as a
function of Propeller RPM

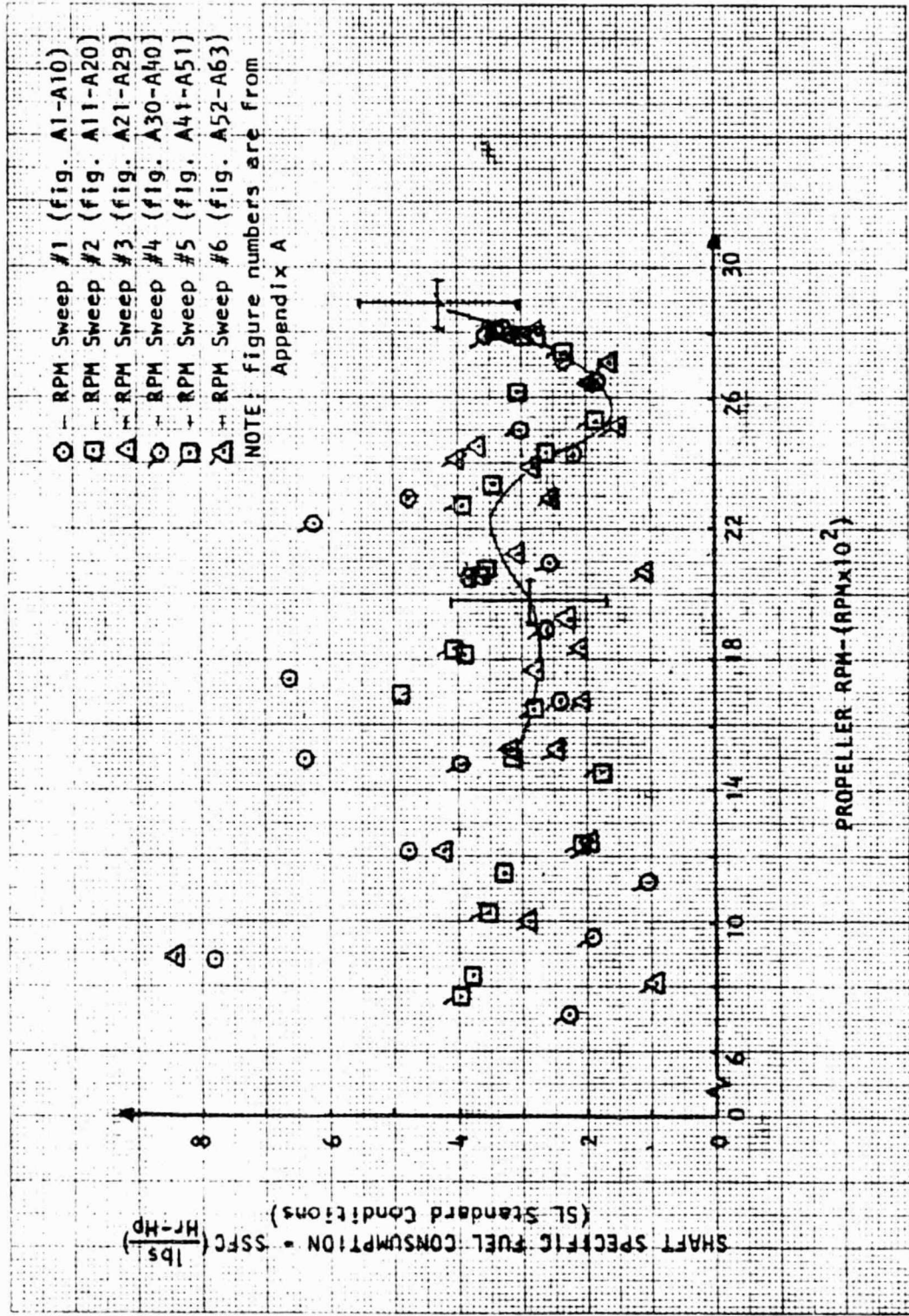

CALC	Blocklock	9/6/82	REVISED	DATE
CHECK				
APPD				
AOPD				

Figure D11 -
Shaft Specific Fuel Consump. (SL Stand.)
as a function of the Propeller RPM

ORIGINAL PAGE IS
OF POOR QUALITY

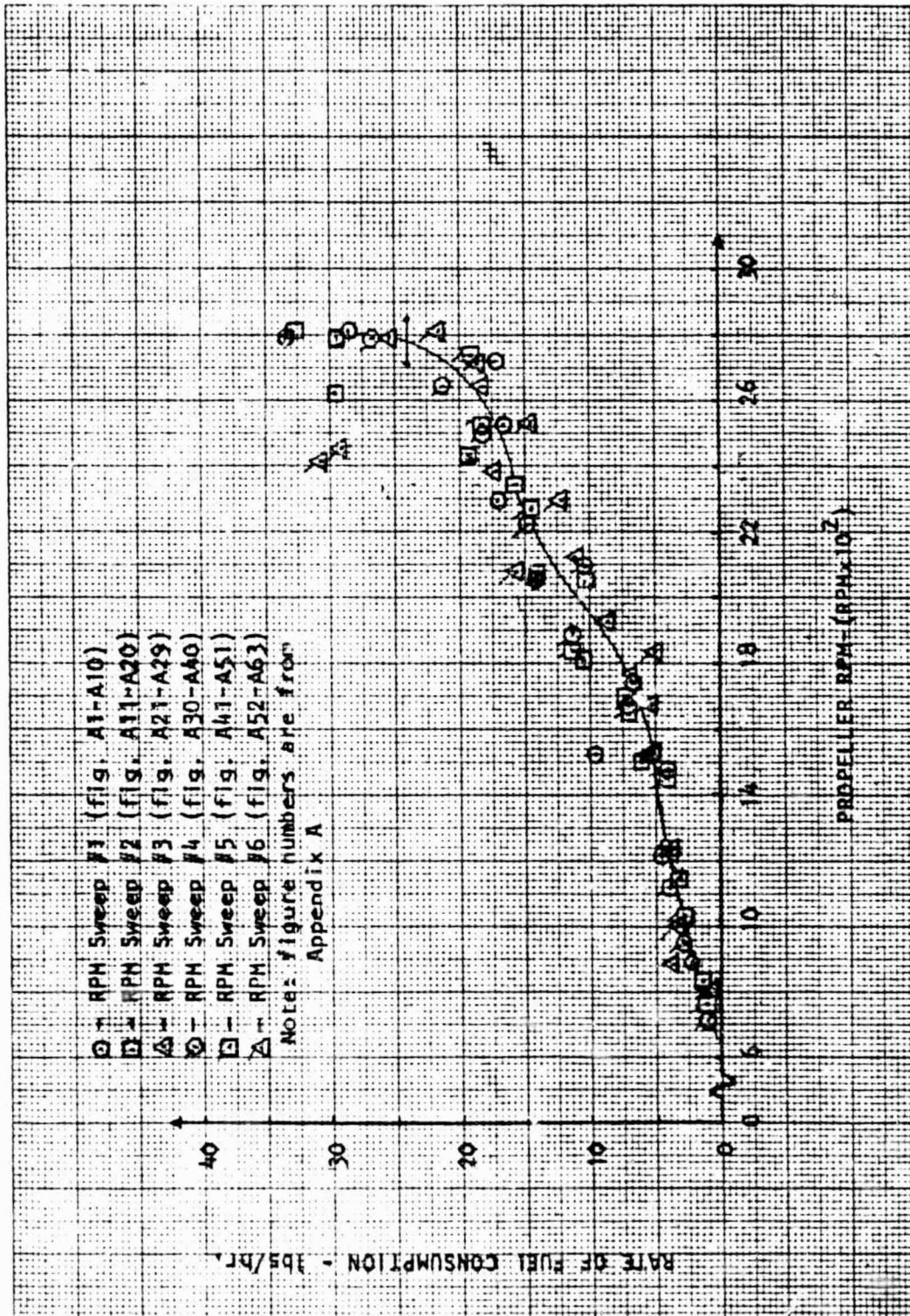

CALC	<i>Blank</i>	<i>9/26</i>	REVISED	DATE
CHECK				
APPD				
APPD				

Figure D12 -
Rate of Fuel Consumption for a Cuyuna
UL-430RR Engine as a function of RPM

ORIGINAL PAGE IS
OF POOR QUALITY

Run#	Fig. #	S.H.P. H.P.	R.P.M.	RATE OF CONSUMPTION ± 0.02 lbs./Hr.	S.S.F.C. lbs./H.P. Hr. ± 1.3 lbs./H.P. Hr.
A1	A- 1	0.3 ± 0.5	881	2.34	8.41
A2	A- 2	0.9 ± 0.7	1214	4.74	5.12
A3	A- 3	1.4 ± 1.0	1524	9.54	6.85
A4	A- 4	0.9 ± 1.0	1738	6.66	7.18
A5	A- 5	3.4 ± 1.1	2048	14.17	4.13
A6	A- 6	3.3 ± 1.3	2286	17.17	5.14
A7	A- 7	7.0 ± 1.4	2524	16.50	2.37
A8	A- 8	7.7 ± 1.5	2714	17.37	2.56
A9	A- 9	8.2 ± 1.6	2810	28.60	3.50
A10	A-10	9.8 ± 1.6	2786	33.50	3.40
B1	A-11	0.4 ± 0.5	833	1.50	4.04
B2	A-12	0.9 ± 0.7	1143	3.30	3.56
B3	A-13	1.8 ± 0.8	1500	6.00	3.41
B4	A-14	1.4 ± 0.8	1690	7.32	5.26
B5	A-15	2.5 ± 1.1	1810	10.50	4.19
B6	A-16	3.7 ± 1.2	2071	14.12	3.80
B7	A-17	4.5 ± 1.3	2338	16.70	3.75
B9	A-18	6.9 ± 1.4	2429	19.31	2.81
B10	A-19	8.7 ± 1.5	2619	29.70	3.30
B11	A-20	9.5 ± 1.5	2786	29.29	3.23
C1	A-21	0.4 ± 0.5	881	3.36	9.06
C2	A-22	0.9 ± 0.7	1214	4.20	4.53
C3	A-23	1.8 ± 0.8	1524	5.95	3.37
C4	A-24	2.3 ± 0.9	1762	6.88	2.96

Table D11 - Table showing the calculated Fuel Flow performance parameters.

Table D12 - Table showing the calculated Fuel Flow performance parameters.

I Run#	Fig. #	S.H.P. H.P.	R.P.M.	RATE OF CONSUMPTION + - 0.02 lbs./Hr.	S.S.F.C. lbs./H.P. Hr. + - 1.3 lbs./H.P. Hr.
C5	A-25	3.5 ± 1.0	1929	8.51	2.41
C6	A-26	3.4 ± 1.2	2119	11.29	3.29
C7	A-27	5.7 ± 1.3	2381	17.26	3.06
C8	A-28	8.8 ± 1.5	2643	18.24	2.07
C9	A-29	8.5 ± 1.6	2786	25.30	3.00
1	A-30	0.5 ± 0.5	881	3.36	9.06
2	A-31	1.1 ± 0.5	952	2.82	2.12
3	A-32	1.5 ± 0.6	1119	3.99	1.17
4	A-33	2.0 ± 0.6	1476	4.20	4.09
5	A-34	2.4 ± 0.9	1667	7.03	2.59
6	A-35	3.1 ± 1.0	1881	11.40	2.82
7	A-36	4.0 ± 1.1	2095	10.40	2.81
8	A-37	2.2 ± 1.2	2214	14.95	6.79
9	A-38	5.4 ± 1.4	2500	18.35	3.39
10	A-39	10.4 ± 1.5	2643	21.47	2.07
11	A-40	6.9 ± 1.5	2786	26.85	3.90
13	A-41	0.3 ± 0.4	762	1.20	4.35
14	A-42	0.7 ± 0.6	1024	2.82	3.79
15	A-43	1.8 ± 0.7	1238	3.90	2.21
16	A-44	2.2 ± 0.8	1452	4.20	1.89
17	A-45	2.3 ± 0.9	1643	7.03	3.03
18	A-46	2.6 ± 1.0	1833	11.40	4.39
19	A-47	3.7 ± 1.1	2048	10.40	2.80
20	A-48	3.4 ± 1.2	2262	14.58	4.25

I Run#	Fig. #	S.H.P. H.P.	R.P.M.	RATE OF CONSUMPTION + - 0.02 lbs./Hr.	S.S.F.C. lbs./H.P. Hr. + - 1.3 lbs./H.P. Hr.
21	A-49	9.1 ± 1.4	2524	18.03	1.98
22	A-50	7.7 ± 1.5	2738	19.26	3.70
23	A-51	8.9 ± 1.6	2810	32.93	3.70
25	A-52	0.7 ± 0.5	810	0.73	0.98
26	A-53	1.1 ± 0.5	1000	3.48	3.12
27	A-54	1.8 ± 0.7	1238	3.78	2.15
28	A-55	1.9 ± 0.9	1524	5.10	2.62
29	A-56	2.3 ± 0.9	1667	5.10	2.21
30	A-57	3.1 ± 1.0	1833	5.07	2.62
31	A-58	5.0 ± 1.1	2071	5.72	1.15
32	A-59	4.4 ± 1.3	2286	12.24	2.76
33	A-60	9.5 ± 1.4	2524	14.73	1.55
34	A-61	10.6 ± 1.5	2714	18.63	1.75
35A	A-62	7.5 ± 1.6	2810	21.79	2.91
35B	A-63	7.1 ± 1.3	2405	30.80	4.32
35B	A-63	7.4 ± 1.4	2405	30.80	4.32
35B	A-63	8.1 ± 1.4	2500	-----	-----

ORIGINAL PAGE IS
OF POOR QUALITY

Run#	Fig. #	S.H.P. S.L. H.P.	R.P.M.	RATE OF CONSUMPTION ± 0.02 lbs./Hr.	S.S.F.C. S.L. I lbs./H.P. Hr. ± 1.2 lbs./H.P. Hr.
A1	A- 1	0.3	881	2.34	7.80
A2	A- 2	1.0	1214	4.74	4.79
A3	A- 3	1.5	1524	9.54	6.36
A4	A- 4	1.0	1738	6.66	3.83
A5	A- 5	3.7	2048	14.17	4.77
A6	A- 6	3.6	2286	16.50	2.20
A7	A- 7	7.5	2524	17.37	2.38
A8	A- 8	7.3	2714	28.60	3.25
A9	A- 9	8.8	2810	28.60	3.25
A10	A-10	10.6	2786	33.50	3.16
B1	A-11	0.4	833	1.50	3.75
B2	A-12	1.0	1143	3.30	3.30
B3	A-13	1.9	1500	6.00	3.16
B4	A-14	1.5	1690	7.32	4.88
B5	A-15	2.7	1810	10.50	3.89
B6	A-16	4.0	2071	14.12	3.53
B7	A-17	4.8	2338	16.70	3.48
B9	A-18	7.4	2429	19.31	2.61
B10	A-19	9.4	2614	29.70	3.06
B11	A-20	10.2	2786	29.29	2.99
C1	A-21	0.4	881	3.36	8.40
C2	A-22	1.0	1214	4.20	4.20
C3	A-23	1.9	1524	5.95	3.13
C4	A-24	2.5	1762	6.88	2.75
C5	A-25	3.8	1929	8.51	2.24

Table D13 - Table showing the Sea Level standard
Fuel Flow performance parameters.

Table D14 - Table showing the Sea Level Standard Fuel Flow Performance parameters.

Run#	Fig. #	S.H.P. S.L. H.P.	R.P.M.	RATE OF CONSUMPTION + 0.02 lbs./Hr.	S.S.F.C. S.L. lbs./H.P. Hr. + 1.2 lbs./H.P. Hr.
C6	A-26	3.7	2119	11.29	3.05
C7	A-27	6.1	2381	17.26	2.83
C8	A-28	9.5	2643	18.24	1.92
C9	A-29	9.1	2786	25.30	2.78
1	A-30	0.5	714	1.26	2.28
2	A-31	1.2	952	2.82	1.95
3	A-32	1.6	1119	3.99	1.07
4	A-33	1.5	1476	4.20	3.80
5	A-34	2.6	1667	7.02	2.40
6	A-35	3.3	1881	11.40	2.62
7	A-36	4.4	2095	10.40	2.58
8	A-37	2.4	2214	14.95	6.23
9	A-38	6.0	2500	18.35	3.06
10	A-39	11.4	2643	21.47	1.88
11	A-40	7.6	2786	26.85	3.53
13	A-41	0.3	762	1.20	3.99
14	A-42	0.8	1024	2.82	3.52
15	A-43	1.9	1238	3.90	2.05
16	A-44	2.4	1452	4.20	1.75
17	A-45	2.5	1643	7.03	2.81
18	A-46	2.8	1833	11.40	4.07
19	A-47	4.0	2048	10.40	2.60
20	A-48	3.7	2262	14.58	3.94
21	A-49	9.8	2524	18.03	1.84
22	A-50	8.3	2738	19.26	2.72

Run#	Fig. #	S.H.P. S.L. H.P.	RATE OF CONSUMPTION + 0.02 lbs./Hr.	S.S.F.C. S.L. lbs./H.P. Hr. + 1.2 lbs./H.P. Hr.
23	A-51	9.6	2810	32.93
25	A-52	0.8	810	0.73
26	A-53	1.2	1000	3.48
27	A-54	1.9	1238	3.78
28	A-55	2.1	1542	5.10
29	A-56	2.5	1667	5.10
30	A-57	3.4	1833	5.07
31	A-58	5.4	2071	15.72
32	A-59	4.8	2286	12.24
33	A-60	10.3	2524	14.73
34	A-61	11.8	2714	18.63
35A	A-62	8.1	2810	21.79
35B	A-63	7.7	2405	30.80
35C	A-63	8.0	2452	29.20
35D	A-63	---	2500	----

APPENDIX E

RECOMMENDATIONS FOR OBTAINING THRUST
USING THE ΔP METHOD

TABLE OF CONTENTS

<u>Section</u>	<u>Title</u>	<u>page</u>
E.	Introduction	E1
E1.	ΔP Set-up	E1
E2.	Theoretical Build-up and results	E4
E3.	Problems and Recommendations	E5

E. Introduction

Appendix E deals with the results and problems encountered in the use of the ΔP system for obtaining thrust. Section E1 will explain the set-up of the pressure measurement system. Section E2 deals with the theoretical build-up of why and what this system will do, plus it will show the results obtained. Section E3 will show the problems encountered and give a few recommendations on what should be done in the future.

E1. ΔP Set-up

The set-up of this system was developed such that pressure in front of the propeller and the pressure in back of the propeller could be measured. Figure E1 shows a schematic of the ΔP system. Figure E2 shows

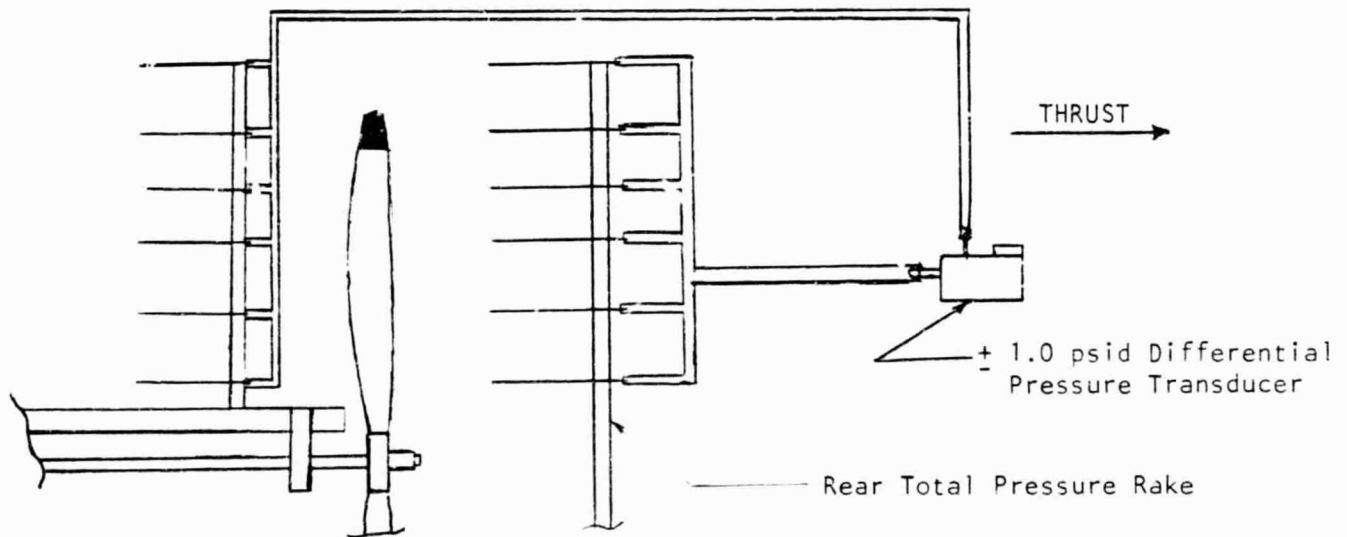

Figure E1 - Schematic of the ΔP measuring system

a photo of the ΔP system used and Figure E3 and E4 show the pressure ports in front and in back respectively. Each tube is placed such that the disk area that each tube occupies is equal. This was done so that all of the tubes could be converged into a single tube for the front rake and the rear rake. With single tubes for each rake, a ± 1.0 psid differential

ORIGINAL PAGE IS
OF POOR QUALITY

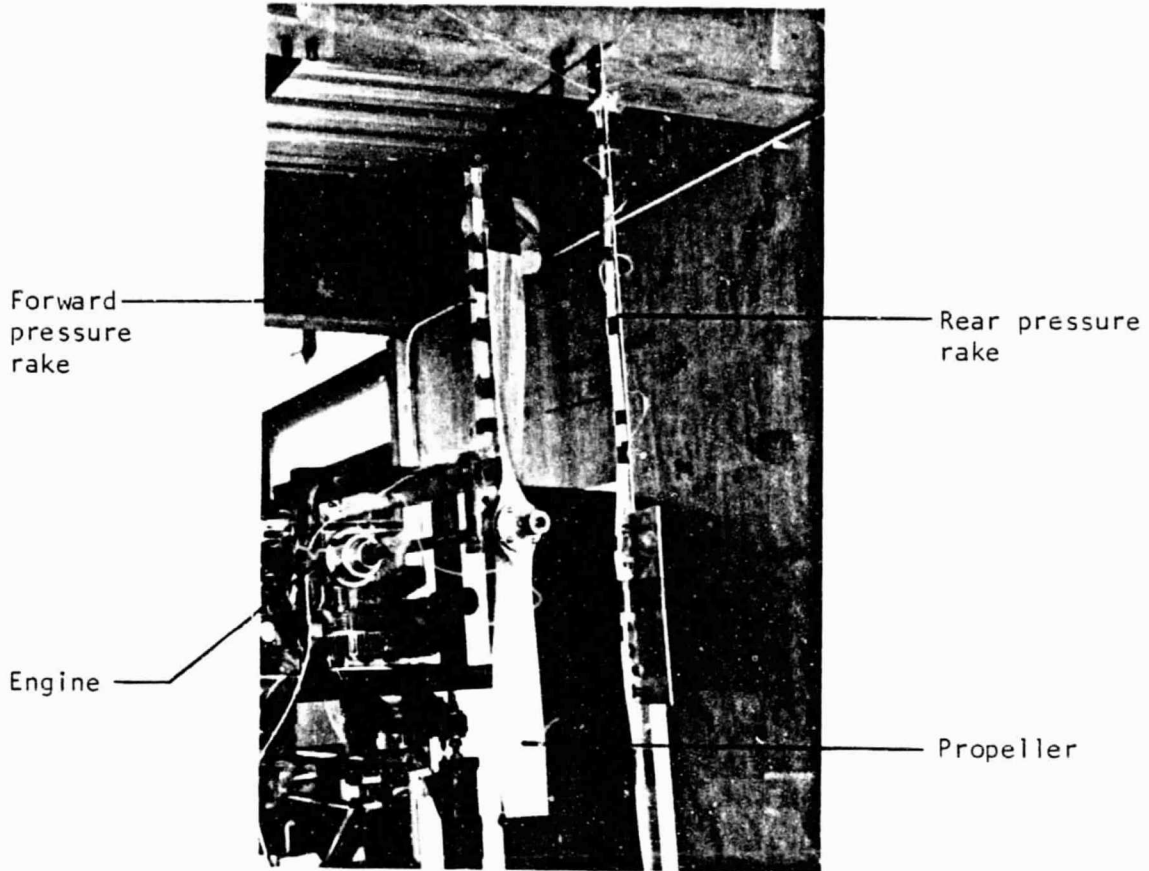
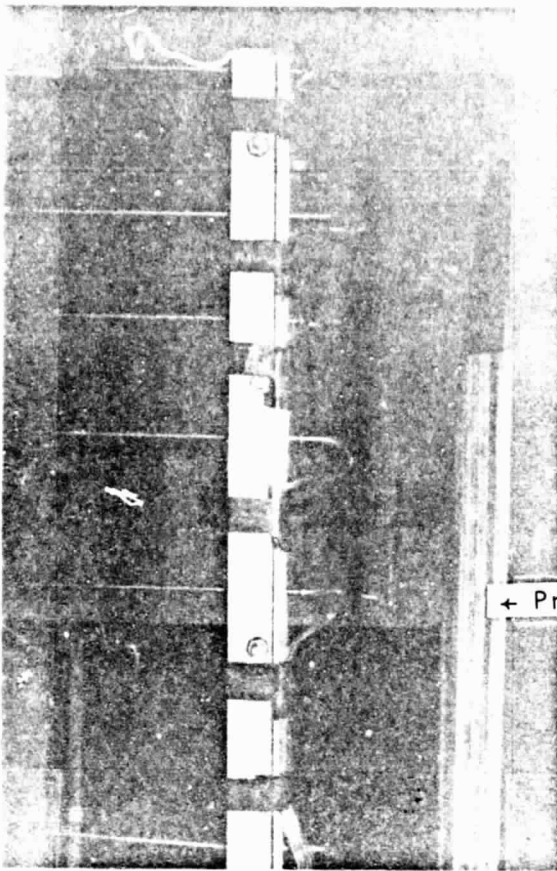

Figure E2 - Photograph of the ΔP System

pressure transducer was used to measure the ΔP . Note that the reason single tubes for each tube can be used will be discussed in Section E2. Figure E5 shows the pressure transducer used where the small diameter tube goes to the front rake and the large diameter tube goes to the rear rake. All of the pressure ports described above are total pressure ports.

ORIGINAL PAGE IS
OF POOR QUALITY



← Propeller →

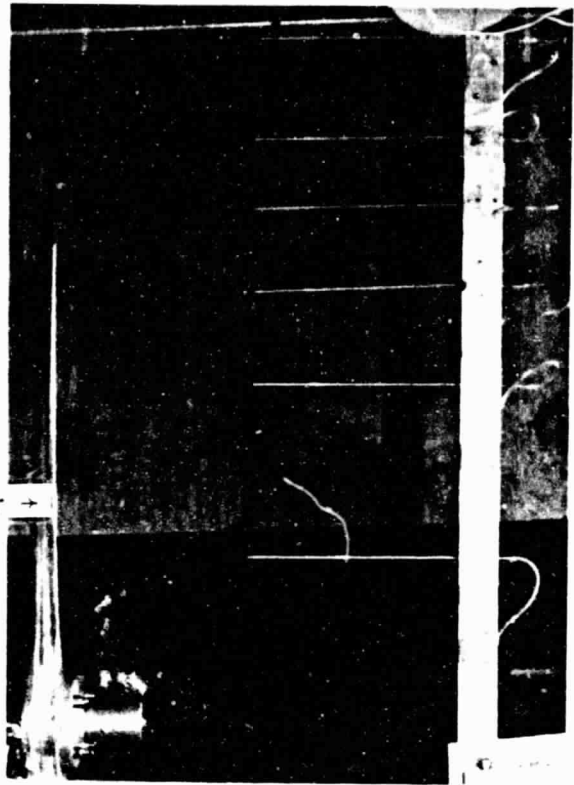
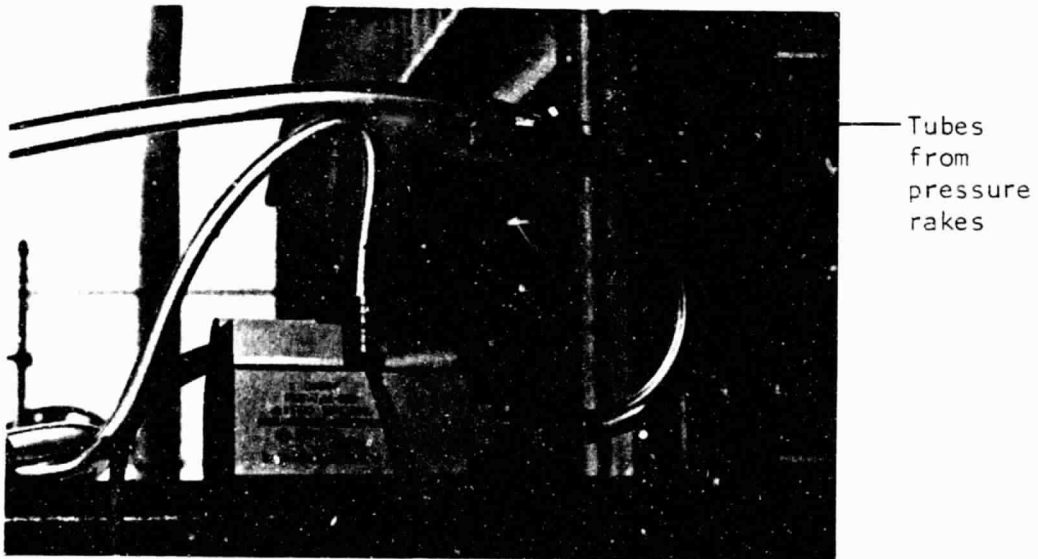

Figure E3 - Forward Rake against the Prop Blade

Figure E4 - Rear Rake against the Prop Blade



Tubes from pressure rakes

Figure E5 - Pressure Transducer Used to Measure ΔP

E2. Theoretical Build-up and Results

In the build-up of the theory used in obtaining thrust from measured values of ΔP , the method of Ref. 5 pg. 238 was used. The method itself is the incompressible momentum theory which makes the following assumptions:

- 1) Incompressible flow.
- 2) Irrotational flow.
- 3) Actuator disk is assumed to be uniformly loaded.
- 4) Actuator disk is also experiencing uniform inflow.
- 5) Static pressure does not change between measuring positions.

with these assumptions, the following equation can be used to obtain thrust:

$$\text{Thrust} = (A) * (\Delta P) \quad (E1)$$

Where: $A = \text{Actuator Disk Area (in}^2\text{)}$

$\Delta P = \text{Measured change in pressure through the propeller (lbs/in}^2\text{)}$

from section E1, the six pressure ports can be converged to a single tube because all six ports have the same prop disk area which means that the average of the pressures is the constant pressure loading for the entire disk, therefore the thrust can be obtained from equation E1.

Sample Calculation: Thrust from ΔP

Data from figure A37

$$\text{Thrust} = A * \Delta P$$

$$\text{Where: } A = 2290.22 \text{ in}^2 \\ \Delta P = .04492 \text{ psi}$$

$$\text{Thrust} = (2290.22) * (.04492)$$

Therefore:

$$\underline{\underline{\text{Thrust} = 102.9 \text{ lbs}}}$$

(E4)

Table E1 shows a culmination of the values of thrust extracted from the measured values of ΔP . Figure E6 shows the ΔP thrust as a function of propeller RPM.

E3. Problems and Recommendations

The problem that occurred was that the values of thrust obtained from ΔP values were not at all similar to the values obtained from the thrust stand (compare figure E6 to figure D1). After looking and rechecking, it was determined that the ΔP measuring system was not constructed correctly and therefore was giving erroneous readings.

Recommendations to obtain a feasible ΔP system in the future are as follows:

- 1) Instead of just a total pressure system, a combination static pressure and total pressure system must be used.
- 2) With the above pressure rake (from recommendation #1), and taking measurements at one RPM, measure each tube separately thus obtaining a radial pressure distribution.

the radial pressure distribution could be integrated obtaining the actual thrust at various RPM's.

ORIGINAL PAGE IS
OF POOR QUALITY

Figure #	mm from zero line	Pressure (psi) $\sigma_{\Delta P} = \pm 3.85 \times 10^{-3}$	Thrust (lbs) $\sigma_T = \pm 8.8$ lbs.	RPM ± 62.5 RPM
A41	2.2	.00710	16.3	762
A42	4.3	.01198	27.4	1024
A43	5.8	.01545	35.4	1238
A44	8.0	.02056	47.1	1452
A45	10.0	.02520	57.7	1643
A46	11.5	.02868	65.7	1853
A47	14.5	.03564	81.6	2048
A48	18.5	.04492	102.8	2262
A49	22.5	.05420	124.1	25.4
A50	26.5	.06348	145.4	273c
A51	28.0	.06696	153.3	281c
A52	2.8	.00849	19.5	810
A53	3.0	.00896	20.5	1000
A54	6.0	.01592	36.5	1238
A55	8.0	.02056	47.1	1524
A56	10.5	.02636	60.4	1667
A57	12.5	.03100	71.0	1833
A58	15.5	.03796	86.9	2071
A59	19.5	.04724	108.2	2286
A60	22.5	.05420	124.1	2524
A61	28.5	.06812	156.0	2714
A62	30.0	.07160	163.9	2810
A63	21.5	.05188	118.8	2405
A63	23.5	.05652	129.4	2452
A63	24.5	.05884	134.7	2500

Table E1 - Table showing the derived thrust obtained from measured values of ΔP .

Figure #	mm from zero line	Δ Pressure (psi) $\sigma_{\Delta P} = \pm 3.85 \times 10^{-3}$	Thrust (lbs) $\sigma_T = \pm 8.8$ lbs.	(RPM) ± 62.5 RPM
A1	3.0	.00896	20.5	881
A2	5.0	.01360	31.1	1214
A3	8.5	.02172	49.7	1524
A4	11.0	.02752	63.0	1738
A5	13.5	.03332	76.3	2048
A6	20.0	.04840	110.8	2286
A7	24.5	.05884	134.7	2524
A8	26.0	.06232	142.7	2714
A9	28.5	.06812	156.0	2810
A10	29.0	.06928	158.6	2786
A11	2.0	.00664	15.2	833
A12	4.5	.01244	28.5	1143
A13	8.0	.02056	47.1	1500
A14	10.5	.02636	60.3	1690
A15	12.0	.02984	68.3	1810
A16	15.5	.03796	86.9	2071
A17	18.5	.04492	102.8	2338
A18	---	---	---	2429
A19	25.0	.06000	137.4	2619
A20	27.5	.06580	150.7	2786
A21	2.0	.00664	15.2	881
A22	5.0	.01360	31.1	1214
A23	8.2	.02102	48.5	1524
A24	10.0	.02520	57.7	1762
A25	12.8	.03169	72.6	1929
A26	15.0	.03680	84.3	2119
A27	19.7	.04770	109.2	2381
A28	24.5	.05884	134.7	2643
A29	27.5	.06580	150.7	2786
A30	2.3	.00733	16.8	714
A31	4.0	.01178	25.8	952
A32	5.5	.01476	33.8	1119
A33	10.0	.02520	57.7	1476
A34	11.0	.02752	63.0	1667
A35	14.0	.03448	78.9	1881
A36	16.5	.04028	92.3	2095
A37	18.5	.04492	102.9	2214
A38	22.0	.05304	121.5	2500
A39	25.0	.06000	137.4	2643
A40	29.0	.06928	158.7	2786

(E6)

ORIGINAL PAGE IS
OF POOR QUALITY

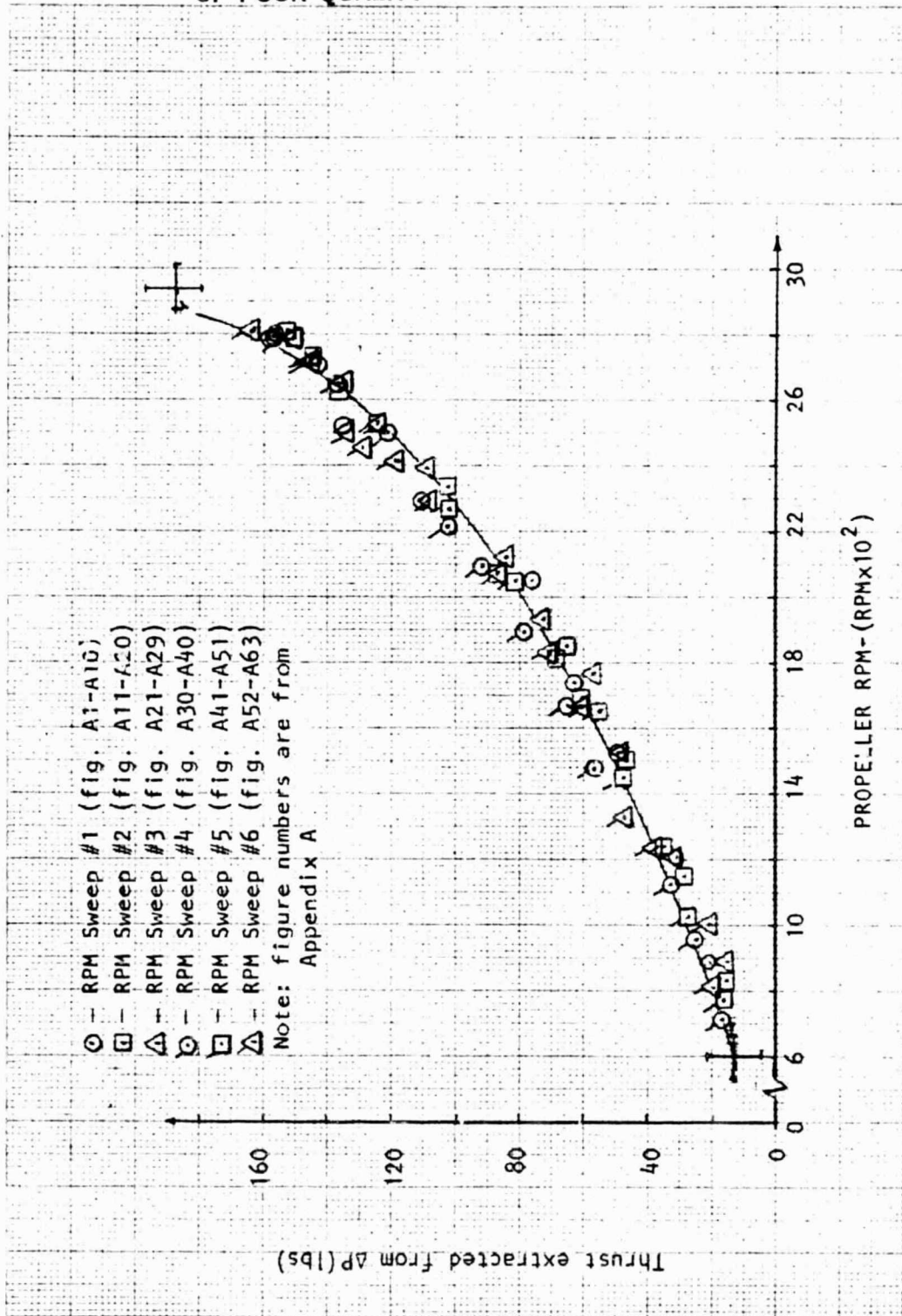

CALC	Blacklock	10/9/83	REVISED	DATE	Figure E6 - Thrust as a function of the Propeller RPM where thrust was obtained using the ΔP through the Propeller.
CHECK					
APPD					
APPD					
UNIVERSITY OF KANSAS					PAGE E7