

NASA TM-76973

NASA TECHNICAL MEMORANDUM

NASA TM-76973

NASA-TM-76973 19840010085

CONCORDE AND THE AERONAUTICAL RESEARCH

M. Salmon

Translation of "Concorde et la recherche aéronautique", L'Aéronautique et L'Astronautique, no. 11, No. 1969-4, p. 7-20, 1969

LIBRARY COPY

SEP 2 1982

LANGLEY RESEARCH CENTER
LIBRARY, NASA
HAMPTON, VIRGINIA

NATIONAL AERONAUTICS AND SPACE ADMINISTRATION
WASHINGTON D.C. 20546
AUGUST 1982



NF00283

1. Report No. NASA TM-76973	2. Government Accession No.	3. Non-Publication Statement
4. Title and Subtitle CONCORDE AND THE AERONAUTICAL RESEARCH	5. Date August 1982	6. Performing Organization Code
7. Author(s) M. Salmon	8. Performing Organization Report No.	9. Work Unit No.
10. Performing Organization Name and Address Leo Kanner Associates Redwood City CA 94063	11. Contract or Grant No. NASW-3541	12. Type of Report and Period Covered Translation
13. Sponsoring Agency Name and Address National Aeronautics and Space Administration, Washington DC 20546	14. Sponsoring Agency Code	
15. Supplementary Notes Translation of "CONCORDE et la recherche aeronautique," L'Aeronautique et L'Astronautique, No. 11, No. 1969-4, pp. 7-20, 1969. (A69-33380)		
16. Abstract This report surveys the theoretical and experimental work carried out which led to the conception and the main technical solutions included in the design of Concorde.		
17. Key Words (Separated by Author(s))	18. Distribution Statement Unclassified - Unlimited	
19. Security Classification (of this report) Unclassified	20. Security Classification (of this page) Unclassified	21. Security Classification (of this page)

N-153,299
N84-18153#

ABSTRACT

This paper, essentially historical, gives a survey of theoretical and experimental work carried out in various research centers, and particularly at ONERA, which led to the conception and to the main technical solutions included in the design of Concorde: plan form twist and camber of the wing, lift augmentation by upper surface vortices, kinetic heating, air intakes and jet exhausts, materials, aeroelasticity. The development of research, and the numerous tests carried out for the benefit of the constructors since the beginning of the project, are also outlined.

CONCORDE AND THE AERONAUTICAL RESEARCH

M. Salmon
ONERA

It is commonly said that the Concorde is an entirely new 7* type of aircraft; some people even say it is "revolutionary". It is true, that for this aircraft more than for any other, manufacturers and researchers have united their talents and efforts. For the first group, the goal was to discover new, although somewhat esoterical knowledge, found in the back corners of laboratories. For the second group, the goal was to leave their discussion parlors and to plunge headlong into practical realities.

The need for a link between laboratory and research institution, indeed between the mathematician's blackboard and the factory, did not start with the Concorde. Many years ago, most countries making aerospace materials started organizing national Centers where designers and manufacturers became accustomed to rubbing elbows, and if not to speaking the same language, at least to learning the language of their associates and their thinking processes: in the United States, N.A.C.A.'s laboratories were absorbed by the gigantic N.A.S.A. ten years ago; in Great Britain, the venerable, and still young Royal Aircraft Establishment; in the U.S.S.R., the Z.A.G.I., in France, ONERA. Germany, Japan, Canada, India, and other nations have also created such centers, either in several units, or by regrouping existing teams into a single institution.

To distinguish in a new project what belongs to research and what aspects the manufacturer has contributed is sometimes quite delicate. This is because the action of researchers takes place at very diverse levels, among which three are distinguishable:

BASIC RESEARCH

This may be defined as an action conducted outside of any

*Numbers in the margin indicate pagination in the foreign text.

project. Without tracing the Concorde back to the work of Euclid or Newton, or even Joukowski, it may still be asserted /8 that certain efforts, which aim to improve the quality of wings or of supersonic air intakes, to give us more knowledge of the laws of kinetic heating, or to perfect the analysis of structural vibrations during flight, belong to this basic research. Such efforts have no specific application and institutions like ONERA incorporate them within its ongoing programme independently of any aircraft project. Even better, it may be asserted that the manufacturer, and the Public Services in charge would be able to foresee the potential of initiating an aircraft study, only if satisfactory answers to new questions raised by the project can be found in current literature of that time.

APPLIED RESEARCH

Once the broad outlines of the new aircraft have been traced, difficulties do not fail to appear. It is when investigations are conducted without a well-defined objective, that loopholes tend to appear, or they do not merge at the same point of perfection, in spite of efforts made by research institutions to give them a direction. Accordingly, air intakes may be well-defined, whereas studies of jet exhausts are just starting. We also see the manufacturer turn to the researcher, while a new project is being formed, either to extend a study already being conducted, or most often, to pursue a general study in more detail and in a well-defined direction, in order to determine the specific elements needed for defining new equipment. This is where a National Research Center is indispensable, because if the manufacturer is able to find the results of general studies in publications, he can find complementary information specific to these results only in institutions directly involved in the project.

DIRECT ASSISTANCE TO THE MANUFACTURER

It is obviously the manufacturer's responsibility to select

from known solutions those which are the most suitable for the system he wants to build. He is also responsible for checking out the validity of his own studies. However, it so happens that in order to carry through its studies, the research institution has to perfect and build certain equipment for its own use. Moreover, this equipment is sometimes too bulky, i.e. large windtunnels, for an industrialist, so that a research center is called on to assure the construction and management of this equipment. Accordingly, this research center makes available to the manufacturer all of its research means.

These applied research actions and direct aid, moreover, often tend to become undistinguishable, because an analysis of industrial type tests by a mind filled with research notions can result in helpful proposals offered to the manufacturer permitting considerable improvements to his project.

Accordingly, the research, kept by the nature of things away from the public, penetrates the deepest aspects of the manufacturer's actions; here lies its nobility, and also its justification.

A FEW DATES

In the light of the preceding considerations, a few dates should be retained in order to have a better understanding of the role taken by research efforts in the development of the Concorde.

1956 - Creation of the British Research Committee on Supersonic Transport Aircraft (STA).

May 21, 1959 - First meeting of representatives from ONERA and manufacturers at A.F.I.T.A.E. to discuss the possibility of building an STA in France. Analysis of existing publications (mainly American).

November 27, 1959 - Le Service Technique (Aeronautical Technical

Department asks the various French manufacturers for STA project plans, and gives ONERA the responsibility of conducting more thorough studies on wing shapes, air intakes, low speed flights, etc.

March 18, 1960

First official meeting between France and Great Britain at Farnborough, R.A.E.: comparison of results of preliminary studies conducted in both countries.

October 13, 1960

Second Franco-British meeting at ONERA: presentation of recent results obtained.

1961

Resumption of a systematic exchange of ideas between Official Departments, RAE and ONERA. Agreements between BAC, SUD-AVIATION, BRISTOL and SNECMA for a joint project.

November 29, 1962

Agreement between the British and French governments pertaining to the construction of Concorde prototypes.

When the German engineer, A. Lippisch drew attention on the /9 benefits of a delta wing in 1929, particularly for supersonic flights, the formual attracted many manufacturers: as soon as 1949, the author used it for a supersonic anti-aircraft missile; in the years that followed, numerous projects of military aircraft equipped with this type of wing saw their beginnings, and even today, our Mirage III and IV form the basic structure of several air forces.

Even if a simple wing could be adapted to an interceptor, or even to a bomber with a maximum supersonic flight of 30 minutes, it could not be adapted to a long range transport aircraft, for which the conditions of economy are vital. To improve the qualities

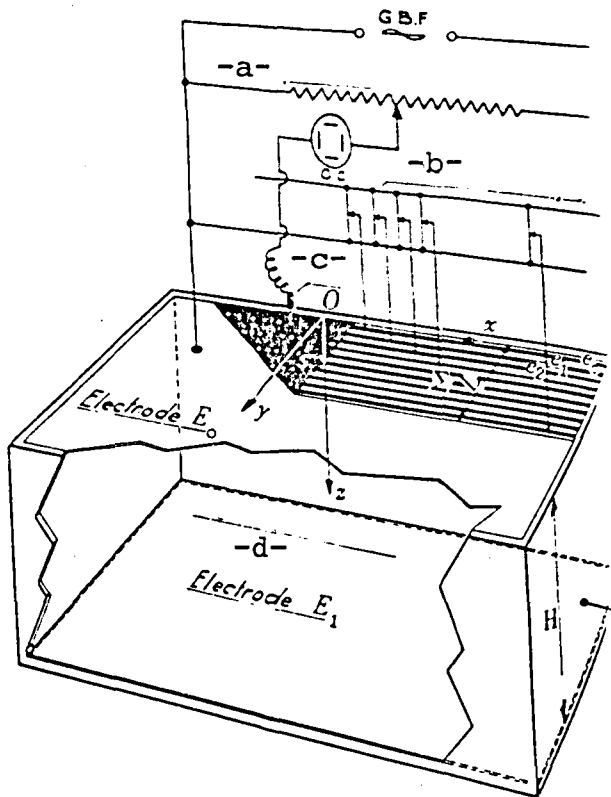

Figure 1 - Determination of the characteristics of a delta wing by electrical analogy with the hydraulic tank (1955).

Key: a-Measurement Potentiometer;
 b-Setting Potentiometer; c-Probe;
 d-Electric Tank.

Without computers, which saw their beginnings only later, ONERA decided to perfect considerably the methods of electrical analogies, created in 1930 by J. Pérès. In 1955, L. Malavard [10] and his ONERA team (figure 1).

Along with the design of wing plan shapes, these works brought to light the advantage of providing a conical camber at the leading edge. This solution, presented already in 1955 by L. Malavard (Fig. 10 E), was to be applied to the Mirage III and Etendard IV aircraft to improve the flight qualities and aerodynamic fineness. It became known to the public only five years later [11].

of the formula, it was first necessary to understand the mechanism of the flow about the wing, and the fuselage that accompanies it. An essential phase of this work was completed when, in 1949, P. Germain established a general theory of conical motions [7] and its generalization to homogeneous flows [8].

In 1951, R. Legendre explained the problem of transonic flows about wings with strong sweepback [9].

These theories could be applied only if they were accompanied by numerical calculations.

The study of the adaptation of airfoils to supersonic flights led in 1956 to a combination of the camber and an overall twist of the airfoil chords along the span (figure 10 F). These results were made available to French manufacturers in 1958 [12] and were not published until three years later. Windtunnel tests, performed in 1956, on a delta wing with a 60° sweepback and in the presence of a schematic fuselage, have confirmed the theoretical fineness gain in cruise flight configurations compared to the flat wing balanced by elevons.

The problem of the adaptation of the wing in the transonic range was treated in 1960 for the wing by itself by R. Legendre [13] and in 1961 for a wing-fuselage combination by P. Bevierre [14]. A verification in the windtunnel on a gothic wing again confirmed the expected fineness gain.

The results thus obtained in the three main flight ranges have been compared, and a compromise was searched for in the light of a possible application of these investigations to a supersonic transport aircraft. The results of these works have been made available to French manufacturers. After defining the plane shape of the wing in conjunction with British researchers, the fundamental solution has been applied to this shape in 1963 (figure 10 K), and the results have been adopted for the aircraft project.

The study of the shape of the Concorde wing is a good example of an investigation which, beginning in an academic form, gradually took on a more precise form while an aircraft project outlined itself, and thus made it possible, when the time came, to give the manufacturer the indispensable elements for selecting the configuration of his project. This is also an example of the enrichment made possible by a confrontation of works conducted by two national teams of researchers and experimentalists.

FRICITION DRAG

Another area where the basic works of ONERA have made contributions right from the project plan stage of the STA is that of turbulent friction with a high Reynolds number in transonic and supersonic flights. The significance of its calculation may be realized by recalling that in supersonic cruise flights, the friction contributes about one-third to the drag.

The formulas established by R. Michel [15] have been used for the Concorde by Sud-Aviation, whereas BAC used the results of British works. Some differences appear between the two solutions, and we will have to wait for the sanction of complete flight tests to know which one approximates reality the most.

Meanwhile, in 1966, the Service Technique Aéronautique (Aeronautical Technical Department) put ONERA in charge of a windtunnel and flight experimentation, in order to give a final analysis of the boundary layer on the upper surface of a wing. A special device has been installed on a Mirage IV at the Flight Safety Center of the Dassault Company, and measurements were taken from Mach 0.9 to Mach 2.1 at altitudes varying from 6 to 15 km (figure 10-0).

APEX VORTICES

It is well-known that a slender wing with strong sweepback may attain considerable incidences, of about 30°, prior to its stall; but such incidences are not usable for approaches (visibility), and even less for landing (ground guard). A maximum incidence of 12° had been set for the Concorde project, which led to a small lift factor for a wing with such a small aspect ratio and which had not horizontal stabilizer to balance a hyper-sustention with flaps.

The problem of low altitude flights would have been unsolvable without the discovery and systematic use of vortices in a

"horn" pattern which appear on the upper surface of delta wings as soon as moderate incidences occur.

Within the framework of a systematic experimental study aiming to improve supersonic flights, ONERA had as early as 1950 undertaken windtunnel tests on pure or scalloped delta wings at the trailing edge, called "swallow tail". Regions of depression were thus found on the top skin during subsonic flights and at mean and high incidences. A grid of wool threads, placed behind the wing or in the vicinity of its trailing edge, brought to light (1951) "horn-pattern vortices" whose path was completely analyzed (figure 2).

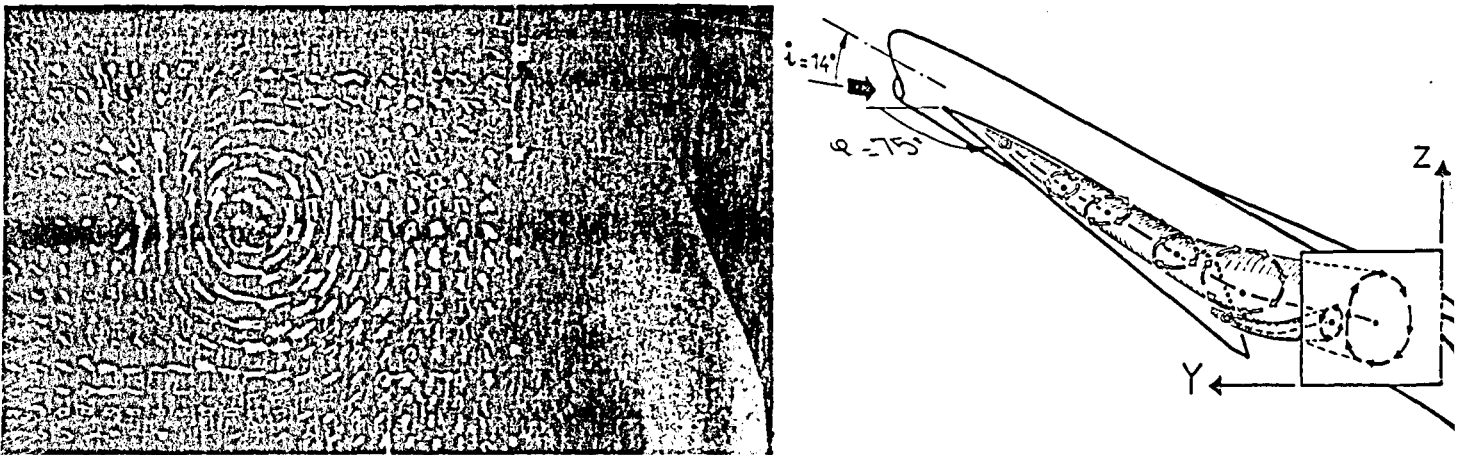

Figure 2 a-b - First detection of upper skin vortices in a "horn pattern" on stream-lined wings at the Windtunnel of Cannes (1950).

The theoretical study of these vortices could therefore be started, and was made public in 1952 by M. Roy and R. Legendre [16 - 17]. Experimental observations were very actively pushed forward in all countries, and particularly in France at ONERA which used the hydrodynamic tunnel built during this period to visualize flows about models by means of various processes [18] (see photo on the cover). The stationary or animated images of this tunnel taken by H. Werle are so striking that they have been reproduced in very numerous French or foreign publications - and often without reference to their source. A full study of the

question was published in 1957 [19].

In 1951, ONERA had decided to build a small experimental aircraft, called Eltaviex (figure 3) to perform windtunnel and flight tests in order to complement the knowledge on low speed delta wings. The few very short flights made by this aircraft in 1954 made it possible to check the results obtained by theory or windtunnel testing.

Systematic tests of these vortices in a subsonic windtunnel brought to light that they became more established and more stable as the leading edge became sharper. After the first tests on an aircraft shape, provided for Mach 3 with 75° sweepback (figure 10A), and those of the Deltaviex with a sweepback limited to 70° (figure 10 B), an investigation was made to find formulas providing a better lift, and adapted to flight with Mach 2. This led to a reduction of the sweepback to 60° ; however, to assure a satisfactory stability of the vortices, the idea came up to keep a very sharp sweepback at the apex of the wing, although the first studies on plan shapes brought to light the opportunity of cutting the wing tips. Thus, in 1952, a wing shape was tested (figure 10 C) that already presented the main characteristics of what was to be, ten years later, the Concorde wing.

If theoretical findings were able to predict the existence of apex vortices in subsonic states, it did not foresee their appearance in supersonic states.

A windtunnel test showed that these vortices actually disappear progressively, as the shock wave approaches the leading edge, and that they do not last when the latter becomes supersonic, because it is hit by the shock wave from its apex (figure 10 D).

Apex vortices of tapered wings have since their discovery been the subject of numerous investigations in all countries.

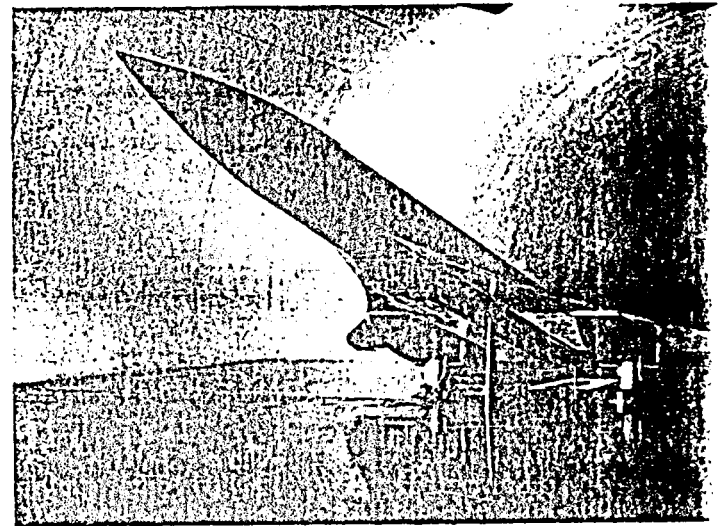
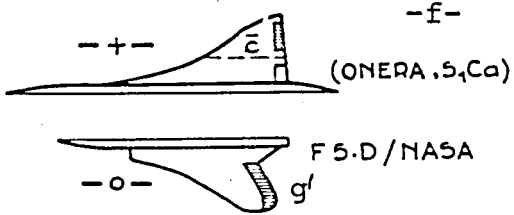
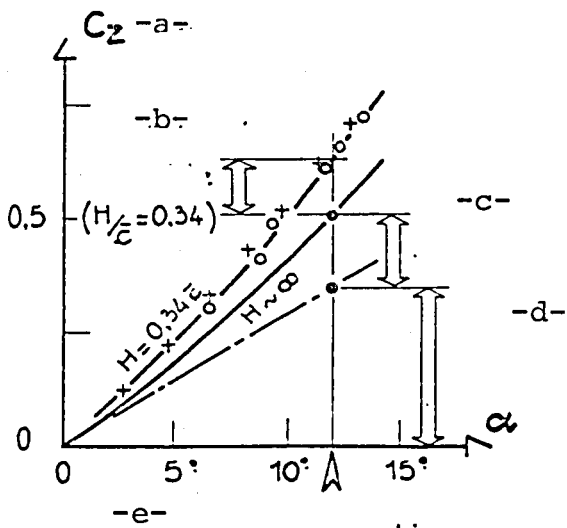
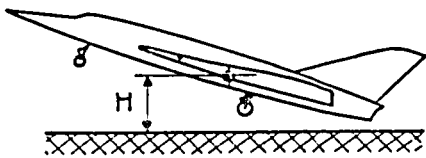
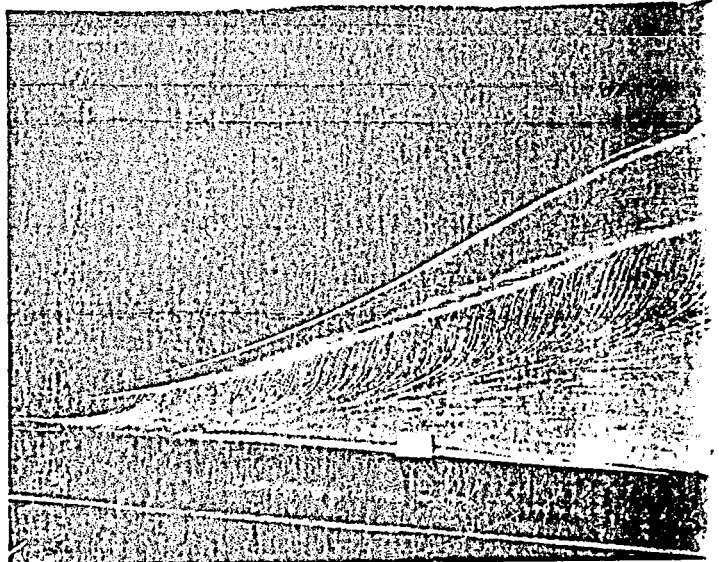
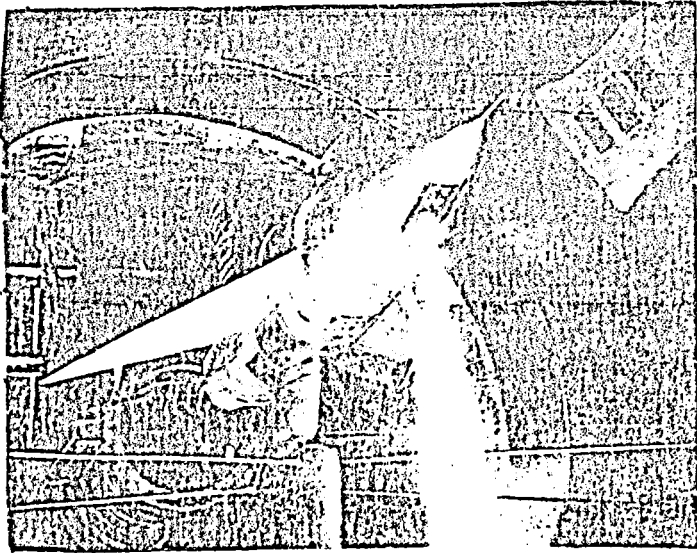

3	5
4	6

Fig. 3 - Testing of the Deltaviex aircraft in the large windtunnel of Modane-Avrieux. Firing of a propellant booster in order to determine the unsteady coefficients (1953).

Fig. 4 - Lift gains on an aircraft with ogival wing due to upper surface vortices and ground effects.

Fig. 5 - Parietal visualization of upper surface vortices owing to viscous layer, at the large wind-tunnel of Modane-Avrieux.

Fig. 6 - Measurements of ground effects at the windtunnel in Cannes (1961).

Key: a. Balanced; b. Favorable ground effect; c. Vortex lift; d. Linear lift; e. Approach incidence; f. CONCORDE shape; g. (Flight Tests).

It was indeed essential to know their characteristics at various incidences for diverse wing shapes and their possible variations as a function of the Reynolds number: as a matter of fact, these vortices branch after a certain distance, and the lift gain disappears locally. If such a branching appears before the trailing edge, the longitudinal stability of the aircraft becomes altered. Large scale investigations could be performed only in a windtunnel where vortices are much harder to observe than in an hydrodynamic windtunnel. However, ONERA developed a visualization procedure where the surface of the model is coated with a viscous product whose deformation from air effects leaves, after the test, an outline of the flow in the wall (figure 5).

On traditional aircraft having a wing lift augmentation with a high aspect ratio, the ground effect is generally unfavorable. Conversely, it leads to a noticeably greater lift on delta wings with a low aspect ratio. Consequently, the ground effect on these types of shapes has been studied in the windtunnel at ONERA in 1961 (Figure 10 J). This study has been resumed in detail in 1963 using a Concorde model, and the extremely favorable results observed (see figure 4) have been confirmed during flight tests performed by NASA on an F.5.D aircraft specially converted for this confirmation using the mounting of a wing with the same shape as the Concorde wing (figure 6). /11

KINETIC HEATING /12

It is a known fact that the Mach number for cruise flights, and to a certain degree, the permissible duration of supersonic flights, are limited in a STA by thermal problems. It was therefore indispensable to have fairly accurate knowledge of local temperatures reached during flight, by calculating the corresponding thermal flows, in order to define the aircraft project.

The first calculations of the Concorde were performed using more or less empirical heat transfer formulas, and it quickly became obvious that its validity had to be checked. In 1962, Sud-Aviation's technical department put ONERA in charge of conducting

an investigation in this regard (figure 10 M). In order to carry it through, a wing of simple shape and construction was fitted with several thermocouples, and was tested at Mach 2.2 in wind-tunnel S3 at Modane-Avrieux (SA MA), where real temperatures are used.

The results obtained (figure 7) have shown that the formulas

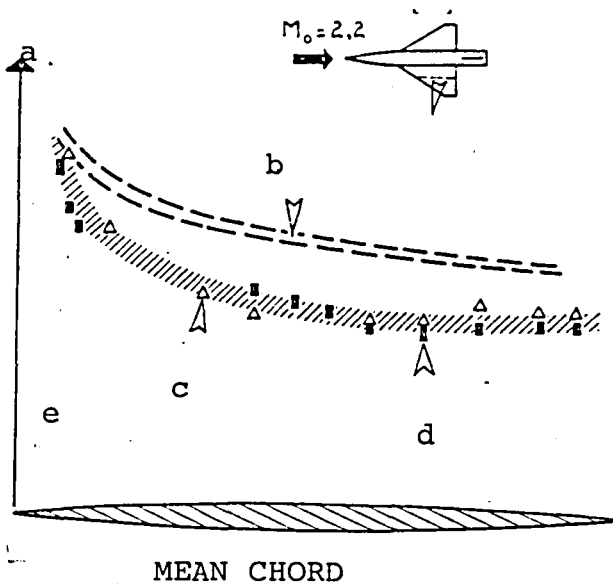

Figure 7 - Kinetic heating on a delta wing at 60° , Mach 2.2: calculation, windtunnel and flight tests.

Key: a. Heat flow; b. Calculation; c. Flight; d. Windtunnel; e. Leading edge.

used did not accurately account for real conditions. However, no matter how carefully the windtunnel tests are carried out, they most likely do not match the real phenomena observed in flight, particularly due to the considerable difference of scale of the turbulence of the two cases. Accordingly, whereas the British modified their supersonic experimental aircraft, the Fairey-Delta, by equipping it with a wing like the Concorde's, ONERA built a rocket missile with three stages, the D-6 (figure 8), which carried a wing on three points similar to that which had been tried at S3 MA. The information obtained using telemetry during the flight stabilized at Mach 2.2 at an almost constant altitude, was very similar to that obtained on the ground (figure 11), thus making it possible to count on the validity of further windtunnel tests. At the same time, the heat transfer formula used to calculate kinetic heating could be corrected to account for the results obtained [20].

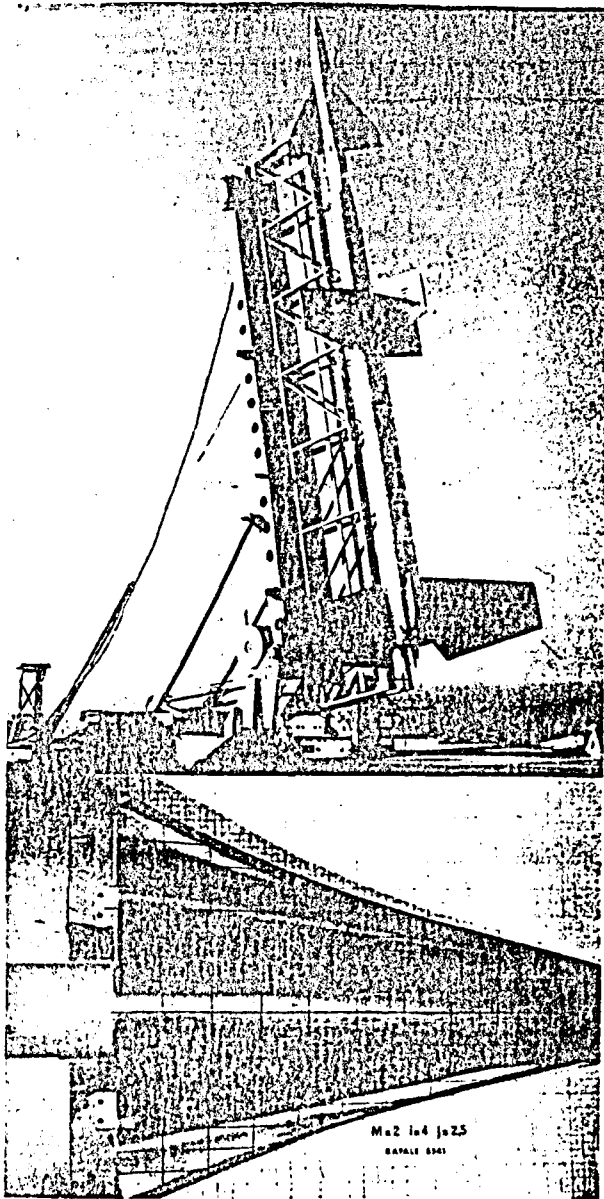

Fig. 8 - D-6 Rocket for studying kinetic heating at Mach 2.2 (1963).
 Fig. 9 - Supersonic windtunnel study of kinetic heating using thermo-sensitive paints.

As useful, or even as good as a theory might be, it is not sufficient for drawing a detailed map of temperatures reached during flight, because there is always the risk of local heating that may present a danger for the structural behavior. Windtunnel tests, with measurements using thermocouples, are faced with the same problem, because there is a risk of not providing for a measuring point in the hazardous region. This is why ONERA has perfected a method of visualizing the heating by using thermo-sensitive paints on models specially built in highly insulating plastics (figure 9). The information, even if it is purely qualitative, thus obtained makes it possible to concentrate the detailed study on the most interesting areas.

INVESTIGATION OF FLIGHT QUALITIES /1

In 1958, when the question came up of the possibility of drawing a supersonic aircraft, ONERA undertook the examination of the possible consequences of applying its previous research findings to an overall project. This task was assigned to Ph. Poisson-Quinton and his collaborators [2].

A first study pertained to longitudinal balancing and hyper-sustentation, in a subsonic windtunnel, of an aircraft with simple

delta or ogival wings, fitted either with elevons, or with a tail unit, or a duck tail (fig. 10 H). It was found that an upward deflection results in a vortex lift, whereas a downward deflection increases the fineness ratio [20], using the same flap in the direction of the adaptor camber. This solution was not retained by the constructors, owing to the mechanical complications it would have caused.

The design of the Concorde wing was finalized only after a systematic study, first by calculation, then in the windtunnel, of a large number of solutions in which the variable parameters were the sweepback angle, the relative wing thickness, the relative diameter, the length of the fuselage nose, the wing load, the altitude, the Mach number (fig. 10-1). At the same time, the possible effects of suction at the leading edge were investigated [see reference 2].

Original solutions were also found for the lift augmentation at low speeds: first, (fig. 10 L), an eclipsable tail unit was proposed [22] which, located at the exhaust, made it possible to balance the aircraft in the presence of the traditional trailing edge flaps on the wing. In supersonic flight, the eclipse of the tail unit made it possible to eliminate the transonic recoil from the wing center, so that this type of a solution would make it possible to avoid the fuel transfers provided for on the Concorde during the sonic speed transition. Moreover, (fig. 10 N), it was verified that a ventral flap, located between the nacelles, would have substantially increased the lift without affecting the aircraft balance [21].

The Concorde constructors have not retained these solutions which risk complicating this particular project, but which may possibly be valuable for future projects.

AIR INTAKES

It is perhaps by its studies on jet engine air intakes that ONERA has played to most basic role in the Concorde design. We know how essential the quality of the air intake is on the power balance of a supersonic vehicle. actually the flight speed increases with the compression part assured by this part of the power nacelle.

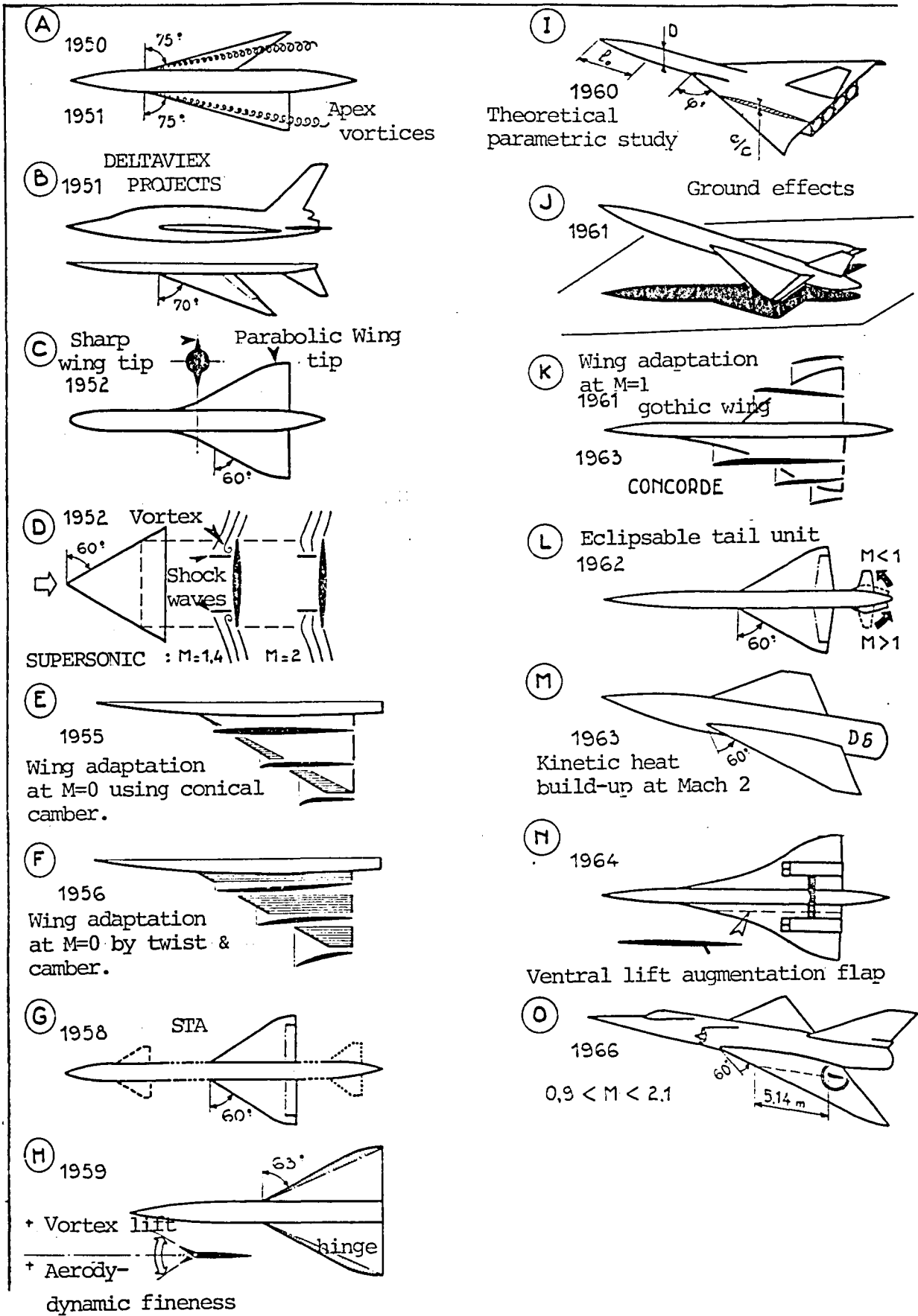

Figure 10-A-0 - Background of ONERA Research on Slender Wings.

ONERA's interest in this problem dates back to 1949 when a publication appeared on this subject [23]. Afterward, within the framework of a study on ram jet engines, then on air scoops for Mirage type aircraft, the study of high speed air collectors was extended in more detail.

It thus came to light that in order for a jet aircraft to be correctly powered in all conditions of jet speed and range, it was indispensable to design an air intake of variable geometry. The latter was characterized not only by the variation of the sonic intake section, but also by the elimination of the internal boundary layer in the vicinity of this section.

To facilitate the study and development of these solutions, by analyzing in detail the complex phenomena involved, such as interactions between shock waves and boundary layers, P. Carrière and J. Lynaert had the idea of making a two-dimensional air intake with transparent lateral walls (fig. 11 & 12). This formula has the advantage of facilitating the mobility of the adjusting parts, and enabling the air intake to be installed on the wing

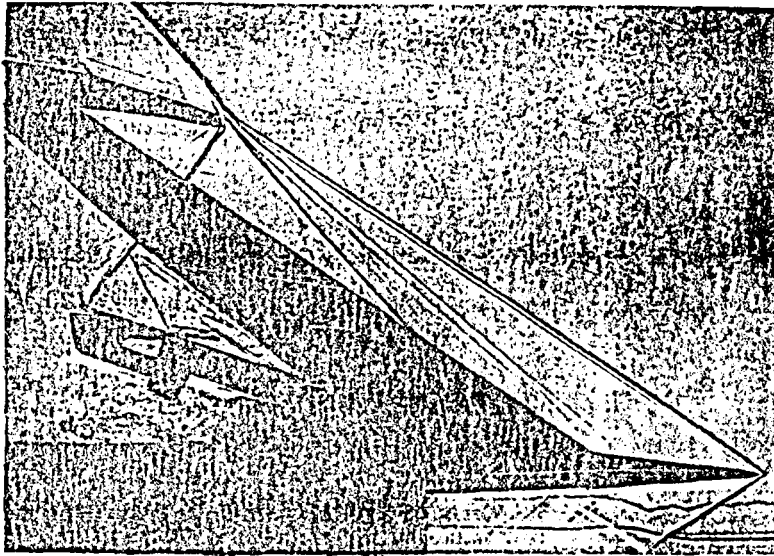

Fig. 11 - Study of a supersonic air intake with internal boundary layer trap on a transparent model (1962).

Fig. 12 - Air intake testing device (1962).

undersurface where it profits from a first compression due to the lift itself of the wing [24-25].

It was in this way that, right from the very first contacts made with French manufacturers (1959) and British officials (1960), ONERA was able to give an original solution to the crucial problem of air intakes, which was immediately adopted. Naturally, the final sketch of the front part of the power nacelle needed to undergo numerous complementary investigations, and here again, ONERA took an important role. It was necessary, for example, to perfect the auxiliary intakes for low speed flights, to study possible interferences between two adjacent intakes, either by cross winds, or if one of the jet engines fails, and lastly to observe on large scale models the full flow in the presence of the real front shape of the wing and of the fuselage, for all possible aircraft speeds. The benefit of such a study is that we can thus be hopeful to obtain qualities of the production aircraft that are superior to those of the prototypes, which had to be sketched out already many years ago.

JET EXHAUSTS

ONERA has conducted in-depth studies on the interference of concentric supersonic jets [26]. In a related area, P. Carrière and M. Siriex explained the problems of tail bodies and refixing the external flow in a supersonic flow [27].

When the problem of jet exhausts, however, was presented for the Concorde project, investigations on either side of the Channel proved to be inadequate, and a special effort had to be made at the level of those concerned with the air intake. Accordingly, ONERA perfected a windtunnel mounting making it possible to measure, with a great deal of accuracy, the thrust of one, two or three concentric jets in an external flow, itself being supersonic or subsonic [28] (figure 13). The major difficulty lies in the dissipation needed between stresses due to the supply of internal

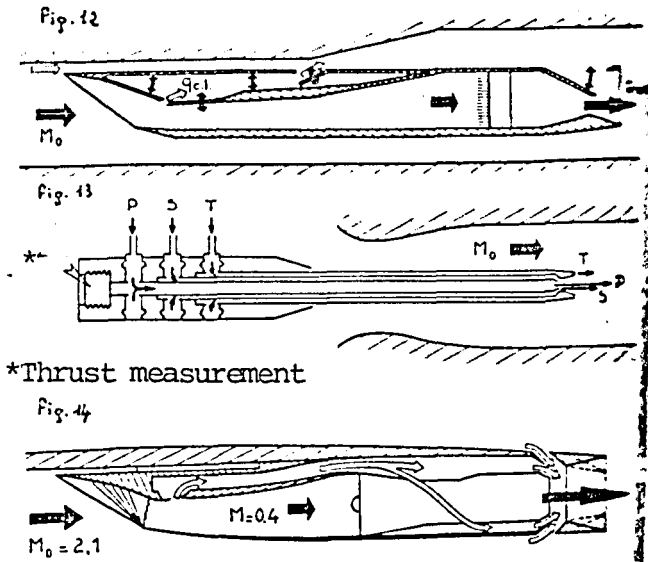

Fig. 13 - Scale for measuring in the windtunnel the thrust of multiple concentric nozzles (1964).
 Fig. 14 - Power nacelle sketched by the manufacturers (B.A.C. - Sud-Aviation - S.N.E.C.M.A).

flows and thrust measurements. A first scale, of small dimensions, as first used in the supersonic windtunnel S5Ch of Chalais-Meudon. Another one was used in the transonic windtunnel S3Ch. These scales have made it possible to perform a systematic study of double or triple concentric jets, with simplified tail-body configurations, in conjunction with the solutions proposed by the manufacturers and the helpful collaboration of SNECMA.

In conclusion, British and French manufacturers were able to make an overall sketch of the power nacelle, in which the detachable external and internal openings of the air intake and the tail part of the nacelle were defined for all speeds and all possible ratings of the jet engine. This widely published diagram has become a classic (figure 14).

MATERIALS

When we recall that the cruise speed of the Concorde is limited by the hot behavior of its aluminum alloys, which its structure is made of, and that the thrust of its jet engines depends largely on the maximum permissible temperature at the intake of their turbines, we realize the importance of investigations on the materials used.

Perhaps more than any other discipline, metallurgy requires long deadlines to carry out its study. Let us simply mention that at ONERA several hundreds of various alloy specimens have been under tensile stress at a constant temperature for several years for the purpose of studying their creep properties [29].

Furthermore, light alloys have reach such an advanced stage that they can be upgraded only after an extremely fine investigation. This is why, when manufacturers were deciding on what shade to use, they opted for a well-known British alloy, RR 58 (AU2GN in French) [30], the best available alloy on the market at the time. However, the work of ONERA on the shade AU6MGT, which is very promising, is still being carried out actively, and we are hopeful that tomorrow's versions of the Concorde will profit from it.

In the area of refractory alloys, and specifically their protection at high temperatures in an oxidizing environment, the work of ONERA, carried out by Ph. Galmiche, is very old. It has been only very recently, however, [31] that the research developments specific to the use of gas turbines have seemed so interesting that several engine manufacturers, particularly in the United States, have applied them in a systematic manner.

UNSTEADY AERODYNAMICS

/16

In order to determine the dynamic properties of an aircraft, it is indispensable to know the aerodynamic "derivatives", i.e. the forces and moments due to the variation in time of its position relative to air. The measurement of these properties has been undertaken a very long time ago at ONERA [32], either by using the method of sustained oscillations, or by the method of free oscillations, in which the aircraft response to the relaxation is analyzed on the basis of an initial position not in balance (see figure 3).

The theoretical studies, including the calculations using the electric analogy [33] and on a simulator, have been pushed ahead concurrently with experimental work performed in the windtunnel and in flight, and extended to the transonic and supersonic domains. It has thus been possible, since 1959, to provide precise indications relevant to the delta wings, although in 1963 and in 1964, full information on the shapes retained for the Concorde have been made available to the manufacturers. Accordingly, they had at

their disposal all the elements needed for calculating the dynamic flight qualities of the aircraft, and therefore that of its automatic pilot.

AEROELASTICITY

If there is one area where ONERA's action has continued actively for the past twenty years, it is certainly that of the association of unsteady aerodynamic forces and structural strength, and this is a problem which, if neglected, would lead to a quasi-instantaneous destruction of a flying aircraft due to "flutter". Between the first report of the problem [34] and the definition of the equipment for test flights of the Concorde [35], the Chief of the ONERA Department of Aircraft Structures, under the encouragement of R. Mazet, prepared a doctrine outline and finalized a system of equipment and methods, put this Department in top rank among teams of researchers worldwide concerned with this topic. For the past 22 years, there is not a single French prototype which has not been studied according to ONERA methods before its first flight, either by a specialized team from the institution, or very recently by an industrial team which implements its principles under its technical supervision. The data of aerodynamic characteristics needed for calculations of aeroelasticity is very similar to that used for determining the flight qualities, although the frequencies used here are definitely higher. The same testing procedures in a wingtunnel - harmonics method and method of impulsions - are used in both cases, but for transonic testing, it was necessary to add measurements performed on models dropped in free flight or which are propelled [35]. Furthermore, the investigation has been extended in detail, particularly by analyzing the variable pressure field on the wings and at the points where slope discontinuities appear, such as the rudder hinge or the wing-fuselage junction. The influence of transient phenomena, such as rudder deflection or air turbulence, has also been carefully analyzed.

Another aspect of the study is concerned with the inertial analysis of the structure. In contrast with methods used in other

countries, and considered to be too uncertain, by which the characteristics - specific modes, generalized masses, structural damping - are calculated on plans, ONERA has proposed, at a very early date, its "overall method" [37] based on the analysis of vibration testing performed on the ground or on a finished prototype (figure 15).

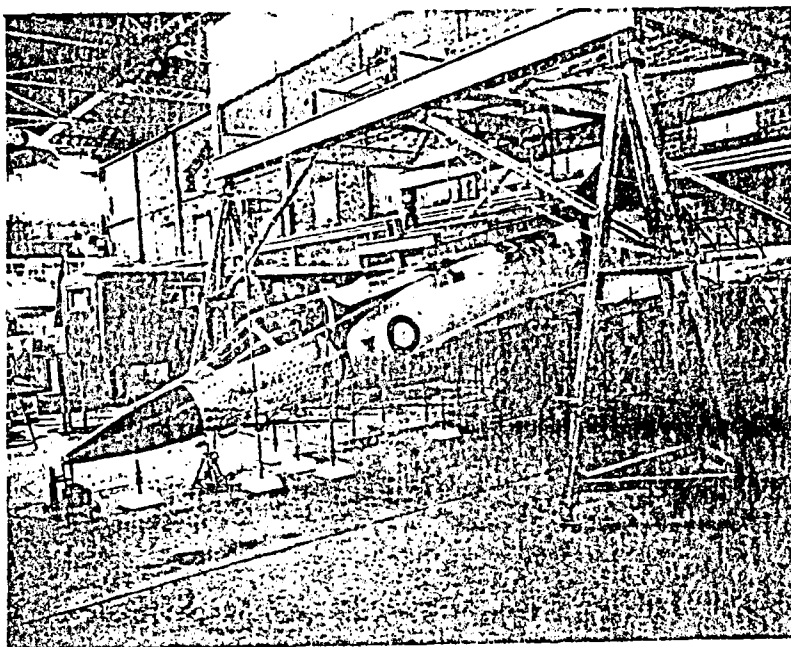

Fig. 15 - Measurement of the vibratory characteristics of a finished prototype.

This is obviously the problem of a possible resonance between the aerodynamic and inertial forces that must be solved in order to predict "flutter". This calculation is performed according to a procedure called "mathematical mold", which is not always clearly defined. The first models were proposed by the British, although it became obvious on either side of the Channel that they had to be perfected. Accordingly, ONERA was led to prepare special tests, not for the purpose of providing a digitized determination

of the values to be introduced in the calculation, but to perfect the method of calculation itself [38]. This procedure was perfected at a time where problems appeared with the Concorde, and was developed as a result of joint efforts between ONERA and Sud-Aviation. Some of these tests were performed with models representing parts of the aircraft, such as this wing (figure 16) fitted with a flap-

ping aileron and numerous pressure inlets in the vicinity of the hinge.

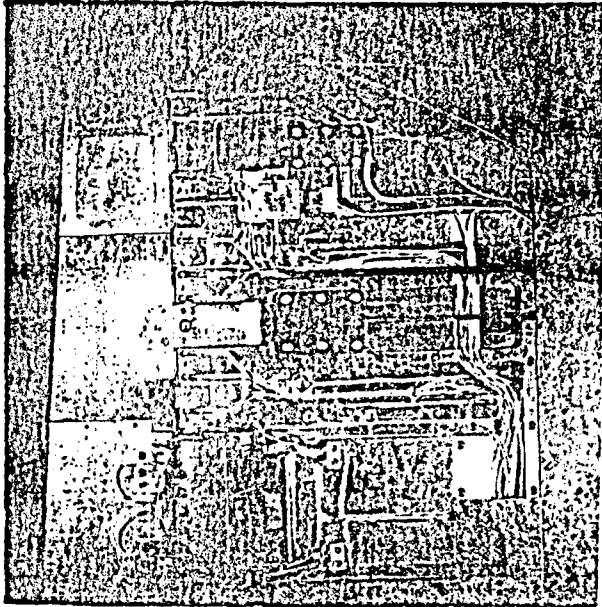

Fig. 16 - Model of a wing fitted with a flapping aileron and various pressure inlets.

safety margin is invariably based on overdimensioning of the structure. This is why it is useful, wherever possible, to complement the ground and windtunnel tests by flight tests. The latter, of course cannot be extended to a dangerous speed level. Rather, they concentrate on checking in flight conditions whether the aerodynamic and structural damping is close to the precalculated values, for certain frequencies and certain points of application of an artificial excitation.

A very bulky equipment is required for these flight tests, both for the excitation and for the measurement considerations (figure 17) and it can be installed only on large aircraft. For the Concorde, it was even necessary to perfect new materials,

No matter how carefully /17
the mode of calculation or
the numerical value of its
data are defined, there is
still an error margin for the
flutter speed, which in prac-
tice means that aircraft
should not be permitted to
fly to close to the calcu-
lated speed. This require-
ment is not without its dis-
advantages, especially for
rapid aircraft, because the

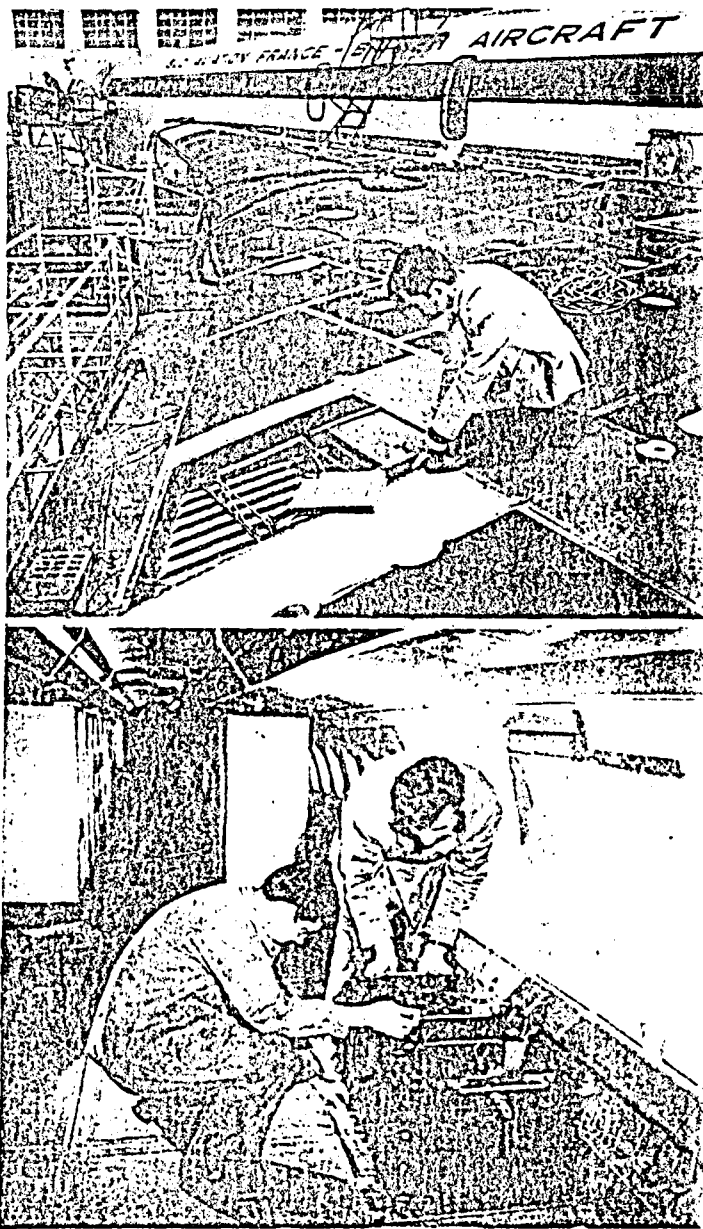

Fig. 17a and b - Preparation of vibration tests of prototype 001 in flight conditions. a - Installation of an exciter in the wing, b - Exciter of the fuselage and the measurement bays on board.

that were perfectly tight and capable of supporting the heat levels brought about by extended supersonic flights.

DIRECT ASSISTANCE TO THE MANUFACTURERS

As we have already mentioned, the action of research centers does not stop the day where the manufacturer has sketched an aircraft, whether or not elements of data made available by research centers are used, depending on his own opinions. The new study is not only likely to instigate numerous investigations or to accelerate those already being conducted, but above all, the industrialist may call on the centers to perform tests for his own exclusive use that have never been carried out by other sources.

ONERA has never "worked as hard for the Concorde" as it has during the last year or two. In 1968, this work corresponded to 9% of its total activity.

ONERA's windtunnels, of course, made their contribution together with many other French and foreign installations, for the standard aerodynamic tests at all flight speeds.

The most typical of the activities of industrial preparation of the preliminary studies pertained to the air intakes and the jet engine exhausts: the research models were replaced by entire full-scale systems (figure 18). An extensive parametric study of the different flows of dual jet exhausts tied up several ONERA windtunnels for several months, and we are hopeful of obtaining considerable improvements in the thrust of jet engines from its findings. /18

The need for extreme precision in the data on the qualities of their aircraft motivates the manufacturers to set problems which, for being of a purely technological nature, are nonetheless difficult to solve. Accordingly, ONERA had to prepare a device enabling the drag of the tail part of the fuselage to be measured in the windtunnel, in order to compare from this viewpoint several peak forms (figure 19). Owing to the fineness of the results to be obtained, it was necessary to give particular care to the pneumatic link between the weighed part and the nonweighed part of the model, using entirely new procedures.

In still another area, ONERA was able to contribute original existing installations for the Concorde's benefit with a few modifications. They provided for icing tests where a calibrated fog was emitted in front of the model, while the temperature in the large windtunnel of Modane, very close to the outside temperature, is between -5 and -10°C (figure 20). During the course of preliminary testing on other equipment, only real size aircraft parts were tested. However, the manufacturers of the Concorde wanted to have detailed information of the ice deposits over the entire wing, so that a reduced scale model had to be provided. This problem of test scale has resulted in making fog with droplets reduced to up to 10 microns, which led to a new risk of

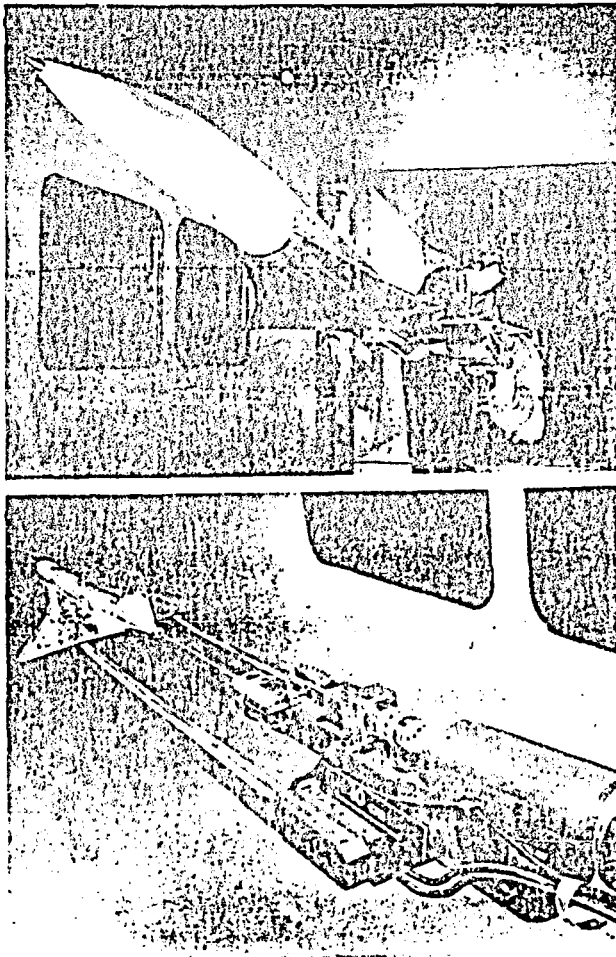

Fig. 18 - Test in the continuous supersonic windtunnel of Modane-Avrieux of a dual air intake installed on a full aircraft model.

Fig. 19 - Scale for accurate measurement of the drag of the tail part of the fuselage.

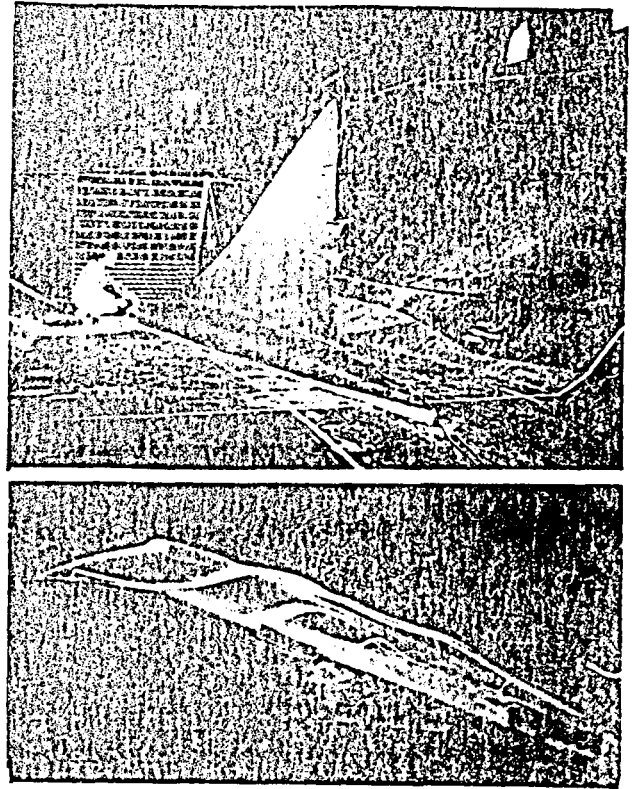

Fig. 20 - Icing tests in the large windtunnel of Modane-Avrieux. Half-model and water spray grid.

Fig. 21 - Visualization in the hydrodynamic tunnel for flows near the ground, undercarriage pulled out.

NOISE MEASUREMENTS

Among ONERA's various activities, there is one which indirectly has acquired a special interest, not in regard to the Concorde's construction, but to its future use. Everyone is aware of the concern of people living near airports about the noise of high power jet engines, and especially the concern of countless people

who are annoyed by the "boom trail" that unrolls along its course.

Limitation of the noise caused by compressors and jets is a problem that only the engine manufacturer is able to validly study, because any solution has consequences on the operational efficiency of the jet engines. However, the analysis and definition of the noise received on the ground is a delicate question, that Public Services, both French and British, have turned over to their research centers. For its part, ONERA has developed, under the encouragement of P. Lienard, working methods and has perfected an automatic measuring equipment which should make it possible to rapidly have an idea of the reality and of the extent of the problem [39].

The ground effects of shock waves from a supersonic aircraft is an unusually tough and quite important problem to solve, in view of the fact that its energy may concentrate or "focus" on a few points of the ground. Such a focusing may be caused by the aircraft motions per se, but also by the absence of homogeneities of the air crossed by the waves. The contribution of ONERA in this theoretical study [40] has been a determinating influence in the eyes of the experts.

It would be presumptuous to pretend to give a list of the elements that ONERA has contributed to the Concorde, or even to specify the part that it shared in the design and perfection of the aircraft. British and French research centers, and even others, indirectly, to the extent that their publications have contributed to the progress of aeronautical science, public services, manufacturers, have collaborated for years in symbiosis, exchanging their knowledge, projecting and conducting their tests, so that it would now be quite difficult to say who is the author and who is the user of an idea.

The action of research centers is felt essentially between

these centers themselves, and by the manufacturers who utilize their results, and give them a special interpretation in their products. Only they would know, for example, if the ogival shape of the wing comes from R.A.E., if the cambure or air intake comes from ONERA, and who gave the best formula to calculate the heat build up or the maximum aircraft flutter rate.

Quite fortunately, the role of the research centers does not stop with the establishment of a formula, as fertile as it might be. This role continues throughout the entire investigation of the equipment, even after it is put into service, because new problems arise, improvements are defined, new methods are created. If one day, a hypersonic aircraft is put into service, or if satellites are launched using air to power and to lift the first stage of the launcher, this will perhaps be because, at that particular time, researchers were dealing with the theoretical problems raised by such projects, but also because they knew how to adapt to the very real and often somewhat "earthy" problems presented to them by the Concorde manufacturers, during a long collaboration to perfect the project.

REFERENCES

The following documents have been selected from extremely abundant publications, either because they provide a good synthesis, or owing to the long background or novelty they provide at the time of their publication. A large number of documents consulted while writing this article have never been published, often because they were classified at the time of their drafting and then became outdated by the time they were declassified.

General

1. Morgan, M.B., "Supersonic Aircraft - Promise and Problems", J. of the Royal Aero. Soc., vol.64, no.594 (June 1960).
2. Poisson-Quinton, Ph., "Expected Future Trends of the Supersonic Transport Aircraft", Conference Proceedings Presented at Royau-
mont, June 21, 1962. Techn. et Sc. Aér. et Sp., No. 3 (1962).
3. XXX - ONERA Movie No. 433, "Aerodynamic Studies of the Concorde Aircraft (1963) (16 mm, 20 mm, in color).
4. Edwards, Sir Georges, "Progress with the Concord Supersonic Trans-
port", Institute of Transport Journal, 30/10 (May 1964).
5. Poisson-Quinton, Ph., "Aerodynamic Research and Tomorrow's Aircraft", Icare, 34, (Summer 1965).
6. Morisset, J., "Concord", Diagrammes du Monde, 141, (Nov. 1968).

Adapting the Wing

7. Germain, P., "General Theory of Conical Motions and Its Applica-
tions To Supersonic Aerodynamics", Paris Thesis and ONERA Publi-
cation No. 34, (1949).
8. Germain, P., "The Theory of Homogeneous Motions and Its Appli-
cation to the Calculation of Certain Delta Wings in the Super-
sonic State", La Recherche Aéronautique, No. 7 (Jan.-Feb. 1949).
9. Legendre, R. et al., "Transonic Flows About Wings With Sharp
Sweepback", ONERA Publication No. 53 (1952).
10. Malavard, L., et al., "Calculated Properties of the Delta Wing
Whether Swept-Out or Not. Calculation Using Electrical Analog-
ies", ONERA Technical Report No. 25 (1955).
11. Poisson-Quinton, Ph., & Jacquignon, H., "Flight Qualities and /20
Lift Augmentation of Sweptback Wings. Application in Flight
Conditions of the Boundary Layer Blowing on the Dassault Air-
craft", Etendard IV Marine, Jahrbuch der WGL, 1960 & Tech. et
Sc. Aér., No. 5 (1961).
12. Fenain, M., Vallée, D., "Application of the Theory of Homogeneous

to the Investigation of the Adaptation of Certain Wings in the Supersonic State", ONERA Technical Report No. 14, Part 1 & 2 1958-59 (Unpublished Documents).

- 13a. Legendre, R., "Simple Method of Calculating a Slender Wing", La Recherche Aéronautique, 78 (Sept.-Oct. 1960).
- 13b. Legendre, R., "Calculation of a Wing With Leading Edge Curvature, Adapted to Supersonic Flights", La Recherche Aéronautique, 79 (Nov.-Dec. 1960).
14. Beviere, P., "Aerodynamic Characteristics of Wing-Fuselage Combinations in the Vicinity of Sonic Speed. Investigation of Optimum Configurations," La Recherche Aéronautique, 84 (Sept.-Oct. 1961).
15. Michel, R., "Practical Calculation of the Compressible Turbulent Boundary Layer. Principle and Applications", ONERA Technical Report, 49 (1959).

Low Speeds

16. Roy, M., "Flow Characteristics About A Sweptback Wing", C.R. Acad. Sc. Paris, Volume 234 (1952), 2501-2504.
17. Legendre, R., "Flows in the Vicinity of the Front Tip of a Wing with Sharp Sweepback and for Mean Incidences," VIIe Congrès de Mécanique Théorique et Appliquée, Istanbul, Aug. 1952, La Recherche Aéronautique, 30 (Nov.-Dec 1952) and 31 (Jan.-Feb. 1953).
18. Werlé, H., "Visualization in the Hydrodynamic Tunnel", La Recherche Aéronautique, 33 (May-June 1953).
19. Roy, M., "On the Theory of the Delta Wing. Apex Vortices and Horn-Pattern Sheets", La Recherche Aéronautique, 56 (Jan.-Feb. 1957).

Kinetic Heat Build-Up

20. Ceresuela, R., Marguet, R., Vaucheret, X., "Kinetic Heat Build-Up of a Schematic Model of a Supersonic Transport Aircraft", IVe Congrès ICAS, Paris, Aug. 1964. Spartan Books, 1965.

Flight Qualities

21. Poisson-Quinton, Ph., Erlich, E., "Lift Augmentation and Balancing of Slender Wings", 1er Colloque d'Aérodynamique Appliquée, AFITAE, Paris, Nov. 12-13 1964. Preprinting ONERA 190, NASA Translation TT-F 9523 (1965).
22. Poisson-Quinton, Erlich, E., "Variable Geometry Applied to a Tail Unit", La Recherche Aérospatiale, 94 (May-June 1963).

Air Intakes

23. Nicolas, J., Benoit, A., "Preliminary Study of an Air Intake in Two-Dimensional Supersonic Flows", ONERA Publication, 27 (1949).
24. Carrière, P., Leynaert, J., "Investigations on Supersonic Air Intakes", Jahrbuch der WGL 1959, Vieweg (1960).
25. Leynaert, J., Brasseur, P., "Internal Aerodynamic Problems of the Supersonic Transport Aircraft at Mach 2", Ve Congrès Aéronautique Européen, Venise, Sept. 1962, La Recherche Aéronautique, 91 (Nov.-Dec. 1962).

Jet Engine Exhausts

26. Gabri, J., Le Grives, E., Siestrunck, R., "Aerodynamic Study of Supersonic Jet Blasts", Jahrbuch der WGL 1953, Vieweg (1954).
27. Carrière, P., Sirieix, M., "Factors Influencing the Refixing of a Supersonic Flow", Xe Congrès de Mécanique Appliquée, Stresa, Sept. 1960. ONERA Publication 102 (1961).
28. Rollin, G., "Thrust Balance for Turbojet Exhaust Studies in Transonic and Supersonic Windtunnels", Supersonic Tunnel Association, Rhodes-St-Genèse (Belgium), 24-25 Sept. 1964 (ONERA Preprinting 172, unpublished).

Materials

29. Martinod, H., Renon, C., Calvet, J., "Deformation Effects After Quenching on the Mechanical Characteristics and Creep Strength of Aluminum Alloys Used in Aeronautiques", Journées d'Automne, Paris, October 1965, Revue de Métallurgie, October 1966.
30. Sertour, G., "Materials Used on Concord", Aéronautique et Astronautique, 4 (1968).
31. Galmiche, Ph., "Chromaluminization and Tantalization of Refractory Materials for Gas Turbines", Metals and Materials, Aug 1968 (English Version), Aéronautique et Astronautique, 8 (1969) (French Version).

Unsteady Aerodynamics

32. Schéerer, M., "Contribution to the Experimental Study of Varied Motions in the Windtunnel", Thesis, Paris 1952 and ONERA Publication 61 (1953).
33. Enselme, M., "On the Analogic Calculation of a Wing in Unsteady Supersonic Flows", C.R. Ac. Sciences, 262 (1966), P.78.

Aeroelasticity

34. De Vries, G., "Precautions to Take to Prevent Aerodynamic Vibrations of Aircraft", La Recherche Aéronautique, 12 (Nov.-Dec. 1949) and 13 (Jan.-Feb. 1950).
35. Piazzoli, "Flight Vibration Test Apparatus for the Concord Aircraft", Technical Report (ONERA), 52, 1959.
- 36a. Dat, R., Destuynder, R., "Determination of Unsteady Aerodynamic Coefficients on a Delta Wing of Mach 0 to Mach 1.35. La Recherche Aéronautique, 64 (May-June 1958) and ONERA Technical Report 52 (1959).
- 36b. XXX, ONERA Movie 393, "Measurement of Unsteady Aerodynamic Coefficients in Transonic Flows (1962), (16 mm, 16 minutes in color).
37. De Vries, G., Beatrix, C., "General Procedures For Measuring Vibratory Characteristics of Weakly Dampened Linear Structures," Progress in Aér. Sc., vol.9, Pergamon Press (1968).
38. Dat R., "A Practical Application of the Method of Sources in Aeroelasticity", La Recherche Aérospatiale, 99 (March-April 1964).

Aircraft Noise

39. Kobrynski, M., "Sound Pressure Spectrum Emitted by Jets", ONERA Technical Report 108 (1967), English Translation Published in the Journal of Sound and Vibrations 7/2 (1968).
40. Guiraud, J.P., "Theory of Ballistic Noise Caused in Nonhomogeneous Air by Supersonic Aircraft Flights", ONERA Technical Report 79 (1964).
41. Guiraud, J.P., "Geometric Acoustics, Ballistic Noise of Supersonic Aircraft and Focussing", Journal de Mécanique, 4/2 (June 1965).

End of Document